

# Buyers Guide

2020 / 2021



**Fellowes**  
Brands™



We want people to be the best they can be. More productive. More efficient. Happier. Healthier. That’s why we make workplace solutions, like business machines, storage products, workspace wellbeing solutions, and air purifiers. Products by our family-owned business have been in your workplace and your home for over 100 years. They’re designed to meet—and exceed—the needs of an ever-changing world. Whether you’re in a big corporate office or a cozy home office, we’ll help you to be at your best.

## OUR BRANDS



Fellowes® provides innovative workspace solutions with a superior experience enabling you to work better and feel better. Our range of shredders, binders, laminators and health and wellbeing products are thoughtfully designed, reliable products, that work effortlessly every time.



Bankers Box® is the original brand that provides confidence your contents are organised and protected. Since 1917 we have been the market leader synonymous with strength and quality and we continue to innovate with our new line of mailing, shipping and moving products.



AeraMax® air purifiers provide hassle free cleaning to help you confidently provide a healthier environment to those that you care for. Its four stage filtration system removes up to 99.97% of harmful germs, viruses and allergens while its responsive technology provides confidence it works as needed.



Fellowes GIVE program is dedicated to building local and global partnerships, which address humanity’s greatest needs. The programmes’ guiding principles align with our strong values as a company and focus on four key areas: Social Services, World Aid and Development, Education and Cancer Research. We are honoured to work as a team in building strong communities, improving lives, and providing a better tomorrow for our world today.



## PRODUCT INNOVATIONS FOR 2020

### Workspace Solutions

Fellowes have a long history in the development of ergonomic solutions, and as we continue to evolve we are pleased to expand our range of sit-stand solutions to include a range of height adjustable desks including the premium Levado™ and the Cambio™ desk and bench, an extensive range of monitor arms including the new and premium EPPA™ range, and the stylish Hana™ range of premium ergonomic accessories.



### Shredders

These revolutionary worry-free shredders maximize workplace efficiency and keep your day in flow. Our patented IntelliBar™ Technology has 5 responsive features to keep you jam-free, safe, productive and shredding with ease. All with the quality and performance you've come to expect from The World's Toughest Shredders®.



### Binding and Laminating

**Pixel Laminator** - a premium personal laminator in A4 and A3 for both home and office use. Features a quick 3-minute heat-up and 125 micron capability.

**Office Laminator Speed Upgrades** - Three of Fellowes best selling office laminators - Neptune 3, Jupiter 2 and Venus 2 received speed improvements for 2019, even greater productivity.



### Storage and Organisation

**SmoothMove™** Moving and Storage Boxes - With this new line you will experience innovative, tape-free design with FastFold® easy assembly. See our full line of moving box and storage box solutions to meet your needs!





5 - 48

Business Machines



49 - 54

Air Treatment



55 - 118

Workspace Solutions



119 - 172

Storage and Organisation





A woman with long brown hair, wearing a blue sleeveless dress and a patterned scarf, is sitting in an office chair at a desk. She is smiling and looking towards a computer monitor. A white Fellowes shredder is positioned in front of her, and she appears to be operating it. The background shows a modern office environment with large windows and glass partitions.

# Business Machines

6 - 21

## Shredders

8 - 9 LX Series Shredders

10 - 11 AutoMax™ Shredders

12 - 15 100% Jam Proof Shredders

16 - 17 Performance Shredders

18 - 20 Personal / Home Office Shredders

21 High Security Shredders

21 Shredder Accessories

22 - 33

## Laminators

24 - 29 Laminating Machines

30 - 33 Laminating Supplies

34 - 44

## Binders

36 - 40 Binding Machines

41 - 44 Binding Supplies

45 - 48

## Trimmers & Guillotines

46 - 47 Trimmers and Accessories

48 Guillotines

## THE WORLD'S TOUGHEST SHREDDERS®

You can't cut corners when it comes to data protection. That's why you need a tough, reliable shredder to get the job done. Our range of desk-side, office and automatic shredders ensures your documents are securely destroyed. Fellowes shredders offer jam proof, quiet and fast performance to help you be more productive.



It's essential to choose a shredder that's appropriate for the number of users, with the security level and features required to get the best possible shredding experience. The guide below will help the user get the best shredder for their needs:

## WHAT KIND OF SHREDDER ARE YOU LOOKING FOR?

I am looking for a stylish design, maximum security and unmatched productivity.

I want to save time with an automatic shredder that allows me to drop in a stack of paper.

I need an easy-to-operate shredder that delivers trouble-free performance.

I want a shredder that offers great performance for the best price.

I need a safe, reliable and compact shredder for my home/small office.

I need a shredder for highly classified shredding - e.g. for military, government and intelligence services.

100%  
Jam Proof LX

AutoMax  
Auto Feed

100%  
Jam Proof

Performance

Personal /  
Home Office

High  
Security

## USAGE: How many people will use the shredder?

1-user

1-user

1-3 users

1-user

1-user

1-user

1-3 users

1-3 users

3-5 users

1-3 users

5-10 users

3-5 users

3-5 users

5-10 users

3-5 users

5-10 users

10+ users

10+ users

## PARTICLE SIZE: What level of security do you need?

Micro-cut P-5

Cross-cut P-4

Strip-cut P-2

Strip-cut P-2

Strip-cut P-1 / P-2

Classified P-6 / P-7

Mini-cut P-4

Cross-cut P-4

Cross-cut P-4

Cross-cut P-3 / P-4

Micro-cut P-5

Micro-cut P-5

Micro-cut P-5

Mini-cut P-4

Micro-cut P-4 / P-5

A strip cut shredder is ok, but it is recommended to shred with at least a cross cut shredder (DIN P-3 or P-4), which will shred each A4 sheet of paper into as many as 410 pieces. The images give examples of the levels of protection available, from the most basic strip-cut to the dust-like particles of the high-security shredders. DIN levels P-3 to P-5 should be suitable for the majority of users.

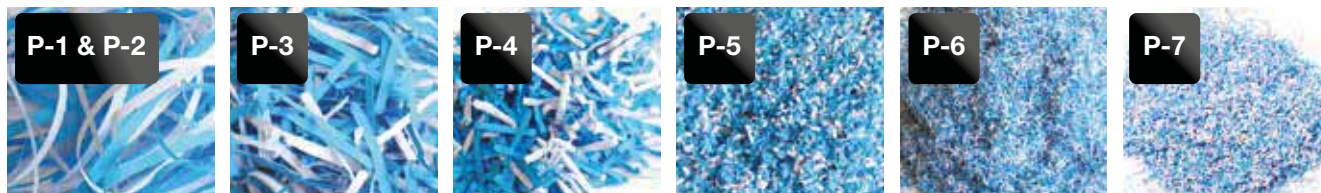

0.8 x 5mm - approximately 15,000 particles per A4 sheet	<b>CLASSIFIED</b> DIN LEVEL <b>P-7</b>	For strictly confidential documents requiring security precautions of the highest level
0.8 x 12mm - approximately 6,000 particles per A4 sheet	<b>CLASSIFIED</b> DIN LEVEL <b>P-6</b>	For high level security requirements e.g. government
2 x 15mm - approximately 2000 particles per A4 sheet	<b>MICRO-CUT</b> DIN LEVEL <b>P-5</b>	For highly confidential documents. Virtually impossible to assemble and read
4 x 12mm - approximately 1200 particles per A4 sheet	<b>MINI-CUT</b> DIN LEVEL <b>P-4</b>	For highly confidential documents. Virtually impossible to assemble and read
4 x 38mm - approximately 410 particles per A4 sheet	<b>CROSS-CUT</b> DIN LEVEL <b>P-4</b>	For confidential documents. Difficult to assemble and read
4 x 50mm - approximately 312 particles per A4 sheet	<b>CROSS-CUT</b> DIN LEVEL <b>P-3</b>	For confidential documents. Difficult to assemble and read
5.8mm - approximately 36 strips per A4 sheet	<b>STRIP-CUT</b> DIN LEVELS <b>P-1 &amp; P-2</b>	Offers basic document security

\* The above mentioned security levels are based on DIN 66399 and only refer to paper destruction

## FEATURES: Which of the following features are required?

<p><b>100% JAM PROOF</b></p> <p>Eliminates paper jams AND powers through tough jobs</p>	<p><b>JAM BLOCKER™</b></p> <p>Blocks jams before they start</p>	<p><b>AUTO REVERSE</b></p> <p>Automatically stops and reverses if a paper jam occurs</p>	<p><b>IntelliBAR™</b></p> <p>Responsive Technology for productive shredding without interruption</p>
<p><b>SAFESENSE TECHNOLOGY™</b></p> <p>Stops shredding when hands touch the paper opening</p>	<p><b>SAFETY LOCK</b></p> <p>Disables shredder for added safety</p>	<p><b>SILENT SHRED™</b></p> <p>Ultra-quiet performance for shared workspaces</p>	<p><b>ENERGY SAVINGS SYSTEM™</b></p> <p>Reduces in-use energy consumption and powers down after periods of inactivity</p>
<p><b>SLEEP MODE</b></p> <p>Powers down the machine after 2 minutes of inactivity</p>	<p><b>AUTO OIL</b></p> <p>Lubricates the cutters automatically to enhance performance and extend shredder life</p>	<p><b>CONTINUOUS DUTY</b></p> <p>Ideal for high volume shredding. The shredder is always ready for operation</p>	<p><b>SMART LOCK™</b></p> <p>Allows the user to lock the shredder to prevent access to documents when shredding</p>



## 100% Jam Proof LX Series

# Next Generation Shredders

Unmatched Productivity.  
Unequaled Jam Prevention.  
Maximum Security.



### Powershred® LX221 Shredders

**SMALL OFFICE USE. 3-5 USERS.**

- Maximum security micro-cut shreds each sheet of A4 paper into over 2000 particles (2x12mm P-5)
- 20-sheet shredding capacity, 25 minute run time and 30L pull-out waste bin
- Includes Fellowes innovative features to provide safe, efficient shredding with 100% Jam Proof and quiet performance to minimise disruption to the whole office



**SMALLER PARTICLES =  
LESS FREQUENT  
BIN EMPTYING**



Model	Sheet Capacity (70gsm)	Cut Type	Cut Size	Throat Width	Bin Capacity	Run Time	Also Shreds	Warranty: Machine / Cutter	Bags
LX221 (Black)	20	Micro-Cut	2 x 12mm (DIN-P-5)	230mm	30 L	25 mins		2 / 5 yr	36053
LX221 (White)	20	Micro-Cut	2 x 12mm (DIN-P-5)	230mm	30 L	25 mins		2 / 5 yr	36053



### Powershred® LX211 Shredders

**DESKSIDE USE. 1-3 USERS.**

- Maximum security micro-cut shreds each sheet of A4 paper into over 2000 particles (2x12mm P-5)
- 15-sheet shredding capacity, 20 minute run time and 23L pull-out waste bin
- Includes Fellowes innovative features to provide safe, efficient shredding with 100% Jam Proof and quiet performance to minimise disruption to the whole office



**SMALLER PARTICLES =  
LESS FREQUENT  
BIN EMPTYING**



Model	Sheet Capacity (70gsm)	Cut Type	Cut Size	Throat Width	Bin Capacity	Run Time	Also Shreds	Warranty: Machine / Cutter	Bags
LX211 (Black)	15	Micro-Cut	2 x 12mm (DIN-P-5)	230mm	23 L	20 mins		2 / 5 yr	36052
LX211 (White)	15	Micro-Cut	2 x 12mm (DIN-P-5)	230mm	23 L	20 mins		2 / 5 yr	36052



# IntelliBAR™

with Patented Responsive Technology



### Unsurpassed Responsiveness

Warns user when the shredder needs to cool off.

### Unmatched Productivity

Lets you know when the shredder is capable of shredding more sheets per pass.

### Unequaled Jam Prevention

100% Jam Proof - automatically detects and powers through tough jobs.

### Unparalleled Convenience

Alerts you when the bin is ready to be emptied.

### Unrivaled Safety

Automatically stops shredding when hands touch the paper entry.



## Powershred® LX201 Shredders

PERSONAL. 1 USER.

- Maximum security micro-cut shreds each sheet of A4 paper into over 2000 particles (2x12mm P-5)
- Includes Fellowes innovative features to provide safe, efficient shredding with 100% Jam Proof and quiet performance to minimise disruption to the whole office

**MICRO SHRED**

SMALLER PARTICLES = LESS FREQUENT BIN EMPTYING

**EASIER LESS EMPTYING**

Model	Sheet Capacity (70gsm)	Cut Type	Cut Size	Throat Width	Bin Capacity	Run Time	Also Shreds	Warranty: Machine / Cutter	Bags
LX201 (Black)	12	Micro-Cut	2 x 12mm (DIN-P-5)	230mm	22 L	10 mins		2 / 5 yr	36052
LX201 (White)	12	Micro-Cut	2 x 12mm (DIN-P-5)	230mm	22 L	10 mins		2 / 5 yr	36052

Code	Model	UNIT			RETAIL PACK			OUTER PACK			
		H x W x D (cm)	Weight (kg)	Qty	H x W x D (cm)	Weight (kg)	Barcode (UPC)	Qty	H x W x D (cm)	Weight (kg)	Barcode (SCS)
5050401	LX221 (Black)	59.0 x 41.9 x 29.9	16.3	1	N/A	N/A	N/A	1	65.0 x 46.1 x 33.4	20	50043859751551
5050501	LX221 (White)	59.0 x 41.9 x 29.9	16.3	1	N/A	N/A	N/A	1	65.0 x 46.1 x 33.4	20	50043859751568
5050201	LX211 (Black)	53.3 x 36.2 x 29.6	12.7	1	58.8 x 38.7 x 31.5	15.4	043859751532	1	60.0 x 39.2 x 32.0	16.4	50043859751537
5050301	LX211 (White)	53.3 x 36.2 x 29.6	12.7	1	58.8 x 38.7 x 31.5	15.4	043859751549	1	60.0 x 39.2 x 32.0	16.4	50043859751544
5050001	LX201 (Black)	52.7 x 35.6 x 25.4	9	1	58.8 x 39.4 x 30.1	11.7	043859751518	1	60.0 x 40.0 x 30.6	12.8	50043859751513
5050101	LX201 (White)	52.7 x 35.6 x 25.4	9	1	58.8 x 39.4 x 30.1	11.7	043859751525	1	60.0 x 40.0 x 30.6	12.8	50043859751520

## AutoMax / Auto Feed

AutoMax™ shredders offer a truly walk-away shredding experience, automatically shredding stacks of paper at the touch of a button. They offer the convenience of allowing the user to continue working whilst shredding is in progress.



### HOW DO YOU SHRED?

You prefer to shred when you need to rather than letting documents accumulate to be shredded in a single session	You accumulate large volumes of paper and need to get it shredded in one go. You need to get on with your work whilst it is in progress
<b>MANUAL</b> ✓	<b>AUTOMATIC</b> ✓



**600M**  
**NEW**  
for 2020

- AUTO REVERSE**
- SLEEP MODE**
- SILENT SHRED™**
- SMART LOCK™**
- CONTINUOUS DUTY**

### AutoMax™ 600M & 550C

DEPARTMENTAL USE. 10+ USERS.

- Ideal for large offices and large volumes of paper waste
- Shreds capacity load in approximately 13 minutes (550C) and 15 minutes (600M)
- 600M shreds each sheet of paper into over 2000 particles per A4 sheet
- Also shreds CDs (550C only) and credit cards via the manual slot and accepts staples and paper clips



- AUTO REVERSE**
- SLEEP MODE**
- SILENT SHRED™**
- SMART LOCK™**

### AutoMax™ 350C

DEPARTMENTAL USE. 5+ USERS.

- Ideal for office environments that regularly accumulate large volumes of paper waste
- Shreds capacity load in approximately 9 minutes
- Smart Lock™ system allows the user to lock the shredder with a 4-digit PIN to prevent access to documents whilst shredding is in progress
- Also shreds CDs and credit cards (manual feed) and staples & paper clips

**MICRO SHRED**

**AutoMax™ 600M**

SMALLER PARTICLES =  
**LESS FREQUENT  
BIN EMPTYING**

**EASIER  
LESS EMPTYING**

Model	Sheet Capacity (70gsm)	Cut Type	Cut Size	Throat Width	Bin Capacity	Run Time	Also Shreds	Warranty: Machine / Cutter	Bags
600M	600 (14 manual)	Micro-cut	2 x 12mm (DIN-P-5)	230mm	83L	Continuous		2 / 7 yr	36054
550C	550 (14 manual)	Cross-Cut	4 x 38mm (DIN-P-4)	230mm	83L	Continuous		2 / 20 yr	36054
350C	350 (12 manual)	Cross-Cut	4 x 38mm (DIN-P-4)	230mm	68L	45 mins		2 / 20 yr	36054





**AutoMax™ 200M**

DESKSIDE USE. 3-5 USERS.

- Ideal for SOHO environments that require the time saving benefits of an auto feed shredder and greater peace of mind with micro-cut shredding
- Shreds documents into 2x14mm micro-cut particles – that’s over 2000 particles per A4 sheet!
- Shreds a 200 sheet capacity load in approximately 6 minutes with a 20-minute duty cycle

**AutoMax™ 200C & 150C**

DESKSIDE USE. 3-5 USERS (200C) & 1-3 USERS (150C).

- Automatic shredding at the deskside for maximum productivity
- Each machine shreds a capacity load in 5-6 minutes
- Shreds documents into 4x38mm cross-cut particles (Security Level P-4)

Model	Sheet Capacity (70gsm)	Cut Type	Cut Size	Throat Width	Bin Capacity	Run Time	Also Shreds	Warranty: Machine / Cutter	Bags
200M	200 (10 manual)	Micro-Cut	2 x 14mm (DIN-P-5)	230mm	32L	20 mins		2 / 7 yr	36053
200C	200 (10 manual)	Cross-Cut	4 x 38mm (DIN-P-4)	230mm	32L	25 mins		2 / 7 yr	36053
150C	150 (8 manual)	Cross-Cut	4 x 38mm (DIN-P-4)	230mm	32L	12 mins		2 / 5 yr	36053

**AutoMax™ 100M**

PERSONAL USE. 1 USER.

- Offers a hybrid of automatic and manual shredding - 100 sheet auto and 10 sheet manual shredding capabilities
- Quiet performance minimises noise disruption
- Sleep Mode powers down the machine after periods of inactivity
- 4x10mm mini-cut (DIN P-4) - shreds each A4 sheet into 1000+ particles!



Model	Sheet Capacity (70gsm)	Cut Type	Cut Size	Throat Width	Bin Capacity	Run Time	Also Shreds	Warranty: Machine / Cutter	Bags
100M	100 (10 manual)	Mini-Cut	4 x 10mm (DIN-P-4)	220mm	23L	15 mins		2 / 7 years	36053

Code	Model	UNIT			RETAIL PACK				OUTER PACK			
		H x W x D (cm)	Weight (kg)	Qty	H x W x D (cm)	Weight (kg)	Barcode (UPC)	Qty	H x W x D (cm)	Weight (kg)	Barcode (SCS)	
4657401	600M	89.0 x 44.1 x 57.8	38.2	1	N/A	N/A	N/A	1	99.7 x 50.8 x 66.0	45.4	50043859747714	
4963101	550C	89.0 x 44.1 x 57.8	33.6	1	N/A	N/A	N/A	1	99.7 x 50.8 x 66.0	38.1	50043859730488	
4964101	350C	81.3 x 39.0 x 57.8	31.8	1	N/A	N/A	N/A	1	92.0 x 50.8 x 66.0	36.3	50043859730495	
4656301	200M	54.5 x 34.5 x 51.5	15.7	1	N/A	N/A	N/A	1	59.8 x 39.3 x 56.0	18.9	50043859726627	
4653601	200C	54.5 x 34.5 x 51.5	14.4	1	N/A	N/A	N/A	1	59.8 x 39.3 x 56.0	18.2	50043859676120	
4680101	150C	54.5 x 34.5 x 51.5	14.4	1	59.3 x 38.7 x 55.5	17.5	043859683741	1	59.8 x 39.3 x 56.0	18.2	50043859683746	
4629201	100M	67.3 x 38.4 x 36.5	13.2	1	68.7 x 38 x 45	14.1	043859741854	1	70.7 x 39.3 x 46.3	17.3	50043859741859	

## 100% Jam Proof

Easy-to-operate shredders that deliver 100% Jam Proof performance - only shredding stacks of paper that are within the shredder's capacity and effortlessly powering through misfeeds.



### Powershred® 485Ci, 485i & 425Ci, 425i

**LARGE OFFICE USE. 10+ USERS.**

- Ideal for shared office use by 10+ users
- 100% Jam Proof system eliminates paper jams and powers through tough jobs
- 485 series features extra-wide 405mm paper entry
- Auto-Oil mechanism automatically lubricates the cutters to enhance performance and extend shredder life (cross-cut models only)

Model	Sheet Capacity (70gsm)	Cut Type	Cut Size	Throat Width	Bin Capacity	Run Time	Also Shreds	Warranty: Machine / Cutter	Bags
485Ci	30-32	Cross-Cut	4 x 30mm (DIN-P-4)	405mm	132L	Continuous		2 / 20 yr	3605801
485i	38-40	Strip-Cut	5.8mm (DIN-P-2)	405mm	132L	Continuous		2 / 20 yr	3605801
425Ci	30-32	Cross-Cut	4 x 30mm (DIN-P-4)	305mm	114L	Continuous		2 / 20 yr	3605801
425i	38-40	Strip-Cut	5.8mm (DIN-P-2)	305mm	114L	Continuous		2 / 20 yr	3605801



### Powershred® 325Ci & 325i

**DEPARTMENTAL USE. 10+ USERS.**

- Ideal for departmental use by multiple users
- 100% Jam Proof system eliminates paper jams and powers through tough jobs
- Patented SafeSense® Technology stops shredding when hands touch the paper entry
- SilentShred® Technology minimises noise disruption in shared work spaces

Model	Sheet Capacity (70gsm)	Cut Type	Cut Size	Throat Width	Bin Capacity	Run Time	Also Shreds	Warranty: Machine / Cutter	Bags
325Ci	22-24	Cross-Cut	4 x 38mm (DIN-P-4)	240mm	83L	Continuous		2 / 20 yr	36056
325i	24-26	Strip-Cut	5.8mm (DIN-P-2)	240mm	83L	Continuous		2 / 20 yr	36056

**Powershred® 225Mi**

**OFFICE USE. 5+ USERS.**

- Up to 10 times smaller particles than standard cross-cut
- Shreds documents into 2x12mm micro-cut particles – that’s over 2500 particles per A4 sheet!
- 100% Jam Proof system eliminates paper jams and powers through tough jobs

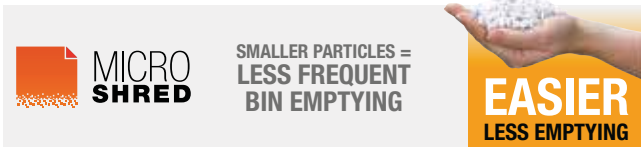

Model	Sheet Capacity (70gsm)	Cut Type	Cut Size	Throat Width	Bin Capacity	Run Time	Also Shreds	Warranty: Machine / Cutter	Bags
225Mi	16	Micro-Cut	2 x 12mm (DIN-P-5)	240mm	60L	Continuous		2 / 20 yr	36054

**Powershred® 225Ci & 225i**

**OFFICE USE. 5+ USERS.**

- Continuous Duty motor for non-stop shredding in small offices
- 100% Jam Proof system eliminates paper jams and powers through tough jobs
- SilentShred® Technology minimises noise disruption in shared work spaces



Model	Sheet Capacity (70gsm)	Cut Type	Cut Size	Throat Width	Bin Capacity	Run Time	Also Shreds	Warranty: Machine / Cutter	Bags
225Ci	22-24	Cross-Cut	4 x 38mm (DIN-P-4)	240mm	60L	Continuous		2 / 20 yr	36054
225i	22-24	Strip-Cut	5.8mm (DIN-P-2)	240mm	60L	Continuous		2 / 20 yr	36054

Code	Model	UNIT			RETAIL PACK			OUTER PACK			
		H x W x D (cm)	Weight (kg)	Qty	H x W x D (cm)	Weight (kg)	Barcode (UPC)	Qty	H x W x D (cm)	Weight (kg)	Barcode (SCS)
4699001	485Ci	95.3 x 63.6 x 50.9	79.6	1	N/A	N/A	N/A	1	76.6 x 104.0 x 66.2	86.2	50043859627276
4699501	485i	95.3 x 63.6 x 50.9	73.5	1	N/A	N/A	N/A	1	76.6 x 104.0 x 66.2	79.7	50043859627283
4698001	425Ci	95.5 x 55.8 x 50.8	67	1	N/A	N/A	N/A	1	69.5 x 104.4 x 65.8	72.9	50043859627320
4698501	425i	95.5 x 55.8 x 50.8	63	1	N/A	N/A	N/A	1	69.5 x 104.4 x 65.8	69.2	50043859627351
4632001	325Ci	88.0 x 51.0 x 46.0	42.4	1	N/A	N/A	N/A	1	101.0 x 70.0 x 68.5	49.4	50043859643702
4633001	325i	88.0 x 51.0 x 46.0	41.2	1	N/A	N/A	N/A	1	101.0 x 70.0 x 68.5	48.2	50043859643733
4620101	225Mi	78.5 x 45.4 x 43.5	37.7	1	N/A	N/A	N/A	1	90.5 x 57.0 x 56.0	43.4	50043859642729
4622001	225Ci	78.5 x 45.4 x 43.5	37.6	1	N/A	N/A	N/A	1	90.5 x 57.0 x 56.0	43.2	50043859628167
4623001	225i	78.5 x 45.4 x 43.5	33.7	1	N/A	N/A	N/A	1	90.5 x 57.0 x 56.0	39.2	50043859628235





- 100% JAM PROOF
- SAFESENSE TECHNOLOGY™
- SILENT SHRED™
- ENERGY SAVINGS SYSTEM™

### Powershred® 125Ci & 125i

**SMALL OFFICE USE. 3-5 USERS.**

- 100% Jam Proof system eliminates paper jams and powers through tough jobs
- Extended run time of 60 minutes for high volume shredding (45 mins for 125i)
- SilentShred™ offers ultra-quiet performance for shared workspaces
- Slimline design ideal for small office spaces



- 100% JAM PROOF
- SAFESENSE TECHNOLOGY™
- ENERGY SAVINGS SYSTEM™
- SILENT SHRED™

### Powershred® 99Ci

**SMALL OFFICE USE. 3-5 USERS.**

- 100% Jam Proof system eliminates paper jams and powers through tough jobs
- Extended run time for high volume shredding
- SilentShred™ offers ultra-quiet performance for shared workspaces
- 34 litre pull-out bin for easy disposal of paper waste

Model	Sheet Capacity (70gsm)	Cut Type	Cut Size	Throat Width	Bin Capacity	Run Time	Also Shreds	Warranty: Machine / Cutter	Bags
125Ci	20	Cross-Cut	4 x 38mm (DIN-P-4)	230mm	53L	60 mins		2 / 20 yr	36054
125i	18	Strip-Cut	5.8mm (DIN-P-2)	230mm	53L	45 mins		2 / 20 yr	36054
99Ci	18	Cross-Cut	4 x 38mm (DIN-P-4)	230mm	34L	30 mins		2 / 5 yr	36053



- 100% JAM PROOF
- SAFESENSE TECHNOLOGY™
- ENERGY SAVINGS SYSTEM™
- SILENT SHRED™

### Powershred® 79Ci

**DESKSIDE USE. 1-3 USERS.**

- 100% Jam Proof system eliminates paper jams and powers through tough jobs
- SilentShred™ offers ultra-quiet performance for shared workspaces
- Patented SafeSense® Technology stops shredding when hands touch the paper opening
- Extended run time - shreds continuously for up to 20 minutes

Model	Sheet Capacity (70gsm)	Cut Type	Cut Size	Throat Width	Bin Capacity	Run Time	Also Shreds	Warranty: Machine / Cutter	Bags
79Ci	16	Cross-Cut	4 x 38mm (DIN-P-4)	230mm	23L	20 mins		2 / 5 yr	36052



**Powershred® 73Ci**

**DESKSIDE USE. 1-3 USERS.**

- 100% Jam Proof system eliminates paper jams and powers through tough jobs
- Patented SafeSense® Technology stops shredding when hands touch the paper entry
- Energy Savings System reduces in-use energy consumption and powers down after periods of inactivity.
- 23 litre pull-out bin for easy disposal of paper waste

Model	Sheet Capacity (70gsm)	Cut Type	Cut Size	Throat Width	Bin Capacity	Run Time	Also Shreds	Warranty: Machine / Cutter	Bags
73Ci	12	Cross-Cut	4 x 38mm (DIN-P-4)	230mm	23L	10 mins		2 / 5 yr	36052

Code	Model	UNIT			RETAIL PACK			OUTER PACK			
		H x W x D (cm)	Weight (kg)	Qty	H x W x D (cm)	Weight (kg)	Barcode (UPC)	Qty	H x W x D (cm)	Weight (kg)	Barcode (SCS)
4612001	125Ci	73.5 x 28.3 x 53.0	27.4	1	N/A	N/A	N/A	1	84.5 x 64.5 x 40.0	30.6	50043859628037
4613001	125i	73.5 x 28.3 x 53.0	26	1	N/A	N/A	N/A	1	84.5 x 64.5 x 40.0	29.2	50043859628105
4691001	99Ci	64.0 x 29.0 x 44.0	16.5	1	68.3 x 36.8 x 50.8	20	043859629251	1	71.0 x 38.8 x 51.8	21.76	50043859629256
4679001	79Ci	47.2 x 38.2 x 26.4	12.86	1	49.2 x 39.2 x 28.4	14.4	043859629022	1	51.0 x 29.6 x 40.2	15.2	50043859629027
4601101	73Ci	53.2 x 37.2 x 27.4	11.5	1	49.6 x 39.2 x 28.2	12.6	043859642526	1	51.2 x 29.6 x 40.4	13.36	50043859642316



## Performance

Excellent value shredders offering high levels of specification and a great performance.



### Powershred® 99Ms & 90S

**SMALL OFFICE USE. 3-5 USERS.**

- 99Ms: Shreds documents into 2x14mm micro-cut particles – that's over 2000 particles per A4 sheet!
- 99Ms: Sleep Mode feature shuts down the shredder after 2 minutes of inactivity
- SilentShred™ offers ultra-quiet performance for shared workspaces
- 34 litre pull-out bin for easy disposal of paper waste



**Powershred® 99Ms**

**SMALLER PARTICLES =  
LESS FREQUENT  
BIN EMPTYING**



Model	Sheet Capacity (70gsm)	Cut Type	Cut Size	Throat Width	Bin Capacity	Run Time	Also Shreds	Warranty: Machine / Cutter	Bags
99Ms	14	Micro-Cut	2 x 14mm (DIN-P-5)	230mm	34L	20 mins		2 / 5 yr	36053
90S	18	Strip-Cut	5.8mm (DIN-P-2)	230mm	34L	25 mins		2 / 5 yr	36053



### Powershred® 46Ms

**SMALL OFFICE USE. 3-5 USERS.**

- Micro-Cut shredders offer up to 10x smaller particles than a standard cross-cut shredder
- Shreds documents into 2x14mm micro-cut particles – that's over 2000 particles per A4 sheet!
- SafeSense® Technology automatically stops the shredding process when hands come into contact with the paper entry



**SMALLER PARTICLES =  
LESS FREQUENT  
BIN EMPTYING**



Model	Sheet Capacity (70gsm)	Cut Type	Cut Size	Throat Width	Bin Capacity	Run Time	Also Shreds	Warranty: Machine / Cutter	Bags
46Ms	12	Micro-Cut	2 x 14mm (DIN-P-5)	220mm	30L	15 mins		2 / 5 yr	36052



### Powershred® 450M

DESKSIDE USE. 1-3 USERS.

- Shreds documents into 2x14mm micro-cut particles – that’s over 2000 particles per A4 sheet!
- Auto Reverse automatically stops and reverses if a paper jam occurs
- SilentShred® Technology minimises noise disruption in shared work spaces



**Microshred 450M**

SMALLER PARTICLES =  
**LESS FREQUENT  
BIN EMPTYING**

**EASIER  
LESS EMPTYING**



Model	Sheet Capacity (70gsm)	Cut Type	Cut Size	Throat Width	Bin Capacity	Run Time	Also Shreds	Warranty: Machine / Cutter	Bags
450M	9	Micro-Cut	2 x 12mm (DIN-P-5)	220mm	22L	10 mins		2 / 5 yr	N/A

### Powershred® 75Cs & 70S

DESKSIDE USE. 1-3 USERS.

- Ideal for moderate use for the home or home office
- Features wide 230mm paper entry; shreds CDs in a designated safety slot
- 27 litre pull-out bin with window allows user to see when basket is full



75Cs Only



70S Only

Model	Sheet Capacity (70gsm)	Cut Type	Cut Size	Throat Width	Bin Capacity	Run Time	Also Shreds	Warranty: Machine / Cutter	Bags
75Cs	12	Cross-Cut	4 x 38mm (DIN-P-4)	230mm	27L	10-12 mins		2 / 5 yr	36052
70S	14	Strip-Cut	5.8mm (DIN-P-2)	230mm	27L	10-12 mins		2 / 5 yr	36052

Code	Model	UNIT			RETAIL PACK			OUTER PACK			
		H x W x D (cm)	Weight (kg)	Qty	H x W x D (cm)	Weight (kg)	Barcode (UPC)	Qty	H x W x D (cm)	Weight (kg)	Barcode (SCS)
4609101	99Ms	64.0 x 29.0 x 44.0	18.8	1	N/A	N/A	N/A	1	69.5 x 37.5 x 52.1	22.4	50043859654722
4690101	90S	64.0 x 29.0 x 44.0	14.8	1	68.3 x 36.8 x 50.8	18.7	043859631070	1	71.0 x 38.8 x 51.8	19.3	50043859631075
4817101	46Ms	65.0 x 36.8 x 29.0	11.2	1	69.6 x 42.8 x 31.8	12.4	043859707720	1	72.2 x 44.2 x 34.1	13.4	50043859707725
4074101	450M	56.5 x 35.0 x 26.0	10.4	1	58 x 39.5 x 29.5	11.7	043859703210	1	61.0 x 41.0 x 31.0	12.7	50043859703215
4675001	75Cs	51.4 x 38.1 x 28.6	12.46	1	48.0 x 28.4 x 39.4	13.64	043859628957	1	49.8 x 30.6 x 40.6	14.42	50043859628952
4671101	70S	51.4 x 38.1 x 28.6	9.68	1	48.0 x 28.4 x 39.4	10.82	043859630998	1	49.8 x 30.6 x 40.6	11.56	50043859630993

## Personal / Home Office

Safe, reliable shredders specifically designed for occasional to moderate use in the home / small office.



- JAM BLOCKER
- SAFESENSE TECHNOLOGY
- ENERGY SAVINGS SYSTEM

### Powershred® 63Cb

PERSONAL USE. 1 USER.

- Jam preventing shredder with SafeSense® - for moderate personal use



- SAFETY LOCK
- MICRO SHRED

### Powershred® 62Mc

PERSONAL USE. 1 USER.

- Superior security shredder for the home & home office. Shreds each sheet of paper into over 2000 particles (3x10mm P-4)



- SAFETY LOCK
- MICRO SHRED

### Powershred® 10M

PERSONAL USE. 1 USER.

- Superior security shredder for the home & home office.
- Shreds each sheet of paper into over 2000 particles (2x12mm P-5)



- SAFESENSE TECHNOLOGY

### Powershred® 21Cs

PERSONAL USE. 1 USER.

- Medium duty shredder with pull-out bin and SafeSense® Technology



- SAFETY LOCK

### Powershred® 11C

PERSONAL USE. 1 USER.

- Cross-cut shredder with 11-sheet capacity and Safety Lock



- SAFESENSE TECHNOLOGY

### Powershred® 60Cs

PERSONAL USE. 1 USER.

- Premium personal shredder with SafeSense® Technology

Model	Sheet Capacity (70gsm)	Cut Type	Cut Size	Throat Width	Bin Capacity	Run Time	Also Shreds	Warranty: Machine / Cutter	Bags
63Cb	10	Cross-Cut	4 x 50mm (DIN-P-3)	230mm	19L	8 mins		2 / 5 yr	36052
62Mc	10	Micro-Cut	3 x 10mm (DIN-P-4)	223mm	19L	7 mins		2 / 5 yr	N/A
10M	10	Micro-Cut	2 x 12mm (DIN-P-5)	220mm	19L	10 mins		2 / 5 yr	N/A
21Cs	12	Cross-Cut	4 x 52mm (DIN-P-3)	230mm	15L	5 mins		2 / 5 yr	N/A
11C	11	Cross-Cut	4 x 40mm (DIN-P-4)	222mm	18L	5 mins		1 / 3 yr	N/A
60Cs	10	Cross-Cut	4 x 40mm (DIN-P-4)	230mm	22L	6 mins		2 / 5 yr	N/A

Code	Model	UNIT			RETAIL PACK			OUTER PACK			
		H x W x D (cm)	Weight (kg)	Qty	H x W x D (cm)	Weight (kg)	Barcode (UPC)	Qty	H x W x D (cm)	Weight (kg)	Barcode (SCS)
4600101	63Cb	45.2 x 36.8 x 24.8	8.8	1	48.8 x 38.8 x 26.4	9.92	043859642304	1	50.8 x 28.2 x 40.6	10.64	50043859642309
4685201	62Mc	48.7 x 34.8 x 26.5	9.3	1	51.8 x 40.4 x 30.4	11.2	043859680726	1	54.0 x 42.2 x 32.0	12.3	50043859680721
4630601	10M	50.0 x 34.5 x 25.0	8.3	1	42.5 x 27.5 x 37.1	9.1	043859743537	1	45.5 x 29.5 x 38.5	9.7	50043859743532
4360201	21Cs	39.1 x 23.2 x 43	7.5	1	46.2 x 49.5 x 28.5	8.8	043859697298	1	48.2 x 51.3 x 30.1	9.3	50043859697293
4350201	11C	42.8 x 34.6 x 23.8	6	1	43.8 x 36.3 x 25.2	7	043859697243	2	45.7 x 52.5 x 37.7	15	50043859697248
4606101	60Cs	40.7 x 23.3 x 37.1	5.8	1	42.6 x 28.8 x 42.4	7.3	043859642854	2	44.8 x 44.0 x 58.8	15.6	50043859642859



**Powershred® 53C**

PERSONAL USE. 1 USER.

- Entry level cross-cut shredder with large bin and CD shredding capability



**Powershred® 8Mc**

PERSONAL USE. 1 USER.

- Shreds 8 sheets of paper (70gsm) per pass into 3 x 10mm micro-cut particles (DIN Level P-4)



**Powershred® 8Cd & 8C**

PERSONAL USE. 1 USER.

- Personal cross-cut shredder available with and without CD shredding capability



**Powershred® M-8C**

PERSONAL USE. 1 USER.

- Stylish cross-cut shredder with Safety Lock feature and 5-minute run time



**Powershred® M-7C**

PERSONAL USE. 1 USER.

- Stylish 7-sheet capacity cross-cut shredder



**Powershred® M-7CM**

PERSONAL USE. 1 USER.

- Stylish 7-sheet capacity cross-cut shredder with mesh bin

Model	Sheet Capacity (70gsm)	Cut Type	Cut Size	Throat Width	Bin Capacity	Run Time	Also Shreds	Warranty: Machine / Cutter	Bags
53C	10	Cross-Cut	4 x 35mm (DIN-P-4)	220mm	23L	3 mins		2 / 5 yr	N/A
8Mc	8	Micro-Cut	3 x 10mm (DIN-P-4)	220mm	14L	5 mins		2 / 3 yr	N/A
8Cd	8	Cross-Cut	4 x 35mm (DIN-P-4)	220mm	14L	3 mins		2 / 3 yr	N/A
8C	8	Cross-Cut	4 x 35mm (DIN-P-4)	220mm	14L	3 mins		2 / 3 yr	N/A
M-8C	8	Cross-Cut	4 x 37mm (DIN-P-4)	229mm	15L	5 mins		2 / 3 yr	N/A
M-7C	7	Cross-Cut	4 x 35mm (DIN-P-4)	230mm	14L	5 mins		1 / 3 yr	N/A
M-7CM	7	Cross-Cut	4 x 35mm (DIN-P-4)	230mm	13L	5 mins		1 / 3 yr	N/A

Code	Model	UNIT			RETAIL PACK				OUTER PACK		
		H x W x D (cm)	Weight (kg)	Qty	H x W x D (cm)	Weight (kg)	Barcode (UPC)	Qty	H x W x D (cm)	Weight (kg)	Barcode (SCS)
4653101	53C	40.0 x 33.8 x 19.6	6.8	1	43.2 x 36.8 x 23.6	7.74	043859646906	2	45.4 x 48.4 x 39.0	16.5	50043859646901
4692501	8Mc	38.4 x 30.5 x 20.0	4.1	1	34.9 x 30.8 x 20.3	4.6	043859724697	2	35.6 x 32.5 x 41.6	9.8	50043859724692
4692101	8Cd	38.4 x 29.9 x 20.0	4.08	1	34.9 x 30.8 x 19.7	4.8	043859724673	2	36.8 x 32.1 x 41.3	10.2	50043859724678
4689601	8C	38.4 x 29.9 x 20.0	3.8	1	34.9 x 30.8 x 19.7	4.4	043859724659	2	36.8 x 32.1 x 41.3	9.7	50043859724654
4604101	M-8C	37.8 x 31 x 24.4	5.6	1	40.6 x 38 x 27.6	6.46	043859647422	2	43.2 x 43.0 x 62.6	13.7	50043859647427
4603101	M-7C	38.7 x 32 x 18.6	3.9	1	36.8 x 35 x 21.0	5.04	043859647316	2	38.6 x 44.0 x 36.2	10.9	50043859647311
4701801	M-7CM	38.7 x 32 x 18.6	3.9	1	36.8 x 35 x 21.0	5.04	043859728510	2	38.6 x 44.0 x 36.2	10.9	50043859728515



### Powershred® 36C

PERSONAL USE. 1 USER.

- 6-sheet, light duty cross-cut shredder with Safety Lock feature



### Powershred® 6M

PERSONAL USE. 1 USER.

- Mini-cut shredder. Shreds each sheet of A4 paper into 1000+ particles



### Powershred® 6C & 3C

PERSONAL USE. 1 USER.

- 6-sheet cross-cut shredder with Safety Lock. For light use



### Powershred® P-28S

PERSONAL USE. 1 USER.

- Basic security 8-sheet strip-cut shredder for occasional use



### Powershred® P-25S

PERSONAL USE. 1 USER.

- Basic security 5-sheet strip-cut shredder for occasional use



### Powershred® Shredmate

PERSONAL USE. 1 USER.

- Compact desktop shredder with 4.5 litre bin

Model	Sheet Capacity (70gsm)	Cut Type	Cut Size	Throat Width	Bin Capacity	Run Time	Also Shreds	Warranty: Machine / Cutter	Bags
36C	6	Cross-Cut	4 x 40mm (DIN-P-4)	230mm	12L	2 mins		1 / 3 yr	N/A
6M	6	Mini-Cut	4 x 12mm (DIN-P-4)	220mm	13L	5 mins		1 / 3 yr	N/A
6C	6	Cross-Cut	4 x 35mm (DIN-P-4)	220mm	11L	3 mins		1 / 3 yr	N/A
3C	6	Cross-Cut	4 x 35mm (DIN-P-4)	220mm	11L	3 mins		1 / 3 yr	N/A
P-28S	8	Strip-Cut	6mm (DIN-P-2)	220mm	15L	3 mins	-	1 / 1 yr	N/A
P-25S	5	Strip-Cut	7mm (DIN-P-1)	220mm	11L	3 mins	-	1 / 1 yr	N/A
Shredmate	4	Cross-Cut	4 x 35mm (DIN-P-4)	115mm	4.5L	5 mins		1 / 1 yr	N/A

Code	Model	UNIT			RETAIL PACK			OUTER PACK			
		H x W x D (cm)	Weight (kg)	Qty	H x W x D (cm)	Weight (kg)	Barcode (UPC)	Qty	H x W x D (cm)	Weight (kg)	Barcode (SCS)
4700301	36C	32.0 x 35.0 x 20.0	2.99	1	38.0 x 36.5 x 21.0	3.52	043859724987	2	39.5 x 38.0 x 43.5	7.79	50043859724982
4631101	6M	37.3 x 31.3 x 17.5	3.2	1	33.3 x 30.0 x 17.1	3.7	043859743568	2	38.0 x 31.6 x 36.1	9.4	50043859743563
4686601	6C	36.6 x 29.7 x 16.8	3.2	1	33.3 x 29.9 x 17.2	4	043859724598	2	35.9 x 31.8 x 36.2	8.2	50043859724593
4687401	3C	36.6 x 29.7 x 16.8	3.2	1	33.3 x 29.9 x 17.2	4	043859724611	2	35.9 x 31.8 x 36.2	8.2	50043859724616
4710101	P-28S	32.0 x 38.1 x 18.8	2.76	1	36.5 x 30.5 x 18.0	3.26	043859691227	2	38.5 x 37.5 x 32.0	7.02	50043859691222
4701001	P-25S	29.9 x 28.6 x 15.3	1.624	1	27.6 x 30.0 x 16.2	1.968	043859690695	4	30.0 x 34.4 x 61.0	8.634	50043859690690
3700501	Shredmate	23.8 x 19.0 x 14.6	2.7	1	23.2 x 22.4 x 17.8	3.02	043859561346	2	25.4 x 24.2 x 36.8	6.4	50043859561341



## High Security

Shredders designed for highly classified data in military, government and intelligence services.



**SHEET CAPACITY SENSOR™** Helps prevent paper jams by indicating sheet capacity levels during the shredding process



**SAFETY SHIELD™** Electronically controlled shield stops shredder when opened for advanced safety



**AUTO SHUT OFF™** Automatically shuts off after 30 minutes of inactivity for zero energy consumption



**Fortishred™ 3250HS & 3250SMC**  
HIGH SECURITY. 5+ USERS.



**Fortishred™ 1050HS**  
HIGH SECURITY. 1 USER.

Model	Sheet Capacity (70gsm)	Cut Type	Cut Size	Throat Width	Bin Capacity	Run Time	Also Shreds	Warranty: Machine / Cutter	Bags
3250HS	5-7	Classified	0.8 x 5mm (DIN-P-7)	260mm	100L	Continuous	-	1 / 1 yr	36055
3250SMC	8-10	Classified	0.8 x 12mm (DIN-P-6)	260mm	100L	Continuous	-	1 / 1 yr	36055
1050HS	4	Classified	0.8 x 5mm (DIN-P-7)	240mm	35L	Continuous	-	1 / 1 yr	36053

Code	Model	UNIT			RETAIL PACK				OUTER PACK		
		H x W x D (cm)	Weight (kg)	Qty	H x W x D (cm)	Weight (kg)	Barcode (UPC)	Qty	H x W x D (cm)	Weight (kg)	Barcode (SCS)
4617201	3250HS	92.6 x 49.5 x 47.0	48	1	N/A	N/A	N/A	1	129.0 x 76.0 x 70.0	68	50043859648813
4617301	3250SMC	92.6 x 49.5 x 47.0	48	1	N/A	N/A	N/A	1	129.0 x 76.0 x 70.0	68	50043859648820
4603801	1050HS	70.0 x 39.5 x 38.5	23	1	N/A	N/A	N/A	1	76.0 x 45.7 x 51.5	27.5	50043859649001

## Shredders Accessories

The necessities for shredded waste management and optimum shredder performance. We recommend that you oil your cross-cut shredder each time you empty your bin.

### Bags

Code	Approx capacity	RETAIL PACK			OUTER PACK		
		Qty	H x W (cm)	Qty	H x W x D (cm)	Weight (kg)	Barcode (SCS)
36052	up to 30 litres	100	66.0 x 38.0mm	1	88.0 x 20.4 x 17.2	1.32kg	10077511360524
36053	30-35 litres	100	76.0 x 38.0mm	1	10.2 x 19.8 x 25.2	2.1kg	10077511360531
36054	50-75 litres	50	92.0 x 46.0mm	1	11.4 x 25.0 x 11.6	1.48kg	10077511360548
36056	80-85 litres	50	99.0 x 54.0mm	1	12.2 x 28.2 x 11.8	1.74kg	10077511360562
3605801	110-130 litres (425 / 485 series)	50	99.0 x 59.0mm	1	12.9 x 13.6 x 33.7	2.4kg	50043859487115
36055	150-160 litres	50	130.0 x 56.0mm	1	92.0 x 30.0 x 18.6	2.46kg	10077511360555

### Oil

Code	Description	RETAIL PACK			OUTER PACK		
		Size	Barcode (UPC)	Qty	H x W x D (cm)	Weight (kg)	Barcode (SCS)
35250	Shredder Oil	355ml	077511352508	6	22.0 x 19.2 x 13.6	2.46kg	10077511352505
3505006	Shredder Oil in PDU	120ml	077511350504	12	17.0 x 24.2 x 10.0	1.7kg	50077511350509
3525601	Shredder Oil for 1050HS, 3250SMC, 3250HS	200ml	4019364950810	10	22.5 x 11.0 x 25.7	1.96kg	50043859693479



## GET READY TO MAKE A GREAT IMPRESSION

By adding a plastic coating to paper or card, a document becomes more durable with a quality, professional-looking finish. Lamination protects documents from fingerprints, smudges and tears and also enhances the colour and contrast of the print, keeping materials in like-new condition for many years. Laminated paper or card can be used for presentations, signage, re-usable displays, and preserving frequently accessed and important documents.

**A laminated document looks better, lasts longer.**



## WHAT TO LAMINATE?

When it comes to laminating, the possibilities are endless. Whether you want to enhance the colours in your documents, capture the moment when laminating photos or preserve documents - Fellowes can provide the solution.



## CHOOSING THE RIGHT LAMINATOR

Fellowes laminators are segmented on usage; how often they are used and the thickness and size of pouch they accept. The thicker the pouches accepted, the more versatile the machine and the more applications for which it can be used.

**USAGE:** Where and how often will the laminator be used?

**HEAVY USE**  
OFFICE ENVIRONMENTS

**MEDIUM USE**  
SMALL & HOME OFFICES

**LIGHT / MODERATE USE**  
PERSONAL AND HOME

**FEATURES:** Which of the following features are required?

 Detects pouch thickness and self-adjusts to the optimal laminating setting	 Ready to laminate in as little as 30-60 seconds every time	 Clear Path mechanism, and pouch reverse / release features prevent jams when used with Fellowes pouches	 Powers down after periods of inactivity, reducing energy consumption
 Reduces the surface temperature of the laminator, ensuring it is safe to touch	 Allows immediate, manual switching between different pouch thicknesses	 Detects potential jams, stops laminating and allows user to reverse and realign the pouch	 Indicator light tells the user when the laminator is ready to accept the next pouch



Fellowes laminators cover pouch thicknesses between 80 and 250 microns. The thicker the pouches accepted, the more versatile the machine and the more applications for which it can be used.

*The table shows the pouch thicknesses which are accepted by each laminator:*

	up to 80 micron	up to 100 micron	up to 125 micron	up to 175 micron	up to 250 micron
Proteus A3	✓	✓	✓	✓	✓
Voyager A3	✓	✓	✓	✓	✓
Venus 2 A3	✓	✓	✓	✓	✓
Jupiter 2 A3	✓	✓	✓	✓	✓
Neptune 3 A3	✓	✓	✓	✓	
Calibre A3 & A4	✓	✓	✓		
Saturn 3i A3 & A4	✓	✓	✓		
Pixel A3 & A4	✓		✓		
Cosmic 2 A3 & A4	✓		✓		
Spectra A3 & A4	✓	✓	✓		
Lunar / Lunar+ A3 & A4	✓		✓		
Ion A3 & A4	✓	✓	✓		
L125 A3 & A4	✓	✓	✓		
Arc A4	✓				

## Large Office Laminators



### Proteus A3 Laminator

**HEAVY USE.**

- 6 roller technology heating 4 large diameter rollers for high quality results
- Fully variable controls + 6 pre-set controls for popular applications
- Laminates up to 95 cm/min (approx. 180x A4 pouches per hour)
- Ability to laminate hot and cold, with or without carriers, mounting board and foils



### Voyager A3 Laminator

**HEAVY USE.**

- AutoSense™ detects pouch thickness and self-adjusts to the optimal laminating setting
- Easi-Access mechanism allows the user to open the machine for cleaning and maintenance of the rollers ensuring consistent, high quality lamination
- Auto reverse function detects misfeeds and prevents jams

Model	Entry Width	No. of Rollers	Heat-up Time	Temp Settings	Cold Setting	Max Speed	Misfeed Mechanism	Starter Kit	Warranty
Proteus A3	325mm	6	3 mins	Variable (6 pre-sets)	Yes	95 cm/min	Manual Reverse	No	1 year
Voyager A3	320mm	Belt Driven	4 mins	AutoSense	No	90 cm/min	Auto Reverse	10 doc	2 years

Code	Model	UNIT			RETAIL PACK				OUTER PACK		
		H x W x D (cm)	Weight (kg)	Qty	H x W x D (cm)	Weight (kg)	Barcode (UPC)	Qty	H x W x D (cm)	Weight (kg)	Barcode (SCS)
5709001	Proteus A3	12.5 x 55.4 x 31.5	14.6	1	N/A	N/A	N/A	1	22.5 x 66.0 x 39.8	17.5	50043859618519
5704201	Voyager A3	16.5 x 63.0 x 23.0	10.5	1	N/A	N/A	N/A	1	25.2 x 73.0 x 29.2	12	50043859568814



# Office Laminators



Laminates an A4 pouch in as little as  
**17 Seconds**



## Venus 2 A3 Laminator

**HEAVY USE.**

- Laminates an 80 micron A4 pouch in approx. 17 seconds - that's around 35 pouches every 10 minutes.
- Robust 6-roller laminator for superior lamination quality, can laminate all pouches up to 250 microns (2x250)
- Advanced Pouch Tracking System detects potential paper jams and automatically reverses, allowing the user to realign the pouch
- Feed IQ indicates when the next pouch can be inserted, preventing jams and maximising productivity



## Jupiter 2 A3 Laminator

**HEAVY USE.**

- Laminates an 80 micron A4 pouch in approx. 19 seconds - that's around 30 pouches every 10 minutes.
- Robust 6-roller laminator for superior lamination quality, can laminate all pouches up to 250 microns (2x250)
- Advanced Pouch Tracking System detects potential paper jams and automatically reverses, allowing the user to realign the pouch



## Neptune 3 A3 Laminator

**HEAVY USE.**

- Laminates an 80 micron A4 pouch in approx. 23 seconds - that's around 25 pouches every 10 minutes.
- 4-roller laminator for high quality results, can laminate all pouches up to 175 microns (2x175)
- Advanced Pouch Tracking System detects potential paper jams and automatically reverses, allowing the user to realign the pouch



Model	Entry Width	No. of Rollers	Heat-up Time	Temp Settings	Cold Setting	Max Speed	Misfeed Mechanism	Starter Kit	Warranty
Venus 2 A3	320mm	6	30-60 secs	AutoSense	Yes	135 cm/min	Auto Reverse	10 doc	2 years
Jupiter 2 A3	320mm	6	1 min	AutoSense	Yes	120 cm/min	Auto Reverse	10 doc	2 years
Neptune 3 A3	320mm	4	1 min	AutoSense	Yes	80 cm/min	Manual Reverse	10 doc	2 years

Code	Model	UNIT			RETAIL PACK			OUTER PACK			
		H x W x D (cm)	Weight (kg)	Qty	H x W x D (cm)	Weight (kg)	Barcode (UPC)	Qty	H x W x D (cm)	Weight (kg)	Barcode (SCS)
5734201	Venus 2 A3	12.1 x 54.6 x 17.2	6.7	1	N/A	N/A	N/A	1	17.5 x 59.2 x 28.0	8.0	50043859641234
5733501	Jupiter 2 A3	12.1 x 54.6 x 17.2	6.7	1	16.5 x 58.0 x 27.0	6.8	043859641161	1	17.5 x 59.0 x 29.0	7.7	50043859641166
5721501	Neptune 3 A3	12.2 x 50.8 x 14.0	4.6	1	18.0 x 56.8 x 24.4	5.6	043859667772	1	20.0 x 58.2 x 25.8	6.0	50043859667777

## Small & Home Office Laminators



up to 125 micron



### Calibre A3 & A4 Laminators

MEDIUM USE.

- Fast lamination speed – max. 50cm / minute for 80 micron pouches
- Laminator feed sensor indicates when a document has been misfed and stops & auto reverses, allowing the user to realign the pouch
- Auto shut off after 30 minutes inactivity, reducing energy consumption



up to 125 micron



### Saturn 3i A3 & A4 Laminators

MEDIUM USE.

- 30cm/min laminating speed for 80-125 micron pouches
- Laminator feed sensor indicates when a document has been misfed and stops the laminating process, allowing the pouch to be manually released and realigned
- Auto shut off after 30 minutes of inactivity, reducing energy consumption

Model	Entry Width	No. of Rollers	Heat-up Time	Temp Settings	Cold Setting	Max Speed	Misfeed Mechanism	Starter Kit	Warranty
Calibre A3	320mm	2	1 min	3 (+ cold)	Yes	50 cm/min (max)	Auto Reverse	10 doc	2 years
Calibre A4	240mm	2	1 min	3 (+ cold)	Yes	50 cm/min (max)	Auto Reverse	10 doc	2 years
Saturn 3i A3	320mm	2	1 min	3 (+ cold)	Yes	30 cm/min	Release	10 doc	2 years
Saturn 3i A4	235mm	2	1 min	3 (+ cold)	Yes	30 cm/min	Release	10 doc	2 years

Code	Model	UNIT			RETAIL PACK			OUTER PACK			
		H x W x D (cm)	Weight (kg)	Qty	H x W x D (cm)	Weight (kg)	Barcode (UPC)	Qty	H x W x D (cm)	Weight (kg)	Barcode (SCS)
5740101	Calibre A3	11.0 x 57.0 x 15.6	2.54	1	18.0 x 67.0 x 16.2	2.95	043859718184	2	20.5 x 69.0 x 34.0	5.9	50043859718189
5740701	Calibre A4	11.0 x 45.0 x 14.5	2.27	1	18.0 x 55.4 x 16.2	2.5	043859718245	2	20.5 x 57.3 x 34.0	5	50043859718240
5736001	Saturn 3i A3	10.5 x 53.2 x 14.6	2.75	1	17.0 x 58.2 x 17.5	3	043859679980	2	18.8 x 36.7 x 59.5	6.35	50043859679985
5724801	Saturn 3i A4	10.5 x 43.6 x 13.9	2.25	1	17.0 x 48.6 x 17.5	2.5	043859679904	2	18.8 x 36.7 x 49.9	5.5	50043859679909

Personal & Home Laminators



up to 125 micron

**NEW**  
for 2020



**Pixel A3 & A4 Laminators**

**MODERATE USE.**

- Auto shut off after 30 minutes of inactivity, reducing energy consumption
- Individual temperature settings for 80 and 125 micron pouches for a better quality finish
- Release trigger for retrieving and realigning misfed documents

up to 125 micron



**Cosmic 2 A3 & A4 Laminators**

**MODERATE USE.**

- HeatGuard™ Technology - reduces the surface temperature of the laminator, ensuring it is always safe to touch
- Individual temperature settings for 80 and 125 micron pouches for a better quality finish
- Release trigger for retrieving and realigning misfed documents



Model	Entry Width	No. of Rollers	Heat-up Time	Temp Settings	Cold Setting	Max Speed	Misfeed Mechanism	Starter Kit	Warranty
Pixel A3	330mm	2	3 mins	2 (+ cold)	Yes	30 cm/min	Release	10 doc	2 years
Pixel A4	240mm	2	3 mins	2 (+ cold)	Yes	30 cm/min	Release	10 doc	2 years
Cosmic 2 A3	320mm	2	5 mins	2 (+ cold)	Yes	30 cm/min	Release	10 doc	2 years
Cosmic 2 A4	235mm	2	5 mins	2 (+ cold)	Yes	30 cm/min	Release	10 doc	2 years

Code	Model	UNIT			RETAIL PACK			OUTER PACK			
		H x W x D (cm)	Weight (kg)	Qty	H x W x D (cm)	Weight (kg)	Barcode (UPC)	Qty	H x W x D (cm)	Weight (kg)	Barcode (SCS)
5601601	Pixel A3	43.5 x 11.0 x 75.0	1.7	1	48.7 x 16.0 x 12.3	2.4	043859753239	2	50.2 x 17.3 x 26.5	5	50043859753234
5601401	Pixel A4	34.2 x 11.0 x 75.0	1.4	1	39.3 x 16.0 x 12.3	2	043859753215	2	40.8 x 17.3 x 26.5	4.2	50043859753210
5725701	Cosmic 2 A3	8.6 x 56.6 x 12.2	2.2	1	18.0 x 66.4 x 16.5	2.96	043859609901	2	20.5 x 68.3 x 34.5	6.56	50043859609906
5725001	Cosmic 2 A4	9.0 x 45.0 x 12.0	1.8	1	18.0 x 55.3 x 16.5	2.5	043859609833	2	20.5 x 57.0 x 34.5	5.6	50043859609838



**JAM FREE** **AUTO SHUT OFF**

### Spectra A3 & A4 Laminators

**MODERATE USE.**

- User-friendly laminator for moderate use in home & home office environments
- Laminates up to A4 or A3 size documents in 80 - 125 micron pouches
- Release lever disengages pouch for document realignment or removal



**JAM FREE**

### Lunar+ A3 & A4 Laminators

**LIGHT USE.**

- Stylish laminator for light use in home and home office environments
- Laminates 125 micron pouches
- Jam release trigger allows misfed documents to be released and realigned
- Ready to laminate in 4 minutes



**JAM FREE**

### Lunar A3 & A4 Laminators

**LIGHT USE.**

- Laminates 125 micron pouches
- Jam release trigger allows misfed documents to be released and realigned
- Ready to laminate in 4 minutes

Model	Entry Width	No. of Rollers	Heat-up Time	Temp Settings	Cold Setting	Max Speed	Misfed Mechanism	Starter Kit	Warranty
Spectra A3	320mm	2	4 mins	1 (fixed)	No	30 cm/min	Release	10 doc	1 year
Spectra A4	230mm	2	4 mins	1 (fixed)	No	30 cm/min	Release	10 doc	1 year
Lunar+ A3 Blue	320mm	2	4 mins	2	No	30 cm/min	Release	No	1 year
Lunar+ A4 Blue	240mm	2	4 mins	2	No	30 cm/min	Release	No	1 year
Lunar A3	320mm	2	4 mins	2	No	30 cm/min	Release	No	1 year
Lunar A4	240mm	2	4 mins	2	No	30 cm/min	Release	No	1 year

Code	Model	UNIT			RETAIL PACK			OUTER PACK			
		H x W x D (cm)	Weight (kg)	Qty	H x W x D (cm)	Weight (kg)	Barcode (UPC)	Qty	H x W x D (cm)	Weight (kg)	Barcode (SCS)
5738301	Spectra A3	7.8 x 47.0 x 16.2	1.5	1	10.0 x 49.5 x 19.5	2.4	043859680306	4	51.0 x 22.0 x 41.5	9.6	50043859680301
5737801	Spectra A4	7.8 x 37.0 x 16.2	1.3	1	10.0 x 39.5 x 19.5	1.9	043859680214	4	41.0 x 22.0 x 41.5	7.8	50043859680219
5742701	Lunar+ A3 Blue	11.0 x 49.4 x 16.0	1.55	1	19.1 x 52.6 x 13.7	2	043859724390	4	40.0 x 29.2 x 54.8	8.6	50043859724395
5742801	Lunar+ A4 Blue	11.0 x 40.0 x 16.0	1.2	1	19.5 x 43.2 x 13.7	1.55	043859724406	4	29.4 x 40.3 x 44.5	6.8	50043859724401
5716701	Lunar A3	11.0 x 49.4 x 16.0	1.55	1	19.1 x 52.6 x 13.7	2	043859624430	4	40.0 x 29.2 x 54.8	8.6	50043859624435
5715601	Lunar A4	11.0 x 40.0 x 16.0	1.2	1	19.5 x 43.2 x 13.7	1.55	043859624362	4	29.4 x 40.3 x 44.5	6.8	50043859624367





**JAM FREE** **AUTO SHUT OFF**

**L125 A3 & A4 Laminators**

**LIGHT USE.**

- User-friendly laminator for home environments
- Laminates documents and photos in 80 - 125 micron pouches
- Release lever disengages pouch for document realignment or removal



**JAM FREE** **AUTO SHUT OFF**

**Ion A3 & A4 Laminators**

**LIGHT USE.**

- User-friendly laminator for home environments
- Laminates documents and photos in 80 - 125 micron pouches
- Release lever disengages pouch for document realignment or removal



**JAM FREE** **AUTO SHUT OFF**

**Arc A4 Laminator**

**LIGHT USE.**

- User-friendly laminator for home environments
- Laminates documents and photos in 80 micron pouches
- Release lever disengages pouch for document realignment or removal

Model	Entry Width	No. of Rollers	Heat-up Time	Temp Settings	Cold Setting	Max Speed	Misfeed Mechanism	Starter Kit	Warranty
L125-A3	320mm	2	4 mins	1 (fixed)	No	30 cm/min	Release	10 doc	1 year
L125-A4	230mm	2	4 mins	1 (fixed)	No	30 cm/min	Release	10 doc	1 year
Ion A3	320mm	2	4 mins	1 (fixed)	No	30 cm/min	Release	10 doc	1 year
Ion A4	240mm	2	4 mins	1 (fixed)	No	30 cm/min	Release	10 doc	1 year
Arc A4	240mm	2	4 mins	1 (fixed)	No	30 cm/min	Release	10 doc	1 year

Code	Model	UNIT			RETAIL PACK			OUTER PACK			
		H x W x D (cm)	Weight (kg)	Qty	H x W x D (cm)	Weight (kg)	Barcode (UPC)	Qty	H x W x D (cm)	Weight (kg)	Barcode (SCS)
5640701	L125-A3	6.6 x 45.0 x 15.8	2.04	1	9.1 x 48.0 x 18.5	2.38	043859698110	4	37.5 x 21.0 x 49.5	9.55	50043859698115
5737201	L125-A4	6.6 x 35.6 x 15.8	1.3	1	9.1 x 37.8 x 18.7	1.7	043859680160	4	39.2 x 21.7 x 38.4	7.6	50043859680165
4560201	Ion A3	6.6 x 45.0 x 15.8	2.04	1	9.1 x 48.0 x 18.5	2.38	043859752836	4	37.5 x 21.0 x 49.5	9.55	50043859752831
4560001	Ion A4	6.2 x 35.9 x 17.0	1	1	14.3 x 39.5 x 9.4	1.5	043859752829	4	17.1 x 39.0 x 41.2	6.7	50043859752824
4570001	Arc A4	6.2 x 35.9 x 17.0	1	1	14.3 x 39.5 x 9.4	1.5	043859752867	4	17.1 x 39.0 x 41.2	6.7	50043859752862

## Laminating Supplies

### ImageLast™ laminating pouches



Size	Qty/Pack	Code	Pack Dimensions (HxWxD - cm) & Weight	Retail Barcode	Outer	Outer Dimensions (HxWxD - cm) & Weight	Outer Barcode
<b>Enhance80 Glossy Pouches 80 micron</b>							
A3	100	5306207	43.2 x 30.6 x 22.0 / 2.26kg	077511530623	5	11.6 x 33.4 x 45.6 / 12kg	10077511530620
A3	25	5396403	43.0 x 30.4 x 4.0 / 0.52kg	077511539640	5	42.0 x 33.2 x 45.4 / 3.28kg	10077511539647
A4	100	5306114	30.6 x 22.0 x 18.0 / 1.16kg	077511530616	5	11.2 x 24.4 x 32.6 / 6.08kg	20077511530610
A4	25	5396205	34.8 x 23.2 x 6.0 / 0.32kg	077511539626	10	68.0 x 25.2 x 34.0 / 3.38kg	10077511539623
A5	100	5306002	22.4 x 16.0 x 18.0 / 0.58kg	077511530609	5	10.6 x 18.8 x 24.4 / 3.24kg	10077511530606
A5	25	5396003	25.5 x 16.8 x 6.0 / 0.16kg	077511539602	20	10.6 x 24.6 x 19.4 / 3.3kg	20077511539606
<b>Capture125 Glossy Pouches 125 micron</b>							
A3	100	5307506	43.0 x 30.6 x 30.0 / 3.84kg	077511530753	5	15.8 x 33.0 x 45.2 / 19.94kg	10077511530750
A3	25	5396501	47.5 x 31.0 x 5.0 / 0.86kg	077511539657	5	48.0 x 45.8 x 33.8 / 5.24kg	10077511539654
A4	100	5307407	30.8 x 22.0 x 30.0 / 1.94kg	077511530746	10	29.6 x 24.2 x 32.8 / 20kg	30077511530747
A4	25	5396301	35.0 x 23.5 x 9.0 / 0.5kg	077511539633	10	90.0 x 33.0 x 25.2 / 5.22kg	10077511539630
A5	100	5307302	22.2 x 16.0 x 28.0 / 0.96kg	077511530739	5	15.6 x 18.0 x 23.8 / 5.3kg	10077511530736
A5	25	5396101	21.8 x 16.2 x 8.0 / 0.18kg	077511539619	20	16.2 x 19.6 x 24.6 / 5.4kg	10077511539616

### Standard laminating pouches



Size	Qty/Pack	Code	Pack Dimensions (HxWxD - cm) & Weight	Retail Barcode	Outer	Outer Dimensions (HxWxD - cm) & Weight	Outer Barcode
<b>Impress100 Glossy Pouches 100 micron</b>							
A3	100	5351205	43.0 x 30.8 x 24.0 / 2.98kg	077511535123	5	13.6 x 33.0 x 45.0 / 15.4kg	10077511535120
A4	100	5351111	30.8 x 22.0 x 24.0 / 1.56kg	077511535116	10	24.4 x 24.2 x 32.8 / 16.3kg	20077511535110
A5	100	5351002	22.2 x 15.8 x 24.0 / 0.8kg	077511535109	5	13.0 x 18.0 x 23.6 / 4.14kg	10077511535106
<b>Capture125 Glossy Pouches 125 micron</b>							
A2	50	5309302	61.0 x 43.4 x 16.0 / 3.92kg	077511530937	3	60.0 x 62.3 x 46.0 / 12.32kg	10077511530934
<b>Protect175 Glossy Pouches 175 micron</b>							
A3	100	5308803	43.0 x 31.0 x 40.0 / 5.44kg	077511530883	3	13.2 x 33.6 x 44.2 / 17.16kg	10077511530880
A4	100	5308703	30.8 x 22.2 x 40.0 / 2.7kg	077511530876	5	21.6 x 23.8 x 32.8 / 14.08kg	10077511530873
<b>Preserve250 Glossy Pouches 250 micron</b>							
A4	100	5401802	30.6 x 22.2 x 54.0 / 3.76kg	077511540189	4	23.2 x 24.2 x 33.0 / 15.48kg	10077511540186
<b>A4 Value Packs Glossy Pouches</b>							
A4 / 80 mic	250	5312903	31.4 x 24.2 x 52.0 / 2.88kg	043859521838	4	21.4 x 26.8 x 33.6 / 12.36kg	20043859521832
A4 / 100 mic	250	5313904	32.0 x 24.4 x 64.0 / 3.94kg	043859521845	4	25.6 x 26.0 x 33.8 / 16.12kg	20043859521849
A4 / 125 mic	250	5314903	31.8 x 24.6 x 74.0 / 5kg	043859521852	4	30.8 x 26.0 x 33.8 / 20.9kg	20043859521856

# Laminating Supplies

## Admire™ Creative Laminating Pouches from Fellowes



**EasyDisplay**  
Adhesive-backed pouches enable you to easily display your laminated materials



**EasyFold**  
Pre-scored pouches that fold easily to help you create professional results



**Stylish Matt**  
Non-reflective pouches make your content easier to read and give your materials an elegant finish



**Creative Collection**  
Explore new uses and bring your creative ideas to life with this selection of innovative pouches

Size	Qty/Pack	Code	Pack Dimensions (HxWxD - cm) & Weight	Retail Barcode	Outer	Outer Dimensions (HxWxD - cm) & Weight	Outer Barcode
<b>EasyDisplay Laminating Pouches 80 micron</b>							
A3	25	5601803	47.5 x 32.5 x 6.0 cm / 0.85kg	043859730841	5	49.5 x 35.5 x 10.0 cm / 9kg	20043859730845
A4	25	5601703	35.5 x 24.0 x 6.0 cm / 0.43kg	043859730834	10	37.0 x 27.0 x 10.0 cm / 4.4kg	20043859730838
<b>EasyFold Laminating Pouches 80 micron</b>							
A3	25	5602001	47.5 x 32.5 x 6.0 cm / 0.58kg	043859730865	5	49.0 x 35.5 x 75.0 cm / 3.9kg	50043859730860
A4	25	5601901	35.5 x 24.0 x 6.0 cm / 0.28kg	043859730858	10	37.0 x 27.0 x 75.0 cm / 3.3kg	50043859730853
<b>Stylish Matt Laminating Pouches 80 micron</b>							
A3	25	5602201	47.5 x 32.5 x 6.0 cm / 0.58kg	043859730889	5	49.0 x 35.5 x 75.0 cm / 3.9kg	50043859730884
A4	25	5602101	35.5 x 24.0 x 6.0 cm / 0.28kg	043859730872	10	37.0 x 27.0 x 75.0 cm / 3.3kg	50043859730877
<b>Creative Collection Laminating Pouches 80 micron</b>							
A4 x 10 standard pouch 80mic A4 x 10 Stylish Matt 80mic A4 x 10 EasyDisplay 80mic A5 x 10 standard pouch 80mic Photo 10x15cm x 10 pouch 80mic	50	5602301	35.5 x 24.0 x 6.0 cm / 0.55kg	043859730896	10	37.0 x 25.5 x 15.5 cm / 6.3kg	50043859730891

## SuperQuick™ laminating pouches

**SuperQuick™**  
Sealed long side  
Insert this side first

Standard pouch  
Sealed short side  
Insert this side first

**30% FASTER**

Laminate 30% faster with Fellowes SuperQuick™ gloss laminating pouches. The sealed edge on these pouches is on the long side making them perfect for high volume and more efficient lamination.

Size	Thickness	Qty/Pack	Code	Pack Dimensions (HxWxD - cm) & Weight	Retail Barcode	Outer	Outer Dimensions (HxWxD - cm) & Weight	Outer Barcode
<b>SuperQuick™</b>								
A4	80 mic	100	5440001	31.0 x 22.2 x 18.0 / 1.2kg	077511544002	10	20.6 x 24.6 x 33.2 / 12.32kg	10077511544009
A4	125 mic	100	5440101	31.0 x 22.2 x 28.0 / 1.92kg	077511544019	10	27.2 x 32.8 x 24.4 / 19.64kg	50077511544014

## Laminating Supplies

### Speciality laminating pouches

Fellowes offer a range of specialist laminating pouches for non-standard requirements:

**Pre-punched pouches** allow a printed document to be laminated and immediately filed away for future reference

**Matt pouches** offer a non-shiny finish, reducing glare on the pouch in particularly light & bright environments

Pouches with an **adhesive back** can be easily fixed to & displayed on walls or desktops

**Small size** laminating pouches allow photos, ID cards and documents smaller than A5 to be laminated without trimming to size afterwards

Pre-punched Pouches



Matt Pouches



Adhesive Back Pouches



Small Pouches



Size	Thickness	Qty/Pack	Code	Pack Dimensions (HxWxD - cm) & Weight	Retail Barcode	Outer	Outer Dimensions (HxWxD - cm) & Weight	Outer Barcode
<b>Adhesive Back Glossy Pouches (non-repositionable)</b>								
A3	80 mic	100	5302302	43.2 x 31.0 x 3.0 / 3.46kg	077511530234	3	9.6 x 33.0 x 45.4 / 10.46kg	10077511530231
A3	125 mic	100	5329001	43.0 x 30.7 x 3.1 / 4.4kg	043859641536	5	17.8 x 45.0 x 33.4 / 22.9kg	50043859641531
A4	80 mic	100	5302202	31.0 x 22.2 x 2.4 / 1.72kg	077511530227	5	15.4 x 24.2 x 33.0 / 8.92kg	10077511530224
A4	125 mic	100	5328901	31.0 x 22.4 x 3.2 / 2.34kg	043859641529	10	33.0 x 33.2 x 24.8 / 23.1kg	50043859641524
<b>Pre-Punched A4 Glossy Pouches</b>								
A4 (228x303mm)	80 mic	100	5452502	30.8 x 23.2 x 1.8 / 1.14kg	043859521821	10	18.8 x 25.8 x 32.8 / 12.74kg	10043859521828
<b>Matt Pouches</b>								
A3	80 mic	100	5452003	42.6 x 30.4 x 2.0 / 2.3kg	043859522323	5	11.0 x 33.0 x 44.8 / 11.88kg	20043859522327
A3	125 mic	100	5328601	43.0 x 31.0 x 3.0 / 3.8kg	043859641499	5	15.6 x 44.6 x 33.0 / 19.3kg	50043859641494
A4	80 mic	100	5452103	30.4 x 21.8 x 2.2 / 1.2kg	438595223300	10	20.0 x 24.0 x 33.2 / 12.28kg	20043859522334
A4	125 mic	100	5328502	31.5 x 22.6 x 4.1 / 2kg	043859641482	10	30.0 x 24.9 x 33.5 / 20.6kg	10043859641489
<b>Starter kits</b>								
A4	80 Mic	10	5406201	31.6 x 23.2 x 1.85 / 0.14kg	043859715114	200	48.5 x 33.5 x 20.0 / 29kg	50043859715119
Assorted A4, A5, 20x25cm, 13x18cm, 10x15cm	80 mic	50	5328102	30.8 x 22.4 x 1.0 / 0.34kg	043859578535	10	13.4 x 33.0 x 24.4 / 4.54kg	10043859578532
<b>Glossy Photo Pouches</b>								
10x15cm	80 mic	25	5440602	20.5 x 12.4 x 4.0 / 0.08kg	077511544064	10	76.0 x 19.8 x 15.0 / 0.92kg	10077511544061
<b>Smaller Sized Glossy Pouches</b>								
A6	125 mic	100	5307201	16.0 x 11.8 x 2.8 / 0.46kg	077511530722	10	15.8 x 18.4 x 25.4 / 5.5kg	10077511530729
83x113mm	125 mic	100	5307101	12.2 x 88.0 x 2.8 / 0.22kg	077511530715	10	15.6 x 14.6 x 19.2 / 3.06kg	10077511530712
75x105mm	125 mic	100	5306901	11.2 x 80.0 x 3.0 / 0.18kg	077511530692	10	16.4 x 12.8 x 17.4 / 2.56kg	10077511530699
65x95mm	125 mic	100	5306702	10.2 x 28.0 x 7.0 / 0.12kg	077511530678	10	16.2 x 12.0 x 16.2 / 2kg	10077511530675
60x90mm	125 mic	100	5397402	94.0 x 64.0 x 3.0 / 0.18kg	043859526338	10	16.4 x 11.6 x 14.4 / 1.82kg	10043859526335
54x86mm	125 mic	100	5306302	90.0 x 60.0 x 3.0 / 0.14kg	077511530630	10	16.2 x 11.4 x 14.0 / 1.58kg	10077511530637



## Laminating Supplies

### Identification Badges and Laminating Accessories



Description	Size	Qty/Pack	Code	Pack Dimensions (HxWxD - cm) & Weight	Retail Barcode	Outer	Outer Dimensions (HxWxD - cm) & Weight	Outer Barcode
European Clip with straps	5.6 x 9.2 cm	100	5303001	28.0 x 15.4 x 1.5 / 0.58kg	077511530302	5	11.5 x 20.0 x 20.2 / 2.2kg	10077511530309
Pin Badge	4.0 x 6.0 cm	100	53040	23.0 x 12.4 x 5.6 / 0.44kg	077511530401	10	29.4 x 24.4 x 25.8 / 4.66kg	50077511555911
Pin Clip Badge Clear PVC	5.6 x 9.2 cm	50	53041	21.6 x 14.2 x 7.1 / 0.46kg	077511530418	10	35.1 x 23.1 x 29.7 / 4.96kg	50077511555904
Security Badge with Metal Clip	9.0 x 6.0 cm	50	53043	16.8 x 11.6 x 6.8 / 0.7kg	077511530432	5	34.4 x 12.4 x 17.8 / 3.42kg	50077511555881
Protect Card Holder + Clip	9.0 x 6.0 cm	50	53044	78.0 x 18.2 x 19.4 / 1.18kg	077511530449	5	40.2 x 18.8 x 20.2 / 6.04kg	50077511555942
Name Support	4.5 x 12.0 cm	50	53045	21.8 x 13.8 x 6.8 / 0.6kg	077511530456	40	35.0 x 45.4 x 56.6 / 25.36kg	50077511530451
Name Support	6.0 x 25.0 cm	25	53046	26.2 x 14.8 x 6.0 / 0.76kg	077511530463	30	30.4 x 45.8 x 54.8 / 23.78kg	50077511530468

### Laminator Cleaning Sheets

Regularly passing a cleaning sheet through the laminator helps to remove any glue from the rollers and ensure a high-quality, jam-free performance

Description	Size	Qty/Pack	Code	Pack Dimensions (HxWxD - cm) & Weight	Retail Barcode	Outer	Outer Dimensions (HxWxD - cm) & Weight	Outer Barcode
Laminator cleaning & carrier sheets	A4	10	5320604	35.6 x 23.2 x 6.0 / 0.16kg	043859522163	20	78.0 x 24.6 x 33.4 / 3.42kg	10043859522160

# Ideas Centre

Explore 100s of free ready-made resources and inspirational ideas for your home, workplace and school.



**Download**



**Print**



**Laminate**

[www.fellowes.com/ideascentre](http://www.fellowes.com/ideascentre)

## GET READY TO MAKE A GREAT IMPRESSION

First impressions are important. When you've worked hard on a project and invested time and effort into your presentation, you need to give it the professional finish it deserves to make the greatest impact.

*Binding is the perfect way to present your documents.*



## WHAT TO BIND?

Use binding for a wide variety of document finishing tasks at work and at home. If it's important enough to present or securely fasten, add the finishing touch for a professional image.

## TYPES OF BINDING SYSTEM

Different binding systems are suitable for different applications. Fellowes offer 3 types of system:



### COMB BINDING

The most popular and economical binding system. It's practical, easy to use and very flexible.



- Cost effective and quick
- Documents are easy to use; they can be opened out flat so they are easy to read and photocopy. They are ideal for presentations
- Can add and remove pages easily



### WIRE BINDING

Stylish, durable wire binders with unique, user-friendly features. Gives your document a stylish, top-quality finish that is permanent and secure.



- Secure documents, cannot be reopened
- Creates the same durable look used by professional printers
- Documents can be opened out flat so they are easy to read and photocopy and are ideal for presentations



### THERMAL BINDING

A quick, easy way to give any document a perfect "book" finish



- Neat and flat, making them easy to store, carry around and post
- Quick and easy; ideal binding method when time is limited
- Create a professional finish without punching holes into your document

# Comb Binding



## CHOOSING THE RIGHT COMB BINDER

If you've decided that a comb binder is the best option, you should then look for features and specifications that will best match your needs. Fellowes comb binders are segmented according to how often they will be used and the size of the documents they can bind - measured on binding capacity, punch capacity and the maximum size of comb that can be accepted.

### Binding Capacity

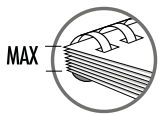

The higher the binding capacity, the larger the document you can bind.

### Punch Capacity

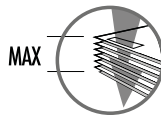

The higher the punching capability of the binder, the quicker the process. (Comb & Wire only).

### Max. Element Size



Maximum comb diameter suitable for use with the binder. (Comb & Wire only).

## USAGE: Where and how often will the binder be used?

**HEAVY USE**  
OFFICE ENVIRONMENTS

**MEDIUM USE**  
SMALL OFFICES

**LIGHT / MODERATE**  
PERSONAL & HOME OFFICE

## FEATURES: Making the binding process simple



Maximum output punch and bind capacities increase productivity for faster binding



Vertical loading maximises document alignment



Punch and bind in one flow – punch and place documents directly on comb



Enhanced accuracy edge guide ensures pinpoint punch alignment



Document and comb measure / comb storage tray

## TYPE: Manual or electric document punching?



### ELECTRIC PUNCHING

Provides ultimate ease of use. Electric punch button makes it easier to punch through large documents and also work through large quantities of documents quickly.



### MANUAL PUNCHING

Strong metal punch handle on Fellowes machines makes it easy to punch through documents by hand.



## Orion-E Electric & Orion Manual Comb Binders

### HEAVY USE.

- Designed to punch and bind documents for heavy duty users with demand for maximum punch and bind capacity
- Pedal operated punching for up to 30 sheets in a single cycle (Orion-E Electric)
- 21 individual and selectable punching pins
- Fully adjustable edge guide (side margin)
- 5 position back margin & document measure



## Satellite SYSTEM

**SATELLITE** removable binding platform allows multiple users to punch and bind simultaneously, saving time in the work place.



## Galaxy-E Electric & Galaxy Manual Comb Binders

### HEAVY USE.

- For high volume binding documents of up to 500 pages
- 28 sheet punch capacity, 500 sheet binding capacity with a maximum comb size of 50mm
- Front access full size storage tray with patented comb & document measure for quick selection of the correct size supplies

Model	Binding System	Manual / Electric	Punch Capacity (80gsm)	Binding Capacity	Max Comb Size	Comb & Doc Size Guide	Chip Tray	Starter Kit	Warranty
Orion-E	Comb	Electric	30 sheets	500 sheets	50mm	Yes	Front	No	1 year
Orion	Comb	Manual	30 sheets	500 sheets	50mm	Yes	Front	No	1 year
Galaxy-E	Comb	Electric	28 sheets	500 sheets	50mm	Yes	Both Sides	20 doc	2 years
Galaxy	Comb	Manual	28 sheets	500 sheets	50mm	Yes	Both Sides	20 doc	2 years

Code	Model	UNIT			RETAIL PACK			OUTER PACK			
		H x W x D (cm)	Weight (kg)	Qty	H x W x D (cm)	Weight (kg)	Barcode (UPC)	Qty	H x W x D (cm)	Weight (kg)	Barcode (SCS)
5642701	Orion-E	21.4 x 40.2 x 40.4	19.34	1	N/A	N/A	N/A	1	39.8 x 53.6 x 52.8	22.98	50043859620086
5642601	Orion	21.4 x 40.2 x 40.4	13.24	1	N/A	N/A	N/A	1	32.8 x 48.0 x 47.6	14.7	50043859620079
5622101	Galaxy-E	15.2 x 49.0 x 44.6	13.06	1	N/A	N/A	N/A	1	51.0 x 21.6 x 59.6	15.36	50043859522267
5622001	Galaxy	15.2 x 52.6 x 44.6	10.28	1	N/A	N/A	N/A	1	50.8 x 21.8 x 59.6	12.58	50043859522250



### Quasar-E Electric & Quasar+ Manual Comb Binders

**HEAVY USE.**

- For frequent use in busy office environments
- 25 sheet punch capacity, 500 sheet binding capacity with a maximum comb size of 50mm
- Storage tray with patented comb & document measure for quick selection of the correct size supplies

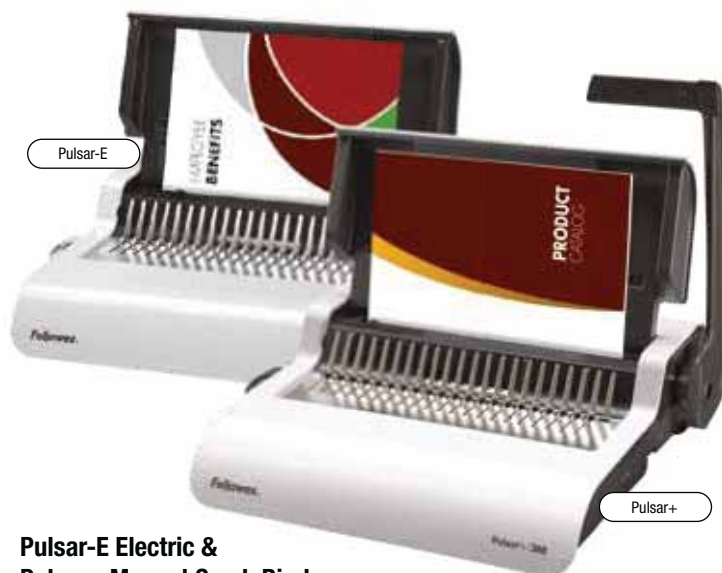
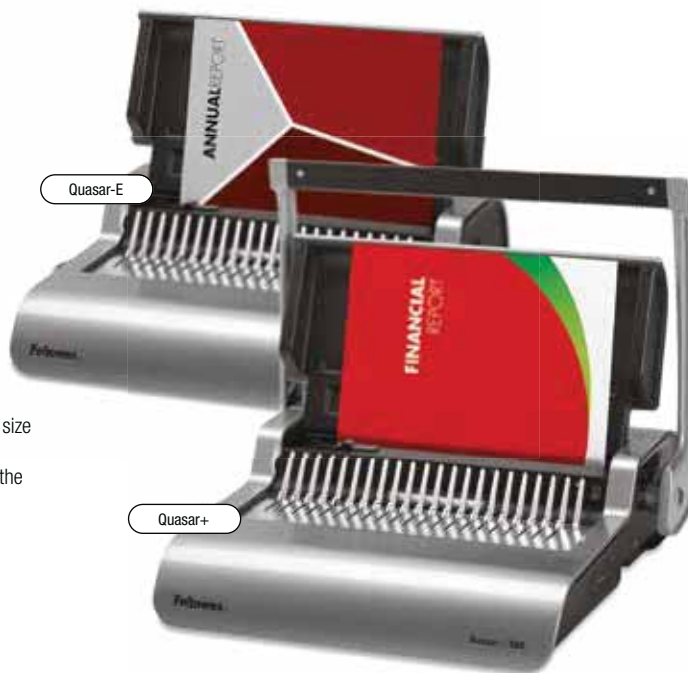

### Pulsar-E Electric & Pulsar+ Manual Comb Binders

**MEDIUM USE.**

- For regular use in the small office / home office
- 20 sheet punch capacity, 300 sheet binding capacity with a maximum comb size of 38mm
- Storage tray with patented comb & document measure for quick selection of the correct size supplies



Model	Binding System	Manual / Electric	Punch Capacity (80gsm)	Binding Capacity	Max Comb Size	Comb & Doc Size Guide	Chip Tray	Starter Kit	Warranty
Quasar-E	Comb	Electric	25 sheets	500 sheets	50mm	Yes	Single Side	10 doc	2 years
Quasar+	Comb	Manual	25 sheets	500 sheets	50mm	Yes	Single Side	10 doc	2 years
Pulsar-E	Comb	Electric	20 sheets	300 sheets	38mm	Yes	Single Side	10 doc	2 years
Pulsar+	Comb	Manual	20 sheets	300 sheets	38mm	Yes	Single Side	10 doc	2 years

Code	Model	UNIT			RETAIL PACK			OUTER PACK			
		H x W x D (cm)	Weight (kg)	Qty	H x W x D (cm)	Weight (kg)	Barcode (UPC)	Qty	H x W x D (cm)	Weight (kg)	Barcode (SCS)
5620901	Quasar-E	13.0 x 42.6 x 39.8	9.92	1	47.4 x 52.0 x 20.0	11.52	043859512157	1	49.8 x 21.8 x 53.8	12.26	50043859512152
5627701	Quasar+	12.6 x 45.6 x 41.8	7.44	1	47.4 x 20.2 x 52.2	8.82	043859651252	1	49.6 x 53.6 x 21.4	9.44	50043859651257
5620701	Pulsar-E	13.0 x 43.2 x 38.8	9.52	1	47.6 x 51.6 x 20.8	11.6	043859512119	1	50.2 x 22.2 x 53.2	12.32	50043859512114
5627601	Pulsar+	13.0 x 45.6 x 39.6	6.9	1	47.2 x 20.8 x 52.2	8.38	043859651245	1	49.8 x 22.6 x 53.6	9	50043859651240



### Star+ Manual Comb Binder

#### MODERATE USE.

- For moderate use in the home office
- 15 sheet punch capacity, 150 sheet binding capacity with a maximum comb size of 18mm
- Full width handle reduces punching effort



### Starlet 2+ Manual Comb Binder

#### LIGHT USE.

- For occasional use in home / home office environments
- 12 sheet punch capacity, 120 sheet binding capacity with a maximum comb size of 16mm
- Long punch lever requires minimum force for easy punching

Model	Binding System	Manual / Electric	Punch Capacity (80gsm)	Binding Capacity	Max Comb Size	Comb & Doc Size Guide	Chip Tray	Starter Kit	Warranty
Star+	Comb	Manual	15 sheets	150 sheets	19mm	Yes	Single Side	No	2 years
Starlet 2+	Comb	Manual	12 sheets	120 sheets	16mm	Yes	Single Side	No	2 years

Code	Model	UNIT			RETAIL PACK				OUTER PACK		
		H x W x D (cm)	Weight (kg)	Qty	H x W x D (cm)	Weight (kg)	Barcode (UPC)	Qty	H x W x D (cm)	Weight (kg)	Barcode (SCS)
5627501	Star+	80.0 x 44.8 x 28.0	4.9	1	34.8 x 50.8 x 14.8	5.1	043859651238	2	37.4 x 30.8 x 52.0	10.48	50043859651233
5227901	Starlet 2+	13.0 x 48.5 x 19.5	3.3	1	21.6 x 52.0 x 17.6	3.9	043859680719	4	45.2 x 36.6 x 54.2	16.9	50043859680714

## Wire Binders



Wire and document storage



Wire measure



Document measure



Adjustable Edge Guide



Galaxy-E Wire

Galaxy Wire

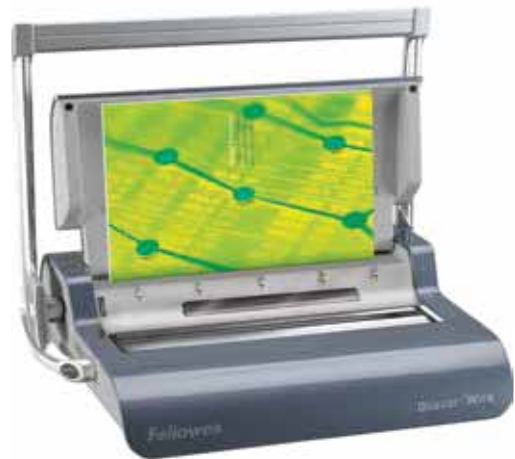

### Galaxy-E Electric & Galaxy Wire Binders

**HEAVY USE.**

- Stylish, durable wire binder gives a high quality, professional finish
- 20 sheet punch capacity, 130 sheet binding capacity with a maximum wire size of 14mm
- Punch selection for A4 & A5 sized documents
- Pre-selectable closure control for easy wire closure

### Quasar Wire Binder

**MEDIUM USE.**

- For regular use in busy office environments
- 15 sheet punch capacity, 130 sheet binding capacity with a maximum wire size of 14mm

Model	Binding System	Manual / Electric	Punch Capacity (80gsm)	Binding Capacity	Max Comb Size	Comb & Doc Size Guide	Chip Tray	Starter Kit	Warranty
Galaxy-E Wire	Wire	Electric	20 sheets	130 sheets	14mm	Yes	Both Sides	20 doc	2 years
Galaxy Wire	Wire	Manual	20 sheets	130 sheets	14mm	Yes	Both Sides	20 doc	2 years
Quasar Wire	Wire	Manual	15 sheets	130 sheets	14mm	Yes	Single Side	20 doc	2 years

Code	Model	UNIT			RETAIL PACK			OUTER PACK			
		H x W x D (cm)	Weight (kg)	Qty	H x W x D (cm)	Weight (kg)	Barcode (UPC)	Qty	H x W x D (cm)	Weight (kg)	Barcode (SCS)
5622501	Galaxy-E Wire	15.4 x 50.6 x 45.2	12.8	1	51.0 x 59.6 x 21.8	15.48	043859530038	1	51.0 x 59.6 x 21.8	15.48	50043859530033
5622401	Galaxy Wire	15.4 x 51.4 x 45.2	9.86	1	51.2 x 60.0 x 22.6	12.3	043859530021	1	51.2 x 60.0 x 22.6	12.3	50043859530026
5224101	Quasar Wire	13.2 x 47.0 x 41.2	7.38	1	47.0 x 52.2 x 20.4	9.48	043859530014	1	49.2 x 22.2 x 53.6	10.2	50043859530019



## Thermal Binders



A safety barrier designed to prevent accidental contact with the heating plate. The barrier is opened manually and closes automatically.



Switches to standby mode after periods of inactivity, reducing energy consumption.



Automatically detects thickness of documents to determine the correct heating time. (Helios 60 only)



### Helios 60 Thermal Binder

**HEAVY USE.**

- Multiple documents up to 600 sheets (60mm max. per document) can be bound simultaneously
- ThermoSense automatically detects the thickness of documents to determine the correct binding cycle



### Helios 30 Thermal Binder

**MEDIUM USE.**

- Multiple documents up to 300 sheets (30mm max. per document) can be bound simultaneously
- Variable binding cycle for different size documents

Model	Binding System	Capacity	Max Thickness	Warm-up Time	Variable Heat Cycle	Cover / Spine Selector	Automatic Binding Cycle	Warranty
Helios 60	Thermal	600 sheets	60mm	4 mins	ThermoSense	Yes	Yes	2 years
Helios 30	Thermal	300 sheets	30mm	4 mins	Yes	Yes	No	2 years

Code	Model	UNIT			RETAIL PACK				OUTER PACK		
		H x W x D (cm)	Weight (kg)	Qty	H x W x D (cm)	Weight (kg)	Barcode (UPC)	Qty	H x W x D (cm)	Weight (kg)	Barcode (SCS)
5642003	Helios 60	9.9 x 53.1 x 23.9	2.6	1	14.1 x 57.1 x 32.0	3.83	043859570089	1	16.5 x 58.5 x 35.0cm	4.24	10043859570086
5641001	Helios 30	8.2 x 53.2 x 23.2	2.9	1	32.2 x 57.0 x 14.2	3.72	043859570034	2	34.4 x 58.8 x 30.6	8.12	50043859570039





Give any document a professional finish using Fellowes quality plastic and wire binding elements. The following range includes a variety of sizes, colours and pack sizes for binding between 1-500 page documents when used with a suitable plastic comb or wire binding machine.

## PLASTIC COMBS

### Plastic Comb (Round, A4) - 21 Rings, Pitch 9/16" / 14.28mm - Commercial Pack

Colour	Size	Pages (80gsm)	Qty/Pack	Code	Pack Dimensions (HxWxD - cm) & Weight	Retail Barcode	Outer	Outer Dimensions (HxWxD - cm) & Weight	Outer Barcode
Black	6mm	2-20	100	5345307	32.0 x 9.4 x 4.5 / 0.22kg	077511534539	10	23.8 x 21.2 x 33.6 / 3.14kg	20077511534533
White	6mm	2-20	100	5345005	32.0 x 9.4 x 4.5 / 0.22kg	077511534508	10	23.8 x 21.2 x 33.6 / 3.14kg	10077511534505
Red	6mm	2-20	100	5345204	32.0 x 9.4 x 4.5 / 0.22kg	077511534522	10	23.8 x 21.2 x 33.6 / 3.14kg	10077511534529
Blue	6mm	2-20	100	5345106	32.0 x 9.4 x 4.5 / 0.22kg	077511534515	10	23.8 x 21.2 x 33.6 / 3.14kg	20077511534519
Black	8mm	21-40	100	5345707	32.2 x 10.4 x 5.6 / 0.28kg	077511534577	10	31.4 x 34.0 x 22.8 / 3.8kg	20077511534571
White	8mm	21-40	100	5345406	32.2 x 10.4 x 5.6 / 0.28kg	077511534546	10	31.4 x 34.0 x 22.8 / 3.8kg	20077511534540
Red	8mm	21-40	100	5345604	32.2 x 10.4 x 5.6 / 0.28kg	077511534560	10	31.4 x 34.0 x 22.8 / 3.8kg	20077511534564
Blue	8mm	21-40	100	5345506	32.2 x 10.4 x 5.6 / 0.28kg	077511534553	10	31.4 x 34.0 x 22.8 / 3.8kg	20077511534557
Black	10mm	41-55	100	5346108	31.5 x 12.5 x 6.5 / 0.425kg	077511534614	10	34.0 x 33.4 x 27.8 / 4.74kg	20077511534618
White	10mm	41-55	100	5345805	31.5 x 12.5 x 6.5 / 0.425kg	077511534584	10	34.0 x 33.4 x 27.8 / 4.74kg	20077511534588
Red	10mm	41-55	100	5346004	31.5 x 12.5 x 6.5 / 0.425kg	077511534607	10	34.0 x 33.4 x 27.8 / 4.74kg	20077511534601
Blue	10mm	41-55	100	5345906	31.5 x 12.5 x 6.5 / 0.425kg	077511534591	10	34.0 x 33.4 x 27.8 / 4.74kg	20077511534595
Black	12mm	56-80	100	5346507	32.2 x 16.4 x 9.0 / 0.7kg	077511534652	10	43.8 x 34.4 x 34.2 / 7.84kg	20077511534656
White	12mm	56-80	100	5346206	32.2 x 16.4 x 9.0 / 0.7kg	077511534621	10	43.8 x 34.4 x 34.2 / 7.84kg	20077511534625
Red	12mm	56-80	100	5346404	32.2 x 16.4 x 9.0 / 0.7kg	077511534645	10	43.8 x 34.4 x 34.2 / 7.84kg	20077511534649
Blue	12mm	56-80	100	5346305	32.2 x 16.4 x 9.0 / 0.7kg	077511534638	10	43.8 x 34.4 x 34.2 / 7.84kg	20077511534632
Black	14mm	81-100	100	5346907	32.2 x 19.2 x 8.2 / 0.72kg	077511534690	10	43.0 x 34.4 x 41.0 / 8.84kg	10077511534697
White	14mm	81-100	100	5346604	32.2 x 19.2 x 8.2 / 0.72kg	077511534669	10	43.0 x 34.4 x 41.0 / 8.84kg	10077511534666
Red	14mm	81-100	100	5346804	32.2 x 19.2 x 8.2 / 0.72kg	077511534683	10	43.0 x 34.4 x 41.0 / 8.84kg	10077511534680
Blue	14mm	81-100	100	5346706	32.2 x 19.2 x 8.2 / 0.72kg	077511534676	10	43.0 x 34.4 x 41.0 / 8.84kg	10077511534673
Black	16mm	101-120	100	5347307	32.2 x 20.0 x 10.2 / 0.84kg	077511534737	10	51.2 x 33.6 x 41.4 / 9.96kg	10077511534734
White	16mm	101-120	100	5347005	32.2 x 20.0 x 10.2 / 0.84kg	077511534706	10	51.2 x 33.6 x 41.4 / 9.96kg	20077511534700
Red	16mm	101-120	100	5347204	32.2 x 20.0 x 10.2 / 0.84kg	077511534720	10	51.2 x 33.6 x 41.4 / 9.96kg	20077511534724
Blue	16mm	101-120	100	5347106	32.2 x 20.0 x 10.2 / 0.84kg	077511534713	10	51.2 x 33.6 x 41.4 / 9.96kg	10077511534710
Black	19 mm	121-150	100	5347705	32.4 x 22.6 x 11.4 / 1.12kg	077511534775	10	58.6 x 34.4 x 46.8 / 13.52kg	20077511534779
White	19 mm	121-150	100	5347405	32.4 x 22.6 x 11.4 / 1.12kg	077511534744	10	58.6 x 34.4 x 46.8 / 13.52kg	20077511534748
Black	22mm	151-180	50	5348103	32.4 x 13.8 x 12.4 / 0.7kg	077511534812	10	64.4 x 33.8 x 30.0 / 8.16kg	10077511534819
White	22mm	151-180	50	5347803	32.4 x 13.8 x 12.4 / 0.7kg	077511534782	10	64.4 x 33.8 x 30.0 / 8.16kg	20077511534786
Black	25mm	181-200	50	5348504	32.4 x 15.6 x 14.4 / 1.02kg	077511534850	10	74.4 x 34.4 x 33.8 / 11.32kg	10077511534857
White	25mm	181-200	50	5348204	32.4 x 15.6 x 14.4 / 1.02kg	077511534829	10	74.4 x 34.4 x 33.8 / 11.32kg	20077511534823
Black	28mm	201-240	50	5348902	32.4 x 23.0 x 14.4 / 1.28kg	077511534898	10	75.8 x 34.6 x 47.4 / 14.1kg	10077511534895
White	28mm	201-240	50	5348602	32.4 x 23.0 x 14.4 / 1.28kg	077511534867	10	75.8 x 34.6 x 47.4 / 14.1kg	20077511534861

### Plastic Comb (Oval, A4) - 21 Rings, Pitch 9/16" / 14.28mm - Commercial Pack

Colour	Size	Pages (80gsm)	Qty/Pack	Code	Pack Dimensions (HxWxD - cm) & Weight	Retail Barcode	Outer	Outer Dimensions (HxWxD - cm) & Weight	Outer Barcode
Black	32mm	241-280	50	5349302	32.4 x 17.2 x 11.6 / 1.08kg	077511534935	4	26.2 x 34.2 x 36.0 / 4.96kg	20077511534939
White	32mm	241-280	50	5349002	32.4 x 17.2 x 11.6 / 1.08kg	077511534904	4	26.2 x 34.2 x 36.0 / 4.96kg	20077511534908
Black	38mm	281-340	50	5349702	32.4 x 20.4 x 14.8 / 1.28kg	077511534973	4	28.0 x 34.0 x 41.8 / 5.98kg	10077511534970
White	38mm	281-340	50	5349402	32.4 x 20.4 x 14.8 / 1.28kg	077511534942	4	28.0 x 34.0 x 41.8 / 5.98kg	20077511534946
Black	45mm	341-410	50	5350102	32.4 x 23.4 x 14.4 / 1.42kg	077511535017	4	30.8 x 34.4 x 48.6 / 6.76kg	20077511535011
White	45mm	341-410	50	5349802	32.4 x 23.4 x 14.4 / 1.42kg	077511534980	4	30.8 x 34.4 x 48.6 / 6.76kg	20077511534984
Black	51mm	411-450	50	5350502	32.4 x 22.0 x 18.6 / 1.62kg	077511535055	4	40.2 x 34.6 x 45.2 / 7.44kg	10077511535052
White	51mm	411-450	50	5350202	32.4 x 22.0 x 18.6 / 1.62kg	077511535024	4	40.2 x 34.6 x 45.2 / 7.44kg	20077511535028

## Binding Supplies

### PLASTIC COMBS

Plastic Comb (Round, A4) - 21 Rings, Pitch 9/16" / 14.28mm - Retail Pack

Colour	Size	Pages (80gsm)	Qty/Pack	Code	Pack Dimensions (HxWxD - cm) & Weight	Retail Barcode	Outer	Outer Dimensions (HxWxD - cm) & Weight	Outer Barcode
Black	6mm	2-20	25	5330302	33.4 x 5.6 x 1.8 / 0.08kg	077511533037	10	11.8 x 13.0 x 35.0 / 0.88kg	10077511533034
White	6mm	2-20	25	5330003	33.4 x 5.6 x 1.8 / 0.08kg	077511533006	10	11.8 x 13.0 x 35.0 / 0.88kg	10077511533003
Red	6mm	2-20	25	5330202	33.4 x 5.6 x 1.8 / 0.08kg	077511533020	10	11.8 x 13.0 x 34.8 / 0.88kg	10077511533027
Blue	6mm	2-20	25	5330102	33.4 x 5.6 x 1.8 / 0.08kg	077511533013	10	11.8 x 13.0 x 34.8 / 0.88kg	10077511533010
Black	8mm	21-40	25	5330702	33.4 x 5.6 x 3.0 / 0.1kg	077511533075	10	19.4 x 13.0 x 35.0 / 1.12kg	10077511533072
White	8mm	21-40	25	5330403	33.4 x 5.6 x 3.0 / 0.1kg	077511533044	10	19.4 x 13.0 x 35.0 / 1.12kg	10077511533041
Red	8mm	21-40	25	5330602	33.4 x 5.6 x 3.0 / 0.1kg	077511533068	10	19.4 x 13.0 x 35.0 / 1.12kg	10077511533065
Blue	8mm	21-40	25	5330502	33.4 x 5.6 x 3.0 / 0.1kg	077511533051	10	19.4 x 13.0 x 35.0 / 1.12kg	10077511533058
Black	10mm	41-55	25	5331102	33.4 x 5.6 x 3.4 / 0.1kg	077511533112	10	19.4 x 13.6 x 35.2 / 1.24kg	10077511533119
White	10mm	41-55	25	5330803	33.4 x 5.6 x 3.4 / 0.1kg	077511533082	10	19.4 x 13.6 x 35.2 / 1.24kg	10077511533089
Red	10mm	41-55	25	5331002	33.4 x 5.6 x 3.4 / 0.1kg	077511533105	10	19.4 x 13.6 x 35.2 / 1.24kg	10077511533102
Blue	10mm	41-55	25	5330902	33.4 x 5.6 x 3.4 / 0.1kg	077511533099	10	19.4 x 13.6 x 35.2 / 1.24kg	10077511533096
Black	12mm	56-80	25	5331502	33.4 x 6.2 x 5.8 / 0.12kg	077511533150	10	30.0 x 14.6 x 34.8 / 1.98kg	10077511533157
White	12mm	56-80	25	5331203	33.4 x 6.2 x 5.8 / 0.12kg	077511533129	10	30.0 x 14.6 x 34.8 / 2.04kg	10077511533126
Red	12mm	56-80	25	5331402	33.4 x 6.2 x 5.8 / 0.12kg	077511533143	10	30.0 x 14.6 x 34.8 / 2.04kg	10077511533140
Blue	12mm	56-80	25	5331302	33.4 x 6.2 x 5.8 / 0.12kg	077511533136	10	30.0 x 14.6 x 34.8 / 2.06kg	10077511533133
Black	14mm	81-100	25	5331902	33.2 x 6.8 x 6.2 / 0.18kg	077511533198	10	33.6 x 16.0 x 34.8 / 2.42kg	10077511533195
White	14mm	81-100	25	5331603	33.2 x 6.8 x 6.2 / 0.18kg	077511533167	10	33.6 x 16.0 x 34.8 / 2.42kg	10077511533164
Black	16mm	101-120	25	5332302	33.6 x 8.2 x 6.2 / 0.24kg	077511533235	10	37.0 x 17.4 x 35.2 / 2.7kg	10077511533232
White	16mm	101-120	25	5332002	33.6 x 8.2 x 6.2 / 0.24kg	077511533204	10	37.0 x 17.4 x 35.2 / 2.7kg	10077511533201

### WIRE COMBS

Wire Comb (A4) - 34 Loops, Pitch 3:1" - Commercial Pack

Colour	Size	Pages (80gsm)	Qty/Pack	Code	Pack Dimensions (HxWxD - cm) & Weight	Retail Barcode	Outer	Outer Dimensions (HxWxD - cm) & Weight	Outer Barcode
Black	6mm	1-35	100	53218	31.2 x 15.8 x 4.8 / 0.56kg	077511532184	10	24.2 x 33.6 x 33.8 / 6.16kg	50077511532189
White	6mm	1-35	100	53215	31.2 x 15.8 x 4.8 / 0.56kg	077511532153	10	24.2 x 33.6 x 33.8 / 6.16kg	50077511532158
Silver	6mm	1-35	100	54450	31.2 x 15.8 x 4.8 / 0.56kg	077511544507	10	24.2 x 33.6 x 33.8 / 6.16kg	50077511544502
Black	8mm	36-60	100	53261	31.2 x 18.6 x 5.4 / 0.86kg	077511532610	10	29.4 x 33.8 x 39.2 / 9.12kg	50077511532615
White	8mm	36-60	100	53258	31.2 x 18.6 x 5.4 / 0.86kg	077511532580	10	29.4 x 33.8 x 39.2 / 9.12kg	50077511532585
Silver	8mm	36-60	100	54451	31.2 x 18.6 x 5.4 / 0.86kg	077511544514	10	29.4 x 33.8 x 39.2 / 9.12kg	50077511544519
Black	10mm	61-80	100	53265	31.2 x 21.6 x 6.0 / 1.04kg	077511532658	10	32.0 x 34.6 x 45.2 / 11.1kg	50077511532653
White	10mm	61-80	100	53262	31.2 x 21.6 x 6.0 / 1.04kg	077511532627	10	32.0 x 34.6 x 45.2 / 11.1kg	50077511532622
Silver	10mm	61-80	100	532901	31.2 x 21.6 x 6.0 / 1.04kg	043859542611	10	32.0 x 34.6 x 45.2 / 11.1kg	50043859542616
Black	12mm	81-100	100	53273	31.6 x 17.2 x 6.8 / 1.52kg	077511532733	10	35.8 x 33.8 x 36.6 / 15.8kg	50077511532738
White	12mm	81-100	100	53270	31.6 x 17.2 x 6.8 / 1.52kg	077511532702	10	35.8 x 33.8 x 36.6 / 15.8kg	50077511532707
Silver	12mm	81-100	100	54453	31.6 x 17.2 x 6.8 / 1.52kg	077511544538	10	35.8 x 33.8 x 36.6 / 15.8kg	50077511544533
Black	14mm	101-130	100	53277	31.8 x 19.2 x 7.6 / 2.08kg	077511532771	10	39.0 x 34.2 x 40.2 / 21.5kg	50077511532776
White	14mm	101-130	100	53274	31.8 x 19.2 x 7.6 / 2.08kg	077511532740	10	39.0 x 34.2 x 40.2 / 21.5kg	50077511532745
Silver	14mm	101-130	100	54454	31.8 x 19.2 x 7.6 / 2.08kg	077511544545	10	39.0 x 34.2 x 40.2 / 21.5kg	50077511544540

### STARTER KITS Retail Pack

Description	Size	Qty/Pack	Code	Pack Dimensions (HxWxD - cm) & Weight	Retail Barcode	Outer	Outer Dimensions (HxWxD - cm) & Weight	Outer Barcode
Comb Binding - Starter Kit 6mm comb (white) x5, 8mm comb (blue) x5 A4 Leatherboard cover (dark blue) x5, A4 Leatherboard cover (white) x5, A4 PVC 150 mic clear cover x10	A4	For 10 documents	5371701	34.8 x 23.8 x 1.4 / 0.34kg	043859514724	10	36.8 x 18.2 x 25.4 / 3.8kg	50043859514729
Comb Binding - Premium Kit 6mm plastic comb (white) x5 8mm plastic comb (blue) x10 12mm plastic comb (black) x5 A4 PP 300 mic cover (frosted) x10 A4 PVC 150 mic clear cover x10 A4 Leatherboard cover (dark blue) x5 A4 Leatherboard cover (white) x5 A4 PP 300 mic cover (black) x5 A4 PP 300 mic cover (blue) x5	A4	For 20 documents	5371801	34.8 x 21.2 x 3.2 / 0.72kg	0043859514731	10	30.0 x 24.4 x 36.6 / 7.74kg	50043859514736

### FILING STRIPS

Provides the added flexibility of allowing bound documents to be filed and stored in lever arch files and folders

Description	Code	Retail Pack Qty	Retail Pack Dimensions (HxWxD - cm)	Retail Pack Weight KG	Retail Barcode	Outer Pack Qty	Outer Pack Dimensions (HxWxD - cm)	Outer Pack Weight KG	Outer Barcode
A4 Filing Strip for Comb Binding	5360401	100	3.0 x 29.6 x 3.4	0.26	043859641550	20	15.6 x 31.8 x 15.8	5.4	50043859641555
A4 Filing Strip for Wire Binding	5360501	100	3.0 x 29.6 x 3.4	0.26	043859641567	20	16.2 x 31.6 x 15.4	5.4	50043859641562

# Binding Supplies

**FSC® Certified Paper Binding Covers**

Products made from FSC® MIX which ensures responsible use of forest resources



**FSC® Certified Delta Leatherboard (Heavy Weight) Coloured Covers (A4) - Retail Pack**

Colour	Weight	Size	Qty/Pack	Code	Pack Dimensions (HxWxD - cm) & Weight	Retail Barcode	Outer	Outer Dimensions (HxWxD - cm) & Weight	Outer Barcode
Black	250 gsm	A4	25	5373802	34.4 x 21.6 x 1.0 / 0.38kg	043859539642	10	9.0 x 25.4 x 35.0 / 3.94kg	10043859539649
White	250 gsm	A4	25	5373602	34.4 x 21.6 x 1.0 / 0.38kg	043859539628	10	9.0 x 25.4 x 35.0 / 3.94kg	10043859539625
Red	250 gsm	A4	25	5373702	34.4 x 21.6 x 1.0 / 0.38kg	043859539635	10	9.0 x 25.4 x 35.0 / 3.94kg	10043859539632
Royal Blue	250 gsm	A4	25	5373902	34.4 x 21.6 x 1.0 / 0.38kg	043859539659	10	9.0 x 25.4 x 35.0 / 3.94kg	10043859539656

**FSC® Certified Delta Leatherboard (Heavy Weight) Coloured Covers - Retail Pack**

Black	250 gsm	A4	100	5370405	29.8 x 21.0 x 3.4 / 1.42kg	077511537042	10	32.4 x 22.4 x 31.0 / 15.32kg	10077511537049
White	250 gsm	A4	100	5370104	29.8 x 21.0 x 3.4 / 1.42kg	077511537011	10	32.4 x 22.4 x 31.0 / 15.32kg	10077511537018
Red	250 gsm	A4	100	5370305	29.8 x 21.0 x 3.4 / 1.42kg	077511537035	10	32.4 x 22.4 x 31.0 / 15.32kg	10077511537032
Royal Blue	250 gsm	A4	100	5371305	29.8 x 21.0 x 3.4 / 1.42kg	077511537134	10	32.4 x 22.4 x 31.0 / 15.32kg	10077511537131
Ivory	250 gsm	A4	100	5370004	29.8 x 21.0 x 3.4 / 1.42kg	077511537004	10	32.4 x 22.4 x 31.0 / 15.32kg	10077511537001
Yellow	250 gsm	A4	100	5370503	29.8 x 21.0 x 3.4 / 1.42kg	077511537059	10	32.4 x 22.4 x 31.0 / 15.32kg	10077511537056
Grey	250 gsm	A4	100	5371103	29.8 x 21.0 x 3.4 / 1.42kg	077511537110	10	32.4 x 22.4 x 31.0 / 15.32kg	10077511537117
Wedgwood Blue	250 gsm	A4	100	5371403	29.8 x 21.0 x 3.4 / 1.42kg	077511537141	10	32.4 x 22.4 x 31.0 / 15.32kg	10077511537148
Dark Green	250 gsm	A4	100	5371503	29.8 x 21.0 x 3.4 / 1.42kg	077511537158	10	32.4 x 22.4 x 31.0 / 15.32kg	10077511537155
Dark Red	250 gsm	A4	100	5371603	29.8 x 21.0 x 3.4 / 1.42kg	077511537165	10	32.4 x 22.4 x 31.0 / 15.32kg	10077511537162
Black	250 gsm	A3	100	5374401	29.8 x 42.0 x 2.6 / 2.84kg	077511537448	5	16.6 x 32.0 x 44.0 / 14.96kg	10077511537445
Ivory	250 gsm	A3	100	5374001	29.8 x 42.0 x 2.6 / 2.84kg	077511537400	5	16.6 x 32.0 x 44.0 / 14.96kg	10077511537407

**FSC® Certified Linen Texture Board (Heavy Weight) Coloured Covers (A4) - Commercial Pack**

Black	250 gsm	A4	100	5381402	29.8 x 21.0 x 3.0 / 1.44kg	0077511538148	10	32.8 x 22.6 x 31.0 / 15.34kg	10077511538145
White	250 gsm	A4	100	5381302	29.8 x 21.0 x 3.0 / 1.44kg	0077511538131	10	32.8 x 22.6 x 31.0 / 15.34kg	10077511538138
Royal Blue	250 gsm	A4	100	5381502	29.8 x 21.0 x 3.0 / 1.44kg	0077511538155	10	32.8 x 22.6 x 31.0 / 15.34kg	10077511538152



**CHROMOLUX PAPER COVERS**

**Chromolux Gloss Board (Heavy Weight) Coloured Covers (A4) - Commercial Pack**

Colour	Weight	Size	Qty/Pack	Code	Pack Dimensions (HxWxD - mm) & Weight	Retail Barcode	Outer	Outer Dimensions (HxWxD - mm) & Weight	Outer Barcode
Black	250 gsm	A4	100	5378504	29.8 x 21.0 x 3.0 / 1.56kg	077511537851	10	36.2 x 23.2 x 31.4 / 16.52kg	10077511537858
White	250 gsm	A4	100	5378006	29.8 x 21.0 x 3.0 / 1.56kg	043859681068	10	36.2 x 23.2 x 31.4 / 16.52kg	10043859681065
Red	250 gsm	A4	100	5378303	29.8 x 21.0 x 3.0 / 1.56kg	077511537837	10	36.2 x 23.2 x 31.4 / 16.52kg	10077511537834
Blue	250 gsm	A4	100	5378203	29.8 x 21.0 x 3.0 / 1.56kg	077511537820	10	36.2 x 23.2 x 31.4 / 16.52kg	10077511537827
Green	250 gsm	A4	100	5378403	29.8 x 21.0 x 3.0 / 1.56kg	077511537844	10	36.2 x 23.2 x 31.4 / 16.52kg	10077511537841

**POLYPROPYLENE COVERS**

**Futura Polypropylene (Heavy Weight) Binding Covers (A4) - Commercial Pack**

Black	280 mic	A4	100	5476602	29.8 x 21.0 x 3.0 / 1.6kg	077511547669	10	31.8 x 31.8 x 23.8 / 17.42kg	10077511547666
Clear / frosted	280 mic	A4	100	5376501	29.8 x 21.0 x 3.0 / 1.56kg	077511537653	10	32.4 x 31.6 x 23.4 / 16.26kg	10077511537650

**Fantaisie Polypropylene (Heavy Weight) Lined Pattern Transparent Covers (A4) - Commercial Pack**

Clear / lined	500 mic	A4	50	5350601	29.8 x 21.0 x 2.8 / 1.32kg	077511535062	10	24.8 x 31.6 x 23.2 / 10.88kg	10077511535069
---------------	---------	----	----	---------	----------------------------	--------------	----	------------------------------	----------------

**Standard Polypropylene (Medium Weight) Covers (A4) - Retail Pack**

Clear	200 mic	A4	100	5361401	30.0 x 21.4 x 2.2 / 1.12kg	043859624058	10	24.2 x 23.4 x 32.0 / 12.06kg	50043859624053
-------	---------	----	-----	---------	----------------------------	--------------	----	------------------------------	----------------

## Binding Supplies

### PVC COVERS

#### PVC Transparent Covers (A4) - Retail Pack

Weight	Size	Qty/Pack	Code	Pack Dimensions (HxWxD - cm) & Weight	Retail Barcode	Outer	Outer Dimensions (HxWxD - cm) & Weight	Outer Barcode
150 mic	A4	100	5376001	30.0 x 21.0 x 1.6 / 1.16kg	077511537608	10	16.6 x 23.6 x 31.6 mm / 12.1 kg	50043859513258
180 mic	A4	25	5380001	34.4 x 22.8 x 0.8 / 0.38kg	043859539604	10	6.4 x 24.8 x 33.6 mm / 4.02 kg	50043859539609
180 mic	A4	100	5375901	29.6 x 21.0 x 1.8 / 1.42kg	043859526321	10	19.6 x 22.6 x 31.4 mm / 14.76 kg	50043859526326
200 mic	A4	100	5376102	30.0 x 21.0 x 2.2 / 1.58kg	077511537615	10	21.4 x 23.2 x 31.4 mm / 16.06 kg	50043859513265
Super Clear 200 mic	A4	100	5376107	30.0 x 21.0 x 2.2 / 1.58kg	043859632589	10	21.4 x 23.2 x 31.4 mm / 16.06 kg	10043859632586
200 mic	A3	100	53764	30.0 x 42.0 x 2.0 / 3.12kg	077511537646	5	11.6 x 31.6 x 43.6 mm / 15.88 kg	50077511553399
240 mic	A4	100	53762	29.4 x 21.2 x 2.4 / 1.86kg	077511537622	5	13.8 x 23.2 x 31.6 mm / 9.68 kg	50077511553405
300 mic	A4	100	53763	29.6 x 21.2 x 2.8 / 2.34kg	077511537639	5	15.8 x 23.0 x 31.8 mm / 11.92 kg	50077511553436

#### PVC Covers (Medium Weight) Tinted Transparent Covers (A4) - Retail Pack

Colour	Weight	Size	Qty/Pack	Code	Pack Dimensions (HxWxD - cm) & Weight	Retail Barcode	Outer	Outer Dimensions (HxWxD - cm) & Weight	Outer Barcode
Yellow	200 mic	A4	100	5377001	29.8 x 21.0 x 1.8 / 1.54kg	077511537707	10	20.8 x 23.0 x 31.4 / 16.08kg	50043859513272
Blue	200 mic	A4	100	5377101	29.8 x 21.0 x 1.8 / 1.54kg	077511537714	10	20.8 x 23.0 x 31.4 / 16.08kg	50043859513289
Red	200 mic	A4	100	5377201	29.8 x 21.0 x 1.8 / 1.54kg	077511537721	10	20.8 x 23.0 x 31.4 / 16.08kg	50043859513296
Green	200 mic	A4	100	5377301	29.8 x 21.0 x 1.8 / 1.54kg	077511537738	10	20.8 x 23.0 x 31.4 / 16.08kg	50043859513302
Smoked	200 mic	A4	100	5377401	29.8 x 21.0 x 1.8 / 1.54kg	077511537745	10	20.8 x 23.0 x 31.4 / 16.08kg	50043859513319

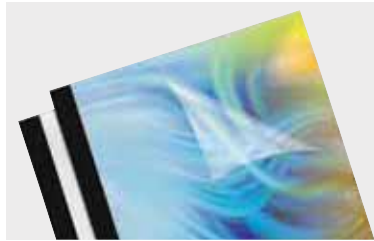

### THERMAL BINDING COVERS

#### Prestige Covers (Medium Weight) PVC Front + Leatherboard Thermal Binding Covers (A4) - Commercial Pack

Colour	Weight	Size	Pages (80gsm)	Qty/Pack	Code	Pack Dimensions (HxWxD - cm) & Weight	Retail Barcode	Outer	Outer Dimensions (HxWxD - cm) & Weight	Outer Barcode
White	150mic + 220gsm	1.5mm	1-8	100	5317001	31.0 x 12.8 x 24.0 / 3.02kg	043859676477	1	31.0 x 12.8 x 24.0 / 3.02kg	0077511531705
Blue	150mic + 220gsm	1.5mm	1-8	100	53171	31.0 x 12.8 x 24.0 / 3.02kg	077511531712	1	31.0 x 12.8 x 24.0 / 3.02kg	077511531712
White	150mic + 220gsm	3mm	9-32	100	5317501	31.0 x 13.2 x 24.2 / 3.2kg	043859676521	1	31.0 x 13.2 x 24.2 / 3.2kg	0077511531750
Blue	150mic + 220gsm	3mm	9-32	100	53176	31.0 x 13.2 x 24.2 / 3.2kg	077511531767	1	31.0 x 13.2 x 24.2 / 3.2kg	0077511531767

#### Standard Covers (Medium Weight) PVC Front + Gloss Board Thermal Binding Covers (A4) - Commercial Pack

White	150mic + 200gsm	1.5mm	1-8	100	53151	30.8 x 13.4 x 24.2 / 2.88kg	077511531514	1	30.8 x 13.4 x 24.2 / 2.88kg	0077511531514
White	150mic + 200gsm	3mm	9-32	100	53152	31.0 x 13.2 x 24.0 / 2.88kg	077511531521	1	31.0 x 13.2 x 24.0 / 2.88kg	0077511531521
White	150mic + 200gsm	4mm	33-43	100	53153	31.0 x 12.8 x 24.2 / 2.9kg	077511531538	1	31.0 x 12.8 x 24.2 / 2.9kg	0077511531538
White	150mic + 200gsm	6mm	44-60	100	53154	31.0 x 13.4 x 24.0 / 2.96kg	077511531545	1	31.0 x 13.4 x 24.0 / 2.96kg	0077511531545
White	150mic + 200gsm	8mm	61-80	100	5391202	31.0 x 16.4 x 24.0 / 3kg	043859519118	1	31.0 x 16.4 x 24.0 / 3kg	0043859519118
White	150mic + 200gsm	10mm	81-100	100	5391401	31.0 x 24.0 x 16.2 / 3.08kg	043859522491	1	31.0 x 24.0 x 16.2 / 3.08kg	0043859522491
White	150mic + 200gsm	12mm	101-120	100	53150	31.0 x 16.2 x 24.4 / 3.12kg	077511531507	1	31.0 x 16.2 x 24.4 / 3.12kg	0077511531507
White	150mic + 200gsm	15mm	121-150	50	5390001	31.0 x 24.0 x 13.0 / 1.68kg	043859519026	1	31.0 x 24.0 x 13.0 / 1.68kg	0043859519026
White	150mic + 200gsm	20mm	151-200	50	5390602	30.8 x 13.2 x 24.0 / 1.74kg	043859519040	1	30.8 x 13.2 x 24.0 / 1.74kg	0043859519040
White	150mic + 200gsm	25mm	201-250	50	5390702	31.4 x 24.2 x 16.4 / 1.8kg	043859519057	1	31.4 x 24.2 x 16.4 / 1.8kg	0043859519057

#### Coverlight (Light Weight) PVC Front + Matt Board Thermal Binding Covers (A4) - Retail Pack

White	150mic + 170gsm	1.5mm	1-8	20	5379601	30.2 x 23.6 x 2.2 / 0.65kg	043859539826	10	30.7 x 24.2 x 22.6 mm / 7 kg	50043859539821
White	150mic + 170gsm	3mm	9-32	20	5379701	30.2 x 23.6 x 2.2 / 0.65kg	043859539833	10	30.7 x 24.2 x 22.6 mm / 7 kg	50043859539838

### PRESENTATION WITHOUT MACHINES

#### Relido Spines (PVC) Slide Binder Spines (Round Back) - A4 - Commercial Pack

Colour	Size	Qty/Pack	Code	Pack Dimensions (HxWxD - cm) & Weight	Retail Barcode	Outer	Outer Dimensions (HxWxD - cm) & Weight	Outer Barcode
Blue	3 - 6mm	50	5383201	33.0 x 11.2 x 6.0 / 0.65kg	043859655519	20	26.5 x 32.0 x 45.5 mm / 12 kg	10043859655516
White	3 - 6mm	50	5383101	33.0 x 11.2 x 6.0 / 0.65kg	043859655502	20	26.5 x 32.0 x 45.5 mm / 12 kg	10043859655509
Black	3 - 6mm	50	5383001	33.0 x 11.2 x 6.0 / 0.65kg	043859655496	20	26.5 x 32.0 x 45.5 mm / 12 kg	10043859655493
Clear	3 - 6mm	50	5383401	33.0 x 11.2 x 6.0 / 0.65kg	043859655526	20	26.5 x 32.0 x 45.5 mm / 12 kg	10043859655523
Black	9 - 12mm	50	5384001	30.6 x 11.4 x 7.8 / 0.74kg	043859655533	10	40.0 x 24.2 x 32.2 mm / 7.92 kg	10043859655530
Clear	9 - 12mm	50	5384401	30.6 x 11.4 x 7.8 / 0.74kg	043859655557	10	40.0 x 24.2 x 32.2 mm / 7.92 kg	10043859655554



## WHY USE A CUTTING SYSTEM?

Cutting machines enable the user to trim and cut large amounts of paper in one go. They are operated using one smooth movement which ensures precision cutting and a professional finish. They save time and effort and are an essential tool when working with large stacks of paper, books, and laminated documents. They are also ideal for print-outs of digital photographs.



## TYPES OF CUTTING SYSTEM



### ROTARY TRIMMERS

Ideal for cutting smaller stacks of paper. The round blade enclosed in a cutting head slides along a metal guide bar to create straight cuts. Widely used by photographers, graphics studios and schools.



### GUILLOTINES

Ideal for cutting thick stacks of paper. A premium solution, designed for high-volume cutting. The leverage handle is brought down in one motion to cleanly cut through paper.

**USAGE:** How often will the trimmer / guillotine be used?



**FEATURES:** Which of the following features are required?



Retractable safety blade



Precision LED safety guide



Protective safety guard



Encapsulated safety blade



Supplied with straight, wavy, perforated and fold blade types

## Paper Trimmers



### Atom A3 & A4 Trimmers

**HEAVY USE.**

- 30 sheet (80gsm) cutting capacity for high volume trimming
- Encapsulated stainless steel SafeCut™ blade for heavy duty applications

### Gamma A3 & A4 Trimmers

**HEAVY USE.**

- 20 sheet (80gsm) cutting capacity
- Encapsulated stainless steel SafeCut™ blade for heavy duty applications

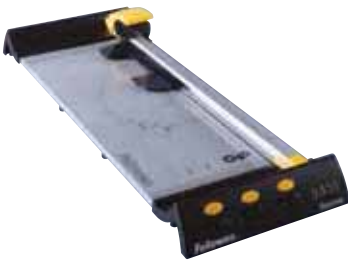
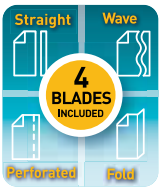

### Electron A3 & A4 Trimmers

**MEDIUM USE.**

- Cuts up to 10 sheets of paper (80gsm) at a time - ideal for the small office / home office
- Durable metal trimmer with 4 SafeCut™ Blades - straight, perforated, wavy, fold

### Proton A3 & A4 Trimmers

**MEDIUM USE.**

- Cuts up to 10 sheets of paper (80gsm) at a time - ideal for the small office / home office

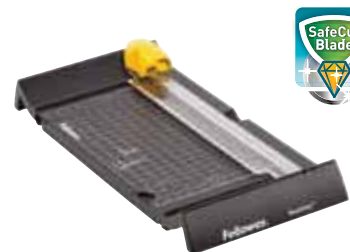
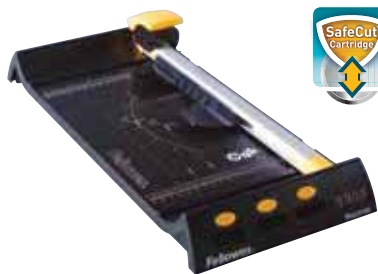

### Neutron Plus A4 Trimmer

**LIGHT USE.**

- Cuts up to 10 sheets of paper (80gsm) at a time - for home / home office use
- Supplied with 4 SafeCut™ Blades - straight, perforated, wavy, fold

### Neutron A4 Trimmer

**LIGHT USE.**

- Cuts up to 10 sheets of paper (80gsm) at a time - occasional use

### Neutrino Photo Trimmer

**LIGHT USE.**

- Trims up to 5 sheets of paper (A5, 80gsm) at a time - ideal for hobby & craft use
- Extendable arm to support or measure A4 documents

# Trimmers

Model	Cutting Length	Sheet Capacity (80gsm)	Accepts	Replaceable Cutting Strip	Adjustable Back Stop	Paper Clamp	Interchangeable Blades	Base	Warranty
Atom A3	460mm	30 sheets	Paper/Film/Photos/Board	No	Yes	Yes	No	Metal	2 years
Atom A4	380mm	30 sheets	Paper/Film/Photos/Board	No	Yes	Yes	No	Metal	2 years
Gamma A3	460mm	20 sheets	Paper/Film/Photos	No	Yes	Yes	No	Metal	2 years
Gamma A4	305mm	20 sheets	Paper/Film/Photos	No	Yes	Yes	No	Metal	2 years
Electron A3	460mm	10 sheets	Paper/Film/Photos	Yes	No	Yes	Yes	Metal	2 years
Electron A4	320mm	10 sheets	Paper/Film/Photos	Yes	No	Yes	Yes	Metal	2 years
Proton A3	460mm	10 sheets	Paper/Film/Photos	Yes	No	Yes	Yes	Metal	2 years
Proton A4	320mm	10 sheets	Paper/Film/Photos	Yes	No	Yes	Yes	Metal	2 years
Neutron Plus	320mm	10 sheets	Paper/Film/Photos	Yes	No	Yes	Yes	Aluminium top	2 years
Neutron A4	320mm	10 sheets	Paper/Film/Photos	Yes	No	Yes	Yes	Plastic	2 years
Neutrino Photo	240mm	5 sheets	Paper/Photos	Yes	No	Yes	No	Plastic	1 year

Code	Model	UNIT			RETAIL PACK			OUTER PACK			
		H x W x D (cm)	Weight (kg)	Qty	H x W x D (cm)	Weight (kg)	Barcode (UPC)	Qty	H x W x D (cm)	Weight (kg)	Barcode (SCS)
5410701	Atom A3	12.8 x 37.4 x 66.8	4.74	1	N/A	N/A	N/A	1	45.2 x 18.8 x 73.8	6.46	50043859550970
5410601	Atom A4	12.8 x 37.4 x 59.8	4.26	1	N/A	N/A	N/A	1	44.8 x 66.2 x 19.2	5.8	50043859550963
5437401	Gamma A3	11.0 x 27.4 x 65.8	3.5	1	N/A	N/A	N/A	1	33.8 x 73.3 x 17.1	4.62	50043859586207
5437001	Gamma A4	11.0 x 27.4 x 49.8	3.2	1	N/A	N/A	N/A	1	34.0 x 60.6 x 18.0	4.1	50043859586160
5410501	Electron A3	7.8 x 21.8 x 62.2	1.6	1	70.6 x 22.6 x 9.4	2.04	0043859550463	4	35.0 x 25.0 x 64.8	8.84	50043859550468
5410401	Electron A4	7.8 x 21.8 x 47.6	1.28	1	56.0 x 22.6 x 8.8	1.62	0043859550456	4	25.2 x 34.8 x 51.0	7.14	50043859550451
5410301	Proton A3	7.6 x 21.8 x 62.2	1.56	1	70.6 x 22.6 x 9.4	2	0043859550449	4	35.0 x 25.0 x 64.8	8.7	50043859550444
5410201	Proton A4	7.6 x 21.8 x 47.6	1.2	1	56.0 x 22.6 x 8.8	1.56	043859550432	4	25.2 x 34.8 x 51.0	6.9	50043859550437
5410101	Neutron Plus A4	7.8 x 21.8 x 47.6	0.86	1	56.0 x 22.6 x 8.8	1.22	0043859550425	4	25.2 x 34.8 x 51.0	5.62	50043859550420
5410001	Neutron A4 Trimmer	7.8 x 21.8 x 47.6	0.82	1	56.0 x 22.6 x 8.8	1.16	0043859550401	4	25.2 x 34.8 x 51.0	5.38	50043859550406
5412701	Neutrino Photo	4.5 x 13.5 x 34	0.2	1	39.5 x 16.5 x 5	0.4	0043859586066	10	39.5 x 47.0 x 21.2	5	50043859586061

## Trimmers Accessories



Code	Description	Suitable For	Qty/Pack	Retail box dimensions (HxWxD - cm) & Weight	Retail Barcode	Outer	Outer Dimensions (HxWxD - cm) & Weight	Outer Barcode
5411301	Assorted Blades - wavy, perforated, folding	Electron, Proton, Neutron Plus & Neutron	3	22.4 x 9.0 x 1.0 / 0.04kg	0043859554782	20	11.6 x 15.8 x 23.8 / 1.12kg	50043859554787
5411401	Straight Blades	Electron, Proton, Neutron Plus & Neutron	2	22.4 x 8.6 x 1.4 / 0.04kg	0043859554799	20	11.8 x 15.6 x 24.0 / 0.9kg	50043859554794
5411501	A4 Cutting Strips	Electron, Proton, Neutron Plus & Neutron	3	43.6 x 9.0 x 1.0 / 0.04kg	0043859554805	20	10.6 x 10.2 x 44.8 / 1.7kg	50043859554800
5411601	A3 Cutting Strips	Electron & Proton	3	57.8 x 8.6 x 0.5 / 0.12kg	0043859556342	20	11.0 x 59.2 x 10.4 / 2.68kg	50043859556347

## Guillotines



### Astro A4 Guillotine

**HEAVY USE.**

- Cuts up to 50 sheets of paper (80gsm) at a time - for professional use
- High quality professional A4 guillotine designed for heavy duty applications
- Heavy weight metal base includes automatic safety guard
- High quality steel blade capable of cutting paper, carton and thin plastic film



### Plasma A3 & A4 Guillotines

**HEAVY USE.**

- Protective SafeCut™ safety guard - guillotine can only be operated when the guard is in place
- Cuts up to 40 sheets of paper (80gsm) at a time - for large office environments
- Heavy duty stainless steel blade - ideal for demanding cutting jobs



### Stellar A3 & A4 Guillotines

**MEDIUM USE.**

- Protective SafeCut™ safety guard - guillotine can only be operated when the guard is in place
- Cuts up to 20 sheets of paper (80gsm) at a time - for general office use
- Heavy duty stainless steel blade



### Fusion A3 & A4 Guillotines

**MODERATE USE.**

- Protective SafeCut™ safety guard - guillotine can only be operated when the guard is in place
- Cuts up to 10 sheets of paper (80gsm) at a time - an ideal entry level guillotine
- Quality stainless steel blade

Model	Cutting Length	Sheet capacity (80gsm)	Accepts	Replaceable Cutting Strip	Adjustable Back Stop	Paper Clamp	Markings	Base	Warranty
Astro A4	385mm	50 sheets	Paper/Film/Photos/Cardboard/Fabric	No	Yes	Yes	cm & inch	Metal	1 year
Plasma A3	480mm	40 sheets	Paper/Film/Photos/Board	No	Yes	Yes	cm & inch	Metal	2 years
Plasma A4	380mm	40 sheets	Paper/Film/Photos/Board	No	Yes	Yes	cm & inch	Metal	2 years
Stellar A3	460mm	20 sheets	Paper/Film/Photos	No	Yes	Yes	cm & inch	Metal	2 years
Stellar A4	305mm	20 sheets	Paper/Film/Photos	No	Yes	Yes	cm & inch	Metal	2 years
Fusion A3	460mm	10 sheets	Paper/Film/Photos	No	No	Yes	cm & inch	Metal	2 years
Fusion A4	320mm	10 sheets	Paper/Film/Photos	No	No	Yes	cm & inch	Metal	2 years

Code	Model	UNIT			RETAIL PACK			OUTER PACK			
		H x W x D (cm)	Weight (kg)	Qty	H x W x D (cm)	Weight (kg)	Barcode (UPC)	Qty	H x W x D (cm)	Weight (kg)	Barcode (SCS)
5415001	Astro A4	26.5 x 57.0 x 38.6	9.6	1	N/A	N/A	N/A	1	29.2 x 65.4 x 44.2	11.32	50043859634090
5411101	Plasma A3	49.0 x 37.6 x 63.6	7.4	1	N/A	N/A	N/A	1	45.8 x 17.8 x 92.0	10.2	50043859551014
5411001	Plasma A4	49.0 x 37.6 x 55.6	6.52	1	N/A	N/A	N/A	1	45.6 x 16.8 x 84.0	9.06	50043859551007
5438401	Stellar A3	27.5 x 35.0 x 73.2	5	1	N/A	N/A	N/A	1	43.0 x 84.0 x 18.3	6.6	50043859586283
5438001	Stellar A4	27.5 x 35.0 x 59.5	4	1	N/A	N/A	N/A	1	35.5 x 72.2 x 18.4	5.5	50043859586245
5410901	Fusion A3	41.8 x 21.6 x 58.8	2.64	1	85.6 x 23.4 x 10.6	3.3	0043859550999	2	25.6 x 20.4 x 80.6	7.12	50043859550994
5410801	Fusion A4	34.0 x 21.6 x 48.2	2.02	1	70.2 x 28.8 x 10.2	2.76	0043859550982	2	31.2 x 20.6 x 65.4	6.04	50043859550987





# Air Treatment

50 - 54

AeraMax<sup>®</sup> Air Purifiers

52 AeraMax<sup>®</sup> Personal

53 AeraMax<sup>®</sup> Baby

54 AeraMax<sup>®</sup> Pet

54 AeraMax<sup>®</sup> Replacement Filters

## WHY DOES THE AIR NEED PURIFYING?

Studies indicate that indoor air can be up to five times more polluted than outdoor air\*. Combined with the fact that many people spend up to 90% of their time indoors, it starts to become clear why the quality of indoor air is so important.

\* Environment Protection Agency

## WHAT DO AIR PURIFIERS REMOVE FROM THE AIR?

De nombreux facteurs contribuent à détériorer la qualité de l'air intérieur. Les polluants atmosphériques les plus courants sont les moisissures, la poussière, les pollens, les germes ou encore les virus. Ils contribuent en grande partie au développement de nombreuses allergies et maladies respiratoires dont nous souffrons aujourd'hui.

Utiliser un purificateur d'air à la maison ou au bureau réduit sensiblement le nombre de particules nocives contenues dans l'air telles que :



POLLEN



ODOURS



GERMS



VIRUSES



DUST & DUST MITES



PET DANDER

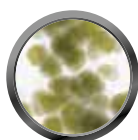

MOULD SPORES

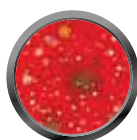

OTHER ALLERGENS

### HOME

Even the cleanest homes will be harbouring potentially harmful airborne pollutants that could be reduced by using an air purifier.



### WORKSPACE

The air you share with your colleagues could contain a number of potentially harmful pollutants.

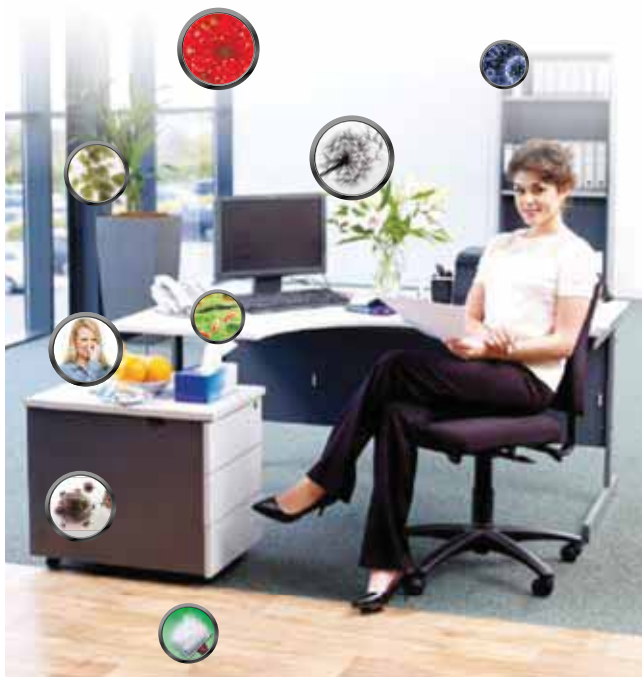

## WHY CHOOSE AERAMAX®?

The AeraMax® DX and DB Air Purifiers use a combination of the most effective filtration and cleaning methods as part of a 4-stage filtration process to remove 99.97% of airborne pollutants and particles down to 0.3 microns in size. This level of performance combined with the intelligent AeraSmart™ sensor technology, makes AeraMax® the perfect clean air solution.

- PlasmaTRUE™ Technology**  
Creates an ionized field to help safely remove airborne pollutants.
- AeraSafe™ Antimicrobial Treatment**  
Built-in protection from the growth of odour causing bacteria, mildew, and fungi on the True HEPA filter.
- True HEPA Filter**  
Captures 99.97% of airborne particles as small as 0.3 microns, including pollen, ragweed and other allergens, viruses, germs, dust mites and mould spores.
- Carbon Filter**  
Removes odours, chemical vapours (VOCs) and captures large airborne particles.

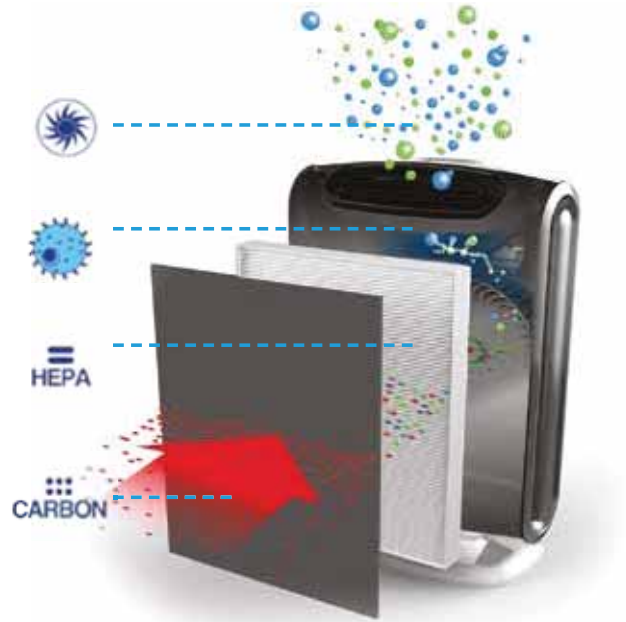

**ALLERGY UK**

Scientifically proven to reduce exposure to pollen, mould, house dust mite, smoke, cat and dog allergens.



**Smart Sensor Technology**

An AeraSmart sensor monitors the air quality in your environment and automatically adjusts the fan speed to keep your air purified.



**Energy Star**

Energy Star-qualified air purifiers are 40% more energy-efficient than non-qualifying models.

## WHO BENEFITS FROM USING AN AERAMAX® AIR PURIFIER?



Allergy & Asthma



City Dwellers



Cold & Flu



Pet Owners



Babies & Parents

# AeraMax® Personal



### AeraMax® DX5 Air Purifier

- Four-stage purification system captures 99.97% of airborne particles as small as 0.3 microns, including pollen and other allergens, dust mites, mould spores, pet dander and cigarette smoke
- AeraSafe™ Antimicrobial Treatment – built-in protection from the growth of odour causing bacteria, mildew and fungi on True HEPA filter
- AeraSmart™ Sensor monitors the air quality & automatically adjusts the fan speed to keep your air purified. Blue, amber and red lights indicate the purity of your air
- Aera+™ Mode is designed for peak allergy conditions & increases air flow by 35%\* to remove allergens from your air
- Filter Change Indicators let you know when it is time to replace your Carbon and True HEPA filters
- The DX5 will deliver up to 5 air changes per hour in a 8m² room and 3 air changes per hour in a 12m² room

Code	Description	UNIT			RETAIL PACK			OUTER PACK			
		H x W x D (cm)	Weight (kg)	Qty	H x W x D (cm)	Weight (kg)	Barcode (UPC)	Qty	H x W x D (cm)	Weight (kg)	Barcode (SCS)
9392801	AeraMax® DX5 Air Purifier	69.22 x 18.42 x 21.59	4.51	1	74.93 x 26.51 x 22.23	5.85	043859664627	1	77.47 x 23.50 x 29.21	6.76	50043859664622



### AeraMax® DX55 Air Purifier

- Four-stage purification system captures 99.97% of airborne particles as small as 0.3 microns, including pollen and other allergens, dust mites, mould spores, pet dander and cigarette smoke
- AeraSafe™ Antimicrobial Treatment – built-in protection from the growth of odour causing bacteria, mildew and fungi on True HEPA filter
- AeraSmart™ Sensor monitors the air quality & automatically adjusts the fan speed to keep your air purified. Blue, amber and red lights indicate the purity of your air
- Aera+™ Mode is designed for peak allergy conditions & increases air flow by 50%\* to remove allergens from your air
- Filter Change Indicators let you know when it is time to replace your Carbon and True HEPA filters
- The DX55 will deliver up to 5 air changes per hour in a 18m² room and 3 air changes per hour in a 28m² room

Code	Description	UNIT			RETAIL PACK			OUTER PACK			
		H x W x D (cm)	Weight (kg)	Qty	H x W x D (cm)	Weight (kg)	Barcode (UPC)	Qty	H x W x D (cm)	Weight (kg)	Barcode (SCS)
9393501	AeraMax® DX55 Air Purifier	52.07 x 33.02 x 18.10	4.49	1	56.20 x 38.42 x 28.26	6.17	043859664658	1	59.69 x 29.85 x 40.01	7.21	50043859664653



### AeraMax® DX95 Air Purifier

- Four-stage purification system captures 99.97% of airborne particles as small as 0.3 microns, including pollen and other allergens, dust mites, mould spores, pet dander and cigarette smoke
- AeraSafe™ Antimicrobial Treatment – built-in protection from the growth of odour causing bacteria, mildew and fungi on True HEPA filter
- AeraSmart™ Sensor monitors the air quality & automatically adjusts the fan speed to keep your air purified. Blue, amber and red lights indicate the purity of your air
- Aera+™ Mode is designed for peak allergy conditions & increases air flow by 50%\* to remove allergens from your air
- Filter Change Indicators let you know when it is time to replace your Carbon and True HEPA filters
- The DX95 will deliver up to 5 air changes per hour in a 28m² room and 3 air changes per hour in a 42m² room

Code	Description	UNIT			RETAIL PACK			OUTER PACK			
		H x W x D (cm)	Weight (kg)	Qty	H x W x D (cm)	Weight (kg)	Barcode (UPC)	Qty	H x W x D (cm)	Weight (kg)	Barcode (SCS)
9393801	AeraMax® DX95 Air Purifier	64.00 x 40.00 x 20.70	6.44	1	69.20 x 30.80 x 44.60	8.92	043859664689	1	72.60 x 32.80 x 46.40	10.10	50043859664684



# AeraMax® Baby



For air as pure  
as they are

Now that's a relief for baby and you

### AeraMax® DB5 Baby Air Purifier

- Maximum protection for the air they breathe with a 4-Stage Purification system that protects air and reduces odour, allergens, mould spores, dust particles, viruses and germs, and nappy odours
- AeraSmart™ Sensor monitors the air quality and automatically adjusts the fan speed to keep your air purified
- Ultra quiet operation and night mode with dimmed lights for undisturbed sleep
- True HEPA filter with AeraSafe™ antimicrobial treatment safely removes 99.97% of airborne particles as small as 0.3 microns, including pollen, ragweed and other allergens, viruses, germs, dust mites, mould spores and cigarette smoke
- Child Lock allows you to lock the display panel to avoid accidental operation
- Filter Change Indicators let you know when it is time to replace your Carbon and True HEPA filters
- The DB5 will deliver up to 5 air changes per hour in a 8m<sup>2</sup> room and 3 air changes per hour in a 12m<sup>2</sup> room



Code	Description	UNIT			RETAIL PACK			OUTER PACK			
		H x W x D (cm)	Weight (kg)	Qty	H x W x D (cm)	Weight (kg)	Barcode (UPC)	Qty	H x W x D (cm)	Weight (kg)	Barcode (SCS)
9401701	AeraMax® DB5 Baby Air Purifier	69.22 x 18.42 x 21.59	4.51	1	74.93 x 26.99 x 22.86	5.92	043859681716	1	78.74 x 24.77 x 29.21	6.78	50043859681711

### AeraMax® DB55 Baby Air Purifier

- Maximum protection for the air they breathe with a 4-Stage Purification system that protects air and reduces odour, allergens, mould spores, dust particles, viruses and germs, and nappy odours
- AeraSmart™ Sensor monitors the air quality and automatically adjusts the fan speed to keep your air purified
- Ultra quiet operation and night mode with dimmed lights for undisturbed sleep
- True HEPA filter with AeraSafe™ antimicrobial treatment safely removes 99.97% of airborne particles as small as 0.3 microns, including pollen, ragweed and other allergens, viruses, germs, dust mites, mould spores and cigarette smoke
- Child Lock allows you to lock the display panel to avoid accidental operation
- Filter Change Indicators let you know when it is time to replace your Carbon and True HEPA filters
- The DB55 will deliver up to 5 air changes per hour in a 18m<sup>2</sup> room and 3 air changes per hour in a 28m<sup>2</sup> room



Code	Description	UNIT			RETAIL PACK			OUTER PACK			
		H x W x D (cm)	Weight (kg)	Qty	H x W x D (cm)	Weight (kg)	Barcode (UPC)	Qty	H x W x D (cm)	Weight (kg)	Barcode (SCS)
9401801	AeraMax® DB55 Baby Air Purifier	52.07 x 33.02 x 18.10	4.49	1	57.79 x 38.10 x 28.58	6.25	043859681723	1	60.96 x 31.12 x 39.37	7.26	50043859681728

# AeraMax® Pet

## Removing whiffs and reducing wheezes

Now that's a relief for pet owners



### AeraMax® PT65 Pet Air Purifier

- Helps reduce odours and allergens from caged pets, litter boxes and pet dander
- Advanced pet odour removal - Double-thick carbon filter removes odours faster and more effectively
- HEPA filter safely removes 99% of airborne particles as small as 0.3 microns, including pet dander, allergens, mould spores and dust particles
- Fan Speed Indicator lets you manually adjust the fan speed setting – low, medium, or high
- Filter Change Indicators let you know when it is time to replace your Carbon or HEPA filter
- The PT65 will deliver up to 5 air changes per hour in a 21m<sup>2</sup> room and 3 air changes per hour in a 30m<sup>2</sup> room

		UNIT			RETAIL PACK			OUTER PACK			
Code	Description	H x W x D (cm)	Weight (kg)	Qty	H x W x D (cm)	Weight (kg)	Barcode (UPC)	Qty	H x W x D (cm)	Weight (kg)	Barcode (SCS)
9401901	AeraMax® PT65 Pet Air Purifier	40.64 x 43.66 x 20.64	5.20	1	48.26 x 25.72 x 50.17	5.86	043859681730	1	50.80 x 27.62 x 51.44	7.26	50043859681735

# AeraMax® Replacement Filters



### Replacement Filters

In order to ensure your AeraMax® Air Purifier remains effective and continues to operate optimally, the Carbon Filter should be replaced approximately every 3 months and the True HEPA Filter approximately every 12 months.

		UNIT			RETAIL PACK			OUTER PACK			
Code	Description	H x W x D (cm)	Weight (kg)	Qty	H x W x D (cm)	Weight (kg)	Barcode (UPC)	Qty	H x W x D (cm)	Weight (kg)	Barcode (SCS)
9287001	Replacement HEPA Filter for DX5/DB5	41.91 x 11.59 x 3.18	0.17	1	43.50 x 13.49 x 4.13	0.27	043859651573	4	44.77 x 14.29 x 17.46	1.11	50043859651578
9287101	Replacement HEPA Filter for DX55/DB55	33.97 x 26.19 x 3.02	0.22	1	35.66 x 27.94 x 4.13	0.37	043859651580	4	37.15 x 17.46 x 28.89	1.70	50043859651585
9287201	Replacement HEPA Filter for DX95	41.43 x 32.07 x 3.02	0.38	1	43.02 x 33.81 x 4.13	0.59	043859651597	4	44.61 x 16.99 x 34.93	2.69	50043859651592
9406502	Replacement HEPA Filter for PT65	36.83 x 27.94 x 2.62	0.36	1	38.58 x 28.58 x 3.81	0.54	043859686117	4	41.91 x 18.42 x 31.12	2.67	10043859686114
9324001	Replacement Carbon Filter for DX5/DB5	36.83 x 27.94 x 2.62	0.36	4	38.58 x 28.58 x 3.81	0.54	043859658169	4	41.91 x 18.42 x 31.12	2.67	50043859658164
9324101	Replacement Carbon Filter for DX55/DB55	41.59 x 11.11 x 0.48	0.02	4	43.18 x 12.70 x 3.65	0.21	043859658183	4	15.24 x 13.65 x 44.45	1.04	50043859658188
9324201	Replacement Carbon Filter for DX95	40.96 x 31.59 x 0.48	0.09	4	41.59 x 32.23 x 3.49	0.54	043859658190	4	15.24 x 34.29 x 44.45	2.50	50043859658195
9406402	Replacement Carbon Filter for PT65	36.83 x 27.94 x 0.64	0.07	2	38.10 x 28.58 x 3.81	0.31	043859686124	4	31.75 x 18.42 x 41.91	1.18	10043859686121
9370001	Replacement HEPA Filter for PlasmaTrue™	33.34 x 27.94 x 3.02	0.25	1	33.97 x 29.85 x 3.65	0.44	043859625451	4	36.83 x 17.78 x 30.48	2.08	50043859625456
9370101	Replacement HEPA Filter for PlasmaTrue™	41.75 x 32.23 x 3.02	0.30	1	45.24 x 35.88 x 3.65	0.58	043859625468	4	44.45 x 18.42 x 36.51	2.64	50043859625463
9372001	Replacement Carbon Filter for PlasmaTrue™	33.02 x 27.62 x 0.48	0.03	1	33.02 x 27.62 x 0.48	0.06	043859625475	4	36.20 x 3.18 x 29.85	0.42	50043859625470
9372101	Replacement Carbon Filter for PlasmaTrue™	41.28 x 31.75 x 0.48	0.05	1	41.28 x 31.75 x 0.48	0.09	043859625482	4	3.18 x 35.88 x 43.82	0.61	50043859625487

# Workspace Solutions

## 56 - 105 Workspace Wellbeing

58 - 61 Foot Supports

62 - 64 Back Supports

65 - 69 Wrist Supports

70 Ergonomic Mice

71 - 77 Monitor Arms

78 - 83 Monitor Supports

84 - 87 Laptop Supports

90 - 91 Document Supports & Writing Slopes

92 - 94 Document Supports

95 - 100 Height Adjustable Desks

101 - 104 Sit-Stand Converters

105 Sit-Stand Accessories

## 106 - 118 Workspace Essentials

106 - 108 PrivaScreen™ Blackout Privacy Filters

109 Green<sub>2</sub>Desk Accessories

110 - 113 Computer and Organisation Accessories

114 CD Storage

115 Mousepads

116 - 118 Technology Cleaning



# YOUR HEALTH OUR PRIORITY

The **Fellowes® 4 Zone Approach®** provides a complete step by step guide to identifying the main areas of ergonomic focus around the workstation, making it easier to choose the right solutions for everyone's needs whilst improving employee health, comfort, and productivity.



## ONLINE HEALTHY WORKSTATION ASSESSMENT

It's the employer's legal obligation to implement a workstation risk assessment for all employees (EU Directive 90/270/EEC). The Fellowes Online Healthy Workstation Assessment is designed in accordance with the EU Directive and only takes around 5 minutes to complete, and delivers instant results.

[www.fellowesergotest.com](http://www.fellowesergotest.com)



Tested by FIRA International Ltd to comply with the ergonomic requirements set out in European Health and Safety Legislation: EN ISO 9241-5



Items with this symbol feature Microban® anti-bacterial protection for active hygiene, helping to keep your office cleaner and healthier.



The patented Health-V™ Channel wrist support range helps relieve pressure on the median nerve to prevent wrist discomfort and injury.



## ZONE 1

Prevent back tension



**Check your posture.**

A back and foot support may help achieve the best working position.

## ZONE 2

Avoid wrist pressure



**Support your wrists.**

Keep forearms parallel with the top of your desk and wrist in a fairly neutral position.

## ZONE 3

Relieve neck strain



**Achieve comfortable viewing.**

Ensure your eyes are in line with the top of your screen.

## ZONE 4

Reduce inactivity



**Introduce movement.**

Regular changes to your working position helps you work better and feel better.



## Foot Supports

### ZONE 1

Prevent back tension



### The Solution

Check your posture. A back and foot support may help achieve the best working position.

#### 1 Adjustable Height

Configures the foot support to achieve optimal ergonomic positioning; removing the pressure on the legs and lower back by correctly angling the feet and improving seated posture.

#### 2 Rocking Motion

Provides a free-floating platform that encourages subtle movement in the feet for increased blood flow and relaxation over long periods.

#### 3 Massage Surface

Designed to relieve stress and rejuvenate tired feet.

#### 4 Non-Slip

Surface supports the user's feet, removing further pressure from the legs.

#### 5 Foot Adjustable

Foot rests can be adjusted by foot movement rather than leaning down to adjust, avoiding further stress on the back.

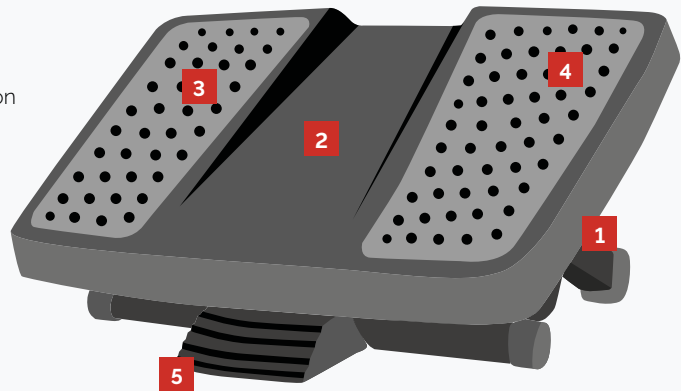

### Hana™ Foot Support

- Support your feet and encourage motion to improve circulation and back comfort
- Promotes motion with the active movement feature, which allows for flexible platform movements
- Light or heavy tension setting to adjust the ease of movement
- Two height settings for sitting and standing
- Change height positions with effortless foot adjustment
- Stylish metal base with non-slip real wood finish, available in black or white
- Approximate specifications:
  - Platform size: 35 x 45cm
  - Height adjustments: 12 – 17.5cm  
17.8 – 21.8cm
  - Incline range: +/- 5° – front to back  
+/-3° – right to left

Code	Description	Colour	UNIT			OUTER PACK			Barcode (SCS)
			H x W x D (cm)	Weight (kg)	Qty	H x W x D (cm)	Weight (kg)		
8055201	Hana™ Foot Support	Black	17.50 x 45.00 x 36.00	4.50	1	23.7 x 45.50 x 51.40	6.10	50043859736954	
8055801	Hana™ Foot Support	White	17.50 x 45.00 x 36.00	4.50	1	23.7 x 45.50 x 51.40	6.10	50043859739146	

# Foot Supports

## Professional Series

### Heavy Duty Foot Support

- Elevates feet and legs to relieve lower back pressure
- Simple height adjustment provides 3 platform heights
- Steel structure and platform provides sturdy support
- No fixed angle enabling rocking motion to improve circulation
- Anti-slip platform surface
- Approximate specifications:
  - Platform size: 56 x 35cm
  - Height adjustments: 10.5 / 12 / 13.5cm
  - Incline range: up to 25°



		UNIT			RETAIL PACK				OUTER PACK			
Code	Description	H x W x D (cm)	Weight (kg)	Qty	H x W x D (cm)	Weight (kg)	Barcode (UPC)	Qty	H x W x D (cm)	Weight (kg)	Barcode (SCS)	
8064101	Professional Series Heavy Duty Foot Support	10.20 x 56.00 x 35.00	5.04	1	13.20 x 38.50 x 61.00	5.12	043859627769	2	27.50 x 39.50 x 62.00	10.32	50043859627764	

## Climate Control Foot Support

- 3 temperature adjustments of cool fan, low heat, and high heat allow you to adjust the workspace airflow to suit your preference
- Platform offers 3 height and tilt options to help relieve lower back pressure and improve posture
- Auto-off feature turns unit off after 8 hours of use
- Energy efficient: 125 watts (low setting) & 250 watts (high setting)
- Approximate specifications:
  - Platform size: 41.5 x 24.6cm
  - Height adjustments: 12.7 / 15.2cm
  - Incline range: up to 5°/14°/20°
  - Cable length: 1.25 metres



		UNIT			RETAIL PACK				OUTER PACK			
Code	Description	H x W x D (cm)	Weight (kg)	Qty	H x W x D (cm)	Weight (kg)	Barcode (UPC)	Qty	H x W x D (cm)	Weight (kg)	Barcode (SCS)	
8070901	Climate Control Foot Support	15.00 x 41.50 x 24.60	1.44	1	27.80 x 43.80 x 16.60	1.92	043859577200	1	27.80 x 16.60 x 43.80	1.92	50043859577205	

## Energizer™ Foot Support

- Unique design inspired by reflexology mapping
- Energising rubber foot pads offer various massage textures and contours targeting pressure points on the feet
- Intuitive rocking motion helps improve circulation and reduce fatigue
- Scissor motion height adjustment provides 3 platform height settings and up to 25° tilt
- Platform design encourages correct positioning of feet and relieves lower back pressure and improves posture by elevating the feet and legs
- Approximate specifications:
  - Platform size: 45.4 x 33.66cm
  - Height adjustments: 10.5 / 13.5 / 16.5cm
  - Incline range: up to 30°



		UNIT			RETAIL PACK				OUTER PACK			
Code	Description	H x W x D (cm)	Weight (kg)	Qty	H x W x D (cm)	Weight (kg)	Barcode (UPC)	Qty	H x W x D (cm)	Weight (kg)	Barcode (SCS)	
8068001	Energizer™ Foot Support	13.02 x 45.40 x 33.66	2.44	1	35.24 x 46.51 x 13.18	2.44	043859675500	2	37.15 x 23.97 x 47.47	5.98	50043859675505	



## Foot Supports



### Office Suites™ Microban® Adjustable Foot Support

- Prevents back and leg discomfort by ensuring the correct posture is adopted
- Built-in Microban® protection fights the growth of harmful bacteria for the lifetime of the product
- Rock freely back-n-forth to help stimulate foot and leg circulation or lock in place for firmer support
- Adjust position using foot pressure and it remains in preferred position until you wish to readjust
- Approximate specifications:
  - Platform size: 44.5 x 33.4cm
  - Height adjustments: 10.8 / 12.7 / 14.6cm
  - Incline range: up to 30°

Code	Description	UNIT			RETAIL PACK			OUTER PACK			
		H x W x D (cm)	Weight (kg)	Qty	H x W x D (cm)	Weight (kg)	Barcode (UPC)	Qty	H x W x D (cm)	Weight (kg)	Barcode (SCS)
8035001	Office Suites™ Microban® Adjustable Foot Support	11.11 x 44.45 x 33.34	1.91	1	34.13 x 45.72 x 12.07	2.31	043859487219	2	48.41 x 25.73 x 35.89	5.13	50043859487214



### Professional Series Ultimate Foot Support

- Intuitive rocking motion helps improve circulation and reduce fatigue
- Surface massage bumps relieve stress and rejuvenate tired feet
- Anti-slip platform surface
- Scissor motion height adjustment provides 3 platform height settings
- Elevates feet and legs to relieve lower back pressure
- Platform design encourages correct positioning of feet
- Approximate specifications:
  - Platform size: 45.09 x 33.66cm
  - Height adjustments: 10 / 13.5 / 16.5cm
  - Incline range: up to 30°

Code	Description	UNIT			RETAIL PACK			OUTER PACK			
		H x W x D (cm)	Weight (kg)	Qty	H x W x D (cm)	Weight (kg)	Barcode (UPC)	Qty	H x W x D (cm)	Weight (kg)	Barcode (SCS)
8067001	Professional Series Ultimate Foot Support	10.48 x 45.09 x 33.66	2.22	1	35.56 x 45.72 x 11.43	2.52	043859625086	2	36.83 x 24.13 x 46.99	5.49	50043859625081



### Smart Suites™ Foot Rocker

- Rocking motion improves circulation and reduces fatigue
- Simple height adjustment - simply flip the foot rocker over
- Unique tread design to overcome 'product creep' when being rocked
- Surface massage bumps rejuvenate tired feet and relieve stress
- Large platform dimensions to allow for more comfortable rocking
- Approximate specifications:
  - Platform size: 49 x 30cm
  - Height adjustments: 6.5 / 9.5cm

Code	Description	UNIT			RETAIL PACK			OUTER PACK			
		H x W x D (cm)	Weight (kg)	Qty	H x W x D (cm)	Weight (kg)	Barcode (UPC)	Qty	H x W x D (cm)	Weight (kg)	Barcode (SCS)
8023901	Smart Suites™ Standard Foot Rocker	13.50 x 49.00 x 30.00	1.32	1	49.00 x 31.00 x 7.60	1.55	043859569700	2	16.30 x 33.00 x 51.00	3.58	50043859569705



# Foot Supports

## Refresh™ Foot Support

- Vented platform allows air to circulate around your feet
- Dual position height settings
- Platform slides to offer angle adjustability for optimal comfort
- 2 oversized massaging panels encourage correct positioning of feet
- Elevates feet and legs to help relieve lower back pressure and improve posture
- Approximate specifications:
  - Platform size: 45.2 x 33cm
  - Height adjustments: 9.5 / 13.5cm
  - Incline range: up to 22°



		UNIT			RETAIL PACK			OUTER PACK			
Code	Description	H x W x D (cm)	Weight (kg)	Qty	H x W x D (cm)	Weight (kg)	Barcode (UPC)	Qty	H x W x D (cm)	Weight (kg)	Barcode (SCS)
8066001	Refresh™ Foot Support	9.53 x 45.24 x 33.02	1.66	1	33.81 x 45.56 x 9.68	1.66	043859675494	2	48.90 x 21.11 x 35.56	3.88	50043859675499

## Standard Adjustable Foot Support

- Free-floating platform allows legs to stretch for increased circulation
- Offers dual position height adjustment
- Textured surface massages soles of feet to relieve tension
- Approximate specifications:
  - Platform size: 42.5 x 30cm
  - Height adjustments: 8.5 / 10.5cm
  - Incline range: up to 25°



		UNIT			RETAIL PACK			OUTER PACK			
Code	Description	H x W x D (cm)	Weight (kg)	Qty	H x W x D (cm)	Weight (kg)	Barcode (UPC)	Qty	H x W x D (cm)	Weight (kg)	Barcode (SCS)
48121-70	Standard Adjustable Foot Support	9.52 x 44.76 x 33.33	1.41	1	33.65 x 45.08 x 9.20	1.65	077511481215	2	48.26 x 20.32 x 35.56	4.04	50077511270906

## I-Spire Series™ Foot Lift

- Innovative design provides comfort and elevation to your feet and legs whilst working
- Flexible plastic cover for added comfort and support
- Contemporary and stylish design to suit any office or home décor
- No assembly required
- Approximate specifications:
  - Platform size: 45 x 30cm
  - Height: 10.5cm



## I-Spire Series™

		UNIT			RETAIL PACK			OUTER PACK			
Code	Description	H x W x D (cm)	Weight (kg)	Qty	H x W x D (cm)	Weight (kg)	Barcode (UPC)	Qty	H x W x D (cm)	Weight (kg)	Barcode (SCS)
9361701	I-Spire Series™ Foot Lift	10.48 x 45.09 x 29.37	1.20	1	11.91 x 45.40 x 29.37	1.47	043859669196	2	26.04 x 31.75 x 46.67	3.41	50043859669191

## Back Supports

### 1 Support Types

Back supports are available as either Full Back or Lumbar variants. The type selected will depend on the body type of the user and the chair they are using.

### 2 Attachment Types

Back supports come with an elasticated or adjustable strap that allows users to set the tension and fit the support to most chairs.

### 3 Fabric

The fabric is typically foam, which moulds to the shape of the user for further support, or mesh, which promotes air flow and may be preferred in warmer working environments.

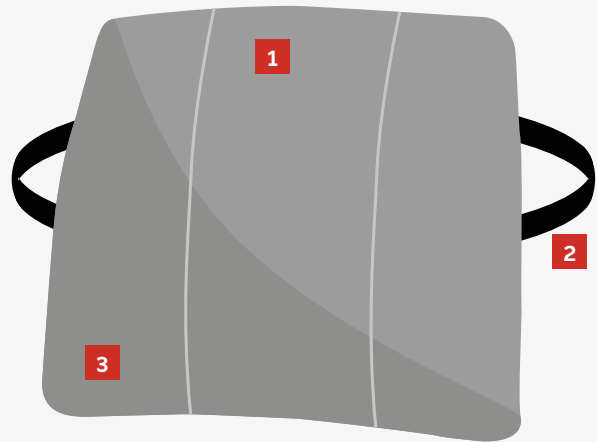

### Back Angel™ Back Support

- Delivers full back support for extended periods of sitting
- 2 wings move independently to mould to your back with vents to promote airflow
- Height adjustable to maximize comfort to 7 different settings (from 14cm in the lowest setting to 23cm on the highest)
- Easy to attach elastic strap fits most chairs
- Modern design complements any workspace

Code	Description	UNIT			RETAIL PACK			OUTER PACK			
		H x W x D (cm)	Weight (kg)	Qty	H x W x D (cm)	Weight (kg)	Barcode (UPC)	Qty	H x W x D (cm)	Weight (kg)	Barcode (SCS)
8026401	Back Angel™ Back Support	38.00 x 44.00 x 14.00	1.60	1	38.50 x 44.50 x 14.50	1.68	043859721856	4	41.00 x 45.00 x 58.90	6.90	50043859721851



### Professional Series Ultimate Back Support

- Innovative Tri-Tachment™ ensures stability eliminating constant readjustment
- Built in Microban® protection fights the growth of harmful bacteria for the lifetime of the product
- 3 Section lumbar support expands and contracts to natural body curvature
- Thoracic Support is contoured with a low density foam to optimise the postural support in a subtle application
- Fully adjustable design allows it to fit most office chairs
- Easy setup: Place support on chair, position your back and just clip the straps!

Code	Description	UNIT			RETAIL PACK			OUTER PACK			
		H x W x D (cm)	Weight (kg)	Qty	H x W x D (cm)	Weight (kg)	Barcode (UPC)	Qty	H x W x D (cm)	Weight (kg)	Barcode (SCS)
8041801	Professional Series Ultimate Back Support	36.50 x 37.50 x 5.50	0.61	1	11.75 x 36.67 x 20.00	0.74	043859685714	2	23.50 x 24.92 x 38.26	1.82	50043859685719

# Back Supports

## Professional Series

### Heat and Soothe Back Support

- Heating and cooling gel pack helps ease muscle aches and pains
- Simply heat up in a microwave or chill in the refrigerator
- Helps reduce tension by maintaining the natural curve of your lower back to correct slouching
- Slim profile with soft touch fabric enhances personal comfort
- Adjustable strap with buckle fits most modern office chairs
- Replacement gel packs also sold separately



Code	Description	UNIT			RETAIL PACK			OUTER PACK			
		H x W x D (cm)	Weight (kg)	Qty	H x W x D (cm)	Weight (kg)	Barcode (UPC)	Qty	H x W x D (cm)	Weight (kg)	Barcode (SCS)
8041901	Professional Series Heat and Soothe Back Support	34.20 x 32.80 x 7.80	0.66	1	34.20 x 32.80 x 7.80	0.66	043859685721	4	40.00 x 33.40 x 36.60	3.62	50043859685726
9191001	Gel Pack	25.00 x 16.50 x 1.00	0.37	1	25.00 x 16.50 x 1.00	0.37	043859579341	20	16.00 x 23.00 x 32.00	7.90	50043859579346

## Professional Series

### Mesh Back Support

- Mesh back support incorporating padded features for additional support
- Gently moulds to your body's contours
- Features vertically adjustable memory foam lumbar support
- Tri-tensioning attachment eliminates the need for re-adjustment and holds the support in place
- Mesh fabric allows air flow for your personal comfort



Code	Description	UNIT			RETAIL PACK			OUTER PACK			
		H x W x D (cm)	Weight (kg)	Qty	H x W x D (cm)	Weight (kg)	Barcode (UPC)	Qty	H x W x D (cm)	Weight (kg)	Barcode (SCS)
8029901	Professional Series Mesh Back Support	19.50 x 30.40 x 37.00	0.58	1	52.00 x 44.00 x 20.00	0.59	043859600960	2	21.00 x 45.80 x 53.60	1.74	50043859600965

## Office Suites™ Mesh Back Support

- Mesh back support gently moulds to your body's contours to provide maximum uniform support
- Tri-tensioning attachment eliminates the need for re-adjustment and easily attaches to any chair
- Mesh fabric allows air flow for your personal comfort



Code	Description	UNIT			RETAIL PACK			OUTER PACK			
		H x W x D (cm)	Weight (kg)	Qty	H x W x D (cm)	Weight (kg)	Barcode (UPC)	Qty	H x W x D (cm)	Weight (kg)	Barcode (SCS)
9191301	Office Suites™ Mesh Back Support	51.28 x 43.97 x 14.13	0.50	1	51.28 x 43.97 x 14.13	0.50	043859600434	2	52.07 x 18.73 x 44.77	1.50	50043859600439

## Back Supports



### Plush Touch™ Lumbar Support

- The Softest Place Your Back Can Rest™!
- Featuring FoamFusion™ technology for maximum comfort and support, to deliver long-term lumbar support for extended periods of sitting
- Adjustable strap with durable buckle fits most chairs
- Modern design accents to suit any workspace and complements PlushTouch™ Wrist Supports

Code	Description	UNIT			RETAIL PACK			OUTER PACK			
		H x W x D (cm)	Weight (kg)	Qty	H x W x D (cm)	Weight (kg)	Barcode (UPC)	Qty	H x W x D (cm)	Weight (kg)	Barcode (SCS)
8026501	Plush Touch™ Lumbar Support	35.50 x 9.00 x 19.50	0.29	1	36.80 x 9.50 x 20.00	0.37	043859722327	2	23.00 x 21.60 x 38.00	1.05	50043859722322



### Smart Suites™ Slimline Back Support

- Slimmer profile to suit today's office chairs
- Greater flexibility of support to suit the individual user
- Modern soft touch fabric and contrasting stitching
- Adjustable straps hold cushion in place

Code	Description	UNIT			RETAIL PACK			OUTER PACK			
		H x W x D (cm)	Weight (kg)	Qty	H x W x D (cm)	Weight (kg)	Barcode (UPC)	Qty	H x W x D (cm)	Weight (kg)	Barcode (SCS)
9190901	Smart Suites™ Slimline Back Support	31.00 x 33.20 x 7.80	0.34	1	31.00 x 33.20 x 7.80	0.34	043859556427	2	34.60 x 19.80 x 33.60	1.04	50043859556422



### Smart Suites™ Portable Lumbar Support

- Compact design for use on the move
- Supports back during extended periods of sitting
- High-density foam promotes neutral posture
- Adjustable straps hold cushion in place
- Soft brushed cover can be removed for cleaning

Code	Description	UNIT			RETAIL PACK			OUTER PACK			
		H x W x D (cm)	Weight (kg)	Qty	H x W x D (cm)	Weight (kg)	Barcode (UPC)	Qty	H x W x D (cm)	Weight (kg)	Barcode (SCS)
8042101	Smart Suites™ Portable Lumbar Support	5.40 x 30.40 x 12.60	0.14	1	13.20 x 30.40 x 8.00	0.18	043859685745	4	16.80 x 32.40 x 33.00	2.18	50043859685740



### I-Spire Series™ Lumbar Cushion

- Innovative design provides comfort to your back whilst working
- Contemporary and stylish design to suit any office or home decor
- Foam cushion for enhanced comfort and support
- Adjustable strap with durable buckle holds lumbar cushion in place
- Breathable mesh fabric enhances personal comfort

### I-Spire Series™

Code	Description	Colour	UNIT			RETAIL PACK			OUTER PACK			
			H x W x D (cm)	Weight (kg)	Qty	H x W x D (cm)	Weight (kg)	Barcode (UPC)	Qty	H x W x D (cm)	Weight (kg)	Barcode (SCS)
8042301	I-Spire Series™ Lumbar Cushion	Black	7.62 x 35.56 x 15.24	0.30	1	17.15 x 35.88 x 7.62	0.43	043859700394	2	20.96 x 17.46 x 37.94	1.14	50043859700399
8042201	I-Spire Series™ Lumbar Cushion	Grey	7.62 x 35.56 x 15.24	0.30	1	17.15 x 35.88 x 7.62	0.43	043859685752	2	20.96 x 17.46 x 37.94	1.14	50043859685757



# Wrist Supports

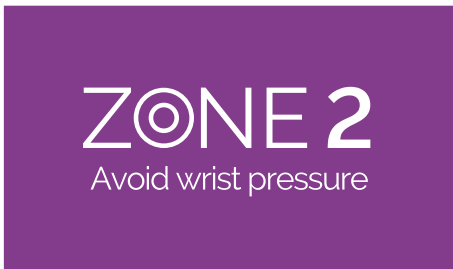

## The Solution

Support your wrists. Keep forearms parallel with the top of your desk and wrist in a fairly neutral position

### 1 Support

To avoid hard contact with the work desk, keeping your wrist in an in-line natural position can help to prevent carpal tunnel syndrome. Available in fabric for a softer rest, or gel for a firmer support while being easier to clean.

### 2 Non-Skid

Ensures that the support/pad does not slip on the work surface.

### 3 Health-V™ Options

Some supports will have the option of Health-V™ Channel that may help protect the wrist further from carpal tunnel syndrome by relieving pressure on the nerves.

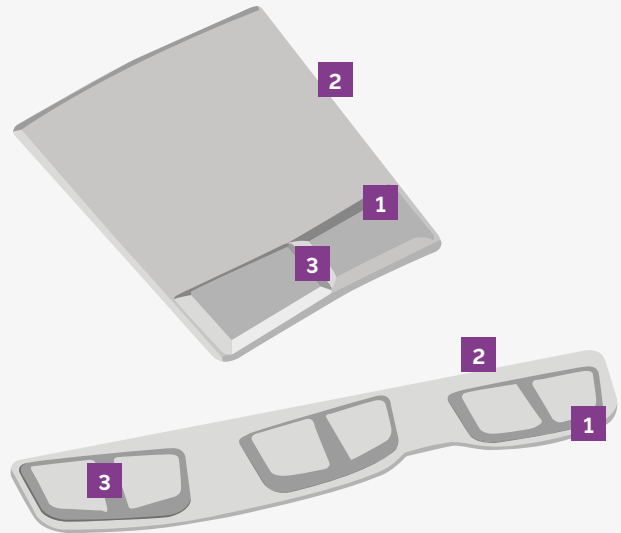

## Hana™ Wrist Supports

- Support wrists to relieve aches and strains when using a mouse or typing
- Ultra-soft feel with real leather surface and memory foam cushion
- Stylish and minimalistic design with stitching detail.
- Non-slip backing keeps mousepad in position
- Available in black or grey



Code	Description	Colour	UNIT			OUTER PACK		
			H x W x D (cm)	Weight (kg)	Qty	H x W x D (cm)	Weight (kg)	Barcode (SCS)
8055501	Hana™ Mousepad Wrist Support	Black	1.95 x 19.00 x 26.00	0.14	1	3.02 x 22.86 x 33.66	0.27	50043859736985
8066501	Hana™ Mousepad Wrist Support	Grey	1.95 x 19.00 x 26.00	0.14	1	3.02 x 22.86 x 33.66	0.27	50043859748520
8055601	Hana™ Keyboard Wrist Support	Black	1.95 x 46.70 x 26.00	0.36	1	29.50 x 2.50 x 50.20	0.68	50043859736992
8065001	Hana™ Keyboard Wrist Support	Grey	1.95 x 46.70 x 26.00	0.36	1	29.50 x 2.50 x 50.20	0.68	50043859748537

## Wrist Supports



### Health-V™ Fabrik Wrist Supports

- Patented Health-V™ channel relieves wrist pressure to help prevent carpal tunnel syndrome
- Built-in Microban® protection fights the growth of harmful bacteria for the lifetime of the product
- Memory foam provides ergonomically correct hand posture for all day comfort
- Palm support glides with the mouse to encourage healthy, natural movement
- Optical friendly mouse pad features superior tracking surface

			UNIT			RETAIL PACK				OUTER PACK			
Code	Description	Colour	H x W x D (cm)	Weight (kg)	Qty	H x W x D (cm)	Weight (kg)	Barcode (UPC)	Qty	H x W x D (cm)	Weight (kg)	Barcode (SCS)	
9181201	Mousepad Wrist Support	Black	2.22 x 20.96 x 25.08	0.24	1	2.70 x 23.02 x 28.89	0.30	043859536351	4	9.53 x 24.29 x 30.16	1.41	50043859536356	
9180301	Gliding Palm Support	Black	1.91 x 22.86 x 27.94	0.15	1	33.02 x 26.04 x 4.13	0.24	043859536269	4	10.32 x 26.35 x 33.34	1.27	50043859536264	
9182801	Keyboard Wrist Support	Black	1.59 x 46.36 x 8.57	0.20	1	53.66 x 11.11 x 2.22	0.26	043859536511	4	12.70 x 11.43 x 55.25	1.13	50043859536516	



### Health-V™ Crystals™ Wrist Supports

- Patented Health-V™ channel relieves wrist pressure to help prevent carpal tunnel syndrome
- Built-in Microban® protection fights the growth of harmful bacteria for the lifetime of the product
- Soothing gel provides comfort and support
- Stain resistant, wipes clean with a damp cloth
- Palm support glides with the mouse to encourage healthy, natural movement
- Optical friendly mouse pad features superior tracking surface

			UNIT			RETAIL PACK				OUTER PACK			
Code	Description	Colour	H x W x D (cm)	Weight (kg)	Qty	H x W x D (cm)	Weight (kg)	Barcode (UPC)	Qty	H x W x D (cm)	Weight (kg)	Barcode (SCS)	
9182301	Mousepad Wrist Support	Black	2.22 x 20.96 x 25.08	0.32	1	28.89 x 22.86 x 2.54	0.37	043859536467	4	6.99 x 24.13 x 29.85	1.64	50043859536462	
9182201	Mousepad Wrist Support	Blue	2.22 x 20.96 x 25.08	0.32	1	28.89 x 22.86 x 2.54	0.37	043859536450	4	6.99 x 24.13 x 29.85	1.64	50043859536455	
9180701	Gliding Palm Support	Black	1.91 x 22.86 x 27.94	0.20	1	33.02 x 26.04 x 4.13	0.29	043859536306	4	13.97 x 27.62 x 34.29	1.49	50043859536301	
9180601	Gliding Palm Support	Blue	1.91 x 22.86 x 27.94	0.20	1	33.02 x 26.04 x 4.13	0.29	043859536290	4	13.97 x 27.62 x 34.29	1.49	50043859536295	
9183201	Keyboard Wrist Support	Black	1.59 x 46.36 x 8.57	0.34	1	53.66 x 11.11 x 2.22	0.39	043859536559	4	9.84 x 11.75 x 54.61	1.72	50043859536554	
9183101	Keyboard Wrist Support	Blue	1.59 x 46.36 x 8.57	0.34	1	53.66 x 11.11 x 2.22	0.39	043859536542	4	9.84 x 11.75 x 54.61	1.72	50043859536547	



# Wrist Supports

## PlushTouch™ Wrist Supports

- The Softest Place Your Wrists Can Rest™!
- Innovative FoamFusion™ Technology provides superior comfort and softness to help relieve wrist pressure
- Built-in Microban® protection fights the growth of harmful bacteria for the lifetime of the product
- Soft, breathable material withstands daily wear and tear
- Non-skid backing keeps wrist support in place
- Optical friendly mouse pad features superior tracking surface



Code	Description	Colour	UNIT			RETAIL PACK			OUTER PACK			
			H x W x D (cm)	Weight (kg)	Qty	H x W x D (cm)	Weight (kg)	Barcode (UPC)	Qty	H x W x D (cm)	Weight (kg)	Barcode (SCS)
9252003	Mousepad Wrist Support	Black	2.54 x 18.42 x 23.81	0.20	1	3.02 x 20.96 x 27.94	0.28	043859718917	4	9.21 x 22.07 x 29.05	1.26	10043859718914
9287302	Mousepad Wrist Support	Blue	2.54 x 18.42 x 23.81	0.20	1	3.02 x 20.96 x 27.94	0.28	043859718931	4	9.21 x 22.07 x 29.05	1.26	10043859718938
9252103	Keyboard Wrist Support	Black	2.54 x 46.04 x 8.10	0.23	1	2.54 x 11.43 x 51.44	0.27	043859718924	4	12.07 x 11.75 x 54.29	1.24	10043859718921
9287402	Keyboard Wrist Support	Blue	2.54 x 46.04 x 8.10	0.23	1	2.54 x 11.43 x 51.44	0.27	043859718948	4	12.07 x 11.75 x 54.29	1.24	10043859718945

## Premium Gel Wrist Supports

- Long lasting polyester covering withstands everyday wear and tear
- Optical friendly mouse pad features superior tracking surface
- Non-skid backing keeps wrist support in place



Angle adjustable with a 10mm forward or negative adjustment, allows for individual customisation and a preferred working position to be adopted

Code	Description	Colour	UNIT			RETAIL PACK			OUTER PACK			
			H x W x D (cm)	Weight (kg)	Qty	H x W x D (cm)	Weight (kg)	Barcode (UPC)	Qty	H x W x D (cm)	Weight (kg)	Barcode (SCS)
9374001	Angle Adjustable Mousepad Wrist Support	Graphite	2.54 x 15.72 x 24.92	0.27	1	2.54 x 16.51 x 26.19	0.32	043859589104	4	11.27 x 18.57 x 31.27	1.42	50043859589109
9374201	Angle Adjustable Keyboard Wrist Support	Graphite	2.54 x 48.90 x 8.89	0.80	1	53.34 x 11.43 x 3.02	0.90	043859589326	4	12.70 x 15.08 x 53.98	3.79	50043859589321
91741	Mousepad Wrist Support	Platinum/Graphite	2.38 x 15.88 x 25.72	0.28	1	28.89 x 17.46 x 3.18	0.41	077511917417	4	7.94 x 16.51 x 26.35	1.38	10077511917414
91737	Keyboard Wrist Support	Graphite	1.59 x 46.99 x 6.99	0.36	1	51.44 x 8.89 x 1.91	0.40	077511917370	4	10.16 x 10.16 x 53.34	1.76	10077511917377

## Wrist Supports



### I-Spire Series™ Wrist Rockers™

- Crisp, clean look coordinates with any home or office décor
- Innovative cylinder design allows for smooth effortless rocking motion for enhanced mousing comfort
- Provides a soft, cool place for your wrists
- Easy to clean
- Optical and laser mouse friendly



### I-Spire Series™

Code	Description	Colour	UNIT			RETAIL PACK			OUTER PACK			
			H x W x D (cm)	Weight (kg)	Qty	H x W x D (cm)	Weight (kg)	Barcode (UPC)	Qty	H x W x D (cm)	Weight (kg)	Barcode (SCS)
9472902	Mousepad Wrist Rocker	Black	2.70 x 19.84 x 25.40	0.15	1	3.18 x 29.53 x 21.91	0.20	043859700332	4	10.00 x 24.77 x 32.07	1.03	10043859700339
9311802	Mousepad Wrist Rocker	Grey	2.70 x 19.84 x 25.40	0.15	1	3.18 x 29.53 x 21.91	0.20	043859665518	4	10.00 x 24.77 x 32.07	1.03	10043859665515
9480201	Keyboard Wrist Rocker	Black	2.22 x 33.02 x 6.35	0.14	1	2.86 x 8.41 x 39.85	0.17	043859700400	4	12.38 x 11.75 x 42.86	0.84	50043859700405
9393201	Keyboard Wrist Rocker	Grey	2.22 x 33.02 x 6.35	0.14	1	2.86 x 8.41 x 39.85	0.17	043859663187	4	12.38 x 11.75 x 42.86	0.84	50043859663182



### Photo Gel Wrist Supports

- Transparent gel adds colour to your workspace with photographic designs
- Gel conforms to your wrist for personalised comfort
- Helps to reduce wrist pressure and fatigue
- Stain resistant
- Non-skid backing keeps wrist support in place
- Optical friendly mouse pad



Code	Description	Colour	UNIT			RETAIL PACK			OUTER PACK			
			H x W x D (cm)	Weight (kg)	Qty	H x W x D (cm)	Weight (kg)	Barcode (UPC)	Qty	H x W x D (cm)	Weight (kg)	Barcode (SCS)
9202601	Mousepad Wrist Support	Tropical Beach	2.00 x 20.00 x 23.30	0.34	1	27.30 x 23.18 x 2.55	0.35	043859601530	4	8.57 x 24.40 x 29.85	1.60	50043859601535
9653401	Mousepad Wrist Support	Chevron	2.00 x 20.00 x 23.30	0.34	1	27.30 x 23.18 x 2.55	0.35	043859740680	4	8.57 x 24.40 x 29.85	1.60	50043859740685
9202701	Keyboard Wrist Support	Tropical Beach	1.59 x 5.87 x 47.15	0.31	1	50.80 x 7.94 x 1.75	0.34	043859601547	4	8.89 x 8.89 x 52.71	1.50	50043859601542
9653601	Keyboard Wrist Support	Chevron	1.59 x 5.87 x 47.15	0.31	1	50.80 x 7.94 x 1.75	0.34	043859740734	4	8.89 x 8.89 x 52.71	1.50	50043859740739





# Wrist Supports

## Crystals™ Gel Wrist Supports

- Stylish, transparent gel adds colour to your workspace
- Soothing gel provides comfort and support
- Stain resistant wipes clean with a damp cloth
- Non-skid backing keeps wrist support in place
- Optical friendly mouse pad



Code	Description	Colour	UNIT			RETAIL PACK			OUTER PACK			
			H x W x D (cm)	Weight (kg)	Qty	H x W x D (cm)	Weight (kg)	Barcode (UPC)	Qty	H x W x D (cm)	Weight (kg)	Barcode (SCS)
9112101	Mousepad Wrist Support	Black	2.00 x 20.00 x 23.30	0.34	1	27.30 x 23.18 x 2.55	0.35	043859527175	4	8.57 x 24.40 x 29.85	1.60	50043859527170
9114120	Mousepad Wrist Support	Blue	2.00 x 20.00 x 23.30	0.34	1	27.30 x 23.18 x 2.55	0.35	077511911415	4	8.57 x 24.40 x 29.85	1.60	50077511911410
9144104	Mousepad Wrist Support	Purple	2.00 x 20.00 x 23.30	0.34	1	27.30 x 23.18 x 2.55	0.35	077511914416	4	8.57 x 24.40 x 29.85	1.60	50077511914411
9112201	Keyboard Wrist Support	Black	1.59 x 5.87 x 47.15	0.31	1	50.80 x 7.94 x 1.75	0.34	043859527182	4	8.89 x 8.89 x 52.71	1.50	50043859527187
9113709	Keyboard Wrist Support	Blue	1.59 x 5.87 x 47.15	0.31	1	50.80 x 7.94 x 1.75	0.34	077511911378	4	8.89 x 8.89 x 52.71	1.50	50077511911373
9143703	Keyboard Wrist Support	Purple	1.59 x 5.87 x 47.15	0.31	1	50.80 x 7.94 x 1.75	0.34	077511914379	4	8.89 x 8.89 x 52.71	1.50	50077511914374
9112301	Flex Rest	Black	1.80 x 12.20 x 8.80	0.18	1	14.80 x 15.00 x 2.40	0.22	043859527199	4	8.20 x 16.60 x 20.00	0.88	50043859527194
91177-72	Flex Rest	Blue	1.80 x 12.20 x 8.80	0.18	1	14.80 x 15.00 x 2.40	0.22	077511911774	4	8.20 x 16.60 x 20.00	0.88	50077511911779
91477-72	Flex Rest	Purple	1.80 x 12.20 x 8.80	0.18	1	14.80 x 15.00 x 2.40	0.22	077511914775	4	8.20 x 16.60 x 20.00	0.88	50077511914770

## Memory Foam Wrist Supports

- Soft foam pillow conforms to your wrist for exceptional comfort, yet never loses its shape
- Retains body heat for improved circulation
- Redistributes pressure points and ensures proper hand position while typing and mousing
- Optical friendly mouse pad features superior tracking surface



Code	Description	Colour	UNIT			RETAIL PACK			OUTER PACK			
			H x W x D (cm)	Weight (kg)	Qty	H x W x D (cm)	Weight (kg)	Barcode (UPC)	Qty	H x W x D (cm)	Weight (kg)	Barcode (SCS)
9175801	Mousepad Wrist Support	Silver Streak	2.50 x 20.00 x 23.34	0.20	1	27.62 x 23.18 x 2.84	0.30	043859497805	4	9.53 x 24.29 x 28.89	1.40	50043859497800
9176501	Mousepad Wrist Support	Black	2.50 x 20.00 x 23.34	0.20	1	27.62 x 23.18 x 2.84	0.30	043859497805	4	9.53 x 24.29 x 28.89	1.40	50043859497800
9172801	Mousepad Wrist Support	Sapphire	2.50 x 20.00 x 23.34	0.20	1	27.62 x 23.18 x 2.84	0.30	043859589074	4	9.53 x 24.29 x 28.89	1.40	50043859589079
9178201	Keyboard Wrist Support	Black	2.38 x 49.05 x 5.87	0.17	1	8.57 x 53.02 x 2.86	0.25	043859503377	4	10.16 x 12.07 x 53.34	1.18	50043859503372
9178401	Keyboard Wrist Support	Sapphire	2.38 x 49.05 x 5.87	0.17	1	8.57 x 53.02 x 2.86	0.25	043859503391	4	10.16 x 12.07 x 53.34	1.18	50043859503396

## Ambidextrous Vertical Mouse



### Penguin® Ambidextrous Vertical Mouse

- Vertical design encourages a more ergonomic position whilst mousing to avoid wrist strain
- BioCote® Anti-bacterial protection keeps your Penguin fresher and cleaner for longer
- Easy-glide symmetrical base with precision laser and scroll wheel aids fast, accurate tracking and document scrolling
- Central bow tie switch allows easy transition between right and left-handed use
- Adjustable dpi settings encourages fast and precise operating movements

### Choosing the Correct Size

Measure your hand from the first crease on your wrist to the tip of your middle finger.

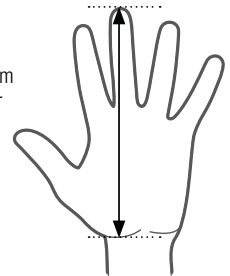

Connectivity	Plug & Play USB 2.0
Compatibility	Linux, Windows 2000, XP, Vista, 7, 8, 10 and versions of these, MAC OS X 10.6 and above
DPI Settings	400, 600, 800 or 1200
Warranty	2 years

Code	Measurement	Size	Type	UNIT			RETAIL PACK			OUTER PACK			
				H x W x D (cm)	Weight (kg)	Qty	H x W x D (cm)	Weight (kg)	Barcode (UPC)	Qty	H x W x D (cm)	Weight (kg)	Barcode (SCS)
9894801	< 16cm	Small	Wired	7.78 x 13.81 x 9.68	0.18	1	9.53 x 17.78 x 11.43	0.32	043859735945	4	12.70 x 25.72 x 36.83	1.54	50043859735940
9894601	16 - 18cm	Medium	Wired	8.57 x 15.72 x 10.95	0.23	1	10.48 x 19.37 x 12.07	0.36	043859735921	4	13.34 x 27.31 x 39.69	1.86	50043859735926
9894401	> 18cm	Large	Wired	9.53 x 17.30 x 12.14	0.27	1	11.43 x 20.96 x 13.65	0.45	043859735907	4	14.29 x 29.85 x 43.50	2.13	50043859735902
9894901	< 16cm	Small	Wireless	7.78 x 13.81 x 9.68	0.18	1	9.53 x 17.78 x 11.43	0.32	043859735952	4	12.70 x 25.72 x 36.83	1.54	50043859735957
9894701	16 - 18cm	Medium	Wireless	8.57 x 15.72 x 10.95	0.23	1	10.48 x 19.37 x 12.07	0.36	043859735938	4	13.34 x 27.31 x 39.69	1.86	50043859735933
9894501	> 18cm	Large	Wireless	9.53 x 17.30 x 12.14	0.27	1	11.43 x 20.96 x 13.65	0.45	043859735914	4	14.29 x 29.85 x 43.50	2.13	50043859735919

# Monitor Arms

## ZONE 3

Relieve neck strain



### The Solution

Achieve comfortable viewing. Ensure your eyes are in line with the top of your screen.



#### Rotation

The degree to which the screen can be fully rotated, to work from either landscape or portrait positions.



#### Pan

The degree to which a screen can pan left or right.

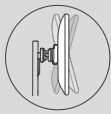

#### Tilt

The degree to which a screen can tilt directly downwards or upwards.

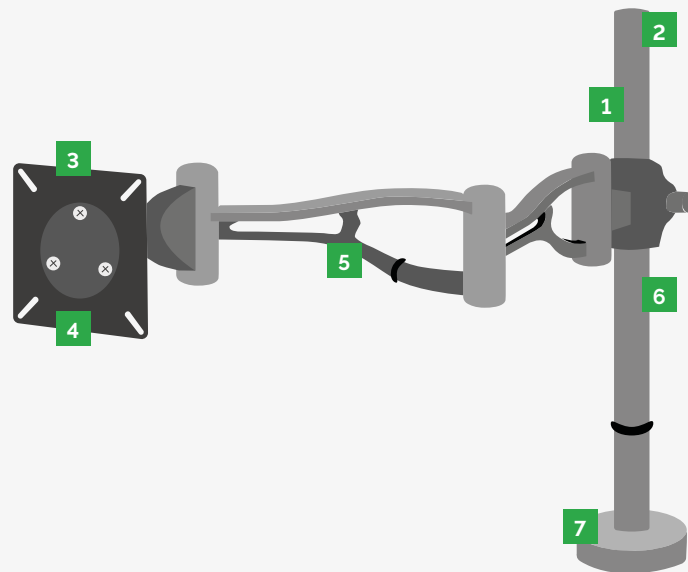

#### 1 Type

Available as Pole or Gas Spring. Pole arms provide height adjustment and an arm that pivots, whereas Gas Spring can provide full motion movement.

#### 2 Maximum Height

Arms have a maximum height they can be raised to, ensuring the monitor is ergonomically positioned.

#### 3 VESA Fitting

Also known as the Mounting Interface Standard (MIS), VESA is a universal standard for mounting flat panel and other visual display equipment. To avoid fixing issues, both the monitor arm and monitor should be VESA compliant.

#### 4 Maximum Screen Size and Load Capacity

A monitor arm can support up to a specific screen size without being detrimental to usability. With dual arms, following this guidance prevents monitors from overlapping.

#### 5 Maximum Reach

The extension of the arm should be set at the correct ergonomic depth for the user to ensure comfortable viewing and avoid eye fatigue.

#### 6 Cable Management

Integrated clips that allow cables to be organised and kept tidy.

#### 7 Desk Fitting

Monitor Arms are either Clamp, Grommet or Free Standing. It's important to consider desk type and fixing method when selecting a model.

## Monitor Arms



### Eppa™ Monitor Arms

- Eppa offers effortless gas spring finger touch adjustment, perfect for hot desking and collaborative working
- Minimalistic and stylish design with built-in cable management to keep you tangle free
- Achieve the perfect position and comfort with 26cm of height adjustability and 53cm of reach
- Desk clamp and grommet mount included for secure and easy attachment options
- Available in black, white and silver



### Eppa™ Dual Monitor Arm Kit

- Available conversion kit easily turns a single arm into a dual arm a flexible solution.

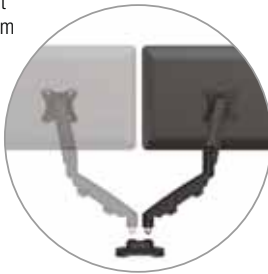

Single Black



Single White



Single Silver



Dual Black



Dual White



Dual Silver

Max Monitor Size	Monitor Weight (per arm)	Rotation	Pan	Tilt	Swivel	Height Adjustability	Maximum Reach	VESA
39" / 99.06cm (left to right)	1 - 8kg	360°	180°	+/-90°	360°	26.6cm 14 - 40.6cm	53.8cm	75 x 75 100 x 100

UNIT						RETAIL PACK				OUTER PACK			
Code	Description	Colour	H x W x D (cm)	Weight (kg)	Qty	H x W x D (cm)	Weight (kg)	Barcode (UPC)	Qty	H x W x D (cm)	Weight (kg)	Barcode (SCS)	
9683101	Eppa™ Single Monitor Arm	Black	48.00 x 11.70 x 56.50	2.99	1	11.11 x 41.91 x 27.94	3.63	043859749300	2	24.00 x 29.50 x 43.50	7.69	50043859749305	
9683201	Eppa™ Single Monitor Arm	White	48.00 x 11.70 x 56.50	2.99	1	11.11 x 41.91 x 27.94	3.63	043859749317	2	24.00 x 29.50 x 43.50	7.69	50043859749312	
9683001	Eppa™ Single Monitor Arm	Silver	48.00 x 11.70 x 56.50	2.99	1	11.11 x 41.91 x 27.94	3.63	043859749294	2	24.00 x 29.50 x 43.50	7.69	50043859749299	
9683401	Eppa™ Dual Monitor Arm	Black	48.00 x 100.00 x 56.50	5.10	1	12.70 x 50.80 x 37.47	6.17	043859749331	2	25.40 x 38.10 x 52.71	13.02	50043859749336	
9683501	Eppa™ Dual Monitor Arm	White	48.00 x 100.00 x 56.50	5.10	1	12.70 x 50.80 x 37.47	6.17	043859749348	2	25.40 x 38.10 x 52.71	13.02	50043859749343	
9683301	Eppa™ Dual Monitor Arm	Silver	48.00 x 100.00 x 56.50	5.10	1	12.70 x 50.80 x 37.47	6.17	043859749324	2	25.40 x 38.10 x 52.71	13.02	50043859749329	
9683601	Eppa™ Dual Monitor Arm Kit	Black	48.00 x 11.70 x 56.50	3.22	1	11.43 x 50.80 x 37.47	4.35	043859749355	2	26.04 x 39.37 x 52.71	13.02	50043859749350	
9683801	Eppa™ Dual Monitor Arm Kit	White	48.00 x 11.70 x 56.50	3.22	1	11.43 x 50.80 x 37.47	4.35	043859749379	2	26.04 x 39.37 x 52.71	13.02	50043859749374	
9683701	Eppa™ Dual Monitor Arm Kit	Silver	48.00 x 11.70 x 56.50	3.22	1	11.43 x 50.80 x 37.47	4.35	043859749362	2	26.04 x 39.37 x 52.71	13.02	50043859749367	



# Monitor Arms

## Platinum Series Monitor Arms

- Fully independent adjustable monitor arms with innovative gas spring technology providing effortless monitor adjustment ideal for collaborative working and screen sharing
- Built in dual USB connectivity makes it easy to connect your favourite devices
- Intuitive cable management system helps minimize clutter
- Easy to mount via clamp or grommet fixing



Gas Spring Technology



Single



Dual



Dual Stacking



Triple

Code	Description	Monitor Size	Monitor Weight (per arm)	Rotation	Pan	Tilt	Swivel	Height Adjustability	Maximum Reach	VESA
8043301	Single	32" (81.28cm)	1.5 - 8kg	360°	180°	+/-45°	360°	28cm 13.5 - 41.5cm	50.5cm	75 x 75 100 x 100
8042501	Dual	32" (81.28cm)	1.5 - 8kg	360°	180°	+/-45°	360°	28cm 13.5 - 41.5cm	50.5cm	75 x 75 100 x 100
8043401	Dual Stacking	32" (81.28cm)	1.5 - 8kg	360°	180°	+/-45°	360°	62cm 9 - 7.1cm	52cm	75 x 75 100 x 100
8042601	Triple	27" (68.5cm)	1.5 - 7kg	360°	180°	+/-45°	360°	42cm 15.5 - 43.5cm Pole - 45.8cm	70.5cm	75 x 75 100 x 100

Code	Description	UNIT			RETAIL PACK			OUTER PACK			
		H x W x D (cm)	Weight (kg)	Qty	H x W x D (cm)	Weight (kg)	Barcode (UPC)	Qty	H x W x D (cm)	Weight (kg)	Barcode (SCS)
8043301	Platinum Series Single Monitor Arm	59.00 x 49.50 x 11.40	2.43	1	11.70 x 41.90 x 28.50	3.52	043859727964	1	14.60 x 43.20 x 30.20	3.96	50043859727969
8042501	Platinum Series Dual Monitor Arm	59.00 x 95.00 x 11.40	4.10	1	13.30 x 40.60 x 31.10	5.30	043859716968	1	15.90 x 41.90 x 33.00	5.90	50043859716963
8043401	Platinum Series Dual Stacking Monitor Arm	88.60 x 102.60 x 11.50	4.80	1	14.90 x 50.50 x 35.90	6.70	043859727971	1	16.50 x 51.70 x 37.80	7.40	50043859727976
8042601	Platinum Series Triple Monitor Arm	92.40 x 127.50 x 14.10	6.00	1	14.90 x 50.50 x 36.20	7.80	043859716975	1	16.80 x 52.10 x 37.50	8.50	50043859716970

## Monitor Arms



### Professional Series Monitor Arms

- Fully adjustable for optimum viewing control
- Intuitive cord management system helps minimize clutter

### Clamp Mount

- Easy to mount to the back of the desk



### Surface Mount

- Surface mount allows dual monitors to be used in spaces that do not allow a clamp or grommet mount
- Low profile base



Freestanding Single



Freestanding Dual

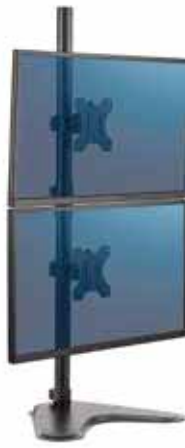

Freestanding Dual Stacking



Dual



Single

Code	Description	Max Monitor Size	Max Monitor Weight (per arm)	Rotation	Pan	Tilt	Height Adjustability	Maximum Reach	VESA
8041601	Professional Series Single Monitor Arm	32" (81.28cm)	10kg	360°	180°	+/- 37°	42cm	69cm	75 x 75 100 x 100
8041701	Professional Series Dual Monitor Arm	26" (66.04cm)	10kg	360°	180°	+/- 37°	42cm	69cm	75 x 75 100 x 100
8049601	Professional Series Freestanding Single Monitor Arm	32" (81.28cm)	8kg	360°	120°	+/-45°	46.5cm	-	75 x 75 100 x 100
8043701	Professional Series Freestanding Dual Monitor Arm	27" (68.5cm)	8kg	360°	120°	+/-30°	46.5cm	-	75 x 75 100 x 100
8044001	Professional Series Freestanding Dual Stacking Monitor Arm	32" (81.28cm)	8kg	360°	120°	+/-45°	90.5cm	-	75 x 75 100 x 100

Code	Description	UNIT			RETAIL PACK				OUTER PACK		
		H x W x D (cm)	Weight (kg)	Qty	H x W x D (cm)	Weight (kg)	Barcode (UPC)	Qty	H x W x D (cm)	Weight (kg)	Barcode (SCS)
8041601	Professional Series Single Monitor Arm	53.34 x 11.11 x 60.96	3.43	1	-	-	043859594214	1	45.30 x 12.00 x 26.00	4.12	50043859594219
8041701	Professional Series Dual Monitor Arm	55.88 x 11.11 x 98.43	4.58	1	-	-	043859629718	1	28.00 x 11.00 x 59.50	5.50	50043859629713
8049601	Professional Series Freestanding Single Monitor Arm	46.50 x 28.00 x 39.00	2.68	1	5.87 x 28.89 x 48.90	2.90	043859748686	1	9.53 x 30.48 x 50.48	3.13	50043859748681
8043701	Professional Series Freestanding Dual Monitor Arm	46.50 x 80.50 x 31.60	4.87	1	9.50 x 46.00 x 33.00	5.55	043859728008	1	11.50 x 47.50 x 34.50	6.09	50043859728003
8044001	Professional Series Freestanding Dual Stacking Monitor Arm	90.17 x 38.89 x 27.94	4.08	1	-	-	043859728060	1	7.46 x 28.80 x 48.90	4.76	50043859728065

# Monitor Arms

## Professional Series

### Laptop Arm Accessory

- Fully angle adjustable laptop platform covered in a soft foam rubber
- Holds up to a 17" / 43.18cm laptop
- Adjustable brackets that secure a laptop with a thickness of 14mm to 29mm and width from 258mm to 375mm
- Includes monitor jack plate to enable monitor height adjustability when using dual arm system
- Ergonomic handle for repositioning the platform
- Cable management system minimises clutter
- Cooling vents to avoid your laptop overheating
- Only compatible with the Professional Series Monitor Arms range
- VESA compliant 75 x 75 / 100 x 100



\*Monitor arm not included

Code	Description	UNIT				OUTER PACK			
		H x W x D (cm)	Weight (kg)	Barcode (UPC)	Qty	H x W x D (cm)	Weight (kg)	Barcode (SCS)	
8211901	Professional Series Laptop Arm Accessory	8.50 x 33.00 x 32.00	2.30	043859706464	4	33.00 x 35.50 x 39.00	10.88	50043859706469	

## Reflex Monitor Arms

- Maximise desk space and elevate your monitor to reduce eye, neck and shoulder strain
- Fully height and depth adjustable for optimum viewing control and a cost-effective ergonomic solution
- Simple design with built-in cable management to keep you tangle free



Code	Description	Max Monitor Size	Max Monitor Weight (per arm)	Rotation	Pan	Tilt	Swivel	Height Adjustability	Maximum Reach	VESA
8502501	Reflex Single Monitor Arm	32" (81.28cm)	8kg	360°	180°	+/-45°	180°	45cm	42.2cm	75 x 75 100 x 100
8502601	Reflex Dual Monitor Arm	27" (68.5cm)	8kg	360°	180°	+/-45°	180°	45cm	38.7cm	75 x 75 100 x 100

Code	Description	UNIT				RETAIL PACK				OUTER PACK			
		H x W x D (cm)	Weight (kg)	Qty	H x W x D (cm)	Weight (kg)	Barcode (UPC)	Qty	H x W x D (cm)	Weight (kg)	Barcode (SCS)		
8502501	Reflex Single Monitor Arm	55.00 x 11.60 x 49.00	3.03	1	11.43 x 16.51 x 47.31	3.76	043859748471	1	13.97 x 18.42 x 48.58	3.99	50043859748476		
8502601	Reflex Dual Monitor Arm	55.00 x 11.60 x 72.60	4.13	1	15.56 x 12.38 x 47.31	4.93	043859748488	1	14.61 x 18.42 x 48.90	5.17	50043859748483		





## Monitor Arms



### Smart Suites™ Monitor Arm

- Elevates flat panel monitors to optimal viewing height
- 5 fixed height positions offering up to 10cm of adjustment
- Easy to mount 2 piece clamp

Max Monitor Size	Max Monitor Weight	Rotation	Pan	Tilt	Height Adjustability	Maximum Reach	VESA
21" (53.30cm)	9kg	360°	120°	+/- 45°	11.4cm	36.8cm	75 x 75 100 x 100

		UNIT			RETAIL PACK			OUTER PACK			
Code	Description	H x W x D (cm)	Weight (kg)	Qty	H x W x D (cm)	Weight (kg)	Barcode (UPC)	Qty	H x W x D (cm)	Weight (kg)	Barcode (SCS)
8038201	Smart Suites™ Monitor Arm	60.96 x 12.07 x 36.83	2.00	1	8.26 x 46.99 x 17.46	2.38	043859528059	2	19.69 x 19.37 x 48.58	4.99	50043859528054



### Laptop Arm Accessory

- Provides adjustability to lift laptop up, or use a monitor and laptop on a dual monitor arm
- Holds up to a 17" / 43.18cm laptop up to 4.5kg
- Provides effortless laptop adjustment
- Features cooling vents
- Compatible with all monitor arms
- VESA compliant 75 x 75 / 100 x 100

\*Monitor arm not included

		UNIT				OUTER PACK		
Code	Description	H x W x D (cm)	Weight (kg)	Barcode (UPC)	Qty	H x W x D (cm)	Weight (kg)	Barcode (SCS)
8044101	Laptop Arm Accessory	27.94 x 44.29 x 6.51	1.18	043859728015	1	6.83 x 30.16 x 33.34	1.59	50043859728010





# Monitor Arms



### Single Arm Wall Mount

- Fully independent adjustable monitor arm with innovative gas spring technology allows for effortless monitor adjustment
- Intuitive cable management system helps minimise clutter
- Mounts to wall and easily tucks into tight places



Max Monitor Size	Monitor Weight	Rotation	Pan	Tilt	Swivel	Height Adjustability	Maximum Reach	VESA
20 - 42" (50.8 - 106.68cm)	5 - 30kgs	+/-3°	-/+ 90°	+5/- 15°	180°	28.2cm	56.3cm	75 x 75 / 100 x 100 / 200 x 200 / 200 x 100

		UNIT				OUTER PACK			
Code	Description	H x W x D (cm)	Weight (kg)	Barcode (UPC)	Qty	H x W x D (cm)	Weight (kg)	Barcode (SCS)	
8043501	Single Arm Wall Mount	47.78 x 22.54 x 51.44	3.54	043859727988	1	7.46 x 36.51 x 50.48	4.31	50043859727983	

### Full Motion TV Wall Mount

- LCD/LED/TV wall mount allows for tilt, swivel and levelling adjustment
- Detachable design allows for quick removal
- Intuitive cord management system helps minimise clutter



Max Monitor Size	Max Monitor Weight	Rotation	Pan	Tilt	Swivel	Height Adjustability	Maximum Reach	VESA
23 - 55" (58.42-139.7cm)	34.9kg	-/+ 5°	-/+ 90°	+2°/-12°	180°	-	49.5cm	100, x 100 / 100 x 150 / 200 x 100 / 200 x 200 / 300 x 300 / 300 x 200 / 400 x 400 / 400 x 300 / 400 x 200

		UNIT				OUTER PACK			
Code	Description	H x W x D (cm)	Weight (kg)	Barcode (UPC)	Qty	H x W x D (cm)	Weight (kg)	Barcode (SCS)	
8043601	Full Motion TV Wall Mount	45.40 x 41.28 x 50.17	2.72	043859727995	1	6.67 x 33.02 x 39.05	3.18	50043859727990	

## Monitor Supports

### 1 Height Adjustable

Height adjustable risers allow the user to optimise their viewing position.

### 2 Maximum Weight

All risers will have a maximum weight which they can support.

### 3 Cable Management

To help keep desks tidy and clutter free, specific risers may have built in cable management.

### 4 Storage Shelf/Tray

An additional feature on some models, helping the user organise their desktop accessories or workload.

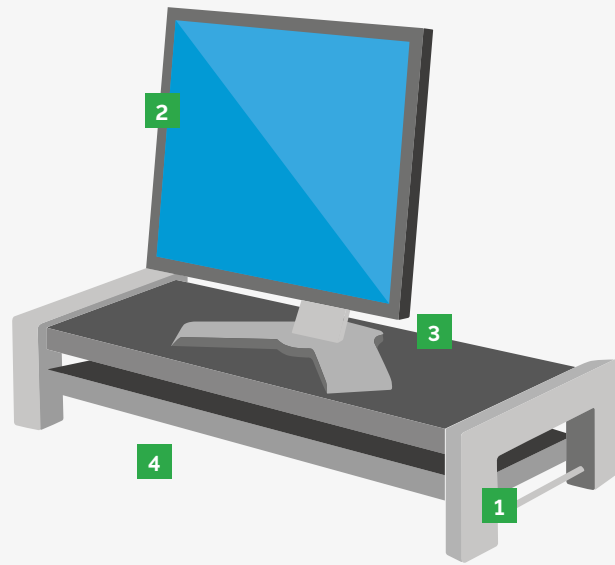

### Hana™ Monitor Support

- Maximise desk space and elevate your monitor to a comfortable viewing height to reduce eye, neck and shoulder strain
- 3 different settings to achieve your perfect viewing height
- Easily accessible fast charging dual USB ports to keep devices powered
- Rear facing dual USB data ports to easily connect your mouse and keyboard
- Stylish metal base with real wood finish, available in black or white
- Approximate specifications:
  - Max monitor weight: 18kg
  - Height adjustments: 10.2 / 12.7 / 15.3cm

Code	Description	Colour	UNIT			OUTER PACK			Barcode (SCS)
			H x W x D (cm)	Weight (kg)	Qty	H x W x D (cm)	Weight (kg)		
8060501	Hana™ Monitor Support	Black	10.20 x 56.00 x 22.20	2.17	1	17.50 x 30.00 x 63.20	3.40	50043859751445	
8064201	Hana™ Monitor Support	White	10.20 x 56.00 x 22.20	2.17	1	17.50 x 30.00 x 63.20	3.40	50043859751452	



# Monitor Supports

## Professional Series Flat Panel Workstation

- 3 height adjustments to maximise viewing comfort
- Laptop Slick-Slide™ allows easy access / storage of both laptop and or docking station under top shelf
- Customisable top shelf allows mini sorter, accessory tray and platform to be moved around
- Integrated cable management and power strip mount organise desk space
- Approximate specifications:
  - Max monitor weight: 18kg
  - Height adjustments: 7 / 9.5 / 12cm



		UNIT			RETAIL PACK			OUTER PACK			
Code	Description	H x W x D (cm)	Weight (kg)	Qty	H x W x D (cm)	Weight (kg)	Barcode (UPC)	Qty	H x W x D (cm)	Weight (kg)	Barcode (SCS)
8037401	Professional Series Flat Panel Workstation	23.50 x 65.72 x 29.21	2.65	1	14.92 x 65.72 x 34.93	3.71	043859514380	2	30.48 x 35.56 x 66.99	7.65	50043859514385

## Office Suites™ Premium Monitor Riser

- Adjustable feet provide 5 height positions to customise to your perfect height
- Stows laptop or keyboard underneath for in-office use and to save space
- Features a convenient cup holder and media storage compartment for up to 8 CD cases
- Approximate specifications:
  - Max monitor weight: 36kg
  - Height adjustments: 10.7 / 12 / 13.3 / 14.6 / 15.9cm



		UNIT			RETAIL PACK			OUTER PACK			
Code	Description	H x W x D (cm)	Weight (kg)	Qty	H x W x D (cm)	Weight (kg)	Barcode (UPC)	Qty	H x W x D (cm)	Weight (kg)	Barcode (SCS)
8031001	Office Suites™ Premium Monitor Riser	10.64 x 68.58 x 35.72	2.54	1	36.83 x 70.33 x 11.75	2.77	043859470969	2	38.10 x 25.40 x 69.55	7.71	50043859470964

## Office Suites™ Standard Monitor Support

- Adjustable feet provide 5 height adjustments to maximise viewing comfort
- Stows laptop underneath for in-office use and to save space
- Storage tray organises business essentials
- Approximate specifications:
  - Max monitor weight: 36kg
  - Height adjustments: 10.7 / 12 / 13.3 / 14.6 / 15.9cm



		UNIT			RETAIL PACK			OUTER PACK			
Code	Description	H x W x D (cm)	Weight (kg)	Qty	H x W x D (cm)	Weight (kg)	Barcode (UPC)	Qty	H x W x D (cm)	Weight (kg)	Barcode (SCS)
8031101	Office Suites™ Standard Monitor Support	10.64 x 50.48 x 35.72	2.13	1	36.83 x 52.07 x 11.43	2.63	043859470976	2	25.10 x 38.74 x 53.67	5.78	50043859470971

## Monitor Supports



### Premium Monitor Riser Plus

- 5 stacking height adjustments maximise viewing comfort
- Includes 5.1cm storage drawer and built-in copyholder
- Cable management to keep your workspace clutter free
- Approximate specifications:
  - Max monitor weight: 36kg
  - Height adjustments: 6.5 / 8.5 / 11.5 / 13.5 / 16.5cm



Code	Description	Colour	UNIT			RETAIL PACK			OUTER PACK			
			H x W x D (cm)	Weight (kg)	Qty	H x W x D (cm)	Weight (kg)	Barcode (UPC)	Qty	H x W x D (cm)	Weight (kg)	Barcode (SCS)
9169501	Premium Monitor Riser Plus	Graphite	18.41 x 33.33 x 33.65	1.98	1	33.97 x 34.60 x 11.74	2.29	043859529759	2	35.87 x 25.08 x 35.87	4.99	50043859529754
91713	Premium Monitor Riser Plus	Platinum	18.41 x 33.33 x 33.65	1.98	1	33.97 x 34.60 x 11.74	2.29	077511917134	2	35.87 x 25.08 x 35.87	4.99	50077511862811



### Clarity™ Adjustable Monitor Riser with Document Support

- Maximise desk space and elevate your monitor to a comfortable viewing height to reduce eye, neck and shoulder strain
- Foldaway document support to promote in-line, ergonomic positioning when working with paper
- Minimalistic design and premium quality clear acrylic seamlessly blend into any office environment
- Approximate specifications:
  - Max monitor weight: 15kg
  - Height adjustments: 10 / 11.5 / 13 / 14.5 / 16cm

Code	Description	UNIT			RETAIL PACK			OUTER PACK			
		H x W x D (cm)	Weight (kg)	Qty	H x W x D (cm)	Weight (kg)	Barcode (UPC)	Qty	H x W x D (cm)	Weight (kg)	Barcode (SCS)
9731201	Clarity™ Adjustable Monitor Riser with Document Support	10.50 x 30.20 x 26.70	1.35	1	11.63 x 37.59 x 29.59	1.79	043859752713	2	25.48 x 31.50 x 38.99	4.01	50043859752718



### Smart Suites™ Monitor Riser Plus

- 3 height adjustments to maximise viewing comfort
- Includes a letter tray and 2 accessory pods for additional storage space
- Stows laptop or documents below top surface to keep desk clutter free
- Approximate specifications:
  - Max monitor weight: 10kg
  - Height adjustments: 10 / 11.5 / 13cm

Code	Description	UNIT			RETAIL PACK			OUTER PACK			
		H x W x D (cm)	Weight (kg)	Qty	H x W x D (cm)	Weight (kg)	Barcode (UPC)	Qty	H x W x D (cm)	Weight (kg)	Barcode (SCS)
8020801	Office Suites™ Monitor Support Plus	10.16 x 47.78 x 32.86	0.88	1	33.34 x 48.26 x 10.64	1.52	043859552665	2	23.65 x 35.40 x 50.01	3.72	50043859552660



# Monitor Supports

## Clarity™ Adjustable Monitor Riser

- Maximise desk space and elevate your monitor to a comfortable viewing height to reduce eye, neck and shoulder strain
- Minimalistic design and premium quality clear acrylic seamlessly blend into any office environment
- Approximate specifications:
  - Max monitor weight: 10kg
  - Height adjustments: 7 / 8.5 / 10 / 11.5 / 13cm



		UNIT			RETAIL PACK			OUTER PACK			
Code	Description	H x W x D (cm)	Weight (kg)	Qty	H x W x D (cm)	Weight (kg)	Barcode (UPC)	Qty	H x W x D (cm)	Weight (kg)	Barcode (SCS)
9731101	Clarity™ Adjustable Monitor Riser	10.48 x 32.00 x 25.60	1.00	1	11.60 x 37.59 x 29.59	1.45	043859752706	2	25.48 x 31.50 x 38.99	3.36	50043859752701

## Premium Monitor Riser

- 5 stacking height adjustments maximise viewing comfort
- Durable plastic base doubles as paper storage shelf
- Cable management to keep your workspace clutter free
- Approximate specifications:
  - Max monitor weight: 36kg
  - Height adjustments: 6.5 / 8.5 / 11.5 / 13.5 / 16.5cm



		UNIT			RETAIL PACK			OUTER PACK				
Code	Description	Colour	H x W x D (cm)	Weight (kg)	Qty	H x W x D (cm)	Weight (kg)	Barcode (UPC)	Qty	H x W x D (cm)	Weight (kg)	Barcode (SCS)
9169401	Premium Monitor Riser	Graphite	16.82 x 33.65 x 34.29	1.27	1	34.60 x 41.59 x 6.66	1.55	043859529742	2	36.04 x 14.45 x 34.77	3.43	50043859529747
91717	Premium Monitor Riser	Platinum	16.82 x 33.65 x 34.29	1.27	1	34.60 x 41.59 x 6.66	1.55	077511917172	2	36.04 x 14.45 x 34.77	3.43	50077511862828

## Rotating Monitor Riser

- Unique height adjustability with 3 fixed height positions
- Minimal desk space, maximum comfort
- Platform rotates 45° to assist shared viewing
- Includes storage tray for paper supplies
- Approximate specifications:
  - Max monitor weight: 14kg
  - Height adjustments: 9 / 10.5 / 12cm

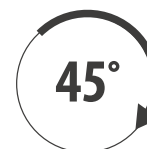

		UNIT			RETAIL PACK			OUTER PACK			
Code	Description	H x W x D (cm)	Weight (kg)	Qty	H x W x D (cm)	Weight (kg)	Barcode (UPC)	Qty	H x W x D (cm)	Weight (kg)	Barcode (SCS)
91450	Rotating Monitor Riser	12.07 x 42.55 x 28.89	1.11	1	29.83 x 43.50 x 9.53	1.47	077511914508	2	20.96 x 31.12 x 45.72	3.04	50077511914503

## Monitor Supports



### Designer Suites™ Monitor Support

- Relieve neck strain with the Designer Suites™ Monitor Riser
- 3 height settings to choose from to raise your monitor to the perfect height
- Modern, stylish design for modern wide screen monitors
- Built in storage tray to help organise your business essentials
- Approximate specifications:
  - Max monitor weight: 18kg
  - Height adjustments: 11 / 13 / 15cm

		UNIT			RETAIL PACK				OUTER PACK		
Code	Description	H x W x D (cm)	Weight (kg)	Qty	H x W x D (cm)	Weight (kg)	Barcode (UPC)	Qty	H x W x D (cm)	Weight (kg)	Barcode (SCS)
8038101	Designer Suites™ Monitor Support	11.11 x 40.64 x 23.81	1.06	1	11.75 x 41.91 x 24.45	1.29	043859528042	2	25.40 x 26.04 x 43.18	3.10	50043859528047



### Clarity™ Monitor Riser

- Raise your monitor to a comfortable viewing height and relieve neck and eye strain
- Minimalistic design and premium quality clear acrylic seamlessly blend into any office environment
- Easily store your keyboard when not in use to maximise desk space
- Approximate specifications:
  - Max monitor weight: 6.5kg
  - Height adjustments: 11cm

		UNIT			RETAIL PACK				OUTER PACK		
Code	Description	H x W x D (cm)	Weight (kg)	Qty	H x W x D (cm)	Weight (kg)	Barcode (UPC)	Qty	H x W x D (cm)	Weight (kg)	Barcode (SCS)
9731001	Clarity™ Monitor Riser	10.69 x 26.99 x 25.40	0.60	1	11.61 x 32.00 x 26.59	0.95	043859752690	2	25.48 x 28.50 x 33.50	2.27	50043859752695



### Smart Suites™ Monitor Riser

- 3 height adjustments to maximise viewing comfort
- Unique shape fits neatly in desk corner to maximise workspace
- Approximate specifications:
  - Max monitor weight: 10kg
  - Height adjustments: 10 / 11.5 / 13cm

		UNIT			RETAIL PACK				OUTER PACK		
Code	Description	H x W x D (cm)	Weight (kg)	Qty	H x W x D (cm)	Weight (kg)	Barcode (UPC)	Qty	H x W x D (cm)	Weight (kg)	Barcode (SCS)
8020101	Smart Suites™ Monitor Riser	13.02 x 46.99 x 31.75	0.71	1	47.94 x 32.70 x 10.48	1.06	043859541386	2	22.86 x 35.24 x 50.48	2.77	50043859541381

# Monitor Supports

## Standard Monitor Riser

- 3 stacking height adjustments to maximise viewing comfort
- Non-skid foot rings ensure stability on any surface
- Cable management to keep your workspace clutter free
- Approximate specifications:
  - Max monitor weight: 27kg
  - Height adjustments: 5 / 7 / 10cm



UNIT			RETAIL PACK				OUTER PACK					
Code	Description	Colour	H x W x D (cm)	Weight (kg)	Qty	H x W x D (cm)	Weight (kg)	Barcode (UPC)	Qty	H x W x D (cm)	Weight (kg)	Barcode (SCS)
9169301	Standard Monitor Riser	Graphite	10.16 x 33.33 x 34.29	0.79	1	34.92 x 34.60 x 6.98	1.05	043859529735	4	34.93 x 20.16 x 35.72	3.33	50043859529730
91712	Standard Monitor Riser	Platinum	10.16 x 33.33 x 34.29	0.79	1	34.92 x 34.60 x 6.98	1.05	077511917127	4	34.93 x 20.16 x 35.72	3.33	50077511917122

## Basic Monitor Riser

- 3 height adjustments to maximise viewing comfort
- Lower shelf provides storage for paper and small supplies
- Efficiently organises monitor and power cables
- Approximate specifications:
  - Max monitor weight: 36kg
  - Height adjustments: 7.6 / 9.9 / 11.4cm



UNIT			RETAIL PACK				OUTER PACK					
Code	Description	Colour	H x W x D (cm)	Weight (kg)	Qty	H x W x D (cm)	Weight (kg)	Barcode (UPC)	Qty	H x W x D (cm)	Weight (kg)	Barcode (SCS)
91456	Basic Monitor Riser	White	11.43 x 38.10 x 41.91	1.32	1	38.74 x 41.91 x 8.41	1.71	077511914560	2	20.32 x 41.91 x 43.18	4.15	50077511914565

## I-Spire Series™ Monitor Lift

- Supports monitors up to 5.5kg in weight
- Contemporary and stylish design to suit any office or home decor
- Design coordinates with other items in the I-Spire Series™
- No assembly required
- Approximate specifications:
  - Max monitor weight: 5.5kg
  - Height adjustments: 8.5cm



## I-Spire Series™

UNIT			RETAIL PACK				OUTER PACK					
Code	Description	Colour	H x W x D (cm)	Weight (kg)	Qty	H x W x D (cm)	Weight (kg)	Barcode (UPC)	Qty	H x W x D (cm)	Weight (kg)	Barcode (SCS)
9472302	I-Spire Series™ Monitor Lift	Black	12.38 x 50.64 x 22.70	0.66	1	13.18 x 22.70 x 51.91	1.05	043859700295	2	28.26 x 24.77 x 53.98	2.51	10043859700292
9311102	I-Spire Series™ Monitor Lift	White	12.38 x 50.64 x 22.70	0.66	1	13.18 x 22.70 x 51.91	1.05	043859665242	2	28.26 x 24.77 x 53.98	2.51	10043859665249

## Laptop Supports

### 1 Adjustable Angles

Allow the support to be ergonomically positioned for optimal viewing, ideally this should be eye level with the top of the screen.

### 2 Supporting Ledge

A feature at the front of some laptop supports that provide additional stability.

### 3 Foldable

Frequent traveller? As more of us work on the go, a foldable support allows for a mobile ergonomic set up.

### 4 Circulation

Some models are designed to ensure there is sufficient air flow to the base of the laptop, preventing overheating.

**Top Tip**  
Always use a separate keyboard and mouse when using a laptop support.

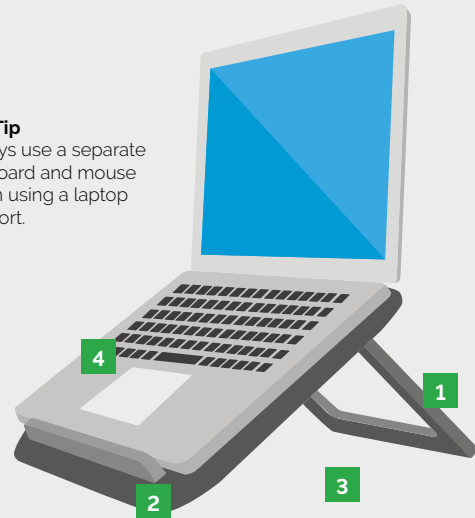

### Hana™ Laptop Riser

- Elevate your laptop to a comfortable viewing position to reduce eye, neck and shoulder strain
- Effortless finger touch height adjustment with gas spring arm
- Easily collaborate with colleagues with flexible movement
- Easily accessible fast charging dual USB ports to keep devices powered
- Rear facing dual USB data ports to easily connect devices such as mouse and keyboard
- Keep tangle free with built-in cable management
- Stylish metal base with real wood finish, available in black or white
- Approximate specifications:
  - Max laptop size: 19" / 48.26cm
  - Max laptop weight: 4.5kg
  - Height adjustments: 10.2 - 40.6cm

Code	Description	Colour	UNIT			OUTER PACK			Barcode (SCS)
			H x W x D (cm)	Weight (kg)	Qty	H x W x D (cm)	Weight (kg)		
8064301	Hana™ Laptop Riser	Black	10.20 x 34.20 x 39.60	2.90	1	47.00 x 17.20 x 39.40	4.20	50043859751469	
8064401	Hana™ Laptop Riser	White	10.20 x 34.20 x 39.60	2.90	1	47.00 x 17.20 x 39.40	4.20	50043859751476	





# Laptop Supports

## Professional Series Laptop Workstation

- 9 height adjustments allow for customisation to the correct eye level to avoid neck strain
- Integrated USB 2.0 hub (4) making it easy to stay connected to your favourite devices
- In-line document holder enables vertical or horizontal orientation
- Air vents to aid laptop cooling
- Rubber strips and padded feet for extra protection for your desk and laptop
- Cable management system minimises clutter
- Approximate specifications:
  - Max laptop size: 17" / 43.18cm
  - Max laptop weight: 6.8kg
  - Height adjustments: 4.1 - 25.8cm
  - Angle range: up to 65°



		UNIT			RETAIL PACK			OUTER PACK			
Code	Description	H x W x D (cm)	Weight (kg)	Qty	H x W x D (cm)	Weight (kg)	Barcode (UPC)	Qty	H x W x D (cm)	Weight (kg)	Barcode (SCS)
8024602	Professional Series Laptop Workstation	76.20 x 30.80 x 33.80	3.18	1	79.40 x 31.10 x 34.10	3.49	043859611164	2	14.00 x 36.00 x 41.50	5.60	50043859611169

## Smart Suites™ Multimedia Workstation

- 5 angle height and angle adjustments to raise laptop screen to optimal viewing level
- In-line, fully adjustable clip holds multimedia device vertically or horizontally in place reducing neck and eye strain
- Convenient front access 4 port 2.0 USB hub
- Document storage tray with pen holder
- Approximate specifications:
  - Max laptop size: 17" / 43.18cm
  - Max laptop weight: 6.8kg
  - Height adjustments: 11.4 - 27cm
  - Angle range: up to 45°



		UNIT			RETAIL PACK			OUTER PACK			
Code	Description	H x W x D (cm)	Weight (kg)	Qty	H x W x D (cm)	Weight (kg)	Barcode (UPC)	Qty	H x W x D (cm)	Weight (kg)	Barcode (SCS)
8024801	Smart Suites™ Multimedia Workstation	14.40 x 28.80 x 35.20	0.82	1	35.60 x 29.40 x 11.40	1.14	043859661275	2	23.00 x 31.40 x 37.40	2.72	50043859661270

## Smart Suites™ Laptop Riser

- 3 angle height and angle adjustments to raise laptop screen to optimal viewing level
- Integrated USB 2.0 hub quad (4) at the rear making it easy to stay connected to your favorite devices
- Large accessory tray to hold personal electronics and other items
- Air vents to aid laptop cooling
- Approximate specifications:
  - Max laptop size: 17" / 43.18cm
  - Max laptop weight: 6.8kg
  - Height adjustments: 7 / 8.5 / 10cm



		UNIT			RETAIL PACK			OUTER PACK			
Code	Description	H x W x D (cm)	Weight (kg)	Qty	H x W x D (cm)	Weight (kg)	Barcode (UPC)	Qty	H x W x D (cm)	Weight (kg)	Barcode (SCS)
8020201	Smart Suites™ Laptop Riser	19.05 x 33.34 x 26.99	0.79	1	27.62 x 34.29 x 18.42	1.20	043859541393	2	28.73 x 35.72 x 39.21	3.00	50043859541398

## Laptop Supports



### Office Suites™ Laptop Riser Plus

- 6 angle height and angle adjustments to raise laptop screen to optimal viewing level
- In-line copyholder places work at a comfortable viewing position
- Swivel feet for easy cable access
- Air vents to aid laptop cooling
- Approximate specifications:
  - Max laptop size: 17" / 43.18cm
  - Max laptop weight: 5kg
  - Height adjustments: 11.5 - 17.5cm
  - Angle range: 14 - 27.5°

Code	Description	UNIT			RETAIL PACK			OUTER PACK			
		H x W x D (cm)	Weight (kg)	Qty	H x W x D (cm)	Weight (kg)	Barcode (UPC)	Qty	H x W x D (cm)	Weight (kg)	Barcode (SCS)
8036701	Office Suites™ Laptop Riser Plus	16.51 x 38.26 x 26.67	0.73	1	29.54 x 38.74 x 13.34	0.95	043859504602	2	31.75 x 27.94 x 40.64	2.83	50043859504607



### Clarity™ Laptop Riser

- Reduce neck and eye strain by raising your laptop screen to a more comfortable viewing height
- Minimalistic design and premium quality clear acrylic seamlessly blend into any office environment
- Cut-outs air vents promote laptop airflow and prevent overheating
- To be used with additional keyboard and mouse
- Approximate specifications:
  - Max laptop size: 15" / 38.1cm
  - Max laptop weight: 6kg
  - Height adjustments: 13.4 / 14.8 / 16.2 / 17.6 / 19 / 20.4cm
  - Angle range: 24 - 47°

Code	Description	UNIT			RETAIL PACK			OUTER PACK			
		H x W x D (cm)	Weight (kg)	Qty	H x W x D (cm)	Weight (kg)	Barcode (UPC)	Qty	H x W x D (cm)	Weight (kg)	Barcode (SCS)
9731401	Clarity™ Laptop Riser	13.40 x 35.00 x 26.99	0.73	1	11.71 x 39.50 x 29.69	1.10	043859752737	2	25.48 x 31.50 x 41.00	2.65	50043859752732



### Designer Suites™ Laptop Riser

- 4 angle height adjustments to raise laptop screen to optimal viewing level
- Stabilising front edge prevents laptop from sliding off the unit
- Cooling vents help dissipate laptop heat
- Provides space for USB hub and easy cable management
- Sliding feet let you move and access unit as needed without damaging surfaces
- Approximate specifications:
  - Max laptop size: 17" / 43.18cm
  - Max laptop weight: 11.3kg
  - Height adjustments: 8.8 - 18.4cm
  - Angle range: up to 30°

Code	Description	UNIT			RETAIL PACK			OUTER PACK			
		H x W x D (cm)	Weight (kg)	Qty	H x W x D (cm)	Weight (kg)	Barcode (UPC)	Qty	H x W x D (cm)	Weight (kg)	Barcode (SCS)
8038401	Designer Suites™ Laptop Riser	10.16 x 33.50 x 28.42	0.89	1	10.16 x 34.29 x 28.89	1.12	043859528066	2	22.86 x 30.48 x 35.56	2.67	50043859528061

# Laptop Supports



### Office Suites™ Laptop Riser

- 6 angle height adjustments to raise laptop screen to optimal viewing level
- Stabilising front edge prevents laptop from sliding off stand
- Adjustable tilt for optimal viewing angle
- Non-skid rubber feet protect work surfaces from scratches
- Approximate specifications:
  - Max laptop size: 17" / 43.18cm
  - Max laptop weight: 5kg
  - Height adjustments: 11.2 - 17.2cm
  - Angle range: 14 - 27.5°



Code	Description	UNIT			RETAIL PACK				OUTER PACK		
		H x W x D (cm)	Weight (kg)	Qty	H x W x D (cm)	Weight (kg)	Barcode (UPC)	Qty	H x W x D (cm)	Weight (kg)	Barcode (SCS)
8032001	Office Suites™ Laptop Riser	16.51 x 38.26 x 26.67	0.73	1	29.53 x 38.74 x 13.34	0.95	043859470952	2	31.75 x 28.57 x 40.01	2.74	50043859470957

### I-Spire Series™ Laptop Quick Lift

- Simple adjustment to 7 angles
- Suit laptops with a limited angle of opening
- Soft touch front ledge holds the laptop in place
- Portable - folds flat to travel
- Recommended usage with an external keyboard and mouse
- Increases air circulation to keep your laptop cool
- Approximate specifications:
  - Max laptop size: 17" / 43.18cm
  - Max laptop weight: 4kg
  - Height adjustments: 3 - 20.5cm
  - Angle range: 110°



### I-Spire Series™

Code	Description	Colour	UNIT			RETAIL PACK				OUTER PACK		
			H x W x D (cm)	Weight (kg)	Qty	H x W x D (cm)	Weight (kg)	Barcode (UPC)	Qty	H x W x D (cm)	Weight (kg)	Barcode (SCS)
8212001	I-Spire Series™ Laptop Quick Lift	Black	4.20 x 32.00 x 28.60	0.80	1	4.60 x 33.00 x 29.00	1.08	043859706792	2	9.50 x 30.00 x 34.00	2.50	50043859706797
8210101	I-Spire Series™ Laptop Quick Lift	White	4.20 x 32.00 x 28.60	0.80	1	4.60 x 33.00 x 29.00	1.08	043859706402	2	9.50 x 30.00 x 34.00	2.50	50043859706407

## Laptop Supports

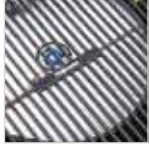

### Maxi Cool Laptop Riser

- Ultra quiet high powered USB cooling fan keeps laptop cool
- 7.5cm incline provides comfortable working position
- Non-slip pads hold laptop securely
- Durable lightweight construction
- Approximate specifications:
  - Max laptop size: 17" / 43.18cm
  - Max laptop weight: 6kg

Code	Description	UNIT			RETAIL PACK			OUTER PACK			
		H x W x D (cm)	Weight (kg)	Qty	H x W x D (cm)	Weight (kg)	Barcode (UPC)	Qty	H x W x D (cm)	Weight (kg)	Barcode (SCS)
8018901	Maxi Cool Laptop Riser	32.00 x 31.50 x 6.70	0.75	1	32.00 x 31.50 x 6.70	0.75	043859613069	6	32.00 x 31.50 x 40.20	4.50	50043859613064



### I-Spire Series™ Laptop Lift

- Raises your laptop screen to eye level relieving stress to the shoulders and neck
- Built-in curvature design prevents laptop from overheating
- Contemporary and stylish design to suit any office or home decor
- No assembly required
- Approximate specifications:
  - Max laptop size: 17" / 43.18cm
  - Max laptop weight: 6kg

### I-Spire Series™

Code	Description	Colour	UNIT			RETAIL PACK			OUTER PACK			
			H x W x D (cm)	Weight (kg)	Qty	H x W x D (cm)	Weight (kg)	Barcode (UPC)	Qty	H x W x D (cm)	Weight (kg)	Barcode (SCS)
9472402	I-Spire Series™ Laptop Lift	Black	10.48 x 33.50 x 23.65	0.43	1	11.43 x 23.18 x 34.29	0.64	043859700301	2	25.72 x 25.08 x 35.24	1.65	10043859700308
9311202	I-Spire Series™ Laptop Lift	White	10.48 x 33.50 x 23.65	0.43	1	11.43 x 23.18 x 34.29	0.64	043859664153	2	25.72 x 25.08 x 35.24	1.65	10043859664150





# Hana™ Range



For wellbeing advocates with design sensibility, the Hana™ range offers aesthetic sophistication with effortless ergonomic functionality to fit around any user's workstyle and environment. Developed with the high quality and performance that you would expect from a leader in workspace health & wellbeing.

Code	Description	Colour	UNIT			OUTER PACK		
			H x W x D (cm)	Weight (kg)	Qty	H x W x D (cm)	Weight (kg)	Barcode (SCS)
8055201	Hana™ Foot Support	Black	21.7 x 45.3 x 39.2	4.5	1	17.8 x 43.2 x 45.7	5.2	50043859736954
8055801	Hana™ Foot Support	White	21.7 x 45.3 x 39.2	4.5	1	17.8 x 43.2 x 45.7	5.2	50043859739146
8055501	Hana™ Mousepad Wrist Support	Black	2 x 19 x 26	0.143	1	3 x 33.7 x 22.8	0.285	50043859736985
8066501	Hana™ Mousepad Wrist Support	Grey	2 x 19 x 26	0.143	1	3 x 33.7 x 22.8	0.285	50043859748520
8055601	Hana™ Keyboard Wrist Support	Black	2 x 45 x 26	0.374	1	3 x 51.3 x 32.6	0.683	50043859736992
8065001	Hana™ Keyboard Wrist Support	Grey	2 x 45 x 26	0.374	1	3 x 51.3 x 32.6	0.683	50043859748537
8060501	Hana™ Monitor Support	Black	10.20 x 61.40 x 22.00	2.5	1	12.70 x 25.40 x 61.00	2.8	50043859751445
8064201	Hana™ Monitor Support	White	10.20 x 61.40 x 22.00	2.5	1	12.70 x 25.40 x 61.00	2.8	50043859751452
8064301	Hana™ Laptop Riser	Black	12.7 x 25.4 x 60.9	2.9	1	12.7 x 36.8 x 44.5	3.3	50043859751469
8064401	Hana™ Laptop Riser	White	12.7 x 25.4 x 60.9	2.9	1	12.7 x 36.8 x 44.5	3.3	50043859751476

## In-Line Document Supports and Writing Slopes

### 1 Sheet Capacity

The maximum number of sheets that can be secured.

### 2 Line Guides

Helps with concentration and being able to work more efficiently by directing the eye to the key information.

### 3 Angle Adjustment

Enables the user to set the angle for their preferred ergonomic positioning depending on the task planned.

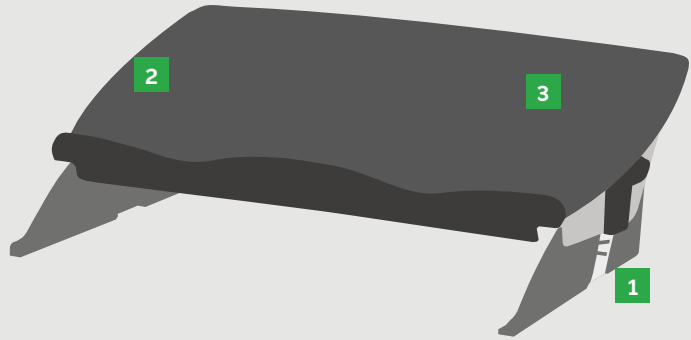

### Hana™ Writing Slope/Document Support

- Work in line and maintain good posture when using documents and writing to avoid neck and back discomfort
- Achieve the perfect ergonomic position with 5 height and angle settings
- Platform effortlessly glides forward, maximising desk space and creating an ergonomic writing area
- Hidden accessory tray with device charging access
- Includes magnetic line guide to hold paper and aid with reading
- Stylish metal design, available in black or white
- Approximate specifications:
  - Max weight: 5kg
  - Height adjustments: 11.6 / 13.4 / 16.2 / 18.8 / 21.4cm
  - Angle adjustments: 8 / 14 / 20 / 26 / 32°

Code	Description	Colour	UNIT			OUTER PACK		
			H x W x D (cm)	Weight (kg)	Qty	H x W x D (cm)	Weight (kg)	Barcode (SCS)
8055701	Hana™ Writing Slope/Document Support	Black	11.59 x 56.20 x 34.93	6.35	1	64.01 x 19.50 x 42.55	7.48	50043859737005
8065801	Hana™ Writing Slope/Document Support	White	11.59 x 56.20 x 34.93	6.35	1	64.01 x 19.50 x 42.55	7.48	50043859749817



# In-Line Document Supports and Writing Slopes

## Easy Glide™ Writing/Document Slope

- To be positioned in between the monitor or laptop and the keyboard
- Main platform glides freely forward to cover the keyboard creating an ergonomic writing area
- Contoured ledge supports catalogues, books & paperwork up to 5kg without causing discomfort
- Easily angle adjustable 7.5° - 37.5° to enable ease of document viewing
- Removable accessory tray with charging cable manager space
- Approximate specifications:
  - Max weight: 5kg
  - Height adjustments: 11.8 / 14.8 / 17.6 / 20.4 / 23 / 25.3cm
  - Angle adjustments: 7 / 13.5 / 19 / 25.4 / 31.4 / 37.5°



Code	Description	UNIT			RETAIL PACK				OUTER PACK			
		H x W x D (cm)	Weight (kg)	Qty	H x W x D (cm)	Weight (kg)	Barcode (UPC)	Qty	H x W x D (cm)	Weight (kg)	Barcode (SCS)	
8210001	Easy Glide™ Writing/Document Slope	11.60 x 57.50 x 38.00	5.6	1	17.50 x 61.50 x 44.00	5.96	043859706396	2	37.00 x 46.00 x 63.00	12.86	50043859706391	

## Clarity™ Document Support

- Maximise desk space and reduce neck and eye strain by positioning documents to a more comfortable, ergonomic viewing position
- Minimalistic design and premium quality clear acrylic seamlessly blend into any office environment
- Six height adjustments to achieve your perfect viewing height (from 160 - 235mm)
- Holds both A4 and A3 documents
- Approximate specifications:
  - Max weight: 6kg
  - Height adjustments: 16 / 17.5 / 19 / 20.5 / 22 / 23.5 cm
  - Angle adjustments: 17 - 39°



Code	Description	UNIT			RETAIL PACK				OUTER PACK			
		H x W x D (cm)	Weight (kg)	Qty	H x W x D (cm)	Weight (kg)	Barcode (UPC)	Qty	H x W x D (cm)	Weight (kg)	Barcode (SCS)	
9731301	Clarity™ Document Support	16.00 x 53.59 x 27.78	1.24	1	11.79 x 58.80 x 29.97	1.75	043859752720	1	25.48 x 31.50 x 60.01	4.05	50043859752725	





## Document Supports

### 1 Sheet Capacity

The maximum number of sheets that can be secured by the document holder.

### 2 Line Guides

Helps with concentration and being able to work more efficiently by directing the eye to the key information.

### 3 Angle Adjustment

Enables the user to set the angle of the copy holder for their preferred ergonomic positioning.

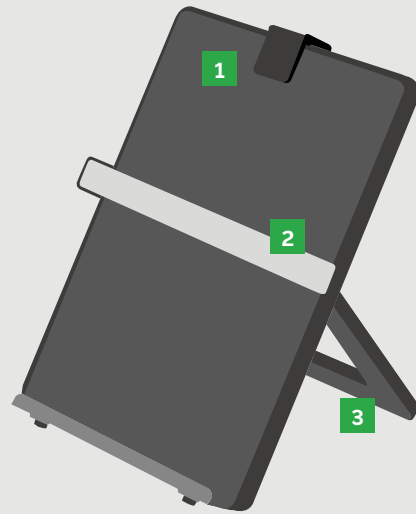

HOLDS  
**150**  
SHEETS



### Flex Arm Document Holder

- Flexible arm adjusts for ergonomically correct viewing height and angle
- Copy clip adjusts to hold A4 documents and wide forms
- Copy holder rotates 90° for portrait or landscape positioning
- Line guide glides up and down or swings out of the way when not in use
- Weighted base offers stability plus storage space for mobile devices and office essentials

Code	Description	UNIT			RETAIL PACK			OUTER PACK			
		H x W x D (cm)	Weight (kg)	Qty	H x W x D (cm)	Weight (kg)	Barcode (UPC)	Qty	H x W x D (cm)	Weight (kg)	Barcode (SCS)
9169801	Flex Arm Document Holder	50.80 x 23.17 x 25.40	2.63	1	36.19 x 24.76 x 9.20	2.86	043859529780	4	38.89 x 27.15 x 39.37	12.84	50043859529785





# Document Supports

## Office Suites™ Desktop Document Holder

- 3-In-1 document holder, memo board and clipboard
- Copyholder adjusts for A3 paper
- Adjustable tilt customises your viewing angle by up to 45°
- Line guide slides up or down and swings out of the way when not in use
- Dry erase memo board is ideal for quick reference notes or reminders



Code	Description	UNIT			RETAIL PACK			OUTER PACK			
		H x W x D (cm)	Weight (kg)	Qty	H x W x D (cm)	Weight (kg)	Barcode (UPC)	Qty	H x W x D (cm)	Weight (kg)	Barcode (SCS)
8033201	Office Suites™ Desktop Document Holder	38.10 x 26.04 x 15.24	0.73	1	33.34 x 25.56 x 7.94	0.91	077511803321	4	35.56 x 27.94 x 33.02	4.33	50077511803326

## I-Spire Series™ Document/Tablet Lift

- 5-in-1 Design: document holder, memo board, clipboard, magnetic board and tablet holder
- Copy clips holds up to 15 sheets of A4 paper
- Memo board and clip can be used in portrait or landscape orientations
- Weighted base for added sturdiness and to help prevent tipping
- No assembly required



## I-Spire Series™

Code	Description	Colour	UNIT			RETAIL PACK			OUTER PACK			
			H x W x D (cm)	Weight (kg)	Qty	H x W x D (cm)	Weight (kg)	Barcode (UPC)	Qty	H x W x D (cm)	Weight (kg)	Barcode (SCS)
9472602	I-Spire Series™ Document/Tablet Lift	Black	36.99 x 24.13 x 15.24	0.88	1	33.34 x 24.77 x 5.40	0.94	043859700325	2	35.24 x 12.54 x 26.99	2.24	10043859700322
9311502	I-Spire Series™ Document/Tablet Lift	White	36.99 x 24.13 x 15.24	0.88	1	33.34 x 24.77 x 5.40	0.94	043859664177	2	35.24 x 12.54 x 26.99	2.24	10043859664174

## Standard Desktop Document Holder

- Easel-style stand adjusts for custom height and viewing angle
- Document Holder plate rotates 90° for portrait or landscape positioning
- Line guide glides up and down or swings out of the way when not in use
- Made of sturdy, impact-resistant plastic
- Adjustable copy clip holds A4 documents and wide forms



Code	Description	UNIT			RETAIL PACK			OUTER PACK			
		H x W x D (cm)	Weight (kg)	Qty	H x W x D (cm)	Weight (kg)	Barcode (UPC)	Qty	H x W x D (cm)	Weight (kg)	Barcode (SCS)
9169701	Standard Desktop Document Holder	32.38 x 23.17 x 20.32	0.37	1	33.97 x 23.81 x 4.76	0.57	043859529773	4	37.20 x 22.30 x 25.00	2.49	50043859529778

## Document Supports



### Booklift™ Document Holder

- Specifically designed for planners, large manuals or reference material
- Two adjustable clips hold pages open at the desired location
- Nine height adjustments accommodate virtually any book size and viewing angle
- Easel-style holder with non-skid base folds flat for easy storage
- Holds standard A4-size ring binders

Code	Description	UNIT			RETAIL PACK			OUTER PACK			
		H x W x D (cm)	Weight (kg)	Qty	H x W x D (cm)	Weight (kg)	Barcode (UPC)	Qty	H x W x D (cm)	Weight (kg)	Barcode (SCS)
21140	Booklift™ Document Holder	24.44 x 29.52 x 5.08	0.31	1	28.57 x 29.52 x 1.58	0.37	077511211409	6	10.47 x 29.84 x 31.11	2.49	50077511211404



### Workstation Document Holder

- Workstation Document Holder includes a removable line guide for highlighting text
- Track design allows user to position line guide and paper holder along the top or side
- Easel back extends for height and angle adjustment or folds flat for easy storage

Code	Description	UNIT			RETAIL PACK			OUTER PACK			
		H x W x D (cm)	Weight (kg)	Qty	H x W x D (cm)	Weight (kg)	Barcode (UPC)	Qty	H x W x D (cm)	Weight (kg)	Barcode (SCS)
21106	Workstation Document Holder	28.57 x 25.71 x 18.73	0.27	1	34.92 x 27.94 x 3.49	0.36	077511211065	6	17.78 x 28.89 x 36.19	2.65	10077511211062



## Height Adjustable Desks

### ZONE 4

Reduce inactivity



#### The Solution

Introduce movement. Regular changes to your working position helps you work better and feel better.

Desk based employees spend hours sitting at their desk, hunched behind a screen each day. The human body isn't designed to be still or sitting for long periods of time; it has been proven that long periods of sitting have a major negative impact on our health and wellbeing.

Using a standing desk has been shown to significantly lift the mood, with workers reporting lower stress levels and higher energy levels. Alternating between standing and sitting increases blood flow and can help with back pain and musculoskeletal disorders.

A standing desk can also help shrink waistlines. Simply by standing up to complete an afternoon's work, an individual can burn around 170 more calories than if they were sitting. During a working week, that adds up to 850 calories! A healthy and happy workforce is a productive workforce.



Source: Healthline (Benefits of a standing desk)

#### 1 Height Adjustable

Raising desks allows for the user to sit or stand through their work session.

#### 2 Control Panel

Allows the user to adjust the height exactly to their level and includes programmable memory settings.

#### 3 Worksurface

Available in several sizes and colours to suit the exact needs of the user.

#### 4 Cable Management

Cable management grommets and tray help keep a workspace tangle free.

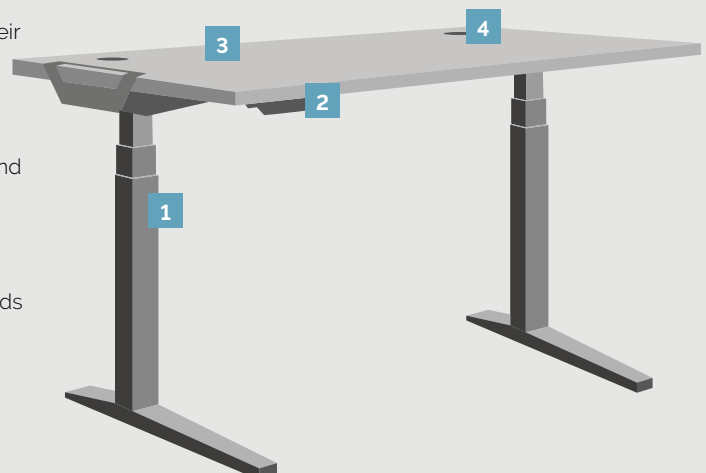

## Height Adjustable Desks



The Levado™ Height Adjustable Desk encourages the user to add movement to their working day at the touch of a button. This alone makes the Levado an excellent investment for the workplace, but it also comes with several other innovative benefits that build into a hugely appealing and valuable asset.



### SMART

The Levado features a sophisticated Feather-Lift™ control paddle with programmable memory settings and LED display, enabling users to achieve their perfect adjustment every time.



### SOPHISTICATED

The built-in collision detection safety feature ensures that the Levado is a truly smart desk, and cables are easily managed with built-in grommet holes and cable tray, for a minimalistic effect.



### QUICK

The Levado frame has been engineered for quick and easy set up, and the patent-pending SwiftLok™ design is a cost benefit not to be underestimated. Save time and money with foldable legs that lock into place, with no tools required. It's quick and secure for a cost-effective installation.



### FLEXIBLE

The sustainably sourced desktops are available in a range of colours and sizes to suit all office environments, and the VersaTop™ clamps can secure an existing work surface onto the frame for a truly tailored solution.

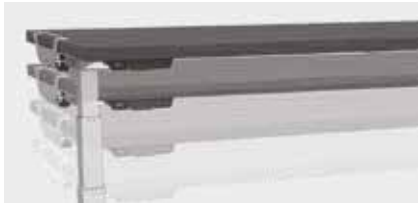

### ADJUSTABLE

The premium three-stage legs adjust to offer generous height and width options for pure flexibility (H - 640mm - 1257mm | W - 1219mm - 1829mm).



# Height Adjustable Desks

## Levado™ Height Adjustable Desk

- Save time and money – simply fold out the legs and lock into place with patent-pending SwiftLok™ design
- Premium, Feather-Lift™ control paddle with four programmable memory settings
- No tool attachment to new or existing work surfaces with VersaTop Clamps™ (traditional mounting hardware also included), accommodates tops 1219 - 1829mm wide
- Maximum height adjustability with 3-Stage legs, 640 – 1257mm
- Built in collision detection safety feature
- Adjusts at 36mm per second with 100kgs lifting capacity
- Easily manage cables with included cable tray



Frame Colour	Silver (Pantone colour ref: P10102 C) / White (RAL 9003)
Desktop	Frame Adjusts 1219 - 1829mm wide Accommodates desk 610 – 800mm in depth and between 19 – 31.75mm in thickness Fits all Fellowes Desktops
Frame Material	Powder coated steel
Height Adjustability	Electric Motor (2 motors) 36mm per second
Height Range	640mm – 1257mm (when using 25mm desktop)
Maximum Weight	100kgs (including desktop)
Memory Features	4 programmable memory settings
Anti Collision	Collision Detection Safety Feature
Power	220-240v / 8A 102w when moving up / 55w moving down 2.7w when Idle < 1mA in sleep mode (after 1 min of inactivity)
Cable Management	Cable Management Tray
Noise level	55DBs
Warranty	Structural – 15 years Electrical – 7 years Worktop – 10 years

Code	Description	Colour	UNIT			OUTER PACK			Barcode (SCS)
			H x W x D (cm)	Weight (kg)	Qty	H x W x D (cm)	Weight (kg)	Qty	
9708601	Levado™ Height Adjustable Desk - Base Only	Silver	62.23 x 152.56 x 69.85	36.29	1	17.46 x 73.98 x 170.18	43.82	50043859742955	
9747001	Levado™ Height Adjustable Desk - Base Only	White	62.23 x 152.56 x 69.85	36.29	1	17.46 x 73.98 x 170.18	43.82	50043859756600	

## Height Adjustable Desks



### Cambio™ Height Adjustable Desk

- Incorporate movement into your working day to stay active and healthy
- Easily go from sitting to standing with control paddle with three programmable memory settings
- Increase activity with optional alert to remind you to alternate between sitting and standing
- Generous height adjustment range of 645mm – 1305mm when using a standard 25mm desktop
- Work safely and confidently with the built-in collision detection feature
- Base and desktop sold and shipped separately



Frame Colour	Silver (Pantone colour ref: P10102 C)
Desktop	Frame Adjusts 1001 - 1699mm wide Accommodates tops 1100 – 1900mm wide Fits all Fellowes Desktops
Frame Material	Powder coated steel
Height Adjustability	38mm/sec Electric Motors (2)
Height Range	645 – 1305mm (when using 25mm desktop)
Maximum Weight	100kgs (including desktop)
Memory Features	3 programmable memory settings
Sit-Stand Timer	Set a timed reminder to change positions (half hour intervals – maximum 2 hour)
Anti Collision	Collision Detection Safety Feature
Cable Management	Cable Management Tray
Warranty	Structural – 15 years Electrical – 7 years Worktop – 10 years

Code	Description	UNIT			OUTER PACK		
		H x W x D (cm)	Weight (kg)	Qty	H x W x D (cm)	Weight (kg)	Barcode (SCS)
9694001	Cambio™ Height Adjustable Desk - Base Only	62.07 X 100.01 X 64.93	33.79	1	22.07 x 29.53 x 110.65	35.20	50043859751759

# Height Adjustable Desks

## Cambio™ Height Adjustable Bench

- Economically incorporate sit-stand working into the office with the Cambio™ bench desk system
- Incorporate movement into your working day to stay active and healthy
- Easily go from sitting to standing with control paddle with three programmable memory settings
- Increase activity with optional alert to remind you to alternate between sitting and standing
- Generous height adjustment range of 645mm – 1305mm when using a standard 25mm desktop
- Work safely and confidently with the built-in collision detection feature
- Base and desktop sold and shipped separately



Frame Colour	Silver (Pantone colour ref: P10102 C)
Desktop	Frame Adjusts 1001 - 1699mm wide Accommodates tops 1100 – 1900mm wide Fits all Fellowes Desktops
Frame Material	Powder coated steel
Height Adjustability	38mm/sec Electric Motors (4)
Height Range	645 – 1305mm (when using 25mm desktop)
Maximum Weight	100kgs (including desktop)
Memory Features	3 programmable memory settings
Sit-Stand Timer	Set a timed reminder to change positions (half hour intervals – maximum 2 hour)
Anti Collision	Collision Detection Safety Feature
Cable Management	Cable Management Tray
Warranty	Structural – 15 years Electrical – 7 years Worktop – 10 years

Code	Description	UNIT			OUTER PACK		
		H x W x D (cm)	Weight (kg)	Qty	H x W x D (cm)	Weight (kg)	Barcode (SCS)
9696001	Cambio™ Height Adjustable Bench - Base Only	62.00 x 100.00 x 147.00	63.60	1	44.13 x 29.05 x 110.49	70.38	50043859751759

## Height Adjustable Desks



### Desktops

- Fellowes Desktops bring a stylish look to any office aesthetic
- Available in a choice of 5 colours
- Made from sustainably sourced MFC (Melamine Faced Chipboard)
- Available in 3 sizes: 1400 / 1600 / 1800 mm x 800 mm x 25 mm
- Built-in circle grommets (2 x 80mm)
- Supplied with metal to metal fixings

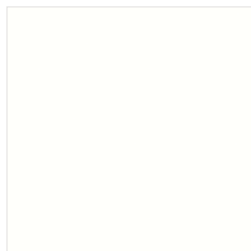

White

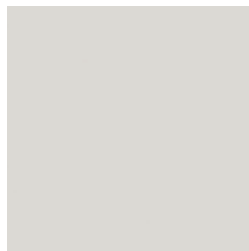

Grey



Maple



Newport Oak



Walnut

Code	Desktop Size (cm)	Colour	UNIT				OUTER PACK			
			H x W x D (cm)	Weight (kg)	Qty	Barcode (UPC)	Qty	H x W x D (cm)	Weight (kg)	Barcode (SCS)
9870001	140 x 80 x 2.5	White	140 x 80 x 2.5	20.5	1	043859744879	1	8.10 x 94.40 x 155.70	25	50043859744874
9870101	160 x 80 x 2.5	White	160 x 80 x 2.5	23.5	1	043859744886	1	8.10 x 94.40 x 175.70	28.5	50043859744881
9870201	180 x 80 x 2.5	White	180 x 80 x 2.5	26.5	1	043859744893	1	8.10 x 94.40 x 195.70	31.2	50043859744898
9870301	140 x 80 x 2.5	Grey	140 x 80 x 2.5	20.5	1	043859744909	1	8.10 x 94.40 x 155.70	25	50043859744904
9870401	160 x 80 x 2.5	Grey	160 x 80 x 2.5	23.5	1	043859744916	1	8.10 x 94.40 x 175.70	28.5	50043859744911
9870501	180 x 80 x 2.5	Grey	180 x 80 x 2.5	26.5	1	043859744923	1	8.10 x 94.40 x 195.70	31.2	50043859744928
9870601	140 x 80 x 2.5	Maple	140 x 80 x 2.5	20.5	1	043859744930	1	8.10 x 94.40 x 155.70	25	50043859744935
9870701	160 x 80 x 2.5	Maple	160 x 80 x 2.5	23.5	1	043859744947	1	8.10 x 94.40 x 175.70	28.5	50043859744942
9870801	180 x 80 x 2.5	Maple	180 x 80 x 2.5	26.5	1	043859744954	1	8.10 x 94.40 x 195.70	31.2	50043859744959
9870901	140 x 80 x 2.5	Newport Oak	140 x 80 x 2.5	20.5	1	043859744961	1	8.10 x 94.40 x 155.70	25	50043859744966
9871001	160 x 80 x 2.5	Newport Oak	160 x 80 x 2.5	23.5	1	043859744978	1	8.10 x 94.40 x 175.70	28.5	50043859744973
9871101	180 x 80 x 2.5	Newport Oak	180 x 80 x 2.5	26.5	1	043859744985	1	8.10 x 94.40 x 195.70	31.2	50043859744980
9871201	140 x 80 x 2.5	Walnut	140 x 80 x 2.5	20.5	1	043859744992	1	8.10 x 94.40 x 155.70	25	50043859744997
9871301	160 x 80 x 2.5	Walnut	160 x 80 x 2.5	23.5	1	043859745005	1	8.10 x 94.40 x 175.70	28.5	50043859745000
9871401	180 x 80 x 2.5	Walnut	180 x 80 x 2.5	26.5	1	043859745012	1	8.10 x 94.40 x 195.70	31.2	50043859745017



# Sit-Stand Converters

## 1 Desk Attachment Type

Desk converters can either be freestanding or clamped to the back of a desk.

## 2 Adjustment Range

Vertical adjustment or flexible TriMotion™ (180° rotation at the base, 90° vertical adjustment, 180° worksurface rotation).

## 3 Cable Management

Integrated cable management keeps the workspace tidy and clutter free.

## 4 Waterfall Design

The waterfall desktop design with device channel, creates more space for increased productivity.

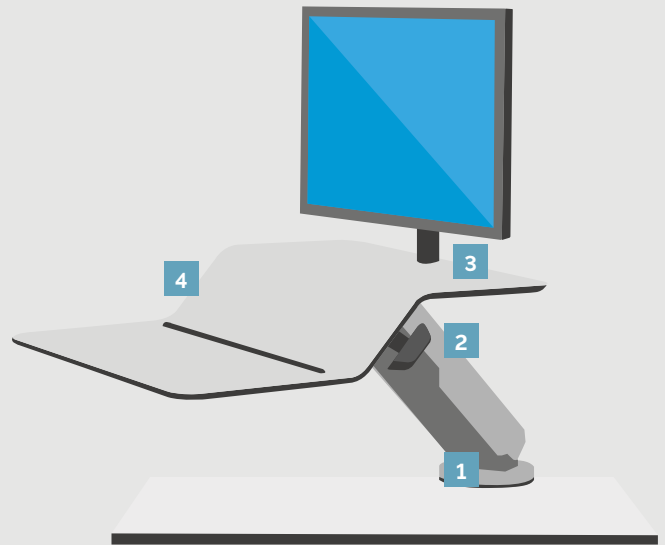

### Lotus™ DX Sit-Stand Workstation

- Transform your sedentary desk into a dynamic sit-stand workstation and add movement to your working day to stay active and healthy
- Built-in wireless Qi charging station with USB ports, making it easy to keep your devices fully charged and at your fingertips
- Waterfall design with device viewing channel to conveniently position documents and accessories
- Microban® antibacterial protection keeps your workstation cleaner, perfect for hotdesking
- Patent pending Smooth Lift Technology™ keeps your workstation stable and makes changing positions effortless
- Premium cable management to keep you tangle free
- Arrives fully assembled – no mounting, just unpack and get started
- Compatible with Lotus™ single and dual monitor arm kits

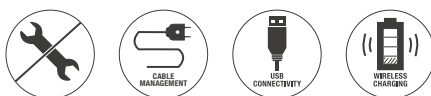

Code	Description	Colour	Height Adjustability (min - max)	Total Max Weight (kg)	Max Monitor Weight (kg)	UNIT			OUTER PACK		
						H x W x D (cm)	Weight (kg)	Qty	H x W x D (cm)	Weight (kg)	Barcode (SCS)
8081001	Lotus™ DX Sit-Stand Workstation	Black	432mm (10 - 442mm)	15.8	13.6	13.97 x 83.19 x 61.60	22.68	1	71.72 x 23.50 x 89.54	24.72	50043859730815
8081101	Lotus™ DX Sit-Stand Workstation	White	432mm (10 - 442mm)	15.8	13.6	13.97 x 83.19 x 61.60	22.68	1	71.72 x 23.50 x 89.54	24.72	50043859730822

## Sit-Stand Converters



### Lotus™ RT Sit-Stand Workstation

- Transform your sedentary desk into a dynamic sit-stand workstation and add movement to your working day to stay active and healthy
- Move freely with the Tri-Motion™ system which facilitates a flexible and unlimited range of movement
- Effortlessly transition from sitting to standing with Smooth Lift Technology™
- Waterfall design with device viewing channel to conveniently position documents and accessories
- Premium cable management to keep you tangle free.
- Easily mount to the back edge of any work surface with the secure clamp design.
- Sturdy real wood surface – available in black or white
- Includes a single or dual Lotus™ monitor arm to keep your screen secure



**Smooth Lift**  
TECHNOLOGY™



Code	Description	Colour	Height Adjustability (min - max)	Total Max Weight (kg)	Max Monitor Size / Max Monitor Weight	Rotation	Pan	Tilt	UNIT			OUTER PACK		
									H x W x D (cm)	Weight (kg)	Qty	H x W x D (cm)	Weight (kg)	Barcode (SCS)
8081501	Single	Black	419mm (12 - 432mm)	15.88	27" (65.58cm) 8kg	180°	180°	100°	22.23 x 90.17 x 60.33	16.23	1	66.04 x 33.02 x 96.52	22.67	50043859735827
8081701	Single	White	419mm (12 - 432mm)	15.88	27" (65.58cm) 8kg	180°	180°	100°	22.23 x 90.17 x 60.33	16.23	1	66.04 x 33.02 x 96.52	22.67	50043859737036
8081601	Dual	Black	419mm (12 - 432mm)	15.88	26" (66.04cm) 11.8kg	180°	180°	100°	22.23 x 90.17 x 60.33	17.14	1	66.04 x 33.02 x 96.52	24.49	50043859735834
8081801	Dual	White	419mm (12 - 432mm)	15.88	26" (66.04cm) 11.8kg	180°	180°	100°	22.23 x 90.17 x 60.33	17.14	1	66.04 x 33.02 x 96.52	24.49	50043859737043

# Sit-Stand Converters

## Lotus™ Sit-Stand Workstation

- Transform your sedentary desk into a dynamic sit-stand workstation and add movement to your working day to stay active and healthy
- Waterfall design with device viewing channel to conveniently position documents and accessories
- Patent pending Smooth Lift Technology™ keeps your workstation stable and makes changing positions effortless
- Premium cable management to keep you tangle free
- Arrives fully assembled – no mounting, just unpack and get started
- Compatible with Lotus™ single and dual monitor arm kits



Smooth Lift  
TECHNOLOGY™



Code	Description	Colour	Height Adjustability (min - max)	Total Max Weight (kg)	Max Monitor Weight (kg)	UNIT			OUTER PACK		
						H x W x D (cm)	Weight (kg)	Qty	H x W x D (cm)	Weight (kg)	Barcode (SCS)
0007901	Lotus™ Sit-Stand Workstation	Black	432mm (10 - 442mm)	15.8	13.6	13.97 x 83.19 x 61.60	22.68	1	71.12 x 23.50 x 89.54	24.72	50043859716369
0009901	Lotus™ Sit-Stand Workstation	White	432mm (10 - 442mm)	15.8	13.6	13.97 x 83.19 x 61.60	22.68	1	71.12 x 23.50 x 89.54	24.72	50043859718905

## Lotus™ VE Sit-Stand Workstation

- Transform your sedentary desk into a dynamic sit-stand workstation and add movement to your working day to stay active and healthy
- Compact waterfall design to conveniently position documents and accessories
- Effortlessly transition from sitting to standing with Smooth Lift Technology™
- Built-in cable management to keep your workspace tangle free
- Easily mount to the back edge of any work surface with the secure clamp design
- Includes a single or dual monitor arm to keep your screen secure



Smooth Lift  
TECHNOLOGY™



Code	Description	Height Adjustability (min - max)	Total Max Weight (kg)	Max Monitor Size / Max Monitor Weight	Rotation	Pan	Tilt	UNIT			OUTER PACK		
								H x W x D (cm)	Weight (kg)	Qty	H x W x D (cm)	Weight (kg)	Barcode (SCS)
8080101	Lotus™ VE Sit-Stand Workstation - Single	366mm (14.5 - 381mm)	11.4	24" (60.96cm) 9.07kg	360°	-	+/- 15°	107.95 x 73.66 x 72.39	17.83	1	72.71 x 26.04 x 86.36	21.68	50043859728027
8082001	Lotus™ VE Sit-Stand Workstation - Dual	366mm (14.5 - 381mm)	11.4	24" (60.96cm) 9.07kg	360°	-	+/- 15°	107.95 x 73.66 x 72.39	19.28	1	72.71 x 26.04 x 86.36	23.13	50043859729475

## Sit-Stand Converters



### Lotus™ LT Sit-Stand Workstation

- Transform your sedentary desk into a dynamic sit-stand workstation and add movement to your working day to stay active and healthy
- Easily transition from sitting to standing with gas spring height adjustment
- Flexible set up; spacious top platform holds two monitors or a laptop – and bottom level fits a keyboard and mouse perfectly
- Keep your phone or other accessories within easy reach with the convenient device channel on top platform
- Arrives fully assembled - no complicated instructions, no mounting; just unpack and get started
- Compatible with Lotus™ Single and Dual Monitor Arm Kits



Code	Description	Colour	Height Adjustability (min - max)	Total Max Weight (kg)	Max Monitor Weight (kg)	UNIT			OUTER PACK		
						H x W x D (cm)	Weight (kg)	Qty	H x W x D (cm)	Weight (kg)	Barcode (SCS)
8215001	Lotus™ LT Sit-Stand Workstation	Black	366mm (28 - 390mm)	17	15	11.10 x 80.00 x 60.10	14.74	1	17.50 x 91.00 x 72.00	17.00	50043859753524



### Corsivo™ Sit-Stand Workstation

- Transform your sedentary desk into a dynamic sit-stand workstation and add movement to your working day to stay active and healthy
- Easily transition from sitting to standing with gas spring height adjustment
- Two-tiered larger work surface can accommodate flexible set up options, holding two monitors or a monitor and a laptop
- Keep your phone or other accessories within easy reach with the convenient device channel
- Easy set up – simply attach the optional keyboard tray and you're ready to go



Code	Description	Colour	Height Adjustability (min - max)	Total Max Weight (kg)	Max Monitor Weight (kg)	UNIT			OUTER PACK		
						H x W x D (cm)	Weight (kg)	Qty	H x W x D (cm)	Weight (kg)	Barcode (SCS)
8091001	Corsivo™ Sit-Stand Workstation	Black	366mm (28 - 390mm)	17	15	11.10 x 80.00 x 61.50	15.40	1	18.5 x 88.50 x 49.00	17.60	50043859751490



# Sit-Stand Accessories

## Lotus™ Sit-Stand Monitor Arms

- For use only with the Fellowes Lotus™ Sit-Stand Workstation
- Single and dual monitor options available
- Raises monitors to an optimal viewing height to prevent neck strain and free up valuable workspace
- Height adjusts up to 40cm above the top surface of Lotus™ Sit-Stand Workstation
- Monitors stay in place when you lift or lower your Lotus™ Sit-Stand Workstation
- Meets VESA mounting standards
- The dual arms are also depth adjustable for the proximity of your screens



Code	Description	Total Max Weight	Max Monitor Size	Rotation	Pan	Tilt	UNIT				OUTER PACK			
							H x W x D (cm)	Weight (kg)	Barcode (UPC)	Qty	H x W x D (cm)	Weight (kg)	Barcode (SCS)	
8042801	Single	8Kg	27" 68.58cm	180°	180°	100°	41.91 x 11.43 x 13.97	0.45	043859723799	1	10.80 x 15.24 x 43.82	1.25	50043859723794	
8042901	Dual	11.8Kg	26" 66.04cm	180°	180°	100°	41.91 x 72.39 x 13.97	2.26	043859723805	1	15.25 x 29.85 x 45.09	2.90	50043859723800	



## ActiveFusion™ Sit-Stand Mat

- Stay active and enjoy the benefits of your Sit-Stand product for longer with the ActiveFusion™ Sit-Stand mat
- Step design promotes stretching and movement throughout the day
- Prevents fatigue by encouraging subtle movement and shifting of body weight
- To be used with any Sit-Stand product whilst standing
- Beveled edges help avoid trip hazards



## Everyday Sit-Stand Mat

- Stand in comfort with this durable Sit-Stand mat
- Prevents fatigue by encouraging subtle movement
- Use with any Sit-Stand product while standing
- Bevelled edges help avoid trip hazards

Code	Description	UNIT			RETAIL PACK			OUTER PACK			
		H x W x D (cm)	Weight (kg)	Qty	H x W x D (cm)	Weight (kg)	Barcode (UPC)	Qty	H x W x D (cm)	Weight (kg)	Barcode (SCS)
8707101	ActiveFusion™ Sit-Stand Mat	8.80 x 91.50 x 61.00	2.09	1	8.89 x 89.85 x 59.69	3.72	043859728053	4	24.13 x 62.07 x 93.35	16.26	50043859728058
8707001	Everyday Sit-Stand Mat	1.90 x 91.50 x 61.00	2.03	1	63.18 x 20.96 x 20.96	2.44	043859728046	4	44.45 x 44.45 x 65.41	10.93	50043859728041

# PrivaScreen™ Blackout Privacy Filters



## PrivaScreen™

### BLACKOUT PRIVACY FILTERS

#### Keep sensitive information out of sight

Anyone who works with sensitive information on their computer, laptop, tablet or mobile phone is at risk from prying eyes. ‘Shoulder Surfing’ as it has become, is a growing form of identity theft when private information is viewed or even photographed over the shoulder of anyone using a device. A Fellowes PrivaScreen™ blackout privacy filter removes the threat of “visual hacking” and keeps on screen information confidential.



# PrivaScreen™ Blackout Privacy Filters

Fellowes® PrivaScreen™ Blackout Privacy Filters black out from the side view to protect your privacy, while maintaining a crystal clear screen straight-on.

- Darkens screen when viewed from the side
- Protects your screen from scratches and fingerprints
- Reversible matte side helps to reduce glare, thus preventing eye strain
- 2 options for attachment:
  - Quick Reveal Tabs™ for easy removal and reattachment
  - Double-sided adhesive strips for a semi-permanent attachment
- 1 year warranty

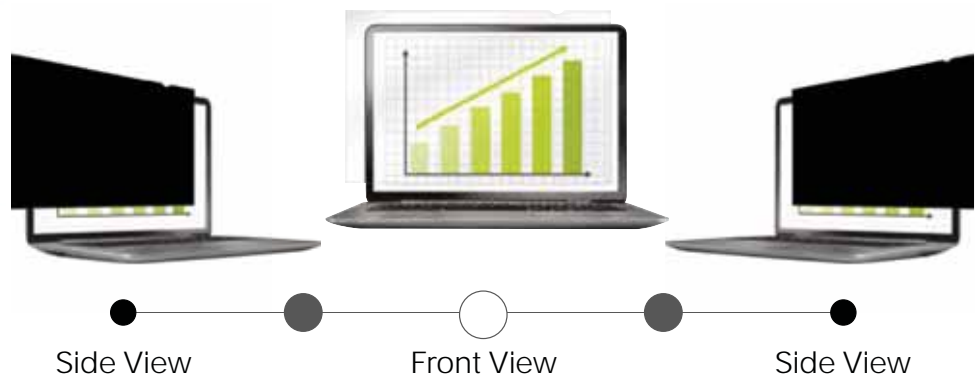

## 3 Steps to protecting your on-screen information

with PrivaScreen™ Blackout Privacy Filters by Fellowes®

<b>1</b> <b>Think</b> about your business	<b>2</b> <b>Check</b> the environment	<b>3</b> <b>Protect</b> on-screen content
Does it involve sensitive information?	Who can view your employees' screens?	Keep sensitive information out of sight

### FIND YOUR CORRECT SIZE FILTER

TRY ONE OF THE FELLOWES **FREE ONLINE TOOLS** TO SELECT YOUR PERFECT FIT.

### THE PERFECT FIT SELECTOR TOOL



Use our handy screen measuring tool to help you identify the size of the screen in use and suggest the matching PrivaScreen™ Blackout Privacy Filters.

OR

### THE DEVICE DIRECTORY



Helps you to identify the right PrivaScreen™ Blackout Privacy Filter for your device (or any device, even if you are not working on it), by searching via the device brand and model.

## PrivaScreen™ Blackout Privacy Filters

Code	Display Size (Inchs / cm)	Format	Aspect Ratio	Width (mm)	Height (mm)	Qty	H x W x D (cm)	Weight (kg)	Barcode (UPC)	Qty	H x W x D (cm)	Weight (kg)	Barcode (SCS)
4818601	11.6"/29.46cm	Widescreen	16:9	257	146	1	38.70 x 26.70 x 0.30	0.23	043859719594	4	5.08 x 28.58 x 40.64	1.15	50043859719599
4815301	12.1"/30.73cm	Widescreen	16:10	260	164	1	38.70 x 26.70 x 0.30	0.21	043859692170	4	5.08 x 28.58 x 40.64	1.11	50043859692175
4813001	12.5"/31.75cm	Widescreen	16:9	278	156	1	38.70 x 26.70 x 0.30	0.22	043859688999	4	5.08 x 28.58 x 40.64	1.16	50043859688994
4818301	13.0"/33.02cm for use with MacBook® Pro (2012-2015)	Widescreen	16:10	306	202	1	38.70 x 26.70 x 0.30	0.23	043859719563	4	5.08 x 28.58 x 40.64	1.15	50043859719568
4806801	13.3"/33.78cm	Widescreen	16:9	292	165	1	38.70 x 26.70 x 0.30	0.22	043859660155	4	5.08 x 28.58 x 40.64	1.16	50043859660150
4814301	13.3"/33.78cm	Widescreen	16:10	287	179	1	38.70 x 26.70 x 0.30	0.22	043859692071	4	5.08 x 28.58 x 40.64	1.13	50043859692076
4814601	13.3"/33.78cm for use with MacBook® Air™	Widescreen	16:10	287	179	1	38.70 x 26.70 x 0.30	0.21	043859692101	4	5.08 x 28.58 x 40.64	1.11	50043859692106
4819201	13.8"/34.96cm (touch screen) for use with Microsoft® Surface Pro™ 3 & 4	Standard	3:2	288	398	1	38.70 x 26.70 x 0.30	0.23	043859749676	4	5.08 x 28.58 x 40.64	1.15	50043859749671
4812001	14.0"/35.56cm	Widescreen	16:9	310	173	1	38.70 x 26.70 x 0.30	0.23	043859688289	4	5.08 x 28.58 x 40.64	1.16	50043859688284
4819301	14.0"/35.56cm (touch screen)	Edge to edge	16:9	325	194	1	38.70 x 26.70 x 0.30	0.23	043859752744	4	5.08 x 28.58 x 40.64	1.15	50043859752749
4800001	14.1"/35.81cm	Standard	4:3	286	216	1	38.70 x 26.70 x 0.30	0.23	043859541454	4	5.08 x 28.58 x 40.64	1.25	50043859541459
4800601	14.1"/35.81cm	Widescreen	16:10	305	191	1	38.70 x 26.70 x 0.30	0.23	043859541515	4	5.08 x 28.58 x 40.64	1.19	50043859541510
4815701	14.1"/35.81cm	Widescreen	16:9	310	175	1	38.70 x 26.70 x 0.30	0.23	043859699698	4	5.08 x 28.58 x 40.64	1.16	50043859699693
4800101	15.0"/38.10cm	Standard	4:3	305	229	1	38.70 x 26.70 x 0.30	0.24	043859541461	4	5.08 x 28.58 x 40.64	1.25	50043859541466
4818401	15.0"/38.10cm for use with MacBook® Pro (2012-2015)	Widescreen	16:10	352	230	1	38.70 x 26.70 x 0.30	0.23	043859719570	4	5.08 x 28.58 x 40.64	1.15	50043859719575
4800701	15.4"/39.12cm	Widescreen	16:10	332	208	1	38.70 x 26.70 x 0.30	0.24	043859541522	4	5.08 x 28.58 x 40.64	1.16	50043859541527
4802001	15.6"/39.62cm	Widescreen	16:9	345	194	1	38.70 x 26.70 x 0.30	0.24	043859638864	4	5.08 x 28.58 x 40.64	1.16	50043859638869
4800301	17.0"/43.18cm	Standard	5:4	338	270	1	44.80 x 35.90 x 0.30	0.35	043859541478	4	5.08 x 36.51 x 46.04	1.70	50043859541473
4801001	17.0"/43.18cm	Widescreen	16:10	368	230	1	44.80 x 35.90 x 0.30	0.34	043859547326	4	5.08 x 37.15 x 46.04	1.84	50043859547321
4802301	17.3"/43.94cm	Widescreen	16:9	382	214	1	44.80 x 35.90 x 0.30	0.34	043859638871	4	5.08 x 37.15 x 46.04	1.84	50043859638876
4800401	18.1"/45.97cm	Standard	5:4	359	289	1	44.80 x 35.90 x 0.30	0.36	043859541485	4	5.08 x 36.51 x 46.04	1.97	50043859541480
4815201	18.5"/46.99cm	Widescreen	16:9	410	230	1	44.80 x 35.90 x 0.30	0.35	043859692163	4	5.08 x 37.15 x 46.04	1.75	50043859692168
4800501	19.0"/48.26cm	Standard	5:4	376	301	1	44.80 x 35.90 x 0.30	0.36	043859541492	4	5.08 x 37.15 x 46.04	1.84	50043859541497
4801101	19.0"/48.26cm	Widescreen	16:10	411	257	1	54.50 x 34.90 x 0.30	0.40	043859560547	4	5.40 x 36.99 x 57.63	2.18	50043859560542
4815801	19.5"/49.53cm	Widescreen	16:9	433	237	1	54.50 x 34.90 x 0.30	0.49	043859699704	4	5.40 x 36.99 x 57.63	2.22	50043859699709
4813101	20.0"/50.80cm	Widescreen	16:9	443	250	1	54.50 x 34.90 x 0.30	0.41	043859689002	4	5.40 x 36.99 x 57.63	2.20	50043859689007
4801201	20.1"/51.05cm	Standard	4:3	409	308	1	54.50 x 34.90 x 0.30	0.42	043859560554	4	5.40 x 36.99 x 57.63	2.20	50043859560559
4801301	20.1"/51.05cm	Widescreen	16:10	435	273	1	54.50 x 34.90 x 0.30	0.42	043859560561	4	5.40 x 36.99 x 57.63	2.09	50043859560566
4807001	21.5"/54.61cm	Widescreen	16:9	476	268	1	54.50 x 34.90 x 0.30	0.42	043859660179	4	5.40 x 36.99 x 57.63	2.09	50043859660174
4801501	22.0"/55.88cm	Widescreen	16:10	473	295	1	54.50 x 34.90 x 0.30	0.44	043859560578	4	5.40 x 36.99 x 57.63	2.18	50043859560573
4807101	23.0"/58.42cm	Widescreen	16:9	510	287	1	54.50 x 34.90 x 0.30	0.44	043859660186	4	5.40 x 36.99 x 57.63	2.22	50043859660181
4814401	23.6"/59.94cm	Widescreen	16:9	521	294	1	54.50 x 34.90 x 0.30	0.44	043859692088	4	5.40 x 36.99 x 57.63	2.18	50043859692083
4816901	23.8"/60.45cm	Widescreen	16:9	528	297	1	65.70 x 37.20 x 0.30	0.58	043859710843	4	5.40 x 38.74 x 68.10	2.79	50043859710848
4801601	24.0"/60.96cm	Widescreen	16:10	518	324	1	54.50 x 34.90 x 0.30	0.45	043859560585	4	5.40 x 36.99 x 57.63	2.22	50043859560580
4811801	24.0"/60.96cm	Widescreen	16:9	531	298	1	65.50 x 36.90 x 0.30	0.59	043859688272	4	5.40 x 39.53 x 68.10	2.68	50043859688277
4815101	26.0"/66.04cm (25.5"/64.77cm diagonal)	Widescreen	16:10	551	345	1	65.70 x 37.20 x 0.30	0.60	043859692156	4	5.40 x 38.74 x 68.10	2.81	50043859692151
4815001	27.0"/68.58cm	Widescreen	16:9	597	335	1	65.70 x 37.20 x 0.30	0.60	043859692149	4	5.40 x 38.74 x 68.10	2.93	50043859692144
4818501	27.0"/68.58cm for use with iMac®	Widescreen	16:9	649	387	1	68.40 x 41.75 x 0.48	0.72	043859719587	4	5.40 x 44.45 x 70.96	3.49	50043859719582



# Green<sub>2</sub>Desk Workspace Accessories

Green<sub>2</sub>Desk products are designed with the aim to reduce their environmental impact to the minimum level throughout their whole life cycle by:

- Minimizing environmental resources consumption, waste and emissions during the production
- Designing smaller, modular and compactable products in order to reduce transport and storage impact
- Using recycled & recyclable materials whilst maintaining the strength and durability of the product



Our range of desk accessories have been developed in accordance with the Life Cycle Design principles by Ascoli Piceno's Design and Architecture School.

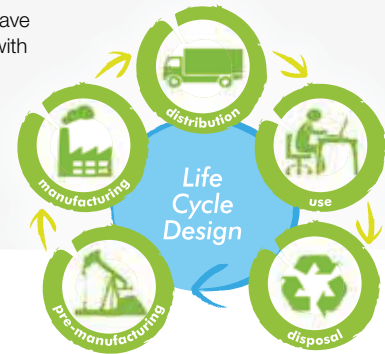

### Green<sub>2</sub>Desk Drawer

- Perfect to organize your desktop space
- 4 drawers (height: 50mm - internally: 45mm)
- Dark Grey shell with coloured drawers
- Green<sub>2</sub>Desk letter tray can be stacked on top to utilize space



### Green<sub>2</sub>Desk Letter Tray

- Perfect to organize your desktop space
- 2 or more units stackable, vertically or graduated
- Can be used in combination with the Green<sub>2</sub>Desk drawer



### Green<sub>2</sub>Desk Magazine File

- Perfect to organize your magazines and literature
- Open back allows for easy identification of contents and creates a handle for lifting



### Green<sub>2</sub>Desk Waste Bin

- 15 litre capacity waste bin
- Bin features a handle for easy lifting and emptying



### Green<sub>2</sub>Desk Pencil Cup

- Attractive desktop storage cup
- Ideal for storage of pens, pencils, scissors, etc

Code	Description	Colour	UNIT			RETAIL UNIT				OUTER PACK		
			H x W x D (cm)	Weight (kg)	Qty	H x W x D (cm)	Weight (kg)	Barcode (UPC)	Qty	H x W x D (cm)	Weight (kg)	Barcode (SCS)
0019101	Green <sub>2</sub> Desk Drawer	White	25.40 x 28.50 x 38.40	1.97	1	25.40 x 28.50 x 38.40	1.97	043859654949	2	26.50 x 38.00 x 59.50	3.90	50043859654944
0019401	Green <sub>2</sub> Desk Drawer	Black	25.40 x 28.50 x 38.40	1.97	1	25.40 x 28.50 x 38.40	1.97	043859663200	2	26.50 x 38.00 x 59.50	3.90	50043859663205
0008101	Green <sub>2</sub> Desk Letter Tray	White	9.00 x 27.50 x 35.40	0.20	1	9.00 x 27.50 x 35.40	0.20	043859654765	12	32.00 x 28.50 x 36.00	2.70	50043859654760
0008301	Green <sub>2</sub> Desk Letter Tray	Black	9.00 x 27.50 x 35.40	0.20	1	9.00 x 27.50 x 35.40	0.20	043859654789	12	32.00 x 28.50 x 36.00	2.70	50043859654784
0017101	Green <sub>2</sub> Desk Magazine File	White	30.00 x 9.00 x 25.80	0.20	1	30.00 x 9.00 x 25.80	0.20	043859654888	12	33.00 x 28.00 x 51.00	2.90	50043859654883
0017301	Green <sub>2</sub> Desk Magazine File	Black	30.00 x 9.00 x 25.80	0.20	1	30.00 x 9.00 x 25.80	0.20	043859654901	12	33.00 x 28.00 x 51.00	2.90	50043859654906
0009401	Green <sub>2</sub> Desk Waste Bin	White	36.70 x 30.00 x 30.00	0.32	1	36.70 x 30.00 x 30.00	0.32	043859654857	12	77.50 x 31.00 x 31.00	4.34	50043859654852
0009101	Green <sub>2</sub> Desk Waste Bin	Black	36.70 x 30.00 x 30.00	0.32	1	36.70 x 30.00 x 30.00	0.32	043859654826	12	77.50 x 31.00 x 31.00	4.34	50043859654821
0016201	Green <sub>2</sub> Desk Pencil Cup	White	15.00 x 10.00 x 10.00	0.03	1	15.00 x 10.00 x 10.00	0.03	043859663224	12	37.00 x 11.00 x 11.00	0.54	50043859663229
0016401	Green <sub>2</sub> Desk Pencil Cup	Black	15.00 x 10.00 x 10.00	0.03	1	15.00 x 10.00 x 10.00	0.03	043859663248	12	37.00 x 11.00 x 11.00	0.54	50043859663243
0040701	Green <sub>2</sub> Desk Desktop Set	White	-	-	-	-	-	-	1	40.30 x 42.00 x 64.00	3.85	043859690923
0041001	Green <sub>2</sub> Desk Desktop Set	Black	-	-	-	-	-	-	1	40.30 x 42.00 x 64.00	3.85	043859690954

## Computer and Organisation Accessories

### Rapido Wireless Charging Pod

- Effortlessly stay powered and productive with easily accessible USB and wireless charging hub
- Flexible design suits all workspaces
- Position upright or lay flat with the removable base
- Features Qi wireless charging pad and two easy access fast charging USB ports (1 x type A & 1 x type C)



Code	Description	UNIT			OUTER PACK		
		H x W x D (cm)	Weight (kg)	Qty	H x W x D (cm)	Weight (kg)	Barcode (SCS)
9816001	Rapido Wireless Charging Pod	12.07 x 8.26 x 11.11	0.45	1	7.62 x 14.76 x 24.61	0.64	50043859752329



### CableZip™

- Tidy all your cables and wires in an instant!
- CableZip™ has been designed to rid your office or home, easily and safely, of the unsightly jumble of cables created by the array of electrical products we all own
- Fully re-usable and can easily be cut to size to suit any space
- Two or more CableZip's can be combined to suit longer wire lengths and it can be opened at any time to allow cables to be removed
- CableZip™ is 2m long and 2cm in diameter

Code	Description	Colour	UNIT			RETAIL PACK			OUTER PACK			
			H x W x D (cm)	Weight (kg)	Qty	H x W x D (cm)	Weight (kg)	Barcode (UPC)	Qty	H x W x D (cm)	Weight (kg)	Barcode (SCS)
99439	CableZip™	Black	2.00 x 2.00 x 200.00	0.09	1	22.50 x 18.40 x 5.60	0.2	077511994395	6	19.70 x 19.10 x 38.10	1.4	50077511994390
9929801	CableZip™	Silver	2.00 x 2.00 x 200.00	0.09	1	22.50 x 18.40 x 5.60	0.2	043859748655	6	19.70 x 19.10 x 38.10	1.4	50043859748650
9929901	CableZip™	White	2.00 x 2.00 x 200.00	0.09	1	22.50 x 18.40 x 5.60	0.2	043859748662	6	19.70 x 19.10 x 38.10	1.4	50043859748667

# Computer and Organisation Accessories

## CPU Stand

- Saves desk space by storing CPU under or beside desk
- Width adjusts from 15.2 to 22.9cm to accommodate virtually all CPUs
- Sturdy heavy duty construction holds up to 22.7kg
- Solid steel construction with padding to protect and cushion CPU
- Four castors provide easy mobility for cleaning and accessing rear cables
- 2 locking castors ensure stability



Code	Description	UNIT			RETAIL PACK			OUTER PACK			
		H x W x D (cm)	Weight (kg)	Qty	H x W x D (cm)	Weight (kg)	Barcode (UPC)	Qty	H x W x D (cm)	Weight (kg)	Barcode (SCS)
9169201	CPU Stand	22.00 x 21.80 x 8.20	1.94	1	23.40 x 22.20 x 9.00	2.06	043859529728	2	25.80 x 19.40 x 24.60	4.34	50043859529723

## Office Suites™ CPU/Shredder Stand

- Saves desk space by storing CPU under or beside your desk
- Fully adjustable width
- Sturdy heavy duty construction holds up to 50kg
- Can also be used to hold shredders, waste bins and other items
- Lockable wheels
- Minimal assembly required



Code	Description	UNIT			RETAIL PACK			OUTER PACK			
		H x W x D (cm)	Weight (kg)	Qty	H x W x D (cm)	Weight (kg)	Barcode (UPC)	Qty	H x W x D (cm)	Weight (kg)	Barcode (SCS)
8039001	Office Suites™ CPU/Shredder Stand	20.00 x 13.00 x 33.00	0.90	1	42.20 x 20.60 x 7.00	1.08	043859524709	4	16.20 x 43.40 x 44.20	4.94	50043859524704

## Computer and Organisation Accessories



### Machine Organiser

- Sturdy machine stand which will support virtually any laser or inkjet printer or fax machine up to 27kg of weight
- Store all your print and fax supplies, envelopes and paper in one convenient location
- Includes 4 storage drawers (1 large 3 standard) with the choice of up to 8 drawer positions
- Features a detachable cable management clip to organise up to 3 sizes of cables

Code	Description	UNIT			RETAIL PACK				OUTER PACK		
		H x W x D (cm)	Weight (kg)	Qty	H x W x D (cm)	Weight (kg)	Barcode (UPC)	Qty	H x W x D (cm)	Weight (kg)	Barcode (SCS)
24004	Machine Organiser	54.00 x 34.50 x 13.50	2.30	1	54.50 x 36.50 x 14.50	2.72	077511240041	4	59.00 x 38.00 x 56.00	11.20	50077511240046



### Office Suites™

#### Deluxe Keyboard Manager

- Features 3 height adjustments to suit preferred work position and reduce neck strain and shoulder tension
- Moves keyboard and mouse off the desktop to save workspace
- Soothing built in wrist supports with Microban® Anti-bacterial protection keeps your product cleaner for longer
- Mouse tray mounts on right or left side of keyboard tray and stows underneath when not in use
- Built in keyboard stop holds the keyboard securely in place
- Adjusts to 4.4, 5.4 or 6.4cm below the desk
- Max weight 15kg

Code	Description	UNIT			RETAIL PACK				OUTER PACK		
		H x W x D (cm)	Weight (kg)	Qty	H x W x D (cm)	Weight (kg)	Barcode (UPC)	Qty	H x W x D (cm)	Weight (kg)	Barcode (SCS)
8031201	Office Suites™ Deluxe Keyboard Manager	6.35 x 81.00 x 35.72	2.27	1	36.83 x 51.12 x 7.46	2.45	043859470921	1	38.10 x 8.59 x 64.14	3.31	50043859470926



### Underdesk Keyboard Manager

- Perfect for converting conventional desks to a more convenient workstation
- Adjust to 3 different heights for custom comfort
- Tray glides are designed for smooth and silent movement
- Fits virtually any keyboard
- Retractable mouse tray installs on left or right hand side
- Adjusts to 4.3, 5.3 or 6.4cm below the desk
- Max weight 36kg

Code	Description	UNIT			RETAIL PACK				OUTER PACK		
		H x W x D (cm)	Weight (kg)	Qty	H x W x D (cm)	Weight (kg)	Barcode (UPC)	Qty	H x W x D (cm)	Weight (kg)	Barcode (SCS)
93804	Underdesk Keyboard Manager	5.87 x 55.88 x 29.53	1.76	1	5.72 x 56.52 x 31.12	2.08	077511938047	2	33.02 x 13.34 x 58.42	4.45	50077511938042



# Computer and Organisation Accessories

## Ball Point Pen with Stand

- Suitable for use on counters and desks
- Microban® anti-bacterial protection keeps product cleaner
- Secure 52cm chrome chain for ease of use
- Stable 300g weighted base
- Contains adhesive pads to secure to counter or desk and 1 Blue ink cartridge
- Refills available in Blue (0910301) / Black (0911502)



PROTECTION THAT LIVES ON  
**MICROBAN**



Code	Description	Colour	UNIT			RETAIL PACK			OUTER PACK			
			H x W x D (cm)	Weight (kg)	Qty	H x W x D (cm)	Weight (kg)	Barcode (UPC)	Qty	H x W x D (cm)	Weight (kg)	Barcode (SCS)
9821502	Ball Point Pen with Stand	Black	14.00 x 9.40 x 9.40	0.22	1	15.00 x 10.20 x 3.60	0.24	3261590982153	12	12.40 x 17.20 x 32.60	3.18	50043859533980
0911502	Replacement Ink (12 Pack)	Black	10.00 x 0.20 x 0.20	0.01	1	0.30 x 4.60 x 13.15	0.01	3261590091152	10	18.00 x 2.50 x 11.00	0.13	50043859534017
0910301	Replacement Ink (12 Pack)	Blue	10.00 x 0.20 x 0.20	0.01	1	0.30 x 4.60 x 13.15	0.01	3261559009129	10	18.00 x 2.50 x 11.00	0.13	50043859534000

## Literature Organisers

- Organize literature, mail, forms and more
- 24 and 36 A4 sized compartments options available
- Faster and easy assembly
- Sturdy melamine faced particle board construction with corrugated board compartments
- Includes plastic finishing channels and self-adhesive labels for easy file identification
- Subtle Dove Grey colour to blend in to any office environment



Code	Literature Organiser	UNIT			RETAIL PACK			OUTER PACK			
		H x W x D (cm)	Weight (kg)	Qty	H x W x D (cm)	Weight (kg)	Barcode (UPC)	Qty	H x W x D (cm)	Weight (kg)	Barcode (SCS)
25041	24 x A4 compartments	59.53 x 73.66 x 30.16	11.98	1	15.24 x 82.55 x 31.12	11.34	077511250415	1	15.24 x 31.12 x 82.55	11.34	10077511250412
25061	36 x A4 compartments	88.11 x 73.66 x 30.16	16.33	1	17.78 x 96.52 x 31.12	14.97	077511250613	1	17.78 x 31.12 x 96.52	14.97	10077511250610

## CD Storage



9823102 (Black)

9823003 (Grey)

### CD Spring

- May be used horizontally or vertically
- 30 CD capacity plus additional storage for 18 CDs on top of unit vertically



98310 (10 Pack)

### CD Jewel Cases

- CD Jewel replacement cases
- Each case holds 1 CD
- Standard 10 pack



98317 (25 Pack - Assorted)

98316 (25 Pack - Transparent)

### Slimline CD Jewel Cases

- Durable plastic replacement cases hold 1 CD/DVD each
- One slimline jewel case is half the thickness of a standard jewel case
- Includes area for insert booklet
- Product is 100% recyclable



83357 (5 Pack)

### DVD Plastic Cases

- Shatter resistant DVD Plastic replacement case
- Holds 1 CD/DVD and booklet



90690 (50 Pack - White)

90691 (100 Pack - White)

### CD Paper Envelopes

- Manufactured from white wood free paper
- Includes a window measuring 10cm in diameter to view CD contents
- Can be used to store media, or as a means of transportation



9831201

### CD/DVD Plastic Wallets

- Made from clear plastic for easy viewing
- Can be used to store media, or as a means of transportation

Code	Description	Colour	UNIT			RETAIL PACK			OUTER PACK			
			H x W x D (cm)	Weight (kg)	Qty	H x W x D (cm)	Weight (kg)	Barcode (UPC)	Qty	H x W x D (cm)	Weight (kg)	Barcode (SCS)
9823102	CD Spring	Black	26.00 x 26.50 x 16.50	0.90	1	26.50 x 27.00 x 17.00	1.12	043859524693	4	29.50 x 36.00 x 55.00	5.35	10043859524690
9823003	CD Spring	Grey	26.00 x 26.50 x 16.50	0.90	1	26.50 x 27.00 x 17.00	1.12	077511982309	4	29.50 x 36.00 x 55.00	5.35	50077511982304
98310	CD Jewel Cases	Clear	12.38 x 13.97 x 0.95	0.09	10	12.50 x 10.00 x 14.00	0.60	077511983108	6	14.50 x 30.50 x 37.00	4.00	10077511983105
98317	Slimline CD Jewel Cases	Assorted	12.54 x 14.29 x 0.48	0.43	25	12.54 x 14.29 x 13.02	0.89	077511983177	6	14.29 x 30.16 x 44.77	5.65	50077511983172
98316	Slimline CD Jewel Cases	Clear	12.54 x 14.29 x 0.48	0.43	25	12.54 x 14.29 x 13.02	0.89	077511983160	6	14.29 x 30.16 x 44.77	5.65	50077511983165
83357	DVD Plastic Cases	Black	19.05 x 13.49 x 1.42	0.07	5	19.00 x 6.80 x 13.40	0.36	077511833571	4	14.20 x 15.00 x 39.30	1.48	50077511833576
90690	CD Paper Envelopes	White	12.54 x 12.54 x 0.08	0.00	50	15.72 x 12.86 x 3.81	0.14	077511906909	6	13.00 x 13.00 x 27.50	0.98	50077511906904
90691	CD Paper Envelopes	White	12.54 x 12.54 x 0.08	0.00	100	15.72 x 12.86 x 6.35	0.39	077511906916	2	14.61 x 13.97 x 40.64	2.00	50077511906911
9831201	CD/DVD Plastic Wallets	Clear	16.40 x 13.80 x 3.40	0.28	100	19.50 x 14.20 x 4.00	0.32	043859590612	6	11.80 x 15.60 x 35.00	2.00	50043859590617

# Mousepads

## Earth Series™ Mousepads

- Optical and laser mouse friendly
- Mousepad consists of 85% pe-consumer recycled content
- Packaging card consists of 100% post-consumer recycled material and printed with soy-based ink
- Non-skid rubber base protects desktop from scratches



Code	Description	Colour	UNIT			RETAIL PACK			OUTER PACK			
			H x W x D (cm)	Weight (kg)	Qty	H x W x D (cm)	Weight (kg)	Barcode (UPC)	Qty	H x W x D (cm)	Weight (kg)	Barcode (SCS)
5903801	Earth Series™ Mousepad	Leaves	20.32 x 22.86 x 0.16	0.10	1	27.94 x 24.13 x 0.32	0.16	043859542819	6	5.08 x 25.40 x 29.85	1.09	50043859542814
5903901	Earth Series™ Mousepad	Blue Ocean	20.32 x 22.86 x 0.16	0.10	1	27.94 x 24.13 x 0.32	0.16	043859542826	6	5.08 x 25.40 x 29.85	1.09	50043859542821
5909701	Earth Series™ Mousepad	Waterfall	20.32 x 22.86 x 0.16	0.10	1	27.94 x 24.13 x 0.32	0.16	043859578467	6	5.08 x 25.40 x 29.85	1.09	50043859578462
5909301	Earth Series™ Mousepad	Under the Sea	20.32 x 22.86 x 0.16	0.10	1	27.94 x 24.13 x 0.32	0.16	043859578436	6	5.08 x 25.40 x 29.85	1.09	50043859578431
5904601	Earth Series™ Mousepad	Spa Flowers	20.32 x 22.86 x 0.16	0.10	1	27.94 x 24.13 x 0.32	0.16	043859573769	6	5.08 x 25.40 x 29.85	1.09	50043859573764
5909501	Earth Series™ Mousepad	Beach Chairs	20.32 x 22.86 x 0.16	0.10	1	27.94 x 24.13 x 0.32	0.16	043859578443	6	5.08 x 25.40 x 29.85	1.09	50043859578448

## Microban® Mousepads Anti-bacterial Protection

- Built in Microban® protection fights the growth of harmful bacteria for the lifetime of the product
- Active hygiene, helps keep your office equipment cleaner and healthier
- Non-slip rubber base



Code	Description	Colour	UNIT			RETAIL PACK			OUTER PACK			
			H x W x D (cm)	Weight (kg)	Qty	H x W x D (cm)	Weight (kg)	Barcode (UPC)	Qty	H x W x D (cm)	Weight (kg)	Barcode (SCS)
5933805	Microban® Mousepad Anti-bacterial Protection	Blue	19.20 x 22.60 x 0.30	0.08	1	0.48 x 23.97 x 27.62	0.12	043859544011	6	5.24 x 25.40 x 29.85	0.93	50043859544016
5933907	Microban® Mousepad Anti-bacterial Protection	Black	19.20 x 22.60 x 0.30	0.08	1	0.48 x 23.97 x 27.62	0.12	043859544028	6	5.24 x 25.40 x 29.85	0.93	50043859544023
5934005	Microban® Mousepad Anti-bacterial Protection	Silver	19.20 x 22.60 x 0.30	0.08	1	0.48 x 23.97 x 27.62	0.12	043859544035	6	5.24 x 25.40 x 29.85	0.93	50043859544030

## Premium Mousepads

- Non-slip base made from natural rubber with long lasting polyester top surface for improved tracking performance
- Optical and laser mouse friendly
- Mouse pad consists of 50% pre consumer recycled content
- Packaging card consists of 100% post-consumer recycled materials
- Packaging card printed with soy-based ink



Code	Description	Colour	UNIT			RETAIL PACK			OUTER PACK			
			H x W x D (cm)	Weight (kg)	Qty	H x W x D (cm)	Weight (kg)	Barcode (UPC)	Qty	H x W x D (cm)	Weight (kg)	Barcode (SCS)
58021	Premium Mousepads	Blue	20.32 x 22.86 x 0.48	0.08	1	27.94 x 24.13 x 0.64	0.13	077511580215	6	5.08 x 25.40 x 29.85	0.93	50077511863504
58024	Premium Mousepads	Black	20.32 x 22.86 x 0.48	0.08	1	27.94 x 24.13 x 0.64	0.13	077511580246	6	5.08 x 25.40 x 29.85	0.93	50077511580241
58023	Premium Mousepads	Silver	20.32 x 22.86 x 0.48	0.08	1	27.94 x 24.13 x 0.64	0.13	077511580239	6	5.08 x 25.40 x 29.85	0.93	50077511580234
58022	Premium Mousepads	Red	20.32 x 22.86 x 0.48	0.08	1	27.94 x 24.13 x 0.64	0.13	077511580222	6	5.08 x 25.40 x 29.85	0.93	50077511580227

## Basic Mousepads

- Long lasting polyester top surface gives improved tracking performance
- Non-slip foam base



Code	Description	Colour	UNIT			RETAIL PACK			OUTER PACK			
			H x W x D (cm)	Weight (kg)	Qty	H x W x D (cm)	Weight (kg)	Barcode (UPC)	Qty	H x W x D (cm)	Weight (kg)	Barcode (SCS)
29700	Basic Mousepads	Blue	18.60 x 22.40 x 0.60	0.02	1	0.60 x 23.00 x 19.00	0.03	077511297007	12	20.40 x 8.60 x 24.20	0.46	50077511297002
29704	Basic Mousepads	Black	18.60 x 22.40 x 0.60	0.02	1	0.60 x 23.00 x 19.00	0.03	077511297045	12	20.40 x 8.60 x 24.20	0.46	50077511297040
29702	Basic Mousepads	Silver	18.60 x 22.40 x 0.60	0.02	1	0.60 x 23.00 x 19.00	0.03	077511297021	12	20.40 x 8.60 x 24.20	0.46	50077511297026
29701	Basic Mousepads	Red	18.60 x 22.40 x 0.60	0.02	1	0.60 x 23.00 x 19.00	0.03	077511297014	12	20.40 x 8.60 x 24.20	0.46	50077511297019

## Surface Cleaning



### Surface Cleaning Wipes

- For use on workstation surfaces except glass and TFT/LCD screens
- Non-streak formula, anti-static properties
- Wipes are biodegradable
- Minimal alcohol content; less than 1%

9971518 / 9971509



Code	Description	Region	RETAIL PACK					OUTER PACK				
			Pack/ Fill	Qty	H x W x D (cm)	Weight (kg)	Barcode (UPC)	Qty	H x W x D (cm)	Weight (kg)	Barcode (SCS)	
9971518	Surface Cleaning Wipes	UK/ Export	100	1	17.15 x 7.94 x 7.94	0.26	077511997150	6	17.15 x 16.00 x 24.00	1.63	10077511997157	
9971509	Surface Cleaning Wipes	Europe	100	1	17.15 x 7.94 x 7.94	0.26	043859587025	6	17.15 x 16.00 x 24.00	1.63	50043859587020	

## Pressurised Dusters



9974905 / 9974906



9977804



9974804 / 9974805

### HFC Free Air Duster 520ml can / 350ml fill

- Ideal for removing stubborn dirt, dust and debris from difficult to reach areas such as printers, keyboards and other electrical equipment
- Use in an upright position only
- HFC Free and Ozone friendly

### HFC Free Air Duster 650ml can / 400ml fill

- Ideal for removing stubborn dirt, dust and debris from difficult to reach areas such as printers, keyboards and other electrical equipment
- Use in an upright position only
- HFC Free and Ozone Friend

### HFC Free Invertible Air Duster 520ml can / 200ml fill

- Ideal for removing stubborn dirt, dust and debris from difficult to reach areas such as printers, keyboards and other electrical equipment
- Can be used in multi-angle positions
- HFC Free and Ozone Friendly

Code	Description	Region	RETAIL PACK					OUTER PACK				
			Pack/ Fill	Qty	H x W x D (cm)	Weight (kg)	Barcode (UPC)	Qty	H x W x D (cm)	Weight (kg)	Barcode (SCS)	
9974905	HFC Free Air Duster	UK/ Export	520ml can / 350ml fill	1	18.50 x 6.50 x 6.50	0.29	043859499182	6	19.50 x 14.00 x 20.50	1.83	20043859499186	
9974906	HFC Free Air Duster	Europe	520ml can / 350ml fill	1	18.50 x 6.50 x 6.50	0.29	043859582648	6	19.50 x 14.00 x 20.50	1.83	50043859582643	
9977804	HFC Free Air Duster	UK/ Export & Europe	650ml can / 400ml fill	1	22.50 x 6.50 x 6.50	0.34	043859499168	6	23.60 x 14.20 x 21.20	2.12	20043859499162	
9974804	HFC Free Invertible Air Duster	UK/ Export	520ml can / 200ml fill	1	18.80 x 6.40 x 6.40	0.20	043859499175	6	19.40 x 14.80 x 21.20	1.32	20043859499179	
9974805	HFC Free Invertible Air Duster	Europe	520ml can / 200ml fill	1	18.80 x 6.40 x 6.40	0.20	043859582662	6	19.40 x 14.80 x 21.20	1.32	50043859582667	
9977702	HFC Free Invertible Air Duster Twin Pack	Europe	520ml can / 200ml fill	2	18.80 x 13.20 x 6.60	0.40	043859584574	6	19.40 x 14.80 x 21.20	1.32	50043859584579	



# Screen / Touchscreen Cleaning



### Screen Cleaning Wipes

- Non-streak formula, anti-static properties
- Wipes are biodegradable
- Minimal alcohol content; less than 1%

9970330 / 9970311



Code	Description	Region	Pack/ Fill	Qty	RETAIL PACK			OUTER PACK			
					H x W x D (cm)	Weight (kg)	Barcode (UPC)	Qty	H x W x D (cm)	Weight (kg)	Barcode (SCS)
9970330	Screen Cleaning Wipes	UK/ Export	100	1	17.00 x 8.20 x 8.20	0.27	077511997037	6	17.00 x 16.00 x 24.30	1.63	50077511997032
9970311	Screen Cleaning Wipes	Europe	100	1	17.00 x 8.20 x 8.20	0.27	043859587131	6	17.00 x 16.00 x 24.30	1.63	50043859587136



99718 / 9971806



99701



9974506



9930501

### 250ml Screen Cleaning Spray

- Ensures perfect streak free viewing
- Cleans any glass scanner bed, PDA, screen filter, CRT or TFT monitor and laptop screen
- Anti-static formula helps to eliminate the build-up of dust
- Minimum alcohol content; less than 1%

### 125ml Screen Cleaning Spray with 20 Absorbent Wipes

- Cleans any glass scanner bed, PDA, screen filter, CRT or TFT/LCD monitor and laptop screen
- Anti-static formula helps to eliminate the build-up of dust
- Minimal alcohol content; less than 1%

### Microfibre Cleaning Cloth

- Microfibre cleaning cloth made from optical grade micro fibres
- Safely removes dust and dirt particles without the use of chemicals
- Re-usable/washable

### Tablet and E-Reader Cleaning Kit

- A screen cleaning spray and microfibre cloth specially designed for cleaning tablet and E-Reader devices
- Includes 120ml screen cleaner and microfibre cloth

Code	Description	Region	Pack/ Fill	Qty	RETAIL PACK			OUTER PACK			
					H x W x D (cm)	Weight (kg)	Barcode (UPC)	Qty	H x W x D (cm)	Weight (kg)	Barcode (SCS)
99718	Screen Cleaning Spray	UK/ Export	250ml	1	18.80 x 5.20 x 5.20	0.28	077511997181	6	20.80 x 11.60 x 16.40	1.68	50077511997186
9971806	Screen Cleaning Spray	Europe	250ml	1	18.80 x 5.20 x 5.20	0.28	043859587070	6	20.80 x 11.60 x 16.40	1.68	50043859587075
99701	Screen Cleaning Spray with 20 Absorbent Wipes	UK/ Export & Europe	125ml	1	18.09 x 7.62 x 6.03	0.19	077511997013	6	17.78 x 16.51 x 18.42	1.27	10077511997010
9974506	Microfibre Cleaning Cloth	UK/ Export & Europe	1	1	22.00 x 15.00 x 0.10	0.16	077511997457	12	7.50 x 16.30 x 23.00	1.97	10077511997454
9930501	Tablet and E-Reader Cleaning Kit	UK/ Export & Europe	120ml	1	16.80 x 7.80 x 4.30	0.20	043859633357	10	19.00 x 17.00 x 23.50	2.22	50043859633352

## General Technology Cleaning



9967707

### 400ml Foam Cleaner

- Non-abrasive foam cleaner
- Effective on all surfaces and removes even the hardest stains like ink from PCs (not to be used on screens and keyboards)
- Anti-static properties help to eliminate the build-up of dust
- Quick drying leaving a streak free finish



9977909

### PC Cleaning Kit

- Multipurpose kit for cleaning your PC includes:
  - 120ml screen cleaner
  - 150ml foam cleaner for cleaning workstation surfaces except screens
  - Microfibre cloth
  - Handy keyboard cleaning tool
- Non-streak



99761

### CD/DVD Lens Cleaner

- Contains small brushes which clean the lens of the CD or DVD to maintain clear reading by the laser
- Can be used in audio, CD Rom, DVD and recordable drives

Code	Description	Region	RETAIL PACK					OUTER PACK			
			Pack/ Fill	Qty	H x W x D (cm)	Weight (kg)	Barcode (UPC)	Qty	H x W x D (cm)	Weight (kg)	Barcode (SCS)
9967707	Foam Cleaner	UK/ Export & Europe	400ml	1	25.00 x 5.80 x 5.80	0.49	077511996771	6	26.00 x 12.50 x 18.00	3.02	10077511996778
9977909	PC Cleaning Kit	UK/ Export & Europe	120ml/ 150ml	1	18.50 x 12.50 x 5.00	0.43	043859510184	6	20.50 x 16.50 x 26.50	2.96	40043859510182
99761	CD/DVD Lens Cleaner	UK/ Export & Europe	100	1	26.35 x 15.55 x 1.27	0.11	077511997617	6	6.35 x 16.66 x 33.02	0.82	50077511997612



# Storage and Organisation

## 120 - 167 Archival

- 123 - 125 Premium
- 126 - 137 System (Grey/Blue)
- 138 - 139 Heavy-Duty Earth Series
- 140 - 143 Earth Series
- 145 - 146 Heavy-Duty Basic
- 147 - 149 Basic Duty
- 150 - 151 Archive Clips
- 152 - 163 Loeff's Patent
- 164 - 165 Style (Small Office/Home Office)
- 166 Handifiles
- 167 Recycling

## 168 - 170 Mailing and Shipping

- 168 Envelopes
- 169 Mailing Wraps
- 168-170 Shipping/Mailing Boxes

## 171 - 172 Moving and Storing

- 171 - 172 SmoothMove<sup>™</sup>



# BENEFITS OF EFFECTIVE RECORDS MANAGEMENT



GDPR compliance



Easy access & retrieval



Data security



Increased productivity



Cost effective



Saves Time



## FIND THE RANGE THAT'S RIGHT FOR YOU...



### STRENGTH

Maximise the space you have available for storage. All boxes and units are graded by strength and maximum stacking height. The stronger the storage boxes, the higher you are able to safely stack them.



**20**  
Second set up



**4**  
Second set up



**1**  
Second set up



### SIMPLICITY

In order to make things simple, look for products that feature PRESTO™ Instant Assembly or FastFold® Automatic Assembly. Not only does this save valuable time but it makes construction hassle free.

## CHOOSE SUSTAINABILITY



All BANKERS BOX® corrugated products are made from FSC® certified board and can be recycled. All inks used are water based and all adhesives are solvent free.



After purchasing a BANKERS BOX archival product, your customer can simply register to plant their tree at [www.bankersbox.com/tree](http://www.bankersbox.com/tree)





# PLANT A TREE



*In partnership with*

**tree-nation**

We at BANKERS BOX® believe in durability and sustainability – whether it be for our products or the planet we live on. We're sure you'll find that sustainability is a key decision for our end-users.

Research shows that 25% of climate change can be attributed to deforestation. Our Plant-a-Tree initiative proactively increases reforestation while tackling wider humanity issues caused by deforestation. This is our contribution. Help us along the way...

After purchasing a BANKERS BOX product, your customer can simply register to plant their tree at [www.bankersbox.com/tree](http://www.bankersbox.com/tree)



Available throughout 2020 across Europe on all BANKERS BOX archival products.



## MADE FOR INSTANT STRENGTH

**PREMIUM** Exceptionally strong, modular and stylish storage suited to every situation

### Durable and stackable

Heavy-Duty Premium boxes can be stacked six high and feature reinforced handles.



### Fast and hassle-free

1-second set up with PRESTO™ instant assembly.



### Recyclable and sustainable

Helping you meet your environmental goals.



MADE FOR LIFE™

## BANKERS BOX® PREMIUM PRODUCTS OFFER MAXIMUM STRENGTH AND DURABILITY FOR THE STORAGE OF RECORDS.

The BANKERS BOX® Premium range is made from high-quality FSC® certified 100% recycled board.

Storage boxes feature the unique PRESTO™ instant assembly, simply push the corners together and the box is ready for use. In addition to the speed of assembly, the boxes are strong enough to be stacked up to 6 units high.

Transfer files and magazine files from the Premium range feature FastFold® automatic assembly which will also reduce the time spent constructing the products.

The complete Premium range is 100% recyclable, all inks used are water based and adhesives used are solvent free.



Use the compatibility chart below to locate the box that is most suitable for your needs.

Modular Compatibility (Storage Boxes)	Classic Storage Box	Tall Storage Box
CRC	■ 72505 ■ 72506	■ 72605 ■ 72606 ■ 72607 ■ 72608
Internal Dimensions H x W x D (mm)	330 x 254 x 381	330 x 298 x 381
PRESTO™ Instant Assembly	✓	✓
Stacking Height	6	6
Transfer File 127mm ■ 0005302 ■ 0005902 ■ 0005802	2	2
Magazine File ■ 0723301 ■ 0722904	×	×
Ring Binder (A4)	10	10
Lever Arch File (A4)	×	5
Lever Arch File (Foolscap)	×	4
Suspension File (A4)	×	×
Suspension File (Foolscap)	×	×

## Premium

### Classic Boxes

- You can trust this box is heavy-duty as it features 2 glued layers of cardboard to all 4 sides and base
- Maximise your floor space by stacking these strong storage boxes up to 6 units high
- The reinforced handles will withstand the toughest of jobs thanks to the anti-tear tape hidden between the layers of cardboard on the sides of this box.
- Avoid frustration as this box is ready for use in 1 second because of the PRESTO™ instant 'pop up' assembly
- This box is the perfect height for racking systems and for storing your ringbinders and paperwork
- For additional security, tamper evident ties can be pushed through the pre-punched holes in the lid (Ties not supplied)
- Made from FSC® certified 100% recycled board, 100% recyclable



Reinforced Tear Resistant Handles



Each box can hold up to:



**Transfer Box Files**  
2x127mm



**Ringbinders**  
10x

Code	Description	Colour	Int. Dimensions H x W x D (cm)	Ext. Dimensions H x W x D (cm)	Board Type	Product Barcode	OUTER CARTON				Minimum Order Multiple
							Qty	H x W x D (cm)	Weight (kg)	Outer Barcode	
7250501	Classic	Woodgrain	25.40 x 33.00 x 38.10	25.70 x 34.20 x 40.00	B-Flute	043859578252	10	75.60 x 22.10 x 47.00	6.46	50043859578257	10 single units
7250601	Classic	Blue	25.40 x 33.00 x 38.10	25.70 x 34.20 x 40.00	B-Flute	043859578269	10	75.60 x 22.10 x 47.00	6.46	50043859578264	10 single units

### Tall Boxes

- You can trust this box is heavy-duty as it features 2 glued layers of cardboard to all 4 sides and base
- Maximise your floor space by stacking these strong storage boxes up to 6 units high
- The reinforced handles will withstand the toughest of jobs thanks to the anti-tear tape hidden between the layers of cardboard on the sides of this box
- Avoid frustration as this box is ready for use in 1 second because of the PRESTO™ instant 'pop up' assembly
- This box is the perfect size for storing your ringbinders, lever arch files and Premium transfer files
- For additional security, tamper evident ties can be pushed through the pre-punched holes in the lid (Ties not supplied)
- Made from FSC® certified 100% recycled board, 100% recyclable



Reinforced Tear Resistant Handles



Each box can hold up to:



**Transfer Box Files**  
2x127mm



**Ringbinders**  
10x



**Lever Arch Files**  
5xA4  
4xFoolscap

Code	Description	Colour	Int. Dimensions H x W x D (cm)	Ext. Dimensions H x W x D (cm)	Board Type	Product Barcode	OUTER CARTON				Minimum Order Multiple
							Qty	H x W x D (cm)	Weight (kg)	Outer Barcode	
7260501	Tall	Woodgrain	29.80 x 33.00 x 38.10	30.30 x 34.20 x 40.00	B-Flute	043859578290	10	75.60 x 22.10 x 47.00	7.07	50043859578295	10 single units
7260601	Tall	Blue	29.80 x 33.00 x 38.10	30.30 x 34.20 x 40.00	B-Flute	043859578306	10	75.60 x 22.10 x 47.00	7.07	50043859578301	10 single units
7260701	Tall	Red	29.80 x 33.00 x 38.10	30.30 x 34.20 x 40.00	B-Flute	043859578313	10	75.60 x 22.10 x 47.00	7.07	50043859578318	10 single units
7260801	Tall	Green	29.80 x 33.00 x 38.10	30.30 x 34.20 x 40.00	B-Flute	043859578320	10	75.60 x 22.10 x 47.00	7.07	50043859578325	10 single units

## Premium



### Magazine Files

- Organise your magazines, catalogues and literature using these strong cardboard magazine files
- You will easily build the magazine file thanks to the FastFold® automatic assembly design
- Locate your literature quickly by using the large labelling areas printed on the magazine file
- Made from FSC® certified 100% recycled board, 100% recyclable



Code	Description	Colour	Int. Dimensions H x W x D (cm)	Ext. Dimensions H x W x D (cm)	Board Type	Product Barcode	Qty	OUTER CARTON			Minimum Order Multiple
								H x W x D (cm)	Weight (kg)	Outer Barcode	
0723301	Magazine File	Woodgrain	29.80 x 10.20 x 22.90	30.10 x 10.50 x 23.70	B-Flute	043859612895	10	35.00 x 9.00 x 33.00	1.11	50043859612890	10 single units
0722904	Magazine File	Blue	29.80 x 10.20 x 22.90	30.10 x 10.50 x 23.70	B-Flute	043859530434	10	35.00 x 9.00 x 33.00	1.11	10043859530424	10 single units





## Premium

### Transfer Box Files

- With strength in mind, this large capacity cardboard transfer file has the added benefit of a reinforced base
- We are sure you will find this transfer file is very easy to build thanks to the FastFold® automatic assembly design
- Suitable for storing your A4 and folio papers
- Locate your files quickly by using the large labelling areas printed on the product
- You can choose weather to use this transfer file as a standalone unit or place it inside a Premium tall storage box for long term storage
- Made from FSC® certified 100% recycled board, 100% recyclable



Code	Description	Colour	Int. Dimensions H x W x D (cm)	Ext. Dimensions H x W x D (cm)	Board Type	Product Barcode	OUTER CARTON				Minimum Order Multiple
							Qty	H x W x D (cm)	Weight (kg)	Outer Barcode	
0005302	Transfer Box File	Woodgrain	25.40 x 12.70 x 35.90	25.80 x 12.90 x 37.20	B-Flute	043859530359	10	43.10 x 8.90 x 50.60	1.96	50043859530354	10 single units
0005902	Transfer Box File	Blue	25.40 x 12.70 x 35.90	25.80 x 12.90 x 37.20	B-Flute	043859530373	10	43.10 x 8.90 x 50.60	1.96	50043859530378	10 single units
0005802	Transfer Box File	Red	25.40 x 12.70 x 35.90	25.80 x 12.90 x 37.20	B-Flute	043859530366	10	43.10 x 8.90 x 50.60	1.96	50043859530361	10 single units



## MADE FOR MULTI-TASKING

**SYSTEM** A hard-working range of modular storage, designed to fit every office task

### Strength and stackability

To help you, all boxes and units are graded by strength and maximum stacking height.



### Speed and simplicity

Zero-hassle, four second set-up boxes designed to fit standard filing products.

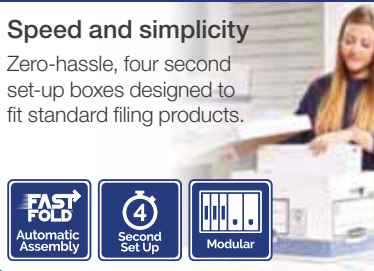

### Recyclable and sustainable

Helping you meet your environmental goals.



MADE FOR LIFE™

## THIS ATTRACTIVE, MODULAR SYSTEM OFFERS THE FOLLOWING BENEFITS:

**A modular system, tailored to meet individual needs:** There is a BANKERS BOX® System product for every stage of a documents life. All products within the system are compatible, allowing you to develop a system to suit your personal needs.

**No need to waste time re-filing for long term storage:** Attractive BANKERS BOX® System will not look out of place in the office, and when a file is full, simply transfer into a box, drawer or stax file store.

### Optimises use of space:

Selected items are suitable for stacking, providing compact, multi-level storage.

### Ideal for use at home, in the office, or on the move:

Suitable for use in the home office, at work, or on the move between home and work for transferring files and paperwork.

### Attractive colour options:

The BANKERS BOX® System range is available in grey or blue and white.



Use the compatibility chart below to locate the products that are most suitable for your needs.

Modular Compatibility (Storage Boxes)	Standard Storage Box	Large Storage Box	Heavy-Duty Box Standard	Heavy-Duty Box Large	Flip Top Cube	Flip Top Maxi
CRC	■ 00810 ■ 00261	■ 01810 ■ 00309	■ 00818 ■ 00388	■ 00812	■ 00216	■ 11815 ■ 11415 ■ 00489
Dimensions H x W x D (mm)	290 x 333 x 390	287 x 430 x 380	285 x 333 x 390	294 x 387 x 430	293 x 350 x 370	293 x 378 x 545
FastFold® Set Up	✓	✓	✓	✓	✓	✓
Stacking Height	4	4	4	4	5	5
A4 Transfer Box Files 80mm	4	5	4	5	4	6
A4 Transfer Box Files 100mm	3	3	3	4	3	5
A4 Transfer Box Files 150mm	2	2	2	2	2	3
A4 Transfer Box Files 200mm	1	2	1	2	×	2
Folio Transfer Box Files 80mm	3	5	3	5	×	6
Folio Transfer Box Files 100mm	3	4	3	4	×	5
Folio Transfer Box Files 120mm	2	3	2	3	×	4
Magazine File (01806)	×	×	×	×	×	×
Ring Binder (A4)	8	10	8	10	8	12
Lever Arch File (A4)	5	5	5	5	4	7
Lever Arch File (Foolscap)	4	5	4	5	×	7
Suspension File (A4)	+40	×	+40	×	×	×
Suspension File (Foolscap)	+40	×	+40	×	×	×

Modular Compatibility (Storage Units)	File Store	File Store Module	Storage Drawer (A4)	Storage Container
CRC	■ 01840 ■ 11304	■ 01880 ■ 11880	■ 01820EU	■ 00299
Dimensions H x W x D (mm)	400 x 400 x 290*	400 x 580 x 290*	290 x 350 x 545	335 557 x 389*
FastFold® Set Up	✓	✓	×	×
Stacking Height	3	3	6	5
A4 Transfer Box Files 80mm	4	6	6	6
A4 Transfer Box Files 100mm	×	×	4	4
A4 Transfer Box Files 150mm	×	×	3	2
A4 Transfer Box Files 200mm	×	×	2	2
Folio Transfer Box Files 80mm	4	6	×	6
Folio Transfer Box Files 100mm	×	×	×	4
Folio Transfer Box Files 120mm	×	×	×	4
Magazine File (01860)	4	6	×	6
Ring Binder (A4)	8	12	11	12
Lever Arch File (A4)	4	6	6	6
Lever Arch File (Foolscap)	4	6	×	×
Suspension File (A4)	×	×	+60	×
Suspension File (Foolscap)	×	×	×	×

\*All dimensions shown are internal unless marked

## System



### A4 Transfer Box Files (80, 100, 150 & 200mm)

- A4 size transfer box file made from high quality corrugated board
- To avoid frustration, and save you time, the file has been designed with FastFold® automatic assembly
- To simplify your filing system it has been designed to fit in the System storage boxes and storage units
- For your convenience there are large labelling areas on 3 sides of the transfer file
- To offer you a secure closure the hinged lid features a locking tab
- Made from FSC® certified 100% recycled board, 100% recyclable

							OUTER CARTON				
Code	Spine	Colour	Int. Dimensions H x W x D (cm)	Ext. Dimensions H x W x D (cm)	Board Type	Product Barcode	Qty	H x W x D (cm)	Weight (kg)	Outer Barcode	Minimum Order Multiple
1080001	80mm	Grey	26.00 x 8.00 x 31.50	26.50 x 8.50 x 32.70	Micro-Flute	043859645077	10	42.00 x 7.50 x 39.50	1.40	50043859645072	10 single units
0026401	80mm	Blue/White	26.00 x 8.00 x 31.50	26.50 x 8.50 x 32.70	Micro-Flute	043859520992	10	42.00 x 7.50 x 39.50	1.40	50043859520997	10 single units
1080501	100mm	Grey	26.00 x 10.00 x 31.50	26.50 x 11.10 x 32.70	Micro-Flute	043859645084	10	44.20 x 7.80 x 42.00	1.44	50043859645089	10 single units
0026501	100mm	Blue/White	26.00 x 10.00 x 31.50	26.50 x 11.10 x 32.70	Micro-Flute	043859521005	10	44.20 x 7.80 x 42.00	1.44	50043859521000	10 single units
0027701	150mm	Blue/White	26.00 x 15.00 x 31.50	26.50 x 15.80 x 32.70	B-Flute	043859562589	10	48.70 x 9.20 x 46.50	2.36	50043859562584	10 single units
0028501	200mm	Blue/White	26.00 x 20.00 x 31.50	26.50 x 20.60 x 32.70	B-Flute	043859562626	10	53.70 x 9.60 x 51.00	2.92	50043859562621	10 single units

							RETAIL PACK*				
Code	Spine	Colour	Int. Dimensions H x W x D (cm)	Ext. Dimensions H x W x D (cm)	Board Type	Product Barcode	Qty	H x W x D (cm)	Weight (kg)	Pack Barcode	Minimum Order Multiple
0026413	80mm - 6pk	Blue/White	26.00 x 8.00 x 31.50	26.50 x 8.50 x 32.70	Micro-Flute	043859520992	6	40.50 x 38.50 x 3.10	0.77	043859590124	1 x 6pk
0026411	100mm - 6pk	Blue/White	26.00 x 10.00 x 31.50	26.50 x 11.10 x 32.70	Micro-Flute	043859521005	6	40.20 x 43.00 x 3.10	0.89	043859590148	1 x 6pk
0027707	150mm - 6pk	Blue/White	26.00 x 15.00 x 31.50	26.50 x 15.80 x 32.70	B-Flute	043859562589	6	44.80 x 47.50 x 4.00	1.25	043859649075	1 x 6pk
0028505	200mm - 6pk	Blue/White	26.00 x 20.00 x 31.50	26.50 x 20.60 x 32.70	B-Flute	043859562626	6	53.00 x 50.30 x 4.80	1.32	043859649082	1 x 6pk

\*Retail packs include full colour insert



### A4+ Transfer File (100, 150 & 200mm)

- A4+ size transfer box file made from high quality corrugated board
- To avoid frustration, and save you time, the file has been designed with FastFold® automatic assembly
- To simplify your filing system it has been designed to fit in the System storage boxes and storage units
- For your convenience there are large labelling areas on 3 sides of the transfer file
- To offer you a secure closure the hinged lid features a locking tab
- Made from FSC® certified 100% recycled board, 100% recyclable

							SHRINK PACK				
Code	Spine	Colour	Int. Dimensions H x W x D (cm)	Ext. Dimensions H x W x D (cm)	Board Type	Product Barcode	Qty	H x W x D (cm)	Weight (kg)	Pack Barcode	Minimum Order Multiple
1130902	100mm - 10pk	Blue/White	24.90 x 9.30 x 33.00	25.30 x 10.00 x 34.50	Micro-Flute	043859712144	10	42.90 x 9.00 x 38.40	1.35	043859712182	1 x 10pk
1131002	150mm - 10pk	Blue/White	24.90 x 14.30 x 33.00	25.30 x 15.00 x 34.50	B-Flute	043859712151	10	47.90 x 9.00 x 43.40	1.65	043859712199	1 x 10pk
1131102	200mm - 10pk	Blue/White	24.90 x 19.30 x 33.00	25.30 x 20.00 x 34.50	B-Flute	043859712168	10	52.60 x 9.00 x 48.10	1.95	043859712205	1 x 10pk



## System

### Folio Transfer Box Files (80, 100 & 120mm)

- Foolscap size transfer box file made from high quality corrugated board
- To avoid frustration, and save you time, the file has been designed with FastFold® automatic assembly
- To simplify your filing system it has been designed to fit in the System storage boxes and storage units
- For your convenience there are large labelling areas on 3 sides of the transfer file
- To offer you a secure closure the hinged lid features a locking tab
- Made from FSC® certified 100% recycled board, 100% recyclable



							OUTER CARTON				
Code	Spine	Colour	Int. Dimensions H x W x D (cm)	Ext. Dimensions H x W x D (cm)	Board Type	Product Barcode	Qty	H x W x D (cm)	Weight (kg)	Outer Barcode	Minimum Order Multiple
1180001	80mm	Grey	25.50 x 8.00 x 36.00	25.80 x 8.50 x 36.60	Micro-Flute	043859645053	10	43.80 x 7.50 x 39.50	1.44	50043859645058	10 single units
0023701	80mm	Blue/White	25.50 x 8.00 x 36.00	25.80 x 8.50 x 36.60	Micro-Flute	043859578023	10	43.80 x 7.50 x 39.50	1.44	50043859578028	10 single units
0030801	100mm	Blue/White	25.50 x 10.00 x 36.00	25.80 x 10.30 x 36.60	B-Flute	043859634767	10	47.50 x 7.50 x 40.90	1.45	50043859634762	10 single units
1180501	120mm	Grey	25.50 x 12.00 x 36.00	26.20 x 12.80 x 36.60	B-Flute	043859645060	10	49.60 x 10.40 x 43.40	1.86	50043859645065	10 single units

							RETAIL PACK*				
Code	Spine	Colour	Int. Dimensions H x W x D (cm)	Ext. Dimensions H x W x D (cm)	Board Type	Product Barcode	Qty	H x W x D (cm)	Weight (kg)	Pack Barcode	Minimum Order Multiple
0023707	80mm - 6pk	Blue/White	25.50 x 8.00 x 36.00	25.80 x 8.50 x 36.60	Micro-Flute	043859578023	6	42.90 x 38.50 x 5.00	0.84	043859590162	1 x 6pk
0030802	100mm - 6pk	Blue/White	25.50 x 10.00 x 36.00	25.80 x 10.30 x 36.60	B-Flute	043859634767	6	46.50 x 39.90 x 3.30	0.79	043859649099	1 x 6pk

\*Retail packs include full colour insert

### A3 Transfer Box File (100mm)

- A3 size transfer box file made from high quality corrugated board
- To avoid frustration, and save you time, the file has been designed with FastFold® automatic assembly
- For your convenience there are large labelling areas on 3 sides of the transfer file
- To offer you a secure closure the hinged lid features a locking tab
- Made from FSC® certified 100% recycled board, 100% recyclable"



							OUTER CARTON				
Code	Description	Colour	Int. Dimensions H x W x D (cm)	Ext. Dimensions H x W x D (cm)	Board Type	Product Barcode	Qty	H x W x D (cm)	Weight (kg)	Outer Barcode	Minimum Order Multiple
0023601	A3 Transfer Box File	Blue/White	31.50 x 10.00 x 43.00	33.10 x 10.80 x 44.20	B-Flute	043859578016	10	48.40 x 9.20 x 55.60	2.78	50043859578011	10 single units



## System



### Magazine File

- Ideal solution for organising your A4 sized magazines and literature
- For your convenience there is a label area on front and back spine
- Easy to assemble with fold together base
- To simplify your filing system it has been designed to fit in the System File Store Units
- Made from FSC® certified 100% recycled board, 100% recyclable\*

OUTER CARTON											
Code	Description	Colour	Int. Dimensions H x W x D (cm)	Ext. Dimensions H x W x D (cm)	Board Type	Product Barcode	Qty	H x W x D (cm)	Weight (kg)	Outer Barcode	Minimum Order Multiple
0186004	Magazine File	Grey	31.10 x 7.80 x 25.80	31.60 x 8.10 x 26.30	B-Flute	5016291885511	10	55.80 x 4.20 x 35.20	0.90	35016291885512	10 single units
0026301	Magazine File	Blue/White	31.10 x 7.80 x 25.80	31.60 x 8.10 x 26.30	B-Flute	043859520985	10	55.80 x 4.20 x 35.20	0.90	50043859520980	10 single units

RETAIL PACK*											
Code	Description	Colour	Int. Dimensions H x W x D (cm)	Ext. Dimensions H x W x D (cm)	Board Type	Product Barcode	Qty	H x W x D (cm)	Weight (kg)	Pack Barcode	Minimum Order Multiple
0026310	Magazine File - 6pk	Blue/White	31.10 x 7.80 x 25.80	31.60 x 8.10 x 26.30	B-Flute	043859520985	6	55.70 x 34.30 x 2.10	0.43	043859590100	1 x 6pk

\*Retail packs include full colour insert



### Desktop Sorter

- Designed with 8 compartments for the easy organisation and identification of your paperwork or literature
- Maximise your storage space by stacking the sorter 3 units high
- To simplify construction the cardboard shell features FastFold® automatic assembly
- For easy identification plastic shelf edging is suitable for labels (labels not supplied)
- Made from FSC® certified 100% recycled board, 100% recyclable

OUTER CARTON											
Code	Description	Colour	Int. Dimensions H x W x D (cm)	Ext. Dimensions H x W x D (cm)	Board Type	Product Barcode	Qty	H x W x D (cm)	Weight (kg)	Outer Barcode	Minimum Order Multiple
08750EU	Desktop Sorter	Grey	5.50 x 31.00 x 23.00	26.00 x 49.00 x 31.00	B-Flute	5016291885634	5	76.40 x 15.20 x 43.60	5.74	05016291885641	5 single units
0875006	Desktop Sorter - 1pk	Grey	5.50 x 31.00 x 23.00	26.00 x 49.00 x 31.00	B-Flute	5016291885634	1	75.00 x 4.50 x 44.50	1.21	043859647170	1 x 1pk



### Recycling Bin

- Letterbox opening designed for use under-desk or top opening for desk side use
- Can be used under-desk or as a central recycling station
- Pre-printed selection guide and tick boxes for identification of contents
- Removable lid and tote handles for use when emptying
- Compatible with Fellowes shredder bag, code: 36054
- Made from FSC® certified board, 100% recyclable

				SHRINK PACK**				OUTER CARTON					
Code	Description	Colour	Int. Dimensions H x W x D (cm)	Ext. Dimensions H x W x D (cm)	Qty	H x W x D (cm)	Weight (kg)	Barcode (UPC)	Qty	H x W x D (cm)	Weight (kg)	Barcode (SCS)	Minimum Order Multiple
0193201	Recycling Bin	Grey	60.00 x 40.00 x 30.00	61.00 x 31.60 x 42.50	1	78.70 x 70.40 x 1.20	0.63	043859561025	5	79.60 x 7.50 x 71.60	3.76	50043859561020	5 single units

\*\*Shrink pack has no retail label and is for protection purposes only.

## System

### File Store

- To offer you versatility, this desktop unit that can be used horizontal or vertically with or without drawers supplied
- Designed to store your 80mm A4 or foolscap transfer files, magazine files, lever arch files and ring binders
- Maximise your storage area by stacking the File Store 3 units high
- To simplify construction the cardboard shell features FastFold® automatic assembly
- Made from FSC® certified 100% recycled board, 100% recyclable



OUTER CARTON											
Code	Description	Colour	Int. Dimensions H x W x D (cm)	Ext. Dimensions H x W x D (cm)	Board Type	Product Barcode	Qty	H x W x D (cm)	Weight (kg)	Outer Barcode	Minimum Order Multiple
01840EU	File Store	Grey	38.00 x 9.30 x 28.50	40.00 x 40.00 x 29.00	B-Flute	5016291885450	5	81.50 x 15.50 x 55.80	6.46	05016291885467	5 single units
1130401	File Store	Blue/White	38.00 x 9.30 x 28.50	40.00 x 40.00 x 29.00	B-Flute	043859645961	5	81.50 x 15.50 x 55.80	6.46	50043859645966	5 single units

### File Store Module

- For convenience, store your lever arch files and System 8cm transfer files and magazine files in this desktop unit
- Maximise your storage area by stacking the File Store Module 3 units high
- To simplify construction the shell cardboard features FastFold® automatic assembly
- Made from FSC® certified 100% recycled board, 100% recyclable



OUTER CARTON											
Code	Description	Colour	Int. Dimensions H x W x D (cm)	Ext. Dimensions H x W x D (cm)	Board Type	Product Barcode	Qty	H x W x D (cm)	Weight (kg)	Outer Barcode	Minimum Order Multiple
01880EU	File Store Module	Grey	38.00 x 9.50 x 28.50	40.00 x 58.00 x 29.00	B-Flute	5016290018804	5	98.50 x 15.00 x 50.30	5.90	05016291018803	5 single units
0188009	File Store Module - 1pk	Grey	38.00 x 9.50 x 28.50	40.00 x 58.00 x 29.00	B-Flute	5016290018804	1	98.00 x 30.50 x 49.20	1.46	043859649204	1 x 1pk

RETAIL PACK*											
Code	Description	Colour	Int. Dimensions H x W x D (cm)	Ext. Dimensions H x W x D (cm)	Board Type	Product Barcode	Qty	H x W x D (cm)	Weight (kg)	Pack Barcode	Minimum Order Multiple
0188014	File Store Module - 1pk	Grey	38.00 x 9.50 x 28.50	40.00 x 58.00 x 29.00	B-Flute	5016290018804	1	97.00 x 48.50 x 2.50	1.10	5016290018804	1 x 1pk

\*Retail packs include full colour insert





## System



### Storage Drawer (A4)

- Extra strong construction reinforced shell and drawer
- Will hold A4 lever arch files, A4 suspension files or 6 x System A4 80mm transfer box files
- Suitable for storage and occasional access of your records
- Will stack up to 6 units high saving you valuable floor space
- Made from FSC® certified board, 100% recyclable



Code	Description	Colour	Int. Dimensions H x W x D (cm)	Ext. Dimensions H x W x D (cm)	Board Type	Product Barcode	OUTER CARTON				Minimum Order Multiple
							Qty	H x W x D (cm)	Weight (kg)	Outer Barcode	
01820EU	Storage Drawer (A4)	Grey	29.00 x 35.00 x 54.50	31.00 x 39.00 x 56.80	B-Flute	5016290182055	5	106.00 x 19.50 x 71.60	12.27	05016291182054	5 single units



### Storage Container

- To create a solid archive solution use this strong stackable storage container
- To give extra stacking strength this unit has been designed with 2 layers of cardboard sides and back panel
- For extra stability the containers should be filled from the bottom of the stack first
- Perfectly sized to store your A4 lever arch files, ring binders or 6 x 80mm System transfer files
- Made from FSC® certified 100% recycled board, 100% recyclable



Code	Description	Colour	Int. Dimensions H x W x D (cm)	Ext. Dimensions H x W x D (cm)	Board Type	Product Barcode	OUTER CARTON				Minimum Order Multiple
							Qty	H x W x D (cm)	Weight (kg)	Outer Barcode	
0029901	Storage Container	Blue/White	32.50 x 54.00 x 37.50	33.50 x 55.70 x 38.90	B-Flute	043859578825	5	130.00 x 4.00 x 77.20	4.90	50043859578820	5 single units



**System**



## System



### Large Storage Box

- You can rely on this large storage box to protect your files and paperwork because it has 3 layers of cardboard to the handle ends and 2 layers to the base
- Maximise your floor space by stacking the boxes up to 4 units high
- We understand time is important so this box will be ready to use quickly thanks to the FastFold® automatic assembly design
- Perfectly sized to store your A4 or foolscap lever arch files, System transfer files and even computer listing paper
- Supplied with a dust cover lid
- Made from FSC® certified 100% recycled board, 100% recyclable

							OUTER CARTON				
Code	Description	Colour	Int. Dimensions H x W x D (cm)	Ext. Dimensions H x W x D (cm)	Board Type	Product Barcode	Qty	H x W x D (cm)	Weight (kg)	Outer Barcode	Minimum Order Multiple
01810-FFEU	Large Storage Box	Grey	28.70 x 38.00 x 43.00	29.40 x 38.70 x 44.50	B-Flute	5016291885375	10	84.50 x 20.00 x 50.20	7.25	05016291885382	10 single units
0030901	Large Storage Box	Blue/White	28.70 x 38.00 x 43.00	29.40 x 38.70 x 44.50	B-Flute	043859635702	10	84.50 x 20.00 x 50.20	7.25	50043859635707	10 single units

							RETAIL PACK*				
Code	Description	Colour	Int. Dimensions H x W x D (cm)	Ext. Dimensions H x W x D (cm)	Board Type	Product Barcode	Qty	H x W x D (cm)	Weight (kg)	Pack Barcode	Minimum Order Multiple
0181040	Large Storage Box - 2pk	Grey	28.70 x 38.00 x 43.00	29.40 x 38.70 x 44.50	B-Flute	5016291885375	2	79.40 x 49.00 x 3.90	1.31	5016291885573	1 x 2pk
0030907	Large Storage Box - 2pk	Blue/White	28.70 x 38.00 x 43.00	29.40 x 38.70 x 44.50	B-Flute	043859635702	2	79.40 x 49.00 x 3.90	1.31	043859649129	1 x 2pk

\*Retail packs include full colour insert



### Standard Storage Box

- You can rely on this storage box to protect your files and paperwork because it has 3 layers of cardboard to the handle ends and 2 layers to the base
- Maximise your floor space by stacking the boxes up to 4 units high
- We understand time is important so this box will be ready to use quickly thanks to the FastFold® automatic assembly design
- Perfectly sized to store your A4 or foolscap lever arch files, suspension files or System transfer files
- To ensure that the lid will fit when you store suspension files, we have made it slightly oversized
- Made from FSC® certified 100% recycled board, 100% recyclable

							OUTER CARTON				
Code	Description	Colour	Int. Dimensions H x W x D (cm)	Ext. Dimensions H x W x D (cm)	Board Type	Product Barcode	Qty	H x W x D (cm)	Weight (kg)	Outer Barcode	Minimum Order Multiple
00810-FFEU	Standard Storage Box	Grey	29.00 x 33.30 x 39.00	29.20 x 33.50 x 40.40	B-Flute	5016291008101	10	75.00 x 19.50 x 47.00	6.42	05016291881278	10 single units
0026101	Standard Storage Box	Blue/White	29.00 x 33.30 x 39.00	29.20 x 33.50 x 40.40	B-Flute	043859520961	10	75.00 x 19.50 x 47.00	6.67	50043859520966	10 single units

							RETAIL PACK*				
Code	Description	Colour	Int. Dimensions H x W x D (cm)	Ext. Dimensions H x W x D (cm)	Board Type	Product Barcode	Qty	H x W x D (cm)	Weight (kg)	Pack Barcode	Minimum Order Multiple
0081042	Standard Storage Box - 2pk	Grey	29.00 x 33.30 x 39.00	29.20 x 33.50 x 40.40	B-Flute	5016291885375	2	72.50 x 46.00 x 3.70	1.18	043859583300	1 x 2pk
0081044	Standard Storage Box - 6pk	Grey	29.00 x 33.30 x 39.00	29.20 x 33.50 x 40.40	B-Flute	5016291885375	6	72.50 x 46.00 x 11.20	3.53	043859649112	1 x 6pk
0026118	Standard Storage Box - 2pk	Blue/White	29.00 x 33.30 x 39.00	29.20 x 33.50 x 40.40	B-Flute	043859520961	2	72.50 x 46.00 x 3.90	1.18	043859581535	1 x 2pk
0026120	Standard Storage Box - 6pk	Blue/White	29.00 x 33.30 x 39.00	29.20 x 33.50 x 40.40	B-Flute	043859520961	6	72.50 x 46.00 x 11.20	3.53	043859649105	1 x 6pk

\*Retail packs include full colour insert



## System

### Flip Top Cube Storage Box

- You can trust this storage box will protect your files and paperwork because it has 3 layers of cardboard to the handle ends and 2 layers to the front and base
- Maximise your floor space by stacking the boxes up to 5 units high
- To avoid frustrations, this box can be built easily thanks to the FastFold® automatic assembly design
- Perfectly sized to store your A4 lever arch files or System transfer files
- For your convenience this box features an attached, hinged lid with a locking tab
- Made from FSC® certified 100% recycled board, 100% recyclable\*

One Piece Box  
Solid construction  
with attached lid



							OUTER CARTON				
Code	Description	Colour	Int. Dimensions H x W x D (cm)	Ext. Dimensions H x W x D (cm)	Board Type	Product Barcode	Qty	H x W x D (cm)	Weight (kg)	Outer Barcode	Minimum Order Multiple
0021601	Flip Top Cube	Blue/White	29.30 x 35.00 x 37.00	31.00 x 37.70 x 39.50	B-Flute	043859578214	10	80.50 x 12.00 x 74.50	7.84	50043859578219	10 single units

							RETAIL PACK*				
Code	Description	Colour	Int. Dimensions H x W x D (cm)	Ext. Dimensions H x W x D (cm)	Board Type	Product Barcode	Qty	H x W x D (cm)	Weight (kg)	Pack Barcode	Minimum Order Multiple
0021619	Flip Top Cube - 2pk	Blue/White	29.30 x 35.00 x 37.00	31.00 x 37.70 x 39.50	B-Flute	043859578214	2	78.70 x 73.60 x 2.00	1.43	043859590179	1 x 2pk
0021611	Flip Top Cube - 6pk	Blue/White	29.30 x 35.00 x 37.00	31.00 x 37.70 x 39.50	B-Flute	043859578214	6	78.70 x 73.60 x 6.00	4.29	043859649136	1 x 6pk

\*Retail packs include full colour insert

### Flip Top Maxi Storage Boxes

- You can trust this storage box will protect your files and paperwork because it has 3 layers of cardboard to the handle ends and 2 layers to the front and base
- Maximise your floor space by stacking the boxes up to 5 units high
- To avoid frustrations, this box can be built easily thanks to the FastFold® automatic assembly design
- Perfectly sized to store your A4 or foolscap lever arch files or System transfer files
- For your convenience this box features an attached, hinged lid with a locking tab
- Made from FSC® certified 100% recycled board, 100% recyclable

One Piece Box  
Solid construction  
with attached lid



							OUTER CARTON				
Code	Description	Colour	Int. Dimensions H x W x D (cm)	Ext. Dimensions H x W x D (cm)	Board Type	Product Barcode	Qty	H x W x D (cm)	Weight (kg)	Outer Barcode	Minimum Order Multiple
1181501	Flip Top Maxi	Grey/White	29.30 x 37.80 x 54.50	31.00 x 39.00 x 56.00	B-Flute	043859645091	10	96.00 x 15.00 x 82.00	10.55	50043859645096	10 single units
1141501	Flip Top Maxi	Blue/White	29.30 x 37.80 x 54.50	31.00 x 39.00 x 56.00	B-Flute	043859645107	10	96.00 x 15.00 x 82.50	10.55	50043859645102	10 single units

							RETAIL CARTON***				
Code	Description	Colour	Int. Dimensions H x W x D (cm)	Ext. Dimensions H x W x D (cm)	Board Type	Product Barcode	Qty	H x W x D (cm)	Weight (kg)	Pack Barcode	Minimum Order Multiple
1141502	Flip Top Maxi - 2pk	Blue/White	29.30 x 37.80 x 54.50	31.00 x 39.00 x 56.00	B-Flute	043859645091	2	95.30 x 81.80 x 3.00	2.70	043859649143	1 x 2pk

\*\*\*Retail carton is full colour print design

## System



### Large Heavy-Duty R-Kive® Box

- With strength in mind, this heavy-duty storage box is made from double thickness cardboard
- For worry-free, comfortable lifting, even when the box is full it features 2 layers of cardboard to the handle ends and the base
- You can maximise your space by stacking these strong boxes up to 6 units high
- To save you time, this box will be ready to use quickly thanks to the FastFold® automatic assembly design
- Perfectly sized to store your A4 or foolscap lever arch files, System transfer files and even computer listing paper
- Supplied with a dust cover lid
- Made from FSC® certified 100% recycled board, 100% recyclable

Code	Description	Colour	Int. Dimensions H x W x D (cm)	Ext. Dimensions H x W x D (cm)	Board Type	Product Barcode	OUTER CARTON				Minimum Order Multiple
							Qty	H x W x D (cm)	Weight (kg)	Outer Barcode	
0181201	Large Heavy-Duty R-Kive® Box	Grey	29.40 x 38.70 x 43.00	29.40 x 39.00 x 46.40	Micro/B-Flute	043859709458	10	84.50 x 33.60 x 50.00	8.75	50043859709453	10 single units



### Heavy-Duty R-Kive® Box

- With strength in mind, this heavy-duty storage box is made from double thickness cardboard
- For worry-free, comfortable lifting, even when the box is full it features 2 layers of cardboard to the handle ends and the base
- You can maximise your space by stacking these strong boxes up to 6 units high
- To save you time, this box will be ready to use quickly thanks to the FastFold® automatic assembly design
- Perfectly sized to store your A4 or foolscap lever arch files, suspension files or System transfer files
- To ensure that the lid will fit when you store suspension files, we have made it slightly oversized
- Made from FSC® certified 100% recycled board, 100% recyclable

Code	Description	Colour	Int. Dimensions H x W x D (cm)	Ext. Dimensions H x W x D (cm)	Board Type	Product Barcode	OUTER CARTON				Minimum Order Multiple
							Qty	H x W x D (cm)	Weight (kg)	Outer Barcode	
0081801	Large Heavy-Duty R-Kive® Box	Grey	28.50 x 33.30 x 39.00	29.90 x 33.50 x 40.40	Micro/B-Flute	043859709816	10	46.50 x 28.60 x 74.70	14.40	50043859709811	10 single units





## System

### Heavy-Duty ERGO-Box™

- Heavy duty storage box featuring ergonomic handles to reduce wrist strain
- To allow your wrists to maintain a neutral position while lifting or carrying, the box handles are engineered with a 30-degree angle
- A neutral wrist position optimizes comfort and reduces wrist strain
- This heavy duty box features 3 layers of cardboard to the handle ends end panels and two layers to sides and base
- For convenience and comfort with carrying the lid tabs lock into the handle holes and reinforce them
- To avoid frustration and save time when building, this box features FastFold® automatic assembly
- Designed to store your A4 or folio transfer files, ring binders or lever arch files
- For additional security, tamper evident ties can be pushed through the pre-punched holes in the lid (Ties not supplied)
- Made from FSC® certified 100% recycled board, 100% recyclable

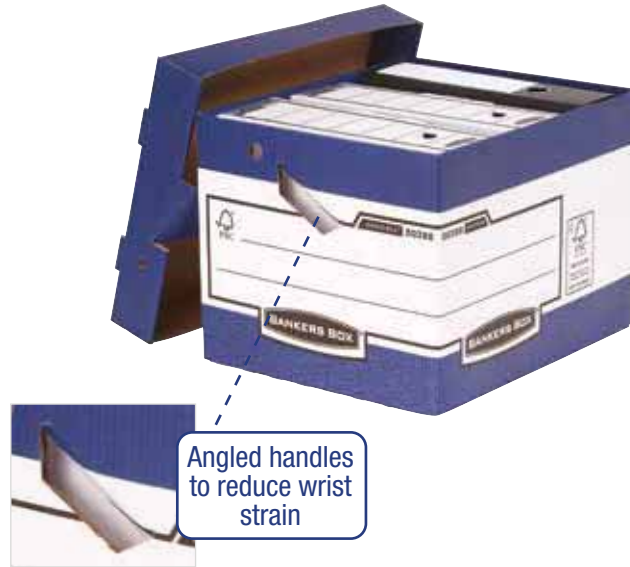

Code	Description	Colour	Int. Dimensions H x W x D (cm)	Ext. Dimensions H x W x D (cm)	Board Type	Product Barcode	OUTER CARTON				Minimum Order Multiple
							Qty	H x W x D (cm)	Weight (kg)	Outer Barcode	
0038801	Heavy-Duty ERGO-Box™	Blue/White	28.50 x 33.30 x 39.00	29.20 x 33.50 x 40.40	B-Flute	043859671113	10	75.40 x 16.00 x 58.80	7.46	50043859671118	10 single units

### Heavy-Duty ERGO-Stor™ Maxi

- Heavy duty large storage box featuring ergonomic handles to reduce wrist strain
- To allow your wrists to maintain a neutral position while lifting or carrying, the box handles are engineered with a 30-degree angle
- A neutral wrist position optimizes comfort and reduces wrist strain
- This heavy duty box features 3 layers of cardboard to the handle ends end panels and two layers to front and base
- For additional strength and comfort with carrying the lid tabs lock into the handle holes and reinforce them
- To avoid frustration and save time when building, this box features FastFold® automatic assembly
- Designed to store your A4 or folio transfer files, ring binders or lever arch files
- For your convenience this box features an attached, hinged lid with a locking tab
- For additional security, tamper evident ties can be pushed through the pre-punched holes in the lid (Ties not supplied)
- Made from FSC® certified 100% recycled board, 100% recyclable



One Piece Box  
Solid construction with attached lid



Code	Description	Colour	Int. Dimensions H x W x D (cm)	Ext. Dimensions H x W x D (cm)	Board Type	Product Barcode	OUTER CARTON				Minimum Order Multiple
							Qty	H x W x D (cm)	Weight (kg)	Outer Barcode	
0048901	Heavy-Duty ERGO-Stor™ Maxi	Blue/White	29.30 x 37.80 x 54.50	31.00 x 39.00 x 56.00	B-Flute	043859678723	10	96.00 x 15.00 x 82.50	10.45	50043859678728	10 single units



## MADE FOR MAXIMUM RELIABILITY

**HEAVY-DUTY EARTH SERIES** Remarkably durable storage that can be relied on

### Hard-wearing and stackable

Heavy-Duty storage solutions classified by strength and maximum stacking height.



### Convenient and adaptable

Strong manual assembly, modular storage solutions.



### Recyclable and sustainable

Helping you meet your environmental goals.



**MADE FOR LIFE™**



### Heavy-Duty A4 Box File

- Heavy duty A4 box file made from strong corrugated board
- To offer you a secure closure the hinged lid features a locking tab
- For your convenience there are label areas on 3 sides allowing you to store the file portrait or landscape
- Made from FSC® certified 100% recycled board, 100% recyclable

							SHRINK PACK				
Code	Description	Colour	Int. Dimensions H x W x D (cm)	Ext. Dimensions H x W x D (cm)	Board Type	Product Barcode	Qty	H x W x D (cm)	Weight (kg)	Outer Barcode	Minimum Order Multiple
4473401	Heavy-Duty A4 Box File	Brown	6.70 x 31.80 x 25.00	7.00 x 32.20 x 26.00	Micro-Flute	043859708932	10	50.70 x 6.75 x 32.00	1.60	50043859708937	10 single units



### Heavy-Duty A3 Box File

- Heavy duty A3 box file made from strong corrugated board
- To offer you a secure closure the hinged lid features a locking tab
- For your convenience there are label areas on 3 sides allowing you to store the file portrait or landscape
- Made from FSC® certified 100% recycled board, 100% recyclable

							SHRINK PACK				
Code	Description	Colour	Int. Dimensions H x W x D (cm)	Ext. Dimensions H x W x D (cm)	Board Type	Product Barcode	Qty	H x W x D (cm)	Weight (kg)	Outer Barcode	Minimum Order Multiple
4473601	Heavy-Duty A3 Box File	Brown	6.70 x 43.00 x 31.00	7.00 x 43.70 x 32.50	Micro-Flute	043859730537	5	53.50 x 3.38 x 43.40	1.38	50043859730532	5 single units



## Heavy-Duty Earth

### Heavy-Duty Box

- To ensure this box is heavy duty it features 3 layers of cardboard board to end panels and 2 layers to sides and base
- To reinforce and make the box more comfortable to carry there are 3 layers of cardboard to the end panels
- You can save floor space by stacking these boxes up to 5 high
- Ideal size to hold your A4 or foolscap lever arch files, ring binders, transfer box files and even suspension files
- To ensure that the lid will fit when you store suspension files we have made it slightly oversized
- Made from FSC® certified 100% recycled board, 100% recyclable



Each box can hold up to:



**Transfer Box Files A4**  
5x70mm  
4x80mm  
3x100mm  
2x150mm



**Ringbinders**  
8x



**Lever Arch Files**  
5xA4  
4xFoolscap



**Suspension Files**  
+40xA4  
+40xFoolscap

Code	Description	Colour	Int. Dimensions H x W x D (cm)	Ext. Dimensions H x W x D (cm)	Board Type	Product Barcode	OUTER CARTON				Minimum Order Multiple
							Qty	H x W x D (cm)	Weight (kg)	Outer Barcode	
4479901	Heavy-Duty Box	Brown	28.50 x 33.30 x 39.00	29.10 x 34.20 x 40.00	B-Flute	043859643608	10	92.30 x 10.00 x 73.50	7.50	50043859643603	10 single units

### Suspension File Transfer Case

- A strong storage solution that offers you 2 options for use
- Option 1: Use as a transfer case for the storage of your A4 documents and files. Can be used portrait or landscape orientation
- Option 2: Store your A4 suspension files with tabs by simply removing the perforated tabs
- To protect your contents from dust and dirt there is a large internal flap and a tuck-in lid for easy identification there are large labelling areas on multiple sides
- Made from FSC® certified 100% recycled board, 100% recyclable



Versatile application



Code	Description	Colour	Int. Dimensions H x W x D (cm)	Ext. Dimensions H x W x D (cm)	Board Type	Product Barcode	SHRINK PACK				Minimum Order Multiple
							Qty	H x W x D (cm)	Weight (kg)	Outer Barcode	
4473501	Suspension File Transfer Case	Brown	26.50 x 11.70 x 32.20	27.30 x 12.00 x 32.50	Micro-Flute	043859708963	10	51.00 x 5.00 x 44.00	1.66	50043859708951	10 single units

### Heavy-Duty Magazine File

- Heavy-duty A4 magazine file made from strong corrugated board
- For your convenience there is a label area on front and back spine
- Easy to assemble with fold together base
- Made from FSC® certified board, 100% recyclable



Code	Description	Colour	Int. Dimensions H x W x D (cm)	Ext. Dimensions H x W x D (cm)	Board Type	Product Barcode	OUTER CARTON				Minimum Order Multiple
							Qty	H x W x D (cm)	Weight (kg)	Outer Barcode	
4473701	Heavy-Duty Magazine File	Brown	31.40 x 7.70 x 26.00	32.00 x 8.00 x 26.50	Micro-Flute	043859730544	10	38.20 x 5.00 x 35.00	1.47	50043859730549	10 single units



## MADE FOR STORING SUSTAINABLY

**EARTH SERIES** Ecological storage solutions produced from recycled materials

### Reliable and stackable

For your understanding, boxes and units are categorised by strength.



- Medium-Duty**  
●●●●●
- Basic-Duty**  
●●●●●
- x2 Stackable**
- x5 Stackable**
- Reinforced Handles**

### Convenient and adaptable

Simple manual assembly, modular storage solutions.



- Manual Assembly**
- Modular**

### Recyclable and sustainable

Helping you meet your environmental goals.



- Plant a Tree**  
Register your product and we will plant a tree in your name.
- 100% Recyclable**

**MADE FOR LIFE™**

## FILING AND STORAGE PRODUCTS THAT DON'T COST THE EARTH

All BANKERS BOX® Earth Series corrugated products are made from FSC® certified 100% recycled board and are 100% recyclable. All inks used are water based and adhesives used are solvent free.



Modular Compatibility (Storage Boxes)	Budget Storage Box	Standard Storage Box	Large Storage Box	Flip Top Cube	Flip Top Maxi
CRC	44724	44706	44707	44708	44722
Internal Dimensions H x W x D (mm)	250 x 390 x 320	260 x 375 x 325	260 x 445 x 325	260 x 325 x 375	287 x 545 x 378
Stacking Height	2	3	3	4	4
A4 Transfer Box Files 80mm	✗	4	5	4	6
A4 Transfer Box Files 100mm	✗	3	4	3	5
A4 Transfer Box Files 150mm	✗	2	2	2	3
Folio Transfer Box Files 100mm	✗	3	3	3	5
Folio Transfer Box Files 150mm	✗	2	2	2	3
Magazine File (44700)	✗	✗	✗	✗	✗
Ring Binder (A4)	✗	8	10	8	12
Lever Arch File (A4)	✗	✗	✗	✗	7
Lever Arch File (Foolscap)	✗	✗	✗	✗	7



## Earth Series

### A4 Transfer Box Files

- A4 size transfer box file made from high quality corrugated board
- To simplify your filing system it has been designed to fit in the Earth Series storage boxes
- For your convenience there are large labelling areas on 3 sides of the transfer file
- To offer you a secure closure the hinged lid features a locking tab
- Made from FSC® certified 100% recycled board, 100% recyclable



OUTER CARTON											
Code	Spine	Colour	Int. Dimensions H x W x D (cm)	Ext. Dimensions H x W x D (cm)	Board Type	Product Barcode	Qty	H x W x D (cm)	Weight (kg)	Outer Barcode	Minimum Order Multiple
4470101	80mm	Brown	25.00 x 8.00 x 31.50	25.40 x 8.30 x 31.90	Micro-Flute	043859577804	20	74.10 x 4.00 x 48.70	2.80	50043859577809	20 single units
4470201	100mm	Brown	25.00 x 10.00 x 31.50	25.40 x 10.30 x 31.90	Micro-Flute	043859577811	20	78.40 x 4.00 x 52.70	3.24	50043859577816	20 single units
4470301	150mm	Brown	25.00 x 15.00 x 31.50	25.40 x 15.30 x 31.90	Micro-Flute	043859577873	20	88.30 x 4.00 x 62.70	4.35	50043859577878	20 single units

RETAIL PACK*											
Code	Spine	Colour	Int. Dimensions H x W x D (cm)	Ext. Dimensions H x W x D (cm)	Board Type	Product Barcode	Qty	H x W x D (cm)	Weight (kg)	Pack Barcode	Minimum Order Multiple
4470103	80mm - 8pk	Brown	25.00 x 8.00 x 31.50	25.40 x 8.30 x 31.90	Micro-Flute	043859577804	8	37.50 x 48.00 x 21.00	0.83	043859590315	1 x 8pk

\*Retail packs include full colour insert

### A4+ Transfer File

- A4+ size transfer box file made from high quality corrugated board
- To simplify your filing system it has been designed to fit in the Earth Series storage boxes
- For your convenience there are large labelling areas on 3 sides of the transfer file
- To offer you a secure closure the hinged lid features a locking tab
- Made from FSC® certified 100% recycled board, 100% recyclable



SHIRINK PACK											
Code	Spine	Colour	Int. Dimensions H x W x D (cm)	Ext. Dimensions H x W x D (cm)	Board Type	Product Barcode	Qty	H x W x D (cm)	Weight (kg)	Pack Barcode	Minimum Order Multiple
4473002	80mm	Brown	25.00 x 7.70 x 33.00	26.00 x 8.00 x 35.00	Micro-Flute	043859707935	20	73.00 x 5.80 x 49.50	2.60	043859707973	1 x 20pk
4473102	100mm	Brown	25.00 x 9.70 x 33.00	26.00 x 10.00 x 35.00	Micro-Flute	043859707942	20	77.00 x 5.80 x 54.50	3.04	043859707980	1 x 20pk
4473202	150mm	Brown	25.00 x 14.70 x 33.00	26.00 x 15.00 x 35.00	Micro-Flute	043859707959	20	87.50 x 5.80 x 64.50	4.06	043859707997	1 x 20pk
4473302	200mm	Brown	25.00 x 29.70 x 33.00	26.00 x 20.00 x 35.00	Micro-Flute	043859707966	20	97.00 x 5.80 x 74.50	4.93	043859708000	1 x 20pk

### Folio Transfer Box Files

- Foolscap size transfer box file made from high quality corrugated board
- To simplify your filing system it has been designed to fit in selected Earth Series storage boxes
- For your convenience there are large labelling areas on 3 sides of the transfer file
- To offer you a secure closure the hinged lid features a locking tab
- Made from FSC® certified 100% recycled board, 100% recyclable



OUTER CARTON											
Code	Spine	Colour	Int. Dimensions H x W x D (cm)	Ext. Dimensions H x W x D (cm)	Board Type	Product Barcode	Qty	H x W x D (cm)	Weight (kg)	Outer Barcode	Minimum Order Multiple
4471801	100mm	Brown	25.50 x 10.00 x 36.00	26.00 x 10.30 x 37.40	Micro-Flute	043859618651	20	79.00 x 6.20 x 57.80	3.10	50043859618656	20 single units
4471901	150mm	Brown	25.50 x 15.00 x 36.00	26.00 x 15.30 x 37.40	Micro-Flute	043859618668	20	88.90 x 4.00 x 67.70	3.98	50043859618663	20 single units

## Earth Series



### Budget Box

- If you are looking for a job for lightweight tasks then this is the box for you
- To add in some extra strength to the base is features 2 layers of cardboard, there is 1 layer of cardboard to all sides
- To add comfort when carrying there are foldback handle holes
- Keep the dust off your files by using the lid supplied
- Made from FSC® certified 100% recycled board, 100% recyclable

Code	Description	Colour	Int. Dimensions H x W x D (cm)	Ext. Dimensions H x W x D (cm)	Board Type	Product Barcode	OUTER CARTON				Minimum Order Multiple
							Qty	H x W x D (cm)	Weight (kg)	Outer Barcode	
4472401	Budget Box	Brown	25.00 x 32.00 x 39.00	25.70 x 32.60 x 39.60	B-Flute	043859670635	10	46.00 x 9.40 x 74.40	3.92	50043859670630	10 single units



### Standard Storage Box

- You can trust this storage box is strong enough for your everyday tasks as it has 2 layers of cardboard to the base and ends
- The foldback handles offer you strength and comfort thanks to the 2 layers of board to the end panels
- You can save valuable storage space when you file as the storage box is strong enough to stack up to 3 units high
- This box is great for storing your ring binders, folders and A4 Earth Series transfer files
- Keep the dust off your files by using the lid supplied
- Made from FSC® certified 100% recycled board, 100% recyclable

Code	Description	Colour	Int. Dimensions H x W x D (cm)	Ext. Dimensions H x W x D (cm)	Board Type	Product Barcode	OUTER CARTON				Minimum Order Multiple
							Qty	H x W x D (cm)	Weight (kg)	Outer Barcode	
4470601	Standard Storage Box	Brown	26.00 x 32.50 x 37.50	27.00 x 33.50 x 39.10	B-Flute	043859577897	10	73.00 x 8.80 x 59.50	4.30	50043859577892	10 single units



### Large Storage Box

- You can trust this large storage box is strong enough for your everyday tasks as it has 2 layers of cardboard to the base and ends
- The foldback handles offer you strength and comfort thanks to the 2 layers of board to the end panels
- You can save valuable storage space when you file as the storage box is strong enough to stack up to 3 units high
- This box is great for storing your ring binders, folders and A4 Earth Series transfer files
- Keep the dust off your files by using the lid supplied
- Made from FSC® certified 100% recycled board, 100% recyclable

Code	Description	Colour	Int. Dimensions H x W x D (cm)	Ext. Dimensions H x W x D (cm)	Board Type	Product Barcode	OUTER CARTON				Minimum Order Multiple
							Qty	H x W x D (cm)	Weight (kg)	Outer Barcode	
4470701	Large Storage Box	Brown	26.00 x 32.50 x 44.50	27.10 x 33.50 x 47.00	B-Flute	043859577903	10	80.50 x 8.80 x 60.00	4.85	50043859577908	10 single units

## Earth Series

### Flip Top Cube

- You can trust this storage box will protect your files and paperwork because it has 3 layers of cardboard to the handle ends and 2 layers to the base
- Maximise your floor space by stacking the boxes up to 4 units high
- Perfectly sized to store your A4 or foolscap Earth Series transfer files
- For your convenience this box features an attached hinged lid and large labelling areas
- Made from FSC® certified 100% recycled board, 100% recyclable



Code	Description	Colour	Int. Dimensions H x W x D (cm)	Ext. Dimensions H x W x D (cm)	Board Type	Product Barcode	SHRINK PACK				Minimum Order Multiple
							Qty	H x W x D (cm)	Weight (kg)	Outer Barcode	
4470809	Flip Top Cube	Brown	26.00 x 32.50 x 37.50	26.90 x 34.00 x 40.00	B-Flute	043859577958	10	60.50 x 40.00 x 17.00	4.5	043859708017	1 x 10pk

### Flip Top Maxi

- You can trust this storage box will protect your files and paperwork because it has 3 layers of cardboard to the handle ends and 2 layers to the base
- Maximise your floor space by stacking the boxes up to 4 units high
- Perfectly sized to store your A4 or foolscap lever arch files or Earth Series transfer files
- For your convenience this box features large labelling areas and an attached hinged lid with a locking tab
- Made from FSC® certified 100% recycled board, 100% recyclable



Code	Description	Colour	Int. Dimensions H x W x D (cm)	Ext. Dimensions H x W x D (cm)	Board Type	Product Barcode	SHRINK PACK				Minimum Order Multiple
							Qty	H x W x D (cm)	Weight (kg)	Outer Barcode	
4472205	Flip Top Maxi	Brown	28.70 x 37.80 x 54.50	29.30 x 39.00 x 56.00	B-Flute	043859645114	10	68.00 x 55.00 x 18.00	6.5	043859708024	1 x 10pk





## Earth Series



### Magazine File

- An economical solution for organising your A4 sized magazines and literature
- For your convenience there is a label area on front and back spine
- Made from FSC® certified 100% recycled board, 100% recyclable

Code	Description	Colour	Int. Dimensions H x W x D (cm)	Ext. Dimensions H x W x D (cm)	Board Type	Product Barcode	OUTER CARTON				Minimum Order Multiple
							Qty	H x W x D (cm)	Weight (kg)	Outer Barcode	
4470001	Magazine File	Brown	30.00 x 8.00 x 26.00	30.40 x 8.20 x 26.80	Micro-Flute	043859577798	20	78.20 x 4.00 x 37.50	1.75	50043859577793	20 single units



### Parts Bins

- Economical storage for all types of components
- Labelling area for easy identification
- Available in 5 widths: 51mm, 76mm, 98mm, 147mm and 200mm
- Made from FSC® certified board, 100% recyclable

Code	Description	Colour	Int. Dimensions H x W x D (cm)	Ext. Dimensions H x W x D (cm)	Board Type	Product Barcode	OUTER CARTON				Minimum Order Multiple
							Qty	H x W x D (cm)	Weight (kg)	Outer Barcode	
07353EU	98mm	Brown	10.20 x 9.80 x 28.00	10.40 x 10.60 x 30.60	B-Flute	5016291073536	50	32.60 x 16.40 x 65.60	3.40	05016291880448	50 single units
07354EU	147mm	Brown	10.20 x 14.70 x 28.00	10.40 x 15.40 x 30.60	B-Flute	5016291073543	50	42.20 x 16.00 x 65.20	4.42	05016291880455	50 single units
07355EU	200mm	Brown	10.20 x 20.00 x 28.00	10.40 x 20.40 x 30.60	B-Flute	5016291073550	50	42.40 x 17.00 x 64.80	4.95	05016291880462	50 single units





## MADE FOR MAXIMUM RELIABILITY

**HEAVY-DUTY BASIC** Remarkably durable and modular storage that can be relied on

### Hard-wearing and stackable

Heavy-Duty storage solutions classified by strength and maximum stacking height.



### Convenient and adaptable

Strong manual assembly, modular storage solutions.



### Recyclable and sustainable

Helping you meet your environmental goals.



MADE FOR LIFE™

### Heavy-Duty A4+ Transfer File

- Heavy duty A4+ size transfer box file made from strong corrugated board
- To simplify your filing system it has been designed to fit in the Basic flip top storage boxes
- For your convenience there are large labelling areas on 3 sides of the transfer file
- To offer you a secure closure the hinged lid features a tuck-in tab
- Ideal for storing your A4 or A4+ sized documents and files
- Made from FSC® certified 100% recycled board, 100% recyclable



Code	Spine	Colour	Int. Dimensions H x W x D (cm)	Ext. Dimensions H x W x D (cm)	Board Type	Product Barcode	SHRINK PACK				
							Qty	H x W x D (cm)	Weight (kg)	Pack Barcode	Minimum Order Multiple
4474002	80mm - 20pk	White/Blue	24.40 x 7.50 x 33.30	25.30 x 8.00 x 34.50	B-Flute	043859711475	20	6.00 x 51.00 x 74.60	2.12	043859711482	1 x 20pk
4472702	100mm - 20pk	White/Blue	24.40 x 9.50 x 33.30	25.30 x 10.00 x 34.50	B-Flute	043859702862	20	6.00 x 54.30 x 77.90	2.90	043859702879	1 x 20pk
4474102	100mm - 20pk	White/Red	24.40 x 9.50 x 33.30	25.30 x 10.00 x 34.50	B-Flute	043859720415	20	6.00 x 54.30 x 77.90	2.90	043859720422	1 x 20pk
4474202	100mm - 20pk	White/Yellow	24.40 x 9.50 x 33.30	25.30 x 10.00 x 34.50	B-Flute	043859720439	20	6.00 x 54.30 x 77.90	2.90	043859720446	1 x 20pk
4474302	100mm - 20pk	White/Green	24.40 x 9.50 x 33.30	25.30 x 10.00 x 34.50	B-Flute	043859720453	20	6.00 x 54.30 x 77.90	2.90	043859720460	1 x 20pk
4472802	150mm - 20pk	White/Blue	24.40 x 14.40 x 33.30	25.30 x 15.00 x 34.50	B-Flute	043859702886	20	6.00 x 63.10 x 89.70	2.90	043859702893	1 x 20pk
4472902	200mm - 20pk	White/Blue	24.40 x 19.50 x 33.30	25.30 x 20.00 x 34.50	B-Flute	043859710317	20	6.00 x 74.00 x 100.00	5.46	043859710324	1 x 20pk

Code	Spine	Colour	Int. Dimensions H x W x D (cm)	Ext. Dimensions H x W x D (cm)	Board Type	Product Barcode	RETAIL PACK*				
							Qty	H x W x D (cm)	Weight (kg)	Pack Barcode	Minimum Order Multiple
4474501	100mm - 8pk	Assorted	24.40 x 9.50 x 33.30	25.30 x 10.00 x 34.50	B-Flute	Various	8	77.9 x 54.3 x 2.5	1.16	043859720484	1x8pk

\*Retail packs include full colour insert

## Heavy-Duty



### ULTRA Heavy-Duty Maxi

- You can trust this storage box is heavy duty as it has 3 layers of double thickness cardboard to the handle ends and 2 layers to the base
- Maximise your floor space by stacking the boxes up to 6 units high
- Perfectly sized to store your A4 or foolscap lever arch files or Basic transfer files
- For your convenience this box features an attached, hinged lid with a locking tab and large labelling areas
- Made from FSC® certified 100% recycled board, 100% recyclable

Code	Description	Colour	Int. Dimensions H x W x D (cm)	Ext. Dimensions H x W x D (cm)	Board Type	Product Barcode	OUTER CARTON				Minimum Order Multiple
							Qty	H x W x D (cm)	Weight (kg)	Outer Barcode	
4474601	Ultra Heavy-Duty Maxi	White/Blue	28.70 x 37.80 x 54.50	29.80 x 39.50 x 56.50	Micro/B-Flute	043859720507	10	132.10 x 7.20 x 86.00	11.67	50043859720502	10 single units



### Heavy-Duty Box

- With strength in mind, this heavy-duty storage box is made from double thickness cardboard
- For worry-free, comfortable lifting, even when the box is full it features 2 layers of cardboard to the handle ends and the base
- You can maximise your space by stacking these strong boxes up to 5 units high
- Perfectly sized to store your A4 or foolscap lever arch files, suspension files or Basic transfer files
- To ensure that the lid will fit when you store suspension files we have made it slightly oversized
- Made from FSC® certified 100% recycled board, 100% recyclable

Code	Description	Colour	Int. Dimensions H x W x D (cm)	Ext. Dimensions H x W x D (cm)	Board Type	Product Barcode	OUTER CARTON				Minimum Order Multiple
							Qty	H x W x D (cm)	Weight (kg)	Outer Barcode	
4461701	Heavy-Duty Box	White/Blue	28.20 x 33.00 x 37.70	29.20 x 33.50 x 40.40	Micro/B-Flute	043859721054	10	75.00 x 12.60 x 63.30	7.00	50043859721059	10 single units



### Heavy-Duty Large Box

- With strength in mind, this heavy-duty storage box is made from double thickness cardboard
- For worry-free, comfortable lifting, even when the box is full it features 2 layers of cardboard to the handle ends and the base
- You can maximise your space by stacking these strong boxes up to 5 units high
- Perfectly sized to store your A4 or foolscap lever arch files, Basic transfer files and even computer listing paper
- Supplied with a dustcover lid
- Made from FSC® certified 100% recycled board, 100% recyclable

Code	Description	Colour	Int. Dimensions H x W x D (cm)	Ext. Dimensions H x W x D (cm)	Board Type	Product Barcode	OUTER CARTON				Minimum Order Multiple
							Qty	H x W x D (cm)	Weight (kg)	Outer Barcode	
4461601	Heavy-Duty Large Box	White/Blue	28.40 x 37.70 x 42.70	29.40 x 38.70 x 44.50	Micro/B-Flute	043859721047	10	84.50 x 12.60 x 68.30	8.22	50043859721042	10 single units

## MADE FOR INSTANT STRENGTH



**BASIC** Durable, reliable and economical storage solutions for every office

### Reliable and stackable

For your understanding boxes and units are categorised by strength.

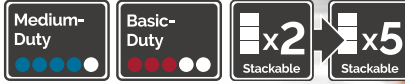

### Simple and foldable

Simple manual assembly, modular storage solutions.



### Recyclable and sustainable

Helping you meet your environmental goals.



MADE FOR LIFE™

### Standard Storage Box

- You can trust this large storage box is strong enough for your everyday tasks as it has 2 layers of cardboard to the base and ends
- The foldback handles offer you strength and comfort thanks to the 2 layers of board to the end panels
- You can save valuable storage space when you file as the storage box is strong enough to stack up to 3 units high
- This box is great for storing your ring binders, folders and Basic transfer files
- Keep the dust off your files by using the lid supplied
- Made from FSC® certified 100% recycled board, 100% recyclable



Code	Description	Colour	Int. Dimensions H x W x D (cm)	Ext. Dimensions H x W x D (cm)	Board Type	Product Barcode	OUTER CARTON				Minimum Order Multiple
							Qty	H x W x D (cm)	Weight (kg)	Outer Barcode	
4460801	Standard Box	White/Blue	28.70 x 31.70 x 38.40	29.00 x 32.10 x 39.10	B-Flute	043859659296	10	61.80 x 10.00 x 73.00	5.47	50043859659291	10 single units

### Basic Tall Storage Box

- You can trust this large storage box is strong enough for your everyday tasks as it has 2 layers of cardboard to the base and ends
- The foldback handles offer you strength and comfort thanks to the 2 layers of board to the end panels
- You can save valuable storage space when you file as the storage box is strong enough to stack up to 3 units high
- This box is great for storing your ring binders, folders and Basic transfer files
- Keep the dust off your files by using the lid supplied
- Made from FSC® certified 100% recycled board, 100% recyclable



Code	Description	Colour	Int. Dimensions H x W x D (cm)	Ext. Dimensions H x W x D (cm)	Board Type	Product Barcode	OUTER CARTON				Minimum Order Multiple
							Qty	H x W x D (cm)	Weight (kg)	Outer Barcode	
4461001	Tall Box	White/Blue	32.00 x 33.00 x 41.00	33.00 x 34.00 x 42.60	B-Flute	043859661688	10	77.00 x 10.00 x 67.00	6.70	50043859661683	10 single units



## Basic



### Flip Top Midi

- You can trust this large storage box will protect your files and paperwork because it has 3 layers of cardboard to the handle ends and 2 layers to the base
- Save floor space by stacking the boxes 2 units high. Perfectly sized to store your ring binders and Basic A4+ transfer files
- For your convenience this box features large labelling areas and an attached hinged lid
- Made from FSC® certified 100% recycled board, 100% recyclable

Code	Description	Colour	Int. Dimensions H x W x D (cm)	Ext. Dimensions H x W x D (cm)	Board Type	Product Barcode	SHRINK PACK				Minimum Order Multiple
							Qty	H x W x D (cm)	Weight (kg)	Outer Barcode	
4460502	Flip Top Midi - 10pk	White/Blue	26.00 x 35.00 x 52.60	28.00 x 35.60 x 55.40	B-Flute	043859655618	10	62.80 x 17.80 x 56.20	5.32	043859655694	1 x 10pk

Code	Description	Colour	Int. Dimensions H x W x D (cm)	Ext. Dimensions H x W x D (cm)	Board Type	Product Barcode	RETAIL PACK*				Minimum Order Multiple
							Qty	H x W x D (cm)	Weight (kg)	Pack Barcode	
4460503	Flip Top Midi - 5pk	White/Blue	26.00 x 35.00 x 52.60	28.00 x 35.60 x 55.40	B-Flute	043859655618	5	1.50 x 54.80 x 63.60	0.52	043859655762	1 x 5pk

\*Retail packs include full colour insert



### Basic Midi & 6 x 80mm A4+ Transfer Files

- You can trust the large flip top storage box will protect your files and paperwork because it has 3 layers of cardboard to the handle ends and 2 layers to the base
- To save you space, you can stack the flip top boxes 2 units high
- To simplify your filing system, the transfer files have been designed to fit in the storage box
- For your convenience there are large labelling areas on 3 sides of the transfer files and both ends of the storage box
- Made from FSC® certified 100% recycled board, 100% recyclable
- Internal Dimensions: W35 x H26 x D52.6cm (Midi)
- Internal Dimensions: W7.7 x H25 x D32.5cm (Transfer les)

Code	Description	Colour	RETAIL PACK*				Minimum Order Multiple
			Qty	H x W x D (cm)	Weight (kg)	Pack Barcode	
4460504	Basic Midi & 6 x 80mm A4+ Transfer Files	White/Blue	1	63.00 x 55.00 x 2.50	1.30	043859671694	1 x 1pk

\*Retail packs include full colour insert



### Desktop Drawer

- A4 size storage drawer ideal for desktop use
- Drawers can be stacked up to 3 units high to save you valuable space
- Drawers lock together to stack securely
- Clear labelling area on drawer front
- Made from FSC® certified board, 100% recyclable

Code	Description	Colour	Int. Dimensions H x W x D (cm)	Ext. Dimensions H x W x D (cm)	Board Type	Product Barcode	RETAIL PACK*				Minimum Order Multiple
							Qty	H x W x D (cm)	Weight (kg)	Pack Barcode	
4461104	Desktop Drawer - 5pk	White/Blue	12.20 x 25.40 x 35.50	13.50 x 27.90 x 36.20	B-Flute	043859664191	5	2.00 x 54.90 x 99.00	1.59	043859671991	1 x 5pk

\*Retail packs include full colour insert



## Basic

### A4+ Transfer File

- A4+ size transfer box file made from corrugated board
- To simplify your filing system it has been designed to fit in the Basic Flip top storage boxes
- For your convenience there are large labelling areas on 3 sides of the transfer file
- To offer you a secure closure the hinged lid features a tuck-in tab
- Made from FSC® certified 100% recycled board, 100% recyclable
- Ideal for storing your A4 or A4+ sized documents and files
- Label areas on the ends and top for clear identification of contents
- Made from FSC® certified 100% recycled board, 100% recyclable



FULL PALLET										
Code	Spine	Colour	Int. Dimensions H x W x D (cm)	Ext. Dimensions H x W x D (cm)	Board Type	Product Barcode	Qty	H x W x D (cm)		Minimum Order Multiple
4460101	80mm	White/Blue	25.00 x 7.70 x 32.50	25.50 x 8.00 x 34.00	Micro-Flute	043859655571	1300	110 x 80 x 120		1300 Single Units
4460201	100mm	White/Blue	25.00 x 9.70 x 32.50	25.50 x 10.00 x 34.00	Micro-Flute	043859655588	1300	120 x 80 x 120		1300 Single Units
4460301	150mm	White/Blue	25.00 x 14.70 x 32.50	25.50 x 15.00 x 34.00	Micro-Flute	043859655595	700	127 x 80 x 120		700 Single Units
4460401	200mm	White/Blue	25.00 x 19.70 x 32.50	25.50 x 20.00 x 34.00	Micro-Flute	043859655601	700	127 x 80 x 120		700 Single Units

SHRINK PACK											
Code	Spine	Colour	Int. Dimensions H x W x D (cm)	Ext. Dimensions H x W x D (cm)	Board Type	Product Barcode	Qty	H x W x D (cm)	Weight (kg)	Outer Barcode	Minimum Order Multiple
4460102	80mm - 25pk	White/Blue	25.00 x 7.70 x 32.50	25.50 x 8.00 x 34.00	Micro-Flute	043859655571	25	4.00 x 49.50 x 76.40	3.46	043859655656	1 x 25pk
4460202	100mm - 25pk	White/Blue	25.00 x 9.70 x 32.50	25.50 x 10.00 x 34.00	Micro-Flute	043859655588	25	4.00 x 54.40 x 79.00	3.70	043859655663	1 x 25pk
4460302	150mm - 25pk	White/Blue	25.00 x 14.70 x 32.50	25.50 x 15.00 x 34.00	Micro-Flute	043859655595	25	4.00 x 63.50 x 91.40	4.70	043859655670	1 x 25pk
4460402	200mm - 25pk	White/Blue	25.00 x 19.70 x 32.50	25.50 x 20.00 x 34.00	Micro-Flute	043859655601	25	4.00 x 74.20 x 101.00	6.05	043859655687	1 x 25pk

RETAIL PACK*											
Code	Spine	Colour	Int. Dimensions H x W x D (cm)	Ext. Dimensions H x W x D (cm)	Board Type	Product Barcode	Qty	H x W x D (cm)	Weight (kg)	Pack Barcode	Minimum Order Multiple
4460103	80mm - 10pk	White/Blue	25.00 x 7.70 x 32.50	25.50 x 8.00 x 34.00	Micro-Flute	043859655571	10	1.00 x 49.50 x 76.50	1.22	043859655724	1 x 10pk
4460203	100mm - 10pk	White/Blue	25.00 x 9.70 x 32.50	25.50 x 10.00 x 34.00	Micro-Flute	043859655588	10	1.80 x 53.90 x 79.70	1.36	043859655731	1 x 10pk
4460303	150mm - 10pk	White/Blue	25.00 x 14.70 x 32.50	25.50 x 15.00 x 34.00	Micro-Flute	043859655595	10	1.30 x 63.90 x 92.00	1.83	043859655748	1 x 10pk
4460403	200mm - 10pk	White/Blue	25.00 x 19.70 x 32.50	25.50 x 20.00 x 34.00	Micro-Flute	043859655601	10	1.60 x 54.80 x 63.60	2.42	043859655755	1 x 10pk

\*Retail packs include full colour insert

### General Archiving and Storage Boxes

- If you are looking for a job for general lightweight filing or storing then this is the box for you
- To save some space you can stack the boxes 2 high
- To help you easily identify what you have stored there are large labelling areas on each end of the box
- Keep the dust off your files by using the lid supplied
- Made from FSC® certified 100% recycled board, 100% recyclable



RETAIL PACK											
Code	Description	Colour	Int. Dimensions H x W x D (cm)	Ext. Dimensions H x W x D (cm)	Board Type	Product Barcode	Qty	H x W x D (cm)	Weight (kg)	Pack Barcode	Minimum Order Multiple
0015406	Box - 10pk	Brown	25.00 x 32.00 x 39.00	25.30 x 32.60 x 39.60	B-Flute	no barcode	10	72.00 x 42.00 x 10.00	3.70	043859728770	1 x 10pk
0015407	Box -3pk	Brown	25.00 x 32.00 x 39.00	25.30 x 32.60 x 39.60	B-Flute	no barcode	3	72.00 x 42.00 x 3.00	1.20	043859731558	1 x 3pk
0015408	Box -5pk	Brown	25.00 x 32.00 x 39.00	25.30 x 32.60 x 39.60	B-Flute	no barcode	5	72.00 x 42.00 x 5.00	1.90	043859731565	1 x 5pk
0015504	Box -10pk	White	25.00 x 32.00 x 39.00	25.30 x 32.60 x 39.60	B-Flute	no barcode	10	72.00 x 42.00 x 10.00	3.70	043859730667	1 x 10pk
0015505	Box -6pk	White	25.00 x 32.00 x 39.00	25.30 x 32.60 x 39.60	B-Flute	no barcode	6	72.00 x 42.00 x 6.00	2.30	043859730674	1 x 6pk

## MADE FOR ARCHIVING PAPERWORK



### ARCHIVE CLIPS Economical solutions for bundling paperwork

#### Strong and hard-wearing

Designed to hold a full file of paperwork



#### Simple and Flexible

Easily secure bundles of papers for storage



#### Secure and long-lasting

Bundled documents can be stored long-term



MADE FOR LIFE™

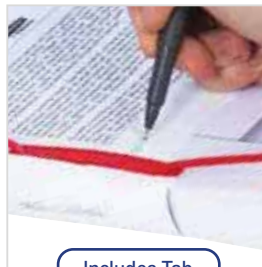
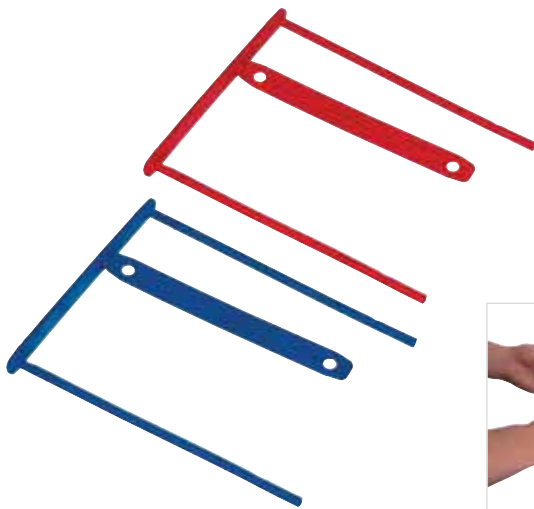

Includes Tab

#### BBD-Clip

- Strong archival clip made from flexible metal that is plastic coated
- Designed to secure bundles of documents/papers up to a maximum thickness of 9.5cm
- For easy identification of contents the clips are supplied with paper filing tabs
- Length of arms 11cm
- Available in red or blue



Code	Description	Colour	UNIT		RETAIL PACK			SHIPPING OUTER			Minimum Order Multiple		
			H x W x D (cm)	Weight (kg)	Qty	H x W x D (cm)	Weight (kg)	Pack Barcode	Qty	H x W x D (cm)		Weight (kg)	Outer Barcode
1189301	BBD-Clip - 100pk	Red	11.00 x 9.00 x 0.50	0.008	100	14.40 x 19.60 x 19.40	1.1	043859730698	8	21.00 x 41.00 x 59.60	9.80	50043859730693	1 x 100pk
1189401	BBD-Clip - 100pk	Blue	11.00 x 9.00 x 0.50	0.008	100	14.40 x 19.60 x 19.40	1.1	043859730704	8	21.00 x 41.00 x 59.60	9.80	50043859730709	1 x 100pk



100pk - Includes Handle

#### Pro Clip

- Quickly transfer paperwork from a lever arch files to an archive clip using this filing solution
- For the easy transfer of papers use the handle included in the pack
- To keep the papers securely bundled, transfer from handle to the 2- piece plastic clip
- Arm length of 10cm
- Made from 100% recycled material



Code	Description	Colour	UNIT*		RETAIL PACK			SHIPPING OUTER			Minimum Order Multiple		
			H x W x D (cm)	Weight (kg)	Qty	H x W x D (cm)	Weight (kg)	Pack Barcode	Qty	H x W x D (cm)		Weight (kg)	Outer Barcode
0089701	Pro Clip - 100pk	White	10.10 x 9.20 x 0.90	0.004	100	14.40 x 19.60 x 19.40	0.56	043859653959	8	20.70 x 40.40 x 59.50	5.00	50043859653954	1 x 100pk
0089801	Pro Clip - 50pk	Blue	10.10 x 9.20 x 0.90	0.004	50	7.20 x 19.60 x 19.40	0.28	043859653966	16	21.20 x 40.40 x 60.20	5.40	50043859653961	1 x 50pk
1189601	Pro Clip - 20pk	Light Blue	10.10 x 9.20 x 0.90	0.004	20	15.70 x 9.80 x 6.00	0.10	043859754922	54	61.00 x 19.80 x 39.60	6.40	50043859754903	1 x 20pk

\*Excluding handle

## Archive Clips

### Archive Clip

- Easily bundle your paperwork together with this 2-piece plastic
- Allows fast and easy removal of papers from lever arch files
- Securely keeps paperwork neatly bundled together for future storage
- Arm length of 9.2cm
- Made from 100% recycled material



Code	Description	Colour	UNIT		RETAIL PACK				SHIPPING OUTER				Minimum Order Multiple
			H x W x D (cm)	Weight (kg)	Qty	H x W x D (cm)	Weight (kg)	Pack Barcode	Qty	H x W x D (cm)	Weight (kg)	Outer Barcode	
00895	Archive Clip - 100pk	White	10.70 x 9.20 x 0.90	0.004	100	14.40 x 19.60 x 19.40	0.52	5904662008952	8	21.00 x 41.00 x 59.60	4.54	05904662018951	1 x 100pk
0089602	Archive Clip - 100pk	Red	10.70 x 9.20 x 0.90	0.004	100	14.40 x 19.60 x 19.40	0.54	043859653942	24	45.00 x 40.00 x 80.00	14.00	10043859653949	1 x 100pk

### Listing Clip

- Easily bundle your paperwork together with this 2-piece plastic
- Specifically designed for use with computer listing paper
- Securely keeps paperwork neatly bundled together for future storage
- Arm length of 11.2cm
- Made from 100% recycled material

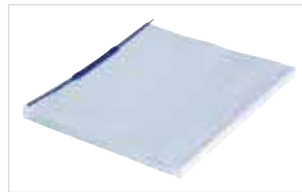

Code	Description	Colour	UNIT		RETAIL PACK				SHIPPING OUTER				Minimum Order Multiple
			H x W x D (cm)	Weight (kg)	Qty	H x W x D (cm)	Weight (kg)	Pack Barcode	Qty	H x W x D (cm)	Weight (kg)	Outer Barcode	
1189201	Listing Clip - 100pk	Blue	11.50 x 8.80 x 0.80	0.004	100	14.40 x 19.60 x 19.40	0.54	043859712953	24	45.00 x 40.00 x 80.00	14.00	50043859712958	1 x 100pk

### Tube Clip

- For the active or archival storage of paperwork
- Reduce the wasted space that half full files take up by using this 3-piece clip
- Use this for active filing as the clip allows documents to be easily added
- Clip allows you to turn the pages to review the contents and even easily remove pages when required
- Easily move paper from a full lever arch file using the transfer handle supplied



Includes Handle



Code	Description	Colour	UNIT*		RETAIL PACK				SHIPPING OUTER				Minimum Order Multiple
			H x W x D (cm)	Weight (kg)	Qty	H x W x D (cm)	Weight (kg)	Pack Barcode	Qty	H x W x D (cm)	Weight (kg)	Outer Barcode	
1189101	Tube Clip - 100pk	Yellow/White	15.50 x 10.50 x 0.50	0.005	100	7.40 x 29.50 x 19.30	0.72	043859690510	10	19.80 x 39.60 x 59.00	8.00	50043859690515	1 x 100pk

\*Excluding handle

## MADE FOR THE ART OF FILING



**LOEFF'S PATENT** Exceptionally strong, modular and adaptable storage

### 1. Bundling

Empty your document file and securely bundle the contents



### 2. Transfer File

Use a transfer file to organise and protect your paperwork before archiving







### 3. Storage Container

Store your transfer files in stacked storage containers



MADE FOR LIFE™

<p><b>ICN 1</b></p>	<p>Suitable for long term retention – a minimum of <u>200 years</u></p>		<p><b>Acid Free Archive Paper (250pk)</b> SKU #7771201</p>
<p><b>ICN 3</b></p>	<p>Suitable for long term retention – a minimum of <u>30 years</u></p>		<p><b>City Box 30+ (50pk)</b> SKU #7771001</p>
<p><b>ICN 4</b></p>	<p>Suitable for long term retention – a minimum of <u>10 years</u></p>		<p><b>City Box 10+ (50pk)</b> SKU #7770901</p>
<p><b>ICN 12</b></p>	<p>Complies with the requirements of the Public Records Act regarding long-term retention and do not affect document during the retention period.</p>		<p><b>Binders</b> SKU #7770201 (Standard 100pk) SKU #7770202 (Standard 50pk) SKU #7770203 (Standard 10pk) SKU #7770301 (Long 100pk) SKU #7770302 (Long 50pk) SKU #7770303 (Long 10pk)</p>
<p><b>ISO 16245:2009 Type A</b></p>	<p>Specifies requirements for boxes and file covers, made of cellulosic material, to be used for long term storage of documents on paper or parchment</p>		<p><b>City Box 30+ (50pk)</b> SKU #7771001</p>





## Loeff's Patent

### Liftboy

- This indestructible lever device is indispensable when using Binders to bundle paperwork
- This handy device empties the full lever arch file in a single move!
- By screwing the fastening clip onto the inside lever of the Liftboy, a connection is made to transfer the contents of the lever arch file to the Binder
- The inside lever of the Liftboy is also used when retrieving or inserting documents to the bundle buy reconnecting the Binder
- Awarded OFFI Label for quality, certificate number OL50325049
- Must be used in conjunction with Binders



Code	Description	Colour	UNIT		RETAIL PACK				SHIPPING OUTER				Minimum Order Multiple
			H x W x D (cm)	Weight (kg)	Qty	H x W x D (cm)	Weight (kg)	Pack Barcode	Qty	H x W x D (cm)	Weight (kg)	Outer Barcode	
7774101	Liftboy	White	15.00 x 13.00 x 4.00	0.19	1	4.00 x 15.00 x 12.50	0.25	8712966045484	50	38.60 x 39.00 x 43.00	12.50	08712966145481	1 x 1pk

### Binders

- Binders are designed to be used in partnership with the Liftboy to neatly bundle documents together
- The Binders are made from environmentally-friendly material and are free from plasticiser and acid
- They are certified ICN 12 and are therefore suitable for long-term document retention
- Awarded OFFI Label for quality, certificate number OL50325049
- Must be used in conjunction with Loeff's Patent Liftboy
- Available in standard ( $\pm 100\text{mm}$ ) and long length ( $\pm 150\text{mm}$ )



ICN 12

Code	Description	Colour	UNIT		RETAIL PACK				SHIPPING OUTER				Minimum Order Multiple
			H x W x D (cm)	Weight (kg)	Qty	H x W x D (cm)	Weight (kg)	Pack Barcode	Qty	H x W x D (cm)	Weight (kg)	Outer Barcode	
7770201	100pk Standard	Green	10.00 x 8.00 x 0.40	0.006	100	8.00 x 18.50 x 14.00	0.65	8712966012226	25	38.6 x 39.00 x 43.00	16.25	8712966022225	1 x 100pk
7770202	50pk Standard	Green	10.00 x 8.00 x 0.40	0.006	50	8.00 x 14.00 x 9.00	0.35	8712966012233	50	38.60 x 39.00 x 43.00	17.5	8712966022232	1 x 50pk
7770203	10pk Standard	Green	10.00 x 8.00 x 0.40	0.006	10	18.50 x 11.20 x 2.40	0.06	8712966012264	50	23.00 x 37.50 x 51.50	3.15	8712966112261	1 x 10pk
7770301	100pk Long	Green	15.00 x 8.00 x 0.40	0.008	100	8.00 x 18.50 x 19.00	0.85	8712966012240	20	38.60 x 39.00 x 43.00	17	8712966022249	1 x 100pk
7770302	50pk Long	Green	15.00 x 8.00 x 0.40	0.008	50	8.00 x 18.50 x 9.00	0.55	8712966012257	40	38.60 x 39.00 x 43.00	22	8712966022256	1 x 50pk
7770303	10pk Long	Green	15.00 x 8.00 x 0.40	0.008	10	18.50 x 11.20 x 2.40	0.08	8712966012288	50	23.00 x 37.50 x 51.50	4.15	8712966112285	1 x 10pk

### Reinforcement Strips

- These polypropylene reinforcement strips are fully recyclable
- The strips are used when bundling the paperwork and prevent tearing of the punch holes
- Awarded OFFI Label for quality, certificate number OL50325049
- Sold in packs of 100



Code	Description	Colour	UNIT		RETAIL PACK			SHIPPING OUTER				Minimum Order Multiple
			W x D (cm)	Qty	H x W x D (cm)	Weight (kg)	Pack Barcode	Qty	H x W x D (cm)	Weight (kg)	Outer Barcode	
7773901	Reinforcement Strips	White	10.00 x 1.20	100	10.00 x 7.00 x 2.00	0.05	8712966045453	50	1.00 x 1.00 x 1.00	3.00	08712966145450	1 x 100pk

## Loeff's Patent



### Quickboy

- The Quickboy is used for the fast removal of the contents of a lever arch file
- A connection is established by applying light pressure of the Quickbinders against the inside lever of the Quickboy
- This connection is quick and easy, however the Liftboy should be used if a secure connection is desired
- Must be used in conjunction with Quickbinders
- Other accessories are available

Code	Description	Colour	UNIT		RETAIL PACK				SHIPPING OUTER				Minimum Order Multiple
			H x W x D (cm)	Weight (kg)	Qty	H x W x D (cm)	Weight (kg)	Pack Barcode	Qty	H x W x D (cm)	Weight (kg)	Outer Barcode	
7774001	Quickboy	White	15.00 x 13.00 x 4.00	0.19	1	4.00 x 15.00 x 12.50	0.25	8712966045477	50	38.60 x 39.00 x 43.00	12.50	08712966345478	1 x 1pk

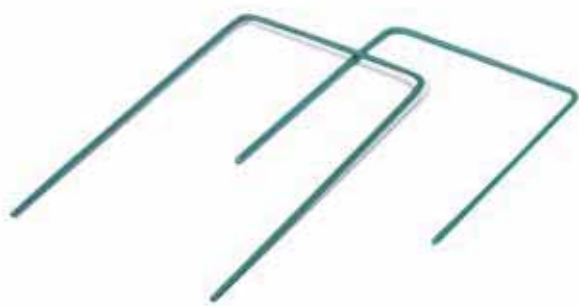

### Quickbinders

- Designed to be used with the Quickboy for the fast and economic storage of records
- The Quickbinders bundle the documents neatly for storage
- The Quickbinders are acid and plasticiser free and can be recycled
- Must be used in conjunction with Loeff's Patent Quickboy
- Available in standard ( $\pm 105\text{mm}$ ) and long length ( $\pm 145\text{mm}$ )
- Sold in packs of 100

Code	Description	Colour	UNIT		RETAIL PACK				SHIPPING OUTER				Minimum Order Multiple
			H x W x D (cm)	Weight (kg)	Qty	H x W x D (cm)	Weight (kg)	Pack Barcode	Qty	H x W x D (cm)	Weight (kg)	Outer Barcode	
7770001	Quickbinders Standard	Green	10.50 x 8.00 x 0.40	0.01	100	6.00 x 18.50 x 13.50	0.60	8712966012158	30	38.60 x 39.00 x 43.00	18.00	8712966312159	1 x 30pk
7770101	Quickbinders Long	Green	14.50 x 8.00 x 0.40	0.01	100	6.00 x 18.50 x 13.50	0.75	8712966012165	30	38.60 x 39.00 x 43.00	22.5	8712966312166	1 x 30pk



### Filing Labels

- Filing label to identify the contents of the bundle and ensure documents can be easily located
- The labels are from FSC® certified material, are 100% recyclable and are acid and chlorine free
- Available in white, blue, red, green or yellow
- Sold in packs of 100

Code	Description	Colour	UNIT		RETAIL PACK				SHIPPING OUTER				Minimum Order Multiple
			H x W x D (cm)	Weight (kg)	Qty	H x W x D (cm)	Weight (kg)	Pack Barcode	Qty	H x W x D (cm)	Weight (kg)	Outer Barcode	
7774601	Filing Labels	Yellow	14.70 x 11.00 x 0.10	0.002	100	17.50 x 11.50 x 2.50	0.2	8712966107113	50	20.00 x 36.50 x 44.00	10.00	8712966110717	1 x 100pk
7774701	Filing Labels	Green	14.70 x 11.00 x 0.10	0.002	100	17.50 x 11.50 x 2.50	0.2	8712966107120	50	20.00 x 36.50 x 44.00	10.00	8712966110724	1 x 100pk
7774801	Filing Labels	Red	14.70 x 11.00 x 0.10	0.002	100	17.50 x 11.50 x 2.50	0.2	8712966107137	50	20.00 x 36.50 x 44.00	10.00	8712966110731	1 x 100pk
7774901	Filing Labels	White	14.70 x 11.00 x 0.10	0.002	100	17.50 x 11.50 x 2.50	0.2	8712966107144	50	20.00 x 36.50 x 44.00	10.00	8712966110748	1 x 100pk
7775001	Filing Labels	Blue	14.70 x 11.00 x 0.10	0.002	100	17.50 x 11.50 x 2.50	0.2	8712966107151	50	20.00 x 36.50 x 44.00	10.00	8712966110755	1 x 100pk

## Loeff's Patent

### Acid Free Archive Paper

- Acid-free archive cover paper of 160 g/m<sup>2</sup> for the long-term protection of your documents
- Archive packages can also be bundled using the bundling clips, which are also entirely acid-free (ICN12)
- The covered package can then be kept in the acid-free archive box for maximum protection!
- Acid & chlorine free
- Complies with ISO 9706. As such, this paper complies with the requirements set out in the Public Records Act for the long-term retention of archival items, i.e. for a period of 200 years
- Complies with ICN 1
- Sheet Size: 36 x 68cm
- Pack of 250 sheets



ICN 1

Code	Description	Colour	Dimensions H x W (cm)	Weight (kg)	OUTER CARTON				Minimum Order Multiple
					Qty	H x W x D (cm)	Weight (kg)	Outer Barcode	
7771201	Acid Free Paper	White	36.00 x 68.00	0.04	250	37.50 x 6.00 x 69.50	15.00	8712966030152	1 x 250pk

### Liftboy Complete Starter Kit

- Make a positive start with your document management
- Empty your lever arch files and bundle the contents within a minute using the products from the Starter Kit!
- The Starter Kit provides you with everything you need in a single box
- Awarded OFFI Label for quality, certificate number OL50325049
- Contents: 1 Liftboy, 100 Binders, 100 Filing Labels, 100 Reinforcement Strips (Binders with ICN 12 certificate and OFFI Label for quality, certificate number OL50325049)



ICN 12

Code	Description	Colour	RETAIL PACK				SHIPPING OUTER				Minimum Order Multiple
			Qty	H x W x D (cm)	Weight (kg)	Pack Barcode	Qty	H x W x D (cm)	Weight (kg)	Outer Barcode	
7773601	Liftboy Complete Starter Kit	n/a	1	70.00 x 28.50 x 13.50	1.00	8712966045224	20	28.50 x 42.20 x 59.50	20.00	08712966145221	1 x 1pk

### Liftboy Mini Starter Kit

- Make a positive start with your document management
- Empty your lever arch files and bundle the contents within a minute using the products from the Starter Kit!
- The Starter Kit provides you with everything you to get started
- Awarded OFFI Label for quality, certificate number OL50325049
- Contents: 1 x Liftboy and 10 x Binders (Binders with ICN 12 certificate and OFFI Label for quality, certificate number OL50325049)



ICN 12

Code	Description	Colour	RETAIL PACK				SHIPPING OUTER				Minimum Order Multiple
			Qty	H x W x D (cm)	Weight (kg)	Pack Barcode	Qty	H x W x D (cm)	Weight (kg)	Outer Barcode	
7776401	Liftboy Mini Starter Kit	n/a	1	4.00 x 15.00 x 12.50	0.28	043859754700	50	38.60 x 39.00 x 43.00	14.05	50043859754705	1x1pk

## Loeff's Patent



### Space Box A4

- Space Box File in A4 format of 600-gram solid cardboard (semi-automatic), for dust-free storage
- Suitable for the contents of one lever arch file. Fitted with additional base inlay (attached with perforation edge to the closure flap, remove before use)
- The Space Box fits in the Standard Container (7772701)
- The corrugated cardboard is made from FSC® certified material and is 100% recyclable
- The box file meets all environmental and sustainability requirements as laid down in the criteria of Agentschap NL, part of the Ministry of Housing, Spatial Planning and the Environment
- Awarded OFFI Label for quality, certificate number OL50425050
- Sold in pack of 50 and retail pack of 8

Code	Description	Colour	Int. Dimensions H x W x D (cm)	Ext. Dimensions H x W x D (cm)	Board Type	Product Barcode	OUTER CARTON				Minimum Order Multiple
							Qty	H x W x D (cm)	Weight (kg)	Outer Barcode	
7774201	Space Box A4 50pk	Brown	23.50 x 6.00 x 31.60	24.50 x 6.30 x 32.00	Solid Board	n/a	1x50*	20.00 x 38.00 x 39.50	10.00	8712966045507	1 x 50pk

\*Set up as 1 = 50 pack

Code	Description	Colour	Int. Dimensions H x W x D (cm)	Ext. Dimensions H x W x D (cm)	RETAIL PACK**				OUTER CARTON				Minimum Order Multiple
					Qty	H x W x D (cm)	Weight (kg)	Pack Barcode	Qty	H x W x D (cm)	Weight (kg)	Outer Barcode	
7774202	Space Box A4 8pk Retail	Brown	23.50 x 6.00 x 31.60	24.50 x 6.30 x 32.00	8	3.00 x 37.00 x 38.00	1.50	8712966845503	6	20.00 x 38.00 x 39.50	10.00	08712966145504	6 x 8pk

\*\*Retail packs include full colour insert



### Quick Box A4

- Box file in A4 format, made of micro-corrugated cardboard. Easy to assemble with the 1-2-3-4 base closure system
- The Quick Box retains its shape throughout the retention period thanks to the glued sides
- The Quick Box fits in the Standard Container (7772701)
- The corrugated cardboard is made from FSC® certified material and is 100% recyclable
- The box file meets all environmental and sustainability requirements as laid down in the criteria of Agentschap NL, part of the Ministry of Housing, Spatial Planning and the Environment
- Awarded OFFI Label for quality, certificate number OL50425050
- Sold in pack of 50 and retail pack of 8

Code	Description	Colour	Int. Dimensions H x W x D (cm)	Ext. Dimensions H x W x D (cm)	Board Type	Product Barcode	OUTER CARTON				Minimum Order Multiple
							Qty	H x W x D (cm)	Weight (kg)	Outer Barcode	
7770401	Quick Box A4	Brown	23.50 x 8.00 x 33.00	24.10 x 8.30 x 33.50	Micro-Flute	n/a	1x50*	48.50 x 22.20 x 42.00	7.00	8712966030008	1 x 50pk

\*Set up as 1 = 50 pack

Code	Description	Colour	Int. Dimensions H x W x D (cm)	Ext. Dimensions H x W x D (cm)	RETAIL PACK**				OUTER CARTON				Minimum Order Multiple
					Qty	H x W x D (cm)	Weight (kg)	Pack Barcode	Qty	H x W x D (cm)	Weight (kg)	Outer Barcode	
7770402	Quick Box A4 8pk Retail	Brown	23.50 x 8.00 x 33.00	24.10 x 8.30 x 33.50	8	47.00 x 42.00 x 2.50	1.00	8712966830004	6	48.50 x 22.20 x 42.00	7.00	08712966330009	6 x 8pk

\*\*Retail packs include full colour insert



## Loeff's Patent



### Filing Box Foolscap/Folio

- Box file in foolscap/folio format, made of high-quality micro-corrugated cardboard, sized to suit the storage of 279 x 241mm computer listing paper
- Easy to assemble thanks to its special base closure system
- These box files retain their shape throughout the retention period thanks to the glued sides
- Quick Box fits in the Standard Container (7772701)
- The corrugated cardboard is made from FSC® certified material and is 100% recyclable
- The box file meets all environmental and sustainability requirements as laid down in the criteria of Agentschap NL, part of the Ministry of Housing, Spatial Planning and the Environment
- Awarded OFFI Label for quality, certificate number OL50425050
- Sold in pack of 50 and retail pack of 8



Code	Description	Colour	Int. Dimensions H x W x D (cm)	Ext. Dimensions H x W x D (cm)	Board Type	Product Barcode	OUTER CARTON				Minimum Order Multiple
							Qty	H x W x D (cm)	Weight (kg)	Outer Barcode	
7770501	Filing Box Foolscap/Folio	Brown	25.00 x 8.00 x 34.00	26.00 x 8.50 x 34.30	Micro-Flute	n/a	1x50*	55.50 x 21.00 x 43.50	9.00	8712966030039	1 x 50pk

\*Set up as 1 = 50 pack

Code	Description	Colour	Int. Dimensions H x W x D (cm)	Ext. Dimensions H x W x D (cm)	RETAIL PACK**			OUTER CARTON				Minimum Order Multiple	
					Qty	H x W x D (cm)	Weight (kg)	Pack Barcode	Qty	H x W x D (cm)	Weight (kg)		Outer Barcode
7770502	Filing Box Foolscap/Folio 50pk Retail	Brown	25.00 x 8.00 x 34.00	26.00 x 8.50 x 34.30	8	54.30 x 42.50 x 2.50	9.00	8712966830035	6	55.50 x 21.00 x 43.50	7.00	08712966330030	6 x 8pk

\*\*Retail packs include full colour insert

## Loeff's Patent



### Universal Box A4

- Municipal box file with glued sides
- Easy to assemble thanks to its 1-2-3-4 base closure system
- Also suitable for filing suspension files in A4 format
- The Universal Box fits in the Jumbo Container (7772901) and in the Jumbo Plus Container (7773001)
- The corrugated cardboard is made from FSC® certified material and is 100% recyclable
- The box file meets all environmental and sustainability requirements as laid down in the criteria of Agentschap NL, part of the Ministry of Housing, Spatial Planning and the Environment
- Awarded OFFI Label for quality, certificate number OL50425050
- Sold in pack of 25 and retail pack of 8

Code	Description	Colour	Int. Dimensions H x W x D (cm)	Ext. Dimensions H x W x D (cm)	Board Type	Product Barcode	OUTER CARTON				Minimum Order Multiple
							Qty	H x W x D (cm)	Weight (kg)	Outer Barcode	
7771301	Universal Box A4	Brown	23.7 x 11.2 x 33.5	26.40 x 11.40 x 33.60	B-Flute	n/a	1x25*	48.00 x 17.00 x 61.30	7.00	8712966030206	1 x 25pk

\*Set up as 1 = 25 pack

Code	Description	Colour	Int. Dimensions H x W x D (cm)	Ext. Dimensions H x W x D (cm)	RETAIL PACK**				OUTER CARTON				Minimum Order Multiple
					Qty	H x W x D (cm)	Weight (kg)	Pack Barcode	Qty	H x W x D (cm)	Weight (kg)	Outer Barcode	
7771302	Universal Box A4 8pk Retail	Brown	23.7 x 11.2 x 33.5	26.40 x 11.40 x 33.60	8	45.50 x 61.00 x 4.50	1.70	8712966130203	3	48.00 x 17.00 x 61.30	6.00	08712966330207	3 x 8pk

\*\*Retail packs include full colour insert



### Loeff Box Foolschap/Folio

- Ready-to-use box file in A4 format of 600-gram solid cardboard (semi-automatic), for dust-free storage
- Suitable for the contents of one lever arch file
- Fitted with additional base inlay (attached with perforation edge to the closure flap, remove before use)
- The Loeff Box fits in the Standard Container (7772701)
- The corrugated cardboard is made from FSC® certified material and is 100% recyclable
- The box file meets all environmental and sustainability requirements as laid down in the criteria of Agentschap NL, part of the Ministry of Housing, Spatial Planning and the Environment
- Awarded OFFI Label for quality, certificate number OL50425050
- Sold in pack of 50 and retail pack of 8

Code	Description	Colour	Int. Dimensions H x W x D (cm)	Ext. Dimensions H x W x D (cm)	Board Type	Product Barcode	OUTER CARTON				Minimum Order Multiple
							Qty	H x W x D (cm)	Weight (kg)	Outer Barcode	
7771401	Loeff Box Foolschap/ Folio	Brown	26.20 x 11.50 x 36.80	26.50 x 11.80 x 37.00	Solid Board	n/a	1x50*	50.00 x 18.00 x 62.00	21.00	8712966030305	1 x 50pk

\*Set up as 1 = 50 pack

Code	Description	Colour	Int. Dimensions H x W x D (cm)	Ext. Dimensions H x W x D (cm)	RETAIL PACK**				OUTER CARTON				Minimum Order Multiple
					Qty	H x W x D (cm)	Weight (kg)	Pack Barcode	Qty	H x W x D (cm)	Weight (kg)	Outer Barcode	
7771402	Loeff Box Foolschap/Folio 8pk Retail	Brown	26.20 x 11.50 x 36.80	26.50 x 11.80 x 37.00	8	45.80 x 61.00 x 3.00	3.00	8712966830301	6	50.00 x 18.00 x 62.00	20.00	8712966330306	6 x 8pk

\*\*Retail packs include full colour insert

## Loeff's Patent

### Jumbo Box

- Municipal box file with glued sides
- Made of solid 900-gram cardboard
- Benefits from the 1-2-3-4 base closure system
- Fitted with additional base inlay (attached with perforation edge to the closure flap, detach for use)
- This base inlay ensures that your documents remain free from damage during the file retention period
- The Jumbo Box fits in the Jumbo Container (7772901) and in the Jumbo Plus Container (7773001)
- The cardboard is made from FSC® certified material and is 100% recyclable
- The box file meets all environmental and sustainability requirements as laid down in the criteria of Agentschap NL, part of the Ministry of Housing, Spatial Planning and the Environment
- Awarded OFFI Label for quality, certificate number OL50425050
- Sold in pack of 25 and retail pack of 8



Code	Description	Colour	Int. Dimensions H x W x D (cm)	Ext. Dimensions H x W x D (cm)	Board Type	Product Barcode	OUTER CARTON				Minimum Order Multiple
							Qty	H x W x D (cm)	Weight (kg)	Outer Barcode	
7770801	Jumbo Box 25pk	Brown	24.70 x 11.30 x 36.70	25.70 x 11.50 x 37.00	Solid Board	n/a	1x25*	49.50 x 11.00 x 58.50	12.00	8712966030077	1 x 25pk

\*Set up as 1 = 25 pack

Code	Description	Colour	Int. Dimensions H x W x D (cm)	Ext. Dimensions H x W x D (cm)	RETAIL PACK**				OUTER CARTON				Minimum Order Multiple
					Qty	H x W x D (cm)	Weight (kg)	Pack Barcode	Qty	H x W x D (cm)	Weight (kg)	Outer Barcode	
7770802	Jumbo Box 8pk Retail	Brown	24.70 x 11.30 x 36.70	25.70 x 11.50 x 37.00	8	49.40 x 58.40 x 3.60	3.50	8712966830073	3	49.50 x 11.00 x 58.50	11.50	08712966330078	3 x 8pk

\*\*Retail packs include full colour insert

### Classic Box Foolsap/Folio

- This generously sized Classic Box File is made of high quality pH-neutral corrugated cardboard
- Designed with a handy and large closing flap
- It features thumb hole at the front back for easy retrieval
- Large label areas on the end spines to identify the contents
- The Classic Box fits in the Jumbo Container (7772901) and in the Jumbo Plus Container (7773001)
- The corrugated cardboard is made from FSC® certified material and is 100% recyclable
- The box file meets all environmental and sustainability requirements as laid down in the criteria of Agentschap NL, part of the Ministry of Housing, Spatial Planning and the Environment
- Awarded OFFI Label for quality, certificate number OL50425050
- Sold in packs of 50



Code	Description	Colour	Int. Dimensions H x W x D (cm)	Ext. Dimensions H x W x D (cm)	Board Type	Product Barcode	OUTER CARTON				Minimum Order Multiple
							Qty	H x W x D (cm)	Weight (kg)	Outer Barcode	
7771501	Classic Box Foolsap/Folio	Brown	25.50 x 11.50 x 36.80	26.00 x 11.80 x 37.00	B-Flute	n/a	1x50*	50.00 x 39.50 x 53.00	15.00	8712966030404	1 x 50pk

\*Set up as 1 = 50 pack

## Loeff's Patent



### Data Box A3

- This archive box is suitable for storing A3 format documents as well as the permanent storage of the largest format of computer listing paper (279 x 390 mm)
- Fitted with special base closure system
- The Data Box fits in the Data Container (7772801)
- The cardboard is made from FSC® certified material and is 100% recyclable
- The box file meets all environmental and sustainability requirements as laid down in the criteria of Agentschap NL, part of the Ministry of Housing, Spatial Planning and the Environment
- Awarded OFFI Label for quality, certificate number OL50425050
- Sold in pack of 50 and retail pack of 8

Code	Description	Colour	Int. Dimensions H x W x D (cm)	Ext. Dimensions H x W x D (cm)	Board Type	Product Barcode	OUTER CARTON				Minimum Order Multiple
							Qty	H x W x D (cm)	Weight (kg)	Outer Barcode	
7770601	Data Box A3	Brown	32.00 x 8.00 x 44.00	33.30 x 8.30 x 44.50	B-Flute	n/a	1x50*	54.50 x 33.50 x 62.50	12.00	8712966030046	1 x 50pk

\*Set up as 1 = 50 pack

Code	Description	Colour	Int. Dimensions H x W x D (cm)	Ext. Dimensions H x W x D (cm)	RETAIL PACK**				OUTER CARTON				Minimum Order Multiple
					Qty	H x W x D (cm)	Weight (kg)	Pack Barcode	Qty	H x W x D (cm)	Weight (kg)	Outer Barcode	
7770602	Data Box A3 8pk Retail	Brown	32.00 x 8.00 x 44.00	33.30 x 8.30 x 44.50	8	52.5 x 62.00 x 33.00	1.5	8712966830042	6	54.50 x 33.50 x 62.00	9.00	8712966130043	6 x 8pk

\*\*Retail packs include full colour insert

## ICN 4



### City Box 10+

- Acid-Free Corrugated cardboard, foldable box file with ICN standard 4 certificate (for the medium term retention of records and archives)
- For institutions and municipalities that are obliged to file acid-free in accordance with the strict requirements of the Public Records Act
- Interior white Kraft and exterior brown Kraft
- The City Box 10+ fits in the Jumbo Container (7772901)
- The corrugated cardboard is 100% recyclable
- Sold in packs of 50

Code	Description	Colour	Int. Dimensions H x W x D (cm)	Ext. Dimensions H x W x D (cm)	Board Type	Product Barcode	OUTER CARTON				Minimum Order Multiple
							Qty	H x W x D (cm)	Weight (kg)	Outer Barcode	
7770901	City Box 10+	Brown	37.80 x 11.80 x 35.50	39.50 x 12.00 x 26.50	B-Flute	n/a	1x50*	62.50 x 17.00 x 91.00	20.00	8712966030084	1 x 50pk

\*Set up as 1 = 50 pack

## ICN 3



Fully complies to the standards of ISO 16245:2009 Type A



### City Box 30+

- Acid-Free corrugated cardboard, foldable box file. Fully complies to the standards of ISO 16245:2009 Type A (for the long term storage of documents on paper or parchment)
- Also awarded ICN standard 3 certificate (for the long term retention – a minimum of 30 years)
- For institutions and municipalities that are obliged to file acid-free
- Interior white Kraft and exterior brown Kraft
- The City Box 30+ fits in the Jumbo Container (7772901) and the Jumbo Plus Container (7773001)
- The corrugated cardboard is 100% recyclable
- Sold in packs of 50

Code	Description	Colour	Int. Dimensions H x W x D (cm)	Ext. Dimensions H x W x D (cm)	Board Type	Product Barcode	OUTER CARTON				Minimum Order Multiple
							Qty	H x W x D (cm)	Weight (kg)	Outer Barcode	
7771001	City Box 30+	Brown	37.80 x 11.80 x 33.50	39.50 x 12.00 x 26.50	B-Flute	n/a	1x50*	62.50 x 17.00 x 91.00	20.00	8712966030091	1 x 50pk

\*Set up as 1 = 50 pack



## Loeff's Patent

### Jumbo Container

- The Jumbo Container can accommodate 3 x Loeff Boxes, 3 x Universal Boxes, 3 x Jumbo or 3 x Classic Boxes
- The robust construction, the smart build-up system and the additional connection supports guarantee a solid filing system with unprecedented flexibility and possibilities
- In order to secure a stable structure, it is recommended to link up the containers back-to-back
- If you opt for a wall-supported structure, use the archive stabiliser (sold separately)
- The corrugated cardboard is made from FSC® certified material and is 100% recyclable
- Sold in pack of 15 (pack includes plastic connectors)



**Suitable for** ▶

Universal Box



Loeff Box



Jumbo Box



Classic Box



Code	Description	Colour	Int. Dimensions H x W x D (cm)	Ext. Dimensions H x W x D (cm)	Board Type	Product Barcode	OUTER CARTON				Minimum Order Multiple
							Qty	H x W x D (cm)	Weight (kg)	Outer Barcode	
7772901	Jumbo Container	Brown	10.81 x 16.13 x 15.19	28.00 x 42.50 x 40.00	B-Flute	n/a	15	10.00 x 80.00 x 113.00	15.00	8712966040045	1 x 15pk

### Jumbo Plus Container

- Thanks to its oversized dimensions, the Jumbo Plus Container is suitable for storing the largest formats of municipal box files
- This container will accommodate 3 municipal box files of up to 120mm spine width
- The robust construction, the smart build-up system and the additional connection supports guarantee a solid filing system with unprecedented flexibility and possibilities
- In order to secure a stable structure, it is recommended to link up the containers back-to-back
- If you opt for a wall-supported structure, use the archive stabiliser (sold separately)
- The corrugated cardboard is made from FSC® certified material and is 100% recyclable
- Sold in pack of 15 (pack includes plastic connectors)



**Suitable for** ▶

City Box 10+



City Box 30+



Code	Description	Colour	Int. Dimensions H x W x D (cm)	Ext. Dimensions H x W x D (cm)	Board Type	Product Barcode	OUTER CARTON				Minimum Order Multiple
							Qty	H x W x D (cm)	Weight (kg)	Outer Barcode	
7773001	Jumbo Plus Container	Brown	29.50 x 42.00 x 43.00	30.00 x 44.00 x 44.50	B-Flute	n/a	15	11.50 x 80.00 x 106.00	15.00	8712966040052	1 x 15pk



## Loeff's Patent



### Standard Container

- The Standard Container is designed for the storage of A4 and foolscap/folio format box files with up to 80mm spine widths
- Will accommodate 6 Space Boxes, 4 Quick Boxes A4 or 4 Filing Boxes Foolscap/Folio
- The robust construction, the smart build-up system and the additional connection supports guarantee a solid filing system with unprecedented flexibility and possibilities
- In order to secure a stable structure, it is recommended to link up the containers back-to-back
- If you opt for a wall-supported structure, use the archive stabiliser (sold separately)
- The corrugated cardboard is made from FSC® certified material and is 100% recyclable
- Sold in pack of 15 (pack includes plastic connectors)

**Suitable for** ▶

Space Box A4



Quick Box A4



Filing Box



Code	Description	Colour	Int. Dimensions H x W x D (cm)	Ext. Dimensions H x W x D (cm)	Board Type	Product Barcode	OUTER CARTON				Minimum Order Multiple
							Qty	H x W x D (cm)	Weight (kg)	Outer Barcode	
7772701	Standard Container	Brown	27.00 x 39.00 x 35.50	27.50 x 41.00 x 37.00	B-Flute	no barcode	15	9.50 x 69.00 x 120.00	15.00	8712966040014	1 x 15pk



### Standard Container Starter Kit

- Start filing with the Loeff's Standard Starter Kit
- Each Standard Container will hold 4 Filing Boxes
- A robust construction, the smart build-up system and the additional connection supports guarantee a solid filing system with unprecedented flexibility and possibilities
- The corrugated cardboard is made from FSC® certified material and is 100% recyclable
- Starter Kit contents: 2 x Standard Container, 8 x Filing Box and 4 x Plastic Connector

Code	Description	Colour	RETAIL OUTER				Minimum Order Multiple
			Qty	H x W x D (cm)	Weight (kg)	Outer Barcode	
7776501	Standard Container Starter Kit	Brown	1	75.00 x 8.50 x 47.00	3.84	043859754786	1 x 1pk



### Data Container

- Suitable for storing 4 x Data Boxes
- Also suitable for storing files or documents in A3 format
- The robust construction, the smart build-up system and the additional connection supports guarantee a solid filing system with unprecedented flexibility and possibilities
- In order to secure a stable structure, it is recommended to link up the containers back-to-back
- If you opt for a wall-supported structure, use the archive stabiliser (sold separately)
- The corrugated cardboard is made from FSC® certified material and is 100% recyclable
- Sold in pack of 10 (pack includes plastic connectors)

**Suitable for** ▶

Data Box A3



Code	Description	Colour	Int. Dimensions H x W x D (cm)	Ext. Dimensions H x W x D (cm)	Board Type	Product Barcode	OUTER CARTON				Minimum Order Multiple
							Qty	H x W x D (cm)	Weight (kg)	Outer Barcode	
7772801	Data Container	Brown	33.50 x 36.00 x 46.50	34.00 x 38.00 x 48.00	B-Flute	no barcode	10	7.00 x 87.00 x 116.00	10.00	8712966040021	1 x 10pk

## Loeff's Patent

### Direct Container

- The Direct Container is suitable for filing 4 lever arch files with a spine width of 80mm or 6 lever arch files with a spine width of 60 mm
- The Direct Container is also suitable for storing 4 Filing Boxes Foolscap or 4 Quick Boxes A4
- The robust construction, the smart build-up system and the additional connection supports guarantee a solid filing system with unprecedented flexibility and possibilities
- In order to secure a stable structure, it is recommended to link up the containers back-to-back
- If you opt for a wall-supported structure, use the archive stabiliser (sold separately)
- The corrugated cardboard is made from FSC® certified material and is 100% recyclable
- Ext. Dimensions: H36 x W38 x D33cm
- Sold in pack of 15 (pack includes plastic connectors)
- Item Code 7772601



**Suitable for** **Quick Box A4** **Filing Box** **Folders & Files**

Code	Description	Colour	Int. Dimensions H x W x D (cm)	Ext. Dimensions H x W x D (cm)	Board Type	Product Barcode	OUTER CARTON				Minimum Order Multiple
							Qty	H x W x D (cm)	Weight (kg)	Outer Barcode	
7772601	Direct Container	Brown	35.50 x 36.00 x 31.50	36.00 x 38.00 x 33.00	B-Flute	no barcode	15	10.00 x 73.50 x 125.00	15.00	8712966040007	1 x 15pk

### Container Stabiliser

- In order to create a stable construction it is recommendable to join the containers back to back
- If this kind of connection is impossible due to lack of space at the archive location and a single wall placement is the most obvious solution, we recommend the use of archive stabilizers (panels that are placed underneath)
- This type of construction allows the containers to be placed tightly against the wall
- Since the polystyrene panels are slanted – the height at the front side is 4 cm/1.57 inch and at the back side 2 cm/ 0.79 inch they will prevent the containers on top from tilting forwards
- Made of polystyrene
- Pack of 2 pieces



Code	Description	Colour	Dimensions H x W x D (cm)	Product Barcode	OUTER CARTON					Minimum Order Multiple
					Qty	H x W x D (cm)	Weight (kg)	Outer Barcode		
7773101	Direct Container Stabiliser	White	4.00 x 75.50 x 32.00	no barcode	2	7.00 x 40.50 x 80.00	0.2	8712966241107		1 x 2pk
7773201	Standard Container Stabiliser	White	4.00 x 83.00 x 37.00	no barcode	2	8.00 x 38.00 x 84.00	0.2	8712966241114		1 x 2pk
7773301	Data Container Stabiliser	White	4.00 x 75.50 x 32.00	no barcode	2	8.00 x 49.00 x 77.00	0.2	8712966241121		1 x 2pk
7773401	Jumbo Container Stabiliser	White	4.00 x 85.00 x 40.00	no barcode	2	8.00 x 41.00 x 86.00	0.2	8712966241145		1 x 2pk
7773501	Jumbo Plus Container Stabiliser	White	4.00 x 88.00 x 60.00	no barcode	2	8.00 x 45.50 x 88.50	0.2	8712966241152		1 x 2pk



## MADE FOR STORING WITH STYLE

**STYLE** Attractive and durable storage solutions for every space

### Strong and stackable

A range of stacking heights



### Time-saving and simple

Designed for quick and easy assembly



### Recyclable and sustainable

Helping you meet your environmental goals.



MADE FOR LIFE™



### Storage Box

- You can rely on this attractive storage box to protect the contents because of the strong construction
- Three layers of cardboard to the handle ends and 2 layers to the base add extra strength to the box
- Maximise your floor space by stacking the boxes up to 4 units high
- We understand time is important so this box will be ready to use quickly thanks to the FastFold® automatic assembly design
- Perfectly sized to store A4 or foolscap lever arch files, suspension files if required
- To ensure that the lid will fit if you store suspension files we have made it slightly oversized
- Made from FSC® certified 100% recycled board, 100% recyclable

							OUTER CARTON				
Code	Description	Colour	Int. Dimensions H x W x D (cm)	Ext. Dimensions H x W x D (cm)	Board Type	Product Barcode	Qty	H x W x D (cm)	Weight (kg)	Outer Barcode	Minimum Order Multiple
4481301	Storage Box 4pk	Green/White	28.50 x 33.30 x 39.00	29.20 x 33.50 x 40.40	B-Flute	no barcode	4	75.00 x 8.50 x 47.00	2.85	043859689415	1 x 4pk
4481901	Storage Box 4pk	Blue/White	28.50 x 33.30 x 39.00	29.20 x 33.50 x 40.40	B-Flute	no barcode	4	75.00 x 8.50 x 47.00	2.85	043859689477	1 x 4pk

							RETAIL PACK*				
Code	Description	Colour	Int. Dimensions H x W x D (cm)	Ext. Dimensions H x W x D (cm)	Board Type	Product Barcode	Qty	H x W x D (cm)	Weight (kg)	Pack Barcode	Minimum Order Multiple
4481306	Storage Box 2pk	Green/White	28.50 x 33.30 x 39.00	29.20 x 33.50 x 40.40	B-Flute	no barcode	2	75.00 x 47.00 x 3.70	1.18	043859695119	1 x 2pk
4481905	Storage Box 2pk	Blue/White	28.50 x 33.30 x 39.00	29.20 x 33.50 x 40.40	B-Flute	no barcode	2	75.00 x 47.00 x 3.70	1.18	043859718757	1 x 2pk

\*Retail packs include full colour insert



### Magazine File

- Attractive A4 magazine file that would complement any work space
- For your convenience there is a label area on front and back spine
- Easy to assemble with fold together base
- Made from FSC® certified 100% recycled board, 100% recyclable"

							OUTER CARTON				
Code	Description	Colour	Int. Dimensions H x W x D (cm)	Ext. Dimensions H x W x D (cm)	Board Type	Product Barcode	Qty	H x W x D (cm)	Weight (kg)	Outer Barcode	Minimum Order Multiple
4481501	Magazine File 10pk	Green/White	31.10 x 7.80 x 25.80	31.60 x 8.10 x 26.30	B-Flute	no barcode	10	55.80 x 4.20 x 35.20	0.90	043859689439	1 x 10pk
4482101	Magazine File 10pk	Blue/White	31.10 x 7.80 x 25.80	31.60 x 8.10 x 26.30	B-Flute	no barcode	10	55.80 x 4.20 x 35.20	0.90	043859689491	1 x 10pk



## Style

### Drawer Unit

- Attractive A4 drawer unit for organising your paperwork and personal items
- To save space you can stack these units up to 3 units high
- To simplify construction the cardboard shell features FastFold® automatic assembly
- Supplied with 4 x A4 sized drawers
- Made from FSC® certified 100% recycled board, 100% recyclable

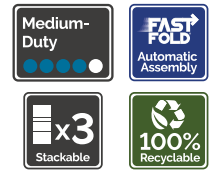

Code	Description	Colour	Int. Dimensions H x W x D (cm)	Ext. Dimensions H x W x D (cm)	Board Type	Product Barcode	OUTER CARTON				
							Qty	H x W x D (cm)	Weight (kg)	Outer Barcode	Minimum Order Multiple
4481701	4 Drawer Unit 1pk	Green/White	8.10 x 26.60 x 31.90	38.30 x 28.90 x 33.90	B-Flute	no barcode	1	68.00 x 5.20 x 54.20	1.53	043859689453	1 x 1pk
4482301	4 Drawer Unit 1pk	Blue/White	8.10 x 26.60 x 31.90	38.30 x 28.90 x 33.90	B-Flute	no barcode	1	68.00 x 5.20 x 54.20	1.53	043859689514	1 x 1pk

### Desktop Sorter

- Designed with 8 compartments for the easy organisation and identification of your paperwork, magazines or personal items
- Maximise your storage space by stacking this attractive sorter 3 units high
- To simplify construction the cardboard shell features FastFold® automatic assembly
- For easy identification plastic shelf edging is suitable for labels (labels not supplied)
- Made from FSC® certified 100% recycled board, 100% recyclable

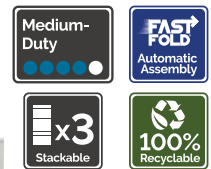

Code	Description	Colour	Int. Dimensions H x W x D (cm)	Ext. Dimensions H x W x D (cm)	Board Type	Product Barcode	OUTER CARTON				
							Qty	H x W x D (cm)	Weight (kg)	Outer Barcode	Minimum Order Multiple
4482601	Desktop Sorter 1pk	Green/White	5.50 x 31.00 x 23.00	26.00 x 49.00 x 31.00	B-Flute	no barcode	1	75.00 x 5.00 x 43.30	1.21	043859689583	1 x 1pk
4482501	Desktop Sorter 1pk	Blue/White	5.50 x 31.00 x 23.00	26.00 x 49.00 x 31.00	B-Flute	no barcode	1	75.00 x 5.00 x 43.30	1.21	043859689576	1 x 1pk



## MADE FOR PORTABLE FILING

### HANDIFILES Strong solutions for filing on the move

#### Strong and Durable

Concertina file with locking clasp and strong carry handle



#### Convenient and adaptable

Supplied with label sheet to offer you options for use.



MADE FOR LIFE™



#### Handifile

- Practical briefcase format concertina file – neat and compact for travel or storage
- Built to last this Handifile is made from strong solidboard and features a plastic carry handle
- To give a secure closure there is a plastic locking clasp on the hinged lid
- Simplify your filing by using this 19 pocket concertina file (Pocket dims: W36 x H23cm)
- For your convenience it is supplied with a sheet of self-adhesive index labels
- The BANKERS BOX® Handifile is available in a range of colours
- Assorted pack contains 1x black, blue, red, white and pink

Code	Description	Colour	Pocket Dimensions H x W (cm)	SINGLE UNIT			OUTER CARTON				
				H x W x D (cm)	Weight (kg)	Product Barcode	Qty	H x W x D (cm)	Weight (kg)	Pack Barcode	Minimum Order Multiple
9352101	Handifile	Black	23.00 x 36.00	25.00 x 36.20 x 12.40	0.79	043859654512	5	27.60 x 37.80 x 63.50	4.64	50043859654517	5 single units
9352201	Handifile	Blue	23.00 x 36.00	25.00 x 36.20 x 12.40	0.79	043859654529	5	27.60 x 37.80 x 63.50	4.64	50043859654524	5 single units
7230601	Handifile	Red	23.00 x 36.00	25.00 x 36.20 x 12.40	0.79	043859717552	5	27.60 x 37.80 x 63.50	4.64	50043859717557	5 single units
7230701	Handifile	White	23.00 x 36.00	25.00 x 36.20 x 12.40	0.79	043859717569	5	27.60 x 37.80 x 63.50	4.64	50043859717564	5 single units
7230801	Handifile	Pink	23.00 x 36.00	25.00 x 36.20 x 12.40	0.79	043859717576	5	27.60 x 37.80 x 63.50	4.64	50043859717571	5 single units
7230501	Handifile	Assorted	23.00 x 36.00	25.00 x 36.20 x 12.40	0.79	Various	5	27.60 x 37.80 x 63.50	4.64	00043859717545	5 single units



#### Handifile Portrait

- Practical tall concertina file designed to store your paperwork upright
- Built to last this Handifile is made from strong solidboard and features a plastic carry handle
- To give a secure closure there is a plastic locking clasp on the hinged lid
- Simplify your filing by using this 19 pocket concertina file (Pocket dims: W23 x H36cm)
- For your convenience it is supplied with a sheet of self-adhesive index labels
- The BANKERS BOX® Handifile is available in black or white

Code	Description	Colour	Pocket Dimensions H x W (cm)	SINGLE UNIT			OUTER CARTON				
				H x W x D (cm)	Weight (kg)	Product Barcode	Qty	H x W x D (cm)	Weight (kg)	Outer Barcode	Minimum Order Multiple
7230301	Handifile Portrait	Black	11.81 x 9.63	33.50 x 25.70 x 12.40	1.08	043859701636	5	28.00 x 40.00 x 64.50	5.88	50043859701631	5 single units
7230401	Handifile Portrait	White	11.81 x 9.63	33.50 x 25.70 x 12.40	1.08	043859701643	5	28.00 x 40.00 x 64.50	5.88	50043859701648	5 single units

## MADE FOR SIMPLIFIED SUSTAINABILITY



### RECYCLING Hard-wearing and easily assembled recycling solutions for offices

#### Tough and reusable

Recycling bins that are built to withstand frequent use



#### Flexible and hassle-free

Designed for office spaces to improve recycling.



#### Recyclable and sustainable

Helping you meet your environmental goals.



MADE FOR LIFE™

### Desktop Recycle Bin

- Let us help you collate recycling easily - Small bin designed for collection non confidential paperwork
- Made from strong corrugated cardboard
- To avoid frustrations the box is designed with FastFold® automatic assembly construction
- Easily empty the contents by lifting the large hinged lid
- Made from FSC® certified board, 100% recyclable



Code	Description	Colour	Int. Dimensions H x W x D (cm)	Ext. Dimensions H x W x D (cm)	Board Type	Product Barcode	SHRINK PACK				Minimum Order Multiple
							Qty	H x W x D (cm)	Weight (kg)	Pack Barcode	
8049301	Desktop Recycle Bin	Green & Blue	23.5 x 24.8 x 31.4	23.2 x 23.0 x 30.5	B-Flute	043859733408	5	50.00 x 7.50 x 56.00	1.620	50043859733403	5 single units

### Tall Recycle Bin

- Let us help you collate recycling easily - Tall bin that offers you options for use
- Conveniently place the bin under your desk and use the front letterbox opening to access
- For use in a more central area, the top opening option is recommended
- Made from strong double thickness corrugated cardboard
- Compatible with Fellowes shredder bag, code:36054
- Max capacity: 69 litres (top opening use) or 53 litres (front opening use)
- Made from FSC® certified board, 100% recyclable



Code	Description	Colour	Int. Dimensions H x W x D (cm)	Ext. Dimensions H x W x D (cm)	Board Type	Product Barcode	SHRINK PACK				Minimum Order Multiple
							Qty	H x W x D (cm)	Weight (kg)	Pack Barcode	
8049202	Desktop Recycle Bin	Green & Blue	60.00 x 29.20 x 39.50	60.80 x 31.50 x 42.70	Micro/B-Flute	043859733392	2	78.40 x 4.00 x 69.60	2.274	50043859733397	2 single units





## MADE FOR DELIVERING PEACE OF MIND

**MAILING & SHIPPING** Durable, reliable and economical storage solutions for every office

### Robust and protective

Strong by design these are the only mailing solutions you will want.



### Simple and quick

A range of postal solutions for all your needs, with easy assembly and sealing.



### Recyclable and sustainable

Helping you meet your environmental goals.



MADE FOR LIFE™



### Mailing Envelopes

- To give high protection from bending and offer size and corner protections, this envelope is made from strong corrugated board
- Quick to use with no need for tape as it features a peel and seal closure and tear-off strip for easy opening
- Suitable for mailing e.g. catalogues, brochures, magazines, DVDs, CDs, etc
- Variable height of up to approx. 5cm offers flexibility of use
- With the environment in mind this envelope is made from material can be recycled

Code	Description	Colour	Int. Dimensions H x W x D (cm)	Ext. Dimensions H x W x D (cm)	Board Type	Product Barcode	OUTER CARTON				Minimum Order Multiple
							Qty	H x W x D (cm)	Weight (kg)	Pack Barcode	
7372101	CD	Brown	2.50 x 14.50 x 19.00	2.80 x 15.80 x 20.30	Micro	4250414103682	100	46.00 x 17.00 x 28.00	3.56	50043859742221	Full Pallet
7372201	DVD	Brown	5.00 x 15.00 x 25.00	5.20 x 16.70 x 26.80	Micro	4250414103705	100	45.00 x 17.90 x 35.40	5.09	50043859742436	Full Pallet
7372301	A5	Brown	5.00 x 18.70 x 27.20	5.20 x 20.00 x 28.80	Micro	4250414103729	100	41.70 x 24.00 x 37.20	6.30	50043859742443	Full Pallet
7372401	A4	Brown	5.00 x 21.00 x 29.20	5.20 x 22.80 x 31.10	Micro	4250414103743	100	45.00 x 24.10 x 39.70	5.57	50043859742450	Full Pallet
7372701	A4+	Brown	3.50 x 23.50 x 33.70	4.00 x 25.00 x 35.20	Micro	4250414103767	100	26.50 x 26.50 x 43.60	9.14	50043859742467	Full Pallet
7372801	C4+	Brown	5.00 x 24.80 x 34.00	5.20 x 26.50 x 35.50	Micro	4250414103798	100	45.00 x 28.00 x 44.00	9.75	50043859742474	Full Pallet
7372901	B4	Brown	5.00 x 24.60 x 35.70	5.20 x 26.10 x 37.30	Micro	4250414103804	100	45.50 x 27.70 x 45.90	10.05	50043859742481	Full Pallet
7373001	B4+	Brown	5.00 x 28.50 x 39.70	5.20 x 30.30 x 41.40	Micro	4250414103828	100	45.00 x 31.70 x 49.90	12.67	50043859742498	Full Pallet
7373101	A3	Brown	5.00 x 33.50 x 50.00	5.20 x 35.20 x 52.00	Micro	4250414103842	100	60.70 x 36.50 x 45.00	17.72	50043859742504	Full Pallet



### FastFold® Variable Height Shipping Boxes

- Strong cardboard boxes ideal for shipping items
- Conveniently adjust the height of the box to suit the contents by using the perforations and pre-scored fold lines
- The box is ready to use quickly and easily thanks to the FastFold® automatic assembly design
- No additional tape is required because the box has a self-seal closure
- Safely access the contents without the need of a knife by using the perforated tear-off strip
- Made from FSC® certified material and 100% recyclable

Code	Description	Colour	Int. Dimensions H x W x D (cm)	Ext. Dimensions H x W x D (cm)	Board Type	Product Barcode	STRAPPED BUNDLE				Minimum Order Multiple
							Qty	H x W x D (cm)	Weight (kg)	Pack Barcode	
7374801	A5+	Brown	11.50 x 16.40 x 22.90	13.00 x 17.00 x 23.70	Micro	4250414104108	10	39.50 x 17.00 x 22.70	2.24	50043859742672	Full Pallet
7374901	A4	Brown	22.00 x 21.60 x 30.40	22.40 x 22.30 x 31.20	Micro	4250414104122	10	43.00 x 17.00 x 35.50	2.50	50043859742689	Full Pallet
7375001	A3+	Brown	30.00 x 30.90 x 46.00	31.30 x 31.50 x 47.00	Micro	4250414104146	10	78.00 x 17.00 x 50.00	8.34	50043859742696	Full Pallet



## Mailing & Shipping

### Mailing Wraps

- Wrap around mailing box suitable for mailing your CDs or similar sized items
- Easy to use with peel and seal self-adhesive closure
- For easy opening there is a perforated tear-off strip
- Variable height allows you to use for items with thickness of up to 8cm
- Made from FSC® certified board and 100% recyclable



Code	Description	Colour	Int. Dimensions H x W x D (cm)	Ext. Dimensions H x W x D (cm)	Board Type	SHRINK BUNDLE							
						H x W x D (cm)	Weight (kg)	Product Barcode	Qty	H x W x D (cm)	Weight (kg)	Pack Barcode	Minimum Order Multiple
7373301	CD	Brown	5.50 x 12.90 x 14.70	6.30 x 13.50 x 19.80	Micro	0.34 x 19.40 x 41.80	0.04	4250414103880	25	41.80 x 8.50 x 19.40	1.10	50043859742528	Full Pallet
7373401	A5	Brown	6.00 x 15.50 x 21.70	7.20 x 16.00 x 26.80	Micro	0.34 x 26.40 x 51.30	0.07	4250414103903	25	51.30 x 8.50 x 26.40	1.68	50043859742535	Full Pallet
7373501	A5+	Brown	6.00 x 16.50 x 24.90	7.50 x 17.50 x 30.00	Micro	0.34 x 28.90 x 54.80	0.08	4250414103927	25	54.80 x 8.50 x 28.90	1.95	50043859742542	Full Pallet
7373601	B5	Brown	8.00 x 19.10 x 27.40	9.20 x 19.30 x 32.60	Micro	0.34 x 31.90 x 58.50	0.09	4250414103941	25	58.50 x 8.50 x 31.90	2.33	50043859742559	Full Pallet
7373701	A4	Brown	8.00 x 22.00 x 30.00	9.20 x 22.20 x 35.30	Micro	0.34 x 34.70 x 71.90	0.13	4250414103965	25	71.90 x 8.50 x 34.70	3.18	50043859742566	Full Pallet
7373801	C4	Brown	8.00 x 25.50 x 32.80	9.20 x 26.00 x 38.00	Micro	0.34 x 37.70 x 76.70	0.15	4250414103989	25	76.70 x 8.50 x 37.70	3.73	50043859742573	Full Pallet
7373901	C4+	Brown	8.00 x 27.50 x 33.50	9.20 x 28.00 x 38.70	Micro	0.34 x 37.80 x 81.50	0.16	4250414104009	25	81.50 x 8.50 x 37.80	3.88	50043859742580	Full Pallet
7374001	B4	Brown	8.00 x 39.50 x 37.80	9.20 x 30.00 x 43.00	Micro	0.34 x 42.60 x 87.50	0.18	4250414104023	25	87.50 x 8.50 x 42.60	4.55	50043859742597	Full Pallet
7374101	A3	Brown	8.00 x 32.50 x 45.50	9.20 x 33.00 x 51.00	Micro	0.34 x 50.70 x 86.70	0.22	4250414104047	25	86.70 x 8.50 x 50.70	5.38	50043859742603	Full Pallet
7374201	A2	Brown	5.40 x 42.00 x 64.00	6.60 x 42.50 x 68.50	Micro	0.40 x 68.50 x 103.50	0.42	4250414135850	10	103.50 x 4.00 x 68.50	4.20	50043859742610	Full Pallet

### A4 Lever Arch File Mailer

- Wrap around mailing box suitable for mailing your A4 size lever arch files
- Easy to use with peel and seal self-adhesive closure
- For easy opening there is a perforated tear-off strip
- To offer you flexibility of use the mailing wrap can expand from a thickness of 3cm up to 8cm
- Made from FSC® certified board and 100% recyclable



Code	Description	Colour	Int. Dimensions H x W x D (cm)	Ext. Dimensions H x W x D (cm)	Board Type	Product Barcode	SHRINK BUNDLE				Minimum Order Multiple
							Qty	H x W x D (cm)	Weight (kg)	Pack Barcode	
7373201	Lever Arch File Mailer	Brown	35-80 x 32.00 x 29.00	45-90 x 37.00 x 29.70	Micro	4250414106669	20	78.00 x 7.50 x 37.00	2.89	50043859742511	Full Pallet

### Mail Boxes

- Cardboard mailing box ideal for a wide range of uses
- For a secure closure the lid of the box features a lock-in tab
- Easy manual assembly and the box is ready to use
- Made from FSC® certified material and 100% recyclable



Code	Description	Colour	Int. Dimensions H x W x D (cm)	Ext. Dimensions H x W x D (cm)	Board Type	Product Barcode	STRAPPED BUNDLE				Minimum Order Multiple
							Qty	H x W x D (cm)	Weight (kg)	Pack Barcode	
7374301	Mail Box (XS)	Brown	4.30 x 14.50 x 24.40	4.20 x 15.70 x 24.90	B-Flute	4250414104382	20	26.20 x 20.00 x 24.20	1.26	50043859742627	Full Pallet
7374401	Mail Box (S)	Brown	7.90 x 24.90 x 17.50	8.50 x 25.50 x 18.50	B-Flute	4250414104405	20	37.50 x 20.00 x 25.50	4.63	50043859742634	Full Pallet
7374501	Mail Box (M)	Brown	10.40 x 33.10 x 24.10	11.00 x 33.60 x 25.10	B-Flute	4250414104429	20	49.00 x 20.00 x 33.60	3.62	50043859742641	Full Pallet
7374601	Mail Box (L)	Brown	14.10 x 39.50 x 24.80	15.00 x 40.00 x 26.10	B-Flute	4250414104443	20	57.50 x 20.00 x 40.00	5.18	50043859742658	Full Pallet
7374701	Mail Box (XL)	Brown	17.40 x 46.00 x 33.30	18.00 x 46.50 x 34.60	B-Flute	4250414104467	20	72.50 x 20.00 x 46.40	7.74	50043859742665	Full Pallet

## Mailing & Shipping



### Gifting Mailing Boxes

- Attractive hassle free packaging made from strong corrugated board
- The box is ready for you to use in seconds thanks to the Quick and easy Fastfold® pull-up design
- Quick to use with no need for tape as it features a peel and seal closure and tear-off strip for easy opening
- To help you, the boxes are pre-printed with addressee and sender label areas
- Maximise the use of the Royal Mail UK Small Parcel Tariff as this box fits the maximum dimension requirements
- Made from FSC® certified material and 100% recyclable

Code	Description	Colour	Int. Dimensions H x W x D (cm)	Ext. Dimensions H x W x D (cm)	Board Type	SINGLE UNIT			OUTER CARTON			Minimum Order Multiple	
						H x W x D (cm)	Weight (kg)	Product Barcode	Qty	H x W x D (cm)	Weight (kg)		Outer Barcode
7371201	Red Ribbon Mailing Box 35x25x16cm	Multi	15.40 x 34.10 x 24.70	15.80 x 35.30 x 24.70	Micro-Flute	40.00 x 34.70 x 0.90	0.14	043859721139	20	41.50 x 22.70 x 38.00	4.72	10043859721136	20 single units
7371301	Bunting Flags Mailing Box 35x25x16cm	Multi	15.40 x 34.10 x 24.70	15.80 x 35.30 x 24.70	Micro-Flute	40.00 x 34.70 x 0.90	0.14	043859721078	20	41.50 x 22.70 x 38.00	4.72	50043859721073	20 single units



### Heavy-Duty Mailing Boxes

- Attractive hassle free packaging made from strong corrugated board
- The box is ready for you to use in seconds thanks to the Quick and easy Fastfold® pull-up design
- Quick to use with no need for tape as it features a peel and seal closure and tear-off strip for easy opening
- To help you, the boxes are pre-printed with addressee and sender label areas with a clear space for postage above
- Maximise the use of the Royal Mail UK Small Parcel Tariff as this box fits the maximum dimension requirements
- Made from FSC® certified material and 100% recyclable

Code	Description	Colour	Int. Dimensions H x W x D (cm)	Ext. Dimensions H x W x D (cm)	Board Type	SINGLE UNIT			OUTER CARTON			Minimum Order Multiple	
						H x W x D (cm)	Weight (kg)	Product Barcode	Qty	H x W x D (cm)	Weight (kg)		Pack Barcode
7372501	322208	White/Blue	7.40 x 31.50 x 21.90	8.00 x 32.00 x 22.00	Micro-Flute	29.60 x 31.50 x 1.20	0.12	043859730773	20	31.30 x 20.50 x 32.40	2.44	50043859730778	20 single units
7372601	352516	White/Blue	15.40 x 34.10 x 24.70	15.80 x 35.30 x 25.20	Micro-Flute	40.00 x 34.70 x 1.20	0.14	043859730780	20	41.10 x 20.50 x 35.50	4.39	50043859730785	20 single units



## MADE FOR A SMOOTH MOVE



**MOVING & STORING** Strong and stable solutions to make moving and storing simple

### Solid and supportive

For your understanding boxes are graded by strength and stacking height



### Quick and simple assembly

To save you time, selected products are designed with fast, simple no-tape setup.



### Recyclable and sustainable

Helping you meet your environmental goals.



MADE FOR LIFE™

### Prime FastFold® Removal Boxes

- Moving has never been easier thanks to SmoothMove™ Fastfold® removal boxes
- These heavy-duty removals box made from strong double thickness corrugated board
- For your convenience no tape required and the lock-in handles secure the lid closed and reinforced the hand-holes
- To ensure you can easily identify the contents there are pre-printed icons and large label areas
- Save money and re-use - Easy to break down and store until they are needed again
- Suggested uses: Small box - small heavy items, XL box - lightweight bulky items
- Made from FSC® certified 100% recycled board, 100% recyclable



Code	Description	Colour	Int. Dimensions H x W x D (cm)	Ext. Dimensions H x W x D (cm)	Capacity	Board Type	Product Barcode	OUTER CARTON				
								Qty	H x W x D (cm)	Weight (kg)	Outer Barcode	Minimum Order Multiple
6205201	Removal Boxes (S)	Brown/Blue	30.40 x 30.40 x 40.60	31.00 x 32.70 x 42.90	37.5L	Micro/B-Flute	043859607037	5	74.40 x 9.10 x 52.60	4.30	50043859607032	5 single units
6205301	Removal Boxes (L)	Brown/Blue	40.60 x 45.70 x 45.70	41.20 x 48.00 x 47.00	85L	Micro/B-Flute	043859607044	5	94.00 x 9.10 x 70.60	7.40	50043859607049	5 single units
6205401	Removal Boxes (XL)	Brown/Blue	45.70 x 60.90 x 45.70	46.30 x 48.00 x 63.20	127L	Micro/B-Flute	043859607051	5	110.40 x 9.10 x 75.60	8.99	50043859607056	5 single units

### Prime FastFold® Removal Box

- Heavy-Duty box made from strong double thickness corrugated board
- For comfort and strength, when lifting and carrying, the handles are reinforced
- Maximise the use of your space by stacking these strong boxes up to 5 units high
- To save time and avoid frustration these boxes feature FastFold® automatic assembly
- To help you easily identify the contents there are pre-printed icons and large label areas
- Made from FSC® certified board, 100% recyclable



Code	Description	Colour	Int. Dimensions H x W x D (cm)	Ext. Dimensions H x W x D (cm)	Capacity	Board Type	Product Barcode	OUTER CARTON				
								Qty	H x W x D (cm)	Weight (kg)	Outer Barcode	Minimum Order Multiple
6206101	Removal Box	Brown/Blue	29.40 x 38.70 x 43.00	29.40 x 39.00 x 46.40	49L	Micro/B-Flute	043859730636	5	84.50 x 17.40 x 50.00	4.40	50043859730631	5 single units



## SmoothMove™



### Heavy-Duty Manual Removal Boxes

- Heavy-Duty box made from strong double thickness corrugated board
- Easy manual assembly with a triple thickness lock-in base
- For your convenience no tape required and the lock-in handles secure the lid closed and reinforced the hand-holes
- To help you easily identify the contents there are pre-printed icons and large label areas
- Made from FSC® certified 100% recycled board, 100% recyclable

Code	Description	Colour	Int. Dimensions H x W x D (cm)	Ext. Dimensions H x W x D (cm)	Capacity	Board Type	Product Barcode	OUTER CARTON				Minimum Order Multiple
								Qty	H x W x D (cm)	Weight (kg)	Outer Barcode	
6205603	Book Box - 5pk	Brown/Black	34.00 x 32.00 x 45.00	35.80 x 33.00 x 46.00	49L	Micro/B-Flute	043859668816	5	79.00 x 6.00 x 89.50	3.90	043859674336	1 x 5pk
6205703	Trunk - 5k	Brown/Black	42.00 x 40.00 x 55.00	43.80 x 41.00 x 56.00	92L	Micro/B-Flute	043859668823	5	109.10 x 6.30 x 96.20	5.30	043859674343	1 x 5pk
6205803	Tea Chest - 5pk	Brown/Black	50.00 x 45.70 x 45.70	51.80 x 46.70 x 46.70	104L	Micro/B-Flute	043859668830	5	125.50 x 6.00 x 92.50	6.30	043859674350	1 x 5pk



### Heavy-Duty Cargo Boxes

- Heavy-Duty box made from strong double thickness corrugated board
- Easy manual assembly with a triple thickness lock-in base
- No need for tape as the lid features a simple close design
- To ensure you can easily identify the contents there are pre-printed icons and large label areas
- Made from FSC® certified 100% recycled board, 100% recyclable

Code	Description	Colour	Int. Dimensions H x W x D (cm)	Ext. Dimensions H x W x D (cm)	Capacity	Board Type	Product Barcode	SHRINK PACK				Minimum Order Multiple
								Qty	H x W x D (cm)	Weight (kg)	Pack Barcode	
6206702	Cargo Box 323240 - 10pk	Brown/Black	32.00 x 32.00 x 40.00	34.50 x 33.00 x 41.00	41L	Micro/B-Flute	043859709373	10	74.20 x 8.40 x 73.00	5.45	043859709380	1 x 10pk
6206802	Cargo Box 303730 - 10pk	Brown/Black	37.00 x 30.00 x 30.00	39.50 x 31.00 x 31.00	33L	Micro/B-Flute	043859709397	10	78.00 x 8.40 x 61.00	5.40	043859709403	1 x 10pk
6206902	Cargo Box 353750 - 10pk	Brown/Black	37.00 x 35.00 x 50.00	39.50 x 36.00 x 51.00	65L	Micro/B-Flute	043859709410	10	86.40 x 13.00 x 85.90	9.95	043859709427	1 x 10pk
6207002	Cargo Box 353766 - 10pk	Brown/Black	37.00 x 35.00 x 66.00	39.80 x 36.40 x 67.40	85.5L	Micro/B-Flute	043859709434	10	102.40 x 13.00 x 96.00	11.90	043859709441	1 x 10pk



### SmoothMove™ Standard Moving Box

- These heavy-duty boxes are made from strong double thickness corrugated board
- Tape is required for assembly closure
- To help you quickly identify the contents these boxes feature pre-printed icons and large label areas
- Optional perforated carry handles that can be pushed in for use if required
- Made from FSC® certified 100% recycled board, 100% recyclable

Code	Description	Colour	Int. Dimensions H x W x D (cm)	Ext. Dimensions H x W x D (cm)	Capacity	Board Type	Product Barcode	SHRINK PACK				Minimum Order Multiple
								Qty	H x W x D (cm)	Weight (kg)	Outer Barcode	
6207201	Standard Moving Box 322647	Brown/Blue	26.00 x 32.00 x 47.00	27.00 x 32.50 x 47.50	39L	Micro/B-Flute	043859732579	10	80.00 x 60.00 x 12.00	6.7	50043859732574	10 single units
6207301	Standard Moving Box 353555	Brown/Blue	35.00 x 35.00 x 55.00	36.00 x 35.50 x 55.50	67L	Micro/B-Flute	043859732586	10	90.00 x 72.00 x 12.00	7.8	50043859732581	10 single units
6207401	Standard Moving Box 454545	Brown/Blue	44.60 x 44.60 x 44.60	45.60 x 45.10 x 45.10	88.5L	Micro/B-Flute	043859732593	10	91.00 x 90.00 x 12.00	9.8	50043859732598	10 single units
6207501	Standard Moving Box 464161	Brown/Blue	40.60 x 45.70 x 61.00	41.60 x 46.20 x 61.50	113L	Micro/B-Flute	043859732609	10	107.00 x 88.00 x 12.00	11.3	50043859732604	10 single units









## FELLOWES GIVE PROGRAM

In the effort to expand our support of community and culture through philanthropy, Fellowes has established the GIVE program. GIVE is dedicated to building local and global partnerships which address humanity's greatest needs. The programs' guiding principles align with our strong values as a company and are the hearts of our people. GIVE is committed to supporting initiatives in four key areas: Social Services, World Aid and Development, Education and Cancer Research. We are honored to work as a team in building strong communities, improving lives, and providing a better tomorrow for our world today.

### SOCIAL SERVICES

GIVE reaches out to our local communities, lending volunteer support to those in need.



### WORLD AID & DEVELOPMENT

GIVE sponsors causes around the world, aiding countries in need.



GIVE™

### EDUCATION

GIVE builds greater opportunities for youth through education.



### CANCER RESEARCH

GIVE supports medical research funding in the fight against life-threatening diseases.



**Fellowes** | FAMILY BUSINESS  
Brands™ | SINCE 1917



[www.facebook.com/FellowesUK/](https://www.facebook.com/FellowesUK/)



[www.linkedin.com/company/fellowes](https://www.linkedin.com/company/fellowes)

Every effort has been made to ensure that information provided in this document is up to date and accurate. However, Fellowes cannot guarantee and assumes no legal liability or responsibility for the accuracy or completeness of the information provided. Information is provided as a guide only. In the case of any queries please contact us at [www.Fellowes.com/locations](http://www.Fellowes.com/locations)