



SIEMENS

Catalog
HG 11.01
Edition 2019

Vacuum Switching Technology and Components for Medium Voltage

Your Guide

[siemens.com/mediumvoltage](https://www.siemens.com/mediumvoltage)



SION 3AE



3AH5



3AK7



3AH36/37/38
generator circuit-breaker



3AH4



3TM/3TL vacuum contactors



3AF0 outdoor circuit-breaker
(live tank)



SDV outdoor circuit-breaker
(dead tank)

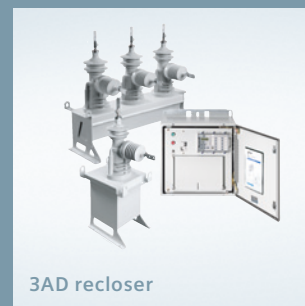

3AD recloser

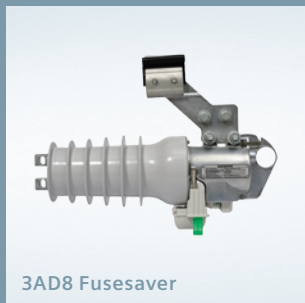

3AD8 Fusesaver



3EF surge limiter
3EJ, 3EK, 3EP-G, 3EQ0
surge arresters



3SV9 auxiliary switches

Vacuum Switching Technology and Components for Medium Voltage

Medium-Voltage Equipment









Catalog HG 11.01 · 2019

Invalid: Catalog HG 11.01 · 2016

www.siemens.com/mediumvoltage



The products and systems described in this catalog are manufactured and sold according to a certified management system (acc. to ISO 9001, ISO 14001 and BS OHSAS 18001).

	Page
Introduction to medium-voltage components	4
<hr/>	
Overview of medium-voltage components	
Switching devices, non-switching components	5
Vacuum interrupter technology in detail	6
<hr/>	
Selection of MV components by switching applications	
Switching applications with undisturbed operation	8
Switching applications with disturbed operation	9
<hr/>	
Ratings for medium-voltage equipment	
Stress caused by network operation	10
Standards	11
<hr/>	
Medium-voltage equipment for indoor applications	
 Vacuum circuit-breakers	12
Application, switching duties, designs, portfolio	
 Switch-disconnectors	19
Application, designs	
 Vacuum contactors, contactor-fuse combination	20
Application, switching duties, designs, portfolio	
SIMOPRIME partnering	22
<hr/>	
Medium-voltage equipment for outdoor applications	
 Outdoor vacuum circuit-breakers	24
Application, switching duties, live-tank and dead-tank designs, portfolio	
 Reclosers	26
Application, switching duties, designs	
 Fusesavers	28
Application, designs, portfolio, mode of operation	
<hr/>	
Medium-voltage equipment	
 Surge arresters and limiters	30
Application, designs, portfolio	
 Auxiliary switches	31
Application, properties, designs	
<hr/>	
Guide	
Catalog overview	32

Introduction to medium-voltage components

Medium voltage is defined as the range above 1 kV up to and including 52 kV (alternating voltage). These voltage ratings are mainly used

for distribution and industrial networks. Low voltage is defined up to and including 1 kV alternating voltage or 1.5 kV direct voltage.

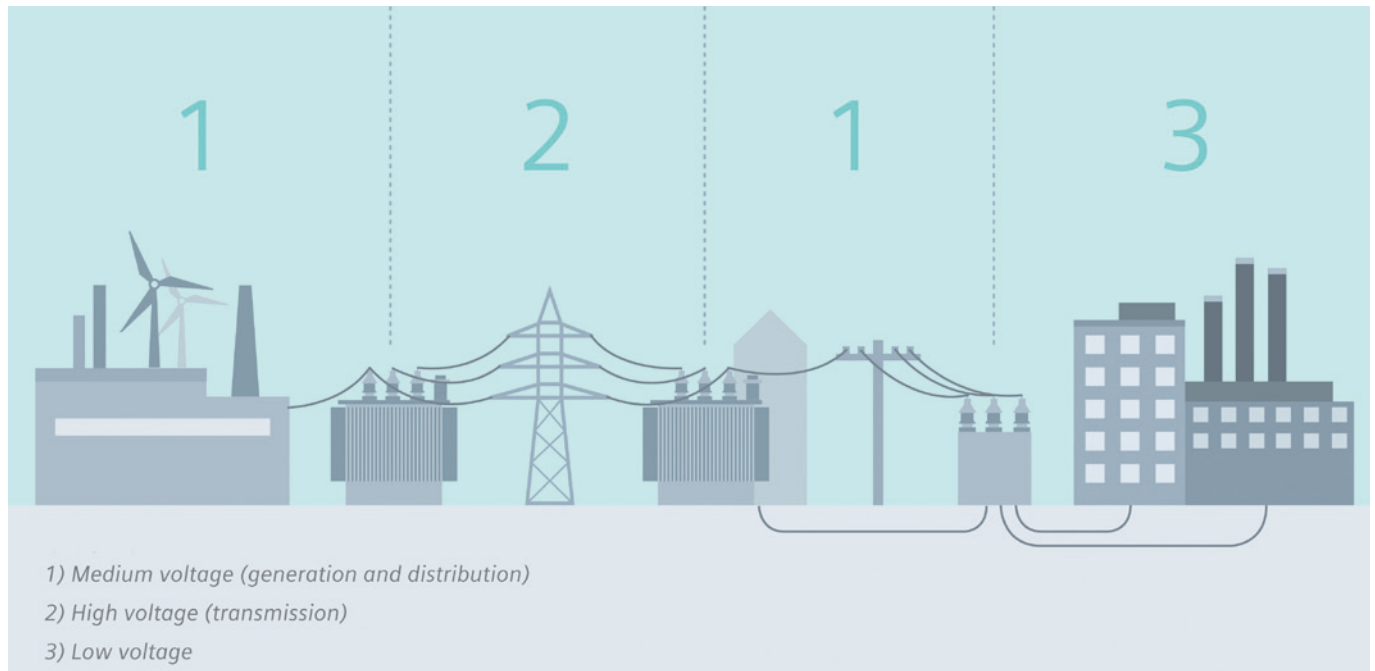

In electrical power supply, most medium-voltage systems are operated between 10 kV and 40 kV. Due to the historical development of technology and the local facts, the ratings differ a lot from country to country. The supply radius of a medium-voltage system is about 5 to 10 km long at 10 kV operating voltage, and about up to 20 km at 20 kV. Large networks or such with a high power density are therefore often operated above 30 kV.

In industrial plants with medium-voltage systems, there are still other voltages fulfilling the needs of consumers; in most cases, the operating voltages of the motors installed are decisive. Operating voltages between 3 kV and 15 kV are very frequently found in industrial systems.

Generators in power plants also generate power at medium-voltage level up to a maximum of 24 kV. This refers both to large generators in base load power plants and to generators with lower ratings from distributed plants. Renewable energy sources mostly generate at low-voltage level.

In case of larger plants (e.g., wind or solar farms) the power is transformed to medium voltage and fed into the distribution system.

Medium-voltage equipment is therefore available in power plants (in generators and station supply systems), in transformer substations of the primary distribution level – which receive power from the high-voltage system and transform it down to the medium-voltage level – as well as in secondary, transformer or transfer substations (secondary distribution level), where the power is transformed down from medium to low voltage and distributed to the end consumer. Apart from that, there are other applications, for example in the distribution systems of large industrial plants, on ships, in the mining industry, for traction power supply, and on locomotives or multiple units. In traction application, the predominant ratings for alternating systems are AC 15 kV, 16.7 Hz (Germany, Austria, Switzerland) as well as 25 kV, 50 Hz. For DC railway systems, the voltages are up to 3 kV as a maximum.

Switching devices



Circuit-breakers

Circuit-breakers are capable of making and breaking all currents both in disturbed and undisturbed operation; from small inductive and capacitive load currents up to the short-circuit current; and this under all fault conditions in the power system such as earth faults, phase opposition, etc. Outdoor circuit-breakers have the same applications, but are designed to withstand weather influences. They are mounted on the ground, on poles, or directly on overhead lines.



Recloser

The recloser is a special device for the application in overhead lines. As for switching capacity, it is a circuit-breaker, being additionally equipped with instrument transformers and a controller as integral parts of the recloser.



Contactors and contactor-fuse combination

Contactors are load breaking devices with a limited making and breaking capacity. They are used for high switching rates. In combination with a fuse, the latter would operate in case of short circuit.



Switch-disconnectors

A switch-disconnector is to be understood as the combination of a switch and a disconnector, or a switch with isolating distance in a single device.

Non-switching components



Surge arresters/limiters

Surge arresters and limiters protect devices and switchgear by discharging overvoltages caused by lightning strikes, switching operations, or earth faults.



Fuses

Fuses protect devices and systems once by breaking overcurrents which the actual switching devices can no longer control by themselves.



Protection and measuring transformers

Instrument transformers are used to transform high voltages and currents to small voltage and current values. Measuring and protection devices are connected to them.

The term medium-voltage equipment summarizes all products and components required for operation of medium-voltage systems. It comprises switching and non-switching components. Depending on the case of application, these devices are installed in grids as independent products, or as components inside a switchgear assembly.

Requirements

When the devices operate in grids, they are subjected to a number of stresses that are decisive for the selection and dimensioning of the devices. The main stresses are briefly summarized in the following, whereby only a limited selection of these values is relevant depending on the type of device:

- Dielectric strength in normal operation. This comprises both the operating voltage (as a rated value including arising voltage fluctuations) and overvoltages (switching and lightning overvoltages)
- Conducting the current – the normal current, continuously; overcurrents, temporarily; fault currents up to short-circuit currents, momentarily
- Making or breaking the current while dominating the arising transient processes, whereby only a part of the listed currents can be switched depending on the type of device
 - Normal current
 - Fault currents
 - Currents with a (temporarily) special characteristic, such as capacitive currents, inductive currents, high-frequency transient currents
- Establishing a safe, i.e. surge-proof isolating distance in the open state. This is requested by the standard as a precondition for isolating and subsequent working on the isolated section. This does not mean the operational segregation of network sections
- Recurring breaking/making operations in short succession and defined time intervals.

Breaking of currents

Breaking is one of the most demanding modes of operation for circuit-breakers and contactors. Especially while breaking short circuits, the maximum stresses arise. The opening of the contacts causes a metal vapor arc discharge, called an electric arc. Safe control and fast quenching of the arc is the key for safe network operation. Therefore, Siemens uses only the latest technology of vacuum interrupters, in order to achieve maximum reliability and endurance.

Overview of medium-voltage components

Vacuum interrupter technology in detail

Arc quenching

During the galvanic separation of the contacts, the current to break produces a metal vapor arc discharge. The current flows through this metal vapor plasma until the next current zero. The arc extinguishes within the next current zero. The remaining metal vapor loses its conductivity after a few microseconds – the insulating capability of the contact gap recovers very quickly. With a recovery of about $5 \text{ kV}/\mu\text{s}$, the vacuum interrupter or the switching device can immediately control the applied voltage again. When breaking small normal currents, it may happen that the current chops before the natural current zero. To prevent impermissible switching overvoltages during such switching operations, the chopping current must be limited to low values. Using a special contact material, the chopping current in the Siemens vacuum interrupters is just 2 A to 3 A, which represents a great advantage compared with other switching technologies.

Depending on the breaking current and the interrupter dimensions, different contact geometries are used:

- In **radial magnetic-field contacts**, the arc burns diffusely until approx. 10 kA. Higher currents burn across a contracted arc. To avoid local overheating of the contacts, an additional radial magnetic field produces a force which makes the arc rotate on the contacts. Thus, contact erosion at the base point of the arc is distributed over the entire ring surface, and the contact wear is minimized. Design examples are the cup-shaped contact and the spiral contact.
- In **axial magnetic-field contacts**, the arc remains diffuse even with high currents due to the axial magnetic field. The disc-type contact surfaces are uniformly stressed, and local melting is avoided.

The arc energy as a base for the contact wear results from the voltage drop over the arc (arc voltage), as well as from the current to break. A small arc voltage is thus a precondition for a long service life. For the Siemens vacuum interrupters, it ranges just between 20 to 200 V. For this reason, and due to the short arcing times, the energy converted in the contact gap is very low. This minimizes the contact wear and provides a high number of operating cycles. Because of this relatively low stress, the quenching system is maintenance-free.



Vacuum interrupter

In stationary condition, the pressures in the interrupter are very low – less than 10^{-7} mbar –, so that contact distances of just 6 to 20 mm are required to reach a very high resistance to the rated short-duration power-frequency withstand voltage and rated lightning impulse withstand voltage.

Apart from circuit-breakers, the vacuum switching technology is also used in contactors and switches. The superiority of the vacuum technology for medium-voltage equipment is demonstrated by the fact that, today, more than 80% of all circuit-breakers installed in medium-voltage systems worldwide are based on the vacuum switching principle.

Portfolio Vacuum Interrupters

	For contactors	For circuit breakers	For load-break switches	For reclosers
Rated voltage	1-24 kV	7.2-52 kV	7.2-15.5 kV	15.5-38 kV
Rated current	300-1,400 A	Up to 12,500 A	800 A	800 A
Rated short circuit-breaking current	3-6 kA	Up to 100 kA	--	12.5-16 kA
Mechanical endurance Operating cycles	1-3 millions	10,000-30,000	10,000-30,000	30,000
External insulating media	Air	Air, SF ₆ , solid	Air, SF ₆ , solid	Solid

Overview of medium-voltage components

Vacuum interrupter technology in detail

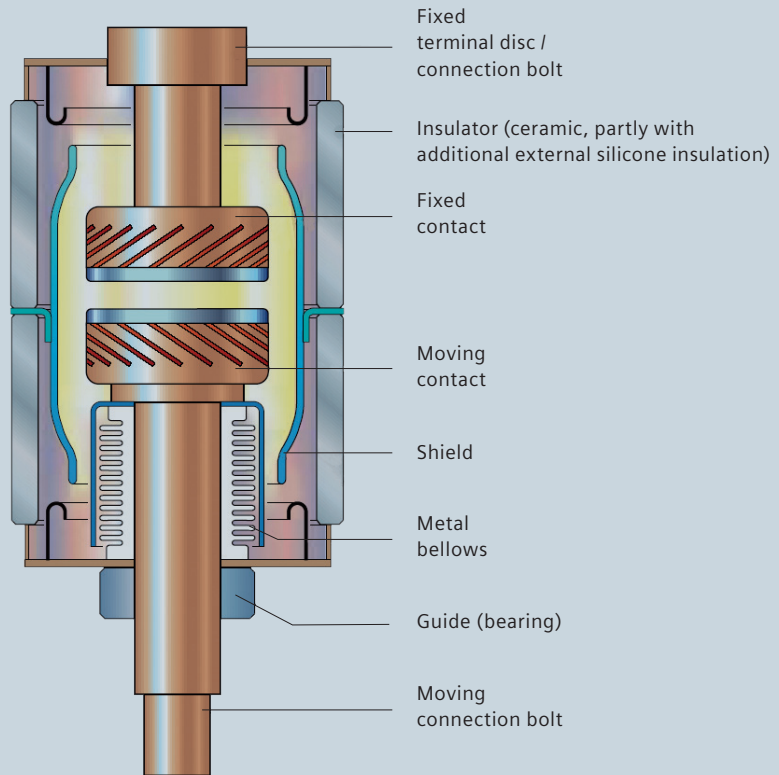

Vacuum interrupter

Radial magnetic-field contact

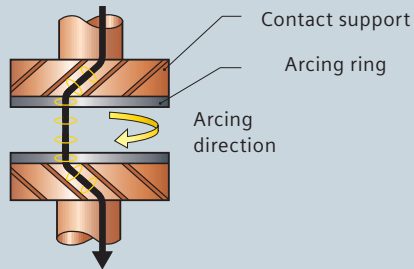
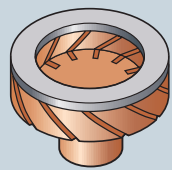

Cup-shaped contact

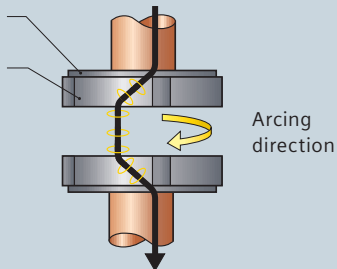
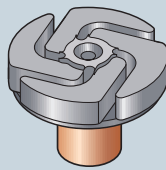

Spiral contact

Axial magnetic-field contact

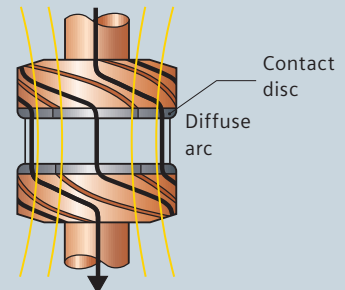
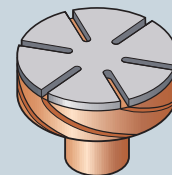

Selection of components by switching applications

Switching applications

Switching applications with undisturbed operation

Appearing load					Components				
					Circuit-breakers	Contactors	Switch-disconnectors	Reclosers	Fusesavers
Switching application		① Current	② Particularity	③ Remark					
Switching duties in inductive circuits									
Transformers	unloaded	$\leq 0.03 I_r$	–	Also valid for neutral earthing transformers	■	■	■	■	–
	loaded	$\leq 1.2 I_r$	–	Generally no protective circuit required	■	■	■	■	–
Furnace transformers		$\leq 2 I_r$	High switching rate	Overvoltage protection circuit to be configured individually	■	–	–	–	–
Earth-fault reactors		$\leq 300 \text{ A}$	–	Surge arresters are common practice	■	–	■	■	–
Compensation reactors		$\leq 2000 \text{ A}$	Transient recovery voltage with rate of rise $\leq 6 \text{ kV}/\mu\text{s}$	Overvoltage protection circuit to be configured individually	■	–	–	–	–
Motors	in operation	$\leq I_r$	–	–	■	■	–	–	–
	during start	$\leq 7 I_r$	Breaking up to $7 I_r$ at $\cos \varphi \leq 0.3$	For motors with $I_{an} \leq 600 \text{ A}$, 3EF surge limiters are suitable as protective circuit. Individually compensated motors need no protective circuit	■	■	–	–	–
Generators in power plants		$\leq I_r$	Transient recovery voltage with high rate of rise	Overvoltage protection is common practice	■	–	–	–	–
Converter transformers		$\leq I_r$	–	Overvoltage protection is common practice	■	–	–	–	–
Small inductive currents		$20 \text{ A} < I_r < 600 \text{ A}$	Virtual current chopping by multiple restrikes	Overvoltage protection circuit is common practice; to be configured individually, if required	■	■	–	■	–
Switching duties in capacitive circuits									
Capacitor banks		$\leq 1.4 I_r$	High recovery voltage	–	■	■	■	■	■
Filter circuits		$\leq 1000 \text{ A}$	High recovery voltage	–	■	–	–	–	–
Parallel connection of capacitor banks		$\leq 20 \text{ kA}$ @ 4250 Hz	High amplitude and high rate of rise of the inrush current due to high-frequency transient recovery voltage	> 10 kA: reactor required, up to 10 kA: reactor recommended	■	–	–	–	–
Unloaded cables		$\leq 100 \text{ A}$	High recovery voltage	–	■	–	■	■	–
Unloaded overhead lines		$\leq 10 \text{ A}$	High recovery voltage	–	■	–	■	■	■
Phase-controlled closing		$\leq I_r$	POW switching	Single-phase switching devices and corresponding controller required	–	–	–	■	–
Switching duties for other cases of operation									
Disconnecting		–	–	Isolating distance, segregation of networks	–	–	*	–	–
Multiple reclosing		–	–	–	–	–	–	■	■

* Disconnectors

① This column defines currents which must be switched on or off in the worst case.

② This column defines the respective particularities. If nothing is stated, this switching application represents no problem for the switching devices to be used, and needs not be especially considered for the selection.

③ This column gives general information about the measures to be observed for the application.

Switching applications with disturbed operation

Appearing load				Components				
				Circuit-breakers	Contactors	Switch-disconnectors	Reclosers	Fusesavers
Switching application	① Current	② Particularity	③ Remark					
Switching duties in case of short circuits								
Making on a short circuit	I_{ma}	High and low inductive currents	–	■	○	■	■	■
Breaking	Terminal short circuit	I_{sc}	–	–	–	–	■	■
	Generator-supplied short circuit	I_{sc}	Transient recovery voltage with rate of rise $\leq 6 \text{ kV}/\mu\text{s}$, high DC component, possible missing current zeros	Overvoltage protection for generators with $I''_k \leq 600 \text{ A}$	■	–	–	–
	Auto-reclosing	I_{sc}	–	–	■	–	–	■
	Transformer-supplied short circuit	I_{sc}	Transient recovery voltage with rate of rise $\leq 4 \text{ kV}/\mu\text{s}$	–	■	–	–	■
	Short-circuit current limiting reactors	I_{sc}	Transient recovery voltage with rate of rise $\leq 10 \text{ kV}/\mu\text{s}$	–	■	–	–	–
	Double earth fault	$0.87 I_{sc}$	–	–	■	–	–	■
	Blocking motors	$\leq 6 I_r$	Breaking $6 I_r$ at $\cos \varphi < 2$	For motors with $I_{an} \leq 600 \text{ A}$, 3EF surge limiters are suitable as protective circuit. Individually compensated motors need no protective circuit	■	–	–	–
	Phase opposition	$0.25 I_{sc}$	–	–	■	–	–	–
Switching duties under earth-fault conditions (primarily capacitive currents)								
Unloaded cables / overhead lines	$\leq 5 \text{ A}$	High recovery voltage	–	■	■	–	■	■
Loaded cables / overhead lines	Fault on supply side	$\leq I_r$	High recovery voltage	–	■	■	–	■
	Fault on load side	$\leq I_r$	–	–	■	■	–	■
Switching duties for other applications								
Protective disconnection (disconnecting under load)	$\leq I_r$	–	–	–	–	■	–	–
Rapid load transfer	$\leq I_r$	Changeover in $< 100 \text{ ms}$	–	■	–	–	■	–

- ① This column defines currents which must be switched on or off in the worst case.
- ② This column defines the respective particularities. If nothing is stated, this switching application represents no problem for the switching devices to be used, and needs not be especially considered for the selection.
- ③ This column gives general information about the measures to be observed for the application.

Abbreviations and symbols for pages 8 and 9

- Application possible, but not intended
- Application is useful
- Application is not useful

I_{an} Motor starting current
 I''_k Initial symmetrical short-circuit current
 I_{ma} Rated short-circuit making current
 I_r Rated normal current
 I_{sc} Rated short-circuit breaking current

Ratings for medium-voltage equipment

Stress caused by network operation

Overview of system data

Medium-voltage equipment must be selected for the stresses appearing at the respective place of use.

Rated voltage

The rated voltage is the upper limit of the highest operating voltage for which the device is designed. It must be equal to or greater than the maximum appearing operating voltage under consideration of the permissible voltage fluctuations. The ratio between the rated voltage and the necessary withstand voltage values is defined in the product standards.

Rated insulation level or withstand voltage

The rated insulation level is the dielectric strength from phase to earth, between phases and across the open contact gap, or across the isolating distance. The dielectric strength is the capability of an electrical component to withstand overvoltages. These can be operating voltages or higher-frequency voltages caused by switching operations or earth faults (internal overvoltages), as well as lightning strikes (external overvoltages). The dielectric strength is defined by the rated lightning impulse withstand voltage and the rated short-duration power-frequency withstand voltage. Both values are verified by type tests; a power-frequency withstand voltage test is also an integral part of the routine test.

Rated normal current

This is the current the device can continuously carry under defined ambient conditions. The dimensioning criterion is the maximum permissible temperature rise of components, which must not exceed the defined temperatures. If a device is mounted in a switchgear, the maximum permissible normal current is determined by the temperature-rise limits when the device is operated in this switchgear.

The ratings of the components describe the maximum values the components can be used for.

Rated breaking current

The rated breaking current defines the breaking capacity of load (normal) currents. For Siemens vacuum switching devices, this value corresponds to the normal current, and is therefore not stated separately.

Rated short-circuit breaking current

The rated short-circuit breaking current is the root-mean-square value of the breaking current in case of short circuit. It is stated as a symmetrical current, and corresponds to the short-circuit current after decay of a superimposed DC component.

Rated peak withstand current

The peak withstand current arises in case of short circuit, and it is the peak value of the first half-wave of the short-circuit current after the beginning of the current flow. It is a measure for the electrodynamic (mechanical) load of an electrical component. This value is highly dependent on the time when the short circuit occurs and on the connected equipment, and it can vary with each switching operation. The rated peak withstand current is the maximum value the device can carry in closed state. The peak withstand current is tested in accordance with the standard, which specifies a fixed ratio between the rated short-circuit breaking current and the rated peak withstand current.

Rated short-circuit making current

The rated short-circuit making current is the peak value of the making current in case of short circuit on the load side of the switching device. Its value corresponds to the rated peak withstand current, but it represents a greater stress for the switching device, as dynamic forces work against the closing movement.

Overview of standards

All devices are subject to national and international standards. The following table shows the main product standards; superior standards are not included.

In addition, Siemens switching devices are subjected to further tests in order to guarantee safe operation in long years of operation.

International	Germany	Designation
EN 61869	VDE 0414	Instrument transformers
IEC 60099	VDE 0675	Surge arresters
IEC 60282-1	VDE 0670-4	High-voltage fuses – Part 1: Current-limiting fuses
IEC 60644	VDE 0670-401	Specification for high-voltage fuse-links for motor circuit application
IEC 62271-1	VDE 62271-1	High-voltage switchgear and controlgear – Part 1: Common specifications
IEC 62271-100	VDE 0671-100	High-voltage switchgear and controlgear – Part 100: Alternating current circuit-breakers
IEC 62271-102	VDE 0671-102	High-voltage switchgear and controlgear – Part 102: Alternating current disconnectors and earthing switches
IEC 62271-103	VDE 0671-103	High-voltage switchgear and controlgear – Part 103: Switches for rated voltages above 1 kV up to and including 52 kV
IEC 62271-105	VDE 0671-105	High-voltage switchgear and controlgear – Part 105: Alternating current switch-fuse combinations
IEC 62271-106	VDE 0671-106	High-voltage switchgear and controlgear – Part 106: Alternating current contactors, contactor-based controllers and motor-starters
IEC 62271-111 / IEEE C37.60	VDE 0671-111	High-voltage switchgear and controlgear – Part 111: Automatic circuit reclosers and fault interrupters for alternating current systems up to 38 kV – Reclosers
IEC/IEEE 62271-37-013		High-voltage switchgear and controlgear – Part 37-013: Alternating-current generator circuit-breakers
IEC 62271-200	VDE 0671-200	High-voltage switchgear and controlgear – Part 200: AC metal-enclosed switchgear and controlgear for rated voltages above 1 kV up to and including 52 kV

In many countries, there are local standards that are mostly based on the international standards, but which contain some specific particularities. The main international standards are IEC (Europe) and IEEE (USA). Most of the users in Europe, Asia and Africa request IEC-based standards, while North America follows the IEEE based standards.

As medium-voltage equipment is generally installed in switchgear, or exclusively operated in closed systems, the CE marking is not required.



Application

- For breaking resistive, inductive and capacitive currents in almost every application
- Universal installation in all customary medium-voltage switchgear types
- As single-pole or multi-pole medium-voltage circuit-breakers for all switching duties in indoor switchgear
- Available with optional withdrawable module with and without earthing switch
- Particular designs for special applications:
 - For switching of generators
 - For switching of contact lines (1- and 2-pole traction circuit-breakers)
 - For frequent switching of arc furnaces
 - For switching of filter circuits.

Switching duties

Switching of overhead lines and cables

When unloaded overhead lines and cables are switched off, the relatively small capacitive currents are safely controlled without restrikes, and thus without overvoltages.

Breaking of short-circuit currents

The breaking of short-circuit currents represents the highest stress for the circuit-breaker. Siemens vacuum circuit-breakers are designed for this duty, offering an extremely fast recovery of the dielectric strength thanks to the vacuum technology.

Extraordinarily high stresses appear while breaking short-circuit currents directly at the generator. Specially designed generator circuit-breakers are suitable for this purpose, which must have been tested accordingly.

Auto-reclosing in overhead-line systems

Faults or short circuits in overhead lines are often only temporary, and they can be caused by e.g. thunderstorms, strong wind, or animals. Vacuum circuit-breakers for auto-reclosing leave such short dead times between closing and opening that the de-energized time interval is hardly appreciable for the power supply to the consumers, but leaves enough time for the fault to disappear. In case of unsuccessful auto-reclosing, there is a new breaking operation and the faulty feeder is shut down definitively.

Multiple-shot reclosing

Vacuum circuit-breakers are also suitable for multiple-shot reclosing. Typical operating sequences are: O-0.3 s-CO-15 s-CO, or O-0.3 s-CO-3 min-CO, or – above 40 kA – O-3 min-CO-3 min-CO. Special devices for even more frequent auto-reclosing operations are defined with an operating sequence, e.g. O-0.2 s-CO-2 s-CO-2 s-CO.

Designs



SION 3AE – The Innovative

Flexible use in power distribution, infrastructure and industry

- Wide drive housing provides space for extra features
- Maintenance-free compact design
- Rapid opening times < 30 ms
- Maintenance-free up to 30,000 operating cycles



Withdrawable module with vacuum circuit-breaker

Switching of transformers

As the chopping current of the Siemens vacuum circuit-breaker is only 2 to 3 A, no dangerous overvoltages are produced when the unloaded transformer is switched off.

Switching of capacitors

Vacuum circuit-breakers are especially designed for switching capacitive circuits. They can switch off capacitors without restrikes, and thus without overvoltages. Capacitive current breaking is normally possible up to 70% of the rated normal current, whereby the test is performed with a reference value of 400 A according to the standard. When capacitors are connected in parallel, high-frequency inrush currents in the range of kA arise. This case of operation can also result when individually compensated motors are connected in parallel, when the compensation capacitors are low-inductively interconnected due to a compact system geometry. Due to their high rate of rise, circuit-breakers that are suitable for this duty must be tested for this so-called "back-to-back" switching application. In this context, inrush currents from 10 to 20 kA at a frequency of 4250 Hz are used.



3AH5 – The Economical

Standard circuit-breaker for small switching capacities

- Maintenance-free up to 10,000 operating cycles

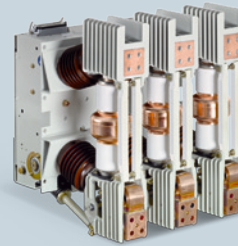

3AH3 – The Powerful

Circuit-breaker for high switching capacities

- Rated short-circuit breaking currents up to 63 kA
- Rated normal currents up to 4,000 A
- Maintenance-free up to 10,000 operating cycles
- For IEC and IEEE/ANSI

Switching of filter circuits

When filter circuits or inductor-capacitor banks are switched off, the stress for the vacuum circuit-breaker caused by the recovery voltage is higher than with mere capacitors. This is due to the series connection of the inductor and the capacitor, and must be observed for the rated voltage when the vacuum circuit-breaker is selected. Energizing parallel filter circuits is mostly uncritical, as the filter inductance limits the inrush currents.

Switching of motors and small inductive currents

When smaller high-voltage motors are stopped during start-up, switching overvoltages may arise. This affects high-voltage motors with a starting current up to 600 A. The magnitude of these overvoltages can be reduced to harmless values by means of special surge limiters. In the case of individually compensated motors, no protective circuit is required. If inductive loads with currents between 20 A and 600 A are switched, switching overvoltages may appear under certain circumstances. An individually adjusted overvoltage protection circuit is necessary.

Synchronizing

The connection of generators requires a previous synchronization. This means that the right moment for connection must be selected, when the voltage, frequency and phase angle of both systems are as coincident as possible. Vacuum circuit-breakers are perfectly suited for this operation, as they (i) withstand the higher voltage stress before connection without any problems, (ii) enable a reproducible synchronization regarding their switching times, and (iii) control the mechanical stresses during connection.

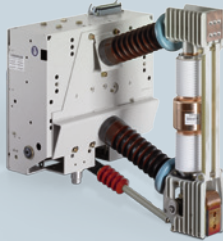

3AH47 – The Special

Circuit-breaker for applications in traction systems

- Developed for different system frequencies, 16 ²/₃, 25 Hz, 50 or 60 Hz
- 1-pole or 2-pole
- Up to 60,000 operating cycles



3AH4 – The Persistent

Circuit-breaker for a high number of operating cycles

- Up to 120,000 operating cycles (with maintenance)
- Rated normal currents up to 4,000 A
- Rated short-circuit breaking currents up to 40 kA

Rapid load transfer

The transfer of consumers to another incoming feeder is called rapid load transfer. With transfer times of about 80-100 ms, operational interruptions are avoided. Vacuum circuit-breakers with stored-energy mechanism feature the very short closing and opening times required for this purpose.

Auto-reclosing in traction line systems

To check the traction line system via test resistors for absence of short circuits after a short-circuit shutdown, the operating sequence is O-15 s-CO.

Switching of arc furnaces

While circuit-breakers for standard applications are only rarely switched during the year, arc furnaces require up to 100 operating cycles a day. The 3AH4 vacuum circuit-breaker is especially adequate for this purpose. In this application, the load currents can be asymmetrical and distorted. To avoid resonance oscillations in the furnace transformers, individually adjusted protective circuits are necessary.

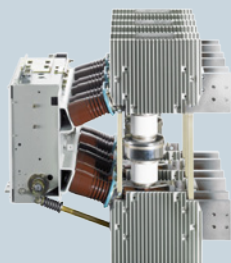

3AH36, 37, 38 – The Strong

Circuit-breaker for high-current and generator applications

- Rated normal currents up to 8,000 A
- Maintenance-free up to 10,000 operating cycles
- According to IEC/IEEE 62271-37-013
- Rated short-circuit breaking currents up to 72 kA
- Design for phase segregation up to 24 kV, 100 kA, 12,000 A



3AK7 – The Powerful in Compact Design

Circuit-breaker for industrial applications and generators

- Maintenance-free up to 30,000 operating cycles
- For IEC and IEC/IEEE 62271-37-013

Switching of generators

The switching of generators is the "premium class" for the circuit-breaker: Here, the maximum normal and – in case of fault – short-circuit currents with the correspondingly high thermal and mechanical stresses arise. For this, Siemens consistently relies on vacuum technology. Thus, applications with high ratings are possible. Generator circuit-breakers from Siemens are generally tested according to the IEC 62271-100 and IEC/IEEE 62271-37-013 standards, which are considered the leading standard for generator circuit-breakers.

Type of operating mechanism

Circuit-breakers are almost exclusively equipped with stored-energy mechanisms, either as stored-energy spring mechanisms or as magnetic actuators:

- Stored-energy spring mechanism
 - Mechanical energy stored in a spring
 - For a normal number of operating cycles and frequent-operation applications
 - Suitable for all applications throughout the complete range of ratings
 - For long years without maintenance thanks to exclusively mechanical components
- Magnetic actuator
 - Mechanical energy stored in a capacitor
 - For a normal number of operating cycles up to extremely frequent applications
 - For applications with small and medium-sized short-circuit currents
 - Maintenance-free mechanical components and maintenance schedule for the electronic control.

Medium-voltage equipment for indoor applications

Vacuum circuit-breakers



Vacuum circuit-breaker portfolio (part 1)

Rated short-circuit breaking current	Rated normal current	Rated voltage and frequency									
		7.2 kV			12 kV			15 kV	17.5 kV		
		50/60 Hz			50/60 Hz			50/60 Hz	50/60 Hz		
kA	A										
12.5	800								SION 3AE		
	1250								SION 3AE		
	1600								SION 3AE		
13.1	800										
16	800	SION 3AE			SION 3AE				SION 3AE		
	1250	SION 3AE			SION 3AE				SION 3AE		
	1600	SION 3AE			SION 3AE				SION 3AE		
20	800	SION 3AE			SION 3AE						
	1250	SION 3AE			SION 3AE						
	1600	SION 3AE			SION 3AE						
	2000										
	2500										
25	800	SION 3AE			SION 3AE				SION 3AE		
	1250	SION 3AE			SION 3AE				SION 3AE		
	1600	SION 3AE			SION 3AE				SION 3AE		
	2000	SION 3AE			SION 3AE				SION 3AE		
	2500	SION 3AE			SION 3AE				SION 3AE		
31.5	800	SION 3AE			SION 3AE				SION 3AE		
	1250	SION 3AE			SION 3AE		3AH4	3AH4	SION 3AE		3AH4
	1600	SION 3AE			SION 3AE						
	2000	SION 3AE			SION 3AE		3AH4	3AH4	SION 3AE		3AH4
	2500	SION 3AE			SION 3AE				SION 3AE		
40	1250	SION 3AE	3AK7		SION 3AE	3AK7	3AH4	3AH4	SION 3AE	3AK7	3AH4
	1600						3AH4	3AH4			3AH4
	2000	SION 3AE	3AK7		SION 3AE	3AK7	3AH4	3AH4	SION 3AE	3AK7	3AH4
	2500	SION 3AE	3AK7		SION 3AE	3AK7	3AH4	3AH4	SION 3AE	3AK7	3AH4
	3150	SION 3AE	3AK7		SION 3AE	3AK7	3AH4	3AH4	SION 3AE	3AK7	3AH4
	4000		3AK7 ¹⁾			3AK7 ¹⁾				3AK7 ¹⁾	
50	1250	3AH3	3AK7/3AK7		3AH3	3AK7/3AK7		3AH3	3AH3	3AK7/3AK7	
	2000	3AH3	3AK7/3AK7		3AH3	3AK7/3AK7		3AH3	3AH3	3AK7/3AK7	
	2500	3AH3	3AK7/3AK7		3AH3	3AK7/3AK7		3AH3	3AH3	3AK7/3AK7	
	3150	3AH3	3AK7/3AK7		3AH3	3AK7/3AK7		3AH3	3AH3	3AK7/3AK7	3AH38
	4000	3AH3	3AK7/3AK7 ¹⁾		3AH3	3AK7/3AK7 ¹⁾		3AH3	3AH3	3AK7/3AK7 ¹⁾	3AH38
	5000										3AH37
	6300										3AH37
	8000										3AH37 ¹⁾
63	1250	3AH3			3AH3			3AH3	3AH3		
	2000	3AH3			3AH3			3AH3	3AH3		
	2500	3AH3			3AH3			3AH3	3AH3		
	3150	3AH3			3AH3			3AH3	3AH3		3AH38
	4000	3AH3			3AH3			3AH3	3AH3		3AH38
	5000										3AH37
	6300										3AH37
	8000										3AH37 ¹⁾
72	3150	3AH3			3AH3			3AH3	3AH3		3AH38
	4000	3AH3			3AH3			3AH3	3AH3		3AH38
	5000										3AH37
	6300										3AH37
	8000										3AH37 ¹⁾

Specifications and values acc. to IEC standard. For ANSI products, the corresponding values acc. to the IEEE/ANSI standard apply (specifications available on request or in the separate ANSI product catalogs).

Circuit-breaker acc. to IEC 62271 and local standards, if appl. **Generator circuit-breaker acc. to IEC/IEEE 62271-37-013** 1) With forced cooling

Vacuum circuit-breaker portfolio (part 2)

Rated short-circuit breaking current	Rated normal current	Rated voltage and frequency							Traction applications		
		24 kV		36 kV		40.5 kV			17.5 kV*	25 kV*	27.5 kV*
		50/60 Hz		50/60 Hz		50/60 Hz			16.7 Hz	25 Hz	50/60 Hz
kA	A										
12.5	800	SION 3AE									
	1250	SION 3AE									
13.1	800										
16	800	SION 3AE	3AH5								
	1250	SION 3AE	3AH5		3AH5						
	1600										
	2000	SION 3AE									
20	800	SION 3AE									
	1250	SION 3AE	3AH5								
	1600										
	2000	SION 3AE	3AH5								
	2500	SION 3AE	3AH5								
25	800	SION 3AE									
	1250	SION 3AE	3AH5	3AH4	3AH5					3AH47	3AH47
	1600										
	2000	SION 3AE		3AH4	3AH5				3AH47	3AH47	3AH47
	2500	SION 3AE	3AH5						3AH47	3AH47	3AH47
31.5	800										
	1250				3AH3	3AH4	3AH3	3AH4		3AH47	3AH47
	1600										
	2000				3AH3	3AH4	3AH3	3AH4	3AH47	3AH47	3AH47
	2500				3AH3	3AH4	3AH3	3AH4		3AH47	3AH47
	3150				3AH3	3AH4	3AH3	3AH4			
	4000				3AH3	3AH4	3AH3	3AH4			
40	1250	3AH3									
	1600										
	2000	3AH3									
	2500	3AH3		3AH4	3AH3	3AH4	3AH3	3AH4	3AH47		
	3150	3AH3		3AH4	3AH3	3AH4	3AH3	3AH4			
	4000				3AH3	3AH4	3AH3	3AH4			
50	1250	3AH3									
	2000	3AH3									
	2500	3AH3							3AH47		
	3150	3AH3	3AH37								
	4000	3AH3	3AH37								
	5000		3AH37								
	6300		3AH37								
	8000		3AH37 ¹⁾								
63	3150		3AH37								
	4000		3AH37								
	5000		3AH37								
	6300		3AH37								
	8000		3AH37 ¹⁾								
72	3150										3AH38
	4000										3AH38
	5000										3AH37
	6300										3AH37
	8000										3AH37 ¹⁾

Specifications and values acc. to IEC standard. For ANSI products, the corresponding values acc. to the IEEE/ANSI standard apply (specifications available on request or in the separate ANSI product catalogs).

Circuit-breaker acc. to IEC 62271 and local standards, if appl. Generator circuit-breaker acc. to IEC/IEEE 62271-37-013

1) With forced cooling

* Phase-to-earth voltage for traction applications



3AK7 – The Powerful in Compact Design

Circuit-breaker for industrial applications and generators

- Maintenance-free up to 30,000 operating cycles
- For IEC and IEC/IEEE 62271-37-013

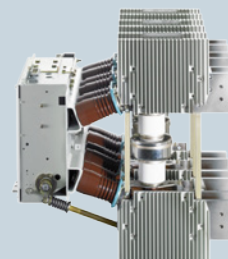

3AH37 – Generator Circuit-Breaker

in classical three-pole design

Application

For more than 40 years, Siemens has been constantly developing and improving high-current and generator circuit-breakers, which are able to withstand increasingly higher currents. More than 2,500 generator circuit-breakers from Siemens are used worldwide by multiple power supply and industrial companies in the most different types of power plants. Based on the vacuum technology, a compact generator circuit-breaker is available, which combines the advantages of vacuum technology in respect of unequaled reliability, long service life, and environmental friendliness in a single device. Siemens has optimized its vacuum circuit-breakers particularly for generator switching applications with high thermal and mechanical stresses.

Type tests as specified in IEC 62271-100 are performed as a rule for all Siemens circuit-breakers. The 3AH37/38 generator circuit-breakers are additionally tested according to IEC/IEEE 62271-37-013. This standard is the only worldwide standard to take into account the increased requirements to which the equipment is subjected when switching generators, such as higher TRV rates of rise, higher test voltage levels, extremely high DC components, and the missing current zeros resulting thereof. Thus, these circuit-breakers are appropriate for power plant application with power ratings of up to 500 MVA. The following table offers an overview of the available designs.

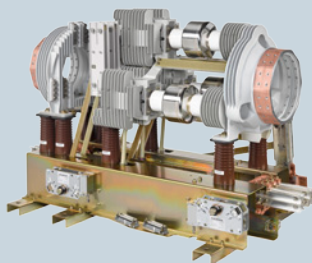

3AH36 – Generator Circuit-Breaker Module

in single-pole design for applications with segregated phases



3AH36 – Generator Circuit-Breaker Module

is used, for example, in the single-phase enclosed generator switchgear type HB3 from Siemens

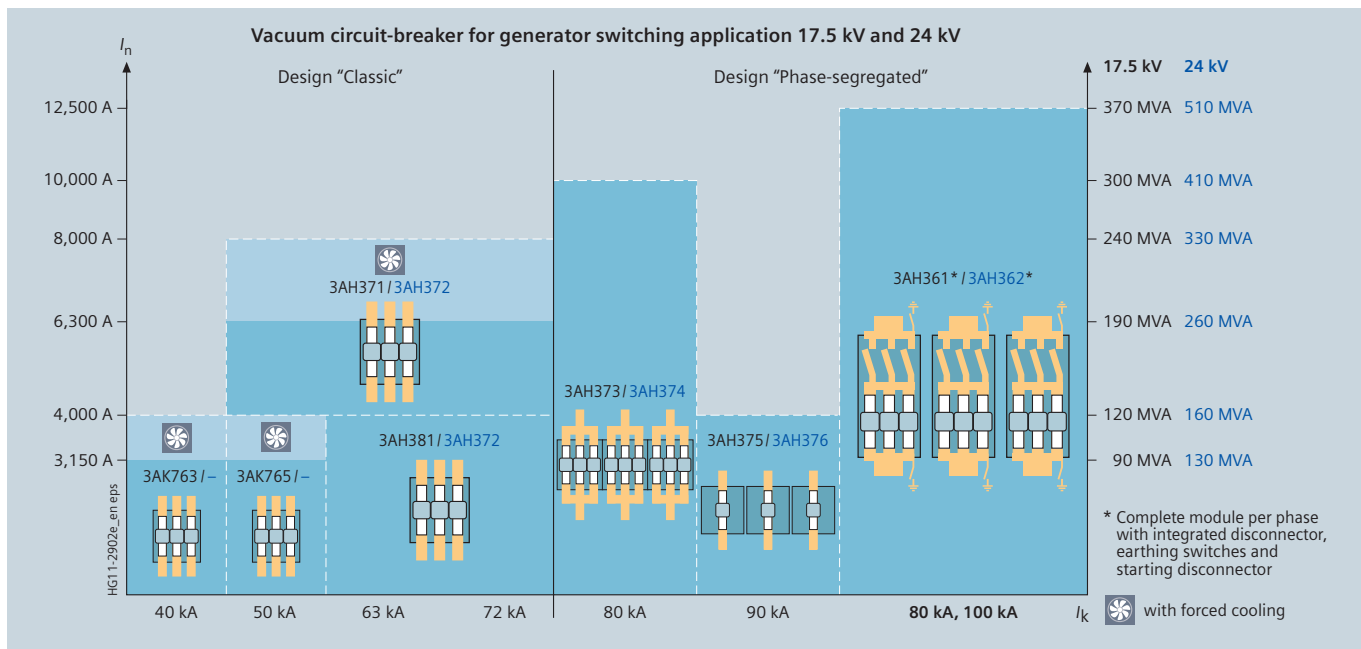

Medium-voltage equipment for indoor applications

Vacuum contactors, contactor-fuse combination



Application

3TM vacuum contactors are 1- and 3-pole and 3TL 3-pole contactors with electromagnetic operating mechanisms. They are load breaking devices with a limited short-circuit making and breaking capacity for applications with high switching rates of up to 3 million operating cycles. The vacuum contactors are suitable for operational switching of alternating current consumers in indoor switchgear, and can be used, e.g., for the following switching duties:

- AC-3: Squirrel-cage motors: Starting, stopping during running motor
- AC-4: Squirrel-cage motors: Starting, plugging and inching
- Switching of three-phase motors in AC-3 or AC-4 operation (e.g. in conveying and elevator systems, compressors, pumping stations, ventilation and heating)
- Switching of transformers (e.g. in secondary distribution switchgear, industrial distributions)
- Switching of reactors (e.g. in industrial distribution systems, DC-link reactors, power factor correction systems)
- Switching of resistive consumers (e.g. heating resistors, electrical furnaces)
- Switching of capacitors (e.g. in power factor correction systems, capacitor banks).

In contactor-type reversing starter combinations (reversing duty), only one contactor is required for each direction of rotation if high-voltage high-rupturing capacity fuses are used for short-circuit protection.

Switching duties

Switching of motors

3TM and 3TL vacuum contactors are especially well-suited for frequent operation of motors. As the chopping currents of the contactors are below 3 A, no impermissibly high overvoltages are produced when accelerated motors are switched during normal operation. However, when high-voltage motors with starting currents of ≤ 600 A are stopped during start-up, switching overvoltages may arise under certain circumstances. The magnitude of these overvoltages must be reduced to harmless values by means of special surge limiters (see page 20).

3TL vacuum contactor portfolio

Type	3TL81	3TL61	3TL65	3TL68	3TL71
Rated voltage	7.2 kV	7.2 kV	12 kV	15 kV	24 kV
Rated frequency (Hz)	50/60	50/60	50/60	50/60	50/60
Rated normal current	400 A	450 A	400 A	320 A	800 A
Rated making current*	4000 A	4500 A	4000 A	3200 A	4500 A
Rated breaking current*	3200 A	3600 A	3200 A	2560 A	3600 A
Mechanical endurance of the contactor: Operating cycles (million)	1	3	1	1	1
Electrical endurance of the vacuum interrupter (rated current): Operating cycles (million)	0.25	1	0.5	0.5	0.5

* Switching capacity according to utilization category AC-4 ($\cos \phi = 0.35$)

Designs



3TM1 and 3TM3 vacuum contactors

Switching of transformers

When inductive currents are interrupted, current chopping can produce overvoltages at the contact gap. Thanks to the use of a special contact material, the chopping current of the vacuum contactor is ≤ 3 A, so that no dangerous overvoltages are produced when the unloaded transformer is switched off.

Switching of capacitors

3TM and 3TL vacuum contactors can interrupt capacitive currents up to 250 A up to the rated voltage of 12 kV without restrikes, and thus without overvoltages.

Contactor-fuse combination

The contactor-fuse combinations 3TL62/63/66 and 3TM43/45 are type-tested units of the 3TL6 and 3TM vacuum contactors in combination with HV HRC fuses.

Contactor-fuse combinations are well-suited for frequent switching of high currents.

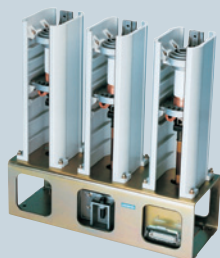

3TL68, 3TL71 and 3TL81 vacuum contactors

3TL62/63/66 contactor-fuse combination

3TM vacuum contactor portfolio

Type	3TM31	3TM32	3TM33	3TM34	3TM35	3TM36	3TM12	3TM13	3TM14	3TM15
Rated voltage	7.2 kV	7.2 kV	7.2 kV	12 kV	12 kV	15 kV	7.2 kV	7.2 kV	12 kV	12 kV
Rated frequency (Hz)	50/60	50/60	50/60	50/60	50/60	50/60	50/60	50/60	50/60	50/60
Rated normal current	400 A	450 A	450 A	450 A	450 A	320 A	450 A	450 A	450 A	450 A
Rated making current	4000 A	4500 A	4500 A	4500 A	4500 A	3200 A	4500 A	4500 A	4500 A	4500 A
Rated breaking current	3200 A	3600 A	3600 A	3600 A	3600 A	2560 A	3600 A	3600 A	3600 A	3600 A
Rated lightning impulse withstand voltage	60 kV	60 kV	60 kV	75 kV	75 kV	75 kV	60 kV	60 kV	75 kV	75 kV
Rated short-duration power-frequency withstand voltage	20 kV	20 kV	32 kV	28 kV	42 kV	28 kV	20 kV	32 kV	28 kV	42 kV
Mechanical endurance of the contactor: Operating cycles (million)	0.25	1	1	1	1	1	0.1	0.1	0.1	0.1
Electrical endurance of the vacuum interrupter (rated current): Operating cycles (million)	0.25	0.25	0.5	0.25	0.5	0.5	0.1	0.1	0.1	0.1

Contactor-fuse combination portfolio

Type	3TL62	3TL63	3TL66
Rated voltage	7.2 kV	7.2 kV	12 kV
Rated normal current (depending on installation and coordination with the selected fuses)	450 A	400 A	400 A
Thermal current	Depending on installation and coordination with the selected fuses		
Rated short-circuit breaking current, r.m.s. (prospective)	50 kA	50 kA	40 kA
Max. let-through current	46 kA	46 kA	46 kA
Short-circuit breaking capacity of the contactor	5 kA	4.5 kA	4.5 kA
Rated lightning impulse withstand voltage (earth / open contact gap)	60 kV / 40 kV	60 kV / 40 kV	75 kV / 60 kV
Rated short-duration power-frequency withstand voltage	20 kV	32 kV	28 kV
Switching rate	1200 operating cycles/h	600 operating cycles/h	600 operating cycles/h
Mechanical endurance	1 million operating cycles	1 million operating cycles	1 million operating cycles
Fuses per phase, maximum ¹⁾	1 x 315 A or 2 x 250 A	1 x 315 A or 2 x 250 A	1 x 200 A or 2 x 200 A
Pole-center distance	120 mm	120 mm	120 mm
Widths across flats	205 mm, 275 mm, 310 mm	205 mm, 275 mm, 310 mm	205 mm, 275 mm, 310 mm

1) Referred to Siemens 3GD2 or SIBA fuses (motor protection characteristic)

Medium-voltage equipment for indoor applications

SIMOPRIME partnering

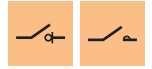

SIMOPRIME partnering concept:
Reliable medium-voltage switchgear for fail-safe operation, up to 24 kV

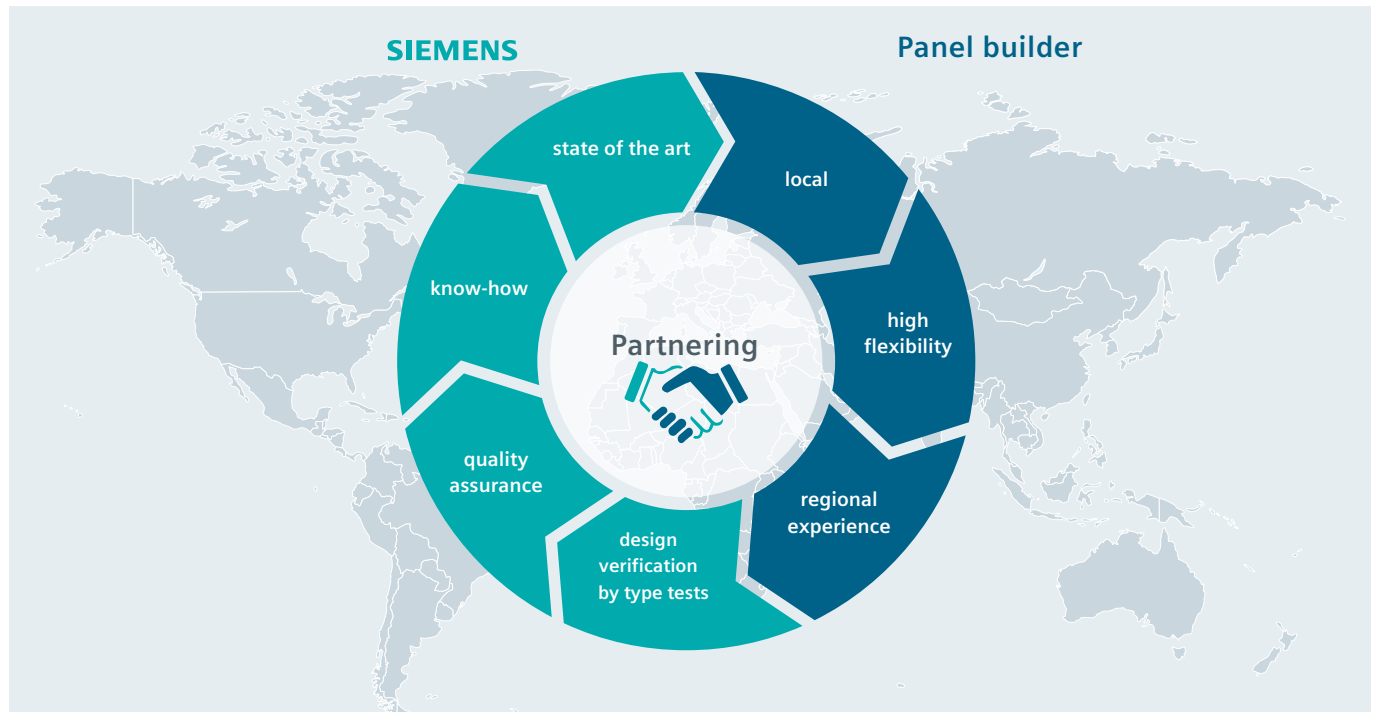

Become Our Technology Partner

01	02	03	04
Product	Configuration software	Training	Service & Support
<ul style="list-style-type: none"> • 100% Siemens • High quality • High level of safety • Type-tested system according to IEC 62271-200 • Design verification acc. to IEC 61439 • Modular design 	<ul style="list-style-type: none"> • Budget quotations • Quotation presentation • Offer and order management • Product and assembly relevant descriptions • Technical documentation (electrical and mechanical) 	<ul style="list-style-type: none"> • SIMOPRIME partnering • SIMOPRIME switchgear and MV components • Configuration software • Quality assurance • Mechanical and electrical assembly 	<ul style="list-style-type: none"> • Newsletter • Exclusive hotline partner • Exclusive information on the Internet • Quality audits • Marketing support

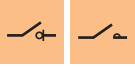

SIMOPRIME Air-Insulated Medium-Voltage Switchgear 17.5/24 kV

01

Product

SIMOPRIME SDC Air-Insulated Switching Device Compartment



02

Configuration software

1 Project data

2 Configuration

3 Documentation

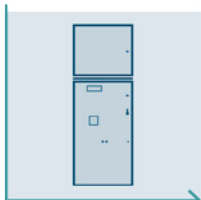

SIMOPRIME switchgear



Technical specification



Define the typical



Select MV components and accessories



Automatic error check



Switchgear arrangement



Printouts of parts lists



Single line diagrams



Technical description

03

Training

Product training

- General characteristics and applications
- Features and components

Software training

- Offer, order and project structure, basic parameters of the switchgear design
- Definition of switchgear systems and selection of components
- Technical product documentation

Quality assurance training

- Basic knowledge for production quality
- Best-practice examples
- Information about type tests

Assembly training

- Panel assembly with documentation
- Supporting tools and equipments
- Application examples

04

Service & Support

Global support service

- User protected extranet for the partners to share the information such as test certificates, technical documents, datasheets and CAx data.
- Exclusive marketing support such as brochures, presentations, text modules, pictures for your catalogue or internet presence, etc.
- Regular Email newsletters and webinars provide you with the latest information about our products, systems and tools
- Our internet website siemens.com/simoprime-partner highlights the concept and benefits of being SIMOPRIME Technology Partner.

Medium-voltage equipment for outdoor applications

Outdoor vacuum circuit-breakers



Application

Outdoor vacuum circuit-breakers are especially designed for outdoor installation. The design is based on the proven 3AH operating mechanism and a simple structure, in order to guarantee a long electrical and mechanical endurance, offering all advantages of indoor vacuum circuit-breakers at the same time.

In live-tank circuit-breakers, the vacuum interrupter is housed inside a weatherproof insulating enclosure, e.g. made of porcelain. The housing of the arcing chamber is thus at electrical potential, which resulted in the term „live tank“.

Due to their low-weight and space-saving design, the 3AF0 vacuum circuit-breakers are easy to transport, and can be divided into separate modules. The safety-oriented design and rugged construction of 3AF0 makes it suitable for use in the harshest conditions. It can be used in the substations of various distribution systems of both power utilities and industries.

Switching duties

Outdoor vacuum circuit-breakers fulfil the same functions as indoor circuit-breakers, and cover a similar product range. Due to their special design they are preferably used in power systems with a large extent of overhead lines. When using outdoor vacuum circuit-breakers, it is not necessary to provide closed service locations for the installation of circuit-breakers. According to IEC 62271-100, higher TRV values are requested for outdoor applications, which is expressed by the class S2. The 3AF0 complies with this class.

A special design of these circuit-breakers with one or two poles has been especially developed and tested for applications in traction power supply switchgear.

Features and benefits

- Conforms to the IEC standards and many local standards
- Suitable for auto-reclosing duty
- Perfect harmony between vacuum interrupter and operating mechanism
- Highly reliable and safe operation
- Low cost of ownership
- High electrical and mechanical endurance
- No maintenance of mechanical parts required, except for regular checks in case of abnormal conditions.

Live-tank designs



3AF0 Live Tank

Live-tank portfolio

Type	3AF01	3AF03	3AF09	3AF04* / 3AF05**
Application in	distribution systems			traction power systems
Rated voltage	36 / 40.5 kV	17.5 kV	12 kV	27.5 kV ¹⁾
Rated short-duration power-frequency withstand voltage	70 / 95 kV	42 kV	48 kV	95 kV
Rated lightning impulse withstand voltage	170 kV	95 / 110 kV	85 kV	200 kV
Rated normal current	1600 / 2000 / 2500 A	2000 A	630 A	2500 A
Rated short-circuit breaking current	25 / 31.5 kA	25 kA	20 kA	31.5 kA
Rated short-circuit making current	62.5 / 80 kA	62.5 kA	50 kA	80 kA

* Single-pole

** Double-pole

¹⁾ Phase-to-earth voltage for traction applications



Dead tank
Arc-resistant circuit-breaker
for distribution systems, type SDV7-AR

Enclosure type	Stored-energy spring mechanism	Magnetic actuator
Non-arc-resistant	SDV7-SE	SDV7-MA
Arc-resistant	SDV7-SE-AR	SDV7-MA-AR

AR = Arc-resistant

Dead-tank portfolio

Type	SDV7
Rated voltage	15.5 – 38 kV
Rated short-duration power-frequency withstand voltage	50 – 80 kV
Rated lightning impulse withstand voltage	110 – 200 kV
Rated normal current	1200 – 3000 A
Rated short-circuit breaking current	20 – 40 kA

Application

The significant characteristic of the dead-tank design is the arrangement of the vacuum interrupter in an earthed metal enclosure, thus defined as dead tank.

The SDV7 (dead tank) family is the latest generation of the successful SDV product line.

The SDV7 family now includes an option for arc-resistant construction. The arc-resistant enclosure has been tested in accordance with ANSI/IEEE C37.20.7, accessibility type 2B. The arc-resistant design shares the same footprint dimensions as the non-arc-resistant design, for ease in application.

Switching duties

This circuit-breaker fulfills the same switching duties as the live-tank circuit-breaker 3AF0. The SDV7 is optionally equipped with a stored-energy spring mechanism or a magnetic actuator. The magnetic actuator design has been qualified with all relevant short-circuit tests to the same performance levels as the stored-energy spring mechanism design. Durable permanent magnets are used in order to provide the closing force required for closing and latching. The magnetic actuator employs an electronic controller to provide the power required for opening and closing the circuit-breaker.

Enclosure

The construction of the circuit-breaker is very compact, resulting in a small footprint, and allowing the SDV7 circuit-breaker to fit into many existing installations that circuit-breakers of earlier designs could not. The enclosure is robust, with the adjustable legs located at the corners of the enclosure rather than recessed under the enclosure.

Available ratings				
Ratings	Non-arc-resistant	Arc-resistant	Stored-energy mechanism	Magnetic actuator
up to 15.5 kV, 25 kA, 2000 A	■	■	■	■
up to 15.5 kV, 40 kA, 3000 A	■	■	■	–
up to 27.6 kV, 25 kA, 2000 A	■	■	■	■
up to 38 kV, 25 kA, 2000 A	■	■	■	–
up to 38 kV, 40 kA, 2500 A	■	■	■	–

■ Available – Not available



Application

3AD vacuum reclosers combine the latest technology in vacuum switching and electronic control as well as network protection. They are based on decades of experience in vacuum switching technology and circuit-breaker design, protection relay development and network planning. Siemens reclosers meet all the requirements in accordance with the recloser standards IEC/IEEE 62271-37-013 / IEC 62271-111.

The recloser consists of two main components: The switch unit, similar to a circuit-breaker, and the controller as protection and control unit. The latter is located inside the control cubicle, which also contains the electronics and auxiliary circuits.

Switching duties

Recloser principle

Reclosers are used in overhead lines as well as in substations. Like circuit-breakers they are capable of switching normal and fault currents. Being equipped with sensors and a controller as protection and control unit, they can trip and reclose up to nine times in case of a temporary fault, thus avoiding longer network interruptions.

As outdoor devices, reclosers are mounted on a pole or a support in an outdoor substation, and are therefore exposed to environmental and weather conditions. Extensive testing beyond the recloser standard has proven the suitability for such applications to ensure long service life.

Recloser cycle

In case of a network fault, the recloser opens and recloses several times. In case of temporary faults, this multiple-shot automatic reclosing significantly reduces the outage times.

The operating cycles can be set individually for each mode of operation optimizing the recloser to:

- The first two interruptions of a fault are set to instantaneous protection, so that downstream protection devices (e.g. sectionalizers, fuses) do not operate. If the fault is temporary, supply is restored after one or several reclosing operations.
- The subsequent interruptions have a delayed protection setting. Thus, downstream fuses on network spur lines have the chance to operate and isolate the affected network section, restoring normal operation in the main feeder.

Designs



3AD vacuum recloser
with control cubicle

Design of the switch unit

The switch unit is the primary part of the recloser. It combines the operating mechanism, mechanical system and poles including the vacuum interrupters, which have been used in a large number of switching devices for more than 40 years. The switch unit has comparable features as a circuit-breaker, though tested differently as per recloser standard. The robust design enables a high resistance against different weather conditions, dust, and small animals.

Magnetic actuator

The recloser is operated by a magnetic actuator enabling the recloser cycle, i.e. the high number of closing and opening operations within a short period of time. The actuator is a bi-stable system, locked in the end positions by permanent magnets. If not in operation, the magnet coils do not consume any power.

Pole design

The vacuum interrupter is embedded in a solid-insulated epoxy-resin pole made of weather-proof cycloaliphatic epoxy resin. This enables a compact design of the interrupter, as well as resistance against environmental effects.

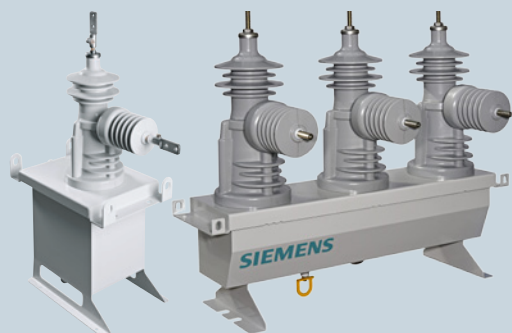

Switch unit



Control cubicle with 7SC80 controller



7SC80 controller



7SR224 controller

Pole design (continued)

The vacuum interrupter is vertically mounted inside the pole, providing a long service life. Each recloser is equipped with an integrated current transformer. For directional protection or measuring purposes resistive voltage sensors can be incorporated in the pole. The accuracy achieved in this manner is much higher than that of capacitive dividers.

Controller

As the brain of the recloser, the controller is located in the control cubicle at the bottom of the pole. On the basis of the protection relay families, Siemens offers two different controllers, the Siemens Reyrolle 7SR224 and the SIPROTEC 7SC80. These relays provide protection, control, monitoring, instrumentation and metering with integrated input and output logic, data logging, and fault reports.

Data exchange and smart-grid integration

Communication access to relay functionality is via a front USB port for local PC connection, RJ45, RS232 or an electrical RS485 port. Additional rear port options including RS232 as well as wireless connections and optical ports are available. Communication is provided through network protocols like IEC 61850, IEC 60870-5-101/103/104 and DNP 3, MODBUS, TCP/IP.

Technical data and ratings

Rated voltage	up to 38 kV
Rated short-circuit breaking current	up to 16 kA
Rated lightning impulse withstand voltage	up to 170 kV
Rated normal current	up to 800 A
Recloser sequence	O-0.2-CO-2 s-CO-2 s-CO
Opening time	< 35 ms
Closing time	< 60 ms
Number of operating cycles	30,000 maintenance-free
Number of phases	three-phase, single-phase, triple-single
Standards	IEC/IEEE 62271-37-013/IEC 62271-111

The controller contains a large number of protection and monitoring functions which can be parameterized through the menu driven display or a laptop.

Control cubicle

The control cubicle includes the complete electronics, the protection relay, printed circuit boards, fuses, a socket outlet for connecting a laptop and the battery system of the recloser. Additional components and features can be selected via the order number or on request.



Application

Rural networks challenges

In most rural networks, the feeder itself is supplied and/or protected by a circuit-breaker or recloser. Spur lines (also referred to as T-offs) are usually protected by fuses.

As a fuse is unable to distinguish between temporary and permanent faults, it blows on all faults, causing downstream customers to lose power and requiring a maintenance crew to replace the fuse. In rural networks it may take hours for the maintenance crew to drive to site, check the line for faults, and reconnect supply. This leads to unnecessarily high maintenance costs for the operator. Since typically 80 percent of the overhead line's faults are temporary, 80 percent of interruptions by fuses are unnecessary.

Fusesaver, the world's fastest outdoor vacuum circuit-breaker, is the most cost-efficient solution for optimizing reliability while minimizing operating costs of rural distribution systems. It is capable of almost completely removing the impacts of temporary faults on spur lines.

Fusesaver is a new class of intelligent, compact and low-cost single-phase circuit-breaker. Fusesaver complies with the relevant parts of IEC 62271-100.

With onboard microprocessor control and wireless communication, Fusesaver has configurable protection and multi-phase operation functions, fault recording, as well as load profiling, and can be integrated into a SCADA system. This device is operated potential-free, as it is hanging directly on the overhead line. It self-powers by decoupling energy from the line current. Fault detection is achieved with an extremely fast protection algorithm.

Designs



3AD8 Fusesaver portfolio

Three main options, based on the minimum line current to self-power Fusesaver, are available.

Rated value	Low range	Standard range	High range
Minimum line current for operation	0.15 A	0.5 A	1.0 A
Fuse ratings	2 to 20 A	5 to 50 A	5 to 100 A
Rated current	40 A	100 A	200 A
Rated short-circuit breaking current I_{sc}	1.5 kA	4 kA	6.3 kA
Rated short-circuit making current I_{peak}	3.75 kA	10 kA	16 kA
Rated short-time withstand current	1.5 kA	4 kA	6.3 kA
Rated short-time current duration	0.2 s	0.2 s	0.5 s
Fault break operations at 100%	300 times	70 times	70 times

Fusesavers are all available with the following voltage range options:

Voltage ranges		
Rated voltage	15.5 kV	27 kV
Rated lightning impulse withstand voltage U_p	110 kV	125 kV
Rated power-frequency withstand voltage U_d (60 s)	50 kV	60 kV



Mode of operation

Fusesaver is designed to

1. be installed in series with a fuse. When it senses a fault current, it will open before the fuse can melt, and stays open for a pre-determined time (dead time). Then, Fusesaver closes again, reconnecting the supply (O-C), and stays closed.
2. replace the fuse altogether. When installed in this manner, Fusesaver can perform the same OPEN-CLOSE functionality as described for the O-C Fusesaver to clear a transient fault. However, it can also perform a second open operation to clear a permanent fault without the help of a fuse (O-CO).

Principle of operation in case of temporary faults

In this case, the fault disappears during Fusesaver's dead time. After closing, the power supply is restored, and the fuse does not blow. Fusesaver is thus ready for the next fault. Only the consumers on the affected spur line experience an interruption in power during Fusesaver's dead time, while all other consumers did not notice any interruption, thanks to the extremely fast opening within a half cycle.

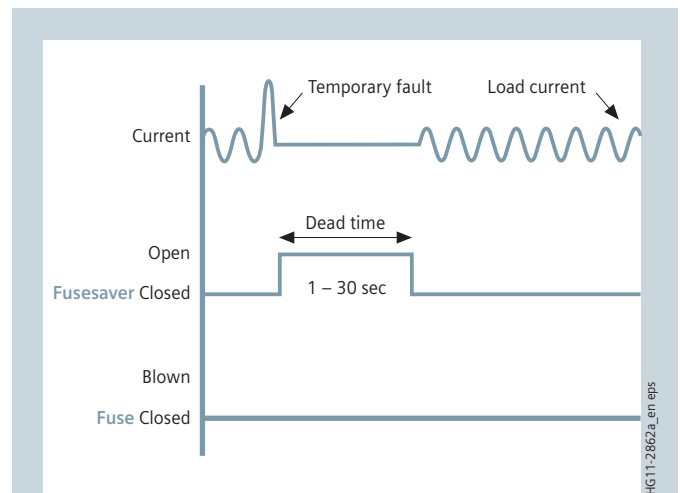

Principle of operation in case of permanent faults

When Fusesaver closes after its dead time, a permanent fault is still present, resulting in an immediate fault current.

Fusesaver with O-C functionality

Fusesaver stays closed; therefore, the fault current will blow the fuse. Due to the permanent fault, loss of power is unavoidable for consumers on this spur line, while all other consumers receive an uninterrupted power supply. Siemens Fusesaver restricts blown fuses on spur lines to such unavoidable cases of permanent faults.

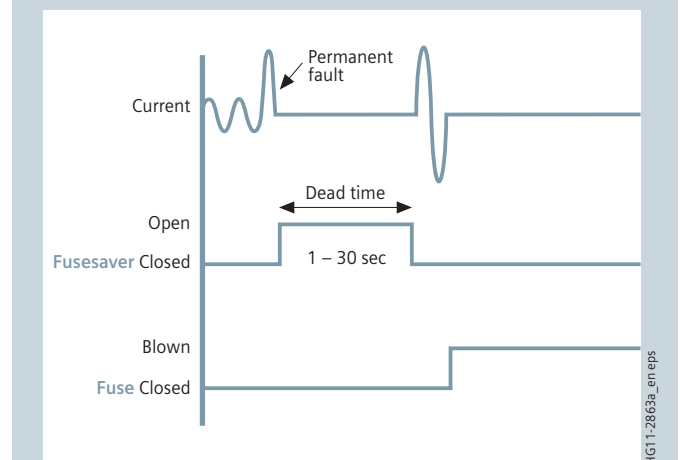

Fusesaver with O-CO functionality

In this case, Fusesaver operates again and stays open. The maintenance crew that has to remove the permanent fault from the line must then bring back Fusesaver to operation. Loss of power is unavoidable for consumers on this spur line, while all other consumers receive an uninterrupted power supply.

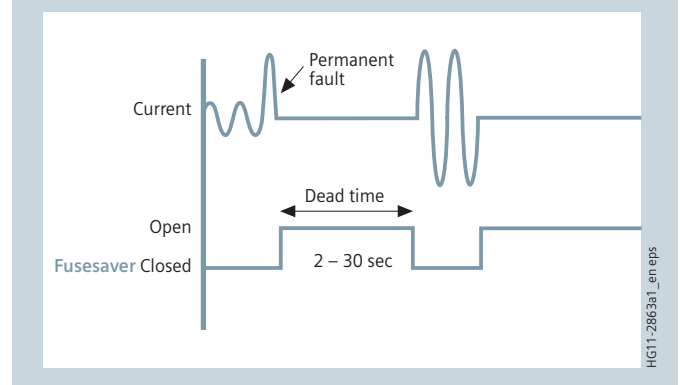



Application

Surge arresters and limiters protect operational equipment both from external overvoltages caused by lightning strikes in overhead lines and from internal overvoltages produced by switching operations or earth faults. Normally, the arrester is installed between phase and earth, but also between the phases in some applications. The built-in stack of non-linear, voltage-dependent resistors (varistors) made of metal oxide (MO) becomes conductive from a defined overvoltage limit value onwards, so that the surge can be discharged through the arrester. A residual voltage is also discharged via the arrester. When the overvoltage is less than this residual voltage the varistors return to their original resistance value and only a leakage current of a few mA then flows. In continuous operation, this leakage current heats up the MO elements, and thus the arrester. Therefore, the device must be designed according to the neutral-point treatment of the system, or the connection of the arresters, in order to prevent impermissible heating of the arrester.

In contrast to the normal surge arrester, the surge limiter contains a series gap in addition to the MO resistor stack. If the energy generated by the overvoltage is large enough, the series gap ignites, and the overvoltage can be discharged to earth until the series gap extinguishes and the varistors return to their non-conductive state. This process is repeated again and again throughout the entire duration of the fault. This makes it possible to design the device with a considerably lower residual voltage as a conventional surge arrester, without having a too high temperature rise in normal operation. Limiters are especially useful for the protection of motors with – normally – a poor dielectric strength. To guarantee a sufficient protective function, the residual voltage value of the arresters or limiters must not

Designs



exceed the dielectric strength of the operational equipment to be protected.

The medium-voltage product range includes:

- The 3EF/3EL group of surge arresters and limiters for the protection of motors, dry-type transformers, older cable sheaths, as well as for the protection of converters for drives.
- The 3EK silicone-housed surge arrester for distribution systems, medium-voltage switchgear up to 72.5 kV, and as a line surge arrester for outdoor use.

Surge arresters and limiters portfolio

	Special applications	Medium-voltage distribution class		Line surge arresters
	3EF1, 3EF3	3EK4	3EK7	3EL2
Applications	Motors, dry-type transformers, cables, protection of converters for drives	Distribution systems and medium-voltage switchgear	Distribution systems and medium-voltage switchgear	Medium-voltage systems, switchgear and lines
Highest voltage for equipment (U_m)	12 kV	45 kV	72.5 kV	40.5 kV
Maximum rated voltage	15 kV	36 kV	60 kV	52 kV
Nominal discharge current	1 kA	10 (AC) kA 20 (DC) kA	10 kA	20 kA
Maximum line discharge class	–	–	–	4
Maximum thermal energy absorption capability (per kV of U_r)	0.8 – 4 kJ/kV	3.5 kJ/kV	4.4 kJ/kV	10 kJ/kV
Maximum long-duration current impulse, 2 ms	–	325 A	325 A	1200 A
Rated short-circuit current	40 kA	20 kA	20 kA	65 kA
Maximum permissible service load	–	–	–	4.0 (SSL) ¹⁾ kNm
Housing material	Polyethylene	Silicone	Silicone	Silicone

1) SSL = Specified short-term load



Application

The auxiliary switch is a switch to be operated mechanically for a short or continuous contact command. It is integrated in the secondary circuit of circuit-breakers of different characteristics as well as in electromagnetic interlocking systems, and is used

- for mutual electrical interlocking of the systems
- for operation of auxiliary contactors, magnet coils, and releases
- for operation of motor operating mechanisms.

In Siemens switching devices it is used as a positively driven auxiliary switch.

Properties

- Auxiliary switch without latches and stops, for mechanical operation
- Can be used for any rotation angles
- Can be ordered with switching levels from 2 to 26; whereby these can be configured individually.

The switching levels can be freely configured as NC, NO or changeover contacts. Moreover, different switching angles and contact overlappings can be selected.

The device conforms to the standards IEC 947 Part 3, Part 5-1 and DIN VDE 0660 Part 107, as well as IEC 721 Part 3-3.

Designs

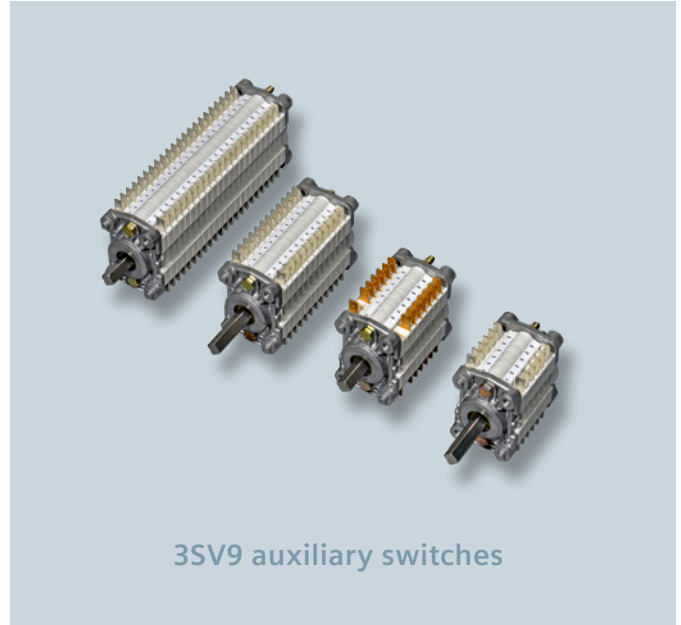

Technical data	
Rated operational voltage U_e	230 V AC / 240 V DC
Rated insulation voltage U_i	250 V AC / DC
Rated thermal current I_{th2}	10 A
Rated making capacity	50 A
Mechanical endurance	100,000 operating cycles
Electrical endurance	30,000 operating cycles
Type of connection	AMP flat plug-in connections
Temperature limit	-25° C

For more information about the switching devices, please refer to the following catalogs:

Catalog HG 11.02



SION Vacuum Circuit-Breakers 3AE5 and 3AE1

Catalog HG 11.07



SION Lateral Vacuum Circuit-Breaker with Lateral Operating Mechanism 3AE6

Catalog HG 11.23



3TM Vacuum Contactors

Catalog HG 11.06



3AK7 Vacuum Circuit-Breakers

Catalog HG 11.03



3AH3 Vacuum Circuit-Breakers

Catalog HG 11.04



3AH4 Vacuum Circuit-Breakers

Catalog HG 11.52



3AH47 Vacuum Circuit-Breakers for Traction Applications

Catalog HG 11.05



3AH5 Vacuum Circuit-Breakers

Brochure



Vacuum Circuit- Breakers for Generator Switching Applications

Catalog HG 11.21



3TL Vacuum Contactors

Catalog HG 11.22



3TL62/63/66 Contactor-Fuse Combination

For more information, please refer to the „Power Engineering Guide“ and to the „Planning Guide HG 11.13“ (in German only)

Brochure



3AF – Outdoor Vacuum Circuit-Breaker up to 40.5 kV

Catalog HG 11.42



Siemens Vacuum Recloser 3AD

Brochure

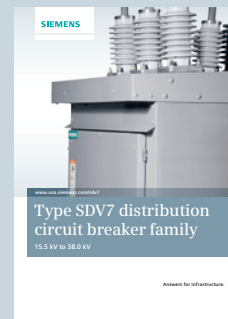

Type SDV7 distribution circuit breaker family

Catalog HG 11.43



Siemens Fusesaver and Remote Control Unit 3AD8

Catalog HG 21



3EE Surge Arresters 3EF Surge Limiters

Published by
Siemens AG 2019

Energy Management Division
Medium Voltage & Systems
Low Voltage & Products
Nonnendammallee 104
13623 Berlin, Germany

For more information,
please contact our
Customer Support Center.
Phone: +49 180 524 70 00
Fax: +49 180 524 24 71
(Charges depending on provider)
E-mail: support.energy@siemens.com
www.siemens.com/mediumvoltage

© Siemens AG 2019
Subject to change without prior notice.
PDF (E86060-K8280-E353-7600)
KG 0319 1.0 En
Printed in Germany

The information given in this document only
contains general descriptions and/or performance
features which may not always specifically reflect
those described, or which may undergo modifica-
tion in the course of further development of the
products. The requested performance features
are binding only when they are expressly agreed
upon in the concluded contract.

