

**SIEMENS**



SINAMICS Drives

# SINAMICS DCM

DC Converter, Control Module

Catalog  
D 23.1

Edition  
2020

[www.siemens.com/sinamics](http://www.siemens.com/sinamics)

## Related catalogs

**Motion Control Drives** D 31.1  
 SINAMICS Inverters for Single-Axis Drives  
 Built-In Units

E86060-K5531-A111-A1-7600



**Motion Control Drives** D 31.2  
 SINAMICS Inverters for Single-Axis Drives  
 Distributed Inverters

E86060-K5531-A121-A1-7600



**SINAMICS G130** D 11  
 Drive Converter Chassis Units  
**SINAMICS G150**  
 Drive Converter Cabinet Units

E86060-K5511-A101-A6-7600



**SINAMICS GM150/SINAMICS SM150** D 12  
 Medium-Voltage Converters

E86060-K5512-A101-A3-7600



**SINAMICS S120** D 21.3  
 Chassis Format Converter Units  
 Chassis-2 Format Converter Units  
 Cabinet Modules, Cabinet Modules-2  
**SINAMICS S150**  
 Converter Cabinet Units

E86060-K5521-A131-A7-7600



**DC motors** DA 12  
 Sizes 160 to 630  
 31.5 kW to 1610 kW

E86060-K5312-A101-A2-7600



**DC motors** DA 12 T  
 Engineering information  
 for Catalog DA 12

E86060-T5312-A101-A2-7600



**Motion Control System** PM 21  
 SIMOTION  
 Equipment for Production Machines

E86060-K4921-A101-A4-7600



**SITRAIN**  
 Digital Industry Academy

[www.siemens.com/sitrain](http://www.siemens.com/sitrain)



**Industry Mall**  
 Information and Ordering Platform  
 on the Internet:

[www.siemens.com/industrymall](http://www.siemens.com/industrymall)



# SINAMICS DCM

## DC Converter, Control Module

### SINAMICS Drives



#### Catalog D 23.1 · 2020

Supersedes:  
Catalog D 23.1 · 2014

Refer to the Industry Mall for current updates of  
this catalog:

[www.siemens.com/industrymall](http://www.siemens.com/industrymall)

Please contact your local Siemens branch.

© Siemens 2020

#### Introduction

1

#### Highlights

2

#### DC Converter and Control Module

3

#### Accessories and supplementary components

4

#### Engineering information

5

#### Tools and engineering

6

#### Services and documentation

7

#### Appendix

8

The products and systems described in this catalog are distributed under application of a certified quality management system in accordance with EN ISO 9001.

# Digital Enterprise

## The building blocks that ensure everything works together perfectly in the digital enterprise

Digitalization is already changing all areas of life and existing business models. It is placing greater pressure on industry while at the same time creating new business opportunities. Today, thanks to scalable solutions from Siemens, companies can already become a digital enterprise and ensure their competitiveness.



### Industry faces tremendous challenges



#### Reduce time-to-market

Today manufacturers have to bring products to market at an ever-increasing pace despite the growing complexity of these products. In the past, a major manufacturer would push aside a small one, but now it is a fast manufacturer that overtakes a slow one.



#### Boost flexibility

Consumers want customized products, but at a price they would pay for a mass-produced item. That only works if production is more flexible than ever before.



#### Improve quality

To ensure a high level of quality while meeting legal requirements, companies have to establish closed quality loops and enable the traceability of products.



#### Boost efficiency

Today the product itself needs to be sustainable and environmentally friendly, while energy efficiency in production has become a competitive advantage.



#### Increase security

Increasing networking escalates the threat to production facilities of cyberattacks. Today more than ever, companies need suitable security measures.



## The digital enterprise has already become a reality

To fully benefit from all the advantages of digitalization, companies first have to achieve complete consistency of their data. Fully digitally integrated business processes, including those of suppliers, can help to create a digital representation of the entire value chain. This requires

- the integration of industrial software and automation,
- expansion of the communication networks,
- security in automation,
- and the use of business-specific industrial services.

## MindSphere

### The cloud-based open IoT operating system from Siemens

With MindSphere, Siemens offers a cost-effective and scalable cloud platform as a service (PaaS) for the development of applications. The platform, designed as an open operating system for the Internet of Things, makes it possible to improve the efficiency of plants by collecting and analyzing large volumes of production data.

### Totally Integrated Automation (TIA) Where digitalization becomes reality

Totally Integrated Automation (TIA) ensures the seamless transition from the virtual to the real world. It already encompasses all the necessary conditions for transforming the benefits of digitalization into true added value. The data that will form the digital twin for actual production is generated from a common base.

### Digital Plant

Learn more about the digital enterprise for the process industry  
[www.siemens.com/digitalplant](http://www.siemens.com/digitalplant)

### Digital Enterprise Suite

Learn more about the digital enterprise for the discrete industry  
[www.siemens.com/digital-enterprise-suite](http://www.siemens.com/digital-enterprise-suite)

# Integrated Drive Systems

Faster on the market and in the black with Integrated Drive Systems

Integrated Drive Systems are Siemens' trendsetting answer to the high degree of complexity that characterizes drive and automation technology today. The world's only true one-stop solution for entire drive systems is characterized in particular by its threefold integration: Horizontal, vertical, and lifecycle integration ensure that every drive system component fits seamlessly into the whole system, into any automation environment, and even into the entire lifecycle of a plant.

The outcome is an optimal workflow – from engineering all the way to service that entails more productivity, increased efficiency, and better availability. That's how Integrated Drive Systems reduce time to market and time to profit.

## Horizontal integration

**Integrated drive portfolio:** The core elements of a fully integrated drive portfolio are frequency converters, motors, couplings, and gear units. At Siemens, they're all available from a single source. Perfectly integrated, perfectly interacting. For all power and performance classes. As standard solutions or fully customized. No other player in the market can offer a comparable portfolio. Moreover, all Siemens drive components are perfectly matched, so they are optimally interacting.

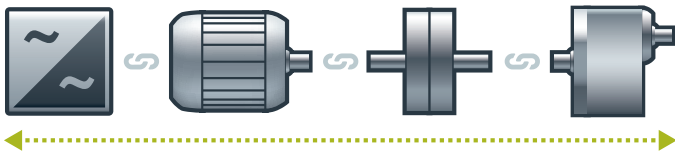

You can boost the availability of your application or plant to up to

**99%\***

\*e.g., conveyor application

## Vertical integration

Thanks to **vertical integration**, the complete drive train is seamlessly integrated in the entire automation environment – an important prerequisite for production with maximum value added. Integrated Drive Systems are part of Totally Integrated Automation (TIA), which means that they are perfectly embedded into the system architecture of the entire industrial production process. This enables optimal processes through maximum communication and control.

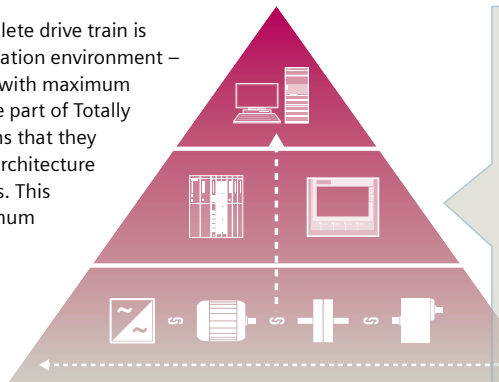

With TIA Portal you can cut your engineering time by up to

**30%**

## Lifecycle integration

**Lifecycle integration** adds the factor of time: Software and service are available for the entire lifecycle of an Integrated Drive System. That way, important optimization potential for maximum productivity, increased efficiency, and highest availability can be leveraged throughout the system's lifecycle – from planning, design, and engineering to operation, maintenance, and all the way even to modernization.

With Integrated Drive Systems, assets become important success factors. They ensure shorter time to market, maximum productivity and efficiency in operation, and shorter time to profit.

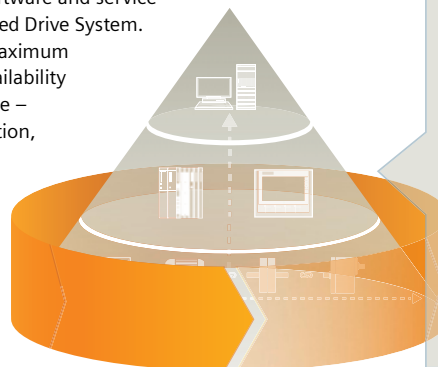

With Integrated Drive Systems you can reduce your maintenance costs by up to

**15%**

## Introduction



<b>1/2</b>	<b>The SINAMICS converter family</b>
<b>1/6</b>	<b>Converter selection</b>
<b>1/8</b>	<b>SINAMICS DCM series of converters</b>
1/8	Overview
<b>1/9</b>	<b>The system components of a DC drive</b>
1/9	Overview
<b>1/10</b>	<b>Selection of the system components</b>
1/10	Configuration

# SINAMICS DCM

## Introduction

### The SINAMICS converter family

#### Overview

##### Integration in automation

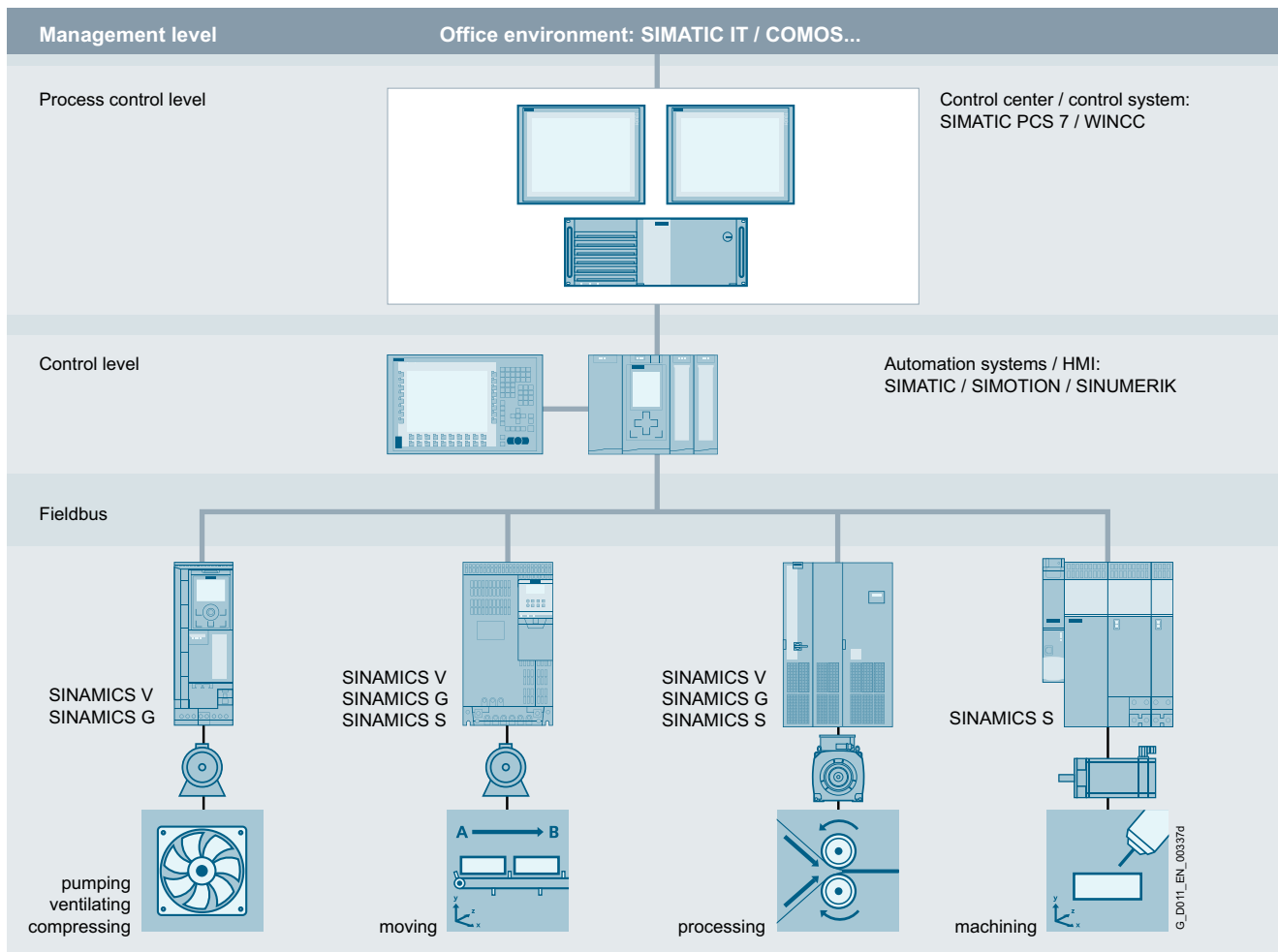

#### Totally Integrated Automation and communication

SINAMICS is an integral component of the Siemens Totally Integrated Automation concept. Integrated SINAMICS systems covering configuration, data storage, and communication at automation level ensure low-maintenance solutions with the SIMATIC, SIMOTION and SINUMERIK control systems.

Depending on the application, the respective optimum frequency converter can be selected and incorporated in the automation concept. With this in mind, the converters are clearly subdivided into their different applications. A wide range of communication options (depending on the converter type) are available for establishing a communication link to the automation system:

- PROFINET
- PROFIBUS
- EtherNet/IP
- Modbus TCP
- Modbus RTU
- AS-Interface
- BACnet MS/TP

#### Application

SINAMICS is the comprehensive family of converters from Siemens designed for industrial machine and plant construction. SINAMICS offers solutions for all drive tasks:

- Simple pump and fan applications in the process industry
- Complex single-motor drives in centrifuges, presses, extruders, elevators, as well as conveyor and transport systems
- Drive line-ups in textile, plastic film and paper machines, as well as in rolling mill plants
- Highly dynamic servo drives for machine tools, as well as packaging and printing machines



**Overview**
*SINAMICS as part of the Siemens modular automation system*

***Innovative, energy-efficient and reliable drive systems and applications as well as services for the entire drive train***

The solutions for drive technology place great emphasis on the highest productivity, energy efficiency and reliability for all torque ranges, performance and voltage classes.

Siemens offers not only the right innovative frequency converter for every drive application, but also a wide range of energy-efficient low-voltage motors, geared motors, explosion-protected motors and high-voltage motors for combination with SINAMICS.

Furthermore, Siemens supports its customers with global pre-sales and after-sales services, with over 295 service points in 130 countries – and with special services such as application consulting or motion control solutions.

***Energy efficiency***
**Energy management process**

Efficient energy management consultancy identifies the energy flows, determines the potential for making savings and implements them with focused activities.

Electric drives account for almost two thirds of industrial power requirements. This makes it all the more important to use drive technology permitting energy consumption to be reduced effectively even in the configuration phase, and consequently to optimize plant availability and process stability. With SINAMICS, Siemens offers powerful energy-efficient solutions which, depending on the application, enable a significant reduction in electricity costs.

G\_D011\_XX\_00515b

# SINAMICS DCM

## Introduction

### The SINAMICS converter family

#### Overview

##### Up to 70 % potential for savings using variable-speed operation

SINAMICS enables great potential for savings to be realized by controlling the motor speed. In particular, huge potential savings can be recovered from pumps, fans and compressors which are operated with mechanical throttle and valves. Here, changing to frequency converters results in enormous economic advantages: In contrast to mechanical control systems, the power consumption at partial load operation is always immediately adjusted to the demand at that time. So energy is no longer wasted, permitting savings of up to 60 % – in exceptional cases even up to 70 %. Frequency converters also offer clear advantages over mechanical control systems when it comes to maintenance and repair: Current spikes when powering up the motor and strong torque surges become things of the past – and the same goes for pressure waves in piping systems, cavitation or vibrations which cause lasting damage to the plant. Smooth starting and ramp-down relieve the load on the mechanical system, ensuring a significantly longer service life of the entire drive train.

##### Regenerative feedback of braking energy

In conventional drive systems, the energy produced during braking is converted to heat using braking resistors. Energy produced during braking is efficiently recovered to the supply system by versions of SINAMICS G and SINAMICS S converters with regenerative feedback capability and these devices do not therefore need a braking resistor. This permits up to 60 % of the energy requirement to be saved, e.g. in lifting applications. Energy that can be re-used elsewhere in the plant. Furthermore, this reduced power loss simplifies the cooling of the system, enabling a more compact design.

##### Energy transparency in all configuration phases

Already during configuration, the SIZER for Siemens Drives configuration tool provides information about the specific energy requirement. The energy consumption across the entire drive train is visualized and compared with different plant concepts.

##### SINAMICS in combination with energy-saving motors

The consistency of the engineering extends beyond the SINAMICS family of converters to the higher-level automation systems, as well as to a wide range of energy-efficient motors in various performance classes, which are up to 10 % more efficient than previous motors.

#### Variants

Depending on the area of application, the SINAMICS converter family offers an optimally tailored variant for any drive task.

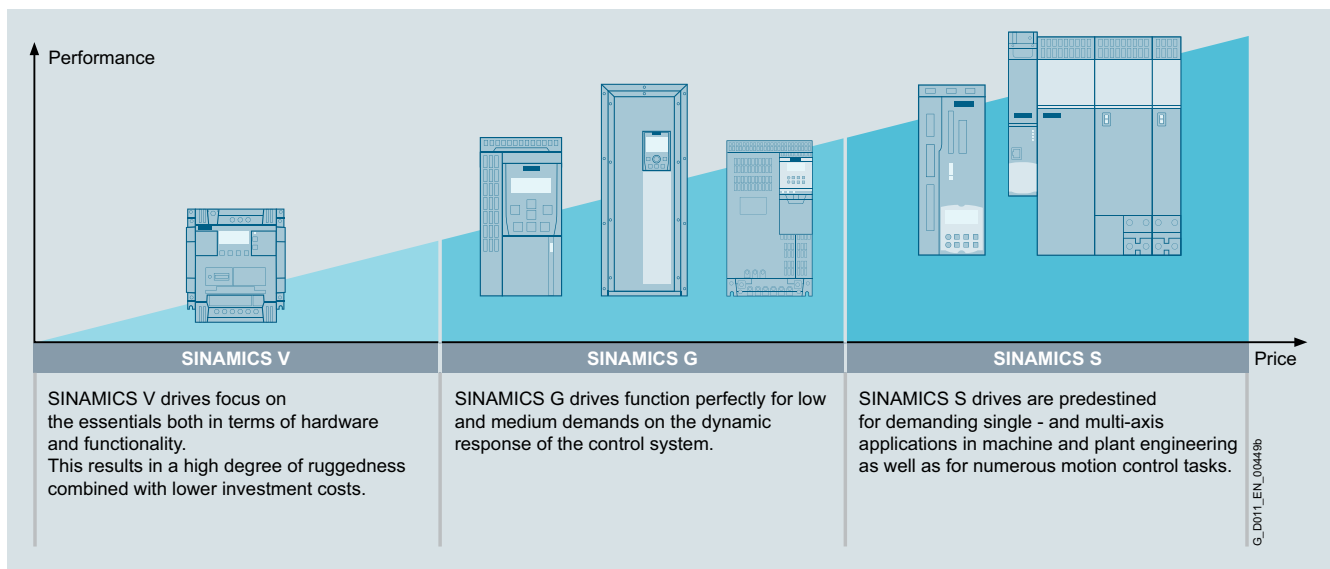

**Overview**

*Platform concept*

All SINAMICS variants are consistently based on a platform concept. Common hardware and software components, as well as standardized tools for design, configuration and commissioning tasks, ensure high-level integration across all components. SINAMICS handles a wide variety of drive tasks without system gaps. The different SINAMICS variants can be easily combined with each other.

*Quality management according to EN ISO 9001*

SINAMICS is able to meet the highest quality requirements. Comprehensive quality assurance measures in all development and production processes ensure a consistently high level of quality.

Of course, our quality management system is certified by an independent authority in accordance with EN ISO 9001.

*IDS – Integration at its very best*

The Siemens Integrated Drive Systems (IDS) solution offers perfectly matched drive components with which you can meet your requirements. The drive components reveal their true strengths as an integrated drive system over the full range from engineering and commissioning through to operation: Integrated system configuration is performed using the Drive Technology Configurator: Just select a motor and a converter and configure them with the SIZER for Siemens Drives configuring tool. The commissioning tools STARTER and SINAMICS Startdrive simultaneously integrate the motor data and facilitate efficient commissioning. Integrated drive systems are incorporated in the TIA Portal – this simplifies engineering, commissioning, and diagnostics.

Low voltage										Direct voltage	Medium voltage
Standard performance frequency converters		Distributed frequency converters	Industry-specific frequency converters		Servo drives			High performance frequency converters		DC converters	Converters for applications with high outputs
SINAMICS V20 G120C G120	SINAMICS G130 G150	SINAMICS G110D G120D G110M SIMATIC ET 200pro FC-2	SINAMICS G120X	SINAMICS G180	SINAMICS V90	SINAMICS S110	SINAMICS S210	SINAMICS S120 S120M	SINAMICS S150	SINAMICS DCM DCP *	SINAMICS GH150 GH180 GM150 SM150 GL150 SL150 SM120CM
0.12 kW to 250 kW	75 kW to 2700 kW	0.37 kW to 7.5 kW	0.75 kW to 630 kW	2.2 kW to 6600 kW	0.05 kW to 7 kW	0.55 kW to 132 kW	0.05 kW to 7 kW	0.55 kW to 5700 kW	75 kW to 1200 kW	6 kW to 30 MW	0.15 MW to 85 MW
Pumps, fans, compressors, conveyor belts, mixers, mills, spinning machines, textile machines, refrigerated display counters, fitness equipment, ventilation systems, single-axis positioning applications in machine and plant engineering	Pumps, fans, compressors, conveyor belts, mixers, mills, extruders	Conveyor technology, single-axis positioning applications (G120D)	Pumps, fans, compressors, building management systems, process industry, HVAC, water/waste water industries	Pumps, fans, compressors, conveyor belts, extruders, mixers, mills, kneaders, centrifuges, separators	Handling machines, packaging machines, automatic assembly machines, metal forming machines, printing machines, winding and unwinding units	Single-axis positioning applications in machine and plant engineering	Packaging machines, handling equipment, feed and withdrawal devices, stacking units, automatic assembly machines, laboratory automation, wood, glass and ceramics industry, digital printing machines	Production machines (packaging, textile and printing machines, paper machines, plastic processing machines), machine tools, plants, process lines and rolling mills, marine drives, test bays	Test bays, cross cutters, centrifuges	Rolling mill drives, wire-drawing machines, extruders and kneaders, cableways and lifts, test bay drives  * DC/DC controllers	Pumps, fans, compressors, mixers, extruders, mills, crushers, rolling mills, conveyor technology, excavators, test bays, marine drives, blast furnace fans, retrofit
Catalog D 31.1	Catalog D 11	Catalog D 31.2	Catalog D 31.5	Catalog D 18.1	Catalog D 33	Catalog D 31.1	Catalog D 32	Catalogs D 21.3, D 21.4 NC 62	Catalog D 21.3	Catalog D 23.1 * Industry Mall	Catalogs D 15.1, D 12
Engineering tools (e.g. Drive Technology Configurator, SIZER for Siemens Drives, STARTER and SINAMICS Startdrive)											

G\_D011\_EN\_004500

# SINAMICS DCM

## Introduction

### Converter selection

1

#### Overview

#### SINAMICS selection guide – typical applications

Application	Requirements for torque accuracy/speed accuracy/position accuracy/coordination of axes/functionality					
	Continuous motion			Non-continuous motion		
	Basic	Medium	High	Basic	Medium	High
<b>Pumping, ventilating, compressing</b> 	Centrifugal pumps Radial/axial fans Compressors V20 G120C G120X	Centrifugal pumps Radial/axial fans Compressors G120X G130/G150 G180 <sup>1)</sup>	Eccentric screw pumps S120	Hydraulic pumps Metering pumps G120	Hydraulic pumps Metering pumps S110	Descaling pumps Hydraulic pumps S120
<b>Moving</b> 	Conveyor belts Roller conveyors Chain conveyors V20 G110D G110M G120C ET 200pro FC-2 <sup>2)</sup>	Conveyor belts Roller conveyors Chain conveyors Lifting/lowering devices Elevators Escalators/moving walkways Indoor cranes Marine drives Cable railways G120 G120D G130/G150 G180 <sup>1)</sup>	Elevators Container cranes Mining hoists Excavators for open-cast mining Test bays S120 S150 DCM	Acceleration conveyors Storage and retrieval machines V90 G120 G120D	Acceleration conveyors Storage and retrieval machines Cross-cutters Reel changers S110 S210 DCM	Storage and retrieval machines Robotics Pick & place Rotary indexing tables Cross-cutters Roll feeds Engagers/disengagers S120 S210 <b>DCM</b>
<b>Processing</b> 	Mills Mixers Kneaders Crushers Agitators Centrifuges V20 G120C	Mills Mixers Kneaders Crushers Agitators Centrifuges Extruders Rotary furnaces G120 G130/G150 G180 <sup>1)</sup>	Extruders Winders/unwinders Lead/follower drives Calenders Main press drives Printing machines S120 S150 DCM	Tubular bagging machines Single-axis motion control such as • position profiles • path profiles V90 G120	Tubular bagging machines Single-axis motion control such as • position profiles • path profiles S110 S210	Servo presses Rolling mill drives Multi-axis motion control such as • multi-axis positioning • cams • interpolations S120 S210 <b>DCM</b>
<b>Machining</b> 	Main drives for • turning • milling • drilling S110	Main drives for • drilling • sawing S110 S120	Main drives for • turning • milling • drilling • gear cutting • grinding S120	Axis drives for • turning • milling • drilling S110	Axis drives for • drilling • sawing S110 S120	Axis drives for • turning • milling • drilling • lasering • gear cutting • grinding • nibbling and punching S120

#### Using the SINAMICS selection guide

The varying range of demands on modern frequency converters requires a large number of different types. Selecting the optimum converter is becoming a significantly more complex process. The application matrix shown simplifies this selection process considerably by suggesting the ideal SINAMICS converter for examples of typical applications and requirements.

- The application type is selected from the vertical column
  - Pumping, ventilating, compressing
  - Moving
  - Processing
  - Machining
- The quality of the motion type is selected from the horizontal row
  - Basic
  - Medium
  - High

<sup>1)</sup> Industry-specific converters.

<sup>2)</sup> Information on the SIMATIC ET 200pro FC-2 frequency converter is available in Catalog D 31.2 and at: [www.siemens.com/et200pro-fc](http://www.siemens.com/et200pro-fc)

### More information

More information about SINAMICS is available online at  
[www.siemens.com/sinamics](http://www.siemens.com/sinamics)

Practical application examples and descriptions are available  
on the Internet at  
[www.siemens.com/sinamics-applications](http://www.siemens.com/sinamics-applications)

# SINAMICS DCM

## Introduction

### SINAMICS DCM series of converters

1

#### Overview

SINAMICS DC MASTER is the new generation of DC converters from Siemens. The name SINAMICS DC MASTER – briefly: SINAMICS DCM – embodies the strengths of this new generation. It combines the advantages of its predecessor SIMOREG DC-MASTER, with the advantages of the SINAMICS family.

When it comes to quality, reliability and functionality, SINAMICS DC MASTER is not only on par with its predecessor - but especially in the area of functionality - offers new features and includes useful functions from its predecessor as standard.

SINAMICS DC MASTER is the new member of the SINAMICS family that now makes many of the SINAMICS tools and components known from AC technology available to DC technology.

As a scalable drive system, the SINAMICS DC MASTER series of converters is convincing both for basic as well as demanding applications. The DC Converter is equipped with a Standard Control Unit (Standard CUD). The option of combining a Standard CUD and Advanced CUD is used to address applications demanding a higher computational performance and more interfaces.

The DC Converter of the SINAMICS DC MASTER series combines the open-loop and closed-loop control and power sections in one device. It especially sets itself apart as a result of the compact, space-saving design.

The AOP30 Advanced Operator Panel and the BOP20 Basic Operator Panel can be used for commissioning and local operation.

The interfaces of the CUD and the number of digital inputs and outputs can be supplemented using additional modules - such as the TM15, TM31 and TM150 Terminal Modules.

The components of a DC drive system and how these are logically interlinked are shown in the following diagram. A flow diagram on pages 1/10 and 1/11 provides support when selecting and dimensioning the required components.

**Overview**

**Motors (see Catalog DA 12)**



**Motor-side components (see Catalogs D 23.1, LV 10.1)**

Fuses  
SICROWBAR DC  
(for retrofit for motors with solid yoke  
and single-phase operation)



**SINAMICS DC MASTER components**

SINAMICS DC MASTER



Advanced CUD

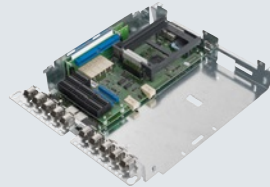

**SINAMICS accessories**

For example:  
Terminal Modules,  
Sensor Module,  
Advanced  
Operator Panel,  
PROFINET Board



Connection system



**Line-side components (see Catalogs D 23.1, IC 10, LV 10.1)**

For example:  
Commutating reactor  
Line fuses  
Circuit breaker or contactor  
Radio interference  
suppression filter  
SICROWBAR AC

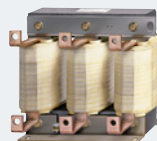

**3 AC line supply**

G\_ID023\_EN\_00070c

**SINAMICS DCM**

## Introduction

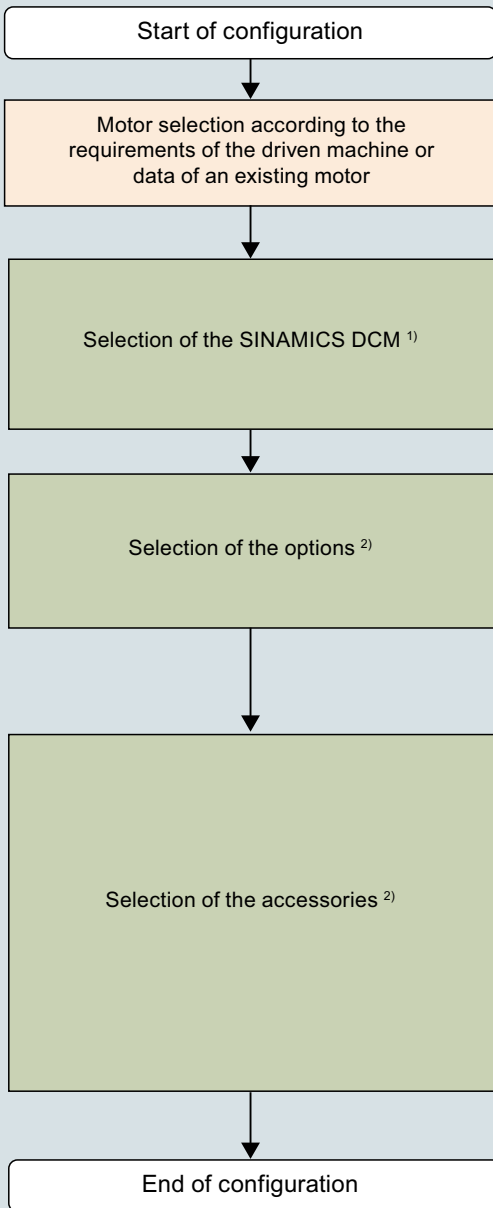
**Selection of the system components****Configuration**
**Selection of a DC drive via the DT Configurator**  
<http://www.siemens.com/dt-configurator>

- Catalog DA 12 – Page 3/2
- Catalog D 23.1 and DT Configurator
- Catalog D 23.1

The following data must be specified by the customer:

- Rated input voltage and frequency
- DC armature voltage and current
- Duty cycle (customer-specific)
- Operating mode (two-quadrant / four-quadrant)
- DC field current
- Installation altitude
- Ambient temperature

The following options are recommended as standard:

- G00 <sup>3)</sup> → Subsequent expandability (e.g. TM31) possible
- G20 → PROFINET, SINAMICS Link, EtherNet/IP, Modbus TCP
- S01 → Additional languages, long-term trace, basic software updates
- L15 → External sensor for ambient or inlet temperature

The following accessories are available:

- AOP30 – Page 4/2
- SMC10 – Page 4/4
- SMC30 – Page 4/5
- TM15 – Page 4/6
- TM31 – Page 4/8
- TM150 – Page 4/11
- Semiconductor fuses <sup>4)</sup> – Page 4/14
- Commutating reactors – Page 4/18
- Contactors, main switches and circuit breakers <sup>5)</sup> – Page 4/24
- Radio interference suppression filters – Page 4/25
- Mounting kit to upgrade to IP20 - Page 4/13

- SICROWBAR AC – Page 4/26
- SICROWBAR DC – Page 4/29

<sup>1)</sup> Pages 3/31 and 3/32 contain an overview of the article numbers.

<sup>2)</sup> Page 3/33 contains an overview of the available options.

<sup>3)</sup> Page 3/39 shows the interfaces of the CUD.

<sup>4)</sup> Catalog LV 10.1 contains further information.

<sup>5)</sup> Catalog IC 10 contains further information



**Configuration**
**Migration from SIMOREG DC-MASTER to SINAMICS DCM**
**Migration procedure:**

- Replace the converter according to the migration steps listed below.
- Use new accessories as specified: e.g. semiconductor fuses, commutating reactors, SICROWBAR
- Continue to use already existing components: e.g. converter transformers, smoothing reactors
- A SINAMICS DCM does not cause greater radio interference voltages than a SIMOREG DC-MASTER. It is not necessary to retrofit the radio interference suppression filter as long as the plant operator does not impose higher requirements.

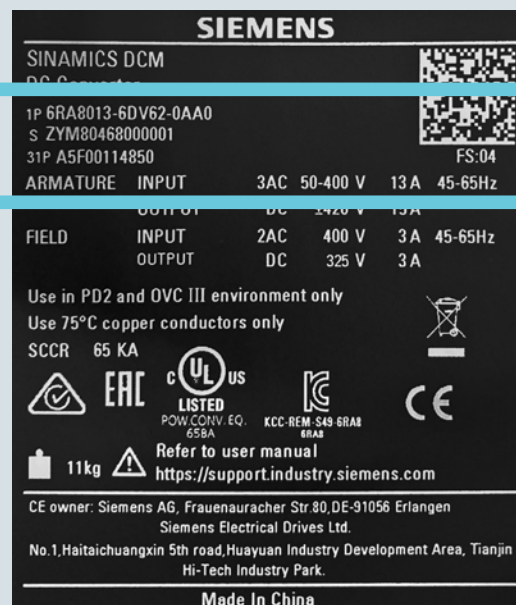
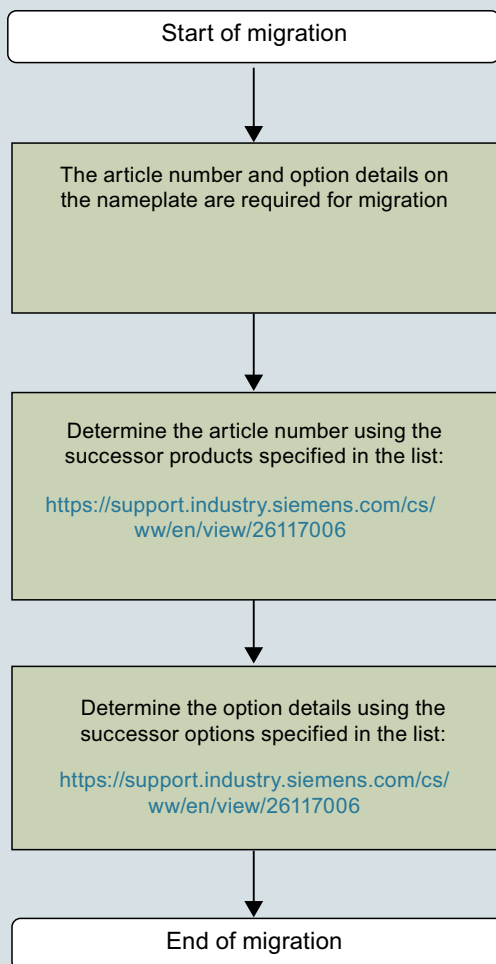

The following options are recommended as standard:

- G00 <sup>1)</sup> -> Subsequent expandability (e.g. TM31) possible
- G20 -> PROFINET, SINAMICS Link, EtherNet/IP, Modbus TCP
- S01 -> Additional languages, long-term trace, basic software updates
- L15 -> External sensor for ambient or inlet temperature

<sup>1)</sup> Page 3/39 shows the interfaces of the CUD.

# SINAMICS DCM

## Introduction

### Notes

1

## Highlights



### 2/2

#### Overview

- 2/2 • The SINAMICS converter family
- 2/2 • PROFIBUS as standard, PROFINET optional
- 2/2 • Variance of the Control Units
- 2/2 • Field power supply in line with requirements
- 2/3 • 24 V DC electronics power supply
- 2/3 • Power section isolated with respect to ground
- 2/3 • Functional Safety
- 2/3 • Free function blocks and Drive Control Chart
- 2/3 • Expandable functionality using SINAMICS components
- 2/3 • Single-phase connection possible
- 2/4 • Coated PCBs and nickel-plated copper busbars
- 2/4 • Wide temperature range

# SINAMICS DCM

## Highlights

### Overview

SINAMICS DC MASTER is the drive system for basic applications and demanding DC applications. The use in a wide range of different sectors and complementary markets demands a high degree of scalability and the ability to expand the converter series over a wide range.

In order to be able to guarantee this versatile use, SINAMICS DC MASTER has a whole raft of new features:

#### The SINAMICS converter family



SINAMICS DC MASTER is a member of the SINAMICS converter family. The individual SINAMICS versions are based on a common platform, especially in the area of interfaces, tools and operator control & monitoring. All of the SINAMICS drives support the TIA philosophy and share common ways of engineering, communication and data management with the SIMATIC, SIMOTION and SINUMERIK automation systems from Siemens. When using these systems, automation solutions can be very simply generated using SINAMICS.

As a result of the standard and seamless integration into the automation environment of Siemens, customers also profit from faster engineering and commissioning of the complete machine automation and drive technology. Further, training-related costs are reduced and support, service & maintenance and spare parts stocking are simplified.

#### PROFIBUS as standard, PROFINET optional

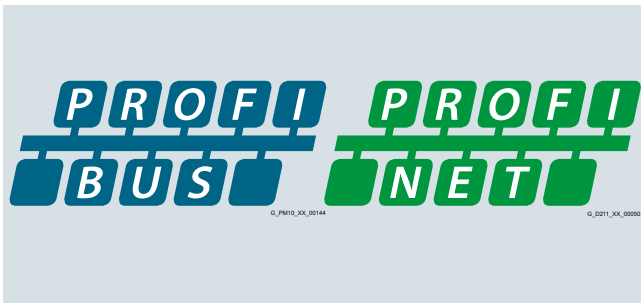

The units are equipped as standard with PROFIBUS - the industry standard. PROFINET or EtherNet/IP is also available as an option. Communication to other fieldbus systems can be realized using external adapters.

#### Variance of the Control Units

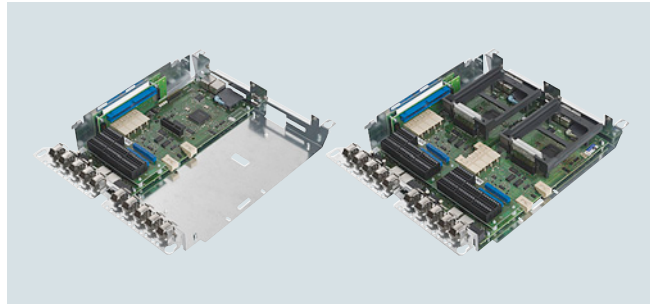

In order to optimally fulfill the requirements relating to interfaces and computational performance for technology functions, a Standard or Advanced CUD or a combination can be selected. It is also possible to use two CUDs to increase the performance for technological open-loop and closed-loop control tasks. This allows optimum adaptation to the wide range of requirements relating to drive technology and complementary markets - both technically and economically.

#### Field power supply in line with requirements

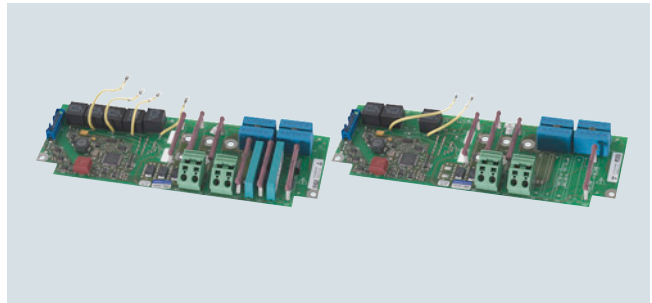

With the introduction of SINAMICS DC MASTER, you have the option of selecting the optimum field power supply for your particular requirements.

SINAMICS DC MASTER is always the optimum choice:

- For units without field (from a rated DC current of 60 A and higher)
- For units with a 1Q field (with integrated free-wheeling circuit)
- For units with a 2Q field to actively reduce the current for high-speed field current changes and integrated field overvoltage protection (from a rated DC current of 60 A and higher)

For units from 1500 A and higher it is also possible to select a version with 85 A rated field current in a 1Q or 2Q version instead of the 40 A field power supply. It goes without saying that an external field power supply unit can also be connected - if the application demands it.

**Overview****24 V DC electronics power supply**

The electronics power supply of the DC Converter will be available in two versions:

- For connection to 230 V/400 V AC or
- For connection to 24 V DC (protected against polarity reversal).

Using a 24 V supply, a UPS function can be simply implemented – and therefore the availability of the plant or system increased.

The figure above shows a 24 V DC power supply SITOP smart.

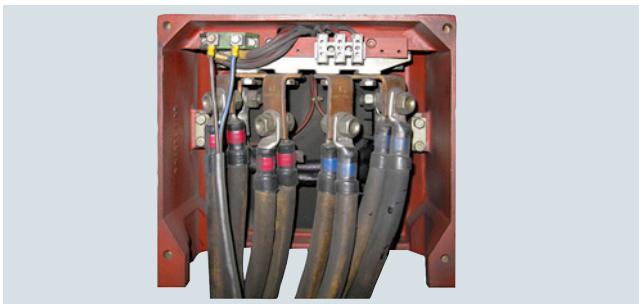
**Power section isolated with respect to ground (floating voltage sensing)**

The power section voltage sensing inside the unit is floating with respect to the electronics (electrically isolated).

This is the reason that in the future it will not be necessary to disconnect/connect the motor cable to measure the insulation resistance of DC motors. In order to secure the availability of the plant or system and to avoid severe damage to the motor, it is absolutely mandatory that the insulation resistance of DC motors is regularly checked.

**Functional Safety**

With SINAMICS DCM, the safety requirement levels SIL 3 and PL e in the entire performance range can now be achieved by "Functional Safety" with only one main contactor or circuit breaker.

In addition, control via a safety relay or F-PLC is necessary.

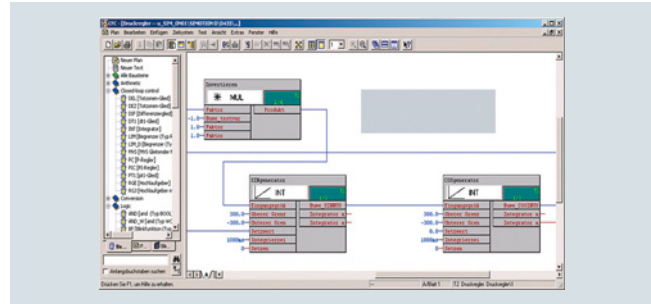
**Free function blocks and Drive Control Chart**

A sufficient number of free function blocks for various applications is included as standard. Optionally, the functional scope can be subsequently extended using free function blocks from Drive Control Chart (DCC). This allows the drive to be optimally adapted to the particular application - both technically and economically.

**Expandable functionality using SINAMICS components**

Additional inputs and outputs are available by coupling supplementary modules from the SINAMICS range to the DRIVE-CLiQ interface (Advanced CUD). As a consequence, the flexibility when engineering the plant or system is increased and at the same time costs are optimized.

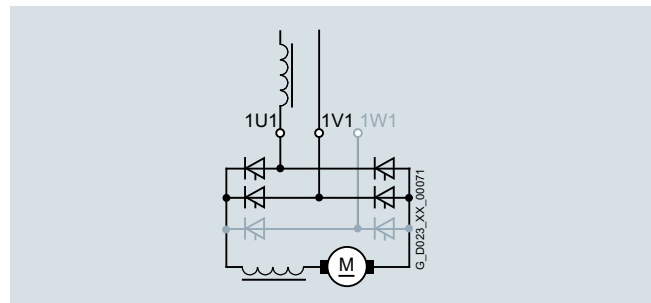
**Single-phase connection possible**

For units up to 125 A and up to 575 V AC, the full functionality is available even when supplied through just two conductors. This means, for example, that when retrofitting a converter with single-phase connection, it is not necessary to make any changes to the existing machine or plant - and the retrofitted drive system can be integrated into state-of-the-art communication concepts (TIA).

## SINAMICS DCM

### Highlights

#### Overview

##### **Coated PCBs and nickel-plated copper busbars**

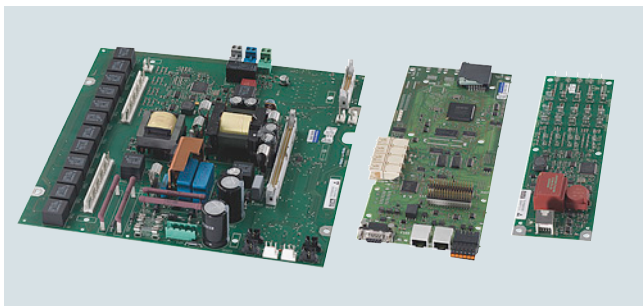

PCBs coated on both sides and nickel-plated copper busbars are two options to improve the reliability for increased degrees of pollution and climatic stressing - as well as for increased environmental stressing (e.g. for aggressive atmospheres).

##### **Wide temperature range**



Use in regions with high climatic stressing is made simpler as a result of the -40 °C to +70 °C temperature range for storage and transport.

## DC Converter and Control Module

**3/2 General information**

- 3/2 Overview
- 3/3 Benefits
- 3/3 Application
- 3/4 Function
  - Functions of the closed-loop control in the armature circuit
  - Functions of the closed-loop control in the field circuit
- 3/6
  - Communication between drive components
- 3/8
  - Single-phase connection
  - Coolant temperature and installation altitude
- 3/9 More information
  - Documentation

**3/10 Functional Safety****3/11 DC Converter**

- 3/11 Overview
- 3/11 Technical specifications
  - General technical specifications
  - SINAMICS DC MASTER converters for:
    - 3/13 - 400 V 3 AC, 60 to 280 A, two-quadrant operation
    - 3/14 - 400 V 3 AC, 400 to 1200 A, two-quadrant operation
    - 3/15 - 400 V 3 AC, 1600 to 3000 A, two-quadrant operation
    - 3/16 - 480 V 3 AC, 60 to 280 A, two-quadrant operation
    - 3/17 - 480 V 3 AC, 450 to 1200 A, two-quadrant operation
    - 3/18 - 575 V 3 AC, 60 to 800 A, two-quadrant operation
    - 3/19 - 575 V 3 AC, 1100 to 2800 A, two-quadrant operation
    - 3/20 - 690 V 3 AC, 720 to 2600 A, two-quadrant operation
    - 3/21 - 830 V 3 AC, 950 to 1900 A and 950 V 3 AC, 2200 A, two-quadrant operation
    - 3/22 - 400 V 3 AC, 15 to 125 A, four-quadrant operation
    - 3/23 - 400 V 3 AC, 210 to 850 A, four-quadrant operation
    - 3/24 - 400 V 3 AC, 1200 to 3000 A, four-quadrant operation
    - 3/25 - 480 V 3 AC, 15 to 210 A, four-quadrant operation
    - 3/26 - 480 V 3 AC, 280 to 1200 A, four-quadrant operation
    - 3/27 - 575 V 3 AC, 60 to 850 A, four-quadrant operation
    - 3/28 - 575 V 3 AC, 1100 to 2800 A, four-quadrant operation
    - 3/29 - 690 V 3 AC, 760 to 2600 A, four-quadrant operation
    - 3/30 - 830 V 3 AC, 950 to 1900 A and 950 V 3 AC, 2200 A, four-quadrant operation

3/31

Selection and ordering data

3/31

- DC Converters for two-quadrant operation

3/32

- DC Converters for four-quadrant operation

3/33

Options

3/33

- Available options

3/34

- Option selection matrix

3/35

- Ordering examples

3/36

- Description of options

3/39

Circuit diagrams

3/39

- Control Units

3/40

- DC Converters

3/41

- Assignment of terminals and connectors

3/47

More information

3/47

- Free function blocks

3/48

- Drive Control Chart (DCC)

3/48

- Power section and cooling

3/48

- Parameterizing devices

3/49

- Closed-loop control and open-loop drive control

3/50

- Optimization run

3/50

- Monitoring and diagnostics

3/51

- Functions of the inputs and outputs

3/52

- Safety shutdown (E-STOP)

3/52

- Serial interfaces

3/52

- Control terminal block

3/53

- Interface to the motor

3/53

- Siemens DC motors

**3/54 Control Module****3/54 Control Module**

3/54

Application

3/54

Design

3/55

Technical specifications

3/56

Selection and ordering data

3/56

Options

3/57

Accessories

3/58

Circuit diagrams

## SINAMICS DCM

### DC Converter and Control Module

#### General information

#### Overview



SINAMICS DC MASTER converter

The SINAMICS DC MASTER series of converters includes the DC Converter and Control Module product versions.

The DC Converter includes built-in units for connection to a three-phase supply. These are used to supply the armature and field of variable-speed DC drives. The rated DC current range of the units extends from 15 to 3000 A and can be increased by connecting DC Converters in parallel.

Depending on the application, units for two-quadrant or four-quadrant operation and with integrated field power section are available. The units are autonomous as a result of the integrated parameterizing device and do not require any additional equipment for parameterization. All functions associated with open-loop and closed-loop control, as well as all monitoring and auxiliary functions, are handled by a microprocessor system. Setpoints and actual values can either be entered as analog or digital values.

The SINAMICS DC MASTER Control Module is the successor of the SIMOREG CM and is mainly used to retrofit and modernize DC drives.

SINAMICS DC MASTER converters are available in the following sizes (self-ventilated up to 125 A):



DC Converter						Control Module
Rated DC current A						
≤ 30	≤ 280	≤ 600	≤ 850	≤ 1200	≤ 3000	–
Dimensions (W × H × D) mm						
268 × 385 × 221	268 × 385 × 252	268 × 625 × 275	268 × 700 × 311	268 × 785 × 435	453 × 883 × 505	271 × 388 × 253

Detailed dimensional drawings in PDF and DXF format are available on the Internet at <http://support.automation.siemens.com/WW/view/en/81717045>.



### Benefits

- Less training time and costs and maximum number of identical parts through the extensive product range of the SINAMICS DC MASTER.  
The standard and seamless series of SINAMICS DC MASTER units addresses a wide current and voltage range. The series of units is designed for connection to three-phase line supplies. Furthermore, the units can also be connected to single-phase line supplies up to and including a rated DC current of 125 A.
- Flexible expandability regarding functionality and performance.  
The extensive product range and the many options allow the DC Converter to be optimally adapted to customer requirements - both technically and economically. Different customer requirements, the type and number of interfaces as well as the computational performance and speed can be precisely fulfilled by selecting between either a Standard CUD, an Advanced CUD or a combination of both.
- Plant and system availability are increased by being able to quickly and simply replace components.  
Replaceable components have been designed so that they can be quickly and simply replaced. The spare parts that are available can be viewed at any time, assigned to the serial number of the unit.
- Easy commissioning and parameterization using interactive menus on the AOP30 Advanced Operator Panel with graphics-capable, backlit LCD and plain-text display, or PC-supported using the STARTER commissioning tool (see "Tools and engineering").
- Since the SINAMICS DC MASTER is already pre-configured at the factory, no device-specific parameters need to be set at all. The device is adapted to the relevant application by parameters in a fully electronic process. The units do not feature any potentiometers, switches, jumpers or DIP switches, which means that they can be put back into operation as soon as they have been serviced.
- During the complete production process, all of the components are subject to comprehensive tests and checks. This guarantees a high functional safety.
- Can be easily integrated into automation solutions, e.g. using a standard PROFIBUS communication interface and various analog and digital interfaces.

### Application

#### ***DC drive technology: Dynamic, rugged and cost-effective***

Depending on the application, DC drives are frequently the most favorably-priced drive solution. They have many advantages when it comes to reliability, operator friendliness and operating characteristics. Just as before, there are some good technical and economic reasons for still using DC drives in many industrial areas:

- Favorably-priced four-quadrant operation
- Continuous operation at a low speed
- Full torque and low torque ripple even at low speeds
- High starting torque
- High overload capability
- Wide speed control range with constant power
- Low space requirement and low weight
- Reliability

Main applications for DC drives include:

- Rolling mill drives
- Wire-drawing machines
- Extruders and kneaders
- Presses
- Elevators and cranes
- Cableways and lifts
- Mine hoists
- Test bay drives

**SINAMICS DCM**

## DC Converter and Control Module

## General information

**Function**

Function	Description
<b>Functions of the closed-loop control in the armature circuit</b>	
Speed setpoint	<p>The source of the speed setpoint and additional setpoints can be freely selected by making the appropriate parameter settings:</p> <ul style="list-style-type: none"> <li>• Entered using analog values 0 to <math>\pm 10</math> V, 0 to <math>\pm 20</math> mA, 4 to 20 mA</li> <li>• Entered via the PROFIBUS fieldbus interface, Ethernet interface for PROFINET (optional)</li> <li>• Using the integrated motorized potentiometer</li> <li>• Using binectors with the functions: Fixed setpoint, jogging, crawl</li> <li>• Entered via serial interfaces of the SINAMICS DC MASTER</li> <li>• Entered via supplementary modules</li> </ul> <p>The scaling is realized so that 100 % setpoint (formed from the main setpoint and supplementary setpoints) corresponds to the maximum motor speed.</p> <p>The setpoint can be limited to a minimum and maximum value via a parameter or connector. Further, additional points are provided in the firmware e.g. in order to be able to enter supplementary setpoints before or after the ramp-function generator. The "setpoint enable function" can be selected using a binector. After a parameterizable filter function (PT1 element), the summed setpoint is transferred to the setpoint input of the speed controller. In this case, the ramp-function generator is also active.</p>
Actual speed	<p>One of four sources can be selected as signal for the speed actual value.</p> <ul style="list-style-type: none"> <li>• <i>Analog tachometer</i> The voltage of the tachogenerator at maximum speed can be between 8 and 270 V. Adaptation to the voltage is realized using parameters.</li> <li>• <i>Pulse encoder</i> The pulse encoder type, the number of pulses per revolution and the maximum speed are set using parameters. Encoder signals (symmetrical: with additional, inverted track, unsymmetrical: referred to ground) up to a maximum differential voltage of 27 V can be processed by the evaluation electronics. The rated voltage range (5 or 15 V) for the encoder is selected via parameters. The power supply for the pulse encoder can be taken from the DC Converter for a rated voltage of 15 V. 5 V encoders require an external power supply. The pulse encoder is evaluated across the three tracks: Track 1, track 2 and zero mark. However, pulse encoders without zero mark can also be used. A position actual value can be sensed using the zero mark. The maximum frequency of the encoder pulses can be 300 kHz. It is recommended that pulse encoders with at least 1024 pulses per revolution are used (due to the smooth running operation at low speeds).</li> <li>• <i>Operation without tachometer with EMF control</i> A speed actual value encoder is not required for closed-loop EMF control. In this case, the output voltage of the device is measured in the DC converter. The measured armature voltage is compensated by the internal voltage drop across the motor (IR compensation). The level of compensation is automatically determined during the current controller optimization run. The accuracy of this control method, which is defined by the temperature-dependent change in the motor armature circuit resistance, is approximately 5 %. We recommend that the current controller optimization run is repeated when the motor is in the warm operating condition to achieve a higher degree of precision. The closed-loop EMF control can be used if the requirements on the precision are not so high, if it is not possible to mount an encoder and the motor is operated in the armature voltage control range. Notice: In this mode, EMF-dependent field weakening is not possible.</li> <li>• <i>Freely selectable speed actual value signal</i> For this mode, any connector number can be selected as speed actual value signal. This setting is especially selected if the speed actual value sensing is implemented on a supplementary technology module. Before the speed actual value is transferred to the speed controller, it can be smoothed using a parameterizable smoothing element (PT1 element) and two adjustable bandstop filters. Bandstop filters are used primarily for the purpose of filtering out resonant frequencies caused by mechanical resonance. The resonant frequency and the filter quality factor can be set.</li> </ul>
Ramp-function generator	<p>When there is a step change in the setpoint applied at its input, the ramp-function generator converts the setpoint into a signal with a steady rate of rise. Ramp-up time and ramp-down time can be selected independently of one another. In addition, the ramp-function generator has initial and final rounding-off (jerk limiting) that are effective at the beginning and end of the ramp-up time.</p> <p>All of the times for the ramp-function generator can be set independently of one another.</p> <p>Three parameter sets are available for the ramp-function generator times; these can be selected via binary select inputs or a serial interface (via binectors). The ramp-up function generator parameters can be switched over in operation. In addition, a multiplication factor can be applied to the value of parameter set 1 via a connector (to change the ramp-function generator data via a connector). When entering ramp-function generator times with the value zero, the speed setpoint is directly input into the speed controller.</p>

**Function**

Function	Description
<b>Functions of the closed-loop control in the armature circuit (continued)</b>	
Speed controller	<p>The speed controller compares the setpoint and actual value of the speed and if there is a deviation, enters an appropriate current setpoint into the current controller (principle: Speed control with lower-level current controller). The speed controller is implemented as PI controller with additional D component that can be selected. Further, a switchable droop function can be parameterized. All of the controller parameters can be adjusted independently of one another. The value for <math>K_p</math> (gain) can be adapted depending on a connector signal (external or internal).</p> <p>In this case, the P gain of the speed controller can be adapted depending on the speed actual value, current actual value, setpoint-actual value distance or the wound roll diameter. This can be pre-controlled in order to achieve a high dynamic performance in the speed control loop. For this purpose, e.g. depending on the friction and the moment of inertia of the drive, a torque setpoint signal can be added after the speed controller. The friction and moment of inertia compensation are determined using an automatic optimization run.</p> <p>The output quantity of the speed controller can be directly adjusted via parameter after the controller has been enabled.</p> <p>Depending on the parameterization, the speed controller can be bypassed and the converter controlled either with closed-loop torque or current control. In addition, it is also possible to switch between speed control/torque control in operation using the "leading/following switchover" selection function. The function can be selected as binector using a binary user-assignable terminal or a serial interface. The torque setpoint is input via a selectable connector and can therefore come from an analog user-assignable terminal or via a serial interface.</p> <p>A limiting controller is active when in the following drive state (torque or current controlled operation). In this case, depending on a speed limit that can be selected using parameters, the limiting controller can intervene in order to prevent the drive accelerating in an uncontrolled fashion. In this case, the drive is limited to an adjustable speed deviation.</p>
Torque limiting	<p>The speed controller output represents the torque setpoint or current setpoint depending on what has been parameterized. In torque-controlled operation, the speed controller output is weighted with the machine flux <math>\Phi</math> and transferred to a current limiting stage as a current setpoint. Torque control is applied primarily in field weakening operation in order to limit the maximum motor torque independent of the speed.</p> <p>The following functions are available:</p> <ul style="list-style-type: none"> <li>• Independent setting of positive and negative torque limits using parameters.</li> <li>• Switchover of the torque limit using a binector as a function of a parameterizable switchover speed.</li> <li>• Free input of a torque limit by means of a connector signal, e.g. via an analog input or via a serial interface.</li> </ul> <p>The lowest specified quantity should always be effective as the actual torque limit. Additional torque setpoints can be added after the torque limit.</p>
Current limiting	<p>The current limit that can be adjusted after the torque limit is used to protect the converter and the motor. The lowest specified quantity is always effective as the actual current limit.</p> <p>The following current limit values can be set:</p> <ul style="list-style-type: none"> <li>• Independent setting of positive and negative current limits using parameters (maximum motor current setting).</li> <li>• Free input of a current limit using a connector, e.g. from an analog input or via a serial interface.</li> <li>• Separate setting of current limit using parameters for stopping and quick stop.</li> <li>• Speed-dependent current limiting: An automatically initiated, speed-dependent reduction of the current limit at high speeds can be parameterized (commutation limit curve of the motor).</li> </ul> <p><math>I^2t</math> monitoring of the power section: The thermal state of the thyristors is calculated for all current values. When the thyristor limit temperature is reached, the unit responds as a function of parameter settings, i.e. the converter current is reduced to the rated DC current or the unit is shut down with a fault message. This function is used to protect the thyristors.</p>
Current controller	<p>The current controller is implemented as PI controller with P gain and integral time that can be set independently from one another. The P and I components can also be deactivated (pure P controller or pure I controller). The current actual value is sensed using a current transformer on the three-phase side and is fed to the current controller via a load resistor and rectification after analog-digital conversion. The resolution is 10 bits for the converter rated current. The current limit output is used as current setpoint.</p> <p>The current controller output transfers the firing angle to the gating unit - the pre-control function is effective in parallel.</p>
Pre-control	<p>The pre-control in the current control loop improves the dynamic performance of the closed-loop control. This allows rise times of between 6 and 9 ms in the current control loop. The pre-control is effective dependent on the current setpoint and EMF of the motor and ensures - for intermittent and continuous current or when the torque direction is reversed - that the required firing angle is quickly transferred as setpoint to the gating unit.</p>
Auto-reversing module	<p>In conjunction with the current control loop, the auto-reversing module (only for units with four-quadrant drives) ensures the logical sequence of all of the operations and processes required to change the torque direction. The torque direction can also be disabled when required via parameter.</p>
Gating unit	<p>The gating unit generates the firing pulses for the power section thyristors in synchronism with the line supply voltage. The synchronization is independent of the rotating field and the electronics supply and is sensed at the power section. The timing of the firing pulses is defined by the output values of the current controller and the pre-control. The firing angle limit can be set using parameters.</p> <p>In a frequency range from 45 to 65 Hz, the gating unit automatically adapts itself to the actual line frequency.</p>

**SINAMICS DCM**

## DC Converter and Control Module

## General information

**Function**

Function	Description
<b>Functions of the closed-loop control in the field circuit</b>	
EMF controller	The EMF controller compares the setpoint and actual value of the EMF (induced motor voltage) and enters the setpoint for the field current controller. This therefore permits field weakening control that is dependent on the EMF. The EMF controller operates as PI controller; P and I components can be adjusted independently of one another and/or the controller can be operated as pure P controller or pure I controller. A pre-control function operates in parallel to the EMF controller. Depending on the speed, it pre-controls the field current setpoint using an automatically recorded field characteristic (refer to the optimization runs). There is an adding point after the EMF controller, where the supplementary field current setpoints can be entered either via a connector, via an analog input or a serial interface. The limit is then effective for the field current setpoint. In this case, the field current setpoint can be limited to a minimum and a maximum value that can be set independently from one another. The limit is realized using a parameter or a connector. The minimum for the upper limit or the maximum for the lower limit is effective.
Field current controller	The field current controller is a PI controller – where $K_p$ and $T_n$ can be independently set. It can also be operated as pure P and I controller. A pre-control function operates in parallel to the field current controller. This calculates and sets the firing angle for the field circuit as a function of current setpoint and line supply voltage. The pre-control supports the current controller and ensures that the field circuit has the appropriate dynamic performance.
Gating unit	The gating unit generates the firing pulses for the power section thyristors in synchronism with the line supply voltage in the field circuit. The synchronization is detected in the power section and is therefore independent of the electronics power supply. The timing of the firing pulses is defined by the output values of the current controller and the pre-control. The firing angle limit can be set using parameters. In a frequency range from 45 to 65 Hz, the gating unit automatically adapts itself to the actual line supply voltage.

**Communication between drive components**

DRIVE-CLiQ	<p>Communication between SINAMICS components is realized using the standard internal SINAMICS interface DRIVE-CLiQ (this is an abbreviation for Drive Component Link with IQ). This couples the Control Unit with the connected drive components (e.g. DC Converter, Terminal Modules, etc.).</p> <p>DRIVE-CLiQ provides standard digital interfaces for all SINAMICS drives. This permits modularization of the drive functions and thus increased flexibility for customized solutions (allows power and intelligence to be separated).</p> <p>The DRIVE-CLiQ hardware is based on the Industrial Ethernet standard and uses twisted-pair cables. The DRIVE-CLiQ line provides the transmit and receive signals and also the 24 V power supply.</p> <p>Setpoints and actual values, control commands, status feedback signals and electronic rating plate data of the drive components are transferred via DRIVE-CLiQ. Only original Siemens cables must be used for DRIVE-CLiQ cables. As a result of the special transfer and damping properties, only these cables can guarantee that the system functions perfectly.</p>
SINAMICS Link	<p>SINAMICS Link allows data to be directly exchanged between several (2 to 64) Control Units. A higher-level master is not required.</p> <p>The following Control Units support SINAMICS Link:</p> <ul style="list-style-type: none"> <li>• CU320-2</li> <li>• Advanced CUD</li> </ul> <p>For use of SINAMICS Link, all of the Control Units must be equipped with the CBE20 Communication Board (option G20). In addition, a memory card (options S01, S02) is required for the Advanced CUD. Communication can either be synchronous (only CU320-2) or non-synchronous or a combination of both. Each participant can send and receive up to 16 process data words.</p> <p>For instance, SINAMICS Link can be used for the following applications:</p> <ul style="list-style-type: none"> <li>• Torque distribution for n drives</li> <li>• Setpoint cascading for n drives</li> <li>• Load distribution of drives coupled through a material web</li> <li>• Master/slave function</li> <li>• Couplings between SINAMICS units</li> </ul>

### Function

Function	Description
<b>Communication between drive components (continued)</b>	
OALINK	<p>OALINK (Open Application Link) allows two Control Units to exchange data directly. A higher-level master is not required. The following Control Units support the OALINK:</p> <ul style="list-style-type: none"> <li>• CU320-2</li> <li>• Advanced CUD</li> </ul> <p>The communication system is based on DRIVE-CLiQ which means that no hardware components other than the DRIVE-CLiQ line are required. OALINK must be loaded as a technology package.</p> <p>A software license is required when it is installed on the CU320-2. The article number for the Certificate of License (CoL) is 6SL3077-0AA01-0AB0.</p> <p>No license is required on the Control Unit CUD of the SINAMICS DC MASTER.</p> <p>OALINK permits the cyclic transmission of a total of 120 words which can comprise the following data types:</p> <ul style="list-style-type: none"> <li>• Integer16 (1 word)</li> <li>• Integer32 (2 words)</li> <li>• FloatingPoint32 (2 words)</li> </ul> <p>For instance, OALINK can be used for the following applications:</p> <ul style="list-style-type: none"> <li>• Torque distribution for n drives.</li> <li>• Setpoint cascading for n drives.</li> <li>• Load distribution of drives coupled through a material web</li> <li>• Technology expansion for the SINAMICS DCM (CU320-2 as T400 substitute)</li> <li>• Couplings between SINAMICS units</li> </ul>

### Overview, closed-loop control structure

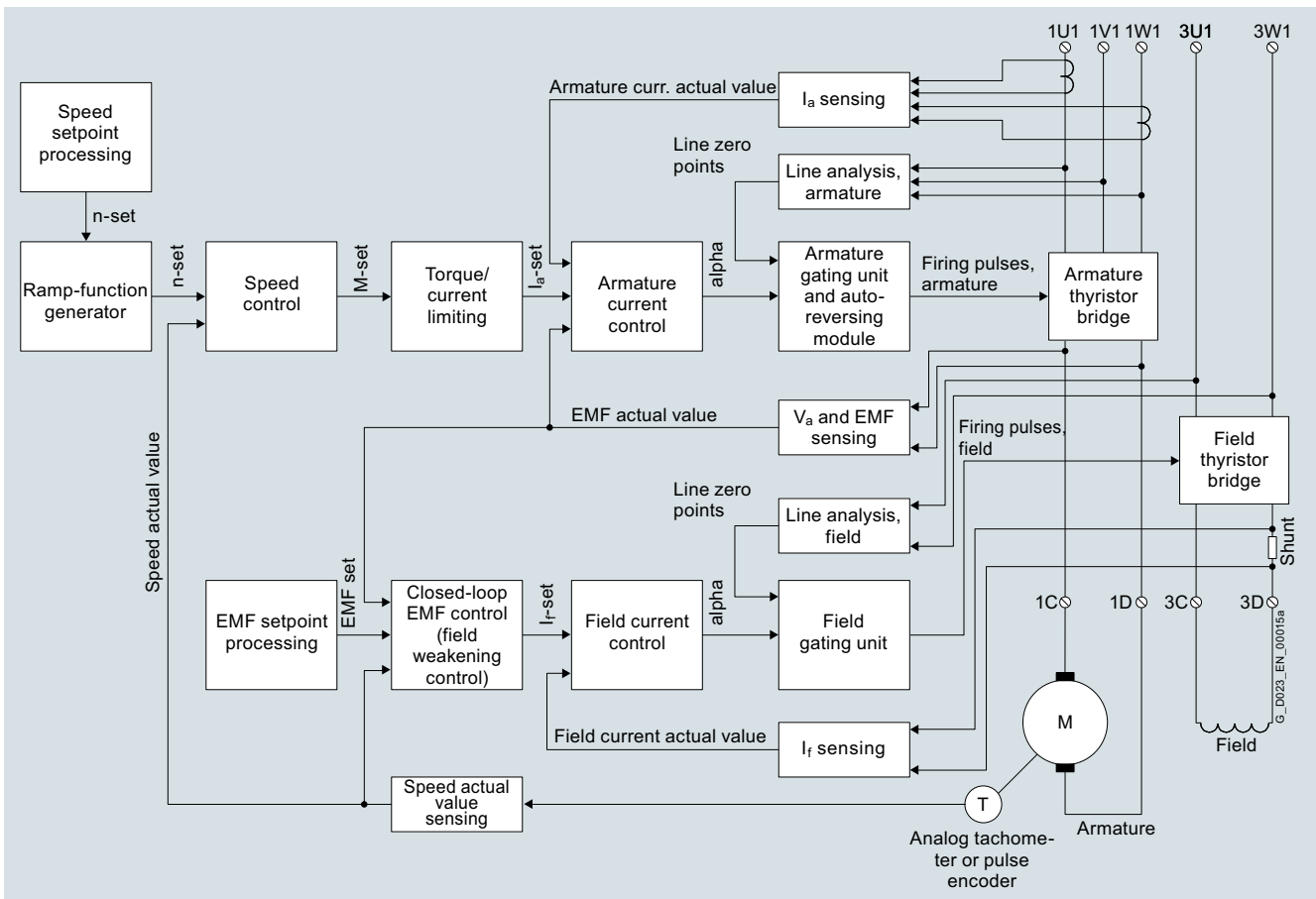

## SINAMICS DCM

### DC Converter and Control Module

#### General information

#### Function

##### Single-phase connection

For all DC Converters, the full functionality of the devices is available even when supplied through only two conductors.

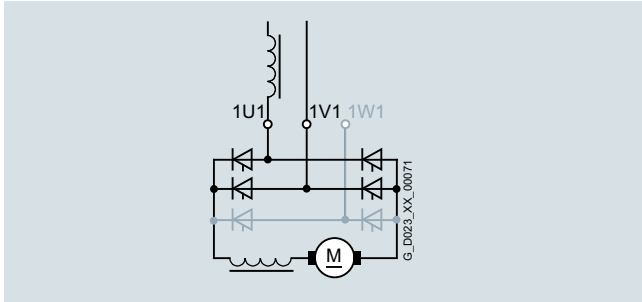

This means that in a retrofit project, for example, a converter with a single-phase connection can be integrated into state-of-the-art communication concepts (TIA) without requiring any changes to the existing machine or plant.

The unit is connected to the line supply via terminals 1U1 and 1V1. It is mandatory that a single-phase commutating reactor or a transformer with 4 %  $u_k$  is provided, which only supplies the DC Converter involved.

Commutating reactor and transformer should be selected according to the rated motor current of the armature circuit.

In this B2 circuit, the line current is equal to the DC current in the armature circuit. All of the other line-side drive components should be dimensioned according to this.

Further, due to the higher current ripple when compared to six-pulse operation, a smoothing reactor must be provided in the DC circuit. Please contact the motor manufacturer when dimensioning the smoothing reactor.

The associated technical specifications of the three-phase converter connected to a single phase can be found in section "Technical specifications" under DC Converter. (Compared to three-phase operation, the rated DC current is derated by a factor of 0.7.)

##### Rated output voltage for single-phase connection

Line supply V	Maximum rated output voltage for single-phase connection	
	Two-quadrant operation V	Four-quadrant operation V
50 ... 230	180	160
50 ... 400	320	280
50 ... 480	385	335
50 ... 575	460	400
100 ... 690	550	480
100 ... 830	665	575
100 ... 950	760	660

#### Coolant temperature and installation altitude

##### Current derating

The permissible coolant temperatures and installation altitudes for SINAMICS DC MASTER as well as the associated maximum permissible load of the DC Converters in continuous operation can be taken from the following table (the load is specified as a % of the rated DC current).

Ambient or coolant temperature	Maximum permissible load of the DC Converter in continuous operation (the load is specified as a % of the rated DC current)									
	Installation altitude above sea level (the derating factors for values in between can be determined using linear interpolation.)									
	1000 m		2000 m		3000 m		4000 m		5000 m	
	Units up to 125 A	Units from 210 A and higher	Units up to 125 A	Units from 210 A and higher	Units up to 125 A	Units from 210 A and higher	Units up to 125 A	Units from 210 A and higher	Units up to 125 A	Units from 210 A and higher
30 °C	100 %		98 %		96 %	88 %	86 %	78 %	78 %	70 %
35 °C	100 %		93 %		90 %	83 %	80 %	73 %		
40 °C	100 %		94 %	88 %	84 %	78 %				
45 °C	100 %		95 %	88 %	83 %					
50 °C	94 %	90 %	82 %	78 %						
55 °C	88 %									

##### Voltage derating

The units can be operated up to an installation altitude of 4000 m above sea level with the specified rated supply voltages. The line supply voltages may have overvoltage category III with respect to ground. For installation altitudes above 4000 m, in some cases, it will be necessary to reduce the supply voltage or ensure that overvoltage category II is maintained. Detailed information is provided in the operating instructions.

**More information****Documentation**

The technical documentation includes the following manuals:

- SINAMICS DC MASTER DC Converter Operating Instructions
- SINAMICS DC MASTER Control Module Operating Instructions
- List Manual (parameter list and function diagrams)
- Function Manual SINAMICS Free Function Blocks

The manuals include all of the data relevant to SINAMICS DC MASTER units:

- Description
- Technical specifications
- Installation instructions
- Commissioning guide
- Maintenance information
- Function diagrams
- Description of faults and alarms
- Parameter list
- List of connectors and binectors
- Dimensional drawings

The documents are available under the following links:

SINAMICS DC MASTER DC Converter Operating Instructions:  
<https://support.industry.siemens.com/cs/ww/en/view/109763558>

SINAMICS DC MASTER Control Module Operating Instructions:  
<https://support.industry.siemens.com/cs/ww/en/view/109763559>

List Manual (parameter list and function diagrams):  
<https://support.industry.siemens.com/cs/ww/en/view/109763564>

Function Manual SINAMICS Free Function Blocks:  
<https://support.industry.siemens.com/cs/ww/en/view/49492040>

## SINAMICS DCM

### DC Converter and Control Module

#### Functional Safety

##### Overview

To ensure the functional safety of a machine or plant, the safety-related parts of the protection and control devices must function correctly and reliably. In addition, the systems must behave in such a way that either the plant remains in a safe state, or it is put into a safe state if a fault occurs. This requires the use of specially qualified technology that meets the requirements of the relevant standards. The requirements for achieving functional safety are based on the following basic goals:

- Avoiding systematic faults
- Controlling systematic faults
- Controlling random faults or failures

The measure for the achieved functional safety is the probability of dangerous failures, the fault tolerance and the quality that is to be guaranteed as a result of freedom from systematic faults.

This is expressed in the standards by different terms: In IEC 61508 by the "Safety Integrity Level (SIL)" and in EN ISO 13849-1 by the "Performance Level" (PL) and "Categories".

The classic safety-related functions comprise the functions:

- Shutdown
- Procedures in an emergency situation
- Preventing unintentional start-up

Previously, these functions have generally been implemented by simple electromechanical components.

##### **"Functional Safety" with SINAMICS DCM**

With SINAMICS DCM, the safety requirement levels SIL 3 and PL e in the entire performance range can now be achieved by "Functional Safety" with only one main contactor or circuit breaker.

In addition, control via a safety relay or F-PLC is necessary.

This provides a consistently uniform solution for safety requirements up to SIL 3 and PL e, which also permits considerable savings in space, investment and service costs. The requirement levels covered are shown in the following table.

IEC 13849: PL	IEC 61508: SIL
PL e	SIL 3
PL d	SIL 2
PL c	SIL 1
PL b	
PL a	–

Functional Safety with SINAMICS DCM comprises the following safety functions as defined in IEC 61800-5-2:

- **Safe Torque Off, STO**  
This safety subfunction corresponds to an uncontrolled shutdown according to IEC 60204-1, stop category 0
- **Safe Stop 1, SS1**  
This safety subfunction corresponds to a controlled shutdown according to IEC 60204-1, stop category 1

Both safety functions have been tested and certified by TÜV SÜD.



### Overview



The series of SINAMICS DC MASTER DC Converters includes the following components:

- Electronics module with Control Unit (CUD) and slot for expansion using another CUD (in a cradle that can be swiveled out)
- Power section with thyristors in a fully-controlled three-phase bridge circuit configuration (two-quadrant drive: B6C or four-quadrant drive: (B6) A (B6) C)<sup>2)</sup>
- Fan (up to 125 A: self-ventilated)
- Single-quadrant field power section with integrated free-wheeling circuit (optionally, also without field or as two-quadrant field for highly dynamic field current changes with integrated field overvoltage protection)
- Electronics power supply
- Standard BOP20 operator panel (AOP30 Advanced Operator Panel as accessory)

### Technical specifications

#### General technical specifications

#### Relevant standards

EN 50178	Electronic equipment for use in power installations
EN 50274	Low-voltage switchgear and controlgear assemblies: Protection against electric shock – Protection against unintentional direct contact with hazardous live parts
EN 60146-1-1	Semiconductor converters: General requirements and line-commutated converters; specification of basic requirements
EN 61800-1	Adjustable speed electrical power drive systems, Part 1 – (DC drives) General requirements - Rating specifications for low voltage adjustable speed DC power drive systems
EN 61800-3	Adjustable speed electrical power drive systems, Part 3 – EMC product standard including specific test methods
EN 61800-5-1	Adjustable speed electrical power drive systems – Part 5-1: Safety requirements – Electrical, Thermal and Energy requirements
IEC 62103 (identical to EN 50178)	Electronic equipment for use in power installations
UBC 97	Uniform Building Code

#### Electrical specifications

Overvoltage category	Category II acc. to EN 61800-5-1 within line supply circuits Category III acc. to EN 61800-5-1 for line supply circuits with respect to the environment (other line supply circuits, housing, electronics)		
Overvoltage strength	Class 1 acc. to EN 50178		
Short-circuit current	Rated supply voltage	Rated DC current	Short-circuit current, max.
	V	A	kA
	400, 480 3 AC	15 ... 1200	65
		1600, 2000	85
		3000	100
	575, 690, 830, 950 3 AC	60 ... 850	65
950 ... 1600		85	
1900 ... 2800		100	
Radio interference suppression	No radio interference suppression according to EN 61800-3		

#### 1) Conditions:

The closed-loop control (PI control) stability is referred to the rated motor speed and applies when the SINAMICS DC MASTER is in the warm operating condition. This is based on the following preconditions:

- Temperature changes of  $\pm 10$  °C
- Line supply voltage changes of +10 % / -5 % of the rated input voltage
- Temperature coefficient of the tachometer generator with temperature compensation 0.15 ‰ every 10 °C (for analog tachometer generators only)
- Constant setpoint

#### 2)

In two-quadrant operation, the drive can operate in "driving" mode in one direction of rotation and in "braking" mode with regenerative feedback in the opposite direction of rotation. In four-quadrant operation, the drive can operate in "driving" mode and in "braking" mode with regenerative feedback in both directions of rotation.

**SINAMICS DCM**

## DC Converter and Control Module

## DC Converters

**Technical specifications**

## General technical specifications

**Mechanical data**

Degree of protection	IP00 acc. to EN 60529; IP20 with accessories "Mounting kit to upgrade to IP20" for units up to 850 A
Protection class	Class 1 acc. to EN 61140
Cooling method	<ul style="list-style-type: none"> <li>Units ≤ 125 A rated DC current: Permissible ambient temperature in operation 0 ... 45 °C – for higher ambient temperature, see current derating on page 3/8</li> <li>Units ≥ 210 A rated DC current: Permissible ambient temperature in operation Forced-air cooling with integrated fan 0 ... 40 °C – for higher ambient temperature, see current derating on page 3/8</li> </ul>
Closed-loop control stability	<ul style="list-style-type: none"> <li>for pulse encoder operation and digital setpoint <math>\Delta n = 0.006\%</math> of the rated motor speed</li> <li>for analog tachometer and analog setpoint <sup>1)</sup> <math>\Delta n = 0.1\%</math> of the rated motor speed</li> </ul>
MTBF	> 170000 h

**Environmental conditions**

Permissible ambient temperature during storage and transport	-40 ... +70 °C
Permissible humidity	Relative air humidity ≤ 95 % (75 % at 17 °C as average annual value, 95 % at 24 °C max., condensation not permissible)
Climate class	3K3 acc. to IEC 60721-3-3 : 2002
Insulation	Pollution degree 2 according to EN 61800-5-1 Condensation not permissible
Installation altitude	≤ 1000 m above sea level (100 % load capability) > 1000 ... 5000 m above sea level (see under "Coolant temperature and installation altitude" on page 3/8)

**Mechanical strength**

	Storage	Transport	Operation
Vibratory load	1M2 acc. to IEC 60721-3-1 : 1997 (dropping not permissible)	2M2 acc. to IEC 60721-3-2 : 1997 (dropping not permissible)	Constant deflection: 0.075 mm at 10 to 58 Hz Constant acceleration: 10 m/s <sup>2</sup> at > 58 to 200 Hz (testing and measuring techniques acc. to EN 60068-2-6, Fc)
Shock load			100 m/s <sup>2</sup> at 11 ms (testing and measuring techniques acc. to EN 60068-2-27, Ea)

**Approvals**

UL/cUL	UL file No.: E323473 Vol 2 Sec 1
UL 508 C (UL Standard for Power Conversion Equipment)	Certification of the units up to and including 575 V
GOST	
Lloyd's Register	In order to maintain the important limit values for marine certification, radio interference suppression filters should be used (see "Accessories and supplementary components") and option M08 (coated PCBs) should be selected.
Det Norske Veritas	
American Bureau of Shipping	
Germanischer Lloyd	

**Technical specifications**
**SINAMICS DC MASTER converters for 400 V 3 AC, 60 to 280 A, two-quadrant operation**

		Type				
		6RA8025-6DS22-0AA0	6RA8028-6DS22-0AA0	6RA8031-6DS22-0AA0	6RA8075-6DS22-0AA0	6RA8078-6DS22-0AA0
Rated armature supply voltage <sup>1)</sup>	V	50 (-10 %) ... 400 (+15 %) 3 AC				
Rated armature input current	A	50	75	104	174	232
Rated supply voltage, electronics power supply	V	380 (-25 %) ... 480 (+10 %) 2 AC; $I_n = 1$ A or 190 (-25 %) ... 240 (+10 %) 2 AC; $I_n = 2$ A				
Rated fan supply voltage	V	Self-ventilated			24 V DC internal	
Rated fan current	A				Internal supply	
Cooling air requirement	m <sup>3</sup> /h				300	
Sound pressure level <sup>2)</sup>	dB (A)				52.4	
Rated field supply voltage <sup>1)</sup>	V	50 (-10 %) ... 400 (+15 %) 2 AC				
Rated frequency	Hz	45 ... 65				
Rated DC voltage <sup>1)</sup>	V	485				
Rated DC current	A	<b>60</b>	<b>90</b>	<b>125</b>	<b>210</b>	<b>280</b>
Overload capability	$x \times I_n$	1.8				
Rated power	kW	29	44	61	102	136
Power loss at rated DC current	kW	0.25	0.36	0.41	0.69	0.81
Rated DC field voltage <sup>1)</sup>	V	Max. 325				
Rated DC field current	A	<b>10</b>			<b>15</b>	
Normal ambient temperature in operation <sup>3)</sup>	°C	0 ... +45			0 ... +40	
Storage and transport temperature	°C	-40 ... +70				
Installation altitude above sea level <sup>3)</sup>		≤ 1000 m for rated DC current				
Dimensions						
• Width	mm	268				
• Height	mm	385				
• Depth	mm	252				
Weight, approx.	kg	10	14			15

**Note:**

Detailed dimensional drawings in PDF and DXF format are available on the Internet at <http://support.automation.siemens.com/WW/view/en/81717045>.

**Data for single-phase connection**

		Type		
		6RA8025-6DS22-0AA0	6RA8028-6DS22-0AA0	6RA8031-6DS22-0AA0
Rated DC voltage	V	320		
Rated DC current	A	42.0	63.0	87.5

<sup>1)</sup> The specified output DC voltage can be maintained up to a voltage of 95 % of the maximum rated supply voltage.

<sup>2)</sup> Fan noise for a unit installed in an IP20 electrical cabinet (door closed, 50 Hz operation or operation at 24 V DC for units with an internal supply)

<sup>3)</sup> For derating factors at higher temperatures and installation altitudes, see page 3/8.

**SINAMICS DCM**

## DC Converter and Control Module

## DC Converters

**Technical specifications****SINAMICS DC MASTER converters for 400 V 3 AC, 400 to 1200 A, two-quadrant operation**

	Type	6RA8081-6DS22-0AA0			
		6RA8085-6DS22-0AA0	6RA8087-6DS22-0AA0	6RA8091-6DS22-0AA0	
Rated armature supply voltage <sup>1)</sup>	V	50 (-10 %) ... 400 (+15 %) 3 AC			
Rated armature input current	A	332	498	706	996
Rated supply voltage, electronics power supply	V	380 (-25 %) ... 480 (+10 %) 2 AC; $I_n = 1$ A or 190 (-25 %) ... 240 (+10 %) 2 AC; $I_n = 2$ A			
Rated fan supply voltage	V	400 V 3 AC $\pm$ 10 % (50 Hz) 460 V 3 AC $\pm$ 10 % (60 Hz)			
Rated fan current	A	0.23 <sup>3)</sup>			0.3 <sup>3)</sup>
Cooling air requirement	m <sup>3</sup> /h	600			1000
Sound pressure level <sup>2)</sup>	dB (A)	64.5			
Rated field supply voltage <sup>1)</sup>	V	50 (-10 %) ... 400 (+15 %) 2 AC			50 (-10 %) ... 480 (+10 %) 2 AC
Rated frequency	Hz	45 ... 65			
Rated DC voltage <sup>1)</sup>	V	485			
Rated DC current	A	<b>400</b>	<b>600</b>	<b>850</b>	<b>1200</b>
Overload capability	$x \times I_n$	1.8			
Rated power	kW	194	291	412	582
Power loss at rated DC current	kW	1.37	1.84	2.47	4.11
Rated DC field voltage <sup>1)</sup>	V	Max. 325			Max. 390
Rated DC field current	A	<b>25</b>		<b>30</b>	<b>40</b>
Normal ambient temperature in operation <sup>4)</sup>	°C	0 ... +40			
Storage and transport temperature	°C	-40 ... +70			
Installation altitude above sea level <sup>4)</sup>		$\leq$ 1000 m for rated DC current			
Dimensions					
• Width	mm	268			
• Height	mm			700	785
• Depth	mm	275		311	435
Weight, approx.	kg	26	28	38	78

Note:

Detailed dimensional drawings in PDF and DXF format are available on the Internet at <http://support.automation.siemens.com/WW/view/en/81717045>.

<sup>1)</sup> The specified output DC voltage can be maintained up to a voltage of 95 % of the maximum rated supply voltage.

<sup>2)</sup> Fan noise for a unit installed in an IP20 electrical cabinet (door closed, 50 Hz operation or operation at 24 V DC for units with an internal supply)

<sup>3)</sup> For fan motor type R2D220-AB02-19 in units 6RA8081, 6RA8085, and 6RA8087 with a rated voltage of 400 V or 575 V, UL systems require a Siemens motor circuit breaker of type 3RV1011-0DA1 or 3RV1011-0EA1, set to 0.3 A.

<sup>4)</sup> For derating factors at higher temperatures and installation altitudes, see page 3/8.

**Technical specifications**
**SINAMICS DC MASTER converters for 400 V 3 AC, 1600 to 3000 A, two-quadrant operation**

	Type	6RA8093-4DS22-0AAA0			6RA8095-4DS22-0AAA0			6RA8098-4DS22-0AAA0		
Rated armature supply voltage <sup>1)</sup>	V	50 (-10 %) ... 400 (+15 %) 3 AC						50 (-10 %) ... 400 (+10 %) 3 AC		
Rated armature input current	A	1328			1660			2490		
Rated supply voltage, electronics power supply	V	380 (-25 %) ... 480 (+10 %) 2 AC; $I_n = 1$ A or 190 (-25 %) ... 240 (+10 %) 2 AC; $I_n = 2$ A								
Rated fan supply voltage	V	400 V 3 AC $\pm$ 10 % (50 Hz) 460 V 3 AC $\pm$ 10 % (60 Hz)								
Rated fan current	A	1 <sup>3)</sup>								
Cooling air requirement	m <sup>3</sup> /h	2400								
Sound pressure level <sup>2)</sup>	dB (A)	75.6								
Rated field supply voltage <sup>1)</sup>	V	50 (-10 %) ... 480 (+10 %) 2 AC								
Rated frequency	Hz	45 ... 65								
Rated DC voltage <sup>1)</sup>	V	485								
Rated DC current	A	<b>1600</b>			<b>2000</b>			<b>3000</b>		
Overload capability	$x \times I_n$	1.8								
Rated power	kW	776			970			1455		
Power loss at rated DC current	kW	5.68			6.78			10.64		
Rated DC field voltage <sup>1)</sup>	V	Max. 390								
Rated DC field current	A	<b>40</b>								
Normal ambient temperature in operation <sup>4)</sup>	°C	0 ... +40								
Storage and transport temperature	°C	-40 ... +70								
Installation altitude above sea level <sup>4)</sup>		$\leq 1000$ m for rated DC current								
Dimensions										
• Width	mm	453								
• Height	mm	883								
• Depth	mm	505								
Weight, approx.	kg	135						165		

**Note:**

Detailed dimensional drawings in PDF and DXF format are available on the Internet at <http://support.automation.siemens.com/WW/view/en/81717045>.

<sup>1)</sup> The specified output DC voltage can be maintained up to a voltage of 95 % of the maximum rated supply voltage.

<sup>2)</sup> Fan noise for a unit installed in an IP20 electrical cabinet (door closed, 50 Hz operation or operation at 24 V DC for units with an internal supply)

<sup>3)</sup> For fan motor type RH28M-2DK.3F.1R in units 6RA8090, 6RA8091, 6RA8093, and 6RA8095 with a rated voltage of 400 V or 575 V, UL systems require a Siemens motor circuit breaker of type 3RV1011-0KA1 or 3RV1011-1AA1, set to 1.25 A.

<sup>4)</sup> For derating factors at higher temperatures and installation altitudes, see page 3/8.

**SINAMICS DCM**

## DC Converter and Control Module

## DC Converters

**Technical specifications****SINAMICS DC MASTER converters for 480 V 3 AC, 60 to 280 A, two-quadrant operation**

		Type				
		6RA8025-6FS22-0AA0	6RA8028-6FS22-0AA0	6RA8031-6FS22-0AA0	6RA8075-6FS22-0AA0	6RA8078-6FS22-0AA0
Rated armature supply voltage <sup>1)</sup>	V	50 (-10 %) ... 480 (+10 %) 3 AC				
Rated armature input current	A	50	75	104	174	232
Rated supply voltage, electronics power supply	V	380 (-25 %) ... 480 (+10 %) 2 AC; $I_n = 1$ A or 190 (-25 %) ... 240 (+10 %) 2 AC; $I_n = 2$ A				
Rated fan supply voltage	V	Self-ventilated			24 V DC internal	
Rated fan current	A				Internal supply	
Cooling air requirement	m <sup>3</sup> /h				300	
Sound pressure level <sup>2)</sup>	dB (A)				52.4	
Rated field supply voltage <sup>1)</sup>	V	50 (-10 %) ... 480 (+10 %) 2 AC				
Rated frequency	Hz	45 ... 65				
Rated DC voltage <sup>1)</sup>	V	575				
Rated DC current	A	<b>60</b>	<b>90</b>	<b>125</b>	<b>210</b>	<b>280</b>
Overload capability	$x \times I_n$	1.8				
Rated power	kW	35	52	72	121	161
Power loss at rated DC current	kW	0.30	0.38	0.43	0.72	0.81
Rated DC field voltage <sup>1)</sup>	V	Max. 390				
Rated DC field current	A	<b>10</b>			<b>15</b>	
Normal ambient temperature in operation <sup>3)</sup>	°C	0 ... +45			0 ... +40	
Storage and transport temperature	°C	-40 ... +70				
Installation altitude above sea level <sup>3)</sup>		≤ 1000 m for rated DC current				
Dimensions						
• Width	mm	268				
• Height	mm	385				
• Depth	mm	252				
Weight, approx.	kg	11	14			15

**Note:**

Detailed dimensional drawings in PDF and DXF format are available on the Internet at <http://support.automation.siemens.com/WW/view/en/81717045>.

**Data for single-phase connection**

		Type		
		6RA8025-6FS22-0AA0	6RA8028-6FS22-0AA0	6RA8031-6FS22-0AA0
Rated DC voltage	V	385		
Rated DC current	A	42.0	63.0	87.5

<sup>1)</sup> The specified output DC voltage can be maintained up to a voltage of 95 % of the maximum rated supply voltage.

<sup>2)</sup> Fan noise for a unit installed in an IP20 electrical cabinet (door closed, 50 Hz operation or operation at 24 V DC for units with an internal supply)

<sup>3)</sup> For derating factors at higher temperatures and installation altitudes, see page 3/8.

**Technical specifications**
**SINAMICS DC MASTER converters for 480 V 3 AC, 450 to 1200 A, two-quadrant operation**

	Type	6RA8082-6FS22-0AAA0			
		6RA8085-6FS22-0AAA0	6RA8087-6FS22-0AAA0	6RA8091-6FS22-0AAA0	
Rated armature supply voltage <sup>1)</sup>	V	50 (-10 %) ... 480 (+10 %) 3 AC			
Rated armature input current	A	374	498	706	996
Rated supply voltage, electronics power supply	V	380 (-25 %) ... 480 (+10 %) 2 AC; $I_n = 1$ A or 190 (-25 %) ... 240 (+10 %) 2 AC; $I_n = 2$ A			
Rated fan supply voltage	V	400 V 3 AC $\pm$ 10 % (50 Hz) 460 V 3 AC $\pm$ 10 % (60 Hz)			
Rated fan current	A	0.23 <sup>3)</sup>			0.3 <sup>3)</sup>
Cooling air requirement	m <sup>3</sup> /h	600			1000
Sound pressure level <sup>2)</sup>	dB (A)	64.5			
Rated field supply voltage <sup>1)</sup>	V	50 (-10 %) ... 480 (+10 %) 2 AC			
Rated frequency	Hz	45 ... 65			
Rated DC voltage <sup>1)</sup>	V	575			
Rated DC current	A	<b>450</b>	<b>600</b>	<b>850</b>	<b>1200</b>
Overload capability	$x \times I_n$	1.8			
Rated power	kW	259	345	489	690
Power loss at rated DC current	kW	1.58	1.91	2.60	4.24
Rated DC field voltage <sup>1)</sup>	V	Max. 390			
Rated DC field current	A	<b>25</b>		<b>30</b>	<b>40</b>
Normal ambient temperature in operation <sup>4)</sup>	°C	0 ... +40			
Storage and transport temperature	°C	-40 ... +70			
Installation altitude above sea level <sup>4)</sup>		$\leq$ 1000 m for rated DC current			
Dimensions					
• Width	mm	268			
• Height	mm	625		700	785
• Depth	mm	275		311	435
Weight, approx.	kg	28		38	78

**Note:**

Detailed dimensional drawings in PDF and DXF format are available on the Internet at <http://support.automation.siemens.com/WW/view/en/81717045>.

<sup>1)</sup> The specified output DC voltage can be maintained up to a voltage of 95 % of the maximum rated supply voltage.

<sup>2)</sup> Fan noise for a unit installed in an IP20 electrical cabinet (door closed, 50 Hz operation or operation at 24 V DC for units with an internal supply)

<sup>3)</sup> For fan motor type R2D220-AB02-19 in units 6RA8081, 6RA8085, and 6RA8087 with a rated voltage of 400 V or 575 V, UL systems require a Siemens motor circuit breaker of type 3RV1011-0DA1 or 3RV1011-0EA1, set to 0.3 A.

<sup>4)</sup> For derating factors at higher temperatures and installation altitudes, see page 3/8.

**SINAMICS DCM**

## DC Converter and Control Module

## DC Converters

**Technical specifications****SINAMICS DC MASTER converters for 575 V 3 AC, 60 to 800 A, two-quadrant operation**

		Type					
		6RA8025-6GS22-0AA0	6RA8031-6GS22-0AA0	6RA8075-6GS22-0AA0	6RA8081-6GS22-0AA0	6RA8085-6GS22-0AA0	6RA8087-6GS22-0AA0
Rated armature supply voltage <sup>1)</sup>	V	50 (-10 %) ... 575 (+10 %) 3 AC					
Rated armature input current	A	50	104	174	332	498	664
Rated supply voltage, electronics power supply	V	380 (-25 %) ... 480 (+10 %) 2 AC; $I_n = 1$ A or 190 (-25 %) ... 240 (+10 %) 2 AC; $I_n = 2$ A					
Rated fan supply voltage	V	Self-ventilated		24 V DC internal	400 V 3 AC $\pm$ 10 % (50 Hz) 460 V 3 AC $\pm$ 10 % (60 Hz)		
Rated fan current	A			Internal supply	0.23 <sup>3)</sup>		
Cooling air requirement	m <sup>3</sup> /h			300	600		
Sound pressure level <sup>2)</sup>	dB (A)			52.4	64.5		
Rated field supply voltage <sup>1)</sup>	V	50 (-10 %) ... 480 (+10 %) 2 AC					
Rated frequency	Hz	45 ... 65					
Rated DC voltage <sup>1)</sup>	V	690					
Rated DC current	A	<b>60</b>	<b>125</b>	<b>210</b>	<b>400</b>	<b>600</b>	<b>800</b>
Overload capability	$x \times I_n$	1.8					
Rated power	kW	41	86	145	276	414	552
Power loss at rated DC current	kW	0.27	0.46	0.74	1.60	2.00	2.69
Rated DC field voltage <sup>1)</sup>	V	Max. 390					
Rated DC field current	A	<b>10</b>		<b>15</b>	<b>25</b>	<b>30</b>	
Normal ambient temperature in operation <sup>4)</sup>	°C	0 ... +45		0 ... +40			
Storage and transport temperature	°C	-40 ... +70					
Installation altitude above sea level <sup>4)</sup>		$\leq$ 1000 m for rated DC current					
Dimensions							
• Width	mm	268					
• Height	mm	385			625		700
• Depth	mm	252			275		311
Weight, approx.	kg	11	14		26	28	38

## Note:

Detailed dimensional drawings in PDF and DXF format are available on the Internet at <http://support.automation.siemens.com/WW/view/en/81717045>.

**Data for single-phase connection**

		Type	
		6RA8025-6GS22-0AA0	6RA8031-6GS22-0AA0
Rated DC voltage	V	460	
Rated DC current	A	42.0	87.5

<sup>1)</sup> The specified output DC voltage can be maintained up to a voltage of 95 % of the maximum rated supply voltage.

<sup>2)</sup> Fan noise for a unit installed in an IP20 electrical cabinet (door closed, 50 Hz operation or operation at 24 V DC for units with an internal supply)

<sup>3)</sup> For fan motor type R2D220-AB02-19 in units 6RA8081, 6RA8085, and 6RA8087 with a rated voltage of 400 V or 575 V. UL systems require a Siemens motor circuit breaker of type 3RV1011-0DA1 or 3RV1011-0EA1, set to 0.3 A.

<sup>4)</sup> For derating factors at higher temperatures and installation altitudes, see page 3/8.



**Technical specifications**
**SINAMICS DC MASTER converters for 575 V 3 AC, 1100 to 2800 A, two-quadrant operation**

	Type	Type				
		6RA8090-6GS22-0AAA0	6RA8093-4GS22-0AAA0	6RA8095-4GS22-0AAA0	6RA8096-4GS22-0AAA0	6RA8097-4GS22-0AAA0
Rated armature supply voltage <sup>1)</sup>	V	50 (-10 %) ... 575 (+10 %) 3 AC				
Rated armature input current	A	913	1328	1660	1826	2324
Rated supply voltage, electronics power supply	V	380 (-25 %) ... 480 (+10 %) 2 AC; $I_n = 1$ A or 190 (-25 %) ... 240 (+10 %) 2 AC; $I_n = 2$ A				
Rated fan supply voltage	V	400 V 3 AC $\pm$ 10 % (50 Hz) 460 V 3 AC $\pm$ 10 % (60 Hz)				
Rated fan current	A	0.3 <sup>3)</sup>	1 <sup>4)</sup>			
Cooling air requirement	m <sup>3</sup> /h	1000	2400			
Sound pressure level <sup>2)</sup>	dB (A)	64.5	75.6			
Rated field supply voltage <sup>1)</sup>	V	50 (-10 %) ... 480 (+10 %) 2 AC				
Rated frequency	Hz	45 ... 65				
Rated DC voltage <sup>1)</sup>	V	690				
Rated DC current	A	<b>1100</b>	<b>1600</b>	<b>2000</b>	<b>2200</b>	<b>2800</b>
Overload capability	$x \times I_n$	1.8				
Rated power	kW	759	1104	1380	1518	1932
Power loss at rated DC current	kW	4.02	6.04	7.07	7.39	10.53
Rated DC field voltage <sup>1)</sup>	V	Max. 390				
Rated DC field current	A	<b>40</b>				
Normal ambient temperature in operation <sup>5)</sup>	°C	0 ... +40				
Storage and transport temperature	°C	-40 ... +70				
Installation altitude above sea level <sup>5)</sup>		$\leq$ 1000 m for rated DC current				
Dimensions						
• Width	mm	268	453			
• Height	mm	785	883			
• Depth	mm	435	505			
Weight, approx.	kg	78	135		165	

**Note:**

Detailed dimensional drawings in PDF and DXF format are available on the Internet at <http://support.automation.siemens.com/WW/view/en/81717045>.

- <sup>1)</sup> The specified output DC voltage can be maintained up to a voltage of 95 % of the maximum rated supply voltage.
- <sup>2)</sup> Fan noise for a unit installed in an IP20 electrical cabinet (door closed, 50 Hz operation or operation at 24 V DC for units with an internal supply)
- <sup>3)</sup> For fan motor type R2D220-AB02-19 in units 6RA8081, 6RA8085, and 6RA8087 with a rated voltage of 400 V or 575 V, UL systems require a Siemens motor circuit breaker of type 3RV1011-0DA1 or 3RV1011-0EA1, set to 0.3 A.

- <sup>4)</sup> For fan motor type RH28M-2DK.3F.1R in units 6RA8090, 6RA8091, 6RA8093, and 6RA8095 with a rated voltage of 400 V or 575 V, UL systems require a Siemens motor circuit breaker of type 3RV1011-0KA1 or 3RV1011-1AA1, set to 1.25 A.

- <sup>5)</sup> For derating factors at higher temperatures and installation altitudes, see page 3/8.

**SINAMICS DCM**

## DC Converter and Control Module

## DC Converters

**Technical specifications****SINAMICS DC MASTER converters for 690 V 3 AC, 720 to 2600 A, two-quadrant operation**

	Type	Type				
		6RA8086-6KS22-0AAA0	6RA8090-6KS22-0AAA0	6RA8093-4KS22-0AAA0	6RA8095-4KS22-0AAA0	6RA8097-4KS22-0AAA0
Rated armature supply voltage <sup>1)</sup>	V	100 (-10 %) ... 690 (+10 %) 3 AC				
Rated armature input current	A	598	830	1245	1660	2158
Rated supply voltage, electronics power supply	V	380 (-25 %) ... 480 (+10 %) 2 AC; $I_n = 1$ A or 190 (-25 %) ... 240 (+10 %) 2 AC; $I_n = 2$ A				
Rated fan supply voltage	V	400 V 3 AC $\pm$ 10 % (50 Hz) 460 V 3 AC $\pm$ 10 % (60 Hz)				
Rated fan current	A	0.23 <sup>3)</sup>	0.3 <sup>3)</sup>	1 <sup>4)</sup>		
Cooling air requirement	m <sup>3</sup> /h	600	1000	2400		
Sound pressure level <sup>2)</sup>	dB (A)	64.5			75.6	
Rated field supply voltage <sup>1)</sup>	V	100 (-10 %) ... 690 (+10 %) 3 AC				
Rated frequency	Hz	45 ... 65				
Rated DC voltage <sup>1)</sup>	V	830				
Rated DC current	A	<b>720</b>	<b>1000</b>	<b>1500</b>	<b>2000</b>	<b>2600</b>
Overload capability	$x \times I_n$	1.8				
Rated power	kW	598	830	1245	1660	2158
Power loss at rated DC current	kW	2.77	3.96	6.67	8.16	10.30
Rated DC field voltage <sup>1)</sup>	V	Max. 390				
Rated DC field current	A	<b>30</b>	<b>40</b>			
Normal ambient temperature in operation <sup>5)</sup>	°C	0 ... +40				
Storage and transport temperature	°C	-40 ... +70				
Installation altitude above sea level <sup>5)</sup>		$\leq$ 1000 m for rated DC current				
Dimensions						
• Width	mm	268		453		
• Height	mm	700	785	883		
• Depth	mm	311	435	505		
Weight, approx.	kg	38	78	135		165

## Note:

Detailed dimensional drawings in PDF and DXF format are available on the Internet at <http://support.automation.siemens.com/WW/view/en/81717045>.

- <sup>1)</sup> The specified output DC voltage can be maintained up to a voltage of 95 % of the maximum rated supply voltage.
- <sup>2)</sup> Fan noise for a unit installed in an IP20 electrical cabinet (door closed, 50 Hz operation or operation at 24 V DC for units with an internal supply)
- <sup>3)</sup> For fan motor type R2D220-AB02-19 in units 6RA8081, 6RA8085, and 6RA8087 with a rated voltage of 400 V or 575 V, UL systems require a Siemens motor circuit breaker of type 3RV1011-0DA1 or 3RV1011-0EA1, set to 0.3 A.

- <sup>4)</sup> For fan motor type RH28M-2DK.3F.1R in units 6RA8090, 6RA8091, 6RA8093, and 6RA8095 with a rated voltage of 400 V or 575 V, UL systems require a Siemens motor circuit breaker of type 3RV1011-0KA1 or 3RV1011-1AA1, set to 1.25 A.
- <sup>5)</sup> For derating factors at higher temperatures and installation altitudes, see page 3/8.

**Technical specifications**
**SINAMICS DC MASTER converters for 830 V 3 AC, 950 to 1900 A and 950 V 3 AC, 2200 A, two-quadrant operation**

	Type	Type			
		6RA8088-6LS22-0AAA0	6RA8093-4LS22-0AAA0	6RA8095-4LS22-0AAA0	6RA8096-4MS22-0AAA0
Rated armature supply voltage <sup>1)</sup>	V	100 (-10 %) ... 830 (+10 %) 3 AC			100 (-10 %) ... 950 (+15 %) 3 AC
Rated armature input current	A	789	1245	1577	1826
Rated supply voltage, electronics power supply	V	380 (-25 %) ... 480 (+10 %) 2 AC; $I_n = 1$ A or 190 (-25 %) ... 240 (+10 %) 2 AC; $I_n = 2$ A			
Rated fan supply voltage	V	400 V 3 AC $\pm$ 10 % (50 Hz) 460 V 3 AC $\pm$ 10 % (60 Hz)			
Rated fan current	A	0.3 <sup>3)</sup>	1 <sup>4)</sup>		
Cooling air requirement	m <sup>3</sup> /h	1000	2400		
Sound pressure level <sup>2)</sup>	dB (A)	64.5	75.6		
Rated field supply voltage <sup>1)</sup>	V	50 (-10 %) ... 480 (+10 %) 2 AC			
Rated frequency	Hz	45 ... 65			
Rated DC voltage <sup>1)</sup>	V	1000			1140
Rated DC current	A	<b>950</b>	<b>1500</b>	<b>1900</b>	<b>2200</b>
Overload capability	$x \times I_n$	1.8			
Rated power	kW	950	1500	1900	2508
Power loss at rated DC current	kW	4.22	7.12	8.67	11.34
Rated DC field voltage <sup>1)</sup>	V	Max. 390			
Rated DC field current	A	<b>40</b>			
Normal ambient temperature in operation <sup>5)</sup>	°C	0 ... +40			
Storage and transport temperature	°C	-40 ... +70			
Installation altitude above sea level <sup>5)</sup>		$\leq$ 1000 m for rated DC current			
Dimensions					
• Width	mm	268	453		
• Height	mm	785	883		
• Depth	mm	435	505		
Weight, approx.	kg	78	135	165	

**Note:**

Detailed dimensional drawings in PDF and DXF format are available on the Internet at <http://support.automation.siemens.com/WW/view/en/81717045>.

- <sup>1)</sup> The specified output DC voltage can be maintained up to a voltage of 95 % of the maximum rated supply voltage.
- <sup>2)</sup> Fan noise for a unit installed in an IP20 electrical cabinet (door closed, 50 Hz operation or operation at 24 V DC for units with an internal supply)
- <sup>3)</sup> For fan motor type R2D220-AB02-19 in units 6RA8081, 6RA8085, and 6RA8087 with a rated voltage of 400 V or 575 V, UL systems require a Siemens motor circuit breaker of type 3RV1011-0DA1 or 3RV1011-0EA1, set to 0.3 A.

- <sup>4)</sup> For fan motor type RH28M-2DK.3F.1R in units 6RA8090, 6RA8091, 6RA8093, and 6RA8095 with a rated voltage of 400 V or 575 V, UL systems require a Siemens motor circuit breaker of type 3RV1011-0KA1 or 3RV1011-1AA1, set to 1.25 A.
- <sup>5)</sup> For derating factors at higher temperatures and installation altitudes, see page 3/8.

**SINAMICS DCM**

## DC Converter and Control Module

## DC Converters

**Technical specifications****SINAMICS DC MASTER converters for 400 V 3 AC, 15 to 125 A, four-quadrant operation**

		Type				
		6RA8013-6DV62-0AA0	6RA8018-6DV62-0AA0	6RA8025-6DV62-0AA0	6RA8028-6DV62-0AA0	6RA8031-6DV62-0AA0
Rated armature supply voltage <sup>1)</sup>	V	50 (-10 %) ... 400 (+15 %) 3 AC				
Rated armature input current	A	12	25	50	75	104
Rated supply voltage, electronics power supply	V	380 (-25 %) ... 480 (+10 %) 2 AC; $I_n = 1$ A or 190 (-25 %) ... 240 (+10 %) 2 AC; $I_n = 2$ A				
Rated fan supply voltage	V	Self-ventilated				
Rated fan current	A					
Cooling air requirement	m <sup>3</sup> /h					
Sound pressure level <sup>2)</sup>	dB (A)					
Rated field supply voltage <sup>1)</sup>	V	50 (-10 %) ... 400 (+15 %) 2 AC				
Rated frequency	Hz	45 ... 65				
Rated DC voltage <sup>1)</sup>	V	420				
Rated DC current	A	<b>15</b>	<b>30</b>	<b>60</b>	<b>90</b>	<b>125</b>
Overload capability	$x \times I_n$	1.8				
Rated power	kW	6.3	12.6	25	38	53
Power loss at rated DC current	kW	0.13	0.18	0.25	0.32	0.41
Rated DC field voltage <sup>1)</sup>	V	Max. 325				
Rated DC field current	A	<b>3</b>	<b>5</b>	<b>10</b>		
Normal ambient temperature in operation <sup>3)</sup>	°C	0 ... +45				
Storage and transport temperature	°C	-40 ... +70				
Installation altitude above sea level <sup>3)</sup>		≤ 1000 m for rated DC current				
Dimensions						
• Width	mm	268				
• Height	mm	385				
• Depth	mm	221			252	
Weight, approx.	kg	11			14	

**Note:**

Detailed dimensional drawings in PDF and DXF format are available on the Internet at <http://support.automation.siemens.com/WW/view/en/81717045>.

**Data for single-phase connection**

		Type				
		6RA8013-6DV62-0AA0	6RA8018-6DV62-0AA0	6RA8025-6DV62-0AA0	6RA8028-6DV62-0AA0	6RA8031-6DV62-0AA0
Rated DC voltage	V	280				
Rated DC current	A	10.5	21.0	42.0	63.0	87.5

<sup>1)</sup> The specified output DC voltage can be maintained up to a voltage of 95 % of the maximum rated supply voltage.

<sup>2)</sup> Fan noise for a unit installed in an IP20 electrical cabinet (door closed, 50 Hz operation or operation at 24 V DC for units with an internal supply)

<sup>3)</sup> For derating factors at higher temperatures and installation altitudes, see page 3/8.

**Technical specifications**
**SINAMICS DC MASTER converters for 400 V 3 AC, 210 to 850 A, four-quadrant operation**

	Type	6RA8075-6DV62-0AAA0				
		6RA8075-6DV62-0AAA0	6RA8078-6DV62-0AAA0	6RA8081-6DV62-0AAA0	6RA8085-6DV62-0AAA0	6RA8087-6DV62-0AAA0
Rated armature supply voltage <sup>1)</sup>	V	50 (-10 %) ... 400 (+15 %) 3 AC				
Rated armature input current	A	174	232	332	498	706
Rated supply voltage, electronics power supply	V	380 (-25 %) ... 480 (+10 %) 2 AC; $I_n = 1$ A or 190 (-25 %) ... 240 (+10 %) 2 AC; $I_n = 2$ A				
Rated fan supply voltage	V	24 V DC internal			400 V 3 AC $\pm$ 10 % (50 Hz) 460 V 3 AC $\pm$ 10 % (60 Hz)	
Rated fan current	A	Internal supply			0.23 <sup>3)</sup>	
Cooling air requirement	m <sup>3</sup> /h	300			600	
Sound pressure level <sup>2)</sup>	dB (A)	52.4			64.5	
Rated field supply voltage <sup>1)</sup>	V	50 (-10 %) ... 400 (+15 %) 2 AC				
Rated frequency	Hz	45 ... 65				
Rated DC voltage <sup>1)</sup>	V	420				
Rated DC current	A	<b>210</b>	<b>280</b>	<b>400</b>	<b>600</b>	<b>850</b>
Overload capability	$x \times I_n$	1.8				
Rated power	kW	88	118	168	252	357
Power loss at rated DC current	kW	0.69	0.81	1.37	1.84	2.47
Rated DC field voltage <sup>1)</sup>	V	Max. 325				
Rated DC field current	A	<b>15</b>		<b>25</b>		<b>30</b>
Normal ambient temperature in operation <sup>4)</sup>	°C	0 ... +40				
Storage and transport temperature	°C	-40 ... +70				
Installation altitude above sea level <sup>4)</sup>		$\leq$ 1000 m for rated DC current				
Dimensions						
• Width	mm	268				
• Height	mm	385			625	
• Depth	mm	252			275	
Weight, approx.	kg	15			26	
					31	
					42	

**Note:**

Detailed dimensional drawings in PDF and DXF format are available on the Internet at <http://support.automation.siemens.com/WW/view/en/81717045>.

<sup>1)</sup> The specified output DC voltage can be maintained up to a voltage of 95 % of the maximum rated supply voltage.

<sup>2)</sup> Fan noise for a unit installed in an IP20 electrical cabinet (door closed, 50 Hz operation or operation at 24 V DC for units with an internal supply)

<sup>3)</sup> For fan motor type R2D220-AB02-19 in units 6RA8081, 6RA8085, and 6RA8087 with a rated voltage of 400 V or 575 V, UL systems require a Siemens motor circuit breaker of type 3RV1011-0DA1 or 3RV1011-0EA1, set to 0.3 A.

<sup>4)</sup> For derating factors at higher temperatures and installation altitudes, see page 3/8.

**SINAMICS DCM**

## DC Converter and Control Module

## DC Converters

**Technical specifications****SINAMICS DC MASTER converters for 400 V 3 AC, 1200 to 3000 A, four-quadrant operation**

	Type	6RA8091-6DV62-0AAA0			
		6RA8093-4DV62-0AAA0	6RA8095-4DV62-0AAA0	6RA8098-4DV62-0AAA0	
Rated armature supply voltage <sup>1)</sup>	V	50 (-10 %) ... 400 (+15 %) 3 AC			50 (-10 %) ... 400 (+10 %) 3 AC
Rated armature input current	A	996	1328	1660	2490
Rated supply voltage, electronics power supply	V	380 (-25 %) ... 480 (+10 %) 2 AC; $I_n = 1$ A or 190 (-25 %) ... 240 (+10 %) 2 AC; $I_n = 2$ A			
Rated fan supply voltage	V	400 V 3 AC $\pm$ 10 % (50 Hz) 460 V 3 AC $\pm$ 10 % (60 Hz)			
Rated fan current	A	0.3 <sup>3)</sup>	1 <sup>4)</sup>		
Cooling air requirement	m <sup>3</sup> /h	1000	2400		
Sound pressure level <sup>2)</sup>	dB (A)	64.5	75.6		
Rated field supply voltage <sup>1)</sup>	V	50 (-10 %) ... 480 (+10 %) 2 AC			
Rated frequency	Hz	45 ... 65			
Rated DC voltage <sup>1)</sup>	V	420			
Rated DC current	A	<b>1200</b>	<b>1600</b>	<b>2000</b>	<b>3000</b>
Overload capability	$x \times I_n$	1.8			
Rated power	kW	504	672	840	1260
Power loss at rated DC current	kW	4.11	5.68	6.78	10.64
Rated DC field voltage <sup>1)</sup>	V	Max. 390			
Rated DC field current	A	<b>40</b>			
Normal ambient temperature in operation <sup>4)</sup>	°C	0 ... +40			
Storage and transport temperature	°C	-40 ... +70			
Installation altitude above sea level <sup>4)</sup>		$\leq$ 1000 m for rated DC current			
Dimensions					
• Width	mm	268	453		
• Height	mm	785	883		
• Depth	mm	435	505		
Weight, approx.	kg	78	155		185

## Note:

Detailed dimensional drawings in PDF and DXF format are available on the Internet at <http://support.automation.siemens.com/WW/view/en/81717045>.

<sup>1)</sup> The specified output DC voltage can be maintained up to a voltage of 95 % of the maximum rated supply voltage.

<sup>2)</sup> Fan noise for a unit installed in an IP20 electrical cabinet (door closed, 50 Hz operation or operation at 24 V DC for units with an internal supply)

<sup>3)</sup> For fan motor type R2D220-AB02-19 in units 6RA8081, 6RA8085, and 6RA8087 with a rated voltage of 400 V or 575 V. UL systems require a Siemens motor circuit breaker of type 3RV1011-0DA1 or 3RV1011-0EA1, set to 0.3 A.

<sup>4)</sup> For derating factors at higher temperatures and installation altitudes, see page 3/8.

**Technical specifications**
**SINAMICS DC MASTER converters for 480 V 3 AC, 15 to 210 A, four-quadrant operation**

		Type						
		6RA8013-6FV62-0AA0	6RA8018-6FV62-0AA0	6RA8025-6FV62-0AA0	6RA8028-6FV62-0AA0	6RA8031-6FV62-0AA0	6RA8075-6FV62-0AA0	
Rated armature supply voltage <sup>1)</sup>	V	50 (-10 %) ... 480 (+10 %) 3 AC						
Rated armature input current	A	12	25	50	75	104	174	
Rated supply voltage, electronics power supply	V	380 (-25 %) ... 480 (+10 %) 2 AC; $I_n = 1$ A or 190 (-25 %) ... 240 (+10 %) 2 AC; $I_n = 2$ A						
Rated fan supply voltage	V	Self-ventilated						24 V DC internal
Rated fan current	A							Internal supply
Cooling air requirement	m <sup>3</sup> /h							300
Sound pressure level <sup>2)</sup>	dB (A)							52.4
Rated field supply voltage <sup>1)</sup>	V	50 (-10 %) ... 480 (+10 %) 2 AC						
Rated frequency	Hz	45 ... 65						
Rated DC voltage <sup>1)</sup>	V	500						
Rated DC current	A	<b>15</b>	<b>30</b>	<b>60</b>	<b>90</b>	<b>125</b>	<b>210</b>	
Overload capability	$x \times I_n$	1.8						
Rated power	kW	6	15	30	45	63	105	
Power loss at rated DC current	kW	0.13	0.19	0.30	0.34	0.43	0.72	
Rated DC field voltage <sup>1)</sup>	V	Max. 390						
Rated DC field current	A	<b>3</b>	<b>5</b>	<b>10</b>	<b>10</b>	<b>10</b>	<b>15</b>	
Normal ambient temperature in operation <sup>3)</sup>	°C	0 ... +45						0 ... +40
Storage and transport temperature	°C	-40 ... +70						
Installation altitude above sea level <sup>3)</sup>		≤ 1000 m for rated DC current						
Dimensions								
• Width	mm	268						
• Height	mm	385						
• Depth	mm	221				252		
Weight, approx.	kg	11			14		15	

**Note:**

Detailed dimensional drawings in PDF and DXF format are available on the Internet at <http://support.automation.siemens.com/WW/view/en/81717045>.

**Data for single-phase connection**

		Type				
		6RA8013-6FV62-0AA0	6RA8018-6FV62-0AA0	6RA8025-6FV62-0AA0	6RA8028-6FV62-0AA0	6RA8031-6FV62-0AA0
Rated DC voltage	V	335				
Rated DC current	A	10.5	21.0	42.0	63.0	87.5

<sup>1)</sup> The specified output DC voltage can be maintained up to a voltage of 95 % of the maximum rated supply voltage.

<sup>2)</sup> Fan noise for a unit installed in an IP20 electrical cabinet (door closed, 50 Hz operation or operation at 24 V DC for units with an internal supply)

<sup>3)</sup> For derating factors at higher temperatures and installation altitudes, see page 3/8.

**SINAMICS DCM**

## DC Converter and Control Module

## DC Converters

**Technical specifications****SINAMICS DC MASTER converters for 480 V 3 AC, 280 to 1200 A, four-quadrant operation**

	Type	Type				
		6RA8078-6FV62-0AA0	6RA8082-6FV62-0AA0	6RA8085-6FV62-0AA0	6RA8087-6FV62-0AA0	6RA8091-6FV62-0AA0
Rated armature supply voltage <sup>1)</sup>	V	50 (-10 %) ... 480 (+10 %) 3 AC				
Rated armature input current	A	232	374	498	706	996
Rated supply voltage, electronics power supply	V	380 (-25 %) ... 480 (+10 %) 2 AC; $I_n = 1$ A or 190 (-25 %) ... 240 (+10 %) 2 AC; $I_n = 2$ A				
Rated fan supply voltage	V	24 V DC internal	400 V 3 AC $\pm$ 10 % (50 Hz) 460 V 3 AC $\pm$ 10 % (60 Hz)			
Rated fan current	A	Internal supply	0.23 <sup>3)</sup>		0.3 <sup>3)</sup>	
Cooling air requirement	m <sup>3</sup> /h	300	600		1000	
Sound pressure level <sup>2)</sup>	dB (A)	52.4	64.5			
Rated field supply voltage <sup>1)</sup>	V	50 (-10 %) ... 480 (+10 %) 2 AC				
Rated frequency	Hz	45 ... 65				
Rated DC voltage <sup>1)</sup>	V	500				
Rated DC current	A	<b>280</b>	<b>450</b>	<b>600</b>	<b>850</b>	<b>1200</b>
Overload capability	$x \times I_n$	1.8				
Rated power	kW	140	225	300	425	600
Power loss at rated DC current	kW	0.81	1.58	1.91	2.60	4.24
Rated DC field voltage <sup>1)</sup>	V	Max. 390				
Rated DC field current	A	<b>15</b>	<b>25</b>	<b>25</b>	<b>30</b>	<b>40</b>
Normal ambient temperature in operation <sup>4)</sup>	°C	0 ... +40				
Storage and transport temperature	°C	-40 ... +70				
Installation altitude above sea level <sup>4)</sup>		$\leq$ 1000 m for rated DC current				
Dimensions						
• Width	mm	268				
• Height	mm	385	625		700	785
• Depth	mm	252	275		311	435
Weight, approx.	kg	15	31		42	78

## Note:

Detailed dimensional drawings in PDF and DXF format are available on the Internet at <http://support.automation.siemens.com/WW/view/en/81717045>.

<sup>1)</sup> The specified output DC voltage can be maintained up to a voltage of 95 % of the maximum rated supply voltage.

<sup>2)</sup> Fan noise for a unit installed in an IP20 electrical cabinet (door closed, 50 Hz operation or operation at 24 V DC for units with an internal supply)

<sup>3)</sup> For fan motor type R2D220-AB02-19 in units 6RA8081, 6RA8085, and 6RA8087 with a rated voltage of 400 V or 575 V, UL systems require a Siemens motor circuit breaker of type 3RV1011-0DA1 or 3RV1011-0EA1, set to 0.3 A.

<sup>4)</sup> For derating factors at higher temperatures and installation altitudes, see page 3/8.



**Technical specifications**
**SINAMICS DC MASTER converters for 575 V 3 AC, 60 to 850 A, four-quadrant operation**

	Type	Type					
		6RA8025-6GV62-0AA0	6RA8031-6GV62-0AA0	6RA8075-6GV62-0AA0	6RA8081-6GV62-0AA0	6RA8085-6GV62-0AA0	6RA8087-6GV62-0AA0
Rated armature supply voltage <sup>1)</sup>	V	50 (-10 %) ... 575 (+10 %) 3 AC					
Rated armature input current	A	50	104	174	332	498	706
Rated supply voltage, electronics power supply	V	380 (-25 %) ... 480 (+10 %) 2 AC; $I_n = 1$ A or 190 (-25 %) ... 240 (+10 %) 2 AC; $I_n = 2$ A					
Rated fan supply voltage	V	Self-ventilated		24 V DC internal	400 V 3 AC $\pm$ 10 % (50 Hz) 460 V 3 AC $\pm$ 10 % (60 Hz)		
Rated fan current	A			Internal supply	0.23 <sup>3)</sup>		
Cooling air requirement	m <sup>3</sup> /h			300	600		
Sound pressure level <sup>2)</sup>	dB (A)			52.4	64.5		
Rated field supply voltage <sup>1)</sup>	V	50 (-10 %) ... 480 (+10 %) 2 AC					
Rated frequency	Hz	45 ... 65					
Rated DC voltage <sup>1)</sup>	V	600					
Rated DC current	A	<b>60</b>	<b>125</b>	<b>210</b>	<b>400</b>	<b>600</b>	<b>850</b>
Overload capability	$x \times I_n$	1.8					
Rated power	kW	36	75	126	240	360	510
Power loss at rated DC current	kW	0.27	0.46	0.74	1.60	2.00	2.83
Rated DC field voltage <sup>1)</sup>	V	Max. 390					
Rated DC field current	A	<b>10</b>	<b>10</b>	<b>15</b>	<b>25</b>	<b>25</b>	<b>30</b>
Normal ambient temperature in operation <sup>4)</sup>	°C	0 ... +45		0 ... +40			
Storage and transport temperature	°C	-40 ... +70					
Installation altitude above sea level <sup>4)</sup>		$\leq$ 1000 m for rated DC current					
Dimensions							
• Width	mm	268					
• Height	mm	385		625		700	
• Depth	mm	252		275		311	
Weight, approx.	kg	11	14	15	26	31	42

**Note:**

Detailed dimensional drawings in PDF and DXF format are available on the Internet at <http://support.automation.siemens.com/WW/view/en/81717045>.

**Data for single-phase connection**

	Type	Type	
		6RA8025-6GV62-0AA0	6RA8031-6GV62-0AA0
Rated DC voltage	V	400	
Rated DC current	A	42.0	87.5

<sup>1)</sup> The specified output DC voltage can be maintained up to a voltage of 95 % of the maximum rated supply voltage.

<sup>2)</sup> Fan noise for a unit installed in an IP20 electrical cabinet (door closed, 50 Hz operation or operation at 24 V DC for units with an internal supply)

<sup>3)</sup> For fan motor type R2D220-AB02-19 in units 6RA8081, 6RA8085, and 6RA8087 with a rated voltage of 400 V or 575 V. UL systems require a Siemens motor circuit breaker of type 3RV1011-0DA1 or 3RV1011-0EA1, set to 0.3 A.

<sup>4)</sup> For derating factors at higher temperatures and installation altitudes, see page 3/8.

**SINAMICS DCM**

## DC Converter and Control Module

## DC Converters

**Technical specifications****SINAMICS DC MASTER converters for 575 V 3 AC, 1100 to 2800 A, four-quadrant operation**

	Type	6RA8090-6GV62-0AAA0				
		6RA8090-6GV62-0AAA0	6RA8093-4GV62-0AAA0	6RA8095-4GV62-0AAA0	6RA8096-4GV62-0AAA0	6RA8097-4GV62-0AAA0
Rated armature supply voltage <sup>1)</sup>	V	50 (-10 %) ... 575 (+10 %) 3 AC				
Rated armature input current	A	913	1328	1660	1826	2324
Rated supply voltage, electronics power supply	V	380 (-25 %) ... 480 (+10 %) 2 AC; $I_n = 1$ A or 190 (-25 %) ... 240 (+10 %) 2 AC; $I_n = 2$ A				
Rated fan supply voltage	V	400 V 3 AC $\pm$ 10 % (50 Hz) 460 V 3 AC $\pm$ 10 % (60 Hz)				
Rated fan current	A	0.3 <sup>3)</sup>	1 <sup>4)</sup>			
Cooling air requirement	m <sup>3</sup> /h	1000	2400			
Sound pressure level <sup>2)</sup>	dB (A)	64.5	75.6			
Rated field supply voltage <sup>1)</sup>	V	50 (-10 %) ... 480 (+10 %) 2 AC				
Rated frequency	Hz	45 ... 65				
Rated DC voltage <sup>1)</sup>	V	600				
Rated DC current	A	<b>1100</b>	<b>1600</b>	<b>2000</b>	<b>2200</b>	<b>2800</b>
Overload capability	$x \times I_n$	1.8				
Rated power	kW	660	960	1200	1320	1680
Power loss at rated DC current	kW	4.02	6.04	7.07	7.39	10.53
Rated DC field voltage <sup>1)</sup>	V	Max. 390				
Rated DC field current	A	<b>40</b>				
Normal ambient temperature in operation <sup>5)</sup>	°C	0 ... +40				
Storage and transport temperature	°C	-40 ... +70				
Installation altitude above sea level <sup>5)</sup>		$\leq$ 1000 m for rated DC current				
Dimensions						
• Width	mm	268	453			
• Height	mm	785	883			
• Depth	mm	435	505			
Weight, approx.	kg	78	155		185	

## Note:

Detailed dimensional drawings in PDF and DXF format are available on the Internet at <http://support.automation.siemens.com/WW/view/en/81717045>.

- <sup>1)</sup> The specified output DC voltage can be maintained up to a voltage of 95 % of the maximum rated supply voltage.
- <sup>2)</sup> Fan noise for a unit installed in an IP20 electrical cabinet (door closed, 50 Hz operation or operation at 24 V DC for units with an internal supply)
- <sup>3)</sup> For fan motor type R2D220-AB02-19 in units 6RA8081, 6RA8085, and 6RA8087 with a rated voltage of 400 V or 575 V, UL systems require a Siemens motor circuit breaker of type 3RV1011-0DA1 or 3RV1011-0EA1, set to 0.3 A.

- <sup>4)</sup> For fan motor type RH28M-2DK.3F.1R in units 6RA8090, 6RA8091, 6RA8093, and 6RA8095 with a rated voltage of 400 V or 575 V, UL systems require a Siemens motor circuit breaker of type 3RV1011-0KA1 or 3RV1011-1AA1, set to 1.25 A.
- <sup>5)</sup> For derating factors at higher temperatures and installation altitudes, see page 3/8.

**Technical specifications**
**SINAMICS DC MASTER converters for 690 V 3 AC, 760 to 2600 A, four-quadrant operation**

	Type	690 V 3 AC, 760 to 2600 A, four-quadrant operation				
		6RA8086-6KV62-0AA0	6RA8090-6KV62-0AA0	6RA8093-4KV62-0AA0	6RA8095-4KV62-0AA0	6RA8097-4KV62-0AA0
Rated armature supply voltage <sup>1)</sup>	V	100 (-10 %) ... 690 (+10 %) 3 AC				
Rated armature input current	A	631	830	1245	1660	2158
Rated supply voltage, electronics power supply	V	380 (-25 %) ... 480 (+10 %) 2 AC; $I_n = 1$ A or 190 (-25 %) ... 240 (+10 %) 2 AC; $I_n = 2$ A				
Rated fan supply voltage	V	400 V 3 AC $\pm$ 10 % (50 Hz) 460 V 3 AC $\pm$ 10 % (60 Hz)				
Rated fan current	A	0.23 <sup>3)</sup>	0.3 <sup>3)</sup>	1 <sup>4)</sup>		
Cooling air requirement	m <sup>3</sup> /h	600	1000	2400		
Sound pressure level <sup>2)</sup>	dB (A)	64.5			75.6	
Rated field supply voltage <sup>1)</sup>	V	50 (-10 %) ... 480 (+10 %) 2 AC				
Rated frequency	Hz	45 ... 65				
Rated DC voltage <sup>1)</sup>	V	725				
Rated DC current	A	<b>760</b>	<b>1000</b>	<b>1500</b>	<b>2000</b>	<b>2600</b>
Overload capability	$x \times I_n$	1.8				
Rated power	kW	551	725	1088	1450	1885
Power loss at rated DC current	kW	2.90	3.96	6.67	8.16	10.30
Rated DC field voltage <sup>1)</sup>	V	Max. 390				
Rated DC field current	A	<b>30</b>	<b>40</b>			
Normal ambient temperature in operation <sup>5)</sup>	°C	0 ... +40				
Storage and transport temperature	°C	-40 ... +70				
Installation altitude above sea level <sup>5)</sup>		$\leq$ 1000 m for rated DC current				
Dimensions						
• Width	mm	268		453		
• Height	mm	700	785	883		
• Depth	mm	311	435	505		
Weight, approx.	kg	42	78	155		185

**Note:**

Detailed dimensional drawings in PDF and DXF format are available on the Internet at <http://support.automation.siemens.com/WW/view/en/81717045>.

<sup>1)</sup> The specified output DC voltage can be maintained up to a voltage of 95 % of the maximum rated supply voltage.

<sup>2)</sup> Fan noise for a unit installed in an IP20 electrical cabinet (door closed, 50 Hz operation or operation at 24 V DC for units with an internal supply)

<sup>3)</sup> For fan motor type R2D220-AB02-19 in units 6RA8081, 6RA8085, and 6RA8087 with a rated voltage of 400 V or 575 V, UL systems require a Siemens motor circuit breaker of type 3RV1011-0DA1 or 3RV1011-0EA1, set to 0.3 A.

<sup>4)</sup> For fan motor type RH28M-2DK.3F.1R in units 6RA8090, 6RA8091, 6RA8093, and 6RA8095 with a rated voltage of 400 V or 575 V, UL systems require a Siemens motor circuit breaker of type 3RV1011-0KA1 or 3RV1011-1AA1, set to 1.25 A.

<sup>5)</sup> For derating factors at higher temperatures and installation altitudes, see page 3/8.

**SINAMICS DCM**

## DC Converter and Control Module

## DC Converters

**Technical specifications****SINAMICS DC MASTER converters for 830 V 3 AC, 950 to 1900 A and 950 V 3 AC, 2200 A, four-quadrant operation**

	Type	Type			
		6RA8088-6LV62-0AAA0	6RA8093-4LV62-0AAA0	6RA8095-4LV62-0AAA0	6RA8096-4MV62-0AAA0
Rated armature supply voltage <sup>1)</sup>	V	100 (-10 %) ... 830 (+10 %) 3 AC			100 (-10 %) ... 950 (+15 %) 3 AC
Rated armature input current	A	789	1245	1577	1826
Rated supply voltage, electronics power supply	V	380 (-25 %) ... 480 (+10 %) 2 AC; $I_n = 1$ A or 190 (-25 %) ... 240 (+10 %) 2 AC; $I_n = 2$ A			
Rated fan supply voltage	V	400 V 3 AC $\pm$ 10 % (50 Hz) 460 V 3 AC $\pm$ 10 % (60 Hz)			
Rated fan current	A	0.3 <sup>3)</sup>	1 <sup>4)</sup>		
Cooling air requirement	m <sup>3</sup> /h	1000	2400		
Sound pressure level <sup>2)</sup>	dB (A)	64.5	75.6		
Rated field supply voltage <sup>1)</sup>	V	50 (-10 %) ... 480 (+10 %) 2 AC			
Rated frequency	Hz	45 ... 65			
Rated DC voltage <sup>1)</sup>	V	875			1000
Rated DC current	A	<b>950</b>	<b>1500</b>	<b>1900</b>	<b>2200</b>
Overload capability	$x \times I_n$	1.8			
Rated power	kW	831	1313	1663	2200
Power loss at rated DC current	kW	4.22	7.12	8.67	11.34
Rated DC field voltage <sup>1)</sup>	V	Max. 390			
Rated DC field current	A	<b>40</b>			
Normal ambient temperature in operation <sup>5)</sup>	°C	0 ... +40			
Storage and transport temperature	°C	-40 ... +70			
Installation altitude above sea level <sup>5)</sup>		$\leq$ 1000 m for rated DC current			
Dimensions					
• Width	mm	268	453		
• Height	mm	785	883		
• Depth	mm	435	505		
Weight, approx.	kg	78	155	185	

## Note:

Detailed dimensional drawings in PDF and DXF format are available on the Internet at <http://support.automation.siemens.com/WW/view/en/81717045>.

- <sup>1)</sup> The specified output DC voltage can be maintained up to a voltage of 95 % of the maximum rated supply voltage.
- <sup>2)</sup> Fan noise for a unit installed in an IP20 electrical cabinet (door closed, 50 Hz operation or operation at 24 V DC for units with an internal supply)
- <sup>3)</sup> For fan motor type R2D220-AB02-19 in units 6RA8081, 6RA8085, and 6RA8087 with a rated voltage of 400 V or 575 V, UL systems require a Siemens motor circuit breaker of type 3RV1011-0DA1 or 3RV1011-0EA1, set to 0.3 A.

- <sup>4)</sup> For fan motor type RH28M-2DK.3F.1R in units 6RA8090, 6RA8091, 6RA8093, and 6RA8095 with a rated voltage of 400 V or 575 V, UL systems require a Siemens motor circuit breaker of type 3RV1011-0KA1 or 3RV1011-1AA1, set to 1.25 A.
- <sup>5)</sup> For derating factors at higher temperatures and installation altitudes, see page 3/8.

**Selection and ordering data**
**DC Converters for two-quadrant operation**

Rated data				Field circuit		DC Converter		Fuses		
Armature circuit				Field circuit		Article No.		Armature circuit		
Rated supply voltage <sup>1)</sup>	Rated DC voltage	Rated DC current	Rated power	Rated supply voltage <sup>1)</sup>	Rated DC current	Article No.	Phase	DC current	Field circuit	
V	V	A	kW	V	A		Type	Type	Type	
400 3 AC	485	60	29	400 2 AC	10	<b>6RA8025-6DS22-0AA0</b>	3NE1817-0	-	5SD420	
		90	44		10	<b>6RA8028-6DS22-0AA0</b>	3NE1820-0	-	5SD420	
		125	61		10	<b>6RA8031-6DS22-0AA0</b>	3NE1021-0	-	5SD420	
		210	102		15	<b>6RA8075-6DS22-0AA0</b>	3NE3227	-	5SD440	
		280	136		15	<b>6RA8078-6DS22-0AA0</b>	3NE3231	-	5SD440	
		400	194		25	<b>6RA8081-6DS22-0AA0</b>	3NE3233	-	5SD440	
		600	291		25	<b>6RA8085-6DS22-0AA0</b>	3NE3336	-	5SD440	
		850	412		30	<b>6RA8087-6DS22-0AA0</b>	3NE3338-8	-	5SD480	
		1200	582		480 2 AC	40	<b>6RA8091-6DS22-0AA0</b>	- <sup>2)</sup>	-	3NE1802-0 <sup>3)</sup>
		1600	776			40	<b>6RA8093-4DS22-0AA0</b>	- <sup>2)</sup>	-	3NE1802-0 <sup>3)</sup>
2000	970	40	<b>6RA8095-4DS22-0AA0</b>	- <sup>2)</sup>		-	3NE1802-0 <sup>3)</sup>			
		3000	1455		40	<b>6RA8098-4DS22-0AA0</b>	- <sup>2)</sup>	-	3NE1802-0 <sup>3)</sup>	
480 3 AC	575	60	35	480 2 AC	10	<b>6RA8025-6FS22-0AA0</b>	3NE1817-0	-	5SD420	
		90	52		10	<b>6RA8028-6FS22-0AA0</b>	3NE1820-0	-	5SD420	
		125	72		10	<b>6RA8031-6FS22-0AA0</b>	3NE1021-0	-	5SD420	
		210	121		15	<b>6RA8075-6FS22-0AA0</b>	3NE3227	-	5SD440	
		280	161		15	<b>6RA8078-6FS22-0AA0</b>	3NE3231	-	5SD440	
		450	259		25	<b>6RA8082-6FS22-0AA0</b>	3NE3233	-	5SD440	
		600	345		25	<b>6RA8085-6FS22-0AA0</b>	3NE3336	-	5SD440	
		850	489		30	<b>6RA8087-6FS22-0AA0</b>	3NE3338-8	-	5SD480	
		1200	690		40	<b>6RA8091-6FS22-0AA0</b>	- <sup>2)</sup>	-	3NE1802-0 <sup>3)</sup>	
		575 3 AC	690		60	41	480 2 AC	10	<b>6RA8025-6GS22-0AA0</b>	3NE1817-0
125	86			10	<b>6RA8031-6GS22-0AA0</b>	3NE1021-0		-	5SD420	
210	145			15	<b>6RA8075-6GS22-0AA0</b>	3NE3227		-	5SD440	
400	276			25	<b>6RA8081-6GS22-0AA0</b>	3NE3233		-	5SD440	
600	414			25	<b>6RA8085-6GS22-0AA0</b>	3NE3336		-	5SD440	
800	552			30	<b>6RA8087-6GS22-0AA0</b>	3NE3338-8		-	5SD480	
1100	759			40	<b>6RA8090-6GS22-0AA0</b>	- <sup>2)</sup>		-	3NE1802-0 <sup>3)</sup>	
1600	1104			40	<b>6RA8093-4GS22-0AA0</b>	- <sup>2)</sup>		-	3NE1802-0 <sup>3)</sup>	
2000	1380			40	<b>6RA8095-4GS22-0AA0</b>	- <sup>2)</sup>		-	3NE1802-0 <sup>3)</sup>	
2200	1518			40	<b>6RA8096-4GS22-0AA0</b>	- <sup>2)</sup>		-	3NE1802-0 <sup>3)</sup>	
		2800	1932	40	<b>6RA8097-4GS22-0AA0</b>	- <sup>2)</sup>	-	3NE1802-0 <sup>3)</sup>		
690 3 AC	830	720	598	480 2 AC	30	<b>6RA8086-6KS22-0AA0</b>	3NE3337-8	-	5SD480	
		1000	830		40	<b>6RA8090-6KS22-0AA0</b>	- <sup>2)</sup>	-	3NE1802-0 <sup>3)</sup>	
		1500	1245		40	<b>6RA8093-4KS22-0AA0</b>	- <sup>2)</sup>	-	3NE1802-0 <sup>3)</sup>	
		2000	1660		40	<b>6RA8095-4KS22-0AA0</b>	- <sup>2)</sup>	-	3NE1802-0 <sup>3)</sup>	
		2600	2158		40	<b>6RA8097-4KS22-0AA0</b>	- <sup>2)</sup>	-	3NE1802-0 <sup>3)</sup>	
830 3 AC	1000	950	950	480 2 AC	40	<b>6RA8088-6LS22-0AA0</b>	- <sup>2)</sup>	-	3NE1802-0 <sup>3)</sup>	
		1500	1500		40	<b>6RA8093-4LS22-0AA0</b>	- <sup>2)</sup>	-	3NE1802-0 <sup>3)</sup>	
		1900	1900		40	<b>6RA8095-4LS22-0AA0</b>	- <sup>2)</sup>	-	3NE1802-0 <sup>3)</sup>	
950 3 AC	1140	2200	2508	480 2 AC	40	<b>6RA8096-4MS22-0AA0</b>	- <sup>2)</sup>	-	3NE1802-0 <sup>3)</sup>	

<sup>1)</sup> 50/60 Hz

<sup>2)</sup> Arm fuses included in the unit, external semiconductor fuses not required

<sup>3)</sup> UL-recognized

**SINAMICS DCM**

## DC Converter and Control Module

## DC Converters

**Selection and ordering data****DC Converters for four-quadrant operation**

Rated data				Field circuit		DC Converter		Fuses		Field circuit			
Armature circuit								Armature circuit		Field circuit			
Rated supply voltage <sup>1)</sup>	Rated DC voltage	Rated DC current	Rated power	Rated supply voltage <sup>1)</sup>	Rated DC current	Article No.	Phase	DC current	2 each				
V	V	A	kW	V	A		Type	Type	Type				
400 3 AC	420	15	6.3	400 2 AC	3	<b>6RA8013-6DV62-0AA0</b>	3NE1814-0	3NE1814-0	5SD420				
			12.6		5	<b>6RA8018-6DV62-0AA0</b>	3NE8003-1	3NE4102	5SD420				
		60	25		10	<b>6RA8025-6DV62-0AA0</b>	3NE1817-0	3NE4120	5SD420				
			38		10	<b>6RA8028-6DV62-0AA0</b>	3NE1820-0	3NE4122	5SD420				
		125	53		10	<b>6RA8031-6DV62-0AA0</b>	3NE1021-0	3NE4124	5SD420				
			88		15	<b>6RA8075-6DV62-0AA0</b>	3NE3227	3NE3227	5SD440				
		280	118		15	<b>6RA8078-6DV62-0AA0</b>	3NE3231	3NE3231	5SD440				
			168		25	<b>6RA8081-6DV62-0AA0</b>	3NE3233	3NE3233	5SD440				
		600	252		25	<b>6RA8085-6DV62-0AA0</b>	3NE3336	3NE3336	5SD440				
			357		30	<b>6RA8087-6DV62-0AA0</b>	3NE3338-8	3NE3334-0B <sup>3)</sup>	5SD480				
		1200	504	480 2 AC	40	<b>6RA8091-6DV62-0AA0</b>	- <sup>2)</sup>	- <sup>2)</sup>	3NE1802-0 <sup>4)</sup>				
					40	<b>6RA8093-4DV62-0AA0</b>	- <sup>2)</sup>	- <sup>2)</sup>	3NE1802-0 <sup>4)</sup>				
					40	<b>6RA8095-4DV62-0AA0</b>	- <sup>2)</sup>	- <sup>2)</sup>	3NE1802-0 <sup>4)</sup>				
					40	<b>6RA8098-4DV62-0AA0</b>	- <sup>2)</sup>	- <sup>2)</sup>	3NE1802-0 <sup>4)</sup>				
480 3 AC	500				15	6	480 2 AC	3	<b>6RA8013-6FV62-0AA0</b>	3NE1814-0	3NE1814-0	5SD420	
30						15		5	<b>6RA8018-6FV62-0AA0</b>	3NE1815-0	3NE4102	5SD420	
60		30		10	<b>6RA8025-6FV62-0AA0</b>	3NE1817-0		3NE4120	5SD420				
		45		10	<b>6RA8028-6FV62-0AA0</b>	3NE1820-0		3NE4122	5SD420				
125		63		10	<b>6RA8031-6FV62-0AA0</b>	3NE1021-0		3NE4124	5SD420				
		105		15	<b>6RA8075-6FV62-0AA0</b>	3NE3227		3NE3227	5SD440				
280	140		15	<b>6RA8078-6FV62-0AA0</b>	3NE3231	3NE3231	5SD440						
	225		25	<b>6RA8082-6FV62-0AA0</b>	3NE3233	3NE3334-0B	5SD440						
600	300		25	<b>6RA8085-6FV62-0AA0</b>	3NE3336	3NE3336	5SD440						
	425		30	<b>6RA8087-6FV62-0AA0</b>	3NE3338-8	3NE3334-0B <sup>3)</sup>	5SD480						
1200	600	480 2 AC	40	<b>6RA8091-6FV62-0AA0</b>	- <sup>2)</sup>	- <sup>2)</sup>	3NE1802-0 <sup>4)</sup>						
			480 3 AC	600	60	36	480 2 AC	10	<b>6RA8025-6GV62-0AA0</b>	3NE1817-0	3NE4120	5SD420	
			125			75		10	<b>6RA8031-6GV62-0AA0</b>	3NE1021-0	3NE4124	5SD420	
			210		126			15	<b>6RA8075-6GV62-0AA0</b>	3NE3227	3NE3227	5SD440	
					240			25	<b>6RA8081-6GV62-0AA0</b>	3NE3233	3NE3233	5SD440	
			600		360			25	<b>6RA8085-6GV62-0AA0</b>	3NE3336	3NE3336	5SD440	
510	30	<b>6RA8087-6GV62-0AA0</b>			3NE3338-8			3NE3334-0B <sup>3)</sup>	5SD480				
1100	660	480 2 AC	40	<b>6RA8090-6GV62-0AA0</b>	- <sup>2)</sup>	- <sup>2)</sup>	3NE1802-0 <sup>4)</sup>						
			1600	960	40	<b>6RA8093-4GV62-0AA0</b>	- <sup>2)</sup>	- <sup>2)</sup>	3NE1802-0 <sup>4)</sup>				
			2000	1200	40	<b>6RA8095-4GV62-0AA0</b>	- <sup>2)</sup>	- <sup>2)</sup>	3NE1802-0 <sup>4)</sup>				
			2200	1320	40	<b>6RA8096-4GV62-0AA0</b>	- <sup>2)</sup>	- <sup>2)</sup>	3NE1802-0 <sup>4)</sup>				
			2800	1680	40	<b>6RA8097-4GV62-0AA0</b>	- <sup>2)</sup>	- <sup>2)</sup>	3NE1802-0 <sup>4)</sup>				
			690 3 AC	725	760	551	480 2 AC	30	<b>6RA8086-6KV62-0AA0</b>	3NE3337-8	3NE3334-0B <sup>3)</sup>	5SD420	
1000	725	40	<b>6RA8090-6KV62-0AA0</b>			- <sup>2)</sup>		- <sup>2)</sup>	3NE1802-0 <sup>4)</sup>				
1500	1088		40		<b>6RA8093-4KV62-0AA0</b>	- <sup>2)</sup>		- <sup>2)</sup>	3NE1802-0 <sup>4)</sup>				
	1450		40		<b>6RA8095-4KV62-0AA0</b>	- <sup>2)</sup>		- <sup>2)</sup>	3NE1802-0 <sup>4)</sup>				
2600	1885		40		<b>6RA8097-4KV62-0AA0</b>	- <sup>2)</sup>		- <sup>2)</sup>	3NE1802-0 <sup>4)</sup>				
	830 3 AC		875		950	831		480 2 AC	40	<b>6RA8088-6LV62-0AA0</b>	- <sup>2)</sup>	- <sup>2)</sup>	3NE1802-0 <sup>4)</sup>
1500	1313	40		<b>6RA8093-4LV62-0AA0</b>	- <sup>2)</sup>	- <sup>2)</sup>	3NE1802-0 <sup>4)</sup>						
1900	1663	40		<b>6RA8095-4LV62-0AA0</b>	- <sup>2)</sup>	- <sup>2)</sup>	3NE1802-0 <sup>4)</sup>						
950 3 AC	1000	2200	2200	480 2 AC	40	<b>6RA8096-4MV62-0AA0</b>	- <sup>2)</sup>	- <sup>2)</sup>	3NE1802-0 <sup>4)</sup>				

<sup>1)</sup> 50/60 Hz<sup>2)</sup> Arm fuses included in the unit, external semiconductor fuses not required<sup>3)</sup> Two fuses connected in parallel.<sup>4)</sup> UL-recognized

## Options

Note:

When ordering a unit with options, add the suffix "-Z" to the Article No. of the unit and then state the order code(s) for the desired option(s) after the suffix.

Example:

6RA8075-6GV62-0AA0-Z  
G00+G20+L85+...

See also ordering examples.

### Available options

The following table provides an overview of the available options. Detailed descriptions of the options are provided in the section "Description of options".

Designation	Order code	Notes	Article No. for separate order	
			not coated	coated
<b>CUD</b>				
Standard CUD left	(Standard)	–	<b>6RY1803-0AA00-0AA1</b>	<b>6RY1803-0AA20-0AA1</b>
Advanced CUD left	<b>G00</b>	–	<b>6RY1803-0AA05-0AA1</b>	<b>6RY1803-0AA25-0AA1</b>
Standard CUD right	<b>G10</b>	This option requires an Advanced CUD left – order code <b>G00</b>	<b>6RY1803-0AA00-0AA1 + 6RY1803-0GA00<sup>2)</sup></b>	<b>6RY1803-0AA20-0AA1 + 6RY1803-0GA20<sup>2)</sup></b>
Advanced CUD right	<b>G11</b>	This option requires an Advanced CUD left – order code <b>G00</b>	<b>6RY1803-0AA05-0AA1 + 6RY1803-0GA00<sup>2)</sup></b>	<b>6RY1803-0AA25-0AA1 + 6RY1803-0GA20<sup>2)</sup></b>
Communication Board CBE20 left	<b>G20</b>	This option requires an Advanced CUD left – order code <b>G00</b>	–	<b>6SL3055-0AA00-2EB0</b>
Communication Board CBE20 right	<b>G21</b>	This option requires an Advanced CUD right – order code <b>G11</b>	–	<b>6SL3055-0AA00-2EB0</b>
Memory card left	<b>S01</b>	–	<b>6RX1800-0AS01</b>	–
Memory card right	<b>S02</b>	This option requires a Standard CUD right – order code <b>G10</b> – or an Advanced CUD right – order code <b>G11</b>	<b>6RX1800-0AS01</b>	–
<b>Field</b>				
Field power section 1Q	(Standard)	–	– <sup>1)</sup>	– <sup>1)</sup>
Field power section 2Q	<b>L11</b>	Only applicable for units from 60 to 3000 A	– <sup>1)</sup>	– <sup>1)</sup>
Without field power section	<b>L10</b>	Only applicable for units from 60 to 3000 A	–	–
85 A field power section	<b>L85</b>	Only applicable for units from 1500 to 3000 A	– <sup>1)</sup>	– <sup>1)</sup>
<b>Fans</b>				
Standard fan	(Standard)	Self-ventilated units do not have a fan	– <sup>1)</sup>	–
Fan for single-phase connection	<b>L21</b>	Only applicable for units from 400 to 1200 A	– <sup>1)</sup>	–
<b>Additional options</b>				
Electronics power supply for connection to 24 V DC	<b>L05</b>	Standard for Control Module, input voltage range 18 to 30 V, current consumption 5 A at 24 V	– <sup>1)</sup>	– <sup>1)</sup>
Armature circuit supply with extra-low voltage 10 to 50 V	<b>L04</b>	Only applicable for units up to ≤ 575 V rated supply voltage	– <sup>1)</sup>	– <sup>1)</sup>
Terminal Module Cabinet	<b>G63</b>	–	<b>6RY1803-0AB05</b>	–
Coated PCBs	<b>M08</b>	–	–	–
Nickel-plated copper busbars	<b>M10</b>	Only applicable for units from 60 to 3000 A	–	–
External sensor for ambient or inlet temperature	<b>L15</b>	–	– <sup>1)</sup>	–
Control for switching over the power section topology for parallel and series connections	<b>S50</b>	–	–	–
Extension of the liability for defects	<b>Q80 ... Q85</b>	See section "Description of options"	–	–

<sup>1)</sup> Available as spare part.

<sup>2)</sup> The Standard CUD (uncoated 6RY1803-0AA00-0AA1; coated 6RY1803-0AA20-0AA1) and the Advanced CUD (uncoated 6RY1803-0AA05-0AA1; coated 6RY1803-0AA25-0AA1) can be inserted in either the left-hand or the right-hand slot and therefore have an article number which does not refer to a specific slot. A Connector Board (6RY1803-0GA00 or 6RY1803-0GA20) is also needed in order to retrofit a CUD.

**SINAMICS DCM**

## DC Converter and Control Module

## DC Converters

**Options****Option selection matrix**

	G00	G10	G11	G20	G21	G63	L04	L05	L10	L11	L15	L20	L21	L85	M08	M10	S01	S02	S50	
G00		✓	✓	✓	✓	✓	✓	✓	✓	✓	✓	✓	✓	✓	✓	✓	✓	✓	✓	✓
G10	✓		–	✓	–	✓	✓	✓	✓	✓	✓	✓	✓	✓	✓	✓	✓	✓	✓	✓
G11	✓	–		✓	✓	✓	✓	✓	✓	✓	✓	✓	✓	✓	✓	✓	✓	✓	✓	✓
G20	✓	✓	✓		✓	✓	✓	✓	✓	✓	✓	✓	✓	✓	✓	✓	✓	✓	✓	✓
G21	✓	–	✓	✓		✓	✓	✓	✓	✓	✓	✓	✓	✓	✓	✓	✓	✓	✓	✓
G63	✓	✓	✓	✓	✓		✓	✓	✓	✓	✓	✓	✓	✓	✓	✓	✓	✓	✓	✓
L04	✓	✓	✓	✓	✓	✓		✓	✓	✓	✓	✓	✓	✓	✓	✓	✓	✓	✓	✓
L05	✓	✓	✓	✓	✓	✓	✓		✓	✓	✓	✓	✓	✓	✓	✓	✓	✓	✓	✓
L10	✓	✓	✓	✓	✓	✓	✓	✓		–	✓	✓	✓	–	✓	✓	✓	✓	✓	✓
L11	✓	✓	✓	✓	✓	✓	✓	✓	–		✓	✓	✓	✓	✓	✓	✓	✓	✓	✓
L15	✓	✓	✓	✓	✓	✓	✓	✓	✓	✓		✓	✓	✓	✓	✓	✓	✓	✓	✓
L20	✓	✓	✓	✓	✓	✓	✓	✓	✓	✓	✓		–	✓	✓	✓	✓	✓	✓	✓
L21	✓	✓	✓	✓	✓	✓	✓	✓	✓	✓	✓	–		✓	✓	✓	✓	✓	✓	✓
L85	✓	✓	✓	✓	✓	✓	✓	✓	–	✓	✓	✓	✓		✓	✓	✓	✓	✓	✓
M08	✓	✓	✓	✓	✓	✓	✓	✓	✓	✓	✓	✓	✓	✓		✓	✓	✓	✓	✓
M10	✓	✓	✓	✓	✓	✓	✓	✓	✓	✓	✓	✓	✓	✓	✓		✓	✓	✓	✓
S01	✓	✓	✓	✓	✓	✓	✓	✓	✓	✓	✓	✓	✓	✓	✓	✓		✓	✓	✓
S02	✓	✓	✓	✓	✓	✓	✓	✓	✓	✓	✓	✓	✓	✓	✓	✓	✓		✓	✓
S50	✓	✓	✓	✓	✓	✓	✓	✓	✓	✓	✓	✓	✓	✓	✓	✓	✓	✓		✓

✓ Option can be combined without any restrictions

– Option cannot be combined



### Options

#### Ordering examples

##### Example 1

###### Task:

A DC drive system is required for a cableway. A SINAMICS DC MASTER is to handle the closed-loop control of the selected 560 kW DC motor with a rated armature voltage of 420 V and a rated armature current of 1306 A. Due to the overdimensioning of 25 % specified by the acceptance authorities, and due to the maximum ambient temperature of 45 °C that can occur, the rated current of the converter had to be further reduced by 5 %. This is the reason that a unit with a rated supply current of 2000 A was selected. The converter capable of energy recovery is to be connected to a 400 V line supply. A PROFINET connection is required for the higher-level control.

###### Solution:

The four-quadrant converter with 2000 A and 400 V AC must be selected for this application. The incremental encoder to sense the speed - mounted on the motor - is directly evaluated in the CUD of the SINAMICS DC MASTER, without requiring any additional option.

The following options must be selected in order to permit the PROFINET connection:

**G00** (Advanced CUD left)

**G20** (PROFINET Communication Board CBE20 left)

The ordering data are as follows:

**6RA8095-4DV62-0AA0-Z**

**G00+G20**

##### Example 2

###### Task:

An unwinder for paper in a reeler-slitter is to be modernized - but the existing motor is to be kept. The power section is to be supplied from the existing 690 V supply. The technological control is to be implemented in the higher-level PCS7 system. The client specified PROFIBUS as the control and setpoint interface. The following measured values and status displays are to be visualized in the cabinet doors of the drive cabinet to facilitate fast and simple diagnostics for the service and maintenance personnel: Armature current, armature voltage, speed, field current, status messages - operation and fault.

The customer explained that he repeatedly had problems with the existing converter relating to overvoltage in the motor armature circuit - and as a consequence, this resulted in tension fluctuations in the paper web when the motor went into the field-weakening range. As a result of instability in the control voltage supply, in the past, there were repeatedly failures that had a negative impact on the availability.

###### Solution:

As a result of the data of the existing motor and the customer specifications relating to acceleration and braking ramps, tambour roll weight and maximum diameter, a four-quadrant converter was selected with a rated supply voltage of 690 V and a rated current of 1500 A. The dynamic overload capability of the units is utilized to brake the drive when the paper web breaks.

The technological control with current setpoint interface is realized in the higher-level control. This is the reason that for this particular application, the Standard CUD is sufficient, which already has an integrated PROFIBUS interface.

The problem with armature overvoltages when entering the field weakening range has now been resolved by selecting the two-quadrant field power section option. By actively reducing the current using a counter-voltage, the field current actual value can now follow the field current setpoint - even for steep acceleration ramps - and therefore overvoltages are avoided in the armature circuit. The tension fluctuations in the paper web are consequentially eliminated.

Selecting the option "electronics power supply for connection to 24 V DC" means that the drive system can be integrated into a favorably-priced and low-maintenance DC UPS system comprising SITOP components.

The requirements regarding actual value and status displays were addressed by installing the AOP30 Advanced Operator Panel in the doors of the drive cabinet.

Coated PCBs and nickel-plated copper busbars were selected as a result of the aggressive atmosphere with a high percentage of H<sub>2</sub>S.

Since the availability of equipment is extremely important in the paper industry, the option "memory card left" should also be selected in order to reduce downtimes. The firmware and additional AOP text languages are stored on this card. Further, parameter values can be additionally saved there and there is a reserved memory range for offline long-time trace records.

The following options must be selected for this particular application:

**L05** (electronics power supply for connection to 24 V DC)

**L11** (2Q field power section)

**M08** (coated PCBs)

**M10** (nickel-plated copper busbars)

**S01** (memory card left)

Further, the following accessories are required:

AOP30 Advanced Operator Panel (6SL3055-0AA00-4CA4)

RS485 cable, 3 m long

The ordering data are as follows:

**6RA8093-4KV62-0AA0-Z**

**L05+L11+M08+M10+S01**

and

**6SL3055-0AA00-4CA4**

and

**6RY1807-0AP00**

## SINAMICS DCM

### DC Converter and Control Module

#### DC Converters

#### Options

##### Description of options

##### **G00**

##### Advanced CUD left

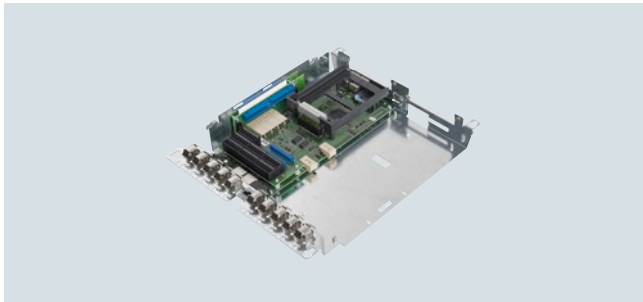

In addition to the connections and functions of the Standard CUD, the Advanced CUD has two DRIVE-CLiQ connections and one option slot. The use of an Advanced CUD also provides the opportunity of inserting an additional CUD (Standard or Advanced) to increase the computational performance and the number of terminals. This can be used, for example, to implement additional technological functions.

By using an Advanced CUD, which is located in the left-hand slot instead of the Standard CUD, the SINAMICS components SMC10, SMC30, TM15, TM31, TM150 and CBE20 can be connected to the SINAMICS DC MASTER, and the OALINK functionality can also be utilized. More detailed information about the SINAMICS components is available in the catalog section "Accessories and supplementary components".

##### **G10**

##### Standard CUD right

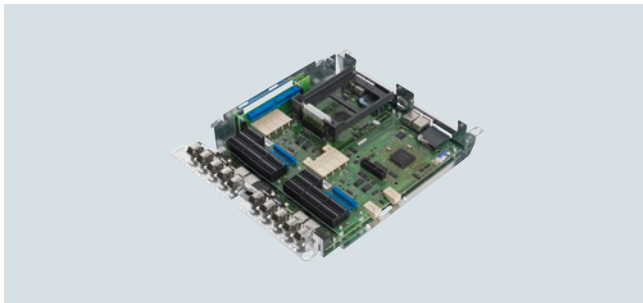

Selecting the option **G10** provides the possibility of further increasing the performance of technology functions for the SINAMICS DC MASTER. As a result of the additional Standard CUD that is inserted in the right-hand slot of the electronics tray, users have additional computational performance at their fingertips in order to fulfill even the highest demands when it comes to closed-loop control performance. Option **G00** is required when selecting option G10. An extension to include two Control Units is only possible when the Advanced CUD is inserted in the left-hand slot.

##### **G11**

##### Advanced CUD right

With option **G11**, users can address the highest demands regarding the closed-loop control performance and use the wide range of interfaces. With this option, in addition to the Advanced CUD located in the left-hand slot, an additional Advanced CUD can be mounted in the right-hand slot. This therefore doubles the number of interfaces of the SINAMICS DC MASTER. Option **G00** is required when selecting option **G11**. An extension to include two Control Units is only possible when the Advanced CUD is inserted in the left-hand slot.

##### **G20**

##### Communication Board CBE20 left



The CBE20 Communication Board can be used to connect to a PROFINET IO network via the Advanced CUD.

The SINAMICS DC MASTER then assumes the function of a PROFINET IO device in the sense of PROFINET and offers the following functions:

- PROFINET IO device
- 100 Mbps full duplex
- Supports real-time classes of PROFINET IO:
- RT (Real-Time)
- Connection to control systems as PROFINET IO devices in accordance with PROFIdrive, Specification V4.
- In addition to PROFIBUS (standard), PROFINET can also be used for engineering with the STARTER commissioning tool.
- Integrated 4-port switch with four RJ45 sockets based on the PROFINET ASIC ERTEC400. The optimum topology (line, star, tree) can therefore be configured without additional external switches.

The following functions can also be used:

- EtherNet/IP
- SINAMICS Link (with memory card, option S01 or S02)

The CBE20 is inserted in the option slot of the Advanced CUD, which is inserted in the left-hand slot. An Advanced CUD must be located in the left-hand slot in order to be able to use option G20. This can be selected with option G00.

Technical specifications	
Permissible ambient temperature	
• Storage and transport	-40 ... +70 °C
• Operation	0 ... 55 °C
Approvals	cULus (File No.: E164110)
Accessories for CBE20	
Industrial Ethernet FC	Type
• RJ45 plug 145 (1 unit)	6GK1901-1BB30-0AA0
• RJ45 plug 145 (10 units)	6GK1901-1BB30-0AB0
• Stripping tool	6GK1901-1GA00
• Standard cable GP 2x2	6XV1840-2AH10
• Flexible cable GP 2x2	6XV1870-2B
• Trailing cable GP 2x2	6XV1870-2D
• Trailing cable 2x2	6XV1840-3AH10
• Marine cable 2x2	6XV1840-4AH10

The cables are sold by the meter.

For further information about connectors and cables, refer to Catalog IK PI.

## Options

### **G21**

#### Communication Board CBE20 right

With option G21, an Advanced CUD can be inserted in the right-hand slot (refer to option G11), which is used to expand CBE20. More detailed information on the functionality, selection and ordering data of the CBE20 is provided under option G20.

### **G63**

#### Terminal Module Cabinet (TMC)

The Terminal Module Cabinet (TMC) is equipped with spring terminals which provide a simple means of connecting CUD standard signals.

This is made possible by routing the appropriate interfaces (X177 of the CUD) to the TMC using an adapter board and a ribbon cable (X71, X72).

The TMC comprises two terminal blocks and a cable set.

Note: To equip two CUDs with one TMC each, option G63 must be ordered twice.

### **L04**

#### Armature circuit supply with extra-low voltage 10 to 50 V

With option L04, the SINAMICS DC MASTER is re-equipped for operation with 10 to 50 V AC. This is frequently required especially for electrochemical applications, when controlling solenoids, when using the converter to supply the fields of special motors or Ward-Leonard converters (MG sets).

This option can only be selected for units with rated supply voltages of up to 575 V.

### **L05**

#### Electronics power supply for connection to 24 V DC

With option L05, users have the possibility of equipping SINAMICS DC MASTER with an electronics power supply for connection to 24 V DC instead of the standard electronics power supply. This option allows users to connect the units to a favorably-priced 24 V UPS system.

This option cannot be selected for Control Modules as the Control Module is supplied as standard with an electronics power supply for connection to 24 V DC.

Input voltage range: 18 to 30 V,  
current consumption: 5 A at 24 V

### **L10**

#### Without field power section

In some applications it may be necessary to individually adapt the field power section. For this particular case, users can order option L10 where SINAMICS DC MASTER is not equipped with the standard integrated field power section. This then allows them to implement their own individual solutions for the field power section.

This option cannot be ordered for units with rated DC currents from 15 to 30 A.

### **L11**

#### 2Q field power section

For applications that demand highly dynamic field current changes, by specifying option L11, the SINAMICS DC MASTER can be equipped with a two-quadrant field with active current reduction. Further, this field power section has an integrated field overvoltage protection function.

This option cannot be ordered for units with rated DC currents from 15 to 30 A.

### **L15**

#### External sensor for the ambient or inlet temperature

Option L15 is a sensor located outside the unit to measure the ambient or inlet temperature. For example, this can be used to simply monitor the cabinet temperature and/or identify when the air intake filter is blocked.

### **L21**

#### Fan for single-phase connection

A fan can be optionally supplied with a single-phase connection for units with rated DC currents between 400 and 1200 A. This allows fans to be more quickly replaced than three-phase fans - especially as the direction of rotation does not have to be checked.

Rated supply voltage: 230 V 1 AC  $\pm$  10 %  
(50 and 60 Hz)

Rated DC current	Line frequency	Rated fan current
400 ... 850 A	50 Hz	0.51 A
	60 Hz	0.72 A
950 ... 1200 A	50 Hz	0.81 A
	60 Hz	1.14 A

Units smaller than 400 A are self-ventilated or have an integrated 24 V DC fan. Units with ratings greater than 1200 A require a three-phase connection for the fan due to the higher power consumption.

### **L85**

#### 85 A field power section

With option L85, users can have the SINAMICS DC MASTER equipped with a rated DC field current of 85 A.

This option can only be ordered for units with rated DC currents from 1500 to 3000 A.

### **M08**

#### Coated PCBs

In order to improve the reliability for increased degrees of pollution and climatic stressing, it is possible to order PCBs of the SINAMICS DC MASTER that are coated on both sides by specifying option M08.

### **M10**

#### Nickel-plated copper busbars

When ordered with option M10, the SINAMICS DC MASTER is equipped with nickel-plated copper busbars. The degree of availability can be increased for aggressive atmospheres.

This option is not available for units with rated DC currents from 15 to 30 A.

## SINAMICS DCM

### DC Converter and Control Module

#### DC Converters

#### Options

##### **S01**

##### Memory card left

With option S01, users receive a memory card for one Standard CUD or one Advanced CUD, which is inserted in the left-hand slot.

This memory card offers the following options:

- Additional languages can be downloaded to the AOP30 Advanced Operator Panel. When using two CUDs, option S01 and option S02 must be ordered.
- Perform an offline long-time trace.
- Download the DCC block library into the drive.
- Update the firmware.

The SINAMICS Link function requires that the memory card is always inserted.

##### **S02**

##### Memory card right

With option S02, users receive a memory card for one Standard CUD or one Advanced CUD, which is inserted in the right-hand slot.

This memory card offers the following options:

- Additional languages can be downloaded to the AOP30 Advanced Operator Panel. When using two CUDs, option S01 and option S02 must be ordered.
- Perform an offline long-time trace.
- Download the DCC block library into the drive.
- Update the firmware.

The SINAMICS Link function requires that the memory card is always inserted.

In order to be able to use option S02, a Standard CUD right (option G10) or an Advanced CUD right (option G11) is required.

##### **S50**

##### Switchover of the power section topology

In certain applications, it is necessary to switch between 12-pulse parallel connection and 12-pulse series connection during operation by means of control command.

External contactors must be used to switch over the power section topology. Option S50 provides the required firmware functionality.

Requirements for using this functionality:

- All units involved must be equipped with option S50.
- No redundant operation mode ("n+m" mode) may be used.
- The function of the "parallel switching master" must remain on the same unit in both power section topologies.

##### **Q80 to Q85**

##### Extension of the liability for defects

We can offer you the possibility of extending the liability for defects periods beyond the standard liability for defects period. The standard liability for defects period, as listed in our standard conditions for the supply of services and products, is 12 months.

The following extension periods are available:

Extension of the liability for defects period for converters	
Additional identification code - <b>Z</b> with order code	Additional text
<b>Q80</b>	Extension of the liability for defects period by 12 months to a total of 24 months from delivery
<b>Q81</b>	Extension of the liability for defects period by 18 months to a total of 30 months from delivery
<b>Q82</b>	Extension of the liability for defects period by 24 months to a total of 36 months from delivery
<b>Q83</b>	Extension of the liability for defects period by 30 months to a total of 42 months from delivery
<b>Q84</b>	Extension of the liability for defects period by 36 months to a total of 48 months from delivery
<b>Q85</b>	Extension of the liability for defects period by 48 months to a total of 60 months from delivery

The currently valid conditions for extending the period of liability for defects can be found at:

<https://support.industry.siemens.com/cs/ww/en/view/109740550>

**Circuit diagrams**

**Control Units**

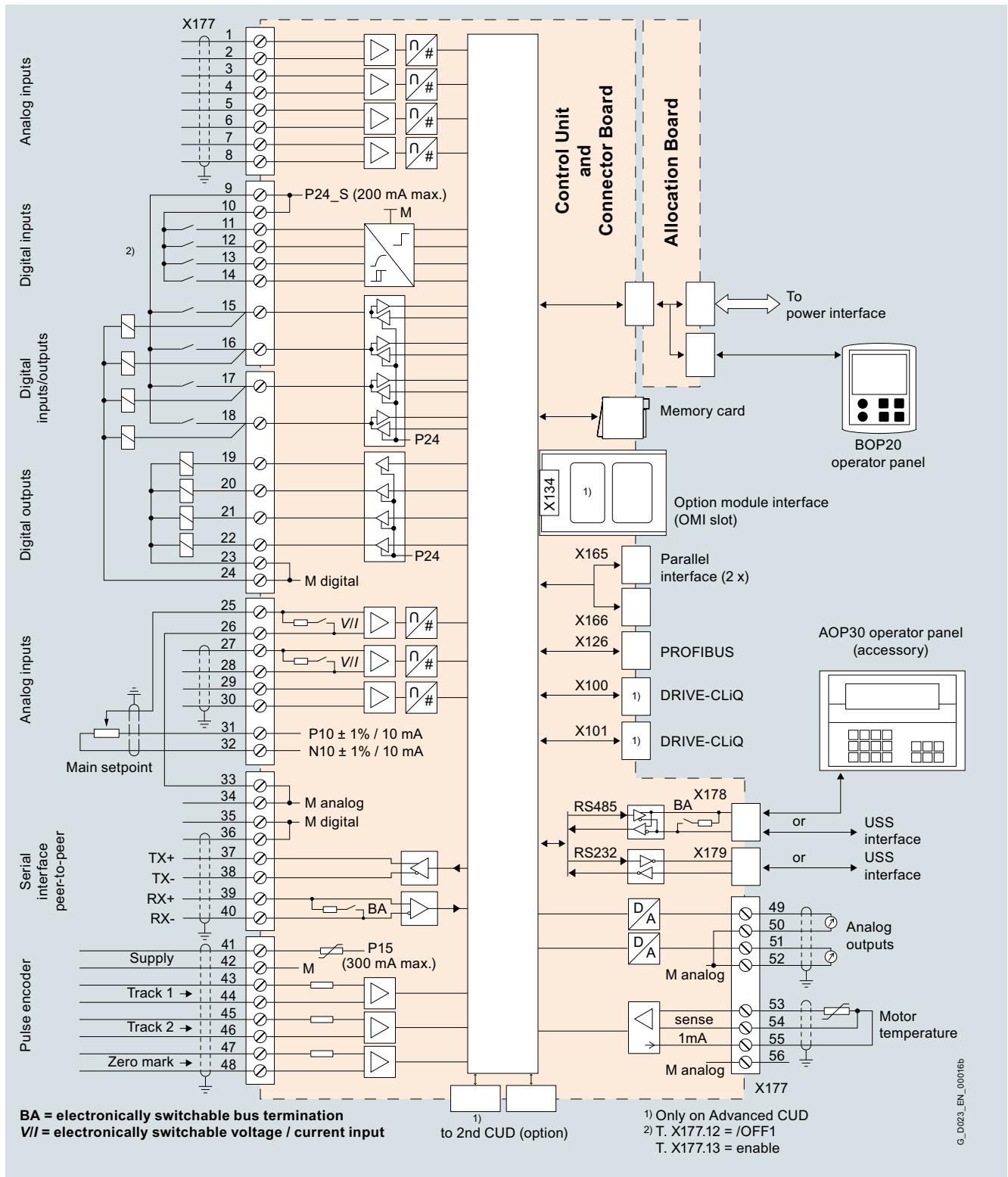

Connection diagram, Standard CUD/Advanced CUD with typical connections

# SINAMICS DCM

## DC Converter and Control Module

### DC Converters

#### Circuit diagrams

#### DC Converter

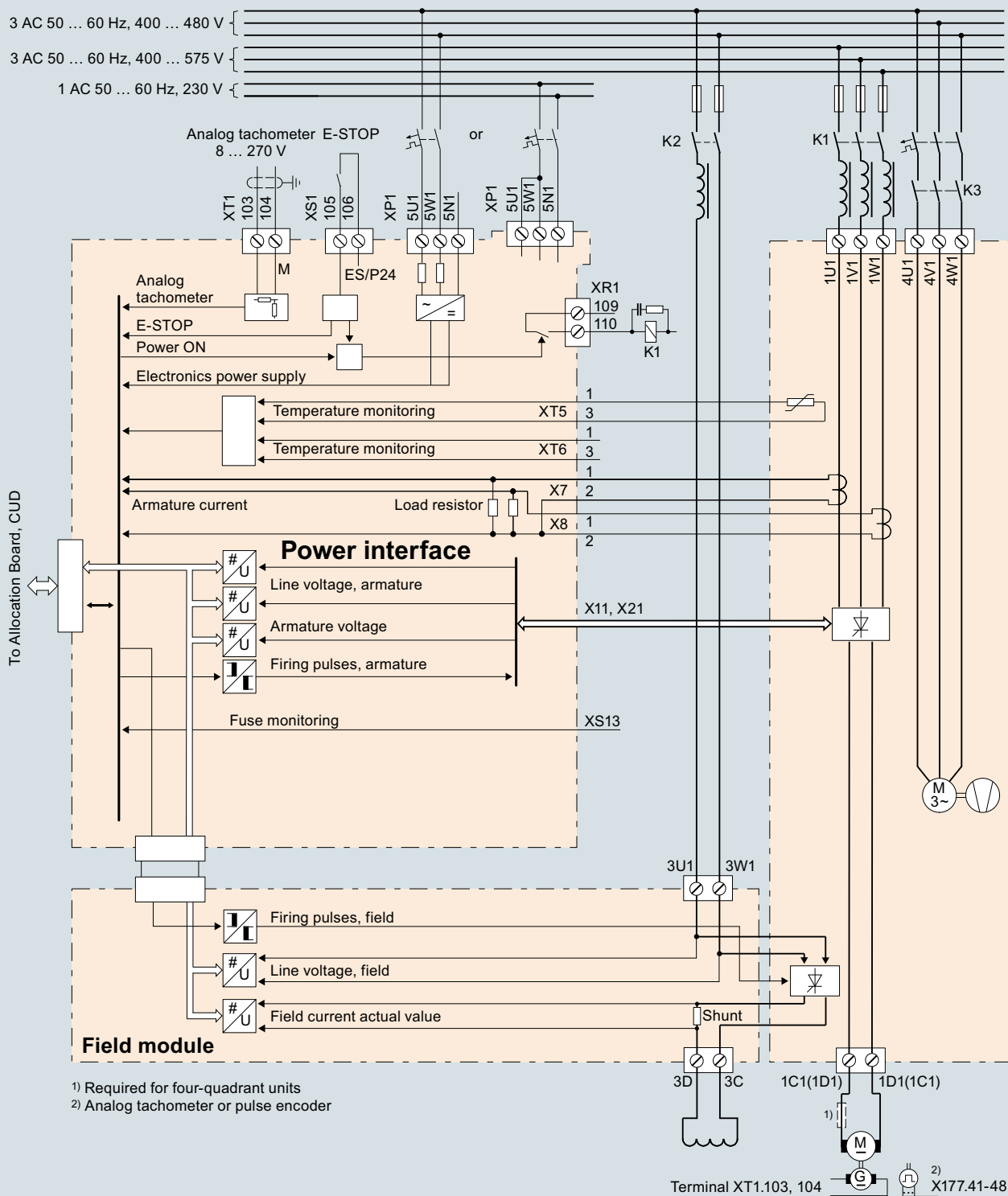

Connection diagram, DC Converters, 400 to 3000 A, electronics power supply 400 V or 230 V, with fan (standard version)

3

## Circuit diagrams

### Assignment of terminals and connectors

#### Overview

##### Overview of terminals and connectors

1U1, 1V1, 1W1, 1C1, 1D1	Power section
3U1, 3W1, 3C, 3D	Field circuit
4U1, 4V1, 4W1, 4N1	Fan
5U1, 5W1, 5N1	Electronics power supply
X100, X101	DRIVE-CLiQ
X126	PROFIBUS
X165, X166	Parallel connection interface
X177	Analog inputs, digital inputs, digital outputs, setpoints, reference voltage (P10/N10), serial interface (peer-to-peer), pulse encoder, analog outputs, temperature sensor
X178	RS485 interface for connecting the AOP30, USS interface as alternative; as a general rule, only one of the two interfaces X178 or X179 can be used
X179	RS232 interface for use as a USS interface; as a general rule, only one of the two interfaces X178 or X179 can be used
XR1, XS1, XT1	Relay output for line contactor, safety shutdown (E-STOP), analog tachometer

#### Power section

##### Terminal type, power connections for 15 A and 30 A units

Type	KDS 10 PC board terminal
Conductor size	<ul style="list-style-type: none"> <li>Rigid: 0.5 ... 16 mm<sup>2</sup></li> <li>Flexible with end sleeve with/without plastic sleeve: 0.5 ... 10 mm<sup>2</sup></li> <li>Conductor sizes: AWG 20 ... 6</li> </ul>
Stripped length	12 mm
Tightening torque	1.2 ... 1.5 Nm

##### Terminal type, power connections for units of 60 A and higher

Units	Data
60 ... 210 A	1U1, 1V1, 1W1: 3 × 20 mm aluminum busbar, through hole for M8 1C1, 1D1: 5 × 20 mm aluminum busbar, through hole for M8
	Max. conductor cross-section for cables with cable lug in acc. with DIN 46234: 1U1, 1V1, 1W1, 1C1, 1D1: 2 × 95 mm <sup>2</sup>
	Tightening torque for 1U1, 1V1, 1W1, 1C1, 1D1: 13 Nm Tightening torque for protective conductor: 25 Nm
280 A	1U1, 1V1, 1W1: 3 × 20 mm copper busbar, through hole for M8 1C1, 1D1: 5 × 20 mm copper busbar, through hole for M8
	Max. conductor cross-section for cables with cable lug in acc. with DIN 46234: 1U1, 1V1, 1W1, 1C1, 1D1: 2 × 95 mm <sup>2</sup>
	Tightening torque for 1U1, 1V1, 1W1, 1C1, 1D1: 13 Nm Tightening torque for protective conductor: 25 Nm
400 ... 450 A	1U1, 1V1, 1W1: 5 × 30 mm aluminum busbar, through hole for M10 1C1, 1D1: 5 × 35 mm aluminum busbar, through hole for M10
	Max. conductor cross-section for cables with cable lug in acc. with DIN 46234: 1U1, 1V1, 1W1: 2 × 150 mm <sup>2</sup> 1C1, 1D1: 2 × 185 mm <sup>2</sup>
	Tightening torque for 1U1, 1V1, 1W1, 1C1, 1D1: 25 Nm Tightening torque for protective conductor: 50 Nm
600 A	1U1, 1V1, 1W1: 5 × 30 mm copper busbar, through hole for M10 1C1, 1D1: 5 × 35 mm copper busbar, through hole for M10
	Max. conductor cross-section for cables with cable lug in acc. with DIN 46234: 1U1, 1V1, 1W1: 2 × 150 mm <sup>2</sup> 1C1, 1D1: 2 × 185 mm <sup>2</sup>
	Tightening torque for 1U1, 1V1, 1W1, 1C1, 1D1: 25 Nm Tightening torque for protective conductor: 50 Nm
720 ... 850 A	1U1, 1V1, 1W1, 1C1, 1D1: 5 × 60 mm copper busbar, through hole for M12
	Max. conductor cross-section for cables with cable lug in acc. with DIN 46234: 1U1, 1V1, 1W1, 1C1, 1D1: 4 × 150 mm <sup>2</sup>
	Tightening torque for 1U1, 1V1, 1W1, 1C1, 1D1: 44 Nm Tightening torque for protective conductor: 50 Nm

Protective conductor:

Minimum cross-section 10 mm<sup>2</sup>, for connection options, see dimensional drawings.

**SINAMICS DCM**

## DC Converter and Control Module

## DC Converters

**Circuit diagrams**

*Terminal type, power connections for units of 60 A and higher (continued)*

Units	Data
900 ... 1200 A	1U1, 1V1, 1W1, 1C1, 1D1: 6 × 80 mm copper busbar, insert nut M12
	Max. conductor cross-section for cables with cable lug in acc. with DIN 46234: 1U1, 1V1, 1W1, 1C1, 1D1: 4 × 150 mm <sup>2</sup>
	Tightening torque for 1U1, 1V1, 1W1, 1C1, 1D1: 44 Nm Tightening torque for protective conductor: 60 Nm
1500 ... 2000 A	1U1, 1V1, 1W1: 10 × 120 mm aluminum busbar, through hole for M12 1C1, 1D1: Aluminum busbar, cross-section 60 × 10 mm / 323 mm wide, insert nut M12
	Max. conductor cross-section for cables with cable lug in acc. with DIN 46234: 1U1, 1V1, 1W1: 4 × 240 mm <sup>2</sup> 1C1, 1D1: 8 × 240 mm <sup>2</sup>
	Tightening torque for 1U1, 1V1, 1W1, 1C1, 1D1: 44 Nm Tightening torque for protective conductor: 60 Nm
2200 ... 3000 A	1U1, 1V1, 1W1: 10 × 120 mm copper busbar, through hole for M12 1C1, 1D1: Copper busbar 60 × 10 mm / 323 mm wide, insert nut M12
	Max. conductor cross-section for cables with cable lug in acc. with DIN 46234: 1U1, 1V1, 1W1: 6 × 240 mm <sup>2</sup> 1C1, 1D1: 8 × 240 mm <sup>2</sup>
	Tightening torque for 1U1, 1V1, 1W1, 1C1, 1D1: 44 Nm Tightening torque for protective conductor: 60 Nm

The units are designed for a permanent line supply connection in accordance with DIN VDE 0160-106, Section 6.5.2.1.

The conductor cross-sections (also for the protective conductor) must be determined in accordance with the regulations that apply in each case – e.g. DIN VDE 0276-1000.

*Assignment of power connections*

Terminal	Function	Technical data
1U1 1V1 1W1	Power section line connection armature circuit	See under "Technical specifications" (Rated armature supply voltage)
	Protective conductor PE	
1C1 (1D1) 1D1 (1C1)	Motor connection, armature circuit	See under "Technical specifications" (Rated DC voltage)

**Field circuit**

*Terminal type, field circuit connections*

Units with rated armature DC current 15 ... 850 A:	
Type	ZFKDS 4-10 PC board terminal
Conductor size	<ul style="list-style-type: none"> <li>• Rigid: 0.2 ... 6 mm<sup>2</sup></li> <li>• Flexible: 0.2 ... 4 mm<sup>2</sup></li> <li>• Conductor sizes: AWG 24 ... 10</li> <li>• Flexible with end sleeve with/without plastic sleeve: 0.25 ... 4 mm<sup>2</sup></li> </ul>
Stripped length	10 mm
Units with rated armature DC current 900 ... 1200 A:	
Type	20E/4DS terminal strip
Conductor size	<ul style="list-style-type: none"> <li>• Rigid: 6 ... 16 mm<sup>2</sup></li> <li>• Flexible: 6 ... 10 mm<sup>2</sup></li> </ul>
Stripped length	8 mm
Units with rated armature DC current 1500 ... 3000 A:	
Type	UK16N terminal block
Conductor size	<ul style="list-style-type: none"> <li>• Rigid: 2.5 ... 25 mm<sup>2</sup>, AWG 14 ... 4</li> <li>• Flexible: 4 ... 16 mm<sup>2</sup>, AWG 12 ... 6</li> </ul>
Stripped length	11 mm
Tightening torque	1.5 ... 1.8 Nm



**Circuit diagrams**
*Terminal type, field circuit connections (continued)*
**Units with option L85 (with rated field DC current 85 A):**

Type	UK35 terminal block
Conductor size	<ul style="list-style-type: none"> <li>• Rigid: 0.75 ... 50 mm<sup>2</sup></li> <li>• Flexible: 0.75 ... 35 mm<sup>2</sup></li> <li>• Conductor sizes: AWG 18 ... 0/1</li> <li>• Flexible with end sleeve with/without plastic sleeve: 0.75 ... 35 mm<sup>2</sup></li> </ul>
Stripped length	16 mm
Tightening torque	3.2 ... 3.7 Nm



*Assignment of connections for the field circuit*

Terminal	Function	Technical data
XF1: 3U1, 3W1	Power section line connection field circuit	See under "Technical specifications" (Rated field supply voltage)
XF2-1: 3D XF2-2: 3C	Motor connection, field circuit	See under "Technical specifications" (Rated field DC voltage)

**Electronics power supply**
*Terminal type, electronics power supply*

Type	MSTB 2.5 / CIF plug-in terminal
Conductor size	<ul style="list-style-type: none"> <li>• Rigid: 0.2 ... 2.5 mm<sup>2</sup></li> <li>• Flexible: 0.2 ... 2.5 mm<sup>2</sup></li> <li>• Conductor sizes: AWG 24 ... 12</li> <li>• Flexible with end sleeve with/without plastic sleeve: 0.25 ... 2.5 mm<sup>2</sup></li> </ul> Multi-conductor connection (2 conductors of the same type and with same cross-section): <ul style="list-style-type: none"> <li>• Rigid: 0.2 ... 1 mm<sup>2</sup></li> <li>• Flexible: 0.2 ... 1.5 mm<sup>2</sup></li> <li>• Flexible with end sleeve without plastic sleeve: 0.25 ... 1 mm<sup>2</sup></li> <li>• Flexible with end sleeve with plastic sleeve: 0.5 ... 1.5 mm<sup>2</sup></li> </ul>
Stripped length	7 mm
Tightening torque	0.5 ... 0.6 Nm

*Assignment of terminals for the electronics power supply*

Terminal	Connection	Function	Technical data
XP1			
5U1 5W1 5N1		400 V supply	380 V (-25 %) ... 480 V (+10 %) 2 AC; $I_n = 1$ A (-35 % for 1 min) Internal fuse with F200, F201 on Power Interface DC Converter External protection max. 6 A, characteristic C recommended
or			
5U1 5W1 5N1		230 V supply	190 V (-25 %) ... 240 V (+10 %) 1 AC; $I_n = 2$ A (-35 % for 1 min) Internal fuse with F200, F201 on Power Interface DC Converter External protection max. 6 A, characteristic C recommended

Power Interface DC Converter

**Note:**

In the case of line supply voltages that fall outside the tolerance range, the supply voltages for the electronics, field circuit, and unit fan must be adapted to the permissible value using transformers. An isolation transformer is absolutely essential for rated line supply voltages above 480 V.

The rated supply voltage for the armature circuit (index i00) and for the field circuit (index i01) must be set at p50078.

**SINAMICS DCM**

## DC Converter and Control Module

## DC Converters

**Circuit diagrams**Fans

*Terminal type, fan connections for units with forced ventilation  $\geq 400 A$*

Type	DFK-PC4 plug-in terminal
Conductor size	<ul style="list-style-type: none"> <li>• Rigid: 0.2 ... 4 mm<sup>2</sup></li> <li>• Flexible: 0.2 ... 4 mm<sup>2</sup></li> <li>• Conductor sizes: AWG 24 ... 10</li> </ul>

The connecting leads must be insulated up to the point where they meet the terminal enclosure.

*Assignment of terminals for fan connection*

Terminal	Function	Technical data
4U1 4V1 4W1	400 ... 460 V supply	400 ... 460 V 3 AC for additional data, refer under "Technical specifications"
	Protective conductor PE	
or		
4U1 4N1	230 V supply	230 V 1 AC for additional data, refer under "Technical specifications"

Open-loop and closed-loop control section

*Terminal type, open-loop and closed-loop control section*

X177:	
Type	SPT 1.5 spring-loaded terminal
Conductor size	<ul style="list-style-type: none"> <li>• Rigid: 0.2 ... 1.5 mm<sup>2</sup></li> <li>• Flexible: 0.2 ... 1.5 mm<sup>2</sup></li> <li>• Conductor sizes: AWG 24 ... 16</li> <li>• Flexible with end sleeve without plastic sleeve: 0.25 ... 1.5 mm<sup>2</sup> (stripped length, 8 mm)</li> <li>• Flexible with end sleeve with plastic sleeve: 0.25 ... 0.75 mm<sup>2</sup> (stripped length, 8 mm)</li> </ul>
Stripped length	10 mm
X178, X179:	
Type	FMC 1.5 plug-in terminal
Conductor size	<ul style="list-style-type: none"> <li>• Rigid: 0.2 ... 1.5 mm<sup>2</sup></li> <li>• Flexible: 0.2 ... 1.5 mm<sup>2</sup></li> <li>• Conductor sizes: AWG 24 ... 16</li> <li>• Flexible with end sleeve without plastic sleeve: 0.25 ... 1.5 mm<sup>2</sup></li> <li>• Flexible with end sleeve with plastic sleeve: 0.25 ... 0.75 mm<sup>2</sup></li> </ul>
Stripped length	10 mm
XR1, XS1, XT1:	
Type	MSTB 2.5 / CIF plug-in terminal
Conductor size	<ul style="list-style-type: none"> <li>• Rigid: 0.2 ... 2.5 mm<sup>2</sup></li> <li>• Flexible: 0.2 ... 2.5 mm<sup>2</sup></li> <li>• Conductor sizes: AWG 24 ... 12</li> <li>• Flexible with end sleeve with/without plastic sleeve: 0.25 ... 2.5 mm<sup>2</sup></li> </ul>
Stripped length	7 mm
Tightening torque	0.5 ... 0.6 Nm
X126:	
Type	Submin D, 9-pin
X100, X101:	
Type	Western socket 8 / 4 (RJ45)

**Circuit diagrams**

## Terminals on Connector Board

## Assignment, terminal X177

Terminal X177	Function	Technical data
<b>Analog inputs (user-assignable inputs)</b>		
1 2	AI3 + AI3 -	Analog input 3 Input type (signal type): Differential input $\pm 10$ V; 150 k $\Omega$ Resolution approx. 5.4 mV ( $\pm 11$ bits) Common-mode controllability: $\pm 15$ V
3 4	AI4 + AI4 -	Analog input 4
5 6	AI5 + AI5 -	Analog input 5
7 8	AI6 + AI6 -	Analog input 6
<b>Digital inputs (user-assignable inputs)</b>		
9 10	24 V DC	24 V supply (output) 24 V DC, short-circuit proof Max. load 200 mA (terminals 9 and 10 together), internal supply referred to internal ground
11	DI0	Digital input 0 H signal: +15 ... +30 V L signal: -30 ... +5 V or terminal open 8.5 mA at 24 V
12	DI1	Digital input 1
13	DI2	Digital input 2
14	DI3	Digital input 3
<b>Digital inputs/outputs (user-assignable inputs/outputs)</b>		
15	DI/ DO4	Digital input/ output 4 Type, input/output parameterizable Properties of inputs: H signal: +15 ... +30 V L signal: 0 ... +5 V or terminal open 8.5 mA at 24 V
16	DI/ DO5	Digital input/ output 5
17	DI/ DO6	Digital input/ output 6 Properties of outputs: H signal: +20 ... +26 V L signal: 0 ... +2 V
18	DI/ DO7	Digital input/ output 7 Short-circuit proof, 100 mA Internal protective circuit (free wheeling diode) For overload: Alarm A60018
19	DO0	Digital output 0 H signal: +20 ... +26 V L signal: 0 ... +2 V
20	DO1	Digital output 1 Short-circuit proof, 100 mA Internal protective circuit (free wheeling diode)
21	DO2	Digital output 2
22	DO3	Digital output 3 For overload: Alarm A60018
23, 24	M	Ground, digital
<b>Analog inputs, setpoint inputs (user-assignable inputs)</b>		
25 26	AI0 + AI0 -	Analog input 0 Main setpoint Input type (signal type), parameterizable: - Differential input $\pm 10$ V; 150 k $\Omega$ - Current input 0 ... 20 mA; 300 $\Omega$ or 4 ... 20 mA; 300 $\Omega$ Resolution approx. 0.66 mV ( $\pm 14$ bits) Common-mode controllability: $\pm 15$ V
27 28	AI1 + AI1 -	Analog input 1
29 30	AI2 + AI2 -	Analog input 2 Input type (signal type): - Differential input $\pm 10$ V; 150 k $\Omega$ Resolution approx. 0.66 mV ( $\pm 14$ bits) Common-mode controllability: $\pm 15$ V
<b>Reference voltage</b>		
31 32	P10 N10	Reference voltage $\pm 10$ V (output) Tolerance $\pm 1$ % at 25 °C Stability 0.1 % per 10 K 10 mA short-circuit proof
33, 34	M	Ground, analog
<b>Serial interface, peer-to-peer RS485</b>		
35, 36	M	Ground, digital
37	TX+	Send cable + 4-wire send cable, positive differential output
38	TX-	Send cable - 4-wire send cable, negative differential output
39	RX+	Receive cable + 4-wire receive cable, positive differential input
40	RX-	Receive cable - 4-wire receive cable, negative differential input

**SINAMICS DCM**

## DC Converter and Control Module

## DC Converters

**Circuit diagrams***Assignment, terminal X177 (continued)*

Terminal X177	Function	Technical data
<b>Pulse encoder input</b>		
41	Pulse encoder supply	+13.7 ... +15.2 V, 300 mA short-circuit proof (electronically protected) For overload: Alarm A60018
42	Pulse encoder ground	
43	Track 1 positive connection	Load: ≤ 5.25 mA at 15 V (without switching losses) Pulse duty factor: 1:1
44	Track 1 negative connection	See below for data relating to cables, cable length, shield connection, input pulse levels, hysteresis, track displacement, and pulse frequency.
45	Track 2 positive connection	
46	Track 2 negative connection	
47	Zero mark positive connection	
48	Zero mark negative connection	
<b>Analog outputs (user-assignable outputs)</b>		
49	AO0 Analog output 0	± 10 V, max. 2 mA short-circuit proof, resolution ± 15 bits
50	M Ground, analog	
51	AO1 Analog output 1	
52	M Ground, analog	
<b>Connections for temperature sensor (motor interface 1)</b>		
53	Temp 1	Sensor acc. to p50490
54	Temp 2 (sense cable)	The cable to the temperature sensor on the motor must be shielded and connected to ground at both ends.
55	Temp 3	The cables for the Temp 1 and Temp 3 connections to the temperature sensor must have approximately the same length. The sense cable (Temp 2) is used for compensating the cable resistances. If you are not using a sense cable, terminals 54 and 55 must be connected.
56	M Ground, analog	

Connector Board

## More information

### Free function blocks

#### Application, properties

Logic operations, which link several states (e.g. access control, plant status) to a control signal (e.g. ON command), are required for controlling the drive system in a wide variety of applications. Along with logic operations, a number of arithmetic operations and storing elements are becoming increasingly important in drive systems.

This functionality is available as function module "Free function blocks" (FBLOCKS) for SINAMICS DC MASTER and can be activated in the Control Unit (CUD). A detailed description is provided in the Function Manual "Free Function Blocks" (see catalog section "Services and documentation").

#### Configuring and use

The free function blocks are configured at the parameter level.

The following parameters are required for this:

- Input parameters (e.g. inputs I0 ... I3 for the AND function block)
- Output parameters (e.g. output Y for the numeric change-over switch)
- Adjustable parameters (e.g. pulse duration for pulse generator MFP)
- Runtime group (this includes the sampling time; the free function blocks are not computed in the factory setting)
- Run sequence within the runtime group

A parameter is assigned to each input, output, and setting variable. These can be accessed by means of the AOP30 Advanced Operator Panel or STARTER commissioning software. The free function blocks can be interconnected at the BICO level. The free function blocks do not support data set dependency.

#### Range of blocks

The table below shows the range of free function blocks available. The special technical properties of the individual function blocks can be taken from the function block diagrams in Chapter 3 of the Function Manual.

Short name	Name of function block	Data type	Count per drive object
AND	AND function block	BOOL	4
OR	OR function block	BOOL	4
XOR	XOR function block	BOOL	4
NOT	Inverter	BOOL	4
ADD	Adder	REAL	2
SUB	Subtractor	REAL	2
MUL	Multiplier	REAL	2
DIV	Divider	REAL	2
AVA	Absolute value generator with sign evaluation	REAL	2
MFP	Pulse generator	BOOL	2
PCL	Pulse shortener	BOOL	2
PDE	ON delay	BOOL	2
PDF	OFF delay	BOOL	2
PST	Pulse stretcher	BOOL	2
RSR	RS flip-flop, reset dominant	BOOL	2
DFR	D flip-flop, reset dominant	BOOL	2
BSW	Binary change-over switch	BOOL	2
NSW	Numeric change-over switch	REAL	2
LIM	Limiter	REAL	2
PT1	Smoothing element	REAL	2
INT	Integrator	REAL	1
DIF	Derivative-action element	REAL	1
LVM	Double-sided limit monitor with hysteresis	BOOL	2

## SINAMICS DCM

### DC Converter and Control Module

#### DC Converters

##### More information

##### Drive Control Chart (DCC)

The "Drive Control Chart" function (DCC) is available for more complex applications.

DCC allows you to graphically configure the required functionality and then download it to the drive. It provides a significantly extended range of block types available.

In online operation, the signal values can be monitored in STARTER/SCOUT in the DCC chart.

##### Power section and cooling

SINAMICS DC MASTER converters distinguish themselves as a result of the compact, space-saving design. The electronics module (available in various customer-specific combinations with options) is installed in a cradle that can be swiveled out. The easy access to individual components makes this technology very service-friendly.

Plug-in terminals are used to connect external signals (binary inputs/outputs, analog inputs/outputs, pulse generators etc.). The firmware is saved in a flash EPROM and can be easily exchanged by loading via the serial interface of the SINAMICS DC MASTER.

##### Power section: Armature and field circuit

The armature circuit is implemented as a three-phase bridge circuit:

- For units for two-quadrant operation, in a fully-controlled three-phase bridge circuit B6C
- For units for four-quadrant operation in two fully-controlled three-phase bridge circuits (B6) A (B6) C.

The field circuit is implemented in a half-controlled single-phase bridge circuit B2HZ.

In the case of units with a 15 A to 1200 A rated DC current, the power sections for the armature and field include electrically isolated thyristor modules, which means that the heat sink is floating. For units up to 30 A, the armature and field power sections are implemented in the form of a printed circuit board with compact modules that are soldered on.

For units with rated currents  $\geq 1500$  A, the power section for the armature circuit uses disc-type thyristors and heat sinks at voltage potential. For units from 1500 to 3000 A, the thyristor phases are implemented as plug-in modules and can therefore be quickly replaced.

Checking the motor insulation has been significantly simplified due to the fact that the line supply voltage sensing for the armature and the field sections is electrically isolated.

##### Cooling

Units with a rated DC current up to 125 A are designed for natural air cooling, units with a rated current above 210 A are designed for forced air cooling (fan). The fans are always horizontally mounted at the top so that they can be quickly replaced without having to disconnect the power connections.

##### Parameterizing devices

##### BOP20 Basic Operator Panel



BOP20 Basic Operator Panel

As standard, all of the units are equipped with a BOP20 Basic Operator Panel from the SINAMICS family.

The basic operator panel offers customers a basic functionality for commissioning as well as operator control and monitoring.

Faults can be acknowledged, parameters set and diagnostics information read out (e.g. alarm and fault messages) using the BOP20.

The BOP20 has a backlit two-line display area and 6 keys.

The BOP20 power supply and communication with the CUD Control Unit are established via the connector integrated at the rear of the BOP20.

##### AOP30 Advanced Operator Panel



The AOP30 Advanced Operator Panel is an optional input/output device for SINAMICS DC MASTER converters. It can be separately ordered. You will find additional information about the AOP30 in catalog section "Accessories and supplementary components".

##### PC based parameterization

The STARTER tool is available for PC-based commissioning and diagnostics. More detailed information is provided in catalog section 5 "Tools and engineering".

## More information

### **Closed-loop control and open-loop drive control**

The closed-loop control and open-loop drive control is essentially designed for supplying the armature and field of variable-speed DC drives.

Using BICO technology permits the closed-loop and open-loop drive control structure to be simply adapted to the application-specific requirements as well as the use in alternative applications (e.g. as excitation equipment for synchronous motors).

The most important functions of the closed-loop control include:

- Setpoint processing (including digital setpoints, jogging, motorized potentiometer)
- Ramp-function generator
- Speed controller actual value processing
- Speed controller
- Torque and armature current control
- Closed-loop armature current control
- Armature gating unit
- Closed-loop EMF control
- Closed-loop field current control
- Field gating unit

#### BICO technology

BICO technology (Binector Connector Technology) allows signal paths to be defined (and therefore the controller structure) using parameters.

Mode of operation:

All important points of the closed-loop control are accessible via connectors.

Connectors are measuring points that are mapped to display parameters.

Important connectors include:

- Analog inputs and outputs
- Interface inputs (e.g. PROFIBUS)
- Actual value sensing inputs (e.g. speed, armature current, armature voltage)
- Inputs and outputs of the ramp-function generator, speed controller, armature current controller, armature gating unit, EMF controller, field current controller, field gating unit
- General quantities such as operating state, motor temperature rise, thyristor temperature rise

All important binary signals of the closed-loop and open-loop control are accessible via binectors.

Binectors are measuring points for binary signals, which are mapped to display parameters.

Important binectors include:

- Status of binary inputs
- Control words, status words
- Status of controllers, limits, faults

All of the important inputs of the open-loop and closed-loop control can be interconnected using BICO selection parameters. This means that by setting the corresponding BICO selection parameter, a connection can be established between any connector or binector.

Important inputs include:

- Setpoint input, supplementary setpoint input
- Ramp-function generator input
- Speed controller input
- Armature current controller input
- Armature gating unit input
- Speed setpoint limiting (before and after the ramp-function generator)
- Torque limiting
- Armature current limiting
- Signal source for binary and analog outputs

#### Data sets

Many open-loop and closed-loop control parameters depend on the particular data set. This means that they have several indices where various values can be set. All data set dependent parameters can be simultaneously switched over to another data set using binary control signals.

There are two groups of data set-dependent parameters:

- **DDS parameters:**  
Parameters that are associated with the drive data set (DDS). The drive data set contains various adjustable parameters that are relevant for open-loop and closed-loop drive control.
- **CDS parameters:**  
Parameters that are associated with the command data set (CDS). Many BICO selection parameters are combined in the command data set. These parameters are used to interconnect the signal sources of a drive.

By parameterizing several command data sets and switching between them, the drive can be operated with different pre-configured signal sources.

## SINAMICS DCM

### DC Converter and Control Module

#### DC Converters

#### More information

##### Optimization run

The SINAMICS DC MASTER converter units are supplied with the factory settings. Controller setting is supported by selecting automatic optimization runs. The selection is made using special key numbers.

The following controller functions can be set using an automatic optimization run:

- Current controller optimization run to set the current controller and pre-controls (armature and field circuit).
- Speed controller optimization run for setting the speed controller characteristics; automatic recording of the friction and moment of inertia compensation for the speed controller pre-control.
- Automatic recording of the field characteristic for an EMF-dependent field-weakening control and automatic optimization of the EMF controller for field-weakening operation.
- In addition, all of the parameters set during the automatic optimization runs can be changed via the operator panel.

##### Monitoring and diagnostics

###### Displaying operating values

The operating state of the converter is displayed using a parameter. Several hundred signals can be displayed via parameter or selected for output on the display unit. Examples of measured values that can be displayed: Setpoints, actual values, status of binary inputs/outputs, line supply voltage, line frequency, firing angle, inputs/outputs of the analog terminals, controller input and output, limits.

###### Trace function

Up to eight measured quantities can be saved by selecting the trace function. A measured quantity or the occurrence of a fault signal can be parameterized as trigger condition. By selecting a trigger delay, it is also possible to record (trace) the pre-history and post-history of events. The sampling time of the measured value storage can be parameterized.

The measured values can be output via the serial interfaces using the STARTER commissioning tool.

###### Fault messages

A number is assigned to each fault message. In addition, the operating hour of the event is saved together with the fault message. This allows the cause of the fault to be quickly pinpointed. By using the optional AOP30 Advanced Operator Panel, fault messages can be stamped in real time. Then, instead of the operating hour of the event, the day and the time of day of the event is displayed in the AOP30 fault list. For diagnostic purposes, the last eight fault messages are saved with fault number, fault value and the operating hours.

When a fault occurs

- the binary output function "Fault" is set to LOW (user-assignable function),
- the drive is switched off (controller inhibit, current  $I = 0$  is entered, pulses are inhibited, the relay "line contactor CLOSE" drops out) and
- an F is displayed with fault number, LED "Fault" is lit.

Fault messages should either be acknowledged via the operator panel, a binary user-assignable terminal or a serial interface. The "switch-on inhibit" state is reached after the fault has been acknowledged. "Switch-on inhibit" is canceled by an OFF command.

Automatic restart: An automatic restart is possible within a time that can be parameterized between 0 and 10 s. If the time is set to zero, a fault message is immediately output (for power failure) without a restart. A restart can be selected for the following fault messages: Phase failure (field or armature), undervoltage, overvoltage, electronics power supply failure, undervoltage condition at the parallel SINAMICS DC MASTER.

A distinction is made between the following groups of fault messages:

- Power system faults: Phase failure, fault in the field circuit, undervoltage, overvoltage, line frequency  $< 45$  or  $> 65$  Hz
- Interface faults: CUD interfaces or interfaces to the supplementary boards faulted
- Drive faults:
  - Controller monitoring for speed controller,
  - Current controller, EMF controller,
  - Field current controller has responded,
  - Drive stalled,
  - No armature current possible
- Electronic motor overload protection ( $I^2t$  monitoring of the motor has responded)
- Tachometer monitoring and overspeed signal
- Commissioning fault
- Fault on the electronics module
- Fault message from the thyristor check: This fault message can only occur if the thyristor check has been activated using the appropriate parameter. In this case, a check is made as to whether the thyristors can be blocked and whether they can be fired.
- Fault messages from the motor sensor system:
  - Monitoring of brush length, bearing condition, motor fan, motor temperature
- External faults via binary user-assignable terminals

The fault messages can be individually deactivated using a parameter. Some fault messages are already deactivated in the factory and can be activated using this parameter.

###### Alarms

Alarm messages display special states; however, they do not cause the drive to be switched off. Alarms that occur do not have to be acknowledged, but rather they are automatically reset as soon as the cause of the alarm is no longer present.

When one or several alarms occur

- the binary output function "Alarm" is set to LOW (user-assignable function) and
- the alarm is displayed by the flashing "Fault" LED.

A distinction is made between the following groups of alarms:

- Motor overtemperature: The calculated  $I^2t$  value of the motor has reached 100 %.
- Alarms from the motor sensor system: Monitoring of brush length, bearing condition, air flow, motor temperature
- Drive alarms: Drive has stalled, no armature current possible
- External alarms via binary user-assignable terminals
- Alarms from supplementary modules



**More information**
**Functions of the inputs and outputs**
Analog user-assignable inputs

After converting to a digital value, the quantity of the analog inputs can be flexibly adapted via parameters for scaling, filter, sign selection and offset input. The values are available as connector. This is the reason that the analog inputs can be effective as main setpoint and also as quantity for a supplementary setpoint or a limit.

Analog outputs

Selectable analog outputs are available to output analog signals. Analog signals can be output as bipolar signal or as absolute value. In this case, scaling, an offset, polarity and a filter time can be parameterized. The required output quantities are selected at the intervention points by entering connector numbers. For instance, speed actual value, ramp-function generator output, current setpoint, line supply voltage etc. can be output.

Binary inputs

- **Switch-on/shutdown (OFF 1)**  
This terminal function is ANDed with the control bit of the serial interface. For an H signal at terminal *switch-on/shutdown*, the main contactor closes via an internal sequence control. The controllers are enabled if there is an H signal at the operating enable terminal. The drive accelerates up to the operating speed with the speed setpoint. For an L signal at the terminal *switch-on/shutdown*, the drive is ramp-down to speed  $n < n_{\min}$  via the ramp-function generator; after the brake control delay time, the controllers are inhibited and at  $I = 0$ , the main contactor is opened. After this, after an adjustable time after the main contactor has dropped out, the field current is reduced to the standstill field current (this can be parameterized). The standstill field can e.g. be used as anti-condensation heating for the motor; to do this, approximately 30 % of the rated field current must be entered as standstill field. The motor fan must be operational for a field current of 100 % of the rated field current. Otherwise, the field winding will be overloaded.
- **Operating enable**  
This function is ANDed with the control bit of the serial interface. The controllers are enabled with an H signal at the *operating enable* terminal. For an L signal, the controllers are inhibited and at  $I = 0$  the pulses are inhibited. The signal *operating enable* has a high priority; this means that if the signal (L signal) is withdrawn in operation, then this always results in  $I = 0$  and therefore the drive coasts down.

Binary user-assignable inputs:

Additional binary input terminals are available for user-assignable functions. In this case, a binector number is assigned to every user-assignable terminal, which can be used for control functions.

Examples of binary input functions:

- **Voltage disconnect (OFF 2):** For OFF 2 (L signal), the controllers are instantaneously inhibited, the current in the armature circuit is reduced and at  $I = 0$ , the main contactor is opened. The drive coasts down uncontrolled.
- **Quick stop (OFF 3):** For a quick stop (L signal), the speed setpoint at the speed controller input is set to zero and the drive is braked along the current limit for quick stop (parameterizable). At  $n < n_{\min}$  after the brake control delay time  $I = 0$  is entered and the main contactor is opened.
- **Jogging:** The jogging function is available for an L signal at terminal *switch-on/shutdown*, for an H signal at terminal *operating enable* and when the jogging function is controlled. In this case, the main contactor is closed and the drive accelerates up to the jogging setpoint defined in a parameter. When the jogging signal is withdrawn, the drive is braked to  $n < n_{\min}$ ; after this, the controllers are inhibited and the main contactor is opened after a parameterizable time (0 to 60 s). Further, it can be selected as to whether the ramp-function generator is active or ramp-up time = ramp-down time = 0 is used.

Binary outputs

User-assignable signaling functions are available at the binary output terminals (open emitter output). Any binector quantity, which can be selected via the associated user-assignable parameter, can be output for each terminal. The polarity of the output signal and an adjustable delay time (0 to 10 s) can be selected using parameters.

Examples of binary output functions:

- **Fault:** An L signal is output when a fault message is present.
- $n < n_{\min}$ : An H signal is output for speeds less than  $n_{\min}$ . This signal is used, for instance, as a zero speed signal.
- **Switch-on command for a mechanical brake:** A motor brake can be controlled using this signal.

When switching on the drive using the "switch-on" function and entering "operating enable", an H signal is output to open the brake, in this case, the internal controller enable is delayed by a parameterizable time (wait for the mechanical brake opening time to expire). When shutting down the drive using the "shutdown" function or "quick stop", an L signal is output to close the brake when speed  $n < n_{\min}$  is reached. At the same time, the internal controller enable is present for a parameterizable time (wait for the mechanical brake closing time to expire): When  $I = 0$  is entered, the pulses are inhibited and the main contactor is opened.

An additional operating mode can be selected using the "close brake" signal (L signal at the binary user-assignable output). As a consequence, when the "internal controller inhibit" is present (the drive is in a no-current condition), the drive does not wait for the status  $n < n_{\min}$ , but the brake is already controlled (operating brake) at speeds greater than  $n_{\min}$ .

Internal control inhibit is present when a fault message occurs, when the voltage is disconnected or the operating enable - *terminal operating enable* - is withdrawn in operation.

## SINAMICS DCM

### DC Converter and Control Module

#### DC Converters

#### More information

##### Safety shutdown (E-STOP)

The E-STOP function is used to open the relay contact for the main contactor control within approximately 15 ms independently of semiconductor components and the correct functioning of the CUD. If the CUD is operating correctly, entering  $I = 0$  via the control ensures that the main contactor is switched in a no-current condition. The drive coasts down once E-STOP has been entered.

After the E-STOP has been reset, the drive goes into the "switch-on inhibit" operating state. This must be acknowledged by activating the "shutdown" function e.g. by opening terminal *switch-on/shutdown*.

##### Note:

The E-STOP function is not an EMERGENCY OFF function in the sense of EN 60204-1.

##### Serial interfaces

The following serial interfaces are available for each CUD:

- A serial interface on the Standard CUD and Advanced CUD for the USS protocol according to RS232 or RS485 to connect the optional AOP30 Advanced Operator Panel or for STARTER via a PC.
- A serial interface at the terminals of the Standard CUD and Advanced CUD, RS485 two-wire or four-wire for a peer-to-peer connection.
- PROFIBUS DP as standard on the Standard CUD and Advanced CUD
- PROFINET via the CBE20 Communication Board on the Advanced CUD (option)
- EtherNet/IP via the CBE20 Communication Board on the Advanced CUD (option)
- DRIVE-CLiQ on Advanced CUD (option) to connect optional SINAMICS components SMC10, SMC30, TM15, TM31 and TM150

Note: A maximum of three Terminal Modules per Advanced CUD can be connected as a combination of TM15, TM31 and TM150. A maximum of one TM150 is permitted. Furthermore, a SMC10 or SMC30 Sensor Module can be added.

##### Physics of the interfaces

- RS232:  $\pm 5$  V interface for the point-to-point connection
- RS485: 3.3 V common mode interface, interference-proof, additionally for one bus connection with a maximum of 31 participants connected to the bus

##### USS protocol

Open Siemens protocol, can be simply programmed e.g. on the PC in third-party systems, any master interfaces can be used. The drives operate as slaves connected to a master. The drives are selected using a slave number.

The following data exchange is possible via the USS protocol:

- PKW data to read and write parameters
- PZD data (process data) such as control words, setpoints, status words, actual values

The send data (actual values) are selected by entering connector numbers in the parameters, the receive data (setpoints) represent the connector numbers, that can act at any intervention points.

##### Peer-to-peer protocol

The peer-to-peer protocol is used to connect devices with one another. For this operating mode, data is exchanged between converters via a serial interface, e.g. to establish a setpoint cascade. By using a serial interface as four-wire cable, data can be received from the previous unit that is then processed (e.g. by being multiplied) and then transferred to the following unit. Only one serial interface is used for this purpose.

The following data can be exchanged between converters:

- Sending control words and actual values.
- Receiving status words and setpoints.

In this case, up to five data words are transferred in both the send and receive directions. Data is exchanged via connector numbers and intervention points.

The serial interfaces can be simultaneously operated. A connection to the automation (USS protocol) can be established via the first interface for control, diagnostics and to enter the main setpoint. A second interface is used to realize a setpoint cascade function via the peer-to-peer protocol.

##### Control terminal block

###### Terminals on the CUD

- Reference voltage P10, 10 mA load rating, Reference voltage N10, 10 mA load rating
- 2 analog inputs via differential amplifier, resolution  $\pm 14$  bits  
0 ...  $\pm 10$  V, 0 ...  $\pm 20$  mA, 4 ... 20 mA
- 1 analog input via differential amplifier, resolution  $\pm 14$  bits  
0 ...  $\pm 10$  V
- 4 analog inputs via differential amplifier, resolution  $\pm 11$  bits  
0 ...  $\pm 10$  V
- One analog input for motor temperature sensor via Pt100, PTC or KTY84
- 2 analog outputs, referred to ground, 0 ...  $\pm 10$  V,  $\pm 15$ -bit resolution, max. 2 mA
- Pulse encoder evaluation for 5 or 24 V encoder, 2 tracks and zero mark, maximum frequency 300 kHz
- P15 power supply, 200 mA for a pulse encoder
- 4 binary inputs, referred to ground, 2 with selectable function
- 4 binary inputs/outputs, referred to ground, outputs with open emitter P24, 100 mA load rating
- 4 binary outputs, referred to ground, open emitter P24, 100 mA load rating
- One serial interface, RS485 two-wire or four-wire, max. 187.5 kBaud
- P24 power supply to control the binary inputs
- Terminals for equipment ground "digital" (e.g.: to connect the loads of the binary outputs)
- Terminals for equipment ground "analog" (e.g.: to connect the reference potentials of analog inputs)
- Connector to connect an AOP30
- Connector to connect a serial RS232 interface and a 5 V power supply, 300 mA (e.g.: for a pulse encoder)

###### Terminals on the gating module

- Analog tachometer 8 to 270 V for maximum speed
- E-STOP

## More information

### Interface to the motor

#### Motor temperature monitoring

Either PTC thermistors or linear temperature sensors (KTY84-130) can be connected. One input is provided on the Standard CUD and one input on the Advanced CUD option for this purpose. An alarm or fault message can be parameterized for PTC thermistors. When using a KTY84-130, one threshold can be entered for an alarm and one threshold for shutdown (trip). The limit values are displayed and entered in °C.

In addition, a thermo switch can be evaluated by the Advanced CUD (option). A parameterizable alarm or fault message can be output when the thermo switch responds (this is a binary switching signal). The evaluation is realized via a binary user-assignable input.

#### Brush length monitoring

The brush length is monitored using a floating microswitch; the shortest brush is evaluated. If the useful brush life has expired, then the microswitch opens; an alarm or fault message can be parameterized. The evaluation is realized via a binary user-assignable input.

#### Monitoring the motor fan air flow

The air flow is monitored by an air flow monitor integrated in the air flow circuit of the motor fan. When this responds, an alarm or fault message is issued. The evaluation is realized via a binary user-assignable input.

### Siemens DC motors

Although the end of DC technology has been forecast now for many years, we will keep hold of our DC technology and it will remain in our portfolio. When all is said and done, DC motors have proven themselves in daily use for decades now and they are essentially indispensable.

In conjunction with the SINAMICS DC MASTER converters, they always form the ideal team – wherever favorably-priced drive technology and the highest degree of availability are demanded.

These motors can also be used where space is restricted thanks to their compact and modular design.

Further, an extensive range of equipment and devices for mounting on the motor is available. A wide range of monitoring and diagnostic options facilitate reliable and disturbance-free operation.

Detailed specifications regarding quality assurance and improvement are integrated in all of the various operations and processes - from motor development through to production and service. Quality management coordinates the interaction between all of the company processes to ensure error-free and smooth processes.

It goes without saying that our stringent quality requirements also apply to our suppliers. All of the suppliers must seamlessly integrate themselves into our quality management system.

The result: Only fault-free and high quality materials are released for use in our motor production.



#### Customer benefits:

- High power density with low envelope dimensions
- High degree of operational reliability and availability through a wide range of diagnostic features, in conjunction with the SINAMICS DC MASTER converter
- High thermal reserves for continuous and overload conditions as a result of the DURIGNIT 2000® insulation system
- Low losses through a very good efficiency
- Long brush lifetimes through an optimized current commutation system

Technical specifications	
Power range	31.5 ... 1610 kW
Rated armature voltage	420 ... 810 V DC
Excitation	Separately excited
Shaft heights	160 ... 630 mm
Number of poles	4- and 6-pole
Speed	Up to 4500 rpm
Degree of protection	IP23 and IP54
Type of construction	IM B3, IM B35, IM V1 and others
Cooling method	IC06/IC17/IC37/IC A06 A66/IC W37 A86
Stator version	Fully laminated
Standards	IEC, EN, DIN, VDE
Operation	Converter operation, 2Q and 4Q, S1 – S9

#### Typical applications:

- Lift and cableway drives
- Rolling mill drives and winders
- Hoisting and travel gear drives for cranes
- Extruders in the plastics industry
- Drives for printing machines
- Drives for paper machines

Additional information on Siemens DC motors is available in the Internet under:  
<https://www.siemens.com/simotics-dc>

## SINAMICS DCM

### DC Converter and Control Module

#### Control Module

##### Application



The SINAMICS DC MASTER Control Module is mainly used for retrofitting and modernizing DC drives in existing plants and systems. There are many older DC installations in existence which cannot be linked to modern automation systems.

When such plants and systems are retrofitted or upgraded, the motor, mechanical system and power section are retained and only the closed-loop control section is replaced by a Control Module. As a consequence, an extremely favorably-priced modern DC drive is obtained with the full functional scope of the well-proven, fully digital units from the SINAMICS DC MASTER series.

The new system is adapted to the configuration of the existing components using simple parameterization.

The SINAMICS DC MASTER Control Module contains a power section for the field supply with a rated current of 40 A.

##### Design

The SINAMICS DC MASTER Control Module sets itself apart as a result of its compact, space-saving design. The compact design where all of the individual components are easily accessible offers a high degree of service friendliness.

In order to be able to optimally use the mounting and installation possibilities in the plant or system, the SINAMICS DC MASTER Control Module can be split depthwise. In addition, the PC boards for generating and distributing firing pulses, and for fuse monitoring and voltage sensing are designed in such a way that they can be installed outside the device in close proximity to the power section.

Alternatively, when commissioning the drive system with STARTER, the adaptations, settings and measured value displays required can be made using the BOP20 Basic Operator Panel or the AOP30 Advanced Operator Panel.

The AOP30 offers a favorably-priced alternative to measuring equipment installed in the electrical cabinet.

The field is supplied from a single-phase, semi-controlled bridge circuit B2HZ. The field power section is implemented using electrically insulated thyristor modules, which means that the heat sink is floating.

**Technical specifications**

For general technical specifications, see section "DC Converters"

		Type
		6RA8000-0MV62-0AA0
Rated armature supply voltage that can be sensed	V	50/125/250/575/1000
Rated supply voltage, electronics power supply	V	24 V DC (18 ... 30 V DC); $I_n = 5 \text{ A}$
Rated field supply voltage <sup>1)</sup>	V	480 2 AC (+10/-20 %)
Rated frequency	Hz	45 ... 65
Rated DC field voltage <sup>1)</sup>	V	Max. 390
Rated DC field current	A	40
Normal ambient temperature in operation	°C	0 ... +55
Dimensions		
• Width	mm	271
• Height	mm	388
• Depth	mm	253
Weight, approx.	kg	12

<sup>1)</sup> The field supply voltage can lie below the rated field voltage (set using a parameter, input voltages of up to 85 V are permissible). The output voltage decreases accordingly. The specified DC output voltage can be maintained up to an undervoltage of 5 % of the line supply voltage (rated field supply voltage).

**SINAMICS DCM**

## DC Converter and Control Module

**Control Module****Selection and ordering data**

Rated data			Control Module	Fuses
Armature circuit	Field circuit		Article No.	Field circuit
Rated supply voltage <sup>1)</sup>	Rated supply voltage <sup>1)</sup>	Rated current		Type
V	V	A		1 each
50/125/250/575/1000 3 AC	480 2 AC (+10/-20 %)	40	<b>6RA8000-0MV62-0AA0</b>	3NE1802-0 <sup>2)</sup>

**Options**

Note:

When ordering a unit with options, add the suffix "-Z" to the Article No. of the unit and then state the order code(s) for the desired option(s) after the suffix.

Example:  
6RA8000-0MV62-0AA0-Z  
G00+G20+L10+...

**Available options**

The following table provides an overview of the available options. Detailed descriptions of the options are provided in the section "Description of options".

Designation	Order code	Notes	Article No. for separate order	
			not coated	coated
<b>CUD</b>				
Standard CUD left	(Standard)	–	<b>6RY1803-0AA00-0AA1</b>	<b>6RY1803-0AA20-0AA1</b>
Advanced CUD left	<b>G00</b>	–	<b>6RY1803-0AA05-0AA1</b>	<b>6RY1803-0AA25-0AA1</b>
Standard CUD right	<b>G10</b>	This option requires an Advanced CUD left – order code <b>G00</b>	<b>6RY1803-0AA00-0AA1</b> <sup>4)</sup>	<b>6RY1803-0AA20-0AA1</b> <sup>4)</sup>
Advanced CUD right	<b>G11</b>	This option requires an Advanced CUD left – order code <b>G00</b>	<b>6RY1803-0AA05-0AA1</b> <sup>4)</sup>	<b>6RY1803-0AA25-0AA1</b> <sup>4)</sup>
Communication Board CBE20 left	<b>G20</b>	This option requires an Advanced CUD left – order code <b>G00</b>	–	<b>6SL3055-0AA00-2EB0</b>
Communication Board CBE20 right	<b>G21</b>	This option requires an Advanced CUD right – order code <b>G11</b>	–	<b>6SL3055-0AA00-2EB0</b>
Memory card left	<b>S01</b>	–	<b>6RX1800-0AS01</b>	–
Memory card right	<b>S02</b>	This option requires a Standard CUD right – order code <b>G10</b> – or an Advanced CUD right – order code <b>G11</b>	<b>6RX1800-0AS01</b>	–
<b>Field</b>				
Field power section 1Q	(Standard)	–	– <sup>3)</sup>	– <sup>3)</sup>
Field power section 2Q	<b>L11</b>	–	– <sup>3)</sup>	– <sup>3)</sup>
Without field power section	<b>L10</b>	–	–	–
<b>Additional options</b>				
Terminal Module Cabinet	<b>G63</b>	–	<b>6RY1803-0AB05</b>	–
Coated PCBs	<b>M08</b>	–	–	–
Nickel-plated copper busbars	<b>M10</b>	–	–	–
Control for switching over the power section topology for parallel and series connections	<b>S50</b>	–	–	–
Extension of the liability for defects	<b>Q80 ... Q85</b>	See section "Description of options"	–	–

<sup>1)</sup> 50/60 Hz<sup>2)</sup> UL-recognized<sup>3)</sup> Available as a spare part.<sup>4)</sup> The Standard CUD (uncoated 6RY1803-0AA00-0AA1; coated 6RY1803-0AA20-0AA1) and the Advanced CUD (uncoated 6RY1803-0AA05-0AA1; coated 6RY1803-0AA25-0AA1) can be inserted in either the left-hand or the right-hand slot and therefore have an article number which does not refer to a specific slot. A Connector Board (6RY1803-0GA00 or 6RY1803-0GA20) is also needed in order to retrofit a CUD.

### Accessories

The SINAMICS DC MASTER Control Module can be split up into several individual modules. These can be mounted separately from one another.

Optional, pre-fabricated cable sets are available to connect the individual modules. This means that the drive system can be quickly but also flexibly adapted to the plant or system configuration.

Description	Content	Connection	Article No.
Rear enclosure part including accessories for mounting the firing pulse transformer module and/or fuse monitoring module for a parallel connection	Set of loose parts		<b>6RY1805-0CM00</b>
Pre-fabricated connection set ribbon cable: To connect the two cradles when separately mounted	2x 26-core ribbon cables shielded (3 m long) 1x 10-core ribbon cable shielded (3 m long) 1x 20-core ribbon cable shielded (3 m long) 1x RJ45 patch cable shielded (3 m long)	from X21A, X22A on PCB -A7109- to X21A, X22A on PCB -A7043- from X23B on PCB -A7109- to X23B on PCB -A7118- from XF1 on PCB -A7109- to XF1 on PCB -A7116- from X45 on PCB -A7109- to X45 on PCB -A7117-	<b>6RY1807-0CM01</b>
Pre-fabricated connection set ribbon cable: To connect the two cradles when separately mounted	2x 26-core ribbon cables shielded (10 m long) 1x 10-core ribbon cable shielded (10 m long) 1x 20-core ribbon cable shielded (10 m long) 1x RJ45 patch cable shielded (10 m long)	from X21A, X22A on PCB -A7109- to X21A, X22A on PCB -A7043- from X23B on PCB -A7109- to X23B on PCB -A7118- from XF1 on PCB -A7109- to XF1 on PCB -A7116- from X45 on PCB -A7109- to X45 on PCB -A7117-	<b>6RY1807-0CM02</b>
Pre-fabricated connection set for current transformer	2x 2-core twisted cables (2 m long)	from XB on PCB -A7109- to the current transformers	<b>6RY1707-0CM03</b> <sup>1)</sup>
Pre-fabricated connection set for current transformer	2x 2-core cables shielded (10 m long)	from XB on PCB -A7109- to the current transformers	<b>6RY1707-0CM04</b> <sup>1)</sup>
Pre-fabricated connection set for heat sink temperature sensing	1x 2-core shielded cable (10 m long)	from XT6 on PCB -A7109- to temperature sensor on the heat sink	<b>6RY1707-0CM05</b> <sup>1)</sup>
Pre-fabricated connection set for firing pulse	Connection set for 12x 2-core twisted cables (3 m long)	from XIMP11, XIMP12, XIMP13, XIMP14, XIMP15, XIMP16 XIMP21, XIMP22, XIMP23, XIMP24, XIMP25, XIMP26 to the thyristors	<b>6RY1707-0CM06</b> <sup>1)</sup>
Pre-fabricated connection set for fuse monitoring	6x 2-core twisted cables (10 m long)	from XS1_5, XS2_5, XS3_5, XS4_5, XS5_5, XS6_5, XS7_5, XS8_5, XS9_5, XS10_5, XS11_5, XS12_5 or XS1_4, XS2_4, XS3_4, XS4_4, XS5_4, XS6_4, XS7_4, XS8_4, XS9_4, XS10_4, XS11_4, XS12_4 or XS1_3, XS2_3, XS3_3, XS4_3, XS5_3, XS6_3, XS7_3, XS8_3, XS9_3, XS10_3	<b>6RY1807-0CM07</b>
Pre-fabricated connection set for voltage sensing	1x 3-core twisted cable U-V-W (3 m long) 1x 2-core twisted cable C-D (3 m long)	from XU6, XV6, XW6 or XU5, XV5, XW5 or XU4, XV4, XW4 or XU3, XV3, XW3 or XU2, XV2, XW2 or XU1, XV1, XW1 depending on voltage (5.6 V, 50 V, 125 V, 250 V, 575 V or 1000 V) to supply XC6, XD6 or XC5, XD5 or XC4, XD4 or XC3, XD3 or XC2, XD2	<b>6RY1807-0CM08</b>
Pre-fabricated connection set for controlling the firing pulse transformers	12x 2-core twisted cables (1 m long)	from XIMP1, XIMP4 or XIMP2, XIMP5 or XIMP3, XIMP6 on PCB -A7043- (side sections) to firing pulse transformer modules (single boards) with terminals X11, X12, X13, X14, X15, X16, X21, X22, X23, X24, X25, X26	<b>6RY1707-0CM13</b> <sup>1)</sup>
Pre-fabricated connection set for controlling firing pulse transformers	2x 12-core cables, shielded (10 m long)	from XIMP1, XIMP4 and/or XIMP2, XIMP5 and/or XIMP3, XIMP6 on PCB -A7043- to external firing pulse transformers	<b>6RY1707-0CM10</b> <sup>1)</sup>
Pre-fabricated connection set for mounting cradles next to each other	2x 26-core ribbon cables shielded (0.68 m long) 1x 10-core ribbon cable shielded (0.5 m long) 1x 20-core ribbon cable shielded (0.76 m long) 1x RJ45 patch cable shielded (1 m long)	from X21A, X22A on PCB -A7109- to X21A, X22A on PCB -A7043- from X23B on PCB -A7109- to X23B on PCB -A7118- from XF1 on PCB -A7109- to XF1 on PCB -A7116- from X45 on PCB -A7109- to X45 on PCB -A7117-	<b>6RY1807-0CM11</b>
Fuse monitoring distribution module for parallel connection of fuse monitors	Module including 3 m ribbon cable to connect to the SINAMICS DCM Control Module; can be snapped onto standard mounting rails according to EN 50022-35x7.5	X23A on Power Interface Control Module and fuse monitor	<b>6RY1803-0CM26</b>

<sup>1)</sup> Unchanged when compared to the SIMOREG DC-MASTER Control Module.

# SINAMICS DCM

## DC Converter and Control Module

### Control Module

### Circuit diagrams

3

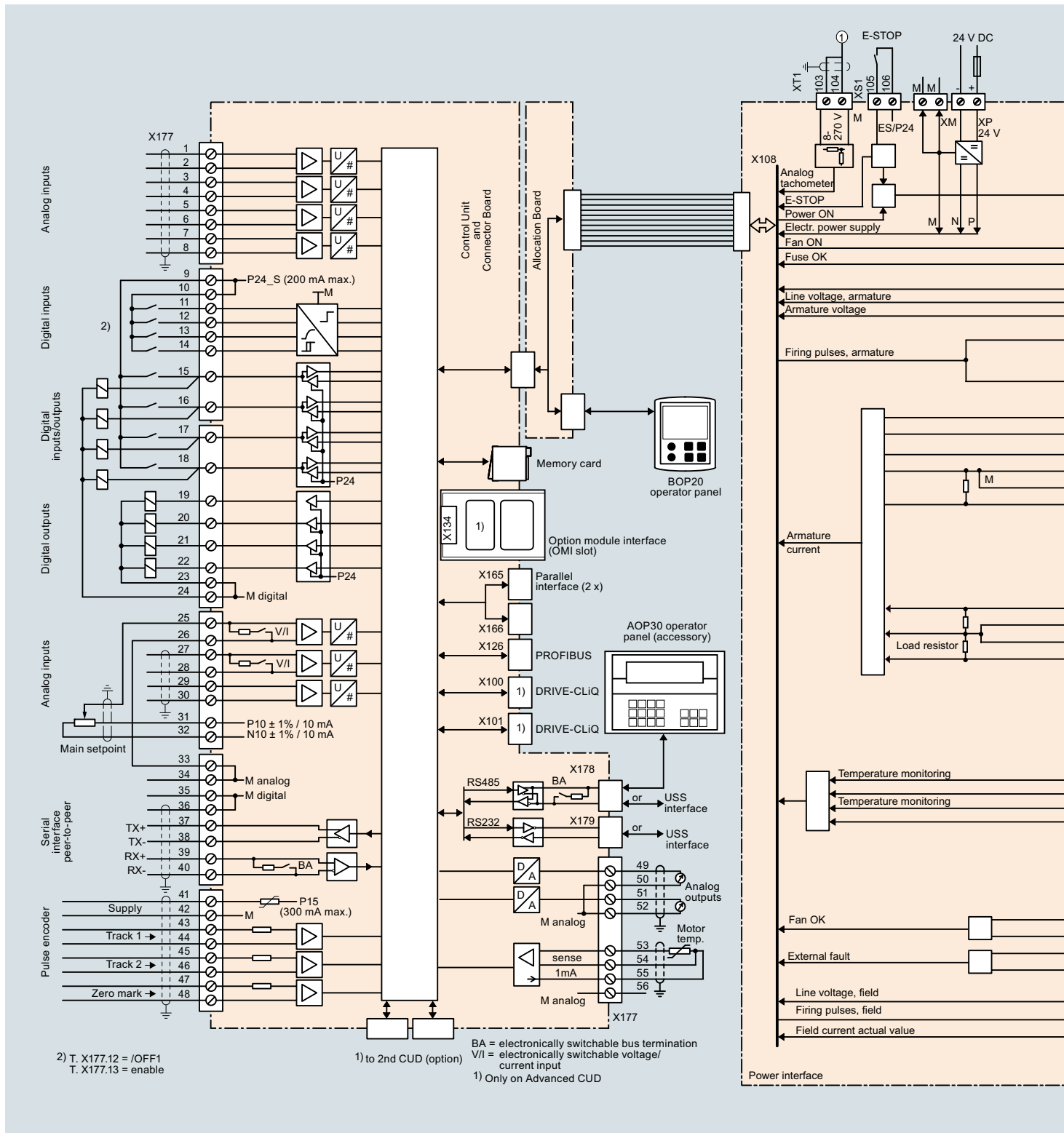



**Circuit diagrams**

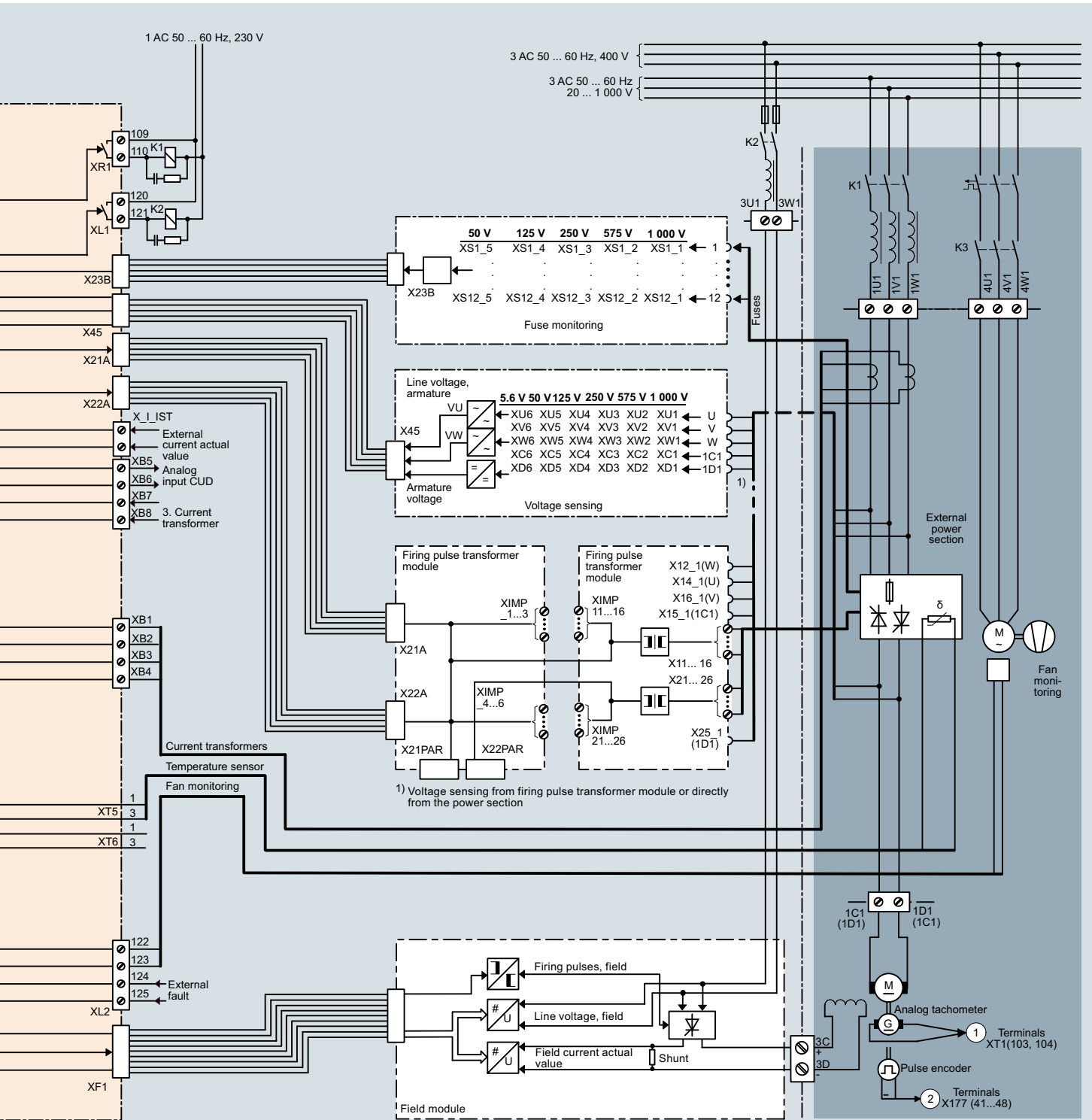

G\_D023\_EN\_00069a

## SINAMICS DCM

DC Converter and Control Module

Notes

3

## Accessories and supplementary components

**4/2 AOP30 Advanced Operator Panel**

- 4/2 Overview
- 4/3 Function
- 4/3 Selection and ordering data

**4/4 SMC10 Sensor Module Cabinet-Mounted**

- 4/4 Overview
- 4/4 Design
- 4/4 Integration
- 4/4 Technical specifications
- 4/4 Selection and ordering data

**4/5 SMC30 Sensor Module Cabinet-Mounted**

- 4/5 Overview
- 4/5 Design
- 4/5 Selection and ordering data
- 4/5 Integration
- 4/5 Technical specifications

**4/6 TM15 Terminal Module**

- 4/6 Overview
- 4/6 Design
- 4/6 Selection and ordering data
- 4/6 Technical specifications
- 4/7 Integration

**4/8 TM31 Terminal Module**

- 4/8 Overview
- 4/8 Design
- 4/8 Selection and ordering data
- 4/9 Technical specifications
- 4/10 Integration

**4/11 TM150 Terminal Module**

- 4/11 Overview
- 4/11 Design
- 4/11 Selection and ordering data
- 4/11 Technical specifications
- 4/12 Integration

**4/13 Mounting kit to upgrade to IP20**

- 4/13 Overview
- 4/13 Selection and ordering data

**4/14 Line fuses**

- 4/14 Overview
- 4/14 Selection and ordering data
- 4/14
  - Fuses for the field circuit
  - Fuses for the armature circuit
- 4/14

**4/18 Commutating reactors**

- 4/18 Overview
- 4/21 Selection and ordering data

**4/24 Circuit breakers and contactors**

- 4/24 Overview
- 4/24
  - Selection criteria

**4/25 Radio interference suppression filters**

- 4/25 Overview
- 4/25
  - List of recommended radio interference suppression filters from EPCOS
  - Permissible operating data

**4/26 SICROWBAR AC**

- 4/26 Application
- 4/26 Design
- 4/26 Mode of operation
- 4/26 Configuration
- 4/27 Technical specifications
- 4/28 Selection and ordering data
- 4/28 Accessories

**4/29 SICROWBAR DC**

- 4/29 Application
- 4/29 Design
- 4/29 Mode of operation
- 4/30 Configuration
- 4/31 Technical specifications
- 4/32 Selection and ordering data
- 4/32 Accessories
- 4/32 Options

## SINAMICS DCM

### Accessories and supplementary components

#### AOP30 Advanced Operator Panel

##### Overview



The AOP30 Advanced Operator Panel is an optional input/output device for SINAMICS DC MASTER converters. It can be separately ordered. The operator panel is only designed for installation outside the converter (e.g. in a cabinet door up to 4 mm thick), installation cut-out 141.5 × 197.5 mm.

It sets itself apart as a result of the following properties:

- Graphics-capable LCD display (240 × 64 pixels) with backlighting for plain-text display and a bar-type display for process variables
- LEDs for displaying the operating states
  - RUN green
  - ALARM yellow
  - FAULT red
- Help function describing the causes of faults and alarms and how to resolve them
- Time and date memory with internal battery backup
- 26-key membrane keyboard
  - Keypad for operational control of a drive
  - Local/remote switchover for selecting the operator control location (operator panel or customer terminal strip/communications channel has the control authority)
  - Numeric keypad for entering setpoints or parameter values
  - Function keys for prompted navigation in the menu
- RS232 and RS485 interface
- Connection for a 24 V power supply
- The converter can be controlled using the AOP30 up to distances of 200 m. A cable with integrated 24 V power supply can be ordered in standard lengths as an accessory.
- Two-stage safety strategy to protect against accidental or unauthorized changes to settings.
  - Operation of the drive from the operator panel can be disabled using the control inhibit function so that only parameter values and process variables can be displayed on the operating panel.
  - A password can be used to prevent converter parameters being changed by unauthorized personnel.
- Front panel with degree of protection IP55, IP20 at rear

The AOP30 communicates with the SINAMICS DC MASTER drive via the serial RS485 interface.

The AOP30 can communicate with the Standard CUD as well as with the Advanced CUD of the SINAMICS DC MASTER.

A 24 V power supply is required to operate the AOP30. For a maximum cable length of 50 m, this can be taken from the CUD of the SINAMICS DC MASTER. An external power supply must be used for cable lengths greater than 50 m.

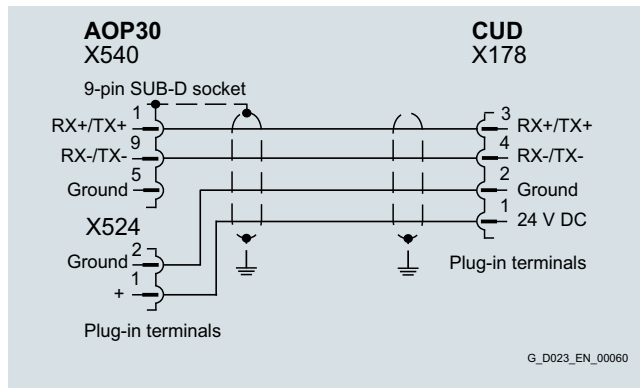

Assignment of the RS485 cable with a 24 V power supply from the CUD – max. cable length 50 m

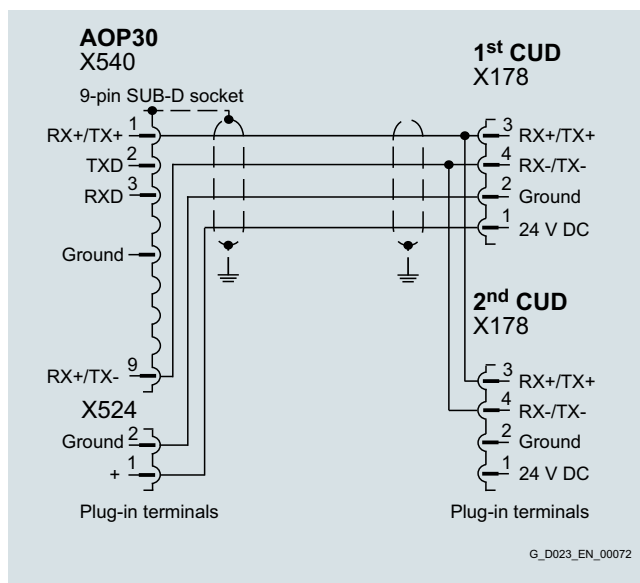

Assignment of the RS485 cable when using two CUDs (24 V power supply from one CUD) – max. cable length 50 m

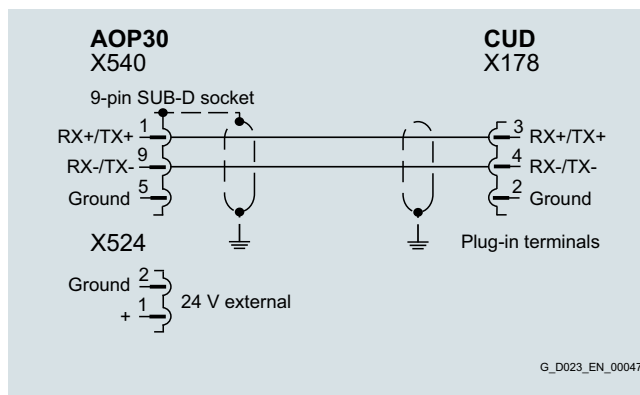

Assignment of the RS485 cable when supplying the AOP30 from an external 24 V DC source – max. cable length 200 m

## Overview

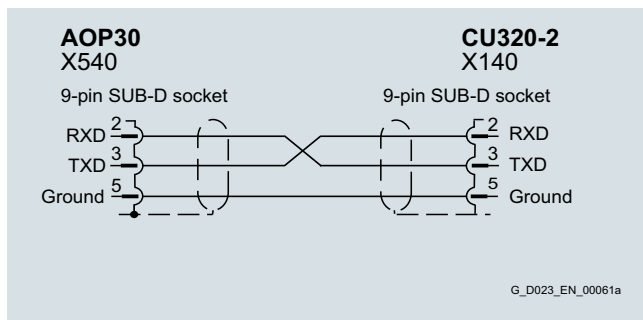

Assignment of the RS232 cable for connecting to an AC SINAMICS unit (not for SINAMICS DC MASTER!)

## Function

The current operating states, setpoints and actual values, parameters, indices, faults and alarms are displayed on the display panel.

German and English are integrated in the SINAMICS DC MASTER as standard. Additional languages, if the memory card with a corresponding language package is inserted in every CUD.

Note:

Only operator panels with Article Nos 6SL3055-0AA00-4CA4 and 6SL3055-0AA00-4CA5 have a second RS485 interface. Preliminary models are not suitable for SINAMICS DC MASTER.

## Selection and ordering data

Description	Article No.
<b>AOP30 Advanced Operator Panel</b>	<b>6SL3055-0AA00-4CA5</b>

A connecting cable with integrated 24 V supply is available to connect the AOP via RS485.

RS485 cable to connect the AOP	Length m	Article No.
to a CUD	3	<b>6RY1807-0AP00</b>
to two CUDs	3	<b>6RY1807-0AP10</b>

Other cable lengths can be ordered with the following options.

Cable length	Order code
5 m	<b>K05</b>
10 m	<b>K10</b>
15 m	<b>K15</b>
20 m	<b>K20</b>
25 m	<b>K25</b>
30 m	<b>K30</b>
35 m	<b>K35</b>
40 m	<b>K40</b>
45 m	<b>K45</b>
50 m	<b>K50</b>

Note:

When ordering the RS485 cable with option, add the suffix "-Z" to the Article No. followed by the order code for the required option.

Ordering example for cable length 35 m: **6RY1807-0AP00-Z K35**

## SINAMICS DCM

### Accessories and supplementary components

#### SMC10 Sensor Module Cabinet-Mounted

##### Overview



For position detection and speed determination with resolver encoder, the SMC10 Sensor Module Cabinet-Mounted is required for signal evaluation.

The following encoder signals can be evaluated: <sup>1)</sup>

- 2-pole resolver
- Multi-pole resolver

The motor temperature input, available on the SMC10, is not evaluated for SINAMICS DC MASTER. A motor temperature sensor can be evaluated using the temperature measurement input provided on each CUD.

##### Design

The SMC10 Sensor Module Cabinet-Mounted features the following interfaces as standard:

- 1 DRIVE-CLiQ interface
- 1 encoder connection via Sub-D connector
- 1 connection for the electronics power supply via the 24 V DC power supply connector
- 1 PE/protective conductor connection

The status of the SMC10 is indicated via a multi-color LED.

The SMC10 can be snapped onto a TH 35 standard mounting rail in accordance with EN 60715 (IEC 60715).

The signal cable shield is connected via the encoder system connector and can also be connected to the SMC10 via a shield connection terminal, e.g. Phoenix Contact type SK8 or Weidmüller type KLBU CO 1. The shield connection terminal must not be used as a strain relief mechanism.

##### Integration

The SMC10 Sensor Module Cabinet-Mounted communicates with a Control Unit via DRIVE-CLiQ.

A maximum of four DRIVE-CLiQ components can be connected per Advanced CUD, with a maximum of one SMC10 or SMC30.

A maximum of three modules from the TM15, TM31 and TM150 group can be connected, of which no more than one TM150.

##### Technical specifications

###### SMC10 Sensor Module Cabinet-Mounted 6SL3055-0AA00-5AA3

<b>Current consumption, max.</b> at 24 V DC, not taking the encoder into account	0.2 A
• Conductor cross-section, max.	2.5 mm <sup>2</sup>
• Fuse protection, max.	20 A
<b>Power loss</b>	< 10 W
<b>Encoders that can be evaluated</b>	<ul style="list-style-type: none"> <li>• 2-pole resolver</li> <li>• Multi-pole resolver</li> </ul>
• Excitation voltage, rms	4.1 V
• Excitation frequency	5 ... 10 kHz; depending on the current controller clock cycle
• Transformation ratio	0.5
• Encoder frequency, max.	2 kHz (120000 rpm); depending on the number of resolver pole pairs and current controller clock cycle
• Signal subdivision (interpolation), max.	16384 times (14 bits)
• Cable length, max.	130 m
<b>PE connection</b>	M4 screw
<b>Dimensions</b>	
• Width	30 mm
• Height	150 mm
• Depth	111 mm
<b>Weight, approx.</b>	0.4 kg

##### Selection and ordering data

Description	Article No.
<b>SMC10 Sensor Module Cabinet-Mounted</b> (without DRIVE-CLiQ cable)	<b>6SL3055-0AA00-5AA3</b>

<sup>1)</sup> Encoders, which have a DRIVE-CLiQ interface, cannot be evaluated at the SINAMICS DC MASTER or at the SMC10. These encoders are usually not used in DC drive technology.

## Overview



For evaluation of the motor encoder signals without DRIVE-CLiQ interface, the SMC30 Sensor Module Cabinet-Mounted is required. External encoders can also be connected via the SMC30.

The following encoder signals can be evaluated:

- Incremental encoders TTL/HTL with and without broken cable detection (broken cable detection is only available with bipolar signals)
- SSI encoder with TTL/HTL incremental signals
- SSI encoder without incremental signals

The motor temperature can also be measured using KTY84-130, Pt1000 or PTC thermistors.

Reliable actual value acquisition is not supported in connection with SINAMICS DCM.

## Design

The SMC30 Sensor Module Cabinet-Mounted features the following interfaces as standard:

- 1 encoder connection including motor temperature sensing (KTY84-130, Pt1000 or PTC) either via Sub-D connector or via terminals
- 1 DRIVE-CLiQ interface
- 1 connection for the electronics power supply via the 24 V DC power supply connector
- 1 PE/protective conductor connection

The status of the SMC30 Sensor Module Cabinet-Mounted is indicated via a multi-color LED.

The SMC30 Sensor Module Cabinet-Mounted can be snapped onto a TH 35 standard mounting rail in accordance with EN 60715 (IEC 60715).

The maximum encoder cable length between SMC30 modules and encoders is 100 m. For HTL encoders, this length can be increased to 300 m if the A+/A- and B+/B- signals are evaluated and the power supply cable has a minimum cross-section of 0.5 mm<sup>2</sup>.

The signal cable shield can be connected to the SMC30 Sensor Module Cabinet-Mounted using a shield connection terminal, e.g., Phoenix Contact type SK8 or Weidmüller type KLBÜ CO 1. The shield connection terminal must not be used as a strain relief mechanism.

## Selection and ordering data

Description	Article No.
<b>SMC30 Sensor Module Cabinet-Mounted</b> Without DRIVE-CLiQ cable	<b>6SL3055-0AA00-5CA2</b>
<i>Accessories for re-ordering</i>	
<b>Dust-proof blanking plugs</b> (50 units) For DRIVE-CLiQ port	<b>6SL3066-4CA00-0AA0</b>

## Integration

The SMC30 Sensor Module Cabinet-Mounted communicates with a Control Unit via DRIVE-CLiQ.

A maximum of four DRIVE-CLiQ components can be connected per Advanced CUD, with a maximum of one SMC10 or SMC30. A maximum of three modules from the TM15, TM31 and TM150 group can be connected, of which no more than one TM150.

## Technical specifications

	<b>SMC30 Sensor Module Cabinet-Mounted</b> 6SL3055-0AA00-5CA2
<b>Current consumption, max.</b> At 24 V DC, not taking encoder into account	0.2 A
• Conductor cross-section, max.	2.5 mm <sup>2</sup>
• Fuse protection, max.	20 A
<b>Power loss, max.</b>	10 W
<b>Encoders that can be evaluated</b>	<ul style="list-style-type: none"> <li>• Incremental encoder TTL/HTL</li> <li>• SSI encoder with TTL/HTL incremental signals</li> <li>• SSI encoder without incremental signals</li> </ul>
• Input current range TTL/HTL	4 ... 20 mA (typ. 10 mA)
• Encoder supply	24 V DC/0.35 A or 5 V DC/0.35 A
• Encoder frequency, max.	300 kHz
• SSI baud rate	100 ... 1000 kBaud
• Limiting frequency	300 kHz
• Resolution absolute position SSI	30 bits
• Cable length, max.	
- TTL encoder	100 m (only bipolar signals permitted) <sup>1)</sup>
- HTL encoder	100 m for unipolar signals 300 m for bipolar signals <sup>1)</sup>
- SSI encoder	100 m
<b>PE connection</b>	M4 screw
<b>Dimensions</b>	
• Width	30 mm
• Height	150 mm
• Depth	111 mm
<b>Weight, approx.</b>	0.45 kg
<b>Certificate of suitability</b>	cULus

<sup>1)</sup> Signal cables twisted in pairs and shielded.

## SINAMICS DCM

### Accessories and supplementary components

#### TM15 Terminal Module

##### Overview



With the TM15 Terminal Module, the number of available digital inputs and outputs within a drive system can be expanded.

##### Design

The following are located on the TM15 Terminal Module:

- 24 bidirectional digital inputs/outputs (isolation in 3 groups with 8 channels each)
- 24 green status LEDs for indicating the logical signal status of the relevant terminal
- 2 DRIVE-CLiQ sockets
- 1 connection for the electronics power supply via the 24 V DC power supply connector
- 1 PE/protective conductor connection

The status of the TM15 Terminal Module is indicated via a multi-color LED.

The TM15 Terminal Module can be snapped onto a TH 35 standard mounting rail in accordance with EN 60715 (IEC 60715).

The signal cable shield can be connected to the TM15 Terminal Module by means of a shield connection terminal, e.g. Phoenix Contact type SK8 or Weidmüller type KLBÜ CO 1. The shield connection terminal must not be used as a strain relief mechanism.

##### Selection and ordering data

Description	Article No.
<b>TM15 Terminal Module</b> Without DRIVE-CLiQ cable	<b>6SL3055-0AA00-3FA0</b>
<i>Accessories for re-ordering</i>	
<b>Dust-proof blanking plugs</b> (50 units) For DRIVE-CLiQ port	<b>6SL3066-4CA00-0AA0</b>

##### Technical specifications

<b>TM15 Terminal Module</b> 6SL3055-0AA00-3FA0	
<b>Current consumption, max.</b> At 24 V DC without load	0.15 A
• Conductor cross-section, max.	2.5 mm <sup>2</sup>
• Fuse protection, max.	20 A
<b>Number of DRIVE-CLiQ sockets</b>	2
<b>I/O devices</b>	
• Digital inputs/outputs	Can be parameterized channel-by-channel as DI or DO
• Number of digital inputs/outputs	24
• Electrical isolation	Yes, in groups of 8
• Connection system	Plug-in screw-type terminals
• Conductor cross-section, max.	1.5 mm <sup>2</sup>
<b>Digital inputs</b>	
• Voltage	-3 ... +30 V
• Low level (an open digital input is interpreted as "low")	-30 ... +5 V
• High level	15 ... 30 V
• Current consumption at 24 V DC	9 mA
• Delay times of digital inputs, typ. <sup>1)</sup>	
- L → H	50 μs
- H → L	100 μs
<b>Digital outputs</b> (continuously short-circuit-proof)	
• Voltage	24 V DC
• Load current per digital output, max.	0.5 A
• Delay times (ohmic load) <sup>1)</sup>	
- L → H, typ.	50 μs
- L → H, max.	100 μs
- H → L, typ.	150 μs
- H → L, max.	225 μs
• Total current of outputs (per group), max.	
- Up to 60 °C	2 A
- Up to 50 °C	3 A
- Up to 40 °C	4 A
<b>Power loss, max.</b>	3 W
<b>PE connection</b>	M4 screw
<b>Dimensions</b>	
• Width	50 mm
• Height	150 mm
• Depth	111 mm
<b>Weight, approx.</b>	1 kg
<b>Certificate of suitability</b>	cULus

<sup>1)</sup> The specified delay times refer to the hardware.  
The actual reaction time depends on the time slice in which the digital input/output is processed.



**Integration**

The TM15 Terminal Module can communicate via DRIVE-CLiQ with the following Control Units:

- CU310-2 Control Unit
- CU320-2 Control Unit

- A maximum of four DRIVE-CLiQ components can be connected per Advanced CUD, with a maximum of one SMC10 or SMC30. A maximum of three modules from the TM15, TM31 and TM150 group can be connected, of which no more than one TM150.

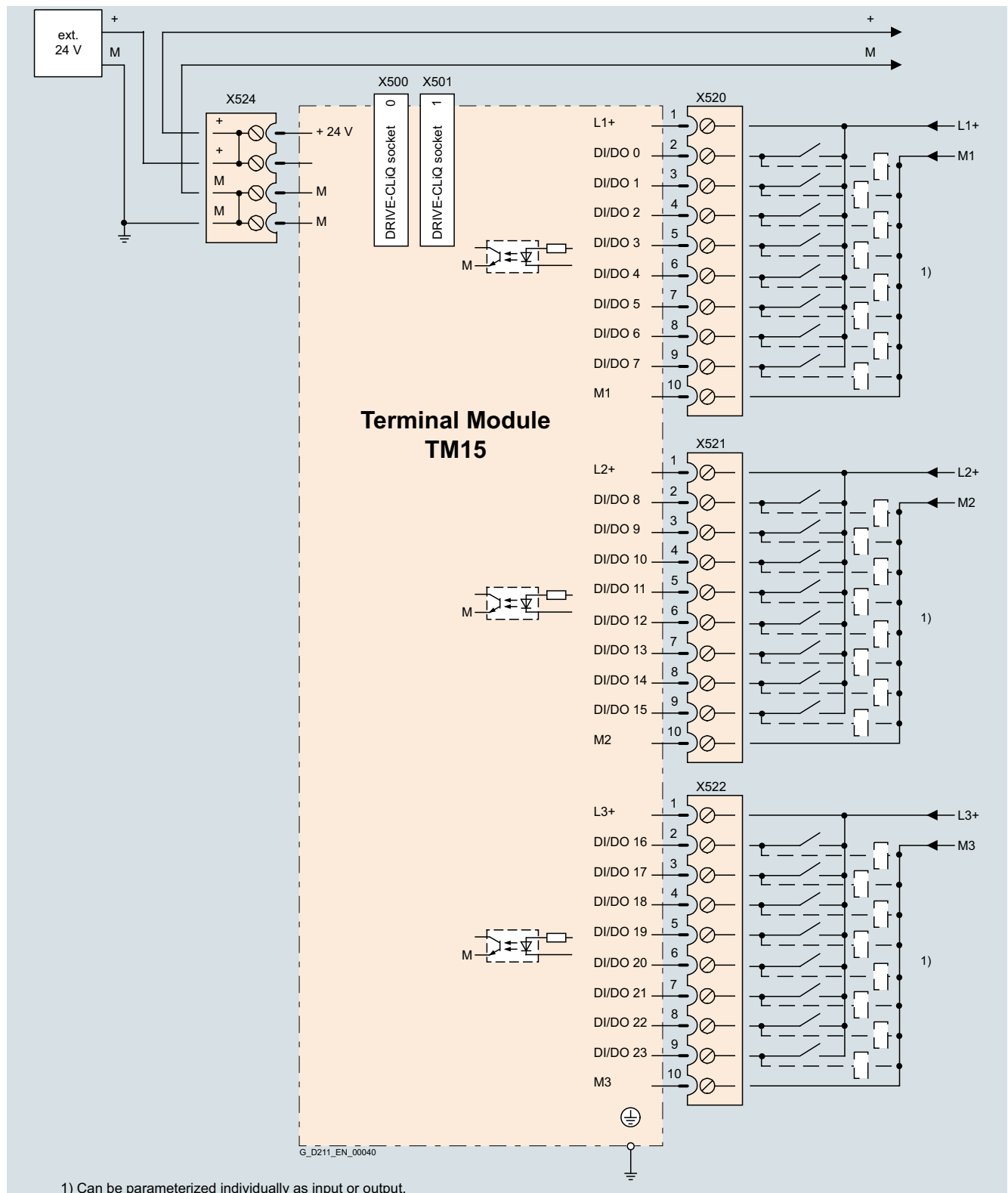

Connection example of a TM15 Terminal Module

## SINAMICS DCM

### Accessories and supplementary components

#### TM31 Terminal Module

##### Overview



The TM31 Terminal Module can be used to expand the number of available digital inputs and outputs and the number of analog inputs and outputs within a drive system.

The TM31 Terminal Module also features relay outputs with changeover contact and a temperature sensor input.

##### Selection and ordering data

Description	Article No.
<b>TM31 Terminal Module</b> Without DRIVE-CLiQ cable	<b>6SL3055-0AA00-3AA1</b>
<i>Accessories for re-ordering</i>	
<b>Dust-proof blanking plugs</b> (50 units) For DRIVE-CLiQ port	<b>6SL3066-4CA00-0AA0</b>

## 4

##### Design

The following are located on the TM31 Terminal Module:

- 8 digital inputs
- 4 bidirectional digital inputs/outputs
- 2 relay outputs with changeover contact
- 2 analog inputs
- 2 analog outputs
- 1 temperature sensor input for KTY84-130, Pt1000 or PTC (Pt1000 can be used from firmware V4.7 HF17)
- 2 DRIVE-CLiQ sockets
- 1 connection for the electronics power supply via the 24 V DC power supply connector
- 1 PE/protective conductor connection

The status of the TM31 Terminal Module is indicated via a multi-color LED.

The TM31 Terminal Module can be snapped onto a TH 35 standard mounting rail in accordance with EN 60715 (IEC 60715).

The signal cable shield can be attached to the TM31 Terminal Module via a shield connection terminal, e.g. type SK8 supplied by Phoenix Contact or type KLBÜ CO 1 supplied by Weidmüller. The shield connection terminal must not be used as a strain relief mechanism.

### Technical specifications

	TM31 Terminal Module 6SL3055-0AA00-3AA1
<b>Current consumption, max.</b> At 24 V DC without taking account of the digital outputs and DRIVE-CLiQ supply	0.5 A
• Conductor cross-section, max.	2.5 mm <sup>2</sup>
• Fuse protection, max.	20 A
<b>Digital inputs</b> In accordance with IEC 61131-2 Type 1	
• Voltage	-3 ... +30 V
• Low level (an open digital input is interpreted as "low")	-3 ... +5 V
• High level	15 ... 30 V
• Current consumption at 24 V DC, typ.	9 mA
• Delay times of digital inputs <sup>1)</sup> , approx.	
- L → H	50 μs
- H → L	100 μs
• Conductor cross-section, max.	1.5 mm <sup>2</sup>
<b>Digital outputs</b> (continuously short-circuit-proof)	
• Voltage	24 V DC
• Load current per digital output, max.	100 mA
• Total current of digital outputs, max.	400 mA
• Delay times of digital outputs <sup>1)</sup>	
- Typ.	150 μs at 0.5 A resistive load
- Max.	500 μs
• Conductor cross-section, max.	1.5 mm <sup>2</sup>
<b>Analog inputs</b> (a switch is used to toggle between voltage and current input)	
• As voltage input	
- Voltage range	-10 ... +10 V
- Internal resistance $R_i$	100 kΩ
- Resolution <sup>2)</sup>	11 bits + sign
• As current input	
- Current ranges	4 ... 20 mA, -20 ... +20 mA, 0 ... 20 mA
- Internal resistance $R_i$	250 Ω
- Resolution <sup>2)</sup>	10 bits + sign
• Conductor cross-section, max.	1.5 mm <sup>2</sup>

	TM31 Terminal Module 6SL3055-0AA00-3AA1
<b>Analog outputs</b> (continuously short-circuit-proof)	
• Voltage range	-10 ... +10 V
• Load current, max.	-3 ... +3 mA
• Current ranges	4 ... 20 mA, -20 ... +20 mA, 0 ... 20 mA
• Load resistance, max.	500 Ω for outputs in the range -20 ... +20 mA
• Resolution	11 bits + sign
• Conductor cross-section, max.	1.5 mm <sup>2</sup>
<b>Relay outputs</b> (changeover contacts)	
• Load current, max.	8 A
• Switching voltage, max.	250 V AC, 30 V DC
• Switching capacity, max.	
- At 250 V AC	2000 VA (cos φ = 1) 750 VA (cos φ = 0.4)
- At 30 V DC	240 W (resistive load)
• Required minimum current	100 mA
• Conductor cross-section, max.	2.5 mm <sup>2</sup>
<b>Power loss, max.</b>	10 W
<b>PE connection</b>	M4 screw
<b>Dimensions</b>	
• Width	50 mm
• Height	150 mm
• Depth	111 mm
<b>Weight, approx.</b>	0.49 kg
<b>Certificate of suitability</b>	cULus

<sup>1)</sup> The specified delay times refer to the hardware. The actual reaction time depends on the time slice in which the digital input/output is processed.

<sup>2)</sup> If the analog input is to be operated in the signal processing sense with a continuously variable input voltage, the sampling frequency  $f_a = 1/t_{\text{time slice}}$  must be at least twice the value of the highest signal frequency  $f_{\text{max}}$ .

# SINAMICS DCM

## Accessories and supplementary components

### TM31 Terminal Module

#### Integration

The TM31 Terminal Module can communicate via DRIVE-CLiQ with the following Control Units:

- CU310-2 Control Unit
- CU320-2 Control Unit

- A maximum of four DRIVE-CLiQ components can be connected per Advanced CUD, with a maximum of one SMC10 or SMC30. A maximum of three modules from the TM15, TM31 and TM150 group can be connected, of which no more than one TM150.

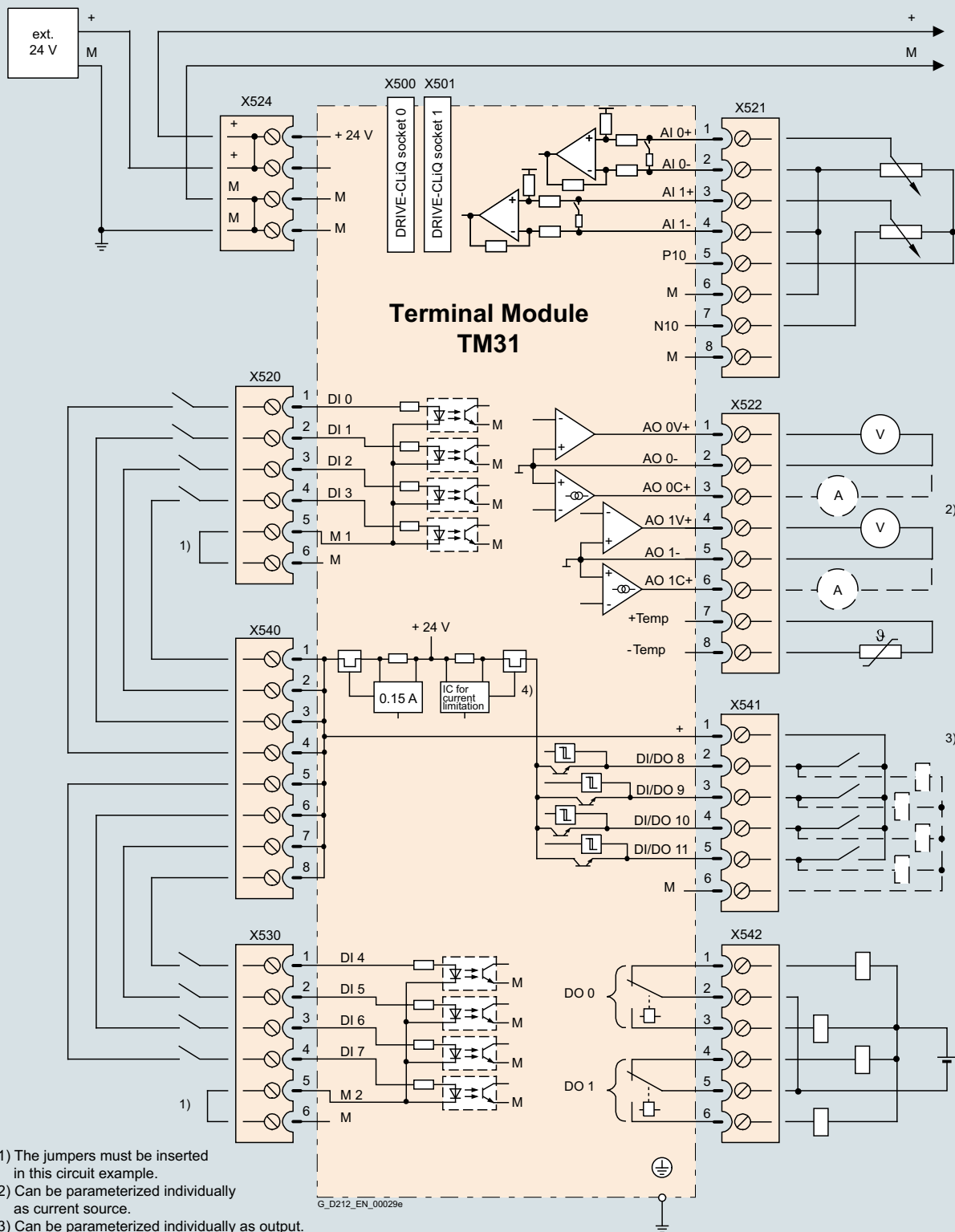

Connection example of TM31 Terminal Module

## Overview



The TM150 Terminal Module is a DRIVE-CLiQ component for temperature evaluation. The temperature is measured in a temperature range from -99 °C to +250 °C for the following temperature sensors:

- Pt100 (with monitoring for open-circuit and short-circuit)
- Pt1000 (with monitoring for open-circuit and short-circuit)
- KTY84 (with monitoring for open-circuit and short-circuit)
- PTC (with short-circuit monitoring)
- Bimetallic NC contact (without monitoring)

For the temperature sensor inputs, for each terminal block the evaluation can be parameterized for 1x2-wire, 2x2-wire, 3-wire or 4-wire. There is no electrical isolation in the TM150 Terminal Module.

The temperature channels can be subdivided into 3 groups and evaluated together.

## Design

The following are located on the TM150 Terminal Module:

- 6 ... 12 temperature sensor inputs
- 2 DRIVE-CLiQ sockets
- 1 connection for the electronics power supply via the 24 V DC power supply connector
- 1 PE/protective conductor connection

The status of the TM150 Terminal Module is indicated via a multi-color LED.

The TM150 Terminal Module can be snapped onto a TH 35 standard mounting rail in accordance with EN 60715 (IEC 60715).

## Selection and ordering data

Description	Article No.
<b>TM150 Terminal Module</b> Without DRIVE-CLiQ cable	<b>6SL3055-0AA00-3LA0</b>
<i>Accessories for re-ordering</i>	
<b>Dust-proof blanking plugs</b> (50 units) For DRIVE-CLiQ port	<b>6SL3066-4CA00-0AA0</b>

## Technical specifications

	TM150 Terminal Module 6SL3055-0AA00-3LA0
<b>Current consumption, max.</b> at 24 V DC	0.5 A
• Conductor cross-section, max.	2.5 mm <sup>2</sup>
• Fuse protection, max.	20 A
<b>Temperature sensor inputs</b> The inputs can be parameterized individually for the evaluation of sensors	
• Conductor cross-section, max.	1.5 mm <sup>2</sup>
• Measuring current per sensor, approx.	0.8 mA
<b>Power loss</b>	1.6 W
<b>PE connection</b>	M4 screw
<b>Dimensions</b>	
• Width	30 mm
• Height	150 mm
• Depth	111 mm
<b>Weight, approx.</b>	0.41 kg

## SINAMICS DCM

### Accessories and supplementary components

#### TM150 Terminal Module

##### Integration

The TM150 Terminal Module can communicate via DRIVE-CLiQ with the following Control Units:

- CU310-2 Control Unit
- CU320-2 Control Unit

- A maximum of four DRIVE-CLiQ components can be connected per Advanced CUD, with a maximum of one SMC10 or SMC30. A maximum of three modules from the TM15, TM31 and TM150 group can be connected, of which no more than one TM150.

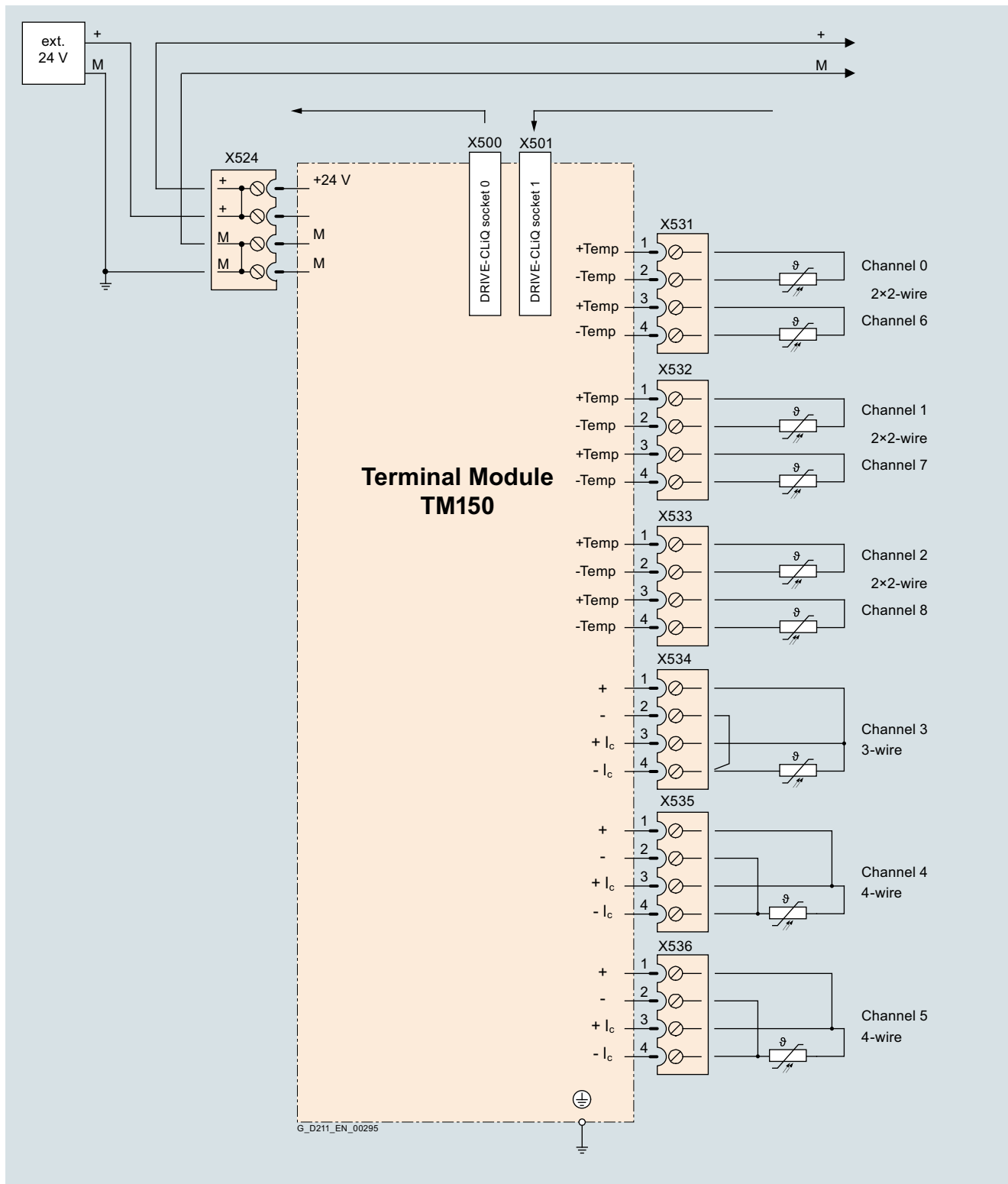

Connection example of a TM150 Terminal Module

**Overview**

With a mounting kit, it is possible to increase the degree of protection of SINAMICS DC MASTER from IP00 up to IP20.

**Selection and ordering data**

For units up to 850 A, there is a suitable mounting kit to increase the degree of protection; this can be ordered using the following article numbers.

**Mounting kit to upgrade to IP20**

Description	Article No.
for units from 15 to 30 A	<b>6RX1800-0MA00</b>
for units from 60 to 280 A	<b>6RX1800-0MA01</b>
for units from 400 to 600 A	<b>6RX1800-0MA02</b>
for units from 720 to 850 A	<b>6RX1800-0MA03</b>

**Note:**

Detailed information about increasing the degree of protection can be found on the Internet at <http://support.automation.siemens.com/WWW/view/en/80633087>.

## SINAMICS DCM

### Accessories and supplementary components

#### Line fuses

##### Overview

3NE1 SITOR double protection fuses allow the cable and semi-conductor protection to be implemented with just one fuse. This results in significant cost savings and shorter assembly times.

An overview of the fuses required for the armature and field circuits is provided in the following table.

Fuse	Armature circuit				Field circuit
	< 900 A		≥ 900 A		
	Two-quadrant operation	Four-quadrant operation	Two-quadrant operation	Four-quadrant operation	
Phase fuse	Required	Required	–	–	Required
Arm fuse	–	–	Integrated in the unit	Integrated in the unit	–
DC fuse	–	Required	–	–	–

##### Selection and ordering data

For technical specifications, engineering data as well as dimensional drawings for Siemens fuses, please refer to Catalog LV 10.1 "Low-Voltage Power Distribution and Electrical Installation Technology".

In order to ensure UL-compliant protection of units, it is essential that you use "UL-listed" or "UL-recognized" fuses.

##### Fuses for the field circuit

Recommended fuses for the field circuit

Rated DC current for converter unit	Max. field current	2 Siemens fuses		2 Bussmann fuses FWP 700V 	
		Article No. per unit	A	Article No. per unit	A
A	A				
15	3	<b>5SD420</b>	16	FWP-5B	5
30	5	<b>5SD420</b>	16	FWP-5B	5
60 ... 125	10	<b>5SD420</b>	16	FWP-15B	15
210 ... 280	15	<b>5SD440</b>	25	FWP-20B	20
400 ... 600	25	<b>5SD440</b>	25	FWP-30B	30
710 ... 850	30	<b>5SD480</b>	30	FWP-35B	35
900 ... 3000	40	<b>3NE1802-0</b> <sup>1)</sup>	40	FWP-50B	50
1500 ... 3000 with option L85	85	<b>3NE8021-1</b> <sup>1)</sup>	100	FWP-100B	100

##### Fuses for the armature circuit

Units, two-quadrant operation: 400 V, 575 V, 690 V, 830 V and 950 V

##### Phase fuses

Unit Type	//U A/V	3 phase fuses Siemens 	
		Article No. per unit	//U A/V
6RA8025-6DS22-0AA0	60/400	<b>3NE1817-0</b>	50/690
6RA8025-6GS22-0AA0	60/575	<b>3NE1817-0</b>	50/690
6RA8028-6DS22-0AA0	90/400	<b>3NE1820-0</b>	80/690
6RA8031-6DS22-0AA0	125/400	<b>3NE1021-0</b>	100/690
6RA8031-6GS22-0AA0	125/575	<b>3NE1021-0</b>	100/690
6RA8075-6DS22-0AA0	210/400	<b>3NE3227</b>	250/1000
6RA8075-6GS22-0AA0	210/575	<b>3NE3227</b>	250/1000
6RA8078-6DS22-0AA0	280/400	<b>3NE3231</b>	350/1000
6RA8081-6DS22-0AA0	400/400	<b>3NE3233</b>	450/1000
6RA8081-6GS22-0AA0	400/575	<b>3NE3233</b>	450/1000
6RA8085-6DS22-0AA0	600/400	<b>3NE3336</b>	630/1000
6RA8085-6GS22-0AA0	600/575	<b>3NE3336</b>	630/1000
6RA8087-6DS22-0AA0	850/400	<b>3NE3338-8</b>	800/800
6RA8087-6GS22-0AA0	800/575	<b>3NE3338-8</b>	800/800
6RA8086-6KS22-0AA0	720/690	<b>3NE3337-8</b>	710/900

<sup>1)</sup> UL-recognized



## Selection and ordering data

## Arm fuses



## Note:

The arm fuses are included in the unit. No external semiconductor fuses are required.

Unit Type	Arm fuses Siemens 			
	I/U A/V	Units	Article No. per unit	I/U A/V
6RA8091-6DS22-0AA0	1200/400	6	<b>3NE3338-8</b>	800/800
6RA8090-6GS22-0AA0	1100/575	6	<b>3NE3338-8</b>	800/800
6RA8090-6KS22-0AA0	1000/690	6	<b>3NE3337-8</b>	710/900
6RA8088-6LS22-0AA0	950/830	6	<b>3NE3337-8</b>	710/900
6RA8093-4DS22-0AA0	1600/400	6	<b>6RY1702-0BA02</b>	1000/660
6RA8093-4GS22-0AA0	1600/575	6	<b>6RY1702-0BA02</b>	1000/660
6RA8093-4KS22-0AA0	1500/690	6	<b>6RY1702-0BA03</b>	1000/1000
6RA8093-4LS22-0AA0	1500/830	6	<b>6RY1702-0BA03</b>	1000/1000
6RA8095-4DS22-0AA0	2000/400	6	<b>6RY1702-0BA01</b>	1250/660
6RA8095-4GS22-0AA0	2000/575	6	<b>6RY1702-0BA01</b>	1250/660
6RA8095-4KS22-0AA0	2000/690	12	<b>6RY1702-0BA04</b>	630/1000
6RA8095-4LS22-0AA0	1900/830	12	<b>6RY1702-0BA04</b>	630/1000
6RA8096-4GS22-0AA0	2200/575	6	<b>6RY1702-0BA05</b>	1500/660
6RA8096-4MS22-0AA0	2200/950	12	<b>3NC3438-6U</b>	800/1100
6RA8097-4KS22-0AA0	2600/690	12	<b>3NC3341-6U</b>	1000/1000
6RA8097-4GS22-0AA0	2800/575	12	<b>3NC3341-6U</b>	1000/1000
6RA8098-4DS22-0AA0	3000/400	12	<b>3NC3341-6U</b>	1000/1000

Units, two-quadrant operation: 480 V

## Phase fuses

Unit Type	I/U A/V	3 phase fuses Siemens 		3 phase fuses Bussmann 		3 phase fuses Bussmann  1)	
		Article No. per unit	I/U A/V	Article No. per unit	I/U A/V	Article No. per unit	I/U A/V
6RA8025-6FS22-0AA0	60/480	<b>3NE1817-0</b>	50/690	170M1565	63/660	FWH-60B	60/500
6RA8028-6FS22-0AA0	90/480	<b>3NE1820-0</b>	80/690	170M1567	100/660	FWH-100B	100/500
6RA8031-6FS22-0AA0	125/480	<b>3NE1021-0</b>	100/690	170M1568	125/660	FWH-125B	125/500
6RA8075-6FS22-0AA0	210/480	<b>3NE3227</b>	250/1000	170M3166	250/660	FWH-225A	225/500
6RA8078-6FS22-0AA0	280/480	<b>3NE3231</b>	350/1000	170M3167	315/660	FWH-275A	275/500
6RA8082-6FS22-0AA0	450/480	<b>3NE3233</b>	450/1000	170M3170	450/660	FWH-450A	450/500
6RA8085-6FS22-0AA0	600/480	<b>3NE3336</b>	630/1000	170M4167	700/660	FWH-600A	600/500
6RA8087-6FS22-0AA0	850/480	<b>3NE3338-8</b>	800/800	170M5165	900/660	FWH-800A	800/500

## Arm fuses

## Note:

The arm fuses are included in the unit. No external semiconductor fuses are required.

Unit Type	Arm fuses Siemens 			
	I/U A/V	Units	Article No. per unit	I/U A/V
6RA8091-6FS22-0AA0	1200/480	6	<b>3NE3338-8</b>	800/800

1) FWH-... fuses are not mechanically compatible with 3NE or 170M fuses.

## SINAMICS DCM



### Accessories and supplementary components

#### Line fuses

##### Selection and ordering data

Units, four-quadrant operation: 400 V, 575 V, 690 V, 830 V and 950 V

*Phase fuses, DC fuse*

Unit Type	//U A/V	3 phase fuses Siemens 		1 DC fuse Siemens 	
		Article No. per unit	//U A/V	Article No. per unit	//U A/V
6RA8013-6DV62-0AA0	15/400	<b>3NE1814-0</b>	20/690	<b>3NE1814-0</b>	20/690
6RA8018-6DV62-0AA0	30/400	<b>3NE8003-1</b>	35/690	<b>3NE4102</b>	40/1000
6RA8025-6DV62-0AA0	60/400	<b>3NE1817-0</b>	50/690	<b>3NE4120</b>	80/1000
6RA8025-6GV62-0AA0	60/575	<b>3NE1817-0</b>	50/690	<b>3NE4120</b>	80/1000
6RA8028-6DV62-0AA0	90/400	<b>3NE1820-0</b>	80/690	<b>3NE4122</b>	125/1000
6RA8031-6DV62-0AA0	125/400	<b>3NE1021-0</b>	100/690	<b>3NE4124</b>	160/1000
6RA8031-6GV62-0AA0	125/575	<b>3NE1021-0</b>	100/690	<b>3NE4124</b>	160/1000
6RA8075-6DV62-0AA0	210/400	<b>3NE3227</b>	250/1000	<b>3NE3227</b>	250/1000
6RA8075-6GV62-0AA0	210/575	<b>3NE3227</b>	250/1000	<b>3NE3227</b>	250/1000
6RA8078-6DV62-0AA0	280/400	<b>3NE3231</b>	350/1000	<b>3NE3231</b>	350/1000
6RA8081-6DV62-0AA0	400/400	<b>3NE3233</b>	450/1000	<b>3NE3233</b>	450/1000
6RA8081-6GV62-0AA0	400/575	<b>3NE3233</b>	450/1000	<b>3NE3233</b>	450/1000
6RA8085-6DV62-0AA0	600/400	<b>3NE3336</b>	630/1000	<b>3NE3336</b>	630/1000
6RA8085-6GV62-0AA0	600/575	<b>3NE3336</b>	630/1000	<b>3NE3336</b>	630/1000
6RA8087-6DV62-0AA0	850/400	<b>3NE3338-8</b>	800/800	<b>3NE3334-0B</b> <sup>1)</sup>	500/1000
6RA8087-6GV62-0AA0	850/575	<b>3NE3338-8</b>	800/800	<b>3NE3334-0B</b> <sup>1)</sup>	500/1000
6RA8086-6KV62-0AA0	760/690	<b>3NE3337-8</b>	710/900	<b>3NE3334-0B</b> <sup>1)</sup>	500/1000

*Arm fuses*

Note:

The arm fuses are included in the unit. No external semiconductor fuses are required.



Unit Type	//U A/V	Units	Arm fuses Siemens 	
			Article No. per unit	//U A/V
6RA8091-6DV62-0AA0	1200/400	6	<b>3NE3338-8</b>	800/800
6RA8090-6GV62-0AA0	1100/575	6	<b>3NE3338-8</b>	800/800
6RA8090-6KV62-0AA0	1000/690	6	<b>3NE3337-8</b>	710/900
6RA8088-6LV62-0AA0	950/830	6	<b>3NE3337-8</b>	710/900
6RA8093-4DV62-0AA0	1600/400	6	<b>6RY1702-0BA02</b>	1000/660
6RA8093-4GV62-0AA0	1600/575	6	<b>6RY1702-0BA02</b>	1000/660
6RA8093-4KV62-0AA0	1500/690	6	<b>6RY1702-0BA03</b>	1000/1000
6RA8093-4LV62-0AA0	1500/830	6	<b>6RY1702-0BA03</b>	1000/1000
6RA8095-4DV62-0AA0	2000/400	6	<b>6RY1702-0BA01</b>	1250/660
6RA8095-4GV62-0AA0	2000/575	6	<b>6RY1702-0BA01</b>	1250/660
6RA8095-4KV62-0AA0	2000/690	12	<b>6RY1702-0BA04</b>	630/1000
6RA8095-4LV62-0AA0	1900/830	12	<b>6RY1702-0BA04</b>	630/1000
6RA8096-4GV62-0AA0	2200/575	6	<b>6RY1702-0BA05</b>	1500/660
6RA8096-4MV62-0AA0	2200/950	12	<b>3NC3438-6U</b>	800/1100
6RA8097-4KV62-0AA0	2600/690	12	<b>3NC3341-6U</b>	1000/1000
6RA8097-4GV62-0AA0	2800/575	12	<b>3NC3341-6U</b>	1000/1000
6RA8098-4DV62-0AA0	3000/400	12	<b>3NC3341-6U</b>	1000/1000

<sup>1)</sup> Two fuses connected in parallel.



### Selection and ordering data

Units, four-quadrant operation: 480 V

#### Phase fuses

Unit Type	//U A/V	3 phase fuses Siemens 		3 phase fuses Bussmann 		3 phase fuses Bussmann  <sup>2)</sup>	
		Article No. per unit	//U A/V	Article No. per unit	//U A/V	Article No. per unit	//U A/V
6RA8013-6FV62-0AA0	15/480	<b>3NE1814-0</b>	20/690	170M1562	32/660	FWH-35B	35/500
6RA8018-6FV62-0AA0	30/480	<b>3NE1815-0</b>	25/690	170M1562	32/660	FWH-35B	35/500
6RA8025-6FV62-0AA0	60/480	<b>3NE1817-0</b>	50/690	170M1565	63/660	FWH-60B	60/500
6RA8028-6FV62-0AA0	90/480	<b>3NE1820-0</b>	80/690	170M1567	100/660	FWH-100B	100/500
6RA8031-6FV62-0AA0	125/480	<b>3NE1021-0</b>	100/690	170M1568	125/660	FWH-125B	125/500
6RA8075-6FV62-0AA0	210/480	<b>3NE3227</b>	250/1000	170M3166	250/660	FWH-225A	225/500
6RA8078-6FV62-0AA0	280/480	<b>3NE3231</b>	350/1000	170M3167	315/660	FWH-275A	275/500
6RA8082-6FV62-0AA0	450/480	<b>3NE3233</b>	450/1000	170M3170	450/660	FWH-450A	450/500
6RA8085-6FV62-0AA0	600/480	<b>3NE3336</b>	630/1000	170M4167	700/660	FWH-600A	600/500
6RA8087-6FV62-0AA0	850/480	<b>3NE3338-8</b>	800/800	170M5165	900/660	FWH-800A	800/500

#### DC fuse

Type	//U A/V	1 DC fuse Siemens 		1 DC fuse Bussmann  <sup>2)</sup>	
		Article No. per unit	//U A/V	Article No. per unit	//U A/V
6RA8013-6FV62-0AA0	15/480	<b>3NE1814-0</b>	20/690	FWP-35B	35/660
6RA8018-6FV62-0AA0	30/480	<b>3NE4102</b>	40/1000	FWP-35B	35/660
6RA8025-6FV62-0AA0	60/480	<b>3NE4120</b>	80/1000	FWP-70B	70/660
6RA8028-6FV62-0AA0	90/480	<b>3NE4122</b>	125/1000	FWP-125A	125/660
6RA8031-6FV62-0AA0	125/480	<b>3NE4124</b>	160/1000	FWP-150A	150/660
6RA8075-6FV62-0AA0	210/480	<b>3NE3227</b>	250/1000	FWP-250A	250/660
6RA8078-6FV62-0AA0	280/480	<b>3NE3231</b>	350/1000	FWP-350A	350/660
6RA8082-6FV62-0AA0	450/480	<b>3NE3334-0B</b>	500/1000	FWP-500A	500/660
6RA8085-6FV62-0AA0	600/480	<b>3NE3336</b>	630/1000	FWP-700A	700/660
6RA8087-6FV62-0AA0	850/480	<b>3NE3334-0B <sup>1)</sup></b>	500/1000	FWP-1000A	1000/660

#### Arm fuses

Note:

The arm fuses are included in the unit. No external semiconductor fuses are required.

Unit Type	//U A/V	Arm fuses Siemens 		
		Units	Article No. per unit	//U A/V
6RA8091-6FV62-0AA0	1200/480	6	<b>3NE3338-8</b>	800/800

<sup>1)</sup> Two fuses connected in parallel.

<sup>2)</sup> FWH-... and FWP-... fuses are not mechanically compatible with 3NE or 170M fuses.

## SINAMICS DCM

### Accessories and supplementary components

#### Commutating reactors

##### Overview

##### Commutating reactors

A converter must always be connected to the line supply through a commutation inductance. This must have at least 4 %  $u_K$ ! The commutation inductance can be in the form of a converter transformer or, for the appropriate line supply, in the form of a commutating reactor.

A line supply can be considered to be "stiff" if the power ratio  $P_s/S_k$  is  $\leq 0.01$ . Even for stiff line supplies, the commutation inductance must have a  $u_K$  of at least 4 %!

For high-rating converters, the line reactance, i.e. the finite fault level (short-circuit power) of the line supply must be taken into account; this also results in higher  $u_K$  values. Recommendation for the ratio of the line supply fault level (short-circuit power) to the apparent drive power  $> 33:1$ .

The commutating reactors are dimensioned according to the rated motor current in the armature or field circuit.

##### Operation with line frequencies of 50 Hz and 60 Hz

The rated currents  $I_{LN}$  of the commutating reactors apply for operation with the line frequencies  $f = 50$  Hz and  $f = 60$  Hz. The assignment of a reactor and SINAMICS DCM converter for 50 Hz or 60 Hz operation is shown in the following table.

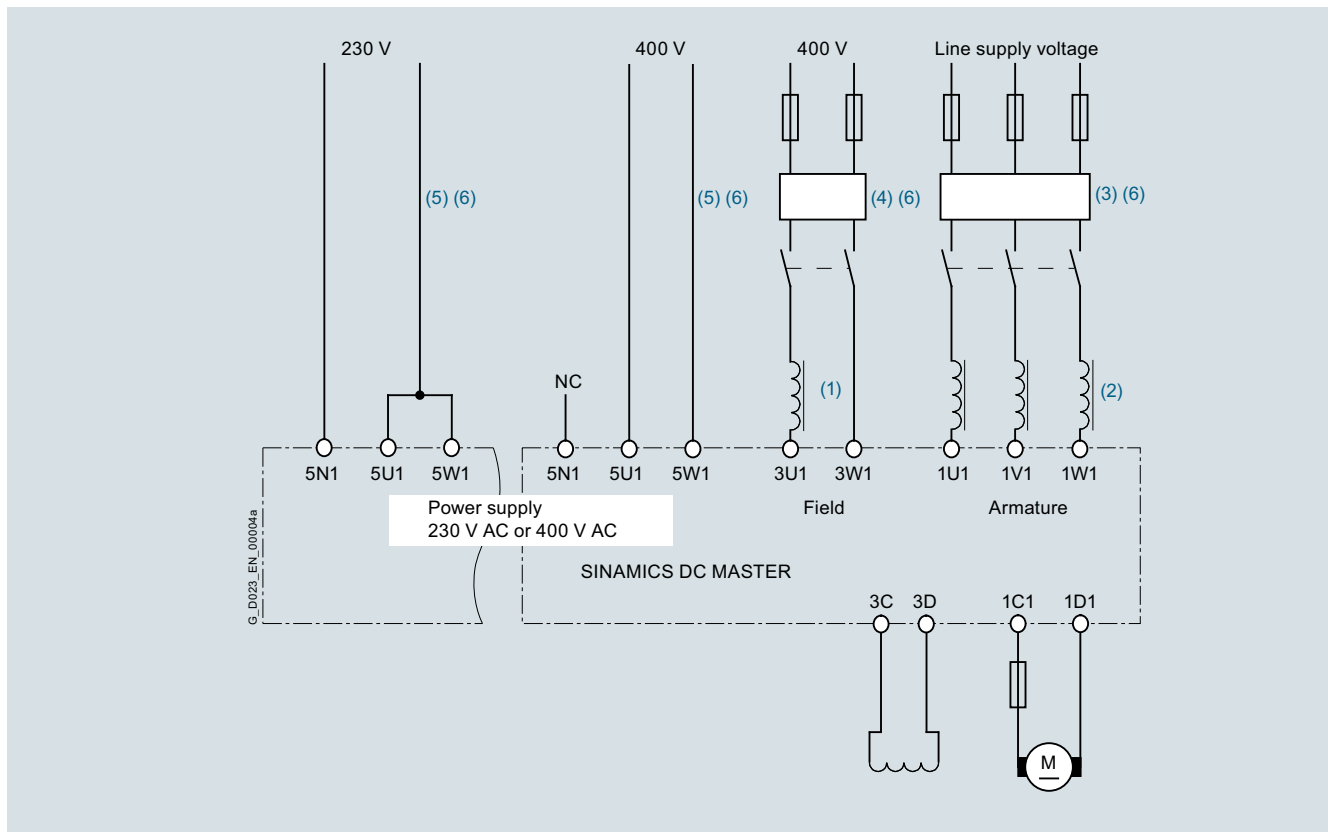

Arrangement of reactors and radio interference suppression filters

- (1) The commutating reactor in the field circuit is dimensioned for the rated motor field current.
- (2) The commutating reactor in the armature circuit is dimensioned for the rated motor armature current. The line current is 0.82 times the DC current.
- (3) The radio interference suppression filter for the armature circuit is dimensioned for the rated motor armature current. The line current is 0.82 times the DC current.
- (4) The radio interference suppression filter for the field circuit is dimensioned for the rated motor field current.
- (5) Radio interference suppression filters are not required for the electronics power supply alone. Current consumption 1 A at 400 V, 2 A at 230 V.
- (6) If the power supply voltages for the armature circuit, field circuit and electronics power supply are the same, then the voltage for the field and electronics power supply can also be taken after the radio interference suppression filter for the armature circuit.

### Overview

#### Assignment of commutating reactors to converter

The single-phase commutating reactors are selected based on the field rated DCM current of the SINAMICS DCM.

SINAMICS DCM	$I_{Ln}$ [A]	4 % reactor 50 Hz	4 % reactor 60 Hz
<b>Rated voltage 400 V 3 AC</b>			
6RA8013-6D...	12.45	6RX1800-4DK00	–
6RA8018-6D...	24.9	6RX1800-4DK01	–
6RA8025-6D...	49.8	6RX1800-4DK02	–
6RA8028-6D...	74.7	6RX1800-4DK03	–
6RA8031-6D...	103.75	6RX1800-4DK04	–
6RA8075-6D...	174.3	6RX1800-4DK05	–
6RA8078-6D...	232.4	6RX1800-4DK06	–
6RA8081-6D...	332	6RX1800-4DK07	–
6RA8085-6D...	498	6RX1800-4DK10	–
6RA8087-6D...	705.5	6RX1800-4DK11	–
6RA8091-6D...	996	6RX1800-4DK12	–
6RA8093-4D...	1328	6RX1800-4DK13	–
6RA8095-4D...	1660	6RX1800-4DK14	–
6RA8098-4D...	2490	6RX1800-4DK15	–
<b>Rated voltage 480 V 3 AC</b>			
6RA8013-6F...	12.45	6RX1800-4FK00	6RX1800-4DK00
6RA8018-6F...	24.9	6RX1800-4FK01	6RX1800-4DK01
6RA8025-6F...	49.8	6RX1800-4FK02	6RX1800-4DK02
6RA8028-6F...	74.7	6RX1800-4FK03	6RX1800-4DK03
6RA8031-6F...	103.75	6RX1800-4FK04	6RX1800-4DK04
6RA8075-6F...	174.3	6RX1800-4FK05	6RX1800-4DK05
6RA8078-6F...	232.4	6RX1800-4FK06	6RX1800-4DK06
6RA8082-6F..	373.5	6RX1800-4FK08	6RX1800-4DK08
6RA8085-6F..	498	6RX1800-4FK10	6RX1800-4DK10
6RA8087-6F...	705.5	6RX1800-4FK12	6RX1800-4DK11
6RA8091-6F..	996	6RX1800-4FK14	6RX1800-4DK12
<b>Rated voltage 575 V 3 AC</b>			
6RA8025-6G...	49.8	6RX1800-4GK00	6RX1800-4FK02
6RA8031-6G...	103.75	6RX1800-4GK01	6RX1800-4FK04
6RA8075-6G...	174.3	6RX1800-4GK02	6RX1800-4FK05
6RA8081-6G...	332	6RX1800-4GK03	6RX1800-4FK07
6RA8085-6G...	498	6RX1800-4GK04	6RX1800-4FK10
6RA8087-6GS...	664	6RX1800-4GK07	6RX1800-4FK11
6RA8087-6GV...	705.5	6RX1800-4GK08	6RX1800-4FK12
6RA8090-6G...	913	6RX1800-4GK11	6RX1800-4FK13
6RA8093-4G...	1328	6RX1800-4GK13	6RX1800-4FK15
6RA8095-4G...	1660	6RX1800-4GK14	6RX1800-4FK16
6RA8096-4G...	1826	6RX1800-4GK15	6RX1800-4FK17
6RA8097-4G...	2324	6RX1800-4GK17	6RX1800-4FK18

**SINAMICS DCM**

Accessories and supplementary components

**Commutating reactors****Overview**

SINAMICS DCM	$I_{Ln}$ [A]	4 % reactor 50 Hz	4 % reactor 60 Hz
<b>Rated voltage 690 V 3 AC</b>			
6RA8086-6KS...	597.6	6RX1800-4KK00	6RX1800-4GK05
6RA8086-6KV...	630.8	6RX1800-4KK01	6RX1800-4GK06
6RA8090-6K...	830	6RX1800-4KK03	6RX1800-4GK10
6RA8093-4K...	1245	6RX1800-4KK04	6RX1800-4GK12
6RA8095-4K...	1660	6RX1800-4KK06	6RX1800-4GK14
6RA8097-4K...	2158	6RX1800-4KK07	6RX1800-4GK16
<b>Rated voltage 830 V 3 AC</b>			
6RA8088-6L...	788.5	6RX1800-4LK00	6RX1800-4KK02
6RA8093-4L...	1245	6RX1800-4LK01	6RX1800-4KK04
6RA8095-4L...	1577	6RX1800-4LK02	6RX1800-4KK05
<b>Rated voltage 950 V 3 AC</b>			
6RA8096-4M...	1826	6RX1800-4MK00	6RX1800-4LK03

### Selection and ordering data



#### Note:

The commutating reactors are dimensioned according to the rated motor current in the armature or field circuit. When the unit is connected to a single phase, single-phase commutating reactors must also be used in the armature circuit. These are available on request.

The tables below list the commutating reactors which are available as standard. Additional information can be found in the Operating Instructions "SINAMICS DCM Commutating reactors" (see <http://support.automation.siemens.com/WW/view/en/85062393>).

General technical specifications	
Degree of protection	IP00
Protection class	Class 1 <sup>2)</sup>
Cooling	AN, self-ventilated
Inductance tolerance	± 10 %
Environmental classes acc. to IEC 60721-3-3: 2002, Parts 1 to 3	<ul style="list-style-type: none"> <li>• Climatic:               <ul style="list-style-type: none"> <li>- Storage: 1K3</li> <li>- Transport: 2K2</li> <li>- Operation: 3K3</li> </ul> </li> <li>• Mechanical: 3M3</li> </ul>
Ambient temperature during operation	<ul style="list-style-type: none"> <li>• 1-phase reactors: 0 to +45 °C, above with derating</li> <li>• 3-phase reactors: 0 to +40 °C, above with derating</li> </ul>
Ambient temperature for storage and transport	-40 to +70 °C
Installation altitude (at rated current)	≤ 1000 m above sea level, above with derating
Operation at 50 Hz and 60 Hz with rated current is permissible	

Three-phase commutating reactors							
AC rated current	Inductance	Copper losses	Total losses	Short-circuit current rating (SCCR)	Weight	Rated insulation voltage	Article No.
A	mH	W	W	kA	kg	V	
<b><math>u_K = 4\%</math> at rated current and 400 V 3 AC/50 Hz or 480 V 3 AC/60 Hz</b>							
13	2.315	22.8	33.1	2.0 (20 ms)	2.9	600	<b>6RX1800-4DK00</b>
25	1.158	30.8	53.2	5.0 (20 ms)	4.4	600	<b>6RX1800-4DK01</b>
51	0.579	43.5	73.2	6.5 (100 ms)	10.9	600	<b>6RX1800-4DK02</b>
76	0.386	64.4	118.5	9.0 (100 ms)	13.8	600	<b>6RX1800-4DK03</b>
106	0.278	51.3	119.3	15 (100 ms)	23.9	600	<b>6RX1800-4DK04</b>
174	0.169	164.8	206.4	15 (100 ms)	24.0	600	<b>6RX1800-4DK05</b>
232	0.127	197.4	256.2	20 (100 ms)	26.8	600	<b>6RX1800-4DK06</b>
332	0.089	190.7	251.1	24 (200 ms)	45.8	600	<b>6RX1800-4DK07</b>
374	0.079	186.7	251.7	24 (200 ms)	56.8	600	<b>6RX1800-4DK08</b>
498	0.059	277.0	357.4	35 (200 ms)	60.0	600	<b>6RX1800-4DK10</b>
706	0.042	329.4	424.8	55 (200 ms)	81.6	1000	<b>6RX1800-4DK11</b>
996	0.030	390.3	562.8	75 (200 ms)	100.1	1000	<b>6RX1800-4DK12</b>
1328	0.022	339.3	554.5	75 (200 ms)	138.8	1000	<b>6RX1800-4DK13</b>
1660	0.018	369.3	591.9	75 (200 ms)	210.7	1000	<b>6RX1800-4DK14</b>
2490	0.012	587.3	1038.3	75 (200 ms)	205.6	1000	<b>6RX1800-4DK15</b>

#### Note:

Commutating reactors with  $u_K = 2\%$  are available on request. A limited tolerance range is also possible for parallel connections.

<sup>1)</sup> All commutating reactors with rated voltages  $V_{rated} \leq 600$  V acc. to UL

<sup>2)</sup> Note about protection class 1: Despite protective conductor connection, no 'touchable conductive parts' with regard to the standard (e.g. EN 61800-5-1) are defined. In this case, the protective conductor ensures that no dangerous voltages/currents can act at the mounting surfaces. The complete reactor must be considered as being an active component.

**SINAMICS DCM**

## Accessories and supplementary components

## Commutating reactors

## Selection and ordering data

**Three-phase commutating reactors**

AC rated current	Inductance	Copper losses	Total losses	Short-circuit current rating (SCCR)	Weight	Rated insulation voltage	Article No.
A	mH	W	W	kA	kg	V	
<b><math>u_K = 4\%</math> at rated current and 480 V 3 AC/50 Hz or 575 V 3 AC/60 Hz</b>							
13	2.779	27.4	39.2	2.0 (20 ms)	2.9	600	6RX1800-4FK00
25	1.389	34.8	57.8	5.0 (20 ms)	6.0	600	6RX1800-4FK01
51	0.695	42.3	77.2	6.5 (100 ms)	11.8	600	6RX1800-4FK02
76	0.463	56.3	118.0	9.0 (100 ms)	16.3	600	6RX1800-4FK03
106	0.333	68.8	152.9	15 (100 ms)	22.3	600	6RX1800-4FK04
174	0.202	204.6	255.6	15 (100 ms)	26.0	600	6RX1800-4FK05
232	0.152	178.3	231.5	20 (100 ms)	37.8	600	6RX1800-4FK06
332	0.106	193.7	261.5	24 (100 ms)	56.1	600	6RX1800-4FK07
374	0.094	189.1	279.2	24 (100 ms)	56.8	600	6RX1800-4FK08
498	0.071	313.8	396.9	35 (200 ms)	78.1	1000	6RX1800-4FK10
664	0.053	255.6	360.8	75 (200 ms)	96.6	1000	6RX1800-4FK11
706	0.050	293.9	404.1	75 (200 ms)	96.6	1000	6RX1800-4FK12
913	0.039	375.6	558.6	75 (200 ms)	114.5	1000	6RX1800-4FK13
996	0.035	332.7	532.8	75 (200 ms)	127.8	1000	6RX1800-4FK14
1328	0.027	320.4	573.7	75 (200 ms)	177.6	1000	6RX1800-4FK15
1660	0.021	436.5	819.0	75 (200 ms)	161.0	1000	6RX1800-4FK16
1826	0.019	464.7	819.9	75 (200 ms)	164.2	1000	6RX1800-4FK17
2324	0.015	671.8	1056.7	75 (200 ms)	258.2	1000	6RX1800-4FK18
<b><math>u_K = 4\%</math> at rated current and 575 V 3 AC/50 Hz or 690 V 3 AC/60 Hz</b>							
51	0.832	56.8	109.7	6.5 (100 ms)	13.6	600	6RX1800-4GK00
106	0.399	65.5	156.7	15 (100 ms)	26.4	600	6RX1800-4GK01
174	0.243	150.0	200.5	15 (100 ms)	34.5	600	6RX1800-4GK02
332	0.127	252.1	327.3	24 (200 ms)	63.1	600	6RX1800-4GK03
498	0.085	330.3	427.5	35 (200 ms)	86.0	1000	6RX1800-4GK04
598	0.071	339.6	455.5	55 (200 ms)	89.8	1000	6RX1800-4GK05
631	0.067	322.8	441.1	55 (200 ms)	95.7	1000	6RX1800-4GK06
664	0.064	380.7	547.2	75 (200 ms)	108.4	1000	6RX1800-4GK07
706	0.060	392.7	564.5	75 (200 ms)	120.6	1000	6RX1800-4GK08
830	0.051	308.1	498.3	75 (200 ms)	134.8	1000	6RX1800-4GK10
913	0.046	320.7	515.9	75 (200 ms)	143.9	1000	6RX1800-4GK11
1245	0.034	371.4	605.4	75 (200 ms)	206.1	1000	6RX1800-4GK12
1328	0.032	503.1	812.4	75 (200 ms)	160.9	1000	6RX1800-4GK13
1660	0.025	631.3	993.1	75 (200 ms)	202.0	1000	6RX1800-4GK14
1826	0.023	614.7	1006.9	75 (200 ms)	212.1	1000	6RX1800-4GK15
2158	0.020	534.6	1073.7	75 (200 ms)	303.0	1000	6RX1800-4GK16
2324	0.018	556.2	1110.0	75 (200 ms)	321.6	1000	6RX1800-4GK17

## Note:

Commutating reactors with  $u_K = 2\%$  are available on request.  
A limited tolerance range is also possible for parallel connections.

<sup>1)</sup> All commutating reactors with rated voltages  $V_{\text{rated}} \leq 600$  V acc. to UL



## Selection and ordering data



## Three-phase commutating reactors

AC rated current	Inductance	Copper losses	Total losses	Short-circuit current rating (SCCR)	Weight	Rated insulation voltage	Article No.
A	mH	W	W	kA	kg	V	
<b><math>u_K = 4\%</math> at rated current and 690 V 3 AC/50 Hz or 830 V 3 AC/60 Hz</b>							
598	0.085	388.2	562.1	55 (200 ms)	108.9	1000	<b>6RX1800-4KK00</b>
631	0.080	402.0	586.4	75 (200 ms)	113.3	1000	<b>6RX1800-4KK01</b>
789	0.064	362.7	564.6	75 (200 ms)	141.9	1000	<b>6RX1800-4KK02</b>
830	0.061	350.7	561.4	75 (200 ms)	153.4	1000	<b>6RX1800-4KK03</b>
1245	0.041	505.2	845.7	75 (200 ms)	169.7	1000	<b>6RX1800-4KK04</b>
1577	0.032	716.8	1093.8	75 (200 ms)	226.1	1000	<b>6RX1800-4KK05</b>
1660	0.031	596.0	1011.8	75 (200 ms)	257.2	1000	<b>6RX1800-4KK06</b>
2158	0.024	484.8	1185.6	75 (200 ms)	360.2	1000	<b>6RX1800-4KK07</b>
<b><math>u_K = 4\%</math> at rated current and 830 V 3 AC/50 Hz or 950 V 3 AC/60 Hz</b>							
789	0.077	312.0	532.1	75 (200 ms)	205.2	1000	<b>6RX1800-4LK00</b>
1245	0.049	692.4	1061.9	75 (200 ms)	222.4	1000	<b>6RX1800-4LK01</b>
1577	0.039	479.4	1059.6	75 (200 ms)	308.5	1000	<b>6RX1800-4LK02</b>
1826	0.033	585.6	1269.0	75 (200 ms)	372.5	1000	<b>6RX1800-4LK03</b>
<b><math>u_K = 4\%</math> at rated current and 950 V 3 AC/50 Hz, operation at 60 Hz and rated current permissible</b>							
1826	0.038	534.9	1303.5	75 (200 ms)	399.7	1000	<b>6RX1800-4MK00</b>

Note:

Commutating reactors with  $u_K = 2\%$  are available on request. A limited tolerance range is also possible for parallel connections.

## Single-phase commutating reactors

AC rated current	Inductance	Copper losses	Total losses	Short-circuit current rating (SCCR)	Weight	Rated insulation voltage	Article No.
A	mH	W	W	kA	kg	V	
<b><math>u_K = 4\%</math> at rated current and 400 V 1 AC/50 Hz or 480 V 1 AC/60 Hz</b>							
3	16.98	3	5	0.8 (20 ms)	0.7	600	<b>6RX1800-4DE00</b>
5	10.19	5	7	0.8 (20 ms)	1.5	600	<b>6RX1800-4DE01</b>
10	5.090	7	12	2 (20 ms)	2.0	600	<b>6RX1800-4DE02</b>
15	3.400	8	17	2 (20 ms)	2.3	600	<b>6RX1800-4DE03</b>
25	2.040	8	29	6 (20 ms)	3.0	600	<b>6RX1800-4DE04</b>
30	1.700	10	30	6 (20 ms)	3.8	600	<b>6RX1800-4DE05</b>
40	1.270	9	49	10 (20 ms)	5.2	600	<b>6RX1800-4DE06</b>
85	0.600	13	67	15 (20 ms)	9.6	600	<b>6RX1800-4DE07</b>

## More information

Additional information on commutating reactors can be found in the Operating Instructions "SINAMICS DCM Commutating Reactors" under the following link:

<https://support.industry.siemens.com/cs/ww/en/view/84138681>

<sup>1)</sup> All commutating reactors with rated voltages  $V_{\text{rated}} \leq 600$  V acc. to UL

## SINAMICS DCM

### Accessories and supplementary components

#### Circuit breakers and contactors

##### Overview

The main contactor or the circuit breaker in front of the three-phase armature circuit infeed of the converter is used to switch on the power section in a correct manner when the electronics and the voltage for the thyristor modules is enabled if the unit is still not operational. This is the reason that the contactor or the circuit-breaker must always be energized via the terminals XR1-109-110. When a circuit breaker is used, a motor-operated mechanism must be used to close the circuit breaker and an undervoltage release to open the circuit breaker.

##### **Selection criteria**

The internal control sequence guarantees that the switching operations are always made in a no-current condition. When selecting the main contactor, the utilization category AC-1 or for a circuit-breaker, the maximum rated current  $I_{n, \max}$  should be used as basis. If the current and voltage quantities permit it, then generally, the more cost-effective solution using a contactor is preferred over a circuit breaker.

**Overview**

SINAMICS DC MASTER applications are in compliance with the EMC product standard EN 61800-3 for electric drives when taking into account that the units are integrated into the plant or system in compliance with EMC rules.

However, EMC legislation does stipulate that the plant or system as a whole must be electromagnetically compatible with its environment.

If radio interference suppression level "A1" according to EN 55011 is to be achieved, then in addition to the commutating reactors, radio interference suppression filters are also required. Radio interference suppression filters reduce radio interference voltages of the converter that occur in conjunction with the commutating reactor.

Radio interference suppression filters generate leakage currents. In accordance with DIN VDE 0160, a PE connection with a cross-section of 10 mm<sup>2</sup> is required. For the filters to have optimum effect, it is absolutely essential that they and the unit are installed on a single metal plate.

For converter units with three-phase connection, the minimum rated filter current is equal to the DC output current of the unit times 0.82. For a two-phase connection (field power section or single-phase connection of the armature power section) only two phases are connected to the three-phase radio interference suppression filter. In this case, the line current is equal to the field DC current.

**List of recommended radio interference suppression filters from EPCOS****Radio interference suppression filters**

Rated current	TN/TT system	IT system	Weight	Terminal cross-section/drill hole for screw M..	Article No. EPCOS	Article No. Siemens
A	V	V	kg			
<b>Line filters for armature circuit</b>						
25	760/440	580/335	4	10 mm <sup>2</sup>	B84143A0025R021	– <sup>1)</sup>
50	760/440	580/335	4	10 mm <sup>2</sup>	B84143A0050R021	– <sup>1)</sup>
80	760/440	630/365	9.5	25 mm <sup>2</sup>	B84143A0080R021	6RX1800-0LF03
120	760/440	630/365	10	50 mm <sup>2</sup>	B84143A0120R021	6RX1800-0LF13
180	–	690/400	13	M10	B84143B0180S024	6RX1800-0KF00
180	520/300	360/208	5	M10	B84143B0180S080	6RX1800-0GF00
180	760/440	560/320	5	M10	B84143B0180S081	6RX1800-0LF04
250	520/300	360/208	5	M10	B84143B0250S080	6RX1800-0GF01
250	760/440	560/320	5	M10	B84143B0250S081	6RX1800-0LF14
400	–	690/400	21	M10	B84143B0400S024	6RX1800-0KF02
400	520/300	360/208	7.5	M10	B84143B0400S080	6RX1800-0GF03
400	760/440	560/320	7.5	M10	B84143B0400S081	6RX1800-0LF07
600	–	690/400	22	M10	B84143B0600S024	6RX1800-0KF03
600	520/300	360/208	7.8	M10	B84143B0600S080	6RX1800-0GF04
600	760/440	560/320	7.8	M10	B84143B0600S081	6RX1800-0LF08
1000	–	690/400	28	M12	B84143B1000S024	6RX1800-0KF04
1000	520/300	360/208	18.5	M12	B84143B1000S080	6RX1800-0GF05
1000	760/440	560/320	18.5	M12	B84143B1000S081	6RX1800-0LF10
1600	–	690/400	34	2 x M12	B84143B1600S024	6RX1800-0KF05
1600	520/300	360/208	24.5	2 x M12	B84143B1600S080	6RX1800-0GF06
1600	760/440	560/320	24.5	2 x M12	B84143B1600S081	6RX1800-0LF11
2500	530/310	460/265	105	4 x M12	B84143B2500S020	6RX1800-0GF07
2500	760/440	560/320	105	4 x M12	B84143B2500S021	6RX1800-0LF12
2500	–	690/400	105	4 x M12	B84143B2500S024	6RX1800-0KF06
<b>Line filters for auxiliary power supply</b>						
25	520/300	440/255	1.1	4 mm <sup>2</sup>	B84143A0025R105	6RX1800-1GF00
50	520/300	440/255	1.75	10 mm <sup>2</sup>	B84143A0050R105	– <sup>1)</sup>
66	520/300	440/255	2.7	16 mm <sup>2</sup>	B84143A0066R105	6RX1800-1GF02
90	520/300	440/255	4.2	35 mm <sup>2</sup>	B84143A0090R105	– <sup>1)</sup>
120	520/300	440/255	4.9	35 mm <sup>2</sup>	B84143A0120R105	6RX1800-1GF04

**Permissible operating data**

Operating temperature: 0 to +40 °C

Rated frequency: 50/60 Hz ± 6 %

<sup>1)</sup> Radio interference suppression filters of this type are not available with Siemens Article No. If necessary, select the next larger type.

## SINAMICS DCM

### Accessories and supplementary components

#### SICROWBAR AC

##### Application



SICROWBAR AC overvoltage protection

**SICROWBAR AC** is used to protect power semiconductors (thyristors and diodes) in converters against overvoltages between the phases of a three-phase line supply. The range of applications is not only restricted to protecting DC drive converters, but can also be used for infeed/regenerative feedback units of AC drive systems that are equipped with thyristors.

Overvoltages that occur on the AC side of converters are mainly caused by switching operations when disconnecting from the line supply at the transformer primary side. This applies both to operational switching operations (shutdown under no-load conditions) as well as in the case of a fault (shutdown under load).

Overvoltage protection is normally used in the following configuration:

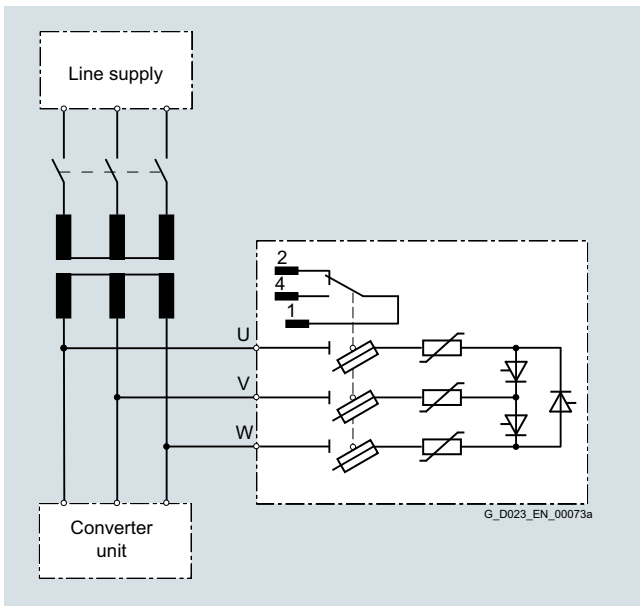

##### Design

There are three device versions depending on the rated voltage:

Version	Rated voltage	Design, installation
A	Up to 580 V	Mounted in an enclosure. For mounting in an upright position on panels in cabinets or machine frames.
B	Up to 725 V	Mounted on a baseplate. For installation in 600 mm wide cabinets.
C	Up to 1150 V	Mounted on a baseplate. For installation in 600 mm wide cabinets.

The power section of the overvoltage protection device has a P3C connection, 3-pulse fully controlled polygon connection. The feeders to the polygon connection have metal-oxide varistors that absorb overvoltage energy.

Semiconductor fuses included in the devices are accommodated in a fused disconnecter with integrated fuse monitoring.

The break-over diodes (BOD) and RC snubbers for the thyristors and varistors are mounted on a printed circuit board as are also the gate series resistors and diodes that transfer the line voltage to the break-over diodes.

##### Mode of operation

If an overvoltage occurs, which reaches the response voltage of the integrated firing module, then the break-over diodes trigger and in turn trigger their associated thyristors. As a consequence, the varistors are switched to the line supply. The varistors absorb the overvoltage energy. An RC protective circuit protects the thyristors against an excessively steep voltage rate of rise when the current is interrupted.

##### Configuration

###### Notes on selection

The following conditions should be maintained when selecting the overvoltage protection:

- The limit voltage of the overvoltage protection  $V_{RRM55}$  must not exceed the highest periodic and permissible peak blocking voltage of the power semiconductors to be protected.
- The rated supply voltage of the overvoltage protection must not be exceeded.
- Commutation overvoltages of the converter that periodically occur must remain below the response voltage of the overvoltage protection. The energy absorption capability of the selected overvoltage protection should be checked. A distinction must be made between two operating cases:
  - Transformer is shut down under no-load conditions
  - Transformer is shut down under load

Detailed notes on configuration, standards and connection of the overvoltage protection are provided in the operating instructions or on the Internet at

<http://support.automation.siemens.com/WW/view/en/18260008/130000>.

**Technical specifications**

General technical specifications	SICROWBAR AC
Degree of protection	IP00 according to EN 60529
Protection class	I according to EN 50178
Overvoltage category	III according to EN 60664
Dimensioning creepages and clearances	Pollution degree 2 acc. to EN 50178
Rated insulation voltage (for installation altitudes up to 2000 m above sea level) <sup>1)</sup>	725 V AC for rated supply voltages of 400 ... 725 V 1200 V AC for rated supply voltages of 850 ... 1150 V
Installation altitude	≤ 2000 m above sea level
Permissible ambient temperature	
• In operation	+5 ... +55 °C
• In storage	-40 ... +70 °C
Climate class	3K3 acc. to IEC 60721-3-3 : 2002
Fuse monitoring (microswitch at the fused disconnecter, 1 changeover contact)	Flat connector 6.3 mm × 0.8 mm
• Disconnecter closed, all fuse links OK	1/2 closed, 1/4 opened
• Disconnecter closed, one or several fuse links defective	1/4 closed, 1/2 opened
• Disconnecter open	1/4 closed, 1/2 opened
• Maximum switching capacity	50 Hz 250 V AC, 3 A 30 V DC, 3 A
MTBF	>165 years

	SICROWBAR AC			
	7VV3002-3CD20	7VV3002-3AD20	7VV3002-3BD20	7VV3002-3GD20
Max. permissible rated supply voltage $V_{rated}$	V	460	550	
Nominal response voltage of BOD element $V_{AN}$	V	1000	1200	1400
Min. limit voltage of BOD element at 5 °C $V_{RRM,05}$	V	864	1056	1248
Max. limit voltage of BOD element at 55 °C $V_{RRM,55}$	V	1166	1378	1590
Max. permissible peak current, $I_{max}$	A	200	1000	2000
Rated insulation voltage (the insulation voltage is determined by the highest rated supply voltage of the relevant construction type) $V_{ISO}$	V	550		
Varistor voltage (breakdown voltage) at $T_A = 25$ °C, 1 mA (data sheet value × 2 for 2 series-connected varistors) $V_V$	V	720	860	
Max. energy (for 2 ms) at $T_A = 85$ °C (data sheet value × 2 for 2 series-connected varistors) $W_0$	Ws	600	720	
Energy that can be absorbed 100 times (determined from the derating data) $W_2$	Ws	350	419	
Energy that can be absorbed 10000 times (determined from the derating data) $W_4$	Ws	42	50	
Version		A		
Dimensions				
• Width	mm	265		
• Height	mm	385		
• Depth	mm	237		
Weight, approx.	kg	7		

<sup>1)</sup> Installation altitudes above 2000 m on request.

## SINAMICS DCM

### Accessories and supplementary components

#### SICROWBAR AC

#### Technical specifications

		SICROWBAR AC				
		7VV3002-3DD20	7VV3002-3ED20	7VV3002-3JD20	7VV3002-3KD20	7VV3002-3LD20
Max. permissible rated supply voltage $V_{\text{rated}}$	V	770	920		1100	
Nominal response voltage of BOD element $V_{\text{AN}}$	V	1900	2400	2600	2800	3000
Min. limit voltage of BOD element at 5 °C $V_{\text{RRM}_05}$	V	1728	2208	2400	2592	2784
Max. limit voltage of BOD element at 55 °C $V_{\text{RRM}_55}$	V	2120	2650	2862	3074	3286
Max. permissible peak current, $I_{\text{max}}$	A	300	800	1000	400	1000
Rated insulation voltage (the insulation voltage is determined by the highest rated supply voltage of the relevant construction type) $V_{\text{ISO}}$	V	770	1100			
Varistor voltage (breakdown voltage) at $T_A = 25\text{ °C}$ , 1 mA (data sheet value $\times 2$ for 2 series-connected varistors) $V_V$	V	1240	1500		1820	
Max. energy (for 2 ms) at $T_A = 85\text{ °C}$ (data sheet value $\times 2$ for 2 series-connected varistors) $W_0$	Ws	2400	3300		3000	
Energy that can be absorbed 100 times (determined from the derating data) $W_2$	Ws	986	1196		1027	
Energy that can be absorbed 10000 times (determined from the derating data) $W_4$	Ws	145	176		214	
Version		B	C			
Dimensions						
• Width	mm	580				
• Height	mm	305				
• Depth	mm	205	245			
Weight, approx.	kg	11	12			

#### Selection and ordering data

Rated supply voltage V	Limit voltage V	SICROWBAR AC Article No.
460	1166	<b>7VV3002-3CD20</b>
460	1378	<b>7VV3002-3AD20</b>
550	1590	<b>7VV3002-3BD20</b>
550	1802	<b>7VV3002-3GD20</b>
770	2120	<b>7VV3002-3DD20</b>
920	2650	<b>7VV3002-3ED20</b>
920	2862	<b>7VV3002-3JD20</b>
1100	3074	<b>7VV3002-3KD20</b>
1100	3286	<b>7VV3002-3LD20</b>

#### Accessories

For more information on spare parts, refer to <http://workplace.automation.siemens.com/sparesonweb>.

## Application



SICROWBAR DC overvoltage protection 7VV3003-5...

**SICROWBAR DC** protects windings and converters against overvoltage when supplying large inductances, e.g. field windings of synchronous machines, DC machines or hoisting solenoids. An appropriate de-excitation/discharge resistor must be provided.

Further, it is optionally possible to initiate fast de-excitation - triggered by a higher-level signal - for 7VV3003-5... units.

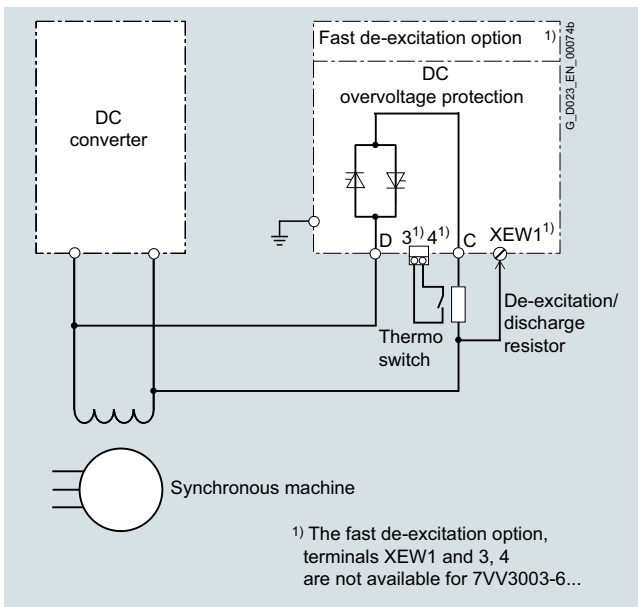

## Design

The most important components of the device are:

- Two thyristors in an anti-parallel connection
- A firing circuit, which, depending on the version, triggers a thyristor in the blocking direction at a defined voltage
- A module to detect the voltage at the de-excitation/discharge resistor, detect the current being conducted, identify when the overvoltage protection device triggers and signal the status using binary outputs (applies only to 7VV3003-5...).
- The power connections C, D (copper bars)
- Terminal XEW1 to connect the sensor cable from the de-excitation/discharge resistor.
- An "Optional fast de-excitation" module (option G11). The module allows the thyristors to be fired at any time by controlling three fast relays that are independent of one another (applies only to 7VV3003-5...).

## Mode of operation

The two thyristors connected in an anti-parallel connection, located between connections C and D, can briefly (approx. 5 s) conduct the pulse current. The overvoltage triggers a break-over diode (BOD) on the trigger circuit which in turn triggers the blocking thyristor and conducts the firing current past the blocking thyristor through a diode connected in an anti-parallel configuration to its gate/cathode. Independent of the polarity of the overvoltage, the break-over diode is always operated in the same direction using a bridge rectifier and the firing current is limited using series resistors. The thyristor fires within just a few microseconds and the voltage decreases quickly down to the forward voltage (1 to 1.5 V). The load current increases the temperature of the thyristor within just a few seconds and the thyristor and the stack construction (in the case of units 7VV3003-5...) absorb the thermal energy. As a consequence, the load cycle can only be repeated after a cooling time has elapsed (see Technical specifications).

### The following also applies to units 7VV3003-5...:

The fast de-excitation option (G11) is connected to the firing circuit in such a way that the thyristors can be triggered at any time by controlling at least one of the three fast relays - that are independent of one another. This assumes that there is sufficient voltage. Generally, this is approximately 5 % of the trigger voltage. Each of the three relays can be controlled with 24 V DC, 110 V to 125 V DC or 220 V to 240 V DC.

The voltage detection for the de-excitation/discharge resistor is connected to the external de-excitation/discharge resistor. When the voltage detection responds, the supplying converter must be blocked or the current controlled down to zero. The voltage detection module requires an external 24 V DC power supply with min. 100 mA.

### The following generally applies:

The de-excitation/discharge resistor is an external device and is not included in the scope of supply of the SICROWBAR DC. Its resistance must be so low that even at the highest load current, the voltage is still under the destruction limit of the supplying converter and/or the winding to be protected. The lowest possible resistance is defined by the supply voltage and the maximum load current of the converter (dimensioning the fuses). The required de-excitation time must also be taken into account when dimensioning the value of the resistance.

# SINAMICS DCM

## Accessories and supplementary components

### SICROWBAR DC

#### Configuration

The complete arrangement comprises a SICROWBAR DC overvoltage protection and a de-excitation/discharge resistor.

The following device parameters that are used to select the device must be determined:

1. The firing voltage – if this is reached, then the thyristors of the SICROWBAR DC are turned on.
2. The maximum current that flows or the maximum  $\beta t$  value that occurs.

Detailed information about configuration, applicable standards and connection of the overvoltage protection are provided in the operating instructions or on the Internet at:

- For units 7VV3003-5...:  
<http://support.automation.siemens.com/WW/view/en/21696826>
- For units 7VV3003-6...:  
<http://support.automation.siemens.com/WW/view/en/86152590>

#### Typical load current characteristic

7VV3003-5...:

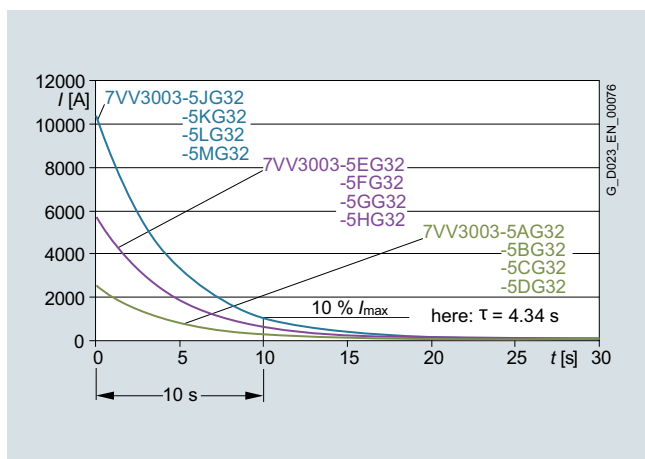

7VV3003-6...:

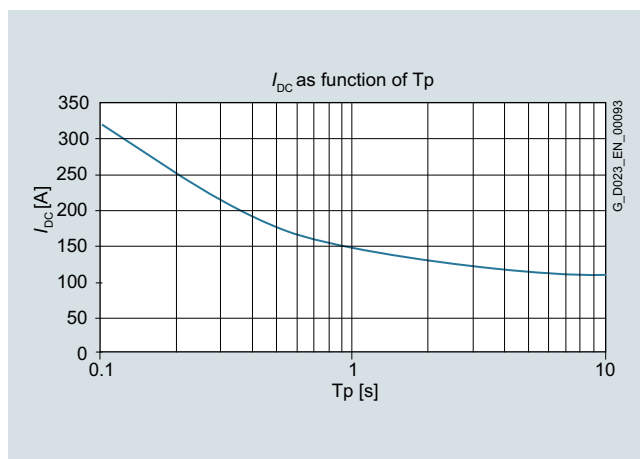

#### Cooling time

7VV3003-5...:

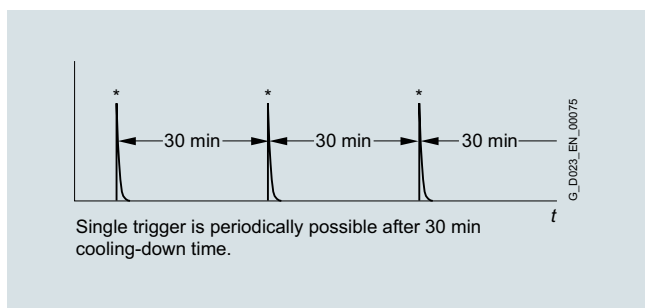

7VV3003-6...:

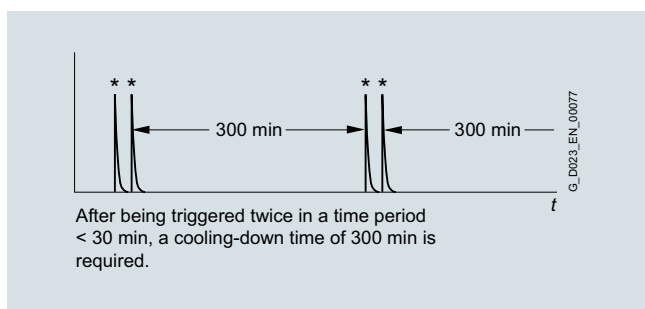
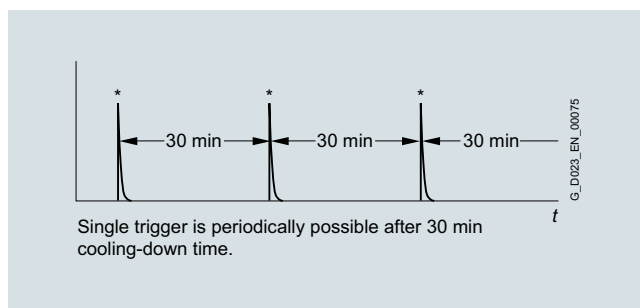

4



**Technical specifications**

General technical specifications	<b>SICROWBAR DC 7VV3003-6...</b>	
Degree of protection	IP00 acc. to EN 60529	
Overvoltage category	II acc. to EN 60664	
Installation altitude	≤ 1000 m above sea level	
Base plate insulation	3600 Vrms/1s	
Climate class	3K5 (without condensation) acc. to IEC 60721-3-3: 2002	
Permissible ambient temperature		
• In operation	-25 ... +45 °C	
• In storage	-40 ... +85 °C	
MTBF	>189 years	

		<b>SICROWBAR DC</b>	
		7VV3003-6BG30	7VV3003-6CG30
Response voltage	V	1200 ± 50	1500 ± 50
Max. rated supply system voltage $V_L$ for B6C circuit	V	0 ... 420 3 AC + 10 %	0 ... 500 3 AC + 10 %
Max. pulse current	kA	0.3	
Maximum load integral $I^2t$	A <sup>2</sup> s	0.02 × 10 <sup>6</sup>	
Dimensions			
• Width	mm	93	
• Height	mm	51	
• Depth	mm	85	
Weight, approx.	kg	0.18	

General technical specifications	<b>SICROWBAR DC 7VV3003-5...</b>	
Degree of protection	IP00 according to EN 60529	
Protection class	I acc. to EN 50178	
Overvoltage category	III acc. to EN 60664	
Dimensioning creepages and clearances	Pollution degree 2 acc. to EN 50178	
Installation altitude	≤ 2000 m above sea level	
Insulation test voltage of the power section (first test) with respect to the housing, voltage detection (signal part) and fast de-excitation (control)	5.5 kV 50 Hz 1 minute corresponding to EN 60034-1 for rated de-excitation voltages up to 750 V DC	
Climate class	3K3 acc. to IEC 60721-3-3 : 2002	
Permissible ambient temperature		
• In operation	0 ... +40 °C	
• In storage	-25 ... +70 °C	
Power supply required for the voltage detection	24 V DC, +10 %, -20 %, 100 mA	
MTBF	>189 years	

		<b>SICROWBAR DC</b>				
		7VV3003-5AG32	7VV3003-5BG32	7VV3003-5CG32	7VV3003-5PG32	7VV3003-5DG32
Response voltage	V	800 ± 100	1200 ± 100	1600 ± 100	1900 ± 100	2200 ± 150
Max. pulse current for typical characteristic	kA	2.5				
Critical pulse current (sine peak 10 ms)	kA	5				
Critical voltage gradient	V/μs	1000				
Critical current gradient	A/μs	80				
Maximum load integral $I^2t$	A <sup>2</sup> s	13.6 × 10 <sup>6</sup>				
Dimensions						
• Width	mm	265				
• Height	mm	350				
• Depth	mm	285				
Weight, approx.	kg	17				

## SINAMICS DCM

### Accessories and supplementary components

#### SICROWBAR DC

#### Technical specifications

		SICROWBAR DC				
		7VV3003-5EG32	7VV3003-5QG32	7VV3003-5FG32	7VV3003-5GG32	7VV3003-5HG32
Response voltage	V	1600 ± 100	1900 ± 100	2200 ± 150	2600 ± 150	3000 ± 150
Max. pulse current for typical characteristic	kA	5.8				
Critical pulse current (sine peak 10 ms)	kA	11.6				
Critical voltage gradient	V/μs	1000				
Critical current gradient	A/μs	300				
Maximum load integral $I^2t$	A <sup>2</sup> s	73 × 10 <sup>6</sup>				
Dimensions						
• Width	mm	265				
• Height	mm	350				
• Depth	mm	285				
Weight, approx.	kg	18				

		SICROWBAR DC				
		7VV3003-5JG32	7VV3003-5RG32	7VV3003-5KG32	7VV3003-5LG32	7VV3003-5MG32
Response voltage	V	1600 ± 100	1900 ± 100	2200 ± 150	2600 ± 150	3000 ± 150
Max. pulse current for typical characteristic	kA	10.5				
Critical pulse current (sine peak 10 ms)	kA	21				
Critical voltage gradient	V/μs	1000				
Critical current gradient	A/μs	300				
Maximum load integral $I^2t$	A <sup>2</sup> s	239 × 10 <sup>6</sup>				
Dimensions						
• Width	mm	265				
• Height	mm	350				
• Depth	mm	285				
Weight, approx.	kg	20				

#### Selection and ordering data

SIMOREG DC-MASTER SINAMICS DC MASTER	SICROWBAR DC		SICROWBAR DC Article No.
	Rated armature supply voltage	Pulse current, max.	
V	kA	V	
	<b>Units 7VV3003-6...</b>		
400	0.3	1200	<b>7VV3003-6BG30</b>
480	0.3	1500	<b>7VV3003-6CG30</b>
	<b>Units 7VV3003-5...</b>		
-	2.5	800	<b>7VV3003-5AG32</b>
400, 480	2.5	1200	<b>7VV3003-5BG32</b>
575	2.5	1600	<b>7VV3003-5CG32</b>
		5.8	<b>7VV3003-5EG32</b>
		10.5	<b>7VV3003-5JG32</b>
690	2.5	1900	<b>7VV3003-5PG32</b>
		5.8	<b>7VV3003-5QG32</b>
		10.5	<b>7VV3003-5RG32</b>
830	2.5	2200	<b>7VV3003-5DG32</b>
		5.8	<b>7VV3003-5FG32</b>
		10.5	<b>7VV3003-5KG32</b>
950	5.8	2600	<b>7VV3003-5GG32</b>
		10.5	<b>7VV3003-5LG32</b>
		10.5	<b>7VV3003-5HG32</b>
-	5.8	3000	<b>7VV3003-5HG32</b>
		10.5	<b>7VV3003-5MG32</b>

#### Accessories

The spare parts are listed in the operating instructions.

#### Options

Options for units 7VV3003-5...:

Option	Order code	Notes	Article No. for separate order
Fast de-excitation	<b>G11</b>	Initiation of fast de-excitation by one of the three relays, of which each has the following control voltages: <ul style="list-style-type: none"> <li>• 220 ... 240 V DC, +10 % -20 %</li> <li>• 110 ... 125 V DC, +10 % -20 %</li> <li>• 24 V DC, +10 % -20 %</li> </ul>	<b>7VV3003-7FG00</b>



<b>5/2</b>	<b>Dynamic overload capability</b>
5/2	Overview
5/2	<ul style="list-style-type: none"> <li>• Determining the dynamic overload capability</li> </ul>
5/15	<ul style="list-style-type: none"> <li>• Load classes</li> </ul>
5/17	<ul style="list-style-type: none"> <li>• Duty cycles for two-quadrant operation</li> </ul>
5/18	<ul style="list-style-type: none"> <li>• Duty cycles for four-quadrant operation</li> </ul>
5/15	More information
<b>5/19</b>	<b>Parallel connection</b>
5/19	Overview
5/19	<ul style="list-style-type: none"> <li>• Parallel connection of SINAMICS DC MASTER units</li> </ul>
5/19	More information
<b>5/20</b>	<b>12-pulse operation</b>
5/20	Overview
5/20	<ul style="list-style-type: none"> <li>• SINAMICS DC MASTER for 12-pulse operation</li> </ul>
5/20	More information
<b>5/21</b>	<b>Supply of high inductances</b>
5/21	Overview
5/21	<ul style="list-style-type: none"> <li>• SINAMICS DC MASTER to supply high inductances</li> </ul>
5/21	More information
<b>5/21</b>	<b>Heating applications</b>
5/21	Overview
5/21	<ul style="list-style-type: none"> <li>• Heating applications</li> </ul>
5/21	More information
<b>5/22</b>	<b>Protection against condensation</b>
5/22	Overview
5/22	<ul style="list-style-type: none"> <li>• Protection against condensation</li> </ul>
<b>5/23</b>	<b>Characteristic values of the pulse tachometer evaluation electronics</b>
5/23	Overview
5/23	<ul style="list-style-type: none"> <li>• Input pulse levels</li> </ul>
5/23	<ul style="list-style-type: none"> <li>• Maximum frequency that can be evaluated</li> </ul>
5/23	<ul style="list-style-type: none"> <li>• Cable, cable length, shield connection</li> </ul>
<b>5/24</b>	<b>Notes for EMC-compliant drive installation</b>
5/24	Overview
5/24	<ul style="list-style-type: none"> <li>• Notes for EMC-compliant installation</li> </ul>
5/24	<ul style="list-style-type: none"> <li>• Basic information about EMC</li> </ul>
5/26	<ul style="list-style-type: none"> <li>• EMC-compliant drive installation (installation instructions)</li> </ul>
<b>5/30</b>	<b>Harmonics</b>
5/30	Overview
5/30	<ul style="list-style-type: none"> <li>• Line-side harmonics produced by converter units in a fully-controlled three-phase bridge circuit B6C and (B6)A(B6)C</li> </ul>

# SINAMICS DCM

## Engineering information

### Dynamic overload capability

#### Overview

##### Determining the dynamic overload capability

###### Function overview

The rated DC current specified on the unit rating plate (maximum permissible continuous DC current) may be exceeded in operation. The extent to which this value is exceeded and how long this lasts are subject to certain limits, which are explained in more detail in the following.

The absolute upper limit for the value of the overload currents is 1.8x the rated DC current. The maximum overload duration depends on the time characteristic of the overload current as well as on the load history of the unit and also depends on the specific unit.

Each overload must be preceded by an underload (load phase with load current < rated DC current). Once the maximum permissible overload duration has elapsed, the load current must return to at least an absolute value  $\leq$  the rated DC current.

The dynamic overload duration is made possible by thermally monitoring the power section ( $\hat{P}t$  monitoring).  $\hat{P}t$  monitoring uses the time characteristic of the actual load current to calculate the time characteristic of a substitute value for the increase of the depletion layer temperature of the thyristors above the ambient temperature. In this case, unit-specific properties (e.g. thermal resistances and time constants) are incorporated in the calculation. When the converter unit is switched on, the calculation process starts with the initial values that were determined before the shutdown/line supply failure. The environmental conditions (ambient temperature and installation altitude) must be taken into account when setting a parameter.

$\hat{P}t$  monitoring responds when the calculated substitute depletion layer temperature rise exceeds the permissible value. Two alternatives can be parameterized as response:

- Alarm with a reduction of the armature current setpoint to the rated DC current or
- Fault with unit shutdown

$\hat{P}t$  monitoring can be disabled. In this case, the armature current is limited to the rated DC current.

##### Configuring for the dynamic overload capability

The configuring sheets contain the following information:

- The maximum overload duration  $t_{an}$  when starting with a cold power section and specified, constant overload,
- The maximum zero current interval  $t_{ab}$  (maximum cooling down time) until the "cold" thermal state of the power section is reached, and
- Fields of limiting characteristics for determining the overload capability during thermally stabilized, intermittent operation with overload (periodic duty cycles)

Technical support personnel from the local Siemens office can provide assistance with the selection of units for duty cycles involving multiple duty stages and cycle times in excess of 300 s.

Remark: The power section is considered to be "cold" if the calculated substitute depletion layer temperature rise is less than 5 % of its maximum permissible value. This state can be queried using a binary assignable output.

##### Structure of the fields of limiting characteristics for intermittent operation with overload

The fields of limiting characteristics refer to a duty cycle of the intermittent overload operation with a total duration (time period) of 300 s. Such a duty cycle comprises two time sections - the base-load duration (armature current actual value  $\leq$  rated DC current) and the overload duration (armature current actual value  $\geq$  rated DC current).

Each limiting characteristic represents a unit-specific maximum base-load current for a specific overload factor (limiting base-load current, specified as a % of the rated DC current) over the minimum base-load duration (limiting base-load duration). For the remaining duration of the duty cycle, the maximum permissible overload current is determined by the overload factor. If no limiting characteristic has been specified for the required overload factor, then it will be subject to the limiting characteristic for the next highest overload factor.

The fields of limiting characteristics are valid for a duty cycle of 300 s. Using basic calculation algorithms, duty cycles can be configured with duty cycle durations of longer than or shorter than 300 s. This will now be shown using two basic tasks.

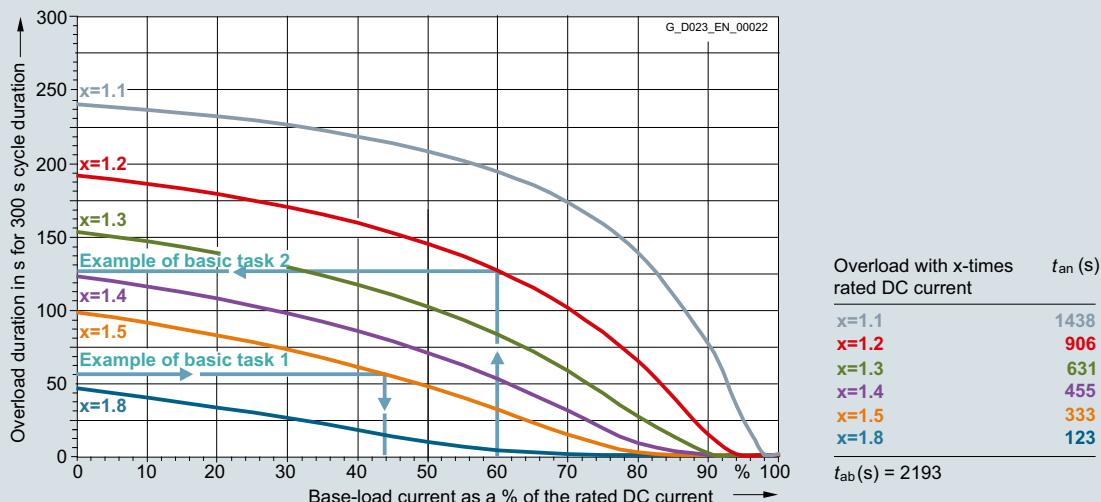

Characteristic example for basic tasks 1 and 2

**Overview**
**Basic task 1**

- Given:  
Unit, cycle duration, overload factor, overload duration
- To be found:  
(Min.) base-load duration and max. base-load current
- Solution:

	Cycle duration	
	< 300 s	≥ 300 s
1. Determine the characteristic	Select the limiting characteristic for the specific unit and the specific overload factor	
2. Overload duration <sub>300</sub> =	300 s/cycle duration × overload duration	Overload duration <sub>300</sub>
3. Base-load duration <sub>300</sub> =	300 s – overload duration <sub>300</sub>	
4. Base-load duration <sub>300</sub> < base-load duration <sub>300</sub> for max. base-load current = 0	Yes: Required duty cycle cannot be configured No: Read the max. base-load current for overload duration <sub>300</sub> from the limiting characteristic	
5. Determine the percentage for the base-load current	Read the percentage for the base-load currents from the diagram	

**Example for basic task 1**

- Given:
  - Unit with 30 A
  - Cycle duration 113.2 s
  - Overload factor 1.45
  - Overload duration 20 s
- To be found:
  - (Min.) base-load duration
  - Max. base-load current
- Solution:
  - Limiting characteristic for a unit with 30 A
  - Overload factor 1.5
  - Overload duration<sub>300</sub> = 300 s/113.2 s × 20 s = 53 s →
  - Max. base-load current = 44 %  $I_{rated}$  = 13.2 A

**Basic task 2**

- Given:  
Unit, cycle duration, overload factor, base-load current
- To be found:  
Maximum overload duration, minimum base-load duration
- Solution:

	Cycle duration	
	< 300 s	≥ 300 s
1. Determine the characteristic	Select the limiting characteristic for the specific unit and the specific overload factor	
2. Max. overload duration =	(Cycle duration/300 s) × overload duration <sub>300</sub>	300 s – base-load duration <sub>300</sub>
3. Min. base-load duration =	Cycle duration - max. overload duration	Cycle duration - max. overload duration

**Example for basic task 2**

- Given:
  - Unit with 30 A
  - Cycle duration 140 s
  - Overload factor 1.15
  - Base-load current = 0.6 ×  $I_{rated}$  = 18 A
- To be found:
  - Maximum overload duration
  - Minimum base-load duration
- Solution:
  - Limiting characteristic for a unit with 30 A
  - Overload factor 1.2
  - Base-load current = 60 %  $I_{rated}$  →
  - Overload duration<sub>300</sub> = 127 s
  - Max. overload duration = 140 s/300 s × 127 s = 59 s
  - Min. base-load duration = 140 s - 59 s = 81 s

**Explanation of terms:**

Base-load duration<sub>300</sub> = min. base-load duration for 300 s cycle duration (300 s – overload duration)

Overload duration<sub>300</sub> = max. overload duration for 300 s cycle duration

# SINAMICS DCM

## Engineering information

### Dynamic overload capability

#### Overview

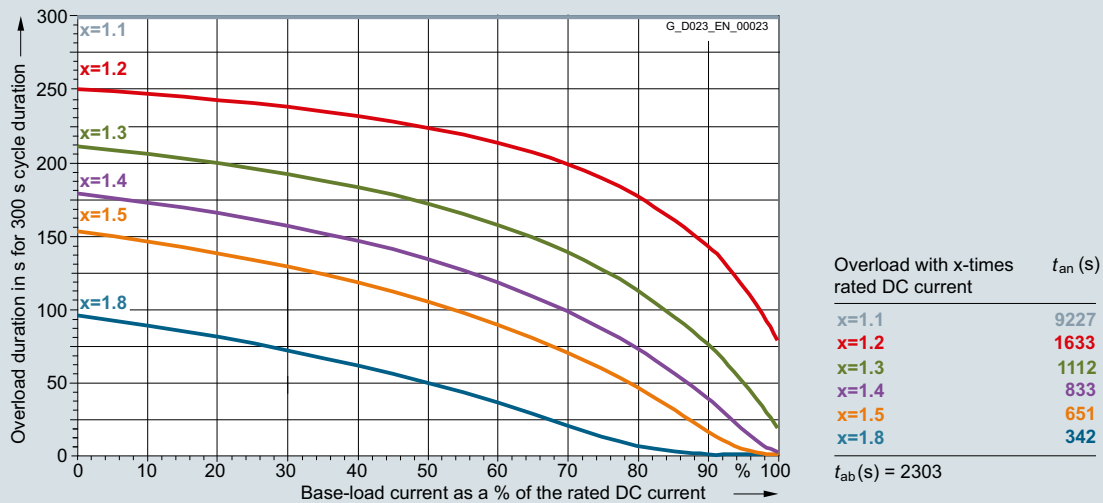

6RA8013-6DV62-0AA0 15 A/four-quadrant operation 400 V, 6RA8013-6FV62-0AA0 15 A/four-quadrant operation 480 V

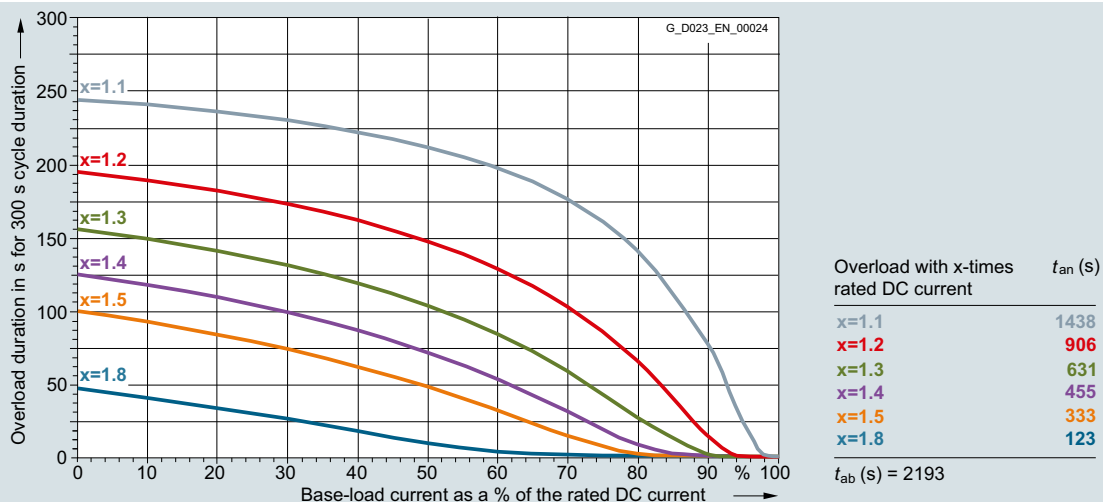

6RA8018-6DV62-0AA0 30 A/four-quadrant operation 400 V, 6RA8018-6FV62-0AA0 30 A/four-quadrant operation 480 V

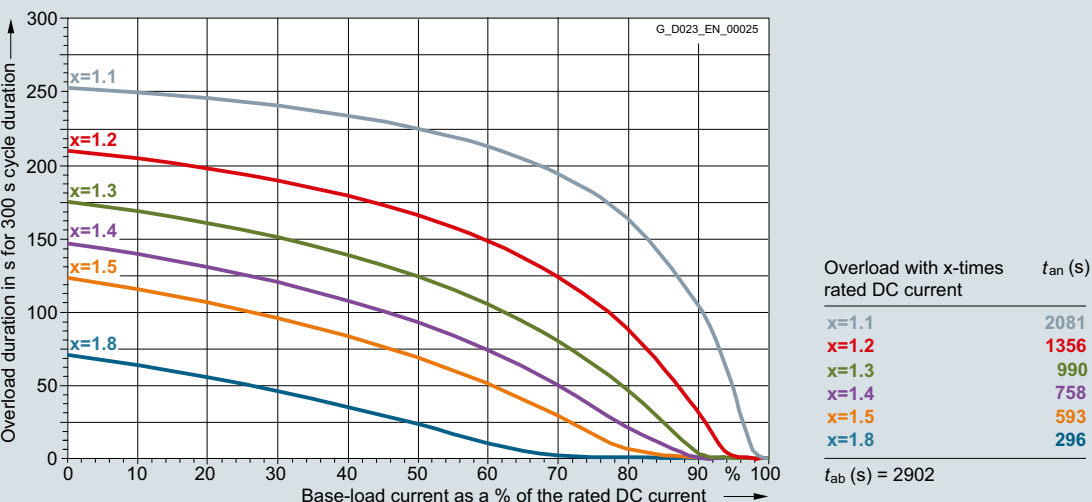

6RA8025-6DS22-0AA0 60 A/two-quadrant operation 400 V, 6RA8025-6FS22-0AA0 60 A/two-quadrant operation 480 V, 6RA8025-6GS22-0AA0 60 A/two-quadrant operation 575 V

**Overview**

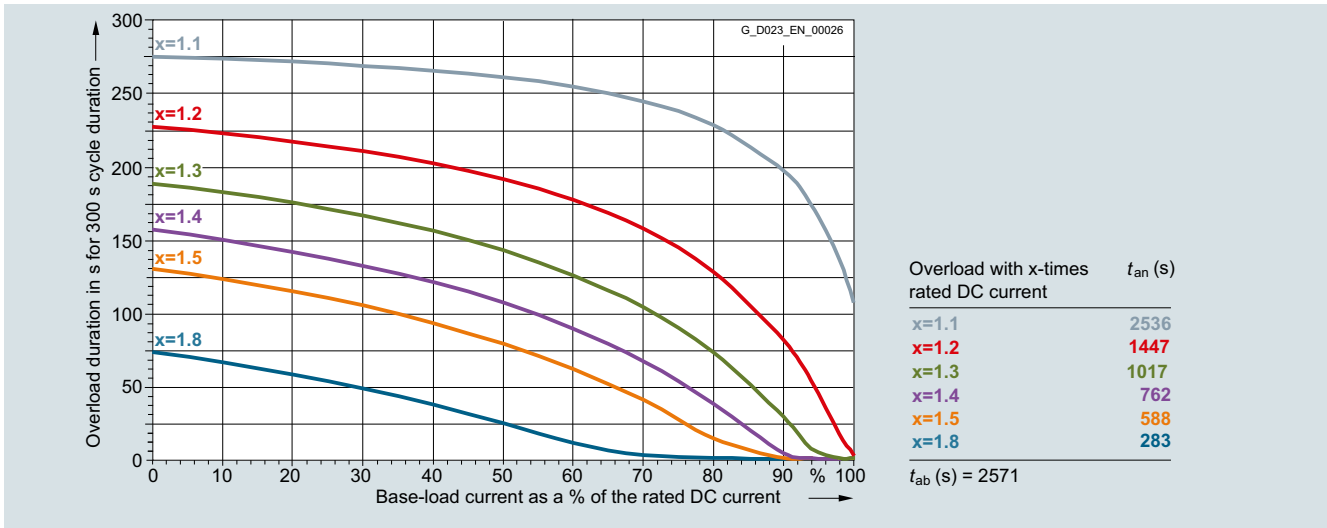

6RA8025-6DV62-0AA0 60 A/four-quadrant operation 400 V, 6RA8025-6FV62-0AA0 60 A/four-quadrant operation 480 V, 6RA8025-6GV62-0AA0 60 A/four-quadrant operation 575 V

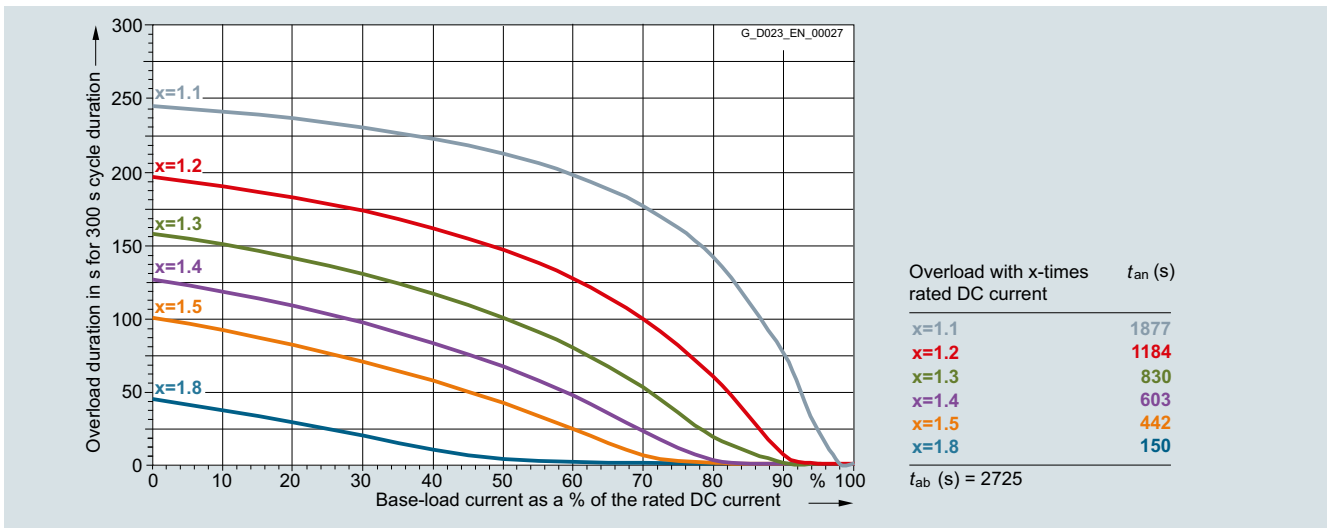

6RA8028-6DS22-0AA0 90 A/two-quadrant operation 400 V, 6RA8028-6FS22-0AA0 90 A/two-quadrant operation 480 V

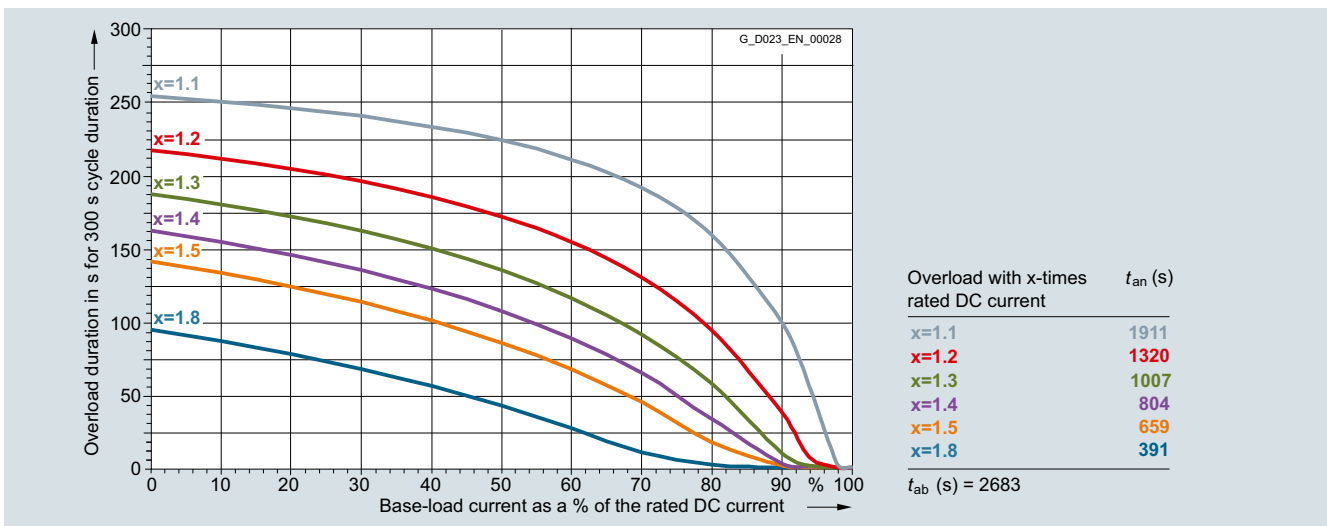

6RA8028-6DV62-0AA0 90 A/four-quadrant operation 400 V, 6RA8028-6FV62-0AA0 90 A/four-quadrant operation 480 V

# SINAMICS DCM

## Engineering information

### Dynamic overload capability

#### Overview

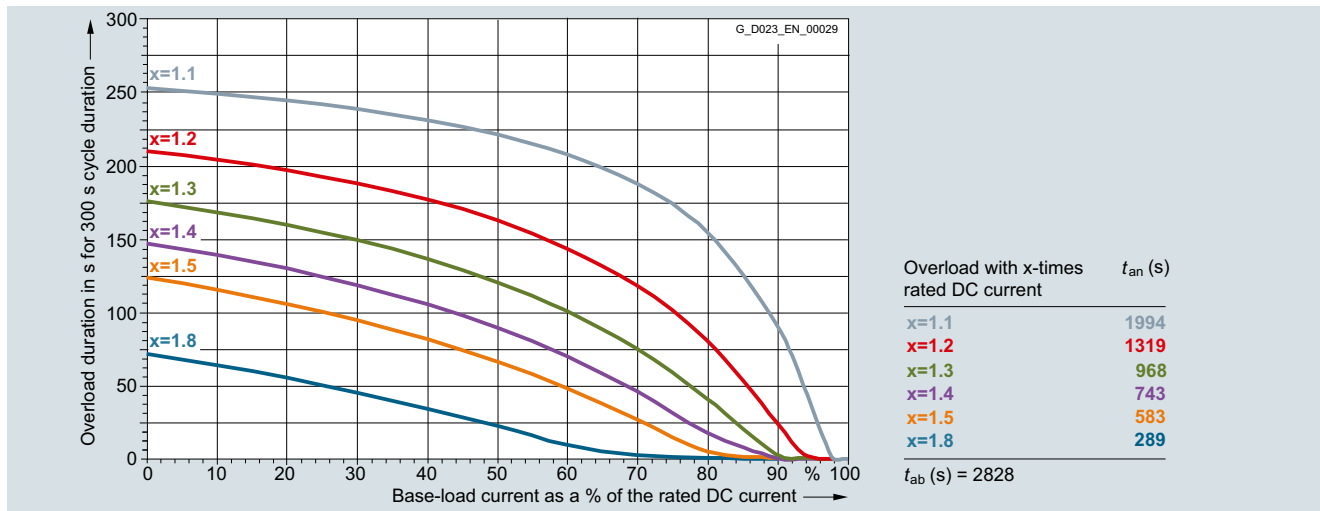

6RA8031-6DS22-0AA0 125 A/two-quadrant operation 400 V, 6RA8031-6FS22-0AA0 125 A/two-quadrant operation 480 V, 6RA8031-6GS22-0AA0 125 A/two-quadrant operation 575 V

5

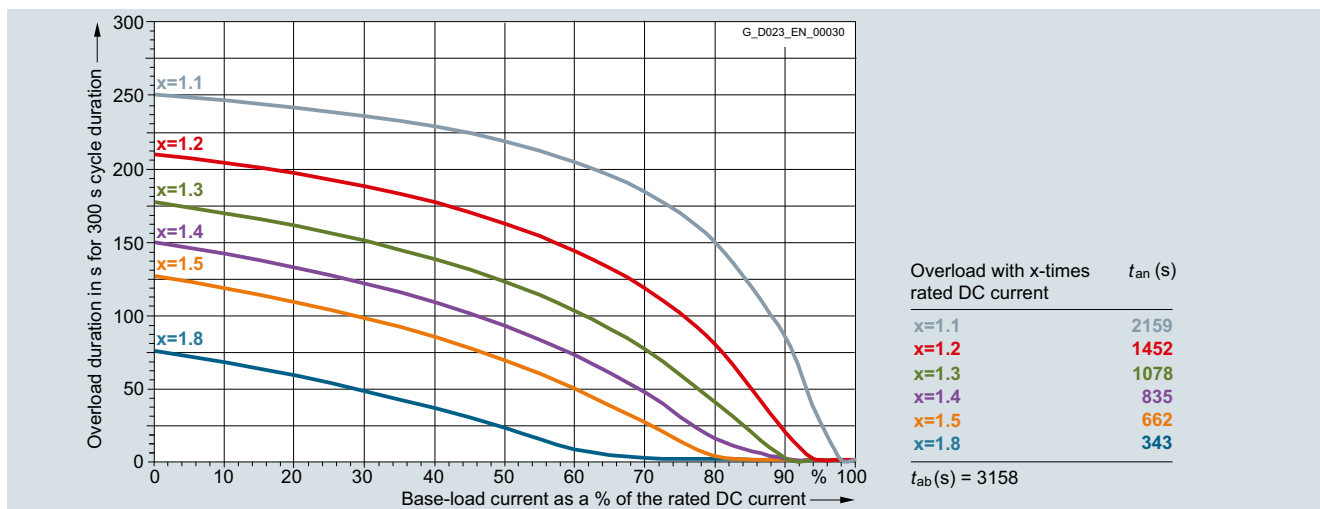

6RA8031-6DV62-0AA0 125 A/four-quadrant operation 400 V, 6RA8031-6FV62-0AA0 125 A/four-quadrant operation 480 V, 6RA8031-6GV62-0AA0 125 A/four-quadrant operation 575 V

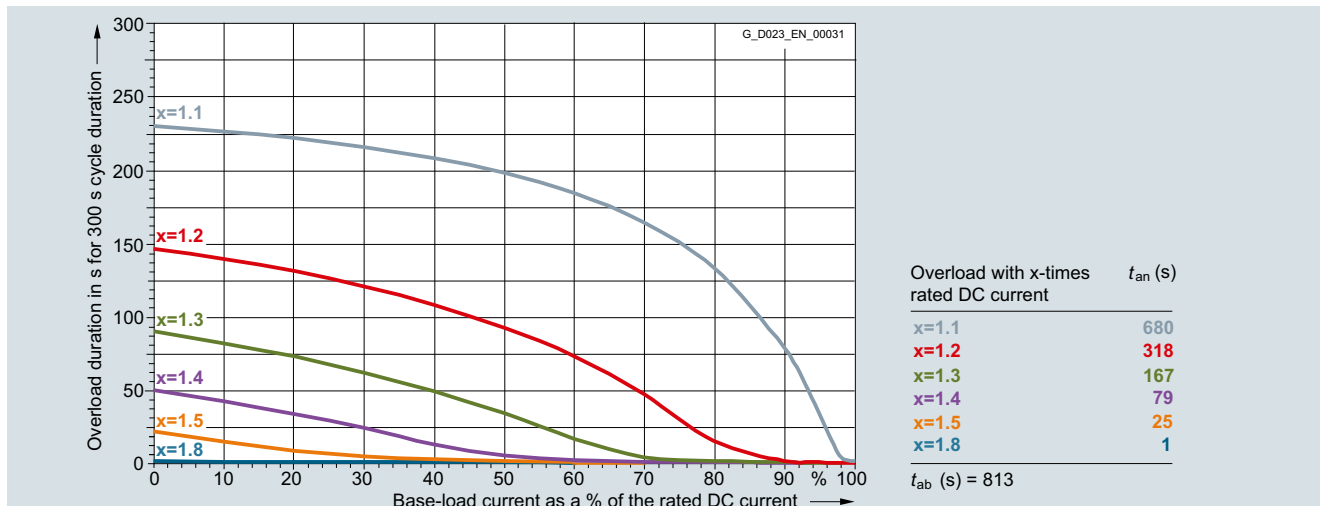

6RA8075-6DS22-0AA0 210 A/two-quadrant operation 400 V, 6RA8075-6DV62-0AA0 210 A/four-quadrant operation 400 V, 6RA8075-6FS22-0AA0 210 A/two-quadrant operation 480 V, 6RA8075-6FV62-0AA0 210 A/four-quadrant operation 480 V, 6RA8075-6GS22-0AA0 210 A/two-quadrant operation 575 V, 6RA8075-6GV62-0AA0 210 A/four-quadrant operation 575 V



**Overview**

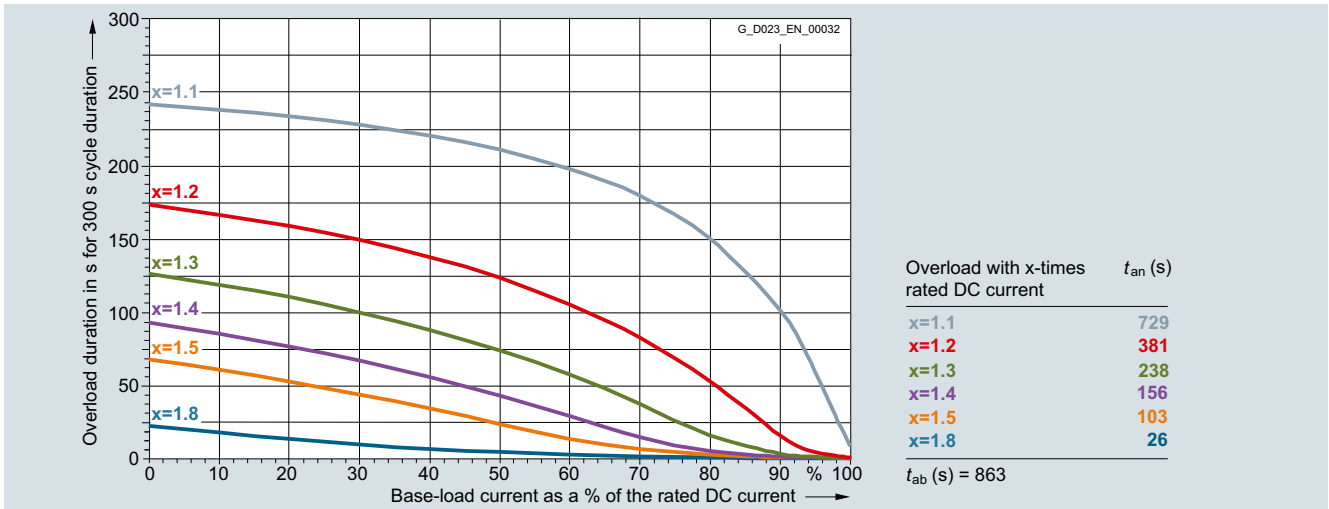

6RA8078-6DS22-0AA0 280 A/two-quadrant operation 400 V, 6RA8078-6DV62-0AA0 280 A/four-quadrant operation 400 V, 6RA8078-6FS22-0AA0 280 A/two-quadrant operation 480 V, 6RA8078-6FV62-0AA0 280 A/four-quadrant operation 480 V

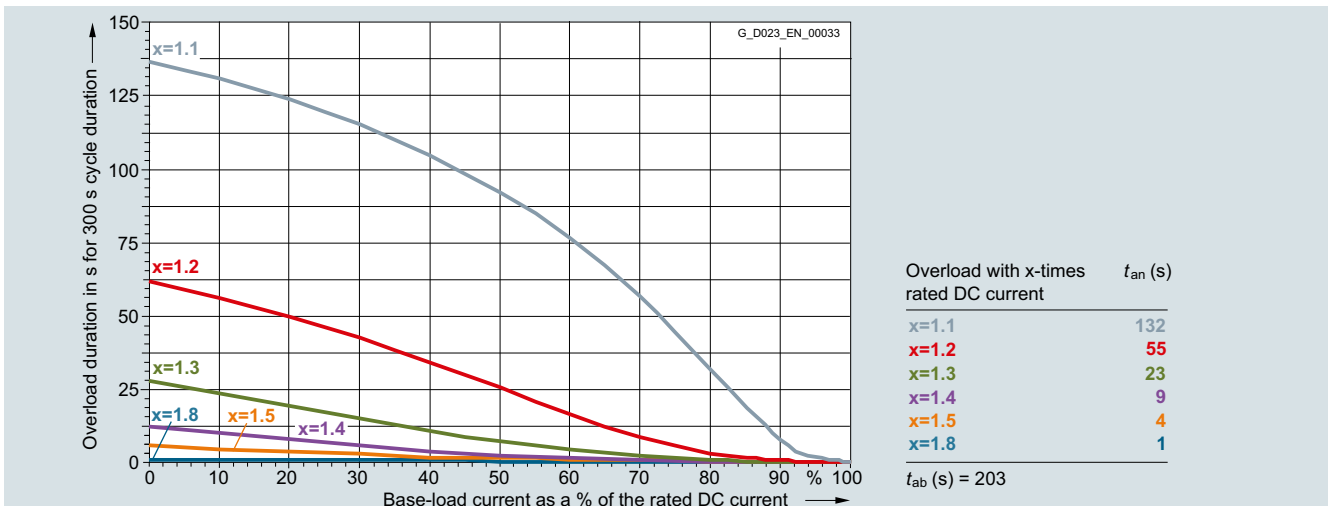

6RA8081-6DS22-0AA0 400 A/two-quadrant operation 400 V, 6RA8081-6GS22-0AA0 400 A/two-quadrant operation 575 V

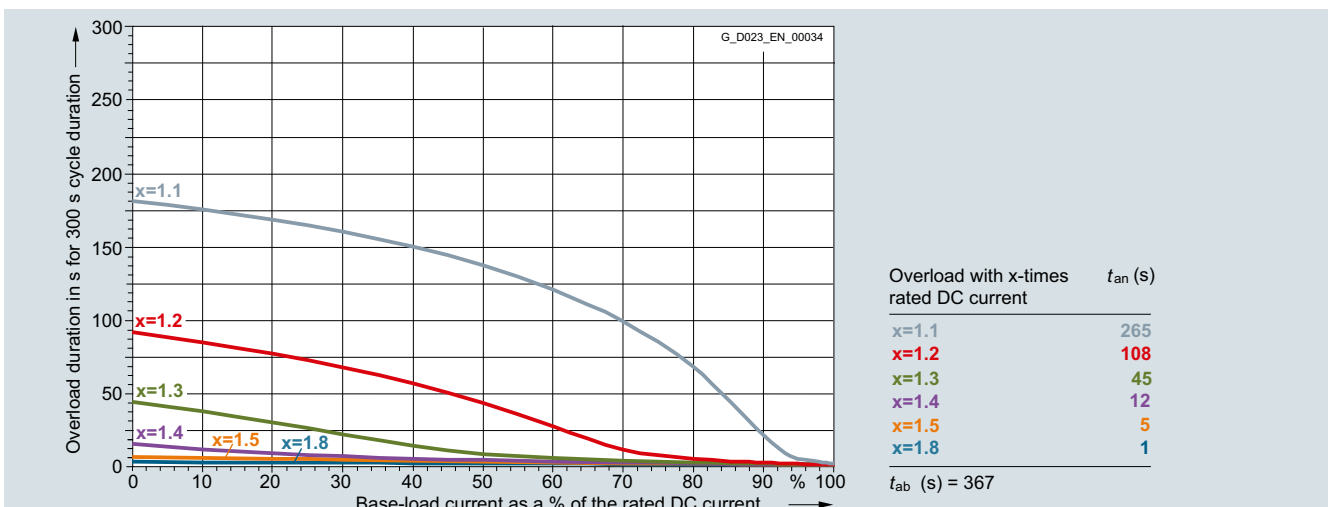

6RA8081-6DV62-0AA0 400 A/four-quadrant operation 400 V, 6RA8081-6GV62-0AA0 400 A/four-quadrant operation 575 V

5

# SINAMICS DCM

## Engineering information

### Dynamic overload capability

#### Overview

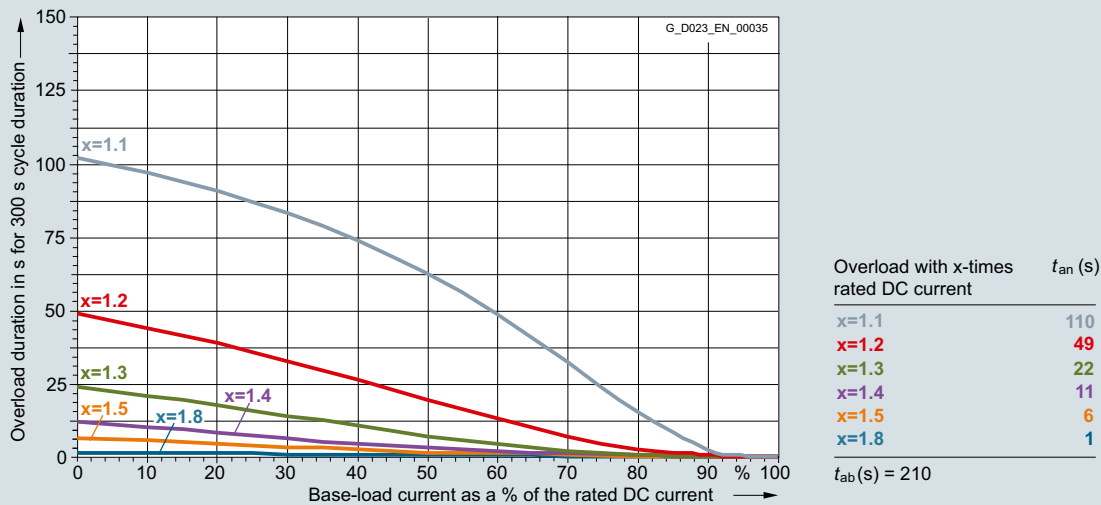

6RA8082-6FS22-0AA0 450 A/two-quadrant operation 480 V, 6RA8082-6FV62-0AA0 450 A/four-quadrant operation 480 V

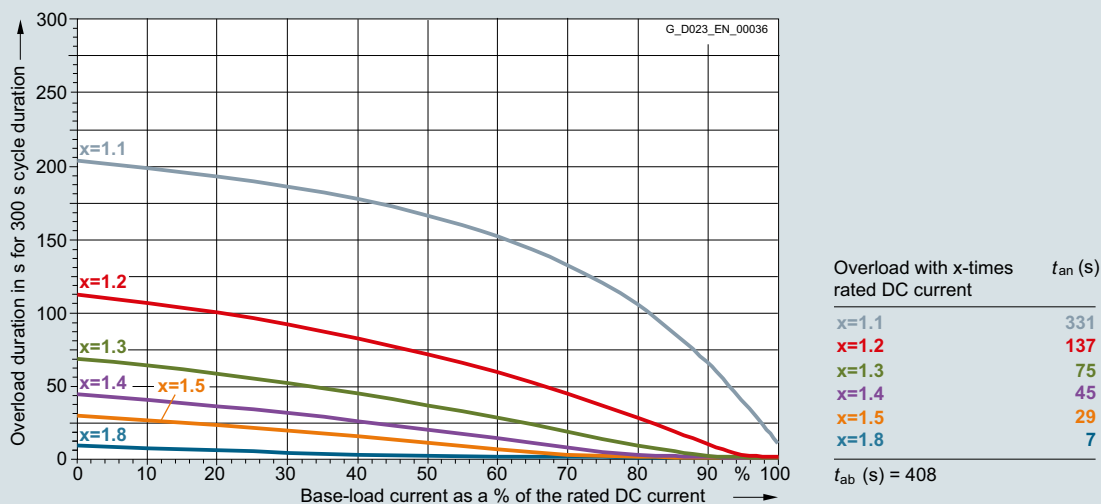

6RA8085-6DS22-0AA0 600 A/two-quadrant operation 400 V, 6RA8085-6FS22-0AA0 600 A/two-quadrant operation 480 V, 6RA8085-6GS22-0AA0 600 A/two-quadrant operation 575 V

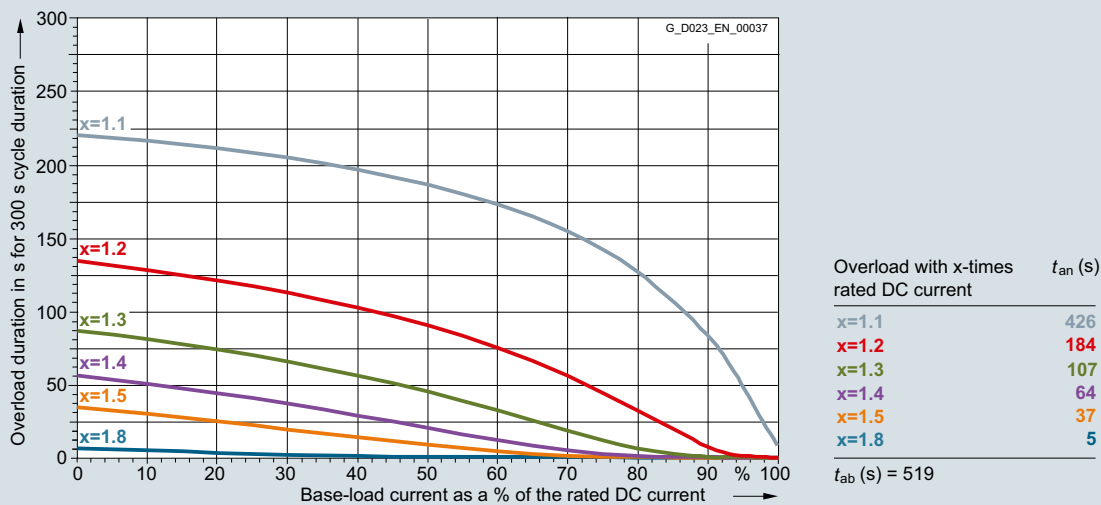

6RA8085-6DV62-0AA0 600 A/four-quadrant operation 400 V, 6RA8085-6FV62-0AA0 600 A/four-quadrant operation 480 V, 6RA8085-6GV62-0AA0 600 A/four-quadrant operation 575 V

Overview

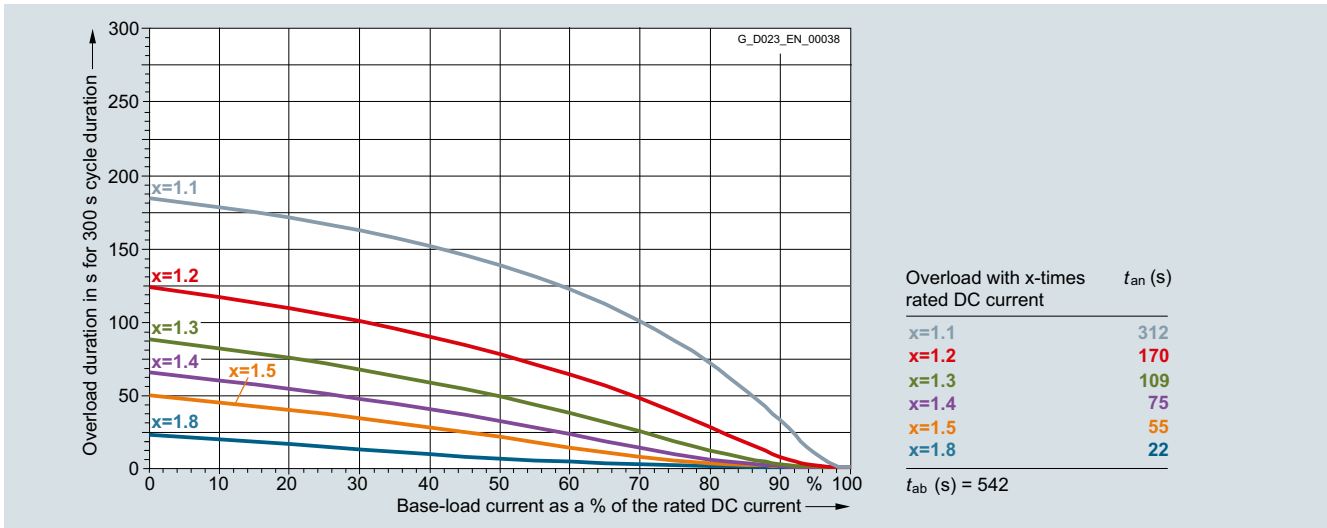

6RA8086-6KS22-0AA0 720 A/two-quadrant operation 690 V

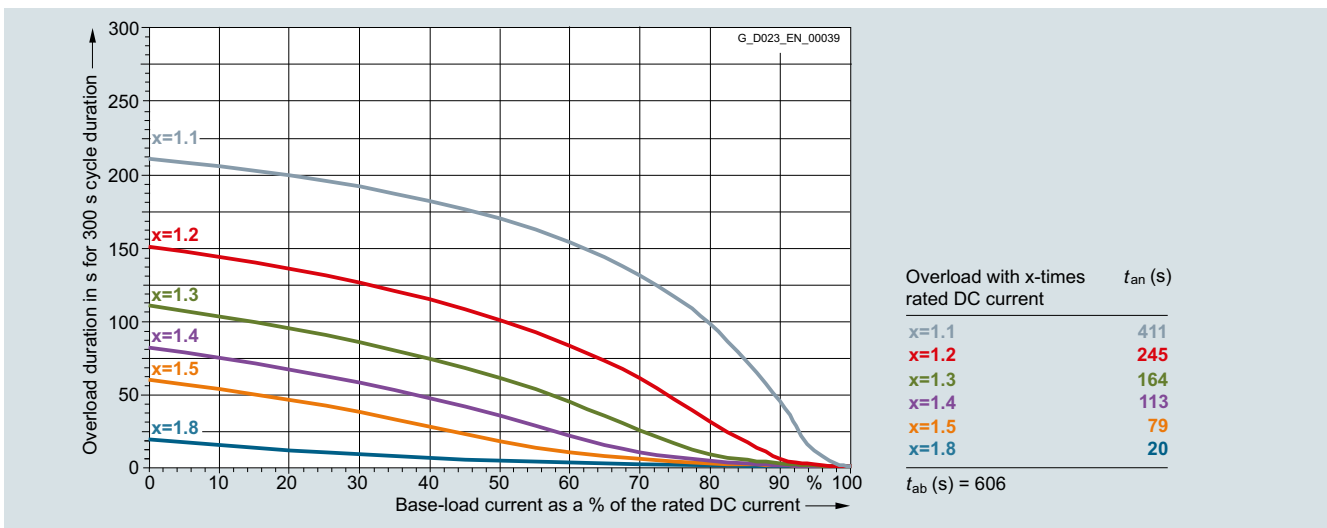

6RA8086-6KV62-0AA0 760 A/four-quadrant operation 690 V

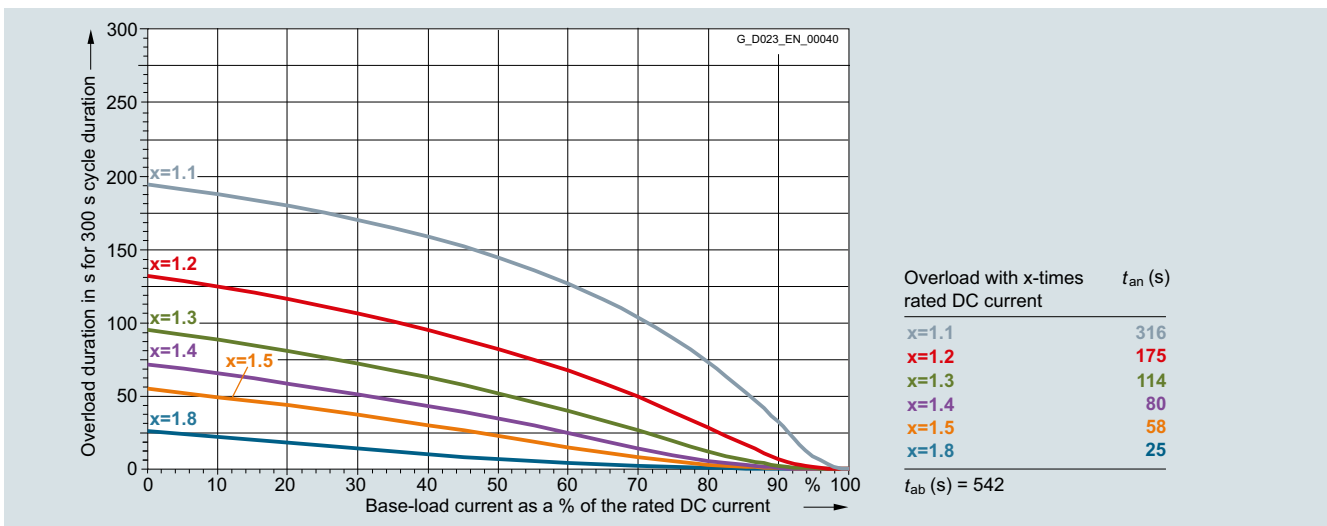

6RA8087-6DS22-0AA0 850 A/two-quadrant operation 400 V,  
6RA8087-6FS22-0AA0 850 A/two-quadrant operation 480 V

# SINAMICS DCM

## Engineering information

### Dynamic overload capability

#### Overview

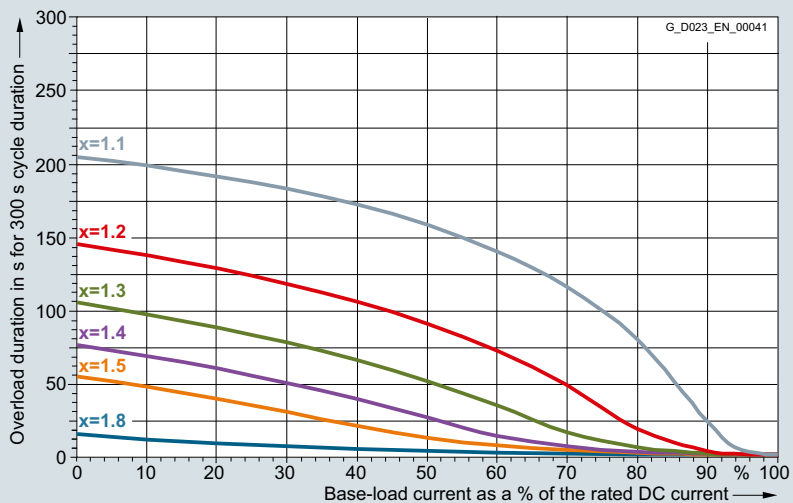

Overload with x-times rated DC current	$t_{an}$ (s)
x=1.1	382
<b>x=1.2</b>	<b>228</b>
x=1.3	151
x=1.4	102
x=1.5	68
x=1.8	13

$t_{ab}$  (s) = 593

6RA8087-6DV62-0AA0 850 A/four-quadrant operation 400 V, 6RA8087-6FV62-0AA0 850 A/four-quadrant operation 480 V, 6RA8087-6GV62-0AA0 850 A/four-quadrant operation 575 V

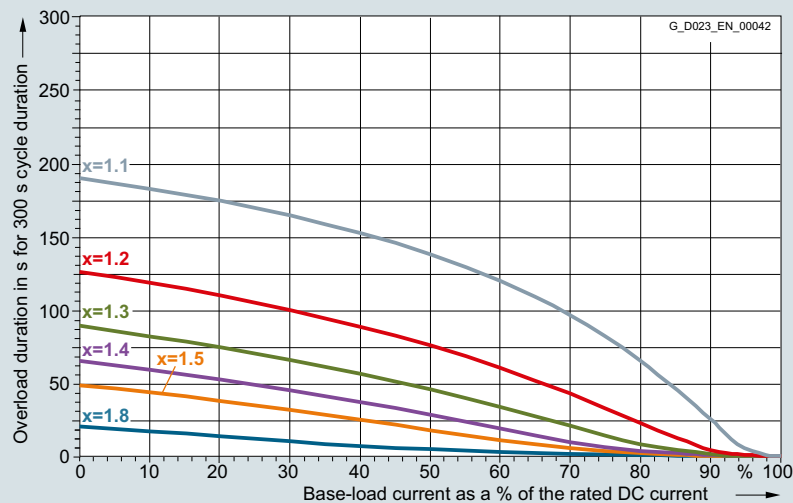

Overload with x-times rated DC current	$t_{an}$ (s)
x=1.1	296
<b>x=1.2</b>	<b>161</b>
x=1.3	102
x=1.4	70
x=1.5	50
x=1.8	19

$t_{ab}$  (s) = 527

6RA8087-6GS22-0AA0 800 A/two-quadrant operation 575 V

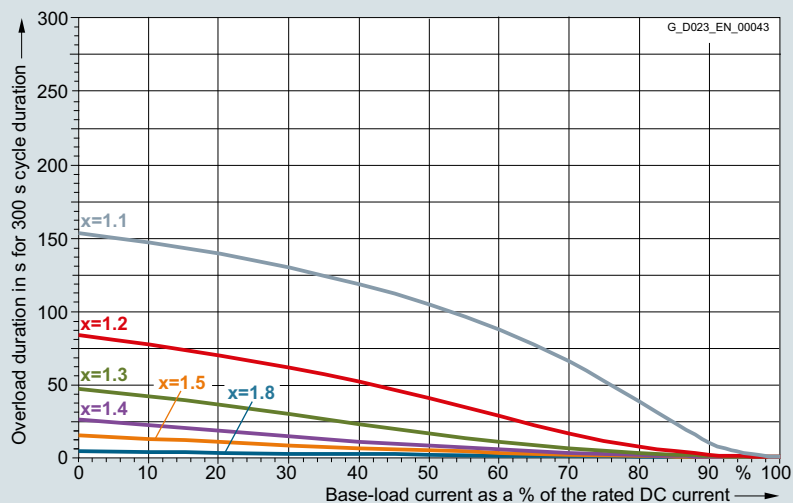

Overload with x-times rated DC current	$t_{an}$ (s)
x=1.1	220
<b>x=1.2</b>	<b>99</b>
x=1.3	50
x=1.4	25
x=1.5	13
x=1.8	4

$t_{ab}$  (s) = 395

6RA8088-6LS22-0AA0 950 A/two-quadrant operation 830 V, 6RA8088-6LV62-0AA0 950 A/four-quadrant operation 830 V

5

**Overview**

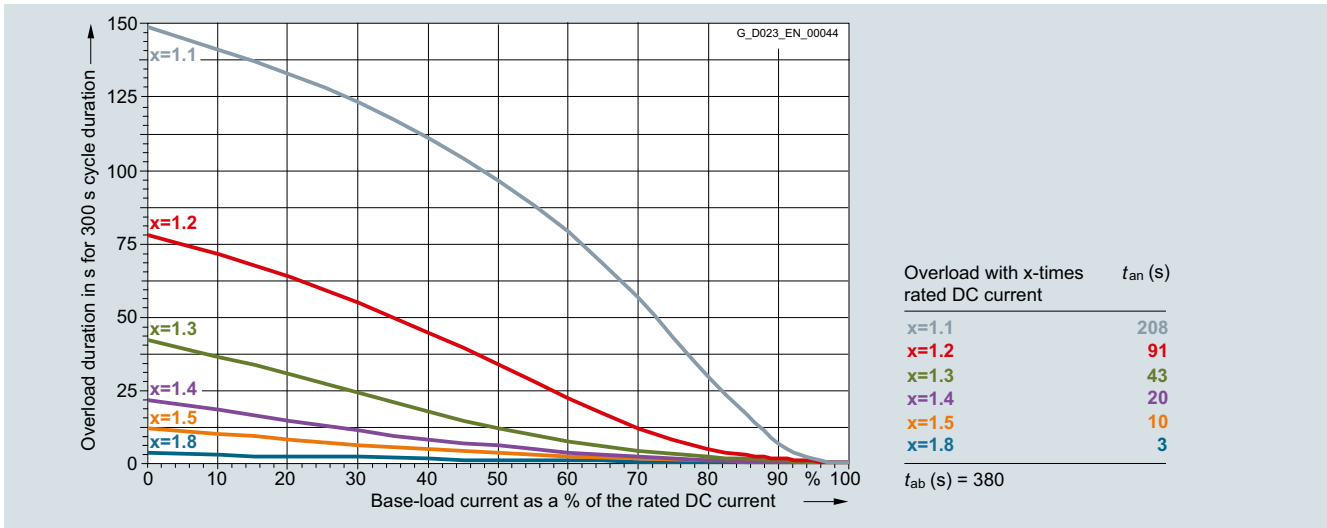

6RA8090-6GS22-0AA0 1100 A/two-quadrant operation 575 V, 6RA8090-6GV62-0AA0 1100 A/four-quadrant operation 575 V

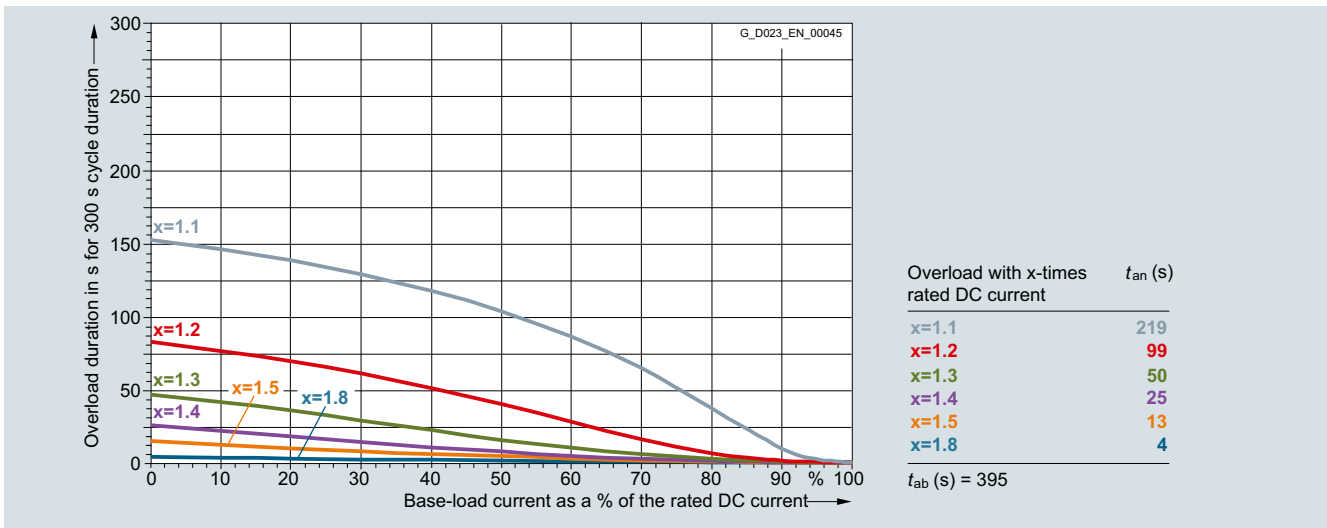

6RA8090-6KS22-0AA0 1000 A/two-quadrant operation 690 V, 6RA8090-6KV62-0AA0 1000 A/four-quadrant operation 690 V

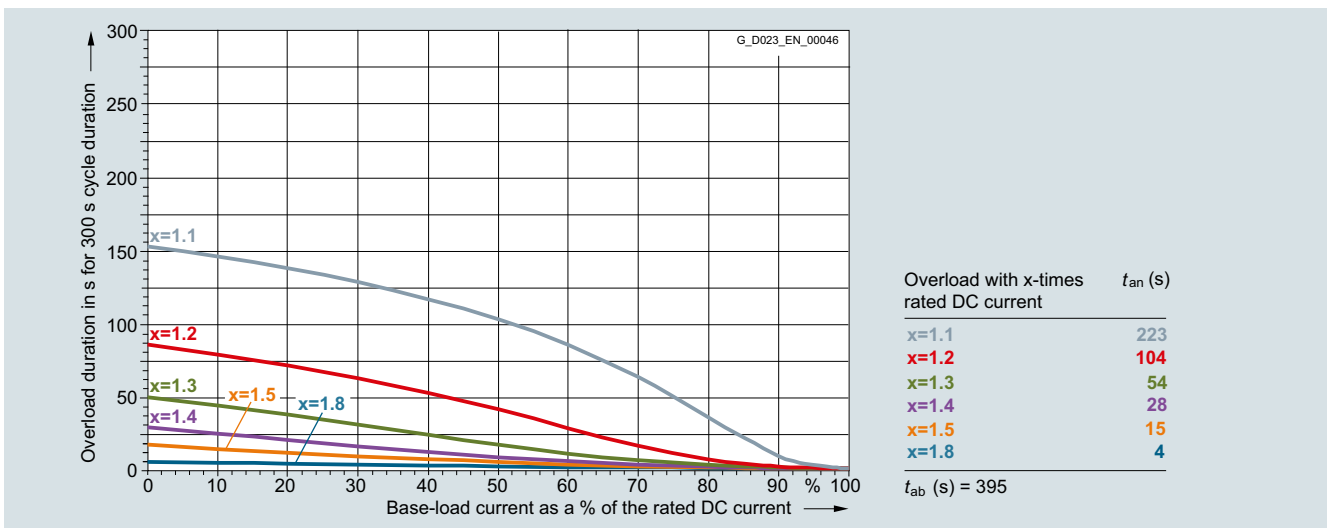

6RA8091-6DS22-0AA0 1200 A/two-quadrant operation 400 V, 6RA8091-6FS22-0AA0 1200 A/two-quadrant operation 480 V, 6RA8091-6FV62-0AA0 1200 A/four-quadrant operation 480 V, 6RA8091-6DV62-0AA0 1200 A/four-quadrant operation 400 V

# SINAMICS DCM

## Engineering information

### Dynamic overload capability

#### Overview

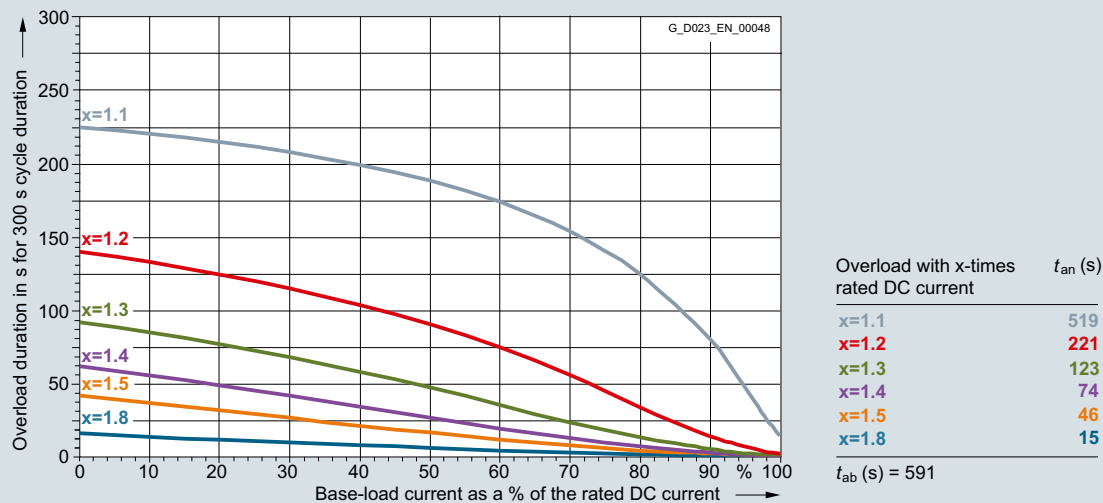

6RA8093-4DS22-0AA0 1600 A/two-quadrant operation 400 V, 6RA8093-4DV62-0AA0 1600 A/four-quadrant operation 400 V, 6RA8093-4GS22-0AA0 1600 A/two-quadrant operation 575 V, 6RA8093-4GV62-0AA0 1600 A/four-quadrant operation 575 V

5

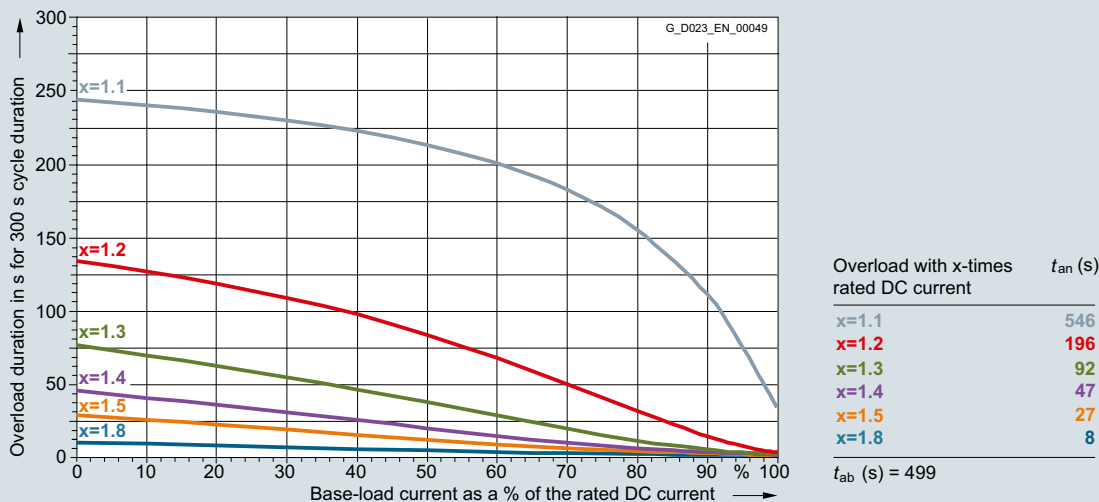

6RA8093-4KS22-0AA0 1500 A/two-quadrant operation 690 V, 6RA8093-4KV62-0AA0 1500 A/four-quadrant operation 690 V, 6RA8093-4LS22-0AA0 1500 A/two-quadrant operation 830 V, 6RA8093-4LV62-0AA0 1500 A/four-quadrant operation 830 V

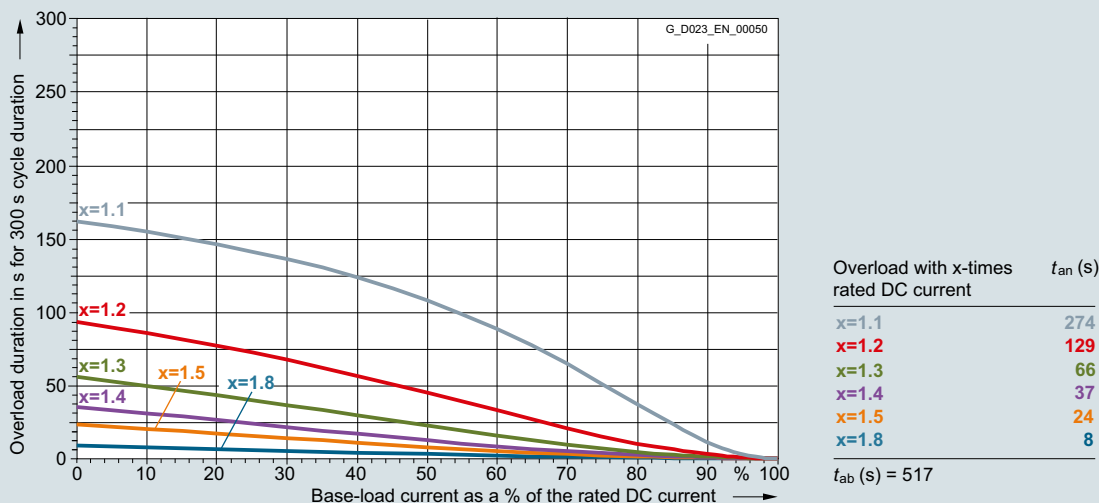

6RA8095-4DS22-0AA0 2000 A/two-quadrant operation 400 V, 6RA8095-4DV62-0AA0 2000 A/four-quadrant operation 400 V

Overview

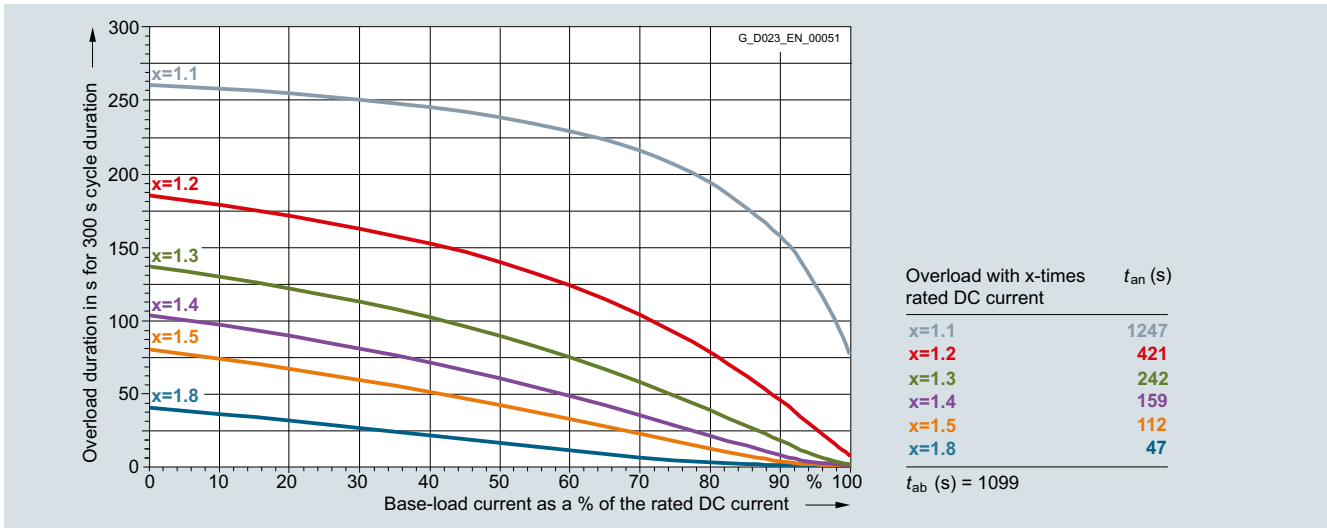

6RA8095-4GS22-0AA0 2000 A/two-quadrant operation 575 V, 6RA8095-4GV62-0AA0 2000 A/four-quadrant operation 575 V

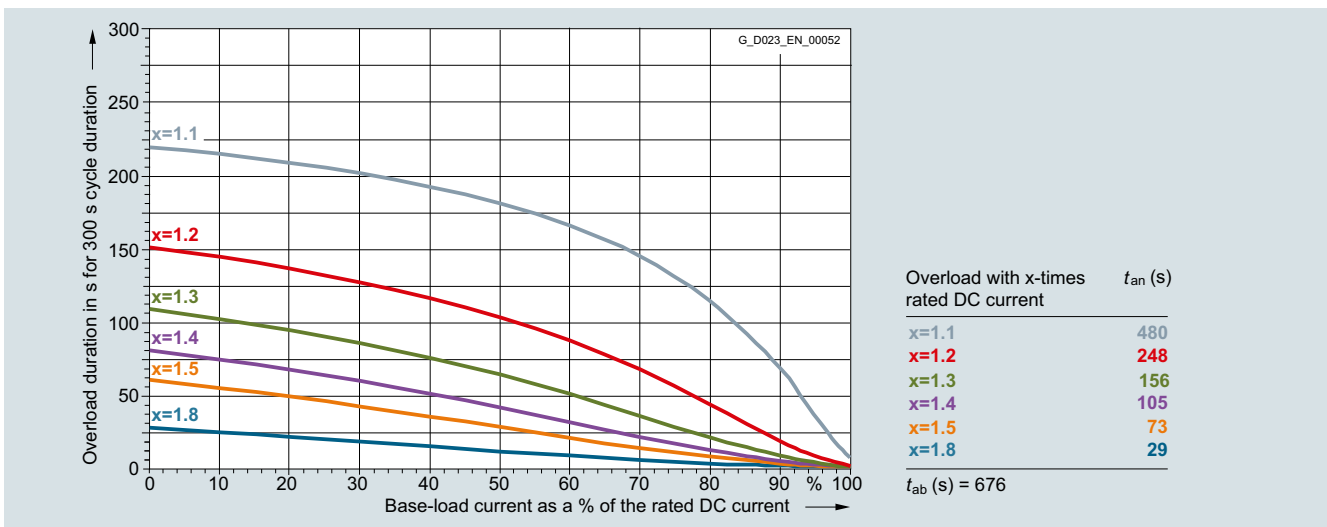

6RA8095-4KS22-0AA0 2000 A/two-quadrant operation 690 V, 6RA8095-4KV62-0AA0 2000 A/four-quadrant operation 690 V

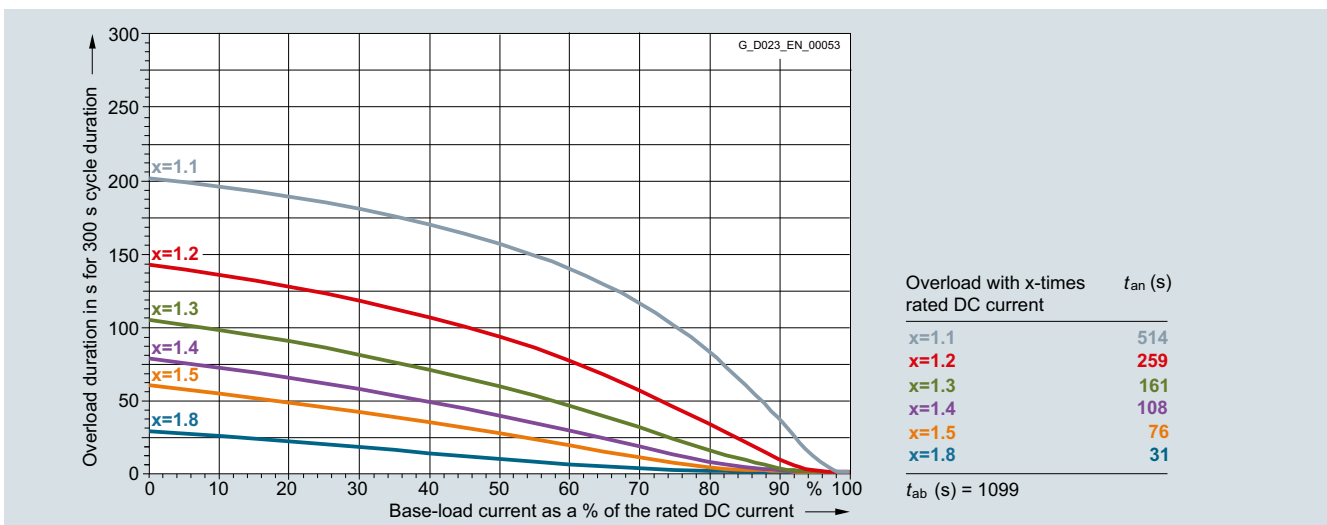

6RA8095-4LS22-0AA0 1900 A/two-quadrant operation 830 V, 6RA8095-4LV62-0AA0 1900 A/four-quadrant operation 830 V

# SINAMICS DCM

## Engineering information

### Dynamic overload capability

#### Overview

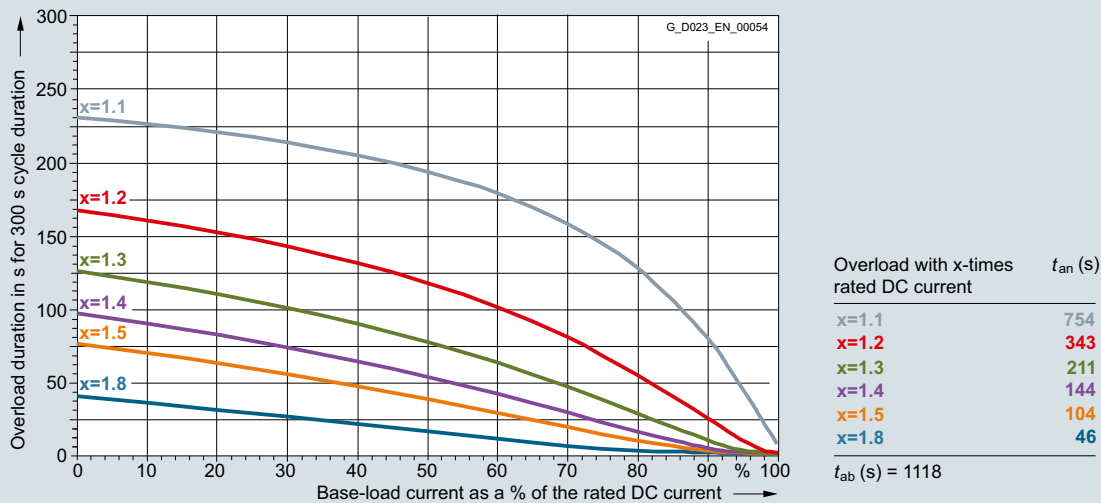

6RA8096-4GS22-0AA0 2200 A/two-quadrant operation 575 V, 6RA8096-4GV62-0AA0 2200 A/four-quadrant operation 575 V

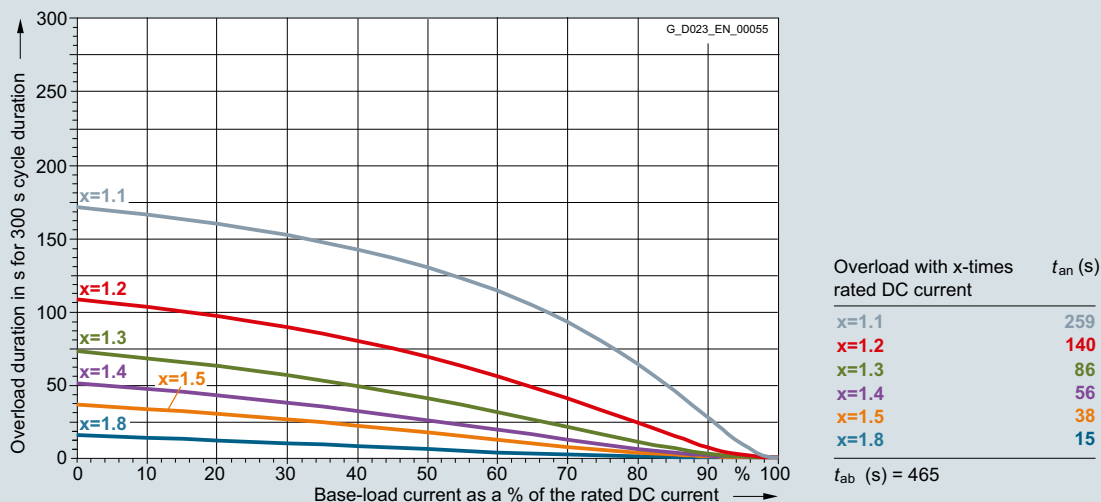

6RA8096-4MS22-0AA0 2200 A/two-quadrant operation 950 V, 6RA8096-4MV62-0AA0 2200 A/four-quadrant operation 950 V

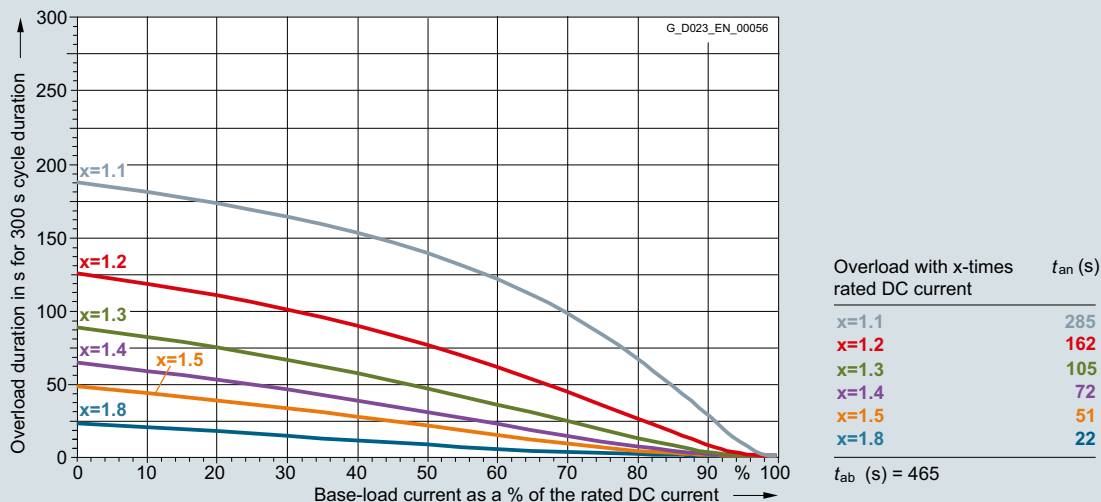

6RA8097-4GS22-0AA0 2800 A/two-quadrant operation 575 V, 6RA8097-4GV62-0AA0 2800 A/four-quadrant operation 575 V

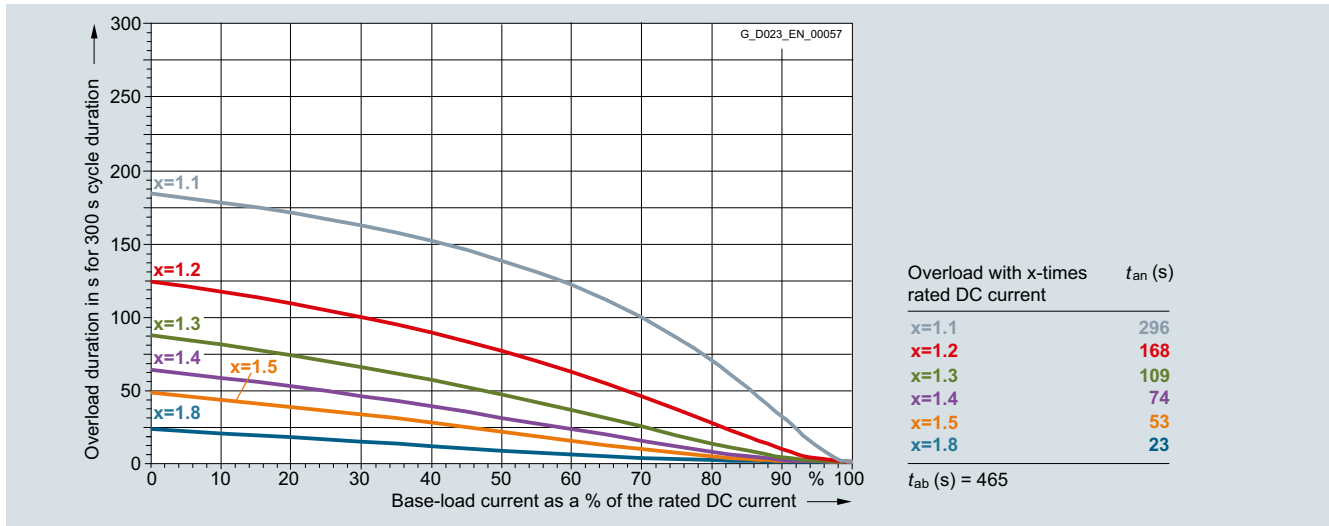

**Overview**

6RA8097-4KS22-0AA0 2600 A/two-quadrant operation 690 V, 6RA8097-4KV62-0AA0 2600 A/four-quadrant operation 690 V

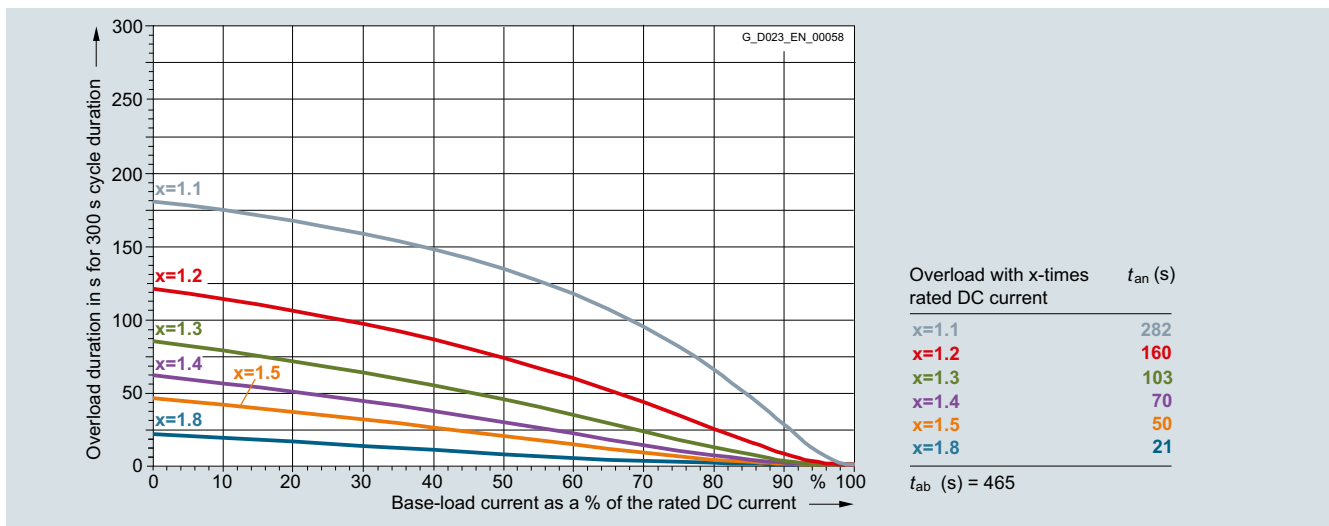

6RA8098-4DS22-0AA0 3000 A/two-quadrant operation 400 V, 6RA8098-4DV62-0AA0 3000 A/four-quadrant operation 400 V

**Load classes**

In order to be able to adapt the SINAMICS DC MASTER as simply as possible to the load profile of the driven machine, in addition to the individual dimensioning using the limit characteristics of the dynamic overload capability, these can also be dimensioned using pre-selected load cycles that are simple to parameterize.

Note:

SINAMICS DC MASTER does not monitor whether the load class - set using parameters - is maintained. If the power section permits it, the unit can operate for overload durations in excess of those defined by the load class. This means that the driven machine of the mechanical system is not protected against overload!

The overload duration that is actually permitted for the power section in question is always longer than the duration defined by the load class. SINAMICS DC MASTER monitors whether the overload duration that is actually permitted for the power section is being maintained.

**More information**

For further information, please go to the following website address:

<http://support.automation.siemens.com/WW/view/en/81714558>

# SINAMICS DCM

Engineering information

## Dynamic overload capability

### Overview

Load class (parameter)	Load for the converter	Load cycle
DC I	$I_{DC I}$ continuous ( $I_{dN}$ )	<p>A graph showing a constant horizontal line at the 100% load level. The vertical axis is labeled with 100%.</p>
DC II	$I_{DC II}$ for 15 min and $1.5 \times I_{DC II}$ for 60 s	<p>A graph showing a step function. The baseline is at 100%. It rises to 150% for a duration of 60 s, then returns to 100% for a duration of 15 min. The vertical axis is labeled with 100% and 150%.</p>
DC III	$I_{DC III}$ for 15 min and $1.5 \times I_{DC III}$ for 120 s	<p>A graph showing a step function. The baseline is at 100%. It rises to 150% for a duration of 120 s, then returns to 100% for a duration of 15 min. The vertical axis is labeled with 100% and 150%.</p>
DC IV	$I_{DC IV}$ for 15 min and $2 \times I_{DC IV}$ for 10 s	<p>A graph showing a step function. The baseline is at 100%. It rises to 200% for a duration of 10 s, then returns to 100% for a duration of 15 min. The vertical axis is labeled with 100% and 200%.</p>
US rating	$I_{US}$ for 15 min and $1.5 \times I_{US}$ for 60 s Note: With this setting, for all unit types, an ambient and/or coolant temperature of 45 °C is permissible.	<p>A graph showing a step function. The baseline is at 100%. It rises to 150% for a duration of 60 s, then returns to 100% for a duration of 15 min. The vertical axis is labeled with 100% and 150%.</p>

**Overview**
**Duty cycles for two-quadrant operation**

Supply voltage V	SINAMICS DC MASTER converter Type	$T_U$ °C	Duty cycles								US rating $T_U = 45\text{ °C}$	
			DC I	DC II		DC III		DC IV		15 min 100 %	60 s 150 %	
			Continu- ous A	15 min 100 % A	60 s 150 % A	15 min 100 % A	120 s 150 % A	15 min 100 % A	10 s 200 % A	15 min 100 % A	60 s 150 % A	
<b>400 3 AC</b>	6RA8025-6DS22-0AA0	45	60	51.4	77.1	50.2	75.3	46.4	92.8	51.4	77.1	
	6RA8028-6DS22-0AA0	45	90	74.4	111	72.8	109	65.4	130	74.4	111	
	6RA8031-6DS22-0AA0	45	125	106	159	103	155	96.3	192	106	159	
	6RA8075-6DS22-0AA0	40	210	164	247	161	242	136	273	157	236	
	6RA8078-6DS22-0AA0	40	280	226	340	219	328	201	402	215	323	
	6RA8081-6DS22-0AA0	40	400	290	435	282	423	244	488	278	417	
	6RA8085-6DS22-0AA0	40	600	462	693	446	669	413	826	443	665	
	6RA8087-6DS22-0AA0	40	850	652	978	622	933	609	1219	619	929	
	6RA8091-6DS22-0AA0	40	1200	884	1326	857	1286	768	1537	842	1263	
	6RA8093-4DS22-0AA0	40	1600	1255	1883	1213	1819	1139	2279	1190	1785	
	6RA8095-4DS22-0AA0	40	2000	1477	2216	1435	2152	1326	2653	1404	2106	
	6RA8098-4DS22-0AA0	40	3000	2288	3432	2189	3283	2164	4328	2178	3267	
<b>480 3 AC</b>	6RA8025-6FS22-0AA0	45	60	51.4	77.1	50.2	75.3	46.4	92.8	51.4	77.1	
	6RA8028-6FS22-0AA0	45	90	74.4	111	72.8	109	65.4	130	74.4	111	
	6RA8031-6FS22-0AA0	45	125	106	159	103	155	96.3	192	106	159	
	6RA8075-6FS22-0AA0	40	210	164	247	161	242	136	273	157	236	
	6RA8078-6FS22-0AA0	40	280	226	340	219	328	201	402	215	323	
	6RA8082-6FS22-0AA0	40	450	320	480	311	466	274	548	306	460	
	6RA8085-6FS22-0AA0	40	600	462	693	446	669	413	826	443	665	
	6RA8087-6FS22-0AA0	40	850	652	978	622	933	609	1219	619	929	
	6RA8091-6FS22-0AA0	40	1200	884	1326	857	1286	768	1537	842	1263	
	6RA8093-4FS22-0AA0	40	1600	1255	1883	1213	1819	1139	2279	1190	1785	
<b>575 3 AC</b>	6RA8025-6GS22-0AA0	45	60	51.4	77.1	50.2	75.3	46.4	92.8	51.4	77.1	
	6RA8031-6GS22-0AA0	45	125	106	159	103	155	96.3	192	106	159	
	6RA8075-6GS22-0AA0	40	210	164	247	161	242	136	273	157	236	
	6RA8081-6GS22-0AA0	40	400	290	435	282	423	244	488	278	417	
	6RA8085-6GS22-0AA0	40	600	462	693	446	669	413	826	443	665	
	6RA8087-6GS22-0AA0	40	800	607	911	581	872	559	1118	578	867	
	6RA8090-6GS22-0AA0	40	1100	804	1207	782	1173	689	1379	766	1150	
	6RA8093-4GS22-0AA0	40	1600	1255	1883	1213	1819	1139	2279	1190	1785	
	6RA8095-4GS22-0AA0	40	2000	1663	2494	1591	2386	1568	3136	1569	2354	
	6RA8096-4GS22-0AA0	40	2200	1779	2669	1699	2549	1697	3394	1678	2517	
	6RA8097-4GS22-0AA0	40	2800	2136	3204	2044	3066	2022	4044	2024	3036	
	<b>690 3 AC</b>	6RA8086-6KS22-0AA0	40	720	553	829	527	791	515	1031	525	788
6RA8090-6KS22-0AA0		40	1000	737	1105	715	1072	639	1279	702	1053	
6RA8093-4KS22-0AA0		40	1500	1171	1757	1140	1710	1036	2073	1116	1674	
6RA8095-4KS22-0AA0		40	2000	1589	2383	1522	2283	1505	3011	1503	2255	
6RA8097-4KS22-0AA0		40	2600	1992	2989	1906	2859	1887	3774	1876	2815	
<b>830 3 AC</b>	6RA8088-6LS22-0AA0	40	950	700	1051	679	1019	607	1215	667	1001	
	6RA8093-4LS22-0AA0	40	1500	1171	1757	1140	1710	1036	2073	1116	1674	
	6RA8095-4LS22-0AA0	40	1900	1485	2228	1421	2132	1396	2793	1414	2121	
<b>950 3 AC</b>	6RA8096-4MS22-0AA0	40	2200	1674	2511	1603	2404	1570	3141	1588	2382	

**SINAMICS DCM**

## Engineering information

## Dynamic overload capability

**Overview****Duty cycles for four-quadrant operation**

Supply voltage V	SINAMICS DC MASTER converter Type	$T_u$ °C	Duty cycles								US rating $T_u = 45$ °C	
			DC I	DC II			DC III		DC IV		15 min 100 %	60 s 150 %
			Continuous A	15 min 100 % A	60 s 150 % A	15 min 100 % A	120 s 150 % A	15 min 100 % A	10 s 200 % A	15 min 100 % A	60 s 150 % A	
<b>400 3 AC</b>	6RA8013-6DV62-0AA0	45	15	13.9	20.8	13.5	20.2	12.6	25.2	13.9	20.8	
	6RA8018-6DV62-0AA0	45	30	24.9	37.3	24.2	36.3	22.4	44.8	24.9	37.3	
	6RA8025-6DV62-0AA0	45	60	53.1	79.6	51.8	77.7	47.2	94.4	53.1	79.6	
	6RA8028-6DV62-0AA0	45	90	78.2	117	76	114	72.2	144	78.2	117	
	6RA8031-6DV62-0AA0	45	125	106	159	103	155	95.4	190	106	159	
	6RA8075-6DV62-0AA0	40	210	164	247	161	242	136	273	157	236	
	6RA8078-6DV62-0AA0	40	280	226	340	219	328	201	402	215	323	
	6RA8081-6DV62-0AA0	40	400	300	450	292	438	247	494	285	428	
	6RA8085-6DV62-0AA0	40	600	470	706	453	680	410	820	450	675	
	6RA8087-6DV62-0AA0	40	850	658	987	634	951	579	1 159	626	939	
	6RA8091-6DV62-0AA0	40	1200	884	1326	857	1286	768	1 537	842	1263	
	6RA8093-4DV62-0AA0	40	1600	1255	1883	1213	1819	1139	2279	1190	1785	
	6RA8095-4DV62-0AA0	40	2000	1477	2216	1435	2152	1326	2653	1404	2106	
	6RA8098-4DV62-0AA0	40	3000	2288	3432	2189	3283	2164	4328	2178	3267	
<b>480 3 AC</b>	6RA8013-6FV62-0AA0	45	15	13.9	20.8	13.5	20.2	12.6	25.2	13.9	20.8	
	6RA8018-6FV62-0AA0	45	30	24.9	37.3	24.2	36.3	22.4	44.8	24.9	37.3	
	6RA8025-6FV62-0AA0	45	60	53.1	79.6	51.8	77.7	47.2	94.4	53.1	79.6	
	6RA8028-6FV62-0AA0	45	90	78.2	117	76	114	72.2	144	78.2	117	
	6RA8031-6FV62-0AA0	45	125	106	159	103	155	95.4	190	106	159	
	6RA8075-6FV62-0AA0	40	210	164	247	161	242	136	273	157	236	
	6RA8078-6FV62-0AA0	40	280	226	340	219	328	201	402	215	323	
	6RA8082-6FV62-0AA0	40	450	320	480	311	466	274	548	306	460	
	6RA8085-6FV62-0AA0	40	600	470	706	453	680	410	820	450	675	
	6RA8087-6FV62-0AA0	40	850	658	987	634	951	579	1 159	626	939	
6RA8091-6FV62-0AA0	40	1200	884	1326	857	1286	768	1537	842	1263		
<b>575 3 AC</b>	6RA8025-6GV62-0AA0	45	60	53.1	79.6	51.8	77.7	47.2	94.4	53.1	79.6	
	6RA8031-6GV62-0AA0	45	125	106	159	103	155	95.4	190	106	159	
	6RA8075-6GV62-0AA0	40	210	164	247	161	242	136	273	157	236	
	6RA8081-6GV62-0AA0	40	400	300	450	292	438	247	494	285	428	
	6RA8085-6GV62-0AA0	40	600	470	706	453	680	410	820	450	675	
	6RA8087-6GV62-0AA0	40	850	658	987	634	951	579	1159	626	939	
	6RA8090-6GV62-0AA0	40	1100	804	1207	782	1173	689	1379	766	1150	
	6RA8093-4GV62-0AA0	40	1600	1255	1883	1213	1819	1139	2279	1190	1785	
	6RA8095-4GV62-0AA0	40	2000	1663	2494	1591	2386	1568	3136	1569	2354	
	6RA8096-4GV62-0AA0	40	2200	1779	2669	1699	2549	1697	3394	1678	2517	
6RA8097-4GV62-0AA0	40	2800	2136	3204	2044	3066	2022	4044	2024	3036		
<b>690 3 AC</b>	6RA8086-6KV62-0AA0	40	760	598	898	575	863	532	1065	569	853	
	6RA8090-6KV62-0AA0	40	1000	737	1105	715	1072	639	1279	702	1053	
	6RA8093-4KV62-0AA0	40	1500	1171	1757	1140	1710	1036	2073	1116	1674	
	6RA8095-4KV62-0AA0	40	2000	1589	2383	1522	2283	1505	3011	1503	2255	
	6RA8097-4KV62-0AA0	40	2600	1992	2989	1906	2859	1887	3774	1876	2815	
<b>830 3 AC</b>	6RA8088-6LV62-0AA0	40	950	700	1051	679	1019	607	1215	667	1001	
	6RA8093-4LV62-0AA0	40	1500	1171	1757	1140	1710	1036	2073	1116	1674	
	6RA8095-4LV62-0AA0	40	1900	1485	2228	1421	2132	1396	2793	1414	2121	
<b>950 3 AC</b>	6RA8096-4MV62-0AA0	40	2200	1674	2511	1603	2404	1570	3141	1588	2382	

## Overview

### Parallel connection of SINAMICS DC MASTER units

SINAMICS DC MASTER units can be connected in parallel to increase the power rating.

The following secondary conditions must be fulfilled:

The hardware and plug connectors necessary to transmit the firing pulses and to establish the higher-level communication are provided on the CUD.

A maximum of 6 units can be connected in parallel. When connecting several units in parallel, the master unit should be positioned centrally due to the signal runtimes. Maximum cable length of the parallel-connection interface cable between master and slave units at each end of the bus: 15 m.

Identical, separate commutating reactors ( $u_K$  min. 2 %) are required for each SINAMICS DC MASTER unit in order to evenly distribute the current. The difference in reactor tolerances determines the current distribution. For operation without derating (current reduction), a tolerance of 5 % or better is recommended.

Only units with the same DC current ratings are permitted to be connected in parallel.

The permissible output current when connecting units in parallel is, when maintaining the secondary conditions:

- $I_{\max} = n \times I_N(\text{SINAMICS DC MASTER})$
- $n =$  number of SINAMICS DC MASTER units

Connection schematic of the armature circuit when connecting SINAMICS DC MASTER units in parallel

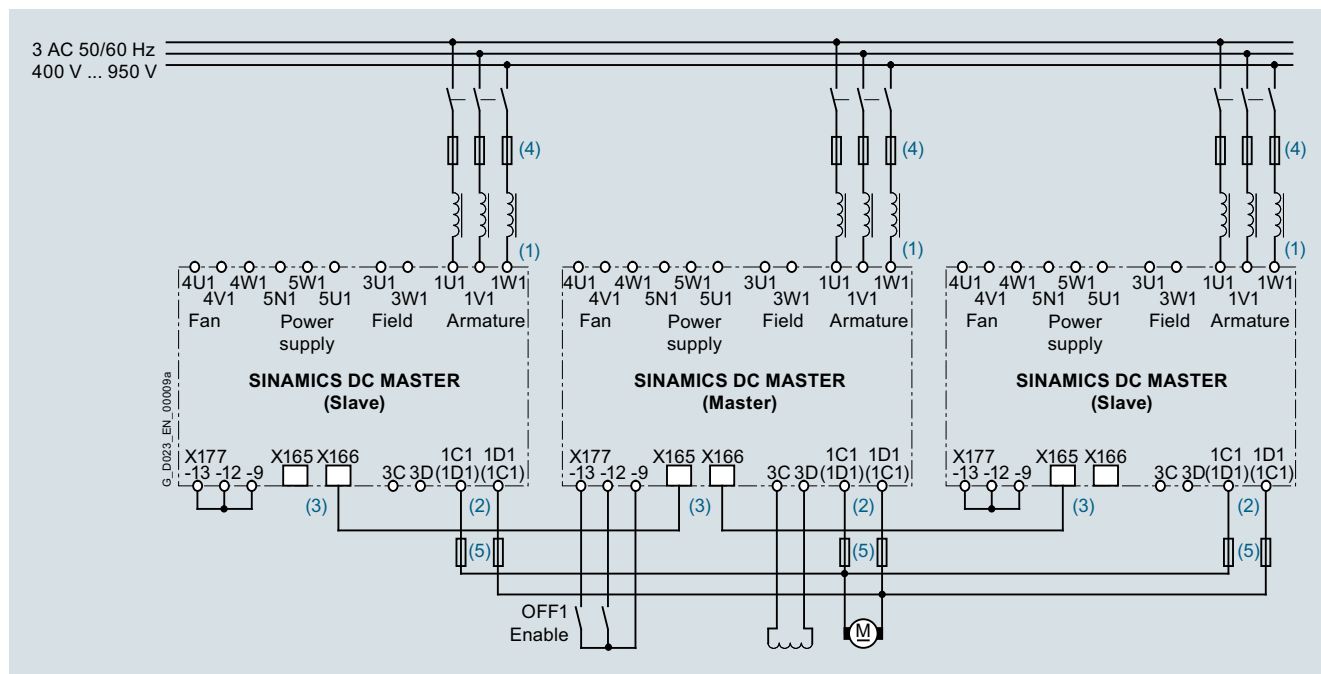

- (1) The same phase sequence is required between 1U1/1V1/1W1.
- (2) The same phase sequence is required between 1C1/1D1.
- (3) The units are connected using (8-pin) shielded patch cables of type UTP CAT5 in acc. with ANSI/EIA/TIA 568, such as those that are used in PC network technology. A standard 5 m long cable can be directly purchased from Siemens (Article No.: 6RY1707-0AA08).  $(n-1)$  cables are required to connect  $n$  units in parallel. The bus termination must be activated at the units/devices connected at the start of the bus and at the end of the bus.
- (4) These fuses may only be used with units up to 850 A.
- (5) Only for units up to 850 A in four-quadrant operation.

### Redundant operation (mode "(n+m) operation")

SINAMICS DC MASTER can also be used in a redundant configuration as a special operating mode of the parallel connection. In this operating mode, it is possible to maintain operation with the remaining SINAMICS DC MASTER units if one unit fails (e.g. if a fuse fails in the power section). When appropriately configured and interconnected, both the armature circuit as well as the field circuit can be redundantly operated.

SINAMICS DC MASTER units that can still function, continue to operate without any interruption when a unit fails. When configuring the system, it is important to note that in redundant applications, the power rating of only  $n$  units (instead of  $n+m$  units) must be sufficient.

In the case of a fault, the master functionality is automatically transferred. As a consequence, this operating mode is possible both when power sections of the slaves fail and when the power section of the master fails. (MTBF data in redundant operation are available on request.)

### More information

For further information and application documents, please go to the following website address:

<http://support.automation.siemens.com/WW/view/en/38157755/130000>

(Entry type "Application")

### Selection and ordering data

Description	Article No.
Parallel patch cable for SIMOREG DC-Master and SINAMICS DCM	6RY1707-0AA08

# SINAMICS DCM

## Engineering information

### 12-pulse operation

#### Overview

##### **SINAMICS DC MASTER for 12-pulse operation**

For 12-pulse operation, two SINAMICS DC MASTER converters are supplied with voltages displaced by 30 degrees. This configuration reduces the harmonics. Each SINAMICS DC MASTER conducts half of the total current. One of the SINAMICS DC MASTER units is operated with closed-loop speed control, and the second with closed-loop current control. A peer-to-peer connection is used to transfer the current setpoint from the first to the second SINAMICS DC MASTER.

Smoothing reactors are required in the DC circuit for 12-pulse operation.

##### Calculating the smoothing reactor

- A smoothing reactor is used for each of the two partial converters. The reactor comprises a 2-value reactor; this means that the inductance of the reactor is defined for two current values.
- The reactor is thermally dimensioned according to the rms value of the DC reactor current.

##### Calculating the required inductance

1. Inductance of the reactor at  $0.2 \times I_{dN}$  ( $L_{D1}$ )

2. Inductance of the reactor for  $I_{dmax}$  ( $L_{D2}$ )

- for 50 Hz line frequency

$$L_{D1} = 0.296 \times 10^{-3} \times V_{di}/(0.2 \times I_{dN})$$

$$L_{D2} = 0.296 \times 10^{-3} \times V_{di}/(0.33 \times I_{dmax})$$

- for 60 Hz line frequency

$$L_{D1} = 0.24 \times 10^{-3} \times V_{di}/(0.2 \times I_{dN})$$

$$L_{D2} = 0.24 \times 10^{-3} \times V_{di}/(0.33 \times I_{dmax})$$

$L$  Inductance in H

$I_{dN}$  half the rated DC current of the DC motor

$I_{dmax}$  half the maximum current of the DC motor

$V_{di} = 1.35 \times V_{rated}$

$V_{rated}$  rated line supply voltage

#### More information

For further information and application documents, please go to the following website address:

<http://support.automation.siemens.com/WW/view/en/38157755/130000>

(Entry type "Application")

5

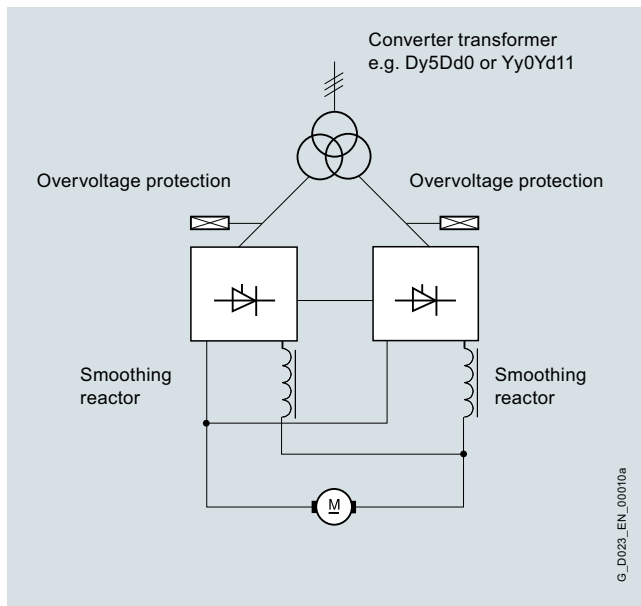

12-pulse operation

## Overview

### **SINAMICS DC MASTER to supply high inductances**

To supply high inductances - such as the fields of large DC or synchronous motors or lifting solenoids - the gating unit is changed over to long pulses using the appropriate parameter settings. At high levels of inductance, the long pulses ensure that the thyristors are reliably triggered. In this case, the armature circuit of the units is not used to supply the armature of DC motors, but to supply large field windings.

#### Note:

An external overvoltage protective circuit must be provided at the DC voltage output of the SINAMICS DC MASTER (e.g. SICROWBAR DC overvoltage protection).

## More information

For further information and application documents, please go to the following website address:

<http://support.automation.siemens.com/WW/view/en/38157755/130000>

(Entry type "Application")

## Overview

### **Heating applications**

Under certain conditions, the SINAMICS DCM DC Converter can be used as an AC power controller for heating applications.

This means that in some cases the SIVOLT A series of AC power controllers can be replaced by SINAMICS DCM converters (see, for example, the following schematic circuit diagram).

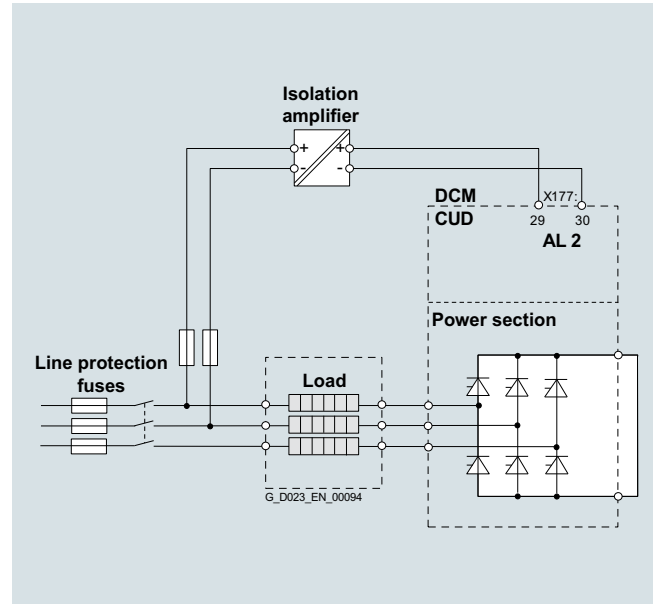

## More information

For further information and application documents, please go to the following website address:

<https://support.industry.siemens.com/cs/ww/en/view/109763610>

## SINAMICS DCM

### Engineering information

#### Protection against condensation

##### Overview

##### ***Protection against condensation***

SINAMICS DC MASTER units are designed in compliance with climate class 3K3 (IEC 60721-3-3 : 2002) without condensation.

When supplied to tropical countries, we recommend that the electrical cabinets are equipped with cabinet heating elements.

Units with coated PCBs are optionally available (option M08); these are insensitive to unfavorable environmental conditions. In order to guarantee safe and reliable operation, under all circumstances, it should be avoided that the units are commissioned with PC boards with moisture condensation.



**Overview**
**Input pulse levels**

The evaluation electronics can process encoder signals (symmetrical as well as asymmetrical) up to a maximum differential voltage of 27 V. The encoder type is selected via parameter. The evaluation electronics are adjusted electronically to the encoder signal voltage. With the parameter setting, a sub-division is made into two rated input voltage ranges.

	Rated input voltage range	
	5 V	15 V
Low level	Differential voltage < 0.8 V	Differential voltage < 5 V
High level	Differential voltage > 2 V	Differential voltage > 8 V <sup>1)</sup>
Hysteresis	> 0.2 V	> 1 V
Common-mode controllability	± 10 V	± 10 V

If the pulse encoder does not supply any symmetrical encoder signals, it must be grounded with each signal cable twisted in pairs and connected to the negative connections of track 1, track 2, and zero mark.

**Maximum frequency that can be evaluated**

The maximum encoder pulse frequency that can be evaluated is 300 kHz. To ensure that the encoder pulses are evaluated correctly, the minimum edge clearance  $T_{\min}$  between two encoder signal edges (track 1, track 2), as listed in the table, must be adhered to.

	Rated input voltage range				
	5 V		15 V		
Differential voltage <sup>2)</sup>	2 V	> 2.5 V	8 V	10 V	> 14 V
$T_{\min}$ <sup>3)</sup>	630 ns	380 ns	630 ns	430 ns	380 ns

If the pulse encoder is incorrectly matched to the encoder cable, disturbing cable reflections will occur at the receiving end. To ensure that encoder pulses of this type can be evaluated without errors, these reflections need to be damped. The limit values listed in the table below must be maintained in order to prevent the resulting power losses in the evaluation electronics adaptor from being exceeded.

	$F_{\max}$				
	50 kHz	100 kHz	150 kHz	200 kHz	300 kHz
Differential voltage <sup>4)</sup>	Up to 27 V	Up to 22 V	Up to 18 V	Up to 16 V	Up to 14 V

**Cable, cable length, shield connection**

The encoder cable capacitance must be recharged at each encoder edge change. The rms value of this current is proportional to the cable length and pulse frequency, and must not exceed the current permitted by the encoder manufacturer. A suitable cable that meets the recommendations of the encoder manufacturer must be used, and the maximum cable length must not be exceeded.

Generally speaking, a twisted cable pair with a single pair shield is sufficient for each track. This reduces crosstalk between the cables. Shielding all the pairs provides protection against interference pulses. The shield should be connected to the SINAMICS DC MASTER shield bar through a large surface area.

<sup>1)</sup> Restriction: See "Maximum frequency that can be evaluated"

<sup>2)</sup> Differential voltage at the terminals of the evaluation electronics

<sup>3)</sup> The phase error  $L_G$  (deviation of 90°) that may occur caused by the encoder and cable can be calculated from  $T_{\min}$ :

$$L_G = + (90^\circ - f_p \times T_{\min} \times 360^\circ \times 10^{-6})$$

$$L_G \text{ Phase error in } ^\circ$$

$$f_p \text{ Pulse frequency in kHz}$$

$$T_{\min} \text{ Minimum edge clearance in ns}$$

<sup>4)</sup> Differential voltage of the encoder pulses without load (approximate encoder power supply voltage)

## SINAMICS DCM

### Engineering information

#### Notes for EMC-compliant drive installation

##### Overview

##### Notes for EMC-compliant installation

These installation instructions do not claim to contain all details and versions of units, or to take into account all conceivable operational cases and applications.

Contact partners of the Siemens regional offices are available for additional information or for specific problems, that have not been handled in sufficient detail for your particular application.

The contents of these installation instructions neither form part of nor modify any prior or existing contract, agreement, or legal relationship. The particular contract of sale represents the overall obligations of Siemens AG. The warranty specified in the contract between the parties is the only warranty accepted by the Siemens AG. Any statements contained in these installation instructions neither create new warranty conditions nor modify the existing warranty conditions.

##### Basic information about EMC

###### What is EMC?

EMC stands for "ElectroMagnetic Compatibility" and describes the capability of a device to function satisfactorily in an electromagnetic environment without itself causing interference unacceptable for other devices in the environment. Therefore, the various units should not mutually interfere with one another.

Within the context of the EMC Directive, the SINAMICS DC MASTER units described in this document are not "units" at all, but are instead "components" that are intended to be installed in an overall system or overall plant. For reasons of clarity, however, the generic term "units" is used in many cases.

###### Interference emissions and interference immunity

EMC is dependent upon two properties demonstrated by the units involved in the system: interference emissions and interference immunity. Electrical units can be sources of interference (senders) and/or potentially susceptible equipment (receivers).

Electromagnetic compatibility is ensured when the existing sources of interference do not impair the function of potentially susceptible equipment.

A unit may even be a source of interference and potentially susceptible equipment at the same time: For example, the power section of a converter unit should be viewed as a source of interference and the control unit as potentially susceptible equipment.

###### Product standard EN 61800-3

The EMC requirements for "Variable-speed drive systems" are described in the product standard EN 61800-3. A variable-speed drive system (or Power Drive System PDS) consists of the drive converter and the electric motor including cables. The driven machine is not part of the drive system.

EN 61800-3 defines different limit values depending on the installation location of the drive system, referred to as the first and second environments.

Residential buildings or locations at which the drive system is directly connected to a public low-voltage supply without intermediate transformer are defined as the **first environment**.

The term **second environment** refers to all locations outside residential areas. These are basically industrial areas which are supplied from the medium-voltage line supply via their own transformers.

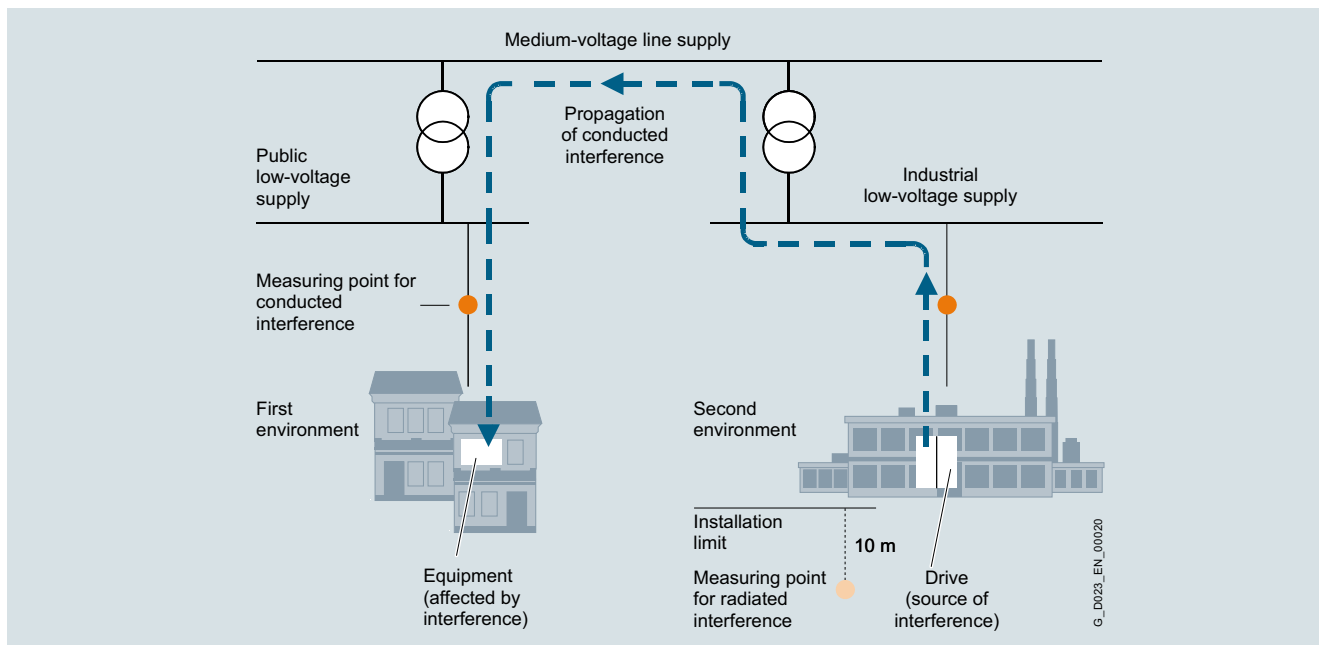

Definition of the first and second environments

## Overview

Four different categories are defined in EN 61800-3 Ed.2 depending on the installation site and the power of the drive:

**Category C1:** Drive systems for rated voltages < 1000 V for unrestricted use in the first environment.

**Category C2:** Stationary drive systems for rated voltages < 1000 V for use in the second environment. Use in the first environment is possible if the drive system is marketed and installed by qualified personnel. The warning information and installation instructions supplied by the manufacturer must be observed.

**Category C3:** Drive systems for rated voltages < 1000 V for exclusive use in the second environment.

**Category C4:** Drive systems for rated voltages  $\geq$  1000 V or for rated currents  $\geq$  400 A for use in complex systems in the second environment.

The following diagram shows how the four categories are assigned to the first and second environments:

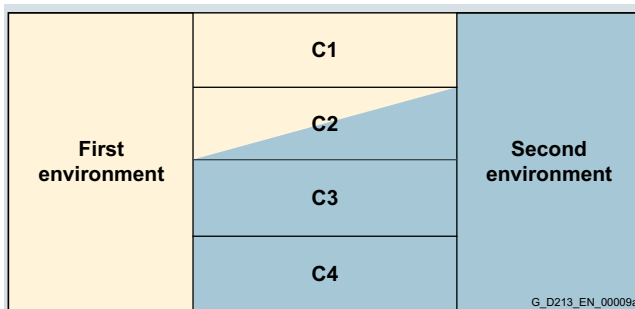

Definition of categories C1 to C4

SINAMICS DC MASTER units are nearly always used in the second environment (Categories C3 and C4).

Radio interference suppression filters and commutating reactors are required whenever they are to be used in Category C2.

SINAMICS DC MASTER units conform to the interference immunity requirements defined in EN 61800-3 for the second environment, and thus also to the lower requirements in the first environment.

### Standard EN 55011

Some situations require compliance with standard EN 55011. This defines limit values for interference emissions in industrial and residential environments. The values that are measured are conducted interference at the line supply connection as interference voltage, and electromagnetically radiated interference as radio interference, under standardized conditions.

The standard defines limit values "A1" and "B1" which, for interference voltage, apply to the 150 kHz - 30 MHz range and, for radio interference, the 30 MHz - 2 GHz range. Since SINAMICS DC MASTER converter units are used in industrial applications, they are subject to the limit value "A1". In order to achieve limit value "A1", the SINAMICS DC MASTER units must be provided with external radio interference suppression filters and commutating reactors.

### SINAMICS DC MASTER, industrial applications

Industrial applications demand that units demonstrate an extremely high level of interference immunity, but by contrast place very low requirements on them in terms of interference emission levels.

SINAMICS DC MASTER converter units are components of an electrical drive, such as contactors and switches. Qualified personnel must integrate them into a drive system which, as an absolute minimum, consists of the converter unit, motor cables, and motor. Commutating reactors and fuses are also required in most cases. Therefore, whether or not a limit value is adhered to is determined by the components being installed correctly. Limiting interference emission levels in line with limit value "A1" requires not only the converter unit itself, but also the radio interference suppression filter assigned to it and the commutating reactor, at the very least. Without a radio interference suppression filter, the interference emission level of SINAMICS DC MASTER converter units exceeds limit value "A1" of EN 55011.

If the drive forms part of a plant or system, it does not initially need to fulfill any interference emission requirements. However, EMC legislation does stipulate that the plant or system as a whole must be electromagnetically compatible with its environment.

If all the control components in the plant or system (such as PLCs) demonstrate a level of interference immunity that is suitable for industrial applications, then it is not necessary for every drive to adhere to limit value "A1".

### Non-grounded line supplies

Non-grounded line supplies (IT line supplies) are used in some branches of industry in order to increase the availability of the plant. In the event of a ground fault, no fault current flows and the plant can continue with production. However, in conjunction with radio interference suppression filters, in the case of a fault, a fault current flows, which can cause the drives to shut down or possibly even destroy the radio interference suppression filter. This is the reason that the product standard does not define any limit values for these types of line supplies. From an economics perspective, any necessary EMC conformance measures should be taken on the grounded primary side of the supply transformer.

### EMC planning

If two units are not electromagnetically compatible, you can reduce the interference emission level of the source of interference or increase the interference immunity of the potentially susceptible equipment.

Sources of interference are generally power electronics units with high power consumption. Reducing their interference emission levels requires complex filters. Potentially susceptible equipment usually refers to controlgear and sensors, including their evaluation circuit. Lower costs are involved with increasing the interference immunity of units with lower power ratings. This means, that from an economics perspective, increasing the interference immunity is generally a more favorable option for industrial applications than reducing the interference emission level. For example, to maintain limit value class A1 of EN 55011, the radio interference voltage at the line supply connection point between 150 and 500 kHz can be a maximum of 79 dB ( $\mu$ V) and between 500 kHz and 30 MHz, a maximum of 73 dB ( $\mu$ V) (9 or 4.5 mV).

In industrial applications, EMC between units should be based on a carefully-balanced combination of the interference emission and interference immunity levels.

The most cost-effective measure that can be put in place to achieve EMC conformance is to physically separate sources of interference and potentially susceptible equipment - provided that you have taken this option into account during the planning stage of your machine/plant. In the first instance, it is necessary to determine whether each unit used is a potential source of interference or potentially susceptible equipment. Within this context, converter units and contactors, for example, can be counted as sources of interference. While examples of potentially susceptible equipment (interference sink) include PLCs, encoders and sensors.

The components in the control cabinet (sources of interference and potentially susceptible equipment) must be physically separated, by means of partition plates if necessary, or by installing them in metal enclosures.

# SINAMICS DCM

## Engineering information

### Notes for EMC-compliant drive installation

#### Overview

#### **EMC-compliant drive installation (installation instructions)**

##### General information

Not only are drives operated in a wide variety of environments, but the electrical components used (controls and switched mode power supplies, and so on) can also differ widely with respect to interference immunity and interference emission levels, meaning that all installation guidelines of any kind can offer is a practical compromise. This is the reason that it is possible to deviate from the EMC rules on a case-for-case basis provided that individual measures are tested.

In order to ensure electromagnetic compatibility (EMC) in your control cabinets in rugged electrical environments and adhere to the standards required by the relevant legislating body, the EMC rules listed below should be followed during the construction and design stages.

Rules 1 to 10 are generally valid. Rules 11 to 15 must be followed in order to fulfill interference emission standards.

##### Rules for EMC-compliant installation

###### *Rule 1*

All metal parts of the control cabinet are connected with one another through a large surface area with a good electrical connection (not paint on paint!). If required, contact or serrated washers should be used. The cabinet door must be connected to the cabinet using the shortest possible grounding straps (at the top, center, and bottom).

###### *Rule 2*

Contactors, relays, solenoid valves, electromechanical operating hours counters, etc., in the cabinet and - where applicable - in neighboring cabinets - must be provided with quenching combination, e.g. RC elements, varistors, and diodes. The protective circuit must be directly connected to the particular coil.

###### *Rule 3*

Signal cables <sup>1)</sup> if at all possible, should only be routed at just one level in the cabinet.

###### *Rule 4*

Unshielded cables in the same circuit (outgoing/incoming conductors) must be twisted wherever possible, or the area between them minimized, to prevent the unnecessary formation of frame antennae.

###### *Rule 5*

Connect spare wires at both ends to the cabinet ground (ground <sup>2)</sup>). This achieves an additional shielding effect.

###### *Rule 6*

Avoid unnecessary cable lengths. This keeps coupling capacitances and inductances low.

###### *Rule 7*

Crosstalk is generally reduced, if cables are routed close to the control cabinet ground. Therefore, do not route cables freely around the cabinet, but route them as close as possible to the cabinet enclosure or to the mounting plates. This also applies to spare cables.

###### *Rule 8*

Signal and power cables must be physically separated (to prevent coupling paths!). A minimum distance of 20 cm must be observed.

If it is not possible to physically separate the encoder and motor cables, the encoder cable must be decoupled either using a partition or by routing it in a metal conduit. The partition or metal conduit must be grounded at several points.

###### *Rule 9*

Ground the shields of digital signal cables at both ends (source and destination), ensuring maximum contact area and good conductivity. In the event of poor equipotential bonding between the shield connections, run an additional equipotential bonding conductor with a cross-section of at least 10 mm<sup>2</sup> parallel to the shield for the purpose of reducing the shield current. Generally speaking, the shields may also be connected to the cabinet enclosure (ground) at several points. The shields can be connected several times even outside the control cabinet.

Foil-type shields should be avoided, as they are at least 5 times less effective than braided shields.

###### *Rule 10*

Shields for analog signal cables may be connected to ground at both ends if the equipotential bonding is good (this must be done through a large surface area with good conductivity!). It can be assumed that equipotential bonding is good if all of the metal parts are interconnected with one another through a good electrical connection and the electronics components are supplied from a single source.

Connecting shields at one end prevents low-frequency, capacitive interference from being coupled in (e.g. 50 Hz hum). In this case, the shield should be connected in the control cabinet; whereby the shield can also be connected using a separate wire.

###### *Rule 11*

Ensure that the radio interference suppression filter is located close to the suspected source of interference. The filter must be attached to the cabinet enclosure, mounting plate, etc., through a large surface area. Incoming and outgoing cables must be physically separated.

###### *Rule 12*

Radio interference suppression filters must be used in order to conform to limit value class A1. Additional loads must be connected upstream of the filter (line side).

The control used and the manner in which the rest of the control cabinet is wired will determine whether an additional line filter needs to be installed.

###### *Rule 13*

A commutating reactor must be included in the field circuit for controlled field power supplies.

###### *Rule 14*

A commutating reactor must be included in the armature circuit of the converter.

###### *Rule 15*

The motor cables do not have to be shielded. There must be a clearance of at least 20 cm between the line supply feeder cable and the motor cables (field, armature). If necessary, a separating metal partition should be used.

The cabinet design shown in the following diagram is intended to help the user become familiar with EMC-critical parts. This example does not claim to show all possible cabinet components or design options.

Additional diagrams show details that are not immediately clear in the overview diagram and which may also have an effect on the resistance to interference/interference emission levels of the cabinet as well as different shield connection techniques.

<sup>1)</sup> Signal cables are defined as:

Digital signal cable:  
Cables for pulse encoders,  
serial interfaces, e.g. PROFIBUS DP or  
analog signal cable, e.g. ± 10 V setpoint cable.

<sup>2)</sup> Generally speaking, "ground" refers to all metallic conductive parts that can be connected to a protective conductor, such as the cabinet enclosure, motor enclosure, or foundation ground, etc.

**Overview**

Arrangement of radio interference suppression filters and commutating reactors

Another section shows how the radio interference suppression filters and commutating reactors are arranged in a SINAMICS DC MASTER. The order in which the reactors and filters are installed must be adhered to. The filter cables on the line side and unit side must be physically separated.

For information on selecting fuses for semiconductor protection, please refer to the section titled "Line fuses".

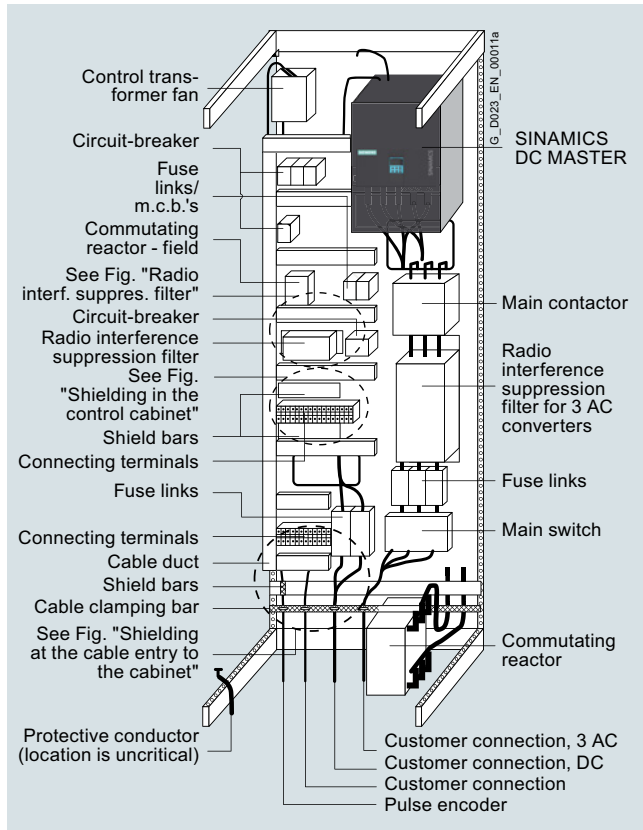

Example of a cabinet design with a SINAMICS DC MASTER of up to 850 A

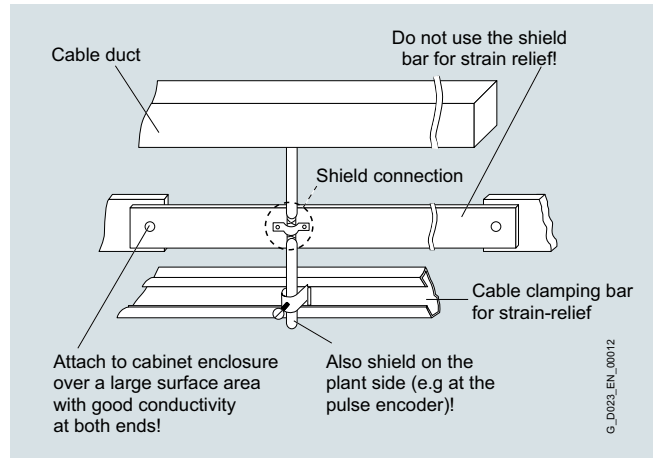

Shielding at the cable entry to the cabinet

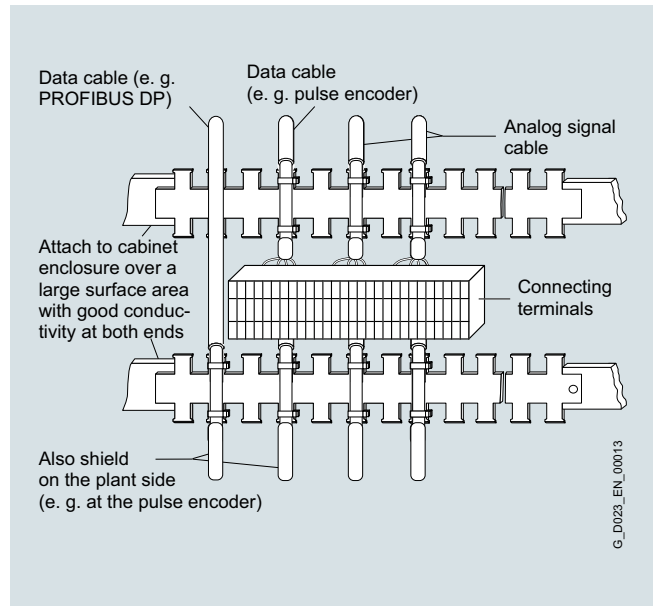

Shielding in the control cabinet

**SINAMICS DCM**

## Engineering information

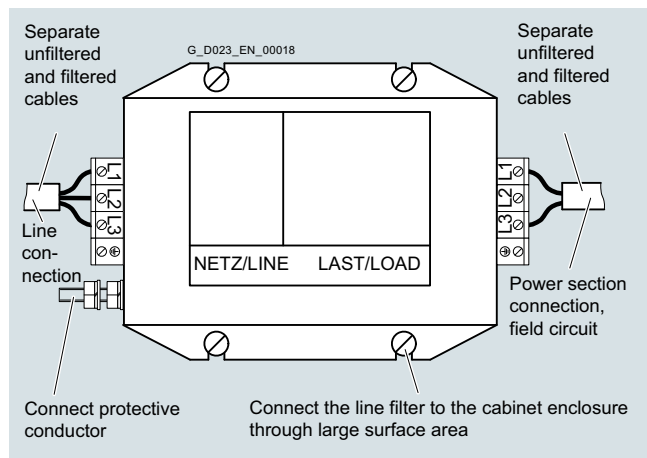
**Notes for EMC-compliant drive installation****Overview**Radio interference suppression filter for the SINAMICS DC MASTER field power section

Radio interference suppression filter

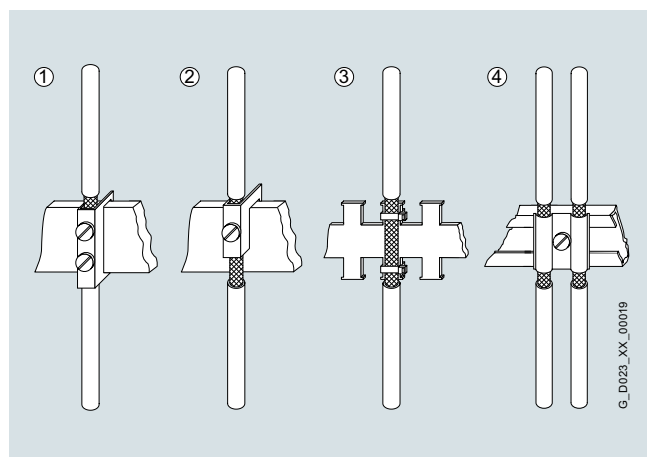
Shield connection

Shield connection

- ① Connecting terminal on a copper bar, max. cable diameter 15 mm
- ② Bar-mounting terminal on a copper bar, max. cable diameter 10 mm
- ③ Metallic tube or cable tie on a bare metallic comb-type/toothed bar
- ④ Clamp with metallic backing plate on cable support rail

## Overview

### Arrangement of the components for converter units

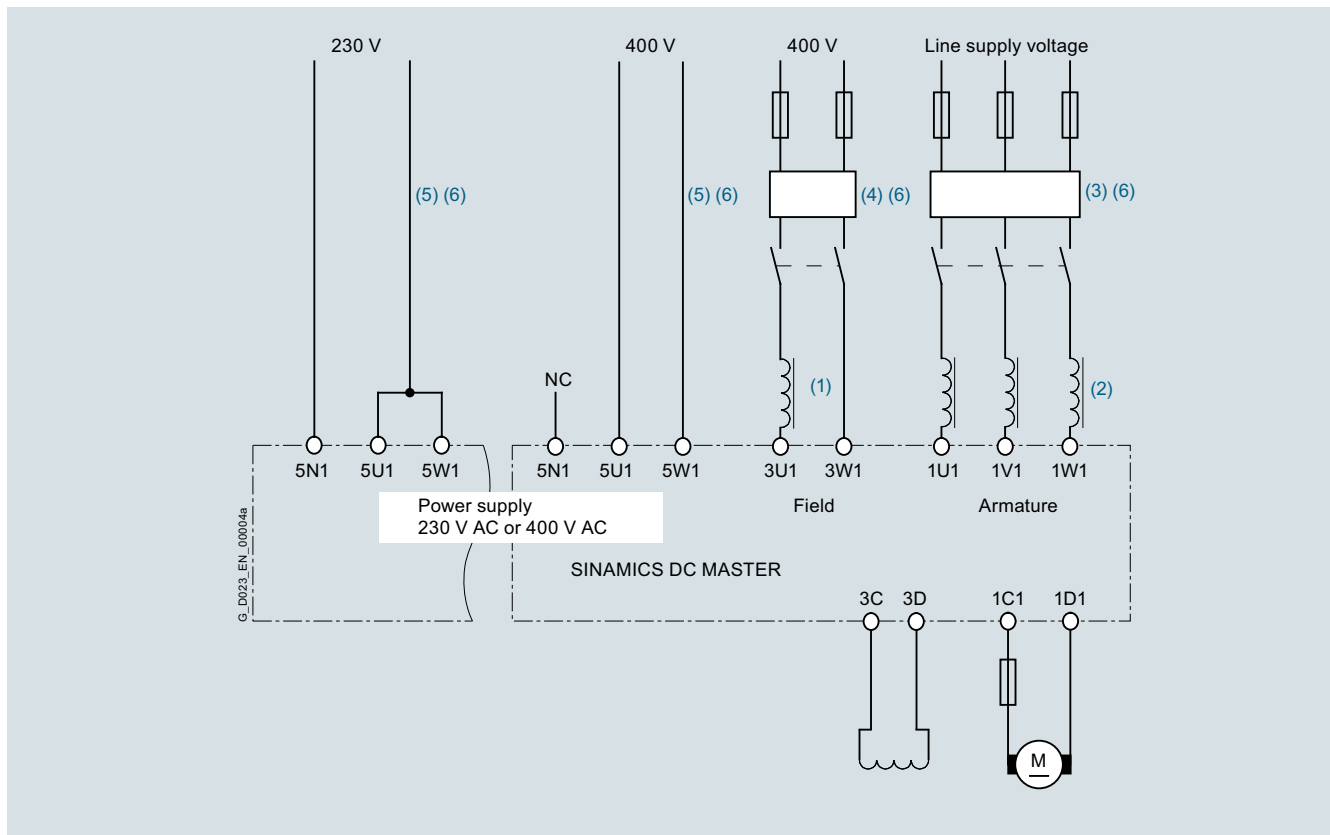

Arrangement of reactors and radio interference suppression filters

- (1) The commutating reactor in the field circuit is dimensioned for the rated motor field current.
- (2) The commutating reactor in the armature circuit is dimensioned for the rated motor armature current. The line current is 0.82 times the DC current.
- (3) The radio interference suppression filter for the armature circuit is dimensioned for the rated motor armature current. The line current is 0.82 times the DC current.
- (4) The radio interference suppression filter for the field circuit is dimensioned for the rated motor field current.
- (5) Radio interference suppression filters are not required for the electronics power supply alone. Current consumption 1 A at 400 V, 2 A at 230 V.
- (6) If the power supply voltages for the armature circuit, field circuit and electronics power supply are the same, then the voltage for the field and electronics power supply can also be taken after the radio interference suppression filter for the armature circuit.

## SINAMICS DCM

### Engineering information

#### Harmonics

##### Overview

##### **Line-side harmonics produced by converter units in a fully-controlled three-phase bridge circuit B6C and (B6)A(B6)C**

The majority of converter units for medium-power applications have a fully-controlled three-phase bridge circuit. Below is an example of the harmonics that can be found in a typical system configuration for two firing angles ( $\alpha = 20^\circ$  and  $\alpha = 60^\circ$ ).

The values have been taken from a previous publication, "Oberschwingungen im netzseitigen Strom sechspulsiger netzgeführter Stromrichter (Harmonics in the Line-Side Current of Six-Pulse, Line-Commutated Converters)" by H. Arremann and G. Möltgen, Siemens Research and Development Division, Volume 7 (1978) No. 2, © Springer-Verlag 1978.

In addition, the formulas are specified which, depending on the actual operating data in use line supply voltage (no-load voltage  $V_{V0}$ ), line frequency  $f_N$ , and DC current  $I_d$ , can be used to calculate the short-circuit power  $S_K$  and armature inductance  $L_a$  for the motor to which the specified harmonics spectrum applies.

If the actual line short-circuit power and/or actual armature inductance deviate from the values calculated in this way, then they will need to be calculated on a case-by-case basis.

The harmonics spectrum shown below is obtained if the values for the short-circuit power  $S_K$  at the point where the unit is connected and the armature inductance  $L_a$  of the motor, calculated using the following formulas, match the actual values of the plant or system. If the values do not match, the harmonics will have to be separately calculated.

n	$I_v/I_1$	
	at $\alpha = 20^\circ$ fundamental factor $g = 0.962$	at $\alpha = 60^\circ$ fundamental factor $g = 0.953$
5	0.235	0.283
7	0.100	0.050
11	0.083	0.089
13	0.056	0.038
17	0.046	0.050
19	0.035	0.029
23	0.028	0.034
25	0.024	0.023
29	0.018	0.026
31	0.016	0.019
35	0.011	0.020
37	0.010	0.016
41	0.006	0.016
43	0.006	0.013
47	0.003	0.013
49	0.003	0.011

The fundamental component of current  $I_1$  as a reference variable is calculated using the following formula:

$$I_1 = g \times 0.817 \times I_d$$

$I_d$  DC current of the operating point being investigated  
 $g$  basic fundamental content

The harmonics currents calculated according to the table only apply for:

##### **a) Short-circuit power $S_K$ at the point where the converter unit is connected**

$$S_K = V_{V0}^2 / X_N \text{ (VA)}$$

where

$$X_N = X_K - X_D = 0.03536 \times V_{V0} / I_d - 2\pi \times f_N \times L_D \text{ (}\Omega\text{)}$$

$V_{V0}$  No-load voltage at the point where the converter unit is connected in V

$I_d$  DC current of the operating point being investigated in A

$f_N$  Line frequency in Hz

$L_D$  Inductance of the commutating reactor being used in H

##### **b) Armature inductance $L_a$**

$$L_a = 0.0488 \times V_{V0} / (f_N \times I_d) \text{ (H)}$$

If the actual values for the short-circuit power  $S_K$  and/or armature inductance  $L_a$  deviate from the values calculated using the formulas above, a separate calculation will need to be made.

##### Example:

Let us assume a drive with the following data:

$$V_{V0} = 400 \text{ V}$$

$$I_d = 150 \text{ A}$$

$$f_N = 50 \text{ Hz}$$

$$L_D = 0.169 \text{ mH (4EU2421-7AA10) with } I_{LN} = 125 \text{ A}$$

where

$$X_N = 0.03536 \times 400 / 150 - 2\pi \times 0.169 \times 10^{-3} = 0.0412 \text{ }\Omega$$

The following short-circuit power of the line supply required at the point where the converter is connected:

$$S_K = 400^2 / 0.0412 = 3.88 \text{ MVA}$$

and the following armature inductance of the motor required:

$$L_a = 0.0488 \times 400 / (50 \times 150) = 2.0 \text{ mH}$$

The harmonic currents  $I_v$  (with  $I_1 = g \times 0.817 \times I_d$  for firing angles  $\alpha = 20^\circ$  and  $\alpha = 60^\circ$ ) that can be taken from the table only apply for the values  $S_K$  and  $L_a$  that have been calculated in this way. If the actual values deviate from these, a separate calculation will have to be made.

For the purpose of dimensioning filters and compensation equipment with reactors, it is only possible to draw on the information provided by the harmonic values calculated in this way if the calculated values  $S_K$  and  $L_a$  match the actual drive values. In all other cases, a separate calculation will have to be made (this particularly applies when using compensated motors as they have very low armature inductance levels).





6/2	<b>Engineering tools</b>
6/3	<b>Drive Technology Configurator (DT Configurator)</b>
6/4	<b>STARTER commissioning tool</b>
6/6	<b>SINAMICS DCC (STARTER)</b>
6/7	<b>Drive ES engineering software</b>

### Security information

Siemens provides products and solutions with industrial security functions that support the secure operation of plants, systems, machines and networks.

In order to protect plants, systems, machines and networks against cyber threats, it is necessary to implement – and continuously maintain – a holistic, state-of-the-art industrial security concept. Siemens' products and solutions constitute one element of such a concept.

Customers are responsible for preventing unauthorized access to their plants, systems, machines and networks. Such systems, machines and components should only be connected to an enterprise network or the internet if and to the extent such a connection is necessary and only when appropriate security measures (e.g. firewalls and/or network segmentation) are in place.

For additional information on industrial security measures that may be implemented, please visit <https://www.siemens.com/industrialsecurity>

Siemens' products and solutions undergo continuous development to make them more secure. Siemens strongly recommends that product updates are applied as soon as they are available and that the latest product versions are used. Use of product versions that are no longer supported, and failure to apply the latest updates may increase customer's exposure to cyber threats.

To stay informed about product updates, subscribe to the Siemens Industrial Security RSS Feed under <https://www.siemens.com/industrialsecurity>

## SINAMICS DCM

Tools and engineering

### Engineering tools

#### Overview

The DT Configurator is available as an engineering tool.

The DT Configurator is recommended for quick configuration of standard products. The configured products can be transferred to the shopping cart of the Industry Mall if the user has the required authorization. Thus the DT Configurator provides a short and efficient procedure from configuring to ordering.

## Overview

The Drive Technology Configurator (DT Configurator) helps you to configure the optimum drive technology products for your application – starting with gear units, motors, converters as well as the associated options and components and ending with controllers, software licenses and connection systems. Whether with little or detailed knowledge of products: You can easily, quickly and efficiently configure your particular drive using product group preselectors, targeted navigation through selection menus or by entering article numbers directly to select the products.

In addition, comprehensive documentation comprising technical data sheets, 2D dimensional drawings/3D CAD models, operating instructions, certificates, etc. can be selected in the DT Configurator. The products that you select can be directly ordered by transferring a parts list to the shopping cart of the Industry Mall.

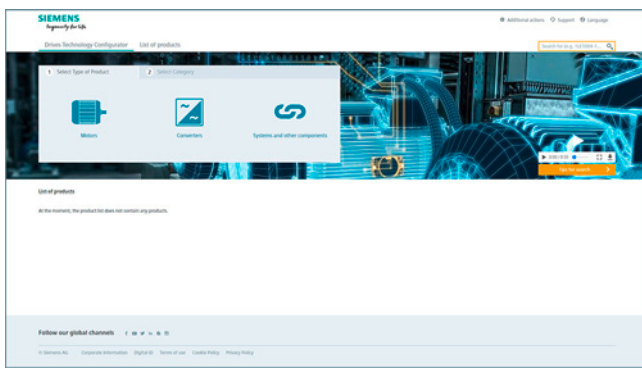

### *Drive Technology Configurator for efficient drive configuration with the following functions*

- Quick and easy configuration of drive products and associated components – gear units, motors, converters, controllers, connection systems
- Configuration of drive systems for pumps, fans and compressor applications from 1 kW to 2.6 MW
- Retrievable documentation for configured products and components such as
  - Data sheets in up to 9 languages in PDF or RTF format
  - 2D dimensional drawings/3D CAD models in various formats
  - Terminal box drawing and terminal connection diagram
  - Operating instructions
  - Certificates
  - Start-up calculation for SIMOTICS motors
  - EPLAN macros
- Support with retrofitting in conjunction with Spares On Web [www.siemens.com/sow](http://www.siemens.com/sow)
- Ability to order products directly through the Siemens Industry Mall

### Access to the Drive Technology Configurator

The Drive Technology Configurator can be called up without registration and without login:  
[www.siemens.com/dt-configurator](http://www.siemens.com/dt-configurator)

## More information

[Online access to the Drive Technology Configurator](#)

More information about the Drive Technology Configurator is available on the Internet at  
[www.siemens.com/dtconfigurator](http://www.siemens.com/dtconfigurator)

## SINAMICS DCM

Tools and engineering

### STARTER commissioning tool

#### Overview

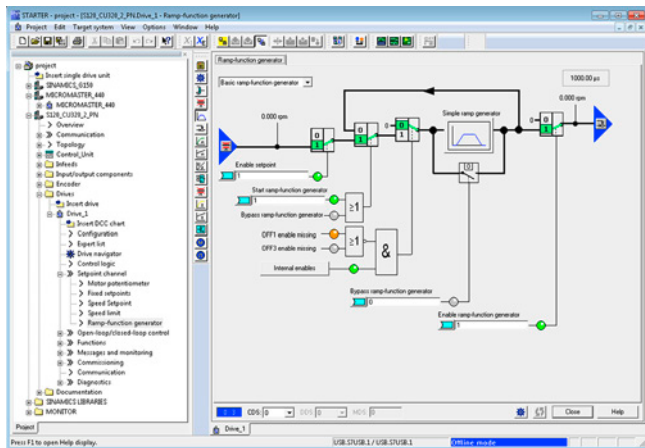

The user-friendly STARTER commissioning tool can be used for:

- Commissioning
- Optimization
- Diagnostics

This software can be operated as a standalone PC application, or integrated as a TIA-compatible program in SIMATIC STEP 7, or highly integrated into the SCOUT Engineering System (for SIMOTION). The basic functions and handling are the same in both cases.

In addition to the SINAMICS drives, STARTER also supports MICROMASTER 4 devices.

The project wizards can be used to create the drives within the structure of the project tree.

Beginners are supported by solution-based dialog guidance, whereby a standard graphics-based display maximizes clarity when setting the drive parameters.

First commissioning is guided by a wizard which makes all of the basic settings in the drive. Therefore, getting a motor up and running is merely a question of setting a few of the drive parameters as part of the drive configuration process.

The individual settings required are made using graphics-based parameterization screens, which also precisely visualize the principle of operation of the drive.

Examples of individual settings that can be made include:

- How terminals are used
- Bus interface
- Setpoint channel (e.g. fixed setpoints)
- Closed-loop speed control (e.g. ramp-function generator, limits)
- BICO interconnections
- Diagnostics

For experts, the expert list can be used to specifically and quickly access individual parameters at any time. An individual compilation of frequently used parameters can be saved in dedicated user lists and watch tables.

In addition, the following functions are available for optimization purposes:

- Self-optimization of the controller settings (depending on drive unit)
- Setup and evaluation of trace recordings<sup>1)</sup>  
Tool function for recording 2 × 8 signals with
  - Measuring cursor function
  - Extensive trigger functions
  - Several Y scales
  - Sampling times in the current controller cycle clock

Diagnostic functions provide information about:

- Control/status words
- Parameter status
- Operating conditions
- Communication states

#### Performance features

- Easy to use: Only a small number of settings need to be made for successful first commissioning: The motor turns
- Solution-based user navigation simplifies commissioning
- Self-optimization functions reduce manual effort for optimization

#### System requirements

The following minimum requirements must be complied with:

- Hardware
  - PG or PC with Pentium III min. 1 GHz (recommended >1 GHz)
  - Work memory 2 GB (4 GB recommended)
  - Screen resolution 1024 × 768 pixels, 16-bit color depth
  - Free hard disk memory: min. 5 GB
- Software
  - Microsoft Internet Explorer V6.0 or higher
  - 64-bit operating systems:
    - Microsoft Windows 7 Professional SP1
    - Microsoft Windows 7 Ultimate SP1
    - Microsoft Windows 7 Enterprise SP1 (standard installation)
    - Microsoft Windows Server 2016
    - Microsoft Windows 10 Pro
    - Microsoft Windows 10 Enterprise

#### Supported virtualization platforms

STARTER (V5.1 SP1 and higher) can be installed on a virtual machine. For this purpose, one of the following virtualization platforms in the specified version or a newer version can be used:

- VMware vSphere Hypervisor (ESXi) 6.7
- VMware Workstation pro V14.1.x
- VMware Player V14.1.x
- Microsoft Windows Server 2016 Hyper-V

You can use the following guest operating systems to install STARTER within the selected virtualization platform:

- Windows 7 Professional/Ultimate/ Enterprise (64-bit)
- Windows 10 Professional/Enterprise (64-bit)

<sup>1)</sup> Depending on drive unit. Not supported for MICROMASTER 4, SINAMICS G110, SINAMICS G120 <firmware V4.4, SINAMICS G110D and SINAMICS G120D <firmware V4.5.

### Integration

Data can be exchanged (depending on the version) via PROFIBUS or PROFINET/Ethernet or via a serial interface.

For commissioning and service, PG/PC can be connected to the CU320-2 Control Unit via PROFIBUS. A PROFIBUS connection must be available with a connecting cable at the PG/PC.

Furthermore, communication between the CU320-2 Control Unit and PG/PC can also be carried out via Ethernet, either using an (optional) CBE20 Communication Board or the Ethernet interface -X127 on the CU320-2 Control Unit.

#### Note:

The terminal strip -X127 is suitable as a communication link to the PG/PC only for the purposes of servicing and commissioning.

### Selection and ordering data

Description	Article No.
<b>STARTER commissioning tool</b> for SINAMICS and MICROMASTER English, French, German, Italian, Spanish	<b>6SL3072-0AA00-0AG0</b>

#### Note:

In addition to the STARTER commissioning tool, SINAMICS Drive Control Chart (SINAMICS DCC) can be installed. This allows the device functionality in the SINAMICS drive system to be expanded with dedicated technological functions as required.

Further information about SINAMICS DCC can be found in the SINAMICS DCC (Drive Control Chart) with STARTER section.

### Accessories

Depending on the version of the Control Unit (CU), the Control Unit of the drive unit can communicate with the programming device (PG) or PC via PROFIBUS or PROFINET/Ethernet or via a serial interface. The following accessories are available for the particular drive system as listed in the following table.

Description	Recommended accessories	
	For communication between the drive unit and the programming device or PC	
	Article No.	
<b>SINAMICS S120</b>		
• PROFIBUS	<b>CP 5711 communication module</b> USB adapter for connecting a PG or notebook to PROFIBUS or MPI USB cable (2 m) included in scope of supply	<b>6GK1571-1AA00</b>
	<b>SIMATIC DP connecting cable</b> 12 MBaud, for PG connection, pre-assembled with 2 x 9-pin Sub-D connector, 3 m	<b>6ES7901-4BD00-0XA0</b>

### More information

The STARTER commissioning tool is also available on the Internet at [www.siemens.com/starter](http://www.siemens.com/starter)

<sup>1)</sup> An overview of all the supplementary products (e.g. cables and connectors) that are available for the distributed converter family can be found at the following link:

[www.siemens.com/distributeddrives-supplementaryproducts](http://www.siemens.com/distributeddrives-supplementaryproducts)

## SINAMICS DCM

Tools and engineering

### SINAMICS DCC (STARTER)

#### Overview

SINAMICS DCC (Drive Control Chart) is a technological expansion for the SINAMICS S120/S150/G130/G150/MV/DCM/DCP drive systems. This allows the device functions of the SINAMICS drive system to be expanded individually with freely available closed-loop control, arithmetic and logic blocks. SINAMICS DCC for STARTER enables simple, graphic configuration of these blocks and integrates them in the drive unit.

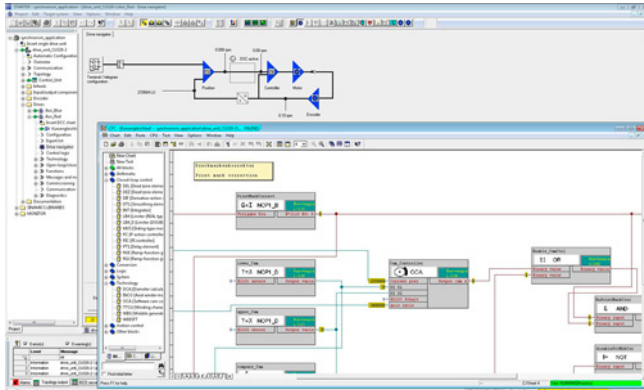

A comprehensive standard library is available for the configuration, which can be expanded by additional libraries, the so-called DCB Extension.

Via the Siemens application support, a range of example applications (winder, synchronous operation, cross-cutter, etc.) are available for download on the basis of SINAMICS DCC with STARTER and can be used as a ready-to-use solution or be individually adapted or expanded.

#### Minimum hardware and software requirements

See [STARTER commissioning tool](#).

#### Selection and ordering data

SINAMICS DCC comprises the graphical configuring tool (DCC Editor) and the standard library. SINAMICS DCC is installed as an add-on to the STARTER commissioning tool.

The license key (Floating License) for SINAMICS DCC is acquired at the same time the order is placed. No runtime license is required for the DCB standard library included in the scope of supply.

Existing licenses for SINAMICS DCC V2.1 and higher can also be used for SINAMICS DCC V3.3. An upgrade version including a license key for application with STARTER V5.3 is available for existing SINAMICS DCC V2.0 SPx.

Description	Article No.
<b>SINAMICS DCC V3.3</b> for STARTER V5.3	
<ul style="list-style-type: none"> <li>On DVD-ROM with license key on USB flash drive</li> </ul>	<b>6AU1810-1HA33-0XA0</b>
<ul style="list-style-type: none"> <li>Upgrade on DVD-ROM with license key on USB flash drive</li> </ul>	<b>6AU1810-1HA33-0XE0</b>
<b>SINAMICS DCB Extension license</b> Runtime license for license upgrading with firmware version V4.6 or later (can also be ordered in conjunction with the CompactFlash card for CU310-2 and CU320-2 Control Units)	<b>6SL3077-0AA00-0AB0</b>
<b>SINAMICS DCB Studio V2.1</b> Development tool for programming blocks that can be imported as an additional library (DCB Extension) for SINAMICS DCC in STARTER or in the TIA Portal	On request

## Overview

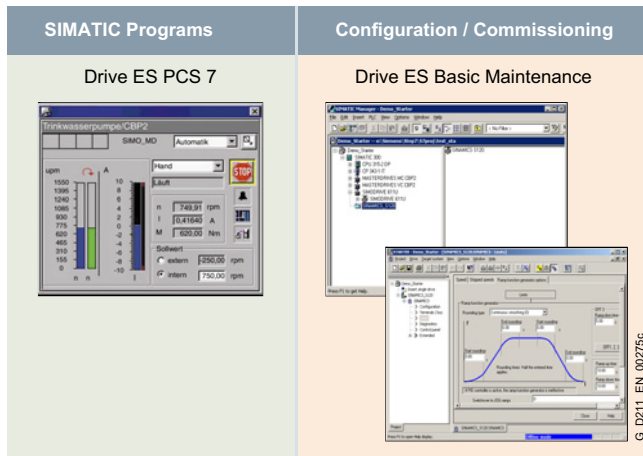

Drive ES is the engineering system used to integrate the communication, configuration and data management functions of Siemens drive technology into the SIMATIC automation world easily, efficiently and cost-effectively.

Various software packages are available:

- Drive ES Basic Maintenance
- Drive ES PCS 7

The Drive ES (**Drive Engineering Software**) fully integrates drives from Siemens into the world of Totally Integrated Automation.

## Design

Various software packages are available:

- **Drive ES Basic Maintenance**
- **Drive ES PCS 7** (APL Style or Classic Style)

### Drive ES Basic Maintenance

This software product will ensure TIA functionality for the previous drive systems not supported by STARTER.

Drive ES Basic Maintenance is for first-time users of the world of Totally Integrated Automation and the basic software for setting the parameters of all drives online and offline in this environment. Drive ES Basic Maintenance enables both the automation system and the drives to be handled using the SIMATIC Manager software. Drive ES Basic Maintenance is the starting point for common data archiving for complete projects and for extending the use of the SIMATIC teleservice to drives. Drive ES Basic Maintenance provides the configuration tools for the new Motion Control functions – slave-to-slave communication, equidistance and isochronous operation with PROFIBUS DP and ensures that drives with PROFINET IO are simply integrated into the SIMATIC environment.

### Note:

For SINAMICS and MICROMASTER 4 drives, this TIA functionality is provided with the STARTER commissioning tool (V4.3.2 and higher).

### Drive ES PCS 7 (APL Style or Classic Style)

Drive ES PCS 7 links the drives with a PROFIBUS DP interface into the SIMATIC PCS 7 process control system, and it requires that SIMATIC PCS 7, V6.1 and higher has first been installed. Drive ES PCS 7 provides a block library with blocks for the drives and the corresponding faceplates for the operator station, which enables the drives to be operated from the PCS 7 process control system. From V6.1 and higher, drives will also be able to be represented in the PCS 7 Maintenance Station.

From Drive ES PCS 7 V8.0 and higher, two versions of the library are available: The APL (Advanced Process Library) variant and the previous version in the so-called Classic Style.

### Detailed contents of the Drive ES PCS 7 (APL Style or Classic Style)

- **Block library for SIMATIC PCS 7** Faceplates and control blocks for SIMOVERT MASTERDRIVES VC and MC, as well as MICROMASTER/MIDIMASTER of the third and fourth generation and SIMOREG DC-MASTER and SINAMICS
- **STEP 7 slave object manager** for user-friendly configuration of drives and non-cyclic PROFIBUS DP communication with the drives
- **STEP 7 device object manager** for easy configuration of drives with PROFINET IO interfaces (V8.0 SP1 and higher)
- **SETUP program** for installing the software in the PCS 7 environment

# SINAMICS DCM

## Tools and engineering

### Drive ES engineering software

#### Selection and ordering data

Description	Article No.
<b>Drive ES Basic Maintenance V5.6 SPx <sup>*)</sup></b> Configuration software for the integration of drives into TIA (Totally Integrated Automation) Requirement: STEP 7 V5.4 SP4 or higher Supplied as: DVD-ROM Languages: DE, EN, FR, IT, ES with electronic documentation <ul style="list-style-type: none"> <li>Floating license, 1 user</li> </ul>	<b>6SW1700-5JA00-6AA0</b>
<b>Drive ES PCS 7 V8.2 SPx <sup>*)</sup></b> Function block library for PCS 7 for the integration of drives in Classic Style (as predecessor) Requirement: PCS 7 V8.2 and higher Supplied as: CD-ROM Languages: DE, EN, FR, IT, ES with electronic documentation <ul style="list-style-type: none"> <li>Single-user license incl. 1 runtime license</li> <li>Runtime license (without data carrier)</li> <li>Update service for single-user license</li> <li>Upgrade from V6.x/V7.x/V8.x to V8.2 SPx <sup>*)</sup></li> </ul>	<b>6SW1700-8JD00-2AA0</b> <b>6SW1700-5JD00-1AC0</b> <b>6SW1700-0JD00-0AB2</b> <b>6SW1700-8JD00-2AA4</b>
<b>Drive ES PCS 7 APL V8.2 SPx <sup>*)</sup></b> Function block library for PCS 7 for the integration of drives in APL Style (Advanced Process Library) Requirement: PCS 7 V8.2 and higher Supplied as: CD-ROM Languages: DE, EN, FR, IT, ES with electronic documentation <ul style="list-style-type: none"> <li>Single-user license incl. 1 runtime license</li> <li>Runtime license (without data carrier)</li> <li>Update service for single-user license</li> <li>Upgrade from APL V8.x to V8.2 SPx <sup>*)</sup> or Drive ES PCS 7 V6.x, V7.x, V8.x classic to Drive ES PCS 7 APL V8.2 SPx <sup>*)</sup></li> </ul>	<b>6SW1700-8JD01-2AA0</b> <b>6SW1700-5JD00-1AC0</b> <b>6SW1700-0JD01-0AB2</b> <b>6SW1700-8JD01-0AA4</b>
<b>Drive ES PCS 7 V9.0 SPx <sup>*)</sup></b> Function block library for PCS 7 for the integration of drives in Classic Style (as predecessor) Requirement: PCS 7 V9.0 or higher Supplied as: CD-ROM Languages: DE, EN, FR, IT, ES with electronic documentation <ul style="list-style-type: none"> <li>Single-user license incl. 1 runtime license</li> <li>Runtime license (without data carrier)</li> <li>Update service for single-user license</li> <li>Upgrade from V6.x/V7.x/V8.x/V9.x to V9.0 SPx <sup>*)</sup></li> </ul>	<b>6SW1700-1JD00-0AA0</b> <b>6SW1700-5JD00-1AC0</b> <b>6SW1700-0JD00-0AB2</b> <b>6SW1700-1JD00-0AA4</b>
<b>Drive ES PCS 7 APL V9.0 SPx <sup>*)</sup></b> Function block library for PCS 7 for the integration of drives in APL Style (Advanced Process Library) Requirement: PCS 7 V9.0 or higher Supplied as: CD-ROM Languages: DE, EN, FR, IT, ES with electronic documentation <ul style="list-style-type: none"> <li>Single-user license incl. 1 runtime license</li> <li>Runtime license (without data carrier)</li> <li>Update service for single-user license</li> <li>Upgrade from APL V8.x, V9.x to V9.0 SPx <sup>*)</sup> or Drive ES PCS 7 V6.x, V7.x, V8.x, V9.x classic to Drive ES PCS 7 APL V9.0 SPx <sup>*)</sup></li> </ul>	<b>6SW1700-1JD01-0AA0</b> <b>6SW1700-5JD00-1AC0</b> <b>6SW1700-0JD01-0AB2</b> <b>6SW1700-1JD01-0AA4</b>

#### Options

##### Drive ES software update service

A software update service can also be purchased for the Drive ES software. The user will automatically receive the latest software, service packs and full versions for one year after ordering.

The update service can only be ordered in addition to an existing (i.e. previously ordered) full version.

- Period of update service: 1 year

The update service is automatically extended by 1 further year unless canceled up to 6 weeks prior to expiration.

Description	Article No.
<b>Drive ES PCS 7</b> <ul style="list-style-type: none"> <li>Update service for single-user license</li> </ul>	<b>6SW1700-0JD00-0AB2</b>
<b>Drive ES PCS 7 APL</b> <ul style="list-style-type: none"> <li>Update service for single-user license</li> </ul>	<b>6SW1700-0JD01-0AB2</b>

#### More information

More information is available on the Internet at [www.siemens.com/drive-es](http://www.siemens.com/drive-es)

<sup>\*)</sup> Orders are automatically supplied with the latest Service Pack (SP).



## Services and documentation



<b>7/2</b>	<b>SINAMICS DCM demonstration case</b>
7/2	Overview
7/2	Application
7/2	Function
7/2	Technical specifications
7/2	Selection and ordering data
<b>7/3</b>	<b>SITRAIN – Digital Industry Academy</b>
7/4	Range of training courses
7/4	• SINAMICS DCM - Diagnostics and service
7/4	• SINAMICS DCM - Parameterization continuation course
<b>7/5</b>	<b>Industry Services</b>
7/6	Portfolio overview
7/6	• Digital Industry Services
7/6	• Training Services
7/6	• Support and Consulting Services
7/6	• Spare Parts
7/6	• Repair Services
7/6	• Field and Maintenance Services
7/6	• Retrofit and Modernization Services
7/6	• Service Programs and Agreements
<b>7/7</b>	<b>Online Support</b>
<b>7/8</b>	<b>Documentation</b>
7/8	More information

## SINAMICS DCM

Services and documentation

### SINAMICS DCM demonstration case

#### Overview



Demonstration case, opened

The SINAMICS DC MASTER demonstration model is installed ready to be connected-up in a rugged transport case and is immediately ready for operation. It comprises a DC converter 480 V 3 AC, DC 30 A, a 0.55 kW DC motor as well as numerous options and accessories. The case has two integrated transport wheels and a hinged handle.

#### Scope of delivery

The following main components are included in the SINAMICS DC MASTER demonstration case, including all of the required wiring, connection and signal cables:

- DC converter 6RA8018-6FV62-0AA0-Z;  
Z=G00+G10+G20+S01+L05  
G00 = Advanced CUD left  
G10 = Standard CUD right  
G20 = Communication Board CBE20 left  
S01 = Memory card left  
L05 = Electronics power supply for connection to 24 V DC

Option L05 permits operation on a three-phase line supply or a single-phase line supply, e.g. 230 V. Presentations or training courses can be carried out locally without requiring a three-phase supply; for instance in hotels or office buildings.

- TM31 Terminal Module
- TM15 Terminal Module
- AOP30 Advanced Operator Panel
- Radio interference suppression filter
- Three-phase commutating reactor for the armature circuit
- Single-phase commutating reactor for the field circuit
- DC motor 0.55 kW, 1750 rpm
- Pulse encoder OG 60 DN 2040 CI
- Analog tachometer GT 5.05 L/410,  $V_0 = 10 \text{ V}/1000 \text{ rpm}$
- Commissioning box for SINAMICS DC MASTER to control analog and digital inputs and outputs

Free function blocks and Drive Control Chart can be used without any restrictions.

#### Application

- Demonstrating DC drives to customers
- Training Siemens employees and customers
- Test configurations

An automation group using a SIMATIC demonstration case together with one or several SINAMICS DC MASTER demonstration cases can be implemented.

#### Function

##### Operation

The converter can be operated from:

- the commissioning box, which is connected to the terminals of the unit or the TM15 and TM31
- the AOP30 operator panel
- the PROFIBUS interface
- the PROFINET interface

A description is provided with the demonstration case. This clearly shows the principle operator panel design and the possible functions of the operator controls.

To use the STARTER commissioning tool, users require a programming device or PC. The system requirements are described in section STARTER.

#### Technical specifications

##### SINAMICS DCM demonstration case

##### Line supply connection

Supply voltage	110 ... 480 V 3 AC (+15 %/-20 %) or 110 ... 480 V 1 AC (+15 %)
Rated frequency	45 ... 65 Hz
Connecting cables	with 16 A Cecon connector (5UR5076 3), length approx. 4 m and a 0.7 m long adapter cable with Cecon socket and connector with ground connection
Line connection fusing required	16 A

##### Dimensions and weights

Width	approx. 680 mm
Height	approx. 700 mm
Depth	approx. 430 mm
Weight with integrated DC motor	approx. 70 kg

#### Selection and ordering data

##### SINAMICS DCM demonstration case

Description	Article No.
With integrated DC motor	<b>6RX1800-0SM00</b>

The demonstration case is also available for rental. Please contact your regional Siemens sales person.

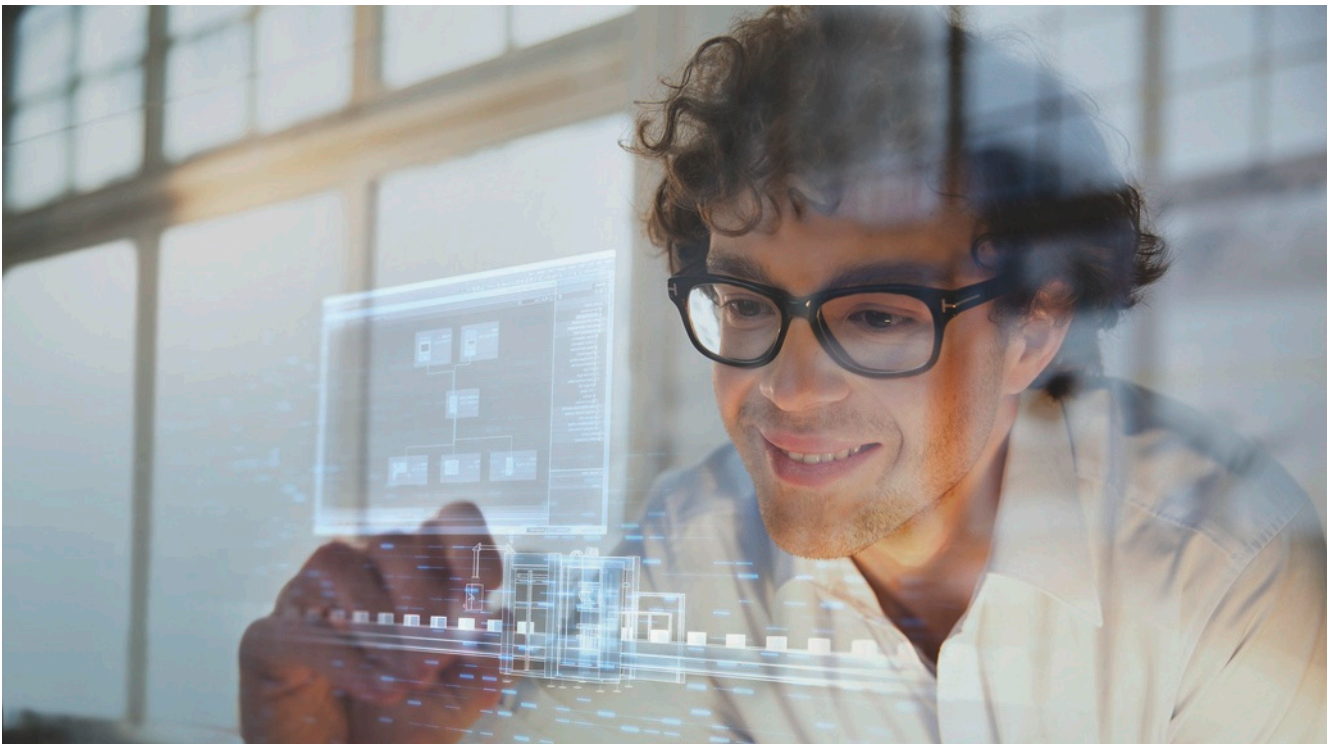

### ***Time for learning***

Today's demands on our knowledge are every bit as diverse and dynamic as our profession itself. We keep learning more and longer – for our work, for our career and for ourselves. Advancing digitalization entails new topics and is also changing the way we absorb and process knowledge. SITRAIN – Digital Industry Academy offers the right source of knowledge here, which we can use anytime in just the way we need it. The time for learning is now.

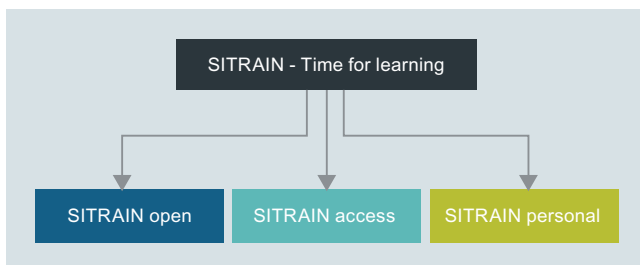

### Knowledge for every need

With its three areas – SITRAIN open, SITRAIN access and SITRAIN personal – SITRAIN offers you an all-encompassing range of options for an ongoing expansion of your knowledge and skills, suited for every type of learner. And SITRAIN uses advancing digitalization to continuously expand content and offer new training methods.

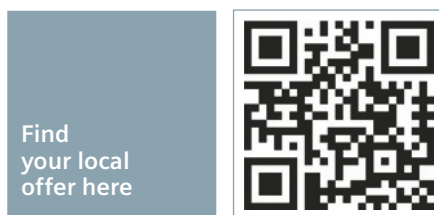

### ***SITRAIN – Digital Industry Academy Customer Support Germany***

Tel.: +49 911 895-7575

Email: [sitrain.digital.industry.academy.de@siemens.com](mailto:sitrain.digital.industry.academy.de@siemens.com)

### Knowledge you can always find

SITRAIN open bundles useful information, worthwhile data and up-to-date expert knowledge about Siemens products for industry. Search it anytime, find anything – and always the right stuff.

### Knowledge that gets you ahead

SITRAIN access is learning in the digital age. It offers you individualized ways to build your knowledge and access to exclusive digital training courses. Take advantage of sustainable learning success with a wide range of learning methods. Improve your skills – whether working in groups with others, or by yourself. Whenever, wherever and however you need to.

### Knowledge you can experience

We all want to learn from the best. And SITRAIN personal's training courses let you benefit from our well-practiced trainers' expert knowledge, along with direct access to our training equipment. That's the best way to convey knowledge – whether at your company or in our training classrooms.

### ***SITRAIN – Digital Industry Academy***

[www.siemens.com/sitrain](http://www.siemens.com/sitrain)

- SITRAIN open:  
[www.siemens.com/sitrain-open](http://www.siemens.com/sitrain-open)
- SITRAIN access:  
[www.siemens.com/sitrain-access](http://www.siemens.com/sitrain-access)
- SITRAIN personal:  
[www.siemens.com/sitrain-personal](http://www.siemens.com/sitrain-personal)

## SINAMICS DCM

### Services and documentation

#### SITRAIN – Digital Industry Academy > Range of training courses

##### Overview

##### **SINAMICS DCM - Diagnostics and service**

###### Course description

In this course you will learn how to eliminate faults in the SINAMICS DCM and determine their causes. When changes are made to the plant or system, you are also in a position to adapt the parameterization.

###### Objectives

You are responsible for reliable operation of the SINAMICS DCM direct current drives. If faults occur, then these should be resolved in the shortest possible time and operation resumed.

In this course, you will learn how to correctly and safely handle SINAMICS DCM drives when a fault occurs. Based on various scenarios, you will practice suitable measures such as data backup and recommissioning.

After the course, you will be able to eliminate faults and determine their causes more quickly. When changes are made to the plant or system, you are also in a position to adapt the parameterization.

###### Target group

Service personnel, maintenance personnel

###### Preconditions for participation

Basic knowledge of drive technology

###### Course contents

- Structure and principle of operation of the SINAMICS DCM converter:
  - Control module, power section with armature circuit and excitation circuit
  - Motor, encoder and interfaces
- Data backup and diagnostics using:
  - STARTER software
  - BOP20 and AOP30 operator panels
- Determining the signal flow in the setpoint channel
- Internal interconnections to PROFIBUS and PROFINET
- Procedure when troubleshooting and recommissioning
  - Checking the operating state and enabling signals
  - Analysis of alarms and error messages
  - Read-out of the diagnostics memory
  - Recording of signals using the trace function
  - Test operation using the control panel and metering functions
- Typical faults in power sections, motors, encoders and cables
- Procedure when replacing:
  - Control module, motor and encoder
  - Thyristors and fuses
- Practical exercises on training equipment with SINAMICS DCM and AOP30

###### Note

The replacement of components is communicated in accordance with the operating instructions and the purchasable spare parts. If required, complete repairs of the converter can be performed by Siemens Customer Support.

<b>Duration</b>	5 days	<b>Order code:</b>	DR-DCM-DG
-----------------	--------	--------------------	-----------

##### **SINAMICS DCM - Parameterization continuation course**

###### Course description/learning objective

In this course you will learn about the functional extensions of the SINAMICS DCM. You will be able to commission the drive for demanding and complex applications.

###### Objectives

You already know how to parameterize and commission the SINAMICS DCM DC drive system.

In this technology course, you will get to know useful functions and complex applications. Signal interconnections and communication are also important topics.

After the course, you will be familiar with these expanded functions of SINAMICS DCM. You will be able to commission the drive for demanding and complex applications and use the possibilities for the STARTER PC program for efficient work.

###### Target group

Programmers, commissioning engineers, configuring engineers

###### Preconditions for participation

Good knowledge of SINAMICS DCM and STARTER according to the course DR-DCM-DG (or also according to the previous courses DR-DCM-PM, DR-DCM-U, DR-DCM-SI)

###### Course contents

- Operation of several SINAMICS DCMs on one motor:
  - 6 and 12-pulse parallel connection
  - 12-pulse series connection
- Operation of several motors on one SINAMICS DCM
- Operation with high inductances
- Coupling via peer-to-peer interface:
  - Armature supply of DC motors
  - Field supply of DC motors
- Protection of the converter against overvoltage with SICROWBAR AC and DC side
- Control Module for retrofit solutions
- Applications:
  - Overview of possible applications
  - Various master-slave couplings of several drives
- Practical exercises on training equipment with SINAMICS DCM

<b>Duration</b>	5 days	<b>Order code:</b>	DR-DCM-PA
-----------------	--------	--------------------	-----------

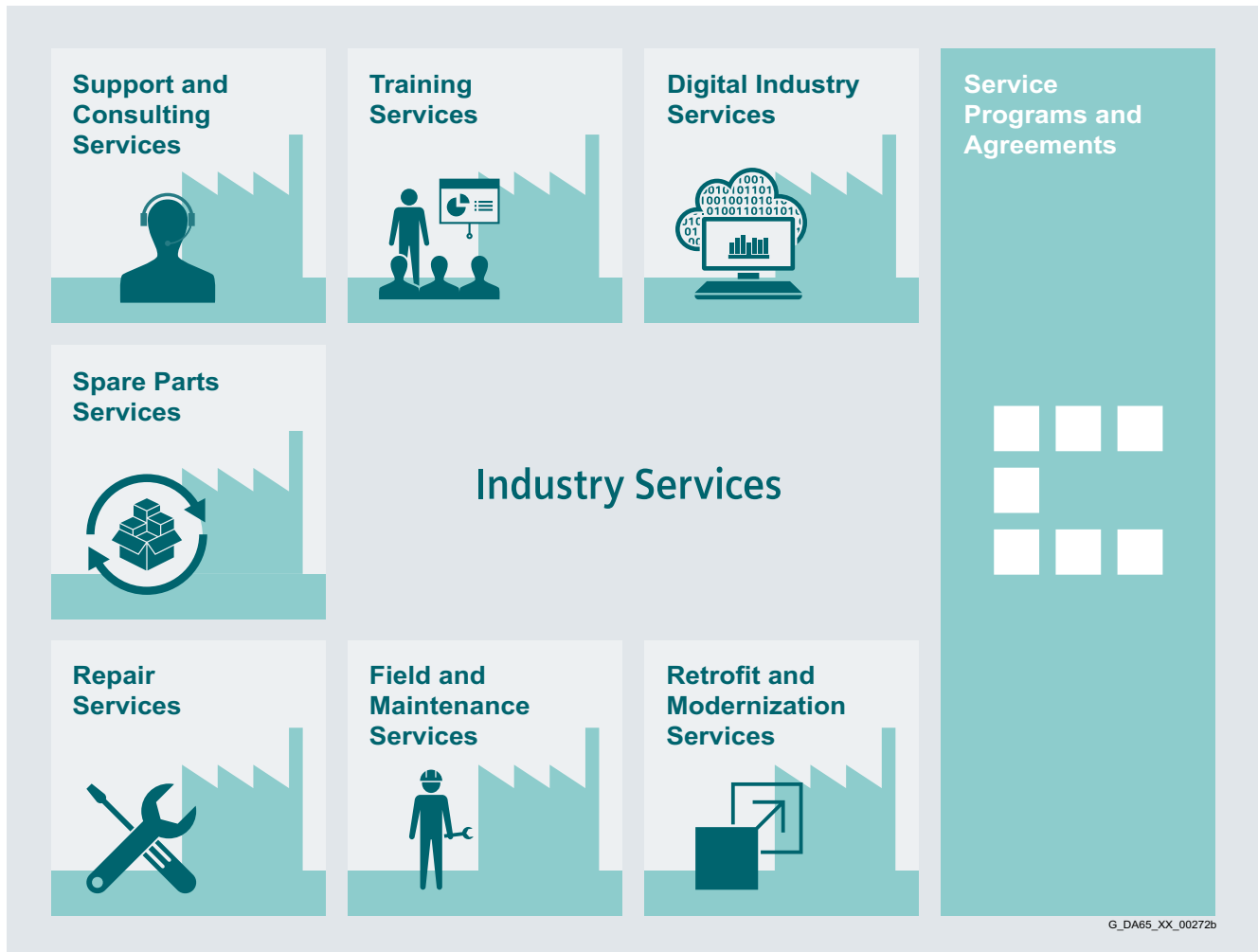
**Overview**

**Keep your business running and shaping your digital future – with Industry Services**

Optimizing the productivity of your equipment and operations can be a challenge, especially with constantly changing market conditions. Working with our service experts makes it easier. We understand your industry's unique processes and provide the services needed so that you can better achieve your business goals.

You can count on us to maximize your uptime and minimize your downtime, increasing your operations' productivity and reliability. When your operations have to be changed quickly to meet a new demand or business opportunity, our services give you the flexibility to adapt. Of course, we take care that your production is protected against cyber threats. We assist in keeping your operations as energy and resource efficient as possible and reducing your total cost of ownership. As a trendsetter, we ensure that you can capitalize on the opportunities of digitalization and by applying data analytics to enhance decision making: You can be sure that your plant reaches its full potential and retains this over the longer lifespan.

You can rely on our highly dedicated team of engineers, technicians and specialists to deliver the services you need – safely, professionally and in compliance with all regulations. We are there for you, where you need us, when you need us.

[www.siemens.com/industryservices](http://www.siemens.com/industryservices)

## SINAMICS DCM

### Services and documentation

#### Industry Services – Portfolio overview

##### Overview



Digital Industry Services

#### Digital Industry Services

Digital Industry Services make your industrial processes transparent to gain improvements in productivity, asset availability, and energy efficiency.

Production data is generated, filtered and translated with intelligent analytics to enhance decision-making.

This is done whilst taking data security into consideration and with continuous protection against cyber-attack threats.

[www.siemens.com/global/en/products/services/industry/digital-industry-services.html](http://www.siemens.com/global/en/products/services/industry/digital-industry-services.html)

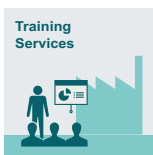

Training Services

#### Training Services

From the basics and advanced to specialist skills, SITRAIN courses provide expertise right from the manufacturer – and encompass the entire spectrum of Siemens products and systems for the industry.

Worldwide, SITRAIN courses are available wherever you need a training course in more than 170 locations in over 60 countries.

<https://support.industry.siemens.com/cs/ww/en/sc/2226>

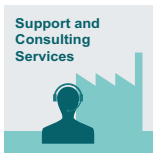

Support and Consulting Services

#### Support and Consulting Services

**Industry Online Support** site for comprehensive information, application examples, FAQs and support requests.

**Technical and Engineering Support** for advice and answers for all inquiries about functionality, handling, and fault clearance. The Service Card as prepaid support for value added services such as Priority Call Back or Extended Support offers the clear advantage of quick and easy purchasing.

**Information & Consulting Services**, e.g. SIMATIC System Audit; clarity about the state and service capability of your automation system or Lifecycle Information Services; transparency on the lifecycle of the products in your plants.

<https://support.industry.siemens.com/cs/ww/en/sc/2235>



Spare Parts Services

#### Spare Parts

Spare Parts Services are available worldwide for smooth and fast supply of spare parts – and thus optimal plant availability. Genuine spare parts are available for up to ten years. Logistic experts take care of procurement, transport, custom clearance, storage and order management.

Reliable logistics processes ensure that components reach their destination as needed.

Since not all spare parts can be kept in stock at all times, Siemens offers a preventive measure for spare parts provisioning on the customer's premises with optimized **Spare Parts Packages** for individual products, custom-assembled drive components and entire integrated drive trains – including risk consulting.

**Asset Optimization Services** help you design a strategy for parts supply where your investment and carrying costs are reduced and the risk of obsolescence is avoided.

<https://support.industry.siemens.com/cs/ww/en/sc/2110>



Repair Services

#### Repair Services

Repair Services are offered on-site and in regional repair centers for fast restoration of faulty devices' functionality.

Also available are extended repair services, which include additional diagnostic and repair measures, as well as emergency services.

<https://support.industry.siemens.com/cs/ww/en/sc/2154>



Field and Maintenance Services

#### Field and Maintenance Services

Siemens specialists are available globally to provide expert field and maintenance services, including commissioning, functional testing, preventive maintenance and fault clearance.

All services can be included in customized service agreements with defined reaction times or fixed maintenance intervals.

<https://support.industry.siemens.com/cs/ww/en/sc/2265>



Retrofit and Modernization Services

#### Retrofit and Modernization Services

Provide a cost-effective solution for the expansion of entire plants, optimization of systems or upgrading existing products to the latest technology and software, e.g. migration services for automation systems.

Service experts support projects from planning through commissioning and, if desired over the entire extended lifespan, e.g. Retrofit for Integrated Drive Systems for an extended lifetime of your machines and plants.

<https://support.industry.siemens.com/cs/ww/en/sc/2286>



Service Programs and Agreements

#### Service Programs and Agreements

A technical Service Program or Agreement enables you to easily bundle a wide range of services into a single annual or multi-year agreement.

You pick the services you need to match your unique requirements or fill gaps in your organization's maintenance capabilities.

Programs and agreements can be customized as KPI-based and/or performance-based contracts.

<https://support.industry.siemens.com/cs/ww/en/sc/2275>

**Overview**

Online Support – fast, intuitive, whenever you want, wherever you need

**Web**

[support.industry.siemens.com](http://support.industry.siemens.com)

**App**

Scan the QR code for information on our Online Support app.

- FAQ / Application examples**  
Information about industrial products, programming and configuration as well as application examples
- Technical information**  
Videos, documentation, manuals, updates, product notes, compatibility tool, certificates, planning data such as dimensional drawings, product data, 3D models
- Forum**  
Exchange information and experience with other users and experts

**Online Support for Siemens Industry Products**

Siemens Industry and Online Support with some 1.7 million visitors per month is one of the most popular web services provided by Siemens. It is the central access point for comprehensive technical know-how about products, systems and services for automation and drives applications as well as for process industries.

In connection with the challenges and opportunities related to digitalization you can look forward to continued support with innovative offerings.

## SINAMICS DCM

Services and documentation

### Documentation

---

#### More information

The documentation is available for download under the following link:

<https://support.industry.siemens.com/cs/ww/en/ps/13298/man>



## Appendix



<b>8/2</b>	<b>Partner</b>
<b>8/3</b>	<b>Software licenses</b>
<b>8/5</b>	<b>Conversion tables</b>
<b>8/7</b>	<b>Conditions of sale and delivery</b>

# SINAMICS DCM

## Appendix

### Partner

#### Partner at Siemens

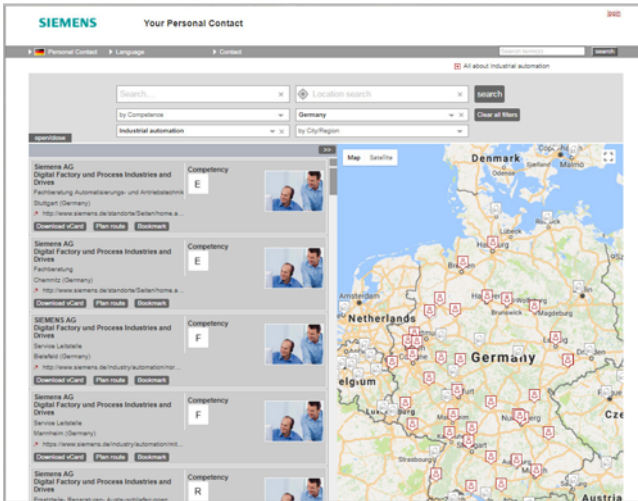

At your service locally, around the globe for consulting, sales, training, service, support, spare parts on the entire portfolio of Digital Industries.

Your partner can be found in our Personal Contacts Database at: [www.siemens.com/automation-contact](http://www.siemens.com/automation-contact)

You start by selecting

- the required competence,
- products and branches,
- a country and a city

or by a

- location search or free text search.

**Overview****Software types**

Software requiring a license is categorized into types. The following software types have been defined:

- Engineering software
- Runtime software

**Engineering software**

This includes all software products for creating (engineering) user software, e.g. for configuring, programming, parameterizing, testing, commissioning or servicing.

Data generated with engineering software and executable programs can be duplicated for your own use or for use by third-parties free-of-charge.

**Runtime software**

This includes all software products required for plant/machine operation, e.g. operating system, basic system, system expansions, drivers, etc.

The duplication of the runtime software and executable programs created with the runtime software for your own use or for use by third-parties is subject to a charge.

You can find information about license fees according to use in the ordering data (e.g. in the catalog). Examples of categories of use include per CPU, per installation, per channel, per instance, per axis, per control loop, per variable, etc.

Information about extended rights of use for parameterization/configuration tools supplied as integral components of the scope of supply can be found in the readme file supplied with the relevant product(s).

**License types**

Siemens Industry Automation & Drive Technologies offers various types of software license:

- Floating license
- Single license
- Rental license
- Rental floating license
- Trial license
- Demo license
- Demo floating license

**Floating license**

The software may be installed for internal use on any number of devices by the licensee. Only the concurrent user is licensed. The concurrent user is the person using the program. Use begins when the software is started. A license is required for each concurrent user.

**Single license**

Unlike the floating license, a single license permits only one installation of the software per license.

The type of use licensed is specified in the ordering data and in the Certificate of License (CoL). Types of use include for example per instance, per axis, per channel, etc.

One single license is required for each type of use defined.

**Rental license**

A rental license supports the "sporadic use" of engineering software. Once the license key has been installed, the software can be used for a specific period of time (the operating hours do not have to be consecutive).

One license is required for each installation of the software.

**Rental floating license**

The rental floating license corresponds to the rental license, except that a license is not required for each installation of the software. Rather, one license is required per object (for example, user or device).

**Trial license**

A trial license supports "short-term use" of the software in a non-productive context, e.g. for testing and evaluation purposes. It can be transferred to another license.

**Demo license**

The demo license support the "sporadic use" of engineering software in a non-productive context, for example, use for testing and evaluation purposes. It can be transferred to another license. After the installation of the license key, the software can be operated for a specific period of time, whereby usage can be interrupted as often as required.

One license is required per installation of the software.

**Demo floating license**

The demo floating license corresponds to the demo license, except that a license is not required for each installation of the software. Rather, one license is required per object (for example, user or device).

**Certificate of License (CoL)**

The CoL is the licensee's proof that the use of the software has been licensed by Siemens. A CoL is required for every type of use and must be kept in a safe place.

**Downgrading**

The licensee is permitted to use the software or an earlier version/release of the software, provided that the licensee owns such a version/release and its use is technically feasible.

**Delivery versions**

Software is constantly being updated.

The following delivery versions

- PowerPack
- Upgrade

can be used to access updates.

Existing bug fixes are supplied with the ServicePack version.

**PowerPack**

PowerPacks can be used to upgrade to more powerful software. The licensee receives a new license agreement and CoL (Certificate of License) with the PowerPack. This CoL, together with the CoL for the original product, proves that the new software is licensed.

A separate PowerPack must be purchased for each original license of the software to be replaced.

# SINAMICS DCM

## Appendix

### Software licenses

#### Overview

##### **Upgrade**

An upgrade permits the use of a new version of the software on the condition that a license for a previous version of the product is already held.

The licensee receives a new license agreement and CoL with the upgrade. This CoL, together with the CoL for the previous product, proves that the new version is licensed.

A separate upgrade must be purchased for each original license of the software to be upgraded.

##### **ServicePack**

ServicePacks are used to debug existing products.

ServicePacks may be duplicated for use as prescribed according to the number of existing original licenses.

##### **License key**

Siemens Industry Automation & Drive Technologies supplies software products with and without license keys.

The license key serves as an electronic license stamp and is also the "switch" for activating the software (floating license, rental license, etc.).

The complete installation of software products requiring license keys includes the program to be licensed (the software) and the license key (which represents the license).

##### **Software Update Service (SUS)**

As part of the SUS contract, all software updates for the respective product are made available to you free of charge for a period of one year from the invoice date. The contract will automatically be extended for one year if it is not canceled three months before it expires.

The possession of the current version of the respective software is a basic condition for entering into an SUS contract.

You can download explanations concerning license conditions from [https://mall.industry.siemens.com/legal/ww/en/terms\\_of\\_trade\\_en.pdf](https://mall.industry.siemens.com/legal/ww/en/terms_of_trade_en.pdf)

**Rotary inertia** (to convert from A to B, multiply by entry in table)

A \ B	lb-in <sup>2</sup>	lb-ft <sup>2</sup>	lb-in-s <sup>2</sup>	lb-ft-s <sup>2</sup> slug-ft <sup>2</sup>	kg-cm <sup>2</sup>	kg-cm-s <sup>2</sup>	gm-cm <sup>2</sup>	gm-cm-s <sup>2</sup>	oz-in <sup>2</sup>	oz-in-s <sup>2</sup>
lb-in <sup>2</sup>	1	$6.94 \times 10^{-3}$	$2.59 \times 10^{-3}$	$2.15 \times 10^{-4}$	2.926	$2.98 \times 10^{-3}$	$2.92 \times 10^3$	2.984	16	$4.14 \times 10^{-2}$
lb-ft <sup>2</sup>	144	1	0.3729	$3.10 \times 10^{-2}$	421.40	0.4297	$4.21 \times 10^5$	429.71	2304	5.967
lb-in-s <sup>2</sup>	386.08	2.681	1	$8.33 \times 10^{-2}$	$1.129 \times 10^3$	1.152	$1.129 \times 10^6$	$1.152 \times 10^3$	$6.177 \times 10^3$	16
lb-ft-s <sup>2</sup> slug-ft <sup>2</sup>	$4.63 \times 10^3$	32.17	12	1	$1.35 \times 10^4$	13.825	$1.355 \times 10^7$	$1.38 \times 10^4$	$7.41 \times 10^4$	192
kg-cm <sup>2</sup>	0.3417	$2.37 \times 10^{-3}$	$8.85 \times 10^{-4}$	$7.37 \times 10^{-5}$	1	$1.019 \times 10^{-3}$	1000	1.019	5.46	$1.41 \times 10^{-2}$
kg-cm-s <sup>2</sup>	335.1	2.327	0.8679	$7.23 \times 10^{-2}$	980.66	1	$9.8 \times 10^5$	1000	$5.36 \times 10^3$	13.887
gm-cm <sup>2</sup>	$3.417 \times 10^{-4}$	$2.37 \times 10^{-6}$	$8.85 \times 10^{-7}$	$7.37 \times 10^{-8}$	$1 \times 10^{-3}$	$1.01 \times 10^{-6}$	1	$1.01 \times 10^{-3}$	$5.46 \times 10^{-3}$	$1.41 \times 10^{-5}$
gm-cm-s <sup>2</sup>	0.335	$2.32 \times 10^{-3}$	$8.67 \times 10^{-4}$	$7.23 \times 10^{-5}$	0.9806	$1 \times 10^{-3}$	980.6	1	5.36	$1.38 \times 10^{-2}$
oz-in <sup>2</sup>	0.0625	$4.34 \times 10^{-4}$	$1.61 \times 10^{-4}$	$1.34 \times 10^{-5}$	0.182	$1.86 \times 10^{-4}$	182.9	0.186	1	$2.59 \times 10^{-3}$
oz-in-s <sup>2</sup>	24.13	0.1675	$6.25 \times 10^{-2}$	$5.20 \times 10^{-3}$	70.615	$7.20 \times 10^{-2}$	$7.09 \times 10^4$	72.0	386.08	1

**Torque** (to convert from A to B, multiply by entry in table)

A \ B	lb-in	lb-ft	oz-in	N-m	kg-cm	kg-m	gm-cm	dyne-cm
lb-in	1	$8.333 \times 10^{-2}$	16	0.113	1.152	$1.152 \times 10^{-2}$	$1.152 \times 10^3$	$1.129 \times 10^6$
lb-ft	12	1	192	1.355	13.825	0.138	$1.382 \times 10^4$	$1.355 \times 10^7$
oz-in	$6.25 \times 10^{-2}$	$5.208 \times 10^{-3}$	1	$7.061 \times 10^{-3}$	$7.200 \times 10^{-2}$	$7.200 \times 10^{-4}$	72.007	$7.061 \times 10^4$
N-m	8.850	0.737	141.612	1	10.197	0.102	$1.019 \times 10^4$	$1 \times 10^7$
kg-cm	0.8679	$7.233 \times 10^{-2}$	13.877	$9.806 \times 10^{-2}$	1	$10^{-2}$	1000	$9.806 \times 10^5$
kg-m	86.796	7.233	$1.388 \times 10^3$	9.806	100	1	$1 \times 10^5$	$9.806 \times 10^7$
gm-cm	$8.679 \times 10^{-4}$	$7.233 \times 10^{-5}$	$1.388 \times 10^{-2}$	$9.806 \times 10^{-5}$	$1 \times 10^{-3}$	$1 \times 10^{-5}$	1	980.665
dyne-cm	$8.850 \times 10^{-7}$	$7.375 \times 10^{-8}$	$1.416 \times 10^{-5}$	$10^{-7}$	$1.0197 \times 10^{-6}$	$1.019 \times 10^{-8}$	$1.019 \times 10^{-3}$	1

**Length** (to convert from A to B, multiply by entry in table)

A \ B	inches	feet	cm	yd	mm	m
inches	1	0.0833	2.54	0.028	25.4	0.0254
feet	12	1	30.48	0.333	304.8	0.3048
cm	0.3937	0.03281	1	$1.09 \times 10^{-2}$	10	0.01
yd	36	3	91.44	1	914.4	0.914
mm	0.03937	0.00328	0.1	$1.09 \times 10^{-3}$	1	0.001
m	39.37	3.281	100	1.09	1000	1

**Force** (to convert from A to B, multiply by entry in table)

A \ B	lb	oz	gm	dyne	N
lb	1	16	453.6	$4.448 \times 10^5$	4.4482
oz	0.0625	1	28.35	$2.780 \times 10^4$	0.27801
gm	$2.205 \times 10^{-3}$	0.03527	1	$1.02 \times 10^{-3}$	N.A.
dyne	$2.248 \times 10^{-6}$	$3.59 \times 10^{-5}$	980.7	1	0.00001
N	0.22481	3.5967	N.A.	100000	1

**Mass** (to convert from A to B, multiply by entry in table)

A \ B	lb	oz	gm	kg	slug
lb	1	16	453.6	0.4536	0.0311
oz	$6.25 \times 10^{-2}$	1	28.35	0.02835	$1.93 \times 10^{-3}$
gm	$2.205 \times 10^{-3}$	$3.527 \times 10^{-2}$	1	$10^{-3}$	$6.852 \times 10^{-5}$
kg	2.205	35.27	$10^3$	1	$6.852 \times 10^{-2}$
slug	32.17	514.8	$1.459 \times 10^4$	14.59	1

**Power** (to convert from A to B, multiply by entry in table)

A \ B	hp	Watts
hp (English)	1	745.7
(lb-in) (deg./s)	$2.645 \times 10^{-6}$	$1.972 \times 10^{-3}$
(lb-in) (rpm)	$1.587 \times 10^{-5}$	$1.183 \times 10^{-2}$
(lb-ft) (deg./s)	$3.173 \times 10^{-5}$	$2.366 \times 10^{-2}$
(lb-ft) (rpm)	$1.904 \times 10^{-4}$	0.1420
Watts	$1.341 \times 10^{-3}$	1

**Rotation** (to convert from A to B, multiply by entry in table)

A \ B	rpm	rad/s	degrees/s
rpm	1	0.105	6.0
rad/s	9.55	1	57.30
degrees/s	0.167	$1.745 \times 10^{-2}$	1

# SINAMICS DCM

## Appendix

### Conversion tables

#### Temperature Conversion

°F	°C	°C	°F
0	-17.8	-10	14
32	0	0	32
50	10	10	50
70	21.1	20	68
90	32.2	30	86
98.4	37	37	98.4
212	100	100	212
subtract 32 and multiply by $\frac{5}{9}$		multiply by $\frac{9}{5}$ and add 32	

#### Mechanism Efficiencies

Acme-screw with brass nut	~0.35–0.65
Acme-screw with plastic nut	~0.50–0.85
Ball-screw	~0.85–0.95
Chain and sprocket	~0.95–0.98
Preloaded ball-screw	~0.75–0.85
Spur or bevel-gears	~0.90
Timing belts	~0.96–0.98
Worm gears	~0.45–0.85
Helical gear (1 reduction)	~0.92

#### Friction Coefficients

Materials	$\mu$
Steel on steel (greased)	~0.15
Plastic on steel	~0.15–0.25
Copper on steel	~0.30
Brass on steel	~0.35
Aluminum on steel	~0.45
Steel on steel	~0.58
Mechanism	$\mu$
Ball bushings	<0.001
Linear bearings	<0.001
Dove-tail slides	~0.2++
Gibb ways	~0.5++

#### Material Densities

Material	lb-in <sup>3</sup>	gm-cm <sup>3</sup>
Aluminum	0.096	2.66
Brass	0.299	8.30
Bronze	0.295	8.17
Copper	0.322	8.91
Hard wood	0.029	0.80
Soft wood	0.018	0.48
Plastic	0.040	1.11
Glass	0.079–0.090	2.2–2.5
Titanium	0.163	4.51
Paper	0.025–0.043	0.7–1.2
Polyvinyl chloride	0.047–0.050	1.3–1.4
Rubber	0.033–0.036	0.92–0.99
Silicone rubber, without filler	0.043	1.2
Cast iron, gray	0.274	7.6
Steel	0.280	7.75

#### Wire Gauges<sup>1)</sup>

Cross-section mm <sup>2</sup>	Standard Wire Gauge (SWG)	American Wire Gauge (AWG)
0.2	25	24
0.3	23	22
0.5	21	20
0.75	20	19
1.0	19	18
1.5	17	16
2.5	15	13
4	13	11
6	12	9
10	9	7
16	7	6
25	5	3
35	3	2
50	0	1/0
70	000	2/0
95	00000	3/0
120	0000000	4/0
150	–	6/0
185	–	7/0

<sup>1)</sup> The table shows approximate SWG/AWG sizes nearest to standard metric sizes; the cross-sections do not match exactly.

## 1. General Provisions

By using this catalog you can purchase products (hardware, software and services) described therein from Siemens Aktiengesellschaft subject to the following Terms and Conditions of Sale and Delivery (hereinafter referred to as "T&C"). Please note that the scope, the quality and the conditions for supplies and services, including software products, by any Siemens entity having a registered office outside Germany, shall be subject exclusively to the General Terms and Conditions of the respective Siemens entity. The following T&C apply exclusively for orders placed with Siemens Aktiengesellschaft, Germany.

### 1.1 For customers with a seat or registered office in Germany

For customers with a seat or registered office in Germany, the following terms and conditions apply subordinate to T&C:

- for products, which include specific terms and conditions in the description text, these specific terms and conditions shall apply and subordinate thereto,
- for installation work the "General Conditions for Erection Works – Germany"<sup>1)</sup> ("Allgemeine Montagebedingungen – Deutschland" (currently only available in German)) and/or
- for stand-alone software products and software products forming a part of a product or project, the "General License Conditions for Software Products for Automation and Drives for Customers with a Seat or registered Office in Germany"<sup>1)</sup> and/or
- for consulting services the "General Terms and Conditions for Consulting Services of the Division DF – Germany"<sup>1)</sup> and/or
- for other supplies and/or services the "General Conditions for the Supply of Products and Services of the Electrical and Electronics Industry"<sup>1)</sup>.

In case such supplies and/or services should contain Open Source Software, the conditions of which shall prevail over the "General Conditions for the Supply of Products and Services of the Electrical and Electronics Industry"<sup>1)</sup>, a notice will be contained in the scope of delivery in which the applicable conditions for Open Source Software are specified. This shall apply mutatis mutandis for notices referring to other third party software components.

### 1.2 For customers with a seat or registered office outside Germany

For customers with a seat or registered office outside Germany, the following terms and conditions apply subordinate to T&C:

- for products, which include specific terms and conditions in the description text, these specific terms and conditions shall apply and subordinate thereto,
- for services the "International Terms & Conditions for Services"<sup>1)</sup> supplemented by "Software Licensing Conditions"<sup>1)</sup> and/or
- for consulting services the "General Terms and Conditions for Consulting Services of the Division DF – Germany"<sup>1)</sup> and/or
- for other supplies of hard- and software the "International Terms & Conditions for Products"<sup>1)</sup> supplemented by "Software Licensing Conditions"<sup>1)</sup>

### 1.3 For customers with master or framework agreement

To the extent our supplies and/or services offered are covered by an existing master or framework agreement, the terms and conditions of that agreement shall apply instead of T&C.

## 2. Prices

The prices are in € (Euro) ex point of delivery, exclusive of packaging.

The sales tax (value added tax) is not included in the prices. It shall be charged separately at the respective rate according to the applicable statutory legal regulations.

Prices are subject to change without prior notice. We will charge the prices valid at the time of delivery.

To compensate for variations in the price of raw materials (e.g. silver, copper, aluminum, lead, gold, dysprosium and neodym), surcharges are calculated on a daily basis using the so-called metal factor for products containing these raw materials. A surcharge for the respective raw material is calculated as a supplement to the price of a product if the basic official price of the raw material in question is exceeded.

The metal factor of a product indicates the basic official price (for those raw materials concerned) as of which the surcharges on the price of the product are applied, and with what method of calculation.

You will find a detailed explanation of the metal factor on the page headed "Metal surcharges".

To calculate the surcharge (except in the cases of dysprosium and neodym), the official price from the day prior to that on which the order was received or the release order was effected is used.

To calculate the surcharge applicable to dysprosium and neodym ("rare earths"), the corresponding three-month basic average price in the quarter prior to that in which the order was received or the release order was effected is used with a one-month buffer (details on the calculation can be found in the explanation of the metal factor).

## 3. Additional Terms and Conditions

The dimensions are in mm. In Germany, according to the German law on units in measuring technology, data in inches apply only to devices for export.

Illustrations are not binding.

Insofar as there are no remarks on the individual pages of this catalog – especially with regard to data, dimensions and weights given – these are subject to change without prior notice.

<sup>1)</sup> The text of the Terms and Conditions of Siemens AG can be downloaded at  
[https://mall.industry.siemens.com/legal/ww/en/terms\\_of\\_trade\\_en.pdf](https://mall.industry.siemens.com/legal/ww/en/terms_of_trade_en.pdf)

# SINAMICS DCM

## Appendix

### Conditions of sale and delivery

#### 4. Export Regulations

We shall not be obligated to fulfill any agreement if such fulfillment is prevented by any impediments arising out of national or international foreign trade or customs requirements or any embargoes and/or other sanctions.

Export may be subject to license. We shall indicate in the delivery details whether licenses are required under German, European and US export lists.

Our products are controlled by the U.S. Government (when labeled with "ECCN" unequal "N") and authorized for export only to the country of ultimate destination for use by the ultimate consignee or end-user(s) herein identified. They may not be resold, transferred, or otherwise disposed of, to any other country or to any person other than the authorized ultimate consignee or end-user(s), either in their original form or after being incorporated into other items, without first obtaining approval from the U.S. Government or as otherwise authorized by U.S. law and regulations.

The export indications can be viewed in advance in the description of the respective goods on the Industry Mall, our online catalog system. Only the export labels "AL" and "ECCN" indicated on order confirmations, delivery notes and invoices are authoritative.

Products labeled with "AL" unequal "N" are subject to European / national export authorization. Products without label, with label "AL:N" / "ECCN:N", or label "AL:9X9999" / "ECCN: 9X9999" may require authorization from responsible authorities depending on the final end-use, or the destination.

If you transfer goods (hardware and/or software and/or technology as well as corresponding documentation, regardless of the mode of provision) delivered by us or works and services (including all kinds of technical support) performed by us to a third party worldwide, you must comply with all applicable national and international (re-)export control regulations.

If required for the purpose of conducting export control checks, you (upon request by us) shall promptly provide us with all information pertaining to the particular end customer, final disposition and intended use of goods delivered by us respectively works and services provided by us, as well as to any export control restrictions existing in this relation.

The products listed in this catalog may be subject to European/German and/or US export regulations. Any export requiring approval is therefore subject to authorization by the relevant authorities.

Errors excepted and subject to change without prior notice.



## Selection and ordering at Siemens Industry Mall, downloading and ordering catalogs

### Easy product selection and ordering: Industry Mall

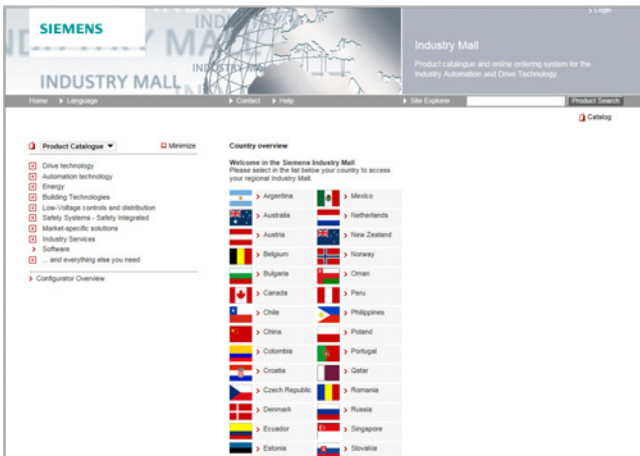

### Industry Mall

The Industry Mall is a Siemens AG Internet ordering platform. It provides you with online access to a comprehensive product spectrum that is presented in an informative, well-organized way.

Powerful search functions help you select the required products, while configurators enable you to configure complex product and system components quickly and easily. CAX data are also available for you to use.

Data transfer allows the entire procedure, from selection through ordering to tracking and tracing, to be carried out online. Availability checks, individual customer discounting, and quotation preparation are also possible.

[www.siemens.com/industrymall](http://www.siemens.com/industrymall)

### Downloading catalogs

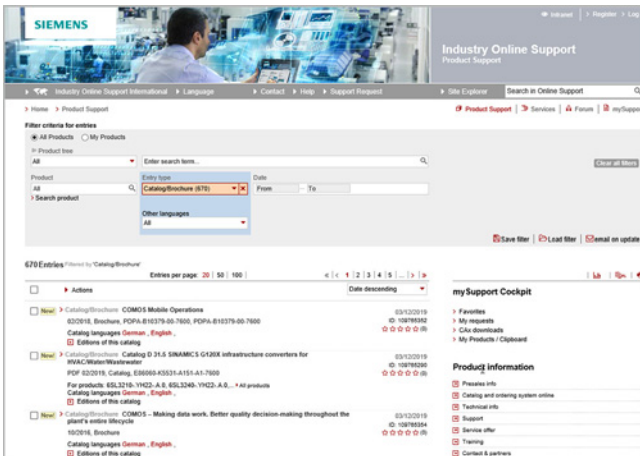

### Siemens Industry Online Support

You can download catalogs and brochures in PDF format from Siemens Industry Online Support without having to register.

The filter box makes it possible to perform targeted searches.

[www.siemens.com/industry-catalogs](http://www.siemens.com/industry-catalogs)

### Ordering printed catalogs



Please contact your local Siemens branch if you are interested in ordering printed catalogs.

Addresses can be found at

[www.siemens.com/automation-contact](http://www.siemens.com/automation-contact)

## Get more information

SINAMICS DC converters

[www.siemens.com/sinamics-dcm](http://www.siemens.com/sinamics-dcm)

Published by  
Siemens AG

Digital Industries  
Motion Control  
Postfach 31 80  
91050 Erlangen, Germany

PDF (E86060-K5523-A111-A3-7600)  
V6.MKKATA.GMC.540  
KG 0920 166 En  
Produced in Germany  
© Siemens 2020

Subject to changes and errors. The information given in this document only contains general descriptions and/or performance features which may not always specifically reflect those described, or which may undergo modification in the course of further development of the products. The requested performance features are binding only when they are expressly agreed upon in the concluded contract.

All product designations may be trademarks or other rights of Siemens AG, its affiliated companies or other companies whose use by third parties for their own purposes could violate the rights of the respective owner.

For the U.S. published by  
Siemens Industry Inc.

100 Technology Drive  
Alpharetta, GA 30005  
United States

## Security information

Siemens provides products and solutions with industrial security functions that support the secure operation of plants, systems, machines and networks.

In order to protect plants, systems, machines and networks against cyber threats, it is necessary to implement – and continuously maintain – a holistic, state-of-the-art industrial security concept. Siemens' products and solutions constitute one element of such a concept.

Customers are responsible for preventing unauthorized access to their plants, systems, machines and networks. Such systems, machines and components should only be connected to an enterprise network or the internet if and to the extent such a connection is necessary and only when appropriate security measures (e.g. firewalls and/or network segmentation) are in place.

For additional information on industrial security measures that may be implemented, please visit

<https://www.siemens.com/industrialsecurity>

Siemens' products and solutions undergo continuous development to make them more secure. Siemens strongly recommends that product updates are applied as soon as they are available and that the latest product versions are used. Use of product versions that are no longer supported, and failure to apply the latest updates may increase customer's exposure to cyber threats.

To stay informed about product updates, subscribe to the Siemens Industrial Security RSS Feed under

<https://www.siemens.com/industrialsecurity>