

User's Manual



MultiSync LCD4020

MultiSync LCD4620

MultiSync LCD5220

Index

Declaration of conformity	English-1
Important Information	English-2
Warning, Caution	English-2
Declaration	English-2
Safety Precautions, Maintenance & Recommended Use	English-3
Contents	English-4
Installation	English-5
Parts Name and Functions	English-8
Control Panel	English-8
Terminal Panel	English-9
Wireless Remote Control	English-10
Operating Range for the Remote Control	English-11
Handling the remote control	English-11
Setup.....	English-12
Connections	English-14
Wiring Diagram	English-14
Connecting a Personal Computer	English-15
Connect the LCD Monitor to a Personal Computer	English-15
Connecting to a Macintosh Computer	English-16
Connect the LCD Monitor to Macintosh	English-16
Connecting with Digital Interface Equipment.....	English-17
Connect the LCD Monitor to a Computer with a Digital Output	English-17
Connecting a DVD Player with component out	English-18
Connect the LCD Monitor to a DVD Player	English-18
Connecting a DVD Player with HDMI out	English-19
Connect the LCD Monitor to a DVD Player	English-19
Connecting a DVD Player with SCART out	English-19
Connect the LCD Monitor to a DVD Player	English-19
Connecting to a Stereo Amplifier	English-20
Connect the LCD Monitor to a Stereo Amplifier	English-20
Basic Operation	English-21
Power ON and OFF Modes	English-21
Power Indicator	English-22
Using Power Management	English-22
Selecting a video source	English-22
Picture Size	English-22
Picture Mode	English-22
Information OSD	English-22
OSD (On-Screen-Display) Controls	English-23
PICTURE	English-24
ADJUST	English-24
AUDIO	English-25
SCHEDULE	English-25
PIP	English-26
OSD	English-26
MULTI DISPLAY	English-27
DISPLAY PROTECTION	English-27
ADVANCED OPTION	English-28
Connecting to a TV (For U.S.)	English-30
Connecting to a TV (For Europe)	English-32
Controlling the LCD monitor via RS-232C Remote Control	English-36
Features	English-37
Troubleshooting	English-38
Specifications - LCD4020	English-39
Specifications - LCD4620	English-40
Specifications - LCD5220	English-41
Pin Assignment	English-42
Manufacturer's Recycling and Energy Information	English-43

DECLARATION OF CONFORMITY

This device complies with Part 15 of FCC Rules. Operation is subject to the following two conditions. (1) This device may not cause harmful interference, and (2) this device must accept any interference received, including interference that may cause undesired operation.

U.S. Responsible Party:	NEC Display Solutions of America, Inc.
Address:	500 Park Boulevard, Suite 1100 Itasca, Illinois 60143
Tel. No.:	(630) 467-3000

Type of Product:	Computer Monitor
Equipment Classification:	Class B Peripheral
Model:	MultiSync LCD4020 (L406T6) MultiSync LCD4620 (L466T7) MultiSync LCD5220 (L527TE)



We hereby declare that the equipment specified above conforms to the technical standards as specified in the FCC Rules.

Windows is a registered trademark of Microsoft Corporation. NEC is a registered trademark of NEC Corporation. OmniColor is a registered trademark of NEC Display Solutions Europe GmbH in the countries of EU and Switzerland. All other brands and product names are trademarks or registered trademarks of their respective owners.

Canadian Department of Communications Compliance Statement

DOC: This Class B digital apparatus meets all requirements of the Canadian Interference-Causing Equipment Regulations.

C-UL: Bears the C-UL Mark and is in compliance with Canadian Safety Regulations according to CAN/CSA C22.2 No. 60950-1.

FCC Information

- Use the attached specified cables with the MultiSync LCD4020 (L406T6)/MultiSync LCD4620 (L466T7)/MultiSync LCD5220 (L527TE) colour monitor so as not to interfere with radio and television reception.
 - Please use the supplied power cord or equivalent to ensure FCC compliance.
 - Please use the supplied shielded video signal cable, Mini D-SUB 15 pin to Mini D-SUB 15 pin.
- This equipment has been tested and found to comply with the limits for a Class B digital device, pursuant to part 15 of the FCC Rules. These limits are designed to provide reasonable protection against harmful interference in a residential installation. This equipment generates, uses, and can radiate radio frequency energy, and, if not installed and used in accordance with the instructions, may cause harmful interference to radio communications. However, there is no guarantee that interference will not occur in a particular installation. If this equipment does cause harmful interference to radio or television reception, which can be determined by turning the equipment off and on, the user is encouraged to try to correct the interference by one or more of the following measures:
 - Reorient or relocate the receiving antenna.
 - Increase the separation between the equipment and receiver.
 - Connect the equipment into an outlet on a circuit different from that to which the receiver is connected.
 - Consult your dealer or an experienced radio/TV technician for help.

If necessary, the user should contact the dealer or an experienced radio/television technician for additional suggestions. The user may find the following booklet, prepared by the Federal Communications Commission, helpful: "How to Identify and Resolve Radio-TV Interference Problems." This booklet is available from the U.S. Government Printing Office, Washington, D.C., 20402, Stock No. 004-000-00345-4.

The product you purchased may not have this feature.

LCD4020-BK-AV, LCD4020-2-AV, LCD4020-BK-AVT, LCD4020-2-AVT
LCD4620-BK-AV, LCD4620-2-AV, LCD4620-BK-AVT, LCD4620-2-AVT
LCD5220-BK-AV, LCD5220-BK-AVT only



HIGH DEFINITION MULTIMEDIA INTERFACE

HDMI, the HDMI logo and High-Definition Multimedia Interface are trademarks or registered trademarks of HDMI Licensing LLC.

Important Information



WARNING



TO PREVENT FIRE OR SHOCK HAZARDS, DO NOT EXPOSE THIS UNIT TO RAIN OR MOISTURE. ALSO, DO NOT USE THIS UNIT'S POLARIZED PLUG WITH AN EXTENSION CORD RECEPTACLE OR OTHER OUTLETS UNLESS THE PRONGS CAN BE FULLY INSERTED.

REFRAIN FROM OPENING THE CABINET AS THERE ARE HIGH VOLTAGE COMPONENTS INSIDE. REFER SERVICING TO QUALIFIED SERVICE PERSONNEL.



CAUTION



CAUTION: TO REDUCE THE RISK OF ELECTRIC SHOCK, MAKE SURE POWER CORD IS UNPLUGGED FROM WALL SOCKET. TO FULLY DISENGAGE THE POWER TO THE UNIT, PLEASE DISCONNECT THE POWER CORD FROM THE AC OUTLET. DO NOT REMOVE COVER (OR BACK). NO USER SERVICEABLE PARTS INSIDE. REFER SERVICING TO QUALIFIED SERVICE PERSONNEL.



This symbol warns user that uninsulated voltage within the unit may have sufficient magnitude to cause electric shock. Therefore, it is dangerous to make any kind of contact with any part inside this unit.



This symbol alerts the user that important literature concerning the operation and maintenance of this unit has been included. Therefore, it should be read carefully in order to avoid any problems.

CAUTION: Please use the power cord provided with this display in accordance with the table below. If a power cord is not supplied with this equipment, please contact your supplier. For all other cases, please use a power cord that matches the AC voltage of the power outlet and has been approved by and complies with the safety standard of your particular country.

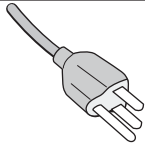
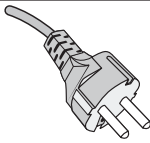
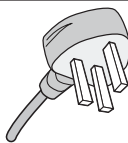
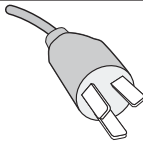
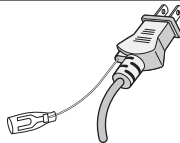
Plug Type	North America	European Continental	U.K.	Chinese	Japanese
Plug Shape					
Region	U.S.A./Canada	EU (except U.K.)	U.K.	China	Japan
Voltage	120*	230	230	220	100

*When operating the MultiSync LCD4020/MultiSync LCD4620/MultiSync LCD5220 monitor with its AC 125-240V power supply, use a power supply cord that matches the power supply voltage of the AC power outlet being used.

NOTE: This product can only be serviced in the country where it was purchased.

Declaration

Declaration of the Manufacturer

We hereby certify that the color monitor MultiSync LCD4020 (L406T6)/MultiSync LCD4620 (L466T7)/MultiSync LCD5220 (L527TE) are in compliance with

Council Directive 2006/95/EC:
– EN 60950-1

Council Directive 2004/108/EC:
– EN 55022
– EN 61000-3-2
– EN 61000-3-3
– EN 55024

and marked with



NEC Display Solutions, Ltd.
4-13-23, Shibaura,
Minato-Ku
Tokyo 108-0023, Japan

Safety Precautions, Maintenance & Recommended Use

FOR OPTIMUM PERFORMANCE, PLEASE NOTE THE FOLLOWING WHEN SETTING UP AND USING THE MULTI-FUNCTION MONITOR:

- **DO NOT OPEN THE MONITOR.** There are no user serviceable parts inside and opening or removing covers may expose you to dangerous shock hazards or other risks. Refer all servicing to qualified service personnel.
- Do not spill any liquids into the cabinet or use your monitor near water.
- Do not insert objects of any kind into the cabinet slots, as they may touch dangerous voltage points, which can be harmful or fatal or may cause electric shock, fire or equipment failure.
- Do not place any heavy objects on the power cord. Damage to the cord may cause shock or fire.
- Do not place this product on a sloping or unstable cart, stand or table, as the monitor may fall, causing serious damage to the monitor.
- The power supply cord you use must have been approved by and comply with the safety standards of your country. (Type H05VV-F 3G 1mm² should be used in Europe)
- In UK, use a BS-approved power cord with molded plug having a black (13A) fuse installed for use with this monitor.
- Do not place any objects onto the monitor and do not use the monitor outdoors.
- The lamps in this product contain mercury. Please dispose according to state, local or federal law.
- Do not bend, crimp or otherwise damage the power cord.
- If glass is broken, handle with care.
- Do not cover vent on monitor.
- Do not use monitor in high temperature, humid, dusty, or oily areas.
- If monitor or glass is broken, do not come in contact with the liquid crystal and handle with care.
- Allow adequate ventilation around the monitor, so that heat can properly dissipate. Do not block ventilated openings or place the monitor near a radiator or other heat sources. Do not put anything on top of the monitor.
- The power cable connector is the primary means of detaching the system from the power supply. The monitor should be installed close to a power outlet, which is easily accessible.
- Handle with care when transporting. Save packaging for transporting.
- Please clean the holes of back cabinet to reject dirt and dust at least once a year because of set reliability.
- If using the cooling fan continuously, it's recommended to wipe holes a minimum of once a month.

Immediately unplug your monitor from the wall outlet and refer servicing to qualified service personnel under the following conditions:

- When the power supply cord or plug is damaged.
- If liquid has been spilled, or objects have fallen into the monitor.
- If the monitor has been exposed to rain or water.
- If the monitor has been dropped or the cabinet damaged.
- If the monitor does not operate normally by following operating instructions.

Recommended Use

- For optimum performance, allow 20 minutes for warm-up.
- Rest your eyes periodically by focusing on an object at least 5 feet away. Blink often.
- Position the monitor at a 90° angle to windows and other light sources to minimize glare and reflections.
- Clean the LCD monitor surface with a lint-free, non-abrasive cloth. Avoid using any cleaning solution or glass cleaner!
- Adjust the monitor's brightness, contrast and sharpness controls to enhance readability.
- Avoid displaying fixed patterns on the monitor for long periods of time to avoid image persistence (after image effects).
- Get regular eye checkups.

Ergonomics

To realize the maximum ergonomic benefits, we recommend the following:

- Use the preset Size and Position controls with standard signals.
- Use the preset Color Setting.
- Use non-interlaced signals.
- Do not use primary color blue on a dark background, as it is difficult to see and may produce eye fatigue due to insufficient contrast.

Cleaning the LCD Panel

- When the liquid crystal panel is stained with dust or dirt, please wipe with soft cloth gently.
- Please do not rub the LCD panel with hard material.
- Please do not apply pressure to the LCD surface.
- Please do not use OA cleaner it will cause deterioration or discolor on the LCD surface.

Cleaning the Cabinet

- Unplug the power supply
- Gently wipe the cabinet with a soft cloth
- To clean the cabinet, dampen the cloth with a neutral detergent and water, wipe the cabinet and follow with a dry cloth.

NOTE: The surface of the cabinet is composed of many types of plastic. DO NOT clean with benzene thinner, alkaline detergent, alcoholic system detergent, glass cleaner, wax, polish cleaner, soap powder, or insecticide. Rubber or vinyl should not be in contact with the cabinet for an extended period of time. These types of fluids and materials can cause the paint to deteriorate, crack or peel.

Contents

Your new MultiSync monitor box* should contain the following:

- LCD monitor
- Power Cord*¹
- Video Signal Cable
- User's Manual
- Wireless Remote Control and AA Batteries
- Cable Cover
- Clamp x 3
- Screw (M4 x 10) x 9
- CD-ROM
- Thumbscrew for stand x 2

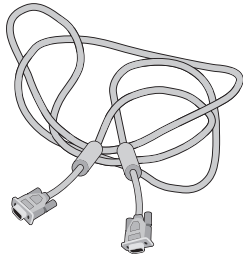

Video Signal Cable
(Mini D-SUB 15 pin to
Mini D-SUB 15 pin)

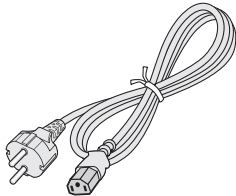

Power Cord*¹



Screw (M4 x 10) x 9



Clamp x 3



Thumbscrew for stand x 2

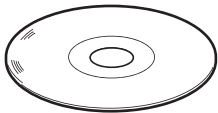

CD-ROM

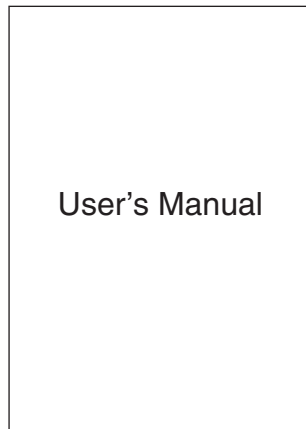

User's Manual

User's Manual



Wireless Remote Control
and AA Batteries

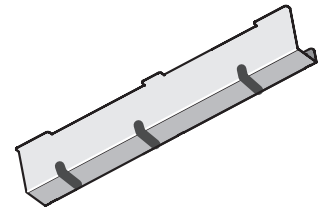

Cable cover

*¹ Type and number of power cords included will depend on the where the LCD monitor is to be shipped. When more than one power cord is included, please use a power cord that matches the AC voltage of the power outlet and has been approved by and complies with the safety standard of your particular country.

* Depending on where the LCD is sold, the stand may or may not be included with some models.

* Remember to save your original box and packing material to transport or ship the monitor.

Installation

This device cannot be used or installed without the Tabletop Stand or other mounting accessory for support. For proper installation it is strongly recommended to use a trained, NEC authorized service person. Failure to follow NEC standard mounting procedures could result in damage to the equipment or injury to the user or installer. Product warranty does not cover damage caused by improper installation. Failure to follow these recommendations could result in voiding the warranty.

Mounting

DO NOT mount the monitor yourself. Please ask dealer. For proper installation it is strongly recommended to use a trained, qualified technician. Please inspect the location where the unit is to be mounted. Mounting on wall or ceiling is the customer's responsibility. Not all walls or ceilings are capable of supporting the weight of the unit. Product warranty does not cover damage caused by improper installation, remodeling, or natural disasters. Failure to comply with these recommendations could result in voiding the warranty.

DO NOT block ventilated openings with mounting accessories or other accessories.

For NEC Qualified Personnel:

To insure safe installation, use two or more brackets to mount the unit. Mount the unit to at least two points on the installation location.

Please note the following when mounting on wall or ceiling

- When using mounting accessories other than those that are NEC approved, they must comply with the VESA-compatible (FDMLv1) mounting method.
- NEC strongly recommends using size M6 screws (10 mm (LCD4020/LCD4620) or 12 mm (LCD5220) + thickness of bracket in length). If using screws longer than 10 mm (LCD4020/LCD4620) or 12 mm (LCD5220), check the depth of the hole. (Recommended Fasten Force: 470 - 635N•cm) NEC recommends mounting interfaces that comply with UL1678 standard in North America.
- Prior to mounting, inspect the installation location to insure that it is strong enough to support the weight of the unit so that the unit will be safe from harm.
- Refer to the instructions included with the mounting equipment for detailed information.

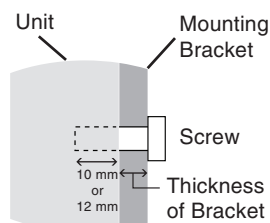

Screw length should equal depth of hole (10mm (LCD4020/LCD4620) or 12mm (LCD5220)) + thickness of mounting bracket.

Orientation

- When using the display in the portrait position, the monitor should be rotated clockwise so that the left side is moved to the top and the LED indicator light is on the bottom. This will allow for proper ventilation and will extend the lifetime of the monitor. Improper ventilation may shorten the lifetime of the monitor.

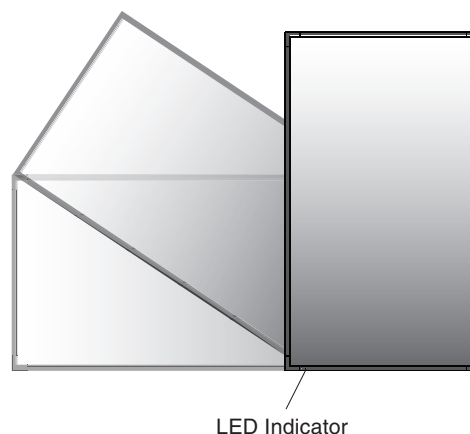

Mounting location

- The ceiling and wall must be strong enough to support the monitor and mounting accessories.
- DO NOT install in locations where a door or gate can hit the unit.
- DO NOT install in areas where the unit will be subjected to strong vibrations and dust.
- DO NOT install near where the main power supply enters the building.
- Do not install in where people can easily grab and hang onto the unit or the mounting apparatus.
- When mounting in a recessed area, as in a wall, leave at least 4 inches (10cm) of space between the monitor and the wall for proper ventilation.
- Allow adequate ventilation or provide air conditioning around the monitor, so that heat can properly dissipate away from the unit and mounting apparatus.

Mounting on ceiling

- Ensure that the ceiling is sturdy enough to support the weight of the unit and the mounting apparatus over time, against earthquakes, unexpected vibrations, and other external forces.
- Be sure the unit is mounted to a solid structure within the ceiling, such as a support beam. Secure the monitor using bolts, spring lock washers, washer and nut.
- DO NOT mount to areas that have no supporting internal structure. DO NOT use wood screws or anchor screws for mounting. DO NOT mount the unit to trim or to hanging fixtures.

Maintenance

- Periodically check for loose screws, gaps, distortions, or other problems that may occur with the mounting apparatus. If a problem is detected, please refer to qualified personnel for service.
- Regularly check the mounting location for signs of damage or weakness that may occur over time.

Attaching Mounting Accessories

The display is designed for use with the VESA mounting system.

1. Attach Mounting Accessories

Be careful to avoid tipping monitor when attaching accessories.

LCD4020/LCD4620

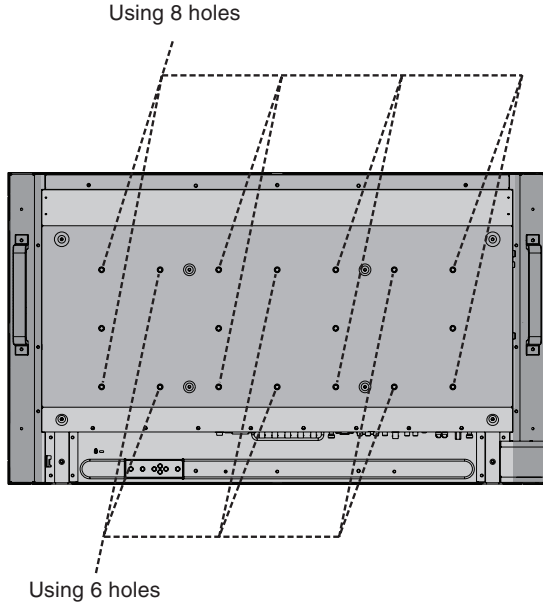

LCD5220

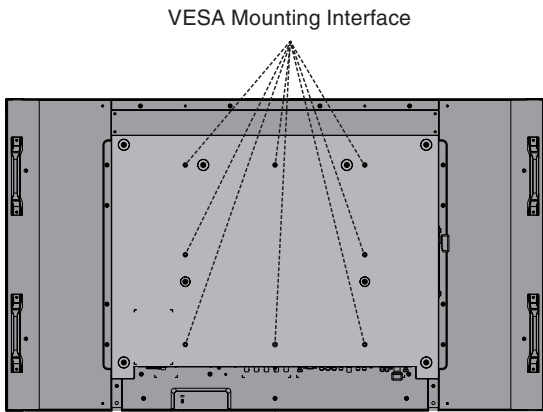

Figure 1

Mounting accessories can be attached with the monitor in the face down position. To avoid damaging the screen face, place the protective sheet on the table underneath the LCD. The protective sheet was wrapped around the LCD in the original packaging. Make sure there is nothing on the table that can damage the monitor.

When using mounting accessories other than NEC compliant and approved, they must comply with the VESA-compatible mounting method.

2. Installing and removing optional table top stand

CAUTION: Installing and removing the stand must be done by four or more people (LCD5220), by two or more people (LCD4020/LCD4620).

To install, follow those instructions included with the stand or mounting apparatus. Use only those devices recommended by the manufacturer.

Handle with care when mounting LCD monitor stand and avoid pinching your fingers.

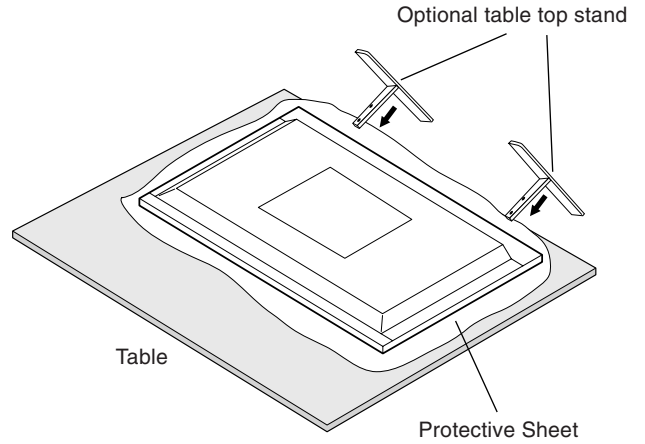

NOTE: Place stand onto monitor so that the long end of the feet are in the front.

3. Ventilation Requirements

When mounting in an enclosed space or recessed area, leave adequate room between the monitor and the enclosure to allow heat to disperse, as shown below.

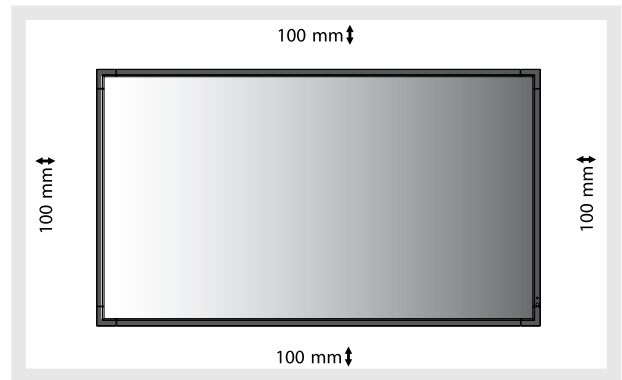

4. Prevent Tipping

When using the display with the Tabletop Stand fasten the LCD to a wall using a cord or chain that can support the weight of the monitor in order to prevent the monitor from falling. Fasten the cord or chain to the monitor using the provided clamp and screw.

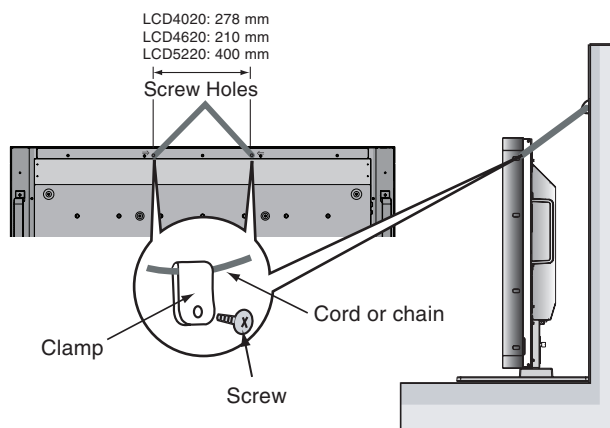

Before attaching the LCD monitor to the wall, make sure that the wall can support the weight of the monitor.

Be sure to remove the cord or chain from the wall before moving the LCD.

Parts Name and Functions

Control Panel

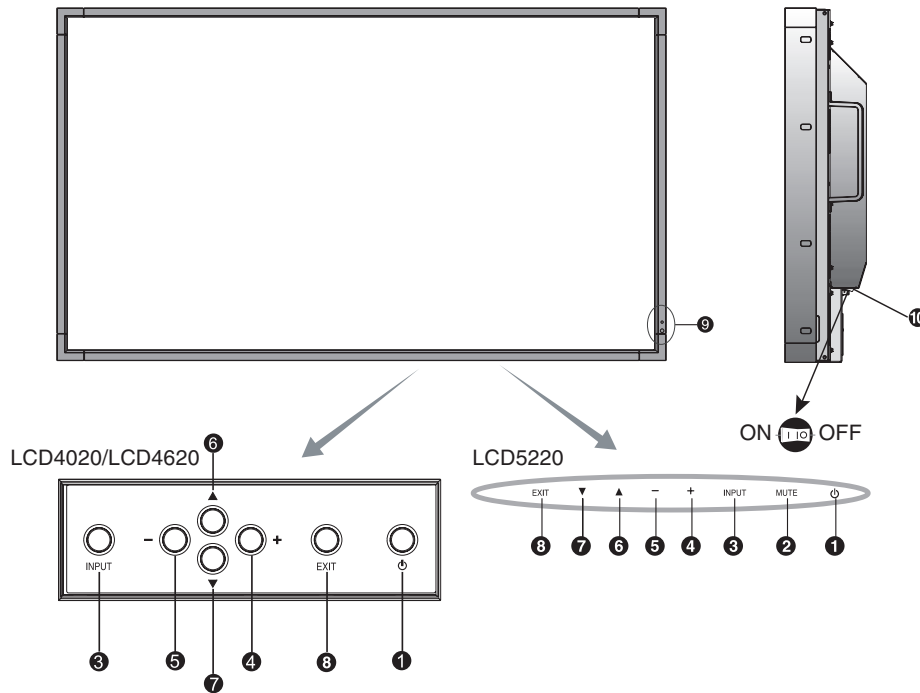

1 POWER button (⏻)

Switches the power on/off. See also page 21.

2 MUTE button (LCD5220 only)

Switches the audio mute ON/OFF.

3 INPUT button

Acts as SET button within OSD menu. (Toggle switches between [DVI], [VGA], [RGB/HV], [HDMI]*, [DVD/HD]*, [VIDEO]*, [S-VIDEO]* or [TV]*). [S-VIDEO] is enabled by selecting the "SEPARATE" mode in the OSD or by having the "S-VIDEO" cable connected with the "S-VIDEO" signal present and selecting "PRIORITY" MODE. See page 28.

4 PLUS (+) button

Acts as (+) button to increase the adjustment with OSD menu. Increases the audio output level when the OSD menu is turned off*.

5 MINUS (-) button

Acts as (-) button to decrease the adjustment with OSD menu. Decreases the audio output level when the OSD menu is turned off*.

6 UP (▲) button

Activates the OSD menu when the OSD menu is turned-off. Acts as ▲ button to move the highlighted area up to select adjustment items within OSD menu.

7 DOWN (▼) button

Activates the OSD menu when the OSD menu is turned-off. Acts as ▼ button to move the highlighted area down to select adjustment items within OSD menu.

8 EXIT button

Activates the OSD menu when the OSD menu is turned-off. Acts as EXIT button within the OSD to move to previous menu.

9 Remote control sensor and Power Indicator

Receives the signal from the remote control (when using the wireless remote control). See also page 11.

Glows green when the LCD monitor is in active mode*. Glows red when the LCD is in POWER OFF (ECO standby) mode. Glows amber when the LCD is in POWER OFF (standby) mode. Blinks amber when the monitor is in Power Save Mode. Green and Amber blink alternately while in Power Standby mode with the "SCHEDULE SETTINGS" function enabled. When a component failure is detected within the monitor, the indicator will blink red.

* If "OFF" is selected in "POWER INDICATOR" (see page 22), LED will not light when the LCD monitor is in active mode.

10 Main Power Switch

On/Off switch to turn main power ON/OFF.

Control Key Lock Mode

This control completely locks out access to all Control Key functions. To activate the control key lock function, press both ▼ and ▲ and hold down simultaneously for more than 3 seconds. To resume user mode, press both ▼ and ▲ and hold simultaneously for more than 3 seconds.

*: The product you purchased may not have this feature.

Terminal Panel

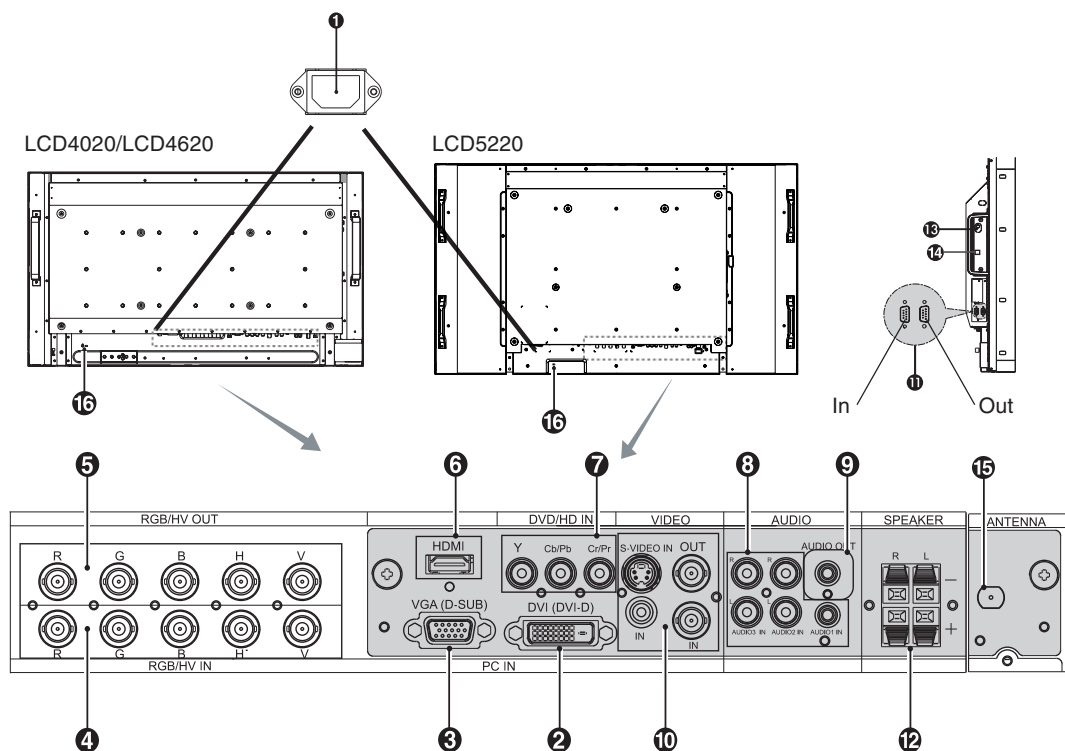

❶ AC IN connector

Connects with the supplied power cord.

❷ DVI IN (DVI-D)

To input digital RGB signals from a computer or HDTV device having a digital RGB output.

* This connector does not support analog input.

❸ VGA IN (mini D-Sub 15 pin)

To input analog RGB signals from a personal computer or from other RGB equipment.

❹ RGB/HV IN [R, G, B, H, V] (BNC)

To input analog RGB signals or signals from other RGB equipment.
This is also to connect equipment such as a DVD player, HDTV device and Set-Top-Box. A Sync-on-Green signal can be connected to the G connector.

❺ RGB/HV OUT (BNC)

To outputs the signal from the RGB/HV IN connector to an input on a separate device.

❻ HDMI connector*

To input digital HDMI signals.

❼ DVD/HD connector* (RCA)

Connecting equipment such as a DVD player, HDTV device, or Set-Top-Box.

❽ AUDIO IN* 1, 2, 3

To input audio signal from external equipment such as a computer, VCR or DVD player.

❾ AUDIO OUT*

To output the audio signal from the AUDIO IN 1, 2, 3, HDMI, and TV jack to an external device (stereo receiver, amplifier, etc.).

❿ VIDEO INPUT/OUTPUT Connector*

VIDEO IN connector (BNC and RCA): To input a composite video signal. BNC and RCA connectors are not available at the same time (Use only one input).

VIDEO OUT connector (BNC): To output the composite video signal from the VIDEO IN connector.

S-VIDEO IN connector (Mini DIN 4 pin): To input the S-video (Y/C separate signal). See page 28, S-VIDEO MODE SETTING.

⓫ EXTERNAL CONTROL (D-Sub 9 pin)

IN connector: Connect RS-232C input from external equipment such as a PC in order to control RS-232C functions.

Out connector: Connect RS-232C output. To connect multiple MultiSync monitors via RS-232C daisy Chain.

⓬ EXTERNAL SPEAKER TERMINAL*

To output the audio signal from AUDIO 1, 2, 3, HDMI and TV jack.

Note: This speaker terminal is for 15W + 15W (8 ohm) speaker.

⓭ RF IN* (For U.S.)

TV signal input.

⓮ S/PDIF OUTPUT* (For U.S.)

Optical digital audio out.

⓯ Antenna Input* (For Europe)

Connects to antenna or to TV signal.

⓰ Kensington Lock

For security and theft prevention.

*: The product you purchased may not have this feature.

Wireless Remote Control

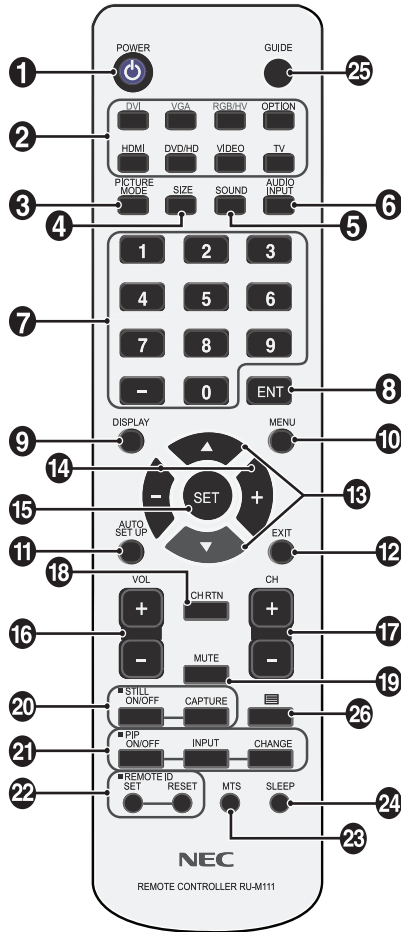

1 POWER button

Switches the power on/off.

2 INPUT button

Selects input signal, [DVI], [VGA], [RGB/HV], [HDMI]*, [DVD/HD]*, [VIDEO]*, [TV]* or [S-VIDEO]*. [S-VIDEO] is enabled by selecting the “SEPARATE” mode in the OSD or by having the “S-VIDEO” cable connected with an “S-VIDEO” signal present and selecting “PRIORITY” MODE in the S-VIDEO OSD menu. See page 28.

3 PICTURE MODE button

Selects picture mode, [HIGHBRIGHT], [STANDARD], [sRGB], [CINEMA]*. See page 22.

- HIGHBRIGHT: for moving images such as DVD
- STANDARD: for images
- sRGB: for text based images
- CINEMA: for movies.

4 SIZE button

Selects picture size, [FULL], [NORMAL], [WIDE]* and [ZOOM]. See page 22.

5 SOUND button*

Artificial surround sound.

6 AUDIO INPUT button*

Selects audio input source [IN1], [IN2], [IN3], [HDMI], [TV]*.

7 KEYPAD

Press buttons to set and change passwords, change channel and set REMOTE ID.

8 ENT button*

Sets channels.

9 DISPLAY button

Turns on/off the information OSD. See page 22.

10 MENU button

Turns on/off the menu mode.

11 AUTO SETUP button

Enters auto setup menu. See page 24.

12 EXIT button

Returns to previous menu within OSD menu.

13 UP/DOWN button

Acts as ▲ ▼ button to move the highlighted area up or down to select adjustment items within OSD menu. Small screen which adjusted “PIP” mode moves up or down.

14 MINUS/PLUS (+/-) button

Increases or decreases the adjustment level within OSD menu settings. Small screen which adjusted “PIP” mode moves left or right.

15 SET button

Makes selection.

16 VOLUME UP/DOWN button*

Increases or decreases audio output level.

17 CH +/- button*

Moves channel up or down.

18 CH RTN button*

Returns to previous channel.

19 MUTE button

Turns on/off mute function.

20 STILL button

ON/OFF button: Activates/deactivates still picture mode.
STILL CAPTURE button: Captures still picture.

21 PIP (Picture In Picture) button

ON/OFF button: Toggle switches between PIP, POP, side-by-side (aspect) and side-by-side (full). See page 26.
INPUT button: Selects the “picture in picture” input signal.
CHANGE button: Replaces to the main picture and sub picture.

		Sub picture							
		DVI	VGA	RGB/HV	HDMI	DVD/HD	VIDEO	TV for U.S.	TV for Europe
Main picture	DVI	-	-	-	-	✓	✓	✓	✓
	VGA	-	-	-	-	✓	✓	✓	✓
	RGB/HV	-	-	-	-	✓	✓	✓	✓
	HDMI	-	-	-	-	✓	✓	✓	✓
	DVD/HD	✓	✓	✓	✓	-	✓	✓	✓
	VIDEO	✓	✓	✓	✓	✓	-	✓	-
	TV for U.S.	✓	✓	✓	✓	✓	✓	-	-
	TV for Europe	✓	✓	✓	✓	✓	-	-	-

*: The product you purchased may not have this feature.

22 REMOTE ID button

Activates REMOTE ID function.

23 MTS button*

Multichannel television sound.

24 SLEEP button

Sets power off timer.

25 GUIDE button*

Enters on screen program guide (For U.S.).

26  button*

Activates closed captioning (For U.S.).

Activates Teletext (For Europe).

*: The product you purchased may not have this feature.

Operating Range for the Remote Control

Point the top of the remote control toward the LCD monitor's remote sensor during button operation.

Use the remote control within a distance of about 7 m (23 ft.) from the front of the LCD monitor's remote control sensor or at a horizontal and vertical angle of within 30° within a distance of about 3.5 m (10 ft.)

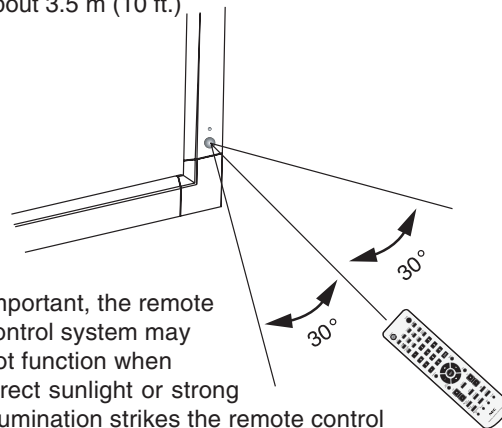

Caution: Important, the remote control system may not function when direct sunlight or strong illumination strikes the remote control sensor of the LCD monitor, or when there is an object in the path.

Handling the remote control

- Do not subject to strong shock.
- Do not allow water or other liquid to splash the remote control. If the remote control gets wet, wipe it dry immediately.
- Avoid exposure to heat and steam.
- Other than to install the batteries, do not open the remote control.

Setup

1. Determine the installation location

CAUTION: Installing your LCD display must be done by a qualified technician. Contact your dealer for more information.

CAUTION: MOVING OR INSTALLING THE LCD MONITOR MUST BE DONE BY FOUR OR MORE PEOPLE (LCD5220), BY TWO OR MORE PEOPLE (LCD4020/LCD4620). Failure to follow this caution may result in injury if the LCD monitor falls.

CAUTION: Do not mount or operate the display upside down, face up, or face down.

CAUTION: This LCD has a temperature sensor and cooling fan. If the LCD becomes too hot, the cooling fan will turn on automatically. If the LCD becomes overheated while the cooling fan is running, a "Caution" warning will appear. If the "Caution" warning appears, discontinue use and allow the unit to cool. Using the cooling fan will reduce the likelihood of early circuit failure and may help reduce image degradation and "Image Persistence".

If the LCD is used in an enclosed area or if the LCD panel is covered with a protective screen, please check the inside temperature of the monitor by using the "HEAT STATUS" control in the OSD (see page 27). If the temperature is higher than the normal operating temperature, please turn the cooling fan to ON within the FAN CONTROL menu within the OSD (see page 27).

IMPORTANT: Lay the protective sheet, which was wrapped around the LCD monitor when it was packaged, beneath the LCD monitor so as not to scratch the panel.

2. Install the remote control batteries

The remote control is powered by two 1.5V AA batteries. To install or replace batteries:

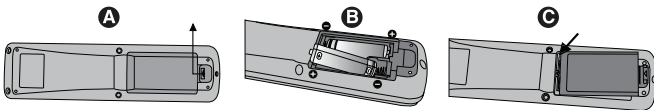

- Press and slide to open the cover.
- Align the batteries according to the (+) and (-) indications inside the case.
- Replace the cover.

CAUTION: Incorrect usage of batteries can result in leaks or bursting.

NEC recommends the following battery use:

- Place "AA" size batteries matching the (+) and (-) signs on each battery to the (+) and (-) signs of the battery compartment.
- Do not mix battery brands.
- Do not combine new and old batteries. This can shorten battery life or cause liquid leakage of batteries.
- Remove dead batteries immediately to prevent battery acid from leaking into the battery compartment.
- Do not touch exposed battery acid, it may injure skin.

NOTE: If you do not intend to use the Remote Control for a long period of time, remove the batteries.

3. Connect external equipment (See pages 14-20)

- To protect the external equipment; turn off the main power before making connections.
- Refer to your equipment user manual for further information.

4. Connect the supplied power cord

- The equipment should be installed close to an easily accessible power outlet.
- Please fasten power cord to the LCD monitor by attaching the screw and clamp.
- Fully insert the prongs into the power outlet socket. A loose connection may cause image degradation.

NOTE: Please refer to the "Safety Precautions and Maintenance" section of this manual for proper selection of AC power cord.

LCD4020/4620

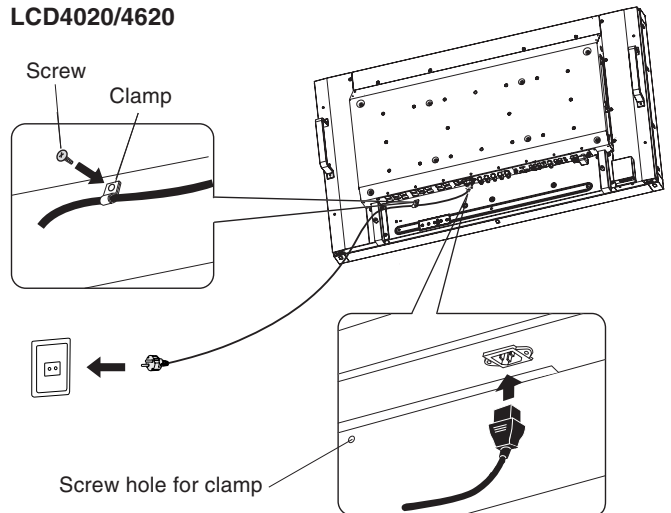

LCD5220

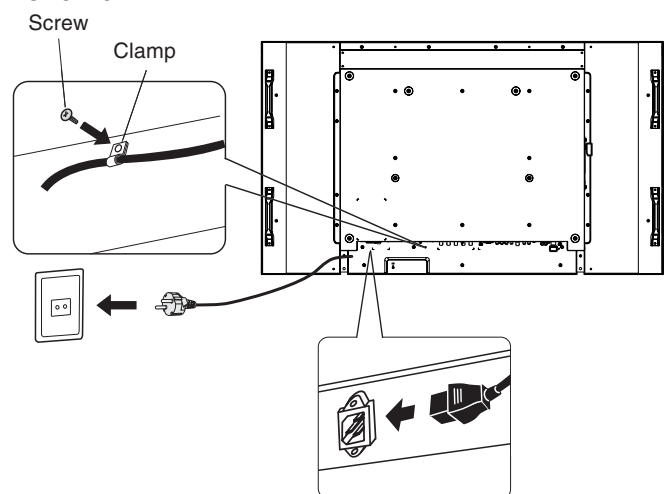

5. Attach the cable cover

[For LCD4020]

- Remove the six screws (Figure 4).
- Use six of the M4 x 10 screws (included) to attach the cable cover (Figure 5).

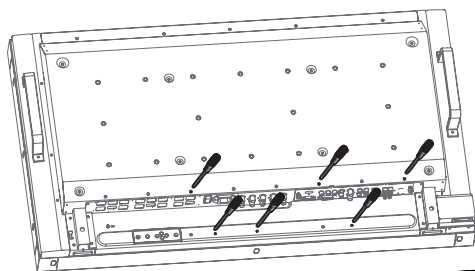

Figure 4

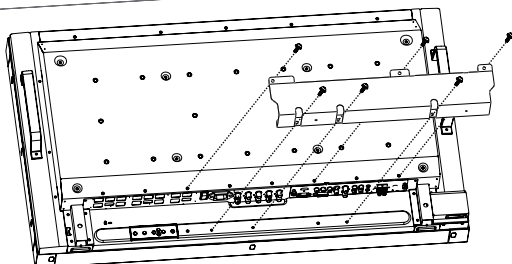

Figure 5

[For LCD4620]

- Remove the three screws (Figure 6).
- Use five of the M4 x 10 screws (included) to attach the cable cover (Figure 7).

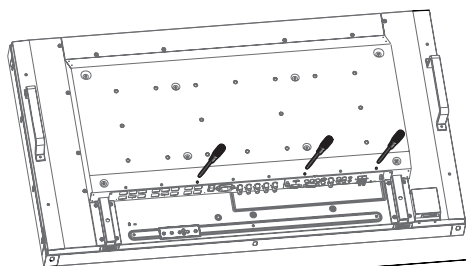

Figure 6

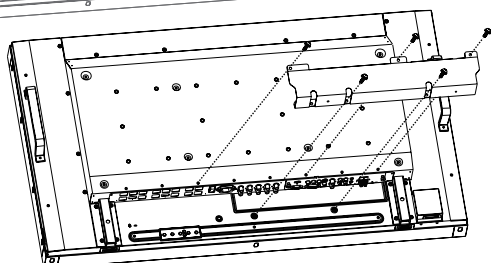

Figure 7

[For LCD5220]

- Remove the six screws (Figure 8).
- Use six of the M4 x 10 screws (included) to attach the cable cover (Figure 9).

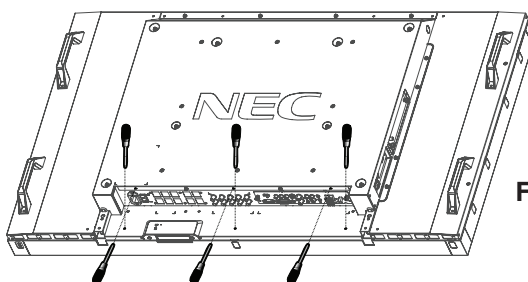

Figure 8

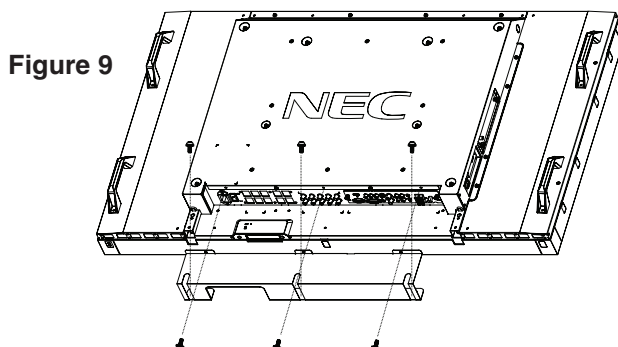

Figure 9

6. Switch on the power of all the attached external equipment

When connected with a computer, switch on the power of the computer first.

7. Operate the attached external equipment

Display the signal from the desired input source.

8. Adjust the sound*

Make volume adjustments when required.

9. Adjust the screen (See pages 24 and 25)

Make adjustments of the screen display position when necessary.

10. Adjust the image (See page 24)

Make adjustments such as brightness or contrast when required.

11. Recommended Adjustments

To reduce the risk of the “Image Persistence”, please adjust the following items based on the application being used: “SCREEN SAVER”, “SIDE BORDER COLOR” (See page 27) “DATE & TIME”, “SCHEDULE SETTINGS” (See page 25). It is recommended that the “FAN CONTROL” setting (See page 27) be turned to ON also.

*: The product you purchased may not have this feature.

Connections

Before making connections:

- * First turn off the power of all the attached equipment and make connections.
- * Refer to the user manual included with each separate piece of equipment.

Wiring Diagram

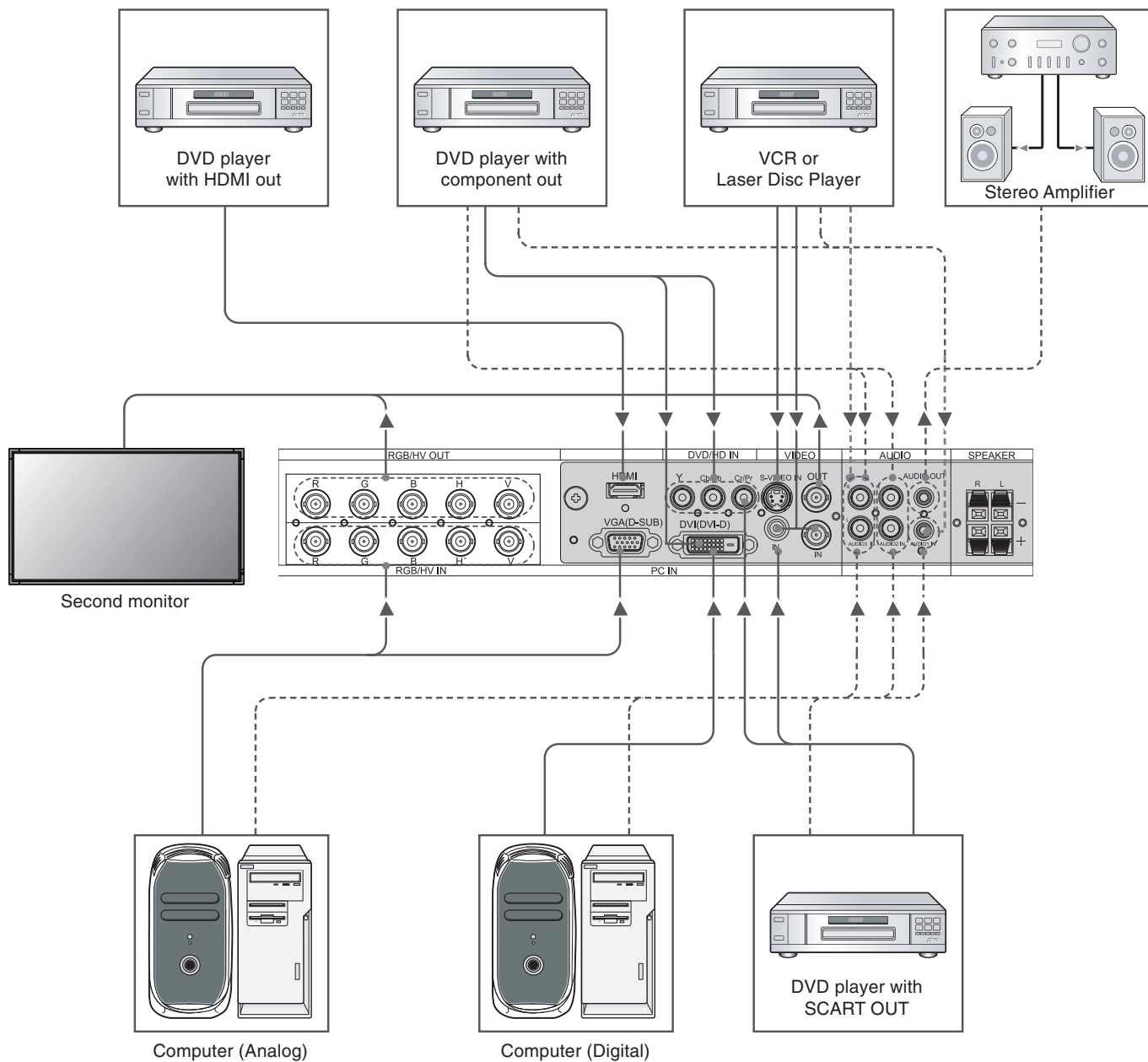

Connecting a Personal Computer

Connecting your computer to your LCD monitor will enable you to display your computer's screen image. Some video cards and a pixel clock over 162MHz may not display an image correctly. Your LCD monitor displays proper image by adjusting the factory preset timing signal automatically.

<Factory preset signal timing>

Resolution	Scanning frequency		Remarks	
	Horizontal	Vertical	LCD4020/LCD4620	LCD5220
640 x 480	31.5kHz	60Hz		
800 x 600	37.9kHz	60Hz		
1024 x 768	48.4kHz	60Hz		
1280 x 768	48kHz	60Hz		
1360 x 768	48kHz	60Hz	Recommended resolution	
1280 x 1024	64kHz	60Hz	Compressed image	
1600 x 1200	75kHz	60Hz	Compressed image	Compressed image
1920 x 1080	66.6kHz	60Hz	Compressed image	Recommended resolution

Connect the LCD Monitor to a Personal Computer

- To connect the VGA IN connector (mini D-sub 15 pin) on the LCD monitor, use the supplied PC - Video RGB signal cable (mini D-sub 15 pin to mini D-sub 15 pin).
- To connect the RGB/HV connector (BNC) on the LCD monitor, use a mini D-sub 15 pin to BNC x 5 signal cable (sold separately). Select RGB/HV from the INPUT button.
- When connecting one or more LCD monitors, use the RGB OUT connector (BNC) (BNC INPUT only).
- AUDIO IN* 1, 2 and 3 can be used for audio input. To select audio source [IN1], [IN2] or [IN3] press the AUDIO INPUT button.

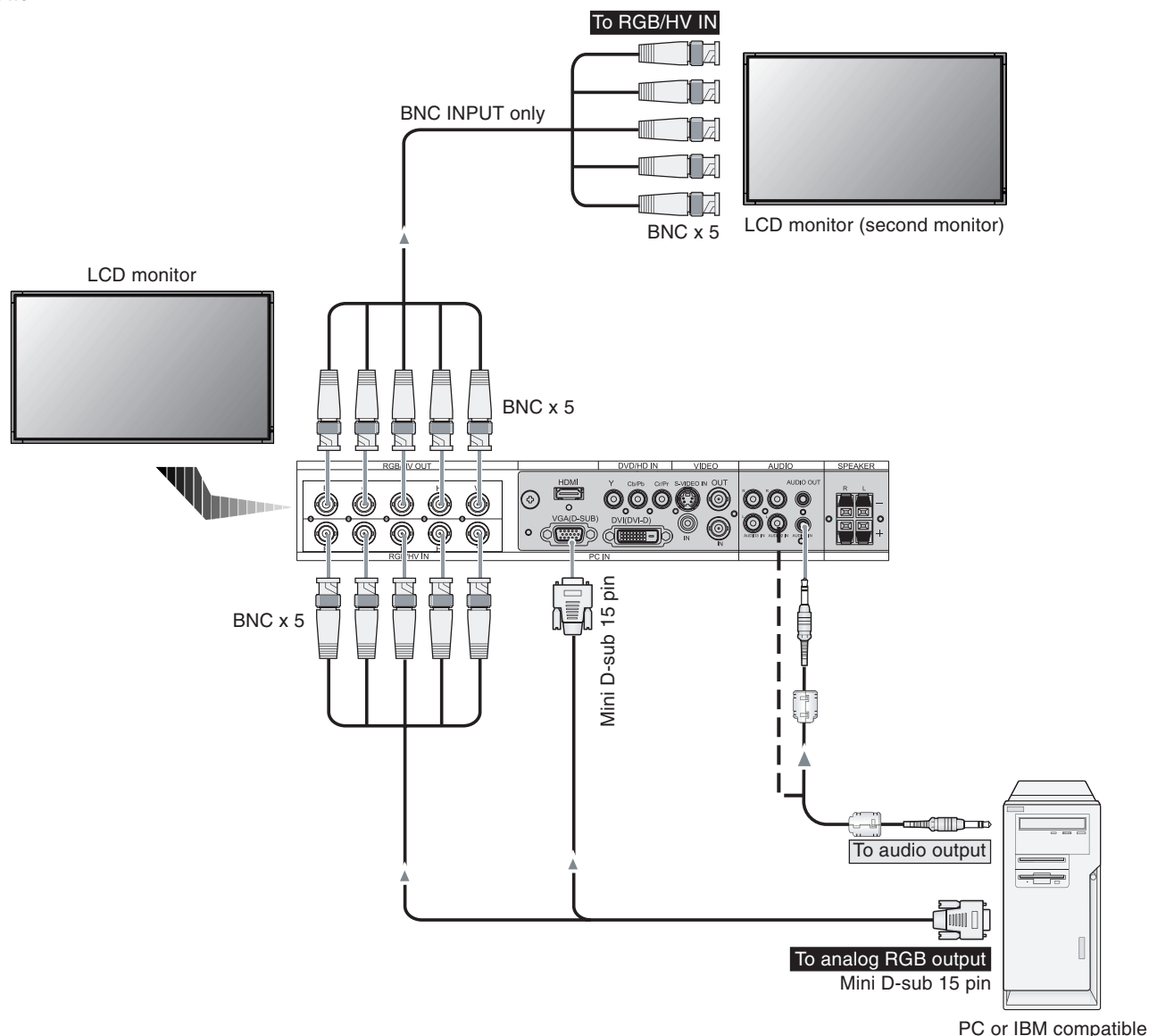

*: The product you purchased may not have this feature.

Connecting to a Macintosh Computer

Connecting your Macintosh computer to your LCD monitor will enable you to display your computer's screen image. Some video cards or drivers may not display images correctly.

Connect the LCD Monitor to Macintosh

- To connect the VGA IN connector (mini D-sub 15 pin) on the LCD monitor, use the supplied PC - Video RGB signal cable (mini D-sub 15 pin to mini D-sub 15 pin).
- To connect the RGB/HV IN connector (BNC) on the LCD monitor, use a mini D-sub 15 pin to BNC x 5 signal cable (sold separately) (BNC INPUT only).
- If you use with a Macintosh PowerBook, set "Mirroring" to Off.

Refer to your Macintosh's owner's manual for more information about your computer's video output requirements and any special identification or configuring your monitor's image and monitor may require.

- AUDIO IN* 1, 2 and 3 can be used for audio input. To select audio source [IN1], [IN2] or [IN3] press the AUDIO INPUT button.

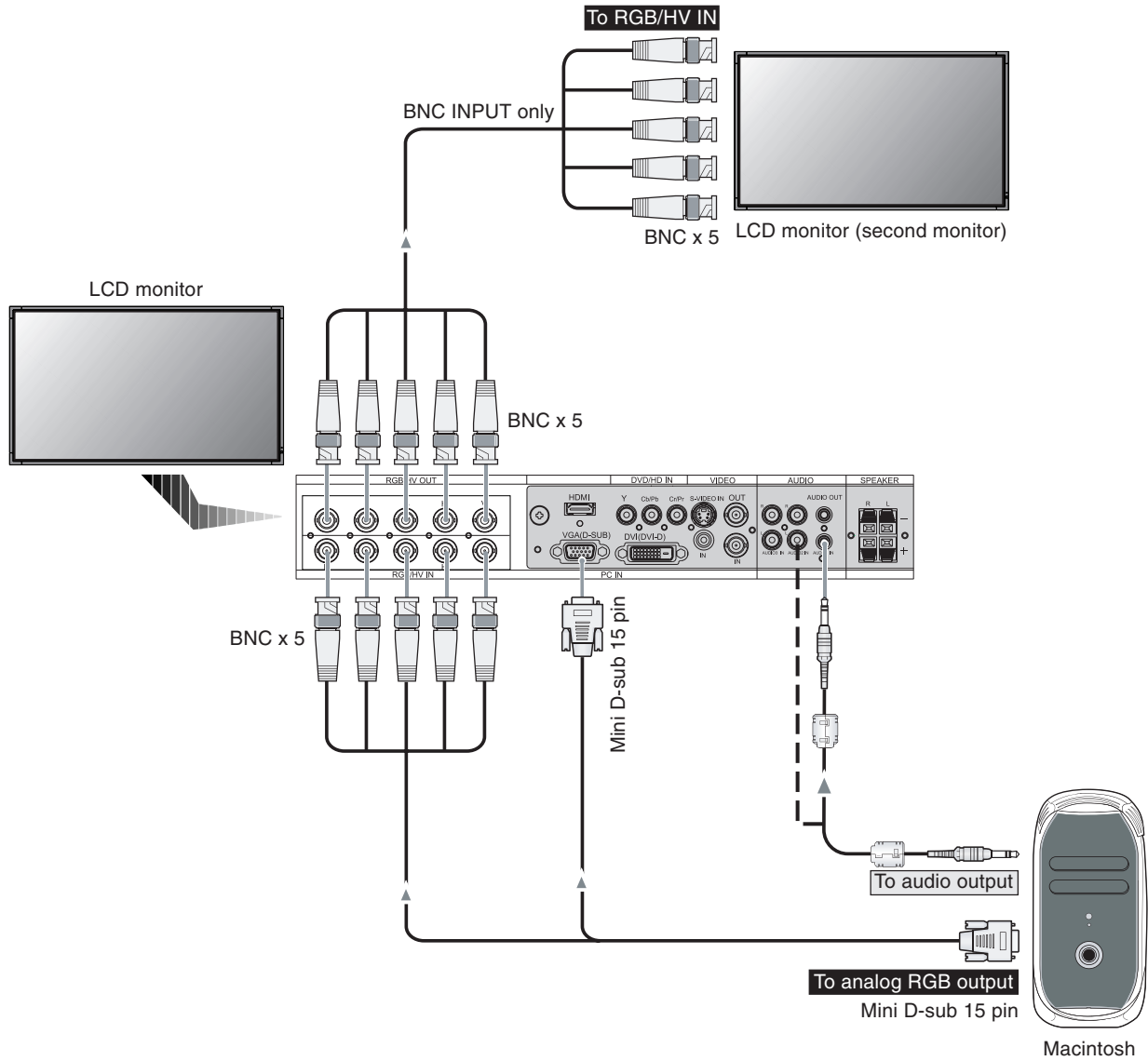

*: The product you purchased may not have this feature.

Connecting with Digital Interface Equipment

Connections can be made with equipment that is equipped with a digital interface that complies with the DVI (Digital Visual Interface) standard.

Connect the LCD Monitor to a Computer with a Digital Output

- The DVI IN connector also accepts a DVI-D cable.
- Input TMDS signals conforming to DVI standards.
- To maintain display quality, use a cable that conforms to DVI standards.
- AUDIO IN* 1, 2 and 3 can be used for audio input. To select audio source [IN1], [IN2] or [IN3] press the AUDIO INPUT button.
- For mode selection, see “DVI MODE” on page 28.

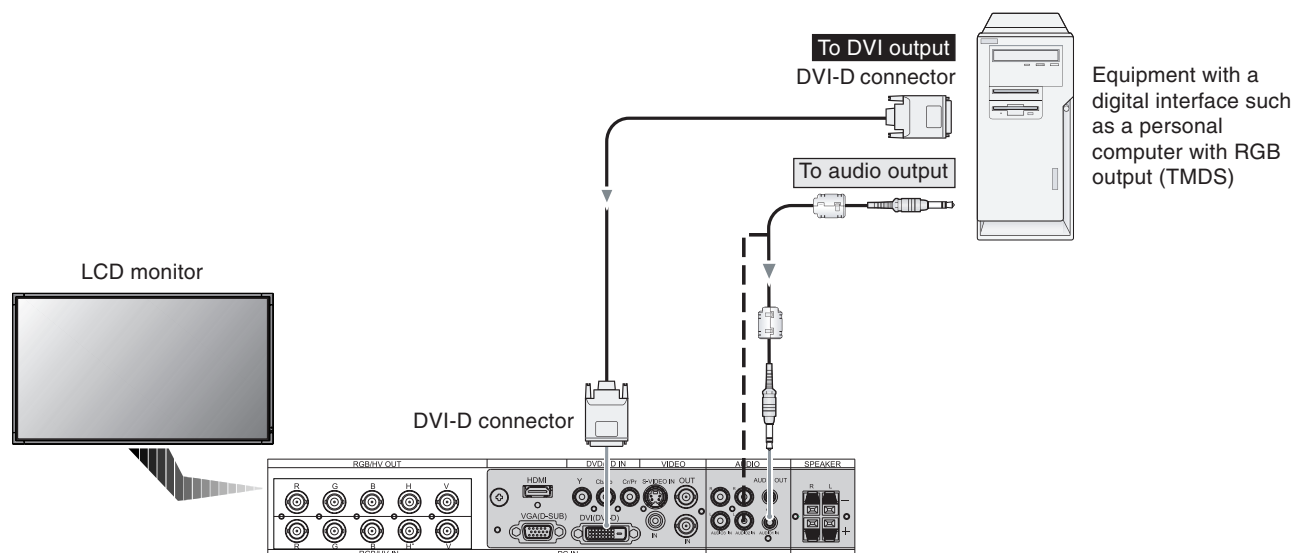

*: The product you purchased may not have this feature.

Connecting a DVD Player with component out*

Connecting your DVD player to your LCD monitor will enable you to display DVD video.

Refer to your DVD player user's manual for more information.

Connect the LCD Monitor to a DVD Player

- To connect the DVD/HD IN connector (RCA) on the LCD monitor, use an RCA connector cable (sold separately). Some DVD players may have different connectors such as DVI-D connector. Select [DVI/HD] mode from the "DVI MODE" menu. For mode selection, see "DVI MODE" on page 28. AUDIO IN* 1, 2 and 3 can be used for audio input. To select audio source [IN1], [IN2] or [IN3] press the AUDIO INPUT button.

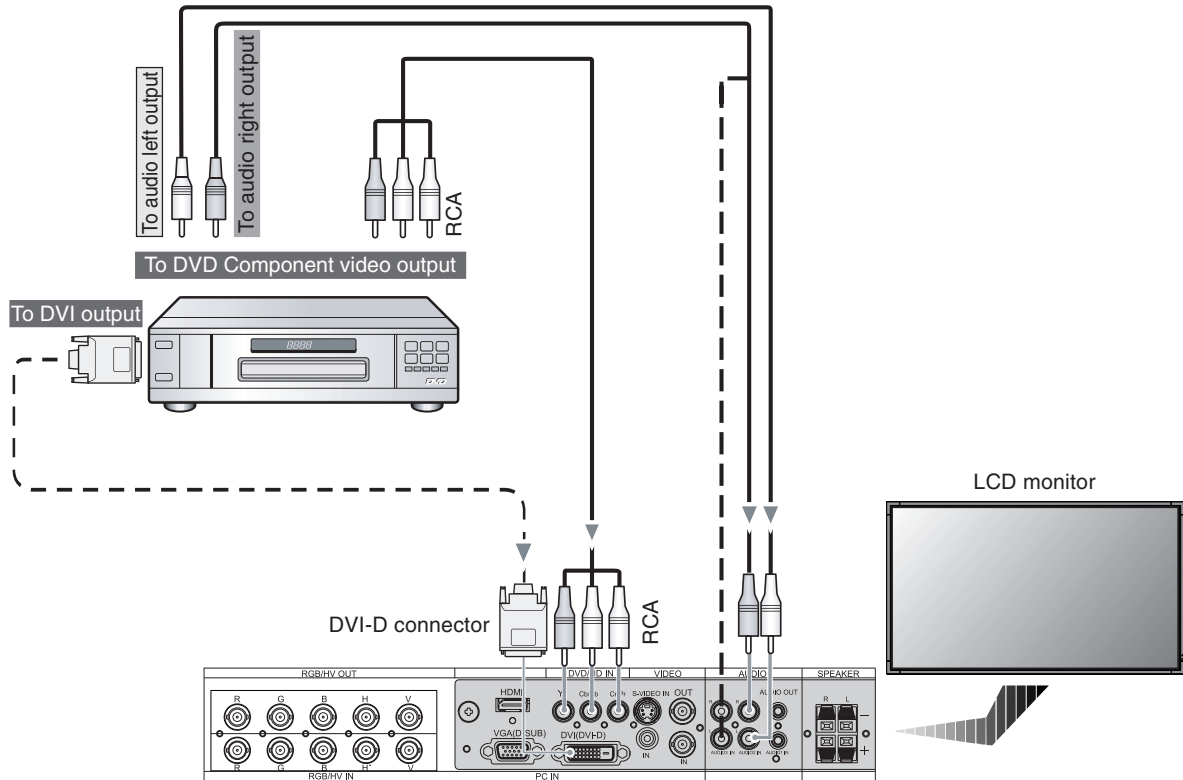

*: The product you purchased may not have this feature.

Connecting a DVD Player with HDMI out*

Connecting your DVD player to your LCD monitor will enable you to display DVD video.

Refer to your DVD player user's manual for more information.

Select [HDMI] from the AUDIO INPUT button.

Connect the LCD Monitor to a DVD Player

- Please use an HDMI cable with HDMI logo.
- It may take a moment for the signal to appear.
- PC-DVI signals are not supported.

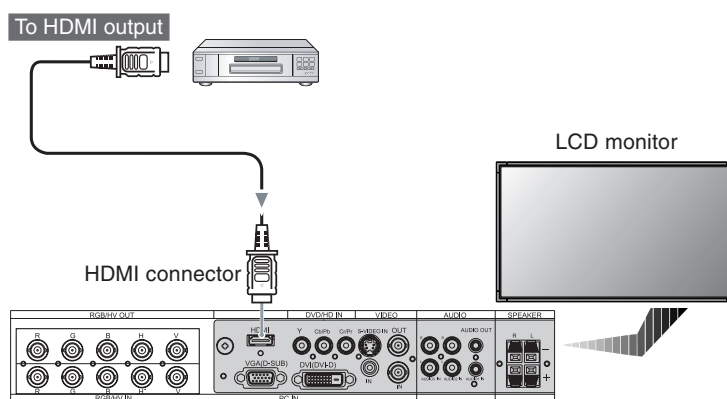

Connecting a DVD Player with SCART out*

Connecting your DVD player to your LCD monitor will enable you to display SCART.

Connect the LCD Monitor to a DVD Player

- To connect the DVD/HD IN connector (RCA) on the LCD monitor and connect the video (sync) and the Video In connector (RCA), use an RCA connector cable (sold separately).

Some DVD players may have different connectors such as DVI-D connector.

Select [ON] mode from the "SCART MODE" menu when you use a SCART connector. For mode selection, see "SCART MODE" on page 28.

The AUDIO IN* 1, 2 and 3 can be used for audio input. To select audio source [IN1], [IN2] or [IN3] press the AUDIO INPUT button.

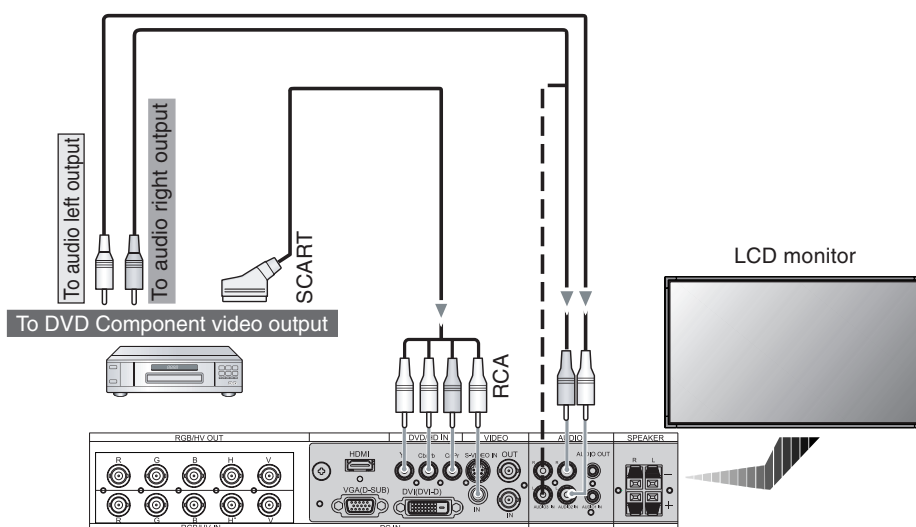

*: The product you purchased may not have this feature.

Connecting to a Stereo Amplifier*

You can connect your stereo amplifier to your LCD monitor. Refer to your amplifier owner's manual for more information.

Connect the LCD Monitor to a Stereo Amplifier

- Turn on the LCD monitor and the amplifier only after all connections have been made.
- Use a stereo Mini-RCA cable to connect the AUDIO OUT* connector (Stereo Mini Jack) on the LCD monitor to the audio input on the amplifier.
- Do not reverse the audio left and right jacks.
- The AUDIO IN* is used for audio input.
- The AUDIO OUT* jack outputs sound from the selected Audio input.

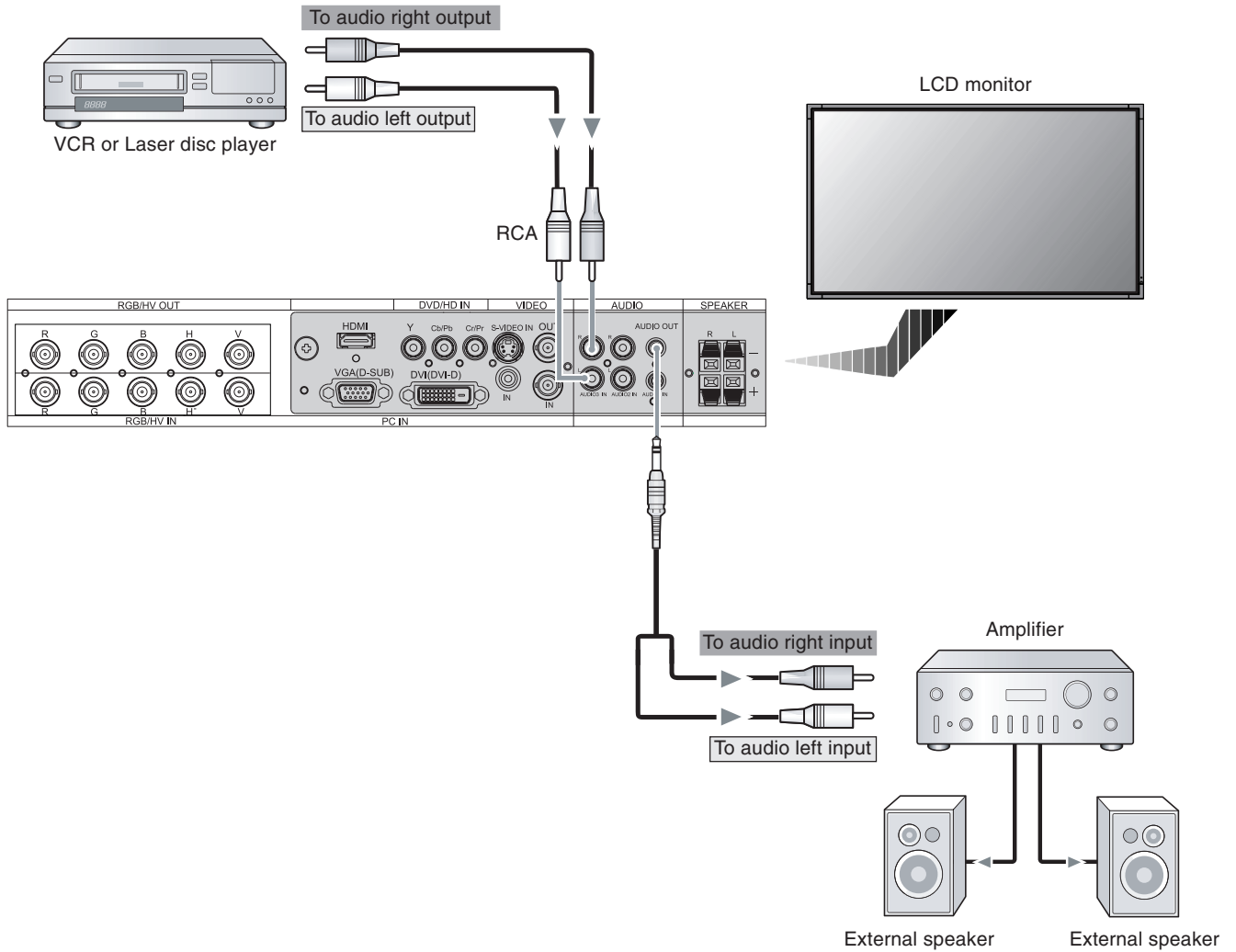

*: The product you purchased may not have this feature.

Basic Operation

Power ON and OFF Modes

The LCD monitor power indicator will turn green while powered on and will turn red or amber while powered off.

NOTE: The Main Power Switch must be in the ON position in order to power up the monitor using the remote control or the Power Button on the front of the LCD.

LCD4020/LCD4620

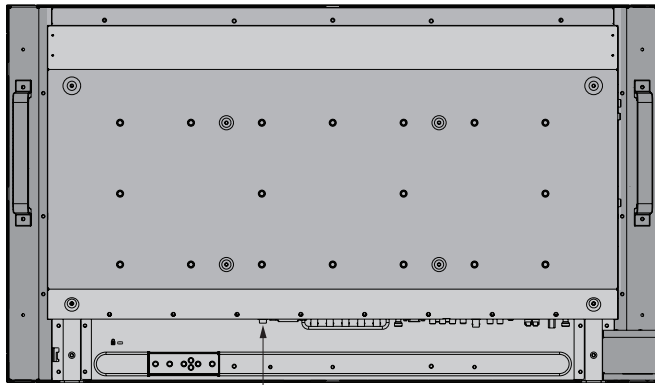

LCD5220

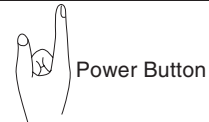
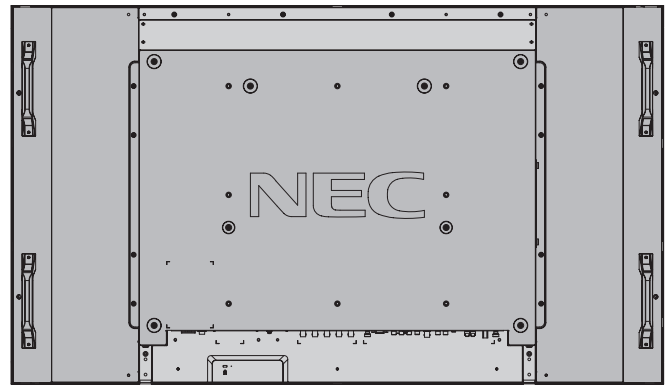
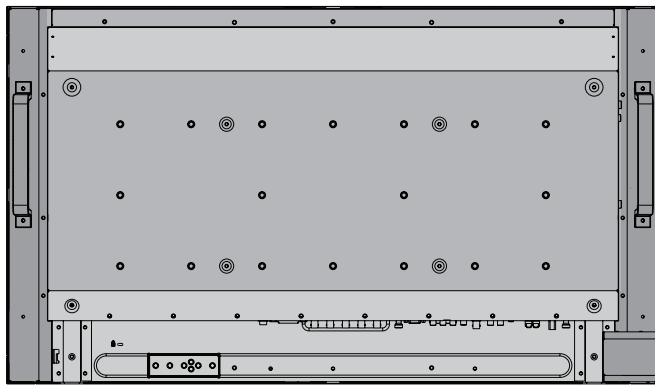
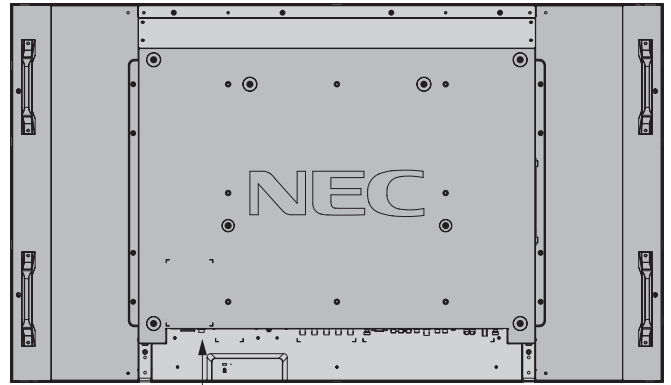

Using the remote control

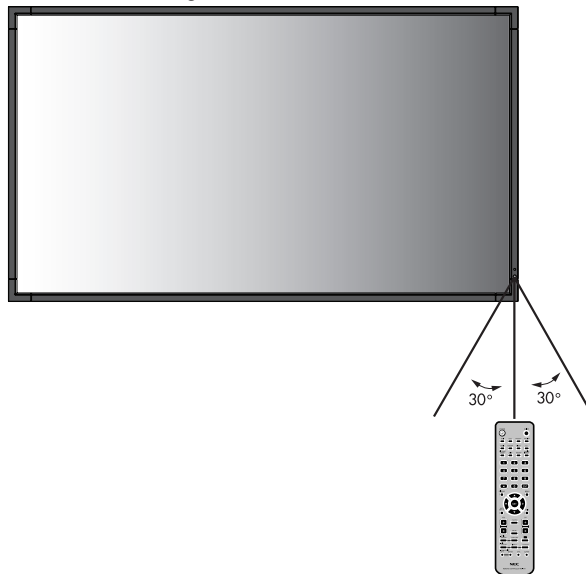

Power Indicator*

Mode	Status Indicator Light
Power ON	Green*2
Power OFF (Eco Standby)*1 Power consumption under 1W	Red
Power OFF (Standby) Power consumption under 5W	Amber
Power Save	Amber Blinking
Power Standby when "SCHEDULE SETTINGS" enabled	Green and Amber blink alternately
Diagnosis (Detecting failure)	Red Blinking (See Troubleshooting page 38)

*1 When in Eco Standby Mode RS-232C controls do not function.
*2 If "OFF" is selected in POWER INDICATOR (page 27), the LED will not light when the LCD monitor is in active mode.

Using Power Management

The LCD monitor follows the VESA approved DPM Power Management function.

The power management function is an energy saving function that automatically reduces the power consumption of the display when the keyboard or the mouse has not been used for a fixed period.

The power management feature on your new display has been set to the "ON" mode. This allows your display to enter a Power Saving Mode when no signal is applied. This could potentially increase the life and decrease the power consumption of the display.

STANDBY mode is used when the display is connected to an RS-232C cable or when using the INPUT DETECT function.

ECO STANDBY uses less power, but the RS-232C and INPUT DETECT functions are not available.

Selecting a video source*

To view a video source:

Use the input button to set [VIDEO].

Use the COLOR SYSTEM menu to set [AUTO], [NTSC], [PAL], [SECAM], [PAL60], [4.43NTSC], according to your video format.

Picture Size

DVI,VGA, RGB/HV FULL → ZOOM → NORMAL
HDMI*, DVD/HD*, VIDEO*, TV* FULL → WIDE* → ZOOM → NORMAL

Aspect ratio of image	Unchanged view*1	Recommended selection for picture size*1
4:3		NORMAL
		ZOOM (DYNAMIC)
Squeeze		FULL
Letterbox		WIDE*

*1 Grey areas indicate unused portions of the screen.

NORMAL: Displays the aspect ratio the same as it is sent from the source.

FULL: Fills entire screen.

WIDE*: Expands a 16:9 letter box signal to fill entire screen.

ZOOM (DYNAMIC): Expands a 4:3 pictures to fill the entire screen with non-linearity. Some of the outside image area will be cut off due to expansion.

ZOOM

The image can be expanded beyond the active display area. The image which is outside of active display area is not shown.

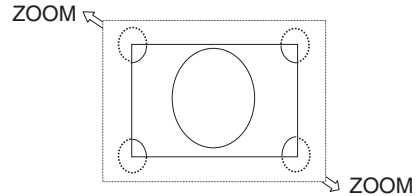

Picture Mode

DVI,VGA, RGB/HV STANDARD → sRGB → HIGHBRIGHT
HDMI*, DVD/HD*, VIDEO*, TV* STANDARD → CINEMA* → HIGHBRIGHT

Information OSD

The Information OSD provides information such as: Monitor ID, Input Source, Picture Size, etc. Press the DISPLAY button on the remote to bring up the Information OSD.



- 1 ID number assigned to current monitor*3
- 2 ID number assigned monitor to be controlled via RS-232C*4
- 3 Input Source
- 4 Audio input mode
- 5 Picture size
- 6 Input Signal Information
- 7 Sub picture information

*3: "IR CONTROL" should be set "Primary" or "Secondary".

*4: "IR CONTROL" should be set "Primary".

*: The product you purchased may not have this feature.

OSD (On-Screen-Display) Controls

NOTE: Some functions may not be available depending on the model or optional equipment.

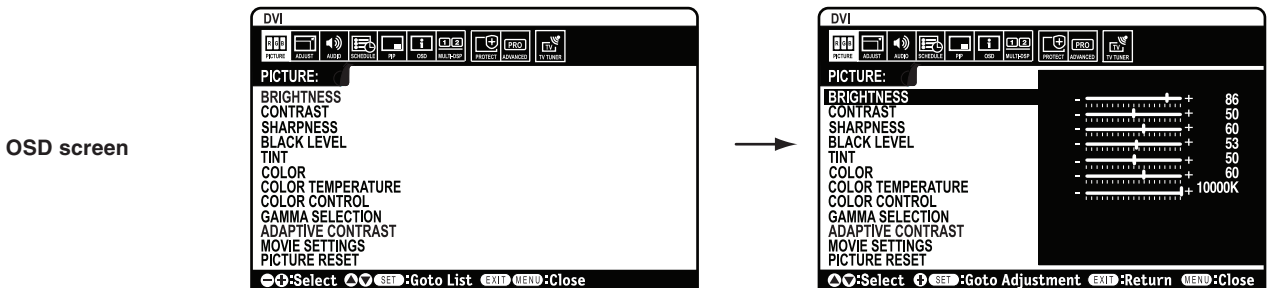
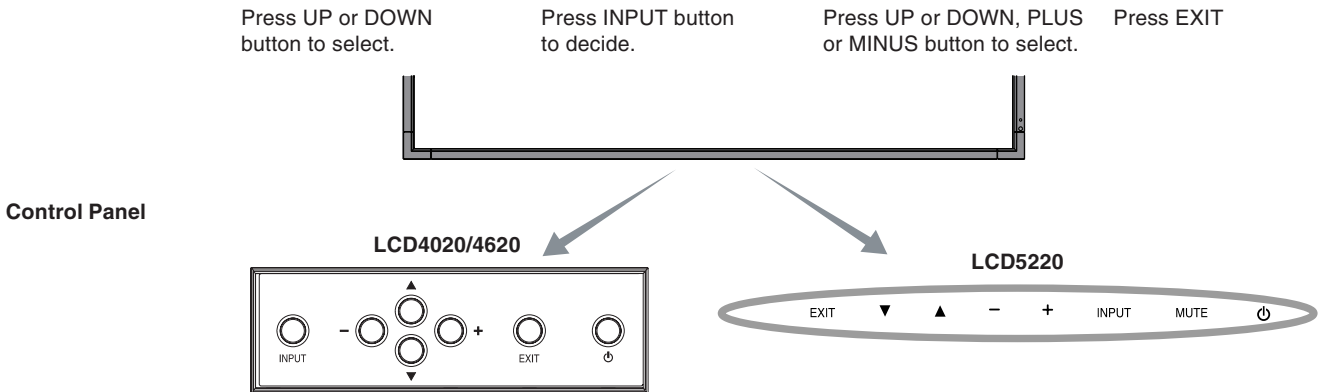
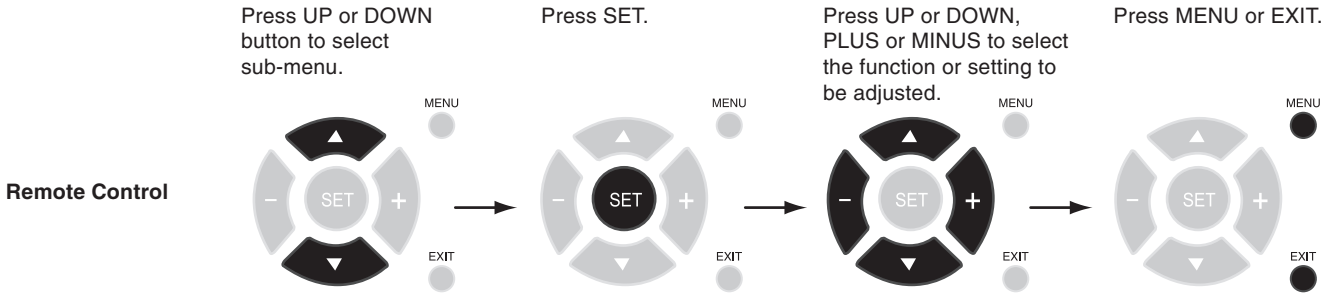
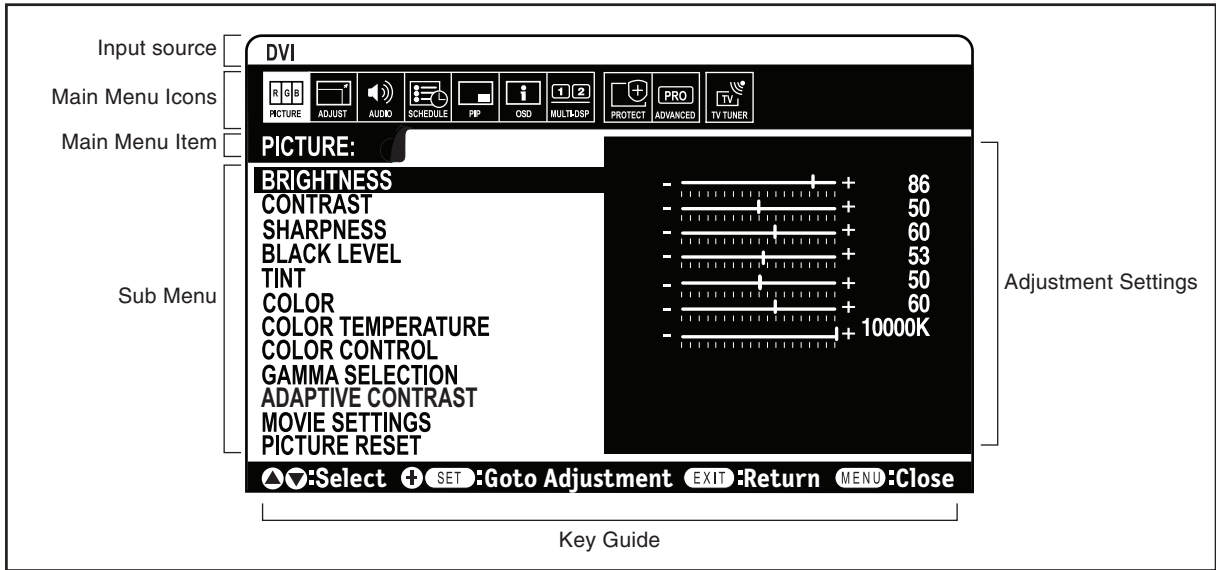

Setting		Default
PICTURE		
BRIGHTNESS	Adjusts the overall image and background brightness. Press + or - to adjust.	*1
CONTRAST	Adjusts the image brightness in relationship to the background. Press + or - to adjust. Note: The sRGB picture mode is standard and cannot be changed.	*2
SHARPNESS	Adjusts the crispness of the image. Press + or - to adjust.	*3
BLACK LEVEL	Adjusts the image brightness in relationship to the background. Press + or - to adjust. Note: The sRGB picture mode is standard and cannot be changed.	*4
TINT* <small>HDMI, DVD/HD, VIDEO, TV inputs only</small>	Adjusts the tint of the screen. Press + or - to adjust.	*5
COLOR* <small>HDMI, DVD/HD, VIDEO, TV inputs only</small>	Adjusts the color depth of the screen. Press + or - to adjust.	*6
COLOR TEMPERATURE	Adjusts the color temperature of the entire screen. A low color temperature will make the screen reddish. A high color temperature will make the screen bluish. Note: The sRGB picture mode is set to a predefined 6500 K standard and cannot be changed.	*7
COLOR CONTROL <small>DVI, VGA, RGB/HV, HDMI inputs only</small>	Adjusts the levels of the Red, Yellow, Green, Cyan, Blue, Magenta and Saturation. Note: The sRGB picture mode is standard and cannot be changed.	*8
GAMMA SELECTION	Select a display gamma for best picture quality. Note: The sRGB picture mode is standard and cannot be changed.	*9
NATIVE	Gamma correction is handled by the LCD panel.	
2.2	Typical display gamma for use with a PC.	
2.4	Good for video (TV, DVD, etc.)	
S GAMMA	Special gamma for certain types of movies. Raises the dark parts and lowers the light parts of the image. (S-Curve)	
DICOM SIM.	DICOM GSDF curve simulated for LCD type.	
PROGRAMMABLE	A programmable gamma curve can be loaded using NEC software.	
ADAPTIVE CONTRAST* <small>HDMI, DVD/HD, VIDEO, TV inputs only</small>	Sets the level of adjustment for dynamic contrast.	*10
OFF		
MID		
HIGH		
MOVIE SETTINGS*		
NOISE REDUCTION <small>TV, VIDEO inputs only</small>	Adjusts the amount of noise reduction. Press + or - to adjust.	6
FILM MODE <small>HDMI, DVD/HD, VIDEO, TV inputs only</small>	Selects Film mode.	AUTO
PICTURE RESET	Resets the following settings within the PICTURE menu back to factory setting: BRIGHTNESS, CONTRAST, SHARPNESS, BLACK LEVEL, TINT, COLOR, COLOR TEMPERATURE, COLOR CONTROL, GAMMA SELECTION, ADAPTIVE CONTRAST, MOVIE SETTINGS.	-
ADJUST		
AUTO SETUP <small>VGA, RGB/HV inputs only</small>	Automatically adjusts Screen Size, H position, V position, Clock, Clock Phase, White Level, and Black Level.	-
AUTO ADJUST <small>VGA, RGB/HV inputs only</small>	H Position, V Position and Clock Phase are adjusted automatically upon power on.	OFF
H POSITION	Controls the horizontal position of the image within the Display area of the LCD. Press + to move right. Press - to move left.	-
V POSITION	Controls the vertical position of the image within the Display area of the LCD. Press + to move up. Press - to move down.	-
CLOCK <small>VGA, RGB/HV inputs only</small>	Press + to expand the width of the image on the right of the screen. Press - to narrow the width of the image on the left.	-

*: The product you purchased may not have this feature.

CLOCK PHASE VGA, RGB/HV, DVD/HD inputs only	Adjusts the visual “noise” on the image.	-
H RESOLUTION DVI, VGA, RGB/HV inputs only	Adjusts the horizontal size of the image.	-
V RESOLUTION DVI, VGA, RGB/HV inputs only	Adjusts the vertical size of the image.	-
ZOOM MODE Does not work with TV input in the U.S.	Select the aspect ratio of the screen image.	-
BASE ZOOM		CUSTOM
16:9 HDMI, DVD/HD, VIDEO, TV for Europe inputs only	For input sources that have a 16:9 aspect ratio.	
14:9 HDMI, DVD/HD, VIDEO, TV for Europe inputs only	For input sources that have a 14:9 aspect ratio.	
DYNAMIC HDMI, DVD/HD, VIDEO, TV for Europe inputs only	Expands 4:3 picture to fill the screen. Some of the image is lost due to expansion.	
OFF	Selecting “OFF” will display the image in a 1 by 1 pixel format. (If the input resolution is higher than a 1360 x 768 resolution, the image will be scaled down to fit the screen.)	
CUSTOM	Displays an image as large as possible without changing the aspect ration.	
ZOOM**	Maintains the aspect ratio while zooming.	1.00
H ZOOM**	Amount of horizontal zoom. Can be adjusted for each BASE ZOOM setting.	1.00
V ZOOM**	Amount of vertical zoom. Can be adjusted for each BASE ZOOM setting.	1.00
H POS**	Horizontal position. Can be adjusted for each BASE ZOOM setting.	0%
V POS**	Vertical position. Can be adjusted for each BASE ZOOM setting.	0%
INPUT RESOLUTION VGA, RGB/HV inputs only	If there is a problem with signal detection, this function forces the monitor to display the signal at the desired resolution. After selection, execute “AUTO SETUP” if required. If no problem is detected, the only available option will be “AUTO”.	AUTO
ADJUST RESET	Resets the following settings within the ADJUST menu back to factory setting: AUTO ADJUST, H POSITION, V POSITION, CLOCK, CLOCK PHASE, H RESOLUTION, V RESOLUTION, ZOOM MODE, INPUT RESOLUTION.	-
AUDIO*		
BALANCE		CENTER
TREBLE		0
BASS		0
PIP AUDIO	Selects source of PIP audio.	MAIN AUDIO
LINE OUT	Selecting “VARIABLE” will enable to control line out level with VOLUME button.	FIXED
AUDIO RESET	Resets “AUDIO” options back to factory settings.	-
SCHEDULE		
OFF TIMER	Sets the monitor to power off after a length of time. A time between 1 to 24 hours is available.	OFF
SCHEDULE SETTINGS	Creates a working schedule for the monitor to use.	-
SCHEDULE LIST	List of schedules.	-
DATE & TIME	Sets the date, time, and daylight saving region. Date & time must be set in order for the “SCHEDULE” function to operate.	-
YEAR		-
MONTH		-
DAY		-
TIME		-
DAYLIGHT SAVING		OFF
SCHEDULE RESET	Resets the following settings within the SCHEDULE menu back to factory setting: OFF TIMER, SCHEDULE SETTINGS.	-

*: The product you purchased may not have this feature.

**: 16:9, 14:9, CUSTOM only

PIP		
KEEP PIP MODE*	Allows the monitor to remain in "PIP" and "TEXT TICKER" mode after powering off. When Power is returned, PIP and TEXT TICKER appear without having to enter the OSD.	OFF
PIP MODE*	Picture-in-Picture	OFF
OFF		
PIP		
POP		
SIDE BY SIDE (ASPECT)		
SIDE BY SIDE (FULL)		
PIP SIZE	Selects the size of the sub-picture used in Picture-in-Picture (PIP) mode.	LARGE
SMALL		
MIDDLE		
LARGE		
PIP POSITION	Determines where the PIP appears on the screen.	X = 95, Y = 92
TEXT TICKER*	Allow text insertion within main screen. The TEXT TICKER and PIP functions cannot be used simultaneously. If the PIP function is on, it will be deactivated and vice versa if the TEXT TICKER is turned on.	OFF
PIP RESET	Resets PIP options back to factory settings.	-
OSD		
LANGUAGE	Select the language used by the OSD.	ENGLISH
ENGLISH		
DEUTSCH		
FRANÇAIS		
ITALIANO		
ESPAÑOL		
SVENSKA		
РУССКИЙ		
日本語		
OSD TURN OFF	Turns off the OSD after a period of inactivity. The preset choices are 10-240 seconds.	30 Sec.
OSD POSITION	Determines the location where the OSD appears on the screen.	X = 128, Y = 225
UP		
DOWN		
LEFT		
RIGHT		
INFORMATION OSD	Selects whether the information OSD is displayed or not. The information OSD will be displayed when the input signal or source changes. The information OSD will also give a warning when there is no-signal or the signal is out-of range. An interval between 3 to 10 seconds for the Information OSD to appear is available.	ON, 3 Sec.
MONITOR INFORMATION	Monitor Information.	-
OSD TRANSPARENCY	Set the transparency level of the OSD.	TYPE2
OFF		
TYPE1		
TYPE2		
OSD RESET	Resets the following settings within the OSD menu back to factory setting: OSD TURN OFF, OSD POSITION, INFORMATION OSD, OSD TRANSPARENCY.	-

*: The product you purchased may not have this feature.

MULTI DISPLAY		
MONITOR ID	Sets the monitor ID number from 1-26.	1
IR CONTROL	Selects the mode of the monitor for use with the infra-red remote control when using the RS-232C daisy chain.	NORMAL
	NORMAL	The monitor will be controlled normally by wireless remote controller.
	PRIMARY	Choose "PRIMARY" for the first monitor within an RS-232C daisy chain.
	SECONDARY	Choose "SECONDARY" for all subsequent monitors within an RS-232C daisy chain.
	LOCK	Prevents the monitor from being controlled by wireless remote controller. To return to normal operation, press the "DISPLAY" button on the remote controller for 5 seconds.
TILE MATRIX	Allows one image to be expanded and displayed over multiple screens (up to 25) through a distribution amplifier.	
	H MONITORS	Number of monitors arranged horizontally.
	V MONITORS	Number of monitors arranged vertically.
	POSITION	Select which section of the tiled image to be displayed on the monitor.
	TILE COMP	Turns the TILE COMP feature on.
	ENABLE	Enables Tile Matrix.
POWER ON DELAY	Adjusts the delay time between being in "standby" mode and entering "power on" mode. "POWER ON DELAY" can be set between 0 and 50 seconds.	0 Sec.
POWER INDICATOR	Turns ON or OFF the LED located at the front of the monitor. If "OFF" is selected, LED will not light when the LCD monitor is in active mode.	ON
MULTI DISPLAY RESET	Resets the following settings within the MULTI DISPLAY menu back to factory setting: MONITOR ID, IR CONTROL, TILE MATRIX, POWER ON DELAY.	-
DISPLAY PROTECTION		
POWER SAVE <small>All inputs except for TV</small>	Sets how long the monitor waits to go into power save mode after a lost signal. Note: When connecting DVI, video card might not stop sending digital data even if image has disappeared. In this case the monitor does not get to power management mode.	ON
STANDBY MODE	Lowers power consumption. Note: RS-232C Function is lost when in Eco Standby mode.	STANDBY
HEAT STATUS	Displays status of the COOLING FAN, BRIGHTNESS and TEMPERATURE.	-
FAN CONTROL	Cooling fan reduces the temperature of the display.	AUTO
SCREEN SAVER	Use the SCREEN SAVER function to reduce the risk of Image Persistence.	
	GAMMA	The display gamma is changed and fixed when "ON" is selected.
	BRIGHTNESS	The brightness is decreased when "ON" is selected.
	MOTION	The screen image is slightly expanded and moves in 4 directions (UP, DOWN, RIGHT, LEFT) at user determined intervals.
SIDE BORDER COLOR	Adjusts the color of the side borders when a 4:3 image is displayed. Press + button, the bar will become lighter. Press - button, the bar will become darker.	15
AUTO BRIGHTNESS <small>DVI, VGA, RGB/HV inputs only</small>	Adjusts the brightness level according to the input signal.	OFF
CHANGE SECURITY PASSWORD	Allows the security password to be changed. The factory preset password is 0000.	-
SECURITY LOCK	Locks the security password.	OFF
DDC/CI	ENABLE/DISABLE: Turns On or OFF the two way communication and control of the monitor.	ENABLE
DISPLAY PROTECTION RESET	Resets the following settings within the DISPLAY PROTECTION menu back to factory setting: POWER SAVE, FAN CONTROL, SCREEN SAVER, SIDE BORDER COLOR, AUTO BRIGHTNESS.	-

*: The product you purchased may not have this feature.

ADVANCED OPTION

INPUT DETECT <small>All inputs except for TV</small>		Selects the method of input detection the monitor uses when more than two input devices are connected.	FIRST DETECT
NONE		The Monitor will not search the other video input ports.	
FIRST DETECT		When the current video input signal is not present, then the monitor searches for a video signal from the other video input port. If the video signal is present in the other port, then the monitor switches the video source input port to the new found video source automatically. The monitor will not look for other video signals while the current video source is present.	
LAST DETECT		When the monitor is displaying a signal from the current source and a new secondary source is supplied to the monitor, the monitor will automatically switch to the new video source. When current video input signal is not present, the monitor searches for a video signal from the other video input port. If the video signal is present in the other port, then the monitor switches the video source input port to the new found video source automatically.	
VIDEO DETECT*		DVD/HD or VIDEO inputs will have priority over DVI, VGA, RGB/HV. When DVD/HD or VIDEO input signal is present the monitor will change and keep to the DVD/DH or VIDEO input.	
LONG CABLE ON/OFF <small>VGA, RGB/HV inputs only</small>		Compensates for image degradation caused from using a long cable.	OFF
LONG CABLE MANUAL <small>VGA, RGB/HV inputs only</small>		Manually compensates for image degradation caused from using a long cable.	
RED DELAY		Adjusts the phase of the red signal.	0
GREEN DELAY		Adjusts the phase of the green signal.	0
BLUE DELAY		Adjusts the phase of the blue signal.	0
RED SHARPNESS		Adjusts the performance degradation of the RED signal.	23
GREEN SHARPNESS		Adjusts the performance degradation of the GREEN signal.	23
BLUE SHARPNESS		Adjusts the performance degradation of the BLUE signal.	23
SOG PEAK.		Adjusts the shape of Sync on Green signal.	0
VIDEO EQ. <small>RGB/HV input only</small>		Optimize the shape (Tailing) of RED, GREEN and BLUE signals.	0
SYNC TERMINATE <small>RGB/HV input only</small>		Selects the terminate resistance for matching the cable impedance.	0
DVI MODE		Selects the kind of DVI-D equipment which is connected DVI. Select "DVI-PC" when PC or other computer equipment is connected. Select "DVI-HD" when DVD player, which has DVI-D output, is connected.	DVI-PC
SCAN CONVERSION <small>All inputs except VGA, RGB/HV</small>		Selects the IP (Interlace to Progressive) conversion function. Note: For DVI input "DVI-HD" need to be enabled in the DVI mode menu.	PROGRESSIVE
PROGRESSIVE		Converts interlaced signals to progressive. This is the default setting.	
INTERLACE		Disables IP conversion. This setting is best suited for motion pictures, but increases the risk of image retention.	
SCART MODE*		Input mode for devices using SCART connectors.	OFF
S-VIDEO MODE*		Selects the S-Video input port function.	PRIORITY
PRIORITY		When an S-Video cable is connected to the S-Video input, it will have priority over the composite input port.	
SEPARATE		The S-Video port and Composite port can be selected as independent input ports.	
COLOR SYSTEM* <small>VIDEO input only</small>		The selected Color System depends on the video format of the input signal.	AUTO
AUTO		Automatically chooses Color System setting based on input signal.	
NTSC			
PAL			
SECAM			
4.43NTSC			

*: The product you purchased may not have this feature.

PAL-60		
SCAN MODE* HDMI, DVD/HD, VIDEO, TV inputs only	Some video formats may require different scanning modes in order to best display the image.	OVER SCAN
OVER SCAN	Image size is larger than what can be displayed. The image edge will appear cropped. Approximately 95% of the image will be shown on the screen.	
UNDER SCAN	Image size stays within the display area. The whole image is displayed on the screen.	
ADVANCED OPTION RESET	Resets the following settings within the ADVANCED OPTION menu back to factory setting: INPUT DETECT, LONG CABLE ON/OFF, LONG CABLE MANUAL, DVI MODE, SCAN CONVERSION, S-VIDEO MODE, SCAN MODE.	-
FACTORY RESET	Resets OSD options back to factory settings EXCEPT FOR: CHANGE SECURITY PASSWORD and SECURITY PASSWORD.	-

*: The product you purchased may not have this feature.

PICTURE MODE	INPUT: HDMI, DVD/HD, VIDEO, S-VIDEO			INPUT: DVI, VGA, RGB/HV		
	HIGHBRIGHT	STANDARD	CINEMA	HIGHBRIGHT	STANDARD	sRGB
*1: BRIGHTNESS	100	75 (LCD4020/LCD4620) 70 (LCD5220)	80	100	75 (LCD4020/LCD4620) 70 (LCD5220)	100
*2: CONTRAST	50	50	50	50	50	-
*3: SHARPNESS	50 (DVD/HD, HDMI) 60 (VIDEO,S-VIDEO)	50 (DVD/HD, HDMI) 60 (VIDEO, S-VIDEO)	50 (DVD/HD, HDMI) 60 (VIDEO, S-VIDEO)	50	50	50
*4: BLACK LEVEL	50	50	50	50	50	-
*5: TINT	50	50	50	-	-	-
*6: COLOR	50 (DVD/HD,HDMI) 60 (VIDEO,S-VIDEO)	50 (DVD/HD,HDMI) 60 (VIDEO,S-VIDEO)	50 (DVD/HD,HDMI) 60 (VIDEO,S-VIDEO)	-	-	-
*7: COLOR TEMPERATURE	10000K	10000K	10000K	10000K	10000K	-
*8: COLOR CONTROL	-	-	-	0 (CENTER)	0 (CENTER)	-
*9: GAMMA SELECTION	S-GAMMA	2.4	S-GAMMA	NATIVE	NATIVE	-
*10: ADAPTIVE CONTRAST	MID	OFF	OFF	-	-	-

NOTE: When connecting to a TV tuner (For U.S.), refer to page 30.
When connecting to a TV tuner (For Europe), refer to page 32.

Connecting to a TV* (For U.S.)

Initial TV Setup

Before watching TV for the first time it is necessary to program the channels.

1. Attach the cable or antenna to the coaxial RF Connector on the side of the monitor.

NOTE: Cable distribution system should be grounded (earthed) in accordance with ANSI/NFPA 70, the National Electric Code (NEC), in particular section 820.93, Grounding of Outer Conductive Shield of a Coaxial Cable.

2. Enter the OSD and go to the TUNER menu below.
3. In the TUNING BAND menu select which tuning method (Air, Cable, Cable HRC, Cable IRC) will be used.
4. Enter the CHANNEL SEARCH menu. Press SET to automatically scan and store channels to memory. The channel search will store both analog and digital channels.

NOTE: Analog channels are indicated with a -0 following the channel number. Digital channels are indicated with a - followed by a number. For example, channel 2-0 is analog and channel 2-1 is digital. Analog channels may also have separate digital subchannels associated with them. For example channel 3-0 would be analog followed by channel 3-1, 3-2, etc.

5. Once channels are in memory, use the CHANNEL EDIT menu to add or remove channels. Use the CHANNEL LABELS menu to create unique names for channels, if desired.

Parental Controls (TV, VIDEO input only)

Parents can block certain types of programming based on rating and the content.

To block programming:

1. Enter the PARENTAL CONTROL menu, found under the CONFIGURATION submenu within the TUNER OSD.
2. Enter the password. Default password is 0000. This password can be changed in the PASSWORD SET menu.
3. Highlight the square next to the type of programming you wish to block and press SET on the remote.

NOTE: Blocking one type of programming will automatically block all higher rated programming also. However, it is possible to unlock this programming while keeping the desired programming blocked.

TV TUNER

Not all models have the Digital Tuner installed.

TUNER		
TUNING BAND		Choose AIR or Cable as TV source.
CHECK DTV SIGNAL		Shows the status of the Digital TV signal.
CHANNEL SEARCH		Searches for TV channels and stores them in memory.
ADD ON CHANNEL SEARCH		Searches for TV channels and stores them in memory without erasing previously stored channels.
FINE TUNING		Performs fine adjustments to analog channels.
CHANNEL EDIT		Add or remove channels stored in memory.
CHANNEL LABELS		Add a label to the channel.
CONFIGURATION		
MENU LANGUAGE		
TIME ZONE		
PASSWORD SET		Set the Parental Control Password. Factory default password is 0000.
PARENTAL CONTROL		
PARENTAL CONTROL MENU		Parents can choose to block types of programming based on rating and content.
ADVANCED RATING		Downloadable rating, depending on broadcast. Press SET to change setting.
CLOSED CAPTION OPTIONS		NOTE: Closed captioning settings can not be adjusted for the VIDEO/S-VIDEO inputs. AUTOMATIC is the only option available for these inputs.
RESOLUTION		Set the displayed image to the desired resolution.
AUDIO		
AUDIO LANGUAGE		Choose the language of audio output.
DIGITAL AUDIO OUTPUT		Select the digital audio output source. Choose Dolby D/PCM/OFF.

* The product you purchased may not have this feature.

TV Parental Guide Ratings Chart	
OFF	No Limitation.
TV-Y	All children. The themes and elements in this program are specifically designed for a very young audience, including children from ages 2-6.
TV-Y7	Directed to older children. Themes and elements in this program may include mild physical or comic violence or may frighten children under the age of 7.
TV-G	General audience. It contains little or no violence, no strong language, and little or no suggestive dialogue or situations.
TV-PG	Parental guidance suggested. The program may contain infrequent coarse language, limited violence, some suggestive sexual dialogue and situations.
TV-14	Parents strongly cautioned. This program contains some material that many parents would find unsuitable for children under 14 years of age. This program may contain intense violence (V), intense sexual situations (S), strong coarse language (L), or intensely suggestive dialogue (D).
TV-MA	Mature audiences only. This program may contain mature themes, indecent language, graphic violence and explicit sexual content.
Video Parental Guide Ratings Chart	
OFF	No Limitation
G	General audiences. All ages are permitted to watch.
PG	Parental guidance suggested. Some material may not be suitable for children.
PG-13	Parents strongly cautioned. Some material may be inappropriate for children under 13.
R	Restricted. Under 17 requires an accompanying parent or adult guardian.
NC-17	No one under 17 permitted to watch.
X	Adults only.

Changing the channel

Both Analog and Digital channels are available using this tuner. In addition to the CH+ and CH- buttons channels can be changed in the following method.

Tuning Analog Channels

Input the desired channel number using the keypad, then press [SET] or [ENT] to immediately tune to the new channel. If the number is input and [SET] or [ENT] is not pushed, after a few seconds the channel will be changed. For example to tune to channel 5, press [5] then press [SET] or [ENT].

Tuning Digital Channels

To tune in to a digital sub-channel enter the number of the main channel, then a dash followed by the number of the sub-channel. For example to tune to digital channel 5-1, press [5] then [-] then [1]. Press [SET] or [ENT] to tune.

Connecting to a TV* (For Europe)

Precautions when connecting the antenna

- Use a coaxial cable which is free from interference. Avoid using a parallel flat wire as interference may occur, causing the reception to become unstable and noise to appear on the screen.
- Avoid using an indoor antenna as this may be affected by interference and poor reception.
- Cable distribution system should be grounded (earthed) in accordance with ANSI/NFPA 70, the National Electrical Code (NEC), in particular Section 820.93, Grounding of Outer Conductive Shield of a Coaxial Cable.
- Keep the power cord as far away from the antenna wire as possible.
- Auto Tuning. Please refer to the OSD menu below.

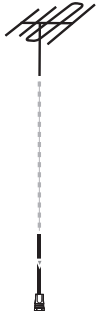

VHF (300-Ohm) antenna / UHF antenna

- When using a 300-ohm twin lead from an outdoor antenna, connect the VHF or UHF antenna leads to the screws of the VHF or UHF adapter. Plug the 300-ohm to 75-ohm adapter into the antenna on the LCD MONITOR.
- When both VHF and UHF antennas are combined: Attach an optional antenna cable signal combiner to the LCD MONITOR antenna terminal, and connect the cables to the antenna mixer. Consult your local electronics retailer about available signal combiners.



Reconnect the unit to the power source and turn on the power

- Using the Remote Control or User Controls, select the “TV TUNER”. Select the appropriate menu based upon which source (cable or antenna) is being used.
- Refer to the OSD menu below for further information on the “TV TUNER” as well as for information on how to use the “CHANNEL SEARCH” function to program available channels.

CAUTION: The screen of the coaxial cable is intended to be connected to earth in the building installation.

TV TUNER

REGION	Selects region.
CHANNEL SEARCH	Automatically stores available channels.
CHANNEL EDIT	Manually adds or removes channels from TV mode.

TELETEXT SELECT

Press the button between TV (VIDEO) picture, TELETEXT or MIXED.

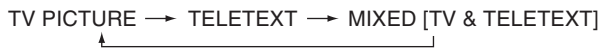

PAGE SELECTION

Use the KEYPAD buttons 0 to 9 to select the required page (3 digit number).

PAGE UP/DOWN

Press the CH +/- buttons to increase or decrease the page number selected.

HOLD

Some TELETEXT information is contained in more than one page. The pages automatically changing after a given reading time. Press the STILL ON/OFF button to stop the page changing (the symbol will appear on the page heading). Press the STILL ON/OFF button again to allow the page to change (the symbol will disappear).

REVEAL

Some TELETEXT pages contain quiz or game questions with hidden answers. Press the STILL CAPTURE button to see the answers. Press the STILL CAPTURE button again to hide the answers.

* The product you purchased may not have this feature.

CANCEL

1. Periodically revised NEWS FLASHES can be obtained from TELETEXT broadcasts. Select the News Flash page in TELETEXT mode then press the PIP ON/OFF button. You can now watch the TV program and every time the news flash page is updated it will be automatically displayed in the TV picture. Press the PIP ON/OFF button to cause the news flash to disappear.
2. When a page is selected in TELETEXT mode it may take some time before it becomes available, pressing the PIP ON/OFF button will switch to the TV mode. When the required page is found the page number will appear at the top of the TV picture, press the PIP ON/OFF button to return to the selected TELETEXT page.
Note: You cannot change TV program while in this mode.

FAST TEXT (For possible future reference)

The “PICTURE MODE”, “SIZE”, “SOUND” and “AUDIO INPUT” buttons are used for quick access to color coded pages transmitted by FAST TEXT broadcast.

RED: PICTURE MODE

GREEN: SIZE

YELLOW: SOUND

CYAN: AUDIO INPUT

INDEX

Press the GUIDE button to select the INDEX page.

NOTE 1: CREATING A SCHEDULE

The schedule function allows the display to be set to power on and off at different times. Up to seven different schedules can be programmed.

To program the schedule:

1. Enter the SCHEDULE menu. Highlight SCHEDULE SETTINGS using the up and down buttons. Press the SET or the + button to enter the Settings menu. Highlight the desired schedule number and press set. The box next to the number will turn yellow. The schedule can now be programmed.
2. Use the up and down arrows to highlight INPUT. Use the + and - buttons to choose the input source.
3. After the INPUT source is selected, use the down button to highlight the hours setting in the ON time slot. Use the + and - buttons to set the hour. Use the up and down buttons to highlight the minutes setting. Use the + and - buttons to set the minutes. Set the OFF time in the same manner.
4. Use the down button to select a day on which the schedule will be enabled. Push the set button to enable. If the schedule is to be ran every day, choose EVERY DAY and press the SET button. The circle next to EVERY DAY will turn yellow. If a weekly schedule is desired, choose the days of the week using the up and down buttons and pressing SET to select. Then highlight the EVERY WEEK option and press SET.
5. After a schedule is programmed the remaining schedules can then be set. Press MENU to leave the OSD or press EXIT to go back to the previous menu.

Note: If schedules are overlapping then the schedule with the highest number will have priority over the schedule with the lowest number. For example schedule #7 will have priority over schedule #1.

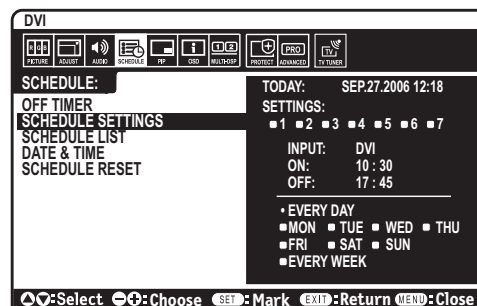

NOTE 2: IMAGE PERSISTENCE

Please be aware that LCD Technology may experience a phenomenon known as Image Persistence. Image Persistence occurs when a residual or “ghost” image of a previous image remains visible on the screen. Unlike CRT monitors, LCD monitors’ image persistence is not permanent, but constant images being displayed for a long period of time should be avoided.

To alleviate image persistence, turn off the monitor for as long as the previous image was displayed. For example, if an image was on the monitor for one hour and a residual image remains, the monitor should be turned off for one hour to erase the image.

As with all personal display devices, NEC DISPLAY SOLUTIONS recommends displaying moving images and using a moving screen saver at regular intervals whenever the screen is idle or turning off the monitor when not in use.

Please set “SCREEN SAVER”, “DATE & TIME” and “SCHEDULE SETTINGS” functions to further reduce the risk of Image persistence.

For long life use as Public Display

< Image Sticking of LCD Panel >

When an LCD panel is operated continuously for long hours, a trace of electric charge remains near the electrode inside LCD, and residual or “ghost” image of previous image may be observed. (Image Persistence)

Image Persistence is not permanent, but when fixed image is displayed for long period, ionic impurities inside LCD are accumulated along the displayed image, and may be permanent. (Image Sticking)

< Recommendations >

To prevent Image Sticking, and for longer life usage of LCD, the following are recommended.

1. Fixed image should not be displayed for long period. Change fixed images after short intervals.
2. When not in use, please turn off the monitor by remote control, or use Power Management or use Schedule Functions.
3. Lower environmental temperatures prolong the lifespan of the monitor.
When Protective surface (glass, acrylic) is installed over the LCD surface, the LCD surface is located in an enclosed space, the monitor are stacked, utilize the temperature sensors inside monitor.
To reduce the environmental temperature, use the Cooling Fan, Screen Saver and Low Brightness.
4. Please use “Screen Saver Mode” of monitor.

Remote Control ID Function

REMOTE CONTROL ID

The remote control included with the display can be used to control up to 26 individual MultiSync monitors using what is called the REMOTE CONTROL ID mode. The REMOTE CONTROL ID mode works in conjunction with the Monitor ID, allowing control of up to 26 individual MultiSync monitors. For example: if there are many monitors being used in the same area, a remote control in normal mode would send signals to every monitor at the same time Figure 1. Using the remote in REMOTE CONTROL ID mode will only operate one specific monitor within the group Figure 2.

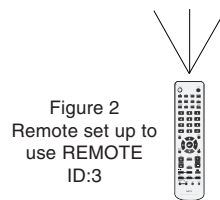
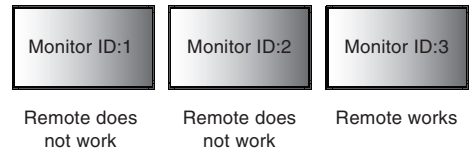
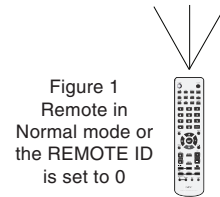
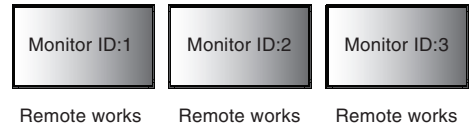

TO SET REMOTE CONTROL ID

While holding down the REMOTE ID SET button on the remote control, use the KEYPAD to input the Monitor ID (1-26) of the display to be controlled via remote. The remote can then be used to operate the monitor having that specific Monitor ID number.

When 0 is selected or when the remote control is in normal mode, all monitors will be operated.

TO SET/RESET REMOTE CONTROL MODE

ID Mode - To enter ID Mode press the REMOTE ID SET button and hold down for 2 seconds.

Normal Mode - To return to Normal Mode press the REMOTE ID RESET button and hold down for 2 seconds.

In order for this feature to work properly, the display must be assigned a Monitor ID number. The Monitor ID number can be assigned under the MULTI DISPLAY menu in the OSD (See page 27).

Point the remote control towards the remote sensor of the desired monitor and press the REMOTE ID SET button. The MONITOR ID number is shown on the display when your remote control is in ID mode.

Use the remote control to operate a monitor that has a specific MONITOR ID number assigned to it.

- Set the MONITOR ID number for the display (See page 27). The MONITOR ID number can range from 1-26. This MONITOR ID number allows the remote control to operate this specific monitor without affecting other monitors.
- On the remote control, press and hold down the REMOTE ID SET button while using the keypad to input the REMOTE CONTROL ID number (1-26). The REMOTE ID NUMBER should match the MONITOR ID number of the display to be controlled. Choose "0" to simultaneously control all displays in range.
- Point the remote control towards the remote sensor of the desired monitor and press the REMOTE ID SET button. The MONITOR ID number is shown in red on the display. If the REMOTE CONTROLID is "0", then all displays in range will show their respective MONITOR ID number in red. If the MONITOR ID number is shown in white on the display, the MONITOR ID number and the REMOTE CONTROL ID are not the same.

This LCD monitor can be controlled via personal computer or wireless remote control using an RS-232C connection.

MONITOR ID and IR CONTROL

Using one PC or one infrared wireless controller, up to 26 individual LCD monitors* can be controlled through a daisy chain via RS-232C connection.

1. Connect PC and LCD monitors*.

Connect a PC's RS-232C control output to the LCD monitor* RS-232C input. You can then connect the RS-232C output from the LCD monitor* to another LCD monitor* RS-232C input. Up to 26 monitors can be connected using RS-232C.

2. Set Monitor ID and IR Control mode.

For proper operation, the Monitor ID should be set in the OSD menu of each monitor that is in the chain. The Monitor ID can be set under the "MULTI DISPLAY" menu in the OSD. The Monitor ID number can be set within a range from 1 to 26. No two monitors should share the same Monitor ID number. It is recommended to number each monitor in a daisy chain sequentially from 1. The first monitor in the daisy chain is designated as the primary monitor. Subsequent monitors with the chain are secondary monitors.

In the "ADVANCED OPTION" menu on the first monitor in the RS-232C daisy chain set the "IR CONTROL" to "PRIMARY".

Set the "IR CONTROL" to "SECONDARY" on all other monitors.

*: MULTEOS M40, MULTEOS M46, MultiSync LCD4020, MultiSync LCD4620, MultiSync LCD5220, MultiSync LCD6520.

3. Press the “DISPLAY” button on the remote control while aiming at the “PRIMARY” monitor. The Information OSD will be shown at top left side of the screen.

Monitor ID: Displays the ID number of the current monitor within the daisy chain.

Target ID: Displays the ID number of the monitor that to be controlled via daisy chain from the current monitor.

Press the “+” or “-” buttons to change the “Target ID” to show the ID number of the monitor to be controlled. To control the entire daisy chained monitors simultaneously, select “ALL” as the “Target ID.”

4. Use the wireless remote controller to control the “SECONDARY” monitor while aiming at the “PRIMARY” monitor.

The “MENU OSD” will appear on the selected target monitor.

NOTE: If the “ID No.” mode select OSD is showing, press the “DISPLAY” button on the remote control while pointing at the “PRIMARY” monitor to clear this OSD.

HINT: If you lost control due to the incorrect setting of “IR CONTROL”, pressing the “DISPLAY” button on the remote control for 5 or more seconds will reset the “IR CONTROL” menu to “NORMAL” function.

Controlling the LCD monitor via RS-232C Remote Control

This LCD monitor can be controlled by connecting a personal computer with a RS-232C terminal.

Functions that can be controlled by a personal computer are:

- Power ON or OFF
- Switching between input signals

Connection

LCD Monitor + PC

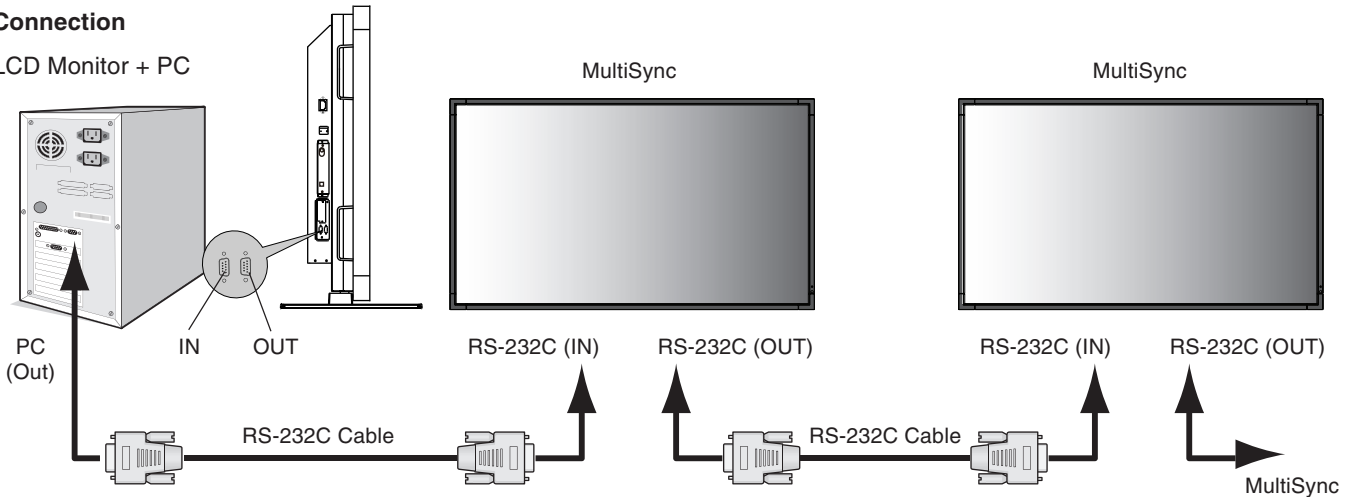

NOTE: If your PC (IBM or IBM compatible) is equipped only with a 25-pin serial port connector, a 25-pin serial port adapter is required. Contact your dealer for details.

* In order to function, the RS-232C OUT terminal can only be connected to another monitor of the same model. Do not connect to other types of equipment.

To control monitor or multiple monitors that are daisy-chained together please use the control command. Instructions for the control command can be found on the CD included with the display. The file is called "External_control.pdf".

1) Interface

PROTOCOL	RS-232C
BAUD RATE	9600 [bps]
DATA LENGTH	8 [bits]
PARITY BIT	NONE
STOP BIT	1 [bit]
FLOW CONTROL	NONE

This LCD monitor uses RXD, TXD and GND lines for RS-232C control.

2) Control command diagram

Please see file "External_Control.pdf" on the CD-ROM.

Features

Reduced Footprint: Provides the ideal solution for environments requiring superior image quality but with size and weight limitations.

Color Control Systems: Allows you to adjust the colors on your screen and customize the color accuracy of your monitor to a variety of standards.

OmniColor: Combines Six-axis color control and the sRGB standard. Six-axis color control permits color adjustments via six axes (R, G, B, C, M and Y) rather than through the three axes (R, G and B) previously available. The sRGB standard provides the monitor with a uniform color profile. This assures that the colors displayed on the monitor are exactly the same as on the color printout (with sRGB supporting operating system and sRGB printer). This allows you to adjust the colors on your screen and customise the color accuracy of your monitor to a variety of standards.

sRGB Color Control: A new optimized color management standard which allows for color matching on computer displays and other peripherals. The sRGB standard, which is based on a calibrated color space, allows for optimal color representation and backward compatibility with other common color standards.

OSD (On-Screen-Display) Controls: Allow you to quickly and easily adjust all elements of your screen image via simple to use on-screen menus.

Plug and Play: The Microsoft® solution with the Windows® operating system facilitates setup and installation by allowing the monitor to send its capabilities (such as screen size and resolutions supported) directly to your computer, automatically optimizing display performance.

IPM (Intelligent Power Manager) System: Provides innovative power-saving methods that allow the monitor to shift to a lower power consumption level when on but not in use, saving two-thirds of your monitor energy costs, reducing emissions and lowering the air conditioning costs of the workplace.

FullScan Capability: Allows you to use the entire screen area in most resolutions, significantly expanding image size.

VESA Standard (FDMLv1) Mounting Interface: Allows users to connect their LCD monitor to any VESA standard (FDMLv1) third party mounting arm or bracket. Allows for the monitor to be mounted on a wall or an arm using any third party compliant device. NEC recommends using mounting interface that comply with TÜV-GS and/or UL1678 standard in North America.

DVI-D: The digital-only subset of DVI ratified by the Digital Display Working Group (DDWG) for digital connections between computers and displays. As a digital-only connector, analog support is not provided for a DVI-D connector. As a DVI-based digital only connection, only a simple adapter is necessary for compatibility between DVI-D and other DVI-based digital connectors such as DFP and P&D. The DVI interface of this display supports HDCP.

TILE MATRIX, TILE COMP: Shows one image over multiple screens with accuracy while compensating for bezel width.

ZOOM: Expands image size for horizontal and vertical direction.

RS-232C daisy chain: You can control the multiple monitors by controller or wireless remote controller.

Self-diagnosis: If an internal error should occur, a failure state will be indicated.

CableComp: Automatic long cable compensation prevents image quality degradation (color shift and dull signals) caused by long cable lengths.

Troubleshooting

No picture

- The signal cable should be completely connected to the display card/computer.
- The display card should be completely seated in its slot.
- Front Power Switch and computer power switch should be in the ON position.
- Check to make sure that a supported mode has been selected on the display card or system being used. (Please consult display card or system manual to change graphics mode.)
- Check the monitor and your display card with respect to compatibility and recommended settings.
- Check the signal cable connector for bent or pushed-in pins.

Power Button does not respond

- Unplug the power cord of the monitor from the AC outlet to turn off and reset the monitor.

Image persistence

- Please be aware that LCD Technology may experience a phenomenon known as Image Persistence. Image Persistence occurs when a residual or “ghost” image of a previous image remains visible on the screen. Unlike CRT monitors, LCD monitors’ image persistence is not permanent, but constant images being displayed for a long period of time should be avoided. To alleviate image persistence, turn off the monitor for as long as the previous image was displayed. For example, if an image was on the monitor for one hour and a residual image remains, the monitor should be turned off for one hour to erase the image.

NOTE: As with all personal display devices, NEC DISPLAY SOLUTIONS recommends displaying moving images and using a moving screen saver at regular intervals whenever the screen is idle or turning off the monitor when not in use.

Image is unstable, unfocused or swimming is apparent

- Signal cable should be completely attached to the computer.
- Use the OSD Image Adjust controls to focus and adjust display by increasing or decreasing the fine adjustment. When the display mode is changed, the OSD Image Adjust settings may need to be re-adjusted.
- Check the monitor and your display card with respect to compatibility and recommended signal timings.
- If your text is garbled, change the video mode to non-interlace and use 60Hz refresh rate.

Image of component signal is greenish

- Check to see if the DVD/HD input connector is selected.

LED on monitor is not lit

(no green or red color can be seen)

- Power Switch should be in the ON position and power cord should be connected.
- Make certain the computer is not in a power-saving mode (touch the keyboard or mouse).

RED LED on monitor is blinking

- A certain failure might have occurred, please contact your nearest authorized NEC DISPLAY SOLUTIONS service facility.

Display image is not sized properly

- Use the OSD Image Adjust controls to increase or decrease the coarse adjustment.
- Check to make sure that a supported mode has been selected on the display card or system being used. (Please consult display card or system manual to change graphics mode.)

Selected resolution is not displayed properly

- Use OSD Display Mode to enter Information menu and confirm that the appropriate resolution has been selected. If not, select corresponding option.

No Sound

- Check to see if speaker cable is properly connected.
- Check to see if mute is activated.
- Check to see if volume is set at minimum.

Remote Control is not available

- Check the Remote Control’s batteries status.
- Check if batteries are inserted correctly.
- Check if the Remote Control is pointing at the monitor’s remote sensor.
- Check the Remote Control Mode status.
- The remote control system may not function when direct sunlight or strong illumination strikes the remote control sensor of the LCD monitor, or when there is an object in the path.

“SCHEDULE”/“OFF TIMER” function is not working properly

- The “SCHEDULE” function will be disabled when the “OFF TIMER” is set.
- If the “OFF TIMER” function is enabled and the power to the LCD monitor is turned off when the power supply is interrupted unexpectedly, then the “OFF TIMER” will be reset.

Snowy Picture, Poor Sound in TV

- Check antenna/cable connection. Use new cable if necessary.

Interference in TV

- Check components for shielding, move away from monitor if necessary.

Inactive area

- There is a 5 mm inactive area between the bezel and the LCD panel. As a result, a gap is visible on the LCD panel between the bezel and the actual picture.

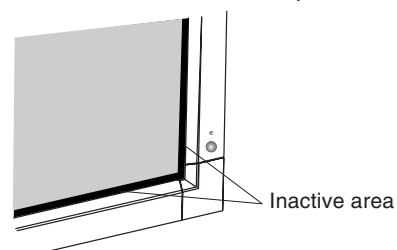

Either light vertical or horizontal stripes may appear, depending on the specific display pattern. This is no product fault or degradation.

Specifications - LCD4020

Product Specifications

LCD Module		Pixel Pitch: Resolution: Color: Brightness: Contrast Ratio: Viewing Angle: Design View Distance:	40" /101.6 cm diagonal 0.648 mm 1366 x 768 dots Over 16 million colors (depending on video card used) 700 cd/m ² (Max.), 500 cd/m ² (Typ.) 2000:1 89° (typ) @ CR>10 1100 mm
Frequency		Horizontal: Vertical:	15.625/15.734 kHz, 31.5 kHz - 91.1 kHz (Analog Input) 31.5 kHz - 91.1 kHz (Digital Input) 50.0 - 85.0 Hz
Pixel Clock			25.2 MHz - 162.0 MHz
Viewable Size			885.168 x 497.664 mm
Input Signal			
DVI	DVI-D 24pin	Digital RGB	DVI (HDCP) VGA60, SVGA60, XGA60, WXGA60, SXGA60, UXGA60*1, 1920X1080*1 (60Hz)
VGA	15pin Mini D-sub	Analog RGB	0.7 Vp-p/75 ohm VGA60, SVGA60, XGA60, WXGA60, SXGA60, UXGA60*1, 1920X1080*1 (60Hz)
		Sync	Separate: TTL level (Pos./Neg.) Composite sync on Green Video: 0.3 Vp-p Neg.
RGB/HV	BNC (R,G,B,H,V)	Analog RGB	0.7 Vp-p/75 ohm VGA60, SVGA60, XGA60, WXGA60, SXGA60, UXGA60*1, 1920X1080*1 (60Hz)
		Sync	Separate: TTL level (Pos./Neg.) Composite sync on Green Video: 0.3 Vp-p Neg.
HDMI*2	HDMI Connector	Digital RGB	HDMI 1080p*1, 1080i*1, 720p@50Hz/60Hz, 576p@50Hz, 480p@60Hz
DVD/HD*2	RCA (Y, Cb/Pb, Cr/Pr)	Component	Y : 1.0 Vp-p/75ohm, Cb/Cr (Pb/Pr) : 0.7 Vp-p/75 ohm HDTV/DVD:1080p*1, 1080i*1, 720p@50Hz/60Hz, 576p@50Hz, 480p@60Hz, 576i@50Hz, 480i@60Hz
VIDEO*2	BNC RCA	Composite	1.0 Vp-p/75 ohm NTSC/PAL/SECAM/4.43NTSC/PAL60
		S-VIDEO	Y: 1.0 Vp-p/75 ohm C: 0.286 Vp-p/75 ohm (NTSC), 0.3 Vp-p/75 ohm (PAL/SECAM) NTSC/PAL/SECAM/4.43NTSC/PAL60
Output Signal			
RGB/HV	BNC (R,G,B,H,V)	Analog RGB	0.7 Vp-p with 75 ohm terminated Separate HV sync: TTL level (Posi / Nega)
VIDEO*2	BNC	Composite	1.0 Vp-p with 75 ohm terminated
AUDIO*2			
AUDIO Input	RCA (L/R) X2 STEREO Mini Jack	Analog Audio	Stereo L/R 0.5 Vrms
	HDMI Connector	Digital Audio	PCM 32, 44.1, 48 KHz (16/20/24bit)
AUDIO Output	STEREO Mini Jack	Analog Audio	Stereo L/R 0.5 Vrms
Speaker Output			External Speaker Jack 15 W + 15 W (8 ohm)
Control		RS-232C In: RS-232C Out:	9 Pin D-sub 9 Pin D-sub (with daisy chain)
TV*2		Antenna: Channel Coverage:	For U.S F-connector Impedance 75 ohm VHF: 2 - 13 ch UHF: 14 - 69 ch CATV: 1 - 130 ch ATSC (8VSB): 2 - 69 ch 64/256 QAM : 1 - 135 ch For Europe F-connector Impedance 75 ohm VHF: E2 to E12/R1 to R12 UHF: E21 to E69 CATV: S1 to S41
Power Supply			3.0 - 1.2 A @ 100-240VAC, 50/60Hz
Operational Environment		Temperature: Humidity: Altitude:	5 - 40°C (Default brightness), 5 - 20°C (Max brightness) 20 - 80% (without condensation) 0 - 3000 m
Storage Environment		Temperature: Humidity:	-20 - 60°C 10 - 90% (without condensation)/ 90% - 3.5% x (Temp - 40°C) regarding over 40°C
Dimension		Net: Gross:	919.7 (W) x 532.2 (H) x 140 (D) mm (without stand) 1147 (W) x 761 (H) x 312 (D) mm
Weight		Net: Gross:	29.4 Kg (Without stand) 38.9 Kg
VESA compatible arm mounting interface			3 x 200 mm x 200 mm (8 Holes) 2 x 200 mm x 200 mm (6 Holes)
Complied Regulatory and Guidelines			UL60950-1/CSA C22.2 No.60950-1/ TUV-GS/EN60950-1/NOM FCC- B/DOC-B/EN55022-B/EN55024/EN61000-3-2/EN61000-3-3/CE/GOST-R
Power Management			VESA DPM
Plug & Play			VESA DDC2B, DDC/CI
Accessories			User's manual, Power Cord, Video Signal Cable, Remote Control, AA Battery x 2, Clamp x 3, Screw x 9, CD-ROM, Thumbscrew for stand x 2, Cable cover

NOTE: Technical specifications are subject to change without notice. *1: Compressed image *2: The product you purchased may not have this feature.

Specifications - LCD4620

Product Specifications

LCD Module		Pixel Pitch: Resolution: Color: Brightness: Contrast Ratio: Viewing Angle: Design View Distance:	46" /116.8 cm diagonal 0.648 mm 1366 x 768 dots Over 16 million colors (depending on video card used) 650 cd/m ² (Max.), 500 cd/m ² (Typ.) 2000:1 89° (typ) @ CR>10 1300 mm
Frequency		Horizontal: Vertical:	15.625/15.734 kHz, 31.5 kHz - 91.1 kHz (Analog Input) 31.5 kHz - 91.1 kHz (Digital Input) 50.0 - 85.0 Hz
Pixel Clock			25.2 MHz - 162.0 MHz
Viewable Size			1018.353 x 572.54 mm
Input Signal			
DVI	DVI-D 24pin	Digital RGB	DVI (HDCP) VGA60, SVGA60, XGA60, WXGA60, SXGA60, UXGA60*1, 1920X1080*1 (60Hz)
VGA	15pin Mini D-sub	Analog RGB	0.7 Vp-p/75 ohm VGA60, SVGA60, XGA60, WXGA60, SXGA60, UXGA60*1, 1920X1080*1 (60Hz)
		Sync	Separate: TTL level (Pos./Neg.) Composite sync on Green Video: 0.3 Vp-p Neg.
RGB/HV	BNC (R,G,B,H,V)	Analog RGB	0.7 Vp-p/75 ohm VGA60, SVGA60, XGA60, WXGA60, SXGA60, UXGA60*1, 1920X1080*1 (60Hz)
		Sync	Separate: TTL level (Pos./Neg.) Composite sync on Green Video: 0.3 Vp-p Neg.
HDMI*2	HDMI Connector	Digital RGB	HDMI 1080p*1, 1080i*1, 720p@50Hz/60Hz, 576p@50Hz, 480p@60Hz
DVD/HD*2	RCA (Y, Cb/Pb, Cr/Pr)	Component	Y : 1.0 Vp-p/75ohm, Cb/Cr (Pb/Pr) : 0.7 Vp-p/75 ohm HDTV/DVD:1080p*1, 1080i*1, 720p@50Hz/60Hz, 576p@50Hz, 480p@60Hz, 576i@50Hz, 480i@60Hz
VIDEO*2	BNC RCA	Composite	1.0 Vp-p/75 ohm NTSC/PAL/SECAM/4.43NTSC/PAL60
		S-VIDEO*2	Mini DIN 4 pin
Output Signal			
RGB/HV	BNC (R,G,B,H,V)	Analog RGB	0.7 Vp-p with 75 ohm terminated Separate HV sync: TTL level (Posi / Nega)
VIDEO*2	BNC	Composite	1.0 Vp-p with 75 ohm terminated
AUDIO*2			
AUDIO Input	RCA (L/R) X2 STEREO Mini Jack	Analog Audio	Stereo L/R 0.5 Vrms
	HDMI Connector	Digital Audio	PCM 32, 44.1, 48 KHz (16/20/24bit)
AUDIO Output	STEREO Mini Jack	Analog Audio	Stereo L/R 0.5 Vrms
Speaker Output			External Speaker Jack 15 W + 15 W (8 ohm)
Control		RS-232C In: RS-232C Out:	9 Pin D-sub 9 Pin D-sub (with daisy chain)
TV*2		Antenna: Channel Coverage:	For U.S F-connector Impedance 75 ohm VHF: 2 - 13 ch UHF: 14 - 69 ch CATV: 1 - 130 ch ATSC (8VSB): 2 - 69 ch 64/256 QAM : 1 - 135 ch For Europe F-connector Impedance 75 ohm VHF: E2 to E12/R1 to R12 UHF: E21 to E69 CATV: S1 to S41
Power Supply			3.4 - 1.35 A @ 100-240VAC, 50/60Hz
Operational Environment		Temperature: Humidity: Altitude:	5 - 40°C (Default brightness), 5 - 20°C (Max brightness) 20 - 80% (without condensation) 0 - 3000 m
Storage Environment		Temperature: Humidity:	-20 - 60°C 10 - 90% (without condensation)/ 90% - 3.5% x (Temp - 40°C) regarding over 40°C
Dimension		Net: Gross:	1055.4 (W) x 608.6 (H) x 140 (D) mm (without stand) 1278 (W) x 837 (H) x 312 (D) mm
Weight		Net: Gross:	36.1 Kg (Without stand) 47.1 Kg
VESA compatible arm mounting interface			3 x 200 mm x 200 mm (8 Holes) 2 x 200 mm x 200 mm (6 Holes)
Complied Regulatory and Guidelines			UL60950-1/CSA C22.2 No.60950-1/ TUV-GS/EN60950-1/NOM FCC-B/DOC-B/EN55022-B/EN55024/EN61000-3-2/EN61000-3-3/CE/GOST-R
Power Management			VESA DPM
Plug & Play			VESA DDC2B, DDC/CI
Accessories			User's manual, Power Cord, Video Signal Cable, Remote Control, AA Battery x 2, Clamp x 3, Screw x 9, CD-ROM, Thumbscrew for stand x 2, Cable cover

NOTE: Technical specifications are subject to change without notice. *1: Compressed image *2: The product you purchased may not have this feature.

Specifications - LCD5220

Product Specifications

LCD Module		Pixel Pitch: Resolution: Color: Brightness: Contrast Ratio: Viewing Angle: Design View Distance:	52" /132.1 cm diagonal 0.6 mm 1920 x 1080 dots Over 16 million colors (depending on video card used) 700 cd/m ² (Max.), 500 cd/m ² (Typ.) 2000:1 89° (typ) @ CR>10 1400 mm
Frequency		Horizontal: Vertical:	15.625/15.734 kHz, 31.5 kHz - 91.1 kHz (Analog Input) 31.5 kHz - 91.1 kHz (Digital Input) 50.0 - 85.0 Hz
Pixel Clock			25.2 MHz - 162.0 MHz
Viewable Size			1192 x 688 mm
Input Signal			
DVI	DVI-D 24pin	Digital RGB	DVI (HDCP) VGA60, SVGA60, XGA60, WXGA60, SXGA60, UXGA60*1, 1920X1080 (60Hz)
VGA	15pin Mini D-sub	Analog RGB	0.7 Vp-p/75 ohm VGA60, SVGA60, XGA60, WXGA60, SXGA60, UXGA60*1, 1920X1080 (60Hz)
		Sync	Separate: TTL level (Pos./Neg.) Composite sync on Green Video: 0.3 Vp-p Neg.
RGB/HV	BNC (R,G,B,H,V)	Analog RGB	0.7 Vp-p/75 ohm VGA60, SVGA60, XGA60, WXGA60, SXGA60, UXGA60*1, 1920X1080 (60Hz)
		Sync	Separate: TTL level (Pos./Neg.) Composite sync on Green Video: 0.3 Vp-p Neg.
HDMI*2	HDMI Connector	Digital RGB	HDMI 1080p, 1080i, 720p@50Hz/60Hz, 576p@50Hz, 480p@60Hz
DVD/HD*2	RCA (Y, Cb/Pb, Cr/Pr)	Component	Y : 1.0 Vp-p/75ohm, Cb/Cr (Pb/Pr) : 0.7 Vp-p/75 ohm HDTV/DVD:1080p, 1080i, 720p@50Hz/60Hz, 576p@50Hz, 480p@60Hz, 576i@50Hz, 480i@60Hz
VIDEO*2	BNC RCA	Composite	1.0 Vp-p/75 ohm NTSC/PAL/SECAM/4.43NTSC/PAL60
		S-VIDEO*2	Mini DIN 4 pin
Output Signal			
RGB/HV	BNC (R,G,B,H,V)	Analog RGB	0.7 Vp-p with 75 ohm terminated Separate HV sync: TTL level (Posi / Nega)
VIDEO*2	BNC	Composite	1.0 Vp-p with 75 ohm terminated
AUDIO*2			
AUDIO Input	RCA (L/R) X2 STEREO Mini Jack	Analog Audio	Stereo L/R 0.5 Vrms
	HDMI Connector	Digital Audio	PCM 32, 44.1, 48 KHz (16/20/24bit)
AUDIO Output	STEREO Mini Jack	Analog Audio	Stereo L/R 0.5 Vrms
Speaker Output			External Speaker Jack 15 W + 15 W (8 ohm)
Control		RS-232C In: RS-232C Out:	9 Pin D-sub 9 Pin D-sub (with daisy chain)
TV*2		Antenna: Channel Coverage:	For U.S F-connector Impedance 75 ohm VHF: 2 - 13 ch UHF: 14 - 69 ch CATV: 1 - 130 ch ATSC (8VSB): 2 - 69 ch 64/256 QAM : 1 - 135 ch For Europe F-connector Impedance 75 ohm VHF: E2 to E12/R1 to R12 UHF: E21 to E69 CATV: S1 to S41
Power Supply			4.7 - 1.9 A @ 100-240VAC, 50/60Hz
Operational Environment		Temperature: Humidity: Altitude:	5 - 40°C (Default brightness), 5 - 20°C (Max brightness) 20 - 80% (without condensation) 0 - 3000 m
Storage Environment		Temperature: Humidity:	-20 - 60°C 10 - 90% (without condensation)/ 90% - 3.5% x (Temp - 40°C) regarding over 40°C
Dimension		Net: Gross:	1200 (W) x 696 (H) x 147.5 (D) mm (without stand) 1481 (W) x 926 (H) x 334 (D) mm
Weight		Net: Gross:	44.3 Kg (Without stand) 55.5 Kg
VESA compatible arm mounting interface			2 x 200 mm x 2 x 200 mm (8 Holes)
Complied Regulatory and Guidelines			UL60950-1/CSA C22.2 No.60950-1/ TUV-GS/EN60950-1 FCC-B/DOC-B/EN55022-B/EN55024/EN61000-3-2/EN61000-3-3/CE/GOST-R
Power Management			VESA DPM
Plug & Play			VESA DDC2B, DDC/CI
Accessories			User's manual, Power Cord, Video Signal Cable, Remote Control, AA Battery x 2, Clamp x 3, Screw x 9, CD-ROM, Thumbscrew for stand x 2, Cable cover

NOTE: Technical specifications are subject to change without notice. *1: Compressed image *2: The product you purchased may not have this feature.

Pin Assignment

1) Analog RGB input (MiniDsub15p): VGA

Pin No	Name
1	Video Signal Red
2	Video Signal Green
3	Video Signal Blue
4	GND
5	DDC-GND
6	Red-GND
7	Green-GND
8	Blue-GND
9	+5V (DDC)
10	SYNC-GND
11	GND
12	DDC-SDA
13	H-SYNC
14	V-SYNC
15	DDC-SCL

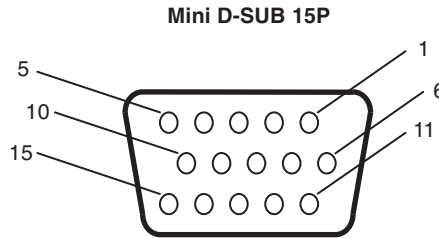

2) S-VIDEO input: VIDEO

Pin No	Name
1	GND
2	GND
3	Y (Luminance)
4	C (Chroma)

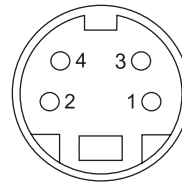

3) Digital RGB input (DVI-D): DVI

Pin - Assignment of DVI connector:					
1	TX2-	9	TX1-	17	TX0-
2	TX2+	10	TX1+	18	TX0+
3	Shield (TX2 / TX4)	11	Shield (TX1 / TX3)	19	Shield (TX0 / TX5)
4	NC	12	NC	20	NC
5	NC	13	NC	21	NC
6	DDC-Serial Clock	14	+5V power	22	Shield (TXC)
7	DDC-Serial Data	15	Ground	23	TXC+
8	NC	16	Hot plug detect	24	TXC-

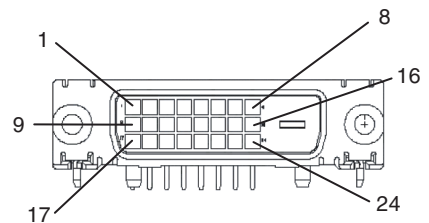

4) RS-232C input/output

Pin No	Name
1	connected to 7&8
2	RXD
3	TXD
4	connected to 6
5	GND
6	connected to 4
7	connected to 1&8
8	connected to 1&7
9	NC

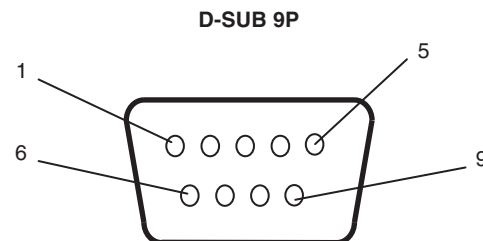

This LCD monitor uses RXD, TXD and GND lines for RS-232C control.

Manufacturer's Recycling and Energy Information

NEC DISPLAY SOLUTIONS is strongly committed to environmental protection and sees recycling as one of the company's top priorities in trying to minimize the burden placed on the environment. We are engaged in developing environmentally-friendly products, and always strive to help define and comply with the latest independent standards from agencies such as ISO (International Organisation for Standardization) and TCO (Swedish Trades Union).

Disposing of your old NEC product

The aim of recycling is to gain an environmental benefit by means of re-use, upgrading, reconditioning or reclamation of material. Dedicated recycling sites ensure that environmentally harmful components are properly handled and securely disposed. To ensure the best recycling of our products, **NEC DISPLAY SOLUTIONS offers a variety of recycling procedures** and gives advice on how to handle the product in an environmentally sensitive way, once it has reached the end of its life.

All required information concerning the disposal of the product and country-specific information on recycling facilities can be found on our following websites:

<http://www.nec-display-solutions.com/greencompany/> (in Europe),

<http://www.nec-display.com> (in Japan) or

<http://www.necdisplay.com> (in USA).

Energy Saving

This monitor features an advanced energy saving capability. When a VESA Display Power Management Signalling (DPMS) Standard signal is sent to the monitor, the Energy Saving mode is activated. The monitor enters a single Energy Saving mode.

Mode	Power consumption	LED color
Normal Operation	Approx. 300W (LCD4020) Approx. 340W (LCD4620) Approx. 420W (LCD5220)	Green
Energy Saving Mode	Less than 5W	Amber Blinking
Power Off	Less than 5W	Amber
Off Mode (Eco standby)	Less than 1W	Red

WEEE Mark (European Directive 2002/96/EC)



Within the European Union

EU-wide legislation, as implemented in each Member State, requires that waste electrical and electronic products carrying the mark (left) must be disposed of separately from normal household waste. This includes monitors and electrical accessories, such as signal cables or power cords. When you need to dispose of your NEC display products, please follow the guidance of your local authority, or ask the shop where you purchased the product, or if applicable, follow any agreements made between yourself and NEC.

The mark on electrical and electronic products only applies to the current European Union Member States.

Outside the European Union

If you wish to dispose of used electrical and electronic products outside the European Union, please contact your local authority so as to comply with the correct disposal method.