

Thermo Scientific ThermoFlex™ Recirculating Chillers (Basic Controller)

Thermo Scientific Manual P/N
U00933 Rev. 09/14/2021



Multilingual Quick Start Guides

Multilingual Essential Safety Instructions

Installation

Operation

Preventive Maintenance

Troubleshooting

Visit our Web site at:

<http://www.thermofisher.com/tc>
Product Service Information, Applications
Notes, SDS Forms, e-mail.

Voice Info: (800) 258-0830

Original instructions written in English

Thermo Scientific ThermoFlex™ Recirculating Chillers (Basic Controller)

Thermo Scientific Manual P/N U00933
Rev. 09/14/2021



Label 1

**Multilingual Quick
Start Guides**

**Multilingual
Essential Safety
Instructions**

Installation

Operation

**Preventive
Maintenance**

Troubleshooting

Label 2

Visit our Web site at:

<http://www.thermofisher.com/tc>
Product Service Information, Applications
Notes, SDS Forms, e-mail.

Voice Info: (800) 258-0830

Thermo Fisher Scientific

25 Nimble Hill Road
Newington, NH 03801
Tel : (800) 258-0830 or
(603) 436-9444
Fax : (603) 436-8411
www.thermofisher.com/tc

Sales, Service, and Customer Support

25 Nimble Hill Road
Newington, NH 03801
Tel: (800) 258-0830
Sales: 8:00 am to 5:00 pm
Service and Support: 8:00 am to 6:00 pm Monday
through Friday (Eastern Time)
Fax: (603) 436-8411
service.tc.us@thermofisher.com

Dieselstrasse 4
D-76227 Karlsruhe, Germany
Tel : +49 (0) 721 4094 444
Fax : +49 (0) 721 4094 300
info.tc.de@thermofisher.com

Building 6, No. 27
Xin Jinqiao Rd., Shanghai 201206
Tel : +86(21) 68654588
Fax : +86(21) 64457830
info.china@thermofisher.com

Statement of Copyright

Copyright © 2021 Thermo Fisher Scientific. All rights reserved.

This manual is copyrighted by Thermo Fisher Scientific.

Users are forbidden to reproduce, republish, redistribute, or resell any materials from this manual in either machine-readable form or any other form.

Contents

Quick Start

Preface	i
Compliance	i
WEEE	i
After-Sale Support	i
Unpacking	ii
Warranty	ii
Feedback.....	ii
Section 1 Safety	1-1
Warnings.....	1-1
Section 2 General Information	2-1
Description	2-1
Specifications	2-1
Section 3 Installation	3-1
Site Requirements	3-1
Electrical Requirements	3-2
Hard Wire Installation.....	3-9
Plumbing Requirements.....	3-10
Process Fluid Requirements.....	3-13
Compatibility with Approved Fluids	3-14
Additional Fluid Information	3-16
Process Water Quality and Standards	3-16
Facility Water Quality - Standards and Recommendations	3-17
Facility Water Requirements.....	3-18
Fluid Filter Bag.....	3-20
Priming.....	3-20
Initial Filling	3-21
Fluid Top Off	3-22
Section 4 Operation	4-1
Basic Controller.....	4-1
Setup	4-2
Start Up	4-2
Controller Loops.....	4-4
Menu Tree	4-5
Setpoint Loop.....	4-6
Setup Loop.....	4-7
Shut Down.....	4-13

Section 5	Additional Options/Accessories	5-1
	Auto Refill	5-1
	Internal DI Cartridge	5-2
	P1 P2 T1 Pump Pressure Relief Valve (Internal Configuration).....	5-3
	P1 P2 T1 Pump Pressure Relief Valve (External Configuration)	5-4
	Flow Control with Flow Readout.....	5-5
	P1 P2 T1 Pump Pressure Relief with Flow Readout	5-5
	T5 Pump Flow Control.....	5-6
	Anti Drainback.....	5-6
	SEMI.....	5-6
	Other Accessories	5-10
Section 6	Preventive Maintenance	6-1
	Preventive Maintenance Timer	6-1
	Fluid Bag Filter.....	6-2
	Fluid Diffuser	6-2
	Reservoir Cleaning.....	6-3
	Fluid Maintenance	6-3
	Condenser Filter.....	6-4
	Chiller Surface	6-5
	Hoses	6-5
	DI Filter (Optional)	6-6
	Diagnostic Loop	6-7
	Testing the Alarm Features	6-8
Section 7	Troubleshooting	7-1
	Operational Error Codes.....	7-1
	Checklist	7-10
	Verifying/Adjusting the Controller PID Values	7-13
Section 8	Additional Information	8-1
	Draining.....	8-1
	Wetted Materials.....	8-3
	Internal Process Fluid Temperature Sensor (rdt1) Calibration.....	8-4
	Process Fluid Pressure (P1) Transducer Calibration	8-6
	Optional Process Fluid Flow (FLo) Transducer Calibration	8-8
	Service Codes	8-10
	Clearing SEr Message.....	8-11
	Decommissioning/Disposal	8-12
	Shipment/Storage.....	8-12
Appendix A	Country Specific 230 VAC, 50 Hz, 1 Ø Requirements	
Appendix B	Voltage Configuration Instructions	
Appendix C	Analog I/O and Remote Sensor	
Appendix D	Serial Communications	

Declaration of Conformity

WARRANTY



This quick start guide is intended for initial start up only. For all other procedures you must refer to the manual. Also, if any of these steps are not clear download the manual before proceeding.

Safety:

- The chiller is designed for indoor use only. Never place the chiller in a location where excessive heat, moisture, inadequate ventilation, or corrosive materials are present.
- Connect the chiller to a properly grounded outlet.
- Refrigerants used are heavier than air and will replace the oxygen causing loss of consciousness. Contact with leaking refrigerant will cause skin burns. Refer to the chiller's nameplate and the manufacturer's most current MSDS for additional information.
- Move the chiller with care. Sudden jolts or drops can damage its components. Always turn the equipment off and disconnect it from its supply voltage before moving it.

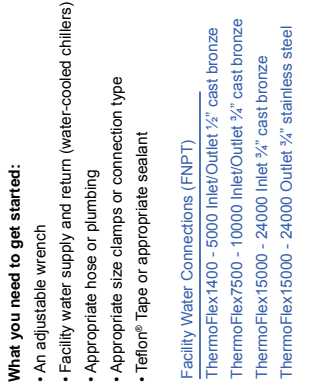
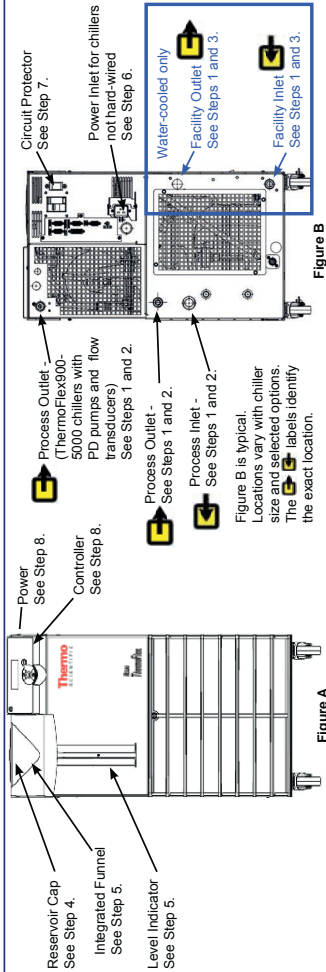

What you need to get started:

- An adjustable wrench
- Facility water supply and return (water-cooled chillers)
- Appropriate hose or plumbing
- Appropriate size clamps or connection type
- Teflon® Taps or appropriate sealant

Facility Water Connections (FNPT)

ThermoFlex1400 - 5000 Inlet/Outlet 1/2" cast bronze	ThermoFlex9000 - 10000 P1 P2 T0 T1 1/2" cast bronze
ThermoFlex7500 - 10000 Inlet/Outlet 3/4" cast bronze	ThermoFlex3500 - 5000 P3 P4 3/4" cast bronze
ThermoFlex15000 - 24000 Inlet 3/4" cast bronze	ThermoFlex7500 - 24000 P3 P5 T5 T9 1" wrought copper
ThermoFlex15000 - 24000 Outlet 3/4" stainless steel	Inlet - Same size as outlet
	Supplied Adapters
	P1 P2 T0 T1 1/2" x 3/8" Polyethylene and 1/2" x 1/2" Nylon
	P3 P4 3/4 MPT x 1/2 barb PVC
	P3 P5 T5 T9 1" MPT x 1" barb PVC and 1" MPT x 3/4" barb PVC

Table 1 - Approved Fluids:

Use of any other fluid will void the manufacturer's warranty.
Filtered/single distilled water (pH 7-8)
Deionized water (1-3 MΩ-cm, compensated)
Distilled water with NaClO biocide and inhibitor
Distilled water with Chlorox (5 ppm)
0 - 75% Laboratory Grade Ethylene Glycol/Water
0 - 75% Laboratory Grade Propylene Glycol/Water

Process Fluid Connections (FNPT)

ThermoFlex9000 - 10000 P1 P2 T0 T1 1/2" cast bronze
ThermoFlex3500 - 5000 P3 P4 3/4" cast bronze
ThermoFlex7500 - 24000 P3 P5 T5 T9 1" wrought copper
Inlet - Same size as outlet
Supplied Adapters
P1 P2 T0 T1 1/2" x 3/8" Polyethylene and 1/2" x 1/2" Nylon
P3 P4 3/4 MPT x 1/2 barb PVC
P3 P5 T5 T9 1" MPT x 1" barb PVC and 1" MPT x 3/4" barb PVC

1 Remove all the plastic shipping plugs (2 or 4).

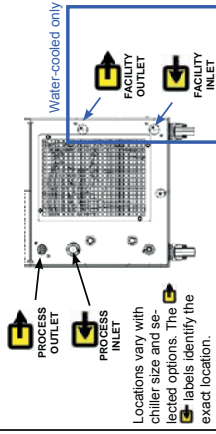

See Figure B.

5 If equipped, place the optional GFCI breaker located on the rear to the up position. For ThermoFlex9000 through 10000 chillers, place the circuit protector to the on (I) position. The controller display will indicate a series of scrolling bars (—). The bars will scroll upward indicating the chiller is initializing, this takes approximately 15 seconds. For other chillers the bars appear when power is supplied to the chiller.

The circuit protector is not intended to act as a disconnecting means.

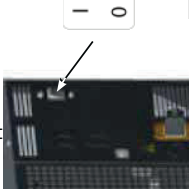

See Figure B.

2 Connect the ThermoFlex PROCESS OUTLET (A) to the fluid inlet on your application. Connect the ThermoFlex PROCESS INLET (B) to the fluid outlet on your application. Ensure the connections are sealed and secure. For air-cooled chillers skip to Step 4.



See Figure B.

6 Never operate the chiller without process fluid in the reservoir or without the fluid filter bag installed.

Gently pull up on the plastic funnel housing to remove it and install the supplied filter bag. Reinstall the housing.

Remove the reservoir cap from the housing by unscrewing it counterclockwise.

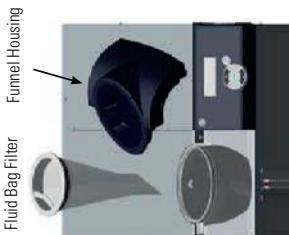

See Figure A.

3 Connect the ThermoFlex FACILITY OUTLET (A) to a facility water return or drain. Connect the ThermoFlex FACILITY INLET (B) to a facility water supply. Ensure the connections are sealed and secure. For water-cooled only.



See Figure B.

7 Slowly fill reservoir with clean process fluid (see Table 1), utilizing sight tube for easy fluid level monitoring. When the reservoir is full re- place the reservoir cap, hand tight. Since the reservoir capacity may be small compared to your application and air may need to be purged from the lines, have extra fluid on hand to keep the system topped off when external circulation is started. If the fluid level drops too low the chiller will shut down to prevent the pump from running dry. Acknowledge the alarm and re-start the priming process.

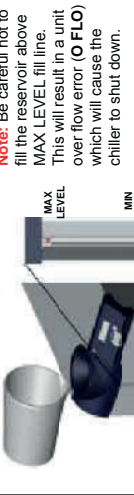

Note: Be careful not to fill the reservoir above MAX LEVEL fill line. This will result in a unit over flow error (O FLO) which will cause the chiller to shut down.

See Figure A.

4 Refer to the name plate on the rear of the chiller and verify the appropriate voltage. For chillers supplied with a line cord, insert female end of line cord into chiller and then insert male end of line cord into power outlet. (The line cord is located under the shipping crate's lid. Do not discard the lid until the cord is located.)

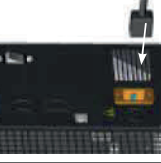

See Figure B.

8 Press



The controller will display **SETUP**.

Note: If the chiller is equipped with a deionization filter cartridge refer to the manual, Section 5, for installation.

Please see reverse side for additional steps.



See Figure A.

Never operate the chiller with a damaged line cord.

Note: ThermoFlex9000-5000 chillers equipped with the Variable Voltage or Global Voltage option have a voltage configuration panel. Refer to the Voltage Instruction Sheet shipped with the chiller, or see manual/Appendix B.

Note: For chillers requiring hard wiring see Section 3 in the manual.

Quick Start - Used for Initial Start Up Only — perform steps 9 to 20 for all units.

<p>NOTE: Some ranges/defaults are pump dependent, see Section 4 in the manual. Once any Setup step is completed, meaning you pressed the enter key a second time, you can not repeat the step to make corrections. You can make changes after the unit is started.</p> <p>SETUP</p> <ul style="list-style-type: none"> Press enter to continue the setup procedure. 	<p>9 UNITS</p> <p>Units are the temperature, fluid flow (optional) and pressure scales.</p> <p>Scales: °C/F GPM/LPM PSI/BAR/KPAS</p> <ul style="list-style-type: none"> The display will flash between UNITS and °C If desired, use ← to change the scale to °F Press enter to sequence to the next display Do the same for Flow and Pressure scales 	<p>10 HI T</p> <p>Hi T sets the fluid's High Temperature Alarm Limit.</p> <p>Range: +3°C to +42°C Factory Default: +42°C</p> <ul style="list-style-type: none"> Press enter The display will flash between Hi T and 42 If desired, use ← to adjust the value Press enter to sequence to the next display
<p>11 LO T</p> <p>Lo T sets the fluid's Low Temperature Alarm Limit.</p> <p>Range: +3°C to +42°C Factory Default: 3°C</p> <ul style="list-style-type: none"> Press enter The display will flash between Lo T and 3 If desired, use ← to adjust the value Press enter 	<p>12 HI P1</p> <p>Hi P1 sets the Pump's High Pressure Discharge Alarm Limit.</p> <p>Range: Varies by pump Factory Default: Varies by pump</p> <ul style="list-style-type: none"> Press enter The display will flash between Hi P1 and the default If desired, use ← to adjust the value Press enter 	<p>13 DELAY</p> <p>dDELAY is the length of time the pump can exceed the Hi P1 Alarm Limit before shutting down.</p> <p>Range: Varies by pump Factory Default: 0 seconds</p> <ul style="list-style-type: none"> The display will flash between dDELAY and 0 If desired, use ← to adjust the value Press enter <p><small>NOTE: This feature is active only if the unit is configured to shut down, see Step 16.</small></p>
<p>14 LO P1</p> <p>Lo P1 sets the Pump's Low Pressure Discharge Alarm Limit.</p> <p>Range: Varies by pump Factory Default: Varies by pump</p> <ul style="list-style-type: none"> Press enter The display will flash between Lo P1 and the default If desired, use ← to adjust the value Press enter 	<p>15 DELAY</p> <p>dDELAY is the length of time the pump can exceed the Lo P1 Alarm Limit before shutting down.</p> <p>Range: 0 to 30 seconds Factory Default: 10 seconds</p> <ul style="list-style-type: none"> The display will flash between dDELAY and 10 If desired, use ← to adjust the value Press enter <p><small>NOTE: This feature is active only if the unit is configured to shut down, see Step 16.</small></p>	<p>16 ALR</p> <p>ALR configures the unit's reaction to temperature, pressure, and flow (optional) alarm limits - either shut down (fLT) or continue to run (INDC). See Section 4 in the manual for more information.</p> <p>Range: fLT* or INDC** Factory Default: fLT</p> <ul style="list-style-type: none"> The display will flash between ALR and fLT If desired, press ← to display INDC Press enter <p><small>*fLT = fault (shut down) **INDC = indicate (continue to run)</small></p>
<p>17 SOUND</p> <p>Turns the unit's audible alarm on or off.</p> <p>Range: on or OFF Factory Default: on</p> <ul style="list-style-type: none"> Press enter The display will flash between SOUND and on If desired, press ← to display OFF Press enter 	<p>18 START</p> <p>START enables/disables auto restart.</p> <p>Range: on or OFF Factory Default: OFF</p> <ul style="list-style-type: none"> Press enter The display will flash between START and OFF If desired, press ← to display on Press enter 	<p>19 CARE</p> <p>CARE is used to set the preventative care cleaning frequency reminder for the unit's air and fluid filters.</p> <p>Range: off, L1 - 1000 hours, L2 - 2000 hours, L3 - 3000 hours Factory Default: L1</p> <ul style="list-style-type: none"> Press enter The display will flash between CARE and L1 If desired, use ← to change display to off, L2 or L3 Press enter

If applicable, see boxes on right to set up options. For units with Analog I/O (ACOM) refer to the additional quick start supplied with your unit.

<p>20 STORE</p> <ul style="list-style-type: none"> Press ← to save all settings <p>The unit will automatically start.</p> <ul style="list-style-type: none"> Press ← to disregard all changes and restore the factory default values. <p>The display will go blank.</p> <ul style="list-style-type: none"> If desired, press ← to restart the procedure. 	<p>The Setup procedure is now complete.</p> <p>When the unit starts the controller will display the process fluid temperature.</p> <p>If desired, you can change/verify the unit's setpoint by pressing MODE</p>	<p>SP</p> <p>SP is used to adjust the setpoint.</p> <p>Range: +5°C to +40°C Factory Default: +20°C</p> <ul style="list-style-type: none"> The display will flash between SP and 20 If desired, use ← to change the setting Press enter to save the new setpoint and return to the temperature display
---	---	---

Option - Voltage — Step A

<p>A HZ</p> <p>HZ is used to identify the incoming frequency for units with P3 - P5 pumps and the capability to run on either 50 Hz or 60 Hz. The selected frequency automatically adjusts the firmware's fixed high pressure default setting.</p> <p>Range: 50 Hz or 60 Hz Factory Default: 60 Hz</p> <ul style="list-style-type: none"> Press enter The display will flash between HZ and 60 If needed, use ← to change the frequency Press enter <p><small>If your unit does not have a flow transducer or serial communications see Step 20.</small></p>	<p>HIFLO</p> <p>HIFLO sets the high flow alarm limit.</p> <p>Range: Varies by pump Factory Default: Varies by pump</p> <ul style="list-style-type: none"> Press enter The display will flash between HIFLO and the default If desired, use ← to adjust the value Press enter
--	---

Option - Flow Transducer — Steps B and C

<p>B HI FLO</p> <p>HIFLO sets the high flow alarm limit.</p> <p>Range: Varies by pump Factory Default: Varies by pump</p> <ul style="list-style-type: none"> Press enter The display will flash between HIFLO and the default If desired, use ← to adjust the value Press enter 	<p>C LO FLO</p> <p>LoFLO sets the low flow alarm limit.</p> <p>Range: Varies by pump Factory Default: Varies by pump</p> <ul style="list-style-type: none"> Press enter The display will flash between LoFLO and the default If desired, use ← to adjust the value Press enter <p><small>If your unit does not have serial communications see Step 20.</small></p>
--	---

Option - Serial Communications (DCOM) — Steps D to I

<p>D SER</p> <p>SER is used to enable/disable and to configure serial communications mode.</p> <p>Range: off, RS232, RS485 Factory Default: off</p> <ul style="list-style-type: none"> Press enter The display will flash between SER and OFF If desired, use ← to change the mode Press enter 	<p>E BAUD</p> <p>BAUD is used to select the baud rate (speed) for serial communication.</p> <p>Range: 9600, 4800, 2400, 1200, 600, or 300 bits per second.</p> <ul style="list-style-type: none"> Press enter The display will flash between BAUD and 9600 If desired, use ← to change the rate Press enter
<p>F DATA</p> <p>DATA is used to display the number of bits.</p> <p>Display: 8</p> <ul style="list-style-type: none"> Press enter The display will flash between DATA and 8 Press enter 	<p>G STOP</p> <p>STOP is used to indicate the number of stop bits.</p> <p>Range: 2 or 1 Factory Default: 1</p> <ul style="list-style-type: none"> Press enter The display will flash between STOP and 1 If desired, use ← to change the setting Press enter
<p>H PAR</p> <p>PAR is used as a means to check for communication errors.</p> <p>Range: even, odd, or none Factory Default: none</p> <ul style="list-style-type: none"> Press enter The display will flash between PAR and none If desired, use ← to change the setting Press enter 	<p>I UID</p> <p>UID (unit id) is used in RS485 only, identifies devices connected to the RS485 port.</p> <p>Range: 1 to 99 Factory Default: 1</p> <ul style="list-style-type: none"> Press enter The display will flash between UID and 1 If desired, use ← to change the setting Press enter <p>See Step 20.</p>



Ce guide de démarrage rapide est destiné à la mise en marche initiale uniquement. Pour toute autre procédure, merci de vous référer au manuel. De plus, si l'une de ses étapes ne vous paraît pas claire, téléchargez le manuel avant de commencer.

Sécurité :

- Les refroidisseurs ont été conçus pour fonctionner uniquement à l'intérieur. Ne jamais exposer le refroidisseur à une chaleur ou une humidité excessive, à une ventilation inadéquate ou à des matières corrosives.
- Brancher le refroidisseur à une prise correctement reliée à la terre.
- Les réfrigérants utilisés sont plus lourds que l'air et peuvent remplacer l'oxygène, provoquant ainsi une perte de conscience. Tout contact avec des réfrigérants qui fuient peut provoquer des brûlures cutanées. Pour plus d'informations, se reporter à la plaque signalétique du refroidisseur et à la Fiche de données de sécurité (MSDS) du fabricant la plus couramment utilisée.
- Déplacer le refroidisseur avec soin. Les secousses soudaines et les chutes peuvent endommager ses composants. À chaque déplacement de l'équipement, toujours le mettre hors tension et le débrancher de son alimentation.
- Ne jamais utiliser un équipement endommagé ou qui présente des fuites.

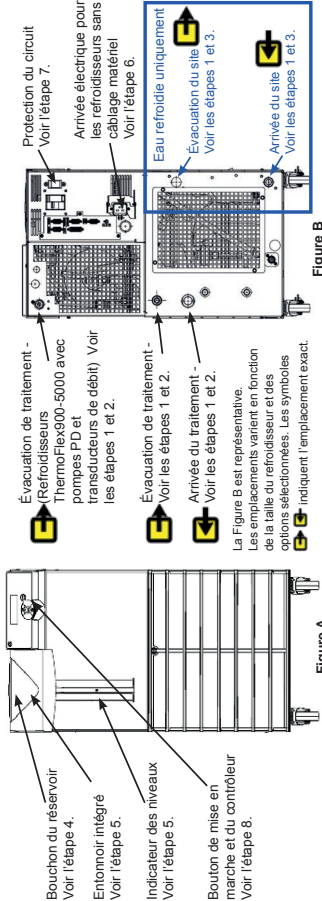

Figure A

1 Retirer tous les bouchons d'expédition en plastique (2 ou 4).

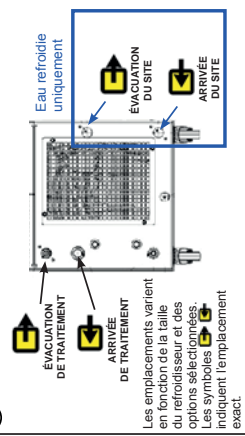

Figure B

5 Si le refroidisseur en est équipé, armer le disjoncteur GFCI en option et situé à l'arrière de l'appareil en position haute. Pour les refroidisseurs ThermoFlex900 jusqu'à 10000, mettre le dispositif de protection du circuit sur la position (1). L'affichage du contrôleur indique une série de barres de défillement (). Les barres indiquent le niveau de défillement du refroidisseur ; cette opération prend environ 15 secondes. Pour les autres refroidisseurs, les barres s'affichent lorsque l'alimentation est fournie au refroidisseur.



Le dispositif de protection du circuit n'a pas été conçu pour déconnecter les appareils.

Figure B

- Si le refroidisseur est équipé d'une pompe à déplacement positif (P1 ou P2), s'assurer que les conduites de plomberie et les raccords de l'application peuvent supporter au moins 185 psi.
- Ne pas utiliser de cartouche de filtre de déionisation (DI) avec EG ou PG inhibés. Un filtre DI retiendra les inhibiteurs de la solution, rendant le liquide inefficace sur la protection contre la corrosion. Les inhibiteurs augmenteront également la conductivité du liquide.
- Utiliser uniquement les liquides approuvés et énumérés dans le Tableau 1. Avant d'utiliser un quelconque liquide ou d'effectuer des travaux d'entretien susceptibles d'entraîner un contact avec le liquide, se reporter à la Fiche de données de sécurité du fabricant.
- Pour éviter toute congélation/glaçage de l'échangeur à plaques, les refroidisseurs ThermoFlex7500-24000 requièrent l'utilisation d'EG/EAU 50/50 ou de PG/EAU 50/50 à une température inférieure de 10°C à celle du traitement.

Matériel nécessaire pour commencer :

- Une clé à molette
- Alimentation et évacuation d'eau du site (pour les refroidisseurs refroidis par eau)
- Tuyau et accessoires de plomberie appropriés
- Colliers de serrage ou raccords de connexion de dimension appropriée
- Ruban adhésif au Teflon® ou produit étanchéifiant approprié

- Raccordements à l'eau du site (FNPT)
- ThermoFlex1400 - 5000 Arrivée/Sortie fonte de bronze 0,5"
 - ThermoFlex7500 - 10000 Arrivée/Sortie fonte de bronze 0,75"
 - ThermoFlex15000 - 24000 Arrivée fonte de bronze 0,75"
 - ThermoFlex15000 - 24000 Sortie acier inoxydable 0,75"

Raccordements du fluide de traitement (FNPT)

Sortie	P1 P2 TO T1	fonte de bronze 0,5"
TFlex900 - 10000	P3 P4	fonte de bronze 0,75"
TFlex3500 - 5000	P3 P5 T5 T9	cuivre forgé 1"

Arrivée - Taille identique à la sortie de tous les refroidisseurs en acier inoxydable

Adaptateurs fournis

- P1 P2 TO T1 Polyéthylène 0,5" x 0,375" et Nylon 0,5" x 0,5"
- P3 P4 MPT 0,75 x PVC cannelé 0,5"
- P3 P5 T5 T9 MPT 1" x PVC cannelé 1" et MPT 1" x PVC cannelé 0,75"

Tableau 1 - Liquides approuvés :

Tout autre liquide annule la garantie du fabricant.

Refrigérants température standard

- Eau filtrée/mono-distillée (pH 7-8)
- Eau déionisée (1 à 3 MD-cm, compensée)
- Eau distillée avec bloc de Nalco et ses inhibiteurs
- Eau distillée avec chlore (5 ppm)
- Éthylène glycol de qualité laboratoire/eau 0 à 75 %
- Propylène glycol de qualité laboratoire/eau 0 à 75 %

3 Raccorder L'ÉVACUATION DU SITE ThermoFlex (A) à une évacuation d'eau du site. Raccorder L'ARRIVÉE DU SITE ThermoFlex (B) à une arrivée d'eau du site. Vérifier que les raccords sont étanches et sûrs.

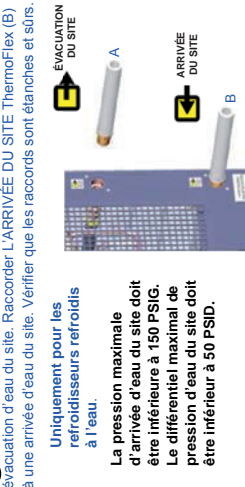
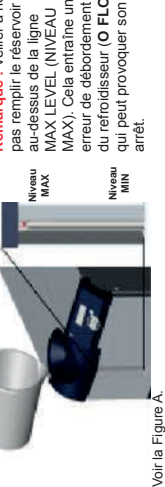

Figure B

7 Remplir lentement le réservoir avec du liquide de traitement propre (voir le Tableau 1) en utilisant le regard pour contrôler facilement le niveau de liquide. Une fois le réservoir rempli, remettre le bouchon en le serrant à la main. La capacité du réservoir pouvant être réduite par rapport à l'application, et l'air devant être purgé des conduites, garder du liquide supplémentaire à portée de la main pour faire l'appoint du système une fois la circulation externe démarrée.



Remarque : Veiller à ne pas remplir le réservoir au-dessus de la ligne MAX LEVEL (NIVEAU MAX). Cela entraîne une erreur de débordement du refroidisseur (O FLO) qui peut provoquer son arrêt.

Figure A

2 Raccorder L'ÉVACUATION DE TRAITEMENT ThermoFlex (A) à l'arrivée de liquide de l'application. Raccorder L'ARRIVÉE DE TRAITEMENT ThermoFlex (B) à l'évacuation de liquide de l'application. Vérifier que les raccords sont étanches et sûrs. Pour les refroidisseurs refroidis par air, passer à l'étape 4.

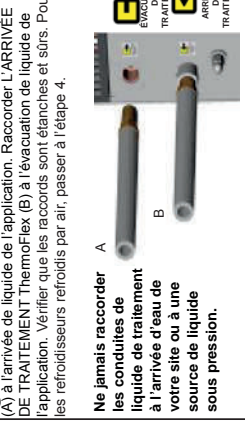

Figure B

6 Ne jamais utiliser le refroidisseur sans liquide dans le réservoir et/ou sans avoir installé le filtre sac. Merci de tirer avec précaution sur la partie plastique du cache type entornoir pour l'enlever et ensuite installer le filtre sac fourni. Une fois cette opération achevée, merci de repositionner le cache type entornoir.



Figure A

4 Se reporter à la plaque signalétique située à l'arrière du refroidisseur et vérifier que la tension est correcte. Pour les refroidisseurs fournis avec un cordon d'alimentation, insérer l'extrémité femelle de ce dernier dans le refroidisseur, et l'extrémité mâle dans la prise électrique. (Le cordon d'alimentation se trouve sous le couvercle de la caisse d'expédition. Ne pas jeter le couvercle avant d'avoir localisé le cordon).

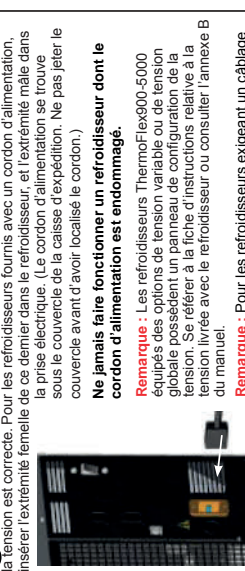

Figure B

8 Appuyer sur le contrôleur affiche SETUP. Le contrôleur affiche SETUP. Remarque : Si le refroidisseur est équipé d'une cartouche de filtre de déionisation, consulter le manuel, Section 5, pour l'installation. Voir au dos les étapes supplémentaires.

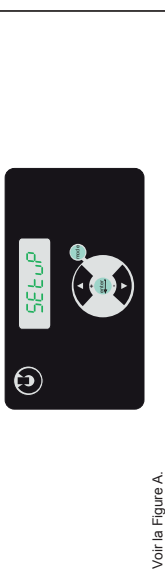

Figure A

Démarrage rapide - Ne sert que pour le premier démarrage - effectuer les étapes 9 à 20 pour toutes les unités.

<p>REMARQUE : Certaines plages/valeurs par défaut dépendent de la pompe, voir la Section 4 du manuel. Une fois l'étape de configuration terminée, c'est-à-dire après avoir appuyé sur la touche enter une deuxième fois, il devient impossible de recommencer l'étape pour effectuer des corrections. Vous pouvez faire des modifications après le démarrage de l'appareil.</p> <p>Setup</p> <p>Appuyez sur enter pour poursuivre la procédure de l'étape.</p>	<p>Units représente les échelles de température, de débit de liquide (en option) et de pression. Échelles : °C/°F, PSI/Bar/KPAS</p> <p>Réglages d'usine par défaut : °C, Gallons, PSI</p> <p>L'affichage clignote en alternant Units (unités) et °C</p> <p>Au besoin, utilisez enter pour passer à un affichage en °F</p> <p>Appuyez sur enter pour passer à l'affichage suivant</p> <p>Procédez de la même façon pour les échelles de débit et de pression</p>	<p>Hi T règle la limite d'alarme de haute température du liquide. Plage : +3°C à +42°C</p> <p>Réglage d'usine par défaut : +42°C</p> <p>Appuyez sur enter</p> <p>L'affichage clignote en alternant Hi T et 42</p> <p>Au besoin, utilisez enter pour modifier la valeur</p> <p>Appuyez sur enter pour passer à l'affichage suivant</p>
<p>Lo T règle la limite d'alarme de basse température du liquide. Plage : +3°C à +42°C</p> <p>Réglage d'usine par défaut : 3°C</p> <p>Appuyez sur enter</p> <p>L'affichage clignote en alternant Lo T et 3</p> <p>Au besoin, utilisez enter pour modifier la valeur</p> <p>Appuyez sur enter</p>	<p>Hi P1 règle la limite d'alarme de décharge haute pression de la pompe. Plage : Varie en fonction de la pompe</p> <p>Réglage d'usine par défaut : Varie en fonction de la pompe</p> <p>Appuyez sur enter</p> <p>L'affichage clignote en alternant Hi P1 et la valeur par défaut</p> <p>Au besoin, utilisez enter pour modifier la valeur</p> <p>Appuyez sur enter</p>	<p>dELAY représente la durée pendant laquelle la pompe peut dépasser la valeur d'alarme Hi P1 avant l'arrêt.</p> <p>Plage : Varie en fonction de la pompe</p> <p>Réglage d'usine par défaut : 0 secondes</p> <p>L'affichage clignote en alternant dELAY et 0</p> <p>Au besoin, utilisez enter pour modifier la valeur</p> <p>Appuyez sur enter</p> <p>REMARQUE Cette fonction n'est active que si l'appareil est configuré pour l'arrêt, voir l'étape 16.</p>
<p>Lo P1 règle la limite d'alarme de décharge basse pression de la pompe. Plage : Varie en fonction de la pompe</p> <p>Réglage d'usine par défaut : Varie en fonction de la pompe</p> <p>Appuyez sur enter</p> <p>L'affichage clignote en alternant Lo P1 et la valeur par défaut</p> <p>Au besoin, utilisez enter pour ajuster la valeur par défaut</p> <p>Appuyez sur enter</p>	<p>dELAY représente la durée pendant laquelle la pompe peut dépasser la limite d'alarme avant arrêt. Plage : 0 à 30 secondes</p> <p>Réglage d'usine par défaut : 10 secondes</p> <p>L'affichage clignote en alternant dELAY et 10</p> <p>Au besoin, utilisez enter pour modifier la valeur</p> <p>Appuyez sur enter</p> <p>REMARQUE Cette fonction n'est active que si l'appareil est configuré pour l'arrêt, voir l'étape 16.</p>	<p>ALR configure la réaction de l'appareil aux limites d'alarme de température, de pression, et de débit (en option) - terme (fL) ou continue l'exécution (InDC). Voir la section 4 du manuel pour des informations plus détaillées.</p> <p>Plage : fL* ou InDC**</p> <p>Réglage d'usine par défaut : fL</p> <p>Appuyez sur enter</p> <p>L'affichage clignote en alternant ALR et fL</p> <p>Au besoin, appuyez sur enter pour afficher InDC</p> <p>Appuyez sur enter</p> <p>*fL = erreur (arrêt)</p> <p>**InDC = indiquer (poursuite de l'exécution)</p>
<p>Active ou désactive le signal sonore d'alarme de l'appareil. Plage : on (marche) ou OFF (ARRÊT)</p> <p>Réglage d'usine par défaut : on (marche)</p> <p>Appuyez sur enter</p> <p>L'affichage clignote en alternant Sound et on (marche)</p> <p>Au besoin, appuyez sur enter pour afficher OFF (ARRÊT)</p> <p>Appuyez sur enter</p>	<p>SMART active/désactive le redémarrage automatique. Plage : on (marche) ou OFF (ARRÊT)</p> <p>Réglage d'usine par défaut : OFF (ARRÊT)</p> <p>Appuyez sur enter</p> <p>L'affichage clignote en alternant SMART et OFF (ARRÊT)</p> <p>Au besoin, appuyez sur enter pour afficher on (marche)</p> <p>Appuyez sur enter</p>	<p>CARE sert à définir le rappel de nettoyage d'entretien préventif pour les filtres à air et à liquide de l'appareil. Réglage d'usine par défaut : L1, L2, L3, L4, L5, L6, L7, L8, L9, L10, L11, L12, L13, L14, L15, L16, L17, L18, L19, L20, L21, L22, L23, L24, L25, L26, L27, L28, L29, L30, L31, L32, L33, L34, L35, L36, L37, L38, L39, L40, L41, L42, L43, L44, L45, L46, L47, L48, L49, L50, L51, L52, L53, L54, L55, L56, L57, L58, L59, L60, L61, L62, L63, L64, L65, L66, L67, L68, L69, L70, L71, L72, L73, L74, L75, L76, L77, L78, L79, L80, L81, L82, L83, L84, L85, L86, L87, L88, L89, L90, L91, L92, L93, L94, L95, L96, L97, L98, L99, L100</p> <p>Réglage d'usine par défaut : L1</p> <p>Appuyez sur enter</p> <p>L'affichage clignote en alternant CARE et L1</p> <p>Au besoin, utilisez enter pour modifier l'affichage sur arrêt, L2 ou L3</p> <p>Appuyez sur enter</p>
<p>Store</p> <p>Appuyez sur enter pour enregistrer tous les réglages</p> <p>L'appareil démarre automatiquement.</p> <p>Appuyez sur enter pour ignorer toutes les modifications et rétablir les valeurs par défaut d'usine. L'affiche est vide.</p> <p>Appuyez sur enter pour recommencer la procédure</p>	<p>La procédure de configuration est désormais terminée.</p> <p>Au démarrage de l'appareil, le contrôleur affiche la température du liquide de l'application.</p> <p>Au besoin, vous pouvez changer/vérifier la valeur de consigne de l'appareil en appuyant sur mode</p>	<p>SP sert à régler la valeur de consigne. Plage : +5°C à +40°C</p> <p>Réglage d'usine par défaut : +20°C</p> <p>L'affichage clignote en alternant SP et 20</p> <p>Au besoin, utilisez enter pour modifier le réglage</p> <p>Appuyez sur enter pour enregistrer la nouvelle valeur de consigne et revenir à l'affichage de la température</p>

Option - Tension globale - Étape A

A HZ

HZ sert à identifier la fréquence d'entrée pour les unités de tension globales. La fréquence sélectionnée ajuste automatiquement le réglage de haute pression par défaut fixe du microprogramme.

Plage : 50 ou 60 Hz Par défaut : 60 Hz

Appuyez sur **enter**

L'affichage clignote en alternant HZ et 60

Au besoin, utilisez **enter** pour modifier la fréquence

Appuyez sur **enter**

Si votre appareil n'est pas équipé d'un transducteur de débit ou de communications série, voir l'étape 20.

Option - Transducteur de débit - étapes B et C

B Hi FLO

Hi FLO définit la limite d'alarme de débit élevé.

Plage : Varie en fonction de la pompe

Réglage d'usine par défaut : Varie en fonction de la pompe

Appuyez sur **enter**

L'affichage clignote en alternant Hi FLO et la valeur par défaut

Au besoin, utilisez **enter** pour modifier la valeur

Appuyez sur **enter**

C Lo FLO

Lo FLO définit la limite d'alarme de faible débit.

Plage : Varie en fonction de la pompe

Réglage d'usine par défaut : Varie en fonction de la pompe

Appuyez sur **enter**

L'affichage clignote en alternant Lo FLO et la valeur par défaut

Au besoin, utilisez **enter** pour modifier la valeur

Appuyez sur **enter**

Si l'unité ne comporte pas de communications série, voir l'étape 20.

Option - Communications série (DCOM) - étapes D à I

D SER

SER sert à activer/désactiver et à configurer le mode de communications série.

Plage : of, rS232, rS485

Réglage d'usine par défaut : of

Appuyez sur **enter**

L'affichage clignote en alternant SER et OFF (ARRÊT)

Au besoin, utilisez **enter** pour modifier le mode

Appuyez sur **enter**

E BAUD

BAUD sert à sélectionner le débit (la vitesse) de communication série.

Plage : 9600, 4800, 2400, 1200, 600 ou 300 bits par seconde.

Réglage d'usine par défaut : 9600

Appuyez sur **enter**

L'affichage clignote en alternant BAUD et 9600

Au besoin, utilisez **enter** pour modifier le débit

Appuyez sur **enter**

G StOP

StOP sert à indiquer le nombre de bits d'arrêt.

Plage : 2 ou 1

Réglage d'usine par défaut : 1

Appuyez sur **enter**

L'affichage clignote en alternant StOP et 1

Au besoin, utilisez **enter** pour modifier le réglage

Appuyez sur **enter**

dATA

dATA sert à indiquer le nombre de bits. Affichage : 8

Appuyez sur **enter**

L'affichage clignote en alternant dATA et 8

Appuyez sur **enter**

Option - Identification de l'appareil - étape H

H u id

u id (identification de l'appareil) sert uniquement en RS485. Identifie les appareils raccordés au port RS485.

Plage : 1 à 99

Réglage d'usine par défaut : 1

Appuyez sur **enter**

L'affichage clignote en alternant u id et 1

Au besoin, utilisez **enter** pour modifier le réglage

Appuyez sur **enter**

Voilà l'étape 20.

S'il y a lieu, consultez les cadres de droite pour définir des options. Pour les appareils I/O analogiques (ACOM) consultez la documentation de démarrage rapide supplémentaire fournie avec l'appareil.

Schnellstart - Nur für die erste Inbetriebnahme — führen Sie die Schritte 9 bis 20 für alle Geräte aus.

<p>9 Units sind die Einheiten für Temperatur, Flüssigkeitsdurchfluss (optional) und Druck. Einheiten: °C/F °G/ML/PM PS/Bar/KPAS Werkseinstellungen: °C, Gallonen, PSI</p> <p>Drücken Sie enter, um die Anzeige blinkt und zeigt abwechselnd Units und °C an</p> <p>Falls erforderlich, drücken Sie ↔, um die Skala auf F umzuschalten</p> <p>Drücken Sie enter, um zur nächsten Anzeige zu wechseln</p> <p>Wiederholen Sie den Vorgang für die Skalen Flow (Durchfluss) und Pressure (Druck)</p>	<p>10 Hi, L</p> <p>Über Hi, wird die Alarmschwelle für den Übertemperaturalarm der Flüssigkeit eingestellt. Bereich: +3°C bis +42°C Werkseinstellung: +42°C</p> <p>Drücken Sie enter</p> <p>Die Anzeige blinkt und zeigt abwechselnd Hi t und 42 an</p> <p>Falls erforderlich, drücken Sie ↔, um den Wert einzustellen</p> <p>Drücken Sie enter, um zur nächsten Anzeige zu wechseln</p>	<p>11 Lo t</p> <p>Über Lo P1 wird die Alarmschwelle für niedrige Flüssigkeitstemperatur eingestellt. Bereich: +3°C bis +42°C Werkseinstellung: 3°C</p> <p>Die Anzeige blinkt und zeigt abwechselnd Lo t und 3 an</p> <p>Falls erforderlich, drücken Sie ↔, um den Wert einzustellen</p> <p>Drücken Sie enter</p>	<p>12 Hi, Pi</p> <p>Über Hi P1 wird die Alarmschwelle für die Entlastung der Pumpe bei hohem Druck eingestellt. Bereich: Je nach Pumpe verschieden</p> <p>Drücken Sie enter, Werkseinstellung: Je nach Pumpe verschieden</p> <p>Die Anzeige blinkt und zeigt abwechselnd Hi P1 und den Standardwert an</p> <p>Falls erforderlich, drücken Sie ↔, um den Wert einzustellen</p> <p>Drücken Sie enter</p>	<p>13 dELAY</p> <p>dELAY gibt an, wie lange die Pumpe nach Überschreiten der P1 Alarmschwelle noch weiterläuft, bevor sie abschaltet. Bereich: Je nach Pumpe verschieden Werkseinstellung: 0 Sekunden</p> <p>Die Anzeige blinkt und zeigt abwechselnd dELAY und 0 an</p> <p>Falls erforderlich, drücken Sie ↔, um den Wert einzustellen</p> <p>Drücken Sie enter, HINWEIS Diese Funktion ist nur aktiv, wenn das Gerät auf Abschalten konfiguriert ist, siehe Schritt 16.</p>	<p>14 Lo Pi</p> <p>Über Lo P1 wird die Alarmschwelle für die Entladung der Pumpe bei niedrigem Druck eingestellt. Bereich: Je nach Pumpe verschieden</p> <p>Drücken Sie enter, Werkseinstellung: Je nach Pumpe verschieden</p> <p>Die Anzeige blinkt und zeigt abwechselnd Lo P1 und den Standardwert an</p> <p>Falls erforderlich, drücken Sie ↔, um den Wert einzustellen</p> <p>Drücken Sie enter</p>	<p>15 dELAY</p> <p>dELAY gibt an, wie lange die Pumpe nach Überschreiten der Lo P1 Alarmschwelle noch weiterläuft, bevor sie abschaltet. Bereich: 0 bis 30 Sekunden Werkseinstellung: 10 Sekunden</p> <p>Die Anzeige blinkt und zeigt abwechselnd dELAY und 10 an</p> <p>Falls erforderlich, drücken Sie ↔, um den Wert einzustellen</p> <p>Drücken Sie enter, HINWEIS Diese Funktion ist nur aktiv, wenn das Gerät auf Abschalten konfiguriert ist, siehe Schritt 16.</p>	<p>16 ALR</p> <p>ALR konfiguriert die Reaktion des Geräts auf Temperatur-, Druck- und (optional) Durchfluss-Alarmlösungen - entweder Abschaltung (IL) oder Betrieb fortsetzen (INDC). Weitere Informationen siehe Abschnitt 4 im Handbuch. Bereich: IL* oder INDC** Werkseinstellung: IL</p> <p>Drücken Sie enter</p> <p>Die Anzeige blinkt und zeigt abwechselnd ALR und IL an</p> <p>Falls gewünscht, drücken Sie ↔, um INDC anzuzeigen</p> <p>Drücken Sie enter, *IL = Fehler (Abschalten) **INDC = Anzeigen (Betrieb fortsetzen)</p>	<p>17 Sound</p> <p>Schalten den akustischen Alarm des Geräts ein bzw. aus. Bereich: on oder OFF Werkseinstellung: on</p> <p>Drücken Sie enter</p> <p>Die Anzeige blinkt und zeigt abwechselnd Sound und ON an</p> <p>Falls gewünscht, drücken Sie ↔, um OFF anzuzeigen</p> <p>Drücken Sie enter</p>	<p>18 StArT</p> <p>Über StArT wird der automatische Neustart ein- bzw. ausgeschaltet. Bereich: on oder OFF Werkseinstellung: OFF</p> <p>Drücken Sie enter</p> <p>Die Anzeige blinkt und zeigt abwechselnd StArT und OFF an</p> <p>Falls gewünscht, drücken Sie ↔, um ON anzuzeigen</p> <p>Drücken Sie enter</p>	<p>19 CARe</p> <p>Über CARe wird das Erinnerungsintervall für die vorbeugende Reinigung der Luft- und Flüssigkeitsfilter des Geräts eingestellt. Bereich: off, L1 - 1000 Stunden, L2 - 2000 Stunden, L3 -3000 Stunden Werkseinstellung: L1</p> <p>Drücken Sie enter</p> <p>Die Anzeige blinkt und zeigt abwechselnd CARe und L1 an</p> <p>Falls erforderlich, drücken Sie ↔, um die Anzeige auf OFF, L2 oder L3 zu ändern</p> <p>Drücken Sie enter</p>	<p>20 SP</p> <p>Über SP wird der Sollwert eingestellt. Bereich: +5°C bis +40°C Werkseinstellung: +20°C</p> <p>Die Anzeige blinkt und zeigt abwechselnd SP und 20 an</p> <p>Falls erforderlich, drücken Sie ↔, um die Einstellung zu ändern</p> <p>Drücken Sie enter, um den neuen Sollwert zu speichern und zur Anzeige der Temperatur zurückzukehren</p>
---	---	--	---	---	---	--	---	--	--	---	---

Falls zutreffend, stellen Sie die Optionen entsprechend den Feldern auf der rechten Seite ein. Für Geräte mit analogen Ein- und Ausgängen (ACOM) siehe mitgelieferte zusätzliche Hinweise für den Schnellstart.

<p>20 StORe</p> <p>Drücken Sie enter, um alle Einstellungen zu speichern</p> <p>Das Gerät startet automatisch.</p> <p>Drücken Sie ↔, um alle Änderungen zu verwenden und zu den Werks-Standard-Einstellungen zurückzukehren</p> <p>Die Anzeige bleibt leer</p> <p>Drücken Sie enter, um den Vorgang neu zu starten</p>	<p>Der Setup-Vorgang ist nun abgeschlossen.</p> <p>Beim Start des Geräts wird die Temperatur der Prozessflüssigkeit angezeigt.</p> <p>Falls gewünscht, können Sie den Sollwert ändern/bestätigen.</p> <p>mode</p>	<p>Option - Variabler Spannungsbereich — Schritt A</p> <p>Hz</p> <p>Drücken Sie enter</p> <p>Die Anzeige blinkt und zeigt abwechselnd Hz und 60 an</p> <p>Falls erforderlich, drücken Sie ↔, um die Frequenz zu ändern</p> <p>Drücken Sie enter</p> <p>Wenn Ihr Gerät nicht über einen Durchfluss-Messumformer oder serielle Kommunikation verfügt, siehe Schritt 20.</p>
--	---	--

<p>Option - Durchfluss-Messumformer — Schritte B und C</p> <p>Hi, Flo</p> <p>Über HiFLO wird die Alarmschwelle für hohen Durchfluss eingestellt. Bereich: Je nach Pumpe verschieden</p> <p>Drücken Sie enter, Werkseinstellung: Je nach Pumpe verschieden</p> <p>Die Anzeige blinkt und zeigt abwechselnd HiFLO und den Standardwert an</p> <p>Falls erforderlich, drücken Sie ↔, um den Wert einzustellen</p> <p>Drücken Sie enter</p>	<p>Option - Serielle Kommunikation (DCOM) — Schritte D bis I</p> <p>SEr</p> <p>Über SEr wird der Modus für die serielle Kommunikation ein- und ausgeschaltet und konfiguriert. Bereich: off, rS232, rS485 Werkseinstellung: off</p> <p>Drücken Sie enter</p> <p>Die Anzeige blinkt und zeigt abwechselnd SEr und OFF an</p> <p>Falls erforderlich, drücken Sie ↔, um den Modus zu ändern</p> <p>Drücken Sie enter</p>
--	--

<p>Option - Durchfluss-Messumformer — Schritte B und C</p> <p>LoFlo</p> <p>Über LoFLO wird die Alarmschwelle für niedrigen Durchfluss eingestellt. Bereich: Je nach Pumpe verschieden</p> <p>Drücken Sie enter, Werkseinstellung: Je nach Pumpe verschieden</p> <p>Die Anzeige blinkt und zeigt abwechselnd LoFLO und den Standardwert an</p> <p>Falls erforderlich, drücken Sie ↔, um den Wert einzustellen</p> <p>Drücken Sie enter</p>	<p>Option - Serielle Kommunikation (DCOM) — Schritte D bis I</p> <p>BAud</p> <p>Über BAud wird die Baudrate (geschwindigkeit) für die serielle Kommunikation ausgewählt. Bereich: 9600, 4800, 2400, 1200, 600 oder 300 Bit pro Sekunde. Werkseinstellung: 9600</p> <p>Drücken Sie enter</p> <p>Die Anzeige blinkt und zeigt abwechselnd BAud und 9600 an</p> <p>Falls erforderlich, drücken Sie ↔, um die Baudrate zu ändern</p> <p>Drücken Sie enter</p>
--	--

<p>Option - Durchfluss-Messumformer — Schritte B und C</p> <p>StoP</p> <p>Über StoP wird die Anzahl der Stopp-Bits angegeben. Bereich: 2 oder 1 Werkseinstellung: 1</p> <p>Drücken Sie enter</p> <p>Die Anzeige blinkt und zeigt abwechselnd StoP und 1 an</p> <p>Falls erforderlich, drücken Sie ↔, um die Einstellung zu ändern</p> <p>Drücken Sie enter</p>	<p>Option - Serielle Kommunikation (DCOM) — Schritte D bis I</p> <p>dAtA</p> <p>Über dAtA wird die Anzahl der Bits angezeigt. Anzeige: 8</p> <p>Drücken Sie enter</p> <p>Die Anzeige blinkt und zeigt abwechselnd dAtA und 8 an</p> <p>Drücken Sie enter</p>
---	--

<p>Option - Durchfluss-Messumformer — Schritte B und C</p> <p>PAR</p> <p>PAR wird verwendet, um Fehler in der Datenübertragung zu finden. Bereich: gleich, ungleich oder keine Werkseinstellung: keine</p> <p>Drücken Sie enter</p> <p>Die Anzeige blinkt und zeigt abwechselnd PAR und none an</p> <p>Falls erforderlich, drücken Sie ↔, um die Einstellung zu ändern</p> <p>Drücken Sie enter</p>	<p>Option - Serielle Kommunikation (DCOM) — Schritte D bis I</p> <p>StoP</p> <p>Über StoP wird die Anzahl der Stopp-Bits angegeben. Bereich: 2 oder 1 Werkseinstellung: 1</p> <p>Drücken Sie enter</p> <p>Die Anzeige blinkt und zeigt abwechselnd StoP und 1 an</p> <p>Falls erforderlich, drücken Sie ↔, um die Einstellung zu ändern</p> <p>Drücken Sie enter</p>
--	---

<p>Option - Durchfluss-Messumformer — Schritte B und C</p> <p>UID</p> <p>UID (Geräte-ID) wird nur bei RS485 verwendet, zur Identifizierung von Geräten, die an den Port RS485 angeschlossen werden. Bereich: 1 bis 99 Werkseinstellung: 1</p> <p>Drücken Sie enter</p> <p>Die Anzeige blinkt und zeigt abwechselnd UID und 1 an</p> <p>Falls erforderlich, drücken Sie ↔, um die Einstellung zu ändern</p> <p>Drücken Sie enter</p>	<p>Option - Serielle Kommunikation (DCOM) — Schritte D bis I</p> <p>StoP</p> <p>Über StoP wird die Anzahl der Stopp-Bits angegeben. Bereich: 2 oder 1 Werkseinstellung: 1</p> <p>Drücken Sie enter</p> <p>Die Anzeige blinkt und zeigt abwechselnd StoP und 1 an</p> <p>Falls erforderlich, drücken Sie ↔, um die Einstellung zu ändern</p> <p>Drücken Sie enter</p>
--	---

<p>Option - Durchfluss-Messumformer — Schritte B und C</p> <p>UID</p> <p>UID (Geräte-ID) wird nur bei RS485 verwendet, zur Identifizierung von Geräten, die an den Port RS485 angeschlossen werden. Bereich: 1 bis 99 Werkseinstellung: 1</p> <p>Drücken Sie enter</p> <p>Die Anzeige blinkt und zeigt abwechselnd UID und 1 an</p> <p>Falls erforderlich, drücken Sie ↔, um die Einstellung zu ändern</p> <p>Drücken Sie enter</p>	<p>Option - Serielle Kommunikation (DCOM) — Schritte D bis I</p> <p>StoP</p> <p>Über StoP wird die Anzahl der Stopp-Bits angegeben. Bereich: 2 oder 1 Werkseinstellung: 1</p> <p>Drücken Sie enter</p> <p>Die Anzeige blinkt und zeigt abwechselnd StoP und 1 an</p> <p>Falls erforderlich, drücken Sie ↔, um die Einstellung zu ändern</p> <p>Drücken Sie enter</p>
--	---



Scopo di questa guida rapida è facilitare la messa in funzione iniziale. Per tutte le altre procedure è necessario fare riferimento al manuale. Se alcuni dei passaggi qui riportati non risultano chiari, scaricare il manuale prima di proseguire.

Sicurezza:

- Il refrigeratore è progettato esclusivamente per l'uso al chiuso. Non posizionare mai il refrigeratore in un ambiente a temperature eccessivamente alte, umido, con ventilazione inadeguata o materiali corrosivi.
- Attaccare il refrigeratore a una presa correttamente collegata a massa.
- I refrigeranti utilizzati sono più pesanti dell'aria e sostituiranno l'ossigeno causando la perdita di coscienza. Il contatto con refrigeranti fuoriusciti causa ustioni della pelle. Per ulteriori informazioni, fare riferimento alla targhetta identificativa del refrigeratore e alla scheda di sicurezza dei materiali (MSDS) più recente.
- Spostare il refrigeratore con cautela. Cadute o urti improvvisi possono danneggiare i componenti. Spegnerne sempre l'apparecchiatura e scollegarla dalla tensione di alimentazione, prima di spostarla.
- Non azionare apparecchiature danneggiate o che presentano perdite.



Figura B

- Se il refrigeratore è dotato di pompa volumetrica (P1 o P2), verificare che le tubazioni idrauliche e i raccordi previsti per l'applicazione siano progettati per sostenere una pressione minima di 185 psi.
- Non utilizzare una cartuccia filtro per deionizzazione (D) con etilenglicole o propilenglicole inibito. Il filtro di rimuove gli inibitori dalla soluzione rendendo il liquido inefficace contro la protezione dalla corrosione. Inoltre, gli inibitori aumentano la conduttività del liquido.
- Utilizzare solo i liquidi approvati riportati nella tabella 1. Prima di utilizzare liquidi o eseguire eventuali interventi di manutenzione che potrebbero implicare il contatto con il liquido, fare riferimento alle schede di sicurezza dei materiali (MSDS) del produttore per le precauzioni d'uso.
- Per impedire il congelamento dello scambiatore di calore a piastre, i refrigeratori ThermoFlex7500-24000 richiedono l'uso di 50/50 di etilenglicole/acqua o propilenglicole/acqua per temperature di processo inferiori a 10°C.

Elementi necessari per la messa in funzione:

- Una chiave regolabile
- Alimentazione e ritorno acqua dell'impianto (refrigeratori ad acqua)
- Tubazioni rigide o flessibili idonee
- Tipo di raccordi o dimensioni fascette adeguati
- Nastro adesivo Teflon® o sigillante idoneo

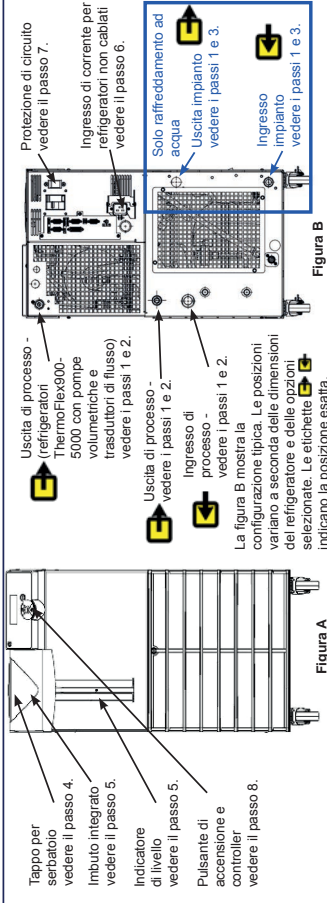
Raccordi acqua dell'impianto (FNPT)

- ThermoFlex 1400 - 5000 Ingressi/uscite in bronzo fuso da 1/2"
- ThermoFlex 7500 - 10000 Ingressi/uscite in bronzo fuso da 3/4"
- ThermoFlex 15000 - 24000 Ingressi in bronzo fuso da 3/4"
- ThermoFlex 5000 - 24000 Uscite in acciaio inossidabile da 3/4"

Raccordi per liquidi di processo (FNPT) - Uscita

- TFlex900 - 10000 P1 P2 T0 T1 in bronzo fuso da 1/2"
- TFlex3500 - 5000 P3 P4 in bronzo fuso da 3/4"
- TFlex7500 - 24000 P3 P5 T5 T9 in rame lavorato da 1"
- Ingresso - stessa dimensione dell'uscita, in acciaio inossidabile per tutti i refrigeratori
- Adattatori forniti
- P1 P2 T0 T1 in polietilene da 1/2" x 3/8" e in nylon da 1/2" x 1/2"
- P3 P4 MPT 3/4 x raccordo dentato in PVC 1/2"
- P3 P5 T5 T9 MPT 1" x raccordo dentato in PVC 1" e MPT 1" x raccordo dentato in PVC 3/4"

Tabella 1 - Liquidi approvati:
L'uso di qualsiasi altro liquido annullerà la garanzia del produttore.
Refrigeratori a temperature standard
Acqua distillata/filtrata (pH 7-8)
Acqua deionizzata (1-3 MQ-cm, compensata)
Acqua distillata con biocida o inibitore Nalco
Acqua distillata con doro (5 ppm)
0 - 75% etilenglicole/acqua per laboratorio
0 - 75% propilenglicole/acqua per laboratorio



Figura B



Figura B

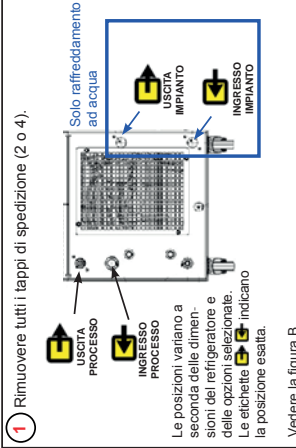

Figura B

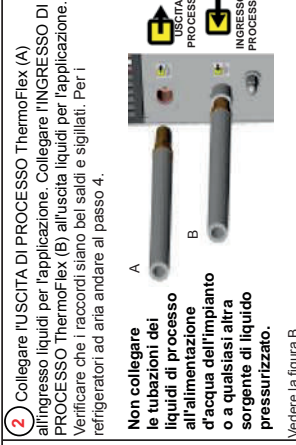

Figura B

1 Rimuovere tutti i tappi di spedizione (2 o 4).

Le posizioni variano a seconda delle dimensioni del refrigeratore e delle opzioni selezionate. Le etichette A e B indicano la posizione esatta.

2 Collegare l'USCITA DI PROCESSO ThermoFlex (A) all'ingresso liquidi per l'applicazione. Collegare l'INGRESSO DI PROCESSO ThermoFlex (B) all'uscita liquidi per l'applicazione. Verificare che i raccordi siano ben saldi e sigillati. Per i refrigeratori ad aria andare al passo 4.

Non collegare le tubazioni dei liquidi di processo all'alimentazione d'acqua dell'impianto o a qualsiasi altra sorgente di liquido pressurizzato.

3 Collegare l'USCITA IMPIANTO ThermoFlex (A) a una tubazione di ritorno o scarico dell'acqua dell'impianto. Collegare l'INGRESSO IMPIANTO ThermoFlex (B) all'alimentazione acqua dell'impianto. Verificare che i raccordi siano ben saldi e sigillati.

Solo per il raffreddamento ad acqua.
La pressione di ingresso massima dell'acqua dell'impianto non deve superare i 150 PSIG. Il differenziale di pressione massimo dell'acqua dell'impianto non deve superare i 50 PSID.

4 Fare riferimento alla targhetta identificativa sul retro del refrigeratore e verificare la tensione corretta. Per i refrigeratori forniti con un cavo di alimentazione, inserire l'estremità femmina del cavo nel refrigeratore e l'estremità maschio nella presa di corrente. Il cavo di alimentazione si trova sotto il coperchio della cassa per la spedizione. Non gettare il coperchio fino a quando non si trova il cavo.)

Non azionare il refrigeratore con un cavo di alimentazione danneggiato.
Nota: i refrigeratori ThermoFlex900-5000 dotati dell'opzione di tensione variabile o globale hanno un pannello di configurazione della tensione. Fare riferimento al foglio delle istruzioni relative alla tensione specificato con il refrigeratore o vedere l'Appendice B al manuale.
Nota: per i refrigeratori che richiedono il cablaggio vedere la sezione 3 del manuale.

5 Se in dotazione, portare l'interruttore GF-Ci opzionale situato sul retro nella posizione sollevata. Per i refrigeratori compresi tra ThermoFlex900 e 10000, portare la protezione di circuito nella posizione attiva (I). Il display del controller indicherà una serie di barre di scorrimento (≡). Le barre scorreranno verso l'alto a indicare l'inizializzazione del refrigeratore; operazione che richiederà circa 15 secondi. Per altri refrigeratori, le barre vengono visualizzate quando viene fornita l'alimentazione.



Figura B

6 Non utilizzare mai il chiller senza il liquido di raffreddamento nel serbatoio o senza avere installato il sacchetto filtro.



Figura A

7 Riempire lentamente il serbatoio con liquido di processo pulito (vedere la tabella 1), utilizzando il tubo spia per controllare facilmente il livello del liquido. Quando il serbatoio è pieno, riapplicare il tappo e serrare a mano. Poiché la capacità del serbatoio potrebbe essere inferiore al necessario per l'applicazione interessata e l'aria potrebbe essere spurgata dalle tubazioni, tenere a portata di mano del liquido extra per rabboccare il sistema all'avvio del riciclo esterno.

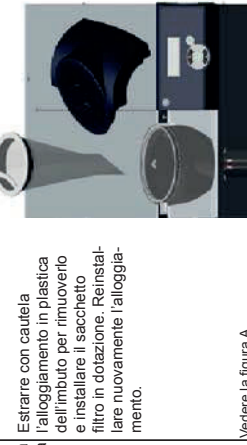

Figura A

8 Premere il controller viene visualizzato SETUP.

Nota: se il refrigeratore viene dotato di una cartuccia filtro per deionizzazione fare riferimento alla sezione 5 del manuale per informazioni sull'installazione. Consultare il retro per ulteriori procedure.



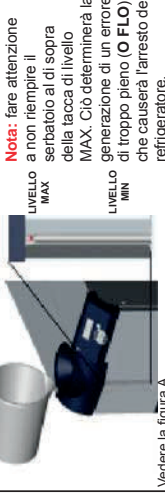







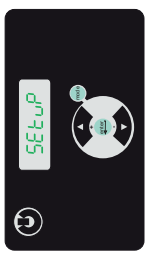



































Figura A

La protezione di circuito non è progettata per agire come strumento di scollegamento.



Avvio rapido - solo per la messa in servizio iniziale — eseguire dal passo 9 al 20 per tutti i refrigeratori.

<p>9 Units</p> <p>Units sono le scale della temperatura, del flusso di liquido (opzionale) e della pressione.</p> <p>Scale: °C/°F GPM/LPM PSI/Bar/KPAS</p> <ul style="list-style-type: none"> • Premere  • Il display lampeggia tra Units e °C • Se desiderato, utilizzare  per modificare la scala in °F • Premere  per passare al display successivo • Effettuare la stessa operazione per le scale di flusso e pressione 	<p>10 Hi L</p> <p>Hi L imposta il limite dell'allarme alta temperatura del liquido.</p> <p>Intervallo: Da +3°C a +42°C Impostazione predefinita dalla fabbrica: +42°C</p> <ul style="list-style-type: none"> • Premere  • Il display lampeggerà tra Hi L e 42 • Se desiderato, utilizzare  per regolare il valore • Premere  per passare al display successivo 	<p>11 Lo L</p> <p>Lo L imposta il limite di allarme bassa temperatura del liquido.</p> <p>Intervallo: Da +3°C a +42°C Impostazione predefinita dalla fabbrica: 3°C</p> <ul style="list-style-type: none"> • Premere  • Il display lampeggerà tra Lo L e 3 • Se desiderato, utilizzare  per regolare il valore • Premere  	<p>12 Hi P1</p> <p>Hi P1 imposta il limite di allarme scarico alta pressione della pompa.</p> <p>Intervallo: variabile a seconda della pompa Impostazione predefinita dalla fabbrica: variabile a seconda della pompa</p> <ul style="list-style-type: none"> • Premere  • Il display lampeggerà tra Hi P1 e il valore predefinito • Se desiderato, utilizzare  per regolare il valore • Premere  	<p>13 deLAY</p> <p>deLAY è il tempo ammesso oltre il limite di allarme Hi P1 prima che la pompa venga spenta.</p> <p>Intervallo: variabile a seconda della pompa Impostazione predefinita dalla fabbrica: 0 secondi</p> <ul style="list-style-type: none"> • Il display lampeggerà tra deLAY e 0 • Se desiderato, utilizzare  per regolare il valore • Premere  • Premere  per spegnersi, vedere il passo 16. 	<p>14 Lo P1</p> <p>Lo P1 imposta il limite di allarme scarico bassa pressione della pompa.</p> <p>Intervallo: variabile a seconda della pompa Impostazione predefinita dalla fabbrica: variabile a seconda della pompa</p> <ul style="list-style-type: none"> • Premere  • Il display lampeggerà tra Lo P1 e il valore predefinito • Se desiderato, utilizzare  per regolare il valore • Premere  	<p>15 deLAY</p> <p>deLAY è il tempo ammesso oltre il limite di allarme Lo P1 prima che la pompa venga spenta.</p> <p>Intervallo: da 0 a 30 secondi Impostazione predefinita dalla fabbrica: 10 secondi</p> <ul style="list-style-type: none"> • Il display lampeggerà tra deLAY e 10 • Se desiderato, utilizzare  per regolare il valore • Premere  • Premere  per spegnersi, vedere il passo 16. 	<p>16 ALr</p> <p>ALr configura la reazione del refrigeratore ai limiti di allarme temperatura, pressione e flusso (opzionale) - sia spegnimento (FL) che funzionamento normale (INDC). Per ulteriori informazioni, vedere la sezione 4 nel manuale.</p> <p>Intervallo: "FL" o "INDC"</p> <p>Impostazione predefinita dalla fabbrica: FL</p> <ul style="list-style-type: none"> • Premere  • Il display lampeggerà tra ALr e FL • Se desiderato, premere  per visualizzare INDC • Premere  * • Premere  ** 	<p>17 Sound</p> <p>Attiva o disattiva l'allarme acustico del refrigeratore.</p> <p>Intervallo: on o OFF Impostazione predefinita dalla fabbrica: On</p> <ul style="list-style-type: none"> • Premere  • Il display lampeggerà tra Sound e on • Se desiderato, premere  per visualizzare OFF • Premere  	<p>18 StArT</p> <p>StArT attivadisattiva il riavvio automatico.</p> <p>Intervallo: on o OFF Impostazione predefinita dalla fabbrica: OFF</p> <ul style="list-style-type: none"> • Premere  • Il display lampeggerà tra StArT e OFF • Se desiderato, premere  per visualizzare ON • Premere  	<p>19 CARe</p> <p>CARe viene utilizzato per impostare il promemoria di frequenza manutenzione preventiva di pulizia per i filtri aria e liquido del refrigeratore.</p> <p>Intervallo: off, L1 - 1000 hours, L2 - 2000 hours, L3 - 3000 hours Impostazione predefinita dalla fabbrica: L1</p> <ul style="list-style-type: none"> • Premere  • Il display lampeggerà tra CARe e L1 • Se desiderato, utilizzare  per cambiare la modalità del display in off, L2 o L3 • Premere  	<p>20 SP</p> <p>SP viene utilizzato per regolare il valore di impostazione.</p> <p>Intervallo: da +5°C a +49°C Impostazione predefinita dalla fabbrica: +20°C</p> <ul style="list-style-type: none"> • Il display lampeggerà tra SP e 20 • Se desiderato, utilizzare  per modificare l'impostazione • Premere  per salvare il nuovo valore di impostazione e tornare alla visualizzazione della temperatura.
--	---	---	---	--	--	--	--	--	---	---	---







Se applicabile, vedere i riquadri a destra per impostare le opzioni. Per i refrigeratori con I/O analogico (ACOM), fare riferimento alla guida di avvio rapido aggiuntiva fornita con il refrigeratore.

<p>Store</p> <ul style="list-style-type: none"> • Premere  per salvare tutte le impostazioni <p>Il refrigeratore viene avviato automaticamente.</p> <ul style="list-style-type: none"> • Premere  per ignorare tutte le modifiche e ripristinare i valori predefiniti della fabbrica. <p>Il display si spegnerà.</p> <ul style="list-style-type: none"> • Se desiderato, premere  per riattivare la procedura. 	<p>A questo punto la procedura di configurazione è completata.</p> <p>All'avvio del refrigeratore, sul controller viene visualizzata la temperatura del liquido di processo.</p> <p>Se desiderato, è possibile modificare/verificare il valore di impostazione del refrigeratore premendo </p>	<p>PAR</p> <p>PAR viene utilizzato come strumento di controllo per gli errori di comunicazione.</p> <p>Intervallo: even, odd o none Impostazione predefinita dalla fabbrica: none</p> <ul style="list-style-type: none"> • Premere  • Il display lampeggerà tra PAR e none • Se desiderato, utilizzare  per modificare l'impostazione • Premere 
---	---	--

Opzione - Tensione — Passo A







<p>A HZ</p> <p>HZ viene utilizzato per identificare la frequenza in entrata per i refrigeratori con pompe P3 - P5 e la capacità di funzionamento a 50 Hz o 60 Hz. La frequenza selezionata regola automaticamente l'impostazione predefinita dell'alta pressione fissa del firmware.</p> <p>Intervallo: 50 Hz o 60 Hz Impostazione predefinita dalla fabbrica: 60 Hz</p> <ul style="list-style-type: none"> • Premere  • Il display lampeggerà tra HZ e 60 • Se necessario, utilizzare  per cambiare frequenza • Premere  • Se il refrigeratore non dispone di un trasduttore di flusso o di comunicazioni seriali, vedere il passo 20.

Opzione - Trasduttore di flusso — Passi B e C

<p>B Hi FLO</p> <p>Hi FLO imposta il limite di allarme flusso elevato.</p> <p>Intervallo: variabile a seconda della pompa Impostazione predefinita dalla fabbrica: variabile a seconda della pompa</p> <ul style="list-style-type: none"> • Premere  • Il display lampeggerà tra Hi FLO e il valore predefinito • Se desiderato, utilizzare  per regolare il valore • Premere  	<p>C Lo FLO</p> <p>Lo FLO imposta il limite di allarme flusso basso.</p> <p>Intervallo: variabile a seconda della pompa Impostazione predefinita dalla fabbrica: variabile a seconda della pompa</p> <ul style="list-style-type: none"> • Premere  • Il display lampeggerà tra Lo FLO e il valore predefinito • Se desiderato, utilizzare  per regolare il valore • Premere  • Se il refrigeratore non dispone di comunicazioni seriali, vedere il passo 20.
---	--

Opzione - Comunicazioni seriali (DCOM) — Passi da D a I

<p>D SEr</p> <p>SEr viene utilizzato per attivare/disattivare e per configurare la modalità di comunicazione seriale.</p> <p>Intervallo: off, RS232, RS485 Impostazione predefinita dalla fabbrica: off</p> <ul style="list-style-type: none"> • Premere  • Il display lampeggerà tra SEr e OFF • Se desiderato, utilizzare  per modificare la modalità • Premere  	<p>E BAud</p> <p>BAud viene utilizzato per selezionare la velocità di trasmissione in baud per le comunicazioni seriali.</p> <p>Intervallo: 9600, 4800, 2400, 1200, 600 o 300 bit al secondo.</p> <ul style="list-style-type: none"> • Premere  • Il display lampeggerà tra BAud e 9600 • Se desiderato, utilizzare  per modificare la velocità • Premere 
<p>F data</p> <p>data viene utilizzato per visualizzare il numero di bit.</p> <p>Display: 8</p> <ul style="list-style-type: none"> • Premere  • Il display lampeggerà tra data e 8 • Premere  	<p>G StOp</p> <p>StOp viene utilizzato per indicare il numero di bit di arresto.</p> <p>Intervallo: 2 o 1 Impostazione predefinita dalla fabbrica: 1</p> <ul style="list-style-type: none"> • Premere  • Il display lampeggerà tra StOp e 1 • Se desiderato, utilizzare  per modificare l'impostazione • Premere 

<p>H PAR</p> <p>PAR viene utilizzato come strumento di controllo per gli errori di comunicazione.</p> <p>Intervallo: even, odd o none Impostazione predefinita dalla fabbrica: none</p> <ul style="list-style-type: none"> • Premere  • Il display lampeggerà tra PAR e none • Se desiderato, utilizzare  per modificare l'impostazione • Premere  	<p>I UID</p> <p>UID (ID unità) viene utilizzato solo in RS485. Indica i dispositivi collegati alla porta RS485.</p> <p>Intervallo: da 1 a 99 Impostazione predefinita dalla fabbrica: 1</p> <ul style="list-style-type: none"> • Premere  • Il display lampeggerà tra uid e 1 • Se desiderato, utilizzare  per modificare l'impostazione • Premere  <p style="text-align: right;">Vedere il passo 20.</p>
---	---



Esta guía de puesta en marcha rápida se ha elaborado únicamente para el arranque inicial. Para obtener información sobre otros procedimientos, debe consultar el manual. Asimismo, en caso de que tuviera dudas sobre alguno de estos pasos, descargue el manual antes de continuar.

Seguridad:

- El enfriador está destinado exclusivamente para uso en interiores. No lo coloque nunca en lugares con calor o humedad excesivos, ventilación inadecuada o presencia de materiales corrosivos.
- Conecte el enfriador a una toma de tierra adecuada.
- Los refrigerantes utilizados son más pesados que el aire, por lo que sustituirán al oxígeno y provocarán la pérdida del conocimiento. En caso de que entre en contacto con el refrigerante procedente de fugas, se producirán quemaduras en la piel. Consulte la placa identificativa del enfriador y la hoja de datos de seguridad de materiales (MSDS) más actual del fabricante.
- Mueva el enfriador con cuidado. Los saltos repentinos o las caídas pueden dañar sus componentes. Apague siempre el equipo y desconecte de la tensión eléctrica antes de moverlo.
- Nunca ponga en funcionamiento un equipo que esté dañado o que presente fugas.

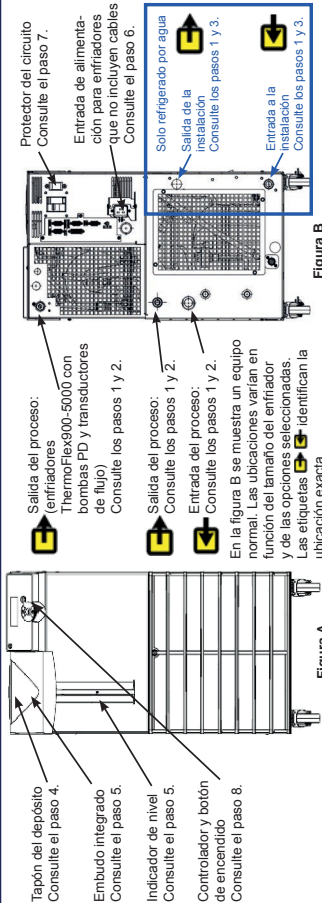

Materiales necesarios:

- Una llave inglesa ajustable
- Instalaciones para el suministro y el retorno del agua (enfriadores refrigerados por agua)
- Manguera o tuberías apropiadas
- Abrazaderas o conexiones con el tamaño adecuado
- Cinta de Teflon® o un sellador adecuado

Conexiones para agua de la instalación (FNPT)

ThermoFlex1400 - 5000 entrada/salida, bronce fundido, 0,5 pulg
ThermoFlex7500 - 10.000 entrada/salida, bronce fundido, 0,75 pulg
ThermoFlex15000 - 24.000 entrada, bronce fundido, 0,75 pulg
ThermoFlex15000 - 24.000 salida, acero inoxidable, 0,75 pulg

Conexiones de los líquidos de proceso (FNPT)

Salida
P1 P2 T0 T1 Bronce fundido, 0,5 pulg
P3 P4 Bronce fundido, 0,75 pulg
TFlex3500: 5000
TFlex7500: 24.000
TFlex15000: 24.000
Cobre forjado, 1 pulg
Entrada: tamaño idéntico al de la salida de todos los enfriadores de acero inoxidable
Adaptadores suministrados
P1 P2 T0 T1 Polietileno de 0,5 pulg x 0,375 pulg y nailon de 0,5 pulg x 0,5 pulg
P3 P4 MPT de 0,75 pulg x conector de PVC de 0,5 pulg
P3 P5 T5 T9 MPT de 1 pulg x conector de PVC de 1 pulg y MPT de 1 pulg x conector de PVC de 0,75 pulg

- Si la unidad está provista de una bomba de desplazamiento positivo (P1 o P2), asegúrese de que los tubos y conectores de su aplicación tienen capacidad para soportar un mínimo de 185 psi.
- No utilice ningún cartucho de filtro de desionización (DI) con EG inhibido o PG inhibido. Los filtros de DI eliminarán los inhibidores de la solución, lo que provocará que el líquido no ofrezca protección frente a la corrosión. Asimismo, los inhibidores incrementarán la conductividad de los líquidos.
- Utilice únicamente los líquidos aprobados que se muestran en la Tabla 1. Antes de utilizar líquidos o realizar tareas de mantenimiento en las que pueda entrar en contacto con ellos, consulte las precauciones de manipulación en las hojas de datos de seguridad de materiales (MSDS) del fabricante.
- Para evitar que el intercambiador de placas se congele o acristale, los enfriadores ThermoFlex7500-24000 requieren el uso de EG/agua de 50/50 o de PG/agua de 50/50 por debajo de una temperatura de proceso de 10 °C.

Tabla 1: Líquidos aprobados

El uso de cualquier otro líquido anula la garantía del cliente.

Enfriadores de temperatura estándar	
Agua filtrada/desilada (pH 7 - 8)	
Agua desionizada (1 - 3 MΩ-cm, compensada)	
Agua desilada con inhibidor y bicicida Nalco	
Agua desilada con cloro (5 ppm)	
Agua/eitenglicol para laboratorio al 0 - 75 %	
Agua/propienglicol para laboratorio al 0 - 75 %	

1 Retire los plásticos de embalaje de los enchufes (2 o 4).

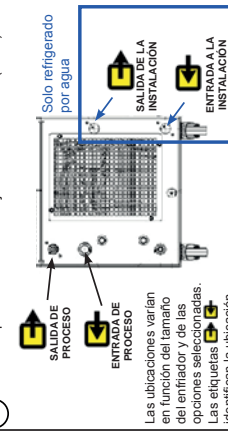

Consulte la Figura B.

5 Si se suministra, coloque en posición vertical el disyuntor GFCI que se ubica en la parte posterior. Para los enfriadores ThermoFlex900 hasta 10.000, coloque el protector del circuito en la posición de encendido (I). En la pantalla del controlador aparecerá una serie de barras de desplazamiento (▬). Las barras se desplazarán hacia arriba, indicando que el enfriador se está inicializando. Este proceso dura 15 segundos aproximadamente. En otros enfriadores, las barras aparecen cuando el enfriador recibe alimentación eléctrica.

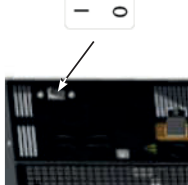

El protector del circuito no se ha diseñado para utilizarse como un medio de desconexión.

Consulte la Figura B.

2 Conecte la SALIDA DE PROCESO de ThermoFlex (A) a la entrada de líquidos de su aplicación. Conecte la ENTRADA DE PROCESO de ThermoFlex (B) a la salida de líquidos de su aplicación. Asegúrese de que las conexiones se han cerrado y fijado correctamente. Para los enfriadores refrigerados por aire, continúe con el paso 4.



Consulte la Figura B.

6 Nunca ponga en marcha el chiller sin líquido refrigerante en el tanque o sin la bolsa de filtro instalada.

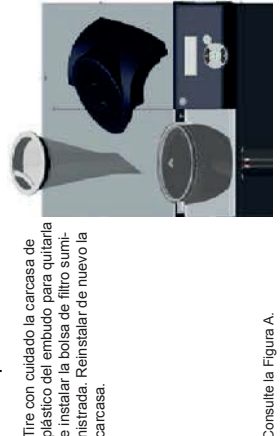

Consulte la Figura A.

3 Conecte la SALIDA DE LA INSTALACIÓN de ThermoFlex (A) a un desagüe o conducto de retorno de agua a la instalación. Conecte la ENTRADA A LA INSTALACIÓN de ThermoFlex (B) a un suministro de agua. Asegúrese de que las conexiones se han cerrado y fijado correctamente.

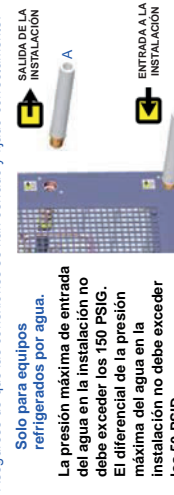

Consulte la Figura B.

7 Lentamente rellene el depósito con líquido de proceso limpio (consulte la tabla 1). Utilice el tubo de control de nivel para controlar con facilidad el nivel de líquido. Cuando el depósito esté lleno, vuelva a colocar el tapón del depósito y apriételo a mano. Ya que la capacidad del depósito puede ser pequeña para la aplicación de que se trate y posiblemente deba purgar el aire de los tubos, tenga a mano líquido extra para mantener el sistema lleno al máximo cuando se inicie la circulación externa.

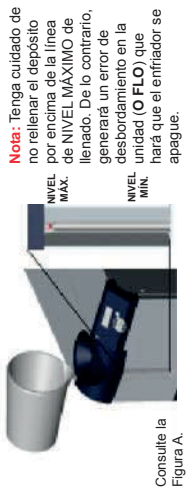

Consulte la Figura A.

4 Consulte la placa identificativa de la parte posterior del enfriador y compruebe la tensión apropiada. Para los enfriadores que se suministran con un cable de alimentación, inserte el extremo hembra del cable de alimentación en el enfriador. A continuación, inserte el extremo macho del cable de alimentación en la toma eléctrica (el cable de alimentación se ubica debajo de la tapa de la caja de transporte. No deseché la tapa hasta que haya encontrado el cable).

En caso de que el cable de alimentación esté dañado, no utilice el enfriador.

Nota: Los enfriadores ThermoFlex900-5000 que se suministran con la opción de tensión variable de tensión global disponen de un panel de configuración de la tensión. Consulte la hoja de instrucciones sobre tensión suministrada con el enfriador o consulte el apéndice B del manual.

Nota: Para obtener información sobre los enfriadores que requieren conectarse mediante cables, consulte la sección 3 del manual.



Consulte la Figura B.

8 Pulse

En el controlador se mostrará Setup (CONFIGURACIÓN).

Nota: Si el enfriador se suministra con un cartucho de filtro de desionización, consulte la sección 5 del manual para su instalación.

Para conocer los pasos adicionales, consulte el dorso.



Consulte la Figura A.

Puesta en marcha rápida - Utilizar solo para el arranque inicial (realizar los pasos 9 a 20 con todos los enfriadores)

<p>9 Units</p> <p>Units hace referencia a las escalas de temperatura, flujo de líquidos (opcional) y presión.</p> <p>Escalas: °C/F GPM/LPM (gal/min o l/min) PSiBar/KPAS</p> <ul style="list-style-type: none"> • Pulse para pasar a la siguiente pantalla. • La pantalla parpadeará alternando entre Units y °C. • Si lo desea, utilice para cambiar la escala a °F. • Pulse para pasar a la siguiente pantalla. • Realice la misma acción con las escalas de flujo y presión. 	<p>10 Hi t</p> <p>Hi t permite establecer el límite superior de alarma de temperatura del líquido.</p> <p>Intervalo: de + 3 °C a + 42 °C</p> <p>Valor predeterminado de fábrica: + 42 °C</p> <ul style="list-style-type: none"> • Pulse para pasar a la siguiente pantalla. • La pantalla parpadeará alternando entre Hi t y 42. • Si lo desea, utilice para ajustar el valor. • Pulse para pasar a la siguiente pantalla. 	<p>11 Lo t</p> <p>Lo t permite establecer el límite inferior de alarma de temperatura.</p> <p>Intervalo: de + 3 °C a + 42 °C</p> <p>Valor predeterminado de fábrica: + 3 °C</p> <ul style="list-style-type: none"> • Pulse para continuar con el procedimiento de configuración. • La pantalla parpadeará alternando entre Lo t y 3. • Si lo desea, utilice para ajustar el valor. • Pulse para continuar con el procedimiento de configuración.
<p>12 Hi PI</p> <p>Hi PI permite establecer el límite superior de alarma de descarga de presión de la bomba.</p> <p>Intervalo: según la bomba</p> <p>Valor predeterminado de fábrica: según la bomba</p> <ul style="list-style-type: none"> • Pulse para pasar a la siguiente pantalla. • La pantalla parpadeará alternando entre Hi PI y el valor predeterminado. • Si lo desea, utilice para ajustar el valor. • Pulse para pasar a la siguiente pantalla. 	<p>13 dELAY</p> <p>dELAY hace referencia al periodo de tiempo durante el que la bomba puede superar el límite de alarma Hi PI antes de apagarse.</p> <p>Intervalo: según la bomba</p> <p>Valor predeterminado de fábrica: 0 segundos</p> <ul style="list-style-type: none"> • La pantalla parpadeará alternando entre dELAY y 0. • Si lo desea, utilice para ajustar el valor. • Pulse para pasar a la siguiente pantalla. 	<p>14 Lo PI</p> <p>Lo PI permite establecer el límite inferior de alarma de descarga de presión de la bomba.</p> <p>Intervalo: según la bomba</p> <p>Valor predeterminado de fábrica: según la bomba</p> <ul style="list-style-type: none"> • Pulse para pasar a la siguiente pantalla. • La pantalla parpadeará alternando entre Lo PI y el valor predeterminado. • Si lo desea, utilice para ajustar el valor. • Pulse para pasar a la siguiente pantalla.
<p>15 dELAY</p> <p>dELAY hace referencia al periodo de tiempo durante el que la bomba puede superar el límite de alarma Lo PI antes de apagarse.</p> <p>Intervalo: de 0 a 30 segundos</p> <p>Valor predeterminado de fábrica: 10 segundos</p> <ul style="list-style-type: none"> • La pantalla parpadeará alternando entre dELAY y 10. • Si lo desea, utilice para ajustar el valor. • Pulse para pasar a la siguiente pantalla. 	<p>16 ALr</p> <p>ALr permite configurar la reacción del enfriador a los límites de alarma de temperatura, presión y flujo (opcional); antes de (FL) o continuará funcionando (IndC). Consulte la sección 4 del manual para obtener más información.</p> <p>Intervalo: fLr, o IndC**</p> <p>Valor predeterminado de fábrica: fLr</p> <ul style="list-style-type: none"> • La pantalla parpadeará alternando entre ALr y fLr. • Si lo desea, pulse para mostrar IndC. • Pulse para mostrar IndC. • **IndC = indicación (continuar en funcionamiento) 	<p>17 Sound</p> <p>Permite activar o desactivar la alarma sonora del enfriador.</p> <p>Intervalo: ON u OFF</p> <p>Valor predeterminado de fábrica: ON</p> <ul style="list-style-type: none"> • Pulse para mostrar OFF. • La pantalla parpadeará alternando entre Sound y ON. • Si lo desea, pulse para mostrar OFF. • Pulse para mostrar OFF.
<p>18 StArE</p> <p>StArE permite activar/desactivar el reinicio automático.</p> <p>Intervalo: ON u OFF</p> <p>Valor predeterminado de fábrica: OFF</p> <ul style="list-style-type: none"> • Pulse para mostrar ON. • La pantalla parpadeará alternando entre StArE y OFF. • Si lo desea, pulse para mostrar ON. • Pulse para mostrar ON. 	<p>19 CARe</p> <p>CARe se utiliza para configurar el recordatorio que indica la frecuencia de limpieza como cuidado preventivo para los filtros de aire y líquidos del enfriador.</p> <p>Intervalo: OFF L1 - 1000 horas, L2 - 2000 horas, L3 - 3000 horas</p> <p>Valor predeterminado de fábrica: L1</p> <ul style="list-style-type: none"> • Pulse para cambiar la pantalla a OFF L2 o L3. • La pantalla parpadeará alternando entre CARe y L1. • Si lo desea, utilice para cambiar la pantalla a OFF L2 o L3. • Pulse para cambiar la pantalla a OFF L2 o L3. 	<p>20 SP</p> <p>SP se utiliza para ajustar el valor de referencia.</p> <p>Intervalo: de + 5 °C a + 40 °C</p> <p>Valor predeterminado de fábrica: + 20 °C</p> <ul style="list-style-type: none"> • La pantalla parpadeará alternando entre SP y 20. • Si lo desea, utilice para cambiar el ajuste. • Pulse para guardar el nuevo valor de referencia y volver a la pantalla de temperatura.

Si procede, consulte los cuadros situados a la derecha para configurar las opciones. En el caso de enfriadores con módulo de entrada/salida analógico (ACOM), consulte las instrucciones de puesta en marcha rápida adicionales suministradas con el equipo.

<p>20 StORe</p> <p>StORe permite guardar todos los ajustes.</p> <p>El enfriador se enciende automáticamente.</p> <p>Para rechazar todos los cambios y restaurar los valores predeterminados de fábrica.</p> <p>La pantalla se quedará en blanco.</p> <ul style="list-style-type: none"> • Si lo desea, pulse para reiniciar el procedimiento. 	<p>Ha completado el procedimiento de configuración.</p> <p>Al encender el enfriador, el controlador muestra la temperatura del líquido del proceso.</p> <p>Si lo desea, puede pulsar para cambiar/verificar el valor de referencia del enfriador.</p>	<p>20 SP</p> <p>SP se utiliza para ajustar el valor de referencia.</p> <p>Intervalo: de + 5 °C a + 40 °C</p> <p>Valor predeterminado de fábrica: + 20 °C</p> <ul style="list-style-type: none"> • La pantalla parpadeará alternando entre SP y 20. • Si lo desea, utilice para cambiar el ajuste. • Pulse para guardar el nuevo valor de referencia y volver a la pantalla de temperatura.
---	--	---

Opción - Tensión — Paso A

A **HZ**

HZ se utiliza para identificar la frecuencia entrante en los enfriadores con bombas P3 - P5 y la capacidad de funcionar a 50 Hz o 60 Hz. La frecuencia seleccionada ajusta automáticamente la configuración predeterminada de presión alta fija del firmware.

Intervalo: 50 Hz o 60 Hz

Valor predeterminado de fábrica: 60 Hz

- Pulse para cambiar la frecuencia.
- Si es necesario, utilice para cambiar la frecuencia.
- Si el enfriador no dispone de transductor de flujo o no admite comunicaciones en serie, consulte el paso 20.

Opción - Transductor de flujo — Pasos B y C

B **Hi FLO**

Hi FLO permite establecer el límite superior de alarma de flujo.

Intervalo: según la bomba

Valor predeterminado de fábrica: según la bomba

- Pulse para pasar a la siguiente pantalla.
- La pantalla parpadeará alternando entre Hi FLO y el valor predeterminado.
- Si lo desea, utilice para ajustar el valor.
- Pulse para pasar a la siguiente pantalla.

C **Lo FLO**

Lo FLO permite establecer el límite inferior de alarma de flujo.

Intervalo: según la bomba

Valor predeterminado de fábrica: según la bomba

- Pulse para pasar a la siguiente pantalla.
- La pantalla parpadeará alternando entre Lo FLO y el valor predeterminado.
- Si lo desea, utilice para ajustar el valor.
- Pulse para pasar a la siguiente pantalla.

Opción - Comunicaciones en serie (DCOM) — Pasos D a I

D **SEr**

SEr se utiliza para activar/desactivar y configurar el modo de comunicaciones en serie.

Intervalo: OFF rS232, rS485

Valor predeterminado de fábrica: OFF

- Pulse para cambiar el modo.
- La pantalla parpadeará alternando entre SEr y OFF.
- Si lo desea, utilice para cambiar el modo.
- Pulse para cambiar el modo.

E **BAud**

BAud se utiliza para seleccionar la velocidad en baudios para la comunicación en serie.

Intervalo: 9600, 4800, 2400, 1200, 600 o 300 bits por segundo.

- Pulse para pasar a la siguiente pantalla.
- La pantalla parpadeará alternando entre BAud y 9600.
- Si lo desea, utilice para cambiar la velocidad.
- Pulse para pasar a la siguiente pantalla.

F **dAtA**

dAtA se utiliza para mostrar el número de bits.

Pantalla: 8

- Pulse para pasar a la siguiente pantalla.
- La pantalla parpadeará alternando entre dAtA y 8.
- Pulse para pasar a la siguiente pantalla.

G **StOp**

StOp se utiliza para indicar el número de bits de parada.

Intervalo: 2 o 1

Valor predeterminado de fábrica: 1

- Pulse para pasar a la siguiente pantalla.
- La pantalla parpadeará alternando entre StOp y 1.
- Si lo desea, utilice para cambiar el ajuste.
- Pulse para pasar a la siguiente pantalla.

H **PAR**

PAR se utiliza como medio para comprobar si hay errores de comunicación.

Intervalo: even, odd o none

Valor predeterminado de fábrica: none

- Pulse para pasar a la siguiente pantalla.
- La pantalla parpadeará alternando entre PAR y none.
- Si lo desea, utilice para cambiar el ajuste.
- Pulse para pasar a la siguiente pantalla.

I **UID**

UID (ID de unidad) se utiliza solo en RS485. Permite identificar los dispositivos conectados al puerto RS485.

Intervalo: de 1 a 99

Valor predeterminado de fábrica: 1

- Pulse para pasar a la siguiente pantalla.
- La pantalla parpadeará alternando entre uid y 1.
- Si lo desea, utilice para cambiar el ajuste.
- Pulse para pasar a la siguiente pantalla.

Consulte el paso 20.

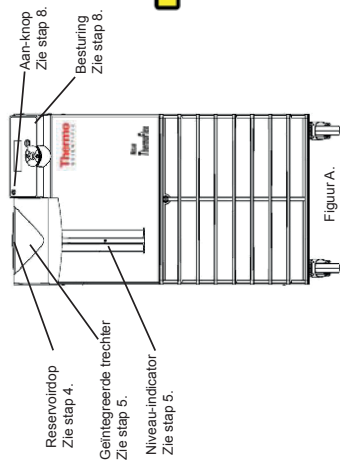

Figuur A.

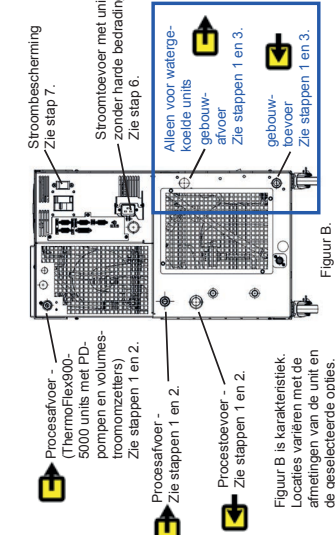

Figuur B.

Dit heeft u nodig om te kunnen beginnen:

- Een verstelbare steeksleutel
- Watervoer en terugvoer op de locatie (watergekoelde units)
- Een geschikte slang of leiding
- Klemmen van de juiste grootte of type aansluiting
- Teflon® Tape of een geschikte afsluiting

Aansluitingen Process/voelst (FNPT)

ThermoFlex1400 - 5000	Toevoer/Afvoer	1/2" gietbrons
ThermoFlex7500 - 10000	Toevoer/Afvoer	3/4" gietbrons
ThermoFlex15000 - 24000	Toevoer	3/4" gietbrons
ThermoFlex15000 - 24000	Afvoer	3/4" roestvrij staal

Wateraansluitingen locatie (FNPT)

ThermoFlex1400 - 5000	Toevoer/Afvoer	1/2" gietbrons
ThermoFlex7500 - 10000	Toevoer/Afvoer	3/4" gietbrons
ThermoFlex15000 - 24000	Toevoer	3/4" gietbrons
ThermoFlex15000 - 24000	Afvoer	3/4" roestvrij staal

<p>1 Trek de plastic transportpluggen eruit.</p> <p>Alleen voor watergekoelde units</p> <p>PROCES AFVOER</p> <p>PROCES TOEVOER</p> <p>Zie figuur B.</p>	<p>2 Sluit de ThermoFlex PROCESAFVOER (A) aan op de vloeistoftoevoer op uw toepassing. Sluit de ThermoFlex PROCESAFVOER (B) aan op de vloeistofafvoer op uw toepassing. Zorg ervoor dat de verbindingen afgesloten zijn en goed vastzitten. Ga voor luchtgekoelde units door naar stap 4.</p> <p>Alleen voor watergekoelde units</p> <p>PROCES AFVOER</p> <p>PROCES TOEVOER</p> <p>Zie figuur B.</p>	<p>3 Sluit de ThermoFlex FACILITY-OUTLET (A) aan op de wateringvoer of -afvoer van uw gebouw. Sluit de ThermoFlex FACILITY-INLET (B) aan op de watervoorziening van uw gebouw. Zorg ervoor dat de verbindingen afgesloten zijn en goed vastzitten.</p> <p>Alleen voor watergekoelde units.</p> <p>Zie figuur B.</p>	<p>4 De doorstroomkoeler mag nooit operationeel zijn zonder dat er de juiste vloeistof in het reservoir zit of zonder dat het vloeistoffilter geïnstalleerd is.</p> <p>Maak het plastic vulkapje los door het omhoog te tillen en installeer dan het meegeleverde vloeistoffilter. Plaats daarna het plastic vulkapje terug.</p> <p>Zie figuur A.</p>
<p>5 Vul het reservoir langzaam met schone procesvloeistof (zie tabel 1) met gebruik van het krukje voor het gemakkelijk in de gaten houden van het vloeistofniveau. Plaats als het reservoir vol is de dop er weer op, handvast. Aanpassen de capaciteit van het reservoir klein kan zijn in vergelijking tot uw toepassing en het nodig kan zijn dat er lucht uit de leidingen geborgen moet worden, dient u extra koelvoelst bij de hand te houden om het systeem bijgevuld te houden als de uitwendige circulatie wordt gestart.</p> <p>Let op: Let goed op dat het reservoir niet boven de lijn MAX NIVEAU wordt gevuld. Dit zal leiden tot een overflowsfout (O FLO) van de unit waardoor de unit zal uitschakelen.</p> <p>Zie figuur A.</p>	<p>6 Controleer de juiste spanning. Voor units die worden geleverd met een retractor, steek de vrouwelijke kant van de stroomkabel in de koeler en steek de mannelijke kant van de stroomkabel in de vermogensingang. (Het retractor bevindt zich onder de deksel van de retractor. Gooi het deksel niet weg voordat u het retractor heeft gevonden).</p> <p>Let op: ThermoFlex900-5000 units uitgerust met de optie Variabele spanning of Universele spanning hebben een configuratiepaneel voor de spanning achter een inspectiekleef aan de achterkant van de unit. Raadpleeg het instructieblad Spanning dat bij de unit is geleverd, of zie Appendix B van de handleiding.</p> <p>Let op: Raadpleeg voor units die harde bedrading nodig hebben hoofdstuk 3 in de handleiding.</p> <p>Zie figuur B.</p>	<p>7 Zet de stroombeschermer op de aan(I)-stand. Het besturingsdisplay zal een reeks schuifbalken (I) laten zien. De balken schuiven naar boven, wat aangeeft dat de unit aan het initialiseren is. Dit duurt ongeveer 15 seconden.</p> <p>Zie figuur B.</p>	<p>8 Druk op . De besturing geeft SEtUp weer.</p> <p>Let op: Als de unit is uitgerust met een deionisatiefiltercassette, raadpleeg dan de handleiding hoofdstuk 5, voor de installatie ervan.</p> <p>Zie de achterkant voor extra stappen.</p> <p>Zie figuur A.</p>

Veiligheidsmaatregelen:

- De unit is alleen ontworpen voor gebruik binnenhuis.
- Plaats een unit nooit op een plek met overmatige warmte, vocht, onvoldoende ventilatie of corrosieve materialen.
- Sluit nooit procesvloeistofleidingen aan op de watervoorziening van uw locatie of andere vloeistofbronnen onder druk.
- Als uw unit is uitgerust met een PD pomp, zorg er dan voor dat de leidingen en aansluitingen van uw toepassing geschikt zijn voor minimaal 185 psi.
- Raadpleeg voordat u vloeistoffen gebruikt of onderhoud uitvoert op plekken waar waarschijnlijk contact is met vloeistof, de veiligheidsbladen van de fabrikant voor voorzorgsmaatregelen.



Tabel 1 - Toegestane vloeistoffen:

Door gebruik van vloeistoffen die niet hieronder worden vermeld komt de fabrieksgarantie te vervallen.

Gefiltreerd/enkelvoudig gedestilleerd water
Gedioniseerd water (1-3 MQ-cm, gecompenseerd)
0 - 75% Ethyleenglycol/water
0 - 75% Propyleenglycol/water

Quick Start - Alleen gebruikt voor het initieel opstarten - voer de stappen 9 tot 20 uit voor alle units.

<p>9 Units zijn de schalen voor temperatuur, flow van de vloeistof (optioneel) en druk. Schalen: °C/F GPMLPM PSI/Bar/KPAS Fabrieksstandaard: °C, Gallons, PSI</p> <ul style="list-style-type: none"> Druk op enter om de schaal in °F te veranderen Het display zal knipperen tussen Units en °C Gebruik, indien gewenst, om de schaal in °F te veranderen Druk op enter om naar het volgende display te gaan Doe hetzelfde voor de schalen voor Flow en druk 	<p>10 Met Hi t kan de Alarmlimiet voor hoge temperatuur voor de vloeistof worden ingesteld. Bereik: +3°C tot +42°C Fabrieksstandaard: +42°C</p> <ul style="list-style-type: none"> Druk op enter Het display zal knipperen tussen Hi t en 42 Gebruik, indien gewenst, om de waarde aan te passen Druk op enter om naar het volgende display te gaan 	<p>11 Met Lo t wordt de onderste alarmlimiet voor de temperatuur van de vloeistof ingesteld. Bereik: +3°C tot +42°C Fabrieksstandaard: 3°C</p> <ul style="list-style-type: none"> Druk op enter Het display zal knipperen tussen Lo t en 3 Gebruik, indien gewenst, om de waarde aan te passen Druk op enter 	<p>12 Met Hi P1 wordt de bovenste alarmlimiet voor drukvoer van de pomp ingesteld. Bereik: Verschildt per pomp Fabrieksstandaard: Verschildt per pomp</p> <ul style="list-style-type: none"> Druk op enter Het display zal knipperen tussen Hi P1 en de standaardwaarde Gebruik, indien gewenst, om de waarde aan te passen Druk op enter
<p>13 dDELAY is de tijdsduur dat de pomp de Hi P1 Alarmlimiet kan overschrijden voor hij uitschakelt. Bereik: Verschildt per pomp Fabrieksstandaard: 0 seconden</p> <ul style="list-style-type: none"> Het display zal knipperen tussen dDELAY en 0 Gebruik, indien gewenst, om de waarde aan te passen Druk op enter LET OP Deze functie is alleen actief als de unit geconfigureerd is om uit te schakelen, zie stap 16. 	<p>14 Met Lo P1 wordt de onderste alarmlimiet voor drukvoer van de pomp ingesteld. Bereik: Verschildt per pomp Fabrieksstandaard: Verschildt per pomp</p> <ul style="list-style-type: none"> Druk op enter Het display zal knipperen tussen Lo P1 en de standaardwaarde Gebruik, indien gewenst, om de waarde aan te passen Druk op enter 	<p>15 dDELAY is de tijdsduur dat de pomp de Lo P1 kan overschrijden Alarmlimiet voordat het uitschakelen plaatsvindt. Bereik: 0 tot 30 seconden Fabrieksstandaard: 10 seconden</p> <ul style="list-style-type: none"> Het display zal knipperen tussen dDELAY en 10 Gebruik, indien gewenst, om de waarde aan te passen Druk op enter LET OP Deze functie is alleen actief als de unit geconfigureerd is om uit te schakelen, zie stap 16. 	<p>16 ALR configureert de reactie van de unit op alarmlimieten voor temperatuur, druk en flow (optioneel) - ofwel uitschakelen (fL) of in werking blijven (indC). Zie Hoofdstuk 4 van de handleiding voor meer informatie. Bereik: fL* of indC** Fabrieksstandaard: fL</p> <ul style="list-style-type: none"> Druk op enter Het display zal knipperen tussen ALR en fL Druk, indien gewenst, op om indC weer te geven Druk op enter *fL = fault (uitschakelen) **indC = indicate (in werking blijven)
<p>17 Zet het hoorbare alarm van de unit aan of uit. Bereik: aan of UIT Fabrieksstandaard: aan</p> <ul style="list-style-type: none"> Druk op enter Het display zal knipperen tussen Sounden aan Druk, indien gewenst, op om OFF weer te geven Druk op enter 	<p>18 START schakelt de auto restart in en uit. Bereik: aan of UIT Fabrieksstandaard: UIT</p> <ul style="list-style-type: none"> Druk op enter Het display zal knipperen tussen START en UIT Druk, indien gewenst, op om aan weer te geven Druk op enter 	<p>19 CARE wordt gebruikt om de frequentie van de herimering voor het preventief schoonmaken van de lucht- en vloeistoffilters van de unit in te stellen. Bereik: uit, L1 - 1000 uur, L2 - 2000 uur, L3 - 3000 uur Fabrieksstandaard: L1</p> <ul style="list-style-type: none"> Druk op enter Het display zal knipperen tussen CARE en L1 Gebruik, indien gewenst, om het display te wijzigen in uit, L2 of L3 Druk op enter 	<p>20 De Setup-procedure is nu voltooid. Als de unit start, zal de besturing de temperatuur van de procesvloeistof weergeven. Indien gewenst kunt u het setpoint van de unit wijzigen/controleren door op mode te drukken.</p> <ul style="list-style-type: none"> Druk op enter om alle instellingen op te slaan Druk op enter om alle wijzigingen ongedaan te maken en de standaard fabrieksstanden te herstellen. Het display zal blanco zijn. Druk op enter om de procedure opnieuw te starten.
<p>Optie - Universele spanning - Stap A</p> <p>A HZ</p> <ul style="list-style-type: none"> Druk op enter Het display zal knipperen tussen HZ en 60 Gebruik, indien nodig, om de frequentie te wijzigen Druk op enter omzet of seriële communicatie heeft, zie stap 20. <p>Optie - Volumestroomomzetter - Stappen B en C</p> <p>B Hi FLO</p> <p>Met HiFLO wordt de bovenste alarmlimiet voor de flow ingesteld.</p> <p>Bereik: Verschildt per pomp Fabrieksstandaard: Verschildt per pomp</p> <ul style="list-style-type: none"> Druk op enter Het display zal knipperen tussen HiFLO en de standaardwaarde Gebruik, indien gewenst, om de waarde aan te passen Druk op enter <p>C Lo FLO</p> <p>Met LoFLO wordt de onderste alarmlimiet voor de flow ingesteld.</p> <p>Bereik: Verschildt per pomp Fabrieksstandaard: Verschildt per pomp</p> <ul style="list-style-type: none"> Druk op enter Het display zal knipperen tussen LoFLO en de standaardwaarde Gebruik, indien gewenst, om de waarde aan te passen Druk op enter Als uw unit geen seriële communicatie heeft, zie stap 20. <p>Optie - Seriële communicatie (DCOM) - Stappen D tot I</p> <p>D SER</p> <p>SER wordt gebruikt voor het inschakelen/uitschakelen en configureren van de seriële-communicatiemodus</p> <p>Bereik: uit, rS232, rS485 Fabrieksstandaard: uit</p> <ul style="list-style-type: none"> Druk op enter Het display zal knipperen tussen SER en UIT Indien gewenst kunt u gebruiken om de modus te wijzigen Druk op enter <p>E BAUD</p> <p>BAUD wordt gebruikt om de baudrate (snelheid) voor seriële communicatie te kiezen.</p> <p>Bereik: 9600, 4800, 2400, 1200, 600 of 300 bits per seconde. Fabrieksstandaard: 9600</p> <ul style="list-style-type: none"> Druk op enter Het display zal knipperen tussen BAUD en 9600 Indien gewenst kunt u gebruiken om de snelheid te wijzigen Druk op enter <p>F DATA</p> <p>DATA wordt gebruikt om het aantal bits weer te geven.</p> <p>Display: 8</p> <ul style="list-style-type: none"> Druk op enter Het display zal knipperen tussen DATA en 8 Druk op enter <p>G STOP</p> <p>STOP wordt gebruikt om het aantal stopbits aan te geven.</p> <p>Bereik: 2 of 1 Fabrieksstandaard: 1</p> <ul style="list-style-type: none"> Druk op enter Het display zal knipperen tussen STOP en 1 Indien gewenst kunt u gebruiken om de instelling te wijzigen Druk op enter <p>H PAR</p> <p>PAR wordt gebruikt als een middel om op communicatiefouten te controleren.</p> <p>Bereik: even, oneven of geen Fabrieksstandaard: geen</p> <ul style="list-style-type: none"> Druk op enter Het display zal knipperen tussen PAR en geen Indien gewenst kunt u gebruiken om de instelling te wijzigen Druk op enter <p>I UID</p> <p>UID (unit id) wordt alleen in RS-485 gebruikt. Identificeert apparaten die op de RS-485-poort zijn aangesloten.</p> <p>Bereik: 1 tot 99 Fabrieksstandaard: 1</p> <ul style="list-style-type: none"> Druk op enter Het display zal knipperen tussen uid en 1 Indien gewenst kunt u gebruiken om de instelling te wijzigen Druk op enter <p>Zie stap 20.</p>			

Preface

Compliance Third Party:

Designed to comply and listed/certified to:

UL 61010-1:2012, Third Edition

CAN/CSA-C22.2 No.61010-1-12, Third Edition



European Union (EU)

The Declaration of Conformity is located in the back of this manual.



WEEE

This product is required to comply with the European Union's Waste Electrical & Electronic Equipment (WEEE) Directive 2012/19/EU. It is marked with 'wheelie bin' symbol:



Thermo Fisher Scientific has contracted with one or more recycling/ disposal companies in each EU Member State, dispose of or recycle this product through them. Further information on Thermo Fisher Scientific's compliance with these Directives is available at www.thermofisher.com/WEEERoHS

After-sale Support

Thermo Fisher Scientific is committed to customer service both during and after the sale. If you have questions concerning the chiller operation, or questions concerning spare parts or Service Contracts, call our Sales, Service and Customer Support phone number, see this manual's inside cover for contact information.

When calling, please refer to the labels on the inside cover. These labels list all the necessary information needed to properly identify your chiller.

Feedback

We appreciate any feedback you can give us on this manual. Please e-mail us at tcmanuals@thermofisher.com. Be sure to include the manual part number and the revision date listed on the front cover.

Warranty

Thermo Scientific ThermoFlex chillers have a warranty against defective parts and workmanship for 24 months (**excluding MD1/MD2 Magnetic Drive and P1/P2 Positive Displacement pumps which are warranted for 12 months**) from date of shipment. See back page for more details.

Unpacking

If the chiller has a line cord it is located under the shipping crate's lid. Do not discard the lid until the cord is located.

Retain all cartons and packing material until the chiller is operated and found to be in good condition. If it shows external or internal damage contact the transportation company and file a damage claim. Under ICC regulations, this is your responsibility.

Out of Box Failure

An Out of Box Failure is defined as any product that fails to operate in conformance with sellers published specifications at initial power up. Install the chiller in accordance with manufacturer's recommended operating conditions within 30 days of shipment from the seller.

Any Temperature Control product meeting the definition of an Out of Box Failure must be packed and shipped back in the original packaging to Thermo Fisher Scientific for replacement with a new chiller; seller to pay the cost of shipping. Customer must receive a Return Material Authorization (RMA) from Thermo Fisher prior to shipping.

Section 1 Safety

Safety Warnings

Make sure you read and understand all instructions and safety precautions listed in this manual before installing or operating your chiller. If you have any questions concerning the operation or the information in this manual, please contact us. See inside cover for contact information.



DANGER indicates an imminently hazardous situation which, if not avoided, *will* result in death or serious injury.



WARNING indicates a potentially hazardous situation which, if not avoided, *could* result in death or serious injury.



CAUTION indicates a potentially hazardous situation which, if not avoided, may result in minor or moderate injury. It is also be used to alert against unsafe practices.



The lightning flash with arrow symbol, within an equilateral triangle, is intended to alert the user to the presence of non-insulated "dangerous voltage" within the chiller's enclosure. The voltage magnitude is significant enough to constitute a risk of electrical shock.



This symbol indicates surfaces which may become hot during use and may cause a burn if touched with unprotected body parts.



Before installing, using or maintaining this product, please be sure to read the manual and product warning labels carefully. Failure to follow these instructions may cause the product to malfunction, which could result in injury or damage..

Performance of installation, operation, or maintenance procedures other than those described in this manual may result in a hazardous situation and may void the manufacturer's warranty and safety compliance. ▲

Observe and never remove warning labels. ▲

Never place the chiller in a location where excessive heat, moisture, or corrosive materials are present. ▲

The chiller's construction provides protection against the risk of electrical shock by grounding appropriate metal parts. The protection will not function unless the power cord is connected to a properly grounded outlet. It is the user's responsibility to assure a proper ground connection is provided. ▲

Never operate equipment with damaged power cords. ▲

The circuit protector located on the rear is not intended to act as a disconnecting means. ▲

Never operate the chiller with panels removed. ▲

Never operate the chiller without process fluid in the reservoir. ▲

Never connect the process fluid inlet or outlet fittings to your building water supply or any water pressure source. ▲

Before using any fluid or performing maintenance where contact with the fluid is likely refer to the manufacturer's SDS for handling precautions and PPE requirements. ▲

To prevent freezing/glazing of the plate exchanger, ThermoFlex7500 through ThermoFlex24000 chillers require the use of 50/50 EG/water or 50/50 PG/water below 10°C process temperature. ▲

When using a process fluid mixture of ethylene glycol and water or propylene glycol and water, check the fluid concentration and pH on a regular basis. Changes in concentration and pH can impact system performance. See Section 3. ▲

Do not use automotive antifreeze. Commercial antifreeze contains silicates that can damage the pump seals. Use of automotive antifreeze will void the manufacturer's warranty. ▲

Many refrigerants which may be undetectable by human senses are heavier than air and will replace the oxygen in an enclosed area causing loss of consciousness. Contact with leaking refrigerant will cause skin burns. Refer to the chiller's nameplate for the type of refrigerant used and then the refrigerant's SDS for additional information. ▲

Drain the chiller before it is transported and/or stored, see Draining in Section 8. Store the chiller in the temperature range -25°C to 60°C (with packaging), and <80% relative humidity. ▲

Always turn off the chiller and disconnect the power cord from the power source before performing any service or maintenance procedures, or before moving. ▲

Transport the chiller with care. Sudden jolts or drops can damage its components. ▲

Never operate damaged or leaking equipment. ▲

Refer service and repairs to a qualified technician. ▲

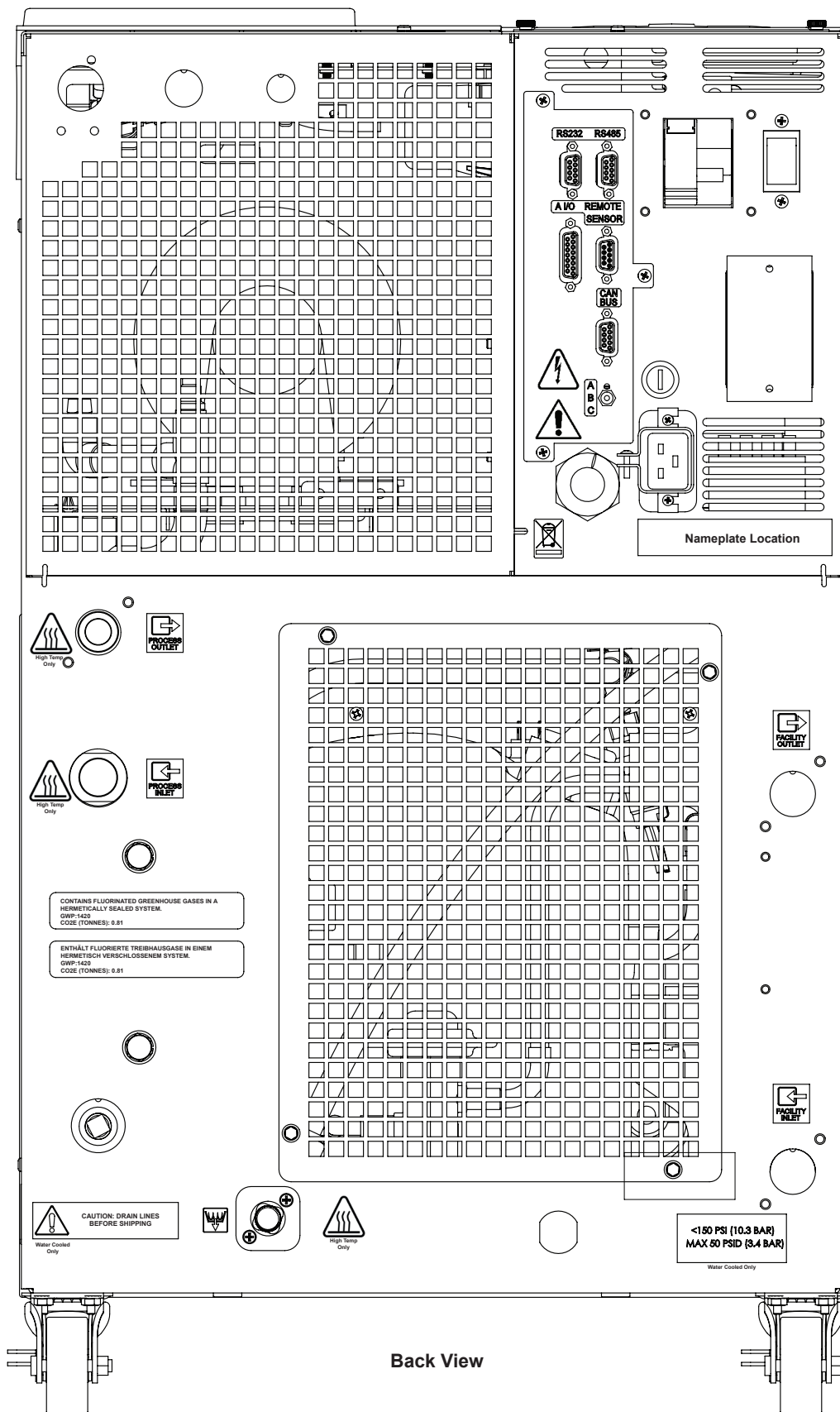

Back View

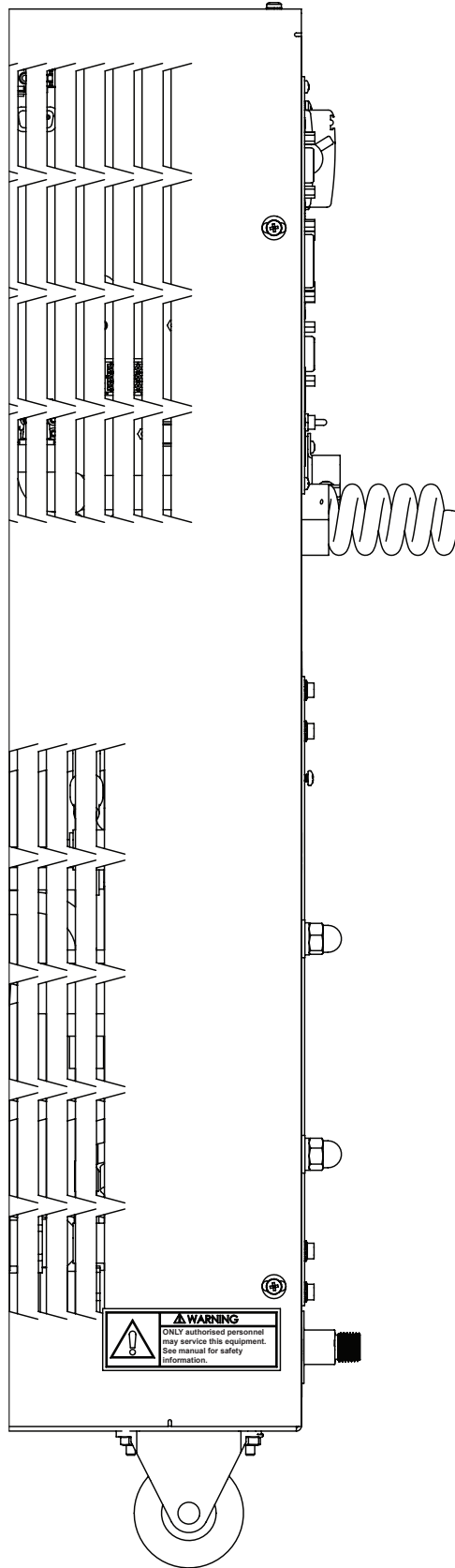

Left Side View

很多人感觉无法察觉的制冷剂可能要比空气重，在封闭区域中将取代氧气，从而导致人失去意识。接触泄漏的制冷剂将会导致皮肤灼伤。请参阅制冷器的铭牌了解其所用的制冷剂类型，并通过查阅制冷剂 SDS 了解更多信息。

安全警告
安装或操作冷却器前，请确保阅读和理解本手册中所列的所有说明和安全预防措施。如果对本手册中的操作或信息存在疑问，请联系我们。有关联系信息，请见内封面。



“危险”表示如不避免，将导致死亡或重伤的紧急危险情况。



“警告”表示如不避免，可能导致死亡或重伤的潜在危险情况。



“小心”表示如不避免，可能导致轻伤或中度损伤的潜在危险情况。其还用于对不安全的做法发出警报。



等边三角形中带箭头的闪电符号用于警告用户冷却器外壳中存在非绝缘“危险电压”。电压幅度足以产生触电风险。



该标签表示需要阅读手册。

不遵循本手册所述的安装、操作或维护程序可能会导致危险情况，并使制造商的保修和安全合规性失效。

请遵循警告标签，切勿将其取下。

请勿将冷却器放在过热、过湿或存在腐蚀性材料的场所。

冷却器结构通过对相应的金属部件进行接地来避免触电风险。如果电源线未连接到正确的插座，将无法发挥保护作用。用户应负责提供正确的接地连接。

请勿操作电源线损坏的设备。

对于 ThermoFlex900-10000 冷却器，位于后部的电路保护器不用于断开连接。

请勿在取下面板的情况下操作冷却器。

请勿在储液罐中没有处理液的情况下操作冷却器。

请勿将处理液入口或出口接头连接到建筑物供水或水压源。

在使用任何液体或执行任何可能需要接触液体的维护之前，请参阅制造商的 SDS 了解处理时的注意事项。

为避免板式换热器冻结/太过光滑，ThermoFlex7500 至 ThermoFlex24000 冷却器需要在处理温度低于 10°C 时使用 50/50 EG/水或 50/50 PG/水。

使用乙二醇与水或丙二醇与水的混合处理液时，请定期检查液体浓度和 pH 值。浓度和 pH 值的变化可能会影响系统性能。请参见第 3 节。

请勿使用汽车防冻液。市售防冻液含有可能会损坏泵密封件的硅酸盐。使用汽车防冻液将导致制造商保修失效。

在运输和/或存放冷却器之前，请先对其进行排空，请参见第 8 节中的“排放”。冷却器应存放在温度为 -25°C 至 60°C（带包装），相对湿度 <80% 的环境。

执行维修或维护程序或进行移动之前，请务必关闭冷却器，并将电源线与电源断开。

运输冷却器时，请务必小心。突然的摇晃或掉落可能会损坏其组件。

请勿操作损坏或泄漏的设备。

请由获得相应资质的技术人员执行维修。

Grundlegende Sicherheitsanweisungen Umwälzkühler

Falls Sie eine dieser Anweisungen nicht verstehen, lesen Sie das Handbuch oder kontaktieren Sie uns bevor Sie fortfahren.

Sicherheit, alle Produkte:

DANGER weist auf eine unmittelbar gefährliche Situation hin, die, falls sie nicht vermieden wird, zum Tod oder schweren Verletzungen führt.

WARNING weist auf eine potenziell gefährliche Situation hin, die zu ernsthaften Verletzungen oder zum Tod führen kann, wenn sie nicht vermieden wird.

CAUTION weist auf eine potenziell gefährliche Situation hin, die, falls sie nicht vermieden wird, zu leichteren bis mittelschweren Verletzungen führen kann. Es kann auch verwendet werden, um gegen unsichere Praktiken zu warnen.

 ist dafür vorgesehen, den Benutzer vor dem Bestehen einer nicht isolierten "gefährlichen Spannung" im Gehäuse des Kühlers zu warnen. Die Höhe der Spannung ist bedeutend genug, sodass ein Stromschlag-Risiko besteht.

 weist auf das Vorhandensein heißer Oberflächen hin.

 weist darauf hin, das Handbuch zu lesen.

Benutzen Sie das Gerät keinesfalls als steriles oder an Patienten angeschlossenes Gerät. Außerdem ist das Gerät nicht für den Gebrauch an Orten mit Gefahrenklasse I, II oder III, wie in den nationalen Vorgaben für elektrische Geräte definiert, ausgelegt.

Das Gerät ist nur für den Gebrauch in Innenräumen ausgelegt. Stelle Sie es niemals an einen Ort wo übermäßige Temperaturen, Feuchtigkeit, unzureichende Belüftung oder korrosive Materialien vorhanden sind. Lesen Sie im Benutzerhandbuch über die Betriebsparameter.

Schließen Sie das Gerät an eine vorschriftsmäßig geerdete Steckdose an.

Die verwendeten Kühlmittel sind schwerer als Luft und werden im Fall einer Leckage den Sauerstoff ersetzen, was zu Bewusstlosigkeit führt. Kontakt mit auslaufendem Kühlmittel führt zu Hautverbrennungen. Den Typ des verwendeten Kühlmittels entnehmen Sie dem Namensschild des Zirkulators und zusätzliche Informationen dem neuesten US Sicherheitsdatenblatt (SDS) des Herstellers, vormals MSDS, und dem EU Sicherheitsdatenblatt.

Transportieren Sie das Gerät mit Sorgfalt. Plötzliche Stöße oder das Herabfallen können seine Komponenten beschädigen. Schalten Sie vor dem Verschieben das Gerät immer ab und trennen Sie es von der Versorgungsspannung.

Betreiben Sie niemals beschädigte oder undichte Geräte.

Verwenden Sie niemals entzündbare oder korrosive Flüssigkeiten. Benutzen Sie nur zugelassene Flüssigkeiten, die in diesem Handbuch aufgelistet sind. Entnehmen Sie vor der Verwendung einer zugelassenen Flüssigkeit oder vor Wartungsarbeiten, bei denen der Kontakt mit der Flüssigkeit wahrscheinlich ist, zusätzliche Informationen dem neuesten US Sicherheitsdatenblatt (SDS) oder dem EU Sicherheitsdatenblatt.

Schalten Sie vor dem Verschieben das Gerät immer ab und trennen Sie es von der Versorgungsspannung.

Lassen Sie die Instandhaltung und Reparaturen von einem qualifizierten Techniker durchführen.

Lagern Sie das Gerät bei Temperaturen von -25°C bis 60°C (mit Packung), und bei einer relativen Feuchtigkeit < 80%.

Die Außerbetriebnahme darf nur von einem Fachhändler unter Verwendung zertifizierter Ausrüstung durchgeführt werden. Alle einschlägigen Vorschriften müssen befolgt werden.

Die Ausführung von Installations-, Betriebs- oder Wartungsprozeduren, außer den im Handbuch beschriebenen, kann zu einer gefährlichen Situation führen und macht die Herstellergarantie ungültig. Legen Sie niemals Netzspannung an einen der Kommunikationsanschlüsse am Kühler an.

Werden der Kühler und die Prozessflüssigkeitsleitungen nicht komplett aufgefüllt, könnte dies die Pumpe des Kühlers beschädigen. Vermeiden Sie eine Überfüllung, Flüssigkeiten dehnen sich bei Erwärmung aus.

Stellen Sie beim ThermoFlex vor dem Austausch des Behältergehäuses sicher, dass die Sichtrohr-Kugelspernung sicher in Stellung ist.

Betreiben Sie beim ThermoFlex900-5000 den Kühler nicht, wenn der Behälterflüssigkeitsdiffusor nicht installiert ist.

Falls Ihr Kühler mit einer Druckpumpe (P1 oder P2) ausgestattet ist, stellen Sie sicher, dass die Rohranschlussleitungen und Armaturen Ihrer Anwendung so ausgelegt sind, dass sie eine Mindestlast von 185 psi aushalten.

Kein Frostschutzmittel für Autos verwenden. Handelsübliche Frostschutzmittel enthalten Silikate, welche die Pumpendichtungen beschädigen.

Um das Entfrieren/die Verglasung des Platten-Wärmetauschers zu verhindern, müssen

ThermoFlex7500-24000 Kühler mit 50/50 EG/Wasser oder 50/50 PG/Wasser bei einer Prozesstemperatur unter 10°C betrieben werden.

Prüfen Sie beim Gebrauch einer Prozessflüssigkeitsmischung aus EG/Wasser oder PG/Wasser, regelmäßig die Konzentration und den pH-Wert der Flüssigkeit. Änderungen der Konzentration und des pH-Wertes können die Leistung des Systems beeinträchtigen. Verwenden Sie keine Entionisierungsfiterpatrone (DI)

mit inhibiertem EG oder inhibiertem PG. Ein DI-Filter entfernt die Inhibitoren aus der Lösung, wodurch die Flüssigkeit wirklos gegen Korrosionsschutz wird. Inhibitoren können auch die Leitfähigkeit der Flüssigkeit erhöhen.

Sie sind schädlichen wenn man sie einatmet, schluckt oder durch die Haut absorbiert. Lesen Sie das neueste SDS des Herstellers.

Um Schäden am Platten-Wärmetauscher des Kühlers zu vermeiden, müssen Kreiselumpen mit einer Mindestdurchflussrate 4.0 gpm (15.1 lpm) betrieben werden. Wird der Kondensatorfilter nicht gereinigt/ersetzt, führt das zu einem Verlust der Kühlleistung und zu einem vorzeitigen Kühlsystemausfall.

Entfernen Sie zur gründlichen Reinigung die Frontgitter-Baugruppe. Bei luftgekühlten Kühler sind die Umrahmung und Rippen des Kondensators, die sich hinter der Frontgitter-Baugruppe befinden, sehr scharfkantig.

Außer im Fall der luftgekühlten Gitter-Baugruppe, darf der Kühler keinesfalls mit einer entfernten Seitenwand betrieben werden.

ThermoFlex900-5000 wassergekühlte Kühler haben einen Ventilator mit scharfen Kanten, stellen Sie deshalb sicher, dass der Kühler abgeschaltet ist, bevor Sie das Frontgitter abnehmen.

Verwendungszweck, Umwälzungskühler:

Umwälzungskühler von Thermo Scientific sind so konstruiert, dass sie einen kontinuierlichen Zulauf der Flüssigkeit bei konstanter Temperatur und Durchflussrate ermöglicht. Der Kühler besteht aus einem luft- und wassergekühlten Kühlsystem, Wärmetauscher, Umwälzpumpe, Prozessflüssigkeitsbehälter und einem Mikroprozessor-Steuergerät.



Die Kühler sind für den Dauerbetrieb und den Innengebrauch unter Einhaltung aller in diesem Handbuch angegebenen Prozeduren und Anforderungen konstruiert.

Installation, Umwälzungskühler:

Platzieren Sie den Kühler so, dass er in der Nähe seiner Trennvorrichtung ist, und leichten Zugang zu diesem hat.

Der Kühler ist für den Gebrauch an einer speziellen Steckdose vorgesehen.

Stellen Sie sicher, dass alle Rohrleitungstransportstecker vor der Installation entfernt werden.

Die Anschlüsse für Prozessflüssigkeit befinden sich auf der Rückseite des Kühlers und sind mit  (PROCESS OUTLET (PROZESSAUSLASS)) und  (PROCESS INLET (PROZESSEINLASS)) gekennzeichnet. Schließen Sie  an den Flüssigkeitseinlass Ihrer Anwendung an. Schließen Sie  an den Flüssigkeitsauslass Ihrer Anwendung an.

Schließen Sie bei wassergekühlten Kühlern den  (FACILITY INLET (ANLAGENEINLASS)) an Ihre Leitungswasserversorgung. Schließen Sie den  (FACILITY OUTLET (ANLAGENAUSLASS)) an Ihren Leitungswasserrücklauf oder -Abfluss.

Bevor Sie den Kühler starten, führen Sie eine Doppelkontrolle aller Kommunikations-, elektrischen und Rohranschlüssen.

Consignes de sécurité Refrigidisiseurs à recirculation

Si vous ne comprenez pas l'une de ces instructions, reportez-vous au manuel ou contactez-nous avant d'effectuer une opération.

Sécurité, tous les produits :

 indique une situation de danger imminent qui, si elle n'est pas évitée, peut entraîner une blessure grave ou mortelle.

 indique une situation de danger potentiel qui, si elle n'est pas évitée, pourrait entraîner une blessure grave ou mortelle.

 indique une situation de danger potentiel qui, si elle n'est pas évitée, peut entraîner une blessure légère à modérée. Ce symbole est également utilisé pour mettre en garde contre des pratiques dangereuses.

 ce symbole avertit l'utilisateur de la présence d'une « tension dangereuse » non isolée dans l'enceinte du refroidisseur. La magnitude de la tension est suffisante pour constituer un risque d'électrocution.

 indique la présence de surfaces chaudes.

 indique qu'il convient de lire le manuel.

N'utilisez pas l'équipement comme appareil stérile ou relié au patient. En outre, l'équipement n'est pas prévu pour une utilisation dans des emplacements dangereux de classe I, II ou III, tels que définis par le National Electrical Code.

Il est conçu pour l'usage intérieur exclusivement. Ne placez jamais l'équipement dans un endroit présentant un excès de chaleur, d'humidité, une ventilation inadaptée ou des matériaux corrosifs. Reportez-vous au manuel pour connaître les paramètres de fonctionnement.

Branchez l'équipement sur une prise correctement mise à la terre.

Les réfrigérants utilisés sont plus lourds que l'air. En cas de fuite, ils chassent l'oxygène et provoquent une perte de connaissance. Tout contact avec la fuite de réfrigérant peut causer des brûlures cutanées. Reportez-vous à la plaque signalétique du circulateur pour connaître le type de réfrigérant utilisé. Lisez également la fiche de données de sécurité (SDS, anciennement MSDS) américaine la plus récente

du fabricant ainsi que la fiche de données de sécurité européenne pour obtenir des informations complémentaires.

Déplacez l'équipement avec précaution. Les secousses ou les chutes peuvent endommager les composants. Éteignez l'équipement et débranchez la tension d'alimentation de sa source avant de le déplacer.

Ne faites jamais fonctionner un équipement endommagé ou qui fuit.

N'utilisez jamais des liquides inflammables ou corrosifs. Utilisez uniquement les liquides approuvés cités dans le manuel. Avant d'utiliser un liquide ou de procéder à une opération de maintenance pouvant comporter un contact avec le liquide, reportez-vous aux fiches de données de sécurité du fabricant et de l'Union européenne pour obtenir des informations complémentaires.

Éteignez l'équipement et débranchez-le de sa tension d'alimentation avant de le déplacer.

Confiez les entretiens et réparations à un technicien qualifié.

Stockez l'équipement à une température comprise entre 25°C et 60°C (avec l'emballage), et sous une humidité relative <80%.

La mise hors service doit être effectuée par un revendeur qualifié à l'aide d'un équipement certifié. Toutes les réglementations en vigueur doivent être respectées.

L'exécution des procédures d'installation, de fonctionnement ou de maintenance autres que celles décrites dans le manuel peut créer une situation dangereuse et annuler la garantie du fabricant.

Ne mettez jamais les raccordements de communications du refroidisseur sous tension.

Si vous ne remplissez pas complètement le refroidisseur et les conduites de liquide, vous risquez d'endommager la pompe. Évitez de trop remplir le réservoir car les liquides se dilatent lorsqu'ils sont chauffés.

Sur le ThermoFlex, avant de remplacer le boîtier du réservoir, vérifiez que le bouchon à bille du tube de regard du réservoir est correctement mis en place.

Sur ThermoFlex900-5000, ne faites pas fonctionner le refroidisseur si le diffuseur de liquide du réservoir est installé.

Si votre refroidisseur est équipé d'une pompe volumétrique (P1 ou P2), vérifiez que les conduites et les raccords de votre application peuvent résister à 185 psi.

N'utilisez pas d'antigel automobile. Les antigels commerciaux contiennent des silicates qui endommagent les joints de la pompe.

Pour éviter la congélation/le givrage de l'échangeur à plaques, les refroidisseurs ThermoFlex7500-24000 nécessitent l'utilisation d'un mélange à part égale d'éthylène glycol et d'eau ou de propylène glycol et d'eau à une température de fonctionnement inférieure à 10°C.

Si vous utilisez un mélange d'éthylène glycol et d'eau ou de propylène glycol et d'eau, vérifiez régulièrement sa concentration et son pH. Les changements de concentration et de pH peuvent avoir une influence sur les performances du système.

N'utilisez pas de cartouche à filtre de désionisation (DI) avec de l'éthylène glycol inhibé ou du propylène glycol inhibé. Un filtre DI éliminera les inhibiteurs de la solution et rendra le liquide inefficace contre la protection anti-corrosion. De même, les inhibiteurs augmentent la conductivité du liquide.

Les biocides sont corrosifs et peuvent causer des lésions oculaires irréversibles ainsi que des brûlures cutanées. Ils sont nocifs s'ils sont inhalés, avalés ou absorbés par la peau.

Reportez-vous à la fiche de données de sécurité la plus récente du fabricant.

Pour éviter d'endommager l'échangeur à plaques du refroidisseur, les pompes centrifugeuses nécessitent un débit minimum de 15,1 l/min.

Le non-nettoyage ou non-remplacement du filtre du condenseur peut causer une perte de capacité de refroidissement et entraîner une panne prématurée du système de refroidissement. Pour un nettoyage complet, déposez la grille avant.

Sur les refroidisseurs à air, le boîtier du condenseur et les ailettes situés derrière la grille avant sont très tranchants.

Hormis la grille refroidie à l'air, ne faites jamais fonctionner le refroidisseur si l'un des panneaux est déposé.

Les refroidisseurs à eau ThermoFlex900-5000 sont dotés d'un ventilateur dont les hélices sont tranchantes. Vérifiez que le refroidisseur est éteint avant de déposer la grille avant.

Utilisation prévue des refroidisseurs à recirculation

Les refroidisseurs à recirculation de Thermo Scientific sont conçus pour fournir du liquide en continu à une température et selon un débit constants. Le refroidisseur se compose d'un système de réfrigération à air ou à eau, d'un échangeur de chaleur, d'une pompe de recirculation, d'un réservoir de liquide et d'un contrôleur à microprocesseur.

Les refroidisseurs sont conçus pour fonctionner en continu à l'intérieur, conformément à toutes les procédures et exigences indiquées dans son manuel.

Installation des refroidisseurs à recirculation

Placez le refroidisseur de manière à ce qu'il soit à proximité et d'accès facile à son dispositif de sectionnement.

Le refroidisseur doit être branché sur une prise dédiée.

Vérifiez que tous les bouchons d'expédition de la tuyauterie sont retirés avant l'installation.

Les raccords du liquide de traitement se situent à l'arrière du refroidisseur et portent les étiquettes  (PROCESS INLET, SORTIE LIQUIDE) et  (PROCESS OUTLET, SORTIE LIQUIDE).

Reliez  sur l'entrée du liquide de votre application. Reliez  sur la sortie du liquide de votre application.

Pour les refroidisseurs à eau, reliez  (FACILITY INLET, ENTRÉE INSTALLATION) sur l'alimentation en eau de votre établissement. Reliez  (FACILITY OUTLET, SORTIE INSTALLATION) sur l'évacuation ou le retour d'eau de votre établissement.

Avant de démarrer le refroidisseur, vérifiez deux fois tous les raccords électriques, de plomberie et de communication.

ES Instrucciones básicas de seguridad Refrigeradores de recirculación

Si no se entiende alguna de estas instrucciones, consulte el manual o póngase en contacto con nosotros antes de proceder.

Seguridad, todos los productos:

 indica una situación de peligro inmediato que, si no se evita, provocará la muerte o lesiones graves.

 indica una situación potencialmente peligrosa que, si no se evita, podría tener como resultado lesiones graves o la muerte.

 indica una situación potencialmente peligrosa que, si no se evita, puede ocasionar lesiones leves o moderadas. También se utiliza para alertar de prácticas inseguras.

 está indicado para alertar al usuario de la presencia de "tensión peligrosa" sin aislar dentro del alojamiento del refrigerador. La magnitud de la tensión es lo suficientemente importante para constituir un riesgo de electrocución.

 indica la presencia de superficies calientes.

 indica que se debe leer el manual.

No utilice el equipo como dispositivo conectado al paciente o dispositivo estéril. Además, el equipo no está diseñado para ser utilizado en lugares peligrosos de Clase I, II o III de acuerdo con el Código Eléctrico Nacional.

Este equipo está diseñado para ser utilizado en interiores solamente. No lo coloque nunca en un lugar donde haya calor excesivo, humedad, ventilación inadecuada o materiales corrosivos. Consulte el manual para conocer los parámetros de funcionamiento.
Conecte el equipo a una toma correctamente conectada a tierra.

Los refrigerante utilizados son más pesados que el aire y, si hay una fuga, sustituirán al oxígeno, lo que provocará la pérdida de consciencia. El contacto con el refrigerante expulsado provocará quemaduras en la piel. Consulte la placa de datos del circulator para conocer el tipo de refrigerante utilizado y, a continuación, la hoja de datos de seguridad (SDS) más reciente del fabricante para EE.UU., anteriormente conocida como MSDS, así como la hoja de datos de seguridad para la UE a fin de obtener información adicional.

Mueva el equipo con cuidado. Las caídas o los impactos repentinos pueden dañar los componentes. Apague siempre el equipo y desconéctelo de la tensión de suministro antes de moverlo.

Nunca utilice un equipo dañado o con fugas.

Nunca utilice fluidos inflamables o corrosivos. Utilice solo los fluidos aprobados que se incluyen en el manual. Antes de utilizar un fluido o realizar tareas de mantenimiento donde es probable que se entre en contacto con el fluido en cuestión, consulte la hoja de datos de seguridad (SDS) más reciente del fabricante para EE.UU., así como la hoja de datos de seguridad para la UE a fin de obtener información adicional.

Apague siempre el equipo y desconéctelo de la tensión de suministro antes de moverlo.

Delegue las tareas de servicio y las reparaciones en un técnico cualificado.

Guarde el equipo a una temperatura comprendida entre -25 °C y 60 °C (con embalaje), y una humedad relativa de <80%.

El desmantelamiento solo debe ser realizado por un proveedor cualificado que utilice el equipo homologado. Debe cumplirse toda la normativa vigente.

La realización de los procedimientos de instalación, funcionamiento o mantenimiento distintos de los que se describen en el manual puede dar lugar a situaciones peligrosas y anularán la garantía del fabricante.

Nunca aplique tensión de línea a ninguna de las conexiones de comunicación del refrigerador.

Si no se llenan por completo las líneas de fluidos del refrigerador y procesos, podría dañarse la bomba del refrigerador. Evite llenar en exceso; los fluidos se expanden al calentarse.

En el caso de ThermoFlex, antes de sustituir el alojamiento del depósito, asegúrese de que el tope de bola del tubo de control del depósito está en su lugar de forma segura.

En el caso de ThermoFlex900-5000, no utilice el refrigerador a menos que se haya instalado el difusor de fluido del depósito.

Si su refrigerador dispone de una bomba de desplazamiento positivo (P1 o P2), asegúrese de que las líneas de bombeo de la aplicación y los accesorios son capaces de soportar al menos 185 psi.

No utilice anticongelante de automoción. Los anticongelantes comerciales contienen silicatos que dañan las juntas de las bombas.

Para evitar la congelación/el vitriado del intercambiador de la placa, los refrigeradores

ThermoFlex7500-24000 precisan el uso de EG/lagua al 50/50 o PG/lagua al 50/50 con una temperatura de proceso inferior a 10 °C.

Al utilizar una mezcla de fluido para procesos de EG/lagua o PG/lagua, revise la concentración y el pH del fluido periódicamente. Los cambios en la concentración y el pH pueden alterar el rendimiento del sistema.

No utilice un cartucho de filtro de desionización (DI) con EG o PG inhibido. Un filtro DI eliminará los inhibidores de la solución y hará que el fluido sea ineficaz contra la protección anticorrosión. Además, los inhibidores aumentan la conductividad de los fluidos.

Son dañinos si se inhalan, se tragan o se absorben a través de la piel. Consulte la hoja SDS más reciente del fabricante.

Para evitar daños en el intercambiador de la placa del refrigerador, las bombas centrífugas exigen una tasa de caudal mínimo de 4.0 gpm (15.1 lpm).

Si no se limpia/sustituye el filtro del condensador, se producirá una pérdida de capacidad de enfriamiento y esto supondrá un fallo prematuro del sistema de enfriamiento. Para llevar a cabo una limpieza minuciosa, retire el conjunto de la rejilla delantera.

En los refrigeradores enfriados por aire, el bastidor del condensador y las aletas situadas detrás del conjunto de la rejilla delantera son muy afilados.

Nunca utilice el refrigerador con los paneles retirados, salvo el conjunto de la rejilla enfriada por aire.

Los refrigeradores ThermoFlex900-5000 enfriados por agua tienen un ventilador con aspas afiladas. Asegúrese de que el refrigerador está apagado antes de retirar la rejilla delantera.

Uso previsto, Refrigeradores de recirculación:

Los refrigeradores de recirculación de Thermo Scientific están diseñados para ofrecer un suministro continuo de fluido a una temperatura y una tasa de caudal constantes. Los refrigeradores constan de un sistema de refrigeración enfriado por aire o por agua, un intercambiador de calor, una bomba de recirculación, un depósito de fluido para procesos y un controlador de microprocesador.





Los refrigeradores están diseñados para llevar a cabo un funcionamiento continuo y para utilizarse en interiores de acuerdo con todos los procedimientos y requisitos que se detallan en su manual.



Instalación, Refrigeradores de recirculación:

Ubique el refrigerador cerca de su dispositivo de desconexión y de forma que resulte fácil acceder a él.

El refrigerador está diseñado para ser utilizado en una toma especial.

Asegúrese de retirar todos los tapones de envío de la línea de tuberías antes de la instalación.

Las conexiones de fluido para procesos se encuentran en la parte posterior del refrigerador y están marcadas con el texto  (PROCESS OUTLET, SALIDA PARA PROCESOS) y  (PROCESS INLET, ENTRADA PARA PROCESOS). Conecte  a la entrada de fluido de su aplicación. Conecte  a la salida de fluido de su aplicación.

En el caso de los refrigeradores enfriados por agua, conecte  (FACILITY INLET, ENTRADA DE LA INSTALACIÓN) al suministro de agua de la instalación. Conecte  (FACILITY OUTLET, SALIDA DE LA INSTALACIÓN) al retorno o al drenaje de agua de la instalación.

Antes de poner en marcha el refrigerador, vuelva a comprobar todas las conexiones de comunicación, eléctricas y de tuberías aplicables.

Instruções de Segurança Essenciais Refrigeradores de Recirculação

No caso de não compreender qualquer uma destas instruções, consulte o manual ou contacte-nos antes de prosseguir.

Segurança, todos os produtos:

 Indica uma situação de perigo iminente que, se não for evitada, vai resultar em morte ou lesões graves.

 Indica uma situação de potencial perigo, que se não for evitada, pode resultar em morte ou lesões graves.

 Indica uma situação de potencial perigo, que se não for evitada, pode resultar em ferimentos leves ou moderados. Também é utilizado para alertar contra práticas não seguras.

 Destina-se a alertar o utilizador para a presença de "voltagem perigosa" sem isolamento na caixa do refrigerador. A magnitude da voltagem é suficientemente significante para constituir um risco de choque eléctrico.

 Indica a presença de superfícies quentes.

 Indica a leitura do manual.

Não utilize o equipamento como um dispositivo estéril ou ligado ao paciente. Em complemento, o equipamento não se destina a ser utilizado em Locais Perigosos de Classe I, II ou III conforme definido pelo Código Eléctrico Nacional.

O equipamento destina-se apenas a utilização interior. Nunca o coloque num local onde exista calor em excesso, humidade, ventilação não adequada, ou materiais corrosivos. Consulte o manual relativamente a parâmetros operacionais.

Ligue o equipamento a uma tomada de alimentação com ligação à terra.

Os refrigerantes utilizados são mais pesados do que o ar e, em caso de fuga, vão substituir o oxigénio causando perda de consciência. O contacto com o refrigerante em vazamento vai causar queimaduras na pele. Consulte a placa de identificação do circulador relativamente ao tipo de refrigerante utilizado e depois a Ficha de Segurança (SDS) dos EUA mais recente, anteriormente designada como MSDS, e a Ficha de Segurança da UE para informação adicional.

Movimente o equipamento com cuidado. Solavancos ou quedas súbitas podem danificar os seus componentes. Desactive sempre o equipamento e desligue-o da sua tensão de alimentação antes de o deslocar.

Nunca coloque em funcionamento equipamento danificado ou em vazamento.

Nunca utilize fluidos inflamáveis ou corrosivos. Utilize apenas os fluidos aprovados listados no manual. Antes de utilizar qualquer fluido ou efectuar manutenção onde for provável o contacto com o fluido, consulte a Ficha de Segurança (SDS) dos EUA mais actualizada e a Ficha de Segurança da UE para informação adicional.

Desactive sempre o equipamento e desligue-o da sua fonte de alimentação antes de o deslocar.

As revisões e reparações devem ser efectuadas por um técnico qualificado.

Armazene o equipamento a um intervalo de temperatura entre -25°C a 60°C (com embalagem), e <80% de humidade relativa.

O desmantelamento deve ser apenas efectuado por um representante qualificado utilizando equipamento certificado. Todos os regulamentos predominantes têm de ser seguidos.

Realizar procedimentos de instalação, operação ou manutenção para além dos descritos no manual pode resultar numa situação perigosa e pode invalidar a garantia do fabricante.

Nunca aplique tensão de linha a qualquer uma das ligações de comunicação no refrigerador.

O não enchimento completo do refrigerador e as linhas de fluido de processamento podem danificar a bomba do refrigerador. Evite o enchimento excessivo, já que os fluidos expandem quando aquecidos.

No ThermoFlex, antes de substituir a caixa do reservatório certifique-se de que a tampa de visualização do reservatório está devidamente colocada.

No ThermoFlex900-5000, não opere o refrigerador a menos que o difusor de fluido do reservatório esteja instalado.

Se o seu refrigerador estiver equipado com uma bomba de deslocamento positivo (P1 ou P2), certifique-se de que os seus encaixes e linhas de canalização estão qualificados para suportarem um mínimo de 185 psi.

Não utilize anticongelante automóvel. O anticongelante comercial contém silicatos que danificam os vedantes da bomba.

Para evitar o congelamento/vitrificação do permutador de placa, os refrigeradores

ThermoFlex7500-24000 requerem a utilização de EG/água 50/50 ou PG/água 50/50 abaixo da temperatura de processamento 10°C.

Quando utilizar uma mistura de fluido de processamento de EG/água ou PG/água, verifique a concentração do fluido e o pH regularmente. Alterações na concentração e no pH podem ter impacto no desempenho do sistema.

Não utilize um cartucho de filtro de Desionização (DI) com EG Inibido ou PG Inibido. Um filtro de DI vai remover os inibidores da solução que estão a tornar o fluido ineficaz contra a protecção de corrosão. Para além disso, os inibidores aumentam a condutividade do fluido.

Os biocidas são corrosivos e podem causar lesões oculares irreversíveis e queimaduras na pele. São prejudiciais se inalados, engolidos ou absorvidos através da pele. Consulte a Ficha de Segurança do fabricante mais actualizada.

Para evitar danos no permutador de placa do refrigerador, as bombas centrífugas requerem um caudal mínimo de 4.0 gpm (15.1 lpm).

A não limpeza/substituição do filtro do condensador causa a perda da capacidade de arrefecimento e conduz a uma falha prematura do sistema de arrefecimento. Para uma limpeza mais completa, remova o conjunto da grelha frontal.

Nos refrigeradores refrigerados a ar, a moldura e rebordos do condensador localizados por detrás do conjunto da grelha frontal são muito aguçados.

Para além do conjunto de grelha refrigerada a ar, nunca opere o refrigerador com qualquer painel removido.

Os refrigeradores de refrigeração a água ThermoFlex900-5000 possuem um ventilador com lâminas aguçadas, pelo que se deve assegurar que o refrigerador está desligado antes de remover a grelha frontal.

Utilização Prevista, Refrigeradores de Recirculação:

Os refrigeradores de recirculação Thermo Scientific são concebidos para facultar um fornecimento contínuo de fluido a um fluxo e temperatura constantes. O refrigerador conste num sistema de refrigeração com arrefecimento a ar ou água, permutador de calor, bomba de recirculação, reservatório de fluido de processamento e um controlador de microprocessador.



Os refrigeradores destinam-se a funcionamento contínuo e para utilização interna de acordo com todos os procedimentos e requisitos descritos deste manual.

Instalação, Refrigeradores de Recirculação:

Coloque o refrigerador de forma a que esteja próximo e tenha fácil acesso ao dispositivo de desconexão.

O refrigerador destina-se a utilização numa tomada dedicada.

Certifique-se de que todas as fichas de expedição da linha de canalização são removidas antes da instalação.

As ligações de fluido de processamento encontram-se localizadas na parte posterior do refrigerador e encontram-se etiquetadas  ((PROCESS OUTLET) (SAÍDA DE PROCESSAMENTO)) e  ((PROCESS INLET) (ENTRADA DE PROCESSAMENTO)). Ligue a  à entrada de fluido na sua aplicação. Ligue a  à saída de fluido na sua aplicação.

Para refrigeradores com refrigeração a água ligue a  ((FACILITY INLET) (ENTRADA DE UNIDADE)) ao abastecimento de água da unidade. Ligue a  ((FACILITY OUTLET) (SAÍDA DE UNIDADE)) ao retorno ou drenagem de água da unidade.

Antes de iniciar o refrigerador, verifique todas as ligações de comunicação, eléctricas e tubagens aplicáveis.

Essentiële veiligheidsinstructies Recirculatiekoelers

Als één van de instructies niet duidelijk is, raadpleeg dan de handleiding of neem contact op met ons vooraleer door te gaan.

Veiligheid, alle producten:

⚠ DANGER duidt op een onmiddellijke gevaarrijke situatie die, indien ze niet wordt vermeden, zal leiden tot de dood of ernstige letsels.

⚠ WARNING duidt op een gevaarrijke situatie die, indien ze niet wordt vermeden, kan leiden tot de dood of ernstige letsels.

⚠ CAUTION duidt op een mogelijke gevaarrijke situatie die, indien ze niet wordt vermeden, zal leiden tot lichte of middelmatige letsels. Het kan ook gebruikt worden als waarschuwing tegen onveilige praktijken.

 bedoeld om de gebruiker te waarschuwen voor de aanwezigheid van een niet-geïsoleerde "gevaarlijke spanning" binnenin de behuizing van de koeler. De grootte van de spanning is voldoende significant om een gevaar te vormen op een elektrisch schok.

 duidt op de aanwezigheid van hete oppervlakken.

 duidt op het raadplegen van de handleiding.

Gebruik de apparatuur niet als steriel of als een met de patiënt verbonden apparaat. Daarnaast is de apparatuur niet ontworpen voor gebruik in gevaarlijke locaties van klasse I, II of III zoals gedefinieerd door de National Electrical Code.

De apparatuur is uitsluitend bedoeld voor gebruik binnenshuis. Plaats deze nooit op een locatie met overmatige hitte, vochtigheid, onvoldoende ventilatie of waar er corrosieve materialen aanwezig zijn. Raadpleeg de handleiding voor de operationele parameters.

Sluit de apparatuur steeds aan op een goed geaard stopcontact.

Koelmiddelen zijn zwaarder dan lucht en als er een lek is, zal het de zuurstof vervangen en kan dit leiden tot bewusteloosheid. Contact met het lekkende koelmiddel kan leiden tot brandwonden op de huid. Raadpleeg het typeplaatje van de circulatiepomp voor het type koelmiddel dat wordt gebruikt en raadpleeg vervolgens het meest recente veiligheidsgegevensblad (Safety Data Sheet - SDS) van de producent, eerder gekend als MSDS, en het Europese veiligheidsgegevensblad voor extra informatie.

Verplaats de apparatuur steeds erg zorgvuldig. Plotsse schokken of druppels kunnen de componenten beschadigen. Schakel de apparatuur steeds uit en haal de stekker uit het stopcontact vooraleer deze te verplaatsen.

Gebruik nooit beschadigde of lekkende apparatuur.

Gebruik nooit ontvlambare of corrosieve vloeistoffen. Maak alleen gebruik van de goedgekeurde vloeistoffen in de handleiding. Raadpleeg, vooraleer een vloeistof te gebruiken of onderhouden uit te voeren waarbij het waarschijnlijk is dat u in aanraking komt met de vloeistof, het meest recente veiligheidsgegevensblad (Safety Data Sheet - SDS) van de producent en het Europese veiligheidsgegevensblad voor extra informatie.

Schakel de apparatuur steeds uit en haal de stekker uit het stopcontact vooraleer deze te verplaatsen. Laat het onderhoud en de herstellingen steeds uitvoeren door een gekwalificeerd technicus.

Sla de apparatuur op bij een temperatuur tussen -25°C tot 60°C (met verpakking) en een relatieve vochtigheid van minder dan 80%.

Het buiten dienst stellen mag alleen uitgevoerd worden door een gekwalificeerde dealer die gebruik maakt van gecertificeerde uitrusting. Alle geldende regelgevingen moeten worden gevolgd.

Het uitvoeren van de installatie-, de werkings- of onderhoudsprocedures op een andere manier dan beschreven in de handleiding kan leiden tot een gevaarlijke situatie en zal de garantie van de producent ongeldig maken.

Sluit nooit de netspanning aan op de communicatie-aansluitingen van de koeler.

Het volledig vullen van de koeler en de leidingen met procesvloeistof kan de koelpomp beschadigen. Vermijd het overvullen omdat vloeistoffen uitzetten wanneer ze worden opgewarmd.

Verzeker bij ThermoFlex voor het vervangen van de behuizing van het reservoir dat de balstopper van de kijkbuis van het reservoir stevig is bevestigd.

Stel de koeler van een ThermoFlex900-5000 niet in werking tenzij het reservoir van de vloeistofdiffuser is geïnstalleerd.

Als uw koeler is uitgerust met een positieve verplaatsingspomp (P1 of P2), verzeker dan dat uw leidingen en fittingen bestand zijn tegen minimaal 185 psi.

Gebruik geen antivriesmiddel voor auto's. Commercieel antivriesmiddel bevat silicaten die de pompdichtingen kunnen beschadigen.

Om het bevroren van en het ontstaan van een ijslaagje op de plaatvormige warmtewisselaar te voorkomen, vereisen de ThermoFlex7500-24000-koelers het gebruik van 50/50 EG/water of 50/50 PG/water bij een temperatuur onder 10°C.

Bij gebruik van een mix van procesvloeistoffen van EG/water of PG/water dient u de vloeistofconcentratie en pH op een regelmatig basis te controleren. Wijzigingen in de concentratie en de pH kunnen een impact hebben op de prestaties van het systeem.

Gebruik geen deionisatie(DI)-filtercartridge met Inhibited EG of Inhibited PG. Een DI-filter zal remmers uit de vloeistof verwijderen waardoor de vloeistof niet meer effectief is als bescherming tegen corrosie. Daarnaast verhogen remmers de geleiding van vloeistoffen.

Biociden zijn corrosief en kunnen onherstelbare schade toebrengen aan de ogen en ook brandwonden veroorzaken. Ze zijn schadelijk als ze worden geïnhaleerd, worden ingeslikt of worden opgenomen via de huid. Raadpleeg het meest recente veiligheidsgegevensblad (SDS) van de producent.

Om schade te voorkomen aan de plaatvormige warmtewisselaar, vereisen de centrifugale pompen een minimale doorstroming van 15,1 liter per minuut.

Het nalaten om de filter van de condensor te reinigen of te vervangen kan leiden tot een verlies van koelcapaciteit en tot het voortijdig defect raken van het koelsysteem. Verwijder de rooster aan de voorzijde voor een grondige reiniging.

Bij luchtgekoelde koelers bevinden het kader en de vinnen van de condensor zich achter de voorste rooster en dient u goed op te letten want ze zijn erg scherp.

Bij andere koelers dan degene met een luchtgekoeld rooster mag u de koeler nooit activeren wanneer het paneel verwijderd is.

ThermoFlex900-5000 watergekoelde koelers beschikken over een ventilator met scherpe schoepen, zorg ook dat de koeler is uitgeschakeld vooraleer de rooster vooraan wordt verwijderd.

Bedoeld gebruik, recirculatiekoelers:

De recirculatiekoelers van Thermo Scientific zijn ontworpen om een continue toevoer van vloeistoffen te voorzien met een constante temperatuur en doorstroming. De koeler bestaat uit een luchtgekoeld of watergekoeld koelsysteem, warmtewisselaar, recirculatiepomp, reservoir voor procesvloeistof en een microprocessorcontroller.





Koelers zijn ontworpen voor een continue werking en voor gebruik binnenshuis in overeenkomst met alle procedures en vereisten die staan vermeld in de handleiding.

Installatie, recirculatiekoelers:

Plaats de koeler zodat deze zich dichtbij het loskoppelapparaat bevindt en dat deze eenvoudig toegankelijk is.

De koeler is bedoeld voor gebruik op een daartoe bestemde uitvoer.

Verzekert dat alle transportpluggen op de leidingen zijn verwijderd voor de installatie.

De aansluitingen van de procesvloeistof bevinden zich op de achterzijde van de koeler en hebben een label  (PROCESS OUTLET (PROCESUITVOER)) en  (PROCESS INLET (PROCESTOEVOER)). Sluit de  aan op de vloeistoftoevoer van uw applicatie. Sluit de  aan op de vloeistofuitvoer van uw applicatie.

Sluit voor watergekoelde koelers de  (FACILITY INLET (TOEVOER VAN DE FACILITEIT)) aan op watertoevoer van uw faciliteit. Sluit de  (FACILITY OUTLET (UITVOER VAN DE FACILITEIT)) aan op de waterretour of -afvoer van de faciliteit.

Vooraleer de koeler te starten dient u alle van toepassing zijnde communicatie-aansluitingen, elektrische aansluitingen en leidingaansluitingen tweemaal te controleren.

Istruzioni essenziali per la sicurezza Chiller a ricircolazione

Se queste istruzioni non sono chiare, fare riferimento al manuale oppure contattare il nostro ufficio prima di procedere.

Sicurezza, tutti i prodotti:

⚠ DANGER indica una situazione di pericolo imminente che, se non evitata, potrebbe causare morte o ferite gravi.

⚠ WARNING indica una situazione potenzialmente pericolosa che se non evitata potrebbe causare lesioni gravi o morte.

⚠ CAUTION indica una situazione di pericolo potenziale che, se non evitata, potrebbe causare ferite lievi o non gravi. Viene anche utilizzato come avviso contro pratiche non sicure.

 destinato ad avvisare l'utente della presenza di "tensioni pericolose" non isolate all'interno dell'involucro del chiller. Il valore della tensione è abbastanza significativo da costituire un rischio di scosse elettriche.

 indica la presenza di superfici calde.

 segnala di leggere il manuale.

Non utilizzare l'apparecchiatura come dispositivo sterile o collegato a un paziente. Inoltre, l'apparecchiatura non è progettata per l'utilizzo in luoghi pericolosi di Classe I, II o III secondo le definizioni del National Electrical Code.

Questa apparecchiatura è destinata all'uso in ambienti chiusi. Non collocarla mai in luoghi soggetti a calore eccessivo, umidità, ventilazione inadeguata o materiali corrosivi. Fare riferimento al manuale per i parametri operativi.

Collegare l'apparecchiatura ad una presa di rete adeguatamente messa a terra.

I refrigeranti utilizzati sono più pesanti dell'aria e, in caso di perdite, possono sostituire l'ossigeno causando perdita di conoscenza. Il contatto della pelle con il refrigerante fuoriuscito causa ustioni. Per ulteriori informazioni, fare riferimento alla targhetta del circuito circolatore per il tipo di refrigerante utilizzato e ai dati tecnici di sicurezza aggiornati del produttore (US Safety Data Sheet - SDS), precedentemente noti come MSDS, non che ai dati tecnici di sicurezza UE.

Spostare l'apparecchiatura con cautela. Sobbalzi o cadute improvvisi possono danneggiare i suoi componenti. Spegnerne sempre l'apparecchiatura e scollegarla dalla tensione di alimentazione prima di spostarla.

Non utilizzare mai apparecchiature danneggiate o con perdite.

Non utilizzare mai fluidi infiammabili o corrosivi. Utilizzare esclusivamente i fluidi certificati elencati nel manuale. Prima di utilizzare fluidi o eseguire operazioni di manutenzione che prevedano il contatto con il fluido, fare riferimento ai dati tecnici di sicurezza aggiornati del produttore (US Safety Data Sheet - SDS) e ai dati tecnici di sicurezza UE per ulteriori informazioni.

Spegnerne sempre l'apparecchiatura e scollegarla dalla tensione di alimentazione prima di spostarla.

Demandare assistenza e riparazioni ad un tecnico qualificato.

Conservare l'apparecchiatura ad una temperatura compresa tra -25°C e 60°C (con imballo), e una umidità relativa <80%.

La disattivazione deve essere eseguita solo da rivenditori qualificati utilizzando attrezzature certificate. Dovranno essere rispettate tutte le norme vigenti.

L'esecuzione di procedure di installazione, funzionamento o manutenzione diverse da quelle descritte nel manuale potrebbero determinare situazioni di pericolo e causare l'annullamento della garanzia del produttore.

Non applicare mai la tensione di linea alle connessioni di comunicazione presenti sul chiller.

Il riempimento incompleto delle linee di trasmissione di fluido per il processo e il chiller può danneggiare la pompa dell'apparecchio. Evitare comunque di riempire in eccesso, in quanto i fluidi si espandono se riscaldati.

Su ThermoFlex, prima di sostituire l'involucro del serbatoio, assicurarsi che il fermo sferico del tubo di verifica serbatoio sia posizionato in sicurezza.

Su ThermoFlex900-5000, non azionare il chiller se non è installato il diffusore di fluido del serbatoio.

Se il chiller è provvisto di una pompa volumetrica positiva (P1 o P2), assicurarsi che le tubazioni dell'applicazione e i relativi raccordi possano resistere ad una pressione di almeno 185 psi.

Non utilizzare antigelo per autotrazione. L'antigelo commerciale contiene silicati che danneggiano le guarnizioni della pompa.

Per evitare il congelamento dello scambiatore a piastra, i chiller ThermoFlex7500-24000 richiedono l'utilizzo di 50/50 EG/acqua o 50/50 PG/acqua sotto la temperatura di processo di 10°C.

Quando si utilizza una miscela di fluido di EG/acqua o PG/acqua, verificare periodicamente la concentrazione del fluido e il pH. Eventuali variazioni di concentrazione e pH possono compromettere le prestazioni del sistema.

Non utilizzare un cartuccia filtro di deionizzazione (DI) con EG o PG inibiti. Un filtro DI rimuoverà gli inibitori dalla soluzione, rendendo il fluido inefficace contro la corrosione. Inoltre, gli inibitori fanno aumentare la conduttività del fluido.

I biocidi sono corrosivi e possono causare danni irreversibili agli occhi e ustioni cutanee. Sono pericolosi se inalati, ingeriti o assorbiti attraverso la pelle. Fare riferimento ai documenti SDS più aggiornati del produttore.

Per evitare danni allo scambiatore a piastra del chiller, le pompe centrifughe richiedono una portata minima di 4,0 gpm (15,1 lpm).

La mancata pulizia/sostituzione del filtro del condensatore provoca una perdita della capacità di raffreddamento con il rischio di guasti prematuri del sistema di raffreddamento. Per una pulizia approfondita, togliere il gruppo della griglia anteriore.

Nei chiller raffreddati ad aria le alette ed il telaio del condensatore dietro il gruppo della griglia anteriore sono molto affiati.

Non azionare mai il chiller con pannelli rimossi, ad eccezione del gruppo griglia raffreddato ad aria. I chiller raffreddati ad acqua ThermoFlex900-5000 dispongono di una ventola con pale affilate; assicurarsi che il chiller sia spento prima di rimuovere la griglia anteriore.

Destinazione d'uso, chiller a ricircolazione:

I chiller a ricircolazione Thermo Scientific sono progettati per fornire un'alimentazione continua di fluido a temperatura e portata costanti. Il chiller è composto da un sistema di refrigerazione raffreddato ad aria o ad acqua, uno scambiatore di calore, una pompa di ricircolazione, un serbatoio del fluido di processo e un controller a microprocessore.

I chiller sono progettati per il funzionamento continuo e per l'utilizzo in ambienti chiusi, in conformità con tutte le procedure e i requisiti definiti in questo manuale.

Installazione, chiller a ricircolazione:

Posizionare il chiller in modo che sia vicino ed abbia un pratico accesso al suo dispositivo di disconnessione.

Il chiller deve essere utilizzato su una presa dedicata.

Assicurarsi che tutte le spine utilizzate per la spedizione nelle linee di tubazione siano state rimosse prima di procedere all'installazione.

Le connessioni per il fluido di processo si trovano sul retro del chiller e sono etichettati  (PROCESS INLET) e  (PROCESS OUTLET). Collegare  all'ingresso del fluido sull'applicazione. Collegare  all'uscita del fluido sull'applicazione.

Per i chiller raffreddati ad acqua collegare  (FACILITY INLET) all'alimentazione idraulica dell'impianto. Collegare  (FACILITY OUTLET) al ritorno o scarico dell'acqua dell'impianto.

Prima di avviare il chiller, ricontrollare tutte le linee di comunicazione e le connessioni elettriche e delle tubazioni.

BG

Важни инструкции за безопасност Рециркуляционни охладители

Ако някоя от тези инструкции не бъде разбрана, се обрънете към ръководството или се свържете с нас, преди да продължите.

Безопасност, всички продукти:

 **DANGER** указва непосредствено опасна ситуация, която, ако не бъде избегната, ще доведе до смърт или тежка телесна повреда.

 **WARNING** указва потенциално опасна ситуация, която, ако не бъде избегната, може да доведе до смърт или тежка телесна повреда.

 **CAUTION** указва потенциално опасна ситуация, която, ако не бъде избегната, може да доведе до лека или средна телесна повреда. Също така се използва, за да предупреди за опасни практики.

 предназначен да предупреди потребителя за наличие на неизолотирано "опасно напрежение" в рамките на корпуса на охладителя. Величината на напрежението е достатъчно значима, за да поражда риск от електрически удар.

 указва наличието на горещи повърхности.

 указва, че ръководството трябва да се прочете.

Не използвайте оборудването като стерилно устройство или устройство, свързано с пациенти. В допълнение устройството не е предназначено за употреба в клас I, II или III опасни места, както е определено от Националния закон за електричеството на САЩ (NEC).

Оборудването е предназначено само за употреба в закрити помещения. Никога не го поставяйте на място, където са налице прекомерна топлина, влага, лоша вентилация или корозивни материали. Вижете ръководството за експлоатационните параметри.

Свържете оборудването към правилно заземен контакт. Използваните хладилни агенти са по-тежки от въздуха и, ако има теч, те ще заменят кислорода, причинявайки загуба на съзнание. Контактът с изтичащ хладилен агент ще предизвика изгаряния на кожата. Направете справка с фирмената табела на циркулатора за типа на използвания хладилен агент, след което към най-актуалния информационен лист за безопасност на САЩ (SDS) от производителя, известен преди като MSDS, и също така и към информационния лист за безопасност на ЕС, за допълнителна информация.

Премествайте оборудването внимателно. Внезапни сътресения или изпускания могат да повредят компонентите му. Винаги изключвайте устройството и го разкачайте от неговото захранващо напрежение, преди да го преместите.

Никога не експлоатирайте повредено оборудване или оборудване с течове.

Никога не използвайте запалими или корозивни течности. Използвайте само одобрените течности, посочени в ръководството. Преди да се използва каквато и да било течност или да се прави поддръжка, където е вероятно да има контакт с течността, направете справка с най-актуалния информационен лист за безопасност на САЩ (SDS) от производителя, както и информационния лист за безопасност на ЕС, за допълнителна информация.

Винаги изключвайте устройството и го разкачайте от неговото захранващо напрежение преди преместване.

За обслужване и ремонтни дейности се обрънете към квалифициран техник.

Съхранявайте оборудването при температура от -25°C до 60°C (с опаковката) и $<80\%$ относителна влажност.

Извеждането от експлоатация трябва да се извършва само от квалифициран дилър, като се използва сертифицирано оборудване. Всички действащи разпоредби трябва да се спазват.

Извършване на монтаж, експлоатация или процедури за поддръжка, различни от тези, описани в ръководството, може да доведе до опасна ситуация и ще анулира гаранцията на производителя.

Никога да не се прилага линейно напрежение към някоя от комуникационните връзки на охладителя. Непълното запълване на охладителя и на технологичните тръбопроводи за течности може да повреди помпата на охладителя. Избягвайте препълването, защото течностите се разширяват при нагряване.

За ThermoFlex, преди да подмените корпуса на резервоара, се уверете, че топката-запушалка на контролната тръба на резервоара е надлежно поставена на място.

За ThermoFlex900-5000 не експлоатирайте охладителя, освен ако не е инсталиран дифузерът за течности на резервоара.

Ако охладителят е оборудван с обемна нагнетателна помпа (P1 или P2), се уверете, че водопроводните тръби и фитинги на приложението са проектирани да издържат минимум 185 psi. Не използвайте антифриз от автомобилната индустрия. Серийният антифриз съдържа силикати, които увреждат уплътненията на помпата.

За да се предотврати замръзването/гланциране на пластинния топлообменник, охладителите ThermoFlex7500-24000 изискват употребата на 50/50 EG/вода или 50/50 PG/вода с температура за обработка под 10°C .

Когато се използва смес от технологична течност от EG/вода или PG/вода, редовно проверявайте концентрацията на течността и pH. Промениите в концентрацията и pH могат да окажат влияние върху производителността на системата.

Не използвайте дейонизиращ (DI) патронен филтър с инхибирана EG или инхибирана PG. DI филтърът ще премахне инхибиторите от разтвор, правейки течността неефективна при защита от корозия. Също така инхибиторите повишават проводимостта на течността.

Бицидите са корозивни и могат да предизвикат необратими увреждания на очите и изгаряния на кожата. Те са вредни при вдишване, поглъщане или абсорбиране през кожата. Направете справка с най-актуалния SDS на производителя.

За да се предотврати повреда на пластинния топлообменник на охладителя, центробежните помпи изискват 4,0 gpm (15,1 lpm) минимален дебит.

Непочистването/неподмяната на кондензаторния филтър ще причини загуба на капацитета на охладяне и ще доведе до преждевременна повреда на охлаждащата система. За цялостно почистване извадете модула на предната решетка.

При охладителите с въздушно охлаждане рамките и перките на кондензатора, разположени зад модула на предната решетка, са много остри.

Освен модула на решетката за въздушно охлаждане, никога не експлоатирайте охладителя с който и да било друг отстранен панел.

Охладителите ThegmoFlex900-5000 с водно охлаждане имат вентилатор с остри перки и затова се уверете, че охладителят е изключен, преди да премахнете предната решетка.

Предназначена употреба, рециркуляционни охладители:

Рециркуляционните охладители на Thegmo Scientific са предназначени да осигуряват непрекъснато подаване на течност при постоянна температура и дебит. Охладителят се състои от хладилна система с въздушно охлаждане или водно охлаждане, топлообменник, рециркуляционна помпа, резервоар за технологична течност и микропроцесорен контролер.

Охладителите са предназначени за непрекъсваема експлоатация и за употреба на закрито в съответствие с всички процедури и изисквания, посочени в съответното ръководство.

Монтиране, рециркуляционни охладители:

Разположете охладителя, така че да е близо и да има лесен достъп до устройството му за изключване.

Охладителят е предназначен за употреба с отделен контакт.

Уверете се, че всички тапи за транспортиране на водопроводните тръби са отстранени преди монтажа.

Връзките на технологичната течност се намират на гърба на охладителя и са отбелязани с етикети  (ТЕХНОЛОГИЧЕН ИЗХОД) и  (ТЕХНОЛОГИЧЕН ВХОД). Свържете  към входа за течности на вашето приложение. Свържете  към изхода за течности на вашето приложение.

За охладители с водно охлаждане свържете  (ВХОД ЗА ПРОМИШЛЕНА) към източника на промишлена вода. Свържете  (ИЗХОД ЗА ПРОМИШЛЕНА) към връщащата тръба за промишлена вода или канала.

Преди да стартирате охладителя, проверете отново всички приложими комуникационни, електрически и водопроводни връзки.

Základní bezpečnostní pokyny Recirkulační chladiče

Pokud některým z těchto pokynů nebudete rozumět, nahlédněte před pokračováním do návodu k obsluze nebo nás kontaktujte.

Bezpečnost, všechny produkty:

DANGER Značí bezprostředně nebezpečnou situaci, která pokud nebude odstraněna, povede ke smrtelnému nebo závažnému úrazu.

WARNING Značí potenciálně nebezpečnou situaci, která pokud nebude odstraněna, může vést ke smrtelnému nebo závažnému úrazu.

CAUTION Značí potenciálně nebezpečnou situaci, která pokud nebude odstraněna, může vést k méně až středně závažnému úrazu. Slouží také jako výstraha před nebezpečnými postupy.

 Slouží k upozornění uživatele na přítomnost neizolovaného „nebezpečného napětí“ v krytu chladičích zařízení. Napětí je dostatečně vysoké na to, aby představovalo riziko úrazu elektrickým proudem.

 Značí přítomnost horkých povrchů.

 Značí, že si má obsluha přečíst návod k obsluze.

Vybavení nepoužívejte jako sterilní zařízení nebo zařízení připojené k pacientovi. Zařízení navíc není určeno k používání v rizikových lokalitách třídy I, II nebo III podle národních elektrotechnických předpisů.

Zařízení je navrženo pouze pro používání ve vnitřních prostorech. Nikdy ho neumisťujte do míst, kde je nadměrné teplo, vlhkost, nedostatečná ventilace nebo kde se nachází korozivní materiály. Provozní parametry jsou uvedené v návodu k obsluze.

Připojte zařízení k řádně uzemněné zásuvce.

Použitá chladiva jsou těžší než vzduch a pokud dojde k jejich úniku, vytlačí veškerý vzduch a způsobí ztrátu vědomí. Kontakt s unikajícím chladivem způsobí popálení pokožky. Typ použitého chladiva zjistíte na štítku s technickými údaji cirkulačního termostatu a další informace jsou uvedeny v aktuálním bezpečnostním listu výrobce.

Při stěhování zařízení buďte opatrní. Náhlé nárazy nebo pády mohou poškodit jeho součásti. Před stěhováním zařízení vždy vypněte a odpojte ho od přívodu napájení.

Nikdy nepoužívejte poškozené nebo netěsné zařízení.

Nikdy nepoužívejte hořlavé nebo korozivní kapaliny. Používejte pouze schválené kapaliny uvedené v návodu k obsluze. Před použitím nějaké kapaliny nebo před prováděním údržby, kde je pravděpodobné, že přijdete s touto kapalinou do styku, si zjistěte další informace v aktuálním bezpečnostním listu výrobce. Před stěhováním zařízení vždy vypněte a odpojte ho od přívodu napájení.

Servis a opravy přenechejte kvalifikovaným servisním technikům.

Skládejte zařízení při teplotách -25 °C až 60 °C (v obalu), a při relativní vlhkosti vzduchu nižší než 80 %.

Výrazení z provozu smí provádět pouze kvalifikovaný prodejce s pomocí certifikovaného vybavení. Musí být dodržena veškerá platná nařízení.

Provádění jiných postupů při instalaci, obsluze nebo údržbě, než které jsou popsány v návodu k obsluze, může vést k nebezpečným situacím a způsobí zneplatnění záruky výrobce.

Nikdy nepřivádějte elektrické napětí k žádným komunikačním konektorům chladičích zařízení.

Když není chladičích zařízení a potrubí kompletně naplněné chladičí kapalinou, může dojít k poškození čerpadla. Zařízení nepřepínájte, kapalinu při zahřátí nabyvájí na objemu.

V případě zařízení ThermoFlex se před výměnou krytu nádržky přesvědčte, jestli je bezpečně na svém místě kuličková zarážka tubicového průzoru.

Zařízení ThermoFlex900-5000 neuvádějte do provozu, dokud není nainstalovaný difúzér kapaliny v nádržce.

Pokud je chladičích zařízení vybavené objemovým čerpadlem (P1 nebo P2), přesvědčte se, jestli hadice, potrubí a spojky vaší instalace vydrží tlak minimálně 185 psi.

Nepoužívejte automobilový odmrazovač. Běžně prodávané odmrazovače obsahují silikáty, které poškodí těsnění čerpadla.

Aby nedocházelo k zamrznutí deskového výměníku nebo jeho pokrytí ledem, chladičích zařízení ThermoFlex7500-24000 vyžadují používání směsi etylenglykolu a vody v poměru 1:1 nebo směsi propylenglykolu a vody v poměru 1:1 s procesní teplotou nižší než 10 °C.

Při používání směsi etylenglykolu a vody nebo propylenglykolu a vody pravidelně kontrolujte koncentraci kapaliny a pH. Změny v koncentraci a pH mohou mít vliv na výkon systému. Nepoužívejte kazetu deionizačního filtru s inhibovaným etylenglykolem nebo inhibovaným propylenglykolem.

Deionizační filtr z roztoku odstraní inhibitory, takže kapalina přestane narušovat antikorozní ochranu.

Biocidní přípravky jsou korozivní a mohou způsobit nevratné poškození očí a popáleniny pokožky. Při vdechnutí, spolknutí nebo vstřebání pokožkou jsou škodlivé. Podívejte se do aktuálních bezpečnostních listů výrobce.

Aby nemohlo dojít k poškození deskového výměníku chladičích zařízení, vyžadují odstředivá čerpadla minimální průtok 15,1 l/m).

Nedostatečně vyčištěný nebo nevytěsněný filtr kondenzátoru způsobuje ztrátu chladičí kapacity a vede k předčasnému selhání systému.

V zájmu důkladného vyčištění demontujte přední mřížku. U vzduchem chlazených chladiců jsou rám kondenzátoru a jeho žebra za přední mřížkou velmi ostré.

V případě mřížky chlazené jinak než vzduchem nikdy chladicí zařízení nepoužívejte s demontovanými panely.

Vodou chlazené chladiče ThermoFlex900-5000 mají ventilátor s ostrými lopatkami, takže se před demontáží přední mřížky přesvědčte, že je chladic vypnutý.

Určené použití, recirkulační chladiče:

Recirkulační chladiče společnosti Thermo Scientific jsou navrženy pro zajišťování nepřetržitého přívodu kapaliny při konstantní teplotě a konstantním průtoku. Chladic se skládá ze vzduchem chlazeného nebo vodou chlazeného chladicího systému, tepelného výměníku, recirkulačního čerpadla, nádržky na procesní kapalinu a řídicí jednotky s mikroprocesorem.



Chladiče jsou navrženy pro nepřetržitý provoz a používání ve vnitřních prostorech v souladu se všemi postupy a požadavky, uvedenými v jejich návodech k obsluze.

Instalace, recirkulační chladiče:

Umístěte chladic tak, aby byl v blízkosti svého odpojovacího zařízení a aby byl k odpojovacímu zařízení snadný přístup.

Chladicí zařízení č je určen pro používání se samostatným výstupem.

Před instalací musí být odstraněny všechny přepravní zátky na potrubích a hadicích.

Připojky procesní kapaliny jsou umístěné na zadní části chladiče a jsou označené  (PROCESS OUTLET – procesní výstup) a  (PROCESS INLET – procesní přívod). Připojte kapalinu na zařízení. Připojte  k výstupu kapaliny na zařízení.

V případě vodou chlazených chladiců připojte  (FACILITY INLET – přívod ze závodu) k přívodu vody ze závodu. Připojte  (FACILITY OUTLET – výstup kapaliny do závodu) k odtoku vody v závodu.

Před spuštěním chladiče překontrolujte příslušné komunikační a elektrické připojky a připojovací armatury.



Essentiell sikkerhedsvejledning Recirkulerende nedkølere

Hvis nogle af disse instrukser ikke kan forstås, så referer til manualen, eller kontakt os, før du fortsætter.

Sikkerhed, alle produkter:

DANGER Indikerer en omgående farlig situation, som, hvis den ikke undgås, vil resultere i død eller alvorlig skade.

WARNING Indikerer en potentielt farlig situation, som, hvis den ikke undgås, vil resultere i død eller alvorlig skade.

CAUTION Indikerer en potentielt farlig situation, som, hvis den ikke undgås, kan resultere i mindre eller moderat skade. Den bruges også til at advare mod usikre fremgangsmåder.

 beregnet til at advare brugeren om tilstedeværelsen af ikke-isoleret "farlig spænding" inden for nedkølerens indelukke. Spændingens styrke er markant nok til at udgøre risiko for elektrisk stød.

 indikerer tilstedeværelsen af varme overflader.

 indikerer læs manualen.

Brug ikke udstyret som en steril eller patientforbundet enhed. Derudover er udstyret ikke designet til brug i Klasse I, II eller III farlige steder som defineret af National Electrical Code.

Udstyret er kun designet til indendørs brug. Placer det aldrig et sted, hvor der findes overdreven varme, fugtighed, ufilstrækkelig ventilation eller ætsende materialer. Referer til manualen for driftsparametre.

Forbind udstyret til en korrekt jordet stikkontakt.

Kølemidler, der bruges her, er tungere end luft, og hvis der er en læk, vil det erstatte oxygenet, hvilket forårsager tab af bevidsthed. Kontakt med lækkende kølemidler vil forårsage hudforbrændinger. Referer til cirkulatorens navneplade for den type kølemiddel, der bruges, og så producentens mest aktuelle amk. sikkerhedsdataark (SDS), tidligere kendt som MSDS, og EUs sikkerhedsdataark for yderligere oplysninger.

Flyt udstyret forsigtigt. Pludselige stød eller tab kan beskadige dets komponenter. Sluk altid udstyret, og afbryd det fra dets strømforsyning, før det flyttes.

Bejten aldrig beskadiget eller lækkende udstyr.

Brug aldrig brændbare eller ætsende væsker. Brug kun tilladte væsker, der er angivet i manualen. Før du bruger nogen væske eller udfører vedligeholdelse, hvor kontakt med væsken er sandsynlig, skal du referere til producentens mest aktuelle amk. sikkerhedsdatablad (SDS) og EUs sikkerhedsdatablad for yderligere oplysninger.

Sluk altid udstyret, og afbryd det fra dets strømforsyning, før det flyttes.

Hvis vedligeholdelse og reparation til en kvalificeret tekniker.

Opbevar udstyret i et temperaturinterval på -25 °C til 60 °C (med indpakning), og <80 % relativ luftfugtighed.

Dekommissionering skal kun udføres af en kvalificeret forhandler, der bruger certificeret udstyr. Alle aktuelle regulativer skal følges.

Udførelse af installation, drift eller vedligeholdelsesprocedurer andre end dem, der er beskrevet i denne manual, kan resultere i en farlig situation og vil annullere producentens garanti.

Påfør aldrig linjespænding til nogen kommunikationsforbindelse på nedkøleren.

Hvis du ikke fylder nedkøler- og procesvæskelinjer helt, kan det beskædige nedkølerens pumpe. Undgå at overfylde. Væsker ekspanderer, når de varmes op.

På ThermoFlex, før du erstatter reservoir-kabinettet, skal du sikre, at den synlige reservoir-rørkuglestopper er sikkert på plads.

På ThermoFlex900-5000 må du ikke bejlene nedkøleren, før reservoir-væskediffuseren er installeret.

Hvis din nedkøler er udstyret med en positiv forskydningspumpe (P1 or P2), skal du sikre, at din applikation af rørlinjer og beslag er vurderet til at modstå et minimum af 185 psi

Ber nyt ikke automobil kølevæske. Kommerciel kølevæske indeholder silikater, der skader pumpeforseglingen.

For at forebygge frysningsglasering af pladeudveksleren kræver ThermoFlex7500-24000 nedkølere brug af 50/50 EG/vand eller 50/50 PG/vand under 10 °C processtemperatur.

Når du bruger en procesvæskemikstur af EG/vand eller PG/vand, skal du kontrollere væskekoncentrationen og pH jævnligt. Ændringer i koncentrationen og pH kan have indflydelse på systemydelsen.

Brug ikke en deioniserings (DI) filterpatron med inhiberet EG eller inhiberet PG. Et DI-filter vil fjerne inhibitorer fra opløsningen, hvilket gør væsken ineffektiv mod beskyttelse mod korrosion. Inhibitorer forøger også væskens ledeevne.

Biocider er ætsende og kan forårsage irreversibel øjenskade og hudforbrændinger. De er skadelige, hvis de inhaleres, sluges eller absorberes gennem huden. Referer til producentens mest aktuelle SDS.

For at forebygge skade på nedkølerens pladeudveksler kræver centrifugalpumper en minimumstrømråde på 4,0 gpm (15,1 lpm).

Hvis kondensatoren ikke rengøres/udskiftes, kan det forårsage et tab af kølekapacitet og føre til tidlig fejlfunktion af kølesystemet. For en grundig rengøring skal du fjerne fronttrissamlingen.

På luftkølede nedkølere er kondensatorramme og -finer bag fronttrissamlingen meget skarpe.

Ud over den luftkølede ristsamling må du aldrig bejlene nedkøleren med nogen aftagne paneler.

ThermoFlex900-5000 vandkølede nedkølere har en blæser med skarpe klinger, så sørg for, at nedkøleren er slukket, før fronttristen fjernes.

Tilsluttet brug, recirkulerende nedkølere:

Thermo Scientific recirkulerende nedkølere er designet til at yde en løbende væskeforsyning ved en konstant temperatur og strømningsrate. Nedkøleren består af et luftkølet eller vandkølet kølesystem, varmeveksler, recirkuleringspumpe, procesvæskerereservoir og en mikroprocessor-controller.





Nedkølere er designet til løbende drift og til indendørs brug i henhold til alle procedurerne og kravene formuleret i denne håndbog.

Installation, recirkulerende nedkølere:

Placer nedkøleren, så den er nær, og har nem adgang til, dens afbryderenhed.

Nedkøleren er beregnet til brug i en dedikeret strømkontakt.

Sørg for, at alle vvs-linjers shipping-stik fjernes før installation.

Procesvæskeforbindelserne befinder sig bag på nedkøleren og er markeret  (PROCESS INLET) og  (PROCESS OUTLET) og  til væskeindtaget på din applikation. Forbind  til væskeudløbet på din applikation. Forbind  til væskeudløbet på din applikation.

For vandkølede nedkølere skal du forbinde  (FACILITY INLET) til din facilitets vandforsyning. Forbind  (FACILITY OUTLET) til din facilitets vandreturering eller afløb.

Før du starter nedkøleren, skal du kontrollere alle relevante kommunikations-, elektriske og vvs-forbindelser en ekstra gang.

EL

Βασικές οδηγίες ασφαλείας Ψύκτες επανακυκλοφορίας

Εάν οποιαδήποτε από αυτές τις οδηγίες δεν είναι κατανοητή, ανατρέξτε στο εγχειρίδιο ή επικονιώνήστε μαζί μας πριν προχωρήσετε.

A DANGER Ασφάλεια, όλα τα προϊόντα:

Υποδεικνύει άμεση κατάσταση κινδύνου που αν δεν αποφευχθεί, μπορεί να προκαλέσει θάνατο ή σοβαρό τραυματισμό.



Υποδεικνύει δυνητικά επικίνδυνη κατάσταση που αν δεν αποφευχθεί, μπορεί να προκαλέσει θάνατο ή σοβαρό τραυματισμό.



Υποδεικνύει δυνητικά επικίνδυνη κατάσταση που αν δεν αποφευχθεί, μπορεί να προκαλέσει μικρό ή ήπιο τραυματισμό. Μπορεί να χρησιμοποιηθεί και ως προειδοποίηση μη ασφαλών πρακτικών.



για την προειδοποίηση του χρήστη σχετικά με την παρουσία μην-μονωμένης "επικίνδυνης τάσης" μέσα στο περίβλημα του ψύκτη. Το μέγεθος της τάσης είναι αρκετά σημαντικό ώστε να αποτελέσει κίνδυνο ηλεκτροπληξίας.



υποδεικνύει την παρουσία ζεστών επιφανειών



υποδεικνύει ανόγκωση του εγχειριδίου.

Μη χρησιμοποιείτε τον εξοπλισμό ως αποστειρωμένη συσκευή ή συσκευή συνδεδεμένη με τον ασθενή. Επιπλέον, ο εξοπλισμός δεν έχει σχεδιαστεί για χρήση στην Κατηγορία I, II ή III Επικίνδυνες Θέσεις από τον Εθνικό Ηλεκτρολογικό Κώδικα.

Ο εξοπλισμός έχει σχεδιαστεί για χρήση σε εσωτερικούς χώρους. Μην τοποθετείται ποτέ σε τοποθεσία με υπερβολική θερμότητα, υγρασία, ανεπαρκή αερισμό ή διαβρωτικά υλικά. Ανατρέξτε στις λειτουργικές παραμέτρους του εγχειριδίου.

Συνδέστε τον εξοπλισμό σε κατάλληλα γειωμένη έξοδο.

Τα ψυκτικά που χρησιμοποιούνται είναι βαρύτερα από τον αέρα και εάν υπάρχει διαρροή, θα αντικαταστήσουν το οξυγόνο και θα προκαλέσουν απώλεια αισθήσεων. Η επαφή με ψυκτικό διαρροής θα προκαλέσει εγκαύματα στο δέρμα. Ανατρέξτε στην πινακίδα για τον τύπο του ψυκτικού που χρησιμοποιείται και το τρέχον φύλλο Δεδομένων Ασφαλείας Η.Π.Α (SDS) γνωστά ως MSDS και το φύλλο Δεδομένων Ασφάλειας Ε.Ε. για περισσότερες πληροφορίες.

Μετακινήστε τον εξοπλισμό με προσοχή. Ξαφνικά τραντάγματα ή πτώσεις ενδέχεται να προκαλέσει βλάβες στα εξαρτήματα. Πάντα σβήνεται τον εξοπλισμό και αποσυνδέστε τον από την παροχή τάσης, πριν από τη μετακίνησή του.

Ποτέ μη λειτουργείτε εξοπλισμό που έχει υποστεί βλάβη ή παρουσιάζει διαρροές.

Ποτέ μη χρησιμοποιείτε εύφλεκτα ή διαβρωτικά υγρά. Χρησιμοποιήστε μόνο εγκεκριμένα υγρά που αναφέρονται στο εγχειρίδιο. Πριν χρησιμοποιήσετε οποιοδήποτε υγρό ή κατά τη διαδικασία της συντήρησης όπου η επαφή με το υγρό είναι πιθανή, ανατρέξτε στα Φύλλα Δεδομένων Ασφαλείας SDS και EC για περισσότερες πληροφορίες.

Πάντα σβήνεται τον εξοπλισμό και αποσυνδέστε τον από την παροχή τάσης, πριν από τη μετακίνησή του.

Για σέρβις και επισκευές απευθυνθείτε σε εξειδικευμένο τεχνικό.

Αποθηκεύστε τον εξοπλισμό σε θερμοκρασία μεταξύ -25°C και 60°C (με τη συσκευασία) και σε σχετική υγρασία <80%.

Η θέση εκτός λειτουργίας θα πρέπει να εκτελείται από εξειδικευμένο προμηθευτή με τη χρήση πιστοποιημένου εξοπλισμού. Όλοι οι κανονισμοί εν ισχύ θα πρέπει να τηρούνται.

Οι διαδικασίες εγκατάστασης, λειτουργίας ή συντήρησης εκτός από εκείνες που περιγράφονται στο εγχειρίδιο ενδέχεται να προκαλέσουν επικίνδυνες καταστάσεις και ακύρωση της εγγύησης του κατασκευαστή.

Ποτέ μην εφαρμόζετε τάση γραμμής σε οποιαδήποτε σύνδεση επικοινωνίας επί του ψύκτη.

Αν οι ψύκτες και οι γραμμές επεξεργασίας υγρού δεν είναι πλήρως γεμάτα, ενδέχεται να προκληθεί βλάβη στην αντλία του ψύκτη. Αποφύγετε την υπερχέλιση, τα υγρά διαστέλλονται όταν θερμαίνονται.

Στη διάταξη ThermoFlex, πριν την αντικατάσταση του περιβλήματος της δεξαμενής, βεβαιωθείτε ότι μπύλια του σωλήνα σκόπευσης έχει ασφαλιστεί στη θέση της.

Στο ThermoFlex900-5000, μη λειτουργείτε τον ψύκτη αν δεν έχει εγκατασταθεί ο διαχυτής υγρού της δεξαμενής.

Εάν ο ψύκτης σας έχει εφοπλιστεί με αντλία θετικού εκποτισματος (P1 ή P2), βεβαιωθείτε ότι οι υδραυλικές σωληνώσεις και οι συνδέσεις έχουν ρυθμιστεί έτσι ώστε να έχουν αντοχή σε ελάχιστο 185 psi.

Μη χρησιμοποιείτε αντιψυκτικό αυτοκινήτου. Τα αντιψυκτικά του εμπορίου περιέχουν πυρίτιο που προκαλεί ζημιά στις στεγανοποιήσεις.

Για την αποτροπή δημιουργίας πάγου/επικάλυψης στην πλάκα του εναλλάκτη, οι ψύκτες,

ThermoFlex7500-24000 απαιτούν τη χρήση 50/50 EG/νερού ή 50/50 P/G/νερό κάτω της θερμοκρασίας διαδικασίας των 10°C. Κατά τη χρήση μειγματος υγρού EG/νερού ή P/G/νερού, ελέγχετε τη συγκέντρωση και το pH σε τακτά χρονικά διαστήματα.

Οι αλλαγές σε συγκέντρωση και pH ενδέχεται να επηρεάσουν τις επιδόσεις του συστήματος. Μη χρησιμοποιείτε φυσίγγιο φίλτρου απιονισμού (DI) με αναστολέα EG ή αναστολέα PG.

Ένα φίλτρο DI θα αφαιρέσει τους αναστολείς από το διάλυμα, καθιστώντας το υγρό αναποτελεσματικό κατά την προστασία από τη διάβρωση. Επίσης, οι αναστολείς αυξάνουν την αγωγιμότητα του υγρού.

Τα βιοκτόνα είναι διαβρωτικά και μπορούν να προκαλέσουν μη αναστρέψιμη βλάβη στα μάτια και εκκτώματα στο δέρμα. Είναι βλαβερά κατά την εισπνοή, την κατάποση και την απορρόφηση από το δέρμα. Ανατρέξτε στο τρέχον φύλλο SDS του κατασκευαστή.

Για να αποτρέψετε βλάβες στην πλάκα εναλλάκτη του ψύκτη, οι φυγόκεντρες αντλίες απαιτούν ελάχιστη ροή 4,0 gpm (15,1 lpm).

Ο μη καθαρισμός ή η μη αντικατάσταση του φίλτρου συμπυκνωτή προκαλεί απώλεια ικανότητας ψύξης και θα οδηγήσει σε πρώιμη αποτυχία του συστήματος ψύξης. Για καλό καθαρισμό αφαιρέστε την εμπρός γρίλια της συναρμολογίας.

Σε αερόψυκτους ψύκτες το πλαίσιο του συμπυκνωτή και τα πτερύγια που βρίσκονται πίσω από την εμπρός σχάρα είναι πολύ κοφτερά.

Εκτός από την αερόψυκτη συναρμολογία της γρίλιας, ποτέ μην λειτουργείτε τον ψύκτη με βγαλμένα τα πλαίσια.

Οι υδρόψυκτοι ψύκτες ThermoFlex900-5000 έχουν έναν ανεμιστήρα με κοφτερές λεπίδες, βεβαιωθείτε ότι ο ψύκτης είναι σβηστός πριν αφαιρέσετε την εμπρός γρίλια.

Προοριζόμενη χρήση, ψύκτες επανακυκλοφορίας:

Οι ψύκτες επανακυκλοφορίας Thermo Scientific έχουν σχεδιαστεί για να παρέχουν συνεχή παροχή υγρού σε σταθερή θερμοκρασία και ροή. Ο ψύκτης αποτελείται από ένα αερόψυκτο ή υδρόψυκτο σύστημα ψύξης, έναν εναλλάκτη θερμότητας, μία αντλία επανακυκλοφορίας, μία δεξαμενή υγρού και έναν ελεγκτή μικροεπεξεργαστή.



Οι ψύκτες έχουν σχεδιαστεί για συνεχόμενη λειτουργία σε εσωτερικούς χώρους σύμφωνα με τις διαδικασίες και τις απαιτήσεις που ορίζει το παρόν εγχειρίδιο.

Εγκατάσταση, Διατάξεις ψύξης επανακυκλοφορίας:

Τοποθετήστε τη διάταξη ψύξης έτσι ώστε να είναι κοντά, με εύκολη στη διάταξη αποσύνδεσης.

Ο ψύκτης προορίζεται για χρήση σε αντίστοιχη έξοδο.

Βεβαιωθείτε ότι όλα τα πώματα συσκευασίας στις υδραυλικές σωληνώσεις έχουν αφαιρεθεί πριν την εγκατάσταση.

Οι συνδέσεις υγρού της διαδικασίας βρίσκονται στο πίσω μέρος του ψύκτη και έχουν ετικέτα (ΕΞΟΔΟΣ ΔΙΑΔΙΚΑΣΙΑΣ) και  και (ΕΙΣΟΔΟΣ ΔΙΑΔΙΚΑΣΙΑΣ). Συνδέστε το  στην είσοδο του υγρού της εφαρμογής σας. Συνδέστε το  στην έξοδο του υγρού της εφαρμογής σας

Για υδρόψυκτους ψύκτες συνδέστε το  (ΕΙΣΟΔΟΣ ΧΡΗΣΗΣ) στην παροχή νερού χρήσης. Συνδέστε την  (ΕΞΟΔΟ ΧΡΗΣΗΣ) στην επιστροφή νερού χρήσης ή στην αποστράγγιση.

Πριν την έναρξη του ψύκτη, ελέγξτε με προσοχή την επικοινωνία και τις ηλεκτρικές και υδραυλικές συνδέσεις.



Olulised ohutusjuhised Ringlusega jahutid

Kui mistahes juhised ei ole arusaadavad, siis enne jätkamist vaadake kasutusjuhendit.

Ohutus, kõik tooted:

DANGER tähistab tõsise ohukorda, millele tähelepanu pööramata jätmise võib põhjustada surma või tõsise vigastuse.

WARNING tähistab potentsiaalselt ohulikku olukorda, millele tähelepanu pööramata jätmise võib põhjustada surma või tõsise vigastuse.

CAUTION tähistab potentsiaalselt ohulikku olukorda, millele tähelepanu pööramata jätmise võib põhjustada väiksema või keskmise raskusega vigastuse. Seda kasutatakse ka ohulikust tegevusest hoiatamiseks.

 ettenähtud kasutaja hoiatamiseks jahuti korpusel olevast isoleerimata "ohulikust pingest".
Pinge tugevus on piisav elektrilöögi tekitamiseks.

 tähistab kuumade pindade olemasolu.

 tähistab kasutusjuhendi vaatamise vajadust.

Ärge kasutage seadmeid steriilsete seadmetena või patsiendiga ühendatavate seadmetena. Lisaks eelnevale, ei ole seadmed ettenähtud kasutamiseks I, II või III klassi ohlikes rakendustes vastavalt NEC nõuetele.

Seadmed on ettenähtud kasutamiseks ainult siseruumides. Ärge kunagi paigutage ülemaärse kuumusega, niiskusega, ebapiisava ventilatsiooniga kohtadesse või soovitatavate materjalide lähedale. Vaadake tööparameetreid kasutusjuhendist.

Ühendage seade nõuetekohaselt maandatud seinapistikuga.

Kasutatavad jahutusained on õhust raskemad ning tõrjuvad lekke korral õhu välja ning võivad põhjustada meelemärkuse kadu. Lekkiva jahutusainega kokkupuutumine põhjustab nahapõletusi. Lisateabeks kasutatava jahutusaine kohta vaadake ringluspumba andmeplaati ja tootja kõige hilisemat ohutuskaarti (SDS, MSDS, EL ohutuskaart).

Ligutage seadet ettevaatlikult. Ootamatud põrutused ja kukkumised võivad kahjustada seadme komponente. Enne seadme liigutamist lülitage seade alati välja ja ühendage lahti toitevõrgust.

Ärge kasutage kunagi kahjustatud või lekkivaid seadmeid.

Ärge kasutage kunagi süttimisohtlikke või soovitavaid vedelikke. Kasutage ainult kasutusjuhendis heakskiidetud vedelikke. Enne mistahes vedelike kasutamist või hooldustööde läbiviimist vaadake lisateabeks tootja kõige hilisemat ohutuskaarti (SDS, MSDS, EL ohutuskaart).

Enne seadme liigutamist lülitage seade alati välja ja ühendage lahti toitevõrgust.

Hooldamisel ja remondi korral pöörduge kogemustega tehniku poole.

Hoidke seadmeid temperatuurivahemikus -25°C kuni 60°C (pakendis) ja <80% suhtelise niiskuse juures.

Kasutusest eemaldamisel pöörduge sertifitseeritud seadmeid kasutava kogemustega ettevõtte poole.

Järgige kõiki kehtivaid eeskirju.

Kasutusjuhendis kirjeldamata paigaldamis-, töötamis- või hooldusprotseduurid võivad kaasa tuua ohliku olukorra ning muudavad garantii kehtetuks.

Ärge kunagi rakendage võrgupinget jahuti mistahes andmesideühendustele.

Täielikult täitmata jahuti ja töövedeliku torustik või põhjustada jahuti pumba kahjustamist. Vältige ületäitmist, soojenemisel vedelikud paisuvad.

Enne ThermoFlex seadmel mahuti katte asendamist veenduge, et mahuti vaatoru kuuli kork on kindlalt oma kohas.

Ärge kasutage ThermoFlex900-5000 seadmel jahuti enne, kui on paigaldatud mahuti vedeliku difuuser.

Kui Teie jahuti on varustatud mahtpumbaga (P1 või P2), siis veenduge, et Teie seadme torustik ja liitmikud taluvad vähemalt 185 psi survet.

Vältige MD pumpadega varustatud Meriin jahutitel torustikus jahutusvedeliku voolu täielikku takistamist. Tühjalt töötav pump kahjustab liitekohta ning võib põhjustada pumba kahjustamist.

Ärge kasutage sõidukite jahutusvedelikku. Kaubanduses kättesaadavad jahutusvedelikud sisaldavad silikaate, mis kahjustavad pumba tihendeid.

Plaatsoojusvaheti külmumise ärahoidmiseks vajavad ThermoFlex7500-24000 jahutid temperatuuridel 10°C alla töötemperatuuri 50/50 EG/vesi või 50/50 PG/vesi kasutamist.

Kui kasutate töövedelikuna EG/vesi või PG/vesi segu, siis kontrollige regulaarselt kontsentratsiooni ja pH-taset. Kontsentratsiooni ja pH-taseme muutused võivad mõjutada süsteemi töötamist.

Ärge kasutage deioniseerimise (DI) filtrikassetti koos inhibeeritud EG-ga või inhibeeritud PG-ga. DI filter eemaldab lahusest inhibiitorid, vähendades vedeliku korrosioonivastast mõju. Lisaks sellele suurendavad inhibiitorid vedeliku juhitavust.

Nad on ohulikud sissehingamisel, allaneelamisel ja imendumisel läbi naha. Vaadake tootja kõige hilisemat ohutuskaarti.

Jahuti plaatsoojusvaheti kahjustamise ärahoidmiseks peab tsentrifugaalpumba minimaalne voolukiirus olema 4,0 gpm (15,1 liitrit/minutis).

Kondensaatori filtri puhastamise/asendamise nõuete mittejärgimine põhjustab jahutusvõimsuse vähenemise ja jahutussüsteemi enneaegse purunemise. Põhjalikuks puhastamiseks eemaldage esivõre.

Õhkjahutusega jahutite esivõre taga asuva kondensaatori raamistik ja ribad on väga teravad.

Ärge kunagi kasutage eemaldatud paneelidega jahutit.

ThermoFlex900-5000 vesijahutusega jahutitel on teravate labadega ventilator, enne esivõre eemaldamist veenduge, et jahuti on välja lülitatud.

Kasutuseesmärk, ringlusega jahutid:

Thermo Scientific ringlusega jahutid on ettenähtud pideva temperatuuriga ja voolukiinusega vedeliku voolamise tagamiseks. Jahuti koosneb õhkjahutusega või vesijahutusega jahutussüsteemist, soojusvahetist, ringluspumbast, töövedeliku mahutist ja mikroprotsessoriga juhtimissüsteemist.





Jahutid on ettenähtud pidevaks töötamiseks sisetingimuteses vastavalt kasutusjuhendis sätestatud protseduuridele ja nõuetele.

Paigaldamine, ringlusega jahutid:

Paigutage jahuti nii, et selle väljalülitamise seadmele on lihtne juurde pääseda.

Jahutile peab olema ettenähtud eraldi seinakontakt.

Veenduge, et torustiku transportikorgid on enne paigaldamist eemaldatud.

Töövedeliku ühendused asuvad jahuti tagaosas ning on tähistatud  (PROCESS INLET) (sisend) ja  (PROCESS OUTLET) (väljund). Ühendage  oma seadme vedeliku sisendiga. Ühendage  oma seadme vedeliku väljundiga.

Vesijahutusega jahutite korral ühendage  (FACILITY INLET)(seadme sisend) oma seadme veevarustususega. Ühendage  (FACILITY OUTLET) (seadme väljund) oma seadme veetagastusega või äravooluga.

Enne jahuti käivitamist kontrollige üle kõik kasutatavad andmesideühendused, elektriühendused ja toruühendused.

Olennaiset turvaohjeet Kiertojäähdyttimet

Jos nämä ohjeet eivät ole selviä, viittaa ohjekirjaan tai ota meihin yhteyttä ennen kuin jatkat eteenpäin.

Turvallisuus, kaikki tuotteet:

DANGER osoittaa välittömää vaaratilannetta, joka johtaa kuolemaan tai vakavaan loukkaantumiseen, ellei sitä vältetä.

WARNING osoittaa potentiaalisen vaaratilanteen, joka voi johtaa kuolemaan tai vakavaan loukkaantumiseen, ellei sitä vältetä.

CAUTION osoittaa potentiaalisen vaaratilanteen, joka saattaa aiheuttaa pienen tai kohtalaisen vamman, ellei sitä vältetä. Sitä käytetään varoittamaan myös vaarallisista tavoista.

 tarkoitettu varoittamaan käyttäjää eristämättömästä "vaarallisesta jännitteestä" jäähdyttimen kotelon sisällä. Jännitteen voimakkuus on merkittävä sähköiskuvaaran aiheuttamiseksi.

 osoittaa kuumien pintojen paikallaoloa.

 osoittaa ohjekirjan lukemiseen liittyvää velvoitusta.

Älä käytä laitetta steriiliinä varusteena tai potilaaseen yhdistettynä. Laitetta ei ole suunniteltu käytettäväksi National Electrical Code -sääntöjen mukaisesti I, II tai III luokan tiloissa.

Laitte on tarkoitettu käytettäväksi vain sisätiloissa. Älä koskaan sijoita sitä paikkoihin joissa esiintyy iliallista kuumuutta, kosteutta, riittämätön tuuletus tai syövyttäviä materiaaleja. Viittaa ohjekirjaan käyttöparametrejä varten.

Liitä laite maadoitettuun pistorasiaan.

Käytetyt jäähdytysaineet ovat ilmaan verrattuna painavampia, ja jos vuotoa esiintyy, se korvaa hapen aiheuttamalla tejon menettämisen. Kosketus vuotavaan jäähdytysaineeseen aiheuttaa palovammoja.

Lisätietoja varten viittaa kiertoilimen arvokilpeen koskien käytettyä jäähdytysainetta ja valmistajan päivitetyihin käyttöturvallisuustietoihin (US Safety Data Sheet - SDS), jotka tunnetaan aiemmin nimellä MSDS, sekä EU:n käyttöturvallisuustietoihin.

Siirrä laitetta varovaisesti. Äkilliset tärinäkset tai putoamiset voivat vahingoittaa siihen kuuluvia osia.

Sammuta laite ja kytke se irti jännitelähteestä ennen sen liikkuttamista.

Älä koskaan käytä laitetta jos se on vahingoittunut tai siinä esiintyy vuotoja.

Älä koskaan käytä tulenarkoja tai syövyttäviä nesteitä. Käytä vain ohjekirjassa lueteltuja hyväksytyjä nesteitä. Ennen nesteiden käyttöä tai huoltotoimenpiteiden suorittamista, joihin liittyy kosketus nesteeseen, viittaa valmistajan päivitettiin käyttöturvallisuustietoihin (US Safety Data Sheet - SDS) ja EU:n käyttöturvallisuustietoihin lisätietoja varten.

Sammuta laite ja kytke se irti jännitelähteestä aina ennen sen liikkuttamista.

Jätä korjaus- ja huoltotyöt pätevän teknikon tehtäväksi.

Säilytä laitetta -25 °C - 60 °C lämpötilassa (pakkauksen kanssa), ja suhteellisen kosteuden ollessa <80 %. Käytöstä poistaminen on suoritettava yksinomaan pätevän jälleenmyyjän toimesta sertifioituja varusteita käyttämällä. Noudata kaikkia voimassa olevia määräyksiä.

Muiden kuin tässä ohjekirjassa kuvattujen asennus-, käyttö- tai huoltotoimenpiteiden suorittaminen voi aiheuttaa vaarallisen tilanteen ja mitätöidä valmistajan myöntämän takuun.

Älä koskaan syötä injannitettua jäähdyttimessä oleviin yhteysliitoksiin.

Nesteen syöttöinjoihin ja jäähdyttimen vajaan täyttö voi vahingoittaa jäähdyttimen pumpua. Vältä kuitenkin ylitäyttöä, sillä nesteet laajenevat kun niitä kuumennetaan.

Ennen ThermoFlexissä olevan säiliökotelon vaihtoa varmista, että säiliön tarkastusputken pyöreää pidike on kiinnitetty kunnolla paikoilleen.

Älä käytä jäähdytintä ThermoFlex900-5000:ssa ennen kuin säiliönesteen jakolaite on asennettu.

Jos jäähdytin on varustettu positiivisella tilavuuspumpulla (P1 tai P2), varmista, että sovellukseen kuuluvat putket ja kiinnikkeet kestävät vähintään 185 psi:n paineen.

Älä käytä ajoneuvoille tarkoitettuja pakkasnesteitä. Myynnissä olevat pakkasnesteet sisältävät siikaatteja, jotka vahingoittavat pumpun tiivisteitä.

Estääksesi levyjämmönvaihtimen jäätymistä ThermoFlex7500-24000 -jäähdyttimet vaativat 50/50 EG/vesi tai 50/50 PG/vesi käyttöä alle 10 °C prosessilämpötilassa.

Kun EG/vesi- tai PG/vesi-nesteseosta käytetään, tarkista säännöllisin väliajoin nesteen pitoisuus ja pH-arvo. Pitoisuuden ja pH-arvon muutokset voivat vaarantaa järjestelmän suorituskykyä.

Älä käytä deionisoivaa (DI) suodatuspatruunaa estetyin EG:n tai PG:n kanssa. DI-suodatin poistaa inhibiittorit nesteestä, tekemällä nesteestä tehottoman syöpymistä vastaan.

Biosidit ovat syövyttäviä ja voivat aiheuttaa parantumatonta silmävauriota ja palovammoja. Ne ovat vaarallisia jos niitä hengitetään, niellään tai ne imeytyvät ihon kautta. Viittaa valmistajan päivitetyihin SDS-asiakirjoihin.

Estääksesi jäähdyttimen levyjämmönvaihtimen vahingoittumista, keskipakopumput vaativat vähintään 4,0 gpm (15,1 lpm) virtausta.

Lauhduttimen suodatimen puhdistamisen/vaihdon suorittamatta jättäminen aiheuttaa jäähdytyskapasiteetin vähenemistä ja johtaa jäähdytysjärjestelmässä syntyviin ennenaikaisiin vikoihin. Perusteellista puhdistusta varten, irrota eturitiläyksikkö.

Ilmajäähdytteissä jäähdyttimissä eturitiläyksikön takana sijaitsevat lauhduttimen siivekkeet ja kehikko ovat erittäin teräviä.

Älä koskaan käynnistä jäähdytintä kun paneelit on irrotettu, lukuun ottamatta ilmajäähdytteistä ritiläyksikköä.

Vesijäähdytteissä ThermoFlex900-5000 -jäähdyttimissä on terävillä lavoilla varustettu tuuletin. Varmista, että jäähdytin on sammutettu ennen eturitiän irrottamista.

Käyttötarkoitus, kiertojäähdyttimet:

Thermo Scientific kiertojäähdyttimet on suunniteltu jatkuvan nesteen syöttöön vakaassa lämpötilassa ja virtausarvossa. Jäähdytin koostuu ilma- tai vesijäähdytteisestä jäähdytysjärjestelmästä, lämmönvaihtimesta, kiertopumpusta, prosessinesteen säiliöstä ja mikroprosessori-ohjaimesta.

Jäähdyttimet on suunniteltu jatkuvaan käyttöön sisätiloissa tässä ohjekirjassa määriteltujen menettelyjen ja vaatimusten mukaisesti.

Asennus, kiertojäähdyttimet:

Aseta jäähdytin siten, että siihen kuuluvaan irtikytkentälaitteeseen päästään helposti.

Jäähdytintä on käytettävä yksinomaan sen käyttöön tarkoitettulla pistorasialla.

Varmista, että kaikki läheyksessä käydyt putkitulpat on irrotettu ennen sen asennusta.

Prosessinesteen liitännät sijaitsevat jäähdyttimen takaosassa ja ne on merkitty  (PROCESS OUTLET) ja  (PROCESS INLET). Liitä  sovellyksessä olevaan nesteeseen sisääntuloon. Liitä  sovellyksessä olevaan nesteeseen ulostuloon.

Vesijäähdytteissä jäähdyttimissä, liitä  (FACILITY INLET) järjestelmän vedensyöttöön. Liitä  (FACILITY OUTLET) järjestelmän paluuveteen tai viemäriin.

Ennen jäähdyttimen käynnistystä, tarkista kaikki yhteyslinjat sekä sähkö- ja vesiliitokset.

GA

Treoracha Riachtanacha Sábháilteachta Fuarthóirí Athfhillteacha

Má tá aon treoir ann nach dtuigtear, ceadaiigh an lámhleabhar nó déan teagmháil linn sula dtéann tú níos faide.

Sábháilteacht, gach táirge:



Iéiríonn sé staid ghuaiseach as a leanfaidh bás nó tromghortú, mura seachnaítear í.



Iéiríonn sé staid ghuaiseach, a bhféadfadh bás nó tromghortú a bheith ina thoradh air, mura seachnaítear í.



Iéiríonn sé staid ghuaiseach, as a leanfaidh mionghortú nó dochar measartha, mura seachnaítear í. Úsáidtear é, leis, chun rabhadh a thabhairt i gcás cleachtais neamhshábháilte.



ceaptha leis an úsáideoir a chur ar an eolas maidir le “voltas contúirteach” neamhinslithe laistigh d’imfháil an fhuarthóra. Tá méid an voltais suntasach a dhóthain le bheith ina bhaol turrainge leictirí.



Iéiríonn sé dromchlaí te.



Iéiríonn sé gur chóir an lámhleabhar a léamh.

Ná húsáid an trealamh mar ghléas steiriúil ná mar ghléas a nasctar le hothar. Lena chois sin, níor ceapadh an trealamh lena úsáid i Láithreacha Guaiseacha Aicme I, II nó III mar a shainmhínítear sa Chód Náisiúnta Leictreach.

Trealamh atá ceaptha le húsáid istigh amháin. Ná suigh riamh é in áit ina bhfuil teas iomarcach, taisce, aerú neamhdhóthanach nó ábhair chreimneacha. Ceadaiigh an lámhleabhar go bhfeice tú na paraiméadair oibriúcháin.

Ceangail an trealamh d’asraon atá talmhaithe i gceart.

Is airde ná aer na cuisneáin a úsáidtear, agus má bhíonn sceitheadh ann, gabhfaidh siad áit na hocsaigne as a leanfaidh cailliúint comhfheasa. Dófar craiceann má bhíonn teagmháil idir craiceann agus cuisneán atá ag sceitheadh. Féach ainmhláta an dáileora go bhfeice tú an cineál cuisneáin a úsáidtear agus ansin féach Leathanach Sonraí Sábháilteachta SA is déanaí an déantóra, an rud a dtugtaí an MSDS air cheana, agus Leathanach Sonraí Sábháilteachta an AE chun breis eolais a fháil.

Bí cúramach agus tú ag bogadh an trealaimh. Is féidir le croitheadh nó isliú tobann na comhpháirteanna a dhamáistiú. Cas an trealamh as i gconáil agus dícheangail é den voltas soláthair sula mbogann tú é.

Ná hoibrigh riamh trealamh damáistithe nó trealamh atá ag sceitheadh.

Ná húsáid leacht inachainte nó creimneach riamh. Ná húsáid ach na leachtanna ceadaithe atá liostaithe sa lámhleabhar. Sula n-úsáidtear aon leacht nó sula ndéantar cothabháil ina bhféadfaí teagmháil a dhéanamh leis an leacht, ceadaiigh Leathanach Sonraí Sábháilteachta SA is déanaí an déantóra agus Leathanach Sonraí Sábháilteachta an AE chun breis eolais a fháil.

Cas an trealamh as i gconáil agus dícheangail é den voltas soláthair sula mbogann tú é.

Iarr ar theicneoir cáilithe gach seirbhísiú agus deisiú a dhéanamh.

Stóráil an trealamh sa raon teochta -25°C go 60°C (in éineacht leis an bpacáistiú), agus i dtaiseacht choibhneasta <80%.

Níor chóir ach do dhéileálai cáilithe, a úsáideann trealamh deimhnithe, an gléas a dhíchoimisíú. Ní mór cloí le gach rialachán atá i bhfeidhm.

Féadfaidh staid ghuaiseach agus cur ar neamhní bharánta an déantóra a bheith ina thoradh ar fheidhmíú níosanna imeachta suiteála, oibriúcháin nó cothabhála seachas iad siúd a ndéantar cur síos orthu sa lámhleabhar.

Ná húsáid voltas líne riamh le haon cheann de na naisc chumarsáide ar an bhfuarthóir.

D’fhéadfaí caidéal an fhuarthóra a dhamáistiú mura líontar an fuarthóir agus na línte leachta próisis go hiomlán. Seachain róilíonadh, fairsingionn leachtanna tar éis iad a théamh.

Ar ThermoFlex, sula gcuirtear cásáil an taiscumair ar ais, cinntigh go bhfuil stopallóir iathróide thiúb radhairc an taiscumair deingnithe ina áit.

Ná hoibrigh an fuarthóir ThermoFlex900-5000 mura bhfuil idirleatóir leachta an taiscumair suiteáilte.

Ar ThermoChill, ná líon os cionn na bile nó sceitfidh an leacht amach as barr an umair ar chomhpháirteanna an fhuarthóra.

Má tá d’fhuarthóir trealmhaithe le caidéal dearfach dlíáithrúcháin (P1 nó P2), cinntigh go bhfuil línte agus feistis phluiméireachta d’fheidhmíúcháin rátáilte chun ar a laghad 185 psi a sheasamh.

Ná húsáid oibreán frithreo uathghluaisneach. Tá sileacáit in oibreán frithreo uathghluaisneach a dhamáistiú sealaí caidéil.

Chun reoigloiniú an mhalartóra plátaí a sheachaint, is gá, i gcás fhuarthóirí ThermoFlex7500-24000, 50/50 EG/uisce nó 50/50 PG/uisce faoi bhun 10°C de theocht próisis a úsáid.

Agus meascán leachta próisis de EG/uisce nó PG/uisce a úsáid, seiceáil túchan an leachta agus an pH ar bhonn rialta. Is féidir le hathruithe ar thiúchan agus ar pH difear a dhéanamh d’fheidhmíocht córais.

Ná húsáid cartús scagaire dí-ianúcháin (DI) le EG Coiscithe nó PG Coiscithe. Bainfidh scagaire DI coscairí den tuaslagán a fhágfaidh an leacht neamhéifeachtach mar chosaint ar chreimeadh. Ina theannta sin, méadaíonn coscairí seoltacht leachta.

Is oibreáin chreimneacha iad bithicídí agus is féidir leo damáiste doleigheasta a dhéanamh don tsúil agus an craiceann a dhó. Déanann siad damáiste má dhéantar iad a anáilú, a shlogadh nó a ionsú tríd an gcráiceann. Ceadaigh an SDS is déanaí ón déantóir.

Chun damáiste do mhalaratóir plátaí an fhuarthóra a chosc, teastaíonn ráta íosta sreafa 4.0 gpm (15.1 lpm) ó chaidéil lártheifeacha.

Mura ndéantar an scagaire comhdhlúthadáin a ghlanadh/a athchur, cailltear cumas fuarthóra agus d'fhéadfadh an córas fuaraithe teip roimh am. Chun glanadh iomlán a dhéanamh, bain cóimeáil na greille tosaigh.

Ar fhuarthóirí aerfhuaraithe bíonn an fhrámáil agus na heití atá suite laistigh de chóimeáil na greille tosaigh an-ghéar.

Seachas an chóimeáil ghreille aerfhuaraithe, ná hoibrigh an fuarthóir niamh agus aon cheann de na painéil bainte.

Tá lanna géara sa bhfean i bhfuarthóirí uiscefhuaraithe ThermoFlex900-5000, féach chuige go bhfuil an fuarthóir casta as sula mbaintear an ghreille thosaigh.

Úsáid Cheaptha, Fuarthóirí Athfhillteacha:

Dearadh fuarthóirí athfhillteacha Thermo Scientific le soláthar leanúnach leachta a sholáthar ag teocht agus ar ráta sreafa seasmhach. Is éard atá san fuarthóir córas cuisniúcháin aerfhuaraithe nó uiscefhuaraithe, teasmhalaratóir, caidéal athfhillteach, taiscumar leachta próisis agus rialtóir micreaphróiseálaí.

Tá fuarthóirí ceaptha le haghaidh oibriú leanúnach agus le húsáid laistigh de réir na nósanna imeachta agus na riachtanas atá luaite sa lámhleabhar a ghabhann leis.

Le Fuarthóirí Athfhillteacha a Shuiteáil:

Suigh an fuarthóir gar dá ghleas dícheangail, agus sa tsílf go bhfuil fáil ar an ngléas sin go héasca. Tá an fuarthóir ceaptha le húsáid ar asraon tiomnaithe.

Cinntigh go mbaintear gach plocóid seolta líne pluiméireachta sula ndéantar an tsuiteáil.

Tá na naisc leachta próisis suite ar chúil an fhuarthóra agus tá siad lipéadaithe  (PROCESS OUTLET (ASRAON PRÓISIS)) agus  (PROCESS INLET (IONRAON PRÓISIS)). Ceangail an  leis an ionraon leachta ar d'fheidhmiúchán. Ceangail an  leis an asraon leachta ar d'fheidhmiúchán.

I gcás fuarthóirí uiscefhuaraithe, ceangail an  (FACILITY INLET (IONRAON SAORÁIDE)) le soláthar uisce do shaoráide. Ceangail an  (FACILITY OUTLET (ASRAON SAORÁIDE)) le fillleadh nó draein uisce do shaoráide.

Sula dtosaítear an fuarthóir, seiceáil faoi dhó gach cumarsáid infheidhmíthe, agus gach nasc leictreach agus pluiméireachta.

Osnovne sigurnosne uput Cirkulirajući rashladni uređaji

Ako ne razumijete bilo koje od ovih uputa, pogledajte priručnik ili nas kontaktirajte prije nego što nastavite.

Signurnost, svi proizvodi:

⚠ DANGER označava neposrednu opasnost koja će, ako se ne izbjegne, uzrokovati smrt ili tešku ozljedu.

⚠ WARNING označava moguću opasnu situaciju koja, ako se ne izbjegne, može uzrokovati smrt ili tešku ozljedu.

⚠ CAUTION označava moguću opasnu situaciju koja, ako se ne izbjegne, može uzrokovati manju ili srednje tešku ozljedu. Također se može koristiti da upozori na nesigurne radnje.

 upozorava korisnika na prisutnost neizoliranog „opasnog napona“ unutar kućišta rashladnog uređaja. Napon je dovoljno velik da predstavlja opasnost od strujnog udara.

 ukazuje na prisutnost vrućih površina.

 ukazuje da je potrebno pročitati priručnik.

Nemojte koristiti opremu kao sterilni proizvod ili proizvod povezan na pacijenta. Pored toga, oprema nije predviđena za upotrebu na opasnim lokacijama klase I, II ili III prema definicijama Nacionalnog električnog standarda (engl. National Electrical Code).

Oprema je predviđena isključivo za upotrebu u zatvorenim prostorima. Nikad je nemojte postavljati gdje je prisutna prekomjerna toplota, vlažnost, neodgovarajuće prozračivanje ili nagrizajući materijali. Radni parametri navedeni su u priručniku.

Povežite opremu na pravilno uzemljenu utičnicu.

Korištena sredstva za hlađenja teža su od zraka i, ako dođe do curenja, zamijenit će kisik te dovesti do gubitka svijesti. Kontakt sa sredstvom za hlađenje koje curi uzrokuje opekline. Pogledajte natpisnu pločicu cirkulatora za vrstu korištenog sredstva za hlađenje, a zatim potražite dodatne informacije u najnovijem sigurnosno-tehničkom listu za SAD (engl. Safety Data Sheet; SDS), ranije poznatom kao MSDS, kao i sigurnosno-tehničkom listu za EU.

Oprezno pomjerajte opremu. Naglo dimanje ili ispuštanje opreme može oštetiti njene komponente. Prije pomjeranja oprema uvijek je isključite i iskopčajte iz napona izvora napajanja.

Nikad nemojte koristiti oštećenu opremu ili opremu koja propušta.

Nikad nemojte koristiti zapaljive ili nagrizajuće tekućine. Koristite samo odobrene tekućine navedene u priručniku. Prije korištenja bilo kakve tekućine ili obavljanja postupaka održavanja u kojima će vjerojatno doći do kontakta s tekućinom, potražite dodatne informacije u najnovijem sigurnosno-tehničkom listu za SAD (engl. Safety Data Sheet; SDS) i sigurnosno-tehničkom listu za EU.

Prije pomjeranja oprema uvijek je isključite i iskopčajte iz napona izvora napajanja.

Servisiranje i popravke treba obavljati kvalificirani serviser.

Opremu držite na rasponu temperature od -25 °C do 60 °C (s pakiranjem) i relativnoj vlažnosti od <80 %.

Stavljanje izvan pogona mora obaviti isključivo kvalificirani trgovac pomoću certificirane opreme. Moraju se slijediti svi važeći propisi.

Obavljanje postupaka ugradnje, korištenja ili održavanja koji nisu opisani u priručniku može dovesti do opasne situacije i poništiti će jamstvo proizvođača.

Nikad nemojte primjenjivati linijski napon na komunikacijske priključke na rashladnom uređaju.

Ako ne napunite rashladni uređaj i crijeva za radnu tekućinu do kraja, može doći do oštećenje pumpe rashladnog uređaja. Nemojte prepunjavati jer se tekućina širi prilikom zagrijavanja.

Na rashladnom uređaju ThermoFlex, prije zamjene kućišta rezervoara potrebno je osigurati da čep indikatora razine u rezervoaru bude čvrsto na mjestu.

Rashladni uređaj ThermoFlex900-5000 nemojte koristiti ako difuzor rezervoara nije ugrađen.

Ako je rashladni uređaj opremljen volumetrijskom pumpom (P1 ili P2), pazite da vodovodna crijeva i spojnice mogu podnijeti najmanje 185 psi.

Nemojte koristiti antifriz za automobile. Komercijalni antifriz sadrži silikate koji oštećuju brtve pumpe.

Kako bi se spriječilo smrzavanje pločastog izmjenjivača, rashladni uređaji ThermoFlex7500-24000 zahtijevaju upotrebu smjese od 50/50 etilen glikola/vode ili 50/50 propilen glikola/vode na radnoj temperaturi ispod 10 °C.

Prilikom upotrebe smjese radne tekućine od etilen glikola/vode ili propilen glikola/vode, redovito provjeravajte koncentraciju tekućine i pH vrijednost. Promjene u koncentraciji i pH vrijednosti mogu utjecati na performanse sustava.

Nemojte koristiti uložak filtra za deioniziranje s inhibiranim etilen glikolom ili inhibiranim propilen glikolom. Filter za deioniziranje uklanjanja inhibitora iz otopine, što tekućinu čini nedjelotvornom u zaštiti od korozije. Pored toga, inhibitori povećavaju provodljivost tekućine. Softver polarnog rashladnog uređaja mora se prilagoditi kako bi odgovarao korištenoj radnoj tekućini.

Biocidi su nagrizajući i mogu uzrokovati nepopravljiva oštećenja očiju i opekline. Štetni su ako se udahnu, progutaju ili upiju kroz kožu. Pogledajte najnoviji sigurnosno-tehnički list proizvođača.

Kako bi se spriječilo oštećenje pločastog izmjenjivača rashladnog uređaja, centrifugalne pumpe zahtijevaju minimalni protok od 4,0 g/min (15,1 l/min).

Ako se filter kondenzatora ne čisti/mjenja, dolazi do gubitka kapaciteta hlađenja i prijevremenog kvara sustava hlađenja. Za temeljito čišćenje uklonite sklop prednje rešetke.

Na zrakom hlađenim rashladnim uređajima okvir i vertikalni stabilizatori kondenzatora nalaze se iza sklopa prednje rešetke i veoma su oštri. Izuzev zračno hlađenog sklopa rešetke nikad nemojte koristiti rashladni uređaj kad je bilo koja ploča skinuta.

Vodom hlađeni rashladni uređaji ThermoFlex900-5000 imaju ventilator s oštrim lopaticama te stoga rashladni uređaj morate isključiti prije skidanja prednje rešetke.

Predviđena namjena, cirkulirajući rashladni uređaji:

Cirkulirajući rashladni uređaji tvrtke Thermo Scientific predviđeni su za pružanje kontinuirane isporuke tekućine uz konstantnu temperaturu i protok. Rashladni uređaj se sastoji od zrakov hlađenog ili vodom hlađenog rashladnog sustava, izmjenjivača topline, cirkulirajuće pumpe, rezervoara radne tekućine i kontrolera mikroprocesora.

Rashladni uređaji su predviđeni za kontinuirani rad i primjenu u zatvorenim prostorima u skladu sa svim postupcima i zahtjevima navedenim u njihovim priručnicima.

Ugradnja, cirkulirajući rashladni uređaji:

Postavite rashladni uređaj tako da je blizu i ima jednostavan pristup svom uređaju za iskopčavanje.

Rashladni uređaj je predviđen za upotrebu na namjenskoj utičnici.

Obavezno skinite sve ambalažne čepove vodovodnih crijeva prije ugradnje.

Priključci rashladne tekućine nalaze se sa stražnje strane rashladnog uređaja i označeni su sa  (PROCESS INLET) (radni ulazni otvor) i  (PROCESS OUTLET) (radni izlazni otvor). Povežite  na ulazni otvor za tekućinu na vašem uređaju. Povežite  na izlazni otvor za tekućinu na vašem uređaju.

Kod vodom hlađenih rashladnih uređaja povežite  (FACILITY INLET) (ulazni otvor za postrojenje) na vodovod postrojenja. Povežite  (FACILITY OUTLET) (izlazni otvor za postrojenje) na povratni vod ili odvod postrojenja.

Prije pokretanja rashladnog uređaja dvaput provjerite sve relevantne komunikacijske, električne i vodovodne priključke.

HU

Alapvető biztonsági utasítások Recirkulációs hűtők

Ha valamelyik utasítást nem érti, lapozza fel a kézikönyvet, vagy forduljon hozzánk, mielőtt folytatná a munkát.

Biztonság – összes termék:

DANGER Közvetlen veszélyhelyzetet jelez, amely halált vagy súlyos sérülést okoz, ha meg nem előzik.

WARNING Potenciálisan veszélyes helyzetet jelez, amely halált vagy súlyos sérülést okoz, ha meg nem előzik.

CAUTION Potenciálisan veszélyes helyzetet jelez, amely enyhe, vagy közepes sérülést okozhat, ha meg nem előzik. A nem biztonságos eljárásokra is ez a jelzés figyelmeztet.

 Veszélyes mértékű, nem szigetelt feszültség jelenlétére figyelmezteti a felhasználót a hűtő házában. A feszültség nagysága elég jelentős ahhoz, hogy áramütés veszélyét jelentse.

 Forró felületek okozta veszélyre figyelmeztet.

 Azt jelzi, hogy el kell olvasni a használati utasítást.

Ne használja a berendezést steril vagy beteghez csatlakoztatott eszközként. Továbbá a berendezés nem használható a National Electrical Code szabvány által definiált I., II. vagy III. osztályú veszélyes helyen.

A berendezés csak beltérben használható. Ne helyezze a hűtőt olyan helyre, amelyet erős hő, nedvesség, elégtelen szellőzés vagy korrozív anyagok jelenléte jellemez. Az üzemi paraméterek megtalálhatók a kézikönyvben.

Csatlakoztassa a berendezést egy megfelelően földelt csatlakozójelzőhöz.

Az alkalmazott hűtőközegek nehezebbek a levegőnél, ezért szivárgás esetén kiszorítják az oxigént, ami eszméletvesztést okoz. A szivárgó hűtőközeg a bőrrel érintkezve fagyást okoz. A hűtőközeg típusa fel van tüntetve a berendezés adattábláján, további információkat pedig a gyártó legfrissebb amerikai biztonsági adattábláján (SDS, korábbi nevén MSDS) vagy európai biztonsági adattábláján találhat.

A berendezés mozgathatókor legyen óvatos. A zökkenések vagy leejtés kárt tehet a berendezés komponenseiben. Mozgathás előtt mindig kapcsolja ki és válassza le az áramforrástól a berendezést.

Ne üzemeltesse a berendezést, ha az sérült vagy szivárog.

Ne használjon gyúlékony vagy korrozív folyadékokat. Csak a kézikönyvben szereplő, jóváhagyott folyadékokat használjon. Mielőtt bármilyen folyadékokat használna, illetve olyan karbantartást végezne, amely várhatóan folyadékkal való érintkezéssel jár, ismerkedjen meg a gyártó legfrissebb amerikai biztonsági adattábláján (SDS) vagy európai biztonsági adattábláján szereplő információkkal.

Mozgathás előtt mindig kapcsolja ki és válassza le az áramforrástól a berendezést.

A szervizelés és a javítást bízva képzett szakemberre.

A berendezést -25 és 60 °C közötti hőmérséklet (csomagolással) és 80% alatti relatív páratartalom mellett kell tárolni.

Az üzemem kívül helyezést csak szakkereskedő hajthatja végre, minősített berendezés használatával. Minden érvényben lévő előírást be kell tartani.

A telepítési, üzemeltetési, illetve karbantartási eljárásoknak a kézikönyvben foglalttól eltérő végrehajtása veszélyes helyzetet teremthet, és érvénytelenné teszi a gyártó garanciáját.

Soha ne vezessen hálózati feszültséget a hűtő kommunikációs csatlakozóiba.

Ha a hűtő és az üzemi folyadék-vezetékek nincsenek teljesen feltöltve, akkor kár keletkezhet a berendezés szivattyújában. Tartózkodjon a túltöltéstől, melegeitör a folyadékok tágulásnak.

ThermoFlex esetében a tartály házának cseréje előtt gondoskodjon arról, hogy a tartály vizsgálócsövének golyós elzárója stabilan a helyén legyen.

ThermoFlex900–5000 esetében ne üzemeltesse a hűtőt, amíg nincs felszerelve a tartály folyadékporlasztója.

Ha a hűtő térfogat-kiszorításos szivattyúval (P1 vagy P2) rendelkezik, akkor a rendszer csővezetékeinek és -szerelvényeinek el kell viselnie legalább 12,8 bar (185 psi) nyomást.

Ne használjon autópipari fagyállót. A kereskedelemben kapható fagyállókban található szilikátok kárt tesznek a szivattyú tömítéseiben.

A lemezes hőcserélő fagyásának/jegesedésének megelőzése érdekében a ThermoFlex7500–24000 hűtők 50/50 EG/víz, illetve 10 °C üzemi hőmérséklet alatt 50/50 PG/víz használatát igénylik.

EG/víz vagy PG/víz üzemi folyadék-keverék használata esetén rendszeres időközönként ellenőrizni kell a folyadék koncentrációját és pH-értékét. A koncentráció és a pH-érték változása befolyásolhatja a rendszer teljesítményét. Inhibitoros EG vagy inhibitoros PG esetén ne használjon deionizáló (DI) szűrőbetétet.

A DI-szűrő eltávolítja az oldatból az inhibitorokat, így a folyadék hatástalan lesz a korrózióvédelem szempontjából. Az inhibitorok emellett növelik a folyadék vezetőképességét.

A biocidok és a korrozív anyagok visszafordíthatatlan szemkárosodást és a bőr égési sérülését okozhatják. Belélegezve, lenyelve és a bőrön át felszívódva is ártalmasak. További információkat a gyártó legfrissebb biztonsági adattábla tartalmaz.

A hűtő lemezes hőcserélője sérülésének megelőzése érdekében a centrifugálszivattyúknak 15,1 l/perc (4,0 gallon/perc) minimális térfogatárammal kell működniük.

A kondenzátorszűrő tisztításának/cseréjének elmulasztása a hűtési kapacitás csökkenéséhez és a hűtőrendszer idő előtti meghibásodásához vezet.

A gondos tisztítás érdekében távolítsa el az elülső rácsszerelvényt. Léghűtőes hűtők esetében az elülső rácsszerelvény mögött található kondenzátor váza és bordázata nagyon éles.

A léghűtőes rácsszerelvénytől eltekintve soha ne üzemeltesse a hűtőt eltávolított panellel.

A vízűtőes ThermoFlex900–5000 hűtőkben éles lapátokkal rendelkező ventilátor található. Az elülső rács eltávolítása előtt győződjön meg arról, hogy a hűtő ki van kapcsolva.

Rendeltetészerű használat, recirkulációs hűtők:

A Thermo Scientific recirkulációs hűtői folyamatos, állandó hőmérsékletű és térfogatáramú folyadékellátás biztosítására szolgálnak. A hűtőt egy lég- vagy vízűtőes hűtőrendszer, egy hőcserélő, egy újrakeringető szivattyú, egy üzemi folyadék-tartály és egy mikroprocesszoros vezérlő alkotja.





A hűtők folyamatos beltéri üzemeltetésre szolgálnak a kézikönyvükben foglalt valamennyi eljárás és követelmény szem előtt tartásával.

Telepítés, recirkulációs hűtők:

Úgy helyezze el a hűtőt, hogy a megszakítója a közelében, könnyen hozzáférhető helyen legyen.

A berendezést kifejezetten erre a célra szolgáló aljzathoz kell csatlakoztatni.

Telepítés előtt távolítsa el valamennyi csővezeték szállítódugóit.

Az üzemi folyadék csatlakozásai a hűtő hátulján található  (PROCESS OUTLET – üzemi kimenet) és  (PROCESS INLET – üzemi bemenet) címkével. A  csatlakozóhoz csatlakoztassa a rendszer folyadékmenetét, a  csatlakozóhoz pedig a folyadékmenetét.

Vízűtőes hűtő esetén csatlakoztassa a létesítmény vizellátását a  (FACILITY INLET – létesítménybemenet) csatlakozáshoz. A  (FACILITY OUTLET – létesítménykimenet)

csatlakozást csatlakoztassa a létesítmény víz visszavezető rendszeréhez vagy a lefolyóhoz.

A hűtő elindítása előtt újból ellenőrizze az összes szükséges kommunikációs, elektromos és csővezeték-csatlakozást.

Pagrindinės saugos instrukcijos Recirkuliuojantys aušintuvai

Jei kurios nors iš šių instrukcijų yra nesuprantamos, prieš tęsdami skaitykite vadovą arba kreipkitės į mus.

Sauga, visi gaminiai:

DANGER nurodo neišvengiamai pavojingą situaciją, kurios neišvengus, galima mirties arba rimto sužalojimo baigtis.

WARNING nurodo galimai pavojingą situaciją, kurios neišvengus, galima mirties arba rimto sužalojimo baigtis.

CAUTION nurodo galimai pavojingą situaciją, kurios neišvengus, kyla neįrimto arba vidutinės sužalojimo tikimybės. Taip pat galima pranešti, kai yra naudojama nesaugiai.

 skirta pranešti naudotojui, kai prie aušintuvo yra neizoliuota „pavojinga įtampa“. Įtampos dydis yra gana svarbus ir gali sukelti elektros šoko pavojų.

 nurodo esamus karštus paviršius.

 nurodo skaityti vadovą.

Nenaudokite įrangos kaip steriliaus ar prie paciento prijungto prietaiso. Be to, įranga nėra skirtas naudoti I, II ir III klasės pavojingose vietose, kaip nurodyta Nacionaliniame elektros kodekse.

Įranga yra sukurta tik naudoti viduje. Niekada nedėkite jo vietoje, kur yra per didelis karštis, drėgmė, netinkamas vėdinimas arba korozinių medžiagų. Darbinių parametru iškokite vadove.

Prijunkite įrangą prie tinkamai žeminto išvado.

Naudojami aušalai yra sunkesni nei oras ir, esant nutęėjimui, jie išstums deguonį, dėl ko galima prarasti sąmonę. Prisilietus prie ištėkėjusių aušalų, galima nudegti odą. Naudojamo aušalo tipo ir gamintojo naujausios JAV saugumo duomenų išklotinės (SDS), anksčiau žinomos kaip MSDS bei ES saugumo duomenų išklotinės papildomos informacijos iškokite cirkuliatoriaus techninių duomenų lentelės.

Įrangą perkelkite atsargiai. Staigus krestelėjimai arba kritimai gali pažeisti jos komponentus. Prieš perkeldami visuomet išjunkite įrangą ir atjunkite juo maitinimo įtampos.

Niekada nenaudokite pažeistos ar tekancios įrangos.

Niekada nenaudokite degių ar korozinių skysčių. Naudokite tik vadove išvardintus patvirtintus skysčius.

Prieš pradėdami naudoti bet kokius skysčius ar atlikdami priežiūrą, kurios metu gali pasitaikyti kontaktų su skysčiu, papildomos informacijos ieškokite gamintojo naujausioje JAV saugumo informacijos išklotinėje (SDS) ir ES saugumo informacijos išklotinėje.

Prieš perkeldami visuomet išjunkite įrangą ir atjunkite juo maitinimo įtampos.

Aptarnavimo ir remonto kreipkitės į kvalifikuotą techniką.

Laikykite įrangą temperatūros intervale nuo -25 °C iki 60 °C (su įpakavimu) ir <80 % santykinėje drėgmeje.

Eksploatacijos nutraukimą turi atlikti tik kvalifikuotas pardavėjas, naudojantis sertifikuotą įrangą. Reikia laikytis visų galiojančių nuostatų.

Kitokių įrengimo, naudojimo ir priežiūros procedūrų nei nurodyta vadove gali sukelti pavojingą situaciją ir aniliuos gamintojo garantiją.

Niekada nejunkite linijos įtampos prie bet kurių komunikacinių jungčių aušintuve.

Ne visiškai užpildžius aušintuvą darbinių skysčių linijos gali sugadinti aušintuvo siurbį. Venkite perpildymo, išilgę skysčiai plečiasi.

„ThermoFlex“ sistemoje prieš pakeisdami rezervuaro korpusą, įsitikinkite, kad rezervuaro matomumo vamzdelio rutulinis kamštelis yra saugiai įstatytas.

„ThermoFlex900-5000“ sistemoje nenaudokite aušintuvo jei nėra įrengtas rezervuaro skysčio skirstytuvas.

Jei jūsų aušintuve yra stūmoklinis siurblys (P1 arba P2), užtikrinkite, kad jūsų pritaikytas kanalizacijos vamzdynas ir jungtys yra nominuoti atlaikyti mažiausiai 185 psi („ThermoChill“ – 115 psi, „Merlin“ – 110 psi).

Nenaudokite automobilinio antifrizo. Komerciniuose antifrizuose yra silikatų, kurie pažeidžia siurblio sandarumą.

Kad plokščių keitiklis neužšaltų / nepasidengtų ledu, „ThermoFlex7500-24000“ aušintuvams reikia naudoti 50/50 EG / vanduo arba 50/50 PG / vanduo 10°C žemiau darbinės temperatūros.

Naudodami darbinio skysčio EG / vandens arba PG / vandens mišinį, reguliariai tikrinkite skysčio koncentraciją ir pH. Koncentracijos ir pH pakitimai gali turėti įtakos sistemos veikimui. Nenaudokite Dejonizacijos (DJ) filtro dėžutės su EG inhibitoriumi arba PG inhibitoriumi.

DJ filtras pašalina inhibitorius iš mišinio ir padarys skysčio apsaugą nuo korozijos neefektyvia. Inhibitoriai taip pat didina specifinį skysčio laidumą.

Biocidai sukelia koroziją ir gali nepagydomai pažeisti akis ar nudeginti odą. Jie yra kenksmingi įkvėpus, nurijus ar įsisavinus per odą. Naujausios SDS kreipkitės į gamintoją.

Kad aušintuvo plokščių keitiklis nebūtų sugadintas, išcentriniams siurbliams reikia 4,0 gpm (15,1 lpm) mažiausio tekėjimo srauto.

Neišvalius / nepakeitus kondensatoriaus filtro gali sumažėti aušinimo apimtys ir tai gali baigtis pirmaiaikiu vėsinimo sistemos gedimu. Visiškam išvalymui išimkite priekinių grotelių sąranką.

Oru vėsinamuose aušintuvuose kondensatoriaus rėmas ir mentės, esantys už priekinių grotelių sąrankos, yra labai aštrūs.

Kitokiose nei oru vėsinamų aušintuvų grotelių sąrankose, niekada nenaudokite aušintuvo su nuimtu skydeliu.

„ThermoFlex900-5000“ vandeniui vėsinami aušintuvai turi ventilatorius su aštriomis mentėmis, prieš nuimdami grotėles, įsitinkite, kad aušintuvas yra išjungtas.

Numatytas naudojimas, Recirkuliuojantys aušintuvai:

„Thermo Scientific“ recirkuliuojantys aušintuvai yra sukurti tiekti nuolatinį kiekį tos pačios temperatūros ir tekėjimo srauto skysčio. Aušintuvą sudaro oru arba vandeniui vėsinama šaldymo sistema, šilumokaitis, recirkuliacinio siurblys, darbinio skysčio rezervuaras ir mikroprocesorinis valdiklis.



Aušintuvai yra sukurti nepertraukiamam veikimui ir tik naudojimui viduje pagal visas procedūras ir reikalavimus, išdėstytus šiame vadove.

Įrengimas, Recirkuliuojantys aušintuvai:

Pastatykite aušintuvą, kad jis būtų arti ir lengvai pasiekiamo atjungimo prietaiso.

Aušintuvas yra skirtas naudoti su atskiru išvadu.

Prieš įrengimą, užtikrinkite, kad visi kanalizacijos vamzdyno transportavimo kamščiai yra išimti.

Darbinio skysčio jungtis yra aušintuvo užpakalyje ir yra pažymėtos  (PROCESS INLET) (DARBINIS ĮVADAS). Prijunkite  prie skysčio įvado jūsų pritaikyme. Prijunkite  prie skysčio išvado jūsų pritaikyme.

Vandeniui vėsinamiems aušintuvams prijunkite  (FACILITY INLET) (KOMPLEKSO ĮVADAS) prie jūsų komplekso vandens tiekimo. Prijunkite  (FACILITY OUTLET) (KOMPLEKSO IŠVADAS) prie jūsų komplekso vandens grąžinimo arba drenažo.

Prieš paleisdami aušintuvą dar kartą patikrinkite visas galimas komunikacines, elektros ir kanalizacijos jungtis.



Būtiskas drošības instrukcijas Recirkulācijas dzesētāji

Ja kāda no šīm instrukcijām nav saprotama, pirms turpināt darbu, skatiet rokasgrāmatu vai sazinieties ar mums.

Drošības apzīmējumi (attiecas uz visiem izstrādājumiem)



Norāda uz nopietnu apdraudējumu, kas var izraisīt nāvi vai nopietnas traumas, ja netiek novērsti.



Norāda uz potenciāli bīstamu situāciju, kas var izraisīt nāvi vai nopietnas traumas, ja netiek novērsti.



Norāda uz potenciāli bīstamu situāciju, kas var izraisīt vieglas vai mērenas traumas, ja netiek novērsti. Šis apzīmējums arī tiek izmantots, lai brīdinātu par nedrošu rīcību.



Brīdina lietotāju par neizolēta bīstama sprieguma klātbūtni dzesētāja korpusā. Spriegums ir pietiekami augsts, lai radītu elektrotrieciena gūšanas risku.



Norāda uz karstu virsmu klātbūtni.



Norādījums lasīt rokasgrāmatu.

Neizmantojiet aprīkojumu kā sterilu vai ar pacientu saistītu ierīci. Turklāt aprīkojums nav paredzēts lietošanai I, II vai III klases bīstamās zonās atbilstoši ASV Nacionālās elektrotehnikas standartu sistēmas prasībām.

Aprīkojums ir paredzēts lietošanai tikai slēgtās telpās. To nekādā gadījumā nedrīkst novietot vietā, kur pastāv pārmērīga karstuma, mitruma vai korozīvu vielu klātbūtne, vai arī nav piemērota ventilācija.

Ekspluatācijas parametrus skatiet rokasgrāmatā.

Pieslēdziet aprīkojumu atbilstoši saņemtai kontaktligzdai.

Izmantoie aukstumagenti ir smēķi par gaisu un noplūdes gadījumā izspiedīs skābekli, izraisot samanažas zudumu. Nonākot saskarē ar noplūdušu aukstumagentu, rodas ādas apdegumi. Izmantojamā aukstumagenta veidu skatiet uz cirkulatora nominālvērtību plāksnītes, savukārt papildinformāciju skatiet jaunākajā ražotāja nodrošinātajā ASV drošības datu lapā (SDS) (kādreizējā MSDS), kā arī ES drošības datu lapā.

Pārvietojot aprīkojumu, ievērojiet piesardzību. Pēkšņi satricinājumi vai krišana var sabojāt tā sastāvdaļas.

Pirms aprīkojuma pārvietošanas vienmēr to izslēdziet un atvienojiet no elektroapgādes tīkla.

Nekādā gadījumā nedarbiniet aprīkojumu, ja tas ir bojāts vai tam ir sāce.

Nekādā gadījumā nelietojiet viegli uzliesmojošus vai korozīvus šķīdumus. Izmantojiet tikai apspīrinātos šķīdumus, kas norādīti rokasgrāmatā. Pirms jebkāda šķīduma lietošanas vai tādu apkopes darbu veikšanas, kuru laikā iespējams nonākt saskarē ar šķīdumu, skatiet papildinformāciju jaunākajās ražotāja nodrošinātajās ASV drošības datu lapās (SDS) un ES drošības datu lapās.

Pirms aprīkojuma pārvietošanas vienmēr to izslēdziet un atvienojiet no elektroapgādes tīkla.

Apkalpošanu un remontu drīkst veikt tikai atbilstoši kvalificēti tehniskie speciālisti.

Aprīkojums jāuzglabā temperatūras diapazonā no -25 °C līdz 60 °C (ar iepakojumu) un pie -80% relatīvā mitruma.

Izņemšanu no ekspluatācijas drīkst veikt tikai attiecīgi kvalificēts izplatītājs, izmantojot sertificētu aprīkojumu. Ir jāievēro visu piemērojamo likumdošanas aktu prasības.

Ja tiek veikta uzstādīšanas, ekspluatācijas vai apkopes procedūras, kas atšķiras no šajā rokasgrāmatā aprakstītajām, var rasties bīstamas situācijas, un tiek anulēta ražotāja garantija.

Nekādā gadījumā nepievienojiet līnijas spriegumu jebkādiem dzesētāja sakaru savienojumiem.

Ja dzesētājs un tehniskā šķīduma līnijas nav pilnībā uzplūdinātas, var rasties dzesētāja sūkņa bojājumi. Ir jāizvairās no pārmērīgas uzplūdes, jo šķīdumi karstuma ietekmē izpļešas.

Pirms ThermoFlex rezervuāra korpusa nomainīšanas nodrošini, lai rezervuāra līmeņa indikatora lodītes aizturis būtu droši nostiprināts vietā.

Ierīcēm ThermoFlex900-5000 nedarbiniet dzesētāju, kamēr nav uzstādīts rezervuāra šķīduma difuzors.

Ja dzesētājs ir aprīkots ar vizuālsūkni (P1 vai P2), nodrošini, lai ierīces caurules un savienojumi varētu izturēt vismaz 185 psi.

Nedrīkst lietot automobiļiem paredzētu antifīzū. Komerciāli pieejamais antifīzrs satur silīkāts, kas bojā sūkņa blīvījumus.

Lai novērstu siltummaiņa plāksņu sasaišanu/apledošanu, ThermoFlex7500-24000 dzesētājiem nepieciešams lietot 50/50 EG/ūdens vai 50/50 PG/ūdens darba temperatūrai zem 10 °C.

Ja tehniskais šķīdums ir EG/ūdens vai PG/ūdens maisījums, regulāri pārbaudiet šķīduma koncentrāciju un pH līmeni. Koncentrācijas un pH līmeņa izmaiņas var ietekmēt sistēmas veiktspēju.

Nelietojiet dejonizācijas (DI) filtra kasetni ar inhibētu EG vai inhibētu PG. DI filtrs atdalīs inhibitorus no šķīduma, padarot šķīdumu neefektīvu aizsardzībai pret koroziju. Inhibitori arī palielina šķīduma vadītspēju.

Biocīdi ir korozīvi un var izraisīt neatgriezeniskus acu bojājumus un ādas apdegumus. To iedarbība ir kaitīga, ja tie tiek ieelpoti, norīti vai absorbēti caur ādu. Skatiet jaunākās ražotāja nodrošinātās SDS.

Lai novērstu dzesētāja siltummaiņa plāksņu bojājumu rašanos, centrifūgas sūkņiem nepieciešamais minimālais caurplūdums ir 4,0 gpm (15,1 lpm).

Ja kondensatora filtrs netiek tīrīts/nomainīts, tiek izraisīts dzesēšanas kapacitātes zudums un priekšlaicīga dzesēšanas sistēmas atteice. Lai veiktu rūpīgu tīrīšanu, noņemiet priekšējo režģi.

Dzesētājiem ar gaisa dzesēšanu kondensatora rāmis un ribas, kas atrodas aiz priekšējā režģa, ir ļoti asas. Izņemot ierīces ar gaisa dzesēšanas režģi, nekādā gadījumā nedarbiniet dzesētāju, ja ir noņemts kāds panelis.

ThermoFlex900-5000 dzesētājiem ar ūdens dzesēšanu ir ventilators ar asām lāpstņām, tādēļ pirms priekšējā režģa noņemšanas nodrošiniet, lai dzesētājs būtu izslēgts.

Recirkulācijas dzesētāju paredzētais lietojums

Thermo Scientific recirkulācijas dzesētāji ir paredzēti, lai nodrošinātu pastāvīgu šķidrums padevi ar konstantu temperatūru un plūsmas ātrumu. Dzesētājs sastāv no dzesēšanas sistēmas ar gaisu vai ūdens dzesēšanu, siltummaiņa, recirkulācijas sūkņa, tehniskā šķidrums rezervuāra un mikroprocesoru kontrolera.

Dzesētāji ir paredzēti pastāvīgai darbināšanai slēgtās telpās telpās atbilstoši visām procedūrām un prasībām, kas norādītas šajā rokasgrāmatā.

Recirkulācijas dzesētāju uzstādīšana

Novietojiet dzesētāju, lai tas atastos atvienošanas ierīces tuvumā un tā būtu viegli pieejama.

Dzesētājs ir paredzēts pievienošanai pie atsevišķas kontaktligzdas.

Nodrošiniet, lai pirms uzstādīšanas būtu noņemti visi transportēšanai paredzētie cauruļvadu aizgriežņi.

Tehniskā šķidrums savienojumi atrodas dzesētāja aizmugurē un ir apzīmēti kā  (PROCESS OUTLET) (DARBA ŠĶIDRUMA IZPLŪDE) un  (PROCESS INLET) (DARBA ŠĶIDRUMA IEPLŪDE). Pievienojiet  ierīces šķidrums ieplūdes vietai. Pievienojiet  ierīces šķidrums izplūdes vietai.

Dzesētājiem ar ūdens dzesēšanu pievienojiet  (FACILITY INLET) (ŪDENS PADEVE) izmantojamā ūdens padevei. Dzesētājiem ar ūdens dzesēšanu pievienojiet  (FACILITY OUTLET) (ŪDENS IZPLŪDE) izmantojamā ūdens atplūdei vai izvadei.

Pirms dzesētāja iedarbināšanas vēlreiz pārbaudiet visus sakarus, elektriskos un cauruļvadu savienojumus.

Istruzzjonijiet Essenzjali tas-Sigurtà Recirculating Chillers

Jekk xi waħda minn dawn l-istruzzjonijiet ma tinfihemx, irreferi għall-manwal jew ikkuntattja qabel ma tipproċedi.

Sigurtà: il-prodotti kollha:

⚠ DANGER jindika sitwazzjoni perikoluża b'mod imminenti, li jekk ma tiġix evitata, se tirriżulta f'mewt jew f'korrimment serju.

⚠ WARNING jindika sitwazzjoni potenzjalment perikoluża, li jekk ma tiġix evitata, tista' tirriżulta f'mewt jew f'korrimment serju.

⚠ CAUTION jindika sitwazzjoni potenzjalment perikoluża, li jekk ma tiġix evitata, tista' tirriżulta f'korrimment żgħir jew moderat. Jista' jintuża wkoll biex iwissi kontra prattici li mhumiex siguri.

 intenzjonat biex iwissi lill-utent dwar il-preżenza ta' "vultaġġ perikoluż" mhux insulat fl-enclosure ta' chiller. Il-qawwa tal-vultaġġ hi sinifikanti biżżejjed biex tikkostitwixxi riskju ta' xokk elettriku.

 jindika l-preżenza ta' wċuħ jaħarqu.

 jindika biex dak li jkun jaqra l-manwal.

Tużax it-tagħmir bħala tagħmir sterili jew tagħmir li jiġi kkonnettjat mal-pazjent. Barra minn hekk, it-tagħmir mhuwieq ma'sub għall-użu f'Postijiet Perikolużi ta' Klassi I, li jiew III kif definit min-National Electrical Code.

Dan it-tagħmir hu ma'sub biex jintuża fuq ġewwa biss. Qatt ipoġġih f' post fejn ikun hemm shana eċċessiva, umdià, ventilazzjoni inadegwata, jew materjali korrużivi. Irreferi għall-manwal għall-parametri tal-operat.

Ikkonnettja t-tagħmir ma' outlet li jkun erġjat kif support.

Ir-refrigerants użati huma itqal mill-arja u, jekk ikun hemm tniixxja, se jissostitwixxu l-ossigenu u jikkawżaw li wieħed jimitief minn sensih. Kuntatt ma' refrigerant li jkun qed inixxi se jikkawża ħruq tal-ġilda. Irreferi għas-circulator nameplate għat-tip ta' refrigerant użat u mbagħad għal US Safety Data Sheet (SDS) l-aktar riċenti tal-manifattur, li qabel kienet magħnufa bħala MSDS, u l-EU Safety Data Sheet għal informazzjoni addizzjonali.

Ċaqlaq it-tagħmir b'attenzjoni. Skossi għall-għarrieda jew li twaqqa' t-tagħmir, jistgħu jagħmlu ħsara lill-komponenti tiegħu. Dejjem iffi t-tagħmir u skonnettjah minn mal-provvista tad-dawl tiegħu qabel iċċaqliqu.

Qatt m'għandek tħaddem tagħmir bil-ħsara jew tagħmir li jkun qed inixxi.

Qatt m'għandek tuża fluwidu li jstgħu jehdu n-nar jew li huma korrużivi. Uża biss il-fluwidu approvati li huma elenkati fil-manwal. Qabel tuża kwalunkwe fluwidu jew tweektaq manutenzjoni fejn x'aktarx se jkun hemm kuntatt mal-fluwidu, irreferi għal US Safety Data Sheet (SDS) l-aktar riċenti tal-manifattur, u l-EU Safety Data Sheet għal informazzjoni addizzjonali.

Dejjem iffi t-tagħmir u skonnettjah minn mal-provvista tad-dawl tiegħu qabel iċċaqliqu.

Irreferi s-service u t-tiswijiet lill-technician ikkwalifikat.

Ahzen it-tagħmir f'medda ta' temperatura ta' -25°C sa 60°C (bl-ippakkjar), u umdià relattiva ta' <80%.

Id-dekmissionar irid isir biss minn aġent ikkwalifikat bl-użu ta' tagħmir iċċertifikat. Ir-regolamenti prevalenti kollha jridu jiġu segwiti.

Il-prestazzjoni tal-proċeduri tal-installazzjoni, operat, jew manutenzjoni, h'ief dawk deskritti fil-manwal, jistgħu jirriżultaw f'sitwazzjoni perikoluża, u dan se jħassar il-garanzija tal-manifattur.

Qatt m'għandek tapplika line voltage III xi waħda mill-konnessjonijiet tal-komunikazzjoni fuq iċ-chiller.

Li ma timliex iċ-chiller u l-process fluid lines kompletament, dan jista' jagħmel ħsara lill-pompa ta'chiller. Evita li timla żżejjed; il-fluwidu jespandu meta jissaħnu.

Fuq ThermoFlex, qabel tibdel ir-reservoir housing, kun żgur li r-reservoir sight tube ball stopper ikun f'postu b'mod sigur.

Fuq ThermoFlex900-5000, tħaddimx iċ-chiller h'ief jekk ir-reservoir fluid diffuser ikun installat.

Jekk iċ-chiller tiegħek ikun m'għammar b'positive displacement pump (P1 jew P2), accertata ruħek li l-application plumbing lines u l-fittings ikunu rated biex jiflihu minimu ta' 185 psi.

Tużax antifreeze ta-karozzi. Antifreeze kummerċjali fih silicates li jagħmlu ħsara lis-sigilli tal-pompa.

Biex tipprevjeni l-ifriżar/glazing tal-plate exchanger, ThermoFlex7500-24000 chillers jeħtieġu l-użu ta' 50/50 EG/lima jew 50/50 PG/lima taħt it-temperatura tal-proċess ta' 10°C.

Meta tuża taħlita ta' fluwidu tal-process ta' EG/lima jew PG/lima, iċċekkja l-koncentrazzjoni tal-fluwidu u l-pH fuq bażi regolari. Bidliet fil-koncentrazzjoni u l-pH jista' jkollhom impatt fuq il-prestazzjoni tas-sistema. Tużax Deionization (DI) filter cartridge b'inhibited EG jew Inhibited PG. DI filter se jneħthi l-inibituri mis-soluzzjoni u dan jagħmel il-fluwidu mhux effettiv kontra l-protezzjoni mill-korrużjoni.

Il-bjoċidi huma korrużivi u jstgħu jikkawżaw ħsara irriversibbli fl-għajnejn u ħruq tal-ġilda. Dawn huma perikolużi jekk jingibdu man-nifs, jinbelgħu jew jiġu assorbiti mill-ġilda. Irreferi għall-SDS l-aktar riċenti tal-manifattur.

Biex tipprevjeni ħsara liċ-chiller's plate exchanger, centrifugal pumps jeħtieġu rata minima ta' cirkolazzjoni ta' 4.0 gpm (15.1 lpm).

Li ma tnaaddax/tbidliex il-condenser filter, se jikkawża telf tal-kapaċità ta' ikessiħ u jwassal għal ħsara prematura tas-sistema ta' ikessiħ. Biex tnaaddaf bir-reqqa, neħthi l-front grill assembly.

Fuq air-cooled chillers, il-condenser framing u fins li jinsabu wara l-front grill assembly, jaqtgħu ħafna.

Fliet għall-air-cooled grill assembly, qatt m'għandek tħaddem iċ-chiller bi kwalunkwe panel imnefhi.

ThermoFlex900-5000 water-cooled chillers għandhom fan bi blades jaqtgħu; aċċerta ruġek li iċ-chiller ikun mifti qabel ma' tnefhi l-grill ta' quddiem.

Użu Intenzjonat, Recirculating Chillers:

Thermo Scientific recirculating chillers huma maħsuba biex jipprovdu provvista kontinwa ta' fluwidu b'rata kostanti ta' temperatura u fluss. Iċ-chiller jikkonsisti minn sistema ta' refrigerazzjoni mkessha bl-arja jew mkessha bi-ljima, recirculating pump, process fluid reservoir u microprocessor controller.





Iċ-chillers huma maħsuba biex jaħdmu l-hin kollu u biex jintużaw fuq gewwa, skont il-proċeduri u r-rekwiżiti kollha deskritti fil-manwali tagħhom.

Installazzjoni, Recirculating Chillers:

Pogġi iċ-chiller b'tali mod li jkun qrib, u jkun hemm access faċli, għat-tagħmir ta' skonetjar tiegħu.

Iċ-chiller hu maħsub għall-użu fuq dedicated outlet.

Kun żgur li l-plumbing line shipping plugs jimejnew kollha qabel l-installazzjoni.

Il-konnessjonijiet tal-process fluid jinsabu fuq in-naħa ta' wara taċ-chiller u huma tikkettati  (PROCESS OUTLET) u  (PROCESS INLET). Ikkonnettja l-  mal-fluid inlet fuq l-applikazzjoni tiegħek. Ikkonnettja l-  mal-fluid outlet fuq l-applikazzjoni tiegħek.

Għal water-cooled chillers ikkonnettja l-  (FACILITY INLET) mal-provvista tal-facility water tiegħek. Ikkonnettja l-  (FACILITY OUTLET) mal-facility water return jew drain tiegħek.

Qabel ma tistartja iċ-chiller, erġa' iċċekkja l-konnessjonijiet tal-komunikazzjoni, tal-elettriku u tal-plumbing applikabbli kollha.

Ważne instrukcje dotyczące bezpieczeństwa Chłodziarki recyrkulacyjne

W przypadku niezrozumienia którychkolwiek z niniejszych instrukcji, przed przystąpieniem do dalszych prac należy zapoznać się z instrukcją obsługi lub skontaktować się z nami.

Bezpieczeństwo, wszystkie produkty:

⚠ DANGER wskazuje na sytuację bezpośredniego zagrożenia, która bez podjęcia środków zaradczych doprowadzi do śmierci lub poważnych obrażeń ciała.

⚠ WARNING wskazuje na sytuację potencjalnie niebezpieczną, która bez podjęcia środków zaradczych może doprowadzić do śmierci lub poważnych obrażeń ciała.

⚠ CAUTION wskazuje na sytuację potencjalnie niebezpieczną, która bez podjęcia środków zaradczych doprowadzi do drobnych lub umiarkowanych obrażeń ciała. Ponadto będzie wykorzystywana do zgłaszania niebezpiecznych zachowań.

 ostrzega użytkownika o nieizolowanym "niebezpiecznym napięciu" w obrębie obudowy chłodziarki. Wartość bezwzględna napięcia jest na tyle wysoka, by nieść za sobą ryzyko porażenia prądem elektrycznym.

 ostrzega przed gorącymi powierzchniami.

 nakazuje przeczytać instrukcję obsługi.

Nie używać sprzętu, jako urządzenia sterylnego ani mającego kontakt z pacjentem. Ponadto sprzęt nie jest przeznaczony do zastosowań w obrębie Lokalizacji Niebezpiecznych, Klasy I, II lub III określonych przez Krajowe Normy Elektryczne.

Sprzęt został stworzony wyłącznie do użytku wewnątrz pomieszczeń. Nigdy nie należy go umieszczać w miejscu, gdzie wystawiony będzie na działanie zbyt wysokich temperatur, wilgoci, materiałów powodujących korozję lub w lokalizacjach o nieodpowiedniej wentylacji. Aby zapoznać się z parametrami roboczymi, patrz instrukcja obsługi.

Sprzęt podłączyć do odpowiednio uziemionego gniazdka.

Wykorzystywane czynniki chłodnicze są cięższe od powietrza, dlatego w przypadku nieszczelności zastąpią tlen, co doprowadzi do utraty przytomności. Kontakt z wyciekającym czynnikiem chłodniczym doprowadzi

do poparzeń skóry. Aby uzyskać więcej informacji, patrz tabliczka znamionowa cyrkulatora, na której oznaczono typ wykorzystywanego czynnika chłodniczego, najnowsza karta charakterystyki substancji niebezpiecznej US (SDS) producenta wcześniej znana jako MSDS, a także karta charakterystyki substancji niebezpiecznej EU.

Podczas transportowania sprzętu niezbędne jest zachowanie należytej ostrożności. Nagle wstrząsy lub upadek mogą skutkować uszkodzeniem podzespołów. Przed przystąpieniem do transportowania sprzętu należy pamiętać o jego wyłączeniu oraz odłączeniu od napięcia zasilającego.

Nigdy nie obsługiwać uszkodzonego lub nieszczelnego sprzętu.

Nigdy nie stosować płynów palnych lub powodujących korozję. Korzystać wyłącznie z zatwierdzonych płynów wymienionych w instrukcji obsługi. Przed użyciem jakiegokolwiek płynu lub przystąpieniem do jakichkolwiek prac konserwacyjnych, gdy prawdopodobny jest kontakt z płynem patrz najnowsza karta charakterystyki substancji niebezpiecznej US (SDS), a także karta charakterystyki substancji niebezpiecznej EU.

Przed przystąpieniem do transportowania sprzętu należy pamiętać o jego wyłączeniu oraz odłączeniu od napięcia zasilającego.

Prace serwisowe oraz naprawcze należy zlecić wykwalifikowanemu technikowi.

Sprzęt należy przechowywać w temperaturach -25°C do 60°C (w opakowaniu) oraz przy zachowaniu <80% wilgotności względnej.

Wycofanie z eksploatacji może zostać przeprowadzone wyłącznie przez wykwalifikowanego sprzedawcę wykorzystującego sprzęt posiadający niezbędne atesty. Niezbędne jest przestrzeganie wszystkich obowiązujących przepisów.

Wykonywanie czynności montażowych, konserwacyjnych lub obsługa odbiegająca od wytycznych opisanych w instrukcji obsługi może skutkować niebezpiecznymi sytuacjami oraz utratą gwarancji producenta.

Nigdy nie stosować napięcia międzyprzewodowego na żadnym ze złączy komunikacyjnych chłodziarki.

Jeśli chłodziarka oraz przewody rurowe medium chłodzącego nie zostaną całkowicie wypelnione może to doprowadzić do uszkodzenia pompy chłodziarki. Unikać przepelnienia. Płyny pod wpływem ciepła zwiększają swoją objętość.

W przypadku ThermoFlex przed dokonaniem wymiany obudowy zbiornika zadbać o odpowiednie zabezpieczenie kulowego ogranicznika wskaźnika poziomu zbiornika.

W przypadku urządzenia ThermoFlex900-5000, chłodziarki nie należy używać, jeśli nie został zamontowany dyfuzor płynów zbiornika.

Jeśli chłodziarka wyposażona została w pompę wporową (P1 bądź P2) należy sprawdzić czy rury kanalizacyjne oraz łączniki są w stanie wytrzymać ciśnienie o wartości minimum 185 psi.

Nie stosować samochodowych płynów zapobiegających zamarzaniu. Komercyjne środki zapobiegające zamarzaniu zawierają krzemiany uszkadzające uszczelnienie pompy.

Aby zapobiec zamarzaniu/oblodzeniu wymiennika płytkowego w przypadku chłodziarek

ThermoFlex7500-24000 niezbędne jest stosowanie mieszaniny 50/50 EG/woda lub 50/50 PG/woda przy temperaturze procesu nieprzekraczającej 10°C.

W przypadku wykorzystywania mieszaniny mediów chłodzących tj. EG/woda lub PG/woda należy regularnie sprawdzać zarówno stężenie płynu, jak i pH. Zmiany stężenia i pH mogą wpłynąć na wydajność układu. Nie należy stosować wkładu filtra dejonizacyjnego (DI) ze stabilizowanym EG lub PG. Filtr DI usunie inhibitory z roztworu przez co płyn nie będzie zapewniał ochrony przeciwkorozyjnej. Ponadto, inhibitory zwiększają przewodność płynu.

Biocydy posiadają właściwości korozyjne i mogą doprowadzić do nieodwracalnego uszkodzenia oczu bądź poparzeń skóry. Wdychanie, połknięcie lub wchłonięcie przez skórę jest szkodliwe dla zdrowia. Patrz najnowsza charakterystyka substancji niebezpiecznej producenta.

Aby zapobiec uszkodzeniu płytki wymiennika chłodziarki niezbędne jest zapewnienie na pompie przepływu wynoszącego minimum 4,0 gpm (15,1 lpm).

Zaniechanie czyszczenia/wymian filtra kondensatora doprowadzi do spadku wydajności chłodniczej oraz przedwczesnej awarii układu chłodzenia. W celu dokładnego wyczyszczenia należy zdjąć okratowanie przednie.

W przypadku chłodziarek chłodzonych powietrzem, obramowanie kondensatora oraz żeberka znajdujące się za przednim okratowaniem mają bardzo ostre krawędzie. Podczas pracy wszystkie panele powinny znajdować się na swoich miejscach.

Wyjątkiem jest okratowanie zespołów chłodzonych powietrzem.

ThermoFlex900-5000 chłodzone wodą wyposażone zostały w wentylator posiadający ostre łopaty. Przed zdjęciem przedniego okratowania upewnić się, że chłodziarka została wyłączona.

Przeznaczenie, Chłodziarki recyrkulacyjne:

Chłodziarki recyrkulacyjne Thermo Scientific zostały stworzone z myślą o ciągłym dostarczaniu płynu o stałej temperaturze i stałym tempie przepływu. Chłodziarka składa się z układu chłodzenia powietrzem lub wodą, wymiennika ciepła, pompy recyrkulacyjnej, zbiornika na płyn chłodniczy oraz sterownika mikroprocesorowego.



Chłodziarki zostały zaprojektowane do pracy ciągłej oraz do użytku w pomieszczeniach zgodnie ze wszystkimi procedurami i wymogami określonymi w ich instrukcjach obsługi.

Instalacja, Chłodziarki recyrkulacyjne:

Chłodziarkę należy umieścić w pobliżu jej urządzenia wyłączającego pamiętając o zapewnieniu do niego łatwego dostępu.

Chłodziarkę należy podłączyć do przeznaczonego dla niej gniazdka.

Zadbać o to, aby przed instalacją zdemontowane zostały wszystkie zaślepki przewodów wodociągowych założone na czas transportu.

Złącza płynu chłodniczego znajdują się w tylnej części chłodziarki i zostały odpowiednio oznaczone etykietami  (PROCESS OUTLET - wylot) oraz  (PROCESS INLET - wlot). Podłączyć  do wlotu płynu po stronie zastosowania. Podłączyć  do wylotu płynu po stronie zastosowania.

W przypadku chłodziarek chłodzonych wodą podłączyć  (FACILITY INLET - wlot) do zasilania wodą zakładową. Podłączyć  (FACILITY OUTLET - wylot) do przewodu powrotnego wody zakładowej lub spustu.

Przed uruchomieniem chłodziarki należy ponownie sprawdzić wszystkie połączenia oraz złącza elektryczne i wodociągowe.

RO

Instrucțiuni Esențiale de Siguranță Aparate frigorifice de recirculate

Consultați manualul sau contactați-ne înainte de a merge mai departe dacă oricare dintre aceste instrucțiuni sunt pe deplin înțelese.

Siguranță, toate produsele:

DANGER indică o situație periculoasă iminentă care, în cazul în care nu se evită, poate cauza moarte sau vătămare corporală gravă.

WARNING indică o situație potențial periculoasă care dacă nu se evită poate cauza moartea sau rănirea gravă.

CAUTION indică o situație potențial periculoasă care dacă nu se evită poate cauza răni minore sau moderate. Se folosește și pentru a atenționa împotriva practicilor periculoase.

 menit să atenționeze utilizatorul cu privire la prezența „voltaajului periculos” neizolat din incinta aparatului frigorific. Magnitudinea voltaajului este destul de mare pentru prezenta risc de șoc electric.

 indică prezenta suprafețelor încinse.

 indică citirea manualului.

Nu folosiți echipamentul ca dispozitiv steril sau dispozitiv conectat la pacient. În plus, echipamentul nu este conceput pentru a se folosi în Locuri Periculoase din Clasele I, II sau III conform definițiilor Codului Electric Național.

Echipamentul este conceput doar pentru uz intern. Nu se plasează niciodată în locuri sau unde se află niveluri crescute de căldură, umezeală sau substanțe corozive. Consultați manualul de utilizare pentru parametrii operaționali.

Conectați echipamentul la o priză împământată corespunzător.

Agenții frigorifici folosiți sunt mai grei decât aerului, iar dacă există o scurgere ei vor înlocui oxigenul și vor cauza pierderi de conștiență. Contactul cu scurgerile de agent frigorific poate cauza ardere la nivelul pielii.

Consultați plăcuța de identificare a propagatorului pentru tipul de agent frigorific folosit și apoi cea mai actuală Fișă cu Date de Siguranță SUA(FDS) a producătorului cunoscută drept MSDS și Fișa cu Date de Siguranță UE pentru informații suplimentare.

Echipamentul se transportă cu grijă. Zguduiele sau căderile pot avaria componentele. Înainte de a-l transporta opriți mereu echipamentul și deconectați-l de la tensiunea de alimentare.

Nu operați niciodată echipament avariat sau care prezintă scurgeri.

Nu folosiți niciodată lichide inflamabile sau corozive. Folosiți numai lichidele aprobate care sunt enumerate în manual. Consultați cea mai actuală Fișă cu Date de Siguranță SUA (FDS) și Fișa cu Date de Siguranță UE pentru informații suplimentare înainte de folosi orice lichid sau de a efectua lucrări de întreținere când există șansa de a intra în contact cu lichide.

Înainte de a-l transporta opriți mereu echipamentul și deconectați-l de la tensiunea de alimentare.

Reparațiile și întreținerea se efectuează de către tehnicienii calificați.

Echipamentul se depozitează la temperaturi afte între -25°C to 60°C (cu ambalaj) și <80% umiditate relativă.

Retragerea din funcționare se efectuează numai de către un furnizor calificat folosind echipament certificat. Trebuie să se respecte toate prevederile curente.

Performanța instalației, operarea sau procedurile de întreținere pe lângă cele descrise în manual pot să cauzeze situații periculoase sau se anuleze garanția producătorului.

Niciodată să nu aplicați tensiune de linie la conexiunile de comunicare ale aparatului frigorific.

Pompa aparatului frigorific ar putea fi avariată dacă aparatul frigorific nu se umple complet și dacă țevile pentru lichidul de procesare sunt avariate. Evitați umplerea în exces. Lichidele se dilată la căldură.

Asigurați-vă că bila de oprire de la indicatorul de nivel al rezervorului este bine fixată înainte de a pune carcasa rezervorului pentru ThermoFlex.

În cazul ThermoFlex900-5000, nu operați aparatul frigorific decât dacă difuzorul de lichid al rezervorului este instalat.

Dacă aparatul frigorific este echipat cu o pompă de refulare (P1 sau P2), asigurați-vă că liniile de instalație și garniturile sunt capabile să reziste la cel puțin 185 psi.

În cazul aparatelor de răcire Merlin cu pompe MD nu se restricționează niciodată complet curgerea pentru aplicație. Blocarea pompei avariază cuplajul și va fi necesară înlocuirea pompei.

Nu folosiți antigetel pentru automobile. Antigetul comercial conține silicați care pot avaria izolația pompei.

Pentru a preveni înghețarea schimbătorului de placă, aparatele frigorifice ThermoFlex7500-24000 necesită folosirea apei50/50 EG/ sau a apei 50/50 PG/ sub 10°C-temperatură de procesare.

Când se folosește un ameste de lichid de procesare cu apă/EG sau apă/PG se verifică regulat concentrația lichidului și a pH-ului. Schimbările concentrației și a Ph-ului afectează randamentul instalației. Nu folosiți cartuș de filtrare deionizant cu EG Inhibit sau PG Inhibit.

Filtrul deionizant va îndepărta inhibitorii din soluție, iar lichidul nu va avea niciun efect de protecție împotriva corozivității. De asemenea, inhibitorii vor mări conductivitatea lichidului.

Biocidele au efect coroziv și pot cauza răni ireversibile la nivelul ochilor și arsurii de piele. Sunt toxice dacă se inhalează, dacă se înghit sau dacă se absorb prin piele. Consultați cea mai recentă Fișă cu Date de

Siguranță de la producător.

Pompele centrifugale au nevoie de o rată minimă de curgere de 4.0 gpm (15.1 lpm) pentru a preveni avarierea schimbătorului de placă al aparatului frigorific.

Dacă nu se curăță înlocuiește filtrul de condensare se poate ajunge la scăderea capacității de răcire și la erori premature ale sistemului de răcire. Pentru a efectua curățarea în profunzime se îndepărtează ansamblul frontal de grilaj.

La aparatele frigorifice răcite cu aer, cadrul și muchiile de condens din spatele grilajului frontal sunt foarte ascuțite.

Nu operați aparatul frigorific dacă panourile sunt îndepărtate în afară de ansamblul de grijale pentru răcire cu aer.

Aparatele frigorifice ThermoFlex900-5000 răcite cu apă au un ventilator cu lame ascuțite. Asigurați-vă că aparatul frigorific este scos din funcțiune înainte să îndepărtați grilajul.

Scop de utilizare, Aparate frigorifice cu Recirculare:

Aparatele frigorifice Thermo Scientific sunt concepute pentru a asigura alimentarea continuă cu lichid la temperatură și rată de curgere constantă. Aparatul frigorific este alcătuit din sistem frigorific răcit cu aer sau cu apă, un schimbător de căldură, pompă de recirculare, rezervor pentru lichid de procesare și un controler cu microprocesor.





Aparatele frigorifice sunt concepute pentru operare continuă și pentru uz intern conform tuturor procedurilor și condițiilor prevăzute în manualul lor.

Instalare, Aparat frigorific cu recirculare:

Plasați aparatul frigorific în așa fel încât să fie aproape și să aibă acces ușor la aparatul de deconectare.

Aparatul frigorific este conceput pentru a se folosi la o priză dedicată.

Asigurați-vă că toate mufele de transport de la linia de instalație s-au îndepărtat înainte de instalare.

Conexiunile pentru lichid de procesare se găsesc pe latura din spate a aparatului de răcire și sunt etichetate  (PROCESS OUTLET) (EVACUARE PROCES) și  (PROCESS INLET) (ADMISIE PROCES). Conectați  la admisia de lichid de la aplicația dumneavoastră. Conectați  la evacuarea de lichid de la aplicația dumneavoastră.

Pentru aparatele frigorifice răcite cu apă se conectează  (ADMISIE INSTALAȚIE) la instalația de alimentare cu apă. Conectați  (FACILITY INLET) (EVACUARE INSTALAȚIE) la instalația de întoarcere sau scurgere pentru apă.

Înainte să porțiți aparatul frigorific verificați de două ori comunicarea aplicabilă, conexiunile electrice și conexiunile de la instalație.

SL

Osnovna varnostna navodila Recirkulacijski ohlajevalniki

Če ne razumete kategorikoli navodila, si poglejte navodila za uporabo ali stopite v stik z nami, še preden nadaljujete.

Varnost - vsi izdelki:



DANGER Opozarja na akutne nevarne okoliščine, ki lahko – če se jim ne izognete – povzročijo resne ali celo smrtne nevarne poškodbe.



WARNING Opozarja na morebitno nevarne okoliščine, ki lahko – če se jim ne izognete – povzročijo resne ali celo smrtne nevarne poškodbe.



CAUTION Opozarja na akutne nevarne okoliščine, ki lahko – če se jim ne izognete – povzročijo lažje ali srednje nevarne poškodbe. Uporablja se tudi kot opozorilo proti nevarni praksi.



opozarja na bližino neizolirane nevarne napetosti v ohišju ohlajevalnika. Napetost je dovolj visoka, da lahko povzroči električni šok.



opozarja na vroče površine.



opozarja, da je potrebno prebrati navodila.

Ne uporabljajte aparata kot sterilno napravo, ali napravo, povezane z bolnikom. Poleg tega naprava ni načrtovana za uporabo v napravah, ki delujejo v nevarnih okoljih I., II. in III. razreda po določilih Nacionalnega pravilnika za električne naprave.

Naprava je načrtovana za uporabo v zaprtih prostorih. Nikoli ne postavite naprave na mesto z visoko temperaturo, vlago, nezadostnim prezračevanjem in jedkimi snovmi. Delovni parametri so navedeni v navodilih.

Priključite napravo v pravilno ozemljeno vtičnico.

Uporabljena hladilna sredstva so težja od zraka. Če obstajajo netesna mesta, bodo izpodrinila kisik in povzročila izgubo zavesti. Stik z uhajajočim hladilnim sredstvom bo povzročil ozeblino. Dodatne informacije boste našli na cirkulatorjevi ploščici s podatki, na kateri je naveden tip hladilnega sredstva, najnovjšem varnostnem listu za ZDA (SDS), ki je bil prej poznan pod nazivom MSDS in varnostnem listu za EU.

Previdno premikajte opremo. Nenadni sunki ali padci lahko poškodujejo njene dele. Preden premikate opremo, jo vedno izklopite in odklopite z omrežnega napajanja.

Nikoli ne delajte z opremo, ki je poškodovana ali pušča.

Nikoli ne uporabljajte vnetljivih ali jedkih tekočin. Uporabite le odobrene tekočine, navedene v predmetnih navodilih za uporabo. Preden uporabite katerokoli tekočino ali opravite vzdrževanje, pri katerem je verjeten stik s tekočino preglejte najnovjši varnostni list ZDA (SDS) in varnostni listu EU, kjer bosta našli podrobnejše informacije.

Preden premikate opremo, jo vedno izklopite in odklopite z omrežnega napajanja.

Servis in popravila lahko izvaja le ustrezno usposobljen tehnik

Shranite opremo pri temperaturi med -25 °C in 60 °C (z embalažo) in relativno zračno vlago <80 %.

Razgradnjo naprave lahko opravi le ustrezno usposobljen zastopnik, ki uporablja odobreno opremo. Uporabljajte vse veljavne zadevne predpise.

Izvajanje kakršnihkoli postopkov, povezanih z montažo, delovanjem ali vzdrževanjem, ki niso navedeni v teh navodilih, lahko povzroči nevarne okoliščine in izniči veljavnost garancije proizvajalca.

Nikoli ne priključite omrežne napetosti na katerikoli komunikacijski priključek ohlajevalnika.

Če ohlajevalnik in cevi za procesni medij niso polni, lahko slednje poškoduje črpalno ohlajevalnika.

Preprečite prenapoljenost, tekočine se pri ogrevanju raztezajo.

Pri modelu ThermoFlex pred zamenjavo ohišja rezervoarja preverite, ali je krogelni ventil s pregledno cevjo pravilno nameščen.

Pri modelu ThermoFlex900-5000 ne vklopite ohlajevalnika, če ni nameščen difuzor za tekočino v rezervoarju.

Če je ohlajevalnik opremljen s črpalno, ki ima pozitivni izpodriv (P1 ali P2), poskrbite, da vodovodne cevi in fitingi prenesejo tlak vsaj 12,8 bar (185 PSI).

Ne uporabljajte avtomobilskega antifriz. Antifrizi iz redne prodaje vsebujejo silikate, ki lahko poškodujejo tesnila črpalke.

Zaradi preprečevanja zmrzovanja/zaledenitve ploskega izmenjevalnika, zahtevajo ohlajevalniki

ThermoFlex7500-24000 uporabo 50/50 EG/voda ali 50/50 PG/voda pri procesni temperaturi, nižji od 10 °C.

Če uporabljate procesno tekočino EG/voda ali PG/voda, redno preverjajte koncentracijo in pH tekočine.

Spremembe koncentracije in pH lahko vplivajo na zmogljivost sistema.

Ne uporabite kartuše deionizacijskega (DI) filtra z inhibiranim EG ali PG. Filter DI bo odstranil inhibitorje iz raztopine, kar pomeni, da tekočina ne bo več ščitila pred korozijo. Inhibitorji poleg tega povečajo prevodnost tekočine.

Biocidi so korozivni in lahko nepopravljivo poškodujejo oči in povzročijo kožne opekline. Škodljivo pri vdihavanju, zaužitju ali absorpciji skozi kožo. Preverite proizvajalčev najnovjši SDS.

Zaradi preprečevanja poškodb ohlajevalnikovega ploščatega izmenjevalnika, zahteva centrifugalna črpalka pretok najmanj 4,0 g/m (15,1 l/m).

Če ne očistite/zamenjate filtra kondenzatorja, lahko slednje povzroči zmanjšanje hladilne zmogljivosti in predčasno odpoved hladilnega sistema. Pri temeljitem čiščenju odstranite prednjo masko.

Pri zračno hlajenih ohlajevalnikih so okvir in lamele, ki se nahajajo za prednjo rešetko zelo ostri.

Razen pri zračno hlajenem sklopu mreže nikoli ne uporabljajte ohlajevalnika, če je odstranjen katerikoli panel.

Vodno hlajeni ohlajevalniki ThermoFlex900-5000 imajo ventilatorje z ostrimi lopaticami. Preverite ali je ohlajevalnik izklopljen preden odstranite prednjo mrežo.

Namenska uporaba, recirkulacijski ohlajevalniki:

Recirkulacijski ohlajevalniki Thermo Scientific so načrtovani za nenehen dovod tekočine z enekomerno temperaturo in pretokom. Ohlajevalnik je sestavljen iz zračno ali vodno hlajenega hladilnega sistema, toplotnega izmenjevalnika, obtočne črpalke, rezervoarjem procesirane tekočine





Ohlajevalniki so načrtovani za neprekinjeno obratovanje v zaprtih prostorih v skladu z vsemi postopki in zahtevami, navedenimi v tem priročniku.

Namestitev, ohlajevalnik z recirkulacijo:

Namestite ohlajevalnik v bližino, da imate enostaven dostop do odklopne naprave.

Ohlajevalnik je namenjen za uporabo na posebni vtičnici.

Pred montažo preverite, ali so z vseh cevi odstranjeni transportni čepi.

Procesne povezave za tekočino se nahajajo na zadnji strani ohlajevalnika in so ustrezno označene  PROCESS OUTLET (PROCESNA VTIČNICA) in  PROCESS INLET (PROCESNI DOVOD). Priključite  na vhod za tekočine vaše aplikacije. Priključite  na dovod za tekočine vaše aplikacije.

Pri vodno hlajenih ohlajevalnikih prikjučite  FACILITY INLET (DOVOD NAPRAVE) na dovod vaše naprave. Priključite  FACILITY OUTLET (ODVOD NAPRAVE) na povratni vod ali iztok vaše naprave.

Pred vklopom ohlajevalnika dvakrat preverite vse razpoložljive komunikacije ter električne in vodovodne povezave.

Osnovna bezbednosna uputstva Cirkulirajući rashladni uređaji

Ako ne razumete bilo koja od ovih uputstava, pogledajte priručnik ili nas kontaktirajte pre nego što nastavite.

Bezbednost, svi proizvođači:

DANGER označava neposrednu opasnost koja, ako se ne izbegne, će da dovede do smrti ili teške povrede.

WARNING označava potencijalno opasnu situaciju koja, ako se ne izbegne, može da dovede do smrti ili teške povrede.

CAUTION označava potencijalno opasnu situaciju koja, ako se ne izbegne, može da dovede do lakše ili srednje teške povrede. Takođe može da se koristi da upozori na nesigurne radnje.

 upozorava korisnika na prisustvo neizolovanog „opasnog napona“ unutar kućišta rashladnog uređaja. Napon je dovoljno velik da predstavlja opasnost od strujnog udara.

 ukazuje na prisustvo vrelih površina.

 ukazuje da je potrebno pročitati priručnik.

Nemojte da koristite opremu kao sterilni uređaj ili uređaj povezan na pacijenta. Pored toga, oprema nije predviđena za upotrebu na opasnim lokacijama klase I, II ili III prema definicijama Nacionalnog električnog standarda (engl. National Electrical Code).

Oprema je predviđena samo za upotrebu u zatvorenim prostorima. Nikad nemojte da je postavljate gde je prisutna prekomerna toplota, vlažnost, neodgovarajuće provetranje ili nagrizajući materijali. Radni parametri navedeni su u priručniku.

Povežite opremu na pravilno uzemljenu utičnicu.

Korišćena sredstva za hlađenje su teža od vazduha a i, ako dođe do curenja, zamenite kiseonik te dovesti do gubitka svesti. Kontakt sa sredstvom za hlađenje koje curi uzrokuje opekotine. Pogledajte pločicu s podacima cirkulatora za vrstu korišćenog sredstva za hlađenje, a zatim potražite dodatne informacije u najnovijem bezbednosnom listu za SAD (engl. Safety Data Sheet; SDS), ranije poznatom kao MSDS, kao i bezbednosnom listu za EU.

Oprezno pomerajte opremu. Naglo dirnanje ili ispuštanje opreme može da ošteti njene komponente. Pre pomeranja opreme uvek je isključite i iskopčajte iz napona izvora napajanja.

Nikad nemojte da koristite oštećenu opremu ili opremu koja propušta.

Nikad nemojte da koristite zapaljive ili nagrizajuće tečnosti. Koristite samo odobrene tečnosti koje su navedene u priručniku. Pre korišćenja bilo kakve tečnosti ili obavljanja postupaka održavanja u kojima će verovatno doći do kontakta s tečnošću, potražite dodatne informacije u najnovijem bezbednosnom listu za SAD (engl. Safety Data Sheet; SDS) i bezbednosnom listu za EU.

Pre pomeranja opreme uvek je isključite i iskopčajte iz napona izvora napajanja.

Servisiranje i popravke treba da obavlja kvalifikovani serviser.

Opremu držite na rasponu temperature od -25 °C do 60 °C (s pakovanjem) i relativnoj vlažnosti od <80 %.

Stavljanje izvan pogona mora da obavi isključivo kvalifikovani trgovac pomoću certifikovane opreme. Mora da se pridržava svih važećih propisa.

Obavljanje postupaka ugradnje, korišćenja ili održavanja koji nisu opisani u priručniku može da dovede do opasne situacije i poništiće garanciju proizvođača.

Nikad nemojte da primerjujete linijski napon na komunikacijske priključke na rashladnom uređaju.

Ako ne napunite rashladni uređaj i creva za radnu tečnost do kraja, može da dođe do oštećenje pumpe rashladnog uređaja. Nemojte da prepunjavate jer se tečnost širi prilikom zagrevanja.

Na rashladnom uređaju ThermoFlex, pre zamene kućišta rezervoara potrebno je proveriti da čep indikatora nivoa u rezervoaru bude čvrsto na mestu.

Rashladni uređaj ThermoFlex900-5000 nemojte da koristite ako difuzor rezervoara nije ugrađen.

Ako je rashladni uređaj opremljen volumetrijskom pumpom (P1 ili P2), pazite da vodovodna creva i spojnice mogu da podnesu najmanje 185 psi.

Nemojte da koristite antifriz za automobile. Komerциjalni antifriz sadrži silikate koji oštećuju zaprtivke pumpe.

Da bi se sprečilo smrzavanje pločastog izmenjivača, rashladni uređaji ThermoFlex7500-24000 zahtevaju upotrebu mešavine od 50/50 etilen glikola/vode ili 50/50 propilen glikola/vode na radnoj temperaturi ispod 10 °C.

Prilikom upotrebe mešavine radne tečnosti od etilen glikola/vode ili propilen glikola/vode, redovno proveravajte koncentraciju tečnosti i pH vrednost. Promene u koncentraciji i pH vrednosti mogu da utiču na performanse sistema .

Nemojte da koristite uložak filtera za dejonizaciju s inhibiranim etilen glikolom ili inhibiranim propilen glikolom. Filter za dejonizaciju uklanja inhibitore iz rastvora, što tečnost čini neefikasnom za zaštitu od korozije. Pored toga, inhibitori povećavaju provodljivost tečnosti.

Biocidi su nagrizajući i mogu da dovedu do nepopravljivih oštećenja očiju i opekotina. Štetni su ako se udahnu, progutaju ili upiju kroz kožu. Pogledajte najnoviji bezbednosni list proizvođača.

Da bi se sprečilo oštećenje pločastog izmenjivača rashladnog uređaja, centrifugalne pumpe zahtevaju minimalni protok od 4,0 g/min (15,1 l/min).

Ako se filter kondenzatora ne čisti/menja, dolazi do gubitka kapaciteta hlađenja i prevremenog kvara sistema hlađenja. Za temeljito čišćenje uklonite sklop prednje rešetke.

Na vazduhom hlađenim rashladnim uređajima okvir i vertikalni stabilizatori kondenzatora nalaze se iza sklopa prednje rešetke i vrlo su oštri.

S izuzetkom vazduhom hlađenog sklopa rešetke nikad nemojte da koristite rashladni uređaj kad je bilo koja ploča skinuta.

Vodnom hlađeni rashladni uređaji ThermoFlex900-5000 imaju ventilator s oštrim lopaticama i zato rashladni uređaj morate da isključite pre skidanja prednje rešetke.

Namena, cirkulirajući rashladni uređaji:

Cirkulirajući rashladni uređaji kompanije Thermo Scientific su predviđeni za pružanje neprekidne isporuke tečnosti uz konstantnu temperaturu i protok. Rashladni uređaj se sastoji od vazduhom hlađenog ili vodnom hlađenog rashladnog sistema, izmenjivača toplote, cirkulirajuće pumpe, rezervoara radne tekućine i kontrolera mikroprocesora.

Rashladni uređaji su predviđeni za neprekidan rad i upotrebu u zatvorenim prostorima u skladu sa svim postupcima i zahtevima navedenim u njihovim priručnicima.

Ugradnja, cirkulirajući rashladni uređaji:

Postavite rashladni uređaj tako da bude blizu i ima lak pristup svom uređaju za iskopčavanje.

Rashladni uređaj je predviđen za upotrebu na namenskoj utičnici.

Obavezno skinite sve ambalažne čepove vodovodnih creva pre ugradnje.

Priključni rashladne tekućine nalaze se sa zadnje strane rashladnog uređaja i označeni su sa  (PROCESS OUTLET) (radni izlazni otvor) i  (PROCESS INLET) (radni ulazni otvor). Povežite  na ulazni otvor za tečnost na uređaju. Povežite  na izlazni otvor za tečnost na uređaju.

Kod vodnom hlađenih rashladnih uređaja povežite  (FACILITY INLET) (ulazni otvor za postrojenje) na vodosnabdevanje postrojenja. Povežite  (FACILITY OUTLET) (izlazni otvor postrojenja na povratni vod ili odvod postrojenja).

Pre pokretanja rashladnog uređaja dvaput proverite sve relevantne komunikacijske, električne i vodovodne priključke.

SK

Základné bezpečnostné pokyny Recirkulačné chladiace jednotky

Ak nerozumiete niektorému z týchto pokynov, pred pokračovaním si prečítajte príručku alebo nás kontaktujte.

Bezpečnosť, všetky produkty:

⚠ DANGER označuje bezprostredne nebezpečnú situáciu, ktorá, ak sa jej nevyhnete, spôsobí usmrtenie alebo vážne poranenie.

⚠ WARNING označuje potenciálne nebezpečnú situáciu, ktorá, ak sa jej nevyhnete, môže spôsobiť usmrtenie alebo vážne poranenie.

⚠ CAUTION označuje potenciálne nebezpečnú situáciu, ktorá, ak sa jej nevyhnete, môže spôsobiť ľahké alebo stredne ťažké poranenie. Používa sa aj ako varovanie pred nebezpečnými postupmi.

 slúži na upozornenie používateľa na prítomnosť neizolovaného „nebezpečného napätia“ pod krytom chladiacej jednotky. Napätie je dostatočne vysoké na to, aby predstavovalo riziko úrazu elektrickým prúdom.

 označuje prítomnosť horúcich povrchov.

 označuje nutnosť prečítania príručky.

Zariadenie nepoužívajte ako sterilné alebo ako zariadenie pripojené k pacientovi. Zariadenie okrem toho nie je určené na použitie v nebezpečných prostrediach triedy I, II alebo III definovaných kódom NEC (National Electrical Code).

Zariadenie je určené len na použitie v interiéri. Nikdy ho neumiestňujte na mieste, kde je prítomné nadmerné teplo, vlhkosť, nedostatočné vetranie alebo korozívne materiály. Prečítajte si prevádzkové parametre uvedené v príručke.

Zariadenie pripojte k správne uzemnenej zásuvke.

Použitie chladivá sú ťažšie ako vzduch a ak dôjde k úniku, nahradia kyslík a spôsobia stratu vedomia.

Kontakt s unikajúcim chladivom môže spôsobiť popálenie pokožky. Typ použitého chladiva nájdete na typovom štítku obehového čerpadla a ďalšie informácie nájdete v poslednej karte bezpečnostných údajov (KBÚ) pre USA, predtým známej ako MSDS a karte bezpečnostných údajov pre EÚ.

Zariadenie presúvajte opatrne. Náhle otrasy alebo pády môžu poškodiť jeho komponenty. Pred každým presúvaním vypnite zariadenie a odpojte ho od napájacieho napätia.

Nikdy nepoužívajte poškodené alebo netesné zariadenie.

Nikdy nepoužívajte horľavé alebo korózne kvapaliny. Používajte iba schválené kvapaliny uvedené v návode na použitie. Pred použitím akejkoľvek kvapaliny alebo vykonaním údržby, kde je pravdepodobný kontakt s kvapalinou, si prečítajte poslednú kartu bezpečnostných údajov (KBU) pre USA a kartu bezpečnostných údajov pre EÚ, v ktorých nájdete ďalšie informácie.

Pred každým presúvaním vypnite zariadenie a odpojte ho od napájacieho napätia.

Servis a opravy prenechajte kvalifikovanému technikovi.

Zariadenie skladujte pri teplotách -25 °C až 60 °C (s obalom) a pri relatívnej vlhkosti <80 %.

Vyradenie z prevádzky môže vykonať len oprávnený predajca pomocou certifikovaného vybavenia. Je nutné dodržiavať všetky platné zákonné ustanovenia.

Vykonanie inštalácie, prevádzky alebo postupov údržby, ktoré nie sú popísané v tomto návode, môže viesť k nebezpečným situáciám a bude viesť k zrušeniu platnosti záruky výrobcu.

Nikdy nepripájajte sieťové napätie k niektorému z komunikačných pripojení na chladiacej jednotke.

Neuplné naplnenie chladiacej jednotky a potrubí s procesnými kvapalinami môže poškodiť čerpadlo chladiacej jednotky. Zabráňte prepĺneniu, kvapaliny sa po zohrnutí rozšahujú.

Pred opätovným nasadením krytu nádržky na jednotkách ThermoFlex zaistite, aby bola guľová záružka potrubia nádrže bezpečne na svojom mieste.

Pri jednotkách ThermoFlex900-5000 neprevádzkujte chladiacu jednotku, kým nie je nainštalovaný difúzor kvapaliny v nádržke.

Ak je chladiaca jednotka vybavená objemovým čerpadlom (P1 alebo P2), zaistite, aby inštalované potrubia a tvarovky boli dimenzované tak, aby odolali tlaku minimálne 185 psi.

Nepoužívajte automobilovú nemrznúcu kvapalinu. Komerčné nemrznúce zmesi obsahujú silikáty, ktoré poškodzujú tesnenia čerpadla.

Aby sa zabránilo zamrznutiu/zaneseniu doskového výmenníka, chladiace jednotky

ThermoFlex7500-24000 vyžadujú použitie kvapaliny 50/50 EG/voda alebo 50/50 PG/voda pri procesnej teplote do 10 °C.

Pri použití zmesi procesnej kvapaliny EG/voda alebo PG/voda v pravidelných intervaloch kontrolujte koncentráciu kvapaliny a pH. Zmeny v koncentrácii a pH môžu mať vplyv na výkon systému.

Nepoužívajte deionizačné (DI) filtračné vložky s inhibovanou EG alebo inhibovanou PG.

Filter DI odstráni inhibitory z roztoku a spôsobí, že bude mať kvapalina neúčinnú protikoroziu ochranu. Inhibitory tiež zvyšujú vodivosť kvapaliny.

Biocidy sú korózne a môžu spôsobiť nevratné poškodenie očí a popálenie pokožky. Sú škodlivé pri vdychnutí, požití alebo pri absorpcii cez pokožku. Prečítajte si poslednú KBÚ výrobcu.

Aby nedošlo k poškodeniu doskového výmenníka chladiacej jednotky, odstredivé čerpadlá musia mať minimálny prietok 4,0 g/min (15,1 l/min).

Ak nevyščistíte/nevymeníte filter kondenzátora, dôjde k strate chladiaceho výkonu a k predčasnému zlyhaniu chladiaceho systému. Pre dôkladné vyčistenie vyberte zostavu prednej mriežky.Na vzduchom chladených chladiacich jednotkách sú rám a lopatky umiestnené za zostavou prednej mriežky veľmi ostré.

V prípade iných ako vzduchom chladených zostáv mriežky nikdy neprevádzkujte chladiace jednotky, ak je odstránený akýkoľvek panel.

Vodou chladené chladiace jednotky ThermoFlex900-5000 majú ventilátor s ostrými čepelami. Pred vybratím prednej mriežky sa uistite, že je chladič vypnutý.

Určené použitie, recirkulačné chladiace jednotky:

Recirkulačné chladiace jednotky Thermo Scientific sú navrhnuté na nepretržitú dodávku kvapaliny pri konštantnej teplote a prietoku. Chladiaca jednotka pozostáva z chladiaceho systému alebo vzduchom chladeného alebo vodou chladeného výmenníka tepla, recirkulačného čerpadla, nádrže na procesnú kvapalinu a mikroprocesorového regulátora.



Chladiace jednotky sú určené na nepretržitú prevádzku a na vnútorné použitie v súlade so všetkými postupmi a požiadavkami uvedenými v príslušnom návode na použitie.

Inštalácia, recirkulačné chladiace jednotky:

Chladiacu jednotku umiestnite tak, aby bola blízko odpojacieho zariadenia, aby bol k nemu ľahký prístup.

Chladiaca jednotka je určená na pripojenie k vyhradenej zásuvke.

Uistite sa, že sú pred inštaláciou odstránené všetky prepravné zátky inštalátorských potrubí.

Pripojky pre procesnú kvapalinu sú umiestnené na zadnej strane chladiacej jednotky a sú označené ako  (PROCESS INLET) (PROCESNÝ VÝSTUP) a  (PROCESS OUTLET) (PROCESNÝ VÝSTUP) a  (PROCESS INLET) (PROCESNÝ VÝSTUP). Pripojte  k vstupu kvapaliny na vašej aplikácii. Pripojte  k výstupu kvapaliny na vašej aplikácii.

V prípade vodou chladených chladiacich jednotiek pripojte  FACILITY INLET (VSTUP ZARIADENIA) k prívodu vody zariadenia. Pripojte  (FACILITY OUTLET) (VÝSTUP ZARIADENIA) k návratu alebo odvodu vody zariadenia.

Pred spustením chladiacej jednotky dvakrát skontrolujte všetky príslušné komunikačné, elektrické a vodovodné pripojky.

Viktiga säkerhetsinstruktioner Atercirkulerande kylare

Om någon av dessa anvisningar är svåra att förstå se handboken eller kontakta oss innan du går vidare.

Säkerhet, alla produkter:

 **DANGER** anger en imminent riskfylld situation som, om den inte undviks, resulterar i allvarliga skador eller dödsfall.

 **WARNING** anger en riskfylld situation som, om den inte undviks, kan resultera i dödsfall eller allvarlig skada.

 **CAUTION** anger en riskfylld situation som, om den inte undviks, kan resultera i lättare eller medelsvåra skador. Den ska även användas för att varna om riskfyllda metoder.

 avsedd för att varna användaren om ej isolerad "farlig spänning" inuti kylarens hölje. Spänningen är tillräckligt hög för att utgöra en risk för elchock.

 anger att det finns heta ytor.

 anger att man bör läsa i handboken.

Använd inte utrustningen som steril eller ansluten till patient. Utrustningen är heller inte designad för användning i riskfyllda miljöer Klass I, II eller III, enligt definition i Nationella elbestämmelser.

Utrustningen är endast designad för inomhusbruk. Placera den aldrig på en plats med hög värme, fuktighet, otillräcklig ventilation eller där det förekommer frätande ämnen. Se handboken för driftsparametrar.

Anslut utrustningen till ett korrekt jordat uttag.

Kylmedium som används är tyngre än luft och kommer, om en läcka uppstår, att tränga ut syre vilket orsakar medvetlöshet. Kontakt med läckande kylmedium orsakar brännskador på hud. Se cirkulationspumpens namsskylt för typ av kylmedium som används och sedan tillverkarens aktuella US Säkerhetsdatablad (SDS), tidigare kallat MSDS, och EU Säkerhetsdatablad för ytterligare information.

Flytta utrustningen varsamt. Plötsliga ryck eller fall kan skada dess komponenter. Stäng alltid av utrustningen och koppla bort strömförsörjningen innan den flyttas.

Använd aldrig skadad eller läckande utrustning.

Använd aldrig brandfarliga eller frätande vätskor. Använd endast godkända vätskor som listas i handboken. Innan man använder vätskor eller utför underhåll där man troligen kommer i kontakt med vätskor ska man se tillverkarens aktuella US Säkerhetsdatablad (SDS) och EU Säkerhetsdatablad för ytterligare information.

Stäng alltid av utrustningen och koppla bort strömförsörjningen innan den flyttas.

Överlåt service och reparationer till en behörig tekniker.

Förvara utrustningen inom temperaturområdet -25°C till 60°C (i förpackning) och <80 % relativ luftfuktighet.

Urtagning ur drift för endast utföras av behörig återförsäljare med certifierad utrustning. Alla gällande bestämmelser måste följas.

Installations-, drift- eller underhållsprocedurer, förutom de som beskrivs i handboken, kan resultera i riskfyllda situationer och kommer att upphäva tillverkarens garanti.

Applicera aldrig nätspänning till någon av kylarens kommunikationsanslutningar.

Om man inte fyller kylaren och processvätskeledningar helt så kan kylarens pump skadas. Undvik övertfyllning. Vätskor expanderar när de värms upp.

Innan man byter ut behållaren på ThermoFlex, så måste man försäkra att kulan i siktröret sitter säkert på plats.

På ThermoFlex900-5000 får man inte använda kylaren om vätskediffusern inte är installerad på behållaren.

På ThermoChill får man inte fylla över läppen, då vätska kommer att läcka ut vid tankens topp över komponenterna inuti kylaren.

Om din kylare har en positiv displacementpump (P1 eller P2), ska du försäkra att ledningarna är klassade för ett tryck på minst 185 psi.

Använd inte kylmedel för bilar. Kommersiella frysskydd innehåller silikat som skadar pumpens tätningar.

För att undvika frysningsfrost av plattvärmeväxlaren, så kräver kylarna ThermoFlex7500-24000 att man använder 50/50 EG/vatten eller 50/50 PG/vatten under 10°C processstemperatur.

När man använder en vätskeblandning med EG/vatten eller PG/vatten, så ska man kontrollera vätskekonzentrationen och pH-värdet regelbundet. Ändringar i koncentration och pH-värde kan påverka systemets prestanda.

Använd inte avjoningsfilter (DI) med inhiberat EG eller inhiberat PG. Ett avjoningsfilter avlägsnar inhibitorer från lösningen vilket gör vätskan ineffektiv mot rost. Inhibitorer höjer även vätskans konduktivitet.

Biocider är frätande och kan orsaka permanenta skador på ögon och brännskador på huden. De är skadliga vid inandning, förtäring eller om de absorberas genom huden. Se tillverkarens aktuella SDS.

För att förebygga skador på kylarens plattvärmeväxlare, så kräver centrifugalpumparna ett flöde på minst 4,0 gpm (15,1 lpm).

Om man inte rengör/ersätter kondensatorfiltret föröror man kylningsprestanda, vilket snabbare leder till fel i kylningssystemet. För en grundlig rengöring så avlägsnar man frontgallret.

På luftkylda kylare så är kondesatorns ram och fenor bakom gallret mycket skarpa.

Förutom med det luftkylda gallret så ska man aldrig starta kylaren med någon panel borttagen.

ThermoFlex900-5000 vattenkylda kylare har en fläkt med skarpa blad, så försäkra att kylaren är avstängd innan frontgallret avlägsnas.

Avsedd användning, Återcirkuleringskylare:

Återcirkuleringskylare från Thermo Scientific är designade för att tillhandahålla kontinuerligt vätskeflöde vid en konstant temperatur och hastighet. Kylaren består av ett lyft- eller vattenkyllt kylningssystem, värmeväxlare, återcirkuleringspump, behållare för processvätska och en styrmodul med mikroprocessor.

Kylare är designade för kontinuerlig drift och för inomhusbruk i enlighet med alla procedurer och krav som anges i denna handbok.

Installation, Återcirkulerande kylare:

Placera kylaren så att den befinner sig nära, med enkel åtkomst till, dess avstängningsanordning.

Kylaren är avsedd för att användas med ett för detta avsett uttag.

Försäkra att alla transportskydd avlägsnas från rör innan installation.

För att förebygga skador vid installation/borttagning av rören på Polar-kylare, så ska man använda en 19 mm nyckel på de externa anslutningarna-

Processvätskornas anslutningar sitter på kylarens baksida och är märkta med  (PROCESS OUTLET) och  (PROCESS INLET). Anslut  till vätskeinloppet på er applikation. Anslut  till vätskeutloppet på er applikation.

För vattenkylda kylare så ansluter man  (FACILITY INLET) till er anläggnings vattenförsörjning. Anslut  (FACILITY OUTLET) till er anläggnings vattenretur eller avlopp.

Innan kylaren startas så ska man dubbelkolla alla kommunikationer, samt elektriska och avloppsanslutningar.

Fluorinated Greenhouse Gases

The following information is included to comply with REGULATION (EU) No 517/2014 OF THE EUROPEAN PARLIAMENT AND OF THE COUNCIL of 16 April 2014 on fluorinated greenhouse gases:

This product contains fluorinated greenhouse gases in a hermetically sealed system.

If a leak in the sealed system is detected, the operator shall repair without undue delay.

For ThermoFlex24000 air-cooled chillers, after repair the operator shall ensure that the equipment is checked by a certified natural person within one month after the repair to verify that the repair has been effective.

Refer to the F-Gas Declaration of Conformity for additional information.

Fluorierte Treib- hausgase

Die folgende Information ist in diesen Unterlagen gemäß der VERORDNUNG (EU) Nr. 517/2014 DES EUROPÄISCHEN PARLAMENTS UND DES RATES vom 16. April 2014 über fluorierte Treibhausgase enthalten.

Dieses Produkt enthält fluorierte Treibhausgase in einem hermetisch geschlossenen System.

Wird ein Leck im geschlossenen System entdeckt, muss der Anwender dieses unverzüglich reparieren.

Im Fall der luftgekühlten Umwälzkühler ThermoFlex24000 muss der Anwender nach der Reparatur sicherstellen, dass das Gerät innerhalb eines Monats nach der Reparatur von einer zertifizierten natürlichen Person daraufhin überprüft wird, ob die Reparatur wirksam war.

Gaz à effet de serre fluorés

Les informations suivantes sont fournies de façon à respecter la RÉGLEMENTATION (UE) N° 517/2014 DU PARLEMENT EUROPÉEN ET DU CONSEIL datée du 16 avril 2014 et portant sur les gaz à effet de serre fluorés :

Ce produit contient des gaz à effet de serre fluorés intégrés à un système hermétiquement scellé.

Toute fuite détectée dans le système scellé doit être réparée immédiatement par l'opérateur.

Pour les refroidisseurs refroidis par air ThermoFlex24000, l'opérateur doit faire en sorte que l'équipement soit contrôlé par une personne physique agréée dans un délai d'un mois suivant la réparation, afin de s'assurer de l'efficacité de la réparation.

Gases de efecto invernadero fluorados

La siguiente información se incluye de acuerdo con la REGULACIÓN (UE) N°. 517/2014 DEL PARLAMENTO Y EL CONSEJO EUROPEO el 16 de abril de 2014 sobre gases de efecto invernadero fluorados:

Este producto contiene gases de efecto invernadero en un sistema sellado herméticamente.

Si se detecta una fuga en el sistema sellado, el operador la reparará sin ninguna demora indebida.

En los enfriadores refrigerados por aire ThemoFlex24000, después de la reparación, el operador se asegurará de que una persona física certificada compruebe el equipo en un plazo de un mes después de la reparación para verificar que esta ha sido efectiva.

Fluorerade växthusgaser

Följande information finns med för att efterleva EUROPAPARLAMENTETS OCH RÅDETS FÖRORDNING (EU) nr. 517/2014 av den 16 april 2014 om fluorerade växthusgaser:

Den här produkten innehåller fluorerade växthusgaser i ett hermetiskt förseglat system.

Om en läcka i det förseglade systemet identifieras, ska operatören reparera det utan dröjsmål.

För ThemoFlex24000 luftkylda kylare, ska operatören efter reparation tillse att utrustningen kontrolleras av en certifierad fysisk person inom en månad från reparationen, för att verifiera att reparationen har varit lyckad.

Fluorovani gasovi sa efektom staklene bašte

Sledeće informacije su uključene u skladu sa UREDBOM (EU) br. 517/2014 EVROPSKOG PARLAMENTA I SAVETA od 16. aprila 2014. o fluorovanim gasovima sa efektom staklene bašte:

Ovaj proizvod sadrži fluorovane gasove sa efektom staklene bašte u hermetički zatvorenom sistemu.

Ako se otkrije curenje iz zatvorenog sistema, korisnik mora popraviti kvar bez nepotrebnog odlaganja.

Za ThemoFlex24000 rashlađivače hladene vazduhom, korisnik posle popravke mora osigurati da se oprema pregleda od strane ovlašćenog fizičkog lica u roku od mesec dana nakon popravke da bi se potvrdilo da je popravka bila efikasna.

Fluorirani toplogredni plini

Informacije v nadaljevanju so vključene za izpolnitev zahtev iz UREDBE (EU) ŠT. 517/2014 EVROPSKEGA PARLAMENTA IN SVETA z dne 16. aprila 2014 o fluoriranih toplogrednih plinih:

Ta izdelek vsebuje fluorirane toplogredne pline v hermetično zaprtem sistemu.

Če se ugotovi uhajanje plinov iz zaprtega sistema, ga upravljavec brez nepotrebnega odlašanja popravi.

Po popravilu zračno hlajenih hladilnih agregatov ThemoFlex24000 upravljavec zagotovi, da opremo v enem mesecu po popravilu pregleda fizična oseba s spričevalom in preveri, ali je bilo popravilo uspešno.

Fluorované skleníkové plyny

Nasledujúce informácie sú tu uvedené z dôvodu súladu s NARIADENÍM (EÚ) Č. 517/2014 EURÓPSKEHO PARLAMENTU A RADY zo 16. apríla 2014 o fluorovaných skleníkových plynoch:

Tento produkt obsahuje fluorované skleníkové plyny v hermeticky uzavretom systéme.

Ak dôjde v uzavretom systéme k únikom, operátor ho musí bez zbytočného oneskorenia opraviť.

Po oprave vzduchových chladičov ThermoFlex 24000 musí operátor zabezpečiť, aby zariadenie do jedného mesiaca od vykonania opravy skontrolovala osvedčená fyzická osoba, ktorá zhodnotí, či bola oprava efektívna.

Gazele fluorurate cu efect de ser

Următoarele informații sunt redactate în conformitate cu REGULAMENTUL (UE) NR. 517/2014 AL PARLAMENTULUI EUROPEAN I AL CONSILIULUI din 16 aprilie 2014 privind gazele fluorurate cu efect de seră:

Acest produs conține gaze fluorurate cu efect de seră închise într-un sistem ermetic.

În cazul în care se detectează o scurgere la sistemul etanșat, operatorul trebuie să efectueze reparațiile necesare fără întârzieri nejustificate.

Pentru refrigeratoarele cu aer răcit ThemoFlex24000, după reparație, operatorii trebuie să se asigure că echipamentul va fi inspectat de către o persoană fizică certificată, la o lună de la reparație, pentru a verifica dacă aceasta s-a realizat în mod eficient.

Gases fluorados com efeito de estufa

As seguintes informações foram incluídas para efeitos de conformidade com o REGULAMENTO (UE) N.º 517/2014 DO PARLAMENTO E CONSELHO EUROPEUS de 16 de abril de 2014 relativo aos gases fluorados com efeito de estufa:

Este produto contém gases fluorados com efeito de estufa num sistema hermeticamente fechado.

Em caso de deteção de fuga no sistema fechado, o operador deverá repará-la sem atraso injustificado.

No caso dos refrigeradores a ar ThermoFlex24000, após uma reparação, o operador deverá assegurar a inspeção do equipamento por parte de uma pessoa qualificada no prazo de um mês após a reparação, de forma a garantir a eficácia da mesma.

Fluorowane gazy cieplarniane

Poniższa informacja została zamieszczona w celu spełnienia wymagań określonych w ROZPORZĄDZENIU PARLAMENTU EUROPEJSKIEGO I RADY (UE) NR 517/2014 z 16 kwietnia 2014 roku w sprawie fluorowanych gazów cieplarnianych:

Ten produkt zawiera fluorowane gazy cieplarniane w hermetycznie zamkniętym układzie.

W przypadku stwierdzenia wycieku z hermetycznie zamkniętego układu operator ma obowiązek dokonania naprawy urządzenia bez zbędnej zwłoki.

Po ewentualnej naprawie agregatów chłodniczych chłodzonych powietrzem ThermoFlex24000 operator ma obowiązek zapewnienia, aby urządzenie zostało skontrolowane przez certyfikowaną osobę fizyczną w ciągu miesiąca od naprawy w celu sprawdzenia, czy naprawa była skuteczna.

Gefluoreerde broei- kassgassen

De volgende informatie is toegevoegd om te voldoen aan VERORDENING (EU) Nr. 517/2014 VAN HET EUROPEES PARLEMENT EN DE RAAD van 16 april 2014 betreffende gefluoreerde broeikasgassen:

Dit product bevat gefluoreerde broeikasgassen in een hermetisch afgesloten systeem.

Indien er een lek wordt gedetecteerd in het afgesloten systeem, dient de gebruiker deze te repareren zonder onnodige vertraging.

Bij de luchtgekoelde koelinstallaties ThermoFlex24000 dient de gebruiker er na de reparatie voor te zorgen dat de apparatuur wordt gecontroleerd door een gecertificeerde natuurlijke persoon, binnen een maand nadat de reparatie plaatsvindt, om te controleren of de reparatie is geslaagd.

Gassijiet Fluworurati b'Effett ta' Serra

L-informazzjonijiet ġejja hi inluża biex tikkonforma mar-REGOLAMENT (UE) Nru 517/2014 TAL-PARLAMENT EWROPEW U TAL-KUNSILL tas-16 ta' April 2014 dwar gassijiet fluworurati b'effett ta' serra:

Dan il-prodott fih gassijiet fluworurati b'effett ta' serra f'sistema ssiġillata ermetikament.

Jekk tinstab tnixxija fis-sistema ssiġillata, l-operatur għandu jsewwi mingħajr dewmien bla bżonn.

Għal chillers ThemoFlex 24000 imkessha bl-arja, wara t-tiswija, l-operatur għandu jiżgura li t-tagħmir jiġi vverifikat minn persuna fiżika ċcertifikata fi żmien xahar wara t-tiswija biex tivverifika li t-tiswija kienet effettiva.

Fluor tas siltumn cefekta g zes

Turpmāk norādītā informācija ir iekļauta, lai nodrošinātu atbilstību EIROPAS PARLAMENTA UN PADOMES REGULAI (ES) Nr. 517/2014 (2014. gada 16. aprīlis) par fluorētām siltumnīcefekta gāzēm.

Šis izstrādājums satur fluorētas siltumnīcefekta gāzes hermētiski noslēgtā sistēmā.

Ja hermētiski noslēgtajā sistēmā tiek konstatēta noplūde, operators to salabo bez nepamatotas kavēšanās.

Pēc gaisa dzesētāju ThemoFlex24000 labošanas operators nodrošina, ka mēneša laikā no labošanas darbu veikšanas brīža sertificēta fiziskā persona pārbauda aprīkojumu, lai apstiprinātu, ka labošanas darbi bijuši sekmīgi.

Fluorintos šiltnamio efekt sukelianios dujos

Toliau pateikta informācija yra iŕtraukta, kad bŭtų laikomasi 2014 m. balandžio 16 d. EUROPOS PARLAMENTO IR TARYBOS REGLAMENTO (ES) Nr. 517/2014 dėl fluorintų šiltnamio efektą sukeliančių dujų.

Hermetiškai sandarioje šio produkto sistemoje yra fluorintų šiltnamio efektą sukeliančių dujų.

Jei aptinkamas sandarios sistemos nuotėkis, operatorius nedelsdamas turi jį suremontuoti.

Jeji naudojami „ThemoFlex24000“ oru aušinami aušintuvai, po remonto darbų operatorius užtikrina, kad įrangą patikrins sertifikuotas fizinis asmuo per vieną mėnesį nuo remonto darbų, kad bŭtų patikrinta, jog remonto darbai buvo veiksmingi.

Gas fluorurati a effetto serra

Si includono le seguenti informazioni in conformità con il REGOLAMENTO (UE) N. 517/2014 DEL PARLAMENTO EUROPEO E DEL CONSIGLIO del 16 aprile 2014 sui gas fluorurati a effetto serra:

Il presente prodotto contiene gas fluorurati a effetto serra all'interno di un sistema a chiusura ermetica.

In caso di perdita del sistema a chiusura ermetica, l'operatore dovrà prontamente provvedere alla riparazione.

Per i refrigeratori ad aria ThemoFlex24000, dopo la riparazione l'operatore dovrà assicurarsi di far controllare l'apparecchiatura da una persona fisica certificata entro un mese dalla riparazione al fine di verificare l'efficacia della stessa.

Fluortartalmú üvegházhatású gázok

A következő tájékoztatás az EURÓPAI PARLAMENT ÉS A TANÁCS (EU) 517/2014. SZÁMÚ, 2014. április 16-i, a fluortartalmú üvegházhatású gázokkal kapcsolatos RENDELETÉBEN előírtak teljesítése érdekében került a dokumentumba:

A termék fluortartalmú üvegházhatású gázokat tartalmaz, hermetikusan zárt rendszerben.

Ha a zárt rendszerben szivárgás jelentkezik, az üzemeltető köteles a lehető leghamarabb megszüntetni azt.

A ThemoFlex24000 léghűtőkön végzett javítás után az üzemeltető köteles a javítástól számított egy hónapon belül megfelelő tanúsítvánnyal rendelkező természetes személlyel ellenőriztetni, hogy a javítás hatásos volt-e.

Fluorirani stakleni ki plinovi

Informacije navedene u nastavku u skladu su s UREDBOM (EU) br. 517/2014 EUROPSKOG PARLAMENTA I VIJEĆA od 16. travnja 2014. o fluoriranim stakleničkim plinovima:

Ovaj proizvod sadrži fluorirane stakleničke plinove u hermetički zatvorenom sustavu.

Ako se u hermetički zatvorenom sustavu otkrije propuštanje, operater ga mora popraviti bez nepotrebne odgode.

Za zrakom hladene rashladnike vode ThemoFlex24000, operater nakon popravka osigurava da opremu provjeri certificirana fizička osoba u roku od mjesec dana od popravka kako bi potvrdila uspješnost popravka.

Gáis Cheaptha Teasa Fhluairínithe

Áirítear an fhaisnéis a leanas chun RIALACHÁN (AE) Uimh. 517/2014 Ó PHARLAIMINT NA hEORPA AGUS ÓN gCOMHAIRLE an 16 Aibreán 2014 maidir le gáis cheaptha teasa fhlúairínithe a chomhlíonadh:

Cuimsíonn an táirgeadh seo gáis cheaptha teasa fhlúairínithe i gcóras atá séalaithe go heirméiteach.

Má bhraitear sceitheadh sa chóras séalaithe, déanfaidh an t-oibreoir deisiúchán gan mhoill.

I gcás fuaraitheoirí aerfhuaraithe ThemoFlex24000, tar éis an deisiúcháin áiritheoidh an t-oibreoir go ndéanfaidh duine nádúrtha deimhnithe an trealamh a sheiceáil laistigh d'aon mhí tar éis an deisiúcháin le deimhniú go raibh an deisiúchán éifeachtach.

Fluoratut kasvihuonekaasut

Seuraavat tiedot on lisätty, jotta noudatetaan 16. päivänä huhtikuuta 2014 fluoratuista kasvihuonekaasuista annettua EUROOPAN PARLAMENTIN JA NEUVOSTON ASETUSTA (EU) N:o 517/2014:

Tämä tuote sisältää fluorattuja kasvihuonekaasuja hermeettisesti tiivistetyssä järjestelmässä.

Jos tiivistetyssä järjestelmässä havaitaan vuoto, käyttäjän on korjattava se viipymättä.

Ilmajäähdytteisten ThemoFlex24000-jäähdyttimien korjaamisen jälkeen käyttäjän on varmistettava, että valtuutettu luonnollinen henkilö varmistaa korjauksen tarkistamalla laitteen kuukauden kuluessa korjauksesta.

Fluoritud kasvuhoo- negaasid

Alljärgnev teave on lisatud, et järgida EUROOPA PARLAMENDI JA NÕUKOGU MÄÄRUST NR 517/2014 16. aprill 2014 fluoritud kasvuhoo-negaaside kohta.

See toode sisaldab hermeetiliselt suletud süsteemis fluoritud kasvuhoo-negaase.

Lekke tuvastamise korral hermeetiliselt suletud süsteemis peab operaator viivitamatult lekke remontima.

Õhkjahutusega jahutite ThemoFlex24000 korral peab operaator pärast remonti tagama, et seadmeid kontrolliks sertifitseeritud füüsiline isik ühe kuu jooksul pärast remonditööd, et kinnitada remonditöö tulemuslikkus.

μ π

Οι ακόλουθες πληροφορίες περιλαμβάνονται για λόγους συμμόρφωσης με τον ΚΑΝΟΝΙΣΜΟ (ΕΕ) αριθ. 517/2014 ΤΟΥ ΕΥΡΩΠΑΪΚΟΥ ΚΟΙΝΟΒΟΥΛΙΟΥ ΚΑΙ ΤΟΥ ΣΥΜΒΟΥΛΙΟΥ της 16ης Απριλίου 2014 για τα φθοριούχα αέρια του θερμοκηπίου:

Το παρόν προϊόν περιέχει φθοριούχα αέρια του θερμοκηπίου σε ερμητικά σφραγισμένο σύστημα.

Σε περίπτωση ανίχνευσης διαρροής στο σφραγισμένο σύστημα, ο χειριστής προβαίνει σε επιδιόρθωση χωρίς αδικαιολόγητη καθυστέρηση.

Για τους αερόψυκτους ψύκτες ThemoFlex24000, ο χειριστής διασφαλίζει ότι ο εξοπλισμός ελέγχεται από πιστοποιημένο φυσικό πρόσωπο εντός ενός μήνα μετά την επιδιόρθωση, ώστε να επιβεβαιώνεται ότι η επιδιόρθωση ήταν αποτελεσματική.

Fluorholdige drivhusgasser

Nedenstående oplysninger er medtaget som dokumentation for overholdelse af EUROPA-PARLAMENTET OG RÅDETS FORORDNING (EU) nr. 517/2014 af 16. april 2014 om fluorholdige drivhusgasser:

Dette produkt indeholder fluorholdige drivhusgasser i et hermetisk forsejlet system.

Hvis der konstateres en lækage i det forsejlede system, skal operatøren hurtigst muligt reparere lækagen.

Hvad angår luftkølede luftkølere af typen ThemoFlex 24000, skal operatøren sørge for, at udstyret inden for én måned efter reparationen kontrolleres af en fagmand, der kan bekræfte, at der er tale om en effektiv reparation.

Fluorované skleníkové plyny

Následující informace jsou zahrnuty pro dodržení PŘEDPISU (EU) č. 517/2014 EVROPSKÉHO PARLAMENTU A RADY ze dne 16. dubna 2014 o fluorovaných skleníkových plynech:

Tento výrobek obsahuje fluorované skleníkové plyny v hermeticky utěsněném systému.

Pokud je v systému zjištěn únik, provozovatel ho musí okamžitě opravit.

U vzduchem chlazených chladičů ThemoFlex24000 musí provozovatel po opravě zajistit, aby bylo zařízení do jednoho měsíce po opravě zkontrolováno fyzickou osobou s osvědčením, aby se ověřilo, že oprava byla účinná.

Флуорсъдържащи парникови газове

Следната информация е включена в съответствие с РЕГЛАМЕНТ (ЕС) № 517/2014 НА ЕВРОПЕЙСКИЯ ПАРЛАМЕНТ И НА СЪВЕТА от 16 април 2014 г. за флуорсъдържащите парникови газове:

Този продукт съдържа флуорсъдържащи парникови газове в херметично затворена система.

Ако в затворената система бъде засечен теч, операторът трябва незабавно да извърши ремонт.

При ремонт на чилъри с въздушно охлаждане ThermoFlex24000 операторът трябва да осигури проверка на оборудването от сертифицирано лице в рамките на един месец след ремонта като гаранция, че ремонтът е ефективен.

Declaration of conformity with Article 14 of Regulation (EU) No 517/2014 of the European Parliament and of the Council

We, Thermo Fisher Scientific (Asheville) LLC, F-Gas Portal Registration Number 23643, declare under our sole responsibility that when placing on the market pre-charged equipment, which we import to or manufacture in the Union, the hydrofluorocarbons contained in that equipment are accounted for within the quota system referred to in Chapter IV of Regulation (EU) No 517/2014 as:

We hold authorisation(s) issued in accordance with Article 18(2) of Regulation (EU) No 517/2014 and registered in the registry referred to in Article 17 of that Regulation, at the time of release for free circulation to use the quota of a producer or importer of hydrofluorocarbons subject to Article 15 of Regulation (EU) No 517/2014 that cover(s) the quantity of hydrofluorocarbons contained in the equipment.

The hydrofluorocarbons contained in the equipment have been placed on the market in the Union, subsequently exported and charged into the equipment outside the Union, and the undertaking that placed the hydrofluorocarbons on the market made a declaration stating that the quantity of hydrofluorocarbons has been or will be reported as placed on the market in the Union and that it has not been and will not be reported as direct supply for export in the meaning of Article 15(2)(c) of Regulation (EU) No 517/2014 pursuant to Article 19 of Regulation (EU) No 517/2014 and Section 5C of the Annex to Commission Implementing Regulation (EU) No 1191/2014.

January 1, 2017

Date

Mark Pearson, Director Global Regulatory Affairs

[name and position of legal representative]



[signature of legal representative]

Manufacturer:

Thermo Fisher Scientific (Asheville) LLC
275 Aiken Road
Asheville, NC 28804
U.S.A.

EU Only Representative:

Thermo Electron LED GmbH
Robert-Bosch-Strasse 1
D-63505 Langenselbold
Germany
VAT ID Number: DE 812 403 137

Section 2 General Information

Description

The Thermo Scientific ThermoFlex™ recirculating chillers are designed to provide a continuous supply of fluid at a constant temperature and flow rate. The chiller consists of an air-cooled or water-cooled refrigeration system, heat exchanger, recirculating pump, polyethylene reservoir and a microprocessor controller.

Specifications

	ThermoFlex900	ThermoFlex1400	ThermoFlex2500
Process Fluid Temperature and Setpoint Range	+5°C to +40°C +41°F to +104°F	+5°C to +40°C +41°F to +104°F	+5°C to +40°C +41°F to +104°F
Ambient Temperature Range	+10°C to +40°C +50°F to +104°F	+10°C to +40°C +50°F to +104°F	+10°C to +40°C +50°F to +104°F
Temperature Stability	±0.1°C	±0.1°C	±0.1°C
Cooling Capacity at 20°C 60Hz 50Hz	900 W (3074 BTU) 750 W (2561 BTU)	1400 W (4781 BTU) 1170 W (3996 BTU)	2500 W (8538 BTU)* 2200 W (7513 BTU)
*To meet this specification, the ThermoFlex2500 air-cooled chillers require the fan to be operating in the high-speed mode, see Section 3.			
Refrigerant	R134A	R134A	R134A
Reservoir Volume Gallons Liters	1.9 7.2	1.9 7.2	1.9 7.2
Footprint or Dimensions (H x W x D)			
Inches	27.3 x 14.2 x 24.6	27.3 x 14.2 x 24.6	29.0 x 17.2 x 26.5
Centimeters	69.2 x 36.0 x 62.4	69.2 x 36.0 x 62.4	73.6 x 43.6 x 67.3
Weight P2 Pump (empty) lb kg	130.5 59.2	130.5 59.2	175.5 79.6
Pumping Capacity			
P1/MD1 - Positive Displacement 60Hz 50Hz		2.1 gpm @ 60 psig (7.9 lpm @ 4.1 bar) 1.7 gpm @ 60 psig (6.4 lpm @ 4.1 bar)	
P2/MD2 - Positive Displacement 60Hz* 50Hz*		4.0 gpm @ 60 psig (15.1 lpm @ 4.1 bar) 3.3 gpm @ 60 psig (12.5 lpm @ 4.1 bar)	
T0 - Turbine 60Hz* 50Hz*		2.0 gpm @ 60 psid (7.6 lpm @ 4.1 bar) 1.3 gpm @ 60 psid (4.9 lpm @ 4.1 bar)	
T1 - Turbine 60Hz* 50Hz*		3.5 gpm @ 60 psid (13.3 lpm @ 4.1 bar) 2.5 gpm @ 60 psid (9.5 lpm @ 4.1 bar)	

* Pressure values for turbine pumps are differential pressures between the inlet and the outlet of the chiller.

- Cooling capacity based on P2 pumps with no backpressure. Heat input from the pump will result in a reduction in cooling capacity. The cooling capacity reduction will vary based on the pump chosen as well as pump backpressure and flow.
- Specifications obtained at sea level using water as the recirculating fluid, at a 20°C process setpoint, 25°C ambient condition, at nominal operating voltage. Other fluids, fluid temperatures, ambient temperatures, altitude or operating voltages will affect performance. See Section 3.
- Additional dimensions are at the end of this section, add 1/8" (3 mm) to height for SEMI.
- Add 5 pounds (2 kilograms) for global voltage chillers.
- Thermo Fisher Scientific reserves the right to change specifications without notice.

Specifications

	ThermoFlex3500	ThermoFlex5000
Process Fluid Temperature and Setpoint Range	+5°C to +40°C +41°F to +104°F	+5°C to +40°C +41°F to +104°F
Ambient Temperature Range	+10°C to +40°C +50°F to +104°F	+10°C to +40°C +50°F to +104°F
Temperature Stability	± 0.1°C	± 0.1°C
Cooling Capacity at 20°C 60 Hz 50 Hz	3500 W (11953 BTU) 3050 W (10416 BTU)	5000 W (17076 BTU) 4400 W (15027 BTU)
Refrigerant	R407C	R407C
Reservoir Volume Gallons Liters	1.9 7.2	1.9 7.2
Footprint or Dimensions (H x W x D) Inches Centimeters	38.9 x 19.3 x 30.9 98.7 x 48.8 x 78.4	38.9 x 19.3 x 30.9 98.7 x 48.8 x 78.4
Weight P1/ P2/P3/P4 (empty) lb kg	264/264/270/303 120/120/123/138	NA/264/270/303 NA/120/123/138
Pumping Capacity		
P1/MD1 - Positive Displacement 60 Hz 50 Hz	2.1 gpm @ 60 psig (7.9 lpm @ 4.1 bar) 1.7 gpm @ 60 psig (6.4 lpm @ 4.1 bar)	Not Available Not Available
P2/MD2 - Positive Displacement 60 Hz* 50 Hz *	4.0 gpm @ 60 psig (15.1 lpm @ 4.1 bar) 3.3 gpm @ 60 psig (12.5 lpm @ 4.1 bar)	4.0 gpm @ 60 psig (15.1 lpm @ 4.1 bar) 3.3 gpm @ 60 psig (12.5 lpm @ 4.1 bar)
T1 - Turbine 60 Hz* 50 Hz*	3.5 gpm @ 60 psid (13.3 lpm @ 4.1 bar) 2.5 gpm @ 60 psid (9.5 lpm @ 4.1 bar)	3.5 gpm @ 60 psid (13.3 lpm @ 4.1 bar) 2.5 gpm @ 60 psid (9.5 lpm @ 4.1 bar)
P3 - Centrifugal Pump 60 Hz* 50 Hz*	10 gpm @ 32 psid (37.9 lpm @ 2.2 bar) 10 gpm @ 20 psid (37.9 lpm @ 1.4 bar)	10 gpm @ 32 psid (37.9 lpm @ 2.2 bar) 10 gpm @ 20 psid (37.9 lpm @ 1.4 bar)
P4 - Centrifugal Pump 60 Hz* 50 Hz*	15 gpm @ 57 psid (56.8 lpm @ 3.9 bar) 15 gpm @ 34 psid (56.8 lpm @ 2.3 bar)	15 gpm @ 57 psid (56.8 lpm @ 3.9 bar) 15 gpm @ 34 psid (56.8 lpm @ 2.3 bar)

* Pressure values for turbine and centrifugal pumps are differential pressures between the inlet and the outlet of the chiller.

- Cooling capacity based on P2 pumps with no backpressure. Heat input from the pump will result in a reduction in cooling capacity. The cooling capacity reduction will vary based on the pump chosen as well as pump backpressure and flow.
- Specifications obtained at sea level using water as the recirculating fluid, at a 20°C process setpoint, 25°C ambient condition, at nominal operating voltage. Other fluids, fluid temperatures, ambient temperatures, altitude or operating voltages will affect performance. See Section 3.
- Additional dimensions are at the end of this section, add 1/8" (3 cm) to height for SEMI.
- Add 30 pounds (14 kilograms) for global voltage chillers.
- Thermo Fisher Scientific reserves the right to change specifications without notice.

Specifications

	ThermoFlex7500	ThermoFlex10000
Process Fluid Temperature and Setpoint Range	+5°C to +40°C +41°F to +104°F	+5°C to +40°C +41°F to +104°F
Ambient Temperature Range	+10°C to +40°C +50°F to +104°F	+10°C to +40°C +50°F to +104°F
Temperature Stability	±0.1°C	±0.1°C
Cooling Capacity at 20°C 60 Hz 50 Hz	7500 W (25575 BTU) 6425 W (21910 BTU)	10000 W (34100 BTU) 8500 W (28985 BTU)
Refrigerant	R407C	R407C
Reservoir Volume Gallons Liters	4.75 17.9	4.75 17.9
Footprint or Dimensions (H x W x D)		
Air-Cooled Inches	52.3 x 25.2 x 33.8	52.3 x 25.2 x 33.8
Centimeters	132.7 x 63.9 x 85.6	132.7 x 63.9 x 85.6
Water-Cooled Inches	45.9 x 25.2 x 33.8	45.9 x 25.2 x 33.8
Centimeters	116.6 x 63.9 x 85.6	116.6 x 63.9 x 85.6
Weight P2/P3/P5 (empty)		
Air-Cooled lb	356/372.5/405.5	356/372.5/405.5
kg	161.5/169/184	161.5/169/184
Water-Cooled lb	315/331.5/364.5	315/331.5/364.5
kg	143/150/165	143/150/165
Pumping Capacity		
P2/MD2 - Positive Displacement 60 Hz	4.0 gpm @ 60 psig (15.1 lpm @ 4.1 bar)	4.0 gpm @ 60 psig (15.1 lpm @ 4.1 bar)
50 Hz	3.3 gpm @ 60 psig (12.5 lpm @ 4.1 bar)	3.3 gpm @ 60 psig (12.5 lpm @ 4.1 bar)
P3 - Centrifugal Pump 60 Hz*	10 gpm @ 32 psid (37.9 lpm @ 2.2 bar)	10 gpm @ 32 psid (37.9 lpm @ 2.2 bar)
50 Hz*	10 gpm @ 20 psid (37.9 lpm @ 1.4 bar)	10 gpm @ 20 psid (37.9 lpm @ 1.4 bar)
P5 - Centrifugal Pump 60 Hz*	20 gpm @ 60 psid (75.7 lpm @ 4.1 bar)	20 gpm @ 60 psid (75.7 lpm @ 4.1 bar)
50 Hz*	20 gpm @ 35 psid (75.7 lpm @ 2.4 bar)	20 gpm @ 35 psid (75.7 lpm @ 2.4 bar)
T 5 - Turbine Pump 60 Hz*	7.3 gpm @ 60 psid (27.6 lpm @ 4.1 bar)	7.3 gpm @ 60 psid (27.6 lpm @ 4.1 bar)
50 Hz*	6.2 gpm @ 60 psid (23.5 lpm @ 4.1 bar)	6.2 gpm @ 60 psid (23.5 lpm @ 4.1 bar)

* Pressure values for centrifugal and turbine pumps are differential pressures between the inlet and the outlet of the chiller.

- Cooling capacity based on P2 pumps with no backpressure. Heat input from the pump will result in a reduction in cooling capacity. The cooling capacity reduction will vary based on the pump chosen as well as pump backpressure and flow.
- Specifications obtained at sea level using water as the recirculating fluid, at a 20°C process setpoint, 25°C ambient condition, at nominal operating voltage. Other fluids, fluid temperatures, ambient temperatures, altitude or operating voltages will affect performance. See Section 3.
- Additional dimensions are at the end of this section.
- For global voltage chillers with a P2 pump add 30 pounds (14 kilograms). Add 10 pounds (4.5 kilograms) for chillers with a P3 or P5 pump.
- Thermo Fisher Scientific reserves the right to change specifications without notice.

Specifications

	ThermoFlex15000	ThermoFlex20000	ThermoFlex24000
Process Fluid Temperature and Setpoint Range	+5°C to +40°C +41°F to +104°F	+5°C to +40°C +41°F to +104°F	+5°C to +40°C +41°F to +104°F
Ambient Temperature Range	+10°C to +40°C +50°F to +104°F	+10°C to +40°C +50°F to +104°F	+10°C to +40°C +50°F to +104°F
Temperature Stability	±0.1°C	±0.1°C	±0.1°C
Cooling Capacity at 20°C 60 Hz 50 Hz	15000 W (51228 BTU) 12525 W (42775 BTU)	20000 W (68304 BTU) 16700 W (57043 BTU)	24000 W (81964 BTU) 21000 W (71719 BTU)
Refrigerant	R407C	R407C	R407C
Reservoir Volume Gallons Liters	4.75 17.9	4.75 17.9	4.75 17.9
Footprint or Dimensions (H x W x D)			
Air-Cooled Inches Centimeters	49.0 x 46.5 x 30.9 124.4 x 118.1 x 78.6	49.0 x 46.5 x 30.9 124.4 x 118.1 x 78.6	58.6 x 46.5 x 30.9 148.9 x 118.1 x 78.6
Water-Cooled Inches Centimeters	49.0 x 46.5 x 30.9 124.4 x 118.1 x 78.6	49.0 x 46.5 x 30.9 124.4 x 118.1 x 78.6	49.0 x 46.5 x 30.9 124.4 x 118.1 x 78.6
Weight P3 Pump (empty)			
Air-Cooled lb kg	550 249.5	550 249.5	650 294.8
Water-Cooled lb kg	510 231.3	510 231.3	510 231.3
Pumping Capacity			
P3 - Centrifugal Pump 60 Hz* 50 Hz*		10 gpm @ 32 psid (37.9 lpm @ 2.2 bar) 10 gpm @ 20 psid (37.9 lpm @ 1.4 bar)	
P5 - Centrifugal Pump 60 Hz* 50 Hz*		20 gpm @ 60 psid (75.7 lpm @ 4.1 bar) 20 gpm @ 35 psid (75.7 lpm @ 2.4 bar)	

* Pressure values are differential pressures between the inlet and the outlet of the chiller.

- Cooling capacity based on P3 pumps set at 10 gpm. Heat input from the pump will result in a reduction in cooling capacity. The cooling capacity reduction will vary based on the pump chosen as well as pump backpressure and flow.
- Specifications obtained at sea level using water as the recirculating fluid, at a 20°C process setpoint, 25°C ambient condition, at nominal operating voltage. Other fluids, fluid temperatures, ambient temperatures, altitude or operating voltages will affect performance. See Section 3.
- Additional dimensions are at the end of this section.
- Thermo Fisher Scientific reserves the right to change specifications without notice.

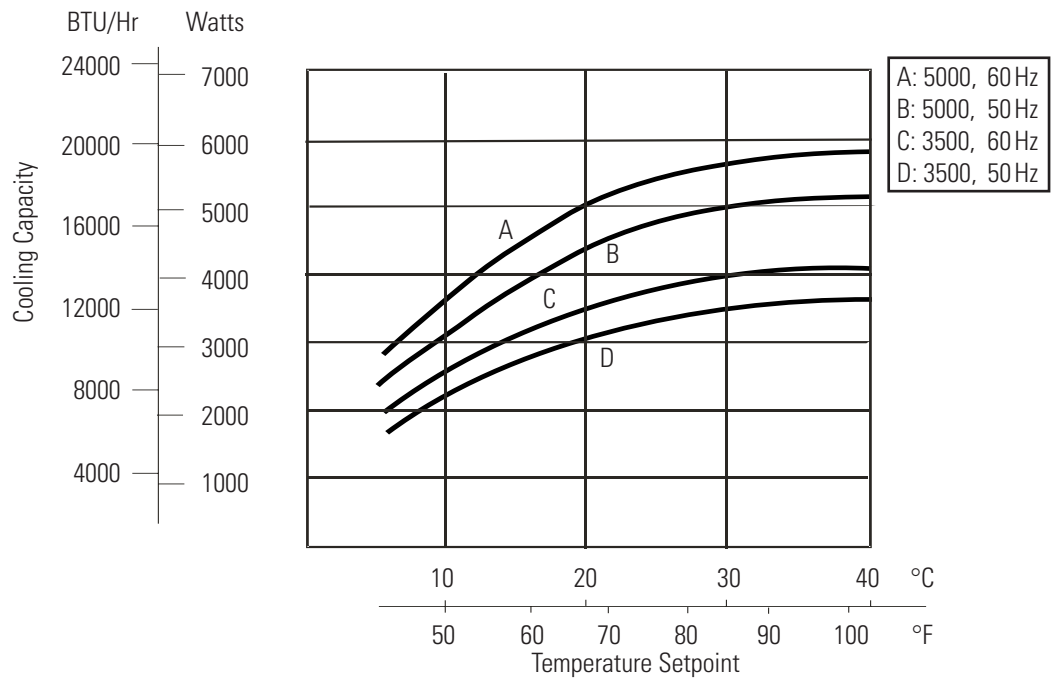
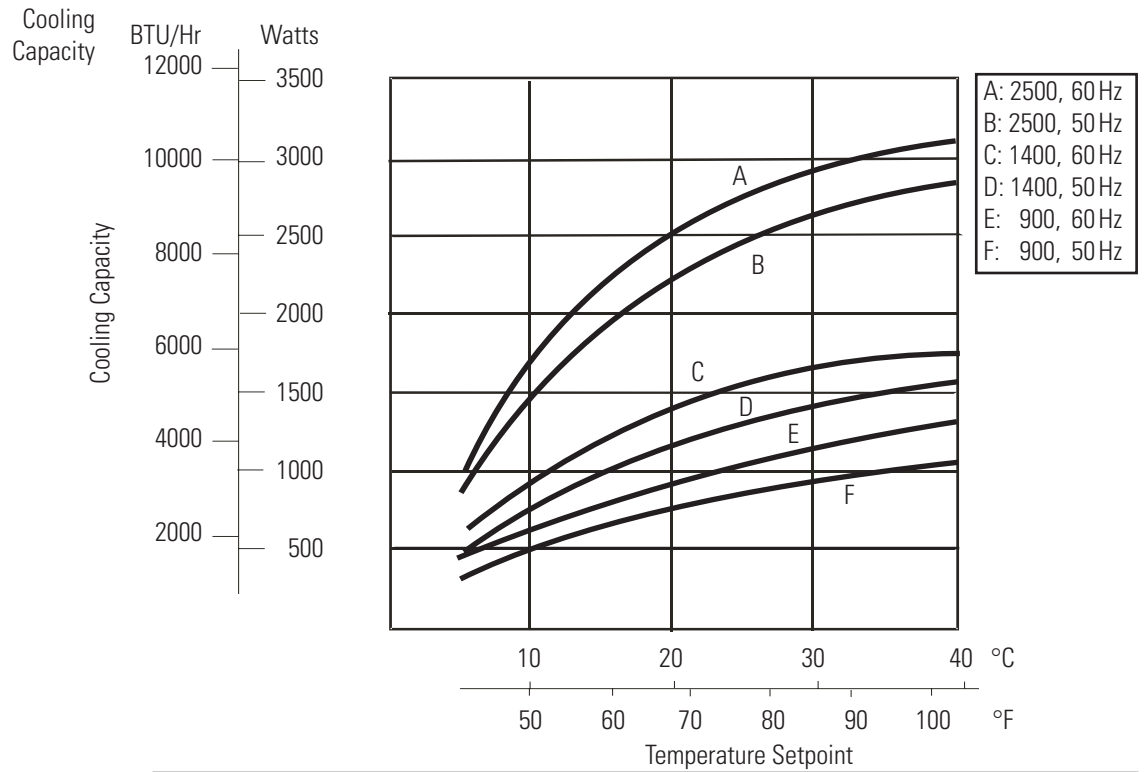

- Specifications obtained at sea level using water as the recirculating fluid, at a 20°C process setpoint, 25°C ambient condition, at nominal operating voltage, on chillers with P2 pumps with no back pressure. Other fluids, fluid temperatures, ambient temperatures, altitude, operating voltages or pumps will affect performance. See Section 3.
- Thermo Fisher Scientific reserves the right to change specifications without notice.

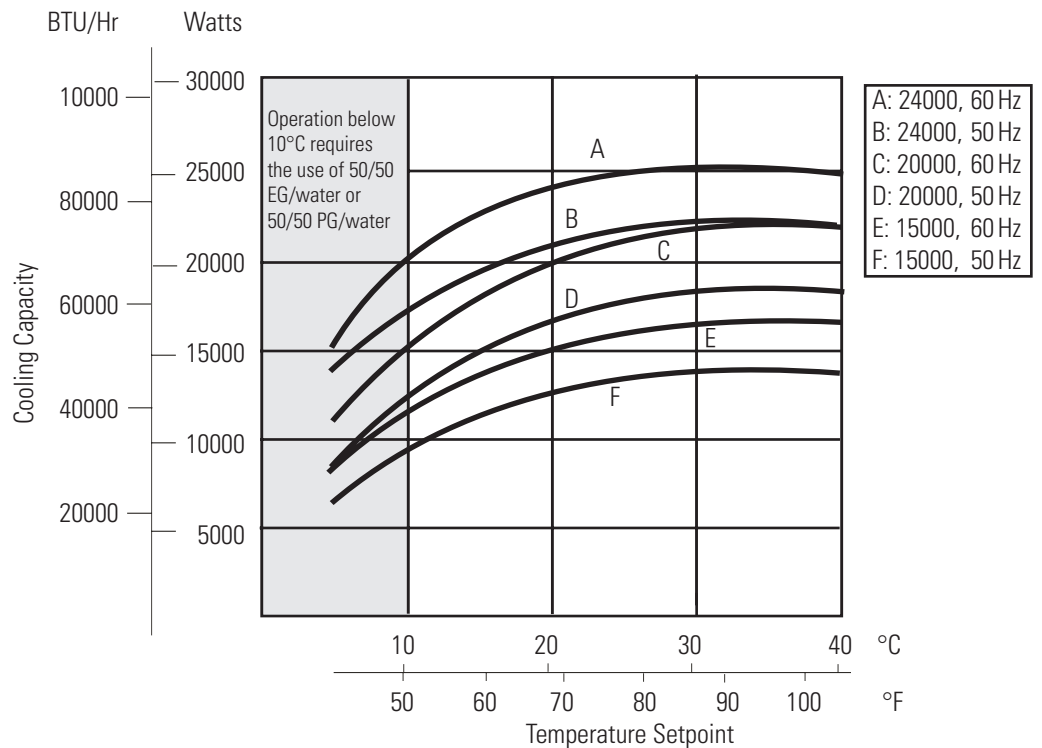
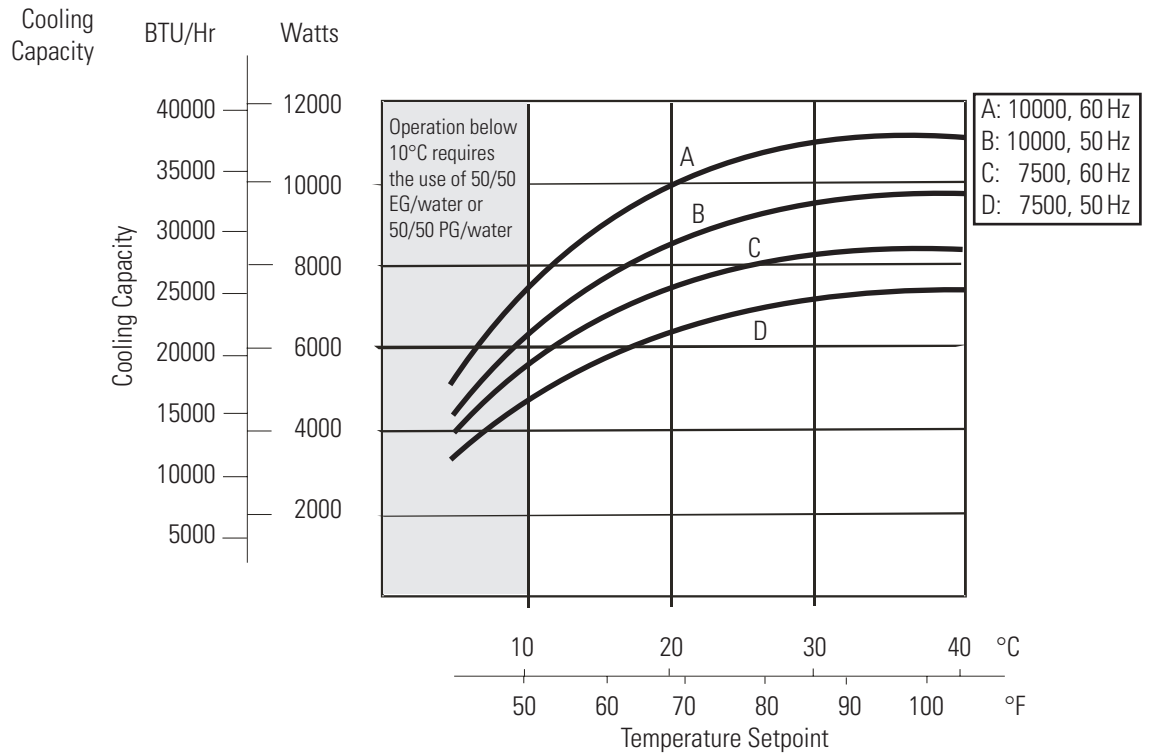

- Specifications obtained at sea level using water as the recirculating fluid, at a 20°C process setpoint, 25°C ambient condition, at nominal operating voltage, on chillers with P2 pumps with no back pressure (P3 pumps set to 10 gpm for ThermoFlex15000 to 24000). Other fluids, fluid temperatures, ambient temperatures, altitude, operating voltages or pumps will affect performance. See Section 3.
- Chillers require the use of 50/50 EG/water or 50/50 PG/water below 10°C process temperature to prevent freezing/glazing of the plate exchanger.
- Thermo Fisher Scientific reserves the right to change specifications without notice.

Pumping Capacity
Positive Displacement Pump P1/P2
Magnetic Drive Pumps MD 1/MD 2

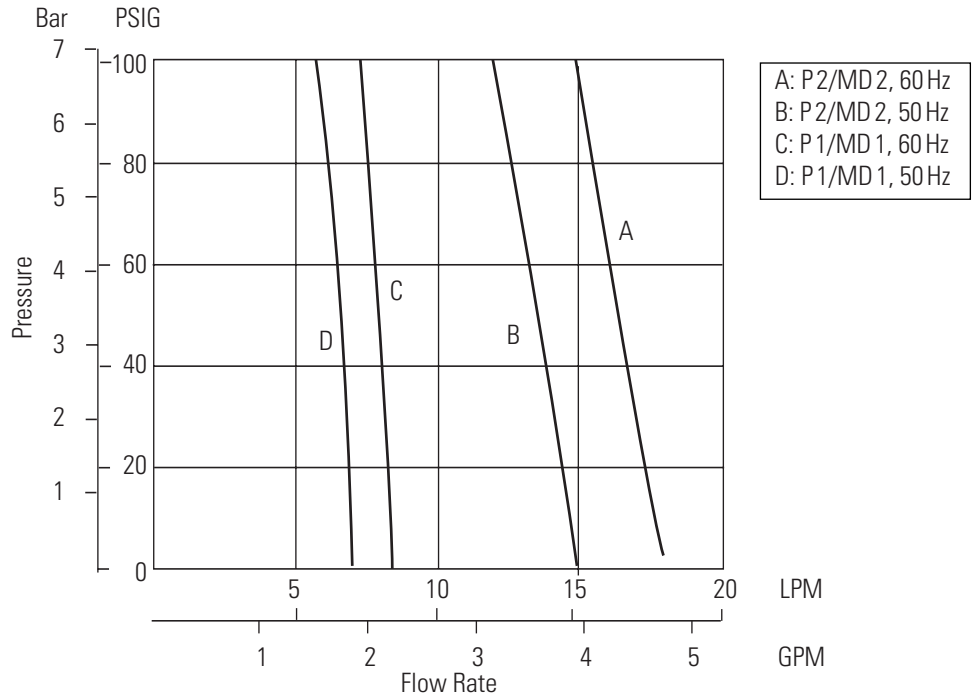

Pumping Capacity
Centrifugal Pump P3/P4

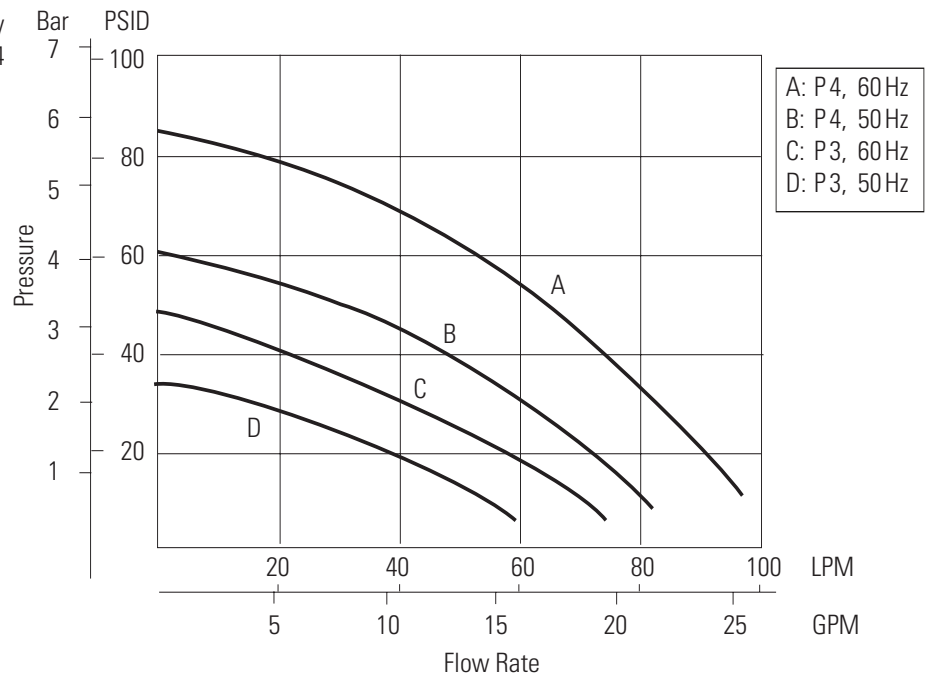

- Pump curves are nominal values. Pressure values for centrifugal pumps are differential pressures between the inlet and the outlet of the chiller.
- Pump performance results were obtained with no restrictions on the return to the system or with any options installed. For example, utilizing the DI option will result in a 0.5 gpm flow reduction .
- Specifications obtained at sea level using water as the recirculating fluid, at a 20°C process setpoint, 25°C ambient condition, at nominal operating voltage. Other fluids, fluid temperatures, ambient temperatures, altitude or operating voltages will affect performance. See Section 3.
- Thermo Fisher Scientific reserves the right to change specifications without notice.

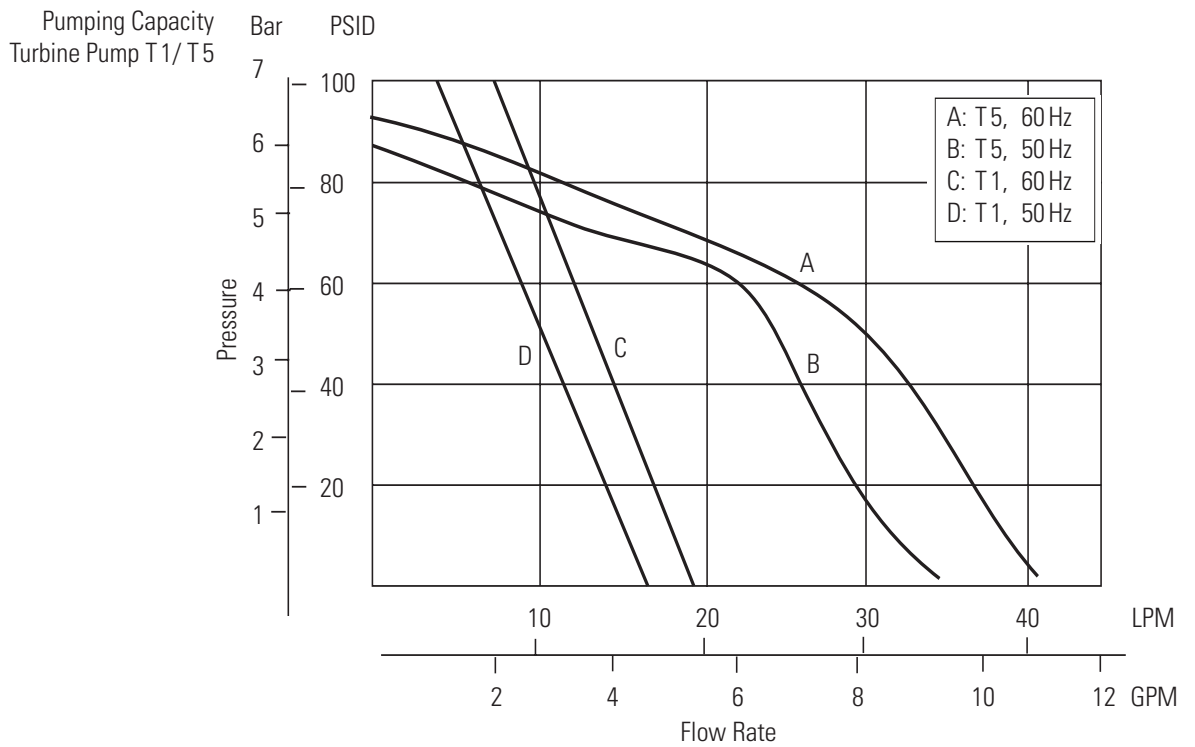
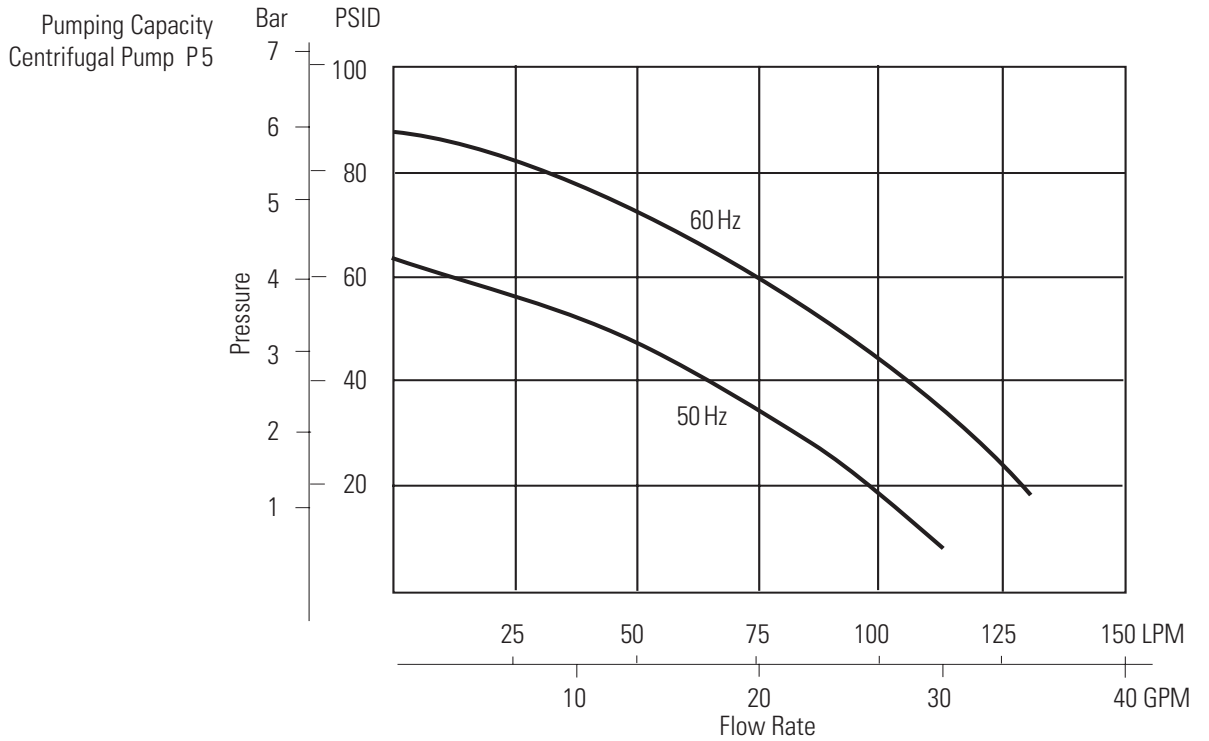

- Pump curves are nominal values. Pressure values for centrifugal and turbine pumps are differential pressures between the inlet and the outlet of the chiller.
- Pump performance results were obtained with no restrictions on the return to the system or with any options installed. For example, utilizing the DI option will result in a 0.5 gpm flow reduction.
- Specifications obtained at sea level using water as the recirculating fluid, at a 20°C process setpoint, 25°C ambient condition, at nominal operating voltage. Other fluids, fluid temperatures, ambient temperatures, altitude or operating voltages will affect performance. See Section 3.
- Thermo Fisher Scientific reserves the right to change specifications without notice.

Pumping Capacity
Turbine Pump T0

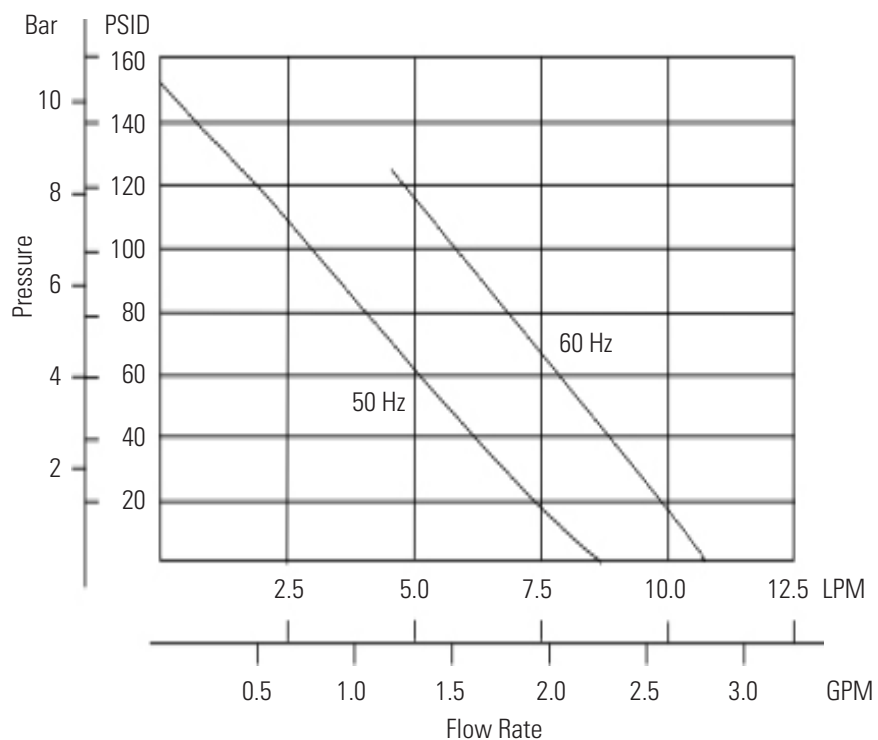

- Pump curves are nominal values. Pressure values for turbine pumps are differential pressures between the inlet and the outlet of the chiller.
- Pump performance results were obtained with no restrictions on the return to the system or with any options installed. For example, utilizing the DI option will result in a 0.5 gpm flow reduction .
- Specifications obtained at sea level using water as the recirculating fluid, at a 20°C process setpoint, 25°C ambient condition, at nominal operating voltage. Other fluids, fluid temperatures, ambient temperatures, altitude or operating voltages will affect performance. See Section 3.
- Thermo Fisher Scientific reserves the right to change specifications without notice.

ThermoFlex900/1400
Dimensions
(inches/centimeters)

Front View

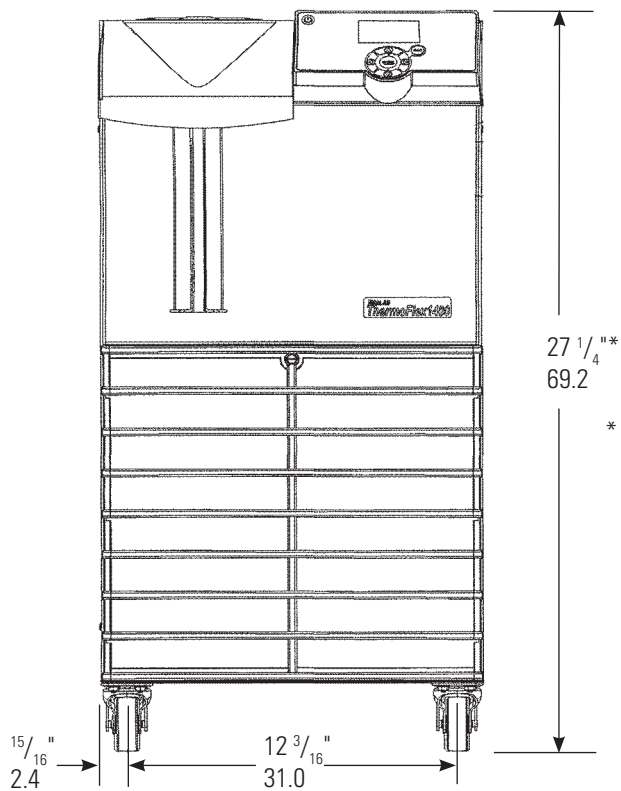

Side View

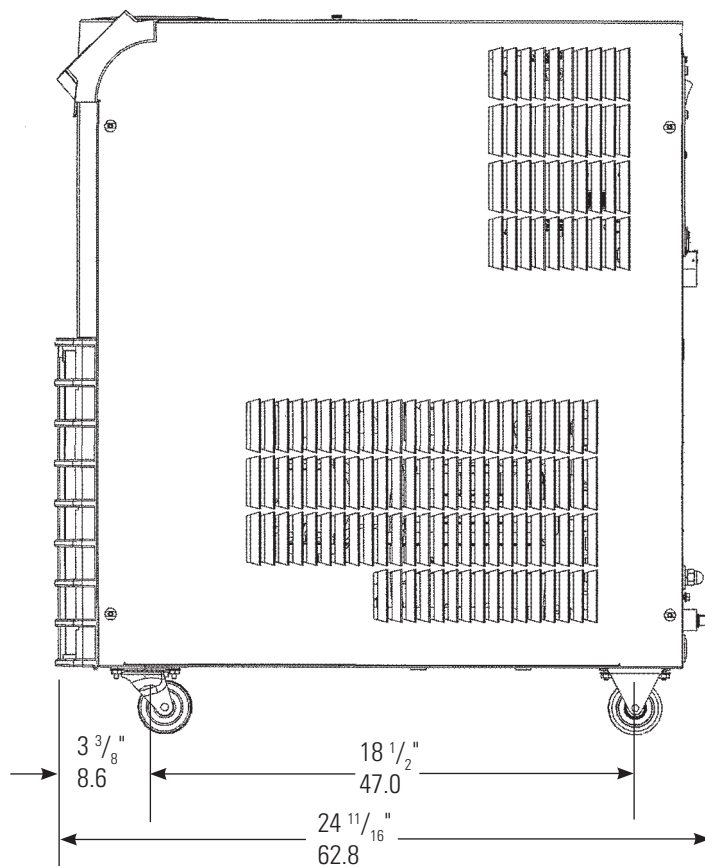

• Thermo Fisher Scientific reserves the right to change specifications without notice.

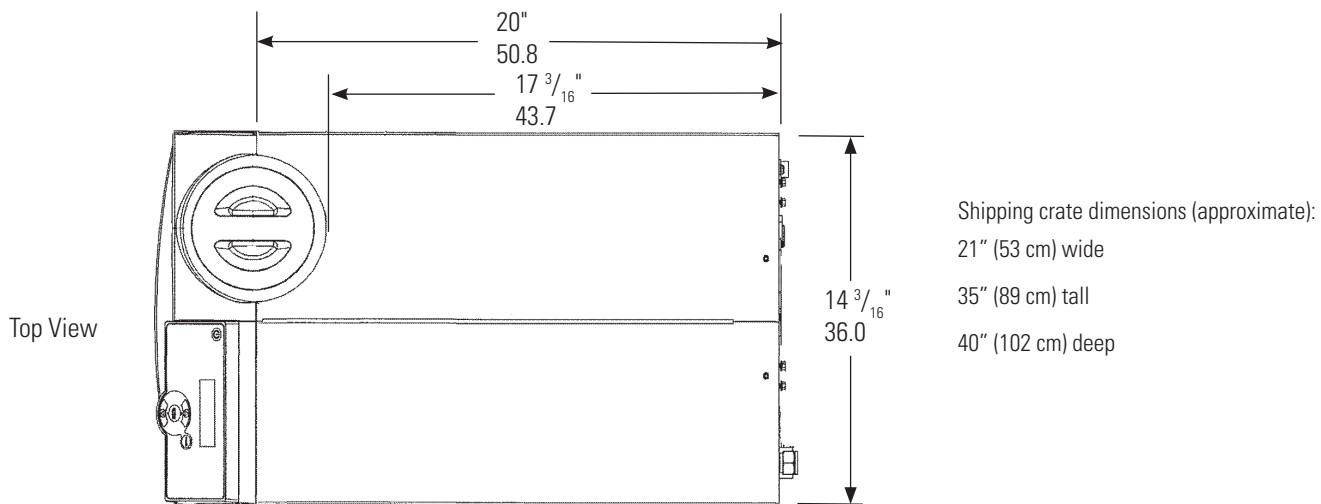
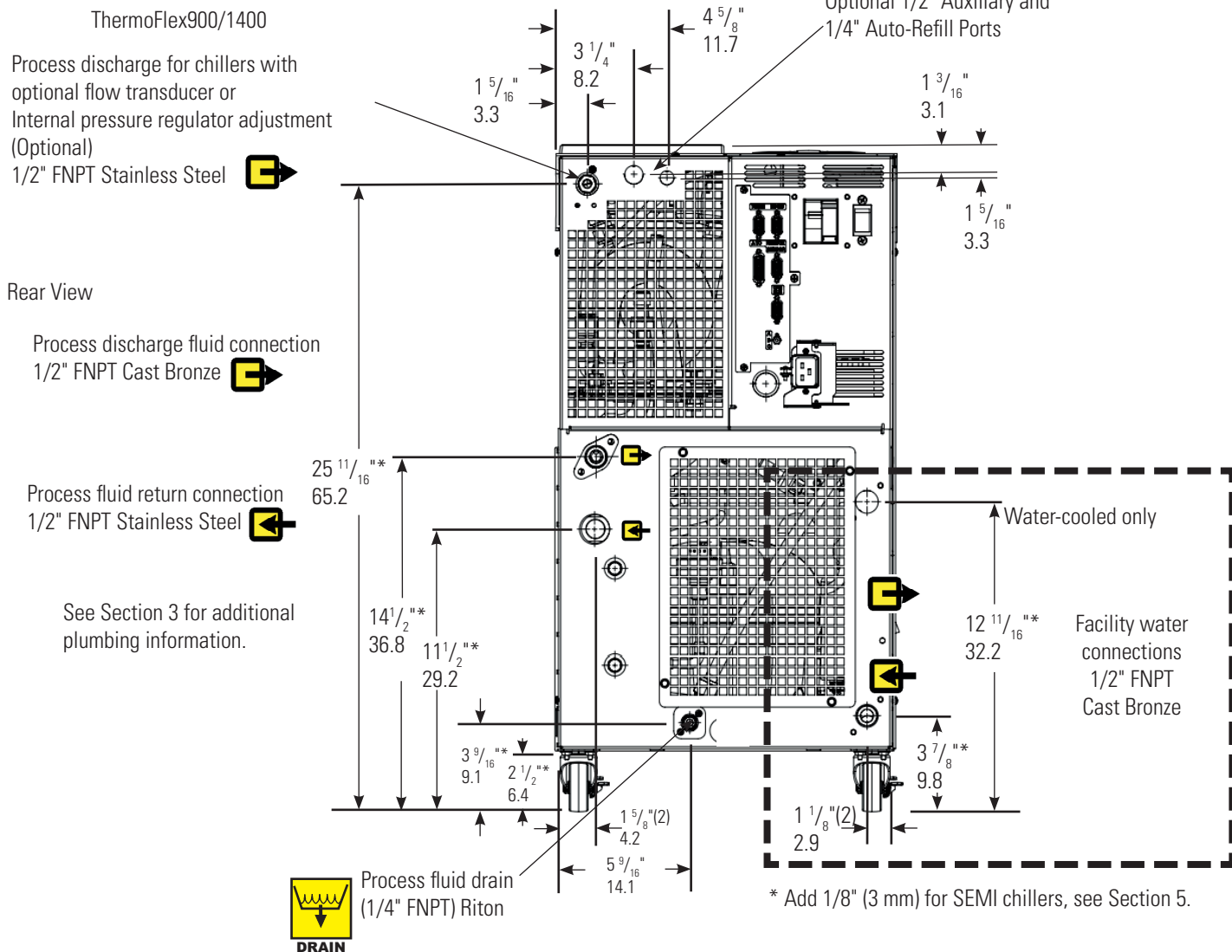

• Thermo Fisher Scientific reserves the right to change specifications without notice.

ThermoFlex2500
Dimensions
(inches/centimeters)

Front View

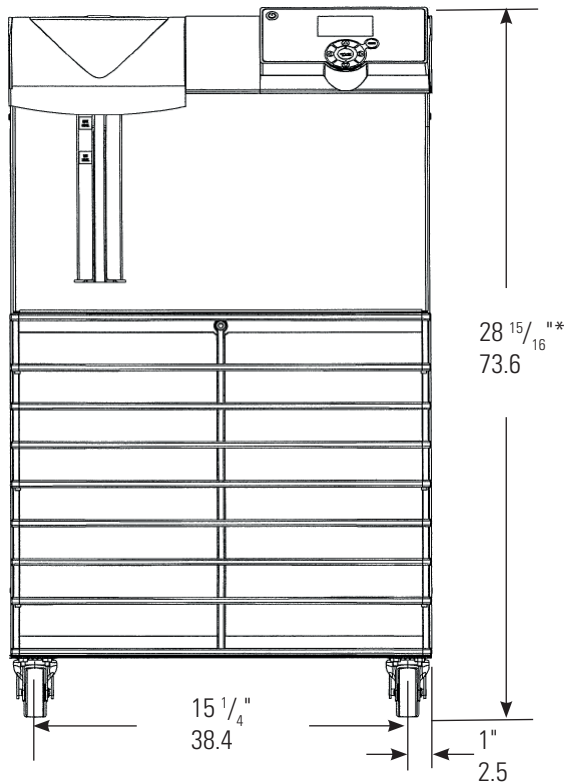

* Add 1/8" (3 mm) for SEMI chillers, see Section 5.

Side View

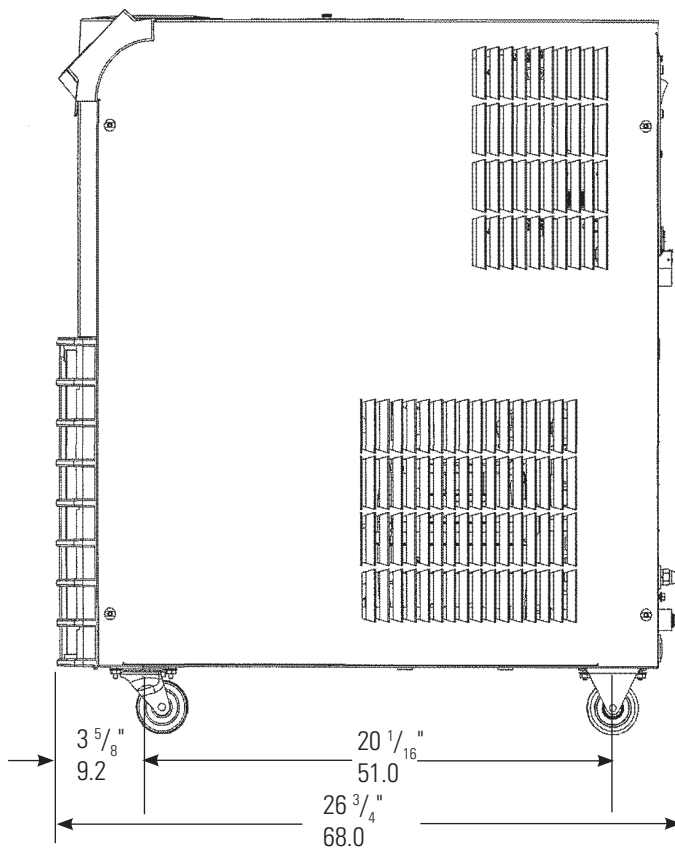

• Thermo Fisher Scientific reserves the right to change specifications without notice.

ThermoFlex2500

Process discharge for chillers with optional flow transducer or Internal pressure regulator adjustment (Optional)
1/2" FNPT Stainless Steel

Process discharge fluid connection
1/2" FNPT Cast Bronze

Process fluid return connection
1/2" FNPT Stainless Steel

Optional 1/2" Auxiliary and 1/4" Auto-Refill Ports

Rear View

See Section 3 for additional plumbing information.



Process fluid drain (1/4" FNPT) Riton

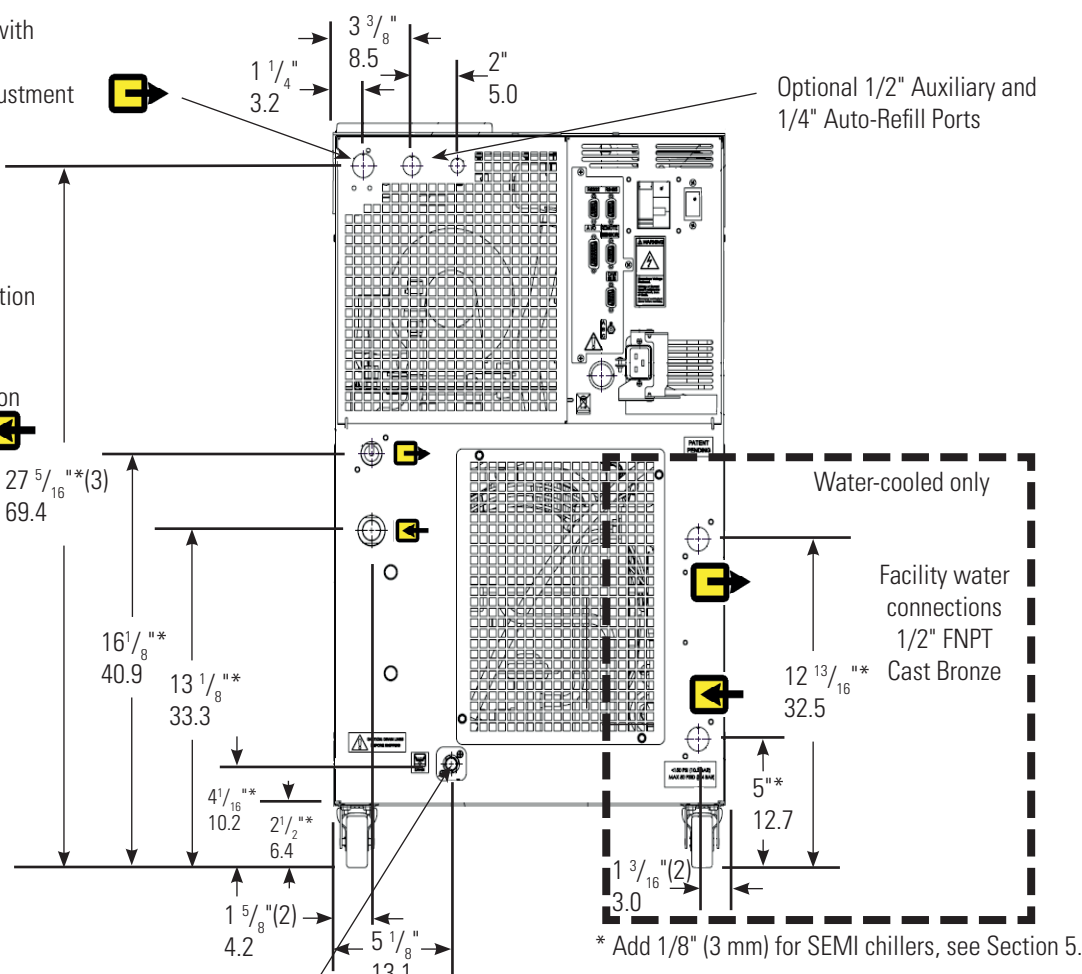

Top View

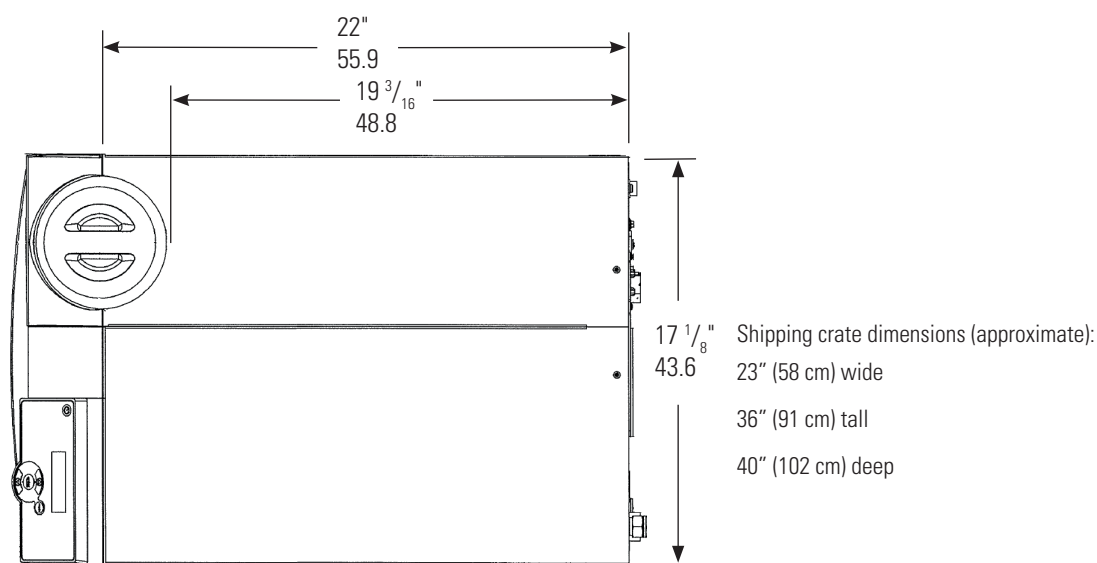

• Thermo Fisher Scientific reserves the right to change specifications without notice.

ThermoFlex3500/5000
Dimensions
(inches/centimeters)

Front View

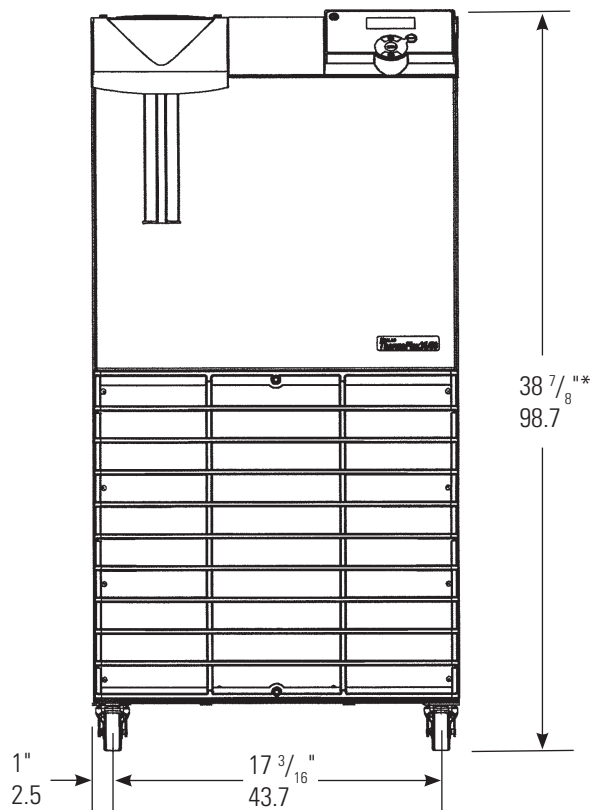

* Add 1/8" (3 mm) for SEMI chillers, see Section 5.

Side View

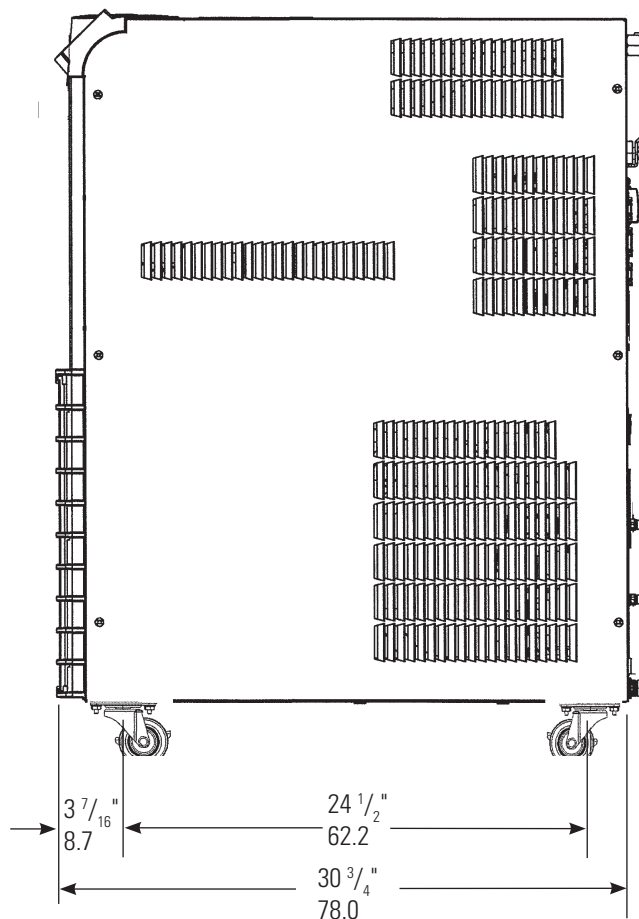

• Thermo Fisher Scientific reserves the right to change specifications without notice.

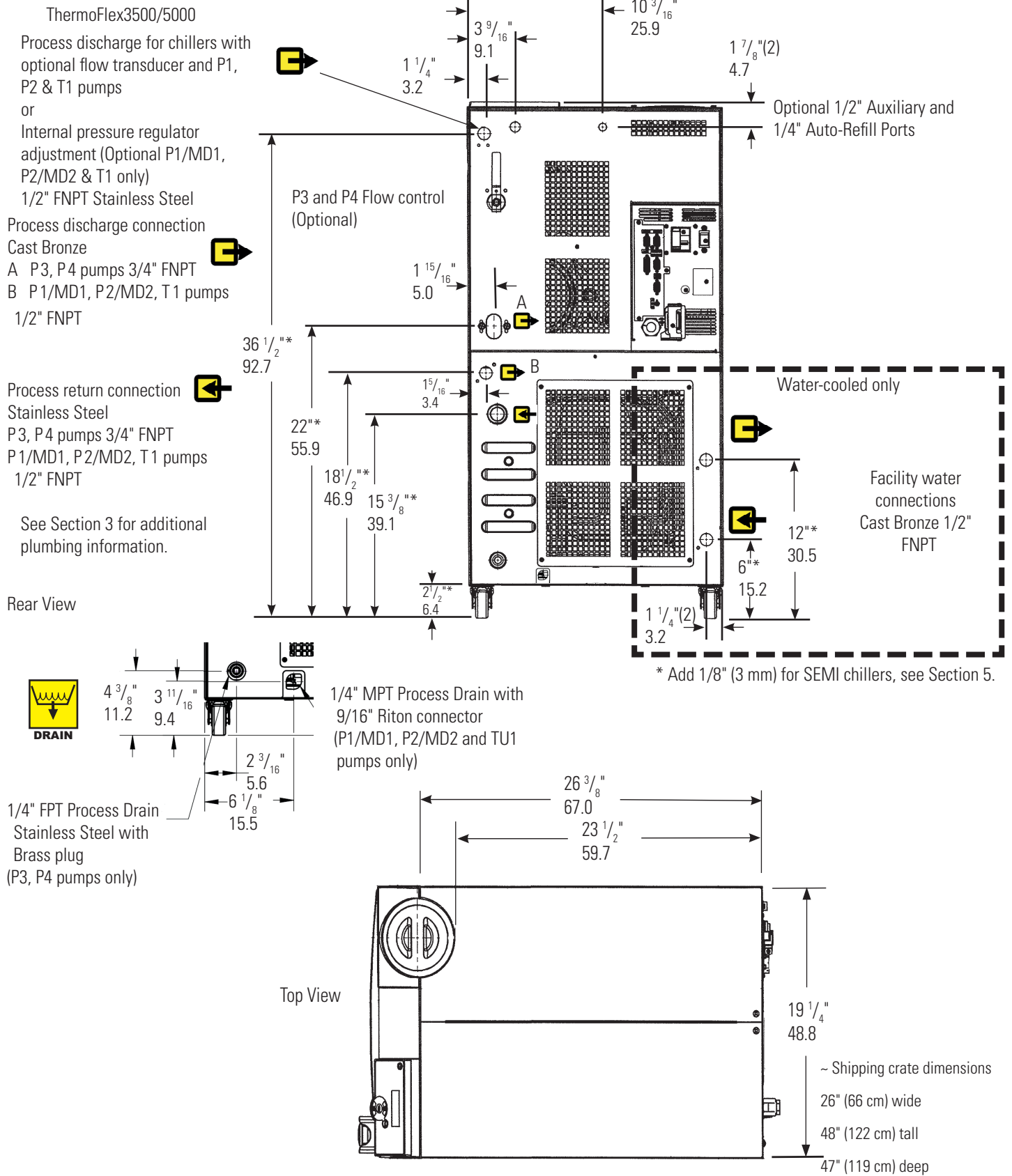

• Thermo Fisher Scientific reserves the right to change specifications without notice.

ThermoFlex7500/10000
 Dimensions
 (inches/centimeters)

Side View

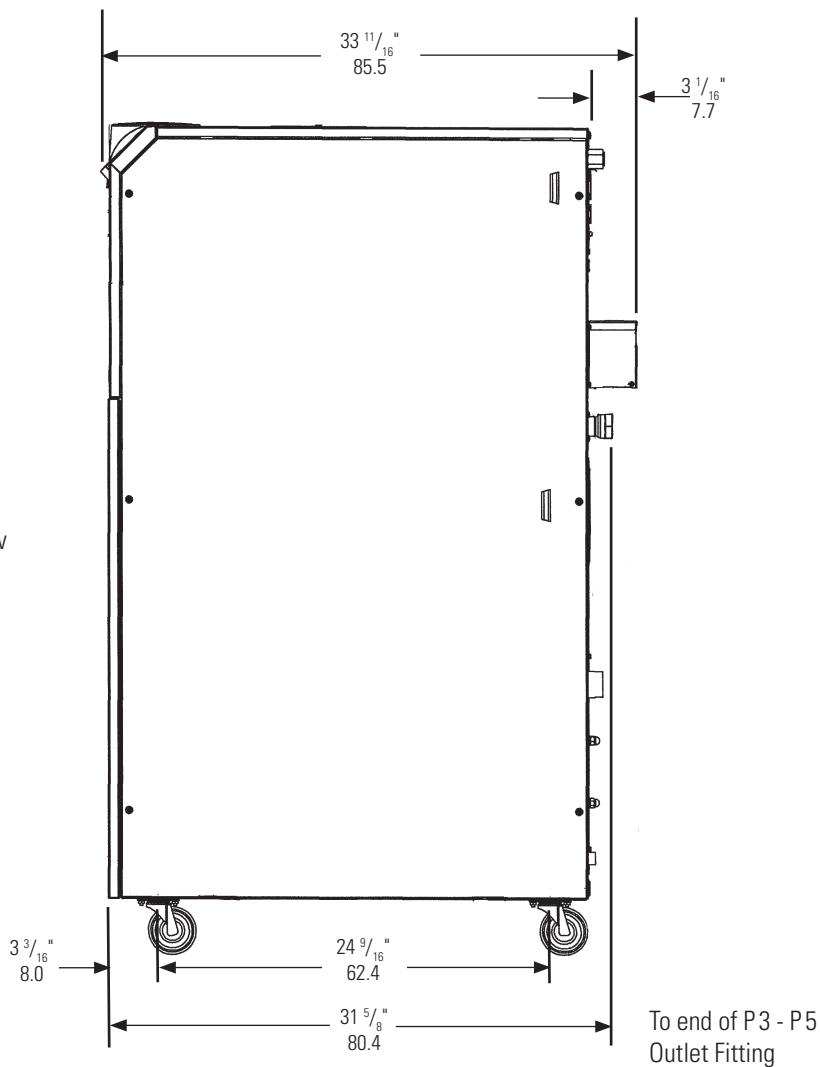

Top View

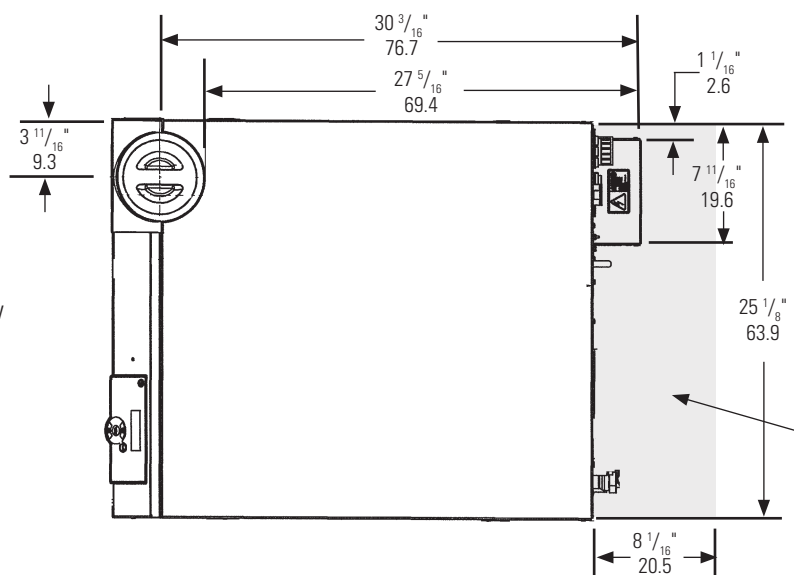

Air-cooled shipping crate
 dimensions (approximate):
 35 3/4" (91 cm) wide
 61 1/2" (156 cm) tall
 46 3/8" (118 cm) deep

The applicable options fit
 within this envelope, see
 Section 5.

- Thermo Fisher Scientific reserves the right to change specifications without notice.

ThermoFlex7500/10000

Rear View
(Air-Cooled)

Process Discharge 

P2/MD2 = 1/2" FNPT
Cast Bronze

P3 - P5, T5= 1" FNPT
Wrought Copper

Process Return

Stainless Steel
P2/MD2 = 1/2" FNPT
P3 - P5, T5 = 1" FNPT 

See Section 3 for
additional plumbing
information.

Process fluid drain (1/4" FNPT)
Stainless Steel with Brass plug or
a Riton connector 

Rear View
(Water-Cooled)

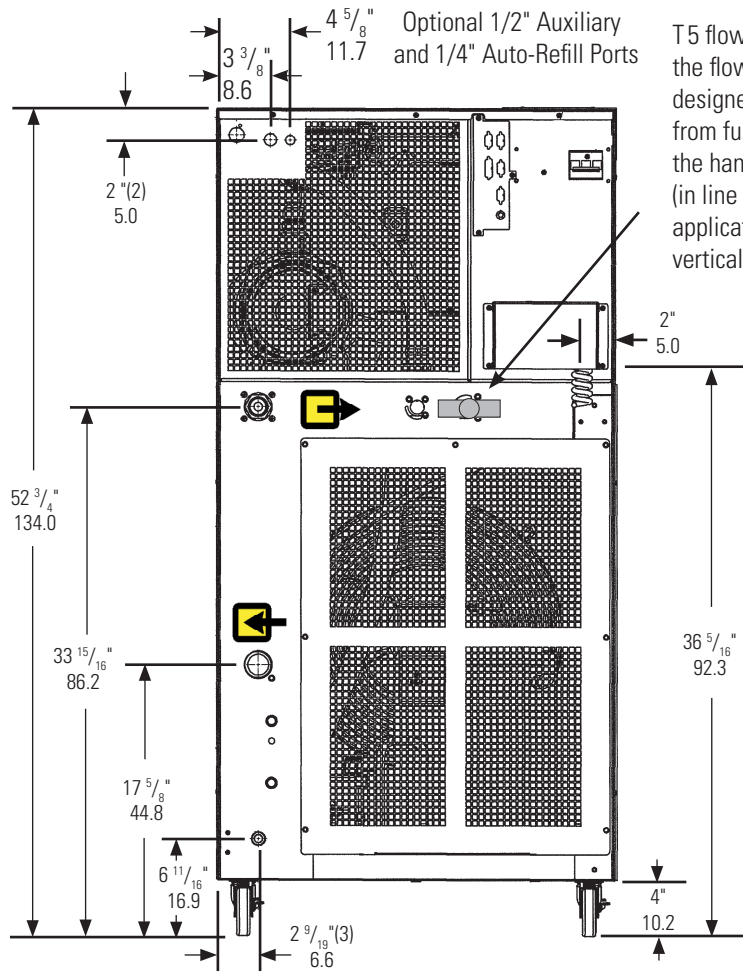

T5 flow control valve is used to adjust the flow rate. The valve's handle is designed to identify the valve's position, from full flow to full bypass. When the handle is in the horizontal position (in line with the discharge line) the application is receiving full flow. When vertical the valve is in full bypass.

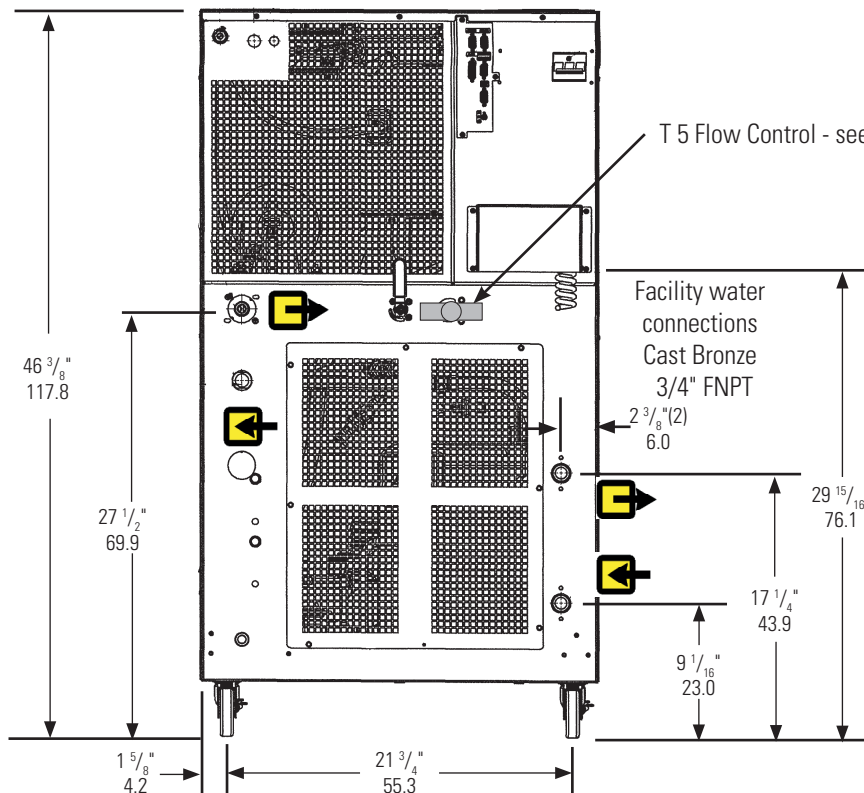
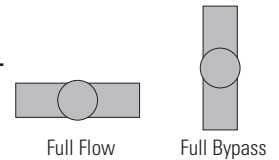

T5 Flow Control - see above.

Facility water
connections
Cast Bronze
3/4" FNPT

ThermoFlex15000/20000/24000
 Dimensions
 (inches/centimeters)

Front View

For ThermoFlex24000
 Air-Cooled Chillers
 $58 \frac{5}{8}''$
 148.9

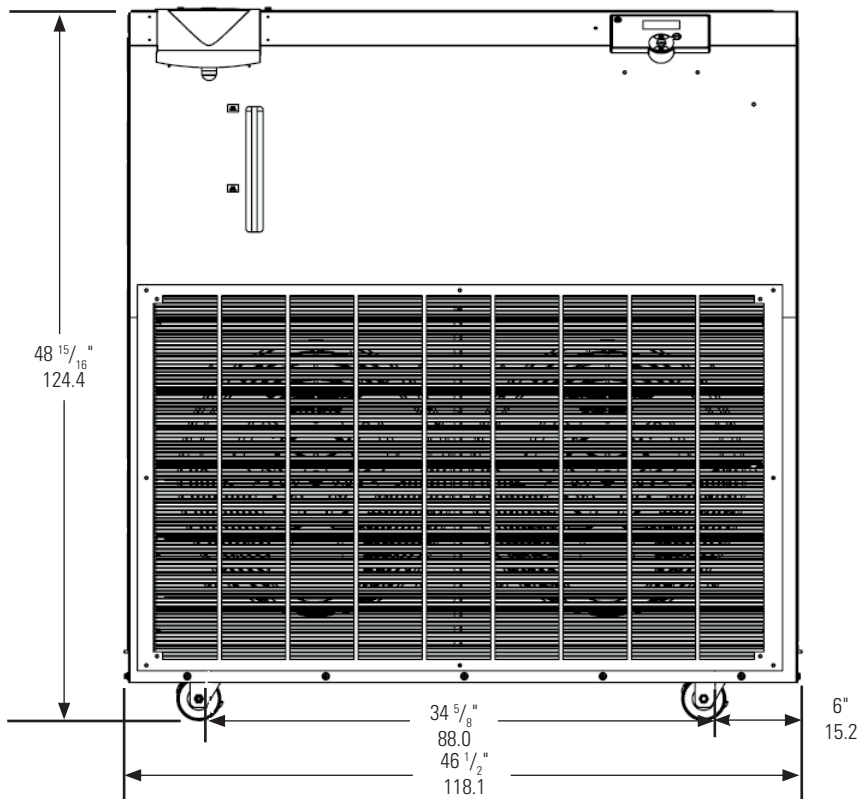

Side View

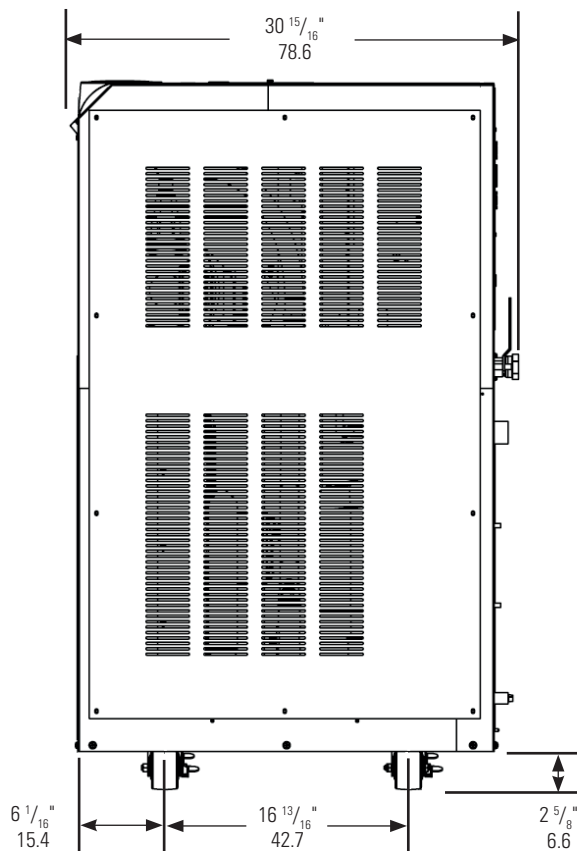

- Thermo Fisher Scientific reserves the right to change specifications without notice.

ThermoFlex15000/20000/24000

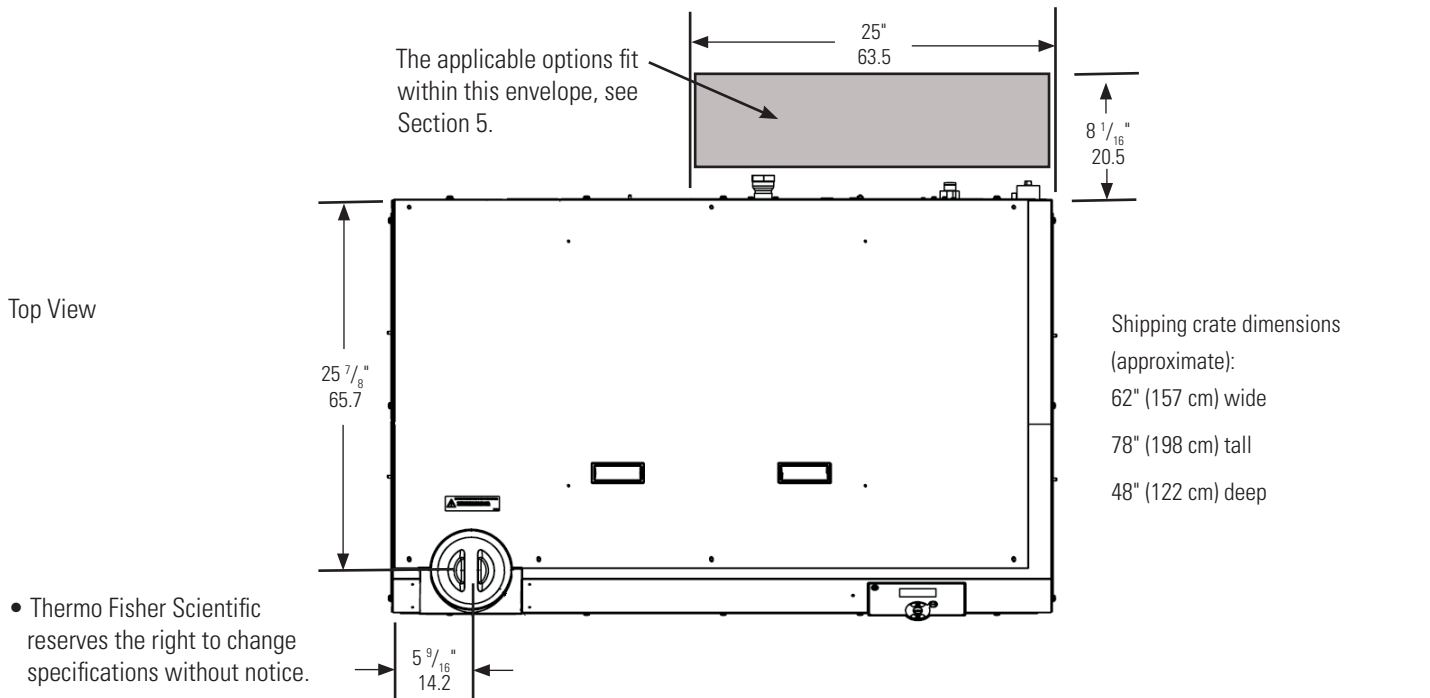
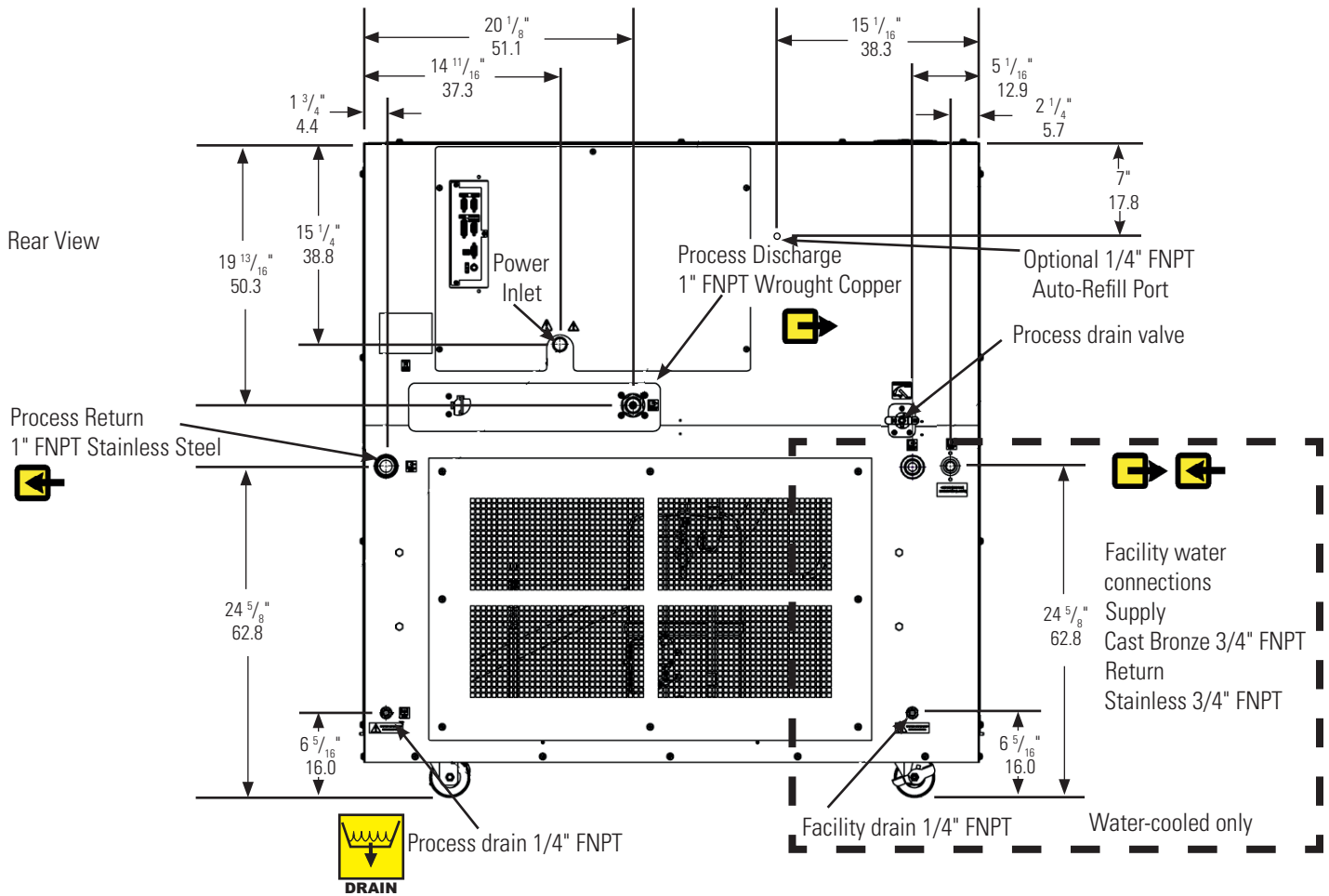

• Thermo Fisher Scientific reserves the right to change specifications without notice.

Section 3 Installation

Site Requirements

Ambient Temperature Range*	10°C to 40°C (50°F to 104°F)
Relative Humidity Range	10% to 80% (non-condensing)
Operating Altitude*	Sea Level to 6562 feet (2000 meters)
Overvoltage Category	II
Pollution Degree	2
Degree of Protection	IP 20
Short Circuit Current Rating	5kA

*Because of the decrease in air density, maximum temperature for the air entering an air-cooled ThermoFlex is reduced by 1°C per 1,000 feet above sea level. In addition, cooling capacity is reduced 1.2% per 1,000 feet above sea level.



Never place the chiller in a location where excessive heat, moisture, inadequate ventilation, or corrosive materials are present. ▲

Note Refer to the nameplate information on the rear of the chiller. ▲

Air-cooled chillers retain their full rated capacity at 20°C setpoint in ambient temperatures up to 25°C (77°F). For ambient temperatures above 25°C please de-rate the cooling capacity 3% for every 1°C above 25°C (77°F), up to a maximum ambient temperature of 40°C (104°F). Note that when operating at a process temperature lower than 20°C the de-rate percentage may increase due to additional gains from losses to ambient.

Note Depending on the setpoint and ambient temperatures, there may be a heat gain or loss through the plumbing resulting in a variation from setpoint temperature at the application inlet. Applications with large temperature variations between ambient and setpoint temperatures, and/or long plumbing lengths, may require additional insulation. ▲

ThermoFlex2500 air-cooled chillers have a two-speed fan. Should the chiller's internal ambient temperature reach 50°C for 30 seconds, or reach 53°C, the fan speed will switch from slow speed to high speed to maintain internal temperatures within acceptable limits. When the temperature reaches 44°C or below for at least 15 minutes the speed will return to low. When in high speed the chiller's decibel level increases significantly.

Note High speed is required for the chiller to achieve its 2500 watt cooling capacity. At high-end operating conditions the fan can be set to run at high speed all the time using the controller's Setup Loop, see Section 4. ▲

Chillers installed below the end-user application may enable system fluid to drain back into the chiller and cause spillage. Thermo Fisher offers an anti-drainback kit to prevent any spillage, see Section 5.

Air-cooled chillers can be installed with both sides blocked, or one side and the rear. See Figure 3-1. The front of the chiller needs a minimum clearance of 24". Air will enter the front and exit through the sides and rear.

Having two sides blocked can impact the chiller's performance due to changes in air flow. If your installation requires two blocked sides please ensure that the following requirements are met:

Process Setpoint Temperature: Below 30°C (86°F)

Ambient: Below 40°C (104°F)

Before operating the chiller in conditions outside any of those listed on this page please contact Thermo Fisher Scientific's Sales, Service and Customer Support to review your installation.

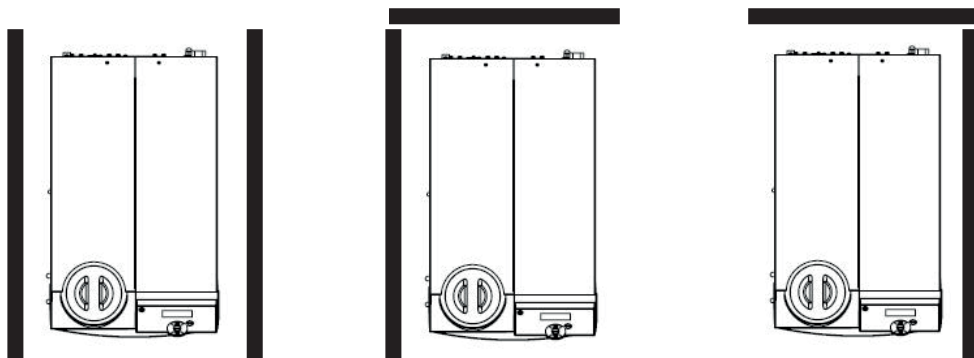

Figure 3-1 Minimum Clearance

Electrical Requirements



The chiller's construction provides protection against the risk of electrical shock by grounding appropriate metal parts. The protection will not function unless the power cord is connected to a properly grounded outlet. It is the user's responsibility to assure a proper ground connection is provided. ▲

The chiller must be installed in accordance with the National Electrical Code and the with reference to the information on the chiller's nameplate located on the rear.

Locate the chiller so it is near, and has easy access to, its disconnecting device.

The user is responsible to ensure that the line cord provided meets local electrical codes. If not, contact qualified installation personnel.

The chiller is intended for use on a dedicated outlet. The ThermoFlex has an internal circuit protection that is equivalent (approximately) to the branch circuit rating. This is to protect the ThermoFlex, and is not intended as a substitute for branch circuit protection. For permanently connected device, the customer and a qualified licensed electrician are responsible for installing the the proper branch overcurrent protection and disconnecting device per local electrical requirements.

Electrical Service Requirements (Standard chillers):

ThermoFlex900	Voltage ±10%	Frequency	Phase	Branch Circuit Requirements	Line Cord Plug
	100 VAC	50 Hz	1Ø	15A	5-15P
	115 VAC	60 Hz	1Ø	15A	5-15P
	200 VAC	50 Hz	1Ø	15A	6-15P
	208-230 VAC	60 Hz	1Ø	15A	6-15P
	230 VAC	50 Hz	1Ø	*16A ¹ , 15A ² , 13A ³	-
ThermoFlex1400	Voltage ±10%	Frequency	Phase	Branch Circuit Requirements	Line Cord Plug
	100 VAC	50 Hz	1Ø	20A	5-20P
	115 VAC	60 Hz	1Ø	20A	5-20P
	200 VAC	50 Hz	1Ø	15A	6-15P
	208-230 VAC	60 Hz	1Ø	15A	6-15P
	230 VAC	50 Hz	1Ø	*16A ¹ , 15A ² , 13A ³	-
ThermoFlex2500	Voltage ±10%	Frequency	Phase	Branch Circuit Requirements	Line Cord Plug
	200 VAC P1, P2 Pump	50 Hz	1Ø	15A	6-15P
	208-230 VAC P1, P2 Pump	60 Hz	1Ø	15A	6-15P
	200 VAC T1 Pump	50 Hz	1Ø	20A	6-20P
	208-230 VAC T1 Pump	60 Hz	1Ø	20A	6-20P
	230 VAC	50 Hz	1Ø	*16A ¹ , 15A ² , 13A ³	-
ThermoFlex3500/5000	Voltage ±10%	Frequency	Phase	Branch Circuit Requirements	Line Cord Plug
	200 VAC P1, P2 Pump	50 Hz	1Ø	15A	6-15P
	200 VAC T1, P3 Pump	50 Hz	1Ø	20A	6-20P
	200 VAC P4 Pump	50 Hz	1Ø	30A	L6-30P
	208-230 VAC P1, P2 Pump	60 Hz	1Ø	15A	6-15P
	208-230 VAC T1, P3 Pump	60 Hz	1Ø	20A	6-20P
	208-230 VAC P4 Pump	60 Hz	1Ø	30A	L6-30P
	230 VAC P1 - P4 Pump	50 Hz	1Ø	*16A ¹ , 15A ² , 13A ³	-

* Refer to Appendix A for country specific ratings.

Continued on next page.

Electrical Service Requirements (Standard chillers):

ThermoFlex7500/10000 (Air-cooled)	Voltage ±10%	Frequency	Phase	MCA	MOPD	Line Cord Plug
	200 VAC P2 Pump	50 Hz	3Ø	16.5	30	L15-20P
	200 VAC P3 Pump	50 Hz	3Ø	18.7	30	L15-30P
	200 VAC P5 Pump	50 Hz	3Ø	22.3	35	L15-30P
	200 VAC T5 Pump	50 Hz	3Ø	17.3	30	L15-20P
	208-230 VAC P2 Pump	60 Hz	3Ø	16.5	30	L15-20P
	208-230 VAC P3 Pump	60 Hz	3Ø	18.7	30	L15-30P
	208-230 VAC P5 Pump	60 Hz	3Ø	22.3	35	L15-30P
	208-230 VAC T5 Pump	60 Hz	3Ø	17.3	30	L15-20P
	400 VAC P2 Pump	50 Hz	3Ø	10.9	20	IEC309
	400 VAC P3 Pump	50 Hz	3Ø	9.6	15	IEC309
	400 VAC P5 Pump	50 Hz	3Ø	11.8	15	IEC309
	400 VAC T5 Pump	50 Hz	3Ø	8.7	15	IEC309
ThermoFlex7500/10000 (Water-cooled)	Voltage ±10%	Frequency	Phase	MCA	MOPD	Line Cord Plug
	200 VAC P2 Pump	50 Hz	3Ø	16.2	30	L15-20P
	200 VAC P3 Pump	50 Hz	3Ø	18.4	30	L15-30P
	200 VAC P5 Pump	50 Hz	3Ø	22.0	35	L15-30P
	200 VAC T5 Pump	50 Hz	3Ø	17.0	30	L15-20P
	208-230 VAC P2 Pump	60 Hz	3Ø	16.2	30	L15-20P
	208-230 VAC P3 Pump	60 Hz	3Ø	18.4	30	L15-30P
	208-230 VAC P5 Pump	60 Hz	3Ø	22.0	35	L15-30P
	208-230 VAC T5 Pump	60 Hz	3Ø	17.0	30	L15-20P
	400 VAC P2 Pump	50 Hz	3Ø	10.6	20	IEC309
	400 VAC P3 Pump	50 Hz	3Ø	9.3	15	IEC309
	400 VAC P5 Pump	50 Hz	3Ø	11.5	20	IEC309
	400 VAC T5 Pump	50 Hz	3Ø	8.4	15	IEC309
ThermoFlex15000/20000 (Air-cooled)	Voltage ±10%	Frequency	Phase	MCA	MOPD	Line Cord Plug
	208-230 VAC P3 Pump	60 Hz	3Ø	32.2	60	Hard wire
	208-230 VAC P5 Pump	60 Hz	3Ø	35.8	60	Hard wire
	400 VAC P3 Pump	50 Hz	3Ø	15.9	30	Hard wire
	400 VAC P5 Pump	50 Hz	3Ø	18.1	30	Hard wire

MCA = Minimum Current Ampacity

MOPD = Maximum Overcurrent Protective Device

Values reflect those on the nameplate located on the rear of the chiller.

Continued on next page.

ThermoFlex15000/20000 (Water-cooled)	Voltage ±10%	Frequency	Phase	MCA	MOPD	Line Cord Plug
	208-230 VAC P3 Pump	60 Hz	3Ø	28.7	50	Hard wire
	208-230 VAC P5 Pump	60 Hz	3Ø	32.3	60	Hard wire
	400 VAC P3 Pump	50 Hz	3Ø	14.5	25	Hard wire
	400 VAC P5 Pump	50 Hz	3Ø	16.7	30	Hard wire

ThermoFlex24000 (Air-cooled)	Voltage ±10%	Frequency	Phase	MCA	MOPD	Line Cord Plug
	208-230 VAC P3 Pump	60 Hz	3Ø	43.9	70	Hard wire
	208-230 VAC P5 Pump	60 Hz	3Ø	52.9	90	Hard wire
	400 VAC P3 Pump	50 Hz	3Ø	20.1	35	Hard wire
	400 VAC P5 Pump	50 Hz	3Ø	22.3	40	Hard wire

ThermoFlex24000 (Water-cooled)	Voltage ±10%	Frequency	Phase	MCA	MOPD	Line Cord Plug
	208-230 VAC P3 Pump	60 Hz	3Ø	37.1	70	Hard wire
	208-230 VAC P5 Pump	60 Hz	3Ø	40.7	70	Hard wire
	400 VAC P3 Pump	50 Hz	3Ø	18.8	35	Hard wire
	400 VAC P5 Pump	50 Hz	3Ø	21.0	35	Hard wire

Electrical Service Requirements (Variable voltage chillers):

ThermoFlex900	Voltage ±10%	Frequency	Phase	Branch Circuit Requirements	Line Cord Plug
	115 VAC	60 Hz	1Ø	15A	5-15P*
	100 VAC	50/60 Hz	1Ø	15A	5-15P*

ThermoFlex1400	Voltage ±10%	Frequency	Phase	Branch Circuit Requirements	Line Cord Plug
	115 VAC	60 Hz	1Ø	20A	-
	100 VAC	50/60 Hz	1Ø	20A	-

* United States and Japan only. All other plugs are country specific.

For installation information on variable voltage chillers refer to Appendix B. Refer to the nameplate label located on the rear of the chiller for specific electrical requirements.

Electrical Service Requirements (Global Voltage chillers):

ThermoFlex900	Voltage ±10%	Frequency	Phase	Branch Circuit Requirements	Line Cord Plug	
	200/208/230 VAC	60 Hz	1Ø	15A	-	
	200/230 VAC	50 Hz	1Ø	**16A ¹ , 15A ² , 13A ³	-	
ThermoFlex1400	Voltage ±10%	Frequency	Phase	Branch Circuit Requirements	Line Cord Plug	
	200/208/230 VAC	60 Hz	1Ø	15A	-	
	200/230 VAC	50 Hz	1Ø	**16A ¹ , 15A ² , 13A ³	-	
ThermoFlex2500	Voltage ±10%	Frequency	Phase	Branch Circuit Requirements	Line Cord Plug	
	200 VAC T 1 Pump	60 Hz	1Ø	15A	-	
	208-230 VAC T 1 Pump	60 Hz	1Ø	20A	-	
	230 VAC	50 Hz	1Ø	*16A ¹ , 15A ² , 13A ³	-	
ThermoFlex3500/5000	Voltage ±10%	Frequency	Phase	Branch Circuit Requirements	Line Cord Plug	
	200/208-230 VAC P 1 P 3 Pump	50/60 Hz	1Ø	15A	-	
	200/208-230 VAC T 1 P 3 Pump	50/60 Hz	1Ø	20A	-	
	200/208-230 VAC P 4 Pump	50/60 Hz	1Ø	30A	Hard wired	
ThermoFlex7500/10000 (Air-cooled)	Voltage ±10%	Frequency	Phase	MCA	MOPD	Line Cord Plug
	400 VAC P 2 Pump	50 Hz	3Ø	8.8	15	Hard wire
	400 VAC P 3 Pump	50 Hz	3Ø	10.1	20	Hard wire
	400 VAC P 5 Pump	50 Hz	3Ø	12.3	20	Hard wire
	400 VAC T 5 Pump	50 Hz	3Ø	9.1	15	Hard wire
	460 VAC P 2 Pump	60 Hz	3Ø	8.8	15	Hard wire
	460 VAC P 3 Pump	60 Hz	3Ø	10.1	20	Hard wire
	460 VAC P 5 Pump	60 Hz	3Ø	12.3	20	Hard wire
	460 VAC T 5 Pump	60 Hz	3Ø	9.1	15	Hard wire
ThermoFlex7500/10000 (Water-cooled)	Voltage ±10%	Frequency	Phase	MCA	MOPD	Line Cord Plug
	400 VAC P 2 Pump	50 Hz	3Ø	8.4	15	Hard wire
	400 VAC P 3 Pump	50 Hz	3Ø	9.7	20	Hard wire
	400 VAC P 5 Pump	50 Hz	3Ø	11.9	20	Hard wire
	400 VAC T 5 Pump	50 Hz	3Ø	8.8	15	Hard wire
	460 VAC P 2 Pump	60 Hz	3Ø	8.4	15	Hard wire
	460 VAC P 3 Pump	60 Hz	3Ø	9.7	20	Hard wire
	460 VAC P 5 Pump	60 Hz	3Ø	11.9	20	Hard wire
	460 VAC T 5 Pump	60 Hz	3Ø	8.8	15	Hard wire

Continued on next page.

ThermoFlex15000/20000 (Air-cooled)	Voltage ±10%	Frequency	Phase	MCA	MOPD	Line Cord Plug
	400 VAC P 3 Pump	50 Hz	3Ø	16.2	30	Hard wire
	400 VAC P 5 Pump	50 Hz	3Ø	18.4	30	Hard wire
	460 VAC P 3 Pump	60 Hz	3Ø	16.2	30	Hard wire
	460 VAC P 5 Pump	60 Hz	3Ø	18.4	30	Hard wire
ThermoFlex15000/20000 (Water-cooled)	Voltage ±10%	Frequency	Phase	MCA	MOPD	Line Cord Plug
	400 VAC P 3 Pump	50 Hz	3Ø	14.5	25	Hard wire
	400 VAC P 5 Pump	50 Hz	3Ø	16.7	30	Hard wire
	460 VAC P 3 Pump	60 Hz	3Ø	14.5	25	Hard wire
	460 VAC P 5 Pump	60 Hz	3Ø	16.7	30	Hard wire
ThermoFlex24000 (Air-cooled)	Voltage ±10%	Frequency	Phase	MCA	MOPD	Line Cord Plug
	400 VAC P 3 Pump	50 Hz	3Ø	20.1	35	Hard wire
	400 VAC P 5 Pump	50 Hz	3Ø	22.3	40	Hard wire
	460 VAC P 3 Pump	60 Hz	3Ø	20.1	35	Hard wire
	460 VAC P 5 Pump	60 Hz	3Ø	22.3	40	Hard wire
ThermoFlex24000 (Water-cooled)	Voltage ±10%	Frequency	Phase	MCA	MOPD	Line Cord Plug
	400 VAC P 3 Pump	50 Hz	3Ø	18.8	35	Hard wire
	400 VAC P 5 Pump	50 Hz	3Ø	21.0	35	Hard wire
	460 VAC P 3 Pump	60 Hz	3Ø	18.8	35	Hard wire
	460 VAC P 5 Pump	60 Hz	3Ø	21.0	35	Hard wire

** Chillers selected for 230 VAC operation have a range of -10% to +7%. Refer to Appendix A for country specific ratings.

For installation information on global voltage chillers refer to Appendix B. Refer to the nameplate label located on the rear of the chiller for specific electrical requirements.

MCA = Minimum Current Ampacity

MOPD = Maximum Overcurrent Protective Device

Values reflect those on the nameplate located on the rear of the chiller .

Hard Wire Installation



For personal safety and equipment reliability, only a qualified technician should perform the following procedure. ▲

Note The technician is responsible for installing circuit protection for incoming power. Before wiring consult the nameplate on the rear of the chiller. Ensure installation is in accordance with the National Electrical Code and any other applicable country and local codes. ▲

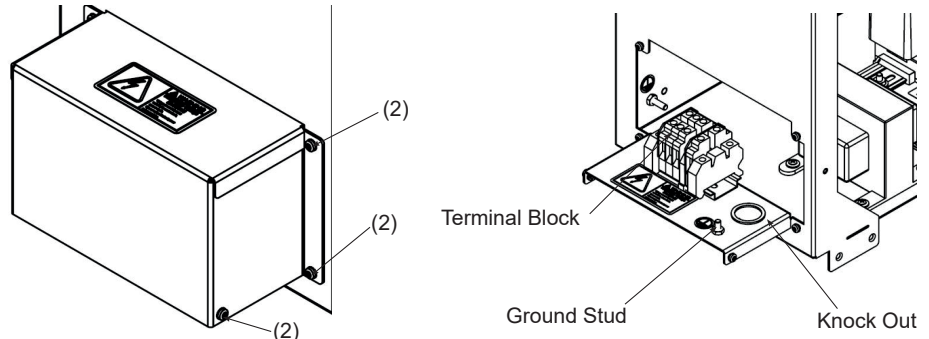

Figure 3-2 Electrical Box

For ThermoFlex900 through 10000 chillers

- Remove the six screws securing the electrical box cover to the chiller.
- Remove the double knock out ($\frac{7}{8}$ " and $1\frac{3}{32}$ ").
- Insert the cable through the hole.
- Refer to the label in the electrical box to configure your chiller, see Figure 3-3.
- Secure the cable's ground wire to the ground stud.
- Reinstall the cover.

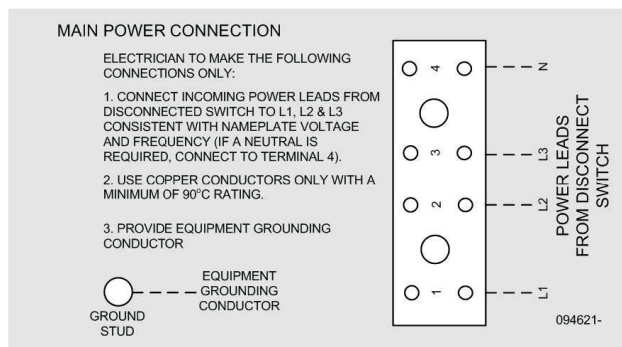

Figure 3-3 Sample Label

For ThermoFlex15000, 20000 and 24000 chillers

- Remove the five screws securing the electrical panel to the chiller.
- Refer to the label in the electrical box to configure your chiller, see Figure 3-3.
- Secure the cable's ground wire to the ground stud.
- Reinstall the panel.

Plumbing Requirements



Ensure that all shipping plugs are removed before installation.



Never connect the process fluid lines to your facility water supply or any pressurized liquid source. ▲



To prevent damage to the chiller's plate exchanger, centrifugal pumps require a 4.0 gpm (15.1 lpm) minimum flow rate. ▲

P1 and P2 pumps are capable of producing 185 psig. Ensure your plumbing is rated to withstand this pressure at your operating temperature. An external pressure relief valve is available, see Section 5. ▲

Note Ensure your plumbing installation develops a back pressure to the ThermoFlex greater than 3 PSIG. Lower pressure will shut down the chiller. ▲

The process fluid connections are located on the rear of the chiller and are labeled (PROCESS OUTLET) and (PROCESS INLET).

Process Fluid Connections (FNPT)

Outlet

ThermoFlex900 - 10000	P 1 P 2 T 0 T 1	1/2" cast bronze
ThermoFlex3500 - 5000	P 3 P 4	3/4" cast bronze
ThermoFlex7500 - 24000	P 3 P 5 T 5 T 9	1" wrought copper
Inlet - Same size as outlet		all connections stainless steel

Supplied Adapters

P 1 P 2 T 0 T 1	1/2" x 3/8" barb polyethylene and 1/2" x 1/2" barb nylon
nylon P 3 P 4	3/4" MPT x 1/2" barb PVC
P 3 P 5 T 5 T 9	1" MPT x 1" barb PVC and 1" MPT x 3/4" barb PVC

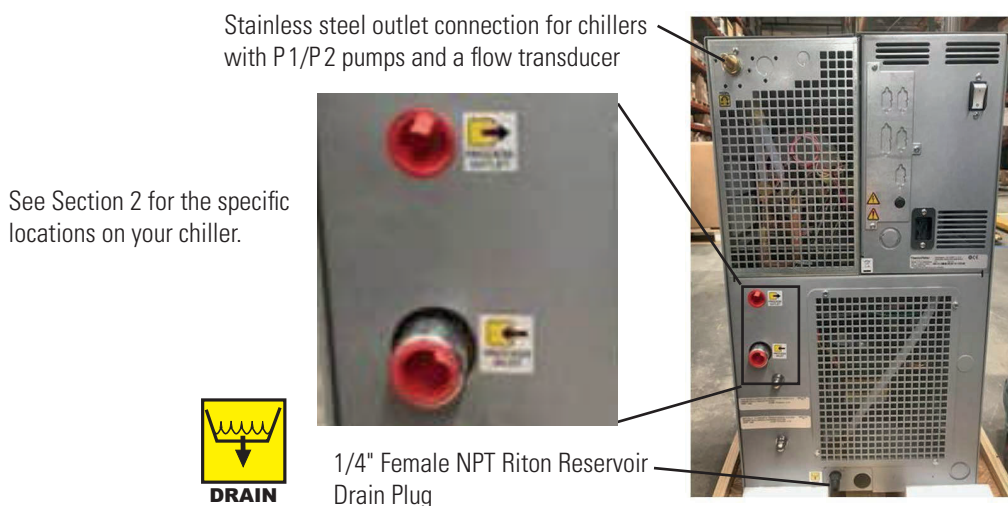

Figure 3-4 Typical Plumbing Connections (1 of 2)

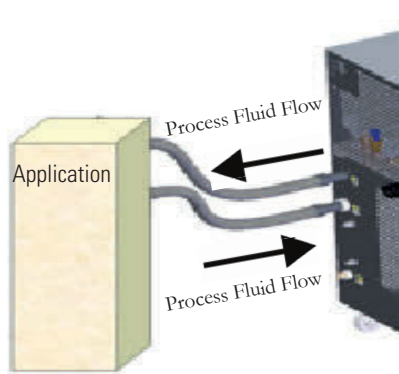







Figure 3-4 Typical Plumbing Connections (2 of 2)

Connect the PROCESS OUTLET  to the fluid inlet on your application. Connect the PROCESS INLET  to the fluid outlet on your application. Ensure all connections are secure and that the proper sealant/lubricant for the fitting material is used. (If Teflon[®] tape is used, ensure the tape does not overhang the first thread as it could shred and get into the fluid.) Keep the distance between the chiller and the instrument being cooled as short as possible. Ensure tubing is straight and without bends. If diameter reductions are required, make them at the inlet and outlet of your application, not at the ThermoFlex.

Water-cooled Chillers only

The facility water plumbing connections are also located on the rear and are labeled  FACILITY INLET and  FACILITY OUTLET. The connections are 1/2" Female NPT for ThermoFlex900 - 5000, 3/4" Female NPT for ThermoFlex7500 - 24000. Both connections for ThermoFlex900 to 10000 are cast bronze. The supply connections for ThermoFlex15000 to 24000 are cast bronze, the return connections are stainless steel.

Connect the  FACILITY INLET to your facility water supply. Connect the  FACILITY OUTLET to your facility water return or drain. Ensure all connections are secure and that the proper sealant/lubricant for the fitting material is used. (If Teflon[®] tape is used, ensure the tape does not overhang the first thread as it could shred and get into the fluid.)

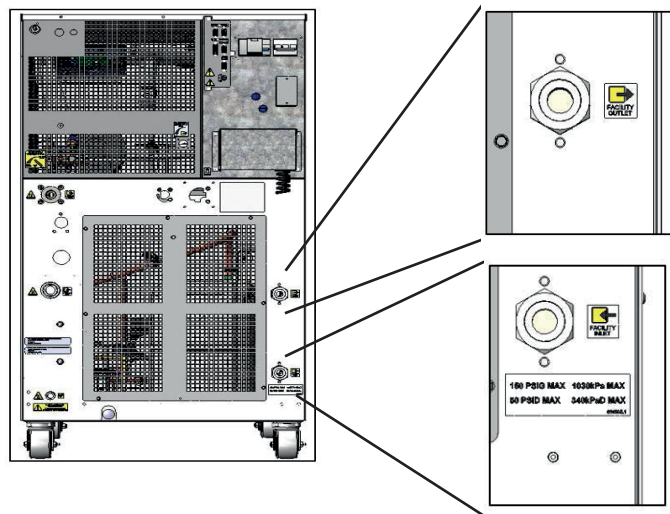

See Section 2 for the specific locations on your chiller.

Figure 3-5 Typical Plumbing Connections, Water-cooled Chillers

Process Fluid Requirements



Do not use automotive antifreeze. Commercial antifreeze contains silicates that can damage the pump seals. Use of any fluid not listed below will void the manufacturer's warranty. ▲

Approved fluids are:

- Filtered/Single Distilled water
- 0 - 75% Laboratory Grade Ethylene Glycol/Water
- 0 - 75% Laboratory Grade Propylene Glycol/Water
- Deionized water (3 MΩ-cm max, compensated)

For applications requiring resistivity greater than 1 MΩ-cm please call and speak to an applications engineer for additional information.



Ethylene glycol (EG) is poisonous and flammable. Before using any fluid or performing maintenance where contact with the fluid is likely refer to the manufacturer's most current SDS for handling precautions. ▲



EG is also hygroscopic, it will absorb water from its environment. This can affect the freezing point and boiling point of the fluid over time and may result in system failure. ▲



To prevent freezing/glazing of the plate exchanger, ThermoFlex7500 through 24000 chillers require the use of 50/50 EG/water or 50/50 PG/water below 10°C process temperature. ▲



When using a process fluid mixture of ethylene glycol and water or propylene glycol and water, check the fluid concentration and pH on a regular basis. Changes in concentration and pH can impact system performance. ▲



When using EG/water or PG/water, top-off with plain water. After top-off check the fluid concentration. ▲



Do not use a Deionization (DI) filter cartridge with Inhibited EG or Inhibited PG. A DI filter will remove inhibitors from the solution rendering the fluid ineffective against corrosion protection. Also, inhibitors increase fluid conductivity. ▲

Compatibility with Approved Fluids

Filtered/Single Distilled Water

Filtered drinking water and single distilled water are good choices for recirculating chillers because the filtering/distilling process used removes microorganisms that could create biological fouling as well as harmful particulates and excessive minerals that could cause deposits and scaling.

Chlorine

Short term usage of tap water may not cause any adverse affects on the chiller or your application, but in the long term problems may arise. To help alleviate these problems Thermo Fisher Scientific recommends the use of chlorine.

The duration of time that chlorine remains in solution depends on factors such as water temperature, pH and availability of direct sunlight. We recommend maintaining chlorine levels at proper levels using chlorine test strips, generally 1 to 5 ppm is adequate.

For best results, maintain the pH of the fluid between 6.5 and 7.5. Do not add additional chlorine without first determining the concentration ratio that already exists in the fluid supply. Corrosion and degradation of the circulation components can result from concentration ratios that are too high. Contact our customer support for additional information.

Deionized Water

Deionized water is water that has had its mineral ions removed using ion exchange resins. The purpose of this process is to remove the ions that allow electrical current to flow more easily through water. This helps to prevent electrical leaks to ground through the recirculating fluid. Deionized water is classified by the electrical resistance of the water, usually measured in M Ω -cm, with pure water having a resistance of 18 M Ω -cm.

Deionized water is in an unbalanced state and will leach the missing ions from the materials it comes in contact with. The aggressive nature of this leaching can cause pitting on metal surfaces. Note that the deionizing process does not remove microorganisms. Because of this, we recommend deionized water only with applications that have it as a specified requirement.

In any case, only deionized water with 3 M Ω -cm resistivity maximum is approved for use in Thermo Fisher Scientific recirculating chillers.

Recommended Biocides and Inhibitors

Thermo Fisher Scientific offers a biocide and inhibitor package Thermo 200 (Nalco) premixed with 5 gallons of water or as a kit to be added to water. No other biocide or inhibitor is recommended for use in our recirculating chillers.



Biocides are corrosive and can cause irreversible eye damage and skin burns. They are harmful if inhaled, swallowed or absorbed through the skin. Refer to the manufacturer's most current SDS for handling and PPE requirements. ▲



To prevent freezing/glazing of the plate exchanger, ThermoFlex7500 through 24000 chillers require the use of 50/50 EG/water or 50/50 PG/water below 10°C process temperature. ▲

Uninhibited Ethylene Glycol/Water

Ethylene glycol is used to depress the freezing point of water and should only be used at temperatures where freeze point suppression is required. Ethylene glycol does not improve heat transfer and is not recommended for use as a biocide. Because glycols lower the surface tension of water and do not evaporate as readily as water, they may cause visible weepage past the pump seals. If weepage cannot be tolerated, seal-less, use magnetically driven pumps where available.

Uninhibited simply means that the glycol does not contain any additives to prevent corrosion. While uninhibited ethylene glycol is acceptable for use, the pH level must be closely monitored and the fluid may need to be replaced more often. Since all glycols produce acids in the presence of air and the fluid, change the glycol if the pH falls below 8. Note that litmus paper will not work to test the pH of ethylene glycol/water.

Inhibited Ethylene Glycol/Water and Inhibited Propylene Glycol/Water

Inhibited glycol can help protect the wetted metals within the cooling circuit from corrosion caused by poor water quality, ethylene glycol oxidation (low pH) and mixed metals (electrolysis). The inhibitor works by either leaving a barrier coating on metal surfaces to buffer them from the corrosive fluid or by creating an oxidized layer that protects the underlying metal (passivating).

Inhibited automotive glycols are never acceptable. They use either silicates or Organic Acid Technology (OAT) as the inhibitor and these components are not compatible with the polymers used in recirculating chillers including the pump seals and internal hoses.

Inhibitors may also accelerate pump seal wear and seal-less, Use magnetically driven pumps where available.

Uninhibited Propylene Glycol/Water

Propylene glycol does not transfer heat as well as ethylene glycol, but can be used when freeze point suppression is required as well as lower toxicity.

Propylene glycol does not function as a biocide and the pH needs to be maintained the same as with ethylene glycol as it also produces acid when oxidized.

Additional Fluid Information

When using the ThermoFlex chiller to circulate through aluminum, use a compatible corrosion inhibitor to prevent galvanic corrosion.

Ensure fluid viscosity is 50 cSt or less at the lowest temperature used.

Visible pump weepage may occur when compatible glycols, oils or other additives are used. Pump weepage is considered as a normal operating condition of mechanical seal pumps.

Process Water Quality and Standards

Process Fluid	Permissible (PPM)	Desirable (PPM)
Microbiologicals (algae, bacteria, fungi)	0	0
Inorganic Chemicals		
Calcium	<25	<0.6
Chloride	<25	<10
Copper	<1.3 0.020 ppm if fluid in contact with aluminum	<1.0
Iron	<0.3	<0.1
Lead	<0.015	0
Magnesium	<12	<0.1
Manganese	<0.05	<0.03
Nitrates\Nitrites	<10 as N	0
Potassium	<20	<0.3
Silicate	<25	<1.0
Sodium	<20	<0.3
Sulfate	<25	<1
Hardness	<17	<0.05
Total Dissolved Solids	<50	<10
Other Parameters		
pH	6.5-8.5	7-8
Resistivity	0.01*	0.05-0.1*

* MΩ-cm (compensated to 25°C)

Unfavorably high total ionized solids (TIS) can accelerate the rate of galvanic corrosion. These contaminants can function as electrolytes which increase the potential for galvanic cell corrosion and lead to localized corrosion such as pitting. Eventually, the pitting will become so extensive that refrigerant will leak into the water reservoir.

As an example, raw water in the United States averages 171 ppm (of NaCl). The recommended level for use in a water system is between 0.5 to 5.0 ppm (of NaCl).

Recommendation: Initially fill the reservoir with distilled or 3 MΩ-cm deionized water. (It is acceptable to have the fluid drop to the other levels over-time.)

Do not use untreated tap water as the total ionized solids level may be too high. This will reduce the electrolytic potential of the water and prevent or reduce the galvanic corrosion observed.

Facility Water Quality and Standards (water-cooled chillers)

Facility Water	Permissible (PPM)	Desirable (PPM)
Microbiologicals		
(algae, bacteria, fungi)	0	0
Inorganic Chemicals		
Calcium	<40	<0.6
Chloride	<250	<25
Copper	<1.3	<1.0
	0.020 ppm if fluid in contact with aluminum	
Iron	<0.3	<0.1
Lead	<0.015	0
Magnesium	<12	<0.1
Manganese	<0.05	<0.03
Nitrates/Nitrites	<10 as N	0
Potassium	<20	<0.3
Silicate	<25	<1.0
Sodium	<20	<0.3
Sulfate	<250	<50
Hardness	<17	<0.05
Total Dissolved Solids	<50	<10
Other Parameters		
pH	6.5-8.5	7-8
Resistivity	0.01*	0.05-0.1*

* MΩ-cm (compensated to 25°C)

Note A corrosion inhibitor is recommended if mixed metals are in the facility water loop. ▲

Facility Water Requirements (water-cooled chillers)

Facility Water Maximum Inlet Pressure must not exceed 150 PSIG. ▲

Facility Water Maximum Pressure Differential must not exceed 50 PSID. ▲
 (Pressure Differential = Inlet Pressure - Outlet Pressure)

Note Contact us before using facility water that is above 35°C. ▲



The facility water must meet the following conditions for the chiller to maintain its full rated capacity.

ThermoFlex1400

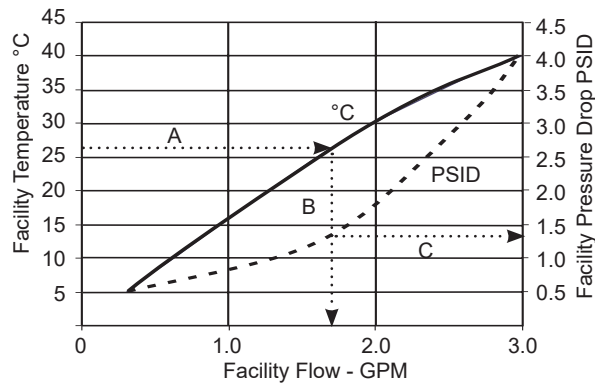

Example:
 Follow the lines.
 Start with a known, e.g., facility water temperature.
 A - go across to temperature curve
 B - drop down to determine the minimum required facility flow.
 C - Where B crosses the PSID curve, go across to determine the minimum required PSID.

ThermoFlex2500

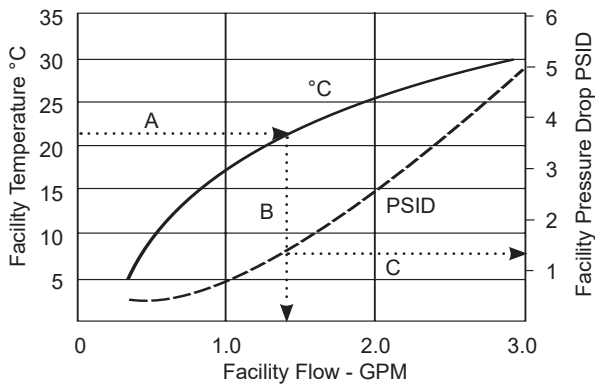

Example: See above.

ThermoFlex3500/5000

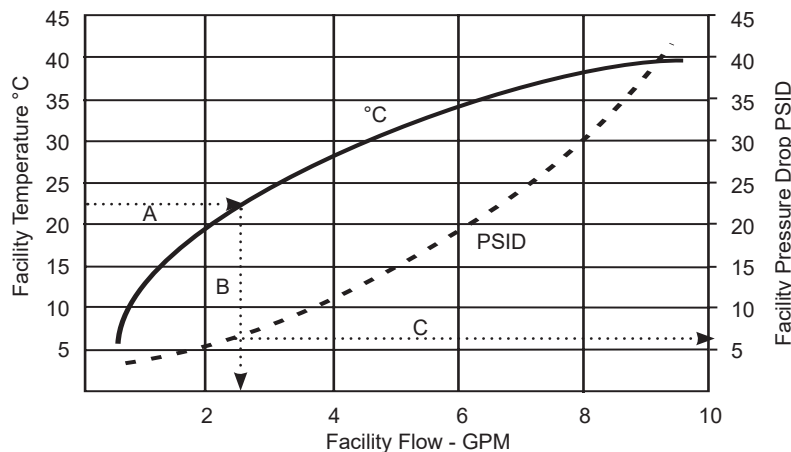

Example: See above.

ThermoFlex7500/10000

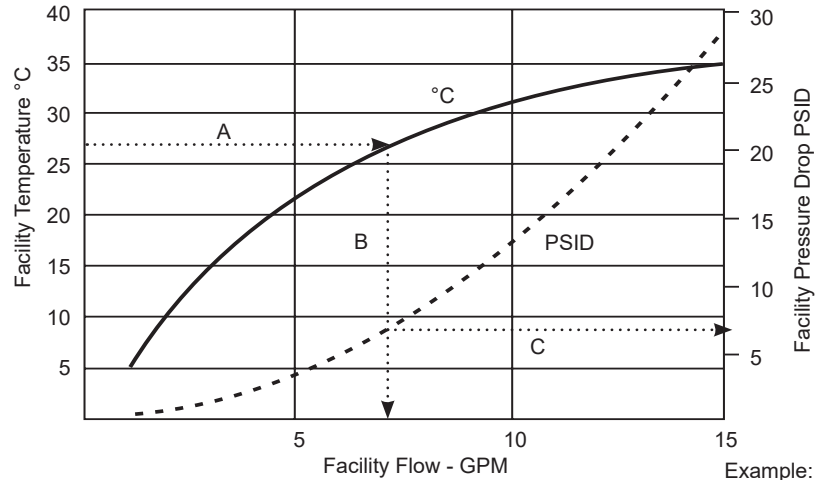

Example: See below.

ThermoFlex15000/20000

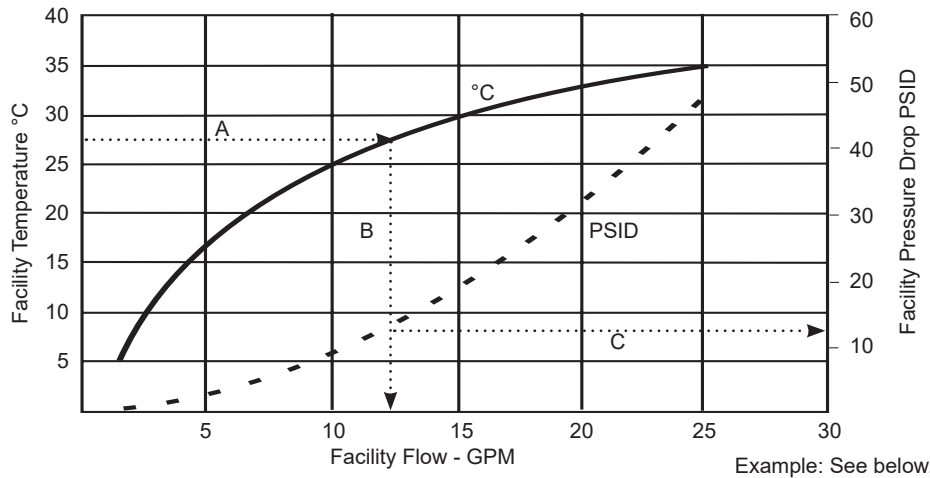

Example: See below.

ThermoFlex24000

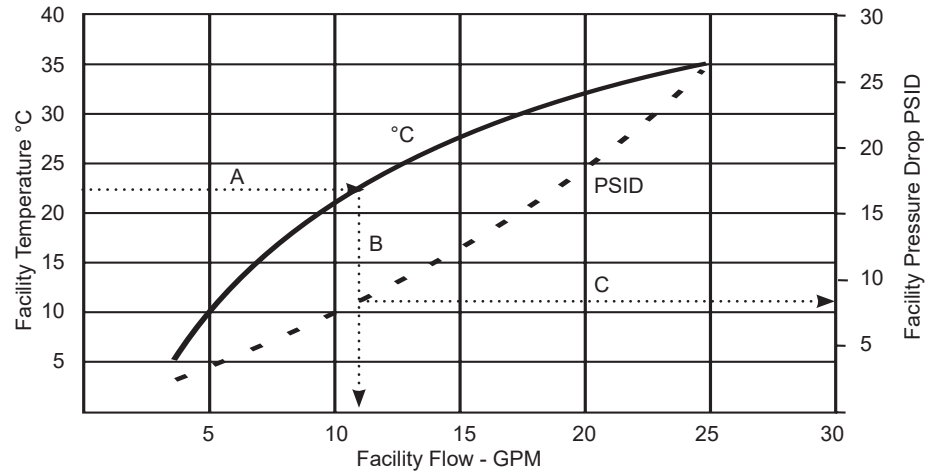

Example:

Follow the> lines.

Start with a known, e.g., facility water temperature.

A - go across to temperature curve

B - drop down to determine the minimum required facility flow.

C - Where B crosses the PSID curve, go across to determine the minimum required PSID.

Fluid Filter Bag



The reservoir has a fluid bag filter designed to prevent the introduction of particulates into the system.

Install the filter bag before starting the chiller. ▲

Place your fingers below the front of the housing and push up on the housing to remove it.



Install the bag.

Replace the housing. Slide its back edge under the lip of the chiller's top panel and then press down until the housing snaps into place.

Figure 3-6 Fluid Filter Bag

Priming

If able, pre-fill the process fluid lines. The chiller is designed to shut down if not properly primed.

Ensure that there is enough fluid prepared to fill both the chiller and your application. If able, pre-fill the process fluid lines to reduce the setup time.

Fill the reservoir to the max fill line on the reservoir sight tube. To prevent the introduction of particulates into the system, fill the chiller with the reservoir bag filter in place.

Start the chiller by pressing  on the control panel.

As the pump fills your application add fluid to the reservoir to maintain the fluid level.

Repeat this process until the fluid level no longer drops in the reservoir.

If you need to pause priming press  to turn the chiller off.



Not completely filling the chiller and process fluid lines could damage the chiller's pump. ▲

Initial Filling Ensure the reservoir drain plug on the back of the chiller is in place, or the Riton fitting is closed, and that all plumbing connections are secure.



Before using any fluid refer to the manufacturer's SDS for handling precautions and PPE requirements. ▲

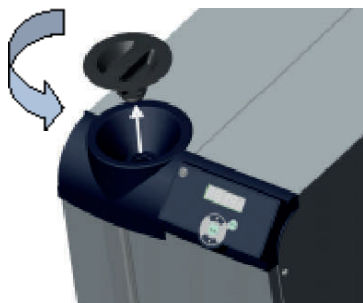

Locate and remove the reservoir cap by unscrewing it counterclockwise.

To prevent the introduction of particulates into the system, fill the chiller with the reservoir bag filter in place.

Figure 3-7 Reservoir Cap

The reservoir has a sight tube and ball for easy fluid level monitoring. *Slowly* fill the reservoir with clean process fluid through the funnel only, failure to comply may result in internal spillage.

Note Filling the reservoir above **MAX LEVEL** fill line will result in an over flow error (**O FLO**) causing the chiller to shut down. ▲

Since the reservoir capacity may be small compared to your application and air may need to be purged from the lines, have extra cooling fluid on hand to keep the system topped off when external circulation is started.

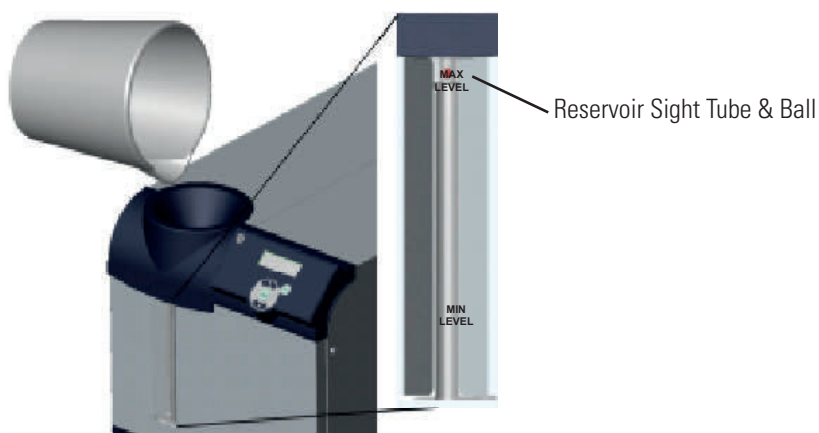

Figure 3-8 Reservoir Sight Tube & Ball



Before replacing the reservoir cap ensure the reservoir sight tube ball stopper is securely in place, see next page. ▲

Replace the reservoir cap by screwing it clockwise. Cap should be hand tight.

Fluid Top Off

Remove the reservoir cap by unscrewing it counterclockwise.

To prevent the introduction of particulates into the system, fill the chiller with the reservoir bag filter in place.

The reservoir has a sight tube and ball for easy fluid level monitoring. *Slowly* fill the reservoir with clean process fluid through the funnel only, failure to comply may result in internal spillage.

Note Filling the reservoir above MAX LEVEL fill line will result in an over flow error (**O FLO**) causing the chiller to shut down. Also, fluids expand when heated. ▲

Note Adding fluid that has a temperature differential with the fluid already in the reservoir will temporarily affect the chiller's stability performance. ▲



Before replacing the reservoir cap ensure the reservoir sight tube ball stopper is securely in place. ▲

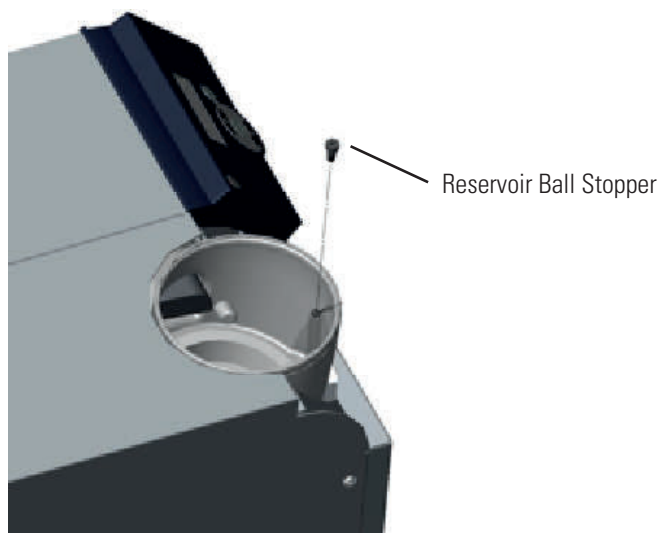

Figure 3-9 Reservoir Ball Stopper

Section 4 Operation

Basic Controller

The controller controls temperature using a Proportional-Integral-Derivative (PID) algorithm. It is designed with an easy to use operator interface.

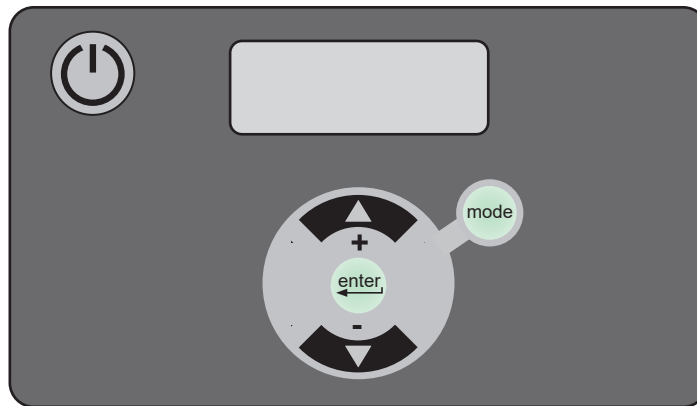

Figure 4-1 Basic Controller



Press this key to start and stop the chiller.



Press this key to navigate through the controller displays, to make changes and to save changes once they are made. It is also used to clear error codes.



Press this key to navigate through controller displays.



Press the up arrow key to navigate through the controller displays and to increase adjustable values.



Press the down arrow key to navigate through the controller displays and to decrease adjustable values.



Setup

Note For first time use, please refer to the quick start instructions included with your chiller or the copy in this manual. The manual's version follows the Table of Contents. ▲

Before starting the chiller, double check all electrical and plumbing connections. Have extra recirculating fluid on hand. If the chiller will not start refer to Section 7 Troubleshooting.

If the chiller is equipped with a deionization filter cartridge refer to Section 5 for installation.

Start Up

- Place the optional GFCI breaker located on the rear to the up position.
- For ThermoFlex900 through 10000s, place the circuit protector located on the rear to the on (I) position. The display will indicate a series of upward scrolling bars (☐ ☐).
- For ThermoFlex15000 and 24000s, the display will indicate a series of upward scrolling bars (☐ ☐) as soon as power is supplied.
- The bars will scroll upward indicating the controller is initializing. The initialization takes approximately 15 seconds.
- When the bars disappear the controller display will go blank.
- Press the  key on the controller. The controller will show the process fluid temperature. The pump and refrigeration system will also start. **Note** You can press the  key anytime after placing the circuit protector to the on position. ▲



If the auto restart is enabled and the chiller shuts down as a result of a power failure, when power is restored the chiller will automatically restart. Auto restart is enabled using the Setup Loop, see Setup Loop in this Section. Consider any possible risks before enabling this mode of operation. ▲

Note After start up, check your plumbing for leaks. ▲

If desired, press  to display the pump's discharge pressure - **P1**. The display will alternate between **P1** and the pump's discharge pressure value.

If the chiller is equipped with an optional flow transducer, pressing  again will display the flow rate - **FLo**. The display will alternate between **FLo** and the flow rate value.

After displaying **P1** or **FLo** for 60 seconds, if  is not pressed the display will automatically revert to the process fluid temperature.

Press  again to display the process fluid temperature.

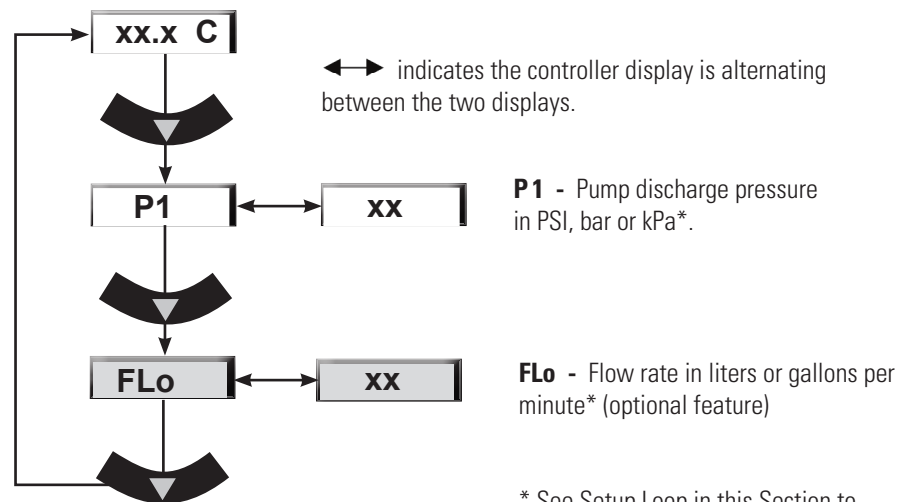

Figure 4-2 Main Loop

* See Setup Loop in this Section to change displayed scales.

Controller Loops

The controller has the capability to display various loops which indicate operating conditions and parameters. The loops are selected and changed by pressing the appropriate keys.

When the controller is first powered up it goes through a short initialization (~15 seconds) and then displays the process fluid temperature. Press the key combination shown below to scroll through the loops.

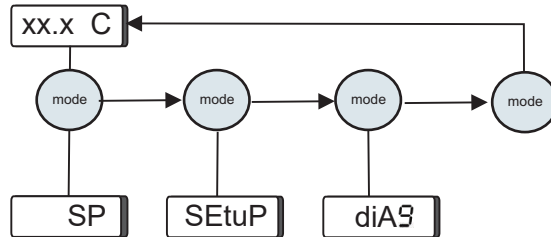





Figure 4-3 Controller Loops (Chiller running)

SP is the Setpoint Loop and is used to display and change the setpoint. The setpoint is the desired process fluid temperature needed for your application. The Setpoint Loop is accessed by pressing the  key, see next page.

SEtuP is the Setup Loop. The Setup Loop allows you to display and/or alter different parameters of the controller. The Setup Loop is accessed from the **SP** display by pressing the  key.

diA9 is the Diagnostic Loop. The Diagnostic Loop allows you to display the operating times for various components. The Diagnostic Loop is accessed from the **Setup** display by pressing the  key, see Section 6 for more details.

Note The loops can be accessed and changed without the chiller running as long as the circuit protector (ThermoFlex900-10000s) is in the on (I) position. ▲

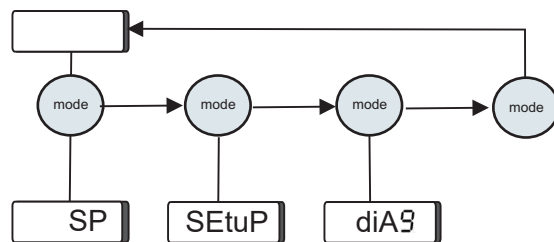







Figure 4-4 Controller Loops (Chiller not running)

Setpoint Loop (SP)

- Ensure the controller is either a blank screen or displaying the process fluid temperature.
- Press the  key and the controller display will alternate between **SP** and the setpoint value.
- If no change is required press  to return the controller to the previous display.
- If a setpoint change is required, press .

The setpoint range is +5°C to +40°C (41°F to 104°F).

Note If  are not pressed within one minute the controller will time out and return to the previous display, any changes will not be saved. ▲

- Once the desired value is displayed press the  key to confirm the change.
- The controller will return to the process fluid temperature display or a blank screen.

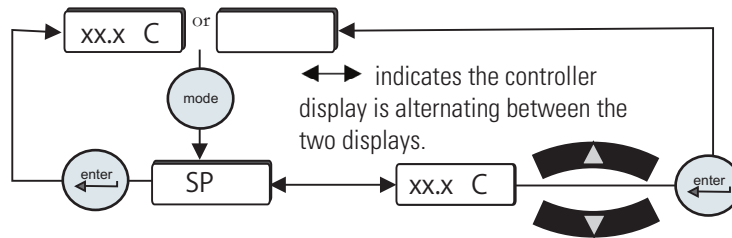

Figure 4-5 Setpoint Loop

Setup Loop (SEtUP)



Use the Setup Loop to adjust/verify the following controller settings.



- Scales: temperature in °C or °F, flow in liters per minute or gallons per minute (only chillers with an optional flow transducer), and pressure in PSI, bar or kPa
- High and low temperature alarm limits
- High and low pump discharge pressure alarm limits and time delays
- Chiller reaction to a temperature, pressure or flow (optional) alarm limit (continue to run or shut down)
- Audible alarm enabled/disabled
- View/change the fan speed (ThermoFlex2500 air-cooled only)
- Auto restart feature enabled/disabled
- Preventive care cleaning frequency reminder for air and fluid filters

Optional Features:



- Global voltage
- Analog I/O
- Auto refill alarm
- DI filter cartridge preventive maintenance interval
- High/low flow alarm limits
- Serial communications
- Anti drainback valve position
- **Save or not save *all* changes**

To enter the Setup Loop ensure the controller display is either a blank screen (chiller off) or displaying the process fluid temperature. Press the  key and the display will indicate **SP**, press it again to display **SEtUP**.

Press the  key to continue, or press  twice to return to the process fluid temperature or blank display.

Press  to sequence down through the loop. Press  to sequence back through the loop up to the **Hi t** display, see next page.

To change any parameter:

- Press the  key.
- Press  to change a displayed value.
- Press  key to confirm the change and bring up the next display.

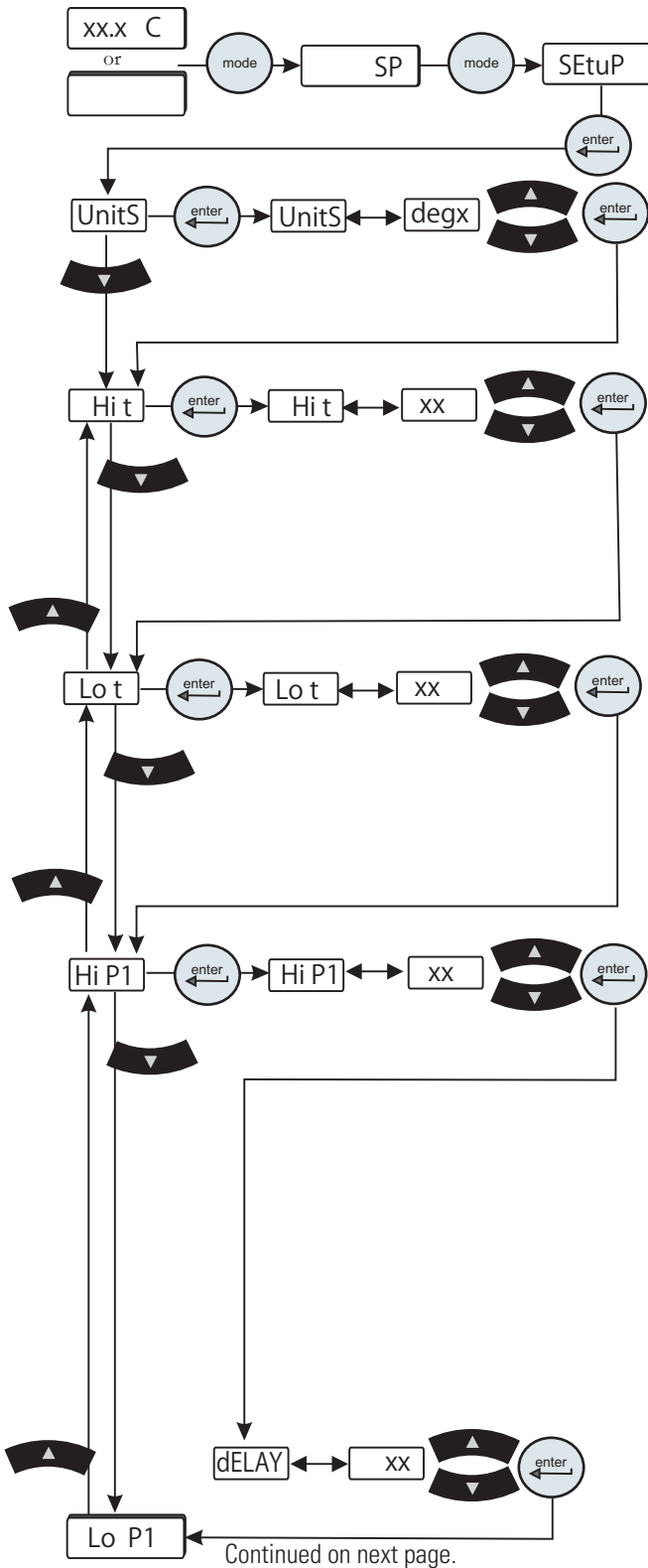

• **UnitS** are the temperature, fluid flow (only chillers with an optional flow transducer) and pressure display scales.
Scales: °C or °F **Defaults:** °C
 GPM or LPM GPM
 PSI, Bar or kPa PSI

• **Hi t** is the fluid's High Temperature alarm limit.
Range: +3°C to +42°C **Default:** +42°C
 Exceeding this limit flashes **Hi t** and, if enabled, sounds the alarm. The chiller reaction depends on the alarm configuration (see **ALr** on next page).

• **Lo t** is the fluid's Low Temperature alarm limit.
Range: +3°C to +42°C **Default:** +3°C
 Falling below this limit flashes **Lo t** and, if enabled, sounds the alarm. The chiller reaction depends on the alarm configuration (see **ALr** on next page).

• **Hi P1** is the pump's High Pressure discharge alarm limit.
 T1 T0 Pump **Range:** 3 to 100 PSI **Default:** 100 PSI
 T5 Pump **Range:** 2 to 105 PSI **Default:** 105 PSI
 P1 P2 Pump **Range:** 3 to 100 PSI **Default:** 100 PSI
 P3 Pump 60Hz **Range:** 3 to 46 PSI **Default:** 46 PSI
 P3 Pump 50Hz **Range:** 3 to 32 PSI **Default:** 32 PSI
 P4 Pump 60Hz **Range:** 3 to 85 PSI **Default:** 85 PSI
 P4 Pump 50Hz **Range:** 3 to 60 PSI **Default:** 60 PSI
 P5 Pump 60Hz **Range:** 3 to 87 PSI **Default:** 87 PSI
 P5 Pump 50Hz **Range:** 3 to 56 PSI **Default:** 56 PSI
 T9 Pump **Range:** 3 to 105 PSI **Default:** 105 PSI

Exceeding this limit flashes **Hi P1** and, if enabled, sounds the alarm (see **Sound** on next page).

• **dELAY** is the length of time the pump can exceed the **Hi P1** alarm limit. **Note** This feature is only active if the chiller is configured to shut down with a pressure alarm. ▲
P1, P2, T0 and T1 Range: 0 to 30 seconds
Default: 0 seconds
P3, P5, T5 and T9 Range: 0 to 60 seconds
Default: 0 seconds
 Exceeding this limit flashes **Hi P1** and, if enabled, sounds the alarm. The chiller reaction depends on the alarm configuration (see **ALr** on next page).

Figure 4-6 Setup Loop (All Chillers)

Continued on next page.

Continued from previous page

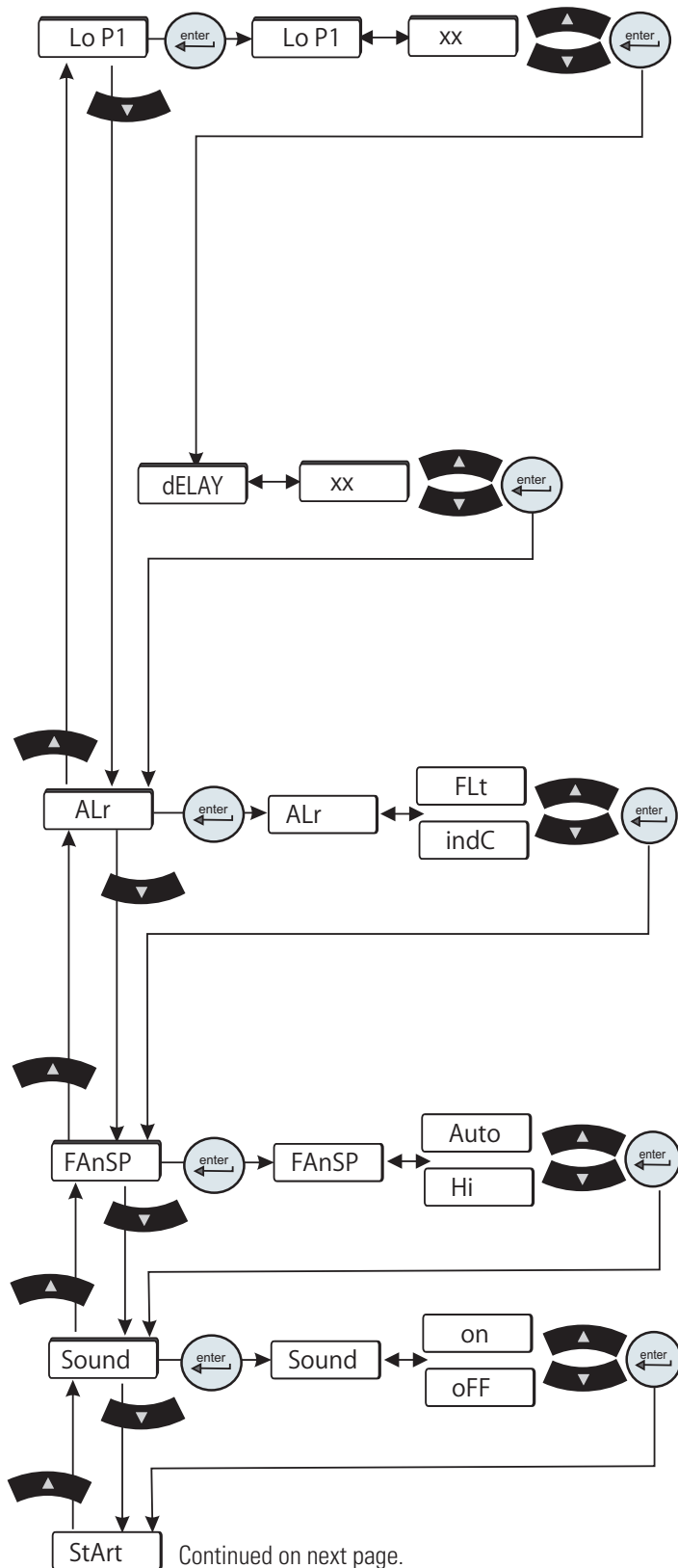

Continued on next page.

- **Lo P1** is the pump's Low Pressure discharge alarm limit.

T0 T1 Pump	Range: 3 to 100 PSI	Default: 4 PSI
T5 Pump	Range: 4 to 105 PSI	Default: 4 PSI
P1 P2 Pump	Range: 3 to 100 PSI	Default: 4 PSI
P3 Pump 60Hz	Range: 3 to 46 PSI	Default: 4 PSI
P3 Pump 50Hz	Range: 3 to 32 PSI	Default: 4 PSI
P4 Pump 60Hz	Range: 3 to 85 PSI	Default: 4 PSI
P4 Pump 50Hz	Range: 3 to 60 PSI	Default: 4 PSI
P5 Pump 60Hz	Range: 3 to 87 PSI	Default: 4 PSI
P5 Pump 50Hz	Range: 3 to 56 PSI	Default: 4 PSI
T9 Pump	Range: 3 to 105 PSI	Default: 4 PSI

Going below this limit flashes **Lo P1** and, if enabled, sounds the alarm.

- **dELAY** is the length of time the pump can exceed the **Lo P1** alarm limit. **Note** This feature is only active if the chiller is configured to shut down with a pressure alarm. ▲

Range: 0 to 30 seconds **Default:** 10 seconds

Exceeding this limit flashes **Lo P1** and, if enabled, sounds the alarm. The chiller reaction depends on the **ALr** alarm configuration set below.

- **ALr** is used to configure the chiller's reaction for exceeding an alarm limit (temperature, pressure and optional flow). The chiller will either shut down (**FLt**) or continue to run (**indC**). In each configuration, the controller will display the error code and sound the audible alarm, if enabled.

Range: FLt or indC **Default:** FLt

- **FAnSP** is used to control the fan speed (air-cooled 2500 only). **Auto** allows the fan to run under the conditions listed in Section 3. Selecting **Hi** allows the fan to run at high speed all the time. **Note Hi** is required for chillers to achieve a ThermoFlex2500 watt cooling capacity. ▲

Range: Auto or Hi **Default:** Auto

- **Sound** is used to enable/disable the audible alarm.

Range: on or oFF **Default:** on

Figure 4-6 Setup Loop (All Chillers)

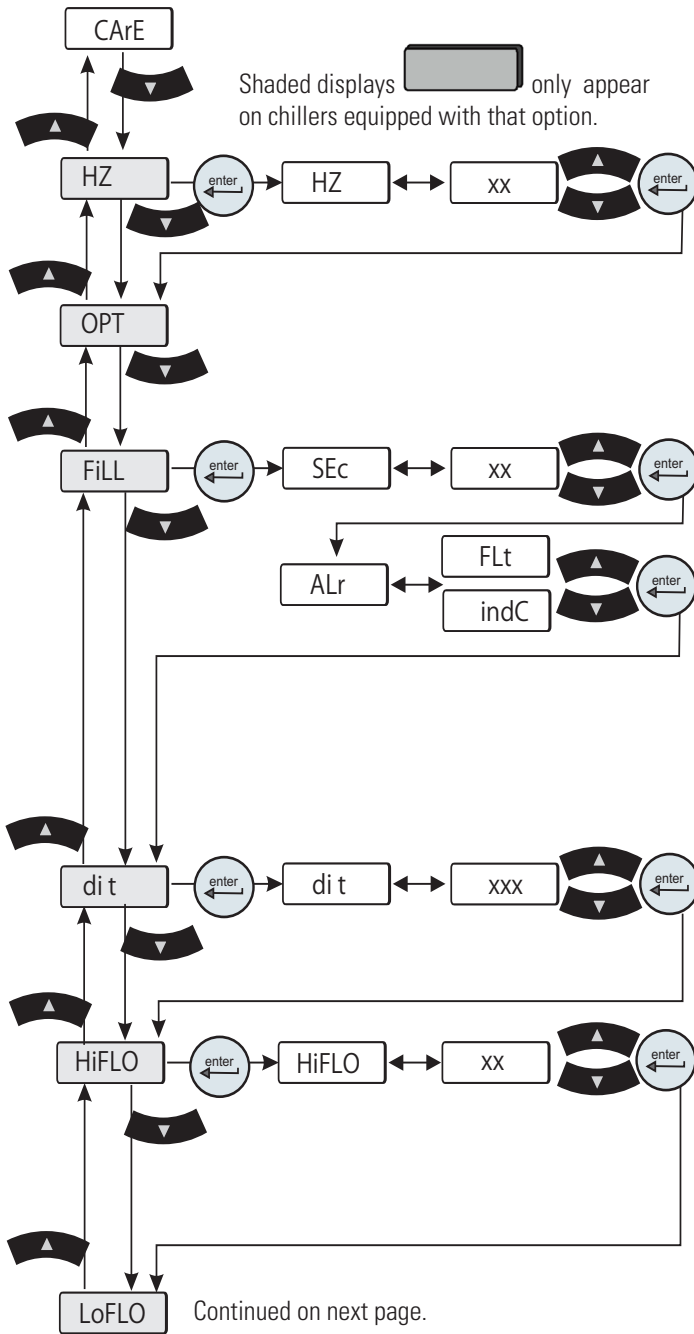

Figure 4-7 Setup Loop (Optional Features)

• **HZ** is used to identify the incoming frequency for chiller's with P3 - P5 pumps *and* the capability to run on either 50 Hz or 60 Hz. The selected frequency automatically adjusts the firmware's *fixed* high pressure default setting.

Range: 50 Hz or 60 Hz **Default:** 60 Hz

• **OPt** is used to configure the analog in/out mode of operation. See Appendix C.

• **FiLL** is used to set the time limit the auto refill has for filling the reservoir to the normal operating level.

Range: 0 to 900 seconds

Default: 45 seconds ThermoFlex900 - 5000

80 seconds ThermoFlex7500 - 24000

Exceeding the time limit flashes **rEFiL** and the auto refill will shut off. The chiller's reaction depends on the alarm **ALr** setting, **FLt** is shut down, **indC** is continue to run.

Note Setting the time limit to 0 disables the auto refill option. ▲ See Section 5 for additional information.

• **di t** is used to set the preventive care cleaning frequency reminder for the chiller's DI filter cartridge.

Range: 0 to 9999 hours **Default:** 448 hours

Exceeding the limit flashes **di**, see Section 6.

• **HiFLO** is used to set the high flow alarm limit.

T0 T1 **Range:** 0.0 to 10.5 GPM **Default:** 0.0 GPM

T5 Pump **Range:** 0.0 to 15.0 GPM **Default:** 0.0 GPM

P1 Pump **Range:** 0.0 to 10.5 GPM **Default:** 0.0 GPM

P2 Pump **Range:** 0.0 to 10.5 GPM **Default:** 0.0 GPM

P3 Pump **Range:** 0.0 to 30.0 GPM **Default:** 0.0 GPM

P4 Pump **Range:** 0.0 to 30.0 GPM **Default:** 0.0 GPM

P5 Pump **Range:** 0.0 to 30.0 GPM **Default:** 0.0 GPM

T9 Pump **Range:** 0.0 to 33.5 GPM **Default:** 0.0 GPM

Exceeding a high limit flashes **HiFLO** and, if enabled, sounds the alarm. The chiller's reaction depends on the alarm (**ALr**) setting.

Note This feature is not enabled until the value is changed to something other than 0.0. ▲

Continued from previous page

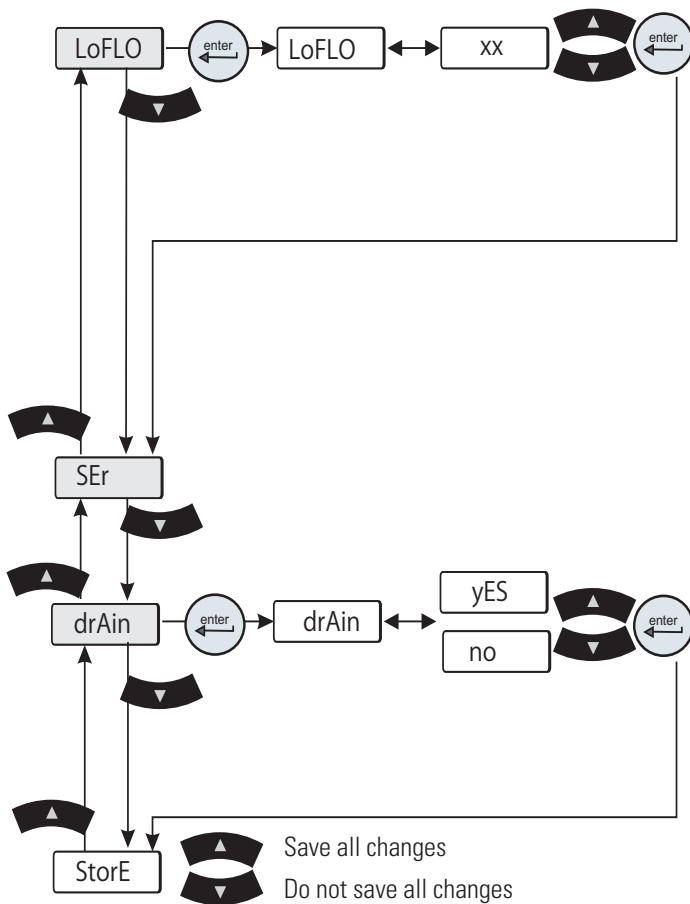

Figure 4-7 Setup Loop (Optional Features)

• **LoFLO** is used to set the low flow alarm limit.

T0 Pump	Range: 0.0 to 10.5 GPM	Default: 0.0 GPM
T1 Pump	Range: 0.0 to 10.5 GPM	Default: 0.0 GPM
T5 Pump	Range: 0.0 to 15.0 GPM	Default: 0.0 GPM
P1 Pump	Range: 0.0 to 10.5 GPM	Default: 0.0 GPM
P2 Pump	Range: 0.0 to 10.5 GPM	Default: 0.0 GPM
P3 Pump	Range: 0.0 to 30.0 GPM	Default: 0.0 GPM
P4 Pump	Range: 0.0 to 30.0 GPM	Default: 0.0 GPM
P5 Pump	Range: 0.0 to 30.0 GPM	Default: 0.0 GPM
T9 Pump	Range: 0.0 to 33.5 GPM	Default: 0.0 GPM

Going below the low limit flashes **LoFLO** and, if enabled, sounds the alarm. The chiller's reaction depends on the alarm (**ALr**) setting.

This feature is not enabled until the value is changed to something other than 0.0. If the feature is not enabled and the flow rate drops below the flow rate listed below the chiller will continue to run and the controller will flash between **FLo** and **LoFlo**.

P1, T0, T1, T5 and T9 Pump	0.3 GPM
P2 Pump	1.0 GPM
P3, P4 and P5 Pump	4.0 GPM

• **SEr** is used to configure the serial communications mode of operation. See Appendix D.

Note Keypad operation is still available with serial communications enabled. ▲

• **drAin** is used to open and close the chiller's anti drainback valve for draining, see Section 5.
Range: yes or no **Default:** no

Note The chiller must be off to drain the valve. The valve automatically closes when you exit the **drAin** display. ▲

When the display indicates **StorE** press ▲ to save *all* changes or press ▼ to not save *all* changes. The display will return either the process fluid temperature or, if the chiller was off when you entered the loop, a blank screen.

Shut Down

Press  on the controller.

Note To protect the chiller's compressor, the chiller will enter a 5 to 20 second shut down cycle (colder process fluids take longer) before the refrigeration system and pump shut down. During this time the display will indicate . The bars will scroll downward indicating the controller is in the shut down cycle. ▲

Using any other means to shut the chiller down can reduce the life of the compressor.

For ThermoFlex900 - 10000 chillers, when the display goes blank it is safe to place the circuit protector located on the rear to the off (**0**) position.



Always turn the chiller off and disconnect it from its supply voltage before moving. ▲



For ThermoFlex900 - 10000s, the circuit protector located on the rear is not intended to act as a disconnecting means. ▲

Section 5 Options/Accessories

Auto Refill The Auto Refill provides makeup fluid to replace any fluid lost to evaporation, etc. It requires a pressurized fluid source connection to the 1/4" Female Pipe Thread fitting on the rear of the chiller. (If Teflon® tape is used, ensure the tape does not cover the connection's starting-end thread.)

Note ThermoFlex7500 through 24000s with a P3 or P5 or ThermoFlex7500s and 10000s with a T5 pump have a 1/4" Male brass plug installed in the connection, remove the plug before connecting the makeup fluid. ▲



Figure 5-1 Auto Refill Fitting

The auto refill fluid must also meet water quality standards or the valve may fail to operate as designed, see Section 3.

The auto refill valve input pressure must be < 80 PSI to ensure the valve functions properly.

The auto refill operates when all of the following conditions are met:

- Fluid is available
- The chiller is turned on
- The fluid reaches a low level condition.

The auto refill shuts off when:

- The fluid reaches the correct operating level.
- The delay timer exceeds user fill time entered in the Setup Loop, see Section 4. If **FLt** is selected in the Setup Loop the chiller also shuts down. (If **indC** is selected the chiller continues to run.) In either case the controller will display **rEFIL**.
- The chiller shuts down for any reason.

Setting the fill time to 0 disables auto refill. If a low level condition occurs the chiller will:

- If **Indc** is selected, continue to run and the controller displays **Add**.
- If **FLt** is selected, shut down and the controller displays **LLF**.

Internal DI Cartridge

A partial flow DI filter cartridge is designed to maintain water resistivity between 1 and 3 MΩ-cm.

Note The DI option results in a 0.5 gpm reduction of available flow. ▲



Do not use a Deionization (DI) filter cartridge with Inhibited EG or Inhibited PG. A DI filter will remove inhibitors from the solution rendering the fluid ineffective against corrosion protection. Also, inhibitors increase fluid conductivity. ▲

The Puralite sensor on the back of the chiller turns red when the cartridge needs changing (< 1 MΩ-cm), see Section 6. **Note** The Puralite sensor that comes with the DI cartridge requires a separate power source. ▲

Remove the two thumbscrews securing the DI access panel. Remove the new cartridge from the shipping bag. The cartridge has a blue and a white connector. Lower the cartridge into the chiller with the blue connector facing downward. Press down on the cartridge lightly to engage and then rotate it ¼ turn clockwise (do not over rotate) or until you feel the filter click into place.

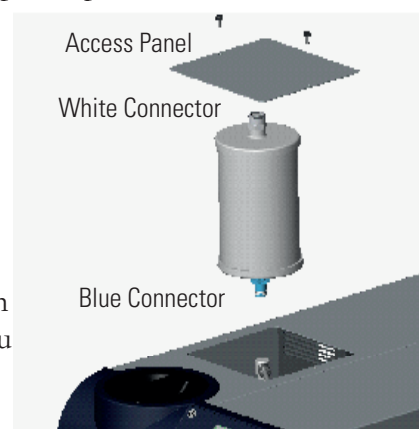

Figure 5-2 Internal DI Cartridge

If there is a cartridge in place, first undo the hose fitting by pressing on the quick disconnect located on the top white connection.



The DI Cartridge will overpressurize if it is removed from the chiller before removing the hose fitting. ▲

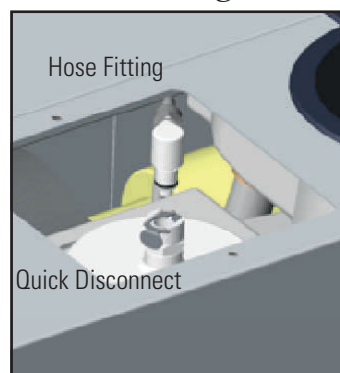

Figure 5-3 DI Fittings

Next rotate the cartridge ¼ turn counter-clockwise and then pull the cartridge straight up to remove it.

Push the hose fitting into the quick disconnect located on the white end of the cartridge.

Replace the access panel and thumbscrews.

Note The cartridge can be changed with the chiller running, however, since the cartridge runs in a parallel arrangement, disconnecting the cartridge adds 0.5 gpm to the main flow. The additional flow will cause an increase in system pressure which may cause a high fluid pressure fault. ▲

P1 P2 T0 T1 Pump Pressure Relief Valve (Internal Configuration)

Use the pressure relief valve, located on the top left rear of the chiller, to set the desired system back pressure to your application. The valve is factory preset to 80 ± 5 psi (5.5 ± 0.4 bar).

If the chiller is not plumbed to an application, set the pressure by installing a loop of hose equipped with a shut-off valve between the supply and return fittings. Start the chiller and allow it to prime, then close the valve.

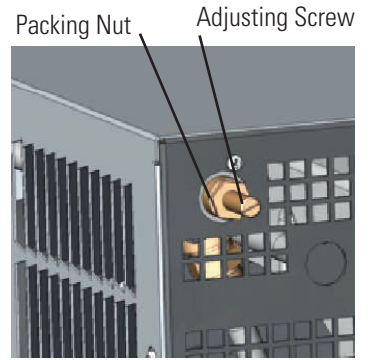

Figure 5-4 Nut and Screw

Use the controller's  to display P1, it should display 80 ± 5 psi.

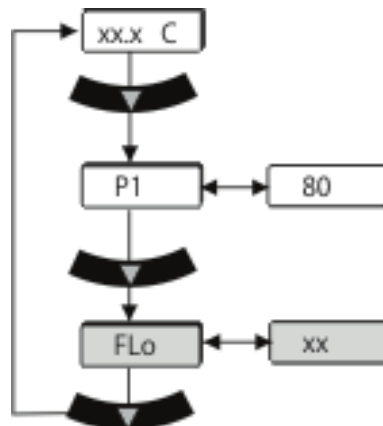

Figure 5-5 Main Loop

Use a screwdriver to turn the adjusting screw (counterclockwise to reduce pressure) until the controller displays the desired setting.



Note Due to internal back pressure, the minimum pressure setting for a deadheaded P2 pump is 32 psi (2.2 bar), and 8 psi (0.6 bar) for a P1 (these settings prohibit external flow from the chiller). ▲

If the chiller is plumbed to an application, ensure the chiller is off. Then back out the adjusting screw counterclockwise to reduce pressure. Turn the chiller on. Ensure that there is back pressure in the system. Turn the adjusting screw until the controller displays the desired setting.



Do not exceed 100 psi (6.9 bar). ▲

When complete, inspect the area around the $\frac{5}{8}$ " packing nut for fluid leaks. If fluid is present, slightly tighten the nut and reinspect.

Note Should the chiller start to vibrate the valve setting may be the cause. Changing the pressure setting ± 5 psi (0.3 bar) will eliminate the vibration. ▲

P1 P2 T0 T1 Pump Pressure Relief Valve (External Configuration)

Use the pressure relief valve to set the desired system back pressure (P1) to your application. The valve is factory preset to 80 ± 5 psi (5.5 ± 0.4 bar).

The valve's inlet/outlet connections are $\frac{1}{2}$ " FNPT.

If the chiller is not plumbed to an application, set the pressure by installing a loop of hose equipped with a shut-off valve between the supply and return fittings. Start the chiller and allow it to prime, then close the valve.

Adjusting Screw
Packing Nut

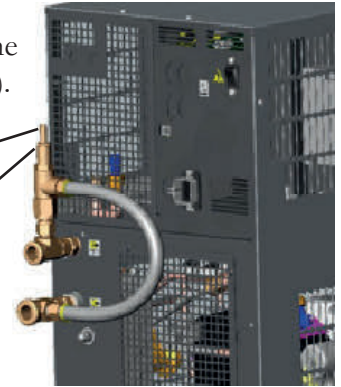

Figure 5-6 Nut and Screw

Use the controller's  to display P1, it should display 80 ± 5 psi.

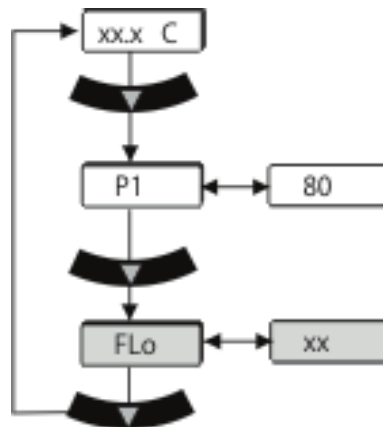

Figure 5-7 Main Loop

Use a screwdriver to turn the adjusting screw (counterclockwise to reduce pressure) until the controller displays the desired setting.



Note Due to internal back pressure, the minimum pressure setting for a deadheaded P2 pump is 40 psi (2.8 bar), and 22 psi (1.5 bar) for a P1 (these settings prohibit external flow from the chiller). ▲

If the chiller is plumbed to an application, ensure the chiller is off. Then back out the adjusting screw counterclockwise to reduce pressure. Turn the chiller on. Ensure that there is back pressure in the system. Turn the adjusting screw until the controller displays the desired setting.



Do not exceed 100 psi (6.9 bar). ▲

When complete, inspect the area around the $\frac{5}{8}$ " packing nut for fluid leaks. If fluid is present, slightly tighten the nut and reinspect.

Flow Control with Flow Readout

Flow control for P1, P2, T0 and T1 pumps on ThermoFlex900 - 5000s is achieved using a 3-way valve plumbed between the standard process outlet and the process inlet on the rear of the chiller. Use the auxiliary process outlet at the top left of the rear of the chiller as a connection point. The connections are 1/2" FNPT. See Figure 5-8.

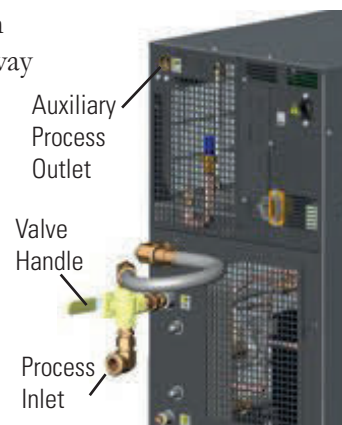

Figure 5-8 Flow Control

ThermoFlex3500 and 5000s with P3 and P4 pumps use a 2-way valve located on the rear of the chiller. The connections are 3/4" FNPT. See Figure 5-9.

ThermoFlex7500 and 24000s with P2 - P5 and T5 pumps (see next page) use a valve located on the rear of the chiller. The connections are 1/2" FNPT for P2, 1" FNPT for P3 and P5. See Figure 5-9.

Press the controller's down arrow  twice to display the controller's **FLO** display, see previous page. Turn the valve handle until the desired rate is displayed.



Figure 5-9 Flow Control Handle (Typical)

Note The valve is sensitive to slight adjustments. ▲

P1 P2 T0 T1 Pump Pressure Relief with Flow Readout

The Pressure Relief with Flow Readout works just like the Pressure Relief Valve discussed on the previous page. It allows you to control the pressure going to your application.

This valve is plumbed between the standard process outlet and the process inlet on the rear of the chiller. Use the auxiliary process outlet at the top left of the rear of the chiller as a connection point, allowing you to also monitor the flow rate to your application using the controller's **FLO** display, see previous page.

The valve's outlet connection is 1/2" FNPT. See Figure 5-10.

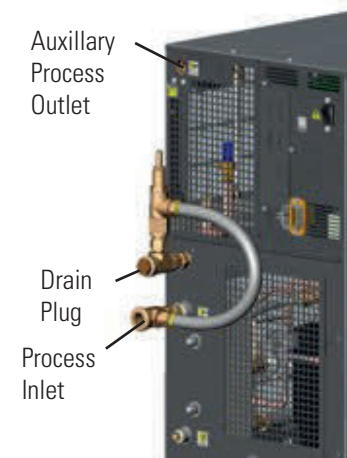
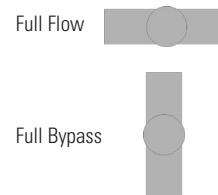

Figure 5-10 Pressure Relief

T5 Pump Flow Control

The flow control valve is used to adjust the flow rate. The valve's handle is designed to identify the valve's position, from full flow to full bypass. When the handle is in the horizontal position (in line with the discharge line) the application is receiving full flow. With the handle is vertical the valve is in full bypass.



Anti-Drainback

Chillers installed below the end-user application may allow system fluid to drain back into the chiller and cause spillage. The anti-drainback valve is designed to prevent any such spillage.

The valve opens just before the pump is turned on and it closes just after the pump shuts off.

This option is required if your chiller is more than 24 feet below your application, or if there is a possibility of drain back due to the opening of the process lines for either application swaps or chiller servicing.

Semiconduct or Equipment and Materials International (SEMI) Chillers

Compliance

SEMI chillers are compliant with:

- SEMI S2 Product Safety Assessment
- SEMI S8 Ergonomic Assessment
- SEMI S14 Fire Risk Assessment
- SEMI F47 Voltage Sag Immunity

(ThermoFlex900-10000 only)

Emergency Off (EMO)

A guarded red mushroom shaped push-button switch with twist-to-reset is provided on the chiller's front to turn it off in case of an emergency. The button head is engraved with "EMO" in large white filled letters.

Note The EMO is controlled by a safety circuit and is not influenced by the chiller's firmware/software. ▲

Activation of the EMO button will remove power from the main contactor coil stopping operation of the chiller. The controller will display **Er 48**.

Resetting the EMO will not restart the chiller. After removing all hazards reset the chiller by pushing the enter key on the controller. In the local mode, the chiller will restart by pressing the START STOP button again. In the serial communications mode, send the appropriate start command. In the analog I/O mode, the chiller starts when the error is cleared.

Chiller Circuit Breaker Interrupt Rating

The main power circuit breaker located on the rear of the chiller has an Interrupting Capacity (AIC) of 10,000 amps.

Lockout/Tagout (LOTO)

Before performing Chiller maintenance, the energy sources associated with the Chiller system must be lockedout and tagged out (LOTO). Hazard control features added to the system (e.g., safety interlocks, EMO) are not a substitute for turning off and locking out electrical or fluid energy.

For chillers that are water cooled, the facility water supply must be shut off prior to conducting maintenance. The supply shut-off must be readily accessible and be capable of being locked out.

For chillers rated 20 Amps or less, electrical LOTO is accomplished by removing the power cord on the rear of the chiller then closing and locking the power receptacle locking device. For other chillers, electrical LOTO is the responsibility of the user and can be provided by:

- Using the main disconnect (knife switch at system control cabinet).
- Disconnecting main power at the facility power source prior to the system controller cabinet.
- In addition, follow all OSHA and local facility LOTO directives.

Drip Pan and Drain

The chiller is equipped with a secondary containment (drip pan) in case there is a leak. The drip pan drain is located on the rear of the chiller. Install the supplied nylon 1/4 turn quick disconnect (QD) fitting into the

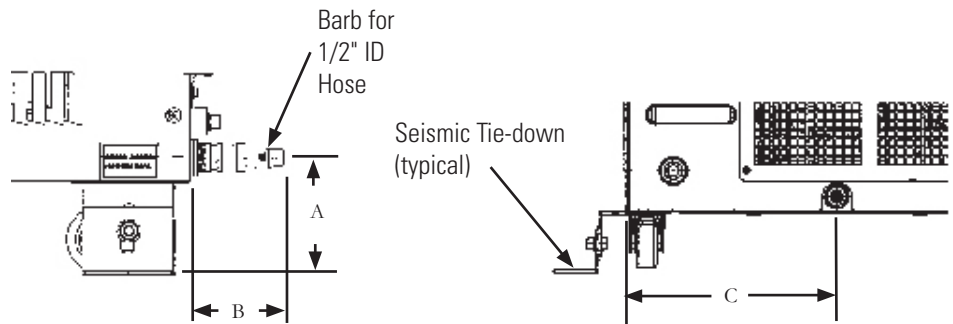

1/4 Turn Quick Disconnect Drip Pan Drain Fitting

Figure 5-11 Drip Pan Drain

	900/1400		2500		3500/5000		7500/10000	
A	3 1/2"	8.8 cm	4"	10.1 cm	3 3/8"	11.3 cm	4 1/4"	10.8 cm
B	2 3/4"	7.0 cm	2 11/16"	6.8 cm	2 3/4"	7.1 cm	2 5/8"	6.6 cm
C	6 15/16"	17.7 cm	6 9/16"	16.7 cm	9 9/16"	24.3 cm	7 11/16"	19.5 cm

Seismic Tie-Downs

Install the seismic tie-downs to the chiller as shown below. Then secure the chiller to the floor with user-supplied hardware.

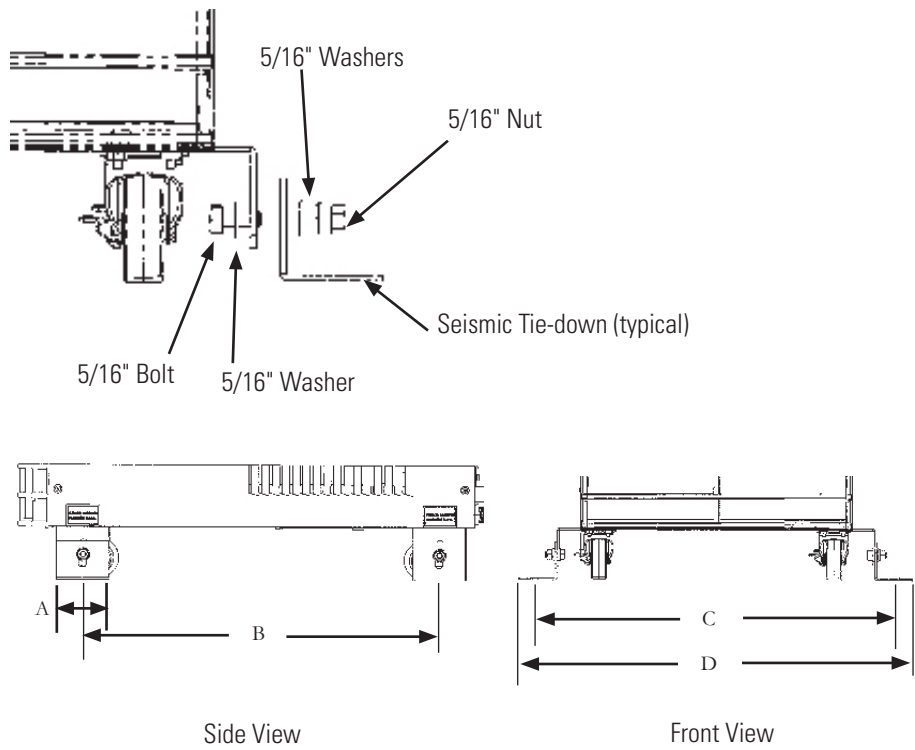

Figure 5-12 Seismic Tie-Downs

	900/1400		2500		3500/5000		7500/10000	
A	2 11/16"	6.8 cm	2 11/16"	6.8 cm	2 11/16"	6.8 cm	2"	5.1 cm
B*	18 1/2"	47.0 cm	20 1/16"	51.0 cm	24 1/2"	62.2 cm	17"	43.1 cm
C*	19 11/16"	50.0 cm	22 3/4"	57.8 cm	24 3/4"	62.9 cm	27 7/16"	69.6
D	21 3/16"	53.8 cm	24 1/4"	61.5 cm	26 1/4"	66.7 cm	28 15/16"	73.4

* Distance between Ø.53 Seismic mounting holes

Center of Gravity

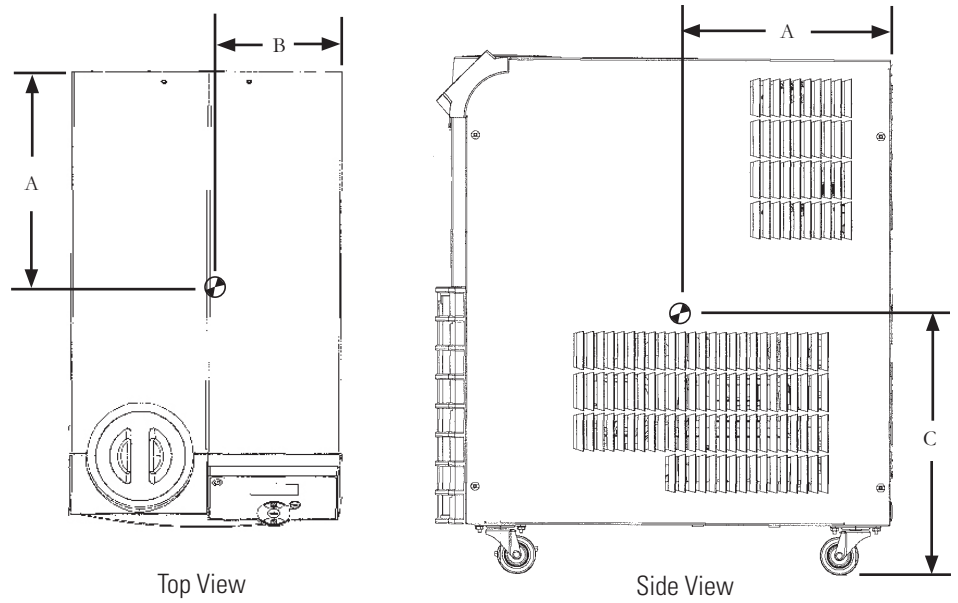

Figure 5-13 Center of Gravity

Center of Gravity $\pm 1/2"$, air-cooled chiller, no fluid in tank

	900/1400 P2 Pump		2500 P2 Pump		3500/5000 P2 Pump		7500/10000 P3 Pump	
A	10 ³ / ₄ "	27.3 cm	12"	30.5 cm	13 ³ / ₈ "	34.0 cm	14 ⁷ / ₈ "	37.8 cm
B	6 ³ / ₄ "	17.2 cm	8 ³ / ₈ "	21.3 cm	9"	22.9 cm	13 ¹ / ₈ "	33.3 cm
C	13 ¹ / ₂ "	34.3 cm	13 ¹ / ₂ "	34.3 cm	17"	43.2 cm	26"	66.0 cm

	15000/20000 P3 Pump		24000 P3 Pump		3500/5000 P4 Pump Global Voltage	
A	13 ³ / ₄ "	34.9 cm	12"	30.5 cm	12 ³ / ₈ "	31.4 cm
B	21 ⁵ / ₈ "	54.9 cm	8 ³ / ₈ "	21.3 cm	9 ³ / ₄ "	24.8 cm
C	21 ¹ / ₄ "	54.0 cm	13 ¹ / ₂ "	34.3 cm	19 ¹ / ₂ "	49.5 cm

Center of Gravity $\pm 1/2"$, water-cooled chiller, no fluid in tank

	3500/5000 P2 Pump		15000/20000 P3 Pump		24000 P3 Pump	
A	13"	33.0 cm	17"	43.2 cm	12"	30.5 cm
B	9 ¹ / ₂ "	24.1 cm	22"	55.9 cm	23"	58.4 cm
C	16"	40.6 cm	20 ¹ / ₂ "	52.1 cm	21"	53.3 cm

Weight Distribution ± 2 lbs, air-cooled chillers

	900/1400 P2		2500 P2		3500/5000 P2		7500/10000 P3	
Left Front	27.1 lbs	12.3 kg	40.7 lbs	18.5 kg	62.0 lbs	28.1 kg	97.8 lbs	44.4 kg
Left Rear	29.8 lbs	13.5 kg	42.0 lbs	19.1 kg	63.7 lbs	28.9 kg	99.9 lbs	45.3 kg
Right Front	32.9 lbs	14.9 kg	45.7 lbs	20.7 kg	68.2 lbs	30.9 kg	89.2 lbs	40.5 kg
Right Rear	36.2 lbs	16.4 kg	47.1 lbs	21.4 kg	70.0 lbs	31.8 kg	91.1 lbs	41.3 kg

Other Accessories Installation kit - includes replacement air and fluid filters

Maintenance kit - includes a set of hoses, adaptor fittings and Teflon[®] tape

Fluids

Fluid treatment kit

Please contact Thermo Fisher Scientific's Sales, Service and Customer Support to assist you with questions that you may have regarding accessories for your ThermoFlex, see inside front cover for contact information.

Section 6 Preventive Maintenance

Only Thermo Fisher should provide any required replacement parts.

Preventive Maintenance Timer (CARE)

The ThermoFlex chiller has an integrated preventive maintenance timer that will alert you when it is time to perform preventive maintenance. This unique feature will remind you to change your air and fluid filters.

Based on the environment in which your chiller is located, you can choose from four levels of preventive maintenance off, L1, L2, and L3:

- off – Disables the alert
- L1 – 1,000 hours - default setting
 - Heavy manufacturing environment
 - Airborne particulate created during manufacturing process
- L2 – 2,000 hours
 - Typical production environment
- L3 – 3,000 hours
 - Clean environment – filtered air
 - Typically laboratory or research environment

Change/set the level using the Setup Loop, see Section 4. When the chiller exceeds the chosen limit, the controller will flash **Chn9** **FLt5** and, if enabled, an audible alarm will sound.

To clear this message press . This will automatically restart the preventive maintenance timer for your filters. Each time the chiller exceeds the chosen time, the controller will remind you that it is time to change your filters.

If you change your filters before the preventive timer trips, you can clear the timer by using the Diagnostic Loop explained in this Section.

Note For air-cooled chillers, both the air and fluid filters in the ThermoFlex can be changed while the chiller is running. For water-cooled chillers, only the fluid filter can be changed while the chiller is running. ▲

Fluid Filter Bag

The reservoir has a fluid bag filter designed to prevent the introduction of particulates into the system.

Note The fluid bag filter can be removed with the chiller operating. ▲



Before using any fluid or performing maintenance where contact with the fluid is likely refer to the manufacturer's SDS for handling precautions and PPE requirements. ▲

Fluid Bag Filter



When it is time to replace the bag, gently pull up on the plastic funnel housing to remove it and simply pull the bag out of the chiller. Replacement bags are available from Thermo Fisher Scientific.

Figure 6-1 Fluid Filter Bag



Before replacing the reservoir housing ensure the reservoir sight tube ball stopper is securely in place, see next page. ▲

Fluid Diffuser

On ThermoFlex900-5000s, when you remove the bag you will notice a wire mesh fluid diffuser inside the reservoir supply line, see Figure 6-2. The diffuser is used to help streamline the flow into the reservoir. After several bag replacements turn the chiller off and remove the diffuser to inspect it for debris/damage.



The fluid velocity into the reservoir will rapidly increase with the diffuser removed and cause splashing. Turn the chiller off before removing the diffuser. This is especially critical when using ethylene or propylene glycol. ▲

Note To prevent particulates from entering the reservoir, ensure the fluid bag filter is in place before removing the diffuser. ▲



Do not operate the chiller unless the diffuser is installed. ▲

Reservoir Cleaning

The user is responsible for maintaining reservoir fluid quality. Check the fluid on a regular interval. Start with frequent checks until a regular interval (based on your application) is established.

If cleaning is necessary, flush the reservoir with a fluid compatible with the process fluid and the chiller's wetted parts, see Section 8.



Before using any fluid or performing maintenance where contact with the fluid is likely refer to the manufacturer's SDS for handling precautions and PPE requirements ▲

Reservoir Sight Tube

Clean the sight tube by gently pulling up on the plastic funnel housing to remove it (see illustration on previous page) and then gently pulling out the black sight ball stopper from the tube. Use a long soft-bristle ¼" brush. Use caution not to scratch the glass.



Before replacing the reservoir housing ensure the reservoir sight tube ball stopper is securely in place. ▲

For easier replacement, wet the stopper first and then use a twisting motion to install it in the sight tube.

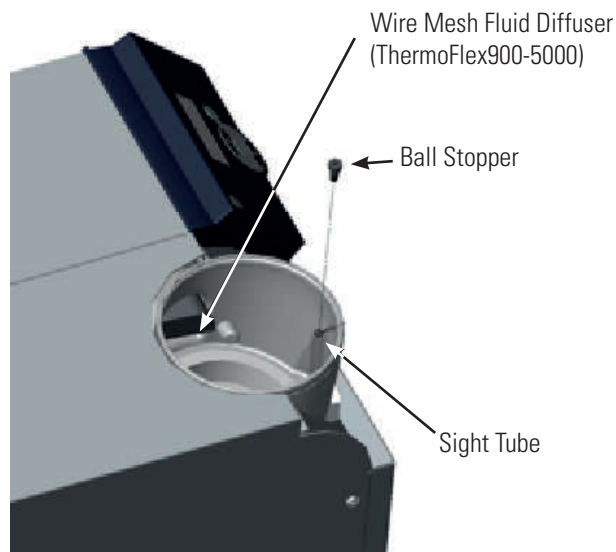

Figure 6-2 Reservoir Cleaning and Diffuser

Fluid Maintenance

An effective recommended maintenance plan would include changing the fluid every six months to optimize chiller reliability, see Section 3 for additional information.

Condenser Filter



Failure to clean/replace the condenser filter will cause a loss of cooling capacity and lead to premature cooling system failure . ▲

ThermoFlex900 - 5000

Clean the filter through the grill using a vacuum with a soft-bristle brush.

When it is time for a more thorough cleaning, remove the one-piece grill assembly by first pulling the bottom of the assembly away from the chiller and then pulling it away from the top.



The condenser framing and fins located behind the grill assembly are very sharp. Use caution when removing the assembly. ▲

Note ThermoFlex900 - 5000 water-cooled chillers have an embedded screw(s) located at the top (and bottom) of the grill. Loosen the screw(s) to remove the grill. ▲



Water-cooled chillers also have a fan with sharp blades, ensure the chiller is off before removing the assembly. ▲

Shake off as much of the excess water as possible before reinstalling. Press the grill back into place.

For water-cooled chillers, tighten the screw(s) at the top (and bottom) of the grill.

Replacement grill assemblies are available from Thermo Fisher.

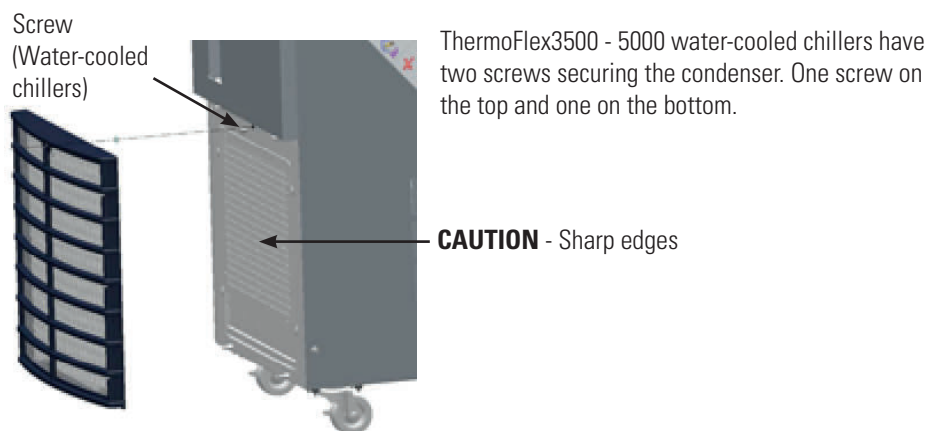

Figure 6-3 ThermoFlex900 - 5000 Condenser Grill Removal

ThermoFlex7500 - 10000

For air-cooled chillers, remove the one-piece grill assembly by pulling the assembly away from the chiller.

Water-cooled chillers do not have a filter.

The filter goes over four studs and plastic "fast nuts" hold it in place.

Replace it or vacuum the old filter with a soft-bristle brush, or wash it. Shake off as much of the excess water as possible before reinstalling.

Tuck the filter around the perimeter of the grill and over the four studs, use the plastic "fast nuts" to hold it in place.

Replacement grills are available from Thermo Fisher.

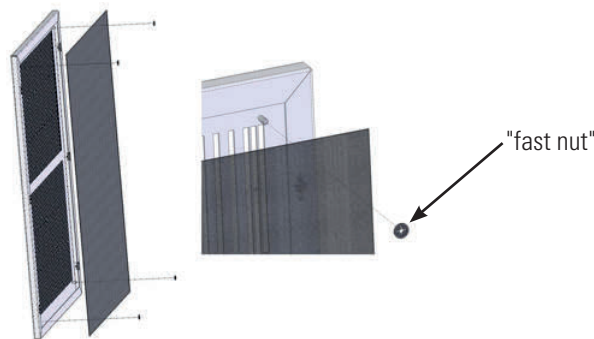

Figure 6-4 Filter Removal/Replacement ThermoFlex7500 - 10000 Air-Cooled

ThermoFlex15000 - 24000

The air-cooled chillers do not have filters but the condenser fins can be cleaned by removing the eight screws securing the lower-front panel.

Chiller Surface Clean the chiller's surface with a soft cloth and warm water only.

Hoses Inspect the chiller's external hoses and clamps on a daily basis.

DI Filter (Optional)

Establish a preventive maintenance schedule for the DI filter cartridge based on your specific application.

The Puralite sensor located on the back of your chiller will illuminate red when it is time to change the DI filter cartridge ($< 1 \text{ M}\Omega\text{-cm}$).

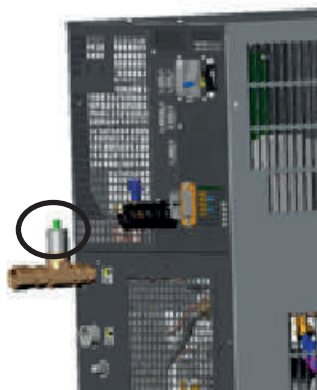

Figure 6-5 Puralite

Note When the chiller is initially powered, or has been sitting idle for a period of time, the sensor may illuminate. The length of time it will be on varies with your application. ▲

Although the Puralite sensor is the primary indicator that the cartridge needs changing, the chiller also has a *separate* integrated alarm that works independently of the Puralite. The alarm is based on chiller run hours that will alert you when it is time to change your filter. The **di t** alarm is enabled using the Setup Loop, see Section 4.

If you already know how often your DI filter needs changing, you can input the number of hours into the Setup Loop's **di t** display. When the time is reached, the controller will flash **di** and the audible alarm, if enabled, will sound.

When alerted, check the Puralite sensor to see if it is illuminated. If it is not illuminated reset the **di t** timer and then check the Puralite periodically.

To clear this message and stop the audible alarm press  .

If the Puralite has turned red and the controller alarm has not gone off, access the Diagnostic Loop **di** display, see next page. Check the system run hours, this will give you an accurate DI replacement time. Adjust the **di t** filter alarm to match the time needed between filter cartridge changes.



This will automatically restart the preventive maintenance timer for your DI filter. If you change the filter before the preventive maintenance timer alerts you, you can clear the timer by again accessing the Diagnostic Loop **di** display, see next page.



Note It may be necessary to monitor the Puralite three or four times to establish an accurate changing schedule. Also, filter operating time is reduced every time new fluid is added. ▲



Diagnostic Loop (d ,R9)

The Diagnostic Loop is used to view or reset the operating times of various chiller components.

To enter the Diagnostic Loop ensure the controller display is either a blank screen (chiller off) or displaying the process fluid temperature.

Press the  key and the display will indicate **SP**, press  again to display **SEtuP**, press  again to display **d ,R9**.

Press  to enter the loop or press  to return to the process fluid temperature or blank display.

Press  to sequence down through the loop. Press  to sequence up through the loop.

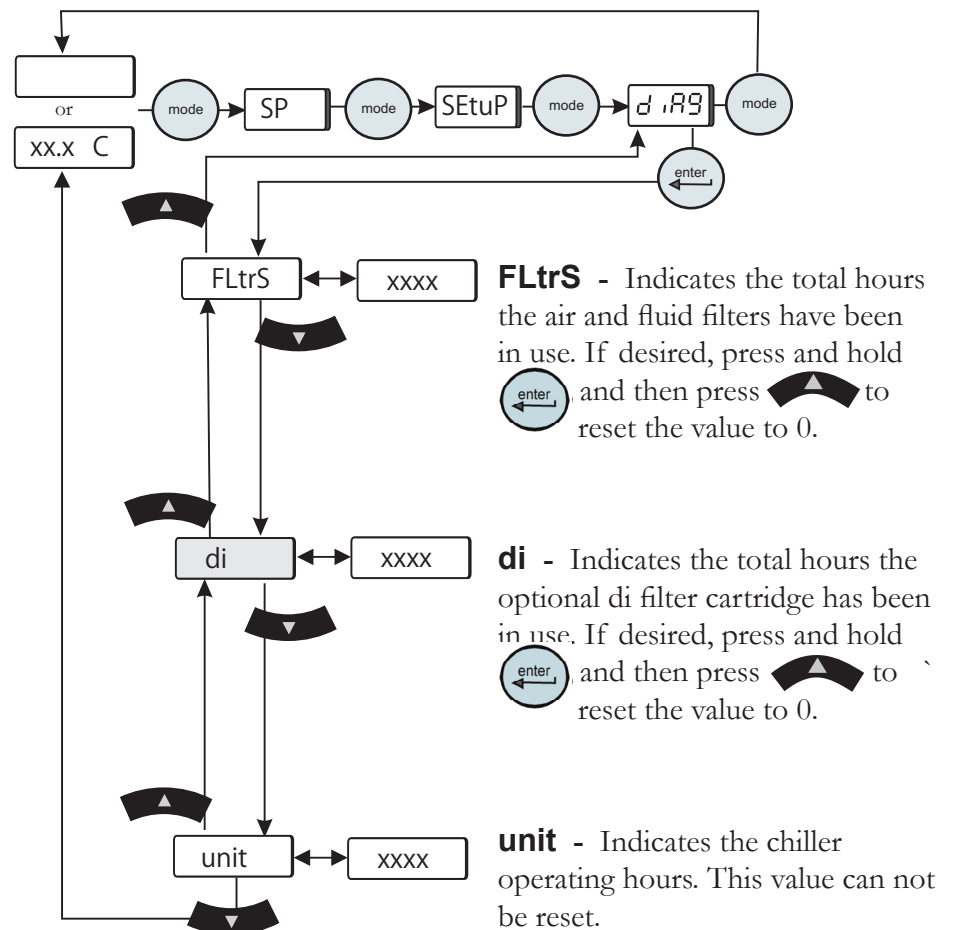

Figure 6-6 Diagnostic Loop

Testing the Alarm Features

Using the Setup Loop, adjust each temperature alarm limit towards the setpoint and ensure the chiller reacts accordingly. Reset each alarm limit to the desired value. See Section 4.

Slowly drain the chiller's reservoir, see Section 8, and ensure the chiller shuts down. For chillers equipped with auto refill switch ensure the auto refill activates.

Section 7 Troubleshooting

Error Codes

The controller can display Error Codes. If the chiller is still running press **enter** to see if the code clears, a limit may have been only temporarily exceeded. If the chiller shut down, the controller will continue to flash the error code. Press **enter** to clear the display and silence any alarm. You can silence the alarm without clearing the code by pressing either the up or down arrow key. Once the cause of the shut down is identified and corrected, start the chiller. If the cause was not corrected the error code will reappear. Contact our Sales, Service and Customer Support.

Error Code	Reaction	Cause	Actions
8888 (or blank screen)	Chiller will not start.	Software communication error.	<ul style="list-style-type: none"> •Cycle circuit protector on the rear of the chiller, ThermoFlex900-10000 only.
Add	Chiller continues to run. Auto refill, if installed, shuts off.	The auto refill time chosen for the customer adjustable <i>fill</i> setting in the Setup Loop is set to 0 and the chiller is configured to keep running, see Section 4.	<ul style="list-style-type: none"> •Check for leaks. •Check reFill settings and adjust if necessary, see Section 4. •Add fluid to the tank.
di	Chiller continues to run. (Optional display)	The chiller operating time exceeded Setup Loop di t alarm value. The optional DI cartridge <i>may</i> need replacing.	<ul style="list-style-type: none"> •Check the Puralite sensor, see Section 6. If the light is red change the cartridge, see Section 5. •If the Puralite sensor is green, see Section 4 to revise di t alarm value.
driP	Chiller will shut down. (Optional display)	Fluid in drip pan (SEMI only).	<ul style="list-style-type: none"> •Check for leaks. •Remove the fluid from the drip pan and reset the fault.
FLO-LoFLO	Chiller continues to run.	The low flow alarm is set to 0.0 and the pump flow rate is below the minimum required, see Section 4.	<ul style="list-style-type: none"> •See LoFLO error code.
FLtrS	Chiller continues to run.	Air and fluid filters require preventive maintenance/replacement.	<ul style="list-style-type: none"> •Check air and fluid filters. If required, clean/change air and fluid filters, see Section 6. •If your filters do not need cleaning, you may increase the number of hours between preventive care reminders. There are four levels, see Section 6.

Error Code	Reaction	Cause	Actions
HiFLO	Chiller reaction depends on ALR setting chosen in the Setup Loop, see Section 4. (Chiller equipped with a flow transducer.)	The process fluid flow rate has exceeded the adjustable high flow setting's value.	<ul style="list-style-type: none"> • If the chiller is still running press enter to see if the code clears, the limit may have been only temporarily exceeded. • Verify your HiFLO setting, see Section 4, and adjust setting if necessary. • Check all application and plumbing shut off valves for correct position. • Adjust flow if chiller is equipped with an optional flow control valve, see Section 5. • If flow transducer was recently calibrated double check calibration, see Section 8.
Hi P1	Chiller reaction depends on ALR setting chosen in the Setup Loop, see Section 4.	The pump's high discharge pressure exceeded Setup Loop high alarm value.	<ul style="list-style-type: none"> • If the chiller is still running press enter to see if the code clears, the limit may have been only temporarily exceeded. • Verify your Hi P1 setting, see Section 4. • Check application valves and ensure that they have not changed or closed. Note If routine shut-off of the process flow is required then add an external pressure relief valve, see Section 5. ▲ • May occur as a result of changing the internal DI cartridge. Disconnecting the cartridge adds an additional 0.5 gpm to the main flow. See Section 5. • Check for debris in the application or external filters. • Double check fluid lines. Excessive bends, long tubing and diameter reductions can affect the pump's discharge pressure. Note If diameter reductions must be made, make them at the inlet and outlet of your application, not at the chiller. ▲

Error Code	Reaction	Cause	Actions
Hi t	Chiller reaction depends on ALR setting chosen in the Setup Loop, see Section 4. Note If the chiller does shut down it can be restarted provided the temperature is still within the factory-set high fixed temperature limit. However, the error will reoccur if the temperature goes below the adjustable setting and then again exceeds it. ▲	The process fluid temperature exceeded Setup Loop alarm value.	<ul style="list-style-type: none"> • If the chiller is still running press enter to see if the code clears, the limit may have been only temporarily exceeded. • Verify your Hi t setting, see Section 4. • Ensure the chiller meets all environmental requirements, see Section 3. • Clean the air filter. Dirt and debris on the filter can prevent the chiller from functioning at full capacity, see Section 6. • Ensure that the heat load being applied to the chiller is not too high. Contact Thermo Fisher for assistance on calculating heat loads. • Bring cooler air in from another area or exhaust the hot air into another location using an auxiliary fan. • Verify/adjust controller PID values, see the end of this section.
HPC	Chiller will shut down.	High refrigeration pressure cutoff activated.	<p>Air-cooled chillers</p> <ul style="list-style-type: none"> • Ensure that the ambient temperature is not exceeding the recommended range, see Section 3. • Ensure chiller has adequate ventilation, see Section 3. • Clean the air filter, see Section 6. • Bring cooler air in from another area or exhaust the hot air into another location using an auxiliary fan. • Contact our Sales, Service and Customer Support. <p>Water-cooled chillers</p> <ul style="list-style-type: none"> • Ensure facility water is on and connected. • Check facility water flow rate and pressure. • Contact our Sales, Service and Customer Support.

Error Code	Reaction	Cause	Actions
LLF	Chiller will shut down. Optional auto refill shuts down.	Reservoir fluid level too low for normal operation. The auto refill time chosen for the customer adjustable <i>fill</i> setting in the Setup Loop is set to 0 and the chiller is configured to shut down, see Section 4.	<ul style="list-style-type: none"> •Excessive evaporation. Ensure the chiller is operating with the funnel and cap in place. •Check for leaks. •Check rEFil settings and adjust if necessary, see Section 4. •Add fluid to the tank.
LoFlo	Chiller reaction depends on ALr setting chosen in the Setup Loop, see Section 4. (Chillers equipped with a flow transducer.)	The process fluid flow rate has gone below the adjustable setting's value.	<ul style="list-style-type: none"> •If the chiller is still running press enter to see if the code clears, the limit may have been only temporarily exceeded. •Verify your LoFlo setting, see Section 4. •Adjust flow if chiller is equipped with an optional flow control valve, see Section 5. •Check all valves in your application and plumbing lines to ensure that they have not changed or closed. •If flow transducer has recently been calibrated, double check calibration to ensure it was done properly, see Section 8.
Lo P1	Chiller reaction depends on ALr setting chosen in the Setup Loop, see Section 4.	Pump's low discharge pressure is below Setup Loop low alarm value.	<ul style="list-style-type: none"> •If the chiller is still running press enter to see if the code clears, the limit may have been only temporarily exceeded. •Ensure that chiller reservoir level is not too low. •Verify your LoP1 setting, see Section 4. •Chiller requires >3 PSIG application pressure drop. If a bypass valve has been installed, some restriction may need to be added to the bypass line.

Error Code	Reaction	Cause	Actions
Lot	Chiller reaction depends on ALr setting chosen in the Setup Loop, see Section 4. Note If the chiller does shut down it can be restarted provided the temperature is still above the factory-set low fixed temperature limit. However, the error will reoccur if the temperature goes above the adjustable setting and then again drops below it. ▲	Process fluid temperature is below Setup Loop alarm value.	<ul style="list-style-type: none"> • If the chiller is still running press enter to see if the code clears, the limit may have been only temporarily exceeded. • Verify your Lot setting, see Section 4. • Ensure that the ambient temperature is not below the recommended low-range, see Section 3. If your application load is constant and/or the lower temperature can be temporarily tolerated, then continue operation. (The ThermoFlex will control setpoint when sufficient heat is added.) • Verify/adjust controller PID values. • Add insulation to external plumbing lines to reduce the heat-loss to the environment. • For water-cooled chillers check facility water temperature.
o FLO	Chiller will shut down.	There is an overflow condition in the reservoir.	<ul style="list-style-type: none"> • Ensure the reservoir was not filled above the MAX LEVEL line. • Check for clogged reservoir filter.
oL	Chiller will shut down. (Chillers equipped with 3- Φ pump motor overload.)	Pump motor overload activated. Pump motor exposed to excessive current due to high pressure, flow or ambient temperature.	<ul style="list-style-type: none"> • Allow pump to cool down.
oL 2	Chiller will shut down. (Chillers equipped with 3- Φ fan.)	Fan motor overload activated.	<ul style="list-style-type: none"> • Allow chiller to cool down. • For air-cooled chillers, clean the air filter
PHER	Chiller will shut down. (3- Φ chiller only)	Phase rotation is wrong.	<ul style="list-style-type: none"> • Disconnect chiller from power source and reverse any two line conductors on the line side of the main circuit breaker.

Error Code	Reaction	Cause	Actions
rEFIL	Auto refill will shut off. Chiller reaction depends on ALR setting chosen in the Setup Loop, see Section 4. Auto refill will shut off. Chiller will continue to run. (Optional display.)	The fluid level did not reach the minimum operating level within the time chosen for the customer adjustable <i>fill</i> settings, chosen in the Setup Loop, see Section 4. The auto refill successfully filled within the time frame chosen for the customer adjustable <i>fill</i> setting, but the chiller tried to refill 5 times in 40 hours.	<ul style="list-style-type: none"> •Check auto refill connection. •Check for leaks. •Check the supply pressure on the auto refill supply line. With low pressure the auto refill time span setting may be set too low and the reservoir does not have time to fill. •Check rEFIL settings and adjust if necessary, see Section 4.
SEr 1	Chiller will continue to run.	Periodic service may be required.	<ul style="list-style-type: none"> •To clear the message see Section 8.
Er 4	Chiller will not start.	Normal if new software installed and all values in the Setup and Tune Loops were reset to factory defaults.	<ul style="list-style-type: none"> •Clear the error code.
Er 15	Chiller will continue to run. (Chiller equipped with serial communications.)	Momentary disruption of the internal communications to control board.	<ul style="list-style-type: none"> •Clear the error code <p>Check the serial communication connection.</p> <ul style="list-style-type: none"> •See serial communication connections in Appendix D.
Er 16	Chiller continues to run.	Bad sensor calibration detected several seconds after performing a calibration.	<ul style="list-style-type: none"> •Redo calibration, see Section 8.

Error Code	Reaction	Cause	Actions
Er 22	This error code has priority over HIT . Chiller will shut down. Note Chiller will not restart until process fluid temperature is below +43°C. ▲	Reservoir fluid temperature exceeded the <i>factory preset</i> value of +43°C.	<ul style="list-style-type: none"> •Ensure the chiller meets all environmental requirements, see Section 3. •Clean the air filter. Dirt and debris on the filter can prevent the chiller from functioning at full capacity, see Section 6. •Ensure that the heat load being applied to the chiller is not too high. Contact Thermo Fisher for assistance on calculating heat loads. •Bring cooler air in from another area or exhaust the hot air into another location using an auxiliary fan. •Verify/adjust controller PID values, see the end of this section. •Contact our Sales, Service and Customer Support.
Er 23	Chiller will shut down.	Refrigeration temperature sensor shorted.	•Contact our Sales, Service and Customer Support.
Er 24	Chiller will shut down.	Refrigeration temperature sensor open.	•Contact our Sales, Service and Customer Support.
Er 25	Chiller will shut down.	Internal temperature sensor shorted.	•Contact our Sales, Service and Customer Support.
Er 26	Chiller will shut down.	Internal temperature sensor open.	•Contact our Sales, Service and Customer Support.
Er 28	Chiller continues to run.	The process fluid resistivity exceeded the lower adjustable value.	<ul style="list-style-type: none"> •Press enter to see if the code clears, the limit may have been only temporarily exceeded. •Verify controller's settings, see Section 4 •Replace process fluid.
Er 30	Chiller continues to run.	The process fluid resistivity exceeded the higher adjustable value.	<ul style="list-style-type: none"> •Press enter to see if the code clears, the limit may have been only temporarily exceeded. •Verify controller's settings, see Section 4 •Replace process fluid.
Er 32	Chiller will shut down.	Refrigeration suction gas temperature exceeded 50°C.	<ul style="list-style-type: none"> •Make sure supply voltage matches the chiller's nameplate rating $\pm 10\%$.

Error Code	Reaction	Cause	Actions
Er 33	<p>This error code has priority over LoT.</p> <p>Chiller will shut down.</p> <p>Note Chiller will not restart until process fluid temperature exceeds +2°C. ▲</p>	<p>Reservoir fluid temperature below the <i>factory preset</i> value of +2°C.</p>	<ul style="list-style-type: none"> • Check ambient temperature. Chiller may not be able to reach setpoint at low ambient temperatures. • Ensure that the ambient temperature is not exceeding the recommended range, see Section 3. • Verify/adjust controller PID values, see Section 7. • Add insulation to external plumbing lines to reduce the heat-loss to the environment. • For water-cooled chillers check facility water temperature.
Er 35	<p>This error code has priority over Hi P1.</p> <p>Chiller will shut down.</p>	<p>Process pressure (P1) exceeded <i>factory preset</i> value for greater than 30 seconds.</p> <p>Preset Values:</p> <p>T0, T1 and T5- 105 psi P1 and P2 - 105 psi P3 60 Hz - 48 psi P3 50 Hz - 32 psi P4 60 Hz - 85 psi P4 50 Hz - 60 psi P5 60 Hz - 87 psi P5 50 Hz - 56 psi</p>	<ul style="list-style-type: none"> • Check application valves and ensure that they have not changed or been closed. Note If routine shut-off of the process flow is required then add an external pressure regulator accessory - contact Thermo Fisher. ▲ • May occur as a result of changing the internal DI cartridge. Disconnecting the cartridge adds an additional 0.5 GPM to the main flow, see Section 5. • Check for debris in the application or clogged external filters. • Double check fluid lines. Excessive bends, long tubing and diameter reductions can affect the pump's discharge pressure. Note If diameter reductions must be made, make them at the inlet and outlet of your application, not at the chiller. ▲
Er 36	<p>This error code has priority over Lo P1.</p> <p>Chiller will shut down.</p>	<p>Process pressure (P1) below <i>factory preset</i> limit of 2 psi (all pumps) for greater than 15 seconds.</p> <p>Possible pump motor overload.</p>	<ul style="list-style-type: none"> • Ensure that the chiller reservoir is not too low. • Chiller requires >2 PSIG application pressure drop. If a bypass valve has been installed, some restriction may need to be added to the bypass line. • Allow chiller to cool down

Error Code	Reaction	Cause	Actions
Er 41	Chiller continues to run.	Momentary communication error between display and main control board.	<ul style="list-style-type: none"> •If using Analog I/O ensure your communication cable is properly shielded from electrical noise, see Appendix C. •Cycle circuit protector on rear of chiller off and on, ThermoFlex900-10000 only. •Contact our Sales, Service and Customer Support.
Er 42	Chiller continues to run.	Momentary internal communications error.	<ul style="list-style-type: none"> •Check application valves and ensure that they have not changed or been closed. •Check for debris in the application or clogged external filters. •Contact our Sales, Service and Customer Support.
Er 47	Chiller will shut down.	High fluid pressure cutout activated.	<ul style="list-style-type: none"> •When able, reset chiller's EMO.
Er 48	Chiller will shut down. (Optional display.)	Chiller's EMO button depressed.	<ul style="list-style-type: none"> •Contact our Sales, Service and Customer Support.
Er 59	Chiller will shut down.	Invalid level fault. Chiller sensed both a high level and low level reservoir fluid level.	<ul style="list-style-type: none"> •Check connection.
Er 62	Chiller will not start. (Chillers equipped with optional Analog I/O.)	Probe not properly connected. Shorted remote temperature probe.	<ul style="list-style-type: none"> •Check connection.
Er 63	Chiller will not start. (Chillers equipped with optional Analog I/O.)	Probe not properly connected. Open remote temperature probe.	<ul style="list-style-type: none"> •The error can be cleared only after a valid set point is received, or the remote analog setpoint is turned off.
Er 64	Chiller will continue to run Chiller the last valid setpoint received. (Chillers equipped with optional Analog I/O.)	Analog remote setpoint is enabled and the chiller receives a voltage or current level that is outside the chiller's set point range.	<ul style="list-style-type: none"> •Check connection.

Checklist

Chiller will not start

Check electrical connections.

For first time use, please refer to the quick start instructions included with your chiller or the copy in this manual. The manual's copy follows the Table of Contents.

Check the controller for error codes, see Error Codes in this Section.

Ensure the optional GFCI breaker located on the rear of the chiller is in the up position.

For ThermoFlex900 - 10000 chillers ensure the circuit protector is in the on (I) position.

Make sure supply voltage is connected and matches the chiller's nameplate rating $\pm 10\%$

No display on controller or display is 8888

For ThermoFlex900 - 10000 recycle the circuit protector on the rear of the chiller.

Clearing Error Codes

Note the code in case it clears before you are done troubleshooting.

If desired, silence the alarm by pressing the up or down arrow key.

If the chiller shut down, the controller will continue to flash the error code. Press **enter** to clear the display and silence any alarm. Refer to Error Codes in this Section. Once the cause of the shut down is identified and corrected, start the chiller. If the cause was not corrected the error code will reappear.

If the chiller is still running, press **enter** to see if the code clears, a limit may have been only temporarily exceeded. If the error code does not clear press  until the display flashes between the error code and the temperature and then press **enter**. If the code still does not clear refer to Error Codes in this Section.

Chiller shuts down

Ensure  wasn't accidentally pressed.

Ensure the optional GFCI breaker located on the rear of the chiller is in the up position.

For ThermoFlex900 - 10000 chillers ensure the circuit protector is in the on (I) position.

Check the controller for error codes, see Error Codes in this Section.

The chiller is designed to shut down if not properly primed, refer to Section 3 for priming instructions.

Make sure supply voltage is connected and matches the chiller's nameplate rating $\pm 10\%$.

Restart the chiller.

Inadequate pump pressure

Ensure any user installed in-line valves are in the desired position.

Ensure the chiller's process fluid outlet is connected to the application's fluid inlet and not the application's fluid outlet, see Section 3.

Ensure all connections are secure and that the proper sealant/lubricant for the fitting material is used.

Keep the distance between the chiller and the instrument being cooled as short as possible.

Ensure tubing is straight and without bends. If diameter reductions are required, make them at the inlet and outlet of your application, not at the chiller.

Chiller will not circulate process fluid

Check the reservoir level. Fill, if necessary.

Ensure the reservoir bag filter is not clogged.

Check the application for restrictions in the cooling lines.

Chiller requires >3 PSIG application pressure drop. If a bypass valve has been installed add some restriction to the bypass line.

The pump motor overloaded. The pump's internal overtemperature overcurrent device will shut off the pump causing the flow to stop. This can be caused by low fluid, debris in system, operating chiller in a high ambient temperature condition or excessively confined space. Allow time for the motor to cool down.

Make sure supply voltage matches the chiller's nameplate rating $\pm 10\%$.

Inadequate temperature control

Verify the setpoint.

If the chiller is over-cooling, recycle the power.

Make sure the condenser/air filter is free of dust and debris.

Check the fluid concentration, see Section 3.

Ensure chiller installation complies with site requirements, see Section 3.

Make sure supply voltage matches chiller nameplate rating $\pm 10\%$.

For ThermoFlex900 - 5000 global voltage chillers ensure the chiller is properly configured, see Appendix B.

If the temperature continues to rise, make sure your application's heat load does not exceed the rated specifications.

Check for high thermal gradients (e.g., the application load is being turned on and off or rapidly changing).

Verify/adjust controller PID values, see next page.

Chiller vibration

The optional pressure relief valve setting may be the cause. Change the pressure setting ± 5 psi to eliminate the vibration.

Please contact Thermo Fisher Scientific Sales Service and Customer Support if you need any additional information, see this manual's inside cover for contact instructions.

Verifying/ Adjusting the Controller PID Values (Tune Loop)

The controller controls temperature using a Proportional-Integral-Derivative (PID) algorithm. Should your chiller experience temperature control issues, verifying/adjusting the controller's PID values may correct the condition.

Note Thermo Fisher recommends that only a qualified technician adjust the PID values. Incorrect values will hamper chiller performance. ▲

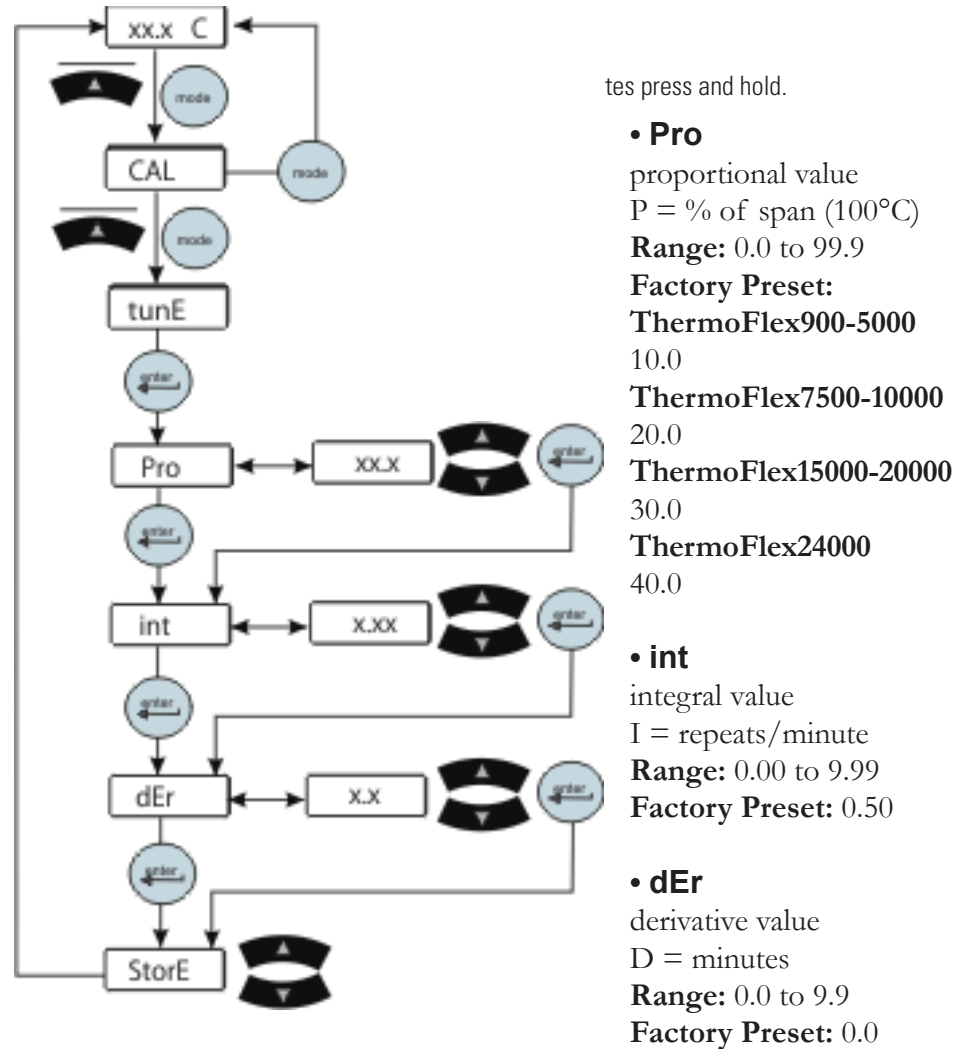

Figure 7-1 Verifying/Adjusting PID Values

Draining



Section 8 Additional Information

Before using any fluid or performing maintenance where contact with the fluid is likely refer to the manufacturer's SDS for PPE requirements.



Ensure the fluid is below the safe-handling temperature (below 40°C) before draining the chiller.▲



The drain port is located on the rear. There are two different types, depending on the pump, a 1/4" stainless steel FPT with 1/4" brass pipe plug or a 1/4" MPT Riton fitting.

Position a suitable pan beneath the drain port. The drain pan must be shallow (under 3 1/2" in height) and have a volume of approximately 3 gallons (6 gallons for ThermoFlex7500 - 24000). Remove the 1/4" Male NPT pipe plug or, using a 9/16" wrench, open the Riton fitting by turning either counter clock wise. For ThermoFlex7500-24000, open the drain valve. This will drain the return line, reservoir, plate exchanger, and the suction side of the pump.

To drain the discharge side of the pump disconnect the Female NPT outlet connection on the rear of the chiller.

Note Internally the chiller does not contain a large quantity of fluid on the discharge side however take care to contain what fluid does drain, a wet-vac can be employed to minimize the potential for spillage. ▲

If the chiller is equipped with the flow control or pressure relief with flow control option, open the valve or remove the drain plug in order to drain the discharge line, see Section 5.

If the chiller is equipped with the anti drainback option, enter the Setup Loop and utilize the **drAin** display to open the valve, see Section 4. Opening the valve allows the fluid to drain out of the chiller.



Reinstall 1/4" Male NPT pipe plug using a sealant suitable for the wetted materials or close the Riton filling prior to refilling.

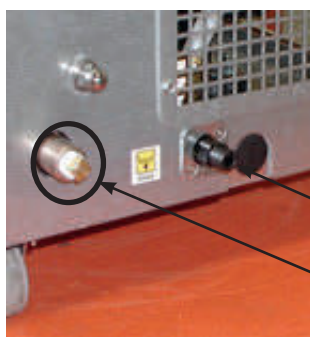

Figure 8-1 Drains

Do not overtighten the fitting. ▲

For ThermoFlex7500-24000, close the drain valve.

Water-Cooled

Draining ThermoFlex1400 - 2500 water-cooled chillers is accomplished by

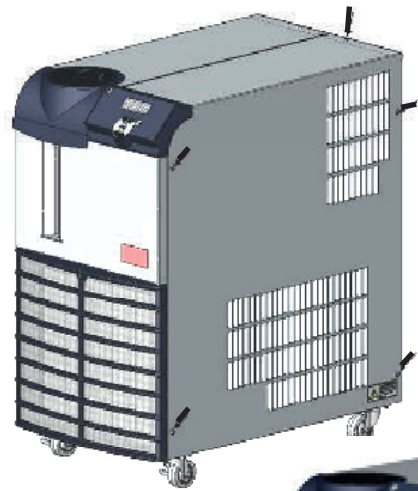

The drain for ThermoFlex3500 and 5000 is located behind the condenser filter.

The drain for ThermoFlex7500 and 10000 is located behind the access panel on the lower left front of the chiller. The panel has two ¼ turn fasteners (cross head).

The drain for ThermoFlex15000 - 24000 is a ¼" plug located on the rear of the chiller.

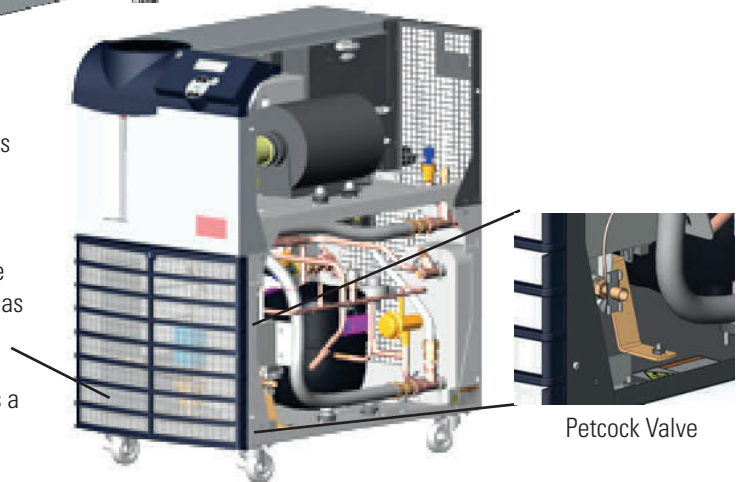

Figure 8-2 Water-Cooled

removing the right side panel. Use a Phillips head screwdriver to remove the five screws indicated in the illustration below. Slide the panel back approximately one inch, then lift slightly from the rear to disengage the panel's two tabs from their slots.

Install a 7/16" ID tube on the drain petcock valve located on the lower end

Wetted Materials**P 1, P 2, MD 1 and MD 2 Pumps**

303 Stainless Steel

Ultem®

Carbon Graphite

Ceramic

Fluorocarbon (Viton®)

Brass

P 3 Pumps

316 Series Stainless Steel

Carbon

Silicon Carbide

Fluorocarbon (Viton®)

P 4 Pumps

304 Stainless Steel

Carbon Ceramic

Fluorocarbon (Viton®)

P 5 Pumps

304, 316 Series Stainless Steel

Carbon Ceramic

Fluorocarbon (Viton®)

T 0 Pumps

Stainless Steel AISI 304

Stainless Steel 316, 18-8

Bronze ASTM B62 and B12

Buna N

Buna/Ceramic and Carbon

Fluorocarbon (Viton®)

Silicon Brass

Filter bag

Polypropylene

Mono-filament nylon

Cap and Funnel

Acetal Copolymer

T 1 Pumps

Stainless Steel AISI 304

Stainless Steel 316, 18-8

Bronze ASTM B62 and B16

Buna N

Silicon Carbide and Brass

Fluorocarbon (Viton®)

T 5 Pumps

Silicon Brass

Stainless Steel AISI 304

Stainless Steel 316, 18-8

Bismuth Bronze

Buna N

Carbon/Ceramic

Viton

Plumbing

300 Series Stainless Steel

Bronze

Fluorocarbon (Viton®)

Nickel

Polypropylene

EPDM

Brass

Copper

Teflon®

PPS (flow transducer)

Nitrile (Buna-n®)

Riton® (optional drain fitting)

Tank

Polyethylene

Brass

EPDM

Pyrex®

Internal Fluid Temperature Sensor (rtd1) Calibration

Riton® (optional drain fitting)	Brass
Tank	EPDM
Polyethylene	Pyrex®

The ThermoFlex was designed to minimize the need for calibration. However, if calibration is desired or recommended by our Sales, Service and Customer Support, please use the following procedure.

This procedure requires a running chiller and a calibrated reference thermometer.

Note Non insulated applications may cause the internal temperature and an external reference temperature to differ and to fluctuate. If inaccurate calibration is suspected, place the reference thermometer as close to the ThermoFlex process outlet as possible. ▲

Note If it is more convenient, perform the low-end calibration before doing the high-end. ▲

Do not pick calibration points that are outside the safe operating limits of the fluid in your application. For example with water, 40°C and 5°C are typical high and low calibration points.

Run the temperature to a suitable high-end calibration point. Place a calibrated reference thermometer in the reservoir. Ensure the fluid temperature is stabilized.

To enter the Calibration Loop ensure the controller display is displaying the process fluid temperature, see the diagram on next page. Press and hold the



and then press the



key. The display will indicate **CAL**.

Press the



key and the controller will display **rtd1**. Press



again and the controller will display **r1 H** (high-end calibration). Press



again and the controller will flash between **r1 H** and the temperature.

Press



to adjust the temperature to match the reference thermometer.

Press the



key again to accept the value.

Press the





key until **Store** is displayed, press



to save the new value, press



to not save it.

Note After pressing  at the **StorE** prompt wait several seconds before proceeding to ensure that a bad calibration message (**Er 16**) does not appear. Premature use of the keypad after pressing  may cancel the bad calibration error message. ▲

Run the temperature to a suitable low-end calibration point. At the **r1 L** (low-end calibration) display repeat the procedure.

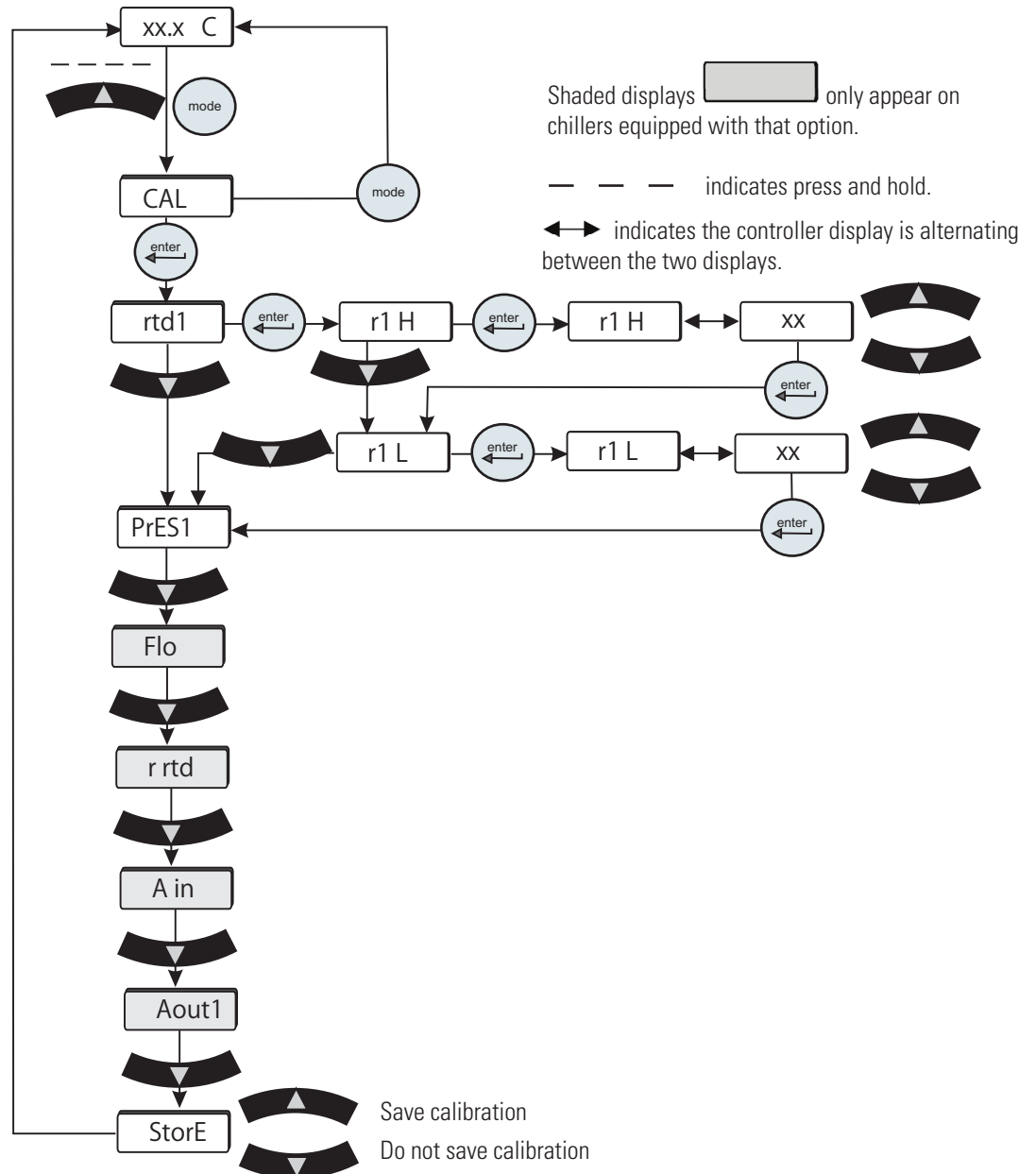

Figure 8-3 Internal Temperature Sensor Calibration



If you have any questions please contact Thermo Fisher Scientific's Sales, Service and Customer Support.



Process Fluid Pressure (P1) Transducer Calibration

The ThermoFlex was designed to minimize the need for calibration. However, if calibration is desired or recommended by our Sales, Service and Customer Support, please use the following procedure.

This procedure requires a running chiller, a calibrated reference pressure gauge and an external flow control valve.

Connect a calibrated reference pressure gauge to the outlet line. Using an external flow control valve, increase the pressure to a suitable high-end calibration point by closing the valve. Ensure the pressure is stabilized.

To enter the Calibration Loop ensure the controller display is displaying the process fluid temperature, see the diagram on the next page. Press and hold the  and then press the  key. The display will indicate **CAL**.



Press the  key and the controller will display **rtd1**. Press  until the controller displays **PrES1**. Press  and the controller will flash between **P1H** and the pressure.

Press  to adjust the rate to match the reference pressure gauge.

Press the  key to accept the value.

Decrease the pressure to a suitable low-end calibration point (avoid a zero pressure). Ensure the pressure is stable.

The controller will flash between **P1L** and the pressure. Press  to adjust the rate to match the reference pressure gauge.

Press the  key and **StorE** is displayed, press  to save both values, press  to not save them.

Note After pressing  at the **StorE** prompt wait several seconds before proceeding to ensure that a bad calibration message (**Er 16**) does not appear. Premature use of the keypad after pressing  may cancel the bad calibration error message. ▲

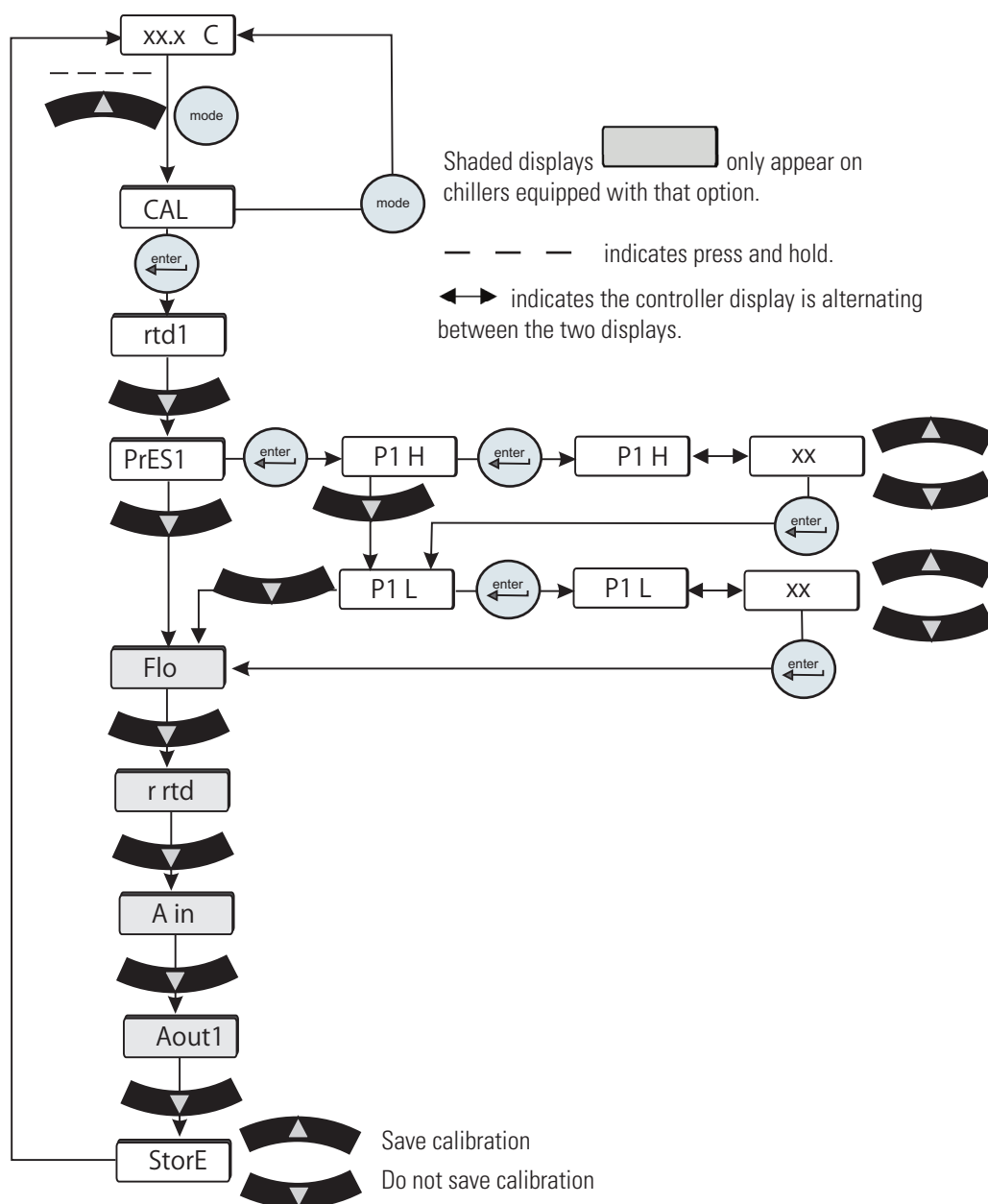

Figure 8-4 Pressure (P1) Calibration



If you have any questions please contact Thermo Fisher Scientific's Sales, Service and Customer Support.



Optional Process Fluid Flow Transducer (FLo) Calibration

The ThermoFlex was designed to minimize the need for calibration. However, if calibration is desired or recommended by our Sales, Service and Customer Support, please use the following procedure.

This procedure requires a running chiller, a calibrated reference flowmeter and an external flow control valve.

Connect a calibrated reference flowmeter to the outlet line. Using an external flow control valve, increase the flow to a suitable high-end calibration point. Ensure the flow is stabilized.

To enter the Calibration Loop ensure the controller display is displaying the process fluid temperature, see the diagram on the next page. Press and hold the  and then press the  key. The display will indicate **CAL**.



Press the  key and the controller will display **rtd1**. Press  until the controller displays **FLo**. Press  and the controller will flash between **HiFLo** and the flow rate.



Press  to adjust the rate to match the reference flowmeter.

Press the  key to accept the value.

Decrease the flow to a suitable low-end calibration point (avoid a zero flow rate). Ensure the flow is stable.

The controller will flash between **LoFLo** and the flow rate. Press  to adjust the rate to match the reference flowmeter.

Press the  key and **StorE** is displayed, press  to save both values, press  to not save them.

Note After pressing  at the **StorE** prompt wait several seconds before proceeding to ensure that a bad calibration message (**Er 16**) does not appear. Premature use of the keypad after pressing  may cancel the bad calibration error message. ▲

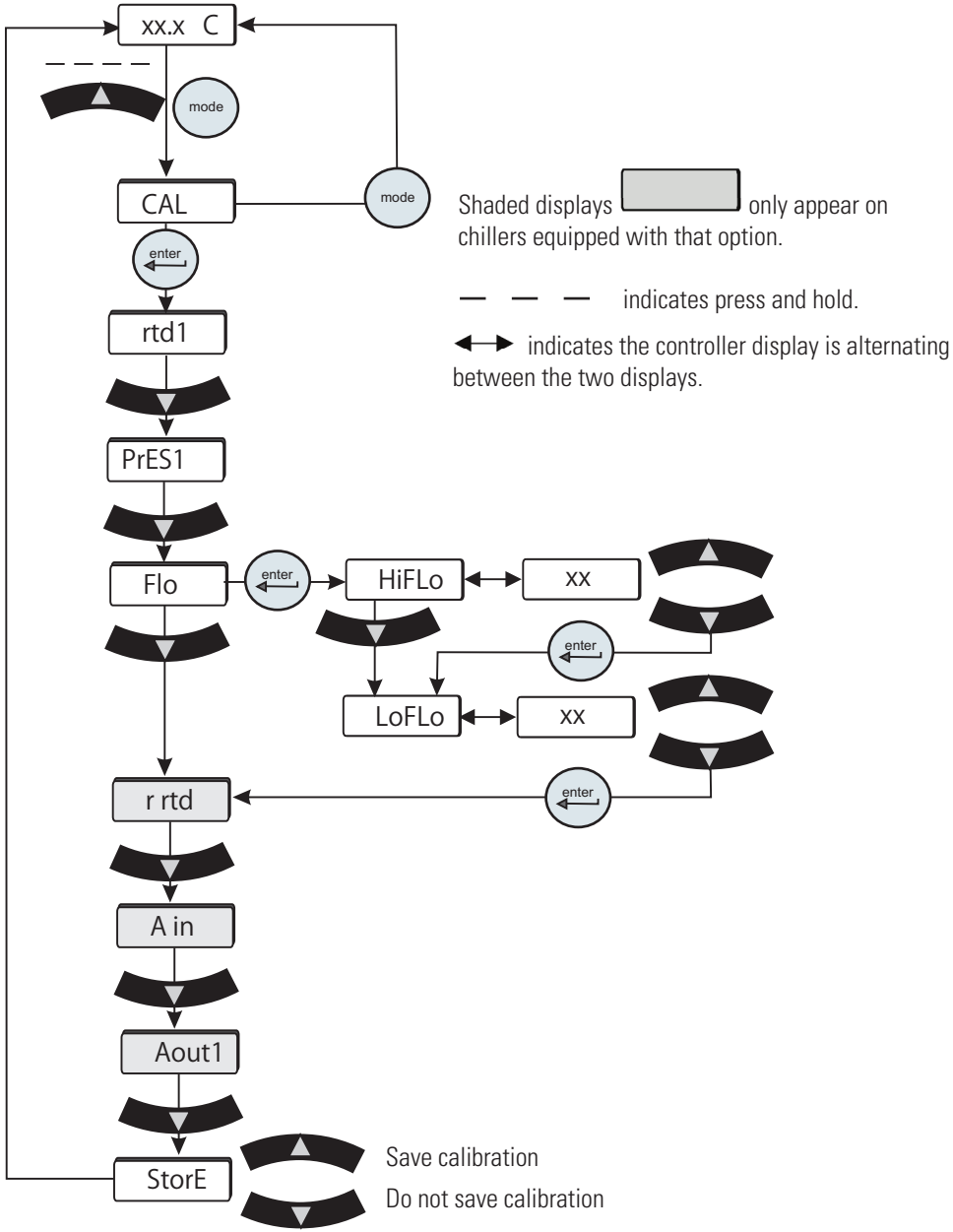

Figure 8-5 Flow Transducer (FLo) Calibration

If you have any questions please contact Thermo Fisher Scientific's Sales, Service and Customer Support.

Service Codes

The controller also displays preventive maintenance service codes. These codes are based on the component run time and are established to avoid unplanned failures. The chiller will continue to run.

SEr 1	Stepper PM	60,000,000 steps
SEr 2	Pump PM	10,000 hours
SEr 3	Motor PM	P1 - 35,000 hours P2 - 31,000 hours P3 - 50,000 hours P4 - 40,000 hours P5 - 40,000 hours Mag drive pumps - 88,000 hours
SEr 4	P1 Transducer PM	10,000 hours
SEr 5	Flow Transducer PM	64,000 hours
SEr 6	Fan Motor PM	20,000 hours

You can press the enter key to clear service codes 2 through 6. To clear service code 1 see next page. Note the service code number because once cleared, the code will not reappear.

If codes 2 through 6 do not clear by pressing the enter key use the same procedure used to clear service code 1.

Clearing SEr Codes

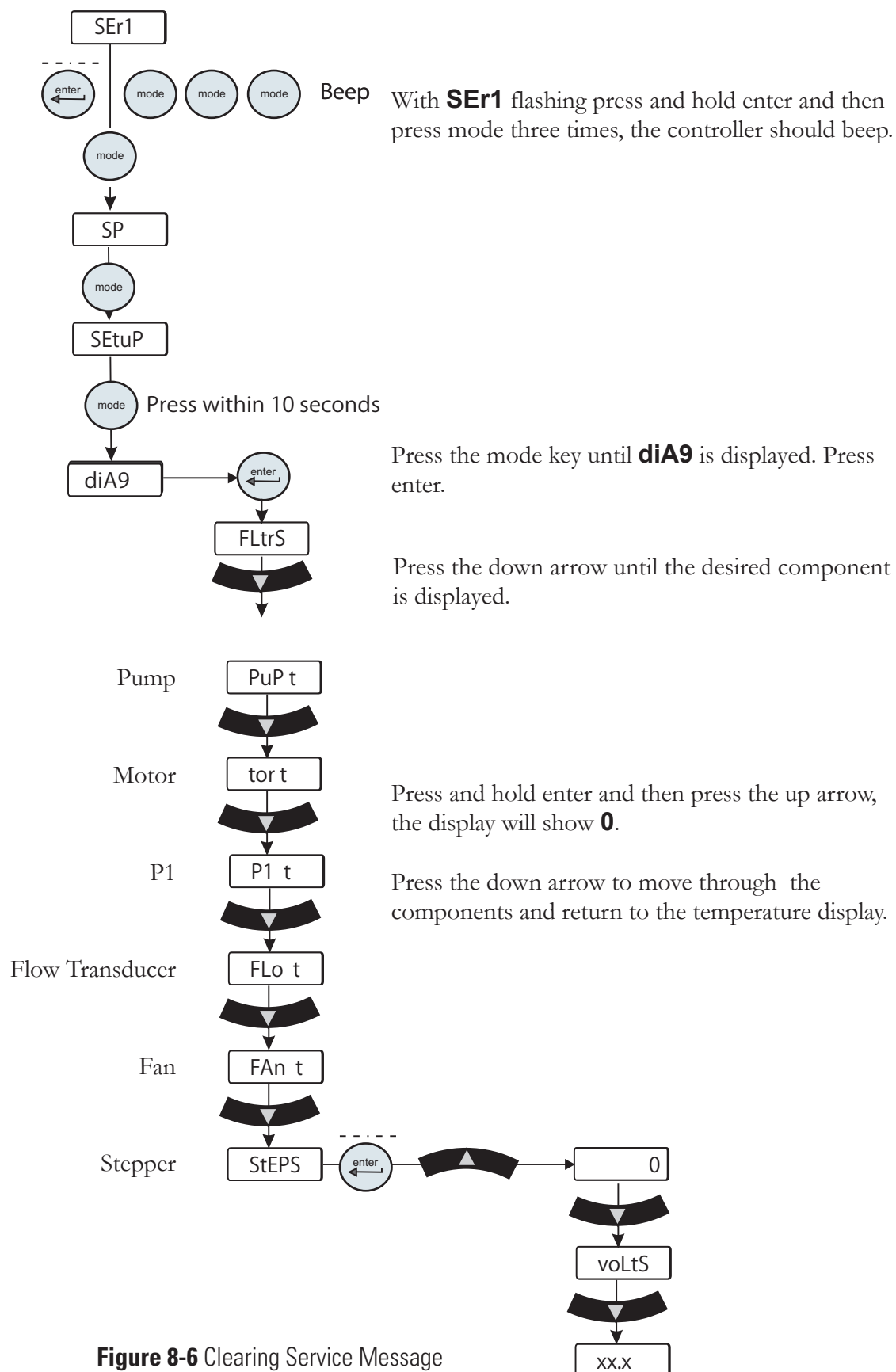

Figure 8-6 Clearing Service Message

Decommissioning/ Disposal



Laboratory Grade Ethylene glycol (EG) is poisonous and flammable. Before disposing refer to the manufacturer's most current SDS for handling precautions. ▲



Decommissioning must be performed only by qualified dealer using certified equipment. All prevailing regulations must be followed. ▲

Consider decommissioning the chiller when:

- It fails to maintain desired specifications
- It no longer meets safety standards
- It is beyond repair for its age and worth

Refrigerant and compressor oil must be recovered from equipment before disposal.

Note Keep in mind any impact your application may have had on the chiller. ▲

Direct questions about chiller decommissioning or disposal to our Sales, Service and Customer Support.



Handle and dispose in accordance with the manufacturers specification and/or the SDS for the material used. ▲

Shipment Storage



Follow the manufacturer's SDS instructions if decontamination is required. ▲



Transporting and/or storing the chiller requires draining, see Draining in this Section. Store the chiller in the temperature range of -25°C to 60°C (with packaging), and <80% relative humidity. ▲



If the chiller is stored for more than 90 days it must be flushed with clean fluid before operating. ▲

Appendix A **Country Specific**

230 VAC, 50 Hz, 1Ø Requirements

Refer to the nameplate label located on the rear of the chiller for specific electrical requirements.

1. Chillers shipped to the following locations require a **16 Amp service**:

Afghanistan, Albania, Algeria, Andorra, Angola, Argentina, Armenia, Austria, Azerbaijan, Belarus, Belgium, Benin, Bolivia, Bosnia and Herzegovina, Brazil, Bulgaria, Burkina Faso, Burundi, Cambodia, Cameroon, Cape Verde, Central African Republic, Chad, Chile, Comoros, Congo, Croatia, Czech Republic, Denmark, Djibouti, DR Congo, Ecuador, Egypt, Eritrea, Estonia, Ethiopia, Finland, France, French Guiana, Gabon, Georgia, Germany, Greece, Guinea, Hungary, Iceland, Indonesia, Iran, Iraq, Israel, Italy, Ivory Coast, Jordan, Kazakhstan, Kyrgyzstan, Latvia, Lebanon, Liberia, Libya, Liechtenstein, Lithuania, Luxembourg, Madagascar, Mali, Mauritania, Moldova, Monaco, Mongolia, Morocco, Mozambique, Namibia, Nepal, Netherlands, Niger, North Korea, Norway, Paraguay, Peru, Poland, Portugal, Romania, Russia, Rwanda, Saint Vincent and the Grenadines, San Marino, Sao Tome and Principe, Saudi Arabia, Senegal, Serbia, Slovakia, Slovenia, Somalia, South Africa, South Korea, Spain, Sweden, Switzerland, Syria, Tajikistan, Thailand, Togo, Tunisia, Turkey, Turkmenistan, Ukraine, Uruguay, Uzbekistan, Vanuatu, Vatican City, Vietnam.

2. Chillers shipped to the following locations require a **15 Amp service**:

Australia, China, Fiji Islands, Nauru, New Zealand, Papua New Guinea, Solomon Island, Tonga, Tuvalu.

3. Chillers shipped to the following locations require a **13 Amp service**:

Abu Dhabi, Bahrain, Bangladesh, Botswana, Brunei, Cyprus, Dominica, Gambia, Ghana, Gibraltar, Grenada, Hong Kong, India, Ireland, Kenya, Kiribati, Kuwait, Lesotho, Malawi, Malaysia, Maldives, Malta, Mauritius, Myanmar, Nigeria, Oman, Pakistan, Qatar, Saint Lucia, Seychelles, Sierra Leone, Singapore, Sri Lanka, Sudan, Swaziland, Tanzania, Uganda, United Arab Emirates, United Kingdom, Yemen, Zambia, Zimbabwe.

Appendix B Voltage Configuration Instructions

ThermoFlex 900 and 1400 chillers equipped with the 115V 60Hz, 100v 50/60Hz Variable Voltage option and ThermoFlex 900 to 5000 chillers equipped with 200-230V 50/60Hz Global Voltage option have a voltage configuration panel located on the rear of the chiller behind an access panel, see Figure B-1.

- Use a 1/4" socket to remove the four screws securing the access panel to the chiller.
- The configuration panel has two 3-position toggle switches, one for voltage and one for frequency. All chillers are shipped with the toggle switch in the center **SHIP** position. Place each switch to the settings that match the voltage/frequency supplied to the chiller.

Note For ThermoFlex900-2500 global voltage chillers, the compressor and fan will not operate when the switch is in the **SHIP** position. ▲

- Reinstall the access panel.

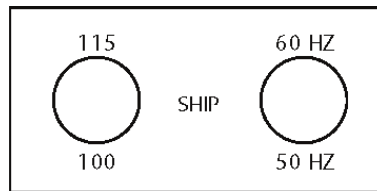
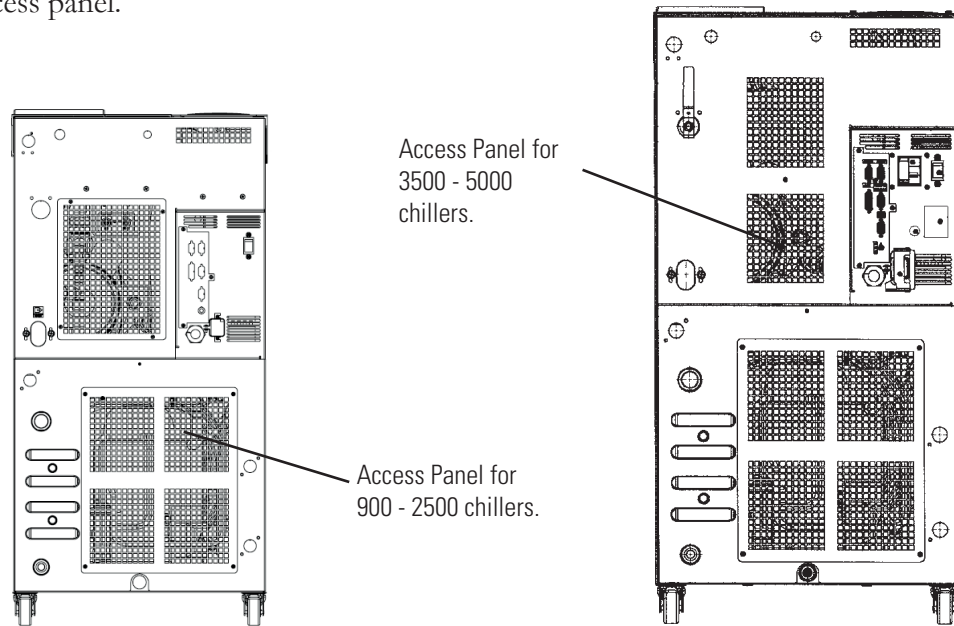

Variable Voltage chillers

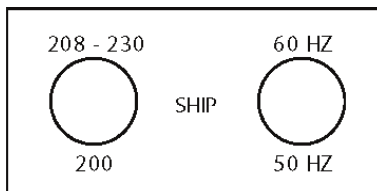

Global Voltage chillers

Figure B-1 Variable/Global Voltage Chillers

Appendix C Analog I/O and Remote Sensor

Analog I/O Connector Pinout

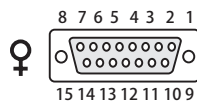

Install your analog input/output device to the 15-pin female connector on the rear of the chiller. Analog I/O is activated using the Setup Loop, see page C-3.

PIN	NAME	NOTES	DEFINITION
1	DIGITAL GROUND		Common round connection for pins 12, 13 and 14
2	Not Used		
3	LOW LEVEL (Only if option chosen)	Note 1	<u>Dry Relay Contact</u> : Reference to pin 11. Closes if either level switch is in the "low" position for more than 1 second.
4	CONFIGURABLE RELAY 2	Note 1	<u>Dry Relay Contact</u> : Reference to pin 11. Closes when any configured fault or warning occurs, see Table 2.
5	PUMP ON	Note 1	<u>Dry Relay Contact</u> : Reference to pin 11. Closes when pump is turned on. Opens when pump is turned off.
6	ANALOG GROUND		Common for analog signals (pins 2, 7 and 15)
7	RESERVOIR TEMP OUT OR EXTERNAL SENSOR TEMPERATURE IF EXTERNAL SENSOR ENABLED	Note 2	Analog Voltage Output 0-10VDC, 10mV/°C, or 4-20mA: Reference to pin 6. This voltage output is proportional to the reservoir fluid temperature: Default scale= 0–10V (where: 0V = Low Temp Span, 10V = Hi Temp Span) Optional Range = 10mV/ °C. (Ex: 200mV = 20°C) (Max Load @ 10V = 5mA) or 4-20mA, 4mA = low temp span, 20 mA = high temp span (maximum output current = 5mA @10VDC.
8	LOW FLOW (Only if option chosen)	Note 1	<u>Dry Relay Contact</u> : Reference to pin 11. Closes when a low flow occurs while the pump is on. Note: To allow the pump to get up to speed at startup, the pump runs for 3 - 5 seconds before the low flow sensor is read.
9	CONFIGURABLE RELAY 1 (Normally Open)	Note 1	<u>Dry Relay Contact</u> : Reference to pin 11. Closes when any of the configured faults occur, see Table 1.
10	CONFIGURABLE RELAY 1 (Normally Closed)	Note 1	<u>Dry Relay Contact</u> : Reference to pin 11. Complement of pin 9 (open when pin 9 is closed).
11	RELAY COMMON		Common for all relay contacts (pins 3, 4, 5, 8, 9, 10).
12	REMOTE START ENABLE	Note 3	Connect to pin 1 to allow chiller to be remotely turned on/off through pin 14 REMOTE START.

Note 1: All relay contacts (except for Pin 10) are normally OPEN when power is off. Pin 10 contacts are normally CLOSED when power is off. Relay contacts are rated: 24V AC/DC, 2A, <= 0.08 Ohm maximum each or 5A total for all relays combined, 1mA minimum, switching capacity: 48VA/48W (Resistive load only).

Note 2: Default = 0-10VDC

Note 3: Connect to digital ground (pin 1) using a low resistance connection (gold contact relay).

PIN	NAME	NOTES	DEFINITION
13	REMOTE SETPOINT ENABLE	Note 3	Connect to pin 1 to allow the setpoint to be changed remotely through pin 15 REMOTE SETPOINT.
14	REMOTE START	Note 3	Connect to pin 1 to turn chiller on. Disconnect to turn chiller off. Note: Pins 1 and 12 must be connected to allow operation from this pin.
15	REMOTE SETPOINT	Note 2, 4	Analog Voltage Input 0-10VDC, 10mV/°C, or 4-20mA: Reference to pin 6. Apply a DC voltage to this pin to adjust the chiller's setpoint: Default Range = 0 – 10V (where: 0V = Low Temp Span, 10V = Hi Temp Span) (Input Impedance > 600K) Optional Range = 10mV/ °C. (Ex: 200mV = 20°C) (Max Input Voltage = 10VDC, or 4-20mA, 4mA = low temp span, 20 mA = high temp span.

Note 1: All relay contacts (except for Pin 10) are normally OPEN when power is off. Pin 10 contacts are normally CLOSED when power is off. Relay contacts are rated: 24V AC/DC, 2A, <= 0.08 Ohm maximum each or 5A total for all relays combined, 1mA minimum, switching capacity: 48VA/48W (Resistive load only).

Note 2: Default = 0-10VDC

Note 3: Connect to digital ground (pin 1) using a low resistance connection (gold contact relay).

Note 4: Remote setpoint must be enabled, pin 13

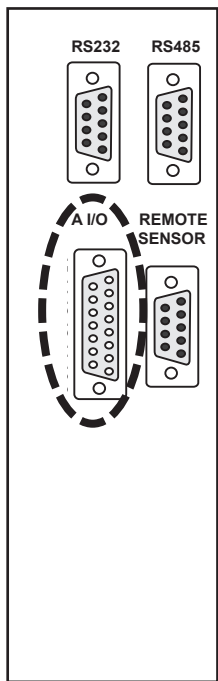

WARNING Never apply line voltage to any of the connections. ▲

When making your connection to the ThermoFlex Analog I/O connector, in order to comply with the EMC directive:

- Use a shielded I/O cable
- Connect the remote end of the cable shield to earth ground.
- Connect cable shield to ThermoFlex end connector.

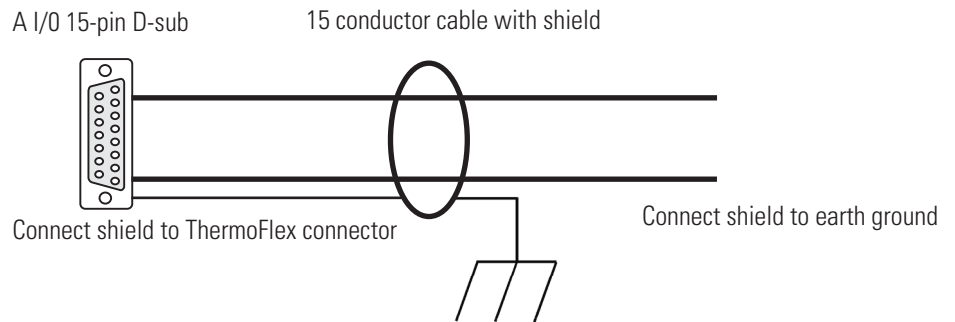

Figure C-1 Analog I/O Connector

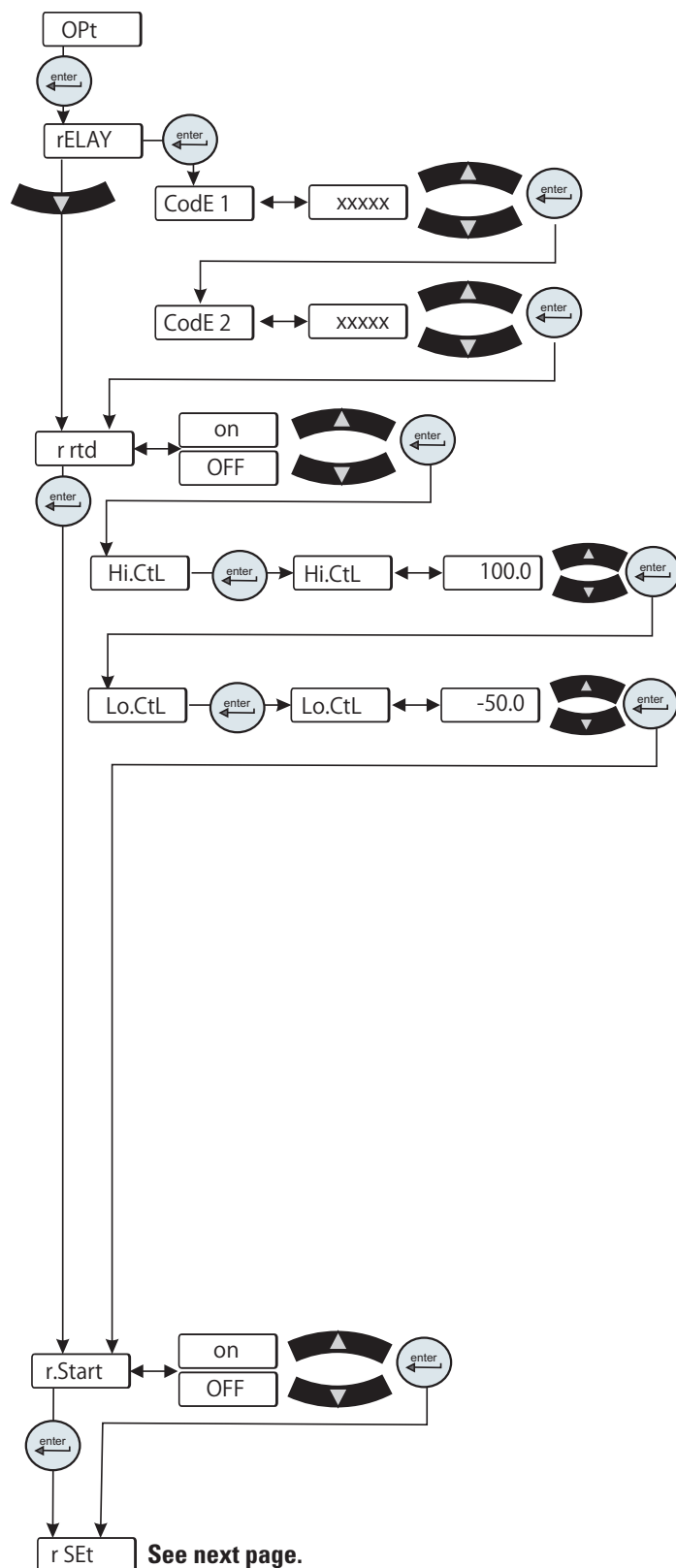

Figure C-2 Analog I/O Loop (1 of 2)

- **rELAY** is used to configure relay 1 (**Code 1**) and relay 2 (**Code 2**), see Tables 1 and 2 on the next page.

For example: To have just the drip pan, 4, and low temp, 8, error faults enabled for relay 1 you would enter their sum, 12, at the **Code 1** display. To have the tank overflow, 2, the low temp, 16, and high pressure, 1024, error faults enabled for relay 2 you would enter their sum, 1040, at the **Code 2** display.

- **r rtd** is used to enable/disable the remote temperature sensor. See Table 3 for pin out information.

Note There is no other indication on the chiller that the remote sensor is enabled. ▲

If the remote temperature probe is enable use **Hi. CtL** and **Lo. CtL** to adjust the internal temperature range limits When operating with the remote sensor the chiller's reaction to changing the setpoint may result in operation exceeding a fixed temperature limit resulting in the chiller shutting down.

When using the remote probe, if an internal range temperature limit is exceeded the control shifts to the internal probe using the appropriate limit as the setpoint. When the internal temperature comes back inside the limits or the remote temperature gets to its setpoint, the control shifts back to the remote probe. The defaults for the high is 100°C and the low is -50°C. If a default is exceeded the chiller will shut down.

If this happens changing the internal range setting a few degrees may prevent the chiller from shutting down.

- **r.Start** is used to enable/disable the remote start/stop.

Note Enabling analog I/O remote start/stop disables the chiller's local controller start/stop capability. Enabling analog I/O remote also overrides serial communications start/stop commands. ▲

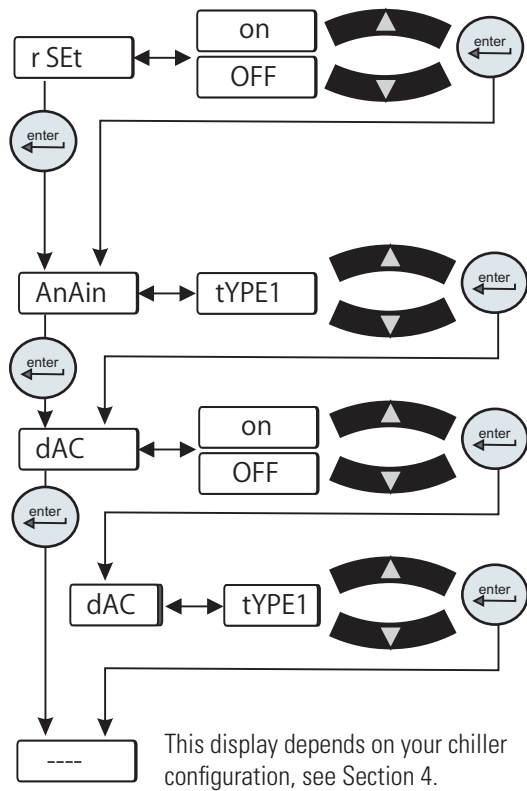
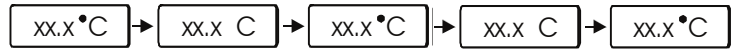

Figure C-2 Analog I/O Loop (2 of 2)

• **r SEt** is used to enable/disable the remote setpoint.

Note When remote setpoint is enabled a flashing dot will appear on the controller's display as shown below. ▲



• **AnAin** is used to configure the analog voltage input type.

Type 1: 0 - 10 VDC (Default)

Type 2: 10 mV/°C

Type 3: 4 - 20 mA

• **dAC** is used to enable/disable the digital to analog converter. Once enabled, the desired output type can be selected.

Note The **Type** display only appears if **dAC** is set to **on**. ▲

Type 1: 0 - 10 VDC (Default)

Type 2: 10 mV/°C

Type 3: 4 - 20 mA

Table 1 Configurable Relay #1 (CodE1)

Error	Error Code	Factory Default	
Low Level (option)	LLF	Enable	1 (Default)
Tank Overflow	o FLo	Disable	2
Drip Pan Full (option)	driP	Disable	4
Low Temp	Lo t*	Disable	8
High Temp	Hi t*	Disable	16
Low Flow (option)	LoFLo*	Enable	32 (Default)
High Flow (option)	HiFLo*	Disable	64
Low Resistivity (option)	Er 28*	Disable	128
High Resistivity (option)	Er 30*	Disable	256
High Pressure	Hi P1*	Disable	512
Low Pressure	Lo P1*	Disable	1024
Chiller Fault	Any Fault	Enable	2048 (Default)
Pump/Chiller Shut Off	Status bit(s)	Disable	4096
Refrigeration Shut Off	Status Bit	Disable	8192
Limit Fault (option)	PHEr, oL, LPC, HPC, Er 47, Er 48	Enable	16384 (Default)
Sensor Fault	Er 23, Er 24, Er 25, Er 26 external sensor opened or shorted	Disable	32768
			Default Relay Code 1 Display = 18465 (1 + 32 + 2048 + 16384 = 18465)

*Regardless of alarm setting - fault or indicator

Table 2 Configurable Relay #2 (CodE2)

Error	Error Code	Factory Default	
Low Level (option)	Add	Disable	1
Tank Overflow	o FLo	Disable	2
Drip Pan Full (option)	driP	Disable	4
Auto Refill Error (option)	rEFiL	Disable	8
Low Temp	Lo t*	Enable	16 (Default)
High Temp	Hi t*	Enable	32 (Default)
Low Flow (option)	Lo FL*	Disable	64
High Flow (option)	Hi FL*	Disable	128
Low Resistivity (option)	Er 28*	Disable	256
High Resistivity (option)	Er 30*	Enable	512 (Default)
High Pressure	Hi P1*	Disable	1024
Low Pressure	Lo P1*	Disable	2048
Indicator (warning)	Any Indicator	Disable	4096
PM Timer (option)	di, SEr 1 to 6	Disable	8192
Communication Error	Er 15, Er 41, Er 42	Disable	16384
Sensor Fault	Er 23, Er 24, Er 25, Er 26 external sensor opened or shorted	Enable	32768 (Default)
			Default Relay Code 2 Display = 33328 (16 + 32 + 512 + 32768 = 33328)

*Regardless of alarm setting - fault or indicator

Analog Input Calibration

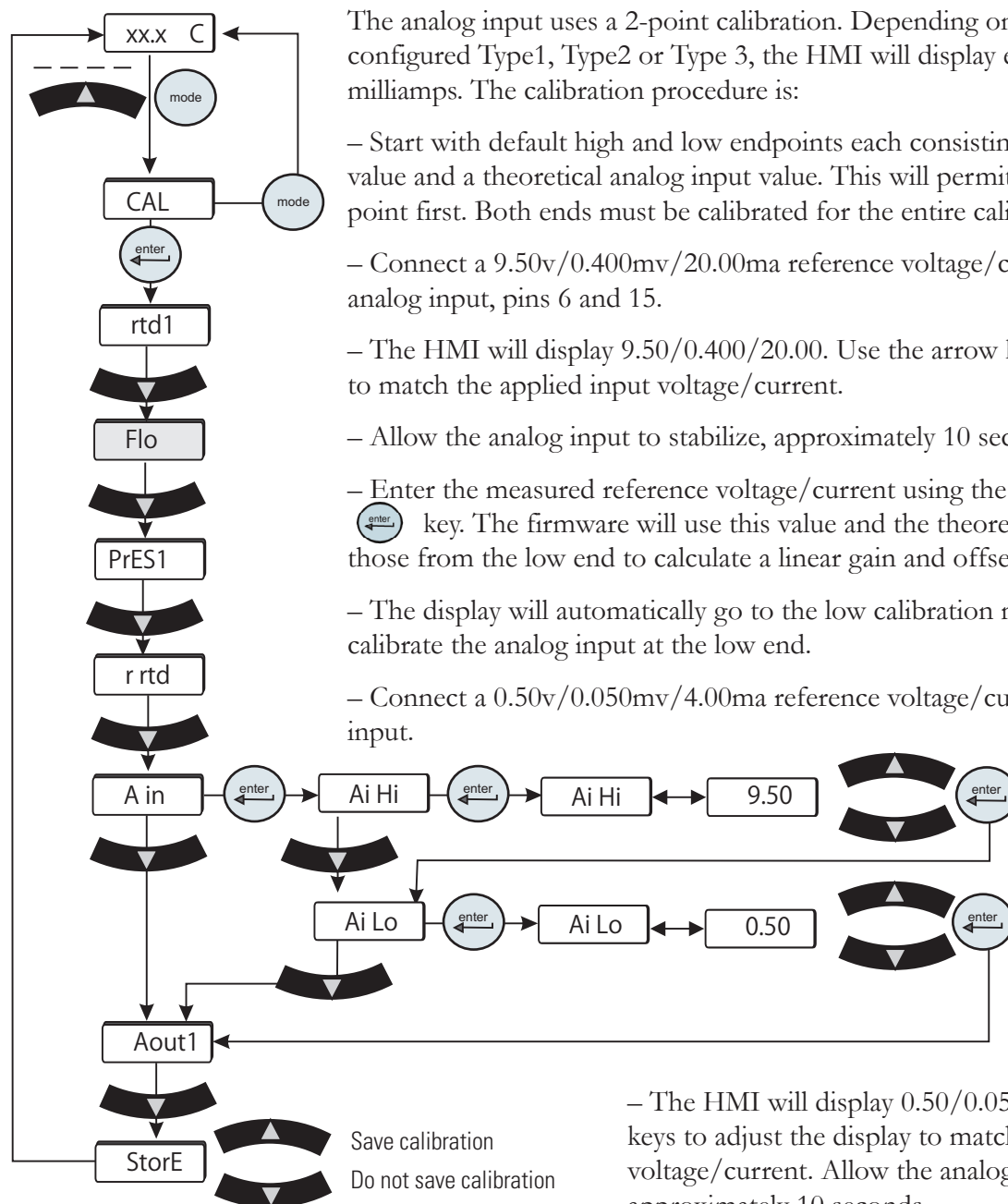





Figure C-3 Analog Input Calibration Loop

The analog input uses a 2-point calibration. Depending on how the analog input is configured Type1, Type2 or Type 3, the HMI will display either volts, millivolts or milliamps. The calibration procedure is:

- Start with default high and low endpoints each consisting of a voltage/current value and a theoretical analog input value. This will permit calibration of either point first. Both ends must be calibrated for the entire calibration to be valid.
- Connect a 9.50v/0.400mv/20.00ma reference voltage/current source to the analog input, pins 6 and 15.
- The HMI will display 9.50/0.400/20.00. Use the arrow keys to adjust the display to match the applied input voltage/current.
- Allow the analog input to stabilize, approximately 10 seconds.
- Enter the measured reference voltage/current using the HMI by pressing the  key. The firmware will use this value and the theoretical analog value and those from the low end to calculate a linear gain and offset.
- The display will automatically go to the low calibration message. Press  to calibrate the analog input at the low end.
- Connect a 0.50v/0.050mv/4.00ma reference voltage/current source to the analog input.

– The HMI will display 0.50/0.050/4.00. Use the arrow keys to adjust the display to match the applied input voltage/current. Allow the analog input to stabilize, approximately 10 seconds.

– Enter the measured reference voltage/current using the HMI by pressing the  key. The firmware will use this value and the theoretical analog input value and those from the high end to calculate a linear gain and offset.

– If the gain and offset are acceptable, the calibration is accepted and the calibration is now valid at the low end. Otherwise, the calibration is rejected and a bad calibration error message (**Er 16**) is displayed.

Analog Output Calibration

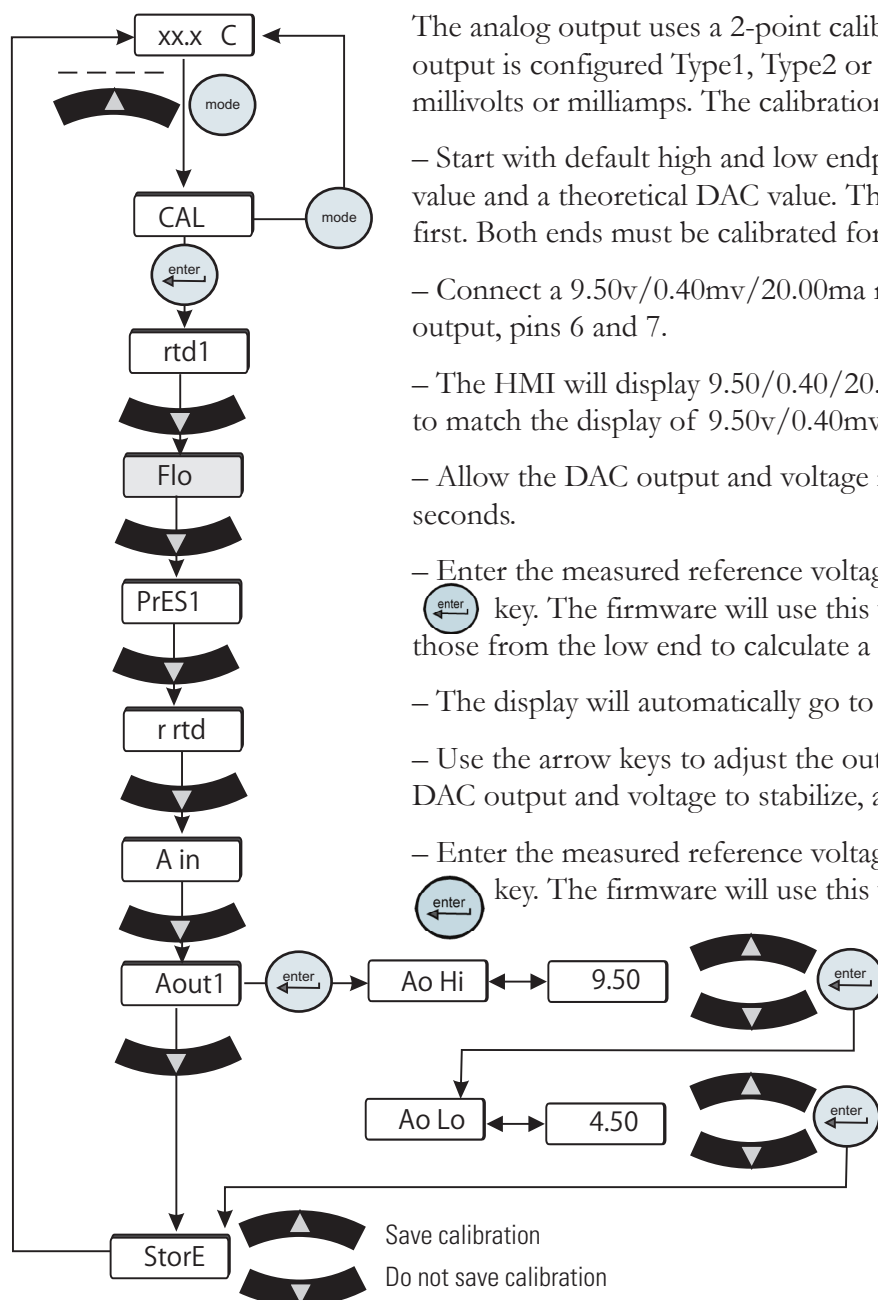

The analog output uses a 2-point calibration. Depending on how the analog output is configured Type1, Type2 or Type 3, the HMI will display either volts, millivolts or milliamps. The calibration procedure is:



- Start with default high and low endpoints each consisting of a voltage/current value and a theoretical DAC value. This will permit calibration of either point first. Both ends must be calibrated for the entire calibration to be valid.
- Connect a 9.50v/0.40mv/20.00ma reference voltage/current meter to the DAC output, pins 6 and 7.
- The HMI will display 9.50/0.40/20.00. Use the arrow keys to adjust the output to match the display of 9.50v/0.40mv/20.00ma.
- Allow the DAC output and voltage reading to stabilize, approximately 10 seconds.
- Enter the measured reference voltage/current using the HMI by pressing the  key. The firmware will use this value and the theoretical DAC value and those from the low end to calculate a linear gain and offset.
- The display will automatically go to the low calibration point.
- Use the arrow keys to adjust the output to match the displayed value. Allow the DAC output and voltage to stabilize, approximately 10 seconds .
- Enter the measured reference voltage/current using the HMI by pressing the  key. The firmware will use this value and the theoretical DAC value and those from the high end to calculate a linear gain and offset.
- If the gain and offset are acceptable, the calibration is accepted and the calibration is now valid at the low end. Otherwise, the calibration is rejected and a bad calibration error message (**Er 16**) is displayed.

Figure C-4 Analog Output Calibration Loop

Remote Sensor Connector Pinout

Table 3

Pin	
1	White
2	NA
3	NA
4	White
5	NA
6	NA
7	Red
8	NA
9	Red (4th wire not connected to the control board)

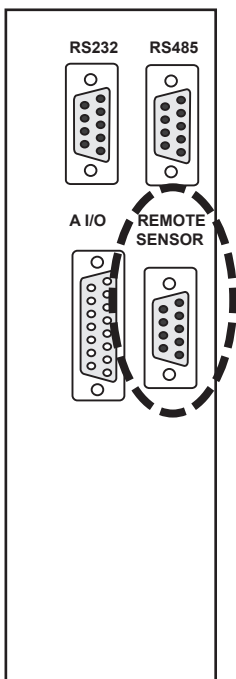
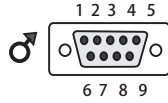

Never apply line voltage to any of the connections. ▲



When operating a ThermoFlex7500-10000 with the remote sensor enabled ensure the chiller's response to lowering the setpoint does not result in operation below 10°C process temperature. Operation below 10°C requires the use of 50/50 EG/water or 50/50 PG/water. ▲

Figure C-5 Remote Sensor Connector

Remote Sensor Calibration

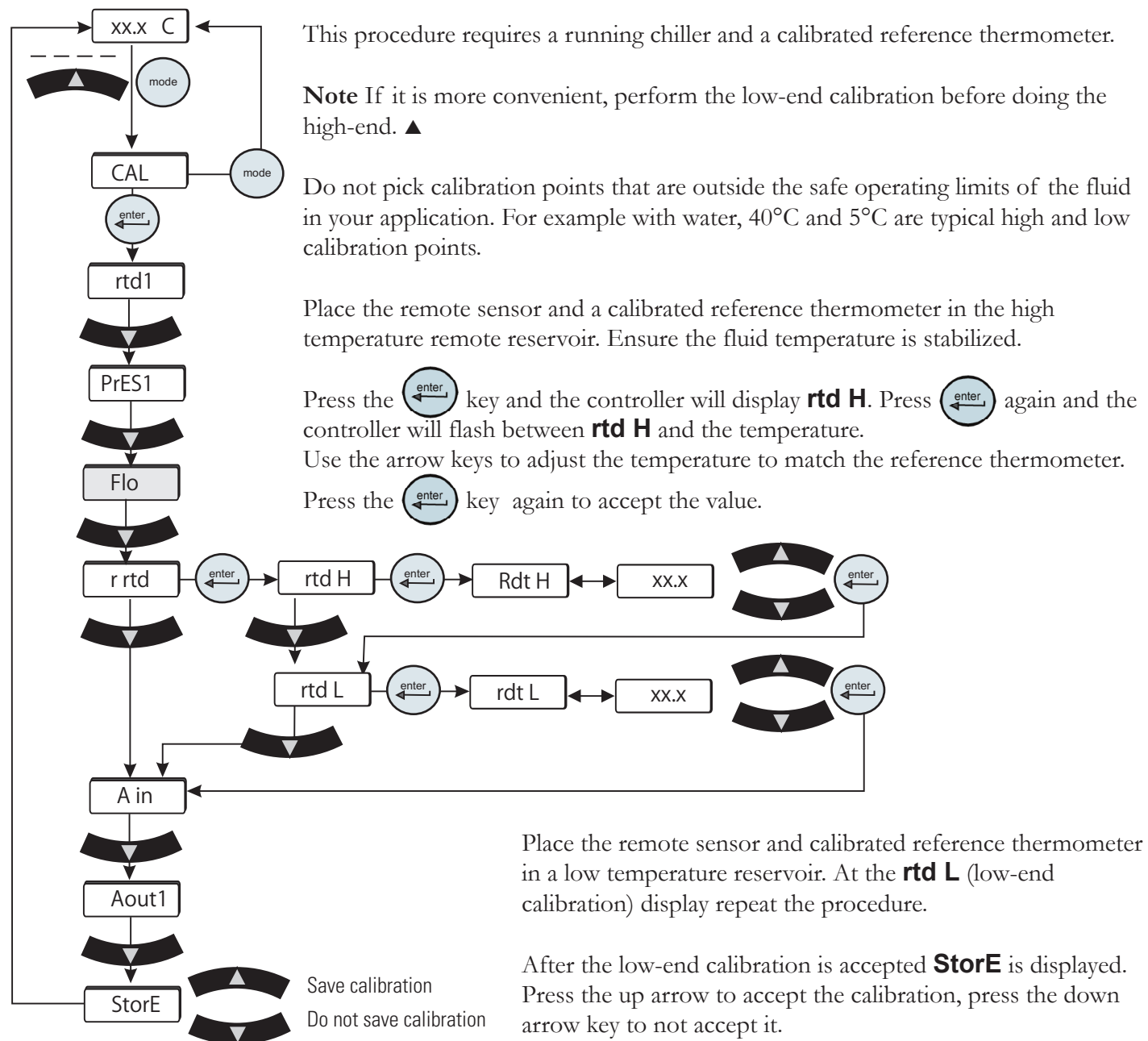
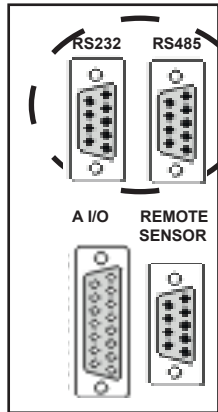

Figure C-6 Remote Sensor Calibration Loop

Appendix D NC Serial Communications Protocol



Note Appendix D assumes you have a basic understanding of communications protocols. ▲

WARNING Never apply line voltage to any of the connections. ▲

Connect your PC to the applicable connector on the rear of the chiller. Use the Setup Loop, see Section 4, to enable serial communications.

Note Keypad operation is still available with serial communications enabled. ▲

Figure D-1 Connectors

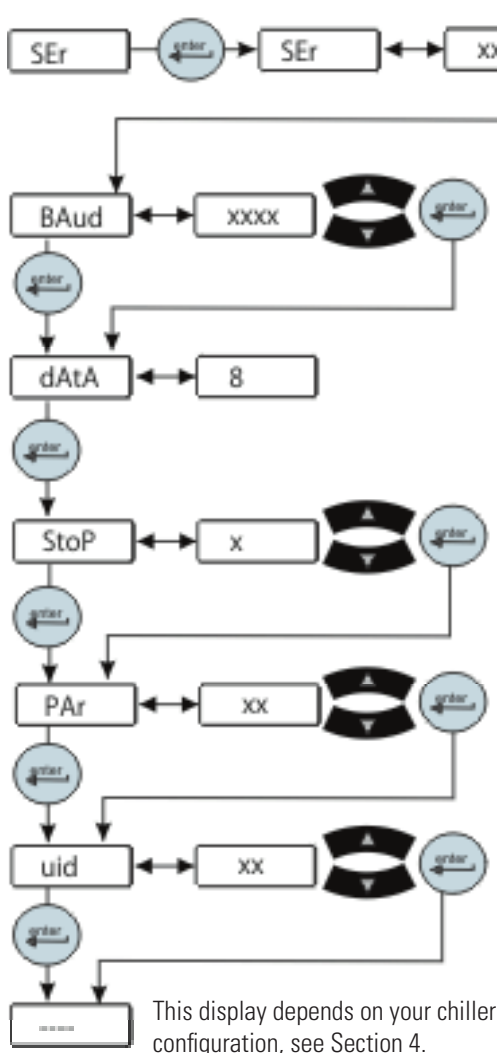

• **SEr** is used to enable/disable and to configure serial communications.

Range: oFF, rS232, rS485 **Default:** oFF

• **BAud** is used to select the baud rate (speed) for serial communications.

Range: 9600, 4800, 2400, 1200, 600, or 300 bits per second
Default: 9600

• **dAtA** is used to display the number of data bits.

Range: Fixed at 8

• **StoP** is used to indicate the number of stop bits.

Range: 2 or 1 **Default:** 1

• **PAr** is used as a means to check for communication errors.

Range: even, odd, or none **Default:** none

• **uid** (chiller id) is used in RS485 only. Identifies devices connected to the RS 485 port.

Range: 1 to 99 **Default:** 1

Note: To prevent data errors limit the number of chillers to 32. ▲

This display depends on your chiller configuration, see Section 4.

Figure D-2 Serial Communications Loop

All data is sent and received in binary form, do not use ASCII. In the following pages the binary data is represented in hexadecimal (hex) format.

The NC Serial Communications Protocol is based on a master-slave model. The master is a host computer, while the slave is the chiller's controller. Only the master can initiate a communications transaction (half-duplex). The slave ends the transaction by responding to the master's query. The protocol uses RS-232/RS-485 serial interface with the default parameters: 9600 baud, 8 data bits, 1 stop bit, and no parity. RS-485 offers a slave address selection, default parameter: 1.

The chiller can be controlled through your computer's serial port by using the chiller's standard female 9-pin connection.

RS-232 COMM

Pin #	Function
1	No connection
2	TX
3	RX
4	No connection
5	GND = Signal ground
6 - 9	No connection

TX = Transmitted data from controller
RX = Received data to controller.

RS-485 COMM

Pin #	Function
1-7	No connection
8	T+
9	T-

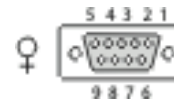

Hardware Mating Connector
AMP Part# 745492-2 or equivalent

Communication cables are available from Thermo Fisher. Contact us for additional information.

All commands must be entered in the exact format shown in the tables on the following pages. The tables show all commands available, their format and responses. Controller responses are either the requested data or an error message. The controller response *must* be received before the host sends the next command.

The host sends a command embedded in a single communications packet, then waits for the controller's response. If the command is not understood or the checksums do not agree, the controller responds with an error command. Otherwise, the controller responds with the requested data. If the controller fails to respond within 1 second, the host should resend the command.

Note All byte values are shown in hex, hex represents the binary values that must be sent to the chiller. **Do not use ASCII.** ▲

The framing of the communications packet in both directions is:

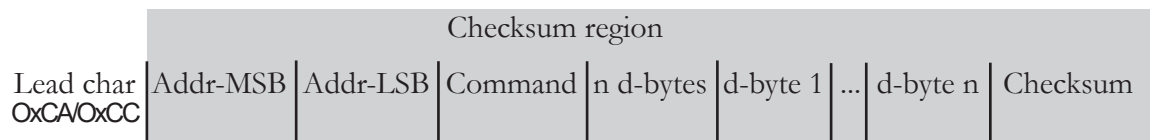

<i>Lead char</i>	0xCA (RS-232) 0xCC (RS-485)
<i>Addr-msb</i>	Device address is 1 (RS-232)
<i>Addr-lsb</i>	Most significant byte of slave address (RS-232: 0)
<i>Command</i>	Least significant byte of slave address (RS-232: 1)
<i>n d-bytes</i>	Command byte (see Table of Commands)
<i>d-byte 1</i>	Number of data bytes to follow
<i>d-byte 1</i>	1 st data byte (the qualifier byte is considered a data byte)
<i>...</i>	...
<i>d-byte n</i>	n th data byte.
<i>Checksum</i>	Bitwise inversion of the 1 byte sum of bytes beginning with the most significant address byte and ending with the byte preceding the checksum. (To perform a bitwise inversion, "exclusive OR" the one byte sum with FF hex.)

When a command has no value associated with it (e.g., REQ ACK), “n d-bytes” will be set to 0. Values such as temperature and flow are sent as either 2 or 4 byte signed integers, depending on how they are stored in the controller RAM.

When the controller sends a value, a qualifier byte is sent first, followed by a 2 or 4 byte integer (the least significant byte is sent last). The qualifier indicates the precision and units of the value. The host does not send the qualifier byte; it must send the value using the correct precision, units and number of bytes. The host first inquires about a value it wants to change, then uses the number of data bytes and the qualifier byte it receives to generate the proper integer to send.

Analog Values

Qualifier Byte	
b.7	Precision of measurement
b.6	
b.5	
b.4	
b.3	Unit of measure index
b.2	
b.1	
b.0	

Unit of Measure	
Index	Unit
0	NONE
1	Temperature in °C
2	Temperature in °F
3	Flow liters per minute
4	Flow in gallons per minute
5	Time in seconds
6	Pressure in PSI
7	Pressure in bars
8	Resistivity in MΩ-cm
9	%
10	Volts
11	Pressure in kPa

A qualifier byte of 0x12 indicated that the value contains one decimal point and the units are °F, e.g., 98.6°F.

Example to set setpoint to 25°C:

If the temperature units are unknown, before changing the setpoint send a command to request setpoint. The response will include both the precision and units. Precision is fixed at 0.1 and units can be either °C or °F. If the units are already known skip to step 3.

1. Master sends: CA 00 01 70 00 8E (REQ SETPOINT1)
2. Slave responds: CA 00 01 70 03 11 00 C8 B2 Precision =0.1, units =°C, value=200
(200 x 0.1°C=20.0°C)

Response indicates:

uses a 2 byte integer (nn=03)
precision and units are 0.1°C (d1=11)

3. Master sends: CA 00 01 F0 02 00 FA 12 (Set Setpoint 1 to 25.0°C)
4. Slave responds: CA 00 01 F0 03 11 00 FA 00 Precision =0.1, units =°C, value=250
(250 x 0.1°=25.0.0°C)

See Additional Command Examples in this Appendix.

Table of Commands

Command	M: Master Sends S: Slave Responds	Notes
Request Status		
REQ ACK	M: lc a1 a2 00 00 cs S: lc a1 a2 00 02 v1 v2 cs	protocol version v1=0; v2=1
REQ CONTROLLER SW VER or FIRMWARE CHECKSUM	M: lc a1 a2 02 00 cs S: lc a1 a2 02 nn d1 ... dn cs	Controller SW version in ASCII
Example: Request SW version, controller returns 084992.2N		
1. Master sends:	lc a1 a2 02 00 cs	
2. Slave responds:	lc a1 a2 02 0A 30 38 34 39 39 32 2E 32 4E 20 E4	
Example: Request controller checksum, controller returns 20FA		
1. Master sends:	CA 00 01 02 01 01 FA	
2. Slave responds:	CA 00 01 02 04 32 30 46 41 0F	
REQ STATUS	M: lc a1 a2 09 00 cs S: lc a1 a2 09 nn d1 ... dn cs	see Request Status Table in this Appendix
ERROR	M: S: lc a1 a2 0F 02 en ed cs	Response Only! ed = Error Data en = Error Number 1: Bad Command 2: Bad Data 3: Bad Checksum See Error in this Appendix

REQUEST LOW ALARM VALUES

REQ LO FLOW1	M: lc a1 a2 30 00 cs S: lc a1 a2 30 03 d1 d2 d3 cs	Process Alarm
REQ LO TEMP1	M: lc a1 a2 40 00 cs S: lc a1 a2 40 03 d1 d2 d3 cs	Process Alarm
REQ LO ANALOG1	M: lc a1 a2 48 00 cs S: lc a1 a2 48 03 d1 d2 d3 cs	Pressure Process Supply Alarm

REQUEST HIGH ALARM VALUES

REQ HI FLOW1	M: lc a1 a2 50 00 cs S: lc a1 a2 50 03 d1 d2 d3 cs	Process Alarm
REQ HI TEMP1	M: lc a1 a2 60 00 cs S: lc a1 a2 60 03 d1 d2 d3 cs	Process Alarm
REQ HI ANALOG1	M: lc a1 a2 68 00 cs S: lc a1 a2 68 03 d1 d2 d3 cs	Pressure Process Supply Alarm

REQUEST MEASUREMENTS

REQ FLOW1	M: lc a1 a2 10 00 cs S: lc a1 a2 10 03 d1 d2 d3 cs	Process Fluid Flow
REQ TEMP1	M: lc a1 a2 20 00 cs S: lc a1 a2 20 03 d1 d2 d3 cs	Process Fluid Supply Temperature (RTD1)
REQ TEMP4	M: lc a1 a2 23 00 cs S: lc a1 a2 23 03 d1 d2 d3 cs	Remote Temperature (RTD4)
REQ ANALOG1	M: lc a1 a2 28 00 cs S: lc a1 a2 28 03 d1 d2 d3 cs	Process Fluid Supply Pressure (P1)
REQ ANALOG2	M: lc a1 a2 29 00 cs S: lc a1 a2 29 03 d1 d2 d3 cs	Refrigeration Suction Pressure (P2)

REQUEST PID SETTINGS

REQ SETPT1	M: lc a1 a2 70 00 cs S: lc a1 a2 70 03 d1 d2 d3 cs	Process Fluid Setpoint
REQ COOL P TERM1	M: lc a1 a2 74 00 cs S: lc a1 a2 74 03 d1 d2 d3 cs	
REQ COOL I TERM1	M: lc a1 a2 75 00 cs S: lc a1 a2 75 03 d1 d2 d3 cs	
REQ COOL D TERM1	M: lc a1 a2 76 00 cs S: lc a1 a2 76 03 d1 d2 d3 cs	

SET STATUS SETTINGS

SET KEYSTROKE	M: lc a1 a2 80 01 d1 cs S: lc a1 a2 80 01 d1 cs	See Keystroke in this Appendix
SET ON/OFF ARRAY	M: lc a1 a2 81 nn d1 ... dn cs S: lc a1 a2 81 nn d1 ... dn cs	See Set On/Off Array in this Appendix d1: 0 = OFF, 1 = ON, 2 = no change
SET LOW ALARM VALUES		
SET LO FLOW1	M: lc a1 a2 B0 02 d1 d2 cs S: lc a1 a2 B0 03 d1 d2 d3 cs	Process Alarm
SET LO TEMP1	M: lc a1 a2 C0 02 d1 d2 cs S: lc a1 a2 C0 03 d1 d2 d3 cs	Process Alarm
SET LO ANALOG1	M: lc a1 a2 C8 02 d1 d2 cs S: lc a1 a2 C8 03 d1 d2 d3 cs	Pressure Process Supply Alarm
SET HIGH ALARM VALUES		
SET HI FLOW1	M: lc a1 a2 D0 02 d1 d2 cs S: lc a1 a2 D0 03 d1 d2 d3 cs	Process Alarm
SET HI TEMP1	M: lc a1 a2 E0 02 d1 d2 cs S: lc a1 a2 E0 03 d1 d2 d3 cs	Process Alarm
SET HI ANALOG1	M: lc a1 a2 E8 02 d1 d2 cs S: lc a1 a2 E8 03 d1 d2 d3 cs	Pressure Process Supply Alarm
SET PID Settings		
SET SETPT1	M: lc a1 a2 F0 02 d1 d2 cs S: lc a1 a2 F0 03 d1 d2 d3 cs	Process Fluid Setpoint
SET COOL P TERM1	M: lc a1 a2 F4 02 d1 d2 cs S: lc a1 a2 F4 03 d1 d2 d3 cs	Cool P Term
SET COOL I TERM1	M: lc a1 a2 F5 02 d1 d2 cs S: lc a1 a2 F5 03 d1 d2 d3 cs	Cool I Term
SET COOL D TERM1	M: lc a1 a2 F6 02 d1 d2 cs S: lc a1 a2 F6 03 d1 d2 d3 cs	Cool D Term

Request Status Table

Basic

nn	4				
	b0	Chiller Running		b0	External EMO fault
	b1	RTD1 open or shorted		b1	Local EMO fault
	b2	RTD2 open or shorted		b2	Low Flow fault
d1	b3	RTD3 open or shorted	d3	b3	Auto Refill fault/ Low Level fault
	b4	High Temp fixed fault		b4	Sense 5V fault
	b5	Low Temp fixed fault		b5	Invalid level fault
	b6	High Temp fault or warn		b6	Low fixed flow warn
	b7	Low Temp fault or warn		b7	High pressure fault (set at factory)
	b0	High Pressure fault or warn		b0	Low pressure fault (set at factory)
	b1	Low Pressure fault or warn	d4	b1	Chiller powering up
	b2	Drip Pan fault		b2	Chiller powering down
d2	b3	High Level fault			
	b4	Phase Monitor fault			
	b5	Motor Overload fault			
	b6	LPC fault			
	b7	HPC fault			

Error

The slave detected an error in the message it received from the master, so it returns this command instead of echoing the command sent by the master. The slave returns the command it received from the master in the ed byte, and an error code in the en byte.

en	Error
1	Bad command – not recognized by slave
2	Bad data
3	Bad checksum

Some errors may not result in any response. The slave ignores incoming bytes until it sees the valid lead character and its slave address. Then it must receive the correct number of bytes (determined by the length byte) before it can respond. If an incomplete frame is received, the slave will time out and clear its input buffer without responding.

Set On/Off Array

This command is used to set the state of the chiller, on or off. Sending a 0 in the array turns off the chiller while sending a 1 turns it on. Sending a 2 does not change the state. The array is returned showing the state after the command has been carried out. Sending all 2's effectively turns this command into a request status command.

nn	1
d1	Chiller On/Off

Set Keystroke

This command is used to affect a keystroke remotely as if someone pressed the key on the HMI.

Value	
0	Null
1	Enter
2	Up/Yes
3	Down/No
4	Mode
5	On/Off

Set Special Commands

These commands are product specific.

Master Sends: lc a1 a2 **8D** nn d1 d2 d3 d4 d5 d6 cs

Slave Returns: lc a1 a2 **8D** nn d1 d2 d3 d4 d5 d6 cs

Byte	Master	Slave
d1	Command byte	
d2	Entered Value MSB	
d3	Entered Value	
d4	Entered Value	
d5	Entered Value	
d6	Entered Value LSB	

Command	Master sends	Description	Slave returns
0x00	CA 00 01 8D 02 d1 d2 cs d1 = command byte = 00 d2 = analog option byte	Set analog option	CA 00 01 8D 03 00 d2 d3 cs
0x80	CA 00 01 8D 01 80 cs	Request PM status	CA 00 01 8D 03 80 d2 d3 cs

Set analog option command

d2 analog option byte

b.6 - b.7 = unused	b.4 - b.5 = DAC enable	b.2 - b.3 = DAC out	b.0 - b.1 = analog in
	0 = voltage	0 = voltage	0 = voltage
	1 = millivolt	1 = millivolt	1 = millivolt
	2 = current	2 = current	2 = current
	3 = no change	3 = no change	3 = no change

Eg. Command to enable DAC, set DAC out to Voltage and set Analog in to millivolt

Master sends

CA 00 01 8D 02 00 11 5E

Slave returns

CA 00 01 8D 02 00 11 5E

Eg. Command to set DAC out to current without changing DAC enable or analog in

Master sends

CA 00 01 8D 02 00 3B 34

Slave returns

CA 00 01 8D 02 00 19 56

[1] Manufacturer

Thermo Fisher Scientific
25 Nimble Hill Rd
Newington, NH 03801
USA

[2] Authorized Representative

Thermo Electron LED GmbH
Robert-Bosch-Str. 1
63505 Langenselbold
Germany

[3] Product Type

ThermoFlex product line of chillers and heat exchangers for process flow applications

[4] Model Name(s)

Unit has a 15-digit or 16-digit part numbers defined on pages 2-3 of this document.

[5] Rated Voltage, Rated Frequency

Voltage ratings are reflected as part of the Model Name, defined on the following pages of this document.

[6] The object of the declaration described above is in conformity with the relevant Union harmonization legislation:

[7] EC Directives

2014/30/EU	Electromagnetic Compatibility Directive
2014/35/EU	Low Voltage Directive
2011/65/EU	RoHS Directive

[8] The object of the declaration described above is in conformity with Directive 2011/65/EU of the European Parliament and of the Council of 8 June 2011 on the restriction of the use of certain hazardous substances in electrical and electronic equipment.

[9] Standards

EN 61326-1:2013
EN 61010-1:2010, EN 61010-2-010:2014, EN 61010-2-011:2017
EN 50581:2012

[10] This declaration is valid from the product manufactured after the date.

28 September, 2018



Mark Pearson
Global Regulatory Affairs Director
Laboratory Products Division
Thermo Fisher Scientific

Model and Voltage Number Definition :

Unit has a 15-digit part number consisting of UU C VV PP c XXXXXXX as follows:

UU = unit type can be:

10= TF900	11= TF1400	12= TF2500	13= TF3500	14= TF5000
15= TF7500	16= TF10000	17= TF15000	18= TF20000	19= TF24000

C = Cooling type and Temperature Range where: A/C= Air-cooled, W/C-Water-cooled

1 - A/C Std Temp 5-40C,	2 - A/C Hi Temp 5-90C	3 - W/C Std Temp 5-40C	4 - W/C Hi Temp 5-90C
5 - A/C Temp -5 to 90C	6 - W/C Temp -5 to 90C	7 - A/C Temp -5 to 40C	8 - W/C Temp -5 to 40C
A - Hi Temp No Cooling	B - A/C Temp -5 to 55C	C - W/C Temp -5 to 55C	

VV = Voltage Ratings:

Single Phase:		Three Phase:	
10 = 115V/60Hz,	100V/50Hz	17 = (200/208/230V)/60Hz,	200V/50Hz
11 = (100/115V)/60Hz,	(100/115V)/50Hz	18 = 400V/50Hz	
12 = (208/230V)/60Hz,	200V/50Hz	20 = (200/208/230V)/60Hz,	(200-230V)/50Hz
16 = 230V/50Hz		21 = 460V/60Hz,	400V/50Hz
20 = (200/208/230V)/60Hz,	(200/230V)/50Hz		

PP = Pump type, can be 10 through 40 inclusive.

c = Controller type. Can be any digit from 1-8, inclusive.

X = Any digit from 0-9, used as sequential numbering only.

16-digit part number consisting of UU C V P c XXXXXXXX defined as follows:

UU = unit type can be:

- | | | | | |
|------------|-------------|-------------|-------------|-------------|
| 10= TF900 | 11= TF1400 | 12= TF2500 | 13= TF3500 | 14= TF5000 |
| 15= TF7500 | 16= TF10000 | 17= TF15000 | 18= TF20000 | 19= TF24000 |

C = Cooling type and Temperature Range where: A/C= Air-cooled, W/C-Water-cooled

- | | | | |
|------------------------|------------------------|------------------------|------------------------|
| 1 - A/C Std Temp 5-40C | 2 - A/C Hi Temp 5-90C | 3 - W/C Std Temp 5-40C | 4 - W/C Hi Temp 5-90C |
| 5 - A/C Temp -5 to 90C | 6 - W/C Temp -5 to 90C | 7 - A/C Temp -5 to 40C | 8 - W/C Temp -5 to 40C |
| A - Hi Temp No Cooling | B - A/C Temp -5 to 55C | C - W/C Temp -5 to 55C | D - W/C Temp 5 to 80C |

V = Voltage Ratings:

Single Phase:

- | | |
|----------------------|-----------------|
| 1 = 115V/60Hz, | 100V/50Hz |
| 2 = (100/115V)/60Hz, | (100/115V)/50Hz |
| 3 = (208/230V)/60Hz, | 200V/50Hz |
| 4 = 230V/50Hz | |
| 7 = (200-230V)/60Hz, | (200-230V)/50Hz |

Three Phase:

- | | |
|--------------------------|-----------|
| 5 = (200/208/230V)/60Hz, | 200V/50Hz |
| 6 = 400V/50Hz | |
| 8 = 460V/60Hz, | 400V/50Hz |

P = Pump type, can be 0-9 or A-Z.

c = Controller type. Can be any digit from 1-6, inclusive.

X = Any alphanumeric character 0-9 or A-Z.

<p>DE ^[1] Hersteller - ^[2] Bevollmächtigter Vertreter - ^[3] Produkttyp - ^[4] Modellbezeichnung(en) - ^[5] Nennspannung, Nennfrequenz – ^[6] Der oben beschriebene Gegenstand der Erklärung erfüllt die einschlägigen Harmonisierungsrechtsvorschriften der Union.: ^[7] EG-Richtlinien - ^[8] Der oben beschriebene Gegenstand der Erklärung erfüllt die Vorschriften der Richtlinie 2011/65/EU des Europäischen Parlaments und des Rates vom 8. Juni 2011 zur Beschränkung der Verwendung bestimmter gefährlicher Stoffe in Elektro- und Elektronikgeräten: ^[9] Normen - ^[10] Diese Erklärung gilt für die nach diesem Datum hergestellten Produkte. ^[10] Diese Erklärung gilt für das Produkt mit folgender Seriennummer und Herstellungsdatum</p>
<p>FR ^[1] Fabricant - ^[2] Représentant agréé - ^[3] Type de produit - ^[4] Désignation(s) du modèle - ^[5] Tension nominale, Fréquence nominale – ^[6] L'objet de la déclaration décrit ci-dessus est conforme à la législation d'harmonisation de l'Union applicable : ^[7] Directives européennes - ^[8] L'objet de la déclaration décrit ci-dessus est conforme à la directive 2011/65/UE du Parlement européen et du Conseil du 8 juin 2011 relative à la limitation de l'utilisation de certaines substances dangereuses dans les équipements électriques et électroniques . ^[9] Normes - ^[10] La présente déclaration est valable à partir de la date de fabrication du produit. ^[10] La présente déclaration est valable pour le produit portant le numéro de série et la date de fabrication suivants.</p>
<p>IT ^[1] Produttore - ^[2] Rappresentante autorizzato - ^[3] Tipo di prodotto - ^[4] Nomi dei modelli - ^[5] Tensione nominale, Frequenza nominali – ^[6] L'oggetto della dichiarazione di cui sopra è conforme alla pertinente normativa di armonizzazione dell'Unione ^[7] Direttive CE - ^[8] L'oggetto della dichiarazione di cui sopra è conforme alla direttiva 2011/65/UE del Parlamento europeo e del Consiglio dell'8 giugno 2011, sulla restrizione dell'uso di determinate sostanze pericolose nelle apparecchiature elettriche ed elettroniche ^[9] Standard - ^[10] Questa dichiarazione è valida dal prodotto costruito dopo la data. ^[10] Questa dichiarazione è valida per il prodotto con i seguenti numero di serie e data di produzione</p>
<p>ES ^[1] Fabricante - ^[2] Representante autorizado - ^[3] Tipo de producto - ^[4] Modelos - ^[5] Tensión nominal, Frecuencia nominal - ^[6] El objeto de la declaración descrita anteriormente es conforme con la legislación de armonización pertinente de la Unión: ^[7] Directivas CE - ^[8] El objeto de la declaración descrito anteriormente es conforme a la Directiva 2011/65/UE del Parlamento Europeo y del Consejo, de 8 de junio de 2011, sobre restricciones a la utilización de determinadas sustancias peligrosas en aparatos eléctricos y electrónicos ^[9] Normas - ^[10] Esta declaración es válida para el producto fabricado después de la fecha. ^[10] Esta declaración es válida para el producto con el siguiente número de serie y fechade manufactura.</p>
<p>PT ^[1] Fabricante - ^[2] Representante Autorizado - ^[3] Tipo de Produto - ^[4] Nome(s) do Modelo - ^[5] Tensão Nominal, Frequência Nominal – ^[6] O objeto da declaração acima descrito está em conformidade com a legislação de harmonização da União aplicável: ^[7] Directivas da CE - ^[8] O objecto da declaração acima mencionada está em conformidade com a Directiva 2011/65/UE do Parlamento Europeu e do Conselho, de 8 de Junho de 2011, relativa à restrição do uso de determinadas substâncias perigosas em equipamentos eléctricos e electrónicos. ^[9] Normas - ^[10] Esta Declaração é válida para o produto fabricado após a data. ^[10] Esta Declaração é válida para o produto com o seguinte número de série e data de fabrico</p>
<p>NL ^[1] Producent - ^[2] Gemachtigd vertegenwoordiger - ^[3] Producttype - ^[4] Modelnaam/namen - ^[5] Nominale spanning, nominale frequentie – ^[6] Het hierboven beschreven voorwerp is in overeenstemming met de desbetreffende harmonisatiewetgeving van de Unie: ^[7] EC-richtlijnen - ^[8] Het hierboven beschreven voorwerp is conform Richtlijn 2011/65/EU van het Europees Parlement en de Raad van 8 juni 2011 betreffende beperking van het gebruik van bepaalde gevaarlijke stoffen in elektrische en elektronische apparatuur: ^[9] Normen - ^[10] Deze verklaring is geldig voor de producten die zijn geproduceerd na deze datum. ^[10] Deze verklaring is geldig voor het product met het volgende serienummer en productiedatum.</p>
<p>PL ^[1] Producent - ^[2] Autoryzowany Przedstawiciel - ^[3] Typ produktu - ^[4] Nazwa(y) modelu - ^[5] Napięcie znamionowe , częstotliwość znamionowa - ^[6] Wymieniony powyżej przedmiot niniejszej deklaracji jest zgodny z odpowiednimi wymaganiami unijnego prawodawstwa harmonizacyjnego: ^[7] dyrektywy KE - ^[8] Opisany powyżej przedmiot deklaracji jest zgodny z dyrektywą Parlamentu Europejskiego i Rady 2011/65/UE z dnia 8 czerwca 2011 r. w sprawie ograniczenia stosowania niektórych niebezpiecznych substancji w sprzęcie elektrycznym i elektronicznym: ^[9] Standardy - ^[10] Deklaracja ta jest ważna dla wyrobów wyprodukowanych po dacie. ^[10] Niniejsza deklaracja jest ważna dla produktu z następującym numerem seryjnym oraz datą produkcji.</p>
<p>CS ^[1] Výrobce - ^[2] Autorizovaný zástupce - ^[3] Typ produktu - ^[4] Názvy modelů - ^[5] Jmenovité napětí, jmenovitý kmitočet – ^[6] Výše popsáný předmět prohlášení je ve shodě s příslušnými harmonizačními právními předpisy Unie: ^[7] Směrnice ES - ^[8] Výše popsáný předmět prohlášení je ve shodě se směrnicí Evropského parlamentu a Rady 2011/65/EU ze dne 8. června 2011 o omezení používání některých nebezpečných látek v elektrických a elektronických zařízeních: ^[9] Normy - ^[10] Toto prohlášení o shodě platí od data výroby produktu. ^[10] Toto prohlášení o shodě platí pro produkt s následujícím výrobním číslem a datem výroby.</p>

<p>DE ^[1] Hersteller - ^[2] Bevollmächtigter Vertreter - ^[3] Produkttyp - ^[4] Modellbezeichnung(en) - ^[5] Nennspannung, Nennfrequenz – ^[6] Der oben beschriebene Gegenstand der Erklärung erfüllt die einschlägigen Harmonisierungsrechtsvorschriften der Union.: ^[7] EG-Richtlinien - ^[8] Der oben beschriebene Gegenstand der Erklärung erfüllt die Vorschriften der Richtlinie 2011/65/EU des Europäischen Parlaments und des Rates vom 8. Juni 2011 zur Beschränkung der Verwendung bestimmter gefährlicher Stoffe in Elektro- und Elektronikgeräten: ^[9] Normen - ^[10] Diese Erklärung gilt für die nach diesem Datum hergestellten Produkte. ^[10] Diese Erklärung gilt für das Produkt mit folgender Seriennummer und Herstellungsdatum</p>
<p>FR ^[1] Fabricant - ^[2] Représentant agréé - ^[3] Type de produit - ^[4] Désignation(s) du modèle - ^[5] Tension nominale, Fréquence nominale – ^[6] L'objet de la déclaration décrit ci-dessus est conforme à la législation d'harmonisation de l'Union applicable : ^[7] Directives européennes - ^[8] L'objet de la déclaration décrit ci-dessus est conforme à la directive 2011/65/UE du Parlement européen et du Conseil du 8 juin 2011 relative à la limitation de l'utilisation de certaines substances dangereuses dans les équipements électriques et électroniques . ^[9] Normes - ^[10] La présente déclaration est valable à partir de la date de fabrication du produit. ^[10] La présente déclaration est valable pour le produit portant le numéro de série et la date de fabrication suivants.</p>
<p>IT ^[1] Produttore - ^[2] Rappresentante autorizzato - ^[3] Tipo di prodotto - ^[4] Nomi dei modelli - ^[5] Tensione nominale, Frequenza nominali – ^[6] L'oggetto della dichiarazione di cui sopra è conforme alla pertinente normativa di armonizzazione dell'Unione ^[7] Direttive CE - ^[8] L'oggetto della dichiarazione di cui sopra è conforme alla direttiva 2011/65/UE del Parlamento europeo e del Consiglio dell'8 giugno 2011, sulla restrizione dell'uso di determinate sostanze pericolose nelle apparecchiature elettriche ed elettroniche ^[9] Standard - ^[10] Questa dichiarazione è valida dal prodotto costruito dopo la data. ^[10] Questa dichiarazione è valida per il prodotto con i seguenti numero di serie e data di produzione</p>
<p>ES ^[1] Fabricante - ^[2] Representante autorizado - ^[3] Tipo de producto - ^[4] Modelos - ^[5] Tensión nominal, Frecuencia nominal - ^[6] El objeto de la declaración descrita anteriormente es conforme con la legislación de armonización pertinente de la Unión: ^[7] Directivas CE - ^[8] El objeto de la declaración descrito anteriormente es conforme a la Directiva 2011/65/UE del Parlamento Europeo y del Consejo, de 8 de junio de 2011, sobre restricciones a la utilización de determinadas sustancias peligrosas en aparatos eléctricos y electrónicos ^[9] Normas - ^[10] Esta declaración es válida para el producto fabricado después de la fecha. ^[10] Esta declaración es válida para el producto con el siguiente número de serie y fechade manufactura.</p>
<p>PT ^[1] Fabricante - ^[2] Representante Autorizado - ^[3] Tipo de Produto - ^[4] Nome(s) do Modelo - ^[5] Tensão Nominal, Frequência Nominal – ^[6] O objeto da declaração acima descrito está em conformidade com a legislação de harmonização da União aplicável: ^[7] Directivas da CE - ^[8] O objecto da declaração acima mencionada está em conformidade com a Directiva 2011/65/UE do Parlamento Europeu e do Conselho, de 8 de Junho de 2011, relativa à restrição do uso de determinadas substâncias perigosas em equipamentos eléctricos e electrónicos. ^[9] Normas - ^[10] Esta Declaração é válida para o produto fabricado após a data. ^[10] Esta Declaração é válida para o produto com o seguinte número de série e data de fabrico</p>
<p>NL ^[1] Producent - ^[2] Gemachtigd vertegenwoordiger - ^[3] Producttype - ^[4] Modelnaam/namen - ^[5] Nominale spanning, nominale frequentie – ^[6] Het hierboven beschreven voorwerp is in overeenstemming met de desbetreffende harmonisatiewetgeving van de Unie: ^[7] EC-richtlijnen - ^[8] Het hierboven beschreven voorwerp is conform Richtlijn 2011/65/EU van het Europees Parlement en de Raad van 8 juni 2011 betreffende beperking van het gebruik van bepaalde gevaarlijke stoffen in elektrische en elektronische apparatuur: ^[9] Normen - ^[10] Deze verklaring is geldig voor de producten die zijn geproduceerd na deze datum. ^[10] Deze verklaring is geldig voor het product met het volgende serienummer en productiedatum.</p>
<p>PL ^[1] Producent - ^[2] Autoryzowany Przedstawiciel - ^[3] Typ produktu - ^[4] Nazwa(y) modelu - ^[5] Napięcie znamionowe , częstotliwość znamionowa - ^[6] Wymieniony powyżej przedmiot niniejszej deklaracji jest zgodny z odpowiednimi wymaganiami unijnego prawodawstwa harmonizacyjnego: ^[7] dyrektywy KE - ^[8] Opisany powyżej przedmiot deklaracji jest zgodny z dyrektywą Parlamentu Europejskiego i Rady 2011/65/UE z dnia 8 czerwca 2011 r. w sprawie ograniczenia stosowania niektórych niebezpiecznych substancji w sprzęcie elektrycznym i elektronicznym: ^[9] Standardy - ^[10] Deklaracja ta jest ważna dla wyrobów wyprodukowanych po dacie. ^[10] Niniejsza deklaracja jest ważna dla produktu z następującym numerem seryjnym oraz datą produkcji.</p>
<p>CS ^[1] Výrobce - ^[2] Autorizovaný zástupce - ^[3] Typ produktu - ^[4] Názvy modelů - ^[5] Jmenovité napětí, jmenovitý kmitočet – ^[6] Výše popsáný předmět prohlášení je ve shodě s příslušnými harmonizačními právními předpisy Unie: ^[7] Směrnice ES - ^[8] Výše popsáný předmět prohlášení je ve shodě se směrnicí Evropského parlamentu a Rady 2011/65/EU ze dne 8. června 2011 o omezení používání některých nebezpečných látek v elektrických a elektronických zařízeních: ^[9] Normy - ^[10] Toto prohlášení o shodě platí od data výroby produktu. ^[10] Toto prohlášení o shodě platí pro produkt s následujícím výrobním číslem a datem výroby.</p>

<p>EL) ^[1] Κατασκευαστής - ^[2] Εξουσιοδοτημένος αντιπρόσωπος - ^[3] Είδος προϊόντος - ^[4] Ονομασία μοντέλου - ^[5] Ονομαστική τάση, Ονομαστική συχνότητα - ^[6] Ο στόχος της δήλωσης που περιγράφεται παραπάνω είναι σύμφωνος με τη σχετική ενωσιακή νομοθεσία εναρμόνισης: ^[7] Οδηγίες ΕΚ - ^[8] Το ανωτέρω περιγραφόμενο αντικείμενο της δήλωσης είναι σύμφωνο με την οδηγία 2011/65/ΕΕ του Ευρωπαϊκού Κοινοβουλίου και του Συμβουλίου, της 8ης Ιουνίου 2011, σχετικά με τον περιορισμό της χρήσης ορισμένων επικίνδυνων ουσιών σε ηλεκτρικό και ηλεκτρονικό εξοπλισμό: ^[9] Πρότυπα - ^[10] Η παρούσα δήλωση ισχύει για το κατασκευασμένο προϊόν μετά την ημερομηνία. ^[10] Η παρούσα δήλωση ισχύει για το προϊόν με τον ακόλουθο σειριακό αριθμό και την ημερομηνία κατασκευής</p>
<p>GA) ^[1] Monaróir - ^[2] Ionadaí údaraithe - ^[3] Cineál Táirge - ^[4] Ainm (neacha) Samhail - ^[5] Rátáil Voltage , Minicíocht Rátáil - ^[6] Tá cuspóir an dearbhaithe a bhfuil tuairisc air thuas i gcomhréir le reachtaíocht ábhartha an Aontais maidir le comhchuibhiú: ^[7] Treoracha CE - ^[8] Tá cuspóir an dearbhaithe a bhfuil tuairisc air thuas i gcomhréir le Treoir 2011/65/AE ó Pharlaimint na hEorpa agus ón gComhairle an 8 Meitheamh 2011 maidir le srian ar shubstaintí guaiseacha áirithe a úsáid i dtrealamh leictreach agus leictreonach ^[9] Caighdeáin - ^[10] Tá an dearbhú bailí ón táirge a mhonaraítear i ndiaidh an dáta sin. ^[10] Tá an dearbhú bailí ar feadh an táirge foirgníochta an sraithuimhir leanas agus dáta monaraithe</p>
<p>HR) ^[1] Proizvodáč - ^[2] Ovlašteni zastupnik - ^[3] Vrsta proizvoda - ^[4] Naziv(i) modela - ^[5] Nazivni napon, nazivna frekvencija - ^[6] Predmet navedene izjave u skladu je s mjerodavnim zakonodavstvom Unije o usklađivanju: ^[7] Direktive EZ-a - ^[8] Gore opisan predmet izjave u skladu je s Direktivom 2011/65/EU Europskog parlamenta i Vijeća od 8. lipnja 2011. o ograničavanju uporabe određenih opasnih tvari u električnoj i elektroničkoj opremi: ^[9] Norme - ^[10] Ova izjava vrijedi za proizvod proizveden nakon navedenog datuma. ^[10] Ova izjava vrijedi za proizvod sa sljedećim serijskim brojem i datumom proizvodnje</p>
<p>RO) ^[1] Producător - ^[2] Reprezentant Autorizat - ^[3] Tipul Produsului - ^[4] Nume model(e) - ^[5] Tensiune nominală, Frecvența nominală - ^[6] Obiectul declarației descris mai sus este în conformitate cu legislația relevantă de armonizare a Uniunii: ^[7] Directive CE - ^[8] Obiectul declarației descris mai sus este conform Directivei 2011/65/UE a Parlamentului European și a Consiliului din 8 iunie 2011 privind restricțiile de utilizare a anumitor substanțe periculoase în echipamentele electrice și electronice: ^[9] Standarde - ^[10] Această declarație este valabilă pentru produsele fabricate după data curentă. ^[10] Această declarație este valabilă pentru produsul cu următorul număr de serie și următoarea dată de fabricație</p>
<p>HU) ^[1] Gyártó - ^[2] Meghatalmazott képviselő - ^[3] Terméktípus - ^[4] Modell(ek) neve - ^[5] Névleges feszültség, névleges frekvencia - ^[6] A fent ismertetett nyilatkozat tárgya megfelel a vonatkozó uniós harmonizációs jogszabálynak: ^[7] EC-irányelvek - ^[8] E nyilatkozat fent leírt tárgya összhangban van az egyes veszélyes anyagok elektromos és elektronikus berendezésekben való alkalmazásának korlátozásáról szóló, 2011. június 8-i 2011/65/EU európai parlamenti és tanácsi irányelvvel: ^[9] Szabványok - ^[10] Jelen nyilatkozat a megadott dátum után gyártott termékekre érvényes. ^[10] Jelen nyilatkozat a következő sorozatszámú és gyártási dátumú termékre érvényes.</p>
<p>BG) ^[1] Производител - ^[2] Оторизиран представител - ^[3] Тип продукт - ^[4] Име на модел - ^[5] Номинално напрежение, Номинална честота - ^[6] Предметът на декларацията, описан по-горе, отговаря на съответното законодателство на Съюза за хармонизация: ^[7] Директиви на ЕО - ^[8] Обектът на декларацията, който е описан по-горе, е в съответствие с Директива 2011/65/ЕС на Европейския парламент и на Съвета от 8 юни 2011 г. относно ограничението на употребата на определени опасни вещества в електрическото и електронното оборудване: ^[9] Стандарти - ^[10] Тази декларация е валидна за продуктите, произведени след датата. ^[10] Тази декларация е валидна за продукта със следния сериен номер и дата на производство.</p>
<p>ZH) ^[1] 制造商 - ^[2] 授权代表 - ^[3] 产品类型 - ^[4] 型号 - ^[5] 额定电压、额定频率 - ^[6] 上述声明对象符合相关欧盟协调法规 ^[7] 欧盟指令 - ^[8] 上述声明对象符合欧洲议会和欧盟理事会2011年6月8日关于在电气和电子设备中限制使用某些有害物质的指令2011/65 / EU ^[9] 标准 - ^[10] 本声明自产品制造之日起生效。 ^[10] 本声明适用于具有下述序列号和制造日期的产品。</p>

WARRANTY

Thermo Fisher Scientific warrants for 24 months (**excluding MD1/MD2 Magnetic Drive and P1/P2 Positive Displacement pumps which are warranted for 12 months**) from date of shipment the Thermo Scientific ThermoFlex chiller according to the following terms.

Any part of the chiller manufactured or supplied by Thermo Fisher Scientific and found in the reasonable judgment of Thermo Fisher to be defective in material or workmanship will be repaired at an authorized Thermo Fisher Repair Depot without charge for parts or labor. The chiller, including any defective part must be returned to an authorized Thermo Fisher Repair Depot within the warranty period. The expense of returning the chiller to the authorized Thermo Fisher Repair Depot for warranty service will be paid for by the buyer. Our responsibility in respect to warranty claims is limited to performing the required repairs or replacements, and no claim of breach of warranty shall be cause for cancellation or rescission of the contract of sales of any chiller. With respect to chillers that qualify for field service repairs, Thermo Fisher Scientific's responsibility is limited to the component parts necessary for the repair and the labor that is required on site to perform the repair. Any travel labor or mileage charges are the financial responsibility of the buyer.

The buyer shall be responsible for any evaluation or warranty service call (including labor charges) if no defects are found with the Thermo Scientific product.

This warranty does not cover any chiller that has been subject to misuse, neglect, or accident. This warranty does not apply to any damage to the chiller that is the result of improper installation or maintenance, or to any chiller that has been operated or maintained in any way contrary to the operating or maintenance instructions specified in this Instruction and Operation Manual. This warranty does not cover any chiller that has been altered or modified so as to change its intended use.

In addition, this warranty does not extend to repairs made by the use of parts, accessories, or fluids which are either incompatible with the chiller or adversely affect its operation, performance, or durability.

Thermo Fisher Scientific reserves the right to change or improve the design of any chiller without assuming any obligation to modify any chiller previously manufactured.

THE FOREGOING EXPRESS WARRANTY IS IN LIEU OF ALL OTHER WARRANTIES, EXPRESSED OR IMPLIED, INCLUDING BUT NOT LIMITED TO WARRANTIES OR MERCHANTABILITY AND FITNESS FOR A PARTICULAR PURPOSE.

OUR OBLIGATION UNDER THIS WARRANTY IS STRICTLY AND EXCLUSIVELY LIMITED TO THE REPAIR OR REPLACEMENT OF DEFECTIVE COMPONENT PARTS AND Thermo Fisher Scientific DOES NOT ASSUME OR AUTHORIZE ANYONE TO ASSUME FOR IT ANY OTHER OBLIGATION.

Thermo Fisher Scientific ASSUMES NO RESPONSIBILITY FOR INCIDENTAL, CONSEQUENTIAL, OR OTHER DAMAGES INCLUDING, BUT NOT LIMITED TO LOSS OR DAMAGE TO PROPERTY, LOSS OF PROFITS OR REVENUE, LOSS OF THE CHILLER, LOSS OF TIME, OR INCONVENIENCE.

This warranty applies to chillers sold by Thermo Fisher Scientific. (Refer to the warranty for chillers sold by the affiliated marketing company of Thermo Fisher Scientific for any additional terms.) This warranty and all matters arising pursuant to it shall be governed by the law of the State of New Hampshire, United States. All legal actions brought in relation hereto shall be filed in the appropriate state or federal courts in New Hampshire, unless waived by Thermo Fisher Scientific.

Thermo Fisher Scientific
168 Third Avenue
Waltham, Massachusetts 02451
United States

www.thermofisher.com