



FESTOOL

Catalogue **2019**

Tools for the toughest demands

You can find all our new products on pages 2 and 3



Dear Festool customers,

what motivates us to tirelessly continue developing our products year after year? The same thing that spurs you on: The passion for our trade.

This year, we have once again improved established products and developed new products with this passion. Many clever details are making our products even more intelligent – for example our new CT MINI and CT MIDI mobile dust extractors can be switched on and off automatically by the cordless tool thanks to Bluetooth® batteries. And our new cordless insulating material saw allows you to cut insulating materials to size in next to no time without a cord.

We would like to provide you with another intelligent tool in the form of our new catalogue. This gives you access to all of our products, accessories and services at any time.

We hope you enjoy using it.

Barbara Austel
Company partner and granddaughter of founder Gottlieb Stoll



01 18-volt system	10
Machines, batteries, chargers	
02 Sawing	30
Jigsaws, plunge-cut and circular saws, compound mitre saws, semi-stationary saws	
03 Machining surfaces	88
Electric and cordless sanders, compressed air sanders, polishers, brush machines, abrasives	
04 Dust extraction	174
Mobile dust extractor, AUTOCLEAN mobile dust extractor, special and safety extractor	
05 Drilling and screwdriving	214
Cordless drills, cordless hammer drills, cordless rotary hammer drills, corded drills, cordless plasterboard screwgun	
06 Routing	242
Routers, bench-mounted routers, laminate trimmers, aluminium composite milling machines	
07 Joining – DOMINO joining system	300
DOMINO joining machines	
08 Planing	316
Electric planers	
09 Edging	324
Edge bander, semi-stationary edge bander	
10 Stirring	336
Stirrers, DUO stirrers	
11 Preparing the substrate	350
Renovation millers, diamond sanders, diamond cutting systems, carpet removers	
12 Illuminating	372
Work lights, working lights, grazing light	
13 Workplace organisation	382
SYSTAINER, packaging, organisation and transport systems, (semi-) stationary devices, radios	
14 Fan shop	422
15 Index	424

New Festool products for 2019.



Intelligent right down to the smallest detail.

Low weight, compact dimensions and a host of innovative details – the new CTL MINI and CTL MIDI compact extractor impresses in all aspects. It has intuitive touch operation, a smooth suction hose and a level storage area for tools and consumables. Manual dedusting and being able to replace the main filter from the outside ensure long-lasting work that protects your health. Includes integrated **Bluetooth®** technology – the mobile dust extractor is automatically started by the Bluetooth® battery pack or by the remote control.

>> Page 184



Get straight down to work thanks to remote control.

Festool is now supplying many 18-volt extraction tools with Bluetooth® battery packs that communicate with the Bluetooth® module on the extractor using a wireless connection. This means that the mobile dust extractor starts automatically when the cordless tool is switched on. This saves time, speeds up work and provides all the benefits of Festool's dust-free system.

>> Page 14



Patented talent.

The ISC 240 cordless insulating material saw revolutionises the sawing of insulating materials. Whether on a roof, scaffolding or on the ground. Whether working with mineral fibre, natural fibre or polyurethane insulation boards. Conveniently save energy, time and the need for rework, even when cutting insulating materials to size.

>> Page 57



The perfect connection. Now even more versatile.

The new basic structure connectors and furniture connectors for the DOMINO DF 500 joining machine enable stable yet detachable furniture designs. A clever invention which simplifies your work during manufacturing, set-up and disassembly tasks in the workshop and on customer premises.

>> Page 312

Turns the construction site into your workshop.

The portable workshop is exactly what its name promises: Ideal working conditions on any construction site. Its intelligent design guarantees that it can be transported, set up and disassembled with ease. A few steps are all that is required to turn the sophisticated, compact unit into a stable workstation, where all tools are in their intended position ready for use. Just like in your own workshop.

>> Page 398



Reinforcement for the mobile dust extractor.

The CT pre-separator can deal with large quantities of dust. It can separate and collect up to 95% of mineral and coarse dust. This takes the strain off the main filter and keeps the suction power high thanks to intelligent use of cyclone technology.

>> Page 194



Uncompromising performance.

Direct, practical and comprehensive service for you and your tools. In addition to excellent tools, we also offer you services of an outstanding quality. We do everything in our power to ensure that you are satisfied and that you place your trust in Festool. After all, we are only satisfied when you are too.

* Warranty all-inclusive is valid for all Festool tools purchased from 6 March 2013 onwards and registered within 30 days of purchase. The Festool service terms and conditions shall apply and are available at www.festool.com/service. The service offer may differ according to country and importer.



Our service. Your success.



Warranty all-inclusive Your plus in performance.

Upon registration your new tool is covered for the first three years.*
If your tool develops a fault, it will be repaired free of charge, including labour, excluding wear parts.



Festool know-how Expert knowledge just a click away.

Comprehensive information on the optimal use of your tools available for you online.



Professional repair Your tool repaired by experts.

Your tool is repaired by our experts, diligently, quickly and with a lot of know-how.



Hello hotline! Your contact for all queries.

Whether you require advice, support or repair – we are always happy to hear from you.



Warranty all-inclusive Your plus in performance.

Benefit from the comprehensive services provided by our all-inclusive warranty. When you register your new Festool tool, it is covered for the first years of use so you can concentrate on what really matters: your work.*

Register fast. Benefits for the long term.

Register online up to 30 days after purchase to ensure that you benefit from all our services. Find out more at:
www.festool.com/register

3 year warranty.

For us, it almost goes without saying that we will replace faulty components free of charge – for fully three years**.

Professional repair.

Quick, thorough and absolutely professional. Our qualified experts make sure that your tool is back in your hands in the shortest possible time.

10 years replacement parts guarantee.

Your Festool tool is made for long life. Nevertheless, it may at some point be necessary to replace a part. This is why we guarantee the availability of every spare part for at least 10 years. If we don't have the part you need in stock, you will receive a new tool from us free of charge.

* Warranty all-inclusive is valid for all Festool tools purchased from 6 March 2013 onwards and registered within 30 days of purchase. The Festool service terms and conditions shall apply and are available at **www.festool.com/service**. The service offer may vary depending on the country and dealer.

** The offer for 3 year warranty does not apply for damage to consumables and accessories, misuse, damage caused by the use of non-original accessories or spare parts, nor in the case of tools which have been dismantled or subjected to constant, hard-wearing use. Wear parts are excluded.

Festool know-how

Expert knowledge just a click away.

Like you, we want you to be able to do your work as well as you possibly can. This is why we provide you with comprehensive information online so you can use your Festool tools in the best possible way, to achieve the best possible results. Expert knowledge, by professionals for professionals.

- › Festool TV with a wealth of instructive application examples
- › Product videos with detailed descriptions of products and their features
- › Website with all technical data relating to our products, and much more.

For more information, visit our website at www.festool.com or www.youtube.com/FestoolInternational



Professional repair

Your tool repaired by experts.



Your tool is fully overhauled in no time and back in your hands like new. We not only repair, we also service, test and fine-tune. The professionals in our repair service use their extensive expertise to take care of your tool diligently and quickly. And you receive all this free of charge for the first three years as part of our all inclusive warranty.*

- > All-round analysis: servicing, testing and fine-tuning
- > Repair by trained specialists
- > Original spare parts
- > Back in action fast

Hello hotline!

Your contact for all your queries.

The direct line to skilled experts is always the best way to get answers to your questions quickly and easily. Whether it's advice, support or repair that you need, we are always happy to hear from you. You can find your local contact details on our website www.festool.com.

* Warranty all-inclusive is valid for all Festool tools registered within 30 days of purchase and which were purchased on or after 06.03.2014. The Festool service terms and conditions shall apply and are available at www.festool.com/service. The service offer may differ according to country and importer.

The offer for warranty all-inclusive does not apply for damage to consumables and accessories, misuse, damage caused by the use of non-original accessories or spare parts, nor in the case of tools which have been dismantled or subjected to constant, hard-wearing use. Wear parts are excluded.





01 18-volt system

CARVEX cordless pendulum jigsaws – PSC 420, PSBC 420	18
Cordless plunge-cut saw – TSC 55	19
Cordless circular saw – HKC 55	20
Cordless insulating-material saw – ISC 240	21
Cordless drill – C 18	22
Cordless drill – T 18+3	23
Cordless hammer drill – BHC 18	24
Cordless drills QUADRIVE – DRC 18/4	25
Cordless impact drill QUADRIVE – PDC 18/4	25
Cordless drywall screwdriver DURADRIVE – DWC 18	26
Working light – SYSLITE UNI	27
Working light – SYSLITE KAL II	28
SYSROCK construction site radio – BR 10, BR 10 DAB+	29

More power. More endurance. More options. The Festool 18-volt system.

With the Festool 18-volt system, there is more in it for you: More power for longer with the new 6.2 Ah battery pack, for runtimes lasting up to 20% longer. More speed thanks to the AIRSTREAM SCA 8 rapid charger with integrated cooling device. More endurance with batteries that can withstand high currents. More possibilities with PowerSelect for your own customised battery system. More efficiency and more working comfort with Bluetooth® battery packs for automatic extractor start-up and all-round sophisticated tools. And, of course, more services with warranty all-inclusive.

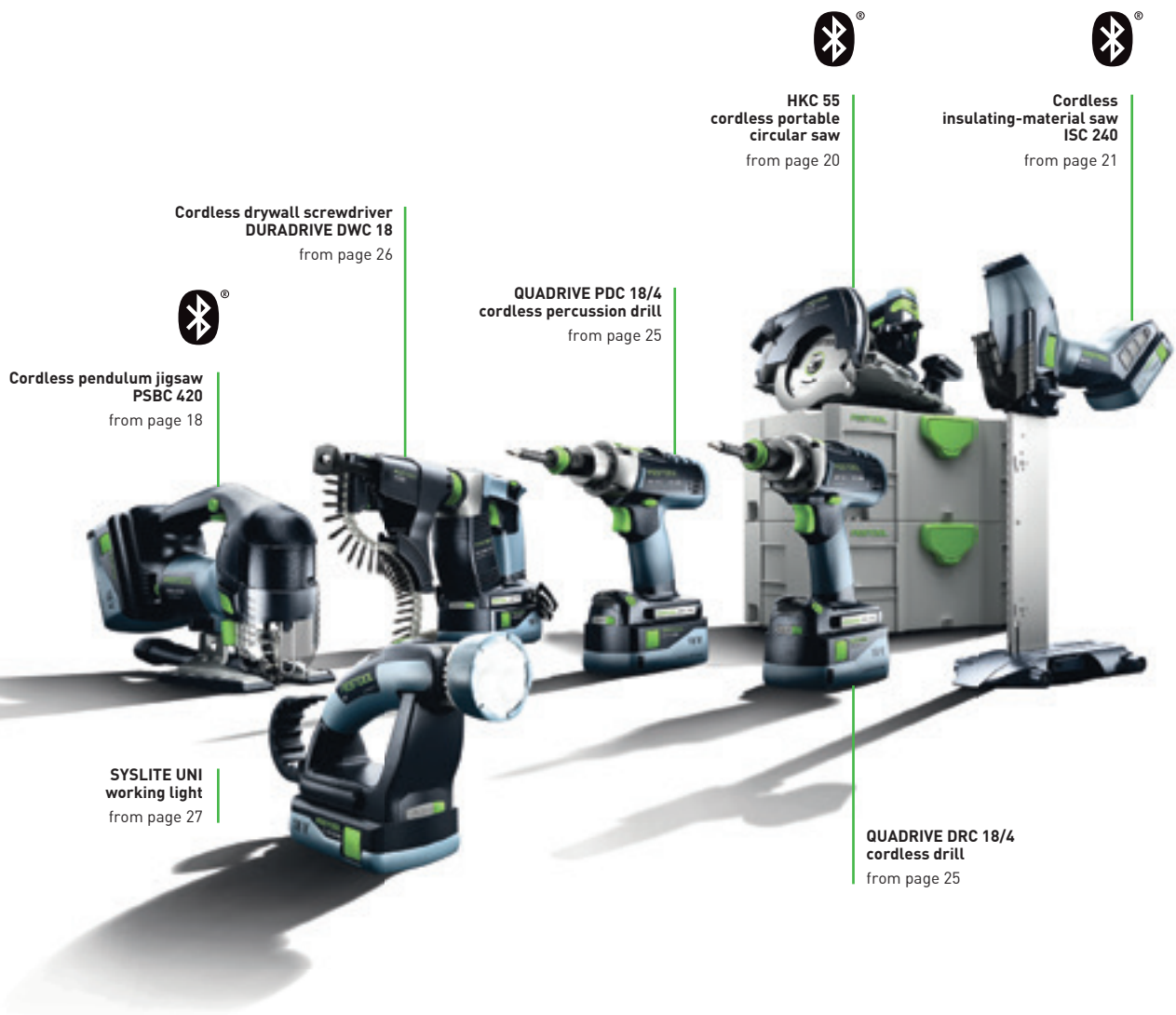

**Cordless drywall screwdriver
DURADRIVE DWC 18**
from page 26



**Cordless pendulum jigsaw
PSBC 420**
from page 18

**QUADRIVE PDC 18/4
cordless percussion drill**
from page 25

**SYSLITE UNI
working light**
from page 27



**HKC 55
cordless portable
circular saw**
from page 20



**Cordless
insulating-material saw
ISC 240**
from page 21

**QUADRIVE DRC 18/4
cordless drill**
from page 25



Warranty all-inclusive Your performance assured.

Benefit from the wide range of services that are part of our Warranty all inclusive. After registering your new Festool tool, it is covered during the first few years, allowing you to concentrate on what really matters: Your work.*

SYSLITE KAL II
working light
from page 28

SYSROCK BR 10 and BR 10 DAB+
site radios
from page 29



Cordless plunge-cut saw
TSC 55
from page 19

T18+3
cordless drills
from page 23



Cordless hammer drill
BHC 18
from page 24

C 18
cordless drill
from page 22



Cordless pendulum jigsaw
PSC 420
from page 18



Battery pack and charger system
accessories
from page 14



* Valid for all Festool tools purchased after 06.03.2013 and registered within 30 days of purchase. Visit www.festool.com/service for the applicable Festool Service Terms and Conditions. The available services may vary depending on country and sales partner.

Power for any task.

Overview of battery packs – with and without Bluetooth®.



3.1 Ah compact battery pack

5.2 Ah AIRSTREAM battery pack

AIRSTREAM				
Bluetooth® variant		●		●
Available with PowerSelect	●		●	
Available in pre-configured versions	●		●	
Suitable chargers	TCL 3 TCL 6 SCA 8		TCL 3 TCL 6 SCA 8 (with AIRSTREAM)	
Benefits	<ul style="list-style-type: none"> > Very light, and therefore ideal for drilling and screwdriving > The specialist for ergonomic work 	<ul style="list-style-type: none"> > Convenient automatic start-up of dust extractors, including on 18 V machines 	<ul style="list-style-type: none"> > The all-rounder for all applications > Fast charging thanks to AIRSTREAM technology 	<ul style="list-style-type: none"> > Convenient automatic start-up of dust extractors, including on 18 V machines
Weight	0.40 kg		0.70 kg	
Order no.	201789	203799	200181	202479

More endurance.
High-current-resistant cells guarantee a long service life.

We use only the best quality in Festool tools – right down to the high-current-resistant battery cells. The cells can withstand even heavy loads for years, such as those which occur during sawing applications, as is proven by the quality check performed on the cell technology.

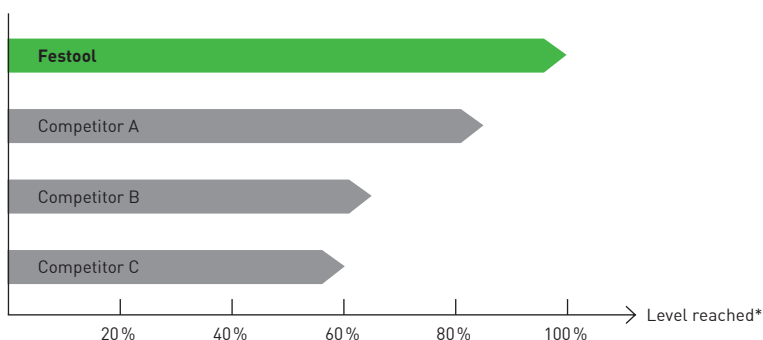

* Test results from the quality check in the Festool laboratory according to discharge tests at maximum load

Overview of the chargers.



6.2 Ah AIRSTREAM battery pack



rapid charger TCL 6

SCA 8 rapid charger

	●
	●
	●
only as accessory	
TCL 3 TCL 6 SCA 8 (with AIRSTREAM)	
<ul style="list-style-type: none"> › For sawing and heavy-duty drilling and screwdriving applications › Fast charging thanks to AIRSTREAM technology 	
	<ul style="list-style-type: none"> › Convenient automatic start-up of dust extractors, including on 18 V machines
0.70 kg	
201774	201797

AIRSTREAM		●
Available with PowerSelect	●	●
Available in pre-configured versions	●	●
Max. charging current	6.0 A	8.0 A
Benefits	<ul style="list-style-type: none"> › LED display for showing the remaining charge time and the charge status › for all Festool battery packs (except CXS/TXS) 	<ul style="list-style-type: none"> › Optimum use in machines with high power consumption and short downtimes
Weight	0.80 kg	1.10 kg
Order no.	201135	200178

Fast and effective – AIRSTREAM battery packs and SCA 8 AIRSTREAM rapid charger.

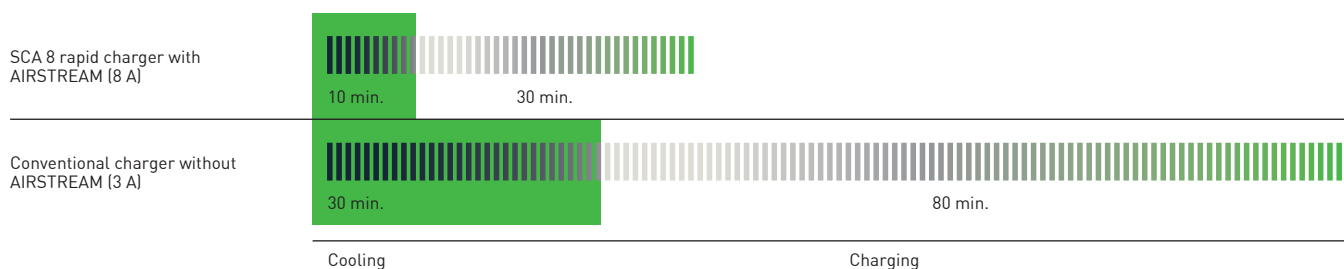

Specifications apply to the 5.2 Ah AIRSTREAM battery

Ready immediately.

Saving you a trip to the extractor: Bluetooth® battery packs are now included in the scope of delivery for selected 18-volt tools. The Bluetooth® module is already integrated in the new CT MINI/MIDI compact extractors and can be easily retrofitted to the CT 26/36/48 mobile dust extractors for communication between tool and extractor.* This means that the mobile dust extractor starts automatically when the cordless tool is switched on. What's more, for existing cordless tools, Bluetooth® battery packs are available as an accessory. This will retrospectively equip your existing Festool 18-volt system for automatic extractor start-up.

Automatic start-up is this quick and easy.

Cordless tool with dust extraction



ETSC, DTSC, RTSC



TSC 55



HKC 55



PSC / PSBC 420



BHC 18



ISC 240



Bluetooth® Ergo battery pack



3,1 Ah

Bluetooth® battery pack



3,1 Ah / 5,2 Ah / 6,2 Ah



Bluetooth®-compatible mobile dust extractor



CT MINI/MIDI (YOM: 2019) with integrated Bluetooth® module



CT 26/36/48 plus Bluetooth® module*



Mobile dust extractor starts automatically in AUTO mode when the power tool is switched on



* Only suitable for retrofitting to the CT 26/36/48. Must be carried out by a qualified and certified electrician.

Simply select. Simply combine. Simply brilliant.

POWERSELECT

PowerSelect always provides you with exactly what you need for your battery system at any given time: For example, individual tools, battery packs and chargers.

You benefit from fairly calculated prices no matter what you choose. And of course, you can also take advantage of Warranty all-inclusive for battery packs and chargers.

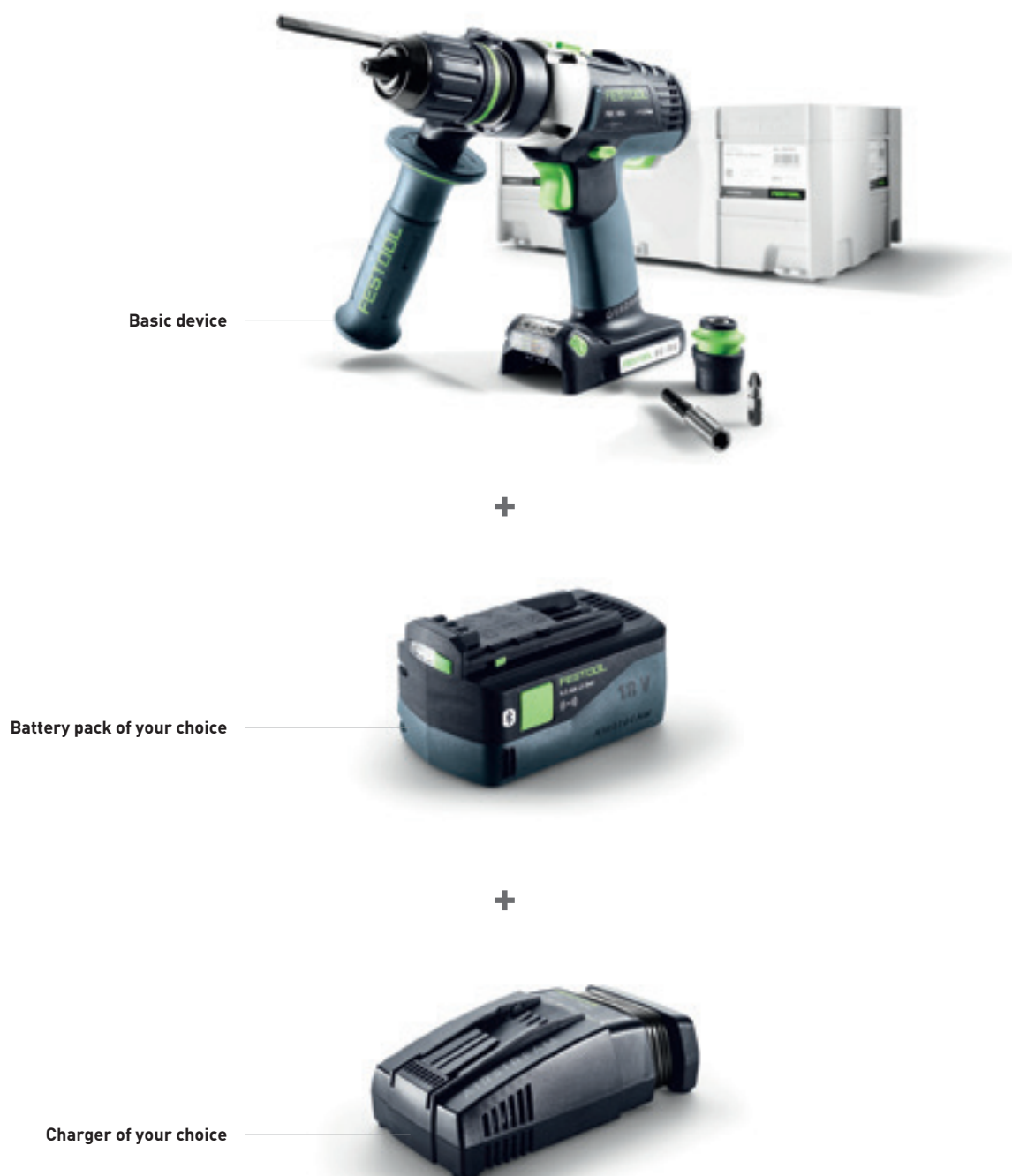

Cordless pendulum jigsaws CARVEX PSC / PSBC 420

Brushless EC-TEC motor for a long service life and a high level of efficiency



NEW Bluetooth® battery included:
Starts mobile dust extractor auto-
matically.*



The cordless version of CARVEX – hard working and powerful.

- › Excellent behaviour in curves thanks to threefold saw blade guide and rigid lifter rod
- › Simple handling thanks to the softgrip and ergonomic design
- › Electronic switch-on/off on both sides, reachable in every grip position
- › Fast, tool-free changing of tables, baseplates and saw blades

Technical data	PSC 420	PSBC 420
Battery voltage (V)	18	18
Stroke rate (RPM)	1.500 – 3.800	1.000 – 3.800
Pendulum cover adjustment in stages	4	4
Cutting depth in wood (mm)	120	120
Cutting depth in NF metals (mm)	20	20
Cutting depth in steel (soft) (mm)	10	10
Li-ion battery capacity (Ah)	5,2	5,2
Weight (kg)	2,4	2,4



■ = MMC digital electronics

Easy to manage and mobile.

The CARVEX PSC 420 and PSBC 420 follow every move. With millimetre precision. The pendulum jigsaws in the hand are extremely light and intuitive to operate. 3,800 strokes per minute ensure overwhelming force on straight lines when working.

Items included	Order no.
2 x saw blade, splinterguard, in SYSTAINER SYS 2 T-LOC	
PSC 420 Li EB-Basic without battery pack, without charger	574713
PSC 420 Li 5,2 EBI-Plus BP 18 Li 5.2 ASI battery pack, rapid charger TCL 6	575683
PSC 420 Li 5,2 EBI-Set BP 18 Li 5.2 ASI battery pack, rapid charger TCL 6, accessories SYSTAINER	575743
PSBC 420 Li EB-Basic without battery pack, without charger	201379
PSBC 420 Li 5,2 EBI-Plus BP 18 Li 5.2 ASI battery pack, rapid charger TCL 6	575679
PSBC 420 Li 5,2 EBI-Set BP 18 Li 5.2 ASI battery pack, rapid charger TCL 6, accessories SYSTAINER	575741

Find the entire Festool sawing range from page 30

* For more information on Bluetooth® Autostart, go to page 16



System accessories from page 62

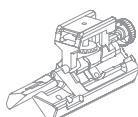

Jigsaw blades from page 76



Battery and charging technology from page 14 onwards





NEW Bluetooth® battery included:
Starts mobile dust extractor automatically.*

Cordless plunge-cut saw TSC 55



DESIGN
AWARD
2015



Brushless EC-TEC
motor for a long service
life and a high level of
efficiency

Our best plunge-cut saw is now independent.

- › Brushless EC-TEC motor combined with lithium-ion batteries for maximum cutting power
- › Flexible dual battery concept: Can be operated with two 18-volt battery packs (36V) for maximum power or one 18-volt battery pack for low weight
- › High-speed EC-TEC motor for perfect cutting quality and rapid working progress
- › Dust collection bag for clean, healthy working

Technical data

Battery voltage (V)	18/36
Idle engine speed (RPM)	2.650 – 3.800/5.200
Saw blade diameter (mm)	160
Angular range (°)	-1 – 47
Cutting depth (mm)	0 – 55
Cutting depth 45° (mm)	43
Dust extraction connection dia. (mm)	27/36
Li-ion battery capacity (Ah)	5,2
Weight 1 x 18 V/2 x 18 V (kg)	4,6/5,3



■ = MMC Multi Material Control electronics

Items included

fine tooth saw blade HW W48, splinterguard, Flag window; vision panel, chip collection bag, operation tool, in SYSTAINER SYS 5 T-LOC

Items included	Order no.
TSC 55 Li REB-Basic without battery pack, without charger	201395
TSC 55 Li 5,2 REBI-Plus-SCA 2 x BP 18 Li 5.2 ASI battery pack, SCA 8 rapid charger	575687
TSC 55 Li 5,2 REBI-Plus/XL-SCA 2 x BP 18 Li 5.2 ASI battery pack, 2 x SCA 8 rapid charger	575689
TSC 55 Li 5,2 REBI-Set-SCA-FS 2 x BP 18 Li 5.2 ASI battery pack, SCA 8 rapid charger, guide rail FS 1400/2	575745



Precise and mobile.

Work with precision instead of performing time-consuming rework – with the TSC 55 cordless plunge-cut saw. With a powerful 5200 revolutions per minute. The dual battery system with flexible configuration options ensures absolute mobility in use, allowing you to forget about cables and sockets when working.

* For more information on Bluetooth® Autostart, go to page 16

Find the entire Festool sawing range from page 30

System accessories
from page 64

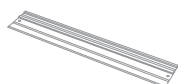

Circular saw blades
from page 82



Battery and charging technology
from page 14 onwards

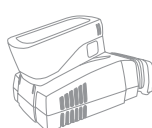

Cordless circular saw HKC 55

Brushless EC-TEC motor for a long service life and a high level of efficiency



NEW Bluetooth® battery included:
Starts mobile dust extractor automatically.*



Precise and portable.

Regardless of how high in the sky you are aiming and how varied your requirements may be – the HKC 55 cordless portable circular saw with FSK cross cutting guide rail can create clean, precise and accurately repeatable cuts practically anywhere.

Standalone in every situation

- › 18V Li-ion battery and connectable cross cutting guide rails ensure mobility and independence
- › Brushless EC-TEC motor combined with lithium-ion batteries for max cutting power
- › In conjunction with the trimming rail, fast, accurate and mobile cross cuts
- › Safe and easy handling thanks to the cutting depth adjustment with plunge function, pendulum hood remote control and guide wedge

Technical data

Battery voltage (V)	18
Idle engine speed (RPM)	4.500
Saw blade diameter (mm)	160
Angular range (°)	0 – 50
Cutting depth 0°, 90° (mm)	0 – 55
Cutting depth 45°/50° (mm)	42/38
Dust extraction connection dia. (mm)	27/36
Li-ion battery capacity (Ah)	5,2
Weight with Li-ion (kg)	4,1



Items included

Items included	Order no.
operation tool, in SYSTAINER SYS 4 T-LOC	
HKC 55 Li EB-Basic HW standard saw blade W18, without battery pack, without charger	201358
HKC 55 Li EB-Basic-FSK 420 HW standard saw blade W18, FSK 420 trimming rail, without battery pack, without charger	575739
HKC 55 Li EBI-Plus-SCA 2 x BP 18 Li 5.2 ASI battery pack, SCA 8 rapid charger, HW standard saw blade W18	575675
HKC 55 Li 5,2 EBI-Set-SCA-FSK 420 2 x BP 18 Li 5.2 ASI battery pack, SCA 8 rapid charger, HW standard saw blade W18, FSK 420 trimming rail	575735

Find the entire Festool sawing range from page 30

* For more information on Bluetooth® Autostart, go to page 16



System accessories from page 65

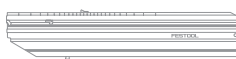

Circular saw blades from page 82



Battery and charging technology from page 14 onwards

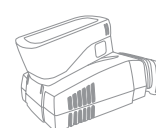

Cordless insulating-material saw

ISC 240

NEW Bluetooth® battery included:
Starts mobile dust extractor automatically.*



Brushless EC-TEC motor for a long service life and a high level of efficiency

The revolution in insulating-material saws.

- › Perfectly coordinated cutting sets for precise and fast cutting of flexible mineral and natural fibre insulating materials as well as PUR insulating materials
- › Mobile, fast and saves effort without a cable: With a powerful 18 V Li-ion battery and brushless EC-TEC motor. Benefit from all the advantages of the Festool dust-free system thanks to Bluetooth® cordless technology
- › For cutting material efficiently: With the guide rail and angle stop (available in a set or as accessories), reproducible angled cuts can be made with precise dimensions
- › Work without tiring thanks to a perfectly balanced design and low weight – for maximum comfort when working, even in one-handed operation

Technical data	ISC 240 Plus/Set	ISC 240 Compact
Battery voltage (V)	18	18
Stroke rate (RPM)	3.000	3.000
Cutting depth (mm)	240	240
Stroke length (mm)	26	26
Dust extraction connection dia. (mm)	27	27
Li-ion battery capacity (Ah)	5,2	3,1
Weight with Li-ion (kg)	2,5	2,2



■ = Electronic

Items included	Order no.
SG-240/W-ISC serrated cutting set, Adapter table, guide rail slide, in SYSTAINER SYS 3 T-LOC	
ISC 240 Li EB-Basic	574821
ISC 240 Li 3,1 EBI-Compact BP 18 Li 3.1 Cl battery pack, rapid charger TCL 6	575733
ISC 240 Li 5,2 EBI-Plus 2 x BP 18 Li 5.2 ASI battery pack, rapid charger TCL 6	574819
ISC 240 Li 5,2 EBI-Set-FS 2 x BP 18 Li 5.2 ASI battery pack, rapid charger TCL 6, angle stop, guide rail FS 1400/2	575592

Find the entire Festool sawing range from page 30

System accessories
from page 72



Saw blades
from page 72



Battery and charging technology
from page 14 onwards

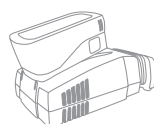

Fast and mobile.

Whether you are working freehand or with a guide rail and stop pin system; on a roof, scaffolding or on the ground; with insulating materials made of mineral fibres or natural fibres or polyurethane insulation boards – the ISC 240 offers amazing mobility, versatility and efficiency.

* For more information on Bluetooth® Autostart, go to page 16



Cordless drill C 18

Brushless EC-TEC motor for a long service life and a high level of efficiency



The perfect shape.

- › Brushless EC-TEC motor with integrated motor management for long service life and the highest output
- › Fully electronic torque setting and switch-off for precise screwdriving
- › FastFix interface for all FastFix attachments and CENTROTEC rapid tool-change system
- › Switchover from screwdriving to drilling without changing the set torque

Technical data	C 18 Plus/Set	C 18 Compact
Battery voltage (V)	18	18
Gears	2	2
Idling speed, 1st gear/2nd gear (RPM)	0 – 450/0 – 1.500	0 – 450/0 – 1.500
Drilling diameter, wood/steel (mm)	40/13	40/13
Torque adjustment 1st/2nd gear (Nm)	0,8 – 8/0,5 – 6	0,8 – 8/0,5 – 6
Max. torque, wood/steel (Nm)	27/45	27/45
Chuck range (mm)	1,5 – 13	1,5 – 13
Li-ion battery capacity (Ah)	5,2	3,1
Weight with Li-ion (kg)	1,8	1,5



■ = Electronic

Versatile and portable.

Versatility in drilling and screwing. With a high speed and high torque – the new C 18 is the tool for the job, whatever your needs. The CENTROTEC rapid tool change system combines chuck with bit holder, allowing you to change rapidly between drilling, counterboring and screwing.

Items included	Order no.
CENTROTEC tool chuck, CENTROTEC bit holder, FastFix keyless chuck 13 mm, bit PZ 2, belt clip, in SYSTAINER SYS 2 T-LOC	
C 18 Li-Basic without battery pack, without charger	574737
C 18 Li 3,1-Compact 2 x BP 18 Li 3.1 C battery pack, rapid charger TCL 6	574921
C 18 Li 5,2-Plus 2 x BP 18 Li 5.2 AS battery pack, rapid charger TCL 6	574738
C 18 Li 5,2-Set 2 x BP 18 Li 5.2 AS battery pack, rapid charger TCL 6, FastFix angle attachment, FastFix eccentric attachment	575672

Find the entire Festool drilling and screw-driving range from page 214

System accessories
from page 231

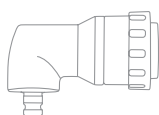

Bits and drills
from page 236



Battery and charging technology
from page 14 onwards



Cordless drill

T 18+3



Brushless EC-TEC motor for a long service life and a high level of efficiency

Brains meet brawn.

- › FastFix interface for all FastFix attachments and CENTROTEC rapid tool-change system
- › Impressive ergonomics: compact, lightweight and perfectly balanced
- › Fully electronic torque setting and switch-off for precise screwdriving
- › Switchover from screwdriving to drilling without changing the set torque

Technical data	T 18+3 Plus/Set	T 18+3 Compact
Battery voltage (V)	18	18
Gears	2	2
Idling speed, 1st gear/2nd gear (RPM)	0 – 450/0 – 1.500	0 – 450/0 – 1.500
Drilling diameter, wood/steel (mm)	45/13	45/13
Torque adjustment 1st/2nd gear (Nm)	0,8 – 8/0,5 – 6	0,8 – 8/0,5 – 6
Max. torque, wood/steel (Nm)	35/50	35/50
Chuck range (mm)	1,5 – 13	1,5 – 13
Li-ion battery capacity (Ah)	5,2	3,1
Weight with Li-ion (kg)	1,8	1,5



■ = Electronic



Flexible and mobile.

The T 18+3 is involved in every job without any work interruptions. With the lightweight and compact CENTROTEC quick-change system, you can quickly and easily replace the chuck and bit holder.

Items included	Order no.
CENTROTEC tool chuck, CENTROTEC bit holder, FastFix keyless chuck 13 mm, belt clip	
T 18+3 Li-Basic without battery pack, without charger, bit PZ 2, in SYSTAINER SYS 2 T-LOC	574763
T 18+3 Li 3,1-Compact 2 x BP 18 Li 3.1 C battery pack, rapid charger TCL 6, bit PZ 2, in SYSTAINER SYS 2 T-LOC	574908
T 18+3 Li 5,2-Plus 2 x BP 18 Li 5.2 AS battery pack, rapid charger TCL 6, bit PZ 2, in SYSTAINER SYS 2 T-LOC	574756
T 18+3 Li 5,2-Set 2 x BP 18 Li 5.2 AS battery pack, rapid charger TCL 6, bit PZ 2, FastFix angle attachment, FastFix eccentric attachment, in SYSTAINER SYS 2 T-LOC	575693
T 18+3/PSC 420 Li I-Set T18+3 cordless drills, pendulum jigsaw PSC 420 EB, 2 x BP 18 Li 5.2 ASI battery pack, rapid charger TCL 6, twinBOX BB-MIX range of bits, 2 x saw blade, splinterguard, in SYSTAINER SYS 3 T-LOC	575696

Find the entire Festool drilling and screw-driving range from page 214

System accessories
from page 231

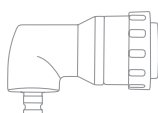

Bits and drills
from page 236



Battery and charging technology
from page 14 onwards

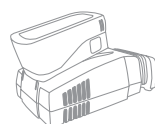

Cordless hammer drill BHC 18

Brushless EC-TEC motor for a long service life and a high level of efficiency



NEW Bluetooth® battery included:
Starts mobile dust extractor automatically.*



Lightweight and mobile.

With the BHC 18 you save energy and can work effortlessly. With extremely high impact energy and integrated vibration damping, which absorbs the impact energy before it is transferred to the hands, the BHC 18 sits easily and smoothly in the hand.

The most powerful compact hammer drill

- › Unbeatable power to weight ratio thanks to the combination of EC-TEC motor and C shape model
- › Vibration damping for effortless work; Maximum working comfort in all work situations
- › Brushless EC-TEC motor with integrated motor management for long service life and the highest output
- › High-quality lithium-ion battery technology for the longest sustained usage

Technical data	BHC 18 Plus	BHC 18 Compact
Battery voltage (V)	18	18
Gears	1	1
Idle engine speed (RPM)	0 – 1.100	0 – 1.100
Max. number of strokes (RPM)	4.895	4.895
Drilling dia. (concrete) (mm)	18	18
Max. crown borer hole diameter (mm)	68	68
Max. torque, wood/steel (Nm)	10/25	10/25
Tool holder	SDS-Plus	SDS-Plus
Single impact energy (J)	1,8	1,8
Li-ion battery capacity (Ah)	5,2	3,1
Weight with Li-ion (kg)	2,6	2,3



Items included	Order no.
additional side-mounted hand grip, depth stop, in SYSTEMER SYS 2 T-LOC	
BHC 18 Li-Basic without battery pack, without charger	574723
BHC 18 Li 3,1 I-Compact 2 x BP 18 Li 3.1 CI battery pack, rapid charger TCL 6	575700
BHC 18 Li 5,2 I-Plus 2 x BP 18 Li 5.2 ASI battery pack, rapid charger TCL 6	575697

Find the entire Festool drilling and screw-driving range from page 214

System accessories
from page 233



Battery and charging technology
from page 14 onwards

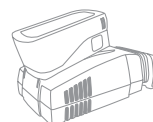

* For more information on
Bluetooth® Autostart, go to page 16





Cordless drills and cordless percussion drills

QUADRIVE DRC 18/4 PDC 18/4



Brushless EC-TEC motor for a long service life and a high level of efficiency

The compact tool with impressive rotary power.

- › Brushless EC-TEC motor for maximum service life and efficiency
- › 4-speed gearbox capable of 3800 rpm for rapid, clean drilling results
- › Universal solution for fastening operations that require high torque and for drilling large diameter holes
- › Individually selectable LED lighting and battery status display



Technical data	DRC 18/4	PDC 18/4
Battery voltage (V)	18	18
Gears	4	4
Idling speed, 1st gear/2nd gear (RPM)	0 – 400/0 – 850	0 – 400/0 – 850
Idling speed, 3rd/4th gear (RPM)	0 – 1.850/0 – 3.800	0 – 1.850/0 – 3.800
Max. number of strokes (RPM)		76.000
Max. torque, wood/steel (Nm)	40/60	40/60
Drilling diameter (wood/steel) (mm)	50/13	50/13
Chuck range (mm)	1,5 – 13	1,5 – 13
Drilling diameter in brickwork (mm)		10
Li-ion battery capacity (Ah)	5,2	5,2
Weight with Li-ion (kg)	1,9	2



■ = Electronic

Items included	Order no.
CENTROTEC tool chuck, CENTROTEC bit holder, FastFix keyless chuck 13 mm, bit PZ 2, additional side-mounted hand grip, in SYSTAINER SYS 2 DF T-LOC	
DRC 18/4 Li-Basic without battery pack, without charger	574695
DRC 18/4 Li 5,2-Plus 2 x BP 18 Li 5.2 AS battery pack, rapid charger TCL 6	574696
DRC 18/4 Li 5,2-Plus-SCA 2 x BP 18 Li 5.2 AS battery pack, SCA 8 rapid charger	574916
PDC 18/4 Li-Basic without battery pack, without charger	574701
PDC 18/4 Li 5,2-Plus 2 x BP 18 Li 5.2 AS battery pack, rapid charger TCL 6	574702
PDC 18/4 Li 5,2-Plus-SCA 2 x BP 18 Li 5.2 AS battery pack, SCA 8 rapid charger	574918

Sturdy and mobile.

The QUADRIVE DRC and PDC are tough performers with excellent staying power. With the sturdy 4-speed metal transmission, you have 4 gears for every work situation. The 60 Nm torque ensures powerful screwdriving in 1st gear and precise drilling in 4th gear at 3800 rpm.

Find the entire Festool drilling and screw-driving range from page 214

System accessories
from page 232



Bits and drills
from page 236



Battery and charging technology
from page 14 onwards

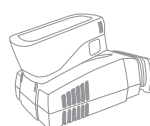

01 18-volt system

Cordless drywall
screwdrivers

DURADRIVE DWC 18

Brushless EC-TEC
motor for a long service
life and a high level of
efficiency



Power and durability for interior work.

- › Precision, wear-free electronic switch-off function for accurate insertion depths and a long service life
- › Energy-saving function for machine start/stop without actuating the main switch
- › Robust, brushless EC motor for maximum efficiency and durability
- › Rapid change to magazine attachment without using tools

Technical data	DWC 18-2500 Plus	DWC 18-2500 Compact	DWC 18-4500 Plus	DWC 18-4500 Compact
Battery voltage (V)	18	18	18	18
Gears	1	1	1	1
Idle engine speed (RPM)	0 – 2.500	0 – 2.500	0 – 4.500	0 – 4.500
Max. torque, wood/steel (Nm)	7/18	7/18	5/14	5/14
Max. machinable screw length (mm)	55	55	55	55
Tool holder	1/4"	1/4"	1/4"	1/4"
Li-ion battery capacity (Ah)	5,2	3,1	5,2	3,1
Weight with depth stop (kg)	1,9	1,6	1,9	1,6
Weight with magazine attachment (kg)	2,3	2,0	2,3	2,0



Innovative and mobile.

The DURADRIVE DWC 18 allows you to make series screw connections comfortably and as efficiently as possible. The innovative stop-and-go function ensures up to 40% higher performance per battery charge.

Items included	Order no.
magazine attachment, depth stop, scaffolding holder, magnetic bit holder, 2 x bit PH2, long, PH 2 bit, belt clip, in SYSTAINER SYS 2 T-LOC	
DWC 18-2500 Li-Basic without battery pack, without charger	574742
DWC 18-2500 Li 3,1-Compact 2 x BP 18 Li 3.1 C battery pack, rapid charger TCL 6	574911
DWC 18-2500 Li 5,2-Plus 2 x BP 18 Li 5.2 AS battery pack, rapid charger TCL 6	574743
DWC 18-4500 Li-Basic without battery pack, without charger	574747
DWC 18-4500 Li 3,1-Compact 2 x BP 18 Li 3.1 C battery pack, rapid charger TCL 6	574913
DWC 18-4500 Li 5,2-Plus 2 x BP 18 Li 5.2 AS battery pack, rapid charger TCL 6	574745

Find the entire Festool drilling and screw-driving range from page 214

System accessories
from page 235



Battery and charging technology
from page 14 onwards

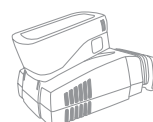

Torch

SYSLITE UNI



The light to the tool.

- › Three powerful, energy-efficient, high-performance LEDs
- › Lamp head can be adjusted into nine different positions by a vertical angle of 135°
- › Stable and tilt-resistant, or can be flexibly attached using belt clip and trestle hook

Technical data

Battery voltage (V)	10,8/18
Light source	3 SMD LEDs
Lumen value (lm)	43
Weight (without battery pack) (kg)	0,34



Compact and mobile.

The handy SYSLITE UNI is always ready to light up dark corners. Its lightweight and compact design makes it a welcome working aid. It is compatible with all conventional Festool batteries.

Items included

SYSLITE UNI
scaffolding holder, without charger, without battery pack,
in self-service display pack

Order no.

769079

Festool's full range of lights can be found from page 372 onwards

Battery and charging technology
from page 14 onwards

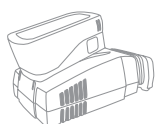

Working light SYSLITE KAL II



2012



Luminous and mobile.

Five available installation and mounting positions: The SYSLITE KAL II lights up the darkest of corners for up to six hours non-stop. The housing is made from shatter-proof, shock-proof and impact-resistant cast aluminium – durable enough for any construction site. The large light dispersion angle of 170° ensures that the entire work surface is illuminated uniformly.

The light to the tool.

- › Excellent light thanks to 12 high-performance LEDs
- › Long life and robust thanks to shatter-proof housing
- › Continuous use – any Festool battery pack can be attached to supplement the internal battery. The 230 V mains power pack and vehicle charging cable offer additional charging and power supply options
- › Compact design – can be flexibly positioned without cable hazards

Technical data

Light source (watt)	12 x 1,5
Lumen value 1st/2nd stage (lm)	310/769
Operating time (internal battery) 1st/2nd stage (min)	290/120
Li-ion battery capacity (Ah)	2,9
Li-ion charging time (min)	200
Permissible operating temperature range (°C)	-5/+ 55
Operation with external Festool battery packs (V)	10,8 – 18
Hook opening (mm)	40
Thread size stand (")	1/4
Dimensions (L x W x H) (mm)	80 x 100 x 150
Weight (without battery pack) (kg)	0,7

Items included

integrated lithium-ion battery 7.2 V, car charger adapter, 230 V adapter, transport bag, in self-service display pack

Items included	Order no.
KAL II	500721
KAL II-Set magnetic spherical head with flat disc	499815

Festool's full range of lights can be found from page 372 onwards

System accessories
from page 379



Battery and charging technology
from page 14 onwards





Construction site radios SYSROCK BR 10 BR 10 DAB+

Perfectly formed for perfect sound. Also available as a DAB+ version.

- › Various receiving and playback options via Bluetooth® and AUX-IN interfaces – available as analogue or digital radio
- › Integrated USB interface for charging devices such as mobile devices (with BR 10 DAB+)
- › Excellent sound in a compact, modern and robust design
- › Intuitive operation via large buttons and colour LCD display

Technical data	BR 10 DAB+	BR 10
Radio reception	DAB+ digital radio	FM analogue radio
FM frequency band (VHF) (MHz)	87,5 – 108	87,5 – 108
Speaker (watt)	10	10
Operation with Festool slide-in battery packs (V)	18	18
Number of stored stations	2 x 4	4
AUX-IN (mm)	3,5	3,5
Bluetooth® standard	4,1	4,1
USB output	5V/1,2A	–
Dimensions (L x W x H) (mm)	95 x 102 x 149	94 x 102 x 149
Weight (kg)	0,7	0,7



Items included	Order no.
230 V adapter, aux-in cable, in bag	
BR 10 DAB+ DAB+ digital radio	202111
BR 10 FM analogue radio	200183



Powerful and mobile.

The SYSROCK construction site radios fit on every windowsill and combine compact dimensions with a low weight and impeccable sound. And thanks to the Bluetooth® interface, you can listen to your favourite radio stations and tracks from your smartphone with SYSROCK sound quality.

Battery and charging technology
from page 14 onwards

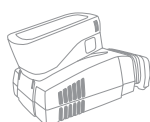



02 Sawing

Overview of products and applications	32
Jig saws	
TRION pendulum jigsaws – PS 300, PSB 300	38
CARVEX pendulum jigsaws – PS 420, PSB 420	39
CARVEX cordless pendulum jigsaws – PSC 420, PSBC 420	40
Bench saw – CMS PS	41
Plunge-cut saws	
Plunge-cut saws – TS 55 R, TS 75	42
Cordless plunge-cut saw – TSC 55	43
Bench saw – CMS-TS	45
Hand-held circular saws	
Hand-held circular saws – HK 55, HK 85	46
Cordless circular saw – HKC 55	47
Cross cutting guide rail – FSK	49
Carpentry portable circular saw – HK 132	50
Compound mitre saws	
KAPEX sliding compound mitre saws – KS 60, KS 88 R, KS 120 R	51
Compound mitre saw SYMMETRIC – SYM 70 R	54
Semi-stationary sawing	
Trimming saw PRECISIO – CS 50 EBG, CS 70 EBG	55
Sword saws	
Cordless insulating-material saw – ISC 240	57
Sword saws – SSU 200, IS 330	58
Accessories and consumable materials	
The Festool system	60

Overview of products and applications

Powerful. Precise. Robust. The impressive Festool pendulum jigsaws guarantee easy handling and rapid cutting progress. Available in body grip or D handle – optimised in every respect to achieve excellent results

TRION pendulum jigsaws

CARVEX pendulum jigsaws



PS 300
Page 38



PSB 300
Page 38



PS 420
Page 39



PSB 420
Page 39

Applications

Sawing with jigsaws

Work independent of the mains power supply

Cut-outs for sinks and kitchen hobs



Trimming work on furniture, kitchens, for interior fitting



Cutting circles and curves



Coping end strips



Cutting workpieces to length



Edge notching on beams



Cutting from below



Semi-stationary sawing

Cutting accurately along the scribe line

Precise coping during trimming work

Preliminary cutting work prior to routing shapes

Technical data

Power consumption (W)	720	720	550	550
Battery voltage (V)				
Li-ion battery capacity (Ah)				
Stroke rate (rpm)	1.000 – 2.900	1.000 – 2.900	1.500 – 3.800	1.000 – 3.800
Pendulum cover adjustment in stages	4	4	4	4
Inclination (°)	0 – 45	0 – 45		
Cutting depth in wood (mm)	120	120	120	120
Cutting depth in NF metals (mm)	20	20	20	20
Cutting depth in steel (soft) (mm)	10	10	10	10
Weight (kg)	2,4	2,4	1,9	1,9

Overview of products and applications

Compact Module System CMS



PSC 420
Page 40

PSBC 420
Page 40

CMS PS 300
Page 41

	●	●	
	●	●	
	●	●	
	●	●	
	●	●	
	●	●	
	●	●	
	●	●	
			●
			●
			●
			720
18	18		
5,2	5,2		
1.500 – 3.800	1.000 – 3.800	1.000 – 2.900	
4	4	4	
		0 – 45	
120	120	120	
20	20	20	
10	10	10	
2,4	2,4	2,4/5,7	

● Extremely appropriate
○ Appropriate

Overview of products and applications

Introducing the saws from Festool. Accurate to the millimetre, they cut with the necessary force for each material, yet are lightweight and easy to handle.

Circular saws

Compact Module System CMS TS



TS 55 R
Page 42

TSC 55
Page 43

TS 75
Page 44



CMS TS 55 R
Page 45

CMS TS 75
Page 45

Applications

Sawing using plunge-cut saws

Cutting recesses in kitchen worktops	●	●	●
Cutting doors to length	●	●	●
Cutting chipboard to size	●	●	●
Cutting house doors to size, up to 75 mm thick	○	○	●

Semi-stationary sawing

Sawing panels and laminate	●	○
Rip cuts in boards and panels	○	●
Cutting plastic and steel cable ducts to size		●
Cutting grooves to a defined depth	○	○

Sawing with portable circular saws

Cutting roof battens to length	
Sawing boards to size	
Sawing chipboard	
Cutting tenons in beams	
Splitting tenons	
Tapering square timber and rafters	
Tenons and square timber with compound mitre cut	

Technical data

Power consumption (W)	1.200		1.600	1.200	1.600
Idle engine speed (rpm)	2.000 – 5.200	2.650 – 3.800/5.200	1.350 – 3.550	2.000 – 5.200	1.350 – 3.550
Battery voltage (V)		1 x 18/2 x 18 (36)			
Li-ion battery capacity (Ah)		5,2			
Saw blade Ø (mm)	160	160	210	160	210
Cutting depth (mm)	0 – 55	0 – 55	0 – 75		
Cutting depth 45° (mm)	43	43	55		
Cutting height 90°/45° (mm)				0 – 51/0 – 38	0 – 70/0 – 48
Weight (kg)	4,5	4,6/5,3	6,2	3,3/7,8	3,3/9,5

Overview of products and applications

Introducing the saws from Festool. Accurate to the millimetre, they cut with the necessary force for each material, yet are lightweight and easy to handle.

KAPEX sliding compound mitre saws

Compound mitre saw SYMMETRIC



KS 60
Page 51



KS 88 R
Page 52



KS 120 R
Page 53



SYM 70 R
Page 54

Applications

Semi-stationary sawing

Sawing panels and laminate	●	●	●	
Rip cuts in boards and panels				
Cutting plastic and steel cable ducts to size	○	●	●	
Cutting grooves to a defined depth	●	●	●	
Trimming aluminium and other non-ferrous metal profiles	●	●	●	○
Trimming skirting boards and cornices up to 120 mm in height			●	
Trimming skirting board along the bisector	○	○	○	●
Cutting strip material to fit	●	●	●	●
Trimming beams and boards up to 60 mm thick	●	●	●	○
Trimming beams and square timber up to 88 mm thick		●	●	
Rip cuts with a cutting depth up to 52 mm				
Rip cuts with a maximum cutting depth of 70 mm				
Sawing obscured cuts, grooves and rebates				

Cutting with sword saws

Soft and hard wood				
Soft mineral wool				
Hard mineral wool				
Hemp				
Soft wood fibres				
Hard wood fibres				
Polyurethane/polystyrene				

Technical data

Power consumption [W]	1.200	1.600	1.600	1.150
Idle engine speed [rpm]	1.300 – 3.500	1.400 – 3.400	1.400 – 3.400	2.700 – 5.200
Battery voltage [V]				
Li-ion battery capacity [Ah]				
Saw blade Ø [mm]	216	260	260	216
Cutting depth [mm]				
Cutting depth 90°/90° [mm]	305 x 60	305 x 88	305 x 88	
Cutting depth 45°/90° [mm]	215 x 60	215 x 88	215 x 88	
Cutting depth 0°, 90°/45°/60° [mm]				
Weight [kg]	17,8	22,3	23,1	9,5

Overview of products and applications

Bench-mounted trimming saws PRECISIO

Cordless insulating-material saw

Sword saws

NEW



CS 50 EBG
CS 50 EBG Set
Page 55



CS 70 EBG
CS 70 EBG Set
Page 56



ISC 240
Page 57



SSU 200
Page 58



IS 330
Page 59

●	●			
●*	●			
○	●			
○	○			
●	●			
○	○			
	●			
●	○			
●	●			
	●			
			●	
		●		
		●		
		●		
		●		
			●	
			●	●
			○	○
			●	●
		●	●	●
1.200	2.200		1.600	1.600
1.600 – 4.200	2.000 – 4.200	3.000	4.600	4.600
		18		
		5,2/3,1		
190	225			
		240 (350)		
0 – 52/0 – 37	0 – 70/0 – 48			
			200/140/100	330/230/165
21,9/42,9	37,0/68,5	2,5/2,2	6,5	7,0

● Extremely appropriate
○ Appropriate

* Set variants

Pendulum jigsaws

TRION PS / PSB 300



Ideal for flexible use.

- › Patented three-way saw blade guide for cutting precise angles
- › FastFix rapid-change system for easy saw blade changes
- › Compatible in the system – integrated in the CMS system as a semi-stationary saw
- › High-quality drive components give longer service life

Technical data	
Power consumption (watt)	720
Stroke rate (RPM)	1.000 – 2.900
Pendulum cover adjustment in stages	4
Inclination (°)	0 – 45
Cutting depth in wood (mm)	120
Cutting depth in NF metals (mm)	20
Cutting depth in steel (soft) (mm)	10
Weight (kg)	2,4



■ = MMC Multi Material Control electronics

Powerful and consistently accurate.

Rapid cutting progress and superior precision are just two of the impressive characteristics of the TRION PS 300. The patented three-way saw blade guide with parallel adjustable carbide saw blade guide with parallel adjustable carbide jaws guarantees straight precision cuts.

Items included	Order no.
2 x saw blade, splinterguard, in SYSTEMER SYS 1 T-LOC	
PS 300 EQ-Plus	561445
PSB 300 EQ-Plus	561453

System accessories
from page 62

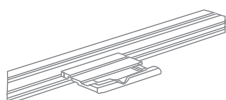

Jigsaw blades
from page 78



Pendulum jigsaws

CARVEX PS / PSB 420



Brushless EC-TEC motor for a long service life and a high level of efficiency



Lightweight. Handy. Unbeatable profile-cutting capacity.

- › Excellent behaviour in curves thanks to threefold saw blade guide and rigid lifter rod
- › Simple handling thanks to the softgrip and ergonomic design
- › Electronic switch-on/off on both sides, reachable in every grip position
- › Fast, tool-free changing of tables, baseplates and saw blades

Technical data	PS 420	PSB 420
Power consumption (watt)	550	550
Stroke rate (RPM)	1.500 – 3.800	1.000 – 3.800
Pendulum cover adjustment in stages	4	4
Cutting depth in wood (mm)	120	120
Cutting depth in NF metals (mm)	20	20
Cutting depth in steel (soft) (mm)	10	10
Weight (kg)	1,9	1,9



■ = MMC digital electronics

Items included	Order no.
2 x saw blade, splinterguard, in SYSTAINER SYS 1 T-LOC	
PS 420 EBQ-Plus	561587
PS 420 EBQ-Set accessories SYSTAINER	561588
PSB 420 EBQ-Plus	561602
PSB 420 EBQ-Set accessories SYSTAINER	561603



Follows only one line. Yours.

Power that you can feel. Revolutionary technology that makes the tightest curve feel like you are cutting in a straight line. It is the combination of outstanding features that makes the CARVEX PS 420 such an exceptional pendulum jigsaw.

System accessories
from page 62

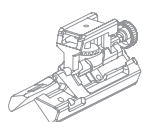

Jigsaw blades
from page 78



Cordless pendulum jigsaws

CARVEX PSC / PSBC 420

Brushless EC-TEC motor for a long service life and a high level of efficiency



NEW Bluetooth® battery included:
Starts mobile dust extractor automatically.*



The cordless version of CARVEX – hard working and powerful.

- › Excellent behaviour in curves thanks to threefold saw blade guide and rigid lifter rod
- › Simple handling thanks to the softgrip and ergonomic design
- › Electronic switch-on/off on both sides, reachable in every grip position
- › Fast, tool-free changing of tables, baseplates and saw blades

Technical data	PSC 420	PSBC 420
Battery voltage (V)	18	18
Stroke rate (RPM)	1.500 – 3.800	1.000 – 3.800
Pendulum cover adjustment in stages	4	4
Cutting depth in wood (mm)	120	120
Cutting depth in NF metals (mm)	20	20
Cutting depth in steel (soft) (mm)	10	10
Li-ion battery capacity (Ah)	5,2	5,2
Weight (kg)	2,4	2,4



■ = MMC digital electronics

Perfect combination of power and flexibility.

What do you get when you cross a powerful cutting stroke with effortless handling around bends and corners? Pure enthusiasm for the CARVEX. Also innovative battery technology that provides greater flexibility. It matches the high cutting performance achieved with cabled versions, is long-lasting and superior to other cordless saws.

Items included	Order no.
2 x saw blade, splinterguard	
PSC 420 Li EB-Basic without battery pack, without charger, in SYSTAINER SYS 2 T-LOC	574713
PSC 420 Li 5,2 EBI-Plus BP 18 Li 5.2 ASI battery pack, rapid charger TCL 6, in SYSTAINER SYS 2 T-LOC	575683
PSC 420 Li 5,2 EBI-Set BP 18 Li 5.2 ASI battery pack, rapid charger TCL 6, accessories SYSTAINER, in SYSTAINER SYS 2 T-LOC	575743
T 18+3/PSC 420 Li I-Set T18+3 cordless drills, pendulum jigsaw PSC 420 EB, 2 x BP 18 Li 5.2 ASI battery pack, rapid charger TCL 6, CENTROTEC tool chuck, CENTROTEC bit holder, FastFix keyless chuck 13 mm, twinBOX BB-MIX range of bits, belt clip, in SYSTAINER SYS 3 T-LOC	575696
PSBC 420 Li EB-Basic without battery pack, without charger, in SYSTAINER SYS 2 T-LOC	201379
PSBC 420 Li 5,2 EBI-Plus BP 18 Li 5.2 ASI battery pack, rapid charger TCL 6, in SYSTAINER SYS 2 T-LOC	575679
PSBC 420 Li 5,2 EBI-Set BP 18 Li 5.2 ASI battery pack, rapid charger TCL 6, accessories SYSTAINER, in SYSTAINER SYS 2 T-LOC	575741

* For more information on Bluetooth® Autostart, go to page 16



System accessories from page 62

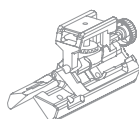

Jigsaw blades from page 78



Battery and charging technology from page 14 onwards



Module mounting and jigsaw module CMS-PS

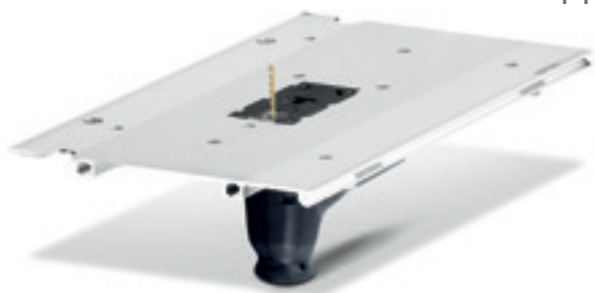

Jigsaw for the CMS system.

- › Module carrier for installing jigsaws to form a jigsaw module
- › Also available with jigsaw PS 300
- › The jigsaw can be used not only as a bench-mounted tool, but also as a handheld tool
- › Flexible extension options – for an even wider range of applications

Technical data	
Power consumption (watt)	720
Stroke rate (RPM)	1.000 – 2.900
Pendulum cover adjustment in stages	4
Cutting depth in wood (mm)	120
Cutting depth in NF metals (mm)	20
Inclination (°)	0 – 45
Cutting depth in steel (soft) (mm)	10
Dust extraction connection dia. (mm)	27
Dimensions module support (mm)	578 x 320
Weight module support (kg)	3,3
Weight (kg)	2,4



■ = MMC Multi Material Control electronics

Items included	Order no.
CMS-PS assembly lugs, operation tool, in carton	561262
CMS-MOD-PS 300 TRION PS 300 EQ-Plus pendulum jigsaw (delivered in a SYSTAINER), module support, assembly lugs, operation tool	561263



From mobile to stationary in a matter of seconds.

This module mounting is used to equip jigsaws for stationary work. For cutting shapes and curves accurately as well as minor notching during trimming work.

CMS system overview
from page 384



Jigsaw blades
from page 78



Plunge-cut saw

TS 55 R



Even more precise. Flat body.

Many of the standard features of today's portable circular saws originated from the TS 55. The TS 55 is now starting the next chapter in its success story with a wide range of innovations such as an ultra slimline housing for even greater flexibility, a recently developed guide wedge for even greater safety and precision and many other ideas that make the TS 55 R the best plunge-cut saw we have ever built.

The best plunge-cut saw we have ever built.

- › Slimline housing for maximum flexibility and close proximity to the wall (12 mm)
- › Angle adjustment with undercut function from -1 to 47°
- › Guide wedge for safer work and simple positioning in existing joint
- › Transparent sliding viewing window provides a good view of the scribe mark and saw blade

Technical data	TS 55 REBQ	TS 55 RQ
Power consumption (watt)	1.200	
Power consumption (watt)		1.050
Idle engine speed (RPM)		6.500
Idle engine speed (RPM)	2.000 – 5.200	
Saw blade diameter (mm)	160	160
Angular range (°)	-1 – 47	-1 – 47
Cutting depth (mm)	0 – 55	0 – 55
Cutting depth 45° (mm)	43	43
Dust extraction connection dia. (mm)	27/36	27/36
Weight (kg)	4,5	4,4



■ = MMC Multi Material Control electronics

Items included	Order no.
splinterguard, Flag window; vision panel, operation tool, in SYSTAINER SYS 4 T-LOC	
TS 55 RQ-Plus HW Universal saw blade W28	561579
TS 55 REBQ-Plus fine tooth saw blade HW W48	561551
TS 55 RQ-Plus-FS HW Universal saw blade W28, guide rail FS 1400/2	712634
TS 55 REBQ-Plus-FS fine tooth saw blade HW W48, guide rail FS 1400/2	561580

System accessories from page 64

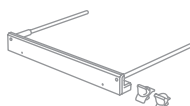

Circular saw blades from page 84





NEW Bluetooth® battery included:
Starts mobile dust extractor automatically.*

Cordless plunge-cut saw TSC 55



Brushless EC-TEC motor for a long service life and a high level of efficiency

Our best plunge-cut saw is now independent.

- › Brushless EC-TEC motor combined with lithium-ion batteries for maximum cutting power
- › Flexible dual battery concept: Can be operated with two 18-volt battery packs (36V) for maximum power or one 18-volt battery pack for low weight
- › High-speed EC-TEC motor for perfect cutting quality and rapid working progress
- › Dust collection bag for clean, healthy working



Technical data

Battery voltage (V)	18/36
Idle engine speed (RPM)	2.650 - 3.800/5.200
Saw blade diameter (mm)	160
Angular range (°)	-1 - 47
Cutting depth (mm)	0 - 55
Cutting depth 45° (mm)	43
Dust extraction connection dia. (mm)	27/36
Li-ion battery capacity (Ah)	5,2
Weight 1 x 18 V/2 x 18 V (kg)	4,6/5,3



■ = MMC Multi Material Control electronics

Items included

fine tooth saw blade HW W48, splinterguard, Flag window, vision panel, chip collection bag, operation tool, in SYSTAINER SYS 5 T-LOC

Items included	Order no.
TSC 55 Li REB-Basic without battery pack, without charger	201395
TSC 55 Li 5,2 REBI-Plus-SCA 2 x BP 18 Li 5.2 ASI battery pack, SCA 8 rapid charger	575687
TSC 55 Li 5,2 REBI-Plus/XL-SCA 2 x BP 18 Li 5.2 ASI battery pack, 2 x SCA 8 rapid charger	575689
TSC 55 Li 5,2 REBI-Set-SCA-FS 2 x BP 18 Li 5.2 ASI battery pack, SCA 8 rapid charger, guide rail FS 1400/2	575745

Sawing perfection with no compromises – except the socket.

Operates with the precision of the corded version but replaces the electrical socket with a high-endurance double-battery system. This enables users to quickly and easily achieve perfect results with the level of quality they have come to expect, even when working without access to power sockets.

System accessories
from page 64

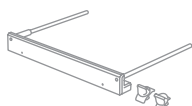

Circular saw blades
from page 84



Battery and charging technology
from page 14 onwards

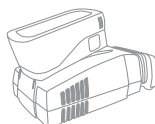

* For more information on
Bluetooth® Autostart, go to page 16



Plunge-cut saw

TS 75



Large saw with depth.

- › 75 mm cutting depth for even more application possibilities
- › FastFix: quick and easy saw blade changing and adapting to the working material
- › Safe and convenient – with sliding clutch and kickback stop
- › Spring-loaded spacer wedge for unhindered plunge cuts

Technical data

Power consumption (watt)	1.600
Idle engine speed (RPM)	1.350 – 3.550
Saw blade diameter (mm)	210
Angular range (°)	0 – 47
Cutting depth (mm)	0 – 75
Cutting depth 45° (mm)	55
Dust extraction connection dia. (mm)	27/36
Weight (kg)	6,2



■ = MMC Multi Material Control electronics

75 mm cuts and no competition.

The cutting depth of 75 mm and the famous circular principle are ideal for jobs involving larger workpieces and enable you to saw thick workpieces with one cut. This saves you having to turn the workpiece and minimises reworking.

Items included

Order no.

HW universal saw blade W 36, set-back stop FS-RSP, operation tool	
TS 75 EBQ in carton	561184
TS 75 EBQ-Plus splinterguard, in SYSTAINER SYS 5 T-LOC	561436
TS 75 EBQ-FS guide rail FS 1400/2, in carton	561185
TS 75 EBQ-Plus-FS guide rail FS 1400/2, splinterguard, in SYSTAINER SYS 5 T-LOC	561512

System accessories from page 64

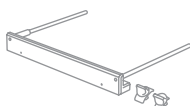

Circular saw blades from page 84



Module mounting and bench saw module

CMS-TS



Circular saw for the CMS system.

- › Module carrier for installing plunge-cut saws to form a bench saw module
- › Also available with plunge-cut saw
- › Circular saws can be installed or used portably
- › Flexible extension options – for an even wider range of applications

Technical data	CMS-MOD-TS 55 R	CMS-MOD-TS 75	CMS-TS 55 R Set
Power consumption (watt)	1.200	1.600	1.200
Idle engine speed (RPM)	2.000 – 5.200	1.350 – 3.550	2.000 – 5.200
Saw blade diameter (mm)	160	210	160
Cutting height 90°/45° (mm)	0 – 51/0 – 38	0 – 70/0 – 48	0 – 51/0 – 38
Dust extraction connection dia. (mm)	27/36	27/36	27/36
Dimensions module support (mm)	578 x 320	578 x 320	578 x 320
Weight module support (kg)	3,3	3,3	
Max. working width for trimming cuts (mm)			830
Weight (kg)	7,8	9,5	
Max. working width longitudinal (mm)			576
Table dimensions (mm)			585 x 400



■ = MMC Multi Material Control electronics

Items included	Order no.
protective cover with supporter, fixing clamps, angle stop, scales, workpiece holder, cutting depth adjustment, clamp for switch and splitting wedge, in carton	
CMS-TS 55 R	570281
CMS-TS 75	493360
module support, operation tool	
CMS-MOD-TS 55 R TS 55 REBQ-Plus plunge-cut saw (delivered in a SYSTAINER)	570282
CMS-MOD-TS 75 TS 75 EBQ-Plus plunge-cut saw (delivered in a SYSTAINER)	561520
CMS-TS 55 R Set TS 55 REBQ-Plus plunge-cut saw (delivered in a SYSTAINER), basic unit with foldaway legs, sliding table, in carton	561566



A workshop does not have to be big.

With the CMS modules, plunge-cut saws can be transformed into bench saws for a wide range of applications. Rip, cross and angled cuts as well as changing quickly from rip to cross cuts is so quick and easy. The transparent protective hood provides a good view of the workpiece and cut.

CMS system overview
from page 384



Circular saw blades
from page 84



Hand-held circular saw

HK 55



Versatility for timber construction.

- › High-torque 1200 W motor with power electronics ensures constant power when sawing
- › Safe and easy handling thanks to the cutting depth adjustment with plunge function, pendulum hood remote control and guide wedge
- › Angle adjustment with central clamping mechanism from 0 to 50 degrees
- › Sawing system: HKC complete with FSK cross cutting guide rail and FS guide rail

Technical data

Power consumption (watt)	1.200
Idle engine speed (RPM)	2.000 – 5.200
Saw blade diameter (mm)	160
Angular range (°)	0 – 50
Cutting depth 0°, 90° (mm)	0 – 55
Cutting depth 45°/50° (mm)	42/38
Dust extraction connection dia. (mm)	27/36
Weight (kg)	4,4



■ = MMC Multi Material Control electronics

Flexibility in timber construction.

The versatile saw solution with high performance and maximum system precision. Guided cuts in combination with connectible FSK cross cutting guide rails.

Items included

Items included	Order no.
HW standard saw blade W18, operation tool, in SYSTAINER SYS 4 T-LOC	
HK 55 EBQ-Plus	561731
HK 55 EBQ-Plus-FS guide rail FS 1400/2	574673
HK 55 EBQ-Plus-FSK 420 FSK 420 trimming rail	574678

System accessories
from page 65

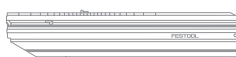

Circular saw blades
from page 84





NEW Bluetooth® battery included:
Starts mobile dust extractor automatically.*

Cordless circular saw HKC 55



Brushless EC-TEC motor for a long service life and a high level of efficiency

Standalone in every situation

- › 18V Li-ion battery and connectable cross cutting guide rails ensure mobility and independence
- › Brushless EC-TEC motor combined with lithium-ion batteries for max cutting power
- › In conjunction with the trimming rail, fast, accurate and mobile cross cuts
- › Safe and easy handling thanks to the cutting depth adjustment with plunge function, pendulum hood remote control and guide wedge

Technical data

Battery voltage (V)	18
Idle engine speed (RPM)	4.500
Saw blade diameter (mm)	160
Angular range (°)	0 – 50
Cutting depth 0°, 90° (mm)	0 – 55
Cutting depth 45°/50° (mm)	42/38
Dust extraction connection dia. (mm)	27/36
Li-ion battery capacity (Ah)	5,2
Weight with Li-ion (kg)	4,1



Items included

	Order no.
operation tool, in SYSTAINER SYS 4 T-LOC	
HKC 55 Li EB-Basic HW standard saw blade W18, without battery pack, without charger	201358
HKC 55 Li EB-Basic-FSK 420 HW standard saw blade W18, FSK 420 trimming rail, without battery pack, without charger	575739
HKC 55 Li EBI-Plus-SCA 2 x BP 18 Li 5.2 ASI battery pack, SCA 8 rapid charger, HW standard saw blade W18	575675
HKC 55 Li 5,2 EBI-Set-SCA-FSK 420 2 x BP 18 Li 5.2 ASI battery pack, SCA 8 rapid charger, HW standard saw blade W18, FSK 420 trimming rail	575735



More independence. More precision.

For more mobility in timber construction: The cordless HKC 55 portable circular saw with FSK cross cutting guide rail demonstrates what saws are now capable of achieving on roofs – without sockets and cable pulling. Connecting this to the FSK cross cutting guide rail instantly produces a portable and easily manageable compound mitre saw system for accurate and precisely angled cuts.

System accessories
from page 65



Circular saw blades
from page 84



Battery and charging technology
from page 14 onwards

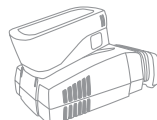

* For more information on
Bluetooth® Autostart, go to page 16



Hand-held circular saw HK 85

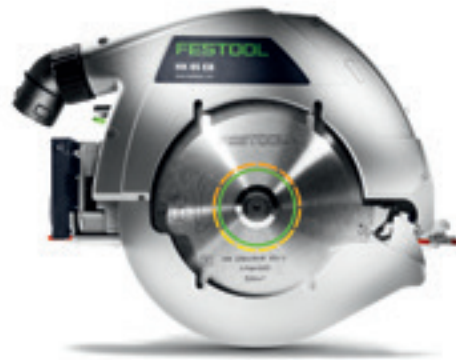

The timber construction all-rounder.

- › High-torque 2300 W motor with power electronics ensures constant power when sawing
- › Safe and easy handling thanks to the cutting depth adjustment with plunge function, pendulum hood remote control and guide wedge
- › Angle adjustment with central clamping mechanism from 0 to 60 degrees
- › Using the conversion kit accessories, the portable circular saw can become a groove cutter

Technical data	
Power consumption (watt)	2.300
Idle engine speed (RPM)	1.500 – 3.300
Saw blade diameter (mm)	230
Angular range (°)	0 – 60
Cutting depth 0°, 90° (mm)	0 – 85
Cutting depth at 45°/60° (mm)	62/47
Dust extraction connection dia. (mm)	27/36
Weight (kg)	7

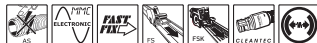

■ = MMC Multi Material Control electronics

Exclusive: Groove cutter included.

This is made possible using the optional adjustable groove cutter conversion kit – just a few steps and the HK 85 portable circular saw is transformed into a high-performance groove cutter. Ideal for longitudinal and transverse grooves, such as milling grooves for struts between rafters and intermediate ceilings.

Items included	Order no.
HW standard saw blade W24, parallel side fence, operation tool	
HK 85 EB in carton	767692
HK 85 EB-Plus in SYSTAINER SYS 5 T-LOC	767694
HK 85 EB-Plus-FS guide rail FS 1400/2, in SYSTAINER SYS 5 T-LOC	574661
HK 85 EB-Plus-FSK420 FSK 420 trimming rail, in SYSTAINER SYS 5 T-LOC	574665

System accessories
from page 66



Circular saw blades
from page 84



Cross cutting guide rail FSK

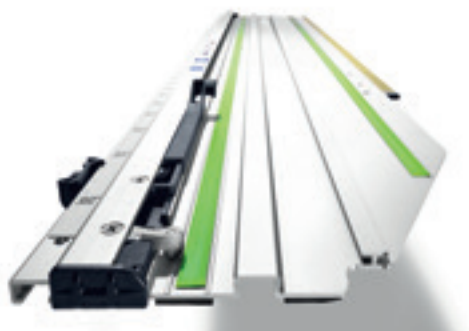

Not just saws—compound mitre saws.

- › The HK 55, HKC 55 and HK 85 portable circular saws can be easily connected to the cross cutting guide rail to form a single unit, by means of a quick fastener
- › The compound mitre saw system makes work easier with fast, guided and precisely-angled cross cuts
- › Stop system for accurately repeated angled cuts
- › Retract function returns the saw to start position after sawing

Technical data	FSK 250	FSK 420	FSK 670
Cutting length (mm)	250	420	670
Angular range [°]	-45 – +60	-60 – +60	-60 – +60
Weight (kg)	0,98	1,26	1,63



Items included	Order no.
in carton	
FSK 250	769941
FSK 420	769942
FSK 670	769943

Click – and go.

The HK 55, HKC 55 and HK 85 Festool circular saws can easily be connected to the FSK cross cutting guide rails, which are available in three different lengths. In just a few steps, this produces a portable and easy-to-use compound mitre saw system for accurate and precisely angled cutting, in just a few steps.

Carpentry portable circular saw

HK 132



3-in-1. Saw, notch cutter, flattening planer.

- › Trouble-free retraction control of the movable guard, particularly of benefit for mitre cutting
- › Accurate, fixed adjustment for mitre-cutting up to 60°
- › Electronic convenience: Soft start, constant speed, overload protection and coil temperature monitoring
- › Stable and exact guidance by means of the guide system: parallel fence, guide plate extension, parallel fence for guide rail

Technical data	HK 132	HK 132/RS-HK	HK 132/NS-HK
Power consumption (watt)	2.300	2.300	2.300
Idle engine speed (RPM)	2.200	2.200	2.200
Cutting depth 0°, 90° (mm)	50 – 132	50 – 132	50 – 132
Cutting depth at 45°/60° (mm)	85/50	85/50	85/50
Mitre cuts [°]	0 – 60	0 – 60	0 – 60
Weight (kg)	18	18	18
Max. routing depth (mm)		0 – 38	
Max. routing width (mm)		80	
Max. planing depth (mm)			80
Max. planing width (mm)			50



Items included	Order no.
HW standard saw blade W24, rip fence combined with guide plate extension, 10 m power cord, in carton	
HK 132 E	769531
HK 132/RS-HK RS-HK 160 x 80 milling set	561755
HK 132/NS-HK planer NS-HK 250 x 50	561754

Three in one.

On the one hand, a portable circular saw with a cutting depth of 132 mm. Replace the saw blade with a notch cutter and the HK 132 becomes a reliable milling machine. Retrofitting on the planer is also easy.

System accessories
from page 67

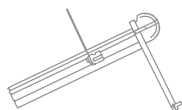

Circular saw blades
from page 84





Sliding compound mitre saw KAPEX KS 60



Mobility, versatility and best results – perfectly combined.

- › Compact and lightweight, with ergonomic handles and cord holder
- › LED spotlight to show cutting lines precisely (included in the set or available as an accessory)
- › Bevel for producing interior and exterior angles
- › Inclination angle of up to 47°/46° on each side and mitre angle of up to 60° on each side

Technical data	
Power consumption (watt)	1.200
Idle engine speed (RPM)	1.300 – 3.500
Saw blade diameter (mm)	216
Cutting depth 90°/90° (mm)	305 x 60
Cutting depth at 45°/90° (mm)	215 x 60
Cutting depth 45°/45° (left) (mm)	215 x 40
Inclination angle [°]	47/46
Mitre angle [°]	60/60
Dimensions (W x D x H) (mm)	661 x 475 x 430
Dust extraction connection dia. (mm)	27/36
Weight (kg)	17,8



■ = MMC digital electronics

Items included	Order no.
HW universal saw blade W 36, clamp FSZ 120, operation tool, in carton	
KS 60 E	561683
KS 60 E-Set LED spotlight, Bevel, elevation	561728
KS 60 E-UG-Set LED spotlight, Bevel, elevation, underframe	574788
KS 60 E-UG-Set/XL LED spotlight, Bevel, elevation, underframe, KS-UG-KS R/L trimming attachment, adjustable stop, telescopic slide-out scale, fold-out pedestal and carry case	574789



Ideal for mobile use.

With the maximum range of applications for assembly: For cutting boards and panels with sizes of up to 305 x 60 mm to length, trimming strips, profiles and square timber at thicknesses of up to 60 mm and adjusting skirting boards and cover strips to precision angles quickly and precisely using the bevel.

System accessories from page 68

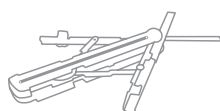

Circular saw blades from page 84



Sliding compound mitre saw KAPEX KS 88 R



Flexible frame.

Comfortable operation also for assembly work – the frame is a stand and transport frame in one. Precise work of up to 2.4 m cutting length with arm and easy to transport thanks to rollers and handle.

Less weight, but better performance.

- › Twin-column guide with two bearings for unique precision
- › Compact, lightweight design for convenient transportation
- › Intelligent details such as an angle preselection and quick-release clamp for rapid adjustment of the inclination angle
- › FastFix saw blade changing for adaptation to the working material

Technical data	
Power consumption (watt)	1.600
Idle engine speed (RPM)	1.400 – 3.400
Saw blade diameter (mm)	260
Cutting depth 90°/90° (mm)	305 x 88
Cutting depth at 45°/90° (mm)	215 x 88
Crown moulding diagonal cut 45°/90° (mm)	168
Inclination angle (°)	47/47
Mitre angle (°)	50/60
Dimensions (W x D x H) (mm)	713 x 500 x 470
Dust extraction connection dia. (mm)	27/36
Weight (kg)	22,3



■ = MMC digital electronics

Items included	Order no.
HW universal saw blade W60, workpiece clamp, operation tool, in carton	
KS 88 RE	575317
KS 88 RE-Set-UG underframe, adjustable stop, telescopic slide-out scale, fold-out pedestal and carry case	575322

System accessories
from page 69

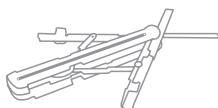

Circular saw blades
from page 84





Sliding compound mitre saw KAPEX KS 120 R

Quality down to the finest detail.

- › Twin-column guide with two bearings for unique precision
- › Dual-line laser for an accurate indication of the cutting line
- › Fine adjustment of the saw blade angle accurate to the millimetre from the front of the machine
- › Special cutting position for cutting depths up to 120 mm

Technical data	
Power consumption (watt)	1.600
Idle engine speed (RPM)	1.400 – 3.400
Saw blade diameter (mm)	260
Cutting depth 90°/90° (mm)	305 x 88
Cutting depth at 45°/90° (mm)	215 x 88
Special cutting depth 90°/90° (mm)	60 x 120
Crown moulding diagonal cut 45°/90° (mm)	168
Inclination angle (°)	47/47
Mitre angle (°)	50/60
Dimensions (W x D x H) (mm)	713 x 500 x 470
Weight (kg)	23,1



■ = MMC digital electronics

Items included	Order no.
HW universal saw blade W60, Bevel, workpiece clamp, operation tool, in carton	
KS 120 REB	575302
KS 120 REB-Set-UG underframe, adjustable stop, telescopic slide-out scale, fold-out pedestal and carry case	575313
KS 120 REB-Set-MFT multifunction table MFT KAPEX, clamping set, 2 x Trimming attachment, 2 x Crown stop	575309



Maximum precision for the perfect cut.

The impressive features of the KS 120 include an outstanding cutting capacity and low weight. The special cutting position allows you to cut coving and cornices in their original wall position. Intelligent details such as the dual-line laser and bevel ensure accurate results.

System accessories from page 69

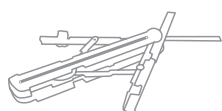

Circular saw blades from page 84

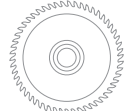

Compound mitre saw SYMMETRIC SYM 70 R



Compound mitre saw.

- › Patented symmetrical stop system
- › Easy angle transfer using a bevel, cutting along the bisector without making calculations
- › Stops easy to clamp, no tools required
- › Intermediate bases for elevating the SYM 70 to the height of a SYS 1 SYSTAINER: Long workpieces can be conveniently supported when working

Technical data	
Power consumption (watt)	1.150
Idle engine speed (RPM)	2.700 – 5.200
Saw blade diameter (mm)	216
Interior angle (°)	0 – 68
Exterior angle (°)	0 – 60
Max. strip height (mm)	70
Max. strip width (mm)	80
Dust extraction connection dia. (mm)	27/36
Weight (kg)	9,5



■ = MMC Multi Material Control electronics

Trimming strips could not be easier.

Precision has never been easier: measure and transfer the angle, make the cut and you're done. The patented symmetrical stop system on the SYMMETRIC SYM 70 simplifies your work considerably.

Items included	Order no.
SYM 70 RE fine tooth saw blade HW W48, precision adjustable square, elevation of EH-SYS-SYM 70, workpiece clamp, operation tool, in carton	574927

System accessories
from page 74



Circular saw blades
from page 84

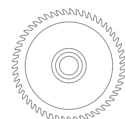



Trimming saw PRECISIO CS 50 EBG



Full power perfectly under control.

- › Tool-less FastFix saw blade changes
- › Multifunction handle: one handle with all functions integrated
- › Change quickly from rip to cross cuts with the angle stop
- › Moving splinterguard for splinter-free cuts on both sides

Technical data	CS 50	CS 50 Set
Power consumption (watt)	1.200	1.200
Idle engine speed (RPM)	1.600 – 4.200	1.600 – 4.200
Saw blade diameter (mm)	190	190
Cutting height 90°/45° (mm)	0 – 52/0 – 37	0 – 52/0 – 37
Inclination (°)	0 (-2)° – 45 (+47)	0 (-2)° – 45 (+47)
Cutting path (mm)	304	304
Table dimensions (mm)	585 x 400	585 x 400
Table height, legs folded away (mm)	316	316
Table height, legs unfolded (mm)	900	900
Dust extraction connection dia. (mm)	27/36	27/36
Weight (kg)	21,9	42,9



■ = MMC digital electronics

Items included	Order no.
HW universal saw blade W32, angle stop, 3 x splinterguard, workpiece holder, accessories holder, operation tool, in carton	
CS 50 EBG-FLR	574770
CS 50 EBG foldaway legs, dust extraction set, support with transport roller	574765
CS 50 EBG-Set ripping-cut fence, sliding table, extension table, extension table, foldaway legs, dust extraction set, support with transport roller	574772



Diversity made easy.

The PRECISIO CS 50 is the perfect solution for cross and rip cuts in applications involving interior fitting, furniture assembly and exhibition stand construction. Thanks to its low weight and a host of ingenious functions, the CS 50 is ideal for applications where the nature of the work constantly changes, e.g. assembly tasks.

System accessories
from page 70

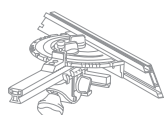

Circular saw blades
from page 84

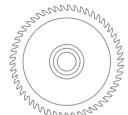

Trimming saw

PRECISIO CS 70 EBG**Like a knife through butter.**

The size and power of the CS 70 really begins to show when cutting workpieces up to 70 mm thick, both in the workshop and on assembly sites. Comprehensive system accessories allow you to upgrade the CS 70 to a complete sawing station.

Solid, strong and uncompromising.

- › 2200 watt universal motor for powerful cutting
- › 70 mm cutting depth for an even wider range of applications
- › Change quickly from rip to cross cuts with the angle stop
- › Moving splinterguard for splinter-free cuts on both sides

Technical data	CS 70	CS 70 Set
Power consumption (watt)	2.200	2.200
Idle engine speed (RPM)	2.000 – 4.200	2.000 – 4.200
Saw blade diameter (mm)	225	225
Cutting height 90°/45° (mm)	0 – 70/0 – 48	0 – 70/0 – 48
Inclination (°)	0 [-2]° – 45 [+47]	0 [-2]° – 45 [+47]
Cutting path (mm)	320	320
Table dimensions (mm)	690 x 500	690 x 500
Table height, legs folded away (mm)	375	375
Table height, legs unfolded (mm)	900	900
Dust extraction connection dia. (mm)	27/36	27/36
Weight (kg)	37	68,5



■ = MMC Multi Material Control electronics

Items included	Order no.
HW universal saw blade W32, angle stop, workpiece holder, accessories holder, support with transport roller, operation tool, in carton	
CS 70 EG	574778
CS 70 EBG 3 x splinterguard, dust extraction set	574776
CS 70 EBG-Set sliding table, extension table CS 70 VB, extension table CS 70 VL, ripping-cut fence, 3 x splinterguard, dust extraction set	574782

System accessories
from page 71

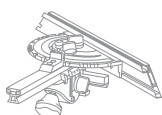

Circular saw blades
from page 84

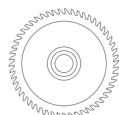

Cordless insulating-material saw

ISC 240

NEW: ISC 240
incl. Bluetooth® battery**



Brushless EC-TEC motor for a long service life and a high level of efficiency

The revolution in insulating-material saws.

- › Perfectly coordinated cutting sets for precise and fast cutting of flexible mineral and natural fibre insulating materials as well as PUR insulating materials
- › Mobile, fast and saves effort without a cable: With a powerful 18 V Li-ion battery and brushless EC-TEC motor. Benefit from all the advantages of the Festool dust-free system thanks to Bluetooth® cordless technology
- › For cutting material efficiently: With the guide rail and angle stop (available in a set or as accessories), reproducible angled cuts can be made with precise dimensions
- › Work without tiring thanks to a perfectly balanced design and low weight – for maximum comfort when working, even in one-handed operation



Technical data	ISC 240 Plus/Set	ISC 240 Compact
Battery voltage (V)	18	18
Stroke rate (RPM)	3.000	3.000
Cutting depth (mm)	240	240
Stroke length (mm)	26	26
Dust extraction connection dia. (mm)	27	27
Li-ion battery capacity (Ah)	5,2	3,1
Weight with Li-ion (kg)	2,5	2,2



Items included	Order no.
SG-240/W-ISC serrated cutting set, Adapter table, guide rail slide, in SYSTAINER SYS 3 T-LOC	
ISC 240 Li EB-Basic	574821
ISC 240 Li 3,1 EBI-Compact BP 18 Li 3.1 Cl battery pack, rapid charger TCL 6	575733
ISC 240 Li 5,2 EBI-Plus 2 x BP 18 Li 5.2 ASI battery pack, rapid charger TCL 6	574819
ISC 240 Li 5,2 EBI-Set-FS 2 x BP 18 Li 5.2 ASI battery pack, rapid charger TCL 6, angle stop, guide rail FS 1400/2	575592

Fast. Precise. Mobile.

Whether you are working freehand or with a guide rail and stop pin system; on a roof, scaffolding or on the ground; with insulating materials made of mineral fibres or natural fibres or polyurethane insulation boards – the ISC 240 offers amazing mobility, versatility and efficiency, making it the ideal solution for anyone wishing to insulate housing with minimum effort.

System accessories
from page 72



Saw blades
from page 72



Battery and charging technology
from page 14 onwards

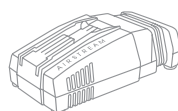

* For more information on
Bluetooth® Autostart, go to page 16



Sword saw

SSU 200



Precise cut.

Whether it is wood or insulating material, the UNIVERS SSU 220 sword saw cuts all common materials in wooden structures up to 200 mm thick.

Small handy machine with 200 mm cutting depth

- › 200 mm cutting depth and 6.5 kg weight
- › Integrated guide slot in the aluminium die cast base plate for accurate cuts using the guide rail
- › Wide application range for mitre cuts up to 60°
- › Chain changed and tensioned without using tools

Technical data

Power consumption (watt)	1.600
Idle engine speed (RPM)	4.600
Cutting depth 0°, 90°/45°/60° (mm)	200/140/100
Mitre cuts (°)	0 – 60
Cutting speed (idling) (m/s)	10,6
Blade position (°)	0 – 10
Weight (kg)	6,5



■ = MMC Multi Material Control electronics

Items included

universal saw chain SC 3/8" 91 U-39E, chain oil 250 ml, 7.5 m power cord, in SYSTAINER SYS 5 T-LOC

SSU 200 EB-Plus

767995

SSU 200 EB-Plus-FS
guide rail FS 800/2

769010

System accessories
from page 75



Sword saw IS 330



The size with 330 mm cutting depth.

- › Ideal for construction sites: cutting depth of 330 mm for cutting thick insulating materials to size and 7.0 kg in weight
- › 60° mitre cutting angle with a cutting depth of 165 mm
- › Straight and splinter-free cuts thanks to guide rails
- › Rotary dust-extraction attachment for connecting an extractor

Technical data

Power consumption (watt)	1.600
Idle engine speed (RPM)	4.600
Ctting depth 0°, 90°/45°/60° (mm)	330/230/165
Mitre cuts (°)	0 – 60
Cutting speed (idling) (m/s)	12
Blade position (°)	0 – 10
Weight (kg)	7



■ = MMC Multi Material Control electronics

Items included

saw chain Iso SC 3/8"-90 I-57E, saw chain Iso Hard SC 3/8"-91 IH-57E, chain oil 250 ml, 7.5 m power cord, in carton

IS 330 EB 767998

IS 330 EB-FS 769006
guide rail FS 1400/2



The specialist for cutting insulating materials.

The sword saw IS 330 combines the advantages of a chain saw and a portable circular saw with a guide rail in a unique mobile system. Cutting pressure-resistant insulating materials such as wood fibre and polyurethane boards is this easy, quick and accurate thanks to the guide rail.

System accessories
from page 75



The Festool system. Everything in view.

Because things work better when everything fits together: Festool saws fit perfectly into the system. For example, the guide rails are compatible both with pendulum jigsaws and plunge-cut saws. Bevels can be used for multiple functions and a hand-guided saw can also be used in a semi-stationary configuration with the CMS Compact Module System.



02 Sawing

Accessories and consumable materials

System accessories	62
Saw blades	76
Saw blades	82



System accessories

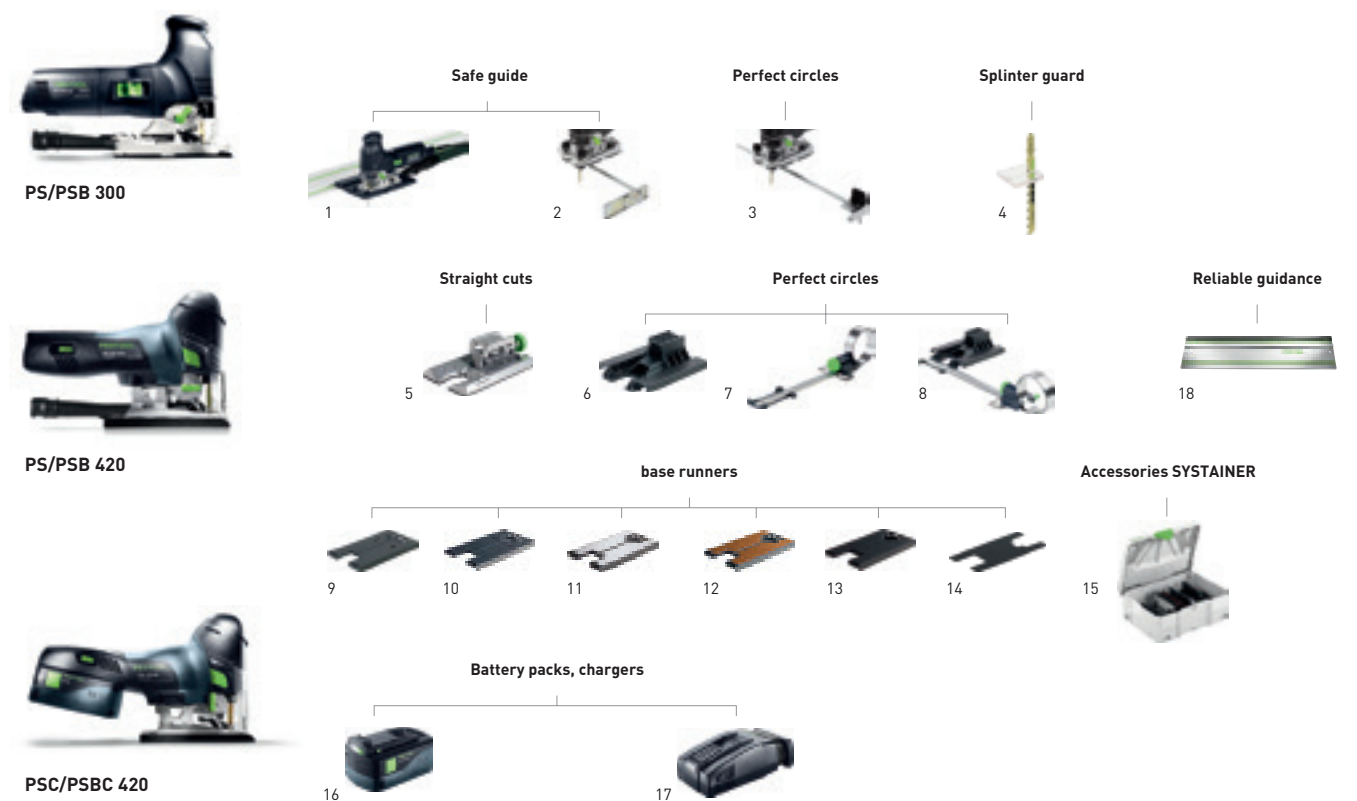

Accessories for pendulum jigsaws PS/PSB 300, PS/PSB 420, PSC/PSBC 420

Denomination	Explanation	Order no.
1 Guide rail adapter FS-PS/PSB 300	for PS 200, PS 300, PSB 300, PS 2, allows use of jigsaws with FS and FS/2 guide systems, in self-service display pack	490031
2 Parallel side fence PA-PS/PSB 300	for PS 300, PSB 300, PS200, PS2, max. workpiece width 200 mm, in self-service display pack	490119
3 Core maker KS-PS/PSB 300	for PS 300, PSB 300, PS200, PS2, circle dia. 130 – 720 mm, in self-service display pack	490118
4 Splinter guard SP-PS/PSB 300/5	for PS 300, PSB 300, PS(C) 400/420, PSB(C) 400/420, prevents splintering, qty. in pack 5 Units, in self-service display pack	490120
Splinter guard SP-PS/PSB 300/20	for PS 300, PSB 300, PS(C) 400/420, PSB(C) 400/420, prevents splintering, qty. in pack 20 Units, in self-service display pack	490121
Splinter guard SP-PS/5	for PS1, PS 2, PS200, prevents splintering, qty. in pack 5 Units, in self-service display pack	483372
5 Angle table WT-PS 420	for PS(C) 400/420, PSB(C) 400/420, for angled cuts from +45° to -45°, stepless angle adjustment, in self-service display pack	496134
6 base adapter ADT-PS 420	for PS(C) 400/420, PSB(C) 400/420, for using the PS on the guide rail, for installation in the Compact Module System CMS, in conjunction with circle cutting attachment KS-PS 400, in self-service display pack	497303
7 Core maker KS-PS 420	for PS(C) 400/420, PSB(C) 400/420, circle dia. from 120 mm – 3 m, in conjunction with adapter table ADT-PS 400, in self-service display pack	497304
8 Core maker KS-PS 420 Set	for PS(C) 400/420, PSB(C) 400/420, circle dia. from 120 mm – 3 m, incl. adapter table ADT-PS 420, in self-service display pack	497443
9 Base runner LAS-PS 420	for PS(C) 400/420, PSB(C) 400/420, plastic all-round base for wood or similar materials, in self-service display pack	497297
10 Base runner LAS-Soft-PS 420	for PS(C) 400/420, PSB(C) 400/420, studded base with optimum sliding properties for wood or similar materials, in self-service display pack	497298
11 Base runner LAS-HGW-PS 420	for PS(C) 400/420, PSB(C) 400/420, durable laminated fabric base for wood or similar materials, in self-service display pack	497299
12 Base runner LAS-St-PS 420	for PS(C) 400/420, PSB(C) 400/420, for all metallic materials, in self-service display pack	497300
13 Base runner LAS-STF-PS 420	for PS(C) 400/420, PSB(C) 400/420, for sensitive surfaces, in self-service display pack	497301
14 Spare felt EF-LAS-STF-PS 420	for PS(C) 400/420, PSB(C) 400/420, 5x spare felt for StickFix LAS-STF-PS 420 base runner, in self-service display pack	497444
15 Accessories SYSTAINER ZH-SYS-PS 420	for PS(C) 400/420, PSB(C) 400/420, 5 splinterguards, Soft base runner, Hard base runner, Steel base runner, StickFix baseplate, angle table, base adapter, core maker, StickFix felt, in SYSTAINER SYS 2 T-LOC	497709

System accessories

Accessories for pendulum jigsaws PS/PSB 300, PS/PSB 420, PSC/PSBC 420

	Denomination	Explanation	Order no.
16	Battery pack BP 18 Li 5,2 AS	with AIRSTREAM function, lithium-ion (Li-ion) replacement battery pack for all Festool 18 V cordless tools (except CXS, TXS, ETSC 125, RTSC 400, DTSC 400), tensioner 18 V, capacity 5,2 Ah, weight 0,7 kg, in self-service display pack	200181
	Battery pack BP 18 Li 5,2 ASI	Bluetooth® lithium-ion (Li-ion) battery pack with AIRSTREAM function for all Festool 18 V cordless tools (except CXS, TXS, ETSC 125, RTSC 400, DTSC 400), Bluetooth® enables the CLEANTEC mobile dust extractor to be started automatically when the cordless tool is switched on (use of a Bluetooth®-compatible mobile dust extractor is required), tensioner 18 V, capacity 5,2 Ah, weight 0,7 kg, in carton	202479
	Battery pack BP 18 Li 6,2 AS	with AIRSTREAM function, lithium-ion (Li-ion) replacement battery pack for all Festool 18 V cordless tools (except CXS, TXS, ETSC 125, RTSC 400, DTSC 400), tensioner 18 V, capacity 6,2 Ah, weight 0,7 kg, in self-service display pack	201774
	Battery pack BP 18 Li 6,2 ASI	Bluetooth® lithium-ion (Li-ion) battery pack with AIRSTREAM function for all Festool 18 V cordless tools (except CXS, TXS, ETSC 125, RTSC 400, DTSC 400), Bluetooth® enables the CLEANTEC mobile dust extractor to be started automatically when the cordless tool is switched on (use of a Bluetooth®-compatible mobile dust extractor is required), tensioner 18 V, capacity 6,2 Ah, weight 0,7 kg, in carton	201797
	Battery pack BP 18 Li 3,1 C	compact, lightweight design, lithium-ion (Li-ion) replacement battery pack for all Festool 18 V cordless tools (except TSC 55, CXS, TXS, ETSC 125, RTSC 400, DTSC 400), tensioner 18 V, capacity 3,1 Ah, weight 0,4 kg, in self-service display pack	201789
	Battery pack BP 18 Li 3,1 CI	Bluetooth® lithium-ion (Li-ion) replacement battery pack for all Festool 18 V cordless tools (except TSC 55, CXS, TXS, ETSC 125, RTSC 400, DTSC 400), Bluetooth® enables the CLEANTEC mobile dust extractor to be started automatically when the cordless tool is switched on (use of a Bluetooth®-compatible mobile dust extractor is required), tensioner 18 V, capacity 3,1 Ah, weight 0,4 kg, in carton	203799
17	Rapid charger TCL 6	for all Li-ion battery packs (except for CXS/TXS), Lithium-ion (Li-ion) replacement charger for all 10.8 – 18 V battery packs, charging current 6 A, input voltage 220 – 240 V, weight 0,8 kg, in self-service display pack	201135
	Rapid charger SCA 8	for all Li-ion battery packs (except for CXS/TXS), with AIRSTREAM function, Lithium-ion (Li-ion) replacement charger for all 10.8 – 18 V battery packs, charging current 8 A, input voltage 220 – 240 V, weight 1,1 kg, in self-service display pack	200178
	Battery and charging technology	from page 14	
18	Guide-rails	see the "Organising your workplace" chapter from page 388	

System accessories



Accessories for circular saws TS 55 R, TSC 55, TS 75

Denomination	Explanation	Order no.
1 Parallel side fence PA-TS 55	for TS 55, TS 55 R, TSC 55, can also be used as table extension, parallel guide, guided on both sides, max. workpiece width 100 mm, in carton	491469
Parallel side fence PA-TS 75	for TS 75, parallel guide, guided on both sides, can also be used as table extension, max. workpiece width 100 mm, in carton	492243
2 Cover ABSA-TS 55	for TS 55, TS 55 R, TSC 55, can also be used as false joint set, cover for improved dust extraction, width of the shadow gap TS 55 15 – 46 mm, in carton	491750
3 Splinter guard SP-TS 55 R/5	for TS 55 R, TSC 55, can be used with or without guide rail, for low-splinter cuts to the right of the saw blade, qty. in pack 5 Units, in self-service display pack	499011
4 Splinter guard SP-TS 55/5	for TS 55, TS 75, for low-splinter cuts to the right of the saw blade, can be used with or without guide rail, qty. in pack 5 Units, in self-service display pack	491473
5 Kickback stop FS-RSP	for TS 55, TS 55 R, TSC 55, TS 75, HKC 55, HK 55, ATF 55, AP 55, AT 65, AP 65, AP 85, can also be used as guide stop, used as a rear and front stop position on guide rail FS/2, in self-service display pack	491582
6 Guide-rails	see the "Organising your workplace" chapter from page 388	
7 Saw blades	from page 84	
8 Battery pack BP 18 Li 5,2 AS	with AIRSTREAM function, lithium-ion (Li-ion) replacement battery pack for all Festool 18 V cordless tools (except CXS, TXS, ETSC 125, RTSC 400, DTSC 400), tensioner 18 V, capacity 5,2 Ah, weight 0,7 kg, in self-service display pack	200181
Battery pack BP 18 Li 5,2 ASI	Bluetooth® lithium-ion (Li-ion) battery pack with AIRSTREAM function for all Festool 18 V cordless tools (except CXS, TXS, ETSC 125, RTSC 400, DTSC 400), Bluetooth® enables the CLEANTEC mobile dust extractor to be started automatically when the cordless tool is switched on (use of a Bluetooth®-compatible mobile dust extractor is required), tensioner 18 V, capacity 5,2 Ah, weight 0,7 kg, in carton	202479
Battery pack BP 18 Li 6,2 AS	with AIRSTREAM function, lithium-ion (Li-ion) replacement battery pack for all Festool 18 V cordless tools (except CXS, TXS, ETSC 125, RTSC 400, DTSC 400), tensioner 18 V, capacity 6,2 Ah, weight 0,7 kg, in self-service display pack	201774
Battery pack BP 18 Li 6,2 ASI	Bluetooth® lithium-ion (Li-ion) battery pack with AIRSTREAM function for all Festool 18 V cordless tools (except CXS, TXS, ETSC 125, RTSC 400, DTSC 400), Bluetooth® enables the CLEANTEC mobile dust extractor to be started automatically when the cordless tool is switched on (use of a Bluetooth®-compatible mobile dust extractor is required), tensioner 18 V, capacity 6,2 Ah, weight 0,7 kg, in carton	201797
9 Rapid charger TCL 6	for all Li-ion battery packs (except for CXS/TXS), Lithium-ion (Li-ion) replacement charger for all 10.8 – 18 V battery packs, charging current 6 A, input voltage 220 – 240 V, weight 0,8 kg, in self-service display pack	201135
Rapid charger SCA 8	for all Li-ion battery packs (except for CXS/TXS), with AIRSTREAM function, Lithium-ion (Li-ion) replacement charger for all 10.8 – 18 V battery packs, charging current 8 A, input voltage 220 – 240 V, weight 1,1 kg, in self-service display pack	200178
Battery and charging technology	from page 14	
10 Chip collection bag SB-TSC	For TSC 55, HKC 55, folds down for space-saving transportation, for all woods, with dust cap, in self-service display pack	500393

System accessories



HK 55

Cross cutting guide rail



1

Bag



2

Saw blades



3



HKC 55

Kickback stop



4

Parallel side fence



5

Reliable guidance



6

Battery packs, chargers



7



8

Chip collection bag



9

Accessories for HK 55, HKC 55 portable circular saws

Denomination	Explanation	Order no.
1 Cross cutting guide rail FSK 250	for HKC 55, HK 55, HK 85, cutting length 250 mm, angular range -45 – +60°, weight 0,98 kg, in carton	769941
Cross cutting guide rail FSK 420	for HKC 55, HK 55, HK 85, cutting length 420 mm, angular range -60 – +60°, weight 1,26 kg, in carton	769942
Cross cutting guide rail FSK 670	for HKC 55, HK 55, HK 85, cutting length 670 mm, angular range -60 – +60°, weight 1,63 kg, in carton	769943
2 Bag FSK420-BAG	for FSK 250, FSK 420, transport bag with shoulder straps, in carton	200160
Bag FSK670-BAG	for FSK 670, transport bag with shoulder straps, in carton	200161
3 Circular saw blades	from page 84	
4 Kickback stop FS-RSP	for TS 55, TS 55 R, TSC 55, TS 75, HKC 55, HK 55, ATF 55, AP 55, AT 65, AP 65, AP 85, can also be used as guide stop, used as a rear and front stop position on guide rail FS/2, in self-service display pack	491582
5 Parallel side fence PA-HKC 55	for HKC 55, HK 55, can also be used as table extension, parallel guide, guided on both sides, in carton	500464
6 Guide-rails	see the "Organising your workplace" chapter from page 388	
7 Battery pack BP 18 Li 5,2 AS	with AIRSTREAM function, lithium-ion (Li-ion) replacement battery pack for all Festool 18 V cordless tools (except CXS, TXS, ETSC 125, RTSC 400, DTSC 400), tensioner 18 V, capacity 5,2 Ah, weight 0,7 kg, in self-service display pack	200181
Battery pack BP 18 Li 5,2 ASI	Bluetooth® lithium-ion (Li-ion) battery pack with AIRSTREAM function for all Festool 18 V cordless tools (except CXS, TXS, ETSC 125, RTSC 400, DTSC 400), Bluetooth® enables the CLEANTEC mobile dust extractor to be started automatically when the cordless tool is switched on (use of a Bluetooth®-compatible mobile dust extractor is required), tensioner 18 V, capacity 5,2 Ah, weight 0,7 kg, in carton	202479
Battery pack BP 18 Li 6,2 AS	with AIRSTREAM function, lithium-ion (Li-ion) replacement battery pack for all Festool 18 V cordless tools (except CXS, TXS, ETSC 125, RTSC 400, DTSC 400), tensioner 18 V, capacity 6,2 Ah, weight 0,7 kg, in self-service display pack	201774
Battery pack BP 18 Li 6,2 ASI	Bluetooth® lithium-ion (Li-ion) battery pack with AIRSTREAM function for all Festool 18 V cordless tools (except CXS, TXS, ETSC 125, RTSC 400, DTSC 400), Bluetooth® enables the CLEANTEC mobile dust extractor to be started automatically when the cordless tool is switched on (use of a Bluetooth®-compatible mobile dust extractor is required), tensioner 18 V, capacity 6,2 Ah, weight 0,7 kg, in carton	201797
8 Rapid charger TCL 6	for all Li-ion battery packs (except for CXS/TXS), Lithium-ion (Li-ion) replacement charger for all 10.8 – 18 V battery packs, charging current 6 A, input voltage 220 – 240 V, weight 0,8 kg, in self-service display pack	201135
Rapid charger SCA 8	for all Li-ion battery packs (except for CXS/TXS), with AIRSTREAM function, Lithium-ion (Li-ion) replacement charger for all 10.8 – 18 V battery packs, charging current 8 A, input voltage 220 – 240 V, weight 1,1 kg, in self-service display pack	200178
Battery and charging technology	from page 14	
9 Chip collection bag SB-TSC	For TSC 55, HKC 55, folds down for space-saving transportation, for all woods, with dust cap, in self-service display pack	500393

System accessories

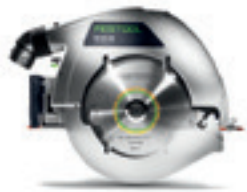

HK 85

Cross cutting guide rail



1

Bag



2

Saw blades

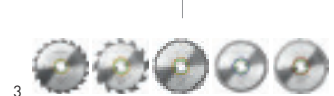

3

Parallel side fence



4

Reliable guidance



5

Groove unit



6

Reversible blade, roughing tap



7

Accessories for HK 85 portable circular saws

Denomination	Explanation	Order no.
1 Cross cutting guide rail FSK 250	for HKC 55, HK 55, HK 85, cutting length 250 mm, angular range -45 – +60°, weight 0,98 kg, in carton	769941
Cross cutting guide rail FSK 420	for HKC 55, HK 55, HK 85, cutting length 420 mm, angular range -60 – +60°, weight 1,26 kg, in carton	769942
Cross cutting guide rail FSK 670	for HKC 55, HK 55, HK 85, cutting length 670 mm, angular range -60 – +60°, weight 1,63 kg, in carton	769943
2 Bag FSK420-BAG	for FSK 250, FSK 420, transport bag with shoulder straps, in carton	200160
Bag FSK670-BAG	for FSK 670, transport bag with shoulder straps, in carton	200161
3 Circular saw blades	from page 84	
4 Parallel side fence PA-HK 85	for HK 85, can also be used as table extension, parallel guide, guided on both sides, in carton	500645
Parallel side fence PA-A-HK 85	for HK 85, bilateral offset parallel stop, in carton	574670
5 Guide-rails	see the "Organising your workplace" chapter from page 388	
6 Groove unit VN-HK85 130x16-25	for HK 85, routing transverse and longitudinal grooves; routing depth 0-35 mm and routing width adjustable by 16-25 mm, reversible blades HW-WP 14x14x2, adjustable groove cutter diameter 130 x 16-25 mm, protective cover (fixed), protective cover (moveable), Clamping flange, Counter flange, Spacer, dust extraction connection dia. 36 mm, weight 0,9 kg, in SYSTAINER SYS 1 T-LOC	200163
7 Reversible blade HW-WP 14x14x2/12	for HK85 adjustable groove cutter, dimensions (L x W x H) 14 x 14 x 2 mm, qty. in pack 12 Units, in self-service display pack	574671

System accessories



HK 132

Parallel side fence



1

Safe guide



2

Angle stop



3

Planing set



4

Milling set



5

Reversible blade, roughing tap



6/7

Saw blades



8

Accessories for carpentry portable circular saws HK 132

Denomination	Explanation	Order no.
1 Parallel side fence PG-HK 132	for HK 132, CSP 132, for using HK 132 E/W with guide rails, type GC 2000/3000, in carton	769538
2 Guide rail GC 2000	for HK 132, CSP 85/60, CSP 132, CSP 165, CCP 380, NRP 90, 2000 mm long, in carton	769669
Guide rail GC 3000	for HK 132, CSP 85/60, CSP 132, CSP 165, CCP 380, NRP 90, 3000 mm long, in carton	769670
3 Angle stop GC 1000-WA	for HK 132, CSP 85/60, CSP 132, CSP 165, CCP 380, NRP 90, angle indicator with 1000 mm guide rail and gauge marker, Angle stop, for variable angle adjustment up to 90° on both sides, With gauge marker for adjusting each mitre cut to scribe mark, in carton	769671
4 Planing set NS-HK 250x50	for HK 132, CSP 132, carbide pre-cutter 14 x 14 x 2.0 mm, carbide reversible blade 50 x 12 x 1.5 mm, protective cover, 1 movable guard with remote control, clamping rails, planing head dia. 250 mm, planing width 50 mm, planing depth 0-80 mm, drilling 30 mm, weight 6,8 kg, in carton	769539
5 Milling set RS-HK 160x80	for HK 132, CSP 132, milling head Ø 160 x 80 mm, 3 x carbide reversible blade 80 x 13 x 2.2 mm, carbide pre-cutter 14 x 14 x 2.0 mm, protective cover, 1 movable guard with remote control, clamping rails, planing head dia. 160 mm, planing width 80 mm, planing depth 0-38 mm, drilling 30 mm, weight 7,1 kg, in carton	769540
6 Reversible cutter blade CT-HK HW 50x12x1,5/3	for planer head NS-HK 250 x 50 and flattening head Ø 260 x 50, NS-CSP 250 x 50, HK 132, NRP 90, qty. in pack 3 Units, dimensions 50 x 12 x 1,5 mm, in self-service display pack	769544
Reversible cutter blade CT-HK HW 80x13x2,2/3	for notch cutter head RS-HK 160 x 80, RS-CSP 160 x 80, HK 132, CSP 132 E, qty. in pack 3 Units, dimensions 80 x 13 x 2,2 mm, in self-service display pack	769543
7 Pre-cutter CT-HK HW 14x14x2/6	for planer and notch cutter head, for HK 132, CSP 132, NRP 90, qty. in pack 6 Units, dimensions 14 x 14 x 2 mm, in self-service display pack	769542
8 Circular saw blades	from page 84	

System accessories



KS 60



Accessories for KAPEX KS 60 sliding compound mitre saw

Denomination	Explanation	Order no.
1 Bevel SM-KS	for KS 60, KS 120, bevel for transferring angles to the circular cross-cut saw, for interior and exterior angles, dissecting angle is generated automatically, no calculations, in self-service display pack	200127
2 Trimming attachment KA-UG-KS 60-L	for KS 60, for use in conjunction with the Festool UG-KAPEX KS 60 base frame, adjustable stop, telescopic slide-out scale, fold-out pedestal and carry case, measurement scale, length of extension arm (without telescope) 1.480 mm, max. meas. length 2.400 mm, weight 4,6 kg, in carton	201907
3 Trimming attachment KA-UG-KS 60-R	for KS 60, for use in conjunction with the Festool UG-KAPEX KS 60 base frame, adjustable stop, telescopic slide-out scale, fold-out pedestal and carry case, measurement scale, length of extension arm (without telescope) 1.480 mm, max. meas. length 2.400 mm, weight 4,6 kg, in carton	201908
Trimming attachment KA-UG-KS 60-R/L	for KS 60, for use in conjunction with the Festool UG-KAPEX KS 60 base frame, consisting of KA-UG-L and KA-UG-R, adjustable stop, telescopic slide-out scale, fold-out pedestal and carry case, measurement scale, length of extension arm (without telescope) 1.480 mm, max. meas. length 2.400 mm, in carton	201909
4 Fastening clamp FSZ 120	for FS/2, MFT, solid steel version, clamping width 120 mm, qty. in pack 2 Units, in self-service display pack	489570
5 Increase A-SYS-KS 60	for KS 60, intermediate bases for elevating the KS 60 to the height of a SYSTAINER SYS 1 T-LOC and Classic, Table height = Systainer: Long workpieces can be comfortably supported on the floor while working, for retrofitting the KS 60, items already included with the KS 60 set variants, in carton	500121
6 Spot lighting SL-KS 60	for KS 60, LED spot lighting for precisely highlighting the cutting line and optimal visibility of the scribe mark, for retrofitting the KS 60, items already included with the KS 60 set variants, in self-service display pack	500120
7 Underframe UG-KA-KS 60 Set	for KS 60, simple folding in for transport, (KA-UG-R and KA-UG-L trimming attachments incl. in the contents), work height 900 mm, weight 21 kg, in carton	202055
Underframe UG-KS 60	for KS 60, simple folding in for transport, work height 900 mm, weight 13 kg, in carton	200129
8 Adapter plate UG-AD-KS 60	for KS 60, adapter plate and saw blade holder for attaching the KS 60 to the UG-KAPEX KS 60 base frame, in carton	202056
9 Multifunction table MFT KAPEX	used as a base frame for the KAPEX, clamping kit SZ-KS required for fixing, table with perforated top and foldaway legs, table dimensions 869 x 581 mm, work height/with foldaway legs 180 mm, working height with legs 790 mm, load capacity 120 kg, weight 19 kg, in carton	495465
10 Clamping kit SZ-KS	for KS 60, KS 88, KS 120, for tightening the KS on the multifunction table, in self-service display pack	494693
11 Circular saw blades	from page 84	

System accessories



Accessories for KAPEX KS 88 R, KS 120 R sliding compound mitre saws

Denomination	Explanation	Order no.
1 Bevel SM-KS	for KS 60, KS 120, bevel for transferring angles to the circular cross-cut saw, for interior and exterior angles, dissecting angle is generated automatically, no calculations, in self-service display pack	200127
2 Trimming attachment KA-UG-KS 120-L	for KS 120, KS 88, for use in conjunction with the Festool UG-KAPEX KS 120 base frame, measurement scale, adjustable stop, telescopic slide-out scale, fold-out pedestal and carry case, length of extension arm (without telescope) 1.480 mm, max. meas. length 2.400 mm, weight 4,6 kg, in carton	497353
Trimming attachment KA-KS 120-L	for KS 120, KS 88, simple extraction and rolling out of measuring tape thanks to telescopic mechanism, only compatible with crown stop AB-KS, for use in conjunction with a Festool multifunction table (MFT) or a work table with a table height of 790 mm, adjustable stop, trimming stop, measurement scale, adjustable legs, total length 1.280 – 2.070 mm, cutting length 380 – 2.300 mm, in carton	495969
3 Trimming attachment KA-UG-KS 120-R	for KS 120, KS 88, for use in conjunction with the Festool UG-KAPEX KS 120 base frame, measurement scale, adjustable stop, telescopic slide-out scale, fold-out pedestal and carry case, length of extension arm (without telescope) 1.480 mm, max. meas. length 2.400 mm, weight 4,6 kg, in carton	497352
Trimming attachment KA-KS 120-R	for KS 120, KS 88, simple extraction and rolling out of measuring tape thanks to telescopic mechanism, only compatible with crown stop AB-KS, for use in conjunction with a Festool multifunction table (MFT) or a work table with a table height of 790 mm, adjustable stop, measurement scale, adjustable legs, trimming stop, total length 1.280 – 2.070 mm, cutting length 380 – 2.300 mm, in carton	495968
Trimming attachment KA-UG-KS 120-R/L	for KS 120, KS 88, consisting of KA-UG-L and KA-UG-R, for use in conjunction with the Festool UG-KAPEX KS 120 base frame, measurement scale, adjustable stop, telescopic slide-out scale, fold-out pedestal and carry case, length of extension arm (without telescope) 1.480 mm, max. meas. length 2.400 mm, in carton	497514
4 Adjustable stop KA-AR	for CS 50, CS 70, for positioning workpieces on trimming attachment CS 70 KA, Basis KA 100/200 and KA-KS L/R, in self-service display pack	488560
5 Terminal KL-KS 120	for KS 120, KS 88, can be used on the left or right, workpiece clamp for securing workpieces, included in the contents of the KS 120, maximum height of workpiece 120 mm, in self-service display pack	494391
6 Crown stop AB-KA-UG/2	for KS 120, KS 88, stop for positioning crown mouldings at an angle, only compatible with KA-UG trimming attachment underframe, qty. in pack 2 Units, in carton	203356
Crown stop AB-KS 120	for KS 120, KS 88, stop for positioning crown mouldings at an angle, also used for securing the table extension KA-KS, only compatible with KA-KS, crown moulding stop with table widener, in self-service display pack	494369
7 Underframe UG-KA-KS 120-Set	for KS 120, KS 88, simple folding in for transport, (KA-UG-R and KA-UG-L trimming attachments incl. in the contents), transport rollers, Trimming attachment KA-UG-KS 120-R, Trimming attachment KA-UG-KS 120-L, work height 900 mm, weight 21 kg, in carton	497354
Underframe UG-KAPEX KS 120	for KS 120, KS 88, simple folding in for transport, transport rollers, work height 900 mm, weight 10,1 kg, in carton	497351
8 Multifunction table MFT KAPEX	used as a base frame for the KAPEX, clamping kit SZ-KS required for fixing, table with perforated top and foldaway legs, table dimensions 869 x 581 mm, work height/with foldaway legs 180 mm, working height with legs 790 mm, load capacity 120 kg, weight 19 kg, in carton	495465
9 Clamping kit SZ-KS	for KS 60, KS 88, KS 120, for tightening the KS on the multifunction table, in self-service display pack	494693
10 Circular saw blades	from page 84	

System accessories

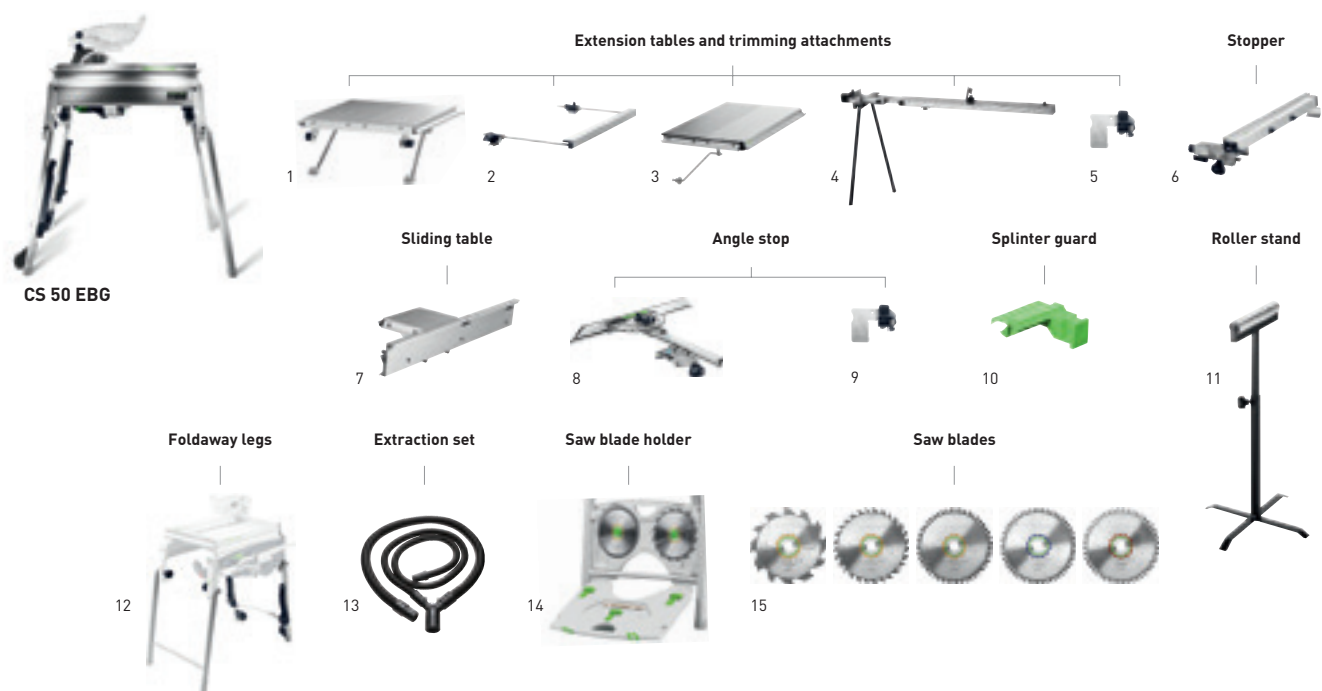

Accessories for CS 50 EBG trimming saw

Denomination	Explanation	Order no.
1 Extension table VL	for CS 50, CMS-GE, simple fitting, folds away, for safe support of long workpieces when sawing to width, enlarges the support surface by 405 mm, dimensions 375 x 454 mm, dimensions length x width 375 x 454 mm, in carton	492092
2 Support AF	for CS 50, CMS-GE, support for both side use, supports workpieces while cutting, enlarges the support surface by 300 mm, dimensions length x width 662 x 390 mm, in carton	492242
3 Extension table VB	for CS 50, with adjustable dimension scale, extends the support area by 410 mm, max. working width longitudinal 610 mm, dimensions length x width 664 x 438 mm, in carton	492090
Extension table VB-CMS/CS 50	for CS 50, CMS-GE, dummy plate, foldaway legs, dimensions length x width 664 x 480 mm, in carton	495531
4 Trimming attachment CS 70 KA	for CS 70 and CS 50, removable, with support, bearing surface, tape measure and adjustable stop, simple extraction and rolling out of measuring tape thanks to telescopic mechanism, length 1.200 – 2.050 mm, in carton	488063
5 Adjustable stop KA-AR	for CS 50, CS 70, for positioning workpieces on trimming attachment CS 70 KA, Basis KA 100/200 and KA-KS L/R, in self-service display pack	488560
6 Stopper LA-CS 50/CMS	for CS 50, CMS-GE, with fine adjustment and rear clamp, can be operated from front, with moveable stop profile for precise and safe longitudinal cuts, in carton	574796
7 Sliding table ST	for CS 50, CMS-GE, for MFT 3-VL, max. working width for trimming cuts 830 mm, in carton	492100
8 Angle stop WA	for CS 70, CS 50, CMS-GE, for work requiring 2 stops, in carton	574797
9 Adjustable stop WA-AR	for CS 50, CS 70, to stop workpieces on trimming attachment CS 70 WA, CS 50 WA and Basis WRA 500, in self-service display pack	491712
10 Splinter guard CS 50 SP/10	for CS 50, for splinter-free cut edges on both sides, qty. in pack 10 Units, in self-service display pack	492241
11 Roller stand RB	for all semi-stationary devices (CS/KS/CMS), may be used with the CS 50, CS 70, CB 120, Basis Plus System, CMS-GE, multifunction table, to use longer workpieces for longitudinal sections and cross sections and cutting and grinding work, height adjustable 630 – 1.000 mm, in carton	488711
12 Foldaway legs CS 50 KB	for CS 50, makes two work heights possible, foldaway legs for the extension of the CS 50 floor version, in carton	575671
13 Dust extraction set CS 70 AB	for CT/CTM, comprising: dust extraction hose D27x2.0 m, dust extraction hose D36x1.0 m, Y terminal, can be used with Basis, CS 70, CS 50 and CMS, dust extraction with MINI/MIDI only possible in combination with adapter hose 499196, diameter 27 /36 mm, in carton	488292
14 Saw blade holder SGA	for CS 50, CMS-GE, for safe and space-saving storage of up to 4 saw blades (max. Ø 190 mm) and up to 3 splinterguards (not included in contents), in carton	492228
15 Circular saw blades	from page 84	

System accessories

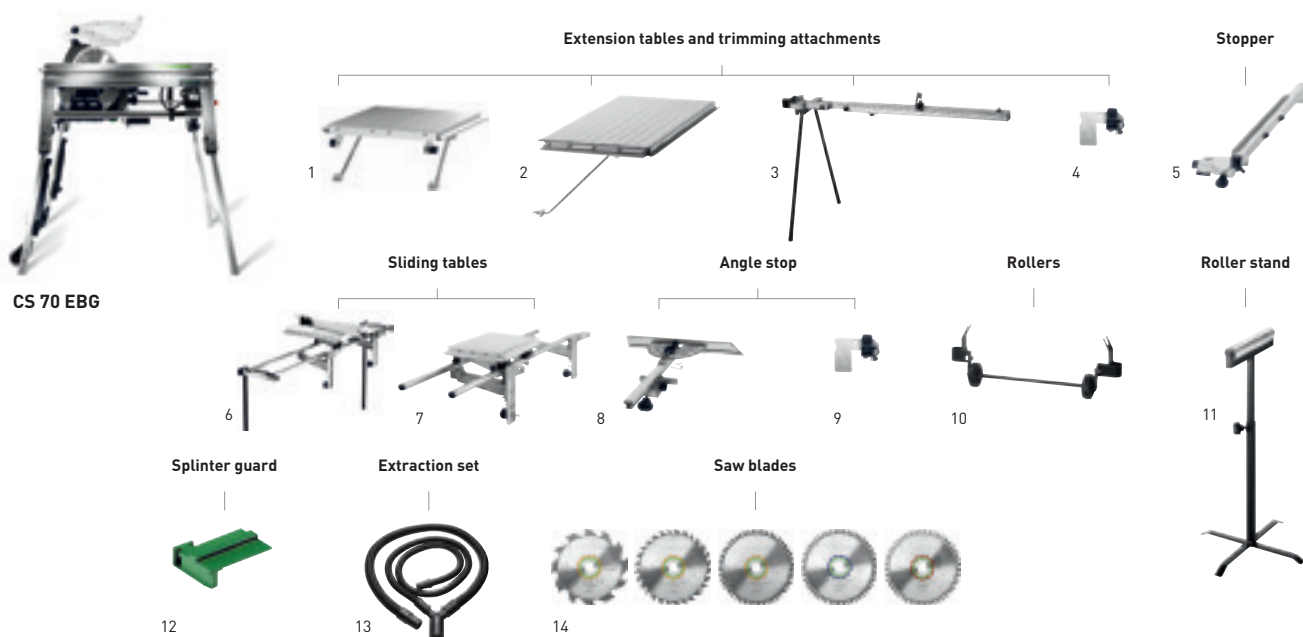

Accessories for CS 70 EBG trimming saw

Denomination	Explanation	Order no.
1 Extension table CS 70 VL	for CS 70, simple fitting, folds away, for safe support of long workpieces when sawing to width, extends the support area by 580 mm, dimensions length x width 525 x 522 mm, in carton	488061
2 Extension table CS 70 VB	for CS 70, with adjustable dimension scale, easy and quick to assemble and dismantle, for safe and precise width sawing, extends the support area by 411 mm, max. working width longitudinal 680 mm, dimensions length x width 773 x 435 mm, in carton	488060
3 Trimming attachment CS 70 KA	for CS 70 and CS 50, removable, with support, bearing surface, tape measure and adjustable stop, simple extraction and rolling out of measuring tape thanks to telescopic mechanism, length 1.200 – 2.050 mm, in carton	488063
4 Adjustable stop KA-AR	for CS 50, CS 70, for positioning workpieces on trimming attachment CS 70 KA, Basis KA 100/200 and KA-KS L/R, in self-service display pack	488560
5 Stopper CS 70 LA	for CS 70, MFT/3-VL, with fine adjustment and rear clamp, can be operated from front, with moveable stop profile for precise and safe longitudinal cuts, in carton	488062
6 Sliding table CS 70 ST	for CS 70, for sawing boards, easy and quick to assemble and dismantle, 2 x supporting legs, stop ruler with additional clamp, max. working width for trimming cuts 920 mm, in carton	488059
7 Sliding table CS 70 ST 650	for CS 70, easy and quick to assemble and dismantle, max. working width for trimming cuts 650 mm, in carton	490312
8 Angle stop WA	for CS 70, CS 50, CMS-GE, for work requiring 2 stops, in carton	574797
9 Adjustable stop WA-AR	for CS 50, CS 70, to stop workpieces on trimming attachment CS 70 WA, CS 50 WA and Basis WRA 500, in self-service display pack	491712
10 Transport rollers CS 70 TR	for CS 70, can be fitted to foldaway legs, for simple and comfortable transportation, in carton	488064
11 Roller stand RB	for all semi-stationary devices (CS/KS/CMS), may be used with the CS 50, CS 70, CB 120, Basis Plus System, CMS-GE, multifunction table, to use longer workpieces for longitudinal sections and cross sections and cutting and grinding work, height adjustable 630 – 1.000 mm, in carton	488711
12 Splinter guard CS 70 SP /10	for CS 70, for splinter-free cut edges on both sides, qty. in pack 10 Units, in self-service display pack	490340
13 Dust extraction set CS 70 AB	for CT/CTM, comprising: dust extraction hose D27x2.0 m, dust extraction hose D36x1.0 m, Y terminal, can be used with Basis, CS 70, CS 50 and CMS, dust extraction with MINI/MIDI only possible in combination with adapter hose 499196, diameter 27 /36 mm, in carton	488292
14 Circular saw blades	from page 84	

System accessories

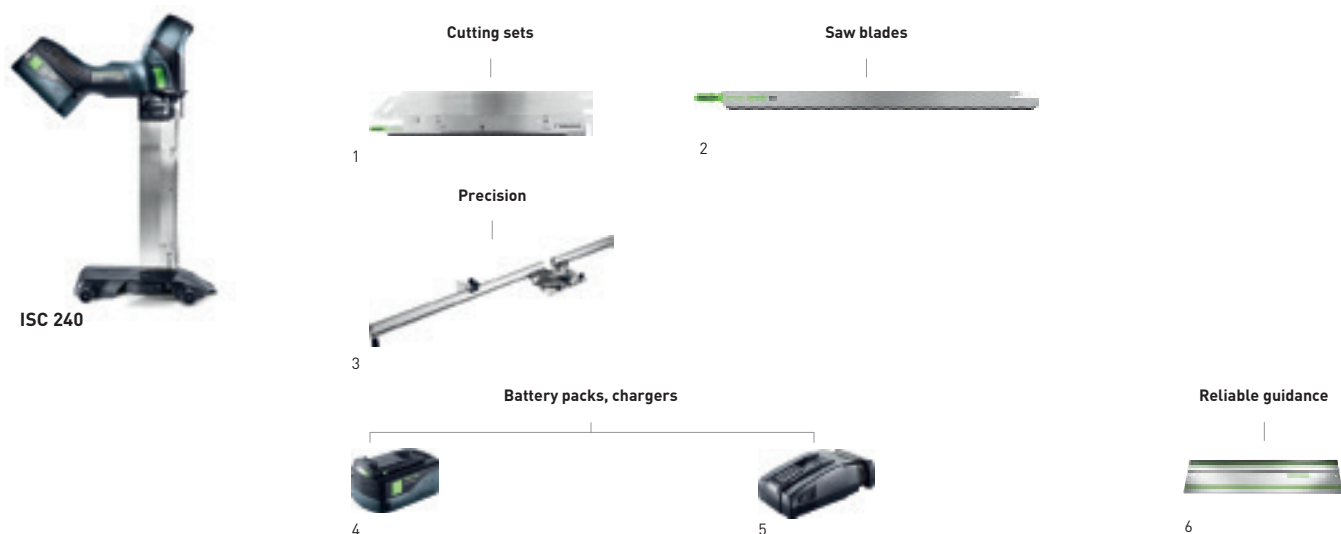

Accessories for ISC 240 cordless insulating-material saw

	Denomination	Explanation	Order no.
1	Cutting set SG-240/G-ISC	for ISC 240 EB, cutting set with cross-set saw blade, for polyurethane and polystyrene insulation boards, hard rock wool and glass wool, cutting length 240 mm, in self-service display pack	575409
	Cutting set SG-350/G-ISC	for ISC 240 EB, cutting set with cross-set saw blade, for polyurethane and polystyrene insulation boards, hard rock wool and glass wool, cutting length 350 mm, in self-service display pack	575410
	Cutting set SG-240/W-ISC	for ISC 240 EB, cutting set with serrated saw blade, for flexible mineral fibre insulating materials and natural insulating materials, cutting length 240 mm, in self-service display pack	575411
	Cutting set SG-350/W-ISC	for ISC 240 EB, cutting set with serrated saw blade, for flexible mineral fibre insulating materials and natural insulating materials, cutting length 350 mm, in self-service display pack	575412
2	Saw blade DSB 240/G	for ISC 240 EB, replacement saw blade for SG-240/G-ISC cross-set cutting set, cutting length 240 mm, saw blade material HCS, in self-service display pack	575414
	Saw blade DSB 350/G	for ISC 240 EB, replacement saw blade for SG-240/G-ISC cross-set cutting set, cutting length 350 mm, saw blade material HCS, in self-service display pack	575415
	Saw blade DSB 240/W	for ISC 240 EB, replacement saw blade for SG-240/G-ISC cross-set cutting set, cutting length 240 mm, saw blade material HCS, in self-service display pack	575416
	Saw blade DSB 350/W	for ISC 240 EB, replacement saw blade for SG-240/G-ISC cross-set cutting set, cutting length 350 mm, saw blade material HCS, in self-service display pack	575417
3	Angle stop FS-WA-ISC	for FS/2 with ISC 240, for fixed cuts, can be re-set using the scale and end stop, mounting on the guide rail without the use of tools, Transport position for compact transport of angle stop connected to the guide rail, stop ruler, adjustable stop, max. workpiece width 900 mm, angular range -47° – $+47^{\circ}$, in carton	575413

System accessories

Accessories for ISC 240 cordless insulating-material saw

	Denomination	Explanation	Order no.
4	Battery pack BP 18 Li 5,2 AS	with AIRSTREAM function, lithium-ion (Li-ion) replacement battery pack for all Festool 18 V cordless tools (except CXS, TXS, ETSC 125, RTSC 400, DTSC 400), tensioner 18 V, capacity 5,2 Ah, weight 0,7 kg, in self-service display pack	200181
	Battery pack BP 18 Li 5,2 ASI	Bluetooth® lithium-ion (Li-ion) battery pack with AIRSTREAM function for all Festool 18 V cordless tools (except CXS, TXS, ETSC 125, RTSC 400, DTSC 400), Bluetooth® enables the CLEANTEC mobile dust extractor to be started automatically when the cordless tool is switched on (use of a Bluetooth®-compatible mobile dust extractor is required), tensioner 18 V, capacity 5,2 Ah, weight 0,7 kg, in carton	202479
	Battery pack BP 18 Li 6,2 AS	with AIRSTREAM function, lithium-ion (Li-ion) replacement battery pack for all Festool 18 V cordless tools (except CXS, TXS, ETSC 125, RTSC 400, DTSC 400), tensioner 18 V, capacity 6,2 Ah, weight 0,7 kg, in self-service display pack	201774
	Battery pack BP 18 Li 6,2 ASI	Bluetooth® lithium-ion (Li-ion) battery pack with AIRSTREAM function for all Festool 18 V cordless tools (except CXS, TXS, ETSC 125, RTSC 400, DTSC 400), Bluetooth® enables the CLEANTEC mobile dust extractor to be started automatically when the cordless tool is switched on (use of a Bluetooth®-compatible mobile dust extractor is required), tensioner 18 V, capacity 6,2 Ah, weight 0,7 kg, in carton	201797
	Battery pack BP 18 Li 3,1 C	compact, lightweight design, lithium-ion (Li-ion) replacement battery pack for all Festool 18 V cordless tools (except TSC 55, CXS, TXS, ETSC 125, RTSC 400, DTSC 400), tensioner 18 V, capacity 3,1 Ah, weight 0,4 kg, in self-service display pack	201789
	Battery pack BP 18 Li 3,1 CI	Bluetooth® lithium-ion (Li-ion) replacement battery pack for all Festool 18 V cordless tools (except TSC 55, CXS, TXS, ETSC 125, RTSC 400, DTSC 400), Bluetooth® enables the CLEANTEC mobile dust extractor to be started automatically when the cordless tool is switched on (use of a Bluetooth®-compatible mobile dust extractor is required), tensioner 18 V, capacity 3,1 Ah, weight 0,4 kg, in carton	203799
5	Rapid charger TCL 6	for all Li-ion battery packs (except for CXS/TXS), Lithium-ion (Li-ion) replacement charger for all 10,8 – 18 V battery packs, charging current 6 A, input voltage 220 – 240 V, weight 0,8 kg, in self-service display pack	201135
	Rapid charger SCA 8	for all Li-ion battery packs (except for CXS/TXS), with AIRSTREAM function, Lithium-ion (Li-ion) replacement charger for all 10,8 – 18 V battery packs, charging current 8 A, input voltage 220 – 240 V, weight 1,1 kg, in self-service display pack	200178
	Battery and charging technology	from page 14	
6	Guide-rails	see the "Organising your workplace" chapter from page 388	

System accessories



SYM 70 R

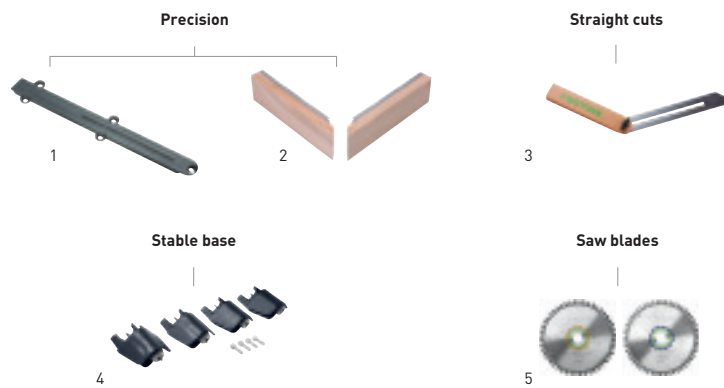

Accessories for SYMMETRIC SYM 70 R compound mitre saw

Denomination	Explanation	Order no.
1 Table top insert TE-SYM 70	for SYMMETRIC 70 E, qty. in pack 3 Units, in self-service display pack	491054
2 Additional stop ZA-SYM 70 E	for SYMMETRIC 70 E, for cutting undercut strips, qty. in pack 2 Units, in carton	491886
3 Precision adjustable square SM-SYM 70	for SYMMETRIC 70 E, in self-service display pack	491053
4 Increase EH-SYS-SYM 70	for SYMMETRIC 70 E, intermediate bases for elevating the SYM 70 to the height of a SYS 1 T-LOC and Classic SYSTAINER, table height = SYSTAINER: Long workpieces can be conveniently supported while working, already included in scope of delivery for SYM 70 RE (for retrofitting to the SYM 70 E), in carton	203425
5 Circular saw blades	from page 84	

System accessories



SSU 200



IS 330

Parallel side fence



1

Swords



4

Saw chains



2

Safe guide



5

Chain lubrication oil



3

Precision



6

Accessories for sword saws SSU 200, IS 330

	Denomination	Explanation	Order no.
1	Parallel side fence PA-SSU 200	for SSU 200, IS 330, SSP 200, ISP 330, parallel guide, guided on both sides, in carton	769098
	Parallel side fence PA-A SSU 200	for SSU 200, IS 330, SSP 200, ISP 330, bilateral offset parallel stop, in carton	769099
2	Chainsaw chain SC 3/8"-91 U-39E	for SSU 200, SSP 200, chain pitch 3/8", saw chain Uni, for rip and cross cuts, in self-service display pack	769101
	Chainsaw chain SC 3/8"-91 L-39E	for SSU 200, SSP 200, chain pitch 3/8", saw chain, longitudinal cuts, for rip cuts, in self-service display pack	769103
	Chainsaw chain SC 3/8"-91 F-39E	for SSU 200, SSP 200, chain pitch 3/8", saw chain fine, for fine and cross cuts, in self-service display pack	769102
	Chainsaw chain SC 3/8"-90 I-39E	for SSU 200, SSP 200, saw chain ISO, chain pitch 3/8", for flexible to pressure-resistant insulating materials, in self-service display pack	769100
	Chainsaw chain SC 3/8"-90 I-57E	for IS 330, ISP 330, saw chain ISO, chain pitch 3/8", for flexible to pressure-resistant insulating materials, in self-service display pack	769088
	Chainsaw chain SC 3/8"-91 IH-57E	for IS 330, ISP 330, for extremely pressure-resistant insulating materials, chain pitch 3/8", saw chain ISO Hard, in self-service display pack	769090
3	Chain lubrication oil CO 1 L	for SSU 200, IS 330, SSP 200, ISP 330, CCP 380, volume 1 litre, in plastic bottle	769038
4	Blade GB 10"-SSU 200	for SSU 200, SSP 200, in self-service display pack	769066
	Blade GB 13"-IS 330	for IS 330, ISP 330, in self-service display pack	769089
5	Guide-rails	see the "Organising your workplace" chapter from page 388	
6	angle stop	see the "Organising your workplace" chapter from page 406	

Saw blades

New versatility for perfect cuts.

Whether you require speed for straight cuts or precision in tight curves. In wood, plastic, building materials or metal. With cross-set or sanded teeth, a small or large pitch, made from HCS tool steel or carbide-tipped. No matter what you want to cut, a glance at the optimised application overview of Festool's new range of jigsaw blades will help you find the correct saw blade right away.

WOOD

Wood

For outstanding results in wooden materials with high-grade HCS tool steel.

PLASTICS

Plastic materials

Specially designed for excellent cutting results in virtually all plastics.

METAL

Metal

Rippled basic form made from HCS bimetal – ideal for machining metals such as aluminium and steel.

BUILDING MATERIALS

Building materials

Carbide-tipped for the longest service life even with abrasive materials.

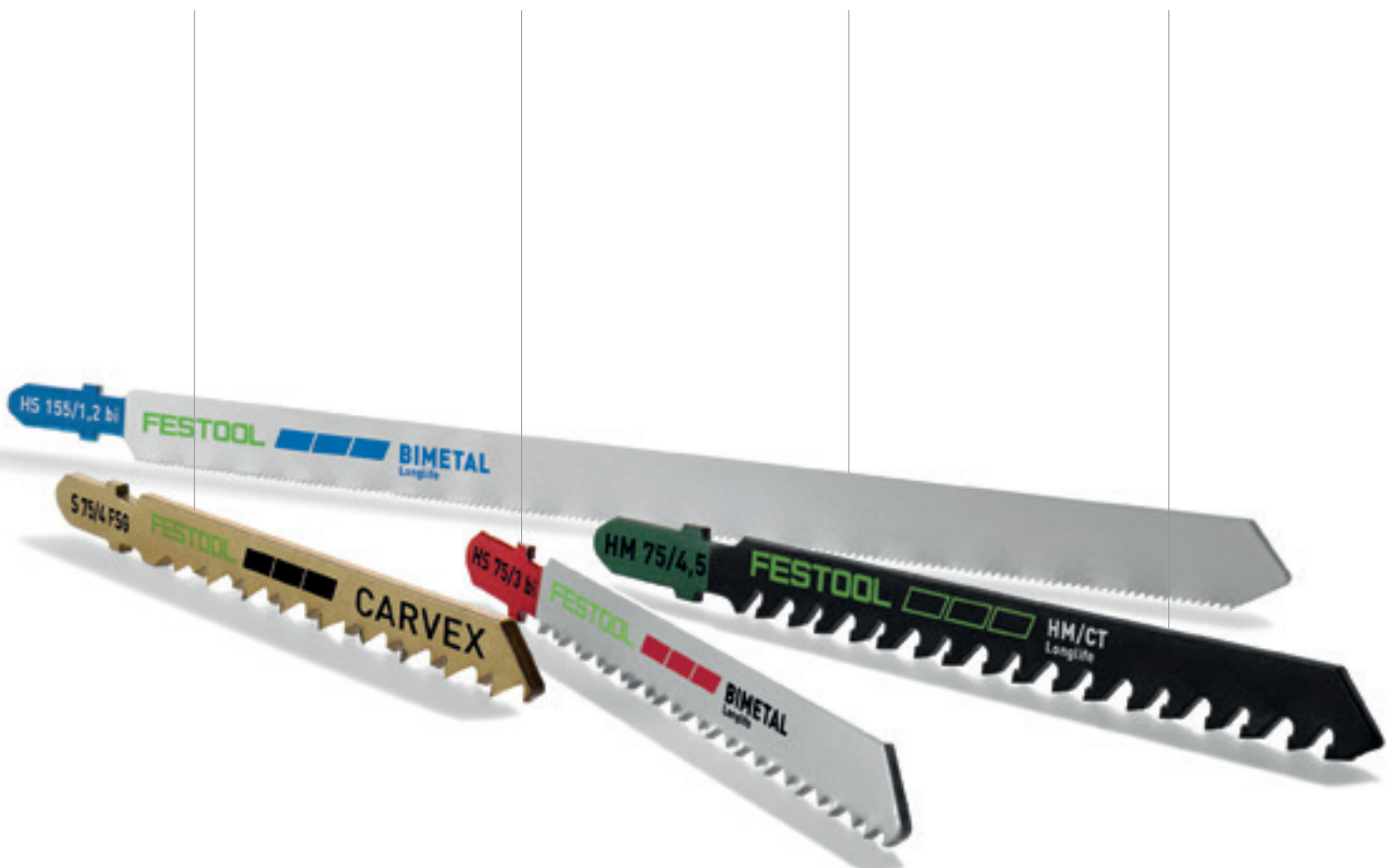

Tips for setting the jigsaw correctly depending on the application.

Speed control

High speeds in settings 4–6 are ideal for machining soft, temperature-resistant materials such as wood. Low speed settings of 1–3 are recommended for temperature-sensitive plastics such as acrylic glass or PET in order to avoid smearing and for metals and building materials in order to minimise jigsaw blade wear and the production of dust.



Pendulum stroke setting

A higher pendulum stroke makes it faster and easier for the jigsaw to work through the material, but it usually results in significant splintering. A low or deactivated pendulum stroke ensures low-splinter, accurate cuts at a low working speed and is therefore ideal for precise adjustment work and curved cuts.



Material	Saw blade	Application	Speed recommendation	Pendulum stroke recommendation
WOOD	Basic	For quick cuts in wood where high precision is not required.	4–6	
	Universal	The universal blade for perpendicular cuts fundamentally encompasses all relevant applications involving wood. Also ideal in combination with the Festool guide rail.	4–6	
	NEW Straight Cut	For highly precise perpendicular cuts thanks to extremely sharp Japanese teeth – the fibres are firstly scored, then cut through cleanly.	4–6	Min. for high precision Max. for high speed
	NEW Curves	Ideal for curves – even extremely tight radii are possible.	4–6	
	NEW Fine Cut	For precisely cut and splinter-free surfaces.	4–6	
PLASTICS	Solid Materials	For the toughest demands such as plastic solid material and fibre-reinforced plastics.	1–3	
	NEW Profile	For plastic profiles, acrylic glass (e.g. Plexiglas®) and soft plastics.	1–3	off
	NEW Laminate	For laminate and boards bonded with melamine resin (e.g. Trespa®).	1–3	
METAL	NEW Steel/Stainless Steel	For machining aluminium, non-ferrous metals and steel.	1–3	off
	Sandwich Materials	For sandwich materials.	1–3	
BUILDING MATERIALS	Abrasive Materials	For gypsum and cement-bonded chipboard and fibreboard.	1–3	
	Ceramics	For machining brickwork and ceramics.	1–3	Min. for high precision Max. for high speed
	Insulation	For soft insulating materials, cardboard and polystyrene.	1–3	

Saw blades

Tooth pitch, type and material



cross-set teeth for quick cuts



conically ground blades for clean cuts



HCS tool steel: standard quality for all types of wood



HS bimetal: resistant to high temperatures and hard-wearing

Saw blade features



carbide: resistant to high temperatures and hard-wearing



brazed carbide grit, fine































coarse or fine saw blade. Rule of thumb: at least 3 teeth should be engaged



serrated blade, milled teeth

Material	Basic		Straight cuts	Curved cuts	perpendicular cuts	Clean, splinter-free cut	Length of cutting blade	Pitch	
WOOD		S 75/4/5	○	○			75 mm	4 mm	
		S 75/4/25	○	○			75 mm	4 mm	
		S 75/4/100	○	○			75 mm	4 mm	
		S 105/4/5	○	○			105 mm	4 mm	
	Universal								
		S 75/4 FSG/5		○	○	●		75 mm	4 mm
		S 75/4 FSG/20		○	○	●		75 mm	4 mm
		S 105/4 FSG/5		○	○	●		105 mm	4 mm
		S 105/4 FSG/20		○	○	●		105 mm	4 mm
		S 145/4 FSG/5		○	○	●		145 mm	4 mm
	Straight Cut								
		S 75/2,8/5		●		●	○	75 mm	2,8 mm
		S 75/2,8/20		●		●	○	75 mm	2,8 mm
		S 105/2,8/5		●		●	○	105 mm	2,8 mm
		S 105/2,8/20		●		●	○	105 mm	2,8 mm
	S 145/2,8/5		●		●	○	145 mm	2,8 mm	
Curves									
	S 75/1,4 K/5			○		○	75 mm	1,4 mm	
	S 75/4 K/5			●			75 mm	4 mm	
	S 75/4 K/20			●			75 mm	4 mm	
Fine Cut									
	S 75/2,5/5		●			●	75 mm	2,5 mm	
	S 75/2,5/25		●			●	75 mm	2,5 mm	
	S 75/2,5/100		●			●	75 mm	2,5 mm	
	S 75/2,5 R/5 (Shaping teeth)		●			●	75 mm	2,5 mm	

Saw blades

	Max. workpiece thickness	Qty. in pack	Order no.	 Solid wood	 Raw chipboard/blockboard, plywood	 Coated chipboard, veneered blockboard	 Melamine resin boards (Trespa®, Resopal®), laminate	 Fibre-reinforced plastics, GFRP	 soft plastics, PVC	 Plastic solid material, acrylic glass (Plexiglas®)	 Plastic profiles, acrylic glass (Plexiglas®)
	30 mm	5 Units	204305	●	●	●					
	30 mm	25 Units	204306	●	●	●					
	30 mm	100 Units	204346	●	●	●					
	60 mm	5 Units	204315	●	●	●					
	30 mm	5 Units	204316	●	●	●					
	30 mm	20 Units	204317	●	●	●					
	60 mm	5 Units	204327	●	●	●					
	60 mm	20 Units	204332	●	●	●					
	100 mm	5 Units	204335	●	●	●					
	30 mm	5 Units	204260	●	●	●					
	30 mm	20 Units	204261	●	●	●					
	60 mm	5 Units	204262	●	●	●					
	60 mm	20 Units	204263	●	●	●					
	100 mm	5 Units	204264	●	●	●					
	30 mm	5 Units	204267	●	●	●					
	30 mm	5 Units	204265	●	●	●					
	30 mm	20 Units	204266	●	●	●					
	30 mm	5 Units	204256	●	○	●			○	○	
	30 mm	25 Units	204257	●	○	●			○	○	
	30 mm	100 Units	204258	●	○	●			○	○	
	30 mm	5 Units	204259	●	○	●			○	○	

● Extremely appropriate
○ Appropriate

Saw blades

Tooth pitch, type and material



cross-set teeth for quick cuts



conically ground blades for clean cuts



HCS tool steel: standard quality for all types of wood



HS bimetal: resistant to high temperatures and hard-wearing

Saw blade features



carbide: resistant to high temperatures and hard-wearing



brazed carbide grit, fine













coarse or fine saw blade. Rule of thumb: at least 3 teeth should be engaged



serrated blade, milled teeth

Material	Solid Materials		Straight cuts	Curved cuts	perpendicular cuts	Clean, splinter-free cut	Length of cutting blade	Pitch
PLASTICS	HS 75/3 BI/5	HS 75/3 BI/5	○	○			75 mm	3 mm
	Profile							
	S 75/1,5/5	S 75/1,5/5	○	○			75 mm	1,5 mm
	Laminate							
	HM 90/3,3/1	HM 90/3,3/1	○				90 mm	3,3 mm
METAL	Steel/Stainless Steel							
	HS 75/1,2 BI/5	HS 75/1,2 BI/5	●				75 mm	1,2 mm
	HS 75/1,2 BI/20	HS 75/1,2 BI/20	●				75 mm	1,2 mm
	HS 105/1 BI/5	HS 105/1 BI/5	●				105 mm	1 mm
	Sandwich Materials							
	HS 155/1,2 BI/5	HS 155/1,2 BI/5	●				155 mm	1,2 mm
BUILDING MATERIALS	Abrasive Materials							
	HM 75/4,5	HM 75/4,5	○	●			75 mm	4,5 mm
	Ceramics							
	R 54 G Riff	R 54 G Riff	○	○				54 mm
	Insulation							
	S 155/W/3	S 155/W/3	○	○			155 mm	
	Jigsaw blade range for wood							
	STS-Sort/25 W	STS-Sort/25 W						75 mm
	Contents:							
	5 x Wood Basic: S 75/4							
	5 x Wood Universal S 75/4 FSG							
	5 x Wood Straight Cut S 75/2.8							
	5 x Wood Curves S75/4 K							
	5 x Wood Fine Cut S75/2.5							

Saw blades

Max. workpiece thickness	Qty. in pack	Order no.	Material Compatibility														
			HPL	EPOXY	Plastic	Plastic solid material, acrylic glass (Plexiglas®)	Plastic profiles, acrylic glass (Plexiglas®)	Aluminium, aluminium composite panels	Non-ferrous metals	Iron, steel	Multilayered boards	NIROSTA STAINLESS INOX	Brickwork, ceramics	Fibre cement, plasterboard	Cardboard, insulating materials		
 30 mm	5 Units	204336	●	○	●	●		○	○								
 30 mm	5 Units	204268			●		●										
 30 mm	1 Units	204269	●													●	
 20 mm	5 Units	204270						●	●	●		●					
 20 mm	20 Units	204271						●	●	●		●					
 40 mm	5 Units	204272						●	●	●		●					
 110 mm	5 Units	204337						●	●	●	●						
 30 mm	1 Units	204343	●	●												●	
 8 mm	1 Units	204344		●					○	○		●					
 110 mm	3 Units	204345															●
 30 mm	25 Units	204275															

● Extremely appropriate
○ Appropriate

Saw blades

Quality cuts better.

Durability and precision under the toughest conditions. Adapted to the application and material. Made from high-quality steel with saw teeth made from fine-grain carbide. After all, you can only achieve a perfect cut when the saw blade is as good as the machine.



Colour code



Wood/Soft plastics

For hardwood, softwood, solid wood and building panels.

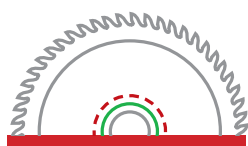

Plastics/Mineral materials

Fine-grain carbide guarantees perfect cuts in coated panels and mineral materials.



Aluminium

For aluminium profiles and panels.



Steel/Sandwich panels

The slightly chamfered teeth are suitable for sawing cable ducts or steel sheets and profiles.



Building materials

The material and teeth are designed specifically for working with abrasive materials.

Saw blades

**Perfect adaptation**

The saw blades are made of high-quality metal for perfect cuts and a long service life. Cutting angle and tooth shapes are adapted to the application and machine.

Long-term precision

A long service life and perfect cutting results come guaranteed thanks to the slow sanding action using diamond discs. Achieve flawless results without the need for major rework.

Simple selection

The practical colour coding system helps you quickly locate the correct saw blade for the specific application.

Minimum heat generation

Slow heating of the circular saw blades through laser-cut and thermally adjusted blade cores.

Robust quality

Long useful life and excellent sharpening properties of saw teeth guarantee an excellent price/performance ratio.

Rapid cutting progress

High-quality steel and optimised expansion slot for smooth, safe cutting progress.

Tooth shapes**Alternate top bevel saw blade (W/PW)**

The teeth on this blade slope to the left and right and cut alternately. The alternate top bevel saw blade is a universal blade for all types of wood.

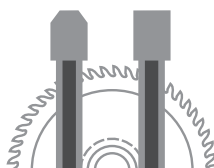
**Flat trapezoidal tooth saw blade (TF)**

With alternating trapezoidal and flat teeth, this blade is used for cutting aluminium, hard plastic and materials with hard coatings.

**Flat tooth saw blade (F)**

The edges of the teeth are straight, not slanted. Each tooth cuts in the same way. This tooth shape is used in saws for cutting steel and construction materials.

Saw blades

Colour code					
Material					
Recommended speed range	3-6	3-5	2-4	3-6	4-6

Standard saw blade

	Diameter	Cutting width	Hole Ø	No. of teeth	Chip angle	Tooth shape	Order no.	
	160x1,8x20 W18	160 mm	1,8 mm	20 mm	18	25°	W	500458
	160x2,2x20 W18	160 mm	2,2 mm	20 mm	18	25°	W	768129
	210x2,6x30 W18	210 mm	2,6 mm	30 mm	18	20°	W	493197
	230x2,5x30 W24	230 mm	2,5 mm	30 mm	24	20°	W	500647
	350x3,5x30 W24	350 mm	3,5 mm	30 mm	24	10°	W	769667

Panther saw blade

	160x1,8x20 PW12	160 mm	1,8 mm	20 mm	12	25°	W	500460
	160x2,2x20 PW12	160 mm	2,2 mm	20 mm	12	20°	PW	496301
	190x2,6 FF PW16	190 mm	2,6 mm	FF*	16	28°	PW	492049
	210x2,6x30 PW16	210 mm	2,6 mm	30 mm	16	28°	PW	493196
	225x2,6x30 PW18	225 mm	2,6 mm	30 mm	18	28°	PW	496303
	230x2,5x30 PW18	230 mm	2,5 mm	30 mm	18	28°	PW	500646

Universal saw blade

	160x2,2x20 W28	160 mm	2,2 mm	20 mm	28	15°	W	496302
	190x2,6 FF W32	190 mm	2,6 mm	FF*	32	10°	W	492048
	210x2,4x30 W36	210 mm	2,4 mm	30 mm	36	15°	W	493198
	216x2,3x30 W36	216 mm	2,3 mm	30 mm	36	-5°	W	500124
	225x2,6x30 W32	225 mm	2,6 mm	30 mm	32	20°	W	488288
	260x2,5x30 W60	260 mm	2,5 mm	30 mm	60	-5°	W	494604

Fine tooth saw blade

	160x1,8x20 W32	160 mm	1,8 mm	20 mm	32	5°	W	500459
	160x2,2x20 W48	160 mm	2,2 mm	20 mm	48	5°	W	491952
	190x2,4 FF W48	190 mm	2,4 mm	FF*	48	8°	W	492050
	210x2,4x30 W52	210 mm	2,4 mm	30 mm	52	5°	W	493199
	216x2,3x30 W48	216 mm	2,3 mm	30 mm	48	-5°	W	491050
	216x2,3x30 W60	216 mm	2,3 mm	30 mm	60	-5°	W	500125
	225x2,6x30 W48	225 mm	2,6 mm	30 mm	48	10°	W	488289
	230x2,5x30 W48	230 mm	2,5 mm	30 mm	48	10°	W	500648
	260x2,5x30 W80	260 mm	2,5 mm	30 mm	80	-5°	W	494605

Recommended speed range

* FF = FastFix interface

Saw blades

Colour code					
Material					
			Fe	Al	
Recommended speed range	3-6	3-5	2-4	3-6	4-6

Special saw blade

	Diameter	Cutting width	Hole Ø	No. of teeth	Chip angle	Tooth shape	Order no.	
	160x2,2x20 TF52	160 mm	2,2 mm	20 mm	52	-5°	TF	496306
	190x2,6 FF TF58	190 mm	2,6 mm	FF*	58	-5°	TF	492051
	210x2,4x30 TF72	210 mm	2,4 mm	30 mm	72	-5°	TF	493201
	216x2,3x30 W60	216 mm	2,3 mm	30 mm	60	-5°	W	491051
	216x2,3x30 TF64	216 mm	2,3 mm	30 mm	64	0°	TF	500122
	225x2,6x30 TF68	225 mm	2,6 mm	30 mm	68	-5°	TF	488291
	230x2,5x30 TF76	230 mm	2,5 mm	30 mm	76	-5°	TF	500649
	260x2,4x30 TF68	260 mm	2,4 mm	30 mm	68	0°	TF	494607

Special saw blade

	160x2,2x20 TF48	160 mm	2,2 mm	20 mm	48	4°	TF	496308
	190x2,6 FF TF54	190 mm	2,6 mm	FF*	54	4°	TF	492052
	210x2,4x30 TF60	210 mm	2,4 mm	30 mm	60	4°	TF	493200
	216x2,3x30 WZ/FA60	216 mm	2,3 mm	30 mm	60	-5°	WZ/FA	500123
	225x2,6x30 TF64	225 mm	2,6 mm	30 mm	64	4°	TF	489459
	260x2,5x30 WZ/FA64	260 mm	2,5 mm	30 mm	64	-5°	WZ/FA	494606

Flat tooth saw blade

	210x2,2x30 F36	210 mm	2,2 mm	30 mm	36	1°	F	493351
	230x2,5x30 F48	230 mm	2,5 mm	30 mm	48	0°	F	500651
	350x2,9x30 TF60	350 mm	2,9 mm	30 mm	60	0°	TF	769668

Diamond saw blade

	160x2,2x20 DIA4	160 mm	2,2 mm	20 mm	4	-5°	F	201910
	Saw blade only suitable for TS 55 R and TSC 55							

Recommended speed range

**FF = FastFix interface

Saw blades

Coated panels, laminate panels																		
Veneered panels, parquet																		
Hard plastic, hard PVC																		
Hard, abrasive building panels, cement-bonded chipboard																		
Aluminium panels 8-25 mm, aluminium profiles																		
MDF and plasterboard, soft cement panels																		
Plywood, multiplex/multilayered wood																		
Acrylic glass																		
Fibre-reinforced plastics																		
Phenolic-resin-bonded fibres and fabrics																		
Steel cable ducts, multilayered board, false floors																		
MDF – Medium-density fibreboard																		
Melamine resin boards																		
Aluminium composite panels																		
Non-ferrous metals, copper, brass																		
Dry plaster material																		

TS 55 R, TSC 55, TS 55, ATF 55, AP 55																		
TS 75																		
HK 55, HKC 55																		
HK 85																		
HK 132																		
PRECISIO CS 70																		
PRECISIO CS 50																		
SYMMETRIC SYM 70																		
KAPEX KS 60																		
KAPEX KS 88, KS 120																		

Processed material

Suitable for machine

	○	○	●	●			●	●	●			●	●		
	○	○	●	●			●	●	●			●	●		
	○	○	●	●			●	●	●			●	●		
	○	○	●	●			●	●	●			●	●		
	○	○	●	●			●	●	●			●	●		
	○	○	●	●			●	●	●			●	●		
	○	○	●	●			●	●	●			●	●		
	○	○	●	●			●	●	●			●	●		
	○	○	○		○	○	○	○	●	○	●				
	○	○	○		○	○	○	○	●	○	●				
	○	○	○		○	○	○	○	●	○	●				
	○	○	○		○	○	○	○	●	○	●				
	○	○	○		○	○	○	○	●	○	●				
							○	○	●						
							○	○	●						
									●						
	●												●		
6	6	4-6	4-6	4-6	4-6	6	4-6	4-6	3-6	2-3	6	4-6	4-6	3-6	4-6

●													
		●											
												●	
		●											
													●



FESTOOL

220

03 Machining surfaces

Overview of products and applications **90**

Electric and cordless sanders

Gear-drive eccentric sander ROTEX – RO 90 DX, RO 125, RO 150 **99**

Eccentric sander – ETS 125 R, ETSC 125, ETS EC 125, ETS 150, ETS EC 150 **102**

Orbital sander RUTSCHER – RS 100, RS 200, RS 300, RTS 400 R, RTSC 400 **108**

Delta sander – DTS 400 R, DTSC 400 **113**

Linear sander DUPLEX – LS 130 **115**

Rotary sander – RAS 180 **116**

PLANEX long-reach sander – LHS-E 225, LHS 225 **117**

Belt sanders – BS 75, BS 105, CMS-BS **119**

Compressed air sanders

Compressed air eccentric sander – LEX 3 **123**

Compressed air RUTSCHER – LRS 93, LRS 400 **126**

Polishers and oil dispensers

Rotary polisher – SHINEX RAP 150, POLLUX 180 **130**

SURFIX oil dispenser – OS **132**

Brush machine

RUSTOFIX brush machine – BMS 180 **133**

Accessories and consumable materials **134**

The Festool system

Overview of products and applications

Whether you need to remove material quickly and efficiently or achieve a particularly fine sanding finish – your applications determine the requirements and Festool sanders provide all the answers. Simply select the right machine for your most frequently performed practical applications.

Gear-drive eccentric sander ROTEX



RO 90 DX
Page 99



RO 125
Page 100



RO 150
Page 101

Applications

Flat surfaces

Coarse sanding	○	●	●
Rough sanding	○	●	●
Fine sanding	○	●	●
Extra-fine sanding	○	○	○

Curved surfaces

Coarse sanding	○	●	●
Rough sanding	●	●	●
Fine sanding	●	●	●
Extra-fine sanding	○	○	○

Internal corners

Coarse sanding	●		
Rough sanding	●		
Fine sanding	●		
Extra-fine sanding	○		







Polishing

Small surfaces	●	●	○
Large surfaces		○	●

Technical data

Battery voltage (V)			
Li-ion battery capacity (Ah)			
Power consumption (with mains adapter*) (W)	400	500	720
ROTEX rotary motion speed (rpm)	260 – 520	300 – 600	320 – 660
Eccentric motion speed (rpm)	3.500 – 7.000	3.000 – 6.000	3.300 – 6.800
Sanding stroke (mm)	3	3,6	5
Sanding pad dia./StickFix sanding pad (mm)	90	125	150
Weight (with li-ion**) (kg)	1,5	1,9	2,3

Overview of products and applications

<u>Eccentric sanders</u>	<u>Cordless eccentric sander</u>	<u>Eccentric sanders</u>				
						
ETS 125 R Page 102	ETSC 125 Page 103	ETS EC 125 Page 104	ETS 150/3 Page 105	ETS 150/5 Page 105	ETS EC 150/3 Page 106	ETS EC 150/5 Page 106

<input type="radio"/>	<input type="radio"/>	<input type="radio"/>	<input type="radio"/>	<input checked="" type="radio"/>	<input type="radio"/>	<input checked="" type="radio"/>
<input checked="" type="radio"/>	<input checked="" type="radio"/>	<input checked="" type="radio"/>	<input checked="" type="radio"/>	<input checked="" type="radio"/>	<input checked="" type="radio"/>	<input checked="" type="radio"/>
<input checked="" type="radio"/>	<input checked="" type="radio"/>	<input checked="" type="radio"/>	<input checked="" type="radio"/>	<input type="radio"/>	<input checked="" type="radio"/>	<input type="radio"/>
<input type="radio"/>	<input type="radio"/>	<input type="radio"/>	<input type="radio"/>	<input checked="" type="radio"/>	<input type="radio"/>	<input checked="" type="radio"/>
<input checked="" type="radio"/>	<input checked="" type="radio"/>	<input checked="" type="radio"/>	<input checked="" type="radio"/>	<input checked="" type="radio"/>	<input checked="" type="radio"/>	<input checked="" type="radio"/>
<input checked="" type="radio"/>	<input checked="" type="radio"/>	<input checked="" type="radio"/>	<input checked="" type="radio"/>	<input type="radio"/>	<input checked="" type="radio"/>	<input type="radio"/>

	18					
	3,1					
250	150*	400	310	310	400	400
6.000 – 12.000	6.000 – 10.000	6.000 – 10.000	4.000 – 10.000	4.000 – 10.000	6.000 – 10.000	6.000 – 10.000
2	2	3	3	5	3	5
125	125	125	150	150	150	150
1,2	1,4**	1,2	1,8	1,8	1,2	1,2

● Extremely appropriate
○ Appropriate

Overview of products and applications

Geared orbital sanders RUTSCHER

Orbital sander RUTSCHER



RS 100
Page 108



RS 100 C
Page 108



RS 200
Page 109



RS 300
Page 110

Applications

Flat surfaces

Coarse sanding	●	●		
Rough sanding	●	●	○	○
Fine sanding	○	○	●	●
Extra-fine sanding			○	○

Curved surfaces

Coarse sanding				
Rough sanding				
Fine sanding				
Extra-fine sanding				

Internal corners

Coarse sanding				
Rough sanding				○
Fine sanding				●
Extra-fine sanding				○

Profiles

Coarse sanding				
Rough sanding				
Fine sanding				
Extra-fine sanding				

Technical data

Battery voltage [V]				
Li-ion battery capacity [Ah]				
Power consumption (with mains adapter*) [W]	620	520	330	280
Idle engine speed [rpm]	6.000	7.000	4.000 – 10.000	4.000 – 10.000
Sanding stroke [mm]	5	5	2,4	2,4
Sanding pad [mm]	115 x 221	115 x 221	115 x 225	93 x 175
Weight (with li-ion**) [kg]	3,1	3,0	2,5	2,3

Overview of products and applications

Cordless orbital sander RUTSCHER

Delta sander

Cordless delta sander

Linear sander DUPLEX



RTS 400 R
Page 111



RTSC 400
Page 112



DTS 400 R
Page 113



DTSC 400
Page 114



LS 130
Page 115

	RTS 400 R	RTSC 400	DTS 400 R	DTSC 400	LS 130
	○	○	○	○	
	●	●	●	●	○
	○	○	○	○	
					●
					●
					○
	○	○	○	○	○
	○	○	○	○	●
	○	○	○	○	○
					○
					●
					●
					○

	18			18	
	3,1			3,1	
	250	150*	250	150*	260
	6.000 – 12.000	6.000 – 10.000	6.000 – 12.000	6.000 – 10.000	4.000 – 6.000
	2	2	2	2	4
	80 x 130	80 x 130	100 x 150	100 x 150	133 x 80
	1,2	1,4**	1,2	1,4**	1,7

● Extremely appropriate
○ Appropriate

Overview of products and applications

Rotary sander

PLANEX long-reach sander



RAS 180
Page 116



LHS-E 225
Page 117



LHS 225
Page 118

Applications

Flat surfaces

Coarse sanding	●
Rough sanding	●
Fine sanding	
Extra-fine sanding	

Curved surfaces

Coarse sanding	○
Rough sanding	○
Fine sanding	
Extra-fine sanding	

Drywalling

Sanding plasterboard and dry wall filler	●	●
Sanding set filler	●	●
Sanding filler on high ceilings	●	●

Texturing surfaces

Technical data

Power consumption (W)	1.500	400	550
Idle engine speed (rpm)	800 – 4.000	400 – 920	340 – 910
Sanding pad Ø (mm)	180	215	215
Belt length x belt width (mm)			
Sanding area (mm)			
Tool Ø (mm)			
Weight (Length 1.10 m) (kg)			3,8
Weight (Length 1.60 m) (kg)			4,6
Weight (kg)	4,2	4,0	

Overview of products and applications

Belt sanders

Compact Module System CMS

RUSTOFIX brush machine



BS 75
Page 119



BS 105
Page 120



CMS-BS
Page 121



BMS 180
Page 133

	●	●	○
	●	●	○
	○	○	○
		●	○
		○	○
			●

800	1.200	550	1.500
		2.800	800 – 4.000
533 x 75	620 x 105	820 x 120	
135 x 75	160 x 105	185 x 185	
			150
3,8	6,5		7,5

● Extremely appropriate
○ Appropriate

Overview of products and applications

LEX compressed air eccentric sander



LEX 3 77
Page 123

LEX 3 125/3
Page 124

LEX 3 125/5
Page 124

LEX 3 150/3
Page 125

LEX 3 150/5
Page 125

Applications

Flat surfaces

Coarse sanding		○	●		●
Rough sanding		○	○	○	○
Fine sanding	●	●	○	●	○
Extra-fine sanding	●	●		●	

Curved surfaces

Coarse sanding		○	●		●
Rough sanding		○	○	○	○
Fine sanding	●	●	○	●	○
Extra-fine sanding	●	●		●	

Internal corners

Coarse sanding					
Rough sanding					
Fine sanding					
Extra-fine sanding					

Technical data

Operating pressure (flow pressure) (bar)	6	6	6	6	6
rpm	21.000	19.000	19.000	20.000	20.000
Eccentric motion speed (rpm)	10.500	9.500	9.500	10.000	10.000
Sanding stroke (mm)	2,5	3	5	3	5
Pad Ø (mm)	77	125	125	150	150
Sanding pad StickFix (mm)					
Air consumption at rated load (l/min)	270	290	290	290	290
Weight (kg)	0,8	1,0	1,0	1,0	1,0

Overview of products and applications

Compressed air orbital sander



LEX 3 150/7
Page 125



LRS 93
Page 126



LRS 400
Page 127



●	●	●
○	●	●
	○	○

●		
○		

	●	●
	●	●
	○	



6	6	6
20.000	14.000	14.000
10.000		
7	4	4
150		
	93 x 175	80 x 400
310	310	390
1,0	1,5	2,1

Overview of products and applications

Rotary polisher



SHINEX RAP 150-14
Page 130



SHINEX RAP 150-21
Page 130



POLLUX 180
Page 131

Applications

Polishing

Small surfaces	○	○	
Large surfaces	●	●	●

Technical data

Power consumption (W)	1.200	1.200	1.500
Idle engine speed (rpm)	600 – 1.400	900 – 2.100	800 – 2.400
Maximum polishing pad diameter (mm)	150	150	180
Spindle thread	M14	M14	M14
Weight (kg)	2,1	2,1	3,6

Extremely appropriate ●
Appropriate ○

Geared eccentric sanders ROTEX RO 90 DX



Round tool that also sands in corners.

- › Four tools in one: for coarse sanding, fine sanding, delta sanding and polishing. Resulting in low investment costs and savings on working time
- › Durable eccentric bearings, a double-sealed gear unit and a dustproof switch extend the service life of the machine
- › ROTEX rotary motion for convenient polishing – the reduced speed keeps the temperature low and prevents the polish from clouding or spraying off
- › FastFix sanding pad system, tool-less

Technical data	
Power consumption (watt)	400
ROTEX rotary motion speed (RPM)	260 – 520
Eccentric motion speed (RPM)	3.500 – 7.000
Sanding stroke (mm)	3
FastFix sanding pad dia. (mm)	90
Dust extraction connection dia. (mm)	27
Weight (kg)	1,5



■ = MMC Multi Material Control electronics

Items included	Order no.
RO 90 DX FEQ-Plus FastFix sanding pad, Ø 90 mm (soft-HT), StickFix sanding pad V93, Festool PROTECTOR, in SYSTAINER SYS 2 T-LOC	571819



Four tools in one.

One machine that can be used for coarse sanding, fine sanding, polishing and delta sanding. Low initial costs, maximum flexibility and a wide range of applications. More efficient and saves more time.

System accessories
from page 136



Abrasives
from page 154



Geared eccentric sanders

ROTEX RO 125



Handy all-rounder.

- › A powerful motor and combination of eccentric and orbital motion removes material three times faster than conventional eccentric sanders
- › Three tools in one for coarse sanding, fine sanding and polishing
- › Healthy, efficient dust extraction with the Jetstream principle
- › FastFix sanding pad system, tool-less

Technical data	
Power consumption (watt)	500
ROTEX rotary motion speed (RPM)	300 – 600
Eccentric motion speed (RPM)	3.000 – 6.000
Sanding stroke (mm)	3,6
FastFix sanding pad dia. (mm)	125
Dust extraction connection dia. (mm)	27
Weight (kg)	1,9



■ = MMC Multi Material Control electronics

Items included	Order no.
----------------	-----------

RO 125 FEQ-Plus
FastFix sanding pad Ø 125 mm (soft-HT), Festool PROTECTOR,
in SYSTAINER SYS 2 T-LOC

571779

Extremely durable.

With robust eccentric bearings, a double-sealed housing and dustproof switches, the ROTEX can even withstand long periods of continuous use.

System accessories
from page 137



Abrasives
from page 156

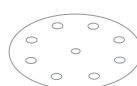

Geared eccentric sanders

ROTEX RO 150



The original 3-in-1 principle with powerful machine concept.

- › Three tools in one for coarse sanding, fine sanding and polishing
- › FastFix sanding pad system, tool-less
- › Eccentric motion for high-quality, scratch-free surfaces
- › Sanding up to the edge thanks to the Festool PROTECTOR

Technical data	
Power consumption (watt)	720
ROTEX rotary motion speed (RPM)	320 – 660
Eccentric motion speed (RPM)	3.300 – 6.800
Sanding stroke (mm)	5
FastFix sanding pad dia. (mm)	150
Dust extraction connection dia. (mm)	27
Weight (kg)	2,3

■ = MMC Multi Material Control electronics

Items included	Order no.
MULTI-JETSTREAM 2 FastFix sanding pad Ø 150 mm (soft W), Festool PROTECTOR	
RO 150 FEQ in carton	575066
RO 150 FEQ-Plus in SYSTAINER SYS 3 T-LOC	575069



Short tooling times thanks to FastFix pad change.

Simple, quick and safe. You don't need any other tools for changes apart from your hands. Simply remove the pad, replace and carry on working...

System accessories
from page 138



Abrasives
from page 157



Eccentric sander ETS 125 R



The compact one-handed sander.

- › Work effortlessly: Thanks to the compact design, weight of just 1.2 kg and a perfectly balanced weight distribution
- › Up to 25% greater material removal capacity: The MMC control electronics transfer the power of 250 watts directly to the work surface
- › A healthy working environment and less rework: In combination with the mobile dust extractor or the long-life dust collection bag and attachable PROTECTOR for smooth sanding along window surfaces, frames and panelling
- › For continuous use: Long-life dust collection bag which can be emptied and reused, made from extra-durable nonwoven polyester

Technical data

Power consumption (watt)	250
Eccentric motion speed (RPM)	6.000 – 12.000
Sanding stroke (mm)	2
Interchangeable sanding pad dia. (mm)	125
Dust extraction connection dia. (mm)	27
Weight (kg)	1,2



■ = Electronic

Better handling, less strenuous work.

The ergonomic design of the compact sander is ideal for one-handed operation – for right and left-handers. The machine is perfectly balanced so that sanding pads run smoothly, allowing you to work effortlessly for longer.

Items included

Order no.

StickFix sanding pad Ø 125 mm (soft-HT), Festool PROTECTOR, long-life chip collection bag

ETS 125 REQ
in carton

201213

ETS 125 REQ-Plus
in SYSTAINER SYS 2 T-LOC

574636

System accessories
from page 139



Abrasives
from page 156



Cordless eccentric sander ETSC 125



NEW Bluetooth® battery included:
Starts mobile dust extractor auto-
matically.*



Brushless EC-TEC motor for a long service life and a high level of efficiency

The ergonomic cordless one-handed sander.

- › Mobile and effortless: Without cable and hose, with perfect ergonomics, low height and a weight of just 1.4 kg
- › Powerful: The 18 V battery pack in combination with the brushless EC-TEC motor ensures power similar to that of a mains-powered tool
- › No interruptions: Thanks to battery packs with a capacity of 3.1 Ah which run for longer than their charge time
- › Unlimited running time: For continuous electrical operation, the battery pack can be replaced with the plug-in mains adapter (included in the set and available as an accessory)



Technical data	
Battery voltage (V)	18
Li-ion battery capacity (Ah)	3,1
Idle engine speed (RPM)	6.000 – 10.000
Sanding stroke (mm)	2
Interchangeable sanding pad dia. (mm)	125
Dust extraction connection dia. (mm)	27
Weight with Li-ion (kg)	1,4



= MMC
Multi Material Control electronics

Items included	Order no.
StickFix sanding pad Ø 125 mm (soft-HT), Festool PROTECTOR, long-life chip collection bag	
ETSC 125 Li-Basic without battery pack, without charger, in SYSTAINER SYS 2 T-LOC	201533
ETSC 125 Li 3,1 I-Plus 2 x BP 18 Li 3.1 ERGO-I battery pack, rapid charger TCL 6, in SYSTAINER SYS T-LOC 2	575719
ETSC 125 Li 3,1 I-Set 2 x BP 18 Li 3.1 ERGO-I battery pack, rapid charger TCL 6, ACA 18 V ERGO mains adapter (incl. plug-it power cable), in SYSTAINER SYS-COMBI 2	575712

Maximum mobility.

Work effortlessly overhead, vertically or in hard-to-reach areas – without power cable and hose, with perfect ergonomics and a weight of just 1.4 kg (including battery), perfectly balanced weight distribution and low height.

System accessories
from page 139



Abrasives
from page 156



* For more information on
Bluetooth® Autostart, go to page 16



Eccentric sander ETS EC 125

Brushless EC-TEC motor for a long service life and a high level of efficiency



The perfect finishing sander in the compact class.

- › Longlife thanks to EC technology and sanding pad brake with carbide tip
- › Continuously variable speed and constant speed control under load
- › Ideally positioned push-button prevents inadvertent switching on and off
- › With Jetstream sanding pad for optimum dust extraction

Technical data	
Power consumption (watt)	400
Eccentric motion speed (RPM)	6.000 – 10.000
Sanding stroke (mm)	3
Interchangeable sanding pad dia. (mm)	125
Dust extraction connection dia. (mm)	27
Weight (kg)	1,2

■ = MMC Multi Material Control electronics

Items included	Order no.
StickFix sanding pad Ø 125 mm (soft-HT), operation tool	
ETS EC 125/3 EQ in carton	571895
ETS EC 125/3 EQ-Plus in SYSTAINER SYS 2 T-LOC	571894
ETS EC 125/3 EQ-GQ suction hose D27/22x3.5 m AS-GQ (in carton), in carton	574642

Compact exterior, clever interior.

The ETS EC 125/3 is a favourite for fine sanding and extra-fine sanding in the compact class. As a one-handed sander with an excellent power to weight ratio, it produces an excellent surface quality with a 3 mm sanding stroke.

System accessories
from page 139



Abrasives
from page 156



Eccentric sander ETS 150



Perfect finishing sander.

- › 3 mm sanding stroke for an excellent surface finish
- › Sanding pad brake for safe, faultless work with no reworking costs
- › Dual bearing for a long service life
- › Weighs only 1.8 kg for particularly effortless work

Technical data	ETS 150/3	ETS 150/5
Power consumption (watt)	310	310
Eccentric motion speed (RPM)	4.000 – 10.000	4.000 – 10.000
Sanding stroke (mm)	3	5
Interchangeable sanding pad dia. (mm)	150	150
Dust extraction connection dia. (mm)	27	27
Weight (kg)	1,8	1,8



■ = MMC Multi Material Control electronics

Items included	Order no.
filter cartridge, operation tool	
ETS 150/3 EQ MULTI-JETSTREAM 2 M8 sanding pad Ø 150 mm (extra soft SW), in carton	575023
ETS 150/3 EQ-Plus MULTI-JETSTREAM 2 M8 sanding pad Ø 150 mm (extra soft SW), in SYSTAINER SYS 3 T-LOC	575022
ETS 150/5 EQ MULTI-JETSTREAM 2 M8 sanding pad Ø 150 mm (soft W), in carton	575057
ETS 150/5 EQ-Plus MULTI-JETSTREAM 2 M8 sanding pad Ø 150 mm (soft W), in SYSTAINER SYS 3 T-LOC	575056



Perfect surface quality.

The ETS 150/3 is a favourite for fine sanding and extra-fine sanding. A lightweight in its class, it produces an excellent surface finish with a 3 mm sanding stroke. The ETS 150/5, with a 5 mm stroke, is a favourite for light sanding or sanding between paint coats. Its manoeuvrability is an example of outstanding ergonomics.

System accessories
from page 140



Abrasives
from page 157



Eccentric sander ETS EC 150

Brushless EC-TEC motor for a long service life and a high level of efficiency



Sanding has many sides. We've thought of them all.

Overhead, at vertical areas or narrow edges – the new ETS EC 150 takes up position in all circumstances: Perfection with handling and sanding result. Thanks to the high-performance and brushless EC-TEC motor, the compact ETS EC 150 is ideal for one-handed and effortless work with simultaneously high demands for smooth running and surface quality.

The perfect finishing sander in the compact class.

- › Stepless speed preselection, constant speed even under load
- › Very high surface quality thanks to 3 mm sanding stroke
- › Longlife thanks to EC technology and sanding pad brake with carbide tip
- › Compact design and weighing only 1.2 kg for optimal ergonomic work conditions

Technical data	ETS EC 150/3	ETS EC 150/5
Power consumption (watt)	400	400
Eccentric motion speed (RPM)	6.000 – 10.000	6.000 – 10.000
Sanding stroke (mm)	3	5
Interchangeable sanding pad dia. (mm)	150	150
Dust extraction connection dia. (mm)	27	27
Weight (kg)	1,2	1,2



■ = MMC Multi Material Control electronics

Items included	Order no.
operation tool	
ETS EC 150/3 EQ MULTI-JETSTREAM 2 M8 sanding pad Ø 150 mm (extra soft SW), in carton	575032
ETS EC 150/3 EQ-Plus MULTI-JETSTREAM 2 M8 sanding pad Ø 150 mm (extra soft SW), in SYSTAINER SYS 2 T-LOC	575031
ETS EC 150/3 EQ-GQ MULTI-JETSTREAM 2 M8 sanding pad Ø 150 mm (extra soft SW), suction hose D27/22x3.5 m AS-GQ (in carton), in carton	575400
ETS EC 150/5 EQ MULTI-JETSTREAM 2 M8 sanding pad Ø 150 mm (soft W), in carton	575043
ETS EC 150/5 EQ-Plus MULTI-JETSTREAM 2 M8 sanding pad Ø 150 mm (soft W), in SYSTAINER SYS 2 T-LOC	575042
ETS EC 150/5 EQ-GQ MULTI-JETSTREAM 2 M8 sanding pad Ø 150 mm (soft W), suction hose D27/22x3.5 m AS-GQ (in carton), in carton	575403

System accessories from page 140



Abrasives from page 157





What is the best way to obtain a perfect surface? With a system.

Rapid material removal and fine sanding pattern as a basis for the perfect finish or preparing high gloss surface. In no other area is the system concept as evident as the development of our sanding tools. Robust, ergonomic tools that were designed to be used effortlessly for long periods. With individually adapted pads and abrasive sheets for transferring force perfectly and abrasives developed with the same care as the machines themselves.

A system concept that focusses on perfect tools and perfect results as well as the people we design our tools for.



+



+



The sanding pad system.

Sanding pads suitable for every type of application are available in different degrees of hardness ranging from extra-soft to hard. Easy to change with Jetstream principle that reduces surface heat and ensures efficient dust extraction.

Abrasive system.

Adapted perfectly to every tool, pad and dust extractor. Individually designed for every application, from coarse to fine sanding. Festool abrasives have an extended useful life and are fast and easy to change due to the StickFix adhesive cushion strips.

The extraction and workspace system.

A well-planned workplace saves time and journeys. A good dust extraction system keeps the air free of dust and ensures consistent quality results while preventing the lungs from inhaling sanding dust.

Orbital sander RUTSCHER RS 100



High material removal rate.

Festool gear-drive sanders with reduction gearing are always designed for heavy-duty material removal and are therefore suitable for sanding old, thick and stubborn coatings over large surfaces.

Professional with integral extractor.

- › Vibration Stop for smooth running and healthy working
- › Efficient dust extraction provides a clear view and ensures a healthy working environment
- › Well-balanced centre of gravity for perfect results and non-tiring work
- › Powerful stirring action and reduction gearing for maximum economic efficiency

Technical data	RS 100 Q	RS 100 CQ
Power consumption (watt)	620	520
Idle engine speed (RPM)	6.000	7.000
No. of strokes (RPM)	12.000	14.000
Sanding stroke (mm)	5	5
Interchangeable sanding pad (mm)	115 x 221	115 x 221
Dust extraction connection dia. (mm)	27	27
Weight (kg)	3,1	3



Items included	Order no.
RS 100 Q StickFix sanding pad 115 x 225 mm, filter cartridge, in carton	567757
RS 100 Q-Plus StickFix sanding pad 115 x 225 mm, filter cartridge, in SYSTAINER SYS 2 T-LOC	567697
RS 100 CQ StickFix sanding pad 115 x 221 mm, in carton	567759
RS 100 CQ-Plus StickFix sanding pad 115 x 221 mm, in SYSTAINER SYS 2 T-LOC	567699

System accessories
from page 141

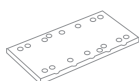

Abrasives
from page 162

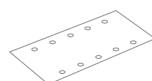

Orbital sander RUTSCHER RS 200



Master of large surfaces.

- › The enclosed dust proof bearing and high tear-resistant MPE sanding pad ensure a long service life and maximum economic efficiency
- › High speed and direct drive produce an extremely smooth sanding pattern – no reworking
- › Large sanding base for economical sanding over large areas
- › Ability to sand up to the edge on three sides



Technical data	RS 200 EQ	RS 200 Q
Power consumption (watt)		330
Power consumption (watt)	330	
Idle engine speed (RPM)	4.000 – 10.000	10.000
No. of strokes (RPM)	8.000 – 20.000	20.000
Sanding stroke (mm)	2,4	2,4
Interchangeable sanding pad (mm)	115 x 225	115 x 225
Dust extraction connection dia. (mm)	27	27
Weight (kg)	2,5	2,5



■ = Electronic

Perfect sanding finish.

The RS 200 produces outstanding quality over large surfaces: it has a 2.4 mm sanding stroke and direct drive; its large sanding pad ensures economical intermediate varnish and final sanding, eg light sanding of doors or large surface areas on furniture. The ability to sand right into corners and edges minimises reworking.

Items included	Order no.
StickFix sanding pad 115 x 225 mm, filter cartridge	
RS 200 Q in carton	567764
RS 200 EQ in carton	567763
RS 200 EQ-Plus in SYSTAINER SYS 2 T-LOC	567841

System accessories
from page 141

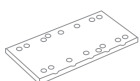

Abrasives
from page 162

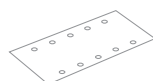

Orbital sander RUTSCHER RS 300



A multi-talent.

- › Interchangeable sanding pads for an extremely wide range of applications
- › Ergonomic design – ideal even for vertical areas and overhead
- › The sturdy bearing, screw-fastened oscillators and extremely tear-resistant MPE sanding pad ensure a long service life

Technical data	RS 300 EQ	RS 300 Q
Power consumption (watt)	280	
Power consumption (watt)		280
Idle engine speed (RPM)	4.000 – 10.000	10.000
No. of strokes (RPM)	8.000 – 20.000	20.000
Sanding stroke (mm)	2,4	2,4
Interchangeable sanding pad (mm)	93 x 175	93 x 175
Dust extraction connection dia. (mm)	27	27
Weight (kg)	2,3	2,3



■ = Electronic

Items included	Order no.
StickFix sanding pad 93 x 175 mm, filter cartridge	
RS 300 Q in carton	567490
RS 300 EQ in carton	567489
RS 300 EQ-Plus in SYSTAINER SYS 2 T-LOC	567845
RS 300 EQ-Set V-shaped sanding pad, in SYSTAINER SYS 2 T-LOC	567848

When things get a little tight.

Universal application – the RS 300 has the right sanding pad for almost every task.

System accessories
from page 141

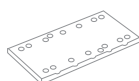

Abrasives
from page 162

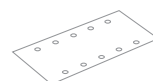

Orbital sander RUTSCHER RTS 400 R



Compact one-handed sander.

- › Work effortlessly: Thanks to the compact design, weight of just 1.2 kg and a perfectly balanced weight distribution
- › Up to 25% greater material removal capacity: The MMC control electronics transfer the power of 250 watts directly to the work surface
- › A healthy working environment and less rework: In combination with the mobile dust extractor or the long-life dust collection bag and attachable PROTECTOR for smooth sanding along window surfaces, frames and panelling
- › For continuous use: Long-life dust collection bag which can be emptied and reused, made from extra-durable nonwoven polyester

Technical data

Power consumption (watt)	250
Idle engine speed (RPM)	6.000 – 12.000
No. of strokes (RPM)	12.000 – 24.000
Sanding stroke (mm)	2
Interchangeable sanding pad (mm)	80 x 130
Dust extraction connection dia. (mm)	27
Weight (kg)	1,2



■ = Electronic

Items included

StickFix sanding pad 80 x 130 mm, Festool PROTECTOR, long-life chip collection bag

RTS 400 REQ in carton 201224

RTS 400 REQ-Plus in SYSTAINER SYS 2 T-LOC 574634



Clean working environment.

Efficient dust extraction for a clear view of the working area and a workplace free from dust.

System accessories
from page 142

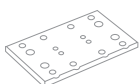

Abrasives
from page 160

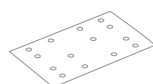

03 Machining surfaces

Cordless orbital sander RUTSCHER RTSC 400

Brushless EC-TEC motor for a long service life and a high level of efficiency



Unique: With battery or cable.

For all applications which require an even longer operating performance, the 18 V battery pack can be replaced with the plug it-mains adapter (included in the set and available as an accessory). This creates a mains-powered machine with an unlimited running time for continuous electrical operation in combination with the plug it-cable – ideal in conjunction with a Festool mobile dust extractor.



NEW Bluetooth® battery included:
Starts mobile dust extractor automatically.*

The ergonomic one-handed cordless orbital sander.

- › Mobile and effortless: Without cable and hose, with perfect ergonomics, low height and a weight of just 1.4 kg
- › Powerful: The 18 V battery pack in combination with the brushless EC-TEC motor ensures power similar to that of a mains-powered tool
- › No interruptions: Thanks to battery packs with a capacity of 3.1 Ah which run for longer than their charge time
- › Unlimited running time: For continuous electrical operation, the battery pack can be replaced with the plug-in mains adapter (included in the set and available as an accessory)

Technical data

Battery voltage (V)	18
Li-ion battery capacity (Ah)	3,1
Idle engine speed (RPM)	6.000 – 10.000
Sanding stroke (mm)	2
Interchangeable sanding pad (mm)	80 x 130
Dust extraction connection dia. (mm)	27
Weight with Li-ion (kg)	1,4

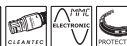

■ = MMC
Multi Material Control electronics

Items included

StickFix sanding pad 80 x 130 mm, Festool PROTECTOR, long-life chip collection bag

RTSC 400 Li-Basic without battery pack, without charger, in SYSTAINER SYS 2 T-LOC 201519

RTSC 400 Li 3,1 I-Plus 2 x BP 18 Li 3.1 ERGO-I battery pack, rapid charger TCL 6, in SYSTAINER SYS T-LOC 2 575731

RTSC 400 Li 3,1 I-Set 2 x BP 18 Li 3.1 ERGO-I battery pack, rapid charger TCL 6, ACA 18 V ERGO mains adapter (incl. plug-it power cable), in SYSTAINER SYS-COMBI 2 575724

System accessories
from page 142

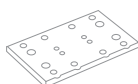

Abrasives
from page 160

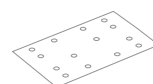

* For more information on
Bluetooth® Autostart, go to page 16



Delta sander DTS 400 R



Compact corner sander.

- › Work effortlessly: Thanks to the compact design, weight of just 1.2 kg and a perfectly balanced weight distribution
- › Up to 25% greater material removal capacity: The MMC control electronics transfer the power of 250 watts directly to the work surface
- › A healthy working environment and less rework: In combination with the mobile dust extractor or the long-life dust collection bag and attachable PROTECTOR for smooth sanding along window surfaces, frames and panelling
- › For continuous use: Long-life dust collection bag which can be emptied and reused, made from extra-durable nonwoven polyester

Technical data

Power consumption (watt)	250
Idle engine speed (RPM)	6.000 - 12.000
Sanding stroke (mm)	2
Interchangeable sanding pad (mm)	100 x 150
Dust extraction connection dia. (mm)	27
Weight (kg)	1,2



■ = Electronic

Items included

StickFix sanding pad 100 x 150 mm, Festool PROTECTOR, long-life chip collection bag

DTS 400 REQ
in carton

201231

DTS 400 REQ-Plus
in SYSTAINER SYS 2 T-LOC

574635



Sanding in corners and along edges.

Perfect preparation of windows and doors – the DTS 400 with iron-shaped pad can be guided accurately along narrow edges and into corners.

System accessories
from page 142



Abrasives
from page 161



Cordless delta sander DTSC 400

Brushless EC-TEC motor for a long service life and a high level of efficiency



NEW Bluetooth® battery included:
Starts mobile dust extractor automatically.*



The ergonomic cordless corner sander.

- › Mobile and effortless: Without cable and hose, with perfect ergonomics, low height and a weight of just 1.4 kg
- › Powerful: The 18 V battery pack in combination with the brushless EC-TEC motor ensures power similar to that of a mains-powered tool
- › No interruptions: Thanks to battery packs with a capacity of 3.1 Ah which run for longer than their charge time
- › Unlimited running time: For continuous electrical operation, the battery pack can be replaced with the plug-in mains adapter (included in the set and available as an accessory)

Technical data	
Battery voltage (V)	18
Li-ion battery capacity (Ah)	3,1
Idle engine speed (RPM)	6.000 – 10.000
Sanding stroke (mm)	2
Interchangeable sanding pad (mm)	100 x 150
Dust extraction connection dia. (mm)	27
Weight with Li-ion (kg)	1,4



Bluetooth® = MMC Multi Material Control electronics

Less reworking.

PROTECTOR for smooth sanding along window surfaces, frames and panelling.

Items included	Order no.
StickFix sanding pad 100 x 150 mm, Festool PROTECTOR, long-life chip collection bag	
DTSC 400 Li-Basic without battery pack, without charger, in SYSTAINER SYS 2 T-LOC	201526
DTSC 400 Li 3,1 I-Plus 2 x BP 18 Li 3.1 ERGO-I battery pack, rapid charger TCL 6, in SYSTAINER SYS T-LOC 2	575710
DTSC 400 Li 3,1 I-Set 2 x BP 18 Li 3.1 ERGO-I battery pack, rapid charger TCL 6, ACA 18 V ERGO mains adapter (incl. plug-it power cable), in SYSTAINER SYS-COMBI 2	575703

System accessories
from page 142



Abrasives
from page 161



* For more information on
Bluetooth® Autostart, go to page 16



Linear sander DUPLEX LS 130



Profile sander.

- › Linear motion provides an efficient alternative to manual work in rebates and profiles for non-tiring work
- › A variety of different sanding pads and abrasives for a wide range of applications
- › Simple, quick and tool-less sanding pad changes
- › Wear-resistant design for a long service life

Technical data

Power consumption (watt)	260
Idle engine speed (RPM)	4.000 – 6.000
No. of strokes (RPM)	8.000 – 12.000
Sanding stroke (mm)	4
Interchangeable sanding pad (mm)	133 x 80
Dust extraction connection dia. (mm)	27
Weight (kg)	1,7



■ = Electronic

Items included

LS 130 EQ-Plus
StickFix profile sanding pad standard, profile sanding pad 90°,
in SYSTAINER SYS 1 T-LOC

Order no.

567850



Curves and profiles.

The DUPLEX is ideal for sanding curves and profiles, thanks to its linear motion, the DIY kit and a large selection of sanding pads.

System accessories
from page 143

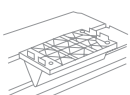

Abrasives
from page 160

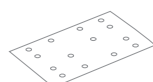

Rotary sanders

RAS 180



MMC electronics.

Smooth start-up, controlled speed and a temperature control to protect against overload make the RAS ideal for demanding, continuous use.

Large heavy-duty sander.

- › Particularly economical when used over large areas, as the machine is designed for high material removal rates and fast work progress
- › Optimum dust extraction ensures a clean workspace, a clear view and a healthy working environment
- › Health-friendly – anti-static equipment for the reliable removal of clear coats on metal, extraction hood for the perfect extraction of fine dust particles and chips
- › Tool-less sanding pad change

Technical data	
Power consumption (watt)	1.500
Idle engine speed (RPM)	800 – 4.000
Interchangeable sanding pad dia. (mm)	180
Spindle	M14
Dust extraction connection dia. (mm)	27
Weight (kg)	4,2



■ = MMC Multi Material Control electronics

Items included	Order no.
----------------	-----------

RAS 180 E
StickFix sanding pad Ø 180, StickFix abrasive discs, extraction hood, operation tool, in carton

570774

System accessories
from page 144



Abrasives
from page 158



Long-reach sander PLANEX easy LHS-E 225



Drywalling has never been so easy.

- › Simply sand for longer: The first long-reach sander from Festool which does not need to be assembled and set up
- › The even balance between control and advantageous weight distribution means that you can work for sustained periods
- › Sand the easy way: The low weight allows you to work conveniently
- › Low-wear thanks to drive in head



Technical data	
Power consumption (watt)	400
Idle engine speed (RPM)	400 – 920
Interchangeable sanding pad dia. (mm)	215
Abrasive dia. (mm)	225
Length (m)	1,6
Dust extraction connection dia. (mm)	36/27
Weight (kg)	4

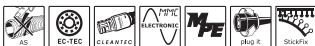

■ = MMC Multi Material Control electronics

Items included	Order no.
StickFix sanding pad LHS-E Ø 215 mm, LHS-E 225-BAG carrying bag, in carton	
LHS-E 225 EQ	571934
LHS-E 225/CTL 36-Set CTL 36 E AC-LHS mobile dust extractor	575447
LHS-E 225/CTM 36-Set CTM 36 E AC-LHS mobile dust extractor	575455

Convenient and reliable.

Optimum results in every position. Whether on ceilings or walls – this product makes sanding extremely simple in any position thanks to its low weight and highly flexible head section.

System accessories
from page 145



Abrasives
from page 159

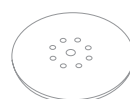

Long-reach sander PLANEX LHS 225



Efficient short-reach or long-reach sanding on walls and ceilings.

- › Two lengths, one machine – extend or reduce in a few simple hand movements
- › Two-speed gears for efficient, rapid material removal on walls and ceilings
- › Perfectly balanced for easy handling
- › Robust, reliable drive components and efficient power transfer

Technical data	
Power consumption (watt)	550
Idle engine speed (RPM)	340 – 910
Interchangeable sanding pad dia. (mm)	215
Dust extraction connection dia. (mm)	36/27
Weight (length 1.60 m) (kg)	4,6
Weight (length 1.10 m) (kg)	3,8



■ = MMC Multi Material Control electronics



Items included	Order no.
in SYSTAINER SYS MAXI	
LHS 225 EQ-Plus/IP StickFix 215 mm diameter sanding pad including 2 interface pads	571719
LHS 225 EQ-Plus/SW StickFix sanding pad dia. 215 mm (extra soft)	575217
LHS 225-SW/CTL 36-Set StickFix sanding pad dia. 215 mm (extra soft), mobile dust extractor CTL 36 E AC PLANEX	575448
LHS 225-IP/CTL 36-Set StickFix 215 mm diameter sanding pad including 2 interface pads, mobile dust extractor CTL 36 E AC PLANEX	575446
LHS 225-SW/CTM 36-Set StickFix sanding pad dia. 215 mm (extra soft), mobile dust extractor CTM 36E AC PLANEX	575456
LHS 225-IP/CTM 36-Set StickFix 215 mm diameter sanding pad including 2 interface pads, mobile dust extractor CTM 36E AC PLANEX	575454
LHS 225/CTM 36/STL 450-Set AD-ST DUO 200 adapter, ST DUO 200 tripod, Surface control light STL 450, LHS 225 EQ-Plus/IP long-reach sander, CTM 36 E AC-LHS mobile dust extractor, PLANEX tool holder	575460

Working near edges.

When sanding the area between two adjacent walls or a ceiling and wall, the PLANEX LHS 225 produces absolutely consistent results when sanding right up to the edge because of its removable brush segment.

System accessories from page 145



Abrasives from page 159

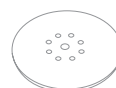

Belt sander BS 75



Manoeuvrable belt sander.

- › The well-balanced centre of gravity of the longitudinally mounted motor ensures non-tiring work
- › Perfect working results on a wide range of materials thanks to infinitely adjustable belt speed for coarse and fine sanding
- › Strong motor pulling force ensures economic working

Technical data

Power consumption (watt)	1.010
Belt speed, rated load (m/min)	200 – 380
Belt length x belt width (mm)	533 x 75
Sanding area (mm)	135 x 75
Dust extraction connection dia. (mm)	27/36
Weight (kg)	3,8



■ = Electronic

Items included

	Order no.
extraction adapter, dust bag, slip band P100	
BS 75 in carton	570206
BS 75 E in carton	570204
BS 75 E-Plus stationary unit, in SYSTAINER SYS MAXI	570203
BS 75 E-Set stationary unit, surface sanding frame, in SYSTAINER SYS MAXI	570207



Smooth touch down.

The sanding frame can be positioned gently and securely, the belt sander does not tilt and is easy to guide.

System accessories
from page 146

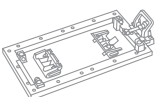

Abrasives
from page 163



Belt sander BS 105



Stationary use.

With the bench unit, you can turn a mobile belt sander into a stationary unit in an instant, allowing you to machine smaller workpieces more efficiently.

Wide belt sander.

- › The well-balanced centre of gravity of the longitudinally mounted motor ensures non-tiring work
- › Perfect working results on a wide range of materials thanks to infinitely adjustable belt speed for coarse and fine sanding
- › Strong motor pulling force ensures economic working

Technical data	
Power consumption (watt)	1.200
Belt speed, rated load (m/min)	230 – 380
Belt length x belt width (mm)	620 x 105
Sanding area (mm)	160 x 105
Dust extraction connection dia. (mm)	27/36
Weight (kg)	6,5



■ = Electronic

Items included	Order no.
dust bag, extraction adapter, slip band P100	
BS 105 in carton	570210
BS 105 E-Plus stationary unit, in SYSTAINER SYS MAXI	570209
BS 105 E-Set stationary unit, surface sanding frame, in SYSTAINER SYS MAXI	570212

System accessories
from page 146

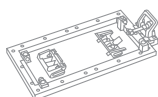

Abrasives
from page 163



Belt sander module CMS-BS



The belt sander for the CMS system.

- › Possibility of lowering the sanding belt for full belt utilisation, achieving greater efficiency
- › Quick, simple belt changing – short changeover times
- › Tilting sanding belt for sanding chamfers and sloping surfaces with ease
- › Powerful motor for sanding large areas with minimum effort

Technical data

Power consumption (watt)	550
Idle engine speed (RPM)	2.800
Belt length x belt width (mm)	820 x 120
Sanding area (mm)	185 x 185
Dust extraction connection dia. (mm)	27
Dimensions module support (mm)	578 x 320



Items included

CMS-MOD-BS 120
belt sander module, extraction hood, connecting hose, SA P100 sanding belt, angle stop, in carton

Order no.

570244



Open to change.

The CMS Compact Module System consists of a basic unit and compatible modules that transform the unit into a stationary bench-mounted saw, jigsaw, bench-mounted router or belt sander.

CMS system overview
from page 384



System accessories
from page 402



Designed for continuous operation.



Extremely robust, durable and reliable. Ideal for heavy-duty applications, paint shops or the industrial sector because compressed air sanders are low-maintenance and significantly lighter than electric power tools. The extremely robust design guarantees a long service life. The innovative IAS 3 system ensures perfect extraction, low vibration values and a noticeably reduced noise level for a healthy working environment.

Three times the benefits – the Festool IAS 3 system.

The unique IAS 3 system combines three functions in one hose: compressed air supply, exhaust air extraction and dust extraction. Sanding dust and exhaust air are kept away from the working area, the surface remains clean and the resulting surface finish is excellent. The compressed air tool operates more quietly due to sound absorption elements in the hose. An intelligently designed exhaust air system prevents the discharge of cold air onto the hands and wrists and makes your work more enjoyable and healthier.

- Compressed air supply
- Exhaust air extraction
- Dust extraction



Compressed air eccentric sander

LEX 3 77



For surface finishing.

- › Extremely sturdy design ensures a long service life, minimal servicing requirements and high cost savings
- › Pleasant operating noise, low vibration levels and safe dispersion of exhaust air through a compressed air hose protects the health of the user
- › Sanding pad brake reduces sanding errors when setting down the machine, thereby avoiding rework and additional costs
- › Low compressed air consumption ensures high cost savings



Technical data

Operating pressure (flow pressure) (bar)	6
No. of strokes (RPM)	21.000
Eccentric motion speed (RPM)	10.500
Sanding stroke (mm)	2,5
Vibration emission value Ah (single-axle) (m/s ²)	0,8
Vibration emissions value Ah (three-axle) (m/s ²)	1,9
Air consumption at rated load (l/min)	270
Sanding pad dia. (mm)	77
Sound pressure level (dB[A])	72
Weight (kg)	0,8



For extreme durability.

For smooth processes free of machine failures and maintenance.

Items included

LEX 3 77/2,5
StickFix sanding pad Ø 77 mm W-HT (soft), operation tool, in carton

Order no.

691131

The IAS 3 connection system is required to operate the compressed air sanders.

System accessories
from page 147



Abrasives
from page 154



Compressed air eccentric sander LEX 3 125



No possibility of confusion.

Clearly visible stroke indicator on the dead-man switch of all LEX 3 models makes it easy to select the correct machine.

Saves compressed air without affecting results.

- › Low compressed air consumption ensures high cost savings
- › Low vibration levels and a pleasant operating noise protect the user's health
- › Extremely sturdy design ensures a long service life, minimal servicing requirements and high cost savings
- › Simplifies permanent dust extraction, guarantees the best working results and protects the user's health when combined with the IAS 3 light hose

Technical data	LEX 3 125/3	LEX 3 125/5
Operating pressure (flow pressure) (bar)	6	6
No. of strokes (RPM)	19.000	19.000
Eccentric motion speed (RPM)	9.500	9.500
Sanding stroke (mm)	3	5
Vibration emission value Ah (single-axle) (m/s ²)	1,1	1,1
Vibration emissions value Ah (three-axle) (m/s ²)	3,6	4,2
Air consumption at rated load (l/min)	290	290
Sound pressure level (dB[A])	70	70
Sanding pad dia. (mm)	125	125
Weight (kg)	1	1



Items included	Order no.
operation tool, in carton	
LEX 3 125/3 StickFix sanding pad Ø 125 mm (extra soft)	691140
LEX 3 125/5 StickFix sanding pad Ø 125 mm (soft-HT)	691141

The IAS 3 connection system is required to operate the compressed air sanders.

System accessories
from page 147



Abrasives
from page 156





Compressed air eccentric sander LEX 3 150



Stops vibrations. Increases efficiency.

- › Precise – sanding pad brake ensures a clean pattern
- › Low compressed air consumption ensures high cost savings
- › Perfect dust extraction and economic abrasive consumption – thanks to the high-quality sanding pad with MULTI-JETSTREAM 2 principle
- › Low vibration levels and a pleasant operating noise protect the user's health

Technical data	LEX 3 150/3	LEX 3 150/5	LEX 3 150/7
Operating pressure (flow pressure) (bar)	6	6	6
No. of strokes (RPM)	20.000	20.000	20.000
Eccentric motion speed (RPM)	10.000	10.000	10.000
Sanding stroke (mm)	3	5	7
Vibration emission value Ah (single-axle) (m/s ²)	2,1	2,7	3,17
Vibration emissions value Ah (three-axle) (m/s ²)	3,7	3,9	5,8
Air consumption at rated load (l/min)	290	290	310
Sound pressure level (dB[A])	72	72	76
Sanding pad dia. (mm)	150	150	150
Weight (kg)	1	1	1



Safe and healthy.

The non-slip soft grip cap on the LEX 3 provides a secure hold. Dust extraction with the MULTI-JETSTREAM 2 principle keeps the air and workpiece clean.

Items included	Order no.
operation tool, in carton	
LEX 3 150/3 MULTI-JETSTREAM 2 M8 sanding pad Ø 150 mm (extra soft SW)	574996
LEX 3 150/5 MULTI-JETSTREAM 2 M8 sanding pad Ø 150 mm (soft W)	575081
LEX 3 150/7 MULTI-JETSTREAM 2 M8 sanding pad Ø 150 mm (soft W)	575077

The IAS 3 connection system is required to operate the compressed air sanders.

System accessories from page 147



Abrasives from page 157



Compressed air orbital sander LRS 93



Perfect for flat surfaces.

- › Machine is easy to guide
- › Variable speed preselection
- › Reduced vibrations for maximum working comfort
- › Robust motor for a longer lifespan

Technical data

Operating pressure (flow pressure) (bar)	6
No. of strokes (RPM)	14.000
Sanding stroke (mm)	4
Air consumption at rated load (l/min)	310
Sanding pad StickFix (mm)	93 x 175
Weight (kg)	1,5



Vibration stop

Less stress on your hands and wrists. VS balancing reduces vibrations and oscillations, and is kind to both you and your machine.

Items included

LRS 93M
StickFix sanding pad 93 x 175 mm, bottle of cleaning and lubricating oil LFC 9022 (50 ml), in carton

Order no.

574811

The IAS 3 connection system is required to operate the compressed air sanders.

System accessories
from page 149

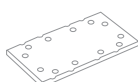

Abrasives
from page 162

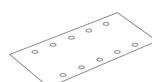

Compressed air orbital sander

LRS 400



Long sander for large surfaces.

- › Lightweight and handy despite its size
- › High material removal rate on large, flat surfaces
- › Highly effective dust extraction
- › Softgrip handle

Technical data

Operating pressure (flow pressure) (bar)	6
No. of strokes (RPM)	14.000
Sanding stroke (mm)	4
Air consumption at rated load (l/min)	390
Sanding pad StickFix (mm)	80 x 400
Weight (kg)	2,1



Easy guidance.

All compressed air orbital sanders are easy to guide, both with one or two hands. The Softgrip and the additional handle on the LRS 400 give you complete control of the machine.

Items included

LRS 400
StickFix sanding pad 80 x 400 mm (soft), bottle of cleaning and lubricating oil LFC 9022 (50 ml), in carton

Order no.

574813

The IAS 3 connection system is required to operate the compressed air sanders.

System accessories
from page 149

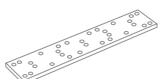

Abrasives
from page 161

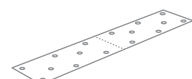

Perfect surfaces from a single source:

Polishing and oiling with Festool.

Detail of success.

Festool creates a perfect interaction between machine, polishing pad, foam pad and abrasive: for sensitive working and gleaming results on different materials from the wood go, without any rework. For high-gloss paints, UV clear coats, mineral materials or acrylic glass.





Oil application in its cleanest form.

Festool also offers a fully adapted system for producing a perfectly oiled surface finish – the SURFIX oil dispenser provides quick, clean and ecological surface protection of the highest quality in combination with high-quality natural oils.



01

01 HEAVY-DUTY

Protection for furniture, worktops and all heavily worn indoor surfaces: HEAVY-DUTY special oil



02

02 ONE-STEP

A gleaming finish and smooth to the touch: the ONE-STEP oil/wax mixture for decorative indoor surfaces.



03

03 OUTDOOR

OUTDOOR universal oil is ideal for weatherproofing all types of wood used in external applications.



Sustainable, high-quality ingredients –
Festool natural oils.

Rotary polishers

SHINEX RAP 150



All-purpose genius.

- › Accelerator switch, speed preselection, controlled speed, smooth start-up
- › Can take heavy loading because of its 2-speed motor
- › Long service life – a temperature-dependent overload protection and filter catcher protect the machine
- › Longer working due to ergonomic handling and light weight

Precise application of power.

Perfect power transfer thanks to the minimum distance between the tool and pad and the various grip positions of the SHINEX RAP 150.

Technical data	RAP 150-14 FE	RAP 150-21 FE
Power consumption (watt)	1.200	1.200
Idle engine speed (RPM)	600 – 1.400	900 – 2.100
Max. polishing pad dia. (mm)	150	150
Spindle	M14	M14
Weight (kg)	2,1	2,1



■ = MMC Multi Material Control electronics

Items included	Order no.
additional side-mounted hand grip, StickFix polishing pad Ø 150 mm	
RAP 150-14 FE in carton	570809
RAP 150-21 FE in carton	570811
RAP 150-21 FE-Set Wood denibber, StickFix sanding disc assortment, MPA 5010 OR polish, MPA 9010 BL polish, PoliStick 150 mm diameter OR W polishing pad, orange, medium, waffle face, PoliStick 150 mm diameter BL W polishing pad, blue, medium-fine, waffle face, PoliStick Ø 150 mm premium sheepskin, microfibre polish drapey, finish cleaner, in SYSTAINER SYS MAXI	574907

System accessories from page 168



Polishing accessories from page 171



Rotary polishers

POLLUX 180



Powerhouse with high coverage capacity.

- › Exceptional cooling in lower speed range – allows work under heavy loads
- › Controlled speed, stepless speed preselection and smooth start-up for adaptation to the working surface
- › Accelerator switch, speed preselection, controlled speed, smooth start-up
- › Ergonomic dome grip and perfect weight distribution for relaxed work



Technical data	
Power consumption (watt)	1.500
Idle engine speed (RPM)	800 – 2.400
Max. polishing pad dia. (mm)	180
Spindle	M14
Weight (kg)	3,6



■ = MMC Multi Material Control electronics

When faced with demanding tasks.

The POLLUX 180 E enables perfect adaptation to different materials and surfaces. The motor speed always remains constant thanks to the MMC electronics and allows you to work evenly without damaging the workpiece and avoid time-consuming reworking.

Items included	Order no.
POLLUX 180 E StickFix polishing pad Ø 180 mm, additional side-mounted hand grip, in carton	570734

System accessories from page 168

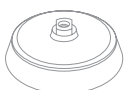

Polishing accessories from page 168



Oil dispenser SURFIX OS



Oil application in its cleanest form.

- › Excellent ergonomic design: the full bottle clicks in and serves as a handle
- › Cleanliness: the safety valve ensures simple metering, closes the oil bottle and protects the oil from drying out
- › Clearly more economical than using a brush or cloth: the sponge with attached StickFix absorbs excesses and dispenses them again in the right places
- › For every application area – Heavy-Duty, One-Step and Outdoor oil grades for all interior and exterior applications and light or dark woods. All high-quality natural oils, free of solvents and ecologically safe



Safe and clean.

The foam pad remains soft and reusable for long periods when stored in the tin provided.

Items included	Order no.
base plate	
OS-Set HD 0,3 l StickFix oil sponge, heavy-duty oil bottle, 0.3 l, in white tin	498060
OS-Set OS 0,3 l StickFix oil sponge, one-step oil bottle, 0.3 l, in white tin	498061
OS-Set OD 0,3 l StickFix oil sponge, outdoor oil bottle, 0.3 l, in white tin	498062
OS-SYS3-Set heavy-duty oil bottle, 0.3 l, one-step oil bottle, 0.3 l, outdoor oil bottle, 0.3 l, 5 x StickFix oil sponge, 5 x green non-woven sanding pad, 5 x white non-woven sanding pad, 10 x sanding discs STF-D150 P180 RU2, 10 x sanding discs STF-D150 P240 Granat, in SYSTAINER SYS 3 T-LOC	498063

System accessories
from page 173



More on natural oils
from page 129



Brush machine RUSTOFIX BMS 180



Quick, fix, RUSTOFIX.

- › Three working steps with one tool: Texturing, intermediate sanding and smoothing
- › Adjustable support rollers for precise setting of the texturing depth
- › Quick, easy brush changes
- › Overload protection for a long service life

Technical data	
Power consumption (watt)	1.500
Idle engine speed (RPM)	800 - 4.000
Tool dia. (mm)	150
Spindle	M14
Dust extraction connection dia. (mm)	27
Weight (kg)	7,5



■ = MMC Multi Material Control electronics



The quick way to produce a rustic wood effect.

The RUSTOFIX is the perfect tool for anyone wishing to lend a rustic touch to wooden surfaces – while guaranteeing maximum reliability and saving as much time and money as possible. Whether in furniture manufacture, building renovation or timber restoration.

Items included	Order no.
BMS 180 E LD 85 brush, KB 85 brush, extraction hood, tool arbour, Clamping flange, operation tool, in case	570775

System accessories
from page 151

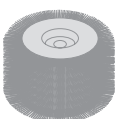

The Festool system. Everything in view.

Because things work better when everything fits together: When sanding, for example. Almost all Festool abrasives and sanding pads are changed without requiring tools and adapted perfectly to the relevant sander as well as the overall system.



03 Machining surfaces

Accessories and consumable materials

Surface preparation

System accessories	136
Abrasives	152
Manual abrasive	164

Polishing

System accessories	168
Polishing agent	168
Foam polishing pads	169

Oils

System accessories	173
--------------------	-----

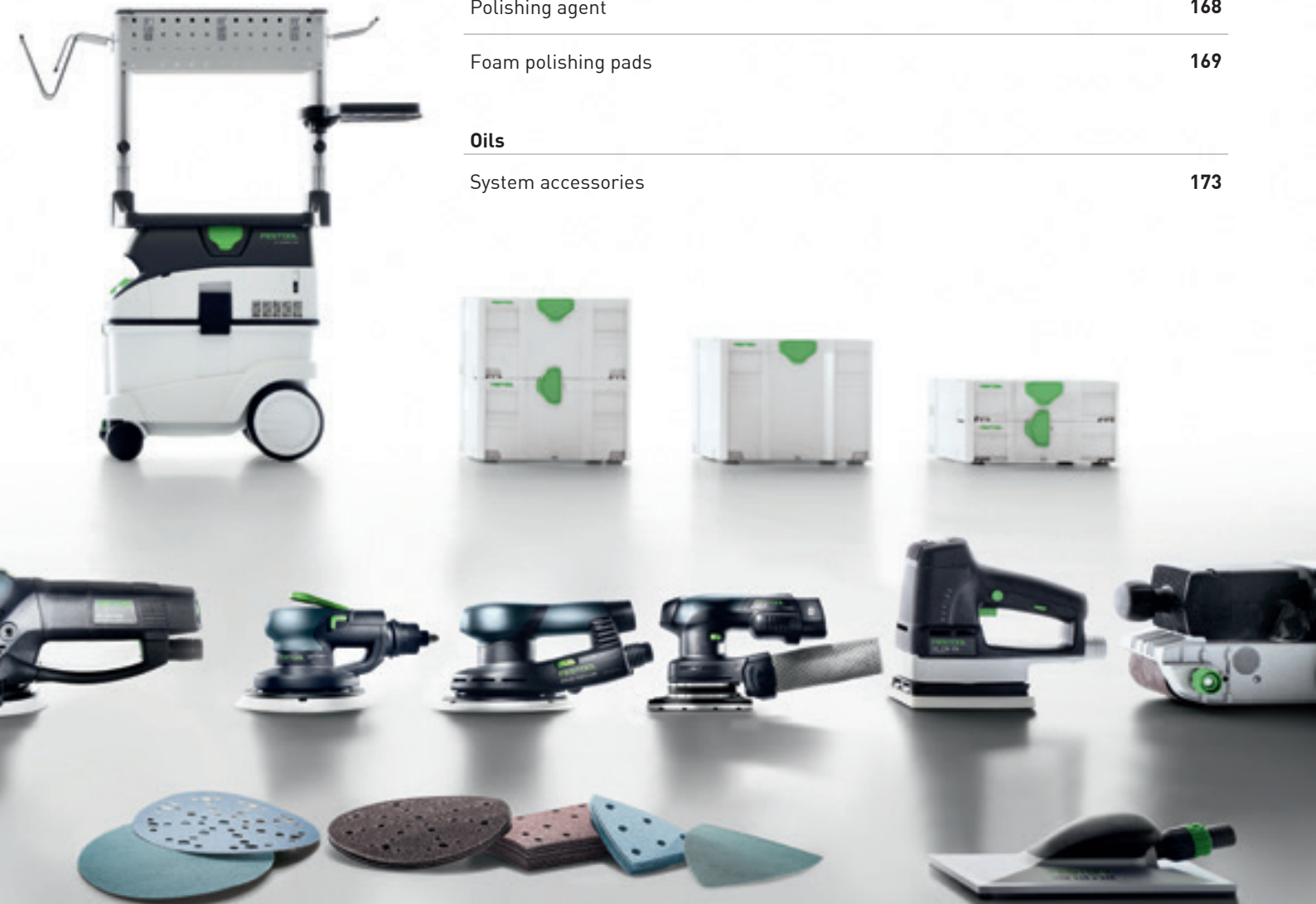

System accessories



ROTEX RO 90 DX

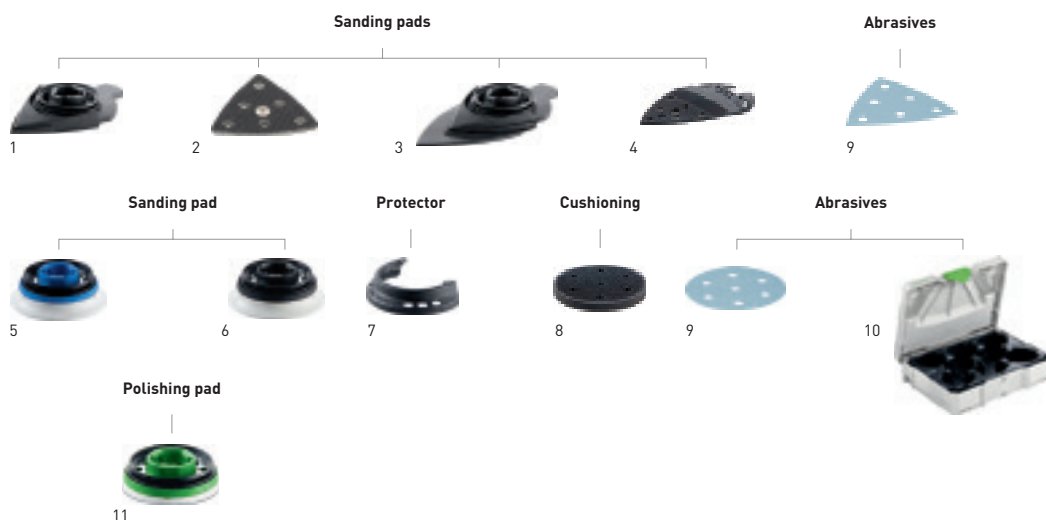

Accessories for geared eccentric sander ROTEX RO 90 DX

Denomination	Explanation	Order no.
1 Sanding pad SSH-GE-STF-R090 DX	suitable for abrasive 93 V, delta sanding pad, plate without interchangeable sanding pad, for attaching StickFix sanding pad, soft and hard, connecting thread FastFix, qty. in pack 1 Units, in self-service display pack	496802
2 Sanding pad SSH-STF-V93/6-W/2	for DX 93, RO 90 DX, StickFix adhesive layer for quick change of sanding pad, soft version, with snap stud, qty. in pack 2 Units, in self-service display pack	488715
Sanding pad SSH-STF-V93/6-H/2	for DX 93, RO 90 DX, StickFix adhesive layer for quick change of sanding pad, hard version, with snap stud, qty. in pack 2 Units, in self-service display pack	488716
3 Sanding pad LSS-STF-R090 V93/6	suitable for abrasive 93 V, plate incl. interchangeable sanding pad, slat sanding pad V93, for sanding in tight spaces, in self-service display pack	496803
4 Sanding pad LSS-STF-R090 V93 E	replacement backing pad for slat sanding pad, in self-service display pack	497483
5 Sanding pad ST-STF D90/7 FX H-HT	FastFix, hard version, fastener resistant to high temperatures, for plain surfaces and narrow edges, connecting thread FastFix, qty. in pack 1 Units, in self-service display pack	495623
6 Sanding pad ST-STF D90/7 FX W-HT	FastFix, soft version, fastener resistant to high temperatures, for universal use on plain and arced surfaces, connecting thread FastFix, qty. in pack 1 Units, in self-service display pack	496804
7 Protector set FP-RO 90	for RO 90 DX, window protectors S, M, L, qty. in pack 3 Units, in self-service display pack	497936
Protector FESTOOL 90FX	for RO 90 DX, for protecting the sanding pad and workpiece, in self-service display pack	496801
8 Interface pad IP-STF-D90/6	as damping element between sanding disc and sanding pad, Interface pad D 90 mm, height 15 mm, qty. in pack 1 Units, diameter 90 mm, in self-service display pack	497481
9 Abrasives	from page 154	
10 SYSTAINER T-LOC SYS-STF-D77/D90/93V	with insert for Ø 90 mm abrasives and 93V abrasives, dimensions (L x W x H) 396 x 296 x 105 mm, number of compartments 8, SYSTAINER size SYS 1 T-LOC	497687
11 Polishing pad PT-STF-D90 FX-R090	for RO 90 DX, FastFix, for holding polishing accessories with dia. 80 mm, Polishing edges, Polishing small surfaces, diameter 75 mm, in self-service display pack	495625

System accessories



ROTEX RO 125



Accessories for geared eccentric sander ROTEX RO 125

Denomination	Explanation	Order no.
1 Sanding pad ST-STF D125/8 FX-H-HT	FastFix, hard version, fastener resistant to high temperatures, high edge solidity, for plain surfaces and narrow edges, connecting thread FastFix, qty. in pack 1 Units, in self-service display pack	492127
2 Sanding pad ST-STF D125/8 FX-W-HT	FastFix, soft version, fastener resistant to high temperatures, for universal use on plain and arced surfaces, connecting thread FastFix, qty. in pack 1 Units, in self-service display pack	492125
3 Sanding pad ST-STF D125/8 FX-SW	FastFix, ultra-soft version, elastic structure, for heavy roundings and cambers, connecting thread FastFix, qty. in pack 1 Units, in self-service display pack	492126
4 FastFix louver pad LT-STF D125/RO125	FastFix, for sanding louvers, connecting thread FastFix, qty. in pack 1 Units, diameter 125 mm, in self-service display pack	492129
5 Protector FESTOOL 125FX	for RO 125 FEQ, for protecting the sanding pad and workpiece, in self-service display pack	493912
6 Interface pad IP-STF-D120/8-J	for sanding contoured parts and fine-sanding parts with eccentric sander Ø 125 mm, as damping element between sanding disc and sanding pad, JETSTREAM, height 15 mm, diameter 120 mm, hole circle diameter 90 mm, qty. in pack 1 Units, in self-service display pack	492271
7 Abrasives	from page 156	
8 SYSTEMER T-LOC SYS-STF D125	with insert for abrasives Ø 125 mm, dimensions (L x W x H) 396 x 296 x 105 mm, number of compartments 5, SYSTEMER size SYS 1 T-LOC	497685
9 Polishing pad PT-STF-D125 FX-RO125	for RO 125 FEQ, FastFix, fits polishing accessories, diameter 115 mm, height 10 mm, in self-service display pack	492128

System accessories



Accessories for geared eccentric sander ROTEX RO 150

Denomination	Explanation	Order no.
1 Sanding pad ST-STF D150/MJ2-FX-H-HT	for RO 150, FastFix, hard version, fastener resistant to high temperatures, high edge solidity, for plain surfaces and narrow edges, MULTI-JETSTREAM 2, diameter 150 mm, connecting thread FastFix, qty. in pack 1 Units, in self-service display pack	202463
2 Sanding pad ST-STF D150/MJ2-FX-W-HT	for RO 150, FastFix, soft version, fastener resistant to high temperatures, for universal use on plain and arced surfaces, MULTI-JETSTREAM 2, diameter 150 mm, connecting thread FastFix, qty. in pack 1 Units, in self-service display pack	202461
3 Sanding pad ST-STF D150/MJ2-FX-SW	for RO 150, FastFix, ultra-soft version, elastic structure, MULTI-JETSTREAM 2, for heavy roundings and cambers, diameter 150 mm, connecting thread FastFix, qty. in pack 1 Units, in self-service display pack	202462
4 Protector FESTOOL 150FX	for RO 150 FEQ, for protecting the sanding pad and workpiece, in self-service display pack	493913
5 Interface pad IP-STF D150/MJ2-5/2	for eccentric sander with diameter of 150 mm, as damping element between sanding disc and sanding pad, MULTI-JETSTREAM 2, optimal thickness for sanding work on bodies and similarly shaped components, diameter 145 mm, height 5 mm, qty. in pack 2 Units, in self-service display pack	203348
Interface pad IP-STF D150/MJ2-15/1	for eccentric sander with diameter of 150 mm, as damping element between sanding disc and sanding pad, MULTI-JETSTREAM 2, optimal thickness for sanding work on curved components, diameter 145 mm, height 15 mm, in self-service display pack	203351
6 Abrasives	from page 157	
7 SYSTAINER T-LOC SYS-STF D150	with insert for abrasives Ø 150 mm, dimensions (L x W x H) 396 x 296 x 210 mm, number of compartments 10, SYSTAINER size SYS 3 T-LOC	497690
8 Polishing pad PT-STF-D150 FX	for RO 150 FEQ, FastFix, fits polishing accessories, diameter 135 mm, height 10 mm, in self-service display pack	496151
Polishing pad PT-STF-D150 M8	for RO 150, fits polishing accessories, diameter 135 mm, height 10 mm, in self-service display pack	496152
9 Auxiliary handle ZG-RAS/RO	for RO 150, RAS, WTS 150, RAP 150, in carton	487865
Handle BG-RO 150	for RO 150 FEQ, in self-service display pack	495188

System accessories

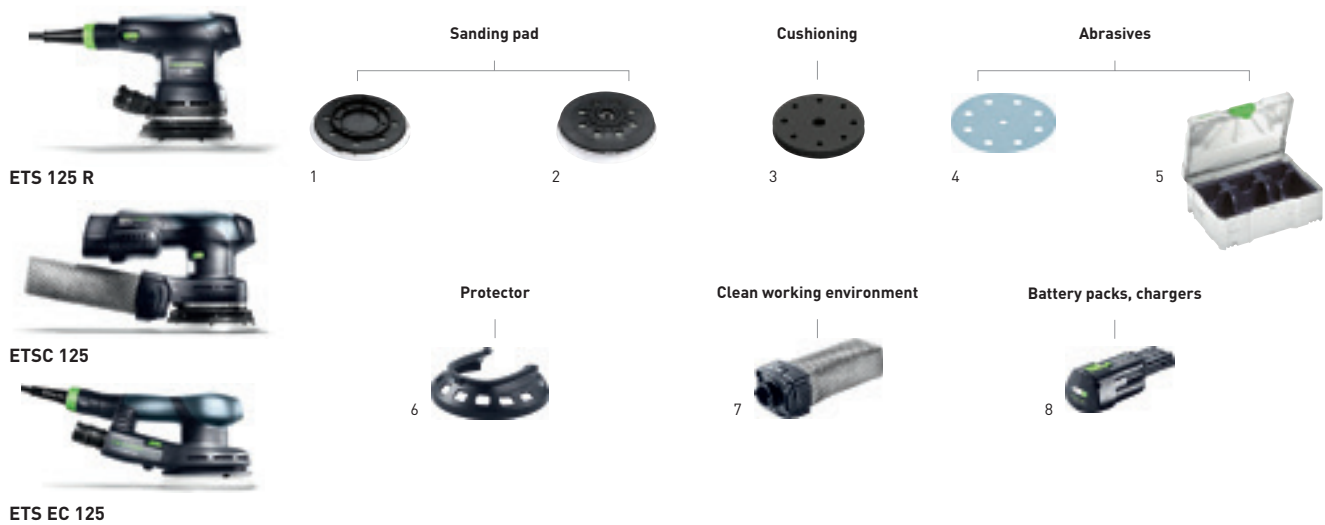

Accessories for ETS 125 R, ETSC 125, ETS EC 125 random orbit sanders

Denomination	Explanation	Order no.
1 Sanding pad ST-STF 125/8-M4-J W-HT	for ES 125, ETS 125, ETSC 125, soft version, fastener resistant to high temperatures, for universal use on plain and arced surfaces, for robust use with grit up to P220, JETSTREAM, connecting thread M4, hole circle diameter 90 mm, qty. in pack 1 Units, in self-service display pack	492280
Sanding pad ST-STF 125/8-M4-J SW	for ES 125, ETS 125, ETSC 125, ultra-soft version, elastic structure, for heavy roundings and cambers, JETSTREAM, connecting thread M4, hole circle diameter 90 mm, qty. in pack 1 Units, in self-service display pack	492282
2 Sanding pad ST-STF 125/8-M8-J H	for ETS EC 125, LEX 125, hard version, fastener resistant to high temperatures, high edge solidity, for plain surfaces and narrow edges, JETSTREAM, connecting thread M8, qty. in pack 1 Units, in self-service display pack	492284
Sanding pad ST-STF 125/8-M8-J W-HT	for ETS EC 125, LEX 125, soft version, fastener resistant to high temperatures, for universal use on plain and arced surfaces, JETSTREAM, connecting thread M8, qty. in pack 1 Units, in self-service display pack	492286
Sanding pad ST-STF 125/8-M8-J SW	for ETS EC 125, LEX 125, ultra-soft version, elastic structure, for heavy roundings and cambers, JETSTREAM, connecting thread M8, qty. in pack 1 Units, in self-service display pack	492288
3 Interface pad IP-STF-D120/8-J	for sanding contoured parts and fine-sanding parts with eccentric sander Ø 125 mm, as damping element between sanding disc and sanding pad, JETSTREAM, height 15 mm, diameter 120 mm, hole circle diameter 90 mm, qty. in pack 1 Units, in self-service display pack	492271
4 Abrasives	from page 156	
5 SYSTAINER T-LOC SYS-STF D125	with insert for abrasives Ø 125 mm, dimensions [L x W x H] 396 x 296 x 105 mm, number of compartments 5, SYSTAINER size SYS 1 T-LOC	497685
6 Protector PR ETS-R 125	for ETS 125 REQ, ETSC 125, for smooth sanding along window panes, frames and panelling, for protecting the sanding pad and workpiece, in self-service display pack	201690
7 Long-life chip collection bag SB-Longlife RTS/DTS/ETS	for RTS 400, RTSC 400, DTS 400, DTSC 400, ETS 125, ETSC 125, for holding dust and for dust-free disposal of the extracted product, can be discharged multiple times and is wear resistant thanks to high-strength, durable nonwoven polyester, in self-service display pack	201693
8 Battery pack BP 18 Li 3,1 Ergo	for RTSC 400, DTSC 400, ETSC 125 cordless sanders, not compatible with all other Festool cordless tools, ergonomic, lightweight design, tensioner 18 V, capacity 3,1 Ah, weight 0,4 kg, in self-service display pack	202499
Battery pack BP 18 Li 3,1 Ergo-I	for RTSC 400, DTSC 400, ETSC 125 cordless sanders, not compatible with all other Festool cordless tools, Bluetooth® enables the CLEANTEC mobile dust extractor to be started automatically when the cordless tool is switched on (use of a Bluetooth®-compatible mobile dust extractor is required), ergonomic, lightweight design for perfect handling with Festool cordless sanders, tensioner 18 V, capacity 3,1 Ah, weight 0,4 kg, in carton	202497
Mains adapter ACA 220-240/18V Ergo	for RTSC 400, DTSC 400, ETSC 125 cordless sanders, not compatible with all other Festool cordless tools, for continuous electrical operation of the RTSC 400, DTSC 400, ETSC 125 cordless sanders, ergonomic, lightweight design, plug it-power cable (4 m), input voltage 220 - 240 V, tensioner 18 - 20 V, rated power 150 watt, weight 0,3 kg, in self-service display pack	202501

System accessories



ETS 150



ETS EC 150

Sanding pad



1

Cushioning



2

Abrasives

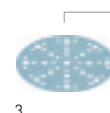

3



4

Clean working environment



5



6

Accessories for ETS 150, ETS EC 150 eccentric sanders

Denomination	Explanation	Order no.
1 Sanding pad ST-STF D150/MJ2-M8-H-HT	for ETS 150, ETS EC 150, LEX 150 and WTS 150/7, hard version, fastener resistant to high temperatures, high edge solidity, for plain surfaces and narrow edges, MULTI-JETSTREAM 2, diameter 150 mm, connecting thread M8, qty. in pack 1 Units, in self-service display pack	202460
Sanding pad ST-STF D150/MJ2-M8-W-HT	for ETS 150, ETS EC 150, LEX 150 and WTS 150/7, soft version, fastener resistant to high temperatures, for universal use on plain and arced surfaces, MULTI-JETSTREAM 2, diameter 150 mm, connecting thread M8, qty. in pack 1 Units, in self-service display pack	202458
Sanding pad ST-STF D150/MJ2-M8-SW	for ETS 150, ETS EC 150, LEX 150 and WTS 150/7, ultra-soft version, elastic structure, for heavy roundings and cambers, MULTI-JETSTREAM 2, diameter 150 mm, connecting thread M8, qty. in pack 1 Units, in self-service display pack	202459
2 Interface pad IP-STF D150/MJ2-5/2	for eccentric sander with diameter of 150 mm, as damping element between sanding disc and sanding pad, MULTI-JETSTREAM 2, optimal thickness for sanding work on bodies and similarly shaped components, diameter 145 mm, height 5 mm, qty. in pack 2 Units, in self-service display pack	203348
Interface pad IP-STF D150/MJ2-15/1	for eccentric sander with diameter of 150 mm, as damping element between sanding disc and sanding pad, MULTI-JETSTREAM 2, optimal thickness for sanding work on curved components, diameter 145 mm, height 15 mm, in self-service display pack	203351
3 Abrasives	from page 157	
4 SYSTAINER T-LOC SYS-STF D150	with insert for abrasives Ø 150 mm, dimensions [L x W x H] 396 x 296 x 210 mm, number of compartments 10, SYSTAINER size SYS 3 T-LOC	497690
5 Turbo filter bag set TFES-ES 150	for ES 150, ETS 150, for clear view and healthy working environment, not suitable for ETS EC 125/150, paper filter bag for turbo dust extraction and one plastic holder, filter cartridge, turbofilter, in self-service display pack	489631
6 Turbo filter bag TF II-RS/ES/ET/25	for RS 300, RS 3, RS 200, RS 2, ES 150, ETS 150, ET 2, for insertion in filter cartridge, paper filter bag for turbo dust extraction, qty. in pack 25 Units, in carton	487871
Turbo filter bag TF II-RS/ES/ET/5	for RS 300, RS 3, RS 200, RS 2, ES 150, ETS 150, ET 2, for insertion in filter cartridge, paper filter bag for turbo dust extraction, qty. in pack 5 Units, in self-service display pack	487779

System accessories



RUTSCHER RS 100



RUTSCHER RS 200



RUTSCHER RS 300



Accessories for RUTSCHER RS 100, RS 200, RS 300

	Denomination	Explanation	Order no.
1	Sanding pad SSH-STF-115x221/10 RS 1 C	for RS 100 C, RS 1 C, StickFix adhesive layer for quick change of sanding pad, dimensions 115 x 221 mm, in self-service display pack	488226
	Sanding pad SSH 115x221/10-RS 1 C	for RS 100 C, RS 1 C, for abrasives for clamping, dimensions 115 x 221 mm, in self-service display pack	492310
	Sanding pad SSH-STF-115x225/10	for RS 200, RS 2, RS 100, RS 1, StickFix adhesive layer for quick change of sanding pad, dimensions 115 x 225 mm, in self-service display pack	483679
	Sanding pad SSH-STF-115x225/10-KS	for RS 200, RS 2, RS 100, RS 1, StickFix adhesive layer for quick change of sanding pad, with edge protection, dimensions 115 x 225 mm, in self-service display pack	485648
	Sanding pad SSH-STF-93x175/8	for RS 300, RS 3, LRS 93, StickFix adhesive layer for quick change of sanding pad, dimensions 93 x 175 mm, in self-service display pack	483905
	Slat sanding pad SSH-STF-L93x230/0	for RS 300, RS 3, LRS 93, StickFix, lamellar sanding pad version, width 230 mm, min. length 93 mm, dimensions 93 x 230 mm, in self-service display pack	486371
	Iron sanding pad SSH-STF-V93x266/14	for RS 300, RS 3, LRS 93, StickFix, pressing iron sanding pad version, dimensions 93 x 266 mm, in self-service display pack	486418
2	Sanding pad SSH-115x225/10	for RS 200, RS 2, RS 100, RS 1, for abrasives for clamping, dimensions 115 x 225 mm, in self-service display pack	489629
	Sanding pad SSH-115x225/10-KS	for RS 200, RS 2, RS 100, RS 1, with edge protection, for abrasives for clamping, dimensions 115 x 225 mm, in self-service display pack	485647
	Sanding pad SSH-93x175/8	for RS 300, RS 3, LRS 93, for abrasives for clamping, dimensions 93 x 175 mm, in self-service display pack	489630
3	Hole punch 10L 115x225	for RS 200, RS 2, RS 100, RS 100 C, RS 1, RS 1 C, HSK 115 x 226, for preparing the Festool hole pattern, no. of holes 10, in self-service display pack	481523
4	Turbo filter bag TF-RS 1/5	for RS 100, RS 1, for insertion in filter cartridge, paper filter bag for turbo dust extraction, qty. in pack 5 Units, in self-service display pack	483674
	Turbo filter bag TF II-RS/ES/ET/25	for RS 300, RS 3, RS 200, RS 2, ES 150, ETS 150, ET 2, for insertion in filter cartridge, paper filter bag for turbo dust extraction, qty. in pack 25 Units, in carton	487871
	Turbo filter bag TF II-RS/ES/ET/5	for RS 300, RS 3, RS 200, RS 2, ES 150, ETS 150, ET 2, for insertion in filter cartridge, paper filter bag for turbo dust extraction, qty. in pack 5 Units, in self-service display pack	487779
	Turbo filter bag set TFS II-ET/RS	for RS 300, RS 3, RS 200, RS 2, ET2, for clear view and healthy working environment, paper filter bag for turbo dust extraction and one plastic holder, filter cartridge, 5 x turbofilter, in self-service display pack	487780
5	Abrasives	from page 162	

System accessories



RUTSCHER RTS 400 R



RUTSCHER RTSC 400



DTS 400 R



DTSC 400

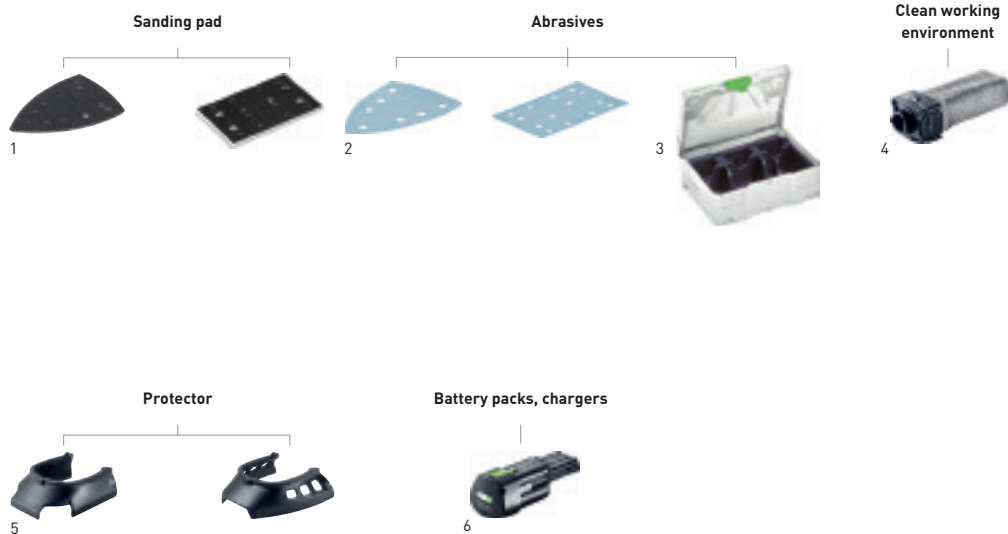

Accessories for RUTSCHER RTS 400 R, RTSC 400 orbital sanders, DTS 400 R, DTSC 400 delta sanders

Denomination	Explanation	Order no.
1 Sanding pad SSH-STF-80x130/8	for RS 4, StickFix adhesive layer for quick change of sanding pad, perforated with eight suction holes, dimensions 80 x 130 mm, in self-service display pack	483906
Sanding pad SSH-80x130/8	for RS 4, for abrasives for clamping, dimensions 80 x 130 mm, in self-service display pack	491366
Sanding pad SSH-STF-80x130/12	for RTS 400, RS 400, RTSC 400, StickFix adhesive layer for quick change of sanding pad, perforated with 12 suction holes, min. length 80 mm, width 130 mm, dimensions 80 x 130 mm, in self-service display pack	489252
Sanding pad SSH-STF-Delta100x150/7	for DTS 400, DTSC 400, DS 400, for sanding even in corners, dimensions 100 x 150 mm, in self-service display pack	493723
2 Abrasives	from page 160	
3 SYSTAINER T-LOC SYS-STF 80x133	with insert for abrasives 80x133 mm, dimensions (L x W x H) 396 x 296 x 105 mm, number of compartments 6, SYSTAINER size SYS 1 T-LOC	497684
SYSTAINER T-LOC SYS-STF Delta 100x150	with insert for abrasives STF Delta 100x150, dimensions (L x W x H) 396 x 296 x 105 mm, number of compartments 5, SYSTAINER size SYS 1 T-LOC	497686
SYSTAINER T-LOC SYS-STF-D77/D90/93V	with insert for Ø 90 mm abrasives and 93V abrasives, dimensions (L x W x H) 396 x 296 x 105 mm, number of compartments 8, SYSTAINER size SYS 1 T-LOC	497687
4 Long-life chip collection bag SB-Longlife RTS/DTS/ETS	for RTS 400, RTSC 400, DTS 400, DTSC 400, ETS 125, ETSC 125, for holding dust and for dust-free disposal of the extracted product, can be discharged multiple times and is wear resistant thanks to high-strength, durable nonwoven polyester, in self-service display pack	201693
5 Protector PR RTS-R 80x133	for RTS 400 REQ, RTSC 400, for smooth sanding along window panes, frames and panelling, for protecting the sanding pad and workpiece, in self-service display pack	201691
Protector PR DTS-R 100x150	for DTS 400 REQ, DTSC 400, for smooth sanding along window panes, frames and panelling, for protecting the sanding pad and workpiece, in self-service display pack	201692
6 Battery pack BP 18 Li 3,1 Ergo	for RTSC 400, DTSC 400, ETSC 125 cordless sanders, not compatible with all other Festool cordless tools, ergonomic, lightweight design, tensioner 18 V, capacity 3,1 Ah, weight 0,4 kg, in self-service display pack	202499
Battery pack BP 18 Li 3,1 Ergo-I	for RTSC 400, DTSC 400, ETSC 125 cordless sanders, not compatible with all other Festool cordless tools, Bluetooth® enables the CLEANTEC mobile dust extractor to be started automatically when the cordless tool is switched on (use of a Bluetooth®-compatible mobile dust extractor is required), ergonomic, lightweight design for perfect handling with Festool cordless sanders, tensioner 18 V, capacity 3,1 Ah, weight 0,4 kg, in carton	202497
Mains adapter ACA 220-240/18V Ergo	for RTSC 400, DTSC 400, ETSC 125 cordless sanders, not compatible with all other Festool cordless tools, for continuous electrical operation of the RTSC 400, DTSC 400, ETSC 125 cordless sanders, ergonomic, lightweight design, plug it-power cable (4 m), input voltage 220 – 240 V, tensioner 18 – 20 V, rated power 150 watt, weight 0,3 kg, in self-service display pack	202501

System accessories



DUPLEX LS 130

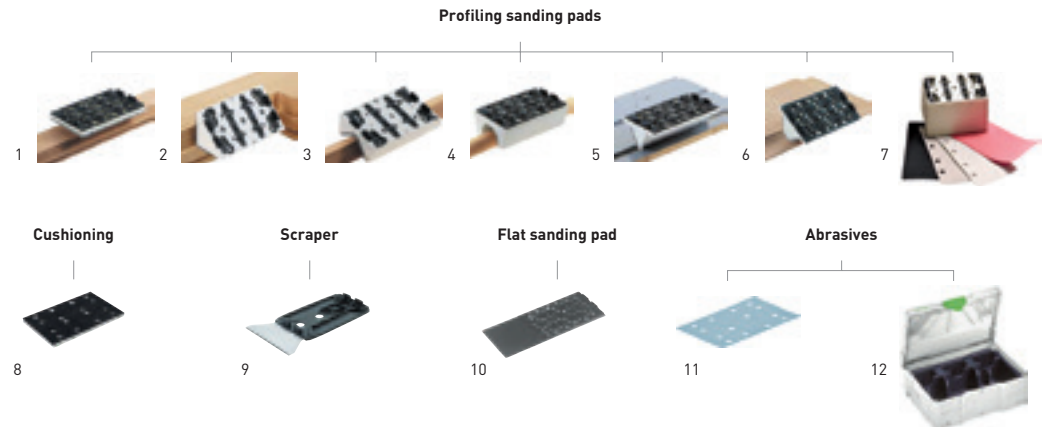

Accessories for linear sander DUPLEX LS 130

Denomination	Explanation	Order no.
1 Flat sanding pad SSH-STF-LS130-F	standard design, dimensions 80 x 130 mm, in self-service display pack	490161
2 Rebate profile sanding pad SSH-STF-LS130-90 GR	90 degrees, dimensions 80 x 130 mm, in self-service display pack	490162
3 Radius profile sanding pad SSH-STF-LS130-R6KV	radius R6 concave, dimensions 80 x 130 mm, in self-service display pack	490163
Radius profile sanding pad SSH-STF-LS130-R10KV	radius R10 concave, dimensions 80 x 130 mm, in self-service display pack	491197
4 Radius profile sanding pad SSH-STF-LS130-R18KV	radius R18, concave, dimensions 80 x 130 mm, in self-service display pack	490164
Radius profile sanding pad SSH-STF-LS130-R25KV	radius R25, concave, dimensions 80 x 130 mm, in self-service display pack	490165
5 V-groove profile sanding pad SSH-STF-LS130-V10	minimum basic dimension of the V-groove 10 mm, dimensions 80 x 130 mm, in self-service display pack	490166
6 Flute profile sanding pad SSH-STF-LS130-R5KX	radius R5 convex, dimensions 80 x 130 mm, in self-service display pack	491198
Flute profile sanding pad SSH-STF-LS130-R12,5KX	radius R12,5, convex, dimensions 80 x 130 mm, in self-service display pack	490167
7 DIY construction kit SSH-STF-LS130 Kit	kit for creating any type of profiling pad, in self-service display pack	490780
8 Interface pad IP-STF-80x133/12-STF LS130/2	damping element between sanding pad and abrasive, dimensions 80 x 133 mm, qty. in pack 2 Units, in self-service display pack	490160
9 Scraper SSH-LS130-B100	for removing coatings, width 100 mm, in self-service display pack	491199
10 Flat sanding pad SSH-STF-LS130-LL195	for relief grinding of facings, dimensions 80 x 195 mm, in self-service display pack	491861
11 Abrasives	from page 160	
12 SYSTAINER T-LOC SYS-STF 80x133	with insert for abrasives 80x133 mm, dimensions (L x W x H) 396 x 296 x 105 mm, number of compartments 6, SYSTAINER size SYS 1 T-LOC	497684

System accessories



RAS 180

Sanding pad



1

Abrasives



2

Additional hand grip



3

Accessories for rotary sander RAS 180

	Denomination	Explanation	Order no.
1	Sanding pad ST-STF-D180/0-M14 W	for RAS 180, soft version, for universal use on plain and arced surfaces, connecting thread M14, in self-service display pack	485253
	Sanding pad ST-D180/0-M14/2F	for RAS 180, for fibre discs Ø 180 mm, connecting thread M14, in self-service display pack	485296
2	Abrasives	from page 158	
3	Auxiliary handle ZG-RAS/RO	for RO 150, RAS, WTS 150, RAP 150, in carton	487865

System accessories



PLANEX easy LHS-E 225



PLANEX LHS 225

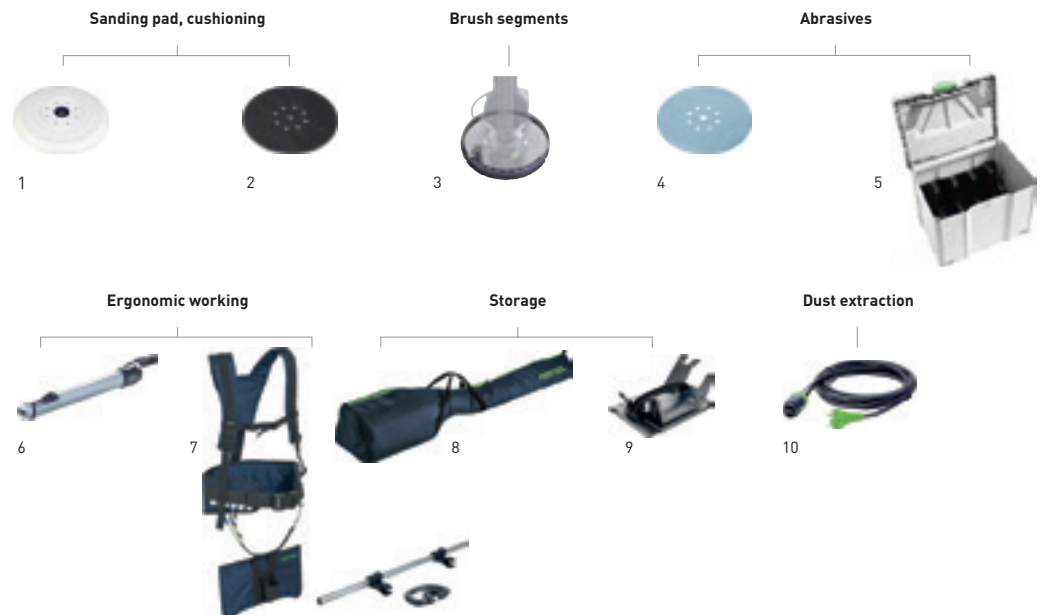

Accessories for PLANEX easy LHS 225 and PLANEX LHS-E 225 long-reach sanders

Denomination	Explanation	Order no.
1 Sanding pad ST-STF-D215/8-LHS 225-SW	for long-reach sander PLANEX, for universal use on plain and arced surfaces, ultra-soft, adaptable sanding pad, optimal suction support makes work effortless for the user, qty. in pack 1 Units, diameter 215 mm, in self-service display pack	202546
Sanding pad ST-STF-D215/8-IP-LHS 225	for long-reach sander PLANEX, for all types of applications, particularly suited for curved surfaces, incl. 2 interface pads, not recommended for PLANEX easy LHS-E 225, diameter 215 mm, in self-service display pack	496106
Sanding pad ST-STF-D215/8-LHS-E	for the PLANEX easy LHS-E 225 EQ long-reach sander, for universal use on plain and arced surfaces, fastener resistant to high temperatures, for heavy-duty applications, not suitable for PLANEX LHS 225 with extraction support, qty. in pack 1 Units, diameter 215 mm, in self-service display pack	201895
2 Interface pad IP-STF-D215/8/2x	as damping element between sanding disc and sanding pad, for use with sanding pad 496106, height 5 mm, diameter 215 mm, qty. in pack 2 Units, in self-service display pack	496140
3 Brush segment BS-LHS 225	for long-reach sander PLANEX, detachable part of the brush strip of the PLANEX LHS 225 EQ sanding head, in self-service display pack	495166
Brush segment BS-LHS-E 225	for the PLANEX easy LHS-E 225 EQ long-reach sander, detachable part of the brush strip of the PLANEX easy LHS-E 225 sanding head, in self-service display pack	203189
Brush strip BE-LHS 225	for the PLANEX 225 EQ long-reach sander, as a replacement for used brush strip, in self-service display pack	495167
Brush strip BE-LHS-E 225	for the PLANEX easy LHS-E 225 EQ long-reach sander, as a replacement for used brush strip, in self-service display pack	203190
4 Abrasives	from page 159	
5 SYSTAINER T-LOC SYS-STF D225	with insert for abrasive, dia. 225 mm, dimensions (L x W x H) 396 x 296 x 315 mm, number of compartments 3, SYSTAINER size SYS 4 T-LOC	497691
6 Guide extension VL-LHS 225	for the PLANEX 225 EQ long-reach sander, quick guide extension of the PLANEX for high ceilings, length 500 mm, in self-service display pack	495169
7 Carrying harness TG-LHS 225	for the PLANEX 225 EQ and PLANEX LHS-E 225 easy long-reach sanders, working aid for sanding ceilings, additional side-mounted hand grip, in SYSTAINER SYS MAXI	496911
Auxiliary handle ZG-LHS 225	for PLANEX and carrying harness, in carton	496916
8 Bag LHS-E 225-BAG	for the PLANEX easy LHS-E 225 EQ long-reach sander, transport bag with shoulder straps, in carton	202477
9 Tool holder WHR-CT 36-LHS 225	for CT 36 PLANEX, with practical carrier handle, for storing PLANEX, not for PLANEX easy, in carton	495964
10 plug it-cable H05 RN-F-4 PLANEX	for the PLANEX 225 EQ and PLANEX LHS-E 225 easy long-reach sanders, rubber insulated cable 240V plug it, particularly suitable for use with the PLANEX LHS 225 thanks to extended cable bushing, for example for sanding work in dry construction, length 4 m, in self-service display pack	203929

System accessories



BS 75



BS 105



CMS-MOD BS 120

Sanding base

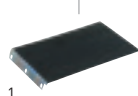

1

Reliable guidance



2

sanding belt



3

Efficient dust extraction



4

5

Safe guide



6

Stationary tasks



7

sanding belt

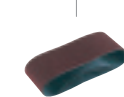

3

Accessories for belt sanders BS 75, BS 105

Denomination	Explanation	Order no.
1 Sanding base SU/GG-BS 75	for BS 75, from fabric/graphite, qty. in pack 2 Units, in self-service display pack	490823
Sanding base SU/KM-BS 75	for BS 75, made from cork/metal for coarse sanding work, qty. in pack 1 Units, in self-service display pack	490824
Sanding base SU/GG-BS 105	for BS 105, from fabric/graphite, qty. in pack 2 Units, in self-service display pack	490825
Sanding base SU/KM-BS 105	for BS 105, made from cork/metal for coarse sanding work, qty. in pack 1 Units, in self-service display pack	490826
2 Sanding frame FSR-BS 75	for BS 75, quick installation without a tool, mounting element, qty. in pack 1 Units, in carton	490827
Sanding frame FSR-BS 105	for BS 105, quick installation without a tool, mounting element, qty. in pack 1 Units, in carton	490828
3 Abrasive belt	from page 163	
4 Extraction adapter AA-BS 75/105	for BS 75, BS 105, for connecting suction hose to belt sander, in self-service display pack	490818
5 Dust bag AS-BS 75/105	for BS 75, BS 105, in carton	490819
6 Stopper LA-BS 75/105	for BS 75, BS 105, enables flexible sanding of workpieces, in carton	490821
7 Bench unit SE-BS 75/105	for BS 75, BS 105, qty. in pack 2 Units, in carton	490820

System accessories

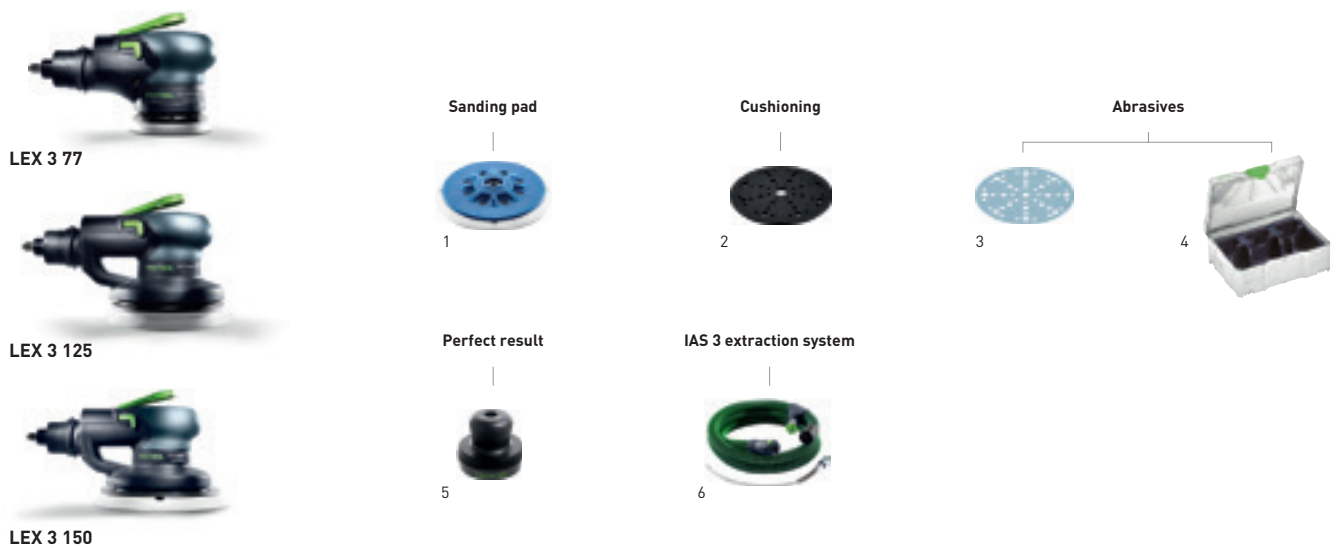

Accessories for LEX 3 77, LEX 3 125, LEX 3 150 compressed air eccentric sanders

Denomination	Explanation	Order no.
1 Sanding pad ST-STF-D77/6-M5 W	for LEX 3 77, soft version, for tough and universal use, diameter 77 mm, connecting thread M5, qty. in pack 1 Units, in self-service display pack	498694
Sanding pad ST-STF 125/8-M8-J H	for ETS EC 125, LEX 125, hard version, fastener resistant to high temperatures, high edge solidity, for plain surfaces and narrow edges, JETSTREAM, connecting thread M8, qty. in pack 1 Units, in self-service display pack	492284
Sanding pad ST-STF 125/8-M8-J W-HT	for ETS EC 125, LEX 125, soft version, fastener resistant to high temperatures, for universal use on plain and arced surfaces, JETSTREAM, connecting thread M8, qty. in pack 1 Units, in self-service display pack	492286
Sanding pad ST-STF 125/8-M8-J SW	for ETS EC 125, LEX 125, ultra-soft version, elastic structure, for heavy roundings and cambers, JETSTREAM, connecting thread M8, qty. in pack 1 Units, in self-service display pack	492288
Sanding pad ST-STF D150/MJ2-M8-SW	for ETS 150, ETS EC 150, LEX 150 and WTS 150/7, ultra-soft version, elastic structure, for heavy roundings and cambers, MULTI-JETSTREAM 2, diameter 150 mm, connecting thread M8, qty. in pack 1 Units, in self-service display pack	202459
Sanding pad ST-STF D150/MJ2-M8-W-HT	for ETS 150, ETS EC 150, LEX 150 and WTS 150/7, soft version, fastener resistant to high temperatures, for universal use on plain and arced surfaces, MULTI-JETSTREAM 2, diameter 150 mm, connecting thread M8, qty. in pack 1 Units, in self-service display pack	202458
Sanding pad ST-STF D150/MJ2-M8-H-HT	for ETS 150, ETS EC 150, LEX 150 and WTS 150/7, hard version, fastener resistant to high temperatures, high edge solidity, for plain surfaces and narrow edges, MULTI-JETSTREAM 2, diameter 150 mm, connecting thread M8, qty. in pack 1 Units, in self-service display pack	202460
Sanding pad ST-STF-D185/16-M8 W	for LEX 185, soft version, for universal use on plain and arced surfaces, connecting thread M8, qty. in pack 1 Units, in self-service display pack	490514
Sanding pad ST-STF-D185/16-M8 SW	for LEX 185, ultra-soft version, elastic structure, for heavy roundings and cambers, connecting thread M8, qty. in pack 1 Units, in self-service display pack	490526
2 Interface pad IP-STF-D77/6	for LEX 3 77, as damping element between sanding disc and sanding pad, height 10 mm, diameter 77 mm, qty. in pack 2 Units, in self-service display pack	498818
Interface pad IP-STF-D120/8-J	for sanding contoured parts and fine-sanding parts with eccentric sander Ø 125 mm, as damping element between sanding disc and sanding pad, JETSTREAM, height 15 mm, diameter 120 mm, hole circle diameter 90 mm, qty. in pack 1 Units, in self-service display pack	492271
Interface pad IP-STF D150/MJ2-5/2	for eccentric sander with diameter of 150 mm, as damping element between sanding disc and sanding pad, MULTI-JETSTREAM 2, optimal thickness for sanding work on bodies and similarly shaped components, diameter 145 mm, height 5 mm, qty. in pack 2 Units, in self-service display pack	203348
Interface pad IP-STF D150/MJ2-15/1	for eccentric sander with diameter of 150 mm, as damping element between sanding disc and sanding pad, MULTI-JETSTREAM 2, optimal thickness for sanding work on curved components, diameter 145 mm, height 15 mm, in self-service display pack	203351
3 Abrasives	from page 154, 156, 157	

System accessories



Accessories for LEX 3 77, LEX 3 125, LEX 3 150 compressed air eccentric sanders

Denomination	Explanation	Order no.
4 SYSTAINER T-LOC SYS-STF-D77/D90/93V	with insert for Ø 90 mm abrasives and 93V abrasives, dimensions [L x W x H] 396 x 296 x 105 mm, number of compartments 8, SYSTAINER size SYS 1 T-LOC	497687
SYSTAINER T-LOC SYS-STF D125	with insert for abrasives Ø 125 mm, dimensions [L x W x H] 396 x 296 x 105 mm, number of compartments 5, SYSTAINER size SYS 1 T-LOC	497685
SYSTAINER T-LOC SYS-STF D150	with insert for abrasives Ø 150 mm, dimensions [L x W x H] 396 x 296 x 210 mm, number of compartments 10, SYSTAINER size SYS 3 T-LOC	497690
5 Guide control black powder HB-Set	for visibly checking surfaces to be sanded, hand sanding block, 2 guide control black powder cartridges (each 30 g), in carton	495939
Refillable cartridge 2 x 30 g	refill for the guide control black powder HB set (2 x 30 g), in carton	495940
6 IAS hoses IAS 3	from page 150	
IAS adapter IAS 3-SD	for LEX 3, LEX 2, LRS, for connecting a Festool compressed air sander directly to a compressed air line (without dust extraction), length 90 mm, in carton	497214
Air hose D 12,4 x 5 m	for LEX 3, LEX 2, LRS, IAS 3-SD, the IAS 3-SD adapter is necessary for connection to the machine, length 5 m, in carton	497215
IAS double adapter IAS 3-DA-CT	for LEX 3, LEX 2, LRS, CT extractor (not CT 11/MINI/MIDI), for simultaneously connecting two air tools with IAS 2 and/or IAS 3 adapter to a Festool dust extractor, Not suitable for M dust extractor, in carton	497284
Adapter AD-IAS/D 36	note: if IAS 2/IAS 3 hoses are used without this adapter to extract dirt directly, the hoses and air tools may be damaged by dirt deposits in connecting parts, for use with D 36 suction nozzles with IAS 2/IAS 3 hoses, in bag	488418
Adapter IAS-ZA	for central extraction units, boom arms manufactured by Rupes, IVO and Herkules, and Rupes power boxes, rubber bushing for connection of IAS 2/IAS 3 air tools via an IAS 2/IAS 3 connection, exterior Ø 59/75 mm, interior Ø 49/57 mm, in carton	489222
Adapter IAS 3-FA	for LEX 3, LEX 2, LRS, for connecting an IAS 3 or IAS 3 light hose to an EAA power box or Herkules exhaust turbine, sleeve diameter 47,5 – 51,8 mm, in self-service display pack	499025
IAS adapter IAS-S-ZA/Herkules	for connection of IAS 2/IAS 3 suction hoses to Herkules central suction system, with closing slide, in carton	490605
Cleaning and lubricating oil LFC 9022/50	for LEX, LRS, special oil for compressed air preparation, 50 ml, in plastic bottle	201077
Cleaning and lubricating oil LFC 9022/1000	for LEX, LRS, special oil for compressed air preparation, in plastic bottle	201076

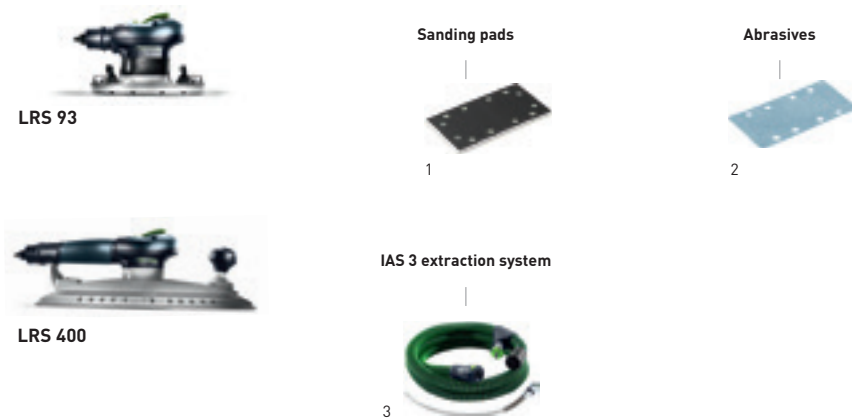

System accessories



Accessories for compressed air orbital sanders LRS 93, LRS 400

	Denomination	Explanation	Order no.
1	Sanding pad SSH-STF-93x175/8	for RS 300, RS 3, LRS 93, StickFix adhesive layer for quick change of sanding pad, dimensions 93 x 175 mm, in self-service display pack	483905
	Sanding pad SSH-93x175/8	for RS 300, RS 3, LRS 93, for abrasives for clamping, dimensions 93 x 175 mm, in self-service display pack	489630
	Iron sanding pad SSH-STF-V93x266/14	for RS 300, RS 3, LRS 93, StickFix, pressing iron sanding pad version, dimensions 93 x 266 mm, in self-service display pack	486418
	Sanding pad SSH-STF-80x400/17	for LRS 400, HSK 80 x 400, HSK 80 x 200, soft, dimensions 80 x 400 mm, qty. in pack 1 Units, in self-service display pack	493140
2	Abrasives	from page 161, 162	
3	IAS hoses IAS 3	from page 150	
	IAS adapter IAS 3-SD	for LEX 3, LEX 2, LRS, for connecting a Festool compressed air sander directly to a compressed air line (without dust extraction), length 90 mm, in carton	497214
	Air hose D 12,4 x 5 m	for LEX 3, LEX 2, LRS, IAS 3-SD, the IAS 3-SD adapter is necessary for connection to the machine, length 5 m, in carton	497215
	IAS double adapter IAS 3-DA-CT	for LEX 3, LEX 2, LRS, CT extractor (not CT 11/MINI/MIDI), for simultaneously connecting two air tools with IAS 2 and/or IAS 3 adapter to a Festool dust extractor, Not suitable for M dust extractor, in carton	497284
	Adapter AD-IAS/D 36	note: if IAS 2/IAS 3 hoses are used without this adapter to extract dirt directly, the hoses and air tools may be damaged by dirt deposits in connecting parts, for use with D 36 suction nozzles with IAS 2/IAS 3 hoses, in bag	488418
	Adapter IAS-ZA	for central extraction units, boom arms manufactured by Rupes, IVO and Herkules, and Rupes power boxes, rubber bushing for connection of IAS 2/IAS 3 air tools via an IAS 2/IAS 3 connection, exterior \varnothing 59/75 mm, interior \varnothing 49/57 mm, in carton	489222
	Adapter IAS 3-FA	for LEX 3, LEX 2, LRS, for connecting an IAS 3 or IAS 3 light hose to an EAA power box or Herkules exhaust turbine, sleeve diameter 47,5 – 51,8 mm, in self-service display pack	499025
	IAS adapter IAS-S-ZA/Herkules	for connection of IAS 2/IAS 3 suction hoses to Herkules central suction system, with closing slide, in carton	490605
	Cleaning and lubricating oil LFC 9022/50	for LEX, LRS, special oil for compressed air preparation, 50 ml, in plastic bottle	201077
	Cleaning and lubricating oil LFC 9022/1000	for LEX, LRS, special oil for compressed air preparation, in plastic bottle	201076

IAS 3 hoses

	Type	Order no.
 <p>IAS hose for LEX 3, LEX 2, LRS, antistatic, in accordance with DIN IEC 312, bleeder resistor (DIN IEC 312) <1 mΩ/m, temperature-resistant up to + 70°C, hose dia. 44 mm, in carton</p>	for connecting a Festool compressed air sander to a Festool mobile dust extractor or energy box, length 3,5 m	IAS 3-3500 AS 497208
	for connecting a Festool compressed air sander to a Festool mobile dust extractor or energy box, length 5 m	IAS 3-5000 AS 497209
	for connecting a Festool compressed air sander to a Festool mobile dust extractor or energy box, length 7 m	IAS 3-7000 AS 497210
	for connecting a Festool compressed air sander to a Festool energy box, length 10 m	IAS 3-10000 AS 497211
	Type	Order no.
 <p>IAS hose for LEX 3, LEX 2, LRS, antistatic, in accordance with DIN IEC 312, bleeder resistor (DIN IEC 312) <1 mΩ/m, temperature-resistant up to + 70°C, hose dia. 37 mm, in carton</p>	for connecting a Festool compressed air sander to a Festool mobile dust extractor or energy box, length 3,5 m	IAS 3 light 3500 AS 497478
	for connecting a Festool compressed air sander to a Festool mobile dust extractor or energy box, length 5 m	IAS 3 light 5000 AS 497213
	for connecting a Festool compressed air sander to a Festool mobile dust extractor or energy box, length 7 m	IAS 3 light 7000 AS 497479
	note: not with combination of CT/SR and ASA, for connecting a Festool compressed air sander to a Festool energy box, length 10 m	IAS 3 light 10000 AS 497480

System accessories

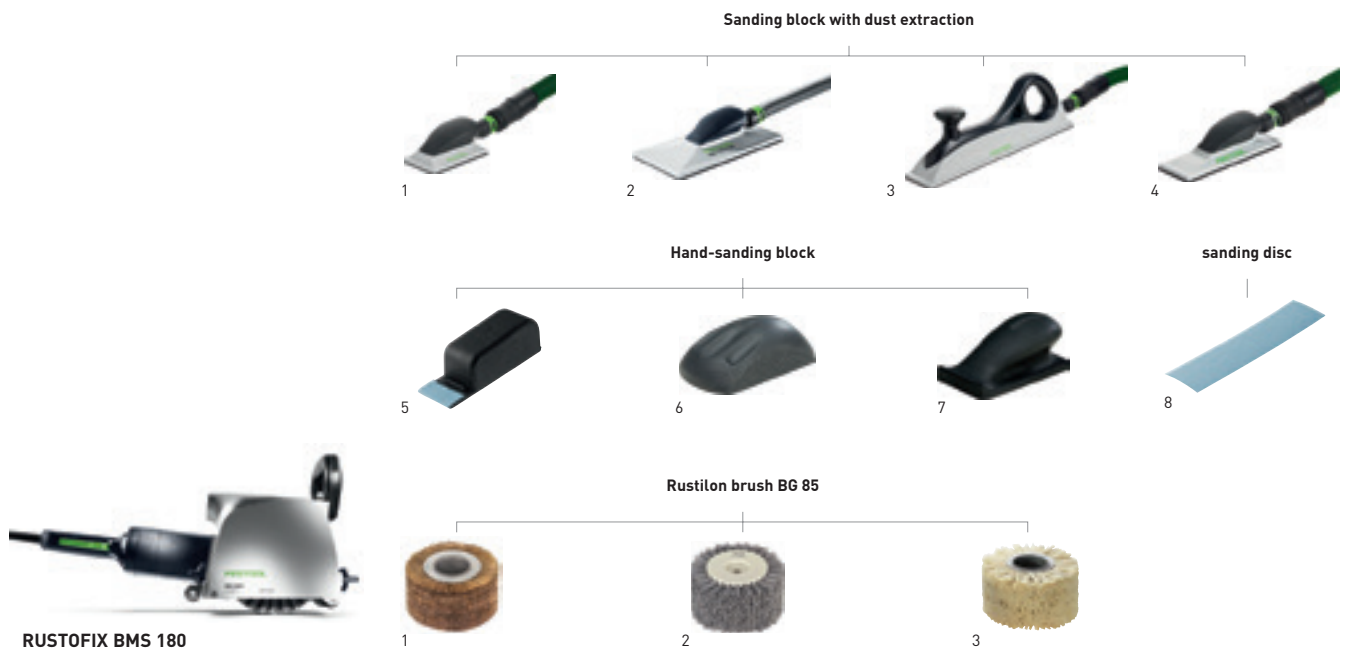

Accessories for manual sanding

Denomination	Explanation	Order no.
1 Sanding block HSK-A 80x130	compatible abrasive 80 x 133 mm, adapter for Festool hose, bypass adapter, weight 0,19 kg, in carton	496962
2 Sanding block HSK-A 115x226	compatible abrasive 115 x 228 mm, adapter for Festool hose, bypass adapter, weight 0,28 kg, in carton	496963
3 Sanding block HSK-A 80x400	compatible abrasive 80 x 400 mm, adapter for Festool hose, bypass adapter, weight 0,52 kg, in carton	496964
4 Sanding block HSK-A 80x200	compatible abrasive 80 x 400 mm (halved), adapter for Festool hose, bypass adapter, weight 0,2 kg, in carton	496965
Sanding block HSK-A-Set	compatible abrasive 80 x 133 mm, 115 x 228 mm, 80 x 400 mm, adapter for Festool hose, HSK-A 80x130, bypass adapter, HSK-A 80x200, HSK-A 80x400, HSK-A 115x226, in carton	497101
5 Hand-sanding block HSK-STF-46x178	for supporting StickFix, abrasive sheets 46 x 178 mm, in self-service display pack	583129
6 Sanding block HSK-D 150 W	soft, for attaching StickFix Ø 150 mm sanding discs, in self-service display pack	495965
Sanding block HSK-D 150 H	hard, for attaching StickFix Ø 150 mm sanding discs, in self-service display pack	495966
7 Sanding block HSK 80x133 H	hard, for attaching StickFix 80 x 133 mm abrasive sheets, in self-service display pack	495967
8 Abrasives	from page 164	

Accessories for RUSTOFIX BMS 180

Denomination	Explanation	Order no.
1 Rustilon brushes LD 85	for BMS 180, with standard steel wire, steel core, for texturing, exterior dia. 150 mm, width 85 mm, hole dia. 50 mm, in carton	411549
2 Rustilon brushes KB 85	for BMS 180, plastic bristles with embedded K80 grit, die-cast plastic core, for intermediate sanding, exterior dia. 150 mm, width 85 mm, hole dia. 16 - 30 mm, in carton	411969
3 Rustilon brushes BG 80	for BMS 180, with sisal bristles, steel core, for smoothing, exterior dia. 150 mm, width 80 mm, hole dia. 50 mm, in carton	411887

Abrasives

Abrasives for our machines

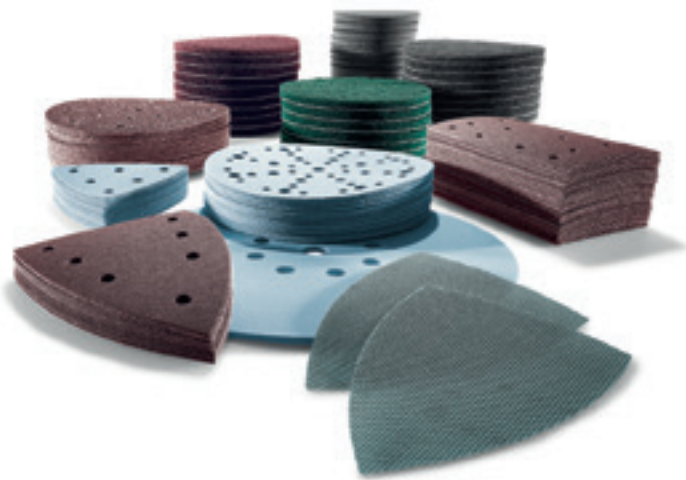

Abrasive type

	Granat	P40-500 abrasive paper P800-1500 abrasive sheet
	Granat Net	Abrasive net + Protection Pad
	Granat Soft	Sandpaper on foam backing
	Rubin 2	Abrasive paper with robust paper backing
	Saphir	Abrasive on extremely robust cloth backing (tear-resistant)
	Vlies	Sanding cloth – abrasive agent
	Platin 2	Fine abrasive cloth on foam backing

Manual abrasive



Granat

Abrasive paper

- > flexible, universal manual abrasive paper for paints, repair compound, fillers, varnishes
- > available as a roll (115 mm x 25 m) or in the form of sheets (230 x 230 mm)
- > P40-400 grit

Granat

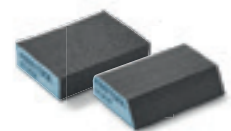
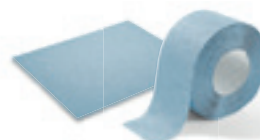

Sanding block

- > Four-sided, rigid sanding block in two versions:
- > **Standard block**; ideal for sanding edges and profiles; 36-60-120-220 grit
- > **Combi block**; with round and acute-angled side; ideal for sanding areas that are difficult to reach and concave profiles; 120 grit



from page 164

from page 165

Area of application										Others			Grit range							
	Solid wood	Composite wooden materials	Varnishes/paint	Filler	Mineral materials	Oils	Varnishes/paint	Filler	Filler	GFRP	Metal	Plastic materials	Sanding off 24-60	Coarse sanding 80-120	Intermediate sanding 150-220	Fine sanding 240-500	Extra-fine sanding 800-1500	Preparation for polishing 1500-4000	Oils/waxes	
Premium abrasive for universal use (coarse to extra-fine sanding)	<input type="radio"/>	<input type="radio"/>	<input checked="" type="radio"/>	<input checked="" type="radio"/>	<input checked="" type="radio"/>		<input checked="" type="radio"/>	<input checked="" type="radio"/>	<input checked="" type="radio"/>	<input type="radio"/>	<input type="radio"/>	<input checked="" type="radio"/>	40		1500					
Perfect for surfaces that produce a large quantity of dust; to be used in conjunction with the protection pad (except for D225)	<input type="radio"/>	<input type="radio"/>	<input type="radio"/>	<input checked="" type="radio"/>	<input type="radio"/>		<input type="radio"/>	<input checked="" type="radio"/>	<input checked="" type="radio"/>	<input type="radio"/>	<input type="radio"/>		80		400					
For a very high level of adaptability and even sanding finish on soft repair compounds (D225 only)									<input checked="" type="radio"/>				80		400					
Perfect for processing wood	<input checked="" type="radio"/>	<input checked="" type="radio"/>											40		220					
For extreme coarse sanding	<input type="radio"/>		<input checked="" type="radio"/>				<input checked="" type="radio"/>			<input checked="" type="radio"/>	<input type="radio"/>		24		80					
For light sanding, cleaning, oiling, waxing			<input checked="" type="radio"/>		<input checked="" type="radio"/>	<input checked="" type="radio"/>	<input checked="" type="radio"/>				<input checked="" type="radio"/>	<input type="radio"/>		100		800			white/green	
For perfect preparation for polishing (dry and wet sanding)					<input checked="" type="radio"/>											400		4000		

Extremely appropriate Appropriate



Granat

Abrasive sponge

- > Two-sided flexible abrasive sponge; ideal for sanding radius profiles and mould surfaces
- > 60-120-220-800 grit



Granat

Abrasive pad

- > One-sided flexible abrasive sponge; ideal for fine and intermediate sanding of profiles and mould surfaces
- > MEDIUM 280 to MICROFINE 1500 grit



Granat Soft

Soft abrasive roll

- > Abrasive paper on foam backing for equal pressure distribution; ideal for light and intermediate sanding
- > Roll 115 mm x 25 m (perforated)
- > P120-800 grit



Vlies

Manual abrasive cloth

- > available as a roll (115 mm x 10 m) or in the form of pre-perforated pads (115 x 152 mm)
- > ideal for roughening and matting old coatings before applying a new coating
- > MEDIUM 100 to ULTRAFINE 1000 grit

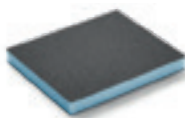

from page 165



from page 165



from page 164



from page 165



Abrasives

LEX 3 77
RO 90 DX

Ø 77 mm

	Grit	Qty. in pack	Order no.		Grit	Qty. in pack	Order no.
	Granat	P80	50	497405	P400	50	497412
		P120	50	497406	P500	50	497413
		P150	50	497407	P800	50	498929
		P180	50	497408	P1000	50	498930
		P240	50	497409	P1200	50	498931
		P280	50	497410	P1500	50	498932
		P320	50	497411			

Ø 90 mm

	Granat	P40	50	497363	P280	100	497850
		P60	50	497364	P320	100	497372
		P80	50	497365	P400	100	497373
		P100	100	497366	P500	100	498326
		P120	100	497367	P800	50	498327
		P150	100	497368	P1000	50	498328
		P180	100	497369	P1200	50	498329
		P220	100	497370	P1500	50	498330
		P240	100	497371			
	Rubin 2	P40	50	499077	P120	50	499081
		P60	50	499078	P150	50	499082
		P80	50	499079	P180	50	499083
		P100	50	499080	P220	50	499084
	Platin 2	S500	15	498322	S2000	15	498324
		S1000	15	498323	S4000	15	498325



Abrasives

RO 90 DX
DX 93
RS 300
LRS 93
RAS 115

93V

	Grit	Qty. in pack	Order no.		Grit	Qty. in pack	Order no.
	Granat						
	P40	50	497390	P180	100	497396	
	P60	50	497391	P220	100	497397	
	P80	50	497392	P240	100	497398	
	P100	100	497393	P280	100	499644	
	P120	100	497394	P320	100	497399	
	P150	100	497395	P400	100	497400	
	Rubin 2			P120	50	499165	
	P40	50	499161	P150	50	499166	
	P60	50	499162	P180	50	499167	
	P80	50	499163	P220	50	499168	
	P100	50	499164				

Ø 115 mm



	Rubin 2			P100	50	499088
	P40	50	499085	P120	50	499089
	P60	50	499086			
	P80	50	499087			
	Saphir			P50	25	485245
	P24	25	484151	P80	25	485246
	P36	25	484152			

Abrasives

RO 125
ETS 125
ETSC 125
LEX 3 125



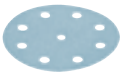

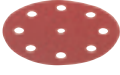
Ø 125 mm

	Grit	Qty. in pack	Order no.		Grit	Qty. in pack	Order no.
Granat 	P40	10	497145		P220	100	497172
	P40	50	497165		P240	100	497173
	P60	10	497146		P280	100	497174
	P60	50	497166		P320	10	497150
	P80	10	497147		P320	100	497175
	P80	50	497167		P360	100	497176
	P100	100	497168		P400	100	497177
	P120	10	497148		P500	100	497178
	P120	100	497169		P800	50	497179
	P150	100	497170		P1000	50	497180
	P180	10	497149		P1200	50	497181
	P180	100	497171		P1500	50	497182
	Granat Net  +	P80	50		203294		P220
P100		50	203295	P240	50		203300
P120		50	203296	P320	50		203301
P150		50	203297	P400	50		203302
P180		50	203298				
Protection Pad		2	203344	for protecting the sanding pad when using abrasive net			
Rubin 2 	P40	10	499101		P120	10	499105
	P40	50	499093		P120	50	499097
	P60	10	499102		P150	10	499106
	P60	50	499094		P150	50	499098
	P80	10	499103		P180	10	499107
	P80	50	499095		P180	50	499099
	P100	10	499104		P220	10	499108
	P100	50	499096		P220	50	499109

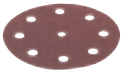

Abrasives

RO 125, ETS 125
 ETS C 125, LEX 3 125
 RO 150, ETS 150
 LEX 3 150

Ø 125 mm

	Grit	Qty. in pack	Order no.		Grit	Qty. in pack	Order no.
	Saphir						
	P24	25	493124		P50	25	493126
	P36	25	493125		P80	25	493127
	Vlies				320	10	201132
	green	10	496510		800	10	201133
	white	10	496511				
	100	10	201131				
	Platin 2				S2000	15	492376
	S400	15	492373		S4000	15	492377
	S500	15	492374				
	S1000	15	492375				

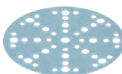
Ø 150 mm

	Granat	P40	10	575154	P220	100	575167
		P40	50	575160	P240	100	575168
		P60	10	575155	P280	100	575169
		P60	50	575161	P320	10	575159
		P80	10	575156	P320	100	575170
		P80	50	575162	P360	100	575171
		P100	100	575163	P400	100	575172
		P120	10	575157	P500	100	575173
		P120	100	575164	P800	50	575174
		P150	100	575165	P1000	50	575175
		P180	10	575158	P1200	50	575176
		P180	100	575166	P1500	50	575177
		Granat Net	P80	50	203303	P220	50
		P100	50	203304	P240	50	203309
		P120	50	203305	P320	50	203310
		P150	50	203306	P400	50	203311
		P180	50	203307			

Protection Pad



		2	203343
---	--	---	--------

for protecting the sanding pad when using abrasive net

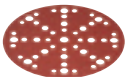
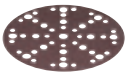

Abrasives

RO 150
ETS 150
LEX 3 150
RAS 180

Ø 150 mm

	Grit	Qty. in pack	Order no.		Grit	Qty. in pack	Order no.	
	Rubin 2	P40	10	575178		P120	10	575182
		P40	50	575186		P120	50	575190
		P60	10	575179		P150	10	575183
		P60	50	575187		P150	50	575191
		P80	10	575180		P180	10	575184
		P80	50	575188		P180	50	575192
		P100	10	575181		P220	10	575185
		P100	50	575189		P220	50	575193
	Saphir	P24	25	575194		P50	25	575196
		P36	25	575195		P80	25	575197
	Vlies	green	10	496508		320	10	201127
		white	10	496509		800	10	201128
		100	10	201126				
	Platin 2	S400	15	492368		S2000	15	492371
		S500	15	492369		S4000	15	492372
		S1000	15	492370				

Ø 180 mm

	Rubin 2	P40	50	499125		P120	50	499129
		P60	50	499126		P150	50	499130
		P80	50	499127		P180	50	499131
		P100	50	499128		P220	50	499132
	Saphir	P24	25	485239		P50	25	485241
		P36	25	485240		P80	25	485242

Abrasives

LEX 2 185/7



LHS-E 225

LHS 225

Ø 185 mm

	Grit	Qty. in pack	Order no.		Grit	Qty. in pack	Order no.
	Granat						
	P40	50	497183	P150	100	497187	
	P60	50	497184	P180	100	497188	
	P80	50	497185	P240	100	497189	
	P100	100	499629	P320	100	497190	
	P120	100	497186	P400	100	497191	

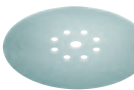
Ø 225 mm

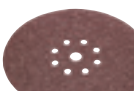



	Granat						
	P40	25	499634	P150	25	499639	
	P60	25	499635	P180	25	499640	
	P80	25	499636	P220	25	499641	
	P100	25	499637	P240	25	499642	
	P120	25	499638	P320	25	499643	
	Granat Net						
	P80	25	203312	P220	25	203317	
	P100	25	203313	P240	25	203318	
	P120	25	203314	P320	25	203319	
	P150	25	203315	P400	25	201885	
	P180	25	203316				
	Granat Soft						
	P80	25	204221	P180	25	204225	
	P100	25	204222	P240	25	204226	
	P120	25	204223	P320	25	204227	
	P150	25	204224	P400	25	204228	
	Saphir						
	P24	25	495174	P36	25	495175	

Abrasives

RTS 400
 RTSC 400
 LS 130
 HSK-A 80x130



80 x 133 mm

	Grit	Qty. in pack	Order no.		Grit	Qty. in pack	Order no.
	Granat						
	P40	10	497127	P150	100	497121	
	P40	50	497117	P180	10	497130	
	P60	50	497118	P180	100	497122	
	P80	10	497128	P220	100	497123	
	P80	50	497119	P240	100	497124	
	P100	100	499628	P280	100	497204	
	P120	10	497129	P320	100	497125	
	P120	100	497120	P400	100	497126	
	Granat Net						
	P80	50	203285	P220	50	203290	
	P100	50	203286	P240	50	203291	
	P120	50	203287	P320	50	203292	
	P150	50	203288	P400	50	203293	
	Protection Pad	2	203346	for protecting the sanding pad when using abrasive net			
	Rubin 2						
	P40	10	499054	P120	10	499058	
	P40	50	499046	P120	50	499050	
	P60	10	499055	P150	10	499059	
	P60	50	499047	P150	50	499051	
	P80	10	499056	P180	10	499060	
	P80	50	499048	P180	50	499052	
	P100	10	499057	P220	10	499061	
P100	50	499049	P220	50	499053		
	Vlies	800	5	483582			



Abrasives

LRS 400
 HSK-A 80 x 400/80 x 200
 DTS 400 R
 DTSC 400

80 x 400 mm (pre-perforated for 80 x 200 mm)

	Grit	Qty. in pack	Order no.		Grit	Qty. in pack	Order no.
	Granat						
	P40	50	497157	P150	50	497161	
	P60	50	497158	P180	50	497162	
	P80	50	497159	P240	50	497163	
	P100	50	499631	P280	50	497203	
	P120	50	497160	P320	50	497164	

100 x 150 mm

	Granat						
	P40	10	497131	P150	100	497139	
	P40	50	497135	P180	10	497134	
	P60	50	497136	P180	100	497140	
	P80	10	497132	P220	100	497141	
	P80	50	497137	P240	100	497142	
	P100	100	499630	P320	100	497143	
	P120	10	497133	P400	100	497144	
	Granat Net						
	P80	50	203320	P220	50	203325	
	P100	50	203321	P240	50	203326	
	P120	50	203322	P320	50	203327	
	P150	50	203323	P400	50	203328	
	P180	50	203324				

Protection Pad	2	203347
-----------------------	---	--------



for protecting the sanding pad when using abrasive net

	Rubin 2						
	P40	10	499141	P120	10	499145	
	P40	50	499133	P120	50	499137	
	P60	10	499142	P150	10	499146	
	P60	50	499134	P150	50	499138	
	P80	10	499143	P180	10	499147	
	P80	50	499135	P180	50	499139	
	P100	10	499144	P220	10	499148	
	P100	50	499136	P220	50	499140	

Abrasives

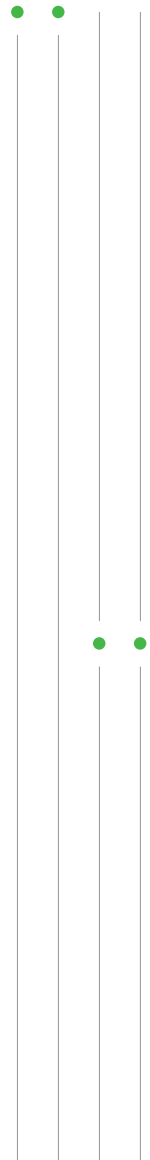

RS 300
LRS 93
RS 100
RS 200



93 x 178 mm

	Grit	Qty. in pack	Order no.		Grit	Qty. in pack	Order no.
	Granat						
	P40	50	498933	P180	100	498938	
	P60	50	498934	P220	100	498939	
	P80	50	498935	P240	100	498940	
	P100	100	499633	P280	100	498941	
	P120	100	498936	P320	100	498942	
	P150	100	498937	P400	100	498943	
	Rubin 2			P120	50	499065	
	P40	50	499185	P150	50	499066	
	P60	50	499062	P180	50	499067	
	P80	50	499063	P220	50	499068	
	P100	50	499064				

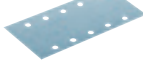
115 x 228 mm

	Granat			P180	100	498949
	P40	50	498944	P220	100	498950
	P60	50	498945	P240	100	498951
	P80	50	498946	P320	100	498953
	P100	100	499632	P400	100	498954
	P120	100	498947			
	P150	100	498948			
	Rubin 2			P120	50	499034
	P40	50	499030	P150	50	499035
	P60	50	499031	P180	50	499036
	P80	50	499032	P220	50	499037
	P100	50	499033			

Abrasives

BS 75

BS 105

CMB 120

533 x 75 mm

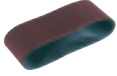
	Grit	Qty. in pack	Order no.	Grit	Qty. in pack	Order no.
	Rubin 2					
	P40	10	499155	P100	10	499158
	P60	10	499156	P120	10	499159
	P80	10	499157	P150	10	499160

620 x 105 mm

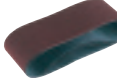
	Rubin 2					
	P40	10	499149	P100	10	499152
	P60	10	499150	P120	10	499153
	P80	10	499151	P150	10	499154

820 x 120 mm

	Saphir					
	P50	10	488081	P120	10	488084
	P80	10	488082	P150	10	488085
	P100	10	488083	P180	10	488086

Manual abrasive

Pocket StickFix 46 x 178 mm for hand sanding block

	Grit	Qty. in pack	Order no.		Grit	Qty. in pack	Order no.	
	Granat	P40	10	204276		P120	10	204278
		P80	10	204277		P180	10	204279

Hand abrasive Granat sandpaper 230 x 280 mm

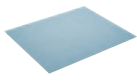
	Grit	Qty. in pack	Order no.		Grit	Qty. in pack	Order no.	
	Granat	P40	10	201256		P150	50	201091
		P40	25	201085		P180	10	201262
		P60	10	201257		P180	50	201093
		P60	50	201087		P220	10	201263
		P80	10	201258		P220	50	201094
		P80	50	201088		P240	10	201264
		P100	10	201259		P240	50	201095
		P100	50	201089		P320	10	201265
		P120	10	201260		P320	50	201096
		P120	50	201090		P400	10	201266
		P150	10	201261		P400	50	201097

Hand abrasive Granat abrasive roll 115 mm x 25 m

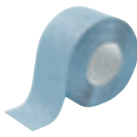
	Grit	Qty. in pack	Order no.		Grit	Qty. in pack	Order no.	
	Granat	P40	1	201103		P150	1	201108
		P60	1	201104		P180	1	201109
		P80	1	201105		P220	1	201110
		P100	1	201106		P240	1	201111
		P120	1	201107		P320	1	201768

Manual abrasive Granat Soft abrasive roll (pre-perforated) 115 mm x 25 m

	Grit	Qty. in pack	Order no.		Grit	Qty. in pack	Order no.	
	Granat Soft	P120	1	497091		P400	1	497096
		P150	1	497092		P500	1	497097
		P180	1	497093		P600	1	497098
		P240	1	497094		P800	1	497964
		P320	1	497095				

Manual abrasive

Granat sanding block manual abrasive 69 x 98 x 26 mm (four-sided)

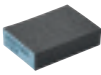
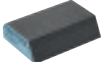
	Grit	Qty. in pack	Order no.	Grit	Qty. in pack	Order no.
	36	6	201080	120	6	201082
	60	6	201081	220	6	201083
	120	6	201084			

Hand abrasive Granat abrasive sponge 98 x 120 x 13 mm (2-sided)

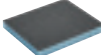
	Grit	Qty. in pack	Order no.	Grit	Qty. in pack	Order no.
	60	6	201112	220	6	201114
	120	6	201113	800	6	201507

Granat abrasive pad manual abrasive 115 x 140 x 5 mm (one-sided)

	Grit	Qty. in pack	Order no.	Grit	Qty. in pack	Order no.
	280	20	201769	1000	20	201101
	500	20	201099	1500	20	201102
	800	20	201100			

Hand abrasive Vlies 115 x 152 mm

	Grit	Qty. in pack	Order no.	Grit	Qty. in pack	Order no.
	100	25	201115	800	30	497089
	320	30	497088	1000	30	497090

Hand abrasive Vlies abrasive roll 115 mm x 10 m

	Grit	Qty. in pack	Order no.	Grit	Qty. in pack	Order no.
	100	1	201116	800	1	201118
	320	1	201117	1000	1	201119

03 Machining surfaces

Preparing the surface

Denibber



Fine sanding

Sander ETS 150/3



Sanding pad Ø 150 mm



Granat P 1500 abrasive
dia. 150 mm



Polishing

Polisher SHINEX RAP 150



Polisher POLLUX 180



Polishing pad
dia. 150 mm
dia. 180 mm



Orange – preliminary polishing

Orange polishing pad (medium)
Premium sheepskin



MPA 5010 polish



Blue – fine polishing

Blue polishing pad (medium-fine)



MPA 9010 polish



Polishing out swirl marks

ROTEX RO 150
ROTEX RO 125
ROTEX RO 90 DX geared eccentric
sanders



Polishing pad
Ø 150 mm
Ø 125 mm
Ø 90 mm



White – high-gloss polishing

White polishing pad (fine)

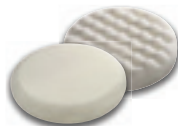

MPA 11010 polish



Cleaning/finish

MPA F+ finish cleaner



MPA SV+ spray sealant



MPA Microfibre cloth



RT PREMIUM cleaning cloth



Polishing system overview

Leave behind a brilliant impression. Festool polishes and polishing sponges.

Polish with ease and achieve brilliant results – Festool polishes are specially designed for their various applications. These polishes are water-based and do not contain silicone. When used in combination with the appropriate sponge they ensure reliable and optimal results for all types of coatings while requiring minimal effort. The clearly organised colour coding system enables users to quickly find the appropriate product.

Polish

MPA 5010

Speed Cut 1-step sanding polish

High sanding performance and a high gloss finish in a single step



MPA 9010

Speed Gloss fine sanding polish

Fine sanding performance for intermediate and fine polishing



MPA 11010

anti-swirl-mark high-gloss polish

Extra fine sanding performance for removing microscratches and swirl marks



Foam polishing pads

Coarse

for polishing heavily weathered surfaces (preparation for painting)



Mid

For polishing and removing imperfections in paintwork. Ideal together with the MPA 5010.

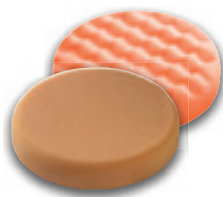

medium-fine

For producing a perfect high-gloss finish. Ideal for use together with MPA 9010.

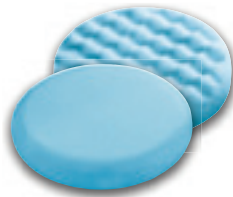

Fine

For polishing out swirl marks and producing a deep shine. Ideal together with the MPA 11010.



Very fine

For removing polish residues on the painted surface.



Polishing felt and sheepskin pad

Hard polishing felt

Particularly suitable for UV clear coats, scratch-resistant clear coats



Premium sheepskin

For preliminary polishing of mineral materials, acrylic glass and clear coats



Soft polishing felt

For follow-up polishing of mineral materials, acrylic glass and clear coats

Finish cleaner and spray sealant

The high-quality microfibre cloths have a scratch-free edge to ensure a perfect finish for paint. They are perfectly suited to removing polish residue and grease spots when used in conjunction with finish cleaner.

The spray sealant is suitable for quickly and easily sealing painted surfaces, conserving, protecting and maintaining the paint.



System accessories



SHINEX RAP 150



POLLUX 180

Polishing pad



1

Foam polishing pads



2

Polishing agent



3

Microfibre cloth



4

Cleaning cloth



5

Finishing



6

Denibber



7

Additional hand grip



8









Accessories for SHINEX RAP 150, POLLUX 180 rotary polishers

Denomination	Explanation	Order no.
1 Polishing pad PT-STF-D150-M14	for RAP 150, with integrated shock absorber for optimum distribution of pressure during polishing, fits polishing accessories, diameter 125 mm, height 25 mm, in self-service display pack	488342
Polishing pad PT-STF-D180-M14	for RAP 180, with integrated shock absorber for optimum distribution of pressure during polishing, fits polishing accessories, diameter 165 mm, height 30 mm, in self-service display pack	488349
2 Foam polishing pads	from page 171	
3 Polishing agent MPA 5010 OR/0,5L	Speed Cut 1-step sanding polish, does not contain silicone, water-based, perfect in combination with a sheepskin pad or polishing pad (ORANGE), volume 500 ml, in plastic bottle	202048
Polishing agent MPA 9010 BL/0,5L	Speed Gloss fine sanding polish, does not contain silicone, water-based, perfect in combination with a polishing pad (BLUE), volume 500 ml, in plastic bottle	202050
Polishing agent MPA 11010 WH/0,5L	anti-swirl-mark high-gloss polish, does not contain silicone, water-based, perfect in combination with a polishing pad (WHITE), volume 500 ml, in plastic bottle	202051
4 Microfibre cloth MPA-Microfibre/2	for excellent finish of new paints, for removing polish residues and grease marks, qty. in pack 2 Units, in self-service display pack	493068
5 Cleaning cloth RT PREMIUM 240x380/200	roller with 200 sheets, fibre-reinforced, tear-proof and extremely absorbent, in dispenser box, in carton	498071
6 Sealing spray MPA SV+/0,5L	for sealing painted surfaces, does not contain silicone, water-based, volume 500 ml, in plastic bottle	202052
Finish-Cleaner MPA F+/0,5L	for removing polish residues and grease marks, does not contain silicone, water-based, volume 500 ml, in plastic bottle	202053
7 Denibber LZK-HM	with cord, for the accurate removal of trapped particles and unevenness, manufactured from carbide, with hollow grinding, dimensions 25 x 30 mm, in self-service display pack	497525
8 Auxiliary handle ZG-RAS/RO	for RO 150, RAS, WTS 150, RAP 150, in carton	487865



Polishing accessories

RAP 80
T 15+3
T 18+3
RO 90 DX

PoliStick polishing sponge for Ø 80 mm

		Diameter	Height in mm	Package contents	Order no.
	yellow, Coarse, for polishing heavily weathered surfaces (preparation for painting)	80 mm	20 mm	5	201989
	orange, Mid, for preliminary polishing when repairing paint flaws, ideal together with the MPA 5010	80 mm	20 mm	5	201993
	medium (waffle face), for preliminary polishing when repairing paint flaws, ideal together with the MPA 5010, orange	80 mm	20 mm	5	201994
	blue, medium-fine, for removing microscratches in clear coats, ideal together with the MPA 9010	80 mm	20 mm	5	202001
	blue, medium-fine (waffle face), for removing microscratches in clear coats, ideal together with the MPA 9010	80 mm	20 mm	5	202002
	high-gloss polishing, ideal together with the MPA 11010, white, Fine, for polishing out swirl marks and producing a deep shine	80 mm	20 mm	5	202009
	white, fine (honeycombed), for polishing out swirl marks and producing a deep shine, high-gloss polishing, ideal together with the MPA 11010	80 mm	20 mm	5	202010
	black, very fine (honeycombed), for removing polish residues on the painted surface	80 mm	20 mm	5	202017









Sheepskin and polishing felt for Ø 80 mm

		Diameter	Height in mm	Package contents	Order no.
	ideal together with the MPA 5010, Suitable for UV paints, scratch-resistant paints, optimum adhesion thanks to full covering with adhesive velour and edge seams, real hair sheepskin for high abrasiveness and an excellent polishing finish	80 mm	18 mm	5	202044
	Polishing felt, hard, For preliminary polishing of mineral materials, acrylic glass and gloss paints, white	80 mm	6 mm	5	488339
	Polishing felt, soft, for re-polishing mineral materials, acrylic glass and gloss paints, white	80 mm	6 mm	5	488341



Polishing accessories

R0 125

● PoliStick polishing sponge for Ø 125 mm

		Diameter	Height in mm	Package contents	Order no.
	yellow, Coarse, for polishing heavily weathered surfaces (preparation for painting)	125 mm	20 mm	5	201990
	orange, Mid, for preliminary polishing when repairing paint flaws, ideal together with the MPA 5010	125 mm	20 mm	1	202367
		125 mm	20 mm	5	201995
	orange, medium (waffle face), for preliminary polishing when repairing paint flaws, ideal together with the MPA 5010	125 mm	20 mm	1	202368
		125 mm	20 mm	5	201996
	ideal together with the MPA 9010, blue, medium-fine, for removing microscratches in clear coats	125 mm	20 mm	1	202371
		125 mm	20 mm	5	202003
	ideal together with the MPA 9010, blue, medium-fine (waffle face), for removing microscratches in clear coats	125 mm	20 mm	1	202372
		125 mm	20 mm	5	202004
	high-gloss polishing, ideal together with the MPA 11010, white, Fine, for polishing out swirl marks and producing a deep shine	125 mm	20 mm	1	202375
		125 mm	20 mm	5	202011
	white, fine (honeycombed), for polishing out swirl marks and producing a deep shine, high-gloss polishing, ideal together with the MPA 11010	125 mm	20 mm	1	202376
		125 mm	20 mm	5	202012
	black, very fine (honeycombed), for removing polish residues on the painted surface	125 mm	20 mm	1	202379
		125 mm	20 mm	5	202018









● Sheepskin and polishing felt for Ø 125 mm

		Diameter	Height in mm	Package contents	Order no.
	real hair sheepskin for high abrasiveness and an excellent polishing finish, ideal together with the MPA 5010, Suitable for UV paints, scratch-resistant paints, optimum adhesion thanks to full covering with adhesive velour and edge seams	125 mm	18 mm	1	202045
	Polishing felt, hard, For preliminary polishing of mineral materials, acrylic glass and gloss paints, white	125 mm	6 mm	5	493078
	Polishing felt, soft, For re-polishing mineral materials, acrylic glass and gloss paints, white	125 mm	6 mm	5	493077



Polishing accessories

RAP 150
RO 150

PoliStick polishing sponge for Ø 150 mm

	Diameter	Height in mm	Package contents	Order no.
 yellow, Coarse, for polishing heavily weathered surfaces (preparation for painting)	150 mm	30 mm	5	201991
 orange, Mid, for preliminary polishing when repairing paint flaws, ideal together with the MPA 5010	150 mm	30 mm	1	202369
	150 mm	30 mm	5	201997
 ideal together with the MPA 5010, orange, medium (waffle face), for preliminary polishing when repairing paint flaws	150 mm	30 mm	1	202370
	150 mm	30 mm	5	201998
 blue, medium-fine, for removing microscratches in clear coats, ideal together with the MPA 9010	150 mm	30 mm	1	202373
	150 mm	30 mm	5	202005
 blue, medium-fine (waffle face), for removing microscratches in clear coats, ideal together with the MPA 9010	150 mm	30 mm	1	202374
	150 mm	30 mm	5	202006
 Fine, for polishing out swirl marks and producing a deep shine, high-gloss polishing, ideal together with the MPA 11010, white	150 mm	30 mm	1	202377
	150 mm	30 mm	5	202013
 high-gloss polishing, ideal together with the MPA 11010, white, fine (honeycombed), for polishing out swirl marks and producing a deep shine	150 mm	30 mm	1	202378
	150 mm	30 mm	5	202014
 black, very fine (honeycombed), for removing polish residues on the painted surface	150 mm	30 mm	1	202380
	150 mm	30 mm	5	202019

Sheepskin and polishing felt for Ø 150 mm

	Diameter	Height in mm	Package contents	Order no.
 real hair sheepskin for high abrasiveness and an excellent polishing finish, ideal together with the MPA 5010, Suitable for UV paints, scratch-resistant paints, optimum adhesion thanks to full covering with adhesive velour and edge seams	150 mm	18 mm	1	202046
 Polishing felt, hard, For preliminary polishing of mineral materials, acrylic glass and gloss paints, white	150 mm	6 mm	1	485970
	150 mm	6 mm	5	488348
Polishing felt, soft, For re-polishing mineral materials, acrylic glass and gloss paints, white	150 mm	6 mm	1	485972
	150 mm	6 mm	5	488347



Polishing accessories

POLLUX 180
RAP 180

PoliStick polishing sponge for Ø 180 mm

	Diameter	Height in mm	Package contents	Order no.
 yellow, Coarse, for polishing heavily weathered surfaces (preparation for painting)	180 mm	30 mm	5	201992
 orange, Mid, for preliminary polishing when repairing paint flaws, ideal together with the MPA 5010	180 mm	30 mm	5	201999
 ideal together with the MPA 5010, orange, medium (waffle face), for preliminary polishing when repairing paint flaws	180 mm	30 mm	5	202000
 blue, medium-fine, for removing microscratches in clear coats, ideal together with the MPA 9010	180 mm	30 mm	5	202007
 blue, medium-fine (waffle face), for removing microscratches in clear coats, ideal together with the MPA 9010	180 mm	30 mm	5	202008
 white, Fine, for polishing out swirl marks and producing a deep shine, high-gloss polishing, ideal together with the MPA 11010	180 mm	30 mm	5	202015
 for polishing out swirl marks and producing a deep shine, high-gloss polishing, ideal together with the MPA 11010, white, fine (honeycombed)	180 mm	30 mm	5	202016
 very fine (honeycombed), for removing polish residues on the painted surface, black	180 mm	30 mm	5	202020

Sheepskin and polishing felt for Ø 180 mm

	Diameter	Height in mm	Package contents	Order no.
 real hair sheepskin for high abrasiveness and an excellent polishing finish, ideal together with the MPA 5010, Suitable for UV paints, scratch-resistant paints, optimum adhesion thanks to full covering with adhesive velour and edge seams	180 mm	18 mm	1	202047
 Polishing felt, hard, For preliminary polishing of mineral materials, acrylic glass and gloss paints, white	180 mm	6 mm	5	488355
 Polishing felt, soft, for re-polishing mineral materials, acrylic glass and gloss paints, white	180 mm	6 mm	5	488354

System accessories



SURFIX

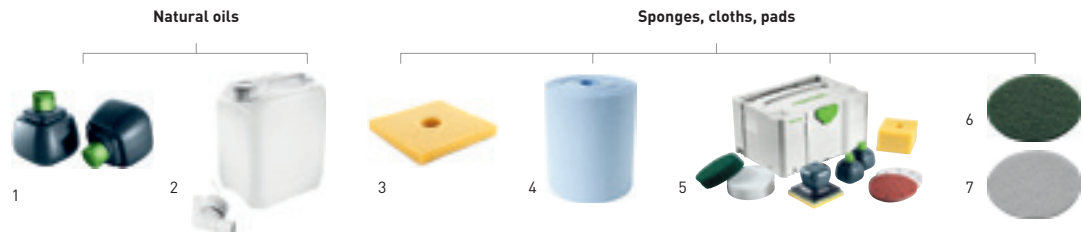

Accessories for SURFIX OS oil dispenser

Denomination	Explanation	Order no.
1 Natural oil RF HD 0,3 l/2	heavy-duty oil, refill bottle, volume 300 ml, qty. in pack 2 Units, in self-service display pack	498064
Natural oil RF OS 0,3 l/2	one-step oil, refill bottle, volume 300 ml, qty. in pack 2 Units, in self-service display pack	498065
Natural oil RF OD 0,3 l/2	outdoor oil, refill bottle, volume 300 ml, qty. in pack 2 Units, in self-service display pack	498066
2 Natural oil RF HD 5l	heavy-duty oil, filling quantity 5 l, in canister	498067
Natural oil RF OS 5l	one-step oil, filling quantity 5 l, in canister	498068
Natural oil RF OD 5l	outdoor oil, filling quantity 5 l, in canister	498069
3 Oil sponge OS-STF 125x125/5	StickFix sponge for SURFIX oil dispenser, qty. in pack 5 Units, dimensions 125 x 125 mm, in carton	498070
4 Cleaning cloth RT PREMIUM 240x380/200	roller with 200 sheets, fibre-reinforced, tear-proof and extremely absorbent, in dispenser box, in carton	498071
5 Oil dispenser OS-SYS3-Set	base plate, heavy-duty oil bottle, 0.3 l, one-step oil bottle, 0.3 l, outdoor oil bottle, 0.3 l, 5 x StickFix oil sponge, 5 x green non-woven sanding pad, 5 x white non-woven sanding pad, 10 x sanding discs STF-D150 P180 RU2, 10 x sanding discs STF-D150 P240 BR2, in SYSTAINER SYS 3 T-LOC	498063
6 Sanding vlies STF D125 green VL/10	for RO 125, ES 125, ETS 125, ETSC 125, ETS EC 125, LEX 125, Oil worked into the surface deep and evenly, grit green, qty. in pack 10 Units, diameter 125 mm, in carton	496510
Sanding vlies STF D150 green VL/10	for RO 150, ES 150, ETS 150, ETS EC 150, LEX 150, WTS 150, HSK-D 150, Oil worked into the surface deep and evenly, grit green, qty. in pack 10 Units, diameter 150 mm, in carton	496508
7 Polishing fleece STF D125 white VL/10	for RO 125, ES 125, ETS 125, ETSC 125, ETS EC 125, LEX 125, Even distribution and polishing of oil and wax for further surface refinement, Non-abrasive polishing without grit, grit white, qty. in pack 10 Units, diameter 125 mm, in carton	496511
Polishing fleece STF D150 white VL/10	for RO 150, ES 150, ETS 150, ETS EC 150, LEX 150, WTS 150, HSK-D 150, Even distribution and polishing of oil and wax for further surface refinement, Non-abrasive polishing without grit, grit white, qty. in pack 10 Units, diameter 150 mm, in carton	496509



04 Dust extraction

Overview of products and applications **176**

Mobile dust extractors

CLEANTEC compact – CT 17, CTL SYS, CT MINI I, CTM MIDI I **182**

CLEANTEC – CT 26/36/48 **186**

CLEANTEC AUTOCLEAN – CT 26/36/48 AC, CT 36 AC PLANEX, CT 26/36 AC HD **188**

Special extractors

CLEANTEC – CT 48 EC, CT 48 EC/B22, CTH 26/48 **191**

Pre-separator

CT-VA **194**

Accessories and consumable materials **196**

The Festool system

Overview of products and applications

Compact yet effective. Lightweight yet powerful. Whether on the construction site or in the workshop – Festool mobile dust extractors are prepared for every challenge.

CLEANTEC mobile dust extractors, compact

CLEANTEC mobile dust extractors



CT 17
Page 182



CTL SYS
Page 183



CTL MINI
CTL MIDI
Page 184



CTM MIDI
Page 185



CTL 26
CTL 36
Page 186



CTM 26
CTM 36
Page 186

Applications

Application area

Assembly (low quantities of coarse dust)	●	●	●	●	●	●
Workshop, industry						●
Building site, drywall construction (large quantities of fine dust)						
Zone 22						

Application

Extraction of dust from power tools	●	●	●	●	●	●
Dust extraction from air tools (LE variants)					●	●
Cleaning work	●	●	●	●	●	●
Continuous industrial use						

Special features

Modular flexibility with second electrical outlet module/compressed air module					●	●
AUTOCLEAN fully automatic main filter cleaning system						
Combination with ASA/EAA					●	●
Manual dedusting			●	●		

Type of dust

Wood dust				●		●
Mineral, quartziferous dust				○		○
Aluminium, powder coating and polyurethane dust						
Carcinogenic dust and asbestos						

Technical data

Power consumption (W)	400 – 1.200	1.000	400 – 1.200	400 – 1.200	350 – 1.200	350 – 1.200
Max. flow rate (l/min)	3.700	3.000	3.700	3.700	3.900	3.900
Max. vacuum (Pa)	24.000	20.000	24.000	24.000	24.000	24.000
Max. container/filter bag capacity (l)	17/17	4,5/3,5	10/7,5 / 15/12,5	15/12,5	26/24/36/34	26/24/36/34
Dimensions (L x W x H) (mm)	445 x 380 x 485	396 x 296 x 270	470 x 320 x 455 470 x 320 x 495	470 x 320 x 495	630 x 365 x 540 630 x 365 x 596	630 x 365 x 540 630 x 365 x 596
Weight (kg)	9,4	6,9	11 / 11,3	11,3	13,9/14,4	13,9/14,4

Overview of products and applications

CLEANTEC AUTOCLEAN mobile dust extractors

CLEANTEC special extractors

Pre-separator

NEW



CTL 48
CTM 48
Page 187



CTL 26 AC
CTL 36 AC
CTL 48 AC
Page 188



CTM 26 AC
CTM 36 AC
CTM 48 AC
Page 188



CTL 36 AC
CTM 36 AC
PLANEX
Page 189



CTL 26 AC HD
CTL 36 AC HD
CTM 26 AC HD
Page 190



CTL 48 EC
CTM 48 EC
Page 191



CTL 48 EC/B22
CTM 48 EC/B22
Page 192



CTH 26
CTH 48
Page 193



CT-VA
Page 194

	CTL 48 CTM 48	CTL 26 AC CTL 36 AC CTL 48 AC	CTM 26 AC CTM 36 AC CTM 48 AC	CTL 36 AC CTM 36 AC PLANEX	CTL 26 AC HD CTL 36 AC HD CTM 26 AC HD	CTL 48 EC CTM 48 EC	CTL 48 EC/B22 CTM 48 EC/B22	CTH 26 CTH 48	CT-VA
		○	○	○	○				
	●*	●	●		○*	●	●		●**
		●	●	●	●			●	●**
							●		
	●	●	●	●	●	●	●	●	●**
	●					●	●		●**
	●	○	○		○	●	●	●	●**
						●	●		●**
	●	●	●	●	●			●	
		●	●	●	●				
	●	●	●	●	●	●	●	●	
	●*		●	●	●*	●*	●*	○	●**
	○*		●	●	●*	○*		○	●**
							●		
								●	○
	350 – 1.200	350 – 1.200	350 – 1.200	350 – 1.200	350 – 1.200	150 – 1.100	150 – 1.100	350 – 1.000	
	3.900	3.900	3.900	3.900	3.900	3.400	3.400	3.900	
	24.000	24.000	24.000	24.000	24.000	23.000	23.000	24.000	
	48/46	26/24/36/34/48/46	26/24/36/34/48/46	36/34	26/24/36/34	48/46	48/46	26/24/48/46	20
	740 x 406 x 1.005	630 x 365 x 540 630 x 365 x 596 740 x 406 x 1.005	630 x 365 x 540 630 x 365 x 596 740 x 406 x 1.005	630 x 365 x 596	673 x 365 x 455 673 x 365 x 522	630 x 406 x 640	630 x 406 x 640	630 x 365 x 540 740 x 406 x 1.005	395 x 295 x 515
	18,8	14,7/15,2/19,6	14,7/15,2/19,6	15,2	14,5/15,2	17,9	18,6	13,9/18,8	7,0

● Extremely appropriate
○ Appropriate

* CTM only
** Dependent on which mobile dust extractor (dust class) is used in combination.

We recommend putting your faith in dust extraction.
We strongly recommend to:

Put your faith in the right extractor for the best dust extraction.

When working in a dusty environment or handling materials that generate large quantities of dust, your main priority should be protecting your health. How harmful the dust is to your health depends on the size of the particles as well as the quantity and time that the materials remain inside your lungs.

The smaller the dust particles are, the deeper they can penetrate into the lung tissue and this is why finer particles are much more harmful to the airways, with many being categorised as extremely hazardous to health.

In the interests of your own health, it is imperative that you keep the air clean when handling mineral dust that invariably contains quartziferous substances and always work with a certified and approved dust extractor or safety extractor.

Your Industrial Employers' Liability Insurance Association will provide you with detailed information and specially prepared lists of substances that exceed specified OEL (occupational exposure limits).



CTL SYS
CTL MINI I/MIDI I
CTL 26/36/48/48 EC

Specialists for dust with OEL > 1 mg/m³.



CTM MIDI I
CTM 26/36/48/48 EC

Specialists for dust with OEL ≥ 0.1 mg/m³.
For quartziferous mineral dust and wood dust.



CTH 26/48

Specialists for dust with OEL < 0.1 mg/m³.
For carcinogenic and pathogenic dust, e.g. asbestos and mould.



CTL 48 LE EC/B 22
CTM 48 LE EC/B 22

Specialised in the extraction of flammable and explosive dust.

Dust categories in accordance with EN 60335-2-69, Appendix AA

	Appropriate	Max. permeability (test)	Disposal	Contamination risk
L (Low)	> Dust with OEL > 1 mg/m ³	1% [filter material]		
M (Medium)	> Dust with OEL ≥ 0.1 mg/m ³ > mineral dust > Wood dust	0.1% [complete tool incl. upholstery nail test]	Dust-free	Cap for transportation
H (High)	> Dust with OEL < 0.1 mg/m ³ > carcinogenic dust > Dust containing pathogens	0.005% [complete tool incl. upholstery nail test]	Dust-free	Cap for transportation

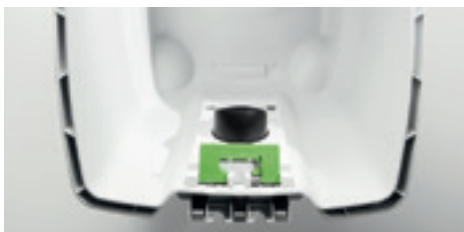

Full utilisation of the container volume

The sophisticated container geometry, compatible SELFCLEAN filter bag and space-saving flat filter combine to produce a net volume that corresponds almost exactly to the gross volume of the container.



New and now even better: SYS DOCK

Simple transportation, better organisation and endless flexibility. The SYS-Dock with T-LOC for the safe connection of SYSTAINER, SORTAINER and SYS-ToolBox units.



Cable holder.

The cable can be wound up quickly and neatly thanks to the new cord holder. And – thanks to the sophisticated folding mechanism – it can be easily removed from the holder without complex unwinding. Now also available with the CT MINI and MIDI compact extractors.



Hose garage

The integral hose holder eliminates the need for external hooks and protects the suction hose and mains cable from damage. The suction hose winds around the holder for clean, compact transportation.



Smooth suction hose with CLEANTEC sleeve

The new suction hose: Smooth and flexible – with a smooth exterior for perfect sliding over surfaces, a longer service life and greater suction power. The new CLEANTEC extraction sleeve ensures a secure fit on the tool.



Bluetooth® technology

CLEANTEC mobile dust extractors can be operated via the remote control on the suction hose and start automatically when Festool cordless tools with Bluetooth® battery packs are switched on. Automatically integrated into CT MINI and MIDI compact extractors and can be custom-retrofitted to CT 26/36/48 with the Bluetooth® module.



AUTOCLEAN automatic main filter cleaning system

Less cleaning work and constant suction power. The AUTOCLEAN automatic cleaning system eliminates the need to clean the main filter manually. Individual cleaning intervals can be defined to guarantee powerful, constant suction.

Simply the best for dust-free work.

The best mobile tool for your health – the new CT MINI and MIDI compact extractors with new highlights: innovative touch operating concept, internal hose holder for the smooth suction hose, level storage area and manual dedusting with fast access to the main filter from the outside.

Approved for dust class M for the first time as CTM MIDI and equipped with suction hose detection for automatic adjustment to the right suction hose diameter.

Already integrated in the CT MINI and MIDI and simple to retrofit for the CT 26/36/48 mobile dust extractors: The innovative Bluetooth® technology that yields benefits when using cordless tools and for manual cleaning tasks.





Simply communicative: Extraction with Bluetooth® control.

Directly integrated or simple to retrofit.

Directly integrated in the CT MINI and MIDI, simple to retrofit in the free slot on the CLEANTEC CT 26/36/48 mobile dust extractors*:

The Bluetooth® module – and the mobile dust extractor can easily be controlled remotely straight away via the remote control on the suction hose or the Bluetooth® battery pack on the cordless tool.

Bluetooth® remote control

Saves you a trip to the extractor: For switching on the mobile dust extractor directly at the suction hose – even when the extractor is in AUTO mode. Ideal for occasional cleaning tasks.

Bluetooth® battery packs

For communication with the Bluetooth® module on the mobile dust extractor – and to make sure that even a cordless tool can start the mobile dust extractor automatically when switched on. Available as an accessory and automatically included with many Festool cordless products.



* Bluetooth® module available as an accessory. Installation must be carried out by a qualified and certified electrician.

Mobile dust extractor CLEANTEC CT 17



Matter of cleanliness.

Ideal for cleaning offices, garages, vehicles and construction sites. Also suitable for extracting water.

Specialists for cleaning work.

- › Maximum utilisation of filter bag capacity due to new, innovative design principle
- › High suction performance and volume flow due to single-level powerful turbine
- › Blow function with end cap on the rear of the housing
- › Electronic level control for liquid suction

Technical data	
Power consumption (watt)	400 – 1.200
Max. volume flow (l/min)	3.700
Max. vacuum (Pa)	24.000
Filter surface area (cm ²)	4.600
Power cord (m)	5,5
Container/filter bag capacity (l)	17/17
Dimensions (L x W x H) (mm)	445 x 380 x 485
Max. appliance socket connected load (watt)	2.400
Weight (kg)	9,4



■ = Electronic

Items included	Order no.
double-wall filtering bag, suction hose Ø 27 mm x 3,5 with rotatable dust extraction coupling, in carton	
CT 17 E	767992
CT 17 E-Set BA cleaning set D36 Set "Building Sites"	768943
CT 17 E-Set BU cleaning set D36 BU-RS	768944

System accessories
from page 198





SYSTAINER extractor CTL SYS



The extractor in SYSTAINER format.

- › Very small, lightweight and compact, in a SYSTAINER format for maximum mobility
- › With a new suction hose: Smooth and flexible – with a smooth exterior which allows it to slide over surfaces perfectly
- › The integrated hose, cable and nozzle store mean everything is always available
- › Compatible with T-LOC in a SYSTAINER system for optimum workplace organisation

Technical data

Power consumption (watt)	1.000
Max. volume flow (l/min)	3.000
Max. vacuum (Pa)	20.000
Filter surface area (cm ²)	5.357
Rubber-insulated mains cable (m)	5
Container/filter bag capacity (l)	4,5/3,5
Dimensions (L x W x H) (mm)	396 x 296 x 270
Max. appliance socket connected load (watt)	1.200
Weight (kg)	6,9

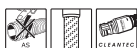

Items included

CTL SYS
fitted filter bag, smooth suction hose dia. 27 x 3 m AS/CT with rotating angle adapter on the extractor side, hose holder, SYS-Dock with T-LOC function, upholstery nozzle D 36 PD, crevice nozzle D 36 FD-150, SYS-CT carrying belt, in carton

Order no.

575279



Spotless and space-saving.

The ideal extractor for fast and mobile use during relatively small fitting and servicing work: Very compact, lightweight, and quiet, and can be coupled with a SYSTAINER system. The SYSTAINER extractor is best suited to cleaning work with small volumes of dust and dirt. For class L dust.

System accessories from page 198



SYSTAINER from page 411

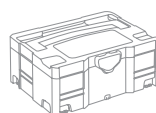

Mobile dust extractors

CLEANTEC CTL MINI I / MIDI I



Compact. Mobile. Sophisticated.
For dust class L.

Thanks to the low weight and compact, ergonomic design, the CTL MINI/MIDI is perfect for transportation. Whether you need it for assembly work, installation work or renovation work – thanks to the 10 l/15 l container volume, the wet/dry extractor for cleaning work is perfect for extracting small to medium volumes of dust and dirt. For class L dust.

NEW: CTL MINI I/MIDI I
incl. Bluetooth® technology**



Compact. Mobile. Sophisticated.

- › Ideal for use on the go thanks to compact dimensions, low weight and robust chassis
- › Touch operation for intuitive control of the mobile dust extractor
- › Keep working until the filter bag is full thanks to manual dedusting
- › Internal hose holder for safe and clean transport of the smooth suction hose

Technical data	CTL MINI I	CTL MIDI I
Power consumption (watt)	350 – 1.200	350 – 1.200
Max. volume flow (l/min)	3.700	3.700
Max. vacuum (Pa)	24.000	24.000
Filter surface area (cm ²)	3.369	3.369
Rubber-insulated mains cable (m)	7,5	7,5
Container/filter bag capacity (l)	10/7,5	15/12,5
Dimensions (L x W x H) (mm)	470 x 320 x 455	470 x 320 x 495
Max. appliance socket connected load (watt)	2.200	2.200
Weight (kg)	11	11,3



Items included **Order no.**

smooth suction hose dia. 27/32 x 3.5 m AS/CT, Bluetooth® functionality for extractor, remote switch-on for cordless tools, SELFCLEAN filter bag SC-FIS-CT MINI/MIDI-2, hose holder, cable holder, SYS-Dock with T-LOC function, in carton

CTL MINI I	574840
CTL MIDI I	574832

System accessories
from page 198



* For more information on Bluetooth®
Autostart, go to page 16, 181





NEW: CTM MIDI I
incl. Bluetooth® technology**

Mobile dust extractor **CLEANTEC CTM MIDI I**



Compact. Mobile. Sophisticated.

- › The first compact extractor for hazardous dust from dust class M with automatic suction hose detection
- › Saves you a trip to the extractor – thanks to the integrated Bluetooth® technology, the mobile dust extractor is started automatically by Bluetooth® battery packs or remote control
- › Ideal for use on the go thanks to compact dimensions, low weight and robust chassis
- › Touch operation for intuitive control of the mobile dust extractor

Technical data

Power consumption (watt)	350 – 1.200
Max. volume flow (l/min)	3.700
Max. vacuum (Pa)	24.000
Filter surface area (cm ²)	3.369
Rubber-insulated mains cable (m)	7,5
Container/filter bag capacity (l)	15/12,5
Dimensions (L x W x H) (mm)	470 x 320 x 495
Max. appliance socket connected load (watt)	2.200
Weight (kg)	11,3



Compact. Mobile. Sophisticated. For dust class M.

The CTM MIDI is the new all-rounder for service and assembly work, even when working with large amounts of wood and quartz dust. With an intuitive touch-based operating concept, automatic suction hose detection, a bigger hose holder and quick access to the main filter, it sets new standards for compact M class extractors. And for your health.

Items included

Order no.

CTM MIDI I

smooth suction hose dia. 27/32 x 3.5 m AS/CT, Bluetooth® functionality for extractor, remote switch-on for cordless tools, SELF-CLEAN filter bag SC-FIS-CT MINI/MIDI-2, hose holder, cable holder, SYS-Dock with T-LOC function, in carton

574822

System accessories
from page 198



* For more information on Bluetooth®
Autostart, go to page 16, 181



Mobile dust extractors

CLEANTEC CT 26 / CT 36



All-rounder in the perfect size.

Compact yet effective. Lightweight yet powerful. Whether on the construction site or in the bodyshop – the perfected container geometry of the CLEANTEC CT 26/36 offers a significantly larger capacity with minimal external dimensions.

The true size can be found inside.

- › Maximum utilisation of the container volume – the gross volume is the same as the net volume
- › Can be individually retrofitted with an additional socket, compressed air or Bluetooth® module for remote control on the suction hose or automatic start via the Bluetooth® battery pack
- › Constantly high suction because of the compact high performance turbine
- › Smooth suction hose and optimised SYS-Dock with cord holder and T-LOC function for conveniently connecting SYSTAINERS to the mobile dust extractor

Technical data	CT 26	CT 36
Power consumption (watt)	350 – 1.200	350 – 1.200
Max. volume flow (l/min)	3.900	3.900
Max. vacuum (Pa)	24.000	24.000
Filter surface area (cm ²)	6.318	6.318
Rubber-insulated mains cable (m)	7,5	7,5
Container/filter bag capacity (l)	26/24	36/34
Dimensions (L x W x H) (mm)	630 x 365 x 540	630 x 365 x 596
Max. appliance socket connected load (watt)	2.400	2.400
Weight (kg)	13,9	14,4



■ = Electronic

Items included	Order no.
SELFCLEAN filter bag, smooth suction hose dia. 27/32 x 3.5 m AS/CT, hose holder, SYS-Dock with T-LOC function, cable holder, in carton	
CTL 26 E	574947
CTL 26 E SD with second socket with continuous current	574955
CTL 26 E SD E/A with second socket with automatic electronic switch-on/shut-off	574956
CTL 36 E	574965
CTL 36 E LE compressed air module	574972
CTM 26 E end cap for intake adapter	574981
CTM 36 E end cap for intake adapter	574988
CTM 36 E LE end cap for intake adapter, compressed air module	574990

System accessories
from page 198



Workcenter WCR 1000
from page 393

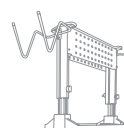

CT-VA pre-separator
from page 194 onwards

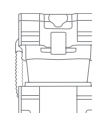



Mobile dust extractor CLEANTEC CT 48



There's more to it than meets the eye.

- › Large capacity for large volumes of dust and coarse chips
- › Constantly high suction because of the compact high performance turbine
- › Can be individually retrofitted with an additional socket, compressed air or Bluetooth® module for remote control on the suction hose or automatic start via the Bluetooth® battery pack
- › Smooth suction hose and optimised SYS-Dock with cord holder and T-LOC function for conveniently connecting SYSTAINERS to the mobile dust extractor

Technical data

Power consumption (watt)	350 – 1.200
Max. volume flow (l/min)	3.900
Max. vacuum (Pa)	24.000
Filter surface area (cm ²)	6.318
Rubber-insulated mains cable (m)	7,5
Container/filter bag capacity (l)	48/46
Dimensions (L x W x H) (mm)	740 x 406 x 1.005
Max. appliance socket connected load (watt)	2.400
Weight (kg)	18,8



■ = Electronic

Items included

SELCLEAN filter bag, smooth suction hose dia. 27/32 x 3.5 m AS/CT, hose holder, SYS-Dock with T-LOC function, cable holder, handle, in carton

CTL 48 E 574975

CTM 48 E 574992
end cap for intake adapter



For use in the workshop.

The CT 48 has a container volume of 48 litres, which is ideal for extracting large quantities of dust in the bodyshop. As CTL and CTM it is suitable for dust classes L and M.

System accessories
from page 198



Workcenter WCR 1000
from page 393

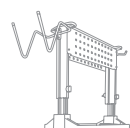

CT-VA pre-separator
from page 194 onwards

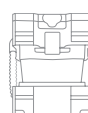

Mobile dust extractors

CLEANTEC CT 26 AC / 36 AC / 48 AC



Ideal in combination
with the CT-VA
pre-separator



Fully automatic filter cleaning.

- › AUTOCLEAN automatic main filter cleaning system with infinitely adjustable cleaning intervals for consistently high suction power
- › Can be individually retrofitted with an additional socket, compressed air or Bluetooth® module for remote control on the suction hose or automatic start via the Bluetooth® battery pack
- › Maximum utilisation of the container volume – the gross volume is the same as the net volume
- › Smooth suction hose and optimised SYS-Dock with cord holder and T-LOC function for conveniently connecting SYSTAINERS to the mobile dust extractor

Technical data	CT 26 AC	CT 36 AC	CT 48 AC
Power consumption (watt)	350 – 1.200	350 – 1.200	350 – 1.200
Max. volume flow (l/min)	3.900	3.900	3.900
Max. vacuum (Pa)	24.000	24.000	24.000
Filter surface area (cm ²)	6.318	6.318	6.318
Rubber-insulated mains cable (m)	7,5	7,5	7,5
Container/filter bag capacity (l)	26/24	36/34	48/46
Dimensions (L x W x H) (mm)	630 x 365 x 540	630 x 365 x 596	740 x 406 x 1.005
Max. appliance socket connected load (watt)	2.400	2.400	2.400
Weight (kg)	14,7	15,2	19,6



■ = Electronic

No more clogged filters.

Prevent clogged filters with the CLEANTEC AC. An automated filter cleaning system keeps the filter clean and maintains a constant suction power. One-touch cleaning can be initiated at any time.

Items included Order no.

High-performance main filter, SELFCLEAN filter bag, hose holder, disposal bag, smooth suction hose dia. 27/32 x 3.5 m AS/CT, SYS-Dock with T-LOC function, cable holder, in carton	
CTL 26 E AC	574945
CTM 26 E AC end cap for intake adapter	574978
CTL 36 E AC	574958
CTM 36 E AC end cap for intake adapter	574983
CTL 48 E AC handle	574974
CTM 48 E AC end cap for intake adapter, handle	574991

System accessories
from page 198



Workcenter WCR 1000
from page 393

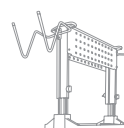

CT-VA pre-separator
from page 194 onwards

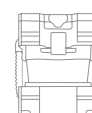



Ideal in combination with the CT-VA pre-separator

Mobile dust extractors CLEANTEC CT 36 AC PLANEX



Ideal for drywall construction.

- › The perfect mobile dust extractor for the PLANEX long-reach sander
- › AUTOCLEAN automatic main filter cleaning system with infinitely adjustable cleaning intervals for consistently high suction power
- › Constantly high suction because of the compact high performance turbine
- › Antistatic function prevents static developing during work

Technical data	
Power consumption (watt)	350 – 1.200
Max. volume flow (l/min)	3.900
Max. vacuum (Pa)	24.000
Filter surface area (cm ²)	6.318
Rubber-insulated mains cable (m)	7,5
Container/filter bag capacity (l)	36/34
Dimensions (L x W x H) (mm)	630 x 365 x 596
Max. appliance socket connected load (watt)	2.400
Weight (kg)	15,2



Items included	Order no.
High-performance main filter, kink-resistant suction hose D36x3.5-AS/LHS 225, SELFCLEAN filter bag, disposal bag, Comfort clean closing slide, hose holder, cable holder, in carton	
CTL 36 E AC-LHS	574960
CTM 36 E AC-LHS	574984
CTL 36 E AC-PLANEX PLANEX tool holder	575427
CTM 36 E AC-PLANEX PLANEX tool holder	575432



Our contribution to a shorter work time.

The quicker a sander removes material, the more powerful the connected mobile dust extractor needs to be. The powerful CT 36 AC PLANEX was designed specifically for the extreme material removal rate of the PLANEX long-reach sander. Includes a tool holder, kink-proof hose and series standard ComfortClean closing slide for even more efficient filter cleaning. Perfect results every time at maximum speed.

System accessories from page 198



PLANEX LHS 225 from page 118



CT-VA pre-separator from page 194 onwards



Mobile dust extractors

CLEANTEC CT 26 AC HD / 36 AC HD



Ideal in combination with the CT-VA pre-separator



The construction site extractor with automatic cleaning.

- › AUTOCLEAN automatic main filter cleaning system for consistently high suction power
- › Extremely robust design with large wheels and steel axis for use on the construction site
- › Optimal for power tools with socket outlet and automatic switch-on with start-up and shut-down delay, as well as infinitely variable extraction power control
- › With a new suction hose: Smooth and flexible – with a smooth exterior which allows it to slide over surfaces perfectly

Technical data	CT 26 AC HD	CT 36 AC HD
Power consumption (watt)	350 – 1.200	350 – 1.200
Max. volume flow (l/min)	3.900	3.900
Max. vacuum (Pa)	24.000	24.000
Filter surface area (cm ²)	6.318	6.318
Rubber-insulated mains cable (m)	7,5	7,5
Container/filter bag capacity (l)	26/24	36/34
Dimensions (L x W x H) (mm)	673 x 365 x 455	673 x 365 x 522
Max. appliance socket connected load (watt)	2.400	2.400
Weight (kg)	14,5	15,2

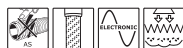

■ = Electronic

Heavy-duty tool.

The CT 26/36 AC HD is in its element when there is an abundance of dust, which occurs, for example, when working with masonry renovators and diamond grinders. The automatic main filter cleaning flushes the main filter regularly, thus ensuring a constantly high suction power.

Items included	Order no.
High-performance main filter, SELFCLEAN filter bag, disposal bag, smooth suction hose dia. 36/32 x 3.5 m AS with rotating connecting sleeves, Comfort clean closing slide, Accessory case, in carton	
CTL 26 E AC HD	575291
CTL 36 E AC HD	575292
CTM 36 E AC HD	575296

System accessories from page 198



Renovation millers from page 356

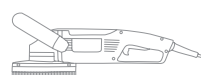

CT-VA pre-separator from page 194 onwards

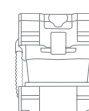



Mobile dust extractor **CLEANTEC CT 48 EC**



Brushless EC-TEC motor for a long service life and a high level of efficiency

Designed for continuous industrial use.

- › Constant power from the EC-TEC drive with a service life several times longer than a universal motor
- › With a new suction hose: Smooth and flexible – with a smooth exterior which allows it to slide over surfaces perfectly
- › Antistatic function prevents static developing during work
- › With integrated connection for EAA and compressed air tools

Technical data

Power consumption (watt)	150 – 1.100
Max. volume flow (l/min)	3.400
Max. vacuum (Pa)	23.000
Filter surface area (cm ²)	6.318
Rubber-insulated mains cable (m)	7,5
Container/filter bag capacity (l)	48/46
Dimensions (L x W x H) (mm)	630 x 406 x 640
Max. appliance socket connected load (watt)	2.400
Weight (kg)	17,9



■ = Electronic

Items included

SELCLEAN filter bag, smooth suction hose dia. 27/32 x 3.5 m AS/CT, cable holder, compressed air module, in carton

Items included	Order no.
CTL 48 E LE EC	575300
CTM 48 E LE EC	575298



Reliable. Durable. Powerful.

Tough continuous operation is its speciality and the EC-TEC drive concept guarantees greater reliability and a longer life. For relentless suction power when processing plastic, ceramic, wooden or painted surfaces.

System accessories
from page 198



Workcenter WCR 1000
from page 393

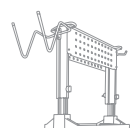

Energy box
from page 392



Mobile dust extractor

CLEANTEC CT 48 EC/B22

Brushless EC-TEC motor for a long service life and a high level of efficiency



For maximum safety.

- › Conforms with ATEX Directive 94/9/EC for Zone 22 – dry, combustible dust on machines and tools is reliably extracted
- › Constant power from the EC-TEC drive with a service life several times longer than a universal motor
- › With a new suction hose: Smooth and flexible – with a smooth exterior which allows it to slide over surfaces perfectly
- › With integrated connection for EAA and compressed air tools

Technical data

Power consumption (watt)	150 – 1.100
Max. volume flow (l/min)	3.400
Max. vacuum (Pa)	23.000
Filter surface area (cm ²)	6.318
Rubber-insulated mains cable (m)	7,5
Container/filter bag capacity (l)	48/46
Dimensions (L x W x H) (mm)	630 x 406 x 640
Max. appliance socket connected load (watt)	2.400
Weight (kg)	18,6



■ = Electronic

For dry and flammable dust.

The CT 48 EC/B22 special extractor with EC-TEC drive is designed for continuous use. The robust ABS plastic container is fitted with additional flame protection and is therefore suitable for the safe extraction of everything from aluminium, paper, soot and powder coating dust to glass-fibre and carbon-fibre reinforced plastics.

Items included

Order no.

SELF-CLEAN filter bag, smooth suction hose dia. 27/32 x 3.5 m AS/CT, cable holder, compressed air module, in carton

CTL 48 E LE EC/B22 R1

575275

CTM 48 E LE EC B22 R1

575286

System accessories from page 198



Workcenter WCR 1000 from page 393

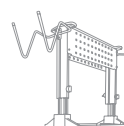

Energy box from page 392





Mobile dust extractors

CLEANTEC CTH 26 / CTH 48



No chance for hazardous dust.

- › Approved for dust category H and asbestos dust
- › Sealed tight – with dual-layer safety filter bag
- › Convenient and with consistently high suction power thanks to the compact high-power turbine, infinitely variable suction power adjustment and antistatic function
- › Smooth suction hose and optimised SYS-Dock with cord holder and T-LOC function for conveniently connecting SYSTAINERS to the mobile dust extractor



Technical data	CTH 26	CTH 48
Power consumption (watt)	350 – 1.000	350 – 1.000
Max. volume flow (l/min)	3.900	3.900
Max. vacuum (Pa)	24.000	24.000
Filter surface area (cm ²)	6.318	6.318
Rubber-insulated mains cable (m)	7,5	7,5
Container/filter bag capacity (l)	26/24	48/46
Dimensions (L x W x H) (mm)	630 x 365 x 540	740 x 406 x 1.005
Max. appliance socket connected load (watt)	2.400	2.400
Weight (kg)	13,9	18,8



■ = Electronic

The specialist for the toughest demands.

Asbestos, mould, mineral fibre dust, lead, cadmium, nickel, zinc chromate. Many risks – one defence: the CTH special application extractor from Festool. Carcinogenic and pathogenic dust stand no chance. With a 99.995% degree of filtration even mould removal and asbestos abatement or wood-working with dangerous impregnating compounds pose no health problems.

Items included	Order no.
safety filter bag, smooth suction hose dia. 27/32 x 3.5 m AS/CT, hose holder, SYS-Dock with T-LOC function, cable holder, in carton	
CTH 26 E / a	574939
CTH 48 E / a handle	574941

System accessories
from page 198



Pre-separator CT-VA



Copes with high volumes of dust. Efficient, simple and reliable.

- › Copes with high volumes of generated dust thanks to cyclone technology
- › Consistently high suction power as a result of reducing the load on the main filter
- › Easy and safe to transport thanks to a stackable collection container with compact dimensions and a sturdy design
- › Work flexibly in every application with and without CT pre-separator

Technical data

Dimensions (L x W x H) (mm)	395 x 295 x 515
Max. container capacity (l)	20
Weight (kg)	7



Work efficiently with constant suction power.

From now on, large quantities of dust and chips are not a problem any more. Neither for the main filter nor for the suction power. This is because the pre-separator, which is compatible with Festool CT mobile dust extractors, collects up to 95% of the dust before it reaches the mobile dust extractor. This takes the strain off the main filter and guarantees consistently high suction power throughout the entire work process.

Items included

Order no.

CT-VA-20
cyclone Systainer, VAB-20 collection container, Systainer pan, connecting hose, disposal bag, container lid, in carton

204083

System accessories from page 213



Cyclone Systainer
 Hose connector between CT-VA and mobile dust extractor
 Hose connector to tool
 Collection container
 Systainer pan, connected to mobile dust extractor via SYS-Dock



The most efficient way to handle large dust volumes.

High volumes of dust, shavings and chips are no longer a problem for neither the main filter, nor for the suction power. The pre-separator (compatible with Festool CT mobile dust extractors) collects up to 95% of dust before it reaches the mobile dust extractor. This reduces the load on the main filter and ensures consistently high suction power throughout the work process.

Cyclone technology

The Festool CT pre-separator with cyclone technology separates and collects coarse and fine dust before it reaches the mobile dust extractor. The dust-heavy air that is drawn in is swirled into a spiral movement in the cyclone, causing the dust particles to hit against the wall of the cyclone and, due to the gravitational force, to fall into the collection container of the CT pre-separator.

Fine mineral dust

Benefits of working with the CT pre-separator

- › Constant, high suction power
- › Quick and easy disposal
- › Removal of load from main filter
- › Work without interruptions
- › Up to approx. 80% of dust extracted

Typical application options

Ideal in combination with the CTL/CTM* 26/36/48 mobile dust extractors with AUTOCLEAN function and with the following tools:



Long-reach sander
PLANEX
and PLANEX easy



Diamond grinder
RENOFIX RG 130



Renovation millers
RENOFIX RG 80
and RG 150



Router
OF 2200



Hand-held circular saw
HK 85



Sword saws and
insulating-material saws
IS 330, SSU 200, ISC 240

Coarse dust (chips from sawing, planing and routing)

Benefits of working with the CT pre-separator

- › Constant, high suction power
- › Quick and easy disposal
- › Removal of load from filter bag
- › Up to 95% of dust extracted

Typical application options

Ideal in combination with the CTL/CTM* 26/36/48 mobile dust extractors with or without AUTOCLEAN function and with the following tools:

* The CT-VA pre-separator is approved for dust classes L and M

The Festool system. Everything in view.

Because things work better when everything fits together: Which is why all Festool mobile dust extractors are equipped with an integrated hose garage and SYS-Dock for holding the SYSTAINER. Many models are also fitted with modular plug-in slots. A handle or removable tool holder can be added as an option. Furthermore, they are not only compatible with all Festool power and compressed air tools, but the various accessories are also interchangeable.



04 Dust extraction

Accessories and consumable materials

Cleaning sets	198
Suction hoses and hose sleeves	199
Tubes and nozzles	204
Modules and boom arms	206
Filters and filter bags	207
CT and compressed air accessories	212
Pre-separator	213







System accessories

CLEANTEC cleaning sets

		Type	Order no.
	Cleaning set crevice nozzle D 36 FD-210, upholstery nozzle D 36 PD, suction brush D 36 SP, in self-service display pack	D 27 / D 36 D-RS	492392
	Standard cleaning set curved hand tube D 36 HR-K AS, extension pipes D 36 VR-K AS, 4-piece floor nozzle D 36 BD270, crevice nozzle D 36 FD-210, upholstery nozzle D 36 PD, in carton	D 27/D 36 S-RS	203428
	Professional cleaning set curved hand tube D 36 HR-K AS, extension tube, special steel 3-piece D 36 VR-M3x, carpet nozzle, D 36 TD, crevice nozzle D 36 FD-210, in carton	D 27/36 P-RS	203429
	Compact cleaning set curved hand tube D 36 HR-K AS, extension pipes D 36 VR-K AS, 4-piece floor nozzle D 36 BD270, crevice nozzle D 36 FD-210, upholstery nozzle D 36 PD, in SYSTAINER SYS 1 T-LOC	D 27/D 36 K-RS-Plus	203430
	Cleaning set for tradesmen smooth suction hose D 36, antistatic, curved hand tube D 36 HR-K AS, extension tube, special steel 3-piece D 36 VR-M3x, carpet nozzle, D 36 TD, crevice nozzle D 36 FD-210, upholstery nozzle D 36 PD, suction brush D 36 SP, in SYSTAINER SYS 5 T-LOC	D 36 HW-RS-Plus	203408
	Cleaning set for the workshop smooth suction hose D 36, antistatic, curved hand tube D 36 HR-K AS, extension tube, special steel 3-piece D 36 VR-M3x, floor nozzle, D 36 BD 370, in SYSTAINER SYS 5 T-LOC	D 36 WB-RS-Plus	203409
	Universal cleaning set Suction hose D 36, curved hand tube D 36 HR-K AS, extension pipes D 36 VR-K AS, floor nozzle, D 36 BD 300, crevice nozzle D 36 FD-210, suction brush D 36 SP, upholstery nozzle D 36 PD, in SYSTAINER SYS 5 T-LOC	D 36 UNI-RS-Plus	203435
	Cleaning set for industrial use suction hose Ø 50 x 2,5m, extension tubes D50VR-K, floor nozzle D 50 BD370, square nozzle D 50 QD, suction brush D 50 SP, crevice nozzle D 50 FD, in carton	D 50 GS-RS	454770
	Masonry renovation cleaning set curved hand tube D 36 HR-K AS, extension tube, special steel 3-piece D 36 VR-M3x, carpet nozzle, D 36 TD, crevice nozzle D 36 FD-210, upholstery nozzle D 36 PD, in SYSTAINER SYS 2 T-LOC	D 36 RS-M-Plus	203431
	Floor cleaning set curved hand tube D 36 HR-K AS, extension tube, special steel 3-piece D 36 VR-M3x, floor nozzle, D 36 BD 370, in SYSTAINER SYS 2 T-LOC	D 36 BD 370 RS-Plus	203432
	Construction cleaning set for all CT and VCP (except VCP 30 E), construction set, suction hose D 36 x 3 m, curved hand tube D 36 HR-K AS, stainless steel extension tubes, 2-piece, 4-piece floor nozzle D 36 BD270, crevice nozzle D 36 FD-210, suction brush D 36 SP, in carton	D 36 BA-RS	203433
	Cleaning set for all CT and VCP (except VCP 30 E), office set, suction hose D 36 x 3 m, curved hand tube D 36 HR-K AS, stainless steel extension tubes, 2-piece, carpet nozzle, D 36 TD, upholstery nozzle D 36 PD, crevice nozzle D 36 FD-210, in carton	D 36 BU-RS	203434

System accessories



Accessories for mobile dust extractors CT and dust extractors SR



CLEANTEC suction hose anti-static version		Type	Order no.
	Suction hose for CTL SYS, antistatic, temperature-resistant to +70°C, with rotating angle adapter at extractor side, smooth, bleeder resistor (DIN IEC 312) <1 mΩ/m, diameter 27 mm, length 3 m, in carton	D 27x3,0m-AS-90°/CT	201665
	Suction hose antistatic, temperature-resistant to +70°C, smooth, Conical, bleeder resistor (DIN IEC 312) <1 mΩ/m, diameter 27 /32 mm, in carton		
	for CTL MINI/MIDI, with rotating angle adapter at extractor side, length 3,5 m	D 27/32x3,5m-AS-90°/CT	500680
	for CT 26/36/48, with rotating adapter and connector, length 3,5 m	D 27/32x3,5m-AS/CT	500677
	for CT 26/36/48, with rotating adapter and connector, length 5 m	D 27/32x5,0m-AS/CT	500678
	Suction hose for cleaning tasks with CT dust extractors, not suitable for dust extractors with Autoclean, antistatic, temperature-resistant to +70°C, with rotating adapter and connector, smooth, bleeder resistor (DIN IEC 312) <1 mΩ/m, diameter 36 mm, in carton		
	length 3,5 m	D 36x3,5m-AS/CT	500681
	length 5 m	D 36x5,0m-AS/CT	500684
	length 7 m	D 36x7,0m-AS/CT	500685
	Suction hose suitable for dust extractors with Autoclean, antistatic, temperature-resistant to +70°C, for masonry renovation and cleaning work, smooth, Conical, bleeder resistor (DIN IEC 312) <1 mΩ/m, diameter 36 /32 mm, length 3,5 m, in carton	D 36/32x3,5m-AS	500682
	Suction hose for long-reach sander PLANEX, antistatic, temperature-resistant to +70°C, extremely flexible, kink-resistant suction hose, diameter 36 mm, length 3,5 m, bleeder resistor (DIN IEC 312) <1 mΩ/m, in carton	D 36x3,5-AS/KS/LHS 225	496972
	Suction hose antistatic, ordered by metre (without rotating adapter or reducing sleeve), temperature-resistant to +70°C, bleeder resistor (DIN IEC 312) <1 mΩ/m, in carton		
	diameter 27 mm	D 27 MW-AS	452384
	diameter 36 mm	D 36 MW-AS	452385

System accessories











Accessories for mobile dust extractors CT and dust extractors SR

CLEANTEC suction hose anti-static version

	Type	Order no.
 <p>Suction hose antistatic, temperature-resistant to +70°C, bleeder resistor (DIN IEC 312) <1 mΩ/m, diameter 50 mm, in carton with 2x rotating adapter, length 2,5 m</p>	D 50x2,5m-AS	452888
<p>with 2x rotating adapter, length 4 m</p>	D 50x4m-AS	452890
 <p>ordered by metre (without rotating adapter or reducing sleeve)</p>	D 50 MW-AS	452386









	Type	Order no.
 <p>Suction hose for all power tools with D27 and D36 flange (all Festool power tools) and cleaning accessories, with plug it-connection, antistatic, suitable for sanding applications, with rotating adapter and reducing sleeve with bayonet fitting, temperature-resistant to +70°C, smooth, bleeder resistor (DIN IEC 312) <1 mΩ/m, diameter 27 /22 mm, in carton</p>		
length 3,5 m	D 27/22x3,5m-AS-GQ/CT	200041
length 5 m	D 27/22x5m-AS-GQ/CT	201758
 <p>Suction hose for all power tools with D27 and D36 flange (all Festool power tools) and cleaning accessories, with plug it-connection, antistatic, suitable for sanding applications, with rotating adapter and reducing sleeve with bayonet fitting, temperature-resistant to +70°C, smooth, length 10 m, bleeder resistor (DIN IEC 312) <1 mΩ/m, diameter 32 /22 mm, in carton</p>	D 32/22x10m-AS-GQ/CT	200051

System accessories







CLEANTEC suction hose		Type	Order no.
	Suction hose for direct connection (without reducing ring) to hand sanding block with extraction, diameter 21,5 mm, length 5 m, in bag	D 21,5 x 5m HSK	495019
	Suction hose temperature-resistant to +70°C, diameter 27 mm, in carton with rotating adapter and connector, length 3,5 m	D 27x3,5m	452877
	with rotating adapter and connector, length 5 m	D 27x5m	452879
	ordered by metre (without rotating adapter or reducing sleeve)	D 27 MW	452383
	Suction hose temperature-resistant to +70°C, diameter 36 mm, in carton with rotating adapter and connector, length 3,5 m	D 36x3,5m	452881
	with rotating adapter and connector, length 5 m	D 36x5m	452883
	with rotating adapter and connector, length 7 m	D 36x7m	452885
	ordered by metre (without rotating adapter or reducing sleeve)	D 36 MW	454157
	Suction hose for all CT and VCP (except VCP 30 E), temperature-resistant to +70°C, with rotatable dust extraction coupling, diameter 36/32 mm, length 3 m, in carton	D 36/32x3m	768114
	Suction hose ordered by metre (without rotating adapter or reducing sleeve), temperature-resistant to +70°C, diameter 50 mm, in carton	D 50 MW	454158
	Adapter hose for CS 50, CS 70, CMS, 0,5 m hose D36 with two rotating adapters and connection coupling, anti-static D50/D50 VM-AS, for Y-shaped connection in conjunction with CTL MINI/MIDI, diameter 36 mm, length 0,5 m, in carton	AD-D 36/CS50/ CS70/CMS	499196

System accessories

Accessories for mobile dust extractors CT and dust extractors SR

CLEANTEC hose sleeves	Type	Order no.	
      	Rotating adapter antistatic, hose sleeve for connection to the inlet nozzle on the mobile dust extractor, outside dia. 58 mm, in self-service display pack for antistatic suction hose D 27, diameter 27 mm	D 27 DAG-AS	452892
	for D 27/32 antistatic suction hose	D 32/27 DAG-AS/CT	500672
	for antistatic suction hose D 36, diameter 36 mm	D 36 DAG-AS/CT	202860
	for antistatic suction hose D 50	D 50 DAG-AS	452896
	for antistatic suction hose D27/22x3.5 AS-GQ/CT and D27/22x5 AS-GQ/CT, diameter 36 mm	D 36 DAG-AS-GQ/CT	202931
	for antistatic suction hose D32/22x10 AS-GQ/CT, diameter 50 mm	D 50 DAG-AS-GQ/CT	203206
		Rotating angle adapter hose sleeve for connection to the inlet nozzle on the mobile dust extractor, outside dia. 58 mm, in self-service display pack for D 22 and D 27 antistatic suction hoses on CTL MINI and CTL MIDI up to BJ 08/2013 and CTL SYS, diameter 27 mm	D 27 DAG90°-AS/CT
for antistatic suction hose D 32/27 on CTL MINI and CTL MIDI, antistatic, for CTL MINI and CTL MIDI from YOM September 2013 onwards		D 32/27 DAG/90°-AS/CT	500673
   	Connecting sleeve antistatic, in self-service display pack for suction hose D 27, for all power tools with D27 flange and cleaning accessories, hose connector for electric tool or suction nozzle, the bayonet fitting produces a secure connection between the mobile dust extractor and the power tool, diameter 27 mm	D 27 DM-AS/CT	202346
	for all power tools with D27 and D36 flange (all Festool power tools) and cleaning accessories, only for the smooth suction hoses with integrated plug it-cable, for connection to tools (power tools or suction nozzle), the secure connection between the mobile dust extractor and the power tool thanks to the bayonet fitting, diameter 27 /22 mm	D 27/22 DM-AS/CT	500668
	for suction hose D 36, for all power tools with D36 flange and cleaning accessories, hose connector for electric tool or suction nozzle, the bayonet fitting produces a secure connection between the mobile dust extractor and the power tool, diameter 36 mm	D 36 DM-AS/CT	500670
	for D 36/32 suction hose, for all power tools with D36 flange and cleaning accessories, hose connector for electric tool or suction nozzle	D 36/32 DM-AS	500671

System accessories

		Type	Order no.
	<p>Reducing sleeve in self-service display pack for suction hose D 36, for reducing to D 27 (machine), sleeve needs to be replaced</p>	RM D 36/27-AS	498528
	<p>for all VCP/CT, dust extraction end, reduction of dia. 36 to 27 mm, can be attached if necessary, diameter 36 mm</p>	DC-D 36/27-AS	768135
	<p>Connecting sleeve for suction hose D 36, for long-reach sander PLANEX, antistatic, hose connector for electric tool or suction nozzle, diameter 36 mm, in self-service display pack</p>	D 36 DM-AS-LHS 225	495013
	<p>Extraction adapter for connecting a D 50 suction hose to D 36 accessory, in self-service display pack</p>	D 50/D 36	452897
	<p>Y-piece for D 50/D 36/D 27, antistatic, for connection of two dust extraction hoses, with blanking plug, for extractors that admit hazardous dust, simultaneous operation is not permitted, in self-service display pack</p>	D 50 SV-AS/D 50 V	452898
	<p>Blanking plug for closing the inlet nozzle, for retrofitting all CT/CTL mobile dust extractors, in self-service display pack</p>	D 50/V	452899
	<p>Connector sleeve antistatic, to connect suction hoses D 50 / D 36 / D 27, the reducing sleeve on D 27/D 36 hoses must be replaced with a D 36/D 27 rotating adapter, in self-service display pack</p>	D 50/D 50 VM-AS	493047

System accessories

Accessories for mobile dust extractors CT and dust extractors SR

Tubes		Type	Order no.
	Hand tube for D 27/D 36, antistatic, with sliding air regulator for suction power adjustment, with bayonet fitting for secure connection to the extractor hose, curved, diameter 36 mm, in self-service display pack	D 36 HR-K AS	203129
	Extension pipe for D 27/D 36, of stainless steel, 3-piece, length 950 mm, in self-service display pack	D 36 VR-M 3x	452902
	for D 27/D 36, antistatic, 3-piece, length 950 mm, in self-service display pack	D 36 VR-K AS 3x	203137
	for D 50, anodised aluminium, 1 piece, length 1.100 mm, in carton	D 50 VR-M	447599
	for D 50, plastic, 2 pieces, length 970 mm, in carton	D 50 VR-K 2x	440412
Floor nozzles		Type	Order no.
	Floor nozzle for D 27/D 36, high-quality industrial design, aluminium, with 2 castors and 2 brush inserts, diameter 36 mm, width 370 mm, in carton	D 36 BD 370	452908
	for D 50, high-quality industrial design, aluminium, with 2 castors and 2 brush inserts, width 450 mm, in carton	D 50 BD 450	452910
	for D 27/D 36, plastic, with 2 castors and 2 brush inserts, diameter 36 mm, width 300 mm, in self-service display pack	D 36 BD 300	452907
	for D 27/D 36, 4 pieces, plastic, with 3 replaceable inserts (brushes, rubber lips, carpet), diameter 36 mm, width 270 mm, in self-service display pack	D 36 BD 270	452906
Carpet and combination suction hose		Type	Order no.
	Carpet nozzle for D 27/D 36, with sliding base, changeover from carpet to smooth floor, width 292 mm, in carton	D 36 TD II	203797
	Turbo combination suction brush for D 27/D 36, for textile and linoleum floors, with 4 castors, brush rollers driven by intake air, width 270 mm, in carton	D 36 TKB II	203809

System accessories

Accessories for CT mobile dust extractors











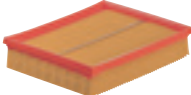
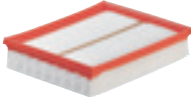

Special nozzles/brushes	Type	Order no.
	Crevice nozzle plastic, in self-service display pack for D 27/D 36, diameter 36 mm, length 300 mm	D 36 FD-300 452904
	for D 27/D 36, diameter 36 mm, length 210 mm	D 36 FD-210 492391
	for D 27/D 36, for CTL SYS, fits in the accessory storage of the CTL SYS, diameter 36 mm, length 150 mm	D 36 FD-150 500593
	for D 50, length 200 mm	D 50 FD 452912
	Suction brush Plastic, in self-service display pack for D 27/D 36, diameter 70 mm	D 36 SP 440404
	for D 50, diameter 85 mm	D 50 SP 440419
	Upholstery nozzle for D 27/D 36, for CTL SYS, plastic, with brush insert, fits in the accessory storage of the CTL SYS, width 120 mm, in self-service display pack	D 36 PD 500592
	Universal brush nozzle for D 27/D 36, plastic, with brush rim and rotary hinge, in self-service display pack	D 36 UBD 498527
	Flat nozzle for D 27, special rubber, oil resistant, diameter 27 mm, width 100 mm, in self-service display pack	D 27 FDG 440408

System accessories

Accessories for CT mobile dust extractors

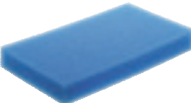







Modules for attachment system CTL/CTM 26/36/48		Type	Order no.
	Energy box module for CT 26/36/48, for connecting a CT mobile dust extractor with an energy box or boom arm, not required in LE version, in carton	EAA CT 26/36/48	496143
	Electrical outlet module for CT 26/36/48, in carton electrical outlet with continuous power	Modul-SD CT 26/36/48	496142
	electrical outlet with automatic On and Off switch	Modul-SD E/A CT 26/36/48	496405
	Compressed air module for CT 26/36/48, for upgrading E model mobile dust extractors, with additional compressed air automatic On and Off switching mechanism, in carton	DL CT 26/36/48	496141
	Remote control the remote control makes it possible to switch on the mobile dust extractor directly from the suction hose (simple changeover to cleaning mode, even when the mobile dust extractor is in AUTO mode), range 10 m, technology Bluetooth®, in carton		
	Bluetooth® remote control for CT 26, 36, 48, retrofit set for CT 26, 36, 48, Module for installation in the free module slot, Remote operation via remote control (included in the set) or via cordless tool (in combination with Bluetooth® battery pack), enables the mobile dust extractor to be started automatically when the cordless tool is switched on (compatible Bluetooth® battery pack required), CT-F I extractor remote control, reception module (for CT 26, 36, 48)	CT-F I/M-Set	202097
	suitable for all dust extractors with Bluetooth® (in combination with Bluetooth® reception module), two fastening straps for D27 and D36 suction hoses	CT-F I	202098
CT boom arm		Type	Order no.
	Boom arm pipe set with connections, length 2.119 mm, width 1.136 mm, in carton for CT 44, CT 48, without handle	CT-ASA	492452
	for CT 26/36, with the SB-CT 26/36 handle, boom arm for mounting to all CT 26/36 models (except CT 26/36 AC HD), handle	CT-ASA CT 26/36/SB	496372
	Tool holder for CT-ASA, CT-ASA/SB, for safe, ergonomic storage of two electric power or pneumatic tools, in carton	WHR/CT-ASA	493558

System accessories







CLEANTEC filter		Type	Order no.
	Filter element for CT 17 E, VCP 170 E, VCP 320 E, for dry extraction, in carton	HF-CT 17	769134
	Main filter for CT MINI and CT MIDI from YOM 2019 onwards, main filter surrounded by practical plastic frame, easy replacement of filter cartridge from outside without opening the mobile dust extractor, in self-service display pack	HF-CT MINI/MIDI-2	204200
	for CTL MINI/MIDI, in self-service display pack	HF-CT-MINI/MIDI	456790
	For CT 26/36/48 and TURBO II, High-performance main filter, not suitable for mobile dust extractors with AUTOCLEAN function, in self-service display pack	HF-CT 26/36/48	496170
	for CT AC, VCP 260 AC, 360 AC, 480 AC, main filter optimised for cleaning with PTFE coating, in self-service display pack	HF-CT 26/36/48 HP	203759
	for CTH 26, CTH 48, special filter complies with the requirements of dust class H, in self-service display pack	HF CTH 26/48	498995
	for CT 11, 22, 33, 44, 55, qty. in pack 2 Units, in carton	HF-CT/2	452923
	for CTL SYS, in self-service display pack	HF-CT SYS	500558
	Long-life main filter for CT 11, 22, 33, 44, 55, used only for extraction of dust types which are not hazardous to health, qty. in pack 2 Units, in carton	Longlife-HF-CT/2	454869
	Wet filter for wet extraction for CT MINI and CT MIDI from YOM 2019 onwards, wet filter surrounded by practical plastic frame, easy replacement of filter cartridge from outside without opening the mobile dust extractor, in self-service display pack	NF-CT MINI/MIDI-2	204202
	for CTL MINI/MIDI, in self-service display pack	NF-CT MINI/MIDI	456805
	for CT 26/36/48, in self-service display pack	NF-CT 26/36/48	496169
	for CT 11, 22, 33, 44, 55, qty. in pack 2 Units, in carton	NF-CT/2	452924
	for CT 17 E, VCP 170 E, VCP 320 E, VCP 171 E-L, VCP 321 E-L, in carton	NF-CT 17	769135

System accessories

Accessories for CT mobile dust extractors



CLEANTEC filter bags	Type	Order no.
 <p>Filter bag for CT 17 E, VCP 170 E, VCP 171 E-L, double wall, qty. in pack 5 Units, in carton</p>	FIS-CT 17/5	769136
 <p>SELFCLEAN filter bag qty. in pack 5 Units</p> <p>for CTL SYS, optimum usage of the filter bag volume, with highly tear resistant filter fleece, SELFCLEAN filter bag made of fleece material, in carton</p>	SC FIS-CT SYS/5	500438
 <p>for CT MINI and CT MIDI from YOM 2019 onwards, optimum utilisation of filter bag volume thanks to SELFCLEAN filter material, optimised for cleaning, max. filling volume 15 l, in self-service display pack</p>	SC-FIS-CT MINI/ MIDI-2/5	204308
 <p>for CTL MINI, optimum usage of filter bag volume and constantly high suction power thanks to SELFCLEAN filter bag, in carton</p>	SC FIS-CT MINI/5	498410
 <p>for CTL MIDI, optimum usage of filter bag volume and constantly high suction power thanks to SELFCLEAN filter bag, in carton</p>	SC FIS-CT MIDI/5	498411
 <p>for CT 26, optimum usage of filter bag volume and constantly high suction power thanks to SELFCLEAN filter bag, in carton</p>	SC FIS-CT 26/5	496187
<p>for CT 36, optimum usage of filter bag volume and constantly high suction power thanks to SELFCLEAN filter bag, in carton</p>	SC FIS-CT 36/5	496186
<p>for CT 48, optimum usage of filter bag volume and constantly high suction power thanks to SELFCLEAN filter bag, in carton</p>	SC FIS-CT 48/5	497539
 <p>Disposable bag not suitable for CT standard version (without AC), qty. in pack 5 Units, in carton</p>		
for CT 26 AC	ENS-CT 26 AC/5	496216
for CT 36 AC/CTL 36 E AC HD	ENS-CT 36 AC/5	496215
for CT/CTL/CTM 48 AC	ENS-CT 48 AC/5	497540
 <p>Safety filter bag double-layered, qty. in pack 3 Units, in carton</p>		
for CTH 26	FIS-CTH 26/3	497541
for CTH 48	FIS-CTH 48/3	497542





System accessories

		Type	Order no.
	Longlife filter bag used only for extraction of dust types which are not hazardous to health, from high strength, 3-layer polyester fleece with a long service life, Not recommended for fine dust		
	for CTL SYS, multiple filter bag for disposal of dust, in self-service display pack	Longlife-FIS-CT SYS	500642
	for CT MINI and CT MIDI from YOM 2019 onwards, max. filling volume 15 l, in carton	LL-FIS-CT MINI/MIDI-2	204309
	for CTL MINI, in carton	Longlife-FIS-CTL MINI	499703
	for CTL MIDI, in carton	Longlife-FIS-CTL MIDI	499704
	for CT 26, in carton	Longlife-FIS-CT 26	496120
	for CT 36, in carton	Longlife-FIS-CT 36	496121
	for CT 48, in carton	Longlife-FIS-CT 48	498506
	for CT 22, in carton	Longlife-FIS-CT 22	456737
	for CT 33, in carton	Longlife-FIS-CT 33	456738
	Filter bag in carton		
	for CT 22, qty. in pack 5 Units	FIS-CT 22/5	452970
	for CT 22, qty. in pack 20 Units	FIS-CT 22/20	494631
	for CT 33, qty. in pack 5 Units	FIS-CT 33/5	452971
	for CT 33, qty. in pack 20 Units	FIS-CT 33/20	494632
	for CT 44, qty. in pack 5 Units	FIS-CT 44/5	452972
	for CT 55, qty. in pack 5 Units	FIS-CT 55/5	452973
	for CT 22, with spunbond outer layer, extremely tearproof, for extracting fine dust particles, qty. in pack 5 Units	FIS-CT 22 SP VLIES/5	456870
	for CT 33, with spunbond outer layer, extremely tearproof, for extracting fine dust particles, qty. in pack 5 Units	FIS-CT 33 SP VLIES/5	456871
	for CT 44, with spunbond outer layer, extremely tearproof, for extracting fine dust particles, qty. in pack 5 Units	FIS-CT 44 SP VLIES/5	456874



System accessories

Accessories for SR dust extractors

SR filter	Type	Order no.
 <p>Absolute filter in carton for SRM 45 LE-EC, SRM 70 LE-EC</p>	AB-FI SRM 45/70	493826
 <p>for SRH 45</p>	AB-FI SRH 45	493825
 <p>Main filter for SRM 45 E-PLANEX, VCP 450 E-L, VCP 450 E-M, Nano, in carton</p>	NANO HF-SRM 45-LHS 225	496406

SR filter bags	Type	Order no.
 <p>Filter bag qty. in pack 5 Units, in carton for SRM 45 LE-EC</p>	FIS-SRM 45 /5	493775
 <p>for SRM 45 E-PLANEX, VCP 450 E-L, VCP 450 E-M</p>	FIS-SRM 45-LHS 225 /5	495014
 <p>for SRM 70 LE-EC</p>	FIS-SRM 70 /5	493777
 <p>for SRH 45 E</p>	FIS-SRH 45 /5	493776

System accessories







	Type	Order no.
 <p>Disposable bag for SRM 45 E-PLANEX, VCP 450 E-L, VCP 450 E-M, qty. in pack 5 Units, in carton</p>	ENS-SRM 45-LHS 225/5	495015
SR filters and filter bags for discontinued models		
	Type	Order no.
 <p>Absolute filter in carton</p>	for SR 5, SR 200, SR 201	AB-FI/U 485808
	for SR151	AB-FI 488461
	for SR 6, SR 12, SR 14, SR 202, SR 203, SR 212, SR 301, SR 302, SR 303, application category C/M	AB-FI/C 486241
 <p>Two-ply filter bag qty. in pack 5 Units, in carton</p>	for SR 5, SR 6, double-layered	FIS-SR 5/6 /5 483143
	for SR 12, SR 14	FIS-SR 12/14 /5 483142
	for SR 151, SRM 152	FIS-SR 150 /5 488460
	for SR 200, SR 201, SR 203	FIS-SR 200 /5 487070
	for SR 301, SR 303, SRM 312	FIS-SR 300 /5 487790
	for SR15, SR12, SR14, for substances with dust emission limits and carcinogenic substances as defined by GefStoffV35, BIA-approved	FIS-SR 15 /5 483889
	for SR 202, SR 212, SRH 204, SR 200, SR 201, SR 203	FIS-SR 202 /5 487482

System accessories

Accessories for mobile dust extractors CT and dust extractors SR

CT accessories	Type	Order no.
 <p>Hose holder for CT 11, 22, 33, 44, 55, for storing the suction hose and mains cable, suitable hose sizes: plug it hose D 22 x 3,5 m / D 27 x 3,5 m / D 27 x 5 m / D 36 x 3,5 m / D 50 x 2,5 m / IAS 2-3500 AS, dimensions (L x W x H) 530 x 360 x 110 mm, in carton</p>	CT-SG	494388
 <p>Tool holder in carton for CT 26/36, galvanised steel tool holder for sanders, for stable and ergonomic placement of an electrical or compressed air power tool</p>	WHR-CT	496122
 <p>for CT 36 PLANEX, with practical carrier handle, for storing PLANEX, not for PLANEX easy</p>	WHR-CT 36-LHS 225	495964
 <p>Handle in carton for CT 26/36, for the convenient transportation of mobile dust extractors, with nozzle holder</p>	SB-CT 26/36	495802
 <p>for CT 48, for the convenient transportation of mobile dust extractors, with nozzle holder</p>	SB-CT 48	497295
 <p>Sealing slide for CT AC / CT 36 AC PLANEX, ensures extreme vacuum in container, the filter undergoes thorough cleaning, in carton</p>	VS-CT AC/SRM45 PLANEX	497926
 <p>Adapter adapter for attaching the WCR and/or service unit VE CT 26/36/48 for CT 48 EC and CT 48 EC B22, in carton</p>	AD-WCR	498805
 <p>Sys-Adapter for CT 36 E HD-AC, CT 26 HD, VCP 260 E-L AC, VCP 260 E-M AC, VCP 260 E-H, from YOM 2011; VCP 480 E-L AC, VCP 480 E-M AC, for connecting Systainer to extractor, in self-service display pack</p>	SYS-AP-CT 36 HD	768115
 <p>Vacuum clamping nozzle for CT mobile dust extractors and D 27 suction hose, flexible aid for temporary clamping and fixing of workpieces at horizontal and vertical areas, max. clamping height 50 mm, max. load 3 kg, dimensions (L x W x H) 130 x 80 x 50 mm, weight 0,35 kg, in self-service display pack</p>	CT-W	500312
 <p>Shoulder strap for CT-SYS and all SYSTAINERS T-LOC, easy transport of the CTL SYS and the SYSTAINER T-LOC, max. load 20 kg, qty. in pack 1 Units, in self-service display pack</p>	SYS-TG	500532

System accessories

CT compressed air accessories		Type	Order no.
	Compressed air module to convert the CT mobile extractor, model E to LE design with additional automatic on/off switch for air tools, only suitable for CT 22/33/44, in carton	DLM-CT	452829
	Service unit for LE version of CT 26/36/48, pressure controller, condensate quick discharge, oiler and oil-free compressed air outlet with quick coupling, in carton	VE-CT 26/36/48	495886
	Assembly set for assembly of supply unit VE-CT 26/36 in conjunction with CT-ASA CT 26/36 SB, in carton	MS DH VE-CT-ASA-CT26/36	496862
Accessories for CT-VA pre-separator		Type	Order no.
	Disposable bag for use in VAB-20 collection container, ideal shape for CT-VA 20 pre-separator collection container, for class L and M dust, max. container capacity 20 l, qty. in pack 10 Units, in carton	ENS-VA-20/10	204296
	Collection container for CT-VA 20 pre-separator, can be stacked, with compact dimensions, good handle options and robust design, can be well sealed for transportation using the cover (included in scope of delivery), dimensions (L x W x H) 395 x 295 x 350 mm, max. container capacity 20 l, in carton		
	qty. in pack 1 Units	VAB-20/1	204294
	qty. in pack 3 Units	VAB-20/3	204295
	Connecting cable for CT-VA 20 pre-separator, for retrofitting the CT-VA pre-separator with additional electrical outlet module, enables particularly easy connection of the plug it suction hose with the CT-VA pre-separator, max. appliance socket connected load 2.400 watt, cable length 0,85 m, in carton	CT-VA AK	575667



05 Drilling and Fastening

Overview of products and applications	216
Cordless drills – CXS, TXS, C 18, T 18+3	218
Cordless drills QUADRIVE – DRC 18/4	222
Cordless impact drill QUADRIVE – PDC 18/4	223
Cordless hammer drill – BHC 18	224
Drill QUADRILL – DR 20	225
Cordless drywall screwdriver DURADRIVE – DWC 18	226
Accessories and consumable materials	228
The Festool system	

Overview of products and applications

Power or precision, compact or durable, high torque or high speed: the task determines the requirements, Festool cordless drills provide the answers.

Cordless drills



CXS
Page 218



TXS
Page 219



C 18
Page 220



T 18+3
Page 221

Applications

Screwdriving in wood, max. diameter

	CXS	TXS	C 18	T 18+3
3x15	●	●	○	
4x35	●	●	●	○
5x40	●	●	●	●
6x80	○	○	●	●

Screwdriving in wood, max. diameter

	CXS	TXS	C 18	T 18+3
6x120			●	●
8x220			○	●
8x300				○
10x300				
12x300				

Drilling in wood, max. diameter

	CXS	TXS	C 18	T 18+3
3	●	●	○	○
15	○	○	●	●
35			●	●
45			○	●
50				
80				

Drilling in stone (max. Ø drilling in stone)

Drilling in concrete (max. Ø drilling in concrete)

Drywall screwdriving – Wooden substructure
(max. screw Ø 4.2 mm)

Drywall screwdriving – Sheet metal substructure
(max. screw Ø 4.2 mm)

Technical data

	CXS	TXS	C 18	T 18+3
Battery voltage (V)	10,8	10,8	18	18
Battery capacity of standard/ compact Li-ion battery pack (Ah)	2,6	2,6	5,2/3,1	5,2/3,1
Idling speed, 1st gear/2nd gear (rpm)	0 – 430/0 – 1.300	0 – 430/0 – 1.300	0 – 450/0 – 1.500	0 – 450/0 – 1.500
Idling speed, 3rd/4th gear (min. rpm)				
Max. torque, wood/steel (Nm)	10/16	10/16	27/45	35/50
Drilling diameter, wood/steel/stone (mm)	12/8/-	12/8/-	40/13/-	45/13/-
Chuck range (mm)	1 – 10	1 – 10	1,5 – 13	1,5 – 13
Tool holder	CENTROTEC	CENTROTEC	CENTROTEC	CENTROTEC
Weight with standard/compact battery pack (kg)	0,9	0,9	1,8/1,5	1,8/1,5

Overview of products and applications

**Cordless drills
QUADRIVE**

**Cordless impact drill
QUADRIVE**

Cordless hammer drill

Drill QUADRILL

Cordless drywall screwdriver DURADRIVE



DRC 18/4
Page 222



PDC 18/4
Page 223



BHC 18
Page 224



DR 20
Page 225



DWC 18-2500
Page 226



DWC 18-4500
Page 226

			●	●
○	○	○	○	
●	●	○		
●	●		○	
●	●		●	
●	●		●	
●	●		●	
○	○		●	
			○	
○	○			
●	●		○	
●	●		●	
●	●		●	
○	○		●	
			○	
10 mm		18 mm		
○	○	18 mm	●	○
○	○		○	●
18	18	18	18	18
5,2	5,2	5,2/3,1	5,2/3,1	5,2/3,1
0 – 400/0 – 850	0 – 400/0 – 850	0 – 1.100/-	0 – 650	0 – 2.500
0 – 1.850/0 – 3.800	0 – 1.850/0 – 3.800			0 – 4.500
40/60	40/60	10/25	98	7/18
50/13/-	50/13/10	25/13/18	65/20/-	5/14
1,5 – 13	1,5 – 13		3 – 16	
CENTROTEC	CENTROTEC	SDS-Plus	CENTROTEC XL	1/4"
1,9	2,0	2,6/2,3	2,7*	2,3/2,0
				2,3/2,0

● Extremely appropriate
○ Appropriate

*Power supply unit

Cordless drill CXS



When it comes to performance, size really isn't that important.

- › Impressive ergonomics and low weight (0.9 kg) for convenient drilling and fastening
- › The compact, handy shape makes work easier, even in cramped spaces
- › FastFix interface and CENTROTEC quick tool-change system
- › Practical – integrated LED light and battery charge indicator

Technical data	
Battery voltage (V)	10,8
Gears	2
Idling speed, 1st gear/2nd gear (RPM)	0 – 430/0 – 1.300
Drilling diameter, wood/steel (mm)	12/8
Torque adjustment 1st/2nd gear (Nm)	0,3 – 3,4
Max. torque, wood/steel (Nm)	10/16
Chuck range (mm)	1 – 10
Li-ion battery capacity (Ah)	2,6
Weight with Li-ion (kg)	0,9



Easy access to every screw.

The XS cordless drills are perfect for when it gets really tight. The elbow adapter is just right for corners and narrow spaces, and the integrated LED light is perfectly suited for dark areas.

Items included	Order no.
2 x battery pack BP-XS, charger MXC, CENTROTEC tool chuck, CENTROTEC bit holder, FastFix keyless chuck 10 mm, bit PZ 2, belt clip, in SYSTAINER SYS 1 T-LOC	
CXS Li 2,6-Plus	564531
CXS Li 2,6-Set XS elbow adapter	564532

System accessories
from page 230



Bits and drills
from page 236



Cordless drill TXS



When it comes to performance, size really isn't that important.

- › High-quality lithium-ion battery technology for the longest sustained usage
- › FastFix interface and CENTROTEC quick tool-change system
- › 12 torque settings and torque switch-off for precision fastening
- › Impressive ergonomics and low weight (0.9 kg) for convenient drilling and fastening

Technical data	
Battery voltage (V)	10,8
Gears	2
Idling speed, 1st gear/2nd gear (RPM)	0 – 430/0 – 1.300
Drilling diameter, wood/steel (mm)	12/8
Torque adjustment 1st/2nd gear (Nm)	0,3 – 3,4
Max. torque, wood/steel (Nm)	10/16
Chuck range (mm)	1 – 10
Li-ion battery capacity (Ah)	2,6
Weight with Li-ion (kg)	0,9



Items included	Order no.
2 x battery pack BP-XS, charger MXC, CENTROTEC tool chuck, CENTROTEC bit holder, FastFix keyless chuck 10 mm, bit PZ 2, belt clip, in SYSTAINER SYS 1 T-LOC	
TXS Li 2,6-Plus	564509
TXS Li 2,6-Set XS elbow adapter	564510



Genuine power pack.

The extra small 10.8 V cordless drills possess a remarkable torque, even in hard-to-reach places. Thanks to FastFix and the CENTROTEC rapid tool change system, they are convincingly flexible.

System accessories from page 230



Bits and drills from page 236



Cordless drill C 18

Brushless EC-TEC motor for a long service life and a high level of efficiency



The perfect shape.

- › Brushless EC-TEC motor with integrated motor management for long service life and the highest output
- › Fully electronic torque setting and switch-off for precise screwdriving
- › FastFix interface for all FastFix attachments and CENTROTEC rapid tool-change system
- › Switchover from screwdriving to drilling without changing the set torque

Technical data	C 18 Plus/Set	C 18 Compact
Battery voltage (V)	18	18
Gears	2	2
Idling speed, 1st gear/2nd gear (RPM)	0 – 450/0 – 1.500	0 – 450/0 – 1.500
Drilling diameter, wood/steel (mm)	40/13	40/13
Torque adjustment 1st/2nd gear (Nm)	0,8 – 8/0,5 – 6	0,8 – 8/0,5 – 6
Max. torque, wood/steel (Nm)	27/45	27/45
Chuck range (mm)	1,5 – 13	1,5 – 13
Li-ion battery capacity (Ah)	5,2	3,1
Weight with Li-ion (kg)	1,8	1,5



■ = Electronic

Distinctive stirrup shape.

The C 18 has won many awards for outstanding design with a proven brushless drive concept. The combination of lithium-ion battery packs and EC-TEC motor makes the C 18 even lighter and gives it even more power and battery life – making the C-series the most powerful ever.

Items included	Order no.
CENTROTEC tool chuck, CENTROTEC bit holder, FastFix keyless chuck 13 mm, bit PZ 2, belt clip, in SYSTAINER SYS 2 T-LOC	
C 18 Li-Basic without battery pack, without charger	574737
C 18 Li 3,1-Compact 2 x BP 18 Li 3.1 C battery pack, rapid charger TCL 6	574921
C 18 Li 5,2-Plus 2 x BP 18 Li 5.2 AS battery pack, rapid charger TCL 6	574738
C 18 Li 5,2-Set 2 x BP 18 Li 5.2 AS battery pack, rapid charger TCL 6, FastFix angle attachment, FastFix eccentric attachment	575672

System accessories
from page 231

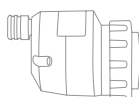

Bits and drills
from page 236



Battery and charging technology
from page 14 onwards

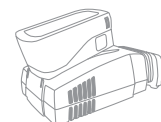

Cordless drill T 18+3



Brushless EC-TEC motor for a long service life and a high level of efficiency

Brains meet brawn.

- › FastFix interface for all FastFix attachments and CENTROTEC rapid tool-change system
- › Impressive ergonomics: compact, lightweight and perfectly balanced
- › Fully electronic torque setting and switch-off for precise screwdriving
- › Switchover from screwdriving to drilling without changing the set torque

Technical data	T 18+3 Plus/Set	T 18+3 Compact
Battery voltage (V)	18	18
Gears	2	2
Idling speed, 1st gear/2nd gear (RPM)	0 – 450/0 – 1.500	0 – 450/0 – 1.500
Drilling diameter, wood/steel (mm)	45/13	45/13
Torque adjustment 1st/2nd gear (Nm)	0,8 – 8/0,5 – 6	0,8 – 8/0,5 – 6
Max. torque, wood/steel (Nm)	35/50	35/50
Chuck range (mm)	1,5 – 13	1,5 – 13
Li-ion battery capacity (Ah)	5,2	3,1
Weight with Li-ion (kg)	1,8	1,5



■ = Electronic



Items included	Order no.
CENTROTEC tool chuck, CENTROTEC bit holder, FastFix keyless chuck 13 mm, belt clip	
T 18+3 Li-Basic without battery pack, without charger, bit PZ 2, in SYSTAINER SYS 2 T-LOC	574763
T 18+3 Li 3,1-Compact 2 x BP 18 Li 3.1 C battery pack, rapid charger TCL 6, bit PZ 2, in SYSTAINER SYS 2 T-LOC	574908
T 18+3 Li 5,2-Plus 2 x BP 18 Li 5.2 AS battery pack, rapid charger TCL 6, bit PZ 2, in SYSTAINER SYS 2 T-LOC	574756
T 18+3 Li 5,2-Set 2 x BP 18 Li 5.2 AS battery pack, rapid charger TCL 6, bit PZ 2, FastFix angle attachment, FastFix eccentric attachment, in SYSTAINER SYS 2 T-LOC	575693
T 18+3/PSC 420 Li I-Set T18+3 cordless drills, pendulum jigsaw PSC 420 EB, 2 x BP 18 Li 5.2 ASI battery pack, rapid charger TCL 6, twinBOX BB-MIX range of bits, 2 x saw blade, splinterguard, in SYSTAINER SYS 3 T-LOC	575696

The powerhouse from the T series.

With an 18-volt power supply, EC-TEC motor and a comfortable, lightweight design for excellent handling. The T 18+3 provides significantly better performance for the most challenging applications. With its brushless EC-TEC motor and lithium-ion battery packs, this tool can drive over 1100 screws (5 x 40 mm in softwood) before needing to be recharged (18 V – 5.2 Ah).

System accessories from page 231

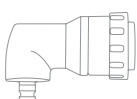

Bits and drills from page 236



Battery and charging technology from page 14 onwards

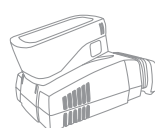

Cordless drill QUADRIVE DRC 18/4

Brushless EC-TEC motor for a long service life and a high level of efficiency



The compact tool with impressive rotary power.

- › Brushless EC-TEC motor for maximum service life and efficiency
- › 4-speed gearbox capable of 3800 rpm for rapid, clean drilling results
- › Universal solution for fastening operations that require high torque and for drilling large diameter holes
- › Individually selectable LED lighting and battery status display

Technical data

Battery voltage (V)	18
Gears	4
Idling speed, 1st gear/2nd gear (RPM)	0 – 400/0 – 850
Idling speed, 3rd/4th gear (RPM)	0 – 1.850/0 – 3.800
Max. torque, wood/steel (Nm)	40/60
Drilling diameter (wood/steel) (mm)	50/13
Chuck range (mm)	1,5 – 13
Li-ion battery capacity (Ah)	5,2
Weight with Li-ion (kg)	1,9



■ = Electronic

Intelligent diversity.

60 Nm torque in first gear for powerful screwing, 3800 rpm in fourth gear for precise drilling. Untiring and enormously tough whether on wood or metal – everyone who knows the QUADRIVE series is impressed by the combination of high power and absolute precision. The FastFix interface enables quick change to a CENTROTEC tool chuck, keyless chuck, crosshead or socket spanner adapter without the need for tools.

Items included

Order no.

CENTROTEC tool chuck, CENTROTEC bit holder, FastFix keyless chuck 13 mm, bit PZ 2, additional side-mounted hand grip, in SYSTAINER SYS 2 DF T-LOC

DRC 18/4 Li-Basic
without battery pack, without charger 574695

DRC 18/4 Li 5,2-Plus
2 x BP 18 Li 5.2 AS battery pack, rapid charger TCL 6 574696

DRC 18/4 Li 5,2-Plus-SCA
2 x BP 18 Li 5.2 AS battery pack, SCA 8 rapid charger 574916

DRC 18/4 Li 5,2-Set-SCA
2 x BP 18 Li 5.2 AS battery pack, SCA 8 rapid charger, angle chuck 574697

System accessories
from page 232



Bits and drills
from page 236



Battery and charging technology
from page 14 onwards



Cordless percussion drill QUADRIVE PDC 18/4



Brushless EC-TEC motor for a long service life and a high level of efficiency

The multi-talented tool that makes a percussion.

- › Brushless EC-TEC motor for maximum service life and efficiency
- › EC-TEC motor combined with high-quality lithium-ion battery technology for up to 100% greater fastening capacity
- › 4-speed gearbox capable of 3800 rpm for rapid, clean drilling results
- › Individually selectable LED lighting and battery status display

Technical data	
Battery voltage (V)	18
Gears	4
Idling speed, 1st gear/2nd gear (RPM)	0 – 400/0 – 850
Idling speed, 3rd/4th gear (RPM)	0 – 1.850/0 – 3.800
Max. number of strokes (RPM)	76.000
Max. torque, wood/steel (Nm)	40/60
Drilling diameter (wood/steel) (mm)	50/13
Drilling diameter in brickwork (mm)	10
Chuck range (mm)	1,5 – 13
Li-ion battery capacity (Ah)	5,2
Weight with Li-ion (kg)	2



■ = Electronic



An argument with impact.

Much like the QUADRIVE DRC 18/4, the QUADRIVE PDC 18/4 offers a full range of features and sophisticated functionalities, and also provides an axial impact function that can be activated for drilling in masonry.

Items included	Order no.
CENTROTEC tool chuck, CENTROTEC bit holder, FastFix keyless chuck 13 mm, bit PZ 2, additional side-mounted hand grip, in SYSTAINER SYS 2 DF T-LOC	
PDC 18/4 Li-Basic without battery pack, without charger	574701
PDC 18/4 Li 5,2-Plus 2 x BP 18 Li 5.2 AS battery pack, rapid charger TCL 6	574702
PDC 18/4 Li 5,2-Plus-SCA 2 x BP 18 Li 5.2 AS battery pack, SCA 8 rapid charger	574918
PDC 18/4 Li 5,2-Set-SCA 2 x BP 18 Li 5.2 AS battery pack, SCA 8 rapid charger, angle chuck	574703
PDC 18/4 Li 5,2-Set/XL-SCA 2 x BP 18 Li 5.2 AS battery pack, SCA 8 rapid charger, angle chuck, depth stop	574704

System accessories from page 232



Bits and drills from page 236



Battery and charging technology from page 14 onwards

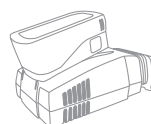

Cordless hammer drill BHC 18

Brushless EC-TEC motor for a long service life and a high level of efficiency



NEW Bluetooth® battery included:
Starts mobile dust extractor automatically.*



Handy and compact – no compromises!

The BHC 18 slices through concrete with ease. It features an ergonomic design for maximum comfort while working, a pneumatic hammer mechanism to provide enormous impact energy and integrated vibration damping that absorbs the impact energy before it reaches your hands. The BHC 18 sets new standards thanks to its efficiency and ease of use and the best power-weight ratio in the 18 V class.

The most powerful compact hammer drill

- › Unbeatable power to weight ratio thanks to the combination of EC-TEC motor and C shape model
- › Vibration damping for effortless work; Maximum working comfort in all work situations
- › Brushless EC-TEC motor with integrated motor management for long service life and the highest output
- › High-quality lithium-ion battery technology for the longest sustained usage

Technical data	BHC 18 Plus	BHC 18 Compact
Battery voltage (V)	18	18
Gears	1	1
Idle engine speed (RPM)	0 – 1.100	0 – 1.100
Max. number of strokes (RPM)	4.895	4.895
Drilling dia. (concrete) (mm)	18	18
Max. crown borer hole diameter (mm)	68	68
Max. torque, wood/steel (Nm)	10/25	10/25
Tool holder	SDS-Plus	SDS-Plus
Single impact energy (J)	1,8	1,8
Li-ion battery capacity (Ah)	5,2	3,1
Weight with Li-ion (kg)	2,6	2,3



Items included	Order no.
additional side-mounted hand grip, depth stop, in SYSTEMER SYS 2 T-LOC	
BHC 18 Li-Basic without battery pack, without charger	574723
BHC 18 Li 3,1 I-Compact 2 x BP 18 Li 3.1 CI battery pack, rapid charger TCL 6	575700
BHC 18 Li 5,2 I-Plus 2 x BP 18 Li 5.2 ASI battery pack, rapid charger TCL 6	575697

System accessories from page 233



Battery and charging technology from page 14 onwards

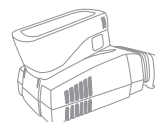

* For more information on Bluetooth® Autostart, go to page 16



Drill

QUADRILL DR 20



The high-torque drill.

- › Multiple reduction gears that achieve a high torque
- › Removable keyless chuck and bit holder in spindle, perfect for drilling and screwdriving
- › Extremely robust and durable with large attachment collar, heavy-duty drive spindle and large spindle bearing
- › Precision keyed chuck with FastFix and locking device

Technical data	
Power consumption (watt)	1.100
Gears	1
Idle engine speed (RPM)	0 – 650
Drilling diameter (steel/alu./wood) (mm)	20/28/65
Max. torque (Nm)	98
Chuck clamping range (mm)	3 – 16
Chuck interface	FastFix
Collar dia. (mm)	57
Weight (kg)	3,4
Weight (without chuck) (kg)	2,7



■ = Electronic

Items included	Order no.
keyed chuck with clawed jaws and locking device, telescopic auxiliary side handle, depth stop	
DR 20 E FF-Plus in SYSTAINER SYS MAXI	767991
DR 20 E FF-Set CENTROTEC XL chuck, accessories set consisting of an angle adapter, socket head adapter, 2 socket wrenches and bit box, in SYSTAINER SYS MAXI 2	768933



The large QUADRILL with excellent speed.

The key feature of the QUADRILL DR 20 is the FastFix interface with which the machine can be set to different functions in an instant.

System accessories
from page 234

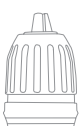

Cordless drywall screwdrivers DURADRIVE DWC 18

Brushless EC-TEC motor for a long service life and a high level of efficiency



Power and durability for interior work.

- › Precision, wear-free electronic switch-off function for accurate insertion depths and a long service life
- › Energy-saving function for machine start/stop without actuating the main switch
- › Robust, brushless EC motor for maximum efficiency and durability
- › Rapid change to magazine attachment without using tools

Technical data	DWC 18-2500 Plus	DWC 18-2500 Compact	DWC 18-4500 Plus	DWC 18-4500 Compact
Battery voltage (V)	18	18	18	18
Gears	1	1	1	1
Idle engine speed (RPM)	0 – 2.500	0 – 2.500	0 – 4.500	0 – 4.500
Max. torque, wood/steel (Nm)	7/18	7/18	5/14	5/14
Max. machinable screw length (mm)	55	55	55	55
Tool holder	1/4"	1/4"	1/4"	1/4"
Li-ion battery capacity (Ah)	5,2	3,1	5,2	3,1
Weight with depth stop (kg)	1,9	1,6	1,9	1,6
Weight with magazine attachment (kg)	2,3	2,0	2,3	2,0



Raises the standard to a very high level.

Large-scale screwdriving applications in drywall construction can be completed conveniently, quickly and efficiently with the DURADRIVE DWC 18. It boasts high speed, low weight at 1.9 kg and a compact design. Its innovative stop-and-go function only activates the brushless EC-TEC motor when it is needed – enabling up to 40% increased screwdriving performance per battery charge. With the depth stop, the DWC can also be used for single screws.

Items included	Order no.
magazine attachment, depth stop, scaffolding holder, magnetic bit holder, 2 x bit PH2, long, PH 2 bit, belt clip, in SYSTAINER SYS 2 T-LOC	
DWC 18-2500 Li-Basic without battery pack, without charger	574742
DWC 18-2500 Li 3,1-Compact 2 x BP 18 Li 3.1 C battery pack, rapid charger TCL 6	574911
DWC 18-2500 Li 5,2-Plus 2 x BP 18 Li 5.2 AS battery pack, rapid charger TCL 6	574743
DWC 18-4500 Li-Basic without battery pack, without charger	574747
DWC 18-4500 Li 3,1-Compact 2 x BP 18 Li 3.1 C battery pack, rapid charger TCL 6	574913
DWC 18-4500 Li 5,2-Plus 2 x BP 18 Li 5.2 AS battery pack, rapid charger TCL 6	574745

System accessories from page 235



Drywall screws from page 241

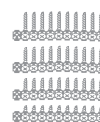

Battery and charging technology from page 14 onwards

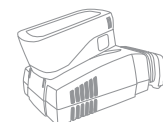



Decidedly different: Cordless drills by Festool.



More time working, less time charging.

The EC-TEC drive concept stands for the extraordinary application of power with minimal power consumption across the entire speed range – from the insertion of large screws to drilling at speeds of up to 3800 rpm. The EC-TEC motor is wear-free, has no carbon brushes and is therefore maintenance-free and extremely robust.



Simply faster.

Drilling, countersinking and screwdriving: The CENTROTEC quick-change system is a drill chuck and bit holder in one, 50% smaller and 80% lighter than a standard drill chuck. The direct and reliable power transmission by the rotary holder directly and centrally in the machine shaft prevents the drill bit from penetrating through, even in hard materials.



A tool that works without needing tools.

Mounted and quickly replaced without the need for tools: The cordless drills or the powerful QUADRILL mains-operated drill can be retrofitted in an instant to a maximum of five tools: Drill, screwdriver, elbow drill, elbow screwdriver or drywall screwdriver, using the FastFix attachments.



The Festool system. Everything in view.

Because things work better when everything fits together: System accessories, matching quick-change attachments, a diverse range of screwdriver and drill bits with the CENTROTEC tool system as well as ingenious battery packs with a charge indicator have made Festool cordless drill and rotary impact driver series even better, more flexible and reliable.



05 Drilling and Fastening

Accessories and consumable materials

System accessories	230
CENTROTEC tool range	236
Drilling guide systems	241



System accessories

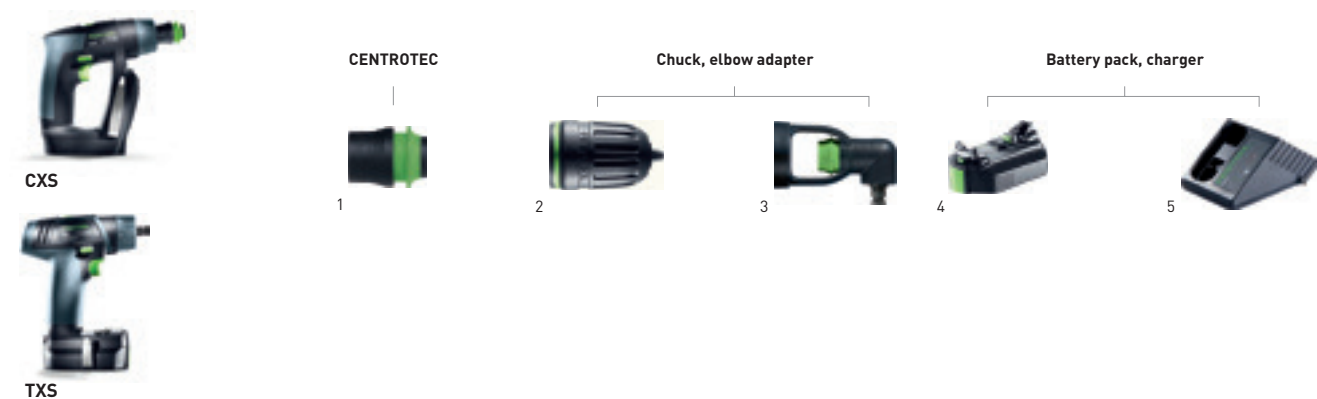

Accessories for CXS and TXS cordless drills

Denomination	Explanation	Order no.
1 Tool chuck WH-CE CENTROTEC	for all Festool cordless and mains-operated drills (except DR 20/DRP 20) with CENTROTEC interface, in self-service display pack	492135
2 Keyless chuck BF-FX 10	for Festool cordless drills CXS and TXS, clamping range 1 – 10 mm, in self-service display pack	499949
3 Angle attachment XS-AS	for CXS and TXS cordless drills, for working in tight spaces, in self-service display pack	497951
4 Battery pack BP-XS 2.6 Ah Li-Ion	lithium-ion spare battery for cordless drills CXS and TXS, tensioner 10,8 V, capacity 2,6 Ah, weight 0,2 kg, in self-service display pack	500184
5 Charger MXC	for BP-XS battery packs, for CXS and TXS cordless drills, charging current 2,8 A, input voltage 220 – 240 V, in carton	497495

System accessories



C 18



T 18+3

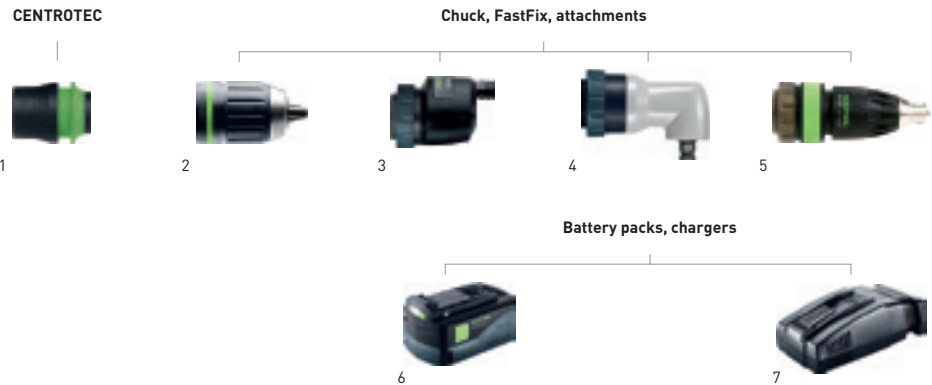

Accessories for C 18, T 18+3 cordless drills

Denomination	Explanation	Order no.
1 Tool chuck WH-CE CENTROTEC	for all Festool cordless and mains-operated drills (except DR 20/DRP 20) with CENTROTEC interface, in self-service display pack	492135
2 Keyless chuck KC 13-1/2-K-FFP	for all Festool cordless drills, cordless impact drills, drills (except DR 20/DRP 20) and impact drills with CENTROTEC interface, impact resistant, plastic ring, with locking device, holder FastFix, clamping range 1,5 – 13 mm, in self-service display pack	769067
3 Eccentric attachment DD-ES	for all Festool C and T cordless drills with FastFix interface (except CXS/TXS), FastFix, in self-service display pack	490294
4 Angle attachment DD-AS	for all Festool C and T cordless drills with FastFix interface (except CXS/TXS), FastFix, in self-service display pack	490293
5 Depth stop DD-DC	for all Festool C and T cordless drills with FastFix interface (except CXS/TXS), FastFix, in self-service display pack	493539
6 Battery pack BP 18 Li 5,2 AS	with AIRSTREAM function, lithium-ion (Li-ion) replacement battery pack for all Festool 18 V cordless tools (except CXS, TXS, ETSC 125, RTSC 400, DTSC 400), tensioner 18 V, capacity 5,2 Ah, weight 0,7 kg, in self-service display pack	200181
Battery pack BP 18 Li 5,2 ASI	Bluetooth® lithium-ion (Li-ion) battery pack with AIRSTREAM function for all Festool 18 V cordless tools (except CXS, TXS, ETSC 125, RTSC 400, DTSC 400), Bluetooth® enables the CLEANTEC mobile dust extractor to be started automatically when the cordless tool is switched on (use of a Bluetooth®-compatible mobile dust extractor is required), tensioner 18 V, capacity 5,2 Ah, weight 0,7 kg, in carton	202479
Battery pack BP 18 Li 6,2 AS	with AIRSTREAM function, lithium-ion (Li-ion) replacement battery pack for all Festool 18 V cordless tools (except CXS, TXS, ETSC 125, RTSC 400, DTSC 400), tensioner 18 V, capacity 6,2 Ah, weight 0,7 kg, in self-service display pack	201774
Battery pack BP 18 Li 6,2 ASI	Bluetooth® lithium-ion (Li-ion) battery pack with AIRSTREAM function for all Festool 18 V cordless tools (except CXS, TXS, ETSC 125, RTSC 400, DTSC 400), Bluetooth® enables the CLEANTEC mobile dust extractor to be started automatically when the cordless tool is switched on (use of a Bluetooth®-compatible mobile dust extractor is required), tensioner 18 V, capacity 6,2 Ah, weight 0,7 kg, in carton	201797
Battery pack BP 18 Li 3,1 C	compact, lightweight design, lithium-ion (Li-ion) replacement battery pack for all Festool 18 V cordless tools (except TSC 55, CXS, TXS, ETSC 125, RTSC 400, DTSC 400), tensioner 18 V, capacity 3,1 Ah, weight 0,4 kg, in self-service display pack	201789
Battery pack BP 18 Li 3,1 CI	Bluetooth® lithium-ion (Li-ion) replacement battery pack for all Festool 18 V cordless tools (except TSC 55, CXS, TXS, ETSC 125, RTSC 400, DTSC 400), Bluetooth® enables the CLEANTEC mobile dust extractor to be started automatically when the cordless tool is switched on (use of a Bluetooth®-compatible mobile dust extractor is required), tensioner 18 V, capacity 3,1 Ah, weight 0,4 kg, in carton	203799
7 Rapid charger TCL 6	for all Li-ion battery packs (except for CXS/TXS), Lithium-ion (Li-ion) replacement charger for all 10.8 – 18 V battery packs, charging current 6 A, input voltage 220 – 240 V, weight 0,8 kg, in self-service display pack	201135
Rapid charger SCA 8	for all Li-ion battery packs (except for CXS/TXS), with AIRSTREAM function, Lithium-ion (Li-ion) replacement charger for all 10.8 – 18 V battery packs, charging current 8 A, input voltage 220 – 240 V, weight 1,1 kg, in self-service display pack	200178
Battery and charging technology	from page 14	

System accessories

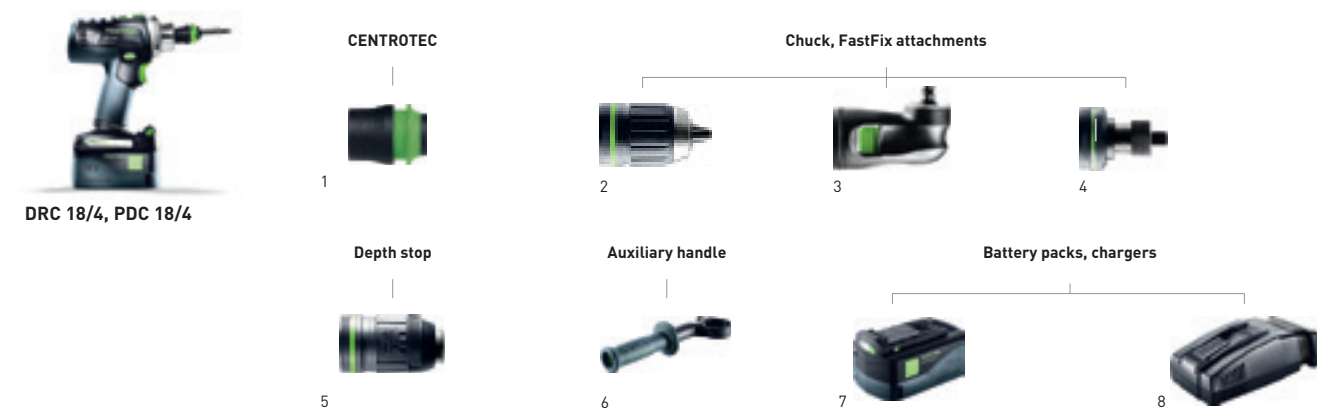

Accessories for QUADRIVE DRC 18/4 cordless drills, QUADRIVE PDC 18/4 cordless impact drills

Denomination	Explanation	Order no.
1 Tool chuck WH-CE CENTROTEC	for all Festool cordless and mains-operated drills (except DR 20/DRP 20) with CENTROTEC interface, in self-service display pack	492135
2 Keyless chuck KC 13-1/2-K-FFP	for all Festool cordless drills, cordless impact drills, drills (except DR 20/DRP 20) and impact drills with CENTROTEC interface, impact resistant, plastic ring, with locking device, holder FastFix, clamping range 1,5 – 13 mm, in self-service display pack	769067
Keyless chuck KC 13-1/2-MMFP	for all Festool cordless drills, cordless impact drills, drills (except DR 20/DRP 20) and impact drills with CENTROTEC interface, impact-resistant, metal ring, with locking device., holder FastFix, clamping range 1,5 – 13 mm, in self-service display pack	769065
3 Angle attachment AU-43 FFP	for DRC 18/4, PDC 18/4, DR 18/4 E, PD 20/4 E, DRP 16 ET, DRP 18-4 DEC, PDP 20-4 DEC, holder FastFix, collar dia. 43 mm, in self-service display pack	769097
4 Adapter AD-3/8" FF	for DRC 18/4, PDC 18/4, DR 18/4 E, PD 20/4 E, DRP 16 ET, DRP 18-4 DEC, PDP 20-4 DEC and all C+T drivers, for holding socket wrenches with 3/8" square i.a.w. DIN 3121 (machine-operated assembly tools), holder FastFix, in self-service display pack	769064
5 Depth stop DC UNI FF	for DRC 18/4, PDC 18/4, DR 18/4 E, PD 20/4 E, DRP 16 ET, DRP 18-4 DEC, PDP 20-4 DEC and all C+T drivers, stop sleeves Ø 17 mm + 23 mm, PH 2 bit, socket wrench, size 8, holder FastFix, in self-service display pack	769126
Guard ring PR D17-DC UNI FF 5x	for DC UNI FF, 5 protective rings for stop sleeves Ø 17 mm, D 17 mm, in self-service display pack	768125
Guard ring PR D23-DC UNI FF 5x	for DC UNI FF, 5 protective rings for stop sleeve Ø 23 mm, D 23 mm, in self-service display pack	768127
Socket spanner SW 3/8"-DC UNI FF 2x	for depth stop DC UNI FF, 2 socket wrenches SW 8 with ball clamping effect, holder 3/8", in self-service display pack	768165
Socket spanner SW 8-DC UNI FF 2x	for depth stop DC UNI FF, 2 socket wrenches SW 8 with ball clamping effect, holder 1/4", in self-service display pack	768113
6 Auxiliary handle AH-43/230	for all QUADRILL DR 18/4 and PD 20/4, for absorbing higher torques, holder dia. 43 mm, length 230 mm, in self-service display pack	768613
7 Battery pack BP 18 Li 5,2 AS	with AIRSTREAM function, lithium-ion (Li-ion) replacement battery pack for all Festool 18 V cordless tools (except CXS, TXS, ETSC 125, RTSC 400, DTSC 400), tensioner 18 V, capacity 5,2 Ah, weight 0,7 kg, in self-service display pack	200181
Battery pack BP 18 Li 5,2 ASI	Bluetooth® lithium-ion (Li-ion) battery pack with AIRSTREAM function for all Festool 18 V cordless tools (except CXS, TXS, ETSC 125, RTSC 400, DTSC 400), Bluetooth® enables the CLEANTEC mobile dust extractor to be started automatically when the cordless tool is switched on (use of a Bluetooth®-compatible mobile dust extractor is required), tensioner 18 V, capacity 5,2 Ah, weight 0,7 kg, in carton	202479
Battery pack BP 18 Li 6,2 AS	with AIRSTREAM function, lithium-ion (Li-ion) replacement battery pack for all Festool 18 V cordless tools (except CXS, TXS, ETSC 125, RTSC 400, DTSC 400), tensioner 18 V, capacity 6,2 Ah, weight 0,7 kg, in self-service display pack	201774
Battery pack BP 18 Li 6,2 ASI	Bluetooth® lithium-ion (Li-ion) battery pack with AIRSTREAM function for all Festool 18 V cordless tools (except CXS, TXS, ETSC 125, RTSC 400, DTSC 400), Bluetooth® enables the CLEANTEC mobile dust extractor to be started automatically when the cordless tool is switched on (use of a Bluetooth®-compatible mobile dust extractor is required), tensioner 18 V, capacity 6,2 Ah, weight 0,7 kg, in carton	201797
Battery pack BP 18 Li 3,1 C	compact, lightweight design, lithium-ion (Li-ion) replacement battery pack for all Festool 18 V cordless tools (except TSC 55, CXS, TXS, ETSC 125, RTSC 400, DTSC 400), tensioner 18 V, capacity 3,1 Ah, weight 0,4 kg, in self-service display pack	201789
Battery pack BP 18 Li 3,1 CI	Bluetooth® lithium-ion (Li-ion) replacement battery pack for all Festool 18 V cordless tools (except TSC 55, CXS, TXS, ETSC 125, RTSC 400, DTSC 400), Bluetooth® enables the CLEANTEC mobile dust extractor to be started automatically when the cordless tool is switched on (use of a Bluetooth®-compatible mobile dust extractor is required), tensioner 18 V, capacity 3,1 Ah, weight 0,4 kg, in carton	203799
8 Rapid charger TCL 6	for all Li-ion battery packs (except for CXS/TXS), Lithium-ion (Li-ion) replacement charger for all 10.8 – 18 V battery packs, charging current 6 A, input voltage 220 – 240 V, weight 0,8 kg, in self-service display pack	201135
Rapid charger SCA 8	for all Li-ion battery packs (except for CXS/TXS), with AIRSTREAM function, Lithium-ion (Li-ion) replacement charger for all 10.8 – 18 V battery packs, charging current 8 A, input voltage 220 – 240 V, weight 1,1 kg, in self-service display pack	200178

Battery and charging technology from page 14

System accessories



BHC 18



Accessories for cordless hammer drill BHC 18

	Denomination	Explanation	Order no.
1	Hammer drill SDS-Set D5-D12/7	for cordless hammer drills BHC 18 and all other hammer drills with SDS-Plus tool reception, hammer drill bit D 5 x 50 mm, 2 x hammer drill bit D 6 x 50 mm, hammer drill bit D 6 x 100 mm, hammer drill bit D 8 x 100 mm, hammer drill bit D 10 x 100 mm, hammer drill bit D 12 x 100 mm, qty. in pack 7 Units, in self-service display pack	204070
2	Adapter AD SDS-plus/FastFix	for BHC 18, RHP 18, CHP 26, for holding a CENTROTEC tool chuck, in self-service display pack	769068
3	Tool chuck WH-CE CENTROTEC	for all Festool cordless and mains-operated drills (except DR 20/DRP 20) with CENTROTEC interface, in self-service display pack	492135
4	Auxiliary handle AH-43/185	for all QUADRIVE DRC 18/4, PDC 18/4 and BHC 18, for absorbing higher torques, length 185 mm, holder dia. 43 mm, in self-service display pack	768615
5	Drilling dust nozzle D 27-BSD	for BHC 18, PDC 18, PD 20 and mobile dust extractors CT/CTL/CTM, adapter with flexible insert, drill sleeve made from nickel-plated steel, compatible with all standard industrial and domestic vacuum cleaners, exception: must be deactivated on extractors with automatic filter cleaning system, connection dia. 27-32 mm, drill bit dia. 0 - 12 mm, in self-service display pack	500483
6	Battery pack BP 18 Li 5,2 AS	with AIRSTREAM function, lithium-ion (Li-ion) replacement battery pack for all Festool 18 V cordless tools (except CXS, TXS, ETSC 125, RTSC 400, DTSC 400), tensioner 18 V, capacity 5,2 Ah, weight 0,7 kg, in self-service display pack	200181
	Battery pack BP 18 Li 5,2 ASI	Bluetooth® lithium-ion (Li-ion) battery pack with AIRSTREAM function for all Festool 18 V cordless tools (except CXS, TXS, ETSC 125, RTSC 400, DTSC 400), Bluetooth® enables the CLEANTEC mobile dust extractor to be started automatically when the cordless tool is switched on (use of a Bluetooth®-compatible mobile dust extractor is required), tensioner 18 V, capacity 5,2 Ah, weight 0,7 kg, in carton	202479
	Battery pack BP 18 Li 6,2 AS	with AIRSTREAM function, lithium-ion (Li-ion) replacement battery pack for all Festool 18 V cordless tools (except CXS, TXS, ETSC 125, RTSC 400, DTSC 400), tensioner 18 V, capacity 6,2 Ah, weight 0,7 kg, in self-service display pack	201774
	Battery pack BP 18 Li 6,2 ASI	Bluetooth® lithium-ion (Li-ion) battery pack with AIRSTREAM function for all Festool 18 V cordless tools (except CXS, TXS, ETSC 125, RTSC 400, DTSC 400), Bluetooth® enables the CLEANTEC mobile dust extractor to be started automatically when the cordless tool is switched on (use of a Bluetooth®-compatible mobile dust extractor is required), tensioner 18 V, capacity 6,2 Ah, weight 0,7 kg, in carton	201797
	Battery pack BP 18 Li 3,1 C	compact, lightweight design, lithium-ion (Li-ion) replacement battery pack for all Festool 18 V cordless tools (except TSC 55, CXS, TXS, ETSC 125, RTSC 400, DTSC 400), tensioner 18 V, capacity 3,1 Ah, weight 0,4 kg, in self-service display pack	201789
	Battery pack BP 18 Li 3,1 CI	Bluetooth® lithium-ion (Li-ion) replacement battery pack for all Festool 18 V cordless tools (except TSC 55, CXS, TXS, ETSC 125, RTSC 400, DTSC 400), Bluetooth® enables the CLEANTEC mobile dust extractor to be started automatically when the cordless tool is switched on (use of a Bluetooth®-compatible mobile dust extractor is required), tensioner 18 V, capacity 3,1 Ah, weight 0,4 kg, in carton	203799
7	Rapid charger TCL 6	for all Li-ion battery packs (except for CXS/TXS), Lithium-ion (Li-ion) replacement charger for all 10.8 - 18 V battery packs, charging current 6 A, input voltage 220 - 240 V, weight 0,8 kg, in self-service display pack	201135
	Rapid charger SCA 8	for all Li-ion battery packs (except for CXS/TXS), with AIRSTREAM function, Lithium-ion (Li-ion) replacement charger for all 10.8 - 18 V battery packs, charging current 8 A, input voltage 220 - 240 V, weight 1,1 kg, in self-service display pack	200178
	Battery and charging technology	from page 14	

System accessories

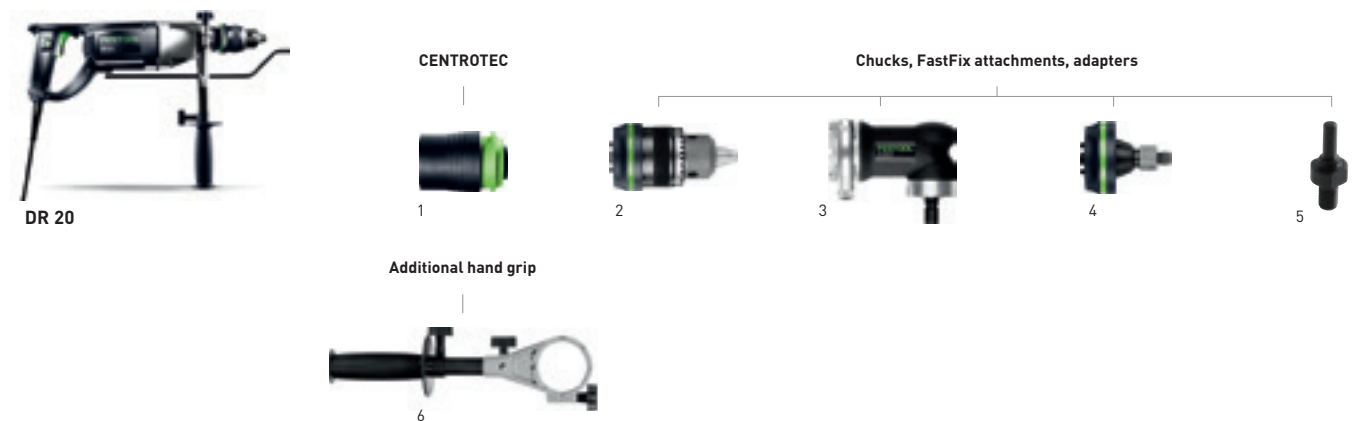

Accessories for the QUADRILL DR 20 drill

Denomination	Explanation	Order no.
1 Tool chuck CC-XL CENTROTEC	for DR 20 E FF, DRP 20 ET FF, DRP 20-2 E FF, for holding CENTROTEC tools, holder FastFix, in self-service display pack	769071
2 Key-type chuck CC-16 FFP	for DR 20 E FF, DRP 20 ET FF, DRP 20-2 E FF, with wrench and locking device, holder FastFix, clamping range 3 – 16 mm, in self-service display pack	769061
3 Angle chuck AU DR 20	for DR 20 E FF, DRP 20 ET FF, DRP 20-2 E FF, holder FastFix, collar dia. 57 mm, in self-service display pack	769060
4 Adapter AD-1/2 FF	for DR 20 E FF, DRP 20 ET FF, DRP 20-2 E FF, for quick-change adapters, For holding socket wrenches with 1/2" square, holder FastFix, in self-service display pack	769062
5 Adapter AD-D10/M14	for Festool stirrers: to mount in a drill chuck, for sanding disc with M14 thread: for mounting in drilling and boring machines, for polishing pad Ø 80: for use in cordless drills, clamping flange dia. 10 mm, in self-service display pack	483944
6 Auxiliary handle AH-57/230	for DRP 20, for absorbing higher torques, holder dia. 57 mm, length 230 mm, telescopic design extendible up to 325 mm, in self-service display pack	769044
Auxiliary handle AH-57/275	for DRP 20, for absorbing higher torques, holder dia. 57 mm, length 275 mm, telescopic design extendible up to 380 mm, in self-service display pack	769045

System accessories



Accessories for cordless drywall screwdrivers DURADRIVE DWC 18







Denomination	Explanation	Order no.
1 Magazine attachment AF 55-DWC	for DWC, DWP, for taped screws, 25-55 mm, bit PH2, long, in carton	769146
2 PH bit PH2-AF-55 3x	AF 55-DWP/DWC, size PH 2, length 152 mm, qty. in pack 3 Units, in self-service display pack	769124
PZ bit PZ 2-AF-55 3x	AF 55-DWP/DWC, size PZ 2, length 152 mm, qty. in pack 3 Units, in self-service display pack	769078
TX bit TX 20-AF-55/3	AF 55-DWP/DWC, processing timber construction screws loaded in a magazine (TX 20) with a length of up to 55 mm, long bits for magazine attachment, ideal for DWC 18-2500, length 152 mm, size TX 20, qty. in pack 3 Units, in self-service display pack	201463
3 Bit holder BH-DWC	for DWC, DWP, qty. in pack 1 Units, in self-service display pack	769125
4 Battery pack BP 18 Li 5,2 AS	with AIRSTREAM function, lithium-ion (Li-ion) replacement battery pack for all Festool 18 V cordless tools (except CXS, TXS, ETSC 125, RTSC 400, DTSC 400), tensioner 18 V, capacity 5,2 Ah, weight 0,7 kg, in self-service display pack	200181
Battery pack BP 18 Li 5,2 ASI	Bluetooth® lithium-ion (Li-ion) battery pack with AIRSTREAM function for all Festool 18 V cordless tools (except CXS, TXS, ETSC 125, RTSC 400, DTSC 400), Bluetooth® enables the CLEANTEC mobile dust extractor to be started automatically when the cordless tool is switched on (use of a Bluetooth®-compatible mobile dust extractor is required), tensioner 18 V, capacity 5,2 Ah, weight 0,7 kg, in carton	202479
Battery pack BP 18 Li 6,2 AS	with AIRSTREAM function, lithium-ion (Li-ion) replacement battery pack for all Festool 18 V cordless tools (except CXS, TXS, ETSC 125, RTSC 400, DTSC 400), tensioner 18 V, capacity 6,2 Ah, weight 0,7 kg, in self-service display pack	201774
Battery pack BP 18 Li 6,2 ASI	Bluetooth® lithium-ion (Li-ion) battery pack with AIRSTREAM function for all Festool 18 V cordless tools (except CXS, TXS, ETSC 125, RTSC 400, DTSC 400), Bluetooth® enables the CLEANTEC mobile dust extractor to be started automatically when the cordless tool is switched on (use of a Bluetooth®-compatible mobile dust extractor is required), tensioner 18 V, capacity 6,2 Ah, weight 0,7 kg, in carton	201797
Battery pack BP 18 Li 3,1 C	compact, lightweight design, lithium-ion (Li-ion) replacement battery pack for all Festool 18 V cordless tools (except TSC 55, CXS, TXS, ETSC 125, RTSC 400, DTSC 400), tensioner 18 V, capacity 3,1 Ah, weight 0,4 kg, in self-service display pack	201789
Battery pack BP 18 Li 3,1 CI	Bluetooth® lithium-ion (Li-ion) replacement battery pack for all Festool 18 V cordless tools (except TSC 55, CXS, TXS, ETSC 125, RTSC 400, DTSC 400), Bluetooth® enables the CLEANTEC mobile dust extractor to be started automatically when the cordless tool is switched on (use of a Bluetooth®-compatible mobile dust extractor is required), tensioner 18 V, capacity 3,1 Ah, weight 0,4 kg, in carton	203799
5 Rapid charger TCL 6	for all Li-ion battery packs (except for CXS/TXS), Lithium-ion (Li-ion) replacement charger for all 10.8 – 18 V battery packs, charging current 6 A, input voltage 220 – 240 V, weight 0,8 kg, in self-service display pack	201135
Rapid charger SCA 8	for all Li-ion battery packs (except for CXS/TXS), with AIRSTREAM function, Lithium-ion (Li-ion) replacement charger for all 10.8 – 18 V battery packs, charging current 8 A, input voltage 220 – 240 V, weight 1,1 kg, in self-service display pack	200178
Battery and charging technology	from page 14	

System accessories



25 mm bits		Type	Order no.
	PZ bit length 25 mm, qty. in pack 10 Units, in self-service display pack size PZ 1	PZ 1-25/10	490481
	size PZ 2	PZ 2-25/10	490482
	size PZ 3	PZ 3-25/10	490483
	TX bit length 25 mm, qty. in pack 10 Units, in self-service display pack size TX 10	TX 10-25/10	490504
	size TX 15	TX 15-25/10	490505
	size TX 20	TX 20-25/10	490506
	size TX 25	TX 25-25/10	490507
	size TX 30	TX 30-25/10	490508
	twinBOX content 10 pieces, in self-service display pack 3 x PZ 1 bit, 4 x bit PZ 2, 3 x PZ 3 bit	BB-PZ	496934
	TX 10 bit, 2 x TX 15 bit, 3 x TX 20 bit, 3 x TX 25 bit, TX 30 bit	BB-TX	496935
	PH 1 bit, PH 2 bit, PZ 1 bit, bit PZ 2, PZ 3 bit, SZ 0.8 x 5.5 bit, TX 15 bit, TX 20 bit, TX 25 bit, TX 30 bit	BB-MIX	496936
100 mm bits		Type	Order no.
	PZ bit length 100 mm, qty. in pack 2 Units, in self-service display pack size PZ 1	PZ 1-100 CE/2	500841
	size PZ 2	PZ 2-100 CE/2	500842
	size PZ 3	PZ 3-100 CE/2	500843
	PH bit length 100 mm, qty. in pack 2 Units, in self-service display pack size PH 1	PH 1-100 CE/2	500844
	size PH 2	PH 2-100 CE/2	500845
	size PH 3	PH 3-100 CE/2	500846
	SZ bit length 100 mm, qty. in pack 2 Units, in self-service display pack size SZ 0,8 x 5,5	SZ 0,8x5,5-100 CE/2	500852
	size SZ 1,2 x 6,5	SZ 1,2x6,5-100 CE/2	500851
	TX bit length 100 mm, qty. in pack 2 Units, in self-service display pack size TX 15	TX 15-100 CE/2	500847
	size TX 20	TX 20-100 CE/2	500848
	size TX 25	TX 25-100 CE/2	500849
	size TX 30	TX 30-100 CE/2	500850
	Bit set for SYS TL with lid compartment, 6 CENTROTEC bits: PZ 2-100 CE, PZ 3-100 CE, TX 15-100 CE, TX 20-100 CE, TX 25-100 CE, TX 30-100 CE, length 100 mm, qty. in pack 6 Units, in self-service display pack	CENTROTEC BITS CE SET TL 6X	769095

System accessories



Bits and bit holders

		Type	Order no.
	Bit box for all Festool cordless drills with FastFix interface, CENTROTEC magnetic bit fastener BH 60 CE, content 10 pieces, in self-service display pack		
	2 x PZ 1 bit, 5 x bit PZ 2, 2 x PZ 3 bit	PZ + BH 60-CE	493260
	TX 10 bit, 2 x TX 15 bit, 3 x TX 20 bit, 2 x TX 25 bit, TX 30 bit	TX + BH 60-CE	493261
	PH 1 bit, PH 2 bit, PZ 1 bit, bit PZ 2, PZ 3 bit, SZ 0.8 x 5.5 bit, TX 15 bit, TX 20 bit, TX 25 bit	MIX + BH 60-CE	493262
	Bit assortment for SYS TL with lid compartment, 24-piece, 2 x PH 1 bit, 2 x PH 3, 2 x TX 10 bit, 2 x PH 2 bit, 2 x PZ 1 bit, 2 x bit PZ 2, 2 x PZ 3 bit, 2 x TX 15 bit, 2 x TX 20 bit, 2 x TX 25 bit, 2 x TX 30 bit, 2 x TX 40 bit, Quick change bit holder, in self-service display pack	BITS + BHS 65 CE TL 24x	769094
	Bit holder for all Festool cordless drills with FastFix interface, qty. in pack 1 Units, in self-service display pack	BHS 65 CE	492648
	Bit holder for all Festool cordless drills with FastFix interface, also suitable for use with impact screwdriver TI15 Impact, qty. in pack 1 Units, in self-service display pack	BH 60 CE-Imp	498974
	Bit holder for all Festool cordless drills with FastFix interface, extra-long, qty. in pack 1 Units, in self-service display pack	BV 150 CE	492540
	Adapter for all Festool cordless drills with FastFix interface, for plug-in bits, with ball lock for manual operation, qty. in pack 1 Units, in self-service display pack		
	holder 1/4", length 50 mm	1/4"-50 CE/KG CENTROTEC	495131
	holder 3/8", length 70 mm	3/8"-70 CE/KG CENTROTEC	495133
	Screwdriver for CENTROTEC tools for drilling and screwdriving, in self-service display pack	SD-CE-DRIVE-UNI	200140

Bit cassette

		Type	Order no.
	Bit cassette 31-piece, 1 magnetic bit holder 1/4", in self-service display pack		
	3 x TX 10 bit, 3 x TX 15 bit, 6 x TX 20 bit, 6 x TX 25 bit, 6 x TX 30 bit, 3 x TX 40 bit, 3 x TX 50	TX 10-50/BH SORT/31x	769137
	1x LS 4,5; LS 5,5; LS 6,5; HEX 4; HEX 5; HEX 6, 2 x TX 10 bit, 2 x TX 15 bit, 2 x TX 20 bit, 2 x TX 25 bit, 2 x TX 30 bit, 2 x TX 40 bit, 2 x PH 1 bit, 2 x PH 2 bit, 2 x PH 3, 2 x PZ 1 bit, 2 x bit PZ 2, 2 x PZ 3 bit	BIT/BH-SORT/31x	769138
	Ratchet set 1/4" socket set from 4.0 to 13 mm, 19 different bit inserts and 2 bit extensions, ratchet and CENTROTEC handle plus various adapters and extensions, in SYSTAINER SYS MINI	1/4"-CE RA-Set 36	497881
	Assembly package for all Festool cordless drills with FastFix interface, CENTROTEC-DRIVE screwdriver handle, CENTROTEC tool chuck, CENTROTEC magnetic bit fastener BH 60 CE, extra-long CENTROTEC magnetic bit holder BV 150 CE, CENTROTEC drill adapter BA-CE, deburring countersink QLS D2-8 CE, deburring countersink QLS D5-15 CE, BTA HW D5 CE drill bit with depth stop, drill countersink with depth stop, BSTA HS D3.5 CE, centering bit ZB HS D5 EURO CE, hook driver HD D18 CE, twinBOX BB-MIX range of bits, drill bit case HSS D3-10 CE/10, drill bit case BKS D3-8 CE/W-K, 12x long CENTROTEC bits PZ/PH/TX, bit assortment 25 mm, 50 pieces, in SYSTAINER SYS 1 T-LOC	SYS 1 CE-SORT	497628

System accessories

CENTROTEC HSS twist drill bit		Type	Order no.
	Twist drill bit in self-service display pack		
	complete drill bit with bit holder and 2 replacement drill bits, hexagon socket wrench, diameter 3 mm, qty. in pack 1 Units	HSS D 3/33 CE/M-Set	493421
	complete drill bit with bit holder and 2 replacement drill bits, hexagon socket wrench, diameter 3,5 mm, qty. in pack 1 Units	HSS D 3,5/39 CE/M-Set	493422
	complete drill bit with bit holder and 2 replacement drill bits, hexagon socket wrench, diameter 4 mm, qty. in pack 1 Units	HSS D 4/43 CE/M-Set	493423
	complete drill bit with bit holder and 2 replacement drill bits, hexagon socket wrench, diameter 4,5 mm, qty. in pack 1 Units	HSS D 4,5/47 CE/M-Set	493424
	complete drill bit with bit holder and 2 replacement drill bits, hexagon socket wrench, diameter 5 mm, qty. in pack 1 Units	HSS D 5/52 CE/M-Set	493425
	complete drill bit with bit holder and 2 replacement drill bits, hexagon socket wrench, diameter 5,5 mm, qty. in pack 1 Units	HSS D 5,5/57 CE/M-Set	493426
	complete drill bit with bit holder and 2 replacement drill bits, hexagon socket wrench, diameter 6 mm, qty. in pack 1 Units	HSS D 6/57 CE/M-Set	493427
	complete drill bit with bit holder and 2 replacement drill bits, hexagon socket wrench, diameter 6,5 mm, qty. in pack 1 Units	HSS D 6,5/63 CE/M-Set	493428
	complete drill bit with bit holder and 1 replacement drill bit, hexagon socket wrench, diameter 8 mm, qty. in pack 1 Units	HSS D 8,0/75 CE/M-Set	495308
	complete drill bit with bit holder and 1 replacement drill bit, hexagon socket wrench, diameter 10 mm, qty. in pack 1 Units	HSS D 10,0/75 CE/M-Set	495309
	Drill bit case, diameter 3 - 10 mm, qty. in pack 10 Units	HSS D3-10 CE/10	495128
	spare part drill bit for CENTROTEC M Set twist drill bit, extra drill for CENTROTEC HSS twist drill, diameter 3 mm, qty. in pack 10 Units	HSS D 3/33 M/10	493437
	spare part drill bit for CENTROTEC M Set twist drill bit, extra drill for CENTROTEC HSS twist drill, diameter 3,5 mm, qty. in pack 10 Units	HSS D 3,5/39 M/10	493438
	spare part drill bit for CENTROTEC M Set twist drill bit, extra drill for CENTROTEC HSS twist drill, diameter 4 mm, qty. in pack 10 Units	HSS D 4/43 M/10	493439
	spare part drill bit for CENTROTEC M Set twist drill bit, extra drill for CENTROTEC HSS twist drill, diameter 4,5 mm, qty. in pack 10 Units	HSS D 4,5/47 M/10	493440
	spare part drill bit for CENTROTEC M Set twist drill bit, extra drill for CENTROTEC HSS twist drill, diameter 5 mm, qty. in pack 10 Units	HSS D 5/52 M/10	493441
	spare part drill bit for CENTROTEC M Set twist drill bit, extra drill for CENTROTEC HSS twist drill, diameter 5,5 mm, qty. in pack 10 Units	HSS D 5,5/57 M/10	493442
	spare part drill bit for CENTROTEC M Set twist drill bit, extra drill for CENTROTEC HSS twist drill, diameter 6 mm, qty. in pack 10 Units	HSS D 6/57 M/10	493443
	spare part drill bit for CENTROTEC M Set twist drill bit, extra drill for CENTROTEC HSS twist drill, diameter 6,5 mm, qty. in pack 10 Units	HSS D 6,5/63 M/10	493444
	spare part drill bit for CENTROTEC M Set twist drill bit, extra drill for CENTROTEC HSS twist drill, diameter 8 mm, qty. in pack 5 Units	HSS D 8,0/75 M/5	495310
	spare part drill bit for CENTROTEC M Set twist drill bit, extra drill for CENTROTEC HSS twist drill, diameter 10 mm, qty. in pack 5 Units	HSS D 10,0/75 M/5	495311















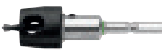



HSS steel drill

HSS steel drill		Type	Order no.
	Drill bit box for HSS steel drill bits Drill bit case, diameter 1-10 mm, qty. in pack 19 Units, in self-service display pack	HSS D 1-10 Sort/19	498981

System accessories

Drill bit	Type	Order no.
 Drill bit for all Festool cordless drills with FastFix interface, qty. in pack 1 Units, in self-service display pack		
diameter 3 mm	D 3 CE/W	492512
diameter 4 mm	D 4 CE/W	492513
diameter 5 mm	D 5 CE/W	492514
diameter 6 mm	D 6 CE/W	492515
diameter 7 mm	D 7 CE/W	492516
diameter 8 mm	D 8 CE/W	492517
diameter 10 mm	D 10 CE/W	492518
 Drill bit case 6 CENTROTEC wood twist drills, diameter 4, 2 x 5, 6, 8, 10 mm, qty. in pack 6 Units, in self-service display pack	DB WOOD CE SET TL 6x	769093
 Drill bit case long drill bit case, with brad point, diameter 3, 4, 5, 6, 8 mm, qty. in pack 5 Units, in self-service display pack	BKS D 3-8 CE/W	493648
 Drill bit case short drill bit case, with brad point, qty. in pack 5 Units, diameter 3, 4, 5, 6, 8 mm, in self-service display pack	BKS D 3-8 CE/W-K	495130
CENTROTEC masonry drills with carbide-tipped cutter	Type	Order no.
 Masonry drill for cordless impact screwdrivers, impact drills with FastFix interface, in self-service display pack		
diameter 4 mm, qty. in pack 3 Units	DB STONE CE D4 3x	769111
diameter 5 mm, qty. in pack 3 Units	DB STONE CE D5 3x	769112
diameter 6 mm, qty. in pack 3 Units	DB STONE CE D6 3x	769113
diameter 8 mm, qty. in pack 3 Units	DB STONE CE D8 3x	769114
diameter 10 mm, qty. in pack 3 Units	DB STONE CE D10 3x	769115
 for SYS TL with lid compartment, 6 CENTROTEC masonry drill bits: dia. 4, 5, 2 x 6, 8, 10 mm, qty. in pack 1 Units	DB STONE CE SET TL	769096

System accessories

CENTROTEC Forstner drill bit system ZOBO		Type	Order no.
	Forstner drill bit ZOBO system, qty. in pack 1 Units, in self-service display pack diameter 15 mm	FB D 15 CE-Zobo	496472
	diameter 20 mm	FB D 20 CE-Zobo	496473
	diameter 25 mm	FB D 25 CE-Zobo	496474
	diameter 30 mm	FB D 30 CE-Zobo	496475
	diameter 35 mm	FB D 35 CE-Zobo	496476
	Forstner drill bit set Sturdy plastic drill bit case, ZOBO system, Forstner drill bit FB D 15 CE-Zobo, Forstner drill bit FB D 20 CE-Zobo, Forstner drill bit FB D 25 CE-Zobo, Forstner drill bit FB D 30 CE-Zobo, Forstner drill bit FB D 35 CE-Zobo, diameter 15 - 35 mm, qty. in pack 5 Units, in self-service display pack	FB Set D 15-35 CE-Zobo	496390
	Spare part set ZOBO centre points (FB-CE 2.5x3.5/ZS and FB-CE 2.5x7.5/ZS), centring bit (FB-CE 3x30/ZB) and punch (FB-Set-D 15-35 CE), for CENTROTEC Forstner drill bit, in self-service display pack	FB-CE/Er-Zobo	497268
CENTROTEC other accessoires		Type	Order no.
	Deburring countersink qty. in pack 1 Units, in self-service display pack diameter 2 - 8 mm	QLS D 2- 8 CE	492520
	for pre-counterboring and flush screwing, diameter 5 - 15 mm	QLS D 5-15 CE	492521
	Drill bit carbide, adjustable depth stop, diameter 5 mm, qty. in pack 1 Units, in self-service display pack	BTA HW D 5 CE	492522
	Spare part drill bit for drill bit with depth stop, carbide, diameter 5 mm, qty. in pack 1 Units, in self-service display pack	HW D 5 F.BTA	491794
	Drill countersink adjustable depth stop, diameter 3,5 mm, qty. in pack 1 Units, in self-service display pack	BSTA HS D 3,5 CE	492523
	Spare part drill bit for drill countersink with depth stop, diameter 3,5 mm, qty. in pack 5 Units, in self-service display pack	EB-BSTA D 3,5/5	494445
	Drill countersink adjustable depth stop, diameter 4,5 mm, qty. in pack 1 Units, in self-service display pack	BSTA HS D 4,5 CE	492524
	Spare part drill bit for drill countersink with depth stop, diameter 4,5 mm, qty. in pack 5 Units, in self-service display pack	EB-BSTA D 4,5/5	494446
	Drill countersink adjustable depth stop, diameter 5 mm, qty. in pack 1 Units, in self-service display pack	BSTA HS D 5 CE	496451
	Spare part drill bit for drill countersink with depth stop, diameter 5 mm, qty. in pack 5 Units, in self-service display pack	EB-BSTA D 5/5	496452
	Drill countersink for all Festool cordless drills, for use with the CENTROTEC tool chuck, adjustable depth stop, especially designed for machining patio flooring, diameter 4 mm, max. drill depth 60 mm, qty. in pack 1 Units, in self-service display pack	BSTA HS D 4 L60 CE	202392
	Spare part drill bit for drill countersink with depth stop, extremely long service life because the drill bit is made of high-quality HSS Böhler steel, extremely long service life because the drill bit is made of high-quality HSS Böhler steel, diameter 4 mm, max. drill depth 60 mm, qty. in pack 2 Units, in self-service display pack	EB-BSTA D4/2	202393
	Centering bit with depth stop for 5 mm Euro-screws, diameter 5 mm, qty. in pack 1 Units, in self-service display pack	ZB HS D 5 EURO CE	492525
	Spare part drill bit for centring bits, diameter 5 mm, qty. in pack 1 Units, in self-service display pack	HS D 5	493572
	Hook driver for all Festool cordless drills with FastFix interface, diameter 18 mm, qty. in pack 1 Units, in self-service display pack	HD D 18 CE	492526
	Drill adapter qty. in pack 1 Units, in self-service display pack	BA-CE CENTROTEC	496450

System accessories

Drilling guide systems		Type	Order no.
	Drill stand for carpentry for powerful drills, easy movement thanks to precise guide rods and bronze slide bearing in the guide block, positive stability due to the square base plate with precision-milled supporting surface, Centering plate for drill bits Ø 8 to 26 mm, 2 x depth stop, 2 x parallel side fence, Adapter ring Ø 57 mm / 43 mm, in carton max. drill depth 240 mm, max. drill bit length 320 mm, weight 2,8 kg	GD 320	768768
	max. drill depth 380 mm, max. drill bit length 460 mm, weight 3,2 kg	GD 460	768119
	swivel-mounted, max. drill depth 310 mm, max. drill bit length 460 mm, weight 3,7 kg	GD 460 A	769042
	Staircase drilling system for mains-operated drills and powerful cordless screwdrivers, precise hole depth due to adjustable depth gauge, The drills are fitted and removed very quickly due to the bayonet lock function, clamp, adapter for the staircase bits with the 9 mm Ø shank, gauge ring, insert for the angular frame, adapter plate, open-end spanner SW8 and SW10, pin key SW3, staircase bits Ø 18-20-22-25-30 mm, 1 ejector rod, 2 x Centring point CP-WD 2,5 x 3,5, CP-WD 2,5x7,7, CP-WD 2,5x14,7, drill bit dia. 10 – 40 mm, in SYSTAINER SYS 1 T-LOC	GD D10-40 A Set	768098

Accessories for drywall screwdriver DWC		Type	Order no.
	Drywall screws AF 55-DWP/DWC, diameter 3,9 mm, in carton magazine-loaded, 1000 pc. fine thread, length 25 mm	DWS C FT 3,9x25 1000x	769142
	magazine-loaded, 1000 pc. fine thread, length 35 mm	DWS C FT 3,9x35 1000x	769143
	magazine-loaded, 1000 pc. coarse thread, length 35 mm	DWS C CT 3,9x35 1000x	769144
	magazine-loaded, 1000 pc. coarse thread, length 45 mm	DWS C CT 3,9x45 1000x	769145



06 Routing

Overview of products and applications	244
Routers – OF 1010, OF 1400, OF 2200, CMS-OF	246
Bench-mounted routers – TF 1400, TF 2200	251
Multi-routing templates – MFS 400, MFS 700	252
Worktop template – APS	253
Jointing system – VS 600 GE	254
Hole series system – LR 32	255
Edging system – OF-FH 2200	256
Edge routers – OFK 500, OFK 700	257
Module edge router – MFK 700	259
Aluminium composite milling machine – PF 1200	261
Accessories and consumable materials	262
The Festool system	

Overview of products and applications

Rounding off corners, routing cut-outs, profiling – tasks best performed using a perfectly adapted range of routers and laminate trimmers.

Routers



OF 1010
Page 246



OF 1400
Page 247



OF 2200
Page 248

Bench-mounted routers



TF 1400
Page 251

TF 2200
Page 251

Applications

Routing cut-outs and circles with MFS	○	●	●		
Worktop corner joints with APS		○	●		
Routing corner joints with VS 600	●	○			
Use with the hole series system	●	○			
Routing shapes using a template	●	●	●	●	●
Routing small curves and profiles	●				
Routing large curves and profiles		●	●	●	●
Routing joints, rebates and grooves	●	●	●	●	●
Processing mineral materials	○	●	●	○	○
Routing edge veneer flush with straight workpieces	○				
Flush-routing of laminate					
Routing edge veneer flush on curved workpieces	○				
Routing accurate grooves in aluminium composite panels					

Technical data

Power consumption (W)	1.010	1.400	2.200	1.400	2.200
Idle engine speed (rpm)	10.000 – 24.000	10.000 – 22.500	10.000 – 22.000	10.000 – 22.500	10.000 – 22.000
Collets Ø (mm)	6 – 8	6 – 12,7	6 – 12,7		
Routing depth adjustment range (mm)	55	70	80		
Fine height adjustment range (mm)	8	8	20		
Max. cutter Ø (mm)	50	63	89	60	60
Connection Ø d/e (mm)	27	27/36	36/27	27/36	27/36
Table dimensions [mm]				585 x 400	585 x 400
Weight (kg)	2,7	4,5	7,8	25,4	29,4

Overview of products and applications

Edge routers

Aluminium composite milling machines



OFK 500
Page 257

OFK 700
Page 258

MFK 700
Page 259

PF 1200
Page 261

	OFK 500	OFK 700	MFK 700	PF 1200
	●	●	●	
			○	
	○	●	●	
		●	●	
	○	●	○	
				●
	450	720	720	1.200
	28.000	10.000 – 26.000	10.000 – 26.000	1.900 – 5.200
		6 – 8	6 – 8	
			14	
	28	26	32	118
	27	27	27	27/36
	1,4	2,0	1,9	5,4

● Extremely appropriate
○ Appropriate

Router

OF 1010



A host of features for perfect working results.

Whether guided independently or on the guide rail, the OF 1010 is the perfect one-handed router. Compact and lightweight, you can guide it accurately along edges, lines or curves, using only one hand.

Small tool for delicate tasks.

- › Outstanding ergonomics and low weight
- › Handle for easy one-handed operation
- › Spindle stop for easy cutter changes
- › Quick-acting brake for improved safety (OF 1010 EBQ)

Technical data

Power consumption (watt)	1.010
Idle engine speed (RPM)	10.000 – 24.000
Collet dia. (mm)	6 – 8
Routing stroke (mm)	55
Routing depth fine adjustment range (mm)	8
Max. cutter diameter (mm)	50
Dust extraction connection dia. (mm)	27
Weight (kg)	2,7



■ = MMC Multi Material Control electronics

Items included

Order no.

Ø 8 mm clamping collet, side stop, operation tool	
OF 1010 EBQ in carton	574175
OF 1010 EBQ-Plus guide rail adapter, chip deflector, in SYSTAINER SYS 3 T-LOC	574335
OF 1010 EBQ-Set guide rail adapter, guide rail FS 800/2, chip deflector, in SYSTAINER SYS 3 T-LOC	574375
OF 1010 EBQ-Set + Box-OF-S 8/10x HW guide rail adapter, guide rail FS 800/2, chip deflector, router bit box, in SYSTAINER SYS 3 T-LOC	574384
OF 1010 EBQ-Plus + Box-OF-S 8/10x HW guide rail adapter, chip deflector, router bit box, in SYSTAINER SYS 3 T-LOC	574383

System accessories from page 264



Router tools from page 274

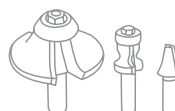

Router OF 1400



Power and ease of operation in perfect harmony.

- › Pure precision: rigid base plate due to guide columns on both sides
- › Short set-up times: Rocker and ratchet principle for convenient cutter changes
- › Routing depth adjustment to 1/10 mm
- › Quick-acting brake and MMC electronics

Technical data	
Power consumption (watt)	1.400
Idle engine speed (RPM)	10.000 – 22.500
Collet dia. (mm)	6 – 12,7
Routing stroke (mm)	70
Routing depth fine adjustment range (mm)	8
Max. cutter diameter (mm)	63
Dust extraction connection dia. (mm)	27/36
Weight (kg)	4,5

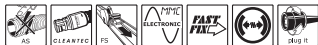

■ = MMC Multi Material Control electronics

Items included	Order no.
----------------	-----------

Ø 8 mm clamping collet, Ø 12 mm clamping collet, side stop with fine setting, copying ring Ø 30 mm, extraction hood, top, chip deflector, operation tool, in SYSTAINER SYS 4 T-LOC

OF 1400 EBQ-Plus	574341
-------------------------	--------

OF 1400 EBQ-Plus + Box-OF-S 8/10x HW router bit box	574398
---	--------



An impressive all-in-one package.

At 4.5 kg, the OF 1400 is the lightest in its class and has an impressive 70 mm routing depth adjustment range. This is particularly useful when making recesses for fittings or routing with templates.

System accessories from page 266



Router tools from page 274

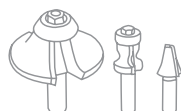

Router OF 2200



Unrivalled performance and operation.

More powerful, easier to use, increased comfort and safer – the OF 2200 offers the greatest low-end torque, the highest precision and the greatest ergonomic comfort. No matter what your task is – with the OF 2200, you have the solution in your hands.

The power pack with enormous torque.

- › Top power development and fully variable speed for hard materials and increased material thicknesses
- › Outstanding ergonomics: guide rods offset by 30 degrees to transfer force efficiently
- › Dual guide column clamp for extra torsional rigidity and greater precision
- › Maximum safety: safety brake stops the cutter promptly

Technical data

Power consumption (watt)	2.200
Idle engine speed (RPM)	10.000 – 22.000
Collet dia. (mm)	6 – 12,7
Routing stroke (mm)	80
Routing depth fine adjustment range (mm)	20
Max. cutter diameter (mm)	89
Dust extraction connection dia. (mm)	36/27
Weight (kg)	7,8



■ = MMC Multi Material Control electronics

Items included

Order no.

Ø 8 mm clamping collet, Ø 12 mm clamping collet, copying ring Ø 30 mm, chip deflector, operation tool, in SYSTAINER SYS 4 T-LOC

OF 2200 EB-Plus

574349

OF 2200 EB-Set

accessories SYSTAINER (Order No. 497655)

574392

System accessories
from page 267



Router tools
from page 274

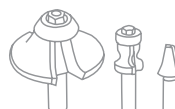



Adapted to the task in hand.

Festool offers a compatible range of routers and laminate trimmers for every task. A range that not only includes tools, but also a wide selection of ingenious system accessories. Interchangeable copying rings and base runners, for example, allow you to adapt your machine to changing task requirements. Multifunctional routing templates can be adjusted to any dimension both quickly and accurately, while routers OF 1010, 1400 and 2200 can be converted into bench-mounted routers. All of these solutions were developed following close collaboration with the handcraft trade – bringing you closer to the perfect result with greater speed and efficiency.



01

02

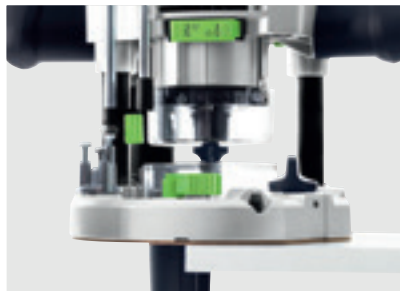

03

01 Quick response to changing requirements.

Base runners and copying rings for the OF 1400/OF 2200 can be replaced quickly using FastFix without requiring tools. Changing router bits is also a simple matter, thanks to the ratcheting mechanism, which allows you to either tighten or release the router bit without having to turn the open ended spanner.

02 Cleaner, healthier work.

The new suction design behind the OF 2200 ensures suction power of up to 99%. The retractable extractor ring seals off the chip space when the router is used in plunge mode. However, the ring can be locked in place on top for a perfect view of the scribe mark. The chip deflector can be rotated 360° and ensures maximum suction power.

03 Impeccable guidance.

The guide rail was invented and perfected by Festool. For enhanced precision of grooves and rows of holes. Fitted with slideway lining to allow machines to glide smoothly along the rail, plus a groove for fastening and lever clamps.

Module mounting CMS-OF



Router for the CMS system.

- › Module mounting for installing routers
- › The router can be used not only as a bench-mounted tool, but also as a handheld tool
- › Simple routing height adjustment with a crank handle
- › Flexible extension options – for an even wider range of applications

From mobile to stationary in a matter of seconds.

With the CMS module, standard routers can be transformed into bench-mounted routers suitable for a wide range of applications. The transparent routing guard guarantees efficient dust extraction while also providing a good view of the workpiece.

Technical data

Max. cutter diameter (mm)	60
Dimensions (mm)	578 x 320
Weight (kg)	10,1



Items included

CMS-OF
assembly lugs, router stop, press-down fixture, guard, in carton

Order no.

570251

CMS system overview
from page 384



System accessories
from page 402

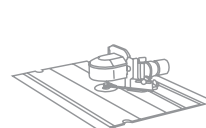

Bench-mounted routers TF 1400 / TF 2200



The system bench-mounted router.

- › Complete set consisting of a basic unit, module mounting and router
- › The router can be used not only as a bench-mounted tool, but also as a handheld tool
- › Simple routing height adjustment with a crank handle
- › Flexible extension options – for an even wider range of applications



Technical data	TF 1400	TF 2200
Power consumption (watt)	1.400	2.200
Idle engine speed (RPM)	10.000 – 22.500	10.000 – 22.000
Max. cutter diameter (mm)	60	60
Table dimensions (mm)	585 x 400	585 x 400
Dimensions module support (mm)	578 x 320	578 x 320
Table height, legs unfolded (mm)	900	900
Table height, legs folded away (mm)	316	316
Working height with legs (mm)	900	900
Dust extraction connection dia. (mm)	27/36	27/36
Basic unit weight (kg)	10,8	10,8
Weight (set) (kg)	25,4	29,4



■ = MMC Multi Material Control electronics

Items included	Order no.
basic unit with foldaway legs, module support, operation tool, in carton	
TF 1400-Set router OF 1400 EBQ-Plus	570269
TF 2200-Set router OF 2200 EB-Plus	570275

Comfortable routing of conventional profiles.

Low space requirements combined with powerful and precise performance make the bench-mounted router ideal for series production. The extensive range of shank cutters with varying geometries enable you to process strips, profiles and medium to large workpieces in a professional manner.

System accessories from page 402



Router tools from page 274

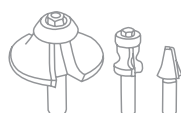

Routing template MFS

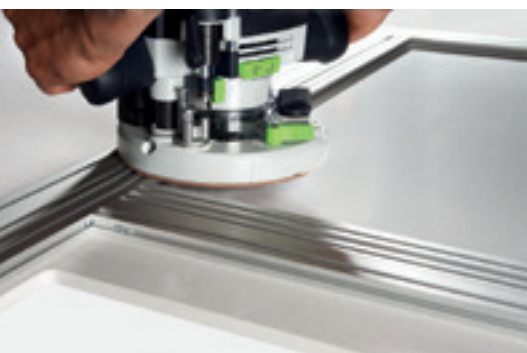

A multi-talent.

The laborious manufacture of templates or temporary solutions has become a thing of the past: the MFS multi-routing template is versatile and perfect for curves, round or square cut-outs and routing staircase stringers.

The template with all the options.

- › Scale on the profiles accurate to the millimetre for absolute precision when making cut-outs and curves
- › Aligned exactly with the workpiece – via the angle stops
- › Secured quickly – workpiece secured in prefabricated groove for fastening and lever clamps
- › Option of systematic extension – with table extensions from 200 mm to 2000 mm

Technical data

Dimensions length x width (mm)	300 x 100
Curves (mm)	40 – 300

Items included

Items included	Order no.
2 x angle stop, tilt protection, circle routing insert, operation tool, in carton	
MFS 400	492610
MFS 700	492611

System accessories
from page 269

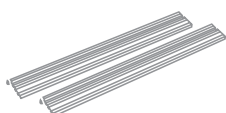

Router tools
from page 274

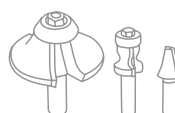

Worktop template APS



Precision as standard.

- › Robust routing template made from aluminium
- › For corner and panel joints with fixed fence with panel depths of 600 and 650 mm or, if moved, up to 900 mm
- › Additionally with two routing templates that can be freely positioned for making recesses for conventional fittings on the underside of panels
- › Panel widths greater than 900 mm also possible using extension profiles

Technical data

Dimensions (L x W x H) (mm)	1.000 x 380 x 16
Panel depth with corner joints, without adjustment (mm)	600/650
Panel depth with corner joints, with adjustment (mm)	900
For worktop connectors, bolt length (mm)	65/150

Items included

APS 900/2
corner connection template, profile MFS-VP 1000, 3 x Bolt, operation tool,
in carton

Order no.

204219



Flush joints.

Clean corner and panel joints are easy to manufacture with the worktop template. The permanently fixed template guarantees precision results, even when the router passes several times along a single groove.

Router tools
from page 274



Jointing system VS 600 GE



Eternal precision.

The jointing system VS 600 is an exceptionally logical method of achieving perfect wood-working results. Offering outstanding precision for partially covered and open dovetail joints, box joints and custom-fit dowelling joints.

Combining tradition with efficiency.

- › Perfection in a system: router, template and copying ring are fully compatible with one another
- › Wide application spectrum: from dovetail joints and box joints to dowelling joints
- › Templates changed quickly and easily without using tools
- › Robust aluminium design and steel contact jaws ensure an extended service life

Technical data

Workpiece thickness (depending on join) (mm)	6 - 29
Max. workpiece width (mm)	600

Items included

VS 600 GE in carton	488876
-------------------------------	--------

A routing template and a suitable router are required to use the VS 600 GE jointing system.

Routing templates
from page 270

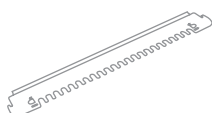

Router tools
from page 274



Hole series system LR 32

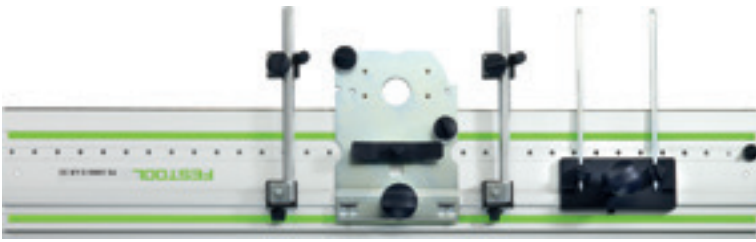

Holes in series.

- › With the LR 32 system – comprising the guide rail FS 1400/2-LR 32 or FS 2424/2-LR 32 and the hole drilling system – precise rows of holes spaced 32 mm apart can be drilled with the Festool router
- › The LR 32 guide rail is aligned quickly and parallel to the two side stops, which are positioned by means of an adjustable stop at the workpiece and guide rail



Items included	Order no.
guide plate, centring mandrel, 2 x Longitudinal stop	
LR 32 Set 2 x side stop, in carton	583290
LR 32-SYS operation tool, hinge location cutter HM Ø 35 mm, dowel drill HW Ø 5 mm (V-shaped tip), dowel drill HM Ø 5 mm (with centring bit and pre-cutter), 2 parallel side fences with adjustable stop, clamp FSZ 120, in SYSTAINER SYS 1 T-LOC	584100

Precise hole rows with the guide rail.

Series of holes must agree in terms of distance and parallelism. To save time when carrying out this type of work, there is the hole row guide rail. It has a series of holes set 32 mm apart, along which the router is guided with the hole row adapter. Thanks to the clever tipping method, the detent pin can be quickly indexed for the next hole. The series of holes are therefore very easy to copy.

System accessories
from page 271

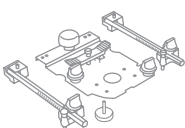

Edge trimming system OF-FH 2200



Safe, precise routing of seal slots

- › For secure guidance of the Festool router along narrow workpiece edges
- › Side stops can be adjusted 60 mm on both sides with long guidance areas
- › High-quality cutter device made from sturdy and solid acrylic glass
- › Used, for example, for the reliable milling of automatic door seals

Routing door seals.

The grooving of doors is often still considered as a task for bench-mounted routers. With the Festool routing aid and the router, the work can be carried out on site achieving results which are not inferior to those of bench-mounted routers. And thanks to the integral dust extraction, the environment also remains free of wood dust.

Items included

OF-FH 2200
in carton

Order no.

495246

System accessories
from page 271

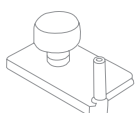

Laminate trimmer OFK 500



Compact edging professional.

- › Routing depth adjustment to 1/10 mm
- › Perfect adaptation of cutter to borehole in bench to prevent routing errors
- › Stable connection between cutter and drive mechanism for maximum true- running precision
- › Spindle stop for quick and easy cutter changes

Technical data	
Power consumption (watt)	450
Idle engine speed (RPM)	28.000
Max. cutter diameter (mm)	28
Dust extraction connection dia. (mm)	27
Weight (kg)	1,4



Items included	Order no.
extraction hood	
OFK 500 Q R3 ogee cutter HW R3-OFK, in carton	574184
OFK 500 Q-Plus R2 ogee cutter HW R2-OFK, in SYSTAINER SYS 2 T-LOC	574357
OFK 500 Q-Plus R3 ogee cutter HW R3-OFK, in SYSTAINER SYS 2 T-LOC	574355



For trimming round objects.

The OFK 500 is particularly lightweight and perfectly balanced, making it manoeuvrable and ideal for both vertical and horizontal use. The small distance between the cutter and router base prevents the machine from tipping over edges, guaranteeing perfect results.

System accessories
from page 272



Router tools
from page 293



Laminate trimmer OFK 700



Impressive both on curves and in straight lines.

The OFK 700 EQ is a multi-talent among edge trimmers because it makes easy work of trimming edges and surface projections, irrespective of whether the workpiece is large or small, or whether the edges are curved or straight. The quick, heavy-duty detachable router table provides a stable surface area and secure guidance for the machine in any working position.

Edging multi-talent.

- › Detachable router table with large support surface
- › Base inclined by 1.5° for excellent working results
- › Routing depth adjustment to 1/10 mm
- › Contact spring for smooth routing pattern

Technical data	
Power consumption (watt)	720
Idle engine speed (RPM)	10.000 – 26.000
Max. cutter diameter (mm)	26
Collet dia. (mm)	6 – 8
Max. cutting depth, vertical (1.5° table) (mm)	9
Max. cutting depth, horizontal (1.5° table) (mm)	5
Max. routing width (mm)	14
Dust extraction connection dia. (mm)	27
Weight (kg)	2



■ = MMC Multi Material Control electronics

Items included	Order no.
----------------	-----------

OFK 700 EQ-Plus Ø 8 mm clamping collet, extraction hood, edge trimming cutter D 19 x 16, operation tool, in SYSTAINER SYS 2 T-LOC	574359
---	--------

System accessories
from page 272



Router tools
from page 294



Module edge router MFK 700



Versatile when trimming edges.

- › Wider application spectrum due to interchangeable router tables
- › Efficient dust extraction integrated directly on the router base
- › 130 mm table support surface for accurate routing results
- › Electronic speed adjustment switch for perfect adaptation to the working material

Technical data	
Power consumption (watt)	720
Idle engine speed (RPM)	10.000 – 26.000
Collet dia. (mm)	6 – 8
Routing depth fine adjustment range (mm)	14
Max. cutter diameter (mm)	32
Dust extraction connection dia. (mm)	27
Weight (kg)	1,9



■ = MMC Multi Material Control electronics

Items included	Order no.
Ø 8 mm clamping collet, parallel side fence with fine adjustment and extraction hood, extraction hood, operation tool, in SYSTAINER SYS 2 T-LOC	
MFK 700 EQ-Plus	574369
MFK 700 EQ-Set 1.5° router table	574364



Large support for accurate routing results.

The MFK 700 is the perfect machine for routing panel edges. Whether you are using a parallel side fence or a router with a ball bearing guide, the large support base prevents the machine from tipping when routing corners to preserve the routing contour.

System accessories
from page 272



Router tools
from page 294



Module edge router MFK 700 Basic



The perfect edge.

The MFK 700 EQ/B-Plus module edge router with special base for flush trimming edge strips – even on edges cut at 45°. Thanks to the newly developed ball bearing brake with integrated chip deflector, it operates cleanly and efficiently without streaks.

The end of the perfect edge.

- › Good view of the workpiece – extraction directly from the table
- › Perfect working results with precision fine adjustment
- › Large support base ensures safe guidance
- › Unique ball bearing brake ensures clean working

Technical data	
Power consumption (watt)	720
Idle engine speed (RPM)	10.000 – 26.000
Collet dia. (mm)	6 – 8
Routing depth fine adjustment range (mm)	14
Max. cutter diameter (mm)	32
Dust extraction connection dia. (mm)	27
Weight (kg)	1,9

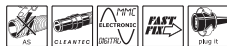

■ = MMC digital electronics

Items included	Order no.
MFK 700 EQ/B-Plus with ball bearing brake and chip deflector, Ø 8 mm clamping collet, operation tool, in SYSTAINER SYS 2 T-LOC	574453

System accessories
from page 272



Router tools
from page 294





Aluminium composite milling machine PF 1200

The professional solution for aluminium composite panels.

- › Removable feeder roller for different material thicknesses
- › Low weight for easy transportation and mobile applications
- › Guide slot for guide rail
- › Blade cutter for rapid progress and effortless precision routing

Technical data	
Power consumption (watt)	1.200
Idle engine speed (RPM)	1.900 – 5.200
Routing depth (mm)	0 – 9
Max. cutter diameter (mm)	118
Dust extraction connection dia. (mm)	27/36
Weight (kg)	5,4



■ = MMC Multi Material Control electronics



Items included	Order no.
V-grooving bit, setting gauge for guide rails, operation tool, without guide rails, in SYSTAINER SYS 4 T-LOC	
PF 1200 E-Plus Alucobond A4 feeler roller	574321
PF 1200 E-Plus Dibond D3 feeler roller	574322

Grooving. Edging. Finished.

Specially developed for edging aluminium composite panels with speed and precision. In combination with the guide rail, the PF 1200 aluminium composite milling machine is ideal for mobile exhibition and façade construction applications. The feeler roller ensures precise routing depths. The router can only plunge into the material as far as the feeler roller allows.

Router tools
from page 273



The Festool system. Everything in view.

Because things work better when everything fits together: The comprehensive range of system accessories for routers and laminate trimmers leaves nothing to be desired and helps accelerate working processes. From the hole series guide rail, which can also be used with plunge-cut saws and jigsaws, to perfectly adapted cutters and a large selection of copying rings and base runners for a range of applications.



06 Routing

Accessories and consumable materials

System accessories

264

Routing tools

274



System accessories



OF 1010

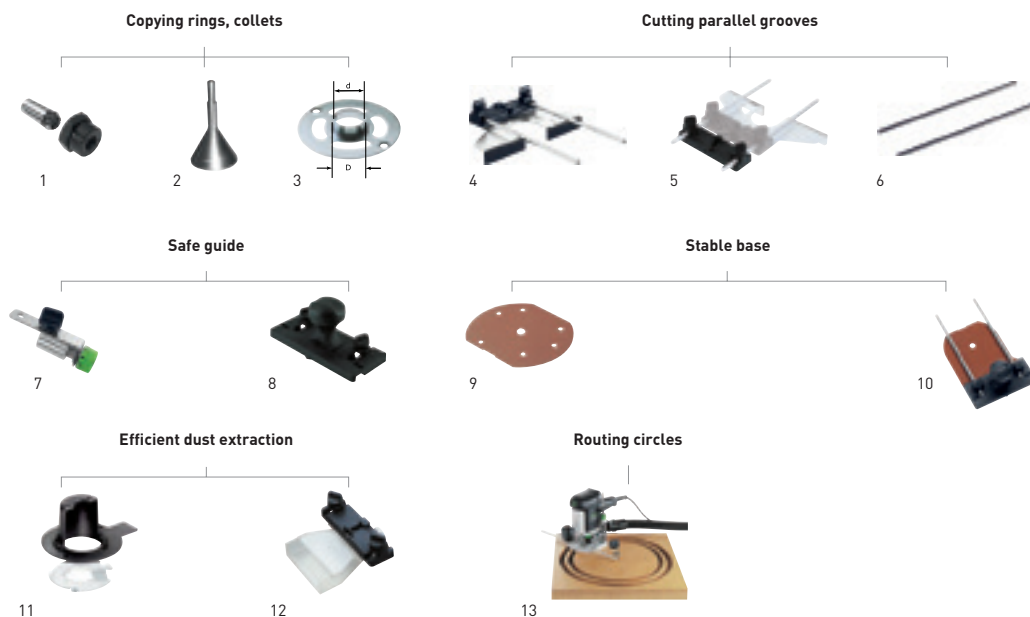

Accessories for router OF 1010

Denomination	Explanation	Order no.
1 Collet SZ-D 6/OF 1000	for MFK/OFK 700, OF 900, OF 1000, OF 1010, KF, with locking nut, for cutter shank \varnothing 6 mm, in self-service display pack	488760
Collet SZ-D 6,35/OF 1000	for MFK/OFK 700, OF 900, OF 1000, OF 1010, KF, with locking nut, for cutter shank \varnothing 6.35 mm (1/4"), in self-service display pack	488761
Collet SZ-D 8/OF 1000	for MFK/OFK 700, OF 900, OF 1000, OF 1010, KF, with locking nut, for router shank \varnothing 8 mm, in self-service display pack	488755
2 Centring mandrel ZD-OF/D 6,35+8	for all Festool routers, for shank support \varnothing 6.35 mm and 8 mm for centering the copying rings, in self-service display pack	492187
3 Copying ring KR D8,5/VS 600-FZ 6	for OF 1010, D 8,5 mm, in bag	490772
Copying ring KR-D 10,8/OF 900	for OF 900, OF 1000, OF 1010, KF, D 10,8 mm, dia. 7,8 mm, in self-service display pack	486029
Copying ring KR-D 13,8/OF 900	for OF 900, OF 1000, OF 1010, KF, D 13,8 mm, dia. 10,8 mm, in self-service display pack	484176
Copying ring KR-D17/OF 900	for OF 900, OF 1000, OF 1010, KF, D 17 mm, dia. 14 mm, in self-service display pack	486030
Copying ring KR D17/VS 600-SZ 14	for OF 1010, D 17 mm, in bag	490770
Copying ring KR-D 24/OF 900	for OF 900, OF 1000, OF 1010, KF, D 24 mm, dia. 21 mm, in self-service display pack	486031
Copying ring KR D24/VS 600-SZ 20	for OF 1010, D 24 mm, in bag	490771
Copying ring KR-D 27/OF 900	for OF 900, OF 1000, OF 1010, KF, D 27 mm, dia. 24 mm, in self-service display pack	486032
Copying ring KR-D 30/OF 900	for OF 900, OF 1000, OF 1010, KF, D 30 mm, dia. 27 mm, in self-service display pack	486033
Copying ring KR-D 40/OF 900	for OF 900, OF 1000, OF 1010, KF, D 40 mm, dia. 37 mm, in self-service display pack	486034
Adapter D 12/M12 OF2000	for the OF 1400, OF 2000, OF 2200, for cutters with female thread M12x1, in bag	487160
4 Parallel side fence SA-OF 1000	for OF 900, OF 1000, OF 1010, KF, with 2 guide rods, in carton	489427
5 Fine adjuster for parallel side fence FE-OF 1000/KF	for OF 900, OF 1000, OF 1010, KF, for fast and dimensionally accurate adjustment on the parallel side fence, can be retrofitted, delivered without side stop and guide rods, in self-service display pack	483358
6 Guide rods	Included in the OF 1010 delivery	

System accessories

Accessories for router OF 1010

	Denomination	Explanation	Order no.
7	Fine adjuster for guide stop FE-FS/OF 1000	for OF 900, OF 1000, OF 1010, KF, in self-service display pack	488754
8	Guide rail adapter FS-OF 1000	complete with support, for use of routers OF 900, OF 1000, OF 1010 with the FS guidance system, without rods, in self-service display pack	488752
9	Base runner TP-OF	for OF 900, OF 1000, OF 1010, KF, hard fibre base runner, centre hole \varnothing 15 mm, in self-service display pack	489229
10	Extension table TV-OF 1000	for OF 900, OF 1000, OF 1010, KF, to increase the bearing surface when working on edges, delivered without guide rods, in self-service display pack	488756
11	Chip deflector KSF-OF 1010	for OF 900, OF 1000, OF 1010, for sideways extraction, max. aperture 37 mm, in self-service display pack	493180
12	Dust extraction attachment AH-OF 1000	for OF 900, OF 1000, OF 1010, KF, for jointing system VS 500 / VS 600 and for edge trimming, in carton	484453
13	Trammel unit SZ-OF 1000	for OF 900, OF 1000, OF 1010, KF, for cutting radii, circles and decorative curves on surfaces and edges, circle dia. 153 – 760 mm, in self-service display pack	483922

System accessories



OF 1400

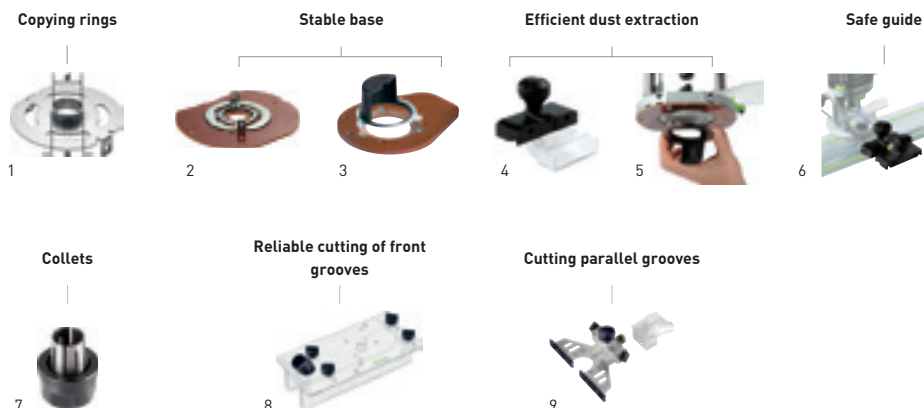

Accessories for router OF 1400

Denomination	Explanation	Order no.
1 Copying ring KR-D 17,0/OF 1400	for OF 1400, D 17 mm, dia. 14 mm, in self-service display pack	493315
Copying ring KR-D 24,0/OF 1400	for OF 1400, D 24 mm, dia. 21 mm, in self-service display pack	492183
Copying ring KR-D 27,0/OF 1400	for OF 1400, D 27 mm, dia. 24 mm, in self-service display pack	492184
Copying ring KR-D 30,0/OF 1400	for OF 1400, D 30 mm, dia. 27 mm, in self-service display pack	492185
Copying ring KR-D 40,0/OF 1400	for OF 1400, D 40 mm, dia. 37 mm, in self-service display pack	492186
Copying ring KR-D 8,5/OF 1400	for OF 1400 / VS 600, D 8,5 mm, dia. 6,5 mm, in self-service display pack	492179
Copying ring KR-D 13,8/OF 1400	for OF 1400 / VS 600, D 13,8 mm, dia. 10,8 mm, in self-service display pack	492180
Copying ring KR-D 17,0/OF 1400	for OF 1400 / VS 600, D 17 mm, dia. 14 mm, in self-service display pack	492181
Copying ring KR-D 24,0/OF 1400	for OF 1400 / VS 600, D 24 mm, dia. 21 mm, in self-service display pack	492182
2 Base runner LA-OF 1400	for OF 1400, hard-fibre base runner with 20 mm centre bore, reduces the opening of the router to the cutter diameter, max. cutter diameter 37 mm, in self-service display pack	492574
3 Base runner LAS-OF 1400	for OF 1400, for sideway extraction, running pad with support extension, running pad with chip deflector, max. aperture 63 mm, in carton	493233
4 Dust extraction attachment AH-OF 1400	for OF 1400 / VS 600, for sideway extraction, in carton	492585
5 Chip deflector KSF-OF 1400	for OF 1400, for sideway extraction, in self-service display pack	492732
6 Guide rail adapter FS-OF 1400	for OF 1400, with fine adjustment and support for router without guide rods, without rods, in carton	492601
7 Collet SZ-D 6,0/OF 1400/2000/2200	for the OF 1400, OF 2000, OF 2200, for cutter shank \varnothing 6 mm, in self-service display pack	494459
Collet SZ-D 8,0/OF 1400/2000/2200	for the OF 1400, OF 2000, OF 2200, for router shank \varnothing 8 mm, in self-service display pack	494460
Collet SZ-D 10,0/OF 1400/2000/2200	for the OF 1400, OF 2000, OF 2200, for cutter shank \varnothing 10 mm, in self-service display pack	494461
Collet SZ-D 12,0/OF 1400/2000/2200	for the OF 1400, OF 2000, OF 2200, for cutter shank \varnothing 12 mm, in self-service display pack	494462
Collet SZ-D 6,35/OF 1400/2000/2200	for the OF 1400, OF 2000, OF 2200, for router shaft 6.35 mm, in self-service display pack	494463
Collet SZ-D 9,53/OF 1400/2000/2200	for the OF 1400, OF 2000, OF 2200, for router shaft 9.53 mm, in self-service display pack	494464
Collet SZ-D 12,7/OF 1400/2000/2200	for the OF 1400, OF 2000, OF 2200, for router shaft \varnothing 12.7 mm, in self-service display pack	494465
8 Routing aid OF-FH 2200	for OF 900, OF 1000, OF 1010, OF 1400, OF 2000, OF 2200, safe guidance of the router thanks to the movable legs, in carton	495246
9 Parallel side fence SA-OF 1400	for OF 1400, With fine adjustment and extraction hood, without rods, in carton	492636

System accessories



OF 2200

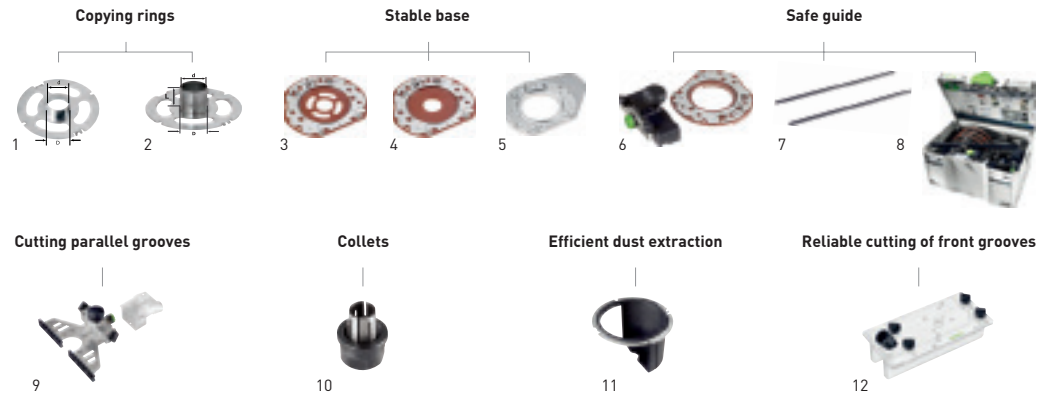

Accessories for the OF 2200 router

	Denomination	Explanation	Order no.
1	Copying ring KR-D 12,7/OF 2200	for OF 2200, D 12,7 mm, dia. 10 mm, in self-service display pack	495339
	Copying ring KR-D 17,0/OF 2200	for OF 2200, D 17 mm, dia. 15 mm, in self-service display pack	494622
	Copying ring KR-D 19,05/OF 2200	for OF 2200, D 19,05 mm, dia. 17 mm, in self-service display pack	495340
	Copying ring KR-D 24,0/OF 2200	for OF 2200, D 24 mm, dia. 22 mm, in self-service display pack	494623
	Copying ring KR-D 25,4/OF 2200	for OF 2200, D 25,4 mm, dia. 23 mm, in self-service display pack	495341
	Copying ring KR-D 27,0/OF 2200	for OF 2200, D 27 mm, dia. 24 mm, in self-service display pack	494624
	Copying ring KR-D 30,0/OF 2200	for OF 2200, D 30 mm, dia. 27 mm, in self-service display pack	494625
	Copying ring KR-D 34,93/OF 2200	for OF 2200, D 34,93 mm, dia. 32 mm, in self-service display pack	495342
	Copying ring KR-D 40,0/OF 2200	for OF 2200, D 40 mm, dia. 37 mm, in self-service display pack	494626
	Copying ring KR-D 30,0/21,5/OF 2200	for OF 2200, extra long safety copying ring D30, 21 mm high, required for use of reversible blade cutters 497455 and 497456, D 30 mm, dia. 27 mm, in self-service display pack	497453
2	Adapter KRA-ZOLL/OF 2200	for OF 2200, adapter for imperial copying rings, in self-service display pack	494627
3	Base runner LA-OF 2200 D36 CT	for OF 2200, for copying rings < 30 mm, With openings for optimised extraction, in carton	494675
4	Base runner LA-OF 2200 D36	for OF 2200, reduces the opening of the router to the cutter diameter, in carton	494677
5	Support AFB-OF 2200	for OF 2200, support widener for safe guidance of the router at workpiece edges, in carton	494682
6	Guide rail adapter FS-OF 2200	for OF 2200, Without guide rods ST-OF 2200/2, With fine adjustment and support plate for router, in carton	494681
7	Rod ST-OF 2200/2	for OF 2200, guide rods for side and guide stops 2 pieces, in self-service display pack	495247
8	Accessories set ZS-OF 2200 M	for OF 2200, guide rail adapter, parallel side fence with fine adjustment and extraction hood, Guide rods, copying ring Ø 17 mm, copying ring Ø 24 mm, copying ring Ø 27 mm, copying ring Ø 40 mm, base runner D36, base runner for copying rings, extension, in SYSTAINER SYS 3 T-LOC	497655

System accessories



OF 2200

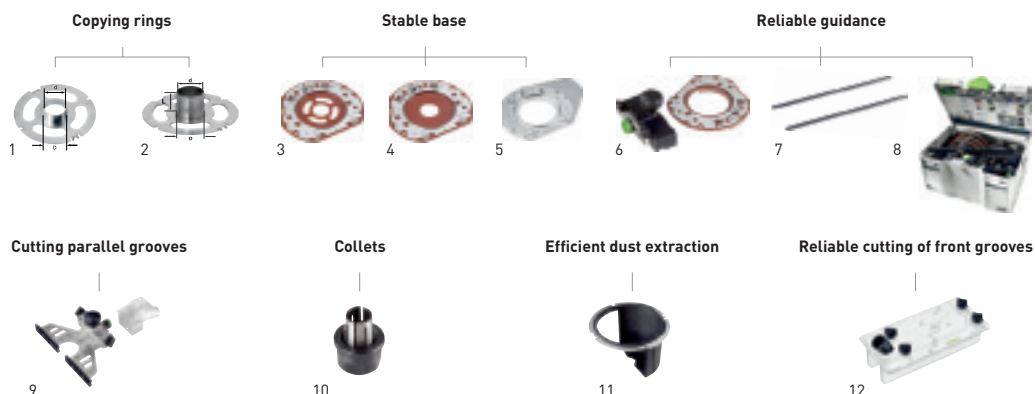

Accessories for the OF 2200 router

Denomination	Explanation	Order no.
9 Parallel side fence SA-OF 2200	for OF 2200, With fine adjustment and extraction hood, Without guide rods ST-OF 2200/2, in carton	494680
10 Collet SZ-D 6,0/OF 1400/2000/2200	for the OF 1400, OF 2000, OF 2200, for cutter shank Ø 6 mm, in self-service display pack	494459
Collet SZ-D 8,0/OF 1400/2000/2200	for the OF 1400, OF 2000, OF 2200, for router shank Ø 8 mm, in self-service display pack	494460
Collet SZ-D 10,0/OF 1400/2000/2200	for the OF 1400, OF 2000, OF 2200, for cutter shank Ø 10 mm, in self-service display pack	494461
Collet SZ-D 12,0/OF 1400/2000/2200	for the OF 1400, OF 2000, OF 2200, for cutter shank Ø 12 mm, in self-service display pack	494462
Collet SZ-D 6,35/OF 1400/2000/2200	for the OF 1400, OF 2000, OF 2200, for router shaft 6.35 mm, in self-service display pack	494463
Collet SZ-D 9,53/OF 1400/2000/2200	for the OF 1400, OF 2000, OF 2200, for router shaft 9.53 mm, in self-service display pack	494464
Collet SZ-D 12,7/OF 1400/2000/2200	for the OF 1400, OF 2000, OF 2200, for router shaft Ø 12.7 mm, in self-service display pack	494465
11 Chip deflector KSF-OF 2200	for OF 2200, for sideways extraction, max. cutter diameter 80 mm, in self-service display pack	494670
12 Routing aid OF-FH 2200	for OF 900, OF 1000, OF 1010, OF 1400, OF 2000, OF 2200, safe guidance of the router thanks to the movable legs, in carton	495246

System accessories



OF 1010



OF 1400



OF 2200

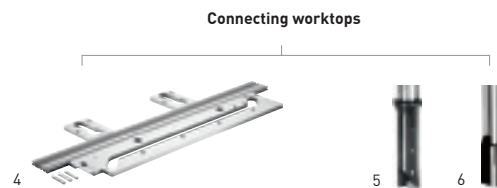
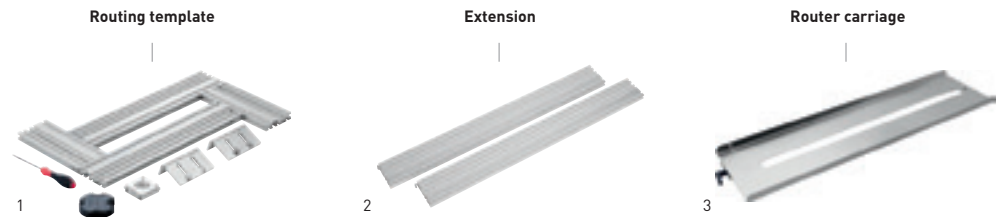

Accessories for multi-routing template MFS

Denomination	Explanation	Order no.
1 Routing template MFS 400	for all routers with copying ring, for rectangular (300 x 100 mm) or curved (Ø 600 mm) cut-outs, 2 x angle stop, tilt protection, circle routing insert, operation tool, dimensions length x width 300 x 100 mm, curves 40 – 300 mm, in carton	492610
Routing template MFS 700	for all routers with copying ring, for rectangular (max. 600 x 300 mm) or curved (max. Ø 1200 mm) cut-outs, 2 x angle stop, tilt protection, circle routing insert, operation tool, dimensions length x width 600 x 300 mm, curves 40 – 600 mm, in carton	492611
2 Extension profile MFS-VP 200	for extension of MFS 400, MFS 700, with scale, 2 x profile 200 mm, longitudinal connectors, qty. in pack 2 Units, in carton	492722
Extension profile MFS-VP 400	for extension of MFS 400, MFS 700, with scale, 2 x 400 mm profile, longitudinal connectors, qty. in pack 2 Units, in carton	492723
Extension profile MFS-VP 700	for extension of MFS 400, MFS 700, with scale, 2 x profile 700 mm, longitudinal connectors, qty. in pack 2 Units, in carton	492724
Extension profile MFS-VP 1000	for extension of MFS 400, MFS 700, with scale, 2 x profile 1000 mm, longitudinal connectors, qty. in pack 2 Units, in carton	492725
Extension profile MFS-VP 2000	for extension of MFS 400, MFS 700, without scale, 2 x profile 2000 mm, longitudinal connectors, qty. in pack 2 Units, in carton	492726
3 Router carriage MFS-FS	for large-surface routing, for MFS 400, MFS 700, traverse path 600 mm, copy ring dia. 30 mm, in carton	495648
4 Worktop template APS 900/2	for corner and panel connectors with depths of up to 900 mm, for diameter of cutter 14 mm and copying ring 30 mm, corner connection template, profile MFS-VP 1000, 3 x Bolt, operation tool, for worktop connectors, bolt length 65/150 mm, dimensions (L x W x H) 1.000 x 380 x 16 mm, panel depth with corner joints, with adjustment 900 mm, panel depth with corner joints, without adjustment 600/650 mm, in carton	204219
5 Groove cutter with reversible blades HW S12 D14/45 WM	for OF 1400, OF 2200, D 14 mm, NL 45 mm, GL 105 mm, s 12 mm, in self-service display pack	491110
6 Groove cutter HW S12 D14/50	D 14 mm, NL 50 mm, GL 100 mm, s 12 mm, in self-service display pack	491089

System accessories



VS 600

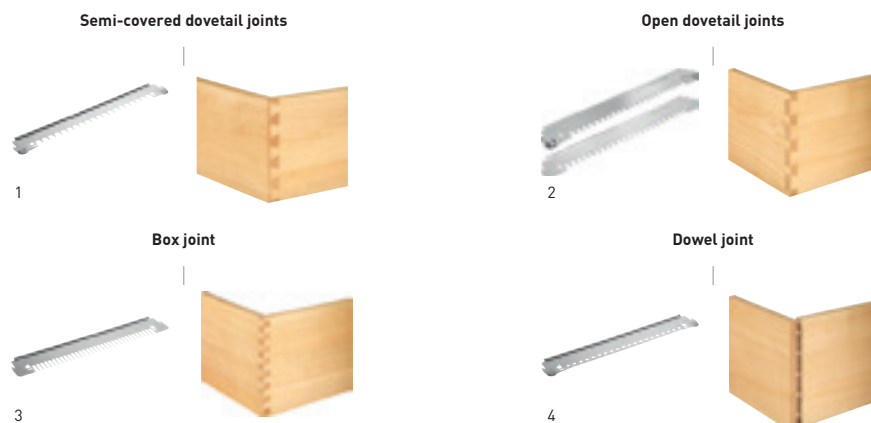

Routing templates and cutters for jointing system VS 600

Denomination	Explanation	Order no.
1 Dovetail joint template VS 600 SZ 14	for OF 1010, OF 1400, for blind dovetail joints, tenon size 14 mm, copying ring \varnothing 17 mm (for OF 1010), workpiece thickness 14 – 20 mm, in carton	488877
Dovetail cutter HS S8 D13,8/13,5/15°	for semi-covered dovetail joints SZ 14, D 13,8 mm, NL 13,5 mm, GL 46 mm, alpha 15°, s 8 mm, in self-service display pack	490991
Dovetail cutter HW S8 D13,8/13,5/15°	for semi-covered dovetail joints SZ 14, D 13,8 mm, NL 13,5 mm, GL 46 mm, alpha 15°, s 8 mm, in self-service display pack	490992
Dovetail joint template VS 600 SZ 20	for OF 1010, OF 1400, for blind dovetail joints, tenon size 20 mm, copying ring \varnothing 24 mm (for OF 1010), workpiece thickness 21 – 28 mm, in carton	488878
Dovetail cutter HS S8 D20/17/15°	for semi-covered dovetail joints SZ 20, D 20 mm, NL 17 mm, GL 49 mm, alpha 15°, s 8 mm, in self-service display pack	490995
Dovetail cutter HW S8 D20/17/15°	for semi-covered dovetail joints SZ 20, D 20 mm, NL 17 mm, GL 49 mm, alpha 15°, s 8 mm, in self-service display pack	490996
2 Template-kit VS 600 SZO 14	for OF 1010, OF 1400, open dovetail joint, slot size 14 mm, copying ring \varnothing 8.5 mm (for OF 1010), copying ring \varnothing 17 mm (for OF 1010), workpiece thickness 10 – 14 mm, in carton	491152
Dovetail cutter HW S8 D14,3/16/10°	for open dovetail joints SZO 14, D 14,3 mm, NL 16 mm, GL 50 mm, alpha 10°, s 8 mm, in self-service display pack	491164
Template-kit VS 600 SZO 20	for OF 1010, OF 1400, for exposed dovetail joints, tenon size 20 mm, copying ring \varnothing 13.8 mm (for OF 1010), copying ring \varnothing 24 mm (for OF 1010), workpiece thickness 14 – 25 mm, in carton	491153
Dovetail cutter HW S8 D20/26/10°	for open dovetail joint slots, SZO 20, D 20 mm, NL 26 mm, GL 58 mm, alpha 10°, s 8 mm, in self-service display pack	491165
Spiral groove cutter HW Spi S8 D10/30	for slot joints FZ 10 and open dovetail joints SZO 20 with fine precision in diameter, D 10 mm, NL 30 mm, GL 60 mm, s 8 mm, in self-service display pack	490980
3 Slot joint template VS 600 FZ 6	for OF 1010, OF 1400, for slot joint connections, tenon size 6 mm, copying ring \varnothing 8.5 mm (for OF 1010), workpiece thickness 6 – 10 mm, in carton	488879
Spiral groove cutter HW Spi S8 D6/21	for slot joints FZ 6 and open dovetail joints SZO 14 with fine precision in diameter, D 6 mm, NL 21 mm, GL 50 mm, s 8 mm, in self-service display pack	490978
Spiral groove cutter HS Spi S8 D6/16	for slot joints FZ 6 and open dovetail joints SZO 14 with fine precision in diameter, D 6 mm, NL 16 mm, GL 50 mm, s 8 mm, in self-service display pack	490944
Slot joint template VS 600 FZ 10	for OF 1010, OF 1400, for slot joint connections, tenon size 10 mm, copying ring \varnothing 13.8 mm (for OF 1010), workpiece thickness 10 – 20 mm, in carton	488880
Spiral groove cutter HS Spi S8 D10/30	for slot joints FZ 10 and open dovetail joints SZO 20 with fine precision in diameter, D 10 mm, NL 30 mm, GL 60 mm, s 8 mm, in self-service display pack	490946
4 Jointing system dowel joint unit VS 600 DS 32	for OF 1010, OF 1400, dowelling joint in the 32 grid, copying ring \varnothing 13.8 mm (for OF 1010), in carton	488881
Dowel drill HW S8 D5/30 Z	with brad point, D 5 mm, NL 30 mm, GL 53,5 mm, s 8 mm, in self-service display pack	491066
Dowel drill HW S8 D6/30 Z	with brad point, D 6 mm, NL 30 mm, GL 53,5 mm, s 8 mm, in self-service display pack	491067
Dowel drill HW S8 D8/30 Z	with brad point, D 8 mm, NL 30 mm, GL 53,5 mm, s 8 mm, in self-service display pack	491068
Dowel drill HW S8 D10/30 Z	with brad point, D 10 mm, NL 30 mm, GL 53,5 mm, s 8 mm, in self-service display pack	491069

System accessories



Hole series system

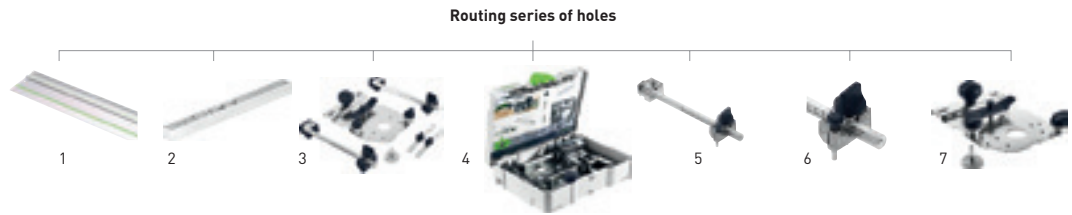

Edge trimming system

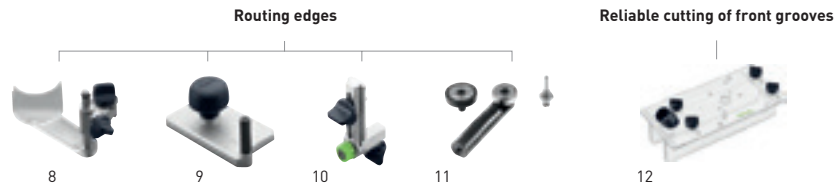

Accessories for hole series system, edge trimming system

	Denomination	Explanation	Order no.
1	Guide rail FS 1400/2-LR 32	with row of holes, length 1.400 mm, in carton	496939
	Guide rail FS 2424/2-LR 32	with row of holes, length 2.424 mm, in carton	491622
2	Stopper LA-LR 32 FS	positions the first hole on the hole series guide rail at a distance of 9.5, 16 or 32 mm from the workpiece edge, qty. in pack 2 Units, in self-service display pack	496938
3	Hole drilling set LR 32 Set	for routers OF 900, OF 1000, OF 1010, OF 1400 in the FS-LR32 hole drilling system, for use with hole line guide rails, guide plate, centring mandrel, 2 x side stop, 2 x Longitudinal stop, in carton	583290
4	Hole drilling set LR 32-SYS	for OF 900, OF 1000, OF 1010, OF 1400, for use with hole line guide rails, guide plate, centring mandrel, operation tool, hinge location cutter HM Ø 35 mm, dowel drill HW Ø 5 mm (V-shaped tip), dowel drill HM Ø 5 mm (with centring bit and pre-cutter), 2 parallel side fences with adjustable stop, clamp FSZ 120, 2 x Longitudinal stop, in SYSTAINER SYS 1 T-LOC	584100
5	Parallel side fence SA-LR 32	with adjustable stop, for parallel alignment of guide rails, in carton	485758
6	Adjustable stop AR-LR 32	for OF 900, OF 1000, OF 1010, OF 1400, for parallel side fence, in carton	485759
7	Guide plate FP-LR 32	for routers OF 900, OF 1000, OF 1010, OF 1400 in the FS-LR32 hole drilling system, centring mandrel, in carton	494340
8	Chip guard SF-OF	for OF 900, OF 1000, OF 1010, KF, in self-service display pack	486242
9	Edging plate UP-OF	for OF 900, OF 1000, OF 1010, KF, angle arm WA-OF and edging plate UP-OF are needed for the flush trimming of projected edges, in self-service display pack	486058
10	Angle arm WA-OF	for OF 900, OF 1000, OF 1010, OF 1400, KF, needed to copy workpieces in conjunction with the copier scanning set KT-OF, in self-service display pack	486052
11	Copier scanning set KT-OF	for OF 900, OF 1000, OF 1010, OF 1400, KF, copier scanning set KT-OF and angle arm WA-OF are needed to copy workpieces, in self-service display pack	486534
12	Routing aid OF-FH 2200	for OF 900, OF 1000, OF 1010, OF 1400, OF 2000, OF 2200, safe guidance of the router thanks to the movable legs, in carton	495246

System accessories



Accessories for laminate trimmer OFK 500, OFK 700, module edge router MFK 700

Denomination	Explanation	Order no.
1 Router table FT 0°	for routing accurate angles, in carton	491427
2 Collet SZ-D 6/OF 1000	for MFK/OFK 700, OF 900, OF 1000, OF 1010, KF, with locking nut, for cutter shank Ø 6 mm, in self-service display pack	488760
Collet SZ-D 6,35/OF 1000	for MFK/OFK 700, OF 900, OF 1000, OF 1010, KF, with locking nut, for cutter shank Ø 6.35 mm (1/4"), in self-service display pack	488761
Collet SZ-D 8/OF 1000	for MFK/OFK 700, OF 900, OF 1000, OF 1010, KF, with locking nut, for router shank Ø 8 mm, in self-service display pack	488755
3 Router table FT-MFK 700 1,5° Set	for MFK/OFK 700, tarnishing pad, extraction hood, in carton	495165
4 Parallel side fence SA-MFK 700	for MFK 700, with fine adjuster, extraction hood, 2 x Guide rods, in carton	495182

System accessories



PF 1200

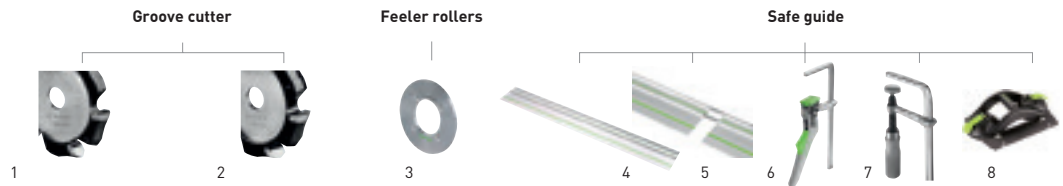

OF 1010

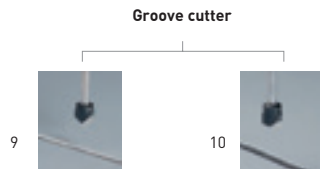

Accessories for PF 1200 aluminium composite milling machine, OF 1010 router

Denomination	Explanation	Order no.
1 V-groove cutter HW 118x14-90°/Alu	D 118 mm, alpha 90°, in self-service display pack	491470
2 V-groove cutter HW 118x18-135°/Alu	D 118 mm, alpha 135°, in self-service display pack	491471
3 Follower roll D2	for aluminium composite milling machine for D2 aluminium composite panels, disc size 2 mm, in self-service display pack	491542
Follower roll D3	for aluminium composite milling machine for D3 aluminium composite panels, disc size 3 mm, in self-service display pack	491543
Follower roll D4	for aluminium composite milling machine for D4 aluminium composite panels, disc size 4 mm, in self-service display pack	491544
Follower roll D6	for aluminium composite milling machine for D6 aluminium composite panels, disc size 6 mm, in self-service display pack	491545
Follower roll A3	for aluminium composite milling machine for A3 aluminium composite panels, disc size 3 mm, in self-service display pack	491538
Follower roll A4	for aluminium composite milling machine for A4 aluminium composite panels, disc size 4 mm, in self-service display pack	491539
Follower roll A6	for aluminium composite milling machine for A6 aluminium composite panels, disc size 6 mm, in self-service display pack	491540
4 Guide-rails	from page 388	
5 Connecting piece FSV	to connect guide rails for long workpieces, qty. in pack 1 Units, in self-service display pack	482107
6 Lever clamp FS-HZ 160	for FS/2, MFT, solid steel version, clamping width 160 mm, in self-service display pack	491594
7 Fastening clamp FSZ 120	for FS/2, MFT, solid steel version, clamping width 120 mm, qty. in pack 2 Units, in self-service display pack	489570
Fastening clamp FSZ 300	for FS/2, MFT, solid steel version, clamping width 300 mm, qty. in pack 2 Units, in self-service display pack	489571
8 dual suction pad GECKO DOSH	from page 389	
9 V-groove cutter HW S8 D18-90°/Alu	D 18 mm, NL 8 mm, GL 59 mm, alpha 90°, s 8 mm, in self-service display pack	491444
10 V-groove cutter HW S8 D18-135°/Alu	D 18 mm, NL 3,3 mm, GL 59 mm, alpha 135°, s 8 mm, in self-service display pack	491443

Expertise in routing – Festool cutters.

Unconditional quality is uncompromising. That is why we recommend original Festool routing accessories for all Festool routers. Produced with the same care as the tools. With cutting blades that boast micro-grain quality and micro-grain density, and with a cutting geometry that guaranties first-class results and an excellent service life. Machines, routers and accessories – we provide optimum equipment from a single source for versatile and efficient working.



The right material for every application

HW Tungsten carbide

HW routers are ideally suited to processing hardwood, panel materials and plastic.

HS High performance, high speed steel

This steel has mechanical and thermal properties that are best suited for routing soft materials such as spruce and pine.

Reversible-blade classic ogee cutter
from page 295

Rebating head and cutter spindle
from page 288

Specialised cutters for solid surface and mineral materials
from page 296

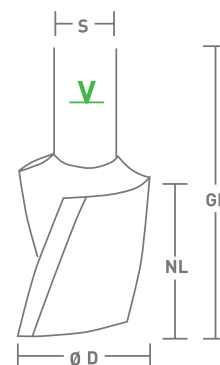

- GL** Total length (mm)
- NL** Working length (mm)
- D** Cutter diameter (mm)
- s** Shank diameter (mm)
- alpha** Chamfering angle (°)
- R** Radius (mm)
- V** Marking for minimum clamping length
- △** n max. = maximum router speed
- HW** Tungsten carbide
- HS** High performance, high speed steel

Tip

For the best routing patterns, the cutters should always be mounted at the lowest depth possible, and at least as far as the marking for minimum clamping length on the router shank.

06 Routing

Routing tools Groove cutter

Router cutter HW, solid hard metal with base blade, shank 8 mm

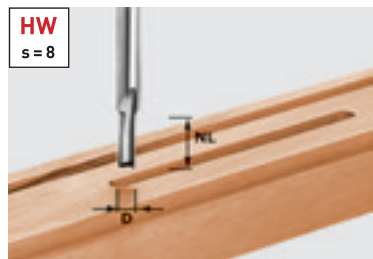

D	NL	GL	s	Order no.
3	6	45	8	490952
4	10	45	8	490953
5	12	45	8	490954
6	14	55	8	490955
7	17	55	8	490956
8	20	55	8	490957
8	30	60	8	491647

No compromises.

The partially ground standard tungsten carbide blade provides an increased service life when drilling panel materials

Router cutter HW with fitted base blade, shank 8 mm

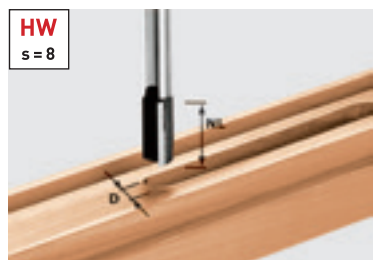

D	NL	GL	s	Order no.
9	23	55	8	490958
10	20	60	8	490959
10	25	60	8	490960*
10	30	60	8	491648
11	20	60	8	490961
12	20	60	8	490962
12	30	60	8	491649
13	20	60	8	490963
14	20	60	8	490964
15	20	60	8	490965
16	20	60	8	490966
16	30	65	8	490967
18	20	60	8	490968
18	30	65	8	490969
19	20	60	8	490970
20	20	60	8	490971
20	30	65	8	490972
22	20	60	8	490973
24	20	60	8	490974
25	20	60	8	490975
30	20	60	8	490976

Long service life, even when plunge cutting.

If you wish to achieve quality cutting results with ease when drilling, grooving, rebating and long-hole routing, you are best advised to use the HW groove cutter. It cuts precisely, makes drilling easier and has a long service life.

Hard-wearing drill point.

After drilling 60 holes in a kitchen worktop (30 mm deep): Cutting edge only shows slight signs of wear.



Ground drill point.

After drilling 60 holes in a kitchen worktop (30 mm deep): Blunt cutting edge.



* for slot jointing with the Festool VS 600, with extra precision in the diameter

Routing tools Groove cutter, router bit box

Router cutter HW with fitted base blade, shank 12 mm

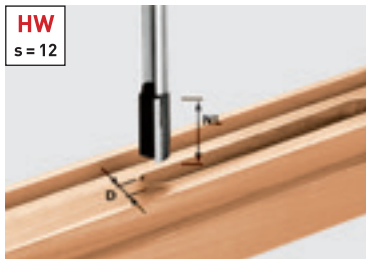

D	NL	GL	s	Order no.
10	35	90	12	491086
12	40	90	12	491087
13,2	35	85	12	493789
14	40	85	12	491088
14	50	100	12	491089
15	35	85	12	493790
16	45	90	12	491090
16	60	100	12	491091
18	45	90	12	491092
20	45	90	12	491093
22	45	90	12	491094
24	45	90	12	491095
30	35	90	12	491096

HW "Schall-Ex" and "Planet" groove cutter.

The perfect solution when installing automatic door seals on-site.

Effective dimensions of seal types

Gasket	Width (mm)	Depth	Cutter type
Planet HS	13,1	30	①
Schall-Ex L	14,8	32	②
Schall-Ex RD	14,8	28	②
Draft excluders	12,0	40	③
Double seals	12,0	40	③
Schall-Ex Ultra	19,7	30	④

Router cutter HS single-edged, with base blade, shank 8 mm

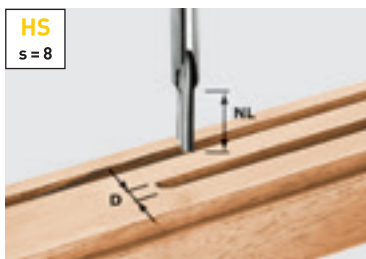

D	NL	GL	s	Order no.
3	8	45	8	490941
4	15	48	8	490942
5	12	50	8	490943

Router bit box



Items included with the router bit box	Order no.
Edge trimming cutter HW D12.7/NL25 KL, dowel drill HW D5 x 30 Z, groove cutter HW D10/20 with drill point, groove cutter HW D18/30 with drill point, classic ogee cutter HW D16.7/R2 KL, classic ogee cutter HW D25.5 R6.3 KL, classic ogee cutter HW D31.7 R9.5 KL, chamfer cutter HW D36/45° KL, groove cutting disc HW D40 x 4, cutter spindle for disk groove cutter KL 16, dovetail cutter HW D13.8/15°	498979

Cutter set for the professional.

The router bit box contains 11 router bits for the most important and most frequent applications. This therefore offers a price saving compared with purchasing each of them individually. The individual router bits are clearly organised and safely stored in a transparent router bit magazine in the router bit set.

Routing tools

Spiral groove cutter, reversible blade rebating cutter

Spiral router cutter HS with base blade, shank 8 mm

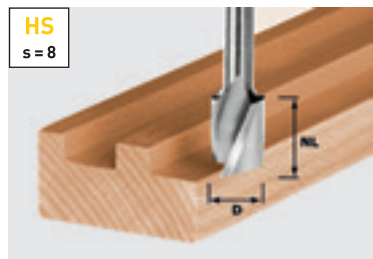

* for slot jointing with the Festool VS 600, with extra precision in the diameter

D	NL	GL	s	Order no.
6	16	50	8	490944*
8	19	50	8	490945
10	30	60	8	490946*
12	20	52	8	490947
14	20	52	8	490948
16	20	52	8	490949
18	25	57	8	490950
20	25	57	8	490951

Multi-talented.

The HS spiral groove cutter and the HW solid carbide spiral groove cutter: Fast rate of advance for grooving, rebating, long-hole cutting, drilling and copy routing. The chips are drawn upwards by the spiral cutter, keeping the groove permanently clean.



Spiral router cutter HW solid hard metal with base blade, shank 8 mm

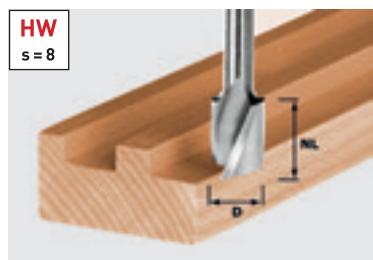

D	NL	GL	s	Order no.
4	10	45	8	490977
6	21	50	8	490978
8	25	55	8	490979
10	30	60	8	490980

Turning plate router cutter HW single-edged, with base blade, shank 8 mm

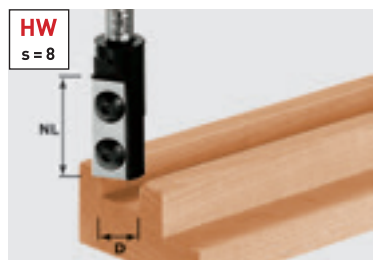

D	NL	GL	s	Order no.
8	20	50	8	491078
10	25	55	8	491079
12	30	61	8	491080
14	30	66	8	492715
16	30	70	8	492716
18	30	70	8	492717

Its efficiency speaks for itself.

The reversible blades provide consistent cutter dimensions and precision – without resharping. Quick cutter changes and reversible blade guarantee sharp cutters and greater economic efficiency at all times.



Accessories for turning plate router cutter HW, single-edged with base blade, shank 8 mm

Replacement blade for cutter HW-WP 20x4,1x1,1 (4x) for cutter 491078	491386
Replacement blade for cutter HW-WP 25x5,5x1,1 (4x) for cutter 491079 (4 pcs)	491387
Replacement blade for cutter HW-WP 30x5,5x1,1 (4x) for cutters 491080, 492715	491388
Reversible blade HW-WP 30x12x1,5 (4x) for 492716, 492717, 491120 cutters, main plate	491393
Replacement blade for cutter HW-WP 7,6x12x1,5 (4x) pre-cutter for 492716, 492717, 491120 cutters	491390

Routing tools

Groove cutter with reversible blades, stepped cutter, ovolo edge cutter

Turning plate router cutter HW single-edged, with base blade, shank 12 mm

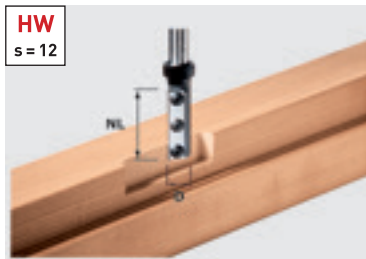

D	NL	GL	s	Order no.
16	50	110	12	497454

Accessories for reversible blade rebating cutter HM, single edge with plunge point, shank 12 mm

Reversible blade Wepla Set D 16 2+2
 spare reversible blades set for cutter
 497454 497458

Turning plate router cutter HW single-edged, with base blade, direct bit holder

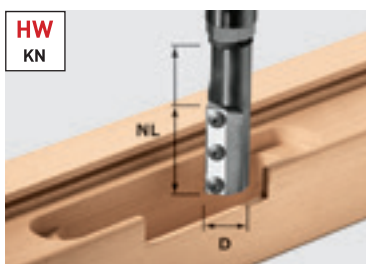

D	NL	GL	Order no.
20	50	110	497455
24	50	117	497456

Accessories for turning plate router cutter HW, single-edged with base blade, direct bit holder

Reversible blade Wepla Set D 20 2+2
 spare reversible blade set for cutter
 497455 497568

Reversible blade Wepla Set D 24 2+2
 spare reversible blades set for cutter
 497456 497569

Copying ring KR-D 30,0/21,5/OF 2200
 for OF 2200, extra long safety copying
 ring D30, 21 mm high, required for use
 of reversible blade cutters 497455 and
 497456, D 30 mm, Dia. 27 mm 497453

For door hinges in block frames and door leaves.

The extra long reversible blade cutter is suitable for extreme routing depths, with direct bit holder for 20 and 24 mm diameters. For precision working in combination with router OF 2200 and extra long copying ring (order no. 497453).



Stepped cutter, shank 12 mm

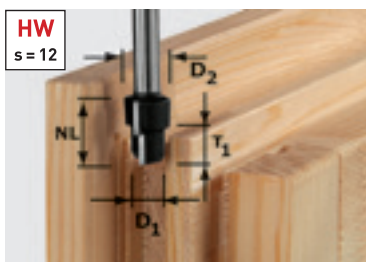

D1	D2	NL	T1	s	Order no.
12,3	16,3	14	9,3	12	492713
20,3	12,3	14	9,3	12	492714

Perfect when combined with the routing aid.

The stepped cutter and the Festool routing aid can be used to rout windows and house doors quickly and precisely, making sure they do not tilt or wobble.

Ovolo edge cutter HW, shank 8 mm

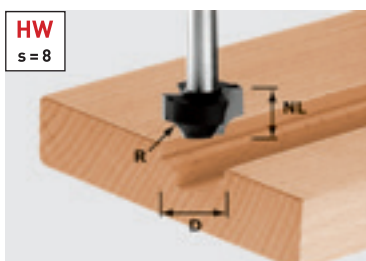

D	NL	GL	R	s	Order no.
17	10	40	3	8	491004
23	13	45	6	8	491007

For decorative front design of inlays

It is possible to plunge-cut centrally into the front of the furniture using the standard bit.

06 Routing

Routing tools

Half-round cutter, roundover cutter

Half-round cutter HW with ball bearing guide, shank 8 mm

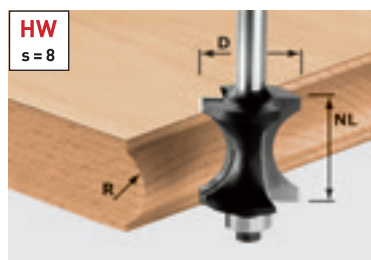

D	NL	GL	R	s	Order no.
27	28	70	12	8	491139

Accessories for half-round cutter HW

Ball bearing guide D12,7 (2x) Diameter 12,7 mm, Qty. in pack 2 Units	491383
--	--------

For the complete job.

For decorative board edging the HW halfround cutter does a great job. It is perfectly designed for 28 mm thick laminated wood board. Its ball bearing guide guides the router directly along the template and ensures that curved parts can also be profiled.

Ogee cutter HW with ball bearing guide, shank 8 mm



* delivered items include \varnothing 12.7 mm and \varnothing 9.5 mm ball bearing

D	NL	GL	R	s	Order no.
16,7	9	49	2	8	491009
19,1	10	50	3	8	491010*
20,7	11	51	4	8	491011*
22,7	12	52	5	8	491012*
25,5	13,5	54	6,35	8	491013*
28,7	15	55	8	8	491014*
31,7	16,5	56	9,5	8	491015*
38,1	19	59	12,7	8	491016*
42,7	22	62	15	8	491017*

Accessories for classic ogee cutter HW

Ball bearing guide D12,7 (2x) Diameter 12,7 mm, Qty. in pack 2 Units	491383
--	--------

Ball bearing guide D 9,53 (2x) Diameter 9,53 mm, Qty. in pack 2 Units	491382
---	--------

One tool – two uses.



With ball bearing guide \varnothing 12.7 mm for rounding



With ball bearing guide \varnothing 9.5 mm for beading

Ogee cutter HW with ball bearing guide, shank 12 mm



D	NL	GL	R	s	Order no.
63	32	82	25	12	491107

Accessories for classic ogee cutter HW

Ball bearing guide D12,7 (2x) Diameter 12,7 mm, Qty. in pack 2 Units	491383
--	--------

Ball bearing guide D 9,53 (2x) Diameter 9,53 mm, Qty. in pack 2 Units	491382
---	--------

Routing tools

Roundover/chamfer cutter, chamfer cutter/edge router with reversible blades, chamfer cutter

Ogee chamfer cutter HW with ball bearing guide, shank 8 mm



HW
s = 8

D	NL	GL	R	Alpha	s	Order no.
17,5	19	61	6	15	8	491134
23,1	19	60	6	30	8	491135
31,4	18,5	60	6	45	8	491136

Accessories for classic ogee/chamfer cutter HW

Ball bearing guide D17,5/15° (2x) for cutter 491134, Alpha 15°, D 17,5 mm, Min. diameter 17,5 mm, Qty. in pack 2 Units	491403
Ball bearing guide D23,1/30° (2x) for cutter 491135, Alpha 30°, D 23,1 mm, Qty. in pack 2 Units	491404
Ball bearing guide D31,4/45° (2x) for cutter 491136, Alpha 45°, D 31,4 mm, Qty. in pack 2 Units	491405



Turning plate chamfer/edge-trimming cutter HW with ball bearing guide, shank 8 mm

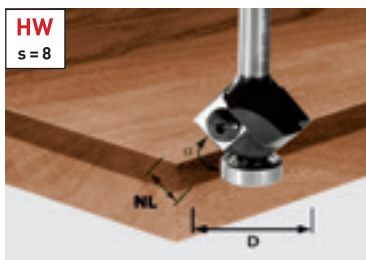

HW
s = 8

D	NL	GL	Alpha	s	Order no.
27	8	55	45	8	499807

Accessories for turning plate slot cutter HW

Ball bearing guide D12,7 (2x) Diameter 12,7 mm, Qty. in pack 2 Units	491383
Reversible blade HW-WP 12x12x1,5 (4x)	491391

Precisely calculated.

The edge trimming cutter with HW reversible blades is the ideal tool for those who attach great importance to a long service life, outstanding economic efficiency and constant precision. Purchase one reversible blade, receive the service life of four cutters and save on consequential costs because the cutter can be reversed.

Chamfer cutter HW with ball bearing guide, shank 8 mm

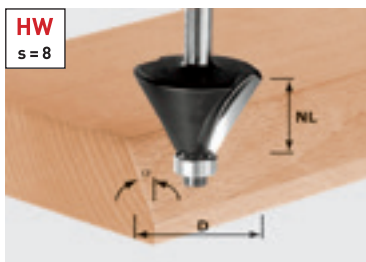

HW
s = 8

D	NL	GL	Alpha	s	Order no.
18	11	50	15	8	499801
25,7	25,1	70	15	8	491132
25	11	50	30	8	499800
38,5	25,7	64	30	8	491133
26	7	48	45	8	499799
36	11,5	53	45	8	491025

Accessories for chamfer cutter HW

Ball bearing guide D12,7 (2x) Diameter 12,7 mm, Qty. in pack 2 Units	491383
--	--------

An unbeatable team.

You can also produce this familiar edge shape commonly found in industry using these shank cutters in a portable router. Here the chamfer cutter and classic ogee cutter with conical ball bearing guide work together perfectly.



06 Routing

Routing tools

Chamfer cutter, round nose cutter, flute cutter

Chamfer cutter HW, shank 12 mm

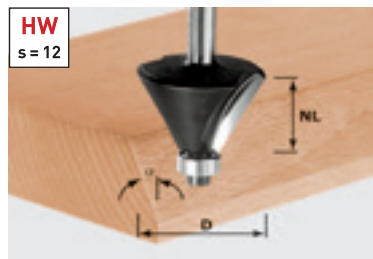

D	NL	GL	Alpha	s	Order no.
44	30	80	30	12	491101
55	20	76	45	12	491102

Accessories for chamfer cutter HW

Ball bearing guide D12,7 (2x) Diameter 12,7 mm, Qty. in pack 2 Units	491383
--	--------

Water gutter cutter HW with ball bearing guide, shank 8 mm

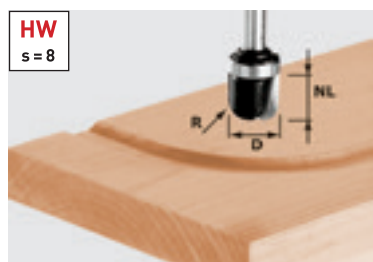

D	NL	GL	R	s	Order no.
19	16	53	6,4	8	490982

Accessories for round nose cutter HW

Ball bearing guide D19 (2x) Diameter 19 mm, Qty. in pack 2 Units	491396
--	--------

Routing without a copying ring.

This cutter can produce curved or round water channels 1:1 without any problem using a template. Time-consuming calculation of curves and distances is no longer necessary.

Water gutter cutter HW, shank 8 mm

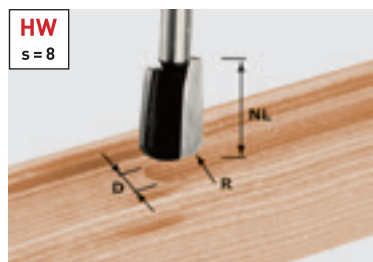

D	NL	GL	R	s	Order no.
16	25	65	5	8	490981



Flute cutter HW, shank 8 mm

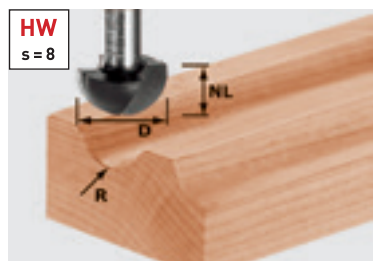

D	NL	GL	R	s	Order no.
8	8	38	4	8	490983
12,7	10	40	6,35	8	490984
16	11	41	8	8	490985
19,4	11	41	9,7	8	490986
25,4	14	44	12,7	8	490987

Flute cutter HW, shank 12 mm

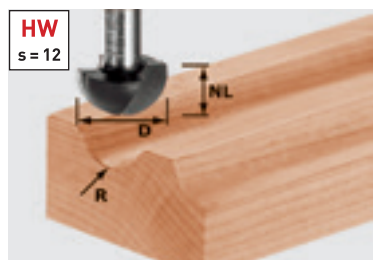

D	NL	GL	R	s	Order no.
30	20	60	15	12	491104
40	25	65	20	12	491105

Routing tools Flute cutter, edge-trimming cutter, edge-trimming cutter with reversible blades

Flute cutter HW with ball bearing guide, shank 8 mm

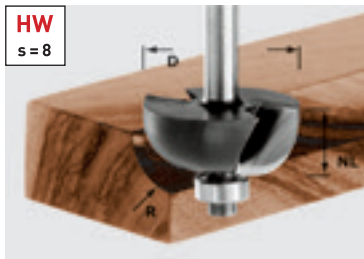

D	NL	GL	R	s	Order no.
25,5	12,7	54	6,35	8	491018
28,7	14	56	8	8	491019
31,7	14,3	56	9,5	8	491020
38,1	16	57	12,7	8	491021

Accessories for flute cutter HW

Ball bearing guide D12,7 (2x) 491383
Diameter 12,7 mm, Qty. in pack 2 Units

Edge trimming cutter HW with ball bearing guide, shank 8 mm

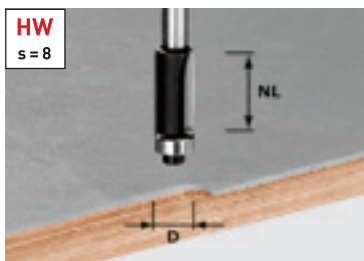

D	NL	GL	Alpha	s	Order no.
12,7	25	65	0	8	491027

Accessories for edge trimming cutter HW

Ball bearing guide D12,7 (2x) 491383
Diameter 12,7 mm, Qty. in pack 2 Units

Through thick and thin.

The HW template router is the ideal tool for simple 1:1 copy routing thanks to its large ball bearing guide.

Edge trimming cutter HW with ball bearing guide, shank 8 mm

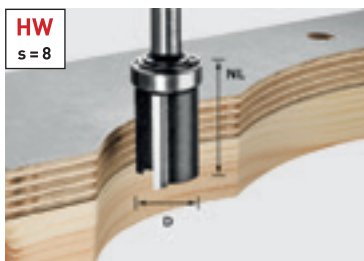

D	NL	GL	Alpha	s	Order no.
19,05	25	62	0	8	491028

Accessories for edge trimming cutter HW

Ball bearing guide D19 (2x) 491396
Diameter 19 mm, Qty. in pack 2 Units



Turning plate edge trimming cutter HW with ball bearing guide, shank 8 mm

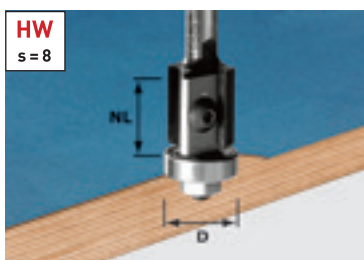

D	NL	GL	Alpha	s	Order no.
19	20	64	0	8	491082
19	12	52	0	8	499806

Accessories for turning plate slot cutter HW

Ball bearing guide D19 (2x) 491385
Diameter 19 mm

Reversible blade HW-WP 20x12x1,5 (4x) 491392

Reversible blade HW-WP 12x12x1,5 (4x) 491391

Precision – even after sharpening.

When sharpening blunt edges on conventional cutters, the diameter aligned to the ball bearing guide normally decreases. This causes a ridge to form when edges are trimmed flush after the bit is sharpened. The turning plate slot cutter and ball bearing guide maintain a high level of precision.

06 Routing

Routing tools

Edge trimming chamfer cutter, drilling cutter, rebating cutter

Chamfer/edge trimming cutter with ball bearing guide, shank 8 mm

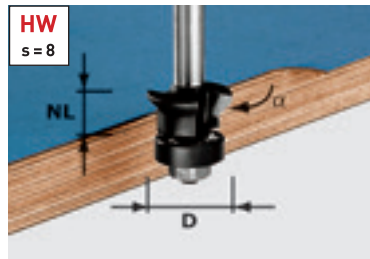

D	NL	GL	s	Order no.
24	11	54	8	491026

Accessories for edge trimming chamfer cutter

Ball bearing guide D18 (2x) Diameter 18 mm	491400
--	--------

One tool – three uses.

Flush trimming of protruding coatings at a right angle, with a 45° chamfer or even both in one working process. The plastic-coated ball bearing guide does not leave any marks and protects the edge of the workpiece.



Flush Chamfered Flush + chamfered

Drilling cutter HW, shank 8 mm

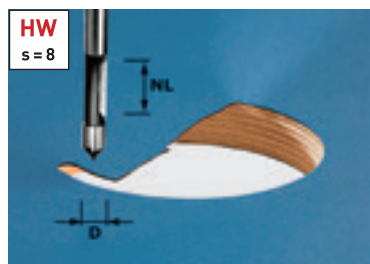

D	NL	GL	s	Order no.
8	19	65	8	491037

Plunge – cut – finished.

The drilling cutter plunges directly into the laminate without requiring pre-drilling and trims the prepared contour flush when guided along the side face.

Turning plate rebating cutter with ball bearing guide, shank 8 mm



D	NL	GL	s	Order no.
38	12	53,7	8	491085*

Accessories for turning plate rebating cutter

Reversible blade HW-WP 12x12x1,5 (4x)	491391
Ball bearing guide D9,5/12,7/16/19/22 Diameter 9,5; 12,7; 16; 19; 22 mm	491406

Amazingly versatile.

Change ball bearings to rout to 5 different rebate depths with only one basic bit.

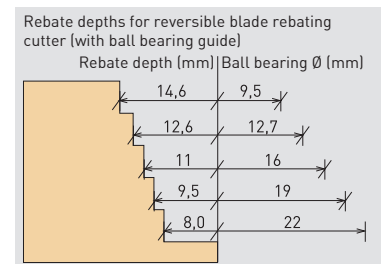

* Items included: ball bearing set, Ø 9.5 mm to Ø 22 mm

Rebating cutter HW with ball bearing guide, shank 8 mm

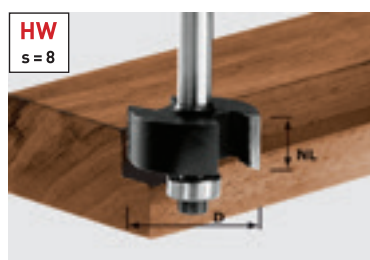

D	NL	GL	T1	s	Order no.
31,7	12,7	54	9,5	8	491022**

Accessories for rebating cutter HW

Ball bearing guide D12,7 (2x) Diameter 12,7 mm, Qty. in pack 2 Units	491383
Ball bearing guide D9,5/12,7/16/19/22 Diameter 9,5; 12,7; 16; 19; 22 mm	491406

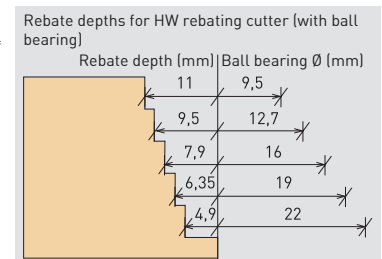

** Items included: 1 ball bearing Ø 12.7 mm with 9.5 mm rebate depth

Routing tools Dovetail cutter, hand grip/hand rail cutter

Dovetail cutter with pre-cutter, shank 8 mm

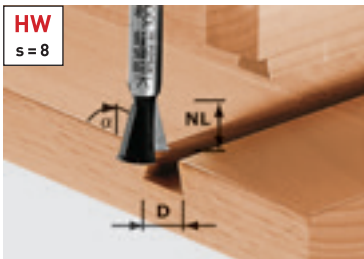

D	NL	GL	Alpha	s	Order no.
14,3	13,5	46	15	8	490990

Perfect for dovetail joints.

It is possible to produce traditional open and hidden dovetail joints in no time at all using the appropriate router, template and router tool system.

Dovetail cutters, shank 8 mm

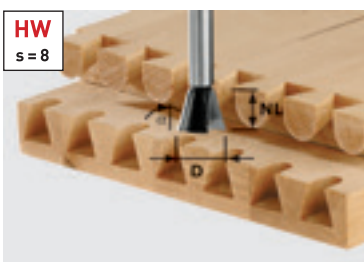

D	NL	GL	Alpha	s	Order no.
13,8	13,5	46	15	8	490992*
16	13,5	46	15	8	490993*
20	17	49	15	8	490996*
14,3	16	50	10	8	491164**
20	26	58	10	8	491165**



Dovetail cutters, shank 8 mm

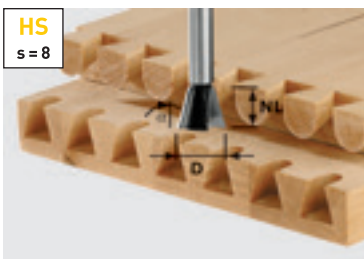

D	NL	GL	Alpha	s	Order no.
13,8	13,5	46	15	8	490991*
20	17	49	15	8	490995*

For use with jointing system VS 600:
* for partially covered dovetail joint
** for open dovetail joint



Recessed grip cutter HW with ball bearing guide, shank 8 mm

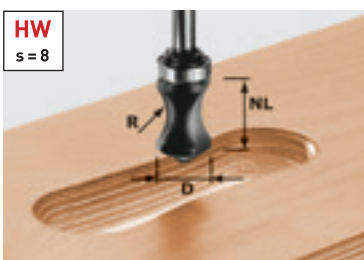

D	NL	GL	R	s	Order no.
19	19	68	16	8	491033

Accessories for hand hole cutter HW

Ball bearing guide D19 (2x) 491396
Diameter 19 mm, Qty. in pack 2 Units

Hand rail cutter HW, shank 8 mm

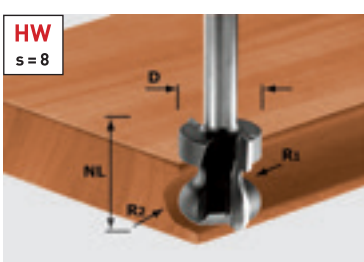

D	NL	GL	R	s	Order no.
22	16	59	2,5/6	8	491140



06 Routing

Routing tools

Tongue and groove cutter, script cutter

Tongue and groove cutter HW, shank 8 mm

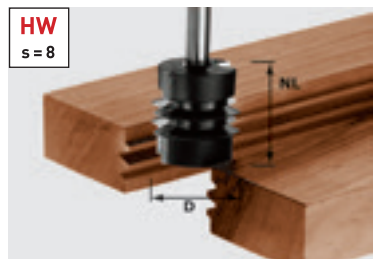

D	NL	GL	s	Order no.
34	32	62	8	491034

Setting table for tongue and groove cutters

Wood thickness (1)	Height, Y dimension (2)	Stop, X dimension (3)
12	9,2	8,8
13	9,7	9,3
14	10,2	9,8
15	10,7	10,3
16	11,2	10,8
17	11,7	11,3
18	12,2	11,8
19	12,7	12,3
20	13,2	12,8
21	13,7	13,3

As both workpieces that are to be glued are to be processed in one cutter setting, the setting of the mitre tongue and groove cutter requires the precise adjustment of the stop and the table height. The graphic above and the settings table can be used for assistance. Nevertheless, readjustment may be necessary.

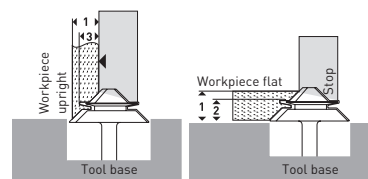

Mitre tongue and groove cutter, shank 12 mm

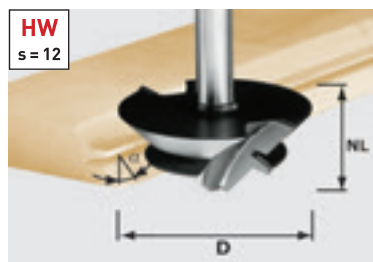

D	NL	GL	Alpha	s	Order no.
△ 64	27	67	45	12	492709

△ n max. 22,000

Script cutter, shank 8 mm

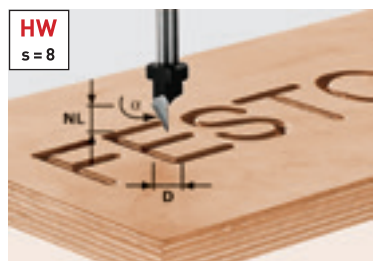

D	NL	GL	Alpha	s	Order no.
11	9,5	55	60	8	491003

Script cutter, shank 8 mm

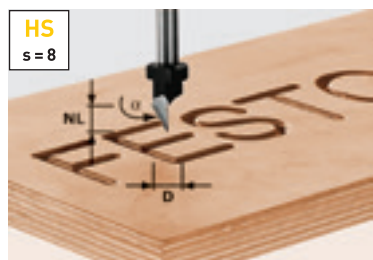

D	NL	GL	Alpha	s	Order no.
11	9,5	55	60	8	491002

Routing tools V-groove cutter, plasterboard V-groove cutter

V-groove cutter, shank 8 mm

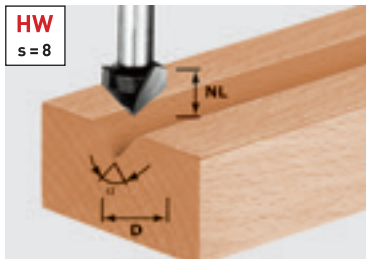

D	NL	GL	Alpha	s	Order no.
14	7	50	90	8	490999

Ideal for decorative veining.

The V-groove cutter is the right choice for decorative veining on workpieces with flush joints – e.g. door frames, furniture frame joints and furniture components.

V-groove cutter, shank 8 mm

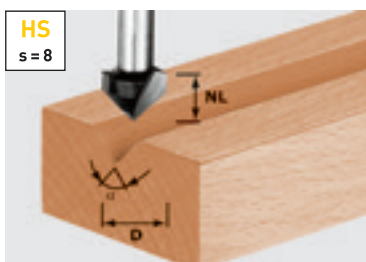

D	NL	GL	Alpha	s	Order no.
14	7	50	90	8	490998
11	9,5	50	60	8	490997

V-groove cutter, for processing aluminium composite panels, shank 8 mm

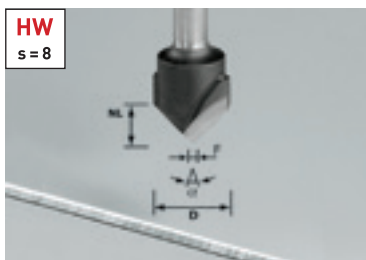

D	NL	GL	Alpha	s	Order no.
18	3,3	59	135	8	491443
18	8	59	90	8	491444

Routing aluminium composite panels

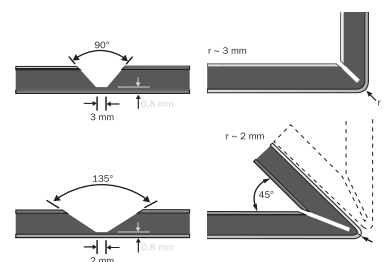

Cutter V groove HW, shank 8 mm



D	NL	GL	Alpha	s	Order no.
12,5	14	55	45	8	491000*
32	16	49	90	8	491001

Routing and jointing instead of gluing and smoothing.

A 45° cutter for rebating 45° corner joints is now available in addition to the 90° plasterboard V-groove cutter.

* single-edged tool

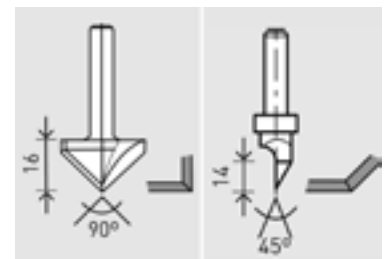

90° plasterboard V-groove cutter (Order no. 491001)

45° plasterboard V-groove cutter (Order no. 491000)

06 Routing

Routing tools

Disk groove cutter, hinge location cutter

Groove cutting disc HW, shank 8 mm

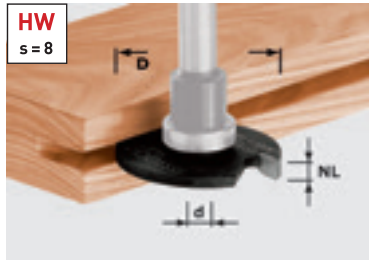

D	Dia.	NL	Order no.
40	6	1,5	491038
40	6	2	491040
40	6	2,5	491056
40	6	3	491057
40	6	3,5	491058
40	6	4	491059
40	6	5	491060

3 different cutter spindles are available for use of the disc groove cutter from 1.5 mm to 5 mm groove width.

Cutter spindle 1 has a fixed shaft, which is not suitable as a thrust surface (fire hazard). Therefore, this cutter spindle is only intended for work with a side stop.

Cutter spindle 2 is equipped with a 16 mm ball bearing (above the disc slot), which serves as a thrust surface. With this cutter spindle, a groove depth of 12 mm results from the use of the 40 mm disc slot.

Cutter spindle 3 is equipped with a 28 mm ball bearing (above the disc slot), which serves as a thrust surface. With this cutter spindle, a groove depth of 6 mm results from the use of the 40 mm disc slot.

Cutter spindle for groove cutting disc HW, shank 8 mm

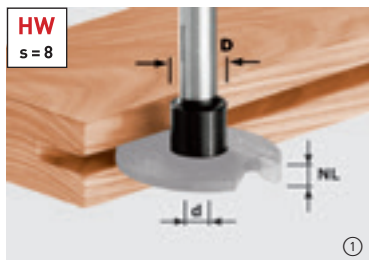

D	Dia.	GL	BB	Order no.
14	6	49	①	499805
16	6	43	16 ②	499803
28	6	45	28	499804

For sealed doors.

A cutter spindle with ball bearing guide D 28 and disc groove cutter with a width of 4 mm are ideal for routing door seals in door frames.



Accessories for cutter spindle, shank 8 mm

Ball bearing guide D16 (2x) Diameter 16 mm	②	491384
Ball bearing guide D28 (2x) Diameter 28 mm		491397

HW hinge location cutter with HW chip breaker, shank 8 mm

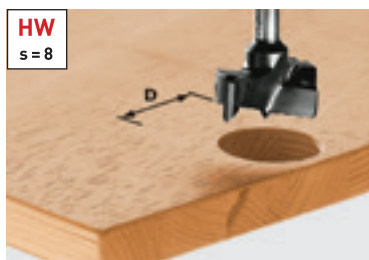

D	GL	s	Order no.
15	54,5	8	491070
18	54,5	8	491071
20	54,5	8	491072
25	54,5	8	491073
26	54,5	8	491074
30	54,5	8	491075
34	54,5	8	491076
35	54,5	8	491077

Accurate dimensioning with System 32.

The LR 32 hole series system makes routing a row of holes for shelves and false floors amazingly simple. The holes for hinge fittings are also cut accurately between the holes on the System 32 grid.

Routing tools Dowel drill, roman ogee cutter, multi-profile cutter, T-slot cutter

Dowel drill HW, shank 8 mm

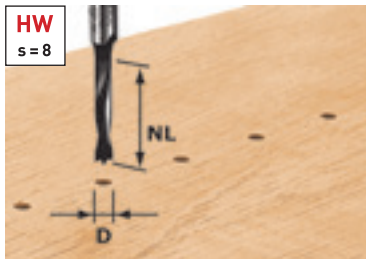

* without centre point

D	NL	GL	s	Order no.
3	16	55	8	491065*
5	30	53,5	8	491066
6	30	53,5	8	491067
8	30	53,5	8	491068
10	30	53,5	8	491069

Versatile use.

The dowel drill HW is ideal for drilling rows of holes and combining with the dowel unit from jointing system VS 600.



Drill HW, shank 8 mm

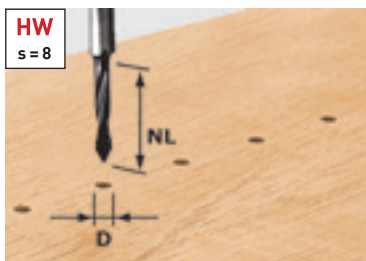

D	NL	GL	s	Order no.
5	30	53,5	8	491064



Roman ogee cutter HW with ball bearing guide, shank 8 mm

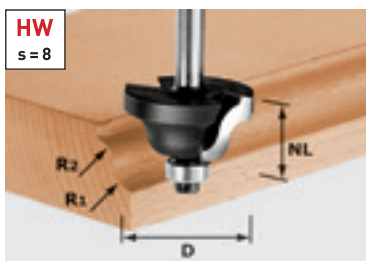

D	NL	GL	R1	R2	s	Order no.
31,7	13	53	4	4	8	491029
38,1	19	59	6,35	6,35	8	491030

Accessories for double radius cutter

Ball bearing guide D12,7 (2x)
Diameter 12,7 mm, Qty. in pack 2 Units 491383

Multi-profile cutter HW with ball bearing guide, shank 8 mm



D	NL	GL	R	s	Order no.
36,7	21	61	6	8	491031

Accessories for multi-profile cutter

Ball bearing guide D12,7 (2x)
Diameter 12,7 mm, Qty. in pack 2 Units 491383

Key-hole cutter HW, shank 8 mm

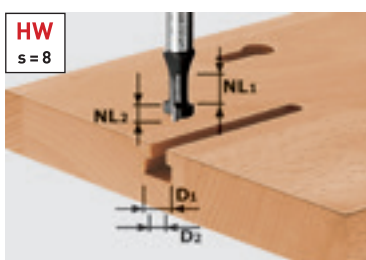

D1	D2	NL1	NL2	GL	s	Order no.
10,5	6	8	5	50	8	491035

Excellent for special tasks.

For cutting T-grooves, shaped holes and keyhole mountings in solid wood and panel material.

06 Routing

Routing tools

Profile cutter, counterprofile cutter

Profile cutter HW, shank 8 mm

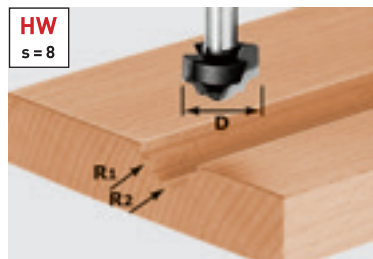

D	NL	GL	R1	R2	s	Order no.
19	12,5	54	4	5	8	491032



Profile cutter HW, shank 8 mm

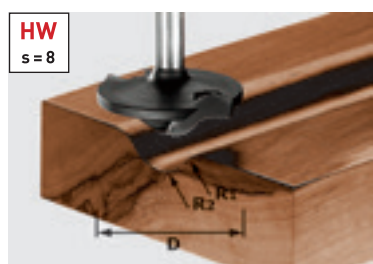

D	NL	GL	R1	R2	s	Order no.
42	13	50	6	12	8	491137

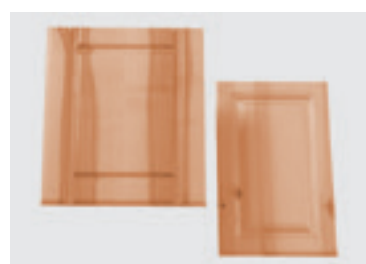

Profile cutter radius HW with ball bearing guide, shank 8 mm



D	NL	GL	R	s	Order no.
42	14	54	6	8	491131

Accessories for profile cutters, radius

Ball bearing guide D12,7 (2x) Diameter 12,7 mm, Qty. in pack 2 Units	491383
--	--------

Simple and exact.

This profile cutter with its long-drawn radius is the ideal power tool for rounding furniture fronts, tabletops, benches or chairs. Curved or round parts can also be rounded easily with this tool.

Counterprofile cutter spring HW with ball bearing guide, shank 8 mm



D	NL	B	R	s	Order no.
43	21	5	16	8	491130

Accessories for counterprofile cutter, tongue

Ball bearing guide D16 (2x) Diameter 16 mm	491384
--	--------

Framed doors with counterprofile and panelling.

Whether you wish to produce traditional profiles or modern shapes – adjusting the cutting rings is simple with the ball bearing guide.

Counterprofile cutter groove HW with ball bearing guide, shank 8 mm

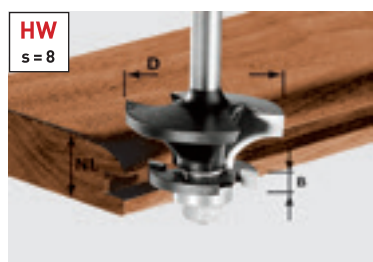

D	NL	B	R	s	Order no.
43	21	5	16	8	491129

Accessories for counterprofile cutter groove HW

Ball bearing guide D16 (2x) Diameter 16 mm	491384
--	--------

Routing tools

Profile tongue cutter, profile groove cutter, facing cutter

Profile/spring cutter HW with ball bearing guide, shank 8 mm

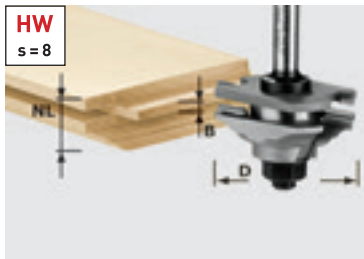

D	NL	B	R	s	Order no.
46	20	4	22	8	490643

For classic furniture fronts.

You can cut classic framed doors in differing styles using these tool sets. The double-edged carbide tools achieve a clean, even routing pattern.

Profile/groove cutter HW with ball bearing guide, shank 8 mm



D	NL	B	R	s	Order no.
46	20	4	22	8	490645



Plane cutter HW with ball bearing guide, shank 12 mm

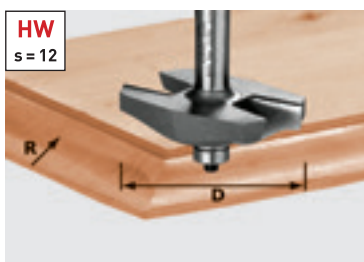

D	NL	GL	R	s	Order no.
67	12	68	19	12	490127

⚠ n max. 22,000



Facing cutter with ball bearing: for cutting classic curved panelling.

Facing cutter HW, shank 8 mm

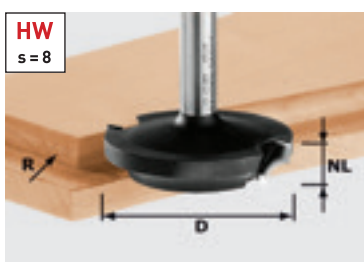

D	NL	GL	R	s	Order no.
42,7	13	50	6	8	491138

Facing and counterprofiling all in one.

You can use this tool to cut the panelling and the frame and produce complete fronts in combination with a disc groove cutter.



06 Routing

Routing tools

Facing cutter, handrail cutter, aluminium cutter

Facing cutter HW, shank 12 mm

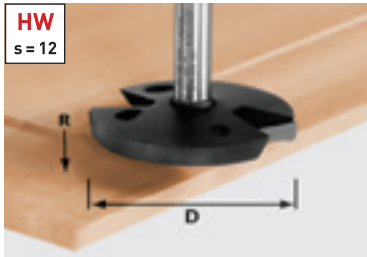

	D	NL	GL	R	s	Order no.
△	68	14	58	35	12	492712
△	n max. 22,000					



Facing cutter without ball bearing: for deeper tapers.

HW hand rail cutter, shank 12 mm

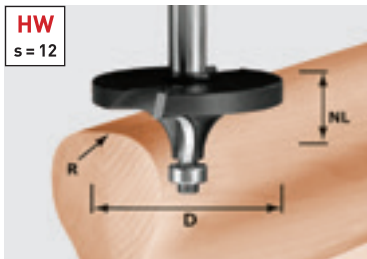

	D	NL	R	s	Order no.	
△	64	26	16	12	492710	
△	n max. 22,000					

Accessories for HW hand rail cutter

Ball bearing guide D12,7 (2x) Diameter 12,7 mm, Qty. in pack 2 Units	491383
--	--------

Bench-mounted router TF 2200.

The CMS with OF 2200 router is ideal for cutting workpieces with larger diameters and always provides a secure support surface during routing.

Hand rail cutter HW Profile, shank 12 mm

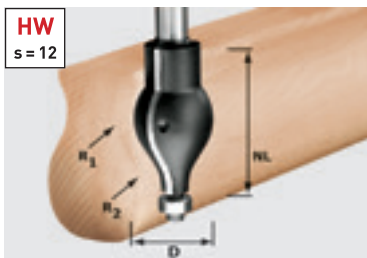

	D	NL	R1	R2	s	Order no.
△	32	57	20	16	12	492711
△	n max. 22,000					

Accessories for HW hand rail cutter

Ball bearing guide D12,7 (2x) Diameter 12,7 mm, Qty. in pack 2 Units	491383
--	--------



Aluminium cutter HS, shank 8 mm

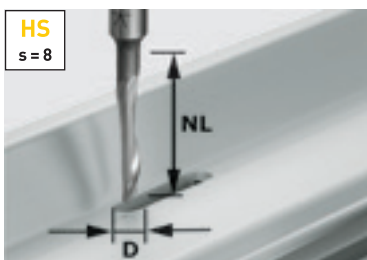

	D	NL	GL	s	Order no.
	5	23	65	8	491036

The aluminium specialist.

The HS aluminium cutter is designed for routing water drainage channels in aluminium profiles up to 2 mm thick.

Routing tools Cutter tools for OFK 500 and putty router KF 5

Roundover cutter, without ball bearing guide

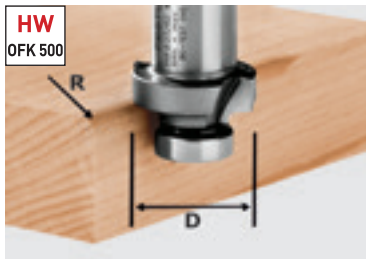

D	R	Order no.
27	2	490092
27	3	490093
27	4	490094
27	5	490095
27	6	490096

Accessories for cutters OFK 500

Ball bearing guide KLS-D 15,8-OFK 490249
for cutter 490090, 490091, 490092,
490093, 490094, 490095, 490096,
491533, with clamping screw



Rounding plastic or solid wood veneer.

Chamfer cutter, without ball bearing guide



D	Alpha	Order no.
27	60	491533
27	45	490090
27	30	490091

Accessories for cutters OFK 500

Ball bearing guide KLS-D 15,8-OFK 490249
for cutter 490090, 490091, 490092,
490093, 490094, 490095, 490096,
491533, with clamping screw



Chamfering plastic or solid wood veneer.

Edge trimming cutter, with ball bearing guide

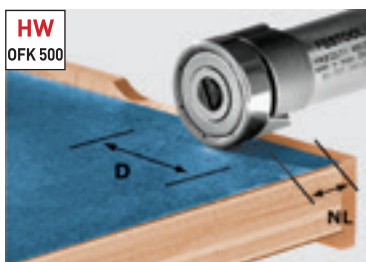

D	NL	s	Order no.
22	8	8	490565
22	8	8	490085*

Accessories for cutters OFK 500

Ball bearing guide KLS-D22-OFK 490250
for cutter 490085, with clamping screw



Flush trimming of plastic or solid wood veneer.

* Flush trim cutter without ball bearing

06 Routing

Routing tools

Cutter tools for OFK 700 and MFK 700

Edge trimming cutter HW, shank 8 mm

HW
s = 8

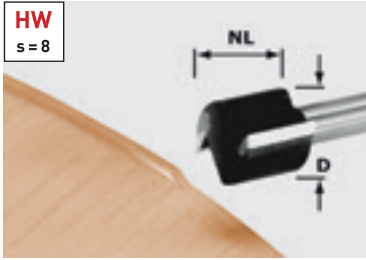

D	NL	GL	s	Order no.
19	15	46	8	491666



You can find a comprehensive selection of slot cutters specially designed for routing and cutting slots for edging on page 288. The cutter spindle is required for this application.

Turning plate edge trimming cutter HW, shank 8 mm

HW
s = 8



D	NL	GL	Alpha	s	Order no.
19	12	52	0	8	499806

Accessories for turning plate edge trimming cutter

Reversible blade HW-WP 12x12x1,5 (4x) 491391

Ball bearing guide D19 (2x) 491385
Diameter 19 mm

Can be used with or without ball bearing.

The recently developed ball bearing attachment system allows you to use trimming cutters with or without a ball bearing guide. Any tool with a ball bearing or external guide system (on the OFK 700, for example) is compatible.

Turning plate chamfer cutter HW, shank 8 mm

HW
s = 8

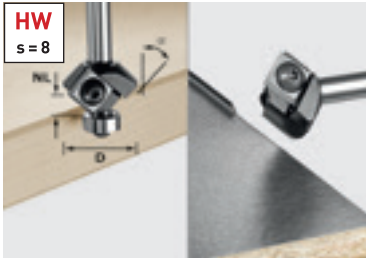

D	NL	GL	Alpha	s	Order no.
27	8	55	45	8	499807

Accessories for turning plate chamfer cutter HW

Ball bearing guide D12,7 (2x) 491383
Diameter 12,7 mm, Qty. in pack 2 Units

Reversible blade HW-WP 12x12x1,5 (4x) 491391

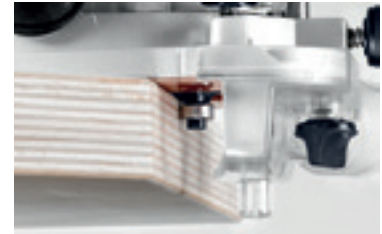

Chamfer cutter HW, shank 8 mm

HW
s = 8



D	NL	GL	Alpha	s	Order no.
18	11	50	15	8	499801
25	11	50	30	8	499800
26	7	48	45	8	499799

Accessories for chamfer cutter HW

Ball bearing guide D12,7 (2x) 491383
Diameter 12,7 mm, Qty. in pack 2 Units



Routing tools Cutter tools for OFK 700 and MFK 700

Classic ogee cutter HW, shank 8 mm



D	NL	GL	R	s	Order no.
20	2,2	47	2	8	499798
22	3,2	48	3	8	499797

Accessories for HW classic ogee cutter

Ball bearing guide D12,7 (2x) Diameter 12,7 mm, Qty. in pack 2 Units	491383
--	--------



Router table 0° for straight routing. Order no. 491427.

Roundover cutter with reversible blades

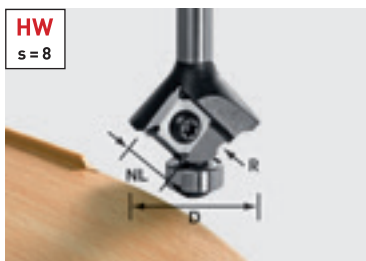

D	NL	GL	R	s	Order no.
28	3	55	1	8	499811
28	3	55	1,5	8	499810
28	3	55	2	8	499809
28	3	55	3	8	499808

Accessories for classic ogee cutter HW with reversible blades

Replacement cutters HW-WP R3 D28 KL12,70FK for Wepla roundover cutters 499808, qty. in pack: 2, reversible blades can be used 4 times, R 3 mm, Diameter 28 mm, Ball bearing 12,7 mm	500369
Replacement cutters HW-WP R2 D28 KL12,70FK for Wepla roundover cutters 499809, qty. in pack: 2, reversible blades can be used 4 times, Ball bearing 12,7 mm, Diameter 28 mm, R 2 mm	500370
Replacement cutters HW-WP R1,5 D28 KL12,70FK for Wepla roundover cutters 499810, qty. in pack: 2, reversible blades can be used 4 times, Ball bearing 12,7 mm, Diameter 28 mm, R 1,5 mm	500371
Replacement cutters HW-WP R1 D28 KL12,70FK for Wepla roundover cutters 499811, qty. in pack: 2, reversible blades can be used 4 times, Ball bearing 12,7 mm, Diameter 28 mm, R 1 mm	500372
Ball bearing guide D12,7 (2x) Diameter 12,7 mm, Qty. in pack 2 Units	491383

Ideal for routing edging: The MFK 700 Basic edge router with spring-loaded ball bearing guide brake and chip deflector, designed specially for machining the most delicate of edging without leaving behind marks.



HW plane cutter for MFK 700 EQ/B-Plus module edge router, shank 8 mm

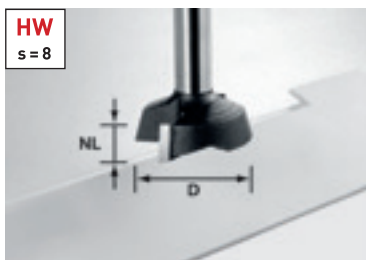

D	NL	GL	Alpha	s	Order no.
28	7	40	15	8	500368



06 Routing

Routing tools

Specialised cutters for solid surface and mineral materials

Reversible blade groove cutter HW, shank 12 mm

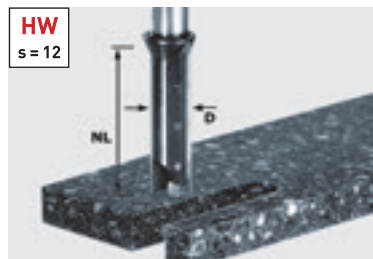

HW
s = 12

D	NL	GL	s	Order no.
14	45	105	12	491110*

Accessories for turning plate groove cutter

Reversible blade HM-WP 50x5,5x1,1 (4x)	491389
--	--------

Extremely resistant to breaking and very efficient.

Solid carbide spiral groove cutters are manufactured from cylindrical rods of carbide specially developed for machining mineral materials and particularly resistant to breaking.

* also suitable for use with OF 2200 and worktop template APS 900

Spiral groove cutter, TC, shank 12 mm

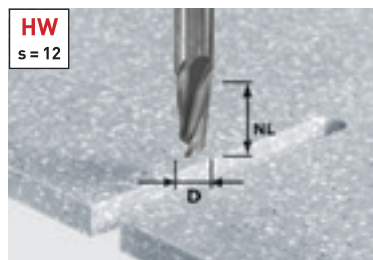

HW
s = 12

D	NL	GL	s	Order no.
12	27	70	12	492654
12	42	87	12	492655



Spiral groove cutter with roughing and finishing, TC, shank 12 mm

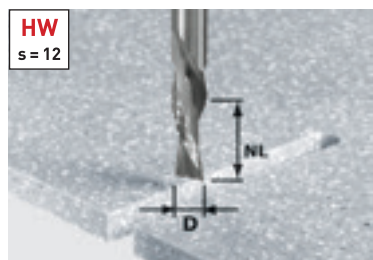

HW
s = 12

D	NL	GL	s	Order no.
12	42	87	12	492656

For fast working progress.

Solid carbide cutters specially designed for routing cut-outs for basins, for example.



Routing tools Specialised cutters for solid surface and mineral materials

Turning plate edge trimming cutter HW with ball bearing guide, shank 12 mm

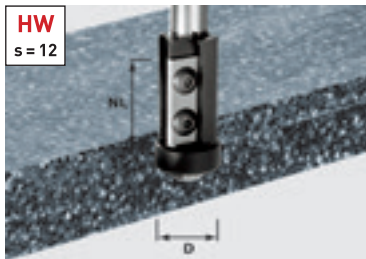

D	NL	GL	s	Order no.
21	30	89	12	491120

Accessories for turning plate edge trimming cutter

Reversible blade HW-WP 30x12x1,5 (4x) for 492716, 492717, 491120 cutters, main plate	491393
Ball bearing guide D21-15,88 (2x) Diameter 21 mm	491408

Precise and durable.

Mineral materials are very demanding on the cutting blade. When working with the ball bearing guide, it is absolutely vital that the cutter and ball bearing guide are permanently aligned. This is why tools with reversible blades pay dividends within a very short time.



Chamfer cutter HW with ball bearing guide, shank 12 mm

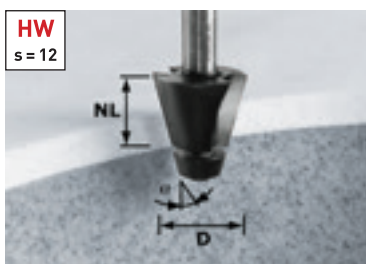

D	NL	Alpha	s	Order no.
33,54	25	15	12	492665

Accessories for chamfer cutter with ball bearing guide

Ball bearing guide D18,5/15° Diameter 18,5 mm	493057
---	--------

Reservoir cutter HW with ball bearing guide, shank 12 mm

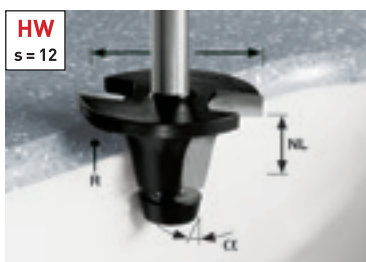

D	NL	R	Alpha	s	Order no.
45	25	6,35	6	12	492671

Accessories for basin cutter with ball bearing guide

Ball bearing guide D21,1/6° for router 6°, Diameter 21,1 mm	493061
Ball bearing guide D12,7 Alpha 6°, Diameter 12,7 mm	491398

Simply ingenious.

If the cutting blade is not aligned with the ball bearing guide exactly after sharpening, the join to the cutter blade can be readjusted by moving the axial ball bearing guide, extending the service life of your Festool basin cutters even longer.

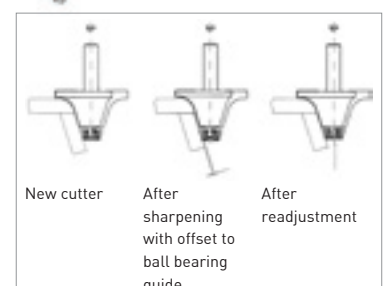

06 Routing

Routing tools

Specialised cutters for solid surface and mineral materials

Carbide-tipped facing cutter, shank 12 mm



D	NL	R	s	Order no.
52	7,3	1,5	12	492701

To suit any task.

Flat protruding edges, e.g. pilaster strip inserts, can be trimmed flush without any problem using the plane cutter.

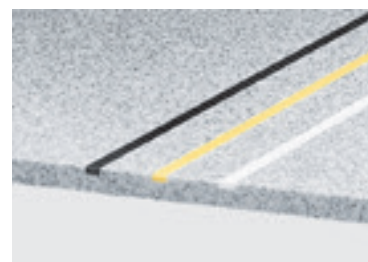

Ogee cutter HW with ball bearing guide, shank 12 mm

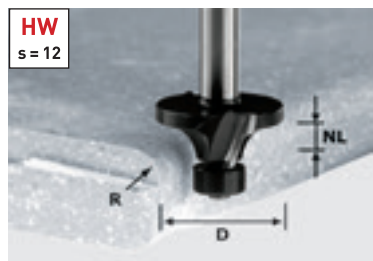

D	NL	R	s	Order no.
22	10	3	12	492681

Accessories for HW classic ogee cutter

Ball bearing guide D16 Diameter 16 mm	493062
Ball bearing guide D12,7 (2x) Diameter 12,7 mm, Qty. in pack 2 Units	491383
Ball bearing guide D 9,53 (2x) Diameter 9,53 mm, Qty. in pack 2 Units	491382



Accessories for HW classic ogee cutter, undercut



Diameter	Order no.
28	493063

Routing tools Specialised cutters for solid surface and mineral materials

Edge trimming cutter with ball bearing, top, shank 12 mm



HW
s = 12

D	NL	s	Order no.
28	25	12	492705

Accessories for edge trimming cutter with roller bearing at the top

Ball bearing guide D28 Diameter 28 mm	493063
---	--------

Edge trimming cutter with ball bearing, bottom, shank 12 mm

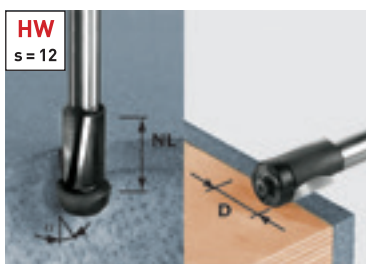

HW
s = 12

D	NL	s	Order no.
19	25	12	492661

Accessories for edge trimming cutter with ball bearing, bottom

Ball bearing guide D19 Diameter 19 mm	493055
Ball bearing guide D22/11° Diameter 22 mm	493056

Two tools in one.

Cutting inlays flush or routing overhangs on fitted basins at an angle of 11°. Both are possible simply by changing the ball bearing guide included in the delivery.

Both replacement ball bearing guides are included in delivery







07 Joining – DOMINO joining system

Overview of products and applications **302**

DOMINO joining machines – DF 500, DF 700 **304**

Accessories and consumable materials **306**

The Festool system

Overview of products and applications

The DOMINO system: Perfect for panel, frame and rack joints as well as narrow, wide, delicate and bulky workpieces. Dowel diameters ranging from 4 to 14 mm for unlimited jointing possibilities.

The DOMINO joiner



DF 500
Page 304



DF 700
Page 305

Applications

Joining boards

Drawers, Ø 4 mm dowels or larger	●	
Cabinet with Ø 5 and 6 mm dowels	●	
Solid wood furniture with Ø 8 and 10 mm dowels	●	○
Solid wood furniture (e.g. beds) with Ø 12 and 14 mm dowels		●

rack joints

Lightweight frame construction (e.g. chairs) up to Ø 10 mm dowels	●	○
Stable frame construction (e.g. tables) with Ø 10 to 14 mm dowels		●
Frame and base structures		●

Frame joints

Furniture fronts with framework construction with Ø 8 and 10 mm dowels	●	○
Solid wood furniture with frame design	○	●
House doors and internal doors		●

Other applications

Joining thin strips, width 25 mm or more.	●	
Joining round poles with the handrail fence.	●	○
Connecting wide cornices (e.g. solid wood panels)	●	●

Technical data

Power consumption (W)	420	720
Max. routing depth (mm)	28	70
DOMINO slot cutter Ø (mm)	4, 5, 6, 8, 10	8, 10, 12, 14
Routing height adjustment (mm)	5 – 30	10 – 50
Mitre routing (°)	0 – 90	0 – 90
Weight (kg)	3,2	5,2

Extremely appropriate ●
Appropriate ○

Every wooden joint has its advantages.
The DOMINO joining system combines them all.



The DOMINO long-hole principle.

Custom-fit alignment: The first DOMINO is positioned in a precision cut elongated hole, the next DOMINOs are inserted into wider holes with play so that the joint can be aligned effortlessly. The result is a stable joint, rotation-proof from the first DOMINO.

Enormous variety of applications.

Two machines. DOMINO sizes ranging from 4 to 14 mm in diameter, flexible adjustment options and compatible system accessories offer virtually unlimited joining possibilities. Even narrow strip material and round poles can easily be joined.

Impressive time savings.

No complicated adjustments or measurements: with integral stop pins for positioning the machine quickly and accurately. It is easy to adapt the routing height and depth to different material thicknesses. When making solid joints, you can save up to half the time with the DOMINO XL.



Beechwood DOMINO

Bear the Pan European Forest Council (PEFC) quality seal for wood products originating from sustainable, well-maintained, responsible forest cultivation.



Hardwood DOMINO

Are weatherproof and resistant to insects and mould, making them ideal for outdoor applications. They are manufactured from wood from sustainably managed and monitored forests.

Joining machine DOMINO DF 500



More precise joints.

- › Varied use with dowel sizes from 4 x 20 mm to 10 x 50 mm
- › Patented routing principle unique to hand-held machines for accurate work with no kickbacks
- › Stops that are quick and easy to adjust, for accurate results
- › Ergonomic shape for ease of operation in any position

Technical data

Power consumption (watt)	420
Idle engine speed (RPM)	25.500
Depth stop for routing depth (mm)	12, 15, 20, 25, 28
Max. routing depth (mm)	28
DOMINO slot cutter dia. (mm)	4, 5, 6, 8, 10
Routing height adjustment (mm)	5 - 30
Mitre routing (°)	0 - 90
Dust extraction connection dia. (mm)	27
Weight (kg)	3,2



Items included

Items included	Order no.
DOMINO cutter D5, support bracket, operation tool, in SYSTAINER SYS 2 T-LOC	
DF 500 Q-Plus	574325
DF 500 Q-Set trim stop, cross stop	574427

A system that joins everything up.

The DOMINO DF 500 is particularly easy to handle and offers almost unlimited jointing possibilities. No matter whether it is panel or cabinet construction, for lightweight frame or rack joints – the DF 500 impresses with maximum precision, flexibility and simple handling.

System accessories
from page 308

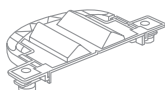

DOMINOs shown starting
on page 308



DOMINO connectors
from page 314 onwards

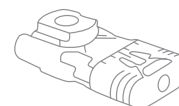

Joining machine DOMINO XL DF 700



Extra mobile. Extra stable.

- › Maximum stability of joints up to a DOMINO size of 14 x 140 mm
- › Patented routing principle unique to hand-held machines for accurate work with no kickbacks
- › Saves more time compared to a stationary machine
- › Stops that are quick and easy to adjust, for accurate results



Technical data	
Power consumption (watt)	720
Idle engine speed (RPM)	21.000
Depth stop for routing depth (mm)	15 – 70
Max. routing depth (mm)	70
DOMINO slot cutter dia. (mm)	8, 10, 12, 14
Routing height adjustment (mm)	10 – 50
Mitre routing (°)	0 – 90
Dust extraction connection dia. (mm)	27
Weight (kg)	5,2



Items included	Order no.
DF 700 EQ-Plus DOMINO cutter D 12, support bracket, 2 x empty dowel box, operation tool, in SYSTAINER SYS 5 T-LOC	574320



The quickest way to join large workpieces.

Comes to the workpiece and not vice versa: DOMINO XL. Quick, simple, precise and extremely stable – with measurably shorter tooling times and up to 50% time-saving in comparison to stationary machines. The DOMINO XL is therefore ideally suited for furniture and door construction and solid wood joints.

System accessories from page 310

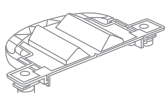

DOMINOs shown starting on page 310



DOMINO connectors from page 315 onwards

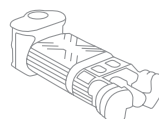

The Festool system. Everything in view.

Because things work better when everything fits together: The DOMINO jointing system offers the right dowels and cutters for every application. Even complicated shapes are easy to join using different stops compatible with both DOMINO jointers.

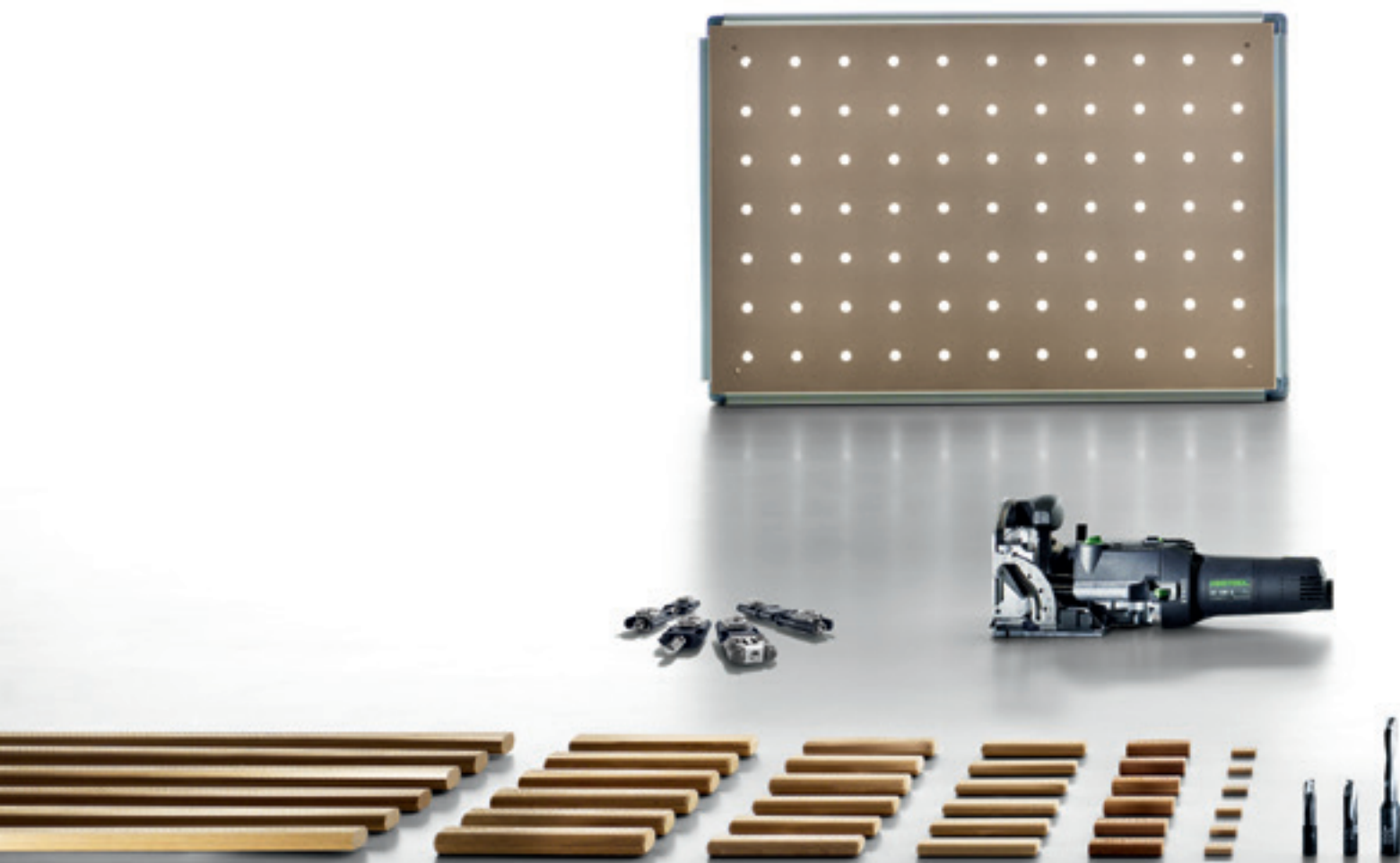

07 Joining – DOMINO joining system

Accessories and consumable materials



System accessories

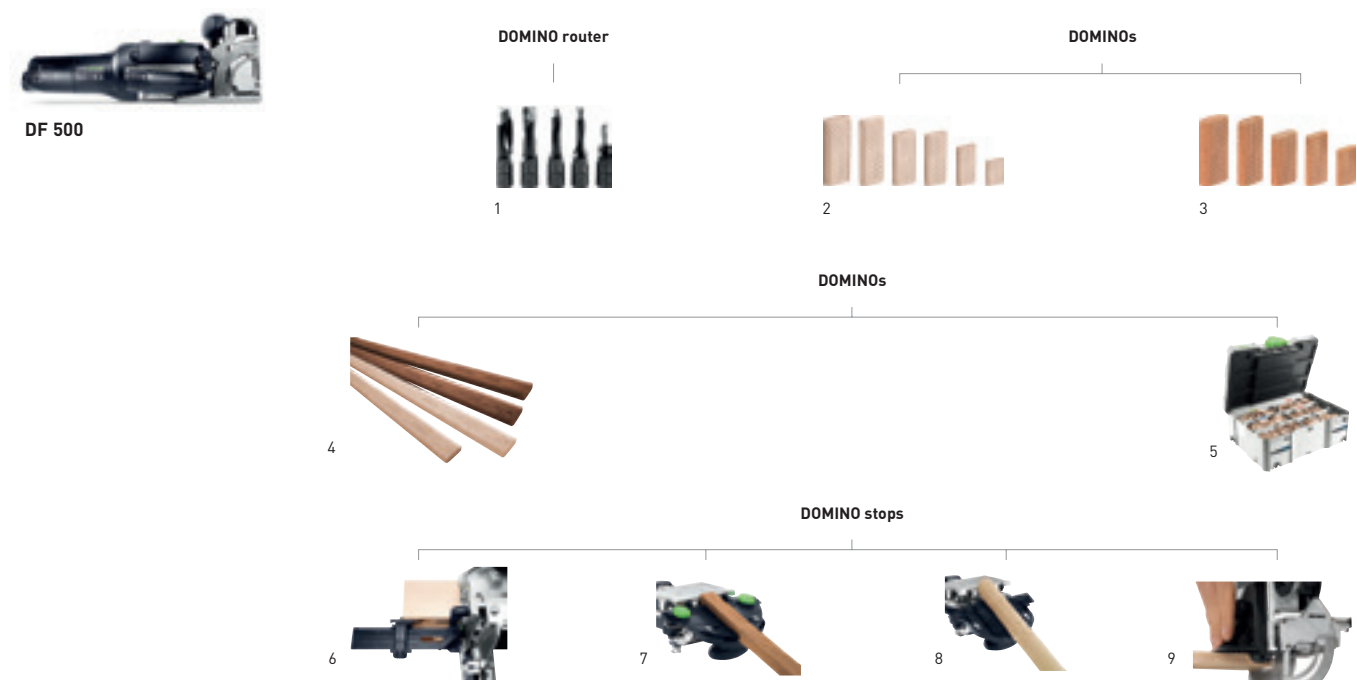

Accessories for DOMINO DF 500 joining machine

Denomination	Explanation	Order no.
1 DOMINO router D 4-NL 11 HW-DF 500	for DF 500, D 4 mm, NL 11 mm, in self-service display pack	495663
DOMINO router D 5-NL 20 HW-DF 500	for DF 500, D 5 mm, NL 20 mm, in self-service display pack	493490
DOMINO router D 6-NL 28 HW-DF 500	for DF 500, D 6 mm, NL 28 mm, in self-service display pack	493491
DOMINO router D 8-NL 28 HW-DF 500	for DF 500, D 8 mm, NL 28 mm, in self-service display pack	493492
DOMINO router D 10-NL 28 HW-DF 500	for DF 500, D 10 mm, NL 28 mm, in self-service display pack	493493
2 DOMINO, beech D 4x20/450 BU	for DF 500, material: Beech, dimensions 4 x 20 mm, qty. in pack 450 Units, in self-service display pack	495661
DOMINO, beech D 5x30/300 BU	for DF 500, material: Beech, dimensions 5 x 30 mm, qty. in pack 300 Units, in self-service display pack	494938
DOMINO, beech D 5x30/1800 BU	for DF 500, material: Beech, dimensions 5 x 30 mm, qty. in pack 1.800 Units, in carton	493296
DOMINO, beech D 6x40/190 BU	for DF 500, material: Beech, dimensions 6 x 40 mm, qty. in pack 190 Units, in self-service display pack	494939
DOMINO, beech D 6x40/1140 BU	for DF 500, material: Beech, dimensions 6 x 40 mm, qty. in pack 1.140 Units, in carton	493297
DOMINO, beech D 8x36/130 BU	for DF 500, material: Beech, dimensions 8 x 36 mm, qty. in pack 130 Units, in self-service display pack	203175
DOMINO, beech D 8x40/130 BU	for DF 500, material: Beech, dimensions 8 x 40 mm, qty. in pack 130 Units, in self-service display pack	494940
DOMINO, beech D 8x40/780 BU	for DF 500, material: Beech, dimensions 8 x 40 mm, qty. in pack 780 Units, in carton	493298
DOMINO, beech D 8x50/100 BU	for DF 500, material: Beech, dimensions 8 x 50 mm, qty. in pack 100 Units, in self-service display pack	494941
DOMINO, beech D 8x50/600 BU	for DF 500, material: Beech, dimensions 8 x 50 mm, qty. in pack 600 Units, in carton	493299
DOMINO, beech D 10x50/85 BU	for DF 500, material: Beech, dimensions 10 x 50 mm, qty. in pack 85 Units, in self-service display pack	494942
DOMINO, beech D 10x50/510 BU	for DF 500, material: Beech, dimensions 10 x 50 mm, qty. in pack 510 Units, in carton	493300

System accessories

Accessories for DOMINO DF 500 joining machine

	Denomination	Explanation	Order no.
3	Sipo DOMINO D 5x30/300 MAU	for DF 500, material: Sipo, mahogany dowels, weatherproof, dimensions 5 x 30 mm, qty. in pack 300 Units, in self-service display pack	494869
	Sipo DOMINO D 5x30/900 MAU	for DF 500, material: Sipo, mahogany dowels, weatherproof, dimensions 5 x 30 mm, qty. in pack 900 Units, in carton	494859
	Sipo DOMINO D 6x40/190 MAU	for DF 500, material: Sipo, mahogany dowels, weatherproof, dimensions 6 x 40 mm, qty. in pack 190 Units, in self-service display pack	494870
	Sipo DOMINO D 6x40/570 MAU	for DF 500, material: Sipo, mahogany dowels, weatherproof, dimensions 6 x 40 mm, qty. in pack 570 Units, in carton	494860
	Sipo DOMINO D 8x40/130 MAU	for DF 500, material: Sipo, mahogany dowels, weatherproof, dimensions 8 x 40 mm, qty. in pack 130 Units, in self-service display pack	494871
	Sipo DOMINO D 8x40/390 MAU	for DF 500, material: Sipo, mahogany dowels, weatherproof, dimensions 8 x 40 mm, qty. in pack 390 Units, in carton	494861
	Sipo DOMINO D 8x50/100 MAU	for DF 500, material: Sipo, mahogany dowels, weatherproof, dimensions 8 x 50 mm, qty. in pack 100 Units, in self-service display pack	494872
	Sipo DOMINO D 8x50/300 MAU	for DF 500, material: Sipo, mahogany dowels, weatherproof, dimensions 8 x 50 mm, qty. in pack 300 Units, in carton	494862
	Sipo DOMINO D 10x50/85 MAU	for DF 500, material: Sipo, mahogany dowels, weatherproof, dimensions 10 x 50 mm, qty. in pack 85 Units, in self-service display pack	494873
	Sipo DOMINO D 10x50/255 MAU	for DF 500, material: Sipo, mahogany dowels, weatherproof, dimensions 10 x 50 mm, qty. in pack 255 Units, in carton	494863
4	DOMINO beechwood D 8x750/36 BU	for DF 700, material: Beech, dimensions 8 x 750 mm, qty. in pack 36 Units, in carton	498686
	DOMINO beechwood D 10x750/28 BU	for DF 700, material: Beech, dimensions 10 x 750 mm, qty. in pack 28 Units, in carton	498687
	DOMINO Sipo D 8x750/36 MAU	for DF 700, material: Sipo, dimensions 8 x 750 mm, qty. in pack 36 Units, in carton	498690
	DOMINO Sipo D 10x750/28 MAU	for DF 700, material: Sipo, dimensions 10 x 750 mm, qty. in pack 28 Units, in carton	498691
5	DOMINO, beech range DS 4/5/6/8/10 1060x BU	for DF 500, DOMINO 4 x 20, 5 x 30, 6 x 40, 8 x 40, 8 x 50, 10 x 50 mm and DOMINO router cutters for sizes 4, 5, 6, 8 and 10, dimensions 396 x 296 x 157,5 mm, qty. in pack 1.060 Units, in SYSTAINER SYS 2 T-LOC	498899
6	Cross stop QA-DF 500/700	for DF 500 and DF 700, for repeat hole spacing between 100 and 205 mm, items included: A left and right cross stop, for precise positioning of milling grooves 100-205 mm away from edges, in self-service display pack	498590
7	Trim stop LA-DF 500/700	for DF 500 and DF 700, for strip material with widths between 22 and 70 mm, qty. in pack 1 Units, in self-service display pack	493487
8	Handrail fence RA DF 500/700	for DF 500 and DF 700, for round wooden poles, dia. 35 – 60 mm, for precise routing of round poles Ø 35 – 60 mm, in self-service display pack	494847
9	Additional stop ZA-DF 500	for DF 500, support widener and side stop, for reducing the dowel centre from 37 mm to 20 mm, for secure positioning of the router, in carton	495666

System accessories



DF 700

DOMINO router



1

DOMINOs



2

DOMINOs



3



4



5

DOMINO stops



6



7



8

Accessories for DOMINO XL DF 700 joining machine

Denomination	Explanation	Order no.
1 DOMINO router D 8-NL 50 HW-DF 700	for DF 700, routing tools with threaded supports for the DOMINO joining machine XL DF 700, D 8 mm, NL 50 mm, in self-service display pack	497868
DOMINO router D 10-NL 70 HW-DF 700	for DF 700, routing tools with threaded supports for the DOMINO joining machine XL DF 700, D 10 mm, NL 70 mm, in self-service display pack	497869
DOMINO router D 12-NL 70 HW-DF 700	for DF 700, routing tools with threaded supports for the DOMINO joining machine XL DF 700, D 12 mm, NL 70 mm, in self-service display pack	497870
DOMINO router D 14-NL 70 HW-DF 700	for DF 700, routing tools with threaded supports for the DOMINO joining machine XL DF 700, D 14 mm, NL 70 mm, in self-service display pack	497871
2 DOMINO, beech D 8x80/190 BU	for DF 700, material: Beech, dimensions 8 x 80 mm, qty. in pack 190 Units, in carton	498212
DOMINO, beech D 8x100/150 BU	for DF 700, material: Beech, dimensions 8 x 100 mm, qty. in pack 150 Units, in carton	498213
DOMINO, beech D 10x80/150 BU	for DF 700, material: Beech, dimensions 10 x 80 mm, qty. in pack 150 Units, in carton	498214
DOMINO, beech D 10x100/120 BU	for DF 700, material: Beech, dimensions 10 x 100 mm, qty. in pack 120 Units, in carton	498215
DOMINO, beech D 12x100/100 BU	for DF 700, material: Beech, dimensions 12 x 100 mm, qty. in pack 100 Units, in carton	498216
DOMINO, beech D 12x140/90 BU	for DF 700, material: Beech, dimensions 12 x 140 mm, qty. in pack 90 Units, in carton	498217
DOMINO, beech D 14x75/104 BU	for DF 700, for processing using the DOMINO XL DF 700 joining machine, material: Beech, ideal in combination with the DOMINO corner connectors (precisely matched to the milling depth of the corner connectors), provides further load transfer in addition to the connectors, qty. in pack 104 Units, dimensions 14 x 75 mm, in carton	201499
DOMINO, beech D 14x100/80 BU	for DF 700, material: Beech, dimensions 14 x 100 mm, qty. in pack 80 Units, in carton	498218
DOMINO, beech D 14x140/70 BU	for DF 700, material: Beech, dimensions 14 x 140 mm, qty. in pack 70 Units, in carton	498219

System accessories

Accessories for DOMINO XL DF 700 joining machine

Denomination	Explanation	Order no.
3 DOMINO beechwood D 8x750/36 BU	for DF 700, material: Beech, dimensions 8 x 750 mm, qty. in pack 36 Units, in carton	498686
DOMINO beechwood D 10x750/28 BU	for DF 700, material: Beech, dimensions 10 x 750 mm, qty. in pack 28 Units, in carton	498687
DOMINO beechwood D 12x750/22 BU	for DF 700, material: Beech, dimensions 12 x 750 mm, qty. in pack 22 Units, in carton	498688
DOMINO beechwood D 14x750/18 BU	for DF 700, material: Beech, dimensions 14 x 750 mm, qty. in pack 18 Units, in carton	498689
DOMINO Sipo D 8x750/36 MAU	for DF 700, material: Sipo, dimensions 8 x 750 mm, qty. in pack 36 Units, in carton	498690
DOMINO Sipo D 10x750/28 MAU	for DF 700, material: Sipo, dimensions 10 x 750 mm, qty. in pack 28 Units, in carton	498691
DOMINO Sipo D 12x750/22 MAU	for DF 700, material: Sipo, dimensions 12 x 750 mm, qty. in pack 22 Units, in carton	498692
DOMINO Sipo D 14x750/18 MAU	for DF 700, material: Sipo, dimensions 14 x 750 mm, qty. in pack 18 Units, in carton	498693
4 DOMINO XL beechwood DOMINO DS/XL D8/D10 306x BU	for DOMINO XL, DOMINO XL beechwood dowel range, DOMINO 8 x 50, 8 x 80, 8 x 100, 10 x 50, 10 x 80, 10 x 100 mm and DOMINO XL cutter for sizes 8 and 10, qty. in pack 306 Units, in SYSTAINER SYS 2 T-LOC	498204
DOMINO XL beechwood DOMINO DS/XL D12/D14 128x BU	for DOMINO XL, DOMINO XL beechwood dowel range, DOMINO 12 x 100, 12 x 140, 14 x 100, 14 x 140 mm and DOMINO XL cutter for size 14, qty. in pack 128 Units, in SYSTAINER SYS 2 T-LOC	498205
5 SYSTAINER T-LOC SORT-SYS 2 TL DOMINO	empty Systainer SYS 2 T-LOC, contains 3 boxes with flexible compartment division for individual filling of DOMINOs, in SYSTAINER SYS 2 T-LOC	498889
6 Cross stop QA-DF 500/700	for DF 500 and DF 700, for repeat hole spacing between 100 and 205 mm, items included: A left and right cross stop, for precise positioning of milling grooves 100-205 mm away from edges, in self-service display pack	498590
7 Trim stop LA-DF 500/700	for DF 500 and DF 700, for strip material with widths between 22 and 70 mm, qty. in pack 1 Units, in self-service display pack	493487
8 Handrail fence RA DF 500/700	for DF 500 and DF 700, for round wooden poles, dia. 35 – 60 mm, for precise routing of round poles Ø 35 – 60 mm, in self-service display pack	494847



Stability joins flexibility.

Quick

The connectors can be accurately and precisely positioned in next to no time, without any need for templates or other special machines. Complex measuring and marking are no longer required. This saves a lot of time, prevents unnecessary reworking and makes work easier.

Stable

The combination of dowel and fixed clamp guarantees an extremely strong joint. In addition, the large pulling and tightening distance ensures it is very stable, even during set-up. You can rely on the flexible DOMINO connectors in every situation.

Flexible

Create robust joints quickly and simply with the DOMINO connectors – and loosen them again when required. Perfect for corner and surface joints, and now for center panel joints and joints between series of holes. The cover caps in various colours provide the perfect finishing touch.

Perfect connections made easy.
The DOMINO family at a glance.

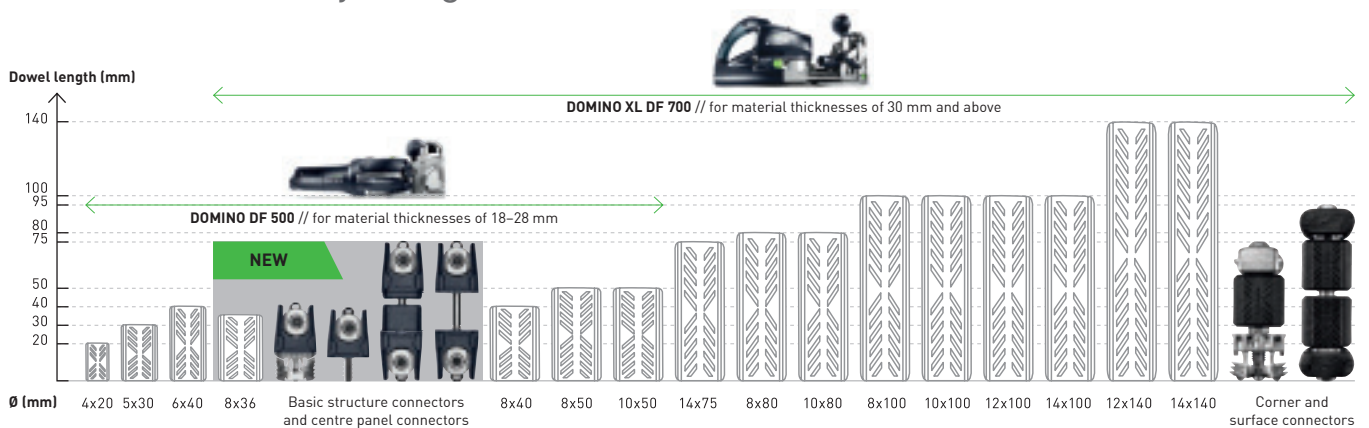

The 8–14 mm diameters are also available as rods and in two types of timber for interior and exterior applications. From sustainable forestry.

NEW

The basic structure connectors and furniture connectors for the DOMINO DF 500 joining machine.

Corner joints, center panel joints and joints between series of holes for material thicknesses of 18 mm to 28 mm. Everything is possible with the new connectors. They can be universally positioned with DOMINO dowel or in a series of holes and guarantee scratch-free transportation of items of furniture thanks to the flush-screwed fixture elements. These connectors significantly facilitate work when producing, assembling and disassembling furniture.



Corner connector –
for DOMINO/DOMINO joint



Corner connector –
for DOMINO/LR 32 joint



Centre panel connector –
for DOMINO/DOMINO joint



Centre panel connector –
for DOMINO/LR 32 joint

The corner and surface connectors for the DOMINO XL DF 700 joining machine.

For frame, rack and panel joints for material thicknesses of 30 mm and above – these impress not only with their extremely high precision and stability, but also thanks to their optimum flexibility and unparalleled efficiency. Create perfect wooden joints in next to no time with these connectors and the DOMINO XL DF 700 – and loosen them again just as quickly.



Corner connector



Flat connectors



Surface connector with extension clips –
specially for materials such as kitchen worktops

System accessories



DF 500

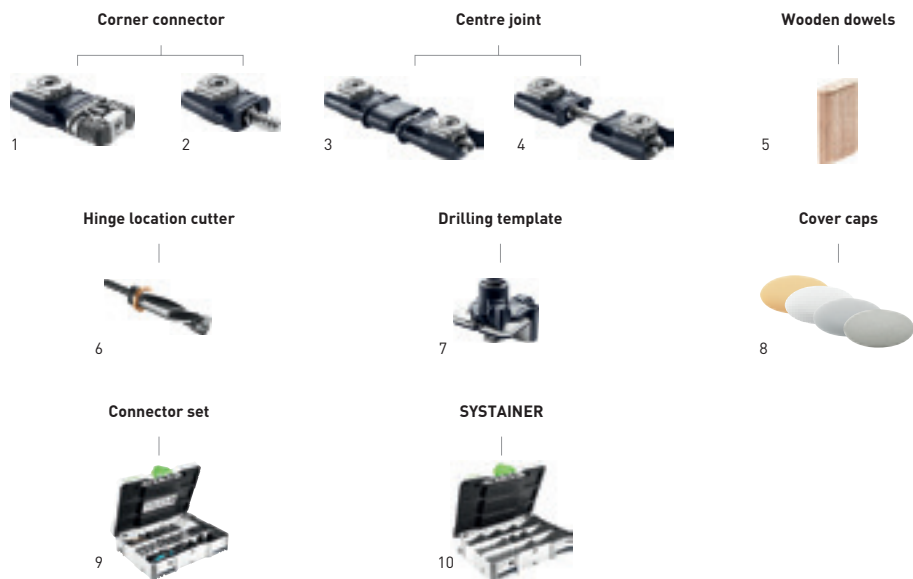

DOMINO corner and surface connectors for DF 500

Denomination	Explanation	Order no.
1 Corner connection KV D8/50	for 50 corner joints with the DF 500, the DOMINO/DOMINO KV D8/50 connector is positioned both in the cupboard panel and the base of the structure with the DOMINO joiner DF 500, 50 x Split anchor, 50 x Bolt with M4 thread, 50 x Plastic trays, 50 x Cross anchor with threaded pin, without cover caps, joint fixture (8 mm DOMINO dowel cross-cuts) D8, dino routing depth for side part 15 mm, DOMINO routing depth for base part 28 mm, drilling diameter in base part 15 mm, panel thickness 18 – 28 mm, in carton	203166
2 Corner connection KV-LR32 D8/50	for 50 corner joints with the DF 500 and drilling series of holes, the DOMINO/LR 32 KV-LR 32 D8/50 connector is positioned both in the cupboard panel in a 5 mm hole in the series of holes and the base of the structure with the DOMINO joiner DF 500, Split anchor, 50 x Bolt with Euro thread for drilling series of holes, 50 x Plastic trays, 50 x Cross anchor with threaded pin, without cover caps, joint fixture (8 mm DOMINO dowel cross-cuts) D8, drilling diameter for Euro bolt 5 mm, DOMINO routing depth for base part 28 mm, drilling diameter in base part 15 mm, panel thickness 18 – 28 mm, in carton	203168
3 Centre panel connector MSV D8/25	for 25 centre panel joints with the DF 500, drill template is required for drilling holes in the surface of the DOMINO D 8 mm joint fixture, the DOMINO/DOMINO MSV D8/25 connector is positioned both in the cupboard panel and the base of the structure with the DOMINO joiner DF 500, 25 x Bolt with external thread for DOMINO centre panel connector, 25 x Bolt with internal thread for DOMINO centre panel connector, 50 x Plastic trays, 50 x Cross anchor with threaded pin, without cover caps, joint fixture (8 mm DOMINO dowel cross-cuts) D8, dino routing depth for side part 15 mm, DOMINO routing depth for base part 28 mm, drilling diameter in base part 15 mm, panel thickness 18 – 28 mm, in carton	203167
4 Centre panel connector MSV-LR32 D8/25	for 25 centre panel joints with the DF 500 and drilling series of holes, drill template is required for drilling holes in the surface of the DOMINO D 8 mm joint fixture, the DOMINO/LR 32 MSV-LR 32 D8/25 connector is positioned both in the cupboard panel in a 5 mm hole in the series of holes and the base of the structure with the DOMINO joiner DF 500, 25 x Bolt with external thread for centre panel connector, 25 x Bolt with internal thread for centre panel connector, 50 x Plastic trays, 50 x Cross anchor with threaded pin, without cover caps, joint fixture (8 mm DOMINO dowel cross-cuts) D8, drilling diameter for Euro bolt 5 mm, DOMINO routing depth for base part 28 mm, drilling diameter in base part 15 mm, panel thickness 18 – 28 mm, in carton	203169
5 DOMINO, beech D 8x36/130 BU	for DF 500, material: Beech, dimensions 8 x 36 mm, qty. in pack 130 Units, in self-service display pack	203175
6 Hinge location cutter KVB-HW D15 CE	for DF 500, 15 mm hinge location cutter is required for drilling holes in the surface of the DOMINO D 8 mm joint fixture, Shaft mount: CENTROTEC, the drill bit is adapted to Festool drill template no. 203164, depth stop, drill bit dia. 15 mm, in self-service display pack	203165
7 Drilling template BS-KV D15	for DF 500, drill template is required for drilling holes in the surface of the DOMINO D 8 mm joint fixture, adapted to Festool D15 hinge location cutter, no. 203165, drill guide dia. 15 mm, panel thickness 18 – 28 mm, in carton	203164
8 Cover cap KV-AK D15 brn/50	for DF 500, for covering the DOMINO D 8 mm joint fixture, colour: Light brown, qty. in pack 50 Units, in self-service display pack	203171
Cover cap KV-AK D15 wht/50	for DF 500, for covering the DOMINO D 8 mm joint fixture, white, qty. in pack 50 Units, in self-service display pack	203173
Cover cap KV-AK D15 gr/50	for DF 500, for covering the DOMINO D 8 mm joint fixture, Colour: grey, qty. in pack 50 Units, in self-service display pack	203174
Cover cap KV-AK D15 slr/50	for DF 500, for covering the DOMINO D 8 mm joint fixture, colour: Lacquered silver, qty. in pack 50 Units, in self-service display pack	203172
9 DOMINO connector range KV-SYS D8	70 x DOMINO/DOMINO KV D8 basic structure connector, 20 x DOMINO/LR32 KV-LR32 D8 basic structure connector, 10 x DOMINO/DOMINO MSV D8 centre panel connector, 10 x DOMINO/LR32 MSV-LR32 D8 centre panel connector, 50 dark brown cover caps, KV-AK D15 brn, 50 silver cover caps, KV-AK D15 slr, 50 white cover caps, KV-AK D15 wht, 50 grey cover caps, KV-AK D15 gr, 20 x DOMINO D 8 x 36 mm, BS-KV D15 drill template, KVB-HW D15 CE hinge location cutter, Screwdriver, in SYSTAINER SYS 1 T-LOC	203170
10 SYSTAINER SORT-SYS1TL DOMINO	Empty Systainer SYS 1 T-LOC, contains 3 boxes with flexible compartment division for individual filling of DOMINOs or other accessories or tools, Long plastic containers, in SYSTAINER SYS 1 T-LOC	203176

System accessories



DF 700

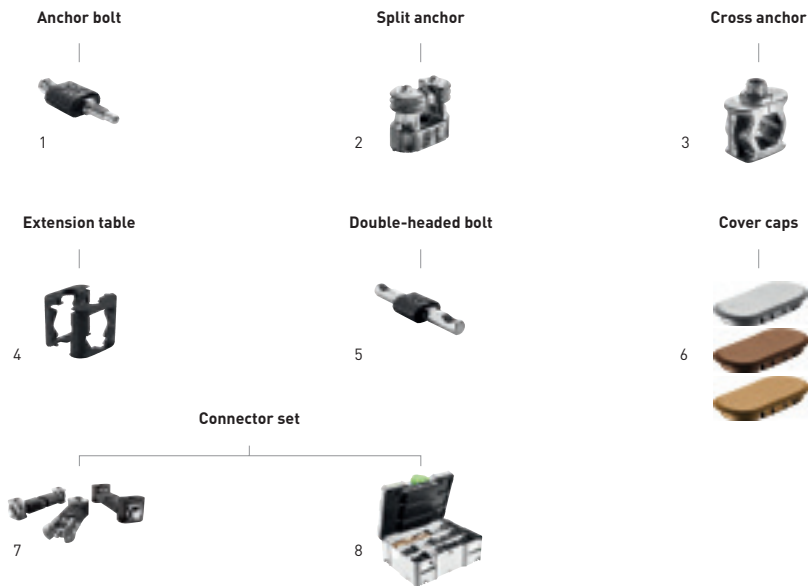

DOMINO corner and surface connectors for DF 700

Denomination	Explanation	Order no.
1 Anchor bolt SV-AB D14/32	for processing using the DOMINO XL DF 700 joining machine, corner connectors for frame and rack joints at material thicknesses of 30 mm or higher, in conjunction with SV-SA D14 split anchors and SV-QA D14 cross anchors for creating corner connections, 64 x dowel half-shells, qty. in pack 32 Units, in carton	201350
2 Split anchor SV-SA D14/32	for processing using the DOMINO XL DF 700 joining machine, corner connectors for frame and rack joints at material thicknesses of 30 mm or higher, in conjunction with SV-AB D14 anchor bolts and SV-QA D14 cross anchors for creating detachable corner connections, qty. in pack 32 Units, in carton	201349
3 Cross anchor SV-QA D14/32	for processing using the DOMINO XL DF 700 joining machine, at a material thickness of 30 mm or higher, acts as a counter bearing and tightening element for anchor bolts or double-headed bolts, with soft or porous material such as chipboard, the use of the cross anchor expander SV-V D14 is recommended (for material thickness 35 mm and greater – stops the cross anchor being pulled into the material), in conjunction with SV-SA D14 split anchors and SV-AB D14 anchor bolts for creating corner connections, in conjunction with SV-DB D14 double-headed bolts for creating flat connections, 32 x set screws, qty. in pack 32 Units, in carton	201351
4 Extension table SV-V D14/32	for SV-QA D14 cross anchors, for processing cross anchors for improved pressure distribution for applications in porous or soft materials such as kitchen worktops, prevents the cross anchor being drawn into the material, 64 half-shells for widening 32 cross anchors, qty. in pack 32 Units, in carton	201498
5 Double-headed bolt SV-DB D14/16	for processing using the DOMINO XL DF 700 joining machine, in conjunction with 2x SV-QA D14 cross anchors (and optional SV-V D14 widening clips for soft materials) for creating flat connections in furniture manufacturing, 64 x dowel half-shells, qty. in pack 16 Units, in carton	201352
6 Cover cap SV-AK D14 slr/32	for processing using the DOMINO XL DF 700 joining machine, plastic cover caps for closing D14 dowel cross-cuts, colour: Lacquered silver, qty. in pack 32 Units, in self-service display pack	201354
Cover cap SV-AK D14 brn1/32	for processing using the DOMINO XL DF 700 joining machine, plastic cover caps for closing D14 dowel cross-cuts, colour: Dark brown, qty. in pack 32 Units, in self-service display pack	201355
Cover cap SV-AK D14 brn2/32	for processing using the DOMINO XL DF 700 joining machine, plastic cover caps for closing D14 dowel cross-cuts, colour: Light brown, qty. in pack 32 Units, in self-service display pack	201356
7 Connector set EV/32-Set	corner connectors for frame and rack joints at material thicknesses of 30 mm or higher, complete set consisting of anchor bolts, split anchors and cross anchors for 32 corner connectors, 32 anchor bolts, SV-AB D14, 32 cross anchors, SV-QA D14, 32 split anchors, SV-SA D14, in carton	203420
Connector set FV/16-Set	surface connectors, complete set for 16 surface connections consisting of double-headed bolts, cross anchors and wideners, 16 double-headed bolts, SV-DB D14, 32 cross anchors, SV-QA D14, SV-V D14 widener for 32 cross anchors, in carton	203421
8 DOMINO connector range SV-SYS D14	for processing using the DOMINO XL DF 700 joining machine, includes corner connectors and flat connectors incl. cover caps and DOMINO wooden dowels, required accessories: DOMINO cutter D 14 (497871), 32 anchor bolts, SV-AB D14, 16 double-headed bolts, SV-DB D14, 32 split anchors, SV-SA D14, 32 x DOMINO birch D 14 x 75, 2 x 32 cross anchors, SV-QA D14, SW 4 pin wrench for tightening the set screws, SV-V D14 widener for 32 cross anchors, 32 cover caps, silver, SV-AK D14 slr, 32 cover caps, dark brown, SV-AK D14 brn1, 32 cover caps, light brown, SV-AK D14 brn2, in SYSTAINER SYS 2 T-LOC	201353



08 Planing

Overview of products and applications	318
--	------------

Electric planers

One handed planer – EHL 65 EQ	320
-------------------------------	------------

Planer – HL 850	321
-----------------	------------

Accessories and consumable materials	323
---	------------

The Festool system



Overview of products and applications

Whether lightweight and handy for assembly tasks or with the maximum rebate depth for an unlimited range of applications – Festool planers have one thing in common: Excellent results.

Electric planers



EHL 65 EQ
Page 320



HL 850
Page 321

Applications		
rebating		
Door and window rebates up to 23 mm	●	
Unlimited rebate depth		●
Strip material, edges, beams, planks, flat surfaces		
Trimming work (strip material, edges, board material)	●	
Planing beams, planks and broad surfaces		●
Proximate planing		●
Texturing wooden surfaces		●
Precise results		
Drawing cut for clean surfaces	●	●
Trimming and planing precise angles		●
Operation and handling		
One-handed operation	●	
Suitable for stationary operation	●	●
Dust extraction connector on either side	●	●
Technical data		
Power consumption (W)	720	850
Rotational speed (rpm)	15.600	11.000
Planing width (mm)	65	82
Planing depth (mm)	0 – 4	0 – 3,5
Max. rebate depth (mm)	23	∞
Connection Ø d/e (mm)	27	36
Weight (kg)	2,4	3,9

Extremely appropriate ●
Appropriate ○



The principle of the one-handed planer is exemplary.

Carpenters still regard the classic hand planer as the machine to use for demanding surfaces. With a drawing cut and perfect adjustment of the blade angle, we have adopted and transferred this principle to the unique spiral blade.

Noticeably more refined, considerably quieter.

The spiral blade is diagonal instead of horizontal and makes a drawing cut that reduces machine noise considerably and produces a much more refined planing pattern. No chatter marks. No reworking.

Simply faster.

The simple blade replacement system with automatic adjustment function eliminates the need to adjust the blade cutting circle diameter.

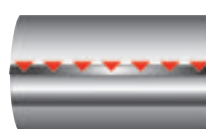

Operating principle: classic planer blade

The blade meets the wood head-on, resulting in a "chopping cut" that leaves behind chatter marks and splinters. The high forces exerted on the drive shaft also increase tool wear.

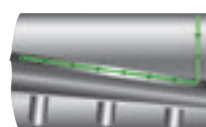

Operating principle: spiral blade

Initial contact is made over a small surface and force is then transferred smoothly across the entire width of the blade. The angled blade strips off the wood more gently and decreases tool wear.

One handed planer EHL 65 EQ



Modified slightly. Improved decisively.

- › Only 2.4 kg, compact height, soft grip on handle and chip depth adjustment, additional grips for better support
- › Quiet: The spiral blade reduces the noise level considerably
- › Maximum 4 mm planing depth and 23 mm rebate depth for more speed and flexibility
- › Variable chip depth adjustment and spiral blade for high surface quality in diverse application areas

Technical data

Power consumption (watt)	720
Planer shaft speed (RPM)	15.600
Planing width (mm)	65
Planing depth (mm)	0 – 4
Max. rebate depth (mm)	23
Dust extraction connection dia. (mm)	27
Weight (kg)	2,4



Items included

EHL 65 EQ-Plus
parallel side fence, operation tool, in SYSTAINER SYS 2 T-LOC

Order no.

574557

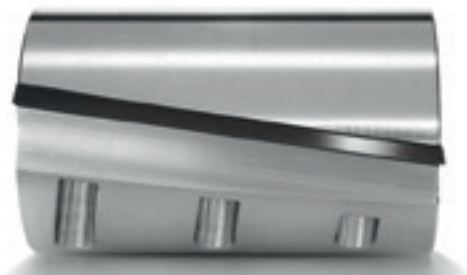

Unique results.

The EHL 65 EQ operates with a drawing cut to produce a particularly fine planing pattern. No chatter marks. No rework.

System accessories from page 323

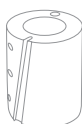

Planer HL 850



Planer with no limits.

- › Planing to the edge, single-bearing planing head for unlimited rebating depths
- › Precision chamfering – with 90° V groove in the planer foot
- › Precision – stepless cutting depth
- › Greater precision when rebating and trimming

Technical data

Power consumption (watt)	850
Planer shaft speed (RPM)	11.000
Planing width (mm)	82
Planing depth (mm)	0 – 3,5
Dust extraction connection dia. (mm)	36
Weight (kg)	3,9
Max. rebate depth	∞



■ = Electronic

Items included

HL 850 EB-Plus
parallel side fence, rebate depth stop, extraction adapter, operation tool,
in SYSTAINER SYS 3 T-LOC

Order no.

574550



Texturing surfaces.

Individual rustic planer heads for creating textured surfaces – replaced with a single hand movement.

System accessories
from page 323

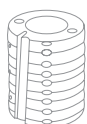

Narrow, wide or rustic waves.

Narrow, wide or rustic waves. Replacing the planing head for textured planing requires a single hand movement. Achieving attractive, natural wooden surfaces could not be easier.

Special planer heads for individually textured wooden surfaces.



Rustic

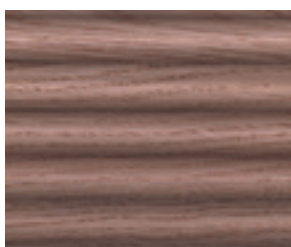

Wide

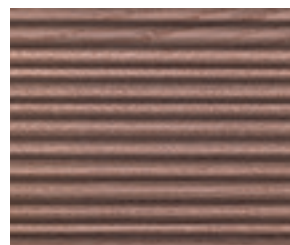

Narrow



System accessories

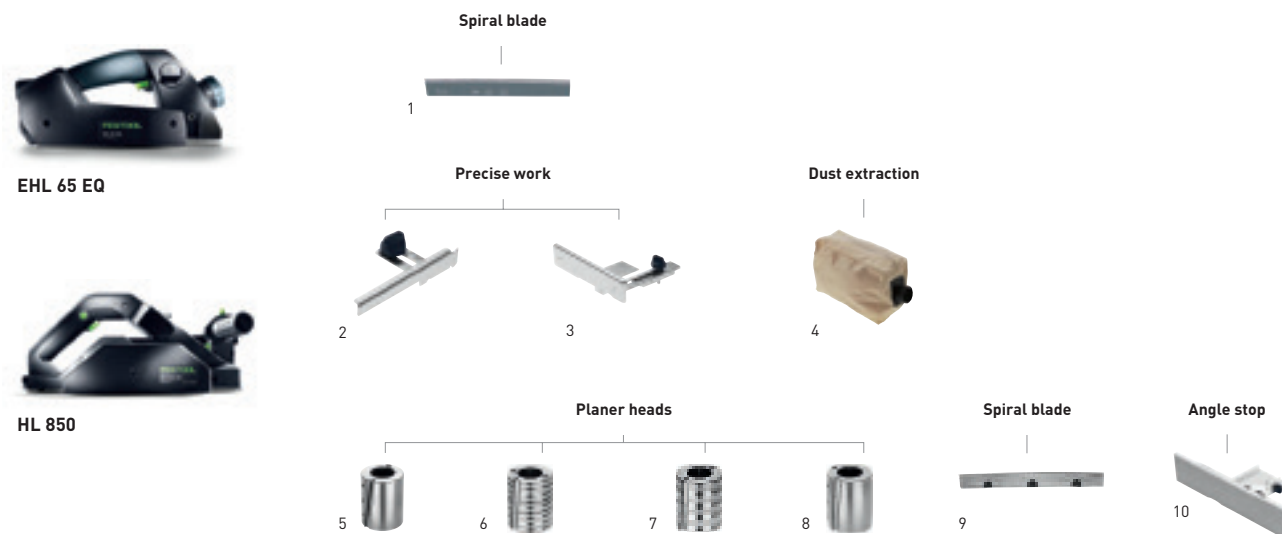

Accessories for one-handed planer EHL 65, planer HL 850

Denomination	Explanation	Order no.
1 Spiral blade HW 65	for EHL 65, HW version for the EHL 65, HW standard planer blades with 65 mm width, in self-service display pack	488503
2 Rebate depth stop FA-EHL	for EHL 65, for rebate depths of 0-23 mm, in self-service display pack	488543
Rebate depth stop FA-HL	for HL 850, for rebate depths of 0-30 mm, in self-service display pack	484512
3 Parallel side fence PA-EHL	for EHL 65, for side guidance, adjustable between 0 mm and 65 mm, in self-service display pack	488544
Parallel side fence PA-HL	for HL 850, for side guidance, adjustable between 0 mm and 82 mm, in self-service display pack	484513
4 Chip collection bag SB-EHL	for EHL 65, in carton	488566
Chip collection bag SB-HL	for HL 850, without suction adapter, in carton	484509
Extraction adapter AD-HL	for HL 850, for chip collection bag and suction hose with bushing, suction hose diameter 36 mm, in self-service display pack	484507
5 Planing head HK 82 SD	standard design, with HW carbide-tipped spiral blade HW 82 SD, in self-service display pack	484520
6 Planing head HK 82 RF	rustic design, fine, with spiral blade HS 82 RF, depth limiter, in self-service display pack	484521
7 Planing head HK 82 RG	for HL 850, rustic design, coarse, with HS spiral blade HS 82 RG, depth limiter, in self-service display pack	484522
8 Planing head HK 82 RW	for HL 850, rustic design, undulating, with HS spiral blade HS 82 RW, depth limiter, in self-service display pack	485331
9 Spiral blade HW 82 SD	for planer head HK 82 SD, HM standard design, HW standard planer blades with 82 mm width, in self-service display pack	484515
Spiral blade HS 82 RF	for planer head HK 82 RF, HSS rustic design, fine, in self-service display pack	484518
Spiral blade HS 82 RG	for planer head HK 82 RG, HSS rustic design, coarse, in self-service display pack	484519
Spiral blade HS 82 RW	for planer head HK 82 RW, HSS rustic design, undulating, in self-service display pack	485332
10 Angle stop WA-HL	for HL 850 EB, can also be used as stop for bench unit SE-HL, for planing at angles of 0-45°, stop area (length x height) 350 x 70 mm, in carton	485018



09 Edging

Overview of products and applications **326**

Edge bander – CONTURO KA 65, KP 65/2 **328**

Semi-stationary edge bander – AP-KA 65, MFT/3 CONTURO **330**

Accessories and consumable materials **332**

The Festool system



Overview of products and applications

Edging curves, radii, convex and concave shapes is easy with the CONTURO. Even mitred edges can be cut to an outstanding quality with the stationary unit. Quick, easy and clean – ideal for shaped parts and small batches. Suitable for machining all types of wood, plastic or melamine edging with a height of 18-65 mm and edge strength of 0.5-3.0 mm (depending on material). The CONTURO is packed away safely in a SYSTAINER, extremely mobile and delivers a perfect edge quality, even in combination with system accessories.

CONTURO edge bander



KA 65
Page 328

Semi-stationary edge banding



MFT/3 CONTURO
Page 331

Applications

Gluing with the edge bander

Affixing straight edging	●	○
Edging concave and convex moulded parts	●	○
Gluing circular sections	●	○
Edging inner corners	●	○

Stationary gluing of edges

Affixing narrow and straight edging		●
Affixing wide and straight edging	●	●
Edging small moulded parts		●
Edging mitre joints		●

Technical data

Power consumption (W)	1.200
Edge height (mm)	18 – 65
Edge thickness (mm)	0,5 – 3*
Inner radius (mm)	> 50
Warm-up time (min)	8
Melting temperature (°C)	100 – 210
Infeed speed (m/min)	2/4
Safety class	I
Weight (kg)	7,9

* heavily dependent on the material

Extremely appropriate ●
Appropriate ○

The perfect edge. The CONTURO in a system.

At the heart of the system, the CONTURO is responsible for the gluing process while the surrounding system components perform all other working steps. From cutting and milling chipboard to size or applying glue, pressing down edging, cutting and flush trimming, smoothing and polishing – the Festool system operates with a level of professionalism and clean quality that only bench-mounted machines can achieve.

Edge gluing with CONTURO



System



Working with MFT



Working with the VAC SYS



Preparing the workpiece



Perfect edge finish

Accessories



Adhesives



Trimming edging

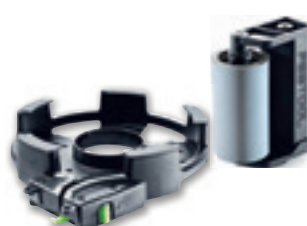

Special accessories



Stationary tasks

Edge bander CONTURO KA 65



The basis for the perfect edge.

Versatile and easy to operate, the CONTURO represents a genuine solution for manufacturing individual moulded parts, as well as affixing edging to workpieces or furniture components produced in small batches. Packed in a SYSTAINER, the CONTURO is also suitable for mobile use as well as manufacturing edging in situ with a perfect quality finish.

The start of the perfect edge.

- › Easy, clean and efficient working progress and patented cartridge gluing system for quick colour changes
- › Precision glue application for a perfect join quality and maximum adhesion
- › Nozzle system that is easy to clean, machine housing does not heat up, allowing safe working progress
- › Adhesive melts according to requirements and does not boil, discolour or deteriorate

Technical data

Power consumption (watt)	1.200
Edge height (mm)	18 – 65
Edge thickness (mm)	0,5 – 3
Inner radius (mm)	> 50
Heating time (min)	8
Melting temperature (°C)	100 – 210
Feed speed (m/min)	2/4
Safety class	I
Weight (kg)	7,9



Items included

Items included	Order no.
front handle, 4 x EVA adhesive, natural, in SYSTAINER SYS 4 T-LOC	
KA 65 Plus	574605
KA 65 Set edge trimming set SYS KB-KA 65	574613

System accessories
from page 334



Edge router
from page 259





Trimming machine KP 65/2

The precise cut.

- › Ergonomic handle location for easy, effortless trimming, even on thick edging
- › Patented eccentric fine adjustment for precision impact trimming
- › Tabletop on both sides of the trimming machine allows the user to trim left and right panel edges from above – with a perfect view of the workpiece
- › Impact trimming function (for round table) and trimming of panel edges (final trimming) with a single machine

Technical data

Trimming height (mm)	65
Trimming thickness (mm)	2

Items included

KP 65/2
in carton

Order no.

499896



Flush trimming.

The protruding edging is trimmed with Festool's KP 65/2 trimming machine: Insert the edge band between the trimming blades, move the trimming machine up to the stop pin, position parallel to the workpiece and press the handles together.

Adapter plate AP-KA 65



Stationary gluing.

Stationary work with the CONTURO. Not a problem! With the adapter plate AP-KA 65. This allows not only the trimming of straight edges and curves, but also slanted edges at 90°-45° angles.

Swivel-mounted stationary edging.

- › For mounting the edge bander on a workbench
- › Installation of adapter plate in a self-constructed table frame or in intended MFT perforated board
- › For small batches, straight edges, free form elements and gluing inclined edges, angle from 0-47°

Technical data

Dimensions length x width (mm)	254 x 420
Min. installation height (mm)	150
Cutting angle adjustment (°)	0 – 47

Items included

Items included	Order no.
AP-KA 65 mounting plate for edge bander complete with 15 sliding guides, additional roll, in carton	500175
GP-MFT/3 KA65 15x in self-service display pack	500367



1 table. 1000 possibilities.

- › For mounting the edge bander on a workbench
- › Sliding guides for guiding the workpiece safely
- › Allows the user to swivel the machine (0-47°) in the bench and position the workpiece horizontally during edging – for convenient and safe guidance, even with larger objects

Technical data

Table dimensions (mm)	1.157 x 773
Work height (mm)	900
Swivel-mounted edge bander (°)	47
Weight (kg)	29

Items included

MFT/3 Conturo-AP
adapter plate AP-KA 65, cross brace QT-MFT/3, in carton

Order no.

500869

Multifunction table MFT/3 CONTURO



Stationary unit for edge gluing.

Stationary edging? Yes, with the MFT/3 CONTURO – a special multifunction table for the CONTURO KA 65. Simply insert the edge bander in the multifunction table MFT/3 CONTURO via an adapter plate. As a result, not only straight edges and curves can be trimmed, but also sloping edges. The CONTURO KA 65 can be swivel-mounted in the stationary unit from 90° – 45°.

The Festool system. Everything in view.

As the basis for the perfect edge, the CONTURO assumes the gluing process. Its system completes all the other steps. From the glue application, pressing the edges, trimming to smoothing down and polishing – the Festool system makes everything possible in an equally professional and clean quality which was previously only possible with bench-mounted machines.



09 Edging

Accessories and consumable materials



System accessories



CONTURO KA 65

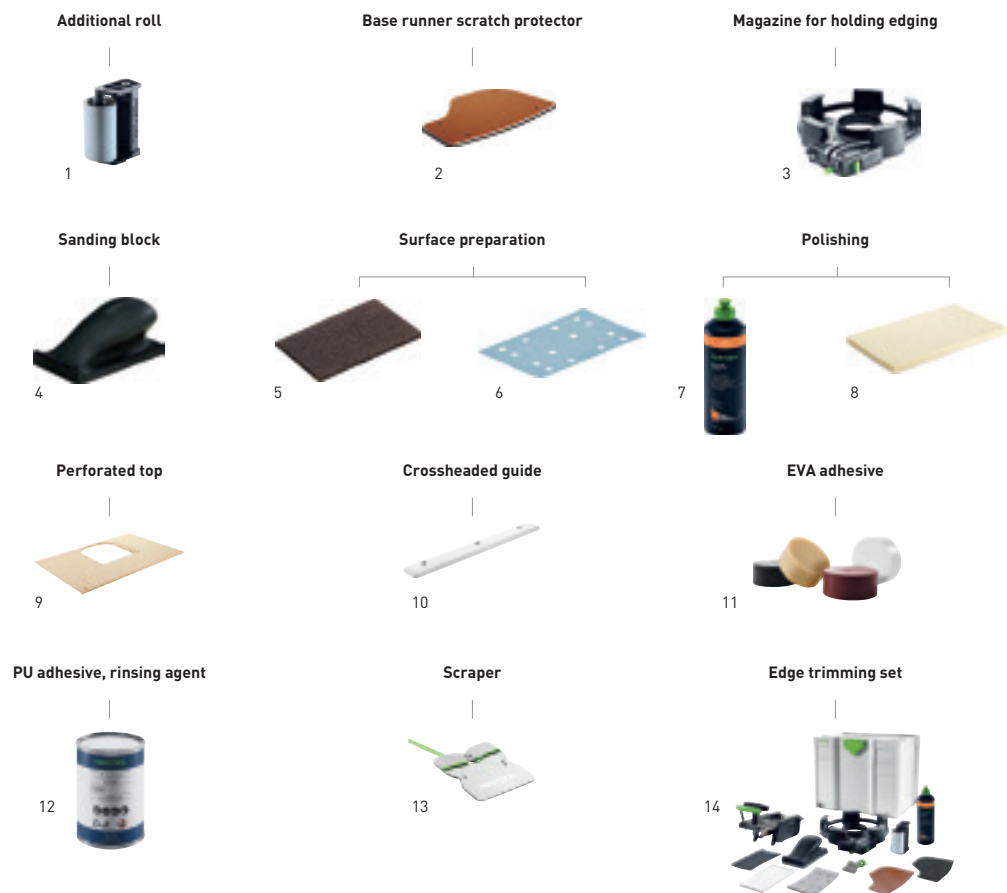

Accessories for edge bander CONTURO KA 65

Denomination	Explanation	Order no.
1 Additional roll ZR-KA 65	for KA 65, for affixing edging to tight curves and shaped parts, offers additional pressure point for applying more pressure on the edge of the board when glued, roll height 65 mm, in self-service display pack	499480
2 Scratch protector LAS-STF-KA 65	for KA 65, for using the edge bander on delicate or high-gloss surfaces, 4 x retaining screws, 3 x felt pads, in self-service display pack	499892
Spare felt EF-LAS-STF-KA 65 10x	for scratch protector LAS-STF-KA 65, for using the edge bander on delicate or high-gloss surfaces, qty. in pack 10 Units, in self-service display pack	499893
3 Magazine for holding edging KSP-KA 65	for KA 65, for the safe guidance of delicate and thin edging into the edge bander KA 65, safe guidance of long edges without damaging or soiling, max. edge lengths of 8 m (edge thickness of 2 mm) possible, max. edge height 45 mm, max. edge thickness 2 mm, in carton	499479
4 Sanding block HSK 80x133 H	hard, for attaching StickFix 80 x 133 mm abrasive sheets, in self-service display pack	495967
5 Sanding vlies STF 80x130/0 S800 VL/5	for HSK 80x133 hand sanding block, for light sanding, grit 800, qty. in pack 5 Units, in self-service display pack	483582
6 Abrasive sheet STF 80x133 P220 GR/100	for RTS 400, RTSC 400, RS 400, RS 4, LS 130, grit P220, qty. in pack 100 Units, in carton	497123
Abrasive sheet STF 80x133 P240 GR/100	for RTS 400, RTSC 400, RS 400, RS 4, LS 130, grit P240, qty. in pack 100 Units, in carton	497124
Abrasive sheet STF 80x133 P280 GR/100	for RTS 400, RTSC 400, RS 400, RS 4, LS 130, grit P280, qty. in pack 100 Units, in carton	497204
Abrasive sheet STF 80x133 P320 GR/100	for RTS 400, RTSC 400, RS 400, RS 4, LS 130, grit P320, qty. in pack 100 Units, in carton	497125
7 Polishing agent MPA 5010 OR/0,5L	Speed Cut 1-step sanding polish, does not contain silicone, water-based, perfect in combination with a sheepskin pad or polishing pad (ORANGE), volume 500 ml, in plastic bottle	202048
8 Polishing felt PF-STF 80x133 STF H/5	for hand sanding block HSK 80 x 133, in conjunction with the MPA 5010 polishing agent, for polishing high-gloss edges, dimensions length x width 80 x 133 mm, qty. in pack 5 Units, in self-service display pack	499894

System accessories

Accessories for edge bander CONTURO KA 65

Denomination	Explanation	Order no.
9 Perforated top LP-KA65 MFT/3	for KA 65, allows the user to swivel the machine [0-47°] in the bench in combination with the AP-KA 65 adapter plate and therefore position the workpiece horizontally during edging – for convenient and safe guidance, even with larger objects, dimensions length x width 1.102 x 718 mm, in carton	500366
10 Crossheaded guide GP-MFT/3 KA65 15x	for KA 65, replacement or extension slide plates for stationary use of the edge bander with the AP-KA 65 adapter plate in the MFT (with KA 65 perforated board, order no. 500366) or installed in a separate workbench, dimensions 255 x 31 mm, dimensions (L x W x H) 255 x 31 x 6 mm, qty. in pack 15 Units, in self-service display pack	500367
11 EVA adhesive, natural EVA nat 48x-KA 65	for KA 65, unfilled EVA adhesive – natural colour tone suitable for all types of decor, EVA universal adhesive with high melting point, high softening range of approx. 90°C, therefore also suitable for use on objects with a relatively high temperature resistance from -10°C to +75°C, chemical basis: Adhesive, resin, adhesive diameter 63 mm, adhesive height 26 mm, processing temperature 190°C, moisture resistance in accordance with D1, qty. in pack 48 Units, in carton	499812
EVA adhesive, white EVA wht 48x-KA 65	for KA 65, Unfilled EVA adhesive – perfect join quality on white decor, EVA universal adhesive with high melting point, high softening range of approx. 90°C, therefore also suitable for use on objects with a relatively high temperature resistance from -10°C to +75°C, chemical basis: Adhesive, resin, adhesive diameter 63 mm, adhesive height 26 mm, processing temperature 190°C, moisture resistance in accordance with D1, qty. in pack 48 Units, in carton	499813
EVA adhesive, brown EVA brn 48x-KA 65	for KA 65, Unfilled EVA adhesive – perfect join quality on brown decor, EVA universal adhesive with high melting point, high softening range of approx. 90°C, therefore also suitable for use on objects with a relatively high temperature resistance from -10°C to +75°C, chemical basis: Adhesive, resin, adhesive diameter 63 mm, adhesive height 26 mm, processing temperature 190°C, moisture resistance in accordance with D1, qty. in pack 48 Units, in carton	200059
EVA adhesive, black EVA blk 48x-KA 65	for KA 65, Unfilled EVA adhesive – perfect join quality on black decor, EVA universal adhesive with high melting point, high softening range of approx. 90°C, therefore also suitable for use on objects with a relatively high temperature resistance from -10°C to +75°C, chemical basis: Adhesive, resin, adhesive diameter 63 mm, adhesive height 26 mm, processing temperature 190°C, moisture resistance in accordance with D1, qty. in pack 48 Units, in carton	200060
12 PU adhesive, natural PU nat 4x-KA 65	for KA 65, caution: use rinsing agent to clean machine after use (PU spm 4x KA65, number 200062), can be stored for a maximum of 12 months, adhesive has high initial strength, and cold elasticity, and good solvent resistance, natural colour tone, PU adhesive packed in 200 g airtight containers, chemical basis: Polyurethane adhesive, caution! The polyurethane adhesive provided here contains "o-[p-isocyanatobenzyl]phenyl isocyanate; diphenylmethane-2,4'-diisocyanate" and as a result is labelled with the R40 phrase "Limited evidence of a carcinogenic effect". We are obligated by the Chemikalien-Verbotsverordnung (German Chemicals Prohibition Ordinance) to draw your attention to the presence of hazardous substances in our polyurethane adhesive no. 200056. By purchasing said polyurethane adhesive, you are confirming that you are at least 18 years old, that you shall use the PU adhesive properly and protect skin, eyes and mucous membranes from direct contact with it, e.g. by wearing protective goggles, respiratory protection/mask and disposable gloves. We are trained and assessed in accordance with Section 5 of the Chemicals Prohibition Ordinance, adhesive diameter 63 mm, adhesive height 42 mm, processing temperature 140°C, temperature resistance -40°C – +140° C, softening range 90°C, moisture resistance in accordance with D3/D4, weight 0,8 kg, qty. in pack 4 Units, in carton	200056
Rinsing agent PU spm 4x-KA 65	for KA 65, rinsing cartridge for the CONTURO KA 65 edge bander after use of PU adhesive, must be used after PU adhesive use to stop remaining PU adhesive chemically reacting, can be stored for a maximum of 12 months, packaged in 140 g containers, weight 0,56 kg, qty. in pack 4 Units, in carton	200062
13 Scraper ZK HW 45/45	trimming overhanging material after the edge is cut (plastic edging) without damaging the surface of the workpiece, smoothing away impact marks left by cutters during the routing process (R1, R1.5 and R2 mm curves), dimensions 45 x 45 mm, dimensions (L x W x H) 45 x 45 x 1,2 mm, curves 1/1,5/2 mm, in self-service display pack	499749
14 Edge trimming set KB-KA 65 SYS	for KA 65, protective edging, 20x StickFix Brilliant 2 80 x 133 P320 abrasive sheets, additional roll, trimming device, HSK 80 x 133 H sanding block, scraper, base runner scratch protector with 3x felt layers, Polishing felt, S 800 StickFix sanding cloth, MPA 5010 OR polish, in SYSTAINER SYS 4 T-LOC	500177



10 Stirring

Overview of products and applications **338**

Stirrers – MX 1000, MX 1000/2, MX 1200, MX 1200/2, MX 1600/2 **341**

DUO stirrers – MX 1600/2 DUO **343**

Accessories and consumable materials **344**

The Festool system

Overview of products and applications

Our stirrers focus on the most important requirements in your daily stirring and mixing applications: Sturdiness, durability, constant power under load and outstanding ergonomics.

Stirrers



MX 1000
Page 341



MX 1000/2
Page 341



MX 1200
Page 341

Applications

Mixing and stirring

Liquid materials: paints, clear coats, wallpaper paste	●	●	●
Viscous materials: filling mixtures and smoothing cement	●	●	●
Stiff, compact materials: plaster, tile cement, mortar	○	○	○

Mixing volume

up to 40 l	●	●	○
up to 70 l			●
up to 90 l			

Technical data

Power consumption (W)	1.020	1.020	1.200
Idling speed, 1st gear (rpm)	360 – 630	360 – 630	360 – 630
Idling speed, 2nd gear (rpm)	-	580 – 1.010	-
Tool holder	M14/ErgoFix	M14/ErgoFix	M14/ErgoFix
Clamping collar diameter (mm)	57	57	57
Max. stirrer basket diameter (mm)	120	120	140
Weight (kg)	4,5	4,9	4,5

Maintains its position.

Stooped over mixing is now a thing of the past. The size of the MX stirrers can be adapted with the ErgoFix height adjustment. You work upright, protect your back and can completely rely on the powerful engines, which ensure intensive and quick mixing. The stirrers have anti-slip rubber corners for positioning against the wall between use. And after the work is completed, they are easy to clean and transport – the machine and stirrer can be disconnected without the need for any tools.



Ergonomic – mix while standing upright.

Simply adjust the stirrer to match your height with the patented ErgoFix height adjustment system. Mix in a natural upright position for relaxed and effortless working.

One for all.

The ErgoFix adapter has a classic M14 tool holder so that all current stirrer baskets can be used. In addition, it is designed for the entire service life of the stirrer thanks to its special coating.

Lightning quick changes without using tools.

The FastFix quick-change system allows the detachment of the stirrer basket from the machine and rapid basket changes without the need for tools, easy cleaning and space-saving transportation.



Stirrers

MX 1000 / MX 1000/2 MX 1200



Robust, ergonomic, powerful.

- › ErgoFix height adjustment with integrated quick-change function
- › No material splash upon start-up thanks to soft start with variable speed trigger
- › Less effort required for guiding the stirrer thanks to ergonomic handle design with large lever arm
- › Powerful motor with power electronics for constant power development



Technical data	MX 1000	MX 1000/2	MX 1200
Power consumption (watt)	1.020	1.020	1.200
Gears	1	2	1
Idling speed, 1st gear/2nd gear (RPM)	360 – 630/-	360 – 630/580 – 1.010	360 – 630/-
Tool holder	M14/ErgoFix	M14/ErgoFix	M14/ErgoFix
Collar dia. (mm)	57	57	57
Max. mixer container diameter (mm)	120	120	140
Mix quantity (l)	40	40	60
Weight (kg)	4,5	4,9	4,5



■ = MMC digital electronics



Items included	Order no.
ErgoFix adapter, double open-ended wrench, in carton	
MX 1000 E EF HS2 stirrer rod HS 2 120x600 M14	767999
MX 1000 E EF HS3R stirrer rod HS 3 120x600 R M14	768001
MX 1000/2 E EF HS2 stirrer rod HS 2 120x600 M14	768002
MX 1000/2 E EF HS3R stirrer rod HS 3 120x600 R M14	768003
MX 1200 E EF HS2 stirrer rod HS 2 140x600 M14	768007
MX 1200 E EF HS3R stirrer rod HS 3 140x600 R M14	768004

Powerful.

Powerful motors combined with a perfectly adapted gear unit ensure a constant performance under load, can tackle even the most demanding mixing applications and withstand long periods of continuous use.

System accessories
from page 346



Stirrer



MX 1200/2 / MX 1600/2



Extremely powerful for harsh industrial environments.

- › For tough and heavy material with high torque, 2-gear transmission
- › ErgoFix height adjustment with integrated quick-change function
- › Less effort required for guiding the stirrer thanks to ergonomic handle design with large lever arm
- › Powerful motor with power electronics for constant power development

Technical data	MX 1200/2	MX 1600/2
Power consumption (watt)	1.200	1.500
Gears	2	2
Idling speed, 1st gear/2nd gear (RPM)	150 – 360/320 – 780	150 – 300/320 – 650
Tool holder	M14/ErgoFix	M14/ErgoFix
Collar dia. (mm)	57	57
Max. mixer container diameter (mm)	140	160
Mix quantity (l)	70	90
Weight (kg)	6,2	6,4



■ = MMC digital electronics

Extremely sturdy design.

The new stirrers can withstand the toughest of conditions, from heavy contamination to hard impacts or collisions, thanks to the drive with its long service life, the solid tubular steel frame, the switch guard and the rubber edges.

Items included	Order no.
ErgoFix adapter, double open-ended wrench, in carton	
MX 1200/2 E EF HS3R stirrer rod HS 3 140x600 R M14	768008
MX 1600/2 E EF HS3R stirrer rod HS 3 160x600 R M14	768009

System accessories
from page 346



Stirrer MX 1600/2 DUO



DUO stirrer: Quicker, easier, more intensive.

- › Quicker at lower power thanks to mixing tools working in opposite direction
- › Intensive and thorough mixing process with combing effect
- › Quick change of stirring rod with FastFix system
- › Electronic control and 2-gear manual transmission: The correct speed for every material

Technical data	
Power consumption (watt)	1.500
Gears	2
Idling speed, 1st gear/2nd gear (RPM)	100 – 250/130 – 350
Tool holder	FastFix
Collar dia. (mm)	57
Max. mixer container diameter (mm)	140
Spindle clearance (mm)	110
Mix quantity (l)	90
Weight (kg)	7,9



■ = MMC digital electronics

Items included	Order no.
----------------	-----------

MX 1600/2 EQ DUO DOUBLE

1 pair of stirring rods, HS 3 Double 140x600, in carton

769236



Stationary application.

The DUO stirrer becomes the complete mixing station in the MS 57 stirrer stand. While you process the already mixed material, the next quantity is already being prepared in the stirrer stand.

System accessories
from page 349



The Festool system. Everything in view.

Because it's simply better when everything fits together: The right stirrer for every application. With the FastFix quick-change system, the stirrer basket can be changed easily and quickly for different materials.



10 Stirring

Accessories and consumable materials

Stirring rods	346
Adapter	349
Mixing centre, stirrer	349



10 Stirring

The ultimate solution for every mixing task.

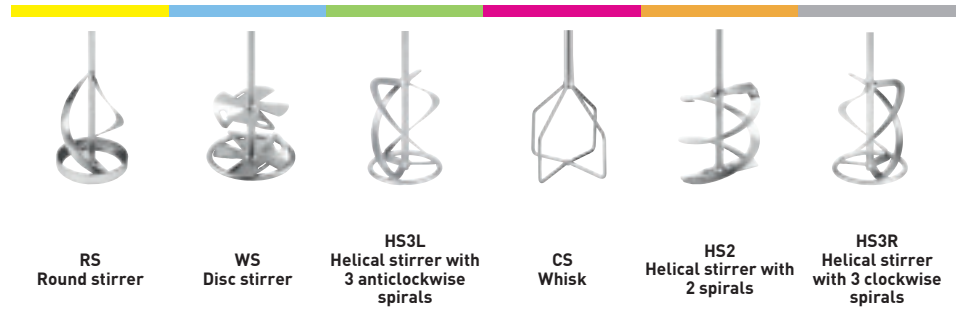

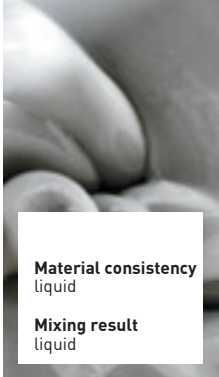
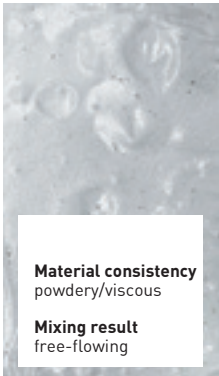
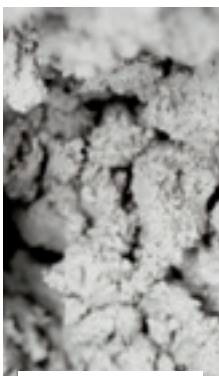
	RS Round stirrer	WS Disc stirrer	HS3L Helical stirrer with 3 anticlockwise spirals	CS Whisk	HS2 Helical stirrer with 2 spirals	HS3R Helical stirrer with 3 clockwise spirals
 <p>Material consistency liquid</p> <p>Mixing result liquid</p>	Paints	●	●	●		
	Emulsion paint	○	●	●		
	Wallpaper paste	●	●	○		
	Clear coat, varnish	●	●	○		
 <p>Material consistency powdery/viscous</p> <p>Mixing result free-flowing</p>	Epoxy resin	○	○	○	●	
	Filler			●	●	○
	Bonding mortar			○	●	○
	Levelling compound			●	○	
	Waterproofing filler			●	●	○
 <p>Material consistency powdery/viscous</p> <p>Mixing result compact</p>	Bitumen			○		○
	Ready-mix plaster				○	○
	Plaster			○	●	●
	Tile cement				●	○
	Joint mortar				●	●
	Mortar				●	●
	Quartz-filled epoxy resin				○	●
	Concrete, screed					○

Stirring rods

Round stirrer

**Round stirrer**

for fluid materials, wall and emulsion paints, standard paste, sealing compounds, clear coats, bitumen, sludge, in self-service display pack

	Type	Order no.
for chuck with clamping range ≥ 10 mm, material quantity – 15 kg, diameter 85 mm, length 400 mm	RS 2 85x400 SW 8	769023
for chuck with clamping range ≥ 13 mm, material quantity 15 – 25 kg, diameter 100 mm, length 600 mm	RS 2 100x600 SW 10	769024
for MX 1000, MX 1000/2, MXP 800, MXP 1000, MXP 1002, material quantity 15 – 25 kg, diameter 100 mm, length 600 mm	RS 2 100x600 M14	769020
for MX 1000, MX 1000/2, MXP 800, MXP 1000, MXP 1002, material quantity 20 – 40 kg, diameter 120 mm, length 600 mm	RS 2 120x600 M14	769021

Disk stirrer WS

**Disc stirrer**

for liquid materials, paints, varnishes, wall paint, emulsion paint, wallpaper paste, glue, tile cement, in self-service display pack

	Type	Order no.
for chuck with clamping range ≥ 10 mm, material quantity – 5 kg, diameter 60 mm, length 350 mm	WS 2 60x350 SW 8	769033
for chuck with clamping range ≥ 10 mm, material quantity 5 – 10 kg, diameter 80 mm, length 350 mm	WS 2 80x350 SW 8	769034
for chuck with clamping range ≥ 13 mm, material quantity 10 – 15 kg, diameter 100 mm, length 600 mm	WS 2 100x600 SW 10	769035

Disk stirrer

**Disc stirrer**

for liquid materials, paints, varnishes, wall paint, emulsion paint, wallpaper paste, glue, tile cement, length 600 mm, in self-service display pack

	Type	Order no.
for MX 1000, MX 1000/2, MXP 800, MXP 1000, MXP 1002, material quantity 15 – 20 kg, diameter 120 mm	WS 2 120x600 M14	768122
for MX 1200, MX 1200/2, MXP 1200, MXP 1202, material quantity 20 – 30 kg, diameter 140 mm	WS 2 140x600 M 14	769022
for MX 1600/2, MXP 1602, material quantity 30 – 60 kg, diameter 160 mm	WS 2 160x600 M 14	769036

Spiral stirrer

**Spiral stirrer**

3 anticlockwise spirals, for thin materials, gypsum plaster, emulsion paint, clear coats, wall paints, sealing compounds, length 600 mm, in self-service display pack

	Type	Order no.
for MX 1000, MX 1000/2, MXP 800, MXP 1000, MXP 1002, material quantity 15 – 25 kg, diameter 120 mm	HS 3 120x600 L M14	767921
for MX 1200, MX 1200/2, MXP 1200, MXP 1202, material quantity 25 – 40 kg, diameter 140 mm	HS 3 140x600 L M14	768138
for MX 1600/2, MXP 1602, material quantity 30 – 60 kg, diameter 160 mm	HS 3 160x600 L M14	768709

Stirring rods



Stirrer CS	Type	Order no.	
	Stirrer for filling mixtures and smoothing cement, sealant, adhesives, for stirring without trapping air (no air bubbles), length 600 mm, in self-service display pack		
	for chuck with clamping range ≥ 13 mm, material quantity 10 – 25 kg, diameter 120 mm	CS 120x600 SW10	769119
	for MX 1000, MX 1000/2, MXP 800, MXP 1000, MXP 1002, material quantity 10 – 15 kg, diameter 120 mm	CS 120x600 M14	769118
	for MX 1200, MX 1200/2, MXP 1200, MXP 1202, material quantity 20 – 40 kg, diameter 140 mm	CS 140x600 M14	769117
	for MX 1600/2, MXP 1602, material quantity 40 – 60 kg, diameter 160 mm	CS 160x600 M14	769116

Spiral stirrer HS 2	Type	Order no.	
	Spiral stirrer for chuck with clamping range ≥ 10 mm, 2 spirals, for viscous materials, tile cement, filling compounds, flooring mixtures, ready-mix plasters, screed, smoothing cement, filling mixtures, length 400 mm, in self-service display pack		
	material quantity – 8 kg, diameter 70 mm	HS 2 70x400 SW 8	769025
	material quantity 8 – 10 kg, diameter 85 mm	HS 2 85x400 SW 8	769026

Spiral stirrer	Type	Order no.	
	Spiral stirrer 2 spirals, for viscous materials, tile cement, filling compounds, flooring mixtures, ready-mix plasters, screed, smoothing cement, filling mixtures, in self-service display pack		
	for chuck with clamping range ≥ 10 mm, material quantity 10 – 15 kg, diameter 100 mm, length 400 mm	HS 2 100x400 SW 8	769027
	for chuck with clamping range ≥ 13 mm, material quantity 15 – 20 kg, diameter 120 mm, length 600 mm	HS 2 120x600 SW 10	769028
	for chuck with clamping range ≥ 13 mm, material quantity 20 – 40 kg, diameter 140 mm, length 600 mm	HS 2 140x600 SW 12	769029
	for MX 1000, MX 1000/2, MXP 800, MXP 1000, MXP 1002, material quantity 15 – 20 kg, diameter 120 mm, length 600 mm	HS 2 120x600 M14	769030
	for MX 1200, MX 1200/2, MXP 1200, MXP 1202, material quantity 20 – 40 kg, diameter 140 mm, length 600 mm	HS 2 140x600 M14	769031
	for MX 1600/2, MXP 1602, material quantity 30 – 60 kg, diameter 160 mm, length 600 mm	HS 2 160x600 M14	769032

HS 3 R helical stirrer with ring	Type	Order no.	
	Spiral stirrer 3 clockwise spirals, for stiff materials with a high viscosity, mortar, concrete, cement and lime plaster, mounting binder, screed, quartz-filled epoxy resin, bitumen, thick coatings, length 600 mm, in self-service display pack		
	for MX 1000, MX 1000/2, MXP 800, MXP 1000, MXP 1002, material quantity 15 – 25 kg, diameter 120 mm	HS 3 120x600 R M14	767887
	for MX 1200, MX 1200/2, MXP 1200, MXP 1202, material quantity 25 – 40 kg, diameter 140 mm	HS 3 140x600 R M14	768708
	for MX 1600/2, MXP 1602, material quantity 30 – 60 kg, diameter 160 mm	HS 3 160x600 R M14	768710

Stirring rods for MX 1600/2 EQ DUO

		Type	Order no.
	Stirring rod for MX 1600/2 DUO, MXP 1602 DUO, for liquid and viscous materials, lower part of the stirrer cage raises mixture from the bottom of the container upwards. Upper part of the stirrer cage pushes mixture downwards, diameter 140 mm, length 600 mm, in carton	HS 3 COMBI 140x600 FF	768092
	Stirring rod for MX 1600/2 DUO, MXP 1602 DUO, For high viscosity or heavy materials needing thorough mixing, two stirrer rods, each with three helixes, counter-rotate. Mixture is pulverised and whisked, diameter 140 mm, length 600 mm, in carton	HS 3 DOUBLE 140x600 FF	768800



ErgoFix adapter

		Type	Order no.
	Adapter with M14 thread, For holding Festool stirrer rods M14 at ErgoFix stirrers, stroke length 80 mm, in self-service display pack	AD-EF-M14/80 ErgoFix	769091

Adapters and extensions

		Type	Order no.
	in self-service display pack Adapter fitting stirrer rods with internal thread	MA M14-M14	769148
	Adapter fitting Festool stirring rods with external thread to stirrers (RW 1000)	MAI M14-M14	769151
	Guide extension for extending all stirrer rods by 400 mm, thread M14, M14 thread on both ends	PL 400 M14/M14	769037

Mixing centre, stirrer

		Type	Order no.
	Stirrer stand excellent stability and reliability due to the robust zinc-coated steel construction, the stand can be simply disassembled for easy transport, stirrer stand with safety switch, 4 m power cord, clamp for attachment collar 57 mm, length x width 950 x 550 mm, height adjustable 1.000 - 1.520 mm, max. dia. mixture container 400 mm, weight 30 kg, in carton	MS 57	769039
	Fixed rod for attaching mixing containers to the stirrer stand MS 57, suitable for container heights between 300 mm and 500 mm, in carton	CL-MS	769048
	Adapter ring for holding stirrers with a collar dia. 43 mm in MS 57, in self-service display pack	A-GD 57/43	768712





11 Preparing the substrate

Overview of products and applications	352
Diamond grinders RENOFIX – RG 130	356
RENOFIX renovation millers – RG 80, RG 150	357
Diamond cutting system – DSC-AG 125, DSC-AG 125 FH, DSC-AG 230	359
Carpet remover – TPE	362
Wallpaper perforator – TP 220	363
Accessories and consumable materials	364
The Festool system	

Overview of products and applications

Concrete, stone, plaster, adhesive, paint and other old coatings can often only be removed with great effort. That's why there is the RENOFIX renovation millers, with which you can easily master all challenges in material removal capacity.

Diamond grinders RENOFIX



RG 130
Page 356

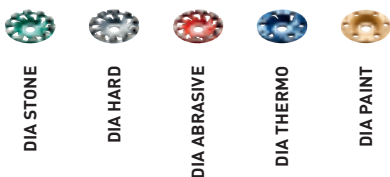

RENOFIX renovation millers



RG 80
Page 357

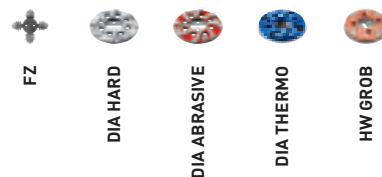

Applications

Plaster

Milling off mineral/soft plaster on walls and façades		●	○		●	○		○
Milling off hard (cement) plaster on walls and façades	○	●	○		●	○	●	○
Milling off synthetic resin plaster		●	○		●			○

Adhesive

Removing tile adhesive/adhesive residue		●	○		●		○	○
Removing elasticised adhesive for PVC or wooden flooring			○		○	●		●

Concrete

Grinding unset concrete area/parts			●				●	
Light grinding of weathered and cured concrete areas	○	●				●		
Roughing up smooth surfaces on concrete	○	●		●		●		●
Grinding very hard concrete (C30/37 and harder)	●							

Colour

Removing latex paints, oil-based paints and paint coatings on plaster		○	○		●	○		○	○
Removing concrete paint on concrete surfaces		●		○	○		●		
Removing elasticised protective coating			●		●			○	
Remove thick coats of paint from wood				●	○				

Coatings

Removing bitumen				○				○
Removing PU coatings			●		○	○		●
Levelling unevenness on screed flooring			●				●	○
Removing epoxy resin coatings	●	○		○		●		○
Removing impaired fillers			●		●	○	●	

Others

Light sanding/Roughing of Terazzo/tiles	○	○					○	
---	---	---	--	--	--	--	---	--

Technical data

Power consumption (W)	1.600	1.100
Idle engine speed (rpm)	3.000 – 7.700	2.000 – 5.900
Tool diameter (mm)	130	80
Connection Ø d/e (mm)	36	36
Tool holder	D25/M14	2 x M5
Weight (kg)	3,8	3,2

Overview of products and applications



RG 150
Page 358



SZ



FZ



DIA HARD



DIA ABRASIVE



DIA THERMO

	<input checked="" type="radio"/>	<input type="radio"/>		<input type="radio"/>
	<input checked="" type="radio"/>		<input type="radio"/>	<input checked="" type="radio"/>
	<input checked="" type="radio"/>			<input type="radio"/>
	<input checked="" type="radio"/>		<input type="radio"/>	
	<input type="radio"/>	<input checked="" type="radio"/>		<input checked="" type="radio"/>
			<input checked="" type="radio"/>	
		<input checked="" type="radio"/>		<input checked="" type="radio"/>
	<input checked="" type="radio"/>	<input type="radio"/>		<input type="radio"/>
	<input type="radio"/>	<input checked="" type="radio"/>		
	<input checked="" type="radio"/>			<input type="radio"/>
	<input type="radio"/>	<input type="radio"/>		<input checked="" type="radio"/>
			<input checked="" type="radio"/>	
	<input checked="" type="radio"/>	<input type="radio"/>	<input checked="" type="radio"/>	<input type="radio"/>
		<input type="radio"/>		

1.600

1.000 - 2.200

150

36

D14/M8

5,5

- Extremely appropriate
- Appropriate

Suitable for areas in size shown, by comparison

11 Preparing the substrate

Overview of products and applications

The Festool diamond cutting system constantly works dust-free. With the extractor system from Festool, you avoid time consuming cleaning of the construction site.

Diamond cutting system



DSC-AG 125
Page 359



DSC-AG 125 FH
Page 360



DSC-AG 230
Page 361

Applications

Cutting panels to size

Cutting tiles	●	●	
Cutting plasterboard/cement-bonded fibreboard	○	○	
Cutting HPL sheets	○	○	
Cutting natural stone	○	○	●
Cutting roof tiles	○	●	○
Cutting expansion joints	●	●	●
Cutting open cracks in screed	●	●	●
Cutting screed/concrete	●	○	●
Cutting finished concrete parts	○	○	●
Cutting grooves			
Grooves for electrical installations	○	○	○

Technical data

Power consumption (W)	1.400	1.400	2.600
Idle engine speed (rpm)	3.500 – 11.000	3.500 – 11.000	6.500
Disc Ø (mm)	125	125	230
Connection Ø d/e (mm)	36/27	36/27	36/27
Weight (kg)	4,1	2,9	8,9

Overview of products and applications

Materials and requirements in the refurbishment, dry mortarless construction and restoration are diverse. Festool offers a wide range of solutions for this, incorporated in a complete system with accessories and consumables.

Carpet remover

Wallpaper perforator



TPE
Page 362



TP 220
Page 363

Applications

Renovation and refurbishment

Removing wallpaper		●
Carpet removal	●	
Removing backing and adhesive layers	●	

Technical data

Power consumption (W)	620	
Idle engine speed (rpm)	6.000	
rpm	12.000	
Sanding stroke (mm)	5	
Weight (kg)	3,6	1,5

Diamond grinder RENOFIX RG 130



The specialist for hard sub-surfaces.

- › Diamond grinder operates at the perfect speed for diamond tools
- › 1,600 W motor for rapid material removal and working progress
- › Folding segment allows you to work directly on walls
- › Reliable guidance and adjustable, defined material removal with guide table

Technical data

Power consumption (watt)	1.600
Idle engine speed (RPM)	3.000 – 7.700
Tool dia. (mm)	130
Tool holder	D25/M14
Dust extraction connection dia. (mm)	36
Weight (kg)	3,8



Powerful, fast and dust-free.

The RG 130 diamond sander meets all requirements. The speed optimised for diamond tools enables quick removal of concrete, screed and coatings on hard substrates. The segment which can be folded without any tools makes it possible to work right up to the edge. Thanks to the patented extraction spiral, excellent dust extraction results are guaranteed.

Items included

Items included	Order no.
front handle, flange set, Spanner, in SYSTAINER SYS 5 T-LOC	
RG 130 E-Plus	768809
RG 130 E-Set DIA HD Diamond disc DIA HARD-D130	768977
RG 130 E-Set DIA ABR Diamond disc DIA ABRASIVE-D130	768978
RG 130 E-Set DIA TH Diamond disc DIA THERMO-D130	768981

System accessories
from page 366



Renovation miller RENOFIX RG 80



The universal machine for walls, ceilings and floors.

- › Universal renovation miller operates at the perfect speed for machining soft materials, option of using DIA tools
- › Compact, flexible and powerful machine with 1,100 W motor
- › Constant speed under load due to MMC Electronic
- › Dust extraction – clean work place

Technical data	
Power consumption (watt)	1.100
Idle engine speed (RPM)	2.000 – 5.900
Tool dia. (mm)	80
Tool holder	2 x M5
Dust extraction connection dia. (mm)	36
Weight (kg)	3,2



■ = Electronic

Items included	Order no.
extraction hood, Auxiliary handle VIBRASTOP, hexagon socket wrench, in SYSTAINER SYS 3 T-LOC	
RG 80 E-Plus	768016
RG 80 E-Set SZ tool head SZ-RG 80	768966
RG 80 E-Set DIA HD tool head DIA HARD-RG 80	768967
RG 80 E-Set DIA ABR tool head DIA ABRASIVE-RG 80	768968



One for all.

The RG 80 renovation miller is a multitasking tool for medium-sized and larger areas. Thanks to the wide range of accessories, you can effortlessly remove hard and soft materials. Adhesives, paint and coatings, synthetic resin plaster, porous concrete and sand-lime brick on flooring, walls and ceilings can be removed easily and quickly.

System accessories
from page 367



Renovation miller RENOFIX RG 150



The all-rounder for larger areas.

- › Renovation miller operates at the perfect speed for machining soft materials over large surface areas
- › Robust and powerful 1,600 W motor
- › “D” handles for safe, comfortable handling
- › Efficient dust extraction and automatic seal with guard

Technical data

Power consumption (watt)	1.600
Idle engine speed (RPM)	1.000 – 2.200
Tool dia. (mm)	150
Tool holder	D14/M8
Dust extraction connection dia. (mm)	36
Weight (kg)	5,5



The right tool for every material.

The RG 150 renovation miller is your perfect partner for large areas thanks to the 150 mm tool diameter and a wide range of accessories. In conjunction with the floor guide, screed, coatings and adhesive residue can be removed conveniently. The ergonomic D-shaped double handle sits perfectly in your hands in every work position.

Items included

Items included	Order no.
Puller/removal tool, Socket spanner, in SYSTEMER SYS 5 T-LOC	
RG 150 E-Plus	768019
RG 150 E-Set SZ tool head SZ-RG 150	768984
RG 150 E-Set DIA HD tool head DIA HARD-RG 150	768985
RG 150 E-Set DIA ABR tool head DIA ABRASIVE-RG 150	768986

System accessories
from page 368



Diamond cutting system DSC-AG 125



Precise cutting without dust.

- › Cutting system with efficient dust extraction, protects health
- › Suitable for use with Festool guide rail for precision cutting
- › Guide table with easy-running rollers for accurate guidance along the workpiece
- › Vision panel provides a clear view of the cutting line

Technical data	
Power consumption (watt)	1.400
Idle engine speed (RPM)	3.500 - 11.000
Disc dia. (mm)	125
Side clearance (mm)	32
Front clearance (mm)	78
Cutting depth without/with guide rail (mm)	27/23
Dust extraction connection dia. (mm)	36/27
Weight of cover/system (kg)	2,2/4,1



■ = MMC Multi Material Control electronics

Items included	Order no.
extraction hood DCC-AG 125, ALL-D125 Premium diamond cutting disc, in SYSTAINER SYS 4 T-LOC	
DSC-AG 125 Plus	767996
DSC-AG 125 Plus-FS guide rail FS 800/2	768993



Dust-free work.

The diamond cutting system DSC-AG 125 with its efficient dust extraction protects your health when working. In combination with the Festool guide rail precise cuts can be made at doors, windows, grooves and expansion joints in the floor area.

System accessories
from page 369

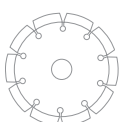

11 Preparing the substrate

Freehand diamond cutting system

DSC-AG 125 FH



As flexible as an angle grinder: But without dust.

- › High suction power for dust-free cutting
- › Excellent view of the cutting point for precise, free cuts
- › Enables proximate work by opening the cover
- › Speed control for adapting to the working material

Technical data

Power consumption (watt)	1.400
Idle engine speed (RPM)	3.500 – 11.000
Disc dia. (mm)	125
Side clearance (mm)	23
Front clearance (mm)	16
Cutting depth without/with guide rail (mm)	27/-
Dust extraction connection dia. (mm)	36/27
Weight of cover/system (kg)	0,6/2,9

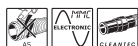

■ = MMC Multi Material Control electronics

Dust-free cutting work.

The freehand cutting system with a cutting depth up to 27 mm. For dust-free, precise cutting of mineral panels such as tiles and natural stone. Ideal for laying tiles, correcting damage to walls and floors, repairing cracks or cutting expansion joints.

Items included

DSC-AG 125 FH-Plus
extraction hood DCC-AG 125 FH, ALL-D125 Premium diamond cutting disc, plate TP-DSC-AG 125 FH, Auxiliary handle VIBRASTOP, in SYSTAINER SYS 3 T-LOC

Order no.

769954

System accessories from page 369

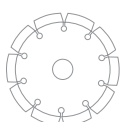

Diamond cutting system DSC-AG 230



Cuts powerfully through mineral construction materials up to 63 mm thick.

- › Cutting system with efficient dust extraction, protects health
- › Suitable for use with Festool guide rail for precision cutting
- › Guide table with easy-running rollers for accurate guidance along the workpiece
- › sealing lip for perfect dust extraction when used with the guide rail

Technical data	
Power consumption (watt)	2.600
Idle engine speed (RPM)	6.500
Disc dia. (mm)	230
Side clearance (mm)	35
Front clearance (mm)	85
Cutting depth without/with guide rail (mm)	63/59
Dust extraction connection dia. (mm)	36/27
Weight of cover/system (kg)	3,2/8,9



Items included	Order no.
extraction hood DCC-AG 230, ALL-D230 Premium diamond cutting disc, in case	
DSC-AG 230	767997
DSC-AG 230 FS guide rail FS 800/2	769001



Precise and efficient cutting – without dust.

Dusty atmospheres during cutting work are now a thing of the past. The hazardous dust is now extracted reliably, the health of the user protected and a clear view of the work piece. Together with compatible accessories and consumables, the perfect solution for efficient, clean and precise work is created.

System accessories
from page 369

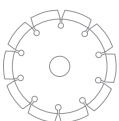

Carpet remover TPE



Quick and easy.

- › Hand-held use for awkward spots and stairs
- › Extension handle for non-tiring work over large areas
- › Powerful stirring action and reduction gearing for maximum economic efficiency
- › High area capacity: 25 m² per hour on compact foam-backed carpets

Technical data

Power consumption (watt)	620
Idle engine speed (RPM)	6.000
No. of strokes (RPM)	12.000
Stroke (mm)	5
Blade width (mm)	195
Weight (kg)	3,6



Wear-resistant blade.

The carpet blade moves back and forth, doing all the hard work for you. Always reliable, easy to sharpen. It quickly works its way in between the sublayer and the adhesive layer. All you have to do is push forwards slightly. Saving time has never been easier.

Items included

TPE-RS 100 Q-Plus
in SYSTAINER SYS 3 T-LOC

Order no.

567873

System accessories
from page 371

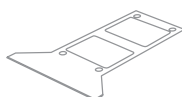

Wallpaper perforator TP 220



Attacks the wallpaper. Then removes it.

- › Little effort is required because of the completely new working principle
- › The adjustable penetration depth of the rollers protects the subsurface from being damaged
- › The adjustable telescoping handle is perfect for working in rooms with high walls and on ceilings
- › Protective cover for safe and clean transport

Technical data

Telescoping handle length (mm)	900 – 1.300
Max. depth adjustment (mm)	3,5
Cutting diameter (mm)	45
Dimensions (L x W x H) (mm)	168 x 224 x 52
Weight (kg)	1,5

Items included

TP 220
protective cover, telescoping handle, in carton

Order no.

495747



Completely new working principle.

The TP 220 is our professional tool for removing wallpaper. Rollers rotating at different speeds create funnel-shaped openings so that water can optimally flow in behind the wallpaper and then seep into the wallpaper – all without damaging the coat underneath.

System accessories
from page 371



The Festool system. Everything in view.

Because things work better when everything fits together: The comprehensive system accessories for refurbishment and renovation provide the appropriate and dust-free solution for removing concrete, stone, plaster, adhesive, paint, carpet and wallpaper. Festool has the appropriate solution in its product range, starting with the correct tool heads for processing a wide variety of materials with RENOFIX tools through to the exemplary mobile dust extractors for renovation millers.



11 Preparing the substrate

Accessories and consumable materials



11 Preparing the substrate

System accessories

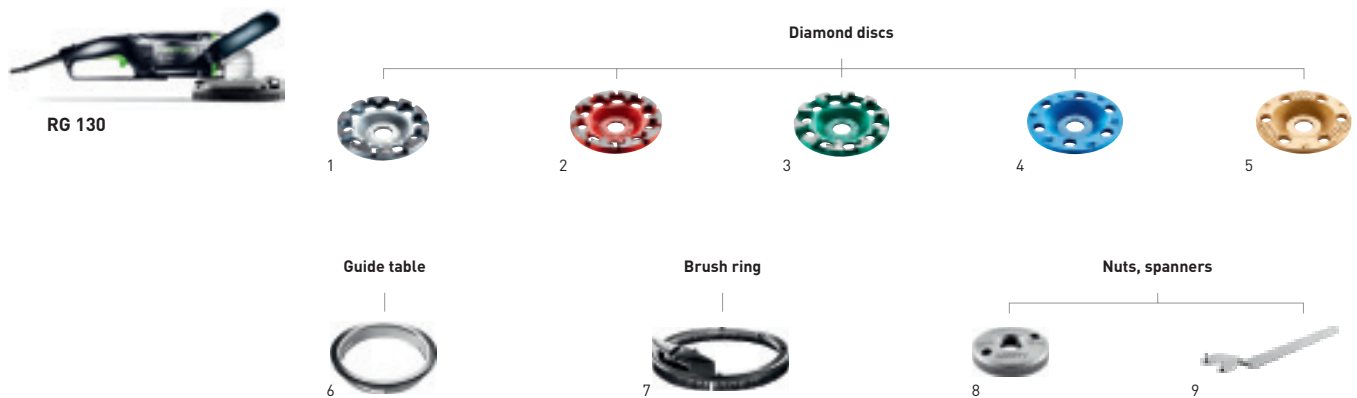

Accessories for diamond grinder RENOFIX RG 130

	Denomination	Explanation	Order no.
1	Diamond disc DIA HARD-D130 PREMIUM	for RG 130, AG 125, RGP 130, AGP 125, for old solid concrete, removal of epoxy resin from solid surfaces or coatings/paints from concrete, diameter 130 mm, interior dia. 25/22,2 mm, active surface 3.000 mm ² , segment height 7 mm, in self-service display pack	768017
	Diamond disc DIA HARD-D130-ST	for RG 130, AG 125, RGP 130, AGP 125, for old solid concrete, removal of epoxy resin from solid surfaces or coatings/paints from concrete, diameter 130 mm, interior dia. 25/22,2 mm, active surface 2.300 mm ² , segment height 5 mm, in carton	499972
2	Diamond disc DIA ABRASIVE-D130 PREMIUM	for RG 130, AG 125, RGP 130, AGP 125, for sand-based materials, screed, fresh concrete, adhesive on screed, sand-lime brick and cellular concrete, diameter 130 mm, interior dia. 25/22,2 mm, active surface 3.460 mm ² , segment height 7 mm, in self-service display pack	768018
	Diamond disc DIA ABRASIVE-D130-ST	for RG 130, AG 125, RGP 130, AGP 125, for sand-based materials, screed, fresh concrete, adhesive on screed, sand-lime brick and cellular concrete, diameter 130 mm, interior dia. 25/22,2 mm, active surface 2.300 mm ² , segment height 5 mm, in carton	499973
3	Diamond disc DIA STONE-D130 PREMIUM	for RG 130, AG 125, RGP 130, AGP 125, for extremely hard materials and hard concrete (harder than B 35), diameter 130 mm, interior dia. 25/22,2 mm, active surface 2.560 mm ² , segment height 7 mm, in self-service display pack	769166
4	Diamond disc DIA THERMO-D130 PREMIUM	for RG 130, AG 125, RGP 130, AGP 125, for removing thermoelastic materials, diameter 130 mm, interior dia. 25/22,2 mm, segment height 3 mm, in self-service display pack	768023
5	Diamond disc DIA PAINT-D130 PREMIUM	for RG 130, AG 125, RGP 130, AGP 125, for removing thick layers of paint and clear coats from wood, diameter 130 mm, interior dia. 25/22,2 mm, segment height 2 mm, in self-service display pack	204176
6	Guide table GT-RG 130	for RG 130, RGP 130, Enables the material removal capacity rate to be adjusted and thus the removal in defined layers, in self-service display pack	769080
7	Brush ring BC-RG 130	for RG 130, RGP 130, replaceable spare brush rim, in self-service display pack	769110
8	Clamping nut UF-DSC/DSG-AG M14	for DSC-AG 125/230, DSG-AG 125 and RG 130, for disc Ø 115-230 mm, Front clamping flange, for clamping the grinding disc, from BJ 03/2015, holder M14, in self-service display pack	200241
9	Key KF-AG	for DSC-AG 125/230, for flange, in bag	769040

System accessories



RG 80

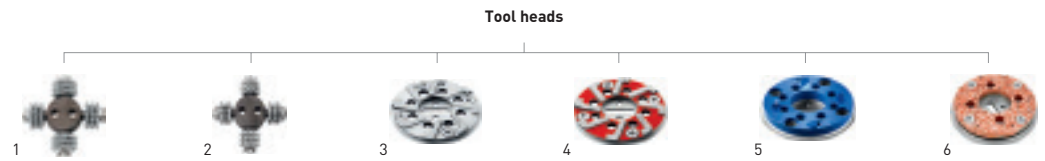

Accessories for renovation miller RG 80 E

	Denomination	Explanation	Order no.
1	Machine/tool head SZ-RG 80	for RG 80, RGP 80, for hard plaster, adhesive residues and synthetic resin plaster, 12 carbide cutter wheels "pointed", diameter 80 mm, in self-service display pack	767982
	Cutter wheel HW-SZ 12	12 carbide milling heads with "pointed teeth", replacement heads for SZ-RG 80, complete set with spacer discs and clamping elements, in self-service display pack	769132
2	Machine/tool head FZ-RG 80	for RG 80, RGP 80, for soft plaster, fresh concrete, adhesive residues and protective coatings, 12 "flat" carbide-tipped milling heads, diameter 80 mm, in self-service display pack	769131
	Cutter wheel HW-FZ 12	complete set with spacer discs and clamping elements, 12 "flat" carbide-tipped milling heads, replacement heads for FZ-RG 80, in self-service display pack	769133
3	Machine/tool head DIA HARD-RG 80	for RG 80, RGP 80, for old solid concrete, removal of epoxy resin from solid surfaces or coatings/paints from concrete, tool head with hard diamond segments, diameter 80 mm, active surface 1.385 mm ² , segment height 6 mm, in self-service display pack	767983
	Diamond disc DIA HARD-D80	replacement disc for tool head DIA HARD-RG 80, diameter 80 mm, active surface 1.385 mm ² , segment height 6 mm, in self-service display pack	769054
4	Machine/tool head DIA ABRASIVE-RG 80	for RG 80, RGP 80, for sand-based materials, screed, fresh concrete, adhesive on screed, sand-lime brick and cellular concrete, tool head with abrasive diamond segments, diameter 80 mm, active surface 1.385 mm ² , segment height 6 mm, in self-service display pack	767984
	Diamond disc DIA ABRASIVE-D80	replacement disc for tool head DIA ABRASIVE-RG 80, diameter 80 mm, active surface 1.385 mm ² , segment height 6 mm, in self-service display pack	769055
5	Machine/tool head DIA THERMO-RG 80	for RG 80, RGP 80, For thermoelastic materials on concrete, screed, etc., tool head with THERMO diamond disc, diameter 80 mm, segment height 3 mm, in self-service display pack	769082
	Diamond disc DIA-THERMO 80	replacement disc for tool head DIA THERMO-RG 80, diameter 80 mm, segment height 3 mm, in self-service display pack	769084
6	Machine/tool head HW COARSE-RG 80	for RG 80, RGP 80, for elastic coatings, adhesive on soft plaster, plaster and limestone on beams, thick and old layers of paint and roughening GRP, tool head with Coarse tungsten-carbide disc, diameter 80 mm, in self-service display pack	769056

System accessories

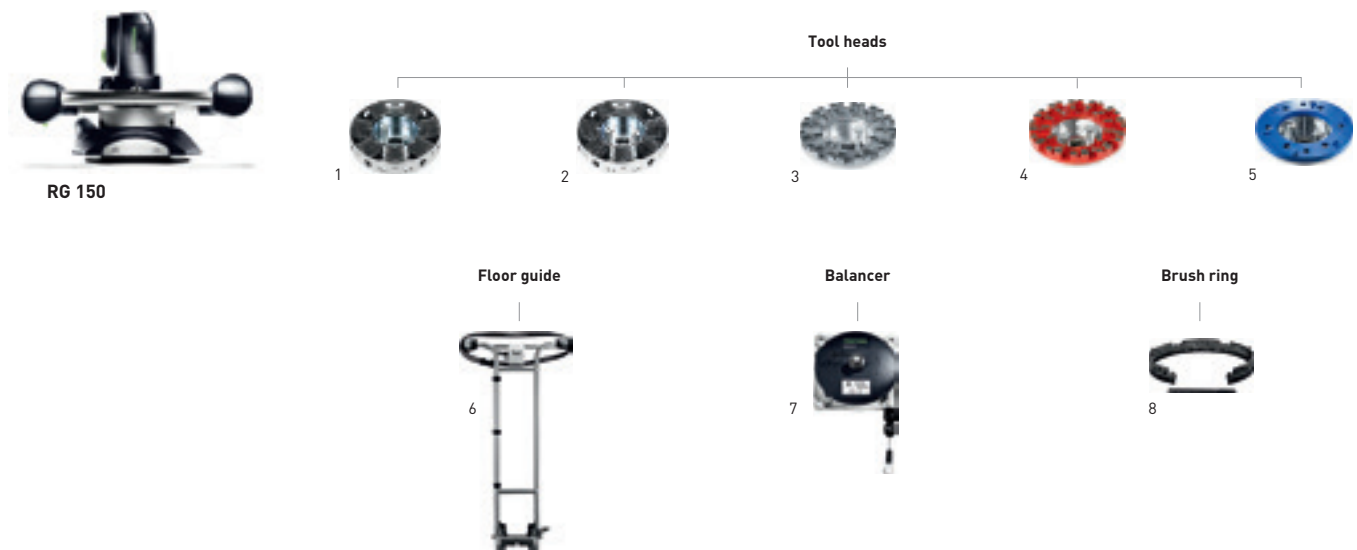

Accessories for renovation miller RG 150 E

Denomination	Explanation	Order no.
1 Machine/tool head SZ-RG 150	for RG 150, RGP 150, for hard plaster, adhesive residues and synthetic resin plaster, tool head with 35 carbide milling heads with "pointed teeth", diameter 150 mm, in self-service display pack	768020
Cutter wheel HW-SZ 35	35 carbide milling heads with "pointed teeth", replacement heads for SZ-RG 150, complete set with running sleeves, in self-service display pack	769050
2 Machine/tool head FZ-RG 150	for RG 150, RGP 150, for soft plaster, fresh concrete, adhesive residues and protective coatings, tool head with 35 carbide milling heads with "flat teeth", diameter 150 mm, in self-service display pack	769105
Cutter wheel HW-FZ 35	35 "flat carbide-tipped milling heads", replacement heads for FZ-RG 150, complete set with running sleeves, in self-service display pack	769051
3 Machine/tool head DIA HARD-RG 150	for RG 150, RGP 150, for old solid concrete, removal of epoxy resin from solid surfaces or coatings/paints from concrete, tool head with hard diamond segments, diameter 150 mm, active surface 3.660 mm ² , segment height 11 mm, in self-service display pack	768021
Diamond disc DIA HARD-D150	replacement disc for tool head DIA HARD-D150, diameter 150 mm, active surface 3.660 mm ² , segment height 11 mm, in self-service display pack	769069
4 Machine/tool head DIA ABRASIVE-RG 150	for RG 150, RGP 150, for sand-based materials, screed, fresh concrete, adhesive on screed, sand-lime brick and cellular concrete, tool head with abrasive diamond segments, diameter 150 mm, active surface 3.660 mm ² , segment height 11 mm, in self-service display pack	768022
Diamond disc DIA ABRASIVE-D150	replacement disc for tool head DIA ABRASIVE-D150, diameter 150 mm, active surface 3.660 mm ² , segment height 11 mm, in self-service display pack	769070
5 Machine/tool head DIA THERMO-RG 150	for RG 150, RGP 150, For thermoelastic materials on concrete, screed, etc., tool head with THERMO diamond disc, diameter 150 mm, segment height 3 mm, in self-service display pack	769083
Diamond disc DIA THERMO-D150	replacement disc for tool head DIA THERMO-D150, diameter 150 mm, segment height 3 mm, in self-service display pack	769085
6 Floor guide BG-RG 150	for RG 150, RGP 150, for easy guidance of RENOFIX RG 150 E over large areas, in carton	769109
7 Balancer BR-RG 150	for RG 150, RGP 150, for secure and simple guidance of the RENOFIX RG 150 E on the wall, max. load 8 kg, length 2,5 m, in carton	769121
8 Brush ring BC-RG 150	for RG 150, RGP 150, replaceable spare brush rim, in self-service display pack	769123

System accessories

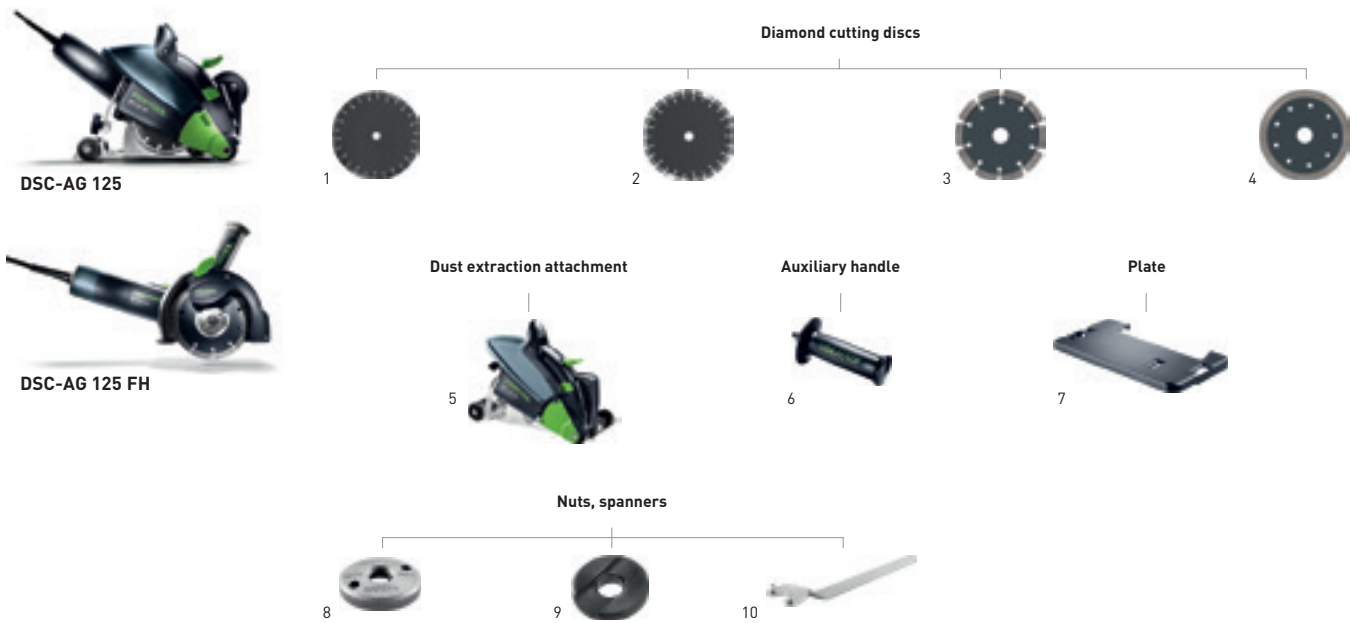

Accessories for DSC-AG 125 and DSC-AG 125 FH diamond cutting system

Denomination	Explanation	Order no.
1 Diamond cutting disc ALL-D 125 PREMIUM	for DSC-AG 125, DSC-AG 125 FH, AGP 125, WCP 32, universal range of applications, cutting width 2 mm, diameter 125 mm, segment height 10 mm, holder dia. 22,2 mm, in self-service display pack	769154
2 Diamond cutting disc C-D 125 PREMIUM	for DSC-AG 125, DSC-AG 125 FH, AGP 125, WCP 32, for concrete, diameter 125 mm, segment height 10 mm, cutting width 2,2 mm, holder dia. 22,2 mm, in self-service display pack	769158
3 Diamond cutting disc MJ-D125 PREMIUM	for DSC AG 125, DSC-AG 125 FH, AGP 125, For cleaning grouted joints., cutting width 6,5 mm, diameter 125 mm, segment height 10 mm, holder dia. 22,2 mm, in carton	769087
4 Diamond cutting disc TL-D125 PREMIUM	for DSC AG 125, DSC-AG 125 FH, AGP 125, suitable for cutting floor tiles, roof tiles and concrete roofing tiles, diameter 125 mm, segment height 10 mm, cutting width 1,2 mm, holder dia. 22,2 mm, in self-service display pack	769162
5 Dust extraction attachment DCC-AG 125	for AG 125, AGP 125-12/14, for the reduction of dust, hexagon socket wrench, Clamping flange, Spanner, diameter 125 mm, weight 2,2 kg, dust extraction connection dia. 36/27 mm, in carton	769075
Dust extraction attachment DCC-AG 125 FH	for AG 125 and AGP 125-14, for dust-free work with the angle grinder, hexagon socket wrench, diameter 125 mm, dust extraction connection dia. 36/27 mm, weight 0,6 kg, in carton	769953
6 Auxiliary handle AH-M8 VIBRASTOP	for AG 125, AGP 115, AGP 125, AGP 150, VIBRASTOP, holder M8, in self-service display pack	769620
7 Plate TP-DSC-AG 125 FH	for DSC-AG 125 FH Plus, DCC-AG 125 FH, protects the surface against possible signs of abrasion during cutting, for fastening at guide table of extraction hood DCC-AG 125 FH, dimensions [L x W x H] 195 x 103 x 14 mm, in self-service display pack	200002
8 Clamping nut UF-AG M14	for DSC-AG 125/230, DSG-AG 125 and RG 130, for disc Ø 115-230 mm, Front clamping flange, for clamping the grinding disc, up to BJ 02/2015, holder M14, in self-service display pack	769018
Clamping nut UF-DSC/DSG-AG M14	for DSC-AG 125/230, DSG-AG 125 and RG 130, for disc Ø 115-230 mm, Front clamping flange, for clamping the grinding disc, from BJ 03/2015, holder M14, in self-service display pack	200241
9 Flange BF-AG 22,2	for DSC-AG 125/230, for disc Ø 115-230 mm, Rear clamping flange, for clamping the grinding disc, holder 22,2 mm, in self-service display pack	767973
10 Key KF-AG	for DSC-AG 125/230, for flange, in bag	769040

11 Preparing the substrate

System accessories

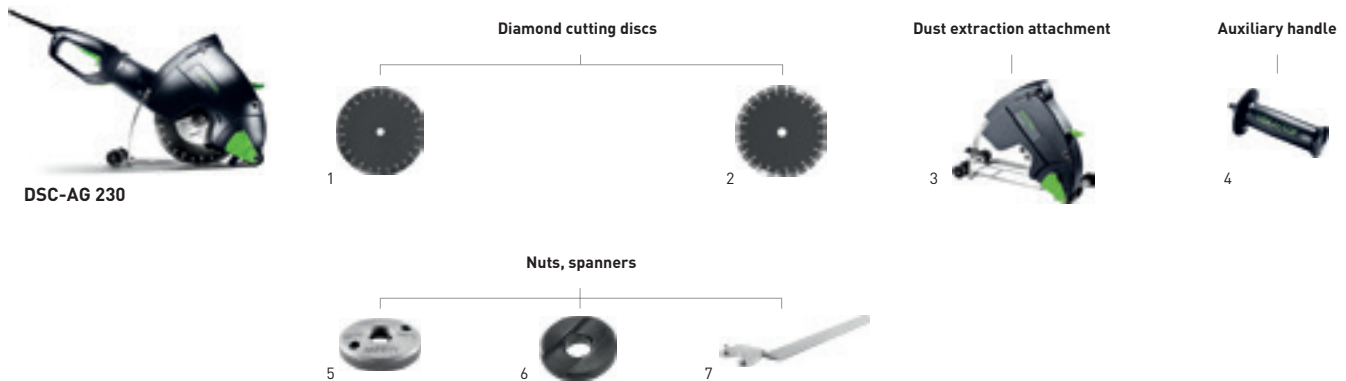

Accessories for DSC-AG 230 diamond cutting system

Denomination	Explanation	Order no.
1 Diamond cutting disc ALL-D 230 PREMIUM	for DSC-AG 230, AGP 230, universal range of applications, cutting width 2,4 mm, diameter 230 mm, segment height 9 mm, holder dia. 22,2 mm, in self-service display pack	769155
2 Diamond cutting disc C-D 230 PREMIUM	for DSC-AG 230, AGP 230, for concrete, diameter 230 mm, cutting width 2,4 mm, segment height 12 mm, holder dia. 22,2 mm, in self-service display pack	769159
3 Dust extraction attachment DCC-AG 230	for AG 230, AGP 230-22/26, for the reduction of dust, hexagon socket wrench, Clamping flange, Spanner, diameter 230 mm, weight 3,2 kg, dust extraction connection dia. 36/27 mm, in carton	769077
Rubber gasket DR-DCC-AG 230	for DCC-AG 230, DCC-AGP 230, increase efficiency of dust extraction, in self-service display pack	769092
4 Auxiliary handle AH-M14 VIBRASTOP	for AG 230, AGP 180, AGP 230, VIBRASTOP, holder M14, in self-service display pack	769621
5 Clamping nut UF-AG M14	for DSC-AG 125/230, DSG-AG 125 and RG 130, for disc Ø 115-230 mm, Front clamping flange, for clamping the grinding disc, up to BJ 02/2015, holder M14, in self-service display pack	769018
Clamping nut UF-DSC/DSG-AG M14	for DSC-AG 125/230, DSG-AG 125 and RG 130, for disc Ø 115-230 mm, Front clamping flange, for clamping the grinding disc, from BJ 03/2015, holder M14, in self-service display pack	200241
6 Flange BF-AG 22,2	for DSC-AG 125/230, for disc Ø 115-230 mm, Rear clamping flange, for clamping the grinding disc, holder 22,2 mm, in self-service display pack	767973
7 Key KF-AG	for DSC-AG 125/230, for flange, in bag	769040

System accessories



TP 220

Replacement rollers



1



TPE

Extension handle



2

Carpet remover blade

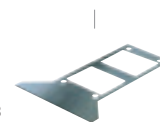

3

Accessories for TP 220 wallpaper perforator and TPE carpet remover

Denomination	Explanation	Order no.
1 Replacement roller EW-TP 220	for TP 220, 2 x rollers, in self-service display pack	496111
2 Extension-handle SG-TPE/RS 1	with 2 additional hand grips and shoulder cushion, in two sections, allows use of TPE in standing position, length 1.700 mm, in carton	486375
3 Carpet remover-blade TM 195	for TPE-RS 100, blade width 195 mm, in carton	486374



12 Illuminating

Overview of products and applications **374**

Working light – SYSLITE UNI **375**

Working light – SYSLITE KAL II **376**

Working light – SYSLITE DUO **377**

Surface control light – SYSLITE STL 450 **378**

Accessories and consumable materials **379**

The Festool system

Overview of products and applications

Working lights

Working light

Grazing light



SYSLITE UNI
Page 375



SYSLITE KAL II
Page 376



SYSLITE DUO
Page 377



SYSLITE STL 450
Page 378

Applications

For illuminating smaller surface areas



For illuminating larger areas



For illuminating large rooms



For inspecting surfaces



Work independent of the mains power supply



Extremely appropriate ●
Appropriate ○

Torch

SYSLITE UNI



The light to the tool.

- › Three powerful, energy-efficient, high-performance LEDs
- › Lamp head can be adjusted into nine different positions by a vertical angle of 135°
- › Stable and tilt-resistant, or can be flexibly attached using belt clip and trestle hook

Technical data

Battery voltage (V)	10,8/18
Light source	3 SMD LEDs
Lumen value (lm)	43
Weight (without battery pack) (kg)	0,34



Small, but surprisingly powerful.

The handy SYSLITE UNI is always ready to light up dark corners. Its lightweight and compact design makes it a welcome working aid. It is compatible with all conventional Festool batteries.

Items included

SYSLITE UNI
scaffolding holder, without charger, without battery pack, in self-service display pack

Order no.

769079

Battery and charging technology
from page 14 onwards

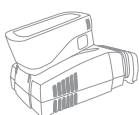

Working light SYSLITE KAL II



Total flexibility.

Five available installation and mounting positions: The SYSLITE KAL II lights up the darkest of corners for up to six hours non-stop. The housing is made from shatter-proof, shock-proof and impact-resistant cast aluminium – durable enough for any construction site. The large light dispersion angle of 170° ensures that the entire work surface is illuminated uniformly.

The light to the tool.

- › Excellent light thanks to 12 high-performance LEDs
- › Long life and robust thanks to shatter-proof housing
- › Continuous use – any Festool battery pack can be attached to supplement the internal battery. The 230 V mains power pack and vehicle charging cable offer additional charging and power supply options
- › Compact design – can be flexibly positioned without cable hazards

Technical data

Light source (watt)	12 x 1,5
Lumen value 1st/2nd stage (lm)	310/769
Operating time (internal battery) 1st/2nd stage (min)	290/120
Li-ion battery capacity (Ah)	2,9
Li-ion charging time (min)	200
Permissible operating temperature range (°C)	-5/+ 55
Operation with external Festool battery packs (V)	10,8 – 18
Hook opening (mm)	40
Thread size stand (")	1/4
Dimensions (L x W x H) (mm)	80 x 100 x 150
Weight (without battery pack) (kg)	0,7

Items included

Items included	Order no.
integrated lithium-ion battery 7.2 V, car charger adapter, 230 V adapter, transport bag, in self-service display pack	
KAL II	500721
KAL II-Set magnetic spherical head with flat disc	499815

System accessories
from page 379



Battery and charging technology
from page 14 onwards

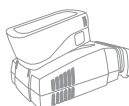

Working light SYSLITE DUO



Because light quality is reflected in the quality of your work.

- › Unique LED configuration for 180° scattering angle and homogeneous illumination
- › High illuminating power (8000 lm) for brilliant lighting of a large surface area
- › Daylight-like colour (5000 K)
- › Sturdy and durable with 10,000-hour lifetime (L70) and shock-proof corners

Technical data

Colour (kelvin)	5.000
Light source (watt)	80 x 1,4
Lumen value (lm)	8.000
LED service life (L70) (h)	10.000
Colour rendering index, Ra	80
Housing protection class	IP 55
Cable length (m)	4,8
Weight (kg)	3,4

Items included

Items included	Order no.
DUO in carton	200164
DUO-Plus in SYSTAINER SYS 3 T-LOC	769962
DUO-Set ST DUO 200 tripod, in SYSTAINER SYS 3 T-LOC	574653



A new generation of light.

Illuminates extensively, instead of selectively. Can be used with the stable tripod extended up to a height of 2.00 m and stowed away safely in a SYSTAINER. One-hand grip, suspension means and cord holder? But of course.

System accessories
from page 379

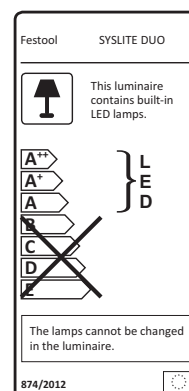

Grazing light

SYSLITE STL 450**Detects faults before anyone else does.**

- › Solution for checking putty/sanding results while still working
- › The optimum focus of light ensures all of the imperfections on the surface are immediately visible
- › Long-lasting and efficient LEDs
- › Variable height and angle with compatible tripod with adapter



Technical data	
Lumen value (lm)	1.200
Colour (kelvin)	5.000
Housing protection class	IP 55
Cable length (m)	5
Weight (kg)	1,5

Items included	Order no.
STL 450 in bag	201937
STL 450-Set AD-ST DUO 200 adapter, ST DUO 200 tripod, in carton	202911
LHS 225/CTM 36/STL 450-Set AD-ST DUO 200 adapter, ST DUO 200 tripod, Surface control light STL 450, LHS 225 EQ-Plus/IP long-reach sander, CTM 36 E AC-LHS mobile dust extractor, PLANEX tool holder, in SYSTAINER SYS MAXI	575460

Adjusts according to your needs.

Using the tripod and flexible adapter, the grazing light can be immediately made ready for use at the desired height and inclination

System accessories
from page 379



System accessories



SYSLITE UNI

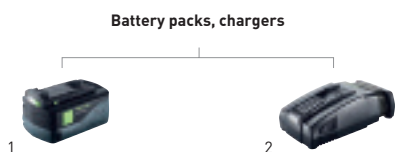

SYSLITE KAL II

Magnetic spherical head



Tripod



Adapter



SYSLITE DUO

bag



SYSLITE STL 450

Accessories for SYSLITE UNI, SYSLITE KAL II, SYSLITE DUO work lights, SYSLITE STL 450 inspection light

Denomination	Explanation	Order no.
1 Battery pack BP 18 Li 5,2 AS	with AIRSTREAM function, lithium-ion (Li-ion) replacement battery pack for all Festool 18 V cordless tools (except CXS, TXS, ETSC 125, RTSC 400, DTSC 400), tensioner 18 V, capacity 5,2 Ah, weight 0,7 kg, in self-service display pack	200181
Battery pack BP 18 Li 5,2 ASI	Bluetooth® lithium-ion (Li-ion) battery pack with AIRSTREAM function for all Festool 18 V cordless tools (except CXS, TXS, ETSC 125, RTSC 400, DTSC 400), Bluetooth® enables the CLEANTEC mobile dust extractor to be started automatically when the cordless tool is switched on (use of a Bluetooth®-compatible mobile dust extractor is required), tensioner 18 V, capacity 5,2 Ah, weight 0,7 kg, in carton	202479
Battery pack BP 18 Li 6,2 AS	with AIRSTREAM function, lithium-ion (Li-ion) replacement battery pack for all Festool 18 V cordless tools (except CXS, TXS, ETSC 125, RTSC 400, DTSC 400), tensioner 18 V, capacity 6,2 Ah, weight 0,7 kg, in self-service display pack	201774
Battery pack BP 18 Li 6,2 ASI	Bluetooth® lithium-ion (Li-ion) battery pack with AIRSTREAM function for all Festool 18 V cordless tools (except CXS, TXS, ETSC 125, RTSC 400, DTSC 400), Bluetooth® enables the CLEANTEC mobile dust extractor to be started automatically when the cordless tool is switched on (use of a Bluetooth®-compatible mobile dust extractor is required), tensioner 18 V, capacity 6,2 Ah, weight 0,7 kg, in carton	201797
Battery pack BP 18 Li 3,1 C	compact, lightweight design, lithium-ion (Li-ion) replacement battery pack for all Festool 18 V cordless tools (except TSC 55, CXS, TXS, ETSC 125, RTSC 400, DTSC 400), tensioner 18 V, capacity 3,1 Ah, weight 0,4 kg, in self-service display pack	201789
Battery pack BP 18 Li 3,1 CI	Bluetooth® lithium-ion (Li-ion) replacement battery pack for all Festool 18 V cordless tools (except TSC 55, CXS, TXS, ETSC 125, RTSC 400, DTSC 400), Bluetooth® enables the CLEANTEC mobile dust extractor to be started automatically when the cordless tool is switched on (use of a Bluetooth®-compatible mobile dust extractor is required), tensioner 18 V, capacity 3,1 Ah, weight 0,4 kg, in carton	203799
2 Rapid charger TCL 6	for all Li-ion battery packs (except for CXS/TXS), Lithium-ion (Li-ion) replacement charger for all 10.8 – 18 V battery packs, charging current 6 A, input voltage 220 – 240 V, weight 0,8 kg, in self-service display pack	201135
Rapid charger SCA 8	for all Li-ion battery packs (except for CXS/TXS), with AIRSTREAM function, Lithium-ion (Li-ion) replacement charger for all 10.8 – 18 V battery packs, charging current 8 A, input voltage 220 – 240 V, weight 1,1 kg, in self-service display pack	200178
Battery and charging technology	from page 14	
3 Magnetic spherical head MA KAL	for Festool guide rail clamps, spherical head can be rotated 360°, for flexible positioning of the work light SYSLITE KAL and KAL II, pad for external stand, magnetic holding force 16 kg, in self-service display pack	499814
4 Tripod ST DUO 200	for SYSLITE DUO, continuously height-adjustable from 150 to 200 cm via two pull-outs, folds to save space and easy to transport at just 5,6 kg, in carton	200038
5 Adapter AD-ST DUO 200	for SYSLITE STL 450 inspection light, for attaching to the ST DUO 200 tripod, weight 1,1 kg, in carton	201936
6 Bag ST-BAG	for the ST DUO 200 tripod, STL 450 surface control light and AD-ST DUO 200 adapter, transport bag with shoulder strap and carry handle, for storage and simple transport of the tripod for the SYSLITE DUO and the SYSLITE STL surface control light, with practical side pockets for additional system accessories, in self-service display pack	203639

See everything. Work with more precision. With the right light for every situation.

The SYSLITE DUO working light, the SYSLITE KAL work light, the portable SYSLITE UNI or the SYSLITE STL 450 inspection light for surfaces – whichever you choose, all our lighting solutions are developed with the same aim in mind as our tools: Making your work easier, and improving your results, by providing excellent lighting for every situation – from small surfaces through to entire rooms. Because high-quality lighting is essential for good work.

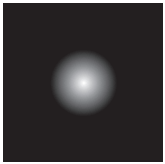

SYSLITE UNI

Small and compact for ultimate mobility. Compatible with all Festool battery packs.



SYSLITE KAL II

Turns dark surfaces into work surfaces in an extremely versatile manner. Can be positioned or suspended in five positions and powered by a wide variety of sources (internal battery, battery pack, mains cable or car charger).



SYSLITE DUO

Extensive illumination (mains-powered) of entire rooms with light quality that replicates daylight. Can be used in a wide variety of ways: Stands alone on the floor or flat surfaces, attaches to the Festool tripod or, if preferred, hangs on hooks using the suspension means on the rear side of the SYSLITE DUO.



SYSLITE STL 450

The inspection light optimally focuses the light – ideal for inspecting surfaces even when working. Variable height and inclination with compatible tripod and long cable for a large range of applications.





With the SYSLITE STL 450 inspection light you can inspect surfaces while working, benefitting from perfect results and satisfied customers from the outset.



Classic halogen lamp

Yellow luminous colour, diminishes in peripheral vision.

The most powerful member of the Festool's range of lights: The SYSLITE DUO.

Because light quality is reflected in the quality of your work. Experience the difference:



Conventional LED light

Blue light colour, small light dispersion angle, lower luminosity.



Festool SYSLITE DUO

180° scattering angle, uniform two-dimensional illumination, replicates the colour of daylight.



13 Workplace organisation

Compact Module System – CMS	384
Multifunction table – MFT 3	386
Vacuum clamping system – VAC-SYS	387
Guide rail – FS/2	388
Dual suction pad – GECKO	389
Vacuum clamping nozzle – CT WINGS	390
Boom arm – ASA	391
Energy box – EAA	392
Workcenter – WCR 1000	393
Multifunction stool – MFH 1000, UCR 1000	394
Toolcenter – TC 3000/2	395
SYSROCK construction site radio – BR 10, BR 10 DAB+	396
Power distributor – SYS-PowerHub	397
Mobile workshop – MW 1000	398
Transportation systems – SYS-Port, SYS-Roll, SYS-Cart	399
Storage systems – SYSTAINER, SORTAINER, SYS-ToolBox	411
Accessories and consumable materials	400
The Festool system	

The CMS Compact Module System

CMS Compact Module System. Open to change.

Five machines in one. Stationary or handheld. Covers 0.5 m². Only possible with a system. The CMS Compact Module System consists of a basic unit and compatible modules that transform the unit into a stationary bench-mounted saw, jigsaw, bench-mounted router or belt sander.

Safe and convenient.

The machines can be switched on and off from the basic unit.

Mobile and stable.

At only 10.8 kg, the basic unit is extremely lightweight yet robust.

Adjustable height.

Foldaway legs on the basic unit allow you to work on the floor or standing up.

Easy to extend.

A comprehensive selection of accessories, such as the sliding table, angle stop and extension table, allow the CMS to be adapted for a wide range of applications.

CMS modules



TS 55 R Plunge-cut saw
Page 42



Module mounting CMS-TS 55 R
Page 45



Module CMS-MOD-TS 55-R
Page 45



Circular saw TS 75
Page 44



Module mounting CMS-TS 75
Page 45



Module CMS-MOD-TS 75
Page 45



Router OF
Page 246



Module mounting CMS-OF
Page 250



Pendulum jigsaws PS
Page 38



Module mounting CMS-PS
Page 41
ADT-PS 400 adapter table
Page 62



(PS 420/400)



All modules in the established Basis-Plus System can be combined with the basic unit of the CMS, except for the Basis 1 A module.



Module CMS-MOD BS 120
Page 121

The CMS Compact Module System

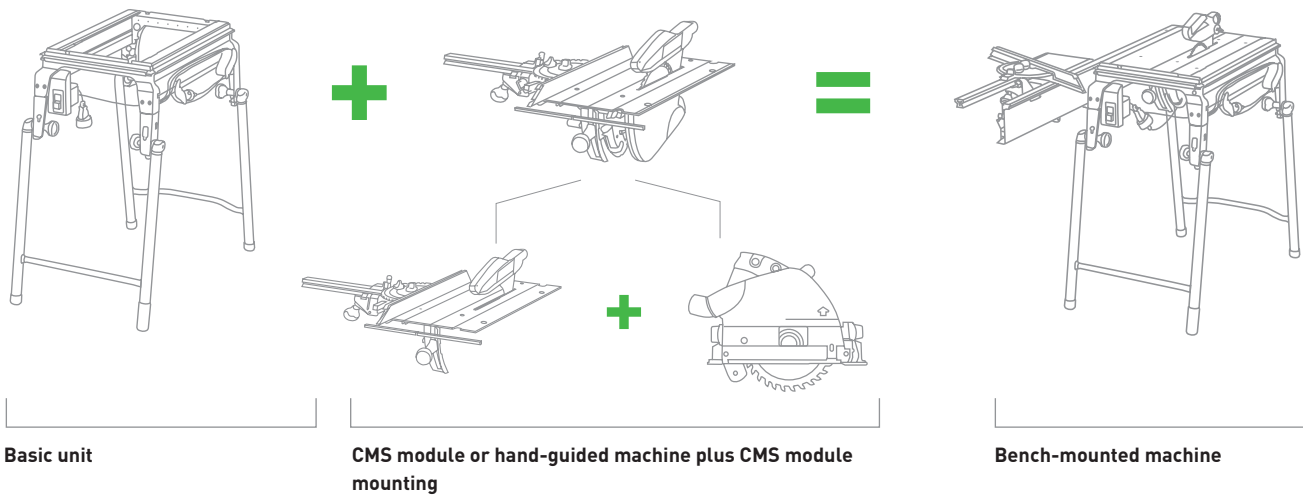

Basic unit

+

+

+

+

+



Technical data

Table height, legs unfolded	900 mm
Table height, legs folded away	316 mm
Table dimensions	585 x 400 mm
Weight	10.8 kg

Delivered parts

Basic unit CMS-GE
 Basic unit for fitting CMS modules,
 foldaway legs, main safety switch,
 cable holder/workpiece holder,
 cable and socket

Order no.

561228

Bench-mounted machine

=

=

=

=

=



Bench saw CMS-TS 55 R Set
Page 45



Bench saw with TS 75



Bench-mounted router TF 2200 Set
Page 251

TF 1400 set
Page 251

Bench-mounted router with OF 1010



Bench-mounted jigsaw with PS



Bench-mounted belt sander with BS 120

Multifunction table MFT 3



1 table. 1000 possibilities.

- › Maximum precision – with aluminium profile for retaining a guide rail and the angle stop
- › Angle stop, stop slide and additional clamping device ensure exact results
- › Ergonomic work position thanks to the table height of 90 cm
- › Mobile use of the MFT 3 through space-saving foldaway legs



Technical data

Table dimensions (mm)	1.157 x 773
Table height, legs folded away (mm)	180
Table height, legs unfolded (mm)	900
Max. workpiece thickness (mm)	78
Max. workpiece width (mm)	700
Load capacity (kg)	120
Weight (kg)	28



Always the right accessories.

Everything is secured safely in place, from guide rails to combination levels. The MFT/3 extension allows the insertion of all CMS modules, while the sliding table enables cross cuts with a maximum width of 830 mm.

Items included

table with perforated top and foldaway legs, in carton

MFT/3
swivel unit, support unit, angle stop, adjustable stop, guide rail FS 1080/2, deflector FS-AW, additional clamp

MFT/3 Basic

Order no.

495315

500608

System accessories
from page 403

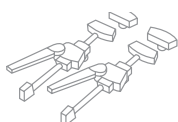

Vacuum clamping system VAC SYS



The future of clamping.

- › Workpieces can be turned up to 360° and swivelled up to 90°
- › Sensitive surfaces can be clamped without damaging them
- › Powerful control – each clamping unit can secure workpieces up to 30 kg and 1 x 1 m
- › For mobile use – pump and clamping units are stored in a SYSTAINER for easy transportation

Technical data

Min. power consumption at 50 Hz (watt)	160
Max. power consumption at 50 Hz (watt)	200
Power consumption at 50 Hz (watt)	160 – 200
Power consumption at 60 Hz (watt)	200 – 230
Pump capacity at 50 Hz (m ³ /h)	2,7
Pump capacity at 60 Hz (m ³ /h)	3,5
Minimum vacuum	≥ 81% / ≥ 810
Weight (kg)	8



Items included

Items included	Order no.
vacuum hose	
VAC SYS SE 2 vacuum pad VAC SYS VT 275 x 100 mm, connector, in SYSTAINER SYS 4	580062
VAC SYS Set SE1 vacuum pump VAC SYS VP, vacuum clamping unit VAC SYS SE1, foot valve, in carton	712223



Pads replaced without using tools.

There are four pad sizes for different workpieces to choose from and they can be replaced quickly with FastFix.

System accessories
from page 404

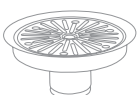

Guide rail FS/2

The guide rail is available in 8 different lengths, from 800 mm to 5000 mm.



Impeccable guidance.

- › Zero-play guidance – you can adjust the guidance jaws on the circular saw to fit the guide rail without using tools
- › Splinter-free cuts – the splinter guards positioned directly on the scribe line prevent the edges from splintering, even on angled cuts
- › Precision results – the router guide stop was designed for precision grooves
- › Quick for diagonal cuts – with guide rail and combination bevel, angles are easy to transfer from the workpiece or wall



Suitable for furniture construction.

A router and guide rail with rows of holes simplify the installation of shelves or fittings.

Items included	Length (mm)	Order no.
in carton		
FS 800/2	800	491499
FS 1080/2	1080	491504
FS 1400/2	1400	491498
FS 1900/2	1900	491503
FS 2400/2	2400	491502
FS 2700/2	2700	491937
FS 3000/2	3000	491501
FS 5000/2	5000	491500
FS 1400/2-LR 32	1400	496939
FS 2424/2-LR 32	2424	491622

FS 800/2 = length 800 mm; FS 1080/2 = length 1080 mm; FS 1400/2 = length 1400 mm, etc. FS 1400/2-LR 32 and FS 2424/2-LR 32 = guide rails with rows of holes spaced 32 mm apart.

System accessories
from page 406

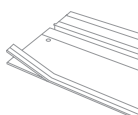

Dual suction pad GECKO



Secure connection for a long time.

- › Ergonomic – the torsionally rigid handle makes it much easier to lift heavy loads
- › Retains the position, preserves the material – special sliding rings mounted on both suction cups allow you to position the GECKO precisely and release it just as easily
- › Secure hold – the green clamping levers provide quick and reliable suction. For a loading capacity of 50 kg
- › Designed for a system – the GECKO can be mounted directly to a guide rail using the guide rail adapter



Items included	Order no.
in self-service display pack	
GECKO DOSH	492617
GECKO DOSH-Set adapter DOSH-FSAD, dual suction pad GECKO DOSH	493507

Designed for a system.

The GECKO can be mounted directly to a guide rail using the guide rail adapter.

System accessories
from page 406

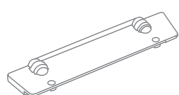

Vacuum clamping nozzle CT WINGS



The third hand. Precisely when you need it.

- › In many cases replaces the assistant when it comes to having a free hand for marking, clamping, gripping, etc.
- › For effortless, precise and safe work
- › Small, compact and always at hand
- › Perfect in the system – in combination with a Festool mobile dust extractor and extractor hose with a diameter of 27 mm or 27/32 mm

Technical data

Max. clamping height (mm)	50
Max. load (kg)	3
Dimensions (L x W x H) (mm)	130 x 80 x 50
Weight (kg)	0,35



Assembly aid through suction force.

The practical assembly aid for clamping and fixing workpieces on horizontal and vertical surfaces. Simply position CT WINGS onto a 27 mm or 27/32 mm suction hose with machine sleeve, switch on the mobile dust extractor and then the workpiece is held in place by the suction power.

Items included

CT-W
in self-service display pack

Order no.

500312

CT mobile dust extractor
from page 174 onwards



Boom arm ASA



For large working areas.

- › Maximum flexibility, extra safety, no dangerous obstacles
- › For use with Festool CT/SRM mobile dust extractors
- › Integrated compressed air and electrical lines for connection to EAA and CT
- › Saves time, space and increases economic efficiency

Technical data	ASA 5000	ASA 6000
Connecting cable length (m)	3	3
Boom extension (m)	2 x 2,5	2 x 3
Application area (m ²)	39 – 58	56 – 84
Weight (kg)	92	105
Cutting angle adjustment (°)	39 – 58	56 – 84

Items included	Order no.
double-jointed arm with wall bracket, cable duct, wall mounting components are not included, in carton	
ASA 5000 CT/SR-EU	583867
ASA 6000 CT/SR-EU	583868



Workplace changes made easy.

Boom arms are primarily used in locations where workplaces need to be flexible or where a large operating radius is required. Power and dust extraction is supplied where it is needed, while avoiding tripping hazards. This saves you time moving equipment and creates more space in the workshop.

System accessories
from page 405

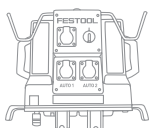

Energy box EAA



For greater ease of movement.

- › Minimises set-up costs, increases economic efficiency
- › Opening of the extraction channel by actuating a coupled, manual slide
- › Always ready for use by up to 2 electrical and/or compressed air power tools (depending upon the version of the EW/DW)
- › Dust extraction for two tools possible

Technical data

Dimensions (L x W x H) (mm)	516 x 580 x 367
Pressure range (bar)	4 – 8
Weight (kg)	13

Sophisticated design right down to the smallest detail.

The EAA, with manually or automatically operated sliders for use with CT mobile dust extractors or the TURBO II central exhaust, spares the user from cumbersome handles and travels, and ensures optimal dust extraction. Electric power tools and air tools are ready for use and ready to hand at all times.

Items included

EAA EW/DW CT/SRM/M-EU energy box with 3 x 230 V connections, compressed air supply unit with 3 compressed air connections (2 x oiled and 1 x not oiled), 2 x Abrasive paper holder, in carton	583821
---	--------

System accessories
from page 405



Workcenter WCR 1000



Mobility in the tightest of spaces.

- › Compact and mobile – the WCR can be coupled with any Festool mobile dust extractor with integral SYS-Dock (except CTL MINI/MIDI)
- › Flexible equipment – hooks for hanging two machines with extractor hoses, a universal holder, storage compartment and rotating storage tray for sundries
- › Individual extension – additional storage trays, hooks or holders can be mounted on the perforated plate and profiled groove
- › Work without straining your back – the height of the Workcenter, hooks and storage trays is easy to adjust

Technical data

Length (mm)	1.050
Width (mm)	362
Height adjustable (mm)	545 – 785
Size of square hole pattern (mm)	9,2 x 9,2
Inner hole distance of square hole pattern (mm)	38
Weight (kg)	10,2

Items included

WCR 1000

Storage shelf, storage trough, storage base for pegboard, double tool hook, double universal hook, 6 x standard hooks (125 mm long), 2 x pegboards with square holes, SYSTAINER retainer, in carton

Order no.

497471



Customised configuration.

SYSTAINER sizes 1 to 4 or SORTAINERs can be integrated into the Workcenter.

System accessories
from page 408



Multifunction stool and Universalcenter MFH 1000 / UCR 1000



Mobile seating arrangement, efficient work.

- › Multifunction stool MFH 1000 + Workcenter WCR 1000 = Universalcenter UCR 1000
- › Use the Universalcenter UCR 1000 in mobile applications and benefit from the advantages of the Workcenter WCR 1000
- › Pleasant working environment – without the Workcenter WCR, the multifunction stool MFH 1000 is a stable, comfortable seat
- › Efficient organisation – hooks and storage trays ensure quick access to machines, accessories and work equipment



Clever, mobile organisation.

Pull-out drawer that can be locked – for storing accessories, work equipment and personal effects.

Technical data	MFH 1000	UCR 1000
Length (mm)		695
Dimensions (L x W x H) (mm)	695 x 436 x 524	
Width of roll (mm)	32	32
Width (mm)		436
Roll dia. (mm)	100	100
Height adjustable (mm)		1.031 – 1.271
Size of square hole pattern (mm)	9,2 x 9,2	9,2 x 9,2
Inner hole distance of square hole pattern (mm)	38,1	38,1
Weight (kg)	27	37

Items included	Order no.
in carton	
MFH 1000 seat cushion MFH 1000 SK, Assembly set	498967
UCR 1000 WCR 1000 Workcenter, multifunction stool MFH 1000 (without seat cushion)	498966

System accessories
from page 408



Toolcenter TC 3000/2



Flexibility and extra work space.

- › Beneficial organisation – tools, materials and mobile dust extractor are always stored away tidily and close at hand
- › Mobile equipment – simple transportation between different locations in the workshop
- › Secure attachment – the mobile dust extractor is secured safely in the extractor dock
- › More space – machine and hose holders keep storage areas free for working equipment



Technical data

Dimensions (L x W x H) (mm)	470 x 1.070 x 960
Storage area (mm)	460 x 990
Storage area working height (mm)	925
Weight (kg)	43

Items included

TC 3000/2
hose holder, anti-slip mat, in carton

Order no.

583881



Safety included.

Locking cabinet compartment for size 3 SYSTAINERS or smaller provides safe storage for machines and accessories.

System accessories
from page 409

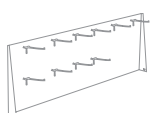

Construction site radios SYSROCK BR 10, BR 10 DAB+



Light, compact and powerful.

The SYSROCK construction site radios fit on every windowsill and combine compact dimensions with a low weight and impeccable sound. And thanks to the Bluetooth® interface, you can listen to your favourite radio stations and tracks from your smartphone with SYSROCK sound quality.

Perfectly formed for perfect sound. Also available as a DAB+ version.

- › Various receiving and playback options via Bluetooth® and AUX-IN interfaces – available as analogue or digital radio
- › Integrated USB interface for charging devices such as mobile devices (with BR 10 DAB+)
- › Excellent sound in a compact, modern and robust design
- › Intuitive operation via large buttons and colour LCD display

Technical data	BR 10 DAB+	BR 10
Radio reception	DAB+ digital radio	FM analogue radio
FM frequency band (VHF) (MHz)	87,5 – 108	87,5 – 108
Speaker (watt)	10	10
Operation with Festool slide-in battery packs (V)	18	18
Number of stored stations	2 x 4	4
AUX-IN (mm)	3,5	3,5
Bluetooth® standard	4,1	4,1
USB output	5V/1,2A	–
Dimensions (L x W x H) (mm)	95 x 102 x 149	94 x 102 x 149
Weight (kg)	0,7	0,7



Items included	Order no.
230 V adapter, aux-in cable, in bag	
BR 10 DAB+ DAB+ digital radio	202111
BR 10 FM analogue radio	200183

Battery and charging technology
from page 409 onwards

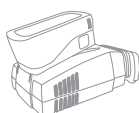

Power distributor SYS-PowerHub



The first system-integrated power cable in SYSTAINER format.

- › Tidy: There is plenty of room inside for the securely connected 10 m long cable. The SYS-PowerHub also features room for any battery packs or small parts required
- › Can supply power to up to four power tools simultaneously. The internal power socket can also be used to charge a mobile phone, for example, while protecting it against contamination
- › Can be connected to other Systainers even when closed, thanks to the two cable outlets
- › When connected to the mains, the red light on the front signals that it is ready for operation



Technical data

Safety class	IP44
Cable length (m)	10
Power consumption (watt)	2.500
Number of sockets	5
Dimensions (L x W x H) (mm)	396 x 296 x 157,5
Inner dimensions (L x W x H) (mm)	383 x 154 x 128
Weight (kg)	4,2



A brand new generation of power distributors.

The new SYS-PowerHub combines all the benefits of a conventional cable drum with the benefits of the Festool Systainer system. With its 10 m cable and four sockets mounted on the exterior, it offers all the freedom that you could need for connecting your power tools.

Items included

SYS-PH
in SYSTAINER SYS 2 T-LOC

Order no.

200231

Mobile workshop MW 1000



Turns the construction site into your workshop.

- › Easy to transport up and down steps due to the large wheels, which are fully rubber-lined and shock-resistant
- › Handle with adjustable angle, sliding surfaces and recessed grip on the pan for easy loading into a vehicle by one person
- › Compact dimensions and effortless assembly and disassembly
- › Worktops and storage areas with optional customised extension: Simple option of adding multiple multifunction tables and SYSTAINER pull-out drawers

Technical data

Work height (mm)	900
Dimensions (L x W x H) (mm)	641 x 600 x 1.076
Table dimensions (mm)	445 x 363
Total load capacity (kg)	100
Drawer load capacity (kg)	20
Roll dia. (mm)	200
Weight (kg)	19

Your workplace wherever you are.

Thanks to its robust design and compact dimensions, you can take the mobile workshop anywhere with no effort at all. The large tyres are fully rubber-lined and shock-resistant, even making light work of trips up and down stairs.

Items included

Items included	Order no.
SYS-AZ-MW 1000 pull-out drawer, in carton	
MW 1000 Basic	203454
MW 1000 TSB/1-MW 1000 table	203802

System accessories from page 410

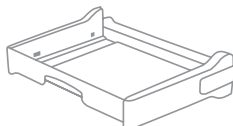

SYS-Port, SYS roller, SYS-Cart, mobile workshop

From machines to sundries.
From the workshop to the assembly site.

The SYS-Cart roll board

Compact, agile, quick.
Everything under control –
even in tight spaces.

The SYS roller Systainer transporter

Combines roll board and hand cart.
Saves time and effort.

The mobile workshop

Assembling, transporting,
working – all in one.



Easy loading into vehicles by just one person thanks to handle with angle adjustment, sliding surfaces and recessed grip on the basic element.



Compact dimensions for effortless assembly and disassembly. The large wheels are fully rubber-lined and shock-resistant, making light work of trips up and down stairs.



If the worktop and storage area are not large enough, they can be easily extended and customised by adding further multifunction tables and SYSTAINER pull-out drawers. There are unlimited options for customisation.

Organisation/Storage	SYSTAINER 1-5 SYS-MFT SYS-Combi	SORTAINER	SYS-ToolBox SYS-StorageBox	MAXI-SYSTAINER	MIDI-SYSTAINER	MINI-SYSTAINER	SYS-Cart	SYS-Roll	Mobile workshop	Systainer-Port SYS pull-out
Power tools	● 1)	○ 2)		● 1)	○					● 3)
Sundries	● 1)	●	●	○	○	● 1)		○		● 3)
Abrasives	● 1)	○	○	○	○					● 3)
Cartridges	● 1)	○	○	○	○					● 3)
Hand tool	● 1)	●	●	○	●	○		○		● 3)
Combinations										
SYSTAINER 1-5	●	●	●	●	●		●	●	●	●
SORTAINER	●	●	●	●			●	●	●	●
SYS-ToolBox I/II	●	●	●		●		●	●	●	
MAXI-SYSTAINER	●	●	●	●						
MIDI-SYSTAINER	●				●				●	
MINI-SYSTAINER	●					●			●	
SYS-Cart	●	●	●							
SYS-Roll	●	●	●							
Mobile workshop	●	●	●		●	●				●
Systainer-Port	●	●								
Mobile dust extractors	●	●	●							
Use/Transportation										
Workshop	●	●	●	●	●	●	●	●		●
Construction site	●	●	●	●	●	●	●	●	●	○

- Extremely appropriate
- Very appropriate
- Appropriate

- 1) In combination with insert
- 2) Only with Sys 3-Sort/4
- 3) In combination with a suitable SYSTAINER or SORTAINER

The Festool system. Everything in view.

Because things work better when everything fits together: The Festool system always creates a tidy environment and guarantees better organisation.



13 Workplace organisation

Accessories and consumable materials



System accessories

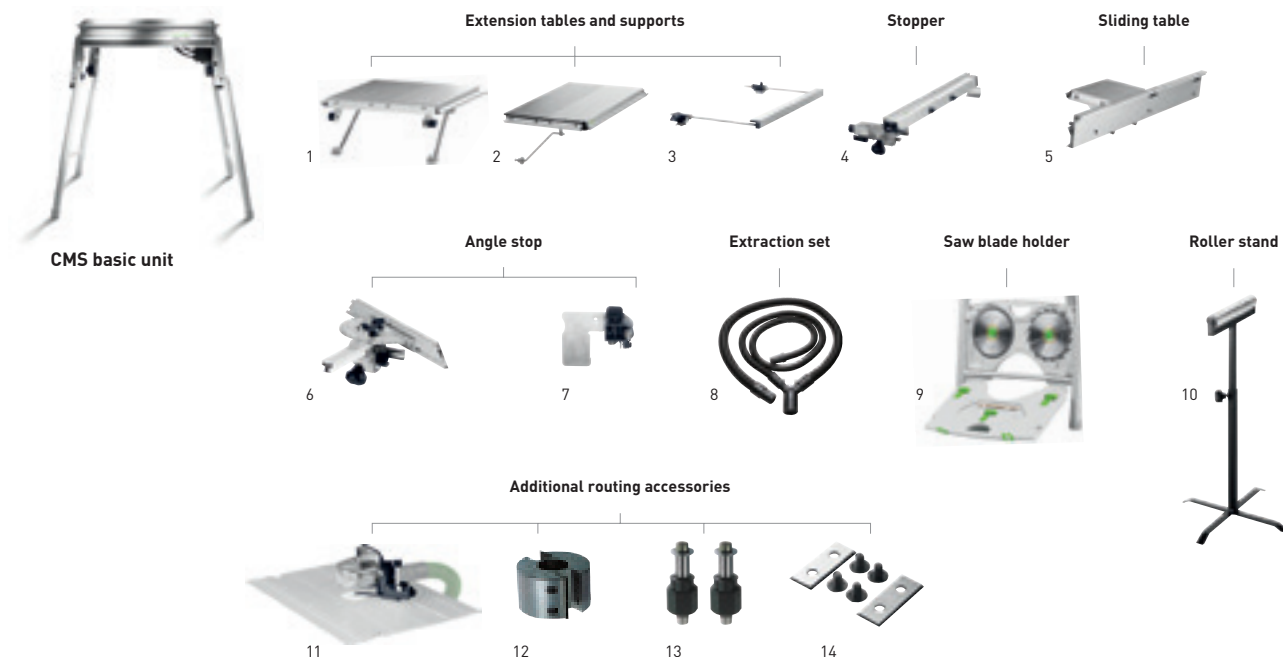

Accessories for Compact Module System CMS

Denomination	Explanation	Order no.
1 Extension table VL	for CS 50, CMS-GE, simple fitting, folds away, for safe support of long workpieces when sawing to width, enlarges the support surface by 405 mm, dimensions 375 x 454 mm, dimensions length x width 375 x 454 mm, in carton	492092
2 Extension table VB-CMS	for CMS-GE, with adjustable dimension scale, extends the support area by 410 mm, cutting width 570 mm, dimensions length x width 664 x 438 mm, in carton	493822
3 Support AF	for CS 50, CMS-GE, support for both side use, supports workpieces while cutting, enlarges the support surface by 300 mm, dimensions length x width 662 x 390 mm, in carton	492242
4 Stopper LA-CS 50/CMS	for CS 50, CMS-GE, with fine adjustment and rear clamp, can be operated from front, with moveable stop profile for precise and safe longitudinal cuts, in carton	574796
5 Sliding table ST	for CS 50, CMS-GE, for MFT 3-VL, max. working width for trimming cuts 830 mm, in carton	492100
6 Angle stop WA	for CS 70, CS 50, CMS-GE, for work requiring 2 stops, in carton	574797
7 Adjustable stop WA-AR	for CS 50, CS 70, to stop workpieces on trimming attachment CS 70 WA, CS 50 WA and Basis WRA 500, in self-service display pack	491712
8 Dust extraction set CS 70 AB	for CT/CTM, comprising: dust extraction hose D27x2.0 m, dust extraction hose D36x1.0 m, Y terminal, can be used with Basis, CS 70, CS 50 and CMS, dust extraction with MINI/MIDI only possible in combination with adapter hose 499196, diameter 27 /36 mm, in carton	488292
Adapter hose AD-D 36/CS50/CS70/CMS	for CS 50, CS 70, CMS, 0.5 m hose D36 with two rotating adapters and connection coupling, anti-static D50/D50 VM-AS, for Y-shaped connection in conjunction with CTL MINI/MIDI, diameter 36 mm, length 0,5 m, in carton	499196
9 Saw blade holder SGA	for CS 50, CMS-GE, for safe and space-saving storage of up to 4 saw blades (max. Ø 190 mm) and up to 3 splinterguards (not included in contents), in carton	492228
10 Roller stand RB	for all semi-stationary devices (CS/KS/CMS), may be used with the CS 50, CS 70, CB 120, Basis Plus System, CMS-GE, multifunction table, to use longer workpieces for longitudinal sections and cross sections and cutting and grinding work, height adjustable 630 - 1.000 mm, in carton	488711
11 Guard BF-OF-CMS	for CMS-OF 1010, for CMS-OF 1400/OF 2000/OF 2200, guard and extractor hood, dust extraction connection dia. 27/36 mm, in carton	494643
12 Rebating head FK D 50x30	for CMS-OF, for use with cutter spindles, diameter 50 mm, in self-service display pack	489284
13 Cutter spindle ASL20/OF1400-OF2200	for CMS-OF 1400/OF 2000/OF 2200, for use with rebating head Basis FK D 50x30 in the Basis 6 A and CMS-OF, in self-service display pack	490131
Cutter spindle ASL20/OF1010	for CMS-OF, allows use of rebating head Basis FK D 50x30 in the Basis 5 A and CMS-OF 1010, in self-service display pack	489285
14 Reversible blade WP 30x12x1,5	for rebating head, qty. in pack 2 Units, in self-service display pack	489286

System accessories



Accessories for the MFT 3 multifunction table

Denomination	Explanation	Order no.
1 Cross brace MFT 3-QT	for additional MFT 3 stability, qty. in pack 2 Units, diameter 20 mm, length 675 mm, in carton	495502
2 Additional clamp MFT/3-ZK	for securing the stop rail to the V-groove, in self-service display pack	495541
3 Fixed clamps MFT-SP	for MFT, for safe and precise securing of the workpiece (sawing, sanding, routing, drilling, etc.), qty. in pack 2 Units, in self-service display pack	488030
4 Fastening clamp FSZ 120	for FS/2, MFT, solid steel version, clamping width 120 mm, qty. in pack 2 Units, in self-service display pack	489570
Fastening clamp FSZ 300	for FS/2, MFT, solid steel version, clamping width 300 mm, qty. in pack 2 Units, in self-service display pack	489571
5 Lever clamp FS-HZ 160	for FS/2, MFT, solid steel version, clamping width 160 mm, in self-service display pack	491594
6 Guide extension MFT 3-VL	for the MFT 3, for the use of CMS modules, foldaway legs, main safety switch, cable and socket, in carton	495510
7 Base TSB/1-MW 1000	for MW 1000 mobile workshop and MFT 3, extended work space, aluminium profile and perforated top allow for use of many existing accessories, work height 900 mm, dimensions (L x W x H) 1.045 x 500 x 74 mm, weight 12,2 kg, in carton	203457
8 Connecting piece VS	for attachment of FST660/85 or MFT 800 to Basis Plus, for connecting several MFT 3, in self-service display pack	484455
9 Adapter VAC SYS AD MFT 3	for VAC SYS SE 1, VAC SYS SE 2, for connecting the VAC SYS clamping unit with the MFT 3, in carton	494977
10 Adjustable stop MFT/3-AR	for securing workpieces on the angle stop, Can be folded away, in self-service display pack	495542

System accessories

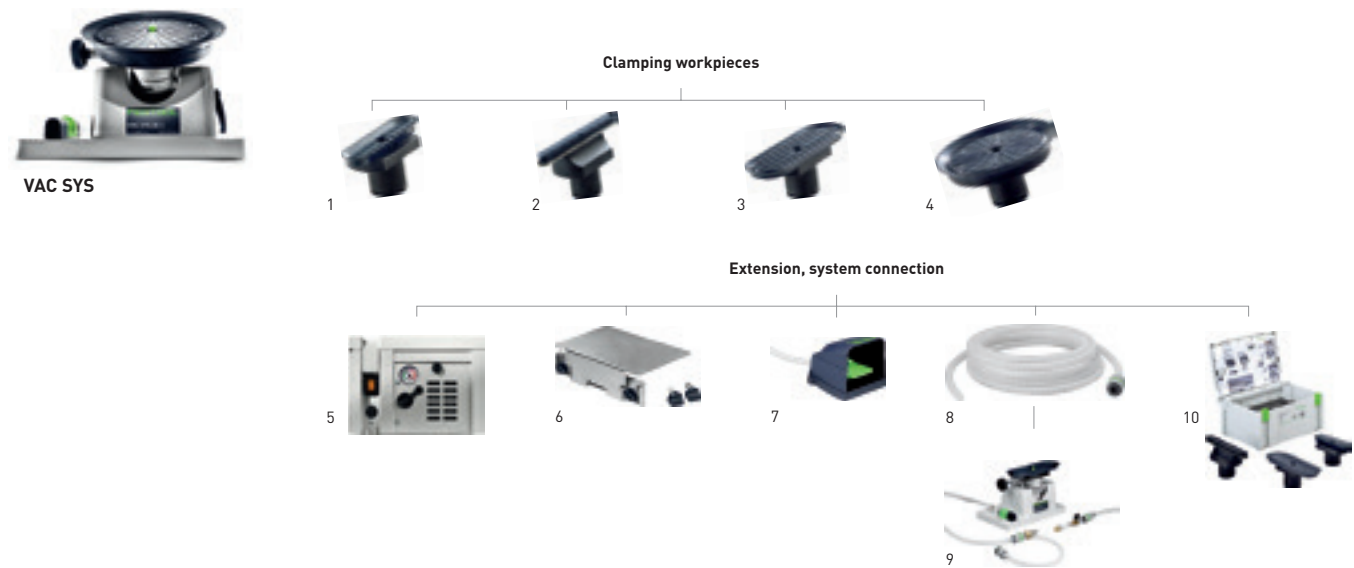

Accessories for the VAC SYS vacuum clamping system

Denomination	Explanation	Order no.
1 Vacuum pad VAC SYS VT 200x60	for VAC SYS SE 1, VAC SYS SE 2, pad dimensions 200 x 60 mm, in carton	580064
2 Vacuum pad VAC SYS VT 277x32	for VAC SYS SE 1, VAC SYS SE 2, pad dimensions 277 x 32 mm, in carton	580065
3 Vacuum pad VAC SYS VT 275x100	for VAC SYS SE 1, VAC SYS SE 2, pad dimensions 275 x 10 mm, in carton	580066
4 Vacuum pad VAC SYS VT D 215	for VAC SYS SE 1, VAC SYS SE 2, diameter 215 mm, in carton	580067
5 Vacuum pump VAC SYS VP	power consumption at 50 Hz 160 – 200 watt, power consumption at 60 Hz 200 – 230 watt, pump capacity at 50 Hz 2,7 m³/h, pump capacity at 60 Hz 3,5 m³/h, minimum vacuum ≥ 81%/ ≥ 810, weight 8 kg, in carton	580060
6 Adapter VAC SYS AD MFT 3	for VAC SYS SE 1, VAC SYS SE 2, for connecting the VAC SYS clamping unit with the MFT 3, in carton	494977
7 Foot valve VAC SYS FV	for the VAC SYS SE 1 or in a combination of the VAC SYS SE 1 with the VAC SYS SE 2, for releasing the vacuum pad, in carton	580063
8 Vacuum hose D 16 x 5m VAC SYS	for VAC SYS Set SE 1, VAC SYS SE2, for guide extension, length 5 m, in carton	495293
9 Vacuum unit VAC SYS SE 2	vacuum hose, vacuum pad VAC SYS VT 275 x 100 mm, connector, max. power consumption at 50 Hz 200 watt, min. power consumption at 50 Hz 160 watt, power consumption at 50 Hz 160 – 200 watt, power consumption at 60 Hz 200 – 230 watt, pump capacity at 50 Hz 2,7 m³/h, pump capacity at 60 Hz 3,5 m³/h, minimum vacuum ≥ 81%/ ≥ 810, weight 8 kg, in SYSTAINER SYS 4	580062
10 Accessories SYSTAINER VAC SYS VT Sort	for VAC SYS SE 1, VAC SYS SE 2, VAC SYS VT 200x60, VAC SYS VT 277x32, vacuum pad VAC SYS VT 275 x 100 mm, also provides space for the VAC SYS VT D 215, in SYSTAINER SYS 3	495294

System accessories



Accessories for the ASA boom arm, EAA energy box

Denomination	Explanation	Order no.
1 Ceiling suspension EAA-D-EU	for energy boxes (models starting in 2009), 2.5 m cable set, 2.5 m compressed air hose, mounting, aluminium tube (1310 mm) with connecting sleeve, in carton	495890
2 Wall mounting EAA-W-EU	for energy boxes (models starting in 2009), 4 m cable sets, 4 m compressed air hose, aluminium tube (350 mm) with connecting sleeve, installation set for energy boxes, in carton	495889
3 Boom arm ASA 5000 CT/SR-EU	for CT mobile dust extractors and SRM extractors, double-jointed arm with wall bracket, cable duct, wall mounting components are not included, connecting cable length 3 m, boom extension 2 x 2,5 m, application area 39 – 58 m ² , weight 92 kg, cutting angle adjustment 39 – 58°, in carton	583867
Boom arm ASA 6000 CT/SR-EU	for CT mobile dust extractors and SRM extractors, double-jointed arm with wall bracket, cable duct, wall mounting components are not included, connecting cable length 3 m, boom extension 2 x 3 m, application area 56 – 84 m ² , weight 105 kg, cutting angle adjustment 56 – 84°, in carton	583868
4 Abrasive paper holder SH-EAA	without mounting hardware, for abrasives up to Ø 150 mm, in carton	496044
5 Energy box module EAA CT 26/36/48	for CT 26/36/48, for connecting a CT mobile dust extractor with an energy box or boom arm, not required in LE version, in carton	496143
6 IAS 3 hose	from page 150	

System accessories

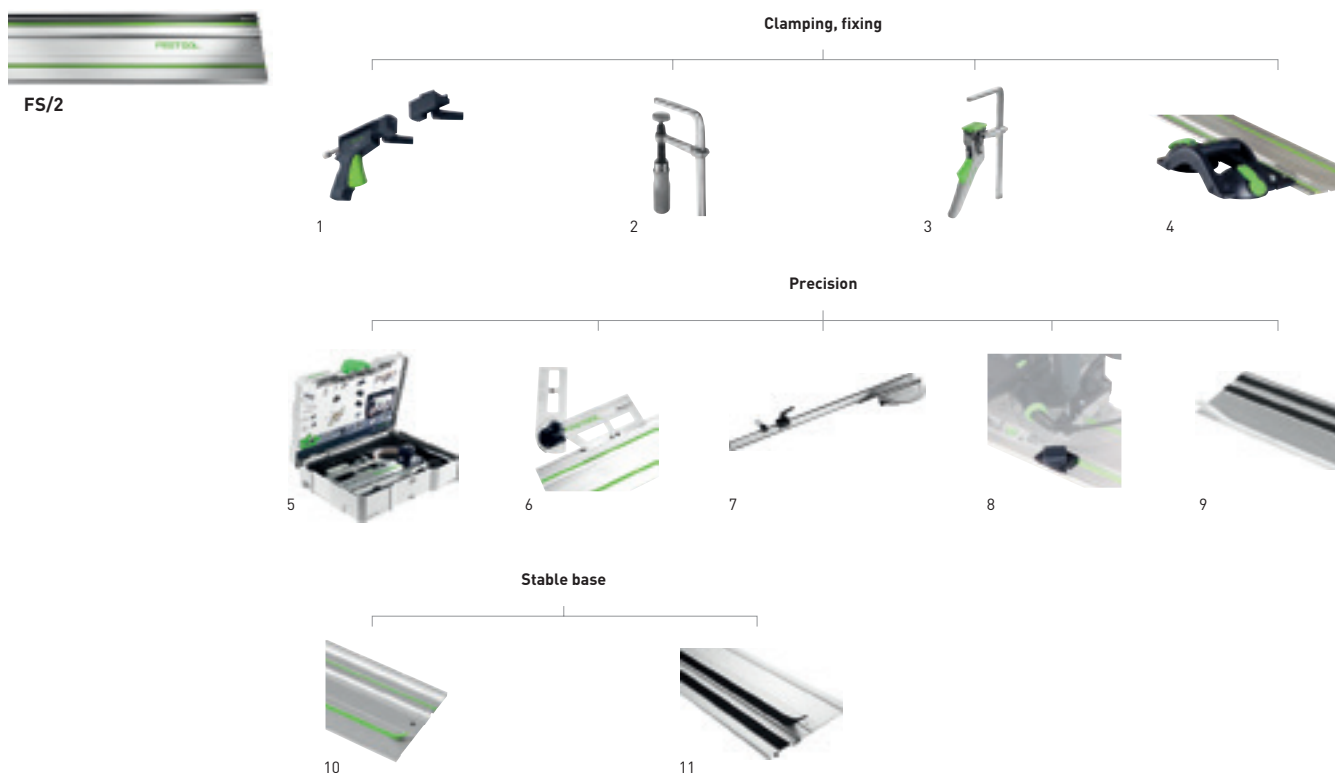

Accessories for the guide rail FS/2

Denomination	Explanation	Order no.
1 Quick-action clamp FS-RAPID/R	for clamping and positioning guide rails FS, FS/2 and GRP/2, Clamping jaws, fixed jaws, in self-service display pack	489790
Quick-action clamp FS-RAPID/L	for use of SSU 200, IS 330 with guide rail, for clamping and positioning with Festool guide rails, Clamping jaws, fixed jaws, in self-service display pack	768116
2 Fastening clamp FSZ 120	for FS/2, MFT, solid steel version, clamping width 120 mm, qty. in pack 2 Units, in self-service display pack	489570
Fastening clamp FSZ 300	for FS/2, MFT, solid steel version, clamping width 300 mm, qty. in pack 2 Units, in self-service display pack	489571
3 Lever clamp FS-HZ 160	for FS/2, MFT, solid steel version, clamping width 160 mm, in self-service display pack	491594
4 dual suction pad GECKO DOSH	from page 389	
Adapter DOSH-FSAD	to fix the guide rail at the GECKO, in self-service display pack	492616
5 Accessories set FS-SYS/2	2 x clamp FSZ 120, deflector FS-AW, combination angle FS-KS, set-back stop FS-RSP, 2 connecting elements FSV, splinter guard FS-SP 1400, in SYSTAINER SYS 1 T-LOC	497657
6 Combination bevel FS-KS	for FS/2, for angle cuts on guide rail between 0 and 180, in self-service display pack	491588
7 Angle stop FS-AG-2	for FS/2 and GRP/2, for straight angle cuts for use with the guide rail, in carton	768168
8 Kickback stop FS-RSP	for TS 55, TS 55 R, TSC 55, TS 75, HKC 55, HK 55, ATF 55, AP 55, AT 65, AP 65, AP 85, can also be used as guide stop, used as a rear and front stop position on guide rail FS/2, in self-service display pack	491582
9 Splinter guard FS-SP 1400/T	replacement splinterguard for guide rails, transparent, length 1.400 mm, in self-service display pack	495207
Splinter guard FS-SP 5000/T	replacement splinterguard for guide rails, transparent, length 5.000 mm, in self-service display pack	495209
10 Slideway lining FS-GB 10M	replacement sliding surface for guide rail, 10 m length, in self-service display pack	491741
11 Adhesive cushion strip FS-HU 10M	10 m roll, replacement adhesive cushion strip for FS and FS/2 guide rail, in self-service display pack	485724

System accessories



FS/2

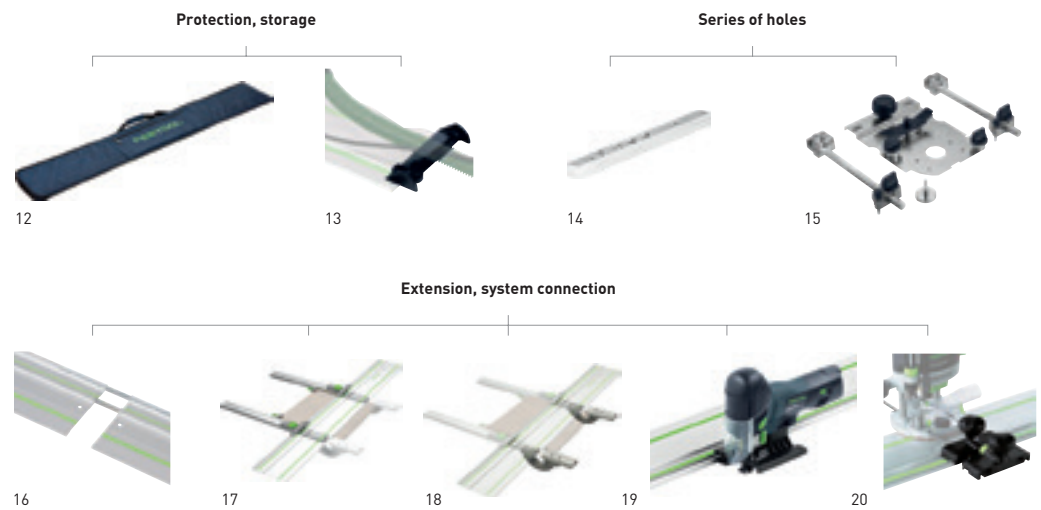

Accessories for the guide rail FS/2

Denomination	Explanation	Order no.
12 Bag FS-BAG	carrying bag with shoulder straps, up to length of FS 1400/2, in bag	466357
13 Deflector FS-AW	prevents suction hoses and cables from catching on the end of the guide rail, in self-service display pack	489022
14 Stopper LA-LR 32 FS	positions the first hole on the hole series guide rail at a distance of 9.5, 16 or 32 mm from the workpiece edge, qty. in pack 2 Units, in self-service display pack	496938
15 Hole series system for FS/2	from page 255	
16 Connecting piece FSV	to connect guide rails for long workpieces, qty. in pack 1 Units, in self-service display pack	482107
17 Parallel side fence FS-PA	for FS/2, for sawing along the width, for fixed cuts, can be re-set using the scale and end stop, mounting on the guide rail without the use of tools, stop ruler with additional clamp, adjustable stop, max. workpiece width 650 mm, qty. in pack 2 Units, in self-service display pack	495717
18 Guide extension FS-PA-VL	for FS/2, only for use with the FS-PA, stop ruler, bridge, scale, max. workpiece width 195 mm, max. material strength 70 mm, qty. in pack 2 Units, in self-service display pack	495718
19 Guide rail adapter FS-PS/PSB 300	for PS 200, PS 300, PSB 300, PS 2, allows use of jigsaws with FS and FS/2 guide systems, in self-service display pack	490031
base adapter ADT-PS 420	for PS(C) 400/420, PSB(C) 400/420, for using the PS on the guide rail, for installation in the Compact Module System CMS, in conjunction with circle cutting attachment KS-PS 400, in self-service display pack	497303
20 Guide stops for routers	from page 265	

System accessories

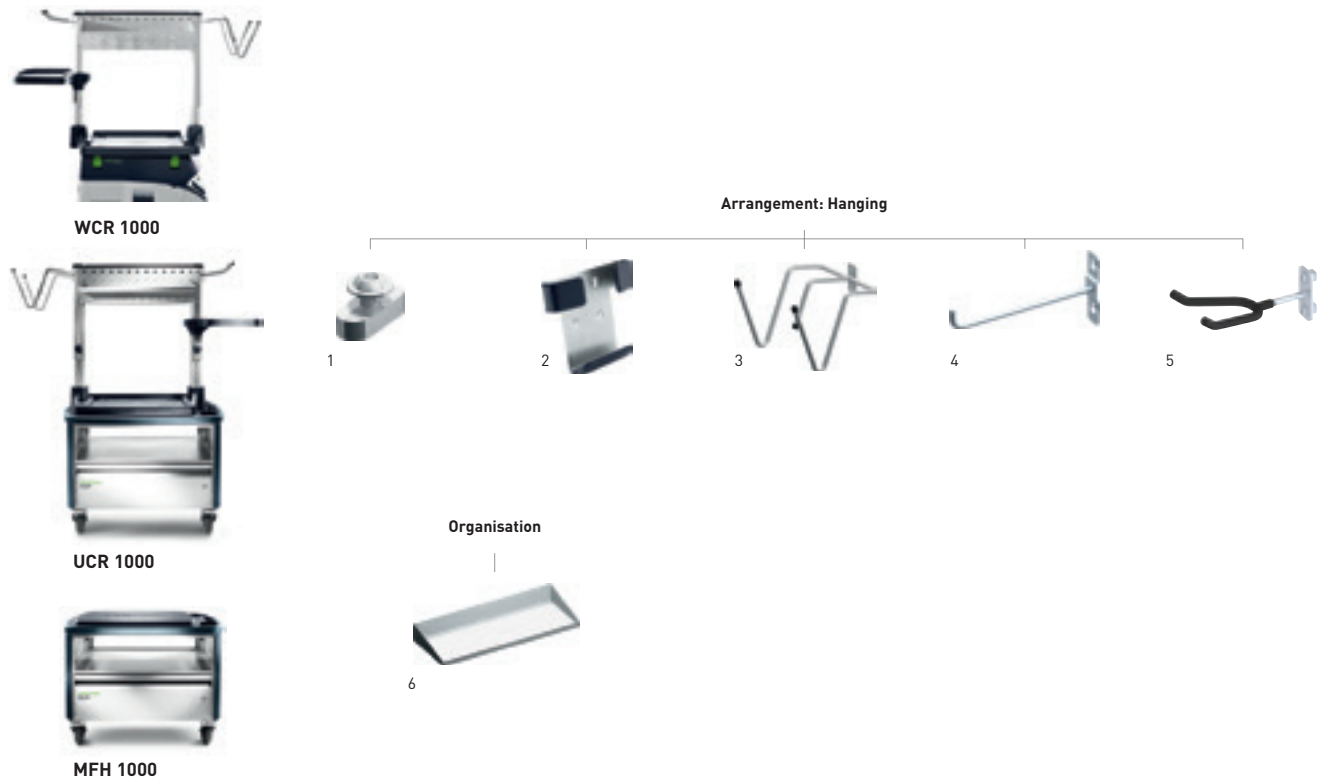

Accessories for Workcenter WCR 1000, Universalcenter UCR 1000, multifunction stool MFH 1000

Denomination	Explanation	Order no.
1 Feather key WCR 1000 PF 2x	for WCR 1000, UCR 1000, The keys enable the attachment of individual accessories to the profiled groove, 2x keys incl. bits, in self-service display pack	497476
2 Pegboard hook LWH HSK-A	for WCR 1000, MFH 1000, UCR 1000, for hanging hand sanding blocks HSK-A 80x130, HSK-A 80x200 and HSK-A 115x226, not suitable for hand sanding block HSK-A 80x400, the protective coating prevents damage, dimensions length x width 38,1 x 38,1 mm, in carton	498968
3 Tool hook WCR 1000 WH	for WCR 1000, UCR 1000, for hanging two tools, for use as a hose holder, in carton	497474
4 Hook WCR 1000 SHQ	for WCR 1000, UCR 1000, Standard hooks for mounting on the pegboard, qty. in pack 6 Units, in self-service display pack	497475
5 Holder for spray gun WCR 1000 LPH	for WCR 1000 Workcenter, holder for paint gun, for assembly at the profile groove for the WCR 1000 Workcenter, 2x screw, 2x square nut, dimensions [L x W x H] 148 x 76 x 60 mm, weight 0,5 kg, in carton	498361
6 Storage surface WCR 1000 AB	for WCR 1000, UCR 1000, Large storage surface for placing sundries, boxes of abrasives or screws, etc., in carton	497477

System accessories

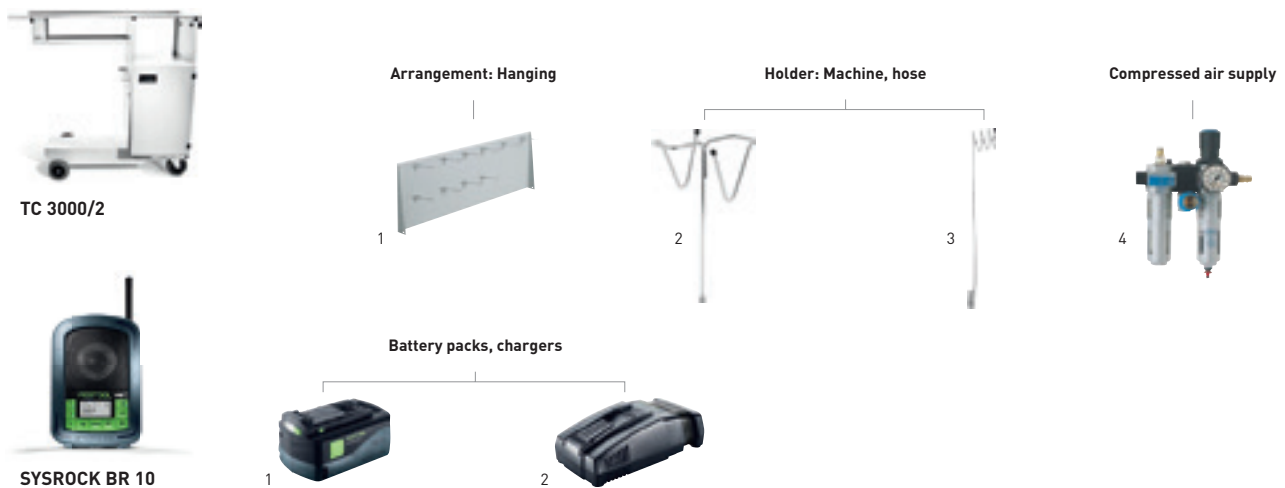

Accessories for the TC 3000/2 Toolcenter

Denomination	Explanation	Order no.
1 Rear wall TC 3000 RW	for Toolcenters TC 3000, TC 3000/2 incl. 10 hooks, dimensions length x width 990 x 340 mm, in carton	452986
2 Tool holder WHR/D-TC	for the TC 2000, TC 3000, TC 3000/2, for safe, ergonomic storage of two electric and air tools at the same time, in carton	493415
3 Hose holder TC-SH	for the TC 2000, TC 3000, TC 3000/2, for retrofitting TC 3000, in carton	487304
4 Service unit VE-TC 3000	for Toolcenter TC 2000, TC 3000, for compressed air supply to mobile dust extractors CT 22/33 and SR 151, SR 200 series dust extractors in LE design, in carton	454808

Accessories for SYSROCK BR 10, BR 10 DAB+ construction site radios

Denomination	Explanation	Order no.
1 Battery pack BP 18 Li 5,2 AS	with AIRSTREAM function, lithium-ion (Li-ion) replacement battery pack for all Festool 18 V cordless tools (except CXS, TXS, ETSC 125, RTSC 400, DTSC 400), tensioner 18 V, capacity 5,2 Ah, weight 0,7 kg, in self-service display pack	200181
Battery pack BP 18 Li 5,2 ASI	Bluetooth® lithium-ion (Li-ion) battery pack with AIRSTREAM function for all Festool 18 V cordless tools (except CXS, TXS, ETSC 125, RTSC 400, DTSC 400), Bluetooth® enables the CLEANTEC mobile dust extractor to be started automatically when the cordless tool is switched on (use of a Bluetooth®-compatible mobile dust extractor is required), tensioner 18 V, capacity 5,2 Ah, weight 0,7 kg, in carton	202479
Battery pack BP 18 Li 6,2 AS	with AIRSTREAM function, lithium-ion (Li-ion) replacement battery pack for all Festool 18 V cordless tools (except CXS, TXS, ETSC 125, RTSC 400, DTSC 400), tensioner 18 V, capacity 6,2 Ah, weight 0,7 kg, in self-service display pack	201774
Battery pack BP 18 Li 6,2 ASI	Bluetooth® lithium-ion (Li-ion) battery pack with AIRSTREAM function for all Festool 18 V cordless tools (except CXS, TXS, ETSC 125, RTSC 400, DTSC 400), Bluetooth® enables the CLEANTEC mobile dust extractor to be started automatically when the cordless tool is switched on (use of a Bluetooth®-compatible mobile dust extractor is required), tensioner 18 V, capacity 6,2 Ah, weight 0,7 kg, in carton	201797
Battery pack BP 18 Li 3,1 C	compact, lightweight design, lithium-ion (Li-ion) replacement battery pack for all Festool 18 V cordless tools (except TSC 55, CXS, TXS, ETSC 125, RTSC 400, DTSC 400), tensioner 18 V, capacity 3,1 Ah, weight 0,4 kg, in self-service display pack	201789
Battery pack BP 18 Li 3,1 CI	Bluetooth® lithium-ion (Li-ion) replacement battery pack for all Festool 18 V cordless tools (except TSC 55, CXS, TXS, ETSC 125, RTSC 400, DTSC 400), Bluetooth® enables the CLEANTEC mobile dust extractor to be started automatically when the cordless tool is switched on (use of a Bluetooth®-compatible mobile dust extractor is required), tensioner 18 V, capacity 3,1 Ah, weight 0,4 kg, in carton	203799
2 Rapid charger TCL 6	for all Li-ion battery packs (except for CXS/TXS), Lithium-ion (Li-ion) replacement charger for all 10.8 – 18 V battery packs, charging current 6 A, input voltage 220 – 240 V, weight 0,8 kg, in self-service display pack	201135
Rapid charger SCA 8	for all Li-ion battery packs (except for CXS/TXS), with AIRSTREAM function, Lithium-ion (Li-ion) replacement charger for all 10.8 – 18 V battery packs, charging current 8 A, input voltage 220 – 240 V, weight 1,1 kg, in self-service display pack	200178
Battery and charging technology	from page 14	

System accessories

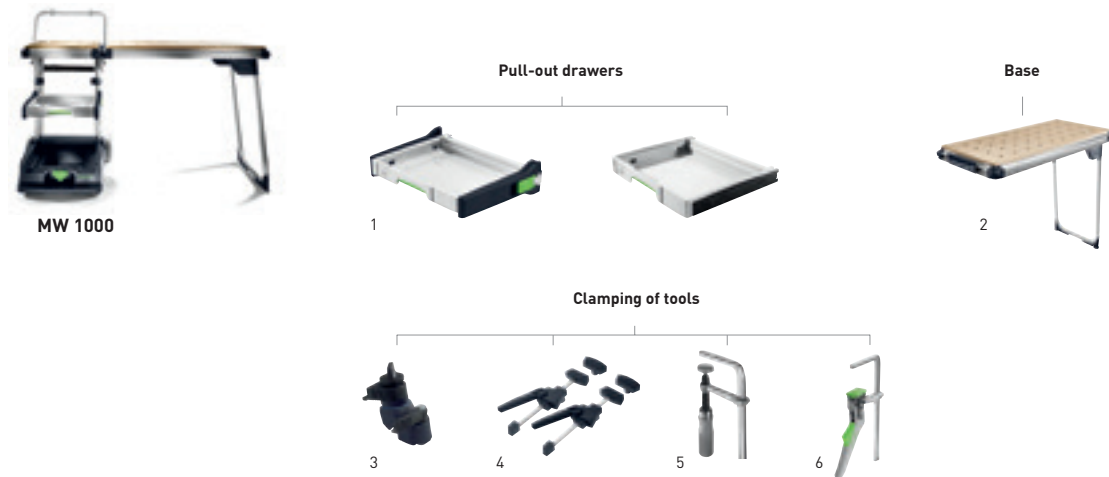

Accessories for MW 1000 mobile workshop

Denomination	Explanation	Order no.
1 Pull-out drawer SYS-AZ-MW 1000	for MW 1000 mobile workshop, tool-free attachment and customised height adjustment, dimensions (L x W x H) 493 x 373 x 118 mm, drawer load capacity 20 kg, weight 3,2 kg, in carton	203456
Pull-out drawer SYS-AZ	for all Systainers (Classic and T-LOC), for constructing an individual shelf system, in 32 hole grid, dimensions (L x W x H) 425 x 376 x 57 mm, max. load 20 kg, in carton	500692
2 Base TSB/1-MW 1000	for MW 1000 mobile workshop and MFT 3, extended work space, aluminium profile and perforated top allow for use of many existing accessories, work height 900 mm, dimensions (L x W x H) 1.045 x 500 x 74 mm, weight 12,2 kg, in carton	203457
3 Additional clamp MFT/3-ZK	for securing the stop rail to the V-groove, in self-service display pack	495541
4 Fixed clamps MFT-SP	for MFT, for safe and precise securing of the workpiece (sawing, sanding, routing, drilling, etc.), qty. in pack 2 Units, in self-service display pack	488030
5 Fastening clamp FSZ 120	for FS/2, MFT, solid steel version, clamping width 120 mm, qty. in pack 2 Units, in self-service display pack	489570
Fastening clamp FSZ 300	for FS/2, MFT, solid steel version, clamping width 300 mm, qty. in pack 2 Units, in self-service display pack	489571
6 Lever clamp FS-HZ 160	for FS/2, MFT, solid steel version, clamping width 160 mm, in self-service display pack	491594

Simply tidier, more clearly arranged and better organised.

SYSTAINER/SORTAINER – can be stacked or connected, are extremely robust and virtually indestructible.

Machines, accessories and consumable materials are protected from dust, water, changes in temperature and heavy impacts. All your sundries and consumables are stored tidily and are easier to transport – size 1 and 2 SYS T-LOC units can even be carried upright with the attachable additional handle (accessory).

SYS-ToolBox – the open SYSTAINER for instant access.

The sturdy design using high-quality plastic provides a maximum load capacity of 7 kg. Two spacious compartments keep your workplace tidy and an open top gives quick access to hand-held tools, consumables and accessories.



Combines three functions.

The central control element of the SYSTAINER: Lock, open, connect with a single turn.



Secure connection.

In combination with a SYSTAINER or a mobile dust extractor, Systainer-Port and Workcenter WCR.



Easy to open.







The new SYSTAINER T-LOC can be opened at any time without having to be disconnected.

Everything at a glance – the drawers of the SORTAINER offer lots of space for sundries.









- › Individual compartments and additional labelling option for good overview.
- › The pull-out catch and individual lock prevent accidental removal of the drawers.
- › A range of different sizes and a modular drawer system offer a SORTAINER to suit every requirement.



System accessories









SYSTAINER T-LOC		Type	Order no.
	SYSTAINER T-LOC 1x cover for label field dimensions (L x W x H) 396 x 296 x 105 mm, dimensions with adjustable legs (L x W x H) 396 x 296 x 112 mm, inner dimensions (L x W x H) 383 x 273 x 75 mm, weight 1,3 kg	SYS 1 TL	497563
	dimensions (L x W x H) 396 x 296 x 157,5 mm, dimensions with adjustable legs (L x W x H) 396 x 296 x 164,5 mm, inner dimensions (L x W x H) 383 x 267 x 127,5 mm, weight 1,5 kg	SYS 2 TL	497564
	dimensions (L x W x H) 396 x 296 x 210 mm, dimensions with adjustable legs (L x W x H) 396 x 296 x 217 mm, inner dimensions (L x W x H) 382 x 266 x 180 mm, weight 1,8 kg	SYS 3 TL	497565
	dimensions (L x W x H) 396 x 296 x 315 mm, dimensions with adjustable legs (L x W x H) 396 x 296 x 322 mm, inner dimensions (L x W x H) 382 x 266 x 285 mm, weight 2,1 kg	SYS 4 TL	497566
	dimensions (L x W x H) 396 x 296 x 420 mm, dimensions with adjustable legs (L x W x H) 396 x 296 x 427 mm, inner dimensions (L x W x H) 381 x 265 x 384 mm, weight 2,7 kg	SYS 5 TL	497567
MAXI-SYSTAINER		Type	Order no.
	MAXI-SYSTAINER to connect with SYS 1, SYS 2, SYS 3, SYS 4, SYS 5, SORTAINER dimensions (L x W x H) 596 x 390 x 210 mm, inner dimensions (L x W x H) 545 x 330 x 168 mm, weight 4 kg	SYS MAXI	490701
	dimensions (L x W x H) 596 x 390 x 157,5 mm, inner dimensions (L x W x H) 545 x 330 x 124 mm, weight 3 kg	SYS MAXI 2	492582
MIDI-SYSTAINER T-LOC		Type	Order no.
	MIDI-SYSTAINER T-LOC can be connected to SYS T-LOC, for clear and structured arrangement of small parts, power tools, hand-held tools and accessories, dimensions (L x W x H) 496 x 296 x 210 mm, inner dimensions (L x W x H) 483 x 267 x 180 mm, weight 2 kg	SYS-MIDI 3 TL	499621

System accessories

MINI-SYSTAINER T-LOC		Type	Order no.
	MINI-SYSTAINER T-LOC for clear and structured arrangement of small parts and hand-held tools, can be combined with SYS-MINI 1 and 3 TL, cannot be connected to SYS 1-5, SORTAINER, SYS MINI classic,		
	dimensions (L x W x H) 265 x 171 x 71 mm, inner dimensions (L x W x H) 255 x 155 x 53 mm, weight 0,4 kg	SYS-MINI 1 TL	499622
	transparent cover, dimensions (L x W x H) 265 x 171 x 71 mm, inner dimensions (L x W x H) 255 x 155 x 53 mm, weight 0,4 kg	SYS-MINI 1 TL TRA	203813
	TZE-UNI SYS MINI TL multi-purpose insert, transparent cover, dimensions (L x W x H) 265 x 171 x 71 mm, inner dimensions (L x W x H) 255 x 155 x 53 mm, weight 0,6 kg	SYS-MINI 1 TL TRA UNI	203821
	dimensions (L x W x H) 265 x 171 x 142 mm, inner dimensions (L x W x H) 255 x 155 x 124 mm, weight 0,4 kg	SYS-MINI 3 TL	202544
SYSTAINER T-LOC with lid compartment		Type	Order no.
	SYSTAINER T-LOC DF 1x cover for label field		
	dimensions (L x W x H) 396 x 296 x 105 mm, dimensions with adjustable legs (L x W x H) 396 x 296 x 112 mm, inner dimensions (L x W x H) 383 x 273 x 68 mm, weight 1,5 kg	SYS 1 TL-DF	497851
	dimensions (L x W x H) 396 x 296 x 157,5 mm, dimensions with adjustable legs (L x W x H) 396 x 296 x 164,5 mm, inner dimensions (L x W x H) 383 x 267 x 121 mm, weight 1,7 kg	SYS 2 TL-DF	497852
	dimensions (L x W x H) 396 x 296 x 210 mm, dimensions with adjustable legs (L x W x H) 396 x 296 x 217 mm, inner dimensions (L x W x H) 382 x 266 x 173 mm, weight 2 kg	SYS 3 TL-DF	498390
SYSTAINER T-LOC SYS-Combi		Type	Order no.
	SYSTAINER T-LOC flexibly divisible drawer for accessories, consumables, small parts and sundries, internal dimensions of the drawer (L x W x H) 350 x 255 x 69 mm		
	combination of the classic SYSTAINER size 2 and a spacious drawer, dimensions (L x W x H) 396 x 296 x 263 mm, dimensions with adjustable legs (L x W x H) 396 x 296 x 270 mm, internal dimensions of the top compartment (L x W x H) 383 x 267 x 127 mm, weight 3,2 kg	SYS-Combi 2	200117
	combination of the classic SYSTAINER size 3 and a spacious drawer, dimensions (L x W x H) 396 x 296 x 315 mm, dimensions with adjustable legs (L x W x H) 396 x 296 x 322 mm, internal dimensions of the top compartment (L x W x H) 382 x 266 x 180 mm, weight 3,5 kg	SYS-Combi 3	200118





13 Workplace organisation

System accessories



SORTAINER		Type	Order no.
	SORTAINER 2 x small drawer (L x W x D) 255x75x30 mm, medium drawer (L x W x D) 255 x 165 x 30 mm, large drawer (L x W x D) 255 x 348 x 85 mm, 2 dividers per drawer, 6 x label holders, 8 x lettering strips, dimensions (L x W x H) 395 x 295 x 210 mm, weight 4 kg	SYS 3-SORT/4	491522
	6 x medium drawer (L x W x D) 255 x 165 x 30 mm, 2 dividers per drawer, 6 x label holders, 8 x lettering strips, dimensions (L x W x H) 395 x 295 x 210 mm, weight 4,9 kg	SYS 3-SORT/6	491984
	6 x small drawer (L x W x D) 255x75x30 mm, 2 dividers per drawer, 3 x medium drawer (L x W x D) 255 x 165 x 30 mm, 9 x label holders, 16 x lettering strips, dimensions (L x W x H) 395 x 295 x 210 mm, weight 5,1 kg	SYS 3-SORT/9	491985
	12 x small drawer (L x W x D) 255x75x30 mm, 2 dividers per drawer, 12 x label holders, 16 x lettering strips, dimensions (L x W x H) 395 x 295 x 210 mm, weight 5,3 kg	SYS 3-SORT/12	491986
	three drawers, each with a capacity of 6.7 litres, can be set up and divided individually with plastic containers and partitions (plastic containers and small partitions are not included), connects to all T-LOC and Classic Systainers, SORTAINERS and CLEANTEC mobile dust extractors, dimensions (L x W x H) 396 x 296 x 322 mm, weight 5,7 kg	SYS 4 TL-SORT/3	200119
SYS tool box		Type	Order no.
	SYS-ToolBox for practical transportation of hand tools, consumable materials and accessories, contact surface 396 x 296 mm		
	dimensions (L x W x H) 396 x 296 x 150 mm, height 150 mm, load capacity 7 kg, volume 12,5 l	SYS-TB-1	495024
	dimensions (L x W x H) 396 x 296 x 257 mm, height 257 mm, load capacity 14 kg, volume 20 l	SYS-TB-2	499550
SYS-StorageBox		Type	Order no.
	SYS-StorageBox plastic container, no content, with individually removable plastic containers, can be connected to the entire Systainer range (except SYS-Mini), 2 x Box 60x60x71 SYS-SB, 2 x Box 60x120x71 SYS-SB, 1 x Box 180x120x71 SYS-SB, dimensions (L x W x H) 396 x 296 x 167 mm, height including handle 240 mm, weight 2,5 kg	SYS-SB	499901

System accessories



Systainer-Port

		Type	Order no.
	Systainer-Port no admission for assembly in car, stable full metal body, 5 x labels for drawers, with 3 SYSTAINER telescopic drawers, without SYSTAINER, dimensions [L x W x H] 400 x 500 x 500 mm, weight 19 kg, in carton	SYS-PORT 500/2	491921
	Systainer-Port no admission for assembly in car, stable full metal body, 5 x labels for drawers, with 5 SYSTAINER telescopic drawers, 4 ball bearing-mounted swivel castors (2 with locking brakes), without SYSTAINER, dimensions [L x W x H] 400 x 500 x 1.100 mm, weight 33 kg, in carton	SYS-PORT 1000/2	491922
	Set of castors for SYS port, for assembly on SYS-Port, diameter 75 mm, in carton	SYS-PORT R/2	491932
	Telescopic drawer in carton	SYS-PORT/TA	491923





SYSTAINER pull-out drawer

		Type	Order no.
	Pull-out drawer for all Systainers (Classic and T-LOC), for constructing an individual shelf system, in 32 hole grid, dimensions [L x W x H] 425 x 376 x 57 mm, max. load 20 kg, in carton	SYS-AZ	500692
	qty. in pack 5 Units	SYS-AZ-Set	500767
	Lock for SYS-AZ, simultaneous lock, for subsequent installation in the pull-out drawer SYS-AZ, locks the individual pull-out drawer on the side of the body (simultaneous), in carton	S-AZ	500693

Means of transport for SYSTAINER



		Type	Order no.
	SYS-Cart for easy transportation of SYSTAINER sizes 1-5 and SORTAINERS., robust handles, 4 steering rollers, 2 of which can be locked, bASE 360 x 520 mm, load capacity 100 kg, roll dia. 100 mm, weight 2,8 kg, in carton	RB-SYS	495020
	SYS-Roll transportation of SYS Classic and SYS T-LOC, extra large wheels (D 200 mm) for easy transportation up and down steps, rotating lockable front rollers – manoeuvre in all directions, incl. safety belt, dimensions [L x W x H] 440 x 600 x 1.100 mm, total load capacity 100 kg, drawer load capacity 5 kg, front roll dia. 75 mm, rear roll dia. 200 mm, weight 6,5 kg, in carton	SYS-Roll 100	498660

System accessories

Means of transport for SYSTAINER		Type	Order no.
	<p>in carton</p> <p>Mobile workshop SYS-AZ-MW 1000 pull-out drawer, work height 900 mm, dimensions (L x W x H) 641 x 600 x 1.076 mm, table dimensions 445 x 363 mm, total load capacity 100 kg, drawer load capacity 20 kg, roll dia. 200 mm, weight 19 kg</p>	MW 1000 Basic	203454
	<p>Mobile workshop SYS-AZ-MW 1000 pull-out drawer, TSB/1-MW 1000 table, work height 900 mm, dimensions (L x W x H) 641 x 600 x 1.185 mm, table dimensions 445 x 363 mm, extension table dimensions 970 x 445 mm, total load capacity 100 kg, drawer load capacity 20 kg, roll dia. 200 mm, weight 31 kg</p>	MW 1000-Set	203802
	<p>Pull-out drawer for MW 1000 mobile workshop, tool-free attachment and customised height adjustment, dimensions (L x W x H) 493 x 373 x 118 mm, drawer load capacity 20 kg, weight 3,2 kg</p>	SYS-AZ-MW 1000	203456
	<p>Base for MW 1000 mobile workshop and MFT 3, extended work space, aluminium profile and perforated top allow for use of many existing accessories, work height 900 mm, dimensions (L x W x H) 1.045 x 500 x 74 mm, weight 12,2 kg</p>	TSB/1-MW 1000	203457

System accessories

SYSTAINER T-LOC with inlays for abrasives

		Type	Order no.
	SYSTAINER T-LOC with insert for abrasives Ø 125 mm, dimensions (L x W x H) 396 x 296 x 105 mm, number of compartments 5, SYSTAINER size SYS 1 T-LOC	SYS-STF D125	497685
	with insert for abrasives 80x133 mm, dimensions (L x W x H) 396 x 296 x 105 mm, number of compartments 6, SYSTAINER size SYS 1 T-LOC	SYS-STF 80x133	497684
	with insert for abrasives STF Delta 100x150, dimensions (L x W x H) 396 x 296 x 105 mm, number of compartments 5, SYSTAINER size SYS 1 T-LOC	SYS-STF Delta 100x150	497686
	with insert for Ø 90 mm abrasives and 93V abrasives, dimensions (L x W x H) 396 x 296 x 105 mm, number of compartments 8, SYSTAINER size SYS 1 T-LOC	SYS-STF-D77/ D90/93V	497687
	with insert for abrasives Ø 150 mm, dimensions (L x W x H) 396 x 296 x 210 mm, number of compartments 10, SYSTAINER size SYS 3 T-LOC	SYS-STF D150	497690
	with insert for abrasive, dia. 225 mm, dimensions (L x W x H) 396 x 296 x 315 mm, number of compartments 3, SYSTAINER size SYS 4 T-LOC	SYS-STF D225	497691

System accessories

SYSTAINER with universal insert		Type	Order no.
	SYSTAINER T-LOC with universal insert for sundries, dimensions (L x W x H) 396 x 296 x 105 mm, SYSTAINER size SYS 1 T-LOC	SYS 1 UNI	497692
	with single diced foam insert to produce an aperture of any desired shape, dimensions (L x W x H) 396 x 296 x 105 mm, inner dimensions (L x W x H) 383 x 273 x 75 mm, SYSTAINER size SYS 1 T-LOC	SYS 1 VARI	497693
	with double diced foam insert to produce an aperture of any desired shape, dimensions (L x W x H) 396 x 296 x 157,5 mm, inner dimensions (L x W x H) 383 x 267 x 127,5 mm, SYSTAINER size SYS 2 T-LOC	SYS 2 VARI	497696
	with foam insert, for safe storage of cutters D 8, D 12, dimensions (L x W x H) 396 x 296 x 105 mm, inner dimensions (L x W x H) 383 x 273 x 75 mm, SYSTAINER size SYS 1 T-LOC	SYS-OF D8/D12	497695
	with individual removable plastic containers, plastic container, no content, dimensions (L x W x H) 396 x 296 x 105 mm, SYSTAINER size SYS 1 T-LOC	SYS 1 BOX	497694
Plastic containers and inserts for SYS-StorageBox, SYS 1 BOX, SYS-Combi, SYS 4 TL-SORT/3		Type	Order no.
	Plastic containers for SYS-Storage Box SYS-SB, qty. in pack: 6, dimensions (L x W x H) 60 x 60 x 71 mm, qty. in pack 6 Units, in carton	Box 60x60x71/ 6 SYS-SB	500066
	for SYS-Storage Box SYS-SB, qty. in pack: 4, dimensions (L x W x H) 60 x 120 x 71 mm, qty. in pack 4 Units, in carton	Box 60x120x71/ 4 SYS-SB	500067
	for SYS-Storage Box SYS-SB, qty. in pack: 2, dimensions (L x W x H) 180 x 120 x 71 mm, qty. in pack 2 Units, in carton	Box 180x120x71/ 2 SYS-SB	500068
	for SYS-Combi 2, SYS-Combi 3 and SYS 4 TL-SORT/3, plastic containers and compartment dividers for individual drawer partitions, 8 x box of plastic containers 60 x 60 x 71 mm, 4 x box of plastic containers 60 x 120 x 71 mm, 3 x compartment dividers, 2 x cover pads, in bag	Set 60x60/120x71 3xFT	201124

System accessories





Plastic containers and inserts for SYS-StorageBox, SYS 1 BOX, SYS-Combi, SYS 4 TL-SORT/3		Type	Order no.
	for SYS 1 T-LOC box, in carton Plastic containers red, boxes excl. content, for clear storage and organisation, dimensions (L x W x H) 49 x 49 x 71 mm, qty. in pack 12 Units	Box 49x49/ 12 SYS1 TL	498038
	Plastic containers yellow, boxes excl. content, for clear storage and organisation, dimensions (L x W x H) 49 x 98 x 71 mm, qty. in pack 6 Units	Box 49x98/ 6 SYS1 TL	498039
	Plastic containers blue, boxes excl. content, for clear storage and organisation, dimensions (L x W x H) 98 x 98 x 71 mm, qty. in pack 3 Units	Box 98x98/ 3 SYS1 TL	498040
	Plastic containers green, boxes excl. content, for clear storage and organisation, dimensions (L x W x H) 98 x 147 x 71 mm, qty. in pack 2 Units	Box 98x147/ 2 SYS1 TL	498041
	Plastic containers orange, boxes excl. content, for clear storage and organisation, dimensions (L x W x H) 49 x 245 x 71 mm, qty. in pack 2 Units	Box 49x245/ 2 SYS1 TL	498042
	Deep-drawer insert for SYS 1 T-LOC box, insert for fixing and positioning boxes, plastic containers are not included in the scope of delivery, in carton	Box TZE-SYS 1 TL	498043
SYSTAINER T-LOC with insert for hand tools		Type	Order no.
	SYSTAINER T-LOC the required tool can be found quickly since all hand tools are clearly displayed for the joiner, items included without tools, wooden insert, installation recommendations, dimensions (L x W x H) 396 x 296 x 315 mm, inner dimensions (L x W x H) 382 x 266 x 285 mm, SYSTAINER size SYS 4 T-LOC	SYS-HWZ	497658
SYSTAINER T-LOC SYS-MFT		Type	Order no.
	SYSTAINER T-LOC 1x cover for label field, can be connected to the entire Systainer range (except SYS-MINI), simple, compact transportation, cover with MDF board for clamping and fixing workpieces, dimensions (L x W x H) 396 x 296 x 105 mm, dimensions with adjustable legs (L x W x H) 396 x 296 x 112 mm, inner dimensions (L x W x H) 383 x 273 x 75 mm, weight 2 kg	SYS-MFT	500076
Hole drilling set		Type	Order no.
	Hole drilling set for OF 900, OF 1000, OF 1010, OF 1400, for use with hole line guide rails, guide plate, centring mandrel, operation tool, hinge location cutter HM Ø 35 mm, dowel drill HW Ø 5 mm (V-shaped tip), dowel drill HM Ø 5 mm (with centring bit and pre-cutter), 2 parallel side fences with adjustable stop, clamp FSZ 120, 2 x Longitudinal stop, in SYSTAINER SYS 1 T-LOC	LR 32-SYS	584100

System accessories

Foam inserts for SYSTAINER		Type	Order no.
	Foam insert for SYS 1-5 T-LOC, dimpled insert (for lid), base insert and diced insert, qty. in pack 3 Units, in bag	SYS-VARI SE TL	497877
	Diced foam insert set for SYS 1-5 T-LOC, diced sections can be pushed out to produce any desired aperture, qty. in pack 2 Units, in bag	SYS-VARI RM TL	497878
Lids and bottoms for Systainers		Type	Order no.
	Cover pad in bag		
	for SYS 1-5 T-LOC, with knobs, dimensions (L x W x H) 355 x 245 x 30 mm	SE-DP SYS 1-5 TL	498044
	for SYS MAXI, with knobs, dimensions (L x W x H) 560 x 340 x 30 mm	SE-DP SYS-MAXI	491633
	for SYS MIDI 3 TL, dimensions (L x W x H) 472 x 247 x 30 mm	SE-DP SYS-MIDI	499617
	for SYS MINI TL, dimensions (L x W x H) 247 x 134 x 15 mm	SE-DP SYS-MINI TL	499619
	Base pad in bag		
	for SYS 1-5 T-LOC, protects the content	SE-BP SYS 1-5 TL	498045
	for SYS MAXI	SE-BP SYS-MAXI	491632
	for SYS MIDI 3 TL, dimensions (L x W x H) 480 x 278 x 30 mm	SE-BP SYS-MIDI	499618
Inlays and inserts for SYSTAINER		Type	Order no.
	Multi-purpose insert for SYS MINI TL, dimensions (L x W x H) 258 x 163 x 45 mm, in bag	TZE-UNI SYS MINI TL	499620
	Cartridge inlay for SYS 5 T-LOC, to store cartridges, height 130 mm, in carton	TZE-KT SYS 5 TL	497876
Other accessories		Type	Order no.
	Auxiliary handle for carrying SYS 1 T-LOC and SYS 2 T-LOC upright, in self-service display pack	ZSG -Sys 1/2 TL	497856
	Shoulder strap for CT-SYS and all SYSTAINERs T-LOC, easy transport of the CTL SYS and the SYSTAINER T-LOC, max. load 20 kg, qty. in pack 1 Units, in self-service display pack	SYS-TG	500532
	Cover cover for labelling panels SYS T-LOC, protects the labelling panels on the SYSTAINER T-LOC from damage and moisture, qty. in pack 10 Units, in self-service display pack	AB-BF SYS TL 55x85mm /10	497855

System accessories

plug it-accessories

		Type	Order no.
	plug it-cable in self-service display pack		
	rubber insulated cable 240V plug it, length 4 m	H05 RN-F-4	203914
	rubber insulated cable 240V plug it, length 4 m, qty. in pack 3 Units	H05 RN-F-4/3	203935
	rubber insulated cable 240V plug it, length 5,5 m	H05 RN-F-5,5	203899
	rubber insulated cable 240V plug it, length 7,5 m	H05 RN-F-7,5	203920
	rubber insulated cable 240V plug it, length 10 m	H05 RN-F-10	203937
	for the PLANEX 225 EQ and PLANEX LHS-E 225 easy long-reach sanders, rubber insulated cable 240V plug it, particularly suitable for use with the PLANEX LHS 225 thanks to extended cable bushing, for example for sanding work in dry construction, length 4 m	H05 RN-F-4 PLANEX	203929
	green rubber-insulated cable, length 4 m	H05 BQ-F-4	203921
	green rubber-insulated cable, length 7,5 m	H05 BQ-F-7,5	203922
	plug it conversion-kit in self-service display pack		
	For RS1, RS 1 C, DX 93, RO 150/RO2, RAS 115, BF 1, PS 200/PS/2, KF 4, length 360 mm	UBS-PUR 360 plug it 240 V	491144
	For RS 2, RS 3, RS 400/RS 4, DS 400, ES 125, OF 1000, OF 900, ATF 55, AT 65, AP 55, AP 65, EHL 65, length 420 mm	UBS-PUR 420 plug it 240 V	491145

Make your day with Festool.

! More products from our current collection can be found on: www.festool.com



Babygrow

Babygrow in blue, Festool Fan logo on the chest, short sleeves and crew neck collar. Three green snap fasteners in the crotch.

	Order no.
Material: 100% organic cotton, produced in accordance with the OEKO-TEX® standard, size 68	202307

Hoodie

Hood with drawstring cord in green. Wicking interior and front kangaroo pocket, knitted cuffs and waistband. Colouring: Dark blue with Festool printed on the left breast and the back.

	Order no.
Material: 60% cotton, 40% polyester Produced in accordance with the OEKO-TEX® standard	
XS	202849
S	201300
M	201301
L	201302
XL	201303
XXL	201304



Universal pen

The "FOR ALL" 2B graphite lead enables you to make markings on the surface of almost any material. No matter whether it is dry or wet, smooth or rough, dusty or oily. It can be wiped from smooth surfaces with a damp cloth. For light or dark surfaces with integrated sharpener in the quiver cap and a pressure mechanism for automatic lead feed in the stainless steel tube.

	Order no.
Lead diameter: 2.8 mm, Made in Germany	204147

Notebook

Large hardcover notebook. 200 squared, tear-off pages, including bookmark.

	Order no.
DIN A4	498866



Golf cap

Cap with Festool and www.festool.com embroidery. Curved visor with green stripe. Width adjustment at the back for an optimum fit.

	Order no.
Material: Denim, one size	497899



Snack Set

All-purpose serrated blade incl. bamboo wood cutting board with magnetic holder for the blade.

Order no. 203992
 Dimensions: 240 x 160 x 12 mm



Micro SYSTAINER

Made from sturdy ABS plastic, connectable and fitted with T-LOC lock. There is space for drill bits, business cards or other small items.

Order no. 203995
 Dimensions: 30 x 105 x 65 mm
 Made in Germany

Toolie multi function tool

There are nine hexagon socket wrenches with MagicRing in the sturdy and ergonomically designed housing, which can be selected and folded out simply using an eject button.

Order no. 498863
 12 cm long



Tape measure

Practical 3 m long tape measure showing centimetres and inches. With an extendable compass needle to scribe a circle.

Order no. 495415
 Material: Housing from plastic, tape measure from metal, length: 3 m



Sports bag

Sturdy sports bag with green decorative stitching and embossed logo on the side pocket. Large main compartment, inside compartment with Velcro fastening and separate compartment for wet items. Extra-reinforced base and sewn-on plastic pyramid feet for even more stability. Adjustable carrying strap, black side pocket with embossed logo.

Order no. 498494
 Volume: Approx. 45 l, dimensions: 50 x 30 x 30 cm



Insulated mug

Stainless steel insulated mug with double wall. Folding lid protects the drink opening from dirt. Snap fastener with safety seal enables one-handed use.

Order no. 203065
 Capacity: 450 ml, free from BPA



Knitted hat

Breathable with excellent insulating properties.

Order no. 202308
 Material: 100% acrylic, produced in accordance with the OEKO-TEX® standard, one size

A – Z

18-volt system	11
25 mm bits	236
100 mm bits	236

A

Abrasive belt	146
Abrasive materials	80
Abrasive paper holder	405
Abrasive sheet	334
Abrasives	136-163
Absolute filter	210-211
Accessories SYSTAINER	62, 404
Adapter hose	201, 402
Adapter plate	70, 330
Adapter ring	349
Adapters and extensions	349
Additional clamp	403, 410
Additional roll	334
Additional stop	74, 309
Adhesive cushion strip	406
Adjustable stop	69-71, 271, 402-403
Air hose	148-149
Aluminium composite milling machine	261
Aluminum cutter HS, shank 8 mm	292
Anchor bolt	315
Angle arm	271
Angle attachment	230-232
Angle chuck	234
Angle stop	67, 70-72, 75, 323, 402, 406
Angle table	62
AP-KA 65	330
APS	253
ASA	391
Assembly package	237
Assembly set	213
Auxiliary handle	138, 144-145, 168, 232-234, 369-370

B

Bag	65-66, 145, 379, 407
Balancer	368
Base	403, 410, 416
Base adapter	62, 407
Base runner	62, 265-267
Battery and charging technology	14
Battery pack	14
Belt sander	119-120
Belt sander module	121
Bench unit	146
Bench-mounted routers	251
Bevel	69-70
BHC 18	24, 217, 224
Bit assortment	237
Bit box	237
Bit cassette	237
Bit holder	235-237
Bit set	236
Blade	75
Blanking plug	203
BMS 180	95
Boom arm	206, 391, 405

Brush machine	133
Brush ring	366, 368
Brush segment	145
Brush strip	145
BS 75	95, 119
BS 105	95, 120

C

C 18	22, 216, 220
Carpentry circular saw	50
Carpet and combination suction hose	204
Carpet nozzle	204
Carpet remover	362
Carpet remover blade	371
Carrying harness	145
Cartridge inlay	420
CARVEX PS 420	39
CARVEX PSB 420	39
CARVEX PSBC 420	18, 40
CARVEX PSC 420	18, 40
Ceiling suspension	405
Centre panel connector	314
Centring bit	240
Centring mandrel	264
CENTROTEC Forstner drill bit, ZOBO system	240
CENTROTEC HSS twist drill bit	238
CENTROTEC tools for drilling and countersinking	240
Ceramics	80
Chain lubrication oil	75
Chainsaw chain	75
Chamfer cutter HW with ball bearing guide, shank 8 mm	281
Chamfer cutter HW with ball bearing guide, shank 12 mm	297
Chamfer cutter HW, shank 8 mm	294
Chamfer cutter HW, shank 12 mm	282
Chamfer cutter, without ball bearing	293
Chamfer-edge trimming cutter with ball bearing guide, shank 8 mm	284
Charger	230
Chip collection bag	64-65, 323
Chip deflector	265-268
Chip guard	271
Circular saw	42, 44, 46, 48
Clamping device	349
Clamping kit	68-69
Clamping nut	366, 369-370
Classic ogee cutter HW with ball bearing guide, shank 8 mm	280
Classic ogee cutter HW with ball bearing guide, shank 12 mm	280, 298
Classic ogee cutter HW, shank 8 mm	295
Classic ogee cutter with reversible blades	295
Classic ogee cutter, without ball bearing	293
Classic ogee/chamfer cutter with ball bearing guide, shank 8 mm	281
Cleaning and lubricating oil	148-149
Cleaning cloth	168, 173
Cleaning set	198
Cleaning set for industrial use	198
Cleaning set for the workshop	198
Cleaning set for tradesmen	198
CLEANTEC cleaning sets	198

CLEANTEC CT 17	182
CLEANTEC CT 26 / CT 36	186
CLEANTEC CT 26 AC / 36 AC / 48 AC	188
CLEANTEC CT 26 AC HD / 36 AC HD	190
CLEANTEC CT 36 AC PLANEX	189
CLEANTEC CT 48	187
CLEANTEC CT 48 EC	191
CLEANTEC CT 48 EC/B22	192
CLEANTEC CTH 26 / CTH 48	193
CLEANTEC CTL MINI I / MIDI I	184
CLEANTEC CTM MIDI I	185
CLEANTEC filter	207
CLEANTEC filter bags	208
CLEANTEC hose sleeves	202
CLEANTEC suction hose	201
CLEANTEC suction hose anti-static version	199-200
CMS PS 300	33
CMS TS 55 R	34
CMS TS 75	34
CMS-BS	95, 121
CMS-OF	250
CMS-PS	41
CMS-TS	45
Collection container	213
Collet	264-272
Combination bevel	406
Compact cleaning set	198
Compact Module System (CMS)	384
Compound mitre saw	54
Compressed air eccentric sander	123-125
Compressed air module	206, 213
Compressed air orbital sander	126-127
Connecting – DOMINO joining system – Accessories and consumables	307
Connecting – DOMINO joining system – Overview of products and applications	302
Connecting piece	273, 403, 407
Connecting sleeve	202-203
Connector set	315
Connector sleeve	203
Construction cleaning set	198
CONTURO KA 65	328
Copier scanning set	271
Copying ring	264, 266-267
Cordless circular saw	20, 47
Cordless delta sander	114
Cordless drill	22-25, 218-222
Cordless drywall screwdriver	26, 226
Cordless eccentric sander	103
Cordless hammer drill	24, 224
Cordless insulating-material saw	21, 57
Cordless orbital sander	112
Cordless pendulum jigsaws	18, 40
Cordless percussion drill	25, 223
Cordless plunge-cut saw	19, 43
Core maker	62
Corner connector	314
Counterprofile cutter groove HW with ball bearing guide, shank 8 mm	290
Counterprofile cutter tongue HW with ball bearing guide, shank 8 mm	290
Cover	64, 420
Cover cap	314-315
Crevice nozzle	205
Cross anchor	315
Cross brace	403

Cross cutting guide rail 49, 65-66
 Cross stop 309, 311
 Crossheaded guide 335
 Crown stop 69
 CS 50 EB. 37
 CS 50 EBG Set. 37
 CS 70 EB. 37
 CS 70 EBG Set. 37
 CT 17. 176
 CT accessories 212
 CT boom arm 206
 CT compressed air accessories 213
 CT WINGS 390
 CTH 26. 177
 CTH 48. 177
 CTL 26. 176
 CTL 26 AC 177
 CTL 26 AC HD. 177
 CTL 36. 176
 CTL 36 AC HD. 177
 CTL 36 AC 177
 CTL 48. 177
 CTL 48 EC 177
 CTL 48 EC/B22 177
 CTL 48 AC 177
 CTL MIDI. 176
 CTL MINI 176
 CTL SYS 176, 183
 CTM 26. 176
 CTM 26 AC. 177
 CTM 26 AC HD 177
 CTM 36. 176
 CTM 36 AC. 177
 CTM 36 AC PLANEX 177
 CTM 48. 177
 CTM 48 EC. 177
 CTM 48 EC / B22 177
 CTM 48 AC. 177
 CTM MIDI 176
 CT-VA 177, 194
 Curves 78
 Cutter spindle. 288, 402
 Cutter V groove HW, shank 8 mm 287
 Cutter wheel 367-368
 Cutters. 276-299
 Cutting set. 72
 CXS. 216, 218

D

Deburring countersink 240
 Deep-drawer insert 419
 Deflector 407
 Delta sander 113
 Delta sanding pad 141, 149
 Depth stop. 231-232
 DF 500 302
 DF 700 302
 Diamond cutting disc. 369-370
 Diamond cutting system 359, 361
 Diamond disc 366-368
 Diamond grinders 356
 Diamond saw blade. 86
 Diced foam insert set. 420
 Disk stirrer 347

Disk stirrer WS 347
 Disposable bag 208, 211, 213
 DIY construction kit. 143
 DOMINO beechwood 308-310
 DOMINO beechwood 309-311
 DOMINO connector range 314-315
 DOMINO DF 500. 304
 DOMINO router 308-310
 DOMINO Sipo 309-311
 DOMINO XL beechwood domino. 311
 DOMINO XL DF 700 305
 Double-headed bolt 315
 Dovetail cutter 270
 Dovetail cutter with pre-cutter, shank 8 mm. 285
 Dovetail cutter, shank 8 mm. 285
 Dovetail joint template 270
 Dowel drill. 270
 Dowel drill HW, shank 8 mm 289
 DR 20 217
 DRC 18/4 217
 Drill 225
 Drill adapter. 240
 Drill bit. 239
 Drill bit box for HSS steel drill bits 238
 Drill bit case. 239
 Drill bits 240
 Drill countersink 240
 Drill HW, shank 8 mm 289
 Drill stand for carpentry 241
 Drilling and screwdriving 215
 Drilling and screwdriving – Accessories and consumables 229
 Drilling and screwdriving – Overview of products and applications 216
 Drilling cutter HW, shank 8 mm. 284
 Drilling dust nozzle. 233
 Drilling guide systems 241
 Drilling template 314
 Drywall screws 241
 DSC-AG 125 354, 359
 DSC-AG 125 FH 354, 360
 DSC-AG 230 354, 361
 DTS 400 R 93, 113
 DTSC 400 93, 114
 DUPLEX LS 130 115
 DURADRIVE DWC 18 26, 226
 Dust bag 146
 Dust extraction 175
 Dust extraction – Accessories and consumables 197
 Dust extraction – Overview of products and applications. 176
 Dust extraction attachment 265-266, 369-370
 Dust extraction set 70-71, 402
 DWC 18-2500 217
 DWC 18-4500 217

E

EAA 392
 Eccentric adapter. 231
 Eccentric sander 102-106
 Edge bander. 328
 Edge router 257-258

Edge trimming cutter HW with ball bearing guide, shank 8 mm 283
 Edge trimming cutter HW, shank 8 mm 294
 Edge trimming cutter with ball bearing 293
 Edge trimming cutter with ball bearing on bottom, shank 12 mm 299
 Edge trimming cutter with ball bearing on top, shank 12 mm 299
 Edge trimming set 335
 Edge trimming system 256
 Edging 325
 Edging – Accessories and consumables 333
 Edging – Overview of products and applications. 326
 Edging plate. 271
 EHL 65 EQ 318, 320
 Electrical outlet module 206
 Energy box 392
 Energy box module 206, 405
 ErgoFix adapter. 349
 ETS 125 R 91, 102
 ETS 150 105
 ETS 150/3 91
 ETS 150/5 91
 ETS EC 125 91, 104
 ETS EC 150 106
 ETS EC 150/3 91
 ETS EC 150/5 91
 ETSC 125 91, 103
 EVA adhesive, black 335
 EVA adhesive, brown 335
 EVA adhesive, natural 335
 EVA adhesive, white 335
 Extension handle 371
 Extension pipe 204
 Extension profile 269
 Extension table 72, 315
 Extension table (length) 70-71, 402
 Extension table (width) 70-71, 265, 402
 Extraction adapter 146, 203, 323

F

Facing cutter HW with ball bearing guide, shank 12 mm 291
 Facing cutter HW, shank 8 mm 291
 Facing cutter HW, shank 12 mm 292
 Fan shop. 422-423
 Fastening clamp 70, 273, 403, 406, 410
 FastFix louver pad 137
 Feather key 408
 Filter bag 208-210
 Filter element. 207
 Fine adjuster for guide stop 265
 Fine adjuster for parallel side fence 264
 Fine Cut 78
 Fine tooth saw blade 84
 Finish cleaner. 168
 Fixed clamps 403, 410
 Flange 369-370
 Flat nozzle. 205
 Flat sanding pad 143
 Flat tooth saw blade 86
 Floor cleaning set 198
 Floor guide 368

A – Z

Floor nozzle 204
 Flute cutter HW with ball bearing guide,
 shank 8 mm 283
 Flute cutter HW, shank 8 mm 282
 Flute cutter HW, shank 12 mm 282
 Flute profile sanding pad 143
 Foam inserts for SYSTAINER 420
 Foldaway legs 72
 Follower roll 273
 Foot valve 404
 Forstner drill bit 240
 Freehand diamond cutting system 360
 FS/2 388
 FSK 49

G

Geared eccentric sander 99-101
 GECKO 389
 GECKO DOSH dual suction pad 273, 389, 406
 General notes on the catalogue 430
 Groove cutter 269
 Groove cutter HS single-edged, with base blade,
 shank 8 mm 277
 Groove cutter HW with fitted base blade,
 shank 8 mm 276
 Groove cutter HW with fitted base blade,
 shank 12 mm 277
 Groove cutter HW, solid hard metal with base
 blade, shank 8 mm 276
 Groove cutter with reversible blades 269
 Groove cutting disc HW, shank 8 mm 288
 Groove unit 66
 Guard 402
 Guard ring 232
 Guide control black powder 148
 Guide extension 145, 349, 403, 407
 Guide plate 271
 Guide rail 388, 406
 Guide rail adapter 62, 265-267
 Guide rail adapters for routers 407
 Guide rods 264
 Guide table 366

H

Half-round cutter HW with ball bearing guide,
 shank 8 mm 280
 Hammer drill 233
 Hand abrasives 152, 164-165
 Hand rail cutter HW, shank 8 mm 285
 Hand rails cutter HW profile, shank 12 mm 292
 Hand rails cutter HW, shank 12 mm 292
 Hand tube 204
 Handle 138, 212
 Handrail fence 309, 311
 Hand-sanding block 151
 Hinge location cutter 314
 HK 55 35, 46
 HK 85 35, 48
 HK 132 35, 50
 HKC 55 20, 35, 47

HL 850 318, 321
 Holder for spray gun 408
 Hole drilling set 271, 419
 Hole punch 141
 Hole series system 255, 407
 Hook 408
 Hook driver 240
 Hose holder 212, 409
 HSS steel drill 238
 HW hinge location cutter with HW chip breaker,
 shank 8 mm 288
 HW plane cutter for MFK 700 EQ/B-Plus module
 edge router, shank 8 mm 295

I

IAS 3 hose 150, 405
 IAS adapter 148-149
 IAS double adapter 148-149
 IAS hoses IAS 3 148-149
 Increase 68, 74
 Inlays and inserts for SYSTAINER 420
 Insulation 80
 Interface pad 136-147
 IS 330 37, 59
 ISC 240 21, 37, 57

J

Jigsaw blades 76-81
 Joining – DOMINO joining system 301
 Joining machine 304-305
 Joining system 254, 270

K

KA 65 326
 KAPEX KS 60 51
 KAPEX KS 88 R 52
 KAPEX KS 120 R 53
 Key 366, 369-370
 Keyless chuck 230-232
 Key-type chuck 234
 Kickback stop 64-65, 406
 KP 65/2 329
 KS 60 36
 KS 88 R 36
 KS 120 R 36

L

Laminates 80
 Lever clamp 273, 403, 406, 410
 LEX 3 77 96, 123
 LEX 3 125 124
 LEX 3 125/3 96
 LEX 3 125/5 96
 LEX 3 150 125

LEX 3 150/3 96
 LEX 3 150/5 96
 LEX 3 150/7 97
 LHS 225 94
 LHS-E 225 94
 Lids and bottoms for SYSTAINER 420
 Lighting 373
 Lighting – Accessories and consumables 379
 Lighting – Overview of products and
 applications 374
 Linear sander 115
 Lock 415
 Long-life chip collection bag 139, 142
 Long-life filter bag 209
 Long-life main filter 207
 Long-reach sander 117-118
 LR 32 255
 LRS 93 97, 126
 LRS 400 97, 127
 LS 130 93

M

Machine/tool head 367-368
 Magazine attachment 235
 Magazine for holding edging 334
 Magnetic spherical head 379
 Main filter 207, 210
 Mains adapter 139, 142
 Mains cable 213
 Masonry drill 239
 Masonry renovation cleaning set 198
 MAXI-SYSTAINER 412
 Means of transport for SYSTAINER 415-416
 MFH 1000 / UCR 1000 394
 MFK 700 245, 259
 MFK 700 Basic 260
 MFS 252
 MFT 3 386
 MFT/3 CONTURO 326, 331
 Microfibre cloth 168
 MIDI-SYSTAINER T-LOC 412
 Milling set 67
 MINI-SYSTAINER T-LOC 413
 Mitre tongue and groove cutter HW,
 shank 12 mm 286
 Mobile dust extractor 182-193
 Mobile workshop 398
 Module edge router 259-260
 Module mounting 250
 Module mounting and bench saw module 45
 Module mounting and jigsaw module 41
 Modules for attachment system
 CTL/CTM/CTH 26/36/48 206
 Multifunction stool and Universalcenter 394
 Multifunction table 68-69, 331, 386
 Multi-profile cutter HW with ball bearing guide,
 shank 8 mm 289
 MW 1000 398
 MX 1000 338, 341
 MX 1000/2 338, 341
 MX 1200 338, 341
 MX 1200/2 339, 342
 MX 1600/2 339, 342
 MX 1600/2 DUO 339, 343

N

Natural oil 173

O

OF 1010 244, 246
 OF 1400 244, 247
 OF 2200 244, 248
 OF-FH 2200 256
 OFK 500 245, 257
 OFK 700 245, 258
 Oil dispenser 132, 173
 Oil sponge 173
 One handed planer 320
 Orbital sander RUTSCHER 108-111
 Ovolo edge cutter HW, shank 8 mm 279

P

Panther saw blade 84
 Parallel side
 fence 62-67, 75, 264, 266, 268, 271-272, 323, 407
 PDC 18/4 217
 Pegboard hook 408
 Pendulum jigsaws 38-39
 Perforated top 335
 PF 1200 245, 261
 PH bit 235-236
 Plane cutter HW, shank 12 mm 298
 PLANEX easy LHS-E 225 117
 PLANEX LHS 225 118
 Planing 317
 Planing – Accessories and consumables 323
 Planing – Overview of products and
 applications 318
 Planing head 323
 Planing set 67
 Plastic containers 418-419
 Plate 369
 plug it-accessories 421
 Plug-it cable 145
 Polishing agent 168, 334
 Polishing felt 334
 Polishing fleece 173
 Polishing pad 136-138, 168
 Polishing sponges 168
 PoliStick polishing sponge for dia. 80 mm 169
 PoliStick polishing sponge for dia. 125 mm 170
 PoliStick polishing sponge for dia. 150 mm 171
 PoliStick polishing sponge for dia. 180 mm 172
 POLLUX 180 98, 131
 Power distributor 397
 PRECISIO CS 50 EBG 55
 PRECISIO CS 70 EBG 56
 Precision adjustable square 71
 Pre-cutter 67
 Preparing the subsurface 351
 Preparing the subsurface – Accessories and
 consumables 365
 Preparing the subsurface – Overview of products
 and applications 352

Pre-separator 194
 Product identification key Cover
 Product performance features Cover
 Professional cleaning set 198
 Profile cutter HW, shank 8 mm 290
 Profile groove cutter HW with ball bearing guide,
 shank 8 mm 291
 Profile radius cutter HW with ball bearing guide,
 shank 8 mm 290
 Profile tongue cutter HW with ball bearing guide,
 shank 8 mm 291
 Profiles 8 mm 80
 Protector 136-142
 PS 300 32
 PS 420 32
 PSB 300 32
 PSB 420 32
 PSBC 420 33
 PSC 420 33
 PU adhesive, natural 335
 Pull-out drawer 410
 PZ bit 235-236

Q

QUADRILL DR 20 225
 QUADRIVE DRC 18/4 25, 222
 QUADRIVE PDC 18/4 25, 223
 Quick-action clamp 406

R

Radius profile sanding pad 143
 Rapid charger 15
 RAS 180 94, 116
 Ratchet set 237
 Rear wall 409
 Rebate depth stop 323
 Rebate profile sanding pad 143
 Rebating cutter HW with ball bearing guide,
 shank 8 mm 284
 Rebating head 402
 Recessed grip cutter HW with ball bearing guide,
 shank 8 mm 285
 Rechargeable torch 27, 375
 Reducing sleeve 203
 Refillable cartridge 148
 Remote control 206
 RENOFIX RG 80 352, 357
 RENOFIX RG 130 352, 356
 RENOFIX RG 150 353, 358
 Renovation miller 357-358
 Replacement roller 371
 Reservoir cutter HW with ball bearing guide,
 shank 12 mm 297
 Reversible blade 66, 402
 Reversible blade groove cutter HW single-edged,
 with base blade, direct taper mount 279
 Reversible blade groove cutter HW single-edged,
 with base blade, shank 8 mm 278
 Reversible blade groove cutter HW single-edged,
 with base blade, shank 12 mm 279

Reversible blade groove cutter HW,
 shank 12 mm 296
 Reversible cutter blade 67
 RG 80 352, 357
 RG 130 352, 356
 RG 150 353, 358
 Rinsing agent 335
 RO 90 DX 90, 99
 RO 125 90, 100
 RO 150 90, 101
 Rod 267
 Roller stand 70-71, 402
 Roman ogee cutter HW with ball bearing guide,
 shank 8 mm 289
 Rotary polisher 130-131
 Rotary sanders 116
 Rotating adapter 202
 Rotating angle adapter 202
 ROTEX RO 90 DX 90, 99
 ROTEX RO 125 90, 100
 ROTEX RO 150 90, 101
 Round stirrer 347
 Router 246-248
 Router bit box 277
 Router carriage 269
 Router table 272
 Routing 243
 Routing – Accessories and consumables 263
 Routing – Overview of products and
 applications 245
 Routing aid 266, 268, 271
 Routing template 252, 269
 RS 100 92, 108
 RS 200 92, 109
 RS 300 92, 110
 RTS 400 R 93, 111
 RTSC 400 93, 112
 Rubber gasket 370
 Rustilon brushes 151
 RUSTOFIX BMS 180 133

S

Safety filter bag 208
 Sanding base 146
 Sanding block 151, 334
 Sanding frame 146
 Sanding pad 136-149
 Sanding vties 173, 334
 Sandwich materials 80
 Saw blade 74
 Saw blade holder 70, 402
 Saw blades 64-87
 Sawing 31
 Sawing – Accessories and consumables 61
 Sawing – Overview of products and
 applications 33
 Scraper 143, 335
 Scratch protector 334
 Screwdriver 237
 Script cutter, shank 8 mm 286
 Sealing slide 212
 Sealing spray 168
 SELFCLEAN filter bag 208
 Service unit 213, 409

A – Z

- Sheepskin and polishing felt for dia. 80 mm . . . 169
 Sheepskin and polishing felt for dia. 125 mm . . . 170
 Sheepskin and polishing felt for dia. 150 mm . . . 171
 Sheepskin and polishing felt for dia. 180 mm . . . 172
 SHINEX RAP 150 130
 SHINEX RAP 150-14 98
 SHINEX RAP 150-21 98
 Shoulder strap 212
 Sipo DOMINO 309
 Site radios 29, 396
 Slat sanding pad 141, 143
 Slideway lining 406
 Sliding compound mitre saws 51-53
 Sliding table 70-71, 402
 Slot joint template 270
 Socket spanner 232
 Solid materials 80
 SORTAINER 414
 Spare felt 62, 334
 Spare part drill bit 240
 Spare part set ZOBO 240
 Special nozzles/brushes 205
 Special saw blade 86
 Special T-groove cutter HW, shank 8 mm . . . 289
 Spiral blade 323
 Spiral groove cutter 270
 Spiral groove cutter HS with base blade,
 shank 8 mm 278
 Spiral groove cutter HW, shank 12 mm . . . 296
 Spiral groove cutter HW, solid hard metal with
 base blade, shank 8 mm 278
 Spiral groove cutter with roughing and finishing
 HW, shank 12 mm 296
 Spiral stirrer 347-348
 Splinter guard 62, 64, 70-71, 406
 Split anchor 315
 Spot lighting 68
 Spot repair scraper 168
 SR filter 210-211
 SR filter bags 210-211
 SSU 200 37, 58
 Staircase drilling system 241
 Standard cleaning set 198
 Standard saw blade 84
 Stepped cutter HW, shank 12 mm 279
 Stirrer 341-343, 348
 Stirrer stand 349
 Stirring 337
 Stirring – Accessories and Consumables . . . 345
 Stirring – Overview of products and
 applications 338
 Stirring rod 347-349
 Stopper 70-71, 146, 271, 402, 407
 Storage surface 408
 Straight cut 78
 Suction brush 205
 Suction hose 199-201
 Support 72, 267, 402
 Surface control light 378
 Surface treatment 89
 Surface treatment – Accessories and
 consumables 135
 Surface treatment – Overview of products and
 applications 91
 SURFIX OS 132
 Sword saw 58-59
 SYM 70 R 36
 SYMMETRIC SYM 70 R 54
 SYS adapter 212
 SYS roller 415
 SYS tool box 414
 SYSLITE DUO 374, 377
 SYSLITE KAL II 28, 374, 376
 SYSLITE STL 450 374, 378
 SYSLITE UNI 27, 374-375
 SYS-PowerHub 397
 SYSROCK BR 10 BR, 10 DAB+ 29, 396
 SYS-StorageBox 414
 SYSTAINER 412
 SYSTAINER extractor 183
 SYSTAINER pull-out drawer 415
 SYSTAINER T-LOC SYS-Combi 413
 SYSTAINER T-LOC SYS-MFT 419
 SYSTAINER T-LOC with inlays for abrasives . . 417
 SYSTAINER T-LOC with insert for hand tools . . 419
 SYSTAINER T-LOC with lid compartment . . . 413
 SYSTAINER T-LOC with multi-purpose insert . . 418
 Systainer-Port 415
 SZ bit 236
- T**
- T 18+3 23, 216, 221
 Table top insert 71
 TC 3000/2 395
 Telescopic drawer 415
 Template-kit 270
 Terminal 68
 TF 1400 244, 251
 TF 2200 244, 251
 Tongue and groove cutter HW, shank 8 mm . . 286
 Tool chuck 230-234
 Tool holder 145, 206, 212, 409
 Tool hook 408
 Toolcenter 395
 TP 220 355, 363
 TPE 355, 362
 Trammel unit 265
 Transport rollers 73
 Trim stop 309, 311
 Trimming attachment 68-71
 Trimming machine 329
 Trimming saw 55-56
 TRION PS 300 38
 TRION PSB 300 38
 Tripod 379
 TS 55 R 34, 42
 TS 75 34, 44
 TSC 55 19, 34, 43
 Tubes 204
 Turbo combination suction brush 204
 Turbo filter bag 140-141
 Turning plate chamfer cutter HW,
 shank 8 mm 294
 Turning plate chamfer/edge trimming cutter HW
 with ball bearing guide, shank 8 mm 281
 Turning plate edge trimming cutter HW with ball
 bearing guide, shank 8 mm 283
 Turning plate edge trimming cutter HW with ball
 bearing guide, shank 12 mm 297
 Turning plate edge trimming cutter HW,
 shank 8 mm 294
- Turning plate rebating cutter HW with ball bearing
 guide, shank 8 mm 284
 twinBOX 236
 Twist drill bits 238
 Two-ply filter bag 211
 TX bit 235-236
 TXS 216, 219
- U**
- Underframe 68-69
 Universal brush nozzle 205
 Universal cleaning set 198
 Universal saw blade 84
 Upholstery nozzle 205
- V**
- VAC SYS 387
 Vacuum clamping nozzle 212, 390
 Vacuum clamping system 387
 Vacuum hose 404
 Vacuum pad 404
 Vacuum pump 404
 Vacuum unit 404
 V-groove cutter 273, 287
 V-groove profile sanding pad 143
 VS 600 GE 254
- W**
- Wall mounting 405
 Wallpaper perforator 363
 Water gutter cutter 282
 WCR 1000 393
 Wet filter 207
 Workcenter 393
 Working light 28, 376-377
 Workplace organisation 383
 Workplace organisation – Accessories and
 consumables 401
 Worktop template 253, 269
- Y**
- Y-piece 203

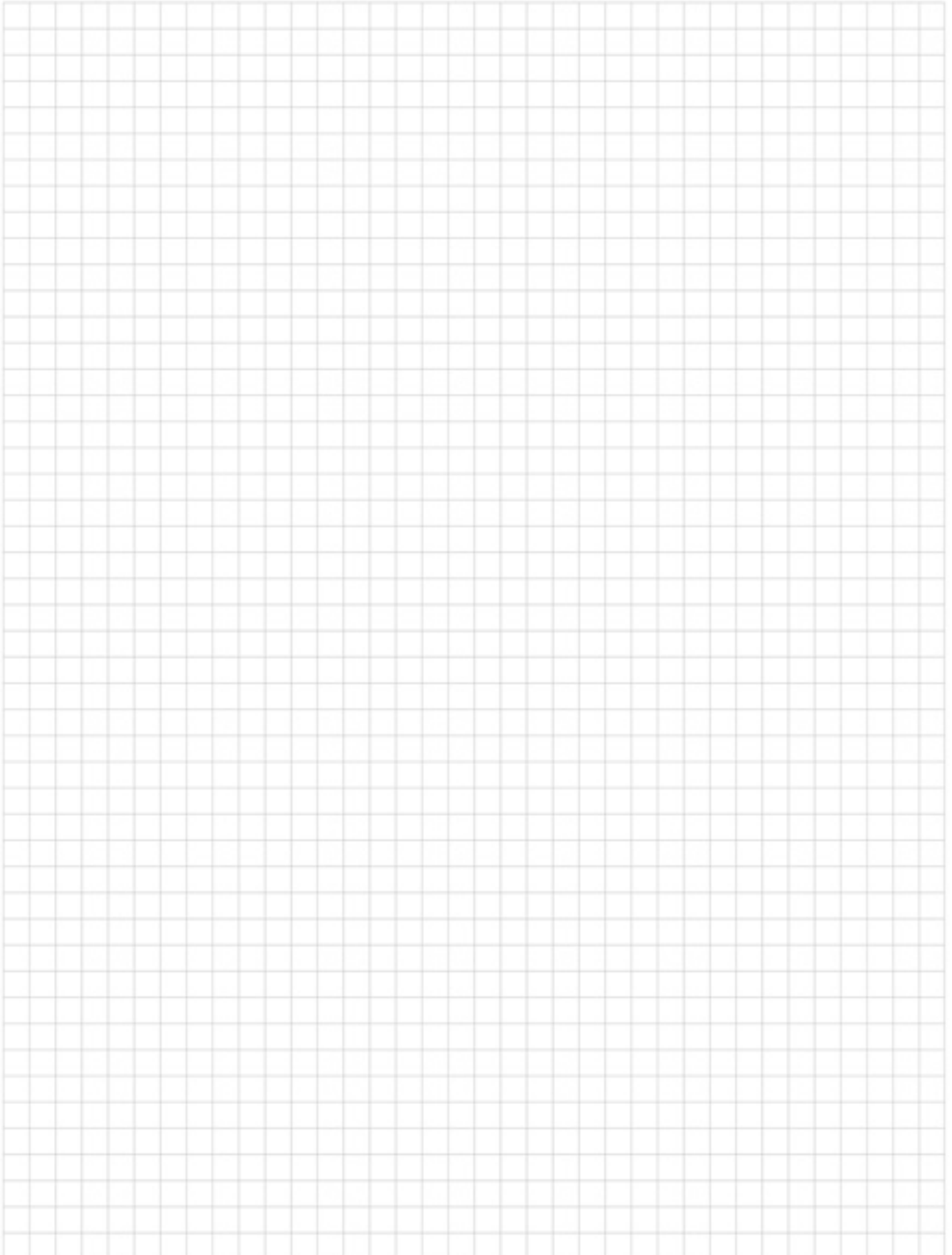

General notes on the catalogue:

01

Please remember to fit appropriate protective devices or wear personal protective equipment when using Festool products such as compressed air and electric power tools with accessories and consumable materials or when machining hazardous materials. For further information, please refer to the relevant safety documentation or consult the relevant regulating authority if you have questions.

02

Machine specifications included in the catalogue, such as quantity specifications, time savings, coverage capacities, etc., are average values and may deviate significantly, depending on the material being processed. The manufacturer does not guarantee that the values will be achieved in each individual case. Your Festool specialist dealer will be glad to answer any queries you may have concerning this matter.

03

The machine weights specified in the catalogue usually refer to the weight of a machine ready for use and with a standard tool, but without a cable, accessories or consumables. Please note that the weights stated may deviate from the specifications in the catalogue, depending on the tool, battery pack, accessories or other additional parts used.

04

All trademark rights, patent rights and other commercial property rights mentioned in this catalogue remain the property of the relevant beneficiary, even in cases where this is not explicitly stated. The reproduction in particular of common names, trade names, goods designations, etc. in this catalogue (even if not identified as such) does not render these names exempt from trademark or brand protection legislation and does not therefore authorise anyone to use them.

05

We reserve the right to make modifications, especially to technical data or specifications, without prior notification. Individual features may vary depending on country-specific conditions.

06

Products may differ from those shown and the images may at times present components or parts that are not included as standard with the tools. If you have any questions, please contact your Festool specialist retailer.

07

Safety: All power tools and compressed air tools listed in this catalogue conform to the valid and applicable IEC or EN safety standards, depending on the type of tool (e.g. IEC/EN 61 029, IEC/EN 60 745, IEC/EN 62 841, IEC/EN 60 335, EN ISO 11 148, IEC/CISPR/EN 55 014, IEC/EN 61 000).

08

Insulation: The power tools listed in this catalogue are insulated in accordance with regulations.

09

CE conformity: All power tools and compressed air tools listed in this catalogue comply with the provisions of the relevant applicable EU directives (e.g. Machinery Directive 2006/42/EC, Low Voltage Directive 2014/35/EU, EMC Directive 2014/30/EU, RoHS Directive 2011/65/EU).

10

ISO certification: All the power tools and compressed air tools listed in this catalogue are manufactured in our production plants which are DIN EN ISO 9001 certified.

11

The Bluetooth® word mark and the logos are registered trademarks of Bluetooth SIG, Inc.; they are used by TTS Tooltechnic Systems AG & Co. KG, and therefore by Festool, under licence.

**Egypt**

Equipment plus sarl
Mkales street 41
Beirut - Lebanon
Tel. 00961 16 92 136
Mob. 00961 71 861234
info@equipment-plus.com
www.equipment-plus.com

**Algeria**

PRO'DISTRIBUTEUR sarl
NIF 099909080287849
LOTISSEMENT AIDJA BOUFARIK ALGERIE
Tel. 00213 25 28 39 12/13
Fax 00213 25 28 39 14
info@pro-dist.com
www.pro-dist.com

**Azerbaijan**

Alman Texnikalari Evi MMC
A. Molla Cuma kuc. 32
1072 Baku, Azerbaijan
Tel. 0099 4 12 565 23 23
Fax 0099 4 12 565 23 30
ate_mmc@yahoo.com
www.atemmc.com

**Australia**

Tooltechnic Systems Australia Pty Ltd
21-27 Evolution Drive
Dandenong South VIC 3175
Tel. 1300 063 900
Fax 03 8845 7079
customer@tooltechnic.com.au
www.festool.com.au

**Belgium**

Festool Belgium SA
Rue Colonel Bourg 101
1030 Bruxelles
Tel. 0032 2 893 36 36
Fax 0032 2 726 98 81
info-be@festool.com
www.festool.be

**Bosnia-Herzegovina**

MAJO D.O.O.
Goričica pri Ihanu 2
1230 Domžale (Slovenija)
Tel. 00386 17 24 82 16
Fax 00386 17 24 11 07
majo.doo@siol.net
www.majo.si

**Botswana**

Vermont Sales (Pty) Ltd
192 Tsessebe Crescent,
Corporate Park South, Old Pretoria Road,
Randjespark, Midrand, South Africa
PO Box 264, Halfway House, 1685
Tel. 0027 (0)11 314 7711
Fax 0027 (0) 866 88 66 33
orders@vermontsales.co.za
www.festool-powertools.co.za

**Brazil**

W&S Saura Ltda.
Av. José Fortunato Santon 580
Distrito Industrial Abdo Najar
13474-750 Americana/ São Paulo
Tel. 0055 19 3469-9889
Fax 0055 19 3469-9888
ws@wsequipamentos.com.br
www.wsequipamentos.com.br

**Bulgaria**

Tooltechnic Systems E00D
kv. Dragalevtsi
ul. Vitoshka Zornitsa 2
1415 Sofia
Bulgaria
Tel. 00359 888574208, 00359 888989917
office@festool.bg
www.festool.bg

**Chile**

SOCIEDAD COMERCIAL RHEKO LTDA.
Victoria 984, Villa Llacolen
San Pedro de la Paz
4130000 Concepcion
Tel. 0056 41 2372 060
info@reko.cl
www.reko.cl

**China**

Festool China
1159 Kangqiao East Rd, No.91-Buildg 1
Kangqiao Industrial Zone
201315 Shanghai (Pudong)
Tel. 0086 21 68 18 28 00
Fax 0086 21 68 18 26 90
info@festool.cn
www.festool.cn

**Denmark**

Festool Danmark ApS
Postboks 1242
2300 København S
Tel. 0045 44 84 20 24
info-dk@festool.com
www.festool.dk

**Germany**

Festool Deutschland GmbH
Wertstrasse 20
73240 Wendlingen a.N.
Tel. 0049 (0)7024/ 804-24010
Fax 0049 (0)7024/ 804-29699
vertrieb@festool.com
www.festool.de

**Estonia**

UAB „TTS Tooltechnic Systems“
Ašigalio g. 6
LT-49142, Kaunas, Lietuva
Tel. 00370 37 308 414
Fax 00370 37 323 848
info@tts-company.lt
www.festool.ee

**Finland**

Tooltechnic OY
Mäkituvantie 7
01510 Vantaa
Tel. 00358 10 22 95 111
info@festool.fi
www.festool.fi

**France**

Festool France
33 rue Gabriel
77185 LOGNES
Tel. 00 33 (1) 60 06 64 30
Fax 00 33 (1) 60 06 62 26
info-fr@festool.com
www.festool.fr

**Georgia**

LTD Electron
Agladze str. 7/a
0154 Tbilisi
Tel. 00995 32 2911121
Mob. 00995 599 291122
contact@rcheuli.com

**Greece**

Hellenic Tool Center
Driadon 4
141 22 Neo Heraklio (Attica)
Tel. 0030 21 02 81 10 72
Fax 0030 21 02 81 17 64
info@hellenictool.gr
www.hellenictool.gr

**Great Britain**

Saxham Business Park, Saxham
Bury St. Edmunds, Suffolk
IP28 6RX
Tel. 0044 1284 760 791
info@festool.co.uk
www.festool.co.uk

**India**

Caple Industrial Solutions,
WEH, Malad E, Mumbai 97.
Ahmedabad: +91 9930069907
Bengaluru: +91 9148788500
Delhi +91 9999394047
Kolkata: +91 9599487490
Mumbai +91 9930069906
festool.web@caple.in
www.caple.in

**Ireland**

TTS Tooltechnic Systems Ireland Ltd
C/O McCann Duffy Cleary, E12 Calmount Park
Ballymount
Dublin 12
Tel. 00353 18 64 22 40
Fax 00353 18 64 22 47
sales@festool.ie
www.festool.ie

**Iceland**

ISOL Ltd.
P.O. Box 8436
Armuli 17
128 Reykjavik
Tel. 00354 53 31 234
isol@isol.is
www.isol.is

**Iceland**

Husamidjan Ehf
Holtavegur 10
104 Reykjavik
Tel. 00354 525 3000
jon@husa.is
www.husa.is

**Israel**

A. Sherizly & Son Ltd.
Shderot Hamiktsot, 15
Einav Center
Modiin - 7177849
Tel. 00972 89 23 37 77
Fax 00972 89 23 44 77
sherizly@sherizly.com
www.festool.com

**Italy**

Festool Italia S.r.l.
Via Galileo Galilei 16
20090 Assago MI
Tel. 0039 02 457851
Fax 0039 02 45785320
marketingit@festool.com
www.festool.it

**Japan**

Häfele Japan K.K.
14-17, Kami-Shinano, Totsuka-ku
244-0806 Yokohama
Tel. 0081 45 82 83 111
Fax 0081 45 82 83 110
festool@hafele.co.jp
www.festool.jp

**Jordan**

Equipment plus sarl
Mkales street 41
Beirut
Tel. 00961 16 92 136
Fax 00961 99 25 993
info@equipment-plus.com
www.equipment-plus.com

**Canada**

Festool Canada Inc.
400 N. Enterprise Blvd
Lebanon, IN 46052
Tel. 001 88 83 37 86 00
Fax 001 76 54 83 09 03
sales@festoolcanada.com
www.festoolcanada.com



Kazakhstan

Voronin I.V.
Mikrorayon Aksay 3 a, dom 80
050031 Almaty
Tel. 007 727 242 94 55
ritm@ritm.asia
www.ritm.ltd.kz



Qatar

Equipment plus sarl
Mkales street 41
Beirut - Lebanon
Tel. 00961 16 92 136
Mob. 00961 71 861234
info@equipment-plus.com
www.equipment-plus.com



Columbia

Ferreteria Al-Diaz
Cra. 50 No. 71C-31
Bogotá, D.C.
Tel. 0057 1 660 0083
Fax 0057 231 4350
gerencia@ferreteraldiaz.com
www.ferreteraldiaz.com



Croatia

ALAGO d.o.o.
Horvati 112
10436 Rakov Potok
Tel. 00385 1 653 93 92
Fax 00385 1 653 93 93
kontakt@alago.hr
www.alago.hr



Latvia

Festool LV
A. Deglava 66
Riga, LV-1035
Tel. 00371 29282972
kartis.eqlitis@festool.lv
www.festool.lv



Lebanon

Equipment plus sarl
Mkales Street 41
Beirut - Lebanon
Tel. 00961 1 692136
Mob. 00961 71 861234
info@equipment-plus.com
www.equipment-plus.com



Lithuania

UAB „Festool LT“
Ašigalio g. 6
LT-49142, Kaunas, Lietuva
Tel. 00370 37 308 414
Fax 00370 37 323 848
info@tts-company.lt
www.festool.lt



Luxembourg

Festool Belgium SA
Rue Colonel Bourg 101
1030 Bruxelles
Tel. 0032 2 893 36 36
Fax 0032 2 726 98 81
info-be@festool.com
www.festool.be



Malta

PIOVE HOLDINGS Ltd.
C&C Technik
Profs Carmelo Coliero Street
Handaq Industrial Estate
Handaq
QRM4005 Qormi
Tel. 00356 21 44 67 98
info@cctechnikmalta.com
www.cctechnikmalta.com



Macedonia

Rosa Dooel
st. Jadranska Magistrala 90
1000 Skopje
Tel. 00389 022 602 092
Fax 00389 022 602 093
info@rosa.com.mk
contact@rosa.com.mk
www.rosa.com.mk



Moldova

UAB „TTS Tooltechnic Systems“
Ašigalio g. 6
LT-49142, Kaunas, Lietuva
Tel. 00370 37 308 414
Fax 00370 37 323 848
info@tts-company.lt
www.tts-company.lt



Namibia

Vermont Sales (Pty) Ltd
192 Tsessebe Crescent,
Corporate Park South, Old Pretoria Road,
Randjespark, Midrand, South Africa
PO Box 264, Halfway House, 1685
Tel. 0027 (0)11 314 7711
Fax 0027 (0) 866 88 66 33
orders@vermontsales.co.za
www.festool-powertools.co.za



New Zealand

Hindin Marquip Ltd.
1012 Great South Road
1061 Penrose - Auckland
Tel. 0064 9 9131666
hamish@hml.co.nz
www.hml.co.nz



The Netherlands

Festool Nederland B.V.
Coenecoop 2 G
2741 PG Waddinxveen
Tel. 0031 18 26 21 940
Fax 0031 18 26 21 949
info-nl@festool.com
www.festool.nl



Norway

MOTEK AS
Alf Bjerkesvei 22 B
BOX 81 Oekern
0508 Oslo
Tel. 0047 23 05 25 00
Fax 0047 22 64 00 63
odd-arve.rygh@motek.no
www.motek.no



Austria

Festool Österreich GmbH
Schloss Glanegg 2
5082 Grödig
Tel. 0043 (0)810/95 53 14
Fax 0043 (0)810/95 53 12
vertrieb-at@festool.com
www.festool.at



Panama

Formica Distribution Center, S.A.
City of Panama, Panama, street
85, Urb. Ind. Los Angeles
0832-2532 WTC PANAMA
Tel. 00507 260 5503
Fax 00507 260 1440
grettel.amores@bacosa.com
www.renpar.com.py



Paraguay

Renpar S.A.
Juan Leopardi N° 1879 c/ Pedro Peña
2160 San Lorenzo
Tel. 00595 21 51 13 29
Fax 00595 21 51 13 29
nlopes@renpar.com.py
www.formicadistributioncenter.com



Peru

EURO TOOLS MASCHINEN E.I.R.L.
Costa Rica N° 513
J. Hunter, Arequipa
Tel. 0051 54 65 7454 / 0051 54 65 7455
Mob. 958370884 / 977626433
euroimportacion@hotmail.com
eurotoolsmaschinen@hotmail.com
www.euro-importacion.com



Poland

Festool Polska Sp. z o.o.
Sokotów, ul. Sokotowska 47a
05-806 Komorów
Tel. 0048 22 122 74 00
Fax 0048 22 122 74 01
info-pl@festool.com
www.festool.pl



Portugal

Festool Portugal Unipessoal, Lda
Zona Industrial Pau Queimado
E.N. 5, Armazém 25
2870-500 Montijo
Tel. 0034 93 264 30 30
info-pt@festool.com
www.festool.pt



Romania

Tooltechnic System Kft.
H-1184 Budapest
Lakatos út 40.
Mobile: +40-746-377-056;
+40-757-985-595
info@festool.hu
www.festool.ro



Russia

TTS Tooltechnic Systems 000
Russia, Moscow region
Noginsk district, 142400 Noginsk,
Noginsk-Technopark area, 13
Tel. 007 49 57 75 83 54
Fax 007 49 56 41 23 72
info@festool.ru
www.festool.ru



Saudi Arabia

Equipment plus sarl
Mkales street 41
Beirut - Libanon
Tel. 00961 1 692136
Mob. 00961 71 861234
info@equipment-plus.com
www.equipment-plus.com



Sweden

Festool Sverige AB
Stenåldersgatan 3
213 76 Malmö
Tel. 0046 40 670 10 00
info-se@festool.com
www.festool.se



Switzerland

Festool Schweiz AG
Moosmatstr. 24
8953 Dietikon
Tel. 0041 44 744 27 27
Fax 0041 44 744 27 28
info-ch@festool.com
www.festool.ch



Serbia

MAKSAL LINE D.O.O.
Pavla Pavlovica 11
office: Radojke Lakić 6
11000 BEOGRAD
Mob. 00381 64 127 7581
Tel. 00381 11 407 8421
Fax 00381 11 2412 266
maksat.bg@gmail.com
www.maksal-line.rs



Singapore

Hiap Huat Chemicals & Industrials Co.
No.6 Tanjong Penjuru
Singapore 609018
Tel. 0065 67 45 4111
Fax 0065 67 46 29 77
chem@hiaphuat.com.sg
www.hiaphuat.com.sg



Slovakia

Festool CZ s.r.o.
 Chelčického 1932
 CZ - 470 37 Česká Lípa
 Tel. 00420 48 16 45 167
 festool.info@festool.com
www.festool.cz



Slovenia

MAJO D.O.O.
 Goričica pri Ihanu 2
 1230 Domžale
 Tel. 00386-17 248 216
 Fax 00386-17 241 107
 majo.doo@siol.net
www.majo.si



Spain

Festool Spain, S.L.U.
 Parque Empresarial Cityparc - Edificio Lisboa.
 Carretera de L' Hospitalet 147-149
 CP 08940 Cornellà de Llobregat
 Tel. 0034 93 264 30 30
 Fax 0034 93 396 95 27
 info-es@festool.com
www.festool.es



South Africa

Vermont Sales (Pty) Ltd
 192 Tsessebe Crescent,
 Corporate Park South, Old Pretoria Road,
 Randjespark, Midrand, South Africa
 PO Box 264, Halfway House, 1685
 Tel. 0027 (0)11 314 7711
 Fax 0027 (0) 866 88 66 33
 orders@vermontsales.co.za
www.festool-powertools.co.za



South Korea

Festool Korea Ltd.
 501-2ho, 67, Malgeunnae-gil, Uiwang-si,
 Gyeonggi-do, 16071,
 Republic of Korea
 Tel. 0082 2 6002 6740
 Fax 0082 2 6022 6799
www.festool.co.kr
info-kr@festool.com



Taiwan

Bestor Trading Corp.
 No.12, Chung-Yang Lane
 Kuang-Fu Village Shetou
 Hsiang Chang-Hua Hsien
 Tel. 00886 48 72 66 97
 Fax 00886 48 72 52 09
bestor.steven@msa.hinet.net
www.bestor.com.tw



Thailand

Häfele (Thailand) Ltd.
 57 Soi Sukhumvit 64
 Bangjak Prakhonong
 10260 Bangkok
 Tel. 0066 27 41 71 71
 Fax 0066 27 41 72 72
festool@hafele.co.th
www.hafele.com/th/en



Czech Republic

Festool CZ s.r.o.
 Chelčického 1932
 CZ - 470 37 Česká Lípa
 Tel. 00420 48 16 45 167
 festool.info@festool.com
www.festool.cz



Turkey

www.festool.com.tr



Ukraine

UAB „TTS Tooltechnic Systems“
 Ašigalio g. 6
 LT-49142, Kaunas, Lietuva
 Tel. 00370 37 308 414
 Fax 00370 37 323 848
info@tts-company.lt
www.festool.ua



Hungary

Tooltechnic System Kft.
 H-1184 Budapest
 Lakatos út 40.
 Tel: +36-1-297-1350
 Fax: +36-1297-1359
info@festool.hu
www.festool.hu



Uruguay

Luganer S.A.
 Martin C. Martínez 2126
 Montevideo 11800
 Tel. 00598 24 090 100
centroeventas@luganer.com.uy
www.luganer.com.uy



USA

Festool USA LLC
 400 N. Enterprise Blvd
 Lebanon, IN 46052
 Tel. 001 88 83 37 86 00
 Fax 001 76 54 83 09 03
sales@festoolusa.com
www.festoolusa.com



United Arab Emirates

POLIMAR
 Unit D-8 Sharjah Furniture Complex
 Al Wahda Street
 P.O. Box 433 Sharjah
 Tel. 00971-6-533 4147
 Fax 00971-6-533 0009
polimar@emirates.net.ae



Belarus

UAB „TTS Tooltechnic Systems“
 Ašigalio g. 6
 LT-49142, Kaunas, Lietuva
 Tel. 00370 37 308 414
 Fax 00370 37 323 848
info@tts-company.lt
www.festool.by



Cyprus

K and S Industrial Supplies Ltd.
 31, Vasilissis Frederikis street
 P.O. Box 27147
 1642 - Nicosia
 Tel. 00357 22 67 46 64
 Fax 00357 22 67 22 40
seraphim@cytanet.com.cy
www.festool.com

FESTOOL

Festool GmbH

Export Department

Wertstrasse 20

D-73240 Wendlingen

Phone +49 (0)70 24/804-25400

Fax +49 (0)70 24/804-120724

E-mail SalesSupport@festool.com

www.festool.com

Art. no. 068 117 IMP_LT/en



Festool catalogue 2019

As at: 01/2019, replaces all previous catalogues.

Subject to alterations and errors. Products may differ from those pictured.

Product performance features



Antistatic function
Mobile dust extractors and tools with the antistatic function to prevent static charge from accumulating when working.



LED spotlight
LED light for simple and precise placement against the scribe mark.



Dual-line laser
Two laser lines for simple, precision positioning along the scribe mark from the left or right.



Torque shut-off
Intelligent technology ensures the optimum screwdriving force for every material.



Jigsaw with precision guidance
Long-wearing carbide jaws guide the saw blade directly over the cutting location. For precise work results.



AUTOCLEAN
AUTOCLEAN automatic main filter cleaning system with infinitely adjustable cleaning intervals.



FlowDetect
Health protection: The flow sensor checks for a minimum air speed of 20 m/sec and issues a warning if the air speed falls below this value.



Spir-O-Cut
single-edged planer head offers crucial advantages: No need to adjust cutting circle diameter after blade replacement, and oblique shearing for high surface quality



Electronic
Speed control for adjusting to all types of materials.



MMC electronics
"Multi Material Control" power electronics with constant adjustable speed and temperature monitor for work on all types of material.



MMC digital electronics
Processor controlled "Multi Material Control" power electronics provide adjustable and constant speeds as well as temperature monitoring for work on all types of material.



PoliStick
Fast fixing concept for attaching polishing felt, polishing sponges or sheepskins – for greater efficiency.



IAS 3 system
Hose system incorporates compressed air, dust extraction and exhaust air.



IAS 3 light
Dust extraction, compressed air with external exhaust air dissipation.



IAS 3-SD
For connecting a Festool compressed air sander directly to a compressed air line (without dust extraction).



IAS 2-System
Combines three functions in one hose: compressed air supply, exhaust air extraction and dust extraction.



Smooth suction hose
With a smooth exterior which allows it to slide over surfaces perfectly.



Standard connection
Standard connection for dust extractors.



EC-TEC
The EC-TEC drive concept generates an extraordinary amount of power while consuming extremely low amounts of energy.



StickFix
Quick, economical fastening system for abrasives – no adhesives, no clamping.



MPE sanding pad
Sanding pads and sanding discs made from extremely durable materials for long service life.



Lithium-ion (Li)
Fitted with high-performance lithium ion battery pack.



Jetstream principle
The 9-hole principle for reduced dust accumulation, less heat and less clogging. Up to a 30% longer service life.



MULTI-JETSTREAM 2 principle
Sanding system with integral dust conveying concept. With the patented MULTI-JETSTREAM 2 principle.



SDS-plus
Tool holder for quick tool changes.



AIRSTREAM battery
Faster reuse of battery packs thanks to AIRSTREAM technology (cooling function for faster availability) and significantly increased charging capacity



High torque
Tool with high torque.



Protector
Protects the sanding pad and material when working close to edges.



Impact stop
Allows manual deactivation of the impact function when drilling into wood or brittle materials.



Electronic monitoring
Electronic monitoring of the coil temperature protects against damage to the motor.



Splinter guard
Patented splinterguard for splinter-free cuts on both sides when sawing.



Safety sliding clutch principle
Mechanical sliding clutch provides protection if the tool suddenly seizes or tilts.



Start/stop function
AUTO mode, also without having to press the main switch.



Guide system
Patented guide system for safe guidance of saws and router bits.



Trimming rails
Compound mitre saw system which securely joins machine and cross cutting guide rails together for precisely accurate repeat cuts.



ErgoFix adapter
For holding a M14 stirring rod.



Quick-acting brake
For safe work when planing, sawing and routing.



FastFix
Makes changing routing, sawing, planing, sanding, drilling and screwdriving tools easier.



Starting current limiter
Simple start for household fuses.



plug it
Removable, replaceable mains cable with safety lock for quick conversion.



CLEANTEC dust extraction
Standard connector [27/36/50 mm] for dust extraction to safeguard the operator and the environment.



CLEANTEC connecting system
Integrated bayonet fitting as the connecting element between the extractor and the tool.



Electronic overload protection
Protects the motor with blocking tool.



Vibration stop
Patented VS balancing so that tools run smoothly during sanding, which makes working less hazardous.



Groove in saw table
Lever clamps on the saw table fix the workpiece securely and prevent it from shifting accidentally



Electro-dynamic run-down brake
The chainsaw will stop immediately once the speed controller is released.



Turbo dust extraction
Turbo dust extraction ensures clean, dust-free air and a clear view of the workpiece.



Bluetooth®
Bluetooth® communication between battery pack and extractor.



Hands-free function
Telephone conversations (in full duplex) via feedback.



USB port
For charging external devices.



DAB+
Playback with the DAB+ standard.



Forward/Reverse rotation
For screwing and unscrewing screws.



Warranty all-inclusive
Your performance assured.

Your new tool is covered for the first three years following registration. For more information on Festool SERVICE, please go to pages 4 – 9.

Product identification key

Product type	Performance class	Equipment variants	Packed in a SYSTAINER	Also included in delivery
RO	150	FEQ	Plus	Set
	Pad Ø, container volume, etc.	F Tool change system E Electronic B Quick-acting brake CE CENTROTEC Q Plug it SG Hose holder EW Electric tool DW Compressed air tool LE Compressed air variant I Bluetooth®-compatible	with a SYSTAINER	Extensive range of accessories included with the product

In self-service display pack Accessory is positioned in the retailer for self-operation