

GASTON

GRÜMMER

THE ART OF CARROSSERIE

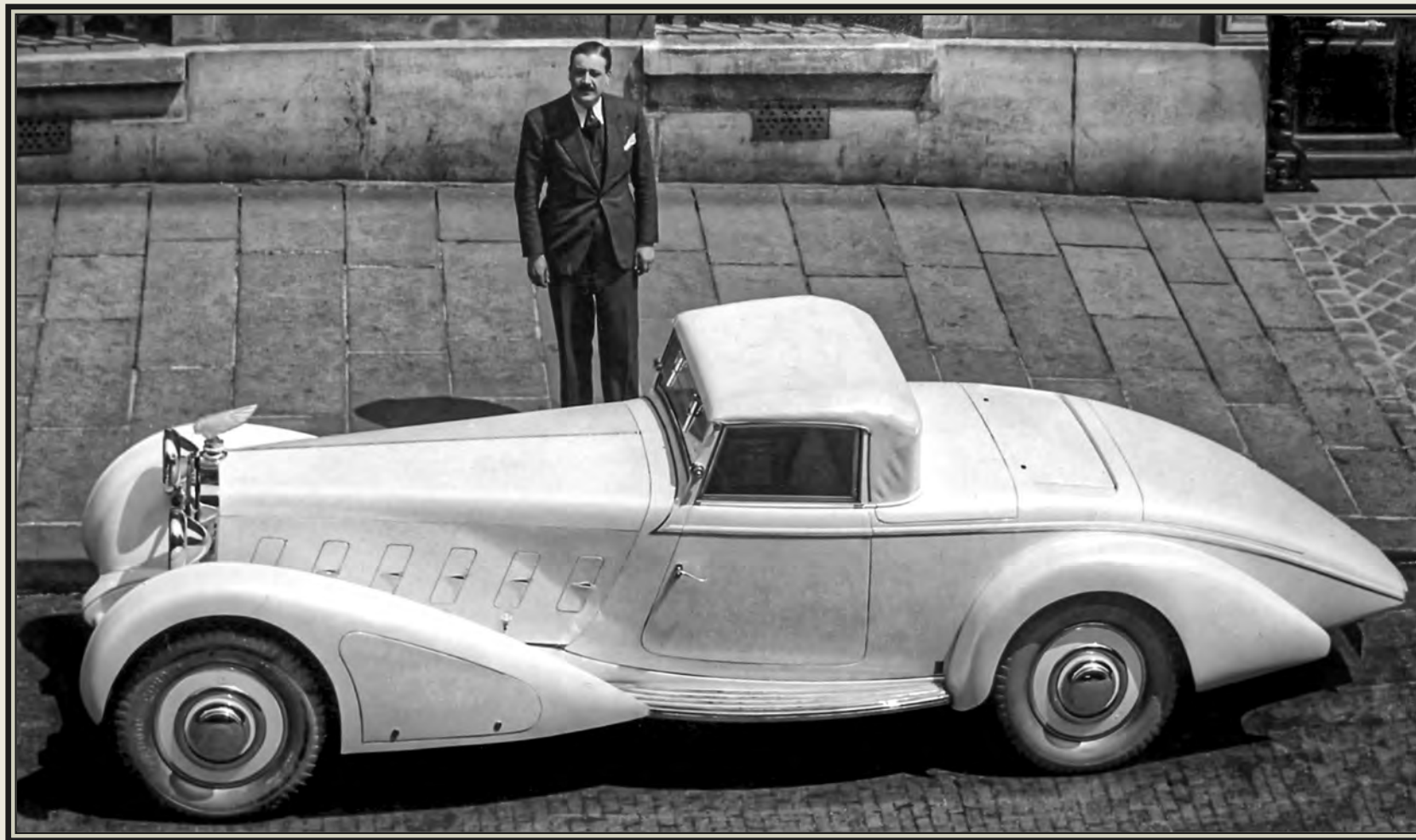

Philippe-Gaston Grümmer & Laurent Friry

DALTON WATSON FINE BOOKS

Volume One

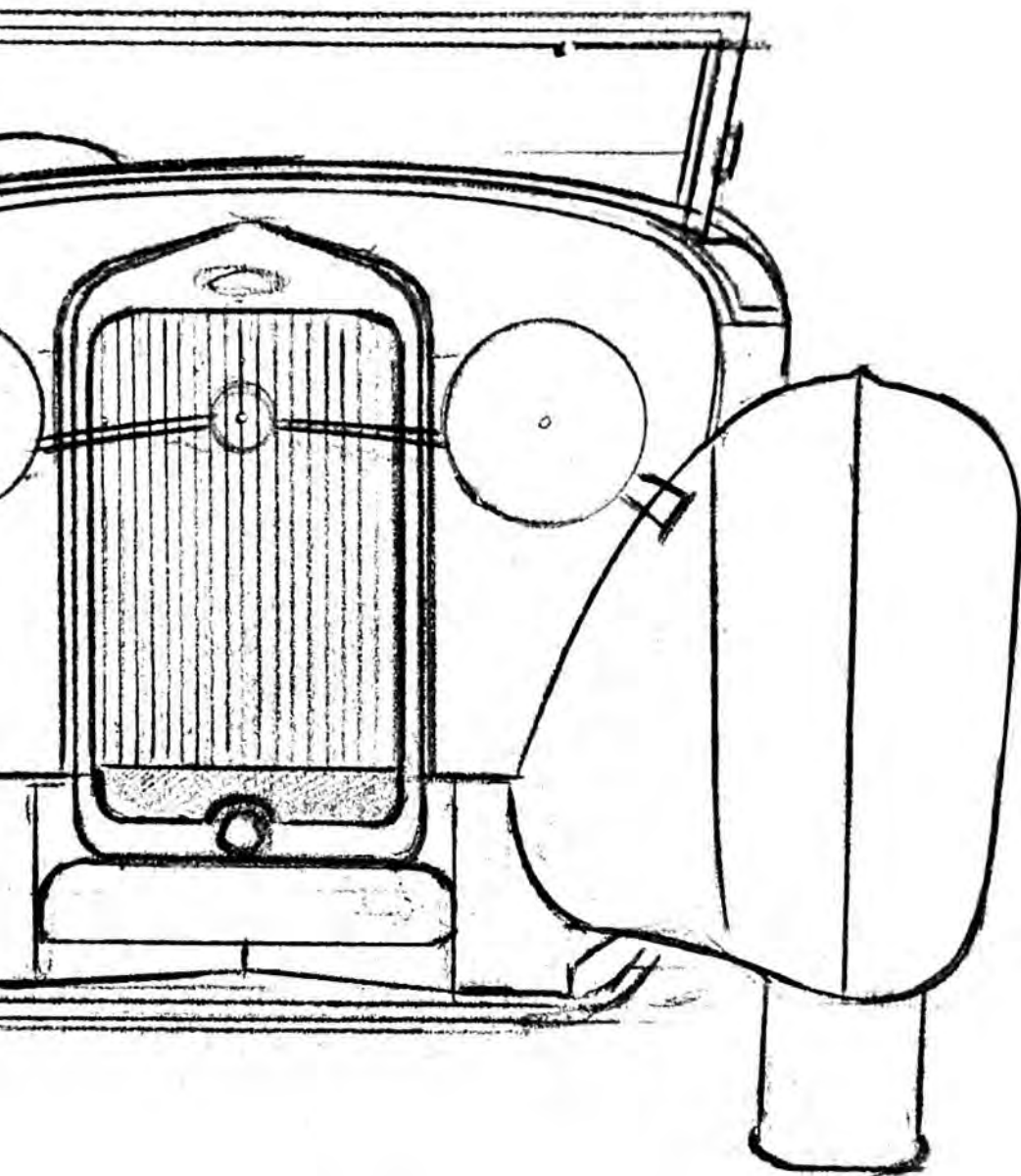

| | |
|--|------|
| Introduction | xi |
| Preface | xiii |
| The Grümmer family: A Coachbuilding Dynasty | 14 |
| Gaston Grümmer: Education and Military Life | 32 |
| 1924: The Foundation of the Carrosserie Gaston Grümmer | 58 |
| 1925: The Carrosserie <i>Surbaissée</i> E.B.V. Licence | 72 |
| 1926: A Foray into the World of Aviation | 100 |

TABLE of CONTENTS

| | |
|---|-----|
| 1927: The 100th Car Bodied in Clichy | 128 |
| 1928: The Panhard Sportsman's Coupé | 162 |
| 1929: Jury Member for the Concours d'Elégance de L'Auto | 198 |
| 1930: Appointed Foreign Trade Advisor | 226 |
| 1931: A Rolls-Royce for Jack Hylton | 272 |
| 1932: An Agreement with Ford | 294 |
| 1933: A Successful Year | 310 |

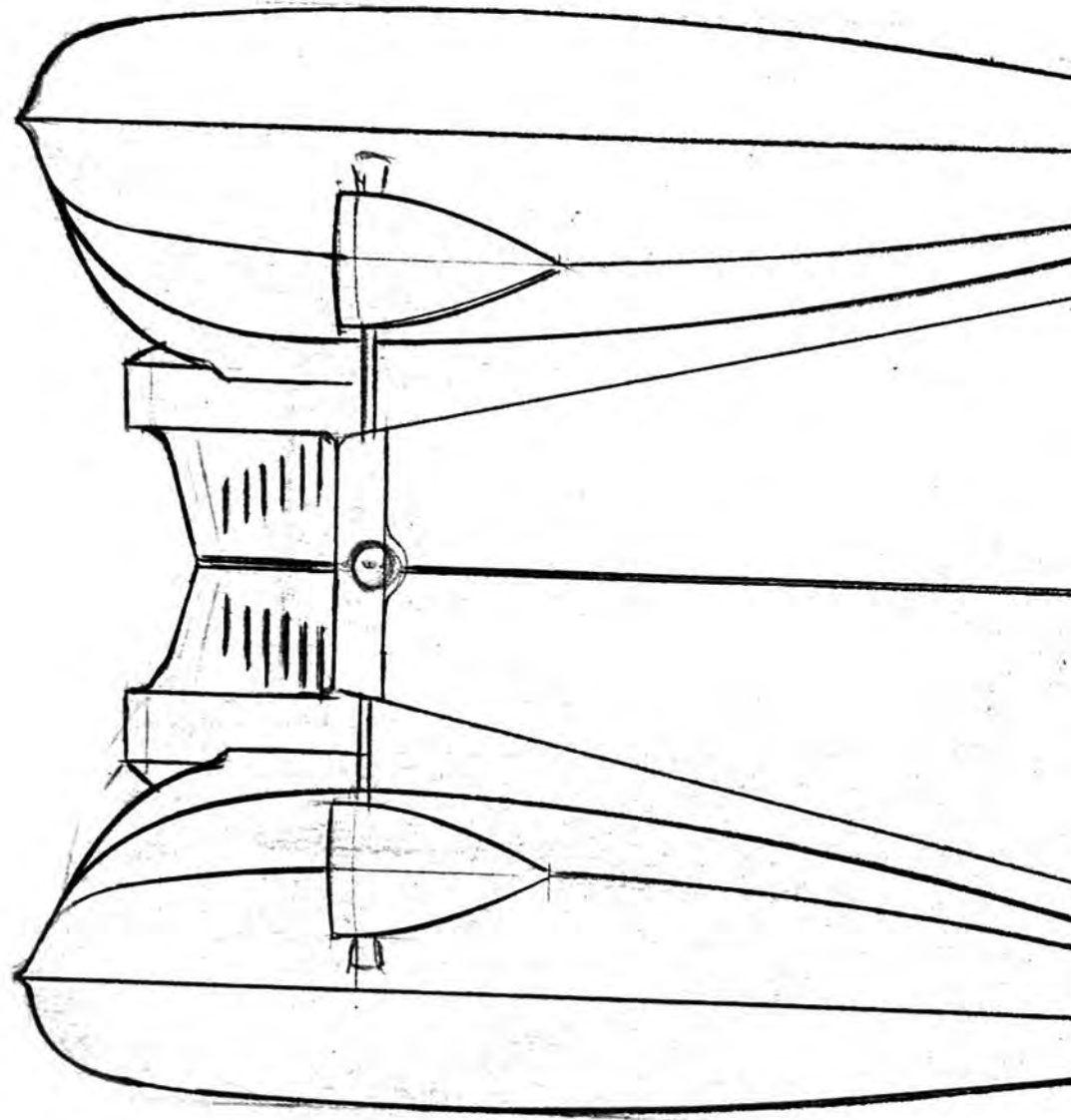

Pierre Grümmer
(1660-1740) Aachen, Germany

Wilhelm Grümmer
(1701-1767) Aachen, Germany

Jules-Wilhelm Grümmer
(1732-1780) Aachen, Germany

Michael-Wilhelm Grümmer
(1765-1843) Aachen, Germany

Frédéric-Joseph Grümmer + Anne-Marie Vander Noot
(1803-1867) Brussels, Belgium

Antoine-Joseph Grümmer + Anne-Marie Larue
(1834-1909) Paris, France (1857-1934)

Frédéric Grümmer
(1878-1953) Paris, France

Maximilienne Grümmer
(1882-1957) Paris, France

Maurice Grümmer
(1885?-1889?) Paris, France

Gaston Grümmer + Yvonne Broudic-Verry
(1892-1965) Paris, France (1911-2005)

Anne-Marie Grümmer
(1933-1934) Paris, France

Jean-Louis Grümmer + Denise Walker
(1935-1992) Paris, France (1939-) Australia

Philippe Grümmer + Marie-Christine d'Autheville
(1942-) Paris, France (1946-) Paris, France

Géraldine Grümmer
(1967-) Paris, France

Virginie Grümmer
(1972-) Paris, France

Louis Grümmer
(1972-) Paris, France

Caroline Grümmer
(1976-) Paris, France

Benoît Grümmer
(1978-) Paris, France

THE GRÜMMER FAMILY: A COACHBUILDING DYNASTY

There is a saying, “an apple never falls far from its tree” and similarly a *carrossier* needs strong antecedents. The Grümmer family had been in the saddling and coachbuilding business long before the creation of the Grümmer company in Clichy, France, in 1924.

The oldest traceable origins of the family have been found in the region of Oldenburg, Lower Saxony. In about 1500, one of its members left for Hungary, and in 1541, fleeing the Turkish invasion, the family returned to settle in Aachen near the River Rhine in Germany. The French conquests of the region in the late 1700s made Aachen the capital of the department of the Roer (1797-1814) and therefore the Grümmer family became French. Around the same time, Michael-Wilhelm was appointed a *maître de sellerie* or master saddler for Napoleon I, and one of his sons, born in 1811, was named Louis-Napoleon after the Emperor.

TOP LEFT: Anne-Marie Grümmer, Gaston's mother, with Gaston and nanny at their Sèvres summer house in 1899. (Philippe Grümmer)

MIDDLE LEFT: Business card from Maison V. Morel, manufacturer of luxury carriages, situated at 26 rue Cambacérés in central Paris near the Elysée Palace. (Philippe Grümmer)

TOP RIGHT: Antoine-Joseph Grümmer, Gaston's father, in Paris in 1876. Passionate about riding and coaching, he had joined the *carrossier* V. Morel in 1850 and purchased the company in 1882. (Philippe Grümmer)

BOTTOM (BOTH) & OPPOSITE PAGE: Carriages made by Maison Grümmer, in approximately 1880. (Drawings/Philippe Grümmer, *Coupé de ville* photography/Jean-Louis Libourel)



THE GRÜMMER FAMILY: A COACHBUILDING DYNASTY

Antoine-Joseph died in January 1909 and was buried in the Père Lachaise cemetery. His wife Marie, assisted by their oldest son, Frédéric, continued running the family business. She had been immersed since childhood in the world of carriages as she was descended from a family of painters originally from Nancy who decorated coaches built by the great *maîtres carrossiers* for the high society of the time. The wealthy families continued to patronise her and she managed the company until 1920. The vehicles constructed during this time carried the signature plates “Maison M. Grümmer” for Marie Grümmer. She died in 1934.

Frédéric Grümmer was known as an excellent carriage designer. *La Vie Parisienne*, on 10 December, 1904, stated that “like his father, he has a love of his profession and is one of the best specialist carriage designers. He is a distinguished engineer and water colour artist.”

RIGHT: Frédéric Grümmer, Gaston's older brother, was an excellent carriage designer. (Philippe Grümmer)



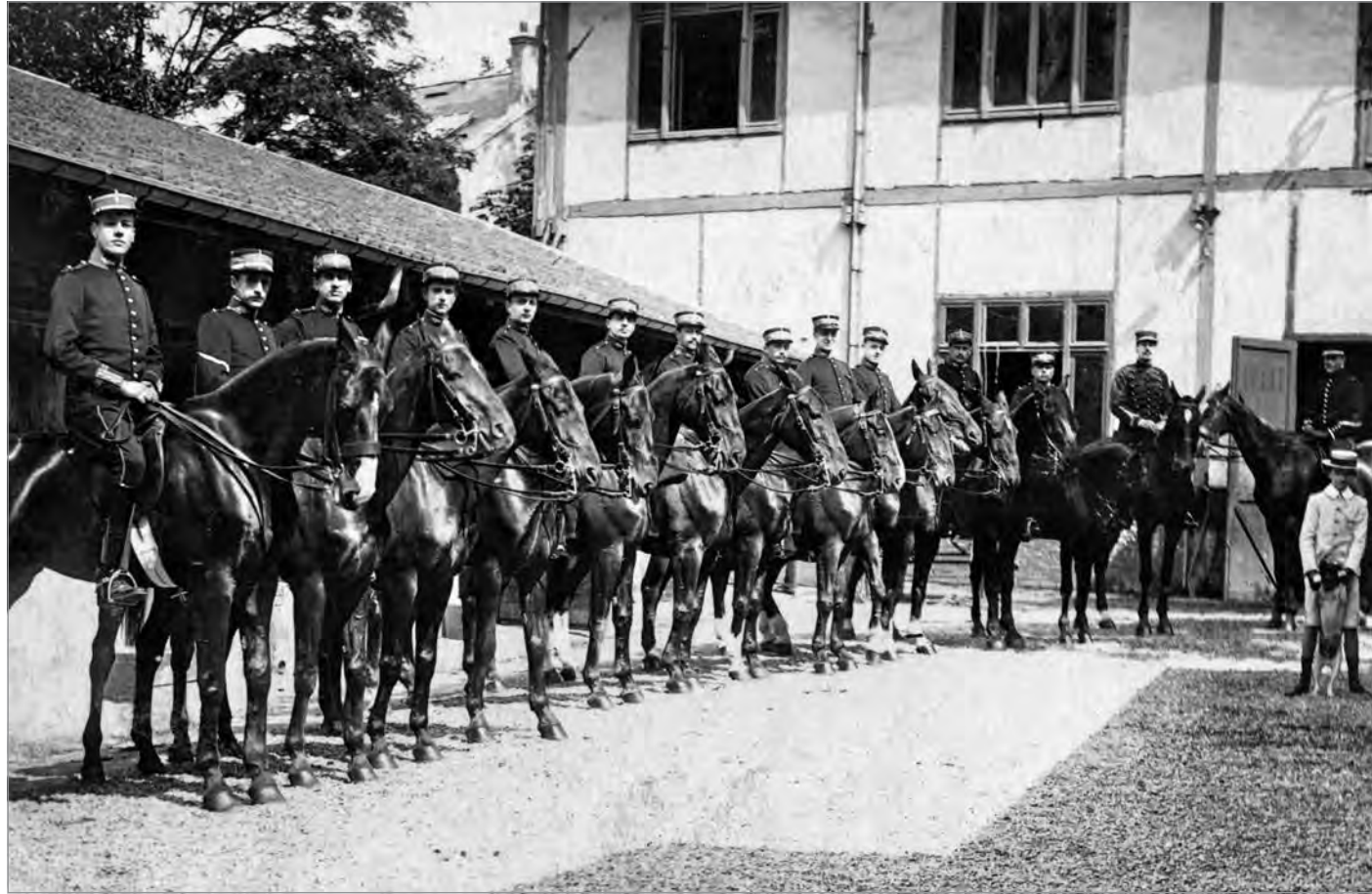



World War I, Gaston became a pioneer in experimenting with aerodynamics for the automobile. In 1930, he began detailed studies and research, including extensive tests on roads and in wind tunnels, and used his conclusions to apply for the "Aéropofil" patent in 1933.

Very active in professional organisations, Gaston Grümmer was appointed Board Member of the Trade Association of Carrossiers in 1929, then Secretary and Member of the Board in March 1931. He was also Chairman of the Apprentice Training Course.

But as the 1930s progressed and the great depression hit Europe there became fewer demands for the Grand Luxe cars, and despite Gaston's attempts to diversify into such vehicles as armoured military vehicles on Hotchkiss chassis (13 were ordered by the army) or even his attempt at manufacturing lacquered steel kitchen furniture for Sauvel, the company closed its doors in late 1935. Gaston Grümmer then permanently left the world of the automobile.

On a personal level, Gaston was first married in 1925 to a young widow named Christiane Chigot. This was not a successful union and after a short time, the couple divorced. He remarried in December 1931 at the age of 39 to 20-year-old Yvonne Broudic-Verry, a member of the Verry ship-owning family from Binic, after a whirlwind romance having known each other for only four months. They had first met at a reception in honour of Marshal Lyautey and Gaston was



TOP: Yvonne Grümmer née Broudic in 1931.

ABOVE: Gaston fishing during a holiday in the Loire Valley.

ABOVE RIGHT: Yvonne and Gaston on their engagement, summer 1931.



OPPOSITE LEFT (BOTH): Gaston and Yvonne visiting the "Temple of Love" of the house they eventually bought in Les Ponts-de-Cé.

OPPOSITE MIDDLE (BOTH) AND FAR RIGHT: Gaston and Yvonne attending an airplane exhibition in le Bourget near Paris.

All photographs these two pages courtesy of Philippe Grümmer.



Voisin C3 L, bodied as a tourer by Carrosserie Gaston Grümmer. The hood mascot is a young lady seated, not the traditional "Cocotte" created by Gabriel Voisin. (Philippe Grümmer)

Gaston Grümmer's order book began to fill up and 1925 was full of promise.

One of his first creations, a dual cowl sports tourer with four seats and dual windshields, was described in detail in the January-February 1925 issue of the *L'Auto-Carrosserie*. The front windshield was flat while that in the rear was in three parts. The doors were slanted to give the car a sense of speed even when stationary, and the front doors were, in addition, slightly scalloped at the rear. The body, which was covered with coated fabric, ended with a built-in trunk that housed several suitcases. But the main innovation concerned the running board which fitted harmoniously with the front and rear fenders in a continuous line, and was about twenty centimetres wide, incorporating two tool boxes which opened on top.

This tourer design was constructed on several chassis including at least one Panhard & Levassor, one Oméga-Six and a Voisin 18 HP type C3L. The Voisin was the subject of articles printed in French magazines and even in a few foreign publications such as *Autobody*, a professional journal for coachbuilders published in the US.

The body of the Voisin was covered with Zapon, a coated fabric that has been designed and used primarily for the interior lining of aeroplane fuselages. It had the advantage of lightness and speed in construction, but its major drawback was the fragility of the material

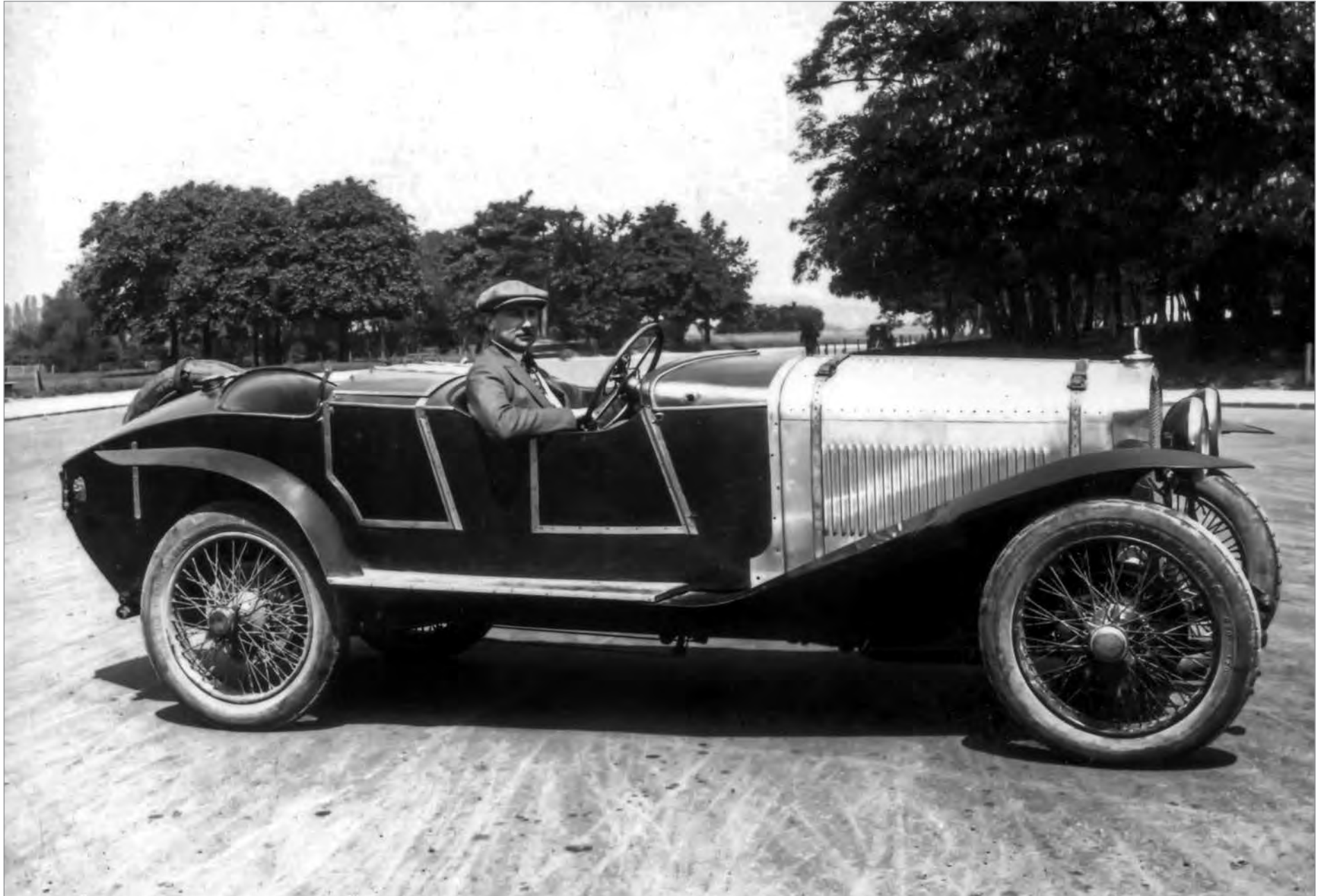

One of the two Oméga-Six that took part of the endurance race of the 24 Hours of Le Mans in June 1924. Jacques Margueritte who teamed with Louis Bonne is seen here testing the car. The second team was composed of Marcel Mongin and Roland Coty. Neither of the teams finished the race. (*Laurent Frity*)

1926: A FORAY INTO THE WORLD OF AVIATION

After the event the three-seat convertible Bugatti was purchased by Virgil D. Giannini, son of Amadeo P. Giannini, founder of the Bank of America, one of the largest banking institutions in the United States. Virgil Giannini was born in 1899 and was on a visit to Paris in June 1926 with his parents when his mother bought him the Bugatti as a present. He suffered from haemophilia, like his brother and sister, and died, aged just 38, following a fall in his apartment. He did not drive the Bugatti much and after a small accident, stored it in his garage with the odometer showing 4,000 miles. The car remained there until after the World War II, and it now survives in near perfect, unrestored condition as part of the Nethercuff Collection in California.

With the three highest awards in the class in which he competed, Gaston Grümmer could not do better. He was obviously delighted with the result and he was establishing an excellent reputation within the coachbuilding community.

TOP: The two gentlemen are demonstrating how easy it is to fold down the top of the three-seat Bugatti cabriolet. Note the special shape of the sliding windows. *(Philippe Grümmer)*

RIGHT: The profile drawing of the three-seat Bugatti was published in the issue dedicated to the Concours d'Elégance de L'Auto by *L'Équipement Automobile*. *(Laurent Froy)*

OPPOSITE: Gaston Grümmer proudly stood beside this Bugatti that had just won a second place prize. *(Philippe Grümmer)*

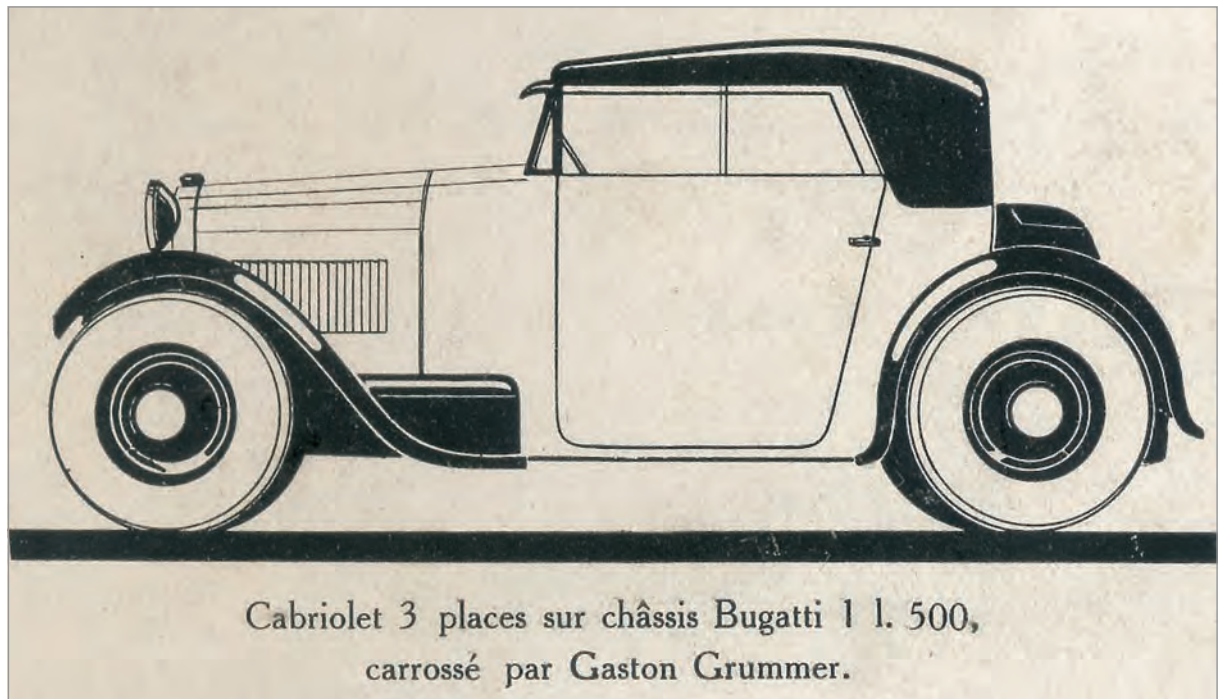



P. LEVASSEUR, Constructions Aéronautiques
 17 à 21, Place Félix Faure -:- Paris (15^e)

LIMOUSINE DE TRANSPORT

P. LEVASSEUR

Constructions Aéronautiques — Avions — Hélices

L'avion marin biplace de chasse Levasseur

AVIONS TERRESTRES - AVIONS MARINS

✦

AVION TORPILLEUR
 AVION MARIN TRIPLACE D'OBSERVATION
 AVION BIPLACE DE CHASSE MARIN OU TERRESTRE

✦

HÉLICES EN BOIS
 Hélices métalliques "LEVASSEUR"
 (BREVETS REED)

USINES et BUREAUX: 17 à 21, PLACE FÉLIX-FAURE, PARIS (XV^e)
 Téléphone: SÉGUR 65-78, 57-20, 18-78 R.C. Seine 48269 Adresse télégraphique: HÉLICE PARIS

ABOVE: Pierre Levasseur was a manufacturer of propellers and military aircraft. This advertisement is from 1927. (Laurent Friry)

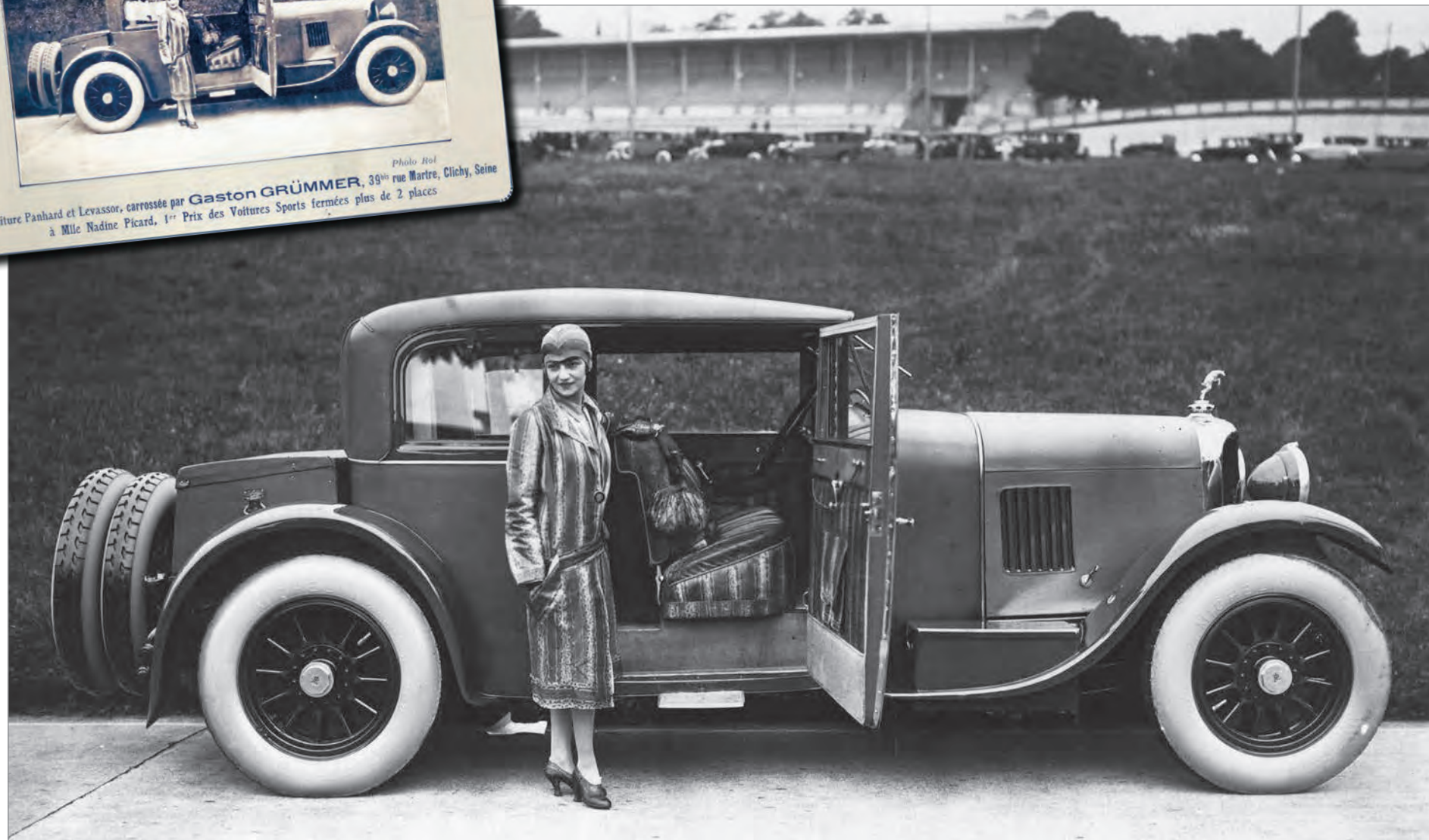
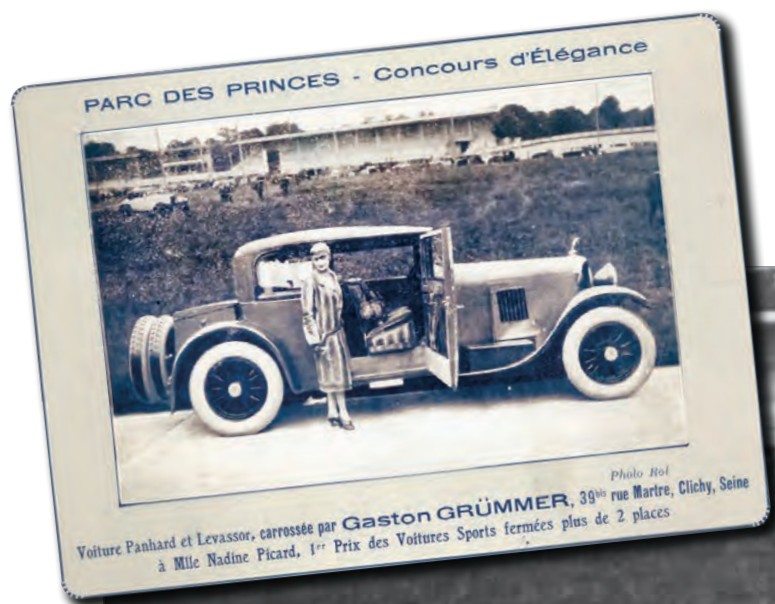

Movie actress Nadine Picard attended the Concours d'Élégance de L'Auto with a Panhard 20 CV Sport Special bodied as an E.B.V. sport sedan. The interior of the car was trimmed with snakeskin from Alpina, and Mademoiselle Picard wore a coat and hat also in snakeskin to completely match the car. **INSET:** Based on his success at the concours, Gaston ran an advertising campaign in several magazines. (*Phillippe Grümmer*)



ABOVE: A profile view of the sole Chenard & Walcker bodied by Gaston Grümmer.

LEFT (BOTH): This Talbot was completely trimmed with snakeskin. Note that the backrest could be folded to ease access to the rear seats. (*Phillippe Grümmer*)



GASTON GRUMMER
CARROSSIER

39^{bis} Rue Martre - CLICHY (Seine)
Téléph. Levallois 10-58 - R.C. SEINE 291345

CARRIOLET SUBASSISÉ
MODÈLE DÉPOSÉ



FAUX CARRIOLET
SUBASSISÉ
(Lignes Veyron)
MODÈLE DÉPOSÉ



LA CARROSSERIE SUR
GASTON GRUMMER

Dans l'évolution de la construction automobile — qui a en constaté la même évolution en faveur de la carrosserie normale, car on se représenterait mal un châssis moderne sans elle.

Dans ses détails, la carrosserie automobile s'est elle-même tendue vers une ligne très caractéristique et a été marquée en conséquence.

Pourquoi cette tendance et pourquoi la carrosserie doit-elle être normale ?

Pour de multiples raisons, plus intéressantes et plus variées que celles que l'on croit.

CONDUITE INTÉRIEURE
SUBASSISÉE
MODÈLE DÉPOSÉ



PALMARÈS

RÉCOMPENSES OBTENUES AUX DIFFÉRENTS CONCOURS D'ÉLÉGANCE

| ANNÉE | CONCOURS | RÉSULTAT |
|-------|---------------------------|-----------------------|
| 1922 | PARIS, Salon des Primeaux | Grand Prix d'Élégance |
| 1923 | PARIS, Salon des Primeaux | Grand Prix d'Élégance |
| 1924 | PARIS, Salon des Primeaux | Grand Prix d'Élégance |
| 1925 | PARIS, Salon des Primeaux | Grand Prix d'Élégance |
| 1926 | PARIS, Salon des Primeaux | Grand Prix d'Élégance |
| 1927 | PARIS, Salon des Primeaux | Grand Prix d'Élégance |
| 1928 | PARIS, Salon des Primeaux | Grand Prix d'Élégance |
| 1929 | PARIS, Salon des Primeaux | Grand Prix d'Élégance |
| 1930 | PARIS, Salon des Primeaux | Grand Prix d'Élégance |
| 1931 | PARIS, Salon des Primeaux | Grand Prix d'Élégance |
| 1932 | PARIS, Salon des Primeaux | Grand Prix d'Élégance |
| 1933 | PARIS, Salon des Primeaux | Grand Prix d'Élégance |
| 1934 | PARIS, Salon des Primeaux | Grand Prix d'Élégance |
| 1935 | PARIS, Salon des Primeaux | Grand Prix d'Élégance |
| 1936 | PARIS, Salon des Primeaux | Grand Prix d'Élégance |
| 1937 | PARIS, Salon des Primeaux | Grand Prix d'Élégance |
| 1938 | PARIS, Salon des Primeaux | Grand Prix d'Élégance |
| 1939 | PARIS, Salon des Primeaux | Grand Prix d'Élégance |
| 1940 | PARIS, Salon des Primeaux | Grand Prix d'Élégance |

MARQUE DÉPOSÉE EN 1920

FAUX CARRIOLET
SUBASSISÉ
MODÈLE DÉPOSÉ



CONDUITE INTÉRIEURE
SUBASSISÉE
(Lignes Veyron)
MODÈLE DÉPOSÉ



CONDITIONS DE VENTE
(EXTRAIT)

ARTICLE I. — Commandes. — Pour être exécutoires, toutes commandes doivent être accompagnées de la somme de leur montant en espèces ou en chèques à vue sur Paris, à l'ordre de M. Gaston Grummer, 39 bis rue Martre à Clichy.

Le versement reste acquis à M. Gaston Grummer à titre de dédit si pour une raison quelconque, autre que celle énoncée dans les conditions générales de vente, le client ne parvient pas à livrer la voiture en commande.

Aucune commande, quelle que soit sa destination, n'est définitive.

Les commandes de carrosserie doivent être faites sur bulletins de commande établis dans la forme officielle et adoptée par M. Gaston Grummer.

Les modifications ou additions acceptées seront facturées à part, et peuvent entraîner des délais supplémentaires pour la livraison.

ART. II. — Prix. — Il est entendu que les prix indiqués pour la livraison des carrosseries s'entendent pour déduits des taxes d'importation et des droits de douane.

Les prix sont établis en tenant compte des taxes, impôts et autres redevances fiscales applicables à la date d'établissement des tarifs, ils peuvent être modifiés sans préavis.

Les prix sont établis en tenant compte des taxes, impôts et autres redevances fiscales applicables à la date d'établissement des tarifs, ils peuvent être modifiés sans préavis.

ART. III. — Délais. — Les délais de livraison partent de la date de la signature des bulletins de commande. Ils ne sont dus qu'à titre de renseignements et ne sont en aucun cas garantis.

ART. IV. — Réception-Livraison. — Les marchandises sont livrées à nos Clients, 39 bis rue Martre à Clichy.

ART. V. — Paiement. — Les prix sont remboursés nets pour nos carrosseries ou accessoires par chèque, mandat ou espèces, immédiatement et en espèces au moment de la date de leur établissement à l'adresse de M. Gaston Grummer.

Cette garantie est de conservation d'origine limitée au remplacement des pièces qui pourraient présenter un vice de matière ou être reconnues défectueuses. Elle n'est pas applicable à une réparation ou à un échange de pièces.

AGENT GÉNÉRAL POUR LA RIVIERA : ENTREPRISE GÉNÉRALE CARROSSERIES AUTOMOBILES 81^{ter}, BOULEVARD GAMBETTA - NICE

1928: THE PANHARD SPORTSMAN'S COUPÉ

same kind of boot for his own models and even for a Bugatti Royale chassis. Mr. Edwards' Talbot also had an interesting combination of colours. Most of the car was painted sky blue but the wings and roof were light beige. The interior had blue cloth trim and walnut woodwork with inlays of silver threads. The car received a third-place prize.

Gaston Grümmer again received a full complement of awards: the Grand Prize of Honour for all categories, the cup from *L'Auto*, the cup from *La Carrosserie*, the Grand Prize in the Convertible class, first prize in the Closed Sports Car class, and first prize in the Convertible class. It was well deserved. A wide variety of styles and construction techniques were on display and the high level of finish and attention to detail made each car a true work of art. The daily newspaper *Le Gaulois* wrote in its issue dated June 10, 1928: "The big winner of the day was Gaston Grümmer. In previous years Grümmer has already gleaned an ample harvest of awards. The triumph is complete." A few weeks earlier, *Omnia* magazine in its May issue had published a major study on the low-profile cars in which the author reminded his readers that the first coachbuilders to build this

THESE TWO PAGES: This Talbot 11 CV M76 had a sedan coupé two-door, four-window body from Carrosserie Gaston Grümmer. It was owned by a British citizen, Mr. A. H. Edwards who lived in Marseilles and took part in the Concours d'Elegance de l'Auto where it was awarded a third prize. (*Philippe Grümmer*)



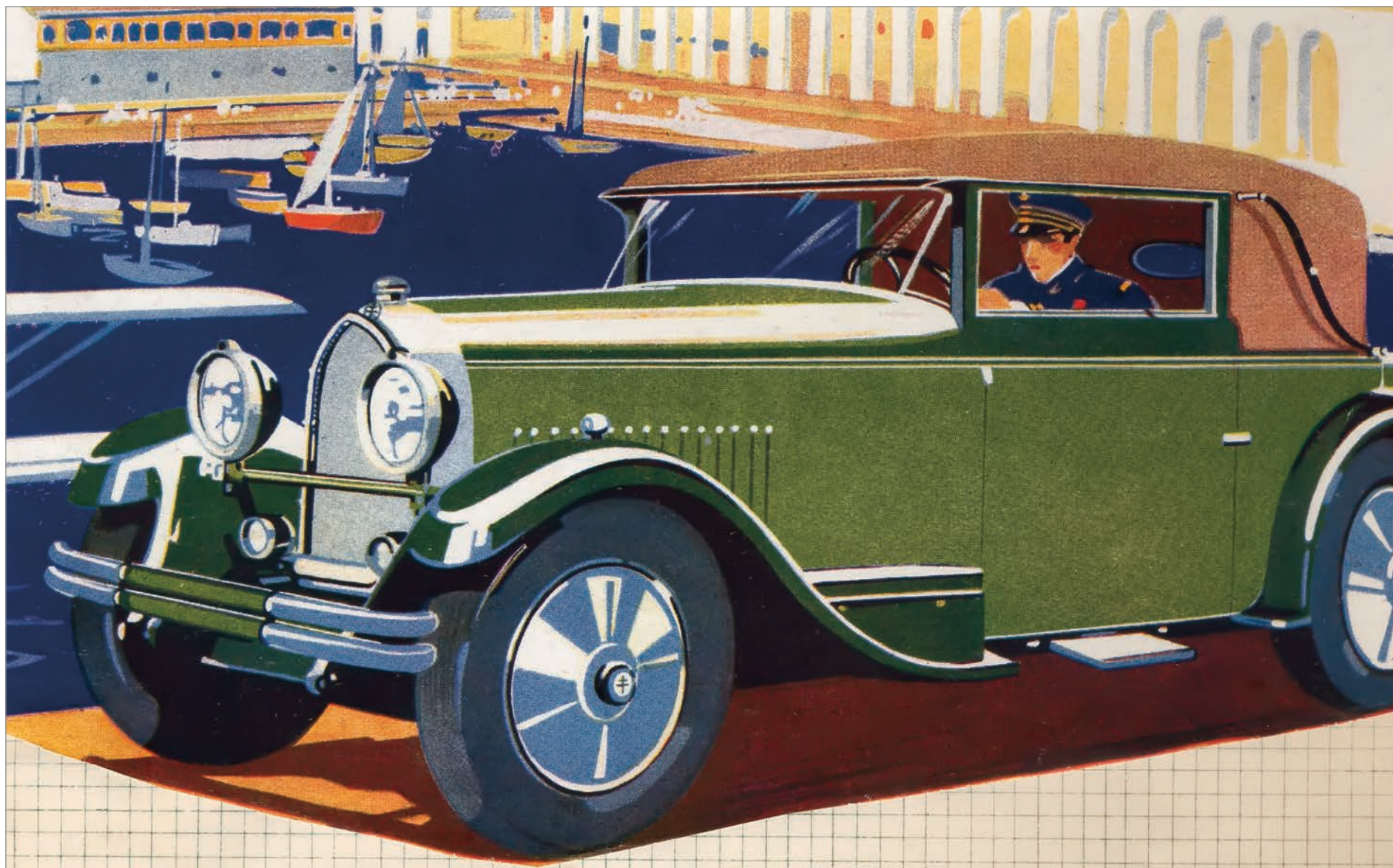

OPPOSITE: This impressive eight-cylinder Panhard 35 CV was bodied as an E.B.V. sport sedan. Although with a design very similar to Marcelle Rahna's Panhard seen at the 1928 Concours d'Elégance de L'Auto, this car was not covered with leatherette. (Philippe Grümmer)

ABOVE: The front cover of the January 1929 issue of *Omnia* magazine pictured a Lorraine-Dietrich low-profile E.B.V. cabriolet bodied by Gaston Grümmer. (Philippe Grümmer)





Gaston Bruner



THESE TWO PAGES: Jack Hylton, the famous band leader from the 1920s, was the owner of the Phantom II. He frequently travelled to Paris in 1930 where he worked with Igor Stravinsky. During one of his visits, he met Gaston Grümmer and ordered the body for his Rolls-Royce. (*Philippe Grümmer*)



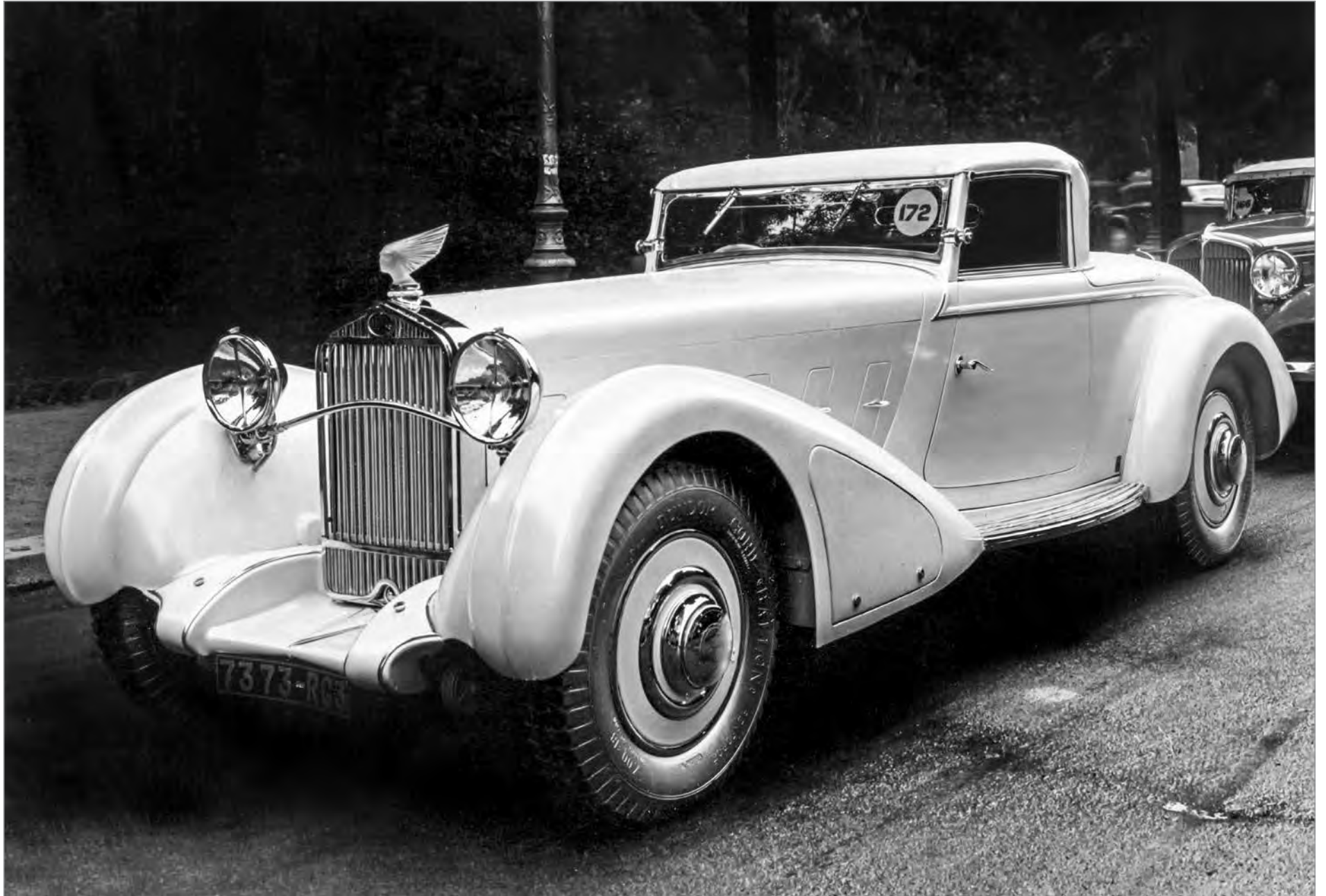

The radiator mascot, from the famous Lalique crystal factory, was the "Victoire" model, also sometimes known as the "Spirit of the Wind," and was one of the most exclusive hood ornaments. (Philippe Grümmer)

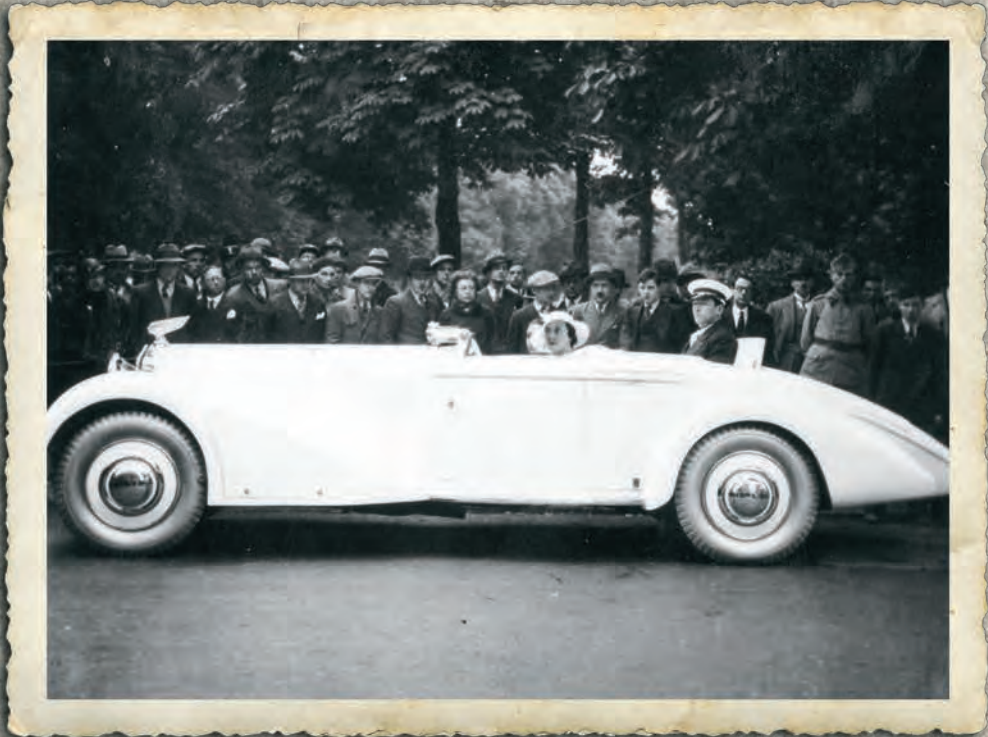

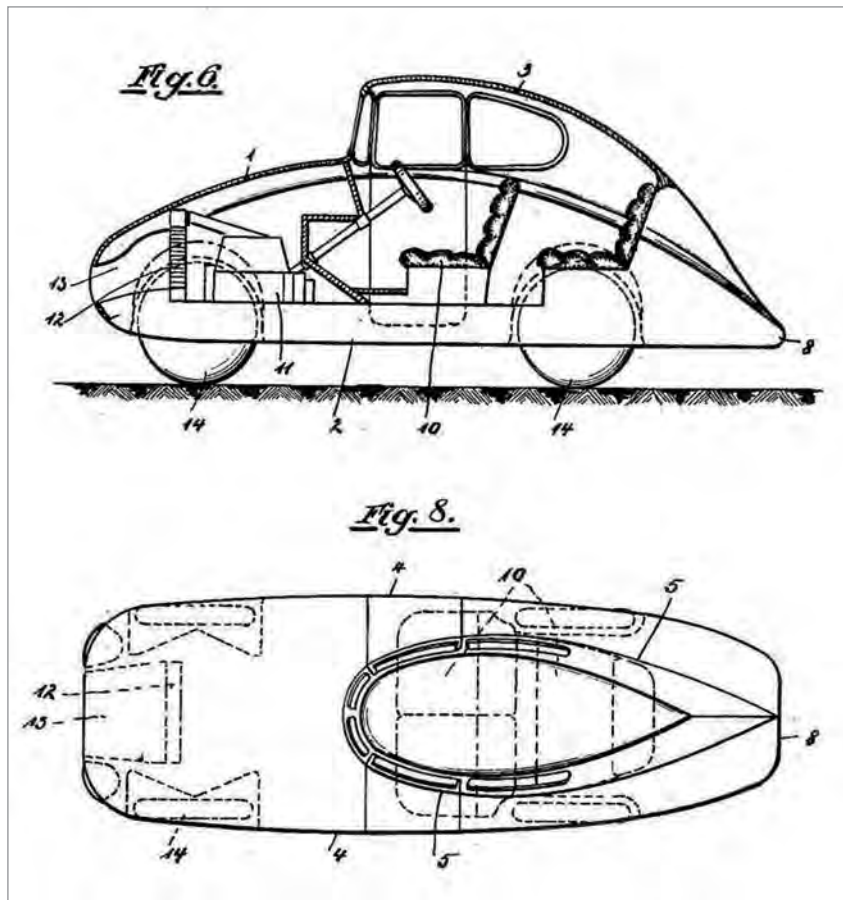

OPPOSITE TOP: The Voisin Laboratoire used for the 1923 Grand Prix of the ACF. (Laurent Friry)

OPPOSITE BOTTOM: Camille Jenatzy celebrating the 100km/h record in April 1899 with La Jamais Contente, an electric car that was bodied by the Carrosserie Rheims & Auscher. (Laurent Friry)

ABOVE: US Patent for Paul Jaray streamlined car designed in 1922. (Laurent Friry)

RIGHT AND OVERLEAF: The *Aéropofil* patent dated 30 September, 1933. Three items were listed: the small coupé and the sport sedan, and the special door that was "open at the top." (Philippe Grümmer)

MINISTÈRE DU COMMERCE
ET DE L'INDUSTRIE.

RÉPUBLIQUE FRANÇAISE.

OFFICE NATIONAL DE LA PROPRIÉTÉ INDUSTRIELLE.

DESSINS ET MODÈLES.

CERTIFICAT D'IDENTITÉ.
(Art. 6 et 7 de la loi du 14 juillet 1909.)

34.344

GRUMMER (Gaston) et BUSSON (Guillaume)
Carrossiers,
39 bis rue Martre, Clichy (Seine)

Représentés par Mr. Maulvault, 25, rue de Richelieu, Paris.

-o-o-o-o-o-o-o-

Photographies et dessins représentant 3 modèles :

1^{er} Portière pour carrosserie - 2^e Carrosseries.

Modèles déposés le 30 septembre 1933 au Secrétariat
du Conseil de Prud'hommes de Paris (Métaux) sous le n^o 32.962.

La publicité a été requise par le mandataire le 30
Septembre 1933.

Le dépôt a été ouvert le 18 octobre 1933 pour être
mis à la disposition du Public et du Tribunal, s'il y a lieu.

Les épreuves photographiques de ces modèles établies
par les soins de l'Office National de la Propriété Industrielle
ont été exposées dans la Salle de Communication, à partir
du 10 NOV 1933

-o-o-o-o-o-o-o-

Voir d'autre part les re-
productions photographiques de ces modèles accompagnées de
légendes avec copie de la déclaration de dépôt.

00-127-1-2655-32. [31113]

1933: A SUCCESSFUL YEAR

designs for streamlined car body designs and then issued licences to Tatra and major vehicle manufacturers in Germany.

In France, although some auto makers created aerodynamic cars for racing, they remained at the prototype stage with no commercial production. Ballot and Bugatti both designed a cigar-shaped car for the 1922 A.C.F. Grand Prix, and the next year in the same event, Bugatti raced a car shaped like an aeroplane wing, the Type 32 "Tank." Gabriel Voisin came with a car called "Laboratoire," the first with a monocoque chassis also in the shape of an aeroplane wing. Henri Farman, an aircraft designer and aviator, produced two racing cars whose bodies were tested at the Eiffel wind tunnel.

The patent of the *Aéroprofil* car was registered under number 32,962 at the French National Patent and Trademark Institute with the joint names of Gaston Grümmer and Guillaume Busson, coachbuilders, 39bis rue Martre, Clichy.

This patent had three parts and was described succinctly and accurately to protect the

RIGHT: The seats were covered with Connolly leather. To facilitate access to the rear bench, the backrest of the front seat could be folded forwards. (*Phillippe Grümmer*)

OPPOSITE: The large four-part windscreen afforded excellent visibility. Note the two Marchal electrical wipers that were mounted on the bottom of the windshield. The dashboard of the Delage was standard, from stock. (*Phillippe Grümmer*)



1933: A SUCCESSFUL YEAR

The Grümmer sketch register for 1933 has various studies for *Aéroprofil* cars including drawing No. 678 dated 25 July, 1933 for a coupé on a Renault Nervasport chassis, then on the next day, drawing No. 682 for a 2-door, 4-seater coupé on an Alfa Romeo chassis, and drawings for an *Aéroprofil* Delage D8, a Bugatti Type 57, and a Ford V8.

In an article published by *La Carrosserie* in April 1934 Gaston Grümmer was quoted:

“The *Aéroprofil* mounted on a Delage chassis, which I delivered in America, has produced interesting results. I have no official confirmation, but the performance is superior to the Citroën *Aéroprofil* by about 14%. The *Aéroprofil* not only has the benefits of aerodynamics, but also offers maximum comfort and easily seats three people on benches at front and rear. It provides excellent visibility both laterally and vertically for all

TOP: After being on display at the Berlin Motor Show, this Maybach Zeppelin DS8 with a special streamlined body built by Carrosserie Hermann Spohn from Ravensburg was exhibited at the Paris Motor Show in October 1933. (*Laurent Friry*)

RIGHT: The profile view of the streamlined Maybach Zeppelin showed some similarities with the *Aéroprofil*, especially the overall airplane-type profile, the ponton line with the wrap-around front fenders, and the semi-recessed door handles. The first pictures of this Maybach were published in the press in February 1933 after the Berlin Motor Show and it is likely that Guillaume Busson was inspired by this impressive car. (*Laurent Friry*)





ABOVE: 18 June, 1933, on the 24 Hours of Le Mans endurance track, soon after the end of the race. The private team composed of André Rousseau (left) the owner of the Alfa Romeo and François Paco (right) finished eighth overall but first in the 2-litre class. Car number 8, in the background, is the Alfa Romeo 8C 2300 driven by Luigi Chinetti and Philippe de Gunsburg from the Scuderia Alfa Romeo that finished second. (*Charles Camberoque*)

OPPOSITE: The Alfa Romeo 6C 1750 GS during the 24 Hours of Le Mans race. (*Charles Camberoque*)

Volume Two

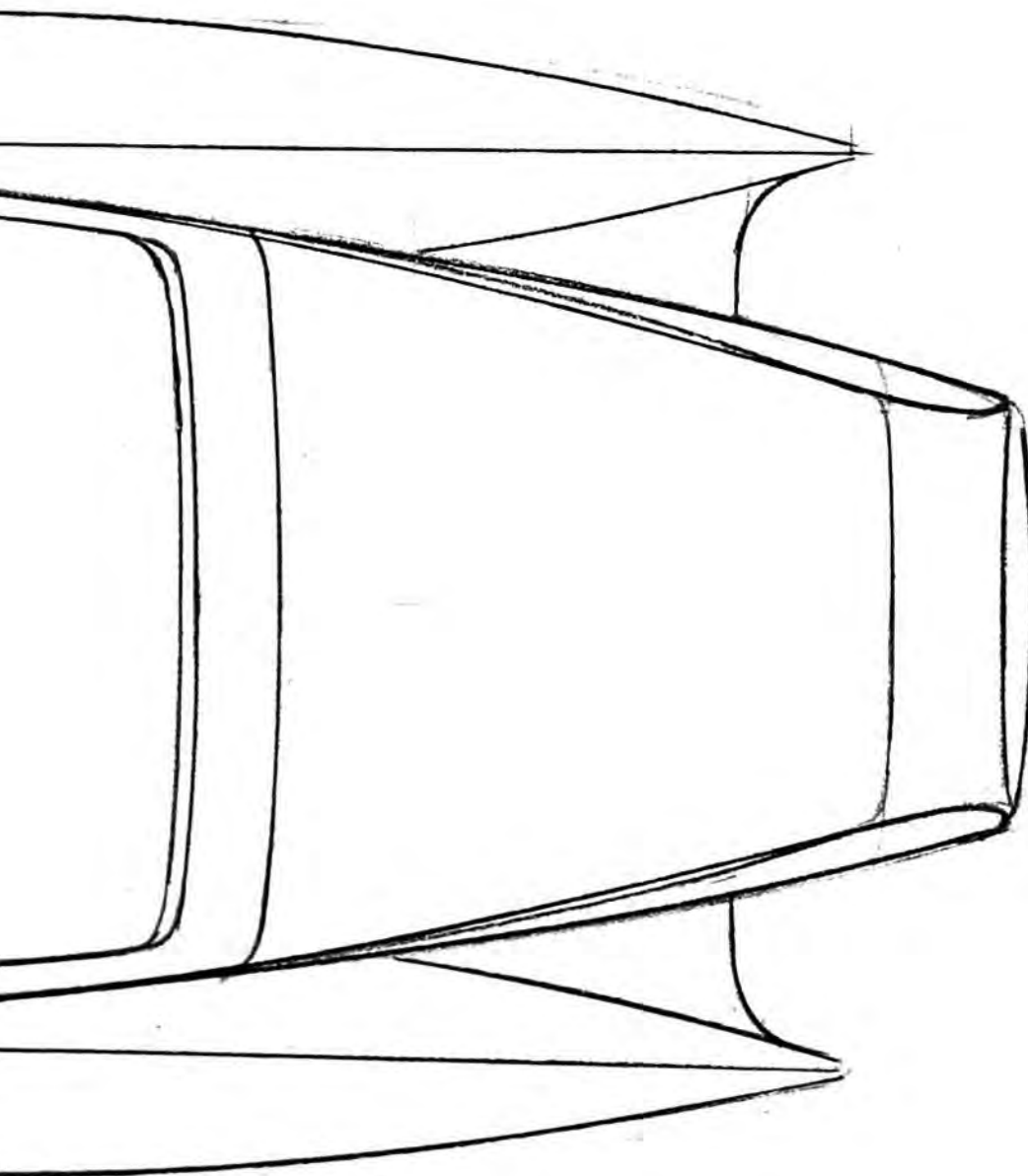

| | |
|---|-----|
| 1934: The <i>Aéropofil</i> | 394 |
| 1935: Last Success in a Concours d'Élégance | 450 |
| The Surviving Cars | 468 |
| Epilogue | 498 |
| Appendix One: Chassis Listing | 502 |
| Appendix Two: Grümmer-Designed Bodies | 512 |
| Appendix Three: | |
| The Drawing Register | 526 |
| The Drawing Register Table | 634 |

TABLE of CONTENTS

| | |
|--|-----|
| Appendix Four: Catalogues & Brochures | 666 |
| Appendix Five: Prizes & Concours Appearances | 704 |
| Appendix Six: Les Etablissements Grümmer | 712 |
| Notes/Acknowledgements | 718 |
| Bibliography | 719 |
| Index | 720 |
| The Grümmer Family's Next Generations | 728 |

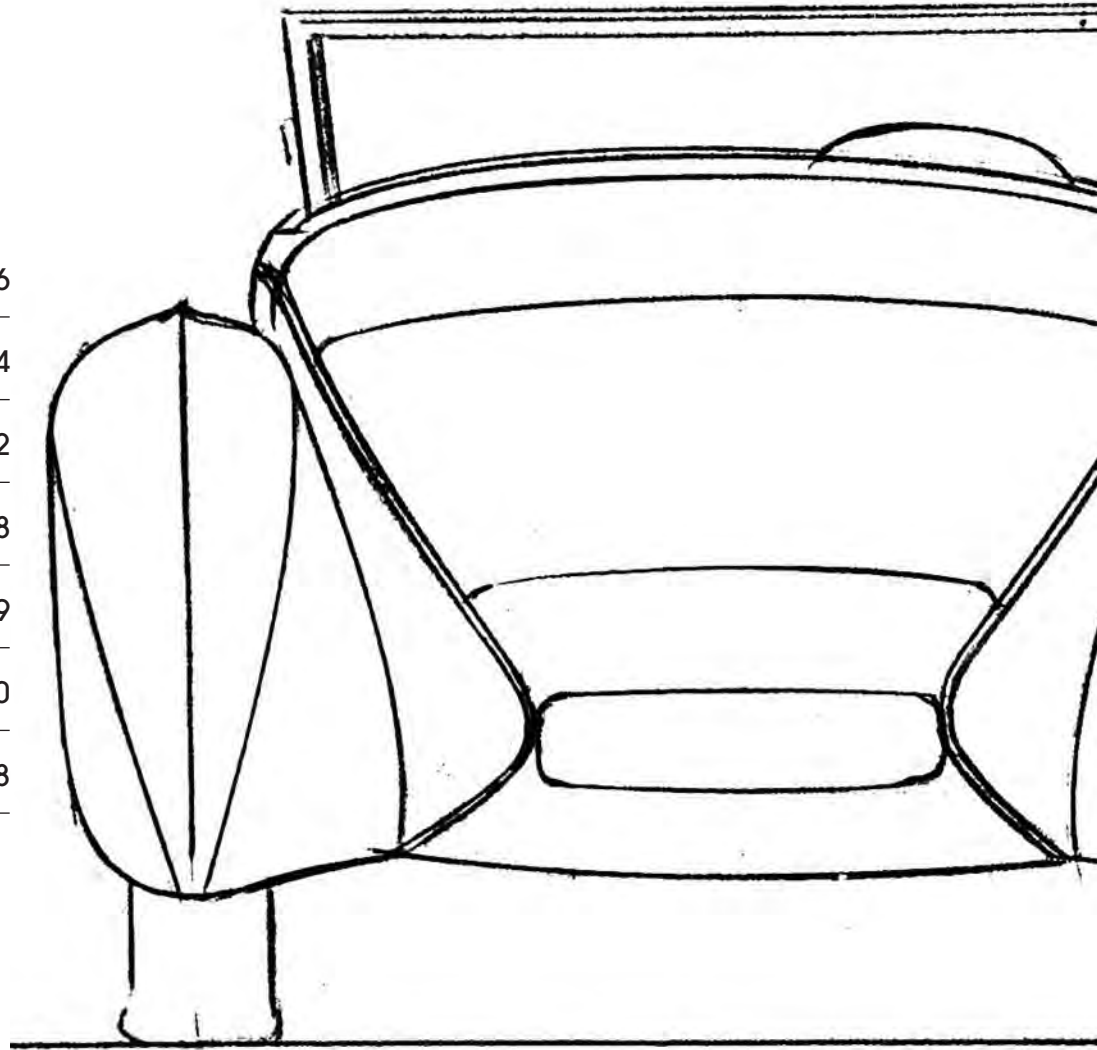

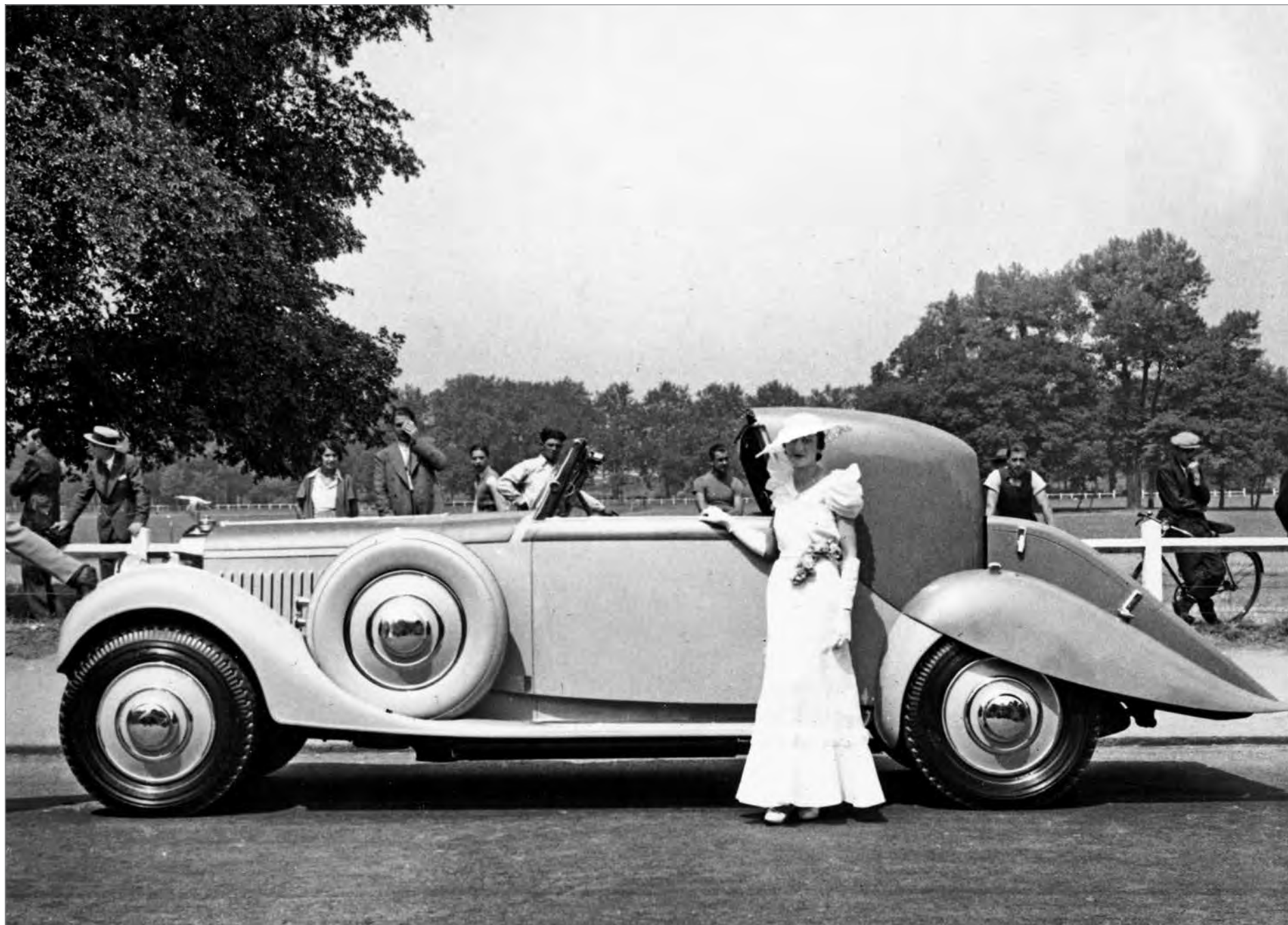



A happy Gaston Grümmer discussing the outcome of the concours with a friend. He is photographed behind the *Hironde*. (Philippe Grümmer)

1934: THE AÉROPROFIL

but the rest of the body was built according to the *Aéroprofil* patent. The windshield was not V-shaped but flat and was surmounted by a second triangular part which went up over the roof. The body was relatively high and ended with a significant tail. The four doors had slanting windows which rose fairly deeply into the carriage, and the car was painted in two tones with the wings and the body darker than the hood, possibly in two shades of blue.

It is not known what became of the 601 immediately after the concours, but two years later, on 30 June, 1936, a small ad appeared in the *Paris-Soir* newspaper placed by Autex, the luxury automobile agency on avenue Victor Emmanuel III, for a Peugeot 601 sedan with a Grümmer body, described as very spacious and in new condition. This must have been the little *Aéroprofil*, but nothing more is known and it is more than likely that the car was destroyed either in the chaos of war or more simply in the press of a car breaker.

RIGHT: Probably for cost reasons, the main part of the windscreen was flat and the upper part was then composed of two windows on which the wipers were fixed. Just finished for the concours, the Peugeot wore a trade registration number that was painted on the front bumper. (*Philippe Grümmer*)



RIGHT: The Renault *Aéropofil* was exhibited at the Paris Motor Show that took place from 4-14 October, 1934. (Laurent Friry)

FAR RIGHT: This clipping from the *New York World-Telegram* was found in Gaston Grümmer's archive. It is interesting to note that the American journalist mentioned in the caption that the Grümmer *Aéropofil*, "keeps pace with developments in the wind-blown bodies of American cars." Most probably it was a reference to the Chrysler Airflow that was introduced a few months earlier at the New York Motor Show. (Phillippe Grümmer)

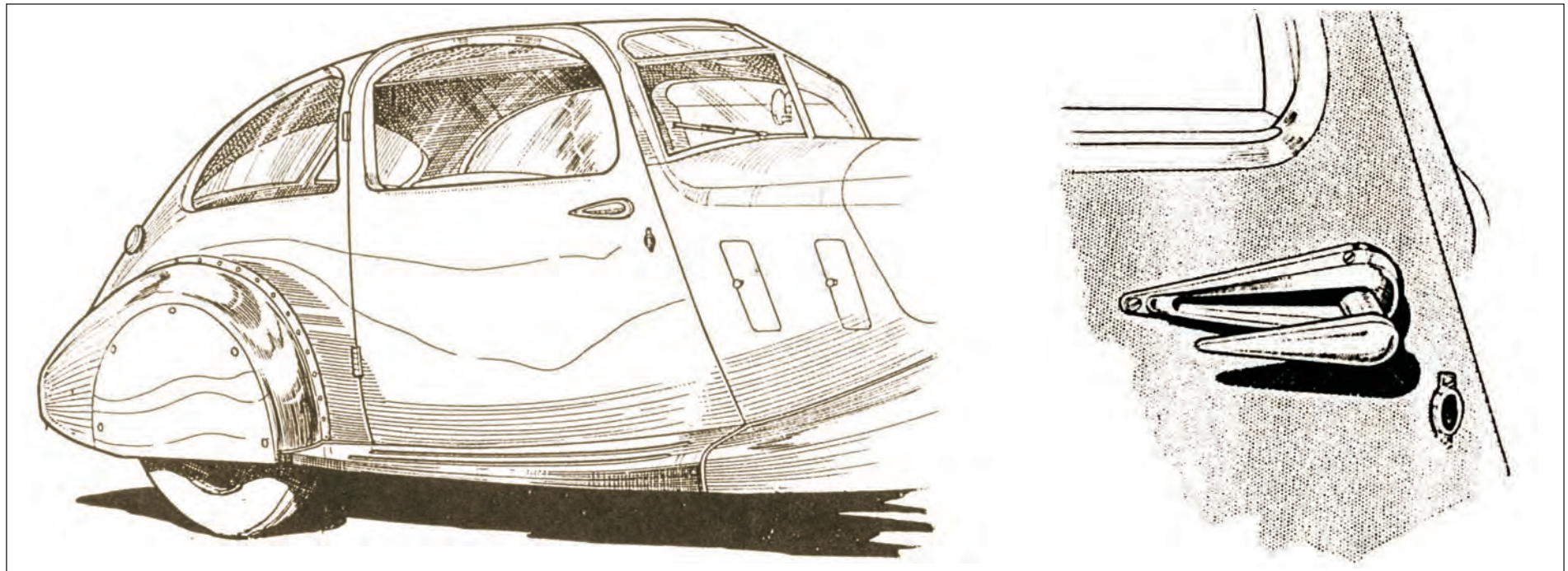
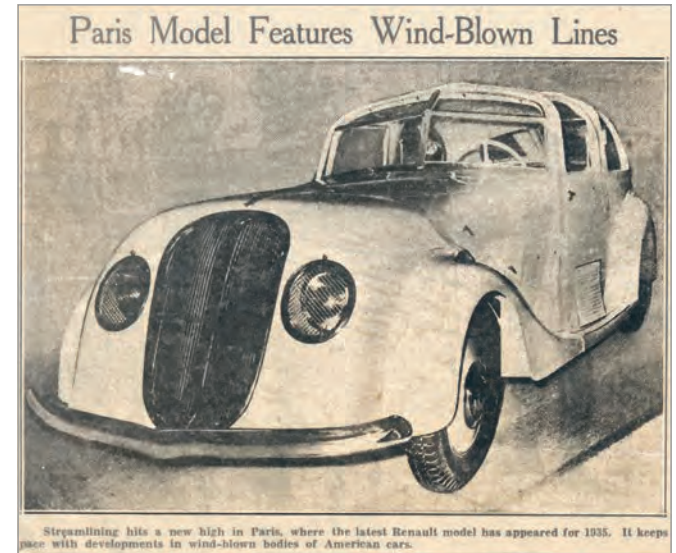

ABOVE: The retractable door handles of the Renault *Aéropofil* were a completely new design intended to improve the streamlining of the car. They emerged from the door using a spring mechanism. (Laurent Friry)

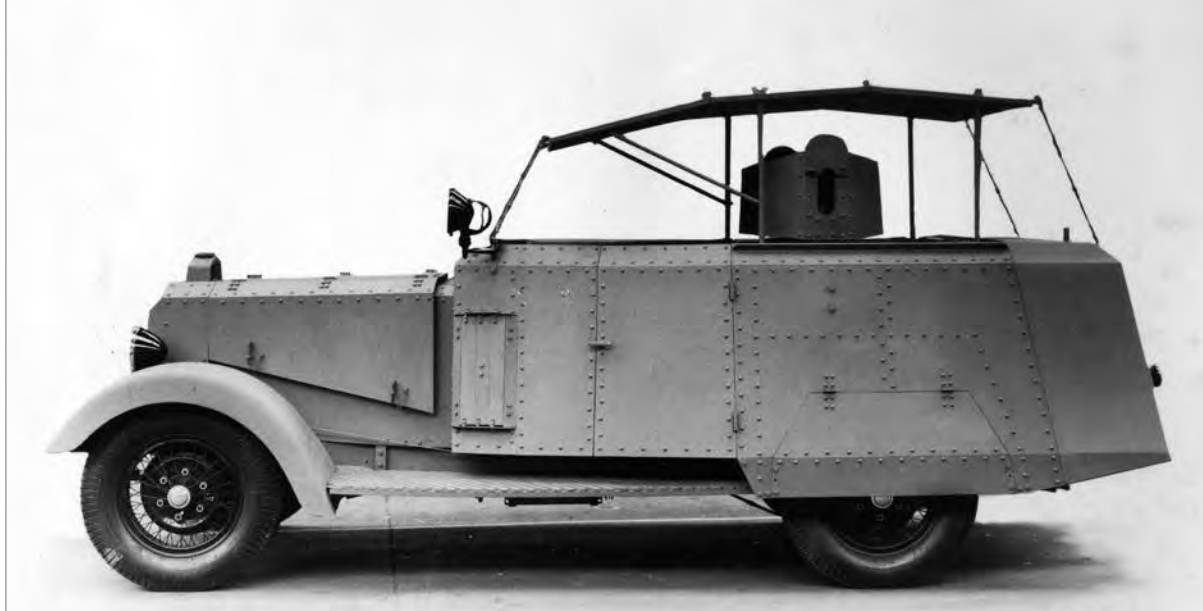

A contract from the French Army for Syria and Lebanon

In search of work for his shop, Gaston Grümmer, like most coachbuilders, undertook the construction of bodies for commercial vehicles, a sector that had not suffered so much from the financial crisis because truck manufacturers delivered only chassis and the vehicles were then bodied according to their intended use. There are a number of projects illustrated in the Grümmer drawing register including a bakery delivery body on a Hotchkiss 411 chassis, and an ambulance on a Panhard X46 18 CV. In the absence of a production register, it is difficult to form a precise idea of the number of utility vehicles that were built, but it was probably few. Gaston also won a contract from the French Army for a small series of light armored cars destined for the Army of the Levant, the French troops in Syria and Lebanon. Thirteen of these vehicles were built on Hotchkiss 411 chassis and were equipped with open bodies with 5mm-thick armour. Two machine guns



THIS PAGE: The standard wire wheels supplied by Hotchkiss with the chassis were not exchanged for more substantial disc wheels. Two machine guns were installed on each side and the operators were protected by a shield. Note also the metallic roof that was a good protection against the sun.
(Philippe Grümmer)



The Surviving Cars

Because the financial registers and production books of the Grümmer company are missing, the exact number of cars bodied in Clichy is not known, but it is possible to speculate by studying the remaining records. One of these is the drawing register which consists of two small handwritten booklets that contain every project drawing done for Carrosserie Gaston Grümmer. It starts in 1924 with an Aldi design and ends in 1935, the last design being number 777, a convertible body on a Buick 90 chassis.

Other evidence comes in the form of company records and press reports. The first car was bodied in December 1924 and in April 1927, the 100th body was celebrated and finally there is the date that the company was closed, August 1935. Based on these facts, it is estimated that about 600 cars were bodied by Carrosserie Gaston Grümmer, less than ten cars are known to still exist.

LEFT: Philippe Grümmer meeting the Grümmer-bodied Bugatti T38 and T46 for the first time, in La Jolla in 2014. *(Philippe Grümmer)*



From a horse-drawn carriage by Joseph Grümmer to luxury coachbuilding for cars by Gaston Grümmer. (*Philippe Grümmer*)

Landaulet limousine with transformable front on Cadillac

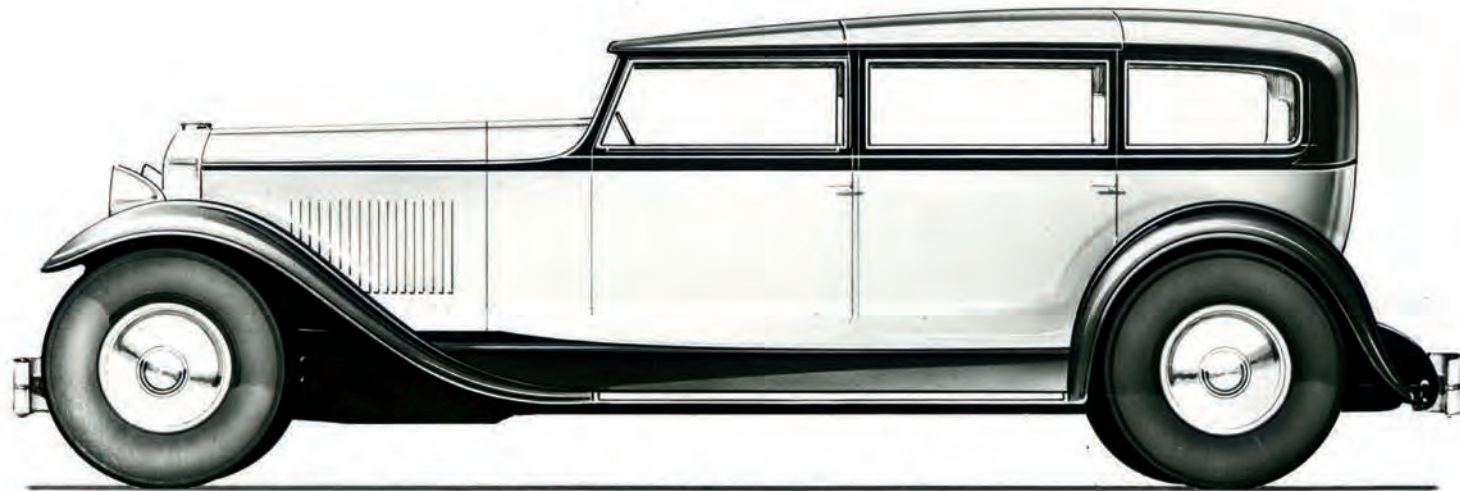
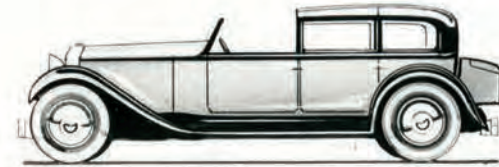
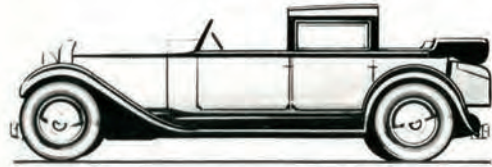

GASTON GRUMMER
CARROSSIER
39^{me} RUE MARTRE
CLICHY - SEINE

The following pages are a transcription of the notebook called "Mémoire de dessins au 1/10ème," or Drawing Register, a guide to the 1/10 scale drawings, some of which are shown in the previous section. They were numbered from 1 to 777, each of them being very briefly described with chassis and body type. From drawing No. 621 onwards, there are a few additional details, the date of the drawing, the type of drawing (black ink or colour) and the name of the recipient of the proposal.

Almost two hundred of the drawings survive. Some of them have a number higher than 777 and these correspond to the last projects undertaken by Gaston Grümmer between 1934 and 1935. They were most probably described in another notebook that has not been found.

It is important to keep in mind that these drawings were proposals. They were made following a request by a

potential customer who expressed his or her wishes, for example, for a two-door cabriolet on a Bugatti chassis, or a limousine large enough to travel with parents, children and luggage, or an open car on a Hispano-Suiza 32 CV chassis, and so on. The proposal would have been accepted or refused by the client, which means that some of them were indeed built, and others remained as drawings.

The naming convention of body types has always been a difficult subject. Following several centuries of horse-drawn carriage construction, automobile coachbuilders had developed a specific vocabulary, but each coachbuilder used his own terms that were not always the same throughout the industry and there were no established conventions that could be applied.

Nevertheless, some generic French terms seemed to be universal.

- A *conduite* or *conduite intérieure* was an enclosed car. It may have had two or four doors and two, four or six windows. Usually a *conduite intérieure* with two doors and four windows was called a coach. With four doors and four windows, it was a *berline*, and with four doors and six windows, a *limousine*.
- *Cabriolet*, *roadster* and *torpédo* were open drive cars with two doors for the first two and four doors for the *torpédo*.
- A *landaulet* was a partly convertible car. Only the rear part could be opened.

In 1930, the French Coachbuilders' Association tried to establish a standard and it published a list of twenty-three body types in three different categories: open cars, closed cars and convertible cars that also included sports cars. The intention was worthy, but the timing was rather late and because of the economic crisis nothing came of the initiative.



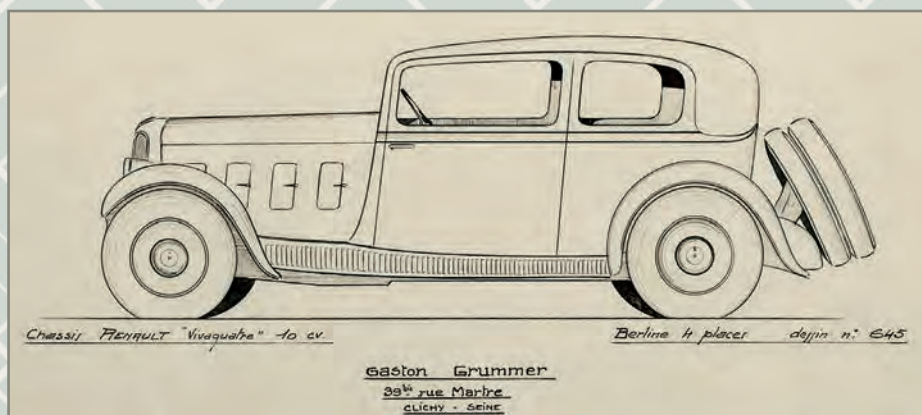

645: 1933-04-20 Renault Vivaquatre berline

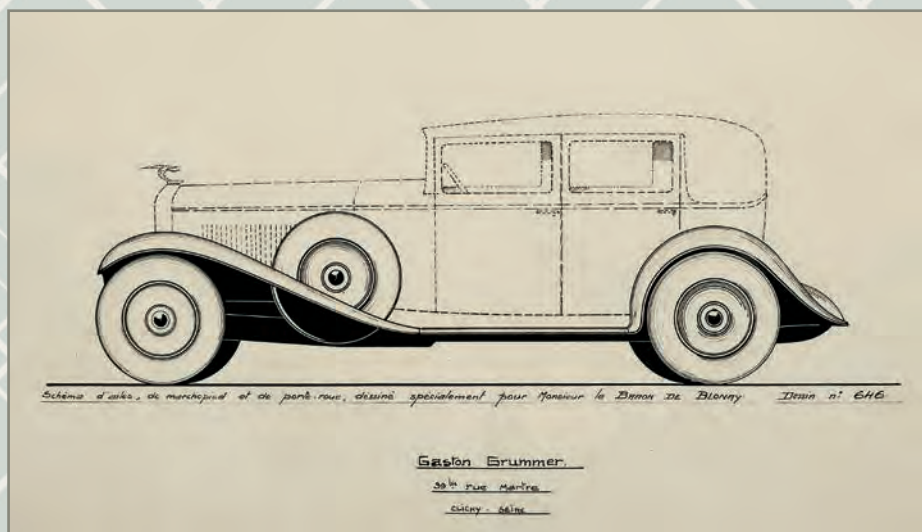

646: 1933-04-26 / Hispano-Suiza 32 CV conduite, 4-door / Front and rear fender shape, drawn for Baron de Blonay

647 cabriolet Cond. int. 4 p. port. 6 pl. Hotchkiss 617 long
 648 cabriolet 2 p. 4 pl. Hispano 32 cv.
 649. conduite int. 4 pl. 4 p. Panhard 605 long.
 650 cond. int 6 pl. 6 pl. faub. Ford V8 40
 651 cond int 4 eu & 5 pl. Delahaye 125
 652 cond. int sports 4 pl. Alfa. Romeo amies cotées.
 653 Coupe Américain AV Ent. Hispano 32 cv
 654 cond int & port 4 places Daimler 1843
 655 cond. int 2 p. 2 p. Citroën 100 L
 656 cabriolet 2 p. 4 pl. Delage 118 Sport
 657. " " " " " "
 658 con 2 p. 4 p. Ford 177² long.
 659. cabriolet 4 pl. Hispano 32 CV.
 660 cabriolet 4 pl. 2 p. " 32 cv
 661 " 4 pl. 2 p. Citroën 10 cv

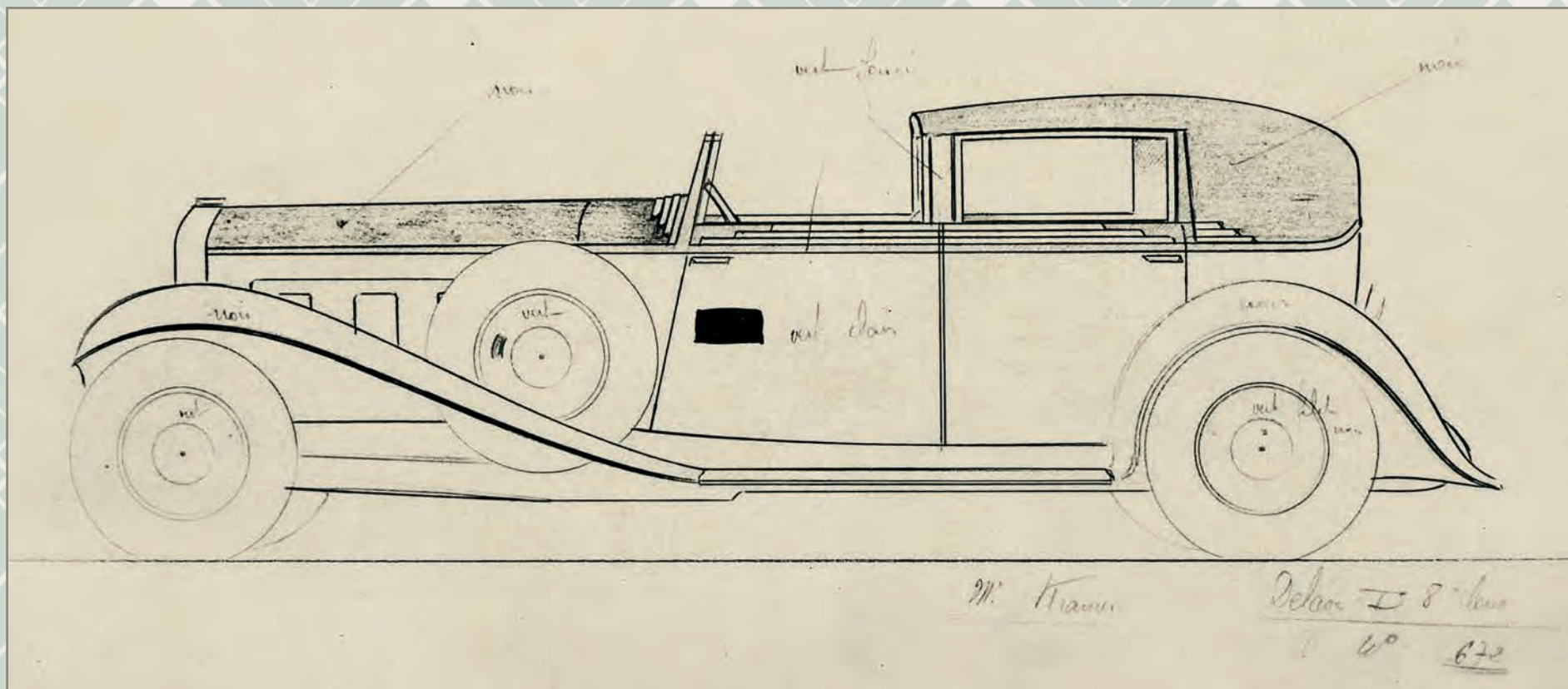

672: 1933-06-26 / Delage D8 faux cabriolet with extensible front / drawn for M. Kramer

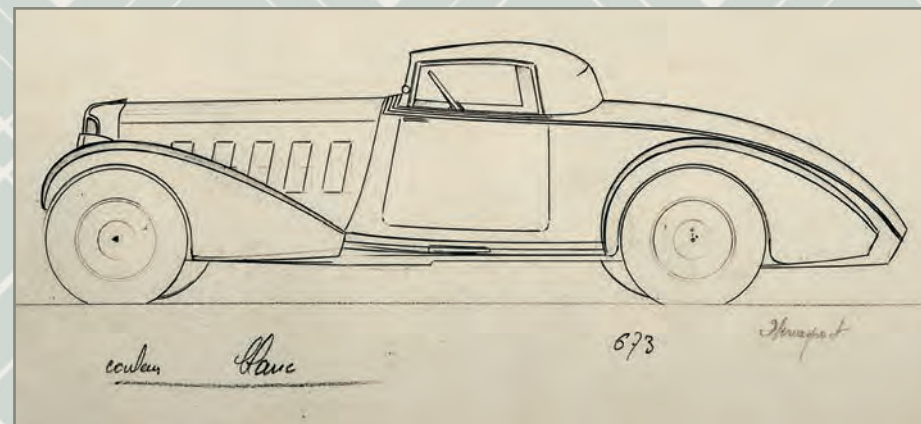
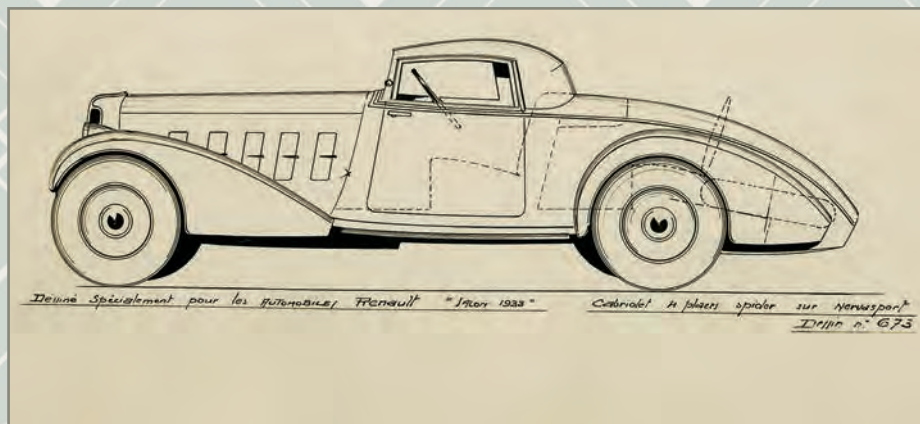

673 AND 673^{BIS}: 1933-07-01 / Renault Nervasport cabriolet, 4-seat with spider / drawn for Renault for Paris Motor Show

THE DRAWING REGISTER

| NO. | DRAWING | DRAWING DATE | CHASSIS | TYPE | BODY | RECIPIENT | NOTES | PAGE IN BOOK |
|-----|---------|--------------|--------------------|----------|------------------------------|-----------|--|--------------|
| 1 | | | Oméga-Six | | | | | |
| 2 | | | Buick | Standard | Torpédo sport 4-seat | | | |
| 3 | | | Buick | Master | Torpédo course 4-seat | | | |
| 4 | | | Panhard & Levassor | 20 CV | Cabriolet 3 to 4-seat | | | |
| 5 | | | Panhard & Levassor | 12 CV | Cabriolet 3 to 4-seat | | | |
| 6 | | | Renault | 18 CV | Cabriolet conduite | | | |
| 7 | | | Bugatti | 1500 cc | Cabriolet E.B.V. | | | |
| 8 | | | Bugatti | 1500 cc | Cabriolet E.B.V. | | | |
| 9 | | | Talbot | DUS | Cabriolet 2-seat with spider | | | |
| 10 | | | Peugeot | 174 | Cabriolet 2-seat with spider | | | |
| 11 | | | Peugeot | 181 B | Cabriolet 2-seat with spider | | | |
| 12 | | | Crossley | | Cabriolet E.B.V. | | | |
| 13 | | | Isotta Fraschini | 8A | Cabriolet E.B.V. | | | |
| 14 | | | Oméga-Six | | Cabriolet E.B.V. | | | |
| 15 | | | Citroën | 10 CV | Cabriolet E.B.V. | | | |
| 16 | | | Voisin | C5 | Cabriolet E.B.V. | | | |
| 17 | | | Bugatti | 1500 cc | Cabriolet E.B.V. | | | |
| 18 | | | Lorraine-Dietrich | | Cabriolet E.B.V. | | | |
| 19 | | | Buick | Master | Cabriolet E.B.V. | | | |
| 20 | | | Buick | Standard | Cabriolet E.B.V. | | | |
| 21 | | | Willys-Knight | | Cabriolet 2-seat with spider | | | |
| 22 | | | Hispano-Suiza | Boulogne | Faux cabriolet | | Although it is shown as a "Boulogne" in the register, it is probably a 32CV, type H6B. | |
| 23 | | | Hotchkiss | | Conduite 4-doors | | | |
| 24 | | | Hotchkiss | AM2 | Faux cabriolet E.B.V. | | Short Length chassis | |
| 25 | | | Hotchkiss | AM2 | Faux cabriolet E.B.V. | | Long length chassis | |
| 26 | | | Buick | | Faux cabriolet E.B.V. | | Long length chassis | |

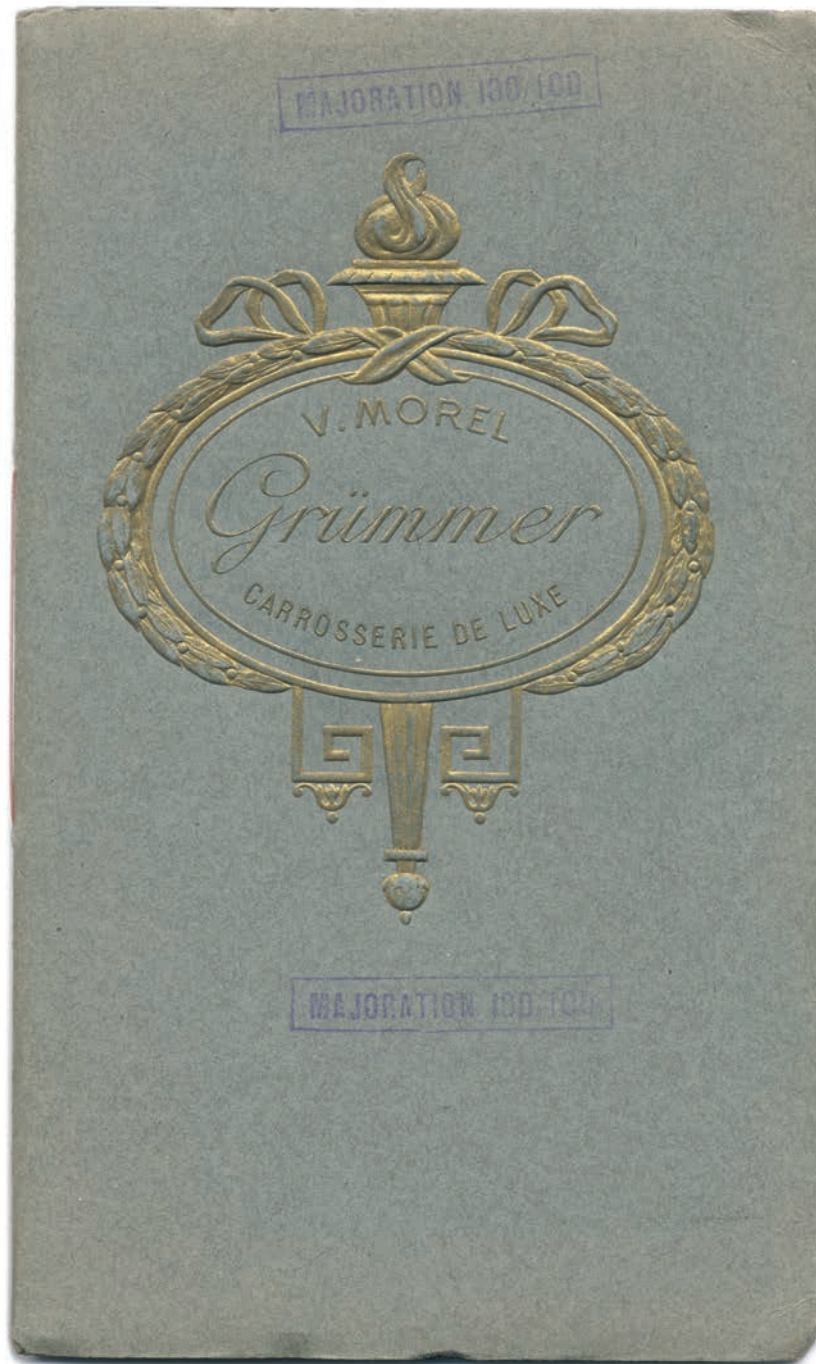

1914 Marie Grümmer Catalogue

This section reproduces the catalogues published by the Grümmer companies from 1914 up to 1929. They represent the evolution of the carrosserie art from the horse-driven carriages to the precursors of modern car designs.

1929

Concours d'Elégance, Monte Carlo, 15 March, 1929

- Oméga-Six 8 cyl., E.B.V. faux cabriolet, Yvette Laurent, 1st Prize
- Panhard & Levassor X57 16 CV, two-door sport sedan, Mme Perugia

Concours d'Elégance, Cannes, 23 March, 1929

- Oméga-Six 8 cyl., E.B.V. faux cabriolet, Yvette Laurent, 2nd Prize
- Panhard & Levassor X57 16 CV, two-door sport sedan, Mme Perugia, silver plate

Concours d'Elégance de L'Auto, Paris, 4 to 7 June, 1929

- Bugatti Type 44, coupé de ville, Gertrude Vanderbilt
- LaSalle 8 cyl., cabriolet
- Lorraine-Dietrich 15 CV, cabriolet, Gaby Meyer
- Oméga-Six 8 cyl., E.B.V. faux cabriolet, Yvette Laurent

Fémina - L'Intransigeant Concours, Paris, 28 June, 1929

- LaSalle 8 cyl., cabriolet, Mme Allemand
- Renault 15 CV, Mme Pizani

Concours d'Elégance, Le Touquet-Paris-Plage, 22 July, 1929

- Panhard & Levassor 35 CV, E.B.V. sport sedan, Mme Manesse, Overall Grand Prize of Honour, Cup of La Carrosserie
- Lorraine 20 CV, Gaston Roche d'Estrez

Concours d'Elégance, Lille, 22 September, 1929

- Panhard & Levassor 35 CV, E.B.V. sport sedan, Mme Manesse, Award of Excellence

1930

Concours d'Elégance de L'Auto, Paris, 4 to 6 June, 1930

- Bugatti Type 46, faux cabriolet, Kira Sklarova, Grand Prize of Honour, Cup of La Carrosserie, 1st Prize, Ladies' Trophy
- Minerva 30 CV, cabriolet sport, Yvette Laurent, 1st Prize, Two-Door Convertible class, 19th Place, Ladies' Trophy
- Hispano-Suiza H6C, sedan, Mme Higgins, 2nd Prize, Sedan class
- Renault Reinastella, transformable sport sedan, Marquise d'Aigues-Vives, 2nd Prize, Two-door Convertible Sedan class
- Renault Vivastella, torpédo sport, Jeanne Helbling, 6th Place, Open Car class, 8th Place Ladies' Trophy
- Renault Vivastella, torpédo sport, Jeanne de l'Espée, 4th Prize, Cabriolet class

Fémina - L'Intransigeant Concours, Paris, 27 June, 1930

- Hispano-Suiza H6C, sedan, Mme de Fouquières
- Renault Reinastella, transformable sport sedan, Jeanne Provost
- Renault Vivastella, sports roadster, Jeanne Helbling, Grand Prize of Honour
- Renault Vivastella, torpédo sport, Lucienne Vazier, Banner of Honour
- Renault Vivastella, torpédo sport, Mlle de Baillhache, Banner of Honour

Concours d'Elégance, Vichy, 17 June, 1930

- Renault Reinastella, transformable sport sedan, May Muriel, Grand Prize of Honour

Concours d'Elégance, Le Touquet-Paris-Plage, 21 July, 1930

- Renault Reinastella, transformable sport sedan, Mlle de Baillhache, Grand Prize of Honour

Concours d'Elégance, Pourville, July 1930

- Renault Vivastella, sports roadster, Mme Rédélé, Grand Prize

Concours d'Elégance, Dieppe, August 1930

- Renault Vivastella, torpédo sport, Mme Rédélé, 1st Prize

Carrosserie de Grand Luxe

Ancienne Maison V. MOREL, Fondée en 1845

Société Anonyme des Etablissements

GRUMMER

CAPITAL : 3.000.000 DE FRANCS

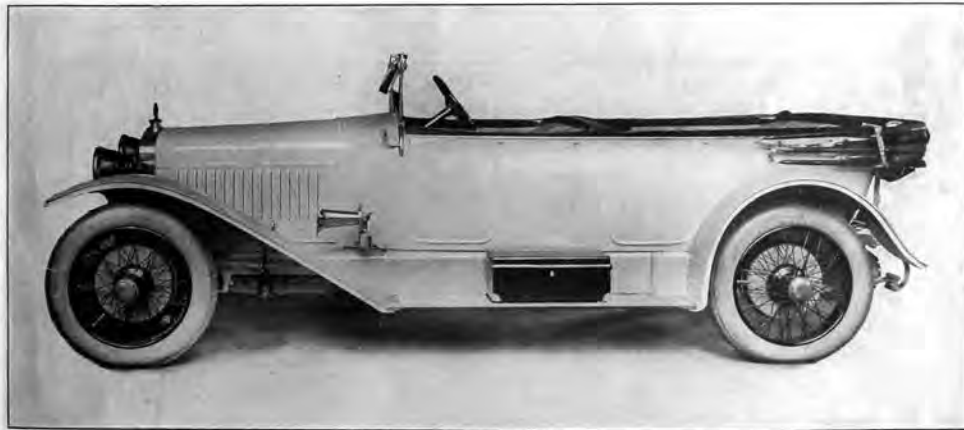

Bureaux et Usines : 228, Rue Lecourbe -:- PARIS (XV^e Arr^t)

Téléphone : Saxe 57-59, 89-94 — Télégrammes : Grummercar-Paris

As has been related in the chapter describing the events of 1924, the Société Anonyme des Etablissements Grümmer based at 228 rue Lecourbe in Paris was established on 26 December, 1919 with a capital of three million francs. The shareholders were Léo Wallach, Jacques Marx and Gaston Grümmer.

In July 1924, when Gaston Grümmer left the Etablissements Grümmer, the company was managed by Léo Wallach who was also the commercial director of Automobiles Lorraine-Dietrich, the famous manufacturer of aircraft and car engines. As a result, during the 1920s, the Etablissements Grümmer became an important subcontractor of Lorraine-Dietrich. The 6 October, 1927 issue of *La Pratique Automobile* noted that "since last year Lorraine-Dietrich has made a speciality of manufacturing interior ducts of artificial leather and it is the famous coachbuilder, Société Anonyme des Etablissements Grümmer that installs most of them. Since the Director of Grümmer and the Director of Lorraine-Dietrich are the same person, it is understandable why this marriage of chassis and body constitutes a happy union." In the 1927 Paris Salon issue of *La Vie Automobile*, it was reported that they were used on many

Published in *Le Sport Universel Illustré*, on June 1921, this advertisement for Les Etablissements Grümmer was illustrated with a profile photograph of a Delage tourer. (Daniel Cabart)

GASTON
GRÜMMER

THE ART OF CARROSSERIE

Philippe-Gaston Grümmer & Laurent Friry

The years between the two World Wars was an extraordinary period for the French luxury car trade and during this time, Carrosserie Gaston Grümmer was one of the leading coachbuilding houses in Paris.

Descended from a long line of coachbuilders, Gaston Grümmer was the son of Antoine-Joseph whose company, J. Grümmer formerly V. Morel, produced first, from 1845, exceptional horse-drawn carriages and from the 1890s, automobile bodies. Trained in the family business before World War I, Gaston Grümmer, spent the war as a soldier, first on horseback and then in the trenches and finally in the air as a pilot. At the end of hostilities, he brilliantly re-launched the family business transforming it into the Société Anonyme des Etablissements Grümmer. As the company moved towards the production of series bodywork for various manufacturers, Gaston decided that he wanted to break away to build custom cars and in 1924 he created his own company under the name of Carrosserie Gaston Grümmer. For the next ten years he achieved great success on both aesthetic and technical levels, winning many awards.



Thanks to recently discovered and previously unpublished archives, his son, Philippe Grümmer, in association with one of the best French automotive historians, Laurent Friry, takes us back to this glorious period recalling the major events of the Concours d'Elégance and Motor Shows, and describes the bodies that Gaston Grümmer produced for the chassis of around 54 manufacturers and the many prizes that he won.

Illustrated with photographs, press articles and period documents, including the reproduction of a series of design drawings, this is an essential reference book on coachwork in the 1920s and 1930s for any student of the period.

2 volumes / 736 pages / 1,023 images
Special Edition: 978-1-85443-294-0

Dalton Watson Fine Books
www.daltonwatson.com

info@daltonwatson.com / +1 847 945 0568

