



BERMUDA ZOOLOGICAL SOCIETY

presents

# The Bermuda Forests



## Project Nature

Field Study Guides for Bermuda Habitats

Sponsored by

**The Bermuda Paint Co. Ltd.**



# The Bermuda Forests

(Third Edition)

## Project Nature Field Study Guide

Sponsored by

The Bermuda Paint Co. Ltd.

**The Bermuda Forests**

Third in the series of Project Nature Guides  
published by the Bermuda Zoological Society  
in collaboration with the  
Bermuda Aquarium, Museum & Zoo

Third Edition

Published December 2005

Copyright © 2005 Bermuda Zoological Society

**Details of other titles available in the Project Nature series are:**

**Rocky Coasts.** Martin L. H. Thomas

First Edition (The Rocky Coast) April 1993

Second Edition May 2007. 100 pages. **ISBN: 978-1-897403-03-7**

**Sandy Coasts,** Martin L. H. Thomas

First Edition (The Sandy Shore) November 1994

Second Edition May 2008. 102 pages. **ISBN: 978-1-897403-49-5**

**Bermuda's Wetlands.** By Martin L. H. Thomas.

First Edition January 2001.

Second Edition March 2002.

Third Edition July 2005

Fourth Edition December 2005. 186 pages. **ISBN: 1-894916-62-X**

**Oceanic Island Ecology of Bermuda.** By Martin L. H. Thomas.

First Edition February 2002.

Second Edition September 2004.

Third Edition September 2005. 88 pages. **ISBN: 1-894916-63-8**

**Coral Reefs of Bermuda.** By Martin L. H. Thomas.

First Edition May 2002.

Second Edition September 2005. 80 pages. **ISBN: 1-894916-67-0**

**Sheltered Bays and Seagrass Beds of Bermuda.** By Martin L. H. Thomas.

First Edition August 2002.

Second Edition September 2005. 88 pages. **ISBN: 1-894916-66-2**

**The Ecology of Harrington Sound, Bermuda.** By Martin L. H. Thomas.

First Edition May 2003.

Second Edition September 2005. 96 pages. **ISBN: 1-894916-65-4**

**The Open Ocean around Bermuda.** By Martin L. H. Thomas.

First Edition September 2003.

Second Edition September 2005. 86 pages. **ISBN: 1-894916-64-6**

**Cover photograph of Butterfield Park  
by Martin L. H. Thomas**

**ISBN 1-894916-26-3**

## Foreword

'Project Nature' is an excellent series of local field guides and source of reference for the rich diversity of natural habitats found on Bermuda. This landmark undertaking is being carried out by volunteers and staff of the Bermuda Aquarium, Museum and Zoo and is co-ordinated by the Bermuda Zoological Society. These guides have a dual use as they can be studied at home or in the classroom, and also taken to the habitats being described and used as true field guides for the identification of plants, animals and the diverse communities that they can form.

This book continues this ambitious series and focuses on the habitat originally most common on terrestrial Bermuda, and now most at risk through development. 'The Bermuda Forests' covers the various types of tree communities, which play such a vital, if largely unappreciated role in the maintenance of the high quality of life and standard of living enjoyed on Bermuda. Woodlands provide shelter and protection against salt-laden ocean winds and storms, protecting dwellings and farmlands; they prevent the rapid runoff and evaporation of rainwater, increase soil fertility, and prevent soil erosion; they filter dust and pollution from the air, produce life-giving oxygen, absorb and store carbon dioxide, helping to offset the Greenhouse effect. They also provide a lush natural background and pleasing aesthetic setting to buildings, and indeed contribute greatly in hiding just how densely developed Bermuda has become.

The monetary costs of all the services and benefits provided, free of charge by one medium-sized tree has recently been estimated at well over \$600,000 over a 50-year lifespan. This is in stark contrast to only a few thousand dollars for even the largest, most valuable trees if they are cut down for lumber. How much greater must be the sum total of Bermuda's remaining Forest area.

This book provides an excellent summary of the history of Bermuda's Forests, the plant and animal communities that they support, and discussions on how they may best be protected and preserved. It provides real hope as a tool to enable Bermudians to become aware of the problems and make the difficult decisions that will be required to protect and preserve them and enable future generations to enjoy the same quality of life that we so often take for granted.

Jeremy Madeiros  
Conservation Officer  
Parks Department  
January 2001

---

---

## Acknowledgements

This guide incorporates the work of many individuals. The introduction, acknowledgments and text on geological, historical, general biological and ecological aspects of the forests was written by Martin L. H. Thomas together with the general field trip outline. He also contributed descriptions for many of the plants and some of the birds. Mary Lodge contributed the additional pre-visit, on-site and post-visit field trip activities on pages 8-4 through 8-27. Marg Hammond contributed the section on development and conservation. Illustrations were provided by Andrew Dobson and Wendy Frith (birds), Janet Percy (insects, molluscs and plants), Martin L. H. Thomas (spiders and birds) and David Wingate (reptiles, birds and amphibians). Penny Hill and Louise Lamphier helped greatly in locating plant illustrations. Louise Lamphier and Lisa Greene wrote descriptions for many of the plants and Lisa Greene located specimens of insects for drawing. Roz Collins provided the descriptions of all the forest invertebrates and Claire Jessey gave useful information on appropriate insects for inclusion.

Mary Winchell was responsible for the overall management of this study guide and for the entire Project Nature guide series. She also made many helpful comments on various parts of the text and encouraged the contributors towards a timely finish. Liz Nash tackled the daunting task of assembling and collating the text, preparing the table of contents and generally preparing the document for printing, as she has done so well for previous documents in this series. We all owe her a debt of gratitude.

No guide that considers the plants of Bermuda would be complete without acknowledgment of Nathaniel Lord Britton for his invaluable book "The Flora of Bermuda". Now, sadly, out of print, this book is an invaluable source of information on the plant life of Bermuda and has been an inspiration to many of us.

Without the help of all these people this nature guide could not have been produced.

We are especially grateful to The Bermuda Paint Company Limited for once again providing the financial support for this project.

---

---

# Contents

## Description

<b>Introduction .....</b>	<b>1-1</b>
<b>Geology .....</b>	<b>2-1</b>
Geological Background to the Forest Habitat .....	2-1
<b>Forest Natural History .....</b>	<b>3-1</b>
The Rise of the Bermudian Forests .....	3-1
Unlocking the secrets of the Ancient Forests .....	3-1
Evolution in the Bermuda Forests .....	3-2
Important Native trees of the Original Forest .....	3-2
<b>Forest Plants &amp; Animals.....</b>	<b>4-1</b>
Principal Herbs, Shrubs, Grasses and Vines of the Bermuda Forests .....	4-1
Animals associated with the Bermudian Forests .....	4-1
General Forest Types in Bermuda.....	4-2
<b>Man's Impact on Forests .....</b>	<b>5-1</b>
The Decline of the Bermudian Forests .....	5-1
The Role of Introduced Species in the Upland Forest.....	5-1
Changes Resulting from Introduced Diseases and Pests.....	5-1
The New Lowland Forest .....	5-2
<b>Forest Ecology.....</b>	<b>6-1</b>
The Forest Structure .....	6-1
Forest Function .....	6-1
<b>Plants and Animals Important in Bermuda's Forests .....</b>	<b>7-1</b>
List of Species Mentioned and/or Illustrated in this Guide .....	7-1
Key to Habitat Codes.....	7-1
Species Illustrations and Descriptions.....	7-4
Lichens .....	7-4
Mosses .....	7-4
Ferns .....	7-5
Clubmosses.....	7-6
Grasses .....	7-7
Sedges.....	7-7
Herbaceous Flowering Plants .....	7-7
Vines.....	7-10
Shrubs .....	7-13
Trees.....	7-17
Insects .....	7-22
Centipedes and Millipedes .....	7-25
Spiders.....	7-26
Gastropoda.....	7-27
Frogs and Toads.....	7-29
Lizards .....	7-30
Birds .....	7-30
Land Mammals.....	7-38

---

<b>Field Trips</b> .....	<b>8-1</b>
A Visit to the Forest .....	8-1
Additional Pre-visit, On-site and Post-visit Activities .....	8-3
Field Study .....	8-4
Construct a Clinometer (for measuring ground slope) .....	8-6
How High is the Hillside .....	8-7
Test Wind Speed and Direction .....	8-8
Temperature Recording .....	8-9
Plants of Bermuda's Forests .....	8-10
Plant Life In the Forest .....	8-12
Forest Observations.....	8-13
Bird Watching .....	8-14
Bird Mobiles .....	8-15
Endangered Bermuda Birds .....	8-15
Bird Poems.....	8-15
Design a Forest .....	8-16
Forest Creature Card Game.....	8-17
Geology of Bermuda .....	8-18
The Composition of Soil .....	8-19
The Composition of Soil .....	8-20
The Permeability of Soils.....	8-21
The Porosity of Soils .....	8-22
Growing Plants .....	8-23
Every Litter Bit Helps .....	8-24
Environment-picture Problems .....	8-26
Species Variation Maths .....	8-27
<b>Glossary</b> .....	<b>9-1</b>
<b>Bibliography</b> .....	<b>10-1</b>
<b>Appendix - Development vs. Conservation</b> .....	<b>11-1</b>
Who's Right? .....	11-1
Finding a Balance.....	11-1
Development and Conservation: Bermuda's Early Days .....	11-1
Issues and Trends in the 1990s .....	11-3
The History of Planning in Bermuda .....	11-4
The Role of The Planning Department .....	11-5
The Planning Team.....	11-6
How does Today's Planning Process Work? .....	11-7
The Development Plan Process .....	11-7
The Development Application Process .....	11-7
Balancing Conservation and Development: Who is Ultimately Responsible? .....	11-8
The Bermuda Plan 1992.....	11-9
The New Zones .....	11-9
The Conservation Maps .....	11-9
Conservation Areas.....	11-9
Agricultural Land .....	11-9
Woodland Reserve.....	11-9
Woodland.....	11-9
Green Space. ....	11-10
National Park.....	11-10
Recreation. ....	11-10
Nature Reserve .....	11-10

---

---

---

Protection Areas .....	11-10
Ground Water .....	11-10
Cave .....	11-10
Historic.....	11-10
The Development Zoning Maps .....	11-10
Development Zones .....	11-10
Residential 1 .....	11-10
Residential 2.....	11-10
Rural .....	11-10
Tourism.....	11-10
Commercial .....	11-11
Industrial.....	11-11
Institutional.....	11-11
Government.....	11-11
Questions and Answers .....	11-11
Resources.....	11-12



## Introduction

Bermuda is a very small island comprising only 55 square kilometres or 20 square miles. Before colonisation by man about 2.5% of the land area was freshwater wetland and the remainder was forested. Of this original forest, none now remains and original forest plants and animals can only be seen in a few very restricted areas. Some of these are much-changed remnants of the original forest, others are places where original forest conditions have been re-created by man.

The first use of original forested areas was both for dwellings and farm operations. Originally farming was very important, and all the lower, valley bottom amounting to about 30% of the total was cleared for agriculture by 1921. Since then, agricultural use has declined somewhat to about 20% of original forest; however, residential and commercial use has increased so that over 50% of the original forest is now taken up for this use. Other major uses are golf courses, water catchments, roads, etc. Only 8% is devoted to parks and protected areas and only a small part of this could be described as forested. There are a few areas of woodland as yet undeveloped but species introduced by man have made them totally different from the original forest.

The forest ecosystem is the one which has suffered most from man's activities, and the few areas that remain in even reasonable condition are not fully protected. Some hard decisions are going to have to be made if any reasonably natural forest areas are going to remain. Unless what we have left is protected, we will only be able to get a vague impression of the character of the original forest in a few areas such as Walsingham and Nonsuch Island where restoration to partly original conditions has been accomplished.

This guide describes the forests as they probably were in the past and discusses what has happened to them. Animals and plants of the present forests are described as are the main aspects of their ecology. Since forest conservation is so vital, a special section is devoted to this topic. A general field trip which can be carried out in any piece of woodland will teach the major aspects of forest natural history and a series of field exercises suitable for students of various ages augments this.

Although it is not necessary to go into original forest to learn about forest natural history, it is certainly most educational to do so. However, we have not given instructions on finding old forest remnants in Bermuda because these are so few and far between and quite small. We feel that such areas are better left as they are and visited only by their custodians and knowledgeable biologists. If you are in a forest tract which you suspect contains rare and unusual material, please be very careful not to trample delicate plants and do not pick anything at all, alive or dead!

We urge all readers and users of this guide to help in the preservation of Bermuda's forests. If a concerted effort to do this is not undertaken soon, we will lose what little is left.

# Geology

## Geological Background to the Forest Habitat

To appreciate the development of the higher land in Bermuda formerly occupied by unbroken stands of forest, and now largely developed for human use, we must go back in time to the end of the last ice age. This ice age was called the 'Pleistocene' ice age and lasted for many thousands of years. One of the most important consequences of the lowered temperature on earth during ice ages is the great increase in the areas occupied by the ice caps at the North and South ends of the planet. While the Northern ice cap did extend well down into the USA it did not reach Bermuda. However, this did not mean that the islands were immune to the effects of this cold period. The increase in the ice caps meant that water to create the huge bulk of ice had to come from somewhere. This water source was the oceans of the world. Water evaporated from the oceans fell as snow or hail in northern climates and because of the low temperature did not re-melt as it does today. So water was slowly removed from the oceans and the level fell. The maximum lowering of sea level during the pleistocene amounted to at least 120 m or 400 ft. This is a very significant reduction in sea level and it applied throughout the world.

About 10,000 years ago the warming of the climate, at the close of the ice age, started a slow melting of accumulated ice. This was very slow at first and not really noticeable until about 6,000 years ago. Six thousand years ago the coastline of the USA and Canada extended a lot further eastwards than it does now. What are now fishing banks such as Georges Bank, Emerald Bank etc. were then large islands. Bermuda too was very much larger than it is today. The land mass of the islands extended south from just north of the northern rim reefs to just off the present south shore. Imagine an island stretching from somewhat north of North Rock to south of Southwest Breakers in the south, and from well beyond Western Blue Cut to well off the eastern shore of Bermuda. This island was at least 15 times larger than present day Bermuda.

While exposed to the air, corals and other shelled creatures and the hard seaweeds eroded to sand, adding to the already large deposits of sand present. In dry, windy periods, this sand was blown into huge tracts of dunes, with extensive hollows between them. At first these dunes would be what are called 'Mobile Dunes'; they would slowly move downwind, large ones engulfing smaller. However, in warmer climates dunes are rapidly colonised by plants. How could that happen? You might seriously ask, since the land had mostly been under seawater at some time and would not have supported land plants. Well, we know that seeds and even plant fragments constantly reached Bermuda from the southwest, borne on the current of the Gulf

Stream. Additionally, birds carrying viable seed in their digestive tracts, or with traces of mud on their feet, no doubt flew in from the North American continent. So the material to start plant growth would have been present. The first plants were probably ones like Scurvy Grass or Sea Rocket (*Cakile lanceolata*) and Seashore Rush Grass (*Sporobolus virginicus*) and Seaside Morning Glory (*Ipomoea pes-caprae*). These plants are called pioneer plants, because they are the first to colonise new environments. They are able to grow rapidly and in very poor soils. These pioneers stabilise the sand so that it does not blow around and if they do get buried can grow back rapidly to the surface. They also start the process whereby sand changes to soil. The essential ingredient in this process is the addition of organic material derived from dead plant parts. Organic matter helps the soil to retain both water and plant nutrients such as nitrogen and phosphorus compounds.

As soon as the pioneer plants render conditions more stable, a wide variety of dune plants start to grow. These would include Iodine Bush (*Mallotonia gnaphalodes*), Beach Lobelia (*Scaevola plumieri*), Bay Bean (*Canavali lineata*), Burr-grass (*Cenchrus tribuloides*), Tassel Plant (*Suriana maritima*) and Spanish Bayonet (*Yucca aloifolia*). These plants, more robust and longer-lived than the pioneers, continue the stabilisation and soil building processes.

As the biological stabilisation proceeds, so too does a parallel geological process. This is lithification or the conversion of sand to rock.

The sand in Bermuda is limestone sand and it is derived from living marine organisms. These organisms such as corals, coralline algae, clams, snails, foraminiferans etc all extract calcium carbonate from the sea water to lie down in skeletal structures. This process is called bio-deposition. When these organisms die, or are eaten by other creatures, the remains either become sand or reef rock. If the sand is exposed to the weather, some of it is dissolved by slightly acidic rain water which percolates down through the sand. When this water evaporates, the dissolved calcium carbonate precipitates out cementing the sand grains together. Over time this cementing produces a strong calcium carbonate rock. This is called aeolianite. Aeolian means 'wind blown' thus the rock's name reflects its origin as wind-blown sand. Over time, the dunes solidified into 'fossil dunes'. Many road cuts in Bermuda cut down into the aeolinite and the fossilised dune faces can be clearly seen. These exposures often show several episodes of dune building separated by soil layers wherein old dunes are inundated by new ones; the slopes can also reveal past wind directions since the windward side of unvegetated dunes slopes less steeply than the leeward side.

At least some of the dunes must have been quite large. The fossilised remains of dunes now rise up to 60 m or 200 ft above present sea level.

However, these dunes are composite structures with newer dunes overlying old. Nevertheless, the most recent of the fossilised dunes were very large for a sub-tropical, limestone situation. These old dunes were mainly formed in coastal situations at periods of relatively high sea level, most probably as sea level slowly receded from a high stand. The largest exposed dune hills probably formed when sea levels were 1-6 m (3-18 ft) above present. Dunes could not have formed when sea level fell well down the sides of the old volcano that became Bermuda. Neither could they form when sea level was greatly higher than at present, because the land-mass would have been reduced to a few small islands. Most of the older dunes now lie buried under younger dunes and the lower dunes and the hollows between them are now drowned in sea water. Deeper low areas formed present day sounds and harbours, while shallower areas became salt and freshwater ponds, lagoons, marshes and swamps. Small coastal dunes became the bases of the present day boiler reefs.

The oldest exposed fossilised dunes lie in the Walsingham area. These dunes, over time became very hard in texture and very jagged on the surface. Since such areas were difficult to develop before modern building methods were available, they have retained some of the character of the old forests.

# Forest Natural History

## The Rise of the Bermudian Forests

As the ancient dunes stabilised by geological and biological means, the sand left at the surface slowly weathers, contributing to the formation of soil. The essential ingredients in this soil were sand, organic material and small wind-blown soil particles from the continents. These wind-blown materials were quite rich in iron and tended to colour the soils a reddish colour reminiscent of rust. Where significant depths of wind-blown particles built up over thousands of years the 'red beds' of reddish soils became established. Although these upland soils were quite well developed, they always tended to dry out quickly because the underlying aeolianite remained quite porous, allowing surface moisture to drain down easily. This also helped, along with the plants, to prevent serious water erosion.

The early dune plants which clothed the island hills in early years were poorly adapted to live in shaded areas dominated by taller plants and they died out as the forests developed. We must assume that the forest species got here by the same means as the dune species. However, they would have a harder time making the journey since the seeds would be less salt-tolerant and limited to those species which are naturally dispersed by floating across salt water, blown in on the wind, carried in the digestive tracts or on muddy feet of migratory birds. It is not surprising therefore that the make up of the early forest was relatively simple.

### Unlocking the secrets of the Ancient Forests

Very little is known for certain about the composition of the first forests in Bermuda. The trees of upland areas left little in the way of fossil remains except, perhaps, their pollen deposited in swamps and ponds and preserved in sediments. Unfortunately this 'pollen record' has been little investigated to date. We can look back at the written records of the first explorers and settlers but little detail is available. They tended not to spend a lot of time describing the old forests in detail, being more intent to find what was most useful to them there. What we do know for sure is that with the arrival of man the forests went into a rapid decline. There were several reasons for this. Pigs released by early visitors on many of the larger islands rooted through the forests for food, disrupting natural regeneration and decimating the ground layer of delicate herbs, ferns, mosses etc. At about the same time rats from vessels also invaded most of the islands and started eating seeds of forest species. Man himself also contributed to the decline by wholesale clearing and burning for agriculture and harvesting several useful tree species for timber. Somewhat later man cut

huge areas of forest for housing and business. Once civilisation progressed in Bermuda to the point where ornamental gardens were planted, a further destructive series of changes happened. This was because man purposely introduced species that competed with native ones, accidentally brought in others and also introduced insect pests and diseases to which native trees were susceptible. The end result of all this is that of all the natural habitats in Bermuda, the upland forest is the most changed. Nothing remains of the original forest and there are only scattered remnants that are richer in the original species than others. Not surprisingly, these remnants are in difficult terrain or on islands where pigs and rats did not become established. For instance the face of Abbott's Cliff and some rough ground in the Walsingham area show a richer complement of original species. Even these areas, however, are choked with introduced species of plants, littered with trash and altered by the harvesting of saplings used for various purposes.

I am afraid we have to admit that we know little of the character of the early forests and only painstaking and methodical work and consideration of fragmentary evidence will fill this gap.

### Evolution in the Bermuda Forests

Some of the original trees reaching Bermuda evolved into distinct new species after they started to grow and reproduce here; these are the **endemic** species that occur naturally nowhere else but Bermuda. The two supreme examples of this trend are the Bermuda Cedar (*Juniperus bermudiana*) and the Bermuda Palmetto (*Sabal bermudana*). There is little doubt that these two trees dominated the original forest. Both were useful to man and their presence was therefore well documented. When these trees arrived by whatever means brought them here they would have found a very different environment to their mainland forebears. One of the main differences would have been that competition from other species would have been at a very low level. On the continent they could live only in areas to which they were uniquely adapted, whereas in Bermuda, without competition, they could move into a wider variety of habitats. This certainly happened in both of these cases. Palmettos closely related to the Bermuda Palmetto are characteristic of low damp areas whereas the cedars from which the Bermuda Cedars evolved are more typical of higher, drier ground. There is good evidence that in Bermuda, palmettos formed a good percentage of trees in the upland forest as well as dominating some swamp-forests (See Wetlands of Bermuda in the Project Nature series), while cedar dominated the upland forests but also formed swamp forest in areas such as Devonshire Marsh. In the original upland forests, Bermuda Cedar became dominant and Bermuda Palmetto sub-dominant.

Another tree, the Bermuda Olivewood (*Cassine laneana*) also evolved in the Bermudian forests. This beautiful, very compact tree up to 10 m or 30 ft high was probably never dominant in any forest but scattered among the cedars, palmettos and native trees; its bark was used for tanning by early settlers. As the forest became established, a unique new habitat was created under the trees and there other new species evolved in this damp, stable environment. Examples of these are the Bermuda Sedge (*Carex bermudiana*), the moss Bermuda Trichostoma (*Trichostomum bermudanum*), the Bermuda Maidenhair Fern (*Adiantum bellum*) and the shrub Bermuda Snowberry (*Chiococca bermudiana*).

### Important Native trees of the Original Forest

**Native** species are those that arrived in Bermuda by natural means but remain essentially identical with their forebears elsewhere. Thus they arrived by the same means as the endemics but did not evolve into new species. The reasons for this may never be clear; perhaps they arrived later than those which formed the endemics but had characteristics which adapted them to the structure of the already created upland forest. Alternatively they may have arrived very early but were not well adapted to Bermudian conditions and only flourished after the endemics evolved to dominate the forest. Several of these formerly quite common trees are now very rare and endangered. Perhaps the best known of these is the Yellow-wood (*Zanthoxylum flavum*) now existing as only a few specimens in the Walsingham limestone formation. Yellow-wood was common at the time of settlement but its wood was valued for furniture making; it was heavily exploited and it seems not to propagate well in the altered forest of today. The Southern Hackberry (*Celtis laevigata*) was also probably widely distributed in the valleys and on sheltered hillsides. This tree up to 15 m (45 ft) high is native of the southeast United States. Like the Yellow-wood it was probably scattered or in small clumps among the cedars and palmettos. Another interesting native tree is Lamarck's Trema (*Trema lamarckiana*), a small shrubby tree of untidy growth form. Now quite rare, this tree was probably much more common before the arrival of man.

Several other native species important in the original forest, never form large trees and are usually classified as shrubs. These are Forestiera (*Forestiera segregata*), White Stopper (*Eugenia axillaris*) and Jamaica Dogwood (*Dodonaea viscosa*). These shrubs growing up to 7 m or 20 ft in height probably formed what is called the understorey, growing beneath the canopy of the larger trees.

The real character of the forests before the arrival of man can only be the subject of conjecture. Were they like a dense jungle in character or were they of more open character that one could easily penetrate? There is some evidence for both possibilities and it seems likely that there

were both dense and more open forest stands. Some of the earliest settlers commented on the impenetrable forest, but they were very likely referring to more coastal areas. The fact that some native and endemic plants that require quite high light levels now do well only in cleared

areas of upland forests, strongly suggests that in the past areas of more open forest were common. The very dense character of the upland forests today is largely the result of species introduced by man.

---



## Forest Plants & Animals

The plants and animals of the Bermuda forests, commonly termed the 'forest biota', are made up of a wide variety of ecological groups. Some are typical forest species that live nowhere else. Others are from a broader ecological group of organisms which are found in a variety of habitats but can tolerate forest conditions. This latter group can be expected to frequent forest edges rather than the deep recesses of woodland. Quite a few of the animals are not by any means permanent forest dwellers but move in and out seasonally, in migration or when certain food sources become available. Others including some birds use forest habitat as a protected nesting site, but feed elsewhere. The forest is a very highly structured system that has habitats within it that are extremely stable. One example is the forest floor where humidity is high, temperature very stable and light levels low. This unique environment supports many delicate animals and plants unable to live in harsher conditions. Additionally there is a rich micro-flora and fauna within the forest leaf litter and soil. These specialised organisms are beyond the scope of this guide, but be aware that they are there.

### Principal Herbs, Shrubs, Grasses and Vines of the Bermuda Forests

The shaded condition within the forests excluded many species but still there was a characteristic associated flora. This would have included Woodgrass (*Oplismenus setarius*), a native, now very rare grass; Bermuda Sedge (*Carex bermudiana*), a very rare endemic; Wild Bermuda Pepper (*Peperomia septentrionalis*), an endemic now very localised; Ink-berry or Small Passion Flower (*Passiflora suberosa*), an uncommon native; Wild Coffee (*Psychotria ligustrifolia*), a seldom seen native shrub; Turkey Berry (*Callicarpa americana*), a native herb that was extirpated but now re-introduced in several nature reserves; Virginia Creeper (*Parthenocissus quinquefolia*), a common native vine that would have climbed tree trunks; Bermuda Snowberry (*Chiococca bermudiana*), an endemic vine-like shrub widespread in uplands; Balloon Vine (*Cardiospermum halicacabum*), a native vine of shrubby places; Burr Bush (*Triumfetta semitriloba*), a smallish native shrub of forest openings; Bear's Foot (*Polymnia uvedalia*), a small native shrub of the forest edge; Bird Pepper (*Capsicum baccatum*), a tall native herb of the forest fringe; Black Nightshade (*Solanum americanum*), a native small shrub of forest openings with poisonous berries, and Virgate Mimosa (*Desmanthus virgatus*), an uncommon native shrub.

Three other plants of doubtful status should be mentioned. Poison Ivy (*Rhus radicans*) is very common in forest and marsh habitats. It has been considered a native but there is some

evidence that it may have been introduced. If a native it was probably widespread in the forests. Common Sage or Lantana (*Lantana involucrata*) presents the opposite case; it was thought to be introduced but one of the species may have been native. Again it would very likely have been common in the understorey of the forest. Bay Grape (*Coccoloba uvifera*), once thought to be native, may have been introduced.

### Animals associated with the Bermudian Forests

Both vertebrate and invertebrate animals are quite common in Bermudian forests. Resident birds that might be expected are the Bermuda White-eyed Vireo or Chick-of-the-village (*Vireo griseus*), the Cardinal (*Cardinalis cardinalis*), the Catbird (*Dumatella carolinensis*), the Great Kiskadee (*Pitangus sulphuratus*), the Starling (*Sturnus vulgaris*), the Barn Owl (*Tyto alba*), the European Goldfinch (*Carduelis carduelis*), the Mourning Dove (*Zenaida macroura*) and the Yellow-crowned Night Heron (*Nyctanassa violacea*). The White-throated Sparrow (*Zonotrichia albicollis*) may occasionally be present. Many migrating warblers would be present in autumn and less commonly at other times. The commonest warblers seen in forested areas are the Ovenbird (*Seiurus aurocapillus*), American Redstart (*Setophaga ruticilla*), Worm-eating (*Helminthos vermivorus*) and Hooded (*Wilsonia citrina*) Warblers. Much less commonly seen, but still possible are the Black-and-white Warbler (*Mniotilta varia*), the Common Yellowthroat (*Goethlypsis trichas*), the Palm Warbler (*Dendroica palmarum*), the Kentucky

Warbler (*Oporornis formosus*) the Northern Parula (*Parula americana*), the Prothonotary Warbler (*Protonotaria citrea*), Swainson's Warbler (*Limnothlypis swainsonii*) and the Yellow-rumped Warbler (*Dendroica coronata*). Other migratory birds that you may see in autumn and winter are; the Cedar Waxwing (*Bombycilla cedrorum*), the only visiting woodpecker, the Yellow-bellied Sapsucker (*Sphyrapicus varius*), the only common woodpecker, and, rarely, the American Robin (*Turdus migratorius*). Three species of thrush, the Hermit Thrush (*Catharus guttatus*), Swainson's Thrush (*Catharus ustulatus*) and the Wood Thrush (*Hylocichla mustelina*) are also very occasionally seen in this habitat. The introduced Brown or Norway, and Black Rats (*Rattus norvegicus* and *Rattus rattus*) would be evident at night or in poor light. Among the lizards, the Jamaican Anole (*Anolis grahami*) is a common resident of wooded areas. Both the Giant Toad (*Bufo marinus*) and the Whistling Frog (*Eleutherodactylus johnstoni*) are common in damper locations.

**General Forest  
Types in Bermuda**

The main area of forest in Bermuda was an **upland forest** on the hillsides and tops of hills. These locations were well drained but the forest itself maintained good moist soils over the

bedrock. In valleys which were also well-drained there was a **lowland forest**. Originally, these two general forest types had the same mixture of trees, the difference being in the relative abundance of major trees and in the shrub and herb layers. The upland forests were probably more strongly dominated by Bermuda Cedar and palmetto and the lowland forests by Southern Hackberry. Lower sites probably supported a greater diversity of ferns including the endemic Bermuda Shield Fern (*Dryopteris bermudiana*) now rare in the wild, the Long Spleenwort (*Asplenium heterochroum*) and the Sword Fern (*Nephrolepis exaltata*), and mosses such as Bermuda Trichostoma (*Trichostomum bermudanum*) and perhaps Bermuda Campylopus (*Campylopus bermudiana*), both endemic to Bermuda.

In poorly drained, marshy peat basins a third type of forest persisted, this was the **swamp forest** described in Project Nature 'Wetlands'. Although the environment of these wet forests was totally different, the same two tree species, Bermuda Cedar and Bermuda Palmetto, dominated the forest community. The variety of habitats colonised by these two trees is totally amazing.

Illustrations of other plants you may encounter in the Bermudian forest, but not mentioned in the text, are included in this guide.



## Man's Impact on Forests

### The Decline of the Bermudian Forests

As mentioned above, the arrival of man in Bermuda heralded the decline of the forests and this continues to the present day. Now even the very few upland remnants rich in endemic and native trees and other species are threatened by commercial development and lowland sites are virtually gone. Soon all that may persist are patches of introduced forest trees, totally different from the original forests.

Fortunately, great efforts have been made to re-establish forests in protected areas so that these have the characteristics of the original forests. Two such areas are Nonsuch Island and the Walsingham Nature Reserve and Park. In these locations, introduced species are carefully removed or controlled where possible and native and endemic species are re-established. This work is largely attributable to Dr. David Wingate, Bermuda Conservation Officer for many years. Without his dedication the original forests largely would be lost forever.

#### The Role of Introduced Species in the Upland Forest

Most of the upland forests in Bermuda today are strongly dominated by introduced trees. The main two species in this group are the Fiddlewood (*Citharexylum spinosum*) and the Allspice (*Pimenta dioica*) although the Brazil or Mexican Pepper (*Schinus terebinthifolia*) has also become very common in recent years. An introduced shrub, the Surinam Cherry (*Eugenia uniflora*) now dominates many areas that were originally treed forest. All these species, although introduced, have become **naturalized**. This means that they reproduce naturally in the wild and are now widespread.

Fiddlewood, which is quite a large broad leaf tree attaining at least 17 m or 50 ft in height, was introduced in about 1830 in the Paynters Vale area. The wood is light-weight and brittle and not used for fiddle making although it makes good firewood. It now dominates large areas of forest. It is unusual in that the leaves turn orange and fall in spring. The habitat in these forests does not favour the growth of native and endemic forest plants. Allspice is not nearly as large as Fiddlewood, rarely exceeding 13 m or 40 ft but nevertheless forms dense monoculture stands in many areas. The Mexican Pepper, a medium sized tree up to 10 m (30 ft) high, has become a problem more recently than the preceding two. However it is now widely established in a great variety of upland and lowland treed habitats. It too now forms dense monoculture stands but

is also widespread among other trees. No doubt it will increase in abundance in future; it is exceedingly difficult to remove. Surinam Cherry has delicious fruits, which is the reason for its introduction. It is small and shrubby, rarely over 8 m or 24 ft tall, but tends to grow in very dense stands which exclude other species.

#### Changes Resulting from Introduced Diseases and Pests

It is not only the introduced species out-competing the native and endemic ones which are the problem but also diseases and pests arriving on introduced species and spreading to endemic ones. It has been the experience that pests of introduced species may be much more harmful on related endemic plants than on their original host. The reason for this is that host and pest evolved together away from Bermuda and the host developed, at least partial, natural resistance. The related endemic species would have evolved in isolation from the pest and would not have developed natural resistance. The pest population therefore could explode on the endemic relative.

The best examples of this are the Oystershell Scale (*Insulaspis pallida*) and the Cedar Scale (*Carulaspis minima*) both of which attacked the Bermuda Cedar. The scale insects are tiny creatures that are protected by a shell like covering. They feed on plant sap and spread virus diseases. The Oystershell scale was introduced in 1940 and the Cedar Scale probably in 1942,

both on ornamental junipers closely related to Bermuda Cedar. The Oystershell Scale attacked Bermuda Cedars right away but did not rival the devastation of the Cedar Scale. By 1949 over 15,000 dead cedar trees had been cut down; by 1953 90% of the population was dead. A total of over 3 million trees had been lost because of the Cedar Scale! Fortunately, some of the surviving Bermuda Cedars had some resistance to the scale and others have been bred from these. Today the Bermuda Cedar is being reintroduced on a wide scale and in places is quite common. Another scale insect, the Palmetto Scale (*Comstockiella sabalis*), introduced on ornamental palms, attacked the endemic Bermuda Palmetto but its effects have, fortunately, not been as severe as with the Cedar Scale.

#### **The New Lowland Forest**

Although remnants of upland forest maintain a little of the character and species composition of the original forest, this is hardly true of lower valley areas. These were virtually all totally cleared by man and the few that persisted in areas that were harder to develop were changed for all time by the Cedar Blight carried by the Scale Insects. One side effect of the demise of almost all the cedars was that the effect of tropical storms became much more pronounced in low valleys and along shorelines. Bermuda Cedars are excellent windbreak trees and few are uprooted even in hurricanes. When they were gone, the need for an alternative windbreak tree was obvious. The tree that was introduced for this purpose was the Casuarina, Australian Whistling Pine or Whispering Pine (*Casuarina equisetifolia*). This tree native to Australia was

planted in large numbers in the 1950s and 1960s. As introductions go this one was moderately successful and the young trees, if planted densely, formed good windbreaks. However, this tree grows up to 22 m (65 ft) high and at this size has little foliage at the lower levels. Additionally in very severe storms Casuarinas tend to uproot or break off some distance above the ground. They also make superb firewood. Whispering Pines don't seem to penetrate upland forests to any extent but they are now naturalized in lower well-drained areas. Where they are growing densely they tend to form a characteristic forest with a closed canopy and open understory with very little vegetation growing on the ground beneath them. Some nice stands have developed in Ferry Point Park and in Spittal Pond Nature Reserve. The tree is also being used as a temporary windbreak in locations such as Nonsuch Island where the Bermuda Cedars are slowly becoming reestablished.

Many other introduced trees are now quite common and increasing. An example is the Indian Laurel Tree (*Ficus retusa*), a large tree in the Fig Tree group. This tree has been present for many years but did not start to really spread until the Ficus Wasp (*Parapristina verticillata*), which pollinates the tree, was introduced in the 1900's. Another tree that is on the increase is the Chinese Fan Palm (*Livistonia chinensis*) which seems able to out compete and out reproduce the endemic Bermuda Palmetto (*Sabal bermudana*). Literally hundreds of other introduced trees are potential members of the new forest in Bermuda.

Examples of plants you may see in the Bermudian forest are shown in the illustrations accompanying this guide.

# Forest Ecology

## The Forest Structure

Forests are an example of what is called a **stratified ecosystem**. Basically this means that there are readily recognised layers in the structure. The environment is distinctly different in each layer.

The uppermost layer, consisting of the bulk of the leaves and branches of the dominant trees is called the **canopy**. The canopy cuts out most of the light, which is absorbed by the leaves and used as the energy source for photosynthesis. Thus most of the production in the forest occurs in the canopy. The canopy also greatly affects physical conditions. Wind velocity drops very quickly within and below the canopy and there is much less variation in temperature and humidity than in the air above.

Below the canopy is the **sub-canopy**, it is a much more open area than the canopy and there may be more wind there than in the canopy above. Some young trees growing into the canopy may terminate in the sub-canopy.

The make up of the lower two layers depends very much on the amount of sunlight absorbed by the canopy. If the canopy absorbs 90% or more of the light the area below the sub-canopy will support little in the way of plant life. If more light penetrates, the lower forest layers may be quite densely vegetated.

The third layer down may be called the **shrub layer** or the **understorey**. At any rate this layer is characterised by shrubs up to 5 m or 15 ft in height. They may be sparse or dense depending on light levels. Depending on the density of growth, this layer further stabilises climatic variations. Wind velocity is low, humidity high and temperature fairly constant.

The lowest layer above the ground is the **herb layer**. Where it is well-developed it supports fungi, ferns, mosses, club-mosses, various herbs and also juvenile trees and shrubs. It has the most constant physical conditions of all the layers. Wind is negligible, humidity very high and temperature very constant. Because of this it is the forest habitat that supports most invertebrates such as insects, millipedes, spiders, crustaceans and snails.

Of course, the **soil** itself can be considered as a further layer. Containing the roots and masses of fungal threads, it is also rich in burrowing insects and worms.

### Forest Function

On the whole forests are productive ecosystems and have efficient systems to recycle plant nutrients such as nitrates, phosphates and potassium compounds. As mentioned above the bulk of forest photosynthesis takes place in the canopy. There organic compounds are synthesised in photosynthesis and then distributed throughout the tree or used in the growth of leaves and branches as well as flowers in season. Some of this production is taken by herbivorous insects and other creatures and some is taken from the roots by fungi. So the trees are the base of food webs both in the air

and in the soil. A lesser amount of photosynthesis also occurs in the lower levels of the forest and is used similarly.

Leaves are the main product of the forest and are either dropped continuously as in the evergreen trees or seasonally as in the deciduous trees. In Bermudian forests there are deciduous trees that drop their leaves at different seasons. For example Hackberry leaves fall in winter whereas Fiddlewood leaves are shed in spring. Trees like Yellow-wood and Forestiera never shed all their leaves but do drop most of them in either spring or autumn. The falling leaves accumulate on the ground and rot rapidly, releasing plant nutrients and forming leaf mould or detritus which is a rich

food source for many invertebrates and fungi. This is another way in which trees contribute to the forest food web. All the herbivorous and detritivorous creatures are themselves preyed upon by carnivores including spiders, insects, snails, centipedes, birds and reptiles.

Forests all change with time in a process called succession. If man had not appeared to alter fundamental forest ecological processes, it is likely that the Bermudian forests would be mostly mature **climax** forests. Climax forests are the end result of succession and are normally stable and highly productive. It is important to realise that even without the disturbance caused by man, the Bermudian forests would

have formed a mosaic of differing forest communities at various stages of succession. This is because natural events such as severe storms, hurricanes, tornados and naturally caused fires would have set forest patches back to various pre-climax stages. Heavy outbreaks of insect pests could also have contributed to this situation. Nevertheless, with the arrival of man forest disturbance became general, both because of the direct effect of harvesting and grazing but also because introduced species began competing very severely with the native and endemic forest flora. Only time will tell what the new forest climax will be, if indeed there are forests that survive long enough for this to take place.

---

# Plants and Animals Important in Bermuda's Forests

## List of Species Mentioned and/or Illustrated in this Guide

### Key to Habitat Codes

CA = Caves and Cave Mouths	OC = Open Coastal
CL = Cliffs and Steep Rocky Coasts	SD = Sand Dunes
EX = Extinct	SP = Saltwater Ponds
F = Forest	U = Urban Environments
FW = Freshwater Habitats	W = Wasteland, Open Spaces, Wayside
M = Mangrove Swamps and Salt Marshes	

**Note:** Common names are listed in the first column except where there is no accepted common name, in these cases the scientific name is used. For each group of organisms, the common names are in alphabetical order. The habitat codes defined in the key show where the organisms are commonly found. The illustrations following the list are in the same order as the list and are also accompanied by habitat codes.

Common Name	Scientific Name	Taxonomy	Habitat Code
Parmelia martinicana	Parmelia martinicana	Lichens	F, OC
Physcia alba	Physcia alba	Lichens	F
Ramalina denticulata	Ramalina denticulata	Lichens	F
Bermuda Campylopus	Campylopus bermudiana	Mosses	F, FW
Bermuda Trichostoma	Trichostomum bermudanum	Mosses	F, FW, OC, U, W
Bermuda Shield Fern	Dryopteris bermudiana	Ferns	F, CA
Bermuda Maidenhair Fern	Adiantum bellum	Ferns	CA, CL, F, W
Long Spleenwort	Asplenium heterochroum	Ferns	CA, F, W
Long-leaved Brake	Pteris longifolia	Ferns	F, U, W
Plume Polypody	Polypodium plumula	Ferns	CL, F
Sword Fern	Nephrolepis exaltata	Ferns	F
Psilotum	Psilotum nudum	Club Mosses	F, FW
Woodgrass	Oplismenus setarius	Grasses	F
Bermuda Sedge	Carex bermudiana	Sedges	F
Bear's Foot	Polymnia uvedalia	Herbaceous Flowering Plants	F, W
Bermuda Bedstraw	Galium hispidulum	Herbaceous Flowering Plants	F, W
Bird Pepper	Capsicum baccatum	Herbaceous Flowering Plants	F
Black Nightshade	Solanum americanum	Herbaceous Flowering Plants	F, W
Fern Asparagus	Asparagus densiflorus	Herbaceous Flowering Plants	F, W
Lace Fern or Bridal Fern	Asparagus setaceus	Herbaceous Flowering Plants	F, W
Rhacoma	Crossopetalum rhacoma	Herbaceous Flowering Plants	F
Turkey Berry	Callicarpa americana	Herbaceous Flowering Plants	F
White Eupatorium	Eupatorium riparium	Herbaceous Flowering Plants	F, U, W
Wild Bermuda Pepper	Peperomia septentrionalis	Herbaceous Flowering Plants	CA, F
Balloon Vine	Cardiospermum halicacabum	Vines	F, U
Bay Bean	Canavali lineata	Vines	F, OC, SD
Bermuda Bean	Phaseolus lignosus	Vines	F
Blue Dawn Flower or Morning Glory	Ipomea indica	Vines	F, M, W
Brier-Bush or Grey Nickers	Caesalpinia bonduc	Vines	F
Ink-berry or Small Passion Flower	Passiflora suberosa	Vines	F, W
Simple-leaved Jasmine	Jasminum simplicifolium	Vines	F, OC, W
Maurandya Vine	Asarina scandens	Vines	F
Small-Fruited Balloon Vine	Cardiospermum microcarpum	Vines	F
Virginia Creeper	Parthenocissus quinquefolia	Vines	F, FW
West Indian Cissus	Cissus sicyoides	Vines	F, FW
Bermuda Holly	Ilex vomitoria	Shrubs	F, OC
Bermuda Snowberry	Chiococca bermudiana	Shrubs	F

**Plants and Animals Important in Bermuda's Forests**
**The Bermuda Forests**

Burr Bush	<i>Triumfetta semitriloba</i>	Shrubs	F, W
Bush Clerodendron	<i>Clerodendrum glabrum</i>	Shrubs	F
Carolina Laurel Cherry	<i>Laurocerasus carolinianum</i>	Shrubs	F, FW
Common Sage or Lantana	<i>Lantana involucrata</i>	Shrubs	F, OC, U, W
Doc-bush	<i>Baccharis glomeruliflora</i>	Shrubs	F, FW, W
Jamaica Dogwood	<i>Dodonaea viscosa</i>	Shrubs	F
Pittosporum or Mock Orange	<i>Pittosporum tobira</i>	Shrubs	F, U, W
Poison Ivy	<i>Rhus radicans</i>	Shrubs	F, FW, W
Shrubby Fleabane	<i>Pluchea odorata</i>	Shrubs	F, FW, W
Surinam Cherry	<i>Eugenia uniflora</i>	Shrubs	F, W
Virgate Mimosa	<i>Desmanthus virgatus</i>	Shrubs	F, W
White Stopper	<i>Eugenia axillaris</i>	Shrubs	F
Wild Coffee	<i>Psychotria ligustrifolia</i>	Shrubs	F
Allspice	<i>Pimenta dioica</i>	Trees	F
Ardisia	<i>Ardisia polycephala</i>	Trees	F, FW
Bay Grape	<i>Coccoloba uvifera</i>	Trees	F, OC
Bermuda Cedar	<i>Juniperus bermudiana</i>	Trees	F, OC, U, W
Bermuda Olivewood	<i>Cassine laneana</i>	Trees	F, U
Bermuda Palmetto	<i>Sabal bermudana</i>	Trees	F, OC, U
Brazil or Mexican Pepper	<i>Schinus terebinthifolia</i>	Trees	F, M, OC, W
Casuarina, Australian Whistling Pine or Whispering Pine	<i>Casuarina equisetifolia</i>	Trees	F, OC, W
Chinese Fan Palm or Chinese Fountain Palm	<i>Livistonia chinensis</i>	Trees	F, U, W
Fiddlewood	<i>Citharexylum spinosum</i>	Trees	F
Forestiera	<i>Forestiera segregata</i>	Trees	F
Indian Laurel	<i>Ficus retusa</i>	Trees	F, U, W
Lamarck's Trema	<i>Trema lamarckiana</i>	Trees	F
Mulberry	<i>Morus nigra</i>	Trees	F, U
Southern Hackberry or Hackberry	<i>Celtis laevigata</i>	Trees	F
Yellow-wood	<i>Zanthoxylum flavum</i>	Trees	F
Argentinian Ant	<i>Iridomyrex humilis</i>	Insects - Ants	F, SD, U, W
Juniper Aphid	<i>Cinara tujafilina</i>	Insects - Aphids	F, OC, U
Spittlebug	<i>Clastoptera undulata</i>	Insects - Aphids	F, W
Donkey Beetle	<i>Diaprepes esuriens</i>	Insects - Beetles	F, U, W
Harlequin Bug	<i>Murgantia histrionica</i>	Insects - Bugs	F, U
Buckeye Butterfly	<i>Junonia coenia</i>	Insects - Butterflies	F, U, W
Cloudless Sulphur	<i>Phoebis sennae</i>	Insects - Butterflies	F, U, W
Gulf Fritillary	<i>Agraulis vanillae</i>	Insects - Butterflies	F, U, W
Cicada or Bermuda Singer	<i>Tibicen bermudiana</i>	Insects - Cicadas	EX, F
American Black Cricket	<i>Gryllus firmus bermudensis</i>	Insects - Crickets and Grasshoppers	F, U, W
Giant Grey Sphinx Moth	<i>Pseudosphinx tetrio</i>	Insects - Moths	F, U, W
Cedar Scale	<i>Carulaspis minima</i>	Insects - Scales	F, W
Oystershell Scale	<i>Insulaspis pallida</i>	Insects - Scales	F, OC, U
Palmetto Scale	<i>Comstockiella sabalis</i>	Insects - Scales	F, OC, U
Wood Termite	<i>Kaloterms approximatus</i>	Insects - Termites	F, U
St. David's Centipede	<i>Scolopendra subspinosa</i>	Centipedes and Millipedes - Centipedes	F, U, W
Church Worm	<i>Julus sp.</i>	Centipedes and Millipedes - Millipedes	F, U, W
Millipede, Thousand Legs or Galley-worm	<i>Spirobolus heilprini</i>	Centipedes and Millipedes - Millipedes	F, U, W
Crab Spider or Spiny-bellied Orb Weaver	<i>Gasteracantha cancriformis</i>	Spiders	F, M, U
Golden Silk Spider	<i>Nephila clavipes</i>	Spiders	F, M, U
Pill-bug or "Roly Poly"	<i>Armadillidium vulgare</i>	Crustacea - Isopods	F, U, W
American Toothed Snail	<i>Polygyra appressa</i>	Gastropoda - Snails	F



**The Bermuda Forests****Plants and Animals Important in Bermuda's Forests**

Little Orb Helicina	<i>Helicina convexa</i>	Gastropoda - Snails	F
Poecilozonites	<i>Poecilozonites</i> spp.	Gastropoda - Snails	EX, F
Rosy Euglandina or Predaceous Snail	<i>Euglandina rosea</i>	Gastropoda - Snails	F, U, W
Shiny Puppilla	<i>Pupoides nitidulus</i>	Gastropoda - Snails	F
Spiral Snail	<i>Rumina decollata</i>	Gastropoda - Snails	F, W
Tree Snail	<i>Succinea bermudensis</i>	Gastropoda - Snails	F
White Snail	<i>Eulota similis</i>	Gastropoda - Snails	F
Whistling Frog	<i>Eleutherodactylus johnstoni</i>	Frogs and Toads - Frogs	F, FW, U
Giant Toad	<i>Bufo marinus</i>	Frogs and Toads - Toads	F, FW, U, W
Bermuda Skink	<i>Eumeces longirostris</i>	Lizards	F, OC
Jamaican Anole	<i>Anolis grahami</i>	Lizards	F, M, U, W
Ground Dove	<i>Columbina passerina</i>	Birds - Doves	F, W
Mourning Dove	<i>Zenaida macroura</i>	Birds - Doves	F, U, W
Cardinal	<i>Cardinalis cardinalis</i>	Birds - Finches	F, U, W
European Goldfinch	<i>Carduelis carduelis</i>	Birds - Finches	F, U, W
Great Kiskadee	<i>Pitangus sulphuratus</i>	Birds - Flycatchers	F, U, W
Yellow-crowned Night Heron	<i>Nyctanassa violacea</i>	Birds - Herons	F, M, SP
Catbird	<i>Dumatella carolinensis</i>	Birds - Mockingbirds	F, U
Barn Owl	<i>Tyto alba</i>	Birds - Owls	F, U
White-throated Sparrow	<i>Zonotrichia albicollis</i>	Birds - Sparrows	F, U, W
Starling	<i>Sturnus vulgaris</i>	Birds - Starlings	F, U, W
American Robin	<i>Turdus migratorius</i>	Birds - Thrushes	F, U, W
Hermit Thrush	<i>Catharus guttatus</i>	Birds - Thrushes	F
Northern Waterthrush	<i>Seiurus noveboracensis</i>	Birds - Thrushes	F, FW
Swainson's Thrush	<i>Catharus ustulatus</i>	Birds - Thrushes	F
Wood Thrush	<i>Hylocichla mustelina</i>	Birds - Thrushes	F
Bermuda White-eyed Vireo or Chick-of-the-village	<i>Vireo griseus</i>	Birds - Vireos	F, U
American Redstart	<i>Setophaga ruticilla</i>	Birds - Warblers	F, W
Black and White Warbler	<i>Mniotilta varia</i>	Birds - Warblers	F, M
Common Yellowthroat	<i>Goethlypsis trichas</i>	Birds - Warblers	F, M
Hooded Warbler	<i>Wilsonia citrina</i>	Birds - Warblers	F, M
Kentucky Warbler	<i>Oporornis formosus</i>	Birds - Warblers	F, M
Northern Parula	<i>Parula americana</i>	Birds - Warblers	F, M
Ovenbird	<i>Seiurus aurocapillus</i>	Birds - Warblers	F
Palm Warbler	<i>Dendroica palmarum</i>	Birds - Warblers	F, FW, M, W
Prothonotary Warbler	<i>Protonotaria citrea</i>	Birds - Warblers	F, M
Swainson's Warbler	<i>Limnithlypis swainsonii</i>	Birds - Warblers	F
Worm-eating Warbler	<i>Helminthos vermivorus</i>	Birds - Warblers	F, FW, M
Yellow-rumped (Myrtle) Warbler	<i>Dendroica coronata</i>	Birds - Warblers	F, FW, M
Cedar Waxwing	<i>Bombycilla cedrorum</i>	Birds - Waxwings	F, U, W
Yellow-bellied Sapsucker	<i>Sphyrapicus varius</i>	Birds - Woodpeckers	F, U
Black Rat	<i>Rattus rattus</i>	Land Mammals	F, U
Brown Rat or Norway Rat	<i>Rattus norvegicus</i>	Land Mammals	F, U

## Species Illustrations and Descriptions

## Lichens

*Parmelia martinicana*

Forms oval or near circular discs on the trunks and branches of trees, close to the shore. The colour a pale, tannish grey, blackish on the underside. 3-9 cm (1 1/4-3 1/2 in) across.

**Native.**

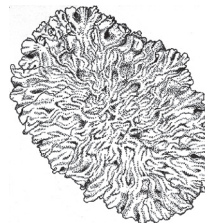

F, OC

*Physcia alba*

This lichen forms roughly circular patches with rather a rough surface texture, but fairly flat. The colour is a whitish mineral grey with white spots on top and white underneath. There are numerous narrow lobes around the margin. This lichen is common on trees exposed to sun and wind. Up to about 10 cm (4 in) across. **Native.**

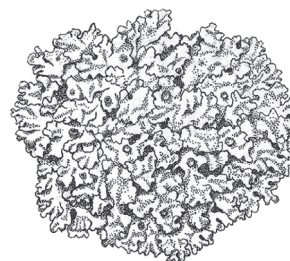

F

*Ramalina denticulata*

The body of this lichen is divided into many lobes which are narrow and divided forming a tuft. The colour is a pale greenish-yellow. The texture is leathery with many small lumps on the upper surface. This lichen lives on the trunks and branches of trees in open woodland. Up to 10cm (4 in) high. **Native.**

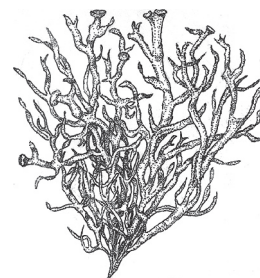

F

## Mosses

**Bermuda Campylopus***Campylopus bermudiana*

A rare moss found at the bases of Bermuda Palmetto trees in Paget Marsh. The moss is dark green in colour, about 6 cm (2.5 in) high and has bunches of leaves along the stem. **Endemic.**



F, FW



**Bermuda Trichostoma**

*Trichostomum bermudanum*

A very common moss only about 2.5 cm (1 in) high, occurring in bright green to yellowish green patches on rocks, walls and in marshes.

**Endemic.**

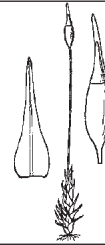

F, FW, OC, U, W

**Ferns**

**Bermuda Maidenhair Fern**

*Adiantum bellum*

A dainty fern endemic to Bermuda. The leaves are thin and delicate and are divided into fan-shaped leaflets. The stem is black and wiry. This delicate plant varies in size and texture according to the amount of light it receives. It is common throughout the island on shady rocks and walls. Spores are held in clusters on the underside edge of the fan shaped. The leaves are 10-15 cm (4-6 in) long. **Endemic.**



CA, CL, F, W

**Bermuda Shield Fern**

*Dryopteris bermudiana*

A very rare endemic fern, once common in the Walsingham and Castle Harbour areas but now on the verge of extinction. This fern has very attractive, twice-pinnate leaves arising in a clump from a compact centre. The leaflets are smooth edged. Dark sporangia appear in rows along the underside of the leaflets. Up to 30 cm (1 ft) high. **Endemic.**

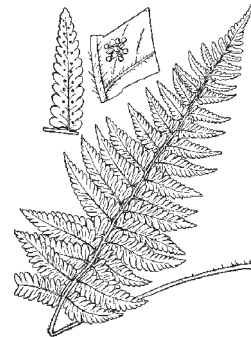

F, CA

**Long Spleenwort**

*Asplenium heterochroum*

This native fern is common on cliffs, walls and shaded rocks. It is a tiny fern only 5 cm (2 in) high, with tiny, rounded, toothed leaflets.

**Native.**



CA, F, W

**Long-leaved Brake***Pteris longifolia*

The leaf is 15-30 cm (6 to 12 in) long. The leaflets are long and thin. At the tip of the leaf stalk is an extra long leaflet which can be twice as long as the other leaflets. This fern is usually found on walls and banks. The covering of the reproductive cells which are found on the undersides of the leaflets is a yellowish brown. About 1 m (3 f) high. **Naturalized.**

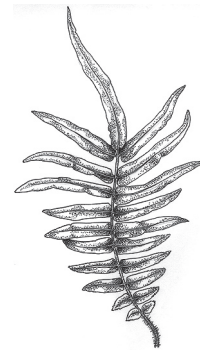

F, U, W

**Plume Polypody***Polypodium plumula*

A very graceful fern found in forest habitats, particularly in Walsingham. The fronds are long and narrow and form a spray-like clump. Each frond is once pinnate and dark green in colour. Size is very variable but the plant grows up to about 60 cm (2 ft) tall. **Native.**

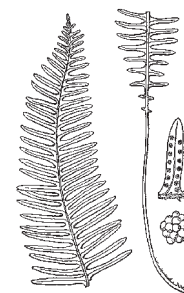

CL, F

**Sword Fern***Nephrolepis exaltata*

The Sword Fern has a simpler leaf than most ferns with the leaflets along the leaf stalk being undivided. It is a medium to small fern up to about 70 cm (2 ft) high. In marshes and drier ground. **Native.**



F

**Clubmosses****Psilotum***Psilotum nudum*

Psilotum is an exceedingly interesting plant of great antiquity. Psilotum is a small, stiff, leafless plant with green stems. Not common except in Paget Marsh. About 15-20 cm (6-8 in) high. **Native.**



F, FW

**Grasses**

**Woodgrass**

*Oplismenus setarius*

Woodgrass is a rare native grass typical of the forest habitat. It requires considerable shade. It has a whorl of long, slender basal leaves, followed by much shorter, elongate leaves up the stem that are broadest at the base. The inconspicuous flowers are on long, initially coiling stems. To 30 cm (1 ft) high. **Native.**



F

**Sedges**

**Bermuda Sedge**

*Carex bermudiana*

This sedge has triangular stems and flat leaves as long as the stems. Fertile stems have several compact flower clusters at the tip. 50-85 cm (1.5-2.5 ft) high. Endemic. **Native.**



F

**Herbaceous Flowering Plants**

**Bear's Foot**

*Polymnia uvedalia*

This plant in the daisy family has very attractive yellow flowers and large, finely haired, rather triangular leaves that have a wavy margin. Native to the eastern U.S.A. this plant is naturalised in hilly locations. About 1 m (3 ft) high.

**Naturalized.**

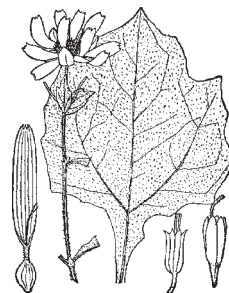

F, W

**Bermuda Bedstraw**

*Galium hispidulum*

This native plant has declined rapidly as old forests disappeared. Found on hillsides, this small plant has square stems and whorls of pointed, small leaves. The plant has tiny white flowers followed by reddish to dark blue, berry-like fruit. Up to 60 cm (2 ft) high. **Native.**

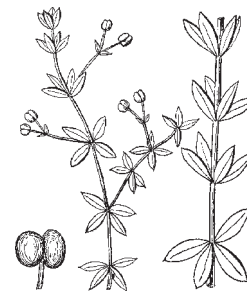

F, W

**Bird Pepper***Capsicum baccatum*

This is a true Pepper which produces tiny, bright red peppers that can be used to flavour food. The flowers are small and white with 5 petals. The plant grows up to about 1 m ( 3 ft) high. It is found in rocky, upland woodland. **Native.**



F

**Black Nightshade***Solanum americanum*

The nightshades are a poisonous group of small shrubs or tall herbs. Never eat the berries. This native plant is common in uncultivated ground and open woodland. The flowers are smallish with a ring of pointed white petals around a characteristic compact, pointed, yellow centre. The leaves are simple, rounded at the base and broadly pointed at the tip. The plant may reach at least 1 m (3 ft) high and has stiff stems.

**Native.**

F, W

**Fern Asparagus***Asparagus densiflorus*

This is not a true fern (true ferns never have flowers). The roots are tuberous while the older stems are woody with some spines and can grow to 1 m (3 ft). Foliage is yellow-green and resembles pine tree needles. The minute flowers are white or pale pink and the mature fruit are bright red berries. This is a sprawling, invasive plant found everywhere. **Introduced** and **naturalized.**



F, W

**Lace Fern or Bridal Fern***Asparagus setaceus*

An evergreen plant with woody climbing stems, this more delicate looking asparagus fern has pale to lime-green foliage in flat sprays. The tiny white flowers bloom throughout the foliage creating a lovely lace like appearance. The fruit is a purple-black berry. It is a native of South Africa. Like its relative, *A. densiflorus*, this plant can be found everywhere. Again, like its relative, this is not a true fern. Up to 90 cm (3 ft) high.

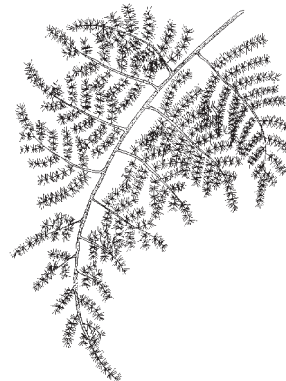
**Introduced** and **naturalized.**

F, W

**Rhacoma***Crossopetalum rhacoma*

Rhacoma is an endangered native shrub, found in only a few locations in upland forest. The flowers are tiny and red in colour and found in small groups. They are followed by small green berries which turn red when ripe. The leaves are broadest near to the tip with widely separated teeth around the margin. Up to 1.5 m (5 ft) high.

**Native.**

F

**Turkey Berry***Callicarpa americana*

This rare native plant used to be quite common in woodlands, however it could not compete with invasive introduced woodland plants and died out between 1900 and 1950. It was re-introduced and is now on the increase again in managed areas where invasive introduced plants are culled out. It has clumps of small, pretty, pink flowers borne in repeated clusters along the end of the stalks. The leaves are fairly large and broadest about one third of the way from base to tip. They are coarsely toothed. About 65 cm (2 ft) tall.

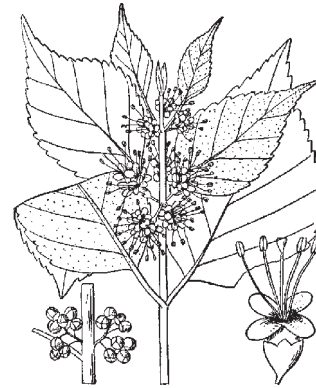
**Native.**

F

**White Eupatorium***Eupatorium riparium*

A small roadside plant. The stems are often widely branched. Leaves are lance-like with saw-toothed edges. The leaves are 5-10 cm (2-4 in) long and 1-2.5 cm (1/2 to 1 in) wide. Small daisy-like flowers grow in clusters at the end of a stem. Eupatorium flowers in winter and spring. Grows from 55-85 cm (1 1/2 to 2 1/2 ft) high.

**Introduced.**

F, U, W

**Wild Bermuda Pepper***Peperomia septentrionalis*

This plant lives in shaded areas and cave mouths. It is only locally common. It has rather fleshy leaves broadest close to the tip but with a slight indentation there. The flower spike is very characteristic, being brown and pencil shaped with very minute blossoms. About 15 cm (6 in) high. **Endemic.**



CA, F

**Vines****Balloon Vine***Cardiospermum halicacabum*

Originally a forest plant, the Balloon Vine is now more common in hedges and gardens. It can climb to a considerable height using tendrils to grip the supporting twigs. The leaves vary but are usually compound, the leaflets have coarsely toothed margins. Flowers are borne in clumps and are yellowish-white in colour. The characteristic fruit capsule is an inflated balloon-like structure about 2 1/2 cm (1 in) long, containing black fruit. Up to 10 m (30 ft) long. **Naturalized.**

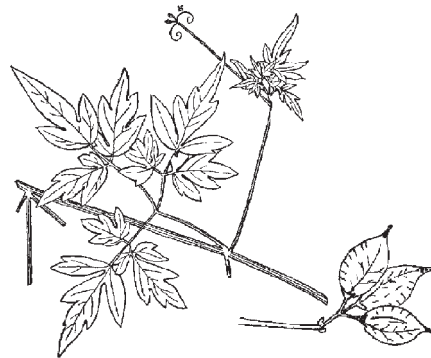

F

**Bay Bean***Canavali lineata*

This is easily confused with seaside morning glory when it is not in bloom. It has rounded leathery leaves which grow on little branches, in threes, along the vine. Its flowers, which look like miniature purple sweet peas, can be seen in the autumn and winter. Wide pods can be seen on the vine all year. It has the capacity for rapid vertical and horizontal growth so it can deal with the problem of shifting sand. The vine may grow as long as 7.5 m (25 ft). **Native.**

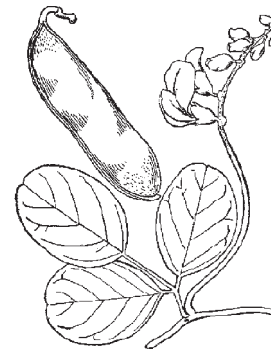

F, OC, SD



**Bermuda Bean**

*Phaseolus lignosus*

The Bermuda Bean is now rare, but was once very common. The flowers are pea-like and vary from yellow to blue. The leaves are heart-shaped with a sharp tip. It is a vine up to 3.2 m (10 ft) long. **Endemic.**



F

**Blue Dawn Flower or Morning Glory**

*Ipomoea indica*

The Blue Dawn Flower is one of the Morning Glories. The plant is a vine up to several yards (m) long that trails over ground and up other foliage. The very pretty, trumpet-shaped, blue flowers appear in the morning and fade later. This plant can be a pest. Up to 10 m (30 ft) long. **Native.**



F, M, W

**Brier-Bush or Grey Nickers**

*Caesalpinia bonduc*

The Brier-Bush, which is native, is now very rare and localised in a few patches of shoreline woodland. It is a large rambling vine. Its most noticeable feature are the large recurved spines on the stems, leaves and fruit pod. The leaves are compound and the flowers, borne in spikes are an attractive yellow colour. Reaching at least 5 m (15 ft) in length. **Native.**

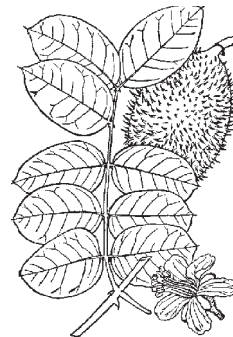

F

**Ink-berry or Small Passion Flower**

*Passiflora suberosa*

A ground covering vine whose leaves from 5-15 cm (2-6 in) may be covered with short downy hairs. The leaves are egg shaped in outline. Flowers are tiny, greenish-white passion flowers. The purple to black berries are oval or somewhat globular. Up to 5 m (15 ft) long. **Native.**

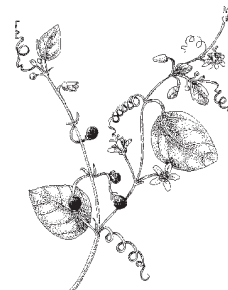

F, FW

**Simple-leaved Jasmine***Jasminum simplicifolium*

This vine is common in woodland in the Castle Harbour area. The vine climbs through the trees, sometimes in quite dense masses. The white star-shaped flowers have been used in Bermuda for perfume production and are very fragrant. As the scientific name suggests the leaves are very simple, broadest in the middle and found in pairs along the stalk. Up to 10 m (30 ft) long. **Introduced.**



F, OC, W

**Maurandya Vine***Asarina scandens*

This vine is also known as the Climbing Foxglove and is an introduced plant native to Mexico. It prefers wilder tracts of woodland and climbs shrubs and trees up to 3 m (10 ft) high. The purple, tubular flowers arise in the leaf axils from the long twining stem. The leaves are very triangular with three sharp points. **Introduced.**



F

**Small-Fruited Balloon Vine***Cardiospermum microcarpum*

Like its relative the Balloon Vine, which it closely resembles, this tall climbing, or trailing, native vine is a forest plant now uncommon but found in protected land. For characteristics see the balloon vine above. This one differs in having a smaller fruit capsule only about 1 cm (1/2 in) long. Up to 10 m (30 ft) long. **Native.**

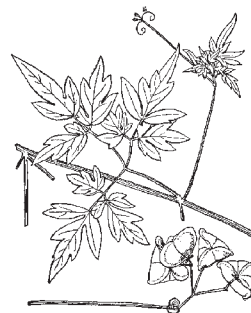

F

**Virginia Creeper***Parthenocissus quinquefolia*

A tall-growing clinging vine. Easily recognised by the vine habit and the leaves with five prominent leaflets. The leaves turn red in autumn. Common in swamps. Up to at least 10 m (30 ft) high. **Native.**



F, FW



**West Indian Cissus***Cissus sicyoides*

A tall, clinging vine of the swamps and marshes. May completely cover small trees with its foliage. It has characteristic heart-shaped, shiny, light green leaves about 6 cm (2.5 in) long. Up to 7 m (20 ft) high. **Native.**



F, FW

**Shrubs****Bermuda Holly***Ilex vomitoria*

As suggested by the scientific name the berries have been used as a purgative. Holly is a shrub about 2 m (6 ft) high with simple leaves, that bears bright red berries in autumn. Survives in Devonshire Marsh. **Naturalized.**



F, OC

**Bermuda Snowberry***Chiococca bermudiana*

A sprawling shrub that normally grows to two meters (six feet) but Bermuda Snowberry is sometimes vine-like and branches can grow up to 5 m (10 ft) long. It has shiny leathery leaves 5-10 cm (2-4 in) long. The leaves are shaped like an oval that is pointed on both ends. They grow opposite one another on the stem. Sprays of small yellow bell flowers appear in autumn and develop into pure white berries. Up to 2 m (6 ft) high. **Native.**



F

**Burr Bush***Triumfetta semitriloba*

This plant is native to Florida and the West Indies. It is of very wide distribution in Bermuda but particularly common in woodland and wild areas. This shrub takes its name from the groups of spiny burrs found on the plant after its late summer flowering. These burrs up to 1 cm (3/8 in) in diameter look like tiny mines. The leaves alternate along the stem and are quite large, broadest at the base and coarsely toothed. Considered to be **native.**

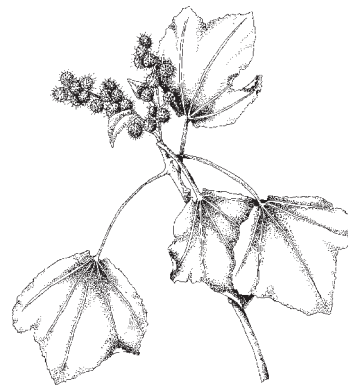

F, W

**Bush Clerodendron***Clerodendrum glabrum*

A shrub or small tree. The leaves are thin pointed ovals up to 13 cm (5 in) long. The leaves grow opposite one another or in a whorl. They have a distinctive, bitter smell when crushed. Small, fragrant, pinkish flowers with the stamen protruding cluster along terminal spikes. The fruit is a pale grey berry about the size of a pea. Can grow to 5 m (15 ft). **Introduced.**



F

**Carolina Laurel Cherry***Laurocerasus carolinianum*

A small tree up to 12 m (40 ft) high with a slender trunk. The 6-10 cm (3-4 in) long leaves are leathery, oblong and pointed on a short stalk. The flowers are white and small, borne in the leaf axils. The fruit is black and plum-like 3 cm (3/4 in) long. Invading swamp-forests. **Introduced.**



F, FW

**Common Sage or Lantana***Lantana involucrata*

This is the common very fragrant sagebush of Bermuda. A relatively small shrub up to 1.3 m (4 ft) high it is common in many habitats as well as in cultivation. The leaves about 2.5 cm (1 in) long are oval in shape with a scalloped edge. The flowers vary somewhat in colour as they mature but are basically reddish-purple. **Native.**



F, OC, U, W

**Doc-bush***Baccharis glomeruliflora*

A shrub reaching 3 m (10 ft) high that is common in most peat marshes and uplands. It is evergreen and the light greenish-yellow leaves about 8 cm (3 in) long have a few coarse teeth near to the pointed tip. The fruits have hairy tufts. **Native.**



F, FW, W

**Jamaica Dogwood***Dodonaea viscosa*

A shrub whose bark on the trunk is a reddish brown and it has string like strips. The yellow green leaves are lance like to 12 cm (4 3/4 in) long. They are rough textured with distinctive veins, particularly the central vein. The stems of the leaves are angular. The flowers are tiny and grow on short spikes. Pinkish-brown papery fruit made up of three capsules or segments produce winged seeds. This plant is sticky. About 2 m (6 ft) tall. **Native.**



F

**Pittosporum or Mock Orange***Pittosporum tobira*

A shrub or small tree. The leaves, which can grow to 10 cm (4 in) long, are egg shaped with the broader end above the middle. They are dark green, shiny and leathery in texture. The edges of the leaf are rolled toward the underside of the leaf. The leaves have quite a distinctive smell when crushed. Five-petaled flowers are white to lemon-yellow. The half inch long flowers grow in fragrant clusters. The fruit is a green capsule which splits into three segments containing attractive, red, sticky seeds. Can grow to 6.5 m (18 ft). **Introduced.**



F, U, W

**Poison Ivy***Rhus radicans*

This nasty little shrub or low vine, up to 1 m (3 ft) high is common both in swamps and marshes and also occurs at the back of mangrove swamps and around ponds. The three-lobed leaves are shiny, but varied in shades of green, and sometimes exude a black liquid. The whole leaf is about 7-10 cm (3-4 in) across. About 1 m (3 ft) high. Very poisonous. **Probably native.**



F, FW, W

**Shrubby Fleabane***Pluchea odorata*

This is an aptly named shrub with typical fleabane character. The leaves are oblong from 8-16 cm (3-6 in) long. White flowers are small and daisylike. Numerous flowers are arranged in flat topped clusters. Growing from 1-2.5 m (3-8 ft) tall. **Native.**



F, FW, W

**Surinam Cherry***Eugenia uniflora*

A shrub or small tree that was introduced and has become naturalised in Bermuda. The leaves are 4-7 cm (1-2 1/2 in) long. They are dark green and shiny, somewhat spear shaped, rounded at the base and pointed at the tip. The leaves grow opposite each other. New leaf growth is reddish. The smell is distinctive when the leaves are crushed. The small, white flowers have four or five petals. The fruit is bright red and round with deep grooves. The bark of the trunk is a smooth, pale brown with patches that are easy to peel off. Can grow up to 8 m (25 ft). **Introduced and naturalised.**

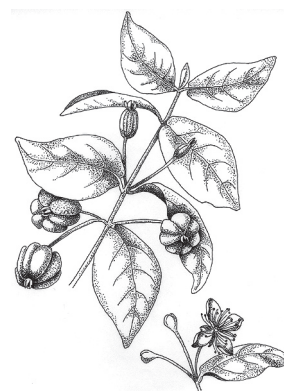

F, W

**Virgate Mimosa***Desmanthus virgatus*

Its most obvious feature is the long, delicate pinnate leaves found in opposite pairs along the stalk. It has flowers in feathery balls which are followed by brown, slender, pointed seed pods. The plant commonly grows 2 m (6 ft) high. **Native.**



F, W

**White Stopper***Eugenia axillaris*

A shrub or small tree that grows up to 5 m (15 ft) tall that is now quite rare. It is most commonly seen in the Walsingham district and has been re-introduced to Nonsuch Island. The rather leathery leaves are almost always attacked by a leaf mining insect that leaves sinuous, whitish, obvious tracks within the leaves. **Endemic.**

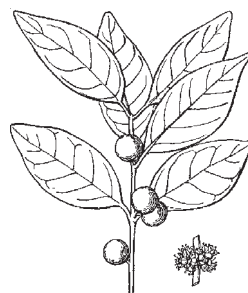

F

**Wild Coffee***Psychotria ligustrifolia*

This is a rare shrub growing in woodland. It flowers in spring and then bears bright red fruits. The leaves are elongate and pointed without marginal teeth. The leaves leave prominent leaf scars on the stem when they are shed. Up to about 1.5 m (5 ft) in height. **Native.**

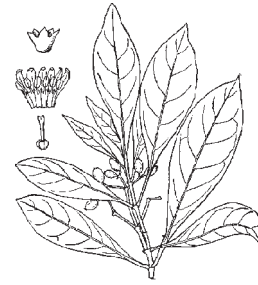

F

**Trees****Allspice***Pimenta dioica*

Allspice is a tree. The leaves are narrow oblong or slightly lance shaped, approximately 10 cm (6 in) long. They are leathery and shiny. When crushed they produce the fragrant smell of allspice. The small white flowers are produced in broad flat-topped clusters. They are followed by green berries which turn black when ripe. The green berries are dried and ground to make the culinary allspice. The bark has a mottled olive-green and tan appearance, like camouflage. Growing up to 13 m (40 ft) high. **Introduced and naturalized.**



F

**Ardisia***Ardisia polycephala*

An invading shrub of the swamp-forests. The leaves are 10-15 cm (4-6 in) long and pointed. The greenish-purple flowers are in flat groups at the end of branches or on side shoots. Up to about 3-3.5 m (9-10 ft) high. **Introduced.**



F, FW

**Bay Grape***Coccoloba uvifera*

Commonly found either as a large shrub or a tree, this native plant has a short, twisted trunk and large rounded leathery leaves, highly resistant to salt spray. The flowers are borne on long spikes from spring to autumn and are tiny and whitish in colour. The fruit that follow resemble grapes in size and colour and are often used in jams and jellies. Variable in height 2-18 m (6-18 ft). **Native.**

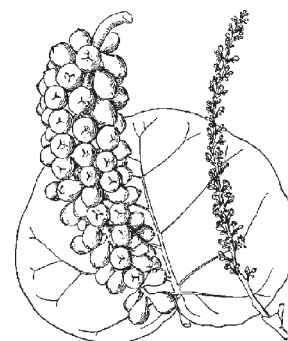

F, OC

**Bermuda Cedar***Juniperus bermudiana*

Bermuda Cedar was a dominant upland tree when the islands were colonised but has since been decimated by exploitation and insect damage. The wood is highly aromatic. Cedar is a large tree with scale-like foliage and purple-black berries. Up to 13 m (40 ft) high. **Endemic.**

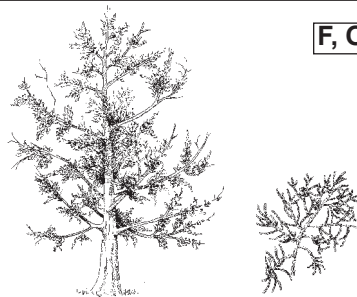

F, OC, U, W

**Bermuda Olivewood***Cassine laneana*

An endemic tree. Compact and oval when young. The mature leaves are dark green and somewhat leathery. They are slightly toothed. The edges of the leaf are rolled toward the underside. The leaves are egg shaped with the broader end above the middle of the leaf. The young leaves are a light yellowish-green, contrasting with the dark green older foliage. Small greenish or white flowers are either male or female and grow in clusters. The female flowers produce a fleshy yellowish, olive-shaped fruit about an inch long. The bark was used for tanning in the early days of Bermuda. Can grow to 10 m (30 ft) tall. **Endemic.**

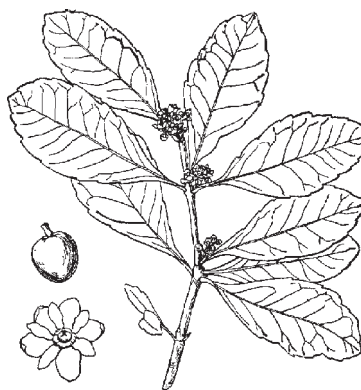

F, U



**Bermuda Palmetto**

*Sabal bermudana*

Bermuda Palmettos were once the dominant lowland tree of Bermuda. They have been exploited quite heavily in the past and are out-competed by some introduced fan-palms. The trunks are stout with numerous leaf-scars and the fan-shaped fronds emerge in a mass from the top. Fruit black in large clusters. Up to 8.5 m (25 ft) high. **Endemic.**

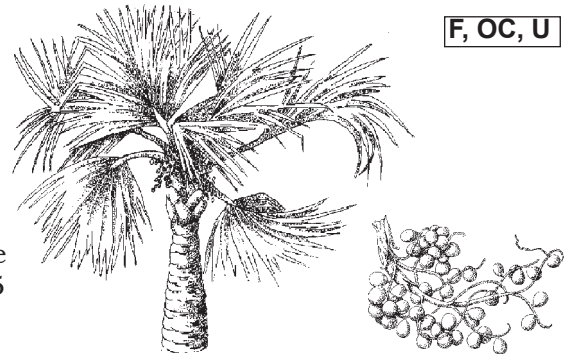

F, OC, U

**Brazil or Mexican Pepper**

*Schinus terebinthifolia*

This tree has occupied a huge variety of habitats in Bermuda. It competes with native trees in mangroves and swamps and is encroaching in marshes. The leaves are compound and pungent if crushed. The large groups of small berries borne in winter ripen to a deep red. Up to 7 m (20 ft) high. **Introduced.**



F, M, OC, W

**Casuarina, Australian Whistling Pine  
or Whispering Pine**

*Casuarina equisetifolia*

Casuarina is a shallow rooted tree. It resembles a conifer but the "pine needles" are segmented branchlets about 1 cm.(3/8 in) long with tiny leaf scales appearing at the segments. The branchlets appear in sprays. There are separate male and female flowers. The female flowers produce a prickly cone with tiny winged seeds. This fast growing tree was planted in large numbers during the 1940s, following the Bermuda Cedar blight. Grows from 10-25 m (30 to 80 ft) high. **Introduced.**

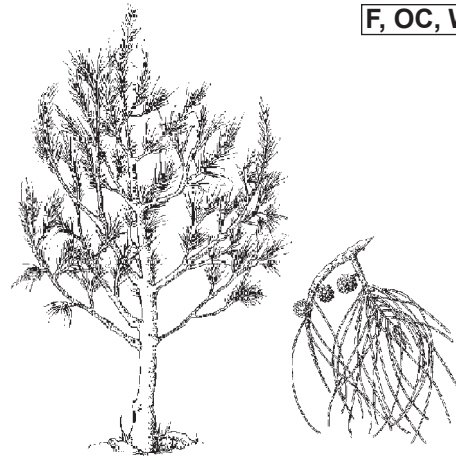

F, OC, W

**Chinese Fan Palm or Chinese Fountain Palm***Livistonia chinensis*

This fan palm has leaf stalks that are toothed toward the base. The large leaf blade has prominent accordion pleats. The leaves droop producing a fountain-like effect. Flowers are produced in clusters of up to 6. The resulting fruit are blue-green, egg shaped and are nearly 2.5 cm (1 in) long. The pulp of the fruit is an intense orange. Growing up to 10 m (30 ft) or more high. **Introduced.**

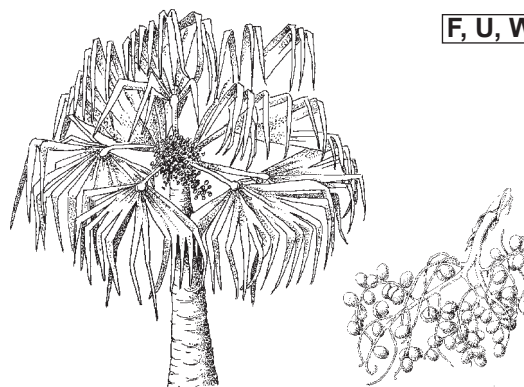

F, U, W

**Fiddlewood***Citharexylum spinosum*

A tree up to 15 m (50 ft) high and with a trunk up to 1 m (3 ft) in diameter. The large leaves are shaped like an elongated heart and are unique in that they turn yellow and fall in early summer. The white flowers borne in long strings are small and fragrant. Common. **Naturalized.**



F

**Forestiera***Forestiera segregata*

A small, bushy, deciduous tree with a trunk that can be up to 15 cm (6 in) but is usually less. The leaves are roughly spear shaped, 2.5-6.5 cm (1 to 3 in) long. The flowers are very small. The fruit is oblong and fleshy up to 3 mm (1/6 in) long. Forestiera flowers in the autumn and winter. Leaf fall is very erratic, normally occurring as the result of drought or insect infestation that can grow up to 7 m (20 ft). **Native.**



F

**Indian Laurel***Ficus retusa*

A real pest tree that has become established in a wide variety of habitats. Up to 50 ft (16 m) high it has small leaves and gives dense shade. **Introduced.**



F, U, W



**Lamarck's Trema**

*Trema lamarckiana*

A small tree with a rather straggly growth form. Rare now but formerly much more common. Up to about 3 m (9 ft) in height. **Native.**



F

**Mulberry**

*Morus nigra*

The history of mulberries in Bermuda is a bit mysterious. The Black Mulberry is considered native to western Asia. It is a smallish tree up to 8 m (25 ft) high bearing elongate toothed leaves and flowers in drooping catkin-like structures. The delicious fruits are red to black in colour with a large central stone. About 5 m (15 ft) high. Either **native** or **introduced**.

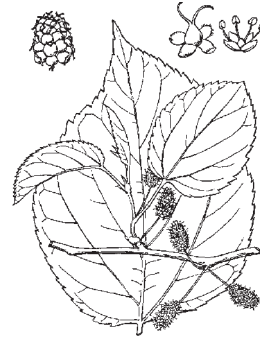

F, U

**Southern Hackberry or Hackberry**

*Celtis laevigata*

A deciduous tree with thin, pale green, spear like, rough textured leaves which are alternate on the stem and grow up to 10 cm (4 in) long. The flowers are small and greenish. They produce small orange-red fruit that ripen to dark purple. Hackberry is fairly uncommon but can be found in Walsingham and small pockets of upland forest. The bark can have a warty appearance. Southern Hackberry spreads by root suckers. Grows to 13 m (40 ft) high. **Native.**

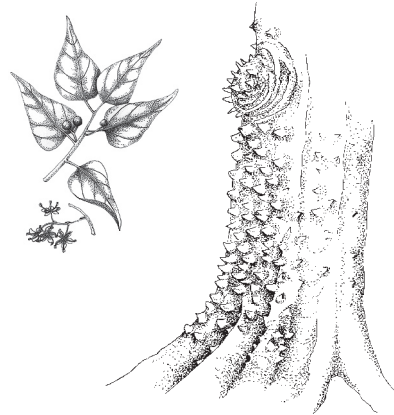

F

**Yellow-wood**

*Zanthoxylum flavum*

Yellow-wood trees were common in the upland forests when Bermuda was colonised. They form beautiful, robust trees that have wood that was highly prized for furniture making. Sadly, now only a handful of these trees survive and young ones are not found. They need special protection. The tree has nice compound leaves. The clusters of white flowers are followed by purplish-black berries. Up to 13 m (40 ft) high. **Native.**



F

## Insects

### Ants

#### Argentinian Ant

*Iridomyrex humilis*

This small ant is very common in a wide variety of habitats from houses to sand dunes. It lives in large colonies in holes or cavities excavated into the ground. It is often abundant under trash lying on the ground. These ants are brownish and only 3 mm (1/8 in) long.

**Naturalized.**

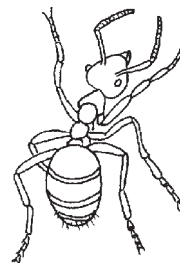

F, SD, U, W

### Aphids

#### Juniper Aphid

*Cinara tujafilina*

The most important host of the Juniper Aphid in Bermuda is the Bermuda Cedar. The aphid is very dark in colour, ranging from purple through brown to almost black. It is quite large compared to other aphids being 2-3 mm (1/8 in) long. **Introduced.**

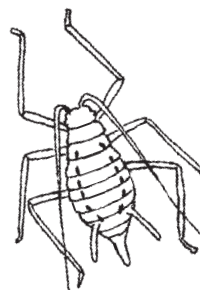

F, OC, U

#### Spittlebug

*Clastoptera undulata*

This common pest of the Casuarina tree was first recorded in Bermuda in 1959. The adults and nymphs suck the juice of foliage and the nymphs secrete a protective covering of bubbly fluid, which appears as little balls of white foam seen at the base of the needles. The Spittlebug eggs are laid in the tree needles and twigs in May and the Spittlebug population peaks in October. Adults 5 mm (1/5 in) long. **Introduced.**



U

### Beetles

#### Donkey Beetle

*Diaprepes esuriens*

One of the largest beetles on Bermuda and greyish-brown in colour. Adults feed on the foliage of citrus, Hibiscus and other ornamental trees and shrubs. Larvae live in the soil and feed on roots. About 3 cm (1 1/4 in) long. **Native.**



F, U, W

## Bugs

### Harlequin Bug

*Murgantia histrionica*

A member of the stinkbug family, this colourful insect is commonly found on cabbage and tomato crops. It is barrel-shaped and black and white. Eggs are laid on the underside of leaves. 2.5 cm (1 in) long. **Introduced.**

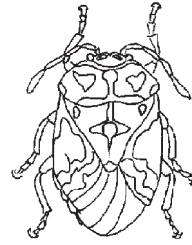

F, U

## Butterflies

### Buckeye Butterfly

*Junonia coenia*

Probably the most common butterfly on Bermuda. The caterpillar feeds on snapdragon, plantain, and other low herbs. The adult is a swift flyer. It is brown overall with blue and red markings. About 4 cm (1.5 in) across. **Native.**

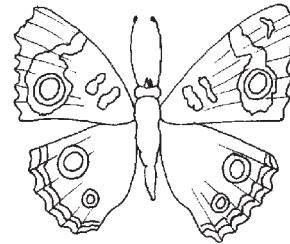

F, U, W

### Cloudless Sulphur

*Phoebis sennae*

This butterfly is a striking yellow colour. The adult feeds on nectar and the larvae eat foliage of *Cassia spp.* 3.5 cm (1 1/4 in) across. **Native.**

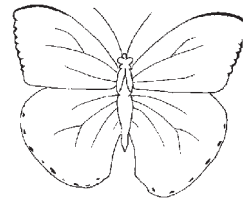

F, U, W

### Gulf Fritillary

*Agraulis vanillae*

Smaller than the monarch, it is also black and orange, however with silver patches on the underside of the wing. Feeds on passion flower vine. 2.5 cm (1 in) across. **Native.**

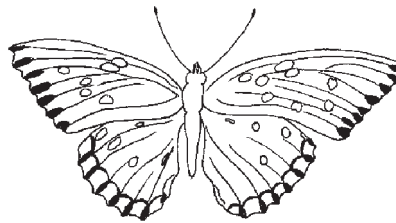

F, U, W

## Cicadas

### Cicada or Bermuda Singer

EX, F

*Tibicen bermudiana*

One of the earliest insects recorded from Bermuda, being mentioned by Butler in 1691 as the "good housewife" by virtue of the sound they make like the whirring of a spindle. Singers were formerly widespread and common. Numbers dropped dramatically in the 1950s after the blight on the cedar trees and the introduction of the Kiskadee. The Cicada nymphs feed on the root of the Bermuda Cedar during their seven-year larval period. It is also thought that the Kiskadee has been a major predator of the cicada. 3 cm (1 1/4 in) long. **Extinct.**

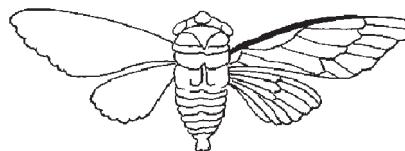

## Crickets and Grasshoppers

### American Black Cricket

F, U, W

*Gryllus firmus bermudensis*

Common. Lives under stones, logs and debris in fairly open terrain. Adult males "sing" loudly at night and less frequently during the day all year round. 4 cm (1 1/2 in) long. **Introduced.**



## Moths

### Giant Grey Sphinx Moth

F, U, W

*Pseudosphinx tetrio*

Apparently established since 1930s, the large caterpillar feeds on the frangipani tree and sometimes causes severe defoliation. Although not very common it is striking by its size. 9 cm (3.5 in) long. **Native.**

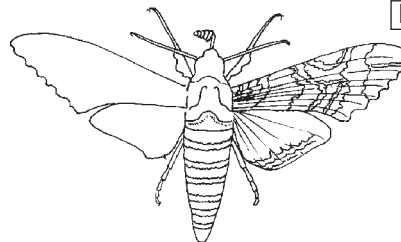

## Scales

### Cedar Scale

F, W

*Carulaspis minima*

This tiny pest species was first found in 1945, and eventually resulted in the death of over 90% of the Bermuda Cedars. It is an inconspicuous flattened insect adhering tightly to cedar leaves. 3 mm (1/8 in) long. **Introduced.**



**Oystershell Scale**

*Insulaspis pallida*

A tiny insect with an elongated larva, found on Bermuda Cedars. 3mm (1/8 inch) long.

**Introduced.**



F, OC, U

**Palmetto Scale**

*Comstockiella sabalis*

This scale attacks the Bermuda Palmetto. The scale was first recorded in 1921 when it was restricted to the eastern end of Bermuda; by 1933 it had spread throughout the islands.

About 4 mm (1/6 in) long. **Introduced.**

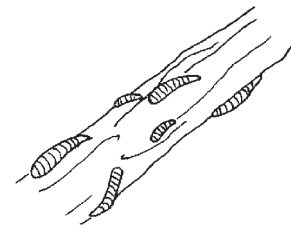

F, OC, U

**Termites**

**Wood Termite**

*Kalotermes approximatus*

The most common of the three species of dry wood termites which occur in Bermuda may be found in almost any dead cedar tree. About 2 cm (3/4 in) long. **Introduced.**

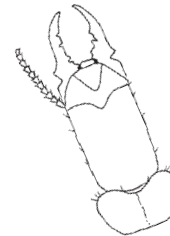

F, U

**Centipedes and Millipedes**

**Centipedes**

**St. David's Centipede**

*Scolopendra subspinosa*

During the day this centipede is usually found under stones and old logs. Once very common, now found mainly at the east end and Dockyard. One theory is that toads have reduced their numbers. Like all centipedes this species is predaceous and generally beneficial; however, it may inflict a powerful, poisonous bite if handled. Up to 15 cm (6 in) long. **Native.**

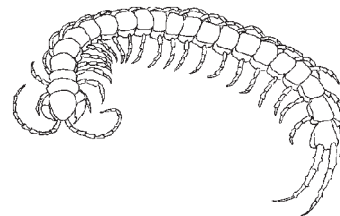

F, U, W

## Millipedes

### Church Worm

*Julus sp.*

This terrestrial isopod crustacean is very common. The body is flattened and brownish-grey. It is usually found in protected locations such as under rocks or logs. It may sometimes become a household pest. Produces a distinctive odour when handled. 1 cm (3/8 in) long. **Native.**

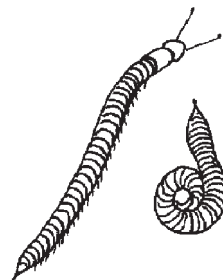

F, U, W

### Millipede, Thousand Legs or Galley-worm

*Spirobolus heilprini*

Recorded on Bermuda in 1889, this common worm found under stones is a native of the Azores. Adults have chestnut brown bodies with reddish brown legs. Young have a black dorsal line bordered with yellow and a row of black spots on each side. Millipedes often attack sprouting seeds or roots and bulbs. About 2 cm (1/4 in) long. **Introduced.**

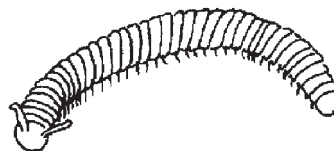

F, U, W

## Spiders

### Crab Spider or Spiny-bellied Orb Weaver

*Gasteracantha cancriformis*

First recorded in the 1930s and now common. This small spider builds a new web (orb) each night and eats the old web to conserve protein. Glands produce silk in liquid form as a protein called fibroin, which is pumped out through spigot-like spinnerets at the creature's abdomen. When stretched the fibroin hardens into a thread. About 1 cm (3/8 in) across. **Introduced.**



F, M, U

### Golden Silk Spider

*Nephila clavipes*

The females of this species are the largest spiders in Bermuda and the very large net may be many metres (feet) across. The female spider may be 15 cm (6 in) across including the legs. The body is banana-shaped and the colour yellow with brown bands. **Native.**

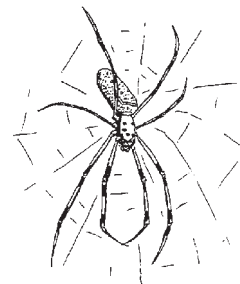

F, M, U



## Isopods

### Pill-bug or "Roly Poly"

*Armadillidium vulgare*

This isopod crustacean has a grey body with plate-like segments which somewhat resemble a miniature armadillo. The pillbug is originally from Europe but now found world-wide. Can be found under stones, in moist leaf litter and in cellars. Like the Sow-bug it is sometimes called the Wood Louse. They feed on the tender roots and shoots of plants. About 1 cm (3/8 in) long.

**Introduced.**

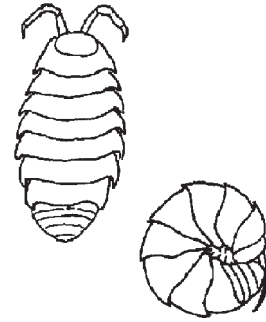

F, U, W

## Gastropoda

### Snails

#### American Toothed Snail

*Polygyra appressa*

Introduced from Southern USA prior to 1852. It is nocturnal in its habits and may be found during the day concealed under stones. The shell is almost circular and the lip is rolled; there is a prominent tooth in the aperture. Pale brown in colour. This snail is herbivorous. 1.5 cm (1/2 in) in diameter. **Introduced.**

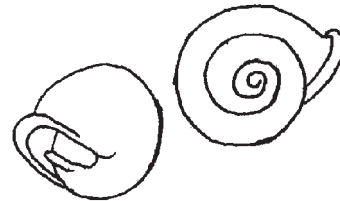

F

#### Little Orb Helicina

*Helicina convexa*

This snail has a small pale shell with a low spire and a large comma-shaped opening. Found under forest litter. 1 cm (3/8 in) across.

**Introduced.**

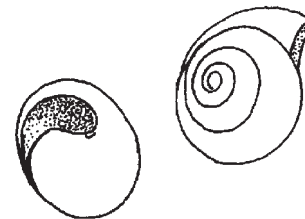

F

**Poecilozonites***Poecilozonites* spp.

This snail, unique to Bermuda, evolved into 15 species, most of which subsequently died out during high stands of interglacial seas. Living specimens of three (*P. reinianus*, *P. circumfirmatus* and *P. bermudensis*) were collected by well-known biologist Stephen Gould in 1969; however, however only *P. circumfirmatus* have been reliably observed since then. Varied in size. 5 mm to 6 cm (3/16-2 1/2 in). **Endemic** or **Extinct**.

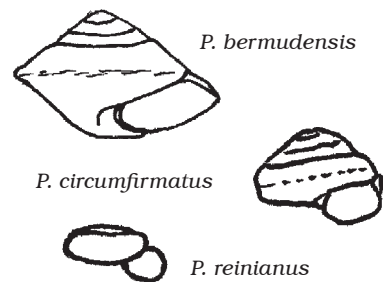

F, EX

**Rosy Euglandina or Predaceous Snail***Euglandina rosea*

Introduced from Cuba as a biological control of the Edible Snail *Otala lactea*, it is carnivorous and common in the inland forest. The adult has a pale pink shell which is translucent in younger specimens. Up to 5 cm (2 in) long. **Introduced**.

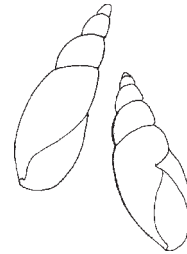

F, U, W

**Shiny Puppila***Pupoides nitidulus*

This is a small, shiny, smooth, 1 cm (3/8 in) long snail found under bark or fallen leaves in the forest. It has a lip around the opening. **Introduced**.

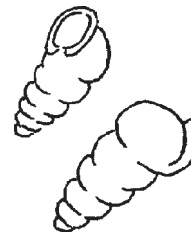

F

**Spiral Snail***Rumina decollata*

The shell of this species is quite elongated and the apex is characteristically worn away, giving it a blunt tip. Accidentally introduced by Governor Lefroy with growing plants from Tenerife in 1876. Pale translucent brown in colour. A common snail in gardens. 3 cm (1 1/8 in) long. **Introduced**.

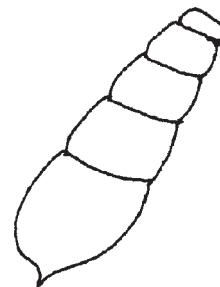

F, W

**Tree Snail**

*Succinea bermudensis*

This medium-sized snail has a white inflated looking shell with a very large aperture. It can be found under rocks and on tree trunks. To 7 mm (1/4 in) long. **Endemic.**

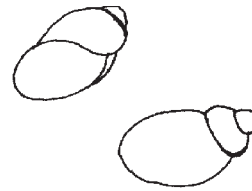

F

**White Snail**

*Eulota similaris*

Probably introduced to Bermuda from the West Indies, it was first recorded from Bermuda in 1889. The shell is translucent and pale yellowish-white in colour. A herbivorous snail. The shell is somewhat flattened and circular. 2.5 cm (1 in) in diameter. **Introduced.**

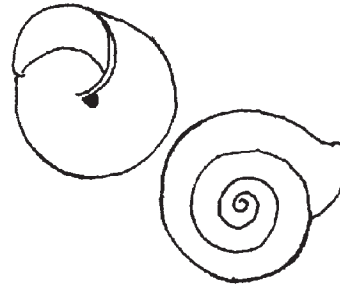

F

**Frogs and Toads**

**Frogs**

**Whistling Frog**

*Eleutherodactylus johnstoni*

This is a tree frog of small size. The length is about 2 cm (1 in) and the body is pinkish brown. There are suckers on the feet. This frog along with other amphibians is on the decline in Bermuda. **Introduced.**



F, FW, U

**Toads**

**Giant Toad**

*Bufo marinus*

The Giant Toad can be quite large measuring up to 23 cm (9 in) long. It is brown with darker blotches and has poison secreting glands behind the head. The only amphibian that can stand quite salt water. Breeds in ponds but lives in a wide variety of habitats. **Introduced.**



F, FW, U, W

## Lizards

### Bermuda Skink

F, OC

*Eumeces longirostris*

This is the only non-introduced lizard in Bermuda. It is now endangered being reduced to a few small populations mostly along the south shore. This is a small, rather stiff lizard with short legs and clawed feet. Blunt-nosed and dark greyish-brown except for mature adults which have a reddish throat. Length 15-20 cm (6-8 in).

**Endemic.**



### Jamaican Anole

F, M, U, W

*Anolis grahami*

The common lizard of Bermuda. The colour is a blueish green but some males are a chocolate brown. In virtually all habitats. The length with tail is up to about 17 cm (7 in). **Introduced.**



## Birds

### Doves

#### Ground Dove

F, W

*Columbina passerina*

This delightful bird is usually seen feeding on the ground. It is rather plumb instature and grey in colour with a short square tail 15-16 cm (6-6 1/2 in) long. Probably **introduced**, now **Naturalized.**



#### Mourning Dove

F, U, W

*Zenaida macroura*

This common dove reaches a length of 30 cm (12 in). The Mourning Dove is slender and long-tailed. They are an attractive brownish-grey with darker spots on the wings and black tips to the major wing feathers. They are usually seen in pairs and the name comes from the somewhat mournful but pleasant song. **Native.**



### Finches

#### Cardinal

*Cardinalis cardinalis*

This bird commonly known as the “Redbird” in Bermuda cannot be confused with any other species. The male is the only all red bird with a crest and the female is yellowish brown. Cardinals are about 20-22 cm (8-9 in) in length. They are common in the edges of woodland and in gardens. **Naturalized.**



F, U, W

#### European Goldfinch

*Carduelis carduelis*

A seed-eater, found in parks, gardens, woodland (especially casuarina trees) and overgrown fields. The goldfinch is about 13 cm (5 in) long bird. It is basically brown but with striking red face and yellow on the wings. **Naturalized.**



F, U, W

### Flycatchers

#### Great Kiskadee

*Pitangus sulphuratus*

This is a large, basically yellow flycatcher with a black and white striped head and a raucous call. It is 27 cm (10 1/2 in) long and has a broad black beak. The back is browner than the underparts. **Introduced** to control lizards.



F, U, W

### Hérons

#### Yellow-crowned Night Heron

*Nyctanassa violacea*

A rather small heron. The adult is slate-grey with a black head capped with a yellowish crown and plumes. The beak is black and the legs yellow to orange. Has become very common after its introduction in 1976-8. Eats mainly land crabs. 56-69 cm (22-27 in) long. **Introduced.**



F, M, SP

## Mockingbirds

### Catbird

*Dumatella carolinensis*

Very visible in spring and summer but at other times hidden in dense thickets, hedges and woodland. The catbird is a slender dark grey bird with a black cap. It imitates the calls of other birds. 20-22 cm (8-9 in) long. **Native.**



F, U

## Owls

### Barn Owl

*Tyto alba*

A resident and rare migrant, this owl is crow-sized. It is tan above and white below with a pronounced heart-shaped white face and dark brown eyes. Feeds over marshes and golf courses in Bermuda. 46 cm (18 in).

**Introduced.**



F, U

## Sparrows

### White-throated Sparrow

*Zonotrichia albicollis*

An uncommon migrant and winter visitor. The breast is greyish and there is a white throat patch. The top of the head is striped black and white and there is a yellow spot between the eye and beak. A bird of thickets and shrubby forest edges. This sparrow measures 16-19 cm (6 1/2 to 7 1/2 in) in length. **Native.**



U, W

## Starlings

### Starling

*Sturnus vulgaris*

Abundant and widespread throughout Bermuda. The Starling measures 20 cm (8 in) long. This iridescent blackish bird has a short tail and a long yellow beak. **Introduced** from Europe to the US, from where it extended its range to Bermuda. **Naturalized.**



F, U, W



## Thrushes

### American Robin

*Turdus migratorius*

An uncommon vagrant to Bermuda. This is really quite an unmistakable bird with its characteristic reddish breast and grey back. In the male the head and tail are blackish; in the female these parts are grey. More a bird of meadows than woodland, it is nevertheless often seen in fairly open woodland in winter. 21-26 cm (8 1/2-10 1/2 in) long. **Native.**

F, U, W

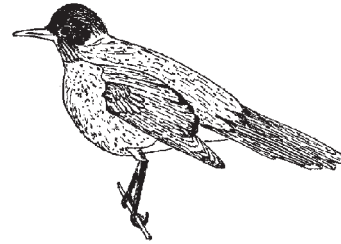

### Hermit Thrush

*Catharus guttatus*

The Hermit Thrush has a brown back and a spotted breast. The tail is a conspicuous rusty-red and the beak is slender. Very secretive, feeds on the ground in the understorey of woodland and mangroves. About 16-19 cm (6 1/2-7 1/2 in) in length. **Native.**

F



### Northern Waterthrush

*Seiurus noveboracensis*

A common migrant from northern North America seen in the spring, fall and winter walking on the edges of ponds, tidal flats and rain pools. This bird has a dark brown back, bright eyebrow, streaked below. The underparts and eyebrow are usually tinged yellow, sometimes more white. Most spend the winter in the mangroves but they can also be seen in woods and parks. Usually solitary and secretive but rather noisy. About 20 cm (8 in) long. **Native.**

F, FW



### Swainson's Thrush

*Catharus ustulatus*

This thrush is very dull in colouration. The back is grey to olive brown, the breast streaked with spots and there is a beige eye-ring. A very uncommon migrant. 16-19 cm (6 1/2-7 1/2 in) long. **Native.**

F

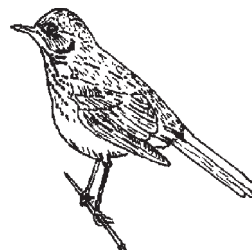

**Wood Thrush***Hylocichla mustelina*

The Wood Thrush is one of the larger thrushes. The breast and the sides are heavily spotted on a whiteish background. The back of the head is a very reddish brown which fades down the back. This thrush likes well-developed woodland. A rare migrant. Measuring 19-21 cm (7 1/2- 8 1/2 in) in length. **Native.**

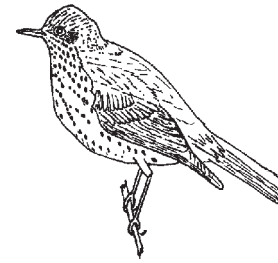

F

**Vireos****Bermuda White-eyed Vireo or Chick-of-the-village***Vireo griseus bermudianus*

The "Chick of the Village" is a small vireo measuring 13 cm (5 in) long. It is olive green above and white below with yellow sides. The adult has a white eye but more distinctive is the yellow eye-ring and double wing-bar. The Bermuda sub-species is **endemic.**

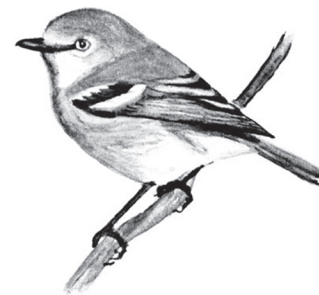

F, U

**Warblers****American Redstart***Setophaga ruticilla*

This warbler is common migrant and winter visitor to Bermuda. It tends to flit around rather like a butterfly. The male and female are rather different, the male being almost all black with bright orange patches on the tail and wings. The female, on the other hand is olive brown on the back and white below with yellow patches on wings and tail. Found in parks, gardens, mangroves and golf courses as well as woodlands. This small warbler is about 11-14 cm (4 1/2-5 1/2 in) long. **Native.**

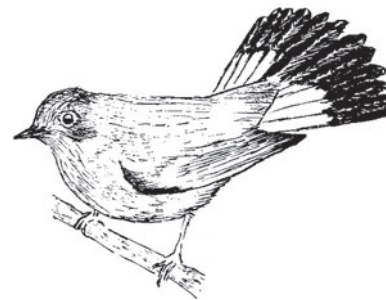

F, W

**Black and White Warbler***Mniotilta varia*

A bold stripe, black streaks on back and sides. The adult male has a black throat and cheeks. This bird is a common vagrant from eastern North America seen in the fall and spring in gardens, woods, orchards and mangroves feeding on the trunks and branches of trees. 13 cm (5 in) long. **Native.**



F, M

**Common Yellowthroat***Geothlypis trichas*

A brilliant yellow throat contrasts with white neck spot, black face and black stripes on sides. Grey back with white wing bars. This bird is a common vagrant from North America seen in the fall, spring and winter foraging for food in weedy wastelands, hedgerows, dunes and golf courses, dumps, aquatic vegetation around ponds. 13 cm (5 in) long. **Native.**



F, M

**Hooded Warbler***Wilsonia citrina*

This is a smallish warbler. Both sexes are brownish-green above and yellow below, but the male has a distinctive black hood on the head connecting to a black chin-patch. There are white areas at the outer corners of the tail. A warbler of thick woodlands and wooded swamps. Measuring 14-19 cm (5 1/2-7 1/2 in) long. **Native.**



F, M

**Kentucky Warbler***Oporornis formosus*

This warbler's main identification feature is a broad black stripe running down from the eye down the side of the yellow throat. There is a yellow ring around the eye. The back is olive-green. This warbler is typical of woodland thickets. Measures about 14 cm (5 1/2 in) long. **Native.**

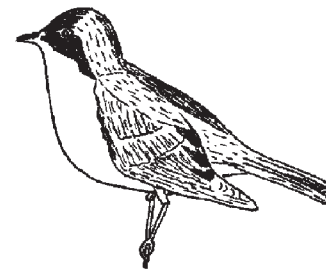

F, M

**Northern Parula***Parula americana*

A regular and common migrant warbler seen in spring and fall foraging in foliage in ones, twos, and small flocks on golf courses, in mangroves, parks, gardens, overgrown fields and woods. Blue-grey above, white wing bar, limited yellow throat and pale eye crescents. Adult male has black and rust chest bands. About 14 cm (5 1/2 in) long. **Native.**

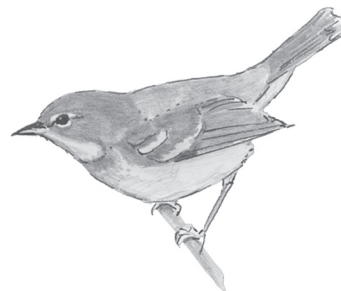

F, M

**Ovenbird***Seiurus aurocapillus*

The Ovenbird is one of the larger warblers, being sparrow-sized. It is a ground-feeding warbler of woodland. It is olive-brown on the back and striped on the breast. A good aid to identification is the orange patch on top of the head. One of Bermuda's most commonly occurring migrant warbler and winter visitor. 14-16 cm (5 1/2-6 1/2 in) long. **Native.**



F

**Palm Warbler***Dendroica palmarum*

A medium sized warbler 14 cm (5.5 in) long which is olive-brown on the back and yellow, streaked with chestnut below. There is a dark eye stripe. This warbler has a habit of wagging its tail while feeding on the ground. This bird is a common vagrant in Bermuda and may be seen in a variety of habitats including woodland, gardens and open spaces. **Native.**

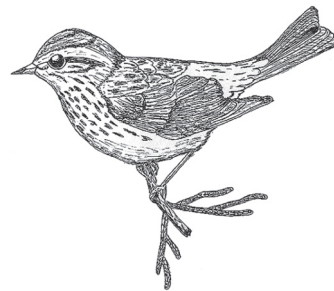

F, FW, M, W

**Prothonotary Warbler***Protonotaria citrea*

A regular, fairly common migrant from southeastern North America. Golden yellow head and chest, white under tail, blue-grey wings and tail with white tail spots. Female duller than the male. Most abundant in the early fall but can also be spotted in the spring and winter. Beautiful golden-yellow colour. Can be seen foraging in foliage in ones, twos and small flocks with other warblers. 12 cm (4 3/4 in) long. **Native.**



F, M

**Swainson's Warbler***Limnothlypis swainsonii*

This small warbler is olive brown above and a dirty white beneath. There is a conspicuous whitish stripe above the eye. Likes wooded swamps or thick shrub growths. A rare migrant. 13 cm (5 in) in length. **Native.**



F

**Worm-eating Warbler***Helminthos vermivorus*

This small warbler measures 12-14 cm (5 - 5 1/2 in) long. The body is a dull olive-green with alternating black and creamy stripes on the head. A stripe runs through each eye. Its habitat is shady woodlands where it feeds on hanging dead foliage. A regular migrant and winter visitor in small numbers. **Native.**



F, FW, M

**Yellow-rumped (Myrtle) Warbler***Dendroica coronata*

A regular migrant from northern North America, abundant in the fall and spring and seen occasionally in the winter. This bird has a bright yellow rump patch, white spots in its tail, and small yellow patch at the side of its chest. It has a white throat and well-defined cheek patch. The yellow-rump patch is obvious as the bird flies away. Usually seen in flocks with other land birds feeding on the ground on golf courses, farm land, parks, gardens and fields. 12-14 cm (5- 5 1/2 in) long. **Native.**



F, FW, M

**Waxwings****Cedar Waxwing***Bombcilla cedrorum*

Cedar Waxwings are quite frequently spotted in Bermuda but are not resident. Their most striking feature is a prominent crest, although the bright red spots, resembling wax droplets, at the tips of the main wing feathers are unique to waxwings. They are a delicate brownish-grey in colour and have a prominent black stripe through the eye. They reach 18 cm (7 in) in length and are fond of berries for food. **Native.**



F, U, W

## Woodpeckers

### Yellow-bellied Sapsucker

*Sphyrapicus varius*

A scarce migrant and winter visitor. The Sapsucker is a small woodpecker about 20-21 cm (8 - 8 1/2 in) long. The diagnostic feature is a longitudinal broad, white stripe on the fore part of the largely black wing. It has a red forehead patch and the male has a red throat. The throat on the female is white. A forest bird that feeds on sap that exudes from holes made in the bark. Evidence of feeding are the horizontal rows of holes around the trunks of trees. **Native.**



F, U

## Land Mammals

### Black Rat

*Rattus rattus*

The species is said to have been introduced into Bermuda on a captured Spanish grain ship towed into St. Georges by the privateer Frith in 1613. Blackish-grey in colour, the tail is always longer than the body. The eyes and ears are relatively large and the nose pointed. Adult body size, 17-23 cm (7-9 in). **Introduced.**



F, U

### Brown Rat or Norway Rat

*Rattus norvegicus*

The Norway rat probably reached the island on ships about the mid 18th Century. The tail is always shorter than the body and the nose blunt. Eyes and ears are relatively small. The pelt is rough and brownish and the underside grey. Adult body size, 20-28 cm (8-11 in). **Introduced.**



F, U



# Field Trips

## A Visit to the Forest

This section is a generalised field trip guide which can be carried out at a wide variety of forest locations. As long as there is a good stand of trees, no matter what type, this field exercise can be carried out. Several of the parks and nature reserves provide suitable locations; examples are Spittal Pond Nature Reserve, Nonsuch Island, Ferry Point Park, The Walsingham Park Reserve complex.

**Preparation.** Read this Project Nature Guide and find out anything you can on Bermudian forests and their history.

**Equipment.** Copy of Project Nature, Bermuda Forests. Clip-board and pencil. Several yard or meter sticks. 30ft or 10m measuring tape. A pair of binoculars for every few students would be good. A stiff wire probe at least a foot (30cm) long {A piece of coat-hanger is fine}. Plastic sandwich bags. A bottle of isopropyl rubbing alcohol and some paper towel.

**Dress.** Long pants and sturdy footwear are required.

**Observations.** At whatever location is selected, get into the forest, under the trees, rather than working on the edge or in a clearing.

1. Decide whether you are in an upland or lowland forest and make notes on your reasons for this decision.
2. Identify the main or **dominant** tree at the location. Try to name the second most important or **sub-dominant** tree. For both these trees state whether they are **endemic, native** or **introduced**. If other trees are present try to identify them and comment on how common they are. *(Note: **Dominance** is usually judged on the basis of which species contributes the majority of the biomass [living weight] in a community. The dominant organism is taken to be the most important one. The sub-dominant is the species below the dominant in terms of biomass. One can go on to name the sub-sub-dominant etc.)*
3. If there are herbs, shrubs, vines, mosses or ferns in the ground and shrub layers, list as many species as you can, make notes on how common they are. Does the abundance of plants in these lowest two layers have any relationship to how much light penetrates through the leafy canopy above? If you have time, mark out a square 15ft by 15ft (5x5m) on the forest floor and count either a) the total number of plants in it, b) the totals of trees, shrubs, vines, herbs and ferns, or c) as a maximum the number of specimens of each species.
4. Look carefully at the forest structure and identify a) The Canopy, b) The Sub-canopy, c) The Understorey or Shrub Layer and d) The Ground or Herb Layer. Make a sketch of this structure, estimating the height of each layer. Decide where the greatest weight of plant material would be located.
5. If it is windy note how the wind is affected by each of the forest layers. Look at the amount of movement in leaves to get a good idea of this. Where is the wind velocity highest? Where is it lowest?
6. Measure the slope of the ground using a clinometer. If you don't have access to a clinometer, a method for making a simple one is given on page 12-6.

7. Is it cooler or warmer in the forest than in the open? Is it more or less humid? Are these differences altered in different weather conditions and why are they different?
8. Look at the ground surface. Is it covered with fallen leaves, and if so from which tree? Would this vary with the seasons?
9. Look at the soil under the trees. Is it light or dark coloured? Does it have a lot of partially rotted plant remains in it? If you have a wire probe with you, push it into the soil to see if it is deep or shallow.
10. For each 5 students collect a small, but typical, sample of soil in a small plastic bag. This can later be examined to note its texture, colour, any identifiable remains and its general characteristics. Try to compare it with a sample from a garden and explain the differences observed. If desired a more thorough study of the forest soil can be done; some guides for doing this are appended to this guide.
11. Look for larger animals. See if you can see any birds, lizards, toads or frogs. If you can try to identify them.
12. Look carefully for insects, some of which may be tiny, on the plants or on the surface of the soil. If you find any try to decide what they may be eating.
13. Write a description of how the forests of Bermuda have changed since the arrival of man. Make suggestions on how we may preserve samples of forest in as near a natural state as possible. Try to explain the importance of the forests of Bermuda (Think about endemic species and unique habitats).
14. Look for evidence of pollution and disturbance. How can these undesirable processes be minimised?

**Caution. In this and any other natural biological system in Bermuda, be aware that some or even many of the plants and animals may be rare or even endangered. Do not pick anything and try not to trample things on the ground. Take any soil samples where it does not affect small plants.**

**Possible Hazards.** The biggest potential hazard is Poison Ivy. If this shrub is present have it pointed out to you and try not to touch it. If you do touch it wipe the area of contacted skin off as soon as possible with rubbing alcohol. This will stop any effects of this nasty plant.

Always watch out for trash, such as broken glass or cans.

**Additional Pre-visit, On-site and Post-visit Activities  
for a variety of age groups follow.**

**FIELD STUDY**

Group Name: \_\_\_\_\_

Location: \_\_\_\_\_

Description of Area to be Studied: \_\_\_\_\_

\_\_\_\_\_

Date: \_\_\_\_\_ Time: \_\_\_\_\_

Weather Conditions: \_\_\_\_\_

Survey Details:

i) Length of transect \_\_\_\_\_

ii) Intervals of sampling \_\_\_\_\_

iii) Other relevant information \_\_\_\_\_

\_\_\_\_\_

\_\_\_\_\_

\_\_\_\_\_

**Sketch map to show area sampled:**

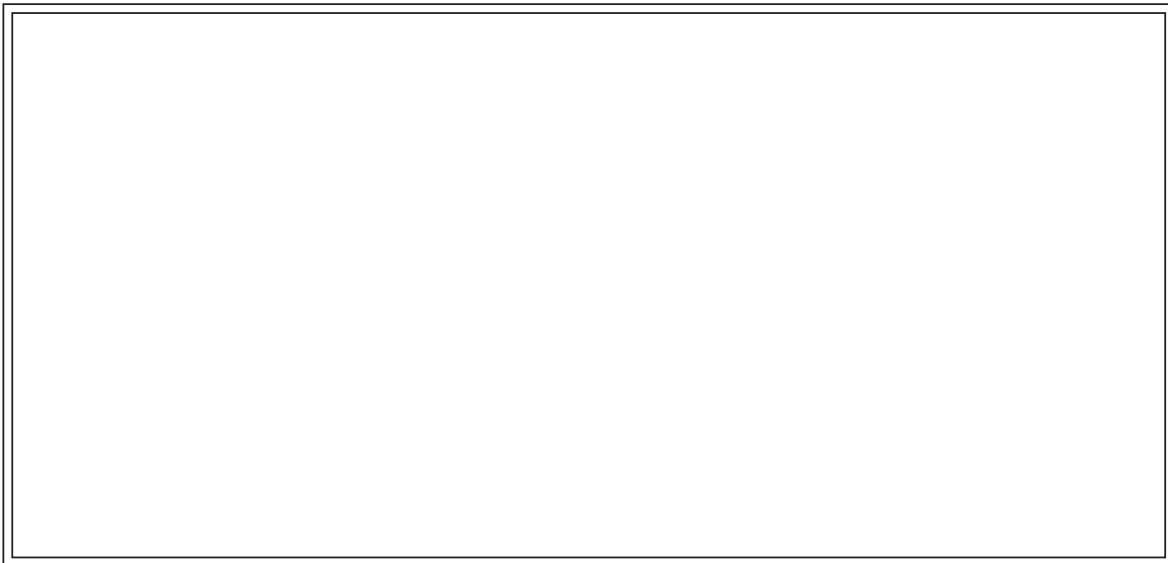

Any other information: \_\_\_\_\_

\_\_\_\_\_

\_\_\_\_\_

**Continued on next page**



**Construct a Clinometer** (for measuring ground slope)

**Materials:**

Sheet of thick card (5 mm thick)  
 Sheet of firm card  
 Tape  
 Protractor  
 Straw  
 Matchbox

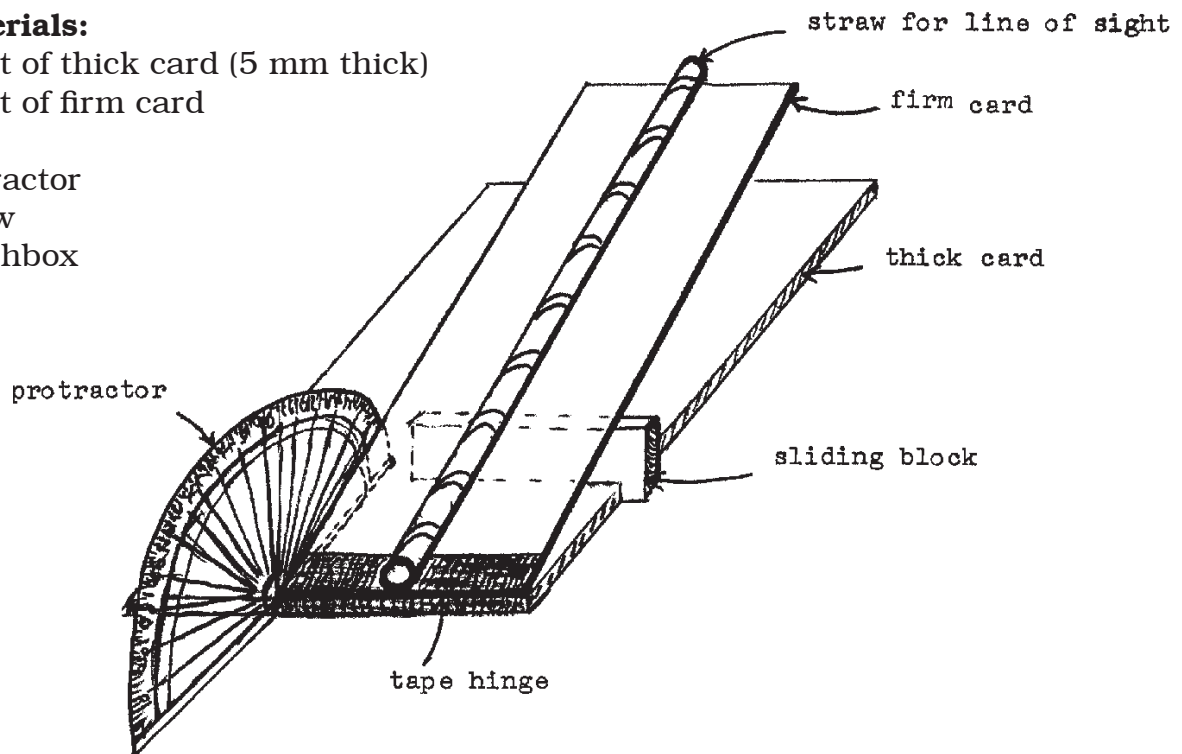
**Procedure:**

- Cut a rectangle of the thick card measuring 18 cm x 8 cm for the base. Cut a rectangle of the firm card measuring 6 cm x 18 cm. Using a piece of tape, hinge the firm card onto the thick card as shown in diagram. Glue a straw lengthwise on the centre line.
- Cut a 5 cm groove in the base so that a protractor will fit tightly into it. Place the protractor so that only half fits and the 0°-180° line is exactly level with the top of the firm card.
- A sliding block (matchbox) will help steady the hinged card when adjusting to line of sight.

**Notes:**

Use for "How High is a Hillside" activity on next page.



**How High is the Hillside**

**Name:** \_\_\_\_\_ **Date:** \_\_\_\_\_

**Materials:**

- |                |                |
|----------------|----------------|
| Clinometer (*) | Measuring tape |
| Metre stick    | String         |

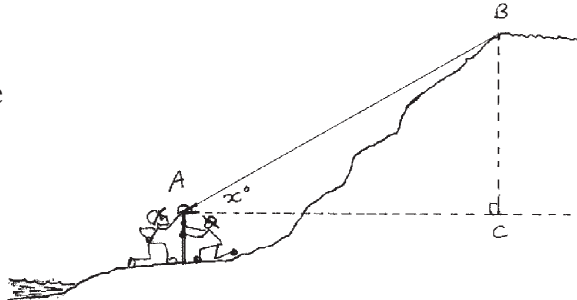

**Procedure:**

- One student holds the clinometer 1 metre above the soil at the bottom of the slope making sure the clinometer is level.
- His partner adjusts the clinometer and sights the top of the hill. The angle formed ( $x^\circ$ ) is recorded.
- The distance from the clinometer to the top of the hill is measured. This can be done using a string and then measuring the string.
- Construct angle  $x^\circ$  on paper extending the horizontal (base) line. Select a suitable scale and draw AB to scale. Drop a line (BC) perpendicular to the base.
- Measure BC, convert using the scale, add 1 metre and that is the height of the hill.

**Results:**    Distance AB = \_\_\_\_\_                      Angle x = \_\_\_\_\_  
                     Distance BC = \_\_\_\_\_                      Angle c = 90°

**Conclusion:**                      The height of the hill = \_\_\_\_\_

\* See page 8-6 for instructions for making a clinometer.

**Test Wind Speed and Direction**

**Name:** \_\_\_\_\_ **Date:** \_\_\_\_\_

**Materials:**

Paper streamer or anemometer  
Compass

**Procedure:**

Use the anemometer or hold a paper streamer at arm's length and pretend that it is the arm of a clock. If it hangs vertically, it is six o'clock and there is no wind. Record below the wind speed on the anemometer or whether the streamer stayed at six o'clock, or moved to seven, or eight, or nine o'clock.

\_\_\_\_\_ Holding paper streamer/anemometer over your head

\_\_\_\_\_ Holding paper streamer/anemometer at your waist

\_\_\_\_\_ Holding paper streamer/anemometer down near the ground

- Use the compass and record the wind direction.
- Record wind speed during your visit, e.g. every 15 minutes.
- Write your conclusions:

\_\_\_\_\_  
\_\_\_\_\_  
\_\_\_\_\_

**Extension:**

*Compare your results with the weather report in the newspaper.*

**Notes:**

**Temperature Recording**

**Name:** \_\_\_\_\_ **Date:** \_\_\_\_\_

**Materials:**  
Thermometer

Put the thermometer in each position listed below for about a minute. Read each temperature and record it below.

\_\_\_\_\_ At shoulder height (hold thermometer carefully; keep your fingers off the bulb)

\_\_\_\_\_ At the surface of the soil

\_\_\_\_\_ 3" into the soil

**Points to think about:**

- Has it been sunny, cloudy or raining?
- How would the above factors possibly change your results?
- Write your observations and conclusions:

\_\_\_\_\_  
\_\_\_\_\_  
\_\_\_\_\_

**Notes:**

**Plants of Bermuda's Forests**

**Name:** \_\_\_\_\_ **Date:** \_\_\_\_\_

**Procedure:**

Choose 2 plants which grow in the forests of Bermuda. Make well observed drawings of the plants in the boxes below.

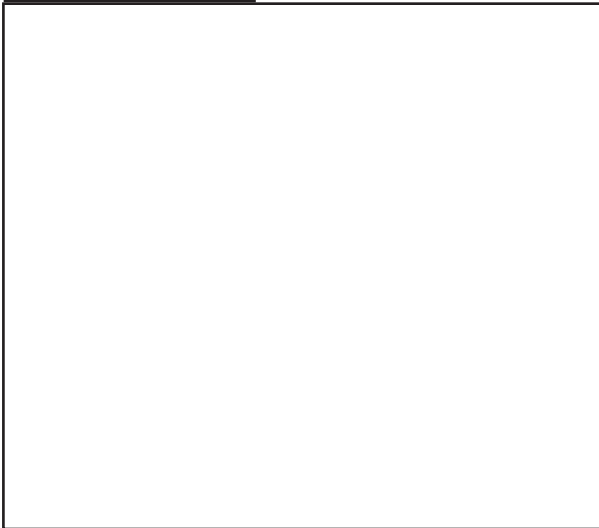
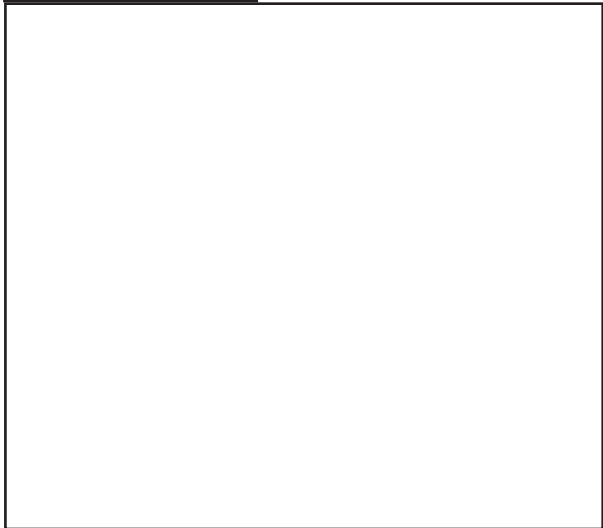
Name of Plant	Name of Plant
	

Comment on the following features for each plant:

- 1) Height of plant  
\_\_\_\_\_
- 2) Texture and thickness of leaves  
\_\_\_\_\_
- 3) Growth pattern of plant (Is it bushy or thin, etc.)?  
\_\_\_\_\_
- 4) Is the plant in a sheltered or exposed area?  
\_\_\_\_\_
- 5) How deep and damp is the soil?  
\_\_\_\_\_

---

---

**Plants of Bermuda's Forests** (Continued)

6) Is the ground rocky, sandy, hilly or flat?

\_\_\_\_\_

**Conclusions:**

What features are common to plants which grow in the Bermuda forests?

---

---

---

---

---

---

---

---

**Plant Life In the Forest**

**Name:** \_\_\_\_\_ **Date:** \_\_\_\_\_

**Materials:**

Clipboards

Flat crayon

Extra paper for plant rubbings

**Procedure:**

In the box below, draw and name one plant you find in the forest. Label all adaptations that enable it to survive its habitat.

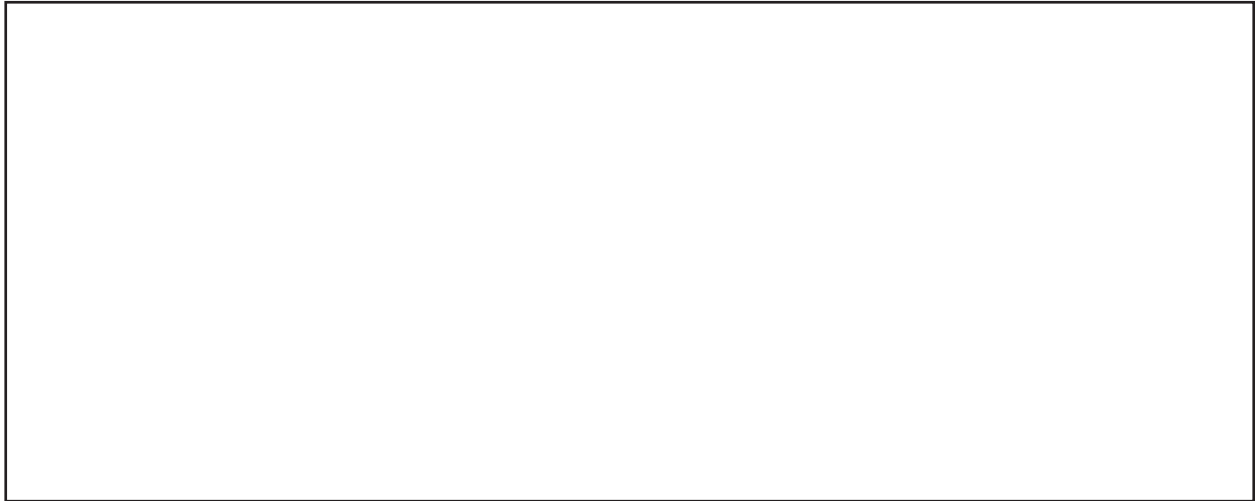

Are there any creatures living under/on the plant you found? Describe them and where you found them.

**Plant Rubbing:**

Place plant part between board and paper - use flat side of crayon and rub gently.

**Discussion:**

- What inter-relationship might exist between plants and animals?
- Are these plants beneficial or a nuisance? (*oxygen suppliers/wind break/shelter/home/food*)
- What would plants in the forest do over a period of time? (*erode rocks/build up soil?*)
- Which plants are native/naturalised?



**Forest Observations**

**Name:** \_\_\_\_\_ **Date:** \_\_\_\_\_

Draw and describe examples of the following forest organisms:

Birds	Reptiles and Amphibians
Invertebrates	Plants (bushes)
Plants (trees)	Plants (flowers)

**Bird Watching**

**Name:** \_\_\_\_\_ **Date:** \_\_\_\_\_

**Materials:**  
Binoculars  
Field guides

- Procedure:**
- Look for local birds and visiting migratory birds. (Try not to disturb them).
  - Observe their shape, size, colour, location and behaviour.
  - Record your observations below.

See Eco File document BIR-01, Birdwatching in Bermuda, for more information.

\* The ECO FILE is a collection of information documents on Bermuda natural history topics. It can be found in all school and public libraries in Bermuda.

**Bird Mobiles****Materials:**

Card

Crayons

Bird information sheet from field trip or information sheet about Bermuda song birds

String

Mobile sticks

**Procedure:**

- Draw and colour a bird
- Attach string and hang from stick
- Assemble whole into mobile

**Endangered Bermuda Birds****Procedure:**

Read the Eco File document BIR-02, Breeding Birds of Bermuda

**Discussion:**

Discuss how the bluebird is threatened and how we can help it.

*The following points should arise:*

- *loss of habitat / cedar blight*
- *competition from introduced birds*
- *bluebird nesting boxes*

**Bird Poems**

Write a poem about a bird you observed. Describe what the bird looked like, what it was doing and where you saw it.

**Notes:**

- \* The ECO FILE is a collection of information documents on Bermuda natural history topics. It can be found in all school and public libraries in Bermuda.

**Design a Forest**

**Name:** \_\_\_\_\_ **Date:** \_\_\_\_\_

- In the box below draw your ideal forest. Show the ground features and the access paths.
- List and/or illustrate the plants (including trees) and animals found in your forest.

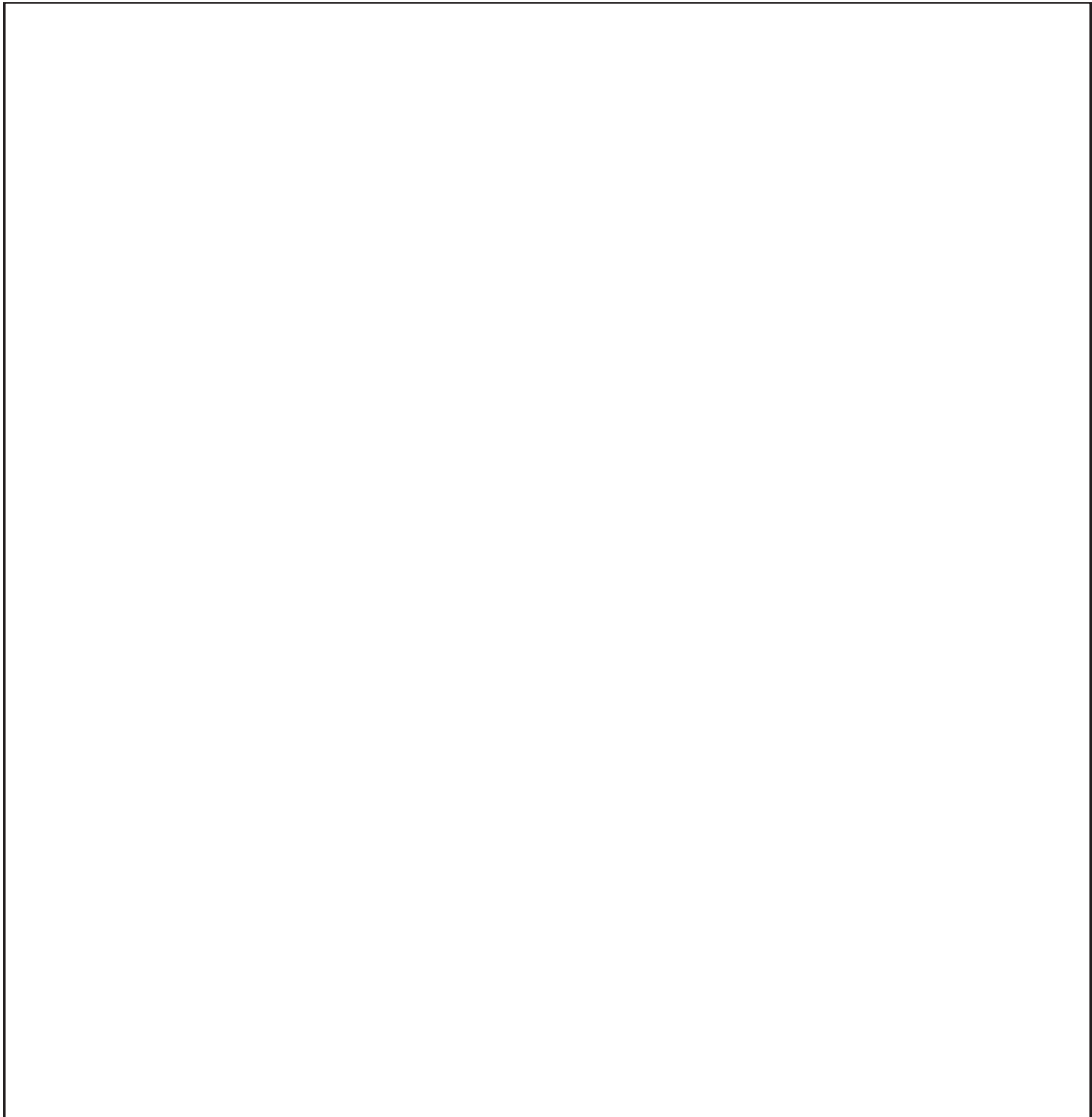

**Forest Creature Card Game****Materials:**

Index Cards  
Pencils etc.  
Glue

Students should make pairs of cards; one showing only the organism's name and the other showing only an illustration of that organism. (You may wish to laminate the cards). You should make enough pairs to play the game below.

**Possible Cards :**

Cedar	Jamaican lizard
Palmetto	Warwick lizard
Olivewood	Kiskadee
Fiddlewood	Tree frog
Mexican pepper	Ant

**Procedure:**

The student will try to obtain the most pairs of cards (i.e. animal/plant and name card) in the card game "FISH". Deal four cards to each player. In rotating order, one player selects one other player to ask for a card to match the one in his/her hand. If the player does not have the card, he/she tells the "requesting player" to "fish" (to pick a card from the deck). If the player is given the card that was requested, he/she puts the pair face down in front of him/her and is allowed to request another card from another player. As pairs are accumulated and the game has ended, players count their pairs. The player with the most pairs wins.

**Extension:**

*Cards could be used on future field trips for a "locating" game.*

**Notes:**

**Geology of Bermuda**

The “Geology of Bermuda” lesson at Bermuda Aquarium Museum and Zoo is recommended as a pre-requisite to the Field Trips - Contact the Education Coordinator at BAMZ.

**Test for limestone****Materials:**

Piece of rock  
Dish  
Vinegar (acid)

**Procedure:**

Take a small piece of rock  
Pour vinegar over it

**Discussion:**

- What happens when vinegar is added?  
*Bubbles appear, holes appear, sediment collects in container.*
- Acid in rain (although weak) over a long period of time gradually eats away at rocks (*honeycomb effect*).

**Notes:**



**The Composition of Soil**

**Name:** \_\_\_\_\_ **Date:** \_\_\_\_\_

**Materials:**

Dry soil samples  
Microscope  
Slides or petri dish  
Needles

**Procedure:**

- Place a small sample of soil on the slide or petri dish. Examine the soil sample under the microscope.
- Use the needle to separate the soil. Record your observations.
- List any materials that you can recognise.
- Draw a sample of the soil.

**Discussion:**

- Do your observations provide any clues to how soil is formed?
- Can you recognise any soil components?
- What colour is the soil sample?
- Do samples of different colours have different components?

**The Composition of Soil**

**Name:** \_\_\_\_\_ **Date:** \_\_\_\_\_

**Materials:**

Soil sample(s) from the forest

A tall transparent container of uniform thickness, e.g. measuring cylinder or tennis ball container

Water

**Procedure:**

- Half-fill the container with a soil sample.
- Fill the container with water.
- Carefully shake the soil and water to distribute the soil.
- Wait for approximately 5 minutes until the sample has settled.
- Observe and draw the various layers which the soil has settled into.

**Discussion:**

- The contents settle according to their mass.
- What layers were observed?
- Were the layers the same for all samples?
- Can this experiment predict how fertile a soil may be?

**The Permeability of Soils**

**Name:** \_\_\_\_\_ **Date:** \_\_\_\_\_

**Materials:**

- Tin can with one end removed
- Tin can with both ends removed
- Metric ruler
- Piece of wood
- Watch with a second hand
- Water

**Procedure:**

- Choose an area on-site to be tested.
- Use the piece of wood to press the can with both ends removed into the ground a few centimeters.
- Place the ruler against the inside of the can.
- Pour water into the can to a depth of 10cm.
- Record how many seconds it took for the first 5cm of water to be absorbed.
- Record how many seconds it took for the next 5cm of water to be absorbed.
- Move to a different location close by the first one and repeat the procedure.
- Take 5 locations and average the results.

**Results:**

<b>Trial #</b>	<b># seconds for 1st 5 cm to absorb</b>	<b># seconds for 2nd 5 cm to absorb</b>
<b>1</b>		
<b>2</b>		
<b>3</b>		
<b>4</b>		
<b>5</b>		
<b>Total</b>		
<b>Average</b>		

**Discussion:**

- Was there a difference in the absorption rate for the first and second 5cm samples? If so, can you explain this?
- What does the term permeability mean?
- How do you think the rate of permeability affects plant growth?

**The Porosity of Soils**

Name: \_\_\_\_\_ Date: \_\_\_\_\_

**Materials:**

Sand  
Clay  
Gravel  
Top soil  
Graduated cylinder  
Water  
5 paper cups

**Procedure:**

- Fill one cup  $\frac{3}{4}$  full of sand.
- Fill one cup  $\frac{3}{4}$  full of clay.
- Fill one cup  $\frac{3}{4}$  full of top soil
- Fill one cup  $\frac{3}{4}$  full of gravel
- Fill one cup  $\frac{3}{4}$  full of a mixture of sand, clay, topsoil and gravel.
- Fill the graduated cylinder with water and record the volume.
- Slowly pour water into the cup of sand until a very small amount of water can be seen above the surface of the sand, allow time for settling.
- Record the amount of water added to the sand.
- Repeat the above procedure adding water to each sample in turn.

**Record Results:**

Soil Type	ml of water held
sand	
clay	
topsoil	
gravel	
mixture	

**Discussion:**

- Which type of soil held the most water?
- Which type of soil held the least water?
- Why do you think some soils are able to hold more water than others?
- How does the porosity of soil affect plant growth?

**Growing Plants**

**Name:** \_\_\_\_\_ **Date:** \_\_\_\_\_

**Materials:**

250ml (1 cup) sand  
250ml (1 cup) soil sample(s) taken from different locations  
Paper cups  
Foam meat trays  
Seeds (radish or alfalfa)  
Measuring cup  
Water

**Procedure:**

- Poke a hole in the bottom of each paper cup and place it on a foam tray.
- Place the measured sample of sand into a cup, place each soil sample into a different cup.
- Place 8 seeds in each cup and cover lightly with soil.
- Pour 60 ml (1/4 cup) water into each cup, continue to water each cup approximately every 2 days.
- Examine the cups every day for 2 weeks and record your observations.

**Discussion:**

- Did all of the soil samples produce plants?
- Did the time for germination differ between samples?
- Were there any differences in the plants in different samples?

**Every Litter Bit Helps**

**Name:** \_\_\_\_\_ **Date:** \_\_\_\_\_

**Materials:**

Trash bag  
Worksheet

**Procedure:**

- Collect debris (leave potentially hazardous items where you find them and report them to The Parks Department, Agriculture & Fisheries).
- Sort debris (on site or in classroom)
- Record your findings on the worksheet below. Recycle all you can.

<b>Worksheet</b>				
<b>Type</b>	<b>Degradable</b>	<b>Man Made</b>	<b>Quantity Found</b>	<b>Recyclable</b>
<i>e.g. Bottles</i>	<i>No</i>	<i>Yes</i>	<i>10, various types</i>	<i>Yes</i>
<b>Soda Cans</b>				
<b>Bottles</b>				
<b>Shoes</b>				
<b>Rope</b>				
<b>Plastic Bits</b>				
<b>Paper</b>				
<b>Styrofoam</b>				
<b>Metal</b>				
<b>Wood</b>				
<b>Cloth</b>				
<b>Cigarette Butts</b>				
<b>Other</b>				

**Every Litter Bit Helps** (Continued)

- Make a pie or bar graph to illustrate your results.
- Can you use your graph to answer these questions?
- How many kinds of litter did you find?
- Which type of litter do you predict a friend would find if you sent him/her to the area where you found your litter?
- What other inferences could you make from your graph?
- Prepare a list of suggestions for reducing the amount and type of litter you collected.

**Discussion:**

- Is any of this litter harmful to creatures?
- In what ways is the litter a nuisance to humans?

**Notes:**



**Environment-picture Problems**

**Name:** \_\_\_\_\_ **Date:** \_\_\_\_\_

**Materials:**

Find some pictures or do drawings in the boxes below to make up environment-picture problem cards.

**Procedure:**

- Discuss environment problems found in Bermuda Forests.
- Have students make environment-picture problem cards.

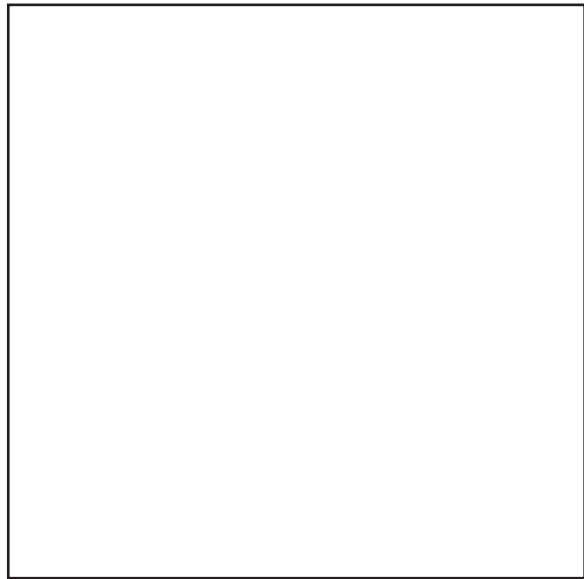
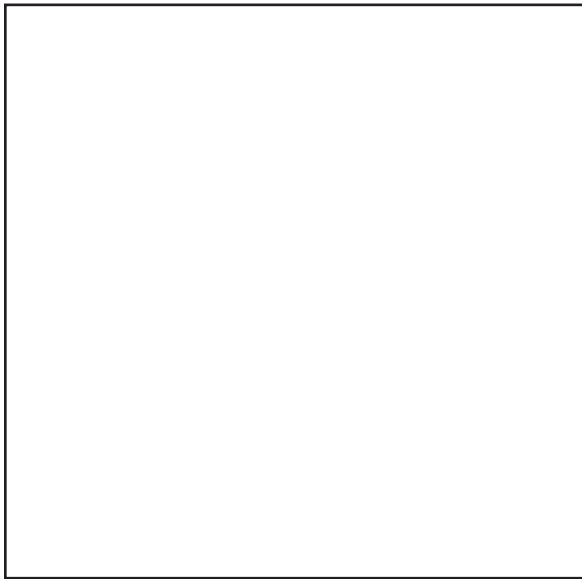

**Notes:**

**Species Variation Maths**

**Name:** \_\_\_\_\_ **Date:** \_\_\_\_\_

**Materials:**

Rulers  
Paper

**Procedure:**

- Locate several plants of the same kind.
- Measure and record their height and width.
- Carefully measure and record the length and breadth of several leaves on each plant.
- Compute the average plant height, width and leaf size.
- Can you think of any explanation for the variations?

	Plant 1	Plant 2	Averages
<b>Height</b>			
<b>Width</b>			
<b>Leaf 1 - Length</b>			
<b>Leaf 1 - Breadth</b>			
<b>Leaf 2 - Length</b>			
<b>Leaf 2 - Width</b>			

**Conclusions:** \_\_\_\_\_

**Extension:**

*Many other features can also be measured; size of flowers, length of stem etc. The students may be surprised at the variations within the species.*

## Glossary

<b>Aeolianite</b>	Rock created by the lithification of wind-blown sand.
<b>Alternate</b>	Not opposite one another; arranged singly at different heights and on different sides of the stem.
<b>Annual</b>	Of one year's duration from germination to maturity to death.
<b>Aromatic</b>	Fragrant, pleasant smelling.
<b>Axil</b>	The point where a leaf arises from the stem or stalk.
<b>Barbed</b>	Having a set of short, stiff bristles at either end and/or sides that are sharply slanted downward or backward.
<b>Bio-deposition</b>	The creation of rock by biological processes.
<b>Biological Control</b>	Use of living organisms to control pests.
<b>Biota</b>	Living organisms. Includes animals, plants and microorganisms.
<b>Bract</b>	A modified and often brightly coloured leaf. Often mistaken for a petal.
<b>Canopy</b>	The top layer of a forest containing the bulk of the tree leaves.
<b>Climax</b>	The final community in succession in which change is very slow.
<b>Carnivorous</b>	A flesh-eating animal, feeding on herbivores, detritivores (animals feeding on dead material) or other carnivores.
<b>Carrying capacity (physical)</b>	The intensity of human activity that a natural ecosystem can absorb without harm.
<b>Carrying capacity (social and cultural)</b>	The intensity of human activity that a social or cultural system can absorb without harm.
<b>Chitin</b>	A tough material giving strength to the outer body wall of insects and a few other organisms.
<b>Clasping</b>	Partially or completely surrounding the stem.
<b>Clusters</b>	Close group or bunch of similar things growing together.
<b>Community</b>	A naturally occurring group of organisms.

---

---

<b>Competition</b>	A biological process where two or more organisms attempt to utilise the same essential resource.
<b>Compound leaf</b>	One leaf made up of several to many small “leaves”. Ex. Royal Poinciana.
<b>Conifer</b>	Any evergreen tree of a group usually bearing cones, includes pines, yews, cedars and redwoods.
<b>Conservation</b>	The protection, preservation and careful management of natural resources and of the environment.
<b>Conserve</b>	To keep or protect from harm, loss or decay, to save.
<b>Conservationist</b>	A person who advocates or strongly promotes preservation and careful management of natural resources and of the environment.
<b>Cord</b>	A strand of strong tissue. Ex. hamstring.
<b>Develop</b>	(1) to exploit or make available the natural resources of a country or a region (2) to improve the value or change the use of land, as by building.
<b>Deciduous</b>	Shedding all or nearly all of the foliage each year.
<b>Developer</b>	A person who develops property.
<b>Development</b>	(1) the act or process of growing, progressing, or <u>developing</u> . (2) an area or tract of land that has been developed or has an assigned use.
<b>Dominant</b>	Refers to the most important organism in a community. Usually taken as the one contributing the greatest biomass.
<b>Dune</b>	A hill of sand created by the wind.
<b>Ecology</b>	The external surroundings in which a plant or animal lives which tend to influence its development and behaviour.
<b>Ecosystem</b>	A system involving the interactions between a community and its non-living environment.
<b>Elliptic</b>	Oblong but narrowed to rounded ends and widest at or about the middle.
<b>Endemic</b>	An organism that has evolved to a new species that does not naturally occur elsewhere.

---

---

---

<b>Entomology</b>	Study of Insects.
<b>Environment</b>	Living and non-living surroundings of natural groups of organisms.
<b>Evolved</b>	Developed in the past to a new species, in the process of natural selection.
<b>Evergreen</b>	A plant whose leaves remain green and functional throughout the year.
<b>Exoskeleton</b>	<b>(Gk. exo, without, skeleton, hard)</b> The external supportive covering of certain invertebrates, such as arthropods
<b>Exploit</b>	To make the best use of or to take advantage of a person or a situation for one's own ends.
<b>Extinction</b>	The total disappearance of a species from the Earth.
<b>Family</b>	A group of closely related plants that are similar in basic structure and reproductive characteristics.
<b>Fibroin</b>	The liquid protein which provides spiders' silk.
<b>Foliage</b>	Leaves.
<b>Forest stand</b>	An area of forest characterised by a particular tree.
<b>Fronde</b>	Leaf of a fern; sometimes used in the general sense of a large compound leaf, especially of palms.
<b>Fruit</b>	The part of the plant that carries the seeds. It is not necessarily edible.
<b>Gastropod</b>	A mollusc with a single, normally coiled, shell. Eg. A snail.
<b>Genus (pl. genera)</b>	A closely related group within a family. A family may contain many genera.  Genus is the first of the two words that scientifically name a plant. Species is the second. Genus and species are internationally consistent.
<b>Globular</b>	Ball-shaped.
<b>Gulf Stream</b>	A large oceanic current issuing from the Gulf of Mexico and moving NE off the E coast of the USA.
<b>Habitat</b>	A small area of environment.

---

---

---

<b>Herb</b>	A relatively small non-woody flowering plant.
<b>Herb Layer</b>	The layer of a forest immediately above the ground, dominated by herbs.
<b>Herbivore</b>	An animal that feeds on plants only.
<b>Ice Age</b>	A very long period of time in the history of the Earth when global temperatures were well below average.
<b>Ice Cap</b>	Accumulation of ice around the poles during an ice age.
<b>Introduced</b>	Plant or animal introduced to Bermuda by man.
<b>Invasive</b>	An introduced plant which has become naturalised and grows and reproduces aggressively, displacing native and endemic plants. (e.g. Mexican Pepper).
<b>Leaf Scars</b>	Characteristic patterns left on a stem when a leaf is shed.
<b>Leaflets</b>	One of several “leaves” that, together, make a compound leaf.
<b>Lithification</b>	The cementation of sand into rock.
<b>Lobed</b>	Roughly shaped like the lobe of an ear.
<b>Lowland Forest</b>	A forest developed in well drained valleys.
<b>Metamorphoses</b>	To undergo the process of metamorphosis or to undergo an abrupt change in body structure, transforming from the larval to the adult stage, e.g. a caterpillar metamorphoses into a butterfly. The process is widespread among marine invertebrates e.g. arthropods such as barnacles.
<b>Mobile Dune</b>	A sand dune that moves steadily downwind.
<b>Native</b>	Plant or animal occurring naturally on Bermuda but also abroad.
<b>Naturalised Species</b>	A species introduced by man. Not endemic or native but self-propagating and firmly established.
<b>Oblong</b>	Longer than broad and with the sides nearly or quite parallel most of their length.
<b>Omnivore</b>	An animal that feeds on plants and animals.
<b>Ornamental Plants</b>	Plants that have been introduced to Bermuda for their decorative value (e.g. Hibiscus and Oleander).

---

---

---

---

<b>Oval</b>	Egg shaped.
<b>Perennial</b>	Living 3 or more years.
<b>Pinnate</b>	A type of leaf structure where the leaf is divided regularly into leaflets along each side of the central vein.
<b>Pioneer Plant</b>	A plant adapted to the colonisation of newly created environment.
<b>Pod</b>	A long fruit (Ex. a pea pod) that splits open when dry.
<b>Production</b>	The synthesis of new organic matter by green plants.
<b>Pulmonata</b>	Snails and slugs.
<b>Red Beds</b>	Accumulations of reddish soil derived from atmospheric fallout.
<b>Ribbed</b>	Having prominent veins or marked with ridges.
<b>Scale</b>	A small leaf or bract, closely and flatly pressed against something else.
<b>Shrub</b>	A woody plant smaller than a tree with very short stems and branches near the ground.
<b>Species</b>	The basic unit in scientific classification applied to organisms that are genetically and physically similar. They can interbreed and produce viable offspring of life. There may be many plants in the genus named <i>Asparagus</i> but <i>Asparagus</i> defines a group of more than 100 plants. <i>Asparagus densiflorus</i> means only <u>one</u> type of plant. The species name <i>densiflorus</i> tells us exactly which plant we mean.
<b>Spore</b>	A simple reproductive body usually composed of a single detached cell, and containing a nucleated mass of protoplasm (but no embryo) and capable of developing into a gametophyte.
<b>Stalk</b>	A more or less long and slender support of a plant, leaf, flower, fruit etc.
<b>Stratified Ecosystem</b>	An ecosystem showing pronounced horizontal layering.
<b>Sub-canopy</b>	The layer of forest directly below the canopy, generally quite open.

---

---



<b>Succession</b>	An orderly and predictable series of changes in an ecosystem.
<b>Succulent</b>	Juicy, fleshy and usually also rather thick.
<b>Sustainable Development</b>	Development which meets the needs of the present without compromising the ability of future generations to meet their needs.
<b>Swamp Forest</b>	A forest developed on permanently waterlogged ground.
<b>Tanning</b>	Converting raw hide into leather by soaking in a liquid containing tannic acid.
<b>Tendril</b>	A threadlike, usually spiral plant organ used to anchor some vines to their support.
<b>Tuber</b>	Short, thick, usually underground root or stem that serves as a storage organ. Ex. potato.
<b>Understorey</b>	The forest layer above the ground, usually shrub-dominated.
<b>Upland Forest</b>	A forest developed on hills.
<b>Vine</b>	An elongated plant that is not self-supporting. It may either trail along the ground or grow up using other plants or structures for support.
<b>Viscera</b>	Internal organs of the body.
<b>Weed</b>	A wild plant growing where it is not wanted.
<b>Whorl</b>	A circle of 3 or more leaves or flowers joined at one joint or knob.

## Bibliography

### Geology

Thomas, M. L. H. and Logan, A. 1991. **A Guide to the Ecology of Shoreline and Shallow Water Marine Communities of Bermuda.** Bda. Biol. Sta. For Research, Spec. Publ. #30. 346p

Thomas, M. L. H. 1998. **Marine and Island Ecology of Bermuda.** Bermuda Aquarium Natural History Museum and Zoo, Bermuda Zoological Society and Friends of the Bermuda Aquarium. 148p.

Vacher, H. L. 1986. **Geology of Bermuda.** Public Works Department, Hamilton. 316p

Verrill, A. E. **The Bermuda Islands. Pt.4, Geology and Palaeontology.** Trans. Conn. Acad. Arts Sci. 12, 316p.

### Plants and Forests

Phillips-Watlington, C. 1996. **Bermuda's Botanical Wonderland.** MacMillan Education Limited. 128p.

Thomas, M. L. H. 1998. **Marine and Island Ecology of Bermuda.** Bermuda Aquarium Natural History Museum and Zoo, Bermuda Zoological Society and Friends of the Bermuda Aquarium. 148p.

### Development vs. Conservation

The Bermuda Government, Department of Planning. September 1991. **Bermuda 2000: Facing the Future.** Island Press Limited, Hamilton, Bermuda.

The Bermuda Government, Department of Planning. **The Bermuda Plan 1992 Information Sheet.**

The Bermuda Government, Department of Planning. April 1994. **The Bermuda Plan 1992: Planning Statement.** Bermuda Press Limited.

The Bermuda Government, Department of Planning. **The Role of Planning.** Document prepared for the "Bermuda 2000" Exhibition.

Frith, Jeremy, 1983, **Agriculture, Bermuda's Delicate Balance**, edited by Hayward, Stuart, Gomez, Vicki and Sterrer, Wolfgang, Ph.D., pp. 137-145.

Hayward, Stuart J., Gomez, Vicki Holt and Sterrer, Wolfgang, ed. 1982. **Bermuda's Delicate Balance.** Island Press, Hamilton, Bermuda.

Hayward, Stuart J. and Brian Rowlinson. 1983, **Land. Bermuda's Delicate Balance**, edited by Hayward, Stuart, Gomez, Vicki and Sterrer, Wolfgang, Ph.D. pp., 71-92.

Jickells, Sue, 1983. **Plants and Animals. Bermuda's Delicate Balance**, edited by Hayward, Stuart, Gomez, Vicki and Sterrer, Wolfgang, Ph.D. pp. 154-166.

Rowlinson, Brian, Speech to Rotary Club. November 18, 1997. **Planning - The Original Balancing Act.** The Bermuda Government, Department of Planning.

Titterton, Glen, M., 14th October. 1986. **Conservation vs. Exploitation: Controlling Development.** The Bermuda Government, Department of Planning.

Wingate, David B. 1983. **Conservation Laws. Bermuda's Delicate Balance**, edited by Hayward, Stuart, Gomez, Vicki and Sterrer, Wolfgang, Ph.D., pp. 295-305.

Peterson, Roger Tory. 1980. **A Field Guide to the Birds of Eastern and Central North America.** Houghton & Mifflin

Sterrer, Wolfgang, Ph. D. **Marine Fauna and Flora of Bermuda, A Systematic Guide to the Identification of Marine Organisms.** A Wiley Interscience Publication, John Wiley & Sons.

Wingate, David B., Ph. D. 1973. **A Checklist and Guide to the Birds of Bermuda.**

Wingate, David B., Ph. D. 1992. **Bermuda Zoological Society Information Document "Bermuda Rock Lizard (Skink) *Eumeces longirostris*."**

Wingate, David B., Ph. D. 1992. **Bermuda Zoological Society Information Document "White-tailed Tropicbird or Longtail".**

### **Terrestrial Invertebrates**

Burpee, L.L. 1981. **Mediterranean Fruit Fly.** Dept Ag & Fish Bulletin Vol 52, No 8.

Hilburn, Daniel, 1986. **Eye Flies,** Dept Ag & Fish Bulletin Vol 57 No 8.

Hilburn, Daniel. 1986. **Household Ants.** Dept Ag & Fish Bulletin Vol 57, p70-71.

Hilburn, Daniel. 1995. **Insects of Bermuda BZS Eco File ILA - 04.**

Hilburn, Daniel. 1987. **Spittlebugs on Casuarina.** Dept Ag Bulletin Vol 58 No 1.

Hilburn, Daniel. **Butterflies - Critter Talk Vol 14 No 2.**

Hughes, I.W. 1981. **Mosquitoes,** Dept Ag & Fish Bulletin Vol 52 No 7.

Hughes, I.W. 1984. **Biting Midges.** Dept of Ag Bulletin Vol 55 No 9.

Hughes, I.W. 1986. **Review of Entomology in Bermuda, BAMZ Eco-File.**

Rand, Tom. 1982. **Hymenopterans and Bermuda Ants, Critter Talk Autumn.**

Sterrer, Wolfgang. 1996. **Extinction, perhaps not at a snail's pace. Critter Talk.**

Pierce, Q.L. **Insects, Amazing Facts Activity Fun Book.** Playmore Inc., Waldman Publish. Corp.

Jessey, Claire. 1997. **Plant Protection Section, Dept Ag & Fish Bulletin Vol 68, No 8.**

Lonsdale, David D. 1977. **Audubon Camp Field Guide.**

Monkman, Kevin. 1992. **Juniper Aphid, Dept Ag & Fish Bulletin Vol 63 No 3.**

Monkman, Kevin. 1990. **Ladybird Beetle, Dept Ag & Fish Bulletin Vol 61 No 10.**

Nelson, Elizabeth. 1995. **Bermuda Land Snails. BAMZ Library.**

Phillips, Christine. **Insects of Bermuda and their near Relatives.** Dept. Ed. Poster.

Verrill, A.E. 1902. **The Bermuda Islands; Trans. Conn. Acad. Sc. Vol XI. BZS Eco-File. Fossil Land Snails of Bermuda. BAMZ Library.**

**Recent Terrestrial Mollusks of Bermuda. BAMZ Library.**

Arnett, Ross H. Jr. 1985. **American Insects - A handbook of the insects of America North of Mexico.** Van Nostrand Reinhold Company, Inc., 115 Fifth Avenue, New York, New York 10003, U.S.A.. 449 p.p.

Borror, Donald J. & DeLong, Dwight M. 1964 and 1971. **An Introduction to the Study of Insects.** Holt, Reinhart and Winston Inc., U.S.A., 154, 159, 433, 622 p.p.

### **Vertebrates**

Amos, E. J. R. 1991. **A Guide to the Birds of Bermuda.** E. J. R. Amos, Warwick, Bermuda. 206p.

Thomas, M.L.H. 1998. **Marine and Island Ecology of Bermuda.** Bermuda Aquarium Natural History Museum and Zoo, Bermuda Zoological Society and Friends of the Bermuda Aquarium. 148p.

Peterson R.T. 1947. **A Field Guide to the Birds.** Peterson Field Guide Series. Houghton Mifflin Co. 230p.

### **Plants**

Collett, Jill. 1987. **Bermuda; Her Plants & Gardens, 1609-1850.** Macmillan Publishers Ltd. and the Bermuda National Trust, London and Basingstoke.

Britton, N. L. 1918. **Flora of Bermuda.** Charles Scribner's Sons, New York. 585p.

The Bermuda Zoological Society. 1994. **The Sandy Shore, Project Nature, Field Study Guides for Bermuda Habitats.** Bermuda Zoological Society, Bermuda.

Edited by Elfrida L. Wardman. 1971. **The Bermuda Jubilee Garden.** Robert MacLehose and Company Limited. The University Press, Glasgow, Scotland.

Initially compiled by Liberty Hyde Bailey and Ethel Zoe Bailey, revised and expanded by The Staff of the Liberty Hyde Bailey Hortorium, A Unit of the New York State College of Agriculture and Life Sciences, a Statutory College of the State University at Cornell University. **Hortus Third, a Concise Dictionary of Plants Cultivated in the United States and Canada.** Macmillan Publishing Company, New York, Collier Macmillan Publishers, London.

The Bermuda Zoological Society. 1993. **The Rocky Coast, Project Nature, Field Study Guides for Bermuda Habitats.** Bermuda Zoological Society, Bermuda.

## Appendix - Development vs. Conservation

**“There is nothing in which the birds differ more from man than the way in which they can build and yet leave a landscape as it was before”**

**Robert Lynd**

### **Who's Right?**

Let's imagine that Mr. Billie Builder's Aunt Gladys has, in her will, left him a beautiful three acre woodland lot, running down to the sea. Several families live in the group of small houses surrounding his property. The neighbourhood children play on the shore and take walks in the woods, enjoying the birds and the rare cedar forest. Billie, seeing a business opportunity, wants to build a small shopping centre on his lot. It will have a laundry and dry-cleaning facility, a restaurant and a video arcade. To **develop** his land he will need to cut down trees, concrete the slope behind the shop as a water catchment area and put in a road and a parking lot for his customers. How will his neighbours feel about his plans? As owner of the property Billie thinks he should be able to do what he likes with it. But how will his **development** affect the lives of the people around him? Can he do whatever he wants? Should he be allowed to? Who resolves this conflict and how?

This scenario illustrates how the interests of an individual can sometimes conflict with those of the community. Billie wants to make money for himself, but in the process he will also be helping his employees to feed their families. His neighbours want to **conserve** the forest with its bird and animal habitats so that their children and those of future generations can enjoy nature. Billie's interests seem to address economic needs in the short term while his neighbours are looking further into the future. Clearly, there are arguments for and against both sides.

### **Finding a Balance**

Many people think of '**development**' and '**conservation**' as opposing ideas, naturally leading to conflict. Indeed, **developers** and **conservationists** are often at odds with each other, but this need not always be the case.

It is both natural and necessary for man to make use of the earth's resources in order to feed, clothe and shelter himself, but when he overuses them and risks their depletion

he compromises his very ability to survive. Taking from the **environment**, and giving back to it through conservation efforts ensures equilibrium, stability and the long-term future of the system; in short, the survival of all life on the planet.

Striking a balance between the development and conservation of resources works in a way like a bank account. We can take money out of our account and make use of it to meet our needs (development) and as long as we are careful to put money back in when we can, (conservation) we will have something to draw upon when times are hard. If we spend all our money and never attempt to save, we set ourselves up for eventual ruin when our resources run out.

Balancing man's economic needs with the needs of the environment has been an issue since the earliest days of Bermuda's settlement. The on-going search for this balance can be seen as a learning process with mistakes made, knowledge gained, and changes and adjustments put into place. As in any learning process, there have been both successes and failures.

### **Development and Conservation: Bermuda's Early Days**

Bermuda's first developer, the Bermuda Company, began to **exploit** the islands in 1612. The Company's purely economic goals were to extract the resources, explore the potential for agriculture and enrich its shareholders back in England. Little thought was given to the islands' long-term future as a settlement.

In the beginning, Bermuda's early inhabitants found an abundance of resources. The land yielded hogs and birds, especially the easily-caught cahows. The surrounding reefs were teeming with turtles and fish. Timber, in the form of cedar, yellow-wood and palmetto was readily available for building, fuel and food.

The seemingly limitless supply of these resources and the ease with which they could be harvested led to reckless greed. In 1616, Governor Daniel

Tucker called for restraint when it became clear that the cahow was nearly extinct but his pleas were ignored. Other food sources also threatened to disappear, so pleas had to be replaced by protective laws.

The first conservation legislation in the New World was passed by the Bermuda Assembly in 1620, "against the killing of young tortoises (sea turtles)". The depletion of fish stock was so serious that a second law had to be passed in 1627, to protect even the small bait fish which were being consumed as food or processed for oil. These legislative measures were taken to avert imminent disaster rather than out of a desire to preserve resources for the long term, as a true understanding of conservation did not exist at the time.

Just as the limits of the island's food supply became clear so did those of her other resources. Between the 1630s and the 1680s, the cedar and palmetto forests were quickly depleted, and the valuable yellow-wood tree almost wiped out. In spite of several pieces of legislation to conserve them, the island's forests were nearly stripped.

The Bermuda Company's last option, agriculture, proved economically unproductive, causing the Company to fail in 1684. After just seventy years, the formerly abundant islands had been stripped of resources. Those who could, returned to England or moved on to other colonies in the new world, leaving the remaining settlers to subsist on the very little that was left.

Bermuda's early inhabitants made a serious mistake. Unwittingly they exceeded the **physical carrying capacity** of the environment. The fragile **ecosystem** of the islands could not sustain such intense harvesting. Greed and ignorance of the breeding biology of the species they were taking had led to disaster. The results of some of this early over-exploitation can still be seen today: the remaining yellow-wood trees can be counted on two hands, turtles no longer breed on Bermuda's beaches and the cahow, almost extinct, clings to an existence only through the most painstaking of conservation efforts.

During the 1700s and the early 1800s, settlers eked out an existence on the land or engaged in ship building, sailing, and trading for food. By

the end of the century agriculture had improved and became very successfully established after the 1840s. The population was growing. Protective legislation was once again necessary, as the actions of the people encroached on the environment. The Birds Act of 1870 was enacted to protect resident and migratory birds, as widely available firearms had led to a reduction of their numbers.

Around 1885, tourists began to visit and returned home enthusiastic about the islands' beauty, gentle climate and relaxed pace. As tourism increased in economic importance, hotels and accommodations were built, services expanded and Bermudians became more aware of the need to preserve the natural beauty of their islands.

The 20th century brought rapid and dramatic change. During this time, 'the golden age of agriculture' came to an end as the North American markets for Bermuda's onions, lily bulbs and produce disappeared. By the end of the Second World War farmland sat unworked, as the farmers had turned to employment in the tourist industry or in construction.

For the first time, large quantities of land were available for building, and as there were no laws in place to prevent the trend, farmland disappeared rapidly, rising in value as it did so. Most of it was converted into housing tracts, tourist accommodation or golf courses. Between 1921 and 1977, available agricultural land dropped from 3,000 acres to a mere 650.<sup>1</sup>

The 20th century also brought a rise in population of 208% between 1900 and 1980.<sup>2</sup> Increasingly people were drawn to the towns to live and work. Accordingly, the pressure for development rose dramatically.

As the competition for space and resources increased, much new protective legislation had to be enacted, especially from the 1960's onward. This reflected a growing awareness of the environment and pollution, of **ecology** and of the principles of conservation. Legislation

<sup>1</sup> 'Land', by Stuart Hayward and Brian Rowlinson, Bermuda's Delicate Balance, p.76

<sup>2</sup> 'Land', by Stuart Hayward and Brian Rowlinson, Bermuda's Delicate Balance, p.78



now exists to protect, among other things, birds, animals, fish and the coral reef, public health and endangered species.

The near environmental collapse of her early days seemingly far behind her, Bermuda entered the 20th century with the scales of conservation and development more or less in balance, due to lessons learned and adjustments made, but by the latter part of the century public concern was mounting that the scales were too heavily tipped in favour of development.

#### **Issues and Trends in the 1990s**

The Bermuda economy today is primarily supported by tourism and international business. The islands, with just 20.49 sq. miles of habitable land have a population of approximately 60,000, making it one of the most densely populated places in the world. By the year 2000, the population is expected to reach 65,000. In addition to the resident population, the islands are visited by some 500,000 tourists a year, arriving by air or by large cruise ships. Since farmland is no longer available for agriculture, the island must import nearly all its food.

Servicing residents, businesses and tourists is a challenge for government and businesses. People must have housing, office buildings and hotels, schools, hospitals, an airport, docks, roads, recreation facilities and services such as transportation, electricity, telecommunications, water, sewage and waste disposal.

Intensifying the pressure on decision-makers is the fact that our society is no longer content to have only its basic needs met. It has embraced consumerism and has adopted a lifestyle which seems to crave more and more – bigger houses, more cars and more material goods. The 'haves' want more and the disadvantaged understandably want their fair share. The pressure to grow is increasing but Bermuda is fast approaching her physical limits for expansion.

There are few attractive options. Building over the small amount of remaining green space and shoreline would destroy the beauty which our visitors come to see, seriously affecting the economy, not to mention the quality of life. This leaves only 'air space' to grow into, but

few, if any of us, would like to see Bermuda like the island of Manhattan jammed tight with skyscrapers and teeming with people.

At this point in her history Bermuda is once again very close to exceeding the physical carrying capacity of the environment. Habitats for birds and animals are destroyed each time a new building goes up. Endemic species are near extinction. The surrounding waters are becoming more polluted, putting a strain on the fragile ecosystem of Bermuda's natural treasure, the northernmost coral reef system in the world. Conservation measures to protect the reef are in place but may not be enough to keep it from being damaged beyond repair, overwhelmed by the consequences of overbuilding and overpopulation.

Bermuda today is also approaching the limit of its social carrying capacity. Overcrowding in housing and on the roads, noise and competition for fewer resources adds stress to our lives. Increased social problems – crime, substance abuse and violence – are on the rise. Places such as woodlands and open spaces in which to relax and enjoy nature are disappearing, diminishing the quality of life for which Bermuda was once renowned.

As we enter the new millennium, Bermuda is at a critical point in her history. Some difficult questions need to be asked. What kind of society do we want for the future? Can it be sustained, both economically and environmentally for the long-term? What price are we willing to pay for our lifestyle?

In order to answer these questions, society as a whole must become aware of the impact human activity has on the environment. As competition for space and resources increases, individuals may have to think less about their own short-term gain and more about the long-term needs of the society as a whole. This may mean deciding to make do with less, deciding not to build, scaling down plans or re-developing an existing property instead of building on empty land.

Now more than ever before, it is critical that a balance be found between conservation and development and that the process by which this is done involve all segments of the community. Fortunately, there is a process in place which can

help to control the kind of development taking place. It is called the planning process.

**The History of Planning in Bermuda**

Planning where people live and work and how they access essential services or get from one place to another has existed in some form throughout Bermuda's history. The brief history below illustrates its increasing complexity and expanded role in the latter half of this century, and reflects the changing concerns of Bermuda's inhabitants.

The first town established in the new colony was the town of St. George, in 1612 and was laid out with a central square and according to a plan that would make it easy to defend, reflecting the concerns of the times. This was to remain the capital for 200 years.

The land on the rest of the island was surveyed by Richard Norwood. He divided the islands into nine tribes or parishes and then subdivided them in proportion to the shares owned by the shareholders of the Bermuda Company. The pattern of sub-division forming narrow strip-shares across the island at right-angles to the lay of the land was done deliberately to give every shareholder access to the sea for the purpose of transporting produce as there were no roads at the time.

Other settlements grew up around sheltered harbours or developments such as the Royal Naval Dockyard. Over the years and as the population grew, large estates were subdivided and built on as the owners saw fit. Development was haphazard and dependent on the transportation of building materials by water or by horse.

The first town plan was put into effect in Hamilton in 1790 and in 1815 the capital was moved to the thriving town. Hamilton's development followed a rectangular plan which like St. George's didn't always fit the topography. Owners were urged to "give the Towne a decent and advantageous look" As it grew, more regulations had to be made, governing such things as safety and public health but owners could still build where and how they wished.

By 1901, the population had grown to 17,535. It had doubled again by the outbreak of the

Second World War. The railway, built in the late 1920s, encouraged settlement further away from Hamilton. This was accelerated further by the introduction of cars in 1946.

With rapid population growth came problems – overcrowding, a decline in food production, and conflicting interests, so in 1944 the Bermuda Government decided to get involved. A Housing Commission was set up to "make recommendations for supplying deficiencies, correcting defects, and controlling the erection of future buildings and the development and use of land...in the interest of the general community." The recommendations, lacking teeth, did not result in real change. Building standards were introduced, however. Building permits had to be approved by the newly established Building Authority, which also administered rules regarding construction, safety, drainage and ventilation, etc.

With the advent of the car in 1946, more areas became accessible for development. In response to the large and fast-growing tourist industry with its demand for accommodation, more large parcels of farmland were broken up and developed.

Alarmed by the trends, the Bermuda Government asked United Nations consultant Thornley Dyer to devise a plan for the future use of land. His report, "The Next 20 Years" was published in 1963 and led to the passing by the legislature of the Development and Planning Act (1965), "to make provision for the orderly and progressive development of land and to preserve and improve amenities thereof." Order had to be brought to the chaotic situation in which land was subdivided and developed solely at an owner's whim, so Dyer established a zoning system, based upon the land use pattern in place at the time, and which is still in place today.

The modern concept of 'forward planning or comprehensive long-range planning' began with the 1965 Act. The Act called for a plan to be submitted to the Legislature. This was done and resulted in the first Bermuda Development Plan in 1968. The Planning Department was established at that time. The Government's Member for Planning controlled policy, while the determination of planning applications



became the responsibility of the Development Applications Board. Together they would prepare periodic broad development plans as well as smaller, local plans. The process of submitting a plan to Government every ten years or so began at this time.

The 1968 Plan, adopted by Government, emphasised the importance of local open spaces, parks, coastal, scenic and natural areas. It recommended “an island-wide system of bridle paths, footpaths and tourist roads to form an effective open space network throughout Bermuda” and “a policy of preservation of woodland and re-forestation whenever possible.” The success of this plan would be dependent on public awareness, which was uneven.

The pressure for development in the 1970s led to the broadened terms of reference in the 1974 Planning Act. A development plan was to be prepared “on the basis of surveys and studies of land use, population growth, the economic base of the planning area, its transportation and communication needs, public services and social services.” The Bermuda Development Plan 1974 reflected a concern to maintain Bermuda’s image in order to attract tourists. General environmental concerns and the preservation of the ridge line took precedence over an island-wide parks system and open spaces plan.

The 1983 Plan reflected growing public concern over preserving arable land, open space and areas of environmental significance. As the result of surveys, for the first time woodlands, caves, nature reserves, arable land and coastal areas were deemed worthy of protection. It called for legislation to create, protect and manage a national parks system and Government began to acquire open space for parkland. This plan was criticised for lacking a strategy for balancing development needs against the need for open space.

The current 1992 Plan is built on the concept of **‘sustainable development’** as advocated by the United Nations. In response to the alarming global trends of rapid population growth, overcrowded cities rife with crime and disease, degradation of the land and sea and the large scale exploitation of natural resources, the UN

urged all countries to pursue, “development which meets the needs of the present without compromising the ability of future generations to meet their needs.” For the first time, a moral duty to consider the long-term effects of our actions was acknowledged.

The 1992 Plan, in effect to the year 2000, reflects the concern that Bermuda’s carrying capacity will soon be exceeded, that her environment will no longer be able to absorb unharmed the present rate of development. The general aim of the Plan is: “To maintain the quality of life in Bermuda by the wise use of resources and by effectively controlling and directing development so as to safeguard the environment, and as a consequence, the economic, cultural, social and general welfare of the people.” Its goals are: to conserve open space, to provide a high quality environment while allowing sufficient development to meet the community’s needs in housing, tourism, and industry, and to encourage a more efficient use and development of land. It also recognised that, “sufficient capacity exists within areas already committed to development to meet estimated needs to the year 2000”. Formally acknowledged was the need to merge economic and environmental objectives and to strike a balance between development and conservation.

As can be seen, today’s planning process is much more complex than in Bermuda’s early days when landowners were completely free to use their land as they saw fit. Greater and greater responsibility is being placed on Government and the Planning Department to balance the needs of people with those of the environment. How do they undertake this task?

#### **The Role of The Planning Department**

At the time of writing the Department of Planning is one of three branches of the Ministry of the Environment. It has three sections: forward planning, development control and building control, manned by a staff of 34. Its basic responsibilities are: the planning and control of orderly development, the protection of the environment and the maintenance of proper building construction standards.

The role of the Minister of the Environment as head of the Ministry is to promote and

co-ordinate the departments in Government that have responsibility for resource and land use management; that is, the Department of Planning, Agriculture and Fisheries and the Land Valuation Office. The Minister of the Environment is also empowered to appoint the Development Applications Board, prepare development plans, take enforcement action and decide appeals.

The role of the Planning Department is best summed up by Mr. Brian Rowlinson, currently Director of Planning: "The overriding purpose of any planning authority is to reconcile the conflicting demands made by individuals for the use and development of the land in a manner that achieves the greatest public good. It is fair to say that where there are limited resources and a high level of development, as in Bermuda, the more intense these conflicts become, and the more necessary it is to have a strong planning process for resolving these conflicts."<sup>3</sup>

A strong planning process depends in part on teamwork. The functions of the sections described below suggest the complexity of Bermuda's planning process in the 1990s.

#### **The Planning Team**

The **Minister of the Environment** is an elected Member of Parliament and is appointed by the Premier. Besides his responsibilities for environmental, fisheries and agricultural matters under numerous pieces of legislation, he has planning responsibilities according to the Development and Planning Act 1974. He is empowered to appoint the members of the Development Applications Board, prepare development plans, take enforcement action and decide appeals.

The **Development Applications Board** is appointed each year by the Minister. It consists of a Chairman, Deputy Chairman and seven to ten members. One member represents the Corporation of Hamilton, one the Corporation of St. George's. The DAB meets once a week to determine all applications for planning permission. A committee of two meets once a week to discuss the applications. Committee

decisions are referred to the full Board for confirmation. When appropriate, the Board allows applicants and objectors to make a verbal presentation, especially when a proposal is objected to by a number of people living close to the development site.

The **Director of Planning** manages the day-to-day running of the Department. His administrative functions include setting the budget, staffing, and coordinating the management of the sections of Forward Planning, Development Control and Building Control. He formulates and co-ordinates the Department's planning policies. He submits recommendations on development applications, reviews plans and policies being developed in Forward Planning and advises the Ministry and other departments on questions and interpretations of planning policy.

The **Forward Planning Section** prepares the policies, controls and guidelines used in the Control Section in the management of the ongoing development of the Island. These are published in the form of plans, e.g. The Bermuda Plan 1992. It is responsible for surveys, studies, original research and the preparation of plans. It also analyses information and drafts detailed legislation, policies and regulations. It liaises with other departments on questions of policy and interpretation, e.g. reviewing major planning applications, landscaping schemes, road improvement proposals and land acquisition proposals.

The **Development Control Section** puts into practice the policies and plans prepared by the Department and approved by the Legislature. It assesses all planning applications to make sure that they comply with regulations. It prepares a recommendation and submits it with the application to the Development Applications Board for a decision. This section handles about 1,200 applications a year. It advises the public, discusses applications, helps find a satisfactory planning solution and provides customer service.

The **Building Control Section** includes a team of building and electrical inspectors and an enforcement officer. They inspect building projects under construction to make sure that the work is in accordance with the planning

<sup>3</sup> Speech to the Rotary Club, Brian Rowlinson, November 18, 1997

approval given, and to check that the work is progressing in a safe and sound manner in accordance with local building codes. The section can determine minor projects not requiring the Board's approval. The enforcement officer advises the Director and Minister on illegal development and may follow such cases to the courts.

#### **How does Today's Planning Process Work?**

The planning process has two elements: the development plan process and the development application process. In conjunction with each other, they set the standards for development and establish procedures for resolving conflicts.

#### **The Development Plan Process**

1. The development plan of the day (redrawn every ten years or so) sets out the policies, provisions and regulations which govern the development and use of all land in Bermuda. A plan is normally made up of three documents: a Report of Survey (e.g. 'Bermuda 2000: Facing the Future'); a Planning Statement (the written rules and regulations); and a set of Zoning Maps. The current plan is the Bermuda Plan 1992.
2. The Planning Statement and Zoning Maps are prepared by the Department of Planning and published as a **draft** plan. Draft plans become effective immediately. In other words, all planning applications submitted after the publication date are tested against the provisions of the draft plan. The public is given a minimum of two months in which to make representations with respect to any matter contained in a draft plan. This usually takes the form of "An objection to the zoning of land" submitted by the landowner.
3. The Department of Planning reviews all the objections and in the majority of cases negotiates a mutually acceptable resolution. All unresolved objections are referred to the objections Tribunal appointed by the Minister. Representatives of the Department, the objector and any third party make oral presentations to the Tribunal at a public inquiry. The Tribunal forwards a report to the Minister setting out its recommendations on each objection case.

4. The zoning maps and the regulations are amended to take into account the outcome of the resolved objections and the recommendations of the Tribunal. The plan is submitted to the Legislature for approval.

Against the background of the current development plan, individuals like Billie Builder in our opening scenario can make an application to develop property. He and his neighbours would be involved in a process like the one outlined below:

#### **The Development Application Process**

1. The applicant submits the drawings, form and fee for planning permission to develop land.
2. All applications are advertised and the public is afforded 14 days in which to submit objections.
3. The Department assesses the application against the provisions of the development plan, taking into consideration the comments of other Government departments consulted and also any objections received.
4. The applicant is given an opportunity to respond to objections.
5. The Department submits the application to the Development Applications Board with a recommendation of approval or refusal and forwards to each Board member a copy of all objections received and a copy of the applicant's response.
6. The Board will consider the application and render a decision on the basis of the written representations of the Department, the applicant and the objectors.
7. If it is a major application or if weighty objections have been received, the Board may choose to hold a hearing (not public) at which representatives of all the parties are given an opportunity to make oral submissions.
8. Once the Board's decision is published, any aggrieved person may appeal the Board's decision to the Minister within 21 days of

the date of the decision letter. (About 1200 decisions are made every year. Of those, 9% are refusals.) Bermuda's planning legislation is different to most jurisdictions insofar as it allows an objector to appeal the Board's decision to approve an application.

9. Appeals are forwarded to a visiting Planning Inspector who considers the evidence on the basis of the written representations or at a public inquiry, and thereafter submits a report and his recommendations to the Minister. (About 40 appeals are made each year)
10. The Minister considers the Inspector's report and renders his decision.
11. Once an application is approved (either by the Board or on appeal), the applicant must submit full working drawings of the project and apply for a building permit. Structural details of the building must comply with the requirements of the Building Code and the Health and Fire Departments.

**Balancing Conservation and Development:  
Who is Ultimately Responsible?**

We have seen that balancing conservation and development is an on-going process which has to take into account economic and environmental considerations, the needs of both the individual and the community, the short and the long-term view, as well as concerning itself with issues of quality and quantity. Achieving a balance is dependent on many factors and is complicated by the fact that the concept of balance is subjective – a degree of development acceptable to one person may be completely unacceptable to another.

Today conservation laws and development regulations play a considerable role in ensuring orderly development but they cannot be relied upon exclusively. They have their limitations. There are inevitably loopholes and gaps in

legislation and the presence of too many rules can sometimes have the effect of obscuring the issues, producing an undesirable outcome. The regulations and procedures themselves also must be revised from time to time to ensure that they are both relevant and effective. And in the final analysis, laws and regulations must be applied and enforced with consistency in order to have the desired effect.

The Bermuda Government, the Ministry of the Environment, the Planning Department and the Development Applications Board have a heavy responsibility, charged as they are with ensuring sustainable development. In their roles they must be well-informed on social and environmental issues, both locally and globally. And although they will always be subject to pressure from special interest groups, they must be wise and impartial in their decisions.

Ultimately the responsibility for finding and maintaining a balance between conservation and development lies not just with Government or the Planning Department but also with Bermuda's citizens. As a prerequisite, they too need to be informed on the issues both locally and globally, and consider many points of view. They can then influence the direction their society is taking. By exercising their democratic rights and voting in elections, they can challenge the decision-makers. They can provide input when new development plans are being prepared and make their opinions known when a draft plan is presented to the public for comment. They can be watchdogs for conservation and practise responsible development on their own properties as well as encouraging it in their neighbourhoods. They can join special interest groups and apply pressure through the media. All these measures can help to achieve sustainable development in Bermuda, a goal which is attainable, but not without the commitment, and the sustained commitment, of all of her people.



*The Bermuda Plan 1992 is repeated here in its entirety by kind permission of Mr. Brian Rowlinson, Director, The Department of Planning.*

**THE BERMUDA PLAN 1992**

**Information Sheet**

The new Bermuda Plan 1992 was brought into force on 3rd July 1992. The Plan will be used to control the development and use of all land in Bermuda outside the City of Hamilton. The 1992 Plan replaces the Bermuda Development Plan 1983.

**New zoning maps and new planning regulations**

The 1992 Plan consists of the Maps and the Planning Statement and it is accompanied by a report of survey "Bermuda 2000: Facing the Future" which was first released in October last year. The Maps illustrate the new zonings and the Planning Statement sets out the new planning rules and regulations for the 1992 Plan.

**Maps and documents on display and on sale**

The zoning Maps for each Parish are on display at the respective Parish post office and complete sets of maps can be inspected at the Department of Planning offices. Copies of the Planning Statement (\$15) and the "Bermuda 2000" report (\$20) may be purchased at the reception desk on the ground floor of the Government Administration Building (or \$30 a pair). Full sets of Maps may be purchased from the Department of Planning (\$750) and copies of individual maps are available at the Department's front desk (\$10 a sheet).

This pamphlet is for information purposes. Please refer to the zoning maps and the provisions set out in the Planning Statement for precise details of the regulations which affect your property.

**Any questions?**

If you have any questions about the new plan, the zoning of your property, how to submit an objection or any other related matter please

- address any correspondence to Forward Planning ('92 Plan), Department of Planning, Government Administration Building, Parliament Street, Hamilton HM 12; or
- call into the Department on the third floor of the Government Administration Building and speak to one of the technical officers on duty; or
- telephone 297-7778.

**THE BERMUDA PLAN 1992**

**The New Zones**

The Bermuda Plan 1992 is based on a two-tier zoning method using maps which separate and identify environmental limitations (as shown on the Conservation Maps) and development opportunities (as shown on the Development Zoning Maps).

**The Conservation Maps**

The Conservation Maps use ordnance base maps and colour to show the location and extent of all important open spaces, natural features and resources. The Maps differentiate between Conservation Areas and Protection Areas.

**Conservation Areas**

Development will be precluded or strictly controlled in the Conservation Areas described below. The Planning Statement stipulates that the protection, preservation and careful management of these resources will take precedence over all other planning considerations.

**Agricultural Land** : land which is capable of cultivation or is suitable for a wider range of farming activities regardless of the use to which the land is being put. Greater protection is given to the protection of farm units.

**Woodland Reserve** : extensive belts of mature trees, other areas of dense vegetation which are important features of the landscape and smaller clumps of trees in prominent locations.

**Woodland** : trees, shrubs and vegetation which are less uniform in quality than Woodland Reserve but, nonetheless, important for their visual and habitat value. Carefully sited development may be permitted provided the best trees are protected.

**Green Space** : land which is important for its natural appearance, amenity value and scenic qualities and other areas which contribute to the network of linked open spaces. Only minor accessory structures and additions to existing residential buildings are permitted.

**National Park** : the extent of the National Parks System on the commencement day of the Plan.

**Recreation** : land to be set aside and reserved for a variety of recreational activities including public and private playing fields, sports facilities and golf courses.

**Nature Reserve** : areas of special environmental significance and ecological or scientific value including mangroves, marshlands, bird sanctuaries, islands and other important wildlife habitats. These areas represent the few which remain to provide glimpses of Bermuda's natural heritage.

### Protection Areas

Protection Areas are shown on the Maps by a boundary line which indicates the extent of areas within which there are resources which must be protected in the process of development. In other words, this presupposes that development will take place in accordance with the provisions of the applicable Development Zone.

**Ground Water** : identifies the approximate extent of Bermuda's four underground water lenses - the St. George's Lens, Central Lens, Port Royal Lens and Somerset Lens. All development must dispose of sewage in a satisfactory manner and without harm to the underlying water lens.

**Cave** : identifies the extent of the sensitive cavernous area around Harrington Sound and the location of known caves. Extreme care must be taken with the siting and design of development and the disposal of sewage to ensure cave entrances and underlying cave systems are properly protected.

**Historic** : defines the boundaries of Dockyard and the Town of St. George within which there are concentrations of buildings of significant historical and architectural value. Particular historic sites and fortifications are also identified. All development must respect the historical, architectural and cultural character of the area.

### The Development Zoning Maps

The Development Zoning Maps use transparent overlays to show the boundaries of Development Zones which have been established to accommodate Bermuda's development needs for a range of land uses. The type and intensity

of development permitted in each zone is set out in the Planning Statement.

### Development Zones

**Residential 1**: the most intensive of the two zones set aside for future housing development. Realistic density standards have been set to avoid increasing the density of development in Bermuda's most populated areas.

Maximum density

6 per acre

(detached houses):

Maximum density

20 dwelling units

(apartment units):

per acre

Minimum lot size:

6,000 sq. ft

Maximum site coverage:

35%

**Residential 2.**: the second of the two primary zones designated for housing. The density standards provide for a marginal increase in development potential without harming the character of established residential neighbourhoods.

Maximum density

2 per acre

(detached houses):

Maximum density

6 dwelling units

(apartment units):

per acre

Minimum lot size:

18,000 sq. ft

Maximum site coverage:

20%

**Rural** : Bermuda's remaining tracts of open countryside and areas of a rural character. Limited new development may be permitted provided it is clustered around and well-related to existing structures in a way which protects the rural character of the land. Subdivision is limited to existing residential structures and to sites in excess of 4 acres.

**Tourism** : to provide for the orderly development, expansion and upgrading of facilities required to maintain a successful tourism industry. Applies to the larger properties with 50 or more licensed bedspaces.

**Commercial** : to establish a hierarchy of commercial centres for the development of shops, offices and services. Applies to Dockyard, Somerset Village, Somerset Road, Riddell's Bay, Warwick Central, Pitts Bay Road, Flatts, Collector's Hill, Shelly Bay and the Town of St. George. The planning regulations are tailored to the characteristics and needs of each area.

**Industrial** : to provide for the development of industrial uses and warehousing. Some sites are restricted to light industrial uses in order to protect the environment of neighbouring areas.

**Institutional** : to provide for the orderly development of facilities such as public and private schools, the college, hospital, St. Brendan's and the Biological Station.

**Government** : to provide for the development of public works and services in areas such as Prospect, the prison sites, the government quarry, incinerator and bus garage.

### Questions and Answers

Q *When did the Bermuda Plan 1992 come into force?*

A The 1992 Plan was brought into effect as a draft development plan on Friday 3rd July 1992.

Q *What is the effect of the Bermuda Plan 1992 on my property?*

A The 1983 Plan is no longer in force. Your property is now subject to new zonings shown on the Maps and new planning regulations set out in the Planning Statement. All planning applications submitted on or after 3rd July will be subject to the new zonings and regulations of the 1992 Plan.

Zonings such as High Density, Medium Density, and Garden District for example, no longer apply and have been replaced by Residential 1 and Residential 2 under the 1992 Plan.

You should check the Maps to find out the new zoning of your property and then check the relevant sections of the Planning Statement to find out about the new planning regulations.

Q *What effect does the Plan have on existing planning permissions?*

A None. Any development application which has been approved by the Board will not be affected by the new Plan, provided the approval has not lapsed. The approval will have lapsed if it is more than two years old and you have not started work.

Q *Where can I check the Maps to find out the zoning of my property?*

A You can check the zoning of your property by visiting any of the Parish post offices or the Department of Planning offices in the Government Administration Building on Parliament Street.

Each Parish post office has the zoning maps for that Parish and a copy of the Planning Statement on display. Complete sets of Maps for all of Bermuda can be inspected at the Department of Planning. The Planning Statement (\$15) can be purchased at the reception desk on the ground floor of the Government Administration Building and copies of individual zoning maps are available from the Department of Planning (\$10 a sheet).

Q *Can I object to the zoning of my property?*

A Yes. As a "draft" plan it is subject to a two month objections period. Anyone can object to the zoning of any property or to any of the provisions contained in the Planning Statement.

Q *How do I make an objection?*

A All objections must be submitted in accordance with the new Development and Planning (Tribunal Procedure) Rules 1992. The Department has copies of these rules. A valid objection must include the following

- an Objection Form completed in full;
- a statement setting out the details and grounds of your objection including details of any proposed zoning change (there is space on the Form for providing this information); and
- an ordnance survey map extract showing the property outlined in red.

If the objector is not the owner of the land, the Objection Form must be accompanied by a Certificate to show that the objector has notified the owner that an objection has been submitted. Copies of the Objection Form can be obtained from the post offices and the Department of Planning.

Blank certificates are available from the Department.

*Q When is the closing date for the submission of objections?*

*A* The deadline for the submission of objections is Friday 11th September 1992.

All objections must be addressed to the Permanent Secretary, Ministry of the Environment, Government Administration Building, Parliament Street, Hamilton HM 12.

*Q What is the procedure once an objection has been submitted??*

*A* Each objection will be carefully reviewed

by technical officers in the Department of Planning. Where agreement is reached between the Department and the objector the objection will be "resolved". Unresolved objections will be referred to an appointed Tribunal which will consider them at a public enquiry and then make recommendations to the Minister of the Environment. The necessary changes will then be made to the zoning maps and the Planning Statement.

The Department will keep in touch with you throughout the objections process and you, or your representative, will be given an opportunity to make written and oral submissions to the Tribunal.

---

### **Resources**

**Contact:** Mr. Brian Rowlinson, Director, The Department of Planning,  
3rd Floor, Government Administration Building,  
30 Parliament Street, Hamilton HM 12.  
Telephone: 297-7778 Facsimile: 295-4100

#### **Available from the Department of Planning:**

- Copies of ordnance maps. Copies of zoning maps free of charge to schools.
- Can prepare composite, area ordnance maps using their Geographical Information System.
- Copies of all available publications free of charge.
- Video prepared for the Bermuda 2000 exhibition, 'The Changing Face of an Island' Prepared in 1988. Though slightly dated, this is a good tool for introducing and generating discussion of the main issues which face the community. Copies can be ordered but there will be a charge.

**Human Resources:** The Director of Planning and his colleagues would be happy to visit any school to do short presentations or to help with activities such as mock Board meetings.

<sup>1</sup> 'Land', by Stuart Hayward and Brian Rowlinson, Bermuda's Delicate Balance, p.76

<sup>2</sup> 'Land', by Stuart Hayward and Brian Rowlinson, Bermuda's Delicate Balance, p.78

<sup>3</sup> Speech to the Rotary Club, Brian Rowlinson, November 18, 1997.

<sup>4</sup> Brian Rowlinson, Notes.





BERMUDA ZOOLOGICAL SOCIETY