

BEL LIGHTING

since 1991

Floodlight Floor lighting

IP54 • IP65 • IP66 • IP67 • IP68

COLLECTION 2024 - 2025

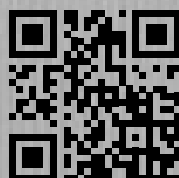

Terms & conditions

Catalogue edition 01/2024

The data in this catalogue are provided in good faith and only for your information. This data may not be used against BEL Lighting.

Prices valid from 01.02.2024 and cancels all previous price lists.

Prices ex works and without taxes (VAT, Recycling contribution,...).

BEL LIGHTING reserves all rights to alter all product price and data any time, without any notice.

The general BEL LIGHTING conditions of sale are always applicable.

Nothing in this catalog may be reproduced without permission in writing from the BEL LIGHTING company.



The design, production and assembling are all made in the company.

We use solid and durable materials like stainless steel, aluminium, brass, copper, Belgian blue stone and the exotic wood "Iroko".



BEL LIGHTING is certified with a quality management system in conformance with ISO 14001-2015 & ISO 9001-2015

The ISO standard specifies requirements for organizations of any type to demonstrate the ability to consistently provide services and products that consistently meet client requirements and aim to enhance customer satisfaction through application and improvement of the quality management system.



The ISO 14001:2015 Specifies the requirements for an environmental management system that an organization can use to enhance its environmental performance.

The ISO 9001:2015 Quality Management System provides a framework for implementation, maintenance, and continual improvement of quality best practices.



Bel Lighting offers you the possibility to extend the initial legal guarantee of 2 years from most of our lights in adding 3 more years. You should get, in total, 5 years guarantee !

Most of our lights have also 15 years guarantee against perforation.

For use in an aggressive environment (near the sea,...), we recommend to use our stainless steel fixtures with an electro-polishing treatment, see info pages in our general catalog.

To have access to the service, fill in the document online in the 3 months after your purchase.

More informations on www.bel-lighting.com/extended-warranty



WHO WE ARE

EN

Founded in 1991, BEL-LIGHTING is still to this day an independant family company with over fifty employees working here at our present factory in Megara (Greece) and headquarters in Saintes (Belgium). Lighting creator specialized in outdoor lighting, we constantly follow new developments in lighting technology and we are always attentive to the specific needs of our partners around the world to design and produce new innovative products that correspond to the requirements of our customers in the private or public domain.

Meanwhile, our technical department provides support for « customized » products, we provide assistance to architects and business partners on their projects together.

We also strengthen our products with recognized certifications, confirming the quality of our fixtures according to international standards. Likewise, we're providing our partners all the information needed about our products including photometric data accredited by a specialized laboratory to determine the performance of our lighting before their implementation through various simulation programs.

The creation, design and production is done in-house, we have firmly decided to build our reputation with high quality, that's why we always use first choice materials, some products are also manufactured with natural materials (aluminum , brass, stainless steel, copper, exotic iroko wood and Belgian stone) without coating and are fully integrated into their natural environment.

The technical quality and our exceptional design are the key priorities of our work in the development and manufacture of our products, with only proper use, installation and maintenance done by a specialist guarantee operational safety.

This edition of our catalog is more than an update of the full range of our lighting products, it is the result of the work of our research teams, design, technical contribution, production and marketing.

BEL LIGHTING, value added to the light!



Headquarters in Belgium



Factory in Greece



EXTERIOR - FLOODLIGHT

xxxmA
LED
Constant
current



Swing 16



Kozi S 18



Kozi S 18



Kozi S 18



Lena Pro S-A 28



Lena Pro M-A 32



Saturn HPL 56



Lena Pro S-B 30

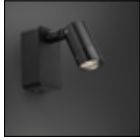

Lena Pro S-B 30



Lena Pro S-B 30



Lena Pro S-B 30



Lena Pro M-B 34



Lena Pro M-B 34



Lena Pro M-B 34



Sami 22



Sami-flex 26



Kozi S 18



Lena Pro S-B 30



Lena Pro M-B 34



Zax-S 60



Saturn HPL 56

Special
product



Line-Up 48



Line-Up 48

EXTERIOR - FLOODLIGHT

220-240V

LED
module
included



Maxima-50 40



Maxima-65 42



Maxima-100 44



Saturn Led 54



Saturn Led 54



Salsa 62



Salsa 62



Saturn HPL 58



Maxima-50 40



Maxima-50 40



Maxima-65 42



Maxima-65 42



Maxima-100 44



Nocturn 66



Salsa-S 64



Kozi FL 20

220-240V
GU10



Cylinder-S 50



Cylinder-S 50



Lena GU-A 36



Lena GU-B 38



Lena-GU-B 38



Lena-GU-B 38



Maxima-GU 46



Cylinder-S 50



Max FL 52



Lena GU-B 38



Lena GU-B 38

EXTERIOR - FLOOR LIGHTING



Floor uplighting - surface

**xxxmA
LED**
Constant
current



Micro TR 72



Focus 76



Target 78

**220-240V
LED**



Micro TR 72

**220-240V
GU10**



Micro TR 74



Floor - ground surface illumination - surface



**xxxmA
LED**
Constant
current



Pharos V 92



Pharos V 92



Pharos H 92



Pharos X 92

100%
useful light

EXTERIOR - FLOOR LIGHTING



Floor - ground surface illumination - recessed



xxxmA
LED
Constant current

3,2W

 \varnothing min: 32mm



Zona V 80



Zona H 82



Zona X 82



Tango R-V 84



Tango R-H 84

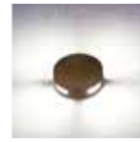

Tango R-X 84



Tango K-V 86



Tango K-H 86



Tango K-X 86



Bolas V 88



Bolas V 88



Bolas H 88



Bolas X 88

from 11W
to 17W

 \varnothing min: 78mm

220-240V
LED

from 1,1W
to 6,4W

 \varnothing min: 65mm



Pharos V 230V 94



Pharos V 230V 94



Pharos H 230V 94



Pharos X 230V 94

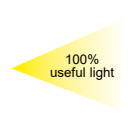

from 6W
to 10W

 \varnothing min: 78mm



Bolas V 230V 90



Bolas V 230V 90



Bolas H 230V 90



Bolas X 230V 90

EXTERIOR - FLOOR LIGHTING



Floor uplighting - recessed

xxxmA
LED
Constant current

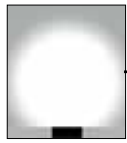

DIFFUSE

from 1,1W
to 3,2W

Ø min: 40mm

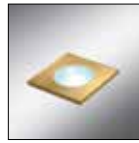

Genesis 96



Genesis 96

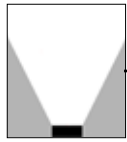

DIRECTIONAL

from 1,1W
to 3,2W

Ø min: 32mm



Zona R 98



Zona R Dark 100



Zona S 102

from 1,1W
to 6,5W

Ø min: 65mm

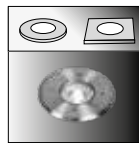

Zaxor Mini 114

from 6W
to 9,5W

Ø min: 68mm



Perla-R Dark 110



Perla-S Dark 112

from 3,2W
to 24W

Ø min:
78mm to 100mm

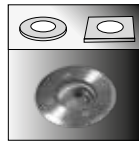

Bolas HPL 120



Zaxor Led 128

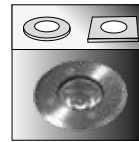

Zaxor 10° 132

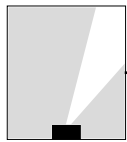

ASYMMETRIC

from 1,1W
to 3,2W

Ø min: 45mm



Xeno Y 108

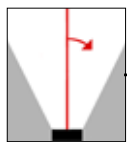

**DIRECTIONAL
ADJUSTABLE**

from 1,1W
to 3,2W

Ø min: 45mm



Xeno R 104



Xeno S 106

from 3,2W
to 24W

Ø min:
100mm to 150mm



Zaxor Led-O 134



Bolas O-HPL 140

EXTERIOR - FLOOR LIGHTING



Floor uplighting - recessed

220-240V
LED

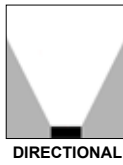

from 1,1W
to 3,2W

Ø min: 65mm

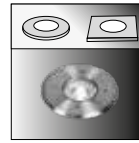

from 3,2W
to 17W

Ø min:
78mm to 150mm

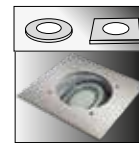
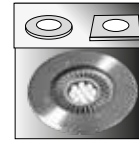

from 3,2W
to 17W

Ø min:
100mm to 200mm

220-240V
GU10

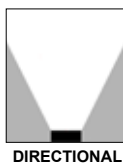

Ø min:
78mm to 100mm

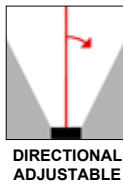
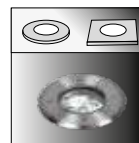

Ø min: 100mm

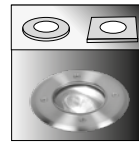

Underwater

xxxmA
LED
Constant
current

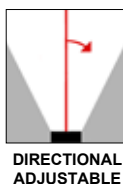
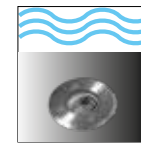
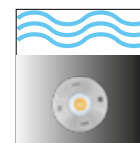
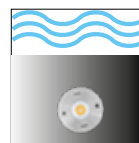
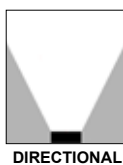



EXTERIOR

Flood light 16

Floor lighting 70

Floor uplighting - surface 72



Floor - ground surface illumination 80



Floor uplighting - recessed 96



Underwater 146



Accessories

Accessories for flood light 162

Accessories for floor lighting 170

Waterproof connection & other 172

Led power supply 176

General Information 184

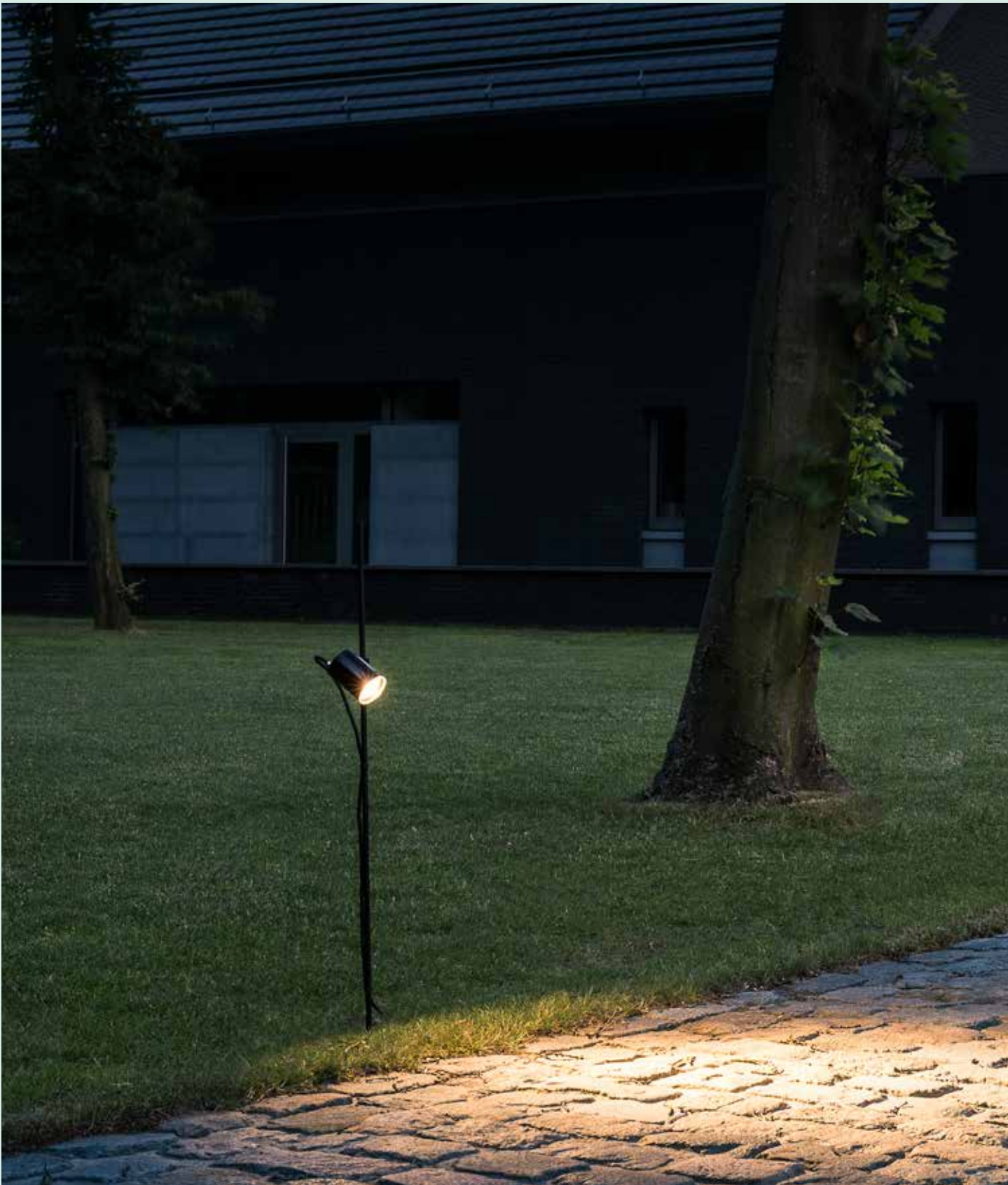

Maxima-GU



Exterior

Flood light



Swing



IP54

350mA

IK06



DESCRIPTION

Body made in solid anodized aluminum
Screws in stainless steel
Degree of protection IP54 - IK06
Safety clear plexiglass
Led 350mA CRI>80 3SDCM 50.000hrs L80 B10
Provided with 20cm cable

ACCESSORIES

Led driver AC/CC 350mA
Led driver DC/CC (12-36VDC/350mA)
Stem with spike for ground fixing: Stem B
IP68 connection - Connex 4 ref: X083

ON REQUEST

Other led color: 2700K / 4000K
Other material: stainless steel 316L

350mA
1W

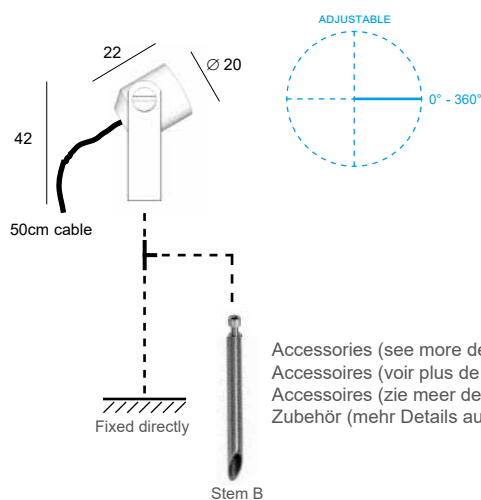

code: 312. 30 . XX
led | color



max. efficacy
137lm/W

LED

30 3000K 40°

COLOR

02A Anodized black
32 Anodized aluminum

Typical luminous flux (lm)	
1W	
2700 K	119
3000 K	125
4000 K	137

2700K / 4000K = on request

Swing

Reference	Price €
312.30._._	67.00

Swing

Led flood light



EXTERIOR LIGHTING
FLOOD LIGHT

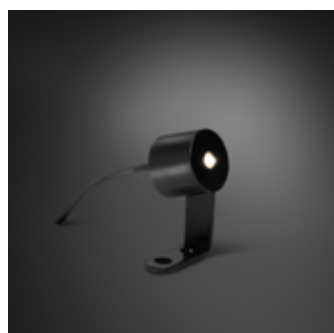

stainless steel 316L
(on request)



1 x SWING
1 x STEM B

code: 312.30.02A
code: T1.050.SP.K.04



DESCRIPTION

Body made in solid stainless steel, brass, copper or aluminum
 Screws in stainless steel
 Degree of protection IK06 - IP68, water depth up to 1m
 Safety clear glass
 Led 350mA CRI>90 3SDCM 85.000hrs L80 B10
 Provided with 1m cable

350mA
1,1W - 3,2W

ACCESSORIES

- Led driver AC/CC 350mA
- Led driver DC/CC (12-36VDC/350mA)
- Base & stem for ground/wall/ceiling
- IP68 Stem with spike for ground fixing: Stem B / E
- Anti-glare ring - ref: AC.8042.AG._._
- 350mA IP68 connection : Connex 2 / 3 / 4

ON REQUEST

- Anodized aluminum (32) / bronze (33) or Other RAL colors
- Other led color: 3000K / 5000K
- Other cable length (customized)

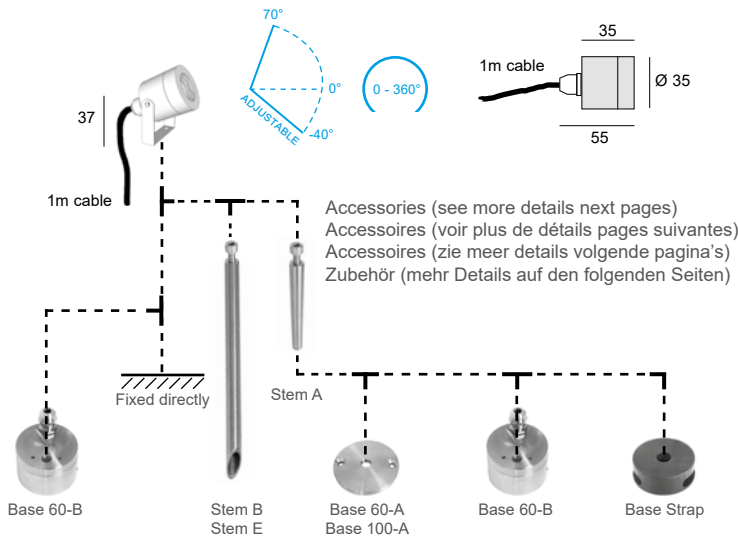

code: **8042. XXX . XX**
 led color



LED

- D11** 1,1W - 4000K - 10°
- D13** 1,1W - 4000K - 35°
- D31** 3,2W - 4000K - 35°
- D32** 3,2W - 4000K - 50°
- W11** 1,1W - 2700K - 10°
- W13** 1,1W - 2700K - 35°
- W31** 3,2W - 2700K - 35°
- W32** 3,2W - 2700K - 50°

COLOR

- 02A** Anodized black
- 04** Brushed stainless steel
- 07** Brushed brass
- 21** Brushed copper

max. efficacy
132lm/W

	Typical luminous flux (lm)	
	1,1W	3,2W
2700 K	115	355
3000 K	125	370
4000 K	135	395
5000 K	145	410

3000K / 5000K = on request

For some applications, led 1,1W can be used with a driver 500mA to obtain for example +/- 1,6W 10° 4000K 185 lumens

Kozi S

Reference	Price €
8042._._.02A	162.00
8042._._.04	162.00
8042._._.07	207.00
8042._._.21	220.00

Kozi S

Led flood light



1 x KOZI S code: 8042.W32.02A
 1 x ANTI-GLARE 01 code: AC.8042.AG.02A
 1 x STEM A code: TI.010.M10A.02A
 1 x BASE 60-A code: BASE.060A.02A



1 x KOZI S code: 8042.W32.04
 1 x BASE 60-B code: BASE.060B.04



1 x KOZI S code: 8042.W32.21
 1 x STEM B code: TI.050.SPK.21



1 x KOZI S code: 8042.W32.04
 1 x STEM B code: TI.020.SPK.04

EXTERIOR LIGHTING
 FLOOD LIGHT



230V
2x 3,2W



Anodized black



Anodized bronze



Brushed stainless steel

Kozi FL

Led flood light



DESCRIPTION

Body made in solid anodized aluminum or stainless steel
 Screws in stainless steel
 Degree of protection IP65 - IK06
 Safety clear plexiglass
 Led module COB CRI>90 3SDCM 85.000hrs L80 B10
 Led power supply 220-240V included

ACCESSORIES

Spike for ground fixing - Pic 1 ref: 802.00.02
 Anti-glare ring - ref: AC.8042.AG._ _

ON REQUEST

Other led color: 4000K / 5000K
 Other dimensions (customized)

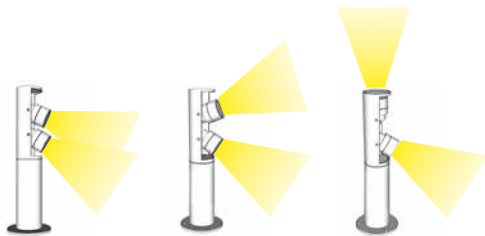

Kozi FL

EXTERIOR LIGHTING
 FLOOD LIGHT

code: **8043 . X XX . XX**
 height | led | color

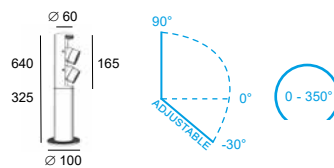

max. efficacy
 128lm/W

Typical luminous flux (lm)	
2x 3,2W	
2700 K	2x 355
3000 K	2x 370
4000 K	2x 395
5000 K	2x 410

HEIGHT

1 325mm
 2 640mm

LED

27 2 x 3,2W - 2700K - 50°
 30 2 x 3,2W - 3000K - 50°

COLOR

02A Anodized black
 04 Brushed stainless steel
 32D Anodized aluminum
 33 Anodized bronze

4000K / 5000K = on request
 diffusion angle 35° = on request

Kozi FL

Reference	Price €	Reference	Price €
8043.1__02A	589.00	8043.2__02A	629.00
8043.1__04	789.00	8043.2__04	849.00
8043.1__32D	589.00	8043.2__32D	629.00
8043.1__33	589.00	8043.2__33	629.00



Sami

DESCRIPTION

Body made in copper
 Degree of protection IP65 - IK06
 Safety sandblasted plexiglass
 Led 350mA CRI>90 3SDCM 85.000hrs L80 B10
 Provided with spike «Ecopic» for ground fixing
 Provided with 1m cable



IP65

350mA

IK06



ACCESSORIES

Led driver AC/CC 350mA
 Led driver DC/CC (12-36VDC/350mA)
 Anti-glare ring ref: 8031.AC01.21
 IP68 connection - Connex 4 ref: X083

ON REQUEST

Other led color: 3000K / 5000K
 Other dimensions (customized)
 Base plate for ground/wall/ceiling fixing
 Other cable length (customized)

350mA
1,1W - 3,2W

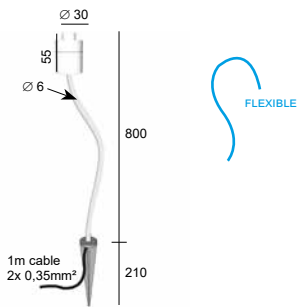

Sami AG

code: **8031.AC01.21**



Anti-glare accessory
 Ø 30 mm Height: 40mm

Sami AG

Reference	Price €
8031.AC01.21	35.50

code: 8031 . XXX . 21
 led



DIMMABLE

LED

D13 1,1W - 4000K
D32 3,2W - 4000K
W13 1,1W - 2700K
W32 3,2W - 2700K

3000K / 5000K = on request

COLOR

21 Brushed copper

max. efficacy
 132lm/W

	Typical luminous flux (lm)	
	1,1W	3,2W
2700 K	115	355
3000 K	125	370
4000 K	135	395
5000 K	145	410

Sami

Reference	Price €
8031.D13.21	239.00
8031.D32.21	239.00
8031.W13.21	239.00
8031.W32.21	239.00

Sami

Led flood light



EXTERIOR LIGHTING
FLOOD LIGHT



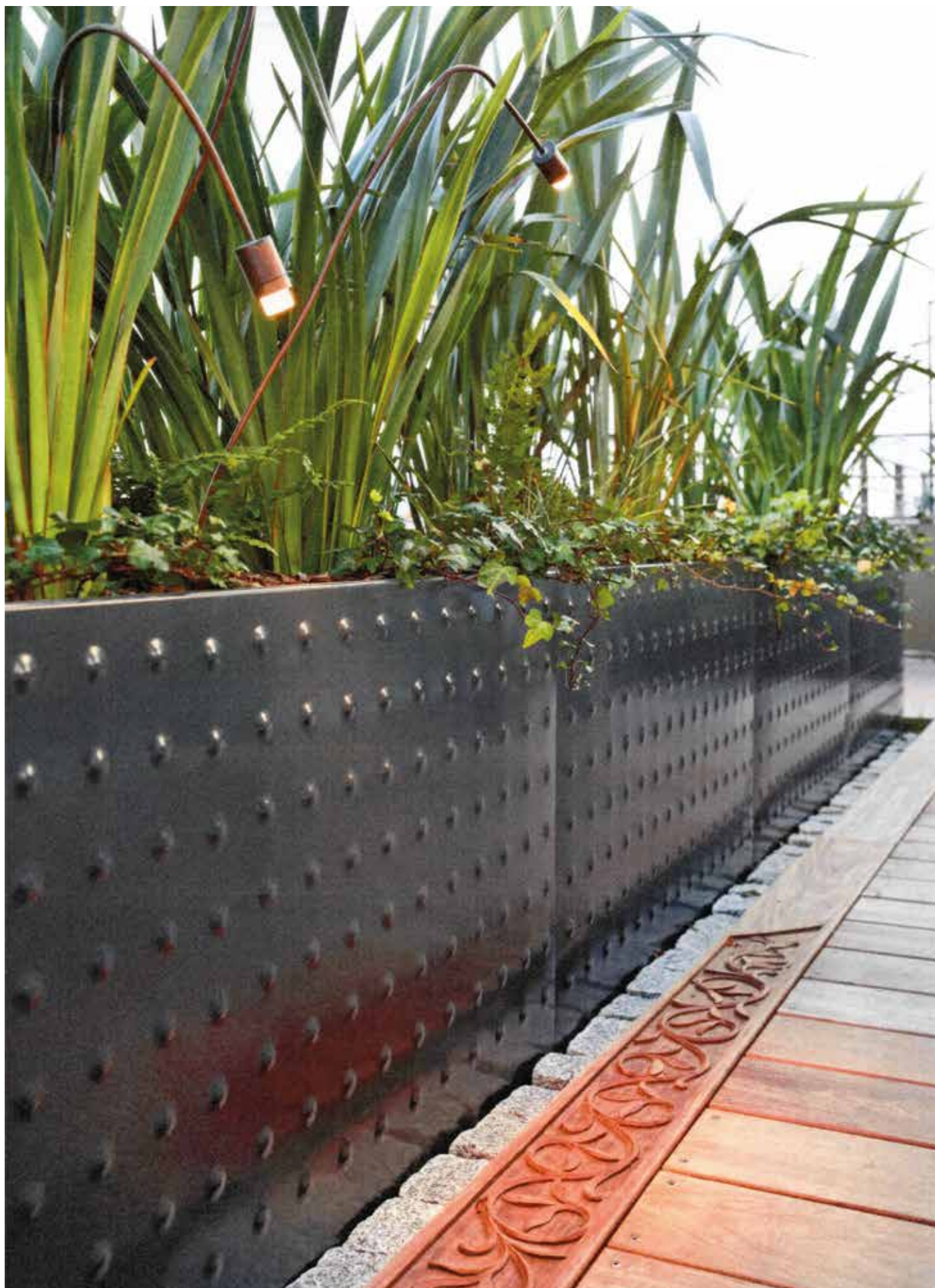

© Agence Christophe Gautrand & Associés Paysagistes / Photographies : Hugo Hébrard
Aménagement de la terrasse de la Suite Royale Orientale de l'Hôtel Mandarin Oriental Paris.





Sami-flex

DESCRIPTION

Body made in anodized aluminum
 Flexible rod with polyolefin heat shrink tubing
 Degree of protection IP65 - IK06
 Safety sandblasted plexiglass
 Led 350mA CRI>90 3SDCM 85.000hrs L80 B10
 Provided with spike «Ecopic» for ground fixing
 Provided with 1m cable

ACCESSORIES

Led driver AC/CC 350mA
 Led driver DC/CC (12-36VDC/350mA)
 Anti-glare ring ref: 7021.AC01.02A
 IP68 connection - Connex 4 ref: X083

ON REQUEST

Other led color: 3000K / 5000K
 Base plate for ground/wall/ceiling fixing
 Other cable length (customized)



IP65

350mA

IK06



350mA
1,1W - 3,2W

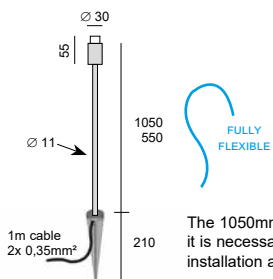

The 1050mm version is completely flexible but unstable, it is necessary to find the point of balance during installation and maybe fixed one part of the rod.

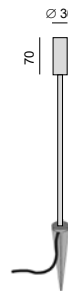

Sami-flex AG

code: **7021.AC01.02A**

Anti-glare accessory
 Ø 30 mm Height: 40mm

Sami-flex AG

Reference	Price €
7021.AC01.02A	24.50

max. efficacy
132lm/W

code: **7021. X XXX . 02A**

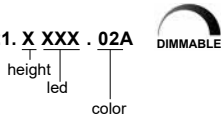

HEIGHT

- 1 550 mm
- 2 1050 mm

LED

- D13** 1,1W - 4000K
- D32** 3,2W - 4000K
- W13** 1,1W - 2700K
- W32** 3,2W - 2700K

COLOR

- 02A** Anodized black

	Typical luminous flux (lm)	
	1,1W	3,2W
2700 K	115	355
3000 K	125	370
4000 K	135	395
5000 K	145	410

3000K / 5000K = on request

Sami-flex

Reference	Price €
7021.1___.02A	220.00
7021.2___.02A	254.00

Sami-flex



Led flood light



with Anti-glare ring ref: 7021.AC01.02A



with Anti-glare ring ref: 7021.AC01.02A

on request



EXTERIOR LIGHTING
FLOOD LIGHT





Lena Pro-S-A



IP66

350mA

IK06



DESCRIPTION

Body made in solid anodized aluminum
 Screws in stainless steel
 Degree of protection IP66 - IK07
 With anti-glare ring included
 Safety clear plexiglass
 Led COB 350mA CRI>90 3SDCM 85.000hrs L80 B10
 Provided with 1m cable

ACCESSORIES

Led driver AC/CC from 200mA to 350mA
 Led driver DC/CC (12-36VDC/200mA to 350mA)
 Spike for ground fixing : Pic 4 ref: 804.04.02A
 Anti-glare honeycomb - Louver ref: X060.029.3
 IP68 connection : Connex 2 / 3 / 4

ON REQUEST

Other cable length (customized)
 Base for strap around a tree

350mA
4,2W

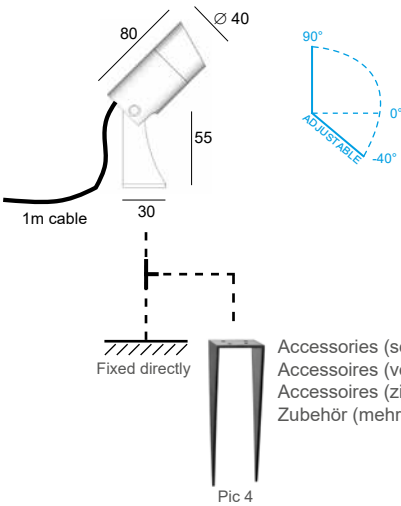

Accessories (see more details next pages)
 Accessoires (voir plus de détails pages suivantes)
 Accessoires (zie meer details volgende pagina's)
 Zubehör (mehr Details auf den folgenden Seiten)

max. efficacy
 87lm/W

	Typical luminous flux (lm)	
	200mA 2,3W	350mA 4,2W
2700 K	190	310
3000 K	200	325
4000 K	200	325

code: 7024A. XX XXX . XX
 led power color



LED

27	2700K
30	3000K
40	4000K

POWER

410	4,2W - 10°
440	4,2W - 40°

COLOR

02A	Anodized black
32D	Anodized aluminum
33	Anodized bronze

Lena Pro-S-A

Reference	Price €
7024A_-----	195.00

Lena PRO S-A



Led flood light



EXTERIOR LIGHTING
FLOOD LIGHT



Lena Base for Strap
(on request)



Lena Pro-S-B



IP66

350mA

IK06



DESCRIPTION

Body made in solid anodized aluminum
Screws in stainless steel
Degree of protection IP66 - IK07
With anti-glare ring included
Safety clear plexiglass
Led COB 350mA CRI>90 3SDCM 85.000hrs L80 B10
Provided with 1m cable

350mA
4,2W

ACCESSORIES

Led driver AC/CC from 200mA to 350mA
Led driver DC/CC (12-36VDC/200mA to 350mA)
Base & stem for ground/wall/ceiling
Stem with spike for ground fixing: Stem D
Anti-glare honeycomb - Louver ref: X060.029.3
IP68 connection : Connex 2 / 3 / 4

ON REQUEST

Other cable length (customized)

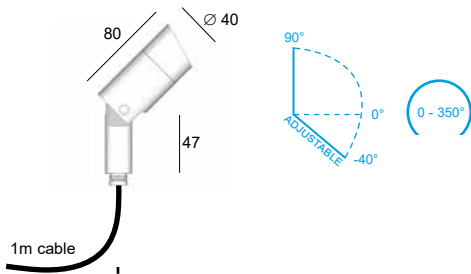

Accessories (see more details next pages)
Accessoires (voir plus de détails pages suivantes)
Accessoires (zie meer details volgende pagina's)
Zubehör (mehr Details auf den folgenden Seiten)



max. efficacy
87lm/W

	Typical luminous flux (lm)	
	200mA 2,3W	350mA 4,2W
2700 K	190	310
3000 K	200	325
4000 K	200	325

code: 7024B. XX XXX . XX
led power color



LED

27 2700K
30 3000K
40 4000K

POWER

410 4,2W - 10°
440 4,2W - 40°

COLOR

02A Anodized black
32D Anodized aluminum
33 Anodized bronze

Lena Pro-S-B

Reference	Price €
7024B_-----	215.00

Lena PRO S-B



Led flood light



1 x LENA PRO S-B code: 7024B.27440.33
with fixation M14, only for spécial project.



1 x LENA PRO S-B code: 7024B.27440.33
1 x BASE 50-B code: BASE.050B.33



1 x LENA PRO S-B code: 7024B.27440.02A
1 x BASE 100-L code: BASE.100L.02A
1 x DRIVER 6W code: DC006.0350.20D0



2 x LENA PRO S-B code: 7024B.27440.02A
1 x BASE 200-B code: BASE.200B.02A
1 x DRIVER 10W code: DC010.0350.65D1



1 x LENA PRO S-B code: 7024B.27440.02A
1 x STEM D code: TI20.050.SK.02A



2 x LENA PRO S-B code: 7024B.27440.02A
1 x BASE 100-C code: BASE.100C.02A
1 x DRIVER 10W code: DC010.0350.65D1

EXTERIOR LIGHTING
FLOOD LIGHT





Lena Pro-M-A



IP66

500mA

IK07



DESCRIPTION

Body made in solid anodized aluminum
Screws in stainless steel
Degree of protection IP66 - IK07
With anti-glare ring included
Safety clear plexiglass
Led COB 500mA CRI>90 3SDCM 85.000hrs L80 B10
Provided with 1m cable

ACCESSORIES

Led driver AC/CC from 200mA to 500mA
Led driver DC/CC (12-36VDC/200mA to 500mA)
Spike for ground fixing - Pic 4 ref: 804.04.02A
Anti-glare honeycomb - Louver ref: X060.050.3
IP68 connection : Connex 2 / 3 / 4

ON REQUEST

Other led color: 5000K
Other cable length (customized)
Base for strap around a tree

500mA
9,5W

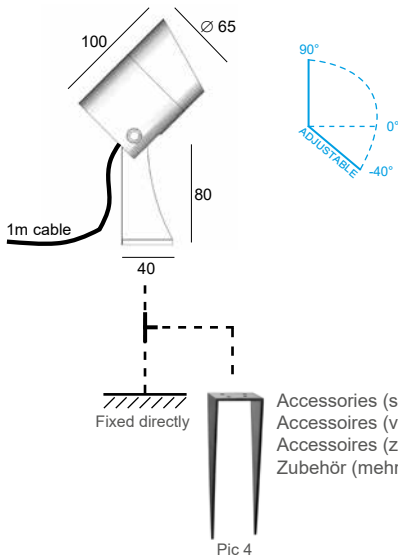

Accessories (see more details next pages)
Accessoires (voir plus de détails pages suivantes)
Accessoires (zie meer details volgende pagina's)
Zubehör (mehr Details auf den folgenden Seiten)

max. efficacy
141lm/W

	Typical luminous flux (lm)	
	350mA 6W	500mA 9,5W
2700 K	725	995
3000 K	760	1035
4000 K	805	1095
5000 K	845	1150

code: 7025A. XX XXX . XX
led power color



LED

27	2700K
30	3000K
40	4000K

POWER

910	9,5W - 10°
925	9,5W - 25°
940	9,5W - 40°

COLOR

02A	Anodized black
32D	Anodized aluminum
33	Anodized bronze

5000K = on request

Lena Pro-M-A

Reference	Price €
7025A_-----	255.00

Lena PRO M-A



Led flood light

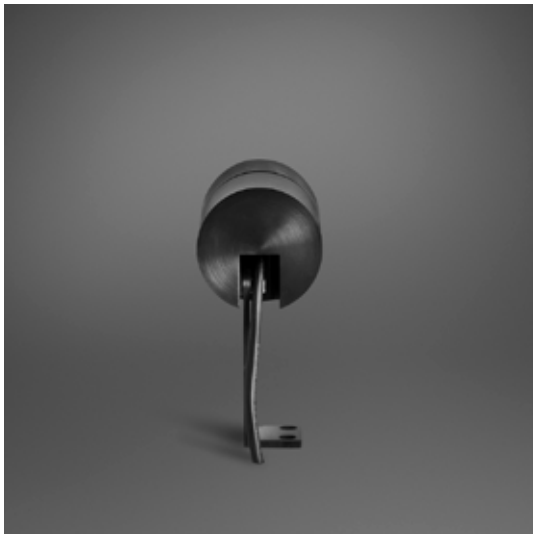

EXTERIOR LIGHTING
FLOOD LIGHT



Lena Base for Strap
(on request)



Lena Pro-M-B



0.5°

IP66

500mA

IK06



DESCRIPTION

Body made in solid anodized aluminum
Screws in stainless steel
Degree of protection IP66 - IK07
With anti-glare ring included
Safety clear plexiglass
Led COB 500mA CRI>90 3SDCM 85.000hrs L80 B10
Provided with 1m cable

ACCESSORIES

Led driver AC/CC from 200mA to 500mA
Led driver DC/CC (12-36VDC/200mA to 500mA)
Base & stem for ground/wall/ceiling
Stem with spike for ground fixing: Stem D
Anti-glare honeycomb - Louver ref: X060.050.3
IP68 connection : Connex 2 / 3 / 4

ON REQUEST

Other led color: 5000K
Other cable length (customized)

500mA
9,5W

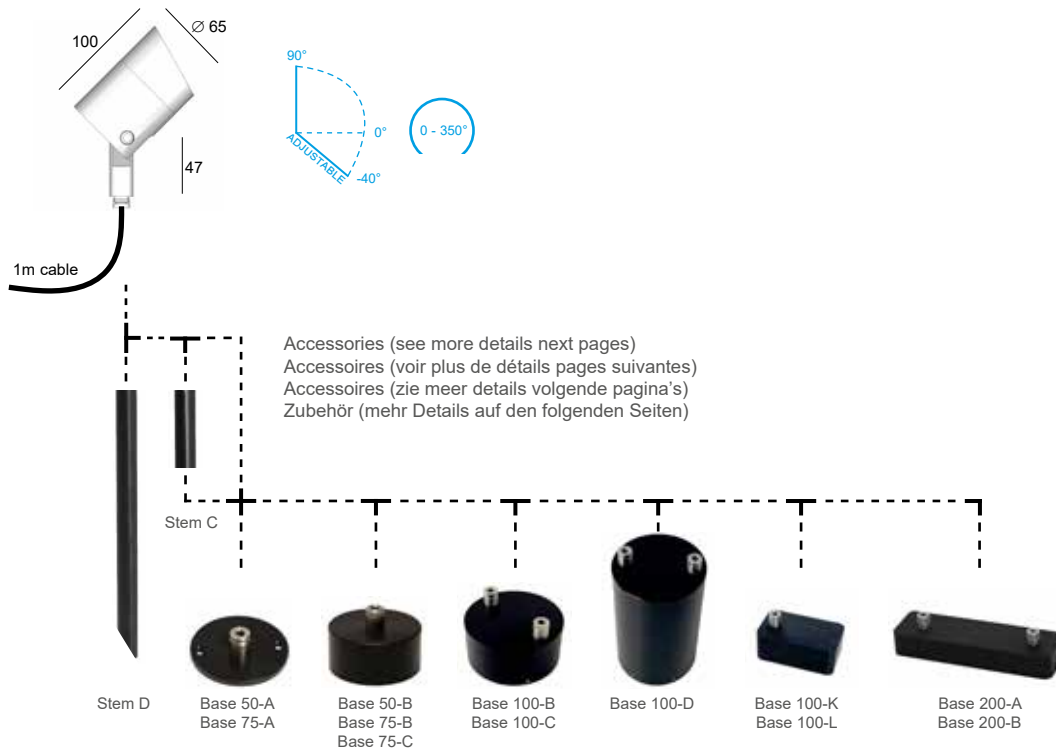

max. efficacy
141lm/W

	Typical luminous flux (lm)	
	350mA 6W	500mA 9,5W
2700 K	725	995
3000 K	760	1035
4000 K	805	1095
5000 K	845	1150

code: **7025B.XX XXX.XX** 
 led power color

LED	
27	2700K
30	3000K
40	4000K

POWER	
910	9,5W - 10°
925	9,5W - 25°
940	9,5W - 40°

COLOR	
02A	Anodized black
32D	Anodized aluminum
33	Anodized bronze

5000K = on request

Lena Pro-M-B

Reference	Price €
7025B._._._._._	279.00

Lena PRO M-B

Led flood light



1 x LENA PRO M-B
1 x BASE 75-B

code: 7025B.27940.02A
code: BASE.075B.02A



1 x LENA PRO M-B
1 x STEM C
1 x BASE 75-B

code: 7025B.27940.02A
code: TI20.050.M1.02A
code: BASE.075B.02A

1 x LENA PRO M-B
1 x BASE 75-A

code: 7025B.27940.02A
code: BASE.075A.02A



1 x LENA PRO M-B
1 x BASE 100-L
1 x DRIVER 10W

code: 7025B.27940.33
code: BASE.100L.33
code: DC010.0500.65D0

2 x LENA PRO M-B
1 x BASE 200-B
2 x DRIVER 6W

code: 7025B.27940.33
code: BASE.200B.33
code: DC006.0350.20D0

EXTERIOR LIGHTING
FLOOD LIGHT





Lena GU-A

DESCRIPTION

Body made in solid anodized aluminum
Screws in stainless steel
Degree of protection IP66 - IK07
With anti-glare ring included
Safety clear plexiglass
Provided with 1m cable



ACCESSORIES

IP66 Spike for ground fixing - Pic 4 ref: 804.04.02A
230V Anti-glare honeycomb - Louver ref: X060.050.3
IK07 IP68 connection : Connex 2 / 3 / 4 / 6



ON REQUEST



Other cable length (customized)
Base for strap around a tree



230V

GU10

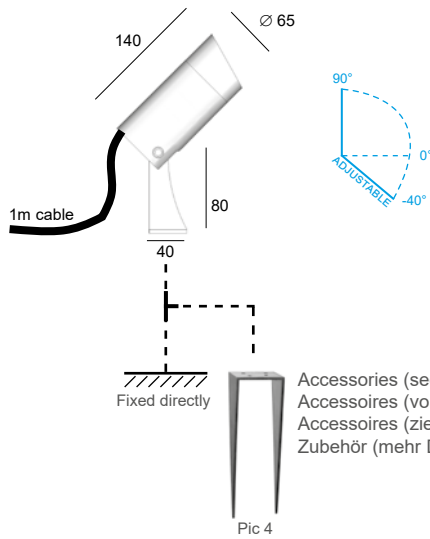

Accessories (see more details next pages)
Accessoires (voir plus de détails pages suivantes)
Accessoires (zie meer details volgende pagina's)
Zubehör (mehr Details auf den folgenden Seiten)

code: 7026A.GU.XX



color

BULB

GU GU10 LED (max. height 58mm)

COLOR

02A Anodized black
32D Anodized aluminum
33 Anodized bronze

Lena GU-A

Reference	Price €
7026A.GU._.	255.00

Lena GU-A

Led flood light



EXTERIOR LIGHTING
FLOOD LIGHT





Lena GU-B

DESCRIPTION

Body made in solid anodized aluminum
 Screws in stainless steel
 Degree of protection IP66 - IK07
 With anti-glare ring included
 Safety clear plexiglass
 Provided with 1m cable



ACCESSORIES

IP66 Base & stem for ground/wall/ceiling
 230V Stem with spike for ground fixing = Stem D
 IK07 Anti-glare honeycomb - Louver ref: X060.050.3
 IP68 connection : Connex 2 / 3 / 4 / 6



ON REQUEST



Other cable length (customized)

230V
 GU10

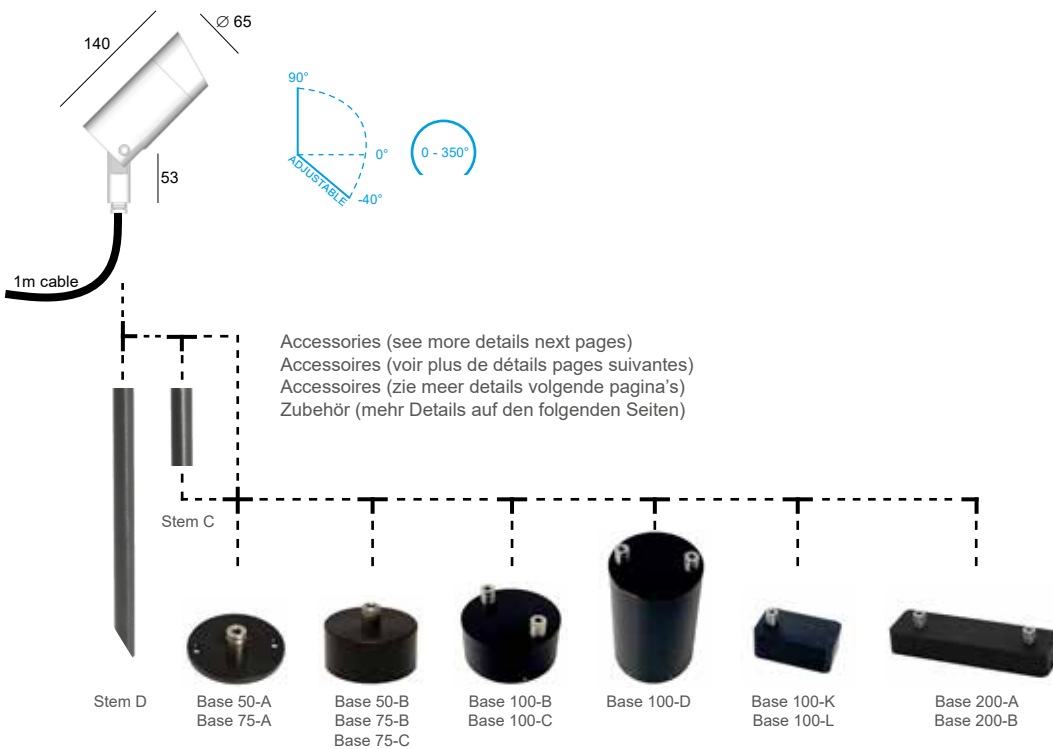

code: 7026B.GU.XX

color



DIMMABLE

BULB

GU GU10 LED (max. height 58mm)

COLOR

02A Anodized black
 32D Anodized aluminum
 33 Anodized bronze

Lena GU-B

Reference	Price €
7026B.GU._._	279.00

Lena GU-B



Led flood light



1 x LENA GU-B
1 x BASE 75-B

code: 7026B.GU.32D
code: BASE.075B.32D



2 x LENA GU-B
1 x BASE 200-A

code: 7026B.GU.02A
code: BASE.200A.02A

2 x LENA GU-B
1 x BASE 100-B

code: 7026B.GU.33
code: BASE.100B.33



2 x LENA GU-B
1 x STEM C
1 x STEM C
1 x BASE 100-D

code: 7026B.GU.02A
code: TI20.050.M1.02A
code: TI20.020.M1.02A
code: BASE.100D.02A

2 x LENA GU-B
1 x STEM C
1 x STEM C
1 x BASE 100-D

code: 7026B.GU.32D
code: TI20.050.M1.32D
code: TI20.020.M1.32D
code: BASE.100D.32D

EXTERIOR LIGHTING
FLOOD LIGHT





Maxima-50

DESCRIPTION

Body made in solid stainless steel, copper or aluminum
 Screws in stainless steel
 Degree of protection IP65 - IK07
 Safety plexiglass
 Led 230V CRI>90 3SDCM 54.000hrs L80 B10
 Provided with 1m cable

230V
4W

ACCESSORIES

- Base & stem for ground/wall/ceiling
- Stem with spike for ground fixing: Stem B / E
- IP68 connection : Connex 2 / 3 / 4 / 6

IP65

230V

ON REQUEST

- IK07
- Anodized bronze (33)
- Other material: brass
- Other led color: 3000K / 4000K
- Led 3,2 or 6W 350mA : 2700K / 3000K / 4000K / 5000K
- Other cable length (customized)

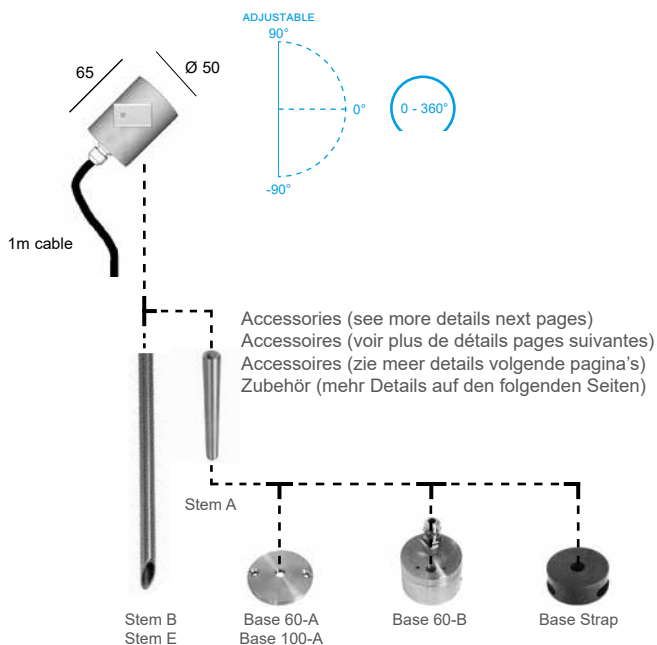

code: **7004.W27.XX**
 color



LED

W27 4W 230V - 2700K - 70°

COLOR

- 02A** Anodized black
- 04** Brushed stainless steel
- 21** Brushed copper
- 32** Anodized aluminum

max. efficacy
85lm/W

Typical luminous flux (lm)	
	4W
2700 K	315
3000 K	320
4000 K	340

3000K / 4000K = on request
 3.2W or 6W 350mA : 2700K / 3000K / 4000K / 5000K = on request

Maxima-50

Reference	Price €
7004.W27.02A	199.50
7004.W27.04	249.50
7004.W27.21	313.00
7004.W27.32	199.50

Maxima 50

Led flood light



1 x MAXIMA 50
1 x STEM B
code: 7004.W27.21
code: T1.050.SPK.21



1 x MAXIMA 50
1 x STEM E
code: 7004.W27.02A
code: T112.080.Z.02A



1 x MAXIMA 50
1 x STEM A
1 x BASE 60-A
code: 7004.W27.04
code: T1.010.M10A.04
code: BASE.060A.04

EXTERIOR LIGHTING
FLOOD LIGHT





Maxima-65

DESCRIPTION

Body made in solid stainless steel, brass or aluminum
 Screws in stainless steel
 Degree of protection IP65 - IK07
 Safety clear plexiglass
 Led 230V CRI>90 3SDCM 54.000hrs L80 B10
 Provided with 1m cable

230V
6W

ACCESSORIES

- Base & stem for ground/wall/ceiling
- Stem with spike for ground fixing: Stem B / E
- Anti-glare ring - ref: AC.7002.AG._._
- IP65 Anti-glare honeycomb - Louver ref: X060.043.3
- IP68 connection : Connex 2 / 3 / 4 / 6

ON REQUEST

- Anodized bronze (33)
- Other led color: 4000K
- Other beam angle: 50°
- Led 6W or 11W 350mA : 2700K / 3000K / 4000K / 5000K
- Other cable length (customized)

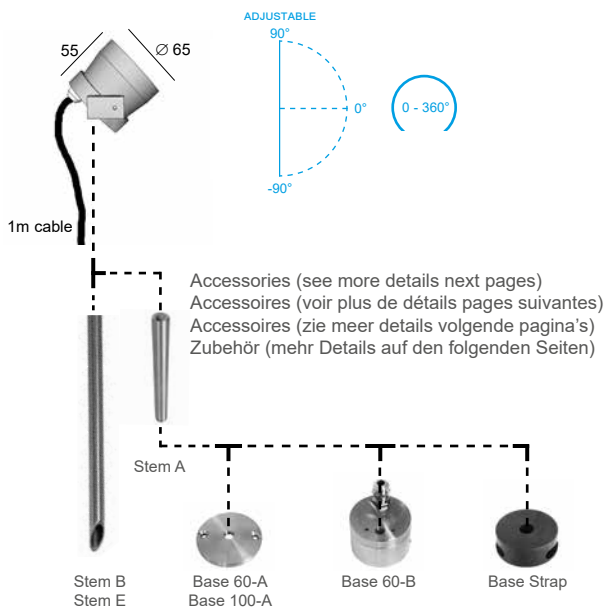

code: 7002. XXX . XX
 led color



LED

- W11** 6W 230V - 2700K - 15°
- W12** 6W 230V - 2700K - 36°
- W21** 6W 230V - 3000K - 15°
- W22** 6W 230V - 3000K - 36°

COLOR

- 02A** Anodized black
- 04** Brushed stainless steel
- 07** Brushed brass
- 32** Anodized aluminum

max. efficacy 80lm/W

Typical luminous flux (lm)	
6W	
2700 K	460
3000 K	470
3000 K	480

50° = on request
 4000K = on request
 6W or 11W 350mA 2700K / 3000K / 4000K / 5000K = on request

Maxima-65

Reference	Price €
7002._._.02A	249.50
7002._._.04	333.00
7002._._.07	358.00
7002._._.32	249.50

Maxima 65



Led flood light



1 x MAXIMA 65
1 x STEM A
1 x BASE 60-A

code: 7002.W22.07
code: TI.010.M10A.07
code: BASE.060A.02A



1 x MAXIMA 65
1 x STEM B

code: 7002.W22.04
code: TI.050.SPK.04



2 x MAXIMA 65
2 x ANTI-GLARE 03
1 x STEM B

code: 7002.W22.02A
code: AC.7002.AG.02A
code: TI.100.SPK.02A





Maxima-100

DESCRIPTION

Body made in solid anodized aluminum
 Screws in stainless steel
 Degree of protection IP65 - IK07
 Safety clear plexiglass
 Led 230V 10W CRI>90 3SDCM 54.000hrs L80 B10
 Led 230V 20W CRI>80 3SDCM 42.000hrs L70 B10
 Provided with 1m cable



ACCESSORIES



IP65

230V

IK07

Base & stem for ground/wall/ceiling
 Stem with spike for ground fixing: Stem B / E
 Anti-glare ring - ref: AC.7003.AG._._
 Anti-glare honeycomb - Louver ref: X060.082.3
 IP68 connection : Connex 2 / 3 / 4 / 6



ON REQUEST



Anodized bronze (33)
 Other cable length (customized)
 Led 10W 230V 2700K / 4000K
 Led 24W 700mA : 2700K / 3000K / 4000K / 5000K

230V
10W - 20W

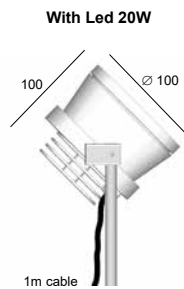
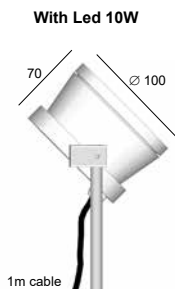
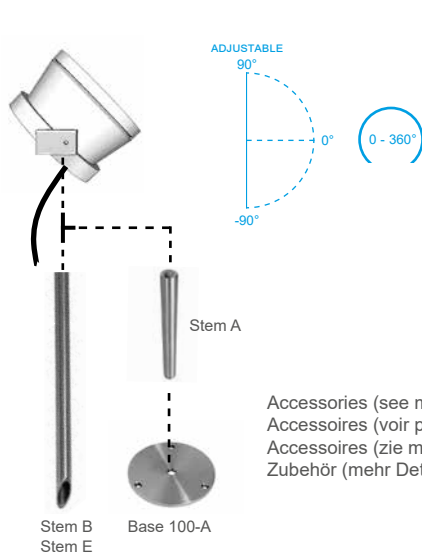

Accessories (see more details next pages)
 Accessoires (voir plus de détails pages suivantes)
 Accessoires (zie meer details volgende pagina's)
 Zubehör (mehr Details auf den folgenden Seiten)

code: **7003.XXX.XX**
 led color



LED

- W11** 10W 230V - 3000K - 16°
- W12** 10W 230V - 3000K - 40°
- W21** 20W 230V - 3000K - 16°
- W22** 20W 230V - 3000K - 40°

COLOR

- 02A** Anodized black
- 32** Anodized aluminum

max. efficacy 102lm/W

	Typical luminous flux (lm)	
	10W	20W
2700 K	930	
3000 K	950	1800
4000 K	1020	

Led 10W 2700K / 4000K = on request
 24W 700mA 2700K / 3000K / 4000K / 5000K = on request

Maxima-100

Reference	Price €
7003.W1 _ _ _	325.00
7003.W2 _ _ _	375.00

Maxima 100



Led flood light



1 x MAXIMA 100
1 x LOUVER
1 x STEM B

code: 7003.W12.02A
code: X060.082.3
code: Tl.100.SP.K.02A



1 x MAXIMA 100
1 x ANTI-GLARE 04
1 x STEM A
1 x BASE 100-A

code: 7003.W12.02A
code: AC.7003.AG.02A
code: Tl.010.M10A.02A
code: BASE.100A.02A

EXTERIOR LIGHTING
FLOOD LIGHT





Maxima-GU

DESCRIPTION

Body made in solid stainless steel, brass, copper or aluminum
 Screws in stainless steel
 Degree of protection IP66 - IK07
 Safety clear plexiglass
 Provided with 1m cable

230V
GU10

ACCESSORIES



Base & stem for ground/wall/ceiling
 Stem with spike for ground fixing: Stem B / E
 Anti-glare ring - ref. AC.7001.AG.__
 IP66 Anti-glare honeycomb - Louver ref: X060.050.3
 IP68 connection : Connex 2 / 3 / 4 / 6



230V

IK07

ON REQUEST



Anodized bronze (33)
 Other cable length (customized)

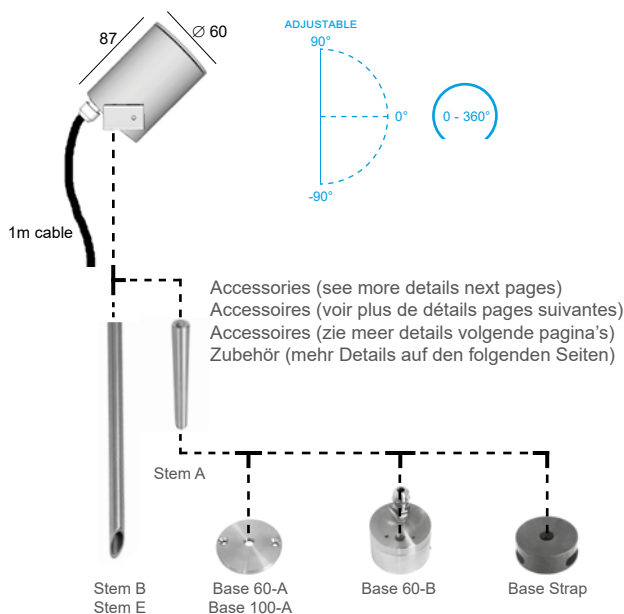

code: 7001.GU.XX

color



BULB

GU GU10 LED (max. height 58mm)

COLOR

02A	Anodized black	
04	Brushed stainless steel	
07	Brushed brass	
21	Brushed copper	
32	Anodized aluminum	

Maxima-GU

Reference	Price €
7001.GU.02A	195.00
7001.GU.04	220.00
7001.GU.07	220.00
7001.GU.21	275.00
7001.GU.32	195.00

Maxima GU



Led flood light



3 x MAXIMA-GU code: 7001.GU.02A
3 x STEM B code: TI.100.SPK.02A

EXTERIOR LIGHTING
FLOOD LIGHT



7001.01.02A

3 x MAXIMA-GU code: 7001.GU.02A
3 x STEM B code: TI.100.SPK.02A



example with 2 x Maxima-50 copper

2 x MAXIMA-50 code: 7004.W27.21
 1 x LINE-UP code: 7007.050.21

Line-Up

DESCRIPTION

Body made in solid stainless steel, brass, copper or aluminum
 Screws in stainless steel

ON REQUEST

Other dimensions (customized)
 Anodized bronze (33)

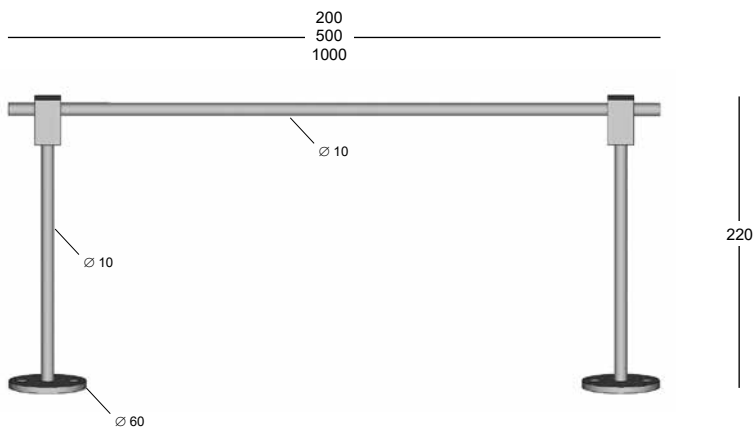

code: **7007. XXX . XX**
 height | color

LENGTH

020 200 mm
050 500 mm
100 1000 mm

COLOR

02A Anodized black
04 Brushed stainless steel
07 Brushed brass
21 Brushed copper
32 Anodized aluminum

Line-Up

Reference	Price €
7007.020.02A	182.00
7007.020.04	207.00
7007.020.07	225.00
7007.020.21	249.50
7007.020.32	182.00

Reference	Price €
7007.050.02A	187.00
7007.050.04	212.00
7007.050.07	238.00
7007.050.21	275.00
7007.050.32	187.00

Reference	Price €
7007.100.02A	207.00
7007.100.04	225.00
7007.100.07	263.00
7007.100.21	308.00
7007.100.32	207.00

Line-Up



To use with «Maxima» flood light



3 x MAXIMA-GU
1 x LINE-UP

code: 7001.GU.04
code: 7007.100.04

example with 3 x Maxima-GU stainless steel

EXTERIOR LIGHTING
FLOOD LIGHT



only available with the following floodlights

Maxima-50



Maxima-65



Maxima-100



Maxima-GU









Cylinder S

DESCRIPTION

Body made in solid anodized aluminum, stainless steel or brass
 Screws in stainless steel
 Degree of protection IP66 - IK07
 Safety clear plexiglass
 Provided with 1m cable

230V
GU10

ACCESSORIES

-  Base & stem for ground/wall/ceiling
-  Stem with spike for ground fixing: Stem B / E
-  Anti-glare ring - ref: AC.7001.AG:___
-  Anti-glare honeycomb - Louver ref: X060.050.3
- IP66 IP68 connection : Connex 2 / 3 / 4 / 6

230V

IK07



ON REQUEST

Anodized bronze (33) or Other RAL colors
 Other materials (copper)
 Other cable length (customized)

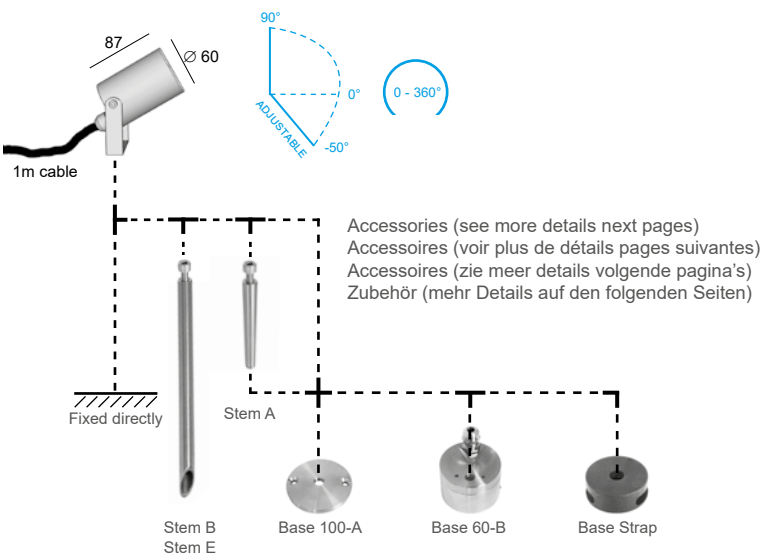

code: 240. GU . XX





color



BULB

GU GU10 LED (max. height 58mm)

COLOR

- 02A** Anodized black 
- 04** Brushed stainless steel 
- 07** Brushed brass 
- 32** Anodized aluminum 

Cylinder S

Reference	Price €
240.GU.02A	175.00
240.GU.04	195.00
240.GU.07	199.50
240.GU.32	175.00

Cylinder S

Led flood light



1 x CYLINDER S code: 240.GU.04
1 x STEM B code: TI.100.SPK.04

240.01.04



1 x CYLINDER S code: 240.GU.04
1 x BASE 60-B code: BASE.060B.04

240.02.04

EXTERIOR LIGHTING
FLOOD LIGHT



230V GU10



Max FL

DESCRIPTION

Body made in aluminum or stainless steel
Screws in stainless steel
Degree of protection IP65 - IK07
Safety clear plexiglass

ACCESSORIES

Spike for ground fixing - Pic 1 ref: 802.00.02

ON REQUEST

Anodized bronze (33)
Other RAL colors
Other dimensions (customized)
Available with 2 adjustable spotlights



IP65

230V

IK07

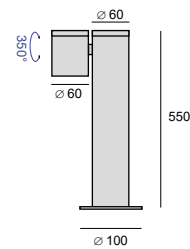

code: 975. GU . XX

color



BULB

GU GU10 LED (max. height 56mm)

COLOR

02 Black
04 Brushed stainless steel
32 Anodized aluminum
39 Grey

Max FL

Reference	Price €
975.GU.02	349.50
975.GU.04	375.00
975.GU.32	375.00
975.GU.39	349.50

Max FL



Led flood light



EXTERIOR LIGHTING
FLOOD LIGHT



230V

6W - 10W



Saturn Led



IP67

230V

IK10



DESCRIPTION

Body made in solid stainless steel, brass or aluminum
Screws in stainless steel
Degree of protection IP67 - IK10
Safety extra clear glass 10mm thickness
Led 230V CRI>90 3SDCM 54.000hrs L80 B10
Provided with 1m cable

ACCESSORIES

Base & stem for ground/wall/ceiling
Stem with spike for ground fixing: Stem B / E
Anti-glare honeycomb : Louver ref: X060.043.3
Anti-glare ring - ref: AC.8029.AG._._
IP68 connection : Connex 2 / 3 / 4 / 5

ON REQUEST

Anodized bronze (33)
Other led color: 2700K / 4000K
Other beam angle: 50°
Other cable length (customized)



with Anti-glare ring

code: 7006. XXX . XX 
led color

LED

W21 6W 230V - 3000K - 15°
W22 6W 230V - 3000K - 36°
W41 10W 230V - 3000K - 15°
W42 10W 230V - 3000K - 36°

50° = on request
2700K / 4000K = on request

COLOR

02A Anodized black
07 Brushed brass
16 Brushed stainless steel 316L
32 Anodized aluminum

max.
efficacy
102lm/W

	Typical luminous flux (lm)	
	6W	10W
2700 K	460	930
3000 K	470	950
4000 K	480	1020

Saturn Led

Reference	Price €
7006.W2 _02A/32	238.00
7006.W2 _07/16	433.00
7006.W4 _02A/32	288.00
7006.W4 _07/16	489.00

Saturn Led



Led flood light

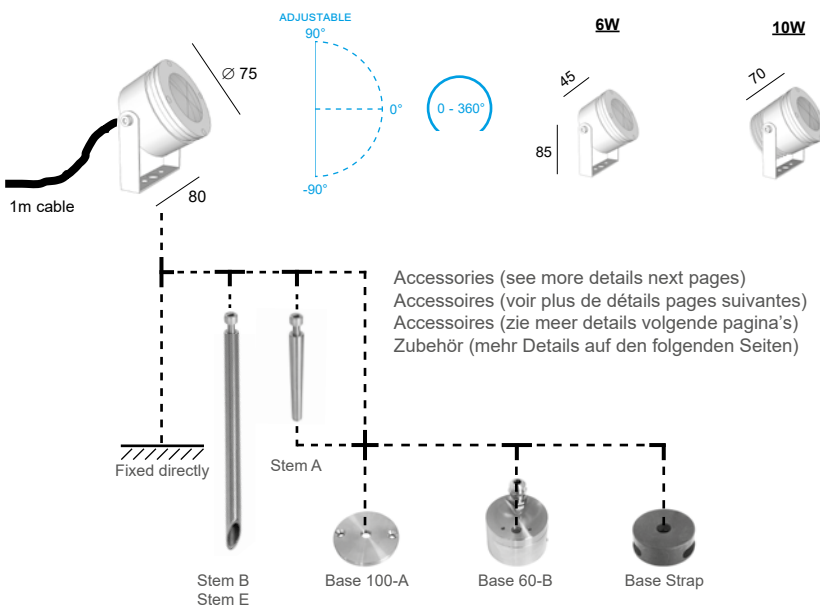

EXTERIOR LIGHTING
FLOOD LIGHT



350-500mA

6W - 17W



Saturn HP led



IP68

IK10



DESCRIPTION

Body made in solid stainless steel, brass or aluminum
Screws in stainless steel
Degree of protection IP68 - IK10
Safety extra clear glass 10mm thickness
Led module CRI>90 3SDCM 85.000hrs L80 B10
Provided with 1m cable

ACCESSORIES

Led driver 350mA or 500mA CC
Base & stem for ground/wall/ceiling
Stem with spike for ground fixing - Stem B - E
Anti-glare honeycomb - Louver ref: X060.043.3
Anti-glare ring - ref: AC.8029.AG._ _
IP68 connection : Connex 2 / 3 / 4

ON REQUEST

Anodized bronze (33)
Other led color: 3000K / 5000K
Other beam angle: 36°
Other cable length (customized)



with Anti-glare ring

code: 8029.A XXX.XX

Led
Power
Angle
Color



max. efficacy
142lm/W

	Typical luminous flux (lm)		
	6W	11W	17W
2700 K	725	1350	2090
3000 K	760	1400	2180
4000 K	805	1480	2310
5000 K	845	1540	2415

LED	POWER	ANGLE	COLOR
D 4000K	0 6W - 350mA	1 15°	02A Anodized black
W 2700K	1 11W - 350mA	3 50°	07 Brushed brass
	2 17W - 500mA		16 Brushed stainless steel 316L
			32 Anodized aluminum

36° = on request
3000K / 5000K = on request

Saturn HP led

Reference	Price €
8029.A_0_02A/32	225.00
8029.A_0_07/16	420.00
8029.A_1_02A/32	278.00
8029.A_1_07/16	479.00
8029.A_2_02A/32	288.00
8029.A_2_07/16	489.00

Saturn HP Led



Led flood light

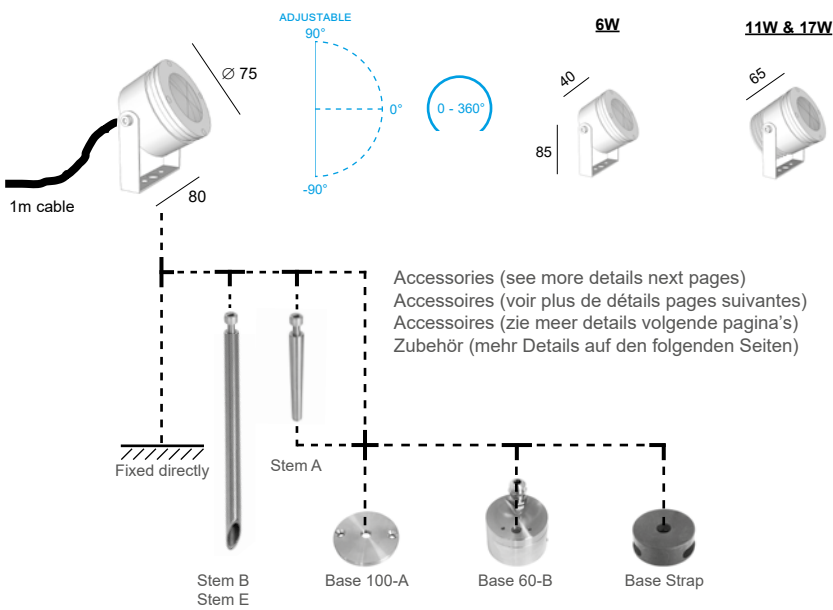

230V

6W - 17W



Saturn HP led 230V

DESCRIPTION

Body made in solid anodized aluminum
Screws in stainless steel
Degree of protection IP65 - IK10
Safety extra clear glass 10mm thickness
Led module CRI>90 3SDCM 85.000hrs L80 B10
Led driver 220-240V incorporated



IP65

230V

IK10



ACCESSORIES

Spike for ground fixing - Pic 3 ref: 804.00.32
Anti-glare honeycomb : Louver ref: X060.043.3
Anti-glare ring - ref: AC.8029.AG._._

ON REQUEST

Anodized bronze (33)
Other materials: Brass / s-steel 316L
Other led color: 3000K / 5000K
Other beam angle: 36°

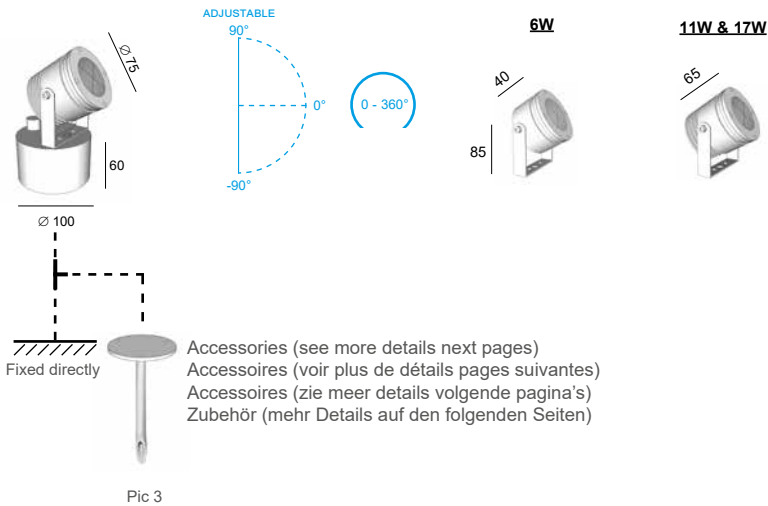

Accessories (see more details next pages)
Accessoires (voir plus de détails pages suivantes)
Accessoires (zie meer details volgende pagina's)
Zubehör (mehr Details auf den folgenden Seiten)

max. efficacy 142lm/W

code: 8029.B XXX. XX

Led
Power
Angle
Color

	Typical luminous flux (lm)		
	6W	11W	17W
2700 K	725	1350	2090
3000 K	760	1400	2180
4000 K	805	1480	2310
5000 K	845	1540	2415

LED	POWER	ANGLE	COLOR
D 4000K	0 6W	1 15°	02A Anodized black
W 2700K	1 11W	3 50°	32 Anodized aluminum
	2 17W		

36° = on request
3000K / 5000K = on request

Saturn HP led 230V

Reference	Price €
8029.B_0_._._	364.00
8029.B_1_._._	439.00
8029.B_2_._._	459.00

Saturn HP Led



Led flood light



EXTERIOR LIGHTING
FLOOD LIGHT





Zax-S 10°

DESCRIPTION

Body made in solid anodized aluminum
 Screws in stainless steel
 Degree of protection IP66 - IK07
 Safety clear plexiglass
 Led module CRI>80 3SDCM 85.000hrs L80 B10
 Provided with 1m cable



IP66

200mA

IK07



ACCESSORIES

Led driver AC/CC from 200mA to 500mA
 Led driver DC/CC (12-36VDC/200mA to 500mA)
 Base & stem for ground/wall/ceiling
 IK07 Stem with spike for ground fixing: Stem B / E
 Anti-glare honeycomb : Louver ref: X060.068.3
 IP68 connection : Connex 2 / 3 / 4

ON REQUEST

Other led color: 4000K
 Led CRI>90
 Other cable length (customized)

200-500mA

7W - 20W

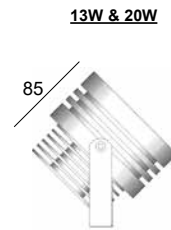
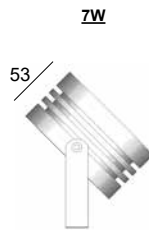
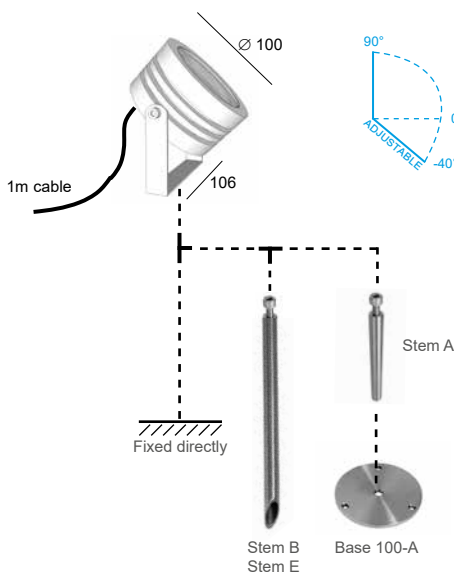

Accessories (see more details next pages)
 Accessoires (voir plus de détails pages suivantes)
 Accessoires (zie meer details volgende pagina's)
 Zubehör (mehr Details auf den folgenden Seiten)

code: 352. XX X . XX

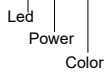

max. efficacy 110lm/W

	Typical luminous flux (lm)		
	200mA 7W	350mA 13W	500mA 20W
2700 K	750	1350	2000
3000 K	800	1400	2100
4000 K	850	1450	2200

LED	POWER	COLOR
27 2700K	1 7W - 10° - 200mA	02A Anodized black
30 3000K	2 13W - 10° - 350mA	32D Anodized aluminum
	3 20W - 10° - 500mA	33 Anodized bronze

4000K = on request
 CRI>90 = on request

Zax-S 10°

Reference	Price €
352. 1. _ _	299.50
352. 2. _ _	375.00
352. 3. _ _	375.00

Zax-S 10°



Led flood light



model 7W



model 13W & 20W

EXTERIOR LIGHTING
FLOOD LIGHT





Salsa



1 x SALSA code: 8091.W3.07
 1 x SALSA BASE code: AC.8091.07



DESCRIPTION

Body made in solid brass or anodized aluminum
 Screws in brass or stainless steel
 Degree of protection IP65 - IK07
 Safety sandblasted plexiglass
 Led 230V CRI>90 3SDCM 54.000hrs L80 B10
 Provided with 1m cable

230V
6W - 10W

ACCESSORIES

Base for ground/wall/ceiling - Salsa Base ref: AC.8091. __
 Stem with spike for ground fixing: Stem B / E
 Spike for ground fixing - Ecopic ref: 805.00.07
 IP68 connection : Connex 2 / 3 / 4 / 6

ON REQUEST

Other led color: 2700K or 4000K
 Led 6W or 11W 350mA : 2700K / 3000K / 4000K / 5000K
 Anodized aluminum (32) or bronze (33)
 Other materials (copper)
 Other cable length (customized)

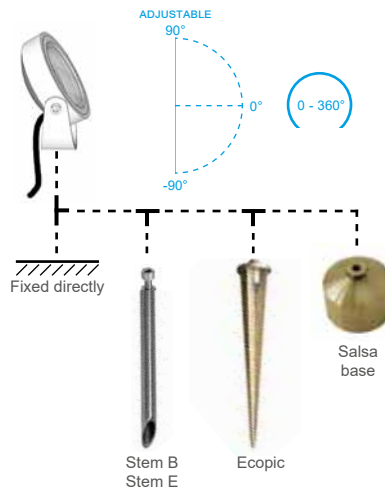
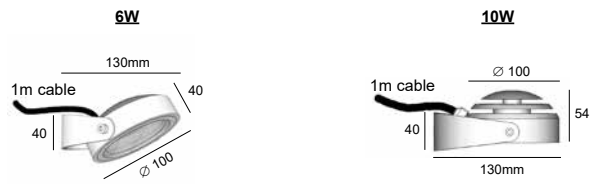

Accessories (see more details next pages)
 Accessoires (voir plus de détails pages suivantes)
 Accessoires (zie meer details volgende pagina's)
 Zubehör (mehr Details auf den folgenden Seiten)

code: 8091. **XX** . **XX**
 led color

LED

W2 6W - 3000K
W3 10W - 3000K

2700K / 4000K = on request
 6W or 11W 350mA 2700K / 3000K / 4000K / 5000K = on request

COLOR

02A Anodized black
07 Brushed brass

max. efficacy 102lm/W

	Weight (kg)	
	6W	10W
02A	0,50	0,60
07	1,30	2,00

	Typical luminous flux (lm)	
	6W	10W
2700 K	460	930
3000 K	470	950
4000 K	480	1020

Salsa

Reference	Price €
8091.W2.02A	283.00
8091.W2.07	358.00
8091.W3.02A	358.00
8091.W3.07	463.00

Salsa

Led flood light

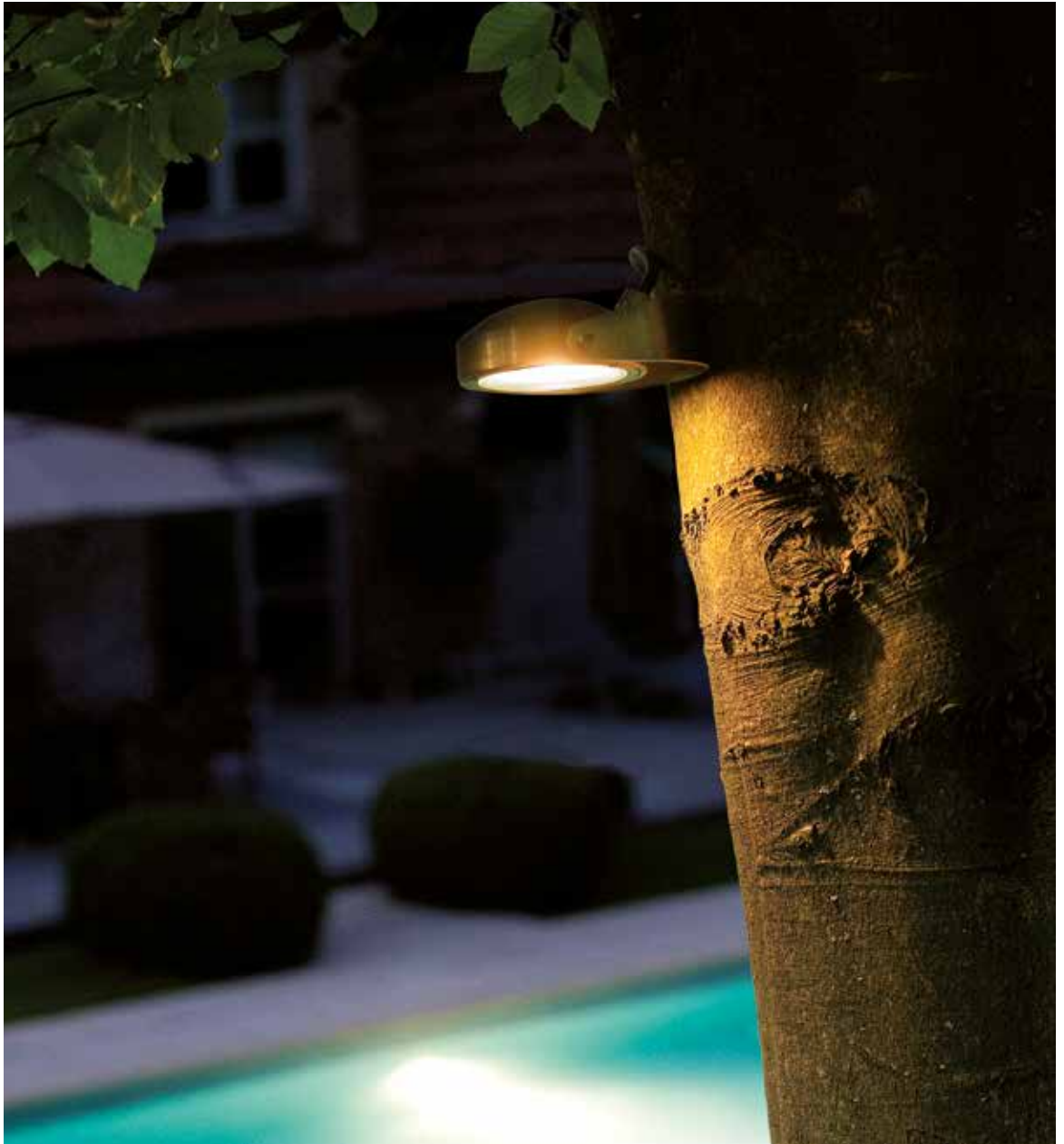

EXTERIOR LIGHTING
FLOOD LIGHT





Salsa-S

DESCRIPTION

Head spot made in solid brass
 flexible rod made in copper
 Screws in brass
 Degree of protection IP65 - IK07
 Safety sandblasted plexiglass
 Led 230V CRI>90 3SDCM 52.000hrs L80 B10
 Provided with 1m cable

230V
6W - 10W

ACCESSORIES

IP68 connection : Connex 2 / 3 / 4 / 6

ON REQUEST

Other led color: 2700K or 4000K
 Led 6W or 11W 350mA : 2700K / 3000K / 4000K / 5000K
 Other cable length (customized)

-
-
- IP65
- 230V
- IK07
-
-

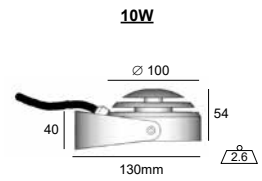
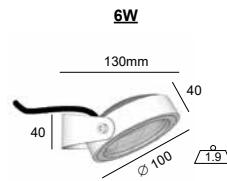

Straight rod to be bent on site according to the desired design
 Tige droite à plier sur site selon le design souhaité
 Rechte steel die ter plaatse in het gewenste ontwerp kan worden gebogen
 Gerade Stange, die vor Ort nach dem gewünschten Design gebogen werden kann

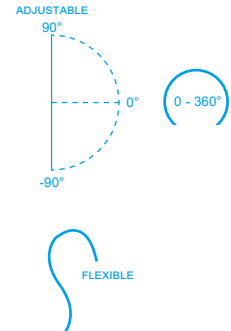
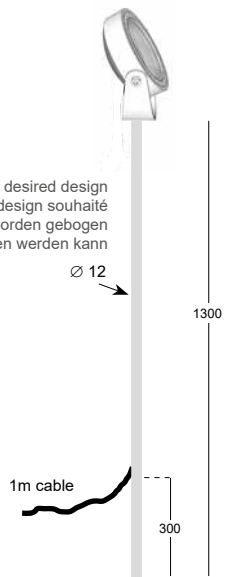

Flexible but unstable, it is necessary to find the point of balance during installation.

code: 8092. XXX . 07
 led



LED

- W2** 6W - 3000K
- W3** 10W - 3000K

2700K / 4000K = on request
 6W or 11W 350mA 2700K / 3000K / 4000K / 5000K = on request

COLOR

- 07** Brushed brass (flexible rod in copper)

max. efficacy 102lm/W

	Typical luminous flux (lm)	
	6W	10W
2700 K	460	930
3000 K	470	950
4000 K	480	1020

Salsa-S

Reference	Price €
8092.W2.07	463.00
8092.W3.07	563.00

Salsa-S

Led flood light



EXTERIOR LIGHTING
FLOOD LIGHT



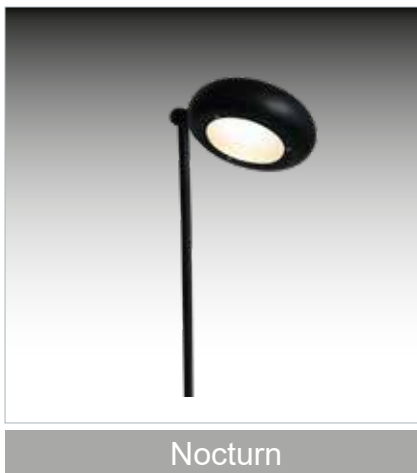

Nocturn

DESCRIPTION

Body made in solid anodized aluminum
 Screws in stainless steel
 Degree of protection IP65 - IK07
 Safety sandblasted plexiglass
 Led 230V CRI>90 3SDCM 54.000hrs L80 B10
 Provided with spike for ground fixing
 Provided with 1m cable



IP65

230V

IK07



ACCESSORIES

IP68 connection : Connex 2 / 3 / 4 / 6

ON REQUEST

Other led color: 2700K or 4000K
 Led 6W or 11W 350mA : 2700K / 3000K / 4000K / 5000K
 Base plate for ground/wall/ceiling fixing
 Other cable length (customized)

230V
6W - 10W

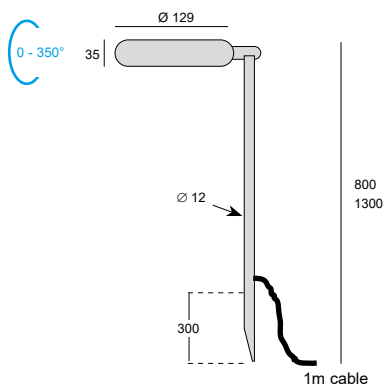

code: **8032.XXXX.XX**
 height | led | color



HEIGHT

2 800 mm
3 1300 mm

LED

W60 6W - 3000K
W70 10W - 3000K

COLOR

02A Anodized black
32 Anodized aluminum



	Typical luminous flux (lm)	
	6W	10W
2700 K	460	930
3000 K	470	950
4000 K	480	1020

2700K / 4000K = on request
 6W or 11W 350mA 2700K / 3000K / 4000K / 5000K = on request

Nocturn

Reference	Price €
8032.2W60.02A	325.00
8032.2W60.32	325.00
8032.2W70.02A	338.00
8032.2W70.32	338.00
8032.3W60.02A	338.00
8032.3W60.32	338.00
8032.3W70.02A	349.50
8032.3W70.32	349.50

Nocturn

Led flood light



EXTERIOR LIGHTING
FLOOD LIGHT



on request

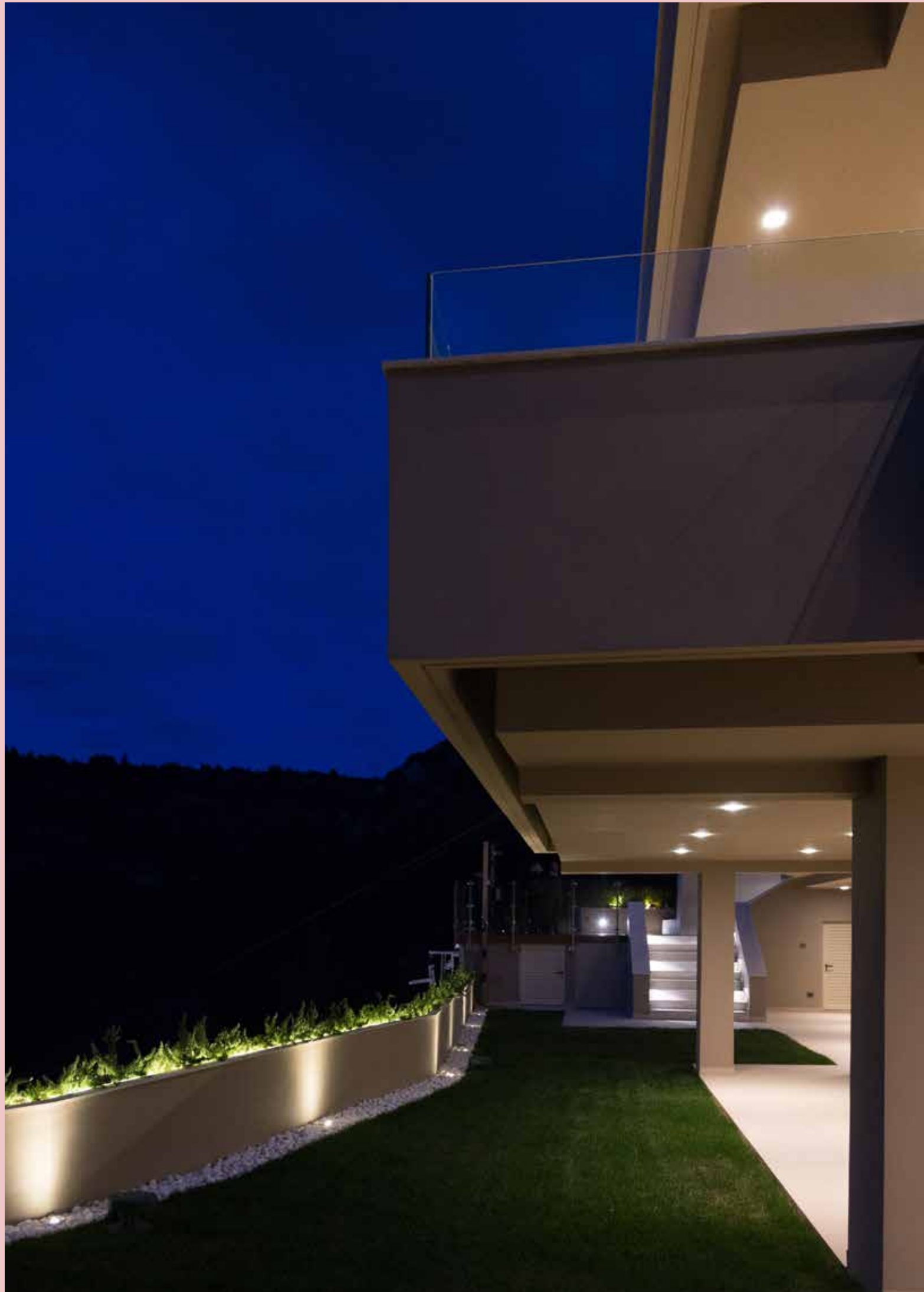

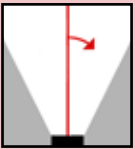
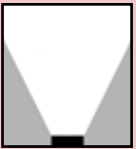

Exterior

Floor lighting

CUSTOMIZATION - PERSONNALISATION

Floor uplighting

For more than 30 years, we have been continuously innovating and improving our lighting techniques for recessed in-ground luminaires. Our quality criteria and manufacturing processes by machining allow perfect control of the quality and robustness of this class of devices. There are many possibilities to install these luminaires as there are many different types of recess. Flood protection, the weight supported, the need to be in permanent immersion, the depth and quality of the ground, the dimension of the recess, etc... are important criteria which play a decisive role in defining the selection of the right one product.

You will find below the different series possibilities offered by BEL Lighting.

WE ALSO CUSTOMIZE:

- Dimension of the cover plate
- Custom output cable length
- 2700K, 3000K, 4000K and 5000K are often available on request (if not standard)
- LED CRI>90 is often available on request (if not standard)
- White sandblasted glass is available on request (if not standard)

Feel free to ask a question if you would like customization

Spots de sol

Depuis plus de 30 ans, nous innovons et améliorons en permanence nos techniques d'éclairage pour les luminaires encastrés dans le sol. Nos critères de qualité et procédés de fabrication par usinage permettent une maîtrise parfaite de la qualité et la robustesse de cette classe d'appareils. Il existe de nombreuses possibilités d'installer ces luminaires comme il existe de nombreux types d'encastrement différents. La protection contre les inondations, le poids supporté, le besoin d'être en immersion permanente, la profondeur et la qualité du sol, la dimension d'encastrement, etc... sont des critères importants qui jouent un rôle décisif pour définir la sélection du bon produit.

Vous trouverez ci-après les différentes possibilités de série qu'offre BEL Lighting.

NOUS PERSONNALISONS AUSSI :

- Dimension de la collerette sur mesure
- Longueur du câble de sortie sur mesure
- 2700K, 3000K, 4000K et 5000K sont souvent disponibles sur demande (si pas de série)
- LED CRI>90 est souvent disponible sur demande (si pas de série)
- Verre sablé blanc est disponible sur demande (si pas de série)

N'hésitez pas à poser une question si vous souhaitez une personnalisation

Bodenleuchten

Seit mehr als 30 Jahren erneuern und verbessern wir unsere Beleuchtungstechniken für Bodeneinbauleuchten kontinuierlich. Unsere Qualitätskriterien und Fertigungsverfahren durch spanende Bearbeitung ermöglichen eine perfekte Kontrolle der Qualität und Robustheit dieser Geräteklasse. Es gibt viele Möglichkeiten, diese Leuchten zu installieren, da es viele verschiedene Arten von Aussparungen gibt. Hochwasserschutz, das abgestützte Gewicht, die Notwendigkeit des ständigen Untertauchens, die Tiefe und Beschaffenheit des Bodens, die Größe der Vertiefung usw. sind wichtige Kriterien, die bei der Auswahl des richtigen Bodens eine entscheidende Rolle spielen produkt.

Nachfolgend finden Sie unsere verschiedene Serienmöglichkeiten die BEL Lighting anbietet.

ANPASSUNGSMÖGLICHKEITEN:

- Abmessung der Deckplatte
- Benutzerdefinierte Länge des Ausgangskabels
- 2700K, 3000K, 4000K und 5000K sind oft auf Anfrage erhältlich (wenn nicht Standard)
- LED CRI>90 ist oft auf Anfrage erhältlich (wenn nicht Standard)
- Weißes sandgestrahltes Glas ist auf Anfrage erhältlich (falls nicht Standard)

Sprechen Sie uns gerne an, wenn Sie eine Frage haben oder Sie wünschen evtl. Anpassungen.

ΜΑΑΤΩΕΚ - ΑΝΠΑΣΣΑΝΓ - ΠΡΑΑΡΜΑΑΓΗ

Grondspots

ΑΙ μεερ δαν 30 jaar zijn we continu bezig met het innoveren en verbeteren van onze verlichtingstechnieken voor grond inbouwspots. Onze kwaliteitscriteria en fabricageprocessen door bewerking in eigen bedrijf zorgen voor een perfecte controle van de kwaliteit en robuustheid van deze klasse toestellen. Gezien er veel soorten inbouw variaties zijn bieden we veel verschillende inbouw mogelijkheden aan. Bescherming tegen overstromingen, de bescherming voor overrijdend gewicht, de noodzaak tot permanente onderdompeling, de inbouwdiepte en soort van de ondergrond, de afmeting van de uitsparing, enz... zijn belangrijke criteria die een beslissende rol spelen bij het bepalen van de keuze van het juiste product.

Hieronder vindt u de verschillende seriemogelijkheden die BEL Lighting biedt.

WIJ PASSEN OOK AAN:

- Afmeting van de op maat gemaakte afwerkingsplaat
- Aangepaste kabellengte voor aansluiting
- 2700K, 3000K, 4000K en 5000K zijn vaak op aanvraag leverbaar (indien niet standaard)
- LED CRI>90 is vaak op aanvraag leverbaar (indien niet standaard)
- Wit gezandstraald glas is op aanvraag leverbaar (indien niet standaard)

Stel gerust een vraag als je maatwerk wilt

ΣΠΑΑ εδάφους

Για περισσότερα από 30 χρόνια, καινοτομούμε και συνεχώς βελτιώνουμε τα προϊόντα μας, τα οποία προορίζονται για τοποθέτηση στο έδαφος (χωνευτά εδάφους). Τα ποιοτικά μας κριτήρια και οι διαδικασίες κατασκευής με μηχανική κατεργασία, μάς επιτρέπουν τον απόλυτο έλεγχο της ποιότητας και της στιβαρότητας αυτής της κατηγορίας φωτιστικών. Οι δυνατότητες εγκατάστασης αυτών, δεδομένου ότι υπάρχουν πολλοί διαφορετικοί τύποι εσοχής, είναι πάρα πολλές. Τα κριτήρια, που παίζουν καθοριστικό ρόλο στην επιλογή του σωστού προϊόντος είναι πολλά: η στεγανότητα, το υποστηριζόμενο βάρος, η ανάγκη για μόνιμη βύθιση, το βάθος και η ποιότητα του εδάφους, η διάσταση της εσοχής είναι κάποια από αυτά.

Παρακάτω θα βρείτε τις διάφορες σειρές δυνατότητες που προσφέρει η BEL Lighting.

ΕΠΙΣΗΣ ΠΡΑΑΡΜΑΑΖΑΥΜΕ:

- Διαστάσεις πλάκας
- Μήκος καλωδίου των προκαλωδιωμένων φωτιστικών
- 2700K, 3000K, 4000K, 5000K είναι διαθέσιμα στην πλειονότητα των φωτιστικών κατόπιν ζήτησης (εάν δεν είναι στην εργοστασιακή έκδοση του φωτιστικού)
- LED CRI >90 είναι επίσης διαθέσιμο κατόπιν ζήτησης (εάν δεν είναι στην εργοστασιακή έκδοση του φωτιστικού)
- Αμβρολισμένο γυαλί επίσης διαθέσιμο κατόπιν ζήτησης

Στη διάθεσή σας για οποιαδήποτε ερώτηση αναφορικά με εξειδικευμένη έκδοση οποιουδήποτε φωτιστικού

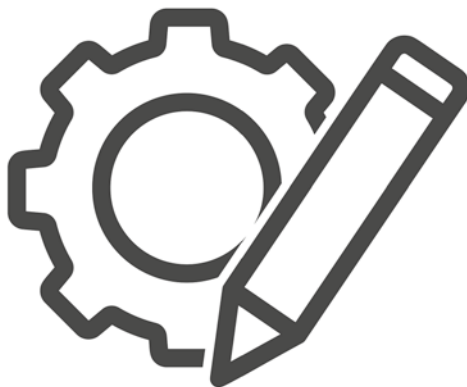

350mA & 230V

3,2W - 4W



Micro TR



IP65

IK09



DESCRIPTION

Body made in solid aluminum or stainless steel
Screws in stainless steel
Degree of protection IP65 - IK09
Safety plexiglass
Led 350mA CRI>90 3SDCM 85.000hrs L80 B10
Led 230V CRI>90 3SDCM 52.000hrs L80 B10
Class 1 (230V) or Class 3 (350mA)

ACCESSORIES

Led driver 350mA CC (not for 230V model)
Lens 10° - code: AC.8041.32

ON REQUEST

Other RAL colors
Other anodized color: black (02A) / bronze (33)
Other materials (brass / copper)
Only for led 3,2W 350mA : 3000K / 5000K
Only for led 4W 230V : 3000K / 4000K

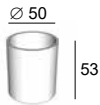

code: 1107. XXX . XX
 led color



LED

D32 3,2W 350mA - 4000K - 70°
W03 4W 230V - 2700K - 70°
W32 3,2W 350mA - 2700K - 70°

COLOR

01 White
02 Black
04 Brushed stainless steel
32 Anodized aluminum

1,1W 350mA 2700K / 3000K / 4000K / 5000K = on request
3,2W 350mA 3000K / 5000K = on request
4W 230V 3000K / 4000K = on request

max.
efficacy
128lm/W

	Typical luminous flux (lm)	
	4W	3,2W
2700 K	315	355
3000 K	320	370
4000 K	340	395
5000 K		410

Micro TR

Reference	Price €
1107.D32.04	160.00
1107.D32._ _	125.00
1107.W03.04	167.00
1107.W03._ _	133.00
1107.W32.04	160.00
1107.W32._ _	125.00

Micro TR

Led uplighting



EXTERIOR LIGHTING
FLOOR UPLIGHTING - Surface



230V GU10



IP65

230V

IK09



DESCRIPTION

Body made in aluminum, stainless steel, brass or copper
Screws in stainless steel
Degree of protection IP65 - IK09
Safety clear plexiglass

ON REQUEST

Other RAL colors
Anodised color: black / bronze
Other dimensions (customized)

Ø 60



117mm

code: 756. GU . XX
color



BULB

GU GU10 LED (max. height 58mm)

COLOR

00 Natural brushed aluminum
02 Black
04 Brushed stainless steel
07 Brushed brass
21 Brushed copper
39 Grey

Max TR

Reference	Price €
756.GU.00	130.00
756.GU.02	138.00
756.GU.04	162.00
756.GU.07	190.00
756.GU.21	204.00
756.GU.39	138.00

Max TR

Led uplighting



EXTERIOR LIGHTING
FLOOR UPLIGHTING - Surface



350mA

3,2W - 6W



Focus

DESCRIPTION

Body made in solid anodized aluminum or stainless steel 316L
Screws in stainless steel
Degree of protection IP67 - IK09
Safety clear plexiglass
Led 350mA CRI>90 3SDCM 85.000hrs L80 B10
Provided with 3m cable



IP67

350mA

IK09



ACCESSORIES

Led driver AC/CC 350mA
Led driver DC/CC (12-36VDC/350mA)
Anti-glare honeycomb - Louver ref: X060.029.3
Spike for ground fixing - Pic 5 ref: 804.05.02A
IP68 connection : Connex 2 / 3 / 4

ON REQUEST

Other led color: 5000K
Other cable length (customized)

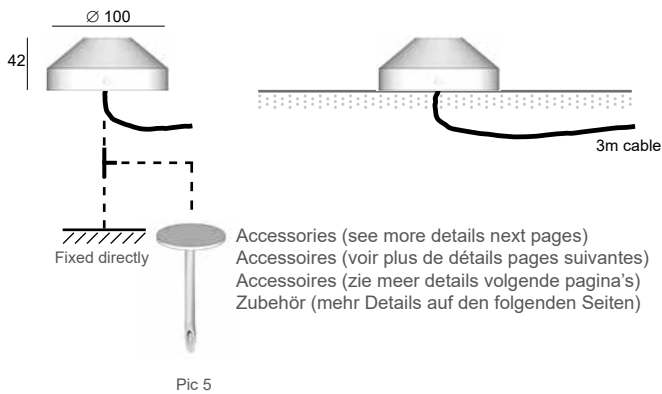

code: 365. XX X . XX
led power color



max. efficacy
141lm/W

	Typical luminous flux (lm)	
	3,2W	6W
2700 K	355	725
3000 K	370	760
4000 K	395	805
5000 K	410	845

LED

27 2700K
30 3000K
40 4000K

POWER

2 3,2W 70°
3 6W 70°

COLOR

02A Anodized black
16 Brushed stainless steel 316L
32 Anodized aluminum
33 Anodized bronze

5000K = on request

Focus

Reference	Price €
365.____.16	389.00
365.____.	279.00

Focus

Led uplighting



EXTERIOR LIGHTING
FLOOR UPLIGHTING - Surface

500mA

4,5W - 9,5W



Target



IP66

500mA

IK07



DESCRIPTION

Body made in solid anodized aluminum
Screws in stainless steel
Degree of protection IP66 - IK07
Safety clear plexiglass
Led 500mA CRI>90 3SDCM 85.000hrs L80 B10
Provided with 3m cable

ACCESSORIES

Led driver AC/CC from 200mA to 500mA
Led driver DC/CC (12-36VDC/200mA to 500mA)
Spike for ground fixing - Pic 5 ref: 804.05.02A
IP68 connection : Connex 2 / 3 / 4

ON REQUEST

Anodized bronze color (33)
RAL colors
Other led color: 5000K
Other cable length (customized)

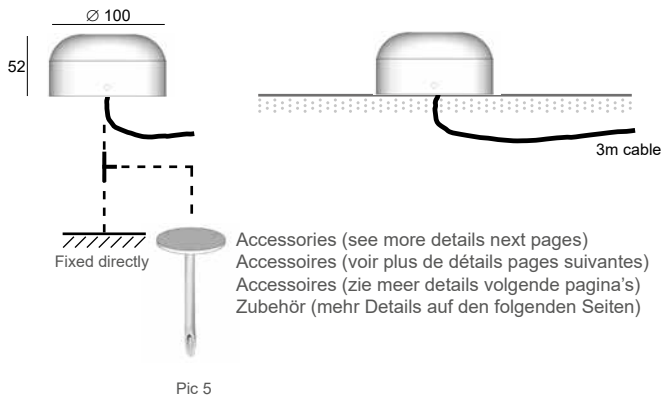

max. efficacy 134lm/W

	Typical luminous flux (lm)			
	Led 4,5W		Led 9,5W	
	350mA 3,2W	500mA 4,5W	350mA 6W	500mA 9,5W
2700 K	355	480	725	995
3000 K	370	510	760	1035
4000 K	395	540	805	1095

code: 367. XX X XX . XX

led | power | angle | color



LED	POWER	ANGLE	COLOR
27 2700K	2 4,5W 500mA	15 15°	02A Anodized black
30 3000K	3 9,5W 500mA	36 36°	32 Anodized aluminum
40 4000K		50 50°	

5000K = on request

Reference	Price €
367_-----	316.00

Target

Led uplighting



EXTERIOR LIGHTING
FLOOR UPLIGHTING - Surface



Ø min: 32mm

min: 85mm

350mA

3,2W



Zona V



IP68

350mA

IK10



DESCRIPTION

Body made in solid anodized aluminum or solid brass
Cover plate in stainless steel 316L or copper
Degree of protection IP68, water depth up to 1m
Safety clear plexiglass
Led COB 350mA CRI>90 3SDCM 85.000hrs L80 B10
Provided with 1m cable
Max. 1500kg

ACCESSORIES

Recessed box : Pop 9a/9b ref: X068A / X068B
Led driver AC/CC 350mA
Led driver DC/CC (12-36VDC/350mA)
IP68 connection : Connex 2 / 3 / 4

ON REQUEST

Anodized black (02A) or anodized bronze (33)
Other material: brushed brass
Other led color: 3000K / 5000K
Other cable length (customized)

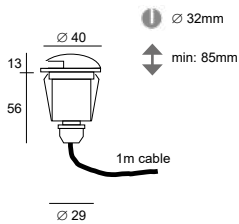

code: 8084V. XXX . XX
 | |
 led color



max.
efficacy
128lm/W

Typical luminous flux (lm)	
3,2W	
2700 K	355
3000 K	370
4000 K	395
5000 K	410

LED

D30 3,2W - 4000K
W30 3,2W - 2700K

COLOR

16 Brushed stainless steel 316L
21 Brushed copper

3000K / 5000K = on request

Zona V

Reference	Price €
8084V_..._16	157.00
8084V_..._21	182.00

Zona V

Led ground surface illumination



Ø min: 32mm

min: 85mm

350mA

3,2W



Zona H



IP68

350mA

IK10



code: 8084H. XXX . XX



DIMMABLE

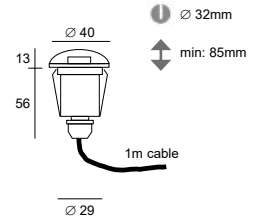

code: 8084X. XXX . XX
led color



DIMMABLE

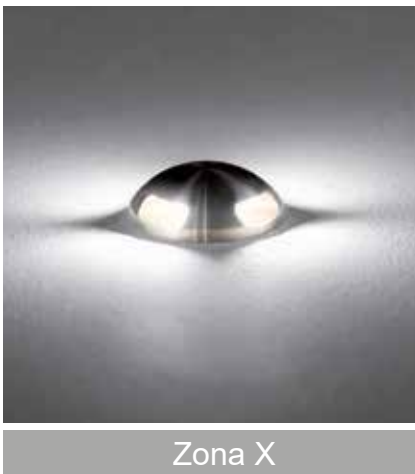

Zona X



IP68

350mA

IK10



max. efficacy
128lm/W

Typical luminous flux (lm)	
3,2W	
2700 K	355
3000 K	370
4000 K	395
5000 K	410

LED

D30 3,2W - 4000K
W30 3,2W - 2700K

COLOR

16 Brushed stainless steel 316L
21 Brushed copper

3000K / 5000K = on request

Zona H

Reference	Price €
8084H. _ _ _ _ 16	177.00
8084H. _ _ _ _ 21	199.50

Zona X

Reference	Price €
8084X. _ _ _ _ 16	211.00
8084X. _ _ _ _ 21	238.00

Zona HX

Led ground surface illumination



DESCRIPTION

Body made in solid anodized aluminum or solid brass
Cover plate in stainless steel 316L or copper
Degree of protection IP68, water depth up to 1m
Safety clear plexiglass
Led COB 350mA CRI>90 3SDCM 85.000hrs L80 B10
Provided with 1m cable
Max. 1500kg

ACCESSORIES

Recessed box : Pop 9a/9b ref: X068A / X068B
Led driver AC/CC 350mA
Led driver DC/CC (12-36VDC/350mA)
IP68 connection : Connex 2 / 3 / 4

ON REQUEST

Anodized black (02A) or anodized bronze (33)
Other material: brushed brass
Other led color: 3000K / 5000K
Other cable length (customized)



EXTERIOR LIGHTING
FLOOR - GROUND SURFACE ILLUMINATION

Ø min: 32mm

min: 85mm

350mA
3,2W



Tango R-V



IP67

350mA

IK10



Tango R-H



IP67

350mA

IK10



Tango R-X



IP67

350mA

IK10



code: 8085V. XXX . XX



code: 8085H. XXX . XX



code: 8085X. led . color . XX

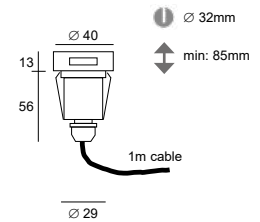

max. efficacy
128lm/W

Typical luminous flux (lm)	
	3,2W
2700 K	355
3000 K	370
4000 K	395
5000 K	410

LED

- D30** 3,2W - 4000K
- W30** 3,2W - 2700K

3000K / 5000K = on request

COLOR

- 01** White
- 22** Brown
- 39** Grey
- 48** Dark Grey (RAL 7016 structured)

Tango R-V

Reference	Price €
8085V_ _ _ _	130.00

Tango R-H

Reference	Price €
8085H_ _ _ _	138.00

Tango R-X

Reference	Price €
8085X_ _ _ _	153.00

Tango R

Led ground surface illumination



DESCRIPTION

Body made in solid aluminum
Screws in stainless steel
Degree of protection IP67 - IK10
Safety clear plexiglass
Led COB 350mA CRI>90 3SDCM 85.000hrs L80 B10
Provided with 1m cable

ACCESSORIES

Recessed box - Pop 9a or Pop 9b
Led driver AC/CC 350mA
Led driver DC/CC (12-36VDC/350mA)
IP68 connection : Connex 2 / 3 / 4

ON REQUEST

Other RAL colors
Anodized black (02A) or anodized bronze (33)
Other led color: 3000K / 5000K
Other cable length (customized)



Ø min: 32mm

min: 85mm

350mA
3,2W



Tango K-V



0,5

IP67

350mA

IK10

0,20



Tango K-H



0,5

IP67

350mA

IK10

0,20



Tango K-X



0,5

IP67

350mA

IK10

0,20



code: 8087V. XXX . XX



code: 8087H. XXX . XX



code: 8087X. XXX . XX
led color

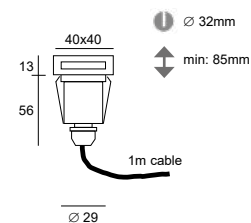

LED

D30 3,2W - 4000K
W30 3,2W - 2700K

COLOR

01 White
22 Brown
39 Grey
48 Dark Grey (RAL 7016 structured)

3000K / 5000K = on request

Tango K-V

Reference	Price €
8087V_ _ _ _	132.00

Tango K-H

Reference	Price €
8087H_ _ _ _	140.00

Tango K-X

Reference	Price €
8087X_ _ _ _	155.00

max. efficacy 128lm/W

Typical luminous flux (lm)	
3,2W	
2700 K	355
3000 K	370
4000 K	395
5000 K	410

Tango K

Led ground surface illumination



DESCRIPTION

Body made in solid aluminum
Screws in stainless steel
Degree of protection IP67 - IK10
Safety clear plexiglass
Led COB 350mA CRI>90 3SDCM 85.000hrs L80 B10
Provided with 1m cable

ACCESSORIES

Recessed box - Pop 9a or Pop 9b
Led driver AC/CC 350mA
Led driver DC/CC (12-36VDC/350mA)
IP68 connection : Connex 2 / 3 / 4

ON REQUEST

Other RAL colors
Anodized black (02A) or anodized bronze (33)
Other led color: 3000K / 5000K
Other cable length (customized)



Ø min: 78mm

min: 90mm

350-500mA

11W - 17W



Bolas V



0.5°

IP67

IK10

0.55



code: 8028V. X XX . XX



Bolas H



0.5°

IP67

IK10

0.55



code: 8028H. X XX . XX



Bolas X



0.5°

IP67

IK10

0.55

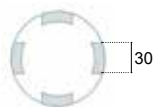

code: 8028X. X XX . XX



led power color

LED

D 5000K
N 4000K
W 2700K

POWER

13 11W - 350mA
23 17W - 500mA

COLOR

02 Black
32 Anodized aluminum
39 Grey

3000K = on request

6W 350mA 2700K / 3000K / 4000K / 5000K = on request

Bolas V

Reference	Price €
8028V_13_ _	365.00
8028V_23_ _	375.00

Bolas H

Reference	Price €
8028H_13_ _	379.00
8028H_23_ _	389.00

Bolas X

Reference	Price €
8028X_13_ _	415.00
8028X_23_ _	425.00



Bolas VHX

Led ground surface illumination



EXTERIOR LIGHTING
FLOOR - GROUND SURFACE ILLUMINATION

6W (on request)

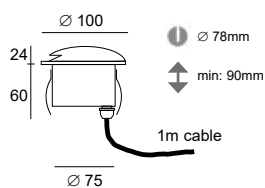

11W - 17W

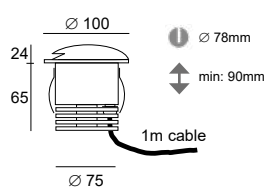

max.
efficacy
142lm/W

Typical luminous flux (lm)			
	6W	11W	17W
2700 K	725	1350	2090
3000 K	760	1400	2180
4000 K	805	1480	2310
5000 K	845	1540	2415

DESCRIPTION

Body made in solid anodized aluminum
Screws in stainless steel
Safety extra clear glass 10mm thickness
Degree of protection IP67 - IK10
Led module COB CRI>90 3SDCM 85.000hrs L80 B10
Provided with 1m cable
Max. 2140kg (21000 N)

ACCESSORIES

Recessed box : Pop 8b ref. X067B
Led driver AC/CC 350mA or 500mA CC
Led driver DC/CC (24VDC/350mA or 500mA)
IP68 connection : Connex 2 / 3 / 4

ON REQUEST

Anodized black (02A) or anodized bronze (33)
Other RAL colors
Other materials (brass / copper ...)
Other led color: 3000K
Other cable length (customized)

Ø min: 78mm

min: 95mm

230V
6W - 10W



Bolas V 230V



IP67

230V

IK10



code: 8028V. X XX . XX



Bolas H 230V



IP67

230V

IK10



code: 8028H. X XX . XX



Bolas X 230V



IP67

230V

IK10

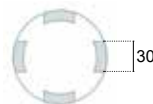

code: 8028X. X XX . XX

led power color



LED

W 3000K

2700K / 4000K = on request

POWER

63 6W - 230V
73 10W - 230V

COLOR

02 Black
32 Anodized aluminum
39 Grey

Bolas V 230V

Reference	Price €
8028V.W63_..	338.00
8028V.W73_..	388.00

Bolas H 230V

Reference	Price €
8028H.W63_..	357.00
8028H.W73_..	407.00

Bolas X 230V

Reference	Price €
8028X.W63_..	388.00
8028X.W73_..	438.00

Bolas VHX 230V

Led ground surface illumination



EXTERIOR LIGHTING
FLOOR - GROUND SURFACE ILLUMINATION

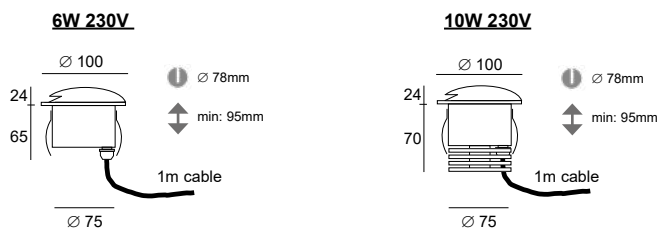

max.
efficacy
102lm/W

	Typical luminous flux (lm)	
	6W	10W
2700 K	460	930
3000 K	470	950
4000 K	480	1020

DESCRIPTION

Body made in solid anodized aluminum
Screws in stainless steel
Safety extra clear glass 10mm thickness
Degree of protection IP67 - IK10
Led module COB CRI>90 3SDCM 45.000hrs L70 B50
Provided with 1m cable
Max. 2140kg (21000 N)

ACCESSORIES

Recessed box : Pop 8a/8b ref: X067A / X067B
IP68 connection : Connex 2 / 3 / 4 / 6

ON REQUEST

Anodized black (02A) or anodized bronze (33)
Other RAL colors
Other materials (brass / copper ...)
Other led color: 2700K / 4000K
Other cable length (customized)

350-500mA

1,1W - 9W



Pharos V



IP67

350mA

IK10



code: 363V. **XX** **X** . **XX**
led power color



LED	POWER	COLOR
27 2700K	1 1,1W - 350mA	02A Anodized black
30 3000K	2 3,2W - 350mA	32 Anodized aluminum
40 4000K		33 Anodized bronze

With 500mA power supply = 1,6W or 4,5W



Pharos H



IP67

350mA

IK10



code: 363H. **XX** **X** . **XX**
led power color



LED	POWER	COLOR
27 2700K	1 2x 1,1W - 350mA	02A Anodized black
30 3000K	2 2x 3,2W - 350mA	32 Anodized aluminum
40 4000K		33 Anodized bronze

With 500mA power supply = 2x 1,6W or 2x 4,5W



Pharos X



IP67

350mA

IK10

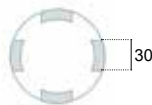

code: 363X. **XX** **X** . **XX**
led power color



LED	POWER	COLOR
27 2700K	1 4x 1,1W - 350mA	02A Anodized black
30 3000K		32 Anodized aluminum
40 4000K		33 Anodized bronze

With 500mA power supply = 4x 1,6W

Pharos V

Reference	Price €
363V.____	319.00

Pharos H

Reference	Price €
363H.____	339.00

Pharos X

Reference	Price €
363X.____	369.00



Pharos VHX

Led ground surface illumination



100%
useful light

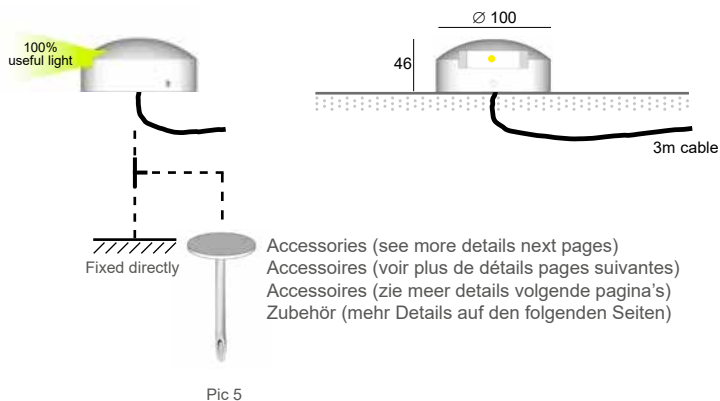

max.
efficacy
123lm/W

	Typical luminous flux (lm)			
	Led 1,1W		Led 3,2W	
	350mA	500mA	350mA	500mA
	1,1W	1,6W	3,2W	4,5W
2700 K	115	165	355	480
3000 K	125	175	370	510
4000 K	135	185	395	535

Example:
PHAROS X 3000K With 500mA power supply
4x 1,6W = total 6,4W
4x 175lm = total 700 lumens

DESCRIPTION

Body made in solid anodized aluminum
Screws in stainless steel
Safety satinice plexiglas
Degree of protection IP67 - IK10
Led module CRI>90 3SDCM 85.000hrs L80 B10
Provided with 3m cable

ACCESSORIES

Led driver AC/CC 350mA or 500mA CC
Led driver DC/CC (24VDC/350mA or 500mA)
Spike for ground fixing - Pic 5 ref: 804.05.02A
IP68 connection : Connex 2 / 3 / 4

ON REQUEST

Painted in RAL colors
Other materials (brass / copper ...)
Other cable length (customized)

Ø min: 65mm

min: 120mm

230V

1,1W - 6,4W



Pharos V 230V



IP67

230V

IK10



code: 364V. **XX** **X** . **XX**
 led power color



LED	POWER	COLOR
27 2700K	1 1,1W - 230V	02A Anodized black
30 3000K	2 3,2W - 230V	32 Anodized aluminum
40 4000K		33 Anodized bronze

On request: 1,6W or 4,5W



Pharos H 230V



IP67

230V

IK10



code: 364H. **XX** **X** . **XX**
 led power color



LED	POWER	COLOR
27 2700K	1 2x 1,1W - 230V	02A Anodized black
30 3000K	2 2x 3,2W - 230V	32 Anodized aluminum
40 4000K		33 Anodized bronze

On request: 2x 1,6W or 2x 4,5W



Pharos X 230V



IP67

230V

IK10

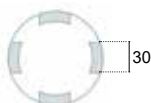

code: 364X. **XX** **X** . **XX**
 led power color



LED	POWER	COLOR
27 2700K	1 4x 1,1W - 230V	02A Anodized black
30 3000K		32 Anodized aluminum
40 4000K		33 Anodized bronze

On request: 4x 1,6W

Pharos V 230V

Reference	Price €
364V.____	389.00

Pharos H 230V

Reference	Price €
364H.____	419.00

Pharos X 230V

Reference	Price €
364X.____	459.00

Pharos VHX

Led ground surface illumination



EXTERIOR LIGHTING
FLOOR - GROUND SURFACE ILLUMINATION

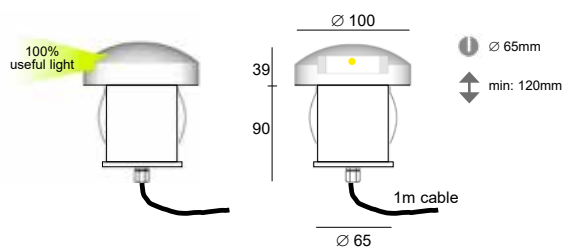

max. efficacy
123lm/W

	Typical luminous flux (lm)			
	1,1W	1,6W	3,2W	4,5W
2700 K	115	165	355	480
3000 K	125	175	370	510
4000 K	135	185	395	535

DESCRIPTION

Body made in solid anodized aluminum
Screws in stainless steel
Safety satinice plexiglas
Degree of protection IP67 - IK10
Led module CRI>90 3SDCM 85.000hrs L80 B10
Power supply 220-240V incorporated
Provided with 1m cable

ACCESSORIES

Recessed box : Pop 10a/10b ref: X054A / X054B
IP68 connection : Connex 2 / 3 / 4 / 6

ON REQUEST

Dimmable power supply 220-240V (Triac)
Power supply 24VDC included
Painted in Ral colors
Other materials (brass / copper / ...)
Other cable length (customized)

Ø min: 40mm

min: 70mm

350mA

1,1W - 3,2W

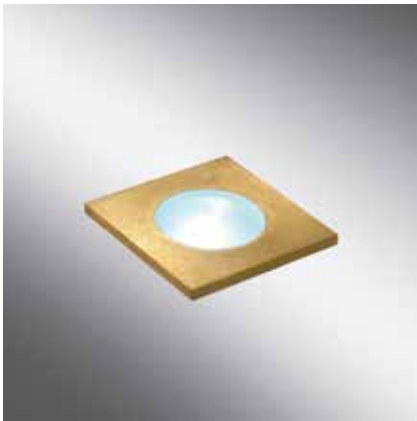

Genesis



IP66

350mA



code: 1152. **XXX** . **XX**
led color

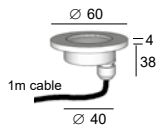

Ø 40mm

min: 70mm

fixing is also possible with 2 screws
distances: 50mm

code: 1153. **XXX** . **XX**
led color

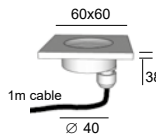
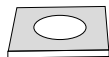

Ø 40mm

min: 80mm

fixing is also possible with 2 screws
distances: 50mm

max. efficacy
132lm/W

Typical luminous flux (lm)		
	1,1W	3,2W
2700 K	115	355
3000 K	125	370
4000 K	135	395
5000 K	145	410

LED

D11 1,1W - 4000K
W11 1,1W - 2700K

COLOR

04 Brushed stainless steel
07 Brushed brass

3000K / 5000K = on request

3,2W 350mA 2700K / 3000K / 4000K / 5000K = on request

Genesis

Reference	Price €
1152. _ _ _ _ _	130.00
1153. _ _ _ _ _	130.00

Genesis

Led uplighting



DESCRIPTION

Body made in solid stainless steel or brass
Degree of protection IP66
Safety sandblasted glass
Led 350mA CRI>90 3SDCM 85.000hrs L80 B10
Provided with 1m cable

ACCESSORIES

Recessed box - Pop 3 ref: X053
Led driver AC/CC 350mA
Led driver DC/CC (12-36VDC/350mA)
IP68 connection : Connex 2 / 3 / 4

ON REQUEST

Anodized black (02A) or bronze (33) cover plate
Other led color: 3000K / 5000K
Led 3,2W 350mA 2700k / 3000K / 4000K / 5000K
Other cable length (customized)



∅ min: 32mm

min: 85mm

350mA
1,1W - 3,2W



Zona R



IP68

350mA

IK06



DESCRIPTION

Body made in solid anodized aluminum
Cover plate in stainless steel or anodized black aluminum
Degree of protection IP68, water depth up to 1m
Safety extra clear glass
Led 350mA CRI>90 3SDCM 85.000hrs L80 B10
Provided with 1m cable
Max. 1000kg

ACCESSORIES

Recessed box : Pop 9a/9b ref: X068A / X068B
Led driver AC/CC 350mA
Led driver DC/CC (12-36VDC/350mA)
Anti-glare honeycomb - Louver ref: X060.021.3
Asymmetrical beam - visor HC : ref: X061.022.2
IP68 connection : Connex 2 / 3 / 4

ON REQUEST

Anodized bronze cover plate (33)
Other materials (brass / copper ...)
Sandblasted glass
Other led color: 3000K / 5000K
Other cover plate dimensions (customized)

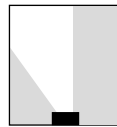
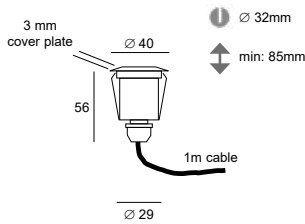

Asymmetrical beam with Visor HC (half-circle)

code: 8022. X XX .XX

led
power
color



max. efficacy
132lm/W

	Typical luminous flux (lm)	
	1,1W	3,2W
2700 K	115	355
3000 K	125	370
4000 K	135	395
5000 K	145	410

LED

D 4000K
W 2700K

POWER

11 1,1W 10°
13 1,1W 35°
31 3,2W 35°
32 3,2W 50°

COLOR

02A Anodized black
04 Brushed stainless steel

3000K / 5000K = on request

For some applications, led 1,1W can be used with a driver 500mA to obtain for example +/- 1,6W 10° 4000K 185 lumens

Zona R

Reference	Price €
8022_ _ _ _ _	114.00

Zona R

Led uplighting



EXTERIOR LIGHTING
FLOOR UPLIGHTING - Recessed

Ø min: 32mm

min: 95mm

350mA

1,1W - 3,2W



Zona R Dark



IP68

350mA

IK06



DESCRIPTION

Body made in solid anodized aluminum
Cover plate in stainless steel or anodized black aluminum
Degree of protection IP68, water depth up to 1m
Safety extra clear glass
Led 350mA CRI>90 3SDCM 85.000hrs L80 B10
Provided with 1m cable
Max. 1000kg

ACCESSORIES

Recessed box : Pop 9a/9b ref: X068A / X068B
Led driver AC/CC 350mA
Led driver DC/CC (12-36VDC/350mA)
Anti-glare honeycomb - Louver ref: X060.021.3
Asymmetrical beam - visor HC : ref: X061.022.2
IP68 connection : Connex 2 / 3 / 4

ON REQUEST

Anodized bronze cover plate (33)
Other materials (brass / copper ...)
Sandblasted glass
Other led color: 5000K
Other cover plate dimensions (customized)

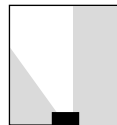
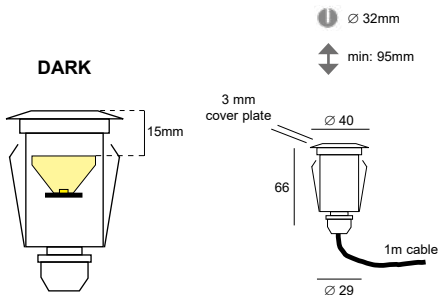

Asymmetrical beam with Visor HC (half-circle)

max. efficacy 132lm/W

	Typical luminous flux (lm)	
	1,1W	3,2W
2700 K	115	355
3000 K	125	370
4000 K	135	395
5000 K	145	410

code: 8022D. XX XX .XX
led power color



LED	POWER	COLOR
27 2700K	11 1,1W 10°	02A Anodized black
30 3000K	31 3,2W 20°	04 Brushed stainless steel
40 4000K		

5000K = on request

For some applications, led 1,1W can be used with a driver 500mA to obtain for example +/- 1,6W 10° 4000K 185 lumens

Zona R Dark

Reference	Price €
8022D_ _ _ _ _	119.00

Zona R Dark

Led uplighting

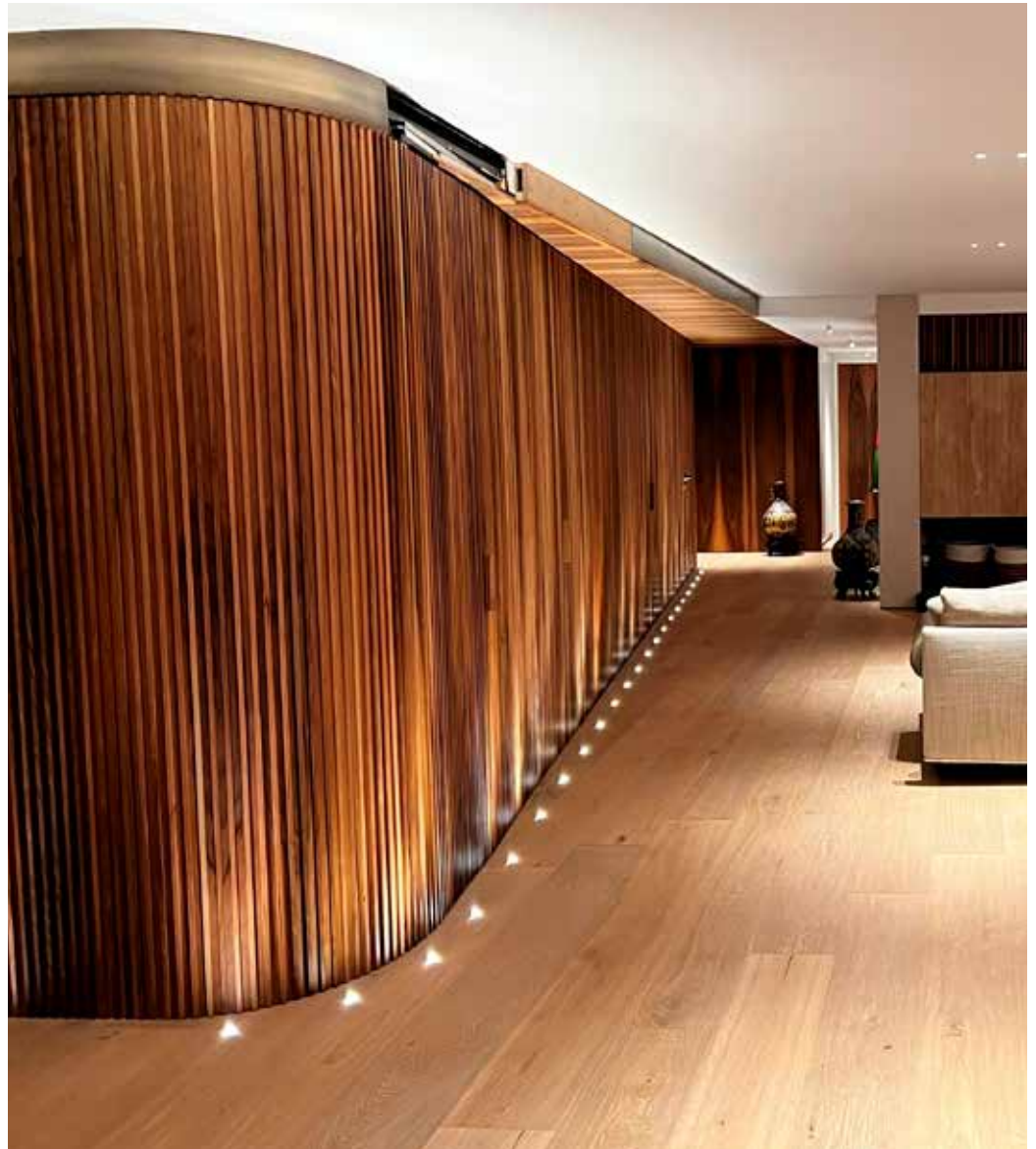

EXTERIOR LIGHTING
FLOOR UPLIGHTING - Recessed

Ø min: 32mm

min: 85mm

350mA

1,1W - 3,2W



Zona S



IP68

350mA

IK06



DESCRIPTION

Body made in solid anodized aluminum
Cover plate in stainless steel or anodized black aluminum
Degree of protection IP68, water depth up to 1m
Safety extra clear glass
Led 350mA CRI>90 3SDCM 85.000hrs L80 B10
Provided with 1m cable
Max. 1000kg

ACCESSORIES

Recessed box : Pop 9a/9b ref: X068A / X068B
Led driver AC/CC 350mA
Led driver DC/CC (12-36VDC/350mA)
Anti-glare honeycomb - Louver ref: X060.021.3
Asymmetrical beam - visor HC : ref: X061.022.2
IP68 connection : Connex 2 / 3 / 4

ON REQUEST

Anodized bronze cover plate (33)
Other materials (brass / copper ...)
Sandblasted glass
Other led color: 3000K / 5000K
Other cover plate dimensions (customized)

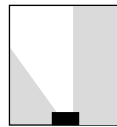
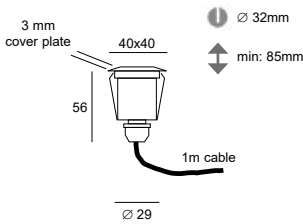

Asymmetrical beam with Visor HC (half-circle)

max. efficacy
132lm/W

	Typical luminous flux (lm)	
	1,1W	3,2W
2700 K	115	355
3000 K	125	370
4000 K	135	395
5000 K	145	410

code: 8023.X XX.XX

led
power
color



LED

D 4000K
W 2700K

POWER

11 1,1W 10°
13 1,1W 35°
31 3,2W 35°
32 3,2W 50°

COLOR

02A Anodized black
04 Brushed stainless steel

3000K / 5000K = on request

For some applications, led 1,1W can be used with a driver 500mA to obtain for example +/- 1,6W 10° 4000K 185 lumens

Zona S

Reference	Price €
8023_ _ _ _ _	124.00

Zona S

Led uplighting



EXTERIOR LIGHTING
FLOOR UPLIGHTING - Recessed

∅ min: 45mm
 min: 100mm



350mA
 1,1W - 3,2W

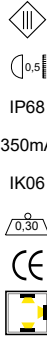

DESCRIPTION

Body made in solid anodized aluminum
 Cover plate in stainless steel or anodized black aluminum
 Degree of protection IP68, water depth up to 1m
 Safety extra clear glass
 Led 350mA CRI>90 3SDCM 85.000hrs L80 B10
 Provided with 1m cable
 Max. 1000kg

ACCESSORIES

Recessed box - Pop 1a/1b ref: X016A / X016B
 Led driver AC/CC 350mA
 Led driver DC/CC (12-36VDC/350mA)
 IP68 connection : Connex 2 / 3 / 4

ON REQUEST

Anodized bronze cover plate (33)
 Other materials (brass / copper ...)
 Sandblasted glass
 Other led color: 3000K / 5000K
 Other cover plate dimensions (customized)

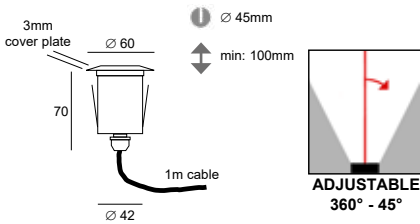

code: 8024. X XX .XX
 led
 power
 color



max. efficacy
 132lm/W

	Typical luminous flux (lm)	
	1,1W	3,2W
2700 K	115	355
3000 K	125	370
4000 K	135	395
5000 K	145	410

LED	POWER	COLOR
D 4000K	11 1,1W 10°	02A Anodized black
W 2700K	13 1,1W 35°	04 Brushed stainless steel
	31 3,2W 35°	
	32 3,2W 50°	

3000K / 5000K = on request

For some applications, led 1,1W can be used with a driver 500mA to obtain for example +/- 1,6W 10° 4000K 185 lumens

Xeno R

Reference	Price €
8024. _ _ _ _	169.00

Xeno R



Led uplighting



EXTERIOR LIGHTING
FLOOR UPLIGHTING - Recessed



Ø min: 45mm
 min: 100mm



ADJUSTABLE

350mA
 1,1W - 3,2W



Xeno S



IP68

350mA

IK06



DESCRIPTION

Body made in solid anodized aluminum
 Cover plate in stainless steel or anodized black aluminum
 Degree of protection IP68, water depth up to 1m
 Safety extra clear glass
 Led 350mA CRI>90 3SDCM 85.000hrs L80 B10
 Provided with 1m cable
 Max. 1000kg

ACCESSORIES

Recessed box - Pop 1a/1b ref: X016A / X016B
 Led driver AC/CC 350mA
 Led driver DC/CC (12-36VDC/350mA)
 IP68 connection : Connex 2 / 3 / 4

ON REQUEST

Anodized bronze cover plate (33)
 Other materials (brass / copper ...)
 Sandblasted glass
 Other led color: 3000K / 5000K
 Other cover plate dimensions (customized)

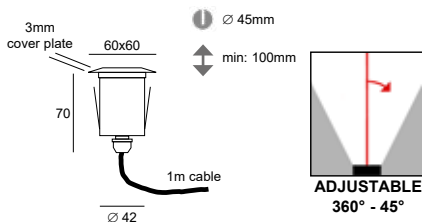

code: 8025. X XX .XX
 led | power | color



DIMMABLE

max. efficacy
 132lm/W

	Typical luminous flux (lm)	
	1,1W	3,2W
2700 K	115	355
3000 K	125	370
4000 K	135	395
5000 K	145	410

LED	POWER	COLOR
D 4000K	11 1,1W 10°	02A Anodized black
W 2700K	13 1,1W 35°	04 Brushed stainless steel
	31 3,2W 35°	
	32 3,2W 50°	

3000K / 5000K = on request

For some applications, led 1,1W can be used with a driver 500mA to obtain for example +/- 1,6W 10° 4000K 185 lumens

Xeno S

Reference	Price €
8025. _ _ _ _ _	187.00

Xeno S

Led uplighting



EXTERIOR LIGHTING
FLOOR UPLIGHTING - Recessed



Ø min: 45mm

min: 120mm

350mA

1,1W - 3,2W



Xeno Y



IP68

350mA

IK06



DESCRIPTION

Body made in solid anodized aluminum
Cover plate in stainless steel or anodized black aluminum
Degree of protection IP68, water depth up to 1m
Safety extra clear glass
Led 350mA CRI>90 3SDCM 85.000hrs L80 B10
Provided with 1m cable
Max. 1000kg

ACCESSORIES

Recessed box - Pop 1a/1b ref: X016A / X016B
Led driver AC/CC 350mA
Led driver DC/CC (12-36VDC/350mA)
IP68 connection : Connex 2 / 3 / 4

ON REQUEST

Anodized bronze cover plate (33)
Other materials (brass / copper ...)
Sandblasted glass
Other led color: 5000K
Other cover plate dimensions (customized)

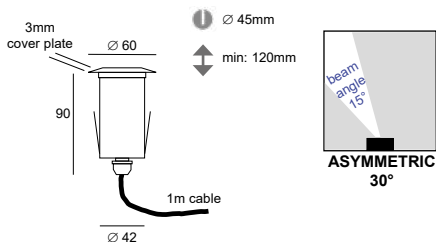

code: 8024Y. XX X .XX DIMMABLE
led
power
color

max. efficacy 132lm/W

	Typical luminous flux (lm)	
	1,1W	3,2W
2700 K	115	355
3000 K	125	370
4000 K	135	395
5000 K	145	410

LED	POWER	COLOR
27 2700K	13 1,1W 15°	02A Anodized black
30 3000K	31 3,2W 15°	04 Brushed stainless steel
40 4000K		

5000K = on request

For some applications, led 1,1W can be used with a driver 500mA to obtain for example +/- 1,6W 10° 4000K 185 lumens

Xeno Y

Reference	Price €
8024Y.-----	162.00

Xeno Y

Led uplighting

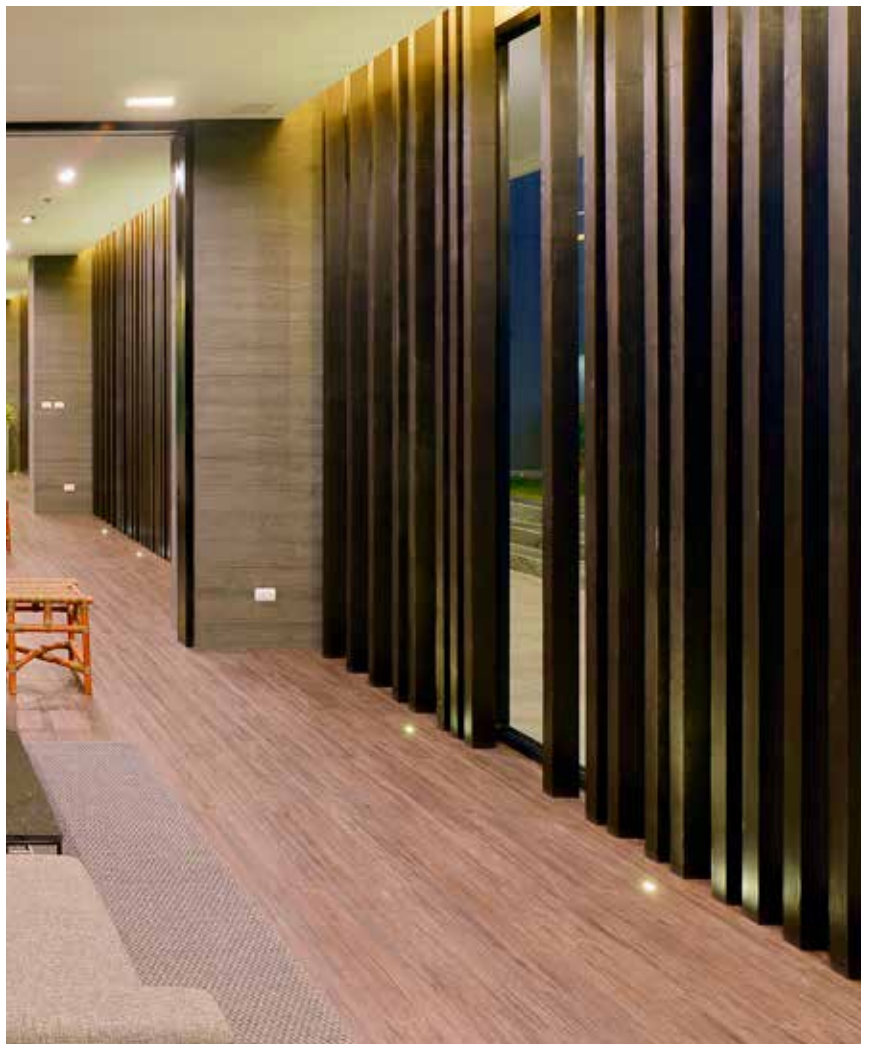
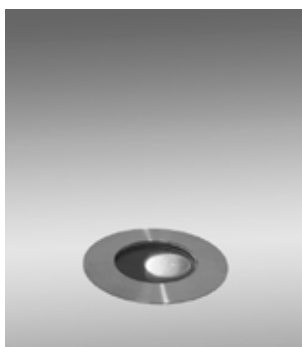

EXTERIOR LIGHTING
FLOOR UPLIGHTING - Recessed

Ø min: 68mm
 min: 90mm

350mA - 500mA

6W - 9,5W



Perla-R Dark



IP68

500mA

IK10



DESCRIPTION

Body made in solid anodized aluminum
 Cover plate in stainless steel 316L or anodized aluminum
 Degree of protection IP68, water depth up to 1m
 Safety extra clear glass
 Led module COB CRI>90 3SDCM 85.000hrs L80 B10
 Provided with 1m cable
 Max. 2140kg (21000 N)

ACCESSORIES

Recessed box : Pop 10a/10b ref: X054A / X054B
 Led driver AC/CC from 200mA to 500mA
 Led driver DC/CC (12-36VDC/200mA to 500mA)
 Anti-glare honeycomb - Louver ref: X060.050.3
 IP68 connection : Connex 2 / 3 / 4

ON REQUEST

Sandblasted glass
 Led 3,2W 350mA 2700k / 3000K / 4000K / 5000K
 Other cable length (customized)
 Other cover plate dimensions (customized)

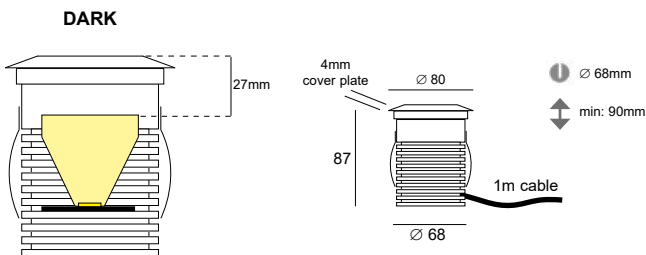

code: 362. **XX** **XXX** . **XX** 
 led power color

max. efficacy
141lm/W

	Typical luminous flux (lm)	
	350mA 6W	500mA 9,5W
2700 K	725	995
3000 K	760	1035
4000 K	805	1095
5000 K	845	1150

LED	POWER	COLOR
27 2700K	910 9,5W - 10°	02A Anodized black
30 3000K	925 9,5W - 25°	16 Brushed stainless steel 316L
40 4000K	940 9,5W - 40°	32D Anodized aluminum
		33 Anodized bronze

5000K = on request
 3,2W 350mA 2700K / 3000K / 4000K / 5000K = on request

Perla-R Dark

Reference	Price €
362.____.16	289.00
362.____.	259.00

Perla-R Dark

Led uplighting



EXTERIOR LIGHTING
FLOOR UPLIGHTING - Recessed

Ø min: 68mm
 min: 90mm

350mA - 500mA

6W - 9,5W



Perla-S Dark



IP68

500mA

IK10



DESCRIPTION

Body made in solid anodized aluminum
 Cover plate in anodized aluminum
 Degree of protection IP68, water depth up to 1m
 Safety extra clear glass
 Led module COB CRI>90 3SDCM 85.000hrs L80 B10
 Provided with 1m cable
 Max. 2140kg (21000 N)

ACCESSORIES

Recessed box : Pop 10a/10b ref: X054A / X054B
 Led driver AC/CC from 200mA to 500mA
 Led driver DC/CC (12-36VDC/200mA to 500mA)
 Anti-glare honeycomb - Louver ref: X060.050.3
 IP68 connection : Connex 2 / 3 / 4

ON REQUEST

Sandblasted glass
 Led 3,2W 350mA 2700k / 3000K / 4000K / 5000K
 Other cable length (customized)

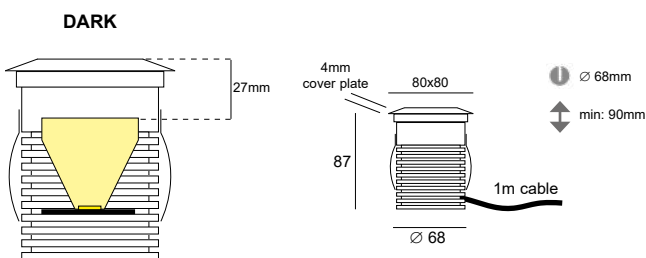

code: 368. XX . XXX . XX DIMMABLE
 led power color

max. efficacy
141lm/W

	Typical luminous flux (lm)	
	350mA 6W	500mA 9,5W
2700 K	725	995
3000 K	760	1035
4000 K	805	1095
5000 K	845	1150

LED	POWER	COLOR
27 2700K	910 9,5W - 10°	02A Anodized black
30 3000K	925 9,5W - 25°	32D Anodized aluminum
40 4000K	940 9,5W - 40°	33 Anodized bronze

5000K = on request
 3,2W 350mA 2700K / 3000K / 4000K / 5000K = on request

Perla-S Dark

Reference	Price €
368.-----	275.00

Perla-S Dark

Led uplighting



EXTERIOR LIGHTING
FLOOR UPLIGHTING - Recessed

Ø min: 65mm

min: 100mm

350mA
1,1W - 6W

EXTRA CLEAR GLASS



code : 1

SANDBLASTED GLASS



code : 2

Ø 75mm



code : 7.16

75 x 75mm



code : 8.16

Ø 100mm

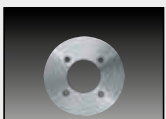

code : 9.16

100 x 100mm



code : D.16

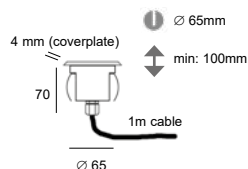

max. efficacy
141lm/W

	Typical luminous flux (lm)		
	1,1W	3,2W	6W
2700 K	115	355	725
3000 K	125	370	760
4000 K	135	395	805
5000 K	145	410	845

code: 2257 XXXC X X .16

led
glass
cover plate



Without driver (350mA)

LED

D14 1,1W - 4000K - 35°
D37 3,2W - 4000K - 50°
D67 6W - 4000K - 50°
W14 1,1W - 2700K - 35°
W37 3,2W - 2700K - 50°
W67 6W - 2700K - 50°

GLASS

1 Extra clear glass
2 Sandblasted glass

COVER PLATE

7 Round d.75mm
8 Square 75x75mm
9 Round d.100mm
D Square 100x100mm

COLOR

16 Brushed stainless steel 316L

On request:

02A Anodized black
 07 Brushed brass
 33 Anodized bronze

3000K / 5000K = on request
 1,1W 10° = on request
 3,2W or 6W 35° = on request

Zaxor Mini (350mA)

Reference	Price €
2257_14C_7.16	219.00
2257_14C_8.16	219.00
2257_14C_9.16	231.00
2257_14C_D.16	256.00
2257_37C_7.16	225.00
2257_37C_8.16	225.00
2257_37C_9.16	238.00
2257_37C_D.16	263.00
2257_67C_7.16	225.00
2257_67C_8.16	225.00
2257_67C_9.16	238.00
2257_67C_D.16	263.00

Zaxor Mini



Led uplighting

DESCRIPTION

Body made in solid anodised aluminum
Cover plate 4mm in stainless steel 316L
Screws and spring in stainless steel
Safety extra clear or sandblasted glass 10mm thickness
Led 350mA CRI>90 3SDCM 85.000hrs L80 B10
Max. 2140kg (21000 N)
Degree of protection IP67 - IK10
Provided with 1m cable

ACCESSORIES

Recessed box - Pop 4a/4b ref: X066A / X066B
Led driver AC/CC 350mA
Led driver DC/CC (12-36VDC/350mA)
Anti-glare honeycomb - Louver ref: X060.021.3
Asymmetrical beam - visor HC : ref: X061.022.2
IP68 connection : Connex 2 / 3 / 4

ON REQUEST

Other cover plate dimensions (customized)
Cover plate in anodized black (02A) or anodized bronze (33)
Cover plate in brushed brass (07)
Other led color: 3000K / 5000K
Other cable length (customized)

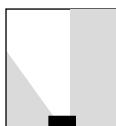

Asymmetrical beam with Visor HC (half-circle)



IP67

350mA

IK10



Zaxor Mini (350mA)

Ø min: 65mm

min: 130mm

230V
1,1W - 3,2W

EXTRA CLEAR
GLASS



code : 1

SANDBLASTED
GLASS



code : 2

Ø 75mm



code : 7.16

75 x 75mm



code : 8.16

Ø 100mm

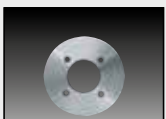

code : 9.16

100 x 100mm



code : D.16

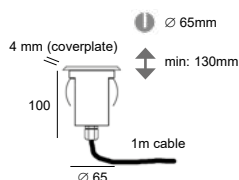

max.
efficacy
132lm/W

	Typical luminous flux (lm)	
	1,1W	3,2W
2700 K	115	355
3000 K	125	370
4000 K	135	395
5000 K	145	410

code: 2258 XXXC X X .16 Driver 220-240V incorporated

led
glass
cover plate

LED

D14 1,1W - 4000K - 35°
D37 3,2W - 4000K - 50°
W14 1,1W - 2700K - 35°
W37 3,2W - 2700K - 50°

3000K / 5000K = on request
1,1W 10° = on request
3,2W 35° = on request

GLASS

1 Extra clear glass
2 Sandblasted glass

COVER PLATE

7 Round d.75mm
8 Square 75x75mm
9 Round d.100mm
D Square 100x100mm

COLOR

16 Brushed stainless steel 316L

On request:
02A Anodized black
07 Brushed brass
33 Anodized bronze

Zaxor Mini (220-240V)

Reference	Price €
2258_14C_7.16	326.00
2258_14C_8.16	326.00
2258_14C_9.16	339.00
2258_14C_D.16	364.00
2258_37C_7.16	333.00
2258_37C_8.16	333.00
2258_37C_9.16	345.00
2258_37C_D.16	370.00

Zaxor Mini

Led uplighting



DESCRIPTION

Body made in solid anodised aluminum
 Cover plate 4mm in stainless steel 316L
 Screws and spring in stainless steel
 Safety extra clear or sandblasted glass 10mm thickness
 Led module CRI>90 3SDCM 85.000hrs L80 B10
 Power supply 220-240V incorporated
 Max. 2140kg (21000 N)
 Degree of protection IP67 - IK10
 Provided with 1m cable

ACCESSORIES

Recessed box - Pop 4a/4b ref: X066A / X066B
 Anti-glare honeycomb - Louver ref: X060.021.3
 Asymmetrical beam - visor HC : ref: X061.022.2
 IP68 connection : Connex 2 / 3 / 4 / 6

ON REQUEST

Power supply 24VDC included / led 3000K or 5000K
 Other cover plate dimensions (customized)
 Cover plate in anodized black (02A) or anodized bronze (33)
 Cover plate in brushed brass (07)
 Other cable length (customized)

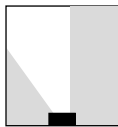

Asymmetrical beam with Visor HC (half-circle)



IP67



230V

IK10



Zaxor Mini (220-240V)



 \varnothing min: 78mm
 min: 95mm

230V
4W - 10W



code: 800C1 **XX** **X** **X** . **XX**
 led angle cover plate color

max. efficacy 102lm/W

	Typical luminous flux (lm)		
	4W	6W	10W
2700 K	315	460	930
3000 K	320	470	950
4000 K	340	480	1020

LED	ANGLE	COVER PLATE	COLOR
W4 4W - 3000K	1 15°	R Round d.100mm	16 Brushed stainless steel 316L
W6 6W - 3000K	2 36°	S Square 100x100mm	21 Copper
W7 10W - 3000K	3 50°		

2700K / 4000K = on request

On request:
 02A Anodized black
 07 Brushed brass
 33 Anodized bronze

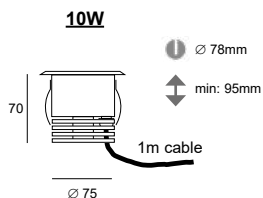
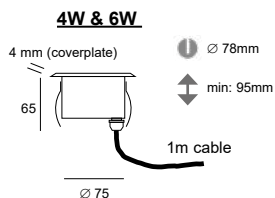

Bolas Led 230V

Reference	Price €
800C1_4_R.16	263.00
800C1_4_R.21	275.00
800C1_4_S.16	263.00
800C1_6_R.16	263.00
800C1_6_R.21	275.00
800C1_6_S.16	263.00
800C1_7_R.16	313.00
800C1_7_R.21	325.00
800C1_7_S.16	313.00

Bolas Led

Led uplighting



DESCRIPTION

Body made in solid anodised aluminum
 Cover plate 4mm in stainless steel 316L or copper
 Screws and spring in stainless steel
 Safety extra clear glass 10mm thickness
 Led 230V CRI>90 3SDCM 54.000hrs L80 B10
 Max. 2140kg (21000 N)
 Degree of protection IP67 - IK10
 Provided with 1m cable

ACCESSORIES

Recessed box : Pop 8a/8b ref: X067A / X067B
 Anti-glare honeycomb - Louver ref: X060.043.3
 Asymmetrical beam - visor HC : ref: X061.050.2
 IP68 connection : Connex 2 / 3 / 4 / 6

ON REQUEST

Other cover plate dimensions (customized)
 Cover plate in anodized black (02A) or anodized bronze (33)
 Cover plate in brushed brass (07)
 Led 2700K or 4000K / Sandblasted glass
 Other cable length (customized)



IP67

230V

IK09



Bolas Led 230V

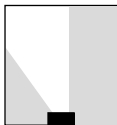

Asymmetrical beam with Visor HC (half-circle)



EXTERIOR LIGHTING
 FLOOR UPLIGHTING - Recessed



Ø min: 78mm

min: 90mm

350mA - 500mA

6W - 17W



code: 8028.X X X X.XX

led
power
angle°
cover plate
color



max. efficacy
142lm/W

	Typical luminous flux (lm)		
	6W	11W	17W
2700 K	725	1350	2090
3000 K	760	1400	2180
4000 K	805	1480	2310
5000 K	845	1540	2415

LED	POWER	ANGLE	COVER PLATE	COLOR
D 4000K	0 6W 350mA	1 15°	R Round d.100mm	16 Brushed stainless steel 316L
W 2700K	1 11W 350mA	2 36°	S Square 100x100mm	21 copper
	2 17W 500mA	3 50°		

3000K / 5000K = on request
3,2W 350mA 2700K / 3000K / 4000K / 5000K = on request

On request:
02A Anodized black
07 Brushed brass
33 Anodized bronze

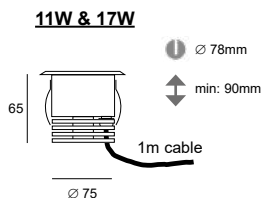
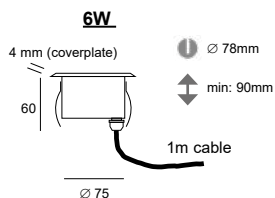

Bolas HP led

Reference	Price €
8028_0_R.16	232.00
8028_0_R.21	248.00
8028_0_S.16	232.00
8028_1_R.16	279.00
8028_1_R.21	295.00
8028_1_S.16	279.00
8028_2_R.16	291.00
8028_2_R.21	306.00
8028_2_S.16	291.00

Bolas HPL

Led uplighting



DESCRIPTION

Body made in solid anodised aluminum
 Cover plate 4mm in stainless steel 316L or copper
 Screws and spring in stainless steel
 Safety extra clear glass 10mm thickness
 Led module COB CRI>90 3SDCM 85.000hrs L80 B10
 Max. 2140kg (21000 N) - IK10
 Degree of protection IP68, water depth up to 1m
 Provided with 1m cable

ACCESSORIES

Recessed box : Pop 8a/8b ref: X067A / X067B
 Led driver AC/CC 350mA or 500mA CC
 Led driver DC/CC (24VDC/350mA or 500mA)
 Anti-glare honeycomb - Louver ref: X060.043.3
 Asymmetrical beam - visor HC : ref: X061.050.2
 IP68 connection : Connex 2 / 3 / 4

ON REQUEST

Other cover plate dimensions (customized)
 Cover plate in anodized black (02A) or anodized bronze (33)
 Cover plate in brushed brass (07)
 Led 3000K or 5000K / Sandblasted glass
 Other cable length (customized)

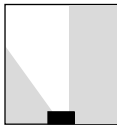

Asymmetrical beam with Visor HC (half-circle)

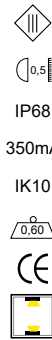

Bolas HP led



EXTERIOR LIGHTING
 FLOOR UPLIGHTING - Recessed



Ø min: 78mm

min: 145mm

230V
GU10



code: 800C1GU X.XX



cover plate
color

GU10 LED (max. height 56mm)



COVER PLATE

R Round d.100mm
S Square 100x100mm

COLOR

16 Brushed stainless steel 316L
21 Copper

[On request:](#)

02A Anodized black
07 Brushed brass
33 Anodized bronze

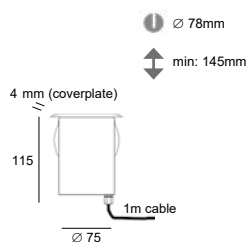

Bolas

Reference	Price €
800C1GUR.16	259.00
800C1GUR.21	271.00
800C1GUS.16	259.00

Bolas

Led uplighting



DESCRIPTION

Body made in solid anodised aluminum
Cover plate 4mm in stainless steel 316L or copper
Screws and spring in stainless steel
Safety extra clear glass 10mm thickness
Max. 2140kg (21000 N)
Degree of protection IP67 - IK10
Provided with 1m cable

ACCESSORIES

Recessed box : Pop 8b ref: X067B
IP68 connection : Connex 2 / 3 / 4 / 6
Anti-glare honeycomb - Louver ref: X060.043.3

ON REQUEST

Other cover plate dimensions (customized)
Cover plate in anodized black (02A) or anodized bronze (33)
Cover plate in brushed brass (07)
Sandblasted glass
Other cable length (customized)



IP67

230V

IK09



Bolas

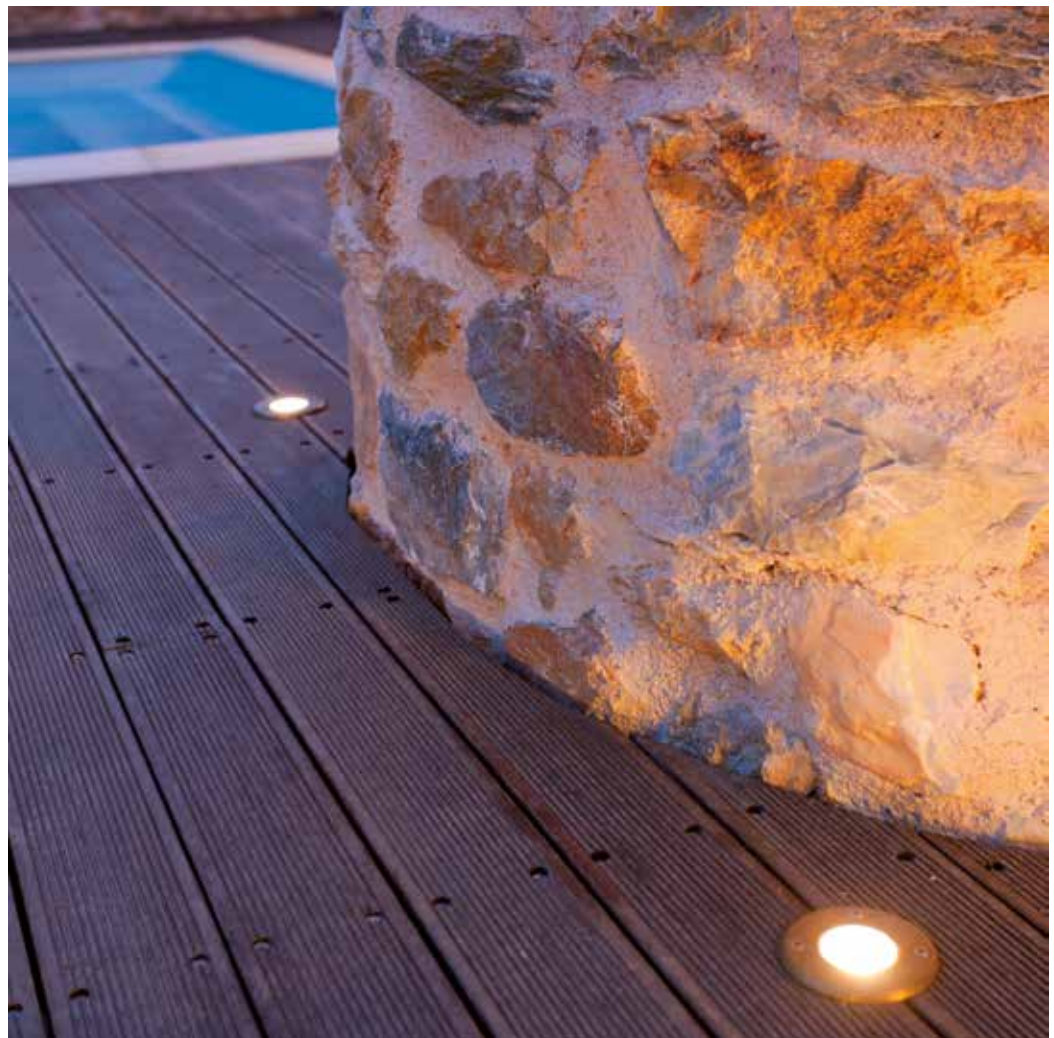

Ø min: 100mm
 min: 105 - 165mm

230V
 GU10

ON THE BOTTOM



code : A

CLEAR GLASS



code : 1

ON THE SIDE



code : B

SANDBLASTED GLASS



code : 2

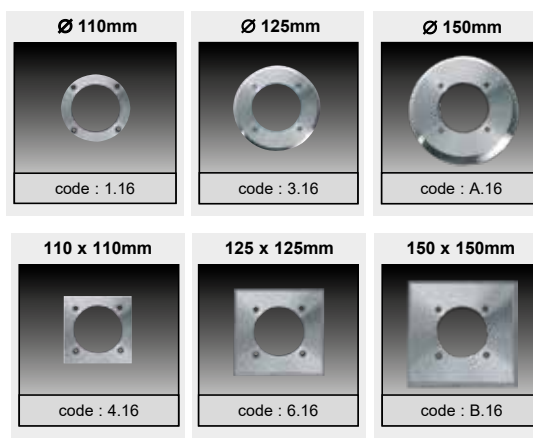

code: 2201X X X .16



cable gland
 glass
 cover plate

GU10 LED (max. height 56mm)



CABLE GLAND

A on the bottom
B on the side

GLASS

1 Extra clear glass
2 Sandblasted glass

COVER PLATE

1 Round d.110mm
3 Round d.125mm
4 Square 110x110mm
6 Square 125x125mm
A Round d.150mm
B Square 150x150mm

COLOR

16 Brushed stainless steel 316L

On request:
 02A Anodized black
 07 Brushed brass
 33 Anodized bronze

Cable gland: A

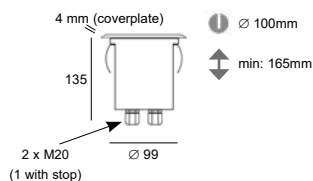

Cable gland: B

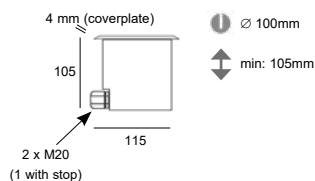

Zaxor GZ

Reference	Price €
2201_1.16	288.00
2201_3.16	299.50
2201_4.16	288.00
2201_6.16	319.00
2201_A.16	313.00
2201_B.16	331.00

Zaxor GZ



Led uplighting

DESCRIPTION

Body made in solid anodised aluminum
Cover plate 4mm in stainless steel 316L
Screws and spring in stainless steel
Safety extra clear glass 10mm thickness
Max. 2140kg (21000 N)
Degree of protection IP67 - IK10

ACCESSORIES

Recessed box - Pop 5b ref: X055B (only for cable gland A)
IP68 connection : Connex 2 / 3 / 4 / 6

ON REQUEST

Other cover plate dimensions (customized)
Cover plate in anodized black (02A) or anodized bronze (33)
Cover plate in brushed brass (07)
With pre-assembled cable, custom length



IP67

230V

IK10



Zaxor GZ



Ø min: 100mm
 min: 120 - 180mm



230V
 GU10

ON THE BOTTOM



code : A

CLEAR GLASS



code : 1

ON THE SIDE



code : B

SANDBLASTED GLASS



code : 2

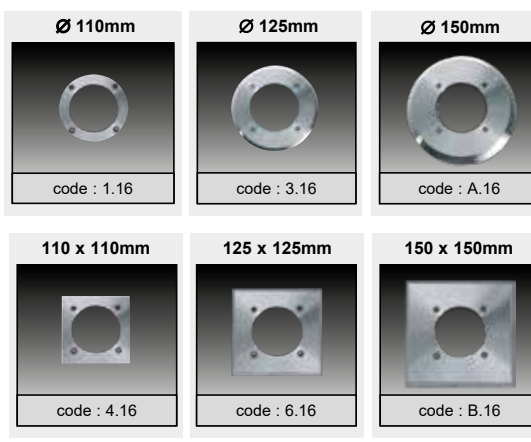

code: 2211X X X .16

cable gland
 glass
 cover plate

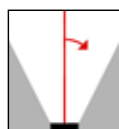

GU10 LED (max. height 56mm)



CABLE GLAND

- A on the bottom
- B on the side

GLASS

- 1 Extra clear glass
- 2 Sandblasted glass

COVER PLATE

- 1 Round d.110mm
- 3 Round d.125mm
- 4 Square 110x110mm
- 6 Square 125x125mm
- A Round d.150mm
- B Square 150x150mm

COLOR

- 16 Brushed stainless steel 316L

On request:
 02A Anodized black
 07 Brushed brass
 33 Anodized bronze

Cable gland: A

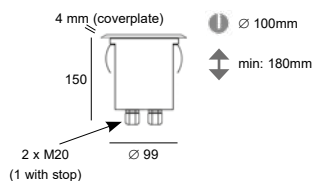

Cable gland: B

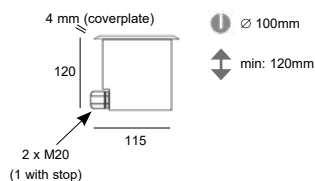

Zaxor GZ0

Reference	Price €
2211_1.16	320.00
2211_3.16	333.00
2211_4.16	320.00
2211_6.16	349.50
2211_A.16	345.00
2211_B.16	362.00

Zaxor GZO



Led uplighting

DESCRIPTION

Body made in solid anodised aluminum
Cover plate 4mm in stainless steel 316L
Screws and spring in stainless steel
Safety extra clear glass 10mm thickness
Max. 2140kg (21000 N)
Degree of protection IP67 - IK10

ACCESSORIES

Recessed box - Pop 5b ref: X055B (only for cable gland A)
IP68 connection : Connex 2 / 3 / 4 / 6

ON REQUEST

Other cover plate dimensions (customized)
Cover plate in anodized black (02A) or anodized bronze (33)
Cover plate in brushed brass (07)
With pre-assembled cable, custom length



IP67

230V

IK10



Zaxor GZO



Ø min: 100mm
 min: 95mm

350mA - 700mA

3,2W - 24W

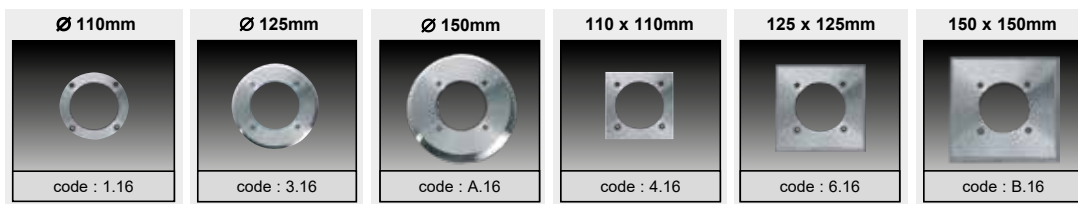

max. efficacy 142lm/W

	Typical luminous flux (lm)				
	3,2W	6W	11W	17W	24W
2700 K	355	725	1350	2090	2900
3000 K	370	760	1400	2180	3050
4000 K	395	805	1480	2310	3200
5000 K	410	845	1540	2415	3350

code: 2277.XXXX.16



led
 power
 angle°
 cover plate

LED	POWER	ANGLE	COVER PLATE	COLOR
D 4000K W 2700K	0 3,2W - 350mA 1 6W - 350mA 2 11W - 350mA 3 17W - 500mA 4 24W - 700mA	1 15° 3 50°	1 Round d.110mm 3 Round d.125mm 4 Square 110x110mm 6 Square 125x125mm A Round d.150mm B Square 150x150mm	16 Brushed stainless steel 316L

3000K / 5000K = on request

On request:
 2 lens 36°

On request:
 02A Anodized black
 07 Brushed brass
 33 Anodized bronze

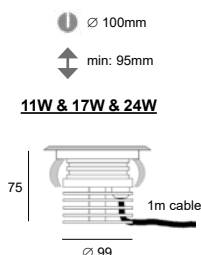
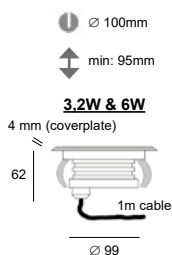

Zaxor led (xxx mA)

Reference	Price €	Reference	Price €	Reference	Price €	Reference	Price €	Reference	Price €
2277_0_1.16	275.00	2277_1_1.16	275.00	2277_2_1.16	323.00	2277_3_1.16	333.00	2277_4_1.16	343.00
2277_0_3.16	288.00	2277_1_3.16	288.00	2277_2_3.16	335.00	2277_3_3.16	345.00	2277_4_3.16	355.00
2277_0_4.16	275.00	2277_1_4.16	275.00	2277_2_4.16	323.00	2277_3_4.16	333.00	2277_4_4.16	343.00
2277_0_6.16	313.00	2277_1_6.16	313.00	2277_2_6.16	360.00	2277_3_6.16	370.00	2277_4_6.16	380.00
2277_0_A.16	299.50	2277_1_A.16	299.50	2277_2_A.16	348.00	2277_3_A.16	358.00	2277_4_A.16	368.00
2277_0_B.16	349.50	2277_1_B.16	349.50	2277_2_B.16	398.00	2277_3_B.16	408.00	2277_4_B.16	418.00

Zaxor Led

Led uplighting



DESCRIPTION

Body made in solid anodised aluminum
 Cover plate 4mm in stainless steel 316L
 Screws and spring in stainless steel
 Safety extra clear glass 10mm thickness
 Led module COB CRI>90 3SDCM 85.000hrs L80 B10
 Max. 2140kg (21000 N)
 Degree of protection IP67 - IK10
 Provided with 1m cable

ACCESSORIES

Recessed box : Pop 5a/5b ref: X055A / X055B
 Led driver AC/CC 350mA to 700mA CC
 Led driver DC/CC (24VDC/350mA to 700mA)
 IP68 connection : Connex 2 / 3 / 4
 Anti-glare honeycomb - Louver ref: X060.068.3

ON REQUEST

Other cover plate dimensions (customized)
 Cover plate in anodized black (02A) or anodized bronze (33)
 Cover plate in brushed brass (07)
 Lens 36° / led 3000K or 5000K / Sandblasted glass
 Other cable length (customized)



IP67

IK10



Zaxor led (xxx mA)

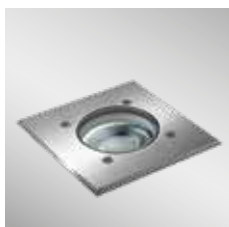

Ø min: 100mm

min: 150mm

230V
3,2W - 9,5W

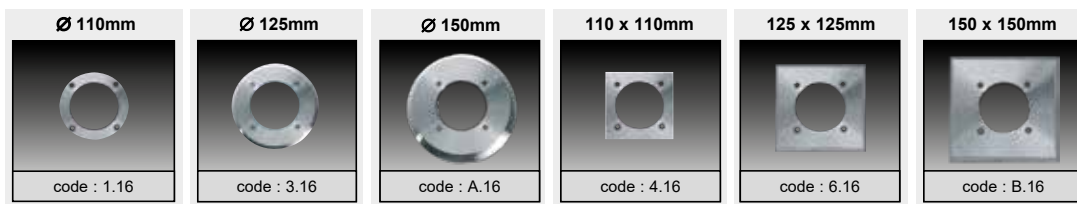

code: 2278.XXXX.16

led
power
angle°
cover plate

max.
efficacy
141lm/W

	Typical luminous flux (lm)		
	3,2W	6W	9,5W
2700 K	355	725	995
3000 K	370	760	1035
4000 K	395	805	1095
5000 K	410	845	1150

LED	POWER	ANGLE	COVER PLATE	COLOR
D 4000K	0 3,2W - 230V	1 15°	1 Round d.110mm	16 Brushed stainless steel 316L
W 2700K	1 6W - 230V	3 50°	3 Round d.125mm	
	2 9,5W - 230V		4 Square 110x110mm	
			6 Square 125x125mm	
			A Round d.150mm	
			B Square 150x150mm	
				<u>On request:</u>
				02A Anodized black
				07 Brushed brass
				33 Anodized bronze

3000K / 5000K = on request

On request:
2 lens 36°

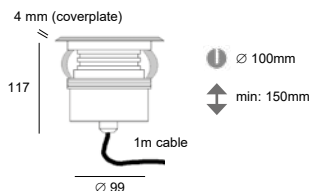

Zaxor led (220-240V)

Reference	Price €	Reference	Price €	Reference	Price €
2278_0_1.16	375.00	2278_1_1.16	375.00	2278_2_1.16	388.00
2278_0_3.16	388.00	2278_1_3.16	388.00	2278_2_3.16	399.00
2278_0_4.16	375.00	2278_1_4.16	375.00	2278_2_4.16	388.00
2278_0_6.16	413.00	2278_1_6.16	413.00	2278_2_6.16	426.00
2278_0_A.16	399.00	2278_1_A.16	399.00	2278_2_A.16	413.00
2278_0_B.16	449.50	2278_1_B.16	449.50	2278_2_B.16	463.00



2278.XXX3.16

Zaxor Led



Led uplighting

DESCRIPTION

Body made in solid anodised aluminum
Cover plate 4mm in stainless steel 316L
Screws and spring in stainless steel
Safety extra clear glass 10mm thickness
Led module COB CRI>90 3SDCM 85.000hrs L80 B10
Power supply 220-240V incorporated
Max. 2140kg (21000 N)
Degree of protection IP67 - IK10
Provided with 1m cable

ACCESSORIES

Recessed box : Pop 5b ref: X055B
IP68 connection : Connex 2 / 3 / 4 / 6
Anti-glare honeycomb - Louver ref: X060.068.3

ON REQUEST

Power supply 24VDC included / led 3000K or 5000K / Lens 36°
Other cover plate dimensions (customized) / Sandblasted glass
Cover plate in anodized black (02A) or anodized bronze (33)
Cover plate in brushed brass (07)
Other cable length (customized)



IP67

230V

IK10





Zaxor led (220-240V)

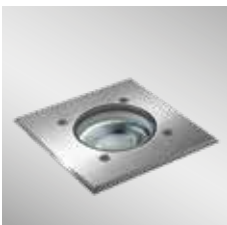

Dimmable power supply = on request



 \varnothing min: 100mm
 min: 100mm

200mA - 450mA

7W - 17W

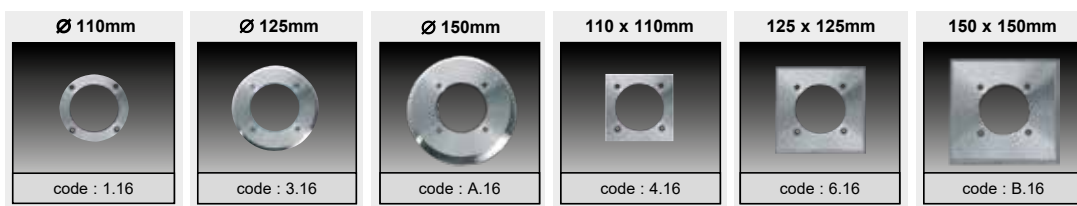

code: 7016.XXX X .16

led
cover plate



7W to 17W

Without driver (200 → 450mA)

max. efficacy
108lm/W

	Typical luminous flux (lm)		
	200mA 7W	350mA 13W	450mA 17W
2700 K	750	1350	1650
3000 K	800	1400	1750
4000 K	850	1450	1800

LED

W27 2700K - 10°
W30 3000K - 10°

4000K = on request

COVER PLATE

1 Round d.110mm
3 Round d.125mm
4 Square 110x110mm
6 Square 125x125mm
A Round d.150mm
B Square 150x150mm

COLOR

16 Brushed stainless steel 316L

On request:

02A Anodized black
 07 Brushed brass
 33 Anodized bronze

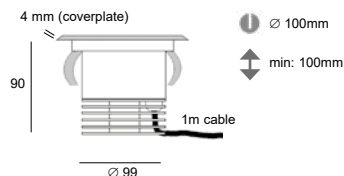

Zaxor 10°

Reference	Price €
7016.W__1.16	408.00
7016.W__3.16	420.00
7016.W__4.16	408.00
7016.W__6.16	446.00
7016.W__A.16	433.00
7016.W__B.16	483.00

Zaxor 10°

Led uplighting



DESCRIPTION

Body made in solid anodised aluminum
 Cover plate 4mm in stainless steel 316L
 Screws and spring in stainless steel
 Safety extra clear glass 10mm thickness
 Led module COB CRI>90 3SDCM 85.000hrs L80 B10
 Max. 2140kg (21000 N)
 Degree of protection IP67 - IK10
 Provided with 1m cable

ACCESSORIES

Recessed box : Pop 5b ref: X055B
 Led driver AC/CC from 200mA to 450mA
 Led driver DC/CC (12-36VDC/200-450mA)
 IP68 connection : Connex 2 / 3 / 4
 Anti-glare honeycomb - Louver ref: X060.064.3

ON REQUEST

Other cover plate dimensions (customized)
 Cover plate in anodized black (02A) or anodized bronze (33)
 Cover plate in brushed brass (07)
 Sandblasted glass / led color 4000K
 Other cable length (customized)



IP67

230V

IK10



Zaxor 10°

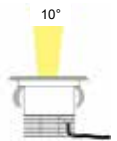
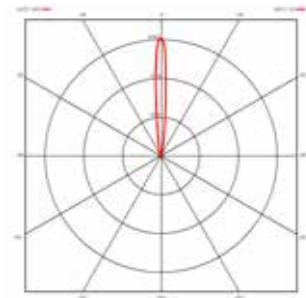

EXTERIOR LIGHTING
 FLOOR UPLIGHTING - Recessed

Ø min: 100mm
 min: 170mm



350mA
 3,2W - 11W

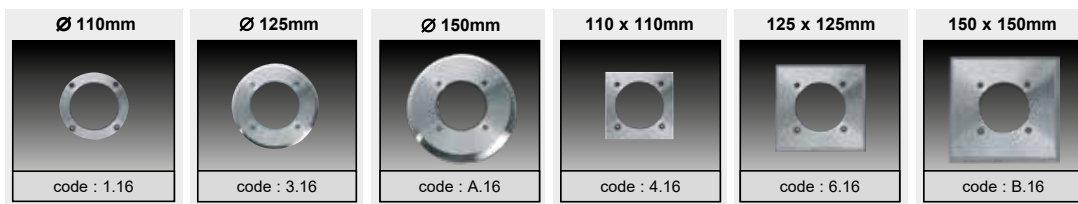

max. efficacy 141lm/W

	Typical luminous flux (lm)		
	3,2W	6W	11W
2700 K	355	725	1350
3000 K	370	760	1400
4000 K	395	805	1480
5000 K	410	845	1540

code: 2407.XXXX.16



led
 power
 angle°
 cover plate

LED	POWER	ANGLE	COVER PLATE	COLOR
D 4000K	0 3,2W - 350mA	1 15°	1 Round d.110mm	16 Brushed stainless steel 316L
W 2700K	1 6W - 350mA	3 50°	3 Round d.125mm	
	2 11W - 350mA		4 Square 110x110mm	
			6 Square 125x125mm	
			A Round d.150mm	
			B Square 150x150mm	

3000K / 5000K = on request

On request:
 2 lens 36°

On request:
 02A Anodized black
 07 Brushed brass
 33 Anodized bronze

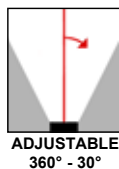
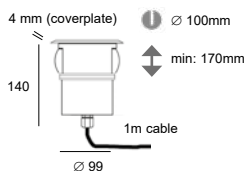

Zaxor led-O (350mA)

Reference	Price €	Reference	Price €	Reference	Price €
2407_0_1.16	426.00	2407_1_1.16	426.00	2407_2_1.16	438.00
2407_0_3.16	438.00	2407_1_3.16	438.00	2407_2_3.16	449.50
2407_0_4.16	426.00	2407_1_4.16	426.00	2407_2_4.16	438.00
2407_0_6.16	463.00	2407_1_6.16	463.00	2407_2_6.16	476.00
2407_0_A.16	449.50	2407_1_A.16	449.50	2407_2_A.16	463.00
2407_0_B.16	499.50	2407_1_B.16	499.50	2407_2_B.16	513.00

Zaxor Led-O



Led uplighting

DESCRIPTION

Body made in solid anodised aluminum
Cover plate 4mm in stainless steel 316L
Screws and spring in stainless steel
Safety extra clear glass 10mm thickness
Led module COB CRI>90 3SDCM 85.000hrs L80 B10
Max. 2140kg (21000 N)
Degree of protection IP67 - IK10
Provided with 1m cable

ACCESSORIES

Recessed box : Pop 5b ref: X055B
Led driver AC/CC 350mA
Led driver DC/CC (12-36VDC/350mA)
IP68 connection : Connex 2 / 3 / 4
Anti-glare honeycomb - Louver ref: X060.050.3

ON REQUEST

Other cover plate dimensions (customized)
Cover plate in anodized black (02A) or anodized bronze (33)
Cover plate in brushed brass (07)
Lens 36° / led 3000K or 5000K / Sandblasted glass
Other cable length (customized)



IP67

350mA

IK10



Zaxor led-O (350mA)

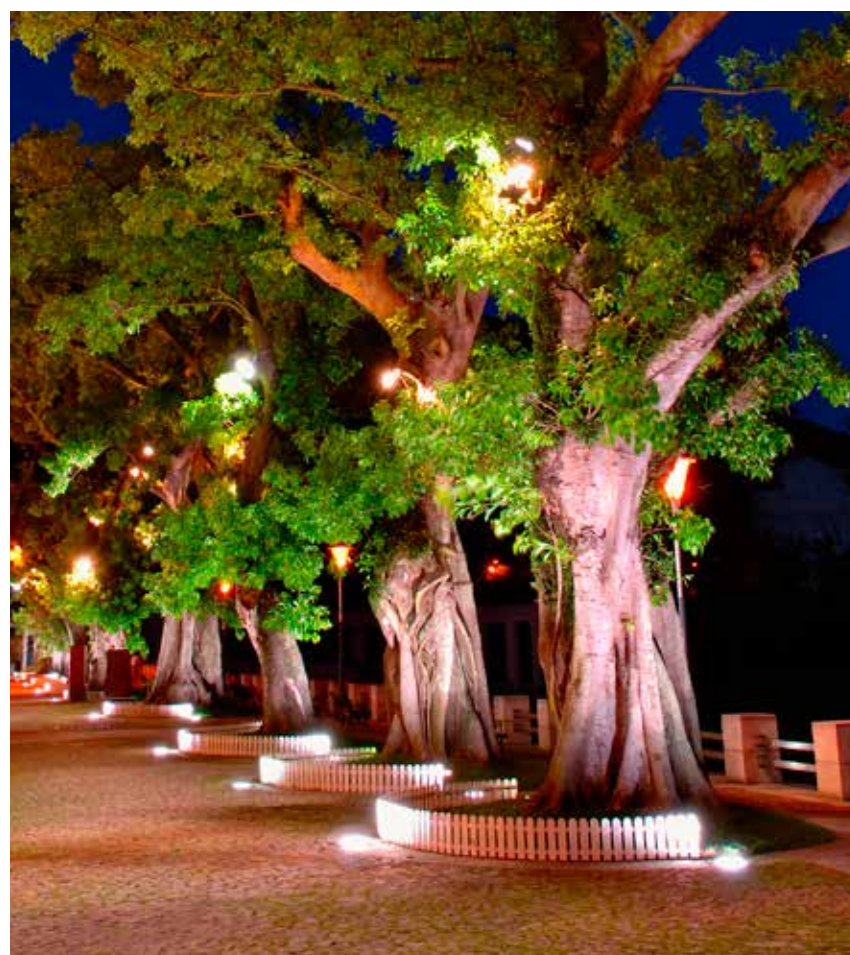
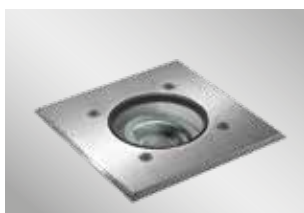

Ø min: 100mm
 min: 215mm



230V
 3,2W - 9,5W

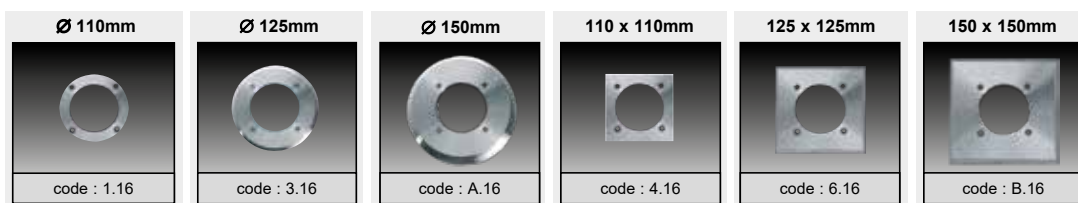

max. efficacy 141lm/W

	Typical luminous flux (lm)		
	3,2W	6W	9,5W
2700 K	355	725	995
3000 K	370	760	1035
4000 K	395	805	1095
5000 K	410	845	1150

code: 2408.XXXX.16
 led
 power
 angle°
 cover plate

LED	POWER	ANGLE	COVER PLATE	COLOR
D 4000K	0 3,2W - 230V	1 15°	1 Round d.110mm	16 Brushed stainless steel 316L
W 2700K	1 6W - 230V	3 50°	3 Round d.125mm	
	2 9,5W - 230V		4 Square 110x110mm	
			6 Square 125x125mm	
			A Round d.150mm	
			B Square 150x150mm	

3000K / 5000K = on request

On request:
 2 lens 36°

On request:
 02A Anodized black
 07 Brushed brass
 33 Anodized bronze

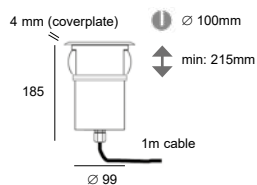

Zaxor led-O (220-240V)

Reference	Price €	Reference	Price €	Reference	Price €
2408_0_1.16	526.00	2408_1_1.16	526.00	2408_2_1.16	538.00
2408_0_3.16	538.00	2408_1_3.16	538.00	2408_2_3.16	549.50
2408_0_4.16	526.00	2408_1_4.16	526.00	2408_2_4.16	538.00
2408_0_6.16	563.00	2408_1_6.16	563.00	2408_2_6.16	576.00
2408_0_A.16	549.50	2408_1_A.16	549.50	2408_2_A.16	563.00
2408_0_B.16	599.50	2408_1_B.16	599.50	2408_2_B.16	614.00

Zaxor Led-O



Led uplighting

DESCRIPTION

Body made in solid anodised aluminum
Cover plate 4mm in stainless steel 316L
Screws and spring in stainless steel
Safety extra clear glass 10mm thickness
Led module COB CRI>90 3SDCM 85.000hrs L80 B10
Power supply 220-240V incorporated
Max. 2140kg (21000 N)
Degree of protection IP67 - IK10
Provided with 1m cable

ACCESSORIES

Recessed box : Pop 5b ref: X055B
IP68 connection : Connex 2 / 3 / 4 / 6
Anti-glare honeycomb - Louver ref: X060.050.3

ON REQUEST

Power supply 24VDC included / led 3000K or 5000K / Lens 36°
Other cover plate dimensions (customized) / Sandblasted glass
Cover plate in anodized black (02A) or anodized bronze (33)
Cover plate in brushed brass (07)
Other cable length (customized)



IP67

230V

IK10



Zaxor led-O (220-240V)



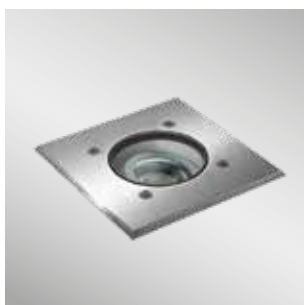

Dimmable power supply = on request



2408.D233.16



 \varnothing min: 150mm
 min: 140mm

230V
17W

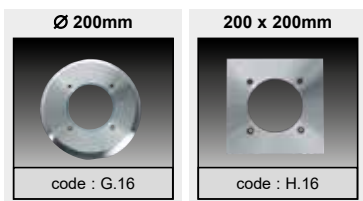

code: 2417 XX X C1 X .16

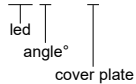

max. efficacy 100lm/W

Typical luminous flux (lm)	
	17W
3000 K	1650
4000 K	1700

LED	ANGLE	COVER PLATE	COLOR
N7 17W 230V - 4000K	5 24°	G Round d.200mm	16 Brushed stainless steel 316L
W7 17W 230V - 3000K	6 40°	H Square 200x200mm	

On request:
 02A Anodized black
 33 Anodized bronze

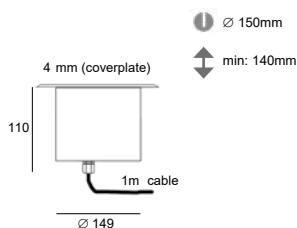

Zaxor HP led

Reference	Price €
2417N7_C1_16	624.00
2417W7_C1_16	624.00

Zaxor-HPL



Led uplighting

DESCRIPTION

Body made in solid anodised aluminum
Cover plate 4mm in stainless steel 316L
Screws in stainless steel
Safety clear glass 10mm thickness
Led module CRI>80 3SDCM 35.000hrs L70 B50
Max. 1000kg
Degree of protection IP67 - IK09
Provided with 1m cable

ACCESSORIES

Recessed box : Pop 6a/6b ref: X056A / X056B
IP68 connection : Connex 2 / 3 / 4 / 6

ON REQUEST

Other cover plate dimensions (customized)
Cover plate in anodized black (02A) or anodized bronze (33)
Sandblasted glass
Other cable length (customized)



0,5

IP67

230V

IK09

4,10



Zaxor HP led



Ø min: 150mm
 min: 180-220mm



xxxmA & 230V

11W - 17W

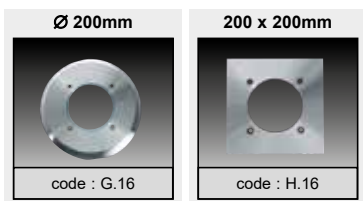

code: 2437XXXX.16



Without driver (350mA or 500mA)

code: 2438XXXX.16

Driver 220-240V incorporated

led
 angle°
 cover plate

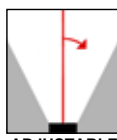

max. efficacy
 142lm/W

	Typical luminous flux (lm)		
	6W	11W	17W
2700 K	725	1350	2090
3000 K	760	1400	2180
4000 K	805	1480	2310
5000 K	845	1540	2415

LED	ANGLE	COVER PLATE	COLOR
D1 11W - 4000K	1 15°	G Round d.200mm	16 Brushed stainless steel 316L
D2 17W - 4000K°	3 50°	H Square 200x200mm	
W1 11W - 2700K			
W2 17W - 2700K			

3000K / 5000K = on request

On request:
 2 lens 36°

On request:
 02A Anodized black
 33 Anodized bronze

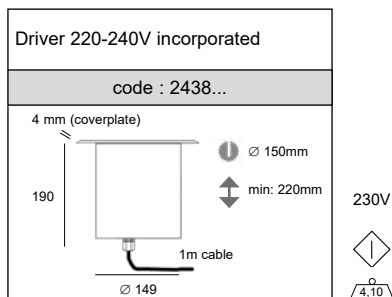
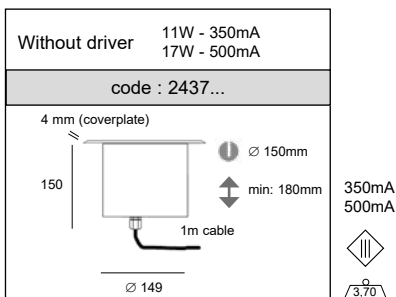

Bolas-O-HPL (xxx mA)

Reference	Price €
2437_1_G.16	782.00
2437_1_H.16	782.00
2437_2_G.16	821.00
2437_2_H.16	821.00

Bolas-O-HPL (220-240V)

Reference	Price €
2438_1_G.16	875.00
2438_1_H.16	875.00
2438_2_G.16	945.00
2438_2_H.16	945.00

Bolas O-HPL



Led uplighting

DESCRIPTION

Body made in profile anodised aluminum
Cover plate 4mm in stainless steel 316L
Safety clear glass 10mm thickness
Led module COB CRI>90 50.000hrs L80 B10
Power supply 220-240V incorporated (only code 2438)
Degree of protection IP67 - IK09
Max. 1000kg
Provided with 1m cable

ACCESSORIES

Recessed box : Pop 6a/6b ref: X056A / X056B
Led driver 350mA or 500mA CC (only code 2437)
Led driver 24VDC/350mA or 500mA (only code 2437)
IP68 connection : Connex 2 / 3 / 4
Anti-glare honeycomb - Louver ref: X060.050.3

ON REQUEST

Dimmable power supply 220-240V
Power supply 24VDC included / led 3000K or 5000K / Lens 36°
Other cover plate dimensions (customized) / Sandblasted glass
Cover plate in anodized black (02A) or anodized bronze (33)
Other cable length (customized)



0,5

IP67

IK09



Bolas-O-HPL



Dimmable power supply = on request



Ø min: 200mm
 min: 170mm



230V
 17W

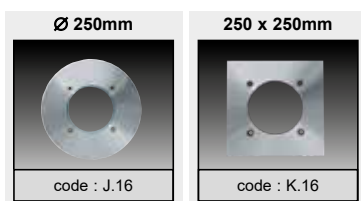

code: 2427 XX X C1 X .16



max. efficacy
 100lm/W

Typical luminous flux (lm)	
	17W
3000 K	1650
4000 K	1700

LED	ANGLE	COVER PLATE	COLOR
N7 17W 230V - 4000K	5 24°	J Round d.250mm	16 Brushed stainless steel 316L
W7 17W 230V - 3000K	6 40°	K Square 250x250mm	

On request:
 02A Anodized black
 33 Anodized bronze

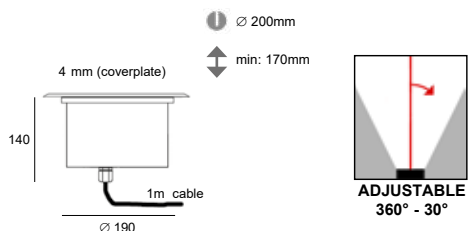

Zaxor O-HP led

Reference	Price €
2427N7_C1_16	999.00
2427W7_C1_16	999.00

Zaxor O-HPL



Led uplighting

DESCRIPTION

Body made in solid anodised aluminum
Cover plate 4mm in stainless steel 316L
Screws in stainless steel
Safety clear glass 12mm thickness
Led module CRI>80 3SDCM 35.000hrs L70 B50
Max. 1500kg
Degree of protection IP67 - IK09
Provided with 1m cable

ACCESSORIES

Recessed box : Pop 7 ref: X057
IP68 connection : Connex 2 / 3 / 4 / 6

ON REQUEST

Other cover plate dimensions (customized)
Cover plate in anodized black (02A) or anodized bronze (33)
Sandblasted glass
Other cable length (customized)



IP67

230V

IK09

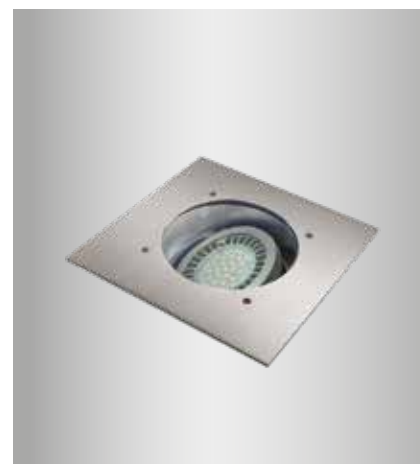

Zaxor O-HP led

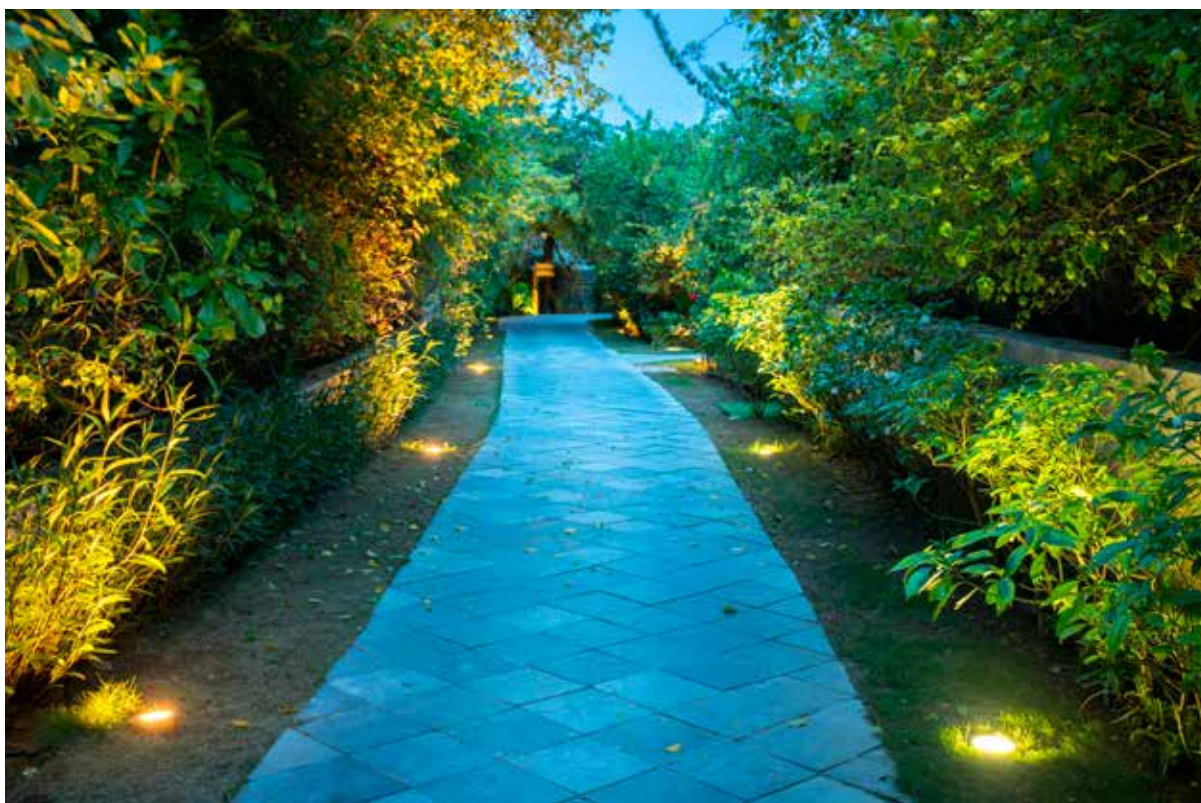

completely in
stainless steel 316L

UNDERWATER LIGHTING

∅ : 79mm
 min: 110mm

200-500mA

1,6W - 4,5W



Nautic S

DESCRIPTION

Box & luminaire made completely in solid stainless steel 316L electropolish
 To use only in permanent immersion (underwater)
 Operation up to a max. water temperature of 35°C
 Safety clear or sandblasted glass
 Led module COB CRI>90 3SDCM 85.000hrs L80 B10
 Degree of protection IP68, water depth up to 2m
 Provided with 10m cable + 3m plastic spiral



ACCESSORIES

Led driver AC/CC (from 200mA to 500mA)
 Led driver DC/CC (12-24VDC/200mA to 500mA)
 IP68 connection : Connex 2 / 3 / 4

ON REQUEST

Other led color: 5000K
 Other beam angle: 10°
 Other cable length (customized)

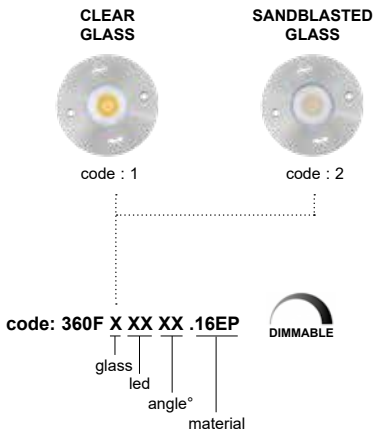
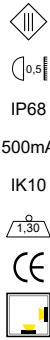

1,6W to 4,5W

Without driver (200 → 500mA)

max. efficacy 128lm/W

	Typical luminous flux (lm)		
	200mA 1,7W	350mA 3,2W	500mA 4,5W
2700 K	200	355	480
3000 K	215	370	510
4000 K	230	395	535
5000 K	235	410	560
voltage DC	8,5V	9V	9V

GLASS

- 1 Clear glass
- 2 Sandblasted glass

LED

- 27 2700K
- 30 3000K
- 40 4000K

ANGLE

- 40 40°

MATERIAL

- 16EP Stainless steel 316L + Electropolishing

5000K = on request
 10° = on request

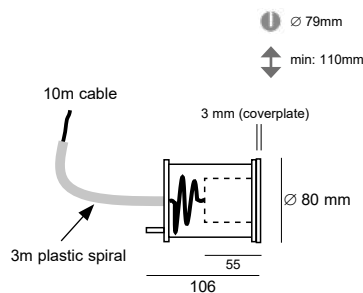

Nautic S recessed box included (completely in stainless steel 316L)

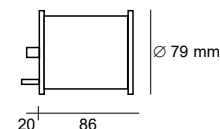

Nautic S

Reference	Price €
360F_---_16EP	619.00



Nautic S

Underwater Led light



EXTERIOR LIGHTING
UNDERWATER LIGHTING

∅ : 99mm
 min: 110mm

200-700mA

3,4W - 13W



Nautic M



IP68

700mA

IK10



DESCRIPTION

Box & luminaire made completely in solid stainless steel 316L electropolish
 To use only in permanent immersion (underwater)
 Operation up to a max. water temperature of 35°C
 Safety clear or sandblasted glass
 Led module COB CRI>80 3SDCM 85.000hrs L80 B10
 Degree of protection IP68, water depth up to 2m
 Provided with 10m cable + 3m plastic spiral

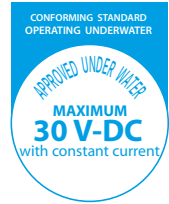

ACCESSORIES

Led driver AC/CC (from 200mA to 700mA)
 Led driver DC/CC (12-24VDC/200mA to 700mA)
 Anti-glare honeycomb - Louver ref: X060.043.3
 IP68 connection : Connex 2 / 3 / 4

ON REQUEST

Other led color: 5000K
 Other beam angle: 15° & 36°
 Other cable length (customized)

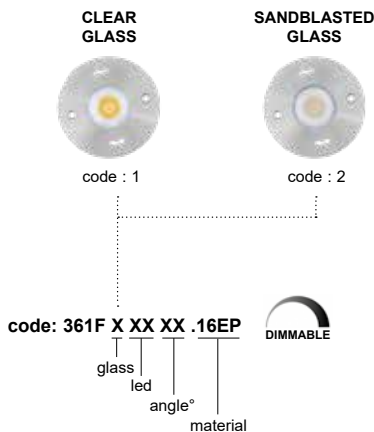

max. efficacy 141lm/W

3,4W to 13W
 Without driver (200 → 700mA)

	Typical luminous flux (lm)			
	200mA 3,4W	350mA 6W	500mA 9W	700mA 13W
2700 K	455	725	995	1350
3000 K	480	760	1035	1400
4000 K	500	805	1095	1500
5000 K	550	845	1150	1570
voltage DC	17V	17,2V	18V	18,6V

GLASS		LED		ANGLE	MATERIAL
1	Clear glass	27	2700K	50	16EP Stainless steel 316L + Electropolishing
2	Sandblasted glass	30	3000K		
		40	4000K		

5000K = on request
 15° / 36° = on request

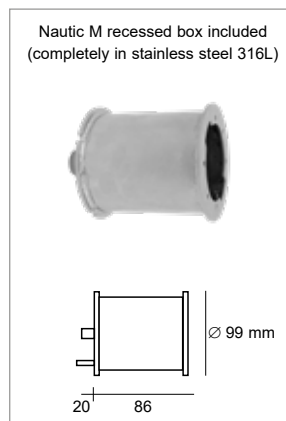
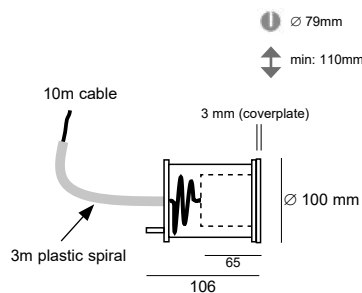

Nautic M

Reference	Price €
361F_..._16EP	799.00



Nautic M

Underwater Led light



EXTERIOR LIGHTING
UNDERWATER LIGHTING



∅ min: 32mm

min: 85mm

200-500mA

1,7W - 4,5W



Zona F



IP68

500mA

IK06



DESCRIPTION

Made completely in solid stainless steel 316L
To use only in permanent immersion (underwater)
Operation up to a max. water temperature of 35°C
Safety extra clear glass
Led module COB CRI>90 3SDCM 85.000hrs L80 B10
Degree of protection IP68, water depth up to 2m
Provided with 3m cable



ACCESSORIES

Recessed box : Pop 9a/9b ref: X068A / X068B
Led driver AC/CC (from 200mA to 500mA)
Led driver DC/CC (12-24VDC/200mA to 500mA)
Anti-glare honeycomb - Louver ref: X060.021.3
Asymmetrical beam - visor HC : ref: X061.022.2
IP68 connection : Connex 2 / 3 / 4

ON REQUEST

Sandblasted glass
Other led color: 3000K / 5000K
Other beam angle: 50°
Other cover plate dimensions (customized)

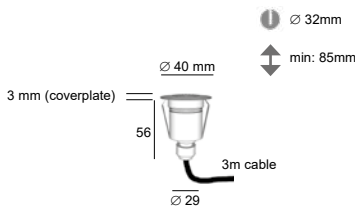

Asymmetrical beam with Visor HC (half-circle)

code: 8022F. **XXX** . **XX** 
led material

1,7W to 4,5W

Without driver (200 → 500mA)

max. efficacy 128lm/W

LED

D31 4000K - 35°
W31 2700K - 35°

MATERIAL

16 Stainless steel 316L
16EP Stainless steel 316L + Electropolishing

	Typical luminous flux (lm)		
	200mA 1,7W	350mA 3,2W	500mA 4,5W
2700 K	200	355	480
3000 K	215	370	510
4000 K	230	395	535
5000 K	235	410	560
voltage DC	8,5V	9V	9V

3000K / 5000K = on request
50° = on request

Zona F

Reference	Price €
8022F.D31.16	182.00
8022F.D31.16EP	214.00
8022F.W31.16	182.00
8022F.W31.16EP	214.00

+ startup cost for Electropolishing treatment
+ coût de démarrage pour le traitement d'électropolissage
+ opstartkosten voor Electropolishing-behandeling
+ Startkosten für Elektropolierbehandlung
+ κόστος εκκίνησης για την επεξεργασία Electropolishing

Regarding Electropolishing treatment (16EP), please refer to the information pages of this catalog for explanations.



Zona F Underwater Led light



EXTERIOR LIGHTING
UNDERWATER LIGHTING

∅ min: 45mm
 min: 100mm



200-500mA
 1,7W - 4,5W

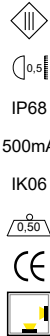

DESCRIPTION

Made completely in solid stainless steel 316L
 To use only in permanent immersion (underwater)
 Operation up to a max. water temperature of 35°C
 Safety extra clear glass
 Led module COB CRI>90 3SDCM 85.000hrs L80 B10
 Degree of protection IP68, water depth up to 2m
 Provided with 3m cable

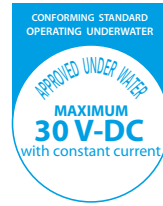

ACCESSORIES

Recessed box - Pop 1a/1b ref: X016A / X016B
 Led driver AC/CC (from 200mA to 500mA)
 Led driver DC/CC (12-24VDC/200mA to 500mA)
 IP68 connection : Connex 2 / 3 / 4

ON REQUEST

Sandblasted glass
 Other led color: 3000K / 5000K
 Other beam angle: 50°
 Other cover plate dimensions (customized)

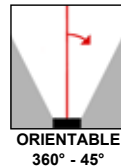
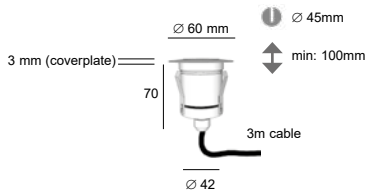

code: 8024F. XXX . XX
 |
 led
 |
 material

DIMMABLE

1,7W to 4,5W
 Without driver (200 → 500mA)

max. efficacy
 128lm/W

LED

D31 4000K - 35°
 W31 2700K - 35°

MATERIAL

16 Stainless steel 316L
 16EP Stainless steel 316L + Electropolishing

	Typical luminous flux (lm)		
	200mA 1,7W	350mA 3,2W	500mA 4,5W
2700 K	200	355	480
3000 K	215	370	510
4000 K	230	395	535
5000 K	235	410	560
voltage DC	8,5V	9V	9V

3000K / 5000K = on request
 50° = on request

Xeno F

Reference	Price €
8024F.D31.16	245.00
8024F.D31.16EP	283.00
8024F.W31.16	245.00
8024F.W31.16EP	283.00

- + startup cost for Electropolishing treatment
- + coût de démarrage pour le traitement d'électropolissage
- + opstartkosten voor Electropolishing-behandeling
- + Startkosten für Elektropolierbehandlung
- + κόστος εκκίνησης για την επεξεργασία Electropolishing

Regarding Electropolishing treatment (16EP), please refer to the information pages of this catalog for explanations.

Xeno F 
Underwater Led light



EXTERIOR LIGHTING
UNDERWATER LIGHTING

∅ min: 32mm

min: 90mm

200-700mA

3,4W - 13W



Bolas F



IP68

700mA

IK10



DESCRIPTION

Made completely in solid stainless steel 316L
To use only in permanent immersion (underwater)
Operation up to a max. water temperature of 35°C
Safety extra clear glass 10mm thickness
Led module COB CRI>90 3SDCM 85.000hrs L80 B10
Degree of protection IP68, water depth up to 2m
Provided with 3m cable



ACCESSORIES

Recessed box : Pop 8b ref: X067B
Led driver AC/CC (from 200mA to 700mA)
Led driver DC/CC (12-24VDC/200mA to 700mA)
Anti-glare honeycomb - Louver ref: X060.043.3
Asymmetrical beam - visor HC : ref: X061.050.2
IP68 connection : Connex 2 / 3 / 4

ON REQUEST

Sandblasted glass
Other led color: 3000K / 5000K
Other beam angle: 15° & 36°
Other cover plate dimensions (customized)

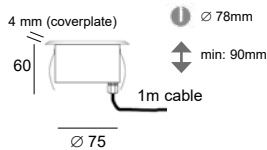

Asymmetrical beam with Visor HC (half-circle)

code: 8028F. XXX . XX

led

material



3,4W to 13W

Without driver (200 → 700mA)

max. efficacy 141lm/W

LED

D03 4000K - 50°

W03 2700K - 50°

MATERIAL

16 Stainless steel 316L

16EP Stainless steel 316L + Electropolishing

	Typical luminous flux (lm)			
	200mA 3,4W	350mA 6W	500mA 9W	700mA 13W
2700 K	455	725	995	1350
3000 K	480	760	1035	1400
4000 K	500	805	1095	1500
5000 K	550	845	1150	1570
voltage DC	17V	17,2V	18V	18,6V

3000K / 5000K = on request

15° / 36° = on request

Bolas F

Reference	Price €
8028F.D03R.16	420.00
8028F.D03R.16EP	471.00
8028F.W03R.16	420.00
8028F.W03R.16EP	471.00

- + startup cost for Electropolishing treatment
- + coût de démarrage pour le traitement d'électropolissage
- + opstartkosten voor Electropolishing-behandeling
- + Startkosten für Elektropolierbehandlung
- + κόστος εκκίνησης για την επεξεργασία Electropolishing

Regarding Electropolishing treatment (16EP), please refer to the information pages of this catalog for explanations.



Bolas F Underwater Led light



EXTERIOR LIGHTING
UNDERWATER LIGHTING

200-500mA

1,7W - 4,5W



Kozi F



IP68

500mA

IK06



DESCRIPTION

Made completely in solid stainless steel 316L
 To use only in permanent immersion (underwater)
 Operation up to a max. water temperature of 35°C
 Safety extra clear glass
 Led module COB CRI>90 3SDCM 85.000hrs L80 B10
 Degree of protection IP68, water depth up to 1m
 Provided with 3m cable

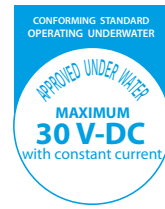

ACCESSORIES

Led driver AC/CC (from 200mA to 500mA)
 Led driver DC/CC (12-24VDC/200mA to 500mA)
 IP68 connection : Connex 2 / 3 / 4

ON REQUEST

Sandblasted glass
 Other led color: 3000K / 5000K
 Other beam angle: 50°
 Other cable length (customized)

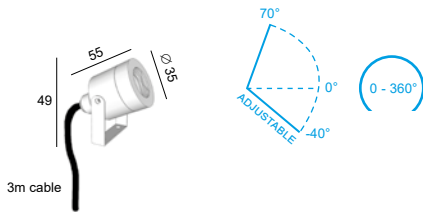

code: 8042F. XXX . XX
 | |
 led material

1,7W to 4,5W

Without driver (200 → 500mA)



LED

D31 4000K - 35°
W31 2700K - 35°

MATERIAL

16 Stainless steel 316L
16EP Stainless steel 316L + Electropolishing

	Typical luminous flux (lm)		
	200mA 1,7W	350mA 3,2W	500mA 4,5W
2700 K	200	355	480
3000 K	215	370	510
4000 K	230	395	535
5000 K	235	410	560
voltage DC	8,5V	9V	9V

3000K / 5000K = on request
 50° = on request

Kozi F

Reference	Price €
8042F.D31.16	195.00
8042F.D31.16EP	245.00
8042F.W31.16	195.00
8042F.W31.16EP	245.00

+ startup cost for Electropolishing treatment
 + coût de démarrage pour le traitement d'électropolissage
 + opstartkosten voor Electropolishing-behandeling
 + Startkosten für Elektropolierbehandlung

Regarding Electropolishing treatment (16EP), please refer to the information pages of the general catalog for explanations.



Kozi F



Underwater Led flood light



EXTERIOR LIGHTING
UNDERWATER LIGHTING

200-700mA

3,4W - 13W



Saturn F



IP68

700mA

IK10



DESCRIPTION

Made completely in solid stainless steel 316L
 To use only in permanent immersion (underwater)
 Operation up to a max. water temperature of 35°C
 Safety extra clear glass 10mm thickness
 Led module COB CRI>80 3SDCM 85.000hrs L80 B10
 Degree of protection IP68, water depth up to 1m
 Provided with 3m cable

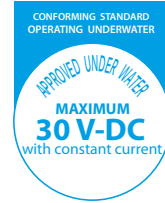

ACCESSORIES

Led driver AC/CC (from 200mA to 700mA)
 Led driver DC/CC (12-24VDC/200mA to 700mA)
 Anti-glare honeycomb - Louver ref: X060.043.3
 IP68 connection : Connex 2 / 3 / 4

ON REQUEST

Sandblasted glass
 Other led color: 3000K / 5000K
 Other beam angle: 15° & 36°
 Other cable length (customized)

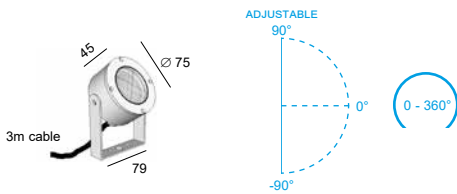

code: 8029F. **XXX** . **XX**
 led material

3,4W to 13W

Without driver (200 → 700mA)



LED

D03 4000K - 50°
W03 2700K - 50°

MATERIAL

16 Stainless steel 316L
16EP Stainless steel 316L + Electropolishing

	Typical luminous flux (lm)			
	200mA 3,4W	350mA 6W	500mA 9W	700mA 13W
2700 K	455	725	995	1350
3000 K	480	760	1035	1400
4000 K	500	805	1095	1500
5000 K	550	845	1150	1570
voltage DC	17V	17,2V	18V	18,6V

3000K / 5000K = on request
 15° / 36° = on request

Saturn F

Reference	Price €
8029F.D03.16	420.00
8029F.D03.16EP	483.00
8029F.W03.16	420.00
8029F.W03.16EP	483.00

- + startup cost for Electropolishing treatment
- + coût de démarrage pour le traitement d'électropolissage
- + opstartkosten voor Electropolishing-behandeling
- + Startkosten für Elektropolierbehandlung

Regarding Electropolishing treatment (16EP), please refer to the information pages of the general catalog for explanations.



Saturn F



Underwater Led flood light

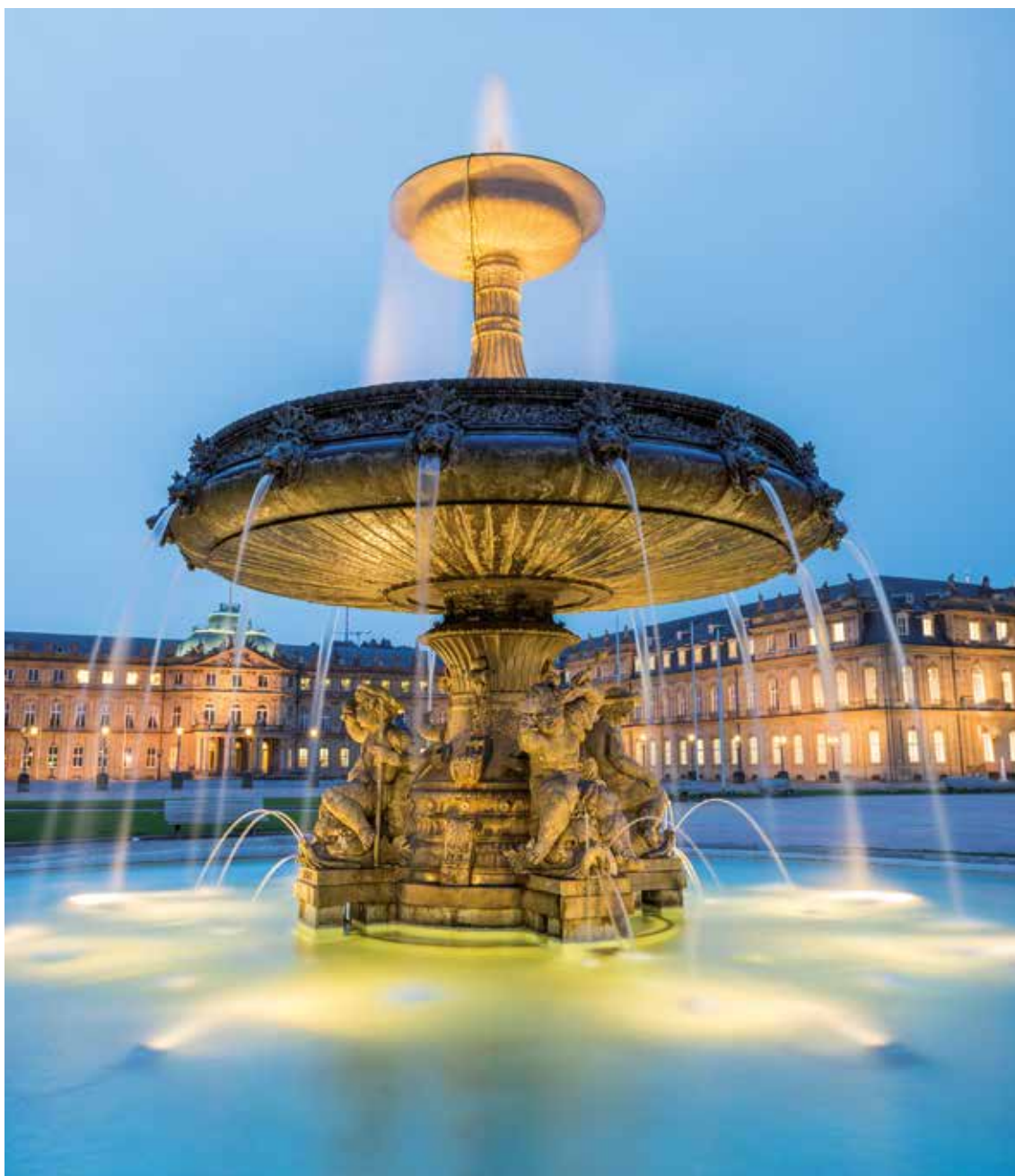

EXTERIOR LIGHTING
UNDERWATER LIGHTING



ACCESSORIES

Bases for LENA



Name	Dimension	Code	For product (name)
Base 100-K	100x60mm Thickness 27mm	BASE.100K._ _	Stem C Lena Pro M - B
Base 100-L	100x60mm Thickness 37mm	BASE.100L._ _	Lena Pro S - B Lena GU - B

With M14 - Can be used with Led power supply
 Led power supply CC 350mA or 500mA not included
 Make your selection on the accessory pages

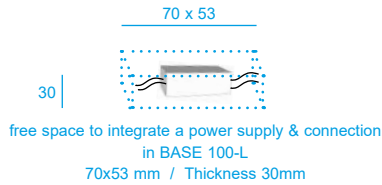
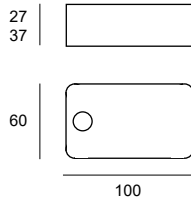

Base 100-L
Compatible power supply
 DC006.0350.20D0
 DC010.0350.65D1
 DC010.0500.65D0
 DC010.0500.65D1



1 x LENA Pro S-B code: 7024B.30440.02A
 1 x BASE 100-L code: BASE.100L.02A
 1 x Power Supply code: .DC.006.0350.20D0



1 x LENA Pro M-B code: 7025B.30440.33
 1 x BASE 100-L code: BASE.100L.33
 1 x Power Supply code: .DC.010.0500.65D0



Name	Dimension	Code	For product (name)
Base 200-A	200x60mm Thickness 27mm	BASE.200A._ _	Stem C Lena Pro M - B
Base 200-B	200x60mm Thickness 37mm	BASE.200B._ _	Lena Pro S - B Lena GU - B

With M14 - Can be used with Led power supply
 Led power supply CC 350mA or 500mA not included
 Make your selection on the accessory pages

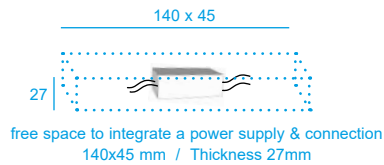
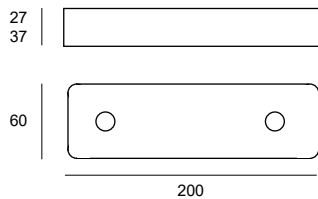

Base 200-B
Compatible power supply
 DC010.0350.65D1



2 x LENA Pro S-B code: 7024B.30440.02A
 1 x BASE 200-B code: BASE.200B.02A
 1 x Power Supply code: .DC.010.0350.65D1



2 x LENA GU-B code: 7026B.GU.02A
 1 x BASE 200-A code: BASE.200A.02A

Base 100-K

Reference	Price €
BASE.100K._ _	99.00

Base 100-L

Reference	Price €
BASE.100L._ _	129.00

Base 200-A

Reference	Price €
BASE.200A._ _	145.00

Base 200-B

Reference	Price €
BASE.200B._ _	189.00

Led flood light



Accessories for LENA

Bases for LENA



Name	Dimension	Code	Color	For product (name)
Base 50-A	Ø 50 mm Thickness 5mm	BASE.050A.##_	02A Anodized black 32D Anodized aluminum	Stem C Lena Pro M - B
Base 75-A	Ø 75 mm Thickness 5mm	BASE.075A.##_	33 Anodized bronze	Lena Pro S - B Lena GU - B

With M14

5 |

Ø 50

5 |

Ø 75

1 x LENA Pro M-B code: 7025B.30940.02A
1 x BASE 75-A code: BASE.075A.02A



Name	Dimension	Code	Color	For product (name)
Base 50-B	Ø 50 mm Thickness 35mm	BASE.050B.##_	02A Anodized black 32D Anodized aluminum	Stem C Lena Pro M - B
Base 75-B	Ø 75 mm Thickness 30mm	BASE.075B.##_	33 Anodized bronze	Lena Pro S - B Lena GU - B

With M14

35 |

Ø 50

30 |

Ø 75

1 x LENA Pro S-B code: 7024B.30440.33
1 x BASE 50-B code: BASE.050B.33



Name	Dimension	Code	Color	For product (name)
Base 75-C	Ø 75 mm Thickness 60mm	BASE.075C.##_	02A Anodized black 32D Anodized aluminum 33 Anodized bronze	Stem C Lena Pro M - B Lena Pro S - B

With M14 - To use with Led power supply

Led power supply CC 350mA or 500mA not included
Make your selection on the accessory pages

60 |

Ø 75

Ø 64

45

free space to integrate a power supply & connection
Ø 64 mm / Thickness 45mm

Compatible power supply
DC006.0350.20D0
DC010.0350.65D1
DC012.0350.65D0
DC010.0500.65D0
DC010.0500.65D1



Base 50-A

Reference	Price €
BASE.050A.##_	25.00

Base 50-B

Reference	Price €
BASE.050B.##_	54.00

Base 75-A

Reference	Price €
BASE.075A.##_	38.00

Base 75-B

Reference	Price €
BASE.075B.##_	86.00

Base 75-C

Reference	Price €
BASE.075C.##_	119.00

Bases for LENA



Name	Dimension	Code	For product (name)
Base 100-B	Ø 100 mm Thickness 35mm	BASE.100B.__	Stem C Lena Pro M - B Lena Pro S - B Lena GU - B
With M14		02A Anodized black 32D Anodized aluminum 33 Anodized bronze	
		2 x LENA GU-B code: 7026B.GU.33 1 x BASE 100-B code: BASE.100B.33	



Name	Dimension	Code	For product (name)
Base 100-C	Ø 100 mm Thickness 45mm	BASE.100C.__	Stem C Lena Pro M - B Lena Pro S - B Lena GU - B
With M14 - Can be used with Led power supply		02A Anodized black 32D Anodized aluminum 33 Anodized bronze	
		Led power supply CC 350mA or 500mA not included Make your selection on the accessory pages 	Compatible power supply DC010.0350.65D1 DC012.0350.65D0 DC010.0500.65D0 DC010.0500.65D1
		2 x LENA Pro S-B code: 7024B.30440.02A 1 x BASE 100-C code: BASE.100C.02A 1 x Power Supply code: .DC.010.0350.65D1	



Name	Dimension	Code	For product (name)
Base 100-D	Ø 100 mm Thickness 150mm	BASE.100D.__	Stem C Lena Pro M - B Lena Pro S - B Lena GU - B
With M14 - Can be used with Led power supply		02A Anodized black 32D Anodized aluminum 33 Anodized bronze	
			Compatible power supply DC010.0350.65D1 DC012.0350.65D0 DC010.0500.65D0 DC010.0500.65D1 ... and many other
		2 x LENA GU-B code: 7026B.GU.02A 1 x STEM C code: TI20.050.M1.02A 1 x STEM C code: TI20.020.M1.02A 1 x BASE 100-D code: BASE.100D.02A	

Base 100-B

Reference	Price €
BASE.100B.__	129.00

Base 100-C

Reference	Price €
BASE.100C.__	139.00

Base 100-D

Reference	Price €
BASE.100D.__	175.00

Led flood light



Accessories for LENA

Fixations for LENA



Name	Dimension	Code	Color	For product (name)
Stem C	Ø 20 mm Height 200mm	TI20.020.M1._ _	02A Anodized black	Lena Pro M - B
	Height 500mm	TI20.050.M1._ _	32D Anodized aluminum	Lena Pro S - B
	Height 1000mm	TI20.100.M1._ _	33 Anodized bronze	Lena GU - B

With M14 for fixing on a Base

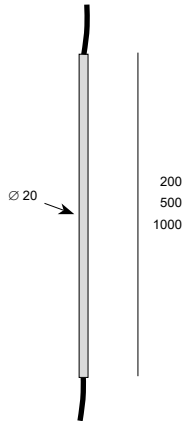

1 x LENA Pro M-B code: 7025B.30940.02A
 1 x STEM C code: TI20.050.M1.02A
 1 x BASE 75-B code: BASE.075B.02A



Name	Dimension	Code	Color	For product (name)
Stem D	Ø 20 mm Height 200mm	TI20.020.SK._ _	02A Anodized black	Lena Pro M - B
	Height 500mm	TI20.050.SK._ _	32D Anodized aluminum	Lena Pro S - B
	Height 1000mm	TI20.100.SK._ _	33 Anodized bronze	Lena GU - B

With Spike for ground fixing

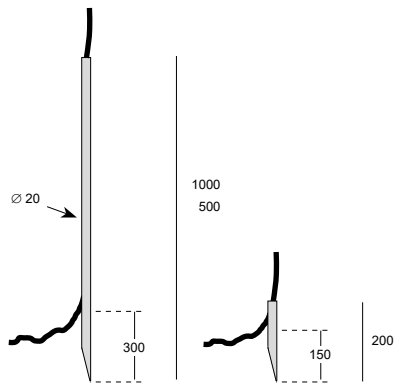

1 x LENA Pro S-B code: 7024B.30440.02A
 1 x STEM D code: TI20.050.SK.02A



Name	Dimension	Code	Color	For product (name)
Pic 4	50x38mm Height 145mm	804.04.02A	02A Anodized black	Lena Pro M - A Lena Pro S - A Lena GU - A

Spike for ground fixing



Stem C

Reference	Price €
TI20.020.M1._ _	47.00
TI20.050.M1._ _	62.00
TI20.100.M1._ _	93.00

Stem D

Reference	Price €
TI20.020.SK._ _	34.00
TI20.050.SK._ _	48.00
TI20.100.SK._ _	79.00

Pic 4

Reference	Price €
804.04.02A	32.00

Bases for flood light

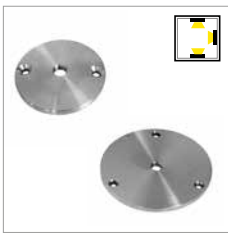

Name	Dimension	Code	Color	For product (name)
Base 60-A	Ø 60mm Thickness 5mm	BASE.060A._ _	02A Anodized black 04 Brushed stainless steel 07 Brushed brass 21 Brushed copper 32 Anodized aluminum	Stem A Cylinder S Saturn Led - HP Led
Base 100-A	Ø 100mm Thickness 5mm	BASE.100A._ _		
With M10				
	Ø 60	Ø 100	1 x MAXIMA-65 code: 7002.W22.07 1 x STEM A code: TI.010.M10A.07 1 x BASE 060A code: BASE.060A.02A	



Name	Dimension	Code	Color	For product (name)
Base 60-B	Ø 60mm Thickness 40mm	BASE.060B._ _	02A Anodized black 04 Brushed stainless steel 07 Brushed brass 21 Brushed copper 32 Anodized aluminum	Stem A Cylinder S Kozi S Saturn Led - HP Led
With M10				
Cable gland included				
	Ø 60		1 x KOZI-S code: 8042.W32.04 1 x BASE 060B code: BASE.060B.04	



Name	Dimension	Code	Color	For product (name)
Base Strap	Ø 40mm Thickness 15mm	AC.FX01.02A	02A Anodized black	Stem A Cylinder S Saturn Led - HP Led
With M10				
		<ul style="list-style-type: none"> - Strap not included - Sangle non incluse - Strap niet inbegrepen - Gurt nicht im Lieferumfang enthalten 		
	Ø 40			

Base 60-A

Reference	Price €
BASE.060A.02A	30.00
BASE.060A.04	32.00
BASE.060A.07	41.00
BASE.060A.21	47.00
BASE.060A.32	30.00

Base 60-B

Reference	Price €
BASE.060B.02A	82.00
BASE.060B.04	91.00
BASE.060B.07	112.00
BASE.060B.21	149.50
BASE.060B.32	82.00

Stem A

Reference	Price €
TI.010.M10A.02A/04/32	24.00
TI.010.M10A.07	28.00
TI.010.M10A.21	28.00
TI.020.M10A.02A/04/32	29.00
TI.020.M10A.07	32.00
TI.020.M10A.21	32.00
TI.050.M10A.02A/04/32	32.00
TI.050.M10A.07	44.00
TI.050.M10A.21	55.00
TI.100.M10A.02A/04/32	46.00
TI.100.M10A.07	62.00
TI.100.M10A.21	85.00

Stem B

Reference	Price €
TI.010.SPK.02A/04/32	24.00
TI.010.SPK.07	28.00
TI.010.SPK.21	28.00
TI.020.SPK.02A/04/32	29.00
TI.020.SPK.07	32.00
TI.020.SPK.21	32.00
TI.050.SPK.02A/04/32	32.00
TI.050.SPK.07	44.00
TI.050.SPK.21	55.00
TI.100.SPK.02A/04/32	46.00
TI.100.SPK.07	62.00
TI.100.SPK.21	85.00

Stem E

Reference	Price €
TI12.080.Z.02A/04/32	56.00
TI12.080.Z.07	79.50
TI12.130.Z.02A/04/32	64.50
TI12.130.Z.07	89.50

Base 100-A

Reference	Price €
BASE.100A.02A	44.00
BASE.100A.04	46.00

Base Strap

Reference	Price €
AC.FX01.02A	49.50

Led flood light



Accessories

Fixations for flood light



Name	Dimension	Code	Color	For product (name)
Stem A	Ø 10mm Height 100mm	TI.010.M10A._ _	02A Anodized black	Cylinder S
	Height 200mm	TI.020.M10A._ _	04 Brushed stainless steel	Kozi S
	Height 500mm	TI.050.M10A._ _	07 Brushed brass	Maxima 50-65-100-GU
	Height 1000mm	TI.100.M10A._ _	21 Brushed copper	Saturn Led - HP Led
			32 Anodized aluminum	Zax-S 10°

With M10 for fixing on a Base



1 x MAXIMA-50 code: 7004.W27.04
 1 x STEM A code: TI.010.M10A.04
 1 x BASE 060A code: BASE.060A.04



Name	Dimension	Code	Color	For product (name)
Stem B	Ø 10 mm Height 100mm	TI.010.SPK._ _	02A Anodized black	Cylinder S
	Height 200mm	TI.020.SPK._ _	04 Brushed stainless steel	Kozi S
	Height 500mm	TI.050.SPK._ _	07 Brushed brass	Maxima 50-65-100-GU
	Height 1000mm	TI.100.SPK._ _	21 Brushed copper	Salsa
			32 Anodized aluminum	Saturn Led - HP Led

With Spike for ground fixing



1 x KOZI-S code: 8042.W32.21
 1 x STEM B code: TI.050.SPK.21



Name	Dimension	Code	Color	For product (name)
Stem E	Ø 12 mm Height 800mm	TI12.080.Z._ _	02A Anodized black	Cylinder S
	Height 1300mm	TI12.130.Z._ _	04 Brushed stainless steel	Kozi S
			07 Brushed brass	Maxima 50-65-100-GU
			32 Anodized aluminum	Salsa

With Spike for ground fixing

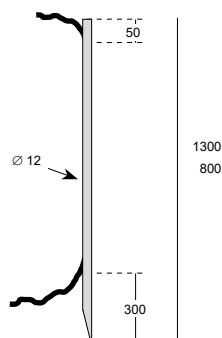

1 x MAXIMA-50 code: 7004.W27.02A
 1 x STEM E code: TI12.130.Z.02A

Others accessories for flood light



Name	Dimension	Code	Color	For product (name)
Anti-glare 01	Ø 40 mm Height 50mm	AC.8042.AG._ _	02A Anodized black	Kozi S / Kozi FL
Anti-glare 02	Ø 65 mm Height 85mm	AC.7001.AG._ _	04 Brushed stainless steel	Cylinder S / Maxima GU
Anti-glare 03	Ø 70 mm Height 85mm	AC.7002.AG._ _	07 Brushed brass	Maxima 65
Anti-glare 06	Ø 80 mm Height 100mm	AC.8029.AG._ _	21 Brushed copper	Saturn
Anti-glare 04	Ø 110 mm Height 130mm	AC.7003.AG._ _	32 Anodized aluminum	Maxima 100

please check the color availability in the price list



1 x SATURN LED code: 7006.W22.32
1 x ANTIGLARE 06 code: AC.8029.AG.32

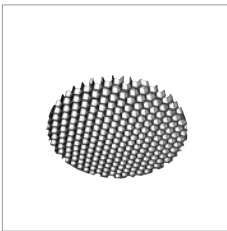

Name	Dimension	Code	Color	For product (name)
Louver	Ø 29 mm Thickness 3mm	X060.029.3	Black	Lena Pro S
	Ø 43 mm Thickness 3mm	X060.043.3		Maxima 65 / Saturn
	Ø 50 mm Thickness 3mm	X060.050.3		Cylinder S Lena Pro M Maxima GU
	Ø 68 mm Thickness 3mm	X060.068.3		Zax-S 10°
	Ø 82 mm Thickness 3mm	X060.082.3		Maxima 100



1 x MAXIMA-100 code: 7003.W12.02A
1 x LOUVER code: X060.082.3

Anti-glare

Reference	Price €
AC.8042.AG.02A	21.00
AC.8042.AG.04	65.00
AC.8042.AG.07	65.00
AC.8042.AG.21	65.00
AC.7001.AG.02A	36.00
AC.7001.AG.32	36.00

Louver

Reference	Price €
AC.7002.AG.02A	38.00
AC.7002.AG.32	38.00
AC.7003.AG.02A	56.00
AC.7003.AG.32	56.00
AC.8029.AG.02A	41.00
AC.8029.AG.32	41.00

Reference	Price €
X060.029.3	15.00
X060.043.3	16.00
X060.050.3	16.00
X060.068.3	18.00
X060.082.3	21.00

Led flood light



Accessories

Fixations for flood light



Name	Dimension	Code	Color	For product (name)
Salsa base	Ø 60 mm Thickness 45mm	AC.8091._ _	02A anodized black 07 Brushed brass	Salsa

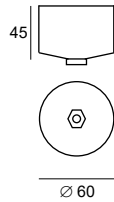

1 x SALSA code: 8091.W3.07
1 x SALSA BASE code: AC.8091.07



Name	Dimension	Code	Color	For product (name)
Ecopic	Ø 40 mm Height 210mm	805.00.07	07 Cast Brass	Salsa

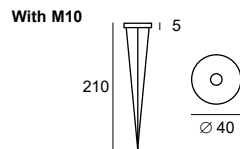

Name	Dimension	Code	Color	For product (name)
Pic 3	Ø 100 mm Height 200mm	804.00.32	32 Anodized aluminum	Saturn HP Led 230V

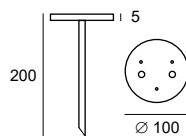

Salsa base	
Reference	Price €
AC.8091.02A	83.00
AC.8091.07	153.00

Ecopic	
Reference	Price €
805.00.07	21.00

Pic 3	
Reference	Price €
804.00.32	75.00

Recessed boxes for uplighting



Name		Dimension		Code	Material	For product (name)
Pop 1	a	Ø 55 mm	Length 65mm	X016A	Plastic PVC tube	Xeno ...
	b	Ø 55 mm	Length 150mm	X016B		
Pop 3		Ø 45 mm	Length 55mm	X053	Plastic PVC tube	Genesis
Pop 4	a	Ø 70 mm	Length 100mm	X066A	Galvanised tube	Zaxor Mini
	b	Ø 70 mm	Length 150mm	X066B		
Pop 5	a	Ø 106 mm	Length 117mm	X055A	Plastic PVC tube	Zaxor Led /...Led-O/...10° Zaxor GZ/...GZO
	b	Ø 106 mm	Length 250mm	X055B		
Pop 6	a	Ø 160 mm	Length 150mm	X056A	Plastic PVC tube	Zaxor HPL / Bolas O-HPL
	b	Ø 160 mm	Length 250mm	X056B		
Pop 7		Ø 200 mm	Length 200mm	X057	Plastic PVC tube	Zaxor O-HPL
Pop 8	a	Ø 80 mm	Length 80mm	X067A	Plastic PVC tube	Bolas VHX Bolas / ...Led / ...HPL /...F
	b	Ø 80 mm	Length 160mm	X067B		
Pop 9	a	Ø 37 mm	Length 47mm	X068A	Plastic PVC tube	Zona ... / Tango
	b	Ø 37 mm	Length 150mm	X068B		
Pop 10	a	Ø 75 mm	Length 120mm	X054A	Plastic PVC tube	Perla Dark / Pharos VHX
	b	Ø 75 mm	Length 250mm	X054B		

Pop

Reference	Price €
X016A	3.80
X016B	12.00
X053	3.50
X054A	6.90
X054B	8.20
X055A	6.00

Reference	Price €
X055B	24.50
X056A	8.50
X056B	11.50
X057	10.50
X066A	14.00
X066B	22.00

Reference	Price €
X067A	9.00
X067B	10.50
X068A	1.50
X068B	10.50

Led floor lighting



Accessories

Others accessories for Uplighting

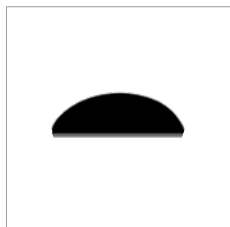

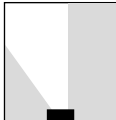
Name	Dimension	Code	Color	For product (name)
Visor HC	Ø 22 mm Thickness 2mm	X061.022.2	Black	Zona R (Dark) / .. S / .. F Zaxor Mini
	Ø 50 mm Thickness 2mm	X061.050.2		Bolas Led / ...HPL / ...F

Asymmetrical beam with Visor HC (half-circle)

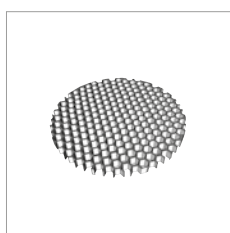

Name	Dimension	Code	Color	For product (name)
Louver	Ø 21 mm Thickness 3mm	X060.021.3	Black	Zona R (Dark) / .. S / .. F Zaxor Mini
	Ø 29 mm Thickness 3mm	X060.029.3		Focus
	Ø 43 mm Thickness 3mm	X060.043.3		Bolas / ...Led / ...HPL / ...F
	Ø 50 mm Thickness 3mm	X060.050.3		Perla Dark / Bolas O-HPL
	Ø 68 mm Thickness 3mm	X060.068.3		Zaxor Led / ...10° / ...Led-O

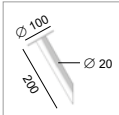

Name	Dimension	Code	Color	For product (name)
Pic 5	Ø 100 mm Height 200mm	804.05.02A	Black	Focus Pharos VHX Sonar Target

 Made of anodised black aluminum

Visor HC

Reference	Price €
X061.022.2	7.60
X061.050.2	21.40

Louver

Reference	Price €
X060.021.3	16.00
X060.029.3	15.00
X060.043.3	16.00
X060.050.3	16.00
X060.068.3	18.00

Pic 5

Reference	Price €
804.05.02A	75.00



For all products



Accessories

Junction box and connector IP68

			
NAME	Connex 2	Connex 3	Connex 4
CODE	X082	X082.Y	X083
Information	connection with 3 poles Rated voltage: 250V Rated current: 10 A for cables Ø 5,8-12mm CE - IP68	3 lines connection Rated voltage: 250V Rated current: 10 A for cables Ø 5,8-11mm CE - IP68	connection box Fast repair of damaged cables for cables Ø 1-13mm CE - Class II - IP68
Dimensions (mm)	Ø 23 mm L68mm	110x60x30mm	63x41x28mm
Price €	19.50	27.50	16.00

			
NAME	Connex 5	Connex 6	KitBox IP68
CODE	X131	X132	X121
Information	Equipped with cable glands Pre-filled with non-toxic gel Complete with connector 2 poles Minimal aesthetic impact for cables Ø 6-10mm CE - IP68	Equipped with cable glands Pre-filled with non-toxic gel Complete with connector 3 poles Minimal aesthetic impact for cables Ø 8-13mm CE - IP68	Junction box - with 8 entries & 3 cable glands M25 x 1,5 / caps - with Single bicomponent bottle - with 1 small basin - 1 mixing spoon CE - Class II - IP68
Dimensions (mm)	75x28x19mm	80x36x23mm	100x100x50mm
Price €	14.50	17.00	59.00

Codes to use for led changement “On request”

LED from 350mA to 700mA

MOD.0024.27K	LED modification:1,1W-2700K-CRI>90-115lm-350mA
MOD.0024.30K	LED modification:1,1W-3000K-CRI>90-125lm-350mA
MOD.0024.40K	LED modification:1,1W-4000K-CRI>80-135lm-350mA
MOD.0024.50K	LED modification:1,1W-5000K-CRI>80-145lm-350mA
MOD.0030.27K	LED modification:3,2W-2700K-CRI>90-355lm-350mA
MOD.0030.30K	LED modification:3,2W-3000K-CRI>90-370lm-350mA
MOD.0030.40K	LED modification:3,2W-4000K-CRI>80-395lm-350mA
MOD.0030.50K	LED modification:3,2W-5000K-CRI>80-410lm-350mA
MOD.0030F.27K	LED modification:4,5W-2700K-CRI>90-480lm-500mA
MOD.0030F.30K	LED modification:4,5W-3000K-CRI>90-510lm-500mA
MOD.0030F.40K	LED modification:4,5W-4000K-CRI>80-535lm-500mA
MOD.0030F.50K	LED modification:4,5W-5000K-CRI>80-560lm-500mA
MOD.0031A.27K	LED modification:6W-2700K-CRI>90-725lm-350mA
MOD.0031A.30K	LED modification:6W-3000K-CRI>90-760lm-350mA
MOD.0031A.40K	LED modification:6W-4000K-CRI>80-805lm-350mA
MOD.0031A.50K	LED modification:6W-5000K-CRI>80-845lm-350mA
MOD.0031B.27K	LED modification:9,5W-2700K-CRI>90-995lm-500mA
MOD.0031B.30K	LED modification:9,5W-3000K-CRI>90-1035lm-500mA
MOD.0031B.40K	LED modification:9,5W-4000K-CRI>80-1095lm-500mA
MOD.0031B.50K	LED modification:9,5W-5000K-CRI>80-1150lm-500mA
MOD.0038.27K	LED modification:11W-2700K-CRI>90-1350lm-350mA
MOD.0038.30K	LED modification:11W-3000K-CRI>90-1400lm-350mA
MOD.0038.40K	LED modification:11W-4000K-CRI>80-1480lm-350mA
MOD.0038.50K	LED modification:11W-5000K-CRI>80-1540lm-350mA
MOD.0039.27K	LED modification:17W-2700K-CRI>90-2090lm-500mA
MOD.0039.30K	LED modification:17W-3000K-CRI>90-2180lm-500mA
MOD.0039.40K	LED modification:17W-4000K-CRI>80-2310lm-500mA
MOD.0039.50K	LED modification:17W-5000K-CRI>70-2415lm-500mA
MOD.0039B.27K	LED modification:24W-2700K-CRI>90-2900lm-700mA
MOD.0039B.30K	LED modification:24W-3000K-CRI>90-3050lm-700mA
MOD.0039B.40K	LED modification:24W-4000K-CRI>80-3200lm-700mA
MOD.0039B.50K	LED modification:24W-5000K-CRI>70-3350lm-700mA

LED 220-240V AC

MOD.0046.27K	LED modification:4W-2700K-CRI>90-315lm-230V
MOD.0046.30K	LED modification:4W-3000K-CRI>90-320lm-230V
MOD.0046.40K	LED modification:4W-4000K-CRI>90-340lm-230V
MOD.0047.27K	LED modification:6W-2700K-CRI>90-460lm-230V
MOD.0047.30K	LED modification:6W-3000K-CRI>90-470lm-230V
MOD.0047.40K	LED modification:6W-4000K-CRI>90-480lm-230V
MOD.0048.27K	LED modification:10W-2700K-CRI>90-930lm-230V
MOD.0048.30K	LED modification:10W-3000K-CRI>90-950lm-230V
MOD.0048.40K	LED modification:10W-4000K-CRI>90-1020lm-230V

Reference	Price €
MOD_-----	4.00

For all products



On request

Cables



Name	Extra cable 1 meter	Code	Color	For product (name):	
Cable 01	Type as RN8-F 2x 0,5mm ²	SUP.001	Black	Floodlight	Uplighting
For luminaire from 200mA to 700mA					
Rubber PCP (polychloroprene) maximum 48V diameter 5,9mm					
				Kozi S-F Lena Pro Saturn F Saturn HP Led Zax-S 10°	Bolas HPL Bolas VHX Focus Genesis Nautic Perla Dark Pharos VHX Tango Target Xeno Zaxor Led Zaxor Led-O Zaxor Mini Zaxor 10° Zona



Name	Extra cable 1 meter	Code	Color	For product (name):	
Cable 03	Type H05RN-F 3x 1,0mm ²	SUP.003	Black	Floodlight	Uplighting
For luminaire 220-240V AC					
Rubber PCP (polychloroprene) maximum 300V 50-60Hz diameter: 7,2mm					
				Cylinder S Lena GU Maxima 50-65-100-GU Nocturn Salsa Saturn Led	Bolas Bolas Led Bolas O-HPL Bolas VHX 230V Pharos VHX 230V Zaxor GZ Zaxor GZO Zaxor HPL Zaxor O-HPL Zaxor Led 230V Zaxor Led-O 230V Zaxor Mini 230V



Name	Extra cable 1 meter	Code	Color	For product (name):	
Cable 05	Type 2x 0,35mm ²	SUP.005	Black	Floodlight	
For luminaire from 200mA to 350mA					
PVC insulation (to use with a protective sheath in the ground) maximum 48V diameter 3,6mm					
				Sami Sami-flex	

ACCESSORIES

A

Cable

Reference	Price €
SUP.001	5.50
SUP.003	6.50
SUP.005	4.20

Model Code : XX XXX . XXXX . XX XX



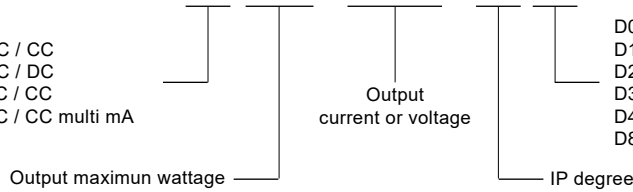











DC = Driver AC / CC
 DD = Driver AC / DC
 DL = Driver DC / CC
 DP = Driver AC / CC multi mA











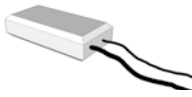
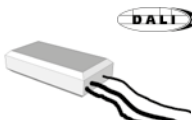
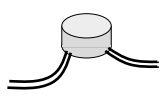
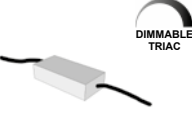



D0 = On / Off
 D1 = Dimmable Triac
 D2 = Dimmable 0-10V or 1-10V
 D3 = Dimmable Dali
 D4 = Dimmable Dali & Push dimming
 D8 = Dimmable PWM

Input: 110-240V LED Power Supply AC/CC 350mA Constant Current

350mA
 1W - 70W

					
LED DRIVER	350mA 1,2W	350mA 1-3,5W	350mA 3-6W	350mA 5-10W	350mA 6-12W
CODE	DC001.0350.65D0	DC003.0350.65D0	DC006.0350.20D0	DC010.0350.65D1	DC012.0350.65D0
	 CE  IP65	 CE  IP65	 CE  IP20	 CE  IP65	 CE  IP65
Dimensions: L x W x H (mm)	37 x 26 x 21	37 x 23 x 21	53 (38) x 27 x 21	58 (48) x 36 x 20	50 x 48 x 24
Input	110-240V 50-60Hz	110-240V 50-60Hz	220-240V 50-60Hz	220-240V 50-60Hz	220-240V 50-60Hz
Output	0,5-4 VDC	2,5-10 VDC	9-17 VDC	15-29 VDC	17-34 VDC
Power factor λ	0,45	0,50	0,60	0,90	0,90
Efficiency % (full load)	> 60%	> 68%	> 68%	> 78%	> 84%
Operating temperature (Ta)	- 10° ... + 50° C	- 20° ... + 50° C	- 20° ... + 60° C	- 20° ... + 60° C	- 20° ... + 50° C
Max. Case temperature (Tc)	75°C	75°C	85°C	85°C	80°C
Dim	no	no	no	Triac (100% ... 1%)*	no
Price €	16.50	19.50	21.50	25.50	21.50

					
LED DRIVER	350mA 1-17W	350mA 1-17W	350mA 15-25W	350mA 25-37W	350mA 35-70W
CODE	DC017.0350.68D0	DC017.0350.68D3	DC025.0350.65D0	DC037.0350.42D1	DC070.0350.67D2
	 CE  IP68	 CE  IP68	 CE  IP65	 CE  IP42	 CE  IP67
Dimensions: L x W x H (mm)	107 x 54 x 26	107 x 54 x 26	Ø 65 x 28	128 x 60 x 32	171 x 62 x 37
Input	220-240V 50-60Hz	220-240V 50-60Hz	110-240V 50-60Hz	220-240V 50-60Hz	110-240V 50-60Hz
Output	2-49 VDC	2-49 VDC	43-72V DC	70-108V DC	100-200V DC
Power factor λ	0,96	0,95	> 0,95	> 0,90	0,96
Efficiency % (full load)	> 87%	> 88%	> 86%	> 87%	> 91%
Operating temperature (Ta)	- 40° ... + 60° C	- 40° ... + 60° C	- 20° → + 50° C	- 30° → + 50° C	- 40° ... + 80° C
Max. Case temperature (Tc)	90°C	80°C	85°C	75°C	80°C
Dim	no	DALI 2 (100% ... 1%)	no	Triac (100% ... 1%)*	1-10V (100% ... 10%)
Price €	60.50	96.00	32.50	76.00	119.50

Led Power Supply





- Protections: - Overload
- Overvoltage
- Overheating
- Short circuit





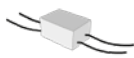
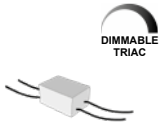
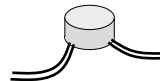

Input: 110-240V

LED Power Supply AC/CC 500mA Constant Current

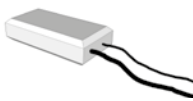
500mA

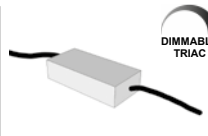
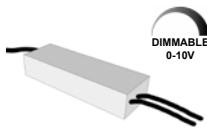
1W - 75W

		 DIMMABLE TRIAC			
LED DRIVER	500mA 5-10W	500mA 5-10W	500mA 11-18W		
CODE	DC010.0500.65D0	DC010.0500.65D1	DC018.0500.65D0		
	 CE $\Delta_{0,06}$ IP65	 CE $\Delta_{0,06}$ IP65	CE $\Delta_{0,20}$ IP65		
Dimensions: L x W x H (mm)	58 (48) x 36 x 20	58 (48) x 36 x 20	Ø 55 x 26		
Input	220-240V 50-60Hz	220-240V 50-60Hz	110-240V 50-60Hz		
Output	10-20V DC	10-20V DC	22-36V DC		
Power factor λ	0,90	0,90	> 0,94		
Efficiency % (full load)	> 76%	> 76%	> 86%		
Operating temperature (Ta)	- 20° ... + 60° C	- 20° ... + 60° C	- 20° → + 50° C		
Max. Case temperature (Tc)	85°C	85°C	80°C		
Dim	no	Triac (100% ... 1%)*	no		
Price €	21.50	25.50	32.50		

		 DALI 2	 DIMMABLE TRIAC	 DIMMABLE 0-10V		
LED DRIVER	500mA 1-24W	500mA 1-24W	500mA 35-54W	500mA 38-75W		
CODE	DC024.0500.68D0	DC024.0500.68D3	DC054.0500.42D1	DC075.0500.67D2		
	 CE $\Delta_{0,25}$ IP68	 CE $\Delta_{0,25}$ IP68	 CE $\Delta_{0,35}$ IP42	 CE $\Delta_{0,80}$ IP67		
Dimensions: L x W x H (mm)	107 x 54 x 26	107 x 54 x 26	128 x 60 x 32	180 x 63 x 36		
Input	220-240V 50-60Hz	220-240V 50-60Hz	220-240V 50-60Hz	220-240V 50-60Hz		
Output	2-49V DC	2-49 VDC	70-108V DC	75-150V DC		
Power factor λ	0,97	0,95	0,90	0,95		
Efficiency % (full load)	> 88%	> 88%	> 87%	> 91%		
Operating temperature (Ta)	- 40° ... + 60° C	- 40° ... + 60° C	- 30° ... + 45° C	- 40° ... + 85° C		
Max. Case temperature (Tc)	90°C	80°C	75°C	85°C		
Dim	no	DALI 2 (100% ... 1%)	Triac (100% ... 1%)*	0-10V (100% ... 0%)		
Price €	60.50	96.00	86.00	119.50		

ACCESSORIES

A

* D1 = Dimmable with leading-edge and trailing edge TRIAC dimmers

Model Code : XX XXX . XXXX . XX XX

DC = Driver AC / CC
 DD = Driver AC / DC
 DL = Driver DC / CC
 DP = Driver AC / CC multi mA

Output maximum wattage

Output current or voltage

IP degree

D0 = On / Off
 D1 = Dimmable Triac
 D2 = Dimmable 0-10V or 1-10V
 D3 = Dimmable Dali
 D4 = Dimmable Dali & Push dimming
 D8 = Dimmable PWM

Input: 220-240V

LED Power Supply AC/CC 700mA Constant Current

700mA

1W - 75W

LED DRIVER	700mA 1-30W	700mA 1-30W	700mA 35-60W	700mA 38-75W
CODE	DC030.0700.68D0	DC030.0700.68D3	DC060.0700.42D1	DC075.0700.67D2
Dimensions: L x W x H (mm)	107 x 54 x 26	107 x 54 x 26	128 x 60 x 32	180 x 63 x 36
Input	220-240V 50-60Hz	220-240V 50-60Hz	220-240V 50-60Hz	220-240V 50-60Hz
Output	2-49 VDC	2-49 VDC	50-86V DC	53-107V DC
Power factor λ	0,97	0,95	0,90	0,95
Efficiency % (full load)	> 88%	> 88%	> 86%	> 91%
Operating temperature (Ta)	- 40° ... + 55° C	- 40° ... + 60° C	- 30° ... + 45° C	- 40° ... + 85° C
Max. Case temperature (Tc)	90°C	80°C	75°C	85°C
Dim	no	DALI 2 (100% ... 1%)	Triac (100% ... 1%)*	0-10V (100% ... 0%)
Price €	60.50	96.00	86.00	119.50

Input: 220-240V

LED Power Supply AC/CC Constant Current with DALI interface & push dimming function

350-700mA

1W - 60W

LED DRIVER	selection with DIP switch 350mA 3-18W 500mA 3-25W 700mA 5-25W	selection with DIP switch 350mA 1-35W 500mA 1-40W 700mA 1-40W	selection with DIP switch 500mA 1-45W 700mA 1-60W	synchronization cable for driver : DR025.DP1.IP20D4	synchronization cable for driver: DR040.DP1.IP20D4 DR060.DP1.IP20D4
CODE	DP025.0700.20D4	DP040.0700.20D4	DP060.0700.20D4	DIM.AC.01	DIM.AC.02
Dimensions: L x W x H (mm)	105 x 68 x 23	124 x 82 x 23	124 x 82 x 23	Length: 30cm	Length: 30cm
Input AC	220-240V 50-60Hz	220-240V 50-60Hz	220-240V 50-60Hz		
Output CC	350mA (6-54V DC) 500mA (6-50V DC) 700mA (6-36V DC)	350mA (2-100V DC) 500mA (2-80V DC) 700mA (2-57V DC)	500mA (2-90V DC) 700mA (2-86V DC)		
Power factor λ	0,94	0,97	0,97		
Efficiency % (full load)	> 86%	> 91%	> 92%		
Operating temperature (Ta)	- 30° ... + 85° C	- 30° ... + 90° C	- 30° ... + 90° C		
Max. Case temperature (Tc)	85°C	90°C	90°C		
Dim	DALI 2 (100% ..10%)	DALI 2 (100% ..10%)	DALI 2 (100% ..10%)		
Price €	110.00	129.00	142.00	6.00	6.00











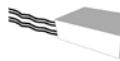
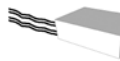
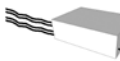

Led Power Supply



- Protections: - Overload
- Overvoltage
- Overheating
- Short circuit









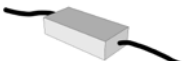

Input: 12-36V DC LED Power Supply DC/CC Constant Current

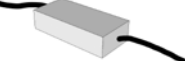
350-700mA
1W - 44W

					
LED DRIVER	350mA 1-11W Input 12V DC: 1- 4W 24V DC: 1- 8W 36V DC: 1- 11W	500mA 1-16W Input 12V DC: 1- 5W 24V DC: 1- 11W 36V DC: 1- 16W	350mA 8-44W Input 24V DC: 8- 44W	500mA 11-44W Input 24V DC: 11- 44W	700mA 15-44W Input 24V DC: 15- 44W
CODE	DL011.0350.67D8	DL016.0500.67D8	DL044.0350.44D8	DL044.0500.44D8	DL044.0700.44D8
	 CE  IP67	 CE  IP67	 CE  IP44	 CE  IP44	 CE  IP44
Dimensions: L x W x H (mm)	23 x 10 x 9	23 x 10 x 9	75 x 53 x 23	75 x 53 x 23	75 x 53 x 23
Input DC	12-36V DC	12-36V DC	24V DC	24V DC	24V DC
Output CC	350mA (2-32V DC)	500mA (2-32V DC)	350mA (21-126V DC)	500mA (21-86V DC)	700mA (21-64V DC)
Power factor λ					
Efficiency % (full load)	> 95%	> 95%	> 93%	> 86%	> 91%
Operating temperature (Ta)	- 40° ... + 85° C	- 40° ... + 85° C	- 40° ... + 70° C	- 40° ... + 70° C	- 40° ... + 70° C
Max. Case temperature (Tc)	85°C	85°C	70°C	70°C	70°C
Dim	PWM (100% ... 0%)	PWM (100% ... 0%)	PWM (100% ... 0%)	PWM (100% ... 0%)	PWM (100% ... 0%)
Price €	15.50	17.50	35.50	35.50	35.50

Input: 110-240V LED Power Supply AC/DC 24V Constant Voltage

24V DC
1W - 150W

				
LED DRIVER	24V DC 1-24W	24V DC 1-60W	24V DC 1-100W	24V DC 1-150W
CODE	DD024.24.67D0	DD060.24.67D0	DD100.24.67D0	DD150.24.67D0
	 CE  IP67	 CE  IP67	 CE  IP67	 CE  IP67
Dimensions: L x W x H (mm)	118 x 35 x 26	163 x 43 x 32	190 x 52 x 37	191 x 63 x 38
Input AC	220-240V 50-60Hz	110-240V 50-60Hz	110-240V 50-60Hz	220-240V 50-60Hz
Output DC	24V DC / 0-1A	24V DC / 0-2,5A	24V DC / 0-4,2A	24V DC / 0-6,3A
Power factor λ	0,95			
Efficiency % (full load)	> 86%	> 86%	> 88%	> 89%
Operating temperature (Ta)	- 20° ... + 75° C	- 30° ... + 70° C	- 25° ... + 70° C	- 25° ... + 65° C
Max. Case temperature (Tc)	70°C	70°C	70°C	70°C
Dim	no	no	no	no
Price €	36.00	51.50	92.00	119.00

* D1 = Dimmable with leading-edge and trailing edge TRIAC dimmers

Installation with a Constant Current power supply AC/CC

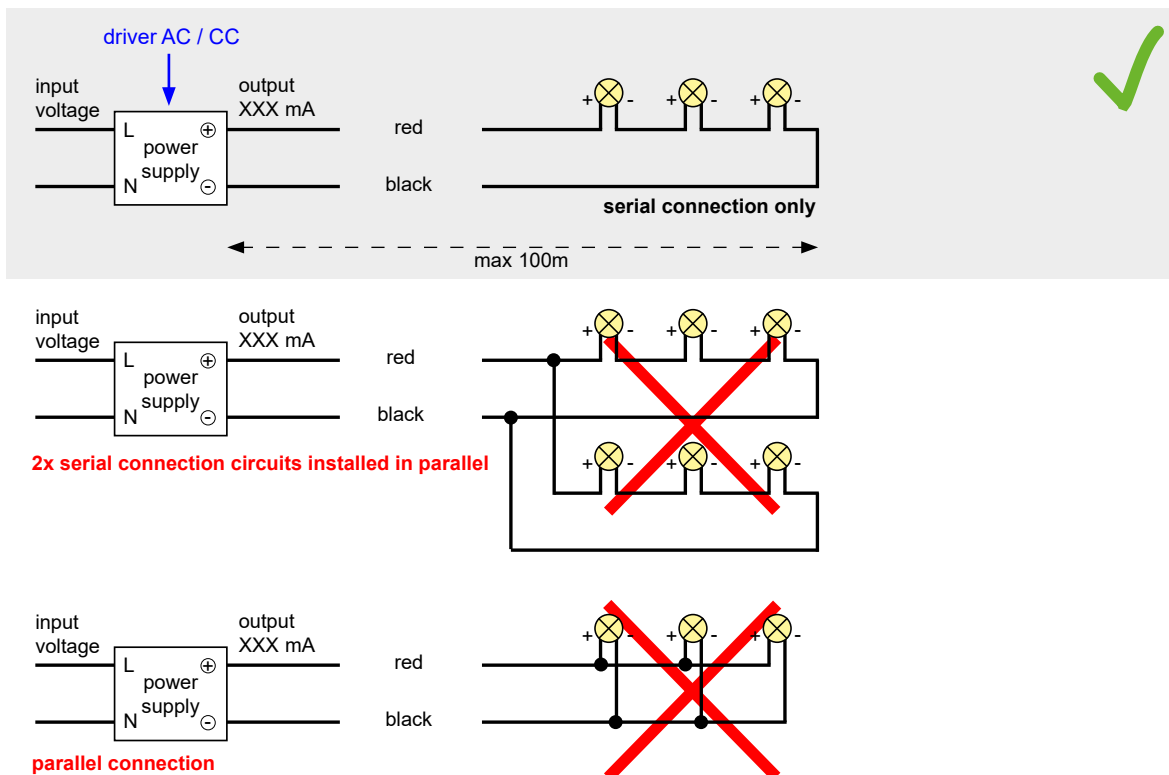

Installation with a DALI interface & push dimming function

10 drivers (max.) synchronization (1 master + 9 slaves)
 Maximum length of the cable from first driver to last driver is 15 meter.

DALI interface

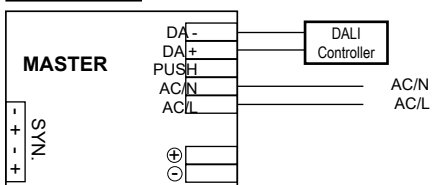

PUSH dim

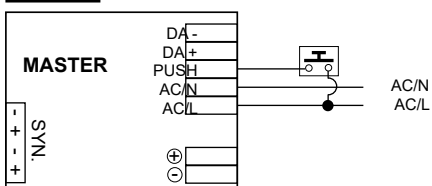

Warning: The push button can only be connected between the PUSH terminal and AC/N. It would cause short circuit if it is connected to AC/L.

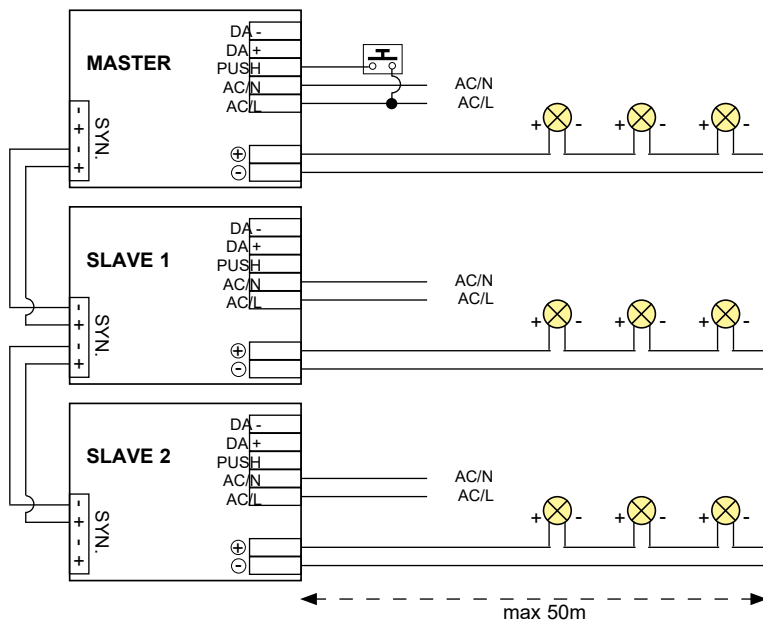

Led Power Supply Information

Installation with a Constant Voltage power supply **DC/CC**

Advantages:

- a very small driver DC/CC per luminaire (with DL011.0350.67D8)
- if one luminaire is defect, only this is off
- the whole installation is in very low voltage for better safety in the garden

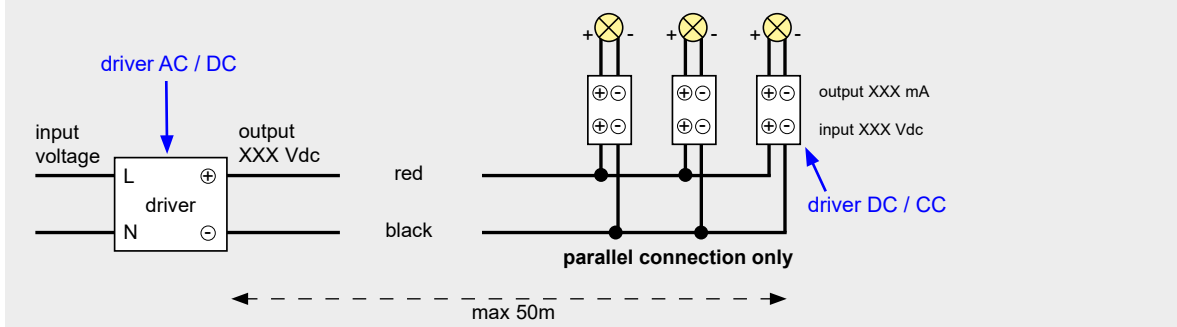

Advantages:

- the whole installation is in very low voltage for better safety in the garden

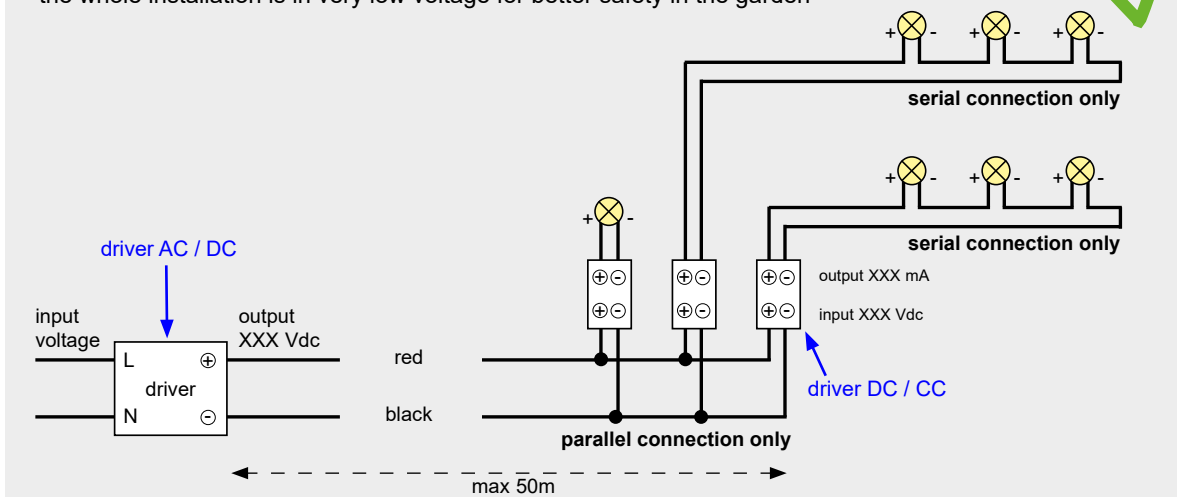

Max. distance driver LED

Driver constant current (350mA or 500mA)				
Distance	5 m	10 m	20 m	50m
Cable section	0,25 mm ²	0,25 mm ²	0,5 mm ²	1,0 mm ²

Driver constant current (700mA)				
Distance	5 m	10 m	20 m	50m
Cable section	0,5 mm ²	0,5 mm ²	1,0 mm ²	2,5 mm ²

Driver constant voltage (max. 70W - 24VDC)				
Distance	5 m	10 m	20 m	30m
Cable section	0,75 mm ²	1 mm ²	1,5 mm ²	2,5 mm ²

Driver constant voltage (max. 150W - 24VDC)				
Distance	5 m	10 m	20 m	30m
Cable section	1,5 mm ²	2,5 mm ²	4,0 mm ²	4,0 mm ²

INFORMATION

Raw materials

Stainless steel 316 and 304L

Stainless steel is a unique material with exceptional resistance that can be easily recycled. Its values and its functional cash value allows it to be used not only for prestigious and major industrial projects, but also for any type of industry (automotive, food, ...). Stainless steel can remain unchanged for decades before having to undergo any treatment. In addition to its extreme resistance to corrosion, it also has thermal and mechanical resistance. Stainless steel is self protected by responding to atmospheric oxygen by creating a resistant protective membrane. The 304L stainless can cause oxidation stains (ironic) that disappear through cleaning. Its nickel content, mainly chromium, increases its resistance to corrosion. Beware stainless steel that has been treated by instruments as lathes, CNC, etc.. is magnetized due to electrical charges that develop during treatment because of friction.

Turned stainless steel 304L products - brushed appearance (color code = 04):

They can be used indoors and outdoors but should not be placed in a polluted atmosphere (industrial zone, port, swimming pool, chemical industry, barn, etc.). The place of your project must be located more than 20km from the coast.

For optimal installation in aggressive environments, we offer:

- High version (code = 04EP) = Stainless steel 304L brushed appearance + Electropolishing

Do not hesitate to ask for a personalized offer

Turned stainless steel 316L products - brushed appearance (color code = 16):

They can be used in aggressive environments (seaside, poolside, etc.), but be careful, this does not exclude the appearance of some rust spots if the luminaire is not maintained regularly (especially in chlorinated environments and iodized, or if the products are exposed to severe weather)

For optimal installation in aggressive environments, we offer:

- High + version (code = 16EP) = Stainless steel 316L brushed appearance + Electropolishing

Do not hesitate to ask for a personalized offer

Electropolishing of stainless steel

Stainless steel (304L or 316L) installed in a marine environment (up to 20km from the sea) is doomed to become dull. Dirt and other microscopic dust loaded with iron will be able to store and mix with the salts of seaside spray and accelerate their oxidation into rust stains.

After electropolishing treatment, dust and spray can no longer be stored. This purely electrochemical treatment removes impurities and iron and reduces the surface by micro-deburring. The surface, smoother and richer in chrome, gets a brilliant shine and an optimal and durable corrosion resistance.

This process is used for the chemical and pharmaceutical industry, for external and architectural applications, boats and yachts, swimming pools, for marine situations and other applications facing to pitting corrosion. Feel free to request a personalized offer, this process is available on most of our lights in stainless steel 304L or 316L.

Copper

Together with gold, copper is the only metal that is naturally colored. The natural aspect of this metal has a red color which gives it a metal look when it shines. It has a thermal and electrical conductivity and has excellent resistance to erosion of water, Marine environment and organic acids. It has no magnetic attributes. Copper is self protected by developing a layer of natural brown-green when exposed to the outside environment.

Brass

This is an alloy of copper and zinc. A harder metal than copper, it has a yellowish natural view. Brass creates a natural layer of brown-black on its surface for self protection from corrosion when exposed to the external environment.

Aluminum (series 6000)

Alloys like Aluminum of silicon and magnesium, are used in principal for our production profiles of different thicknesses of the 6000 series. It has very good decorative conduct, but also an exceptional resistance to atmospheric erosion.

Aluminum treatments

● **Anodization:** is the transformation of the surface of the aluminum and the creation of an artificial layer of oxide. The process is done under controlled conditions and so this oxide layer is very consistent and hard in order to protect the aluminum. On all our products with the color code «32», we perform a standard anodization equal to **15 microns**.

For optimal installation in aggressive environments, we offer:

double clear anodization (code = 32D) or black (code = 02A): **20+ microns «sea side»**

This double anodizing is recommended for installation in aggressive environments (seaside, poolside, etc.)

Do not hesitate to ask for a personalized offer.

● **Electrostatic painting:** it is a polyester layer of paint. The prior stage is the coating of the metal with a multi-step full chromate conversion coating to make it even more resistant to erosion.

BEL LIGHTING mainly uses AkzoNobel's ultra-durable polyester paints, designed for outdoor architecture requiring a high level of weather resistance and long-term color stability.

Belgian stone

Of Belgian origin, it has been used for over 300 years in buildings throughout Belgian history. This is part of the story that the designers of Bel-Lighting have introduced into their production.

The blue stone is an irreplaceable material of exceptional quality, just like wood, it increases in value with time: erosion and patina continue to enhance & garnish.

Our range in stone are labeled «real Belgian Hainaut Blue Stone» with the approval and technical certificate delivered by U. B.A.t.c

Iroko

The exotic wood «Iroko» comes from South Africa. The same type of wood is used for ships building, hydraulics, outdoor furniture, ... It's strength lasts more than 25 years (Wood class I).

Maintenance is done once a year with:

- an oil for Iroko or Tek
- a protective varnish for exterior wood

Before delivery, the wood has received two layers of primer (impregnation) and no topcoat, it is to do during installation to improve its weather resistance.

It is a wood of excellent quality and reliable resistance.

RECOMMENDATIONS FOR OUTDOOR WIRING



Luminaires must be installed and connected by a qualified technician.

Recessed floor lights

THE CONNECTION

So that your recessed floor can work, you must naturally connect them to the mains. This connection must be protected against humidity, specified by the IP (International Protection) value of the product. This value has two numbers: the first number designates protection against solid objects and the second number designates protection against water and humidity.

Recessed floor luminaires are often installed in places subject to bad weather, so it is imperative:

- To opt for a connection solution with an IP68 rating.
- To seal the cable sheath and not the conductors.
- To use a recessing box when installed in the ground.

Errors to avoid:

- Use of undesignated IP20 connectors (photo 1) or adhesive tape (photo 2).
- The waterproof connection is not made on the cable sheath but on the conductors (photos 3 and 4).
- The resin or the insulating gel is not properly cast (photo 5).

Poor seals, even partials, will gather up water in the product through the cable. This phenomenon of rising water by «capillarity» damages the electrical components and it no longer allows the proper operation of the product.



1



2



3



4



5

IP68 JUNCTION BOX

The safest way to do this, is to make the connection inside the junction box and fill this up with resin (or bicomponent gel). The casting resin will keep your connection and your floor uplighter completely free of water.

Making your connection in watertight connectors with cable glands is another possibility. However, this option is less safe. Chances are that water will still find its way.

Once the connection in the junction box is made and you've tested your spots multiple times, you can fill the junction box with resin. Don't forget to test your spots before casting the resin. Once the resin is solidified, you cannot make any more changes to your connection!



SEALED CONNECTOR

This connector with cable glands can be used in the recess or under a wooden floor to make an IP68 waterproof connection between 2 or 3 flexible rubber cables type H07RN-F or equivalent. Once the connection has been made, this connector has the advantage of being completely removable.



LOCATION

Never install your ground spots in a den. Install them on a flat or a higher surface.

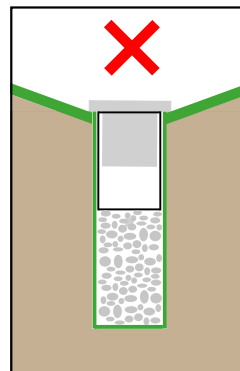
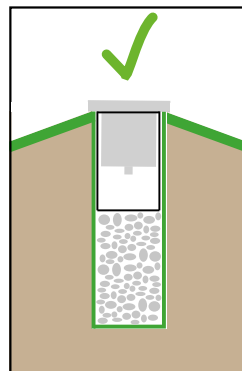
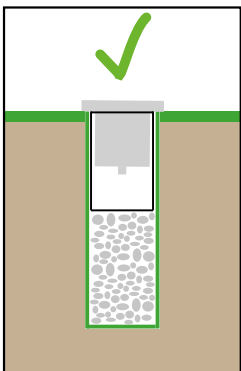

THE DRAINING

IP68 luminaires:

Drainage is not necessary, but it is important to know that these fixtures are intended to be permanently immersed only in clear water. They are not designed to be immersed in chlorinated water, seawater or any other aggressive environment.

IP67 luminaires:

To ensure good drainage, install a layer of gravel with a minimum depth of 30cm under the recessed box.

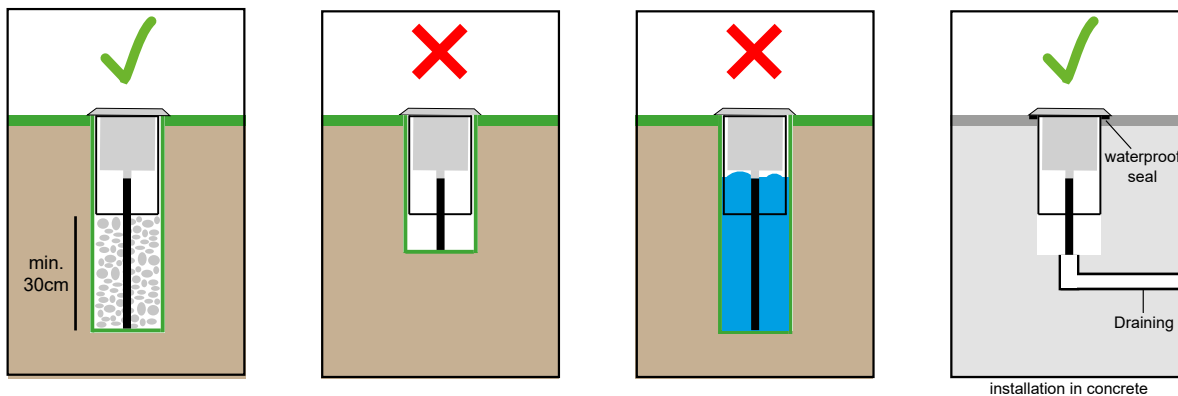

We recommend to perform the following test:

Fill the recessing box with water (Fig.A) and make sure that it has completely dissolved in 30min.

Otherwise, additional drainage is required (Fig.B)

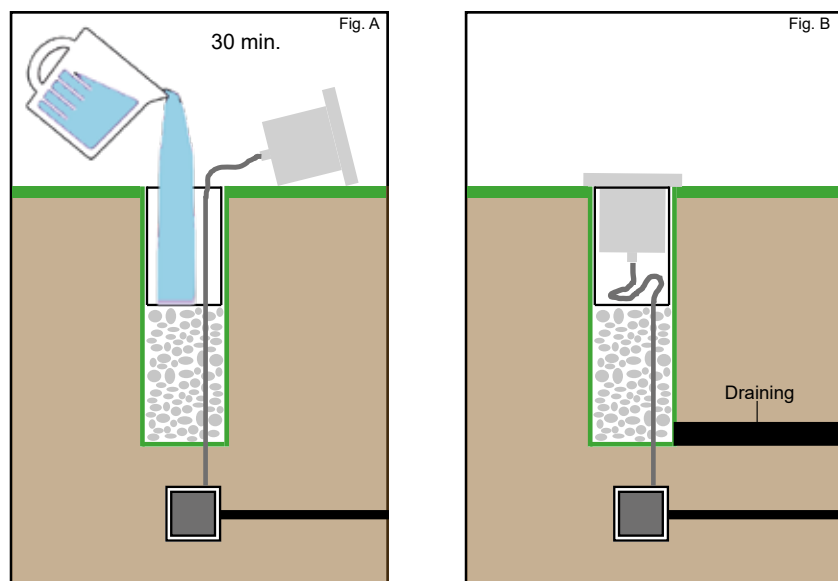

IMPORTANT

To ensure a good seal of the IP68 cable gland, it is important to leave a sufficient length and not to «bend» the cable just at the exit of the cable gland.

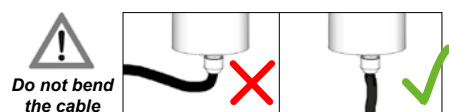
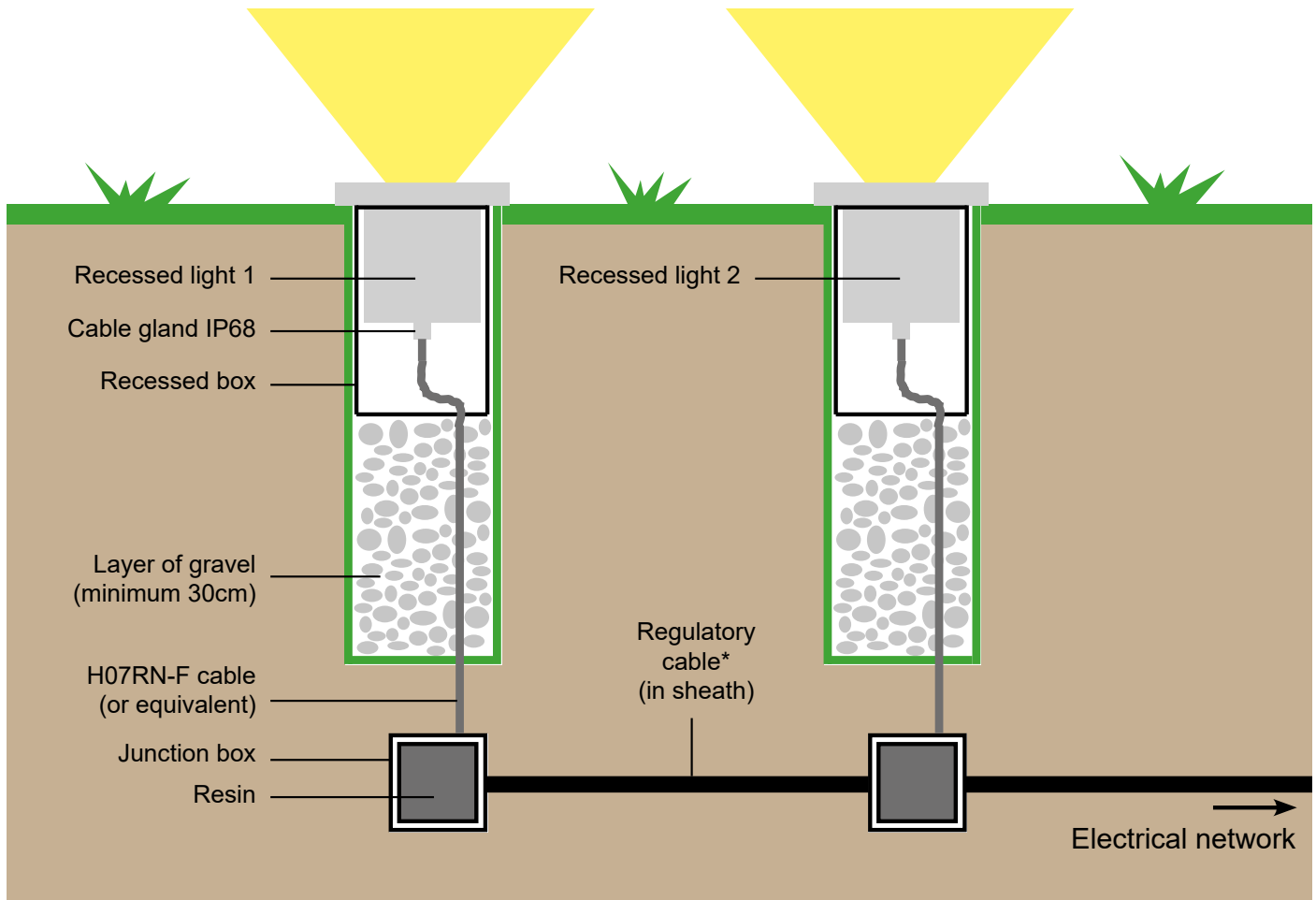

ILLUSTRATION OF A CONNECTION



* see national regulations.

THE CABLE

To ensure the tightness of the connection, with waterproof connectors or junction box, use a flexible rubber power cable type H07RN-F or equivalent. A flexible, rubber cable is much easier to seal off against water. When the swivel of the ground spot is fastened to the cable, the rubber cable sheath will function as a grommet. Nowadays, the cable will often be already attached to the ground spot. In this case, you don't need a separate cable.

Caution: if there's a cable attached to the ground spot, don't remove it! By doing this, you'll lose your warranty.

THE DEPTH OF THE ELECTRICAL SHEATH

First of all, it is necessary to refer to national regulations.

Here is what we recommend:

- For an area not accessible to cars:

The electrical conduits must be buried at a minimum depth of 50 cm.

- For an area accessible to cars or under the sidewalks:

Electrical conduits must be buried to a minimum depth of 80 cm.

The buried electrical circuits must circulate in a sheath that can withstand shocks and crushing.

When covering these sheaths, it will be necessary to use soil or sand.

Under no circumstances should heavy stones be used to degrade the buried electric sheath with settlement.

INTEGRATION IN A WOOD FLOOR OR TERRACE

The drilling of the wood blades will be at the recommended drilling diameter (see product sheet, manual, etc ...). The depth under the floor must allow to embed the spot and the waterproof connections. It is also necessary to ensure that there is sufficient space under the recess to prevent stagnation of the water and not to «bend» the cable just at the exit of the cable gland. Otherwise, drainage will be done.

CONNECTING CURRENT CONTROLLED LED LIGHTS: DO'S AND DON'TS

Some LED fixtures are current controlled (eg. 350mA, 500mA and 700mA). These require a continuous current. To turn the 220-240V mains voltage into current, you need a separate power supply, a current controlled power supply.

Must be in series circuit

Current controlled LEDs can never be connected under voltage! Furthermore, they should always be connected in a series circuit. In series circuits there's only one current path. The current enters through the + and leaves the spotlight through the - to continue its way to the next spotlight. The current travels in one direction through all spotlights until they are all under current.

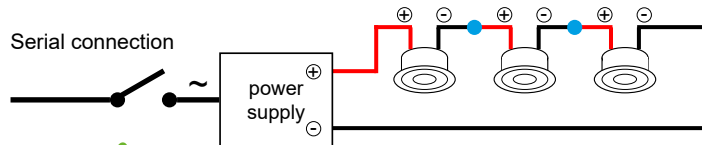

OK ✓

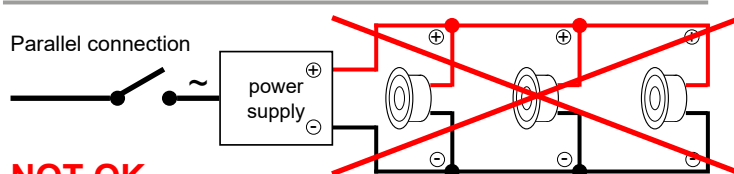

NOT OK

The external power supply needs to be adjusted to the number of spotlights and their power. With a constant current, the voltage will spread equally over the different spots.

Setup simulation

Let's try to simplify the matter with an example. In this setup, we're going to install three LED spotlights, each with a power of 3,2W. The spotlights require a continuous current of 350mA.

Calculate required voltage LED spotlight

Starting from the formula for electrical power, we can calculate the voltage needed by every separate spotlight. Power equals volts times amps.

Formula for electrical power :

$$P \text{ (Watt)} = U \text{ (Volt)} \times I \text{ (Ampère)}$$

When we turn the formula around, we can calculate the voltage per spotlight:

$$U \text{ (Volt)} = \frac{P \text{ (Watt)}}{I \text{ (Ampère)}} \quad \longrightarrow \quad \frac{3,2 \text{ Watt}}{0,35 \text{ Ampère (350mA)}} = 9,14 \text{ Volt}$$

Every separate LED spotlight needs 9,14V to keep a constant current of 350mA. In total, the three spotlights will need 27,42V (= 3 x 9,14V). The total voltage of the spotlights needs to be within the output reach of the power supply.

So, in this case, a 350mA LED power supply with an output from 17 to 34V, will do just fine. This power supply has a minimal voltage output of 17V and a maximal voltage output of 34V. The total voltage required for the spotlights can't be over or under the output level of the power supply.

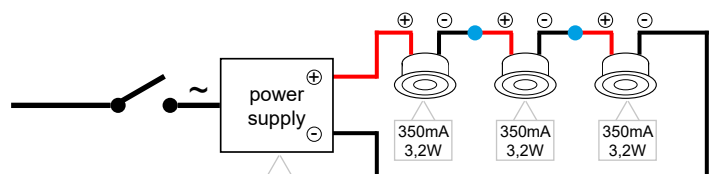

$$U(V) = \frac{P(W)}{I(A)} = \frac{3,2W}{0,35A(350mA)} = 9,14 \text{ Volt per spot}$$

Total voltage : 3 spotlights x 9,14V = 27,42 Volt

OK: within output range ✓

Power supply delivers too much voltage for number of spots:

Let's say you want to connect only one 3,2W spotlight, you'll only need 9,14V. This is lower than the 17V minimal voltage of the power supply. This will result in a defect in the spotlight, because the voltage is too high.

The entire circuit of spotlights always needs to be tested at once. When the installer tests the power supply with each spotlight separately, the spotlight, which requires only 9,14V, immediately receives the full 17V minimum voltage. This too much, so the spot will malfunction.

Power supply delivers too little voltage for number of spots:

When you connect 8 of these 3,2W spotlights to the same power supply, you'll need a total current of 73,12V (= 8 x 9,14V). This is higher than the maximal voltage of the power supply. The LED spotlights won't reach their full luminous efficiency. In other words, they will look 'dimmed'.

Minimum and maximum number of spots on power supply:

For this 350mA power supply (17 – 34V) you need to install at least two of these 3,2W spotlights. The maximum capacity of the power supply is three of these spotlights. In case you want to install more of them, you'll need a power supply with a higher output.

Never install current controlled LED spotlights under voltage

During the installation of current controlled LED spotlights, the LED power supply may **never be under voltage!** Neglect this and you'll risk damaging the LEDs. You'll even lose your warranty by doing so. In case of doubt, contact a professional electrician.

When LED power supplies are put under voltage, they start looking for the amount of voltage they need to distribute. When there are no spotlights connected, most power supplies will keep building up voltage up to their maximum.

If you connect a LED spotlight to this fully charged power supply, it will immediately receive the maximum output voltage. If this is higher than the maximum voltage of the LED spotlight, the LED will get damaged. It only takes a split second to make this happen.

So, it's extremely important to switch off the voltage on your power supply while installing your LED spotlights.

Wrong installation :

Suppose we put a 350mA (17-34V) power supply under voltage. Then, we connect a 3,2W LED spotlight. The spotlight will immediately get the full 34V output. The maximum voltage for this 3,2W spotlight is only 9,14V (= 3,2W / 350mA), so the LED will get damaged.

You need to connect all your LEDs in advance, before putting your power supply under voltage. This way the power supply can build up to the required voltage.

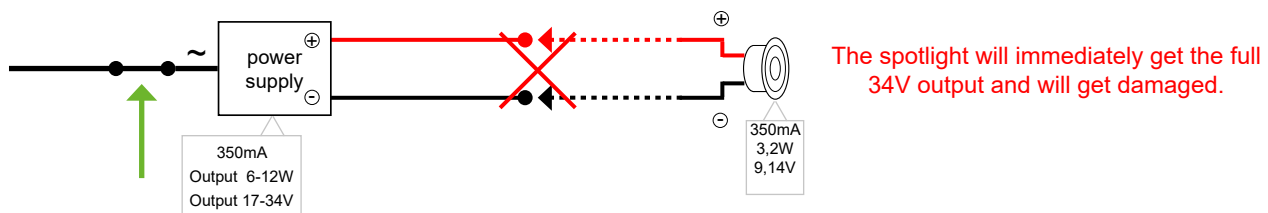

The power supply can only be switched on the primary side i.e. before the 230V mains voltage comes in. Otherwise the LED will get damaged, just like in the situation above.

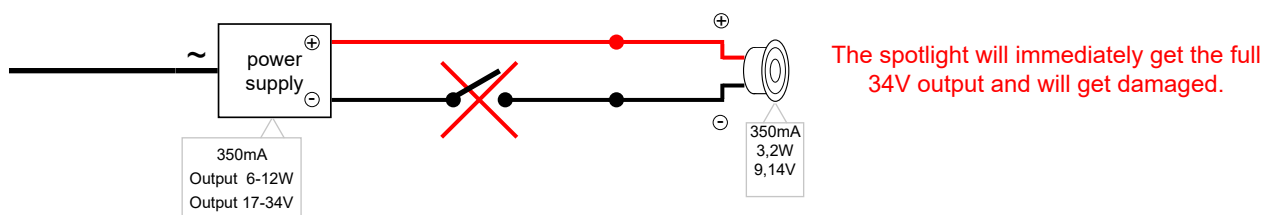

Secured LED power supplies:

Some power supplies are secured against the above phenomenon. When this kind of power supply is put under voltage and no spotlights are connected, they won't give off their maximum voltage. Instead, they won't distribute any voltage at all.

The power supply will only start distributing voltage when the spotlights are connected and the power supply is restarted.

IP DEGREE OF PROTECTION

FIRST DIGIT CODE: Protection against penetration by solid bodies Beschermd tegen voorwerpen Protection contre les corps solides Schutz vor festen Stoffen IP 1ο ΨΗΦΙΟ (ΣΤΕΡΕΑ)		SECOND DIGIT CODE: Protection against penetration by water Beschermd tegen vocht Protection contre l'humidité Schutz vor Feuchtigkeit IP 2ο ΨΗΦΙΟ (ΝΕΡΟ)	
0	No protection Niet beschermd Non Protégé Ohne Schutz Καμία προστασία	0	No protection Niet beschermd Non Protégé Ohne Schutz Καμία προστασία
1	Protected against solid matters > 50mm Beschermd tegen voorwerpen > 50mm Protégé contre les corps solides > 50mm Schutz vor festen Stoffen > 50mm Προστασία από στερεά σώματα μεγαλύτερα από 50mm	1	Protected against dripping water Beschermd tegen verticaal vallende druppels Protégé contre chute de gouttes d'eau verticale Schutz vor senkrecht fallendem Tropfwasser Προστασία από κάθετη πτώση σταγόνων νερού
2	Protected against solid matters > 12mm Beschermd tegen voorwerpen > 12mm Protégé contre les corps solides > 12mm Schutz vor festen Stoffen > 12mm Προστασία από στερεά σώματα μεγαλύτερα από 12mm	2	Protected against dripping water when tilted up to 15° Beschermd tegen druppels onder hoek van max. 15° Protégé contre chute d'eau oblique max. 15° Schutz vor schräg fallendem Tropfwasser bis 15° Neigung Προστασία από πτώση σταγόνων νερού υπό γωνία ως 15ο από τον κατακόρυφο άξονα
3	Protected against solid matters > 2,5mm Beschermd tegen voorwerpen > 2,5mm Protégé contre les corps solides > 2,5mm Schutz vor festen Stoffen > 2,5mm Προστασία από στερεά σώματα μεγαλύτερα από 2,5mm	3	Protected against spraying water when tilted up to 60° Beschermd tegen sproeiwater onder hoek van max. 60° Protégé contre la pluie oblique max. 60° Schutz vor schräg fallendem Sprühwasser bis 60° Neigung Προστασία από πτώση νερού βροχής υπό γωνία έως 60ο από τον κατακόρυφο άξονα
4	Protected against solid matters > 1mm Beschermd tegen voorwerpen > 1mm Protégé contre les corps solides > 1mm Schutz vor festen Stoffen > 1mm Προστασία από στερεά σώματα μεγαλύτερα από 1mm	4	Protected against splashing water Beschermd tegen spatwater uit alle richtingen Protégé contre les projections d'eau de toutes directions Schutz vor Spritzwasser Προστασία από πτώση νερού από όλες τις κατευθύνσεις
5	Dust Protected Beschermd tegen stof Protégé contre la poussière Staubgeschützt Προστασία από τη σκόνη	5	Protected against water jets Beschermd tegen waterstralen uit alle richtingen Protégé contre les jets d'eau de toutes directions Schutz vor Strahlwasser Προστασία από ρίψη νερού υπό πίεση από όλες τις κατευθύνσεις
6	Fully tight Volledig stofdicht Etanche aux poussières Staubdicht Απόλυτη προστασία από τη σκόνη	6	Protected against heavy seas Beschermd tegen golven, zware zeeën Protection contre les jets d'eau forts Schutz vor starkem Strahlwasser Προστασία από ρίψη νερού υπό πίεση ισοδύναμη με θαλάσσια κύματα
		7	Protected against the effects of immersion Beschermd tegen beperkte onderdompeling Protection contre courtes immersions Schutz vor zeitweiligem Untertauchen Προστασία από επιρροές βύθισης
		8	Protected against submersion Beschermd tegen permanente onderdompeling Protection contre l'immersion permanente Schutz vor dauerndem Untertauchen Προστασία από επιρροές βύθισης διάρκειας, σε καθορισμένες συνθήκες



MAXIMUM 12VAC ,18VDC OR 30VDC WITH CONSTANT CURRENT.

- Underwater lighting fixtures can be powered only at very low safety voltage.
- De verlichtingstoestellen gebruikt in een zwembad of waterpartij mogen enkel met een zeer lage veiligheid spanning gevoed worden.
- Les luminaires à l'intérieur d'un bassin ne peuvent être alimentés qu'en très basse tension de sécurité.
- Unterwasserleuchten können nur mit sehr niedriger Sicherheitsspannung betrieben werden.
- Τα υποβρύχια φωτιστικά μπορούν να τροφοδοτούνται μόνο με πολύ χαμηλή τάση ασφαλείας.

IK DEGREE OF PROTECTION

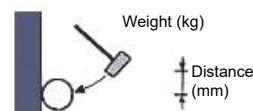

Protection against impact of mechanical origin
Bescherming tegen de invloed van mechanische oorsprong
Protection contre les chocs d'origine mécanique
Schutz vor Stromschlägen mechanischen Ursprungs
Ανθεκτικότητα στην κρούση

IK	00	01	02	03	04	05	06	07	08	09	10
Joule (J)	0	0,15	0,20	0,37	0,50	0,70	1	2	5	10	20
Weight (kg)	0	0,15	0,15	0,15	0,25	0,15	0,50	0,50	1,70	5,00	5,00
Distance (mm)	0	100	133	233	333	485	200	400	300	200	400



CLASS I - CLASSE I - SCHUTZKLASSE I

- Light fixture whose safety is guaranteed by the main insulation and an additional protective conductor (earth contact) connected with the metal frame of the lamp. Earth contact is obligatory.
- Deze armaturen zijn uitgerust met aansluitmogelijkheid voor aarding, waarmee alle aanraakbare metalen delen die bij een isolatiestoring direct onder spanning kunnen komen, moeten verbonden zijn. Aansluiting aan de aardleiding is verplicht.
- Les luminaires sont équipés d'un moyen de raccordement pour la mise à la terre, qui interconnecte toutes les parties métalliques exposées susceptibles d'être mises sous tension suite à un défaut de l'isolation. Le raccordement de mise à la terre est obligatoire. En cas de défectuosité, le courant est coupé par fusible.
- Die Leuchten sind mit Verkabelungen für den Erdanschluß ausgestattet, die alle ausgelegten metallischen Bestandteile miteinander vernetzen, welche im Falle einer Isolationspanne mit Strom versorgt werden können. Die Erdanschlußverkabelungen sind obligatorisch. Im Falle eines Defektes, wird der Strom durch eine Sicherung abgestellt.
- Ένα φωτιστικό, του οποίου η ασφάλεια είναι εγγυημένη από ένα πρόσθετο προστατευτικό αγωγό (γείωση), που συνδέεται με το μεταλλικό πλαίσιο του λαμπτήρα.



CLASS II - CLASSE II - SCHUTZKLASSE II

- Light fixture whose safety is guaranteed by the main insulation and additional safety devices as double or reinforced insulation of conductive parts. Earth contact is not necessary.
- Deze armaturen hebben een beschermende isolatie zonder metaaldelen die genaakbaar zijn. Dubbele isolatie zonder aarding.
- Les luminaires possèdent une isolation renforcée sans partie métallique accessible. Double isolation sans mise à la terre.
- Die Leuchten besitzen eine verstärkte Isolierung ohne metallische Bestandteile. Doppelte Isolierung ohne Erdanschluß.
- Ένα φωτιστικό, του οποίου η ασφάλεια είναι εγγυημένη από ένα πρόσθετο προστατευτικό αγωγό (γείωση), που συνδέεται με το μεταλλικό πλαίσιο του λαμπτήρα.



CLASS III - CLASSE III - SCHUTZKLASSE III

- Light fittings whose safety is guaranteed by the very low safety supply voltage. Authorized maximal voltage: 50 volts (AC)
- Deze armaturen waarin de bescherming tegen elektrische schokken beschermt word door zijn lage spanning (SELV) (Maximale spanning 50volt (AC).
- Luminaire dont la protection contre les chocs électriques repose sur son alimentation sous très basse tension de sécurité (TBTS) (tension maximale autorisée : 50 Volts (courant alternatif)).
- Leuchten deren Schutz vor Stromschlägen auf eine sehr niedrige, abgesicherte Stromspannung beruht. (Max. erlaubte Spannung: 50 Volts Wechselstrom). Ένα φωτιστικό, του οποίου η ασφάλεια είναι εγγυημένη από ένα πρόσθετο προστατευτικό αγωγό (γείωση), που συνδέεται με το μεταλλικό πλαίσιο του λαμπτήρα.



CE standard - CE norm - norme CE

- The mark CE represents an implicit assurance of quality and affixed under the sole responsibility of the manufacturer. The mark CE must be affixed on the product, or in alternative, on the packing or on directions.
- De CE markering waarborgt een stilzwijgende kwaliteitsgarantie en wordt aangebracht onder uitdrukkelijke verantwoordelijkheid van de fabrikant. De CE markering wordt aangebracht op het toestel of als alternatief op de verpakking of de gebruiksaanwijzing.
- La marque CE représente une implicite assurance de qualité et est apposée sous la responsabilité exclusive du fabricant. La marque CE doit être apposée sur l'appareil, ou en alternative, sur l'emballage ou sur les modes d'emploi.
- Das CE-Zeichen verkörpert eine klare Sicherung der Qualität und wird auf ausschliessliche Verantwortung des Herstellers angebracht. Das CE-Zeichen muss auf dem Produkt, auf der Verpackung oder auf der Gebrauchsanweisung angebracht werden.
- Η σήμανση CE αποτελεί μια έμμεση διασφάλιση της ποιότητας και τίθεται υπό την αποκλειστική ευθύνη του κατασκευαστή.

BEAM ANGLE

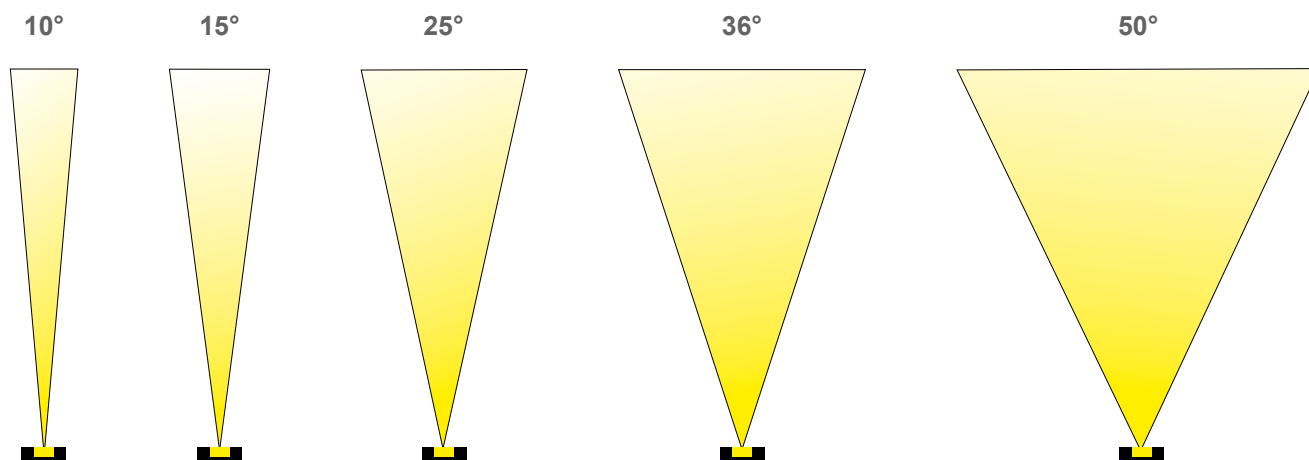

Lichtbundels

Alle lichtbundels in deze catalogus zijn aangegeven in FWHM stralingshoek.

FWHM = Full Width Half Maximum: Het is de afstand tussen twee punten waarvan de intensiteit 50% van de piek bedraagt.

FWTM = Full Width Tenth Maximum: Het is de afstand tussen twee punten waarvan de intensiteit 10% van de piek bedraagt.

Faisceaux lumineux

Tous les faisceaux lumineux de ce catalogue sont indiqués en angle FWHM

FWHM = Full Width Half Maximum: ça représente la distance entre deux points dont l'intensité est de 50 % du pic.

FWTM = Full Width Tenth Maximum: ça représente la distance entre deux points dont l'intensité est de 10 % du pic.

Beam angle

All light beams in this catalog are indicated in FWHM beam angle.

FWHM = Full Width Half Maximum: it represents the distance between two points whose intensity is 50 % of the peak.

FWTM = Full Width Tenth Maximum: it represents the distance between two points whose intensity is 10 % of the peak.

Lichtstrahlen

Alle Lichtstrahlen in diesem Katalog sind in FWHM-Abstrahlwinkel angegeben.

FWHM = Full Width Half Maximum: Es stellt den Abstand zwischen zwei Punkten dar, deren Intensität 50 % des Peaks beträgt.

FWTM = Full Width Tenth Maximum: Es stellt den Abstand zwischen zwei Punkten dar, deren Intensität 10 % des Peaks beträgt.

Δέσμες φωτός

Όλες οι δέσμες φωτός σε αυτόν τον κατάλογο προσδιορίζονται στο "FWHM beam angles".

FWHM = Full Width Half Maximum: Είναι η απόσταση μεταξύ δύο σημείων των οποίων η ένταση είναι 50% της κορυφής.

FWTM = Full Width Tenth Maximum: Είναι η απόσταση μεταξύ δύο σημείων των οποίων η ένταση είναι 10% της κορυφής.

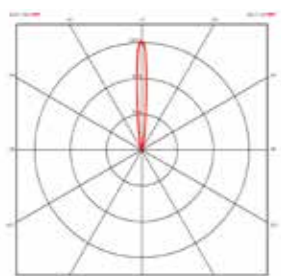

LIFESPAN OF LEDS

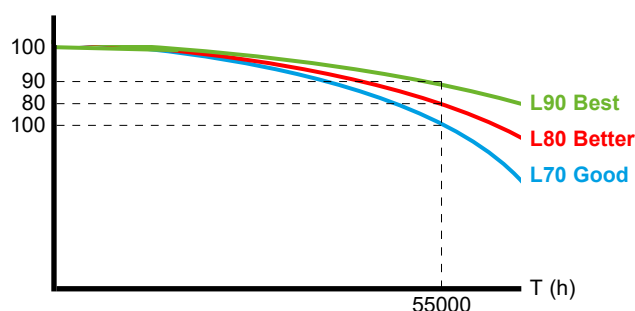

example

Tc	L70	L70B50	L70B20	L70B10	L80	L80B50	L80B20	L80B10	L90	L90B50	L90B20	L90B10
85C	>55.000 hr	200.000 hr	148.000 hr	137.000 hr	>55.000 hr	123.000 hr	93.000 hr	85.000 hr	>55.000 hr	56.000 hr	44.000 hr	41.000 hr

Levensduur van de leds

Een L80-B10 85.000 hrs LED-classificatie van uur betekent dat na 85.000 bedrijfsuren 90% van de LED's meer dan 80% van hun oorspronkelijke lichtstroom produceert en 10% van de LED's minder dan 80% van hun oorspronkelijke lichtstroom produceert. Maar dat betekent niet dat de levensduur 85.000 uur is, de lamp werkt nog steeds!

Durée de vie des leds

Une classification des leds L80 B10 85000 hrs, signifie, qu'après 85000 heures de fonctionnement, 90 % des LED produiront un flux supérieur à 80 % de leur flux lumineux initial et 10 % des LED produiront un flux inférieur à 80 % de leur flux lumineux initial. Mais ça ne signifie pas que sa durée de vie soit de 85 000 heures, le luminaire fonctionnera encore !

Lifespan of leds

An L80 B10 85000 hrs LED rating means that after 85000 hours of operation, 90% of LEDs will produce a flux greater than 80% of their initial luminous flux and 10% of LEDs will produce a flux less than 80% of their initial luminous flux . But that doesn't mean that its lifespan is 85,000 hours, the fixture will still work!

Lebensdauer der LEDs

Eine L80-B10-LED-Bewertung von 85.000 Stunden bedeutet, dass nach 85.000 Betriebsstunden 90 % der LEDs mehr als 80 % ihres ursprünglichen Lichtstroms und 10 % der LEDs weniger als 80 % ihres ursprünglichen Lichtstroms erzeugen. Das heißt aber nicht, dass die Lebensdauer 85.000 Stunden beträgt, die Lampe funktioniert immer noch!

Διάρκεια ζωής των LED

Η βαθμολογία LED L80 B10 85000 hrs ωρών σημαίνει ότι μετά από 85000 ώρες λειτουργίας, το 90% των LED θα παράγει περισσότερο από το 80% της αρχικής φωτεινής ροής και το 10% των LED θα παράγει λιγότερο από το 80% της αρχικής φωτεινής ροής τους. Αλλά αυτό δεν σημαίνει ότι η διάρκεια ζωής του είναι 85.000 ώρες, το φωτιστικό θα εξακολουθεί να λειτουργεί!

Unit of light measurement

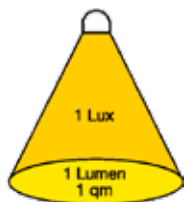

Illuminance (lx)

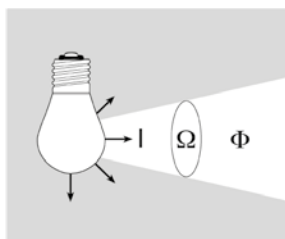

Luminous flux (lm)

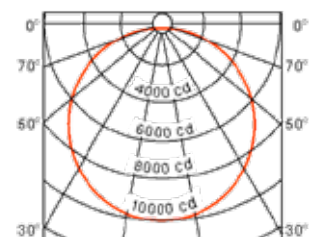

Luminous intensity (cd)

Verlichting

lux : (lx) de lux stemt dus overeen met de verlichtingssterkte die men heeft wanneer iedere vierkante meter van het beschouwde oppervlak een lichtstroom van één lumen ontvangt. Het aantal lux wordt bijgevolg gevonden als het quotiënt van de totaal ontvangen lichtstroom, uitgedrukt in lumen, en de grootte van het verlichte oppervlak uitgedrukt in vierkante meters; derhalve is 1 lux = 1 lumen/m².

L'éclairage

lux : (lx) compte la luminosité ,c'est-à-dire l'écoulement lumineux qui tombe sur une surface concrète.Cette mesure est influencée par la fréquence de la radiation et la distance de la source. Plus grande est la distance de la source lumineuse, plus petite sera la luminosité. L'unité lux représente les lumens par mètre carré de surface (lumen/m²) et est utilisée pour déterminer l'écoulement lumineux indispensable au point éclairé. La différence entre lux et lumen est que le lux prend en compte la surface sur laquelle tombe l'écoulement lumineux.

Illuminance

lux : (lx) the brightness, i.e. the luminous flow which falls on a concrete surface. This measure is influenced by the frequency of the radiation and the distance from the source. The greater the distance from the light source, the smaller the brightness. The lux unit represents brightness per square meter of surface (lumen/m²) and is used to determine the flow of light in critical points. The difference between lux and lumen is that lux takes into account the surface on which the light flow falls.

Beleuchtung

lux : (lx) misst die Leuchtkraft, d.h. den Lichteinfall auf eine bestimmte Fläche. Diese Messung wird von der Strahlenfrequenz und der Distanz zur Lichtquelle beeinflusst. Je weiter der Abstand zur Leuchtquelle, desto kleiner die Leuchtkraft. Die Einheit lux steht für Lumens pro m² Fläche (lumen/m²) und wird zur Bestimmung des notwendigen Lichteinfalls am beleuchteten Punkt genutzt. Der Unterschied zwischen Lux und Lumen ist der, dass Lux die Fläche auf die das Licht einfällt, mitberücksichtigt.

Φωτισμός

lux : lx (λούξ) Σε lux μετρείται η φωτεινότητα (illuminance), δηλαδή η φωτεινή ροή που προσπίπτει σε μία συγκεκριμένη επιφάνεια, μακριά από μία φωτεινή πηγή. Η τιμή αυτή επηρεάζεται από τη συχνότητα της ακτινοβολίας και την απόσταση από την πηγή. Όσο μεγαλύτερη είναι η απόσταση από τη φωτεινή πηγή, τόσο μικρότερη θα είναι η φωτεινότητα. Η μονάδα lux αντιπροσωπεύει τα lumens ανά τετραγωνικό μέτρο επιφάνειας (lumen/m²) και χρησιμοποιείται, για να προσδιορίσει την απαραίτητη φωτεινή ροή στο φωτιζόμενο σημείο. Η διαφορά ανάμεσα σε lux και σε lumen είναι ότι το lux λαμβάνει υπόψη την επιφάνεια, στην οποία προσπίπτει η φωτεινή ροή.

Lichtstroom

Alle uitgestraald vermogen uitgezonden door een lichtbron en waargenomen door het heet lichtstroom.

lumen : (lm) rekening houdend met de stroom van licht (flux), dat een lichtbron produceert.

Flux lumineux

Toute la puissance rayonnée émise par une source lumineuse et perçue par l'œil est appelée flux lumineux .

lumen : (lm) compte l'écoulement lumineux(flux), que produit une source lumineuse.

Luminous flux

All the radiated power emitted by a light source and perceived by the eye is called luminous flux.

lumen : (lm) is the luminous flow (flux), that a light source produces.

Lichtstrom

Die gesamte Strahlkraft die von einer Lichtquelle ausgeht, wird durch das Auge wahrgenommen und Lichtstrom genannt.

lumen : (lm) zählt den Lichtstrom den eine Leuchtquelle produziert.

Φωτεινή ροή

Όλες η εκπεμπόμενη ισχύς που εκπέμπεται από μια πηγή φωτός και αντιληπτή από το μάτι καλείται φωτεινή ροή.

lumen : lm (λούμεν) Η μονάδα μέτρησης της φωτεινής ροής (luminous flux), την οποία παράγει μια φωτεινή πηγή.

De lichtintensiteit

In het algemeen straald een lichtbron haar lichtstroom in verschillende richtingen en met verschillende sterktes. De intensiteit van de zichtbare straling in een bepaalde richting wordt lichtsterkte genoemd.

candela :(cd) Dit is de intensiteit van de lichtbron, die aan een meter van de lichtbron een helderheid van 1 lumen/m² (dat wil zeggen 1 lux).

Intensité lumineuse

D'une manière générale, une source de lumière émet son flux lumineux dans des directions différentes et à des intensités différentes. L'intensité de rayonnement visible dans une direction particulière est appelée intensité lumineuse.

candela :(cd) Il s'agit de l'intensité de la source lumineuse, qui à distance d'un mètre de la source a une luminosité de 1 lumen/m² (c'est-à-dire 1 lux).

Luminous intensity

Generally speaking, a light source emits its luminous flux in different directions and at different intensities. The visible radiant intensity in a particular direction is called luminous intensity.

candela :(cd) Hier handelt es sich um die Intensität der Lichtquelle, welche bei einem Abstand von 1m von der Lichtquelle eine Leuchtkraft von 1 Lumen/m² beträgt (also 1 lux).

Lichtintensität

Im allgemeinen strahlt eine Lichtquelle ihren Lichtstrom in verschiedene Richtungen und in unterschiedlicher Intensität aus. Die Intensität der sehbaren Leuchtkraft in eine bestimmte Richtung wird Lichtintensität genannt.

candela :(cd) die Intensität der Lichtquelle, eine Entfernung von einem Meter von der Quelle eine Helligkeit von 1 Lumen/m² (dh 1 Lux) in Bezug auf die Farbzuordnung des Lichts.

Η ένταση του φωτός

Σε γενικές γραμμές, μια πηγή φωτός εκπέμπει φωτεινή ροή της προς διαφορετικές κατευθύνσεις και σε οιαφορετικές εντάσεις. Το ορατό ένταση ακτινοβολίας σε μια συγκεκριμένη κατεύθυνση ονομάζεται φωτεινή ένταση.

candela:cd (καντέλα) Πρόκειται για την ένταση της φωτεινής πηγής, που σε απόσταση ενός μέτρου από την πηγή έχει φωτεινότητα ενός lumen/m² (δηλ. ενός lux).

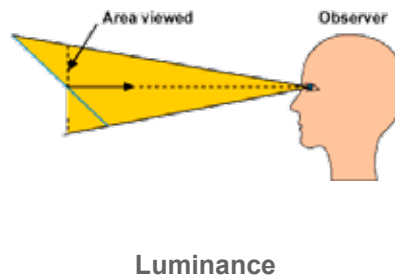
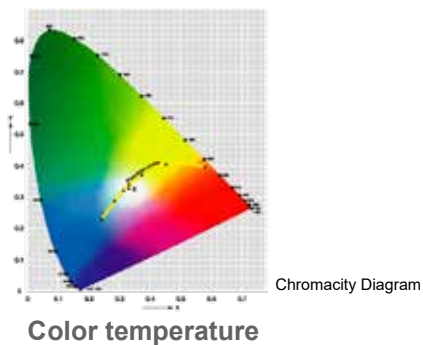

Kleurtemperatuur

De kleurtemperatuur van een lichtbron wordt gedefinieerd ten opzichte van een "zwarte straal" en weergegeven op de "Planck curve", zoals weergegeven op het diagram. Hoe meer de kleurtemperatuur van deze "zwarte straal" hoog is, hoe hoger het blauw spectrum is en hoe minder rood aanwezig is.

La température de couleur

La température de couleur d'une source lumineuse est définie par rapport à un «corps radiateur noir» et reportée sur ce qui est connu sous le nom de la «courbe de Planck», comme le montre le diagramme. Plus la température de ce «corps radiateur noir» est élevée, plus grande est la composante bleue du spectre et plus petite la composante rouge.

Color temperature

The color temperature of a light source is defined in relation to a «black body radiator» and plotted on what is known as the «Planckian curve» as shown in the diagram. The higher the temperature of this «black body radiator», the greater the blue component of the spectrum and the smaller the red component.

Farbtemperatur

Die Farbtemperatur einer Lichtquelle wird anhand eines „schwarzen Strahlkörpers“ definiert und auf die „Plancksche Kurve“ übertragen, wie in dem Diagramm dargestellt. Je höher die Temperatur des „schwarzen Strahlkörpers“, desto höher ist der Blauanteil des Spektrums und desto kleiner ist der Rotanteil.

Θερμοκρασία χρώματος

Η θερμοκρασία χρώματος της φωτεινής πηγής ορίζεται σε σχέση με ένα «μαύρο σώμα καλοριφέρ» και αποτυπώνονται σε αυτό που είναι γνωστό ως η «καμπύλη ακτινοβολητή Planck», όπως φαίνεται στο διάγραμμα. Όσο υψηλότερη είναι η θερμοκρασία αυτής της «μαύρης καλοριφέρ σώμα» είναι υψηλή, τόσο μεγαλύτερη είναι η μπλε συνιστώσα του φάσματος και η μικρότερη είναι η κόκκινη συνιστώσα.

Indicative:

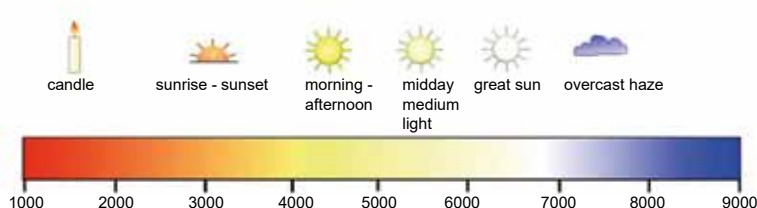

warm white < 3500 K°

neutral white > 3500 K°

daylight > 5000 K°

Luminantie

Met de lichtsterkte, dat wil zeggen de stroom van licht dat valt op een welbepaald oppervlak. Deze maatregel wordt beïnvloed door de frequentie van de straling en de afstand tot de bron. Hoe groter de afstand tot de lichtbron, hoe kleiner de helderheid. De eenheid lux vertegenwoordigt het aantal lumen per vierkante meter (lumen/m²) en wordt gebruikt om de lichtstroom te bepalen vereist voor het te belichten punt. Het verschil tussen lux en lumen is dat lux rekening houdt met het te belichten oppervlak.

La luminance

La luminance d'une source de lumière ou une zone éclairée est une mesure de combien l'œil est stimulé et donc de la façon dont une grande impression de luminosité est créée dans le cerveau. Elle est mesurée en candelas par mètre carré.

Luminance

The luminance of a light source or an illuminated area is a measure of how much the eye is stimulated and therefore of how great an impression of brightness is created in the brain. It is measured in candelas per square meter.

Die Leuchtdichte

Die Leuchtdichte einer Lichtquelle oder einer beleuchteten Fläche ist ein Maßstab für die Augenstimulation und somit dafür, wie eine starke Wahrnehmung der Helligkeit im Gehirn entsteht. Sie wird in Candela pro m² gemessen.

Φωτεινότητας

Η φωτεινότητα της φωτεινής πηγής ή μια φωτεινή επιφάνεια είναι ένα μέτρο του πόσο πολύ το μάτι διεγείρεται και επομένως το πόσο μεγάλη είναι η εντύπωση της φωτεινότητας δημιουργείται στον εγκέφαλο. Μετριέται σε candela ανά τετραγωνικό μέτρο.

L'efficacité lumineuse

Lichtopbrengst geeft aan dat de efficiëntie waarmee de elektrische stroom wordt omgezet in licht. Dit wordt gemeten in lumen per Watt (lm / W).

L'efficacité lumineuse

L'efficacité lumineuse indique l'efficacité avec laquelle la puissance électrique consommée est convertie en lumière. Elle est mesurée en lumens par watt (lm / W).

Luminous efficacy

Luminous efficacy indicates the efficiency with which the electrical power consumed is converted into light. It is measured in lumens per watt (lm/W).

Leuchtkraft

Die Leuchtkraft gibt die Wirkungskraft an, mit der die verbrauchte Stromleistung in Licht umwandelt wird. Sie wird in Lumens pro Watt (lm/W) gemessen.

Φωτεινή απόδοση

Φωτεινή απόδοση δείχνει την αποτελεσματικότητα με την οποία η ηλεκτρική ενέργεια που καταναλώνεται μετατρέπεται σε φως. Μετριέται σε lumens ανά watt (lm / W).

INDEX BY NAME

Name	page	Name	page	Name	page
Base 100-A	166	Pic 3	169		
Base 100-B	164	Pic 4	165		
Base 100-C	164	Pic 5	171		
Base 100-D	164	Pop	170		
Base 100-K	162	Salsa	62		
Base 100-L	162	Salsa base	169		
Base 200-A	162	Salsa-S	64		
Base 200-B	162	Sami	22		
Base 50-A	163	Sami AG	22		
Base 50-B	163	Sami-flex	26		
Base 60-A	166	Sami-flex AG	26		
Base 60-B	166	Saturn F	158		
Base 75-A	163	Saturn HP led	56		
Base 75-B	163	Saturn HP led 230V	58		
Base 75-C	163	Saturn Led	54		
Base Strap	166	Stem A	166		
Bolas	122	Stem B	166		
Bolas F	154	Stem C	165		
Bolas H	88	Stem D	165		
Bolas H 230V	90	Stem E	166		
Bolas HP led	120	Swing	16		
Bolas Led 230V	118	Tango K-H	86		
Bolas V	88	Tango K-V	86		
Bolas V 230V	90	Tango K-X	86		
Bolas X	88	Tango R-H	84		
Bolas X 230V	90	Tango R-V	84		
Bolas-O-HPL	141	Tango R-X	84		
Cable	175	Target	78		
Connex 2	173	Visor HC	171		
Connex 3	173	Xeno F	152		
Connex 4	173	Xeno R	104		
Connex 5	173	Xeno S	106		
Connex 6	173	Xeno Y	108		
Cylinder S	50	Zax-S 10°	60		
Ecopic	169	Zaxor 10°	132		
Focus	76	Zaxor GZ	124		
Genesis	96	Zaxor GZ0	126		
KitBox IP68	173	Zaxor HP led	138		
Kozi F	156	Zaxor led (220-240V)	130		
Kozi FL	21	Zaxor led (xxx mA)	128		
Kozi S	18	Zaxor led-O (220-240V)	136		
Led Driver AC/24V DC	179	Zaxor led-O (350mA)	134		
Led Driver AC/350mA CC	176	Zaxor Mini (220-240V)	116		
Led Driver AC/500mA CC	177	Zaxor Mini (350mA)	114		
Led Driver AC/700mA CC	178	Zaxor O-HP led	142		
Led Driver DALI/CC	178	Zebra DZona F	150		
Led Driver DC/CC	179	Zona H	82		
Lena GU-A	36	Zona R	98		
Lena GU-B	38	Zona R Dark	100		
Lena Pro-M-A	32	Zona S	102		
Lena Pro-M-B	34	Zona V	80		
Lena Pro-S-A	28	Zona X	82		
Lena Pro-S-B	30				
Line-Up	48				
Louver	168,171				
Max FL	52				
Max TR	74				
Maxima-100	44				
Maxima-50	40				
Maxima-65	42				
Maxima-GU	46				
Nautic M	148				
Nautic S	146				
Nocturn	66				
Perla-R Dark	110				
Perla-S Dark	112				
Pharos H	92				
Pharos H 230V	94				
Pharos V	92				
Pharos V 230V	94				
Pharos X	92				
Pharos X 230V	94				

INDEX BY CODE

Code	page	Code	page	Code	page
1107.	72	8085V.	84		
1152.	96	8085X.	84		
2201	124	8087H.	86		
2211	126	8087V.	86		
2257	114	8087X.	86		
2258	116	8091.	62		
2277.	128	8092.	64		
2278.	130				
240.	50				
2407.	134				
2408.	136				
2417	.16				
2427	.16				
2437	.16				
2438	.16				
312.30.	16				
352.	60				
360F.	146				
361F.	148				
362.	110				
363H.	92				
363V.	92				
363X.	92				
364H.	94				
364V.	94				
364X.	94				
365.	76				
367.	78				
368.	112				
7001.	46				
7002.	42				
7003.	44				
7004.	40				
7006.	54				
7007.	48				
7016.W	.16				
7021.	26				
7024A.	28				
7024B.	30				
7025A.	32				
7025B.	34				
7026A.GU.	36				
7026B.GU.	38				
756.	74				
800C1	122				
8022.	98				
8022D.	100				
8022F.	150				
8023.	102				
8024.	104				
8024F.	152				
8024Y.	108				
8025.	106				
8028.	120				
8028F.	154				
8028H.	88				
8028V.	88				
8028X.	88				
8029.	56				
8029F.	158				
8031.	22				
8032.	66				
804.00.32	169				
804.04.02A	165				
804.05.02A	171				
8042.	18				
8042F.	156				
8043.	21				
805.00.07	169				
8084H.	82				
8084V.	80				
8084X.	82				
8085H.	84				

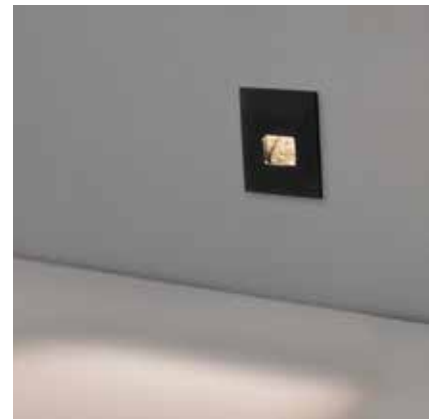

Coming Soon





Headquarters

BEL - LIGHTING
Zoning industriel de Saintes, Avenue Ernest Solvay 42
BE 1480 Saintes (Tubize) - Belgium
Tel: + 32 (0) 2355 2428
info@bel-lighting.com

Factory

BEL - LIGHTING / SENICO
Βιοπα Μεγαρων , Θεση Παππα – Περιβολι
T.Θ. 90 T.K. 19 100 Μεγαρα – Αττικής - Greece
Τηλ: + 30 229 6027763
greece@bel-lighting.com

Sales organisation



Benelux

BEL - LIGHTING
Tel: 02 3552428

email: info@bel-lighting.com

France

BEL - LIGHTING
email: info@bel-lighting.com
*Visitez notre site internet www.bel-lighting.com et
sélectionnez notre agent pour votre département*

Greece

BEL - LIGHTING
Τηλ: 229 6027763

email: greece@bel-lighting.com

Germany

BEL - LIGHTING
email: info@bel-lighting.com
*Besuchen Sie bitte unser Website www.bel-lighting.com und
selektieren Sie den Handelsagent Ihrer Gegend (Postleitzahl).*

Others worldwide partners, visit our website www.bel-lighting.com



Product Design & Concept: © by Nicolaos Terzis - Yannis Terzis - Georgios Zorpidis
Coordination - research & development : Bel Lighting & Senico
Photography : J.Rouben - M. Guillaume - P. Dijkmans - E. Bourgois - G. Tzortzis - I. Smolinski

catalogue edition 01/2024

The data in this catalogue are provided in good faith and only for your information. This data may not be used against BEL LIGHTING & SENICO, who reserves the right to alter all product data any time, without any notice. The general BEL LIGHTING & SENICO conditions of sale are always applicable. Nothing in this catalogue may be reproduced without permission in writing from the BEL LIGHTING company.

