



Molecular Phylogeny of *Pectis* (Tageteae, Asteraceae), a C4 Genus of the Neotropics, and its Sister Genus *Porophyllum*

Authors: Hansen, Debra R., Jansen, Robert K., Sage, Rowan F., Villaseñor, José Luis, and Simpson, Beryl B.

Source: *Lundellia*, 19(1) : 6-38

Published By: The Plant Resources Center, The University of Texas at Austin

URL: <https://doi.org/10.25224/1097-993X-19.1.6>

BioOne Complete (complete.BioOne.org) is a full-text database of 200 subscribed and open-access titles in the biological, ecological, and environmental sciences published by nonprofit societies, associations, museums, institutions, and presses.

Your use of this PDF, the BioOne Complete website, and all posted and associated content indicates your acceptance of BioOne's Terms of Use, available at www.bioone.org/terms-of-use.

Usage of BioOne Complete content is strictly limited to personal, educational, and non - commercial use. Commercial inquiries or rights and permissions requests should be directed to the individual publisher as copyright holder.

BioOne sees sustainable scholarly publishing as an inherently collaborative enterprise connecting authors, nonprofit publishers, academic institutions, research libraries, and research funders in the common goal of maximizing access to critical research.

MOLECULAR PHYLOGENY OF *PECTIS* (TAGETEAE, ASTERACEAE), A C₄ GENUS OF THE NEOTROPICS, AND ITS SISTER GENUS *POROPHYLLUM*

Debra R. Hansen,¹ Robert K. Jansen,¹ Rowan F. Sage,² José Luis Villaseñor,³
and Beryl B. Simpson¹

¹Department of Integrative Biology, The University of Texas at Austin, 205 West 24th Street, Austin, Texas 78712, USA, email: debrahansen@utexas.edu

²Department of Ecology & Evolutionary Biology, University of Toronto, 25 Willcocks Street, Room 3055, Toronto, Ontario, Canada M5S 3B2

³Departamento de Botánica, Instituto de Biología, Universidad Nacional Autónoma de México, Apartado Postal 70-233, 04510 México, D.F. Mexico

Abstract: *Pectis* is a genus of ± 90 xeric adapted New World species. Previous molecular phylogenetic studies showed *Pectis* closely related to *Porophyllum*, and one analysis resolved *Porophyllum* species nested within *Pectis*. Some *Pectis* species are known to use C₄ photosynthesis. Here we investigate the phylogeny of *Pectis* and *Porophyllum*, examine the ploidy levels and geographical distribution of *Pectis* species in light of its phylogeny, and infer the origin and extent of C₄ photosynthesis in both genera. Chloroplast and ITS data from 78 *Pectis* and 22 *Porophyllum* species were used to test the monophyly of *Pectis* and its previously described sections. Carbon isotope data were obtained to infer the photosynthetic pathway of 80 species, and the results mapped on the inferred phylogenies to determine the timing and pattern of evolution of the C₄ pathway. The ITS dataset supports a monophyletic *Pectis* sister to a monophyletic *Porophyllum*, while the chloroplast dataset places two *Porophyllum* species sister to a combined *Pectis*+*Porophyllum* clade. Five well-supported lineages are recovered in *Pectis*. All *Pectis* sampled have $\delta^{13}\text{C}$ values consistent with C₄ photosynthesis, and all *Porophyllum* species sampled have $\delta^{13}\text{C}$ values consistent with C₃ photosynthesis. We conclude that *Pectis* is monophyletic but only two of its recognized sections are monophyletic. *Porophyllum* is monophyletic but its sections are not. *Porophyllum amplexicaule* and *Pr. scoparium* should be treated as members of a new genus. The switch to the C₄ pathway in *Pectis* happened in the late Miocene, probably in north/central Mexico, at or after the divergence of *Pectis* and *Porophyllum*. This location and timing is consistent with the evolution of C₄ photosynthesis in other North American eudicot lineages, suggesting similar environmental conditions may underlie the switch to C₄ photosynthesis.

Keywords: Asteraceae, C₄ photosynthesis, *Pectis*, Pectidinae, *Porophyllum*, Tageteae.

Pectis L. is the largest genus in the marigold tribe (Pectidinae: Tageteae: Asteraceae), and comprises about 90 annual and perennial species (Keil, 2006) adapted to warm, arid regions of the New World. Species are found in deserts, thorn scrub, coastal plains, savannas, and openings in seasonally dry tropical forests and oak-pine woodlands. *Pectis* is most diverse in Mexico and the Caribbean, but its species range from Wyoming and Nebraska in the U.S. to southern Brazil and northern Argentina. Two species are endemic to the Galapagos, one is introduced in Hawaii, and one has

recently been naturalized in Taiwan (Jung et al., 2011). *Pectis* is distinguished from the other Tageteae by its combination of simple, opposite leaves with pairs of bristles at their bases; phyllaries that are each adnate to, and subtend the base of, a ray floret (often falling as a single unit at maturity) and very short and often densely papillose style branches. Most *Pectis* species have noticeable oil glands on their phyllaries and on the margins or undersides of their leaves, a character they share with other genera in Tageteae subtribe Pectidinae. The oil of *Pectis* species often has a strong medicinal, spicy, or lemony scent,

and various *Pectis* species have traditional culinary or medicinal uses (Asprey & Thornton, 1953; Bye, 1996). A few species have a distasteful odor likened to that of stinkbugs, leading to the common name “cinchweed.” *Pectis angustifolia* has a high thimole content (Albers, 1942), and *Pectis papposa* has been suggested as a potential source of commercial food and beverage flavoring because of its high cumaldehyde and carvone content (Bradley & Haagen-Smit, 1949). Phototoxic, antibacterial, and antifungal properties of *Pectis* oil have been reported (Downum et al., 1985; Downum & Rodriguez, 1986; Downum et al., 1989; da Silva et al., 2005; Soares et al., 2009). *Pectis* is noteworthy because some species previously surveyed were shown to use C₄ photosynthesis, a photosynthetic pathway that confers enhanced efficiency in conditions of high heat and high light intensity (Sage et al., 2011). C₄ photosynthesis is uncommon in eudicots, and especially rare in the Asteraceae, in which just 0.3% of the genera use the C₄ pathway (Kellogg, 1999).

The goals of the present study were to clarify the relationship between *Pectis* and *Porophyllum*, test the monophyly of previously described generic subdivisions, and determine the age, origin, and extent of the evolution of C₄ photosynthesis in *Pectis*. We primarily focused on the phylogeny of *Pectis*, but sampled deeply in *Porophyllum* to confirm the relationship between the two genera. Using a greatly expanded sample of 78 *Pectis* and 22 *Porophyllum* species and varieties, we provide the first molecular evidence for relationships within the genera, and suggest direction regarding sectional organization for both *Pectis* and *Porophyllum*. We also present carbon isotope values for 62 *Pectis* and 18 *Porophyllum* species and varieties, the first comprehensive survey of photosynthetic pathway for both genera.

TAXONOMY. Linnaeus included two species of Caribbean *Pectis* (*Pt. ciliaris* L. and *Pt. linifolia* L.) when describing the genus in 1759. *Pectis* was included in the original circumscription of tribe Tageteae

(Cassini, 1819) along with other former Heliantheae genera with leaves and phyllaries bearing glands. Based on molecular and morphological similarities, Panero (2007) included Tageteae in his Heliantheae Alliance, placing the traditional Tageteae genera, including *Pectis* and *Porophyllum* Guett., into subtribe Pectidinae.

The most extensive taxonomic treatments of *Pectis* are by Gray (1849, 1852, 1884, 1888), Fernald (1897), and Keil (1975, 1977a, 1978). Gray described six subgeneric divisions within *Pectis* based largely on differences in pappus elements (1849, 1852). By 1883 Gray recognized just three sections, *Pt. sect. Eupectis*, *Pt. sect. Pectothrix*, and *Pt. sect. Pectidium*. In 1897 Fernald elevated the sections to subgenera, and used pappus characters to assign 34 North American species to five subgenera: *Eupectis*, *Heteropectis*, *Pectothrix*, *Pectidopsis* (resurrected from Gray 1852) and *Pectidium*. Fernald’s treatment remains the most complete revision to date.

In the mid-70s, Keil revised four of the *Pectis* subgenera. For *Pectis* subg. *Heteropectis* (1975) and *Pectidium* (= *Pt. sect. Pectis*, Keil, 1978) he followed Fernald’s treatment of the species (two species in each section) but reduced the subgenera to sections. Although various workers used pappus characters to segregate *Pectis* into different genera (Lessing, 1830; de Candolle, 1836) or divide it into sections or subgenera (Gray, 1849, 1884; Fernald, 1897), these characters can be variable, even within populations. In 1977, Keil dismantled subgenera *Pectothrix* and *Pectidopsis*, using some species from each (as well as a few previously-unassigned taxa) to form a redefined *Pt. sect. Pectothrix*. Keil included species in *Pt. sect. Pectothrix* based on a combination of characters – position of foliar glands, shape of capitula, number of ray and disc florets, and corolla pubescence. In spite of these significant revisions, fewer than half of *Pectis* species have been assigned to sectional rank, and no treatment has covered the full geographic range of the genus.

Porophyllum is a genus of about 25 species of annual herbs and perennial shrubs (or subshrubs) found from the southwestern United States to southern Brazil, including the Caribbean islands. Some are arid-adapted but, unlike *Pectis*, many species of *Porophyllum* occur in mesic areas. Like *Pectis*, they have prominent oil glands on their leaves and phyllaries but in *Porophyllum* the scent is usually described as strong and unpleasant. The genus differs from others in the Tageteae by its combination of well-developed leaves, discoid heads, and a pappus entirely of bristles. In the most recent treatment of the genus, Johnson (1969) placed *Porophyllum* species into *Pr.* sect. *Hunteria* Moc. & Sessé (DC.) and *Pr.* sect. *Porophyllum* based primarily on leaf characters and habitat. Species of *Pr.* sect. *Hunteria* have thick leaves that are sessile to short-petioled, with narrow blades and are distributed in arid or semi-arid Mexico and the southwestern U.S. Species of *Pr.* sect. *Porophyllum* have thin, petioled leaves that are filiform to broad, and are distributed in South and Central America and in more mesic regions of North America.

Two molecular studies have included various *Pectis* and *Porophyllum* species. Baldwin et al. (2002) analyzed the helenioid Heliantheae using ITS data, and included one species each of *Pectis* and *Porophyllum*. Loockerman et al. (2003) used ITS and *ndhF* sequences to infer relationships within Tageteae and included six *Pectis* and four *Porophyllum* species. Both studies suggested a close relationship between *Pectis* and *Porophyllum* but Loockerman et al. (2003) found three *Porophyllum* species nested within *Pectis*, calling into question the monophyly of the two genera. However, both analyses had very small sample sizes and lacked strong support for their relationships. In the Loockerman et al. (2003) study, *Porophyllum tridentatum* was strongly supported as being sister to *Leucactinia bracteata* and *Urbinella palmeri*, and thus a new genus, *Bajacalia*, was erected for the three taxa.

CHROMOSOME NUMBERS IN *PECTIS* AND *POROPHYLLUM*. The base chromosome number for *Pectis* is $x = 12$ (Keil, 1977). Of the 54 *Pectis* species and varieties for which chromosomes have been counted, 39 (72%) are diploid and 15 are polyploid (Appendix S2 in Supplemental Data with the online version of this article). Eight species are tetraploid, two of which (*Pt. longipes* and *Pt. repens*) have been reported as having diploid individuals as well. Six *Pectis* are hexaploid, among them *Pt. saturejoides*, which has also been reported as diploid. *Pectis ericifolia* is the only octoploid reported in the genus. Most *Porophyllum* species have a base number of $x = 12$, but five species (*Pr. lanceolatum*, *Pr. macrocephalum*, *Pr. punctatum*, *Pr. ruderale* and *Pr. viridiflorum*) have been counted as $x = 11$. Of these, *Pr. punctatum* and *Pr. ruderale* have also been reported with $x = 12$ counts. Of the 14 *Porophyllum* species for which the ploidy level is known, nine are diploids, four are tetraploid and *Pr. ruderale* has been reported with diploid, triploid, and tetraploid counts. *Porophyllum greggii* is the only known hexaploid in the genus.

PHOTOSYNTHETIC PATHWAY. C_4 photosynthesis is a complex trait in which anatomical, chemical and regulatory modifications reorganize the first steps of carbon assimilation found in the C_3 pathway. In C_3 plants, the first enzyme involved in photosynthesis is Rubisco. In C_4 photosynthesis, the first enzyme is PEP-C. Rubisco discriminates more against C^{13} than PEP-C does, and as a result, C_4 plants have a higher proportion of C^{13} than C_3 plants. This difference allows determination of the pathway used by a given plant by measuring the proportion of C^{13} in a tissue sample. Although C_4 photosynthesis has arisen repeatedly and takes many different forms, there is a phylogenetic component to its distribution. The 65 C_4 lineages occur in just 19 families (Sage et al., 2012). In the Asteraceae, one of the largest families of flowering plants, there are five C_4 lineages that occur in just two tribes: Coreopsidae (in

Chrysanthellum Pers., *Glossogyne* Cass., and *Isostigma* Less. of subtribe Chrysanthellinae) and Tageteae (in *Flaveria* Juss. of subtribe Flaveriinae and in *Pectis* of subtribe Pectidiinae). The C₄ genera in Chrysanthellinae form a monophyletic group and thus are thought to represent a single acquisition of the syndrome (Kimball & Crawford, 2004). However, based on phylogenetic analysis, C₄ photosynthesis is thought to have multiple origins in *Flaveria* (McKown et al., 2005). Muhaidat et al. (2007) included *Pectis glaucescens* in their survey of C₄ eudicots, and reported its chemical subtype as NADP-ME and its Kranz type as atriplicoid. This clustered phylogenetic distribution suggests an underlying predisposition toward C₄ photosynthesis in certain clades. An evolutionary change in a common C₃ ancestor might facilitate additional modifications down the line and could explain multiple origins of C₄ among close relatives.

Just as there is a phylogenetic signal in the occurrence of C₄ photosynthesis, the origin of the syndrome is clustered in particular geographic areas as well. The majority of New World C₄ eudicot lineages arose in North America (Sage et al., 2011). The evolution of C₄ lineages has been linked to the Oligocene decline of atmospheric CO₂, but environmental factors such as heat, drought, and fire regime may have played a role (Osborne, 2011). Pollen records show that C₄ grasses began to dominate just 8–3 mya (Cerling, 1999) but only recently have molecular studies allowed an estimate of the timing of their origin. The rise of C₄ photosynthesis in monocots is estimated at 32.0–25.0 mya for Chloridoideae (Christin et al., 2008) and 10–20 mya for Cyperaceae (Besnard et al., 2009). *Portulaca* is the oldest known lineage of C₄ eudicots, having diverged ± 30 mya (Ocampo & Columbus, 2010; Christin et al., 2011).

Much of our knowledge of the evolution of C₄ photosynthesis is from *Flaveria* (Engelmann et al., 2003; Westhoff & Gowik, 2004; McKown et al., 2005; McKown & Dengler, 2007), which has both C₃ and C₄

species, as well as C₃–C₄ intermediates. The modifications in C₃–C₄ intermediates are thought to confer evolutionary benefits in their own right, and may leave C₃–C₄ intermediates in a more or less stable state of photosynthetic efficiency appropriate to their environment, with no momentum toward one or the other state. However, the development of fully functional C₄ photosynthesis involves as a series of modifications, from changes in leaf anatomy to up-regulation and cell-specificity of C₄ chemicals. C₃–C₄ intermediates may also represent snapshots of the process of evolution toward full C₄ photosynthesis, with each state a precursor to full C₄ functionality. With the benefit of a phylogeny to determine ancestral vs. derived states, one can trace anatomical and biochemical alterations that may predispose plants with intermediate traits to develop the full C₄ pathway. This analysis has been done in *Flaveria* (Engelmann et al., 2003; Westhoff & Gowik, 2004; McKown et al., 2005; McKown & Dengler, 2007) with the resulting acquisition path outlined in Sage (2003) and Gowik and Westhoff (2011).

By expanding the focus to other C₄ eudicots, we may see anatomical and physiological commonalities in the evolution of the C₄ syndrome. Such studies are continuing in Amaranthaceae (Kadereit et al., 2003; Sage et al., 2007), *Cleome* (Brown et al., 2005; Marshall et al., 2007), *Heliotropium* (Vogan et al., 2007), and Molluginaceae (Christin et al., 2010). Each lineage examined will offer insights into C₄ biology and evolution.

MATERIALS AND METHODS

TAXON AND MARKER SELECTION. Our strategy was designed to sample as widely as possible both *Pectis* and *Porophyllum*, with the primary focus on *Pectis*. Roughly 230 names have been applied to various taxa in *Pectis*, ca. two thirds of which are considered taxonomic synonyms. Recent treatments and floras were utilized when deciding which species to include and which

to treat as synonyms. For previously synonymized taxa that are wide-ranging, accessions from each region were included (when possible) to assess whether molecular data support their placement in synonymy. Since no single treatment covers *Pectis* throughout its range, *Pectis* species recognized by Aristeguieta (1964), Bautista (1987), Cabrera (1978), Jørgensen and León-Yáñez (1999), Keil (1975, 1977a, 1978, 1996), and Liogier (1962, 1996, 2000) were sampled. *Porophyllum* species recognized by Johnson (1969) and Turner (1996) were also examined. *Porophyllum tridentatum* Benth., (= *Bajacalia tridentatum* (Benth.) Loockerman, B.L. Turner & R.K. Jansen was not included in our analysis of *Porophyllum*, as the molecular analysis of Loockerman et al. (2003) and cytological data ($x = 15$) of Reveal & Moran (1977) suggested it is not closely related to the rest of *Porophyllum*.

Not all species were sampled, due either to rarity in the field, paucity of herbarium collections, or both. The final sampling included 78 species and varieties of *Pectis*, 22 of *Porophyllum*, and one species each of *Chrysactinia* A. Gray, *Nicolletia* A. Gray and *Tagetes* L. as outgroups. Thus, approximately 75% of both *Pectis* and *Porophyllum* species were included. Outgroups were chosen based on relationships indicated in Loockerman et al. 2003. Sampled taxa and voucher information with GenBank numbers are listed in Appendix 1.

For the molecular analyses we used loci that were 400–2,000 bases long and sufficiently variable to resolve relationships at the species level. The internal transcribed spacer (ITS) region of nuclear ribosomal DNA (nrDNA) was included because of its prior use in elucidation of sub-generic Asteraceae relationships (Baldwin, 1993; Baldwin et al., 2002) and ease of amplification from herbarium material. The chloroplast (CP) loci selected based on length and *p*-distance between species (Shaw et al., 2007; Timme et al., 2007; Hansen et al., 2009) were coding regions *matK* and 3' *ndhF*, and the CP non-coding areas *rpl16* intron, *trnL-rpl32* spacer,

3' *trnV-ndhC* spacer, 5' *trnY-rpoB* spacer). Primer and locus information are summarized in Appendix S1 (see Supplemental Data with the online version of this article).

DNA ISOLATION, PCR AMPLIFICATION, AND SEQUENCING. Total genomic DNA was extracted from ± 20 mg of dried leaves using Qiagen DNeasy Plant Mini Kits (Qiagen, Valencia, California). Dilution of the genomic DNA to 1:10 provided the best amplification of both nuclear and chloroplast loci. PCR methods followed Loockerman et al. (2003). PCR products were visualized under UV light in a 1.5% agarose gel containing SYBR safe DNA gel stain (Invitrogen, Carlsbad, CA, USA). Amplicons were cleaned by adding 4.0% Shrimp Alkaline Phosphatase and 1.0% Exonuclease I to the PCR tube and heating to 37° C for 30 min followed by 80° for 15 min (Werle et al., 1994), and sequenced using BigDye (v.3.1) Terminator Cycle Sequencing (Applied Biosystems, Foster City, Ca, USA) at the Institute for Cell and Molecular Biology Core Facility, The University of Texas at Austin.

PHYLOGENETIC ANALYSIS. Individual sequences were trimmed and edited using Sequencher (Gene Codes CorPt., Ann Arbor, Michigan), and contigs aligned with MacClade 4.08 OSX (Maddison & Maddison, 2005). If a particular accession would not amplify for a certain locus, that region of the combined dataset was coded as missing data. All sequences are deposited in GenBank (<http://www.ncbi.nlm.nih.gov/genbank/>), with accession numbers listed in Appendix 1.

Because ITS sequences can present polymorphisms through hybridization, introgression, and incomplete lineage sorting (Alvarez & Wendel, 2003), PCR products of some accessions were cloned to test for variation between and within species. Since cloning all accessions was not feasible, only those samples for which direct sequencing showed evidence of polymorphisms (13 accessions) were cloned. Successful amplifications were visualized on an agarose gel and cloned using the TOPO-TA cloning kit (Invitrogen,

Carlsbad, CA, USA). Ten colonies were chosen from each plate and amplified using the M13 plasmid primers provided in the cloning kit. All 5.8S motifs were screened to identify pseudogenes (Harpke & Peterson, 2008), and this resulted in the elimination of a total of 5 clones.

Clone copies from the same accession almost never appeared in separate well-supported clades. For accessions that had different clone copies, the clones were either monophyletic or appeared with other related species in polytomies (tree not shown). Because the support for such clades was so low, we did not believe any particular copy to be more representative of a species than any another copy, and so chose the clone from the first of ten colonies selected from each plate to include in the final analyses. An exception, *Pectis multiflosculosa*, had two clone copies in two distinct clades, so a copy of each type was included in the ITS and the combined CP+ITS analyses. The *Pt. multiflosculosa* CP sequence was duplicated and added to each ITS clone sequence.

Before further analysis, duplicate samples of taxa for which the sequences were identical across all loci were eliminated. Sequence length of each locus and percentage of missing and parsimony-informative (P.I.) characters are shown in Table 1.

The ITS and the combined CP datasets were analyzed separately and together, using maximum likelihood (ML) with RAxML (Stamatakis, 2006) and Bayesian inference (BI) with MrBayes 3.1.1 (Huelsenbeck & Ronquist, 2001). All characters were weighted equally, character state transitions were treated as unordered, and gaps were treated as missing data.

RAxML allows for individual partitions of a dataset to be run with their own model of molecular evolution, including partitioning by codon position. The CP and CP+ITS datasets were partitioned as follows: chloroplast non-coding, chloroplast coding (by codon position), and ITS. The combined partitions were run together under the same GTR model, with parameters estimated

separately for each partition. Each analysis was performed ten times from a random starting tree, with 500 bootstrap replicates. As the final likelihood values of each run were very similar (within 0.003% of final score), bootstrap replicates from each run were combined to estimate support for the tree with the best ML score. Clades with bootstrap values above 70% are considered well-supported (Hillis & Bull, 1993).

Prior to conducting the Bayesian analyses, the Akaike information criterion (AIC) was used via Modeltest 3.7 (Posada and Crandall, 1998) to determine the most appropriate model of DNA sequence evolution for each of the seven loci. The results were incorporated into the three analyses: ITS, CP, and CP+ITS combined. Bayesian analyses were performed using default priors, with two simultaneous runs with four Markov chains with heating values of 0.15, 0.2 (default), or 0.3, sampling every 100 generations. Each chain was run for at least 10 million generations and up to 20 million generations, depending on how long it took to reach stationarity (the average standard deviation of split frequencies between runs ≤ 0.01), and convergence was confirmed by using AWTY graphical analysis (Wilgenbusch et al., 2004). Burn-in trees (30%) were discarded, and the remaining trees and their parameters saved. The frequency of inferred relationships was used to represent estimated posterior probabilities (PP). Clades with PP ≥ 0.95 are considered strongly supported (Wilcox et al., 2002).

HYPOTHESIS TESTING. Conflicting topologies between analyses of CP and ITS datasets led to testing the results of each analysis against the topology of the other. Hypotheses of alternate topologies were tested using the approximately unbiased (AU) test (Shimodaira, 2002) implemented in CONSEL (Shimodaira & Hasegawa, 2001), comparing constrained vs. best trees from 500 RAxML bootstrap replicates. Specifically, conflicts were addressed between the ITS and the CP datasets regarding the placement of three clades/taxa: *Porophyllum amplexicaule*

TABLE 1. Statistics for datasets used including results from ML searches.

	5'	matK	matK	matK-3'	3'	ndhF-ycf1	rpl16	trnL-rpl32	3'	trnV-ndhC	5'	trnY-rpoB	CP	ITS	CP+ITS
No. accessions sequenced	156	156	156	152	152	152	130	164	149	149	153	157	157	156	157
Aligned dataset (bp)	70	1,488	347	822	228	228	1,742	1,147	821	821	858	6,201	6,201	838	6,885
bp included in final analysis	47	1,488	234	594	61	61	1,371	865	754	754	788	6,201	6,201	684	6,885
# Pt.I. chars. (no outgps)	4	64	15	45	5	5	120	127	39	39	49	468	468	308	776
Missing data (incl gaps)	n/a	n/a	n/a	n/a	n/a	n/a	n/a	n/a	n/a	n/a	n/a	n/a	17.69%	5.53%	16.6%
ML model selected (AIC)	n/a	TVM+G	n/a	TVM+G	n/a	n/a	GTR+G+I	TVM+G	TVM+G	TVM+G	GTR+G	n/a	n/a	GTR+G+I	n/a
Likelihood CI	n/a	n/a	n/a	n/a	n/a	n/a	n/a	n/a	n/a	n/a	n/a	0.697	0.540	0.540	0.521
Likelihood RI	n/a	n/a	n/a	n/a	n/a	n/a	n/a	n/a	n/a	n/a	n/a	0.905	0.905	0.908	0.854
Likelihood score (-ln)	n/a	n/a	n/a	n/a	n/a	n/a	n/a	n/a	n/a	n/a	n/a	18,348.32	18,348.32	7,478.80	27,363.46

+ *Pr. scoparium*, *Pectis linifolia* + *Pt. coulteri*, and *Pt. papposa* var. *papposa*. This was done by analyzing the ITS dataset with RAxML under a constraint of the CP topology, and comparing the best topology under the constraint with the best unconstrained topology recovered from the ITS dataset. A reciprocal test was then conducted using the CP dataset, comparing the best topologies recovered from the CP dataset, both unconstrained and under the constraint of the ITS topology.

MOLECULAR DATING. To infer divergence times, data were combined with sequences from GenBank to create a dataset of *matK* and 3' *ndhF* sequences. This included 21 sequences from the five major *Pectis* clades recovered from the phylogenetic analysis, as well as several *Porophyllum* and other species of tribe Tageteae. Data from six of the 12 major Asteraceae clades recovered in Panero and Funk (2008) were included, for a total of 46 taxa. The phylogeny was rooted on the branch leading to *Barnadesia* and *Doniophyton* (Barnadesioideae), which is well-supported as sister to the rest of Asteraceae (Jansen & Palmer 1987; Kim et al., 2005; Panero & Funk, 2008).

Modeltest 3.06 (Posada & Crandall, 1998) with the Akaike Information Criterion was used to determine the most appropriate model of sequence evolution for the dataset. The Likelihood Ratio Test (LRT) was used to determine whether the data satisfied the assumptions of a molecular clock, with the formula of $LR = 2^{*(\ln L1 - \ln L2)}$, where $\ln L1$ is the likelihood of the tree with a molecular clock enforced, and $\ln L2$ is the likelihood of the tree without the clock constraint, and degrees of freedom of $n-2$, where n is the number of taxa (Felsenstein, 1988). The LRT resulted in a significant difference between the trees, so a Bayesian relaxed uncorrelated lognormal molecular clock was used to account for rate heterogeneity across lineages.

Not all lineages evolve at the same rate, and when using molecular data to infer dates for lineages, it is best to use multiple fossils

to constrain various nodes throughout the tree to lessen the margin of error associated with rate smoothing. Fossils provide only approximate dates, can be difficult to associate accurately with extant taxa, and are necessarily younger than the lineage they represent. Most paleobotanical evidence of the Asteraceae is from fossil pollen, but a macrofossil from Patagonia of 47.5 mya was allied with the Mutisioideae (Barreda et al., 2010). Although constraining a tree at multiple nodes is best, due to the uncertainty of the relationships between some Asteraceae subfamilies (Panero & Funk, 2008), only the node between the Barnadesioideae and the remainder of the Asteraceae was constrained.

The aligned data matrix was analyzed in BEAST 1.7.0 (Drummond & Rambaut, 2007) from an input file created in BEAUti 1.7.0 (packaged with BEAST). Two independent runs of 10,000,000 were conducted. Settings were as follows: a substitution model of GTR+G+I (based on Modeltest results), with base frequencies estimated; relaxed uncorrelated lognormal clock with rates estimated; a Yule process speciation tree prior with the starting tree randomly generated; prior distributions were set at default except for the ingroup. The node separating Barnadesioideae from the rest of the Asteraceae was calibrated based on the Mutisioideae fossil date of 47.5 mya. Assuming the Barreda et al. (2010) fossil date is a minimum age of the split, a lognormal prior distribution with a mean of 2.0, standard deviation of 0.5, and offset of 44.5 mya was applied. These settings provide a 5% probability of 47.75 mya, set the median probability at 51.89 MY, and a 95% probability of 61.32 mya for the most recent common ancestor (MRCA) of Barnadesioideae and the rest of the Asteraceae. Tracer v1.5 (Rambaut & Drummond, 2007) was used to assess convergence of the runs, confirm an appropriate estimated sample size, and determine the appropriate number of burn-in trees. Tree information from each run was combined with LogCombiner

(packaged with BEAST), with the first 20% (2,000 trees) of each run discarded. A maximum clade credibility tree was constructed with TreeAnnotator (packaged with BEAST), and FigTree v1.3.1 (Rambaut, 2008) was used to visualize the estimations of divergence dates on the tree.

CARBON ISOTOPE RATIOS. Since plants differentially use carbon isotopes (C^{12} and C^{13}) depending on whether they use C_3 or C_4 photosynthesis, the proportion of C^{13} in leaf tissue can be used as a proxy for the type of photosynthesis employed by that plant. Because rubisco discriminates against C^{13} , C_4 plants have a higher proportion of C^{13} than C_3 plants. This proportion is expressed as delta (δ) in parts per thousand (‰). The metric $\delta C^{13}\text{‰}$ is the difference between the tissue sample reading and a reference reading. The reference used for C^{13} is Pee Dee Belemnite (PDB), a Cretaceous marine fossil (*Belemnitella americana*, †Belemnitellidae) from the Pee Dee formation of South Carolina. PDB has a C^{13}/C^{12} ratio that is higher than other natural samples. By convention, this standard is set to zero, so the amount of carbon measured in plants and animals is expressed as a negative number (Petersen & Fry, 1987). As C_4 plants have more C^{13} than C_3 plants, their $\delta C^{13}\text{‰}$ signature (-15‰ to -10‰) is higher than that of C_3 (-21‰ to -30‰) plants (Cerling, 1999; Marchese et al., 2005), so $\delta C^{13}\text{‰}$ provides an indirect method for inferring C_4 photosynthesis.

To infer the photosynthetic pathway for each sample, 2 mg of plant tissue (stem or leaves) were assayed for carbon isotope ratio using an Integramass spectrometer with a PDB standard. Carbon isotope ratios were determined by the University of California stable isotope facility (<http://stableisotopefacility.ucdavis.edu>).

RESULTS

CP DATASET. The final CP dataset comprising all CP loci contained 157 accessions. The models indicated by Modeltest

were GTR+G+I for the *rpl16* intron, GTR+G for the 5' *trnY-rpoB* spacer, and TVM+G for the remaining four CP loci. As MrBayes does not allow for the TVM submodel, GTR+G was substituted for the Bayesian analysis. Prior to combining the CP loci, areas of ambiguous alignment were excluded from each CP locus, with a total of 1,321 bases excluded. The aligned dataset comprised 6,201 bp, and ten RaxML runs resulted in a best tree of $-\ln = 18,348.32$ (Fig. 1A). Table 1 provides a summary of loci and dataset statistics.

ITS DATASET. The final ITS dataset was reduced to those accessions for which sequences for the chloroplast loci were obtained. Because of uncertainty of the alignment, 154 bases were excluded prior to analysis. The final aligned dataset comprised 156 accessions of 684 bp. Ten RaxML runs resulted in a best tree with a likelihood score of $-\ln = 7,478.80$ (Fig. 1B). Table 1 shows a summary of results statistics for the datasets.

CP+ITS DATASET. An incongruence length difference (ILD) test indicated a significant conflict between the ITS and CP datasets ($p = 0.02$). However, visual inspection of the majority rule trees from ML bootstrap and Bayesian analyses showed that most of the conflicts were not well supported. The ILD test is thought to be very conservative, falsely rejecting congruence (Cunningham, 1997; Darlu & Lecointre, 2002) showed that when the ILD test resulted in a p-value of greater than 0.01, combining the datasets improved or did not diminish phylogenetic accuracy. Therefore, the CP and ITS datasets were combined. The final CP+ITS dataset contained 157 accessions, with 6,885 aligned bp. Ten RaxML runs of this dataset resulted in a best tree of $-\ln = 27,363.46$ (Figs. 2-4).

PHYLOGENETIC ANALYSES—PECTIS. Analyses of the CP, ITS, and CP+ITS datasets provide strong support for the monophyly of *Pectis*. Figure 1 shows a comparison of the CP and ITS topologies, and the topology recovered from the combined CP+ITS

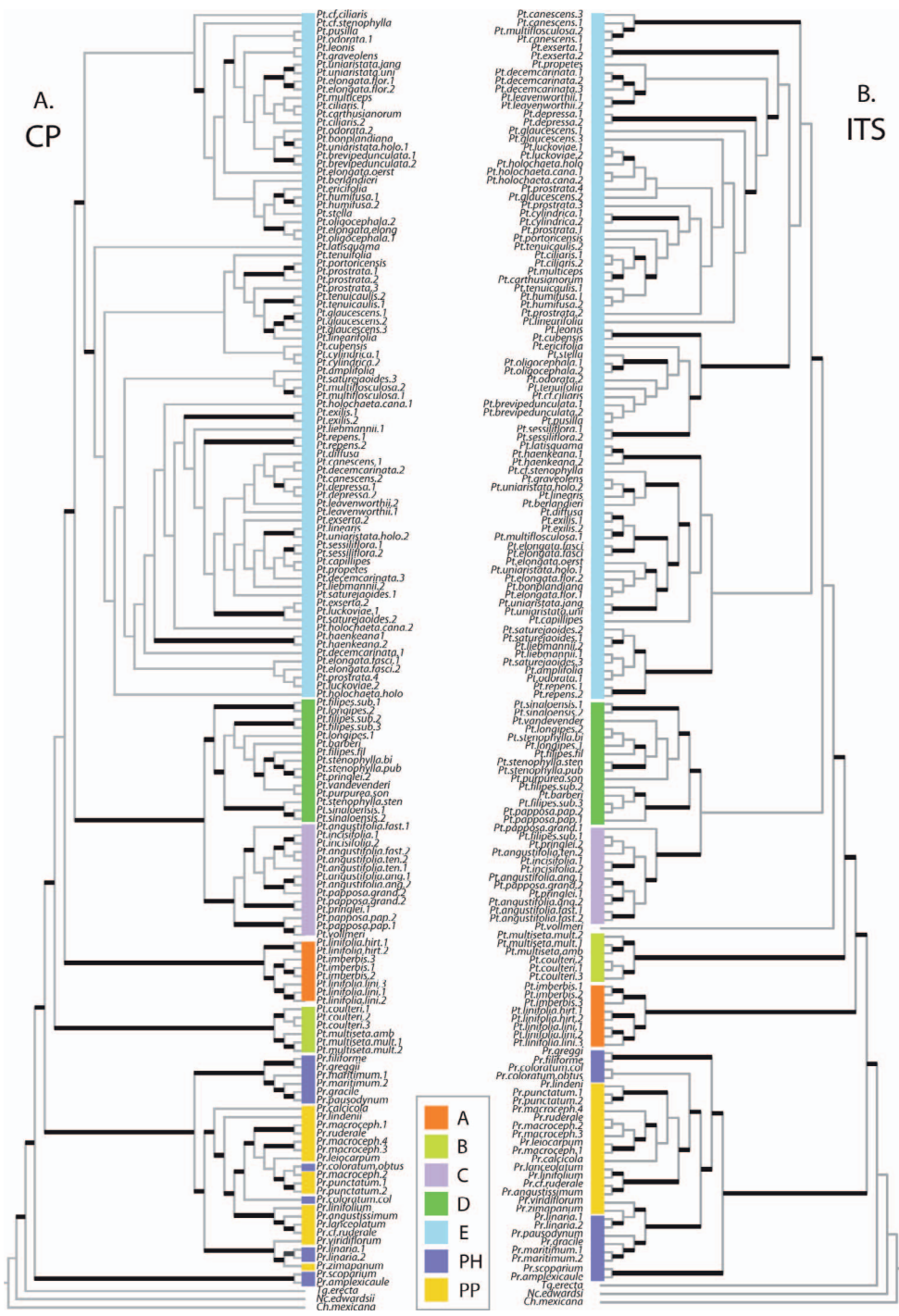

FIG. 1. Comparison of CP and ITS topologies. A: ML cladogram from CP dataset, ln = -18348.3266. B: ML cladogram from ITS dataset, ln = -7478.8052. Branches in bold are well-supported (≥ 70 bootstrap or ≥ 0.95 PP). Colors refer to *Pectis* clades A-E, PH=*Porophyllum* sect. *Hunteria*, PP=*Porophyllum* sect. *Porophyllum*.



FIG. 2. ML cladogram from CP+ITS analysis, showing species of *Pectis*, with clades A-D color-coded. ML bootstrap support is shown above branches, and Bayesian PP support is shown below. An asterisk indicates support below 50% bootstrap or 0.95 PP. Thick-lined branches lead to well-supported clades (≥ 70 bootstrap, ≥ 0.95 P). $\ln = -27363.4645$. Phylogram of same analysis appears below the cladogram.

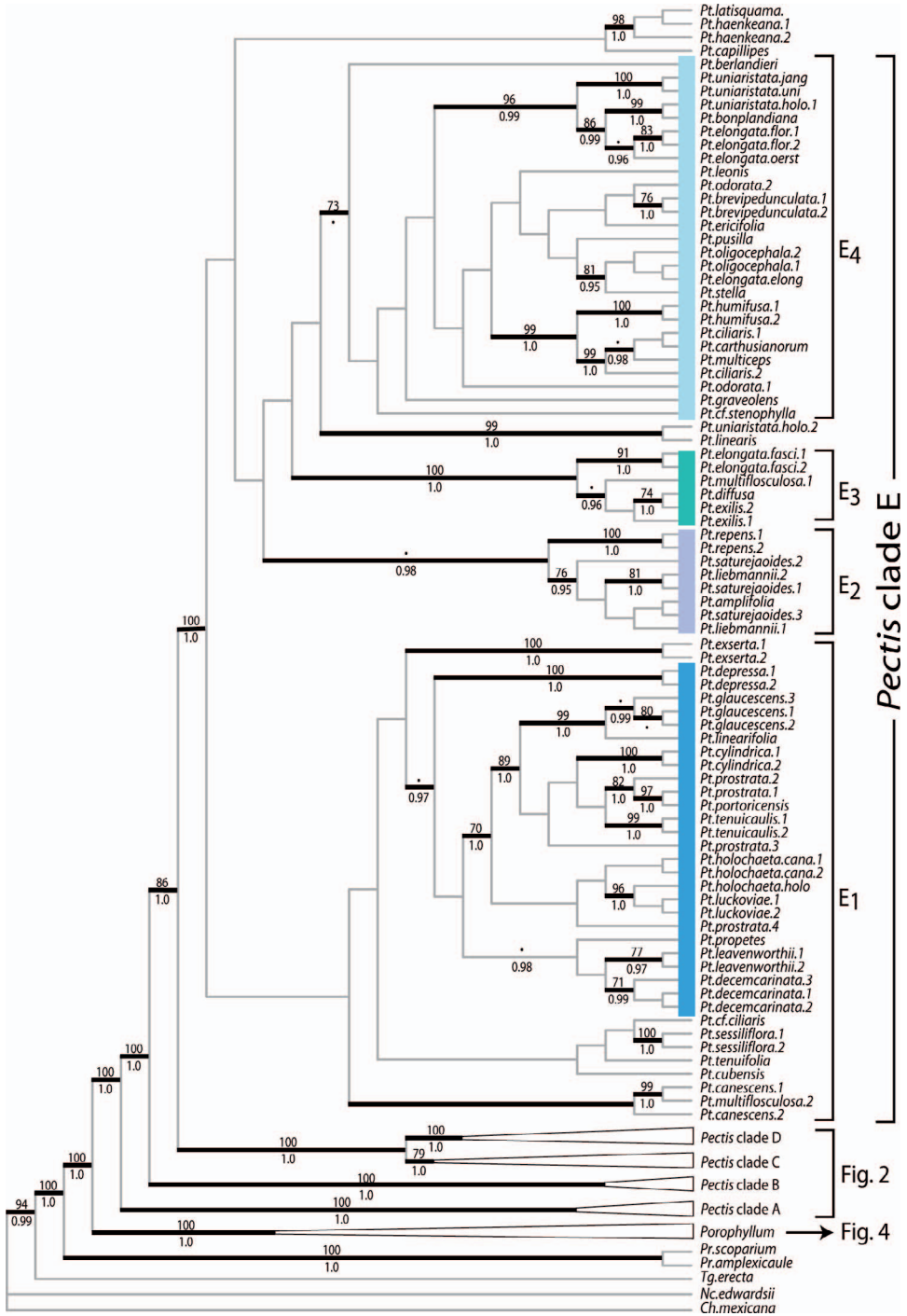

FIG. 3. ML cladogram from CP+ITS analysis, showing species of *Pectis* clade E.

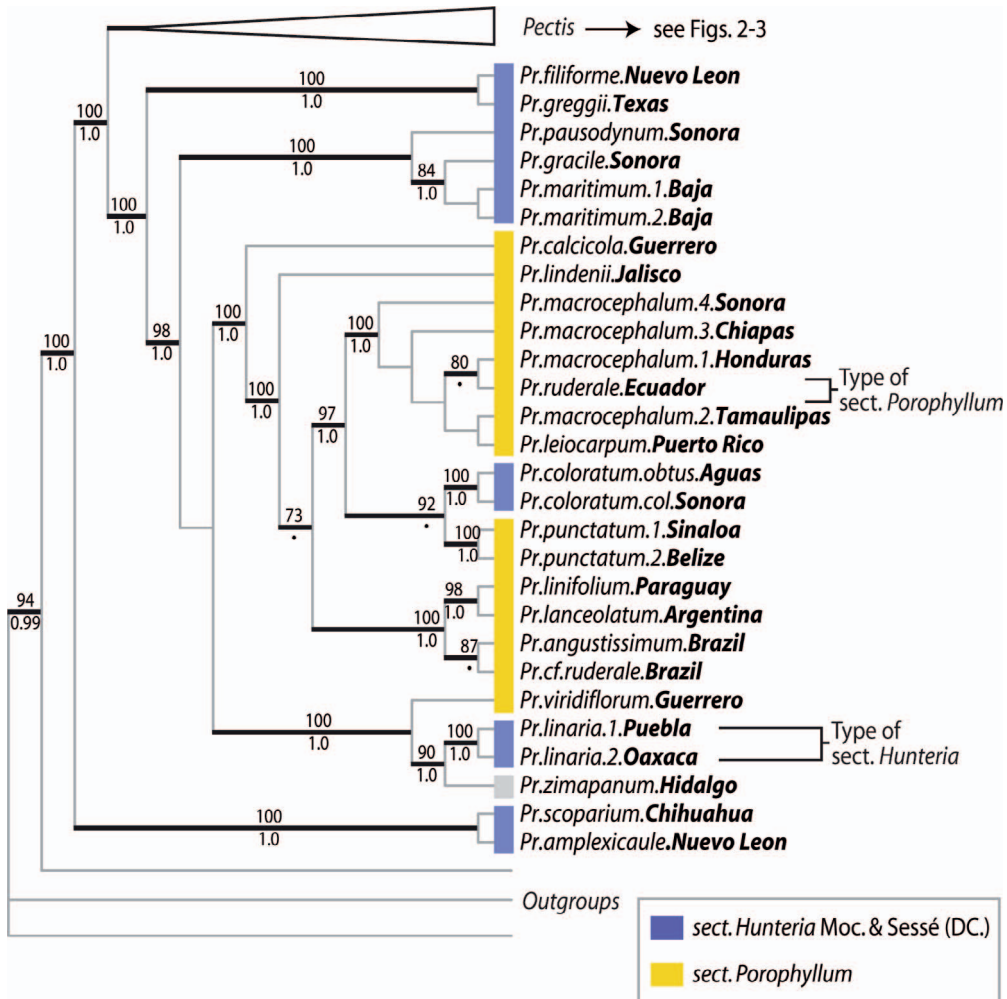

FIG. 4. ML cladogram from CP+ITS analysis, showing *Porophyllum* species, collection site, and sectional affiliations.

dataset is shown in Figs. 2 and 3 (*Pectis*) and Fig. 4 (*Porophyllum*). All datasets recover five well-supported clades within *Pectis* (clades A-E, Fig. 1). The CP and ITS differ in their placement of either clade A (ITS) or clade B (CP) as sister to the rest of the genus. In all analyses, the remainder of the genus is split between two well-supported Sonoran and Chihuahuan Desert clades (C and D in Fig. 1) and a large clade (E) with species that occur from central Mexico to San Luis, Argentina.

PHYLOGENETIC ANALYSES—*POROPHYLLUM*. The inclusion of 22 of roughly 30

Porophyllum species allowed conclusions to be made regarding the relationships of *Porophyllum* to *Pectis* and within *Porophyllum*. The results suggest that *Pr. amplexicaule* and *Pr. scoparium* do not belong to *Porophyllum* (sensu Johnson, 1969). They form a strongly-supported clade that is the sister-group to a combined *Pectis*+*Porophyllum* clade. *Porophyllum filiform* and *Pr. greggii* form a well-supported clade sister to the rest of *Porophyllum*, which appears as a grade of clades (Fig. 4). *Pr.* sect. *Hunteria* and *Pr.* sect. *Porophyllum* are not recovered as monophyletic.

HYPOTHESIS TESTING. The CP and ITS datasets provided incongruent results in three groups of note: *Pectis imberbis* + *Pt. linifolia* (clade A), *Pt. papposa* var. *papposa*, and *Porophyllum amplexicaule* + *Pr. scoparium*. Reciprocal AU tests were performed to assess whether, given a dataset, there was a significant difference in likelihoods between the best tree obtained from that dataset and the alternative topology (the constraint) obtained from the other dataset. The constraint topologies and results are shown in Fig. 5.

The ITS topology (Fig. 1B) shows clade A (*Pectis imberbis*+*Pt. linifolia*) as a sister group to the rest of the genus, followed by clade B (*Pt. coulteri* + *Pt. multisetata*). These relationships are swapped in the CP dataset, which recovers clade B sister to the rest of *Pectis*, and clade A appearing next in the grade (Fig. 1A). The latter relationship is not strongly supported (59% ML bootstrap and 0.67 Bayesian PP support), and the AU test shows that, when using the CP dataset, the best CP topology is not significantly better than the best ITS topology. The CP+ITS dataset strongly supports the position of clade A as sister to the rest of the genus.

Pectis papposa var. *papposa* groups with *Pt. vollmeri* in the topology suggested by the CP dataset (Clade C of Fig. 1A). However, the ITS topology (Fig. 1B) shows *Pt. papposa* var. *papposa* grouped in Clade D with *Pt. filipes* var. *subnuda* and *Pt. barberi*. Given the ITS dataset, the CP topology can be rejected; likewise, given the CP dataset, the ITS topology can be rejected. The CP+ITS dataset strongly supports the position of *Pt. papposa* var. *papposa* in clade C with *Pt. vollmeri*.

The CP dataset recovered a clade of *Porophyllum amplexicaule*+*Pr. scoparium* at the base of *Pectis*+*Porophyllum* (Fig. 1A), whereas the ITS dataset showed this clade to be sister to the rest of *Porophyllum* (Fig. 1B). Given the ITS dataset, the CP topology cannot be rejected, but given the CP dataset, the ITS topology can be rejected. In the combined CP+ITS dataset, *Pr. amplexicaule*

and *Pr. scoparium* are well-supported as sister to the combined *Pectis*+*Porophyllum*.

PHYLOGENETIC DISTRIBUTION OF POLYPOIDS. In *Pectis*, most of the known polyploids occur in the more terminal clades (Appendix S3, see Supplemental Data with the online version of this article). Clade E4 (Fig. 3) contains five polyploid species, clade E1 has three, and clades D and E3 both have one. Two of the four taxa in clade E2 (tetraploid *Pt. repens* and hexaploid *Pt. saturejoides*) have reports of both diploid and polyploid counts. In two cases (*Pt. latisquama* and *Pt. multiflosculosa*), the polyploid species appears sister to a diploid species, but most polyploids in the genus are sister to taxa for which the chromosome number is unknown. The four known polyploid *Porophyllum* species included in this study occur in separate clades throughout the genus. The combined CP+ITS dataset places the hexaploid *Pr. greggii* with *Pr. filiforme* (chromosome number unknown), which together are sister to the rest of *Porophyllum*.

One internal *Porophyllum* clade comprises all $x = 11$ taxa, together with one $x = 12$ (*Pr. coloratum*) and several for which the chromosome numbers are not known.

MOLECULAR DATING. The dataset of *matK* (1,902 bp) and 3' *ndhF* (603 bp) sequences comprised 2,505 characters and 46 taxa. The maximum clade credibility tree recovered most clades with greater than 0.95 PP (Fig. 6). The BEAST analysis showed Tageteae and *Helianthus* diverging 26.55 (19.23–33.73) mya. The MRCA of Tageteae is 24.34 mya, but this node has just 0.92 PP support. *Porophyllum amplexicaule* diverged from *Pectis* + *Porophyllum* at 15.92 MYA (11.03–21.53). The divergence of *Pectis* and *Porophyllum* s.s. is estimated at 11.27 (7.56–15.58) mya, and divergence within *Pectis* began 9.12 (5.75–12.61) mya but most of the nodes split within the last 5 my.

CARBON ISOTOPE ANALYSIS. We obtained $\delta^{13}\text{C}\text{‰}$ values for 80 *Pectis* and *Porophyllum* species, as well as *Tagetes erecta*. All *Pectis* accessions have $\delta^{13}\text{C}\text{‰}$ values consistent

1. Testing CP topology with ITS data

2. Testing ITS topology with CP data

A. placement of *Porophyllum amplexicaule*+*Porophyllum scoparium*B. placement of *Pectis linifolia* and *P. imberbis* (clade A)C. placement of *Pectis papposa* var. *papposa*

FIG. 5. Reciprocal tests of alternate topologies. Figures on the left (1A, 1B, 1C) show the topologies recovered with the CP dataset, and figures on the right (2A, 2B, 2C) show the topologies recovered with the ITS dataset. * p -values of ≥ 0.05 indicate that the topology shown has a significantly lower likelihood than the best tree recovered using that dataset.

with C_4 photosynthesis (-15.60% to -10.70% , mean = -13.14%), and all *Porophyllum* accessions have values consistent with C_3 photosynthesis (-30.65% to -22.90% , mean = -27.64%). *Tagetes erecta* has a $\delta^{13}C$ value of -30.37% . The frequency

distribution of the $\delta^{13}C$ values is presented in Fig. 7, and the average $\delta^{13}C$ value for each species, including previously reported data from species not surveyed by us, is shown in Table 2. Voucher information is given in Appendix 1.

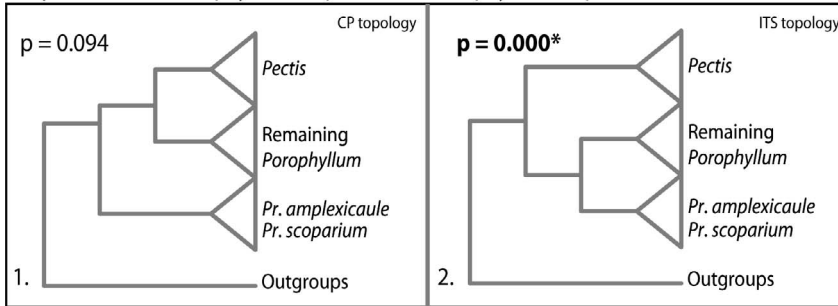
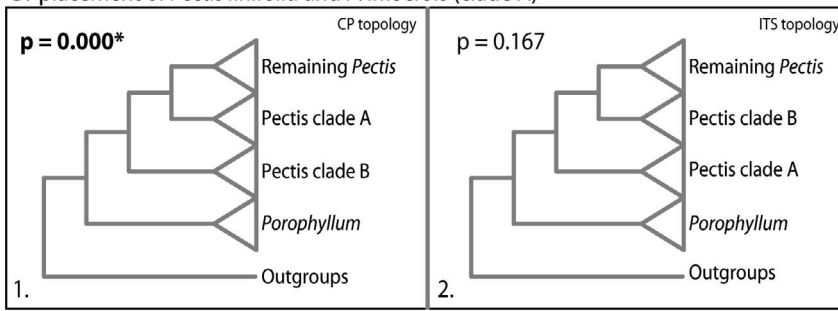
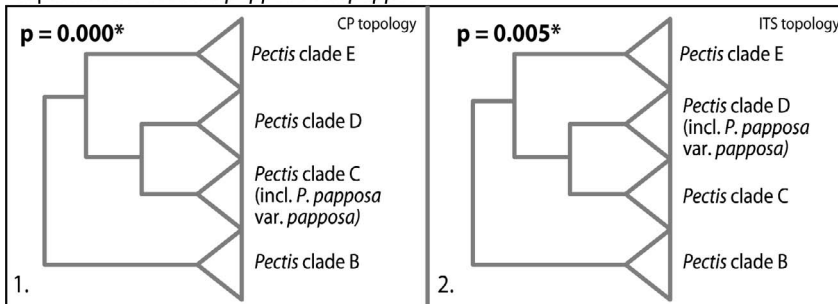
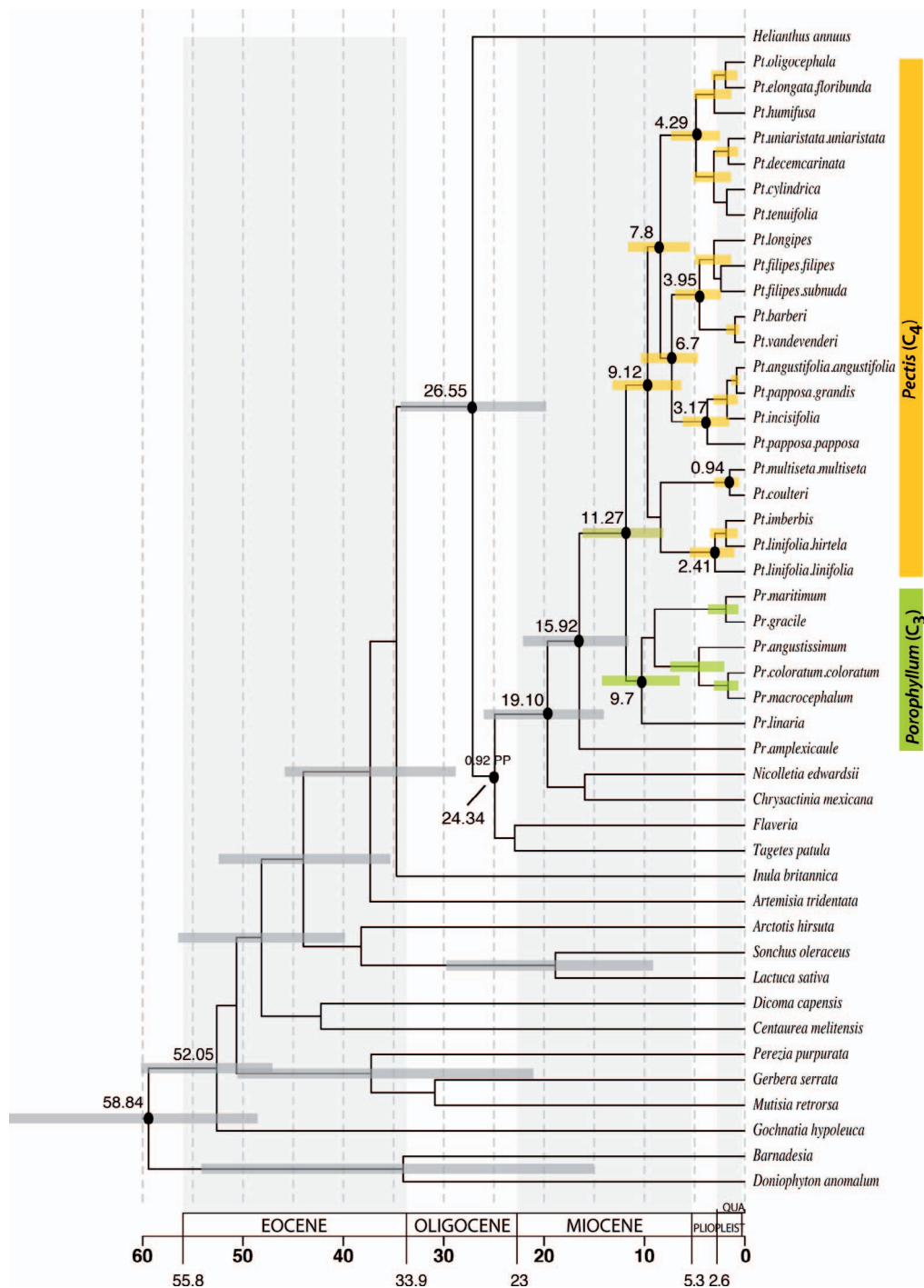

FIG. 6. Chronogram of the maximum clade credibility tree estimated from *matK*+3'*ndhF* sequences using BEAST. Horizontal bars are the 95% highest probability density (HPD) for the age of that node (green bars are on *Porophyllum* nodes, yellow bars are on *Pectis* nodes). Nodes with HPD bars have PP support of ≥ 0.95 . Nodes without HPD bars have <0.95 PP. Mean ages are shown for clades mentioned in the text. A partial timescale is shown at the bottom, with units in millions of years. Epoch dates follow The Geological Society of America (GSA, 2009).

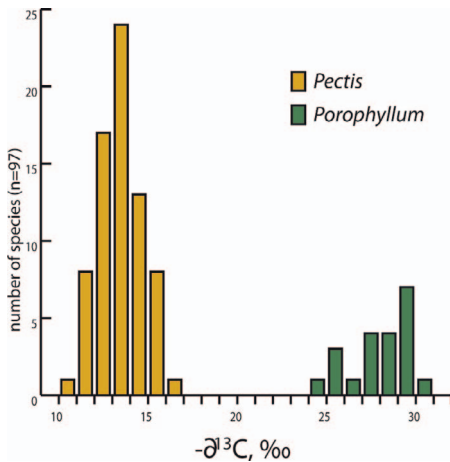

FIG. 7. The frequency distribution of carbon isotope ratios for the species listed in Table 2. All *Pectis* species sampled have ratios consistent with C_4 plants, all *Porophyllum* species sampled have ratios consistent with C_3 plants.

DISCUSSION

Pectis species have traditionally been considered a natural, morphologically distinctive group (Strother, 1977). However, molecular analysis of the Tageteae (Loockerman et al., 2003) showed *Pectis linifolia* as sister to the combined *Pectis*+*Porophyllum*, based on a combined ITS+ndhF dataset. By expanding the dataset to 6,201 bases of CP loci and more taxa, a well-supported and monophyletic *Pectis* is recovered as sister to *Porophyllum*. The combined CP+ITS dataset suggests that two *Porophyllum* species, *Pr. amplexicaule* and *Pr. scoparium*, fall outside of the genus, and are sister to the combined *Pectis*+*Porophyllum*. *Porophyllum amplexicaule* is restricted to southwestern Coahuila, and *Pr. scoparium* can be found in desert scrub from southern New Mexico, southeast into southwest Texas, and into Mexico from Coahuila to Nuevo Leon. Johnson (1969) suggested that *Pr. amplexicaule* and *Pr. scoparium* hybridize where they co-occur. Both are suffruticose perennials up to 60 cm high and have yellow corollas (vs. the green, purple or off-white corollas of most of the genus).

Pectis clades A through E (Fig. 1) generally correspond to geographic distribution; however, a few members are widespread. Clades A and B (Fig. 2) are generally associated with the Sonoran desert. However, *Pectis linifolia* var. *linifolia* of clade A has the largest natural range of the genus. Some of its distribution (the Galapagos and Hawaiian Islands) is probably due to recent introductions (Wiggins & Porter, 1971; Wagner et al., 1990), but its natural range spans from Arizona to Bolivia, with a large disjunct region between Guatemala and Colombia. It is also found throughout the Caribbean islands. Keil (1978) suggested that *Pt. linifolia* var. *linifolia* is autogamous, and that this breeding system, combined with its stiff, recurved awns suited for animal dispersal, contribute to its success as a colonizer. In contrast, *Pectis linifolia* var. *hirtella* has a very small range, and is endemic to the Mexican states of Guerrero and Michoacan. Both taxa are taller than most *Pectis* species, and are often erect, with long internodes and sparse, linear leaves.

Pectis coulteri and *Pt. multisetata* of clade B (Fig. 2) are both low growing annuals with distinctive antrorsely-barbed pappus awns. *Pectis coulteri* is endemic to the mainland Sonoran desert, whereas *Pt. multisetata* is endemic to the Baja California Peninsula. Clade C (Fig. 2) is composed of low-growing annuals that are mostly associated with the Sonoran and Chihuahuan deserts, but the range of *Pt. angustifolia* extends from southeast Wyoming to Chihuahua, Mexico, and *Pt. papposa* extends into central Sinaloa. Clade D species (Fig. 2) are annuals and perennials associated with several different habitats, from the Sonoran desert, foothills of the Sierra Madre Occidental, and the thorn scrub and coastal savannahs of Sonora and Sinaloa. Clade E (Fig. 3) species are diverse and cover a broad geographic area, essentially mirroring the geographic and morphological range of the whole genus. Aside from *Pt. linifolia*, all the Caribbean and South American species of *Pectis* are in this clade. The CP dataset provides support for four clades within clade E (Fig. 3), and

TABLE 2. Photosynthetic pathways in *Pectis* and *Porophyllum*. Data are the average $\delta^{13}\text{C}$ value for each species (sample size if $N > 1$). Average $\delta^{13}\text{C}$ value for *Pectis* = -13.14‰; Average $\delta^{13}\text{C}$ value for *Porophyllum* = -27.64‰. All values are newly reported here unless indicated with an asterisk (*). See Appendix 1 for voucher information.

Species	$\delta^{13}\text{C}$ ‰	Species	$\delta^{13}\text{C}$ ‰
1. <i>Nicolletia edwardsii</i> *	-26.50	51. <i>Pectis papposa</i> var. <i>papposa</i> *	-11.5
2. <i>Pectis amplifolia</i>	-15.00	52. <i>Pectis peruviana</i>	-13.65 (2)
3. <i>Pectis angustifolia</i> var. <i>angustifolia</i>	-14.10 (2)	53. <i>Pectis portoricensis</i>	-14.15 (2)
4. <i>Pectis arida</i>	-13.70	54. <i>Pectis pringlei</i>	-13.45 (2)
5. <i>Pectis barberi</i>	-13.41 (4)	55. <i>Pectis propetes</i>	-13.70 (2)
6. <i>Pectis berlandieri</i> *	-11.2	56. <i>Pectis prostrata</i> *	-10.7 (3)
7. <i>Pectis bonplandiana</i>	-15.30	57. <i>Pectis pumila</i>	-13.97 (3)
8. <i>Pectis brachycephala</i>	-14.40 (2)	58. <i>Pectis purpurea</i>	-15.39 (5)
9. <i>Pectis brevipedunculata</i>	-13.00	59. <i>Pectis pusilla</i>	-13.50 (2)
10. <i>Pectis cajamarcana</i>	-14.40 (2)	60. <i>Pectis pygmaea</i>	-11.90
11. <i>Pectis canescens</i> *	-11.4	61. <i>Pectis repens</i> *	-12.1
12. <i>Pectis ciliaris</i>	-11.79 (2)	62. <i>Pectis rusbyi</i>	-14.35 (2)
13. <i>Pectis coulteri</i>	-13.51	63. <i>Pectis satirejoides</i>	-12.65 (3)
14. <i>Pectis cubensis</i>	-13.25 (4)	64. <i>Pectis sessiliflora</i>	-13.80
15. <i>Pectis cylindrica</i>	-15.60 (2)	65. <i>Pectis sinaloensis</i>	-13.10 (2)
16. <i>Pectis decemcarinata</i>	-14.47 (4)	66. <i>Pectis stella</i>	-13.45 (2)
17. <i>Pectis depressa</i> *	-11.7	67. <i>Pectis</i> cf. <i>stenophylla</i> var. <i>rosei</i>	-14.11
18. <i>Pectis diffusa</i>	-12.15 (2)	68. <i>Pectis stenophylla</i> var. <i>stenophylla</i>	-13.71
19. <i>Pectis elongata</i> var. <i>floribunda</i>	-13.03	69. <i>Pectis subsquarrosa</i>	-12.50 (2)
20. <i>Pectis elongata</i> var. <i>fasciculiflora</i>	-13.10 (2)	70. <i>Pectis substriata</i>	-13.85 (2)
21. <i>Pectis elongata</i> var. <i>oerstediana</i>	-12.80 (2)	71. <i>Pectis tenuicaulis</i>	-11.90 (2)
22. <i>Pectis ericifolia</i>	-12.00 (2)	72. <i>Pectis tenuifolia</i>	-14.10
23. <i>Pectis exilis</i>	-13.93 (4)	73. <i>Pectis uniaristata</i> var. <i>holostemma</i> *	-11.3
24. <i>Pectis exserta</i>	-12.96 (2)	74. <i>Pectis uniaristata</i> var. <i>uniaristata</i>	-12.91 (2)
25. <i>Pectis filipes</i> *	-11.4	75. <i>Pectis vandevenderi</i>	-15.15 (2)
26. <i>Pectis gardneri</i>	-12.80	76. <i>Pectis vollmeri</i>	-14.95 (2)
27. <i>Pectis glaucescens</i>	-12.85 (2)	77. <i>Porophyllum amplexicaule</i>	-24.85 (2)
29. <i>Pectis graveolens</i>	-13.90 (2)	78. <i>Porophyllum angustissimum</i>	-28.05 (2)
30. <i>Pectis haenkeana</i>	-15.10 (2)	79. <i>Porophyllum calcicola</i>	-28.90 (2)
31. <i>Pectis holochaeta</i> var. <i>cana</i>	-12.55 (2)	80. <i>Porophyllum coloratum</i> var. <i>coloratum</i>	-25.50
32. <i>Pectis holochaeta</i> var. <i>holochaeta</i> *	-11.0	81. <i>Porophyllum coloratum</i> var. <i>obtusifolium</i>	-29.00
33. <i>Pectis humifusa</i> *	-11.3	82. <i>Porophyllum filiforme</i>	-25.95 (2)
34. <i>Pectis imberbis</i>	-14.25 (2)	83. <i>Porophyllum gracile</i> *	-27.01
35. <i>Pectis incisifolia</i> *	-12.6	84. <i>Porophyllum greggii</i>	-27.80 (2)
36. <i>Pectis latisquama</i> *	-12.5	85. <i>Porophyllum lanceolatum</i>	-29.50 (2)
37. <i>Pectis leavenworthii</i>	-13.43 (4)	86. <i>Porophyllum leiocarpum</i>	-28.43 (2)
38. <i>Pectis leonis</i>	-12.05 (2)	87. <i>Porophyllum linaria</i>	-28.75 (2)
39. <i>Pectis liebmannii</i>	-15.98 (2)	88. <i>Porophyllum lindenii</i>	-29.15 (2)
40. <i>Pectis linearifolia</i>	-12.63 (2)	89. <i>Porophyllum linifolium</i>	-29.30
41. <i>Pectis linearis</i>	-11.66 (2)	90. <i>Porophyllum macrocephalum</i>	-30.65 (4)
42. <i>Pectis linifolia</i> var. <i>linifolia</i>	-11.60	91. <i>Porophyllum maritimum</i>	-27.20 (2)
43. <i>Pectis longipes</i>	-12.85 (2)	92. <i>Porophyllum pausodinum</i>	-25.60 (2)
44. <i>Pectis luckoviae</i>	-14.24 (2)	93. <i>Porophyllum punctatum</i>	-29.48 (4)
45. <i>Pectis monocephala</i>	-11.30 (2)	94. <i>Porophyllum</i> cf. <i>ruderales</i>	-30.6
46. <i>Pectis multiceps</i>	-13.40 (2)	95. <i>Porophyllum scoparium</i> *	-22.9
47. <i>Pectis multiflosculosa</i>	-11.90	96. <i>Porophyllum viridiflorum</i>	-27.10 (2)
48. <i>Pectis multiseta</i> var. <i>ambigua</i> *	-13.05 (2)	97. <i>Porophyllum zimapanum</i>	-26.75 (2)
49. <i>Pectis odorata</i>	-13.00	98. <i>Tagetes erecta</i>	-30.37 (2)
50. <i>Pectis oligocephala</i>	-13.24 (2)		



FIG. 8. Taxonomic classifications in *Pectis*. Cladogram from Fig. 2 with classifications mapped onto the tree. Taxa with two colors were placed into two separate categories under different names but are now considered synonyms. Column 1 shows the genera of *Lorentea*, *Pectidium*, *Pectidopsis* and *Pectis* at the time that Gray described the former three as sections of *Pectis*. Thick-lined branches lead to well-supported clades (≥ 70 bootstrap, ≥ 0.95 PP).

suggests several species-pairs. The ITS dataset does not show support for the large clades of the CP topology, but does suggest several smaller clades within clade E, as well as species-pair affinities in common with the CP topology. The combined CP+ITS dataset recovers several clades and species-pairs with strong support (Fig. 3).

INFRAGENERIC RELATIONSHIPS WITHIN *PECTIS*. Six subgeneric divisions have been recognized in *Pectis*, variously treated as subgenera or as sections. Figure 8 shows the CP+ITS cladogram with these divisions mapped onto the tree according to the revisions of Gray (1852), Fernald (1897) and Keil (1975, 1977a, 1978).

Gray's (1852) *Pectis* sect. *Eupectis* was proposed to include species having uniseriate, paleate, or broad-based and chaffy awns. Aside from *Pt. prostrata*, which he described in the same publication, Gray did not detail which species were to be included in his section *Eupectis*, and the species in column 1 of Fig. 8 are the species of *Pectis* recognized by de Candolle at the time. In the same 1852 treatment, Gray transferred *Pectidium punctatum* Less. into *Pectis*, placing it under *Pt. sect. Pectidium*. *Pectis punctatum* is synonymous with *Pt. linifolia*, which was, at the time, in *Pt. sect. Eupectis*. After the designation of *Pt. linifolia* (of former *Pt. sect. Pectidium*) as the type of *Pectis* (Britton & Millspaugh, 1920), *Pt. sect. Pectidium* de facto became *Pt. sect. Pectis*. The species variously recognized within section *Eupectis* by Fernald or Gray have not been treated since, and do not form a monophyletic group in any of our analyses.

Pectis sect. *Heteropectis*, comprising *Pectis coulteri* and *Pt. multiseta* (sensu Gray 1852, Fernald, and Keil), is recovered as a well-supported clade (Clade B of Figs. 2, 8). Members of this section (Figs. 2, 8 clade B) are restricted to the Sonoran Desert of Baja California and mainland Mexico.

Pectis sect. *Pectis* (= *Pt. sect. Pectidium* Less. sensu Fernald, and later, Keil), is well supported and monophyletic (Clade A Figs. 2, 8). *Pectis* sect. *Pectis* has two species, *Pt. imberbis* and *Pt. linifolia* (the type of

Pectis). Both are tall, erect plants with sparse, cylindrical leaves and elongated internodes. This section (Figs. 2, 8 clade A) includes *Pt. imberbis*, a rare species of southern Arizona and northern Sonora region, and *Pt. linifolia*. *Pectis linifolia* is divided into two varieties. *Pectis linifolia* var. *hirtella* is a narrow endemic of Guerrero and Michoacan, Mexico, and *Pt. linifolia* var. *linifolia* is a weedy species widely distributed throughout *Pectis*' range.

Pectis sect. *Lorentea* has a complicated history. In 1797, the genus *Lorentea* was described by Ortega, and referred to a plant that was later identified as a member of the genus *Sanvitalia*. In 1816, Lagasca published the name *Lorentea* for species of *Pectis* that he considered separate from *Pectis*. The type of *Lorentea* Lag. was based on a specimen of *Pectis prostrata* Cav. from Cuba (this specimen was later identified as *Pt. humifusa* Sw.). In 1830, Lessing segregated a group of *Pectis* species into a new genus, for which he also used the name *Lorentea*. *Lorentea* Lag. and *Lorentea* Less. were both superfluous, but in practice, both names were used. Gray (1852) described section *Lorentea* A. Gray for species of *Pectis* with a biseriate pappus and a ray pappus sometimes greatly diminished or absent. He did not specify which species would be included. Schultz Bipontinus (Seemann et al., 1852) followed Gray's suggestion that *Lorentea* sensu Lessing was best included with *Pectis*, and transferred the *Lorentea* of de Candolle (1836) and Gardner (1846) into *Pectis* (Seemann et al., 1852). Although Keil (1977b) mentioned several species as members of *Pt. sect. Lorentea*, to our knowledge no one has treated the section with a listing of the species to be included. Those noted as "Lorentea" in Fig. 8 are the *Lorentea* species known at the time that Gray described *Pt. section Lorentea*.

The sole member of Gray's original *Pectis* subg. *Pectidopsis* was *Pt. angustifolia* (Gray, 1849). Gray later added *Pt. filipes* and *Pt. uniaristata*. Fernald followed Gray's definition of *Pectidopsis* as those *Pectis* species with a pappus that is coroniform or

has a few slender but rigid, scabrid awns. Fernald (1897) expanded the subgenus to include 12 taxa, which do not form a monophyletic group in the combined CP+ITS analyses (Appendix S4).

Fernald followed Gray's 1884 expanded definition of *Pectis* sect. *Pectothrix* as a taxon with a pappus (of the disc florets, if not the ray florets) of many equal or unequal bristles, which are often broad at the base, but not true scales. Neither Gray's nor Fernald's concept of section *Pectothrix* forms a monophyletic group in our analyses. On the contrary, their species appear scattered throughout the tree. However, all members of clade C correspond to *Pt.* sect. *Pectothrix* sensu Keil (1977a), with additional members of Keil's *Pt.* sect. *Pectothrix* found in clade D (Figs. 2, 8). Pappus morphology therefore seems to be homoplastic in *Pectis*.

Most species of clades C and D (Figs. 2, 8) occur in or adjacent to the Sonoran and Chihuahuan Deserts, and clade E contains many species of the Pacific Slope of Mexico, as well as those of South America and the Caribbean.

SECTIONAL RELATIONSHIPS WITHIN *POROPHYLLUM*. Results from our analyses suggest that the primary characters used to designate the sections of Johnson (1969), i.e., leaf morphology and habitat, do not define clades in *Porophyllum*. The species relationships show that the genus does not consist of two clades, which correspond to the two sections (Fig. 1). Geography correlates better with relationship, with Sonoran and Chihuahuan species at the base of the tree and southern Mexico-Central American and South American species forming the derived clades. Of the roughly eight South American species, four out of the five sampled form a well-supported clade. The fifth is *Pr. ruderale*, a variable species of tropical North and South America that is sister to the Honduran accession of *Pr. macrocephalum*, nested within the *Pr. macrocephalum* clade. Johnson (1969) subsumed over 20 described species and varieties into the single, widespread and variable *Pt. ruderale*, with two

subspecies, *Pr. ruderale* subsp. *macrocephalum* and *Pr. ruderale* subsp. *ruderale*. He used *Pr. ruderale* subsp. *macrocephalum* to refer to what he called the "northern" taxa (SW U.S. to northern Brazil, southern Peru, and Bolivia), and *Pr. ruderale* subsp. *ruderale* to refer to the "southern" taxa (Costa Rica and the West Indies south to southern Peru, through Brazil into northern Argentina). He noted that in northern South America, intermediate forms were common where the two taxa were sympatric. *Porophyllum leiocarpum*, endemic to Puerto Rico, was originally described by Urban as a variety of *Pr. macrocephalum* but was elevated to specific status by Rydberg and has been treated as such by subsequent authors (Rydberg, 1916; Johnson, 1969; McVaugh, 1984). In our analyses, we have followed Turner's (1996) morphological criteria in designating the Mexican and Central American taxa as *Pr. macrocephalum*, and the South American accession as *Pr. ruderale*. Although intermediate forms surely exist, Turner noted that *Pr. macrocephalum* has large heads on more stout peduncles and is diploid, whereas *Pr. ruderale* has small heads on slender peduncles, and is tetraploid. Ecuadorian and Brazilian *Pr. ruderale* have been reported as $n = 22, 23, 24, 34, 35$ and 36 (Turner et al., 1979; Robinson et al., 1981; Carr et al., 1999) but Dillon et al. (1982) reported $n = 12$ for a Peruvian accession. Therefore, although only diploid ($n = 11$) specimens of *Pr. macrocephalum* have been found in Chiapas (Strother, 1983) and Arizona (Keil & Pinkava, 1976), *Pr. ruderale* of South America has diploid and tetraploid (and possibly hexaploid) members. The North and Central American accessions (*Pr. macrocephalum*) have distinctly more ovate-oblong leaves, whereas the South American accessions (*Pr. ruderale*) have leaves that are linear-lanceolate. The accessions of *Pr. macrocephalum*, *Pr. ruderale* and *Pr. leiocarpum* form a well-supported clade, with the Central American accession of *Pr. macrocephalum* sister to the *Pr. ruderale* from Ecuador (Fig 4). *Porophyllum*

ruderales from Brazil appears in a clade with *Pr. angustissimum*, *Pr. lanceolatum*, and *Pr. linifolium*. Hind (2002) has noted that *Porophyllum* of Brazil and Argentina may be under collected, and that there could be diversity in the genus that has, in these areas, been overlooked.

POLYPLOIDY IN *PECTIS*. Roughly 40% of the known polyploids in *Pectis* occur on islands. Just nine of the ± 20 *Pectis* species that grow in the Caribbean or the Galapagos Islands have been examined in cytological studies, and of these, three are diploids, and six are polyploids. Thus while polyploids comprise 18% of the total *Pectis* species, they comprise 77% of the island species (Appendix S2). This pattern is also seen in Hawaii, where 80% of the native plants are polyploid (Carr, 1988). While these ratios could change if more *Pectis* species were sampled, there is no reason to think that the current sampling of cytological data is skewed toward diploid or polyploid taxa.

Two mechanisms are often proposed to explain why islands may be rich in polyploid species. The first is that there is a general trend toward self-fertilization in polyploids (Barringer, 2007) and autogamy is often proposed as one of the catalysts for a widespread distribution or successful colonization (Baker, 1955). However, the trend is not clear for the Asteraceae, which has sporophytic self-incompatibility (SSI). The breeding systems of most *Pectis* species are unknown, but Keil (1978) reported that *Pt. cylindrica*, a tetraploid, and *Pt. prostrata*, a diploid, are autogamous. A second explanation for the high occurrence of polyploidy on islands is that successful establishment favors plants with high genetic diversity (Carr, 1988) sometimes associated with polyploidy. Finally, many species in the Asteraceae have SSI systems that allow occasional self-fertilization. The ability to self-pollinate increases the odds of reproducing after a colonizing event.

Our results showed that all species of *Pectis* appear to use C₄ photosynthesis (see below). Genome duplication is one of the

preconditioning events proposed for a transition from C₃ to C₄ photosynthesis (Monson, 2003). Although 28% of the known species of *Pectis* are polyploid, these species are not at the base of the tree (Appendix S3). The four known independent origins of C₄ photosynthesis in the Asteraceae all occur within the Helianthoideae supertribe, in a group called the phytomelanic cypseloid clade. Barker et al. (2008) found evidence for at least two paleopolyploidy events in the history of the Asteraceae—one at the base of the family, and another in a lineage that eventually gave rise to *Helianthus*. They also found that genes related to cellular organization are overrepresented in the paleologs of the Asteraceae. Although these genome duplications may have allowed for novel functions that eventually gave rise to C₄ photosynthesis in the this group, the scarcity of C₄ lineages in the Asteraceae shows that many other conditions must be required.

ORIGIN AND EXTENT OF C₄ PHOTOSYNTHESIS. After Smith and Turner (1975) surveyed 20 *Pectis* and one *Porophyllum* species, it was suggested that all *Pectis* species were C₄, and all *Porophyllum* (and, in fact, the remainder of the Tageteae) were C₃. However, the closely-related *Flaveria* has just 21 species yet shows great variation in photosynthetic pathway, suggesting that similar variability might exist in *Porophyllum* (~25 spp.) or *Pectis* (~90 spp.). The $\delta^{13}\text{C}_{\text{‰}}$ values reported here appear to confirm that C₄ photosynthesis does not occur in *Porophyllum*. Furthermore, the switch from C₃ to C₄ appears to have happened after the generic split between *Pectis* and *Porophyllum*, as all *Pectis* have $\delta^{13}\text{C}_{\text{‰}}$ values indicative of C₄ photosynthesis.

North America is one of the hotspots of origin for C₄ photosynthesis (Sage et al., 2011), and the North American C₄ lineages for which divergence times have been estimated have appeared since the mid-late Miocene: 13 mya for *Tidestromia*, 6.1 mya for *Allionia*, 4.7 mya for *Boerhavia*, and 3.1 mya for *Flaveria* (Christin et al. 2011). The anatomical preconditioning that may

facilitate C_4 photosynthesis must be selected for, and in general, warm and dry environmental conditions are thought to make such adaptations more advantageous. Did *Pectis* evolve in such an environment? Keil (1978) suggested that the ancestors of *Pt.* sect. *Pectis* diverged in the Mexican Highlands. *Porophyllum amplexicaule* and *Pr. scoparium*, sister to the rest of *Pectis*+*Porophyllum*, are Chihuahuan desert species. The basal species within *Pectis* are distributed mostly in north and central Mexico from sea level to 800 m; *Pt.* sect. *Pectis* (*Pt. imberbis* and *Pt. linifolia*, clade A of Fig. 2) is sister to the rest of *Pectis*. *Pectis imberbis* is endemic to the Sonoran and Chihuahuan desert areas at the U.S./Mexico border, and *Pt. linifolia* var. *hirtella* is endemic to the Mexican states of Michoacan and Guerrero. After *Pt.* sect. *Pectis*, the next diverging clade (*Pt.* sect. *Heteropectis*) is endemic to the Sonoran Desert. Fossil evidence shows that the general drying trend since the late Miocene led to a flora of increasing tolerance to aridity, with an altitudinal fluctuation during the pluvial stages of the Pleistocene (Axelrod, 1979; Spaulding et al., 1983). The uplift of the Sierra Madre Occidental and Transvolcanic Belt further increased aridity by providing rain shadows. Becerra (2005) suggested these ranges provided a barrier to the northern cold fronts, thereby allowing the development of cold-intolerant taxa 10-20 mya. Although mesic woodlands existed in the present-day desert regions during the pluvial periods of the Pleistocene, evidence from pack-rat middens suggests that pockets of arid refugia persisted throughout these periods (Elias et al., 1995; Van Devender, 2000).

Our BEAST analysis recovers a mean date of ~11 mya for the common ancestor of *Pectis* and *Porophyllum* (Fig. 6), and given the geographic distributions of the basal species of the genera, we can surmise that they diverged in Central/Northern Mexico. Thus, C_4 photosynthesis in this lineage evolved in an area that was increasingly warm and dry, with a pattern of summer monsoon. Sage and

colleagues (2011) suggested that these are the environmental conditions that would increase photorespiration in C_3 lineages, setting the stage for a fitness advantage to C_3 - C_4 intermediacy.

SUMMARY

By sampling widely in both *Porophyllum* and *Pectis*, we have shown that *Pectis* is monophyletic and sister to a clade containing the majority of the 7 *Porophyllum* species. Just two recognized *Pectis* sections are monophyletic, and neither of the two *Porophyllum* sections is monophyletic. *Porophyllum amplexicaule* and *Pr. scoparium* are sister to the *Pectis*+*Porophyllum* clade, and should be treated as members of a new genus. Within *Pectis*, the Caribbean and South American species are in the more derived clades that also contain most of the polyploids of the genus. The evolution of C_4 photosynthesis in *Pectis* occurred at or after the initial divergence of *Pectis* and *Porophyllum*, in the late Miocene. In the time since they diverged, *Porophyllum* has diversified into ~25 species, whereas *Pectis* comprises at least 90 species. Perhaps the acquisition of the full C_4 syndrome fueled the success and relatively rapid diversification of the *Pectis*, the largest genus of the marigold tribe.

ACKNOWLEDGEMENTS

The authors thank Dave Cannatella, José Panero, Stan Roux, and the anonymous reviewers for providing valuable comments on earlier drafts of the manuscript. We thank the following colleagues for field-collecting assistance: Les Landrum and Liz Makings at Arizona State University; Tom Van Devender and Anna Lilia Reina in Sonora and Sinaloa, Mexico; Teodoro Clase and Alberto Veloz at The National Botanic Garden of Santo Domingo, Dominican Republic; Oscar Hinojosa and Enrique Ortiz at Universidad Nacional Autónoma de México, Mexico City. For general herbarium assistance, we

thank Tom Wendt and Lindsay Woodruff at the Plant Resources Center at The University of Texas at Austin. For providing specimen loans and/or permission to sample leaf material, we thank the following herbaria: ARIZ, GH, LPB, MEXU, MO, NYGB, TEX/LL, and US. We thank Tammy Sage for assistance with preliminary anatomical studies. This research was supported in part by a Doctoral Dissertation Award (DEB 0808388) from the National Science Foundation to DRH, multiple grants from The University of Texas at Austin Graduate Program in Plant Biology to DRH, the Lundell Chair of BBS, and the S.F. Blake Professorship to RKJ.

LITERATURE CITED

- Abbott, R. J., A. C. Brennan, J. K. James, D. G. Forbes, M. J. Hegarty, and S. J. Hiscock. 2009. Recent hybrid origin and invasion of the British Isles by a self-incompatible species, Oxford ragwort (*Senecio squalidus* L., Asteraceae). *Biological Invasions* 11: 1145–1158.
- Albers, C. C. 1942. Thimole in the volatile oil of *Pectis texana* Cory. *Pharmaceutical Arch.* 13: 29–31.
- Alvarez, I., and J. F. Wendel. 2003. Ribosomal ITS sequences and plant phylogenetic inference. *Molec. Phylogen. Evol.* 29: 417–434.
- Aristeguieta, L. 1964. *Flora de Venezuela*. Vol. 10, pt. 2 Compositae. Instituto Botánico, Caracas.
- Asprey, G. F., and Pt. Thornton. 1953. Medicinal Plants of Jamaica. Part I. *West Indian Medical J.* 2: 1–86.
- Axelrod, D. I. 1979. Age and origin of Sonoran Desert vegetation. *Occas. Paps. Calif. Acad. Sci.* 132: 1–74.
- Baker, H. G. 1955. Self-compatibility and establishment after 'long-distance' dispersal. *Evol.* 9: 347–348.
- Baldwin, B. G. 1993. Molecular phylogenetics of *Calycadenia* (Compositae) based on its sequences of nuclear ribosomal DNA: chromosomal and morphological evolution reexamined. *Amer. J. Bot.* 80: 222–238.
- , B. L. Wessa, and J. L. Panero. 2002. Nuclear rDNA evidence for major lineages of helenioid Heliantheae (Compositae). *Syst. Bot.* 27: 161–198.
- Barker, M. S., N. C. Kane, M. Matvienko, A. Kozik, R. W. Michelmore, S. J. Knapp, and L. H. Rieseberg. 2008. Multiple paleopolyploidizations during the evolution of the Compositae reveal parallel patterns of duplicate gene retention after millions of years. *Molec. Biol. Evol.* 25: 2445–2455.
- Barreda, V. D., L. Palazzesi, M. C. Telleria, L. Katinas, J. V. Crisci, K. Bremer, M. G. Passalia, R. Corsolini, R. R. Brizuela, and F. Bechis. 2010. Eocene Patagonia fossils of the daisy family. *Science* 329: 1621.
- Barringer, B. C. 2007. Polyploidy and self-fertilization in flowering plants. *Amer. J. Bot.* 94: 1527–1533.
- Bautista, H. P. 1987. *Pectis* L. (Compositae-Tageteae). *Espécies ocorrentes no Brasil. Arch. Jard. Bot. Rio de Janeiro* 28: 5–107.
- Becerra, J. X. 2005. Timing the origin and expansion of the Mexican tropical dry forest. *Proc. Nalt. Acad. Sci. (USA)* 102: 10919–10923.
- Besnard, G., A. M. Muasya, F. Russier, E. H. Roalson, N. Salamin, and P.-A. Christin. 2009. Phylogenomics of C₄ photosynthesis in sedges (Cyperaceae): multiple appearances and genetic convergence. *Molec. Biol. Evol.* 26: 1909–1919.
- Bradley, C. E., and A. J. Haagen-Smit. 1949. Essential oil of *Pectis papposa*. *Econ. Bot.* 3: 407–412.
- Brennan, A. C., D. A. Tabah, S. A. Harris, and S. J. Hiscock. 2011. Sporophytic self-incompatibility in *Senecio squalidus* (Asteraceae): S allele dominance interactions and modifiers of cross-compatibility and selfing rates. *Heredity* 106: 113–123.
- Britton, N. L., and A. Brown. 1913. *An Illustrated Flora of the Northern United States*, Ed. 2. Vol 3. C. Scribner's Sons, New York.
- , and C. F. Millsbaugh. 1920. *The Bahama Flora*, pp. 456–457. Authors, New York.
- Brown, N. J., K. Parsley, and J. M. Hibberd. 2005. The future of C₄ research - maize, *Flaveria* or *Cleome*? *Trends Pl. Sci.* 10: 215–221.
- Bye, R. 1996. Medicinal plants of the Sierra Madre: comparative study of Tarahumara and Mexican market plants. *Econ. Bot.* 40: 103–124.
- Cabrera, A. L. 1978. Compositae (Parte X). In A. L. Cabrera [ed.], *Flora de la Provincia de Jujuy, Republica Argentina*. Coleccion Cientifica del INTA, Buenos Aires.
- Carr, G. D. 1988. Chromosome evolution and speciation in Hawaiian flowering plants. In T. F. Stuessy and M. Ono [eds.], *Evolution and Speciation of Island Plants*. Cambridge University Press, Cambridge.
- , R. M. King, A. M. Powell, and H. Robinson. 1999. Chromosome numbers in Compositae. XVIII. *Amer. J. Bot.* 86: 1003–1013.
- Cassini, H. 1819. Sixième mémoire sur la famille des Synanthérées, contenant les caractères des tribus. *J. Physique Chimie Hist. Nat.* 88: 150–163, 189–204.
- Cerling, T. E. 1999. Paleorecords of C₄ plants and ecosystems. In R. F. Sage and R. K. Monson [eds.], *C₄ plant biology*, 445–469, Academic Press, San Diego, California.
- Christin, P.-A., C. P. Osborne, R. F. Sage, M. Arakaki, and E. J. Edwards. 2011. C₄ eudicots are not younger than C₄ monocots. *J. Exp. Bot.* 62: 3171–3181.

- , T. L. Sage, E. J. Edwards, M. R. Ogburn, R. Khoshravesh, and R. F. Sage. 2010. Complex evolutionary transitions and the significance of C₃–C₄ intermediate forms of photosynthesis in Molluginaceae. *Evol.* 65: 643–660.
- , G. Besnard, E. Samaritani, M. R. Duvall, T. R. Hodkinson, V. Savolainen, and N. Salamin. 2008. Oligocene CO₂ decline promoted C₄ photosynthesis in grasses. *Current Biol.* 18: 37–43.
- Cunningham, C. W. 1997. Can three incongruence tests predict when data should be combined? *Molec. Biol. Evol.* 14: 733–740.
- da Silva, Milton Helie L., Eloisa Helena A. Andrade, and José Guilherme S. Maia. 2005. The essential oil of *Pectis elongata* Kunth occurring in north Brazil. *Flav. Frag. J.* 20: 462–464.
- Darlu, P., and G. Lecointre. 2002. When does the incongruence length difference test fail? *Molec. Biol. Evol.* 19: 432–437.
- de Candolle, A. P. 1836. *Prodromus systematis naturis regni vegetabilis, sive enumeratio contracta ordinum generum, specierumque plantarum*. Treuttel & Würtz, Paris.
- Dillon, M., and B. L. Turner. 1982. Chromosome numbers of some Peruvian Compositae. *Rhodora* 84: 131–137.
- Downie, S. R., D. S. Katz-Downie, and M. F. Watson. 2000. A phylogeny of the flowering plant family Apiaceae based on chloroplast DNA *rpl16* and *rpoCl* intron sequences: towards a suprageneric classification of subfamily Apioideae. *Amer. J. Bot.* 87: 273–292.
- Downum, K. R., D. J. Keil, and E. Rodriguez. 1985. Distribution of acetylenic thiophenes in the Pectidinae. *Bioch. Syst. Ecol.* 13: 109–113.
- , and E. Rodriguez. 1986. Toxicological action and ecological importance of plant photosensitizers. *J. Chem. Ecol.* 12: 823–834.
- , S. Villegas, E. Rodriguez, and D. J. Keil. 1989. Plant photosensitizers: A survey of their occurrence in arid and semiarid plants from North America. *J. Chem. Ecol.* 15: 345–355.
- Drummond, A. J., and A. Rambaut. 2007. BEAST: Bayesian evolutionary analysis by sampling trees. *BMC Evol. Biol.* 7: 214.
- Elias, S. A., T. R. Van Devender, and R. de Baca. 1995. Insect fossil evidence of late glacial and Holocene environments in the Bolson De Mapimi, Chihuahua Desert, Mexico: comparisons with the Paleobotanical record. *Palaios* 10: 454–464.
- Engelmann, S., O. E. Blasing, U. Gowik, P. Svensson, and P. Westhoff. 2003. Molecular evolution of C₄ phosphoenolpyruvate carboxylase in the genus *Flaveria* - a gradual increase from C₃ to C₄ characteristics. *Planta* 217: 717–725.
- Felsenstein, J. 1988. Phylogenies from molecular sequences: Inference and reliability. *Ann. Rev. Genet.* 22: 521–565.
- Fernald, M. L. 1897. A systematic study of the United States and Mexican species of *Pectis*. *Proc. Amer. Acad. Arts. Sci.* 33: 57–86.
- Gardner, G. 1846. *Flora of Brazil*. London J. Bot. 5: 239–242.
- Gowik, U., and P. Westhoff. 2011. The path from C₃ to C₄ photosynthesis. *Pl. Physiol.* 155: 56–63.
- Gray, A. 1849. *Plantae Fendlerianae Novi-Mexicanae*. *Mem. Amer. Acad. Arts.* 4: 1–116.
- . 1852. *Plantae Wrightianae Texano-Neo-Mexicanae*. I. *Smithsonian Contr. Knowledge* 3: 1–146.
- . 1884. Contributions to North American botany. *Proc. Amer. Acad. Arts Sci.* 19: 1–96.
- . 1888. *Synoptical Flora of North America*. The Gamopetalae. Compositae. *Smithsonian Miscellaneous Collections* 591.
- GSA. 2009. Geologic Timescale. The Geological Society of America. Accessed March, 2012. <http://www.geosociety.org/science/timescale/>.
- Hansen, D. R., G. S. Spicer, and R. Patterson. 2009. Phylogenetic relationships and within *Phacelia* sections *Whitlavia* and *Gymnobythis* (Boraginaceae). *Syst. Biol.* 34: 737–746.
- Harpke, D., and A. Peterson. 2008. 5.8S motifs for the identification of pseudogenetic ITS regions. *Botany* 86: 300–305.
- Hillis, D. M., and J. J. Bull. 1993. An empirical test of bootstrapping as a method for assessing confidence in phylogenetic analysis. *Syst. Biol.* 42: 182–192.
- Hind, D. J. N. 2002. A new species of *Porophyllum*. (Compositae: Heliantheae) from Bahia, Brazil. *Kew Bull.* 57: 705–709.
- Hiscock, S. J. 2000. Self-incompatibility in *Senecio squalidus* L (Asteraceae). *Ann. Bot.* 85: 181–190.
- Huelsenbeck, J. P., and F. Ronquist. 2001. MRBAYES: Bayesian inference of phylogeny. *Bioinformatics* 17: 754–755.
- Jansen, R. K., and J. D. Palmer. 1987. A chloroplast DNA inversion marks an ancient evolutionary split in the sunflower family (Asteraceae). *Proc. Natl. Acad. Sci. USA* 84: 5818–5822.
- Johnson, R. R. 1969. Monograph of the plant genus *Porophyllum* (Compositae: Helenieae). *Kansas Univ. Sci. Bull.* XL VIII: 225–267.
- Jørgensen, P. M., and S. León-Yáñez. 1999. Catalogue of the Vascular Plants of Ecuador. In P. M. Jørgensen and S. León-Yáñez [eds.], *Monographs in Systematic Botany from the Missouri Botanical Garden* Missouri Botanical Garden Press, St. Louis.
- Jung, M.-J., C.-W. Hsien, Y.-C. Kao, and C.-L. Yeh. 2011. *Pectis* L. (Asteraceae), a newly recorded genus to the Flora of Taiwan. *Taiwania* 56: 173–176.
- Kadereit, G., T. Borsch, K. Weising, and H. Freitag. 2003. Phylogeny of Amaranthaceae and Chenopodiaceae and the evolution of C₄ photosynthesis. *Internatl. J. Pl. Sci.* 164: 959–986.
- Keil, D. J. 1975. Revision of *Pectis* sect. *Heteropectis*. (Compositae: Tageteae). *Madroño* 23: 181–191.

- . 1977a. A revision of *Pectis* section *Pectothrix* (Compositae: Tageteae). *Rhodora* 79: 32–78.
- . 1977b. Chromosome studies in North and Central American species of *Pectis* L. (Compositae: Tageteae). *Rhodora* 79: 79–93.
- . 1978. Revision of *Pectis* section *Pectidium* (Compositae Tageteae). *Rhodora* 80: 135–146.
- . 1984. New species of *Pectis* (Asteraceae) from the West-Indies, Mexico, and South-America. *Brittonia* 36: 74–80.
- . 1996. *Pectis*. pp. 22–43 in *The Comps of Mexico: A systematic account of the Family Asteraceae. 6: Tageteae and Anthemideae*. *Phytologia Mem.* 10: 1–93.
- . 2002. Two new species of *Pectis* (Asteraceae: Tageteae) from South America. *Novon* 12: 471–473.
- . 2006. *Pectis*. In: *Flora of North America* Editorial Committee, eds. 1993+ *Flora of North America North of Mexico*. 28+ vols. New York and Oxford. Vol. 21, pp. 222–230.
- , and **S. Stuessy**. 1975. Chromosome counts of Compositae from the United States, Mexico, and Guatemala. *Rhodora* 77: 171–195.
- , and **D. J. Pinkava**. 1976. Chromosome counts and taxonomic notes for Compositae from the United States and Mexico. *Amer. J. Bot.* 63: 1393–1403.
- , and **J. D. Morefield**. 1989. *Porophyllum pygmaeum* (Asteraceae) a disinctive new species from southern Nevada. *Syst. Bot.* 14: 583–588.
- , **M. A. Luckow**, and **D. J. Pinkava**. 1988. Chromosome-studies in Asteraceae from the United-States, Mexico, the West-Indies, and South-America. *Amer. J. Bot.* 75: 652–668.
- Kellogg, E. A.** 1999. Phylogenetic aspects of the evolution of C₄ photosynthesis. In R. F. Sage and R. K. Monson [eds.], *C₄ Plant Biology*, pp. 411–444, Academic Press, San Diego, California.
- Kim, K. J., K. S. Choi, and R. K. Jansen.** 2005. Two chloroplast DNA inversions originated simultaneously during the early evolution of the sunflower family (Asteraceae). *Molec. Biol. Evol.* 22: 1783–1792.
- Kimball, R. T., and D. J. Crawford.** 2004. Phylogeny of Coreopsidae (Asteraceae) using ITS sequences suggests lability in reproductive characters. *Molec. Phylogenet. Evol.* 33: 127–139.
- Lagasca, M.** 1816. *Genera et species plantarum* 28. Matriti ex Typographia Regia.
- Lessing, C. F.** 1830. *De synanthereis herbarii regni Berolinensis. Dissertatio secunda. Nassauviae.* *Linnaea* 5: 1–236.
- Linnaeus, C.** 1759. *Systema naturae*. Ed. 10. Tomus II: Vegetabilia, Stockholm.
- Liogier, A. H.** 1962. *Flora de Cuba*, Tomo V. Editorial Universitaria, Universidad de Puerto Rico, Rio Piedras.
- . 1996. *La flora de la Española*. VIII. Universidad Central del Este, San Pedro de Macoris.
- . 2000. *Flora of Puerto Rico and Adjacent Islands: a Systematic Synopsis*. Editorial de la Universidad de Puerto Rico, Rio Piedras.
- Loockerman, D. J., B. L. Turner, and R. K. Jansen.** 2003. Phylogenetic relationships within the Tageteae (Asteraceae) based on nuclear ribosomal ITS and chloroplast *ndhF* gene sequences. *Syst. Bot.* 28: 191–207.
- Löve, Á.** 1974. IOPB Chromosome number reports XLV. *Taxon* 23: 619–624.
- Maddison, D. R., and W. Maddison.** 2005. *MacClade 4: Analysis of phylogeny and character evolution*. Sinauer Associates, Inc., Sunderland, Massachusetts.
- Marchese, J. A., F. Broetto, L. C. Ming, C. Ducatti, R. A. Rodella, M. C. Ventrella, G. D. R. Gomes, and L. de Franceschi.** 2005. Carbon isotope composition and leaf anatomy as a tool to characterize the photosynthetic mechanism of *Artemisia annua* L. *Brazilian J. Pl. Physiol.* 17: 187–190.
- Marshall, D. M., R. Muhaidat, N. J. Brown, Z. Liu, S. Stanley, H. Griffiths, R. F. Sage, and J. M. Hibberd.** 2007. *Cleome*, a genus closely related to *Arabidopsis*, contains species spanning a developmental progression from C₃ to C₄ photosynthesis. *Plant J.* 51: 886–896.
- McKown, A. D., and N. G. Dengler.** 2007. Key innovations in the evolution of Kranz anatomy and C₄ vein pattern in *Flaveria* (Asteraceae). *Amer. J. Bot.* 94: 382–399.
- , **J. M. Moncalvo, and N. G. Dengler.** 2005. Phylogeny of *Flaveria* (Asteraceae) and inference of C₄ photosynthesis evolution. *Amer. J. Bot.* 92: 1911–1928.
- McNeill, J.** 2006. *International Code of Botanical Nomenclature*. Seventeenth International Botanical Congress, Vienna, Austria, 146.
- McVaugh, R.** 1984. *Pectis*. In W. R. Anderson [ed.], *Flora Novo-Galiciana*, 760–771, University of Michigan Press, Ann Arbor.
- Molero, J., A. Rovira, J. Simón, R. Duré, and D. Franco.** 2002. IOPB chromosome data 18. *Newsletter Int. Organ. Pl. Biosyst. (Pruhonice)* 34: 22–24.
- Monson, R. K.** 2003. Gene duplication, neofunctionalization, and the evolution of C₄ photosynthesis. *Internat. J. Pl. Sci.* 164: S43–S54.
- Muhaidat, R., R. F. Sage, and N. G. Dengler.** 2007. Diversity of Kranz anatomy and biochemistry in C₄ eudicots. *Amer. J. Bot.* 94: 362–381.
- Ocampo, G., and J. T. Columbus.** 2010. Molecular phylogenetics of suborder Cactineae (Caryophyllales), including insights into photosynthetic diversification and historical biogeography. *Amer. J. Bot.* 97: 1827–1847.
- Osborne, C. P.** 2011. The Geologic History of C₄ Plants. In A. S. Raghavendra and R. F. Sage [eds.], *Advances in Photosynthesis and Respiration*, 339–357, Springer, Dordrecht.

- Panero, J. L.** 2007. Compositae: Tribe Tageteae Cass (1819). In J. W. Kadereit and C. Jeffrey [eds.], *Flowering Plants, Eudicots, Asterales*, 420–431, Springer-Verlag, Berlin.
- , and **V. A. Funk.** 2008. The value of sampling anomalous taxa in phylogenetic studies: major clades of the Asteraceae revealed. *Molec. Phylogen. Evol.* 47: 757–782.
- Petersen, B. J., and B. Fry.** 1987. Stable isotopes in ecosystem studies. *Ann. Rev. Ecol. Syst.* 18: 293–320.
- Pinkava, D. J., and D. J. Keil.** 1977. Chromosome counts of Compositae from the United States and Mexico. *Amer. J. Bot.* 64: 680–686.
- Posada, D., and K. A. Crandall.** 1998. Modeltest: testing the model of DNA substitution. *Bioinformatics* 14: 817–818.
- Powell, A. M., and B. L. Turner.** 1963. Chromosome numbers in the Compositae. VII. Additional species from the southwestern United States and Mexico. *Madroño* 17: 128–140.
- , and **S. Sikes.** 1970. Chromosome numbers of some Chihuahuan Desert Compositae. *S. W. Naturalist* 15: 175–186.
- Ralston, B., G. Nesom, and B. L. Turner.** 1989. Documented plant chromosome numbers 1989:1. Chromosome numbers in Mexican Asteraceae with special reference to the Tribe *Tageteae*. *Sida* 13: 359–368.
- Rambaut, A.** 2008. FigTree version 1.3.1. Distributed by the author. <http://tree.bio.ed.ac.uk/software/figtree>. Accessed March 2012.
- , and **A. J. Drummond.** 2007. Tracer v1.5 2003–2009 MCMC Trace Analysis Package. <http://beast.bio.ed.ac.uk/Tracer>.
- Raven, P. H., and D. W. Kyhos.** 1961. Chromosome numbers in Compositae. II. Helenieae. *Amer. J. Bot.* 48: 842–850.
- Reveal, J. L., and R. Moran.** 1977. Miscellaneous chromosome counts of western American plants—IV. *Madroño* 24: 227–235.
- , and **R. Spellenberg.** 1976. Miscellaneous chromosome counts of Western American plants—III. *Rhodora* 78: 37–72.
- Robinson, H.** 1981. A revision of the tribal and subtribal limits of the Heliantheae (Asteraceae). *Smithsonian Contrib. Bot.* 51: 1–102.
- , **A. M. Powell, R. M. King, and J. F. Weedon.** 1981. Chromosome Numbers in Compositae, XII: Heliantheae. Smithsonian Institution Press, Washington, D. C.
- Rydberg, P. A.** 1916. (Carduales) Carduaceae. Tageteae, Anthemidae. *N. Am. Fl.* 34: 181–288.
- Sage, R. F.** 2003. The evolution of C₄ photosynthesis. *New Phytol.* 161: 341–370.
- , **P.-A. Christin, and E. J. Edwards.** 2011. The C₄ plant lineages of planet Earth. *J. Exp. Bot.* 62: 3155–3169.
- , **T. L. Sage, and R. W. Kocacinar.** 2012. Photorespiration and the evolution of C₄ photosynthesis. *Ann. Rev. Pl. Biol.* 63: 19–47.
- , **T. L. Sage, R. W. Pearcy, and T. Borsch.** 2007. The taxonomic distribution of C₄ photosynthesis in Amaranthaceae sensu stricto. *Amer. J. Bot.* 94: 1992–2003.
- Schöch, E.** 1971. Mata und Aspartat als Hauptprodukte der ¹⁴CO₂-Kurzzeit Fixierung nun auch bei einer Composite. *Z. Pflanzenphysiol.* 64: 367–368.
- , and **K. Kramer.** 1971. Korrelation von Merkmalen der C₄-Photosynthese bei Vertretern verschiedener Ordnungen der Angiospermen. *Planta* 101: 51–66.
- Seemann, B.** 1852–1857. *The Botany of the Voyage of H.M.S. Herald: Under the Command of Captain Henry Kellett, R.N., C.B., During the Years 1845–51.* Lovell Reeve, London.
- Shaw, J., E. B. Lickey, E. E. Schilling, and R. L. Small.** 2007. Comparison of whole chloroplast genome sequences to choose noncoding regions for phylogenetic studies in angiosperms: the tortoise and the hare III. *Amer. J. Bot.* 94: 275–288.
- Shimodaira, H.** 2002. An approximately unbiased test of phylogenetic tree selection. *Syst. Biol.* 51: 492–508.
- , and **M. Hasegawa.** 2001. CONSEL: for assessment the confidence of phylogenetic tree selection. *Bioinformatics* 17: 1246–1247.
- Smith, B. N., and B. L. Turner.** 1975. Distribution of Kranz syndrome among Asteraceae. *Amer. J. Bot.* 62: 541–545.
- Soares, C. C., T. M. Marques, G. G. Rigolin, E. Neis, A. M. V. Friaça, A. S. Silva, G. S. Barreto, and L. Lopes.** 2009. Atividade analgésica do extrato da *Pectis jangadensis* (S. Moore). *Braz. J. Pharmacognosy* 19(1A): 77–81.
- Spaulding, W. G., E. B. Leopold, and T. R. van Devender.** 1983. Late Wisconsin paleoecology of the American Southwest. In S. C. Porter [ed.], *Late-Quaternary Environments of the United States.* University of Minnesota Press, Minneapolis.
- Stamatakis, A.** 2006. RAxML-VI-HPC: maximum likelihood-based phylogenetic analysis with thousands of taxa and mixed models. *Bioinformatics* 22: 2688–2690.
- Strother, J. L.** 1977. Tageteae—systematic review. In V. H. Heywood, J. B. Harborne, and B. L. Turner [eds.], *The Biology and Chemistry of the Compositae*, 769–783, Academic Press, New York.
- . 1983. More chromosome studies in Compositae. *Amer. J. Bot.* 70: 1217–1224.
- , and **J. L. Panero.** 2001. Chromosome studies: Mexican Compositae. *Amer. J. Bot.* 88: 499–502.
- Timme, R. E., J. V. Kuehl, J. L. Boore, and R. K. Jansen.** 2007. A comparative analysis of the *Lactuca* and *Helianthus* (Asteraceae) plastid genomes:

- identification of divergent regions and categorization of shared repeats. *Amer. J. Bot.* 94: 302–312.
- Turner, B. L.** 1996. *Porophyllum*. pp. 43–50 in *The Comps of Mexico: A systematic account of the Family Asteraceae. 6: Tageteae and Anthemideae*. Phytologia Memoirs 10: 1–93.
- , and **D. Flyr.** 1966. Chromosome numbers in the Compositae. X. North American species. *Amer. J. Bot.* 53: 24–33.
- , **J. Bacon, L. Urbatsch, and B. Simpson.** 1979. Chromosome numbers in South American Compositae. *Amer. J. Bot.* 66: 173–178.
- , **J. H. Beaman, and H. F. L. Rock.** 1961. Chromosome numbers in the Compositae. V. Mexican and Guatemalan species. *Rhodora* 63: 121–129.
- Van Devender, T. R.** 2000. The deep history of the Sonoran Desert. In S. J. Phillips and P. W. Cornus [eds.], *A Natural History of the Sonoran Desert*, 61–69, Arizona-Sonoran Desert Museum Press, Tucson.
- Vogan, Pt. J., M. W. Frohlich, and R. F. Sage.** 2007. The functional significance of C₃–C₄ intermediate traits in *Heliotropium* L. (Boraginaceae): gas exchange perspectives. *Plant. Cell Environ.* 30: 1337–1345.
- Wagner, W. L., D. R. Herbst, and S. H. Sohmer.** 1990. *Manual of the Flowering Plants of Hawai'i* (Bishop Museum Special Publication). University of Hawai'i Press, Bishop Museum Press, Honolulu.
- Werle, E., C. Schneider, M. Renner, M. Völker, and W. Fiehn.** 1994. Convenient single-step, one tube purification of PCR products for direct sequencing. *Nucl. Acids Res.* 20: 4354–4355.
- Westhoff, P., and U. Gowik.** 2004. Evolution of C₄ phosphoenolpyruvate carboxylase. Genes and proteins: a case study with the genus *Flaveria*. *Ann. Bot.* 93: 13–23.
- White, T. J., S. L. Bruns, and J. Taylor.** 1990. Amplification and direct sequencing of fungal ribosomal RNA genes for phylogenetics. In M. Innis, D. Gelfand, J. Sninsky, and T. White [eds.], *PCR Protocols: a Guide to Methods and Application*, 315–322, Academic Press, San Diego.
- Wiggins, I. L., and D. M. Porter.** 1971. *Flora of the Galápagos Islands*. Stanford University Press, Stanford, California.
- Wilcox, T. P., D. J. Zwickl, T. A. Heath, and D. M. Hillis.** 2002. Phylogenetic relationships of the dwarf boas and a comparison of Bayesian and bootstrap measures of phylogenetic support. *Molec. Phylogenet. Evol.* 25: 361–371.
- Wilgenbusch, J. C., D. L. Warren, and D. L. Swofford.** 2004. AWTY: A system for graphical exploration of MCMC convergence in Bayesian phylogenetic inference., <http://ceb.csit.fsu.edu/awty>.
- Zhao, Z., and B. L. Turner.** 1993. Documented chromosome numbers 1993: 3. Miscellaneous U.S.A. and Mexican species, mostly Asteraceae. *Sida* 15: 649–653.

APPENDICES

APPENDIX 1. List of taxa sampled in the following order: *taxon*, i.d. number (when more than one accession per species): voucher information (herbarium), GenBank accession numbers for ITS, *matK*, 3' *ndhF*, *rpl16* intron, *trnL-rpl32*, 3' *trnV-ndhC*, 5' *trnY-rpoB*. An asterisk denotes accessions that did not amplify for a particular locus. Herbarium acronyms follow Index Herbariorum.

Chrysactinia mexicana A. Gray, Coahuilla, Mexico, *E. L. Bridges 13067* (TEX), KJ524912, KJ525212, KJ525071, KJ557938, KJ558064, KJ525508, KJ525358. *Nicolletia edwardsii* A. Gray, Coahuilla, Mexico, *D. R. Hansen 65* (TEX), KJ524913, KJ525213, KJ525072, KJ557939, KJ558065, KJ525509, KJ525359. *Pectis amplifolia* D.J. Keil, Oaxaca, Mexico, *M. Elorsa C. 5010* (TEX), KJ524915, KJ525215, KJ525074, KJ557941, KJ558067, KJ525511, KJ525361. *Pt. angustifolia* var. *angustifolia* Torr., No. 1: Chihuahua, Mexico, *D. R. Hansen 80* (TEX), KJ524916, KJ525216, KJ525075, KJ557942, KJ558068, KJ525512, KJ525362. No. 2: Texas, U.S.A., *B.L. Turner 22409* (TEX), KJ524917, KJ525217, KJ525076, KJ557943, KJ558069, KJ525513, KJ525363. *Pt. angustifolia* var. *fastigiata* (A. Gray) D.J. Keil, No. 1: Texas, U.S.A., *D. R. Hansen 148* (TEX), KJ525060, KJ525351, KJ525204, KJ558055, KJ558212, KJ525641, KJ525499. No. 2: Texas, U.S.A., *W. R. Carr 15797* (TEX), KJ524918, KJ525218, KJ525077, KJ557944, KJ558070, KJ525514, KJ525364. *Pt. angustifolia* var. *tenella* (DC.) D.J. Keil, No. 1: Mexico, *D. R. Hansen 63* (TEX), *, KJ525219, KJ525078, KJ557945, KJ558071, KJ525515, KJ525365. No. 2: Coahuilla, Mexico, *D. R. Hansen 69* (TEX), KJ524919, KJ525220, KJ525079, KJ557946, KJ558072, KJ525516, KJ525366. *Pt. barberi* Greenm., Chihuahua, Mexico, *J. Spencer 1454* (TEX), KJ524920, KJ525221, KJ525080, KJ557947, KJ558073, KJ525517, KJ525367. *Pt. berlandieri* DC., Tamaulipas, Mexico, *M. C. Johnston 5579* (TEX), KJ524921, KJ525222, KJ525081, KJ557948, KJ558074, KJ525518, KJ525368. *Pt. bonplandiana* Kunth, Belize City, Belize, *R. D. Worthington 21255* (TEX), KJ524922, KJ525223, KJ525082, KJ557949, KJ558075, KJ525519, KJ525369. *Pt. brevipedunculata* Sch. Bip., No. 1: Bahia, Brazil, *V. C. Souza 5.391* (LL), KJ524923, KJ525224, KJ525083, *, KJ558076, KJ525520, KJ525370. No.

2: Minas Gerais, Brazil, *R. M. Harley H 49978* (MO), KJ525030, KJ525323, KJ525178, KJ558029, KJ558182, KJ525614, KJ525471. **Pt. canescens** Kunth, No. 1: Nariño, Colombia, *B. R. Ramirez Pt. s.n.* (MO), KJ525029, KJ525322, KJ525177, *, KJ558181, KJ525613, KJ525470. No. 2: Guerrero, Mexico, *A. Cronquist 10842* (TEX), KJ524924, KJ525225, KJ525084, KJ557950, KJ558077, KJ525521, KJ525371. No. 3: Sinaloa, Mexico, *M. Ruiz G. 2006-459* (TEX), KJ524966, KJ525262, KJ525121, KJ557978, KJ558120, KJ525556, KJ525411. **Pt. capillipes** (Benth.) Hemsl., El Salvador, *J. M. Tucker 456* (LL), KJ524925, *, KJ525085, *, KJ558078, *, KJ525372. **Pt. carthusianorum** Less., Dominican Republic, *Dr. A. & P. Liogier* (NYBG), KJ524926, *, KJ525086, *, KJ558079, * KJ525373. **Pt. ciliaris** L., No. 1: San Cristobal, Dominican Republic, *T. Classe 4401* (TEX), KJ524983, *, *, KJ557992, KJ558137, KJ525571, *. No. 2: Monte Plata, Dominican Republic, *D. R. Hansen 98* (TEX), KJ524927, KJ525226, KJ525087, KJ557951, KJ558080, KJ525522, KJ525374. *cf. ciliaris* L., Guyas, Ecuador, *E. Asplund 5620* (TEX), KJ524928, KJ525227, KJ525088, *, KJ558081, KJ525523, KJ525375. **Pt. coulteri** Harv. & A. Gray, No. 1: Sonora, Mexico, *A. Sanders 13193* (TEX), KJ524929, KJ525228, *, KJ557952, KJ558082, KJ525524, KJ525376. No. 2: Sonora, Mexico, *A.L. Reina G. 2007-254* (TEX), KJ524931, KJ525230, KJ525090, *, KJ558084, KJ525526, KJ525378. No. 3: Sonora, Mexico, *D. R. Hansen 117* (TEX), KJ524930, KJ525229, KJ525089, KJ557953, KJ558083, KJ525525, KJ525377. **Pt. cubensis** (A. Rich.) Griseb., Grand Cayman Island, *N. Chevalier 149* (NYBG), KJ524932, KJ525231, KJ525091, KJ557954, KJ558085, KJ525527, KJ525379. **Pt. cylindrica** (Fernald) Rydb., No. 1: Sonora, Mexico, *A. L. Reina G. 2006-507* (TEX), KJ524933, KJ525232, KJ525092, KJ557955, KJ558086, KJ525528, KJ525380. No. 2: Sonora, Mexico, *T. R. Van Devender 2007-865* (TEX), KJ524934, KJ525233, KJ525093, KJ557956, KJ558087, KJ525529, KJ525381. **Pt. decemcarinata** McVaugh, No. 1: Michoacan, Mexico, *D. R. Hansen 139* (TEX), KJ525050, KJ525341, KJ525195, KJ558045, KJ558202, KJ525631, KJ525490. No. 2: Michoacan, Mexico, *Jose C. Soto Nuñez 3582* (MO), KJ525034, KJ525326, KJ525180, KJ558031, KJ558186, KJ525616, KJ525474. No. 3: Michoacan, Mexico, *M. Luckow 2937* (TEX), KJ524935, KJ525234, KJ525094, KJ557957, KJ558088, KJ525530, KJ525382. **Pt. depressa** Fernald, No. 1: Guerrero, Mexico, *A. M. Powell & J. Edmondson 768* (TEX), KJ524936, KJ525235, KJ525095, KJ557958, KJ558089, KJ525531, KJ525383. No. 2: Guerrero, Mexico, *Y. Yahara 1353* (TEX), KJ525063, *, *, *, KJ558215, *, KJ525502. **Pt. diffusa** Hook. & Arn., Michoacán, Mexico, *D. R. Hansen 135* (TEX), KJ525048, KJ525339, KJ525193, KJ558043, KJ558200, KJ525629, KJ525488. **Pt. elongata** var. *elongata* Kunth, Concepción, Paraguay, *E. M. Sardini 38698* (MO), *, *, *, KJ558185, *, *. **Pt. elongata** var. *fasciculiflora* (DC.) D.J. Keil, No. 1: Guerrero, Mexico, *Fred R. Barrie 732* (TEX), KJ524937, *, *, *, KJ558090, *, *. No. 2: Guerrero, Mexico, *R. Torres C. 1809* (MO), KJ525033, KJ525325, *, KJ558030, KJ558184, *, KJ525473. **Pt. elongata** var. *floribunda* (A. Rich.) D.J. Keil, No. 1: Monte Plata, Dominican Republic, *D. R. Hansen 100* (TEX), KJ524938, KJ525236, KJ525096, KJ557959, KJ558091, KJ525532, KJ525384. No. 2: Veracruz, Mexico, *J. Dorantes 5076* (TEX), KJ524939, KJ525237, *, *, KJ558092, *, KJ525385. **Pt. elongata** var. *oerstediana* (Rydb.) D.J. Keil, Guatemala, *E. Contreras 10400* (TEX), KJ524940, KJ525238, KJ525097, *, KJ558093, *, KJ525386. **Pt. ericifolia** D.J. Keil, Barbuda, *Richard S. Cowan 1663* (NYBG), KJ524941, *, *, *, KJ558094, *, *. **Pt. exilis** D.J. Keil, No. 1: Guerrero, Mexico, *J. Calónico Soto 17612* (MEXU), KJ525058, KJ525349, KJ525202, KJ558053, KJ558210, KJ525639, KJ525497. No. 2: Michoacán, Mexico, *D. R. Hansen 138* (TEX), KJ525049, KJ525340, KJ525194, KJ558044, KJ558201, KJ525630, KJ525489. **Pt. exserta** McVaugh, No. 1: Jalisco, Mexico, *R. McVaugh 26321* (MEXU), KJ525055, KJ525346, KJ525200, KJ558050, KJ558207, KJ525636, KJ525495. No. 2: Jalisco, Mexico, *A. C. Sanders 11177* (MO), KJ525032, KJ525324, KJ525179, *, KJ558183, KJ525615, KJ525472. **Pt. filipes** var. *filipes* Harv. & A. Gray, Sonora, Mexico, *A.L. Reina G. 2006-509* (TEX), KJ524943, KJ525240, KJ525099, KJ557961, KJ558096, KJ525534, KJ525388. **Pt. filipes** var. *subnuda* Fernald, No. 1: Texas, U.S.A., *Emily J. Lott 5257* (TEX), KJ524944, KJ525241, KJ525100, KJ557962, KJ558097, KJ525535, KJ525389. No. 2: New Mexico, U.S.A., *R. D. Worthington 27323* (TEX), KJ524945, KJ525242, KJ525101, KJ557963, KJ558098, KJ525536, KJ525390. No. 3: Arizona, U.S.A., *D. R. Hansen 85* (TEX), KJ524942, KJ525239, KJ525098, KJ557960, KJ558095, KJ525533, KJ525387. **Pt. glaucescens** (Cass.) D.J. Keil, No. 1: Bahama Islands, *D. S. Correll 49664* (NYBG), KJ524947, KJ525244, KJ525103, KJ557965, KJ558100, KJ525538, KJ525392. No. 2: Florida, U.S.A., *Ruben Pt. 8755* (TEX), KJ524948, *, KJ525104, *, KJ558101, *, *. No. 3: Distrito Nacional, Dominican Republic, *D. R. Hansen 111* (TEX), KJ524946, KJ525243, KJ525102, KJ557964, KJ558099, KJ525537, KJ525391. **Pt. graveolens** Klatt, Colombia, *J. E. Ramos 459* (MO), KJ525028, KJ525321, KJ525176, KJ558028, KJ558180, KJ525612, KJ525469. **Pt. haenkeana** (DC.) Sch. Bip, No. 1: Guerrero, Mexico, *M. Luckow 3548* (TEX), KJ524949, KJ525245, KJ525105, KJ557966, KJ558102, KJ525539, KJ525393. No. 2: Oaxaca, Mexico, *J. Calónico Soto 24000* (MEXU), KJ525056, KJ525347, *, KJ558051, KJ558208, KJ525637, *. **Pt. holochaeta** var. *cana* D.J. Keil, No. 1: Michoacan, Mexico, *J. C. Soto Nuñez 4257* (MEXU), KJ525054, KJ525345, KJ525199, KJ558049, KJ558206, KJ525635, KJ525494. No. 2: Michoacan, Mexico, *M. Luckow with F. Barrie 3493* (LL), KJ524950, KJ525246, KJ525106, KJ557967, KJ558103, KJ525540, KJ525394. **Pt. holochaeta** var. *holochaeta* (S.F. Blake) D.J. Keil, Guerrero, Mexico, *J. Calónico Soto 11952* (MEXU), KJ525057, KJ525348, KJ525201, KJ558052, KJ558209, KJ525638, KJ525496. **Pt. humifusa** Sw., No. 1: Puerto Rico, U.S.A., *D. R. Hansen 95* (TEX), KJ524951, KJ525247, KJ525107, KJ557968, KJ558104, KJ525541, KJ525395. No. 2: Puerto Rico, U.S.A., *D. R.*

Hansen 96 (TEX), KJ524952, KJ525248, KJ525108, *, KJ558105, KJ525542, KJ525396. **Pt. imberbis** A. Gray, No. 1: Arizona, U.S.A., *E. Lehto L20487* (LL), KJ524953, KJ525249, KJ525109, KJ557969, KJ558106, KJ525543, KJ525397. No. 2: Arizona, U.S.A., *J. E. Bowers 3702* (ARIZ), KJ524955, KJ525251, KJ525111, *, KJ558108, KJ525545, KJ525399. No. 3: Arizona, U.S.A., *M. Fishbein #1508* (ARIZ), KJ524954, KJ525250, KJ525110, KJ557970, KJ558107, KJ525544, KJ525398. **Pt. incisifolia** I.M. Johnston, No. 1: Coahuila, Mexico, *J. Henrickson 6991* (LL), KJ525066, KJ525355, KJ525209, KJ558060, KJ558217, KJ525646, KJ525505. No. 2: Chihuahua, Mexico, *D. R. Hansen 72* (TEX), KJ524956, KJ525252, KJ525112, KJ557971, KJ558109, KJ525546, KJ525400. **Pt. latisquama** Sch. BiPt. ex Greenm., Puebla, Mexico, *Robert Merrill King 3557* (LL), KJ524957, KJ525253, KJ525113, KJ557972, KJ558110, KJ525547, KJ525401. **Pt. leavenworthii** Standl., No. 1: Michoacán, Mexico, *D. R. Hansen 132* (TEX), KJ525047, KJ525338, KJ525192, KJ558042, KJ558199, KJ525628, KJ525487. No. 2: Michoacán, Mexico, *B.L. Turner P-70* (TEX), KJ524958, KJ525254, KJ525114, *, KJ558111, KJ525548, KJ525402. **Pt. leonis** Rydb., Cuba, *George R. Proctor 3138* (NYBG), KJ524959, KJ525255, *, *, KJ558112, KJ525549, KJ525403. **Pt. liebmannii** Sch. BiPt. ex Hemsl., No. 1: Oaxaca, Mexico, *Misael Elorsa C. 778* (MEXU), KJ525059, KJ525350, KJ525203, KJ558054, KJ558211, KJ525640, KJ525498. No. 2: Oaxaca, Mexico, *Hinton et al. 26470* (TEX), KJ524960, KJ525256, KJ525115, *, KJ558113, KJ525550, KJ525404. **Pt. linearifolia** Urb., Florida, U.S.A., *J. D. Ray, Jr. 10160* (TEX), KJ524961, KJ525257, KJ525116, KJ557973, KJ558114, KJ525551, KJ525405. **Pt. linearis** La Llave, Jamaica, *M.R. Crosby 141* (LL), KJ524962, KJ525258, KJ525117, KJ557974, KJ558115, KJ525552, KJ525406. **Pt. linifolia** var. *hirtella* S.F. Blake, No. 1: Michoacán, Mexico, *D. R. Hansen 123* (TEX), KJ525045, KJ525337, KJ525191, KJ558040, KJ558196, KJ525626, KJ525485. No. 2: Michoacán, Mexico, *D. R. Hansen 143* (TEX), KJ525052, KJ525343, KJ525197, KJ558047, KJ558204, KJ525633, KJ525492. **Pt. linifolia** var. *linifolia* L., No. 1: Amazonas, Peru, *H. van der Werff 15886* (MO), KJ525027, KJ525320, KJ525175, KJ558027, KJ558179, KJ525611, KJ525468. No. 2: Azua, Dominican Republic, *D. R. Hansen 107* (TEX), KJ524963, KJ525259, KJ525118, KJ557975, KJ558116, KJ525553, KJ525407. No. 3: Arizona, U.S.A., *E. Lehto L20273* (LL), KJ524964, KJ525260, KJ525119, KJ557976, KJ558117, KJ525554, KJ525408. **Pt. longipes** A. Gray, No. 1: Arizona, U.S.A., *S. Sundberg 2114* (TEX), KJ524965, KJ525261, KJ525120, KJ557977, KJ558118, KJ525555, KJ525409. No. 2: Sonora, Mexico, *T. R. Van Devender 2008-249* (TEX), KJ525044, KJ525336, KJ525190, KJ558039, KJ558195, KJ525625, KJ525484. **Pt. luckoviae** D.J. Keil, No. 1: Michoacán, Mexico, *D. R. Hansen 140* (TEX), KJ525051, KJ525342, KJ525196, KJ558046, KJ558203, KJ525632, KJ525491. No. 2: Michoacán, Mexico, *D. R. Hansen 145* (TEX), KJ525053, KJ525344, KJ525198, KJ558048, KJ558205, KJ525634, KJ525493. **Pt. multiceps** Urb., Dominican Republic, *A. H. Liogier 12330* (NYBG), KJ524967, KJ525263, KJ525122, KJ557979, KJ558121, KJ525557, KJ525412. **Pt. multiflosculosa** (DC.) Sch. BiPt., Costa Rica, *W. Haber 9243* (LL), KJ524968 (ITS clone 1), KJ524969 (ITS clone 2), KJ525264, KJ525123, KJ557980, KJ558123, KJ525558, KJ525414. **Pt. multisetata** var. *ambigua* (Fernald) D.J. Keil, Baja Calif. Sur, Mexico, *S. W. Sikes 274* (TEX), KJ524970, KJ525265, KJ525124, KJ557981, KJ558124, KJ525559, KJ525415. **Pt. multisetata** var. *multisetata* Benth., No. 1: Baja Calif Sur, Mexico, *Melissa Luckow 2827* (TEX), KJ524971, KJ525266, KJ525125, KJ557982, KJ558125, KJ525560, KJ525416. No. 2: Baja Calif Sur, Mexico, *D. R. Hansen 149* (TEX), KJ525061, KJ525352, KJ525205, KJ558056, KJ558213, KJ525642, KJ525500. **Pt. odorata** Griseb., No. 1: Beni, Bolivia, *S.G. Beck 12815* (LPB), KJ524972, KJ525267, KJ525126, KJ557983, KJ558126, KJ525561, KJ525417. No. 2: Central, Paraguay, *F. Mereles 3971* (MO), KJ525026, KJ525319, KJ525174, KJ558026, KJ558178, KJ525610, KJ525466. **Pt. oligocephala** var. *oligocephala* Sch. BiPt., No. 1: Goiás, Brazil, *H. S. Irwin* (NYBG), KJ524973, KJ525268, KJ525127, KJ557984, KJ558127, KJ525562, KJ525418. No. 2: Goiás, Brazil, *W. R. Anderson 6859* (NYBG), KJ524974, KJ525269, KJ525128, *, KJ558128, KJ525563, KJ525419. **Pt. papposa** var. *grandis* D.J. Keil, No. 1: Chihuahua, Mexico, *D. R. Hansen 78* (TEX), KJ524976, KJ525271, KJ525130, KJ557986, KJ558130, KJ525564, KJ525421. No. 2: Texas, U.S.A., *D. R. Hansen 62* (TEX), KJ524975, KJ525270, KJ525129, *, KJ558129, KX815121, KJ525420. **Pt. papposa** var. *papposa* Harv. & A. Gray, No. 1: Arizona, U.S.A., *D. R. Hansen 83* (TEX), KJ524977, KJ525272, KJ525131, KJ557986, KJ558131, KJ525565, KJ525422. No. 2: California, U.S.A., *B. Pitzer 4021* (TEX), KJ525068, KJ525357, KJ525211, KJ558062, KJ558219, KJ525648, KJ525507. **Pt. portoricensis** Urb., Puerto Rico, *T. A. Zanoni* (NYBG), KJ524978, KJ525273, KJ525132, KJ557987, KJ558132, KJ525566, KJ525423. **Pt. pringlei** Fernald, No. 1: Chihuahua, Mexico, *D. R. Hansen 74* (TEX), KJ524979, KJ525274, KJ525133, KJ557988, KJ558133, KJ525567, KJ525424. No. 2: Chihuahua, Mexico, *A. Cronquist 10759*, (TEX), KJ525067, KJ525356, KJ525210, KJ558061, KJ558218, KJ525647, KJ525506. **Pt. propetes** Greenm., Zacatecas, Mexico, *D. E. Breedlove 61549* (TEX), KJ524980, KJ525275, KJ525134, KJ557989, KJ558134, KJ525568, KJ525425. **Pt. prostrata** Cav., No. 1: Arizona, U.S.A., *D. R. Hansen 86* (TEX), KJ524981, KJ525276, KJ525135, KJ557990, KJ558135, KJ525569, KJ525426. No. 2: Sinaloa, Mexico, *D. R. Hansen 120* (TEX), KJ524984, KJ525278, KJ525137, KJ557993, KJ558138, KJ525572, KJ525428. No. 3: Texas, U.S.A., *W. R. Carr 19134* (TEX), KJ524982, KJ525277, KJ525136, KJ557991, KJ558136, KJ525570, KJ525427. No. 4: Managua, Nicaragua, *M. Guzman 425* (MO), KJ525038, KJ525330, KJ525184, KJ558033, KJ558190, KJ525619, KJ525478. **Pt. purpurea** var. *sonorae* D.J. Keil, Sonora, Mexico, *T. R. Van Devender 92-1061* (TEX), KJ524985, KJ525279, KJ525138, KJ557994, KJ558139,

KJ525573, KJ525429. *Pt. pusilla* Urb., Haiti, E. L. Ekman 8343 (LL), KJ524986, KJ525280, KJ525139, KJ557995, KJ558140, KJ525574, KJ525430. *Pt. repens* Brandegee, No. 1: Queretaro, Mexico, J. Rzedowski (TEX), KJ524987, KJ525281, KJ525140, KJ557996, KJ558141, KJ525575, KJ525431. No. 2: Guanajuato, Mexico, R. Galván 2578 (MO), KJ525039, KJ525331, KJ525185, KJ558034, KJ558191, KJ525620, KJ525479. *Pt. satirejoides* (Mill.) Sch. Bip., No. 1: Oaxaca, Mexico, A. Saynes V. 4246 (TEX), KJ524988, KJ525282, KJ525141, KJ557997, KJ558143, KJ525576, KJ525433. No. 2: El Progreso, Guatemala, M. Garcia 671 (MO), KJ525037, KJ525329, KJ525183, KJ558033, KJ558189, KJ525618, KJ525477. No. 3: Oaxaca, Mexico, M. Elorsa C. 7760 (TEX), KJ524914, KJ525214, KJ525073, KJ557940, KJ558066, KJ525510, KJ525360. *Pt. sessiliflora* (Less.) Sch. Bip., No. 1: Jujuy, Argentina, A. Krapovickas 46652, (TEX), KJ524989, KJ525283, KJ525142, KJ557998, *, KJ525577, KJ525434. No. 2: La Paz, Bolivia, St. G. Beck 7987 (LPB), KJ524990, KJ525284, KJ525143, KJ557999, KJ558144, KJ525578, KJ525435. *Pt. sinaloensis* Fernald, No. 1: Sinaloa, Mexico, A.L.Reina G. 2005-1606 (ARIZ), KJ524992, KJ525286, KJ525145, KJ558001, KJ558146, KJ525580, KJ525437. No. 2: Sinaloa, Mexico, D. Flyr 135 (TEX), KJ524991, KJ525285, KJ525144, KJ558000, KJ558145, KJ525579, KJ525436. *Pt. stella* Malme, Mato Grosso, Brazil, G. Hatschbach 62720 (MO), KJ525025, KJ525318, *, *, KJ558177, *, *. *Pt. stenophylla* var. *biaristata* (Rydb.) D.J. Keil, Sonora, Mexico, S. Sikes 1788 (TEX), KJ525064, *, KJ525207, KJ558058, *, KJ525644, KJ525503. *Pt. stenophylla* var. *puberula* (Greenm.) D.J. Keil, Sinaloa, Mexico, A. T. Whittemore 83-035 (TEX), KJ525065, KJ525354, KJ525208, KJ558059, KJ558216, KJ525645, KJ525504. *Pt. stenophylla* var. *stenophylla* A.Gray, Chihuahua, Mexico, W. A.Weber & R. Bye 8382 (TEX), KJ524994, KJ525288, KJ525147, KJ558003, KJ558148, KJ525582, KJ525439. *Pt. c.f. stenophylla* A.Gray, Sonora, Mexico, A. L.Reina G. 2007-1034 (TEX), KJ524993, KJ525287, KJ525146, KJ558002, KJ558147, KJ525581, KJ525438. *Pt. tenuicaulis* Urb., No. 1: Dominican Republic, Bro. A. H. Liogier (NYBG), KJ524995, KJ525289, KJ525148, *, KJ558149, KJ525583, KJ525440. No. 2: Boyaca, Colombia, John Olsen and Linda Escobar 590 (LL), KJ524996, KJ525290, KJ525149, KJ558004, KJ558150, KJ525584, KJ525441. *Pt. tenuifolia* (DC.) Sch. Bip., Galapagos Islands, Ecuador, I. L. Wiggins & D. M. Porter 210 (NYBG), KJ524997, KJ525291, KJ525150, *, KJ558151, KJ525585, KJ525442. *Pt. uniaristata* var. *holostemma* A. Gray, No. 1: Valle, Honduras, D. Keil 9509 (MO), KJ525036, KJ525328, KJ525182, *, KJ558188, KJ525617, KJ525476. No. 2: Nueva Segovia, Nicauragua, W.D. Stevens 3069 (MO), KJ525035, KJ525327, KJ525181, *, KJ558187, KJ525617, KJ525475. *Pt. uniaristata* var. *jangadensis* (S. Moore) D.J. Keil, Sinaloa, Mexico, T. R. Van Devender 2004-1488 (TEX), KJ524998, KJ525292, KJ525151, KJ558005, KJ558152, KJ525586, KJ525443. *Pt. uniaristata* var. *uniaristata* DC., No. 1: Sonora, Mexico, A. L. Reina G. 2006-1311 (TEX), KJ524999, KJ525293, KJ525152, KJ558006, KJ558153, KJ525587, KJ525444. *Pt. vandevenderi* B.L. Turner, Sonora, Mexico, A. L. Reina G. 2007-1030 (TEX), KJ525000, KJ525294, KJ525153, KJ558007, KJ558154, KJ525588, KJ525445. *Pt. vollmeri* Wiggins, Baja Calif Sur, Mexico, T. L.Burgess 6134 (ARIZ), KJ525001, KJ525295, KJ525154, KJ558008, KJ558155, KJ525589, KJ525446. *Porophyllum amplexicaule* Engelm. ex A. Gray, Nuevo Leon, Mexico, Hinton 22702 (TEX), KJ525002, KJ525296, KJ525155, KJ558009, KJ558156, KJ525590, KJ525447. *Pr. angustissimum* Gardner, Minas Gerais, Brazil, H. S. Irwin (LL), KJ525003, KJ525297, KJ525156, KJ558010, KJ558157, KJ525591, KJ525448. *Pr. calcicola* B.L. Rob. & Greenm., Guerrero, Mexico, S.D. Koch 7984 (TEX), KJ525004, KJ525298, KJ525157, KJ558011, KJ558158, KJ525592, KJ525449. *Pr. coloratum* var. *coloratum* (Kunth) DC., Sonora, T. R. Van Devender 95-447 (TEX), KJ525005, KJ525299, KJ525158, KJ558012, KJ558159, KJ525593, KJ525450. *Pr. coloratum* var. *obtusifolium* (DC.) McVaugh, Aguascalientes, Mexico, J. Rzedowski & R. McVaugh 868 (TEX), KJ525006, KJ525300, KJ525159, KJ558013, KJ558160, KJ525594, KJ525451. *Pr. filiforme* Rydb., Nuevo Leon, Mexico, Hinton 20959 (TEX), KJ525007, KJ525302, *, *, *, KJ525453. *Pr. gracile* Benth, California, USA, L. Gross 1276 (RSA), KJ525009, KJ525303, KJ525161, KJ558015, KJ558161, KJ525596, KJ525454. *Pr. greggii* A. Gray, Texas, U.S.A., S. Sikes & J. Smith 531 (TEX), KJ525010, KJ525304, KJ525162, KJ558016, KJ558162, KJ525597, KJ525455. *Pr. lanceolatum* DC., Corrientes, Argentina, A. Schinini (TEX), KJ525011, KJ525305, KJ525163, KJ558017, KJ558163, KJ525598, KJ525456. *Pr. leiocarpum* (Urb.) Rydb, , Puerto Rico, A. H. Liogier (NYBG), KJ525012, KJ525306, KJ525164, KJ558018, KJ558164, KJ525599, KJ525457. *Pr. linaria* (Cav.) DC., No. 1: Puebla, Mexico, David Keil 15479 (TEX), KJ525013, KJ525307, KJ525165, KJ558019, KJ558165, KJ525600, KJ525458; No. 2: Oaxaca, Mexico, J. I. Calzada 20259 (TEX), KJ525014, KJ525308, KJ525166, KJ558020, KJ558166, KJ525601, KJ525459. *Pt. lindenii* Sch. Bip, Jalisco, Mexico, J. L. Panero 2872 (TEX), KJ525015, KJ525309, KJ525167, KJ558021, KJ558167, KJ525602, KJ525460. *Pr. linifolium* (Ard.) DC. Central, Paraguay, E. M. Zardini 36323 (MO), KJ525043, KJ525335, KJ525189, KJ558038, KJ558194, KJ525624, KJ525483. *Pr. macrocephalum* DC., No. 1: Honduras, T. F. Daniel 9591 (MO), KJ525040, KJ525332, KJ525186, KJ558035, KJ558192, KJ525621, KJ525480. No. 2: Tamaulipas, Mexico, T. F. Patterson 7388 (TEX), KJ525016, KJ525310, KJ525168, KJ558022, KJ558168, KJ525603, KJ525461. No. 3: Chiapas, Mexico, A. Reyes-Garcia 5623 (TEX), KJ525041, KJ525333, KJ525187, KJ558036, *, KJ525622, KJ525481. No. 4: Sonora, Mexico, A.L. Reina G 2006-1180 (TEX), KJ525021, KJ525315, KJ525172, KJ558024, KJ558173, KJ525607, KJ525465. *Pr. maritimum* Brandegee, No. 1: Baja California Sur, Mexico, M. Luckow 2866 (TEX), KJ525017, KJ525311, KJ525169, *, KJ558169, KJ525604, KJ525462. No. 2: Baja California Sur, Mexico, D. R. Hansen

150 (TEX), KJ525062, KJ525353, KJ525206, KJ558057, KJ558214, KJ525643, KJ525501. *Pr. pausodinum* B.L. Rob. & Greenm., Sonora, Mexico, *Richard S. Felger 85-1530* (TEX), KJ525018, KJ525312, *, *, KJ558170, *, *. *Pr. punctatum* (Mill.) S.F. Blake, No. 1: Sinaloa, Mexico, *J. L. Panero 6179* (TEX), KJ525020, KJ525314, KJ525171, KJ558023, KJ558172, KJ525606, KJ525464. No. 2: Belize, *R. D. Worthington 23852* (TEX), KJ525019, KJ525313, KJ525170, *, KJ558171, KJ525605, KJ525463. *Pr. ruderale* (Jacq.) Cass., Ecuador, *R. M. King 10060* (MO), KJ525042, KJ525334, KJ525188, KJ558037, KJ558193, KJ525623, KJ525482. *Pr. cf. ruderale* (Cass.) A. Gray ex B.L. Rob., Goiás, Brazil, *H. S. Irwin* (TEX), KJ525007, KJ525301, KJ525160, KJ558014, *, KJ525595, KJ525452. *Pr. scoparium* A. Gray, Chihuahua, Mexico, *D. R. Hansen 79* (TEX), KJ525022, KJ525316, *, *, KJ558174, KJ525608, *. *Pr. viridiflorum* (Kunth) DC., Guerrero, Mexico, *J. L. Panero 6187* (TEX), KJ525023, KJ525317, KJ525173, KJ558025, KJ558175, KJ525609, KJ525466. *Pr. zimapanum* B.L. Turner, Zacatecas, Mexico, *L. Woodruff 397* (TEX), KJ525024, *, *, *, KJ558176, *, *. *Tagetes erecta* Fernald, Michoacán, Mexico, *D. R. Hansen 126* (TEX), KJ525046, *, *, KJ558041, KJ558197, KJ525627, *.

APPENDIX 2. List of taxa used for molecular dating, in the following order: **taxon**, available voucher information (herbarium), GenBank accession numbers for *matK*, *ndhF*. Herbarium acronyms follow Index Herbariorum. If the *matK* and *ndhF* sequences are from different collections, they are listed separately after the species name. Sequences representing *Barnadesia* and *Flaveria* were taken from different species because *matK* and *ndhF* were not available from the same species.

Arctotis hirsuta (Harv.) Pt. Beauv., *J. Panero 2002-61*, cultivated, seed source: Kirstenboch Botanical Garden, South Africa (TEX), EU385224, EU385133. *Artemisia tridentata* Nutt., *matK*: AF456776; *ndhF*: A. Kornkven 11872 (OKL), AF153630. *Barnadesia* Mutis ex L. f. *matK*: *B. spinosa* L.f., Argentina, *Panero and Crozier 8492* (TEX), EU385327; *ndhF*: *B. caryophylla* (Vell.) S.F. Blake, L39394. *Centaurea melitensis* L., USA, *J. Panero 2002-48*, (TEX), EU385332, EU385140. *Chrysactinia mexicana* A. Gray, Coahuilla, Mexico, *E. L. Bridges 13067* (TEX), KJ525212, KJ525071. *Dicoma capensis* Less., South Africa, *Trinder-Smith 349* (US), EU385344, EU385152. *Doniophyton anomalum* (D. Don) Kurtz, Argentina, *Bonifacino 96*, (US), EU385348, EU385156. *Flaveria* Juss., *matK*: *F. australasica* Hook., AF456788; *ndhF*: *F. ramosissima* Klatt, *Keil 15588* (TEX); AF405266. *Gerera serrata* (Thunb.) Druce, South Africa, *Koekemoer 2001* (US), EU385356, EU385164. *Gochnatia hypoleuca* (DC.) A. Gray, Mexico, *J. Panero MEX-1* (TEX), EU385357, EU385165. *Helianthus annuus* L. cultivar line HA383, ABD47127.1, ABD47204. *Inula britannica* L., *Santos and Francisco ACC55-98*, cultivated at TEX, (ORT), AY215812, AF384737. *Lactuca sativa* L. cultivar *Salinas*, ABD47214.1, ABD47291.1. *Mutisia retrorsa* Cav., Argentina, *Bonifacino 148* (US), EU385376, EU385185. *Nicolletia edwardsii* A. Gray, Coahuilla, Mexico, *D. R. Hansen 65* (TEX), KJ525213, KJ525072. *Pectis angustifolia* var. *angustifolia* Torr., Texas, U.S.A., *B.L. Turner 22409* (TEX), KJ525217, KJ525076. *Pectis barberi* Greenm., Chihuahua, Mexico, *J. Spencer 1454* (TEX), KJ525221, KJ525080. *Pectis coulteri* Harv. & A. Gray, Sonora, Mexico, *D. R. Hansen 117* (TEX), KJ525229, KJ525089. *Pectis cylindrica* (Fernald) Rydb., Sonora, Mexico, *A.L. Reina G. 2006-507* (TEX), KJ525232, KJ525092. *Pectis decemcarinata* McVaugh, Michoacan, Mexico, *D. R. Hansen 139* (TEX), KJ525341, KJ525195. *Pectis elongata* var. *floribunda* (A. Rich.) D.J. Keil, Monte Plata, Dominican Republic, *D. R. Hansen 100* (TEX), KJ525236, KJ525096. *Pectis filipes* var. *filipes* Harv. & A. Gray, Sonora, Mexico, *A.L. Reina G. 2006-509* (TEX), KJ525240, KJ525099. *Pectis filipes* var. *subnuda* Fernald, New Mexico, U.S.A., *R. D. Worthington 27323* (TEX), KJ525242, KJ525101. *Pectis humifusa* Sw., Puerto Rico, U.S.A., *D. R. Hansen 95* (TEX), KJ525247, KJ525107. *Pectis imberbis* A. Gray, Arizona, U.S.A., *M. Fishbein #1508* (ARIZ), KJ525250, KJ525110. *Pectis incisifolia* I.M. Johnst., Chihuahua, Mexico, *D. R. Hansen 72* (TEX), KJ525252, KJ525112. *Pectis linifolia* L. Arizona, U.S.A., *E. Lehto L20273* (LL), KJ525260, KJ525119. *Pectis linifolia* var. *hirtella* S.F. Blake, Michoacán, Mexico, *D. R. Hansen 143* (TEX), KJ525045, KJ525337. *Pectis longipes* A. Gray, Arizona, U.S.A., *Scott Sundberg 2114* (TEX), KJ525261, KJ525120. *Pectis multiseta* var. *multiseta* Benth., Baja Calif Sur, Mexico, *D. R. Hansen 149* (TEX), KJ525352, KJ525205. *Pectis oligocephala* var. *oligocephala* Sch. Bip., Goiás, Brazil, *W. R. Anderson 6859* (NYBG), KJ525269, KJ525128. *Pectis papposa* var. *grandis* D.J. Keil, Texas, U.S.A., *D. R. Hansen 62* (TEX), KJ525270, KJ525129. *Pectis papposa* var. *papposa* Harv. & A. Gray, California, U.S.A., *B. Pitzer 4021* (TEX), KJ525357, KJ525211. *Pectis tenuifolia* (DC.) Sch. Bip., Galápagos Islands, Ecuador, *Ira L. Wiggins & D. M. Porter 210* (NYBG), KJ525291, KJ525150. *Pectis uniaristata* var. *uniaristata* DC., No. 1: Sonora, Mexico, *A.L. Reina G. 2006-1311* (TEX), KJ525293, KJ525152. *Pectis vandevenderi* B.L. Turner, Sonora, Mexico, *A. L. Reina G. 2007-1030* (TEX), KJ525294, KJ525153. *Perezia purpurata* Wedd., Argentina, *Simon 594* (US) EU385385, EU385194. *Porophyllum amplexicaule* Engelm. ex A. Gray, Nuevo Leon, Mexico, *Hinton 22702* (TEX), KJ525296, KJ525155. *Porophyllum angustissimum* Gardner, Minas Gerais, Brazil, *H. S. Irwin* (LL), KJ525297, KJ525156. *Porophyllum coloratum* var. *coloratum* (Kunth) DC., Sonora, Mexico, *T. R. Van Devender 95-447* (TEX), KJ525299, KJ525158. *Porophyllum gracile* Benth., California, USA, *L. Gross 1276* (RSA), KJ525303, KJ525161. *Porophyllum linaria* (Cav.) DC., Puebla, Mexico, *David Keil 15479* (TEX), KJ525307, KJ525165.

Porophyllum macrocephalum DC., Sonora, Mexico, *A. L. Reina G 2006-1180* (TEX), KJ525315, KJ525172.
Porophyllum maritimum Brandegee, Baja California Sur, Mexico, *D. R. Hansen 150* (TEX), KJ525353, KJ525206.
Sonchus oleraceus L., USA, *J. Panero 2002-80*, (TEX). EU385397, EU385206. *Tagetes patula* L., *matK*: Mexico:
Commercial source, *Bayer s.n.* (CANB), AF151515; *ndhF*: AB530942.