

GE

# AF-600 FP™ Fan & Pump Drive Programming Guide



a product of  
**ecomagination**





---

**Contents**

<b>1 Introduction</b>	<b>4</b>
1.1.1 Copyright, Limitation of Liability and Revision Rights	4
1.1.2 Approvals	4
1.1.3 Symbols	4
1.1.4 Abbreviations	5
1.1.5 Definitions	5
1.1.6 Electrical wiring - control cables	9
<b>2 How to Program</b>	<b>11</b>
2.1 Keypad	11
2.1.1 How to operate graphical keypad	11
2.1.4 Quick Menu Mode	15
2.1.5 Macros	16
2.1.6 Main Menu Mode	20
<b>3 Parameter Description</b>	<b>23</b>
3.1 K-## Keypad Set-up	23
3.2 F-## Fundamental Parameters	33
3.3 E-## Digital In/Outs	39
3.4 C-## Frequency Control Functions	48
3.5 P-## Motor Data	50
3.6 H-## High Perf Parameters	52
3.7 AN-## Analog In/Out	57
3.8 SP-## Special Functions	63
3.9 O-## Options/Comms	66
3.10 AO-## Analog I/O Options	72
3.11 DN-## DeviceNet	77
3.12 PB-## Profibus	80
3.13 EN-## EtherNet	83
3.14 BN-## BACnet	87
3.15 LN-## - LonWorks	88
3.16 ID-## Drive Information	89
3.17 DR-## Data Readouts	94
3.18 LG-## Logs & I/O Opt. Status	99
3.19 AP-## HVAC Appl. Param.	101
3.20 FB-## Fire/Bypass Operation	114
3.21 T-## Timed Functions	120
3.22 CL-## PID Closed Loop	130
3.23 XC-## Ext. PID Closed Loop	140
3.24 PC-## Pump Controller	147



3.25 LC-## Logic Controller	156
3.26 B-## Braking Functions	165
<b>4 Troubleshooting</b>	<b>166</b>
4.1 Status Messages	166
4.1.1 Alarms and Warnings	166
4.1.2 Alarm Words	168
4.1.3 Warning Words	169
4.1.4 Extended Status Words	170
4.1.5 Fault Messages	171
<b>5 Parameter Lists</b>	<b>174</b>
5.1 Parameter Lists	174
5.1.1 Main Menu Structure	174
5.1.2 K-## Keypad Set-up	175
5.1.3 F-## Fundamental Parameters	177
5.1.4 E-## Digital In/Outs	178
5.1.5 C-## Frequency Control Functions	180
5.1.6 P-## Motor Data	181
5.1.7 H-## High Perf Parameters	182
5.1.8 AN-## Analog In / Out	183
5.1.9 SP-## Special Functions	184
5.1.10 O-## Options/Comms	185
5.1.11 AO-## Analog I/O Option	186
5.1.12 DN-## DevicNet	187
5.1.13 PB-## Profibus	188
5.1.14 EN-## EtherNet	189
5.1.15 BN-## BACnet	190
5.1.16 LN-## LonWorks	190
5.1.17 ID-## Drive Information	191
5.1.18 DR-## Data Readouts	192
5.1.19 LG-## Logs & I/O Opt. Status	194
5.1.20 AP-## HVAC Appl. Param.	195
5.1.21 FB-## Fire/Bypass Operation	197
5.1.22 T-## Timed Functions	198
5.1.23 CL-## PID Closed Loop	199
5.1.24 XC-## Ext. PID Closed Loop	200
5.1.25 PC-## Pump Controller	202
5.1.26 LC-## Logic Controller	204
5.1.27 B-## Braking Functions	204



<b>Index</b>	205
--------------	-----



# 1 Introduction

## AF-600 FP



This guide can be used with all AF-600 FP frequency converters with software version 2.12 or later. The actual software version number can be read from *ID-43 Software Version*.

### 1.1.1 Copyright, Limitation of Liability and Revision Rights

This publication contains information proprietary to GE. By accepting and using this manual the user agrees that the information contained herein will be used solely for operating equipment from GE or equipment from other vendors provided that such equipment is intended for communication with GE equipment over a serial communication link. This publication is protected under the Copyright laws of Denmark and most other countries.

GE does not warrant that a software program produced according to the guidelines provided in this manual will function properly in every physical, hardware or software environment.

Although GE has tested and reviewed the documentation within this manual, GE makes no warranty or representation, neither expressed nor implied, with respect to this documentation, including its quality, performance, or fitness for a particular purpose.

In no event shall GE be liable for direct, indirect, special, incidental, or consequential damages arising out of the use, or the inability to use information contained in this manual, even if advised of the possibility of such damages. In particular, GE is not responsible for any costs, including but not limited to those incurred as a result of lost profits or revenue, loss or damage of equipment, loss of computer programs, loss of data, the costs to substitute these, or any claims by third parties.

GE reserves the right to revise this publication at any time and to make changes to its contents without prior notice or any obligation to notify former or present users of such revisions or changes.

It has been assumed that all devices will be sitting behind a firewall that does packet filtering and the environment has well-implemented restrictions on the software that can run inside the firewall. All nodes are assumed to be "trusted" nodes.

### 1.1.2 Approvals

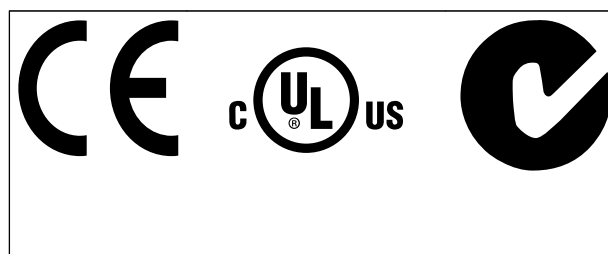

### 1.1.3 Symbols

Symbols used in this guide.

#### NOTE

Indicates something to be noted by the reader.

#### CAUTION

Indicates a potentially hazardous situation which, if not avoided, may result in minor or moderate injury or equipment damage.

#### WARNING

Indicates a potentially hazardous situation which, if not avoided, could result in death or serious injury.

\* Indicates default setting



### 1.1.4 Abbreviations

Alternating current	AC
American wire gauge	AWG
Ampere/AMP	A
Current limit	I <sub>LIM</sub>
Degrees Celsius	°C
Direct current	DC
Drive Control Tool PC Software	DCT 10
Drive Dependent	D-TYPE
Electro Magnetic Compatibility	EMC
Electronic Thermal Overload	Elec. OL
Gram	g
Hertz	Hz
Kilohertz	kHz
Meter	m
Millihenry Inductance	mH
Milliampere	mA
Millisecond	ms
Minute	min
Nanofarad	nF
Newton Meters	Nm
Nominal motor current	I <sub>M,N</sub>
Nominal motor frequency	f <sub>M,N</sub>
Nominal motor power	P <sub>M,N</sub>
Nominal motor voltage	U <sub>M,N</sub>
Parameter	par.
Protective Extra Low Voltage	PELV
Printed Circuit Board	PCB
Rated Inverter Output Current	I <sub>INV</sub>
Revolutions Per Minute	RPM
Regenerative terminals	Regen
Second	s
Synchronous Motor Speed	n <sub>s</sub>
Torque limit	T <sub>LIM</sub>
Volts	V

Group 1	Reset, Coasting stop, Reset and Coasting stop, Quick-stop, DC braking, Stop and the [OFF] key.
Group 2	Start, Pulse start, Reversing, Start reversing, Jog and Freeze output

**Motor:**

Motor Running

Torque generated on output shaft and speed from zero rpm to max. speed on motor.

f<sub>JOG</sub>

Motor frequency when the jog function is activated (via digital terminals).

f<sub>M</sub>

Motor frequency.

f<sub>MAX</sub>

Maximum motor frequency.

f<sub>MIN</sub>

Minimum motor frequency.

f<sub>M,N</sub>

Rated motor frequency (nameplate data).

I<sub>M</sub>

Motor current (actual).

I<sub>M,N</sub>

Rated motor current (nameplate data).

n<sub>M,N</sub>

Rated motor speed (nameplate data).

n<sub>s</sub>

Synchronous motor speed

$$n_s = \frac{2 \times \text{par. } F - 04 \times 60 \text{ s}}{\text{par. } P - 01}$$

P<sub>M,N</sub>

Rated motor power (nameplate data in kW or HP).

T<sub>M,N</sub>

Rated torque (motor).

U<sub>M</sub>

Instantaneous motor voltage.

U<sub>M,N</sub>

Rated motor voltage (nameplate data).

### 1.1.5 Definitions

**Drive:**

I<sub>DRIVE,MAX</sub>

Maximum output current.

I<sub>DRIVE,N</sub>

Rated output current supplied by the drive.

U<sub>DRIVE, MAX</sub>

Maximum output voltage.

**Input:**

Control command

Start and stop the connected motor by means of keypad and digital inputs.

Functions are divided into two groups.

Functions in group 1 have higher priority than functions in group 2.

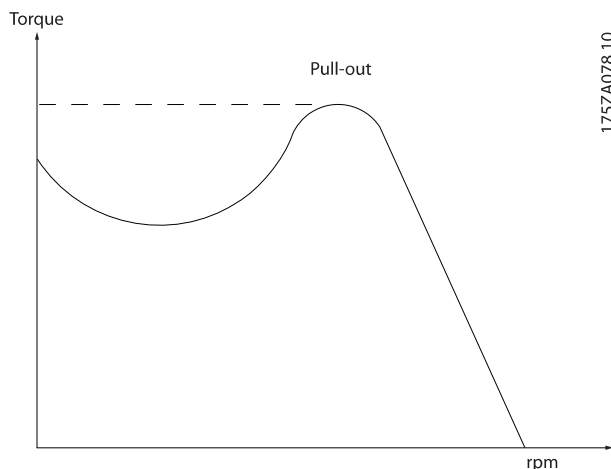
Break-away torque $\eta_{DRIVE}$ 

The efficiency of the drive is defined as the ratio between the power output and the power input.

Start-disable command

A stop command belonging to the group 1 control commands - see this group.

Stop command

See Control commands.

**References:**Advanced Vector Control

If compared with standard voltage/frequency ratio control, (Adv. Vector Control) improves the dynamics and the stability, both when the speed reference is changed and in relation to the load torque.

Analog Reference

A signal transmitted to the analog inputs 53 or 54, can be voltage or current.

Binary Reference

A signal transmitted to the serial communication port.

Preset Reference

A defined preset reference to be set from -100% to +100% of the reference range. Selection of eight preset references via the digital terminals.

Pulse Reference

A pulse frequency signal transmitted to the digital inputs (terminal 29 or 33).

Ref<sub>MAX</sub>

Determines the relationship between the reference input at 100% full scale value (typically 10V, 20mA) and the resulting reference. The maximum reference value set in *F-53 Maximum Reference*.

Ref<sub>MIN</sub>

Determines the relationship between the reference input at 0% value (typically 0V, 0mA, 4mA) and the resulting reference. The minimum reference value set in *F-52 Minimum Reference*.

**Miscellaneous:**Analog Inputs

The analog inputs are used for controlling various functions of the drive.

There are two types of analog inputs:

Current input, 0-20mA and 4-20mA

Voltage input, 0-10V DC

Voltage input, -10 - +10V DC.

Analog Outputs

The analog outputs can supply a signal of 0-20mA, 4-20mA.

Auto Tuning

The Auto Tune algorithm determines the electrical parameters for the connected motor at standstill.

Brake Resistor

The brake resistor is a module capable of absorbing the brake power generated in regenerative braking. This regenerative braking power increases the intermediate circuit voltage and a brake chopper ensures that the power is transmitted to the brake resistor.

CT Characteristics

Constant torque characteristics used for all applications such as conveyor belts, displacement pumps and cranes.

Digital Inputs

The digital inputs can be used for controlling various functions of the drive.

Digital Outputs

The drive features two Solid State outputs that can supply a 24V DC (max. 40mA) signal.

DSP

Digital Signal Processor.

Electronic Thermal Overload

The Electronic Overload is a thermal load calculation based on present load and time. Its purpose is to estimate the motor temperature.

Intermittent Duty Cycle

An intermittent duty rating refers to a sequence of duty cycles. Each cycle consists of an on-load and an off-load period. The operation can be either periodic duty or non-periodic duty.

Keypad

The Keypad makes up a complete interface for control and programming of the drive. The keypad is detachable and can be installed up to 10ft/3M from the drive, i.e. in a front panel with the optional Remote Keypad Mounting Kit (RMKYPDAC)..



Logic Controller (LC)

The LC is a sequence of user defined actions executed when the associated user defined events are evaluated as true by the Logic Controller. (Par. group LC-##).

lsb

Least significant bit.

msb

Most significant bit.

MCM

Short for Mille Circular Mil, an American measuring unit for cable cross-section. 1 MCM = 0.5067mm<sup>2</sup>.

On-line/Off-line Parameters

Changes to on-line parameters are activated immediately after the data value is changed. Changes to off-line parameters are not activated until you enter [OK] on the keypad.

Process PID

The PID control maintains the desired speed, pressure, temperature, etc. by adjusting the output frequency to match the varying load.

PCD

Process Control Data

Power Cycle

Switch off the mains until display (keypad) is dark – then turn power on again

Pulse Input/Incremental Encoder

An external, digital pulse transmitter used for feeding back information on motor speed. The encoder is used in applications where great accuracy in speed control is required.

RCD

Residual Current Device.

Set-up

You can save parameter settings in four Set-ups. Change between the four parameter Set-ups and edit one Set-up, while another Set-up is active.

SFAVM

Switching pattern called Stator Flux oriented Asynchronous Vector Modulation (F-37 Adv. Switching Pattern).

Slip Compensation

The drive compensates for the motor slip by giving the frequency a supplement that follows the measured motor load keeping the motor speed almost constant.

STW

Status Word

Drive Standard Bus

Includes RS-485 bus with Drive protocol or MC protocol. See O-30 Protocol.

Thermistor:

A temperature-dependent resistor placed where the temperature is to be monitored (drive or motor).

Trip

A state entered in fault situations, e.g. if the drive is subject to an over-temperature or when the drive is protecting the motor, process or mechanism. Restart is prevented until the cause of the fault has disappeared and the trip state is cancelled by activating reset or, in some cases, by being programmed to reset automatically. Trip may not be used for personal safety.

Trip Locked

A state entered in fault situations when the drive is protecting itself and requiring physical intervention, e.g. if the drive is subject to a short circuit on the output. A locked trip can only be cancelled by cutting off mains, removing the cause of the fault, and reconnecting the drive. Restart is prevented until the trip state is cancelled by activating reset or, in some cases, by being programmed to reset automatically. Trip may not be used for personal safety.

VT Characteristics

Variable torque characteristics used for pumps and fans.

60° AVM

Switching pattern called 60° Asynchronous Vector Modulation (F-37 Adv. Switching Pattern).

Power Factor

The power factor is the relation between I<sub>1</sub> and I<sub>RMS</sub>.

$$\text{Power factor} = \frac{\sqrt{3} \times U \times I_1 \cos\phi}{\sqrt{3} \times U \times I_{RMS}}$$

The power factor for 3-phase control:

$$= \frac{I_1 \times \cos\phi}{I_{RMS}} = \frac{I_1}{I_{RMS}} \text{ since } \cos\phi = 1$$

The power factor indicates to which extent the drive imposes a load on the mains supply.

The lower the power factor, the higher the I<sub>RMS</sub> for the same kW performance.

$$I_{RMS} = \sqrt{I_1^2 + I_5^2 + I_7^2 + \dots + I_n^2}$$

In addition, a high power factor indicates that the different harmonic currents are low.

The frequency converters' built-in DC link reactor produce a high power factor, which minimizes the imposed load on the mains supply.

**⚠WARNING**

The voltage of the drive is dangerous whenever connected to mains. Incorrect installation of the motor, drive or network may cause death, serious personal injury or damage to the equipment. Consequently, the instructions in this manual, as well as national and local rules and safety regulations, must be complied with.





### Safety Regulations

1. The mains supply to the drive must be disconnected whenever repair work is to be carried out. Check that the mains supply has been disconnected and that the necessary time has elapsed before removing motor and mains supply plugs.
2. The [OFF] button on the keypad of the drive does not disconnect the mains supply and consequently it must not be used as a safety switch.
3. The equipment must be properly earthed, the user must be protected against supply voltage and the motor must be protected against overload in accordance with applicable national and local regulations.
4. The earth leakage current exceeds 3.5mA.
5. Protection against motor overload is not included in the factory setting. If this function is desired, set *F-10 Electronic Overload* to data value Elec. OL trip 1 [4] or data value Elec. OL warning 1 [3].
6. Do not remove the plugs for the motor and mains supply while the drive is connected to mains. Check that the mains supply has been disconnected and that the necessary time has elapsed before removing motor and mains plugs.
7. Please note that the drive has more voltage sources than L1, L2 and L3, when load sharing (linking of DC intermediate circuit) or external 24V DC are installed. Check that all voltage sources have been disconnected and that the necessary time has elapsed before commencing repair work.

### Warning against unintended start

1. The motor can be brought to a stop by means of digital commands, bus commands, references or a local stop, while the drive is connected to mains. If personal safety considerations (e.g. risk of personal injury caused by contact with moving machine parts following an unintentional start) make it necessary to ensure that no unintended start occurs, these stop functions are not sufficient. In such cases the mains supply must be disconnected.
2. The motor may start while setting the parameters. If this means that personal safety may be compromised (e.g. personal injury caused by contact with moving machine parts), motor starting must be prevented by disconnection of the motor connection.
3. A motor that has been stopped with the mains supply connected, may start if faults occur in the electronics of the drive, through temporary overload or if a fault in the power supply grid or

motor connection is remedied. If unintended start must be prevented for personal safety reasons (e.g. risk of injury caused by contact with moving machine parts), the normal stop functions of the drive are not sufficient. In such cases the mains supply must be disconnected.

4. Control signals from, or internally within, the drive may in rare cases be activated in error, be delayed or fail to occur entirely. When used in situations where safety is critical, e.g. when controlling the electromagnetic brake function of a hoist application, these control signals must not be relied on exclusively.

### **▲WARNING**

#### High Voltage

**Touching the electrical parts may be fatal - even after the equipment has been disconnected from mains.**

**Also make sure that other voltage inputs have been disconnected, such as external 24 V DC, load sharing (linkage of DC intermediate circuit), as well as the motor connection for kinetic back up.**

**Systems where frequency converters are installed must, if necessary, be equipped with additional monitoring and protective devices according to the valid safety regulations, e.g. law on mechanical tools, regulations for the prevention of accidents etc. Modifications on the frequency converters by means of the operating software are allowed.**

#### NOTE

**Hazardous situations shall be identified by the machine builder/ integrator who is responsible for taking necessary preventive means into consideration. Additional monitoring and protective devices may be included, always according to valid national safety regulations, e.g. law on mechanical tools, regulations for the prevention of accidents.**

#### Protection Mode

Once a hardware limit on motor current or dc-link voltage is exceeded the frequency converter will enter "Protection mode". "Protection mode" means a change of the PWM modulation strategy and a low switching frequency to minimize losses. This continues 10 sec after the last fault and increases the reliability and the robustness of the frequency converter while re-establishing full control of the motor.

1.1.6 Electrical wiring - control cables

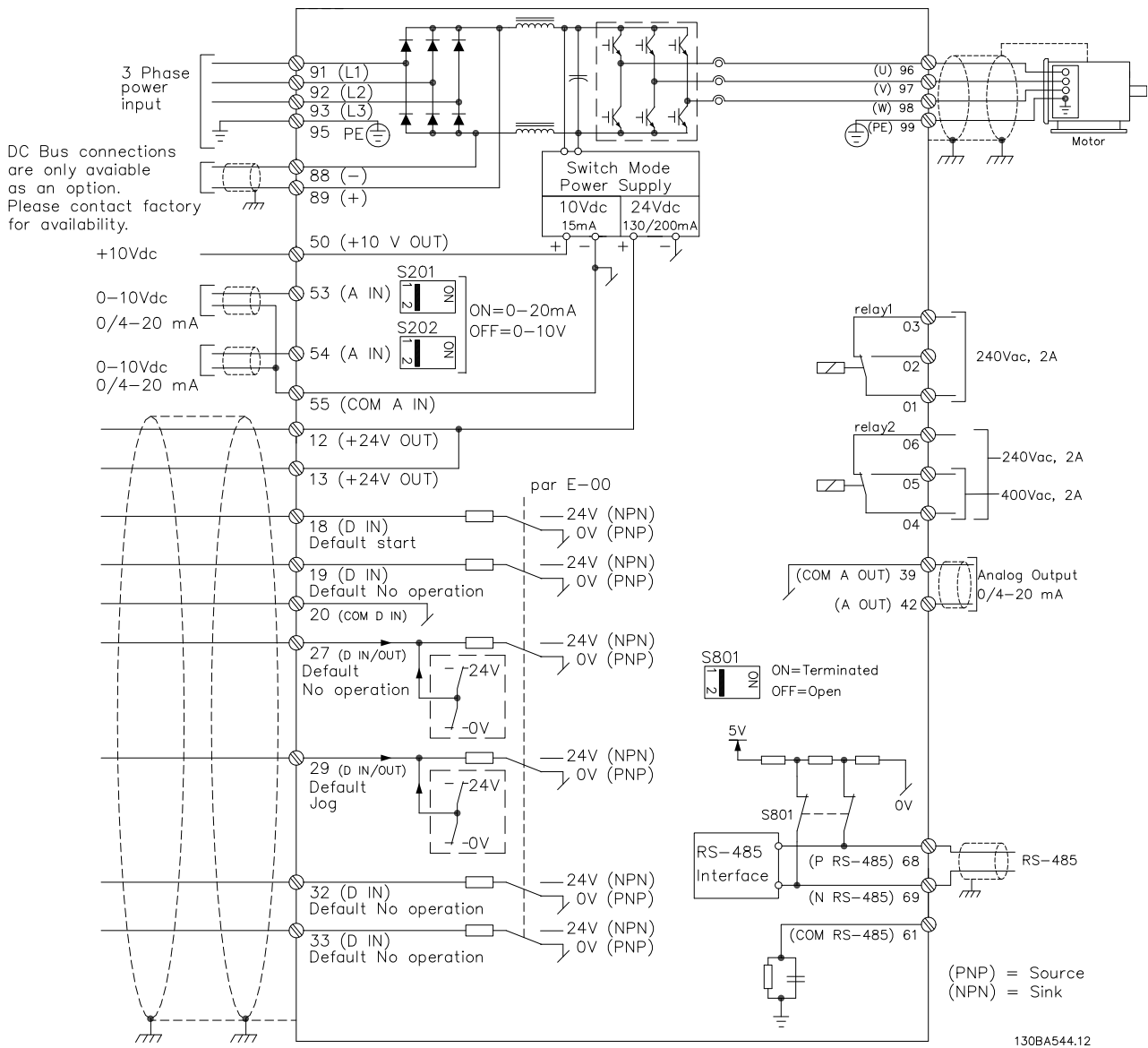

Illustration 1.1 Diagram showing all electrical terminals without options.

Very long control cables and analog signals may in rare cases and depending on installation result in 50/60 Hz earth loops due to noise from mains supply cables.

If this occurs, it may be necessary to break the screen or insert a 100 nF capacitor between screen and chassis.

The digital and analog inputs and outputs must be connected separately to the common inputs (terminal 20, 55, 39) of the frequency converter to avoid ground currents from both groups to affect other groups. For example, switching on the digital input may disturb the analog input signal.



Input polarity of control terminals

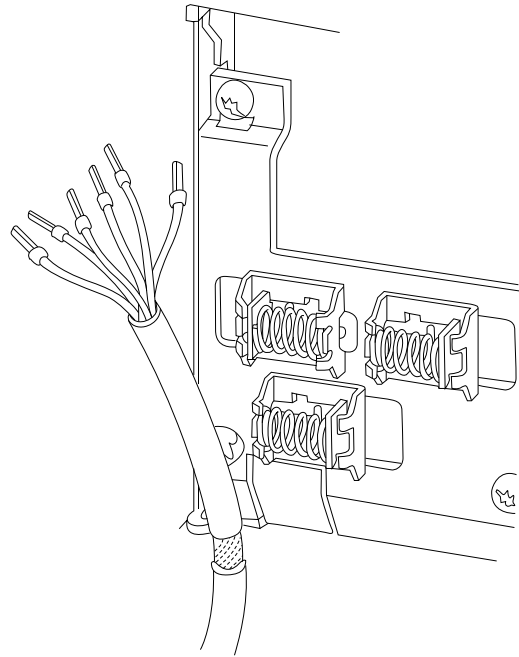
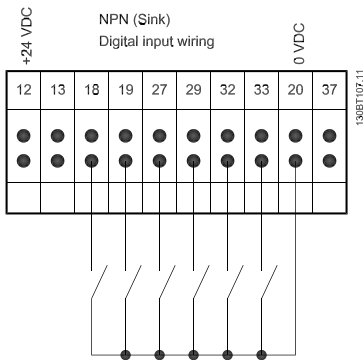
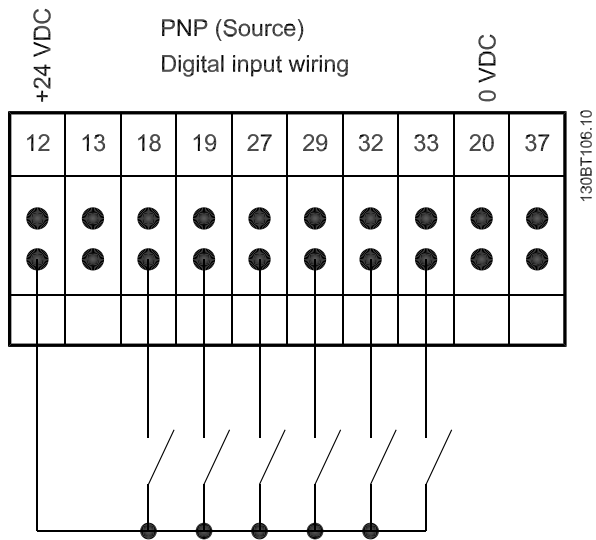

Control cables must be screened/armoured.

See section entitled *Earthing of Screened/Armoured Control Cables* for the correct termination of control cables.

## 2 How to Program

### 2.1 Keypad

#### 2.1.1 How to operate graphical keypad

The keypad is divided into four functional groups:

1. Graphical display with Status lines.
2. Menu keys and indicator lights (LEDs) - selecting mode, changing parameters and switching between display functions.
3. Navigation keys and indicator lights (LEDs).
4. Operation keys and indicator lights (LEDs).

#### Graphical display:

The LCD-display is back-lit with a total of 6 alpha-numeric lines. All data is displayed on the keypad which can show up to five operating variables while in [Status] mode.

#### Display lines:

- a. **Status line:** Status messages displaying icons and graphics.
- b. **Line 1-2:** Operator data lines displaying data and variables defined or chosen by the user. By pressing the [Status] key, up to one extra line can be added.
- c. **Status line:** Status messages displaying text.

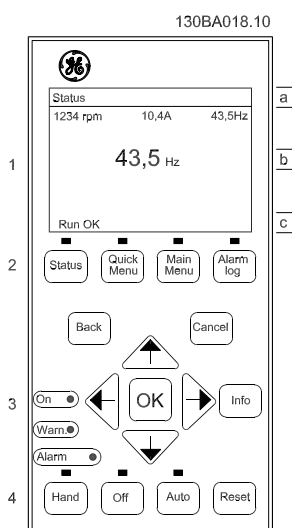

The display is divided into 3 sections:

**Top section** (a) shows the status when in status mode or up to 2 variables when not in status mode and in the case of Alarm/Warning.

The number of the Active Set-up (selected as the Active Set-up in *K-10 Active Set-up*) is shown. When programming in another Set-up than the Active Set-up, the number of the Set-up being programmed appears to the right in brackets.

The **Middle section** (b) shows up to 5 variables with related unit, regardless of status. In case of alarm/warning, the warning is shown instead of the variables.

The **Bottom section** (c) always shows the state of the frequency converter in Status mode.

It is possible to toggle between three status read-out displays by pressing the [Status] key.

Operating variables with different formatting are shown in each status screen - see below.

Each value / measurement readout parameter selected in *K-20 Display Line 1.1 Small* to *K-24 Display Line 3 Large* has its own scale and number of digits after a possible decimal point. Larger numeric values are displayed with few digits after the decimal point.

Ex.: Current readout  
5.25 A; 15.2 A 105 A.

#### Status display I:

This read-out state is standard after start-up or restore.

Use [INFO] to obtain information about the value/ measurement linked to the displayed operating variables (1.1, 1.2, 1.3, 2, and 3).

See the operating variables shown in the display in this illustration. 1.1, 1.2 and 1.3 are shown in small size. 2 and 3 are shown in medium size.

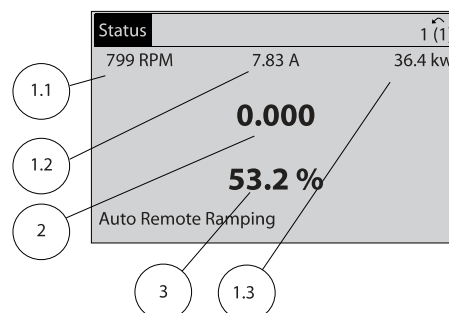

130BP041.10

**Status display II:**

See the operating variables (1.1, 1.2, 1.3, and 2) shown in the display in this illustration. In the example, Speed, Motor current, Motor power and Frequency are selected as variables in the first and second lines. 1.1, 1.2 and 1.3 are shown in small size. 2 is shown in large size.

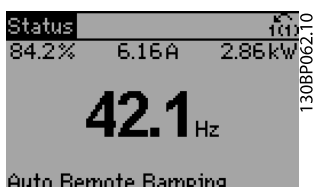

**Status display III:**

This state displays the event and action of the Logic Controller. For further information, see section *Logic Controller*.

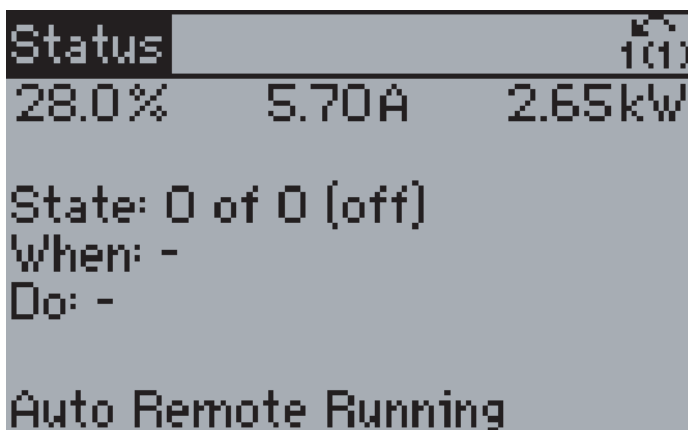

**Display Contrast Adjustment**

Press [status] and [▲] for darker display  
 Press [status] and [▼] for brighter display

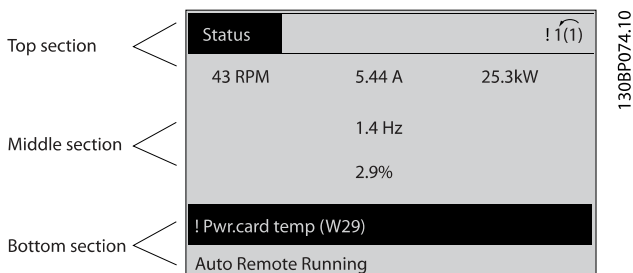

**Indicator lights (LEDs):**

If certain threshold values are exceeded, the alarm and/or warning LED lights up. A status and alarm text appear on the keypad.

The On LED is activated when the frequency converter receives power from mains voltage, a DC bus terminal, or an external 24 V supply. At the same time, the back light is on.

- Green LED/On: Control section is working.
- Yellow LED/Warn.: Indicates a warning.
- Flashing Red LED/Alarm: Indicates an alarm.



**Keys**

**Menu keys**

The menu keys are divided into functions. The keys below the display and indicator lamps are used for parameter set-up, including choice of display indication during normal operation.



**[Status]**

indicates the status of the frequency converter and/or the motor. 3 different readouts can be chosen by pressing the [Status] key: 5 line readouts, 4 line readouts or Logic Controller. Use [Status] for selecting the mode of display or for changing back to Display mode from either the Quick Menu mode, the Main Menu mode or Alarm mode. Also use the [Status] key to toggle single or double read-out mode.



**[Quick Menu]**

allows quick set-up of the frequency converter. **The most common AF-600 FP functions can be programmed here.**

The [Quick Menu] consists of:

- Quick Start
- Fan Macros
- Pump Macros
- Compressor Macros
- Closed Loop
- Parameter Data Check
- Trendings

The Function set-up provides quick and easy access to all parameters required for the majority of AF-600 FP applications including most VAV and CAV supply and return fans, cooling tower fans, Primary, Secondary and Condenser Water Pumps and other pump, fan and compressor applications. Amongst other features it also includes parameters for selecting which variables to display on the keypad, digital preset speeds, scaling of analog references, closed loop single zone and multi-zone applications and specific functions related to Fans, Pumps and Compressors.

The Quick Menu parameters can be accessed immediately unless a password has been created via *K-60 Main Menu Password*, *K-61 Access to Main Menu w/o Password*, *K-65 Quick Menu Password* or *K-66 Access to Quick Menu w/o Password*.

It is possible to switch directly between Quick Menu mode and Main Menu mode.

**[Main Menu]**

is used for programming all parameters. The Main Menu parameters can be accessed immediately unless a password has been created via *K-60 Main Menu Password*, *K-61 Access to Main Menu w/o Password*, *K-65 Quick Menu Password* or *K-66 Access to Quick Menu w/o Password*. For the majority of AF-600 FP applications it is not necessary to access the Main Menu parameters but instead the Quick Menu, Quick Set-up and Function Set-up provides the simplest and quickest access to the typical required parameters.

It is possible to switch directly between Main Menu mode and Quick Menu mode.

Parameter shortcut can be carried out by pressing down the [Main Menu] key for 3 seconds. The parameter shortcut allows direct access to any parameter.

**[Alarm Log]**

displays an Alarm list of the ten latest alarms (numbered A1-A10). To obtain additional details about an alarm, use the arrow keys to manoeuvre to the alarm number and press [OK]. Information is displayed about the condition of the frequency converter before it enters the alarm mode.

The Alarm log button on the keypad allows access to both Alarm log and Maintenance log.

**[Back]**

reverts to the previous step or layer in the navigation structure.

**[Cancel]**

last change or command will be cancelled as long as the display has not been changed.

**[Info]**

displays information about a command, parameter, or function in any display window. [Info] provides detailed information when needed.

Exit Info mode by pressing either [Info], [Back], or [Cancel].

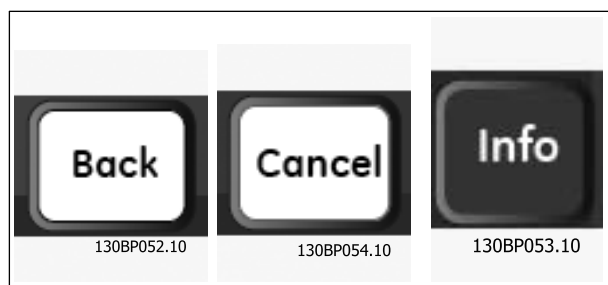

**Navigation Keys**

The four navigation arrows are used to navigate between the different choices available in [Quick Menu], [Main Menu] and [Alarm Log]. Use the keys to move the cursor.

[OK] is used for choosing a parameter marked by the cursor and for enabling the change of a parameter.

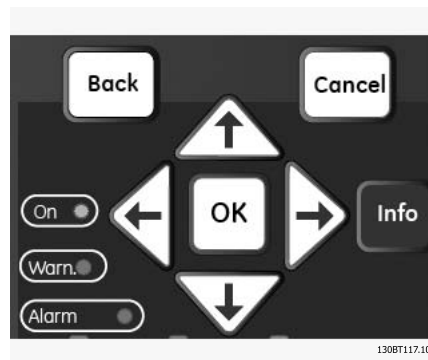



Operation Keys for local control are found at the bottom of the keypad.

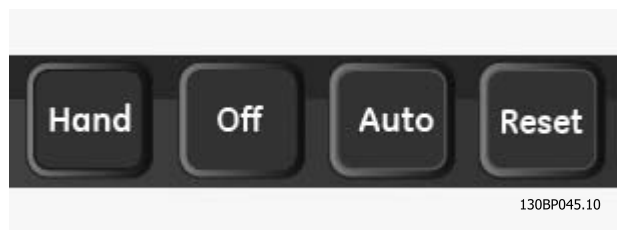

**[Hand]**

enables control of the frequency converter via the keypad. [Hand] also starts the motor, and it is now possible to enter the motor speed data by means of the arrow keys. The key can be selected as *Enable* [1] or *Disable* [0] via K-40 [Hand] Button on Keypad.

The following control signals will still be active when [Hand] is activated:

- [Hand] - [Off] - [Auto]
- Reset
- Coasting stop inverse
- Reversing
- Set-up select lsb - Set-up select msb
- Stop command from serial communication
- Quick stop
- DC brake

**NOTE**

External stop signals activated by means of control signals or a serial bus will override a "start" command via the keypad.

**[Off]**

stops the connected motor. The key can be selected as *Enable* [1] or *Disable* [0] via K-41 [Off] Button on Keypad. If no external stop function is selected and the [Off] key is inactive the motor can only be stopped by disconnecting the mains supply.

**[Auto]**

enables the frequency converter to be controlled via the control terminals and/or serial communication. When a start signal is applied on the control terminals and/or the bus, the frequency converter will start. The key can be selected as *Enable* [1] or *Disable* [0] via K-42 [Auto] Button on Keypad.

**NOTE**

An active HAND-OFF-AUTO signal via the digital inputs has higher priority than the control keys [Hand] – [Auto].

**[Reset]**

is used for resetting the frequency converter after an alarm (trip). It can be selected as *Enable* [1] or *Disable* [0] via K-43 [Reset] Button on Keypad.

The parameter shortcut can be carried out by holding down the [Main Menu] key for 3 seconds. The parameter shortcut allows direct access to any parameter.

**2.1.2 Quick Transfer of Parameter Settings between Multiple Frequency Converters**

Once the set-up of a drive is complete, we recommend that you store the data in the keypad or on a PC via Drive Control Tool Software DCT 10.

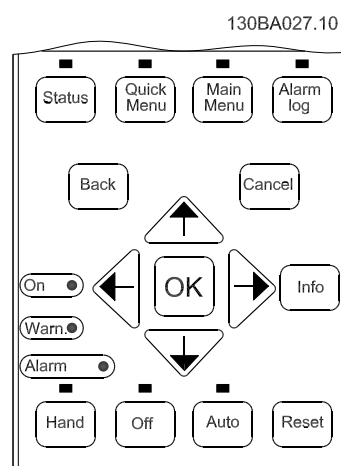

**Data storage in keypad**

1. Go to K-50 Keypad Copy
2. Press the [OK] key
3. Select "All to keypad"
4. Press the [OK] key

All parameter settings are now stored in the keypad indicated by the progress bar. When 100% is reached, press [OK].

**NOTE**

**Stop the motor before performing this operation.**

You can now connect the keypad to another drive and copy the parameter settings to this drive as well.

**Data transfer from keypad to drive**

1. Go to K-50 Keypad Copy
2. Press the [OK] key
3. Select "All from keypad"
4. Press the [OK] key





The parameter settings stored in the keypad are now transferred to the drive indicated by the progress bar. When 100% is reached, press [OK].

**NOTE**

**Stop the motor before performing this operation.**

**2.1.3 Parameter Set-Up**

The frequency converter can be used for practically all assignments, thus offering a significant number of parameters. The series offers a choice between two programming modes - the Quick Menu mode and the Main Menu mode.

The latter provides access to all parameters. The former takes the user through a few parameters making it possible to **program the majority of AF-600 FP applications.**

Regardless of the mode of programming, you can change a parameter both in the Quick Menu mode and in the Main Menu mode.

**2.1.4 Quick Menu Mode**

**Parameter Data**

The keypad provides access to all parameters listed under the Quick Menus. To set parameters using the [Quick Menu] button - enter or change parameter data or settings in accordance with the following procedure:

1. Press Quick Menu button then press Quick Start
2. Use the [▲] and [▼] buttons to find the parameter you want to change
3. Press [OK]
4. Use [▲] and [▼] buttons to select the correct parameter setting
5. Press [OK]
6. To move to a different digit within a parameter setting, use the [◀] and [▶] buttons
7. Highlighted area indicates digit selected for change
8. Press [Cancel] button to disregard change, or press [OK] to accept change and enter the new setting

**Example of changing parameter data**

Assume parameter F-07 Accel Time 1 is set to 6 seconds and you want to change it to 10 seconds. Use the following procedure:

1. Press Quick Menu key
2. Choose Quick Start
3. Press [OK]

4. With the [▼] button find par. F-07 Accel Time 1
5. Press [OK]
6. Use the arrow keys to change the 6.00 to 10.00.
7. Press [OK]

The drive will now accelerate to rated speed in 10 seconds instead of 6 seconds.

It is recommended to do the set-up in the order that the parameters are listed!

**Select [Parameter Data Check] to get information about:**

- The last 10 changes. Use the up/down navigation keys to scroll between the last 10 changed parameters.
- The changes made since default setting.

**Select [Trendings]:**

to get information about the display line read-outs. The information is shown as graphs.

Only display parameters selected in *K-20 Display Line 1.1 Small* and *K-24 Display Line 3 Large* can be viewed. It is possible to store up to 120 samples in the memory for later reference.

**Efficient Parameter Set-up for AF-600 FP Applications:**

The parameters can easily be set up for the vast majority of the AF-600 FP applications only by using the [Quick Setup] option.

After pressing [Quick Menu], the different choices in the Quick Menu are listed.

**Example of using the Quick Setup option:**

**NOTE**

A complete description of the function is found in the parameter sections of this manual.

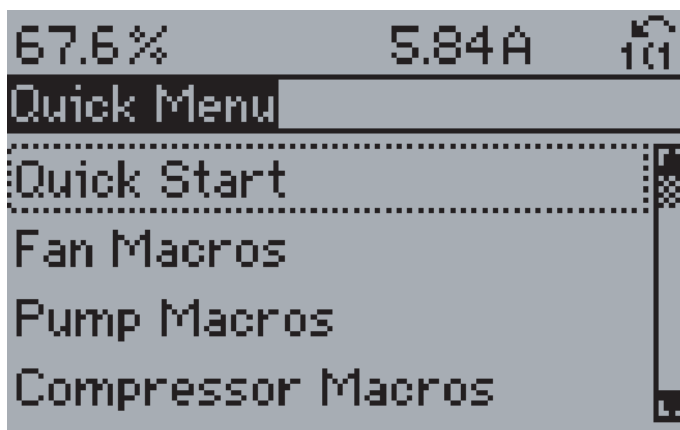

130BP064.10

Illustration 2.1 Quick Menu view.



The Quick Setup menu gives access to the most important setup parameters of the frequency converter. After programming the frequency converter will, in most cases, be ready for operation. The Quick Setup parameters are shown in the table below. A complete description of the function is given in the parameter description sections of this manual.

Parameter	[Units]
K-01 Language	
K-02 Motor Speed Unit	
P-02 Motor Power [HP]*	[HP]
P-07 Motor Power [kW]	[kW]
F-05 Motor Rated Voltage	[V]
F-04 Base Frequency	[Hz]
P-03 Motor Current	[A]
P-06 Base Speed	[RPM]
F-01 Frequency Setting 1	
F-02 Operation Method	
F-07 Accel Time 1	[s]
F-08 Decel Time 1	[s]
F-10 Electronic Overload	
F-15 Motor Speed High Limit [Hz]*	[Hz]
F-16 Motor Speed Low Limit [Hz]*	[Hz]
F-17 Motor Speed High Limit [RPM]	[RPM]
F-18 Motor Speed Low Limit [RPM]	[RPM]
H-08 Reverse Lock	
P-04 Auto Tune	

Table 2.1 Quick Setup parameters

\*The display showing depends on choices made in K-02 Motor Speed Unit and K-03 Regional Settings. The default settings of K-02 Motor Speed Unit and K-03 Regional Settings depend on which region of the world the frequency converter is supplied to but can be re-programmed as required.

### 2.1.5 Macros

The Macros provide quick and easy access to all parameters required for the majority of AF-600 FP applications including most VAV and CAV supply and return fans, cooling tower fans, Primary, Secondary and Condenser Water Pumps and other pump, fan and compressor applications.

#### How to access Macros - example



Illustration 2.2 Step 1: Turn on the frequency converter (green LED lights)

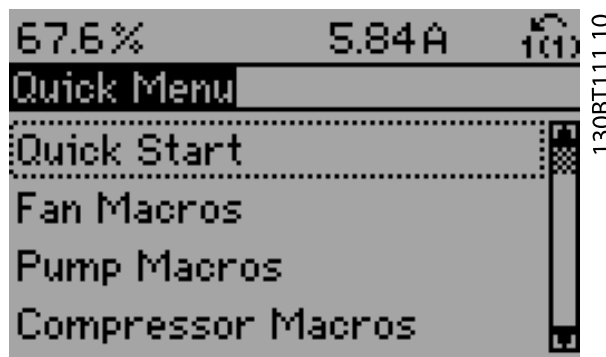

Illustration 2.3 Step 2: Press the [Quick Menus] button (Quick Menu choices appear).

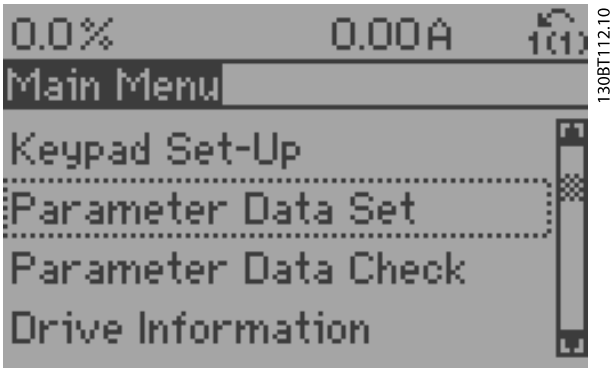

Illustration 2.4 Step 3: Use the up/down navigation keys to scroll down to Fan Macros. Press [OK].

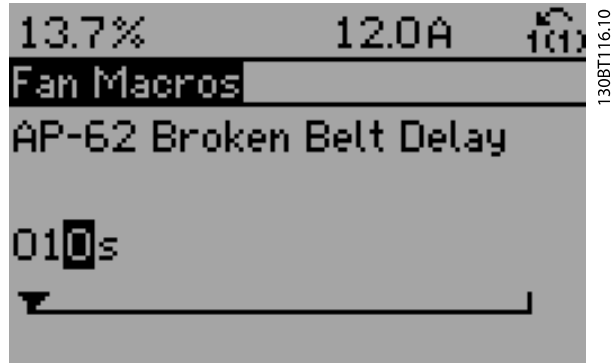

Illustration 2.7 Step 6: Use the up/down navigation keys to change the delay time.

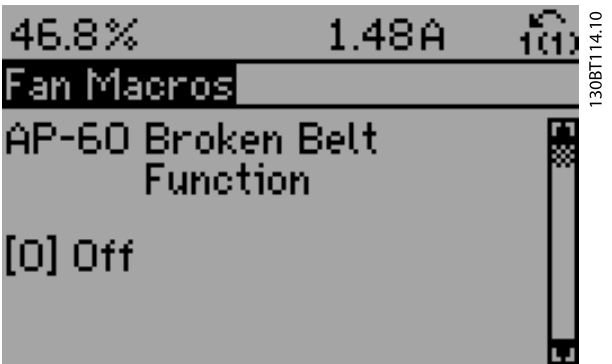

Illustration 2.5 Step 4: Use the up/down navigation keys to scroll down to find AP-62 Broken Belt Delay.

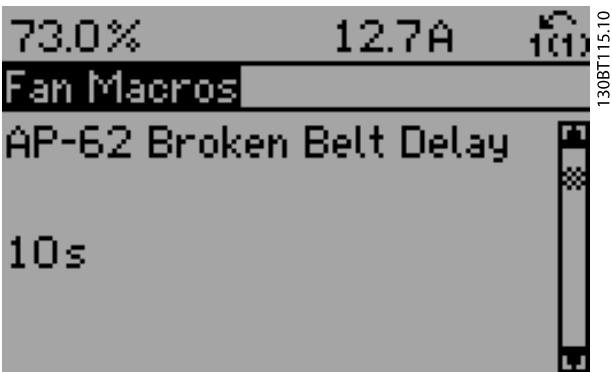

Illustration 2.6 Step 5: Press [OK].



**Function Set-ups parameters**

The Quick Menu parameters are grouped in the following way:

2

Application Settings		
Fan Macros	Pump Macros	Compressor Macros
AP-60 Broken Belt Function	AP-20 Low Power Auto Set-up	H-43 Torque Characteristics
AP-61 Broken Belt Torque	AP-21 Low Power Detection	F-24 Holding Time
AP-62 Broken Belt Delay	AP-22 Low Speed Detection	AP-75 Short Cycle Protection
C-40 Semi-Auto Jump Freq Set-up	AP-23 No-Flow Function	AP-76 Interval between Starts
H-43 Torque Characteristics	AP-24 No-Flow Delay	AP-77 Minimum Run Time
AP-22 Low Speed Detection	AP-40 Minimum Run Time	E-51 Terminal 27 Mode
AP-23 No-Flow Function	AP-41 Minimum Sleep Time	E-52 Terminal 29 Mode
AP-24 No-Flow Delay	AP-42 Wake-up Speed [RPM]	E-03 Terminal 27 Digital Input
AP-40 Minimum Run Time	AP-43 Wake-up Speed [Hz]	E-04 Terminal 29 Digital Input
AP-41 Minimum Sleep Time	AP-44 Wake-up Ref./FB Difference	E-24 Function Relay
AP-42 Wake-up Speed [RPM]	AP-45 Setpoint Boost	H-09 Start Mode
AP-43 Wake-up Speed [Hz]	AP-46 Maximum Boost Time	H-36 Trip Speed Low [RPM]
AP-44 Wake-up Ref./FB Difference	AP-26 Dry Pump Function	H-37 Trip Speed Low [Hz]
AP-45 Setpoint Boost	AP-27 Dry Pump Delay	
AP-46 Maximum Boost Time	AP-80 Flow Compensation	
B-10 Brake Function	AP-81 Square-linear Curve Approximation	
B-16 AC brake Max. Current	AP-82 Work Point Calculation	
B-17 Over-voltage Control	AP-83 Speed at No-Flow [RPM]	
H-09 Start Mode	AP-84 Speed at No-Flow [Hz]	
F-24 Holding Time	AP-85 Speed at Design Point [RPM]	
H-80 Function at Stop	AP-86 Speed at Design Point [Hz]	
B-00 DC Hold Current	AP-87 Pressure at No-Flow Speed	
H-08 Reverse Lock	AP-88 Pressure at Rated Speed	
	AP-89 Flow at Design Point	
	AP-90 Flow at Rated Speed	
	H-43 Torque Characteristics	
	H-09 Start Mode	



Closed Loop Settings		
Single Zone Int. Set Point	Single Zone Ext. Set Point	Multi Zone / Adv
H-40 Configuration Mode	H-40 Configuration Mode	H-40 Configuration Mode
CL-12 Reference/Feedback Unit	CL-12 Reference/Feedback Unit	F-01 Frequency Setting 1
CL-13 Minimum Reference/Feedb.	CL-13 Minimum Reference/Feedb.	C-30 Frequency Command 2
CL-14 Maximum Reference/Feedb.	CL-14 Maximum Reference/Feedb.	CL-00 Feedback 1 Source
AN-22 Terminal 54 Low Current	AN-10 Terminal 53 Low Voltage	CL-01 Feedback 1 Conversion
AN-24 Terminal 54 Low Ref./Feedb. Value	AN-11 Terminal 53 High Voltage	CL-02 Feedback 1 Source Unit
AN-25 Terminal 54 High Ref./Feedb. Value	AN-12 Terminal 53 Low Current	CL-03 Feedback 2 Source
AN-26 Terminal 54 Filter Time Constant	AN-13 Terminal 53 High Current	CL-04 Feedback 2 Conversion
AN-27 Terminal 54 Live Zero	AN-14 Terminal 53 Low Ref./Feedb. Value	CL-05 Feedback 2 Source Unit
AN-00 Live Zero Timeout Time	AN-15 Terminal 53 High Ref./Feedb. Value	CL-06 Feedback 3 Source
AN-01 Live Zero Timeout Function	AN-22 Terminal 54 Low Current	CL-07 Feedback 3 Conversion
CL-21 Setpoint 1	AN-24 Terminal 54 Low Ref./Feedb. Value	CL-08 Feedback 3 Source Unit
CL-81 PID Normal/ Inverse Control	AN-25 Terminal 54 High Ref./Feedb. Value	CL-12 Reference/Feedback Unit
CL-82 PID Start Speed [RPM]	AN-26 Terminal 54 Filter Time Constant	CL-13 Minimum Reference/Feedb.
CL-83 PID Start Speed [Hz]	AN-27 Terminal 54 Live Zero	CL-14 Maximum Reference/Feedb.
CL-93 PID Proportional Gain	AN-00 Live Zero Timeout Time	AN-10 Terminal 53 Low Voltage
CL-94 PID Integral Time	AN-01 Live Zero Timeout Function	AN-11 Terminal 53 High Voltage
	CL-81 PID Normal/ Inverse Control	AN-12 Terminal 53 Low Current
	CL-82 PID Start Speed [RPM]	AN-13 Terminal 53 High Current
	CL-83 PID Start Speed [Hz]	AN-14 Terminal 53 Low Ref./Feedb. Value
	CL-93 PID Proportional Gain	AN-15 Terminal 53 High Ref./Feedb. Value
	CL-94 PID Integral Time	AN-16 Terminal 53 Filter Time Constant
		AN-17 Terminal 53 Live Zero
		AN-20 Terminal 54 Low Voltage
		AN-21 Terminal 54 High Voltage
		AN-22 Terminal 54 Low Current
		AN-23 Terminal 54 High Current
		AN-24 Terminal 54 Low Ref./Feedb. Value
		AN-25 Terminal 54 High Ref./Feedb. Value
		AN-26 Terminal 54 Filter Time Constant
		AN-27 Terminal 54 Live Zero
		AN-00 Live Zero Timeout Time
		AN-01 Live Zero Timeout Function
		H-76 Warning Feedback Low
		H-77 Warning Feedback High
		CL-20 Feedback Function
		CL-21 Setpoint 1
		CL-22 Setpoint 2
		CL-81 PID Normal/ Inverse Control
		CL-82 PID Start Speed [RPM]
		CL-83 PID Start Speed [Hz]
		CL-93 PID Proportional Gain
		CL-94 PID Integral Time
		CL-70 Closed Loop Type
		CL-71 PID Performance
		CL-72 PID Output Change
		CL-73 Minimum Feedback Level
		CL-74 Maximum Feedback Level
		CL-79 PID Autotuning



2

### 2.1.6 Main Menu Mode

Select the Main Menu mode by pressing the [Main Menu] key. The below read-out appears on the display. The middle and bottom sections on the display show a list of parameter groups which can be chosen by toggling the up and down buttons.

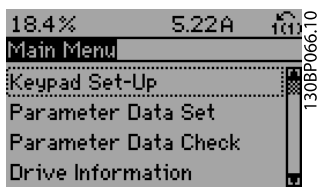

Each parameter has a name and number which remain the same regardless of the programming mode. In the Main Menu mode, the parameters are divided into groups. The first digit of the parameter number (from the left) indicates the parameter group number.

All parameters can be changed in the Main Menu. However, depending on the choice of configuration (*H-40 Configuration Mode*), some parameters can be hidden.

### 2.1.7 Parameter Selection

In the Main Menu mode, the parameters are divided into groups. You select a parameter group by means of the navigation keys. The following parameter groups are accessible:

Group no.	Parameter group:
K	Keypad Set-up
F	Fundamental Parameters
E	Digital In/Outs
C	Frequency Control Functions
P	Motor Data
H	High Perf Parameters
AN	Analog In/Out
SP	Special Functions
O	Options/comms
AO	Analog I/O Option
DN	DeviceNet
PB	Profibus
LN	LonWorks
BN	BACnet
ID	Drive Information
DR	Data Readouts
LG	Logs & I/O Opt. Status
AP	HVAC Appl. Param.
FB	Fire/Bypass Operation
T	Timed Functions
CL	PID Closed Loop
XC	Extended PID Closed Loop
PC	Pump Controller
LC	Logic Controller
B	Braking Functions

After selecting a parameter group, choose a parameter by means of the navigation keys. The middle section on the display shows the parameter number and name as well as the selected parameter value.

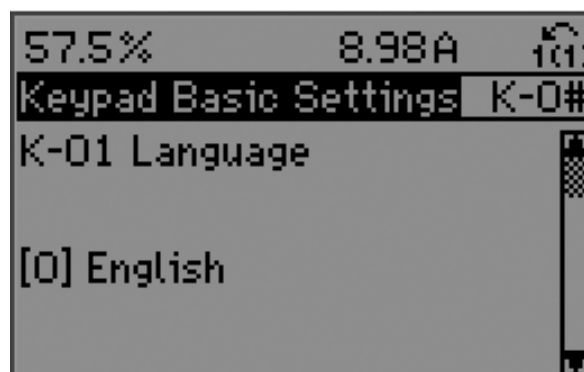

130BP067.10

### 2.1.8 Changing Data

The procedure for changing data is the same whether you select a parameter in the Quick menu or the Main menu mode. Press [OK] to change the selected parameter. The procedure for changing data depends on whether the selected parameter represents a numerical data value or a text value.

### 2.1.9 Changing a Text Value

If the selected parameter is a text value, change the text value with the [▲] [▼] navigation keys. The up key increases the value, and the down key decreases the value. Place the cursor on the value you want to save and press [OK].

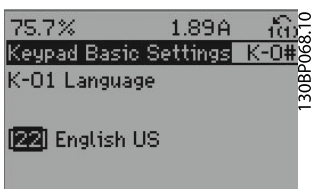

### 2.1.10 Changing a Group of Numeric Data Values

If the chosen parameter represents a numeric data value, change the chosen data value by means of the [◀] [▶] navigation keys as well as the [▲] [▼] navigation keys. Use the [◀] [▶] navigation keys to move the cursor horizontally.



Use the [▲] [▼] navigation keys to change the data value. The up key enlarges the data value, and the down key reduces the data value. Place the cursor on the value you want to save and press [OK].



### 2.1.11 Value, Step-by-Step

Certain parameters can be changed step by step or infinitely varying. This applies to *P-07 Motor Power [kW]*, *F-05 Motor Rated Voltage* and *F-04 Base Frequency*. The parameters are changed both as a group of numeric data values and as numeric data values infinitely varying.

### 2.1.12 Read-out and Programming of Indexed Parameters

Parameters are indexed when placed in a rolling stack. *ID-30 Alarm Log: Error Code* to *ID-33 Alarm Log: Date and Time* contain a fault log which can be read out. Choose a parameter, press [OK], and use the up/down navigation keys to scroll through the value log.

Use *C-05 Multi-step Frequency 1 - 8* as another example: Choose the parameter, press [OK], and use the up/down navigation keys to scroll through the indexed values. To change the parameter value, select the indexed value and press [OK]. Change the value by using the up/down keys. Press [OK] to accept the new setting. Press [CANCEL] to abort. Press [Back] to leave the parameter.

### 2.1.13 Restore to Default Settings

Restore the frequency converter to default settings in two ways:

#### Recommended restore (via H-03 Restore Factory Settings)

1. Select *H-03 Restore Factory Settings*
2. Press [OK]
3. Select "restore"
4. Press [OK]
5. Cut off the mains supply and wait until the display turns off.
6. Reconnect the mains supply - the frequency converter is now reset.
7. Change *H-03 Restore Factory Settings* back to *Normal Operation*.

**NOTE**

Resets parameters selected in Personal Menu with default factory setting.

<i>H-03 Restore Factory Settings</i> restores all except:
<i>SP-50 RFI Filter</i>
<i>O-30 Protocol</i>
<i>O-31 Address</i>
<i>O-32 Drive Port Baud Rate</i>
<i>O-35 Minimum Response Delay</i>
<i>O-36 Maximum Response Delay</i>
<i>O-37 Maximum Inter-Char Delay</i>
<i>ID-00 Operating Hours to ID-05 Over Volt's</i>
<i>ID-20 Historic Log: Event to ID-22 Historic Log: Time</i>
<i>ID-30 Alarm Log: Error Code to ID-32 Alarm Log: Time</i>

**Manual restore**

1.	Disconnect from mains and wait until the display turns off.
2.	Press [Status] - [Main Menu] - [OK] at the same time while power up for keypad, Graphical Display
3.	Release the keys after 5 seconds
4.	The frequency converter is now programmed according to default settings.
This procedure restores all except: <i>ID-00 Operating Hours; ID-03 Power Up's; ID-04 Over Temp's; ID-05 Over Volt's.</i>	

**NOTE**

When you carry out manual restore, you also reset serial communication, *SP-50 RFI Filter* and fault log settings.

**NOTE**

After restore and power cycling, the display will not show any information until after a couple of minutes.



### 3 Parameter Description

#### 3.1 K-## Keypad Set-up

Parameters related to the fundamental functions of the frequency converter, function of the keypad buttons and configuration of the keypad display.

##### 3.1.1 K-0# Keypad Basic Settings

Parameter group for basic frequency converter settings.

K-01 Language		
Option:	Function:	
		Defines the language to be used in the display. The frequency converter is delivered with 4 different languages.
[0] *	English	
[2]	Francais	
[4]	Spanish	
[10]	Chinese	
[22]	English US	

K-02 Motor Speed Unit		
Option:	Function:	
		This parameter cannot be adjusted while the motor is running. The display showing depends on settings in <i>K-02 Motor Speed Unit</i> and <i>K-03 Regional Settings</i> . The default setting of <i>K-02 Motor Speed Unit</i> and <i>K-03 Regional Settings</i> depends on which region of the world the drive is supplied to, but can be re-programmed as required.  <b>NOTE</b> <b>Changing the Motor Speed Unit will reset certain parameters to their initial value. It is recommended to select the motor speed unit first, before modifying other parameters.</b>
[0]	RPM	Selects display of motor speed variables and parameters (i.e. references, feedbacks and limits) in terms of motor speed (RPM).
[1] *	Hz	Selects display of motor speed variables and parameters (i.e. references, feedbacks and limits) in terms of output frequency to the motor (Hz).

K-03 Regional Settings		
Option:	Function:	
		This parameter cannot be adjusted while the motor is running. The display showing depends on settings in <i>K-02 Motor Speed Unit</i> and <i>K-03 Regional Settings</i> . The default setting of <i>K-02 Motor</i>

K-03 Regional Settings		
Option:	Function:	
		<i>Speed Unit</i> and <i>K-03 Regional Settings</i> depends on which region of the world the frequency converter is supplied to but can be re-programmed as required.
[0]	International	Sets <i>P-07 Motor Power [kW]</i> units to [kW] and the default value of <i>F-04 Base Frequency</i> [50 Hz].
[1] *	North America	Sets <i>P-02 Motor Power [HP]</i> units to HP and the default value of <i>F-04 Base Frequency</i> to 60 Hz.

The setting not used is made invisible.

K-04 Operating State at Power-up		
Option:	Function:	
		Select the operating mode upon reconnection of the frequency converter to mains voltage after power down when operating in Hand (local)mode.
[0] *	Resume	Resumes operation of the frequency converter maintaining the same local reference and the same start/stop condition (applied by [Hand]/[Off] on the keypad or Hand Start via a digital input as before the frequency converter was powered down.
[1]	Forced stop, ref=old	Uses saved reference [1] to stop the frequency converter but at the same time retain in memory the local speed reference prior to power down. After mains voltage is reconnected and after receiving a start command (using the keypad [Hand] button or Hand Start command via a digital input) the frequency converter restarts and operates at the retained speed reference.

K-05 Local Mode Unit		
Option:	Function:	
		Defines if the local reference unit should be displayed in terms of the motor shaft speed (in RPM/Hz) or as percent.
[0] *	As Motor Speed Unit	
[1]	%	

#### 3.1.2 K-1# Keypad Set-up Operations

Define and control the individual parameter set-ups.





The frequency converter has four parameter setups that can be programmed independently of each other. This makes the frequency converter very flexible and able to meet the requirements of many different AF-600 FP system control schemes often saving the cost of external control equipment. For example these can be used to program the frequency converter to operate according to one control scheme in one setup (e.g. daytime operation) and another control scheme in another setup (e.g. night set back). Alternatively they can be used by an AHU or packaged unit OEM to identically program all their factory fitted frequency converters for different equipment models within a range to have the same parameters and then during production/commissioning simply select a specific setup depending on which model within that range the frequency converter is installed on.

The active setup (i.e. the setup in which the frequency converter is currently operating) can be selected in *K-10 Active Set-up* and is displayed in the keypad. Using Multi set-up it is possible to switch between set-ups with the frequency converter running or stopped, via digital input or serial communication commands (e.g. for night set back). If it is necessary to change setups whilst running, ensure *K-12 This Set-up Linked to* is programmed as required. For the majority of AF-600 FP applications it will not be necessary to program *K-12 This Set-up Linked to* even if change of set up whilst running is required, but for very complex applications, using the full flexibility of the multiple setups, it may be required. Using *K-11 Edit Set-up* it is possible to edit parameters within any of the setups whilst continuing the frequency converter operation in its Active Setup which can be a different setup to that being edited. Using *K-51 Set-up Copy* it is possible to copy parameter settings between the set-ups to enable quicker commissioning if similar parameter settings are required in different set-ups.

K-10 Active Set-up		
Option:	Function:	
		Select the set-up in which the frequency converter is to operate. Use <i>K-51 Set-up Copy</i> to copy a set-up to one or all other set-ups. To avoid conflicting settings of the same parameter within two different set-ups, link the set-ups together using <i>K-12 This Set-up Linked to</i> . Stop the frequency converter before switching between set-ups where parameters marked 'not changeable during operation' have different values. Parameters which are 'not changeable during operation' are marked FALSE in the parameter lists in the section <i>Parameter Lists</i>
[0]	Factory setup	Cannot be changed. It contains the GE data set, and can be used as a data source when returning the other set-ups to a known state.

K-10 Active Set-up		
Option:	Function:	
[1] *	Set-up 1	<i>Set-up 1</i> [1] to <i>Set-up 4</i> [4] are the four separate parameter set-ups within which all parameters can be programmed.
[2]	Set-up 2	
[3]	Set-up 3	
[4]	Set-up 4	
[9]	Multi Set-up	Is used for remote selection of set-ups using digital inputs and the serial communication port. This set-up uses the settings from <i>K-12 This Set-up Linked to</i> .

K-11 Edit Set-up		
Option:	Function:	
		Select the set-up to be edited (i.e. programmed) during operation; either the active set-up or one of the inactive set-ups. The set-up number being edited is displayed in the keypad in (brackets).
[0]	Factory setup	cannot be edited but it is useful as a data source to return the other set-ups to a known state.
[1]	Set-up 1	<i>Set-up 1</i> [1] to <i>Set-up 4</i> [4] can be edited freely during operation, independently of the active set-up.
[2]	Set-up 2	
[3]	Set-up 3	
[4]	Set-up 4	
[9] *	Active Set-up	(i.e. the set-up in which the frequency converter is operating) can also be edited during operation. Editing parameters in the chosen setup would normally be done from the keypad but it is also possible from any of the serial communication ports.

K-12 This Set-up Linked to		
Option:	Function:	
		This parameter only needs to be programmed if changing set-ups is required whilst the motor is running. It ensures that parameters which are "not changeable during operation" have the same setting in all relevant set-ups.  To enable conflict-free changes from one set-up to another whilst the frequency converter is running, link set-ups containing parameters which are not changeable during operation. The link will ensure synchronising of the 'not changeable during operation' parameter values when moving from one set-up to another during operation. 'Not changeable during operation' parameters can be identified by the label FALSE in the parameter lists in the section <i>Parameter Lists</i> .

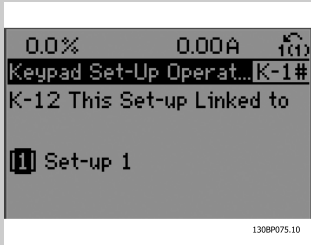
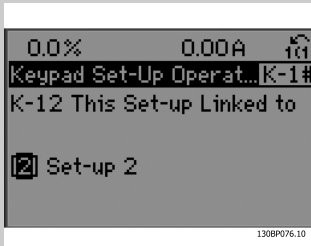

K-12 This Set-up Linked to	
Option:	Function:
	<p>The <i>K-12 This Set-up Linked to</i> feature is used when Multi set-up in <i>K-10 Active Set-up</i> is selected. Multi set-up can be used to move from one set-up to another during operation (i.e. while the motor is running).</p> <p>Example:</p> <p>Use Multi set-up to shift from Set-up 1 to Set-up 2 whilst the motor is running. Programme parameters in Set-up 1 first, then ensure that Set-up 1 and Set-up 2 are synchronised (or 'linked'). Synchronisation can be performed in two ways:</p> <ol style="list-style-type: none"> <li>1. Change the edit set-up to <i>Set-up 2</i> [2] in <i>K-11 Edit Set-up</i> and set <i>K-12 This Set-up Linked to</i> to <i>Set-up 1</i> [1]. This will start the linking (synchronising) process.</li> </ol>  <p>OR</p> <ol style="list-style-type: none"> <li>2. While still in Set-up 1, using <i>K-50 Keypad Copy</i>, copy Set-up 1 to Set-up 2. Then set <i>K-12 This Set-up Linked to</i> to <i>Set-up 2</i> [2]. This will start the linking process.</li> </ol>  <p>After the link is complete, <i>K-13 Readout: Linked Set-ups</i> will read {1,2} to indicate that all 'not changeable during operation' parameters are now the same in Set-up 1 and Set-up 2. If there are changes to a 'not changeable during operation' parameter, e.g. <i>P-30 Stator Resistance (Rs)</i>, in Set-up 2, they will also be changed automatically in Set-up 1. A switch between Set-up 1 and Set-up 2 during operation is now possible.</p>
[0] *	Not linked
[1]	Set-up 1
[2]	Set-up 2
[3]	Set-up 3

K-12 This Set-up Linked to	
Option:	Function:
[4]	Set-up 4
K-13 Readout: Linked Set-ups	
Array [5]	
Range:	Function:
0 N/A* N/A]	[0 - 255 N/A]
View a list of all the set-ups linked by means of <i>K-12 This Set-up Linked to</i> . The parameter has one index for each parameter set-up. The parameter value displayed for each index represents which setups are linked to that parameter setup.	
Index	keypad value
0	{0}
1	{1,2}
2	{1,2}
3	{3}
4	{4}
<p><b>Table 3.2 Example: Set-up 1 and Set-up 2 are linked</b></p>	

K-14 Readout: Edit Set-ups / Channel	
Range:	Function:
0 N/ A*	[-2147483648 - 2147483647 N/ A]
View the setting of <i>K-11 Edit Set-up</i> for each of the four different communication channels. When the number is displayed in hex, as it is in the keypad, each number represents one channel. Numbers 1-4 represent a set-up number; 'F' means factory setting; and 'A' means active set-up. The channels are, from right to left: keypad, Drive-bus, USB, HPFB1.5.	
Example: The number AAAAAA21h means that the Drive-bus selected Set-up 2 in <i>K-11 Edit Set-up</i> , the keypad selected Set-up 1 and all others used the active set-up.	



### 3.1.3 K-2# Keypad Display

Define the variables displayed in the keypad.

3

[0] *	None	No display value selected
[537]	Display Text 1	Enables an individual text string to be written, for display in the keypad or to be read via serial communication.
[538]	Display Text 2	Enables an individual text string to be written, for display in the keypad or to be read via serial communication.
[539]	Display Text 3	Enables an individual text string to be written, for display in the keypad or to be read via serial communication.
[589]	Date and Time Readout	Displays the current date and time.
[953]	Profibus Warning Word	Displays Profibus communication warnings.
[2205]	Readout Transmit Error Counter	View the number of CAN control transmission errors since the last power-up.
[2206]	Readout Receive Error Counter	View the number of CAN control receipt errors since the last power-up.
[2207]	Readout Bus Off Counter	View the number of Bus Off events since the last power-up.
[2213]	Warning Parameter	View a DeviceNet-specific warning word. One separate bit is assigned to every warning.
[1501]	Running Hours	View the number of running hours of the motor.
[1502]	kWh Counter	View the mains power consumption in kWh.
[1200]	Control Word	View the Control Word sent from the frequency converter via the serial communication port in hex code.
[1201]	Reference [Unit]	Total reference (sum of digital/analog/preset/bus/freeze ref./catch up and slow-down) in selected unit.
[1202]	Reference [%]	Total reference (sum of digital/analog/preset/bus/freeze ref./catch up and slow-down) in percent.
[1203]	Status Word	Present status word
[1205]	Main Actual Value [%]	View the two-byte word sent with the Status word to the bus Master reporting the Main Actual Value.
[1209]	Custom Readout	View the user-defined readouts as defined in <i>K-30 Unit for Custom Readout</i> , <i>K-31 Min Value of Custom Readout</i> and <i>K-32 Max Value of Custom Readout</i> .
[1210]	Power [kW]	Actual power consumed by the motor in kW.
[1211]	Power [hp]	Actual power consumed by the motor in HP.
[1212]	Motor Rated Voltage	Voltage supplied to the motor.

[1213]	Frequency	Motor frequency, i.e. the output frequency from the frequency converter in Hz
[1214]	Motor Current	Phase current of the motor measured as effective value.
[1215]	Frequency [%]	Motor frequency, i.e. the output frequency from the frequency converter in percent.
[1216]	Torque [Nm]	Present motor load as a percentage of the rated motor torque.
[1217]	Speed [RPM]	Motor speed reference. Actual speed will depend on slip compensation being used (compensation set in <i>P-09 Slip Compensation</i> ). If not used, actual speed will be the value read in the display minus motor slip.
[1218]	Motor Thermal	Thermal load on the motor, calculated by the Electronic Thermal Overload function. See also parameter group H-9# Motor Temperature.
[1222]	Torque [%]	Shows the actual torque produced, in percentage.
[1230]	DC Link Voltage	Intermediate circuit voltage in the frequency converter.
[1232]	Brake Energy /s	Present brake power transferred to an external brake resistor. Stated as an instantaneous value.
[1233]	Brake Energy /2 min	Brake power transferred to an external brake resistor. The mean power is calculated continuously for the most recent 120 seconds.
[1234]	Heatsink Temp.	Present heat sink temperature of the frequency converter. The cut-out limit is $95 \pm 5^\circ \text{C}$ ; cutting back in occurs at $70 \pm 5^\circ \text{C}$ .
[1235]	Drive Thermal	Percentage load of the inverters.
[1236]	Drive Nominal Current	Nominal current of the frequency converter.
[1237]	Drive Max. Current	Maximum current of the frequency converter.
[1238]	Logic Controller State	State of the event executed by the control.
[1239]	Control Card Temp.	Temperature of the control card.
[1250]	External Reference	Sum of the external reference as a percentage, i.e. the sum of analog/pulse/bus.
[1252]	Feedback [Unit]	Reference value from programmed digital input(s).
[1253]	Digi Pot Reference	View the contribution of the digital potentiometer to the actual reference Feedback.
[1254]	Feedback 1 [Unit]	View the value of Feedback 1. See also par. CL-0#.
[1255]	Feedback 2 [Unit]	View the value of Feedback 2. See also par. CL-0#.



Parameter Description AF-600 FP Programming Guide

[1256]	Feedback 3 [Unit]	View the value of Feedback 3. See also par. CL-0#.
[1258]	PID Output [%]	Returns the Drive Closed Loop PID controller output value in percent.
[1260]	Digital Input	Displays the status of the digital inputs. Signal low = 0; Signal high = 1. Regarding order, see <i>DR-60 Digital Input</i> . Bit 0 is at the extreme right.
[1261]	Terminal 53 Switch Setting	Setting of input terminal 53. Current = 0; Voltage = 1.
[1262]	Analog Input 53	Actual value at input 53 either as a reference or protection value.
[1263]	Terminal 54 Switch Setting	Setting of input terminal 54. Current = 0; Voltage = 1.
[1264]	Analog Input 54	Actual value at input 54 either as reference or protection value.
[1265]	Analog Output 42 [mA]	Actual value at output 42 in mA. Use <i>AN-50 Terminal 42 Output</i> to select the variable to be represented by output 42.
[1266]	Digital Output [bin]	Binary value of all digital outputs.
[1267]	Freq. Input #29 [Hz]	Actual value of the frequency applied at terminal 29 as a pulse input.
[1268]	Freq. Input #33 [Hz]	Actual value of the frequency applied at terminal 33 as a pulse input.
[1269]	Pulse Output #27 [Hz]	Actual value of pulses applied to terminal 27 in digital output mode.
[1270]	Pulse Output #29 [Hz]	Actual value of pulses applied to terminal 29 in digital output mode.
[1271]	Relay Output [bin]	View the setting of all relays.
[1272]	Counter A	View the present value of Counter A.
[1273]	Counter B	View the present value of Counter B.
[1275]	Analog In X30/11	Actual value at input X30/11 either as reference or protection value.
[1276]	Analog In X30/12	Actual value at input X30/12 either as reference or protection value.
[1277]	Analog Out X30/8 [mA]	Actual value at output X30/8 in mA. Use par. AN-60 to select the value to be shown.
[1280]	Fieldbus CTW 1	Control word (CTW) received from the Bus Master.
[1282]	Fieldbus REF 1	Main reference value sent with control word via the serial communications network e.g. from the BMS, PLC or other master controller.
[1284]	Comm. Option STW	Extended fieldbus communication option status word.
[1285]	Drive Port CTW 1	Control word (CTW) received from the Bus Master.
[1286]	Drive Port REF 1	Status word (STW) sent to the Bus Master.
[1290]	Alarm Word	One or more alarms in a Hex code (used for serial communications)

[1291]	Alarm Word 2	One or more alarms in a Hex code (used for serial communications)
[1292]	Warning Word	One or more warnings in a Hex code (used for serial communications)
[1293]	Warning Word 2	One or more warnings in a Hex code (used for serial communications)
[1294]	Ext. Status Word	One or more status conditions in a Hex code (used for serial communications)
[1295]	Ext. Status Word 2	One or more status conditions in a Hex code (used for serial communications)
[1296]	Maintenance Word	The bits reflect the status for the programmed Preventive Maintenance Events in parameter group T-1#
[1830]	Analog Input X42/1	Shows the value of the signal applied to terminal X42/1 on the Analog I/O card.
[1831]	Analog Input X42/3	Shows the value of the signal applied to terminal X42/3 on the Analog I/O card.
[1832]	Analog Input X42/5	Shows the value of the signal applied to terminal X42/5 on the Analog I/O card.
[1833]	Analog Out X42/7 [V]	Shows the value of the signal applied to terminal X42/7 on the Analog I/O card.
[1834]	Analog Out X42/9 [V]	Shows the value of the signal applied to terminal X42/9 on the Analog I/O card.
[1835]	Analog Out X42/11 [V]	Shows the value of the signal applied to terminal X42/11 on the Analog I/O card.
[2117]	Ext. 1 Reference [Unit]	The value of the reference for extended Closed Loop Controller 1
[2118]	Ext. 1 Feedback [Unit]	The value of the feedback signal for extended Closed Loop Controller 1
[2119]	Ext. 1 Output [%]	The value of the output from extended Closed Loop Controller 1
[2137]	Ext. 2 Reference [Unit]	The value of the reference for extended Closed Loop Controller 2
[2138]	Ext. 2 Feedback [Unit]	The value of the feedback signal for extended Closed Loop Controller 2
[2139]	Ext. 2 Output [%]	The value of the output from extended Closed Loop Controller 2
[2157]	Ext. 3 Reference [Unit]	The value of the reference for extended Closed Loop Controller 3
[2158]	Ext. 3 Feedback [Unit]	The value of the feedback signal for extended Closed Loop Controller 3
[2159]	Ext. 3 Output [%]	The value of the output from extended Closed Loop Controller 3
[1230]	No-Flow Power	The calculated No Flow Power for the actual operating speed
[2316]	Maintenance Text	
[2580]	Pump Status	



[2581]	Pump Status	Status for the operation of each individual pump controlled by the Pump Controller.
--------	-------------	---

**K-20 Display Line 1.1 Small**

<b>Option: Function:</b>	
	Select a variable for display in line 1, left position.
	The options are the same as those listed under K-2#.

**K-21 Display Line 1.2 Small**

<b>Option: Function:</b>	
	Select a variable for display in line 1, middle position.
	The options are the same as those listed under K-2#.

**K-22 Display Line 1.3 Small**

<b>Option: Function:</b>	
	Select a variable for display in line 1, right position.
	The options are the same as those listed under K-2#.

**K-23 Display Line 2 Large**

<b>Option: Function:</b>	
	Select a variable for display in line 2.
	The options are the same as those listed under K-2#.

**K-24 Display Line 3 Large**

<b>Option: Function:</b>	
	Select a variable for display in line 3.
	The options are the same as those listed under K-2#.

**K-25 Quick Start**

Array [20]		
<b>Range:</b>	<b>Function:</b>	
0 N/ A*	[0 - 9999 N/ A]	Define up to 50 parameters to appear in the Q1 Quick Start, accessible via the [Quick Menu] key on the keypad. The parameters will be displayed in the Q1 Quick Start in the order they are programmed into this array parameter. Delete parameters by setting the value to '0000'. For example, this can be used to provide quick, simple access to just one or up to 50 parameters which require changing on a regular basis (e.g. for plant maintenance reasons) or by an OEM to enable simple commissioning of their equipment.

3.1.4 K-3# Keypad Custom Readout

It is possible to customize the display elements for various purposes: \*Custom Readout. Value proportional to speed (Linear, squared or cubed depending on unit selected in K-30 Unit for Custom Readout) \*Display Text. Text string stored in a parameter.

Custom Readout

The calculated value to be displayed is based on settings in K-30 Unit for Custom Readout, K-31 Min Value of Custom Readout (linear only), K-32 Max Value of Custom Readout, F-17 Motor Speed High Limit [RPM], F-15 Motor Speed High Limit [Hz] and actual speed.

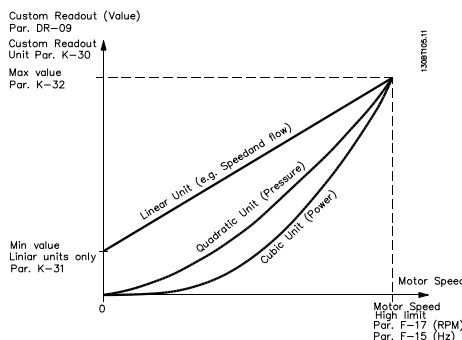

The relation will depend on the type of unit selected in K-30 Unit for Custom Readout:

Unit Type	Speed Relation
Dimensionless	Linear
Speed	
Flow, volume	
Flow, mass	
Velocity	
Length	
Temperature	
Pressure	Quadratic
Power	Cubic

**K-30 Unit for Custom Readout**

<b>Option: Function:</b>	
	Program a value to be shown in the display of the keypad. The value has a linear, squared or cubed relation to speed. This relation depends on the unit selected (see table above). The actual calculated value can be read in DR-09 Custom Readout, and/or shown in the display by selecting Custom Readout [DR-09] in K-20 Display Line 1.1 Small to K-24 Display Line 3 Large.
[0]	
[1] *	%
[5]	PPM
[10]	1/min
[11]	RPM
[12]	Pulse/s
[20]	l/s
[21]	l/min
[22]	l/h
[23]	m <sup>3</sup> /s
[24]	m <sup>3</sup> /min



K-30 Unit for Custom Readout	
Option:	Function:
[25]	m <sup>3</sup> /h
[30]	kg/s
[31]	kg/min
[32]	kg/h
[33]	t/min
[34]	t/h
[40]	m/s
[41]	m/min
[45]	m
[60]	°C
[70]	mbar
[71]	bar
[72]	Pa
[73]	kPa
[74]	m WG
[75]	mm Hg
[80]	kW
[120]	GPM
[121]	gal/s
[122]	gal/min
[123]	gal/h
[124]	CFM
[125]	ft <sup>3</sup> /s
[126]	ft <sup>3</sup> /min
[127]	ft <sup>3</sup> /h
[130]	lb/s
[131]	lb/min
[132]	lb/h
[140]	ft/s
[141]	ft/min
[145]	ft
[160]	°F
[170]	psi
[171]	lb/in <sup>2</sup>
[172]	in WG
[173]	ft WG
[174]	in Hg
[180]	HP

K-31 Min Value of Custom Readout	
Range:	Function:
0.00 Custom-ReadoutUnit*	[0.00 - par. K-32 CustomReadoutUnit] This parameter allows the choice of the min. value of the custom defined readout (occurs at zero speed). It is only possible to select a value different to 0 when selecting a linear unit in <i>K-30 Unit for Custom Readout</i> . For Quadratic and Cubic units the minimum value will be 0.

K-32 Max Value of Custom Readout	
Range:	Function:
100.00 Custom-ReadoutUnit*	[par. K-31 - 999999.99 CustomReadoutUnit] This parameter sets the max value to be shown when the speed of the motor has reached the set value for <i>F-17 Motor Speed High Limit [RPM]</i> or <i>F-15 Motor Speed High Limit [Hz]</i> (depends on setting in <i>K-02 Motor Speed Unit</i> ).

K-37 Display Text 1	
Range:	Function:
0 N/A*	[0 - 0 N/A] In this parameter it is possible to write an individual text string for display in the keypad or to be read via serial communication. If to be displayed permanently select <i>Display Text 1</i> in <i>K-20 Display Line 1.1 Small</i> , <i>K-21 Display Line 1.2 Small</i> , <i>K-22 Display Line 1.3 Small</i> , <i>K-23 Display Line 2 Large</i> or <i>K-24 Display Line 3 Large</i> . Use the [▲] or [▼] buttons on the keypad to change a character. Use the [◀] and [▶] buttons to move the cursor. When a character is highlighted by the cursor, it can be changed. Use the [▲] or [▼] buttons on the keypad to change a character. A character can be inserted by placing the cursor between two characters and pressing [▲] or [▼].

K-38 Display Text 2	
Range:	Function:
0 N/A*	[0 - 0 N/A] In this parameter it is possible to write an individual text string for display in the keypad or to be read via serial communication. If to be displayed permanently select <i>Display Text 2</i> in <i>K-20 Display Line 1.1 Small</i> , <i>K-21 Display Line 1.2 Small</i> , <i>K-22 Display Line 1.3 Small</i> , <i>K-23 Display Line 2 Large</i> or <i>K-24 Display Line 3 Large</i> . Use the [▲] or [▼] buttons on the keypad to change a character. Use the [◀] and [▶] buttons to move the cursor. When a character is highlighted by the cursor, this character can be changed. A character can be inserted by placing the cursor between two characters and pressing [▲] or [▼].





K-39 Display Text 3		
Range:	Function:	
0 N/ A*	[0 - 0 N/ A]	In this parameter it is possible to write an individual text string for display in the keypad or to be read via serial communication. If to be displayed permanently select Display Text 3 in <i>K-20 Display Line 1.1 Small, K-21 Display Line 1.2 Small, K-22 Display Line 1.3 Small, K-23 Display Line 2 Large or K-24 Display Line 3 Large</i> . Use the [▲] or [▼] buttons on the keypad to change a character. Use the [◀] and [▶] buttons to move the cursor. When a character is highlighted by the cursor, this character can be changed. A character can be inserted by placing the cursor between two characters and pressing [▲] or [▼].

K-42 [Auto] Button on Keypad		
Option:	Function:	
		Otherwise define the password in <i>K-60 Main Menu Password</i> .

K-43 [Reset] Button on Keypad		
Option:	Function:	
[0]	Disabled	No function
[1] *	Enabled	[Reset] Key is enabled
[2]	Password Protection	Avoid unauthorized resetting. If <i>K-43 [Reset] Button on Keypad</i> is included in the <i>K-25 Quick Start</i> , then define the password in <i>K-65 Quick Menu Password</i> . Otherwise define the password in <i>K-60 Main Menu Password</i> .

### 3.1.5 K-4# Keypad Buttons

Enable, disable and password protect individual keys on the keypad.

K-40 [Hand] Button on Keypad		
Option:	Function:	
[0]	Disabled	No function
[1] *	Enabled	[Hand ] Key enabled
[2]	Password Protection	Avoid unauthorized start in Hand mode. If <i>K-40 [Hand] Button on Keypad</i> is included in the Quick Start Menu, then define the password in <i>K-65 Quick Menu Password</i> . Otherwise define the password in <i>K-60 Main Menu Password</i> .

K-41 [Off] Button on Keypad		
Option:	Function:	
[0]	Disabled	No function
[1] *	Enabled	[Off] Key is enabled
[2]	Password Protection	Avoid unauthorized stop. If <i>K-41 [Off] Button on Keypad</i> is included in the Quick Start Menu, then define the password in <i>K-65 Quick Menu Password</i> . Otherwise define the password in <i>K-60 Main Menu Password</i> .

K-42 [Auto] Button on Keypad		
Option:	Function:	
[0]	Disabled	No function
[1] *	Enabled	[Auto ] Key is enabled
[2]	Password Protection	Avoid unauthorized start in Auto mode. If <i>K-42 [Auto] Button on Keypad</i> is included in the Quick Start Menu, then define the password in <i>K-65 Quick Menu Password</i> .



### 3.1.6 K-5# Copy / Save

Copy parameter settings between set-ups and to/from the keypad.

K-50 Keypad Copy		
Option:	Function:	
[0] *	No copy	No function
[1]	All to Keypad	Copies all parameters in all set-ups from the frequency converter memory to the keypad memory. For service purposes it is recommended to copy all parameters to the keypad after commissioning.
[2]	All from Keypad	Copies all parameters in all set-ups from the keypad memory to the frequency converter memory.
[3]	Size indep. From Keypad	Copies only the parameters that are independent of the motor size. The latter selection can be used to programme several frequency converters with the same function without disturbing motor data which are already set.

This parameter cannot be adjusted while the motor is running.

K-51 Set-up Copy		
Option:	Function:	
[0] *	No copy	No function
[1]	Copy to set-up 1	Copies all parameters in the present Programming Set-up (defined in <i>K-11 Edit Set-up</i> ) to Set-up 1.
[2]	Copy to set-up 2	Copies all parameters in the present Programming Set-up (defined in <i>K-11 Edit Set-up</i> ) to Set-up 2.
[3]	Copy to set-up 3	Copies all parameters in the present Programming Set-up (defined in <i>K-11 Edit Set-up</i> ) to Set-up 3.
[4]	Copy to set-up 4	Copies all parameters in the present Programming Set-up (defined in <i>K-11 Edit Set-up</i> ) to Set-up 4.
[9]	Copy to all	Copies the parameters in the present set-up over to each of the set-ups 1 to 4.

### 3.1.7 K-6# Password Protection

K-60 Main Menu Password		
Range:	Function:	
100 N/A*	[0 - 999 N/A]	Define the password for access to the Main Menu via the [Main Menu] key. If <i>K-61 Access to Main Menu w/o Password</i> is set to <i>Full access</i> [0], this parameter will be ignored.

K-61 Access to Main Menu w/o Password		
Option:	Function:	
[0] *	Full access	Disables password defined in <i>K-60 Main Menu Password</i> .
[1]	Read only	Prevent unauthorized editing of Main Menu parameters.
[2]	No access	Prevent unauthorized viewing and editing of Main Menu parameters.

If *Full access* [0] is selected then *K-60 Main Menu Password*, *K-65 Quick Menu Password* and *K-66 Access to Quick Menu w/o Password* will be ignored.

K-65 Quick Menu Password		
Range:	Function:	
200 N/A*	[0 - 999 N/A]	Define the password for access to the Quick Start Menu via the [Quick Menu] key. If <i>K-66 Access to Quick Menu w/o Password</i> is set to <i>Full access</i> [0], this parameter will be ignored.

K-66 Access to Quick Menu w/o Password		
Option:	Function:	
[0] *	Full access	Disables password defined in <i>K-65 Quick Menu Password</i> .
[1]	Read only	Prevents unauthorized editing of Quick Start Menu parameters.
[2]	No access	Prevents unauthorized viewing and editing of Quick Start Menu parameters.

If *K-61 Access to Main Menu w/o Password* is set to *Full access* [0], this parameter will be ignored.

### 3.1.8 K-7# Clock Settings

Set the time and date of the internal clock. The internal clock can be used for e.g. Timed Actions, energy log, Trend Analysis, date/time stamps on alarms, Logged data and Preventive Maintenance.

It is possible to program the clock for Daylight Saving Time / summertime, weekly working days/non-working days including 20 exceptions (holidays etc.). Although the clock settings can be set via the keypad, they can also be set along with timed actions and preventative maintenance functions using the DCT10 software tool.





**NOTE**

The frequency converter has no back up of the clock function and the set date/time will reset to default (2000-01-01 00:00) after a power down unless the OPCAIO Analog Option Module or OPC24VPS 24V DC External Supply Option Module is installed. If no module with back up is installed, it is recommended the clock function is only used if the frequency converter is integrated into the BMS using serial communications, with the BMS maintaining synchronization of control equipment clock times. In *K-79 Clock Fault* it is possible to program for a Warning in case clock has not been set properly, e.g. after a power down.

**NOTE**

If mounting an OPCAIO option card, a battery back-up of the date and time is included.

K-70 Date and Time		
Range:	Function:	
0 N/A*	[0 - 0 N/A]	

K-71 Date Format		
Option:	Function:	
		Sets the date format to be used in the keypad.
[0]	YYYY-MM-DD	
[1]	DD-MM-YYYY	
[2] *	MM/DD/YYYY	

K-72 Time Format		
Option:	Function:	
		Sets the time format to be used in the keypad.
[0]	24 h	
[1] *	12 h	

K-74 DST/Summertime		
Option:	Function:	
		Choose how Daylight Saving Time/Summertime should be handled. For manual DST/Summertime enter the start date and end date in <i>K-76 DST/Summertime Start</i> and <i>K-77 DST/Summertime End</i> .
[0] *	Off	
[2]	Manual	

K-76 DST/Summertime Start		
Range:	Function:	
0 N/A*	[0 - 0 N/A]	Sets the date and time when summertime/DST starts. The date is programmed in the format selected in <i>K-71 Date Format</i> .

K-77 DST/Summertime End		
Range:	Function:	
0 N/A*	[0 - 0 N/A]	

K-79 Clock Fault		
Option:	Function:	
		Enables or disables the clock warning, when the clock has not been set or has been reset due to a power-down and no backup is installed. If OPCAIO is installed "enabled" is default
[0] *	Disabled	
[1]	Enabled	

3.1.9 K-8# Days and Date/Time Readout

K-81 Working Days		
Array with 7 elements [0] - [6] displayed below parameter number in display. Press OK and step between elements by means of ▲ and ▼ buttons on the keypad.		
Option:	Function:	
		Set for each weekday if it is a working day or a non-working day. First element of the array is Monday. The working days are used for Timed Actions.
[0] *	No	
[1]	Yes	

K-82 Additional Working Days		
Array with 5 elements [0] - [4] displayed below parameter number in display. Press OK and step between elements by means of ▲ and ▼ buttons on the keypad.		
Range:	Function:	
0 N/A*	[0 - 0 N/A]	Defines dates for additional working days that normally would be non-working days according to <i>K-81 Working Days</i> .

K-83 Additional Non-Working Days		
Array with 15 elements [0] - [14] displayed below parameter number in display. Press OK and step between elements by means of ▲ and ▼ buttons on the keypad.		
Range:	Function:	
0 N/A*	[0 - 0 N/A]	Defines dates for additional working days that normally would be non-working days according to <i>K-81 Working Days</i> .

K-89 Date and Time Readout		
Range:	Function:	
0 N/A*	[0 - 0 N/A]	Displays the current date and time. The date and time is updated continuously. The clock will not begin counting until a setting different from default has been made in <i>K-70 Date and Time</i> .



### 3.2 F-## Fundamental Parameters

#### 3.2.1 F-0# Fundamental Parameters

F-01 Frequency Setting 1		
Option:	Function:	
		Select the reference input to be used for the first reference signal. <i>F-01 Frequency Setting 1, C-30 Frequency Command 2 and C-34 Frequency Command 3</i> define up to three different reference signals. The sum of these reference signals defines the actual reference.  This parameter cannot be adjusted while the motor is running.
[0]	No function	
[1] *	Analog input 53	
[2]	Analog input 54	
[7]	Pulse input 29	
[8]	Pulse input 33	
[20]	Digital Potentiometer	
[21]	Analog input X30/11	(OPCGPIO)
[22]	Analog input X30/12	(OPCGPIO)
[23]	Analog Input X42/1	(OPCAIO)
[24]	Analog Input X42/3	(OPCAIO)
[25]	Analog Input X42/5	(OPCAIO)
[30]	Ext. Closed Loop 1	
[31]	Ext. Closed Loop 2	
[32]	Ext. Closed Loop 3	

F-02 Operation Method		
Option:	Function:	
		Select which reference site to activate.
[0] *	Linked to Hand / Auto	Use local reference when in Hand mode; or remote reference when in Auto mode.
[1]	Remote	Use remote reference in both Hand mode and Auto mode.
[2]	Local	Use local reference in both Hand mode and Auto mode.  <b>NOTE</b> When set to Local [2], the drive will start with this setting again following a 'power down'.

F-03 Max Output Frequency 1		
Range:	Function:	
120.0 Hz*	[1.0 - 1000.0 Hz]	Enter the maximum output frequency value. <i>F-03 Max Output Frequency 1</i> specifies the absolute limit on the frequency converter output frequency for improved safety in applications where accidental over-speeding must be avoided. This absolute limit applies to all configurations and is independent of the setting in <i>H-40 Configuration Mode</i> . This parameter cannot be adjusted while the motor is running.

F-04 Base Frequency		
Range:	Function:	
60. Hz*	[20 - 1000 Hz]	Select the motor frequency value from the motor nameplate data.

**NOTE**

This parameter cannot be adjusted while the motor is running.

F-05 Motor Rated Voltage		
Range:	Function:	
400. V*	[10. - 1000. V]	Enter the nominal motor voltage according to the motor nameplate data. The default value corresponds to the nominal rated output of the unit. This parameter cannot be adjusted while the motor is running.

F-07 Accel Time 1		
Range:	Function:	
10.00 s*	[1.00 - 3600.00 s]	Enter the accel time, i.e. the acceleration time from 0 RPM to <i>P-06 Base Speed</i> . Choose a accel time such that the output current does not exceed the current limit in <i>F-43 Current Limit</i> during ramping. See decel time in <i>F-08 Decel Time 1</i> .

$$par. F - 07 = \frac{tacc \times nnorm [par.P - 06]}{ref [rpm]} [s]$$



F-08 Decel Time 1		
Range:	Function:	
20.00 s* [1.00 - 3600.00 s]	Enter the decel time, i.e. the deceleration time from <i>P-06 Base Speed</i> to 0 RPM. Choose a decel time such that no over-voltage arises in the inverter due to regenerative operation of the motor, and such that the generated current does not exceed the current limit set in <i>F-43 Current Limit</i> . See accel time in <i>F-07 Accel Time 1</i> .	

$$par. F - 08 = \frac{t_{dec} \times n_{norm} [par.P - 06]}{ref[rpm]} [s]$$

### 3.2.2 F-1# Fundamental Parameters 1

F-10 Electronic Overload		
Option:	Function:	
	The frequency converter determines the motor temperature for motor protection in two different ways: <ul style="list-style-type: none"> <li>Via a thermistor sensor connected to one of the analog or digital inputs (<i>F-12 Motor Thermistor Input</i>).</li> <li>Via calculation of the thermal load, based on the actual load and time. The calculated thermal load is compared with the rated motor current <math>I_{M,N}</math> and the rated motor frequency <math>f_{M,N}</math>. The calculations estimate the need for a lower load at lower speed due to less cooling from the fan incorporated in the motor.</li> </ul>	
[0]	No protection	If the motor is continuously overloaded and no warning or trip of frequency converter is wanted.
[1]	Thermistor warning	Activates a warning when the connected thermistor in the motor reacts in the event of motor over-temperature.
[2]	Thermistor trip	Stops (trips) the frequency converter when the connected thermistor in the motor reacts in the event of motor over-temperature.
[3]	Elec. OL Warning 1	
[4] *	Elec. OL Trip 1	
[5]	Elec. OL Warning 2	
[6]	Elec. OL Trip 2	
[7]	Elec. OL Warning 3	
[8]	Elec. OL Trip 3	

F-10 Electronic Overload		
Option:	Function:	
[9]	Elec. OL Warning 4	
[10]	Elec. OL Trip 4	

Electronic Overload functions 1-4 will calculate the load when set-up where they were selected is active. For example Elec. OL Warning 3 or Trip 3 starts calculating when set-up 3 is selected. For the North American market: The Electronic Overload functions provide class 20 motor overload protection in accordance with NEC.

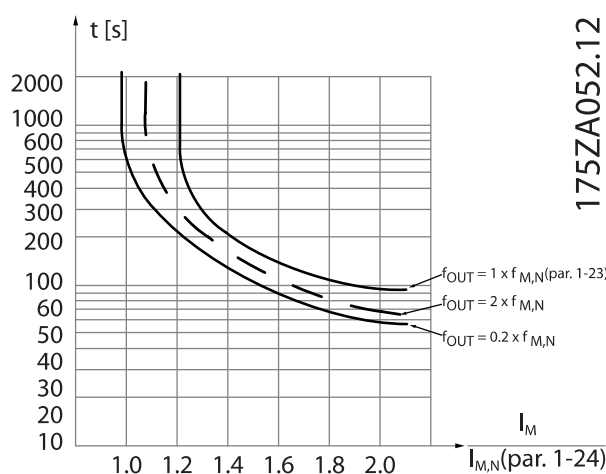

175ZA052.12

### WARNING

In order to maintain PELV, all connections made to the control terminals must be PELV, e.g. thermistor must be reinforced/ double insulated

F-11 Motor External Fan		
Option:	Function:	
[0] *	No	No external fan on motor, i.e. the motor is derated at low speed.
[1]	Yes	Applies an external motor fan (external ventilation), so no derating of the motor is required at low speed. The upper curve in graph above ( $f_{out} = 1 \times f_{M,N}$ ) is followed if the motor current is lower than nominal motor current (see <i>P-03 Motor Current</i> ). If the motor current exceeds nominal current, the operation time still decreases as if no fan were installed.



F-12 Motor Thermistor Input	
Option:	Function:
	Select the input to which the thermistor (PTC sensor) should be connected. An analog input option [1] or [2] cannot be selected if the analog input is already in use as a reference source (selected in <i>F-01 Frequency Setting 1</i> , <i>C-30 Frequency Command 2</i> or <i>C-34 Frequency Command 3</i> ).
[0] *	None
[1]	Analog input 53
[2]	Analog input 54
[3]	Digital input 18
[4]	Digital input 19
[5]	Digital input 32
[6]	Digital input 33

**NOTE**

This parameter cannot be adjusted while the motor is running.

**NOTE**

Digital input should be set to [0] *PNP - Active at 24V in E-0#*.

F-15 Motor Speed High Limit [Hz]	
Range:	Function:
50/60.0 Hz*	[par. F-16 - par. F-03 Hz]

**NOTE**

Max. output frequency cannot exceed 10% of the carrier frequency (*F-26 Motor Noise (Carrier Freq)*).

F-16 Motor Speed Low Limit [Hz]	
Range:	Function:
0 Hz*	[0 - par. F-15 Hz]
	Enter the minimum limit for motor speed. The Motor Speed Low Limit can be set to correspond to the minimum output frequency of the motor shaft. The Speed Low Limit must not exceed the setting in <i>F-15 Motor Speed High Limit [Hz]</i> .

F-17 Motor Speed High Limit [RPM]	
Range:	Function:
1800. RPM*	[par. F-18 - 60000. RPM]
	Enter the maximum limit for motor speed. The Motor Speed High Limit can be set to correspond to the manufacturer's maximum rated motor. The Motor Speed High Limit must exceed the setting in <i>F-18 Motor Speed Low Limit [RPM]</i> . Only <i>F-18 Motor Speed Low Limit [RPM]</i> or <i>F-16 Motor Speed Low Limit [Hz]</i> will be displayed depending on other parameters

F-17 Motor Speed High Limit [RPM]	
Range:	Function:
	in the Main Menu and depending on default settings dependant on global location.

**NOTE**

Max. output frequency cannot exceed 10% of the carrier frequency (*F-26 Motor Noise (Carrier Freq)*).

**NOTE**

Any changes in *F-17 Motor Speed High Limit [RPM]* will reset the value in *H-73 Warning Speed High* to the same value as set in *F-17 Motor Speed High Limit [RPM]*.

F-18 Motor Speed Low Limit [RPM]	
Range:	Function:
0 RPM*	[0 - par. F-17 RPM]
	Enter the minimum limit for motor speed. The Motor Speed Low Limit can be set to correspond to the manufacturer's recommended minimum motor speed. The Motor Speed Low Limit must not exceed the setting in <i>F-17 Motor Speed High Limit [RPM]</i> .

3.2.3 F-2# Fundamental Parameters 2

F-24 Holding Time	
Range:	Function:
0.0 s*	[0.0 - 120.0 s]
	The function selected in <i>H-80 Function at Stop</i> is active in the delay period. Enter the time delay required before commencing acceleration.

F-26 Motor Noise (Carrier Freq)	
Option:	Function:
	Select the carrier frequency. Changing the carrier frequency can help to reduce acoustic noise from the motor.  Switching frequencies higher than 5.0 kHz lead to automatic derating of the maximum output of the frequency converter.
[0]	1.0 kHz
[1]	1.5 kHz
[2]	2.0 kHz
[3]	2.5 kHz
[4]	3.0 kHz
[5]	3.5 kHz
[6]	4.0 kHz
[7] *	5.0 kHz
[8]	6.0 kHz
[9]	7.0 kHz



Parameter Description

AF-600 FP Programming Guide

F-26 Motor Noise (Carrier Freq)		
Option:	Function:	
[10]	8.0 kHz	
[11]	10.0 kHz	
[12]	12.0 kHz	
[13]	14.0 kHz	
[14]	16.0 kHz	

F-27 Motor Tone Random		
Option:	Function:	
[0] *	Off	No change of the acoustic motor switching noise.
[1]	On	Transforms the acoustic motor switching noise from a clear ringing tone to a less noticeable 'white' noise. This is achieved by slightly and randomly altering the synchronism of the pulse width modulated output phases.

3.2.4 F-3# Fundamental Parameters 3

F-37 Adv. Switching Pattern		
Option:	Function:	
		Select the switching pattern: 60° AVM or SFAVM.
[0] *	60 AVM	
[1]	SFAVM	

**NOTE**

Enabling over-modulation can cause vibrations that may destroy the mechanics if running in field weakening area (from 47Hz).

F-38 Overmodulation		
Option:	Function:	
[0]	Off	Selects no over-modulation of the output voltage in order to avoid torque ripple on the motor shaft.
[1] *	On	The over-modulation function generates an extra voltage of up-to 8% of $U_{max}$ output voltage without over-modulation, which results in an extra torque of 10-12% in the middle of the over-synchronous range (from 0% at nominal speed rising to approximately 12% at double nominal speed).

3.2.5 F-4# Fundamental Parameters

F-40 Torque Limiter (Driving)		
Range:	Function:	
110.0 %*	[0.0 - 1000.0 %]	Enter the maximum torque limit for motor operation. The torque limit is active in the speed range up to and including the rated motor speed set in <i>P-06 Base Speed</i> . To protect the motor from reaching the stalling torque, the default setting is 1.1 x the rated motor torque (calculated value).

F-40 Torque Limiter (Driving)		
Range:	Function:	
		See also <i>SP-25 Trip Delay at Torque Limit</i> for further details.

F-41 Torque Limiter (Braking)		
Range:	Function:	
100.0 %*	[0.0 - 1000.0 %]	Enter the maximum torque limit for generator mode operation. The torque limit is active in the speed range up to and including the rated motor speed ( <i>P-06 Base Speed</i> ). Refer to <i>SP-25 Trip Delay at Torque Limit</i> for further details.

F-43 Current Limit		
Range:	Function:	
110.0 %*	[1.0 - 1000.0 %]	Enter the current limit for motor and generator operation. To protect the motor from reaching the stalling torque, the default setting is 1.1 x the rated motor current (set in <i>P-03 Motor Current</i> ).

3.2.6 F-5# Extended References

F-52 Minimum Reference		
Range:	Function:	
0.000*	[-999999.999 - par. F-53]	Enter the Minimum Reference. The Minimum Reference is the lowest obtainable by summing all references. This value defines the lower limit for both the local and remote reference depending on the choice in par. F-02 <i>Operation Method</i> .
		<b>NOTE</b> This parameter is used in open loop only.



**F-53 Maximum Reference**

Range:		Function:
60.000*	[par. F-52 - 999999.999]	Enter the Maximum Reference. The Maximum Reference is the highest obtainable by summing all references. This value defines the upper limit for both the local and remote reference depending on the choice in par. F-02 <i>Operation Method</i> .

**F-54 Reference Function**

Option:	Function:
[0] * Sum	Sums both external and preset reference sources.
[1]	Use either the preset or the external reference source. Shift between external and preset via a command on a digital input.

3.2.7 F-6# References

**F-64 Preset Relative Reference**

Range:		Function:
0.00 %*	[-100.00 - 100.00 %]	The actual reference, X, is increased or decreased with the percentage Y, set in <i>F-64 Preset Relative Reference</i> . This results in the actual reference Z. Actual reference (X) is the sum of the inputs selected in <i>F-01 Frequency Setting 1</i> , <i>C-30 Frequency Command 2</i> , <i>C-34 Frequency Command 3</i> and <i>O-02 Control Word Source</i> .

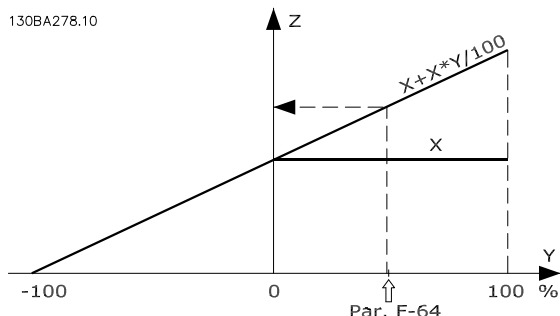
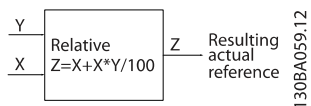

3.2.8 F-9# Digital Potentiometer

The digital potentiometer function allows the user to increase or decrease the actual reference by adjusting the set-up of the digital inputs using the functions INCREASE, DECREASE or CLEAR. To activate the function, at least one digital input must be set up to INCREASE or DECREASE.

**F-90 Step Size**

Range:		Function:
0.10 %*	[0.01 - 200.00 %]	Enter the increment size required for INCREASE/DECREASE, as a percentage of the synchronous motor speed, $n_s$ . If INCREASE/ DECREASE is activated the resulting reference will be increased / decreased by the amount set in this parameter.

**F-91 Accel/Decel Time**

Range:		Function:
1.00 s	[0.00 - 3600.00 s]	Enter the ramp time, i.e. the time for adjustment of the reference from 0% to 100% of the specified digital potentiometer function (INCREASE, DECREASE or CLEAR). If INCREASE / DECREASE is activated for longer than the ramp delay period specified in <i>F-95 Accel/Decel Ramp Delay</i> the actual reference will be acceled/deceled according to this ramp time. The ramp time is defined as the time used to adjust the reference by the step size specified in <i>F-90 Step Size</i> .

**F-92 Power Restore**

Option:	Function:
[0] * Off	Resets the Digital Pot-Meter reference to 0% after power up.
[1]	Restores the most recent Digital Pot-Meter reference at power up.

**F-93 Maximum Limit**

Range:		Function:
100 %*	[-200 - 200 %]	Set the maximum permissible value for the resultant reference. This is advisable if the Digital Pot-Meter is used for fine tuning of the resulting reference.

**F-94 Minimum Limit**

Range:		Function:
0 %*	[-200 - 200 %]	Set the minimum permissible value for the resultant reference. This is advisable if the Digital Pot-Meter is used for fine tuning of the resulting reference.



3

F-95 Accel/Decel Ramp Delay		
Range:		Function:
0.000 N/A*	[0.000 - 0.000 N/A]	Enter the delay required from activation of the digital potentiometer function until the frequency converter starts to ramp the reference. With a delay of 0 ms, the reference starts to ramp as soon as INCREASE / DECREASE is activated. See also <i>F-91 Accel/Decel Time</i> .

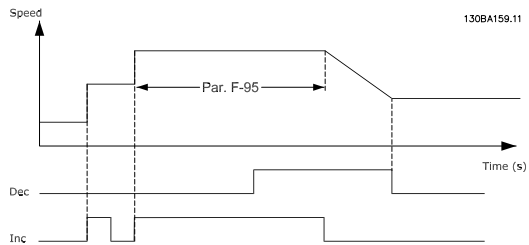
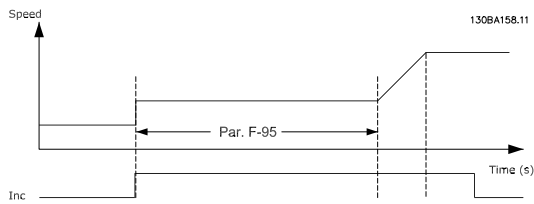



### 3.3 E-## Digital In/Outs

Parameter group for configuring the digital input and output.

[0]	No operation	No reaction to signals transmitted to the terminal.
[1]	Reset	Resets frequency converter after a TRIP/ALARM. Not all alarms can be reset.
[2]	Coast inverse	Coasting stop, inverted input (NC). The frequency converter leaves the motor in free mode. Logic '0' => coasting stop.
[3]	Coast and reset inv	Reset and coasting stop Inverted input (NC). Leaves motor in free mode and resets frequency converter. Logic '0' => coasting stop and reset.
[5]	DC-brake inverse	Inverted input for DC braking (NC). Stops motor by energizing it with a DC current for a certain time period. See par. B-01 to par. B-03. The function is only active when the value in par. B-02 is different from 0. Logic '0' => DC braking.
[6]	Stop inverse	Stop inverted function. Generates a stop function when the selected terminal goes from logical level '1' to '0'. The stop is performed according to the selected ramp time (par. F-08, par. E-11, par. E-13, par. E-15).  When the frequency converter is at the torque limit and has received a stop command, it may not stop by itself. To ensure that the frequency converter stops, configure a digital output to Torque limit & stop [27] and connect this digital output to a digital input that is configured as coast.
[7]	External interlock	Same function as Coasting stop, inverse, but External Interlock generates the alarm message 'external fault' on the display when the terminal which is programmed for Coast Inverse is logic '0'. The alarm message will also be active via digital outputs and relay outputs, if programmed for External Interlock. The alarm can be reset using a digital input or the [RESET] key if the cause for the External Interlock has been removed. A delay can be programmed in <i>AP-00 External Interlock Delay</i> , External Interlock Time. After applying a signal to the input, the reaction described above will be delayed with the time set in <i>AP-00 External Interlock Delay</i> .
[8] *	Start	(Default Digital input 18): Select start for a start/stop command. Logic '1' = start, logic '0' = stop.
[9]	Latched start	The motor starts, if a pulse is applied for min. 2 ms. The motor stops when Stop inverse is activated.

[10]	Reversing	(Default Digital input 19). Change the direction of motor shaft rotation. Select Logic '1' to reverse. The reversing signal only changes the direction of rotation. It does not activate the start function. Select both directions in <i>H-08 Reverse Lock</i> . The function is not active in process closed loop.																																				
[11]	Start reversing	Used for start/stop and for reversing on the same wire. Signals on start are not allowed at the same time.																																				
[14]	Jog	(Default Digital input 29): Use to activate jog speed. See par. C-20.																																				
[15]	Preset reference on	Shifts between external reference and preset reference. It is assumed that External/preset [1] has been selected in par. F-54. Logic '0' = external reference active; logic '1' = one of the eight preset references is active.																																				
[16]	Preset ref bit 0	Preset ref. bit 0,1, and 2 enables a choice between one of the eight preset references according to the table below.																																				
[17]	Preset ref bit 1	Same as Preset ref bit 0 [16].																																				
[18]	Preset ref bit 2	Same as Preset ref bit 0 [16].  <table border="1" style="margin-left: 20px;"> <thead> <tr> <th>Preset ref. bit</th> <th>2</th> <th>1</th> <th>0</th> </tr> </thead> <tbody> <tr> <td>Preset ref. 0</td> <td>0</td> <td>0</td> <td>0</td> </tr> <tr> <td>Preset ref. 1</td> <td>0</td> <td>0</td> <td>1</td> </tr> <tr> <td>Preset ref. 2</td> <td>0</td> <td>1</td> <td>0</td> </tr> <tr> <td>Preset ref. 3</td> <td>0</td> <td>1</td> <td>1</td> </tr> <tr> <td>Preset ref. 4</td> <td>1</td> <td>0</td> <td>0</td> </tr> <tr> <td>Preset ref. 5</td> <td>1</td> <td>0</td> <td>1</td> </tr> <tr> <td>Preset ref. 6</td> <td>1</td> <td>1</td> <td>0</td> </tr> <tr> <td>Preset ref. 7</td> <td>1</td> <td>1</td> <td>1</td> </tr> </tbody> </table>	Preset ref. bit	2	1	0	Preset ref. 0	0	0	0	Preset ref. 1	0	0	1	Preset ref. 2	0	1	0	Preset ref. 3	0	1	1	Preset ref. 4	1	0	0	Preset ref. 5	1	0	1	Preset ref. 6	1	1	0	Preset ref. 7	1	1	1
Preset ref. bit	2	1	0																																			
Preset ref. 0	0	0	0																																			
Preset ref. 1	0	0	1																																			
Preset ref. 2	0	1	0																																			
Preset ref. 3	0	1	1																																			
Preset ref. 4	1	0	0																																			
Preset ref. 5	1	0	1																																			
Preset ref. 6	1	1	0																																			
Preset ref. 7	1	1	1																																			
[19]	Freeze reference	Freezes the actual reference, which is now the point of enable/condition for Speed up and Speed down to be used. If Speed up/down is used, the speed change always follows ramp 2 (par. E-10 and E-11) in the range 0 - par. F-53 Maximum Reference.																																				
[20]	Freeze output	Freezes the actual motor frequency (Hz), which is now the point of enable/condition for Speed up and Speed down to be used. If Speed up/down is used, the speed change always follows ramp 2 (par. E-10 and E-11) in the range 0 - <i>F-04 Base Frequency</i> .  When Freeze output is active, the frequency converter cannot be stopped via a low 'start [8]' signal. Stop the frequency converter via a terminal programmed for Coasting inverse [2] or Coast and reset, inverse.																																				
[21]	Speed up	Select Speed up and Speed down if digital control of the up/down speed is desired																																				





		(motor potentiometer). Activate this function by selecting either Freeze reference or Freeze output. When Speed up/ down is activated for less than 400 msec. the resulting reference will be increased/ decreased by 0.1 %. If Speed up/ down is activated for more than 400 msec. the resulting reference will follow the setting in accelling/decelling parameters F-07, F-08, E-10 and E-11.															
		<table border="1"> <thead> <tr> <th></th> <th>Shut down</th> <th>Catch up</th> </tr> </thead> <tbody> <tr> <td>Unchanged speed</td> <td>0</td> <td>0</td> </tr> <tr> <td>Reduced by %-value</td> <td>1</td> <td>0</td> </tr> <tr> <td>Increased by %-value</td> <td>0</td> <td>1</td> </tr> <tr> <td>Reduced by %-value</td> <td>1</td> <td>1</td> </tr> </tbody> </table>		Shut down	Catch up	Unchanged speed	0	0	Reduced by %-value	1	0	Increased by %-value	0	1	Reduced by %-value	1	1
	Shut down	Catch up															
Unchanged speed	0	0															
Reduced by %-value	1	0															
Increased by %-value	0	1															
Reduced by %-value	1	1															
[22]	Speed down	Same as Speed up [21].															
[23]	Set-up select bit 0	Select Set-up select bit 0 or Select Set-up select bit 1 to select one of the four set-ups. Set <i>K-10 Active Set-up</i> .															
[24]	Set-up select bit 1	Same as Set-up select bit 0 [23].															
[32]	Pulse Input	Select Pulse input when using a pulse sequence as either reference or feedback.															
[34]	Ramp bit 0	Enables a choice between one of the 4 ramps available, according to the table below.															
[36]	Line failure inverse	Activates <i>SP-10 Line failure</i> . Mains failure inverse is active in the Logic .0. situation.															
[37]	Fire Mode	A signal applied will put the frequency converter into Fire Mode and all other commands will be disregarded. See FB-0# <i>Fire Mode</i> .															
[52]	Run permissive	The input terminal, for which the Run permissive has been programmed must be logic "1" before a start command can be accepted. Run permissive has a logic 'AND' function related to the terminal which is programmed for <i>START</i> [8], <i>Jog</i> [14] or <i>Freeze Output</i> [20], which means that in order to start running the motor, both conditions must be fulfilled. If Run Permissive is programmed on multiple terminals, Run permissive needs only be logic '1' on one of the terminals for the function to be carried out. The digital output signal for Run Request ( <i>Start</i> [8], <i>Jog</i> [14] or <i>Freeze output</i> [20]) will not be affected by Run Permissive. If no Run Permissive signal is applied but either Run, Jog or Freeze commands is activated, the status line in the display will show either Run Requested, Jog Requested or Freeze Requested.															

[53]	Hand start	A signal applied will put the frequency converter into Hand mode as if button <i>Hand</i> on the keypad has been pressed and a normal stop command will be overridden. If disconnecting the signal, the motor will stop. To make any other start commands valid, another digital input must be assign to <i>Auto Start</i> and a signal applied to this. The <i>Hand</i> and <i>Auto</i> buttons on the keypad has no impact. The <i>Off</i> button on the keypad will override <i>Hand Start</i> and <i>Auto Start</i> . Press either the <i>Hand</i> or <i>Auto</i> button to make <i>Hand Start</i> and <i>Auto Start</i> active again. If no signal on neither <i>Hand Start</i> nor <i>Auto Start</i> , the motor will stop regardless of any normal Start command applied. If signal applied to both <i>Hand Start</i> and <i>Auto Start</i> , the function will be <i>Auto Start</i> . If pressing the <i>Off</i> button on the keypad the motor will stop regardless of signals on <i>Hand Start</i> and <i>Auto Start</i> .
[54]	Auto start	A signal applied will put the frequency converter into Auto mode as if the keypad button <i>Auto</i> has been pressed. See also <i>Hand Start</i> [53]
[55]	DigiPot increase	INCREASE signal to the Digital Potentiometer function described in parameter group F-9*
[56]	DigiPot decrease	DECREASE signal to the Digital Potentiometer function described in parameter group F-9*
[57]	DigiPot clear	Clears the Digital Potentiometer reference described in parameter group F-9#
[62]	Reset Counter A	Input for reset of counter A.
[65]	Reset Counter B	Input for reset of counter B.
[66]	Sleep Mode	Forces frequency converter into Sleep Mode (see parameter group AP-4#). Reacts on the rising edge of signal applied.
[78]	Reset Maint. Word	Resets all data in <i>DR-96 Maintenance Word</i> to 0.
[120]	Lead Pump Start	
[121]	Lead Pump Alternation	
[130]	Pump 1 Interlock	
[131]	Pump 2 Interlock	
[132]	Pump 3 Interlock	



E-00 Digital I/O Mode		
Option:	Function:	
		Digital inputs and programmed digital outputs are pre-programmable for operation either in PNP or NPN systems.
[0] *	PNP - Active at 24V	Action on positive directional pulses (0). PNP systems are pulled down to GND.
[1]	NPN - Active at 0V	Action on negative directional pulses (1). NPN systems are pulled up to + 24 V, internally in the frequency converter.

**NOTE**

This parameter cannot be adjusted while the motor is running.

E-01 Terminal 18 Digital Input		
Option:	Function:	
		Same options and functions as E-0#, except for <i>Pulse input</i> .

E-02 Terminal 19 Digital Input		
Option:	Function:	
		Same options and functions as E-0#, except for <i>Pulse input</i> .

E-03 Terminal 27 Digital Input		
Option:	Function:	
		Same options and functions as parameter group E-0#, except for <i>Pulse input</i> .

E-04 Terminal 29 Digital Input		
Option:	Function:	
		Same options and functions as parameter group E-0#, except for <i>Pulse input</i> .

E-05 Terminal 32 Digital Input		
Option:	Function:	
		Same options and functions as parameter group E-0#.

E-06 Terminal 33 Digital Input		
Option:	Function:	
		Same options and functions as parameter group. E-0#.

3.3.1 E-1# Additional Accel Decel Ramps

Choosing ramp parameters.

E-10 Accel Time 2		
Range:	Function:	
10.00 s* - 3600.00 s]	[1.00 - 3600.00 s]	Enter the ramp-up time, i.e. the acceleration time from 0 RPM to <i>P-06 Base Speed</i> . Choose a accel time such that the output current does not exceed the current limit in <i>F-43 Current Limit</i> during ramping. See decel time in <i>E-11 Decel Time 2</i> .  $par. E - 10 = \frac{tacc \times nnorm [par. P - 06]}{ref [rpm]} [s]$

E-11 Decel Time 2		
Range:	Function:	
20.00 s* - 3600.00 s]	[1.00 - 3600.00 s]	Enter the ramp-down time, i.e. the deceleration time from <i>P-06 Base Speed</i> to 0 RPM. Choose a decel time such that no over-voltage arises in the inverter due to regenerative operation of the motor, and such that the generated current does not exceed the current limit set in <i>F-43 Current Limit</i> . See accel time in <i>E-10 Accel Time 2</i> .  $par.E - 11 = \frac{tdec \times nnorm [par. P - 06]}{ref [rpm]} [s]$

3

3.3.2 E-2# Digital Outputs

[0] *	No operation	Default for all digital outputs and relay outputs
[1]	Control ready	
[2]	Drive ready	The control board receives supply voltage.
[3]	Drive rdy/rem ctrl	The frequency converter is ready for operation and applies a supply signal on the control board.
[4]	Standby / no warning	Ready for operation. No start or stop command is been given (start/disable). There are no warnings.
[5]	Running	Motor is running.
[6]	Running / no warning	Output speed is higher than the speed set in <i>H-81 Min Speed for Function at Stop [RPM]</i> . The motor is running and there are no warnings.
[8]	Run on ref/no warn	Motor runs at reference speed.
[9]	Alarm	An alarm activates the output. There are no warnings.
[10]	Alarm or warning	An alarm or a warning activates the output.
[11]	At torque limit	The torque limit set in <i>F-40 Torque Limiter (Driving)</i> has been exceeded.
[12]	Out of current range	The motor current is outside the range set in <i>F-43 Current Limit</i> .
[13]	Below current, low	Motor current is lower than set in <i>H-70 Warning Current Low</i> .



[14]	Above current, high	Motor current is higher than set in <i>H-71 Warning Current High</i> .
[15]	Out of speed range	Output frequency is outside the frequency range set in <i>H-72 Warning Speed Low</i> and <i>H-71 Warning Current High</i> .
[16]	Below speed, low	Output speed is lower than the setting in <i>H-72 Warning Speed Low</i> .
[17]	Above speed, high	Output speed is higher than the setting in <i>H-73 Warning Speed High</i> .
[18]	Out of feedb. range	Feedback is outside the range set in <i>H-76 Warning Feedback Low</i> and <i>H-77 Warning Feedback High</i> .
[19]	Below feedback, low	Feedback is below the limit set in <i>H-76 Warning Feedback Low</i> .
[20]	Above feedback, high	Feedback is above the limit set in <i>H-77 Warning Feedback High</i> .
[21]	Thermal warning	The thermal warning turns on when the temperature exceeds the limit in the motor, the frequency converter, the brake resistor, or the thermistor.
[25]	Reverse	<i>Reversing. Logic '1'</i> when CW rotation of the motor. Logic '0' when CCW rotation of the motor. If the motor is not rotating the output will follow the reference.
[26]	Bus OK	Active communication (no time-out) via the serial communication port.
[27]	Torque limit & stop	Use in performing a coasting stop and in torque limit condition. If the frequency converter has received a stop signal and is at the torque limit, the signal is Logic '0'.
[28]	Brake, no brake war	Brake is active and there are no warnings.
[29]	Brake ready, no fault	Brake is ready for operation and there are no faults.
[30]	Brake fault (IGBT)	Output is Logic '1' when the brake IGBT is short-circuited. Use this function to protect the frequency converter if there is a fault on the brake modules. Use the output/relay to cut out the main voltage from the frequency converter.
[35]	External Interlock	External Interlock function has been activated via one of the digital inputs.
[40]	Out of ref range	Reference is outside the range set in <i>H-74 Warning Reference Low</i> and <i>H-75 Warning Reference High</i> .
[41]	Below reference, low	Reference is below the limit set in <i>H-74 Warning Reference Low</i> .
[42]	Above ref, high	Reference is above the limit set in <i>H-75 Warning Reference High</i> .
[45]	Bus ctrl.	Controls output via bus. The state of the output is set in <i>E-90 Digital &amp; Relay Bus Control</i> . The output state is retained in the event of bus time-out.

[46]	Bus ctrl, 1 if timeout	Controls output via bus. The state of the output is set in <i>E-90 Digital &amp; Relay Bus Control</i> . In the event of bus time-out the output state is set high (On).
[47]	Bus ctrl, 0 if timeout	Controls output via bus. The state of the output is set in <i>E-90 Digital &amp; Relay Bus Control</i> . In the event of bus time-out the output state is set low (Off).
[55]	Pulse output	
[60]	Comparator 0	See parameter group LC-1#. If Comparator 0 is evaluated as TRUE, the output will go high. Otherwise, it will be low.
[61]	Comparator 1	See parameter group LC-1#. If Comparator 1 is evaluated as TRUE, the output will go high. Otherwise, it will be low.
[62]	Comparator 2	See parameter group LC-1#. If Comparator 2 is evaluated as TRUE, the output will go high. Otherwise, it will be low.
[63]	Comparator 3	See parameter group LC-1#. If Comparator 3 is evaluated as TRUE, the output will go high. Otherwise, it will be low.
[64]	Comparator 4	See parameter group LC-1#. If Comparator 4 is evaluated as TRUE, the output will go high. Otherwise, it will be low.
[65]	Comparator 5	See parameter group LC-1#. If Comparator 5 is evaluated as TRUE, the output will go high. Otherwise, it will be low.
[70]	Logic rule 0	See parameter group LC-4#. If Logic Rule 0 is evaluated as TRUE, the output will go high. Otherwise, it will be low.
[71]	Logic rule 1	See parameter group LC-4#. If Logic Rule 1 is evaluated as TRUE, the output will go high. Otherwise, it will be low.
[72]	Logic rule 2	See parameter group LC-4#. If Logic Rule 2 is evaluated as TRUE, the output will go high. Otherwise, it will be low.
[73]	Logic rule 3	See parameter group LC-4#. If Logic Rule 3 is evaluated as TRUE, the output will go high. Otherwise, it will be low.
[74]	Logic rule 4	See parameter group LC-4#. If Logic Rule 4 is evaluated as TRUE, the output will go high. Otherwise, it will be low.
[75]	Logic rule 5	See parameter group LC-4#. If Logic Rule 5 is evaluated as TRUE, the output will go high. Otherwise, it will be low.
[80]	Logic Controller digital output A	See <i>LC-52 Logic Controller Action</i> . The output will go high whenever the Logic Action [38] <i>Set dig. out. A high</i> is executed. The output will go low whenever the Logic Action [32] <i>Set dig. out. A low</i> is executed.

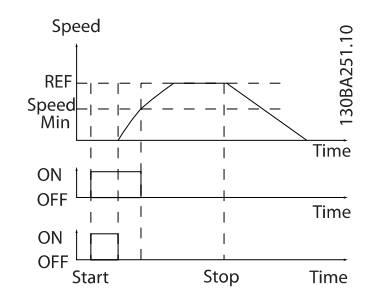

[81]	Logic Controller digital output B	See <i>LC-52 Logic Controller Action</i> . The input will go high whenever the Logic Action [39] <i>Set dig. out. A high</i> is executed. The input will go low whenever the Logic Action [33] <i>Set dig. out. A low</i> is executed.
[82]	Logic Controller digital output C	See <i>LC-52 Logic Controller Action</i> . The input will go high whenever the Logic Action [40] <i>Set dig. out. A high</i> is executed. The input will go low whenever the Logic Action [34] <i>Set dig. out. A low</i> is executed.
[83]	Logic Controller digital output D	See <i>LC-52 Logic Controller Action</i> . The input will go high whenever the Logic Action [41] <i>Set dig. out. A high</i> is executed. The input will go low whenever the Logic Action [35] <i>Set dig. out. A low</i> is executed.
[84]	Logic Controller digital output E	See <i>LC-52 Logic Controller Action</i> . The input will go high whenever the Logic Action [42] <i>Set dig. out. A high</i> is executed. The input will go low whenever the Logic Action [36] <i>Set dig. out. A low</i> is executed.
[85]	Logic Controller digital output F	See <i>LC-52 Logic Controller Action</i> . The input will go high whenever the Logic Action [43] <i>Set dig. out. A high</i> is executed. The input will go low whenever the Logic Action [37] <i>Set dig. out. A low</i> is executed.
[160]	No alarm	Output is high when no alarm is present.
[161]	Running reverse	Output is high when the frequency converter is running counter clockwise (the logical product of the status bits 'running' AND 'reverse').
[165]	Local ref active	Output is high when <i>F-02 Operation Method = [2] Local</i> or when <i>F-02 Operation Method = [0] Linked to hand auto</i> at the same time as the keypad is in Hand mode.
[166]	Remote ref active	Output is high when <i>F-02 Operation Method = Remote [1]</i> or <i>Linked to hand/ auto [0]</i> while the keypad is in [Auto] mode.
[167]	Start command act.	Output is high when there is an active Start command (i.e. via digital input bus connection or [Hand] or [Auto]), and no Stop or Start command is active.
[168]	Hand mode	Output is high when the frequency converter is in Hand mode (as indicated by the LED light above [Hand]).
[169]	Auto mode	Output is high when the frequency converter is in Auto mode (as indicated by the LED light above [on]).
[180]	Clock Fault	The clock function has been reset to default (2000-01-01) because of a power failure.

[181]	Prev. Maintenance	One or more of the Preventive Maintenance Events programmed in <i>T-10 Maintenance Item</i> has passed the time for the specified action in <i>T-11 Maintenance Action</i> .
[190]	No-Flow	A No-Flow situation or Minimum Speed situation has been detected if enabled in <i>AP-21 Low Power Detection</i> and/or <i>AP-22 Low Speed Detection</i> .
[191]	Dry Pump	A Dry Pump condition has been detected. This function must be enabled in <i>AP-26 Dry Pump Function</i> .
[192]	End Of Curve	A pump running with max. speed for a period of time without reaching the set pressure has been detected. To enable this function please see <i>AP-50 End of Curve Function</i> .
[193]	Sleep Mode	The frequency converter/system has turned into sleep mode. See parameter group AP-4#.
[194]	Broken Belt	A Broken Belt condition has been detected. This function must be enabled in <i>AP-60 Broken Belt Function</i> .
[195]	Bypass Valve Control	The bypass valve control (Digital / Relay output in the frequency converter) is used for compressor systems to unload the compressor during start-up by using a bypass valve. After the start command is given the bypass valve will be open until the frequency converter reaches <i>F-18 Motor Speed Low Limit [RPM]</i> . After the limit has been reached the bypass valve will be closed, allowing the compressor to operate normally. This procedure will not be activated again before a new start is initiated and the frequency converter speed is zero during the receiving of start signal. <i>F-24 Holding Time</i> can be used in order to delay the motor start. The Bypass valve control principle:  <p>The diagram shows Speed on the y-axis and Time on the x-axis. A dashed line represents the reference speed (REF). A solid line shows the actual speed starting at a minimum (Speed Min) and rising to meet the REF line. Below the speed graph, two pulse trains are shown: 'ON' and 'OFF'. The 'ON' pulse occurs during the start-up phase when the speed is rising. The 'OFF' pulse occurs when the speed has reached the REF line and is beginning to fall. Vertical dashed lines mark the 'Start' and 'Stop' points on the time axis. The reference number 130BA251.10 is printed vertically on the right side of the diagram.</p>
[196]	Fire Mode	The frequency converter is operating in Fire Mode. See parameter group FB-0# <i>Fire Mode</i> .



[197]	Fire Mode was Act.	The frequency converter has been operating in Fire Mode, but is now back in normal operation.
[198]	Drive Bypass	To be used as signal for activating an external electromechanical bypass switching the motor direct on line. See FB-1# <i>Drive Bypass</i> .
[200]	Full capacity	All pumps running and at full speed The below setting options are all related to the Cascade Controller. Wiring diagrams and settings for parameter, see parameter group PC-## for more details.
[201]	Pump 1 running	One or more of the pumps controlled by the Cascade Controller is/are running. The function will also depend on the setting in <i>PC-06 Number of Pumps</i> . If set to <i>No</i> [0] Pump 1 refers to the pump controlled by relay RELAY1 etc. If set to <i>Yes</i> [1] Pump 1 refers to the pump controlled by the frequency converter only (without any of the build in relays involved) and Pump 2 to the pump controlled by the relay RELAY1. See table below

[202]	Pump 2 running	See [201]
[203]	Pump 3 running	See [201]

Setting in parameter group E-##	Setting in PC-06 Number of Pumps	
	[0] No	[1] Yes
[200] Pump 1 Running	Controlled by RELAY1	Frequency Converter controlled
[201] Pump 2 Running	Controlled by RELAY2	Controlled by RELAY1
[203] Pump 3 Running	Controlled by RELAY3	Controlled by RELAY2

**E-20 Terminal 27 Digital Output**

**Option: Function:**

	Same options and functions as parameter group E-2#.
--	---

**E-21 Terminal 29 Digital Output**

**Option: Function:**

	Same options and functions as parameter group E-2#.
--	---

**E-24 Function Relay**

Array [8]  
 (Relay 1 [0], Relay 2 [1])  
 Option OPCRLY: Relay 7 [6], Relay 8 [7] and Relay 9 [8])

**Option: Function:**

	Same options and functions as parameter group E-2#.
--	---

**E-26 On Delay, Relay**

Array [9], (Relay 1 [0], Relay 2 [1], Relay 3 [2], Relay 4 [3], Relay 5 [4], Relay 6 [5], Relay 7 [6], Relay 8 [7], Relay 9 [8])

**Range: Function:**

0.01 s*	[0.01 - 600.00 s]	Enter the delay of the relay cut-in time. Select one of available mechanical relays and OPCRLY Relay Option Module in an array function. See <i>E-24 Function Relay</i> .
---------	-------------------	---

130BA171.10

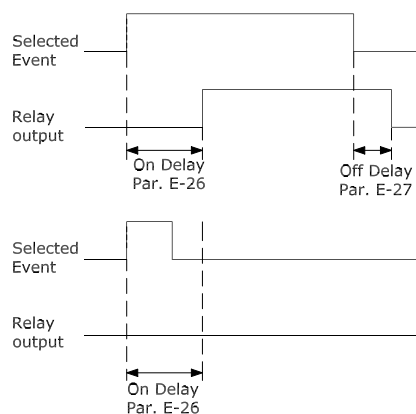



E-27 Off Delay, Relay		
Array [9] (Relay 1 [0], Relay 2 [1], Relay 3 [2], Relay 4 [3], Relay 5 [4], Relay 6 [5], Relay 7 [6], Relay 8 [7], Relay 9 [8])		
Range:	Function:	
0.01 s* [0.01 - 600.00 s]	Enter the delay of the relay cut-out time. Select one of available mechanical relays and OPCRLY Relay Option Module in an array function. See E-24 Function Relay.	

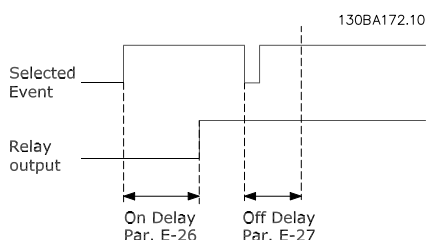

If the selected Event condition changes before the on- or off delay timer expires, the relay output is unaffected.

### 3.3.3 E-5# I/O Mode / Add On I/O

E-51 Terminal 27 Mode		
Option:	Function:	
[0] *	Input	Defines terminal 27 as a digital input.
[1]	Output	Defines terminal 27 as a digital output.

E-52 Terminal 29 Mode		
Option:	Function:	
[0] *	Input	Defines terminal 29 as a digital input.
[1]	Output	Defines terminal 29 as a digital output.

This parameter cannot be adjusted while the motor is running.

E-53 Terminal X30/2 Digital Input		
This parameter is active when the OPCGPIO General Purpose I/O Option Module is installed in the frequency converter. It has the same options and functions as parameter group E-0# except for Pulse input [32].		

E-54 Terminal X30/3 Digital Input		
This parameter is active when the OPCRLY General Purpose I/O Option Module is installed in the frequency converter. It has the same options and functions as parameter group E-0# except for Pulse input [32].		

E-55 Terminal X30/4 Digital Input		
This parameter is active when the General Purpose I/O Option Module is installed in the frequency converter. It has the same options and functions as parameter group E-0# except for Pulse input [32].		

E-56 Term X30/6 Digi Out (OPCGPIO)		
This parameter is active when the General Purpose I/O Option Module is mounted in the frequency converter.		
Option:	Function:	
	Same options and functions as parameter group E-2#.	

E-57 Term X30/7 Digi Out (OPCGPIO)		
This parameter is active when the General Purpose I/O Option Module is mounted in the frequency converter.		
Option:	Function:	
	Same options and functions as parameter group E-2#.	

### 3.3.4 E-6# Pulse Input

E-60 Term. 29 Low Frequency		
Range:	Function:	
100 Hz* [0 - 110000 Hz]	Enter the low frequency limit corresponding to the low motor shaft speed (i.e. low reference value) in E-62 Term. 29 Low Ref./Feedb. Value. Refer to the diagram in this section.	

E-61 Term. 29 High Frequency		
Range:	Function:	
100 Hz* [0 - 110000 Hz]	Enter the high frequency limit corresponding to the high motor shaft speed (i.e. high reference value) in E-63 Term. 29 High Ref./Feedb. Value.	

E-62 Term. 29 Low Ref./Feedb. Value		
Range:	Function:	
0.000 N/A* [-999999.999 - 999999.999 N/A]	Enter the low reference value limit for the motor shaft speed [RPM]. This is also the lowest feedback value, see also E-67 Term. 33 Low Ref./Feedb. Value.	

E-63 Term. 29 High Ref./Feedb. Value		
Range:	Function:	
100.000 N/A* [-999999.999 - 999999.999 N/A]	Enter the high reference value [RPM] for the motor shaft speed and the high feedback value, see also E-68 Term. 33 High Ref./Feedb. Value.	





E-64 Pulse Filter Time Constant #29		
Range:		Function:
100 ms*	[1 - 1000 ms]	Enter the pulse filter time constant. The pulse filter dampens oscillations of the feedback signal, which is an advantage if there is a lot of noise in the system. A high time constant value results in better dampening but also increases the time delay through the filter.  This parameter cannot be adjusted while the motor is running.

E-65 Term. 33 Low Frequency		
Range:		Function:
100 Hz*	[0 - 110000 Hz]	Enter the low frequency corresponding to the low motor shaft speed (i.e. low reference value) in <i>E-67 Term. 33 Low Ref./Feedb. Value</i> .

E-66 Term. 33 High Frequency		
Range:		Function:
100 Hz*	[0 - 110000 Hz]	Enter the high frequency corresponding to the high motor shaft speed (i.e. high reference value) in <i>E-68 Term. 33 High Ref./Feedb. Value</i> .

E-67 Term. 33 Low Ref./Feedb. Value		
Range:		Function:
0.000 N/A*	[-999999.999 - 999999.999 N/A]	Enter the low reference value [RPM] for the motor shaft speed. This is also the low feedback value, see also <i>E-62 Term. 29 Low Ref./Feedb. Value</i> .

E-68 Term. 33 High Ref./Feedb. Value		
Range:		Function:
100.000 N/A*	[-999999.999 - 999999.999 N/A]	Enter the high reference value [RPM] for the motor shaft speed. See also <i>E-63 Term. 29 High Ref./Feedb. Value</i> .

E-69 Pulse Filter Time Constant #33		
Range:		Function:
100 ms*	[1 - 1000 ms]	Enter the pulse filter time constant. The low-pass filter reduces the influence on and dampens oscillations on the feedback signal from the control.  This is an advantage, e.g. if there is a great amount on noise in the system. This parameter cannot be adjusted while the motor is running.

### 3.3.5 E-7# Pulse Output

E-70 Terminal 27 Pulse Output Variable		
Option:		Function:
[0] *	No operation	
[45]	Bus ctrl.	
[48]	Bus ctrl., timeout	
[100]	Output frequency	
[101]	Reference	
[102]	Feedback	
[103]	Motor Current	
[104]	Torque rel to limit	
[105]	Torq relate to rated	
[106]	Power	
[107]	Speed	
[113]	Ext. Closed Loop 1	
[114]	Ext. Closed Loop 2	
[115]	Ext. Closed Loop 3	

E-71 Pulse Output Max Freq #27		
Set the maximum frequency for terminal 27, corresponding to the output variable selected in <i>E-70 Terminal 27 Pulse Output Variable</i> .  This parameter cannot be adjusted while the motor is running.		
Range:		Function:
5000 Hz*	[0 - 32000 Hz]	

E-72 Terminal 29 Pulse Output Variable		
Select the variable for viewing on the terminal 29 display. This parameter cannot be adjusted while the motor is running. Same options and functions as par. group E-75.		
Option:		Function:
[0] *	No operation	
[45]	Bus ctrl.	
[48]	Bus ctrl., timeout	
[100]	Output frequency	
[101]	Reference	
[102]	Feedback	
[103]	Motor Current	
[104]	Torque rel to limit	
[105]	Torq relate to rated	
[106]	Power	
[107]	Speed	
[113]	Ext. Closed Loop 1	
[114]	Ext. Closed Loop 2	
[115]	Ext. Closed Loop 3	

E-74 Pulse Output Max Freq #29		
Set the maximum frequency for terminal 29 corresponding to the output variable set in <i>E-72 Terminal 29 Pulse Output Variable</i> . This parameter cannot be adjusted while the motor is running.		
Range:		Function:
5000 Hz*	[0 - 32000 Hz]	



E-78 Pulse Output Max Freq #X30/6		
<p>Select the maximum frequency on terminal X30/6 referring to the output variable in <i>E-75 Terminal X30/6 Pulse Output Variable</i>. This parameter cannot be adjusted while the motor is running. This parameter is active when the General Purpose I/O Option Module (OPCGPIO) is mounted in the drive.</p>		
<b>Range:</b>	<b>Function:</b>	
5000. Hz*	[0 - 32000 Hz]	

### 3.3.6 E-9# Bus Controlled

This parameter group selects digital and relay outputs via a fieldbus setting.

E-90 Digital & Relay Bus Control																						
Range:	Function:																					
0 N/A*	[0 - 2147483647 N/A]	<p>This parameter holds the state of the digital outputs and relays that is controlled by bus.</p> <p>A logical '1' indicates that the output is high or active.</p> <p>A logical '0' indicates that the output is low or inactive.</p> <table border="1"> <tr><td>Bit 0</td><td>CC Digital Output Terminal 27</td></tr> <tr><td>Bit 1</td><td>CC Digital Output Terminal 29</td></tr> <tr><td>Bit 2</td><td>GPIO Digital Output Terminal X30/6</td></tr> <tr><td>Bit 3</td><td>GPIO Digital Output Terminal X30/7</td></tr> <tr><td>Bit 4</td><td>CC Relay 1 output terminal</td></tr> <tr><td>Bit 5</td><td>CC Relay 2 output terminal</td></tr> <tr><td>Bit 6</td><td>Option B Relay 1 output terminal</td></tr> <tr><td>Bit 7</td><td>Option B Relay 2 output terminal</td></tr> <tr><td>Bit 8</td><td>Option B Relay 3 output terminal</td></tr> <tr><td>Bit 9-31</td><td>Reserved for future terminals</td></tr> </table>	Bit 0	CC Digital Output Terminal 27	Bit 1	CC Digital Output Terminal 29	Bit 2	GPIO Digital Output Terminal X30/6	Bit 3	GPIO Digital Output Terminal X30/7	Bit 4	CC Relay 1 output terminal	Bit 5	CC Relay 2 output terminal	Bit 6	Option B Relay 1 output terminal	Bit 7	Option B Relay 2 output terminal	Bit 8	Option B Relay 3 output terminal	Bit 9-31	Reserved for future terminals
Bit 0	CC Digital Output Terminal 27																					
Bit 1	CC Digital Output Terminal 29																					
Bit 2	GPIO Digital Output Terminal X30/6																					
Bit 3	GPIO Digital Output Terminal X30/7																					
Bit 4	CC Relay 1 output terminal																					
Bit 5	CC Relay 2 output terminal																					
Bit 6	Option B Relay 1 output terminal																					
Bit 7	Option B Relay 2 output terminal																					
Bit 8	Option B Relay 3 output terminal																					
Bit 9-31	Reserved for future terminals																					

E-93 Pulse Out #27 Bus Control		
Range:	Function:	
0.00 %*	[0.00 - 100.00 %]	Contains the frequency to apply to the digital output terminal 27, when it is configured as [Bus Controlled].

E-94 Pulse Out #27 Timeout Preset		
Range:	Function:	
0.00 %*	[0.00 - 100.00 %]	Contains the frequency to apply to the digital output terminal 27, when it is configured as [Bus Controlled Timeout] and timeout is detected.

E-95 Pulse Out #29 Bus Control		
Range:	Function:	
0.00 %*	[0.00 - 100.00 %]	Contains the frequency to apply to the digital output terminal 29, when it is configured as [Bus Controlled].

E-96 Pulse Out #29 Timeout Preset		
Range:	Function:	
0.00 %*	[0.00 - 100.00 %]	Contains the frequency to apply to the digital output terminal 29, when it is configured as [Bus Controlled Timeout] and timeout is detected

E-97 Pulse Out #X30/6 Bus Control		
Range:	Function:	
0.00 %*	[0.00 - 100.00 %]	Contains the frequency to apply to the digital output terminal X30/6, when it is configured as [Bus Controlled].

E-98 Pulse Out #X30/6 Timeout Preset		
Range:	Function:	
0.00 %*	[0.00 - 100.00 %]	Contains the frequency to apply to the digital output terminal X30/6, when it is configured as [Bus Controlled Timeout] and time-out is detected.





### 3.4 C-## Frequency Control Functions

#### 3.4.1 C-0# Frequency Control Functions

C-01 Jump Frequency From [Hz]		
Array [4]		
Range:	Function:	
0 Hz* Application dependent*	[0.0 - par. F-15 Hz] [Application dependant]	Some systems call for avoiding certain output speeds due to resonance problems in the system. Enter the lower limits of the speeds to be avoided.

C-02 Jump Speed From [RPM]		
Array [4]		
Range:	Function:	
0 RPM* [0 - par. F-17 RPM]	Some systems call for avoiding certain output speeds due to resonance problems in the system. Enter the lower limits of the speeds to be avoided.	

C-03 Jump Speed To [RPM]		
Array [4]		
Range:	Function:	
0 RPM* [0 - par. F-17 RPM]	Some systems call for avoiding certain output speeds due to resonance problems in the system. Enter the upper limits of the speeds to be avoided.	

C-04 Jump Frequency To [Hz]		
Array [4]		
Range:	Function:	
0 Hz* [0.0 - par. F-15 Hz]	Some systems call for avoiding certain output speeds due to resonance problems in the system. Enter the upper limits of the speeds to be avoided.	

C-05 Multi-step Frequency 1 - 8		
Array [8]		
Range:	Function:	
0.00 %* [-100.00 - 100.00 %]	Enter up to eight different preset references (0-7) in this parameter, using array programming. The preset reference is stated as a percentage of the value Ref <sub>MAX</sub> (F-53 Maximum Reference, for closed loop see CL-14 Maximum Reference/Feedb.). When using preset references, select Preset ref. bit 0 / 1 / 2 [16], [17] or [18] for the corresponding	

C-05 Multi-step Frequency 1 - 8	
Array [8]	
Range:	Function:
	digital inputs in parameter group E-0# Digital Inputs.

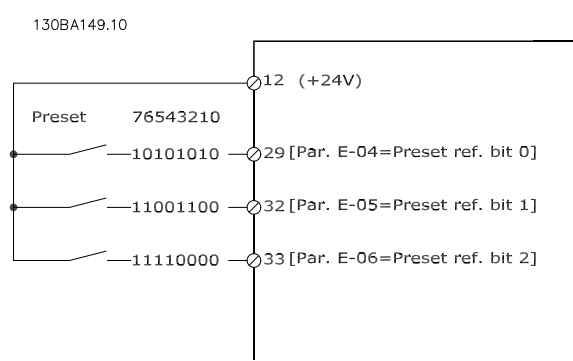
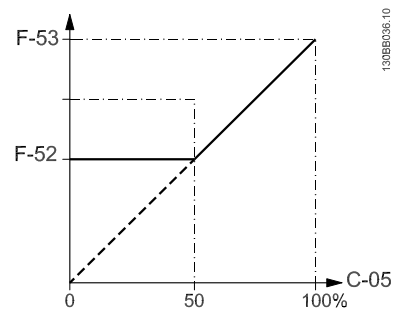

#### 3.4.2 C-2# Jog Setup

C-20 Jog Speed [Hz]		
Range:	Function:	
10.0 Hz* [0.0 - par. F-15 Hz]	The jog speed is a fixed output speed at which the frequency converter is running when the jog function is activated. See also C-22 Jog Accel/Decel Time.	

C-21 Jog Speed [RPM]		
Range:	Function:	
300. RPM* [0 - par. F-17 RPM]	Enter a value for the jog speed n <sub>JOG</sub> , which is a fixed output speed. The frequency converter runs at this speed when the jog function is activated. The maximum limit is defined in F-17 Motor Speed High Limit [RPM]. See also C-22 Jog Accel/Decel Time.	



C-22 Jog Accel/Decel Time		
Range:	Function:	
20.00 s*	[1.00 - 3600.00 s]	Enter the jog ramp time, i.e. the acceleration/ deceleration time between 0 RPM and the rated motor speed ( $n_{M,N}$ ) (set in <i>P-06 Base Speed</i> ). Ensure that the resultant output current required for the given jog ramp time does not exceed the current limit in <i>F-43 Current Limit</i> . The jog ramp time starts upon activation of a jog signal via the keypad, a selected digital input, or the serial communication port.  $par. C - 22 = \frac{t_{jog} \times n_{norm} [par. P - 06]}{jog\ speed [par. C - 21]} [s]$

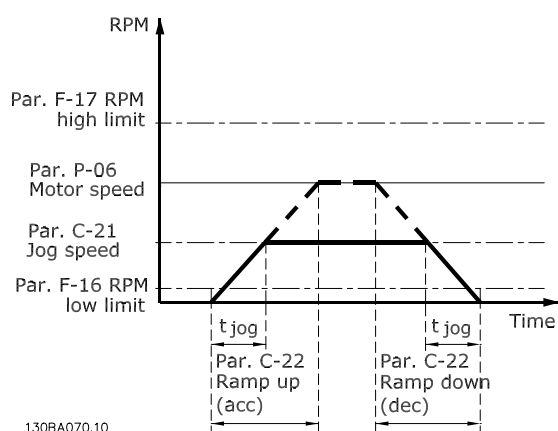

130BA070.10

### 3.4.3 C-3# Frequency Setting 2 and 3

C-30 Frequency Command 2		
Option:	Function:	
		Select the reference input to be used for the second reference signal. <i>F-01 Frequency Setting 1</i> , <i>C-30 Frequency Command 2</i> and <i>C-34 Frequency Command 3</i> define up to three different reference signals. The sum of these reference signals defines the actual reference. This parameter cannot be adjusted while the motor is running.
[0]	No function	
[1]	Analog input 53	
[2]	Analog input 54	
[7]	Pulse input 29	
[8]	Pulse input 33	
[20] *	Digital Potentiometer	
[21]	Analog input X30/11	(OPCGPIO)
[22]	Analog input X30/12	(OPCGPIO)
[23]	Analog Input X42/1	(OPCAIO)
[24]	Analog Input X42/3	(OPCAIO)
[25]	Analog Input X42/5	(OPCAIO)

C-30 Frequency Command 2		
Option:	Function:	
[30]	Ext. Closed Loop 1	
[31]	Ext. Closed Loop 2	
[32]	Ext. Closed Loop 3	

C-34 Frequency Command 3		
Option:	Function:	
		Select the reference input to be used for the third reference signal. <i>F-01 Frequency Setting 1</i> , <i>C-30 Frequency Command 2</i> and <i>C-34 Frequency Command 3</i> define up to three different reference signals. The sum of these reference signals defines the actual reference. This parameter cannot be adjusted while the motor is running.
[0] *	No function	
[1]	Analog input 53	
[2]	Analog input 54	
[7]	Pulse input 29	
[8]	Pulse input 33	
[20]	Digital Potentiometer	
[21]	Analog input X30/11	(OPCGPIO)
[22]	Analog input X30/12	(OPCGPIO)
[23]	Analog Input X42/1	(OPCAIO)
[24]	Analog Input X42/3	(OPCAIO)
[25]	Analog Input X42/5	(OPCAIO)
[30]	Ext. Closed Loop 1	
[31]	Ext. Closed Loop 2	
[32]	Ext. Closed Loop 3	

### 3.4.4 C-4# Semi-Auto Jump Freq Set-up

C-40 Semi-Auto Jump Freq Set-up		
Option:	Function:	
[0] *	Off	No function
[1]	Enabled	Starts the Semi-Automatic Bypass set-up and continue with the procedure described above.



### 3.5 P-## Motor Data

#### 3.5.1 P-0# Motor Data

P-02 Motor Power [HP]		
Range:		Function:
4.00 hp*	[0.09 - 3000.00 hp]	Enter the nominal motor power in HP according to the motor nameplate data. The default value corresponds to the nominal rated output of the unit. This ameter cannot be adjusted while the motor is running. Depending on the choices made in <i>K-03 Regional Settings</i> , either <i>P-07 Motor Power [kW]</i> or <i>P-02 Motor Power [HP]</i> is made invisible.

P-03 Motor Current		
Range:		Function:
7.20 A*	[0.10 - 10000.00 A]	Enter the nominal motor current value from the motor nameplate data. This data is used for calculating motor torque, motor thermal protection etc.

#### NOTE

This parameter cannot be adjusted while the motor is running.

P-04 Auto Tune		
Option:	Function:	
	The Auto Tune function optimizes dynamic motor performance by automatically optimizing the advanced motor <i>P-30 Stator Resistance (Rs)</i> to <i>P-35 Main Reactance (Xh)</i> while the motor is stationary.	
[0] *	Off	No function
[1]	Full Auto Tune	performs Auto Tune of the stator resistance $R_s$ , the rotor resistance $R_r$ , the stator leakage reactance $X_1$ , the rotor leakage reactance $X_2$ and the main reactance $X_h$ .
[2]	Reduced Auto Tune	Performs a reduced Auto Tune of the stator resistance $R_s$ in the system only. Select this option if an LC filter is used between the frequency converter and the motor.

Activate the Auto Tune function by pressing [Hand ] after selecting [1] or [2]. After a normal sequence, the display will read: "Press [OK] to finish Auto Tune". After pressing the [OK] key the frequency converter is ready for operation.

#### NOTE

- For the best results of the frequency converter, run Auto Tune on a cold motor
- Auto Tune cannot be performed while the motor is running

#### NOTE

Avoid generating external torque during Auto Tune.

#### NOTE

If one of the settings in parameter group P-## Motor Data is changed, *P-30 Stator Resistance (Rs)* to *P-39 Motor Poles*, the advanced motor parameters, will return to default setting.

This parameter cannot be adjusted while the motor is running.

#### NOTE

Full Auto Tune should be run without filter only while reduced Auto Tune should be run with filter.

P-06 Base Speed		
Range:		Function:
1420. RPM*	[100 - 60000 RPM]	Enter the nominal motor speed value from the motor nameplate data. This data is used for calculating automatic motor compensations.

#### NOTE

This parameter cannot be adjusted while the motor is running.

P-07 Motor Power [kW]		
Range:		Function:
4.00 kW*	[0.09 - 3000.00 kW]	Enter the nominal motor power in kW according to the motor nameplate data. The default value corresponds to the nominal rated output of the unit. This ameter cannot be adjusted while the motor is running. Depending on the choices made in <i>K-03 Regional Settings</i> , either <i>P-07 Motor Power [kW]</i> or <i>P-02 Motor Power [HP]</i> is made invisible.



P-08 Motor Rotation Check		
Option:	Function:	
		Following installation and connection of the motor, this function allows the correct motor rotation direction to be verified. Enabling this function overrides any bus commands or digital inputs, except External Interlock.
[0] *	Off	Motor Rotation Check is not active.
[1]	Enabled	Motor Rotation Check is enabled. Once enabled, Display shows: "Note! Motor may run in wrong direction".

Pressing [OK], [Back] or [Cancel] will dismiss the message and display a new message: "Press [Hand] to start the motor. Press [Cancel] to abort". Pressing [Hand] starts the motor at 5 Hz in forward direction and the display shows: "Motor is running. Check if motor rotation direction is correct. Press [Off] to stop the motor". Pressing [Off] stops the motor and resets *P-08 Motor Rotation Check*. If motor rotation direction is incorrect, two motor phase cables should be interchanged. IMPORTANT:

**⚠ WARNING**

Mains power must be removed before disconnecting motor phase cables.

P-09 Slip Compensation		
Range:	Function:	
0 %* %]	[-500 - 500	Enter the % value for slip compensation, to compensate for tolerances in the value of $n_{M,N}$ . Slip compensation is calculated automatically, i.e. on the basis of the rated motor speed $n_{M,N}$ .

P-10 Slip Compensation Time Constant		
Range:	Function:	
0.10 s* s]	[0.05 - 5.00	Enter the slip compensation reaction speed. A high value results in slow reaction, and a low value results in quick reaction. If low-frequency resonance problems arise, use a longer time setting.

3.5.2 P-3# Adv. Motor Data

P-30 Stator Resistance (Rs)		
Range:	Function:	
1.4000 Ohm*	[0.0140 - 140.0000 Ohm]	Set the stator resistance value. Enter the value from a motor data sheet or perform an Auto Tune on a cold motor. This ameter cannot be adjusted while the motor is running.

P-35 Main Reactance (Xh)		
Range:	Function:	
100.0000 Ohm*	[1.0000 - 10000.0000 Ohm]	Set the main reactance of the motor using one of these methods: <ol style="list-style-type: none"> <li>1. Run an Auto Tune on a cold motor. The frequency converter will measure the value from the motor.</li> <li>2. Enter the <math>X_h</math> value manually. Obtain the value from the motor supplier.</li> <li>3. Use the <math>X_h</math> default setting. The frequency converter establishes the setting on the basis of the motor name plate data.</li> </ol>

**NOTE**

This parameter cannot be adjusted while running.

P-36 Iron Loss Resistance (Rfe)		
Range:	Function:	
10000.000 Ohm*	[0 - 10000.000 Ohm]	Enter the equivalent iron loss resistance ( $R_{Fe}$ ) value to compensate for iron losses in the motor. The $R_{Fe}$ value cannot be found by performing an Auto Tune. The $R_{Fe}$ value is especially important in torque control applications. If $R_{Fe}$ is unknown, leave <i>P-36 Iron Loss Resistance (Rfe)</i> on default setting.

**NOTE**

This parameter cannot be adjusted while the motor is running.



### 3.6 H-## High Perf Parameters

#### 3.6.1 H-0# High Perf Operations

H-03 Restore Factory Settings		
Option:	Function:	
		Use this parameter to specify normal operation, to perform tests or to restore all parameters except <i>ID-03 Power Up's</i> , <i>ID-04 Over Temp's</i> and <i>ID-05 Over Volt's</i> . This function is active only when the power is cycled (power off-power on) to the frequency converter.
[0] *	Normal operation	Select <i>Normal operation</i> [0] for normal operation of the frequency converter with the motor in the selected application.
[2]	Restore Factory Settings	Select <i>Restore Factory Settings</i> [2] to reset all parameter values to default settings, except for <i>ID-03 Power Up's</i> , <i>ID-04 Over Temp's</i> and <i>ID-05 Over Volt's</i> . The frequency converter will reset during the next power-up. <i>H-03 Restore Factory Settings</i> will also revert to the default setting <i>Normal operation</i> [0].

H-04 Auto-Reset (Times)		
Option:	Function:	
		Select the reset function after tripping. Once reset, the frequency converter can be restarted.
[0] *	Manual reset	Select <i>Manual reset</i> [0], to perform a reset via [RESET] or via the digital inputs.
[1]	Automatic reset x 1	Select <i>Automatic reset x 1...x20</i> [1]-[12] to perform between one and twenty automatic resets after tripping.
[2]	Automatic reset x 2	
[3]	Automatic reset x 3	
[4]	Automatic reset x 4	
[5]	Automatic reset x 5	
[6]	Automatic reset x 6	
[7]	Automatic reset x 7	
[8]	Automatic reset x 8	
[9]	Automatic reset x 9	
[10]	Automatic reset x 10	
[11]	Automatic reset x 15	
[12]	Automatic reset x 20	
[13]	Infinite auto reset	Select <i>Infinite Automatic Reset</i> [13] for continuous resetting after tripping.

### NOTE

The motor may start without warning. If the specified number of AUTOMATIC RESETS is reached within 10 minutes, the frequency converter enters Manual reset [0] mode. After the Manual reset is performed, the setting of *H-04 Auto-Reset (Times)* reverts to the original selection. If the number of automatic resets is not reached within 10 minutes, or when a Manual reset is performed, the internal AUTOMATIC RESET counter returns to zero.

H-05 Auto-Reset (Reset Interval)		
Range:	Function:	
10 s*	[0 - 600 s]	Enter the time interval from trip to start of the automatic reset function. This parameter is active when <i>H-04 Auto-Reset (Times)</i> is set to <i>Automatic reset</i> [1] - [13].

H-06 Fan Operation		
Option:	Function:	
		Select the minimum speed of the main fan.
[0] *	Auto	Select Auto [0] to run the fan only when the internal temperature of the frequency converter is in the range +35°C to approximately +55°C. The fan will run at low speed at +35°C and at full speed at approximately +55°C.
[1]	On 50%	
[2]	On 75%	
[3]	On 100%	

H-08 Reverse Lock		
Option:	Function:	
		Selects the motor speed direction required. Use this parameter to prevent unwanted reversing.
[0]	Clockwise	Only operation in clockwise direction will be allowed.
[2] *	Both directions	Operation in both clockwise and anti-clockwise direction will be allowed.

### NOTE

The setting in *H-08 Reverse Lock* has impact on the Flying Start in *H-09 Start Mode*.

H-09 Start Mode		
Option:	Function:	
		This function makes it possible to catch a motor which is spinning freely due to a mains drop-out. When <i>H-09 Start Mode</i> is enabled, <i>F-24 Holding Time</i> has no function. Search direction for flying start is linked to the setting in <i>H-08 Reverse Lock</i> .



H-09 Start Mode		
Option:	Function:	
		<p><i>Clockwise</i> [0]: Flying start search in clockwise direction. If not successful, a DC brake is carried out.</p> <p><i>Both Directions</i> [2]: The flying start will first make a search in the direction determined by the last reference (direction). If not finding the speed it will make a search in the other direction. If not successful, a DC brake will be activated in the time set in <i>B-02 DC Braking Time</i>. Start will then take place from 0 Hz.</p>
[0]	Disabled	Select <i>Disable</i> [0] if this function is not required *
[1]	Enabled	Select <i>Enable</i> [1] to enable the frequency converter to "catch" and control a spinning motor.

3.6.2 H-3##

H-37 Trip Speed Low [Hz]		
Range:	Function:	
0.0 Hz*	[0.0 - par. F-17 Hz]	<p>If the Trip Speed is set to 0, the function is not active.</p> <p>If the speed at any time after the start (or during a stop) falls below the value in the ameter, the drive will trip with an alarm [A49] Speed Limit. Function at stop.</p>

**NOTE**

This parameter is only available if *K-02 Motor Speed Unit* is set to [Hz].

3.6.3 H-4# Advanced Settings

H-40 Configuration Mode		
Option:	Function:	
[0] *	Open Loop	<p>Motor speed is determined by applying a speed reference or by setting desired speed when in Hand Mode.</p> <p>Open Loop is also used if the frequency converter is part of a closed loop control system based on an external PID controller providing a speed reference signal as output.</p>
[3]	Closed Loop	<p>Motor Speed will be determined by a reference from the built-in PID controller varying the motor speed as part of a closed loop control process (e.g. constant pressure or flow). The PID controller must be configured in parameter group CL-## or via the Function Setups accessed by pressing the [Quick Menus] button.</p>

**NOTE**

This parameter cannot be changed when motor is running.

**NOTE**

When set for Closed Loop, the commands Reversing and Start Reversing will not reverse the direction of the motor.

3

H-43 Torque Characteristics		
Option:	Function:	
[0]	Compressor torque	<i>Compressor</i> [0]: For speed control of screw and scroll compressors. Provides a voltage which is optimized for a constant torque load characteristic of the motor in the entire range down to 10 Hz.
[1]	Variable torque	<i>Variable Torque</i> [1]: For speed control of centrifugal pumps and fans. Also to be used when controlling more than one motor from the same frequency converter (e.g. multiple condenser fans or cooling tower fans). Provides a voltage which is optimized for a squared torque load characteristic of the motor.
[2]	Energy Savings CT	<i>Auto Energy Optimization Compressor</i> [2]: For optimum energy efficient speed control of screw and scroll compressors. Provides a voltage which is optimized for a constant torque load characteristic of the motor in the entire range down to 15Hz but in addition the Energy Saving feature will adapt the voltage exactly to the current load situation, thereby reducing energy consumption and audible noise from the motor. To obtain optimal performance, the motor power factor cos phi must be set correctly. This value is set in <i>SP-43 Motor Cosphi</i> . The parameter has a default value which is automatically adjusted when the motor data is programmed. These settings will typically ensure optimum motor voltage but if the motor power factor cos phi requires tuning, an auto tune function can be carried out using <i>P-04 Auto Tune</i> . It is very rarely necessary to adjust the motor power factor parameter manually.
[3] *	Auto Energy Optim. VT	<i>Energy Saving VT</i> [3]: For optimum energy efficient speed control of centrifugal pumps and fans. Provides a voltage which is optimized for a squared torque load characteristic of the motor but in addition the Energy Saving feature will adapt the voltage exactly to the current load situation, thereby reducing energy consumption and audible noise from the motor. To obtain optimal performance, the motor power factor cos phi must be set correctly. This value is set in



H-43 Torque Characteristics	
Option:	Function:
	<p><i>SP-43 Motor Cosphi</i>. The parameter has a default value and is automatically adjusted when the motor data is programmed. These settings will typically ensure optimum motor voltage but if the motor power factor cos phi requires tuning, an auto tune function can be carried out using <i>P-04 Auto Tune</i>. It is very rarely necessary to adjust the motor power factor parameter manually.</p>

H-48 Clockwise Direction	
<p>This parameter defines the term "Clockwise" corresponding to the keypad direction arrow. Used for easy change of direction of shaft rotation without swapping motor wires. (Valid from SW version 5.84)</p>	
Option:	Function:
[0] *	<p>Normal Motor shaft will turn in clockwise direction when the drive is connected U -&gt; U; V -&gt; V, and W -&gt; W to motor.</p>
[1]	<p>Inverse Motor shaft will turn in counter clockwise direction when the drive is connected U -&gt; U; V -&gt; V, and W -&gt; W to motor.</p>

This parameter cannot be changed while the motor is running.

### 3.6.4 H-6# Load Depend. Setting

H-61 High Speed Load Compensation									
Range:	Function:								
100 %* [0 - 300 %]	<p>Enter the % value to compensate voltage in relation to load when the motor is running at high speed and obtain the optimum U/f characteristic. The motor size determines the frequency range within which this ameter is active.</p> <table border="1"> <thead> <tr> <th>Motor size</th> <th>Change-over</th> </tr> </thead> <tbody> <tr> <td>0.25 kW - 7.5 kW</td> <td>&gt; 10 Hz</td> </tr> <tr> <td>11 kW - 45 kW</td> <td>&lt; 5 Hz</td> </tr> <tr> <td>55 kW - 550 kW</td> <td>&lt; 3-4 Hz</td> </tr> </tbody> </table>	Motor size	Change-over	0.25 kW - 7.5 kW	> 10 Hz	11 kW - 45 kW	< 5 Hz	55 kW - 550 kW	< 3-4 Hz
Motor size	Change-over								
0.25 kW - 7.5 kW	> 10 Hz								
11 kW - 45 kW	< 5 Hz								
55 kW - 550 kW	< 3-4 Hz								

H-64 Resonance Dampening	
Range:	Function:
100 %* [0 - 500 %]	<p>Enter the resonance dampening value. Set <i>H-64 Resonance Dampening</i> and <i>H-65 Resonance Dampening Time Constant</i> to help eliminate high-frequency resonance problems. To reduce resonance oscillation, increase the value of <i>H-64 Resonance Dampening</i>.</p>

H-65 Resonance Dampening Time Constant	
Range:	Function:
5 ms* [5 - 50 ms]	<p>Set <i>H-64 Resonance Dampening</i> and <i>H-65 Resonance Dampening Time Constant</i> to help eliminate high-frequency resonance problems. Enter the time constant that provides the best dampening.</p>

### 3.6.5 H-7# Adjustable Warnings

Warnings are shown on display, programmed output or serial bus.

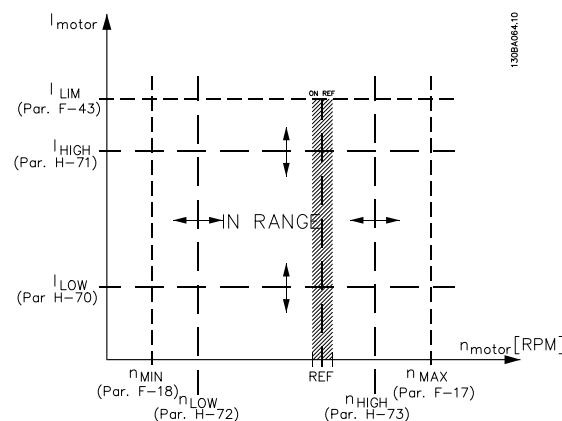

H-70 Warning Current Low	
Range:	Function:
0.00 A* [0.00 - par. H-71 A]	<p>Enter the <math>I_{LOW}</math> value. When the motor current falls below this limit (<math>I_{LOW}</math>), the display reads CURRENT LOW. The signal outputs can be programmed to produce a status signal on terminal 27 or 29 and on relay output 01 or 02. Refer to the drawing in this section.</p>





H-71 Warning Current High		
Range:		Function:
par. DR-37 A*	[par. H-70 - par. DR-37 A]	Enter the I <sub>HIGH</sub> value. When the motor current exceeds this limit (I <sub>HIGH</sub> ), the display reads CURRENT HIGH. The signal outputs can be programmed to produce a status signal on terminal 27 or 29 and on relay output 01 or 02. Refer to the drawing in this section.

H-72 Warning Speed Low		
Range:		Function:
0 RPM*	[0 - par. H-73 RPM]	Enter the n <sub>LOW</sub> value. When the motor speed falls below this limit (n <sub>LOW</sub> ) the display reads SPEED LOW. The signal outputs can be programmed to produce a status signal on terminal 27 or 29 and on relay output 01 or 02. Programme the lower signal limit of the motor speed, n <sub>LOW</sub> , within the normal working range of the frequency converter. Refer to the drawing in this section.

H-73 Warning Speed High		
Range:		Function:
par. F-17 RPM*	[par. H-72 - par. F-17 RPM]	

**NOTE**

Any changes in *F-17 Motor Speed High Limit [RPM]* will reset the value in *H-73 Warning Speed High* to the same value as set in *F-17 Motor Speed High Limit [RPM]*.

If a different value is needed in *H-73 Warning Speed High*, it must be set after programming of *F-17 Motor Speed High Limit [RPM]*

H-74 Warning Reference Low		
Range:		Function:
-999999.999 N/A*	[-999999.999 - par. H-75 N/A]	Enter the lower reference limit. When the actual reference falls below this limit, the display indicates Ref Low. The signal outputs can be programmed to produce a status signal on terminal 27 or 29 and on relay output 01 or 02.

H-75 Warning Reference High		
Range:		Function:
999999.999 N/A*	[par. H-74 - 999999.999 N/A]	Enter the upper reference limit. When the actual reference exceeds this limit, the display reads Ref High. The signal outputs can be programmed to produce a status signal on terminal 27 or 29 and on relay output 01 or 02.

H-76 Warning Feedback Low		
Range:		Function:
-999999.999 ProcessCtrlUnit*	[-999999.999 - par. H-77 ProcessCtrlUnit]	Enter the lower feedback limit. When the feedback falls below this limit, the display reads Feedb Low. The signal outputs can be programmed to produce a status signal on terminal 27 or 29 and on relay output 01 or 02.

H-77 Warning Feedback High		
Range:		Function:
999999.999 ProcessCtrlUnit*	[par. H-76 - 999999.999 ProcessCtrlUnit]	Enter the upper feedback limit. When the feedback exceeds this limit, the display reads Feedb High.

H-78 Missing Motor Phase Function		
Option:	Function:	
		Displays an alarm in the event of a missing motor phase.
[0]	Disabled	No alarm is displayed if a missing motor phase occurs.
[2] *	Trip 1000 ms	

**NOTE**

This parameter cannot be adjusted while the motor is running.

3.6.6 H-8# Stop Adjustments

H-80 Function at Stop		
Option:	Function:	
		Select the frequency converter function after a stop command or after the speed is decelerated to the settings in <i>H-81 Min Speed for Function at Stop [RPM]</i> .
[0] *	Coast	Leaves motor in free mode.
[1]	DC Hold/ Motor Preheat	Energizes motor with a DC holding current (see <i>B-00 DC Hold Current</i> ).

H-81 Min Speed for Function at Stop [RPM]		
Range:		Function:
3. RPM*	[0 - 600 RPM]	Set the speed at which to activate <i>H-80 Function at Stop</i> .





H-82 Min Speed for Function at Stop [Hz]		
Range:		Function:
0.1 Hz*	[0.0 - 20.0 Hz]	Set the output frequency at which to activate <i>H-80 Function at Stop</i> .



### 3.7 AN-## Analog In/Out

Parameter group for configuration of the analog input and output.

#### 3.7.1 AN-0# Analog I/O Mode

Parameter group for setting up the analog I/O configuration.

The frequency converter is equipped with 2 analog inputs: Terminal 53 and 54. The analog inputs can freely be allocated to either voltage (0 - 10 V) or current input (0/4 - 20 mA)

### NOTE

Thermistors may be connected to either an analog or a digital input.

AN-00 Live Zero Timeout Time	
Range:	Function:
10 s* [1 - 99 s]	Enter the Live Zero Time-out time period. Live Zero Time-out Time is active for analog inputs, i.e. terminal 53 or terminal 54, used as reference or feedback sources. If the reference signal value associated with the selected current input falls below 50% of the value set in <i>AN-10 Terminal 53 Low Voltage</i> , <i>AN-12 Terminal 53 Low Current</i> , <i>AN-20 Terminal 54 Low Voltage</i> or <i>AN-22 Terminal 54 Low Current</i> for a time period longer than the time set in <i>AN-00 Live Zero Timeout Time</i> , the function selected in <i>AN-01 Live Zero Timeout Function</i> will be activated.

AN-01 Live Zero Timeout Function	
Option:	Function:
	Select the time-out function. The function set in <i>AN-01 Live Zero Timeout Function</i> will be activated if the input signal on terminal 53 or 54 is below 50% of the value in <i>AN-10 Terminal 53 Low Voltage</i> , <i>AN-12 Terminal 53 Low Current</i> , <i>AN-20 Terminal 54 Low Voltage</i> or <i>AN-22 Terminal 54 Low Current</i> for a time period defined in <i>AN-00 Live Zero Timeout Time</i> . If several time-outs occur simultaneously, the frequency converter prioritises the time-out functions as follows: <ol style="list-style-type: none"> <li><i>AN-01 Live Zero Timeout Function</i></li> <li><i>O-04 Control Word Timeout Function</i></li> </ol> The output frequency of the frequency converter can be: <ul style="list-style-type: none"> <li>[1] frozen at the present value</li> <li>[2] overruled to stop</li> <li>[3] overruled to jog speed</li> </ul>

AN-01 Live Zero Timeout Function	
Option:	Function:
	<ul style="list-style-type: none"> <li>[4] overruled to max. speed</li> <li>[5] overruled to stop with subsequent trip</li> </ul>
[0] *	Off
[1]	Freeze output
[2]	Stop
[3]	Jogging
[4]	Max. speed
[5]	Stop and trip

AN-02 Fire Mode Live Zero Timeout Function	
Option:	Function:
	The function set in <i>AN-01 Live Zero Timeout Function</i> will be activated if the input signal on analogue inputs is below 50% of the value defined in parameter group AN-1# to AN-6# "Terminal xx Low Current" or "Terminal xx Low Voltage" for a time period defined in <i>AN-00 Live Zero Timeout Time</i> .
[0] *	Off
[1]	Freeze output
[2]	Stop
[3]	Jogging
[4]	Max. speed

#### 3.7.2 AN-1# Analog Input 1

Parameters for configuring the scaling and limits for analog input 1 (terminal 53).

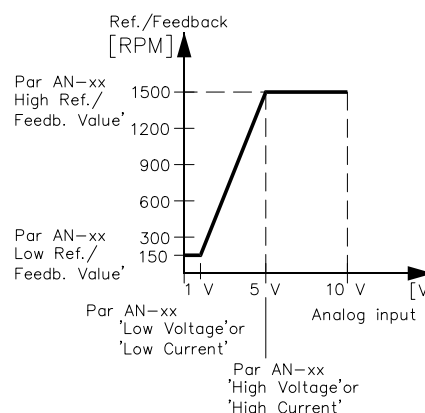

130B4038.13



AN-10 Terminal 53 Low Voltage		
Range:	Function:	
0.07 V* [0.00 - par. AN-11 V]	Enter the low voltage value. This analog input scaling value should correspond to the low reference/feedback value set in AN-14 Terminal 53 Low Ref./Feedb. Value.	

AN-11 Terminal 53 High Voltage		
Range:	Function:	
10.00 V* [par. AN-10 - 10.00 V]	Enter the high voltage value. This analog input scaling value should correspond to the high reference/feedback value set in AN-15 Terminal 53 High Ref./Feedb. Value.	

AN-12 Terminal 53 Low Current		
Range:	Function:	
4.00 mA* [0.00 - par. AN-13 mA]	Enter the low current value. This reference signal should correspond to the low reference/feedback value, set in AN-14 Terminal 53 Low Ref./Feedb. Value. The value must be set at >2 mA in order to activate the Live Zero Time-out Function in AN-01 Live Zero Timeout Function.	

AN-13 Terminal 53 High Current		
Range:	Function:	
20.00 mA* [par. AN-12 - 20.00 mA]	Enter the high current value corresponding to the high reference/feedback set in AN-15 Terminal 53 High Ref./Feedb. Value.	

AN-14 Terminal 53 Low Ref./Feedb. Value		
Range:	Function:	
0.000 N/A* [-999999.999 - 999999.999 N/A]	Enter the analog input scaling value that corresponds to the low voltage/low current set in AN-10 Terminal 53 Low Voltage and AN-12 Terminal 53 Low Current.	

AN-15 Terminal 53 High Ref./Feedb. Value		
Range:	Function:	
60.000 N/A* [-999999.999 - 999999.999 N/A]	Enter the analog input scaling value that corresponds to the high voltage/high current value set in AN-11 Terminal 53 High Voltage and AN-13 Terminal 53 High Current.	

AN-16 Terminal 53 Filter Time Constant		
Range:	Function:	
0.001 s* [0.001 - 10.000 s]	Enter the time constant. This is a first-order digital low pass filter time constant for suppressing electrical noise in terminal 53. A high time constant value improves dampening but also increases the time delay through the filter. This parameter cannot be adjusted while the motor is running.	

AN-17 Terminal 53 Live Zero		
Option:	Function:	
[0]	Disabled	
[1] *	Enabled	

### 3.7.3 AN-2# Analog Input 2

Parameters for configuring the scaling and limits for analog input 2 (terminal 54).

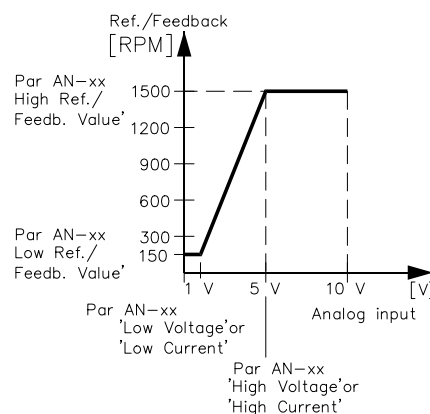

130BA038.13

AN-20 Terminal 54 Low Voltage		
Range:	Function:	
0.07 V* [0.00 - par. AN-21 V]	Enter the low voltage value. This analog input scaling value should correspond to the low reference/feedback value, set in AN-24 Terminal 54 Low Ref./Feedb. Value.	



AN-21 Terminal 54 High Voltage		
Range:		Function:
10.00 V*	[par. AN-20 - 10.00 V]	Enter the high voltage value. This analog input scaling value should correspond to the high reference/feedback value set in <i>AN-25 Terminal 54 High Ref./Feedb. Value</i> .

AN-22 Terminal 54 Low Current		
Range:		Function:
4.00 mA*	[0.00 - par. AN-23 mA]	Enter the low current value. This reference signal should correspond to the low reference/feedback value, set in <i>AN-24 Terminal 54 Low Ref./Feedb. Value</i> . The value must be set at >2 mA in order to activate the Live Zero Time-out Function in <i>AN-01 Live Zero Timeout Function</i> .

AN-23 Terminal 54 High Current		
Range:		Function:
20.00 mA*	[par. AN-22 - 20.00 mA]	Enter the high current value corresponding to the high reference/feedback value set in <i>AN-25 Terminal 54 High Ref./Feedb. Value</i> .

AN-24 Terminal 54 Low Ref./Feedb. Value		
Range:		Function:
0.000 N/A*	[-999999.999 - 999999.999 N/A]	Enter the analog input scaling value that corresponds to the low voltage/low current value set in <i>AN-20 Terminal 54 Low Voltage</i> and <i>AN-22 Terminal 54 Low Current</i> .

AN-25 Terminal 54 High Ref./Feedb. Value		
Range:		Function:
100.000 N/A*	[-999999.999 - 999999.999 N/A]	Enter the analog input scaling value that corresponds to the high voltage/high current value set in <i>AN-21 Terminal 54 High Voltage</i> and <i>AN-23 Terminal 54 High Current</i> .

AN-26 Terminal 54 Filter Time Constant		
Range:		Function:
0.001 s*	[0.001 - 10.000 s]	Enter the time constant. This is a first-order digital low pass filter time constant for suppressing electrical noise in terminal 54. A high time constant value improves dampening but also increases the time delay through the filter. This parameter cannot be adjusted while the motor is running.

AN-27 Terminal 54 Live Zero		
Option:		Function:
[0]	Disabled	
[1] *	Enabled	This parameter makes it possible to disable the Live Zero monitoring. E.g. to be used if the analog outputs are used as part of a de-central I/O system (e.g. when not as part of any frequency converter related control functions, but feeding a Building Management System with data).

3

### 3.7.4 AN-3# Analog Input 3 OPCGPIO General Purpose I/O

Parameter group for configuring the scale and limits for analog input 3 (X30/11) placed on option module OPCGPIO General Purpose I/O.

AN-30 Terminal X30/11 Low Voltage		
Range:		Function:
0.07 V*	[0.00 - par. AN-31 V]	Sets the analog input scaling value to correspond to the low reference/feedback value (set in <i>AN-34 Term. X30/11 Low Ref./Feedb. Value</i> ).

AN-31 Terminal X30/11 High Voltage		
Range:		Function:
10.00 V*	[par. AN-30 - 10.00 V]	Sets the analog input scaling value to correspond to the high reference/feedback value (set in <i>AN-35 Term. X30/11 High Ref./Feedb. Value</i> ).

AN-34 Term. X30/11 Low Ref./Feedb. Value		
Range:		Function:
0.000 N/A*	[-999999.999 - 999999.999 N/A]	Sets the analog input scaling value to correspond to the low voltage value (set in <i>AN-30 Terminal X30/11 Low Voltage</i> ).

AN-35 Term. X30/11 High Ref./Feedb. Value		
Range:		Function:
100.000 N/A*	[-999999.999 - 999999.999 N/A]	Sets the analog input scaling value to correspond to the high voltage value (set in <i>AN-31 Terminal X30/11 High Voltage</i> ).



AN-36 Term. X30/11 Filter Time Constant		
Range:		Function:
0.001 s*	[0.001 - 10.000 s]	A 1 <sup>st</sup> order digital low pass filter time constant for suppressing electrical noise on terminal X30/11. <i>AN-36 Term. X30/11 Filter Time Constant cannot be changed while the motor is running.</i>

AN-37 Term. X30/11 Live Zero		
Option:	Function:	
	This parameter makes it possible to disable the Live Zero monitoring. E.g. to be used if the analog outputs are used as part of a decentral I/O system (e.g. when not part of any frequency converter related control functions, but feeding a Building Management System with data).	
[0] *	Disabled	
[1] *	Enabled	

### 3.7.5 AN-4# Analog Input 4 OPCGPIO General Purpose I/O

Parameter group for configuring the scale and limits for analog input 4 (X30/12) placed on option module OPCGPIO General Purpose I/O.

AN-40 Terminal X30/12 Low Voltage		
Range:		Function:
0.07 V*	[0.00 - par. AN-41 V]	Sets the analog input scaling value to correspond to the low reference/feedback value set in <i>AN-44 Term. X30/12 Low Ref./Feedb. Value</i> .

AN-41 Terminal X30/12 High Voltage		
Range:		Function:
10.00 V*	[par. AN-40 - 10.00 V]	Sets the analog input scaling value to correspond to the high reference/feedback value set in <i>AN-45 Term. X30/12 High Ref./Feedb. Value</i> .

AN-44 Term. X30/12 Low Ref./Feedb. Value		
Range:		Function:
0.000 N/A*	[-999999.999 - 999999.999 N/A]	Sets the analog output scaling value to correspond to the low voltage value set in <i>AN-40 Terminal X30/12 Low Voltage</i> .

AN-45 Term. X30/12 High Ref./Feedb. Value		
Range:		Function:
100.000 N/A*	[-999999.999 - 999999.999 N/A]	Sets the analog input scaling value to correspond to the high voltage value set in <i>AN-41 Terminal X30/12 High Voltage</i> .

AN-46 Term. X30/12 Filter Time Constant		
Range:		Function:
0.001 s*	[0.001 - 10.000 s]	A 1 <sup>st</sup> order digital low pass filter time constant for suppressing electrical noise on terminal X30/12. <i>AN-46 Term. X30/12 Filter Time Constant cannot be changed while the motor is running.</i>

AN-47 Term. X30/12 Live Zero		
Option:	Function:	
	This parameter makes it possible to disable the Live Zero monitoring. E.g. to be used if the analog outputs are used as part of a decentral I/O system (e.g. when not part of any frequency converter related control functions, but feeding a Building Management System with data)	
[0] *	Disabled	
[1] *	Enabled	

### 3.7.6 AN-5# Analog Output 1

Parameters for configuring the scaling and limits for analog output 1, i.e. Terminal 42. Analog outputs are current outputs: 0/4 – 20 mA. Common terminal (terminal 39) is the same terminal and has the same electrical potential for analog common and digital common connection. Resolution on analog output is 12 bit.

AN-50 Terminal 42 Output		
Option:	Function:	
		Select the function of Terminal 42 as an analog current output. A motor current of 20 mA corresponds to $I_{max}$ .
[0]	No operation	
[100]	Output frequency	0 - 100 Hz, (0-20 mA)
[101]	Reference	Minimum reference - Maximum reference, (0-20 mA)
[102]	Feedback	-200% to +200% of <i>CL-14 Maximum Reference/Feedb.</i> , (0-20 mA)
[103]	Motor Current	0 - Inverter Max. Current ( <i>DR-37 Drive Max. Current</i> ), (0-20 mA)
[104]	Torque rel to limit	0 - Torque limit ( <i>F-40 Torque Limiter (Driving)</i> ), (0-20 mA)



AN-50 Terminal 42 Output		
Option:	Function:	
[105]	Torq relate to rated	0 - Motor rated torque, (0-20 mA)
[106]	Power	0 - Motor rated power, (0-20 mA)
[107]	Speed	0 - Speed High Limit (F-17 Motor Speed High Limit [RPM] and F-15 Motor Speed High Limit [Hz]), (0-20 mA)
[113]	Ext. Closed Loop 1	0 - 100%, (0-20 mA)
[114]	Ext. Closed Loop 2	0 - 100%, (0-20 mA)
[115]	Ext. Closed Loop 3	0 - 100%, (0-20 mA)
[130]	Output freq. 4-20mA	0 - 100 Hz
[131]	Reference 4-20mA	Minimum Reference - Maximum Reference
[132]	Feedback 4-20mA	-200% to +200% of CL-14 Maximum Reference/Feedb.
[133]	Motor cur. 4-20mA	0 - Inverter Max. Current (DR-37 Drive Max. Current)
[134]	Torq.% lim 4-20 mA	0 - Torque limit (F-40 Torque Limiter (Driving))
[135]	Torq.% nom 4-20mA	0 - Motor rated torque
[136]	Power 4-20mA	0 - Motor rated power
[137] *	Speed 4-20mA	0 - Speed High Limit (F-17 and F-15)
[139]	Bus ctrl.	0 - 100%, (0-20 mA)
[140]	Bus ctrl. 4-20 mA	0 - 100%
[141]	Bus ctrl t.o.	0 - 100%, (0-20 mA)
[142]	Bus ctrl t.o. 4-20mA	0 - 100%
[143]	Ext. CL 1 4-20mA	0 - 100%
[144]	Ext. CL 2 4-20mA	0 - 100%
[145]	Ext. CL 3 4-20mA	0 - 100%

**NOTE**

Values for setting the Minimum Reference is found in open loop F-52 Minimum Reference and for closed loop CL-13 Minimum Reference/Feedb. - values for maximum reference for open loop is found in F-53 Maximum Reference and for closed loop CL-14 Maximum Reference/Feedb..

AN-51 Terminal 42 Output Min Scale		
Range:	Function:	
0.00 %* [0.00 - 200.00 %]	Scale for the minimum output (0 or 4mA) of the analog signal at terminal 42. Set the value to be the <b>percentage</b> of the full range of the variable selected in AN-50 Terminal 42 Output.	

AN-52 Terminal 42 Output Max Scale		
Range:	Function:	
100.00 %* [0.00 - 200.00 %]	Scale for the maximum output (20 mA) of the analog signal at terminal 42. Set the value to be the percentage of the full range of the variable selected in AN-50 Terminal 42 Output.	
It is possible to get a value lower than 20 mA at full scale by programming values >100% by using a formula as follows:		

$20\text{ mA} \mid \text{desired maximum current} \times 100\%$

i.e.  $10\text{ mA} : \frac{20\text{ mA}}{10\text{ mA}} \times 100\% = 200\%$

**EXAMPLE 1:**

Variable value= OUTPUT FREQUENCY, range = 0-100 Hz

Range needed for output = 0-50 Hz

Output signal 0 or 4 mA is needed at 0 Hz (0% of range) -

set AN-51 Terminal 42 Output Min Scale to 0%

Output signal 20 mA is needed at 50 Hz (50% of range) -

set AN-52 Terminal 42 Output Max Scale to 50%

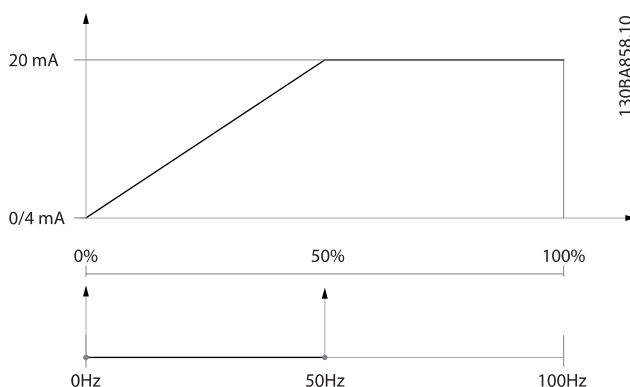



EXAMPLE 2:

Variable= FEEDBACK, range= -200% to +200%  
 Range needed for output= 0-100%  
 Output signal 0 or 4 mA is needed at 0% (50% of range) - set AN-51 Terminal 42 Output Min Scale to 50%  
 Output signal 20 mA is needed at 100% (75% of range) - set AN-52 Terminal 42 Output Max Scale to 75%

EXAMPLE 3:

Variable value= REFERENCE, range= Min ref - Max ref  
 Range needed for output= Min ref (0%) - Max ref (100%), 0-10 mA  
 Output signal 0 or 4 mA is needed at Min ref - set AN-51 Terminal 42 Output Min Scale to 0%  
 Output signal 10 mA is needed at Max ref (100% of range) - set AN-52 Terminal 42 Output Max Scale to 200% (20 mA / 10 mA x 100%=200%).

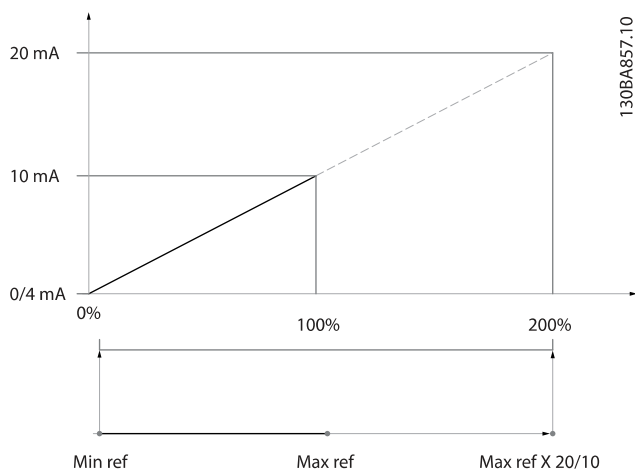

AN-53 Terminal 42 Output Bus Control		
Range:	Function:	
0.00 %*	[0.00 - 100.00 %]	Holds the level of Output 42 if controlled by bus.

AN-54 Terminal 42 Output Timeout Preset		
Range:	Function:	
0.00 %*	[0.00 - 100.00 %]	Holds the preset level of Output 42. In case of a bus timeout and a timeout function is selected in AN-50 Terminal 42 Output the output will preset to this level.

### 3.7.7 AN-6# Analog Output 2 OPCGPIO General Purpose I/O

Analog outputs are current outputs: 0/4 - 20mA. Common terminal (terminal X30/8) is the same terminal and electrical potential for analog common connection. Resolution on analog output is 12 bit.

#### AN-60 Terminal X30/8 Output

Same options and functions as AN-50 Terminal 42 Output.

#### AN-61 Terminal X30/8 Min. Scale

Range:	Function:	
0.00 %*	[0.00 - 200.00 %]	Scales the minimum output of the selected analog signal on terminal X30/8. Scale the minimum value as a percentage of the maximum signal value, i.e. 0mA (or 0hz) is desired at 25% of the maximum output value and 25% is programmed. The value can never be higher than the corresponding setting in AN-62 Terminal X30/8 Max. Scale if value is below 100%.  This parameter is active when option module OPCGPIO General Purpose I/O Option Module is mounted in the drive.

#### AN-62 Terminal X30/8 Max. Scale

Range:	Function:	
100.00 %*	[0.00 - 200.00 %]	Scales the maximum output of the selected analog signal on terminal X30/8. Scale the value to the desired maximum value of the current signal output. Scale the output to give a lower current than 20 mA at full scale or 20 mA at an output below 100% of the maximum signal value. If 20 mA is the desired output current at a value between 0 - 100% of the full-scale output, program the percentage value in the parameter, i.e. 50% = 20 mA. If a current between 4 and 20 mA is desired at maximum output (100%), calculate the percentage value as follows:  $20\text{ mA} \mid \text{desired maximum current} \times 100\%$  <i>i.e.</i> $10\text{ mA} : \frac{20\text{ mA}}{10\text{ mA}} \times 100\% = 200\%$

#### AN-63 Terminal X30/8 Output Bus Control

Range:	Function:	
0.00 %*	[0.00 - 100.00 %]	Contains the value to apply to the output terminal, when it is configured as [Bus Controlled].

#### AN-64 Terminal X30/8 Output Timeout Preset

Range:	Function:	
0.00 %*	[0.00 - 100.00 %]	Contains the value to apply to the output terminal, when it is configured as [Bus Controlled Timeout] and timeout is detected.



### 3.8 SP-## Special Functions

Parameter group for configuring special frequency converter functions.

#### 3.8.1 SP-1#Line On/Off

Parameters for configuring mains failure monitoring and handling.

SP-10 Line failure		
Option:	Function:	
		Select the function at which the frequency converter must act, when the threshold set in <i>SP-11 Line Voltage at Input Fault</i> has been reached or a <i>Mains Failure Inverse</i> command is activated via one of the digital inputs (par. E-0#).
[0] *	No function	The energy left in the capacitor bank will be used to "drive" the motor, but will be discharged.
[1]	Ctrl. Decel	The frequency converter will perform a controlled decel. <i>B-10 Brake Function</i> must be set to <i>Off</i> [0].
[3]	Coasting	The inverter will turn off and the capacitor bank will back up the control card then ensuring a faster restart when mains reconnected (at short power zags).
[4]	Kinetic back-up	The frequency converter will ride through by controlling speed for generative operation of the motor utilizing the moment of inertia of the system as long as sufficient energy is present.

#### NOTE

For best performance of controlled decel and kinetic back-up *H-43 Torque Characteristics* should be set to *Compressor* [0] or *Variable Torque* [1] (no Energy Saving should be active).

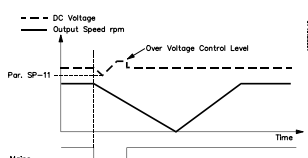

Illustration 3.1 Controlled decel - short mains failure. Decelling to stop followed by accelerating to reference.

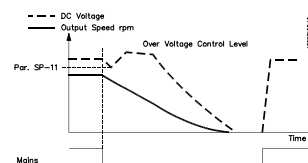

Illustration 3.2 Controlled decel, longer mains failure. Decelling as long as the energy in the system allows for it, then the motor is coasted.

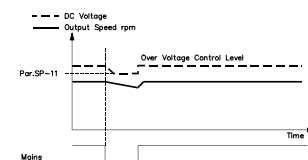

Illustration 3.3 Kinetic Back-up, short mains failure. Ride through as long as the energy in the system allows for it.

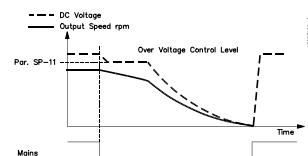

Illustration 3.4 Kinetic Back-up, longer mains failure. The motor is coasted as soon as the energy in the system is too low.

SP-11 Line Voltage at Input Fault		
Range:	Function:	
342. V* [180 - 600 V]	This parameter defines the threshold voltage at which the selected function in <i>SP-10 Line failure</i> should be activated. The detection level is at a faktor sqrt(2) of the value in <i>SP-11 Line Voltage at Input Fault</i> .	

SP-12 Function at Line Imbalance		
Option:	Function:	
		Operation under severe main imbalance conditions reduces the lifetime of the motor. Conditions are considered severe if the motor is operated continuously near nominal load (e.g. a pump or fan running near full speed). When a severe mains imbalance is detected:
[0] *	Trip	Select <i>Trip</i> [0] to trip the frequency converter.
[1]	Warning	Select <i>Warning</i> [1] to issue a warning.
[2]	Disabled	Select <i>Disabled</i> [2] for no action.
[3]	Derate	Select <i>Derate</i> [3] for derating the frequency converter.

Parameters for configuring auto reset handling, special trip handling and control card self test or restore.





SP-25 Trip Delay at Torque Limit		
Range:		Function:
60 s*	[0 - 60 s]	Enter the torque limit trip delay in seconds. When the output torque reaches the torque limits ( <i>F-40 Torque Limiter (Driving)</i> and <i>F-41 Torque Limiter (Braking)</i> ), a warning is triggered. When the torque limit warning has been continuously present for the period specified in this parameter, the frequency converter trips. Disable the trip delay by setting the parameter to 60 s = OFF. Thermal frequency converter monitoring will still remain active.

SP-26 Trip Delay at Drive Fault		
Range:		Function:
0. s*	[0 - 35 s]	When the frequency converter detects an over-voltage in the set time trip will be effected after the set time.

SP-29 Service Code		
Range:		Function:
0 N/A*	[-2147483647 - 2147483647 N/A]	Service use only.

### 3.8.2 SP-3# Current Limit Control

The frequency converter features an integral Current Limit Controller which is activated when the motor current, and thus the torque, is higher than the torque limits set in *F-40 Torque Limiter (Driving)* and *F-41 Torque Limiter (Braking)*.

When the current limit is reached during motor operation or regenerative operation, the frequency converter will try to reduce torque below the preset torque limits as quickly as possible without losing control of the motor.

While the current control is active, the frequency converter can only be stopped by setting a digital input to *Coast inverse* [2] or *Coast and reset inv.* [3]. Any signal on terminals 18 to 33 will not be active until the frequency converter is no longer near the current limit.

By using a digital input set to *Coast inverse* [2] or *Coast and reset inv.* [3], the motor does not use the decel time, since the frequency converter is coasted.

SP-30 Current Lim Ctrl, Proportional Gain		
Range:		Function:
100 %*	[0 - 500 %]	Enter the proportional gain value for the current limit controller. Selection of a high value makes the controller react faster. Too high a setting leads to controller instability.

SP-31 Current Lim Ctrl, Integration Time		
Range:		Function:
0.020 s*	[0.002 - 2.000 s]	Controls the current limit control integration time. Setting it to a lower value makes it react faster. A setting too low leads to control instability.

SP-32 Current Lim Ctrl, Filter Time		
Range:		Function:
26.0 ms*	[1.0 - 100.0 ms]	Sets a time constant for the current limit controller low-pass filter.

### 3.8.3 SP-4#Energy Savings

Parameters for adjusting the energy optimisation level in both Variable Torque (VT) and Energy Saving mode.

Energy Saving is only active if *H-43 Torque Characteristics*, is set for either *Energy Savings CT* [2] or *Auto Energy Optim. VT* [3].

SP-40 VT Level		
Range:		Function:
66 %*	[40 - 90 %]	Enter the level of motor magnetisation at low speed. Selection of a low value reduces energy loss in the motor, but also reduces load capability. This parameter cannot be adjusted while the motor is running.

SP-41 Energy Savings Min. Magnetization		
Range:		Function:
40. %*	[40 - 75 %]	Enter the minimum allowable magnetisation for Automatic Energy Savings. Selection of a low value reduces energy loss in the motor, but can also reduce resistance to sudden load changes.

SP-42 Energy Savings Min. Frequency		
Range:		Function:
10 Hz*	[5 - 40 Hz]	Enter the minimum frequency at which the Automatic Energy Savings is to be active.

SP-43 Motor Cosphi		
Range:		Function:
0.66 N/A*	[0.40 - 0.95 N/A]	The Cos(phi) setpoint is automatically set for optimum Energy Saving performance during Auto Tune. This parameter should normally not be altered. However in some situations it may be necessary to enter a new value to fine-tune.



### 3.8.4 SP-5# Environment

These parameters help the drive to operate under special environmental conditions.

SP-50 RFI Filter		
This parameter is only available for AF-650 GP. It is not relevant to due to different design and shorter motor cables.		
Option:	Function:	
[0]	Off	Select <i>Off</i> [0] if the drive is fed by an isolated mains source (IT mains). If a filter is used, select Off [0] during charging to prevent a high leakage current making the RCD switch. In this mode, the internal RFI filter capacitors between chassis and the mains RFI filter circuit are cut-out to reduce the ground capacity currents.
[1] *	On	Select <i>On</i> [1] to ensure that the drive complies with EMC standards.

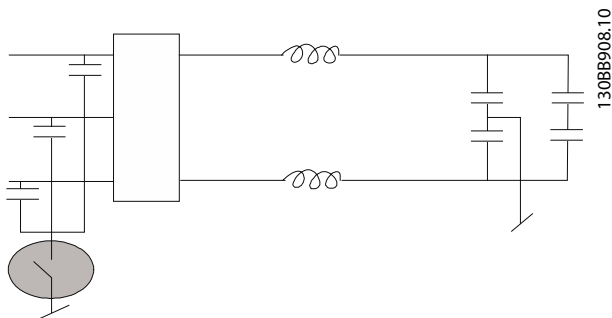

SP-51 DC Link Compensation		
Option:	Function:	
[0]	Off	Disables DC Link Compensation.
[1] *	On	Enables DC Link Compensation.

SP-53 Fan Monitor		
Option:	Function:	
		Select which reaction the drive should take in case a fan fault is detected.
[0]	Disabled	
[1] *	Warning	
[2]	Trip	

SP-55 Output Filter		
Option:	Function:	
[0] *	No Filter	
[2]	Sine Wave Filter Fixed	

### 3.8.5 SP-6# Automatic Derate

This group contains parameters for derating the frequency converter in case of high temperature.

SP-60 Function at Over Temperature		
Option:	Function:	
		If either heatsink or control card temperature exceeds a factory-programmed temperature limit, a warning will be activated. If the temperature increases further, select whether the frequency converter should trip (trip locked) or derate the output current.
[0] *	Trip	The frequency converter will trip (trip locked) and generate an alarm. Power must be cycled to reset the alarm, but will not allow restart of the motor until the heat sink temperature has dropped below the alarm limit.
[1]	Derate	If the critical temperature is exceeded the output current will be reduced until the allowable temperature has been reached.

SP-61 Function at Drive Overload		
Option:	Function:	
		Is used in case of steady overload beyond the thermal limits (110% for 60 sec.).
[0] *	Trip	Choose Trip [0] to make the frequency converter trip and provide an alarm.
[1]	Derate	Derate [1] to reduce pump speed in order to decrease the load on the power section and allowing this to cool down.

SP-62 Drive Overload Derate Current		
Range:	Function:	
95 %*	[50 - 100 %]	Defines the desired current level (in % of rated output current for the frequency converter) when running with reduced pump speed after load on the frequency converter has exceeded the allowable limit (110% for 60 sec.).

3



### 3.9 O-## Options/Comms

#### 3.9.1 O-0# General Settings

O-01 Control Site		
Option:	Function:	
		The setting in this parameter overrides the settings in <i>O-50 Coasting Select</i> to <i>O-56 Preset Reference Select</i> .
[0] *	Digital and ctrl.word	Control by using both digital input and control word.
[1]	Digital only	Control by using digital inputs only.
[2]	Controlword only	Control by using control word only.

O-02 Control Word Source		
Option:	Function:	
		Select the source of the control word: one of two serial interfaces or four installed options. During initial power-up, the drive automatically sets this parameter to <i>Option A</i> [3] if it detects a valid network option installed in slot A. If the option is removed, the drive detects a change in the configuration, sets <i>O-02 Control Word Source</i> back to default setting <i>Drive Port</i> , and the drive then trips. If an option is installed after initial power-up, the setting of <i>O-02 Control Word Source</i> will not change but the drive will trip and display: <i>Alarm 67 Option Changed</i> .  The drive port is the RS-485 port running the protocol as set in par. O-30 ([0] Drive, [1] Drive MC, [2] Modbus RTU, [3] Metasys N2, or [4] FLN
[0]	None	
[1]	Drive Port	The drive port is the RS-485 port running the protocol as set in parameter O-30; Drive, Drive MC, Modbus RTU, Metasys N2, or FLN
[2]	USB Port	
[3] *	Option A	
[4]	Option B	

#### NOTE

This parameter cannot be adjusted while the motor is running.

O-03 Control Word Timeout Time		
Range:	Function:	
60.0 s*	[1.0 - 18000.0 s]	Enter the maximum time expected to pass between the reception of two consecutive messages. If this time is exceeded, it indicates that the serial communication has stopped. The function selected in <i>O-04 Control Word Timeout Function Control Time-out Function</i> will then be carried out.

O-03 Control Word Timeout Time		
Range:	Function:	
		In BACnet the control timeout is only triggered if some specific objects are written. The object list hold information on the objects that triggers the control timeout:  Analog Outputs  Binary Outputs  AV0 AV1 AV2 AV4 BV1 BV2 BV3 BV4 BV5  Multistate Outputs

O-04 Control Word Timeout Function		
Option:	Function:	
		Select the time-out function. The time-out function is activated when the control word fails to be updated within the time period specified in <i>O-03 Control Word Timeout Time</i> . Choice [20] only appears after setting the Metasys N2 protocol.
[0] *	Off	
[1]	Freeze output	
[2]	Stop	
[3]	Jogging	
[4]	Max. speed	
[5]	Stop and trip	
[7]	Select setup 1	
[8]	Select setup 2	
[9]	Select setup 3	
[10]	Select setup 4	
[20]	N2 Override Release	



O-05 End-of-Timeout Function		
Option:	Function:	
		Select the action after receiving a valid control word following a time-out. This parameter is active only when <i>O-04 Control Word Timeout Function</i> is set to [Set-up 1-4].
[0]	Hold set-up	Retains the set-up selected in <i>O-04 Control Word Timeout Function</i> and displays a warning, until <i>O-06 Reset Control Word Timeout</i> toggles. Then the drive resumes its original set-up.
[1] *	Resume set-up	Resumes the set-up active prior to the time-out.

O-06 Reset Control Word Timeout		
Option:	Function:	
		This parameter is active only when the choice <i>Hold set-up</i> [0] has been selected in <i>O-05 End-of-Timeout Function</i> .
[0] *	Do not reset	Retains the set-up specified in <i>O-04 Control Word Timeout Function</i> , [Select setup 1-4] following a control time-out.
[1]	Do reset	Returns the drive to the original set-up following a control word time-out. When the value is set to <i>Do reset</i> [1], the drive performs the reset and then immediately reverts to the <i>Do not reset</i> [0] setting.

O-07 Diagnosis Trigger		
Option:	Function:	
		This parameter has no function for BACnet.
[0] *	Disable	
[1]	Trigger on alarms	
[2]	Trigger alarm/warn.	

### 3.9.2 O-1# Control Settings

O-10 Control Word Profile		
Option:	Function:	
		Select the interpretation of the control and status words corresponding to the installed network. Only the selections valid for the network installed in slot A will be visible in the keypad display.
[0] *	Drive Profile	
[1]	PROFIdrive profile	
[5]	ODVA	

O-13 Configurable Status Word STW		
Option:	Function:	
		This parameter enables configuration of bits 12 – 15 in the status word.
[0]	No function	
[1] *	Profile Default	Function corresponds to the profile default selected in <i>O-10 Control Word Profile</i> .

### 3.9.3 O-3# Drive Port Settings

O-30 Protocol		
Option:	Function:	
		Protocol selection for the integrated Drive (standard) Port (RS485) on the control card. Parameter group BN-7# is only visible when Drive Option [9] is chosen.
[0] *	Drive	Communication according to the Drive Protocol as described in the <i>AF-600 FP Design Guide, RS485 Installation and Set-up</i> .
[1]	Drive MC	Same as Drive [0] but to be used when downloading SW to the drive or uploading dll file (covering information regarding parameters available in the drive and their inter-dependencies) to DCT-10.
[2]	Modbus RTU	Communication according to the Modbus RTU protocol as described in the <i>AF-600 FP Design Guide, RS485 Installation and Set-up</i> .
[3]	Metasys N2	Communication according to the Metasys N2 protocol.
[4]	FLN	Communication according to the Apogee FLN P1 protocol.
[9]	Drive Option	To be used when a gateway is connected to the integrated RS485 port, e.g. the BACnet gateway. Following changes will take place: -Address for the Drive port will be set to 1 and <i>O-31 Address</i> , is now used to set the address for the gateway on the network, e.g. BACnet. -Baud rate for the Drive port will be set to a fixed value (115.200 Baud) and <i>O-32 Drive Port Baud Rate</i> , is now used to set the baud rate for the network port (e.g. BACnet) on the gateway.
[20]	LEN	

O-31 Address		
Range:	Function:	
1. N/A*	[1. - 126. N/A]	Enter the address for the Drive (standard) port. Valid range: 1 - 126.



O-32 Drive Port Baud Rate		
Option:	Function:	
		Baud rates 9600, 19200, 38400 and 76800 baud are valid for BacNet only.
[0]	2400 Baud	
[1]	4800 Baud	
[2] *	9600 Baud	
[3]	19200 Baud	
[4]	38400 Baud	
[5]	57600 Baud	
[6]	76800 Baud	
[7]	115200 Baud	

Default refers to the Drive Protocol.

O-33 Drive Port Parity		
Option:	Function:	
		Parity and Stop Bits for the protocol <i>O-30 Protocol</i> using the Drive Port. For some of the protocols, not all options will be visible. Default depends on the protocol selected.
[0] *	Even Parity, 1 Stop Bit	
[1]	Odd Parity, 1 Stop Bit	
[2]	No Parity, 1 Stop Bit	
[3]	No Parity, 2 Stop Bits	

O-34 Estimated cycle time		
Range:	Function:	
0 ms* [0 - 1000000 ms]	In a noisy environments, the interface may be blocked by due to overload of bad frames. This parameter specifies the time between two consecutive frames on the network. If the interface does not detect valid frames in that time it flushes the receive buffer.	

O-35 Minimum Response Delay		
Range:	Function:	
10. ms* [5. - 10000. ms]	Specify the minimum delay time between receiving a request and transmitting a response. This is used for overcoming modem turnaround delays.	

O-36 Maximum Response Delay		
Range:	Function:	
10001. ms* [11. - 10001. ms]	Specify the maximum permissible delay time between transmitting a request and receiving a response. Exceeding this delay time will cause control word time-out.	

O-37 Maximum Inter-Char Delay		
Range:	Function:	
25.00 ms* [0.00 - 35.00 ms]	Specify the maximum permissible time interval between receipt of two bytes. This parameter activates time-out if transmission is interrupted.	

### 3.9.4 O-4# Drive MC protocol set

O-40 Telegram Selection		
Option:	Function:	
		Enables use of freely configurable messages or standard messages for the Drive port.
[1] *	Standard telegram 1	
[101]	PPO 1	
[102]	PPO 2	
[103]	PPO 3	
[104]	PPO 4	
[105]	PPO 5	
[106]	PPO 6	
[107]	PPO 7	
[108]	PPO 8	
[200]	Custom telegram 1	

O-42 PCD write configuration		
Option:	Function:	
[0]	None	Select the parameters to be assigned to PCD's messages. The number of available PCDs depends on the message type. The values in PCD's will then be written to the selected parameters as data values.
[7]	Accel Time 1	
[8]	Decel Time 1	
[15]	Motor Speed High Limit [Hz]	
[16]	Motor Speed Low Limit [Hz]	
[17]	Motor Speed High Limit [RPM]	
[18]	Motor Speed Low Limit [RPM]	
[40]	Torque Limiter (Driving)	
[41]	Torque Limiter (Braking)	
[52]	Minimum Reference	
[53]	Maximum Reference	
[110]	Accel Time 2	
[111]	Decel Time 2	
[190]	Digital & Relay Bus Control	
[193]	Pulse Out #27 Bus Control	
[195]	Pulse Out #29 Bus Control	



O-42 PCD write configuration		
Option:	Function:	
[197]	Pulse Out #X30/6 Bus Control	
[222]	Jog Accel/Decel Time	
[223]	Quick Stop Decel Time	
[382]	Starting Acceleration Time	
[590]	Digital & Relay Bus Control	
[593]	Pulse Out #27 Bus Control	
[595]	Pulse Out #29 Bus Control	
[597]	Pulse Out #X30/6 Bus Control	
[653]	Terminal 42 Output Bus Control	
[663]	Terminal X30/8 Output Bus Control	
[673]	Terminal X45/1 Bus Control	
[683]	Terminal X45/3 Bus Control	
[890]	Bus Jog 1 Speed	
[891]	Bus Jog 2 Speed	
[894]	Bus Feedback 1	
[895]	Bus Feedback 2	
[896]	Bus Feedback 3	
[1413]	Minimum Reference/Feedb.	
[1414]	Maximum Reference/Feedb.	
[1421]	Setpoint 1	
[1422]	Setpoint 2	
[1423]	Setpoint 3	
[2043]	Terminal X42/7 Bus Control	
[2053]	Terminal X42/9 Bus Control	
[2063]	Terminal X42/11 Bus Control	

O-43 PCD read configuration		
Option:	Function:	
[0]	None	Select the parameters to be assigned to PCD's of the messages. The number of available PCDs depends on the message type. PCDs contain the actual data values of the selected parameters.
[894]	Bus Feedback 1	
[895]	Bus Feedback 2	
[896]	Bus Feedback 3	
[1200]	Control Word	
[1201]	Reference [Unit]	
[1202]	Reference [%]	
[1203]	Status Word	
[1205]	Main Actual Value [%]	
[1209]	Custom Readout	
[1210]	Power [kW]	
[1211]	Power [hp]	
[1212]	Motor Voltage	
[1213]	Frequency	
[1214]	Motor Current	
[1215]	Frequency [%]	
[1216]	Torque [Nm]	
[1217]	Speed [RPM]	

O-43 PCD read configuration		
Option:	Function:	
[1218]	Motor Thermal	
[1222]	Torque [%]	
[1230]	DC Link Voltage	
[1232]	Brake Energy /s	
[1233]	Brake Energy /2 min	
[1234]	Heatsink Temp.	
[1235]	Drive Thermal	
[1238]	Logic Controller State	
[1239]	Control Card Temp.	
[1250]	External Reference	
[1252]	Feedback [Unit]	
[1253]	Digi Pot Reference	
[1254]	Feedback 1 [Unit]	
[1255]	Feedback 2 [Unit]	
[1256]	Feedback 3 [Unit]	
[1260]	Digital Input	
[1261]	Terminal 53 Switch Setting	
[1262]	Analog Input 53	
[1263]	Terminal 54 Switch Setting	
[1264]	Analog Input 54	
[1265]	Analog Output 42 [mA]	
[1266]	Digital Output [bin]	
[1267]	Freq. Input #29 [Hz]	
[1268]	Freq. Input #33 [Hz]	
[1269]	Pulse Output #27 [Hz]	
[1270]	Pulse Output #29 [Hz]	
[1271]	Relay Output [bin]	
[1272]	Counter A	
[1273]	Counter B	
[1275]	Analog In X30/11	
[1276]	Analog In X30/12	
[1277]	Analog Out X30/8 [mA]	
[1284]	Comm. Option STW	
[1285]	Drive Port CTW 1	
[1290]	Alarm Word	
[1291]	Alarm Word 2	
[1292]	Warning Word	
[1293]	Warning Word 2	
[1294]	Ext. Status Word	
[1295]	Ext. Status Word 2	
[1296]	Maintenance Word	
[1330]	Analog Input X42/1	
[1331]	Analog Input X42/3	
[1332]	Analog Input X42/5	
[1333]	Analog Out X42/7 [V]	
[1334]	Analog Out X42/9 [V]	
[1335]	Analog Out X42/11 [V]	



### 3.9.5 O-5# Digital/Bus

Parameters for configuring the control word Digital/Bus merging.

#### NOTE

These parameters are active only when *O-01 Control Site* is set to [0] *Digital and control word*.

3

O-50 Coasting Select		
Option:	Function:	
		Select control of the coasting function via the terminals (digital input) and/or via the network.
[0]	Digit Input	Activates Coast command via a digital input.
[1]	Bus	Activates Coast command via the serial communication port or network option module.
[2]	Logic AND	Activates Coast command via the network/serial communication port, AND additionally via one of the digital inputs.
[3] *	Logic OR	Activates Coast command via the network/serial communication port OR via one of the digital inputs.

O-52 DC Brake Select		
Option:	Function:	
		Select control of the DC brake via the terminals (digital input) and/or via the network.
[0]	Digit Input	ActivatesDC Brake command via a digital input.
[1]	Bus	ActivatesDC Brake command via the serial communication port or network option module.
[2]	Logic AND	ActivatesDC Brake command via the network/serial communication port, AND additionally via one of the digital inputs.
[3] *	Logic OR	ActivatesDC Brake command via the network/serial communication port OR via one of the digital inputs.

O-53 Start Select		
Option:	Function:	
		Select control of the drive start function via the terminals (digital input) and/or via the network.
[0]	Digit Input	Activates Start command via a digital input.
[1]	Bus	Activates Start command via the serial communication port or network option module.
[2]	Logic AND	Activates Start command via the network/serial communication port, AND additionally via one of the digital inputs.

O-53 Start Select		
Option:	Function:	
[3] *	Logic OR	Activates Start command via the network/serial communication port OR via one of the digital inputs.

O-54 Reversing Select		
Option:	Function:	
		Select control of the drive reverse function via the terminals (digital input) and/or via the fieldbus.
[0] *	Digit Input	Activates Reverse command via a digital input.
[1]	Bus	Activates Reverse command via the serial communication port or fieldbus option.
[2]	Logic AND	Activates Reverse command via the fieldbus/serial communication port, AND additionally via one of the digital inputs.
[3]	Logic OR	Activates Reverse command via the fieldbus/serial communication port OR via one of the digital inputs.

#### NOTE

This parameter is active only when *O-01 Control Site* is set to [0] *Digital and control word*.

O-55 Set-up Select		
Option:	Function:	
		Select control of the drive set-up selection via the terminals (digital input) and/or via the network.
[0]	Digit Input	Activates the set-up selection via a digital input.
[1]	Bus	Activates the set-up selection via the serial communication port or network option module.
[2]	Logic AND	Activates the set-up selection via the network/serial communication port, AND additionally via one of the digital inputs.
[3] *	Logic OR	Activate the set-up selection via the network/serial communication port OR via one of the digital inputs.

O-56 Preset Reference Select		
Option:	Function:	
		Select control of the drive Preset Reference selection via the terminals (digital input) and/or via the network.
[0]	Digit Input	Activates Preset Reference selection via a digital input.
[1]	Bus	Activates Preset Reference selection via the serial communication port or network option module.





O-56 Preset Reference Select		
Option:	Function:	
[2]	Logic AND	Activates Preset Reference selection via the network/serial communication port, AND additionally via one of the digital inputs.
[3] *	Logic OR	Activates the Preset Reference selection via the network/serial communication port OR via one of the digital inputs.

O-94 Bus Feedback 1		
Range:	Function:	
0 N/A* [-200 - 200 N/A]	Write a feedback to this parameter via the serial communication port or network option. This parameter must be selected in <i>CL-00 Feedback 1 Source</i> , <i>CL-03 Feedback 2 Source</i> or <i>CL-06 Feedback 3 Source</i> as a feedback source.	

### 3.9.6 O-8# Drive Port Diagnostics

These parameters are used for monitoring the Bus communication via the Drive Port.

O-80 Bus Message Count		
Range:	Function:	
0 N/A* [0 - 0 N/A]	This parameter shows the number of valid messages detected on the network.	

O-81 Bus Error Count		
Range:	Function:	
0 N/A* [0 - 0 N/A]	This parameter shows the number of messages with faults (e.g. CRC fault), detected on the network.	

O-82 Slave Messages Rcvd		
Range:	Function:	
0 N/A* [0 - 0 N/A]	This parameter shows the number of valid messages addressed to the slave, sent by the drive.	

O-83 Slave Error Count		
Range:	Function:	
0 N/A* [0 - 0 N/A]	This parameter shows the number of error messages, which could not be executed by the drive.	

O-95 Bus Feedback 2		
Range:	Function:	
0 N/A* [-200 - 200 N/A]	See <i>O-94 Bus Feedback 1</i> for further details.	

O-96 Bus Feedback 3		
Range:	Function:	
0 N/A* [-200 - 200 N/A]	See <i>O-94 Bus Feedback 1</i> for further details.	

### 3.9.7 O-9# Bus Jog / Feedback

O-90 Bus Jog 1 Speed		
Range:	Function:	
100 RPM* [0 - par. F-17 RPM]	Enter the jog speed. This is a fixed jog speed activated via the serial port or network option.	

O-91 Bus Jog 2 Speed		
Range:	Function:	
200 RPM* [0 - par. F-17 RPM]	Enter the jog speed. This is a fixed jog speed activated via the serial port or network option.	





### 3.10 AO-## Analog I/O Options

Parameter group AO-## is only available when an Analog I/O Option Module (opcao) is added to the frequency converter.

#### 3.10.1 AO-0# Analog I/O Mode

AO-00 Terminal X42/1 Mode		
Option:	Function:	
	Terminal X42/1 can be programmed as an analog input accepting a voltage or input from either Pt1000 (1000 Ω at 0°C) or Ni 1000 (1000 Ω at 0°C) temperature sensors. Select the desired mode. <i>Pt 1000</i> , [2] and <i>Ni 1000</i> [4] if operating in Celsius - <i>Pt 1000</i> [3] and <i>Ni 1000</i> [5] if operating in Fahrenheit. Notice: If the input is not in use, it must be set for Voltage! If set for temperature and used as feed back, the unit must be set for either Celsius or Fahrenheit ( <i>CL-12 Reference/Feedback Unit</i> , <i>XC-10 Ext. 1 Ref./Feedback Unit</i> , <i>XC-30 Ext. 2 Ref./Feedback Unit</i> or <i>XC-50 Ext. 3 Ref./Feedback Unit</i> ).	
[1] *	Voltage	
[2]	Pt 1000 [°C]	
[3]	Pt 1000 [°F]	
[4]	Ni 1000 [°C]	
[5]	Ni 1000 [°F]	

AO-01 Terminal X42/3 Mode		
Option:	Function:	
	Terminal X42/3 can be programmed as an analog input accepting a voltage or input from either Pt 1000 or Ni 1000 temperature sensors. Select the desired mode. <i>Pt 1000</i> , [2] and <i>Ni 1000</i> , [4] if operating in Celsius - <i>Pt 1000</i> , [3] and <i>Ni 1000</i> , [5] if operating in Fahrenheit. Notice: If the input is not in use, it must be set for Voltage! If set for temperature and used as feed back, the unit must be set for either Celsius or Fahrenheit ( <i>CL-12 Reference/Feedback Unit</i> , <i>XC-10 Ext. 1 Ref./Feedback Unit</i> , <i>XC-30 Ext. 2 Ref./Feedback Unit</i> or <i>XC-50 Ext. 3 Ref./Feedback Unit</i> ).	
[1] *	Voltage	
[2]	Pt 1000 [°C]	
[3]	Pt 1000 [°F]	
[4]	Ni 1000 [°C]	
[5]	Ni 1000 [°F]	

AO-02 Terminal X42/5 Mode		
Option:	Function:	
	Terminal X42/5 can be programmed as an analog input accepting a voltage or input from either Pt 1000 (1000 Ω at 0° C) or Ni 1000 (1000 Ω at 0° C) temperature sensors. Select the desired mode. <i>Pt 1000</i> , [2] and <i>Ni 1000</i> , [4] if operating in Celsius - <i>Pt 1000</i> , [3] and <i>Ni 1000</i> , [5] if operating in Fahrenheit. Notice: If the input is not in use, it must be set for Voltage! If set for temperature and used as feed back, the unit must be set for either Celsius or Fahrenheit ( <i>CL-12 Reference/Feedback Unit</i> , <i>XC-10 Ext. 1 Ref./Feedback Unit</i> , <i>XC-30 Ext. 2 Ref./Feedback Unit</i> or <i>XC-50 Ext. 3 Ref./Feedback Unit</i> ).	
[1] *	Voltage	
[2]	Pt 1000 [°C]	
[3]	Pt 1000 [°F]	
[4]	Ni 1000 [°C]	
[5]	Ni 1000 [°F]	

#### 3.10.2 AO-1# Analog Input X42/1

AO-10 Terminal X42/1 Low Voltage		
Range:	Function:	
0.07 V* [0.00 - par. AO-11 V]	Enter the low voltage value. This analog input scaling value should correspond to the low reference/feedback value set in <i>AO-14 Term. X42/1 Low Ref./Feedb. Value</i> .	

AO-11 Terminal X42/1 High Voltage		
Range:	Function:	
10.00 V* [par. AO-10 - 10.00 V]	Enter the high voltage value. This analog input scaling value should correspond to the high reference/feedback value set in <i>AO-15 Term. X42/1 High Ref./Feedb. Value</i> .	

AO-14 Term. X42/1 Low Ref./Feedb. Value		
Range:	Function:	
0.000 N/A* [-999999.999 - 999999.999 N/A]	Enter the analog input scaling value that corresponds to the low voltage value set in <i>AO-10 Terminal X42/1 Low Voltage</i> .	



AO-15 Term. X42/1 High Ref./Feedb. Value		
Range:		Function:
100.000 N/A*	[-999999.999 - 999999.999 N/A]	Enter the analog input scaling value that corresponds to the high voltage value set in <i>AO-11 Terminal X42/1 High Voltage</i> .

AO-16 Term. X42/1 Filter Time Constant		
Range:		Function:
0.001 s*	[0.001 - 10.000 s]	Enter the time constant. This is a first-order digital low pass filter time constant for suppressing noise in terminal X42/1. A high time constant value improves dampening but also increases the time delay through the filter. This parameter cannot be adjusted while the motor is running.

AO-17 Term. X42/1 Live Zero		
Option:	Function:	
	This parameter makes it possible to enable the Live Zero monitoring. E.g. where the analog input is a part of the frequency converter control, rather than being used as part of a decentral I/O system, such as a Building Management System.	
[0]	Disabled	
[1] *	Enabled	

3.10.3 AO-2# Analog Input X42/3

AO-20 Terminal X42/3 Low Voltage		
Range:		Function:
0.07 V*	[0.00 - par. AO-21 V]	Enter the low voltage value. This analog input scaling value should correspond to the low reference/feedback value set in <i>AO-24 Term. X42/3 Low Ref./Feedb. Value</i> .

AO-21 Terminal X42/3 High Voltage		
Range:		Function:
10.00 V*	[par. AO-20 - 10.00 V]	Enter the high voltage value. This analog input scaling value should correspond to the high reference/feedback value set in <i>AO-25 Term. X42/3 High Ref./Feedb. Value</i> .

AO-24 Term. X42/3 Low Ref./Feedb. Value		
Range:		Function:
0.000 N/A*	[-999999.999 - 999999.999 N/A]	Enter the analog input scaling value that corresponds to the low voltage value set in <i>AO-20 Terminal X42/3 Low Voltage</i> .

AO-25 Term. X42/3 High Ref./Feedb. Value		
Range:		Function:
100.000 N/A*	[-999999.999 - 999999.999 N/A]	Enter the analog input scaling value that corresponds to the high voltage value set in <i>AO-21 Terminal X42/3 High Voltage</i> .

AO-26 Term. X42/3 Filter Time Constant		
Range:		Function:
0.001 s*	[0.001 - 10.000 s]	Enter the time constant. This is a first-order digital low pass filter time constant for suppressing noise in terminal X42/3. A high time constant value improves dampening but also increases the time delay through the filter. This parameter cannot be adjusted while the motor is running.

AO-27 Term. X42/3 Live Zero		
Option:	Function:	
	This parameter makes it possible to enable the Live Zero monitoring. E.g. where the analog input is a part of the frequency converter control, rather than being used as part of a decentral I/O system, such as a Building Management System.	
[0]	Disabled	
[1] *	Enabled	

3.10.4 AO-3# Analog Input X42/5

AO-30 Terminal X42/5 Low Voltage		
Range:		Function:
0.07 V*	[0.00 - par. AO-31 V]	Enter the low voltage value. This analog input scaling value should correspond to the low reference/feedback value set in <i>AO-34 Term. X42/5 Low Ref./Feedb. Value</i> .



AO-31 Terminal X42/5 High Voltage		
Range:		Function:
10.00 V*	[par. AO-30 - 10.00 V]	Enter the high voltage value. This analog input scaling value should correspond to the high reference/feedback value set in AO-35 Term. X42/5 High Ref./Feedb. Value.

AO-34 Term. X42/5 Low Ref./Feedb. Value		
Range:		Function:
0.000 N/A*	[-999999.999 - 999999.999 N/A]	Enter the analog input scaling value that corresponds to the low voltage value set in AO-30 Terminal X42/5 Low Voltage.

AO-35 Term. X42/5 High Ref./Feedb. Value		
Range:		Function:
100.000 N/A*	[-999999.999 - 999999.999 N/A]	Enter the analog input scaling value that corresponds to the high voltage value set in AO-21 Terminal X42/3 High Voltage.

AO-36 Term. X42/5 Filter Time Constant		
Range:		Function:
0.001 s*	[0.001 - 10.000 s]	Enter the time constant. This is a first-order digital low pass filter time constant for suppressing noise in terminal X42/5. A high time constant value improves dampening but also increases the time delay through the filter. This parameter cannot be adjusted while the motor is running.

AO-37 Term. X42/5 Live Zero		
Option:		Function:
		This parameter makes it possible to enable the Live Zero monitoring. E.g. where the analog input is a part of the frequency converter control, rather than being used as part of a decentral I/O system, such as a Building Management System.
[0]	Disabled	
[1] *	Enabled	

### 3.10.5 AO-4# Analog Out X42/7

AO-40 Terminal X42/7 Output		
Option:		Function:
		Set the function of terminal X42/7 as an analog voltage output.
[0] *	No operation	
[100]	Output frequency	: 0 - 100 Hz, (0-20 mA)
[101]	Reference	: Minimum reference - Maximum reference, (0-20 mA)
[102]	Feedback	: -200% to +200% of CL-14 Maximum Reference/Feedb., (0-20 mA)
[103]	Motor Current	: 0 - Inverter Max. Current (DR-37 Drive Max. Current), (0-20 mA)
[104]	Torque rel to limit	: 0 - Torque limit (F-40 Torque Limiter (Driving)), (0-20 mA)
[105]	Torq relate to rated	: 0 - Motor rated torque, (0-20 mA)
[106]	Power	: 0 - Motor rated power, (0-20 mA)
[107]	Speed	: 0 - Speed High Limit (F-17 Motor Speed High Limit [RPM] and F-15 Motor Speed High Limit [Hz]), (0-20 mA)
[113]	Ext. Closed Loop 1	: 0 - 100%, (0-20 mA)
[114]	Ext. Closed Loop 2	: 0 - 100%, (0-20 mA)
[115]	Ext. Closed Loop 3	: 0 - 100%, (0-20 mA)
[139]	Bus ctrl.	: 0 - 100%, (0-20 mA)
[141]	Bus ctrl t.o.	: 0 - 100%, (0-20 mA)

AO-41 Terminal X42/7 Min. Scale		
Range:		Function:
0.00 %*	[0.00 - 200.00 %]	Scale the minimum output of the selected analog signal at terminal X42/7, as a percentage of the maximum signal level. E.g. if a 0 V (or 0 Hz) is desired at 25% of the maximum output value. Then programme 25%. Scaling values up to 100% can never be higher than the corresponding setting in AO-42 Terminal X42/7 Max. Scale. See principle graph for AN-51 Terminal 42 Output Min Scale.



AO-42 Terminal X42/7 Max. Scale		
Range:	Function:	
100.00 %* - 200.00 %]	[0.00 - 200.00 %]	Scale the maximum output of the selected analog signal at terminal X42/7. Set the value to the maximum value of the voltage signal output. Scale the output to give a voltage lower than 10V at full scale; or 10V at an output below 100% of the maximum signal value. If 10V is the desired output current at a value between 0-100% of the full-scale output, programme the percentage value in the parameter, i.e. 50% = 10V. If a voltage between 0 and 10V is desired at maximum output, calculate the percentage as follows:  $\left( \frac{10V}{\text{desired maximum voltage}} \right) \times 100 \%$ i.e.  $5V : \frac{10V}{5V} \times 100 \% = 200 \%$

See principle graph for AN-52 Terminal 42 Output Max Scale.

AO-43 Terminal X42/7 Bus Control		
Range:	Function:	
0.00 %*	[0.00 - 100.00 %]	Holds the level of terminal X42/7 if controlled by bus.

AO-44 Terminal X42/7 Timeout Preset		
Range:	Function:	
0.00 %*	[0.00 - 100.00 %]	Holds the preset level of terminal X42/7. In case of a bus timeout and a timeout function is selected in AO-50 Terminal X42/9 Output the output will preset to this level.

### 3.10.6 AO-5# Analog Out X42/9

AO-50 Terminal X42/9 Output		
Option:	Function:	
		Set the function of terminal X42/9.
[0] *	No operation	
[100]	Output frequency	: 0 - 100 Hz, (0-20 mA)
[101]	Reference	: Minimum reference - Maximum reference, (0-20 mA)
[102]	Feedback	: -200% to +200% of CL-14 Maximum Reference/Feedb., (0-20 mA)
[103]	Motor Current	: 0 - Inverter Max. Current (DR-37 Drive Max. Current), (0-20 mA)
[104]	Torque rel to limit	: 0 - Torque limit (F-40 Torque Limiter (Driving)), (0-20 mA)
[105]	Torq relate to rated	: 0 - Motor rated torque, (0-20 mA)

AO-50 Terminal X42/9 Output		
Option:	Function:	
[106]	Power	: 0 - Motor rated power, (0-20 mA)
[107]	Speed	: 0 - Speed High Limit (F-17 Motor Speed High Limit [RPM] and F-15 Motor Speed High Limit [Hz]), (0-20 mA)
[113]	Ext. Closed Loop 1	: 0 - 100%, (0-20 mA)
[114]	Ext. Closed Loop 2	: 0 - 100%, (0-20 mA)
[115]	Ext. Closed Loop 3	: 0 - 100%, (0-20 mA)
[139]	Bus ctrl.	: 0 - 100%, (0-20 mA)
[141]	Bus ctrl t.o.	: 0 - 100%, (0-20 mA)

AO-51 Terminal X42/9 Min. Scale		
Range:	Function:	
0.00 %*	[0.00 - 200.00 %]	Scale the minimum output of the selected analog signal at terminal X42/9, as a percentage of the maximum signal level. E.g. if a 0 V is desired at 25% of the maximum output value. Then programme 25%. Scaling values up to 100% can never be higher than the corresponding setting in AO-52 Terminal X42/9 Max. Scale.

See principle graph for AN-51 Terminal 42 Output Min Scale.

AO-52 Terminal X42/9 Max. Scale		
Range:	Function:	
100.00 %* - 200.00 %]	[0.00 - 200.00 %]	Scale the maximum output of the selected analog signal at terminal X42/9. Set the value to the maximum value of the voltage signal output. Scale the output to give a voltage lower than 10V at full scale; or 10V at an output below 100% of the maximum signal value. If 10V is the desired output current at a value between 0-100% of the full-scale output, programme the percentage value in the parameter, i.e. 50% = 10V. If a voltage between 0 and 10V is desired at maximum output, calculate the percentage as follows:  $\left( \frac{10V}{\text{desired maximum voltage}} \right) \times 100 \%$ i.e.  $5V : \frac{10V}{5V} \times 100 \% = 200 \%$

See principle graph for AN-52 Terminal 42 Output Max Scale.

AO-53 Terminal X42/9 Bus Control		
Range:	Function:	
0.00 %*	[0.00 - 100.00 %]	Holds the level of terminal X42/9 if controlled by bus.



AO-54 Terminal X42/9 Timeout Preset		
Range:		Function:
0.00 %*	[0.00 - 100.00 %]	Holds the preset level of terminal X42/9. In case of a bus timeout and a timeout function is selected in <i>AO-60 Terminal X42/11 Output</i> the output will preset to this level.

3.10.7 AO-6# Analog Out X42/11

AO-60 Terminal X42/11 Output		
Option:	Function:	
		Set the function of terminal X42/11.
[0] *	No operation	
[100]	Output frequency	: 0 - 100 Hz, (0-20 mA)
[101]	Reference	: Minimum reference - Maximum reference, (0-20 mA)
[102]	Feedback	: -200% to +200% of <i>CL-14 Maximum Reference/Feedb.</i> , (0-20 mA)
[103]	Motor Current	: 0 - Inverter Max. Current ( <i>DR-37 Drive Max. Current</i> ), (0-20 mA)
[104]	Torque rel to limit	: 0 - Torque limit ( <i>F-40 Torque Limiter (Driving)</i> ), (0-20 mA)
[105]	Torq relate to rated	: 0 - Motor rated torque, (0-20 mA)
[106]	Power	: 0 - Motor rated power, (0-20 mA)
[107]	Speed	: 0 - Speed High Limit ( <i>F-17 Motor Speed High Limit [RPM]</i> and <i>F-15 Motor Speed High Limit [Hz]</i> ), (0-20 mA)
[113]	Ext. Closed Loop 1	: 0 - 100%, (0-20 mA)
[114]	Ext. Closed Loop 2	: 0 - 100%, (0-20 mA)
[115]	Ext. Closed Loop 3	: 0 - 100%, (0-20 mA)
[139]	Bus ctrl.	: 0 - 100%, (0-20 mA)
[141]	Bus ctrl t.o.	: 0 - 100%, (0-20 mA)

AO-61 Terminal X42/11 Min. Scale		
Range:		Function:
0.00 %*	[0.00 - 200.00 %]	Scale the minimum output of the selected analog signal at terminal X42/11, as a percentage of the maximum signal level. E.g. if a 0 V is desired at 25% of the maximum output value. Then programme 25%. Scaling values up to 100% can never be higher than the corresponding setting in <i>AO-62 Terminal X42/11 Max. Scale</i> .

See principle graph for *AN-51 Terminal 42 Output Min Scale*.

AO-62 Terminal X42/11 Max. Scale		
Range:		Function:
100.00 %*	[0.00 - 200.00 %]	Scale the maximum output of the selected analog signal at terminal X42/9. Set the value to the maximum value of the voltage signal output. Scale the output to give a voltage lower than 10V at full scale; or 10V at an output below 100% of the maximum signal value. If 10V is the desired output current at a value between 0-100% of the full-scale output, programme the percentage value in the parameter, i.e. 50% = 10V. If a voltage between 0 and 10V is desired at maximum output, calculate the percentage as follows: $\left( \frac{10V}{\text{desired maximum voltage}} \right) \times 100\%$ i.e. $5V : \frac{10V}{5V} \times 100\% = 200\%$

See principle graph for *AN-52 Terminal 42 Output Max Scale*.

AO-63 Terminal X42/11 Bus Control		
Range:		Function:
0.00 %*	[0.00 - 100.00 %]	Holds the level of terminal X42/11 if controlled by bus.

AO-64 Terminal X42/11 Timeout Preset		
Range:		Function:
0.00 %*	[0.00 - 100.00 %]	Holds the preset level of terminal X42/11. In case a bus time-out and a time-out function are selected, the output will preset to this level.



### 3.11 DN-## DeviceNet

Parameter group for DeviceNet CAN network parameters.

#### 3.11.1 DN-0# Common Settings

DN-00 DeviceNet Protocol		
Option:	Function:	
[1] *	DeviceNet	View the active CAN protocol.

#### NOTE

The options depend on installed option

DN-01 Baud Rate Select		
Option:	Function:	
		Select the network transmission speed. The selection must correspond to the transmission speed of the master and the other network nodes.
[16]	10 Kbps	
[17]	20 Kbps	
[18]	50 Kbps	
[19]	100 Kbps	
[20] *	125 Kbps	
[21]	250 Kbps	
[22]	500 Kbps	
[23]	800 Kbps	
[24]	1000 Kbps	

DN-02 MAC ID		
Range:	Function:	
63. N/A*	[0 - 63. N/A]	Selection of station address. Every station connected to the same DeviceNet network must have an unambiguous address.

DN-05 Readout Transmit Error Counter		
Range:	Function:	
0 N/A*	[0 - 255 N/A]	View the number of CAN control transmission errors since the last power-up.

DN-06 Readout Receive Error Counter		
Range:	Function:	
0 N/A*	[0 - 255 N/A]	View the number of CAN control receipt errors since the last power-up.

DN-07 Readout Bus Off Counter		
Range:	Function:	
0 N/A*	[0 - 255 N/A]	View the number of network Off events since the last power-up.

### 3.11.2 DN-1# DeviceNet

DN-10 Process Data Type Selection		
Option:	Function:	
		Select the Instance (message) for data transmission. The Instances available are dependent upon the setting of <i>O-10 Control Word Profile</i> . When <i>O-10 Control Word Profile</i> is set to [0] <i>Drive protocol</i> , <i>DN-10 Process Data Type Selection</i> options [0] and [1] are available. When <i>O-10 Control Word Profile</i> is set to [5] <i>ODVA</i> , <i>DN-10 Process Data Type Selection</i> options [2] and [3] are available. Instances 100/150 and 101/151 are GE-specific. Instances 20/70 and 21/71 are ODVA-specific AC Drive profiles. For guidelines in message selection, please refer to the <i>DeviceNet Operating Instructions</i> . Note that a change to this parameter will be executed immediately.
[0] *	INSTANCE 100/150	
[1]	INSTANCE 101/151	
[2]	INSTANCE 20/70	
[3]	INSTANCE 21/71	

DN-12 Process Data Config Read		
Option:	Function:	
		Select the process read data for I/O Assembly Instances 101/151. Elements [2] and [3] of this array can be selected. Elements [0] and [1] of the array are fixed.
[0] *	None	
[894]	Bus Feedback 1	
[895]	Bus Feedback 2	
[896]	Bus Feedback 3	
[1200]	Control Word	
[1201]	Reference [Unit]	
[1202]	Reference [%]	
[1203]	Status Word	
[1205]	Main Actual Value [%]	
[1209]	Custom Readout	
[1210]	Power [kW]	
[1211]	Power [hp]	
[1212]	Motor Voltage	
[1213]	Frequency	
[1214]	Motor Current	
[1215]	Frequency [%]	
[1216]	Torque [Nm]	



DN-12 Process Data Config Read		
Option:	Function:	
[1217]	Speed [RPM]	
[1218]	Motor Thermal	
[1222]	Torque [%]	
[1230]	DC Link Voltage	
[1232]	Brake Energy /s	
[1233]	Brake Energy /2 min	
[1234]	Heatsink Temp.	
[1235]	Drive Thermal	
[1238]	Logic Controller State	
[1239]	Control Card Temp.	
[1250]	External Reference	
[1252]	Feedback [Unit]	
[1253]	Digi Pot Reference	
[1254]	Feedback 1 [Unit]	
[1255]	Feedback 2 [Unit]	
[1256]	Feedback 3 [Unit]	
[1260]	Digital Input	
[1261]	Terminal 53 Switch Setting	
[1262]	Analog Input 53	
[1263]	Terminal 54 Switch Setting	
[1264]	Analog Input 54	
[1265]	Analog Output 42 [mA]	
[1266]	Digital Output [bin]	
[1267]	Freq. Input #29 [Hz]	
[1268]	Freq. Input #33 [Hz]	
[1269]	Pulse Output #27 [Hz]	
[1270]	Pulse Output #29 [Hz]	
[1271]	Relay Output [bin]	
[1272]	Counter A	
[1273]	Counter B	
[1275]	Analog In X30/11	
[1276]	Analog In X30/12	
[1277]	Analog Out X30/8 [mA]	
[1284]	Comm. Option STW	
[1285]	Drive Port CTW 1	
[1290]	Alarm Word	
[1291]	Alarm Word 2	
[1292]	Warning Word	
[1293]	Warning Word 2	
[1294]	Ext. Status Word	
[1295]	Ext. Status Word 2	
[1296]	Maintenance Word	
[1330]	Analog Input X42/1	
[1331]	Analog Input X42/3	
[1332]	Analog Input X42/5	
[1333]	Analog Out X42/7 [V]	
[1334]	Analog Out X42/9 [V]	
[1335]	Analog Out X42/11 [V]	
[1500]	Operating Hours	
[1501]	Running Hours	
[1502]	kWh Counter	

DN-13 Warning Parameter		
Range:	Function:	
0 N/A*	[0 - 65535 N/A]	View a DeviceNet-specific Warning word. One bit is assigned to every warning.

Bit:	Meaning:
0	Bus not active
1	Explicit connection timeout
2	I/O connection
3	Retry limit reached
4	Actual is not updated
5	CAN Network off
6	I/O send error
7	Restore error
8	No bus supply
9	Bus off
10	Error passive
11	Error warning
12	Duplicate MAC ID Error
13	RX queue overrun
14	TX queue overrun
15	CAN overrun

DN-14 Net Reference		
Read only from keypad		
Option:	Function:	
		Select the reference source in Instance 21/71 and 20/70.
[0] *	Off	Enables reference via analog/digital inputs.
[1]	On	Enables reference via the network.

DN-15 Net Control		
Read only from keypad		
Option:	Function:	
		Select the control source in Instance 21/71 and 20/70.
[0] *	Off	Enables control via analog/digital inputs.
[1]	On	Enable control via the network.

### 3.11.3 DN-2# COS Filters

DN-20 COS Filter 1		
Range:	Function:	
0 N/A*	[0 - 65535 N/A]	Enter the value for COS Filter 1 to set up the filter mask for the Status Word. When operating in COS (Change-Of-State), this function filters out bits in the Status Word that should not be sent if they change.





DN-21 COS Filter 2		
Range:		Function:
0 N/A*	[0 - 65535 N/A]	Enter the value for COS Filter 2, to set up the filter mask for the Main Actual Value. When operating in COS (Change-Of-State), this function filters out bits in the Main Actual Value that should not be sent if they change.

DN-22 COS Filter 3		
Range:		Function:
0 N/A*	[0 - 65535 N/A]	Enter the value for COS Filter 3, to set up the filter mask for PCD 3. When operating in COS (Change-Of-State), this function filters out bits in PCD 3 that should not be sent if they change.

DN-23 COS Filter 4		
Range:		Function:
0 N/A*	[0 - 65535 N/A]	Enter the value for COS Filter 4 to set up the filter mask for PCD 4. When operating in COS (Change-Of-State), this function filters out bits in PCD 4 that should not be sent if they change.

DN-32 Devicenet Revision		
Range:		Function:
0 N/A*	[0 - 65535 N/A]	View the DeviceNet revision number. This parameter is used for EDS file creation.

DN-33 Store Always		
Option:	Function:	
[0] *	Off	Deactivates non-volatile storage of data.
[1]	On	Stores parameter data received via DeviceNet in EEPROM non-volatile memory as default.

DN-39 Devicenet F Parameters		
Array [1000] No keypad access		
Range:		Function:
0 N/A*	[0 - 0 N/A]	This parameter is used to configure the drive via DeviceNet and build the EDS-file.

### 3.11.4 DN-3# Parameter Access

Parameter group providing access to indexed parameters and defining programming set-up.

DN-30 Array Index		
Range:		Function:
0 N/A*	[0 - 255 N/A]	View array parameters. This parameter is valid only when a DeviceNet fieldbus is installed.

DN-31 Store Data Values		
Option:	Function:	
		Parameter values changed via DeviceNet are not automatically stored in non-volatile memory. Use this parameter to activate a function that stores parameter values in the EEPROM non-volatile memory, so changed parameter values will be retained at power-down.
[0] *	Off	Deactivates the non-volatile storage function.
[1]	Store edit setup	Stores all parameter values from the active set-up in the non-volatile memory. The selection returns to Off [0] when all values have been stored.
[2]	Store all setups	Stores all parameter values for all set-ups in the non-volatile memory. The selection returns to Off [0] when all parameter values have been stored.



### 3.12 PB-## Profibus

[0] *	None
[7]	Decel Time
[8]	Accel Time
[15]	Torque Limiter (Braking)
[16]	Motor Speed High Limit [RPM]
[17]	Torque Limiter (Driving)
[18]	Motor Speed Low Limit [RPM]
[40]	Torque Limiter (Driving)
[41]	Torque Limiter (Braking)
[52]	Minimum Reference
[53]	Maximum Reference
[110]	Accel Time 2
[111]	Decel Time
[190]	Digital & Relay Bus Control
[193]	Pulse Out #27 Bus Control
[195]	Terminal 42 Output Bus Control
[197]	Terminal X30/8 Output Bus Control
[222]	Jog Accel/Decel Time
[223]	Quick Stop Decel Time
[653]	Terminal 42 Output Bus Control
[663]	Terminal X30/8 Output Bus Control
[890]	Bus Jog 1 Speed
[891]	Bus Jog 2 Speed
[894]	Bus Feedback 1
[895]	Bus Feedback 2
[896]	Bus Feedback 3
[1280]	Fieldbus CTW 1
[1282]	Fieldbus REF 1
[1413]	Minimum Reference/Feedb.
[1414]	Maximum Reference/Feedb.
[1421]	Setpoint 1
[1422]	Setpoint 2
[1423]	Setpoint 3
[2043]	Terminal X42/7 Bus Control
[2053]	Terminal X42/9 Bus Control
[2063]	Terminal X42/11 Bus Control

#### PB-16 PCD Read Configuration

Array [10]

**Option:**      **Function:**

		Select the parameters to be assigned to PCD 3 to 10 of the messages. The number of available PCDs depends on the telegram type. PCDs 3 to 10 contain the actual data values of the selected parameters. For standard Profibus message, see <i>PB-22 Telegram Selection</i> .
[0] *	None	

#### PB-18 Node Address

Range:		Function:
126 N/A*	[0 - 126. N/A]	Enter the station address in this parameter or alternatively in the hardware switch. In order to adjust the station address in <i>PB-18 Node Address</i> , the hardware switch must be set to 126 or 127 (i.e. all switches set to 'on'). Otherwise this parameter will display the actual setting of the switch.

#### PB-22 Telegram Selection

Option:	Function:
	Select a standard Profibus telegram configuration for the frequency converter, as an alternative to using the freely configurable messages in <i>and PB-16 PCD Read Configuration</i> .
[1]	Standard telegram 1
[101]	PPO 1
[102]	PPO 2
[103]	PPO 3
[104]	PPO 4
[105]	PPO 5
[106]	PPO 6
[107]	PPO 7
[108] *	PPO 8
[200]	Custom telegram 1

#### PB-23 Parameters for Signals

Array [1000]

**Option:**      **Function:**

		This parameter contains a list of signals available for selection in <i>PB-15 PCD Write Configuration</i> and <i>PB-16 PCD Read Configuration</i> .
--	--	---

#### PB-27 Parameter Edit

Option:	Function:	
	Parameters can be edited via Profibus, the standard RS485 interface, or the keypad.	
[0]	Disabled	Disables editing via Profibus.
[1] *	Enabled	Enables editing via Profibus.



PB-28 Process Control		
Option:	Function:	
		Process control (setting of Control Word, speed reference, and process data) is possible via either Profibus or standard Network but not both simultaneously. Local control is always possible via the keypad. Control via process control is possible via either terminals or Network depending on the settings in <i>O-50 Coasting Select</i> to <i>O-56 Preset Reference Select</i> .
[0]	Disable	Disables process control via Profibus, and enables process control via standard Network or Profibus Master class 2.
[1] *	Enable cyclic master	Enables process control via Profibus Master Class 1, and disables process control via standard Network or Profibus Master class 2.

PB-53 Profibus Warning Word		
Range:	Function:	
0 N/A*	[0 - 65535 N/A]	This parameter displays Profibus communication warnings. Please refer to the <i>Profibus Operating Instructions</i> for further information.

Read only

Bit:	Meaning:
0	Connection with DP-master is not ok
1	Not used
2	(Network Data link Layer) is not ok
3	Clear data command received
4	Actual value is not updated
5	Baudrate search
6	PROFIBUS ASIC is not transmitting
7	Restore of PROFIBUS is not ok
8	Drive is tripped
9	Internal CAN error
10	Wrong configuration data from PLC
11	Wrong ID sent by PLC
12	Internal error occurred
13	Not configured
14	Timeout active
15	Warning 34 active

PB-63 Actual Baud Rate		
Option:	Function:	
		This parameter displays the actual Profibus baud rate. The Profibus Master automatically sets the baud rate.
[0]	9,6 kbit/s	
[1]	19,2 kbit/s	
[2]	93,75 kbit/s	

PB-63 Actual Baud Rate		
Option:	Function:	
[3]	187,5 kbit/s	
[4]	500 kbit/s	
[6]	1500 kbit/s	
[7]	3000 kbit/s	
[8]	6000 kbit/s	
[9]	12000 kbit/s	
[10]	31,25 kbit/s	
[11]	45,45 kbit/s	
[255] *	No baudrate found	

PB-65 Profile Number		
Range:	Function:	
0 N/A*	[0 - 0 N/A]	This parameter contains the profile identification. Byte 1 contains the profile number and byte 2 the version number of the profile.

**NOTE**

This parameter is not visible via keypad.

PB-70 Edit Set-up		
Option:	Function:	
		Select the set-up to be edited.
[0]	Factory setup	Uses default data. This option can be used as a data source to return the other set-ups to a known state.
[1]	Set-up 1	Edits Set-up 1.
[2]	Set-up 2	Edits Set-up 2.
[3]	Set-up 3	Edits Set-up 3.
[4]	Set-up 4	Edits Set-up 4.
[9] *	Active Set-up	Follows the active set-up selected in <i>K-10 Active Set-up</i> .

This parameter is unique to keypad and fieldbuses. See also *K-11 Edit Set-up*.



PB-71 Profibus Save Data Values		
Option:	Function:	
		Parameter values changed via Profibus are not automatically stored in non-volatile memory. Use this parameter to activate a function that stores parameter values in the EEPROM non-volatile memory, so changed parameter values will be retained at power-down.
[0] *	Off	Deactivates the non-volatile storage function.
[1]	Store edit setup	Stores all parameter values for all set-ups in the non-volatile memory. The selection returns to Off [0] when all parameter values have been stored.
[2]	Store all setups	Stores all parameter values for all set-ups in the non-volatile memory. The selection returns to Off [0] when all parameter values have been stored.

PB-72 ProfibusDriveReset		
Option:	Function:	
[0] *	No action	
[1]	Power-on reset	Resets drive upon power-up, as for power-cycle.
[2]	Power-on reset prep	
[3]	Comm option reset	Resets the Profibus option only, useful after changing certain settings in parameter group PB-##, e.g. <i>PB-18 Node Address</i> . When reset, the drive disappears from the Network, which may cause a communication error from the master.

PB-80 Defined Parameters (1)		
Array [116] No keypad access Read only		
Range:	Function:	
0 N/A*	[0 - 9999 N/A]	This parameter displays a list of all the defined drive parameters available for Profibus.

PB-81 Defined Parameters (2)		
Array [116] No keypad access Read only		
Range:	Function:	
0 N/A*	[0 - 9999 N/A]	This parameter displays a list of all the defined drive parameters available for Profibus.

PB-82 Defined Parameters (3)		
Array [116] No keypad access Read only		
Range:	Function:	
0 N/A*	[0 - 9999 N/A]	This parameter displays a list of all the defined drive parameters available for Profibus.

PB-83 Defined Parameters (4)		
Array [116] No keypad access Read only		
Range:	Function:	
0 N/A*	[0 - 9999 N/A]	This parameter displays a list of all the defined drive parameters available for Profibus.

PB-90 Changed Parameters (1)		
Array [116] No keypad access Read only		
Range:	Function:	
0 N/A*	[0 - 9999 N/A]	This parameter displays a list of all the drive parameters deviating from default setting.

PB-91 Changed Parameters (2)		
Array [116] No keypad access Read only		
Range:	Function:	
0 N/A*	[0 - 9999 N/A]	This parameter displays a list of all the drive parameters deviating from default setting.

PB-92 Changed Parameters (3)		
Array [116] No keypad access Read only		
Range:	Function:	
0 N/A*	[0 - 9999 N/A]	This parameter displays a list of all the drive parameters deviating from default setting.

PB-94 Changed Parameters (5)		
Array [116] No keypad Address Read only		
Range:	Function:	
0 N/A*	[0 - 9999 N/A]	This parameter displays a list of all the drive parameters deviating from default setting.



### 3.13 EN-## EtherNet

The parameters in this group are common for Ethernet IP and Modbus TCP.

#### EN-00 IP Address Assignment

Option:	Function:
	Selects the IP Address assignment method.
[0] * Manual	IP-address can be set in <i>EN-01 IP Address</i> IP Address.
[1] DHCP	IP-address is assigned via DHCP server.
[2] BOOTP	IP-address is assigned via BOOTP server.

#### EN-01 IP Address

Range:	Function:
[000.000.000.000 - 255.255.255.255]	Configure the IP address of the option. Read-only if <i>EN-00 IP Address Assignment</i> set to DHCP or BOOTP.

#### EN-02 Subnet Mask

Range:	Function:
[000.000.000.000 - 255.255.255.255]	Configure the IP subnet mask of the option. Read-only if <i>EN-00 IP Address Assignment</i> set to DHCP or BOOTP.

#### EN-03 Default Gateway

Range:	Function:
[000.000.000.000 - 255.255.255.255]	Configure the IP default gateway of the option. Read-only if <i>EN-00 IP Address Assignment</i> set to DHCP or BOOTP.

#### EN-04 DHCP Server

Range:	Function:
[000.000.000.000 - 255.255.255.255]	Read only. Displays the IP address of the found DHCP or BOOTP server.

#### NOTE

A power-cycle is necessary after setting the IP parameters manually.

#### EN-05 Lease Expires

Range:	Function:
0 N/A* [0 - 0 N/A]	Read only. Displays the lease-time left for the current DHCP-assigned IP address.

#### EN-06 Name Servers

Range:	Function:
0 N/A* [0 - 2147483647 N/A]	IP addresses of Domain Name Servers. Can be automatically assigned when using DHCP.

#### EN-07 Domain Name

Range:	Function:
0 N/A [0 - 2147483647 N/A]	Domain name of the attached network. Can be automatically assigned when using DHCP.

#### EN-08 Host Name

Range:	Function:
Blank [0-19 characters]	Logical (given) name of option.

#### EN-09 Physical Address

Range:	Function:
0 N/A* [0 - 0 N/A]	Read only Displays the Physical (MAC) address of the option.

#### EN-1# Ethernet Link parameters

Option:	Function:
	Applies for whole parameter group.
[0] Port 1	
[1] Port 2	

#### EN-10 Link Status

Option:	Function:
	Read only. Displays the link status of the Ethernet ports.
[0] * No Link	
[1] Link	

#### EN-11 Link Duration

Range:	Function:
0 N/A* [0 - 0 N/A]	Read only. Displays the duration of the present link on each port in dd:hh:mm:ss.

#### EN-12 Auto Negotiation

Option:	Function:
	Configures Auto Negotiation of Ethernet link parameters, for each port: ON or OFF.
[0] Off	<i>Link Speed</i> and <i>Link Duplex</i> can be configured in <i>EN-13 Link Speed</i> and <i>EN-14 Link Duplex</i> .
[1] On	

#### EN-13 Link Speed

Option:	Function:
	Forces the link speed for each port in 10 or 100 Mbps. If <i>EN-12 Auto Negotiation</i> is set to: ON, this parameter is read only and displays the actual link speed. "None" is displayed if no link is present.
[0] * None	
[1] 10 Mbps	
[2] 100 Mbps	



EN-14 Link Duplex		
Option:	Function:	
		Forces the duplex for each port to Full or Half duplex. If <i>EN-12 Auto Negotiation</i> is set to: ON, this parameter is read only.
[0]	Half Duplex	
[1] *	Full Duplex	

EN-20 Control Instance		
Range:	Function:	
[None, 20, 21, 100, 101, 103]	Read only. Displays the originator-to-target connection point. If no CIP connection is present "None" is displayed.	

EN-21 Process Data Config Write		
Range:	Function:	
[[0 - 9] PCD read 0 - 9]	Configuration of readable process data.	

**NOTE**

For configuration of 2-word (32-bit) parameter read/write, use 2 consecutive arrays in *EN-21 Process Data Config Write* and *EN-22 Process Data Config Read*.

EN-22 Process Data Config Read		
Range:	Function:	
[[0 - 9] PCD read 0 - 9]	Configuration of readable process data.	

EN-28 Store Data Values		
Option:	Function:	
		This parameter activates a function that stores all parameter values in the non-volatile memory (EEPROM) thus retaining parameter values at power-down. The parameter returns to "Off".
[0] *	Off	The store function is inactive.
[1]	Store All set-ups	All parameter value will be stored in the non-volatile memory, in all four setups.

EN-29 Store Always		
Option:	Function:	
		Activates function that will always store received parameter data in non-volatile memory (EEPROM).
[0] *	Off	
[1]	On	

EN-30 Warning parameter																																				
Range:	Function:																																			
[0000 – FFFF hex]	Read only. Displays the EtherNet/IP specific 16-bit Status-word.																																			
	<table border="1"> <thead> <tr> <th>Bit</th> <th>Description</th> </tr> </thead> <tbody> <tr><td>0</td><td>Owned</td></tr> <tr><td>1</td><td>Not used</td></tr> <tr><td>2</td><td>Configured</td></tr> <tr><td>3</td><td>Not used</td></tr> <tr><td>4</td><td>Not used</td></tr> <tr><td>5</td><td>Not used</td></tr> <tr><td>6</td><td>Not used</td></tr> <tr><td>7</td><td>Not used</td></tr> <tr><td>8</td><td>Minor recoverable fault</td></tr> <tr><td>9</td><td>Minor unrecoverable fault</td></tr> <tr><td>10</td><td>Major recoverable fault</td></tr> <tr><td>11</td><td>Major unrecoverable fault</td></tr> <tr><td>12</td><td>Not used</td></tr> <tr><td>13</td><td>Not used</td></tr> <tr><td>14</td><td>Not used</td></tr> <tr><td>15</td><td>Not used</td></tr> </tbody> </table>	Bit	Description	0	Owned	1	Not used	2	Configured	3	Not used	4	Not used	5	Not used	6	Not used	7	Not used	8	Minor recoverable fault	9	Minor unrecoverable fault	10	Major recoverable fault	11	Major unrecoverable fault	12	Not used	13	Not used	14	Not used	15	Not used	
Bit	Description																																			
0	Owned																																			
1	Not used																																			
2	Configured																																			
3	Not used																																			
4	Not used																																			
5	Not used																																			
6	Not used																																			
7	Not used																																			
8	Minor recoverable fault																																			
9	Minor unrecoverable fault																																			
10	Major recoverable fault																																			
11	Major unrecoverable fault																																			
12	Not used																																			
13	Not used																																			
14	Not used																																			
15	Not used																																			

EN-31 Net Reference		
Option:	Function:	
		Read only. Displays the reference source in Instance 21/71.
[0] *	Off	Reference from the network is not active.
[1]	On	Reference from the network is active.

EN-32 Net Control		
Option:	Function:	
		Read only. Displays the control source in Instance 21/71.
[0] *	Off	Control via the network is not active.
[1]	On	Control via the network is active

EN-33 CIP Revision		
Option:	Function:	
		Read only. Displays the CIP-version of the option software.
[0]	Major version (00 - 99)	
[1]	Minor version (00 - 99)	

EN-34 CIP Product Code		
Range:	Function:	
1100 (AF-650 GP) 1110 (*)	[0 – 9999]	Read only. Displays the CIP product code.



EN-37 COS Inhibit Timer	
Range:	Function:
[0 - 65.535 ms]	Read only Change-Of-State inhibit timer. If the option is configured for COS operation, this inhibit timer can be configured in the Forward Open telegram to prevent that continuously changing PCD data generates extensive network traffic. The inhibit time is in milliseconds, 0 = disabled.

EN-38 COS Filters	
Range:	Function:
[[0 - 9] Filter 0 - 9 (0000 - FFFFhex)]	Change-Of-State PCD filters. Sets up a filter mask for each word of process data when operating in COS-mode. Single bits in the PCD's can be filtered in/out.

EN-40 Status Parameter	
Range:	Function:
0 N/A*	[0 - 0 N/A]

This parameter is for Modbus TCP only

EN-41 Slave Message Count	
Range:	Function:
0 N/A*	[0 - 0 N/A]

This parameter is for Modbus TCP only

EN-42 Slave Exception Message Count	
Range:	Function:
0 N/A*	[0 - 0 N/A]

This parameter is for Modbus TCP only

EN-80 FTP Server	
Option:	Function:
[0] *	Disabled Disables the built-in FTP server.
[1]	Enabled Enables the built-in FTP server.

EN-81 HTTP Server	
Option:	Function:
[0] *	Disabled Disables the built-in HTTP (web) server.
[1]	Enabled Enables the built-in HTTP (web) server.

EN-82 SMTP Service	
Option:	Function:
[0] *	Disabled Disables the SMTP (e-mail) service on the option.
[1]	Enabled Enables the SMTP (e-mail) service on the option.

EN-89 Transent Socket Channel Port	
Range:	Function:
0*	[0 - 9999] Configures the TCP port-number for the transient socket channel. This enables Drive-messages to be sent transiently on Ethernet via TCP. Default value is 4000, 0 means disabled.

EN-90 Cable Diagnostic	
Option:	Function:
	Enables/disables advanced Cable diagnosis function. If enabled, the distance to cable errors can be read out in <i>EN-93 Cable Error Length</i> . The parameter resumes to the default setting of Disable after the diagnostics have finished.
[0] *	Disabled
[1]	Enabled

**NOTE**

The cable diagnostics function will only be issued on ports where there is no link (see *EN-10 Link Status, Link Status*)

EN-91 Auto Cross-Over	
Option:	Function:
[0]	Disable Disables the auto cross-over function.
[1] *	Enable Enables the auto cross-over function.

**NOTE**

Disabling of the auto cross-over function will require crossed Ethernet cables for daisy-chaining the options.

EN-92 IGMP Snooping	
Option:	Function:
	This prevents flooding of the Ethernet protocol stack by only forwarding multicast packets to ports that are a member of the multicast group
[0]	Disable Disables the IGMP snooping function.
[1] *	Enable Enables the IGMP snooping function.

EN-93 Cable Error Length	
Range:	Function:
0 N/A*	[0 - 65535 N/A] If Cable Diagnostics is enabled in <i>EN-90 Cable Diagnostic</i> , the built-in switch is possible via Time Domain Reflectometry (TDR). This is a measurement technique which detects common cabling problems such as open circuits, short circuits and impedance mismatches or breaks in transmission cables. The distance from the option to the error is displayed in metres with an accuracy of +/- 2m. The value 0 means no errors detected.





3

EN-94 Broadcast Storm Protection		
Range:		Function:
-1 %*	[-1 - 20 %]	The built-in switch is capable of protecting the switch system from receiving too many broadcast packages, which can use up network resources. The value indicates a percentage of the total bandwidth that is allowed for broadcast messages.  Example: The "OFF" means that the filter is disabled - all broadcast messages will be passed through. The value "0%" means that no broadcast messages will be passed through. A value of "10%" means that 10% of the total bandwidth is allowed for broadcast messages, if the amount of broadcast messages increases above the 10% threshold, they will be blocked.

EN-95 Broadcast Storm Filter		
Option:		Function:
		Applies to <i>EN-94 Broadcast Storm Protection</i> ; if the Broadcast Storm Protection should also include Multicast messages.
[0] *	Broadcast only	
[1]	Broadcast & Multicast	

EN-98 Interface Counters		
Range:		Function:
4000 N/A*	[0 - 65535 N/A]	Read only. Advanced Interface counters, from built-in switch, can be used for low-level trouble-shooting, The parameter shows a sum of port 1 + port 2.

EN-99 Media Counters		
Range:		Function:
0 N/A*	[0 - 65535 N/A]	Read only. Advanced Interface counters, from built-in switch, can be used for low-level trouble-shooting, The parameter shows a sum of port 1 + port 2.



## 3.14 BN-## BACnet

## 3.14.1 BN-7# BACnet

BN-70 BACnet Device Instance		
Range:		Function:
1 N/A*	[0 - 4194303 N/A]	Enter a unique ID number for the BACnet device.

**NOTE**

This parameter is active only when *O-30 Protocol* is set to [9] *Drive Option*.

BN-72 MS/TP Max Masters		
Range:		Function:
127 N/A*	[0 - 127 N/A]	Define the address of the master which holds the highest address in this network. Decreasing this value optimises polling for the token.

**NOTE**

This parameter is active only when *O-30 Protocol* is set to [9] *Drive Option*.

BN-73 MS/TP Max Info Frames		
Range:		Function:
1 N/A*	[1 - 65534 N/A]	Define how many info/data frames the device is allowed to send while holding the token.

**NOTE**

This parameter is active only when *O-30 Protocol* is set to [9] *Drive Option*.

BN-74 "I-Am" Service		
Option:		Function:
[0] *	Send at power-up	
[1]	Continuously	Choose whether the device should send the "I-Am" service message only at power-up or continuously with an interval of approx. 1 min.

**NOTE**

This parameter is active only when *O-30 Protocol* is set to [9] *Drive Option*.

BN-75 Initialization Password		
Range:		Function:
0 N/A*	[0 - 0 N/A]	Enter the password needed for execution of Drive Re-initialisation from BACnet.

**NOTE**

This parameter is active only when *O-30 Protocol* is set to [9] *Drive Option*.



### 3.15 LN-## - LonWorks

Parameter group for all LonWorks specific parameters.  
Parameters related to LonWorks ID.

3

LN-00 Neuron ID		
Range:		Function:
0 N/A*	[0 - 0 N/A]	View the Neuron chip's unique Neuron ID number.

LN-10 Drive Profile		
Option:		Function:
		This parameter allows selecting between LONMARK Functional Profiles.
[0] *	VSD profile	The GE Profile and the Node Object are common for all profiles.
[1]	Pump controller	

LN-15 LON Warning Word		
Range:		Function:
0 N/A*	[0 - 65535 N/A]	This parameter contains the LON specific warnings.

Bit	Status
0	Internal fault
1	Internal fault
2	Internal fault
3	Internal fault
4	Internal fault
5	Reserved
6	Reserved
7	Reserved
8	Reserved
9	Changeable types
10	Initialization error
11	Internal communication error
12	Software revision mismatch
13	Bus not active
14	Option not present
15	LON input (nvi/nci) exceeds limits

LN-17 XIF Revision		
Range:		Function:
0 N/A*	[0 - 0 N/A]	This parameter contains the version of the external interface file on the Neuron C chip on the LON option.

LN-18 LonWorks Revision		
Range:		Function:
0 N/A*	[0 - 0 N/A]	This parameter contains the software version of the application program on the Neuron C chip on the LON option.

LN-21 Store Data Values		
Option:		Function:
		This parameter is used to activate storing of data in non-volatile memory.
[0] *	Off	Store function is inactive.
[2]	Store all setups	Stores all parameter values in the E <sup>2</sup> PROM. The value returns to <i>Off</i> when all parameter values have been stored.



### 3.16 ID-## Drive Information

Parameter group containing frequency converter information such as operating data, hardware configuration and software versions.

#### 3.16.1 ID-0# Operating Data

ID-00 Operating Hours		
Range:	Function:	
0 h* [0 - 2147483647 h]	View how many hours the drive has run. The value is saved when the drive is turned off.	

ID-01 Running Hours		
Range:	Function:	
0 h* [0 - 2147483647 h]	View how many hours the motor has run. Reset the counter in <i>ID-07 Reset Running Hours Counter</i> . The value is saved when the drive is turned off.	

ID-02 kWh Counter		
Range:	Function:	
0 kWh* [0 - 2147483647 kWh]	Registering the power consumption of the motor as a mean value over one hour. Reset the counter in <i>ID-06 Reset kWh Counter</i> .	

ID-03 Power Up's		
Range:	Function:	
0 N/A* [0 - 2147483647 N/A]	View the number of times the drive has been powered up.	

ID-04 Over Temp's		
Range:	Function:	
0 N/A* [0 - 65535 N/A]	View the number of drive temperature faults which have occurred.	

ID-05 Over Volt's		
Range:	Function:	
0 N/A* [0 - 65535 N/A]	View the number of drive overvoltages which have occurred.	

ID-06 Reset kWh Counter		
Option:	Function:	
[0] * Do not reset	Select <i>Do not reset</i> [0] if no reset of the kWh counter is desired.	
[1] Reset counter	Select <i>Reset</i> [1] and press [OK] to reset the kWh counter to zero (see <i>ID-02 kWh Counter</i> ).	

#### NOTE

The reset is carried out by pressing [OK].

ID-07 Reset Running Hours Counter		
Option:	Function:	
[0] * Do not reset	Select <i>Do not reset</i> [0] if no reset of the Running Hours counter is desired.	
[1] Reset counter	Select <i>Reset counter</i> [1] and press [OK] to reset the Running Hours counter ( <i>ID-01 Running Hours</i> ) and <i>ID-08 Number of Starts</i> to zero (see also <i>ID-01 Running Hours</i> ).	

ID-08 Number of Starts		
Range:	Function:	
0 N/A* [0 - 2147483647 N/A]	This is a read out parameter only. The counter shows the numbers of starts and stops caused by a normal Start/Stop command and/or when entering/leaving sleep mode.	

#### NOTE

This parameter will be reset when resetting *ID-07 Reset Running Hours Counter*.

#### 3.16.2 ID-1# Data Trending Settings

The Data Log enables continuous logging of up to 4 data sources (*ID-10 Trending Source*) at individual rates (*ID-11 Trending Interval*). A trigger event (*ID-12 Trigger Event*) and window (*ID-14 Samples Before Trigger*) are used to start and stop the logging conditionally.

ID-10 Trending Source		
Option:	Function:	
Array [4]	Select which variables are to be logged.	
[0] * None		
[1200] Control Word		
[1201] Reference [Unit]		
[1202] Reference [%]		
[1203] Status Word		
[1210] Power [kW]		
[1211] Power [hp]		
[1212] Motor Voltage		
[1213] Frequency		
[1214] Motor Current		
[1216] Torque [Nm]		
[1217] Speed [RPM]		
[1218] Motor Thermal		
[1222] Torque [%]		
[1230] DC Link Voltage		
[1232] Brake Energy /s		
[1233] Brake Energy /2 min		
[1234] Heatsink Temp.		
[1235] Drive Thermal		
[1250] External Reference		



ID-10 Trending Source		
Array [4]		
Option:	Function:	
[1252]	Feedback [Unit]	
[1254]	Feedback 1 [Unit]	
[1255]	Feedback 2 [Unit]	
[1256]	Feedback 3 [Unit]	
[1260]	Digital Input	
[1262]	Analog Input 53	
[1264]	Analog Input 54	
[1265]	Analog Output 42 [mA]	
[1266]	Digital Output [bin]	
[1275]	Analog In X30/11	
[1276]	Analog In X30/12	
[1277]	Analog Out X30/8 [mA]	
[1290]	Alarm Word	
[1291]	Alarm Word 2	
[1292]	Warning Word	
[1293]	Warning Word 2	
[1294]	Ext. Status Word	
[1295]	Ext. Status Word 2	
[1330]	Analog Input X42/1	
[1331]	Analog Input X42/3	
[1332]	Analog Input X42/5	
[1333]	Analog Out X42/7 [V]	
[1334]	Analog Out X42/9 [V]	
[1335]	Analog Out X42/11 [V]	
[2110]	Bypass Status Word	

ID-11 Trending Interval		
Range:	Function:	
0.000 N/A*	[0.000 - 0.000 N/A]	

ID-12 Trigger Event		
Option:	Function:	
		Selects the trigger event. When the trigger event occurs, a window is applied to freeze the log. The log will then retain a specified percentage of samples before the occurrence of the trigger event ( <i>ID-14 Samples Before Trigger</i> ).
[0] *	False	
[1]	True	
[2]	Running	
[3]	In range	
[4]	On reference	
[5]	Torque limit	
[6]	Current limit	
[7]	Out of current range	
[8]	Below I low	
[9]	Above I high	
[10]	Out of speed range	

ID-12 Trigger Event		
Option:	Function:	
[11]	Below speed low	
[12]	Above speed high	
[13]	Out of feedb. range	
[14]	Below feedb. low	
[15]	Above feedb. high	
[16]	Thermal warning	
[17]	Line voltage out of range	
[18]	Reversing	
[19]	Warning	
[20]	Alarm (trip)	
[21]	Alarm (trip lock)	
[22]	Comparator 0	
[23]	Comparator 1	
[24]	Comparator 2	
[25]	Comparator 3	
[26]	Logic rule 0	
[27]	Logic rule 1	
[28]	Logic rule 2	
[29]	Logic rule 3	
[33]	Digital input DI18	
[34]	Digital input DI19	
[35]	Digital input DI27	
[36]	Digital input DI29	
[37]	Digital input DI32	
[38]	Digital input DI33	
[50]	Comparator 4	
[51]	Comparator 5	
[60]	Logic rule 4	
[61]	Logic rule 5	

ID-13 Trending Mode		
Option:	Function:	
[0] *	Trend always	Select <i>Log always</i> [0] for continuous logging.
[1]	Trend once on trigger	Select <i>Log once on trigger</i> [1] to conditionally start and stop logging using <i>ID-12 Trigger Event</i> and <i>ID-14 Samples Before Trigger</i> .

ID-14 Samples Before Trigger		
Range:	Function:	
50 N/A*	[0 - 100 N/A]	Enter the percentage of all samples prior to a trigger event which are to be retained in the log. See also <i>ID-12 Trigger Event</i> and <i>ID-13 Trending Mode</i> .



### 3.16.3 ID-2# Historic Log

View up to 50 logged data items via the array parameters in this parameter group. For all parameters in the group, [0] is the most recent data and [49] the oldest data. Data is logged every time an *event* occurs (not to be confused with LC events). *Events* in this context are defined as a change in one of the following areas:

1. Digital input
2. Digital outputs (not monitored in this SW release)
3. Warning word
4. Alarm word
5. Status word
6. Control word
7. Extended status word

*Events* are logged with value, and time stamp in msec. The time interval between two events depends on how often *events* occur (maximum once every scan time). Data logging is continuous but if an alarm occurs, the log is saved and the values can be viewed on the display. This feature is useful, for example when carrying out service following a trip. View the historic log contained in this parameter via the serial communication port or via the display.

ID-20 Historic Log: Event		
Array [50]		
Range:	Function:	
0 N/A* [0 - 255 N/A]	View the event type of the logged events.	

ID-21 Historic Log: Value		
Array [50]		
Range:	Function:	
0 N/A* [0 - 2147483647 N/A]	View the value of the logged event. Interpret the event values according to this table:	

ID-21 Historic Log: Value		
Array [50]		
Range:	Function:	
	Digital input	Decimal value. See <i>DR-60 Digital Input</i> for description after converting to binary value.
	Digital output (not monitored in this SW release)	Decimal value. See <i>DR-66 Digital Output [bin]</i> for description after converting to binary value.
	Warning word	Decimal value. See <i>DR-92 Warning Word</i> for description.
	Alarm word	Decimal value. See <i>DR-90 Alarm Word</i> for description.
	Status word	Decimal value. See <i>DR-03 Status Word</i> for description after converting to binary value.
	Control word	Decimal value. See <i>DR-00 Control Word</i> for description.
	Extended status word	Decimal value. See <i>DR-94 Ext. Status Word</i> for description.

ID-22 Historic Log: Time		
Array [50]		
Range:	Function:	
0 ms* [0 - 2147483647 ms]	View the time at which the logged event occurred. Time is measured in ms since drive start. The max. value corresponds to approx. 24 days which means that the count will restart at zero after this time period.	



### 3.16.4 ID-3# Alarm Log

Parameters in this group are array parameters, where up to 10 fault logs can be viewed. [0] is the most recent logged data, and [9] the oldest. Error codes, values, and time stamp can be viewed for all logged data.

ID-30 Alarm Log: Error Code		
Array [10]		
<b>Range:</b>		<b>Function:</b>
0 N/A*	[0 - 255 N/A]	View the error code and look up its meaning in the <i>Troubleshooting</i> chapter.

ID-31 Alarm Log: Value		
Array [10]		
<b>Range:</b>		<b>Function:</b>
0 N/A*	[-32767 - 32767 N/A]	View an extra description of the error. This parameter is mostly used in combination with alarm 38 'internal fault'.

ID-32 Alarm Log: Time		
Array [10]		
<b>Range:</b>		<b>Function:</b>
0 s*	[0 - 2147483647 s]	View the time when the logged event occurred. Time is measured in seconds from drive start-up.

ID-33 Alarm Log: Date and Time		
<b>Range:</b>		<b>Function:</b>
0 N/A*	[0 - 0 N/A]	

### 3.16.5 ID-4# Drive Identification

Parameters containing read only information about the hardware and software configuration of the drive.

ID-40 Drive Type		
<b>Range:</b>		<b>Function:</b>
0 N/A*	[0 - 0 N/A]	View the Drive type.

ID-41 Power Section		
<b>Range:</b>		<b>Function:</b>
0 N/A*	[0 - 0 N/A]	View the Drive type.

ID-42 Voltage		
<b>Range:</b>		<b>Function:</b>
0 N/A*	[0 - 0 N/A]	View the Drive type.

ID-43 Software Version		
<b>Range:</b>		<b>Function:</b>
0 N/A*	[0 - 0 N/A]	View the SW version

ID-46 GE Product No.		
<b>Range:</b>		<b>Function:</b>
0 N/A*	[0 - 0 N/A]	View the 8-digit number.

ID-47 GE Power Card Model No		
<b>Range:</b>		<b>Function:</b>
0 N/A*	[0 - 0 N/A]	View the power card model number.

ID-48 Keypad ID Number		
<b>Range:</b>		<b>Function:</b>
0 N/A*	[0 - 0 N/A]	View the keypad ID number.

ID-49 SW ID Control Card		
<b>Range:</b>		<b>Function:</b>
0 N/A*	[0 - 0 N/A]	View the control card software version number.

ID-50 SW ID Power Card		
<b>Range:</b>		<b>Function:</b>
0 N/A*	[0 - 0 N/A]	View the power card software version number.

ID-51 Drive Serial Number		
<b>Range:</b>		<b>Function:</b>
0 N/A*	[0 - 0 N/A]	View the drive serial number.

ID-53 Power Card Serial Number		
<b>Range:</b>		<b>Function:</b>
0 N/A*	[0 - 0 N/A]	View the power card serial number.

### 3.16.6 ID-6# Option Ident.

This read-only parameter group contains information about the hardware and software configuration of the options installed in slots A and B.

ID-60 Option Mounted		
<b>Range:</b>		<b>Function:</b>
0 N/A*	[0 - 0 N/A]	View the installed option type.

ID-61 Option SW Version		
<b>Range:</b>		<b>Function:</b>
0 N/A*	[0 - 0 N/A]	View the installed option software version.

ID-62 Option Ordering No		
<b>Range:</b>		<b>Function:</b>
0 N/A*	[0 - 0 N/A]	Shows the ordering number for the installed options.

ID-63 Option Serial No		
<b>Range:</b>		<b>Function:</b>
0 N/A*	[0 - 0 N/A]	View the installed option serial number.





ID-92 Defined Parameters		
Array [1000]		
<b>Range:</b>		<b>Function:</b>
0 N/A*	[0 - 9999 N/A]	View a list of all defined parameters in the drive. The list ends with 0.

ID-93 Modified Parameters		
Array [1000]		
<b>Range:</b>		<b>Function:</b>
0 N/A*	[0 - 9999 N/A]	View a list of the parameters that have been changed from their default setting. The list ends with 0. Changes may not be visible until up to 30 seconds after implementation.

ID-99 Parameter Metadata		
Array [23]		
<b>Range:</b>		<b>Function:</b>
0 N/A*	[0 - 9999 N/A]	This parameter contains data used by the DCT 10 software tool.



### 3.17 DR-## Data Readouts

DR-00 Control Word		
Range:		Function:
0 N/A*	[0 - 65535 N/A]	View the Control word sent from the drive via the serial communication port in hex code.

DR-01 Reference [Unit]		
Range:		Function:
0.000 Reference-FeedbackUnit*	[-999999.000 - 999999.000 ReferenceFeed-backUnit]	View the present reference value applied on impulse or analog basis in the unit resulting from the configuration selected in <i>H-40 Configuration Mode</i> (Hz, Nm or RPM).

DR-02 Reference [%]		
Range:		Function:
0.0 %*	[-200.0 - 200.0 %]	View the total reference. The total reference is the sum of digital, analog, preset, bus, and freeze references, plus catch-up and slow-down.

DR-03 Status Word		
Range:		Function:
0 N/A*	[0 - 65535 N/A]	View the Status word sent from the drive via the serial communication port in hex code.

DR-05 Main Actual Value [%]		
Range:		Function:
0.00 %*	[-100.00 - 100.00 %]	View the two-byte word sent with the Status word to the bus Master reporting the Main Actual Value.

DR-09 Custom Readout		
Range:		Function:
0.00 CustomReadoutUnit*	[-999999.99 - 999999.99 CustomReadoutUnit]	View the user-defined readouts as defined in <i>K-30 Unit for Custom Readout</i> , <i>K-31 Min Value of Custom Readout</i> and <i>K-32 Max Value of Custom Readout</i> .

### 3.17.1 DR-1# Motor Status

DR-10 Power [kW]		
Range:		Function:
0.00 kW*	[0.00 - 10000.00 kW]	Displays motor power in kW. The value shown is calculated on the basis of the actual motor voltage and motor current. The value is filtered, and therefore approx. 30ms may pass from when an input value changes to when the data read-out values change. The resolution of read-out value on fieldbus is in 10 W steps.

DR-11 Power [hp]		
Range:		Function:
0.00 hp*	[0.00 - 10000.00 hp]	View the motor power in HP. The value shown is calculated on the basis of the actual motor voltage and motor current. The value is filtered, and therefore approximately 30ms may pass from when an input value changes to when the data read-out values change.

DR-12 Motor Voltage		
Range:		Function:
0.0 V*	[0.0 - 6000.0 V]	View the motor voltage, a calculated value used for controlling the motor.

DR-13 Frequency		
Range:		Function:
0.0 Hz*	[0.0 - 6500.0 Hz]	View the motor frequency, without resonance dampening.

DR-14 Motor Current		
Range:		Function:
0.00 A*	[0.00 - 10000.00 A]	View the motor current measured as a mean value, IRMS. The value is filtered, and thus approximately 30ms may pass from when an input value changes to when the data read-out values change.

DR-15 Frequency [%]		
Range:		Function:
0.00 %*	[-100.00 - 100.00 %]	View a two-byte word reporting the actual motor frequency (without resonance dampening) as a percentage (scale 0000-4000 Hex) of <i>F-03 Max Output Frequency 1</i> . Set <i>PB-16 PCD Read Configuration</i> index 1 to send it with the Status Word instead of the MAV.



DR-16 Torque [Nm]		
Range:		Function:
0.0 Nm*	[-30000.0 - 30000.0 Nm]	View the torque value with sign, applied to the motor shaft. Linearity is not exact between 110% motor current and torque in relation to the rated torque. Some motors supply more than 160% torque. Consequently, the min. value and the max. value will depend on the max. motor current as well as the motor used. The value is filtered, and thus approx. 1.3 seconds may pass from when an input changes value to when the data read-out values change.

DR-17 Speed [RPM]		
Range:		Function:
0 RPM*	[-30000 - 30000 RPM]	View the actual motor RPM.

DR-18 Motor Thermal		
Range:		Function:
0 %*	[0 - 100 %]	View the calculated thermal load on the motor. The cut-out limit is 100%. The basis for calculation is the Electronic Thermal Overload function selected in <i>F-10 Electronic Overload</i> .

DR-22 Torque [%]		
Range:		Function:
0 %*	[-200 - 200 %]	This is a read out parameter only. Shows the actual torque yielded in percentage of the rated torque, based on the setting of the motor size and rated speed in <i>P-07 Motor Power [kW]</i> or <i>P-02 Motor Power [HP]</i> and <i>P-06 Base Speed</i> .  This is the value monitored by the <i>Broken Belt Function</i> set in parameter group AP-6#.

### 3.17.2 DR-3# Drive Status

DR-30 DC Link Voltage		
Range:		Function:
0 V*	[0 - 10000 V]	View a measured value. The value is filtered with an 30ms time constant.

DR-32 Brake Energy /s		
Range:		Function:
0.000 kW*	[0.000 - 10000.000 kW]	View the brake power transmitted to an external brake resistor, stated as an instantaneous value.

DR-33 Brake Energy /2 min		
Range:		Function:
0.000 kW*	[0.000 - 10000.000 kW]	View the brake power transmitted to an external brake resistor. The mean power is calculated on an average basis for the most recent 120 seconds.

DR-34 Heatsink Temp.		
Range:		Function:
0 C*	[0 - 255 C]	View the drive heatsink temperature. The cut-out limit is $90 \pm 5^\circ\text{C}$ , and the motor cuts back in at $60 \pm 5^\circ\text{C}$ .

DR-35 Drive Thermal		
Range:		Function:
0 %*	[0 - 100 %]	View the percentage load on the inverter.

DR-36 Drive Nominal Current		
Range:		Function:
10.00 A*	[0.01 - 10000.00 A]	View the inverter nominal current, which should match the nameplate data on the connected motor. The data are used for calculation of torque, motor protection, etc.

DR-37 Drive Max. Current		
Range:		Function:
16.00 A*	[0.01 - 10000.00 A]	View the inverter maximum current, which should match the nameplate data on the connected motor. The data are used for calculation of torque, motor protection, etc.

DR-38 Logic Controller State		
Range:		Function:
0 N/A*	[0 - 100 N/A]	View the state of the event under execution by the Logic controller.

DR-39 Control Card Temp.		
Range:		Function:
0 C*	[0 - 100 C]	View the temperature on the control card, stated in $^\circ\text{C}$

DR-40 Trending Buffer Full		
Option:	Function:	
	View whether the logging buffer is full (see parameter group ID-1#). The logging buffer will never be full when <i>ID-13 Trending Mode</i> is set to <i>Log always</i> [0].	
[0] *	No	
[1]	Yes	



3.17.3 DR-5# Ref. & Feedb.

DR-50 External Reference		
Range:		Function:
0.0 N/A*	[-200.0 - 200.0 N/A]	View the total reference, the sum of digital, analog, preset, bus and freeze references, plus catch-up and slow-down.

DR-52 Feedback [Unit]		
Range:		Function:
0.000 ProcessCtrlUnit*	[-999999.999 - 999999.999 ProcessCtrlUnit]	View value of resulting feedback value after processing of Feedback 1-3 (see DR-54 Feedback 1 [Unit], DR-55 Feedback 2 [Unit] and DR-56) in the feedback manager.  See parameter group CL-0# Feedback.  The value is limited by settings in parameter F-52 and parameter F-53. Units as set in parameter CL-12 Reference/Feedback Unit.

DR-53 Digi Pot Reference		
Range:		Function:
0.00 N/A*	[-200.00 - 200.00 N/A]	View the contribution of the Digital Pot. meter to the actual reference.

DR-54 Feedback 1 [Unit]		
Range:		Function:
0.000 ProcessCtrlUnit*	[-999999.999 - 999999.999 ProcessCtrlUnit]	View value of Feedback 1.  The value is limited by settings in F-53 and F-54. Units as set in CL-12 Reference/Feedback Unit.

DR-55 Feedback 2 [Unit]		
Range:		Function:
0.000 ProcessCtrlUnit*	[-999999.999 - 999999.999 ProcessCtrlUnit]	View value of Feedback 2, see parameter group CL-0# Feedback.  The value is limited by settings in par. CL-13 and par. CL-14. Units as set in CL-12 Reference/Feedback Unit.

DR-56 Feedback 3 [Unit]		
Range:		Function:
0.000 ProcessCtrlUnit*	[-999999.999 - 999999.999 ProcessCtrlUnit]	View value of Feedback 3.  The value is limited by settings in CL-13 Minimum Reference/Feedb. and CL-14 Maximum Reference/Feedb.. Units as set in CL-12 Reference/Feedback Unit.

DR-58 PID Output [%]		
Range:		Function:
0.0 %*	[0.0 - 100.0 %]	This parameter returns the Drive Closed Loop PID controller output value in percent.

3.17.4 DR-6# Inputs and Outputs

DR-60 Digital Input		
Range:		Function:
0 N/ A*	[0 - 1023 N/A]	View the signal states from the active digital inputs. Example: Input 18 corresponds to bit no. 5, '0' = no signal, '1' = connected signal.
Bit 0	Digital input term. 33	
Bit 1	Digital input term. 32	
Bit 2	Digital input term. 29	
Bit 3	Digital input term. 27	
Bit 4	Digital input term. 19	
Bit 5	Digital input term. 18	
Bit 6	Digital input term. 37	
Bit 7	Digital input GP I/O term. X30/4 (OPCGPIO)	
Bit 8	Digital input GP I/O term. X30/3 (OPCGPIO)	
Bit 9	Digital input GP I/O term. X30/2 (OPCGPIO)	
Bit 10-63	Reserved for future terminals	



DR-61 Terminal 53 Switch Setting		
Option:	Function:	
		View the setting of input terminal 53. Current = 0; Voltage = 1.
[0] *	Current	
[1]	Voltage	
[2]	Pt 1000 [°C]	
[3]	Pt 1000 [°F]	
[4]	Ni 1000 [°C]	
[5]	Ni 1000 [°F]	

DR-62 Analog Input 53		
Range:	Function:	
0.000 N/A*	[-20.000 - 20.000 N/A]	View the actual value at input 53.

DR-63 Terminal 54 Switch Setting		
Option:	Function:	
		View the setting of input terminal 54. Current = 0; Voltage = 1.
[0] *	Current	
[1]	Voltage	
[2]	Pt 1000 [°C]	
[3]	Pt 1000 [°F]	
[4]	Ni 1000 [°C]	
[5]	Ni 1000 [°F]	

DR-64 Analog Input 54		
Range:	Function:	
0.000 N/A*	[-20.000 - 20.000 N/A]	View the actual value at input 54.

DR-65 Analog Output 42 [mA]		
Range:	Function:	
0.000 N/A*	[0.000 - 30.000 N/A]	View the actual value at output 42 in mA. The value shown reflects the selection in <i>AN-50 Terminal 42 Output</i> .

DR-66 Digital Output [bin]		
Range:	Function:	
0 N/A*	[0 - 15 N/A]	View the binary value of all digital outputs.

DR-67 Freq. Input #29 [Hz]		
Range:	Function:	
0 N/A*	[0 - 130000 N/A]	View the actual frequency rate on terminal 29.

DR-68 Freq. Input #33 [Hz]		
Range:	Function:	
0 N/A*	[0 - 130000 N/A]	View the actual value of the frequency applied at terminal 33 as an impulse input.

DR-69 Pulse Output #27 [Hz]		
Range:	Function:	
0 N/A*	[0 - 40000 N/A]	View the actual value of impulses applied to terminal 27 in digital output mode.

DR-70 Pulse Output #29 [Hz]		
Range:	Function:	
0 N/A*	[0 - 40000 N/A]	View the actual value of pulses to terminal 29 in digital output mode.

DR-71 Relay Output [bin]		
Range:	Function:	
0 N/A*	[0 - 511 N/A]	View the settings of all relays.

Readout choice [Par. DR-71]:  
Relay output [bin]: 00000 bin

1309A195.10

DR-72 Counter A		
Range:	Function:	
0 N/A*	[-2147483648 - 2147483647 N/A]	View the present value of Counter A. Counters are useful as comparator operands, see <i>LC-10 Comparator Operand</i> .  The value can be reset or changed either via digital inputs (parameter group E-0#) or by using an LC action ( <i>LC-52 Logic Controller Action</i> ).

DR-73 Counter B		
Range:	Function:	
0 N/A*	[-2147483648 - 2147483647 N/A]	View the present value of Counter B. Counters are useful as comparator operands ( <i>LC-10 Comparator Operand</i> ).  The value can be reset or changed either via digital inputs (parameter group E-0#) or by using an LC action ( <i>LC-52 Logic Controller Action</i> ).

DR-75 Analog In X30/11		
Range:	Function:	
0.000 N/A*	[-20.000 - 20.000 N/A]	View the actual value at input X30/11 of OPCGPIO General Purpose I/O Option Module.



DR-76 Analog In X30/12		
Range:	Function:	
0.000 N/A* [-20.000 - 20.000 N/A]	View the actual value at input X30/12 of OPCGPIO General Purpose I/O Option Module.	

DR-77 Analog Out X30/8 [mA]		
Range:	Function:	
0.000 N/A* [0.000 - 30.000 N/A]	View the actual value at input X30/8 .	

### 3.17.5 DR-8# network & Drive Port

Parameters for reporting the BUS references and control words.

DR-80 Fieldbus CTW 1		
Range:	Function:	
0 N/A* [0 - 65535 N/A]	View the two-byte Control word (CTW) received from the Bus-Master. Interpretation of the Control word depends on the network option installed and the Control word profile selected in <i>O-10 Control Word Profile</i> . For more information please refer to the relevant network manual.	

DR-82 Fieldbus REF 1		
Range:	Function:	
0 N/A* [-200 - 200 N/A]	View the two-byte word sent with the control word form the Bus-Master to set the reference value. For more information please refer to the relevant network manual.	

DR-84 Comm. Option STW		
Range:	Function:	
0 N/A* [0 - 65535 N/A]	View the extended network comm. option status word.	

DR-85 Drive Port CTW 1		
Range:	Function:	
0 N/A* [0 - 65535 N/A]	View the two-byte Control word (CTW) received from the Bus-Master. Interpretation of the control word depends on the network option installed and the Control word profile selected in <i>O-10 Control Word Profile</i> .	

DR-86 Drive Port REF 1		
Range:	Function:	
0 N/A* [-200 - 200 N/A]	View the two-byte Status word (STW) sent to the Bus-Master. Interpretation of the Status word depends on the network option installed and the Control word profile selected in <i>O-10 Control Word Profile</i> .	

### 3.17.6 DR-9# Diagnosis Read-Outs

DR-90 Alarm Word		
Range:	Function:	
0 N/A* [0 - 4294967295 N/A]	View the alarm word sent via the serial communication port in hex code.	

DR-91 Alarm Word 2		
Range:	Function:	
0 N/A* [0 - 4294967295 N/A]	View the alarm word 2 sent via the serial communication port in hex code.	

DR-92 Warning Word		
Range:	Function:	
0 N/A* [0 - 4294967295 N/A]	View the warning word sent via the serial communication port in hex code.	

DR-93 Warning Word 2		
Range:	Function:	
0 N/A* [0 - 4294967295 N/A]	View the warning word 2 sent via the serial communication port in hex code.	

DR-94 Ext. Status Word		
Range:	Function:	
0 N/A* [0 - 4294967295 N/A]	Returns the extended status word sent via the serial communication port in hex code.	

DR-95 Ext. Status Word 2		
Range:	Function:	
0 N/A* [0 - 4294967295 N/A]	Returns the extended warning word 2 sent via the serial communication port in hex code.	

DR-96 Maintenance Word		
Range:	Function:	
0 N/A*	[0 - 4294967295 N/A]	



### 3.18 LG-## Logs & I/O Opt. Status

#### 3.18.1 LG-0# Maintenance Log

This group contains the last 10 Preventive Maintenance events. Maintenance Log 0 is the latest and Maintenance Log 9 the oldest.

By selecting one of the logs and pressing [OK], the Maintenance Item, Action and time of the occurrence can be found in *LG-00 Maintenance Log: Item* – *LG-03 Maintenance Log: Date and Time*.

The Alarm log button on the keypad allows access to both Alarm log and Maintenance log.

LG-00 Maintenance Log: Item		
Array [10]. Array parameter; Error code 0 - 9: The meaning of the error code can be found in the Troubleshooting section of the Design Guide.		
Range:	Function:	
0 N/A*	[0 - 255 N/A]	Locate the meaning of the Maintenance Item in the description of <i>T-10 Maintenance Item</i> .

LG-01 Maintenance Log: Action		
Array [10]. Array parameter; Error code 0 - 9: The meaning of the error code can be found in the Troubleshooting section of the Design Guide.		
Range:	Function:	
0 N/A*	[0 - 255 N/A]	Locate the meaning of the Maintenance Item in the description of <i>T-11 Maintenance Action</i> .

LG-02 Maintenance Log: Time		
Array [10]. Array parameter; Time 0 - 9: This parameter shows at which time the logged event occurred. Time is measured in seconds since start of the frequency converter.		
Range:	Function:	
0 s*	[0 - 2147483647 s]	Shows when the logged event occurred. Time is measured in seconds since last power-up.

LG-03 Maintenance Log: Date and Time		
Array [10]		
Range:	Function:	
0 N/A*	[0 - 0 N/A]	Shows when the logged event occurred.
<p><b>NOTE</b> This requires that the date and time is programmed in <i>K-70 Date and Time</i>.</p>		

LG-03 Maintenance Log: Date and Time		
Array [10]		
Range:	Function:	
	Date format depends on the setting in <i>K-71 Date Format</i> , while the time format depends on the setting in <i>K-72 Time Format</i> .	
<p><b>NOTE</b> The frequency converter has no back up of the clock function and the set date/time will reset to default (2000-01-01 00:00) after a power down unless an Analog I/O Option Module with Real Time Clock Battery Back Up (OPCAIO) is installed. In <i>K-79 Clock Fault</i> it is possible to program for a Warning in case clock has not been set properly, e.g. after a power down. Incorrect setting of the clock will affect the time stamps for the Maintenance Events.</p>		

**NOTE**  
When mounting an Analog I/O Option Module (OPCAIO) option card, a battery back-up of date and time is included.

#### 3.18.2 LG-1# Fire Mode Log

The log covers the latest 10 faults which have been suppressed by the Fire Mode function. See parameter group *FB-0#*, *Fire Mode*. The log can be viewed either via the below parameters or by pressing the Alarm Log button on the keypad and select Fire Mode Log. It is not possible to reset the Fire Mode Log.

LG-10 Fire Mode Log: Event		
Range:	Function:	
0 N/A*	[0 - 255 N/A]	This parameter contains an array with 10 elements. The number read represent an error code, which corresponds to a specific alarm. This can be found in the Troubleshooting section in the Design Guide.

LG-11 Fire Mode Log: Time		
Range:	Function:	
0 s*	[0 - 2147483647 s]	This parameter contains an array with 10 elements. The parameter shows at which time the logged event occurred. Time is measured in seconds since the first start of the motor.





LG-12 Fire Mode Log: Date and Time		
Range:		Function:
0 N/A*	[0 - 0 N/A]	This parameter contains an array with 10 elements. The parameter shows at which date and time the logged event occurred. The function relies on that the actual date and time has been set in <i>K-70 Date and Time</i> . Note: There is no build in battery back up of the clock. An Analog I/O Option Module with Real Time Clock Battery Back Up (OPCAIO) can be used to back up the clock settings.. See Clock Settings, K-7#.

LG-34 Analog Out X42/9 [V]		
Range:		Function:
0.000 N/A*	[0.000 - 30.000 N/A]	Read out of the value of the signal applied to terminal X42/9 on the Analog I/O Card. The value shown reflects the selection in <i>AO-50 Terminal X42/9 Output</i> .

LG-35 Analog Out X42/11 [V]		
Range:		Function:
0.000 N/A*	[0.000 - 30.000 N/A]	Read out of the value of the signal applied to terminal X42/11 on the Analog I/O Card. The value shown reflects the selection in <i>AO-60 Terminal X42/11 Output</i> .

### 3.18.3 LG-3# I/O Option Status

Parameters for reporting the digital and analog I/O ports.

LG-30 Analog Input X42/1		
Range:		Function:
0.000 N/A*	[-20.000 - 20.000 N/A]	Read out of the value of the signal applied to terminal X42/1 on the Analog I/O Card. The units of the value shown in the keypad will correspond to the mode selected in <i>AO-00 Terminal X42/1 Mode</i> .

LG-31 Analog Input X42/3		
Range:		Function:
0.000 N/A*	[-20.000 - 20.000 N/A]	Read out of the value of the signal applied to terminal X42/3 on the Analog I/O Card. The units of the value shown in the keypad will correspond to the mode selected in <i>AO-01 Terminal X42/3 Mode</i> .

LG-32 Analog Input X42/5		
Range:		Function:
0.000 N/A*	[-20.000 - 20.000 N/A]	Read out of the value of the signal applied to terminal X42/5 on the Analog I/O Card. The units of the value shown in the keypad will correspond to the mode selected in <i>AO-02 Terminal X42/5 Mode</i> .

LG-33 Analog Out X42/7 [V]		
Range:		Function:
0.000 N/A*	[0.000 - 30.000 N/A]	Read out of the value of the signal applied to terminal X42/7 on the Analog I/O Card. The value shown reflects the selection in <i>AO-40 Terminal X42/7 Output</i> .



### 3.19 AP-## HVAC Appl. Param.

This group contains parameters used for monitoring AF-600 FP applications.

AP-00 External Interlock Delay	
Range:	Function:
0 s* [0 - 600 s]	Only relevant if one of the digital inputs in parameter group E-0# has been programmed for <i>External Interlock</i> [7]. The External Interlock Timer will introduce a delay after the signal has been removed from the digital input programmed for External Interlock, before reaction takes place.

3

#### 3.19.1 AP-2# No-Flow Detection

130BA252.15

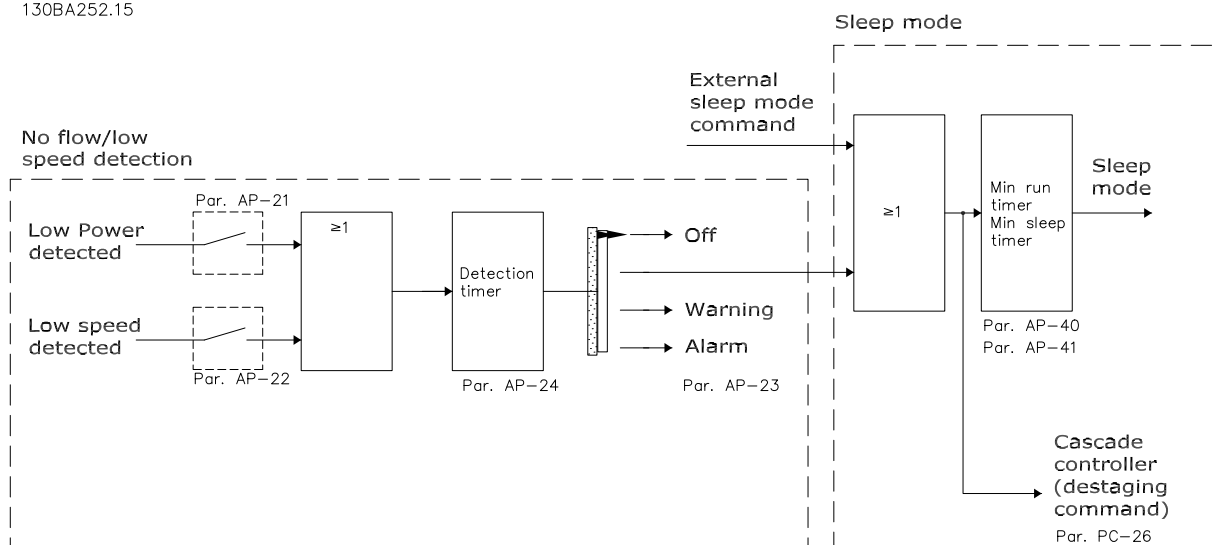

The frequency converter includes functions for detecting if the load conditions in the system allow the motor to be stopped:

\*Low Power Detection

\*Low Speed Detection

One of these two signals must be active for a set time (*AP-24 No-Flow Delay*) before selected action takes place. Possible actions to select (*AP-23 No-Flow Function*): No action, Warning, Alarm, Sleep Mode.

No Flow Detection:

This function is used for detecting a no flow situation in pump systems where all valves can be closed. Can be used both when controlled by the integrated PI controller in the frequency converter or an external PI controller. Actual configuration must be programmed in *H-40 Configuration Mode*.

Configuration mode for

- Integrated PI Controller: Closed Loop
- External PI Controller: Open Loop

## NOTE

Carry out No Flow tuning before setting the PI controller parameters!

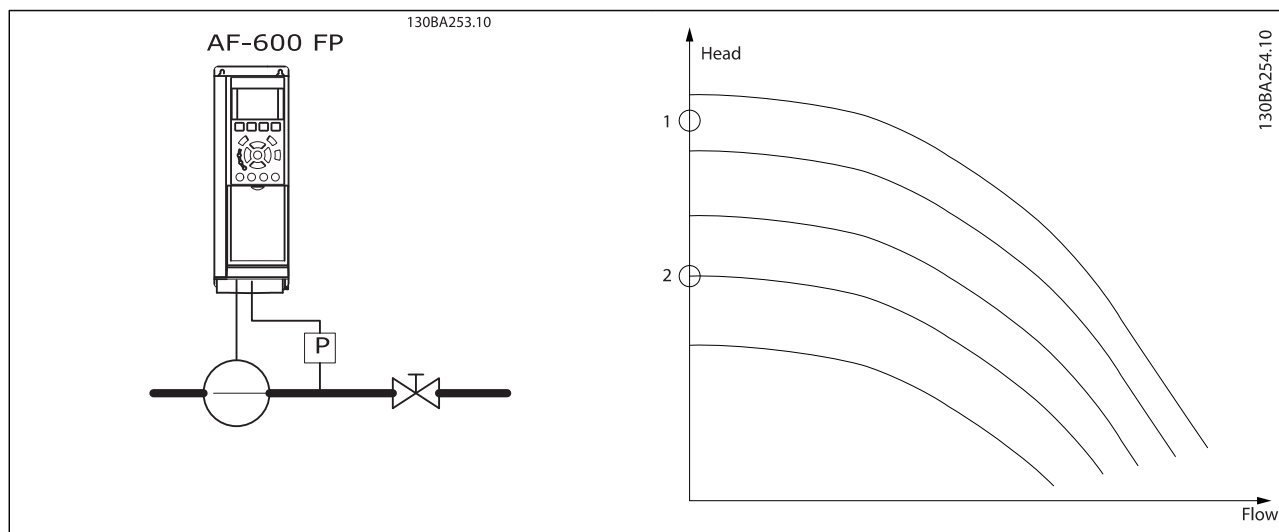

*No Flow Detection* is based on the measurement of speed and power. For a certain speed the frequency converter calculates the power at no flow.

This coherence is based on the adjustment of two sets of speed and associated power at no flow. By monitoring the power it is possible to detect no flow conditions in systems with fluctuating suction pressure or if the pump has a flat characteristic towards low speed.

The two sets of data must be based on measurement of power at approx. 50% and 85% of maximum speed with the valve(s) closed. The data are programmed in the parameter group AP-3#. It is also possible to run a *Low Power Auto Set Up* (AP-20 *Low Power Auto Set-up*) automatically stepping through the commissioning process and also automatically storing the data measured. The frequency converter must be set for Open Loop in H-40 *Configuration Mode*, when carrying out the Auto Set Up (See No Flow Tuning parameter group AP-3#).

## NOTE

If to use the integrated PI controller, carry out No Flow tuning before setting the PI controller parameters!

### Low speed detection:

*Low Speed Detection* gives a signal if the motor is operating with minimum speed as set in F-18 *Motor Speed Low Limit [RPM]* or F-16 *Motor Speed Low Limit [Hz]*. Actions are common with No Flow Detection (individual selection not possible).

The use of Low Speed Detection is not limited to systems with a no flow situation, but can be used in any system where operation at minimum speed allows for a stop of the motor until the load calls for a speed higher than minimum speed, e.g. systems with fans and compressors.

## NOTE

In pump systems ensure that the minimum speed in F-18 *Motor Speed Low Limit [RPM]* or F-16 *Motor Speed Low Limit [Hz]* has been set high enough for detection as the pump can run with a rather high speed even with valves closed.



Dry pump detection:

No Flow Detection can also be used for detecting if the pump has run dry (low power consumption-high speed). Can be used with both the integrated PI controller and an external PI controller.

The condition for Dry Pump signal:

- Power consumption below no flow level

and

- Pump running at maximum speed or maximum reference open loop, whichever is lowest.

The signal must be active for a set time (*AP-27 Dry Pump Delay*) before selected the action takes place.

Possible Actions to select (*AP-26 Dry Pump Function*):

- Warning
- Alarm

No Flow Detection must be enabled (*AP-23 No-Flow Function*) and commissioned (parameter group AP-3#, *No Power Tuning*).

AP-20 Low Power Auto Set-up		
Start of auto set-up of power data for No-Flow Power tuning.		
Option:	Function:	
[0] * Off		
[1]	Enabled	When set for <i>Enabled</i> , an auto set up sequence is activated, automatically setting speed to approx. 50 and 85% of rated motor speed ( <i>F-17 Motor Speed High Limit [RPM]</i> , <i>F-15 Motor Speed High Limit [Hz]</i> ). At those two speeds, the power consumption is automatically measured and stored. Before enabling Auto Set Up: <ol style="list-style-type: none"> <li>1. Close valve(s) in order to create a no flow condition</li> <li>2. The frequency converter must be set for Open Loop (<i>H-40 Configuration Mode</i>). Note that it is important also to set <i>H-43 Torque Characteristics</i>.</li> </ol>

**NOTE**

Auto Set Up must be done when the system has reached normal operating temperature!

**NOTE**

It is important that the *F-17 Motor Speed High Limit [RPM]* or *F-15 Motor Speed High Limit [Hz]* is set to the max. operational speed of the motor!

It is important to do the Auto Set-up before configuring the integrated PI Controller as settings will be reset when changing from Closed to Open Loop in *H-40 Configuration Mode*.

**NOTE**

Carry out the tuning with the same settings in *H-43 Torque Characteristics*, as for operation after the tuning.

AP-21 Low Power Detection		
Option:	Function:	
[0] * Disabled		
[1]	Enabled	If selecting Enabled, the Low Power Detection commissioning must be carried out in order to set the parameters in group AP-3# for proper operation!

AP-22 Low Speed Detection		
Option:	Function:	
[0] * Disabled		
[1]	Enabled	Select Enabled for detecting when the motor operates with a speed as set in <i>F-18 Motor Speed Low Limit [RPM]</i> or <i>F-16 Motor Speed Low Limit [Hz]</i> .

AP-23 No-Flow Function		
Common actions for Low Power Detection and Low Speed Detection (Individual selections not possible).		
Option:	Function:	
[0] * Off	The drive will not respond to a No Flow condition.	
[1]	Sleep Mode	The drive will enter Sleep Mode and stop when a No Flow condition is detected. See parameter group AP-4# for programming options for Sleep Mode.
[2]	Warning	The drive will continue to run, but activate a No-Flow Warning [W92]. A drive digital output or a serial communication bus can communicate a warning to other equipment.
[3]	Alarm	The drive will stop running and activate a No-Flow Alarm [A 92]. A drive digital output or a serial communication bus can communicate an alarm to other equipment.



**NOTE**

Do not set *H-04 Auto-Reset (Times)*, to [13] Infinite auto reset, when *AP-23 No-Flow Functionis* set to [3] Alarm. Doing so will cause the drive to continuously cycle between running and stopping when a No Flow condition is detected.

**NOTE**

If the drive is equipped with a constant speed bypass with an automatic bypass function that starts the bypass if the drive experiences a persistent alarm condition, be sure to disable the bypass's automatic bypass function, if [3] Alarm is selected as the No-Flow Function.

AP-24 No-Flow Delay		
Range:	Function:	
10 s*	[1 - 600 s]	Set the time Low Power/Low Speed must stay detected to activate signal for actions. If detection disappears before run out of the timer, the timer will be reset.

AP-26 Dry Pump Function		
Select desired action for dry pump operation.		
Option:	Function:	
[0] *	Off	
[1]	Warning	The drive will continue to run, but activate a Dry pump warning [W93]. A drive digital output or a serial communication bus can communicate a warning to other equipment.
[2]	Alarm	The drive will stop running and activate a Dry pump alarm [A93]. A drive digital output or a serial communication bus can communicate an alarm to other equipment.
[3]	Man. Reset Alarm	The drive will stop running and activate a Dry pump alarm [A93]. A drive digital output or a serial communication bus can communicate an alarm to other equipment.

**NOTE**

*Low Power Detection* must be Enabled (*AP-21 Low Power Detection*) and commissioned (using either parameter group *AP-3#*, *No Flow Power Tuning*, or *AP-20 Low Power Auto Set-up*) in order to use Dry Pump Detection.

**NOTE**

Do not set *H-04 Auto-Reset (Times)*, to [13] Infinite auto reset, when *AP-26 Dry Pump Function* is set to [2] Alarm. Doing so will cause the drive to continuously cycle between running and stopping when a Dry Pump condition is detected.

**NOTE**

If the drive is equipped with a constant speed bypass with an automatic bypass function that starts the bypass if the drive experiences a persistent alarm condition, be sure to disable the bypass's automatic bypass function, if [2] Alarm or [3] Man. Reset Alarm is selected as the Dry Pump Function.

AP-27 Dry Pump Delay		
Range:	Function:	
10 s*	[0 - 600 s]	Defines for how long the Dry Pump condition must be active before activating Warning or Alarm

3.19.2 AP-3# No-Flow Power Tuning

Tuning Sequence, if not choosing *Auto Set Up* in *AP-20 Low Power Auto Set-up*:

1. Close the main valve to stop flow
2. Run with motor until the system has reached normal operating temperature
3. Press Hand button on the keypad and adjust speed for approx. 85% of rated speed. Note the exact speed
4. Read power consumption either by looking for actual power in the data line in the keypad or call *DR-10 Power [kW]* or *DR-11 Power [hp]* in Main Menu. Note the power read out
5. Change speed to approx. 50% of rated speed. Note the exact speed
6. Read power consumption either by looking for actual power in the data line in the keypad or call *DR-10 Power [kW]* or *DR-11 Power [hp]* in Main Menu. Note the power read
7. Program the speeds used in *AP-32 Low Speed [RPM]*, *AP-33 Low Speed [Hz]*, *AP-36 High Speed [RPM]* and *AP-37 High Speed [Hz]*
8. Program the associated power values in *AP-34 Low Speed Power [kW]*, *AP-35 Low Speed Power [HP]*, *AP-38 High Speed Power [kW]* and *AP-39 High Speed Power [HP]*
9. Switch back by means of *Auto* or *Off*

**NOTE**

Set *H-43 Torque Characteristics* before tuning takes place.



AP-30 No-Flow Power		
Range:		Function:
0.00 kW*	[0.00 - 0.00 kW]	Read out of calculated No Flow power at actual speed. If power drops to the display value the frequency converter will consider the condition as a No Flow situation.

AP-31 Power Correction Factor		
Range:		Function:
100 %*	[1 - 400 %]	Make corrections to the calculated power at AP-30 No-Flow Power. If No Flow is detected, when it should not be detected, the setting should be decreased. However, if No Flow is not detected, when it should be detected, the setting should be increased to above 100%.

AP-32 Low Speed [RPM]		
Range:		Function:
0 RPM*	[0 - par. AP-36 RPM]	To be used if K-02 Motor Speed Unit has been set for RPM (parameter not visible if Hz selected). Set used speed for the 50% level. This function is used for storing values needed to tune No Flow Detection.

AP-33 Low Speed [Hz]		
Range:		Function:
0 Hz*	[0.0 - par. AP-37 Hz]	To be used if K-02 Motor Speed Unit has been set for Hz (parameter not visible if RPM selected). Set used speed for the 50% level. The function is used for storing values needed to tune No Flow Detection.

AP-34 Low Speed Power [kW]		
Range:		Function:
0 kW*	[0.00 - 0.00 kW]	To be used if K-03 Regional Settings has been set for International (parameter not visible if North America selected). Set power consumption at 50% speed level. This function is used for storing values needed to tune No Flow Detection.

AP-35 Low Speed Power [HP]		
Range:		Function:
0 hp*	[0.00 - 0.00 hp]	To be used if K-03 Regional Settings has been set for North America (parameter not visible if International selected). Set power consumption at 50% speed level. This function is used for storing values needed to tune No Flow Detection.

AP-36 High Speed [RPM]		
Range:		Function:
0 RPM*	[0 - par. F-15 RPM]	To be used if K-02 Motor Speed Unit has been set for RPM (parameter not visible if Hz selected). Set used speed for the 85% level. The function is used for storing values needed to tune No Flow Detection.

AP-37 High Speed [Hz]		
Range:		Function:
0.0 Hz*	[0.0 - par. F-17 Hz]	To be used if K-02 Motor Speed Unit has been set for Hz (parameter not visible if RPM selected). Set used speed for the 85% level. The function is used for storing values needed to tune No Flow Detection.

AP-38 High Speed Power [kW]		
Range:		Function:
0 kW*	[0.00 - 0.00 kW]	To be used if K-03 Regional Settings has been set for International (parameter not visible if North America selected). Set power consumption at 85% speed level. This function is used for storing values needed to tune No Flow Detection.

AP-39 High Speed Power [HP]		
Range:		Function:
0 hp*	[0.00 - 0.00 hp]	To be used if K-03 Regional Settings has been set for North America (parameter not visible if International selected). Set power consumption at 85% speed level. This function is used for storing values needed to tune No Flow Detection.

### 3.19.3 AP-4# Sleep Mode

If the load on the system allows for stop of the motor and the load is monitored, the motor can be stopped by activating the Sleep Mode function. This is not a normal Stop command, but ramps the motor down to 0 RPM and stops energizing the motor. When in Sleep Mode certain conditions are monitored to find out when load has been applied to the system again.

Sleep Mode can be activated either from the No Flow Detection/Minimum Speed Detection ( must be programmed via parameters for No-Flow Detection, see the signal flow-diagram in parameter group AP-2#, No-Flow Detection) or via an external signal applied to one of the digital inputs (must be programmed via the parameters for configuration of the digital inputs, par. E-0#

selecting [66] Sleep Mode). Sleep mode is activated only when no wake-up conditions are present. To make it possible to use e.g. an electro-mechanical flow switch to detect a no flow condition and activate Sleep Mode, the action takes place at raising edge of the external signal applied (otherwise the frequency converter would never come out of Sleep Mode again as the signal would be steady connected).

**NOTE**

**If Sleep Mode is to be based on No Flow Detection/ Minimum Speed, remember to choose Sleep Mode [1] in AP-23 No-Flow Function.**

If PC-26 Destage At No-Flow is set for Enabled, activating Sleep Mode will send a command to the pump controller (if enabled) to start de-staging of lag pumps (fixed speed) before stopping the lead pump (variable speed).

When entering Sleep Mode, the lower status line in the keypad shows Sleep Mode.

See also signal flow chart in section AP-2# No Flow Detection.

There are three different ways of using the Sleep Mode function:

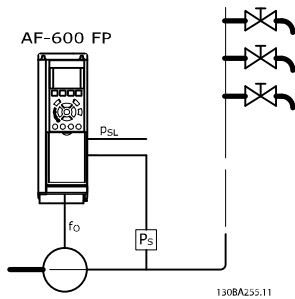

1) Systems where the integrated PI controller is used for controlling pressure or temperature e.g. boost systems with a pressure feed back signal applied to the frequency converter from a pressure transducer. H-40 Configuration Mode must be set for Closed Loop and the PI Controller configured for desired reference and feed back signals. Example: Boost system.

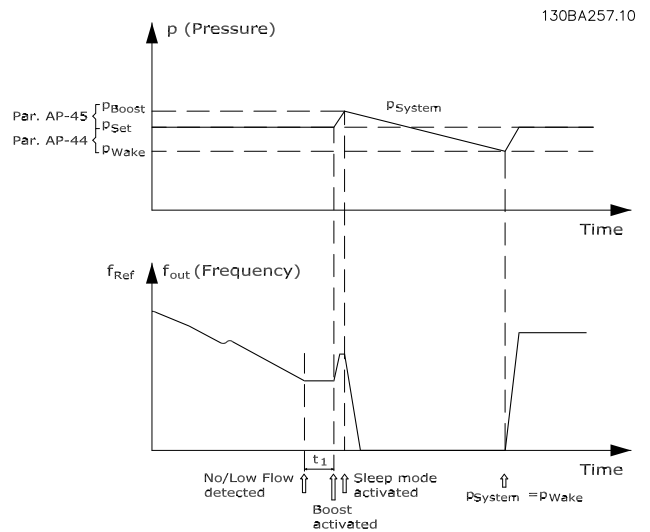

If no flow is detected, the frequency converter will increase the set point for pressure to ensure a slight over pressure in the system (boost to be set in AP-45 Setpoint Boost). The feedback from the pressure transducer is monitored and when this pressure has dropped with a set percentage below the normal set point for pressure (Pset), the motor will accel again and pressure will be controlled for reaching the set value (Pset).

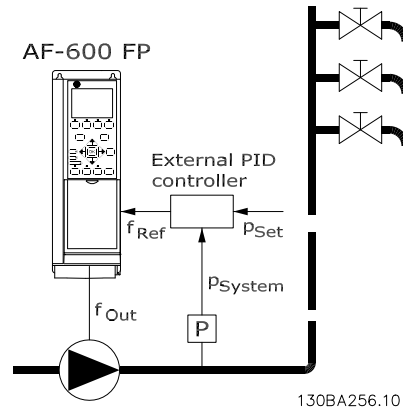

2) In systems where the pressure or temperature is controlled by an external PI controller, the wake up conditions can not be based on feedback from the pressure/temperature transducer as the setpoint is not known. In the example with a boost system, desired pressure Pset is not known. H-40 Configuration Mode must be set for Open Loop. Example: Boost system.



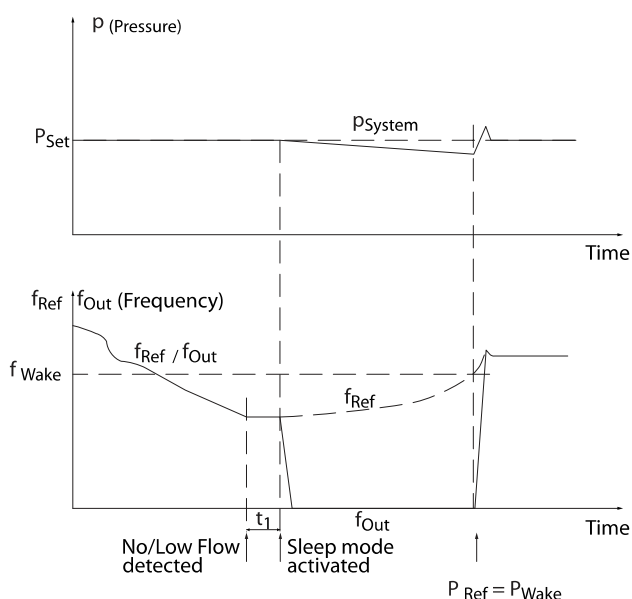

130BA258.10 When low power or low speed is detected the motor is stopped, but the reference signal ( $f_{ref}$ ) from the external controller is still monitored and because of the low pressure created, the controller will increase the reference signal to gain pressure. When the reference signal has reached a set value  $f_{wake}$  the motor restarts.

The speed is set manually by an external reference signal (Remote Reference). The settings (parameter group AP-3#) for tuning of the No Flow function must be set to default.

Configuration possibilities, overview:

	Internal PI Controller (H-40 Configuration Mode: Closed loop)		External PI Controller or manual control (H-40 Configuration Mode: Open loop)	
	Sleep mode	Wake up	Sleep mode	Wake up
No Flow detection (pumps only)	Yes		Yes (except manual setting of speed)	
Low speed detection	Yes		Yes	
External signal	Yes		Yes	
Pressure/Temperature (transmitter connected)		Yes		No
Output frequency		No		Yes

NOTE

Sleep Mode will not be active when Local Reference is active (set speed manually by means of arrow buttons on the keypad). See F-02 Operation Method.

Does not work in Hand-mode. Auto set-up in open loop must be carried out before setting input/output in closed loop.

AP-40 Minimum Run Time		
Range:	Function:	
10 s* [0 - 600 s]	Set the desired minimum running time for the motor after a start command (digital input or Bus) before entering Sleep Mode.	

AP-41 Minimum Sleep Time		
Range:	Function:	
10 s* [0 - 600 s]	Set the desired Minimum Time for staying in Sleep Mode. This will override any wake up conditions.	

AP-42 Wake-up Speed [RPM]		
Range:	Function:	
0 RPM* [par. F-18 - par. F-17 RPM]	To be used if K-02 Motor Speed Unit has been set for RPM (parameter not visible if Hz selected). Only to be used if H-40 Configuration Mode is set for Open Loop and speed reference is applied by an external controller. Set the reference speed at which the Sleep Mode should be cancelled.	

AP-43 Wake-up Speed [Hz]		
Range:	Function:	
0 Hz* [par. F-16 - par F-17 Hz]	To be used if K-02 Motor Speed Unit, has been set for Hz (parameter not visible if RPM selected). Only to be used if H-40 Configuration Mode, is set for Open Loop and speed reference is applied by an external controller controlling the pressure. Set the reference speed at which the Sleep Mode should be cancelled.	



AP-44 Wake-up Ref./FB Difference		
Range:		Function:
10 %*	[0 - 100 %]	Only to be used if <i>H-40 Configuration Mode</i> is set for Closed Loop and the integrated PI controller is used for controlling the pressure. Set the pressure drop allowed in percentage of set point for the pressure (Pset) before cancelling the Sleep Mode.

**NOTE**

If used in application where the integrated PI controller is set for inverse control (e.g. cooling tower applications) in *CL-71 PID Performance*, the value set in *AP-44 Wake-up Ref./FB Difference* will automatically be added.

AP-45 Setpoint Boost		
Range:		Function:
0 %*	[-100 - 100 %]	Only to be used if <i>H-40 Configuration Mode</i> , is set for Closed Loop and the integrated PI controller is used. In systems with e.g. constant pressure control, it is advantageous to increase the system pressure before the motor is stopped. This will extend the time in which the motor is stopped and help to avoid frequent start/stop. Set the desired over pressure/temperature in percentage of set point for the pressure (Pset)/ temperature before entering the Sleep Mode. If setting for 5%, the boost pressure will be Pset*1.05. The negative values can be used for e.g. cooling tower control where a negative change is needed.

AP-46 Maximum Boost Time		
Range:		Function:
60 s*	[0 - 600 s]	Only to be used if <i>H-40 Configuration Mode</i> is set for Closed Loop and the integrated PI controller is used for controlling the pressure. Set the maximum time for which boost mode will be allowed. If the set time is exceeded, Sleep Mode will be entered, not waiting for the set boost pressure to be reached.

3.19.4 AP-5# End of Curve

The End of Curve conditions occur when a pump is yielding a too large volume to ensure the set pressure. This can occur if there is a leakage in the distribution pipe system after the pump causing the pump to operate at the end of the pump characteristic, valid for the max. speed set in *F-17 Motor Speed High Limit [RPM]* or *F-15 Motor Speed High Limit [Hz]*.

In case the feed back is 2.5% of the programmed value in *CL-14 Maximum Reference/Feedb.* (or numerical value of *CL-13 Minimum Reference/Feedb.* whichever is highest) below the set point for the desired pressure for a set time

(*AP-51 End of Curve Delay*), and the pump is running with max. speed set in *F-17 Motor Speed High Limit [RPM]* or *F-15 Motor Speed High Limit [Hz]*, - the function selected in *AP-50 End of Curve Function* will take place.

It is possible to get a signal on one of the digital outputs by selecting End of Curve [192] in parameter group E-2# *Digital Outputs and Relays*. The signal will be present, when an End of Curve condition occurs and the selection in *AP-50 End of Curve Function*, is different from Off. The end of curve function can only be used when operating with the built-in PID controller (Closed loop in *H-40 Configuration Mode*).

AP-50 End of Curve Function		
Option:		Function:
[0] *	Off	End of Curve monitoring not active.
[1]	Warning	The drive will continue to run, but activate a End of Curve warning [W94]. A drive digital output or a serial communication bus can communicate a warning to other equipment.
[2]	Alarm	The drive will stop running and activate a End of Curve alarm [A 94]. A drive digital output or a serial communication bus can communicate an alarm to other equipment.
[3]	Man. Reset Alarm	The drive will stop running and activate a End of Curve alarm [A 94]. A drive digital output or a serial communication bus can communicate an alarm to other equipment.

**NOTE**

Automatic restart will reset the alarm and start the system again.

**NOTE**

Do not set *H-04 Auto-Reset (Times)*, to [13] Infinite auto reset, when *AP-50 End of Curve Function* is set to [2] Alarm. Doing so will cause the drive to continuously cycle between running and stopping when a End of Curve condition is detected.

**NOTE**

If the drive is equipped with a constant speed bypass with an automatic bypass function that starts the bypass if the drive experiences a persistent alarm condition, be sure to disable the bypass's automatic bypass function, if [2] Alarm or [3] Man. Reset Alarm is selected as the End of Curve Function.



AP-51 End of Curve Delay		
Range:		Function:
10 s*	[0 - 600 s]	When an End of Curve condition is detected, a timer is activated. When the time set in this parameter expires, and the End of Curve condition has been steady in the entire period, the function set in AP-50 End of Curve Function will be activated. If the condition disappears before the timer expires, the timer will be reset.

AP-62 Broken Belt Delay		
Range:		Function:
10 s	[0 - 600 s]	Sets the time for which the Broken Belt conditions must be active before carrying out the action selected in AP-60 Broken Belt Function.

### 3.19.5 AP-6# Broken Belt Detection

The Broken Belt Detection can be used in both closed and open loop systems for pumps, fans and compressors. If the estimated motor torque is below the broken belt torque value (AP-61 Broken Belt Torque) and the frequency converter output frequency is above or equal to 15 Hz, the broken belt function (AP-60 Broken Belt Function) is performed

AP-60 Broken Belt Function		
Selects the action to be performed if the Broken Belt condition is detected		
Option:	Function:	
[0] *	Off	
[1]	Warning	The drive will continue to run, but activate a Broken Belt Warning [W95]. A drive digital output or a serial communication bus can communicate a warning to other equipment.
[2]	Trip	The drive will stop running and activate a Broken Belt alarm [A 95]. A drive digital output or a serial communication bus can communicate an alarm to other equipment.

#### NOTE

Do not set H-04 Auto-Reset (Times), to [13] Infinite auto reset, when AP-60 Broken Belt Function is set to [2] Trip. Doing so will cause the drive to continuously cycle between running and stopping when a broken belt condition is detected.

#### NOTE

If the drive is equipped with a constant speed bypass with an automatic bypass function that starts the bypass if the drive experiences a persistent alarm condition, be sure to disable the bypass's automatic bypass function, if [2] Trip is selected as the Broken Belt Function.

AP-61 Broken Belt Torque		
Range:		Function:
10 %*	[0 - 100 %]	Sets the broken belt torque as a percentage of the rated motor torque.

### 3.19.6 AP-7# Short Cycle Protection

When controlling refrigeration compressors, often there will be a need for limiting the numbers of starts. One way to do this is to ensure a minimum run time (time between a start and a stop) and a minimum interval between starts. This means that any normal stop command can be overridden by the *Minimum Run Time* function (AP-77 Minimum Run Time) and any normal start command (Start/Jog/Freeze) can be overridden by the *Interval Between Starts* function (AP-76 Interval between Starts). None of the two functions are active if *Hand* or *Off* modes have been activated via the keypad. If selecting *Hand* or *Off*, the two timers will be reset to 0, and not start counting until *Auto* is pressed and an active start command applied.

AP-70 Compressor Start Max Speed [RPM]		
Range:		Function:
0 RPM*	[0 - par. F-17 RPM]	The parameter enables "High Starting Torque". This is a function, where the Current Limit and Torque Limit are ignored during start of the motor. The time, from the start signal is given until the speed exceeds the speed set in this parameter, becomes a "start-zone" where the current limit and motoric torque limit is set to what is maximum possible for the drive/motor combination. This parameter is normally set to the same value as F-18 Motor Speed Low Limit [RPM]. When set to zero the function is inactive. In this "starting-zone" AP-73 Starting Acceleration Time is active instead of F-07 Accel Time 1 to ensure extra acceleration during the start and to minimize the time where the motor is operated under the minimum speed for the application. The time without protection from the Current Limit and Torque Limit must not exceed the value set in AP-72 Compressor Start Max Time to Trip or the drive will trip with an alarm [A18] Start Failed. When this function is activated to get a fast start then also H-36 Trip Speed Low [RPM] is activated to protect the application from running below minimum motor speed e.g. when in current limit. This function allows high starting torque and use of a fast starting ramp. To ensure the build-up of a high torque during the start, various



AP-70 Compressor Start Max Speed [RPM]		
Range:	Function:	
		tricks can be done through clever use of start delay / start speed / start current.

AP-71 Compressor Start Max Speed [Hz]		
Range:	Function:	
0 Hz*	[0.0 - par. F-15 Hz]	The parameter enables "High Starting Torque". This is a function, where the Current Limit and Torque Limit are ignored during start of the motor. The time, from the start signal is given until the speed exceeds the speed set in this parameter, becomes a "start-zone" where the current limit and motoric torque limit is set to what is maximum possible for the drive/motor combination. This parameter is normally set to the same value as <i>F-18 Motor Speed Low Limit [RPM]</i> . When set to zero the function is inactive. In this "starting-zone" <i>AP-73 Starting Acceleration Time</i> is active instead of <i>F-07 Accel Time 1</i> to ensure extra acceleration during the start and to minimize the time where the motor is operated under the minimum speed for the application. The time without protection from the Current Limit and Torque Limit must not exceed the value set in <i>AP-72 Compressor Start Max Time to Trip</i> or the drive will trip with an alarm [A18] Start Failed. When this function is activated to get a fast start then also <i>H-36 Trip Speed Low [RPM]</i> is activated to protect the application from running below minimum motor speed e.g. when in current limit. This function allows high starting torque and use of a fast starting ramp. To ensure the build-up of a high torque during the start, various tricks can be done through clever use of start delay / start speed / start current.

AP-72 Compressor Start Max Time to Trip		
Range:	Function:	
5.0 s*	[0.0 - 10.0 s]	The time, from the start signal is given until the speed exceeds the speed set in <i>AP-70 Compressor Start Max Speed [RPM]</i> must not exceed the time set in the parameter or the drive will trip with an alarm [A18] Start Failed. Any time set in <i>F-24 Holding Time</i> for use of a start function must be executed within the time limit.

AP-73 Starting Acceleration Time		
Range:	Function:	
20.00 s*	[0.01 - 3600.00 s]	

AP-75 Short Cycle Protection		
Option:	Function:	
[0] *	Disabled	Timer set in <i>AP-76 Interval between Starts</i> is disabled.
[1]	Enabled	Timer set in <i>AP-76 Interval between Starts</i> is enabled.

AP-76 Interval between Starts		
Range:	Function:	
par. AP-77 s*	[par. AP-77 - 3600 s]	Sets the time desired as minimum time between two starts. Any normal start command (Start/Jog/Freeze) will be disregarded until the timer has expired.

AP-77 Minimum Run Time		
Range:	Function:	
0 s*	[0 - par. AP-76 s]	Sets the time desired as minimum run time after a normal start command (Start/Jog/Freeze). Any normal stop command will be disregarded until the set time has expired. The timer will start counting following a normal start command (Start/Jog/Freeze). The timer will be overridden by a Coast (Inverse) or an External Interlock command.

**NOTE**

Does not work in cascade mode.

3.19.7 AP-8#

It is sometimes the case that is not possible for a pressure transducer to be placed at a remote point in the system and it can only be located close to the fan/pump outlet. Flow compensation operates by adjusting the set-point according to the output frequency, which is almost proportional to flow, thus compensating for higher losses at higher flow rates.

$H_{DESIGN}$  (Required pressure) is the setpoint for closed loop (PI) operation of the frequency converter and is set as for closed loop operation without flow compensation.

It is recommended to use slip compensation and RPM as unit.

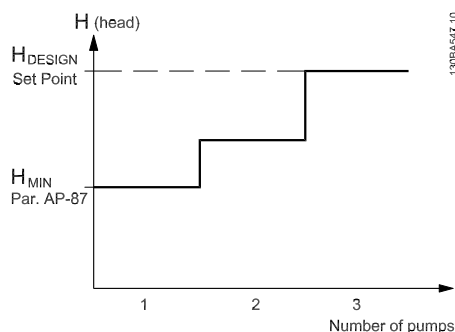
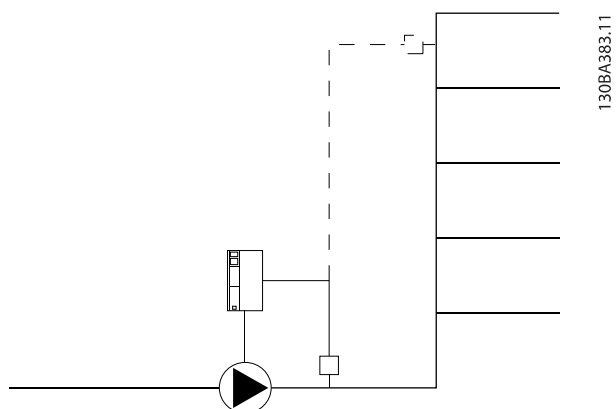

**NOTE**

When flow compensation is used with the Pump Controller (parameter group PC-##), the actual set-point will not depend on speed (flow) but on the number of pumps cut in. See below:

There are two methods which can be employed, depending upon whether or not the Speed at System design Working Point is known.

Parameter used	Speed at Design Point KNOWN	Speed at Design Point UNKNOWN	Pump Controller
Flow Compensation, AP-80	+	+	+
Square-Linear Curve Approximation, AP-81	+	+	-
Work Point Calculation, AP-82	+	+	-
Speed at No Flow, AP-83/AP-84	+	+	-
Speed at Design Point, AP-85/AP-86	+	-	-
Pressure at No Flow, AP-87	+	+	+
Pressure at Rated Speed, AP-88	-	+	-
Flow at Design Point, AP-89	-	+	-
Flow at Rated Speed, AP-90	-	+	-

AP-80 Flow Compensation		
Option:	Function:	
[0] *	Disabled	[0] <i>Disabled:</i> Set-Point compensation not active.
[1]	Enabled	[1] <i>Enabled:</i> Set-Point compensation is active. Enabling this parameter allows the Flow Compensated Setpoint operation.

AP-81 Square-linear Curve Approximation		
Range:	Function:	
100 %*	[0 - 100 %]	<b>Example 1:</b> Adjustment of this parameter allows the shape of the control curve to be adjusted. 0 = Linear 100% = Ideal shape (theoretical).

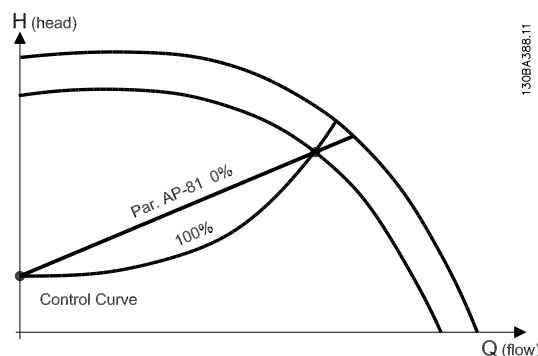

**NOTE**

Not visible when running in cascade.

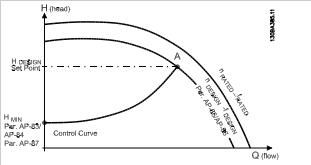
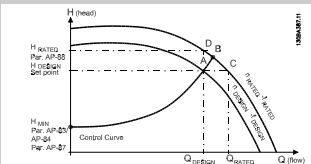

AP-82 Work Point Calculation		
Option:	Function:	
	<p><b>Example 1:</b> Speed at System Design Working Point is known:</p>  <p>From the data sheet showing characteristics for the specific equipment at different speeds, simply reading across from the <math>H_{DESIGN}</math> point and the <math>Q_{DESIGN}</math> point allows us to find point A, which is the System Design Working Point. The pump characteristics at this point should be identified and the associated speed programmed. Closing the valves and adjusting the speed until <math>H_{MIN}</math> has been achieved allows the speed at the no flow point to be identified.</p> <p>Adjustment of AP-81 Square-linear Curve Approximation then allows the shape of the control curve to be adjusted infinitely.</p> <p><b>Example 2:</b> Speed at System Design Working Point is not known: Where the Speed at System Design Working Point is unknown, another reference point on the control curve needs to be determined by means of the data sheet. By looking at the curve for the rated speed and plotting the design pressure (<math>H_{DESIGN}</math>, Point C) the flow at that pressure <math>Q_{RATED}</math> can be determined. Similarly, by plotting the design flow (<math>Q_{DESIGN}</math>, Point D) the pressure <math>H_D</math> at that flow can be determined. Knowing these two points on the pump curve, along with <math>H_{MIN}</math> as described above, allows the frequency converter to calculate the reference point B and thus to plot the control curve which will also include the System design Working Point A.</p> 	
[0]	Disabled	Disabled [0]: Work Point Calculation not active. To be used if speed at design point is known (see table above).
[1]	Enabled	Enabled [1]: Work Point Calculation is active. Enabling this parameter allows the calculation of the unknown System Design Working Point at 50/60 Hz speed, from the input data set in AP-83 Speed at No-Flow [RPM] AP-84 Speed at No-Flow [Hz], AP-87 Pressure at No-Flow Speed,

AP-82 Work Point Calculation		
Option:	Function:	
	AP-88 Pressure at Rated Speed, AP-89 Flow at Design Point and AP-90 Flow at Rated Speed.	

AP-83 Speed at No-Flow [RPM]		
Range:	Function:	
300. RPM*	[0 - par. AP-85 RPM]	Resolution 1 RPM. The speed of the motor at which flow is zero and minimum pressure $H_{MIN}$ is achieved should be entered here in RPM. Alternatively, the speed in Hz can be entered in AP-84 Speed at No-Flow [Hz]. If it has been decided to use RPM in K-02 Motor Speed Unit then AP-85 Speed at Design Point [RPM] should also be used. Closing the valves and reducing the speed until minimum pressure $H_{MIN}$ is achieved will determine this value.

AP-84 Speed at No-Flow [Hz]		
Range:	Function:	
50.0 Hz*	[0.0 - par. AP-86 Hz]	Resolution 0.033 Hz. The speed of the motor at which flow has effectively stopped and minimum pressure $H_{MIN}$ is achieved should be entered here in Hz. Alternatively, the speed in RPM can be entered in AP-83 Speed at No-Flow [RPM]. If it has been decided to use Hz in K-02 Motor Speed Unit then AP-86 Speed at Design Point [Hz] should also be used. Closing the valves and reducing the speed until minimum pressure $H_{MIN}$ is achieved will determine this value.

AP-85 Speed at Design Point [RPM]		
Range:	Function:	
F-17*	[par. AP-83 - 60000. RPM]	Resolution 1 RPM. Only visible when AP-82 Work Point Calculation is set to Disable. The speed of the motor at which the System Design Working Point is achieved should be entered here in RPM. Alternatively, the speed in Hz can be entered in AP-86 Speed at Design Point [Hz]. If it has been decided to use RPM in K-02 Motor Speed Unit then AP-83 Speed at No-Flow [RPM] should also be used.



AP-86 Speed at Design Point [Hz]		
Range:	Function:	
50/60.0 Hz*	[par. AP-84 - par. F-03 Hz]	Resolution 0.033 Hz. Only visible when <i>AP-82 Work Point Calculation</i> is set to <i>Disable</i> . The speed of the motor at which the System Design Working Point is achieved should be entered here in Hz. Alternatively, the speed in RPM can be entered in <i>AP-85 Speed at Design Point [RPM]</i> . If it has been decided to use Hz in <i>K-02 Motor Speed Unit</i> , then <i>AP-83 Speed at No-Flow [RPM]</i> should also be used.

AP-87 Pressure at No-Flow Speed		
Range:	Function:	
0.000 N/A*	[0.000 - par. AP-88 N/A]	Enter the pressure $H_{MIN}$ corresponding to Speed at No Flow in Reference/Feedback Units.

Please also see *AP-82 Work Point Calculation* point D.

AP-88 Pressure at Rated Speed		
Range:	Function:	
999999.999 N/A*	[par. AP-87 - 999999.999 N/A]	Enter the value corresponding to the Pressure at Rated Speed, in Reference/Feedback Units. This value can be defined using the pump datasheet.

Please also see *AP-82 Work Point Calculation* point A.

AP-89 Flow at Design Point		
Range:	Function:	
0.000 N/A*	[0.000 - 999999.999 N/A]	Enter the value corresponding to the Flow at Design Point. No units necessary.

Please also see *AP-82 Work Point Calculation* point C.

AP-90 Flow at Rated Speed		
Range:	Function:	
0.000 N/A*	[0.000 - 999999.999 N/A]	Enter the value corresponding to Flow at Rated Speed. This value can be defined using the pump datasheet.





## 3.20 FB-## Fire/Bypass Operation

## 3.20.1 FB-0# Fire Mode

**CAUTION**

Please note the frequency converter is only one component of the AF-600 FP system. Correct function of Fire Mode depends on the correct design and selection of system components. Ventilation systems working in life safety applications have to be approved by the local fire Authorities. *Non-interruption of the frequency converter due to Fire Mode operation could cause over pressure and result in damage to AF-600 FP system and components, hereunder dampers and air ducts. The frequency converter itself could be damaged and it may cause damage or fire. GE accepts no responsibility for errors, malfunctions personal injury or any damage to the frequency converter itself or components herein, AF-600 FP systems and components herein or other property when the frequency converter has been programmed for Fire Mode. In no event shall GE be liable to the end user or any other party for any direct or indirect, special or consequential damage or loss suffered by such party, which has occurred due to the frequency converter being programmed and operated in Fire Mode*

**Background**

Fire Mode is for use in critical situations, where it is imperative for the motor to keep running, regardless of the frequency converter's normal protective functions. These could be ventilation fans in tunnels or stairwells for

instance, where continued operation of the fan facilitates safe evacuation of personnel in the event of a fire. Some selections of Fire Mode Function cause alarms and trip conditions to be disregarded, enabling the motor to run without interruption.

**Activation**

Fire Mode is activated only via Digital Input terminals. See parameter group E-0# Digital Inputs.

**Messages in display**

When Fire Mode is activated, the display will show a status message "Fire Mode" and a warning "Fire Mode".

Once the Fire Mode is again deactivated, the status messages will disappear and the warning will be replaced by the warning "Fire M Was Active". This message can only be reset by power-cycling the frequency converter supply. If, whilst the frequency converter is active in Fire Mode, a warranty-affecting alarm (see *FB-09 Fire Mode Alarm Handling*) should occur, display will show the warning "Fire M Limits Exceeded".

Digital and relay outputs can be configured for the status messages "Fire Mode Active" and the warning "Fire M Was Active". See parameter group E-2#.

"Fire M was Active" messages can also be accessed in the warning word via serial communication. (See relevant documentation).

The status messages "Fire Mode" can be accessed via the extended status word.

Message	Type	Keypad	Messages in display	Warning Word 2	Ext. Status Word 2
Fire Mode	Status	+	+		+(bit 25)
Fire Mode	Warning	+			
Fire M was Active	Warning	+	+	+(bit 3)	
Fire M Limits Exceeded	Warning	+	+		

**Log**

An overview of events related to Fire Mode can be viewed in the Fire Mode log, parameter group LG-1#, or via the Alarm Log button on the keypad.

The log will include up to 10 of the latest events. Warranty Affecting Alarms will have a higher priority as the two other types of events.

The log cannot be reset!

Following events are logged:

\*Warranty affecting alarms (see *FB-09 Fire Mode Alarm Handling*, Fire Mode Alarm Handling)

\*Fire Mode activated

\*Fire Mode deactivated

All other alarms occurring while Fire Mode activated will be logged as usual.

**NOTE**

**During Fire Mode operation all stop commands to the frequency converter will be ignored, including Coast/Coast inverse and External Interlock. See Section "How to Order / Ordering Form Model number".**



**NOTE**

If in Fire Mode it is desired to use the Live Zero function, then it will also be active for analog inputs other than that used for Fire Mode setpoint / feedback. Should the feedback to any of those other analog inputs be lost, for example a cable is burned, Live Zero function will operate. If this is undesirable then Live Zero function must be disabled for those other inputs.

Desired Live Zero function in case of missing signal when Fire Mode active, must be set in *AN-02 Fire Mode Live Zero Timeout Function*.

Warning for Live Zero will have a higher priority than the warning "Fire Mode".

**NOTE**

If setting the command Start Reversing [11] on a digital input terminal in *E-01 Terminal 18 Digital Input*, the drive will understand this as a reversing command.

FB-00 Fire Mode Function		
Option:	Function:	
[0] *	Disabled	Fire Mode Function is not active.
[1]	Enabled - Run Forward	In this mode the motor will continue to operate in a clockwise direction. Works only in Open Loop. Set <i>FB-01 Fire Mode Configuration</i> to Open Loop [0].
[2]	Enabled - Run Reverse	In this mode the motor will continue to operate in a counter-clockwise direction. Works only in Open Loop. Set <i>FB-01 Fire Mode Configuration</i> to Open Loop [0].
[3]	Enabled - Coast	Whilst this mode is enabled, the output is disabled and the motor is allowed to coast to stop.
[4]	Enabled - Run Fwd/Rev	

**NOTE**

In the above, alarms are produced or ignored in accordance with the selection in *FB-09 Fire Mode Alarm Handling*.

FB-01 Fire Mode Configuration		
Option:	Function:	
[0] *	Open Loop	When Fire Mode is active, the motor will run with a fixed speed based on a Reference set. Unit will be the same as selected in <i>K-02 Motor Speed Unit</i> .
[3]	Closed Loop	When Fire Mode is active, the build in PID controller will control the speed based on the set point and a feed back signal, selected in <i>FB-07 Fire Mode Feedback Source</i> . Unit to be selected in <i>FB-02 Fire Mode Unit</i> . For other PID controller settings use parameter group CL-## as

FB-01 Fire Mode Configuration		
Option:	Function:	
		for normal operation. If the motor also is controlled by the build in PID controller when in normal operation, the same transmitter can be used for both cases by selecting the same source.

**NOTE**

Before adjusting the PID controller set *FB-09 Fire Mode Alarm Handling*, [2] Trip, All Alarms/Test.

**NOTE**

If Enable-Run Reverse is selected in *FB-00 Fire Mode Function*, Closed Loop cannot be selected in *FB-01 Fire Mode Configuration*.

FB-02 Fire Mode Unit		
Option:	Function:	
		Select the desired unit when Fire Mode is active and running in Closed Loop.
[0] *		
[1]	%	
[2]	RPM	
[3]	Hz	
[4]	Nm	
[5]	PPM	
[10]	1/min	
[11]	RPM	
[12]	Pulse/s	
[20]	l/s	
[21]	l/min	
[22]	l/h	
[23]	m <sup>3</sup> /s	
[24]	m <sup>3</sup> /min	
[25]	m <sup>3</sup> /h	
[30]	kg/s	
[31]	kg/min	
[32]	kg/h	
[33]	t/min	
[34]	t/h	
[40]	m/s	
[41]	m/min	
[45]	m	
[60]	°C	
[70]	mbar	
[71]	bar	
[72]	Pa	
[73]	kPa	
[74]	m WG	
[75]	mm Hg	
[80]	kW	
[120]	GPM	
[121]	gal/s	



FB-02 Fire Mode Unit		
Option:	Function:	
[122]	gal/min	
[123]	gal/h	
[124]	CFM	
[125]	ft <sup>3</sup> /s	
[126]	ft <sup>3</sup> /min	
[127]	ft <sup>3</sup> /h	
[130]	lb/s	
[131]	lb/min	
[132]	lb/h	
[140]	ft/s	
[141]	ft/min	
[145]	ft	
[160]	°F	
[170]	psi	
[171]	lb/in <sup>2</sup>	
[172]	in WG	
[173]	ft WG	
[174]	in Hg	
[180]	HP	

FB-03 Fire Mode Min Reference		
Range:	Function:	
0 FireModeUnit*	[-999999.999 - par. FB-04 FireModeUnit]	Minimum value for the reference/set point (limiting the sum of value in <i>FB-05 Fire Mode Preset Reference</i> and value of signal on input selected in <i>FB-06 Fire Mode Reference Source</i> ).  If running in Open loop when Fire Mode is active, the unit is chosen by the setting of <i>K-02 Motor Speed Unit</i> . For closed loop, the unit is selected in <i>FB-02 Fire Mode Unit</i> .

FB-04 Fire Mode Max Reference		
Range:	Function:	
50/60*	[par. FB-03 - 999999.999 FireModeUnit]	Maximum value for the reference/set point (limiting the sum of value in <i>FB-05 Fire Mode Preset Reference</i> and value of signal on input selected in <i>FB-06 Fire Mode Reference Source</i> ).  If running in Open loop when Fire Mode is active, the unit is chosen by the setting of <i>K-02 Motor Speed Unit</i> . For closed loop, the unit is selected in <i>FB-02 Fire Mode Unit</i> .

FB-05 Fire Mode Preset Reference		
Range:	Function:	
0.00 %*	[-100.00 - 100.00 %]	Enter the required preset reference/set point as a percentage of the Fire Mode Max Reference set in <i>FB-04 Fire Mode Max Reference</i> . The set value will be

FB-05 Fire Mode Preset Reference		
Range:	Function:	
		added to the value represented by the signal on the analog input selected in <i>FB-06 Fire Mode Reference Source</i> .

FB-06 Fire Mode Reference Source		
Option:	Function:	
		Select the external reference input to be used for the Fire Mode. This signal will be added to the value set in <i>FB-06 Fire Mode Reference Source</i> .
[0] *	No function	
[1]	Analog input 53	
[2]	Analog input 54	
[7]	Pulse input 29	
[8]	Pulse input 33	
[20]	Digital Potentiometer	
[21]	Analog input X30/11	(OPCGPIO)
[22]	Analog input X30/12	(OPCGPIO)
[23]	Analog Input X42/1	(OPCAIO)
[24]	Analog Input X42/3	(OPCAIO)
[25]	Analog Input X42/5	(OPCAIO)

FB-07 Fire Mode Feedback Source		
Option:	Function:	
		Select the feed back input to be used for the Fire Mode feed back signal when Fire Mode is active. If the motor also is controlled by the built in PID controller when in normal operation, the same transmitter can be used for both cases by selecting the same source.
[0] *	No function	
[1]	Analog input 53	
[2]	Analog input 54	
[3]	Pulse input 29	
[4]	Pulse input 33	
[7]	Analog input X30/11	(OPCGPIO)
[8]	Analog input X30/12	(OPCGPIO)
[9]	Analog Input X42/1	(OPCAIO)
[10]	Analog Input X42/3	(OPCAIO)
[11]	Analog Input X42/5	(OPCAIO)
[100]	Bus feedback 1	
[101]	Bus feedback 2	
[102]	Bus feedback 3	



FB-09 Fire Mode Alarm Handling		
Option:	Function:	
[0]	Trip+Reset, Critical Alarms	If this mode is selected, the frequency converter will continue to run, ignoring most alarms, even if doing so it may result in damage of the frequency converter. Critical alarms are alarms, which cannot be suppressed but a restart attempt is possible (Infinity Automatic Reset).
[1] *	Trip, Critical Alarms	In case of a critical alarm, the frequency converter will trip and not auto-restart (Manual Reset).
[2]	Trip, All Alarms/Test	It is possible to test the operation of Fire Mode, but all alarm states are activated normally (Manual Reset).

**NOTE**

**Warranty-affecting alarms.** Certain alarms can affect the lifetime of the frequency converter. Should one of these ignored alarms occur whilst in Fire Mode, a log of the event is stored in the Fire Mode Log. Here the 10 latest events of warranty-affecting alarms, fire mode activation and fire mode deactivation are stored.

**NOTE**

The setting in *H-04 Auto-Reset (Times)* is disregarded in case of Fire Mode being active (see parameter group FB-0#, Fire Mode).

No:	Description	Critical Alarms	Warranty Affecting Alarms
4	Mains ph. Loss		x
7	DC over volt	x	
8	DC under volt	x	
9	Inverter overloaded		x
13	Over current	x	
14	Earth fault	x	
16	Short circuit	x	
29	Power card temp		x
33	Inrush fault		x
38	Internal fault		x
65	Ctrl. card temp		x
68	SafeStop	x	

3.20.2 FB-1# Drive Bypass

The frequency converter includes a feature, which can be used to automatically activate an external electro-mechanical bypass in case of a trip/trip lock of the frequency converter or the event of a Fire Mode Coast (see *FB-00 Fire Mode Function*).

The bypass will switch the motor to operation direct on line. The external bypass is activated by means of one of the digital outputs or relays in the frequency converter, when programmed in parameter group E-2#.

To deactivate the Drive Bypass at normal operation (Fire Mode not activated), one of following actions must be carried out:

- Press the Off button on the keypad, (or program two of the digital inputs for Hand-Off-Auto).
- Activate External Interlock via digital input
- Carry out a Power Cycling.

**NOTE**

The Drive Bypass cannot be deactivated if in Fire Mode. It can be deactivated only by either removing the Fire Mode command signal or the power supply to the frequency converter!

When the Drive Bypass function is activated, the display on the keypad will show the status message Drive Bypass. This message has a higher priority than the Fire Mode status messages. When the automatic Drive Bypass function is enabled, it will cut in the external bypass according to the below sequence:



Parameter Description AF-600 FP Programming Guide

3

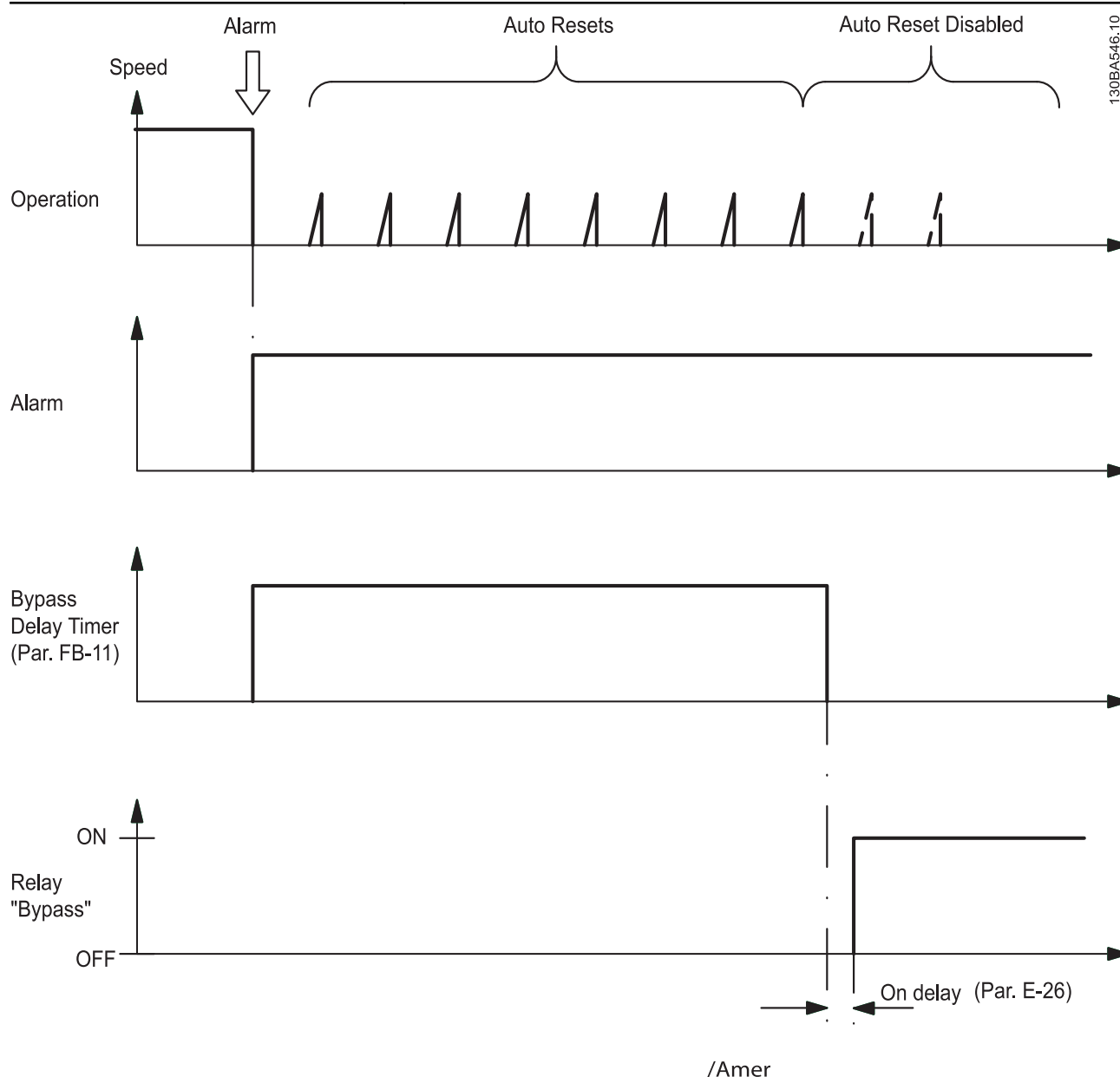

FB-10 Drive Bypass Function		
Option:	Function:	
		This parameter determines, what circumstances will activate the Drive Bypass Function:
[0] *	Disabled	
[1]	Enabled	<p>If in normal operation the automatic Drive Bypass Function will be activated at following conditions:</p> <p>At a Trip Lock or a Trip. After the programmed number of reset attempts, programmed in <i>H-04 Auto-Reset (Times)</i> or if the Bypass Delay Timer (<i>FB-11 Drive Bypass Delay Time</i>) expires before reset attempts have been completed</p> <p>When in Fire Mode, the Bypass Function will operate under following conditions:</p>

FB-10 Drive Bypass Function		
Option:	Function:	
		When experiencing a trip at critical alarms, a Coast or if the Bypass Delay Timer expires before reset attempts have completed when [2] Enabled in Fire Mode. The Bypass Function will operate at trip at critical alarms, Coast or if the Bypass Delay Timer expires before reset attempts have been completed.
[2]	Enabled (Fire M Only)	The Bypass Function will operate at Trip at Critical Alarms, Coast or Bypass Delay Timer if the timer expires before reset attempts have completed.



FB-11 Drive Bypass Delay Time		
Range:	Function:	
0 s* [0 - 600 s]	<p>Programmable in 1 s increments. Once the Bypass Function is activated in accordance with the setting in <i>FB-10 Drive Bypass Function</i>, the Bypass Delay Timer begins to operate. If the frequency converter has been set for a number of restart attempts, the timer will continue to run while the frequency converter tries to restart. Should the motor have restarted within the time period of the Bypass Delay Timer, then the timer is reset.</p> <p>Should the motor fail to restart at the end of the Bypass Delay Time, the Drive Bypass relay will be activated, which will have been programmed for Bypass in <i>E-24 Function Relay</i>. If a [Relay Delay] has also been programmed in <i>E-26 On Delay, Relay, [Relay]</i> or <i>E-27 Off Delay, Relay, [Relay]</i>, then this time must also elapse before the relay action is performed.</p> <p>Where no restart attempts are programmed, the timer will run for the delay period set in this parameter and will then activate the Drive Bypass relay, which will have been programmed for Bypass in <i>E-24 Function Relay, Function Relay</i>. If a Relay Delay has also been programmed in <i>E-26 On Delay, Relay, On Delay, Relay</i> or <i>E-27 Off Delay, Relay, [Relay]</i>, then this time must also elapse before the relay action is performed.</p>	



### 3.21 T-## Timed Functions

#### 3.21.1 T-0#

Use *Timed Actions* for actions needing to be performed on a daily or weekly basis, e.g. different references for working hours / non-working hours. Up to 10 Timed Actions can be programmed in the frequency converter. The Timed Action number is selected from the list when entering parameter group T-0# from the keypad. *T-00 ON Time* – *T-04 Occurrence* then refer to the selected Timed Action number. Each Timed Action is divided into an ON time and an OFF time, in which two different actions may be performed.

The clock control (parameter group *K-7\* Clock Settings*) of Timed Actions can be overridden from *Timed Actions Auto* (Clock Controlled) to *Timed Actions Disabled*, *Constant OFF Actions* or *Constant ON Actions* either in *T-08 Timed Actions Mode* or with commands applied to the digital inputs ([68] *Timed Actions Disabled*, [69] *Constant OFF Actions* or [70] *Constant ON Actions*, in parameter group *E-0\* Digital Inputs*).

Display lines 2 and 3 in the keypad show the status for Timed Actions Mode (*K-23 Display Line 2 Large* and *K-24 Display Line 3 Large*, setting [1243] *Timed Actions Status*).

#### NOTE

A change in mode via the digital inputs can only take place if *T-08 Timed Actions Mode* is set for [0] *Times Actions Auto*.

If commands are applied simultaneously to the digital inputs for Constant OFF and Constant ON, the Timed Actions mode will change to Timed Actions Auto and the two commands will be disregarded.

If *K-70 Date and Time* is not set or the frequency converter is set to HAND or OFF mode (e.g. via the keypad), the Timed Actions mode will be change to *Timed Actions Disabled*.

The Timed Actions have a higher priority than the same actions/commands activated by the digital inputs or the Smart Logic Controller.

#### NOTE

The clock (parameter group *K-7#*) must be correctly programmed for Timed Actions to function correctly.

#### NOTE

When mounting an Analog I/O OPCAIO option card, a battery back up of the date and time is included.

T-00 ON Time		
Array [10]		
<b>Range:</b>		<b>Function:</b>
0 N/A*	[0 - 0 N/A]	Sets the ON time for the Timed Action.
<p><b>NOTE</b> The frequency converter has no back up of the clock function and the set date/time will reset to default (2000-01-01 00:00) after a power down unless the Analog I/O option module (OPCAIO) with Battery Back Up of the Real Time Clock is installed. In <i>K-79 Clock Fault</i> it is possible to program for a Warning in case clock has not been set properly, e.g. after a power down.</p>		

T-01 ON Action		
Arra [10]		
<b>Option:</b>		<b>Function:</b>
		Select the action during ON Time. See <i>LC-52 Logic Controller Action</i> for descriptions of the options.
[0] *	Disabled	
[1]	No action	
[2]	Select set-up 1	
[3]	Select set-up 2	
[4]	Select set-up 3	
[5]	Select set-up 4	
[10]	Select preset ref 0	
[11]	Select preset ref 1	
[12]	Select preset ref 2	
[13]	Select preset ref 3	
[14]	Select preset ref 4	
[15]	Select preset ref 5	
[16]	Select preset ref 6	
[17]	Select preset ref 7	
[18]	Select Accel/Decel 1	
[19]	Select Accel/Decel 2	
[22]	Run	
[23]	Run reverse	
[24]	Stop	
[26]	DC Brake	
[27]	Coast	
[32]	Set digital out A low	
[33]	Set digital out B low	
[34]	Set digital out C low	
[35]	Set digital out D low	
[36]	Set digital out E low	
[37]	Set digital out F low	
[38]	Set digital out A high	
[39]	Set digital out B high	
[40]	Set digital out C high	
[41]	Set digital out D high	





T-01 ON Action		
Array [10]		
Option:	Function:	
[42]	Set digital out E high	
[43]	Set digital out F high	
[60]	Reset Counter A	
[61]	Reset Counter B	
[80]	Sleep Mode	

T-02 OFF Time		
Array [10]		
Range:	Function:	
0 N/A*	[0 - 0 N/A]	Sets the OFF time for the Timed Action.
<p><b>NOTE</b> The frequency converter has no back up of the clock function and the set date/time will reset to default (2000-01-01 00:00) after a power down unless the Analog I/O option module (OPCAIO) with Battery Back Up of the Real Time Clock is installed. In <i>K-79 Clock Fault</i> it is possible to program for a Warning in case clock has not been set properly, e.g. after a power down.</p>		

T-03 OFF Action		
Array [10]		
Option:	Function:	
		Select the action during OFF Time. See <i>LC-52 Logic Controller Action</i> for descriptions of the options.
[0] *	Disabled	
[1] *	No action	
[2]	Select set-up 1	
[3]	Select set-up 2	
[4]	Select set-up 3	
[5]	Select set-up 4	
[10]	Select preset ref 0	
[11]	Select preset ref 1	
[12]	Select preset ref 2	
[13]	Select preset ref 3	
[14]	Select preset ref 4	
[15]	Select preset ref 5	
[16]	Select preset ref 6	
[17]	Select preset ref 7	
[18]	Select Accel/Decel 1	
[19]	Select Accel/Decel 2	
[22]	Run	
[23]	Run reverse	
[24]	Stop	
[26]	DC Brake	
[27]	Coast	
[32]	Set digital out A low	

T-03 OFF Action		
Array [10]		
Option:	Function:	
[33]	Set digital out B low	
[34]	Set digital out C low	
[35]	Set digital out D low	
[36]	Set digital out E low	
[37]	Set digital out F low	
[38]	Set digital out A high	
[39]	Set digital out B high	
[40]	Set digital out C high	
[41]	Set digital out D high	
[42]	Set digital out E high	
[43]	Set digital out F high	
[60]	Reset Counter A	
[61]	Reset Counter B	
[80]	Sleep Mode	

T-04 Occurrence		
Array [10]		
Option:	Function:	
		Select which day(s) the Timed Action applies to. Specify working/non-working days in <i>K-81 Working Days</i> , <i>K-82 Additional Working Days</i> and <i>K-83 Additional Non-Working Days</i> .
[0] *	All days	
[1]	Working days	
[2]	Non-working days	
[3]	Monday	
[4]	Tuesday	
[5]	Wednesday	
[6]	Thursday	
[7]	Friday	
[8]	Saturday	
[9]	Sunday	

### 3.21.2 T-1# Maintenance

Wear and tear calls for periodic inspection and service of elements in the application, e.g. motor bearings, feedback sensors and seals or filters. With Preventive Maintenance the service intervals may be programmed into the frequency converter. The frequency converter will give a message when maintenance is required. 20 Preventive Maintenance Events can be programmed into the frequency converter. For each Event the following must be specified:

- Maintenance item (e.g. "Motor Bearings")
- Maintenance action (e.g. "Replace")
- Maintenance Time Base (e.g. "Running Hours" or a specific date and time)



- Maintenance Time Interval or the date and time of next maintenance

Preventive Maintenance can be programmed from the keypad, but use of the PC-based Drive Control Tool DCT10 is recommended.

**NOTE**

To disable a Preventive Maintenance Event the associated *T-12 Maintenance Time Base* must be set to *Disabled [0]*.

3

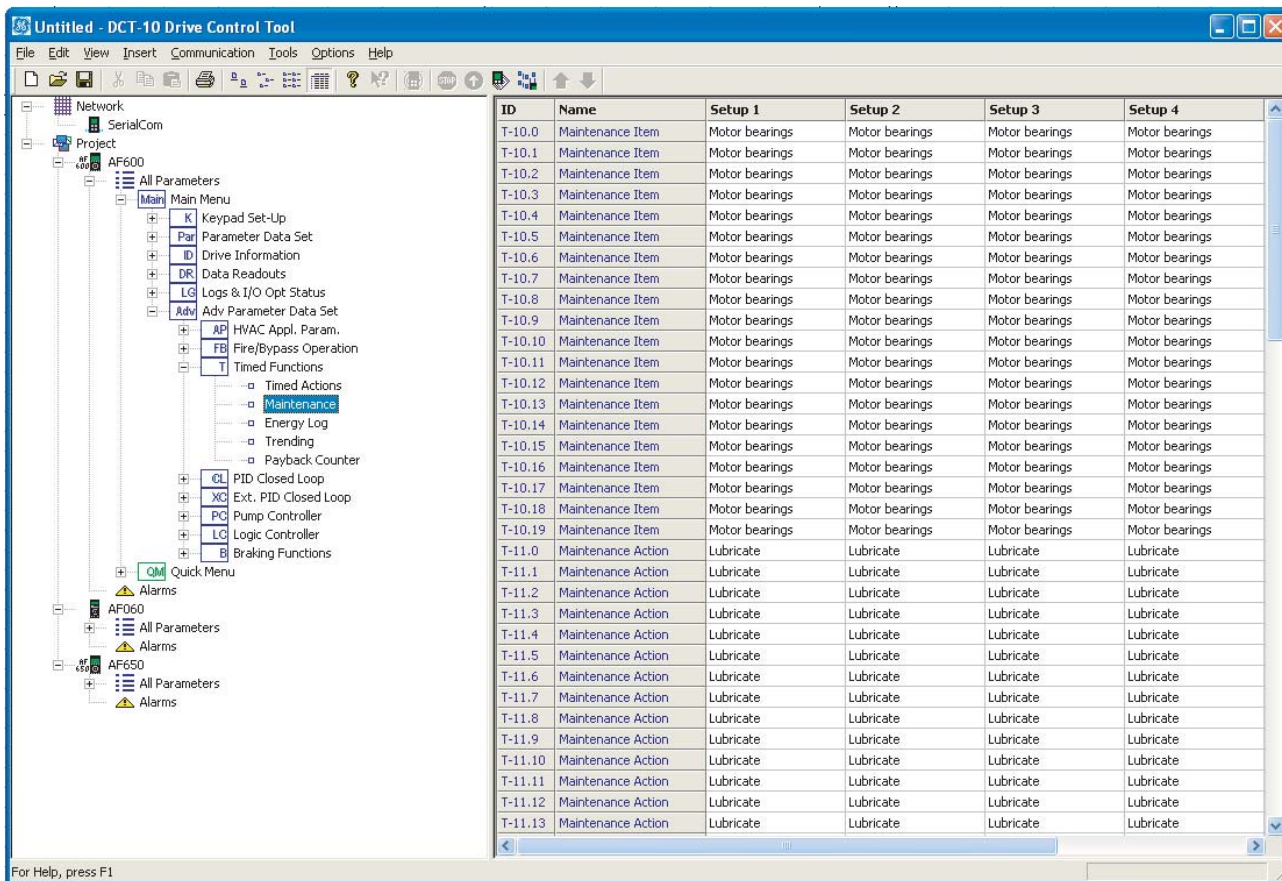

130BA492.10

The keypad indicates (with a wrench-icon and an "M") when it is time for a Preventive Maintenance Action, and can be programmed to be indicated on a digital output in parameter group E-##. The Preventive Maintenance Status may be read in *DR-96 Maintenance Word*. A Preventive Maintenance indication can be reset from a digital input, the Drive bus or manually from the keypad through *T-15 Reset Maintenance Word*.

A Maintenance Log with the latest 10 trendings can be read from parameter group LG-0# and via the Alarm log button on the keypad after selecting Maintenance Log.

**NOTE**

The Preventive Maintenance Events are defined in a 20 element array. Hence each Preventive Maintenance Event must use the same array element index in *T-10 Maintenance Item* to *T-14 Maintenance Date and Time*.

T-10 Maintenance Item	
Option:	Function:
	Array with 20 elements displayed below parameter number in the display. Press [OK] and step between elements by means of and buttons on the keypad.  Select the item to be associated with the Preventive Maintenance Event.
[1] *	Motor bearings
[2]	Fan bearings
[3]	Pump bearings
[4]	Valve
[5]	Pressure transmitter
[6]	Flow transmitter
[7]	Temperature transm.
[8]	Pump seals
[9]	Fan belt
[10]	Filter



T-10 Maintenance Item		
Option:	Function:	
[11]	Drive cooling fan	
[12]	System health check	
[13]	Warranty	
[20]	Maintenance Text 0	
[21]	Maintenance Text 1	
[22]	Maintenance Text 2	
[23]	Maintenance Text 3	
[24]	Maintenance Text 4	
[25]	Maintenance Text 5	

T-11 Maintenance Action		
Option:	Function:	
		Select the action to be associated with the Preventive Maintenance Event.
[1] *	Lubricate	
[2]	Clean	
[3]	Replace	
[4]	Inspect/Check	
[5]	Overhaul	
[6]	Renew	
[7]	Check	
[20]	Maintenance Text 0	
[21]	Maintenance Text 1	
[22]	Maintenance Text 2	
[23]	Maintenance Text 3	
[24]	Maintenance Text 4	
[25]	Maintenance Text 5	

T-12 Maintenance Time Base		
Option:	Function:	
		Select the time base to be associated with the Preventive Maintenance Event.
[0] *	Disabled	<i>Disabled</i> [0] must be used when disabling the Preventive Maintenance Event.
[1]	Running Hours	<i>Running Hours</i> [1] is the number of hours the motor has been running. Running hours are not reset at power-on. The <i>Maintenance Time Interval</i> must be specified in <i>T-13 Maintenance Time Interval</i> .
[2]	Operating Hours	<i>Operating Hours</i> [2] is the number of hours the frequency converter has been running. Operating hours are not reset at power-on. The <i>Maintenance Time Interval</i> must be specified in <i>T-13 Maintenance Time Interval</i> .
[3]	Date & Time	<i>Date &amp; Time</i> [3] uses the internal clock. The date and time of the next maintenance occurrence must be specified in <i>T-14 Maintenance Date and Time</i> .

T-13 Maintenance Time Interval		
Range:	Function:	
1 h* 2147483647 h]	[1 -	Set the interval associated with the current Preventive Maintenance Event. This parameter is only used if <i>Running Hours</i> [1] or <i>Operating Hours</i> [2] is selected in <i>T-12 Maintenance Time Base</i> . The timer is reset from <i>T-15 Reset Maintenance Word</i> .
		<b>Example:</b>  A Preventive Maintenance Event is set up Monday at 8:00. <i>T-12 Maintenance Time Base</i> is <i>Operating hours</i> [2] and <i>T-13 Maintenance Time Interval</i> is 7 x 24 hours=168 hours. Next Maintenance Event will be indicated the following Monday at 8:00. If this Maintenance Event is not reset until Tuesday at 9:00, the next occurrence will be the following Tuesday at 9:00.

T-14 Maintenance Date and Time		
Range:	Function:	
0 N/ A*	[0 - 0 N/A]	Set the date and time for next maintenance occurrence if the Preventive Maintenance Event is based on date/time. Date format depends on the setting in <i>K-71 Date Format</i> while the time format depends on the setting in <i>K-72 Time Format</i> .
		<b>NOTE</b> The frequency converter has no back up of the clock function and the set date/time will reset to default (2000-01-01 00:00) after a power down. In <i>K-79 Clock Fault</i> it is possible to program for a Warning in case the clock has not been set properly, e.g. after a power down. The time set must be at least one hour from the actual time!
		<b>NOTE</b> When mounting an Analog I/O OPCAIO option card, a battery back up of the date and time is included.

T-15 Reset Maintenance Word		
Option:	Function:	
		Set this parameter to <i>Do reset</i> [1] to reset the Maintenance Word in <i>DR-96 Maintenance Word</i> and reset the message displayed in the keypad. This parameter will change back to <i>Do not reset</i> [0] when pressing OK.
[0] *	Do not reset	
[1]	Do reset	



### NOTE

When messages are reset - Maintenance Item, Action and Maintenance Date/Time are not cancelled.

T-12 Maintenance Time Base is set to Disabled [0].

3

T-16 Maintenance Text		
Range:	Function:	
0 N/A* [0 - 0 N/A]	6 individual texts (Maintenance Text 0...Maintenance Text 5) can be written for use in either T-10 Maintenance Item or T-11 Maintenance Action. The text is written according to the guidelines in K-37 Display Text 1.	

### 3.21.3 T-5#

The frequency converter is continuously accumulating the consumption of the motor controlled, based on the actual power yielded by the frequency converter.

These data can be used for an Energy Log function allowing the user to compare and structure the information about the energy consumption related to time.

There are basically two functions:

- Data related to a pre-programmed period, defined by a set date and time for start
- Data related to a predefined period back in time e.g. last seven days within the pre-programmed period

For each of the above two functions, the data are stored in a number of counters allowing for selecting time frame and a split on hours, days or weeks.

The period/split (resolution) can be set in T-50 Energy Log Resolution.

The data are based on the value registered by the kWh counter in the frequency converter. This counter value can be read in ID-02 kWh Counter containing the accumulated value since the first power up or latest reset of the counter (ID-06 Reset kWh Counter).

All data for the Energy Log are stored in counters which can be read from T-53 Energy Log.

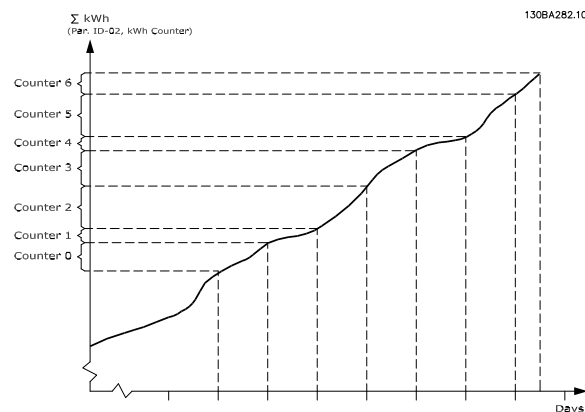

Counter 00 will always contain the oldest data. A counter will cover a period from XX:00 to XX:59 if hours or 00:00 to 23:59 if days.

If logging either the last hours or last days, the counters will shift contents at XX:00 every hour or at 00:00 every day.

Counter with highest index will always be subject to update (containing data for the actual hour since XX:00 or the actual day since 00:00).

The contents of counters can be displayed as bars on keypad. Select Quick Menu, Trendings, Energy Log: Trending Continued Bin / Trending Timed Bin / Trending Comparison.



T-50 Energy Log Resolution		
Option:	Function:	
		Select the desired type of period for logging of consumption. Hour of Day [0] , Day of Week [1] or Day of Month [2]. The counters contain the logging data from the programmed date/time for start ( <i>T-51 Period Start</i> ) and the numbers of hours/days as programmed for ( <i>T-50 Energy Log Resolution</i> ). The logging will start on the date programmed in <i>T-51 Period Start</i> , and continue until one day/week/month has gone. Last 24 Hours [5], Last 7 Days [6] or Last 5 Weeks [7]. The counters contain data for one day, one week or five weeks back in time and up to the actual time. The logging will start at the date programmed in <i>T-51 Period Start</i> . In all cases the period split will refer to Operating Hours (time where frequency converter is powered up).
[0]	Hour of Day	
[1]	Day of Week	
[2]	Day of Month	
[5] *	Last 24 Hours	
[6]	Last 7 Days	
[7]	Last 5 Weeks	

**NOTE**

The frequency converter has no back up of the clock function and the set date/time will reset to default (2000-01-01 00:00) after a power down unless a Real Time Clock module with back up is installed. Consequently the logging will be stopped until date/time is readjusted in *K-70 Date and Time*. In *K-79 Clock Fault* it is possible to program for a Warning in case clock not has been set properly, e.g. after a power down.

T-51 Period Start		
Range:	Function:	
0 N/A* [0 - 0 N/A]	Set the date and time at which the Energy Log starts update of the counters. First data will be stored in counter [00] and start at the time/date programmed in this parameter.  Date format will depend on setting in <i>K-71 Date Format</i> and time format on setting in <i>K-72 Time Format</i> .	

**NOTE**

When mounting an Analog I/O OPCAIO option card, a battery back up of the date and time is included.

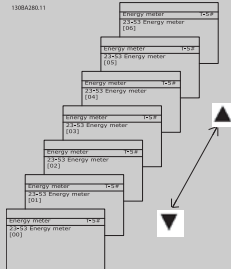
T-53 Energy Log		
Range:	Function:	
0 N/ A*	[0 - 4294967295 N/A]	Array with a number of elements equal to the number of counters ([00]-[xx] below parameter number in display). Press OK and Step between elements by means of ▲ and ▼ buttons on the keypad.  Array elements:   Data from latest period is stored in the counter with the highest index. At power down all counter values are stored and resumed at next power up.

**NOTE**

All counters are automatically reset when changing the setting in *T-50 Energy Log Resolution*. At overflow the update of the counters will stop at maximum value.

**NOTE**

When mounting an Analog I/O OPCAIO option card, a battery back up of the date and time is included.

T-54 Reset Energy Log		
Option:	Function:	
		Select <i>Do reset</i> [1] to reset all values in the Energy Log counters shown in <i>T-53 Energy Log</i> . After pressing OK the setting of the parameter value will automatically change to <i>Do not reset</i> [0].
[0] *	Do not reset	
[1]	Do reset	



### 3.21.4 T-6#

Trending is used to monitor a process variable over a period of time and record how often the data falls into each of ten user-defined data ranges. This is a convenient tool to get a quick overview indicating where to put focus for improvement of operation.

Two sets of data for Trending can be created in order to make it possible to compare current values for a selected operating variable with data for a certain reference period, for the same variable. This reference period can be pre-programmed (*T-63 Timed Period Start* and *T-64 Timed Period Stop*). The two sets of data can be read from *T-61 Continuous Bin Data* (current) and *T-62 Timed Bin Data* (reference).

It is possible to create Trending for following operation variables:

- Power
- Current
- Output frequency
- Motor Speed

The Trending function includes ten counters (forming a bin) for each set of data containing the numbers of registrations reflecting how often the operating variable is within each of ten pre-defined intervals. The sorting is based on a relative value of the variable.

The relative value for the operating variable is

$$\text{Actual/Rated} * 100\%$$

for Power and Current and

$$\text{Actual/Max} * 100\%$$

for Output Frequency and Motor Speed.

The size of each interval can be adjusted individually, but will default be 10% for each. Power and Current can exceed rated value, but those registrations will be included in 90%-100% (MAX) counter.

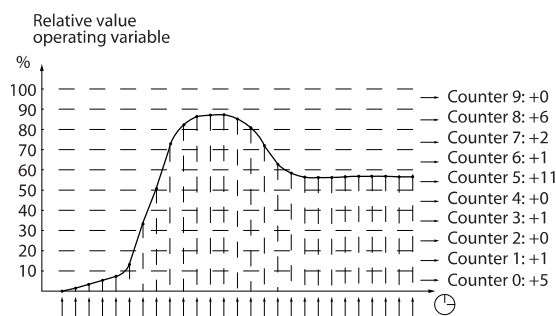

130BA281.10

Once a second, the value of the operating variable selected is registered. If a value has been registered to equal 13%, the counter "10% - <20%" will be updated with the value "1". If the value stays at 13% for 10s, then "10" will be added to the counter value.

The contents of counters can be displayed as bars on keypad. Select *Quick Menu >Trendings: Trending Continued Bin / Trending Timed Bin / Trending Comparison*.

### NOTE

The counters starts counting whenever the frequency converter is powered-up. Power cycle shortly after a reset will zero the counters. EEPROM data are updated once per hour.

T-60 Trend Variable		
Option:	Function:	
		Select the desired operating variable to be monitored for Trending.
[0] *	Power [kW]	Power yielded to the motor. Reference for the relative value is the rated motor power programmed in <i>P-07 Motor Power [kW]</i> or <i>P-02 Motor Power [HP]</i> . Actual value can be read in <i>DR-10 Power [kW]</i> or <i>DR-11 Power [hp]</i> .
[1]	Current [A]	Output current to the motor. Reference for the relative value is the rated motor current programmed in <i>P-03 Motor Current</i> . Actual value can be read in <i>DR-14 Motor Current</i> .
[2]	Frequency [Hz]	Output frequency to the motor. Reference for the relative value is the maximum output frequency programmed in <i>F-15 Motor Speed High Limit [Hz]</i> . Actual value can be read in <i>DR-13 Frequency</i> .
[3]	Motor Speed [RPM]	Speed of the motor. Reference for relative value is the maximum motor speed programmed in <i>F-17 Motor Speed High Limit [RPM]</i> .





T-61 Continuous Bin Data		
Range:	Function:	
0 N/ A*	[0 - 4294967295 N/A]	<p>Array with 10 elements ([0]-[9] below parameter number in display). Press OK and step between elements by means of ▲ and ▼ buttons on the keypad.</p> <p>10 counters with the frequency of occurrence for the operating variable monitored, sorted according to the following intervals:</p> <p style="padding-left: 40px;">Counter [0]: 0% - &lt;10%</p> <p style="padding-left: 40px;">Counter [1]: 10% - &lt;20%</p> <p style="padding-left: 40px;">Counter [2]: 20% - &lt;30%</p> <p style="padding-left: 40px;">Counter [3]: 30% - &lt;40%</p> <p style="padding-left: 40px;">Counter [4]: 40% - &lt;50%</p> <p style="padding-left: 40px;">Counter [5]: 50% - &lt;60%</p> <p style="padding-left: 40px;">Counter [6]: 60% - &lt;70%</p> <p style="padding-left: 40px;">Counter [7]: 70% - &lt;80%</p> <p style="padding-left: 40px;">Counter [8]: 80% - &lt;90%</p> <p style="padding-left: 40px;">Counter [9]: 90% - &lt;100% or Max</p> <p>The above minimum limits for the intervals are the default limits. These can be changed in <i>T-65 Minimum Bin Value</i>.</p> <p>Starts to count when the frequency converter is powered up for the first time. All counters can be reset to 0 in <i>T-66 Reset Continuous Bin Data</i>.</p>

T-62 Timed Bin Data		
Range:	Function:	
0 N/ A*	[0 - 4294967295 N/A]	<p>Array with 10 elements ([0]-[9] below parameter number in display). Press OK and step between elements by means of ▲ and ▼ buttons on the keypad.</p> <p>10 counters with the frequency of occurrence for the operating data monitored sorted according to the intervals as for <i>T-61 Continuous Bin Data</i>.</p> <p>Starts to count at the date/time programmed in <i>T-63 Timed Period Start</i>, and stops at the time/date programmed in <i>T-64 Timed Period Stop</i>. All counters can be reset to 0 in <i>T-67 Reset Timed Bin Data</i>.</p>

T-63 Timed Period Start		
Range:	Function:	
0 N/A*	[0 - 0 N/ A]	Set the date and time at which the Trending starts the update of the Timed Bin counters.

T-63 Timed Period Start		
Range:	Function:	
		Date format will depend on setting in <i>K-71 Date Format</i> , and time format on setting in <i>K-72 Time Format</i> .

**NOTE**

The frequency converter has no back up of the clock function and the set date/time will reset to default (2000-01-01 00:00) after a power down unless the Analog I/O option module (OPCAIO) with Battery Back Up of the Real Time Clock is installed. Consequently the logging will be stopped until date/time is readjusted in *K-70 Date and Time*. In *K-79 Clock Fault* it is possible to program for a Warning in case clock not has been set properly, e.g. after a power down.

**NOTE**

When mounting an Analog I/O OPCAIO option card, a battery back up of the date and time is included.

T-64 Timed Period Stop		
Range:	Function:	
0 N/A*	[0 - 0 N/ A]	<p>Set the date and time at which the Trend Analyses must stop update of the Timed Bin counters.</p> <p>Date format will depend on setting in <i>K-71 Date Format</i>, and time format on setting in <i>K-72 Time Format</i>.</p>

**NOTE**

When mounting an Analog I/O OPCAIO option card, a battery back up of the date and time is included.

T-65 Minimum Bin Value		
Range:	Function:	
0 %*	[0 - 100. %]	<p>Array with 10 elements ([0]-[9] below parameter number in display). Press OK and step between elements by means of ▲ and ▼ buttons on the keypad.</p> <p>Set the minimum limit for each interval in <i>T-61 Continuous Bin Data</i> and <i>T-62 Timed Bin Data</i>. Example: if selecting <i>counter</i> [1] and changing setting from 10% to 12%, <i>counter</i> [0] will be based on the interval 0 - &lt;12% and <i>counter</i> [1] on interval 12% - &lt;20%.</p>





3

T-66 Reset Continuous Bin Data		
Option:	Function:	
[0] *	Do not reset	Select <i>Do reset</i> [1] to reset all values in <i>T-61 Continuous Bin Data</i> . After pressing OK the setting of the parameter value will automatically change to <i>Do not reset</i> [0].
[1]	Do reset	

T-67 Reset Timed Bin Data		
Option:	Function:	
[0] *	Do not reset	
[1]	Do reset	

T-67 Reset Timed Bin Data		
Option:	Function:	
		Select <i>Do reset</i> [1] to reset all counters in <i>T-62 Timed Bin Data</i> . After pressing OK the setting of the parameter value will automatically change to <i>Do not reset</i> [0].

### 3.21.5 T-8# Payback Counter

The frequency converter includes a feature which can give a rough calculation on payback in cases where the frequency converter has been installed in an existing plant to ensure energy saving by changing from fixed to variable speed control. Reference for the savings is a set value to represent the average power yielded before the upgrade with variable speed control.

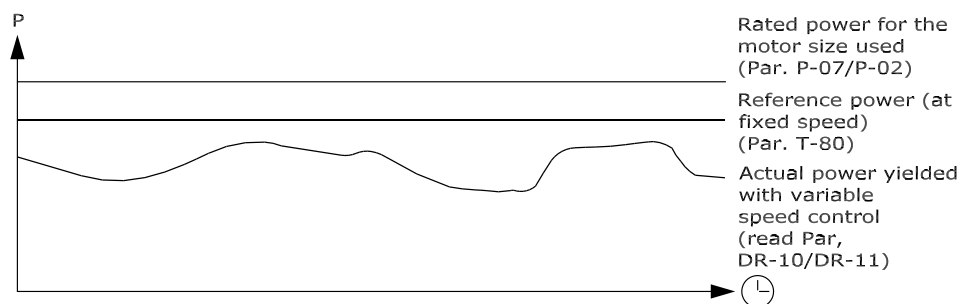

130BA259.11

The difference between the Reference Power at fixed speed and the Actual Power yielded with speed control represent the actual saving.

As value for the fixed speed case, the rated motor size (kW) is multiplied with a factor (set in %) representing the power produced at fixed speed. The difference between this reference power and the actual power is accumulated and stored. The difference in energy can be read in *T-83 Energy Savings*.

The accumulated value for the difference in power consumption is multiplied with the energy cost in local currency and the investment is subtracted. This calculation for Cost Savings can also be read in *T-84 Cost Savings*.

Cost Savings =

$$\left\{ \sum_{t=0}^t [(Rated\ Motor\ Power * Power\ Reference\ Factor) - Actual\ Power\ Consumption] \times Energy\ Cost \right\}$$

- Investment Cost

Break even (payback) occurs when the value read in the parameter turns from negative to positive.



It is not possible to reset the Energy Savings counter, but the counter can be stopped any time by setting *T-80 Power Reference Factor* to 0.

Parameter overview:

Parameter for settings		Parameters for readout	
Rated Motor Power	<i>P-07 Motor Power [kW]</i>	Energy Savings	<i>T-83 Energy Savings</i>
Power Reference Factor in %	<i>T-80 Power Reference Factor</i>	Actual Power	<i>DR-10 Power [kW], DR-11 Power [hp]</i>
Energy Cost per kWh	<i>T-81 Energy Cost</i>	Cost Savings	<i>T-84 Cost Savings</i>
Investment	<i>T-82 Investment</i>		

T-80 Power Reference Factor		
Range:	Function:	
100 %* %	[0 - 100 %]	Set the percentage of the rated motor size (set in <i>P-07 Motor Power [kW]</i> or <i>P-02 Motor Power [HP]</i> ) which is supposed to represent the average power yielded at the time running with fixed speed (before upgrade with variable speed control). Must be set to a value different from zero to start counting.

T-81 Energy Cost		
Range:	Function:	
1.00 N/A*	[0.00 - 999999.99 N/A]	Set the actual cost for a kWh in local currency. If the energy cost is changed later on it will impact the calculation for the entire period.

T-82 Investment		
Range:	Function:	
0 N/A*	[0 - 999999999 N/A]	Set the value of the investment spent on upgrading the plant with speed control, in same currency as used in <i>T-81 Energy Cost</i> .

T-83 Energy Savings		
Range:	Function:	
0 kWh*	[0 - 0 kWh]	This parameter allows a readout of the accumulated difference between the reference power and the actual output power. If motor size set in Hp ( <i>P-02 Motor Power [HP]</i> ), the equivalent kW value will be used for the Energy Savings.

T-84 Cost Savings		
Range:	Function:	
0 N/A*	[0 - 2147483647 N/A]	This parameter allows a readout of the calculation based on the above equation (in local currency).



### 3.22 CL-## PID Closed Loop

This parameter group is used for configuring the closed loop PID Controller, that controls the output frequency of the frequency converter.

#### 3.22.1 CL-0# Feedback

This parameter group is used to configure the feedback signal for the frequency converter's closed loop PID Controller. Whether the frequency converter is in Closed Loop Mode or Open Loop Mode, the feedback signals can also be shown on the frequency converter's display, be used to control a frequency converter analog output, and be transmitted over various serial communication protocols.

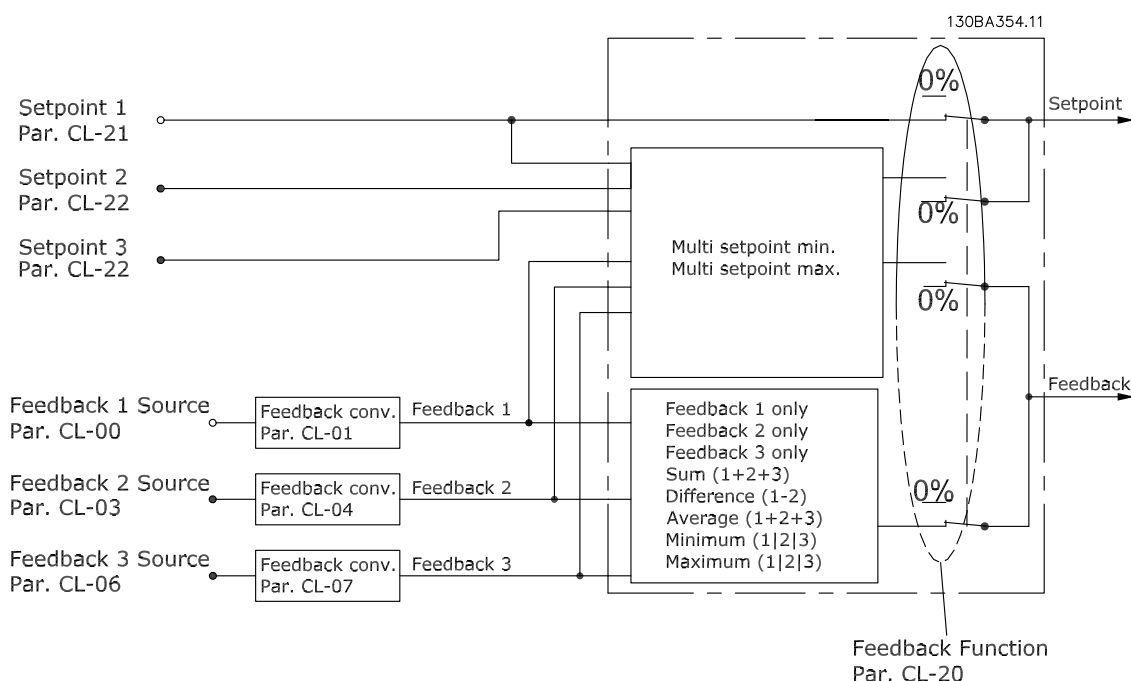

CL-00 Feedback 1 Source	
Option:	Function:
	Up to three different feedback signals can be used to provide the feedback signal for the frequency converter's PID Controller. This parameter defines which input will be used as the source of the first feedback signal. Analog input X30/11 and Analog input X30/12 refer to inputs on the optional General Purpose I/O board (OPCGPIO). Analog Input X42/1, X42/3, X42/5 refer to inputs on the optional Analog I/O board (OPCAIO).
[0]	No function
[1]	Analog input 53
[2] *	Analog input 54
[3]	Pulse input 29
[4]	Pulse input 33
[7]	Analog input X30/11

CL-00 Feedback 1 Source	
Option:	Function:
[8]	Analog input X30/12
[9]	Analog Input X42/1
[10]	Analog Input X42/3
[11]	Analog Input X42/5
[100]	Bus feedback 1
[101]	Bus feedback 2
[102]	Bus feedback 3

**NOTE**

If a feedback is not used, its source must be set to *No Function* [0]. *CL-20 Feedback Function* determines how the three possible feedbacks will be used by the PID Controller.



CL-01 Feedback 1 Conversion		
Option:	Function:	
		This parameter allows a conversion function to be applied to Feedback 1.
[0]	Linear	<i>Linear</i> [0] has no effect on the feedback.
[1]	Square root	<i>Square root</i> [1] is commonly used when a pressure sensor is used to provide flow feedback $((flow \propto \sqrt{pressure}))$ .
[2]	Pressure to temperature	<i>Pressure to temperature</i> [2] is used in compressor applications to provide temperature feedback using a pressure sensor. The temperature of the refrigerant is calculated using the following formula: $Temperature = \frac{A2}{(\ln(Pe + 1) - A1)} - A3,$ where A1, A2 and A3 are refrigerant-specific constants. The refrigerant must be selected in <i>CL-30 Refrigerant</i> . <i>CL-21 Setpoint 1</i> through <i>CL-23 Setpoint 3</i> allow the values of A1, A2 and A3 to be entered for a refrigerant that is not listed in <i>CL-30 Refrigerant</i> .
[3]	Pressure to flow	Pressure to flow is used in applications where the air flow in a duct is to be controlled. The feedback signal is represented by a dynamic pressure measurement (pitot tube). $Flow = Duct\ Area \times \sqrt{Dynamic\ Pressure}$ $\times Air\ Density\ Factor$ See also <i>CL-34 Duct 1 Area [m2]</i> through <i>CL-38 Air Density Factor [%]</i> for setting of duct area and air density.
[4]	Velocity to flow	Velocity to flow is used in applications where the air flow in a duct is to be controlled. The feedback signal is represented by an air velocity measurement. $Flow = Duct\ Area \times Air\ Velocity$ See also <i>CL-34 Duct 1 Area [m2]</i> through <i>CL-37 Duct 2 Area [in2]</i> for setting of duct area.

CL-02 Feedback 1 Source Unit		
Option:	Function:	
		This parameter determines the unit that is used for this Feedback Source, prior to applying the feedback conversion of <i>CL-01 Feedback 1 Conversion</i> . This unit is not used by the PID Controller.
[0] *		
[1]	%	
[5]	PPM	
[10]	1/min	
[11]	RPM	
[12]	Pulse/s	
[20]	1/s	

CL-02 Feedback 1 Source Unit		
Option:	Function:	
[21]	l/min	
[22]	l/h	
[23]	m <sup>3</sup> /s	
[24]	m <sup>3</sup> /min	
[25]	m <sup>3</sup> /h	
[30]	kg/s	
[31]	kg/min	
[32]	kg/h	
[33]	t/min	
[34]	t/h	
[40]	m/s	
[41]	m/min	
[45]	m	
[60]	°C	
[70]	mbar	
[71]	bar	
[72]	Pa	
[73]	kPa	
[74]	m WG	
[75]	mm Hg	
[80]	kW	
[120]	GPM	
[121]	gal/s	
[122]	gal/min	
[123]	gal/h	
[124]	CFM	
[125]	ft <sup>3</sup> /s	
[126]	ft <sup>3</sup> /min	
[127]	ft <sup>3</sup> /h	
[130]	lb/s	
[131]	lb/min	
[132]	lb/h	
[140]	ft/s	
[141]	ft/min	
[145]	ft	
[160]	°F	
[170]	psi	
[171]	lb/in <sup>2</sup>	
[172]	in WG	
[173]	ft WG	
[174]	in Hg	
[180]	HP	

**NOTE**

This parameter is only available when using pressure to temperature feedback conversion. If the choice Linear [0] is selected in *CL-01 Feedback 1 Conversion*, then the setting of any choice in *CL-02 Feedback 1 Source Unit* does not matter as conversion will be one-to-one.



CL-03 Feedback 2 Source		
Option:	Function:	
		See <i>CL-00 Feedback 1 Source</i> for details.
[0] *	No function	
[1]	Analog input 53	
[2]	Analog input 54	
[3]	Pulse input 29	
[4]	Pulse input 33	
[7]	Analog input X30/11	
[8]	Analog input X30/12	
[9]	Analog Input X42/1	
[10]	Analog Input X42/3	
[11]	Analog Input X42/5	
[100]	Bus feedback 1	
[101]	Bus feedback 2	
[102]	Bus feedback 3	

CL-04 Feedback 2 Conversion		
Option:	Function:	
		See <i>CL-01 Feedback 1 Conversion</i> for details.
[0] *	Linear	
[1]	Square root	
[2]	Pressure to temperature	
[3]	Pressure to flow	
[4]	Velocity to flow	

CL-05 Feedback 2 Source Unit		
Option:	Function:	
		See <i>CL-02 Feedback 1 Source Unit</i> for details.

CL-06 Feedback 3 Source		
Option:	Function:	
		See <i>CL-00 Feedback 1 Source</i> for details.
[0] *	No function	
[1]	Analog input 53	
[2]	Analog input 54	
[3]	Pulse input 29	
[4]	Pulse input 33	
[7]	Analog input X30/11	
[8]	Analog input X30/12	
[9]	Analog Input X42/1	
[10]	Analog Input X42/3	
[11]	Analog Input X42/5	
[100]	Bus feedback 1	
[101]	Bus feedback 2	
[102]	Bus feedback 3	

CL-07 Feedback 3 Conversion		
Option:	Function:	
		See <i>CL-01 Feedback 1 Conversion</i> for details.
[0] *	Linear	
[1]	Square root	
[2]	Pressure to temperature	
[3]	Pressure to flow	
[4]	Velocity to flow	

CL-08 Feedback 3 Source Unit		
Option:	Function:	
		See <i>CL-02 Feedback 1 Source Unit</i> for details.

CL-12 Reference/Feedback Unit		
Option:	Function:	
		See <i>CL-02 Feedback 1 Source Unit</i> for details.

CL-13 Minimum Reference/Feedb.		
Range:	Function:	
0.000 ProcessCtrlUnit*	[-999999.999 - par. CL-14 ProcessCtrlUnit]	Enter the desired minimum value for the remote reference when operating with <i>H-40 Configuration Mode</i> set for Closed Loop [3] operation. Units are set in <i>CL-12 Reference/Feedback Unit</i> .  Minimum feedback will be -200% of either the value set in <i>CL-13 Minimum Reference/Feedb.</i> or in <i>CL-14 Maximum Reference/Feedb.</i> , which ever numeric value is the highest.

**NOTE**

If operating with *H-40 Configuration Mode* set for Open Loop [0], *F-52 Minimum Reference* must be used.



CL-14 Maximum Reference/Feedb.		
Range:	Function:	
100.000 ProcessCtrlUnit*	[par. CL-13 - 999999.999 ProcessCtrlUnit]	Enter the maximum reference/feedback for closed loop operation. The setting determines the highest value obtainable by summing all reference sources for closed loop operation. The setting determines 100% feedback in open and closed loop (total feedback range: -200% to +200%).

**NOTE**

If operating with *H-40 Configuration Mode* set for Open Loop [0], *F-53 Maximum Reference* must be used.

**NOTE**

The dynamics of the PID controller will depend on the value set in this parameter. Please see also *CL-93 PID Proportional Gain*.

Par. CL-13 and par. CL-14 also determine the feedback range when using feedback for display readout with *H-40 Configuration Mode* set for Open Loop [0]. Same condition as above.

3.22.2 CL-2# Feedback & Setpoint

This parameter group is used to determine how the frequency converter's PID Controller will use the three possible feedback signals to control the output frequency of the frequency converter. This group is also used to store the three internal setpoint references.

CL-20 Feedback Function		
Option:	Function:	
		This parameter determines how the three possible feedbacks will be used to control the output frequency of the frequency converter.
[0]	Sum	<p><i>Sum</i> [0] sets up the PID Controller to use the sum of Feedback 1, Feedback 2 and Feedback 3 as the feedback.</p> <p><b>NOTE</b> Any unused feedbacks must be set to <i>No Function</i> in <i>CL-00 Feedback 1 Source</i>, <i>CL-03 Feedback 2 Source</i>, or <i>CL-06 Feedback 3 Source</i>.</p> <p>The sum of Setpoint 1 and any other references that are enabled (see par. C-30 and par. C-34) will be used as the PID Controller's set-point reference.</p>

CL-20 Feedback Function		
Option:	Function:	
[1]	Difference	<p><i>Difference</i> [1] sets up the PID controller to use the difference between Feedback 1 and Feedback 2 as the feedback. Feedback 3 will not be used with this selection. Only Setpoint 1 will be used. The sum of Setpoint 1 and any other references that are enabled (see par. C-30 and par. C-34) will be used as the PID controller's set-point reference.</p>
[2]	Average	<p><i>Average</i> [2] sets up the PID Controller to use the average of Feedback 1, Feedback 2 and Feedback 3 as the feedback.</p> <p><b>NOTE</b> Any unused feedbacks must be set to <i>No Function</i> in <i>CL-00 Feedback 1 Source</i>, <i>CL-03 Feedback 2 Source</i>, or <i>CL-06 Feedback 3 Source</i>. The sum of Setpoint 1 and any other references that are enabled (see par. C-30 and par. C-34) will be used as the PID Controller's set-point reference.</p>
[3]	Minimum	<p><i>Minimum</i> [3] sets up the PID Controller to compare Feedback 1, Feedback 2 and Feedback 3 and use the lowest value as the feedback.</p> <p><b>NOTE</b> Any unused feedbacks must be set to <i>No Function</i> in <i>CL-00 Feedback 1 Source</i>, <i>CL-03 Feedback 2 Source</i>, or <i>CL-06 Feedback 3 Source</i>. Only setpoint 1 will be used. The sum of Setpoint 1 and any other references that are enabled (see par. C-30 and par. C-34) will be used as the PID Controller's setpoint reference.</p>
[4]	Maximum	<p><i>Maximum</i> [4] sets up the PID Controller to compare Feedback 1, Feedback 2 and Feedback 3 and use the highest value as the feedback.</p> <p><b>NOTE</b> Any unused feedbacks must be set to <i>No Function</i> in <i>CL-00 Feedback 1 Source</i>, <i>CL-03 Feedback 2 Source</i>, or <i>CL-06 Feedback 3 Source</i>.</p> <p>Only Setpoint 1 will be used. The sum of Setpoint 1 and any other references that are enabled (see par. C-30 and par. C-34) will be used as the PID Controller's setpoint reference.</p>
[5]	Multi Setpoint Min	<p><i>Multi-setpoint minimum</i> [5] sets up the PID Controller to calculate the difference between Feedback 1 and Setpoint 1, Feedback 2 and Setpoint 2, and Feedback 3 and Setpoint 3. It will use the feedback/setpoint pair in which the feedback is the farthest below its corresponding</p>



CL-20 Feedback Function	
Option:	Function:
	<p>setpoint reference. If all feedback signals are above their corresponding setpoints, the PID Controller will use the feedback/setpoint pair in which the difference between the feedback and setpoint is the least.</p> <p><b>NOTE</b> If only two feedback signals are used, the feedback that is not to be used must be set to <i>No Function</i> in <i>CL-00 Feedback 1 Source</i>, <i>CL-03 Feedback 2 Source</i> or <i>CL-06 Feedback 3 Source</i>. Note that each setpoint reference will be the sum of its respective parameter value (<i>CL-21 Setpoint 1</i>, <i>CL-22 Setpoint 2</i> and <i>CL-23 Setpoint 3</i>) and any other references that are enabled (see par. C-30 and par. C-34).</p>
[6] Multi Setpoint Max	<p><i>Multi-setpoint maximum</i> [6] sets up the PID Controller to calculate the difference between Feedback 1 and Setpoint 1, Feedback 2 and Setpoint 2, and Feedback 3 and Setpoint 3. It will use the feedback/setpoint pair in which the feedback is farthest above its corresponding setpoint reference. If all feedback signals are below their corresponding setpoints, the PID Controller will use the feedback/setpoint pair in which the difference between the feedback and the setpoint reference is the least.</p> <p><b>NOTE</b> If only two feedback signals are used, the feedback that is not to be used must be set to <i>No Function</i> in <i>CL-00 Feedback 1 Source</i>, <i>CL-03 Feedback 2 Source</i> or <i>CL-06 Feedback 3 Source</i>. Note that each setpoint reference will be the sum of its respective parameter value (<i>CL-21 Setpoint 1</i>, <i>CL-22 Setpoint 2</i> and <i>CL-23 Setpoint 3</i>) and any other references that are enabled (see par. C-30 and par. C-34).</p>

The frequency converter can be configured to handle multi zone applications. Two different multi zone applications are supported:

- Multi zone, single setpoint
- Multi zone, multi setpoint

## NOTE

Any unused feedback must be set to "No function" in its Feedback Source parameter: *CL-00 Feedback 1 Source*, *CL-03 Feedback 2 Source* or *CL-06 Feedback 3 Source*.

The feedback resulting from the function selected in *CL-20 Feedback Function* will be used by the PID Controller to control the output frequency of the frequency converter. This feedback can also be shown on the frequency converter's display, be used to control a frequency converter's analog output, and be transmitted over various serial communication protocols.





The difference between the two is illustrated by the following examples:

**Example 1 – Multi zone, single setpoint**

In an office building, a VAV (variable air volume) AF-600 FP system must ensure a minimum pressure at selected VAV boxes. Due to the varying pressure losses in each duct, the pressure at each VAV box cannot be assumed to be the same. The minimum pressure required is the same for all VAV boxes. This control method can be set up by setting *CL-20 Feedback Function* to option [3], Minimum, and entering the desired pressure in *CL-21 Setpoint 1*. The PID Controller will increase the speed of the fan if any one feedback is below the setpoint and decrease the speed of the fan if all feedbacks are above the setpoint.

3

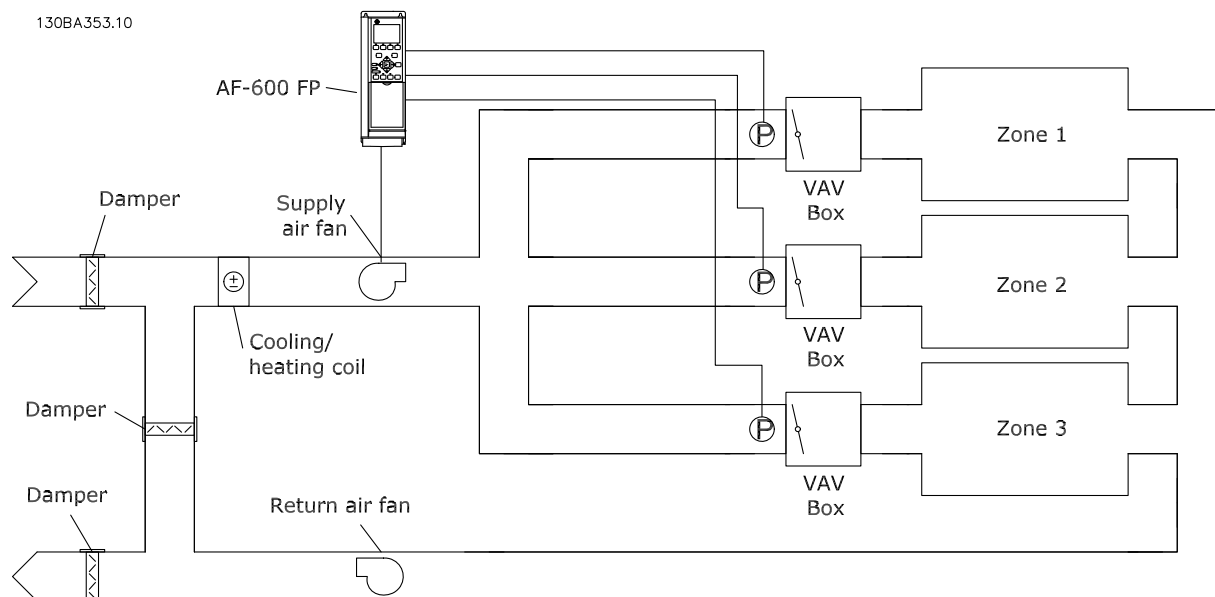

**Example 2 – Multi zone, multi setpoint**

The previous example can be used to illustrate the use of multi zone, multi setpoint control. If the zones require different pressures for each VAV box, each setpoint may be specified in *CL-21 Setpoint 1*, *CL-22 Setpoint 2* and *CL-23 Setpoint 3*. By selecting *Multi setpoint minimum*, [5], in *CL-20 Feedback Function*, the PID Controller will increase the speed of the fan if any one of the feedbacks is below its setpoint and decrease the speed of the fan if all feedbacks are above their individual setpoints.

CL-21 Setpoint 1		Function:
Range:		
0.000 ProcessCtrlUnit*	[-999999.999 - 999999.999 ProcessCtrlUnit]	Setpoint 1 is used in Closed Loop Mode to enter a setpoint reference that is used by the frequency converter's PID Controller. See the description of <i>CL-20 Feedback Function</i> .  <b>NOTE</b> Setpoint reference entered here is added to any other references that are enabled (see par. C-30 and par. C-34).

CL-22 Setpoint 2		Function:
Range:		
0.000 ProcessCtrlUnit*	[-999999.999 - 999999.999 ProcessCtrlUnit]	Setpoint 2 is used in Closed Loop Mode to enter a setpoint reference that may be used by the frequency converter's PID Controller. See the description of <i>Feedback Function</i> , <i>CL-20 Feedback Function</i> .

**NOTE**  
The set-point reference entered here is added to any other references that are enabled (see par. C-30 and par. C-34).



CL-23 Setpoint 3		
Range:		Function:
0.000 ProcessCtrlUnit*	[-999999.999 - 999999.999 ProcessCtrlUnit]	Setpoint 3 is used in Closed Loop Mode to enter a setpoint reference that may be used by the frequency converter's PID Controller. See the description of <i>CL-20 Feedback Function</i> .  <b>NOTE</b> The setpoint reference entered here is added to any other references that are enabled (see parameter group C-30 and par. C-34).

CL-31 User Defined Refrigerant A1		
Range:		Function:
10.0000 N/A*	[8.0000 - 12.0000 N/A]	Use this parameter to enter the value of coefficient A1 when <i>CL-30 Refrigerant</i> is set to <i>User defined</i> [7].

CL-32 User Defined Refrigerant A2		
Range:		Function:
-2250.00 N/A*	[-3000.00 - -1500.00 N/A]	Use this parameter to enter the value of coefficient A2 when <i>CL-30 Refrigerant</i> is set to <i>User defined</i> [7].

CL-33 User Defined Refrigerant A3		
Range:		Function:
250.000 N/A*	[200.000 - 300.000 N/A]	Use this parameter to enter the value of coefficient A3 when <i>CL-30 Refrigerant</i> is set to <i>User defined</i> [7].

### 3.22.3 CL-3# Feedback Adv. Conversion

In air conditioning compressor applications it is often useful to control the system based on the temperature of the refrigerant. However, it is generally more convenient to directly measure its pressure. This parameter group allows the frequency converter's PID Controller to convert refrigerant pressure measurements into temperature values.

CL-30 Refrigerant		
Option:	Function:	
	Select the refrigerant used in the compressor application. This parameter must be specified correctly for the pressure to temperature conversion to be accurate. If the refrigerant used is not listed in choices [0] through [6], select <i>User defined</i> [7]. Then, use <i>CL-31 User Defined Refrigerant A1</i> , <i>CL-32 User Defined Refrigerant A2</i> and <i>CL-33 User Defined Refrigerant A3</i> to provide A1, A2 and A3 for the equation below:  $Temperature = \frac{A2}{(\ln(Pe + 1) - A1)} - A3$	
[0]	R22	
*		
[1]	R134a	
[2]	R404A	
[3]	R407C	
[4]	R410A	
[5]	R502	
[6]	R744	
[7]	User defined	

### 3.22.4 CL-7# PID autotuning

The frequency converter PID Closed Loop controller (parameters CL-##, PID Closed Loop) can be auto-tuned, simplifying and saving time during commissioning, whilst ensuring accurate PID control adjustment. To use auto-tuning it is necessary for the frequency converter to be configured for closed loop in *H-40 Configuration Mode*.

A Graphical keypad must be used in order to react on messages during the auto-tuning sequence.

Enabling *CL-79 PID Autotuning*, puts the frequency converter into auto-tuning mode. The keypad then directs the user with on-screen instructions.

The fan/pump is started by pressing [Auto] button on the keypad and applying a start signal. The speed is adjusted manually by pressing the [▲] or [▼] navigation keys on the keypad to a level where the feedback is around the system set-point.

#### NOTE

It is not possible to run the motor at maximum or minimum speed, when manually adjusting the motor speed due to the need of giving the motor a step in the speed during auto-tuning.

PID auto-tuning functions by introducing step changes whilst operating at a steady state and then monitoring the feedback. From the feedback response, the required values for *CL-93 PID Proportional Gain* and *CL-94 PID Integral Time* are calculated. *CL-95 PID Differentiation Time* is set to value



0 (zero). *CL-81 PID Normal/ Inverse Control* is determined during tuning process.

These calculated values are presented on the keypad and the user can decide whether to accept or reject them. Once accepted, the values are written to the relevant parameters and auto-tuning mode is disabled in *CL-79 PID Autotuning*. Depending on the system being controlled the time required to carry out auto-tuning could be several minutes.

It is advised to set the ramp times in *F-07 Accel Time 1*, *F-08 Decel Time 1* or *E-10 Accel Time 2* and *E-11 Decel Time 2* according to the load inertia before carrying out PID autotuning. If PID autotuning is carried out with slow ramp times, the auto-tuned parameters will typically result in very slow control. Excessive feedback sensor noise should be removed using the input filter (parameter groups AN-##, E-6# and AO-##, Terminal 53/54 Filter Time Constant/ Pulse Filter Time Constant #29/33) before activating PID autotuning. In order to obtain the most accurate controller parameters, it is advised to carry out PID autotuning, when the application is running in typical operation, i.e. with a typical load.

CL-70 Closed Loop Type		
Option:	Function:	
		This parameter defines the application response. The default mode should be sufficient for most applications. If the application response speed is known, it can be selected here. This will decrease the time needed for carrying out PID autotuning. The setting has no impact on the value of the tuned parameters and is used only for the autotuning sequence.
[0] *	Auto	
[1]	Fast Pressure	
[2]	Slow Pressure	
[3]	Fast Temperature	
[4]	Slow Temperature	

CL-71 PID Performance		
Option:	Function:	
[0] *	Normal	Normal setting of this parameter will be suitable for pressure control in fan systems.
[1]	Fast	Fast setting would generally be used in pumping systems, where a faster control response is desirable.

CL-72 PID Output Change		
Range:	Function:	
0.10 N/A*	[0.01 - 0.50 N/A]	This parameter sets the magnitude of step change during autotuning. The value is a percentage of full speed. I.e. if maximum output frequency in <i>F-17 Motor Speed High</i>

CL-72 PID Output Change		
Range:	Function:	
		Limit [RPM]/ <i>F-15 Motor Speed High Limit</i> [Hz] is set to 50Hz, 0.10 is 10% of 50Hz, which is 5Hz. This parameter should be set to a value resulting in feedback changes of between 10% and 20% for best tuning accuracy.

CL-73 Minimum Feedback Level		
Range:	Function:	
-999999.000 ProcessCtrlUnit*	[-999999.999 - par. CL-74 ProcessCtrlUnit]	The minimum allowable feedback level should be entered here in User units as defined in <i>CL-12 Reference/Feedback Unit</i> . If the level falls below <i>CL-73 Minimum Feedback Level</i> , autotuning is aborted and an error message will appear on the keypad.

CL-74 Maximum Feedback Level		
Range:	Function:	
999999.000 ProcessCtrlUnit*	[par. CL-73 - 999999.999 ProcessCtrlUnit]	The maximum allowable feedback level should be entered here in User units as defined in <i>CL-12 Reference/Feedback Unit</i> . If the level rises above <i>CL-74 Maximum Feedback Level</i> , autotuning is aborted and an error message will appear on the keypad.

CL-79 PID Autotuning		
Option:	Function:	
		This parameter starts the PID autotuning sequence. Once the autotuning has successfully completed and the settings have been accepted or rejected by the user, by pressing [OK] or [Cancel] buttons on the keypad at the end of tuning, this parameter is reset to [0] Disabled.
[0] *	Disabled	
[1]	Enabled	

### 3.22.5 CL-8# PID Basic Settings

This parameter group is used to configure the basic operation of the frequency converter's PID Controller, including how it responds to a feedback that is above or below the setpoint, the speed at which it first starts functioning, and when it will indicate that the system has reached the setpoint.



CL-81 PID Normal/ Inverse Control		
Option:	Function:	
[0] *	Normal	<i>Normal</i> [0] causes the frequency converter's output frequency to decrease when the feedback is greater than the setpoint reference. This is common for pressure-controlled supply fan and pump applications.
[1]	Inverse	<i>Inverse</i> [1] causes the frequency converter's output frequency to increase when the feedback is greater than the setpoint reference. This is common for temperature-controlled cooling applications, such as cooling towers.

CL-82 PID Start Speed [RPM]		
Range:	Function:	
0 RPM*	[0 - par. F-17 RPM]	When the frequency converter is first started, it initially ramps up to this output speed in Open Loop Mode, following the active Ramp Up Time. When the output speed programmed here is reached, the frequency converter will automatically switch to Closed Loop Mode and the PID Controller will begin to function. This is useful in applications in which the driven load must first quickly accelerate to a minimum speed when it is started.
<p><b>NOTE</b> This parameter will only be visible if <i>K-02 Motor Speed Unit</i> is set to [0], RPM.</p>		

CL-83 PID Start Speed [Hz]		
Range:	Function:	
0 Hz*	[0.0 - par. F-15 Hz]	When the frequency converter is first started, it initially ramps up to this output frequency in Open Loop Mode, following the active Ramp Up Time. When the output frequency programmed here is reached, the frequency converter will automatically switch to Closed Loop Mode and the PID Controller will begin to function. This is useful in applications in which the driven load must first quickly accelerate to a minimum speed when it is started.
<p><b>NOTE</b> This parameter will only be visible if <i>K-02 Motor Speed Unit</i> is set to [1], Hz.</p>		

CL-84 On Reference Bandwidth		
Range:	Function:	
5 %*	[0 - 200 %]	When the difference between the feedback and the setpoint reference is less than the value of this parameter, the frequency converter's display will show "Run on Reference". This status can be communicated externally by programming the

CL-84 On Reference Bandwidth		
Range:	Function:	
		function of a digital output for <i>Run on Reference/ No Warning</i> [8]. In addition, for serial communications, the On Reference status bit of the frequency converter's Status Word will be high (1). The <i>On Reference Bandwidth</i> is calculated as a percentage of the setpoint reference.

### 3.22.6 CL-9# PID Controller

This group provides the ability to manually adjust this PID Controller. By adjusting the PID Controller parameters the control performance may be improved. See section **PID** in the AF-600 FP Design Guide, for guidelines on adjusting the PID Controller parameters.

CL-91 PID Anti Windup		
Option:	Function:	
[0]	Off	<i>Off</i> [0] The integrator will continue to change value also after output has reached one of the extremes. This can afterwards cause a delay of change of the output of the controller.
[1] *	On	<i>On</i> [1] The integrator will be locked if the output of the built in PID controller has reached one of the extremes (min or max value) and therefore not able to add further change to the value of the process parameter controlled. This allows the controller to respond more quickly when it again can control the system.

CL-93 PID Proportional Gain		
Range:	Function:	
0.50 N/A*	[0.00 - 10.00 N/A]	

If (Error x Gain) jumps with a value equal to what is set in *CL-14 Maximum Reference/Feedb.* the PID controller will try to change the output speed equal to what is set in *F-17 Motor Speed High Limit [RPM] / F-15 Motor Speed High Limit [Hz]* but in practice of course limited by this setting. The proportional band (error causing output to change from 0-100%) can be calculated by means of the formula:

$$\left( \frac{1}{\text{Proportional Gain}} \right) \times (\text{Max Reference})$$



CL-94 PID Integral Time		
Range:		Function:
20.00 s*	[0.01 - 10000.00 s]	<p>Over time, the integrator accumulates a contribution to the output from the PID controller as long as there is a deviation between the Reference/Setpoint and feedback signals. The contribution is proportional to the size of the deviation. This ensures that the deviation (error) approaches zero.</p> <p>Quick response on any deviation is obtained when the integral time is set to a low value. Setting it too low, however, may cause the control to become unstable.</p> <p>The value set, is the time needed for the integrator to add the same contribution as the proportional part for a certain deviation. If the value is set to 10,000, the controller will act as a pure proportional controller with a P-band based on the value set in <i>CL-93 PID Proportional Gain</i>. When no deviation is present, the output from the proportional controller will be 0.</p>

CL-96 PID Diff. Gain Limit		
Range:		Function:
		This parameter is only active when <i>CL-95 PID Differentiation Time</i> is not set to OFF (0 s).

CL-95 PID Differentiation Time		
Range:		Function:
0.00 s*	[0.00 - 10.00 s]	<p>The differentiator monitors the rate of change of the feedback. If the feedback is changing quickly, it will adjust the output of the PID Controller to reduce the rate of change of the feedback. Quick PID Controller response is obtained when this value is large. However, if too large of a value is used, the frequency converter's output frequency may become unstable.</p> <p>Differentiation time is useful in situations where extremely fast frequency converter response and precise speed control are required. It can be difficult to adjust this for proper system control. Differentiation time is not commonly used in AF-600 FP applications. Therefore, it is generally best to leave this parameter at 0 or OFF.</p>

CL-96 PID Diff. Gain Limit		
Range:		Function:
5.0 N/A*	[1.0 - 50.0 N/A]	<p>The differential function of a PID Controller responds to the rate of change of the feedback. As a result, an abrupt change in the feedback can cause the differential function to make a very large change in the PID Controller's output. This parameter limits the maximum effect that the PID Controller's differential function can produce. A smaller value reduces the maximum effect of the PID Controller's differential function.</p>



### 3.23 XC-## Ext. PID Closed Loop

The AF-600 FP offers 3 Extended Closed Loop PID controllers in addition to the PID Controller. These can be configured independently to control either external actuators (valves, dampers etc.) or be used together with the internal PID Controller to improve the dynamic responses to setpoint changes or load disturbances.

The Extended Closed Loop PID controllers may be interconnected or connected to the PID Closed Loop controller to form a dual loop configuration.

In order to control a modulating device (e.g. a valve motor), this device must be a positioning servo motor with built-in electronics accepting either a 0-10V (signal from Analog I/O card OPCAIO) or a 0/4-20 mA (signal from Control Card and/or General Purpose I/O card OPCGPIO) control signal.

The output function can be programmed in the following parameters:

- Control Card, terminal 42: *AN-50 Terminal 42 Output* (setting [113]...[115] or [149]...[151], Ext. Closed Loop 1/2/3
- General Purpose I/O card OPCGPIO, terminal X30/8: *AN-60 Terminal X30/8 Output*, (setting [113]...[115] or [149]...[151], Ext. Closed Loop 1/2/3
- Analog I/O card OPCAIO, terminal X42/7...11: *AO-40 Terminal X42/7 Output, AO-50 Terminal X42/9 Output, AO-60 Terminal X42/11 Output* (setting [113]...[115], Ext. Closed Loop 1/2/3

General Purpose I/O card and Analog I/O card are optional cards.

#### 3.23.1 XC-0# Extended CL autotuning

The extended PID Closed Loop PID controllers (*XC-##, Ext. Closed Loop*) can each be auto-tuned, simplifying and saving time during commissioning, whilst ensuring accurate PID control adjustment.

To use PID autotuning it is necessary for the relevant Extended PID controller to have been configured for the application.

A graphical keypad must be used in order to react on messages during the autotuning sequence.

Enabling autotuning *XC-09 PID Autotuning* puts the relevant PID controller into PID autotuning mode. The keypad then directs the user with on-screen instructions.

PID autotuning functions by introducing step changes and then monitoring the feedback. From the feedback response, the required values for PID Proportional Gain, *XC-21 Ext. 1 Proportional Gain* for EXT CL 1, *XC-41 Ext. 2 Proportional Gain* for EXT CL 2 and *XC-61 Ext. 3 Proportional Gain* for EXT CL 3 and Integral Time, *XC-22 Ext. 1 Integral Time* for EXT CL 1, *XC-42 Ext. 2 Integral Time* for EXT CL 2 and *XC-62 Ext. 3 Integral Time* for EXT CL 3 are calculated. PID Differentiation Time, *XC-23 Ext. 1 Differentiation Time* for EXT CL 1, *XC-43 Ext. 2 Differentiation Time* for EXT CL 2 and *XC-63 Ext. 3 Differentiation Time* for EXT CL 3 are set to value 0 (zero). Normal / Inverse, *XC-20 Ext. 1 Normal/Inverse Control* for EXT CL 1, *XC-40 Ext. 2 Normal/Inverse Control* for EXT CL 2 and *XC-60 Ext. 3 Normal/Inverse Control* for EXT CL 3 are determined during the tuning process.

These calculated values are presented on the keypad and the user can decide whether to accept or reject them. Once accepted, the values are written to the relevant parameters and PID autotuning mode is disabled in *XC-09 PID Autotuning*. Depending on the system being controlled the time required to carry out PID autotuning could be several minutes.

Excessive feedback sensor noise should be removed using the input filter (parameter groups AN-##, E-6# and AO-##, Terminal 53/54 Filter Time Constant/Pulse Filter Time Constant #29/33) before activating PID autotuning.

XC-00 Closed Loop Type		
Option:	Function:	
[0] *	Auto	This parameter defines the application response. The default mode should be sufficient for most applications. If the relative application speed is known, it can be selected here. This will decrease the time needed for carrying out PID Autotuning. The setting has no impact on the value of the tuned parameters and is used only for the PID auto-tuning sequence.
[1]	Fast Pressure	
[2]	Slow Pressure	
[3]	Fast Temperature	
[4]	Slow Temperature	

XC-01 PID Performance		
Option:	Function:	
[0] *	Normal	Normal setting of this parameter will be suitable for pressure control in fan systems.
[1]	Fast	Fast setting would generally be used in pumping systems, where a faster control response is desirable.



XC-02 PID Output Change		
Range:	Function:	
0.10 N/A* [0.01 - 0.50 N/A]	This parameter sets the magnitude of step change during autotuning. The value is a percentage of full operating range. I.e. if maximum analog output voltage is set to 10 V, 0.10 is 10% of 10 V, which is 1 V. This parameter should be set to a value resulting in feedback changes of between 10% and 20% for best tuning accuracy.	

XC-03 Minimum Feedback Level		
Range:	Function:	
-999999.000 N/A*	[-999999.999 - par. XC-04 N/A]	The minimum allowable feedback level should be entered here in User Units as defined in <i>XC-10 Ext. 1 Ref./Feedback Unit</i> for EXT CL 1, <i>XC-30 Ext. 2 Ref./Feedback Unit</i> for EXT CL 2 or <i>XC-50 Ext. 3 Ref./Feedback Unit</i> for EXT CL 3. If the level falls below <i>XC-03 Minimum Feedback Level</i> , PID autotuning is aborted and an error message will appear on the keypad.

XC-04 Maximum Feedback Level		
Range:	Function:	
999999.000 N/A*	[par. XC-03 - 999999.999 N/A]	The maximum allowable feedback level should be entered here in User units as defined in <i>XC-10 Ext. 1 Ref./Feedback Unit</i> for EXT CL 1, <i>XC-30 Ext. 2 Ref./Feedback Unit</i> for EXT CL 2 or <i>XC-50 Ext. 3 Ref./Feedback Unit</i> for EXT CL 3. If the level rises above <i>XC-04 Maximum Feedback Level</i> , PID autotuning is aborted and an error message will appear on the keypad.

XC-09 PID Autotuning		
Option:	Function:	
[0] *	Disabled	This parameter enables selection of the Extended PID controller to be autotuned and starts the PID autotuning for that controller. Once the autotuning has successfully completed and the settings have been accepted or rejected by the user, by pressing [OK] or [Cancel] buttons on the keypad at the end of tuning, this parameter is reset to [0] Disabled.
[1]	Enabled Ext CL 1 PID	

XC-09 PID Autotuning		
Option:	Function:	
[2]	Enabled Ext CL 2 PID	
[3]	Enabled Ext CL 3 PID	

3.23.2 XC-1# Ext. CL 1 Ref./Fb.

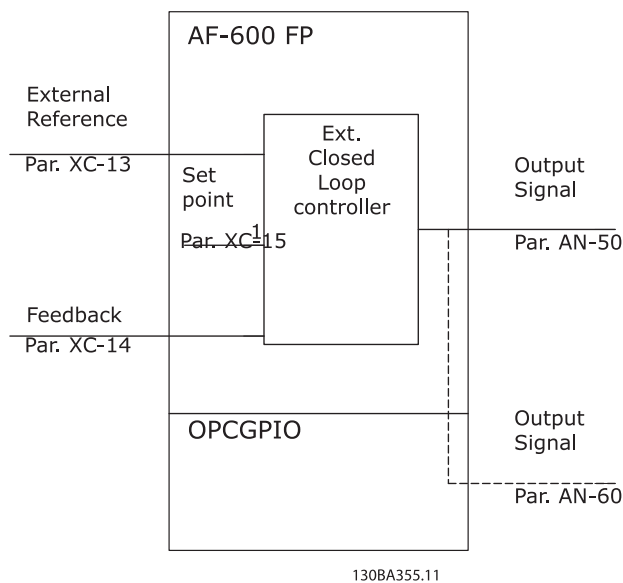

XC-10 Ext. 1 Ref./Feedback Unit		
Option:	Function:	
[0]		Select the unit for the reference and feedback.
[1] *	%	
[5]	PPM	
[10]	1/min	
[11]	RPM	
[12]	Pulse/s	
[20]	l/s	
[21]	l/min	
[22]	l/h	
[23]	m <sup>3</sup> /s	
[24]	m <sup>3</sup> /min	
[25]	m <sup>3</sup> /h	
[30]	kg/s	
[31]	kg/min	
[32]	kg/h	
[33]	t/min	
[34]	t/h	
[40]	m/s	
[41]	m/min	
[45]	m	
[60]	°C	
[70]	mbar	
[71]	bar	





XC-10 Ext. 1 Ref./Feedback Unit		
Option:	Function:	
[72]	Pa	
[73]	kPa	
[74]	m WG	
[75]	mm Hg	
[80]	kW	
[120]	GPM	
[121]	gal/s	
[122]	gal/min	
[123]	gal/h	
[124]	CFM	
[125]	ft <sup>3</sup> /s	
[126]	ft <sup>3</sup> /min	
[127]	ft <sup>3</sup> /h	
[130]	lb/s	
[131]	lb/min	
[132]	lb/h	
[140]	ft/s	
[141]	ft/min	
[145]	ft	
[160]	°F	
[170]	psi	
[171]	lb/in <sup>2</sup>	
[172]	in WG	
[173]	ft WG	
[174]	in Hg	
[180]	HP	

XC-11 Ext. 1 Minimum Reference		
Range:	Function:	
0.000 ExtPID1Unit*	[-999999.999 - par. XC-12 ExtPID1Unit]	Select the minimum for the Closed Loop 1 Controller.

XC-12 Ext. 1 Maximum Reference		
Range:	Function:	
100.000 ExtPID1Unit*	[par. XC-11 - 999999.999 ExtPID1Unit]	Select the maximum for the Closed Loop 1 Controller.  The dynamics of the PID controller will depend on the value set in this parameter. Please see also <i>XC-21 Ext. 1 Proportional Gain</i> .

XC-13 Ext. 1 Reference Source		
Option:	Function:	
		This parameter defines which input on the frequency converter should be treated as the source of the reference signal for the Closed Loop 1 Controller. Analog input X30/11

XC-13 Ext. 1 Reference Source		
Option:	Function:	
		and Analog input X30/12 refer to inputs on the General Purpose I/O.
[0] *	No function	
[1]	Analog input 53	
[2]	Analog input 54	
[7]	Pulse input 29	
[8]	Pulse input 33	
[20]	Digital Potentiometer	
[21]	Analog input X30/11	
[22]	Analog input X30/12	
[23]	Analog Input X42/1	
[24]	Analog Input X42/3	
[25]	Analog Input X42/5	
[30]	Ext. Closed Loop 1	
[31]	Ext. Closed Loop 2	
[32]	Ext. Closed Loop 3	

XC-14 Ext. 1 Feedback Source		
Option:	Function:	
		This parameter defines which input on the frequency converter should be treated as the source of the feedback signal for the Closed Loop 1 controller. Analog input X30/11 and Analog input X30/12 refer to inputs on the General Purpose I/O (OPCGPIO).
[0] *	No function	
[1]	Analog input 53	
[2]	Analog input 54	
[3]	Pulse input 29	
[4]	Pulse input 33	
[7]	Analog input X30/11	
[8]	Analog input X30/12	
[9]	Analog Input X42/1	
[10]	Analog Input X42/3	
[11]	Analog Input X42/5	
[100]	Bus feedback 1	
[101]	Bus feedback 2	
[102]	Bus feedback 3	

XC-15 Ext. 1 Setpoint		
Range:	Function:	
0.000 ExtPID1Unit*	[-999999.999 - 999999.999 ExtPID1Unit]	The setpoint reference is used in extended 1 closed loop. Ext.1 Setpoint is added to the value from the Ext.1 Reference source selected in <i>XC-13 Ext. 1 Reference Source</i> .



Parameter Description AF-600 FP Programming Guide

XC-17 Ext. 1 Reference [Unit]		
Range:	Function:	
0.000 ExtPID1Unit*	[-999999.999 - 999999.999 ExtPID1Unit]	Readout of the reference value for the Closed Loop 1 Controller.

XC-18 Ext. 1 Feedback [Unit]		
Range:	Function:	
0.000 ExtPID1Unit*	[-999999.999 - 999999.999 ExtPID1Unit]	Readout of the feedback value for the Closed Loop 1 Controller.

XC-19 Ext. 1 Output [%]		
Range:	Function:	
0 %*	[0 - 100 %]	Readout of the output value for the Closed Loop 1 Controller.

3.23.3 XC-2# Ext. CL 1 PID

XC-20 Ext. 1 Normal/Inverse Control		
Option:	Function:	
[0] *	Normal	Select <i>Normal</i> [0] if the output should be reduced when feedback is higher than the reference.
[1]	Inverse	Select <i>Inverse</i> [1] if the output should be increased when feedback is higher than the reference.

XC-21 Ext. 1 Proportional Gain		
Range:	Function:	
0.01 N/A*	[0.00 - 10.00 N/A]	

If (Error x Gain) jumps with a value equal to what is set in *CL-14 Maximum Reference/Feedb.*, the PID controller will try to change the output speed equal to what is set in par. F-17/F-18, Motor Speed High Limit, but in practice of course limited by this setting.

The proportional band (error causing output to change from 0-100%) can be calculated by means of the formula:

$$\left(\frac{1}{\text{Proportional Gain}}\right) \times (\text{Max Reference})$$

**NOTE**

Always set the desired for *CL-14 Maximum Reference/Feedb.* before setting the values for the PID controller in parameter group CL-9#.

XC-22 Ext. 1 Integral Time		
Range:	Function:	
10000.00 s*	[0.01 - 10000.00 s]	Over time, the integrator accumulates a contribution to the output from the PID controller as long as there is a deviation between the Reference/Setpoint and feedback signals. The contribution is

XC-22 Ext. 1 Integral Time		
Range:	Function:	
		proportional to the size of the deviation. This ensures that the deviation (error) approaches zero. Quick response on any deviation is obtained when the integral time is set to a low value. Setting it too low, however, may cause the control to become unstable. The value set, is the time needed for the integrator to add the same contribution as the proportional part for a certain deviation. If the value is set to 10,000, the controller will act as a pure proportional controller with a P-band based on the value set in <i>CL-93 PID Proportional Gain</i> . When no deviation is present, the output from the proportional controller will be 0.

XC-23 Ext. 1 Differentiation Time		
Range:	Function:	
0.00 s*	[0.00 - 10.00 s]	The differentiator does not react to a constant error. It only provides a gain when the feedback changes. The quicker the feedback changes, the stronger the gain from the differentiator.

XC-24 Ext. 1 Dif. Gain Limit		
Range:	Function:	
5.0 N/A*	[1.0 - 50.0 N/A]	Set a limit for the differentiator gain (DG). The DG will increase if there are fast changes. Limit the DG to obtain a pure differentiator gain at slow changes and a constant differentiator gain where quick changes occur.

3.23.4 XC-3# Ext. CL 2 Ref./Fb.

XC-30 Ext. 2 Ref./Feedback Unit		
Option:	Function:	
		See <i>XC-10 Ext. 1 Ref./Feedback Unit</i> for details
[0]		
[1] *	%	
[5]	PPM	
[10]	1/min	
[11]	RPM	
[12]	Pulse/s	
[20]	l/s	
[21]	l/min	
[22]	l/h	
[23]	m <sup>3</sup> /s	



XC-30 Ext. 2 Ref./Feedback Unit		
Option:	Function:	
[24]	m <sup>3</sup> /min	
[25]	m <sup>3</sup> /h	
[30]	kg/s	
[31]	kg/min	
[32]	kg/h	
[33]	t/min	
[34]	t/h	
[40]	m/s	
[41]	m/min	
[45]	m	
[60]	°C	
[70]	mbar	
[71]	bar	
[72]	Pa	
[73]	kPa	
[74]	m WG	
[75]	mm Hg	
[80]	kW	
[120]	GPM	
[121]	gal/s	
[122]	gal/min	
[123]	gal/h	
[124]	CFM	
[125]	ft <sup>3</sup> /s	
[126]	ft <sup>3</sup> /min	
[127]	ft <sup>3</sup> /h	
[130]	lb/s	
[131]	lb/min	
[132]	lb/h	
[140]	ft/s	
[141]	ft/min	
[145]	ft	
[160]	°F	
[170]	psi	
[171]	lb/in <sup>2</sup>	
[172]	in WG	
[173]	ft WG	
[174]	in Hg	
[180]	HP	

XC-31 Ext. 2 Minimum Reference		
Range:	Function:	
0.000 ExtPID2Unit*	[-999999.999 - par. XC-32 ExtPID2Unit]	See XC-11 Ext. 1 Minimum Reference for details.

XC-32 Ext. 2 Maximum Reference		
Range:	Function:	
100.000 ExtPID2Unit*	[par. XC-31 - 999999.999 ExtPID2Unit]	See XC-12 Ext. 1 Maximum Reference for details.

XC-33 Ext. 2 Reference Source		
Option:	Function:	
		See XC-13 Ext. 1 Reference Source for details.
[0] *	No function	
[1]	Analog input 53	
[2]	Analog input 54	
[7]	Pulse input 29	
[8]	Pulse input 33	
[20]	Digital Potentiometer	
[21]	Analog input X30/11	
[22]	Analog input X30/12	
[23]	Analog Input X42/1	
[24]	Analog Input X42/3	
[25]	Analog Input X42/5	
[30]	Ext. Closed Loop 1	
[31]	Ext. Closed Loop 2	
[32]	Ext. Closed Loop 3	

XC-34 Ext. 2 Feedback Source		
Option:	Function:	
		See XC-14 Ext. 1 Feedback Source for details.
[0] *	No function	
[1]	Analog input 53	
[2]	Analog input 54	
[3]	Pulse input 29	
[4]	Pulse input 33	
[7]	Analog input X30/11	
[8]	Analog input X30/12	
[9]	Analog Input X42/1	
[10]	Analog Input X42/3	
[11]	Analog Input X42/5	
[100]	Bus feedback 1	
[101]	Bus feedback 2	
[102]	Bus feedback 3	

XC-35 Ext. 2 Setpoint		
Range:	Function:	
0.000 ExtPID2Unit*	[-999999.999 - 999999.999 ExtPID2Unit]	See XC-15 Ext. 1 Setpoint for details.

XC-37 Ext. 2 Reference [Unit]		
Range:	Function:	
0.000 ExtPID2Unit*	[-999999.999 - 999999.999 ExtPID2Unit]	See XC-17 Ext. 1 Reference [Unit], Ext. 1 Reference [Unit], for details.



XC-38 Ext. 2 Feedback [Unit]		
Range:	Function:	
0.000 ExtPID2Unit*	[-999999.999 - 999999.999 ExtPID2Unit]	See XC-18 Ext. 1 Feedback [Unit] for details.

XC-39 Ext. 2 Output [%]		
Range:	Function:	
0 %*	[0 - 100 %]	See XC-19 Ext. 1 Output [%] for details.

### 3.23.5 XC-4# Ext. CL 2 PID

XC-40 Ext. 2 Normal/Inverse Control		
Option:	Function:	
	See XC-20 Ext. 1 Normal/Inverse Control for details.	
[0] *	Normal	
[1]	Inverse	

XC-41 Ext. 2 Proportional Gain		
Range:	Function:	
0.01 N/A*	[0.00 - 10.00 N/A]	See XC-21 Ext. 1 Proportional Gain for details.

XC-42 Ext. 2 Integral Time		
Range:	Function:	
10000.00 s*	[0.01 - 10000.00 s]	See XC-22 Ext. 1 Integral Time for details.

XC-43 Ext. 2 Differentiation Time		
Range:	Function:	
0.00 s*	[0.00 - 10.00 s]	See XC-23 Ext. 1 Differentiation Time for details.

XC-44 Ext. 2 Dif. Gain Limit		
Range:	Function:	
5.0 N/A*	[1.0 - 50.0 N/A]	See XC-24 Ext. 1 Dif. Gain Limit for details.

### 3.23.6 XC-5# Ext. CL 3 Ref./Fb.

XC-50 Ext. 3 Ref./Feedback Unit		
Option:	Function:	
	See XC-10 Ext. 1 Ref./Feedback Unit for details.	
[0]		
[1] *	%	
[5]	PPM	
[10]	1/min	
[11]	RPM	
[12]	Pulse/s	
[20]	l/s	
[21]	l/min	
[22]	l/h	

XC-50 Ext. 3 Ref./Feedback Unit		
Option:	Function:	
[23]	m <sup>3</sup> /s	
[24]	m <sup>3</sup> /min	
[25]	m <sup>3</sup> /h	
[30]	kg/s	
[31]	kg/min	
[32]	kg/h	
[33]	t/min	
[34]	t/h	
[40]	m/s	
[41]	m/min	
[45]	m	
[60]	°C	
[70]	mbar	
[71]	bar	
[72]	Pa	
[73]	kPa	
[74]	m WG	
[75]	mm Hg	
[80]	kW	
[120]	GPM	
[121]	gal/s	
[122]	gal/min	
[123]	gal/h	
[124]	CFM	
[125]	ft <sup>3</sup> /s	
[126]	ft <sup>3</sup> /min	
[127]	ft <sup>3</sup> /h	
[130]	lb/s	
[131]	lb/min	
[132]	lb/h	
[140]	ft/s	
[141]	ft/min	
[145]	ft	
[160]	°F	
[170]	psi	
[171]	lb/in <sup>2</sup>	
[172]	in WG	
[173]	ft WG	
[174]	in Hg	
[180]	HP	

XC-51 Ext. 3 Minimum Reference		
Range:	Function:	
0.000 ExtPID3Unit*	[-999999.999 - par. XC-52 ExtPID3Unit]	See XC-11 Ext. 1 Minimum Reference for details.

XC-52 Ext. 3 Maximum Reference		
Range:	Function:	
100.000 ExtPID3Unit*	[par. XC-51 - 999999.999 ExtPID3Unit]	See XC-12 Ext. 1 Maximum Reference for details.



XC-53 Ext. 3 Reference Source		
Option:	Function:	
		See XC-13 Ext. 1 Reference Source for details.
[0] *	No function	
[1]	Analog input 53	
[2]	Analog input 54	
[7]	Pulse input 29	
[8]	Pulse input 33	
[20]	Digital Potentiometer	
[21]	Analog input X30/11	
[22]	Analog input X30/12	
[23]	Analog Input X42/1	
[24]	Analog Input X42/3	
[25]	Analog Input X42/5	
[30]	Ext. Closed Loop 1	
[31]	Ext. Closed Loop 2	
[32]	Ext. Closed Loop 3	

XC-54 Ext. 3 Feedback Source		
Option:	Function:	
		See XC-14 Ext. 1 Feedback Source for details.
[0] *	No function	
[1]	Analog input 53	
[2]	Analog input 54	
[3]	Pulse input 29	
[4]	Pulse input 33	
[7]	Analog input X30/11	
[8]	Analog input X30/12	
[9]	Analog Input X42/1	
[10]	Analog Input X42/3	
[11]	Analog Input X42/5	
[100]	Bus feedback 1	
[101]	Bus feedback 2	
[102]	Bus feedback 3	

XC-55 Ext. 3 Setpoint		
Range:	Function:	
0.000 ExtPID3Unit*	[-999999.999 - 999999.999 ExtPID3Unit]	See XC-15 Ext. 1 Setpoint for details.

XC-57 Ext. 3 Reference [Unit]		
Range:	Function:	
0.000 ExtPID3Unit*	[-999999.999 - 999999.999 ExtPID3Unit]	See XC-17 Ext. 1 Reference [Unit] for details.

XC-58 Ext. 3 Feedback [Unit]		
Range:	Function:	
0.000 ExtPID3Unit*	[-999999.999 - 999999.999 ExtPID3Unit]	See XC-18 Ext. 1 Feedback [Unit] for details.

XC-59 Ext. 3 Output [%]		
Range:	Function:	
0 %*	[0 - 100 %]	See XC-19 Ext. 1 Output [%] for details.

3.23.7 XC-6# Ext. CL 3 PID

XC-60 Ext. 3 Normal/Inverse Control		
Option:	Function:	
		See XC-20 Ext. 1 Normal/Inverse Control for details.
[0] *	Normal	
[1]	Inverse	

XC-61 Ext. 3 Proportional Gain		
Range:	Function:	
0.01 N/A*	[0.00 - 10.00 N/A]	See XC-21 Ext. 1 Proportional Gain for details.

XC-62 Ext. 3 Integral Time		
Range:	Function:	
10000.00 s*	[0.01 - 10000.00 s]	See XC-22 Ext. 1 Integral Time for details.

XC-63 Ext. 3 Differentiation Time		
Range:	Function:	
0.00 s*	[0.00 - 10.00 s]	See XC-23 Ext. 1 Differentiation Time for details.

XC-64 Ext. 3 Dif. Gain Limit		
Range:	Function:	
5.0 N/A*	[1.0 - 50.0 N/A]	See XC-24 Ext. 1 Dif. Gain Limit for details.



### 3.24 PC-## Pump Controller

Parameters for configuring the Basic Pump Controller for sequence control of multiple pumps. For a more application oriented description and wiring examples, see Chapter *Application Examples*, item *Basic Pump Controller* in the Design Guide.

To configure the Pump Controller to the actual system and the desired control strategy, it is recommended to follow the below sequence, starting with parameter group PC-0# *System Settings* and next parameter group PC-5# *Alternation Settings*. These parameter can normally be set in advance.

Parameters in PC-2# *Bandwidth Settings* and PC-4# *Staging settings*, will often be dependent on the dynamic of the system and final adjustment to be done at the commissioning of the plant.

#### NOTE

The Pump Controller is supposed to operate in closed loop controlled by the built-in PI controller (Closed Loop selected in H-40 Configuration Mode). If Open Loop is selected in H-40 Configuration Mode, all fixed speed pumps will be destaged, but the variable speed pump will still be controlled by the frequency converter, now as an open loop configuration:

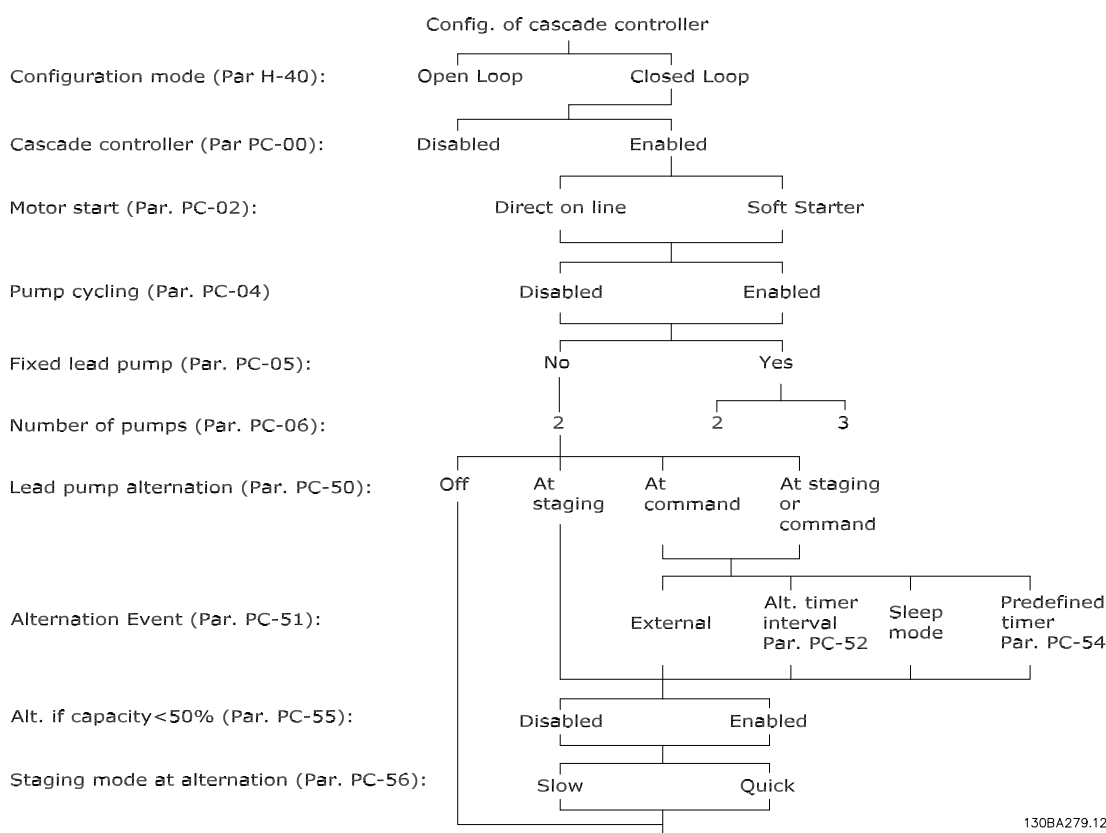

#### 3.24.1 PC-0# System Settings

Parameters related to control principles and configuration of the system.

PC-00 Pump Controller	
Option:	Function:
	For operation of multiple devices (pump/fan) systems where capacity is adapted to actual load by means of speed control combined with on/off control of the devices. For simplicity only pump systems are described.

PC-00 Pump Controller	
Option:	Function:
[0] *	Disabled The Pump Controller is not active. All built-in relays assigned to pump motors in the cascade function will be de-energized. If a variable speed pump is connected to the frequency converter directly (not controlled by a built-in relay); this pump/fan will be controlled as a single pump system.
[1]	Enabled The Pump Controller is active and will stage/destage pumps according to load on the system.



PC-02 Motor Start		
Option:	Function:	
		Motors are connected to the mains directly with a contactor or with a soft starter. When the value of <i>PC-02 Motor Start</i> is set to an option other than <i>Direct on Line</i> [0], then <i>PC-50 Lead Pump Alternation</i> is automatically set to the default of <i>Direct on Line</i> [0].
[0] *	Direct on Line	Each fixed speed pump is connected to line directly via a contactor.
[1]	Soft Starter	Each fixed speed pump is connected to line via a soft starter.
[2]	Star-Delta	

PC-04 Pump Cycling		
Option:	Function:	
		To provide equal hours of operation with fixed speed pumps, the pump use can be cycled. The selection of pump cycling is either "first in – last out" or equal running hours for each pump.
[0] *	Disabled	The fixed speed pumps will be connected in the order 1 – 2 and disconnected in the order 2 – 1. (First in – last out).
[1]	Enabled	The fixed speed pumps will be connected/disconnected to have equal running hours for each pump.

PC-05 Fixed Lead Pump		
Option:	Function:	
		Fixed Lead Pump means that the variable speed pump is connected directly to the frequency converter and if a contactor is applied between frequency converter and pump, this contactor will not be controlled by the frequency converter. If operating with <i>PC-50 Lead Pump Alternation</i> set to other than <i>Off</i> [0], this parameter must be set to <i>No</i> [0].
[0]	No	The lead pump function can alternate between the pumps controlled by the two built in relays. One pump must be connected to the built-in RELAY 1, and the other pump to RELAY 2. The pump function (Cascade Pump1 and Cascade Pump2) will automatically be assigned to the relays (maximum two pumps can in this case be controlled from the frequency converter).
[1] *	Yes	The lead pump will be fixed (no alternation) and connected directly to the frequency converter. The <i>PC-50 Lead Pump Alternation</i> is automatically set to <i>Off</i> [0]. Built-in relays Relay 1 and Relay 2 can be assigned to separate fixed speed pumps. In total three pumps can be controlled by the frequency converter.

PC-06 Number of Pumps		
Range:	Function:	
2 N/A*	[2 - 9. N/A]	The number of pumps connected to the Pump Controller including the variable speed pump. If the variable speed pump is connected directly to the frequency converter and the other fixed speed pumps (lag pumps) are controlled by the two built in relays, three pumps can be controlled. If both the variable speed and fixed speed pumps are to be controlled by built-in relays, only two pumps can be connected.  If <i>PC-05 Fixed Lead Pump</i> , is set to <i>No</i> [0]: one variable speed pump and one fixed speed pump; both controlled by built in relay. If <i>PC-05 Fixed Lead Pump</i> is set to <i>Yes</i> [1]: one variable speed pump and one fixed speed pump controlled by built-in relay.  One lead pump, see <i>PC-05 Fixed Lead Pump</i> . Two fixed speed pumps controlled by built-in relays.

### 3.24.2 PC-2# Bandwidth Settings

Parameters for setting the bandwidth within which the pressure will be allowed to operate before staging/destaging fixed speed pumps. Also includes various timers to stabilize the control.

PC-20 Staging Bandwidth		
Range:	Function:	
10 %*	[1 - par. PC-21 %]	Set the staging bandwidth (SBW) percentage to accommodate normal system pressure fluctuation. In cascade control systems, to avoid frequent switching of fixed speed pumps, the desired system pressure is typically kept within a bandwidth rather than at a constant level.  The SBW is programmed as a percentage of <i>CL-13 Minimum Reference/Feedb.</i> and <i>CL-14 Maximum Reference/Feedb.</i> . For example, if the set-point is 5 bar and the SBW is set to 10%, a system pressure between 4.5 and 5.5 bar is tolerated. No staging or de-staging will occur within this bandwidth.

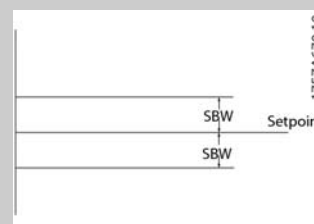



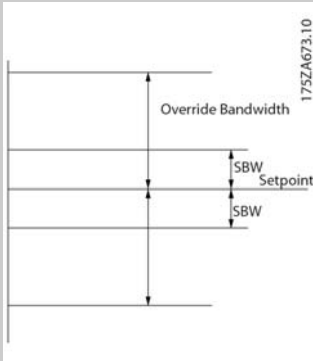

PC-21 Override Bandwidth		
Range:	Function:	
100 %* - 100 %]	[par. PC-20	When a large and quick change in the system demand occurs (such as a sudden water demand), the system pressure rapidly changes and an immediate staging or destaging of a fixed speed pump becomes necessary to match the requirement. The override bandwidth (OBW) is programmed to override the staging/destaging timer ( <i>PC-23 SBW Staging Delay</i> and <i>PC-24 SBW Destaging Delay</i> ) for immediate response.  The OBW must always be programmed to a higher value than the value set in <i>Staging Bandwidth (SBW)</i> , <i>PC-20 Staging Bandwidth</i> . The OBW is a percentage of <i>F-52 Minimum Reference</i> and <i>F-53 Maximum Reference</i> .
		 <p>Setting the OBW too close to the SBW could defeat the purpose with frequent staging at momentary pressure changes. Setting the OBW too high might lead to unacceptably high or low pressure in the system while the SBW timers are running. The value can be optimized with increased familiarity with the system. See <i>PC-25 OBW Time</i>.</p> <p>To avoid unintended staging during the commissioning phase and fine tuning of the controller, initially leave the OBW at the factory setting of 100% (Off). When the fine tuning is completed, the OBW should be set to the desired value. An initial value of 10% is suggested.</p>

PC-22 Fixed Speed Bandwidth		
Range:	Function:	
		SBW. It is possible to stop the fixed speed pumps, in case of an alarm situation, by pressing the keypad OFF or HAND keys or if the signal programmed for Start on digital input goes low.  In case the issued alarm is a trip-lock alarm then the Cascade Controller must stop the system immediately by cutting out all the fixed speed pumps. This is basically the same as Emergency Stop (Coast/Coast inverse Command) for the Cascade Controller.

PC-22 Fixed Speed Bandwidth		
Range:	Function:	
par. PC-20 %*	[par. PC-20 - par. PC-21 %]	When the cascade control system is running normally and the frequency converter issues a trip alarm, it is important to maintain the system head. The Cascade Controller does this by continuing to stage/destage the fixed speed pump on and off. Due to the fact that keeping the head at the setpoint would require frequent staging and destaging when only a fixed speed pump is running, a wider Fixed Speed Bandwidth (FSBW) is used instead of

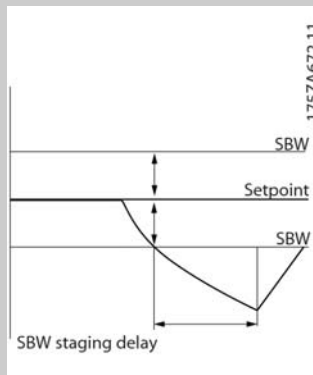
PC-23 SBW Staging Delay		
Range:	Function:	
15 s*	[0 - 3000 s]	Immediate staging of a fixed speed pump is not desirable when a momentary pressure drop in the system exceeds the Staging Bandwidth (SBW). Staging is delayed by the length of time programmed. If the pressure increases to within the SBW before the timer has elapsed, the timer is reset.
		



PC-24 SBW Destaging Delay		
Range:	Function:	
15 s* [0 - 3000 s]	<p>Immediate destaging of a fixed speed pump is not desirable when a momentary pressure increase in the system that exceeds the Staging Bandwidth (SBW). Destaging is delayed by the length of time programmed. If the pressure decreases to within the SBW before the timer has elapsed, the timer is reset.</p>	

PC-25 OBW Time		
Range:	Function:	
10 s* [0 - 300 s]	<p>Staging a fixed speed pump creates a momentary pressure peak in the system, which might exceed the Override Bandwidth (OBW). It is not desirable to destage a pump in response to a staging pressure peak. The OBW Time can be programmed to prevent staging until the system pressure has stabilized and normal control established. Set the timer to a value that allows the system to stabilize after staging. The 10 second factory setting is appropriate in most applications. In highly dynamic systems, a shorter time may be desirable.</p>	

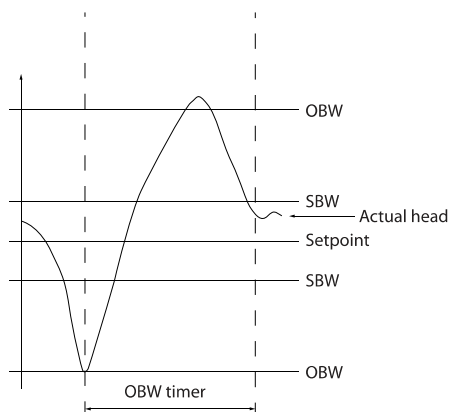

130BA370.10

PC-26 Destage At No-Flow		
Option:	Function:	
[0] *	Disabled	<p>The Destage at No-Flow parameter ensures that when a no-flow situation occurs, the fixed speed pumps will be destaged one-by-one until the no-flow signal disappears. This requires that No Flow Detection is active. See parameter group AP-2#. If Destage at No-Flow is disabled the Pump Controller does not change the normal behavior of the system.</p>
[1]	Enabled	

PC-27 Stage Function		
Option:	Function:	
[0]	Disabled	<p>If the Stage Function is set to <i>Disabled</i> [0], <i>PC-28 Stage Function Time</i> will not be activated.</p>
[1] *	Enabled	

PC-28 Stage Function Time		
Range:	Function:	
15 s* [0 - 300 s]	<p>The Stage Function Time is programmed to avoid frequent staging of the fixed speed pumps. The Stage Function Time starts if it is <i>Enabled</i> [1] by <i>PC-27 Stage Function</i>, and when the variable speed pump is running at <i>Motor Speed High Limit</i>, <i>F-17 Motor Speed High Limit [RPM]</i> or <i>F-15 Motor Speed High Limit [Hz]</i>, with at least one fixed speed pump in the stop position. When the programmed value of the timer expires, a fixed speed pump is staged.</p>	

PC-29 Destage Function		
Option:	Function:	
[0]	Disabled	<p>The Destage Function ensures that the lowest numbers of pumps are running to save energy and to avoid dead head water circulation in the variable speed pump. If the Destage Function is set to <i>Disabled</i> [0], the <i>PC-30 Destage Function Time</i> will not be activated.</p>
[1] *	Enabled	



PC-30 Destage Function Time		
Range:	Function:	
15 s* [0 - 300 s]	The Destage Function Timer is programmable to avoid frequent staging/destaging of the fixed speed pumps. The Destage Function Time starts when the adjustable speed pump is running at <i>F-18 Motor Speed Low Limit [RPM]</i> or <i>F-16 Motor Speed Low Limit [Hz]</i> , with one or more fixed speed pumps in operation and system requirements satisfied. In this situation, the adjustable speed pump contributes a little to the system. When the programmed value of the timer expires, a stage is removed, avoiding dead head water circulation in the adjustable speed pump.	

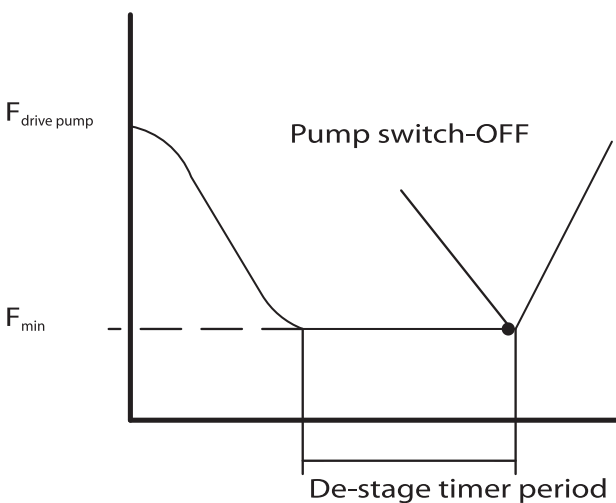

175ZA640.10

### 3.24.3 PC-4# Staging Settings

Parameters determining conditions for staging/destaging the pumps.

PC-40 Decel Ramp Delay		
Range:	Function:	
10.0 s* [0.0 - 120.0 s]	When adding a fixed speed pump controlled by a soft starter, it is possible to delay the decel of the lead pump until a preset time after the start of the fixed speed pump to eliminate pressure surges or water hammer in the system.  Only to be used if <i>Soft Starter</i> [1] is selected in <i>PC-02 Motor Start</i> .	

PC-41 Accel Ramp Delay		
Range:	Function:	
2.0 s* [0.0 - 12.0 s]	When removing a fixed speed pump controlled by a soft starter, it is possible to delay the accel of the lead pump until a preset time after the stopping of the fixed speed pump to eliminate	

PC-41 Accel Ramp Delay		
Range:	Function:	
	pressure surges or water hammer in the system.  Only to be used if <i>Soft Starter</i> [1] is selected in <i>PC-02 Motor Start</i> .	

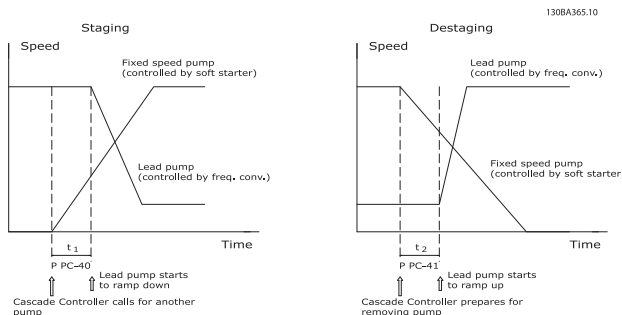

130BA365.10

PC-42 Staging Threshold		
Range:	Function:	
0 %* [0 - 100 %]		

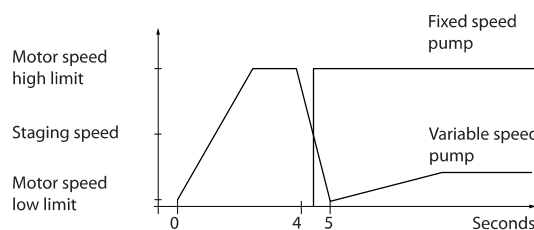

130BA366.10

### NOTE

If the set-point is reached after staging before the variable speed pump reaches its minimum speed - the system will enter the state closed loop as soon as the feedback pressure is crossing the set-point.

PC-43 Destaging Threshold		
Range:	Function:	
0 %* [0 - 100 %]		

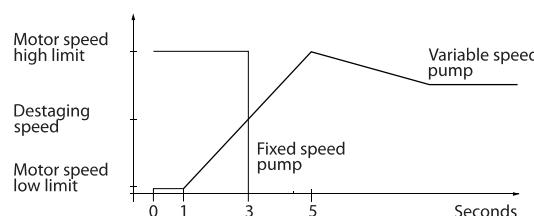

130BA367.10

If the set-point is reached after staging before the variable speed pump reaches its maximum speed - the system will enter the state closed loop as soon as the feedback pressure is crossing the set-point.



PC-44 Staging Speed [RPM]		
Range:	Function:	
0 RPM* [0 - 0 RPM]	<p>Readout of the below calculated value for Staging Speed When adding a fixed speed pump, in order to prevent an overshoot of pressure, the variable speed pump decels to a lower speed. When the variable speed pump reaches the "Staging Speed" the fixed speed pump is staged on. Staging Speed calculation is based on <i>PC-42 Staging Threshold</i>, and <i>F-17 Motor Speed High Limit [RPM]</i>.</p> <p>Staging Speed is calculated with the following formula:</p> $STAGE = HIGH \frac{STAGE\%}{100}$ <p>where <math>n_{HIGH}</math> is Motor Speed High Limit and <math>n_{STAGE100\%}</math> is the value of Staging Threshold.</p>	

PC-47 Destaging Speed [Hz]		
Range:	Function:	
0.0 Hz* [0.0 - 0.0 Hz]	<p>Readout of the below calculated value for Destaging Speed. When removing a fixed speed pump, in order to prevent an undershoot of pressure, the variable speed pump accels to a higher speed. When the variable speed pump reaches the "Destaging Speed" the fixed speed pump is destaged. Destaging Speed is calculated based on <i>PC-43 Destaging Threshold</i>, and <i>F-15 Motor Speed High Limit [Hz]</i>.</p> <p>Destaging Speed is calculated with the following formula:</p> $DESTAGE = HIGH \frac{DESTAGE\%}{100}$ <p>where <math>n_{HIGH}</math> is Motor Speed High Limit and <math>n_{DESTAGE100\%}</math> is the value of Destaging Threshold.</p>	

PC-45 Staging Speed [Hz]		
Range:	Function:	
0.0 Hz* [0.0 - 0.0 Hz]	<p>Readout of the below calculated value for Staging Speed When adding a fixed speed pump, in order to prevent an overshoot of pressure, the variable speed pump decels to a lower speed. When the variable speed pump reaches the "Staging Speed" the fixed speed pump is staged on. Staging Speed calculation is based on <i>PC-42 Staging Threshold</i>, and <i>F-15 Motor Speed High Limit [Hz]</i>.</p> <p>Staging Speed is calculated with the following formula:</p> $STAGE = HIGH \frac{STAGE\%}{100}$ <p>where <math>n_{HIGH}</math> is Motor Speed High Limit and <math>n_{STAGE100\%}</math> is the value of Staging Threshold.</p>	

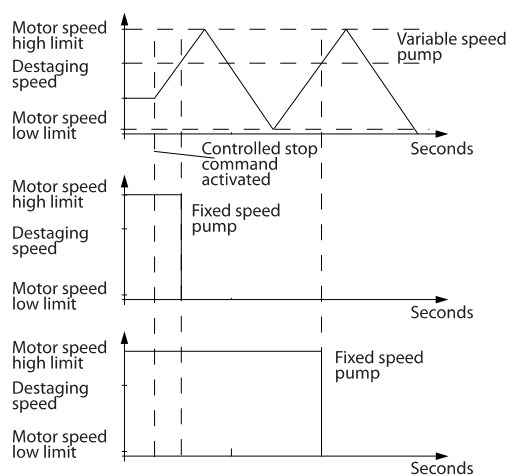

130BA368:10

PC-46 Destaging Speed [RPM]		
Range:	Function:	
0 RPM* [0 - 0 RPM]	<p>Readout of the below calculated value for Destaging Speed. When removing a fixed speed pump, in order to prevent an undershoot of pressure, the variable speed pump accels to a higher speed. When the variable speed pump reaches the "Destaging Speed" the fixed speed pump is destaged. Destaging Speed is calculated based on <i>PC-43 Destaging Threshold</i>, and <i>F-17 Motor Speed High Limit [RPM]</i>.</p> <p>Destaging Speed is calculated with the following formula:</p> $DESTAGE = HIGH \frac{DESTAGE\%}{100}$ <p>where <math>n_{HIGH}</math> is Motor Speed High Limit and <math>n_{DESTAGE100\%}</math> is the value of Destaging Threshold.</p>	

### 3.24.4 PC-5# Alternation Settings

Parameters for defining the conditions for alternation of the variable speed pump (lead), if selected as part of the control strategy.



PC-50 Lead Pump Alternation		
Option:	Function:	
		Lead pump alternation equalizes the use of pumps by periodically changing the pump that is speed controlled. This ensures that pumps are equally used over time. Alternation equalizes the usage of pumps by always choosing the pump with the lowest number of used hours to stage on next.
[0] *	Off	No alternation of lead pump function will take place. It is not possible to set this parameter to options other than <i>Off</i> [0] if <i>PC-02 Motor Start</i> is set other than <i>Direct on Line</i> [0].
[1]	At staging	Alternation of the lead pump function will take place when staging another pump.
[2]	At command	Alternation of the lead pump function will take place at an external command signal or a pre-programmed event. See <i>PC-51 Alternation Event</i> for available options.
[3]	At staging or command	Alternation of the variable speed (lead) pump will take place at staging or the "At Command" signal. (See above.)

PC-52 Alternation Time Interval		
Range:	Function:	
24 h* [1 - 999 h]		If <i>Alternation Time Interval</i> [1] option in <i>PC-51 Alternation Event</i> , is selected, the alternation of the variable speed pump takes place every time the Alternation Time Interval expires (can be checked out in <i>PC-53 Alternation Timer Value</i> ).

PC-53 Alternation Timer Value		
Range:	Function:	
0 N/A*	[0 - 0 N/A]	Readout parameter for the Alternation Time Interval value set in <i>PC-52 Alternation Time Interval</i> .

PC-54 Alternation Predefined Time		
Range:	Function:	
0 N/A*	[0 - 0 N/A]	If option <i>Predefined Time</i> [3] in <i>PC-51 Alternation Event</i> , is selected, the variable speed pump alternation is carried out every day at the specified time set in Alternation Predefined Time. Default time is midnight (00:00 or 12:00AM depending on the time format).

**NOTE**

It is not possible to select other than *Off* [0] if *PC-05 Fixed Lead Pump* is set to *Yes* [1].

PC-51 Alternation Event		
Option:	Function:	
		This parameter is only active if the options <i>At Command</i> [2] or <i>At Staging or Command</i> [3] have been selected in <i>PC-50 Lead Pump Alternation</i> . If an Alternation Event is selected, the alternation of lead pump takes place every time the event occurs.
[0] *	External	Alternation takes place when a signal is applied to one of the digital inputs on the terminal strip and this input has been assigned to <i>Lead Pump Alternation</i> [121] in <i>Digital Inputs</i> .
[1]	Alternation Time Interval	Alternation takes place every time <i>PC-52 Alternation Time Interval</i> , expires.
[2]	Sleep Mode	Alternation takes place each time the lead pump goes into sleep mode. <i>CL-23 Setpoint 3</i> must be set to <i>Sleep Mode</i> [1] or an external signal applied for this function.
[3]	Predefined Time	Alternation takes place at a defined time of the day. If <i>PC-54 Alternation Predefined Time</i> , is set, the alternation is carried out every day at the specified time. Default time is midnight (00:00 or 12:00AM depending on the time format).

PC-55 Alternate if Load < 50%		
Option:	Function:	
		If Alternation If Capacity <50% is enabled, the pump alternation can only occur if the capacity is equal to or below 50%. The capacity calculation is the ratio of running pumps (including the variable speed pump) to the total number of available pumps (including variable speed pump, but not those interlocked). $Capacity = \frac{N_{RUNNING}}{N_{TOTAL}} \times 100\%$ For the Basic Pump Controller all pumps are equal size.
[0]	Disabled	The lead pump alternation will take place at any pump capacity.
[1] *	Enabled	The lead pump function will be alternated only if the numbers of pumps running are providing less than 50% of total pump capacity.

**NOTE**

Only valid if *PC-50 Lead Pump Alternation* is different from *Off* [0].



PC-56 Staging Mode at Alternation		
Option:	Function:	
		This parameter is only active if the option selected in <i>PC-50 Lead Pump Alternation</i> is different from <i>Off</i> [0]. Two types of staging and destaging of pumps are possible. Slow transfer makes staging and destaging smooth. Quick Transfer makes staging and destaging as fast as possible; the variable speed pump is just cut out (coasted).
[0] *	Slow	At alternation, the variable speed pump is acceled to maximum speed and then decelede to a stand still.
[1]	Quick	At alternation, the variable speed pump is acceled to maximum speed and then coasted to stand still.

The below figure is an example of the Slow transfer staging. The variable speed pump (top graph) and one fixed speed pump (bottom graph) are running before the staging command. When the *Slow* [0] transfer command is activated, an alternation is carried out by ramping the variable speed pump to *F-17 Motor Speed High Limit [RPM]* or *F-15 Motor Speed High Limit [Hz]*, and then decelerated to zero speed. After a "Delay Before Starting Next Pump" (*PC-58 Run Next Pump Delay*) the next lead pump (middle graph) is accelerated and another original lead pump (top graph) is added after the "Delay Before Running On Mains" (*PC-59 Run on Line Delay*) as a fixed speed pump. The next lead pump (middle graph) is decelerated to Motor Speed Low Limit and then allowed to vary speed to maintain system pressure.

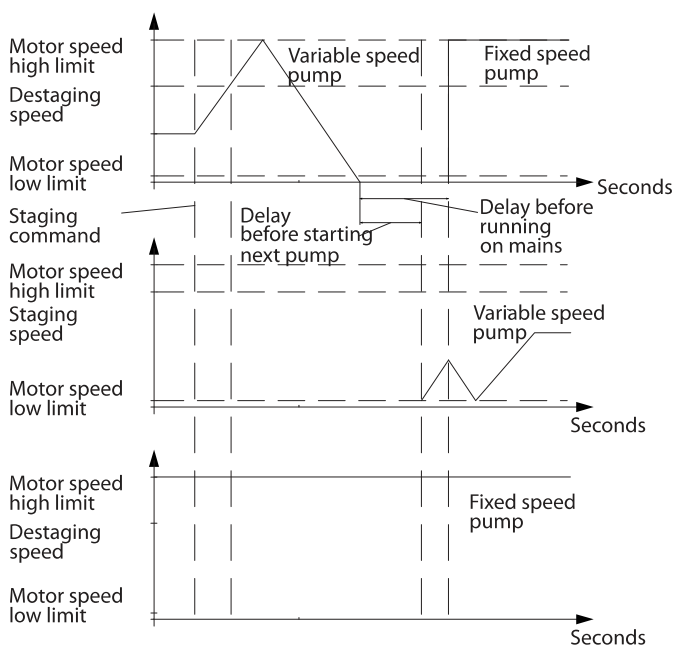

PC-58 Run Next Pump Delay		
Range:	Function:	
0.1 s* [0.1 - 5.0 s]		This parameter is only active if the option selected in <i>PC-50 Lead Pump Alternation</i> , is different from <i>Off</i> [0]. This parameter sets the time between stopping the old variable speed pump and starting another pump as a new variable speed pump. Refer to <i>PC-56 Staging Mode at Alternation</i> , the illustration for description of staging and alternation.

PC-59 Run on Line Delay		
Range:	Function:	
0.5 s* [par. PC-58 - 5.0 s]		This parameter is only active if the option selected in <i>PC-50 Lead Pump Alternation</i> , is different from <i>Off</i> [0]. This parameter sets the time between stopping the old variable speed pump and starting this pump as a new fixed speed pump. Refer to <i>PC-56 Staging Mode at Alternation</i> , the illustration for description of staging and alternation.

### 3.24.5 PC-8# Status

Readout parameters informing about the operating status of the Pump Controller and the pumps controlled.

PC-80 Pump Status		
Range:	Function:	
0 N/A* [0 - 0 N/A]		Read out of the status of the Pump Controller.

PC-81 Pump Status		
Range:	Function:	
0 N/A* [0 - 0 N/A]		Pump Status shows the status for the number of pumps selected in <i>PC-06 Number of Pumps</i> . It is a readout of the status for each of the pumps showing a string, which consists of pump number and the current status of the pump. Example: Readout is with the abbreviation like "1:D 2:O" This means that pump 1 is running and speed controlled by the frequency converter and pump 2 is stopped.



PC-82 Lead Pump		
Range:		Function:
0 N/A*	[0 - par. PC-06 N/A]	Readout parameter for the actual variable speed pump in the system. The Lead Pump parameter is updated to reflect the current variable speed pump in the system when an alternation takes place. If no lead pump is selected (Pump Controller disabled or all pumps interlocked) the display will show NONE.

PC-83 Relay Status		
Array [2]		
Range:		Function:
0 N/A*	[0 - 0 N/A]	Read out of the status for each of the relays assigned to control the pumps. Every element in the array represents a relay. If a relay is activated, the corresponding element is set to "On". If a relay is deactivated, the corresponding element is set to "Off".

PC-84 Pump ON Time		
Array [2]		
Range:		Function:
0 h*	[0 - 2147483647 h]	Readout of the value for Pump ON Time. The Pump Controller has separate counters for the pumps and for the relays that control the pumps. Pump ON Time monitors the "operating hours" of each pump. The value of each Pump ON Time counter can be reset to 0 by writing in the parameter, e.g. if the pump is replaced in case of service.

PC-85 Relay ON Time		
Array [2]		
Range:		Function:
0 h*	[0 - 2147483647 h]	Readout of the value for Relay ON time. The Pump Controller has separate counters for the pumps and for the relays that control the pumps. Pump cycling is always done based on the relay counters, otherwise it would always use the new pump if a pump is replaced and its value in <i>PC-84 Pump ON Time</i> is reset. In order to use <i>PC-04 Pump Cycling</i> the Pump Controller is monitoring the Relay ON time.

PC-86 Reset Relay Counters		
Option:		Function:
		Resets all elements in <i>PC-85 Relay ON Time</i> counters.
[0] *	Do not reset	
[1]	Do reset	

### 3.24.6 PC-9# Service

Parameters used in case of service on one or more of the pumps controlled.

PC-90 Pump Interlock		
Array [2]		
Option:		Function:
		In this parameter, it is possible to disable one or more of the fixed lead pumps. For example, the pump will not be selected for staging on even if it is the next pump in the operation sequence. It is not possible to disable the lead pump with the Pump Interlock command. The digital input interlocks are selected as <i>Pump 1-3 Interlock</i> [130 – 132] in <i>Digital Inputs</i> .
[0] *	Off	The pump is active for staging/destaging.
[1]	On	The Pump Interlock command is given. If a pump is running it is immediately destaged. If the pump is not running it is not allowed to stage on.

PC-91 Manual Alternation		
Range:		Function:
0 N/A*	[0 - par. PC-06 N/A]	Readout parameter for the actual variable speed pump in the system. The Lead Pump parameter is updated to reflect the current variable speed pump in the system when an alternation takes place. If no lead pump is selected (Pump Controller disabled or all pumps interlocked) the display will show NONE.





### 3.25 LC-## Logic Controller

#### 3.25.1 LC-## Logic Controller Prog. Features

Logic Controller (LC) is essentially a sequence of user defined actions (see *LC-52 Logic Controller Action [x]*) executed by the LC when the associated user defined event (see *LC-51 Logic Controller Event [x]*) is evaluated as TRUE by the LC. Events and actions are each numbered and linked together in pairs. This means that when event [0] is fulfilled (attains the value TRUE), action [0] is executed. After this, the conditions of event [1] will be evaluated and if evaluated TRUE, action [1] will be executed and so on. Only one event will be evaluated at any time. If an event is evaluated as FALSE, nothing happens (in the LC) during the current scan interval and no other events will be evaluated. This means that when the LC starts, it evaluates event [0] (and only event [0]) each scan interval. Only when event [0] is evaluated TRUE, will the LC execute action [0] and start evaluating event [1]. It is possible to programme from 1 to 20 events and actions.

When the last event / action has been executed, the sequence starts over again from event [0] / action [0]. The illustration shows an example with three event / actions:

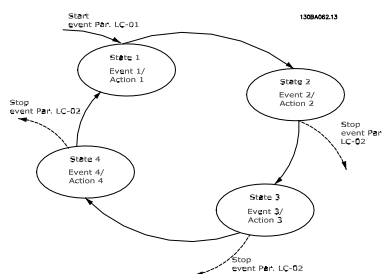

#### Starting and stopping the LC:

Starting and stopping the LC can be done by selecting On [1] or Off [0] in LC-00 Logic Controller Mode. The LC always starts in state 0 (where it evaluates event [0]). The LC starts when the Start Event (defined in LC-01 Start Event) is evaluated as TRUE (provided that On [1] is selected in LC-00 Logic Controller Mode). The LC stops when the Stop Event (LC-02 Stop Event) is TRUE. LC-03 Reset Logic Controller resets all LC parameters and starts programming from scratch.

#### 3.25.2 LC-0# LC Settings

Use the LC settings to activate, deactivate and reset the Logic Controller.

LC-00 Logic Controller Mode		
Option:	Function:	
[0] *	Off	Disables the Logic Controller.
[1]	On	Enables the Logic Controller.

LC-01 Start Event		
Option:	Function:	
		Select the boolean (TRUE or FALSE) input to activate Logic Controller.
[0] *	False	Enters the fixed value of FALSE in the logic rule.
[1]	True	Enters the fixed value TRUE in the logic rule.
[2]	Running	See parameter group E-2# for further description.
[3]	In range	See parameter group E-2# for further description.
[4]	On reference	See parameter group E-2# for further description.
[5]	Torque limit	See parameter group E-2# for further description.
[6]	Current limit	See parameter group E-2# for further description.
[7]	Out of current range	See parameter group E-2# for further description.
[8]	Below I low	See parameter group E-2# for further description.
[9]	Above I high	See parameter group E-2# for further description.
[10]	Out of speed range	
[11]	Below speed low	See parameter group E-2# for further description.
[12]	Above speed high	See parameter group E-2# for further description.
[13]	Out of feedb. range	
[14]	Below feedb. low	
[15]	Above feedb. high	
[16]	Thermal warning	See parameter group E-2# for further description.
[17]	Line voltage out of range	See parameter group E-2# for further description.
[18]	Reversing	See parameter group E-2# for further description.
[19]	Warning	See parameter group E-2# for further description.
[20]	Alarm (trip)	See parameter group E-2# for further description.



LC-01 Start Event		
Option:		Function:
[21]	Alarm (trip lock)	See parameter group E-2# for further description.
[22]	Comparator 0	Use the result of comparator 0 in the logic rule.
[23]	Comparator 1	Use the result of comparator 1 in the logic rule.
[24]	Comparator 2	Use the result of comparator 2 in the logic rule.
[25]	Comparator 3	Use the result of comparator 3 in the logic rule.
[26]	Logic rule 0	Use the result of logic rule 0 in the logic rule.
[27]	Logic rule 1	Use the result of logic rule 1 in the logic rule.
[28]	Logic rule 2	Use the result of logic rule 2 in the logic rule.
[29]	Logic rule 3	Use the result of logic rule 3 in the logic rule.
[33]	Digital input DI18	Use the value of DI18 in the logic rule (High = TRUE).
[34]	Digital input DI19	Use the value of DI19 in the logic rule (High = TRUE).
[35]	Digital input DI27	Use the value of DI27 in the logic rule (High = TRUE).
[36]	Digital input DI29	Use the value of DI29 in the logic rule (High = TRUE).
[37]	Digital input DI32	Use the value of DI32 in the logic rule (High = TRUE).
[38]	Digital input DI33	Use the value of DI33 in the logic rule (High = TRUE).
[39]	Start command	This event is TRUE if the frequency converter is started by any means (either via digital input, field bus or other).
[40]	Drive stopped	This event is TRUE if the frequency converter is stopped or coasted by any means (either via digital input, fieldbus or other).
[41]	Reset Trip	This event is TRUE if the frequency converter is tripped (but not trip-locked) and the reset button is pressed.
[42]	Auto Reset Trip	This event is TRUE if the frequency converter is tripped (but not trip-locked) and an Automatic Reset is issued.

LC-01 Start Event		
Option:		Function:
[43]	OK Key	This event is TRUE if the OK key on the keypad is pressed.
[44]	Reset Key	This event is TRUE if the Reset key on the keypad is pressed.
[45]	Left Key	This event is TRUE if the Left key on the keypad is pressed.
[46]	Right Key	This event is TRUE if the Right key on the keypad is pressed.
[47]	Up Key	This event is TRUE if the Up key on the keypad is pressed.
[48]	Down Key	This event is TRUE if the Down key on the keypad is pressed.
[50]	Comparator 4	Use the result of comparator 4 in the logic rule.
[51]	Comparator 5	Use the result of comparator 5 in the logic rule.
[60]	Logic rule 4	Use the result of logic rule 4 in the logic rule.
[61]	Logic rule 5	Use the result of logic rule 5 in the logic rule.
[90]	ECB Drive Mode	
[91]	ECB Bypass Mode	
[92]	ECB Test Mode	
[100]	Fire Mode	

LC-02 Stop Event		
Option:		Function:
		Select the boolean (TRUE or FALSE) input to deactivate Logic Control.
[0] *	False	Enters the fixed value of FALSE in the logic rule.
[1]	True	Enters the fixed value TRUE in the logic rule.
[2]	Running	See parameter group E-2# for further description.
[3]	In range	See parameter group E-2# for further description.
[4]	On reference	See parameter group E-2# for further description.
[5]	Torque limit	See parameter group E-2# for further description.
[6]	Current limit	See parameter group E-2# for further description.
[7]	Out of current range	See parameter group E-2# for further description.
[8]	Below I low	See parameter group E-2# for further description.



LC-02 Stop Event		
Option:	Function:	
[9]	Above I high	See parameter group E-2# for further description.
[10]	Out of speed range	
[11]	Below speed low	See parameter group E-2# for further description.
[12]	Above speed high	See parameter group E-2# for further description.
[13]	Out of feedb. range	See parameter group E-2# for further description.
[14]	Below feedb. low	See parameter group E-2# for further description.
[15]	Above feedb. high	See parameter group E-2# for further description.
[16]	Thermal warning	See parameter group E-2# for further description.
[17]	Line voltage out of range	See parameter group E-2# for further description.
[18]	Reversing	See parameter group E-2# for further description.
[19]	Warning	See parameter group E-2# for further description.
[20]	Alarm (trip)	See parameter group E-2# for further description.
[21]	Alarm (trip lock)	See parameter group E-2# for further description.
[22]	Comparator 0	Use the result of comparator 0 in the logic rule.
[23]	Comparator 1	Use the result of comparator 1 in the logic rule.
[24]	Comparator 2	Use the result of comparator 2 in the logic rule.
[25]	Comparator 3	Use the result of comparator 3 in the logic rule.
[26]	Logic rule 0	Use the result of logic rule 0 in the logic rule.
[27]	Logic rule 1	Use the result of logic rule 1 in the logic rule.
[28]	Logic rule 2	Use the result of logic rule 2 in the logic rule.
[29]	Logic rule 3	Use the result of logic rule 3 in the logic rule.
[30]	Logic Controller Time-out 0	Use the result of timer 0 in the logic rule.
[31]	Logic Controller Time-out 1	Use the result of timer 1 in the logic rule.

LC-02 Stop Event		
Option:	Function:	
[32]	Logic Controller Time-out 2	Use the result of timer 2 in the logic rule.
[33]	Digital input DI18	Use the value of DI18 in the logic rule (High = TRUE).
[34]	Digital input DI19	Use the value of DI19 in the logic rule (High = TRUE).
[35]	Digital input DI27	Use the value of DI27 in the logic rule (High = TRUE).
[36]	Digital input DI29	Use the value of DI29 in the logic rule (High = TRUE).
[37]	Digital input DI32	Use the value of DI32 in the logic rule (High = TRUE).
[38]	Digital input DI33	Use the value of DI33 in the logic rule (High = TRUE).
[39]	Start command	This event is TRUE if the frequency converter is started by any means (either via digital input, network or other).
[40]	Drive stopped	This event is TRUE if the frequency converter is stopped or coasted by any means (either via digital input, network or other).
[41]	Reset Trip	This event is TRUE if the frequency converter is tripped (but not trip-locked) and the reset button is pressed.
[42]	Auto Reset Trip	This event is TRUE if the frequency converter is tripped (but not trip-locked) and an Automatic Reset is issued.
[43]	OK Key	This event is TRUE if the OK key on the keypad is pressed.
[44]	Reset Key	This event is TRUE if the Reset key on the keypad is pressed.
[45]	Left Key	This event is TRUE if the Left key on the keypad is pressed.
[46]	Right Key	This event is TRUE if the Right key on the keypad is pressed.
[47]	Up Key	This event is TRUE if the Up key on the keypad is pressed.
[48]	Down Key	This event is TRUE if the Down key on the keypad is pressed.
[50]	Comparator 4	Use the result of comparator 4 in the logic rule.
[51]	Comparator 5	Use the result of comparator 5 in the logic rule.



LC-02 Stop Event		
Option:	Function:	
[60]	Logic rule 4	Use the result of logic rule 4 in the logic rule.
[61]	Logic rule 5	Use the result of logic rule 5 in the logic rule.
[70]	Logic Controller Time-out 3	Use the result of timer 3 in the logic rule.
[71]	Logic Controller Time-out 3	Use the result of timer 4 in the logic rule.
[72]	Logic Controller Time-out 3	Use the result of timer 5 in the logic rule.
[73]	Logic Controller Time-out 3	Use the result of timer 6 in the logic rule.
[74]	Logic Controller Time-out 3	Use the result of timer 7 in the logic rule.
[80]	No Flow	
[81]	Dry Pump	
[82]	End of Curve	
[83]	Broken Belt	
[90]	ECB Drive Mode	
[91]	ECB Bypass Mode	
[92]	ECB Test Mode	
[100]	Fire Mode	

LC-03 Reset Logic Controller		
Option:	Function:	
[0] *	Do not reset Logic Controller	Retains programmed settings in all group LC-## parameters .
[1]	Reset Logic Controller	Resets all group LC-## parameters (LC-##) to default settings.

### 3.25.3 LC-1# Comparators

Comparators are used for comparing continuous variables (i.e. output frequency, output current, analog input etc.) to fixed preset values.

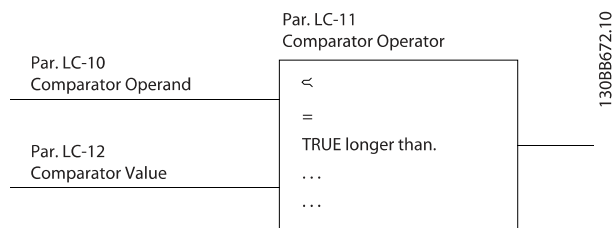

In addition, there are digital values that will be compared to fixed time values. See explanation in *LC-10 Comparator Operand*. Comparators are evaluated once in each scan interval. Use the result (TRUE or FALSE) directly. All parameters in this parameter group are array parameters with index 0 to 5. Select index 0 to programme

Comparator 0, select index 1 to programme Comparator 1, and so on.

LC-10 Comparator Operand		
Array [4]		
Option:	Function:	
		Select the variable to be monitored by the comparator.
[0] *	DISABLED	
[1]	Reference	
[2]	Feedback	
[3]	Motor speed	
[4]	Motor current	
[5]	Motor torque	
[6]	Motor power	
[7]	Motor Rated Voltage	
[8]	DC-link voltage	
[9]	Motor thermal	
[10]	Drive thermal	
[11]	Heat sink temp.	
[12]	Analog input AI53	
[13]	Analog input AI54	
[14]	Analog input AIFB10	
[15]	Analog input AIS24V	
[17]	Analog input AICCT	
[18]	Pulse input FI29	
[19]	Pulse input FI33	
[20]	Alarm number	
[30]	Counter A	
[31]	Counter B	

LC-11 Comparator Operator		
Array [6]		
Option:	Function:	
[0] *	<	Select < [0] for the result of the evaluation to be TRUE, when the variable selected in <i>LC-10 Comparator Operand</i> is smaller than the fixed value in <i>LC-12 Comparator Value</i> . The result will be FALSE, if the variable selected in <i>LC-10 Comparator Operand</i> is greater than the fixed value in <i>LC-12 Comparator Value</i> .
[1]	≈ (equal)	Select ≈ [1] for the result of the evaluation to be TRUE, when the variable selected in <i>LC-10 Comparator Operand</i> is approximately equal to the fixed value in <i>LC-12 Comparator Value</i> .
[2]	>	Select > [2] for the inverse logic of option < [0].



LC-12 Comparator Value		
Array [6]		
<b>Range:</b>	<b>Function:</b>	
0 N/A* [-100000.000 - 100000.000 N/A]	Enter the 'trigger level' for the variable that is monitored by this comparator. This is an array parameter containing comparator values 0 to 5.	

### 3.25.4 LC-2# Timers

Use the result (TRUE or FALSE) from *timers* directly to define an *event* (see *LC-51 Logic Controller Event*), or as boolean input in a *logic rule* (see *LC-40 Logic Rule Boolean 1*, *LC-42 Logic Rule Boolean 2* or *LC-44 Logic Rule Boolean 3*). A timer is only FALSE when started by an action (i.e. Start timer 1 [29]) until the timer value entered in this parameter is elapsed. Then it becomes TRUE again. All parameters in this parameter group are array parameters with index 0 to 2. Select index 0 to program Timer 0, select index 1 to program Timer 1, and so on.

LC-20 Logic Controller Timer		
Array [3]		
<b>Range:</b>	<b>Function:</b>	
0.000 N/ A*	[0.000 - 0.000 N/A]	Enter the value to define the duration of the FALSE output from the programmed timer. A timer is only FALSE if it is started by an action (i.e. Start timer 1 [29]) and until the given timer value has elapsed.

### 3.25.5 LC-4# Logic Rules

Combine up to three boolean inputs (TRUE / FALSE inputs) from timers, comparators, digital inputs, status bits and events using the logical operators AND, OR, and NOT. Select boolean inputs for the calculation in *LC-40 Logic Rule Boolean 1*, *LC-42 Logic Rule Boolean 2* and *LC-44 Logic Rule Boolean 3*. Define the operators used to logically combine the selected inputs in *LC-41 Logic Rule Operator 1* and *LC-43 Logic Rule Operator 2*.

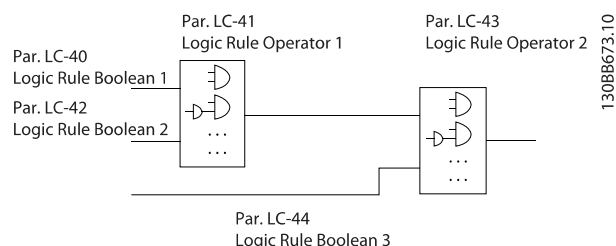

### Priority of calculation

The results of *LC-40 Logic Rule Boolean 1*, *LC-41 Logic Rule Operator 1* and *LC-42 Logic Rule Boolean 2* are calculated first. The outcome (TRUE / FALSE) of this calculation is combined with the settings of *LC-43 Logic Rule Operator 2* and *LC-44 Logic Rule Boolean 3*, yielding the final result (TRUE / FALSE) of the logic rule.

LC-40 Logic Rule Boolean 1		
Array [6]		
<b>Option:</b>	<b>Function:</b>	
[0] *	False	Enters the fixed value of FALSE in the logic rule.
[1]	True	Enters the fixed value TRUE in the logic rule.
[2]	Running	See parameter group E-2# for further description.
[3]	In range	See parameter group E-2# for further description.
[4]	On reference	See parameter group E-2# for further description.
[5]	Torque limit	See parameter group E-2# for further description.
[6]	Current limit	See parameter group E-2# for further description.
[7]	Out of current range	See parameter group E-2# for further description.
[8]	Below I low	See parameter group E-2# for further description.
[9]	Above I high	See parameter group E-2# for further description.
[10]	Out of speed range	
[11]	Below speed low	See parameter group E-2# for further description.
[12]	Above speed high	See parameter group E-2# for further description.
[13]	Out of feedb. range	See parameter group E-2# for further description.
[14]	Below feedb. low	See parameter group E-2# for further description.
[15]	Above feedb. high	See parameter group E-2# for further description.
[16]	Thermal warning	See parameter group E-2# for further description.
[17]	Line voltage out of range	See parameter group for further description.
[18]	Reversing	See parameter group E-2# for further description.
[19]	Warning	See parameter group E-2# for further description.



LC-40 Logic Rule Boolean 1		
Array [6]		
Option:	Function:	
[20]	Alarm (trip)	See parameter group E-2# for further description.
[21]	Alarm (trip lock)	See parameter group E-2# for further description.
[22]	Comparator 0	Use the result of comparator 0 in the logic rule.
[23]	Comparator 1	Use the result of comparator 1 in the logic rule.
[24]	Comparator 2	Use the result of comparator 2 in the logic rule.
[25]	Comparator 3	Use the result of comparator 3 in the logic rule.
[26]	Logic rule 0	Use the result of logic rule 0 in the logic rule.
[27]	Logic rule 1	Use the result of logic rule 1 in the logic rule.
[28]	Logic rule 2	Use the result of logic rule 2 in the logic rule.
[29]	Logic rule 3	Use the result of logic rule 3 in the logic rule.
[30]	Logic Controller Time-out 0	Use the result of timer 0 in the logic rule.
[31]	Logic Controller Time-out 1	Use the result of timer 1 in the logic rule.
[32]	Logic Controller Time-out 2	Use the result of timer 2 in the logic rule.
[33]	Digital input DI18	Use the value of DI18 in the logic rule (High = TRUE).
[34]	Digital input DI19	Use the value of DI19 in the logic rule (High = TRUE).
[35]	Digital input DI27	Use the value of DI27 in the logic rule (High = TRUE).
[36]	Digital input DI29	Use the value of DI29 in the logic rule (High = TRUE).
[37]	Digital input DI32	Use the value of DI32 in the logic rule (High = TRUE).
[38]	Digital input DI33	Use the value of DI33 in the logic rule (High = TRUE).
[39]	Start command	This logic rule is TRUE if the frequency converter is started by any means (either via digital input, field bus or other).
[40]	Drive stopped	This logic rule is TRUE if the frequency converter is stopped or coasted by any means (either via digital input, fieldbus or other).

LC-40 Logic Rule Boolean 1		
Array [6]		
Option:	Function:	
[41]	Reset Trip	This logic rule is TRUE if the frequency converter is tripped (but not trip-locked) and the reset button is pressed.
[42]	Auto Reset Trip	This logic rule is TRUE if the frequency converter is tripped (but not trip-locked) and an Automatic Reset is issued.
[43]	OK Key	This logic rule is TRUE if the OK key on the keypad is pressed.
[44]	Reset Key	This logic rule is TRUE if the Reset key on the keypad is pressed.
[45]	Left Key	This logic rule is TRUE if the Left key on the keypad is pressed.
[46]	Right Key	This logic rule is TRUE if the Right key on the keypad is pressed.
[47]	Up Key	This logic rule is TRUE if the Up key on the keypad is pressed.
[48]	Down Key	This logic rule is TRUE if the Down key on the keypad is pressed.
[50]	Comparator 4	Use the result of comparator 4 in the logic rule.
[51]	Comparator 5	Use the result of comparator 5 in the logic rule.
[60]	Logic rule 4	Use the result of logic rule 4 in the logic rule.
[61]	Logic rule 5	Use the result of logic rule 5 in the logic rule.
[70]	Logic Controller Time-out 3	Use the result of timer 3 in the logic rule.
[71]	Logic Controller Time-out 3	Use the result of timer 4 in the logic rule.
[72]	Logic Controller Time-out 3	Use the result of timer 5 in the logic rule.
[73]	Logic Controller Time-out 3	Use the result of timer 6 in the logic rule.
[74]	Logic Controller Time-out 3	Use the result of timer 7 in the logic rule.
[80]	No Flow	
[81]	Dry Pump	
[82]	End of Curve	
[83]	Broken Belt	
[90]	ECB Drive Mode	
[91]	ECB Bypass Mode	
[92]	ECB Test Mode	
[100]	Fire Mode	



LC-41 Logic Rule Operator 1		
Array [6]		
Option:	Function:	
	Select the first logical operator to use on the Boolean inputs from <i>LC-40 Logic Rule Boolean 1</i> and <i>LC-42 Logic Rule Boolean 2</i> . [LC-##] signifies the boolean input of parameter group LC-##.	
[0] *	DISABLED	Ignores <i>LC-42 Logic Rule Boolean 2</i> , <i>LC-43 Logic Rule Operator 2</i> , and <i>LC-44 Logic Rule Boolean 3</i> .
[1]	AND	Evaluates the expression [LC-40] AND [LC-42].
[2]	OR	evaluates the expression [LC-40] OR[LC-42].
[3]	AND NOT	evaluates the expression [LC-40] AND NOT [LC-42].
[4]	OR NOT	evaluates the expression [LC-40] OR NOT [LC-42].
[5]	NOT AND	evaluates the expression NOT [LC-40] AND [LC-42].
[6]	NOT OR	evaluates the expression NOT [LC-40] OR [LC-42].
[7]	NOT AND NOT	evaluates the expression NOT [LC-40] AND NOT [LC-42].
[8]	NOT OR NOT	evaluates the expression NOT [LC-40] OR NOT [LC-42].

LC-42 Logic Rule Boolean 2		
Array [6]		
Option:	Function:	
	Select the second boolean (TRUE or FALSE) input for the selected logic rule. See <i>LC-40 Logic Rule Boolean 1</i> for further descriptions of choices and their functions.	

LC-43 Logic Rule Operator 2		
Array [6]		
Option:	Function:	
	Select the second logical operator to be used on the boolean input calculated in <i>LC-40 Logic Rule Boolean 1</i> , <i>LC-41 Logic Rule Operator 1</i> , and <i>LC-42 Logic Rule Boolean 2</i> , and the boolean input coming from <i>LC-42 Logic Rule Boolean 2</i> . [LC-44] signifies the boolean input of <i>LC-44 Logic Rule Boolean 3</i> . [LC-40/LC-42] signifies the boolean input calculated in <i>LC-40 Logic Rule Boolean 1</i> , <i>LC-41 Logic Rule Operator 1</i> , and <i>LC-42 Logic Rule Boolean 2</i> . DISABLED [0] (factory setting). select this option to ignore <i>LC-44 Logic Rule Boolean 3</i> .	

LC-43 Logic Rule Operator 2		
Array [6]		
Option:	Function:	
[0] *	DISABLED	
[1]	AND	
[2]	OR	
[3]	AND NOT	
[4]	OR NOT	
[5]	NOT AND	
[6]	NOT OR	
[7]	NOT AND NOT	
[8]	NOT OR NOT	

LC-44 Logic Rule Boolean 3		
Array [6]		
Option:	Function:	
	Select the third boolean (TRUE or FALSE) input for the selected logic rule. See <i>LC-40 Logic Rule Boolean 1</i> for further descriptions of choices and their functions.	

### 3.25.6 LC-5# States

LC-51 Logic Controller Event		
Array [20]		
Option:	Function:	
	Select the boolean input (TRUE or FALSE) to define the Logic Controller event. See <i>LC-02 Stop Event</i> for further descriptions of choices and their functions.	
[0] *	False	
[1]	True	
[2]	Running	
[3]	In range	
[4]	On reference	
[5]	Torque limit	
[6]	Current limit	
[7]	Out of current range	
[8]	Below I low	
[9]	Above I high	
[10]	Out of speed range	
[11]	Below speed low	
[12]	Above speed high	
[13]	Out of feedb. range	
[14]	Below feedb. low	
[15]	Above feedb. high	
[16]	Thermal warning	
[17]	Line voltage out of range	
[18]	Reversing	
[19]	Warning	
[20]	Alarm (trip)	





LC-51 Logic Controller Event		
Array [20]		
Option:	Function:	
[21]	Alarm (trip lock)	
[22]	Comparator 0	
[23]	Comparator 1	
[24]	Comparator 2	
[25]	Comparator 3	
[26]	Logic rule 0	
[27]	Logic rule 1	
[28]	Logic rule 2	
[29]	Logic rule 3	
[30]	Logic Controller Time-out 0	
[31]	Logic Controller Time-out 1	
[32]	Logic Controller Time-out 2	
[33]	Digital input DI18	
[34]	Digital input DI19	
[35]	Digital input DI27	
[36]	Digital input DI29	
[37]	Digital input DI32	
[38]	Digital input DI33	
[39]	Start command	
[40]	Drive stopped	
[41]	Reset Trip	
[42]	Auto Reset Trip	
[43]	OK Key	
[44]	Reset Key	
[45]	Left Key	
[46]	Right Key	
[47]	Up Key	
[48]	Down Key	
[50]	Comparator 4	
[51]	Comparator 5	
[60]	Logic rule 4	
[61]	Logic rule 5	
[70]	Logic Controller Time-out 3	
[71]	Logic Controller Time-out 3	
[72]	Logic Controller Time-out 3	
[73]	Logic Controller Time-out 3	
[74]	Logic Controller Time-out 3	
[80]	No Flow	
[81]	Dry Pump	
[82]	End of Curve	
[83]	Broken Belt	
[90]	ECB Drive Mode	
[91]	ECB Bypass Mode	
[92]	ECB Test Mode	
[100]	Fire Mode	

LC-52 Logic Controller Action		
Array [20]		
Option:	Function:	
		Select the action corresponding to the LC event. Actions are executed when the corresponding event (defined in <i>LC-51 Logic Controller Event</i> ) is evaluated as true. The following actions are available for selection:
[0] *	Disabled	
[1]	No action	
[2]	Select set-up 1	Changes the active set-up ( <i>K-10 Active Set-up</i> ) to '1'.
[3]	Select set-up 2	Changes the active set-up ( <i>K-10 Active Set-up</i> ) to '2'.
[4]	Select set-up 3	Changes the active set-up ( <i>K-10 Active Set-up</i> ) to '3'.
[5]	Select set-up 4	Changes the active set-up ( <i>K-10 Active Set-up</i> ) to '4'. If the set-up is changed, it will merge with other set-up commands coming from either the digital inputs or via a fieldbus.
[10]	Select preset ref 0	Selects preset reference 0.
[11]	Select preset ref 1	Selects preset reference 1.
[12]	Select preset ref 2	Selects preset reference 2.
[13]	Select preset ref 3	Selects preset reference 3.
[14]	Select preset ref 4	Selects preset reference 4.
[15]	Select preset ref 5	Selects preset reference 5.
[16]	Select preset ref 6	Selects preset reference 6.
[17]	Select preset ref 7	Selects preset reference 7. If the active preset reference is changed, it will merge with other preset reference commands coming from either the digital inputs or via a fieldbus.
[18]	Select Accel/Decel 1	Selects ramp 1
[19]	Select Accel/Decel 2	Selects ramp 2
[22]	Run	Issues a start command to the frequency converter.
[23]	Run reverse	Issues a start reverse command to the frequency converter.
[24]	Stop	Issues a stop command to the frequency converter.
[26]	DC Brake	Issues a DC stop command to the frequency converter.
[27]	Coast	The frequency converter coasts immediately. All stop commands including the coast command stop the LC.



LC-52 Logic Controller Action		
Array [20]		
Option:	Function:	
[28]	Freeze output	Freezes the output frequency of the frequency converter.
[29]	Start timer 0	Starts timer 0, see <i>LC-20 Logic Controller Timer</i> for further description.
[30]	Start timer 1	Starts timer 1, see <i>LC-20 Logic Controller Timer</i> for further description.
[31]	Start timer 2	Starts timer 2, see <i>LC-20 Logic Controller Timer</i> for further description.
[32]	Set digital out A low	Any output with 'digital output 1' selected is low (off).
[33]	Set digital out B low	Any output with 'digital output 2' selected is low (off).
[34]	Set digital out C low	Any output with 'digital output 3' selected is low (off).
[35]	Set digital out D low	Any output with 'digital output 4' selected is low (off).
[36]	Set digital out E low	Any output with 'digital output 5' selected is low (off).
[37]	Set digital out F low	Any output with 'digital output 6' selected is low (off).
[38]	Set digital out A high	Any output with 'digital output 1' selected is high (closed).
[39]	Set digital out B high	Any output with 'digital output 2' selected is high (closed).
[40]	Set digital out C high	Any output with 'digital output 3' selected is high (closed).
[41]	Set digital out D high	Any output with 'digital output 4' selected is high (closed).
[42]	Set digital out E high	Any output with 'digital output 5' selected is high (closed).
[43]	Set digital out F high	Any output with 'digital output 6' selected is high (closed).
[60]	Reset Counter A	Resets Counter A to zero.
[61]	Reset Counter B	Resets Counter A to zero.
[70]	Start Timer 3	Starts timer 3, see <i>LC-20 Logic Controller Timer</i> for further description.
[71]	Start Timer 4	Starts timer 4, see <i>LC-20 Logic Controller Timer</i> for further description.
[72]	Start Timer 5	Starts timer 5, see <i>LC-20 Logic Controller Timer</i> for further description.
[73]	Start Timer 6	Starts timer 6, see <i>LC-20 Logic Controller Timer</i> for further description.
[74]	Start Timer 7	Starts timer 7, see <i>LC-20 Logic Controller Timer</i> for further description.
[80]	Sleep Mode	

LC-52 Logic Controller Action		
Array [20]		
Option:	Function:	
[90]	Set ECB Bypass Mode	
[91]	Set ECB Drive Mode	
[100]	Reset Alarms	



### 3.26 B-## Braking Functions

#### 3.26.1 B-0# DC-Brakes

Parameter group for configuring the DC brake and DC hold functions.

B-00 DC Hold Current		
Range:		Function:
50 %*	[0 - 160. %]	Enter a value for holding current as a percentage of the rated motor current $I_{M,N}$ set in <i>P-03 Motor Current</i> . 100% DC holding current corresponds to $I_{M,N}$ . This parameter holds the motor (holding torque) or pre-heats the motor. This parameter is active if [1] DC hold/Preheat is selected in <i>H-80 Function at Stop</i> .

#### NOTE

The maximum value depends on the rated motor current. Avoid 100 % current for too long. It may damage the motor.

B-01 DC Brake Current		
Range:		Function:
50 %*	[0 - 1000. %]	Enter a value for current as a percentage of the rated motor current $I_{M,N}$ , see <i>P-03 Motor Current</i> . 100% DC braking current corresponds to $I_{M,N}$ . DC brake current is applied on a stop command, when the speed is lower than the limit set in <i>B-03 DC Brake Cut In Speed [RPM]</i> ; when the DC Brake Inverse function is active; or via the serial communication port. The braking current is active during the time period set in <i>B-02 DC Braking Time</i> .

#### NOTE

The maximum value depends on the rated motor current. Avoid 100 % current for too long. It may damage the motor.

B-02 DC Braking Time		
Range:		Function:
10.0 s*	[0.0 - 60.0 s]	Set the duration of the DC braking current set in <i>B-01 DC Brake Current</i> , once activated.

B-03 DC Brake Cut In Speed [RPM]		
Range:		Function:
0 RPM*	[0 - par. F-17 RPM]	Set the DC brake cut-in speed for activation of the DC braking current set in <i>B-01 DC Brake Current</i> , upon a stop command.

B-04 DC Brake Cut In Speed [Hz]		
Range:		Function:
0.0 Hz*	[0.0 - par. F-15 Hz]	This parameter is for setting the DC brake cut in speed at which the DC braking current ( <i>B-01 DC Brake Current</i> ) is to be active, in connection with a stop command.

#### 3.26.2 B-1# Brake Energy Funct.

Parameter group for selecting dynamic braking parameters.

B-10 Brake Function		
Option:		Function:
[0] *	Off	No brake resistor installed.
[2]	AC brake	AC Brake will only work in Compressor Torque mode in <i>H-43 Torque Characteristics</i> .

B-16 AC brake Max. Current		
Range:		Function:
100.0 %*	[0.0 - 1000.0 %]	Enter the maximum permissible current when using AC brake to avoid overheating of motor windings.

B-17 Over-voltage Control		
Option:		Function:
		Over-voltage control (OVC) reduces the risk of the frequency converter tripping due to an over voltage on the DC link caused by generative power from the load.
[0]	Disabled	No OVC required.
[2] *	Enabled	Activates OVC.

#### NOTE

The ramp time is automatically adjusted to avoid tripping of the frequency converter.



## 4 Troubleshooting

### 4.1 Status Messages

#### 4.1.1 Alarms and Warnings

4

A warning or an alarm is signalled by the relevant LED on the front of the frequency converter and indicated by a code on the display.

A warning remains active until its cause is no longer present. Under certain circumstances operation of the motor may still be continued. Warning messages may be critical, but are not necessarily so.

In the event of an alarm, the frequency converter will have tripped. Alarms must be reset to restart operation once their cause has been rectified. This may be done in four ways:

1. By using the [RESET] control button on the keypad.
2. Via a digital input with the "Reset" function.
3. Via serial communication/optional network.
4. By resetting automatically using the [Auto Reset] function, which is a default setting for frequency converter. see *H-04 Auto-Reset (Times)* in AF-600 FP Programming Guide,

After a manual reset using the [RESET] button on the keypad, the [AUTO] button must be pressed to restart the motor.

If an alarm cannot be reset, the reason may be that its cause has not been rectified, or the alarm is trip-locked (see also table on following page).

Alarms that are trip-locked offer additional protection, means that the mains supply must be switched off before the alarm can be reset. After being switched back on, the frequency converter is no longer blocked and may be reset as described above once the cause has been rectified.

Alarms that are not trip-locked can also be reset using the automatic reset function in *H-04 Auto-Reset (Times)* (Warning: automatic wake-up is possible!)

If a warning and alarm is marked against a code in the table on the following page, this means that either a warning occurs before an alarm, or it can be specified whether it is a warning or an alarm that is to be displayed for a given fault.

This is possible, for instance, in *F-10 Electronic Overload*. After an alarm or trip, the motor carries on coasting, and the alarm and warning flash on the frequency converter. Once the problem has been rectified, only the alarm continues flashing.

No.	Description	Warning	Alarm/Trip	Alarm/Trip Lock	Parameter Reference
1	10 Volts low	X			
2	Live zero error	(X)	(X)		<i>AN-01 Live Zero Timeout Function</i>
3	No motor	(X)			<i>H-80 Function at Stop</i>
4	Mains phase loss	(X)	(X)	(X)	<i>SP-12 Function at Line Imbalance</i>
5	DC link voltage high	X			
6	DC link voltage low	X			
7	DC over voltage	X	X		
8	DC under voltage	X	X		



**Troubleshooting AF-600 FP Programming Guide**

9	Inverter overloaded	X	X		
10	Motor Electronic Overload over temperature	(X)	(X)		F-10 Electronic Overload
11	Motor thermistor over temperature	(X)	(X)		F-10 Electronic Overload
12	Torque limit	X	X		
13	Over Current	X	X	X	
14	Earth fault	X	X	X	
15	Incomp. HW		X	X	
16	Short Circuit		X	X	
17	Control word timeout	(X)	(X)		O-04 Control Word Timeout Function
18	Start Failed		X		
23	Internal fans	X			
24	External fans	X			SP-53 Fan Monitor
29	Power board over temp	X	X	X	
30	Motor phase U missing	(X)	(X)	(X)	H-78 Missing Motor Phase Function
31	Motor phase V missing	(X)	(X)	(X)	H-78 Missing Motor Phase Function
32	Motor phase W missing	(X)	(X)	(X)	H-78 Missing Motor Phase Function
33	Inrush fault		X	X	
34	Network communication fault	X	X		
35	Option fault		X		
36	Mains failure	X	X		SP-10 Line failure
38	Internal fault		X	X	
40	Overload T27	X			
41	Overload T29	X			
42	Overload X30/6-7	X			
47	24 V supply low	X	X	X	
48	1.8 V supply low		X	X	
49	Speed limit				
50	Auto Tune calibration failed		X		
51	Auto Tune check U <sub>nom</sub> and I <sub>nom</sub>		X		
52	Auto Tune low I <sub>nom</sub>		X		
53	Auto Tune motor too big		X		
54	Auto Tune motor too small		X		
55	Auto Tune parameter out of range		X		
56	Auto Tune interrupted by user		X		
57	Auto Tune timeout		X		
58	Auto Tune internal fault	X	X		
59	Current limit	X			
60	External interlock				
62	Output Frequency at Maximum Limit	X			
65	Control Board Over-temperature	X	X	X	
66	Heat sink Temperature Low	X			
67	Option Configuration has Changed		X		
70	Illegal Drive configuration			X	
80	Drive restored to Default Value		X		
92	No-Flow	X	X		Par. AP-2#
93	Dry Pump	X	X		Par. AP-2#
94	End of Curve	X	X		Par. AP-5#
95	Broken Belt	X	X		Par. AP-6#
96	Start Delayed	X			Par. AP-7#
97	Stop Delayed	X			Par. AP-7#



**Troubleshooting AF-600 FP Programming Guide**

98	Clock Fault	X			K-7#
200	Fire Mode	X			FB-0#
201	Fire Mode was Active	X			K-7#
202	Fire Mode Limits Exceeded	X			K-7#
250	New spare part		X	X	
251	New model number		X	X	

**Table 4.1 Alarm/Warning code list**

(X) Dependent on parameter

LED indication	
Warning	yellow
Alarm	flashing red
Trip locked	yellow and red

4

**4.1.2 Alarm Words**

**DR-90 Alarm Word**

Bit (Hex)	Alarm Word (DR-90 Alarm Word)
00000001	
00000002	Power card over temperature
00000004	Earth fault
00000008	
00000010	Control word timeout
00000020	Over current
00000040	
00000080	Motor thermistor over temp.
00000100	Motor Electronic Thermal Overload over temperature
00000200	Inverter overloaded
00000400	DC link under voltage
00000800	DC link over voltage
00001000	Short circuit
00002000	
00004000	Mains phase loss
00008000	Auto Tune not OK
00010000	Live zero error
00020000	Internal fault
00040000	
00080000	Motor phase U is missing
00100000	Motor phase V is missing
00200000	Motor phase W is missing
00800000	Control Voltage Fault
01000000	
02000000	VDD, supply low
04000000	Not used
08000000	Not used
10000000	Earth fault DESAT
20000000	Drive restored
80000000	

**DR-91 Alarm Word 2**

Bit (Hex)	Alarm Word 2 (DR-91 Alarm Word 2)
00000001	
00000002	Reserved
00000004	Service Trip, Typecode / Sparepart
00000008	Reserved
00000010	Reserved
00000020	
00000040	
00000080	
00000100	Broken Belt
00000200	Not used
00000400	Not used
00000800	Reserved
00001000	Reserved
00002000	Reserved
00004000	Reserved
00008000	Reserved
00010000	Reserved
00020000	Not used
00040000	Fans error
00080000	Reserved
00100000	Reserved
00200000	Reserved
00400000	Reserved
00800000	Reserved
01000000	Reserved
02000000	Reserved
04000000	Reserved
08000000	Reserved
10000000	Reserved
20000000	Reserved
40000000	Reserved
80000000	Reserved



### 4.1.3 Warning Words

#### DR-92 Warning Word

Bit (Hex)	Warning Word (DR-92 Warning Word)
00000001	
00000002	Power card over temperature
00000004	Earth fault
00000008	
00000010	Control word timeout
00000020	Over current
00000040	
00000080	Motor thermistor over temp.
00000100	Motor Electronic Thermal Overload over temperature
00000200	Inverter overloaded
00000400	DC link under voltage
00000800	DC link over voltage
00001000	
00002000	
00004000	Mains phase loss
00008000	No motor
00010000	Live zero error
00020000	
00040000	
00080000	
00100000	
00200000	
00400000	
00800000	
01000000	
02000000	Current limit
04000000	
08000000	
10000000	
20000000	
40000000	Not used
80000000	Not used

#### DR-93 Warning Word 2

Bit (Hex)	Warning Word 2 (DR-93 Warning Word 2)
00000001	
00000002	
00000004	Clock Failure
00000008	Reserved
00000010	Reserved
00000020	
00000040	
00000080	End of Curve
00000100	Broken Belt
00000200	Not used
00000400	Reserved
00000800	Reserved
00001000	Reserved
00002000	Reserved
00004000	Reserved
00008000	Reserved
00010000	Reserved
00020000	Not used
00040000	Fans warning
00080000	
00100000	Reserved
00200000	Reserved
00400000	Reserved
00800000	Reserved
01000000	Reserved
02000000	Reserved
04000000	Reserved
08000000	Reserved
10000000	Reserved
20000000	Reserved
40000000	Reserved
80000000	Reserved





4.1.4 Extended Status Words

Extended status word, DR-94 Ext. Status Word

Extended status word 2, DR-95 Ext. Status Word 2

4

Bit (Hex)	Extended Status Word (DR-94 Ext. Status Word)
00000001	Ramping
00000002	Auto Tune tuning
00000004	Start CW/CCW
00000008	Not used
00000010	Not used
00000020	Feedback high
00000040	Feedback low
00000080	Output current high
00000100	Output current low
00000200	Output frequency high
00000400	Output frequency low
00000800	Not used
00001000	Not used
00002000	Not used
00004000	Out of speed range
00008000	OVC active
00010000	AC brake
00020000	Password Timelock
00040000	Password Protection
00080000	Reference high
00100000	Reference low
00200000	Local Ref./Remote Ref.
00400000	Reserved
00800000	Reserved
01000000	Reserved
02000000	Reserved
04000000	Reserved
08000000	Reserved
10000000	Reserved
20000000	Reserved
40000000	Reserved
80000000	Reserved

Bit (Hex)	Extended Status Word 2 (DR-95 Ext. Status Word 2)
00000001	Off
00000002	Hand / Auto
00000004	Not used
00000008	Not used
00000010	Not used
00000020	Relay 123 active
00000040	Start Prevented
00000080	Control ready
00000100	Drive ready
00000200	Quick Stop
00000400	DC Brake
00000800	Stop
00001000	Standby
00002000	Freeze Output Request
00004000	Freeze Output
00008000	Jog Request
00010000	Jog
00020000	Start Request
00040000	Start
00080000	Start Applied
00100000	Start Delay
00200000	Sleep
00400000	Sleep Boost
00800000	Running
01000000	Bypass
02000000	Fire Mode
04000000	Reserved
08000000	Reserved
10000000	Reserved
20000000	Reserved
40000000	Reserved
80000000	Reserved



### 4.1.5 Fault Messages

**WARNING 1, 10 Volts low:**

The 10 V voltage from terminal 50 on the control card is below 10 V.

Remove some of the load from terminal 50, as the 10 V supply is overloaded. Max. 15 mA or minimum 590 Ω.

**WARNING/ALARM 2, Live zero error:**

The signal on terminal 53 or 54 is less than 50% of the value set in *AN-10 Terminal 53 Low Voltage*, *AN-12 Terminal 53 Low Current*, *AN-20 Terminal 54 Low Voltage*, or *AN-22 Terminal 54 Low Current* respectively.

**WARNING/ALARM 3, No motor:**

No motor has been connected to the output of the frequency converter.

**WARNING/ALARM 4, Mains phase loss:**

A phase is missing on the supply side, or the mains voltage imbalance is too high. This message also appears in case of a fault in the input rectifier on the frequency converter. Check the supply voltage and supply currents to the frequency converter.

**WARNING 5, DC link voltage high:**

The intermediate circuit voltage (DC) is higher than the over-voltage limit of the control system. The frequency converter is still active.

**WARNING 6, DC link voltage low:**

The intermediate circuit voltage (DC) is below the undervoltage limit of the control system. The frequency converter is still active.

**WARNING/ALARM 7, DC over voltage:**

If the intermediate circuit voltage exceeds the limit, the frequency converter trips after a time.

**Possible corrections:**

- Select Over Voltage Control function in *B-17 Over-voltage Control*
- Connect a brake resistor
- Extend the ramp time
- Activate functions in *B-10 Brake Function*
- Increase *SP-26 Trip Delay at Drive Fault*

Selecting OVC function will extend the ramp times.

Alarm/warning limits			
Voltage Range	3 x 200-240 VAC	3 x 380-500 VAC	3 x 550-600 VAC
	[VDC]	[VDC]	[VDC]
Under voltage	185	373	532
Voltage warning low	205	410	585
Voltage warning high (w/o brake - w/brake)	390/405	810/840	943/965
Over voltage	410	855	975

The voltages stated are the intermediate circuit voltage of the frequency converter with a tolerance of ± 5 %. The corresponding mains voltage is the intermediate circuit voltage (DC-link) divided by 1.35

**WARNING/ALARM 8, DC under voltage:**

If the intermediate circuit voltage (DC) drops below the “voltage warning low” limit (see table above), the frequency converter checks if 24 V backup supply is connected.

If no 24 V backup supply is connected, the frequency converter trips after a given time depending on the unit. To check whether the supply voltage matches the frequency converter, see *Section General Specifications*.

**WARNING/ALARM 9, Inverter overloaded:**

The frequency converter is about to cut out because of an overload (too high current for too long). The counter for electronic, thermal inverter protection gives a warning at 98% and trips at 100%, while giving an alarm. You cannot reset the frequency converter until the counter is below 90%.

The fault is that the frequency converter is overloaded by more than nominal current for too long.

**WARNING/ALARM 10, Motor Electronic Thermal Overload over temperature:**

According to the Electronic Thermal Overload, the motor is too hot. You can choose if you want the frequency converter to give a warning or an alarm when the counter reaches 100% in *F-10 Electronic Overload*. The fault is that the motor is overloaded by more than nominal current for too long. Check that the motor *P-03 Motor Current* is set correctly.

**WARNING/ALARM 11, Motor thermistor over temp:**

The thermistor or the thermistor connection is disconnected. You can choose if you want the frequency converter to give a warning or an alarm in *F-10 Electronic Overload*. Check that the thermistor is connected correctly between terminal 53 or 54 (analog voltage input) and terminal 50 (+ 10 Volts supply), or between terminal 18 or 19 (digital input PNP only) and terminal 50. If a KTY sensor is used, check for correct connection between terminal 54 and 55.

**WARNING/ALARM 12, Torque limit:**

The torque is higher than the value in *F-40 Torque Limiter (Driving)* (in motor operation) or the torque is higher than the value in *F-41 Torque Limiter (Braking)* (in regenerative operation).

**WARNING/ALARM 13, Over Current:**

The inverter peak current limit (approx. 200% of the rated current) is exceeded. The warning will last approx. 8-12 sec., then the frequency converter trips and issues an alarm. Turn off the frequency converter and check if the motor shaft can be turned and if the motor size matches the frequency converter.

**ALARM 14, Earth fault:**

There is a discharge from the output phases to earth, either in the cable between the frequency converter and the motor or in the motor itself.

Turn off the frequency converter and remove the earth fault.

**ALARM 15, In-complete hardware:**

A fitted option is not handled by the present control board (hardware or software).

**ALARM 16, Short-circuit:**

There is short-circuiting in the motor or on the motor terminals.

Turn off the frequency converter and remove the short-circuit.

**WARNING/ALARM 17, Control word timeout:**

There is no communication to the frequency converter.

The warning will only be active when *O-04 Control Word Timeout Function* is NOT set to OFF.

If *O-04 Control Word Timeout Function* is set to Stop and Trip, a warning appears and the frequency converter decels to zero speed, while giving an alarm.

*O-03 Control Word Timeout Time* could possibly be increased.

**ALARM 18, Start Failed:**

The speed has not been able to exceed *AP-70 Compressor Start Max Speed [RPM]* during start within the allowed time. (set in *AP-72 Compressor Start Max Time to Trip*). This may be caused by a blocked motor.

**WARNING 23, Internal fans:**

Internal fans have failed due to defect hardware or fans not mounted.

**WARNING 24, External fan fault:**

The fan warning function is an extra protection function that checks if the fan is running / mounted. The fan warning can be disabled in *SP-53 Fan Monitor*, [0] Disabled.

**WARNING/ALARM 29, Drive over temperature:**

If the enclosure is IP00, IP20/Nema1 or IP21/TYP1, the cut-out temperature of the heat-sink is  $95\text{ }^{\circ}\text{C} \pm 5\text{ }^{\circ}\text{C}$ . The temperature fault cannot be reset, until the temperature of the heatsink is below  $70\text{ }^{\circ}\text{C}$ .

**The fault could be:**

- Ambient temperature too high
- Too long motor cable

**ALARM 30, Motor phase U missing:**

Motor phase U between the frequency converter and the motor is missing.

Turn off the frequency converter and check motor phase U.

**ALARM 31, Motor phase V missing:**

Motor phase V between the frequency converter and the motor is missing.

Turn off the frequency converter and check motor phase V.

**ALARM 32, Motor phase W missing:**

Motor phase W between the frequency converter and the motor is missing.

Turn off the frequency converter and check motor phase W.

**ALARM 33, Inrush fault:**

Too many powerups have occurred within a short time period. See the chapter *General Specifications* for the allowed number of power-ups within one minute.

**WARNING/ALARM 34, Fieldbus communication fault:**

The network on the communication option card is not working.

**WARNING/ALARM 36, Mains failure:**

This warning/alarm is only active if the supply voltage to the frequency converter is lost and *SP-10 Line failure* is NOT set to OFF. Possible correction: check the fuses to the frequency converter

**WARNING/ALARM 37, Phase Imbalance:**

There is a current imbalance between the power units.

**ALARM 38, Internal fault:**

Contact your local GE supplier.

**ALARM 39, Heatsink Sensor:**

No feedback from the heatsink sensor.

**WARNING 40, Overload of Digital Output Terminal 27**

Check the load connected to terminal 27 or remove short-circuit connection. Check *E-00 Digital I/O Mode* and *E-51 Terminal 27 Mode*.

**WARNING 41, Overload of Digital Output Terminal 29:**

Check the load connected to terminal 29 or remove short-circuit connection. Check *E-00 Digital I/O Mode* and *E-52 Terminal 29 Mode*.

**WARNING 42, Overload of Digital Output On X30/6 :**

Check the load connected to X30/6 or remove short-circuit connection. Check *E-56 Term X30/6 Digi Out (OPCGPIO)*.

**WARNING 42, Overload of Digital Output On X30/7 :**

Check the load connected to X30/7 or remove short-circuit connection. Check *E-57 Term X30/7 Digi Out (OPCGPIO)*.

**ALARM 46, Pwr. card supply:**

The supply on the power card is out of range.

**WARNING 47, 24 V supply low:**

The external 24 V DC backup power supply may be overloaded, otherwise contact your GE supplier.

**ALARM 48, 1.8 V supply low:**

Contact your GE supplier.

**WARNING 49, Speed limit:**

The speed has been limited by range in *F-18 Motor Speed Low Limit [RPM]* and *F-17 Motor Speed High Limit [RPM]*.

**ALARM 50, Auto Tune calibration failed:**

Contact your GE supplier.

**ALARM 51, Auto Tune check Unom and Inom:**

The setting of motor voltage, motor current, and motor power is presumably wrong. Check the settings.

**ALARM 52, Auto Tune low Inom:**

The motor current is too low. Check the settings.

**ALARM 53, Auto Tune motor too big:**

The motor is too big for the Auto Tune to be carried out.

**ALARM 54, Auto Tune motor too small:**

The motor is too small for the Auto Tune to be carried out.

**ALARM 55, Auto Tune par. out of range:**

The par. values found from the motor are outside acceptable range.

**ALARM 56, Auto Tune interrupted by user:**

The Auto Tune has been interrupted by the user.

**ALARM 57, Auto Tune timeout:**

Try to start the Auto Tune again a number of times, until the Auto Tune is carried out. Please note that repeated runs may heat the motor to a level where the resistance  $R_s$  and  $R_r$  are increased. In most cases, however, this is not critical.

**WARNING/ALARM 58, Auto Tune internal fault:**

Contact your GE supplier.

**WARNING 59, Current limit:**

The current is higher than the value in *F-43 Current Limit*.

**WARNING 60, External Interlock:**

External Interlock has been activated. To resume normal operation, apply 24 V DC to the terminal programmed for External Interlock and reset the frequency converter (via Bus, Digital I/O or by pressing [Reset]).

**WARNING/ALARM 61, Tracking Error:**

Tracking error. Contact your supplier.

**WARNING 62, Output Frequency at Maximum Limit:**

The output frequency is limited by the value set in *F-03 Max Output Frequency 1*

**WARNING 64, Voltage Limit:**

The load and speed combination demands a motor voltage higher than the actual DC link voltage.

**WARNING/ALARM/TRIP 65, Control Card Over Temperature:**

Control card over temperature: The cut-out temperature of the control card is 80 °C.

**WARNING 66, Heatsink Temperature Low:**

The heat sink temperature is measured as 0 °C. This could indicate that the temperature sensor is defective and thus the fan speed is increased to the maximum in case the power part or control card is very hot.

If the temperature is below 15 °C the warning will be present.

**ALARM 67, Option Configuration has Changed:**

One or more options has either been added or removed since the last power-down.

**ALARM 69, Pwr. Card Temp:**

Power card over temperature.

**ALARM 70, Illegal Frequency Converter Configuration:**

Actual combination of control board and power board is illegal.

**ALARM 90, Feedback Mon.:****ALARM 91, Analogue Input 54 Wrong Settings:**

Switch S202 has to be set in position OFF (voltage input), when a KTY sensor is connected to the analogue input terminal 54.

**ALARM 92, NoFlow:**

A no load situation has been detected for the system. See parameter group AP-2#.

**ALARM 93, Dry Pump:**

A no flow situation and high speed indicates that the pump has run dry. See parameter group AP-2#.

**ALARM 94, End of Curve:**

Feed back stays lower than the set point, which may be indicates a leakage in the pipe system. See parameter group AP-5#.

**ALARM 95, Broken Belt:**

Torque is below the torque level set for no load indicating a broken belt. See parameter group AP-6#.

**ALARM 96, Start Delayed:**

Start of the motor has been delayed due to short cycle protection is active. See parameter group AP-7#.

**ALARM 250, New Spare Part:**

The power or Switch Mode Power Supply has been exchanged. The frequency converter model number must be restored in the EEPROM. Select the correct model number in *SP-23 Typecode Setting* according to the label on unit. Remember to select 'Save to EEPROM' to complete.

**ALARM 251, New model number:**

The frequency converter has got a new model number.



## 5 Parameter Lists

### 5.1 Parameter Lists

#### 5.1.1 Main Menu Structure

Parameters for the frequency converter are grouped into various parameter groups for easy selection of the correct parameters for optimized operation of the frequency converter.

The vast majority of AF-600 FP applications can be programmed using the Quick Menu button and selecting the parameters under Quick Setup.

Descriptions and default settings of parameters may be found under the section Parameter Lists at the back of this manual.

K-## Keypad Set-up
F-## Fundamental Parameters
E-## Digital In/Outs
C-## Frequency Control Functions
P-## Motor Data
H-## High Perf Parameters
AN-## Analog In/Out
SP-## Special Functions
O-## Options/Comms
AO-## Analog I/O Options
DN-## DeviceNet
PB-## Profibus
LN-## LonWorks
BN-## BACnet
ID-## Drive Information
DR-## Data Readouts
LG-## Logs & I/O Opt. Status
AP-## HVAC Appl. Param.
FB-## Fire/Bypass Operation
T-## Timed Functions
CL-## PID Closed Loop
XC-## Ext. PID Closed Loop
PC-## Pump Controller
LC-## Logic Controller
B-## Braking Functions



5.1.2 K-## Keypad Set-up

Par. No. #	Parameter description	Default value	4-set-up	Change during operation	Conversion index	Type
<b>K-0#</b>						
K-01	Language	[0] English	1 set-up	TRUE	-	UInt8
K-02	Motor Speed Unit	[1] Hz	2 set-ups	FALSE	-	UInt8
K-03	Regional Settings	[1] North America	2 set-ups	FALSE	-	UInt8
K-04	Operating State at Power-up	[0] Resume	All set-ups	TRUE	-	UInt8
K-05	Local Mode Unit	[0] As Motor Speed Unit	2 set-ups	FALSE	-	UInt8
<b>K-1#</b>						
K-10	Active Set-up	[1] Set-up 1	1 set-up	TRUE	-	UInt8
K-11	Edit Set-up	[9] Active Set-up	All set-ups	TRUE	-	UInt8
K-12	This Set-up Linked to	[0] Not linked	All set-ups	FALSE	-	UInt8
K-13	Readout: Linked Set-ups	0 N/A	All set-ups	FALSE	0	UInt16
K-14	Readout: Edit Set-ups / Channel	0 N/A	All set-ups	TRUE	0	Int32
<b>K-2#</b>						
K-20	Display Line 1.1 Small	ExpressionLimit	All set-ups	TRUE	-	UInt16
K-21	Display Line 1.2 Small	ExpressionLimit	All set-ups	TRUE	-	UInt16
K-22	Display Line 1.3 Small	ExpressionLimit	All set-ups	TRUE	-	UInt16
K-23	Display Line 2 Large	ExpressionLimit	All set-ups	TRUE	-	UInt16
K-24	Display Line 3 Large	ExpressionLimit	All set-ups	TRUE	-	UInt16
K-25	Quick Start	ExpressionLimit	1 set-up	TRUE	0	UInt16
<b>K-3#</b>						
K-30	Unit for Custom Readout	[1] %	All set-ups	TRUE	-	UInt8
K-31	Min Value of Custom Readout	ExpressionLimit	All set-ups	TRUE	-2	Int32
K-32	Max Value of Custom Readout	100.00 CustomReadoutUnit	All set-ups	TRUE	-2	Int32
K-37	Display Text 1	0 N/A	1 set-up	TRUE	0	VisStr[25]
K-38	Display Text 2	0 N/A	1 set-up	TRUE	0	VisStr[25]
K-39	Display Text 3	0 N/A	1 set-up	TRUE	0	VisStr[25]
<b>K-4#</b>						
K-40	[Hand] Button on Keypad	[1] Enabled	All set-ups	TRUE	-	UInt8
K-41	[Off] Button on Keypad	[1] Enabled	All set-ups	TRUE	-	UInt8
K-42	[Auto] Button on Keypad	[1] Enabled	All set-ups	TRUE	-	UInt8
K-43	[Reset] Button on Keypad	[1] Enabled	All set-ups	TRUE	-	UInt8
<b>K-5#</b>						
K-50	Keypad Copy	[0] No copy	All set-ups	FALSE	-	UInt8
K-51	Set-up Copy	[0] No copy	All set-ups	FALSE	-	UInt8
<b>K-6#</b>						
K-60	Main Menu Password	100 N/A	1 set-up	TRUE	0	Int16
K-61	Access to Main Menu w/o Password	[0] Full access	1 set-up	TRUE	-	UInt8
K-65	Quick Menu Password	200 N/A	1 set-up	TRUE	0	Int16
K-66	Access to Quick Menu w/o Password	[0] Full access	1 set-up	TRUE	-	UInt8



Parameter Lists

AF-600 FP Programming Guide

Par. No. #	Parameter description	Default value	4-set-up	Change during operation	Conversion index	Type
<b>K-7#</b>						
K-70	Date and Time	ExpressionLimit	All set-ups	TRUE	0	TimeOfDay
K-71	Date Format	null	1 set-up	TRUE	-	UInt8
K-72	Time Format	null	1 set-up	TRUE	-	UInt8
K-74	DST/Summertime	[0] Off	1 set-up	TRUE	-	UInt8
K-76	DST/Summertime Start	ExpressionLimit	1 set-up	TRUE	0	TimeOfDay
K-77	DST/Summertime End	ExpressionLimit	1 set-up	TRUE	0	TimeOfDay
K-79	Clock Fault	null	1 set-up	TRUE	-	UInt8
<b>K-8#</b>						
K-81	Working Days	null	1 set-up	TRUE	-	UInt8
K-82	Additional Working Days	ExpressionLimit	1 set-up	TRUE	0	TimeOfDay
K-83	Additional Non-Working Days	ExpressionLimit	1 set-up	TRUE	0	TimeOfDay
K-89	Date and Time Readout	0 N/A	All set-ups	TRUE	0	VisStr[25]

5





5.1.3 F-## Fundamental Parameters

Par. No. #	Parameter description	Default value	4-set-up	Change during operation	Conversion index	Type
<b>F-0#</b>						
F-01	Frequency Setting 1	[1] Analog input 53	All set-ups	TRUE	-	Uint8
F-02	Operation Method	[0] Linked to Hand / Auto	All set-ups	TRUE	-	Uint8
F-03	Max Output Frequency 1	ExpressionLimit	All set-ups	FALSE	-1	Uint16
F-04	Base Frequency	ExpressionLimit	All set-ups	FALSE	0	Uint16
F-05	Motor Rated Voltage	ExpressionLimit	All set-ups	FALSE	0	Uint16
F-07	Accel Time 1	ExpressionLimit	All set-ups	TRUE	-2	Uint32
F-08	Decel Time 1	ExpressionLimit	All set-ups	TRUE	-2	Uint32
<b>F-1#</b>						
F-10	Electronic Overload	[4] Elec. OL Trip 1	All set-ups	TRUE	-	Uint8
F-11	Motor External Fan	[0] No	All set-ups	TRUE	-	Uint16
F-12	Motor Thermistor Input	[0] None	All set-ups	TRUE	-	Uint8
F-15	Motor Speed High Limit [Hz]	ExpressionLimit	All set-ups	TRUE	-1	Uint16
F-16	Motor Speed Low Limit [Hz]	ExpressionLimit	All set-ups	TRUE	-1	Uint16
F-17	Motor Speed High Limit [RPM]	ExpressionLimit	All set-ups	TRUE	67	Uint16
F-18	Motor Speed Low Limit [RPM]	ExpressionLimit	All set-ups	TRUE	67	Uint16
<b>F-2#</b>						
F-24	Holding Time	0.0 s	All set-ups	TRUE	-1	Uint16
F-26	Motor Noise (Carrier Freq)	null	All set-ups	TRUE	-	Uint8
F-27	Motor Tone Random	[0] Off	All set-ups	TRUE	-	Uint8
<b>F-3#</b>						
F-37	Adv. Switching Pattern	null	All set-ups	TRUE	-	Uint8
F-38	Overmodulation	[1] On	All set-ups	FALSE	-	Uint8
<b>F-4#</b>						
F-40	Torque Limiter (Driving)	ExpressionLimit	All set-ups	TRUE	-1	Uint16
F-41	Torque Limiter (Braking)	100.0 %	All set-ups	TRUE	-1	Uint16
F-43	Current Limit	ExpressionLimit	All set-ups	TRUE	-1	Uint32
<b>F-5#</b>						
F-52	Minimum Reference	ExpressionLimit	All set-ups	TRUE	-3	Int32
F-53	Maximum Reference	ExpressionLimit	All set-ups	TRUE	-3	Int32
F-54	Reference Function	null	All set-ups	TRUE	-	Uint8
<b>F-6#</b>						
F-64	Preset Relative Reference	0.00 %	All set-ups	TRUE	-2	Int32
<b>F-9#</b>						
F-90	Step Size	0.10 %	All set-ups	TRUE	-2	Uint16
F-91	Accel/Decel Time	1.00 s	All set-ups	TRUE	-2	Uint32
F-92	Power Restore	[0] Off	All set-ups	TRUE	-	Uint8
F-93	Maximum Limit	100 %	All set-ups	TRUE	0	Int16
F-94	Minimum Limit	0 %	All set-ups	TRUE	0	Int16
F-95	Accel/Decel Ramp Delay	ExpressionLimit	All set-ups	TRUE	-3	TimD



5.1.4 E-## Digital In/Outs

5

Par. No. #	Parameter description	Default value	4-set-up	Change during operation	Conversion index	Type
<b>E-0#</b>						
E-00	Digital I/O Mode	[0] PNP - Active at 24V	All set-ups	FALSE	-	Uint8
E-01	Terminal 18 Digital Input	[8] Start	All set-ups	TRUE	-	Uint8
E-02	Terminal 19 Digital Input	[0] No operation	All set-ups	TRUE	-	Uint8
E-03	Terminal 27 Digital Input	[0] No operation	All set-ups	TRUE	-	Uint8
E-04	Terminal 29 Digital Input	[14] Jog	All set-ups	TRUE	-	Uint8
E-05	Terminal 32 Digital Input	[0] No operation	All set-ups	TRUE	-	Uint8
E-06	Terminal 33 Digital Input	[0] No operation	All set-ups	TRUE	-	Uint8
<b>E-1#</b>						
E-10	Accel Time 2	ExpressionLimit	All set-ups	TRUE	-2	Uint32
E-11	Decel Time 2	ExpressionLimit	All set-ups	TRUE	-2	Uint32
<b>E-2#</b>						
E-20	Terminal 27 Digital Output	[0] No operation	All set-ups	TRUE	-	Uint8
E-21	Terminal 29 Digital Output	[0] No operation	All set-ups	TRUE	-	Uint8
E-24	Function Relay	null	All set-ups	TRUE	-	Uint8
E-26	On Delay, Relay	0.01 s	All set-ups	TRUE	-2	Uint16
E-27	Off Delay, Relay	0.01 s	All set-ups	TRUE	-2	Uint16
<b>E-5#</b>						
E-51	Terminal 27 Mode	[0] Input	All set-ups	TRUE	-	Uint8
E-52	Terminal 29 Mode	[0] Input	All set-ups	TRUE	-	Uint8
E-53	Terminal X30/2 Digital Input	[0] No operation	All set-ups	TRUE	-	Uint8
E-54	Terminal X30/3 Digital Input	[0] No operation	All set-ups	TRUE	-	Uint8
E-55	Terminal X30/4 Digital Input	[0] No operation	All set-ups	TRUE	-	Uint8
E-56	Term X30/6 Digi Out (OPCGPIO)	[0] No operation	All set-ups	TRUE	-	Uint8
E-57	Term X30/7 Digi Out (OPCGPIO)	[0] No operation	All set-ups	TRUE	-	Uint8
<b>E-6#</b>						
E-60	Term. 29 Low Frequency	100 Hz	All set-ups	TRUE	0	Uint32
E-61	Term. 29 High Frequency	100 Hz	All set-ups	TRUE	0	Uint32
E-62	Term. 29 Low Ref./Feedb. Value	0.000 N/A	All set-ups	TRUE	-3	Int32
E-63	Term. 29 High Ref./Feedb. Value	100.000 N/A	All set-ups	TRUE	-3	Int32
E-64	Pulse Filter Time Constant #29	100 ms	All set-ups	FALSE	-3	Uint16
E-65	Term. 33 Low Frequency	100 Hz	All set-ups	TRUE	0	Uint32
E-66	Term. 33 High Frequency	100 Hz	All set-ups	TRUE	0	Uint32
E-67	Term. 33 Low Ref./Feedb. Value	0.000 N/A	All set-ups	TRUE	-3	Int32
E-68	Term. 33 High Ref./Feedb. Value	100.000 N/A	All set-ups	TRUE	-3	Int32
E-69	Pulse Filter Time Constant #33	100 ms	All set-ups	FALSE	-3	Uint16



Parameter Lists

AF-600 FP Programming Guide

Par. No. #	Parameter description	Default value	4-set-up	Change during operation	Conversion index	Type
<b>E-7#</b>						
E-70	Terminal 27 Pulse Output Variable	[0] No operation	All set-ups	TRUE	-	Uint8
E-71	Pulse Output Max Freq #27	5000 Hz	All set-ups	TRUE	0	Uint32
E-72	Terminal 29 Pulse Output Variable	[0] No operation	All set-ups	TRUE	-	Uint8
E-74	Pulse Output Max Freq #29	5000 Hz	All set-ups	TRUE	0	Uint32
E-75	Terminal X30/6 Pulse Output Variable	[0] No operation	All set-ups	TRUE	-	Uint8
E-76	Pulse Output Max Freq #X30/6	5000 Hz	All set-ups	TRUE	0	Uint32
<b>E-9#</b>						
E-90	Digital & Relay Bus Control	0 N/A	All set-ups	TRUE	0	Uint32
E-93	Pulse Out #27 Bus Control	0.00 %	All set-ups	TRUE	-2	N2
E-94	Pulse Out #27 Timeout Preset	0.00 %	1 set-up	TRUE	-2	Uint16
E-95	Pulse Out #29 Bus Control	0.00 %	All set-ups	TRUE	-2	N2
E-96	Pulse Out #29 Timeout Preset	0.00 %	1 set-up	TRUE	-2	Uint16
E-97	Pulse Out #X30/6 Bus Control	0.00 %	All set-ups	TRUE	-2	N2
E-98	Pulse Out #X30/6 Timeout Preset	0.00 %	1 set-up	TRUE	-2	Uint16



5.1.5 C-## Frequency Control Functions

5

Par. No. #	Parameter description	Default value	4-set-up	Change during operation	Conversion index	Type
<b>C-0#</b>						
C-01	Jump Frequency From [Hz]	ExpressionLimit	All set-ups	TRUE	-1	Uint16
C-02	Jump Speed From [RPM]	ExpressionLimit	All set-ups	TRUE	67	Uint16
C-03	Jump Speed To [RPM]	ExpressionLimit	All set-ups	TRUE	67	Uint16
C-04	Jump Frequency To [Hz]	ExpressionLimit	All set-ups	TRUE	-1	Uint16
C-05	Multi-step Frequency 1 - 8	0.00 %	All set-ups	TRUE	-2	Int16
<b>C-2#</b>						
C-20	Jog Speed [Hz]	ExpressionLimit	All set-ups	TRUE	-1	Uint16
C-21	Jog Speed [RPM]	ExpressionLimit	All set-ups	TRUE	67	Uint16
C-22	Jog Accel/Decel Time	ExpressionLimit	All set-ups	TRUE	-2	Uint32
C-23	Quick Stop Decel Time	ExpressionLimit	2 set-ups	TRUE	-2	Uint32
<b>C-3#</b>						
C-30	Frequency Command 2	[20] Digital Potentiometer	All set-ups	TRUE	-	Uint8
C-34	Frequency Command 3	[0] No function	All set-ups	TRUE	-	Uint8
<b>C-4#</b>						
C-40	Semi-Auto Jump Freq Set-up	[0] Off	All set-ups	FALSE	-	Uint8



## 5.1.6 P-## Motor Data

Par. No. #	Parameter description	Default value	4-set-up	Change during operation	Conversion index	Type
<b>P-0#</b>						
P-02	Motor Power [HP]	ExpressionLimit	All set-ups	FALSE	-2	Uint32
P-03	Motor Current	ExpressionLimit	All set-ups	FALSE	-2	Uint32
P-04	Auto Tune	[0] Off	All set-ups	FALSE	-	Uint8
P-06	Base Speed	ExpressionLimit	All set-ups	FALSE	67	Uint16
P-07	Motor Power [kW]	ExpressionLimit	All set-ups	FALSE	1	Uint32
P-08	Motor Rotation Check	[0] Off	All set-ups	FALSE	-	Uint8
P-09	Slip Compensation	0 %	All set-ups	TRUE	0	Int16
<b>P-1#</b>						
P-10	Slip Compensation Time Constant	ExpressionLimit	All set-ups	TRUE	-2	Uint16
<b>P-3#</b>						
P-30	Stator Resistance (Rs)	ExpressionLimit	All set-ups	FALSE	-4	Uint32
P-31	Rotor Resistance (Rr)	ExpressionLimit	All set-ups	FALSE	-4	Uint32
P-35	Main Reactance (Xh)	ExpressionLimit	All set-ups	FALSE	-4	Uint32
P-36	Iron Loss Resistance (Rfe)	ExpressionLimit	All set-ups	FALSE	-3	Uint32



5.1.7 H-## High Perf Parameters

5

Par. No. #	Parameter description	Default value	4-set-up	Change during operation	Conversion index	Type
<b>H-0#</b>						
H-03	Restore Factory Settings	[0] Normal operation	All set-ups	TRUE	-	Uint8
H-04	Auto-Reset (Times)	null	All set-ups	TRUE	-	Uint8
H-05	Auto-Reset (Reset Interval)	10 s	All set-ups	TRUE	0	Uint16
H-06	Fan Operation	[0] Auto	All set-ups	TRUE	-	Uint8
H-08	Reverse Lock	[2] Both directions	All set-ups	FALSE	-	Uint8
H-09	Start Mode	[0] Disabled	All set-ups	TRUE	-	Uint8
<b>H-3#</b>						
H-36	Trip Speed Low [RPM]	ExpressionLimit	All set-ups	TRUE	67	Uint16
H-37	Trip Speed Low [Hz]	ExpressionLimit	All set-ups	TRUE	-1	Uint16
<b>H-4#</b>						
H-40	Configuration Mode	null	All set-ups	TRUE	-	Uint8
H-43	Torque Characteristics	[3] Auto Energy Optim. VT	All set-ups	TRUE	-	Uint8
H-48	Clockwise Direction	[0] Normal	All set-ups	FALSE	-	Uint8
<b>H-5#</b>						
H-58	Flystart Test Pulses Current	30 %	All set-ups	FALSE	0	Uint16
H-59	Flystart Test Pulses Frequency	200 %	All set-ups	FALSE	0	Uint16
<b>H-6#</b>						
H-64	Resonance Dampening	100 %	All set-ups	TRUE	0	Uint16
H-65	Resonance Dampening Time Constant	5 ms	All set-ups	TRUE	-3	Uint8
<b>H-7#</b>						
H-70	Warning Current Low	0.00 A	All set-ups	TRUE	-2	Uint32
H-71	Warning Current High	ExpressionLimit	All set-ups	TRUE	-2	Uint32
H-72	Warning Speed Low	0 RPM	All set-ups	TRUE	67	Uint16
H-73	Warning Speed High	ExpressionLimit	All set-ups	TRUE	67	Uint16
H-74	Warning Reference Low	-999999.999 N/A	All set-ups	TRUE	-3	Int32
H-75	Warning Reference High	999999.999 N/A	All set-ups	TRUE	-3	Int32
H-76	Warning Feedback Low	-999999.999 ProcessCtrlUnit	All set-ups	TRUE	-3	Int32
H-77	Warning Feedback High	999999.999 ProcessCtrlUnit	All set-ups	TRUE	-3	Int32
H-78	Missing Motor Phase Function	[2] Trip 1000 ms	All set-ups	TRUE	-	Uint8
<b>H-8#</b>						
H-80	Function at Stop	[0] Coast	All set-ups	TRUE	-	Uint8
H-81	Min Speed for Function at Stop [RPM]	ExpressionLimit	All set-ups	TRUE	67	Uint16
H-82	Min Speed for Function at Stop [Hz]	ExpressionLimit	All set-ups	TRUE	-1	Uint16



5.1.8 AN-## Analog In / Out

Par. No. #	Parameter description	Default value	4-set-up	Change during operation	Conversion index	Type
<b>AN-0#</b>						
AN-00	Live Zero Timeout Time	10 s	All set-ups	TRUE	0	Uint8
AN-01	Live Zero Timeout Function	[0] Off	All set-ups	TRUE	-	Uint8
AN-02	Fire Mode Live Zero Timeout Function	[0] Off	All set-ups	TRUE	-	Uint8
<b>AN-1#</b>						
AN-10	Terminal 53 Low Voltage	0.07 V	All set-ups	TRUE	-2	Int16
AN-11	Terminal 53 High Voltage	10.00 V	All set-ups	TRUE	-2	Int16
AN-12	Terminal 53 Low Current	4.00 mA	All set-ups	TRUE	-5	Int16
AN-13	Terminal 53 High Current	20.00 mA	All set-ups	TRUE	-5	Int16
AN-14	Terminal 53 Low Ref./Feedb. Value	0.000 N/A	All set-ups	TRUE	-3	Int32
AN-15	Terminal 53 High Ref./Feedb. Value	ExpressionLimit	All set-ups	TRUE	-3	Int32
AN-16	Terminal 53 Filter Time Constant	0.001 s	All set-ups	TRUE	-3	Uint16
AN-17	Terminal 53 Live Zero	[1] Enabled	All set-ups	TRUE	-	Uint8
<b>AN-2#</b>						
AN-20	Terminal 54 Low Voltage	0.07 V	All set-ups	TRUE	-2	Int16
AN-21	Terminal 54 High Voltage	10.00 V	All set-ups	TRUE	-2	Int16
AN-22	Terminal 54 Low Current	4.00 mA	All set-ups	TRUE	-5	Int16
AN-23	Terminal 54 High Current	20.00 mA	All set-ups	TRUE	-5	Int16
AN-24	Terminal 54 Low Ref./Feedb. Value	0.000 N/A	All set-ups	TRUE	-3	Int32
AN-25	Terminal 54 High Ref./Feedb. Value	100.000 N/A	All set-ups	TRUE	-3	Int32
AN-26	Terminal 54 Filter Time Constant	0.001 s	All set-ups	TRUE	-3	Uint16
AN-27	Terminal 54 Live Zero	[1] Enabled	All set-ups	TRUE	-	Uint8
<b>AN-3#</b>						
AN-30	Terminal X30/11 Low Voltage	0.07 V	All set-ups	TRUE	-2	Int16
AN-31	Terminal X30/11 High Voltage	10.00 V	All set-ups	TRUE	-2	Int16
AN-34	Term. X30/11 Low Ref./Feedb. Value	0.000 N/A	All set-ups	TRUE	-3	Int32
AN-35	Term. X30/11 High Ref./Feedb. Value	100.000 N/A	All set-ups	TRUE	-3	Int32
AN-36	Term. X30/11 Filter Time Constant	0.001 s	All set-ups	TRUE	-3	Uint16
AN-37	Term. X30/11 Live Zero	[1] Enabled	All set-ups	TRUE	-	Uint8
<b>AN-4#</b>						
AN-40	Terminal X30/12 Low Voltage	0.07 V	All set-ups	TRUE	-2	Int16
AN-41	Terminal X30/12 High Voltage	10.00 V	All set-ups	TRUE	-2	Int16
AN-44	Term. X30/12 Low Ref./Feedb. Value	0.000 N/A	All set-ups	TRUE	-3	Int32
AN-45	Term. X30/12 High Ref./Feedb. Value	100.000 N/A	All set-ups	TRUE	-3	Int32
AN-46	Term. X30/12 Filter Time Constant	0.001 s	All set-ups	TRUE	-3	Uint16
AN-47	Term. X30/12 Live Zero	[1] Enabled	All set-ups	TRUE	-	Uint8
<b>AN-5#</b>						
AN-50	Terminal 42 Output	null	All set-ups	TRUE	-	Uint8
AN-51	Terminal 42 Output Min Scale	0.00 %	All set-ups	TRUE	-2	Int16
AN-52	Terminal 42 Output Max Scale	100.00 %	All set-ups	TRUE	-2	Int16
AN-53	Terminal 42 Output Bus Control	0.00 %	All set-ups	TRUE	-2	N2
AN-54	Terminal 42 Output Timeout Preset	0.00 %	1 set-up	TRUE	-2	Uint16
<b>AN-6#</b>						
AN-60	Terminal X30/8 Output	[0] No operation	All set-ups	TRUE	-	Uint8
AN-61	Terminal X30/8 Min. Scale	0.00 %	All set-ups	TRUE	-2	Int16
AN-62	Terminal X30/8 Max. Scale	100.00 %	All set-ups	TRUE	-2	Int16
AN-63	Terminal X30/8 Output Bus Control	0.00 %	All set-ups	TRUE	-2	N2
AN-64	Terminal X30/8 Output Timeout Preset	0.00 %	1 set-up	TRUE	-2	Uint16





5.1.9 SP-## Special Functions

5

Par. No. #	Parameter description	Default value	4-set-up	Change during operation	Conversion index	Type
<b>SP-1#</b>						
SP-10	Line failure	[0] No function	All set-ups	FALSE	-	Uint8
SP-11	Line Voltage at Input Fault	ExpressionLimit	All set-ups	TRUE	0	Uint16
SP-12	Function at Line Imbalance	[0] Trip	All set-ups	TRUE	-	Uint8
<b>SP-2#</b>						
SP-23	Typecode Setting	null	2 set-ups	FALSE	-	Uint8
SP-25	Trip Delay at Torque Limit	60 s	All set-ups	TRUE	0	Uint8
SP-26	Trip Delay at Drive Fault	ExpressionLimit	All set-ups	TRUE	0	Uint8
SP-28	Production Settings	[0] No action	All set-ups	TRUE	-	Uint8
SP-29	Service Code	0 N/A	All set-ups	TRUE	0	Int32
<b>SP-3#</b>						
SP-30	Current Lim Ctrl, Proportional Gain	100 %	All set-ups	FALSE	0	Uint16
SP-31	Current Lim Ctrl, Integration Time	0.020 s	All set-ups	FALSE	-3	Uint16
SP-32	Current Lim Ctrl, Filter Time	26.0 ms	All set-ups	TRUE	-4	Uint16
<b>SP-4#</b>						
SP-40	VT Level	66 %	All set-ups	FALSE	0	Uint8
SP-41	Energy Savings Min. Magnetization	ExpressionLimit	All set-ups	TRUE	0	Uint8
SP-42	Energy Savings Min. Frequency	10 Hz	All set-ups	TRUE	0	Uint8
SP-43	Motor Cosphi	ExpressionLimit	All set-ups	TRUE	-2	Uint16
<b>SP-5#</b>						
SP-50	RFI Filter	[1] On	1 set-up	FALSE	-	Uint8
SP-51	DC Link Compensation	[1] On	1 set-up	TRUE	-	Uint8
SP-53	Fan Monitor	[1] Warning	All set-ups	TRUE	-	Uint8
SP-55	Output Filter	[0] No Filter	1 set-up	FALSE	-	Uint8
SP-59	Actual Number of Inverter Units	ExpressionLimit	1 set-up	FALSE	0	Uint8
<b>SP-6#</b>						
SP-60	Function at Over Temperature	[0] Trip	All set-ups	TRUE	-	Uint8
SP-61	Function at Drive Overload	[0] Trip	All set-ups	TRUE	-	Uint8
SP-62	Drive Overload Derate Current	95 %	All set-ups	TRUE	0	Uint16



5.1.10 O-## Options/Comms

Par. No. #	Parameter description	Default value	4-set-up	Change during operation	Conversion index	Type
<b>O-0#</b>						
O-01	Control Site	null	All set-ups	TRUE	-	UInt8
O-02	Control Word Source	null	All set-ups	TRUE	-	UInt8
O-03	Control Word Timeout Time	ExpressionLimit	1 set-up	TRUE	-1	UInt32
O-04	Control Word Timeout Function	[0] Off	1 set-up	TRUE	-	UInt8
O-05	End-of-Timeout Function	[1] Resume set-up	1 set-up	TRUE	-	UInt8
O-06	Reset Control Word Timeout	[0] Do not reset	All set-ups	TRUE	-	UInt8
O-07	Diagnosis Trigger	[0] Disable	2 set-ups	TRUE	-	UInt8
<b>O-1#</b>						
O-10	Control Word Profile	[0] Drive Profile	All set-ups	TRUE	-	UInt8
O-13	Configurable Status Word STW	[1] Profile Default	All set-ups	TRUE	-	UInt8
<b>O-3#</b>						
O-30	Protocol	null	1 set-up	TRUE	-	UInt8
O-31	Address	ExpressionLimit	1 set-up	TRUE	0	UInt8
O-32	Drive Port Baud Rate	null	1 set-up	TRUE	-	UInt8
O-33	Drive Port Parity	null	1 set-up	TRUE	-	UInt8
O-34	Estimated cycle time	0 ms	2 set-ups	TRUE	-3	UInt32
O-35	Minimum Response Delay	ExpressionLimit	1 set-up	TRUE	-3	UInt16
O-36	Maximum Response Delay	ExpressionLimit	1 set-up	TRUE	-3	UInt16
O-37	Maximum Inter-Char Delay	ExpressionLimit	1 set-up	TRUE	-5	UInt16
<b>O-4#</b>						
O-40	Telegram Selection	[1] Standard telegram 1	2 set-ups	TRUE	-	UInt8
O-42	PCD write configuration	ExpressionLimit	All set-ups	TRUE	-	UInt16
O-43	PCD read configuration	ExpressionLimit	All set-ups	TRUE	-	UInt16
<b>O-5#</b>						
O-50	Coasting Select	[3] Logic OR	All set-ups	TRUE	-	UInt8
O-52	DC Brake Select	[3] Logic OR	All set-ups	TRUE	-	UInt8
O-53	Start Select	[3] Logic OR	All set-ups	TRUE	-	UInt8
O-54	Reversing Select	null	All set-ups	TRUE	-	UInt8
O-55	Set-up Select	[3] Logic OR	All set-ups	TRUE	-	UInt8
O-56	Preset Reference Select	[3] Logic OR	All set-ups	TRUE	-	UInt8
<b>O-8#</b>						
O-80	Bus Message Count	0 N/A	All set-ups	TRUE	0	UInt32
O-81	Bus Error Count	0 N/A	All set-ups	TRUE	0	UInt32
O-82	Slave Messages Rcvd	0 N/A	All set-ups	TRUE	0	UInt32
O-83	Slave Error Count	0 N/A	All set-ups	TRUE	0	UInt32
O-89	Diagnostics Count	0 N/A	1 set-up	TRUE	0	Int32
<b>O-9#</b>						
O-90	Bus Jog 1 Speed	100 RPM	All set-ups	TRUE	67	UInt16
O-91	Bus Jog 2 Speed	200 RPM	All set-ups	TRUE	67	UInt16
O-94	Bus Feedback 1	0 N/A	1 set-up	TRUE	0	N2
O-95	Bus Feedback 2	0 N/A	1 set-up	TRUE	0	N2
O-96	Bus Feedback 3	0 N/A	1 set-up	TRUE	0	N2



5.1.11 AO-## Analog I/O Option

5

Par. No. #	Parameter description	Default value	4-set-up	Change during operation	Conversion index	Type
<b>AO-0#</b>						
AO-00	Terminal X42/1 Mode	[1] Voltage	All set-ups	TRUE	-	Uint8
AO-01	Terminal X42/3 Mode	[1] Voltage	All set-ups	TRUE	-	Uint8
AO-02	Terminal X42/5 Mode	[1] Voltage	All set-ups	TRUE	-	Uint8
<b>AO-1#</b>						
AO-10	Terminal X42/1 Low Voltage	0.07 V	All set-ups	TRUE	-2	Int16
AO-11	Terminal X42/1 High Voltage	10.00 V	All set-ups	TRUE	-2	Int16
AO-14	Term. X42/1 Low Ref./Feedb. Value	0.000 N/A	All set-ups	TRUE	-3	Int32
AO-15	Term. X42/1 High Ref./Feedb. Value	100.000 N/A	All set-ups	TRUE	-3	Int32
AO-16	Term. X42/1 Filter Time Constant	0.001 s	All set-ups	TRUE	-3	Uint16
AO-17	Term. X42/1 Live Zero	[1] Enabled	All set-ups	TRUE	-	Uint8
<b>AO-2#</b>						
AO-20	Terminal X42/3 Low Voltage	0.07 V	All set-ups	TRUE	-2	Int16
AO-21	Terminal X42/3 High Voltage	10.00 V	All set-ups	TRUE	-2	Int16
AO-24	Term. X42/3 Low Ref./Feedb. Value	0.000 N/A	All set-ups	TRUE	-3	Int32
AO-25	Term. X42/3 High Ref./Feedb. Value	100.000 N/A	All set-ups	TRUE	-3	Int32
AO-26	Term. X42/3 Filter Time Constant	0.001 s	All set-ups	TRUE	-3	Uint16
AO-27	Term. X42/3 Live Zero	[1] Enabled	All set-ups	TRUE	-	Uint8
<b>AO-3#</b>						
AO-30	Terminal X42/5 Low Voltage	0.07 V	All set-ups	TRUE	-2	Int16
AO-31	Terminal X42/5 High Voltage	10.00 V	All set-ups	TRUE	-2	Int16
AO-34	Term. X42/5 Low Ref./Feedb. Value	0.000 N/A	All set-ups	TRUE	-3	Int32
AO-35	Term. X42/5 High Ref./Feedb. Value	100.000 N/A	All set-ups	TRUE	-3	Int32
AO-36	Term. X42/5 Filter Time Constant	0.001 s	All set-ups	TRUE	-3	Uint16
AO-37	Term. X42/5 Live Zero	[1] Enabled	All set-ups	TRUE	-	Uint8
<b>AO-4#</b>						
AO-40	Terminal X42/7 Output	[0] No operation	All set-ups	TRUE	-	Uint8
AO-41	Terminal X42/7 Min. Scale	0.00 %	All set-ups	TRUE	-2	Int16
AO-42	Terminal X42/7 Max. Scale	100.00 %	All set-ups	TRUE	-2	Int16
AO-43	Terminal X42/7 Bus Control	0.00 %	All set-ups	TRUE	-2	N2
AO-44	Terminal X42/7 Timeout Preset	0.00 %	1 set-up	TRUE	-2	Uint16
<b>AO-5#</b>						
AO-50	Terminal X42/9 Output	[0] No operation	All set-ups	TRUE	-	Uint8
AO-51	Terminal X42/9 Min. Scale	0.00 %	All set-ups	TRUE	-2	Int16
AO-52	Terminal X42/9 Max. Scale	100.00 %	All set-ups	TRUE	-2	Int16
AO-53	Terminal X42/9 Bus Control	0.00 %	All set-ups	TRUE	-2	N2
AO-54	Terminal X42/9 Timeout Preset	0.00 %	1 set-up	TRUE	-2	Uint16
<b>AO-6#</b>						
AO-60	Terminal X42/11 Output	[0] No operation	All set-ups	TRUE	-	Uint8
AO-61	Terminal X42/11 Min. Scale	0.00 %	All set-ups	TRUE	-2	Int16
AO-62	Terminal X42/11 Max. Scale	100.00 %	All set-ups	TRUE	-2	Int16
AO-63	Terminal X42/11 Bus Control	0.00 %	All set-ups	TRUE	-2	N2
AO-64	Terminal X42/11 Timeout Preset	0.00 %	1 set-up	TRUE	-2	Uint16



5.1.12 DN-## DevicNet

Par. No. #	Parameter description	Default value	4-set-up	Change during operation	Conversion index	Type
<b>DN-0#</b>						
DN-00	DeviceNet Protocol	null	2 set-ups	FALSE	-	Uint8
DN-01	Baud Rate Select	null	2 set-ups	TRUE	-	Uint8
DN-02	MAC ID	ExpressionLimit	2 set-ups	TRUE	0	Uint8
DN-05	Readout Transmit Error Counter	0 N/A	All set-ups	TRUE	0	Uint8
DN-06	Readout Receive Error Counter	0 N/A	All set-ups	TRUE	0	Uint8
DN-07	Readout Bus Off Counter	0 N/A	All set-ups	TRUE	0	Uint8
<b>DN-1#</b>						
DN-10	Process Data Type Selection	null	All set-ups	TRUE	-	Uint8
DN-11	Process Data Config Write	ExpressionLimit	2 set-ups	TRUE	-	Uint16
DN-12	Process Data Config Read	ExpressionLimit	2 set-ups	TRUE	-	Uint16
DN-13	Warning Parameter	0 N/A	All set-ups	TRUE	0	Uint16
DN-14	Net Reference	[0] Off	2 set-ups	TRUE	-	Uint8
DN-15	Net Control	[0] Off	2 set-ups	TRUE	-	Uint8
<b>DN-2#</b>						
DN-20	COS Filter 1	0 N/A	All set-ups	FALSE	0	Uint16
DN-21	COS Filter 2	0 N/A	All set-ups	FALSE	0	Uint16
DN-22	COS Filter 3	0 N/A	All set-ups	FALSE	0	Uint16
DN-23	COS Filter 4	0 N/A	All set-ups	FALSE	0	Uint16
<b>DN-3#</b>						
DN-30	Array Index	0 N/A	2 set-ups	TRUE	0	Uint8
DN-31	Store Data Values	[0] Off	All set-ups	TRUE	-	Uint8
DN-32	Devicenet Revision	0 N/A	All set-ups	TRUE	0	Uint16
DN-33	Store Always	[0] Off	1 set-up	TRUE	-	Uint8
DN-34	DeviceNet Product Code	210 N/A	1 set-up	TRUE	0	Uint16



5.1.13 PB-## Profibus

5

Par. No. #	Parameter description	Default value	4-set-up	Change during operation	Conversion index	Type
<b>PB-1#</b>						
PB-15	PCD Write Configuration	ExpressionLimit	2 set-ups	TRUE	-	Uint16
PB-16	PCD Read Configuration	ExpressionLimit	2 set-ups	TRUE	-	Uint16
PB-18	Node Address	126 N/A	1 set-up	TRUE	0	Uint8
<b>PB-2#</b>						
PB-22	Telegram Selection	[108] PPO 8	1 set-up	TRUE	-	Uint8
PB-23	Parameters for Signals	0	All set-ups	TRUE	-	Uint16
PB-27	Parameter Edit	[1] Enabled	2 set-ups	FALSE	-	Uint16
PB-28	Process Control	[1] Enable cyclic master	2 set-ups	FALSE	-	Uint8
<b>PB-5#</b>						
PB-53	Profibus Warning Word	0 N/A	All set-ups	TRUE	0	V2
<b>PB-6#</b>						
PB-63	Actual Baud Rate	[255] No baudrate found	All set-ups	TRUE	-	Uint8
<b>PB-7#</b>						
PB-71	Profibus Save Data Values	[0] Off	All set-ups	TRUE	-	Uint8
PB-72	ProfibusDriveReset	[0] No action	1 set-up	FALSE	-	Uint8
<b>PB-8#</b>						
PB-80	Defined Parameters (1)	0 N/A	All set-ups	FALSE	0	Uint16
PB-81	Defined Parameters (2)	0 N/A	All set-ups	FALSE	0	Uint16
PB-82	Defined Parameters (3)	0 N/A	All set-ups	FALSE	0	Uint16
PB-83	Defined Parameters (4)	0 N/A	All set-ups	FALSE	0	Uint16
PB-84	Defined Parameters (5)	0 N/A	All set-ups	FALSE	0	Uint16
<b>PB-9#</b>						
PB-90	Changed Parameters (1)	0 N/A	All set-ups	FALSE	0	Uint16
PB-91	Changed Parameters (2)	0 N/A	All set-ups	FALSE	0	Uint16
PB-92	Changed Parameters (3)	0 N/A	All set-ups	FALSE	0	Uint16
PB-93	Changed Parameters (4)	0 N/A	All set-ups	FALSE	0	Uint16
PB-94	Changed Parameters (5)	0 N/A	All set-ups	FALSE	0	Uint16



5.1.14 EN-## EtherNet

Par. No. #	Parameter description	Default value	4-set-up	Change during operation	Conversion index	Type
<b>EN-0#</b>						
EN-00	IP Address Assignment	null	2 set-ups	TRUE	-	UInt8
EN-01	IP Address	0 N/A	2 set-ups	TRUE	0	OctStr[4]
EN-02	Subnet Mask	0 N/A	2 set-ups	TRUE	0	OctStr[4]
EN-03	Default Gateway	0 N/A	2 set-ups	TRUE	0	OctStr[4]
EN-04	DHCP Server	0 N/A	2 set-ups	TRUE	0	OctStr[4]
EN-05	Lease Expires	ExpressionLimit	All set-ups	TRUE	0	TimD
EN-06	Name Servers	0 N/A	2 set-ups	TRUE	0	OctStr[4]
EN-07	Domain Name	0 N/A	2 set-ups	TRUE	0	VisStr[48]
EN-08	Host Name	0 N/A	2 set-ups	TRUE	0	VisStr[48]
EN-09	Physical Address	0 N/A	1 set-up	TRUE	0	VisStr[17]
<b>EN-1#</b>						
EN-10	Link Status	[0] No Link	All set-ups	TRUE	-	UInt8
EN-11	Link Duration	ExpressionLimit	All set-ups	TRUE	0	TimD
EN-12	Auto Negotiation	[1] On	2 set-ups	TRUE	-	UInt8
EN-13	Link Speed	[0] None	2 set-ups	TRUE	-	UInt8
EN-14	Link Duplex	[1] Full Duplex	2 set-ups	TRUE	-	UInt8
<b>EN-2#</b>						
EN-20	Control Instance	ExpressionLimit	1 set-up	TRUE	0	UInt8
EN-21	Process Data Config Write	ExpressionLimit	All set-ups	TRUE	-	UInt16
EN-22	Process Data Config Read	ExpressionLimit	All set-ups	TRUE	-	UInt16
EN-28	Store Data Values	[0] Off	All set-ups	TRUE	-	UInt8
EN-29	Store Always	[0] Off	1 set-up	TRUE	-	UInt8
<b>EN-3#</b>						
EN-30	Warning Parameter	0 N/A	All set-ups	TRUE	0	UInt16
EN-31	Net Reference	[0] Off	2 set-ups	TRUE	-	UInt8
EN-32	Net Control	[0] Off	2 set-ups	TRUE	-	UInt8
EN-33	CIP Revision	ExpressionLimit	All set-ups	TRUE	0	UInt16
EN-34	CIP Product Code	ExpressionLimit	1 set-up	TRUE	0	UInt16
EN-37	COS Inhibit Timer	0 N/A	All set-ups	TRUE	0	UInt16
EN-38	COS Filter	0 N/A	All set-ups	TRUE	0	UInt16
<b>EN-4#</b>						
EN-40	Status Parameter	0 N/A	All set-ups	TRUE	0	UInt16
EN-41	Slave Message Count	0 N/A	All set-ups	TRUE	0	UInt32
EN-42	Slave Exception Message Count	0 N/A	All set-ups	TRUE	0	UInt32
<b>EN-8#</b>						
EN-80	FTP Server	[0] Disabled	2 set-ups	TRUE	-	UInt8
EN-81	HTTP Server	[0] Disabled	2 set-ups	TRUE	-	UInt8
EN-82	SMTP Service	[0] Disabled	2 set-ups	TRUE	-	UInt8
EN-89	Transparent Socket Channel Port	4000 N/A	2 set-ups	TRUE	0	UInt16
<b>EN-9#</b>						



Par. No. #	Parameter description	Default value	4-set-up	Change during operation	Conversion index	Type
EN-90	Cable Diagnostic	[0] Disabled	2 set-ups	TRUE	-	UInt8
EN-91	MDI-X	[1] Enabled	2 set-ups	TRUE	-	UInt8
EN-92	IGMP Snooping	[1] Enabled	2 set-ups	TRUE	-	UInt8
EN-93	Cable Error Length	0 N/A	1 set-up	TRUE	0	UInt16
EN-94	Broadcast Storm Protection	-1 %	2 set-ups	TRUE	0	Int8
EN-95	Broadcast Storm Filter	[0] Broadcast only	2 set-ups	TRUE	-	UInt8
EN-98	Interface Counters	4000 N/A	All set-ups	TRUE	0	UInt32
EN-99	Media Counters	0 N/A	All set-ups	TRUE	0	UInt32

5.1.15 BN-## BACnet

Par. No. #	Parameter description	Default value	4-set-up	Change during operation	Conversion index	Type
<b>BN-7#</b>						
BN-70	BACnet Device Instance	1 N/A	1 set-up	TRUE	0	UInt32
BN-72	MS/TP Max Masters	127 N/A	1 set-up	TRUE	0	UInt8
BN-73	MS/TP Max Info Frames	1 N/A	1 set-up	TRUE	0	UInt16
BN-74	"I-Am" Service	[0] Send at power-up	1 set-up	TRUE	-	UInt8
BN-75	Initialization Password	ExpressionLimit	1 set-up	TRUE	0	VisStr[20]

5.1.16 LN-## LonWorks

Par. No. #	Parameter description	Default value	4-set-up	Change during operation	Conversion index	Type
<b>LN-0#</b>						
LN-00	Neuron ID	0 N/A	All set-ups	TRUE	0	OctStr[6]
<b>LN-1#</b>						
LN-10	Drive Profile	[0] VSD profile	All set-ups	TRUE	-	UInt8
LN-15	LON Warning Word	0 N/A	All set-ups	TRUE	0	UInt16
LN-17	XIF Revision	0 N/A	All set-ups	TRUE	0	VisStr[5]
LN-18	LonWorks Revision	0 N/A	All set-ups	TRUE	0	VisStr[5]
<b>LN-2#</b>						
LN-21	Store Data Values	[0] Off	All set-ups	TRUE	-	UInt8





5.1.17 ID-## Drive Information

Par. No. #	Parameter description	Default value	4-set-up	Change during operation	Conversion index	Type
<b>ID-0#</b>						
ID-00	Operating Hours	0 h	All set-ups	FALSE	74	Uint32
ID-01	Running Hours	0 h	All set-ups	FALSE	74	Uint32
ID-02	kWh Counter	0 kWh	All set-ups	FALSE	75	Uint32
ID-03	Power Up's	0 N/A	All set-ups	FALSE	0	Uint32
ID-04	Over Temp's	0 N/A	All set-ups	FALSE	0	Uint16
ID-05	Over Volt's	0 N/A	All set-ups	FALSE	0	Uint16
ID-06	Reset kWh Counter	[0] Do not reset	All set-ups	TRUE	-	Uint8
ID-07	Reset Running Hours Counter	[0] Do not reset	All set-ups	TRUE	-	Uint8
ID-08	Number of Starts	0 N/A	All set-ups	FALSE	0	Uint32
<b>ID-1#</b>						
ID-10	Trending Source	0	2 set-ups	TRUE	-	Uint16
ID-11	Trending Interval	ExpressionLimit	2 set-ups	TRUE	-3	TimD
ID-12	Trigger Event	[0] False	1 set-up	TRUE	-	Uint8
ID-13	Trending Mode	[0] Trend always	2 set-ups	TRUE	-	Uint8
ID-14	Samples Before Trigger	50 N/A	2 set-ups	TRUE	0	Uint8
<b>ID-2#</b>						
ID-20	Historic Log: Event	0 N/A	All set-ups	FALSE	0	Uint8
ID-21	Historic Log: Value	0 N/A	All set-ups	FALSE	0	Uint32
ID-22	Historic Log: Time	0 ms	All set-ups	FALSE	-3	Uint32
ID-23	Historic Log: Date and Time	ExpressionLimit	All set-ups	FALSE	0	TimeOfDay
<b>ID-3#</b>						
ID-30	Alarm Log: Error Code	0 N/A	All set-ups	FALSE	0	Uint8
ID-31	Alarm Log: Value	0 N/A	All set-ups	FALSE	0	Int16
ID-32	Alarm Log: Time	0 s	All set-ups	FALSE	0	Uint32
ID-33	Alarm Log: Date and Time	ExpressionLimit	All set-ups	FALSE	0	TimeOfDay
<b>ID-4#</b>						
ID-40	Drive Type	0 N/A	All set-ups	FALSE	0	VisStr[6]
ID-41	Power Section	0 N/A	All set-ups	FALSE	0	VisStr[20]
ID-42	Voltage	0 N/A	All set-ups	FALSE	0	VisStr[20]
ID-43	Software Version	0 N/A	All set-ups	FALSE	0	VisStr[5]
ID-44	GE Model Number	0 N/A	All set-ups	FALSE	0	VisStr[40]
ID-45	Actual Typecode String	0 N/A	All set-ups	FALSE	0	VisStr[40]
ID-46	GE Product No.	0 N/A	All set-ups	FALSE	0	VisStr[8]
ID-47	GE Power Card Model No	0 N/A	All set-ups	FALSE	0	VisStr[8]
ID-48	Keypad ID Number	0 N/A	All set-ups	FALSE	0	VisStr[20]
ID-49	SW ID Control Card	0 N/A	All set-ups	FALSE	0	VisStr[20]
<b>ID-5#</b>						
ID-50	SW ID Power Card	0 N/A	All set-ups	FALSE	0	VisStr[20]
ID-51	Drive Serial Number	0 N/A	All set-ups	FALSE	0	VisStr[10]
ID-53	Power Card Serial Number	0 N/A	All set-ups	FALSE	0	VisStr[19]
<b>ID-6#</b>						
ID-60	Option Mounted	0 N/A	All set-ups	FALSE	0	VisStr[30]
ID-61	Option SW Version	0 N/A	All set-ups	FALSE	0	VisStr[20]
ID-62	Option Ordering No	0 N/A	All set-ups	FALSE	0	VisStr[8]
ID-63	Option Serial No	0 N/A	All set-ups	FALSE	0	VisStr[18]
<b>ID-9#</b>						
ID-92	Defined Parameters	0 N/A	All set-ups	FALSE	0	Uint16
ID-93	Modified Parameters	0 N/A	All set-ups	FALSE	0	Uint16



5.1.18 DR-## Data Readouts

5

Par. No. #	Parameter description	Default value	4-set-up	Change during operation	Conversion index	Type
<b>DR-0#</b>						
DR-00	Control Word	0 N/A	All set-ups	FALSE	0	V2
DR-01	Reference [Unit]	0.000 ReferenceFeed-backUnit	All set-ups	FALSE	-3	Int32
DR-02	Reference [%]	0.0 %	All set-ups	FALSE	-1	Int16
DR-03	Status Word	0 N/A	All set-ups	FALSE	0	V2
DR-05	Main Actual Value [%]	0.00 %	All set-ups	FALSE	-2	N2
DR-09	Custom Readout	0.00 CustomReadoutUnit	All set-ups	FALSE	-2	Int32
<b>DR-1#</b>						
DR-10	Power [kW]	0.00 kW	All set-ups	FALSE	1	Int32
DR-11	Power [hp]	0.00 hp	All set-ups	FALSE	-2	Int32
DR-12	Motor Voltage	0.0 V	All set-ups	FALSE	-1	UInt16
DR-13	Frequency	0.0 Hz	All set-ups	FALSE	-1	UInt16
DR-14	Motor Current	0.00 A	All set-ups	FALSE	-2	Int32
DR-15	Frequency [%]	0.00 %	All set-ups	FALSE	-2	N2
DR-16	Torque [Nm]	0.0 Nm	All set-ups	FALSE	-1	Int32
DR-17	Speed [RPM]	0 RPM	All set-ups	FALSE	67	Int32
DR-18	Motor Thermal	0 %	All set-ups	FALSE	0	UInt8
<b>DR-2#</b>						
DR-22	Torque [%]	0 %	All set-ups	FALSE	0	Int16
<b>DR-3#</b>						
DR-30	DC Link Voltage	0 V	All set-ups	FALSE	0	UInt16
DR-32	Brake Energy /s	0.000 kW	All set-ups	FALSE	0	UInt32
DR-33	Brake Energy /2 min	0.000 kW	All set-ups	FALSE	0	UInt32
DR-34	Heatsink Temp.	0 °C	All set-ups	FALSE	100	UInt8
DR-35	Drive Thermal	0 %	All set-ups	FALSE	0	UInt8
DR-36	Drive Nominal Current	ExpressionLimit	All set-ups	FALSE	-2	UInt32
DR-37	Drive Max. Current	ExpressionLimit	All set-ups	FALSE	-2	UInt32
DR-38	Logic Controller State	0 N/A	All set-ups	FALSE	0	UInt8
DR-39	Control Card Temp.	0 °C	All set-ups	FALSE	100	UInt8
<b>DR-4#</b>						
DR-40	Trending Buffer Full	[0] No	All set-ups	TRUE	-	UInt8
DR-43	Timed Actions Status	[0] Timed Actions Auto	All set-ups	TRUE	-	UInt8
DR-49	Current Fault Source	0 N/A	All set-ups	TRUE	0	UInt8
<b>DR-5#</b>						
DR-50	External Reference	0.0 N/A	All set-ups	FALSE	-1	Int16
DR-52	Feedback [Unit]	0.000 ProcessCtrlUnit	All set-ups	FALSE	-3	Int32
DR-53	Digi Pot Reference	0.00 N/A	All set-ups	FALSE	-2	Int16
DR-54	Feedback 1 [Unit]	0.000 ProcessCtrlUnit	All set-ups	FALSE	-3	Int32
DR-55	Feedback 2 [Unit]	0.000 ProcessCtrlUnit	All set-ups	FALSE	-3	Int32
DR-56	Feedback 3 [Unit]	0.000 ProcessCtrlUnit	All set-ups	FALSE	-3	Int32
DR-58	PID Output [%]	0.0 %	All set-ups	TRUE	-1	Int16
<b>DR-6#</b>						
DR-60	Digital Input	0 N/A	All set-ups	FALSE	0	UInt16
DR-61	Terminal 53 Switch Setting	[0] Current	All set-ups	FALSE	-	UInt8
DR-62	Analog Input 53	0.000 N/A	All set-ups	FALSE	-3	Int32
DR-63	Terminal 54 Switch Setting	[0] Current	All set-ups	FALSE	-	UInt8
DR-64	Analog Input 54	0.000 N/A	All set-ups	FALSE	-3	Int32
DR-65	Analog Output 42 [mA]	0.000 N/A	All set-ups	FALSE	-3	Int16



Parameter Lists

AF-600 FP Programming Guide

Par. No. #	Parameter description	Default value	4-set-up	Change during operation	Conversion index	Type
DR-66	Digital Output [bin]	0 N/A	All set-ups	FALSE	0	Int16
DR-67	Freq. Input #29 [Hz]	0 N/A	All set-ups	FALSE	0	Int32
DR-68	Freq. Input #33 [Hz]	0 N/A	All set-ups	FALSE	0	Int32
DR-69	Pulse Output #27 [Hz]	0 N/A	All set-ups	FALSE	0	Int32
<b>DR-7#</b>						
DR-70	Pulse Output #29 [Hz]	0 N/A	All set-ups	FALSE	0	Int32
DR-71	Relay Output [bin]	0 N/A	All set-ups	FALSE	0	Int16
DR-72	Counter A	0 N/A	All set-ups	TRUE	0	Int32
DR-73	Counter B	0 N/A	All set-ups	TRUE	0	Int32
DR-75	Analog In X30/11	0.000 N/A	All set-ups	FALSE	-3	Int32
DR-76	Analog In X30/12	0.000 N/A	All set-ups	FALSE	-3	Int32
DR-77	Analog Out X30/8 [mA]	0.000 N/A	All set-ups	FALSE	-3	Int16
<b>DR-8#</b>						
DR-80	Fieldbus CTW 1	0 N/A	All set-ups	FALSE	0	V2
DR-82	Fieldbus REF 1	0 N/A	All set-ups	FALSE	0	N2
DR-84	Comm. Option STW	0 N/A	All set-ups	FALSE	0	V2
DR-85	Drive Port CTW 1	0 N/A	All set-ups	FALSE	0	V2
DR-86	Drive Port REF 1	0 N/A	All set-ups	FALSE	0	N2
<b>DR-9#</b>						
DR-90	Alarm Word	0 N/A	All set-ups	FALSE	0	Uint32
DR-91	Alarm Word 2	0 N/A	All set-ups	FALSE	0	Uint32
DR-92	Warning Word	0 N/A	All set-ups	FALSE	0	Uint32
DR-93	Warning Word 2	0 N/A	All set-ups	FALSE	0	Uint32
DR-94	Ext. Status Word	0 N/A	All set-ups	FALSE	0	Uint32
DR-95	Ext. Status Word 2	0 N/A	All set-ups	FALSE	0	Uint32
DR-96	Maintenance Word	0 N/A	All set-ups	FALSE	0	Uint32



5.1.19 LG-## Logs & I/O Opt. Status

5

Par. No. #	Parameter description	Default value	4-set-up	Change during operation	Conversion index	Type
<b>LG-0#</b>						
LG-00	Maintenance Log: Item	0 N/A	All set-ups	FALSE	0	UInt8
LG-01	Maintenance Log: Action	0 N/A	All set-ups	FALSE	0	UInt8
LG-02	Maintenance Log: Time	0 s	All set-ups	FALSE	0	UInt32
LG-03	Maintenance Log: Date and Time	ExpressionLimit	All set-ups	FALSE	0	TimeOf Day
<b>LG-1#</b>						
LG-10	Fire Mode Log: Event	0 N/A	All set-ups	FALSE	0	UInt8
LG-11	Fire Mode Log: Time	0 s	All set-ups	FALSE	0	UInt32
LG-12	Fire Mode Log: Date and Time	ExpressionLimit	All set-ups	FALSE	0	TimeOf Day
<b>LG-3#</b>						
LG-30	Analog Input X42/1	0.000 N/A	All set-ups	FALSE	-3	Int32
LG-31	Analog Input X42/3	0.000 N/A	All set-ups	FALSE	-3	Int32
LG-32	Analog Input X42/5	0.000 N/A	All set-ups	FALSE	-3	Int32
LG-33	Analog Out X42/7 [V]	0.000 N/A	All set-ups	FALSE	-3	Int16
LG-34	Analog Out X42/9 [V]	0.000 N/A	All set-ups	FALSE	-3	Int16
LG-35	Analog Out X42/11 [V]	0.000 N/A	All set-ups	FALSE	-3	Int16



5.1.20 AP-## HVAC Appl. Param.

Par. No. #	Parameter description	Default value	4-set-up	Change during operation	Conversion index	Type
<b>AP-0#</b>						
AP-00	External Interlock Delay	0 s	All set-ups	TRUE	0	Uint16
<b>AP-2#</b>						
AP-20	Low Power Auto Set-up	[0] Off	All set-ups	FALSE	-	Uint8
AP-21	Low Power Detection	[0] Disabled	All set-ups	TRUE	-	Uint8
AP-22	Low Speed Detection	[0] Disabled	All set-ups	TRUE	-	Uint8
AP-23	No-Flow Function	[0] Off	All set-ups	TRUE	-	Uint8
AP-24	No-Flow Delay	10 s	All set-ups	TRUE	0	Uint16
AP-26	Dry Pump Function	[0] Off	All set-ups	TRUE	-	Uint8
AP-27	Dry Pump Delay	10 s	All set-ups	TRUE	0	Uint16
<b>AP-3#</b>						
AP-30	No-Flow Power	0.00 kW	All set-ups	TRUE	1	Uint32
AP-31	Power Correction Factor	100 %	All set-ups	TRUE	0	Uint16
AP-32	Low Speed [RPM]	ExpressionLimit	All set-ups	TRUE	67	Uint16
AP-33	Low Speed [Hz]	ExpressionLimit	All set-ups	TRUE	-1	Uint16
AP-34	Low Speed Power [kW]	ExpressionLimit	All set-ups	TRUE	1	Uint32
AP-35	Low Speed Power [HP]	ExpressionLimit	All set-ups	TRUE	-2	Uint32
AP-36	High Speed [RPM]	ExpressionLimit	All set-ups	TRUE	67	Uint16
AP-37	High Speed [Hz]	ExpressionLimit	All set-ups	TRUE	-1	Uint16
AP-38	High Speed Power [kW]	ExpressionLimit	All set-ups	TRUE	1	Uint32
AP-39	High Speed Power [HP]	ExpressionLimit	All set-ups	TRUE	-2	Uint32
<b>AP-4#</b>						
AP-40	Minimum Run Time	10 s	All set-ups	TRUE	0	Uint16
AP-41	Minimum Sleep Time	10 s	All set-ups	TRUE	0	Uint16
AP-42	Wake-up Speed [RPM]	ExpressionLimit	All set-ups	TRUE	67	Uint16
AP-43	Wake-up Speed [Hz]	ExpressionLimit	All set-ups	TRUE	-1	Uint16
AP-44	Wake-up Ref./FB Difference	10 %	All set-ups	TRUE	0	Int8
AP-45	Setpoint Boost	0 %	All set-ups	TRUE	0	Int8
AP-46	Maximum Boost Time	60 s	All set-ups	TRUE	0	Uint16
<b>AP-5#</b>						
AP-50	End of Curve Function	[0] Off	All set-ups	TRUE	-	Uint8
AP-51	End of Curve Delay	10 s	All set-ups	TRUE	0	Uint16
<b>AP-6#</b>						
AP-60	Broken Belt Function	[0] Off	All set-ups	TRUE	-	Uint8
AP-61	Broken Belt Torque	10 %	All set-ups	TRUE	0	Uint8
AP-62	Broken Belt Delay	10 s	All set-ups	TRUE	0	Uint16
<b>AP-7#</b>						
AP-70	Compressor Start Max Speed [RPM]	ExpressionLimit	All set-ups	TRUE	67	Uint16
AP-71	Compressor Start Max Speed [Hz]	ExpressionLimit	All set-ups	TRUE	-1	Uint16
AP-72	Compressor Start Max Time to Trip	5.0 s	All set-ups	TRUE	-1	Uint8
AP-73	Starting Acceleration Time	ExpressionLimit	2 set-ups	TRUE	-2	Uint32
AP-75	Short Cycle Protection	[0] Disabled	All set-ups	TRUE	-	Uint8
AP-76	Interval between Starts	ExpressionLimit	All set-ups	TRUE	0	Uint16
AP-77	Minimum Run Time	0 s	All set-ups	TRUE	0	Uint16
<b>AP-8#</b>						
AP-80	Flow Compensation	[0] Disabled	All set-ups	TRUE	-	Uint8
AP-81	Square-linear Curve Approximation	100 %	All set-ups	TRUE	0	Uint8
AP-82	Work Point Calculation	[0] Disabled	All set-ups	TRUE	-	Uint8
AP-83	Speed at No-Flow [RPM]	ExpressionLimit	All set-ups	TRUE	67	Uint16

**Parameter Lists****AF-600 FP Programming Guide**

Par. No. #	Parameter description	Default value	4-set-up	Change during operation	Conversion index	Type
AP-84	Speed at No-Flow [Hz]	ExpressionLimit	All set-ups	TRUE	-1	Uint16
AP-85	Speed at Design Point [RPM]	ExpressionLimit	All set-ups	TRUE	67	Uint16
AP-86	Speed at Design Point [Hz]	ExpressionLimit	All set-ups	TRUE	-1	Uint16
AP-87	Pressure at No-Flow Speed	0.000 N/A	All set-ups	TRUE	-3	Int32
AP-88	Pressure at Rated Speed	999999.999 N/A	All set-ups	TRUE	-3	Int32
AP-89	Flow at Design Point	0.000 N/A	All set-ups	TRUE	-3	Int32
<b>AP-9#</b>						
AP-90	Flow at Rated Speed	0.000 N/A	All set-ups	TRUE	-3	Int32

**5**



5.1.21 FB-## Fire/Bypass Operation

Par. No. #	Parameter description	Default value	4-set-up	Change during operation	Conversion index	Type
<b>FB-0#</b>						
FB-00	Fire Mode Function	[0] Disabled	2 set-ups	TRUE	-	Uint8
FB-01	Fire Mode Configuration	[0] Open Loop	All set-ups	TRUE	-	Uint8
FB-02	Fire Mode Unit	null	All set-ups	TRUE	-	Uint8
FB-03	Fire Mode Min Reference	ExpressionLimit	All set-ups	TRUE	-3	Int32
FB-04	Fire Mode Max Reference	ExpressionLimit	All set-ups	TRUE	-3	Int32
FB-05	Fire Mode Preset Reference	0.00 %	All set-ups	TRUE	-2	Int16
FB-06	Fire Mode Reference Source	[0] No function	All set-ups	TRUE	-	Uint8
FB-07	Fire Mode Feedback Source	[0] No function	All set-ups	TRUE	-	Uint8
FB-09	Fire Mode Alarm Handling	[1] Trip, Critical Alarms	2 set-ups	FALSE	-	Uint8
<b>FB-1#</b>						
FB-10	Drive Bypass Function	[0] Disabled	2 set-ups	TRUE	-	Uint8
FB-11	Drive Bypass Delay Time	0 s	2 set-ups	TRUE	0	Uint16
<b>FB-2#</b>						
FB-20	Locked Rotor Function	[0] Off	All set-ups	TRUE	-	Uint8
FB-21	Locked Rotor Coefficient 1	0.0000 N/A	All set-ups	TRUE	-4	Int32
FB-22	Locked Rotor Coefficient 2	0.0000 N/A	All set-ups	TRUE	-4	Int32
FB-23	Locked Rotor Coefficient 3	0.0000 N/A	All set-ups	TRUE	-4	Int32
FB-24	Locked Rotor Coefficient 4	0.000 N/A	All set-ups	TRUE	-3	Int32
<b>FB-3#</b>						
FB-30	Missing Motor Function	[0] Off	All set-ups	TRUE	-	Uint8
FB-31	Missing Motor Coefficient 1	0.0000 N/A	All set-ups	TRUE	-4	Int32
FB-32	Missing Motor Coefficient 2	0.0000 N/A	All set-ups	TRUE	-4	Int32
FB-33	Missing Motor Coefficient 3	0.0000 N/A	All set-ups	TRUE	-4	Int32
FB-34	Missing Motor Coefficient 4	0.000 N/A	All set-ups	TRUE	-3	Int32



5.1.22 T-## Timed Functions

5

Par. No. #	Parameter description	Default value	4-set-up	Change during operation	Conversion index	Type
<b>T-0#</b>						
T-00	ON Time	ExpressionLimit	2 set-ups	TRUE	0	TimeOfDay-WoDate
T-01	ON Action	[0] Disabled	2 set-ups	TRUE	-	UInt8
T-02	OFF Time	ExpressionLimit	2 set-ups	TRUE	0	TimeOfDay-WoDate
T-03	OFF Action	[1] No action	2 set-ups	TRUE	-	UInt8
T-04	Occurrence	[0] All days	2 set-ups	TRUE	-	UInt8
T-08	Timed Actions Mode	[0] Timed Actions Auto	2 set-ups	TRUE	-	UInt8
T-09	Timed Actions Reactivation	[1] Enabled	2 set-ups	TRUE	-	UInt8
<b>T-1#</b>						
T-10	Maintenance Item	[1] Motor bearings	1 set-up	TRUE	-	UInt8
T-11	Maintenance Action	[1] Lubricate	1 set-up	TRUE	-	UInt8
T-12	Maintenance Time Base	[0] Disabled	1 set-up	TRUE	-	UInt8
T-13	Maintenance Time Interval	1 h	1 set-up	TRUE	74	UInt32
T-14	Maintenance Date and Time	ExpressionLimit	1 set-up	TRUE	0	TimeOfDay
T-15	Reset Maintenance Word	[0] Do not reset	All set-ups	TRUE	-	UInt8
T-16	Maintenance Text	0 N/A	1 set-up	TRUE	0	VisStr[20]
<b>T-5#</b>						
T-50	Energy Log Resolution	[5] Last 24 Hours	2 set-ups	TRUE	-	UInt8
T-51	Period Start	ExpressionLimit	2 set-ups	TRUE	0	TimeOfDay
T-53	Energy Log	0 N/A	All set-ups	TRUE	0	UInt32
T-54	Reset Energy Log	[0] Do not reset	All set-ups	TRUE	-	UInt8
<b>T-6#</b>						
T-60	Trend Variable	[0] Power [kW]	2 set-ups	TRUE	-	UInt8
T-61	Continuous Bin Data	0 N/A	All set-ups	TRUE	0	UInt32
T-62	Timed Bin Data	0 N/A	All set-ups	TRUE	0	UInt32
T-63	Timed Period Start	ExpressionLimit	2 set-ups	TRUE	0	TimeOfDay
T-64	Timed Period Stop	ExpressionLimit	2 set-ups	TRUE	0	TimeOfDay
T-65	Minimum Bin Value	ExpressionLimit	2 set-ups	TRUE	0	UInt8
T-66	Reset Continuous Bin Data	[0] Do not reset	All set-ups	TRUE	-	UInt8
T-67	Reset Timed Bin Data	[0] Do not reset	All set-ups	TRUE	-	UInt8
<b>T-8#</b>						
T-80	Power Reference Factor	100 %	2 set-ups	TRUE	0	UInt8
T-81	Energy Cost	1.00 N/A	2 set-ups	TRUE	-2	UInt32
T-82	Investment	0 N/A	2 set-ups	TRUE	0	UInt32
T-83	Energy Savings	0 kWh	All set-ups	TRUE	75	Int32
T-84	Cost Savings	0 N/A	All set-ups	TRUE	0	Int32





5.1.23 CL-## PID Closed Loop

Par. No. #	Parameter description	Default value	4-set-up	Change during operation	Conversion index	Type
<b>CL-0#</b>						
CL-00	Feedback 1 Source	[2] Analog input 54	All set-ups	TRUE	-	UInt8
CL-01	Feedback 1 Conversion	[0] Linear	All set-ups	FALSE	-	UInt8
CL-02	Feedback 1 Source Unit	null	All set-ups	TRUE	-	UInt8
CL-03	Feedback 2 Source	[0] No function	All set-ups	TRUE	-	UInt8
CL-04	Feedback 2 Conversion	[0] Linear	All set-ups	FALSE	-	UInt8
CL-05	Feedback 2 Source Unit	null	All set-ups	TRUE	-	UInt8
CL-06	Feedback 3 Source	[0] No function	All set-ups	TRUE	-	UInt8
CL-07	Feedback 3 Conversion	[0] Linear	All set-ups	FALSE	-	UInt8
CL-08	Feedback 3 Source Unit	null	All set-ups	TRUE	-	UInt8
<b>CL-1#</b>						
CL-12	Reference/Feedback Unit	null	All set-ups	TRUE	-	UInt8
CL-13	Minimum Reference/Feedb.	0.000 ProcessCtrlUnit	All set-ups	TRUE	-3	Int32
CL-14	Maximum Reference/Feedb.	100.000 ProcessCtrlUnit	All set-ups	TRUE	-3	Int32
<b>CL-2#</b>						
CL-20	Feedback Function	[3] Minimum	All set-ups	TRUE	-	UInt8
CL-21	Setpoint 1	0.000 ProcessCtrlUnit	All set-ups	TRUE	-3	Int32
CL-22	Setpoint 2	0.000 ProcessCtrlUnit	All set-ups	TRUE	-3	Int32
CL-23	Setpoint 3	0.000 ProcessCtrlUnit	All set-ups	TRUE	-3	Int32
<b>CL-3#</b>						
CL-30	Refrigerant	[0] R22	All set-ups	TRUE	-	UInt8
CL-31	User Defined Refrigerant A1	10.0000 N/A	All set-ups	TRUE	-4	UInt32
CL-32	User Defined Refrigerant A2	-2250.00 N/A	All set-ups	TRUE	-2	Int32
CL-33	User Defined Refrigerant A3	250.000 N/A	All set-ups	TRUE	-3	UInt32
CL-34	Duct 1 Area [m2]	0.500 m2	All set-ups	TRUE	-3	UInt32
CL-35	Duct 1 Area [in2]	750 in2	All set-ups	TRUE	0	UInt32
CL-36	Duct 2 Area [m2]	0.500 m2	All set-ups	TRUE	-3	UInt32
CL-37	Duct 2 Area [in2]	750 in2	All set-ups	TRUE	0	UInt32
CL-38	Air Density Factor [%]	100 %	All set-ups	TRUE	0	UInt32
<b>CL-7#</b>						
CL-70	Closed Loop Type	[0] Auto	2 set-ups	TRUE	-	UInt8
CL-71	PID Performance	[0] Normal	2 set-ups	TRUE	-	UInt8
CL-72	PID Output Change	0.10 N/A	2 set-ups	TRUE	-2	UInt16
CL-73	Minimum Feedback Level	-999999.000 ProcessCtrlUnit	2 set-ups	TRUE	-3	Int32
CL-74	Maximum Feedback Level	999999.000 ProcessCtrlUnit	2 set-ups	TRUE	-3	Int32
CL-79	PID Autotuning	[0] Disabled	All set-ups	TRUE	-	UInt8
<b>CL-8#</b>						
CL-81	PID Normal/ Inverse Control	[0] Normal	All set-ups	TRUE	-	UInt8
CL-82	PID Start Speed [RPM]	ExpressionLimit	All set-ups	TRUE	67	UInt16
CL-83	PID Start Speed [Hz]	ExpressionLimit	All set-ups	TRUE	-1	UInt16
CL-84	On Reference Bandwidth	5 %	All set-ups	TRUE	0	UInt8
<b>CL-9#</b>						
CL-91	PID Anti Windup	[1] On	All set-ups	TRUE	-	UInt8
CL-93	PID Proportional Gain	0.50 N/A	All set-ups	TRUE	-2	UInt16
CL-94	PID Integral Time	20.00 s	All set-ups	TRUE	-2	UInt32
CL-95	PID Differentiation Time	0.00 s	All set-ups	TRUE	-2	UInt16
CL-96	PID Diff. Gain Limit	5.0 N/A	All set-ups	TRUE	-1	UInt16



5.1.24 XC-## Ext. PID Closed Loop

5

Par. No. #	Parameter description	Default value	4-set-up	Change during operation	Conversion index	Type
<b>XC-0#</b>						
XC-00	Closed Loop Type	[0] Auto	2 set-ups	TRUE	-	UInt8
XC-01	PID Performance	[0] Normal	2 set-ups	TRUE	-	UInt8
XC-02	PID Output Change	0.10 N/A	2 set-ups	TRUE	-2	UInt16
XC-03	Minimum Feedback Level	-999999.000 N/A	2 set-ups	TRUE	-3	Int32
XC-04	Maximum Feedback Level	999999.000 N/A	2 set-ups	TRUE	-3	Int32
XC-09	PID Autotuning	[0] Disabled	All set-ups	TRUE	-	UInt8
<b>XC-1#</b>						
XC-10	Ext. 1 Ref./Feedback Unit	[1] %	All set-ups	TRUE	-	UInt8
XC-11	Ext. 1 Minimum Reference	0.000 ExtPID1Unit	All set-ups	TRUE	-3	Int32
XC-12	Ext. 1 Maximum Reference	100.000 ExtPID1Unit	All set-ups	TRUE	-3	Int32
XC-13	Ext. 1 Reference Source	[0] No function	All set-ups	TRUE	-	UInt8
XC-14	Ext. 1 Feedback Source	[0] No function	All set-ups	TRUE	-	UInt8
XC-15	Ext. 1 Setpoint	0.000 ExtPID1Unit	All set-ups	TRUE	-3	Int32
XC-17	Ext. 1 Reference [Unit]	0.000 ExtPID1Unit	All set-ups	TRUE	-3	Int32
XC-18	Ext. 1 Feedback [Unit]	0.000 ExtPID1Unit	All set-ups	TRUE	-3	Int32
XC-19	Ext. 1 Output [%]	0 %	All set-ups	TRUE	0	Int32
<b>XC-2#</b>						
XC-20	Ext. 1 Normal/Inverse Control	[0] Normal	All set-ups	TRUE	-	UInt8
XC-21	Ext. 1 Proportional Gain	0.01 N/A	All set-ups	TRUE	-2	UInt16
XC-22	Ext. 1 Integral Time	10000.00 s	All set-ups	TRUE	-2	UInt32
XC-23	Ext. 1 Differentiation Time	0.00 s	All set-ups	TRUE	-2	UInt16
XC-24	Ext. 1 Dif. Gain Limit	5.0 N/A	All set-ups	TRUE	-1	UInt16
<b>XC-3#</b>						
XC-30	Ext. 2 Ref./Feedback Unit	[1] %	All set-ups	TRUE	-	UInt8
XC-31	Ext. 2 Minimum Reference	0.000 ExtPID2Unit	All set-ups	TRUE	-3	Int32
XC-32	Ext. 2 Maximum Reference	100.000 ExtPID2Unit	All set-ups	TRUE	-3	Int32
XC-33	Ext. 2 Reference Source	[0] No function	All set-ups	TRUE	-	UInt8
XC-34	Ext. 2 Feedback Source	[0] No function	All set-ups	TRUE	-	UInt8
XC-35	Ext. 2 Setpoint	0.000 ExtPID2Unit	All set-ups	TRUE	-3	Int32
XC-37	Ext. 2 Reference [Unit]	0.000 ExtPID2Unit	All set-ups	TRUE	-3	Int32
XC-38	Ext. 2 Feedback [Unit]	0.000 ExtPID2Unit	All set-ups	TRUE	-3	Int32
XC-39	Ext. 2 Output [%]	0 %	All set-ups	TRUE	0	Int32
<b>XC-4#</b>						
XC-40	Ext. 2 Normal/Inverse Control	[0] Normal	All set-ups	TRUE	-	UInt8
XC-41	Ext. 2 Proportional Gain	0.01 N/A	All set-ups	TRUE	-2	UInt16
XC-42	Ext. 2 Integral Time	10000.00 s	All set-ups	TRUE	-2	UInt32
XC-43	Ext. 2 Differentiation Time	0.00 s	All set-ups	TRUE	-2	UInt16
XC-44	Ext. 2 Dif. Gain Limit	5.0 N/A	All set-ups	TRUE	-1	UInt16
<b>XC-5#</b>						
XC-50	Ext. 3 Ref./Feedback Unit	[1] %	All set-ups	TRUE	-	UInt8
XC-51	Ext. 3 Minimum Reference	0.000 ExtPID3Unit	All set-ups	TRUE	-3	Int32
XC-52	Ext. 3 Maximum Reference	100.000 ExtPID3Unit	All set-ups	TRUE	-3	Int32
XC-53	Ext. 3 Reference Source	[0] No function	All set-ups	TRUE	-	UInt8
XC-54	Ext. 3 Feedback Source	[0] No function	All set-ups	TRUE	-	UInt8
XC-55	Ext. 3 Setpoint	0.000 ExtPID3Unit	All set-ups	TRUE	-3	Int32
XC-57	Ext. 3 Reference [Unit]	0.000 ExtPID3Unit	All set-ups	TRUE	-3	Int32
XC-58	Ext. 3 Feedback [Unit]	0.000 ExtPID3Unit	All set-ups	TRUE	-3	Int32
XC-59	Ext. 3 Output [%]	0 %	All set-ups	TRUE	0	Int32

**Parameter Lists****AF-600 FP Programming Guide**

Par. No. #	Parameter description	Default value	4-set-up	Change during operation	Conversion index	Type
<b>XC-6#</b>						
XC-60	Ext. 3 Normal/Inverse Control	[0] Normal	All set-ups	TRUE	-	Uint8
XC-61	Ext. 3 Proportional Gain	0.01 N/A	All set-ups	TRUE	-2	Uint16
XC-62	Ext. 3 Integral Time	10000.00 s	All set-ups	TRUE	-2	Uint32
XC-63	Ext. 3 Differentiation Time	0.00 s	All set-ups	TRUE	-2	Uint16
XC-64	Ext. 3 Dif. Gain Limit	5.0 N/A	All set-ups	TRUE	-1	Uint16



5.1.25 PC-## Pump Controller

5

Par. No. #	Parameter description	Default value	4-set-up	Change during operation	Conversion index	Type
<b>PC-0#</b>						
PC-00	Pump Controller	[0] Disabled	2 set-ups	FALSE	-	UInt8
PC-02	Motor Start	[0] Direct on Line	2 set-ups	FALSE	-	UInt8
PC-04	Pump Cycling	[0] Disabled	All set-ups	TRUE	-	UInt8
PC-05	Fixed Lead Pump	[1] Yes	2 set-ups	FALSE	-	UInt8
PC-06	Number of Pumps	2 N/A	2 set-ups	FALSE	0	UInt8
<b>PC-1#</b>						
PC-10	Minimum Run Time Override	[0] Disabled	All set-ups	FALSE	-	UInt8
PC-11	Minimum Run Time Override Value	0.000 ProcessCtrlUnit	All set-ups	TRUE	-3	Int32
<b>PC-2#</b>						
PC-20	Staging Bandwidth	10 %	All set-ups	TRUE	0	UInt8
PC-21	Override Bandwidth	100 %	All set-ups	TRUE	0	UInt8
PC-22	Fixed Speed Bandwidth	casco_staging_bandwidth (P2520)	All set-ups	TRUE	0	UInt8
PC-23	SBW Staging Delay	15 s	All set-ups	TRUE	0	UInt16
PC-24	SBW Destaging Delay	15 s	All set-ups	TRUE	0	UInt16
PC-25	OBW Time	10 s	All set-ups	TRUE	0	UInt16
PC-26	Destage At No-Flow	[0] Disabled	All set-ups	TRUE	-	UInt8
PC-27	Stage Function	[1] Enabled	All set-ups	TRUE	-	UInt8
PC-28	Stage Function Time	15 s	All set-ups	TRUE	0	UInt16
PC-29	Destage Function	[1] Enabled	All set-ups	TRUE	-	UInt8
<b>PC-3#</b>						
PC-30	Destage Function Time	15 s	All set-ups	TRUE	0	UInt16
<b>PC-4#</b>						
PC-40	Decel Ramp Delay	10.0 s	All set-ups	TRUE	-1	UInt16
PC-41	Accel Ramp Delay	2.0 s	All set-ups	TRUE	-1	UInt16
PC-42	Staging Threshold	ExpressionLimit	All set-ups	TRUE	0	UInt8
PC-43	Destaging Threshold	ExpressionLimit	All set-ups	TRUE	0	UInt8
PC-44	Staging Speed [RPM]	0 RPM	All set-ups	TRUE	67	UInt16
PC-45	Staging Speed [Hz]	0.0 Hz	All set-ups	TRUE	-1	UInt16
PC-46	Destaging Speed [RPM]	0 RPM	All set-ups	TRUE	67	UInt16
PC-47	Destaging Speed [Hz]	0.0 Hz	All set-ups	TRUE	-1	UInt16
<b>PC-5#</b>						
PC-50	Lead Pump Alternation	[0] Off	All set-ups	TRUE	-	UInt8
PC-51	Alternation Event	[0] External	All set-ups	TRUE	-	UInt8
PC-52	Alternation Time Interval	24 h	All set-ups	TRUE	74	UInt16
PC-53	Alternation Timer Value	0 N/A	All set-ups	TRUE	0	VisStr[7]
PC-54	Alternation Predefined Time	ExpressionLimit	All set-ups	TRUE	0	TimeOfDayWoDate
PC-55	Alternate if Load < 50%	[1] Enabled	All set-ups	TRUE	-	UInt8
PC-56	Staging Mode at Alternation	[0] Slow	All set-ups	TRUE	-	UInt8
PC-58	Run Next Pump Delay	0.1 s	All set-ups	TRUE	-1	UInt16
PC-59	Run on Line Delay	0.5 s	All set-ups	TRUE	-1	UInt16
<b>PC-8#</b>						
PC-80	Pump Status	0 N/A	All set-ups	TRUE	0	VisStr[25]

**Parameter Lists****AF-600 FP Programming Guide**

Par. No. #	Parameter description	Default value	4-set-up	Change during operation	Conversion index	Type
PC-81	Pump Status	0 N/A	All set-ups	TRUE	0	VisStr[25]
PC-82	Lead Pump	0 N/A	All set-ups	TRUE	0	UInt8
PC-83	Relay Status	0 N/A	All set-ups	TRUE	0	VisStr[4]
PC-84	Pump ON Time	0 h	All set-ups	TRUE	74	UInt32
PC-85	Relay ON Time	0 h	All set-ups	TRUE	74	UInt32
PC-86	Reset Relay Counters	[0] Do not reset	All set-ups	TRUE	-	UInt8
<b>PC-9#</b>						
PC-90	Pump Interlock	[0] Off	All set-ups	TRUE	-	UInt8
PC-91	Manual Alternation	0 N/A	All set-ups	TRUE	0	UInt8



5.1.26 LC-## Logic Controller

Par. No. #	Parameter description	Default value	4-set-up	Change during operation	Conversion index	Type
<b>LC-0#</b>						
LC-00	Logic Controller Mode	null	2 set-ups	TRUE	-	UInt8
LC-01	Start Event	null	2 set-ups	TRUE	-	UInt8
LC-02	Stop Event	null	2 set-ups	TRUE	-	UInt8
LC-03	Reset Logic Controller	[0] Do not reset Logic Controller	All set-ups	TRUE	-	UInt8
<b>LC-1#</b>						
LC-10	Comparator Operand	null	2 set-ups	TRUE	-	UInt8
LC-11	Comparator Operator	null	2 set-ups	TRUE	-	UInt8
LC-12	Comparator Value	ExpressionLimit	2 set-ups	TRUE	-3	Int32
<b>LC-2#</b>						
LC-20	Logic Controller Timer	ExpressionLimit	1 set-up	TRUE	-3	TimD
<b>LC-4#</b>						
LC-40	Logic Rule Boolean 1	null	2 set-ups	TRUE	-	UInt8
LC-41	Logic Rule Operator 1	null	2 set-ups	TRUE	-	UInt8
LC-42	Logic Rule Boolean 2	null	2 set-ups	TRUE	-	UInt8
LC-43	Logic Rule Operator 2	null	2 set-ups	TRUE	-	UInt8
LC-44	Logic Rule Boolean 3	null	2 set-ups	TRUE	-	UInt8
<b>LC-5#</b>						
LC-51	Logic Controller Event	null	2 set-ups	TRUE	-	UInt8
LC-52	Logic Controller Action	null	2 set-ups	TRUE	-	UInt8

5.1.27 B-## Braking Functions

Par. No. #	Parameter description	Default value	4-set-up	Change during operation	Conversion index	Type
<b>B-0#</b>						
B-00	DC Hold Current	50 %	All set-ups	TRUE	0	UInt8
B-01	DC Brake Current	50 %	All set-ups	TRUE	0	UInt16
B-02	DC Braking Time	10.0 s	All set-ups	TRUE	-1	UInt16
B-03	DC Brake Cut In Speed [RPM]	ExpressionLimit	All set-ups	TRUE	67	UInt16
B-04	DC Brake Cut In Speed [Hz]	ExpressionLimit	All set-ups	TRUE	-1	UInt16
<b>B-1#</b>						
B-10	Brake Function	[0] Off	All set-ups	TRUE	-	UInt8
B-16	AC brake Max. Current	100.0 %	All set-ups	TRUE	-1	UInt32
B-17	Over-voltage Control	[2] Enabled	All set-ups	TRUE	-	UInt8



## Index

## A

Abbreviations.....	5
Acceleration Time.....	33
Advanced Vector Control.....	6
Alarm	
Log.....	92
Words.....	168
Alarms And Warnings.....	166
AN-0# Analog I/O Mode.....	57
Analog	
Input Scaling Value.....	73
Inputs.....	6
AP-2# No-Flow Detection.....	101
Auto Energy Optimization Compressor.....	53
Automatic Derate.....	65

## B

BACnet.....	87
Brake Power.....	6
Break-away Torque.....	6
Broken Belt Detection.....	109
Bus Controlled.....	47

## C

Cabling.....	85
Change-Of-State.....	85
Changing	
A Group Of Numeric Data Values.....	21
A Text Value.....	21
Data.....	21
Parameter Data.....	15
Coasting.....	5, 14
Communication Option.....	172
Configuration.....	67, 84
Control Cables.....	10
Cooling.....	34
Copyright, Limitation Of Liability And Revision Rights.....	4
Current Limit Control.....	64

## D

Data Trending Settings.....	89
DC Link.....	171
Default Settings.....	21
Definitions.....	5
DeviceNet.....	77

## Display

Line 1.2 Small, 0-21.....	28
Line 1.3 Small, 0-22.....	28
Line 2 Large, 0-23.....	28

## Drive

Bypass.....	117
Identification.....	92
Information.....	89

## E

Electrical Terminals.....	9
Electronic Thermal Overload.....	95, 171
End Of Curve.....	108
Energy Savings.....	64
Environment.....	65
Ethernet.....	83, 85
EtherNet/IP.....	84
Example Of Changing Parameter Data.....	15
Extended	
CL Autotuning.....	140
Status Word.....	170
Status Word 2.....	170

## F

Fault Messages.....	171
Feedback	
Feedback.....	130
& Setpoint.....	133
Adv. Conversion.....	136
Fire Mode.....	114
Forward Open.....	85
Freeze Output.....	5

## G

Graphical Display.....	11
------------------------	----

## H

Historic Log.....	91
How To Operate Graphical Keypad.....	11

## I

IGMP.....	85
Indicator Lights (LEDs).....	12
Intermediate Circuit.....	171

## J

Jog.....	5
----------	---

## K

K-4# Keypad Buttons.....	30
--------------------------	----



Index	AF-600 FP Programming Guide
K-7# Clock Settings.....	31
K-8# Days And Date/Time Readout.....	32
KTY Sensor.....	171
<b>L</b>	
LEDs.....	11
LG-0# Maintenance Log.....	99
Line On/Off.....	63
Local Reference.....	23
LonWorks.....	88
<b>M</b>	
Macros.....	16
<b>Main</b>	
Menu Mode.....	13, 15, 20
Menu Structure.....	174
Reactance.....	50
Mains Supply.....	7
Manual Restore.....	22
<b>Motor</b>	
Protection.....	34
Status.....	94
Multicast.....	86
<b>N</b>	
Network.....	83, 84, 85, 86
<b>O</b>	
Operating Mode.....	23
Option Ident.....	92
<b>P</b>	
<b>Parameter</b>	
Access.....	79
Data.....	15
Info.....	93
Selection.....	20
Set-Up.....	15
<b>PID</b>	
Autotuning.....	136
Basic Settings.....	137
Closed Loop.....	130
Controller.....	138
Protection Mode.....	8
Pump Controller.....	147
<b>Q</b>	
<b>Quick</b>	
Menu.....	13
Menu Mode.....	13, 15
Transfer Of Parameter Settings Between Multiple Frequency Converters.....	14
<b>R</b>	
Rated Motor Speed.....	5
RCD.....	7
Read-out And Programming Of Indexed Parameters.....	21
Reference.....	84
Relay Outputs.....	41
Restore.....	21
<b>S</b>	
Safety Precautions.....	7
Screened/armoured.....	10
Serial Communication.....	6
Short Cycle Protection.....	109
Sleep Mode.....	105
Software Version.....	4
Special Functions.....	63
Stator Leakage Reactance.....	50
<b>Status</b>	
Status.....	12
Messages.....	11
Step-by-Step.....	21
Symbols.....	4
Synchronous Motor Speed.....	5
<b>T</b>	
Thermal Load.....	95
Thermistor.....	34, 7
Trendings.....	15
<b>V</b>	
Value.....	21
<b>W</b>	
Warning Words.....	169



The instructions do not purport to cover all details or variations in equipment nor to provide for every possible contingency to be met in connection with installation, operation or maintenance. Should further information be desired or should particular problems arise which are not covered sufficiently for the purchaser's purposes, the matter should be referred to the GE company.

AF-600 FP is a trademark of the General Electric Company.

GE  
41 Woodford Avenue  
Plainville, CT 06062

[www.geelectrical.com/drives](http://www.geelectrical.com/drives)



imagination at work

130R0359



\* M G 1 1 S 3 Q 2 \*

DET-620B