

Panasonic

Network camera

Network Operating Instructions

Model Nos. **WV-NP240/G**
WV-NP244E

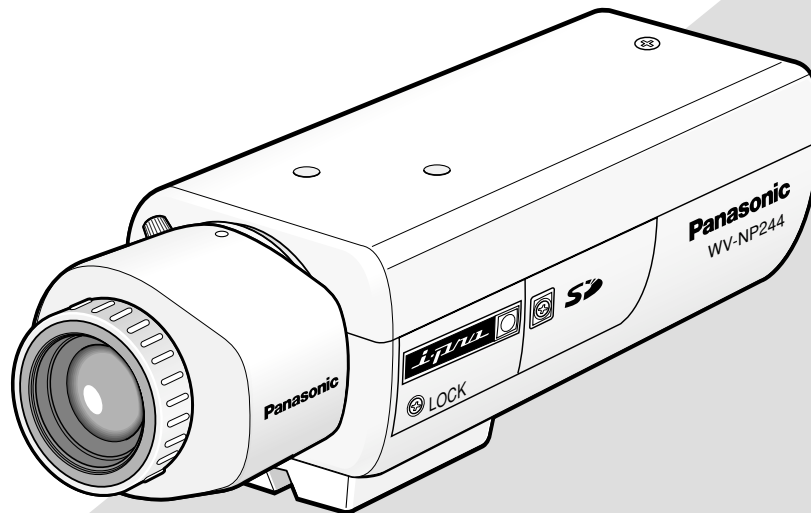

(Lens is option.)

WV-NP244 is shown above.

Before attempting to connect or operate this product,
please read these instructions carefully and save this manual for future use.

The model number is abbreviated in some descriptions in this manual.

CONTENTS

Preface	3
About these operating instructions	3
Trademarks and registered trademarks	3
Monitor Images on a PC	4
Monitor images from a single camera	4
Monitor images from multiple cameras	9
Action at an Alarm Occurrence	10
Transmit Images onto an FTP Server	11
Transmit an alarm image at an alarm occurrence (Alarm image FTP transmission) ..	11
Transmit images at a designated interval or period (FTP periodic transmission)	11
Save images on the SD memory card when failed to transmit images by the FTP periodic transmission function	12
About the Network Security of the Camera	14
Equipped security functions	14
Display the Setup Menu and Configure the Settings of the Camera using a PC	15
How to display the setup menu	15
How to operate the setup menu	16
Configure the basic settings of the camera [Basic setup]	19
Configure the settings relating to images and audio [Camera setup]	22
Configure the multi-screen settings [Multi-screen setup]	27
Configure the alarm settings [Alarm setup]	28
Configure the settings relating to the authentication [Authentication setup]	35
Configure the settings of the servers [Server setup]	37
Configuring the network settings [Network setup]	39
Maintenance of the camera [Maintenance]	45
About the Displayed System Log	48
Troubleshooting	50

Preface

About these operating instructions

There are 2 sets of operating instructions for the WV-NP240/WV-NP244 as follows.

- Operating Instructions
- Network Operating Instructions

These network operating instructions contain descriptions of how to operate this product using a PC via a network and of how to configure the settings. These network operating instructions also contain descriptions of how to display the SETUP menu on the video monitor connected to the VIDEO OUT connector of the camera and of how to configure the settings on the SETUP menu using the operation buttons on the side of the camera.

Refer to the operating instructions for descriptions of how to install this product and of how to connect to a network. Adobe® Reader is required to read PDF. When the Adobe® Reader is not installed on the PC, download the latest Adobe® Reader from the Adobe web site and install it.

Note:

The images of the setup menus in these operating instructions are of the WV-NP244.

Trademarks and registered trademarks

- Adobe, Adobe logos, and Acrobat are registered trademarks of Adobe Systems Incorporated in the U. S. and/ or other countries.
- SD logo is a trademark.
- Other names of companies and products contained in these operating instructions may be trademarks or registered trademarks of their respective owners.

Monitor Images on a PC

The following are descriptions of how to monitor images from the camera on a PC.

Monitor images from a single camera

Step 1

Start up the web browser.

Step 2

Enter the IP address designated using the Panasonic IP setup software in the address box of the browser.
(Example: <http://192.168.0.10>)

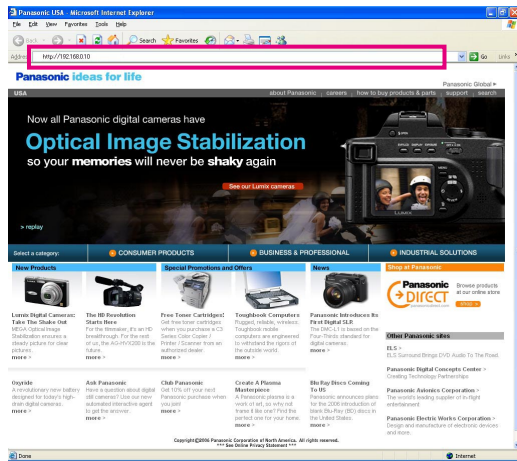

Important:

- When the HTTP port number is changed from "80", enter "[http://IP address of the camera + : \(colon\) + port number](http://IP address of the camera + : (colon) + port number)" in the address box of the browser, for example "<http://192.168.0.11:8080>".
- Configure the web browser to not use the proxy server.

Step 3

Press the [Enter] key on the keyboard.

→ Click this button to display the "Live" page.

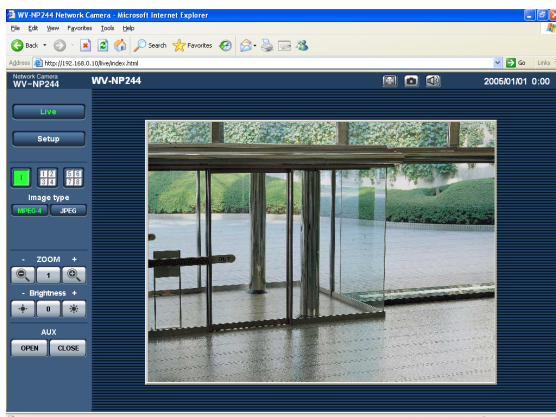

Notes:

- When "ON" is selected for "User Authentication", the authentication window will be displayed before displaying live images for the user name and password entries. The default user name and password are as follows.

User Name: admin

Password: 12345

To enhance the security, change the password for the user "admin". It is recommended to change this password periodically.

- When "Unicast" is selected for "Transmission type" (page 23), up to 8 users can access the camera concurrently. Depending on the set values for "Total bit rate" and "Max bit rate (per 1 client)", the maximum concurrent access number may be less than 8 users. When 8 users have been concurrently accessing already, the access limit message will be displayed for users who accessed subsequently.
- When "ON" is selected for "MPEG-4 transmission" (page 23), MPEG-4 image will be displayed. When "OFF" is select, JPEG image will be displayed. It is possible to display JPEG image even when "ON" is selected for "MPEG-4 transmission". In this case, the refresh interval will be limited.

<Refresh interval (JPEG)>

When "ON" is selected for "MPEG-4 transmission"

JPEG (VGA): 5 fps

JPEG (QVGA): 10 fps

When "OFF" is selected for "MPEG-4 transmission"

JPEG (VGA or QVGA): 30 fps

The refresh interval may be longer depending on a network environment, PC spec, photographic subject, access traffic, etc.

Important:

When displaying multiple MPEG-4 images on a PC, images may not be displayed depending on the performance of the PC.

Refer to the next page for further information about the "Live" page.

About the "Live" page

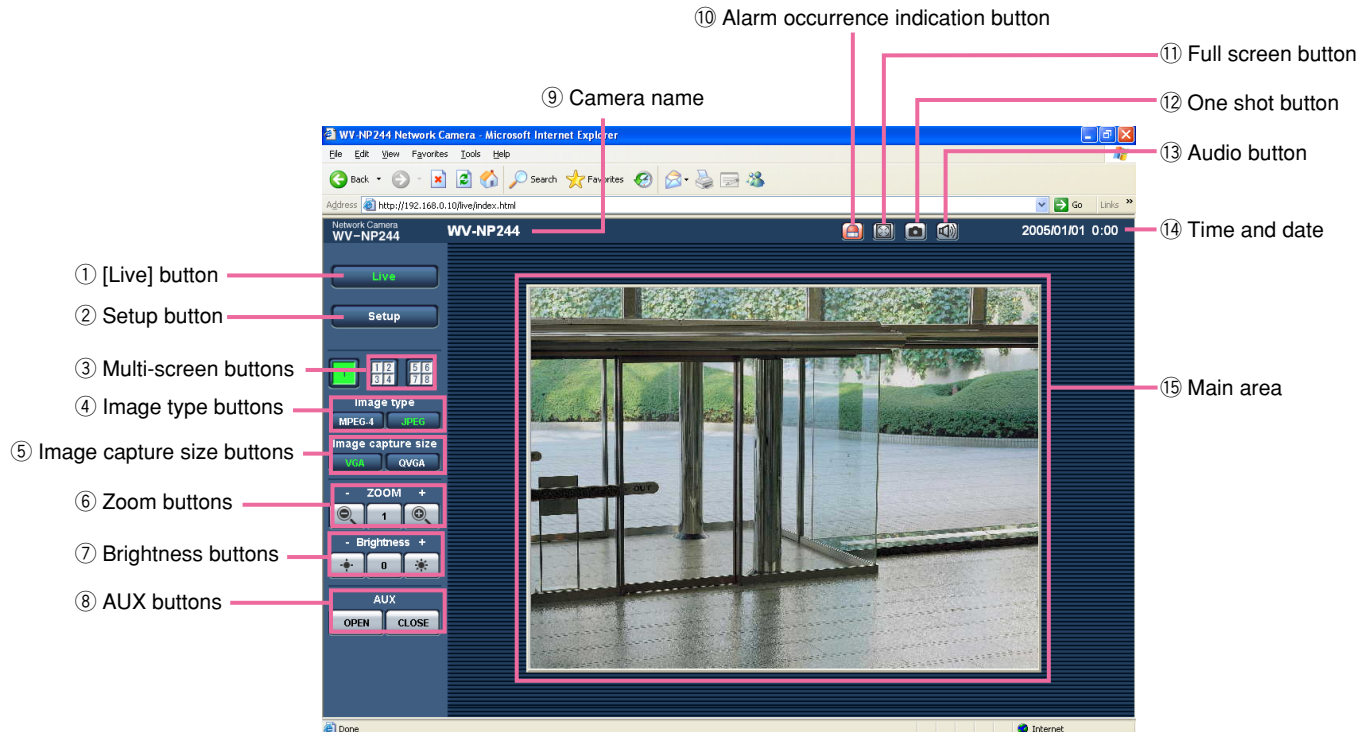

①   **[Live] button**

Click this button to display the "Live" page. Refer to page 7 for descriptions of how to operate the "Live" page.

②  **[Setup] button (*1)**

Click this button to display the setup menu.

③  **Multi-screen buttons**

Click the desired multi-screen (1-4 or 5-8) button to display images on a multi-screen.

④  **Image type buttons**

Click the desired button to change the image type to be displayed. The selected button will turn green.

⑤  **Image capture size buttons**

The selected button will turn green and images in the main area will be displayed in the selected size. Only the image capture size for which "Use" is selected for "Image capture size" on the [JPEG/MPEG-4] tab is available. (☞ page 22)

⑥  **ZOOM buttons (*2)**

Click the desired button to zoom in/out the displayed image. To return the zoomed image to the original size, click the [1] button.

⑦  **Brightness buttons (*2)**

Adjust the brightness of images.

⑧  **AUX buttons (*2)**

Click the desired button to open/close the AUX connector.

⑨ **Camera name**

The set camera name will be displayed.

⑩  **Alarm occurrence indication button (*2)**

This button will be displayed and will blink when an alarm occurred. When the button is clicked, the button will disappear and the alarm output connector will be reset. (☞ page 30)

⑪  **Full screen button**

Images will be displayed on a full screen. To return to the "Live" page, press the [Esc] key.

⑫  **One shot button**

Click this button to take a picture (a still picture). The picture will be displayed on a newly opened window.

⑬  **Audio button**

Click this button to turn on/off audio.

⑭ **Time and date**

Current time will be displayed in the set date/time display format. (☞ page 19)

⑮ **Main area**

Images from the camera will be displayed in this area.

*1: Operable by only users whose access level is "1. Administrator"

*2: Operable by only users whose access level is "1. Administrator" or "2. Camera control" when "ON" is selected for "User authentication" (☞ page 35).



Refer to page 35 for further information about the access level.







Available operations when live images are displayed

*1: Operable by only users whose access level is "1. Administrator"

*2: Operable by only users whose access level is "1. Administrator" or "2. Camera control" when "ON" is selected for "User authentication" (☞ page 35).

Refer to page 35 for further information about the access level.

Operation		Description
Display the setup menu (*1)		The letters "Setup" on the button will turn green and the setup menu will be displayed. To return to the "Live" page, click the [Live] button.
Display images on a multi-screen		Images from multiple cameras can be displayed on a multi-screen by registering cameras on the setup menu. (☞ page 9)
Display MPEG-4 image		The letters "MPEG-4" on the button will turn green and MPEG-4 image will be displayed. When "OFF" is selected for "MPEG-4 transmission" on the setup menu, the [MPEG-4] button will not be displayed. (☞ page 23)
Display JPEG image		The letters "JPEG" on the button will turn green and JPEG image will be displayed.
Change the image capture size	 	The letters "VGA" on the button will turn green and images will be displayed in VGA size. The letters "QVGA" on the button will turn green and images will be displayed in QVGA size. * The image capture size can be changed only when displaying JPEG image.
Zoom in/out of image (*2)	  	The zoomed image will be zoomed out. (Image displayed in the original size cannot be zoomed out.) The zoomed image will return to the original size. The displayed image will be zoomed in.
Change brightness (*2)	  	The displayed image will be darker. Image will be displayed with the default brightness (0). (☞ page 25) The displayed image will be brighter.
Open/close the AUX connector (*2)	 	The AUX connector will open. The AUX connector will close.

Operation	Description
Acknowledge alarm occurrences (*2)	 <p>This button will be displayed and will blink when an alarm occurred. When the button is clicked, the button will disappear and the alarm output connector will be reset. (page 30)</p>
Display an image on a full screen	 <p>Images will be displayed on a full screen. To return to the "Live" page, press the [Esc] key.</p>
Turn on/off audio	 <p>When this button is clicked, the button will turn into the  button and audio will not be heard.</p>  <p>When this button is clicked, the button will turn into the  button and audio will be heard.</p> <p>* The [Audio] button will be displayed only when "ON" is selected for "Mic mode" on the setup menu. (page 26)</p>
Display a still picture (one shot)	 <p>When this button is clicked, a new window will open and the still picture (one shot) displayed on the "Live" page will be displayed on it.</p> <p>To save this picture on a PC, right-click on the image and select "Save" on the displayed pop-up menu.</p>

Monitor images from multiple cameras

Images from multiple cameras can be displayed on a multi-screen. Images from up to 4 cameras can be displayed simultaneously. To display images on a multi-screen, it is necessary to register cameras in advance. 4 cameras can be registered as a group and up to 2 groups (8 cameras) can be registered. (☞ page 27)

Important:

- Select "OFF" for both the user authentication and the host authentication of the camera to be registered. (☞ pages 35 and 36)
 - Only JPEG images can be displayed on a multi-screen. Audio will not be heard.
 - When the power is turned off or the LAN cable is disconnected while displaying images, displaying images on a multi-screen from the "Live" page will become unavailable.
-

Step 1

Click the [Multi-screen] button.

→ Images from the registered cameras will be displayed on a 4-split screen.

- ① To display images on a single screen, click the the [1] button or [Live] button.
- ② Click a camera name. Live images from the camera corresponding to the clicked camera name will be displayed on the "Live" page of the newly opened window.

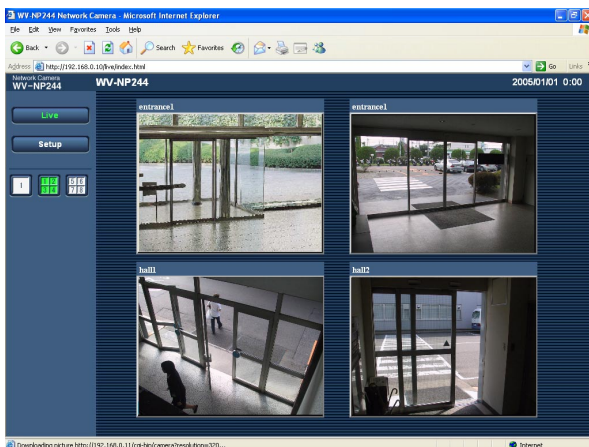

Action at an Alarm Occurrence

The alarm action will be performed when the following alarm occur.

Alarm type

Terminal alarm: When connecting an alarm device such as a sensor to the alarm connector on the rear of the camera, the alarm action will be performed when the connected alarm device activated.

VMD alarm: When a motion is detected in the set VMD area, the alarm action will be performed.

* VMD stands for "Video Motion Detection".

Command alarm: When received a Panasonic alarm protocol from the connected device via a network (☞ page 34), the alarm action will be performed.

Action at an Alarm Occurrence

Display the [Alarm occurrence indication] button on the "Live" page. (☞ page 5)

The [Alarm occurrence indication] button will be displayed on the "Live" page at an alarm occurrence.

Note:

The [Alarm occurrence indication] button will be refreshed in 30 seconds intervals. For this reason, it may take a maximum of 30 seconds until the [Alarm occurrence indication] button is displayed on the "Live" page at an alarm occurrence.

Notify of alarm occurrences to the device connected to the alarm connector.

It is possible to output signals from the alarm connector on the rear of the camera and sound the buzzer when an alarm occurs. The settings for the alarm output can be configured on the [Alarm] tab of the "Alarm setup" page. (☞ page 28)

Transmit an image onto a server automatically

An alarm image can be transmitted at an alarm occurrence to the server designated in advance.

The settings required to transmit alarm image to a server can be configured on the [Alarm] tab of the "Alarm setup" page (☞ page 28) and the [FTP] tab of the "Server setup" page (☞ page 38).

Notify of alarm occurrences by e-mail

Alarm mail (alarm occurrence notification) can be sent at an alarm occurrence to the e-mail addresses registered in advance. Up to 4 addresses can be registered as recipients of the alarm mail. An alarm image can be transmitted at an alarm occurrence to the server designated in advance. The settings for alarm mail can be configured on the [Notification] tab of the "Alarm setup" page (☞ page 33) and the [Mail] tab of the "Server setup" page (☞ page 37).

Notify of alarm occurrences to the designated IP addresses (Panasonic alarm protocol)

This function is available only when Panasonic device, such as the network disk recorder, is connected to the system. When "ON" is selected for "Panasonic alarm protocol", the connected Panasonic device will be notified that the camera is in the alarm state. The settings for Panasonic alarm protocol can be configured on the [Notification] tab of the "Alarm setup" page. (☞ page 33)

Transmit Images onto an FTP Server

Images can be transmitted to an FTP server. By configuring the following settings, transmission of images captured at an alarm occurrence or captured at a designated interval to an FTP server will become available.

Important:

When using this function, set the user name and password to restrict users who can log into the FTP server.

Transmit an alarm image at an alarm occurrence (Alarm image FTP transmission)

An alarm image can be transmitted at an alarm occurrence to the FTP server. To transmit alarm images to an FTP server, it is necessary to configure the settings in advance.

The settings for the FTP server can be configured on the [FTP] tab of the "Server setup" page. (☞ page 38)

The alarm image FTP transmission function can be turned on/off on the [Alarm] tab of the "Alarm setup" page. (☞ page 28)

Notes:

- Depending on the network traffic, number of the transmitted images may not reach the set number of images to be transmitted.
 - Images failed to be transmitted to the FTP server will not be saved on the SD memory card.
-

Transmit images at a designated interval or period (FTP periodic transmission)

Images can be transmitted at a designated interval or period. To transmit images at a designate interval or period, it is necessary to configure the settings in advance.

The settings for the FTP server can be configured on the [FTP] tab of the "Server setup" page. (☞ page 38)

On the [FTP] tab of the "Network setup" page, the FTP periodic transmission function can be turned on/off, and the settings relating to schedules (periods) can be configured. (☞ page 43)

Notes:

- Depending on the network line speed or the network traffic, images may not be transmitted at the exact designated interval or period.
 - When "ON" is selected for both of the alarm image FTP transmission function and the FTP periodic transmission function, the alarm image FTP transmission function will be given priority over the FTP periodic transmission function. For this reason, images may not be transmitted at the exact designated interval or period if alarms occur frequently.
-

Save images on the SD memory card when failed to transmit images by the FTP periodic transmission function

Images failed to transmit by the FTP periodic transmission can be saved automatically on the SD memory card. To obtain the images saved on the SD memory card, use the Windows command prompt or FTP client software. The obtained images can be browsed on a PC.

Important:

We make no guarantee for any damages of files on the SD memory card incurred by malfunction or error occurrence in files saved on the SD memory card regardless of what the cause may be.

Notes:

- When using the "SD memory REC" function of a Panasonic's network disk recorder, select "OFF" for the "FTP periodic transmission" function. (☞ page 43)
 - When using the DHCP function, it is impossible to write image data on the SD memory card until the IP address is provided to this camera.
-

Save images on the SD memory card

By configuring the following settings, saving images which had been failed to transmit to the FTP server using the FTP periodic transmission function will become available.

About SD memory card: Use (☞ page 21)

File name: With time and date (☞ page 43)

Obtain images on the SD memory card

Step 1

Access the camera using the Windows command prompt or FTP client software.

→ The window with the user name and password entry fields will be displayed.

Step 2

Enter the user name whose access level is "1. Administrator" and its password.

→ Log in the camera.

Note:

The default user name with the access level "1. Administrator" and its password are as follows.

User Name: admin

Password: 12345

To enhance the security, it is recommended to change the password for the administrator periodically. Refer to page 35 for descriptions of how to change the password.

Step 3

Move the current directory to drive B and obtain images.

Notes:

- When logging in the camera, the current directory will be drive D. Images on the SD memory card can be found in the "FTP" directory under drive B. Move to the "FTP" directory and obtain images.

<Directory structure of drive B>

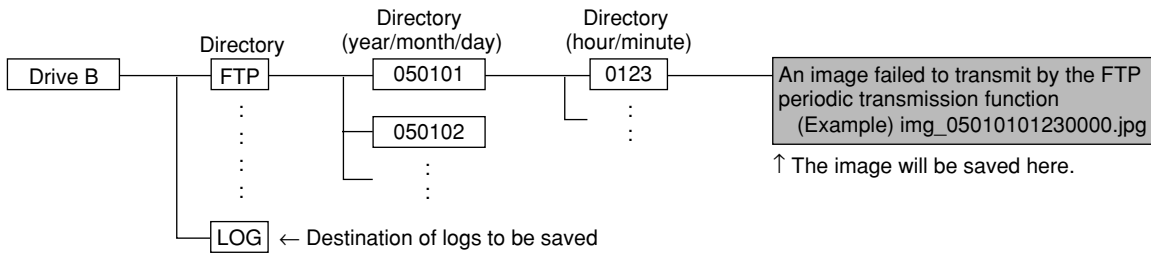

Example: To obtain the image (img_05010101230000.jpg) using the Windows command prompt

1. Enter "c:\>ftp 192.168.0.10" and press the [Enter] key.
→ FTP connection will be established with "192.168.0.10".
2. Log in by entering the user name and the password.
3. Enter "ftp>cd B:\FTP\050101\0123" and press the [Enter] key.
→ The current directory will be "B:\FTP\050101\0123".
4. Enter "ftp>bin" and press the [Enter] key.
→ The transfer mode will be set to the binary mode.
5. Enter "ftp>get img_05010101230000.jpg" and press the [Enter] key.
→ The image will be obtained.
6. Log out by entering "ftp>bye" and press the [Enter] key.

- It is possible to delete images on the SD memory card using the Windows command prompt, etc.

About the Network Security of the Camera

Equipped security functions

The following security functions are featured in this camera.

- ① Access restrictions by the host authentication and the user authentication
It is possible to restrict users from accessing the camera by setting the host authentication and/or the user authentication to on. (☞ pages 35 and 36)
- ② Access restrictions by changing the HTTP port
It is possible to prevent illegal access such as port scanning, etc. by changing the HTTP port number. (☞ page 40)

Note:

When failed to pass the user authentication (authentication error) using the same IP address (PC) for 8 times within 30 seconds, access to the camera will be denied for a while.

Important:

Design and enhance security countermeasures to prevent leakage of information such as image data, authentication information (user name and password), alarm mail information, FTP server information, DDNS server information, etc.

Display the Setup Menu and Configure the Settings of the Camera using a PC

The settings of the camera can be configured on the setup menu. The setup menu is operable by only users whose access level is "1. Administrator".

How to display the setup menu

Step 1

Display the "Live" page. (page 4)

Step 2

Click the [Setup] button on the "Live" page.
→ The window with the user name and password entry fields will be displayed.

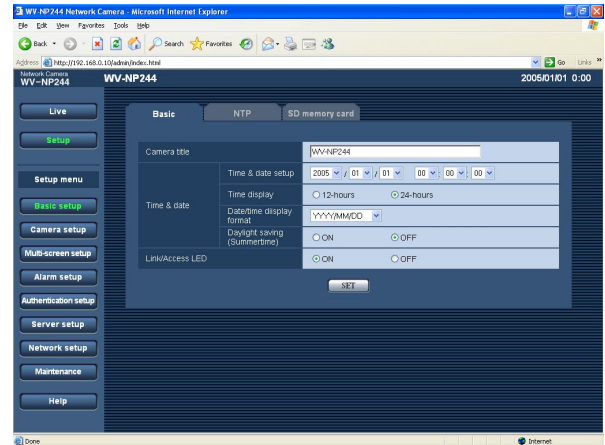
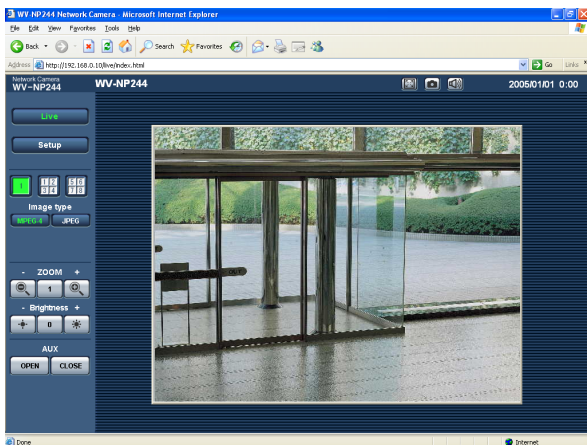

Step 3

Click the [OK] button after entering the user name and the password.

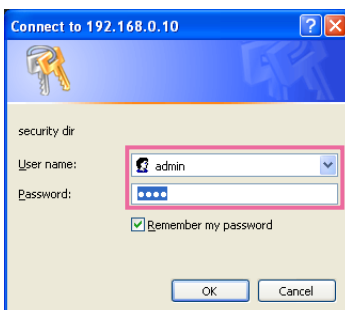

→ Click this button to display the setup menu.
Refer to the next page for further information about this menu.

How to operate the setup menu

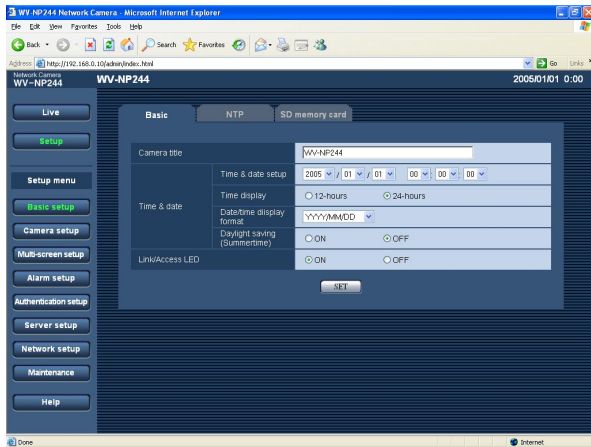

When completing the setting items in field A, click the [SET] button below field A (A-1). The edited setting items in field A will not be applied unless the [SET] button below field A (A-1) is clicked. In the same manner above, click the [SET] button below field B (B-1) when completing the setting items in field B.

Step 1

Click the desired button in the frame on the left of the window to display the respective setup menu. When there are tabs at the top of the setup page displayed in the frame on the right of the window, click the desired tab to display and configure the setting items relating to the name of the tab.

Step 2

Complete each setting item displayed in the frame on the right of the window.

Step 3

After completing each setting item, click the [SET] button to apply them.

Important:

When there are two [SET] buttons (or [REG] buttons) or more on the page, click the respective button to the edited setting item.

<Example>

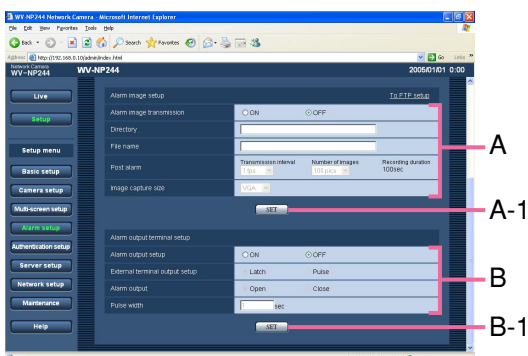

About the operation window

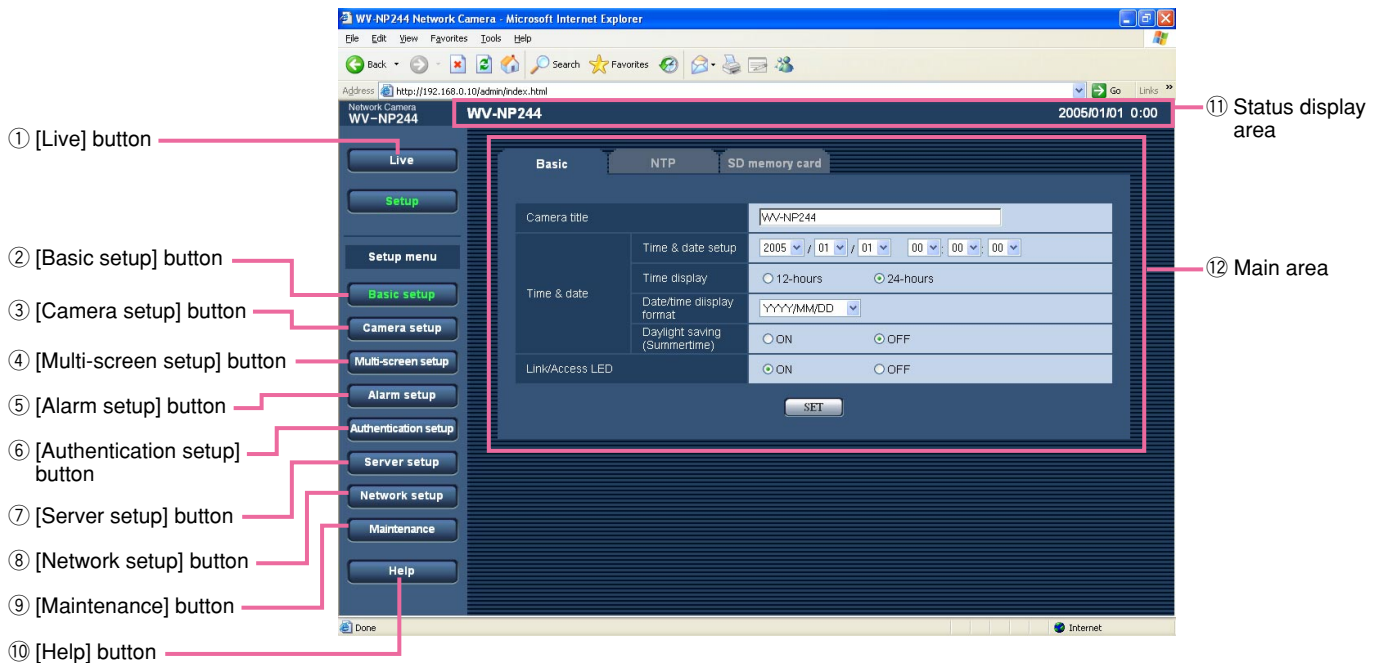

① **Live** [Live] button

Click this button to display the "Live" page.

② **Basic setup** [Basic setup] button

Click this button to display the "Basic setup" page. The basic settings such as time and date and camera name, and the settings relating to the NTP server and the SD memory card can be configured on the "Basic setup" page. Refer to page 19 for further information.

③ **Camera setup** [Camera setup] button

Click this button to display the "Camera setup" page. The settings relating to image from the camera such as image quality and brightness, and the settings relating to audio can be configured on the "Camera setup" page. Refer to page 22 for further information.

④ **Multi-screen setup** [Multi-screen setup] button

Click this button to display the "Multi-screen setup" page. The cameras to be used for the multi-screen display can be registered on the "Multi-screen setup" page. Refer to page 27 for further information.

⑤ **Alarm setup** [Alarm setup] button



Click this button to display the "Alarm setup" page. The settings relating to alarm occurrences such as settings for the alarm action at an alarm occurrence, the alarm occurrence notification, and the VMD area settings can be configured on the "Alarm setup" page. Refer to page 28 for further information.

⑥ **Authentication setup** [Authentication setup] button

Click this button to display the "Authentication setup" page. The settings relating to the authentication such as users and PCs restrictions for accessing the camera can be configured on the "Authentication setup" page. Refer to page 35 for further information.

⑦ **Server setup** [Server setup] button

Click this button to display the "Server setup" page. The settings relating to the mail server and the FTP server to which the camera accesses can be configured on the "Server setup" page. Refer to page 37 for further information.

-
- ⑧  **[Network setup] button**
Click this button to display the "Network setup" page. The network settings and the settings relating to DDNS (Dynamic DNS), SNMP (Simple Network management Protocol) and FTP (File Transfer Protocol) can be configured on the "Network setup" page. Refer to page 39 for further information.
- ⑨  **[Maintenance] button**
Click this button to display the "Maintenance" page. System log check, firmware upgrade and initialization of the setup menu can be performed on the "Maintenance" page. Refer to page 45 for further information.
- ⑩  **[Help] button**
Click this button to display the "Help" page.
- ⑪ **Status display area**
The name of the camera whose settings currently being configured, and date and time will be displayed.
- ⑫ **Main area**
Pages of each setup menu will be displayed. There are tabs for some setup menus.

Configure the basic settings of the camera [Basic setup]

The basic settings such as time and date and camera name, and the settings relating to the NTP server and the SD memory card can be configured on the "Basic setup" page.

The "Basic setup" page has 3 tabs of the [Basic] tab, the [NTP] tab and the [SD memory card] tab.

Configure the basic settings [Basic]

Click the [Basic] tab on the "Basic setup" page. (page 16)

The settings such as the camera name, time and date, etc. can be configured on this page.

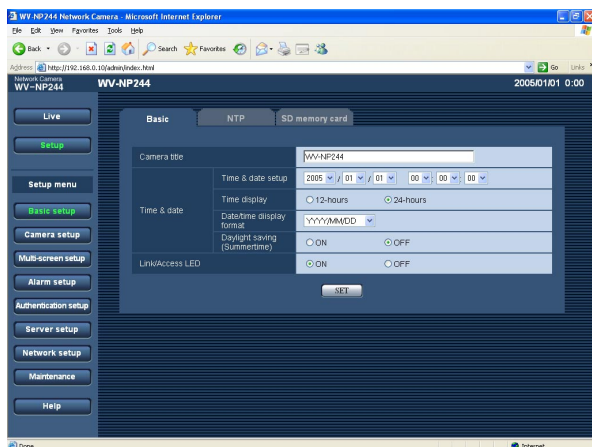

[Camera title]

Enter the title of the camera. Click the [SET] button after entering the title of the camera. The entered title will be displayed in the status display area.

Number of characters for the camera title: 0 - 20 characters

Default: WV-NP240 (for the WV-NP240)
WV-NP244 (for the WV-NP244)

[Time and date setup]

Enter the current time and date. When "12-hours" is selected for "Time display", "AM" or "PM" can be selected.

Available range: 01/01/2005 0:00:00 – 12/31/2035
23:59:59:59

[Time display]

Select "12-hours" or "24-hours". Enter the current hour reflecting this setting when entering the current time and date for "Time and date setup".

Default: 24-hours

[Date/time display format]

Select a date/time display format.

When "04/01/2005 13:10:00" is set for "Time and date setup" after selecting "24-hours" for "Time display", time and date will be displayed as follows respectively.

DD/MM/YYYY

01/04/2005 13:10

MM/DD/YYYY

04/01/2005 13:10

DD/Mmm/YYYY

01/Apr/2005 13:10

YYYY/MM/DD

2005/04/01 13:10

Mmm/DD/YYYY

Apr/01/2005 13:10

Default: MM/DD/YYYY

[Daylight saving (Summertime)]

Select "ON" or "OFF" to determine whether or not to apply daylight saving time.

ON: Applies summer time. An asterisk (*) will be displayed on the left side of the displayed time and date.

OFF: Does not apply summer time.

Default: OFF

[Link/Access LED]

Select "ON" or "OFF" to determine whether or not to light the link LED, the access LED of the network connector, and the SD memory card error LED.

Select "ON" to check the network status by lighting the LEDs. Select "OFF" to turn off the LEDs at all times. However, the power indicator will light even when "OFF" is selected.

Default: ON

Notes:

- **Link LED:** This LED will light when communication with the connected device is available.
 - **Access LED:** This LED will light when accessing to a network.
 - **SD memory card error LED:** This LED will light when it is impossible to write data on the SD memory card.
-

Configure the settings relating to the NTP server [NTP]

Click the [NTP] tab on the "Basic setup" page. (☞ page 16)

The settings relating to the NTP server such as the NTP server address, port number, etc. can be configured on this page.

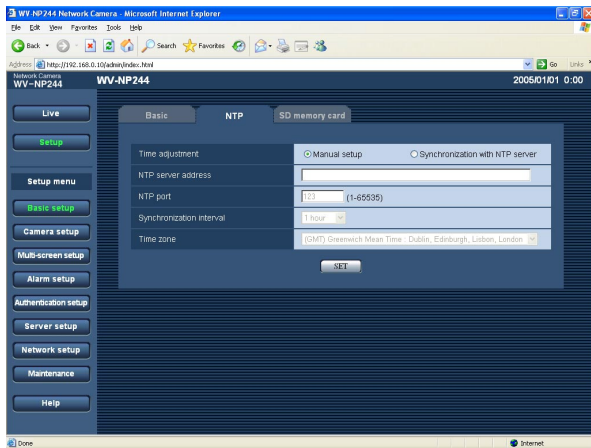

[Time adjustment]

Select the time adjustment method from the following. Time adjusted by the selected method will be used as the standard time of the camera.

Manual setup: Time set on the [Basic] tab on the "Basic setup" page will be used as the standard time of the camera.

Synchronization with NTP server: Time automatically adjusted by synchronizing with NTP server will be used as the standard time of the camera.

Default: Manual setup

[NTP server address]

Enter the IP address or the host name of the NTP server.

Number of characters for the NTP server address:

1 - 128 characters

Default: (blank)

Important:

When entering the host name for "NTP server address", it is necessary to configure the DNS settings on the [Network] tab of the "Network setup" page. (☞ page 39)

[NTP port]

Enter a port number to be used for the NTP server.

Available port number: 1 - 65535

Default: 123

[Synchronization interval]

Select an interval (1 - 24 hours: in 1 hour intervals) of synchronization with the NTP server.

Default: 1 hour

[Time zone]

Select a time zone according to the location where the camera is in use.

Default: (GMT) Greenwich Mean Time: Dublin, Edinburgh, Lisbon, London

Configure the settings relating to SD memory card [SD memory card]

Click the [SD memory card] tab on the "Basic setup" page. (☞ page 16)

The settings relating to the SD memory card can be configured on this page.

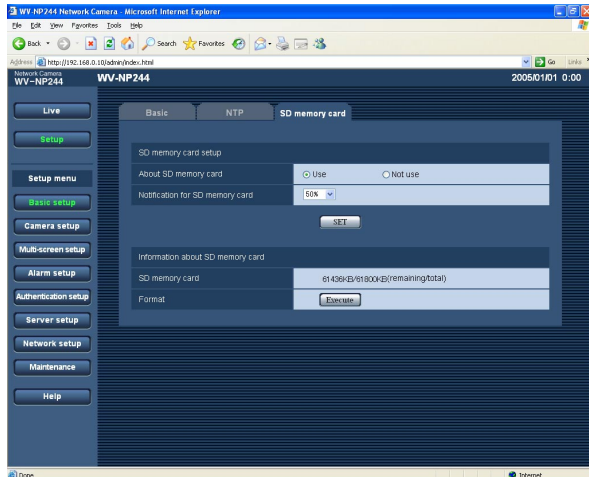

[About SD memory card]

Select "Use" or "Not use" to determine whether or not to use the SD memory card.

Important:

- Before removing the SD memory card from the camera, it is necessary to select "Not use" first.
- After inserting the SD memory card, it is necessary to select "Use" to use the SD memory card.

[Notification for SD memory card]

When the "E-mail notification" function or the "Panasonic alarm protocol" function is used to notify of the remaining space of the SD memory card, select a timing to be notified from the following. Notification will be made when the remaining space of the SD memory card reached the value selected from the following.

50%/20%/10%/5%/2%

Default: 50%

Notes:

- When "50%" is selected, notification will be made each time the remaining space reaches 50%, 20%, 10%, 5% and 2%.
- Notification may not always be made at a very moment when the remaining space of the SD memory card reached the selected value.

[SD memory card]

Available size and the total size of the SD memory card will be displayed.

Depending on the state of the SD memory card, the size indications will differ as follows.

Indication	Description
-----KB/-----KB	No SD memory card is inserted. Failed to obtain available size due to error, etc.
*****KB/*****KB	The SD card memory is unformatted, or locked, etc.

Note:

When the available size reached "0 KB", images will not be saved on the SD memory card. When the "E-mail notification" function is on, notification mail will be sent to the registered addresses when the SD memory card becomes full. (☞ page 33)

[Format]

To format the SD memory card, click the [Execute] button.

Important:

- Before formatting the SD memory card, it is necessary to select "Use" for "About SD memory card" on the [SD memory card] tab of the "Basic setup" page and "OFF" for "FTP periodic transmission" on the [FTP] tab of the "Network setup" page (☞ page 43).
- Format the SD memory card only by clicking the [Execute] button on the setup menu. Otherwise, the following functions using the SD memory card may not work properly with this camera.
 - Save/obtain images when failed to transmit to the FTP server using the FTP periodic transmission function
 - Save/obtain the system logs
- It is recommended to use Panasonic's SD memory card. Otherwise, the camera may not work properly or performance deterioration may be caused.
- It is impossible to access the SD memory card in the process of formatting.
- All data saved on the SD memory card will be deleted when the SD memory card is formatted.

- Do not turn the power of the camera off in the process of formatting.
- After formatting the SD memory card, available size may be smaller than the total size since the default directory is automatically created in the SD memory card.

Configure the settings relating to images and audio [Camera setup]

The settings relating images and audio such as brightness and image quality of JPEG/MPEG-4 can be configured on this page.

The "Camera setup" page has 3 tabs of the [JPEG/MPEG-4] tab, the [Camera] tab and the [Audio] tab.

Configure the settings relating to JPEG image [JPEG/MPEG-4]

Click the [JPEG/MPEG-4] tab on the "Camera setup" page. (page 16)

Configure the settings such as "Refresh interval (JPEG)", "Image capture size" and "Image quality" on this page.

Refer to page 23 for further information about the settings relating to MPEG-4 images.

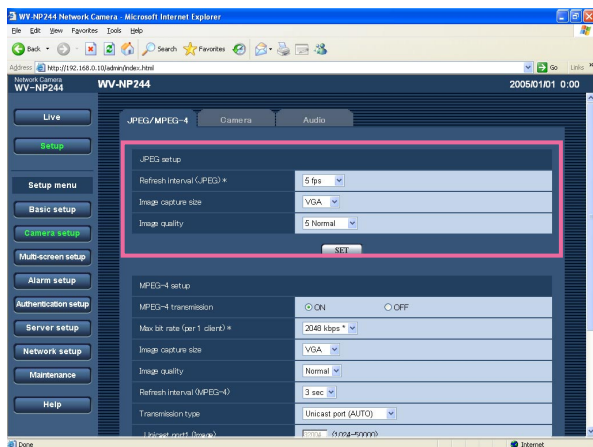

[Image capture size]

Select "QVGA" or "VGA" for the image capture size of JPEG images.

Default: VGA

[Image quality]

Select image quality for JPEG images from the following.

0 Super fine/1 Fine/2/3/4/5 Normal/6/7/8/9 Low

Default: 5 Normal

[Refresh interval (JPEG) *]

Select an interval to refresh the displayed JPEG image from the following.

0.1 fps/0.2 fps/0.33 fps/0.5 fps/1 fps/2 fps/3 fps/5 fps/
6 fps */10 fps */15 fps */30 fps *

Default: 5 fps

Note:

When "ON" is selected for "MPEG-4 transmission", the refresh intervals may be longer than the set value when the setting value with an asterisk (*) on the right is selected.

Configure the settings relating to MPEG-4 image [JPEG/MPEG-4]

Click the [JPEG/MPEG-4] tab on the "Camera setup" page. (☞ page 16)

Configure the settings such as "Refresh interval (MPEG-4)", "Image capture size" and "Image quality" on this page. Refer to page 22 for further information about the settings relating to JPEG images.

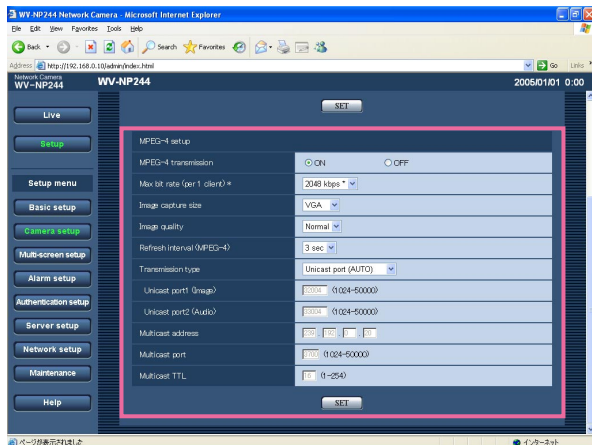

[MPEG-4 transmission]

Select "ON" or "OFF" to determine whether or not to transmit MPEG-4 images.

ON: Transmits MPEG-4 images.

OFF: Does not transmit MPEG-4 images.

Default: ON

Note:

When "ON" is selected for "MPEG-4" transmission, displaying rather of MPEG-4 image or JPEG image will be available. However, the refresh interval (JPEG) may be longer than the set value when displaying JPEG images.

[Max bit rate (per 1 client)*]

Select a MPEG-4 bit rate per a client from the following.
64 kbps/128 kbps */256 kbps */512 kbps */1024 kbps */
1536 kbps */2048 kbps */3072 kbps */4096 kbps *

Default: 2048 kbps *

Note:

The MPEG-4 bit rate is synchronized with "Total bit rate" on the [Network] tab of "Network setup" page. (☞ page 39)
For this reason, the bit rate may be lower than the value when the setting value with an asterisk (*) on the right is selected.

[Image capture size]

Select "QVGA" or "VGA" for the image capture size of MPEG-4 images.

Default: VGA

[Image quality]

Select image quality of MPEG-4 images from the following.

Fine/Normal/Low

Default: Normal

[Refresh interval (MPEG-4)]

Select an interval (1 - 5 seconds) to refresh the displayed MPEG-4 images.

If using under the network environment with frequent error occurrences, shorten the refresh interval for MPEG-4 to diminish image distortions. However, the refresh interval (MPEG-4) may be longer than the set value when displaying JPEG images.

Default: 3 sec

[Transmission type]

Select a MPEG-4 transmission type from the following.

Unicast port (AUTO): Up to 8 users can access a single camera concurrently. "Unicast port1 (Image)" and "Unicast port2 (Audio)" will automatically be selected when transmitting images and audio from the camera.

When it is unnecessary to fix the port number for MPEG-4 image transmission such as when using in a particular LAN environment, it is recommended to select "Unicast port (AUTO)".

Unicast port (MANUAL): Up to 8 users can access a single camera concurrently. It is necessary to select "Unicast port1 (Image)" and "Unicast port2 (Audio)" manually to transmit images and audio from the camera.

It is possible to fix the port number of the router used for MPEG-4 image transmission via the Internet by setting "Unicast port (MANUAL)". Refer to the operating instructions of the router in use.

Multicast: No concurrent access limitation for a camera.

* Refer to page 4 for further information about the maximum concurrent access number.

Default: Unicast port (AUTO)

[Unicast port1 (Image)]

Enter the unicast port number (used to transmit image from the camera).

Available value: 1024 - 50000 (Only even numbers are available.)

Default: 32004

[Unicast port2 (Audio)]

Enter the unicast port number (used to transmit audio from the camera).

Available value: 1024 - 50000 (Only even numbers are available.)

Default: 33004

[Multicast address]

Enter the multicast IP address.

Images and audio will be transmitted to the designated IP address.

Available address: 224.0.0.0 - 239.255.255.255

Default: 239.192.0.20

[Multicast port]

Enter the multicast port number (used to transmit MPEG-4 images from the camera).

Available port number: 1024 - 50000 (Only even numbers are available.)

Default: 37004

[Multicast TTL]

Enter the multicast TTL value.

Available value: 1 - 254

Default: 16

Important:

- Depending on the PC in use for monitoring, the multicast port number may be already in use. In this case, it may be impossible to monitor images. Change the multicast port number.
 - When transmitting MPEG-4 image via a network, the transmitted image sometimes may not be displayed. In this case, refer to the network administrator.
 - When two network interface cards or more are installed on the PC in use, the network interface card(s) not used for receiving images should be invalidated when displaying MPEG-4 images using the multicast port.
-

Configure the camera settings such as image quality and brightness, etc. [Camera]

Click the [Camera] tab on the "Camera setup" page. (page 16)

The following are descriptions of how to configure the settings relating to images such as brightness, etc.

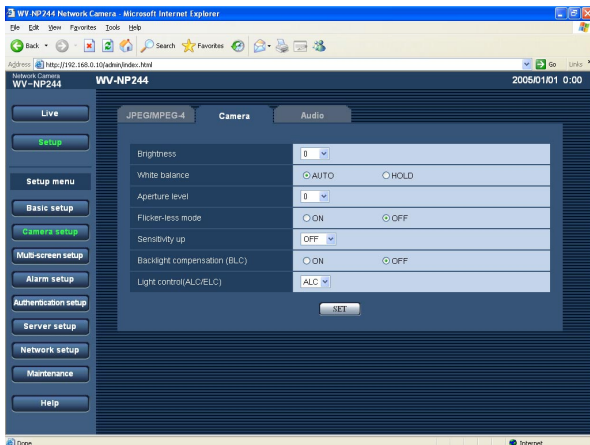

[Brightness]

17 steps (-8 - 8) are available for brightness. "-8" is the darkest and "8" is the brightest.

Default: 0

[White balance]

Select the white balance adjustment method from the following.

AUTO: Adjusts the white balance automatically.

HOLD: Fixes to the white balance applied when the [SET] button is clicked.

Default: AUTO

[Aperture level]

9 steps (-4 - 4) are available for aperture level (sharpness). "-4" is the softest and "4" is the sharpest.

Default: 0

[Flicker-less mode]

Select "ON" or "OFF" to determine whether or not to use the flicker-less mode. Normally, select "OFF". When using the camera under fluorescent lamps and flickers appear, select "ON".

Default: OFF

[Sensitivity up]

Select the sensitivity from the following.

OFF: Does not use the sensitivity adjustment.

[x2]: Adjusts the sensitivity up to x2 automatically.

[x4]: Adjusts the sensitivity up to x4 automatically.

[x8]: Adjusts the sensitivity up to x8 automatically.

[x16]: Adjusts the sensitivity up to x16 automatically.

Default: OFF

Important:

When the sensitivity is incremented, the refresh interval may be longer.

[Backlight compensation (BLC)]

Select "ON" or "OFF" to determine whether or not to compensate backlight.

ON: Compensates backlight. (Suitable when the subject has backlight.)

OFF: Does not compensate backlight. (Suitable when the subject has light in the front.)

Default: OFF

[Light control (ALC/ELC)]

Select "ALC" or "ELC" for light control according to the lens in use.

ALC: Select this when an auto iris lens (DC) is in use.

ELC: Select this when a fixed iris lens is in use.

Default: ALC

Important:

- When "ELC" is selected, "ON" for "Flicker-less mode" will be unavailable.
 - Video servo type lenses are not supported.
 - When "ON" is selected for "Flicker-less mode", sensitivity may be decremented.
-

Configure the settings relating to audio [Audio]

Click the [Audio] tab on the "Camera setup" page. (page 16)
The settings relating to audio can be configured on this page.

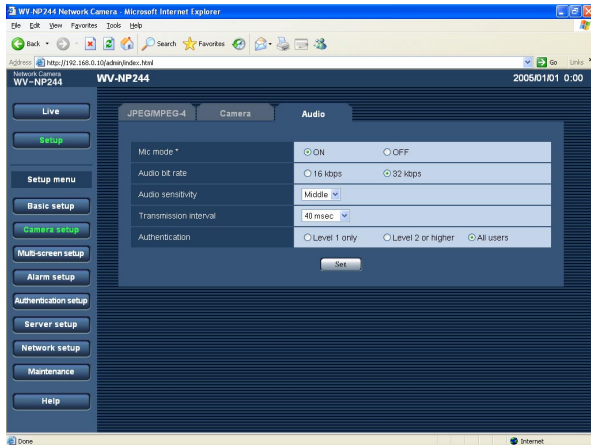

[Mic mode*]

Select "ON" or "OFF" to determine whether to turn on or off audio on a PC.

ON: Transmits audio from the camera to the PC. Audio can be heard with images on the PC. Images and audio will not be synchronized.

OFF: Does not transmit audio from the camera to the PC. Therefore, no settings and controls relating audio will be invalidated.

Default: ON

[Audio bit rate]

Select "16 kbps" or "32 kbps" for audio bit rate.

Default: 32 kbps

[Audio sensitivity]

Select the sensitivity of the built-in microphone of the camera from the following.

Low/Middle/High

Default: Middle

[Transmission interval]

Select an interval for audio transmission from the following.

20 msec/40 msec/80 msec/160 msec

Default: 40 msec

Note:

When a shorter interval is selected, delay time will be shorter. When a longer interval is selected, audio interruption may be diminished even though delay time will be longer.

Select the interval according to the network environment.

[Authentication]

Select an access level for audio transmission from the following. Refer to page 35 for further information about the access level.

Level 1 only/Level 2 or higher/All users

Default: All users

Note:

Images and audio will not be synchronized.

Configure the multi-screen settings [Multi-screen setup]

The cameras to be used for the multi-screen display can be registered on this page.
Refer to page 16 for descriptions of how to display "Multi-screen setup" page.

Note:

The following cameras are applicable for the multi-screen display. (as of April 2008)
WV-NF284 series, WV-NS202 series, WV-NP240 series, WV-NP1000 series, WV-NW470S series, WV-NP472,
WV-NS320 series, WV-NW484S series, WV-NS950 series, WV-NW960 series

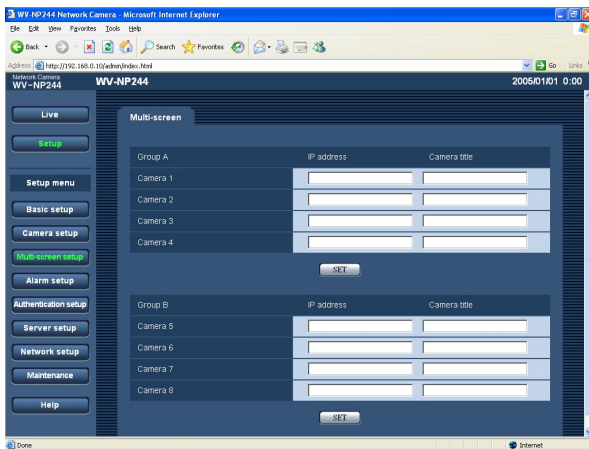

[IP address]

Enter the IP address or the host name of the camera to be used for the multi-screen. 4 cameras can be registered as a group and up to 2 groups (8 cameras) can be registered.

When the HTTP port number for the camera had been changed, enter as follows:

"IP address of the camera:port number", for example
"192. 168. 0. 10:8080".

Number of characters for the IP address: 1 - 128
characters

Note:

When using the host name, it is necessary to configure the DNS settings of the PC in use. (☞ page 40)

[Camera title]

The entered camera title will be displayed on a multi-screen.

Number of characters for the camera title: 0 - 20
characters

Configure the alarm settings [Alarm setup]

The settings relating to alarm occurrences such as settings for the alarm action at an alarm occurrence, the alarm occurrence notification, and the VMD area settings can be configured on this page.

The "Alarm setup" page has 3 tabs of the [Alarm] tab, the [VMD area] tab and the [Notification] tab.

Configure the settings relating to the alarm action [Alarm]

Click the [Alarm] tab on the "Alarm setup" page. (See page 16)

The settings relating to the alarm action can be configured on this page. Refer to pages 29 and 30 for further information about the settings relating to the alarm image and the alarm out connector.

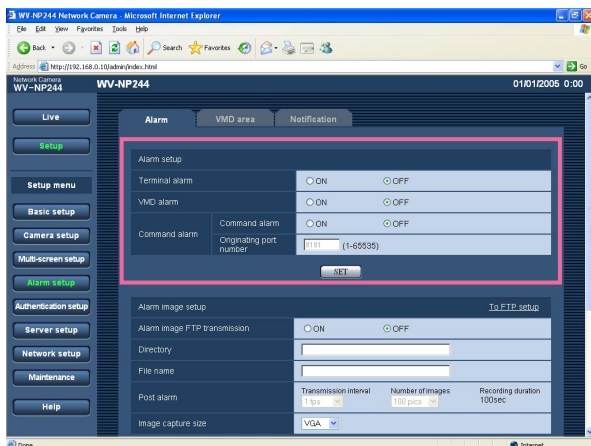

[Originating port number]

Select a port number to be used to receive the command alarm.

Available port number: 1 - 65535

Default: 8181

[Terminal alarm]

Select "ON" or "OFF" to determine whether or not to receive the terminal alarm.

Default: OFF

[VMD alarm]

Select "ON" or "OFF" to determine whether or not to perform the alarm action using the VMD function. Refer to page 31 for descriptions of how to set the VMD areas.

Default: OFF

[Command alarm]

Select "ON" or "OFF" to determine whether or not to receive the command alarm.

The command alarm is the function that notifies of Panasonic protocol alarm from the other cameras. When "ON" is selected, alarm actions will be performed between multiple cameras.

Default: OFF

Configure the settings relating to the alarm image [Alarm image setup]

Click the [Alarm] tab on the "Alarm setup" page. (☞ page 16)

The settings relating to the alarm image to be transmitted to the FTP server can be configured on this page. The alarm image will be transmitted to the FTP server. To transmit alarm images to the FTP server, it is necessary to configure the settings in advance. (☞ page 38)

Refer to pages 28 and 30 for further information about the settings relating to the alarm action and the alarm out connector.

Important:

Depending on the network line speed or the network traffic, images may not be transmitted at the exact designated interval or period.

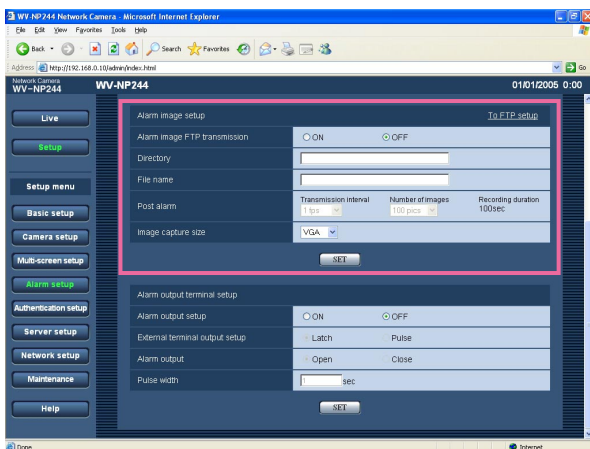

[Alarm image FTP transmission]

Select "ON" or "OFF" to determine whether or not to transmit the alarm image to the FTP server.

Default: OFF

[Directory]

Enter the directory name where the alarm images are to be saved.

For example, enter "/ALARM" to designate the directory "ALARM" under the FTP root directory.

Number of characters for the directory name: 0 - 256 characters

[File name]

Enter the file name used for the alarm image to be transmitted to the FTP server. The file name will be as follows.

["Entered file name" + "Time and date (year/month/day/hour/minute/second)"] + "Serial number"

Number of characters for the camera location: 1 - 8 characters

[Transmission interval]

Select a transmission interval for the alarm image FTP transmission from the following.

0.1 fps/0.2 fps/0.33 fps/0.5 fps/1 fps

Default: 1 fps

[Number of images]

Select the number of images to be transmitted from the following.

10 pics/20 pics/ 30 pics/50 pics/100 pics/200 pics/
300 pics/500 pics/1000 pics/2000 pics/3000 pics/
5000 pics

Default: 100 pics

[Recording duration]

Approximate time to be taken to save the set "number of images" with the set "transmission interval" will be displayed.

[Image capture size]

Select "QVGA" or "VGA" for the image capture size of images to be transmitted to the FTP server or of an image to be attached to the alarm mail.

Default: VGA

Configure the settings relating to the alarm out connector [Alarm output setup]

Click the [Alarm] tab on the "Alarm setup" page. (page 16)

The settings relating to the alarm out connector can be configured on this page. Refer to pages 28 and 29 for further information about the settings relating to the alarm action and the alarm image.

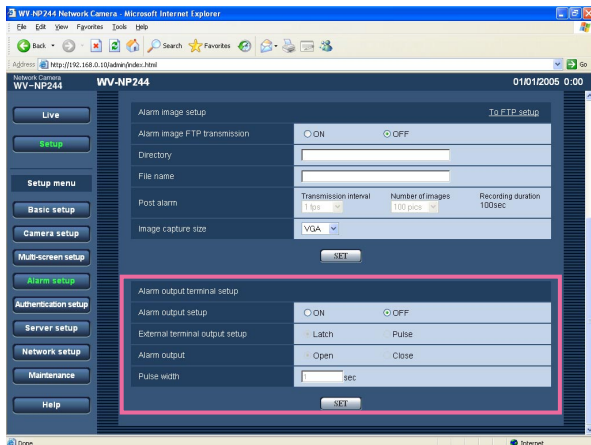

Note:

When "Open" is selected, the alarm signal will be output for around 20 seconds when the power of the camera is turned on.

[Pulse width]

When "Pulse" is selected for "Alarm output", select an pulse width.

Available pulse width: 1 - 120 sec

Default: 1 sec

[Alarm output setup]

Select "ON" or "OFF" to determine whether or not to output the alarm signals to the alarm out connector when an alarm is detected.

Default: OFF

[External terminal output setup]

Select "Latch" or "Pulse" for the alarm out connector at an alarm occurrence.

Latch: When an alarm is detected, alarm output connector will be in the state selected for "Alarm output" until the [Alarm reset] button is clicked.

Pulse: When an alarm is detected, alarm output connector will be in the opposite state to the "Alarm output" setting for the period set for "Pulse width".

Default: Latch

[Alarm Output]

Select "Open" or "Close" to determine whether to open or close the alarm output connector when output the alarm signals.

Open: The alarm out connector will open when output the alarm signals. (Normally close)

Close: The alarm out connector will close when output the alarm signals. (Normally open)

Default: Open

Set the VMD areas [VMD area]

Click the [VMD area] tab on the "Alarm setup" page. (→ page 16)

The video motion detection areas can be set on this page.

When a motion is detected in the set area, the alarm action will be performed.

Set the VMD areas

Step 1

Set the video motion detection area by dragging the mouse on the screen. When the [All areas] button is clicked, the whole area will become the VMD area, and "1 (White)" will be automatically applied to "Area".

→ The designated area will become the VMD area and the outline will be displayed. When 2 - 4 VMD areas are set, each area will be numbered in order.

The areas will be identified by the respective outline colours.

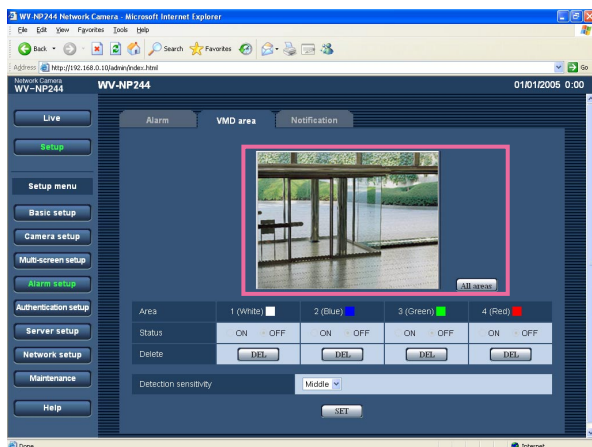

Step 2

Select "ON" or "OFF" for "Status" of each VMD area. When the [SET] button is clicked after selecting "OFF", the outline will become the broken line and no alarm action will be performed even when a motion is detected in the area.

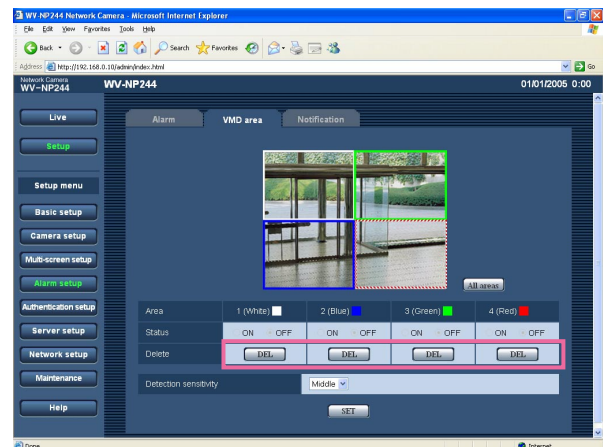

Step 3

Select the detection sensitivity from the following. The selected detection sensitivity will be applied to all the VMD areas.

High/Middle/Low

Default: Middle

Step 4

Click the [SET] button after completing the settings.

Important:

The setting will not be applied unless the [SET] button is clicked.

Delete the set VMD area

Step 1

Click the [Delete] button respective to the area to be deleted.

→ The outline of the area will disappear.

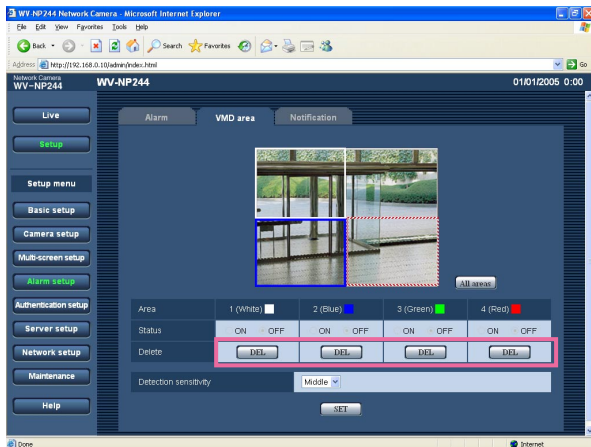

Step 2

Click the [SET] button.

→ The deletion will be completed.

Important:

The deletion will not be completed unless the [SET] button is clicked.

Configure the settings relating to the mail notification [Notification]

Click the [Notification] tab on the "Alarm setup" page. (☞ page 16)

The settings relating to the alarm mail can be configured on this page. To notify of an alarm occurrence by e-mail, it is necessary to configure the settings of the mail server. (☞ page 37)

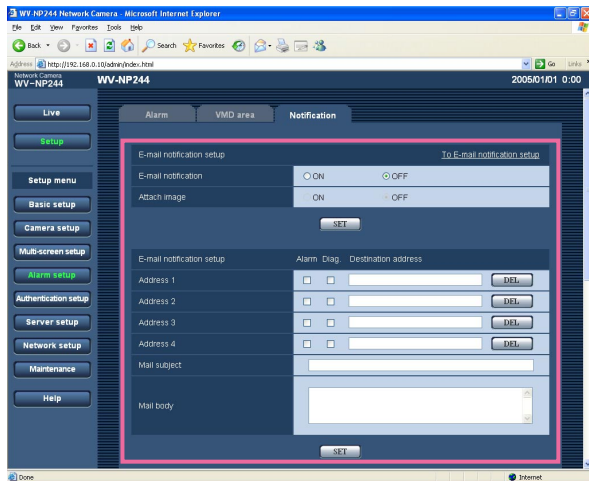

[E-mail notification]

Select "ON" or "OFF" to determine whether or not to notify of an alarm occurrence by e-mail at an alarm occurrence.

Default: OFF

[Attach image]

Select "ON" or "OFF" to determine whether or not to attach an image to the mail to be sent.

Default: OFF

Note:

The settings for "Image capture size" of "Alarm image setup" on the [Alarm] tab (☞ page 29) will be applied to the size of the image to be attached.

[Address]

Enter the destination mail address. Up to 4 destination addresses can be registered.

To notify by e-mail when an alarm occurred, check the "Alarm" checkbox respective to the desired address.

To notify by e-mail when any of the following occurred, check the "Diag." checkbox respective to the desired address.

- When notification of the remaining space of the SD memory card has been made (☞ page 21)
- When the SD memory card became full
- When mounting of the SD memory card failed

To delete the registered address, click the [DEL] button respective to the desired address.

Number of characters for the destination mail address: 3 - 128 characters

[Mail subject]

Enter the mail subject.

Number of characters for the mail subject: 0 - 50 characters

[Mail body]

Enter the mail body.

Number of characters for the mail body: 0 - 200 characters

Note:

Notification mail will be sent with the following message. (The message to be sent differs depending on the status of the SD memory card).

- "The SD memory card is full." (This message will be sent when the SD memory card becomes full.)
 - "The SD memory card cannot be recognized." (This message will be sent when failed to mount the SD memory card.)
-

Configure the settings relating to Panasonic alarm protocol [Panasonic alarm protocol]

Click the [Notification] tab on the "Alarm setup" page. (☞ page 16)

The settings relating to Panasonic alarm protocol can be configured on this page.

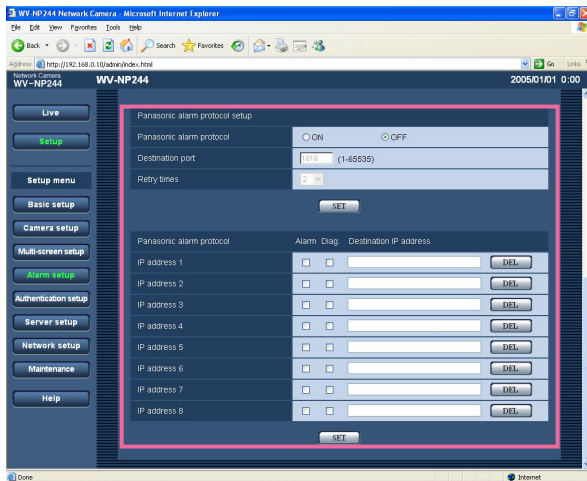

[Panasonic alarm protocol]

Select "ON" or "OFF" to determine whether or not to notify of an alarm occurrence by Panasonic alarm protocol when an alarm is detected.

Default: OFF

Note:

When "ON" is selected, the alarm occurrence will be notified to the registered destination IP addresses in order (to IP address 1 first, to IP address 8 last).

[Destination port]

Select a destination port of the Panasonic alarm protocol from the following.

Available port number: 1 - 65535

Default: 1818

[Retry times]

Select a retry time of Panasonic alarm protocol.

Available retry times: 1 - 30

Default: 2

[Destination IP address]

Enter the destination IP address of the Panasonic alarm protocol from the following. Up to 8 destination addresses can be registered.

To notify by Panasonic alarm protocol when an alarm occurred, check the "Alarm" checkbox respective to the desired address.

To notify by Panasonic alarm protocol when any of the following occurred, check the "Diag." checkbox respective to the desired address.

- When notification of the remaining space of the SD memory card has been made (☞ page 21)
- When the SD memory card became full
- When mounting of the SD memory card failed

To delete the registered address, click the [DEL] button respective to the desired address.

Important:

Confirm that the destination IP addresses are registered correctly. When a registered IP address does not exist, notification may be delayed.

Configure the settings relating to the authentication [Authentication setup]

The settings relating to the authentication such as users and PCs restrictions for accessing the camera can be configured on this page.

The "Authentication setup" page has 2 tabs of the [User] tab and the [Host] tab.

Configure the settings relating to the user authentication [User]

Click the [User] tab on the "Authentication setup" page. (page 16)

The settings relating to the user authentication can be configured on this page. Up to 16 users can be registered.

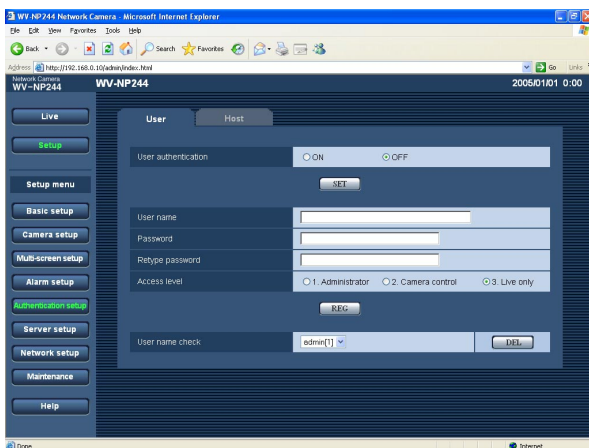

[User authentication]

Select ON or OFF to determine whether or not to authenticate the user.

Default: OFF

[User name]

Enter a user name.

Number of characters for the user name: 1 - 32 characters

Default: (blank)

[Password] [Retype password]

Enter the password.

Number of characters for the password: 4 - 32 characters

Default: (blank)

Note:

When the user name already in use is entered and the [REG] button is clicked, the respective user information will be overwritten.

[Access level]

Select the access level of the user from the following.

1. Administrator: Allowed all available operations of the camera.
2. Camera control: Allowed to display images from the camera and to control the camera. The camera setting configuration is unavailable.
3. Live only: Only displaying live images is available. The camera setting configuration and camera control are unavailable.

Default: 3. Live only

Note:

By clicking [✓] of "User name check", the registered user can be selected and the selected user's information can be checked.

The registered user will be displayed with the access level. (Example: admin [1])

To delete the registered user, click the [DEL] button after selecting the user to be deleted.

Important:

If all users whose access level is "1. Administrator" is deleted, it will be impossible to configure the settings.

Configure the settings relating to the host authentication [Host]

Click the [Host] tab on the "Authentication setup" page. (page 16)

The settings to restrict PCs (IP address) to access the camera can be configured on this page.

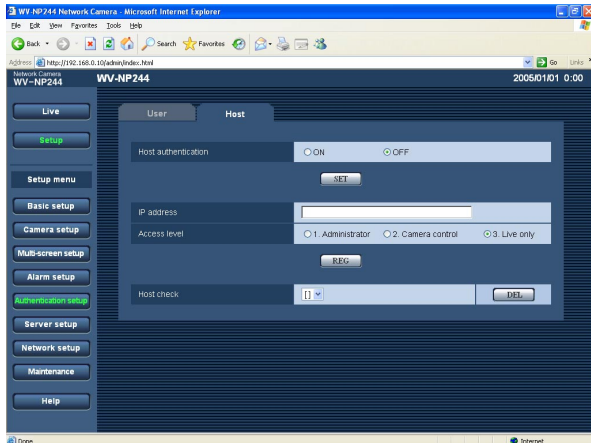

[Host authentication]

Select ON or OFF to determine whether or not to authenticate the host.

Default: OFF

Important:

Before configuring the host authentication, it is necessary to register IP addresses of the PCs to be allowed to access the camera and determine their access levels. If "ON" is selected for "Host authentication" before registering the hosts (IP addresses), it will be impossible to access the camera.

[IP address]

Enter the IP address of the PC to be allowed to access the camera.

Host name is unavailable for the IP address.

Notes:

- When "IP address/subnet mask" is entered, it is possible to restrict PCs in each subnet.
For example, when "192. 168. 0. 1/24" is entered and "2. Camera control" is selected for the access level, the PCs whose IP address is between "192.168.0.0" - "192.168.0.255" can access the camera with the access level "2. Camera control".
- When the IP address already in use is entered and the [REG] button is clicked, the respective host information will be overwritten.

[Access level]

Select the access level of the host from the following.

1. Administrator/2. Camera control/3. Live only
Refer to page 35 for further information about the access level.

Default: 3. Live only

Note:

- By clicking [√] of "Host check", the registered host can be selected and the selected host's IP address can be checked.
The registered IP address will be displayed with the access level. (Example: 192.168.0.21 [1])
To delete the registered host, click the [DEL] button after selecting the IP address to be deleted.

Configure the settings of the servers [Server setup]

The settings relating to the mail server and the FTP server can be configured on this page.
The "Server setup" page has 2 tabs of the [Mail] tab and the [FTP] tab.

Configure the settings relating to the mail server [Mail]

Click the [Mail] tab on the "Server setup" page. (page 16)

The settings relating to the mail server used to send the alarm mail can be configured on this page.

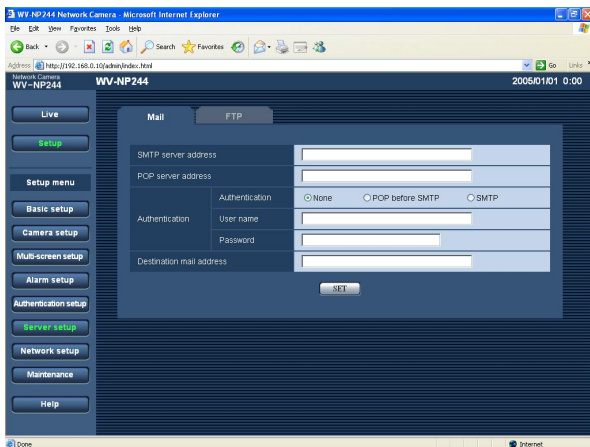

[SMTP server address]*

Enter the IP address or the host name of the SMTP server used to send e-mails.

Number of characters for the SMTP server address:

1 - 128 characters

[POP server address]*

When "POP before SMTP" is selected for "Authentication", enter the IP address or the host name of the POP server.

Number of characters for the POP server address:

1 - 128 characters

* Important:

When entering the host name for "SMTP server address/POP server address", it is necessary to configure the DNS settings on the [Network] tab of the "Network setup" page. (page 40)

[Authentication]

Select the authentication method to send e-mails from the following.

None: It is unnecessary to clear any authentication to send e-mails.

POP before SMTP: It is necessary to clear the POP server authentication first to use the SMTP server to send e-mails.

SMTP: It is necessary to clear the SMTP server authentication to send e-mails.

Default: None

Note:

When you don't know the authentication method to send e-mails, refer to the network administrator.

[User name]

Enter the user name to access the server.

Number of characters for the user name: 1 - 32 characters

[Password]

Enter the password to access the server.

Number of characters for the password: 0 - 32 characters

[Sender's mail address]

Enter the mail address of a sender.

Entered mail address will be displayed in the "From" (sender) line of the sent mails.

Number of characters for the sender's mail address:

3 - 128 characters

Configure the settings relating to the FTP server [FTP]

Click the [FTP] tab on the "Server setup" page. (☞ page 16)

The settings relating to the FTP server used to transmit the alarm images can be configured on this page.

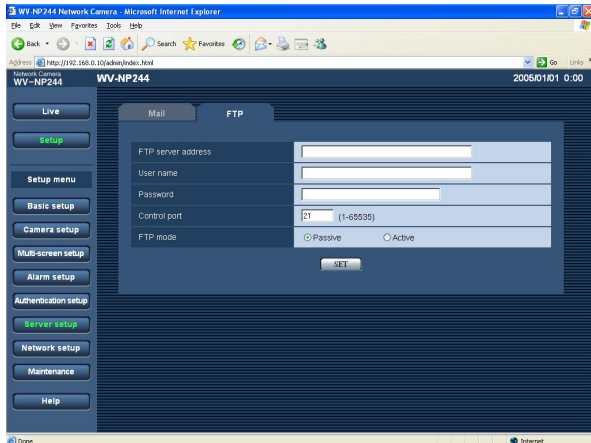

[Control port]

Enter a control port number to be used for the FTP server.

Available port number: 1 - 65535

Default: 21

[FTP mode]

Select "Passive" or "Active" for the FTP mode.

Normally, select "Passive". When failed to establish the connection, select "Active".

Default: Passive

[FTP server address]

Enter the IP address or the host name of the FTP server.

Number of characters for the FTP server address:

1 - 128 characters

Note:

When entering "localhost" for "FTP server address", alarm images will be saved on the SD memory card instead of being transmitted to the FTP server.

In this case, alarm images will not be transmitted to the FTP server.

Important:

When entering the host name for "FTP server address", it is necessary to configure the DNS settings on the [Network] tab of the "Network setup" page. (☞ page 40)

[User name]

Enter the user name (login name) to access the FTP server.

Number of characters for the user name: 1 - 32 characters

[Password]

Enter the password to access the FTP server.

Number of characters for the password: 0 - 32 characters

Configuring the network settings [Network setup]

The network settings and the settings relating to DDNS (Dynamic DNS) and SNMP (Simple Network management Protocol) can be configured on this page.

The "Network setup" page has 3 tabs of the [Network] tab, the [DDNS] tab, the [SNMP] tab and the [FTP] tab.

Configure the network settings [Network]

Click the [Network] tab on the "Network setup" page. (page 16)

The following information is required to configure the network settings.

Contact the network administrator or your Internet service provider.

- IP address
- Net mask
- Default gateway (when using the gateway server/router)
- HTTP port Number
- Primary DNS, Secondary DNS (when using DNS)

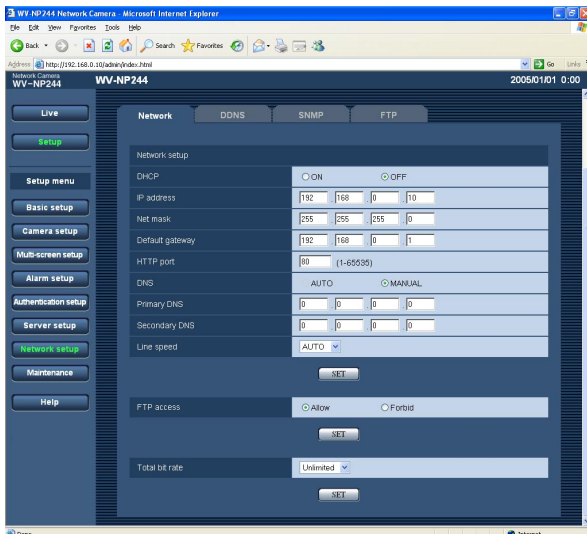

[DHCP]

Select "ON" or "OFF" to determine whether or not to use the DHCP function.

Configure the DHCP server not to assign the same IP addresses used for the other network cameras and PCs whose IP address is unique.

Refer to the network administrator for the settings of the server.

Default: OFF

[IP address]

When not using the DHCP function, enter the IP address of the camera. Do not enter the IP address already in use (for the PCs and the other network cameras).

Default: 192.168.0.10

<Unavailable IP addresses>

0. * . * . *
* . * . * . 0
255. * . * . *
* . * . * . 255
127.0.0.1

Class D address (224.0.0.0 - 239.255.255.255)

Class E address (240.0.0.0 - 255.255.255.255)

Note:

These IP addresses are unavailable even when using the DHCP function. Refer to the network administrator for the settings of the DHCP server.

[Net mask]

When not using the DHCP function, enter the net mask of the camera.

Default: 255.255.255.0

[Default gateway]

When not using the DHCP function, enter the default gateway of the camera.

Default: 192.168.0.1

<Unavailable IP addresses for the default gateway>

0. * . * . *

* . * . * . 0

255. * . * . *

* . * . * . 255

127.0.0.1

Class D address (224.0.0.0 - 239.255.255.255)

Class E address (240.0.0.0 - 255.255.255.255)

Note:

These IP addresses for the default gateway are unavailable even when using the DHCP function. Refer to the network administrator for the settings of the DHCP server.

[HTTP port]

Assign the port numbers independently.

The following port numbers are unavailable since they are already in use.

Available port number: 1 - 65535

Default: 80

<Port numbers already in use>

20, 21, 23, 25, 42, 53, 67, 68, 69, 110, 123, 161, 162, 995, 10669, 10670

[DNS]

Select "AUTO" or "MANUAL" to determine whether or not to use the DNS. When "MANUAL" is selected, it is necessary to configure the settings for the DNS.

When using the DHCP function, it is possible to obtain the DNS address automatically by selecting "AUTO". Refer to the network administrator for further information about the settings.

Default: MANUAL

[Primary DNS], [Secondary DNS]

When "MANUAL" is selected for "DNS", enter the IP address of the DNS. Refer to the network administrator about the IP address of the DNS.

[Line speed]

Select the line speed for data transmission from the followings. It is recommended to use with the default setting "AUTO".

AUTO/100 MF (Mbps full-duplex)/100 MH (Mbps half-duplex)/10 MF (Mbps full-duplex)/10 MH (Mbps half-duplex)

Default: AUTO

[FTP access]

Select "Allow" or "Forbid" to determine whether to allow or forbid the FTP access.

Default: Forbid

[Total bit rate]

Select the total bit rate for data transmission from the followings.

64 kbps/128 kbps/256 kbps/512 kbps/1024 kbps/

2048 kbps/4096 kbps/Unlimited

Default: Unlimited

Notes:

- When selecting "64 kbps", select "OFF" for "Mic mode" on the "Audio" tab. (page 26)
 - When "64 kbps" is selected, it is impossible to carry out the live-transmission of JPEG images and the FTP periodic transmission simultaneously.
-

Notes:

- The port forwarding function changes a global IP address to a private IP address, and "Static IP masquerade" and "Network Address Translation (NAT)" have this function. This function is to be set in a router.
- To access the camera via the Internet by connecting the camera to a broadband router, it is necessary to assign a respective port number for each camera and address translation by using the port forwarding function. For further information, refer to the operating instructions of the broadband router in use.

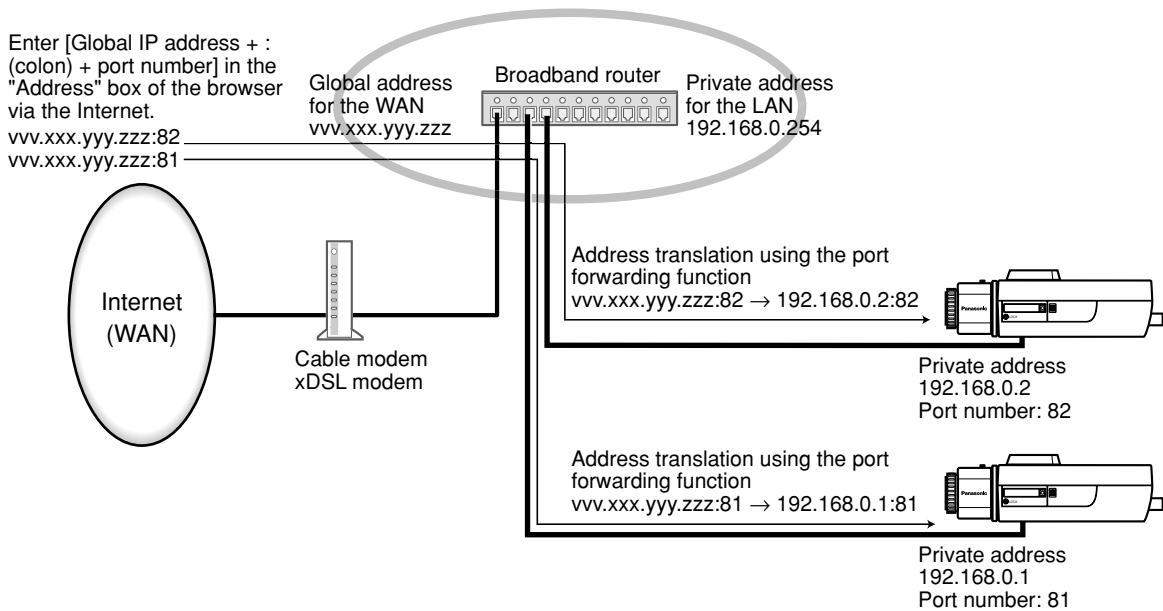

Configure the settings relating to DDNS [DDNS]

Click the [DDNS] tab on the "Network setup" page. (page 16)

The settings relating to DDNS can be configured on this page.

When accessing the camera via the Internet from the network environment of which the global IP address is obtained using DHCP, the DDNS function is necessary.

When using the DDNS function, it is possible to access with "Host name registered in the DDNS server. nmdns.net". To use the DDNS function, it is necessary to connect to the dedicated DDNS server. Refer to the web site for further information about the DDNS. Refer to the "Readme" file about the web site.

It is necessary to configure the host name, user name and password registered in the DDNS server.

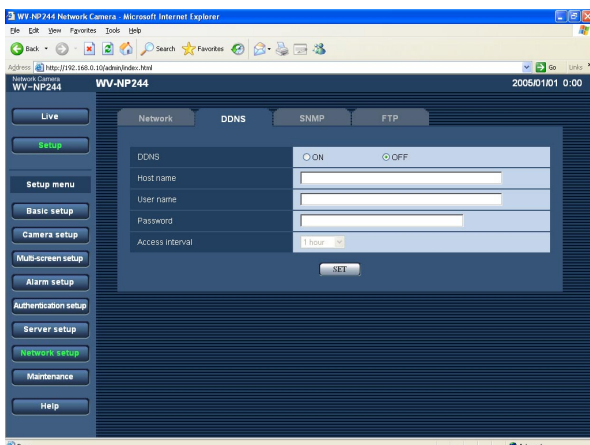

[DDNS]

Select "ON" or "OFF" to determine whether or not to use the DDNS function.

Default: OFF

[Host name]

Enter the host name to be used.

Number of characters for the host name: 1 - 64 characters

[User name]

Enter the user name (login name) to access the DDNS server.

Number of characters for the user name: 1 - 32 characters

[Password]

Enter the password to access the DDNS server.

Number of characters for the password: 0 - 32 characters

[Access interval]

Select the interval to access the DDNS server to check the IP address and the host name from the following.

1 min/10 min/30 min/1 hour/6 hours/24 hours

Default: 1 hour

Configure the settings relating to SNMP [SNMP]

Click the [SNMP] tab on the "Network setup" page. (page 16)

The settings relating to SNMP can be configured on this page. It is possible to check the status of the camera by connecting to the SNMP manager. When using the SNMP function, contact the network administrator.

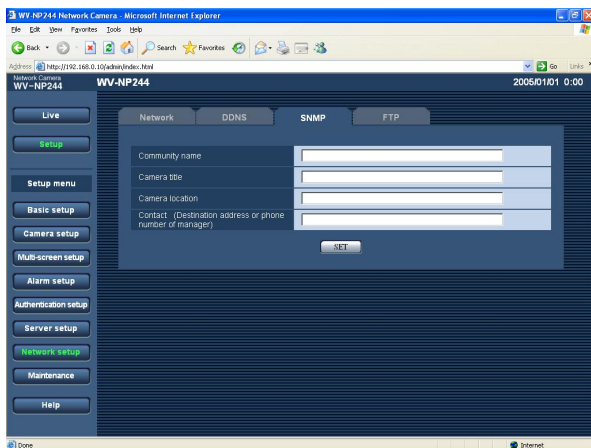

[Camera location]

Enter the name of the location where the camera is installed.

Number of characters for the camera location: 0 - 32 characters

Default: (blank)

[Contact (Destination address or phone number of manager)]

Enter the mail address or the phone number of the SNMP manager.

Number of characters for the destination address or the phone number of manager: 0 - 255 characters

Default: (blank)

[Community name]

Enter the community name to be monitored.

Number of characters for the community name: 0 - 32 characters

Default: (blank)

Important:

When using the SNMP function, it is necessary to enter the community name. When no community name is entered, the SNMP function will not work.

[Camera title]

Enter a camera title to be used to manage the camera with the SNMP function.

Number of characters for the camera title: 0 - 32 characters

Default: (blank)

Configure the settings relating to the FTP periodic transmission [FTP periodic transmission]

Click the [FTP] tab on the "Network setup" page. (☞ page 16)

The settings relating to the periodic transmission of images to an FTP server can be configured on this page. To transmit images to an FTP server periodically, it is necessary to configure the settings of the FTP server in advance. (☞ page 38)

Refer to page 44 for descriptions of how to configure schedules of image transmission.

Important:

- Depending on the network line speed or the network traffic, images may not be transmitted at the exact designated interval or period.
- When "ON" is selected for both of the alarm image FTP transmission function and the FTP periodic transmission function, the alarm image FTP transmission function will be given priority over the FTP periodic transmission function. For this reason, images may not be transmitted at the exact designated interval or period if alarms occur frequently.

Note:

Images failed to transmit by the FTP periodic transmission can be saved automatically on the SD memory card. (☞ page 21)

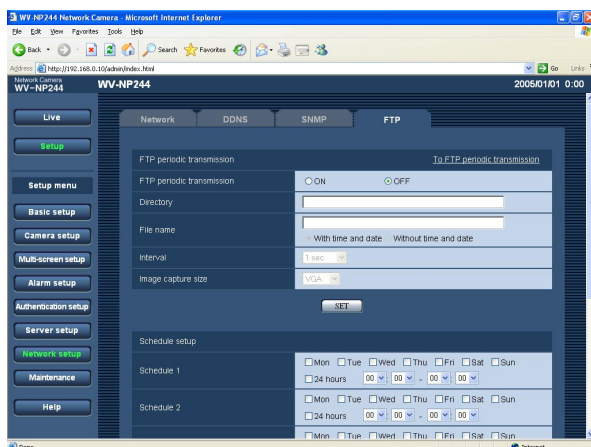

[FTP periodic transmission]

Select "ON" or "OFF" to determine whether or not to transmit images using the FTP periodic transmission function.

When "ON" is selected, it is necessary to configure the settings of the FTP server. (☞ page 38)

Default: OFF

[Directory]

Enter the directory name where the images are to be saved.

For example, enter "/img" to designate the directory "img" under the FTP root directory.

Number of characters for the directory name: 0 - 256 characters

Default: (blank)

[File name]

Enter the file name (name of the image file to be transmitted) and select the naming option from the following.

With time and date: File name will be ["Entered file name" + "Time and date (year/month/day/hour/minute/second)" + "00"].

Without time and date: File name will be the characters entered for "File name" only. When "Without time and date" is selected, the file will be overwritten each time a file is transmitted newly.

Number of characters for the file name: 1 - 32 characters

Default: (blank)

[Interval]

Select the interval for the FTP periodic transmission from the following.

1 sec/2 sec/3 sec/4 sec/5 sec/6 sec/10 sec/15 sec/20 sec/30 sec/1 min/2 min/3 min/4 min/5 min/6 min/10 min/15 min/20 min/30 min/1 hour/1.5 hours/2 hours/3 hours/4 hours/6 hours/12 hours/24 hours

Default: 1 sec

[Image capture size]

Select "QVGA" or "VGA" for the image capture size of the images to be transmitted by the FTP periodic transmission.

Default: VGA

Configure the schedule settings of the FTP periodic transmission [Schedule setup]

Click the [FTP] tab on the "Network setup" page. (page 16)

The schedule settings of the FTP periodic transmission can be configured on this page. Refer to page 43 for further information about the settings relating to the FTP periodic transmission.

How to configure the schedule settings

How to delete the set schedule

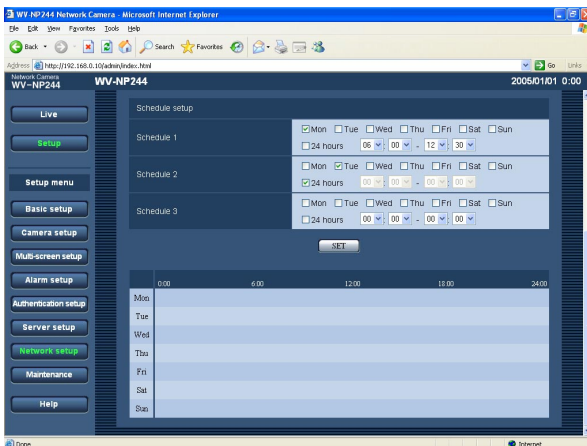

Step 1

Check the check box of the desired day of the week.
→ The selected day of the week will be validated for the schedule.

Step 2

To designate time, click [V] and select the desired "hour" and "minute".
When not designating time, check the checkbox of "24 hours".

Step 3

Click the [SET] button after completing the settings.
→ The result will be displayed at the bottom of the window.

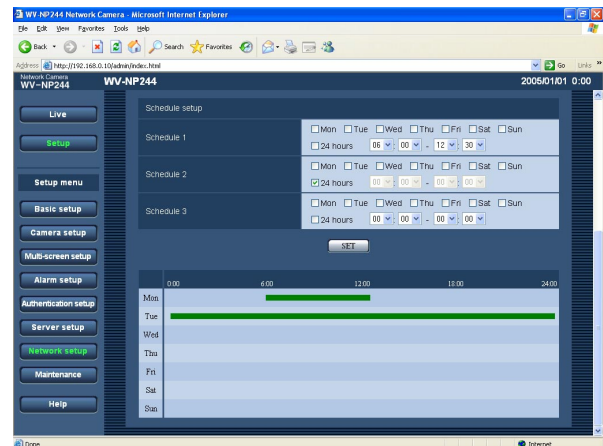
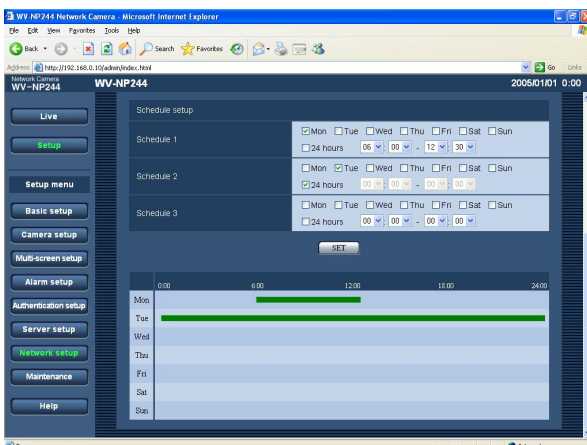

Step 1

Uncheck the check box of the set day of the week.

Step 2

Click the [SET] button after completing the settings.
→ The result will be displayed at the bottom of the window.

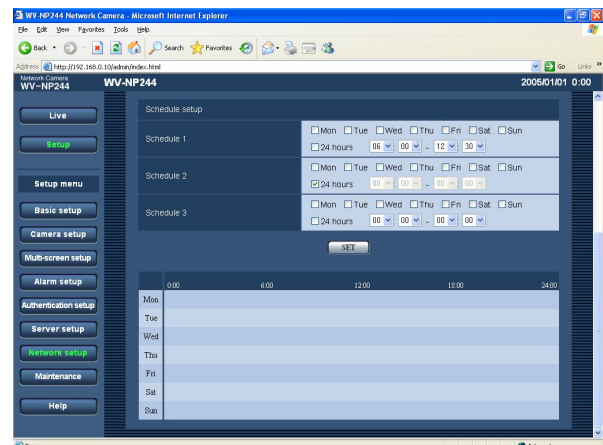

Maintenance of the camera [Maintenance]

System log check, firmware upgrade, and initialization of the setup menu can be performed on this page. The "Maintenance" page has 3 tabs of the [System log] tab, the [Upgrade] tab and the [Initialization] tab.

Check the system log [System log]

Click the [System log] tab of the "Maintenance" page. (☞ page 16)

Up to 4000 system logs can be saved on the SD memory card when the SD memory card is inserted after selecting "Use" for "About the SD memory card" on the [SD memory card] tab (☞ page 21)

When "Not use" is selected for "About the SD memory card", up to 100 system logs can be saved on the built-in memory of the camera.

When the saved system logs reached the maximum number, the older system logs will be overwritten by the newer logs. In this case, the oldest log is the first to be overwritten.

The system logs will be displayed in 100 logs each.

When using the SD memory card, the logs will be saved even when the power of the camera is turned off. When not using the SD memory card, the logs will be deleted when the power of the camera is turned off.

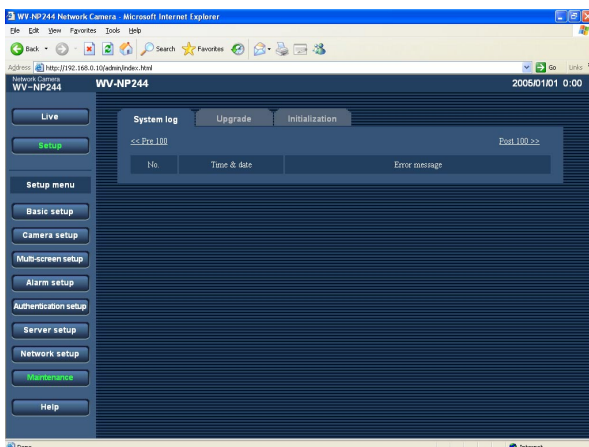

[Time & date]

Time and date at the error occurrence will be displayed.

[Error message]

The descriptions about the error will be displayed.

Refer to page 48 for further information about the system logs.

Upgrade the firmware [Upgrade]

Click the [Upgrade] tab of the "Maintenance" page. (☞ page 16)

The current firmware can be checked and upgraded to the latest version on this page. Contact the dealer for further information about the firmware upgrade.

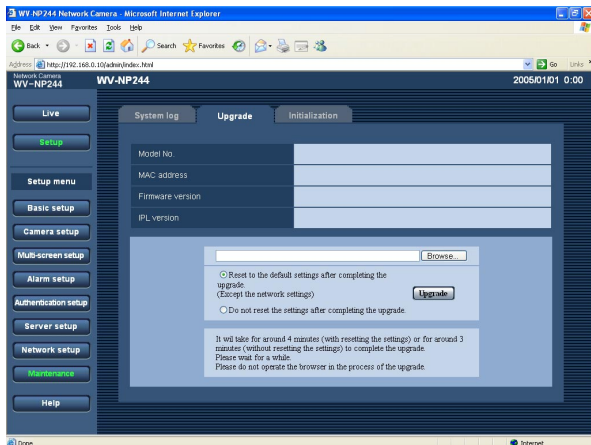

[Model No.], [MAC address], [Firmware version], [IPL version]

Information of each item will be displayed.

How to upgrade the firmware

Step 1

Contact the dealer and download the latest firmware onto a PC.

Step 2

Click the [Browse...] button and designate the downloaded firmware.

Step 3

Click the radio button respective to the desired option to determine whether or not to initialize the settings after the firmware upgrade.

Note:

Read the "readme" file provided with the firmware first and determine whether or not to initialize the settings after the firmware upgrade

Step 4

Click the [Upgrade] button.

→ The confirmation window will be displayed. When "Do not reset the settings after completing the upgrade." was selected, the confirmation window will not be displayed.

Important:

- Upgrade the firmware using a PC in the same sub-net as of the camera's.
- Follow the instruction of the dealer when upgrading the firmware.
- Use the designated file (extension:img) for the firmware upgrade.
- The name of the firmware to be used for upgrade should be "firmware.img".
- Do not turn the power of the camera off in the process of upgrade.
- Do not operate the web browser (including adjusting the window size) in the process of upgrade.
- The following network settings will not be initialized when upgrade the firmware after selecting "Reset to the default setting after completing the upgrade. (Except the network settings)".
IP address, net mask, default gateway, HTTP port, ON/OFF settings for DHCP, AUTO/MANUAL settings for DNS, DNS primary and secondary address, line speed, total bit rate, time and date setup

Initialize/restart the camera [Initialization]

Click the [Initialization] tab of the "Maintenance" page. (☞ page 16)

Initialization of the setup data and HTML files of the camera and restarting of the camera can be performed on this page.

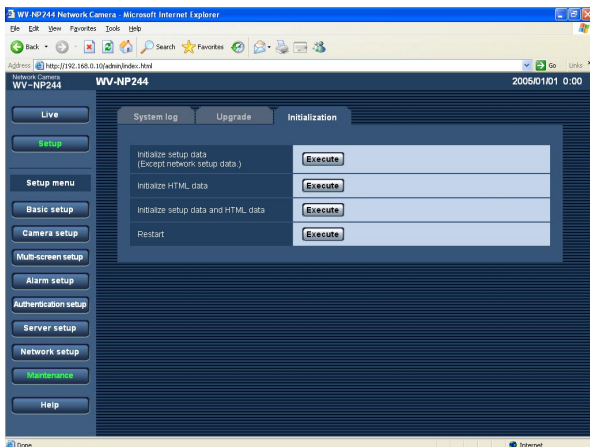

[Initialize setup data]

Click the [Execute] button to reset the settings to the default settings. However, the network settings will not be reset.

It is impossible to operate the camera for around 1 minute after the initialization.

[Initialize HTML data]

Click the [Execute] button to reset the HTML files to the default settings. It is impossible to operate the camera for around 1 minute after the initialization.

[Initialize setup data and HTML data]

Click the [Execute] button to reset the settings and the HTML files to the default settings. However, the network settings will not be reset. It is impossible to operate the camera for around 1 minute after the initialization.

[Restart]

Click the [Execute] button to restart the camera. The camera will be inoperable for around 1 minute after the restart just as when the power is turned on.

Notes:

- Turn on the power of the camera while holding down the [INITIAL SET] button of the camera, and wait around 5 seconds without releasing the [INITIAL SET] button. Wait around 30 seconds after releasing the button. The settings including the network settings (☞ page 39) will be initialized.
 - When the "E-mail notification" function is on, notification mail will be sent to the registered addresses when failed to mount the SD memory card after the restart or when the inserted SD memory card is locked. (☞ page 33)
-

About the Displayed System Log

Error indications relating to SMTP

Category	Content	Description
POP3 server error	Authentication error	Entered user name or password may be incorrect. Check if the mail settings are configured correctly.
	Cannot connect to POP3 server	<ul style="list-style-type: none">• The IP address of the server may be incorrect. Check if the IP address of the server is configured correctly.• The POP3 server may be down. Ask the network administrator.
SMTP server error	Authentication error	Entered user name or password may be incorrect. Check if the mail settings are configured correctly.
	Connection error to DNS server	<ul style="list-style-type: none">• The designated IP address of the DNS may be incorrect. Check if the DNS settings are configured correctly.• The DNS server may be down. Ask the network administrator.
	Cannot connect to SMTP server.	<ul style="list-style-type: none">• The IP address of the server may be incorrect. Check if the IP address of the server is configured correctly.• The SMTP server may be down. Ask the network administrator.
Internal error	Other error	An error occurred in the mail function. Check if the mail settings are configured correctly.

Error indications relating to FTP

Category	Content	Description
FTP server error	Connection error to DNS server	The FTP server or DNS server may be down.
	Cannot connect to FTP server.	
Connection error	File transfer error	<ul style="list-style-type: none">• The FTP server settings may be incorrect.
	Passive mode error	<ul style="list-style-type: none">• The settings relating to the indicated item may be incorrect.
	Log out failed	
	Directory change failed	
	User name and password isn't correct.	
Internal error	Other error	The FTP server settings may be incorrect.

Error indications relating to DDNS

Category	Content	Description
Connection error	Cannot connect to DDNS server.	<ul style="list-style-type: none">• The designated IP address of the DDNS may be incorrect. Check if the DDNS settings are configured correctly.• The DDNS server may be down. Ask the network administrator.
	User name or password isn't correct.	Entered user name or password may be incorrect. Check if the DDNS settings are configured correctly.
	IP address updated failed.	IP address update error occurred in the DDNS server. Ask the network administrator.
Internal error	Other error	An error occurred in the DDNS function. Check if the DDNS settings are configured correctly.

Error indications relating to NTP

Category	Content	Description
Connection error	Cannot connect to NTP server.	<ul style="list-style-type: none">• The IP address of the server may be incorrect. Check if the IP address of the server is configured correctly.• The NTP server may be down. Ask the network administrator.
Internal error	Other error	<ul style="list-style-type: none">• The designated IP address of the DNS server may be incorrect. Check if the DNS server settings are configured correctly.• The DNS server may be down. Ask the network administrator.
Time adjustment synchronizing with NTP succeeded.	Succeeded in the update. (NTP)	Time correction succeeded.

Troubleshooting

Before asking for repairs, check the symptoms with the following table.

Contact your dealer if a problem cannot be solved even after checking and trying the solution or if the problem is not described below.

Symptom	Cause/solution	Reference pages
Cannot access from the browser.	<ul style="list-style-type: none"> Is the LAN cable (category 5) is firmly connected to the network connector on the rear of the camera? 	Operating instructions
	<ul style="list-style-type: none"> Is the link LED right by the network connector lit? When it is not lit, connection to a LAN may not be established or a network may be not working correctly. Check if the cables have any contact failure or if the wiring is correct or not. 	Operating instructions
	<ul style="list-style-type: none"> Are the set IP addresses valid? 	39
	<ul style="list-style-type: none"> Are you accessing the wrong IP address? Check the connection as follows: With the Windows command prompt, > ping "IP address set for the camera" When the WV-NP240/WV-NP244 replies, the camera is functioning normally. If not, restart the WV-NP240/WV-NP244 and proceed as follows (1) Change the IP address by using the "Panasonic IP setting" software. (2) Initialize the camera by pressing the [INITIAL SET] button on the rear of the camera. The IP address will return to the default setting "192.168.0.10". 	47
	<ul style="list-style-type: none"> Is the same IP address provided to other devices? Are there contradictions between the address and the network subnet to be accessed? <When the camera and the PC are connected in the same subnet> Are the IP addresses of the camera and the PC set in a common subnet? Or is "Use Proxy Server" for the settings of the browser checked? When accessing the camera in the same subnet, it is recommended to enter the address of the camera in the "Don't Use Proxy For These Addresses" box. <When the camera and the PC are connected in the different subnet> Is the IP address of the default gateway set for the camera correct? 	—

Symptom	Cause/solution	Reference pages
Cannot access from the browser.	<ul style="list-style-type: none"> Is the power of the camera on? Check if the power of the camera is turned on. 	Operating instructions
No image is displayed.	<ul style="list-style-type: none"> Is the viewer software installed on a PC? Install the viewer software on a PC. 	Operating instructions
	<ul style="list-style-type: none"> Is the lens cap detached? Check if the lens cap is detached. 	—
The displayed images are not fit into the frame border.	<ul style="list-style-type: none"> Images may not be displayed properly when "120 dpi" is set for the dpi setting. Right-click on the desktop and select "Properties" from the displayed pop-up menu. Click the [Advanced] button on the "Settings" tab page of the displayed window, and then change the dpi setting 	—
Images are displayed blurry.	<ul style="list-style-type: none"> Aren't there dusts or dirt on the lens? Check if there are dust or dirt on the lens. 	—
	<ul style="list-style-type: none"> Is the focus adjusted correctly? Check if the focus is adjusted correctly. 	Operating instructions
The image is not being refreshed.	<ul style="list-style-type: none"> Depending on the version of your browser, there might be difficulties refreshing the picture and operating the camera. It is recommended to use Internet Explorer 6.0 SP2. 	Operating instructions
	<ul style="list-style-type: none"> Depending on the traffic of the network or the concentration of access to the camera, there might be difficulties displaying the camera picture. Click the reload button of the browser to request the camera picture to be refreshed. 	—

Symptom

When displaying MPEG-4 images on two browser windows or more, images from two cameras or more are displayed in sequence on a single browser window.

Cause/solution

- This may occur due to the display adapter and driver combination.
When this occurred, update the driver of the display adapter to the latest version first.
If updating the driver does not solve the problem, adjust the hardware acceleration as follows.
1. Right-click on the desktop and select "Properties" from the displayed pop-up menu.
 2. Select "Settings" from "Display Properties", and then click the [Advanced] button.
 3. Click the [Troubleshoot] tab and disable the DirectDraw acceleration by adjusting the level of "Hardware acceleration".

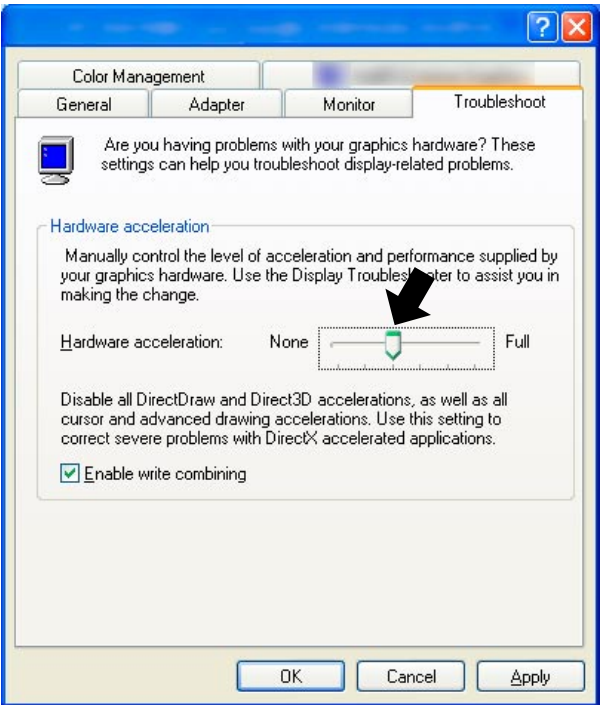

Reference pages

—

When using a PC on which Windows XP Service Pack2 (SP2) is installed

The following may occur during operation when using a PC on which Windows XP Service Pack2 (SP2) is installed. Follow the instructions below when the following occurred. By performing the following solutions, other applications and the security level may not be affected.

The "Information Bar" expressed in the following symptom and solutions will be displayed just below the address bar only when there is information to communicate.

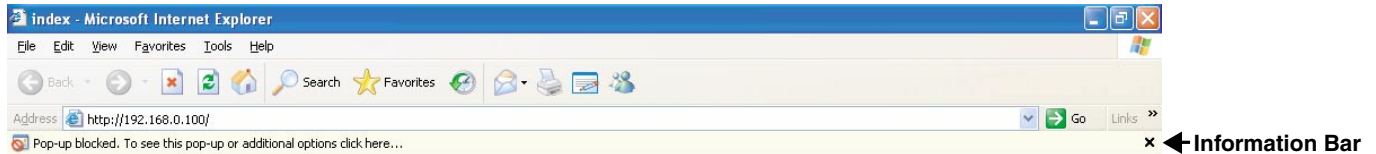

Symptom	Solutions	Reference pages
<p>The following message is displayed on the information bar. "Pop-up blocked. To see this pop-up or additional options, click here..."</p>	<ul style="list-style-type: none"> Click the information bar and select "Always Allow Pop-ups from This Site...". The dialog window saying "Allow pop-ups from this site?" will be displayed. Click the [Yes] button. 	<p>—</p>
<p>Unnecessary status bar or scroll bar is displayed on the pop-up window.</p>	<ul style="list-style-type: none"> Click "Internet Options" on the Tools menu of Internet Explorer, and then click the [Security] tab. Then, click the [Custom Level...] button to open the "Security Setting" window. Under "Miscellaneous", select "Enable" for "Allow script-initiated windows without size or position constraints". Click the [OK] button. The "Warning" window will be displayed. Click the [Yes] button. 	<p>—</p>

Panasonic Corporation

<http://panasonic.net>

Importer's name and address to follow EU rules:

Panasonic Testing Centre
Panasonic Marketing Europe GmbH
Winsbergring 15, 22525 Hamburg F.R.Germany