

**ULTRASONIX**

# SonixSP Ultrasound System User Manual







Ultrasonix Medical Corporation

# **SonixSP Ultrasound System User Manual**

Ultrasonix Medical Corporation  
130 – 4311 Viking Way  
Richmond, BC V6V 2K9  
Canada

[www.ultrasonix.com](http://www.ultrasonix.com)

1.866.437.9508  
1.604.279.8550  
1.778.296.3860 (Support)

© 2012 Ultrasonix Medical Corporation  
00.040.387, Revision F, December 10, 2012  
All Rights Reserved. Printed in Canada.

US Patents 6,216,029 - 6,325,759 - 6,558,326 - 6,911,008 - 7,274,325 - 8,088,070 - D654,178







## TABLE OF CONTENTS

---

<b>CHAPTER 1: INTRODUCTION .....</b>	<b>1-1</b>
1.1 AUDIENCE .....	1-1
1.1.1 Prescription Device .....	1-1
1.2 CONVENTIONS .....	1-1
1.3 UPDATES.....	1-2
1.4 VOLTAGE DISCLAIMER.....	1-2
1.5 CONNECTIVITY DISCLAIMER.....	1-2
1.6 PRIVACY DISCLAIMER.....	1-2
1.7 GENERAL DISCLAIMER.....	1-3
1.8 LICENSE AGREEMENT.....	1-3
1.9 WARRANTY REGISTRATION .....	1-3
1.10 TRADEMARKS AND PATENTS.....	1-4
<b>CHAPTER 2: Sonix INTRODUCTION .....</b>	<b>2-1</b>
2.1 SYSTEM COMPONENTS .....	2-1
2.2 OPERATOR CONSOLE .....	2-3
2.3 CONSOLE HEIGHT, ANGLE AND SWIVEL ADJUSTMENT .....	2-9
2.4 SYSTEM CASE .....	2-11
2.5 POWER PANEL .....	2-11
2.5.1 Powering the System.....	2-11
2.5.2 Powering the System ON/OFF .....	2-12
2.6 BACK CONNECTIVITY PANEL .....	2-13
2.7 CONSOLE CONNECTIVITY .....	2-13
2.8 UPS .....	2-14
2.8.1 UPS Use Model .....	2-14
2.9 SonixGPS .....	2-15
2.10 BARCODE READER.....	2-15
2.11 WIRELESS ADAPTER .....	2-15
2.12 FOOTSWITCH (DUAL OR TRIPLE).....	2-16
<b>CHAPTER 3: GETTING STARTED .....</b>	<b>3-1</b>
3.1 TURNING ON SYSTEM .....	3-1
3.2 CONNECTING TRANSDUCERS .....	3-2
3.3 QSonix FEATURE .....	3-3
3.3.1 Quick Exam Start-Up .....	3-3
3.3.2 Operator Console Tutorial.....	3-7
3.3.3 Documentation Access .....	3-8
3.4 REMOTE SUPPORT .....	3-9
3.5 TOUCH SCREEN LAYOUT .....	3-10
3.5.1 Main Touch Screen .....	3-10
3.5.2 Main Touch Screen – Frozen .....	3-12





<b>CHAPTER 4: PATIENT MANAGEMENT .....</b>	<b>4-1</b>
4.1 ENTERING PATIENT DATA.....	4-1
4.1.1 Patient Information.....	4-4
4.1.2 Application Information .....	4-6
4.1.2.1 OB Previous Exam (Fetal Trending).....	4-9
4.1.3 Exam Information.....	4-12
4.2 SELECTING A TRANSDUCER.....	4-14
4.3 SELECTING AN APPLICATION AND IMAGING PRESET COMBINATION.....	4-15
4.4 BEGINNING AN EXAM FOR A NEW PATIENT .....	4-16
4.5 BEGINNING AN EXAM WITH NO PATIENT SELECTED.....	4-17
4.6 ENDING AN EXAM.....	4-20
4.7 EXAM IMPORT/EXPORT.....	4-21
4.8 STORAGE/DATABASE TABS .....	4-25
4.8.1 Patients.....	4-26
4.8.1.1 Manipulating the Patients Database.....	4-27
4.8.2 DICOM Worklist.....	4-29
4.8.2.1 Manipulating the DICOM Worklist Database.....	4-30
4.8.3 Hide.....	4-32
4.9 USER-DEFINED PRESETS FOR NON-3D/4D FORMATS.....	4-33
<b>CHAPTER 5: IMAGING .....</b>	<b>5-1</b>
5.1 BASIC 2D IMAGING.....	5-1
5.1.1 Clarity (Speckle Reduction).....	5-4
5.1.2 Spatial Compound Imaging.....	5-5
5.1.3 2D Zoom Imaging .....	5-5
5.1.4 Dual Imaging Format .....	5-6
5.1.5 Quad Imaging Format.....	5-7
5.1.6 Brachytherapy and the BPC8-4/10 Transducer.....	5-8
5.1.7 M-Mode Imaging.....	5-9
5.1.7.1 Anatomic M-Mode Imaging.....	5-10
5.1.7.2 Color M-Mode Imaging.....	5-11
5.2 COLOR/POWER DOPPLER .....	5-12
5.2.1 Color Doppler Imaging Mode.....	5-13
5.2.2 Power Doppler Imaging Mode.....	5-14
5.2.3 Tissue Doppler Imaging (TDI).....	5-15
5.2.4 Simultaneous 2D/Color.....	5-15
5.3 PULSED AND CONTINUOUS WAVE DOPPLER (PW AND CW) AND TRIPLEX .....	5-16
5.3.1 PW Imaging Mode .....	5-19
5.3.2 CW Imaging Mode.....	5-20
5.3.3 Triplex Imaging Mode.....	5-21
5.4 AUTO-GAIN/B .....	5-22
5.5 ELASTOGRAPHY .....	5-23
5.6 SonixShine.....	5-25
5.7 SonixGPS .....	5-27
5.8 PANORAMIC IMAGING MODE.....	5-28
5.9 SonixDVR RECORDING .....	5-31
5.10 2D CINE OPTIONS .....	5-32
5.10.1 2D Cine Frame Indicators.....	5-32
5.10.2 2D Cine Options.....	5-33
5.10.3 Cine Clip Storage.....	5-34
5.10.4 Raw Cine Manipulation.....	5-35
5.10.5 Stored Thumbnail Review.....	5-35



- 5.11 FREEHAND 3D IMAGING (ALL NON-4D SONIX TRANSDUCERS).....5-36
- 5.12 STANDARD AND ADVANCED 3D/4D IMAGING.....5-38
  - 5.12.1 3D/4D Touch Screen Layout.....5-40
    - 5.12.1.1 4D Cine Options.....5-42
  - 5.12.2 3D/4D LCD Display Layout.....5-44
    - 5.12.2.1 3D/4D Display Mode (LCD Display and Touch Screen Options).....5-46
    - 5.12.2.2 3D/4D Render Mode (LCD Display Options Only).....5-51
    - 5.12.2.3 3D/4D User Mode (LCD Display Options Only).....5-54
    - 5.12.2.4 Advanced 3D/4D Multislice Mode (LCD Display and Touch Screen Options).....5-56
    - 5.12.2.5 3D/4D Sculpt (Touch Screen Options Only).....5-60
  - 5.12.3 Additional 3D/4D LCD Display Details.....5-61
  - 5.12.4 3D/4D Image Acquisition.....5-62
    - 5.12.4.1 3D Imaging.....5-63
    - 5.12.4.2 4D Imaging.....5-64
  - 5.12.5 Optimization of Acquired Images.....5-65
  - 5.12.6 Spline Editing of 3D/4D Images.....5-67
  - 5.12.7 Repositioning the ROI Box.....5-70
  - 5.12.8 Repositioning the MPR Plane Intersection Point.....5-71
  - 5.12.9 3D/4D Presets.....5-72
    - 5.12.9.1 Selecting a Default 3D/4D User (Preset).....5-72
    - 5.12.9.2 User-Defined 3D/4D Presets.....5-73
    - 5.12.9.3 Loading 3D/4D Presets.....5-74
    - 5.12.9.4 Resetting Factory Defaults.....5-75

**CHAPTER 6: CLINICAL ANALYSIS.....6-1**

- 6.1 GENERIC 2D MEASUREMENTS.....6-4
  - 6.1.1 2D Linear Measurement.....6-4
  - 6.1.2 Area or Circumference Measurement.....6-6
    - 6.1.2.1 Ellipse Method Area or Circumference Measurement.....6-6
    - 6.1.2.2 Continual Method Area or Circumference Measurement.....6-7
    - 6.1.2.3 Point by Point Area or Circumference Measurement.....6-8
    - 6.1.2.4 Cross Area or Circumference Measurement.....6-9
  - 6.1.3 Volume Calculation.....6-10
  - 6.1.4 Percent Diameter Reduction Calculation (% Diam Red).....6-11
  - 6.1.5 Percent Area Reduction Calculation (% Area Red).....6-12
    - 6.1.5.1 Ellipse/Ellipse Method of Area Reduction Calculation.....6-12
    - 6.1.5.2 Ellipse/Trace Method of Percent Area Reduction Calculation.....6-13
    - 6.1.5.3 Trace/Trace Method of Percent Area Reduction Calculation.....6-14
- 6.2 M-MODE MEASUREMENTS.....6-15
  - 6.2.1 M-Mode Heart Rate Measurement.....6-15
  - 6.2.2 M-Mode Slope Measurement (Time, Distance and Slope).....6-16
  - 6.2.3 M-Mode Distance Measurement.....6-16
- 6.3 PW/CW DOPPLER MEASUREMENTS.....6-17
  - 6.3.1 Velocity Measurements.....6-17
  - 6.3.2 Doppler Manual Trace Measurement.....6-19
    - 6.3.2.1 Doppler Manual Trace Measurement – Continual Method.....6-19
    - 6.3.2.2 Doppler Manual Trace Measurement – Point by Point Method.....6-20
  - 6.3.3 Doppler Auto-Trace Measurement (Spectrum Range).....6-20
  - 6.3.4 Doppler Heart Rate Measurement.....6-21
- 6.4 ELASTOGRAPHY MEASUREMENTS.....6-22
- 6.5 3D/4D MEASUREMENTS.....6-23
- 6.6 OB-SPECIFIC MEASUREMENTS/CALCULATIONS.....6-23



**ULTRASONIX**

- 6.7 FERTILITY-SPECIFIC MEASUREMENTS/CALCULATIONS ..... 6-24
- 6.8 REPORTS AND WORKSHEETS ..... 6-25
  - 6.8.1 Accessing Reports/Worksheets ..... 6-25
  - 6.8.2 Obstetrics Report ..... 6-27
  - 6.8.3 Vascular Reports ..... 6-28
  - 6.8.4 Billing and QA Review Report/Worksheet Options ..... 6-28
- CHAPTER 7: TEXT, ANNOTATIONS AND PICTOGRAMS ..... 7-1**
  - 7.1 TEXT AND ANNOTATIONS ..... 7-2
    - 7.1.1 Set Text Home Position ..... 7-3
    - 7.1.2 Annotations (Keyboard Text) ..... 7-3
    - 7.1.3 Application-Specific Annotations ..... 7-4
    - 7.1.4 Deleting Text/Annotations ..... 7-4
    - 7.1.5 Text Arrows ..... 7-5
  - 7.2 PICTOGRAMS ..... 7-6
- CHAPTER 8: SYSTEM SETUP ..... 8-1**
  - 8.1 USER SETTINGS ..... 8-5
    - 8.1.1 SonixLive Setup ..... 8-5
      - 8.1.1.1 SonixLive and VLC Media Player ..... 8-7
      - 8.1.1.2 SonixLive and Windows Media Player ..... 8-13
      - 8.1.1.3 SonixLive Status Bar Settings ..... 8-15
      - 8.1.1.4 Activating/Deactivating SonixLive ..... 8-16
    - 8.1.2 Remote Support ..... 8-17
    - 8.1.3 Chat Support ..... 8-18
  - 8.2 ADMINISTRATOR SETTINGS ..... 8-19
    - 8.2.1 Presets ..... 8-20
      - 8.2.1.1 Show/Hide Imaging Presets ..... 8-22
    - 8.2.2 Presets – Annotations ..... 8-23
      - 8.2.2.1 Modify Annotations ..... 8-24
    - 8.2.3 Presets – Pictograms ..... 8-25
      - 8.2.3.1 Modify the Pictograms Attached to Presets ..... 8-26
    - 8.2.4 Presets – Measurements ..... 8-27
      - 8.2.4.1 Modify the Available Touch Screen Measurements Packages ..... 8-28
    - 8.2.5 Annotations ..... 8-29
      - 8.2.5.1 Text Arrow Customization ..... 8-30
    - 8.2.6 Measurements ..... 8-31
      - 8.2.6.1 Managing Worksheet Settings ..... 8-35
      - 8.2.6.2 Show/Hide Applications, Measurement Packages and Measurements ..... 8-36
      - 8.2.6.3 Managing Custom Measurements ..... 8-40
      - 8.2.6.4 Reordering Measurements ..... 8-48
      - 8.2.6.5 Managing Author Settings ..... 8-49
      - 8.2.6.6 Managing OB Tables ..... 8-51
    - 8.2.7 Training Tutorials ..... 8-54
      - 8.2.7.1 Manipulating Training Tutorials ..... 8-55
  - 8.2.8 SonixGPS ..... 8-58
  - 8.2.9 Biopsy Guide ..... 8-59
  - 8.2.10 System Settings ..... 8-60
    - 8.2.10.1 Password Protection ..... 8-64
    - 8.2.10.2 Export/Import User Data ..... 8-65
    - 8.2.10.3 Reset User Data Settings to Factory Defaults ..... 8-67





- 8.2.11 Network.....8-68
  - 8.2.11.1 Ethernet (LAN) Network Configuration .....8-70
  - 8.2.11.2 Dialup Network Configuration .....8-71
  - 8.2.11.3 Wireless Configuration .....8-72
  - 8.2.11.4 Chat Support .....8-74
  - 8.2.11.5 Remote Support .....8-74
- 8.2.12 DICOM Configuration.....8-75
  - 8.2.12.1 DICOM Storage Settings .....8-76
  - 8.2.12.2 DICOM Print Settings .....8-83
  - 8.2.12.3 DICOM Worklist Settings.....8-88
- 8.2.13 Custom Keys.....8-90
- 8.2.14 Peripherals.....8-92
  - 8.2.14.1 Paper Printer .....8-93
  - 8.2.14.2 LCD Display.....8-95
  - 8.2.14.3 VCR/Photo .....8-96
  - 8.2.14.4 Footswitch .....8-97
  - 8.2.14.5 Brightness/Contrast.....8-99
  - 8.2.14.6 Touch Screen .....8-100
- 8.2.15 Display Settings .....8-103
- 8.2.16 Patient Settings.....8-104
  - 8.2.16.1 EMR Settings .....8-109
- 8.2.17 Status Bar .....8-110
- 8.2.18 Capture Settings .....8-113
- 8.2.19 Imaging Modes .....8-115
- 8.2.20 Documentation Settings.....8-117
- 8.2.21 Software Update .....8-119
- 8.2.22 Licensing.....8-121
- 8.3 SERVICE MENU .....8-124
- CHAPTER 9: IMAGE STORAGE, REVIEW, TRANSFER AND PRINT .....9-1**
  - 9.1 IMAGE STORAGE.....9-1
  - 9.2 IMAGE REVIEW .....9-2
    - 9.2.1 Deleting Image(s)/Exam(s) .....9-8
  - 9.3 IMAGE TRANSFER.....9-9
- CHAPTER 10: CONNECTIVITY, PERIPHERALS AND SOFTWARE .....10-1**
  - 10.1 BACK CONNECTIVITY PANEL .....10-1
  - 10.2 CONSOLE CONNECTIVITY .....10-2
  - 10.3 ULTRASONIX-APPROVED DEVICES .....10-3
    - 10.3.1 Connecting an External Television to the System .....10-3
      - 10.3.1.1 Method 1: Via the TV's HDMI or DVI Input.....10-4
      - 10.3.1.2 Method 2: Via the TV's PC IN Connector .....10-5
  - 10.4 PERIPHERAL RECEPTACLE .....10-6
  - 10.5 UPS .....10-7
    - 10.5.1 UPS Circuit Breakers.....10-7
      - 10.5.1.1 Determining Whether the UPS Breakers are ON or OFF .....10-8
      - 10.5.1.2 Turning OFF/Resetting the UPS Breakers .....10-8
      - 10.5.1.3 Turning ON the UPS Breakers .....10-9
    - 10.5.2 Battery Recharge Issues.....10-10
    - 10.5.3 UPS Sleep/Standby Mode .....10-12
  - 10.6 SonixGPS .....10-13



**ULTRASONIX**

10.7 BARCODE READER ..... 10-13

    10.7.1 Connecting the Barcode Reader ..... 10-13

10.8 WIRELESS ADAPTER ..... 10-14

10.9 CONNECTING THE USB FOOTSWITCH (DUAL OR TRIPLE) ..... 10-14

10.10 USB PRINTER MOUNTING KIT ..... 10-15

10.11 PERIPHERAL TRAY ..... 10-16

    10.11.1 USB Printer Mounted on the Peripheral Tray ..... 10-17

10.12 TRANSDUCER HOLDERS AND CABLE HOOKS ..... 10-19

10.13 SOFTWARE ..... 10-20

    10.13.1 Anti-Virus Protection ..... 10-20

**APPENDIX A: SAFETY ..... A-1**

    A.1 SAFETY ..... A-1

        A.1.1 ALARA Principle and Output Displays ..... A-1

    A.2 BASIC PRECAUTIONS ..... A-2

    A.3 UPS PRECAUTIONS ..... A-3

    A.4 SONIXGPS PRECAUTIONS ..... A-3

    A.5 SYMBOL DEFINITIONS ..... A-4

    A.6 ELECTRICAL SAFETY REQUIREMENTS ..... A-5

        A.6.1 System ..... A-5

        A.6.2 Additional Hardware ..... A-5

    A.7 EMC (ELECTROMAGNETIC COMPATIBILITY) REQUIREMENTS ..... A-6

        A.7.1 System ..... A-6

        A.7.2 Additional Hardware ..... A-6

    A.8 ENVIRONMENTAL CONDITIONS ..... A-7

        A.8.1 System ..... A-7

        A.8.2 Additional Hardware ..... A-7

    A.9 LIMITING TRANSDUCER SURFACE HEATING ..... A-8

    A.10 LATEX ..... A-8

**APPENDIX B: SYSTEM SPECIFICATIONS ..... B-1**

**APPENDIX C: TRANSDUCER SPECIFICATIONS ..... C-1**

    C.1 TRANSDUCER DISCLAIMER ..... C-1

    C.2 ACOUSTIC OUTPUT RECORDING TABLES ..... C-1

    C.3 ULTRASOUND INDICATIONS FOR USE TABLES ..... C-26

**APPENDIX D: MAINTENANCE AND CLEANING ..... D-1**

    D.1 TRANSDUCERS ..... D-1

        D.1.1 Guidelines ..... D-1

        D.1.2 Ultrasound Coupling Gels ..... D-1

        D.1.3 General Transducer Maintenance ..... D-2

            D.1.3.1 Inspection and Testing ..... D-3

            D.1.3.2 Storing and Packaging ..... D-3

        D.1.4 General Transducer Cleaning/Disinfecting Recommendations and Warnings ..... D-4

        D.1.5 Cleaning/Disinfecting Non-Invasive Transducers ..... D-5

            D.1.5.1 Cleaning Non-Invasive Transducers ..... D-6

            D.1.5.2 Disinfecting Non-Invasive Transducers ..... D-6

        D.1.6 Cleaning/Disinfecting Endocavity Transducers ..... D-7

        D.1.7 Sterilization ..... D-8

    D.2 SHIPPING TRANSDUCERS FOR SERVICE ..... D-9

    D.3 RECOMMENDED FREQUENCY OF HIGH-LEVEL MAINTENANCE PROCEDURES ..... D-9



D.4	CLEANING SYSTEM COMPONENTS .....	D-9
D.4.1	LCD Display and Cabinet .....	D-10
D.4.1.1	LCD Display Cabinet .....	D-10
D.4.1.2	LCD Display Screen .....	D-10
D.4.2	Touch Screen .....	D-11
D.4.3	Operator Console .....	D-11
D.4.4	Power Cord .....	D-11
D.4.5	Barcode Reader .....	D-12
D.4.6	Wireless Adapter (When Connected Externally) .....	D-12
D.4.7	SonixGPS Components .....	D-12
D.4.8	Transducer Holders and Cable Hooks .....	D-13
D.4.9	Footswitch (Dual and Triple) .....	D-13
D.4.10	Peripheral Tray and Basket .....	D-14
D.4.11	System Filter .....	D-14
<b>APPENDIX E: MODE ACTION AND IMAGING PARAMETER OPTIONS .....</b>		<b>E-1</b>
<b>APPENDIX F: OB AND CARDIAC AUTHORS .....</b>		<b>F-1</b>
<b>APPENDIX G: REFERENCES .....</b>		<b>G-1</b>
G.1	OB.....	G-1
G.1.1	OB Gestational Age .....	G-1
G.1.2	OB Growth Analysis .....	G-3
G.2	CARDIAC.....	G-4
<b>APPENDIX H: GLOSSARY .....</b>		<b>H-1</b>





**ULTRASONIX**

## CHAPTER 1: INTRODUCTION

---

### 1.1 AUDIENCE

This user manual is a reference for operators using a SonixSP ultrasound system. It is designed for a reader familiar with ultrasound imaging techniques; it does not provide training in sonography or clinical practices. Before using the system the operator must have ultrasound training.

---

*Note: This is not a service manual. The SonixSP Service Manual is available for qualified service personnel.*

---

#### 1.1.1 Prescription Device

---

*Caution: United States law restricts this device to sale or use by, or on the order of a Physician.*

---

### 1.2 CONVENTIONS

The following conventions are used in this manual:

- cross-references for such things as tables, page numbers, sections and chapters are in blue, bold face, non-italic type (e.g., [Chapter 2: SONIX Introduction](#)) and are active hyperlinks when the manual is in Portable Document Format (PDF)
- words that are **bold italic** refer to items on the LCD display and touch screen
- icons are used to represent operator console buttons. Keyboard items are represented in **BOLD UPPER CASE** (e.g., **SHIFT** or **TAB**)
- "Press" and "Turn" indicate the actions required to activate the operator console buttons and dials
- "Tap" indicates the action required to activate a touch screen item
- "Select" directs the operator to choose an item(s) from onscreen pages, menus, dialogs, etc., using the console trackball and onscreen cursor or tapping the touch screen to make the selection
- a **Warning** describes precautions necessary to prevent injury or loss of life
- a **Caution** describes precautions necessary to protect the Sonix system and its associated products
- a **Note** contains helpful information and hidden functionality
- items marked **IMPORTANT** contain vital information that must be understood and followed, but which will not endanger either people or equipment
- bulleted lists present information in list format, but do not imply a sequence
- when operating instructions must be performed in a specific order, the steps are numbered
- instructions separated by ">" indicate that multiple items must be selected (e.g., "Select **Administrator** > **Status Bar**" indicates that the user must first select the "**Administrator**" option, then when the next dialog is presented, select the "**Status Bar**" option).



### 1.3 UPDATES

Updated user manuals will be available for all future Sonix ultrasound system updates.

### 1.4 VOLTAGE DISCLAIMER

The system voltage setting is configured in the factory.

It is the user's responsibility to ensure the system is used only under the electrical conditions dictated by Ultrasonix Medical Corp. Failure to comply with these conditions may result in damage to the system which is not covered by the Ultrasonix warranty.

---

**Caution:** For users running the 100V–120V system, always ensure the utility supply voltage is 100V–120V @ 50/60 Hz.

For users running the 200V–240V system, always ensure the utility supply voltage is 200V–240V @ 50/60 Hz.

---

### 1.5 CONNECTIVITY DISCLAIMER

---

**Caution:** System networking options are intended for use inside your organization's firewall. Organizations that elect to configure/use the networking functionality provided by Ultrasonix are assuming all liabilities and risks associated with that decision.

---

### 1.6 PRIVACY DISCLAIMER

To protect patient data, Ultrasonix strongly recommends regular patient/image file back-up and purging of older patient files stored on the system. Refer to [Chapter 9: Image Storage, Review, Transfer and Print](#) for details on transferring patient data.

---

**IMPORTANT:** The contents of the system hard drive may include Personal Health Information that must be protected as dictated by local or state laws (for example, Federal Privacy Act or the Health Insurance Portability & Accountability Act (HIPAA)). In order to ensure regulatory compliance, Ultrasonix will not remove the system hard drive — and the patient data it contains — from the customer site.

In the event the hard drive must be removed from the system, it will be returned to the customer. Final disposition of the hard drive and its data will remain the customer's responsibility.

---



## 1.7 GENERAL DISCLAIMER

Certain licensed features, hardware options and transducers may not be certified in all markets. Consult your local Ultrasonix Authorized Distributor or Sales Representative to determine availability in your area.

## 1.8 LICENSE AGREEMENT

Portions of the Sonix computer programs have been patented by Ultrasonix Medical Corporation (Ultrasonix) or are patent pending, and are licensed under the following software license agreement:

Ultrasonix, or its suppliers, retain(s) ownership of and title to any computer program supplied with the Equipment and to the trade secrets embodied in such computer programs. Subject to the Buyer's acceptance and fulfillment of the obligations in this paragraph, Ultrasonix grants the Buyer a personal, non-transferable, perpetual, non-exclusive license to use any computer program supplied with the Equipment that is necessary to operate the Equipment solely on the medium in which such program is delivered for the purpose of operating the Equipment in accordance with the instructions set forth in the operator's manuals supplied with the Equipment and for no other purpose whatsoever. Buyer may not reverse – assemble, reverse – compile or otherwise reverse – engineer such computer programs nor may Buyer make a copy of such program or apply any techniques to derive the trade secrets embodied therein. In the event of a failure by Buyer to comply with the terms of this license, the license granted by this paragraph shall terminate. Further, because unauthorized use of such computer programs will leave Ultrasonix without an adequate remedy at law, Buyer agrees that injunctive or other equitable relief will be appropriate to restrain such use, threatened or actual. Buyer further agrees that (i) any of the Ultrasonix suppliers of software is a direct and intended beneficiary of this end-user sublicense and may enforce it directly against Buyer with respect to software supplied by such supplier, and (ii) NO SUPPLIER OF ULTRASONIX SHALL BE LIABLE TO BUYER FOR ANY GENERAL, SPECIAL, DIRECT, INDIRECT, CONSEQUENTIAL INCIDENTAL OR OTHER DAMAGES ARISING OUT OF THE SUBLICENSE OF THE COMPUTER PROGRAMS SUPPLIED WITH THE EQUIPMENT.

## 1.9 WARRANTY REGISTRATION

To protect your investment, ensure the warranty registration card included with your system has been completed and returned to Ultrasonix (using the envelope provided) or register online at [www.ultrasonix.com/register](http://www.ultrasonix.com/register).

---

**Note:** *Warranty registration will ensure uninterrupted Technical Support and system updates.*

---



**ULTRASONIX**

## **1.10 TRADEMARKS AND PATENTS**

Ultrasonix Sonix systems are protected under US Patents 6,216,029 - 6,325,759 - 6,558,326 - 6,911,008 - 7,274,325 - 8,088,070 - D654,178.

The following are trademarks of Ultrasonix Medical Corporation: SonixGPS™, SonixShine™, SonixTablet™ and SonixTouch™.

Windows® is a trademark of Microsoft Corporation.

DICOM® (Digital Imaging and Communications in Medicine) is the registered trademark of the National Electrical Manufacturers Association (NEMA) for its standards publications relating to digital communications of medical information.

All other products and brand names mentioned in this document are trademarks of their respective companies.

## CHAPTER 2: Sonix INTRODUCTION

---

Congratulations on your purchase of the Ultrasonix Sonix Ultrasound system. The Sonix is a high quality, easy to use diagnostic ultrasound system that is stable, highly mobile and designed to be convenient and comfortable to operate.

The various system components, including the LCD display, operator console with touch screen, cart, and transducers, may be configured to better support system use.

### 2.1 SYSTEM COMPONENTS

**Figure 2-1: SonixSP System Components**



---

**Note:** The front wheels on the SonixSP lock completely (i.e., when locked, no movement is allowed in any direction), while the rear wheels lock directionally.

---



**Table 2-1: System Components**

<b>1</b>	LCD Display
<b>2</b>	Speakers
<b>3</b>	Touch Screen
<b>4</b>	Operator Console
<b>5</b>	Front Connectivity Panel (USB ports)
<b>6</b>	Front Pull Handles
<b>7</b>	Transducer Holders
<b>8</b>	System Case with Three (3) Transducer Ports
<b>9</b>	Optional Uninterruptible Power Supply (UPS) with External Breaker Access
<b>10</b>	Foot Rest
<b>11</b>	Wheel Base with Four (4) Locking Wheels
<b>12</b>	Rear Pull Handles
<b>13</b>	Foot Pedal

## 2.2 OPERATOR CONSOLE

The operator console comprises a panel with patient management, system setup and ultrasound imaging controls: trackball, buttons, dials, toggle buttons, touch screen and keyboard. These operator controls enable Sonix functions (e.g., changing imaging modes and adjusting parameters such as **Time Gain Compensation (TGC)**, **Depth**, etc.).

Figure 2-2: Operator Console











---









**Note:** Many features are licensed options and may not be active on all systems. Refer to [8.2.22 Licensing](#) to determine what features are active and [Appendix B: System Specifications](#) for details on available options.

---



Table 2-1: Operator Console Controls

Item	Icon	System Control	Functionality
1		Power Button	System ON/OFF button, located on the console support beneath the LCD display. Refer to <b>8.2.10 System Settings</b> to configure <b>Shutdown Options</b> . Refer to <b>2.5.2 Powering the System ON/OFF</b> for the exact location of the power button.
2		Trackball	Used to position the onscreen arrow graphic, flashing text cursor, arrow cursor, calipers, etc.
3		QSONIX Button	Provides access to: <ul style="list-style-type: none"> <li>Quick exam start-up</li> <li>Sonix Operator Console Tutorial</li> <li><b>Remote Support</b>.</li> </ul>
Print Controls	4	 1 Button ( <i>Custom Key 1</i> )	One of four (4) programmable buttons ( <b>8.2.13</b> ) used to: <ul style="list-style-type: none"> <li>auto-store/print images or <b>Cine loops</b> to a configured printer, archive, etc.</li> <li>access certain functions such as <b>Exam Review</b> and <b>Measurement Packages</b>.</li> </ul>
	5	 2 Button ( <i>Custom Key 2</i> )	One of four (4) programmable buttons ( <b>8.2.13</b> ) used to: <ul style="list-style-type: none"> <li>auto-store/print images or <b>Cine loops</b> to a configured printer, archive, etc.</li> <li>access certain functions such as <b>Exam Review</b> and <b>Measurement Packages</b>.</li> </ul>
	6	 ARCHIVE Button ( <i>Custom Key 3</i> )	One of four (4) programmable buttons used to: <ul style="list-style-type: none"> <li>auto-store/print images or <b>Cine loops</b> to a configured printer, archive, etc.</li> <li>set to provide access to the <b>Exam Management/Image Review</b> system.</li> </ul>
7		SELECT Button	Provides a wide variety of functions depending on the imaging state (e.g., selects/sets measurements, selects onscreen menu items, etc.) as well as left-click mouse button functionality.
8		UPDATE Button	Provides a wide variety of functions depending on the imaging state (e.g., toggle between image fields on <b>Dual/Quad</b> image, toggle between <b>2D</b> and <b>Doppler Trace</b> image fields, toggles the active caliper, etc.) as well as right-click mouse button functionality.
9		FREEZE Button	Pause/resume a live image. Additionally, using <b>Custom Key</b> settings ( <b>8.2.13</b> ) the console  button can be configured to move directly to <b>Measure</b> .















Item	Icon	System Control	Functionality
10		<b>MEASURE</b> Button	Initiates/closes the <b>Measurement Package</b> touch screen. Removes measurements from frozen image field. <hr/> <b>Note:</b> <i>Application-specific measurement tabs are available on the touch screen.</i>
11		<b>DELETE</b> (Measurement) Button	In <b>Measure</b> mode, deletes most recently saved measurement. Deletes selected thumbnail image.
12	<b>ABC</b>	<b>TEXT</b> Button	Activates the keyboard for <b>Text</b> entry and displays <b>Application-specific Annotation</b> buttons on the touch screen.
13		<b>DELETE</b> (Text) Button	Deletes the most recent <b>Text</b> or <b>Annotation</b> entry. Provides "delete character" functionality during data entry mode ( <b>Exam Management</b> page).
14		Keyboard	QWERTY keyboard used for text entry (e.g., patient data, system setup, image text, etc.).
15		<b>PICTOGRAM</b> Button	Turns on/off application-specific <b>Pictogram</b> graphics. Tap <b>Pictogram</b> and dial through the various icons. <ul style="list-style-type: none"> <li>• trackball positions orientation marker</li> <li>• touch screen <b>Rotate</b> dial pivots orientation marker.</li> </ul>
16		<b>ARROW</b> Button	Turns on/off <b>Arrow</b> graphic on the image field. Trackball positions and rotates the <b>Arrow</b> graphic.
17		<b>EXAM MGMT</b> Button	Provides access to the <b>Exam Management</b> page.
18		<b>TRANSDUCER</b> Button	Provides access to transducer selection keys on touch screen.
19		<b>MENU</b> Button	Provides access to setup menus.



Item	Icon	System Control	Functionality
B-Mode/2D and M-Mode Controls	20	<b>B-MODE/2D</b> Button/Dial	Activates (press dial) <b>2D/B-Mode</b> imaging mode and controls <b>2D Gain</b> (turn dial) and <b>M-Mode Gain</b> .
	21	<b>DUAL/QUAD</b> Button	Activates <b>Dual</b> (press once) and <b>Quad</b> (press twice) split screen imaging.  toggles between image fields. Press  to return to single screen imaging.
	22	<b>M-MODE</b> Button	Activates <b>M-Mode</b> imaging. <b>B-Mode</b> dial controls <b>M-Mode Gain</b> .  activates <b>M-Mode Sweep</b> .
	23	<b>FOCUS</b> Rocker Switch	Adjusts the location of the image focal zone UP or DOWN on the image field.
	24	<b>DEPTH</b> Rocker Switch	Adjusts the <b>2D</b> imaging <b>Depth</b> UP (less <b>Depth</b> ) or DOWN (more <b>Depth</b> ).
	25	<b>ZOOM</b> Rocker Switch	Adjusts the <b>2D</b> magnification UP (more magnification) or DOWN (less magnification). Trackball used to pan image.
26	<b>FREQUENCY</b> Rocker Switch	Adjusts the <b>2D</b> image <b>Frequency</b> UP or DOWN: <ul style="list-style-type: none"> <li>• <b>Harmonics</b> (if available)</li> <li>• <b>Resolution</b> (high frequency)</li> <li>• <b>General</b></li> <li>• <b>Penetration</b> (low frequency)</li> <li>• <b>EPI (Extended Pulse Imaging)</b> (greater penetration).</li> </ul>	
Color Doppler Controls	27	<b>COLOR</b> Doppler Button/Dial	Activates (press dial) <b>Color Doppler</b> imaging mode and controls <b>Color Doppler Gain</b> (turn dial). Controls <b>Power Doppler Gain</b> .
	28	<b>POWER DOPPLER</b> Button	Activates/deactivates the <b>Color Power Doppler</b> imaging mode. The  dial controls the <b>Color Power Gain</b> .
	29	<b>INVERT</b> Button	Reverses the direction of the <b>Color Doppler Map</b> .
	30	<b>PRF</b> <b>PRF</b> Rocker Switch	Adjusts the <b>Color Doppler PRF (Pulse Repetition Frequency)</b> UP (higher <b>PRF</b> ) or DOWN (lower <b>PRF</b> ).
	31	<b>WF</b> <b>WF</b> Rocker Switch	Adjusts the <b>Color Doppler Wall Filter</b> UP (more filtering) or DOWN (less filtering).
32	<b>STEER</b> Rocker Switch	Adjusts the steering angle depending on the active imaging mode: <ul style="list-style-type: none"> <li>• <b>Color Doppler</b> Region of Interest (ROI) box</li> <li>• <b>PW Doppler</b> sample line</li> <li>• <b>B-Mode/2D</b> beam on linear transducers.</li> </ul>	





Item	Icon	System Control	Functionality
PW Doppler Controls	33	 <b>PULSED DOPPLER</b> Button/Dial	Activates/deactivates (press dial) <b>Pulsed Wave (PW) Doppler</b> imaging mode and controls <b>PW Doppler Gain</b> (turn dial).  switches between <b>Trace</b> and <b>2D</b> image. <b>Note:</b> To adjust the <b>PW</b> gate size on full screen <b>2D/Doppler</b> cursor, turn the  dial.
	34	 <b>CW</b> Button	Activates/deactivates <b>Continuous Wave (CW) Doppler</b> function. <b>PW</b> button/dial adjusts <b>CW Gain</b> .
	35	 <b>ANGLE CORRECT</b> Button/Dial	Activates (press dial) <b>PW/CW</b> angle correct feature. Each subsequent press toggles through 0, +60, -60 degrees. Turn dial right or left to adjust angle correct in 2 degree increments up or down.
	36	 <b>INVERT</b> Button	Reverses direction of <b>PW/CW Doppler Trace</b> .
	37	<b>PRF</b> PRF Rocker Switch	Adjusts <b>PW/CW Doppler PRF</b> UP (higher <b>PRF</b> ) or DOWN (lower <b>PRF</b> ).
	38	 <b>BASE</b> Rocker Switch	Adjusts <b>PW/CW Doppler Trace Baseline</b> UP or DOWN.
39	 <b>RESEARCH</b> Button	Activates/deactivates optional <b>Research</b> imaging package. Not available on this platform.	
40	 <b>WORKSHEET</b> Button	Presents the active <b>Worksheet</b> on the LCD display with associated options on the touch screen.	
41	 <b>ELASTOGRAPHY</b> Button	Activates/deactivates <b>Elastography</b> imaging mode.	
42	 <b>SPATIAL COMPOUND</b> Button	Activates/deactivates <b>Spatial Compounding</b> imaging mode.	
43	 <b>3D/4D</b> Button	Activates/deactivates optional <b>Standard</b> and <b>Advanced 3D/4D</b> imaging modes.	
44	<b>AUTO</b> <b>OPTIMIZE</b> Button	Adjusts scale and <b>Gain</b> of <b>Doppler</b> spectrum to optimal.	
45	 <b>ACOUSTIC POWER</b> Button/Dial	Adjusts (turn dial) <b>Acoustic Power</b> and toggles (press dial) <b>MI</b> , <b>TIS</b> , <b>TIC</b> , <b>TIB</b> display depending on the active imaging mode.  <b>Warning:</b> Refer to <a href="#">A.1.1 ALARA Principle and Output Displays</a> .	



Item	Icon	System Control	Functionality
46–50		Touch Screen Dials	Five (5) dials that control touch screen options which change depending on the imaging mode/state. Once the touch screen option is tapped, turn the dial to make the relevant adjustments. <hr/> <b>Note:</b> <i>In measure mode, if the <b>Method</b> button is available on the touch screen (i.e., not grayed out), the measurement can be performed in two or more ways. After selecting a measurement, tap <b>Method</b> and turn the relevant touch screen dial to page through the various choices available. The <b>Method</b> selected appears in an information bubble to the bottom right of the image screen. Refer to <a href="#">Chapter 6: Clinical Analysis</a> for further details on measurements.</i>
51		Touch Screen	Displays touch screen menus which change depending on the imaging mode/state. <hr/> <b>Note:</b> <i>The active tab on a touch screen menu is indicated by a "dot" pattern around the tab name.</i>
52		TGC Slide Pods	Adjusts <b>TGC (Time Gain Compensation)</b> curve.
53		<b>AUDIO VOLUME</b> Dial	Adjusts <b>Doppler</b> signal volume.

## 2.3 CONSOLE HEIGHT, ANGLE AND SWIVEL ADJUSTMENT

The console has three (3) adjustments: height, angle and swivel.

### To Adjust the Console Height:

1. Depress the system foot pedal (1).

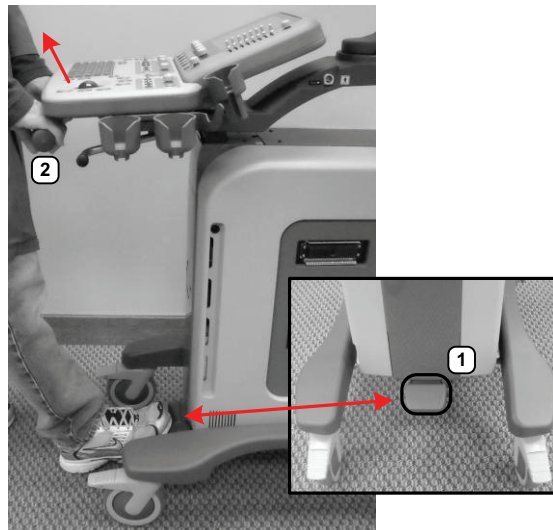

---

**Note:** Keep the foot pedal depressed until the height adjustment is complete.

---

2. Pull up or push down on the front pull handles (2) to raise or lower the console.

---

**Caution:** Use only the front pull handles to make the height adjustment. Do not apply pressure anywhere else on the console.

---



**To Adjust the Console Angle:**

1. Push forward on the lever under the right side of the console.

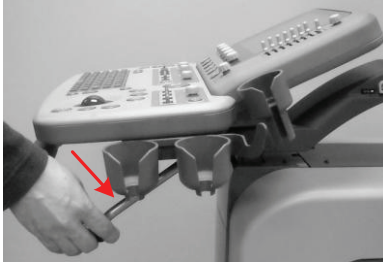

2. Use the front pull handles to gently rock the console forward or backward until the desired tilt is achieved.
3. Pull backward on the lever under the right side of the console to lock the console in place.

**To Swivel the Console:**

1. Push forward on the lever under the left side of the console.



2. Use the front pull handles to gently swivel the console from side to side until the desired position is achieved.
3. Pull backward on the lever under the left side of the console to lock the console in place.

## 2.4 SYSTEM CASE

The system case contains the system PC and the (optional) UPS. Three (3) transducer ports are located on the right side.

Refer to the *SonixSP Service Manual* for complete details about the contents of the system case.



---

**Warning:** Do not touch the patient and the transducer ports simultaneously.

---

## 2.5 POWER PANEL

The Power Panel is located on the back lower portion of the system case. It includes the power cord, main power switch and fuse.

**Figure 2-3: System Power Panel**

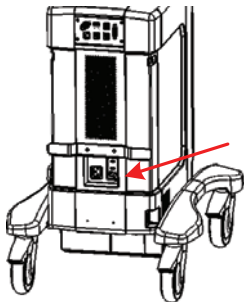

---

**Caution:** **DO NOT** turn off the main power switch when the system is turned on. Turn off the system using the console **POWER** button, then turn off the main power switch. Failure to follow the correct procedure may result in loss of patient data and/or hard drive failure.

---

---

**Note:** If the system does not power up, ensure the power cord is plugged in and the main power switch on the system case is turned to the ON position. The Main Power switch is not required for regular power shut downs and should remain in the ON position.

---

### 2.5.1 Powering the System

Before turning the system on, connect the power cord.

#### To Connect the Power Cord:

1. Connect the power cord to a wall outlet (hospital-grade electrical outlet recommended).



## 2.5.2 Powering the System ON/OFF

After initial installation, it is important to correctly power the system ON/OFF. Failure to follow proper shutdown procedures may result in data corruptions and/or hard drive failure.

Properly powering OFF any system will protect the integrity of patient data. Properly powering OFF a system with a UPS will put it into Sleep Mode, enabling the system to be unplugged from the wall without depleting the battery while the system remains powered off.

Properly powering ON a system with a UPS will wake it from Sleep Mode and ensure the UPS is functioning correctly.

---

**Caution:** *NEVER* shutdown the system by simply unplugging it from the wall:

- even if the battery is fully depleted (applies only to systems with a UPS)
- regardless of whether the system was configured with or without a UPS.

*Either of these actions may result in data corruptions and/or hard drive failure.*

---

### To Power the System ON:

1. Ensure the power cord is connected.
2. Press and hold the console **POWER** button for one (1) second.



---

**Note:** *For systems running with a UPS, powering ON correctly will wake the UPS from Sleep Mode and ensure it is functioning correctly.*

---

### To Power the System OFF:

1. Press the console **POWER** button.
2. If **Shutdown Options** have been configured to request confirmation, select **Yes** when presented with the message **Do you really want to shutdown the system?**

---

**Caution:** *Failure to properly shut down any system may result in data corruptions and/or hard drive failure.*

---

#### **Notes:**

*If **Shutdown Options** have not been configured to request confirmation, the system will simply shut down.*

*During shutdown, a UPS-configured system will enter Sleep Mode to protect the charged battery.*

---

## 2.6 BACK CONNECTIVITY PANEL

The Back Connectivity Panel is located on the back of the system case. Refer to [10.1](#) for connectivity details.

## 2.7 CONSOLE CONNECTIVITY

The system is equipped with two (2) USB ports on the left edge of the console. Refer to [10.2 Console Connectivity](#) for details.



## 2.8 UPS

The system is delivered with an optional UPS running on a lithium ion battery. The UPS, located below the modulo, ensures that no data is lost when the system is temporarily unplugged and moved around. Refer to section [10.5 UPS](#) for more details.

Refer to [10.5.1](#) for UPS circuit breaker shutdown procedures.



---

### **Warnings:**

**NEVER** let liquid from any source enter the UPS. Failure to do this may result in accidental **shorts, shocks or electrocutions**.

**DO NOT attempt to service this product yourself.** Attempting to open the UPS may cause exposure to lethal voltages within the unit even when it is apparently not operating and the input wiring is disconnected from the electrical source. Should the UPS require maintenance or replacement, only qualified Ultrasonix Service Technicians may perform service as detailed in the Service Manual.

For UPS and battery service issues, contact Ultrasonix Technical Support.

If the battery is removed from the system, it is the responsibility of the customer to dispose of it in accordance with all local regulations and laws.

---

### 2.8.1 UPS Use Model

The UPS is intended to facilitate system portability, i.e., a properly charged UPS can protect against the loss of data while the machine is temporarily unplugged and moved to a new location. Unless the system was powered down before being unplugged, make sure that it is reconnected to a power outlet within a few minutes.

When the system is running on battery power it cannot be left unplugged for long periods. For details on battery usage limitations and recharge alerts, refer to [Table 10-5](#) and [Table 10-6](#), respectively.

---

**Note:** When left powered on and unplugged, the rechargeable UPS battery will maintain a charge for a limited time only. Leaving the machine plugged in while unattended will prevent automated shutdown and prolong battery life.

**If the battery has been completely depleted, always recharge completely before attempting to run on battery power only.**

---

As an added precaution, always shut down the system properly ([2.5.2 Powering the System ON/OFF](#)). If, at this point, the system is left unplugged for a prolonged period, it will automatically protect battery integrity using sleep/standby mode. Refer to [10.5.3](#) to restart the system from this state.



## 2.9 SonixGPS

When ordered with the **SonixGPS (Guidance Positioning System)** license, the system is delivered with the **SonixGPS** hardware attached to the system case.



---

**Warning:** *This user manual does not include a comprehensive discussion of the SonixGPS option. For complete details on using SonixGPS, read and follow all instructions and warnings in the most recent SonixGPS User Manual.*

---

## 2.10 BARCODE READER

An optional pre-configured, barcode reader is available. This allows the operator to scan certain patient data for quick and reliable data entry. The results of the scan are entered directly into the fields on the **QSonix Input Patient Information dialog** and the **Exam Management** page—providing the cursor is present in the relevant field when the barcode is scanned.

Refer to **10.7 Barcode Reader** for details on connecting the barcode reader to the various hardware platforms.



---

**Warnings:**

**USE OF CONTROLS** or adjustments or performance of procedures other than those specified in the manufacturer's User's Guide (delivered with system) may result in hazardous laser light exposure.

**NEVER** attempt to look at the laser beam, even if the barcode reader appears to be non-functional.

**NEVER** point the laser beam in anyone's eyes.

**USE OF OPTICAL** instruments with the laser equipment will increase eye hazard.

**UNDER NO CIRCUMSTANCES** should users or technicians attempt to open or service the laser scanner. Attempting to open the barcode reader may cause exposure to hazardous laser light. Should the barcode reader require maintenance or replacement, contact Ultrasonix Technical Support.

---

## 2.11 WIRELESS ADAPTER

In addition to the standard, hard-wired network connection, the system supports an optional, factory-installed wireless adapter (**8.2.11.3 Wireless Configuration**).

---

**Caution:** *System networking options are intended for use inside your organization's firewall. Organizations that elect to configure/use the networking functionality provided by Ultrasonix are assuming all liabilities and risks associated with that decision.*

---

---

**Caution:** *For details on FCC regulations as they apply to the wireless adapter, please refer to the manufacturer's User Guide included with the system.*

---



**ULTRASONIX**

## **2.12 FOOTSWITCH (DUAL OR TRIPLE)**

The system supports an optional, (dual or triple) USB *Footswitch* ([8.2.14.4 Footswitch](#)).

Refer to [10.9 Connecting the USB Footswitch \(Dual or Triple\)](#) for details on connecting the *Footswitch* to the various hardware platforms.

## CHAPTER 3: GETTING STARTED

---

This chapter provides a quick, step-by-step guide through the basic operation of the Sonix Ultrasound System as well as details on general touch screen layout.

### 3.1 TURNING ON SYSTEM

#### To Turn on the System:

1. Ensure the power cord is connected (2.5.1).
2. Press and hold the console **POWER** button for one (1) second. Refer to [2.5.2 Powering the System ON/OFF](#) to view the button's exact location.

---

**Caution:** *DO NOT use main power switch for regular power shut downs. Refer to [2.5.2](#) for instructions on correctly powering the system OFF. Failure to follow the correct procedure may result in loss of patient data and/or hard drive failure.*

---

**Note:** *If the system does not power up, ensure the Main Power switch on the back of the system case is turned to the ON position ("—"). Refer to [Figure 2-3](#) for main power switch location.*

---



### 3.2 CONNECTING TRANSDUCERS

The connection ports for the Ultrasonix transducers are located on the side of the system case ([Figure 2-1](#)).

#### To Connect/Disconnect a Transducer:

1. Turn the latch counter-clockwise to the Open or Unlock position (**2**).

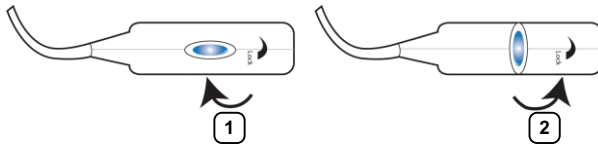

2. Insert the transducer connector into the connection port with the transducer identification label (e.g., L14-5/38) facing up.

---

**Caution:** The 4D transducer must be inserted into the upper-most transducer connection port to ensure proper function.

*Only one (1) 4D transducer can be connected at a time.*

---

3. Ensure the connector is properly seated and turn the latch clockwise to lock it in place (**1**).
4. Turn the latch counter-clockwise to unlock (open) and remove the transducer.

---

**Note:** When a new exam is initiated, the transducer used in the most recent exam will still be selected if it is still connected. If it's no longer connected, the system will default to the first available transducer. This default transducer selection is not affected even if the system is turned off between exams.

---

### 3.3 QSonix FEATURE

The **Q** button provides the following basic functions:

- Quick Exam Start-up (1)
- **Remote Support** Access (2)
- Sonix Console Tutorial (3)

**Figure 3-1: QSonix**

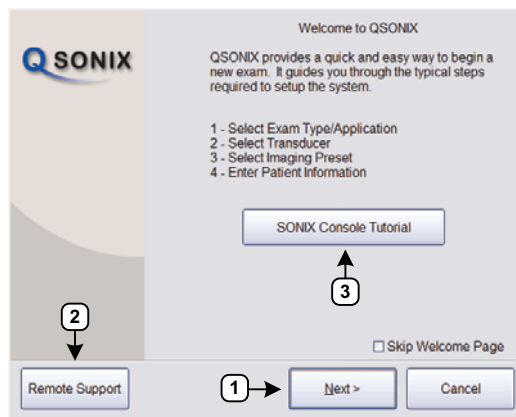



---

**Note:** By default, the **Welcome to QSonix** screen will appear the first time the **Q** button is pressed. If desired, after initial access to the **QSonix** feature, use the trackball and  button to select the **Skip Welcome Page** checkbox in order to hide this page.

---

#### 3.3.1 Quick Exam Start-Up

The Quick Exam Start-up feature provides a series of dialogs which guide the user through the steps required to begin an exam. Once the **Q** button is selected, users have the choice to navigate through the Quick Exam Start-up using the touch screen or with the trackball and  button on the LCD display:

1. Select the **Exam Type/Application**.
2. Select the transducer.
3. Select the **Imaging Preset**.
4. Enter basic **Patient Information**.
5. Begin the exam.

**To Begin the Quick Exam Start-up:**

1. Press the console **Q** button.
2. If the **Welcome to QSonix** page appears, select **Next**.

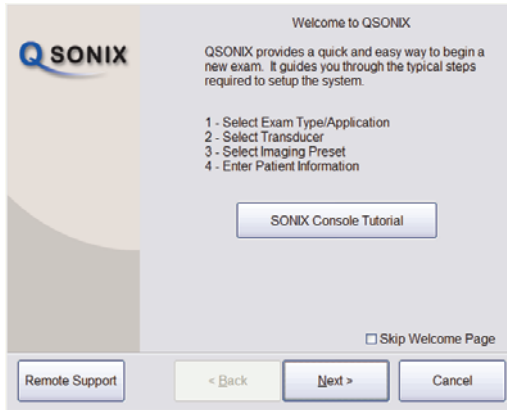

**Note:** If the **Welcome to QSonix** page has been set to skip, it can be reset to appear by selecting the **Welcome Page** button. Select **Skip Welcome Page** to prevent it from appearing the next time the **Q** button is selected.



3. Select the desired **Exam Type/Application** and the system will automatically move to the next page.

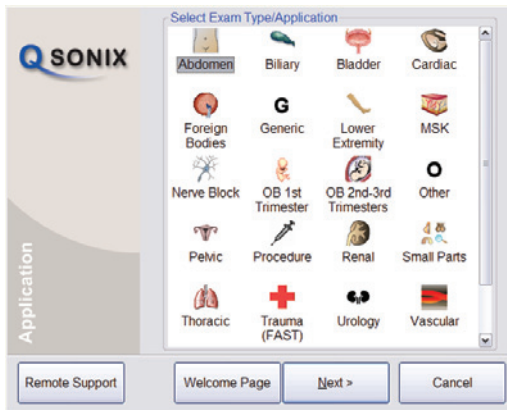

**Note:** **QSonix** selections can also be made on the LCD display using the trackball and  button.

- Select the desired transducer and the system will automatically move to the next page.

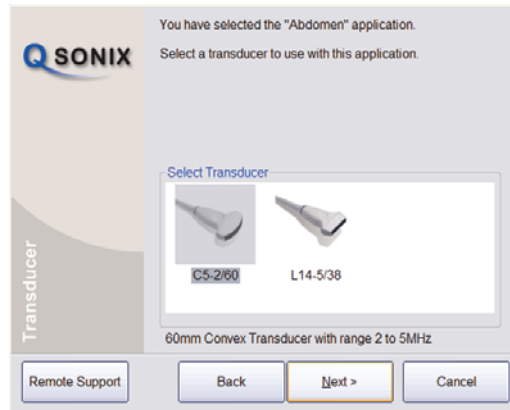

---

**Note:** Only transducers currently connected to the system and applicable to the previously-selected **Exam Type/Application** will be available. If the selected **Application** is not compatible with the currently connected transducers, the system will prompt for a different transducer.

Users can also select **Back** and select a different **Application**.

If a 4D transducer is selected, the system will skip directly to [step 5](#).

---

- Select the desired **Imaging Preset** and the system will automatically move to the next page.



---

**Note:** User-defined **Presets** will be included here.

If a **Preset** has been hidden, it will not be available for selection from **QSonix**. Refer to [8.2.1.1 Show/Hide Imaging Presets](#) for details.

---



6. Use the console keyboard to enter data in the **Input Patient Information** fields. Press the keyboard the **Tab** key to move through the data fields.

---

**Notes:**

If additional patient information is required select **More...** to open the full **Exam Management** data entry page. This will also enable the **Operator** to find and load (if they exist on the system) previous exams for the patient.

Refer to [Chapter 4: Patient Management](#) for complete details on **Exam Management** data entry and manipulation.

**Insert (Symbol)** enables the insertion of text symbol(s) not available on the keyboard (e.g., punctuation, symbols and letters from other languages).

**Reuse Active Patient** allows **Operators** to change **Applications** while continuing to scan the current patient (i.e., the data acquired after switching to a different **Application** continues to be saved to the same patient but under a new exam).

---

7. Select **Start Exam** to begin imaging.



### 3.3.2 Operator Console Tutorial

This feature provides a brief overview of the functionality of the operator console buttons, toggle buttons, dials, etc.

#### To Access the Operator Console Tutorial:

1. Press the console **Q** button.



**Note:** If the **Welcome to QSonix** page does not appear, select the **Welcome Page** button.

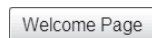

2. Select **Sonix Console Tutorial** and a brief, onscreen description will be presented when any console button, dial or knob is activated.

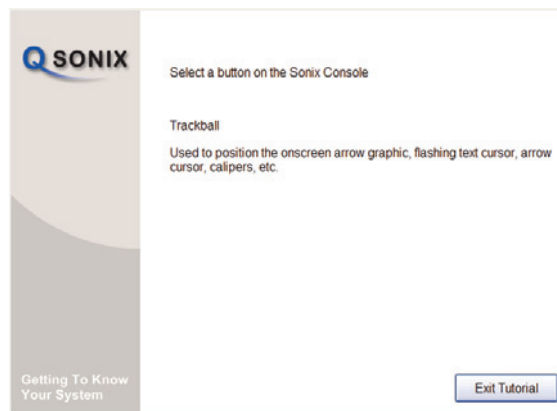

3. Select **Exit Tutorial** to return to the **Welcome to QSonix** page.



### 3.3.3 Documentation Access

**Operators** can access PDF documentation via the  button. This includes a cross-referenced version of the **User Manual**.

---

**Note:** It is not possible to view a PDF when a Sonix dialog (e.g., **Exam Management**) or Windows dialog (e.g., **Date and Time Properties**) is open.

---

#### To Access a PDF:

---

**Note:** PDFs must be loaded before they can be accessed. Refer to [8.2.20 Documentation Settings](#) for details on adding/deleting documents.

---

1. Ensure the main touch screen is visible and that all dialogs are closed.
2. Press the console  button.
3. Select **Documentation**.
4. From the list presented, select the relevant PDF.

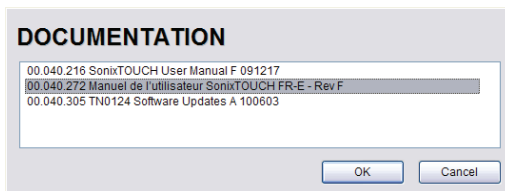

---

**Note:** If only one (1) PDF document has been added, it will be opened automatically.

---

5. The selected document will open in a PDF viewer.

#### To Close the PDF:

1. Select the "X" in the upper right corner of the PDF viewer window.



### 3.4 REMOTE SUPPORT

**Remote Support** allows Ultrasonix Technical Support to view and control a system for diagnostic purposes.

In order to use **Remote Support**, the **Network** must be configured ([8.2.11 Network](#)) and a **PIN (Personal Identification Number)** must be obtained from Ultrasonix Technical Support.

---

**Note:** The **PIN** is valid for 20 minutes only, so be sure to use it right away.

---

#### To Access Remote Support:

---

**Note:** **Remote Support** can also be accessed from the  button. Refer to [8.1.2](#) for details.

---

1. Press the console  button.
2. Select the **Remote Support...** button.

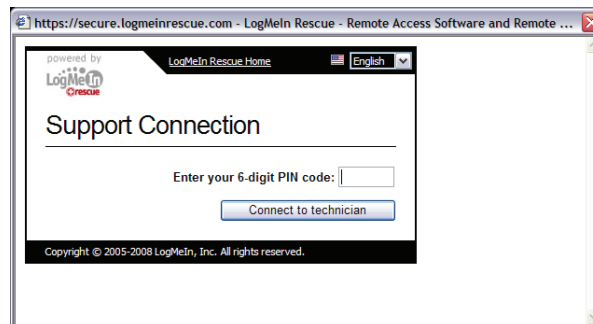

---

**Note:** If **Remote Support** does not appear to be available, contact your IT Department and have them check to make sure the network connection is active and the **Remote Support** option has been configured for use.

---

3. Enter the **PIN (Personal Identification Number)** provided by Ultrasonix Technical Support.

---

**Note:** The **PIN** is valid for 20 minutes only, so be sure to use it right away.

---

4. When prompted, select **Download > Run > Run** in order to install the required programs.
5. The system can now be remotely controlled.



### 3.5 TOUCH SCREEN LAYOUT

Although **B-Mode** will always be the first touch screen presented after initialization, the touch screens for all modes are presented in the same format.

---

**Note:** The options available in sections 2 and 3 (Figure 3-2) will vary from mode to mode.

---

Once an image is frozen, some of the mode-specific touch screen options may be altered, for example **Cine** options will be available.

#### 3.5.1 Main Touch Screen

Figure 3-2: Layout of Main Touch Screen (B-Mode Example)



**Table 3-1: Main Touch Screen Buttons**

1 Touch Screen Tabs	Tap to access additional options. <hr/> <b>Note:</b> <i>Tab availability depends on the current imaging mode.</i> <hr/>
2 Mode Action Buttons	Enable the application of certain actions to an image (e.g., <b>Invert</b> ). Mode Action Buttons are toggle buttons. For example, tap <b>Biopsy</b> to view the <b>Biopsy Guides</b> on the LCD display. Tap it again to remove them. When active, a Mode Action Button will be a graduated green color. The exception to this <b>Layout</b> —which always remains blue as it is tapped to toggle through the various Layout options. <hr/> <b>Note:</b> <i>The actions available are mode and/or transducer-specific.</i> <hr/>
3 Imaging Parameter Buttons	Enable adjustments to be made to the available imaging parameters for the selected mode. <hr/> <b>Note:</b> <i>Most parameters are mode-specific, although some (such as <b>Steer</b>) are transducer-dependant.</i> <hr/> Turn/press the relevant touch screen dial to adjust an active imaging parameter. If an imaging parameter button is a pale gray/white color, that particular parameter is currently active (e.g., <b>Zoom</b> , <b>Figure 3-2</b> ). Turn/press the dial directly to the right of the active button to make adjustments. <hr/> <b>Note:</b> <i>To adjust an imaging parameter that is <u>not</u> currently active, tap the desired imaging parameter button then turn/press the dial directly to its right (e.g., <b>Clarity</b>, <b>Figure 3-2</b>).</i> <hr/>

### 3.5.2 Main Touch Screen – Frozen

Once an image has been acquired and frozen, the touch screen will be updated. While many buttons stay the same, some are removed and others are added so that only relevant buttons remain.

**Figure 3-3: Layout of Main Touch Screen – Frozen (B-Mode Example)**

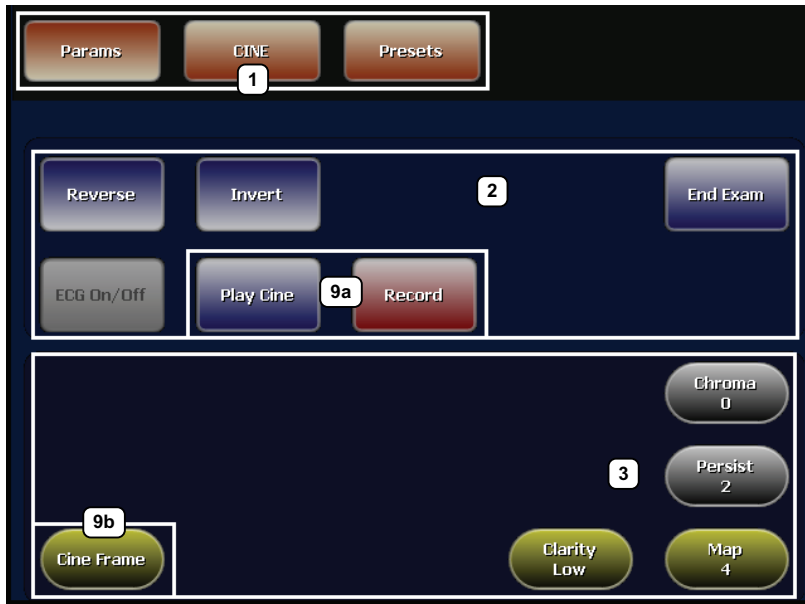

**Note:** For details on the other touch screen buttons, refer to [Table 3-1](#).

**Table 3-2: Main Touch Screen – Frozen (B-Mode)**

1	Touch Screen Tabs	May change, depending on the imaging mode (e.g., <b>B-Mode</b> is no longer available).
2	Mode Action Buttons	May change, depending on the imaging mode (e.g., <b>HD Zoom</b> is no longer available).
3	<b>Imaging Parameter Buttons</b>	May change, depending on the imaging mode (e.g., imaging parameters have been limited to four (4) options, down from the original 10 ( <a href="#">Figure 3-2</a> )).
9a	<b>Play Cine</b> and <b>(Cine) Record</b> Button	Available only when an image has been frozen. To access all <b>Cine</b> options, tap the touch screen <b>Cine</b> tab. <b>Note:</b> Refer to <a href="#">5.10</a> for details on <b>Cine</b> .
9b	<b>(Cine) Action Buttons</b> <b>Cine Frame</b>	Available only when an image has been frozen. This button can also be used in conjunction with the associated touch screen dial. To access all <b>Cine</b> options, tap the touch screen <b>Cine</b> tab. <b>Note:</b> Refer to <a href="#">5.10</a> for more details on <b>Cine</b> .

**Note:** Fields that will accept data entry via the keyboard will also accept data scanned with the barcode reader. Simply ensure that the cursor is located in the required field then scan the relevant barcode.



**ULTRASONIX**



## CHAPTER 4: PATIENT MANAGEMENT

**Exam Management** functionality allows users to enter patient/exam-related data into the system. Entering patient-specific data automatically creates a unique file in which the patient/exam data is stored.

### 4.1 ENTERING PATIENT DATA

The **Exam Management** page is sectioned into **Patient Information**, **Application Information** and **Exam Information** data entry areas. If applicable, data can be accessed via the storage/database tabs at the bottom right side of the page (**Patient** and **Worklist**).

**Figure 4-1: Exam Management Page**

### EXAM MANAGEMENT

Patient Information

Patient ID: 
 DOB (mm/dd/yyyy): 
 Age:  y  m

Last Name: 
 Sex:

First Name: 
 Accession #:

Middle Name:

Application Information

Application: 
 Height:   m  cm

Weight:   kg  g

BSA:

Exam Information

Attending Physician:

Referring Physician:

Operator ID:

Clinical Indication:

Patient ID	Last Name	First Name	Middle Name	Birthdate	Sex	Last Exam	Images
PID_20-10-2010_02-...	Smith	J		12/15/1981	F	10/20/2010	0



Table 4-1: Exam Management Page Options

	Saves the changes made to the <b>Exam Management</b> page and returns to imaging.
<b>OK</b>	<b>Note:</b> If a unique <b>Patient ID</b> is not entered manually the system will create one automatically (e.g., {C9B3F82B-BE52-4C79-8C45-28375D69F8C9}).
<b>Cancel</b>	Cancels any changes made to the <b>Exam Management</b> page and returns to live imaging. <b>Cancel</b> will not undo the <b>End Exam</b> function.
<b>End Exam</b>	Ends the current exam session, clears the <b>Patient</b> , <b>Application</b> and <b>Exam</b> data fields and prints/clears the printer queue (e.g., if printer image sheet is set for <b>2x2</b> and only two (2) images were saved, ending the exam signals the system that no more images are coming to fill up the sheet and sends the image sheet to the printer). All measurements visible on the LCD display are cleared. <b>Note:</b> Before ending an exam, ensure the active image has been saved/printed using the console <b>1</b> or <b>2</b> button (8.2.13 Custom Keys) in order to be able to recall it via the <b>Review</b> button on the <b>Exam Management</b> page or the <b>Exam Review</b> button on the touch screen.
<b>Clear</b>	Clears the <b>Patient</b> and <b>Exam</b> data fields. <b>Clear</b> will also "end" the current exam if one is open, however, it does not delete the file.
<b>Search Worklist</b>	Enables a <b>DICOM</b> or <b>ERM Worklist</b> search.
<b>Insert (Symbol)</b>	Enables the insertion of text symbol(s) not available on the keyboard (e.g., punctuation, symbols and letters from other languages).
<b>Import/Export</b>	Use to <b>Export</b> data to an alternate storage device. Deleting the exported data from the local drive is optional. If the data was deleted during the <b>Export</b> phase, it can be reinstalled at a later date using the <b>Import</b> option.
<b>Review</b>	Opens the <b>Exam Review</b> page for the current patient or patient(s) selected from <b>Patient</b> file storage.
<b>Delete</b>	Removes the currently selected patient(s) from <b>Patient</b> file storage.
<b>Update Worklist</b>	Updates a <b>DICOM</b> or <b>ERM Worklist</b> search. <b>Note:</b> This button will only be available if the system is configured for <b>DICOM</b> (8.2.12.3 <b>DICOM Worklist Settings</b> ). In order to actually update <b>Worklist</b> data, the system must also have an active connection to a <b>DICOM</b> server.
<b>Tabs</b>	<ul style="list-style-type: none"> <li>• <b>Patients:</b> list of Patients/Exams currently available on the system</li> <li>• <b>DICOM</b> <ul style="list-style-type: none"> <li>• <b>Worklist:</b> if enabled in <b>DICOM</b></li> <li>• <b>Store Queue:</b> if enabled in <b>DICOM</b></li> <li>• <b>Print Queue:</b> if enabled in <b>DICOM</b></li> </ul> </li> <li>• <b>Hide:</b> hides data to preserve privacy.</li> </ul> <p><b>Note:</b> Refer to 4.8 Storage/Database Tabs for more details.</p>

Figure 4-2: Exam Management Page Touch Screen

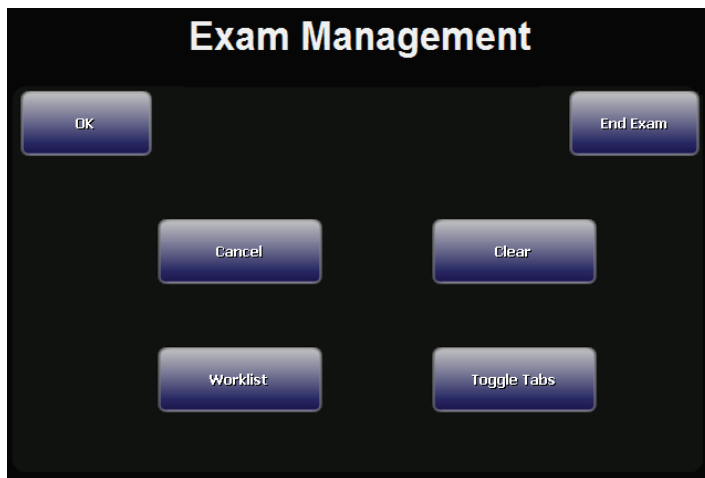

Table 4-2: Exam Management Touch Screen Controls (tap to activate)

<b>OK</b>	Saves the changes made to the <b>Exam Management</b> page and returns to imaging.  <i>Note: If a unique <b>Patient ID</b> is not entered manually the system will create one automatically (e.g., {C9B3F82B-BE52-4C79-8C45-28375D69F8C9}).</i>
<b>End Exam</b>	Ends the current exam session, clears the <b>Patient</b> , <b>Application</b> and <b>Exam</b> data fields and prints/clears the printer queue (e.g., if printer image sheet is set for <b>2x2</b> and only two (2) images were saved, ending the exam signals the system that no more images are coming to fill up the sheet and sends the image sheet to the printer). All measurements visible on the LCD display are cleared.  <i>Note: Before ending an exam, ensure the active image has been saved/printed using the console <b>1</b> or <b>2</b> button (8.2.13 Custom Keys) in order to be able to recall it via the <b>Review</b> button on the <b>Exam Management</b> page or the <b>Exam Review</b> button on the touch screen.</i>
<b>Cancel</b>	Cancels any changes made to the <b>Exam Management</b> page and returns to live imaging. <b>Cancel</b> will not undo the <b>End Exam</b> function.
<b>Clear</b>	Clears the <b>Patient</b> and <b>Exam</b> data fields. <b>Clear</b> will also "end" the current exam if one is open, however, it does not delete the file.
<b>Worklist</b>	Enables a <b>DICOM</b> or <b>ERM Worklist</b> search.
<b>Toggle Tabs</b>	Toggles between the available <b>Storage/Database</b> tabs. Refer to 4.8 for more details.

**To Access the Exam Management Page:**

1. Press the console  button.

## 4.1.1 Patient Information

Figure 4-3: Data Fields for Patient Information

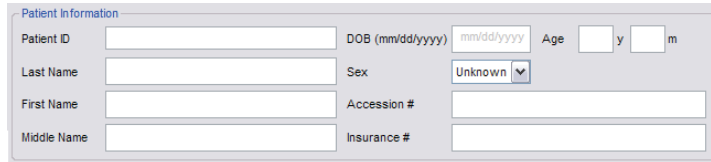

The screenshot shows a form titled "Patient Information" with the following fields:

- Patient ID: Text input field
- DOB (mm/dd/yyyy): Text input field with format mask
- Age: Two separate input fields for years (y) and months (m)
- Last Name: Text input field
- Sex: Dropdown menu with "Unknown" selected
- First Name: Text input field
- Accession #: Text input field
- Middle Name: Text input field
- Insurance #: Text input field

Table 4-3: Patient Information Fields



<b>Patient ID</b>	Enter the <b>Patient Identifier</b> using letters and/or numbers. The system automatically creates a unique <b>Patient ID</b> if one is not entered manually (e.g., {C9B3F82B-BE52-4C79-8C45-28375D69F8C9}). <b>Note:</b> The <b>Patient ID</b> cannot be changed after the patient file has been created (i.e., an exam has begun).
<b>Last Name</b> <b>First Name</b> <b>Middle Name</b>	Enter the patient's <b>Last</b> , <b>First</b> and <b>Middle Names</b> —any of which can be modified at any point during the exam.
<b>DOB (Date Of Birth)</b>	Enter the patient's <b>Date of Birth</b> in the required format (e.g., <b>mm/dd/yyyy</b> ) which is controlled through the <b>Regional Settings</b> options selected in <b>8.2.10 System Settings</b> . <b>Note:</b> A <b>DOB</b> entry will auto-populate the <b>Age</b> field.
<b>Age</b>	Rather than entering a specific <b>DOB</b> , enter the patient's actual <b>Age</b> . <b>Note:</b> The <b>Age</b> field will auto-populate if a <b>DOB</b> is entered.
<b>Sex</b>	Select the patient's gender: <b>Female</b> , <b>Male</b> , <b>Other</b> or <b>Unknown</b> .
<b>Accession #</b>	Enter the exam's <b>Accession Number</b> . <b>Note:</b> This field auto-populates when the <b>DICOM Worklist</b> is used.
<b>Insurance #</b>	Enter the patient's <b>Insurance Number</b> .

**Notes:**

During imaging, if **Patient ID**, **Name**, **LMP**, etc. are not displayed at the top of the image screen, the system may be setup to hide this patient data. For details, refer to **General Options (Table 8-36)** in **8.2.16 Patient Settings**.

All these fields can be completed using the barcode reader. Simply ensure the cursor is in the required field and scan the relevant barcode.

### To Enter Patient Information Manually:

1. Press the console  button.
2. Use the keyboard, trackball and console  button to enter the patient information as required.

Patient Information			
Patient ID	<input type="text"/>	DOB (mm/dd/yyyy)	<input type="text" value="mm/dd/yyyy"/> Age <input type="text"/> y <input type="text"/> m
Last Name	<input type="text"/>	Sex	<input type="text" value="Unknown"/>
First Name	<input type="text"/>	Accession #	<input type="text"/>
Middle Name	<input type="text"/>	Insurance #	<input type="text"/>

---

**Note:** The **Tab** key may be used to move through the various data fields and the **Enter** key to make drop-down menu selections.

---

### To Enter Patient Information with the Barcode Reader:

1. Press the console  button.
2. With the cursor in the **Patient ID** field, scan the relevant patient barcode with the barcode reader.
3. Continue entering the patient/exam data as required.

---

**Note:** Fields that will accept data entry via the keyboard will also accept data scanned with the barcode reader. Simply ensure that the cursor is located in the required field then scan the relevant barcode.

---



### 4.1.2 Application Information

Use this section of the **Exam Management** page to select the appropriate **Application** in order to enter **application**-specific data (e.g., for **Abdomen**, enter **Height** and **Weight**).

**Note:** The **Application** selected here is not tied to an **Imaging Preset** or **Exam Type/ Application**.

Table 4-4: Application Information Fields

- Abdomen
- Biliary
- Bladder
- Foreign Bodies
- Generic
- Lower Extremity
- MSK
- Nerve Block
- Procedure
- Renal
- Small Parts
- Thoracic
- Trauma (FAST)
- Urology
- Vascular
- Vascular Access

- **Height** and **Weight** have both metric and imperial measurement options
- **BSA (Body Surface Area)** is calculated and displayed when **Height/Weight** is entered.

- OB 1st Trimester
- OB 2nd–3rd Trimester

- **LMP (Last Menstrual Period)** auto-calculates **GA (Gestational Age)** and **EDD (Estimated Date of Delivery)**

- **GA** auto-calculates **EDD**

**Note:** When either **OB** option is selected as the **Application**, **GA** will automatically be presented on the Patient Information Bar during imaging.

- **EDD** auto-calculates **GA**

**Note:** **LMP** or **GA** will display at the top of the image field in the selected Windows date format (e.g., **mm/dd/yyyy**). Both **weeks (w)** and **days (d)** are used to auto-calculate **EDD**. If the **GA** and **EDD** are entered manually, they will override the **LMP** field entry.

- **Gravida**, **Para** and **Aborta** fields

- **Fetus #** defaults to 1. Enter up to 8 for multiple gestations



**Warning:** In order to record measurements on multiple—but separate—fetuses, enter a **Fetus #** between 2 and 8 (i.e., to activate the **Fetus** toggle button in **OB Measurement Packages and Reports** (where 1 = A, 2 = B, etc.)).

**OB 1st Trimester**  
**OB 2nd–3rd Trimester**

- **BBT (Basal Body Temperature)** can be entered in °C (Celsius) or °F (Fahrenheit)

**Note:** **BBT** is only available if it was selected in **8.2.16 Patient Settings**.

- **Previous Exam** enables the entry of previous **OB** exam data for **Fetal Trending** (refer to **4.1.2.1 OB Previous Exam (Fetal Trending)** for details).

**Pelvic**

- **LMP**
- **Exp. Ovul. (Expected Date of Ovulation)**
- **Day of Cycles**
- **Gravida, Para** and **Aborta** fields.

**Note:** When **Pelvic** is selected as the **Application**, **LMP** will automatically be presented on the **Patient Information Bar** during imaging.



**To Enter Application-Specific Data:**

1. Press the console button.
2. Tab to the **Application** drop-down menu on the right side of the **Application Information** section.
3. Select the desired **Application** from the drop-down menu.

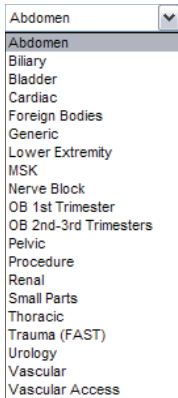

---

**Warnings:**

*In order to record measurements on multiple—but separate—fetuses, enter a **Fetus #** between 2 and 8 (i.e., to activate the **Fetus** toggle button in **OB Measurement Packages** and **Reports** (where **1 = A**, **2 = B**, etc.)).*

*In addition to entering the correct **Fetus #** on the **Exam Management** page, be sure to label each **Fetus** using the console **ABC** button.*

---

**Notes:**

*The **Application**-related data entry fields to the right of the **Application Information** section change with the selection of the various **Applications** (refer to [Table 4-4](#) to view examples of the various options available).*

*Once the cursor is placed in a data entry field, the **Tab** key may be used to move through the various data fields and the **Enter** key may be used to toggle through drop-down menu selections.*

---



#### 4.1.2.1 OB Previous Exam (Fetal Trending)

**Previous Exam** allows users to manually enter data from previous OB exams in order to track **Fetal Trending** details for up to three (3) **Fetuses**.

**Figure 4-4: Previous Exam (Fetal Trending)**

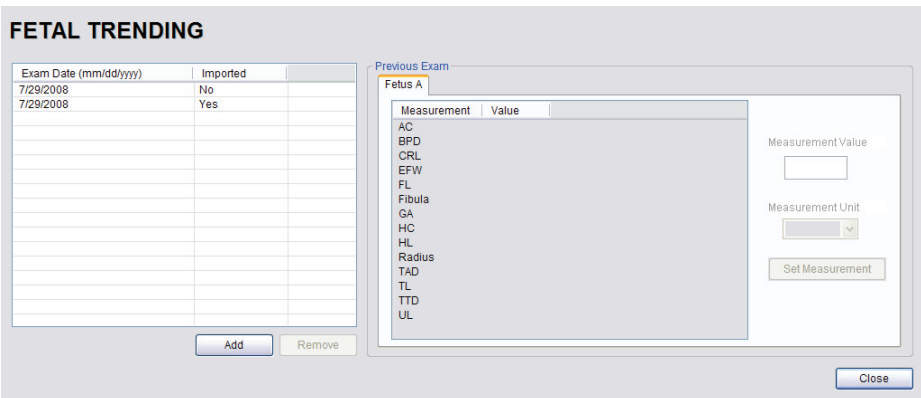
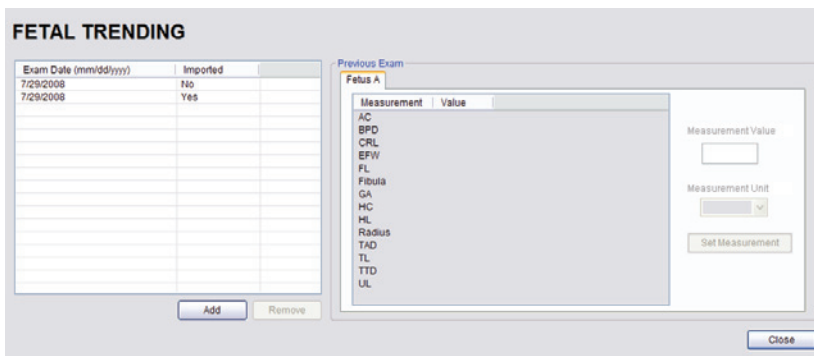

**Table 4-5: Previous Exam (Fetal Trending)**

<b>Exam Date (mm/dd/yyyy)</b>	Indicates the date of the exam, if the exam is on the system or the date of the exam for which data was manually entered.
<b>Imported</b>	<b>Yes</b> or <b>No</b> indicates whether or not exam data is being read from the system ( <b>Imported = No</b> ) or has been entered manually ( <b>Imported = Yes</b> ).
<b>Add</b>	Select to manually enter <b>Previous Exam</b> data.
<b>Remove</b>	Select to remove <b>Previous Exam</b> data. <b>Note:</b> This option is only available for <b>Imported</b> data. Exams that exist on the system cannot be removed from the <b>Fetal Trending</b> page.
<b>Previous Exam</b>	<b>Fetus A, B, C</b> Selects the <b>Fetus</b> for which the exam data is applicable. <b>Note:</b> The number of <b>Fetus</b> tabs will correspond exactly to the <b>Fetus #</b> entered on the <b>Exam Management</b> page, e.g., if the <b>Fetus #</b> is "2" only the <b>Fetus A</b> and <b>Fetus B</b> tabs will be available.
	<b>Measurement</b> Lists the type of <b>Measurement</b> for which data will be entered.
	<b>Value</b> Lists the <b>Value</b> of the entered <b>Measurement</b> .
	<b>Measurement Value</b> <b>Measurement Value</b> data entry field. <b>Note:</b> <b>Measurements</b> can be edited while the exam remains active. Once it has been closed, the exam would have to be deleted and the data re-entered in order to make any edits.
<b>Measurement Unit</b>	Shows the relevant <b>Measurement Unit</b> , e.g., <b>days</b> , <b>cm</b> or <b>g (grams)</b> .
<b>Set Measurement</b>	Accepts the <b>Measurement</b> once it has been entered.

**To Enter Previous OB Exam Data for Fetal Trending:**

1. Press the console  button.
2. Select a **Patient** from the **Patient Database**.
3. Select **Previous Exam** from the **Application Information** data entry section to access the **Fetal Trending** page.



4. If required, select the relevant **Fetus** tab (**Fetus A**, **Fetus B** or **Fetus C**).

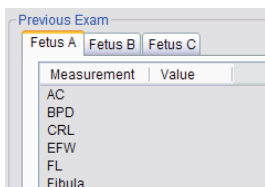



---

**Note:** The number of **Fetus** tabs will correspond exactly to the **Fetus #** entered on the **Exam Management** page, e.g., if the **Fetus #** is "2" only the **Fetus A** and **Fetus B** tabs will be available.

---

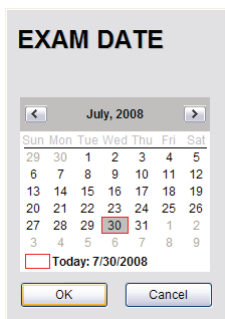
5. Select the **Add** button to access the **Exam Date** selector.



---

**Note:** The system will only allow the addition of one (1) exam per date.

---

6. Select the relevant date for the **Previous Exam**.

---

**Note:** The current date is always enclosed in a red box.

To change the current month, uses the arrow selectors on either side of the calendar header

---

7. Select **OK** to accept the changes or **Cancel** to exit without saving.

---

**Note:** The newly added exam date will be highlighted under **Exam Date (mm/dd/yyyy)** on the left hand side of the **Fetal Trending** page.

---

8. Under **Previous Exam**, highlight the desire **Measurement** and enter the relevant data in the **Measurement Value** data entry field.

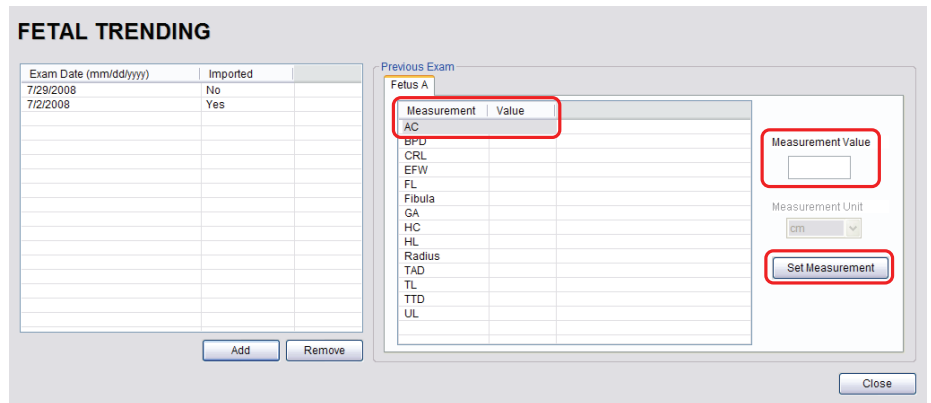

9. Select the **Set Measurement** button.
10. Continue adding **Measurements** in the same manner until all data has been entered for the current **Fetus**.
11. Repeats step 4 to 10 for any additional **Fetus(es)**.
12. Select **Close** to accept the data and return to the **Exam Management** page.
13. The data entered is plotted on the growth graphs as part of the OB report package.

### 4.1.3 Exam Information

Figure 4-5: Exam Information Fields

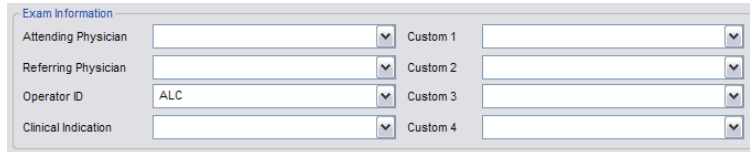

Table 4-6: Exam Information Fields

<b>Attending Physician</b>	Enter name of the <b>Attending Physician</b> manually or select from drop-down menu of previously entered and currently active physician names.
<b>Referring Physician</b>	Enter name of the <b>Referring Physician</b> manually or select from drop-down menu of previously entered and currently active physician names. <b>Referring Physician</b> auto-populates when the patient is selected from <b>DICOM Worklist</b> .
<b>Operator ID</b>	Enter name or initials of the <b>Operator</b> or select from drop-down menu of previously entered and currently active <b>Operator IDs</b> . Operator ID appears at the top of the screen during imaging.
<b>Clinical Indication</b>	Enter <b>Clinical Indication</b> manually or select from drop-down menu of previously entered and currently active <b>Clinical Indications</b> . <b>Clinical Indication</b> auto-populates when the patient is selected from <b>DICOM Worklist</b> , but can be modified.
<b>Custom Label 1, 2, 3, 4</b>	Enter user-defined data manually or select from drop-down menu of previously entered and currently active data.

**Notes:**

Refer to [8.2.16 Patient Settings](#) for details on adding, editing and maintaining data for these fields.

**Attending Physicians and Operator IDs can also be added via [3.3.1 Quick Exam Start-Up](#).**

All these fields can be completed using the barcode reader. Simply ensure the cursor is in the required field and scan the relevant barcode.

#### To Enter Exam Information Manually:

1. Press the console  button.
2. Enter **Exam Information** as required. Once entered, the text is available for recall from the drop-down menu.

---

**Note:** Use the **Tab** or **Enter** key to move around the **Exam Information** fields. Drop-down menu selections can be made with the trackball and  button.

---

#### To Enter Exam Information with the Barcode Reader:

1. Press the console  button.
2. With the cursor in the **Attending Physician** field, scan the relevant patient barcode with the barcode reader.
3. Continue entering the patient/exam data as required.

---

**Note:** Fields that will accept data entry via the keyboard will also accept data scanned with the barcode reader. Simply ensure that the cursor is located in the required field then scan the relevant barcode.

---



## 4.2 SELECTING A TRANSDUCER

Each transducer is restricted to a specific set of **Exam Type/Applications**. Refer to section [C.3 Ultrasound Indications For Use Tables](#) for **Clinical Application** details on each transducer type.

### To Select/Change a Transducer:

1. Press the console  button.
2. Tap the desired **Transducer** and the system will present the **Applications/Imaging Presets** touch screen.



---

**Note:** If an **Exam Type/Application** is active at the time the  button is pressed, any connected transducer that does not support the active **Application** will be shown with a line through the transducer name—temporarily removing it from the pool of currently selectable transducers.

---

### 4.3 SELECTING AN APPLICATION AND IMAGING PRESET COMBINATION

**Imaging Presets** specific to each **Application** are available with each of the system transducers. The **Applications** and **Presets** vary depending on the transducer type (refer to 4.2 for details on transducer selection). Additional user-defined **Imaging Presets** (4.9) may be created and stored with the factory installed or default **Presets**. Due to space limitations, **Applications** and **Presets** may continue on to another page. Use the page selector buttons to move forward and back through the available options.

Refer to C.3 **Ultrasound Indications For Use Tables** for **Clinical Application** details on each transducer type.

---

**Note:** Always tap the **Preset** last as the system automatically moves to imaging after **Preset** selection.

---

#### To Select/Change an Application or Preset:

1. Ensure the relevant transducer has been selected (4.2 **Selecting a Transducer**).
2. A divided **Presets** touch screen is presented. The upper section lists the **Applications** available for the selected transducer and the lower section lists the associated **Imaging Presets**. Tap the desired **Application**.

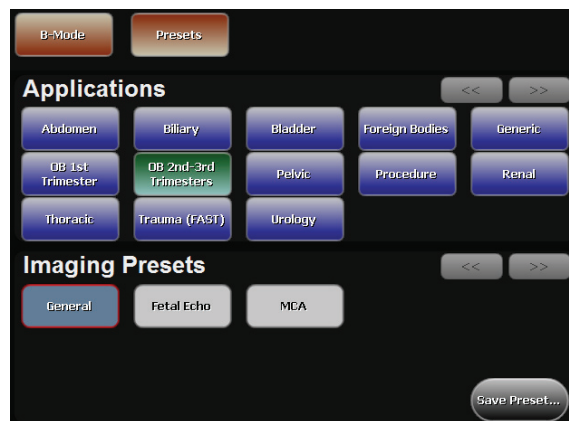

---

**Note:** If the connected transducers do not support the selected **Application**, a message to that effect will be presented (e.g., "The connected transducers do not support the Cardiac Application.").

---

3. Tap the desired **Imaging Preset** and the system will move to live imaging.

---

**Note:** If an **Imaging Preset** has been hidden, it will not be available for selection from the touch screen (or **QSonix**). This option applies to both default and user-defined **Imaging Presets**. Refer to 8.2.1.1 **Show/Hide Imaging Presets** for more details.

---



## 4.4 BEGINNING AN EXAM FOR A NEW PATIENT

---

**Note:** Refer to [4.8.1.1](#) for details on beginning an exam with an existing patient.

---

### To Begin an Exam for a New Patient (Manual Entry):

1. Press the console  button.

---

**Note:** The text cursor defaults to the **Patient ID** field unless a current exam is open. To end the current exam session, select the **End Exam** button near the top right corner of the page.

---

2. Enter **Patient Information** as required.

---

**Note:** The **Patient ID** cannot be edited once the exam is underway.

---

3. Under **Application Information**, select the appropriate **Application** in order to access the **Application**-specific data fields (e.g., for **Cardiac**, complete the **Height** and **Weight** fields).
4. Enter **Exam Information** as required.
5. To save the changes and move to live imaging, select **OK** on the **Exam Management** page or tap **OK** on the touch screen.

---

**Note:** The **Patient ID**, **Name** and **Operator ID** details appear at the top of the image field during an exam. When applicable, **GA** will also be displayed.

If the above-listed fields are relevant to the imaging session but are not displayed, the system may be configured to hide patient data. Refer to [General Options \(Table 8-36\)](#) for details.

---

### To Begin an Exam for a New Patient (Barcode Reader):

1. Press the console  button.
2. With the cursor in the **Patient ID** field, scan the relevant patient barcode with the barcode reader.
3. Continue entering the patient/exam data as required.

---

**Note:** Fields that will accept data entry via the keyboard will also accept data scanned with the barcode reader. Simply ensure that the cursor is located in the required field then scan the relevant barcode.

---



## 4.5 BEGINNING AN EXAM WITH NO PATIENT SELECTED

It is possible to begin an exam without first entering any patient data on either the **Exam Management** page or via **QSonix**. With an unassigned exam, if a measurement is taken or an image is saved, **Operators** will be required to assign or discard the data before being permitted to end the exam.

---

**Note:** *If no data was saved, the exam cannot be assigned to a Patient.*

---

Before attempting to begin an exam with no Patient assigned, ensure that **Enable Unassigned Exam** has been selected in the **Patient Settings** dialog (under **General Options** in [Table 8-36](#)).



**Warning:** *Exams that are assigned to a Patient after images have been saved do not include identifying Patient data (such as **Patient ID** or **Name**).*

*Organizations that elect to configure/use the **Enable Unassigned Exam** functionality provided by Ultrasonix are assuming all liabilities and risks associated with that decision.*

---

There are three (3) methods to assign data to a Patient. On the touch screen, tap:

- **End Exam:** After assigning a Patient the exam will end.
- : After assigning a Patient the **Operator** has the option of continuing the exam.

---

**Note:** *If the **Operator** continues with the exam, all subsequent data saved to the exam will include identifying Patient data (such as **Patient ID**).*

---

On the console, press:

- **Q:** After assigning a Patient the **Operator** can continue imaging.

### To Assign an Exam to a Patient after Tapping End Exam:

1. Ensure **Enable Unassigned Exam** was selected in the **Patient Settings** dialog (under **General Options** in [Table 8-36](#)).
2. Ensure no Patient is currently selected.
3. Begin an exam and ensure that at least one (1) measurement is taken or one (1) image is saved.
4. Ensure the system is at the main touch screen (e.g., if the touch screen is at **Measurement Packages**, press the console  button to return to the main touch screen) .
5. Tap the touch screen **End Exam** button and select **Yes** to assign the exam to a Patient or **No** to discard the data.

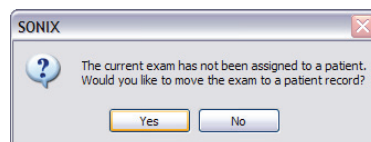



6. If **Yes** was selected in **step 5**, the **Assign Exam** page will be presented.
7. Enter the relevant data for a new patient or select an existing one.



---

**Note:** *The **Assign Exam** page contains all the same fields and options as the **Exam Management** page (4.1).*

---

8. Tap **OK** to exit.

**To Assign an Exam to a Patient after Tapping Exam Mgmt:**

1. Ensure **Enable Unassigned Exam** was selected in the **Patient Settings** dialog (under **General Options** in **Table 8-36**).
2. Ensure no **Patient** is currently selected.
3. Begin an exam and ensure that at least one (1) measurement is taken or one (1) image is saved.
4. Ensure the system is at the main touch screen (e.g., if the touch screen is at **Measurement Packages**, press the console  button to return to the main touch screen) .
5. Press the console  button and select **Yes** to assign the exam to a Patient, **No** to discard the data and move to the **Exam Management** page or **Cancel** to return to imaging.

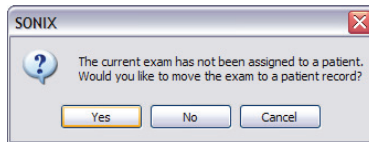

6. If **Yes** was selected in **step 5**, the **Assign Exam** page will be presented.
7. Enter the relevant data for a new patient or select an existing one.

---

**Note:** *The **Assign Exam** page contains all the same fields and options as the **Exam Management** page (4.1).*

---

8. Select **OK** to exit.
9. When prompted, select **Yes** to continue imaging or **No** to end the exam.

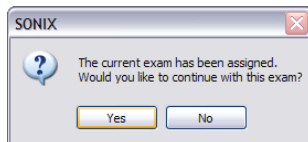

---

**Note:** *If the **Operator** continues with the exam, all subsequent data saved to the exam will include identifying Patient data (such as **Patient ID**).*

---

### To Assign an Exam to a Patient after Pressing Q:

1. Ensure **Enable Unassigned Exam** was selected in the **Patient Settings** dialog (under **General Options** in [Table 8-36](#)).
2. Ensure no **Patient** is currently selected.
3. Begin an exam and ensure that at least one (1) measurement is taken or one (1) image is saved.
4. Ensure the system is at the main touch screen (e.g., if the touch screen is at **Measurement Packages**, press the console  button to return to the main touch screen) .
5. Press the console **Q** button and select **Yes** to assign the exam to a Patient, **No** to discard the data and enter **QSonix** or **Cancel** to return to imaging.

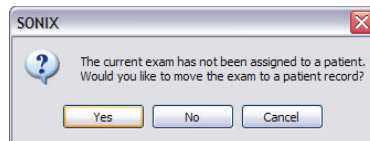

6. If **Yes** was selected in [step 5](#), the **Assign Exam** page will be presented.
7. Enter the relevant data for a new patient or select an existing one.

---

**Note:** *The **Assign Exam** page contains all the same fields and options as the **Exam Management** page (4.1).*

---

8. Select **OK** to exit.
9. When prompted, select **Yes** to continue imaging or **No** to end the exam.

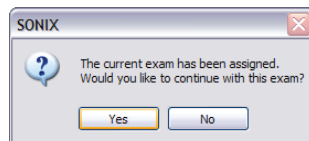

---

**Note:** *If the **Operator** continues with the exam, all subsequent data saved to the exam will include identifying Patient data (such as **Patient ID**).*

---



## 4.6 ENDING AN EXAM

### To End the Current Exam Session:

1. Press the console  button.
2. Tap **End Exam** on the touch screen or select **End Exam** from the **Exam Management** page.

---

**Note:** *End Exam ends the current exam session, clears the **Patient** and **Exam** data fields and clears the printer queue (i.e., if printer image sheet is set for **2x2** and only two (2) images were saved, **End Exam** signals the system that no more images are coming to fill up the sheet).*

*Before ending an exam, ensure the active image has been saved/printed using the console **1** or **2** button (8.2.13 Custom Keys) in order to be able to recall it via the **Review** button on the **Exam Management** page or the **Exam Review** button on the touch screen.*

---

## 4.7 EXAM IMPORT/EXPORT

**Exam Import/Export** enables data to be copied to and from the system, allowing users to make backups that can be imported again at a later date.

---

**Note:** *The data to be backed up can be configured using either **Date** or **Patient-specific** criteria.*

---

When first entering the **Exam Import/Export** page, the default action will always be **Export**. In order to import patient data, simply select any **Source** other than **Local Patient Data** and the button will change from **Export** to **Import**.

**Figure 4-6: Exam Import/Export**

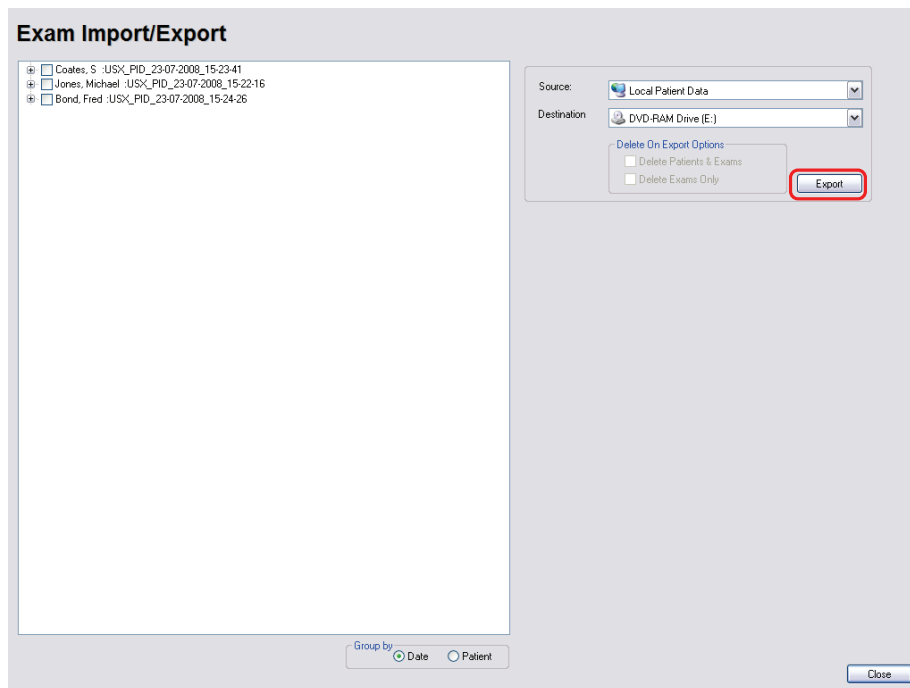





**Table 4-7: Exam Import/Export**

		When importing, select a <b>Source</b> location.
<b>Source</b>		<b>Note:</b> Only currently available <b>Sources</b> will be presented. If the required data is not accessible, ensure the correct media has been connected to the system. For <b>Export</b> , the <b>Source</b> must be <b>Local Patient Data</b> . For <b>Import</b> , the <b>Destination</b> must be <b>Local Patient Data</b> .
		When exporting, select a <b>Destination</b> for the <b>Patient/Exam</b> data.
<b>Destination</b>		<b>Note:</b> Only currently available <b>Destination</b> locations will be presented.
<b>Delete On Export Options</b>		Enables users to decide which exams—if any—to auto-delete after the <b>Exam Export</b> is complete.
	<b>Delete Patient and Exams</b>	Select to delete both the <b>Patients</b> and <b>Exams</b> selected for <b>Export</b> . The deletion will auto-complete after the <b>Export</b> is finished. <b>Note:</b> Once exported, deleted <b>Patients</b> and <b>Exams</b> can be imported at a later date using the <b>Exam Import</b> function.
	<b>Delete Exams Only</b>	Select to delete only the <b>Exams</b> selected for <b>Export</b> . The deletion will auto-complete after the <b>Export</b> is finished. <b>Note:</b> Once exported, deleted <b>Exams</b> can be imported at a later date using the <b>Exam Import</b> function.
<b>Group by</b>	<b>Date</b>	Groups the available <b>Exams</b> by <b>Date</b> .
	<b>Patient</b>	Groups the available <b>Exams</b> by <b>Patient</b> . <b>Note:</b> This is the default setting.

**To Access Exam Import/Export:**

1. Press the console  button.
2. Select the **Import/Export** button.

**To Export Exam Data:**

1. Press the console  button.
2. Select the **Import/Export** button.
3. If desired, change the **Group by** option from **Patient** to **Date**.
4. Select the desired **Patients** and/or **Exams**.



5. From the **Source** drop-down menu, select **Local Patient Data**.

---

**Note:** *Local Patient Data* is the only **Source** for exporting data.

---

6. From the **Destination** drop-down menu, select the **Export Destination**.

---

**Note:** *The Delete On Export Options* will not be available for selection until a valid **Destination** location is selected.

*To create a backup without removing the data from the system, leave both **Delete On Export Options** unselected.*

---

7. Select the **Export** button to begin the backup.
8. When the **Export** is complete, the following message will be presented.





---

**Note:** *If Delete On Export Options* were selected, the data will be deleted before the **Export process is complete** message is presented.

---



**To Import Exam Data:**

1. Press the console  button.
2. Select the **Import/Export** button.
3. From the **Source** drop-down menu, select the **Source** of the data to be imported.

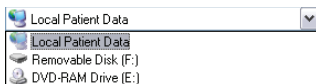

---

**Note:** The following actions will auto-complete once the data **Source** is changed from **Local Patient Data**:

- **Destination** drop-down menu will change to **Local Patient Data**
- **Export** button will change to **Import**.

- 
4. From the list presented on the left hand side of the **Exam Import/Export** page, select the data to be imported.
  5. Select the **Import** button to begin the procedure.
  6. When the **Import** is complete, the following message will be presented.

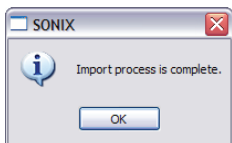

---

**Note:** If the data selected for **Import** is already available on the system, it will not be imported, i.e., it will not overwrite the existing data.

---



## 4.8 STORAGE/DATABASE TABS

To the bottom right of the **Exam Management** page is a series of up to three (3) vertical **Storage** tabs. These tabs can be accessed with the trackball and  button or use the **Exam Management** touch screen **Toggle Tabs** button to move to the appropriate database.

**Table 4-8: Storage/Database Tabs**

<b>Patients</b>	Select to display a list of patients stored in local memory.
<b>DICOM</b>	<b>Worklist</b> Select to display the patient list recently retrieved from the <b>DICOM or EMR Worklist</b> server. <i>Note: This tab is available only when the system is configured for <b>DICOM (8.2.12)</b> or <b>EMR (8.2.16.1)</b>.</i>
	<b>Store Queue</b> Select to display the current <b>DICOM Storage Queue</b> . <i>Note: This tab is available only if <b>DICOM</b> is licensed and a <b>Storage Server</b> has been configured (8.2.12.1).</i>
	<b>Print Queue</b> Select to display the current <b>DICOM Print Queue</b> . <i>Note: This tab is available only if <b>DICOM</b> is licensed and a <b>Print Server</b> has been configured (8.2.12.2).</i>
<b>Hide</b>	Select to blank out patient data on the <b>Exam Management</b> page. This feature provides data privacy.

## 4.8.1 Patients

Using data entered in [4.1.1 Patient Information](#), the system maintains and displays a database containing patient details.

**Figure 4-7: Patients Database**

Patient ID ↕	Last Name	First Name	Middle Name	Birthdate	Sex	Last Exam	Images	
PID_20-10-2010_02-...	Smith	J		12/15/1981	F	10/20/2010	0	

**Table 4-9: Patients Database**

<b>(Patient) ID</b>	<b>Patient Identifier</b> as entered in the <b>Patient Information</b> section.
<b>Last Name</b> <b>First Name</b> <b>Middle Name</b>	Patient's <b>Last</b> , <b>First</b> and <b>Middle Names</b> as entered in the <b>Patient Information</b> section.
<b>Birthdate</b>	Patient's <b>Birthdate</b> as entered in the <b>Patient Information</b> section.
<b>Sex</b>	Patient's <b>Sex</b> as entered in the <b>Patient Information</b> section.
<b>Insurance (#)</b>	Patient's <b>Insurance Number</b> (if applicable) as entered in the <b>Patient Information</b> section.
<b>Last Exam</b>	Date of the <b>Last Exam</b> performed on the patient (if applicable).
<b>(Number of) Images</b>	Total number of <b>Images</b> stored for the patient's most recent exam.

#### 4.8.1.1 Manipulating the Patients Database

##### To Manually Select a Previously Stored Patient from the Patients Database:

1. Press the console  button.
2. Select the **Patients** tab near the bottom of the **Exam Management** page to display a list of locally stored (on the system hard drive) patients or use the **Exam Management** touch screen **Toggle Tabs** button to move to the appropriate database.

Patient ID	Last Name	First Name	Middle Name	Birthdate	Sex	Last Exam	Images
PID_20-10-2010_02-...	Smith	J		12/15/1981	F	10/20/2010	0

3. Select a patient and auto-populate the data fields.
4. Modify patient and exam data fields as required.

---

**Note:** The **(Patient) ID** cannot be modified.

---

5. Select **OK** to save the data and move to live imaging.

---

**Note:** When a new exam is initiated, the transducer used in the most recent exam will still be selected if it is still connected. If it's no longer connected, the system will default to the first available transducer. This default transducer selection is not affected even if the system is turned off between exams.

---

##### To Search the Patients Database for a Previously Stored Patient:

1. Press the console  button.
2. Select the **Patients** tab near the bottom of the **Exam Management** page to display a list of locally stored (on the system hard drive) patients or use the **Exam Management** touch screen **Toggle Tabs** button to move to the appropriate database.
3. Select the **Field Header** of the data to searched (e.g., **Last Name**).
4. Use the keyboard to enter the patient search data (**Patient ID** or **Name**, etc.).

---

**Note:** The **Patients Database** narrows the list of patients to those that match entered search criteria.

---

5. When the list has been narrowed sufficiently (e.g., to one **Patient ID** or all patients with the desired **Last Name**), select the desired patient.



**To Change the Layout of the Patient Data Columns:**

1. Press the console button.
2. Position the arrow cursor over the **Field Header** to be moved.

Patient ID	Last Name	First Name	Middle Name	Birthdate	Sex	Last Exam	Images
PID_20-10-2010_02...	Smith	J		12/15/1981	F	10/20/2010	0

3. Hold down the button and simultaneously use the trackball to drag the column to the desired location.

---

**Note:** o change the order of the list (e.g., from numerical by **Patient ID** number to alphabetical by **Last Name**), position the cursor over the relevant **Field Header** and press . To reverse the order press again.

---

## 4.8.2 DICOM Worklist

The system must be configured for **DICOM Worklist** and connected to a **DICOM** server in order for the **Worklist** database feature to function. For setup instructions, refer to **8.2.12 DICOM Configuration**.

---

**Note:** The data in the fields available on the actual search page are dependant upon the data entered into **DICOM: Patient ID, Last Name, First Name, Accession #, Start Date (mm/dd/yyyy), End Date (mm/dd/yyyy), Exam Type, Procedure ID, Station AE Title, Station Location and Modality Type**.

---

**Figure 4-8: Exam Management Page (DICOM Worklist)**

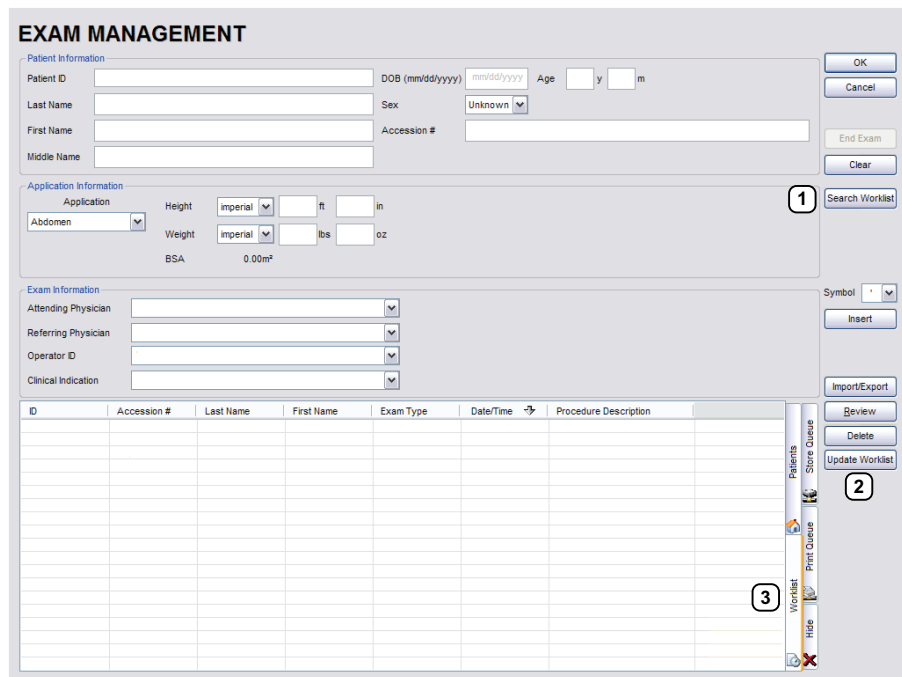

**EXAM MANAGEMENT**

**Patient Information**

Patient ID  DOB (mm/dd/yyyy)  Age  y  m

Last Name  Sex

First Name  Accession #

Middle Name

**Application Information**

Application  Height   ft  in

Weight   lbs  oz

BSA

**Exam Information**

Attending Physician

Referring Physician

Operator ID

Clinical Indication

ID	Accession #	Last Name	First Name	Exam Type	Date/Time	Procedure Description

**1** Search Worklist

**2** Update Worklist

**3** Worklist tab

**Table 4-10: Exam Management Page (DICOM Worklist)**

- |          |                               |
|----------|-------------------------------|
| <b>1</b> | <b>Search Worklist</b> button |
| <b>2</b> | <b>Update Worklist</b> button |
| <b>3</b> | <b>Worklist</b> tab           |

Figure 4-9: DICOM Worklist Search

**WORKLIST SEARCH**

Search Criteria

Patient ID  Start Date (mm/dd/yyyy)  Station AE Title

Last Name  End Date (mm/dd/yyyy)  Station Location

First Name  Exam Type  Modality Type

Accession #  Procedure ID

ID	Accession #	Last Name	First Name	Exam Type	Date/Time	Procedure Description
PD321	acc_full	Lfull	Ffull	Abdomen	4/12/2011	Abdomen
PD322		LastN	FirstN	Cardiac	4/12/2011	Cardiac
PD323	acc_nodob	Lnodob	Fnodob	Pelvic	4/12/2011	Pelvic

#### 4.8.2.1 Manipulating the DICOM Worklist Database

##### To Perform a DICOM Worklist Search:

1. Press the console  button.
2. Select **Search Worklist**.
3. When the **Worklist Search** page appears on the screen enter the patient **Search Criteria** data (**Patient ID** or **Name**, etc.).

**WORKLIST SEARCH**

Search Criteria

Patient ID  Start Date (mm/dd/yyyy)  Station AE Title

Last Name  End Date (mm/dd/yyyy)  Station Location

First Name  Exam Type  Modality Type

Accession #  Procedure ID

**Note:** *Worklist text fields can be searched with wildcards, e.g., entering **SMI\*** in the **Last Name** field will find all names beginning with **SMI**.*

4. Select **Search** to update the **Worklist** with the results of the advanced search.

**Notes:**

*The parameters from the last search will be retained for the duration of the current (computer-defined) date.*

**Worklist Search** results are limited to a maximum of 100 records. Any result list longer than 100 records will be truncated.

### To Select a Patient from the DICOM Worklist:

1. Press the console  button.
2. Select the **Worklist** tab to display the **DICOM Worklist** database or use the **Exam Management** touch screen **Toggle Tabs** button to move to the appropriate database.
3. If the desired patient is not available on the list, select **Update Worklist** to refresh the data.

---

**Note:** Updates will be based upon the last search performed.

---

4. Select the desired patient and the patient data fields will auto-populate.
5. Modify patient and exam data fields as required.

---

**Note:** The **Patient ID** cannot be modified.

*Modifications to auto-populated **Worklist** fields (**Name** and **Accession #**) are not recommended.*

---

6. Select **OK** to save the data, create a patient in the **Patient** database and move to live imaging.

---

**Note:** The patient file is automatically deleted at the end of the exam if no images or measurements are stored to the system for this patient.

---

---

**Note:** When a new exam is initiated, the transducer used in the most recent exam will still be selected *if* it is still connected. If it's no longer connected, the system will default to the first available transducer. This default transducer selection is not affected even if the system is turned off between exams.

---



### 4.8.3 Hide

Selecting the **Hide** tab will instantly blank all patient data visible in the **Patients** or **Worklist** database. This is very useful when an **Operator** needs to quickly protect the privacy of patient data that would otherwise be visible to anyone within viewing distance.

To reveal patient data, simply select another database tab or use the **Exam Management** touch screen **Toggle Tabs** button to move to the appropriate database.

**Figure 4-10: Hide Tab**

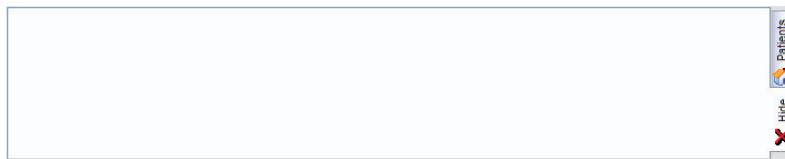





## 4.9 USER-DEFINED PRESETS FOR NON-3D/4D FORMATS

User-defined **PRESETS** may be created and saved to the selected **Application**. They are presented for selection along with factory defaults when selecting **Transducer**, **Application** and **Preset**. Refer to [8.2.1 Presets](#) for more details on user-defined **PRESETS**.

---

**Note:** When saving user-defined **PRESETS** in  or , the actual mode is also saved as part of the **Preset**.

---

In addition to standard **PRESETS**, the system also allows users to create and save user-defined **3D/4D Presets**. Refer to [5.12.9 3D/4D Presets](#) for details.

During imaging, a user-defined **Preset** name is shown on the LCD display in square brackets (e.g., [**User-Defined Preset**]).

---

**Note:** When configuring a user-defined **Preset** for **M**, **PW** or **Triplex** mode, be sure to move to the desired **Layout** as this setting will be saved with the **Preset**. Refer to sections [5.1.7](#), [5.3](#) and [5.3.3](#) for more details.

---

### To Save User-Defined Presets:

1. Ensure the relevant transducer has been selected ([4.2 Selecting a Transducer](#)).
2. Tap the desired **Application–Preset** combination where the **Preset** is similar to the required user-defined **Preset**.

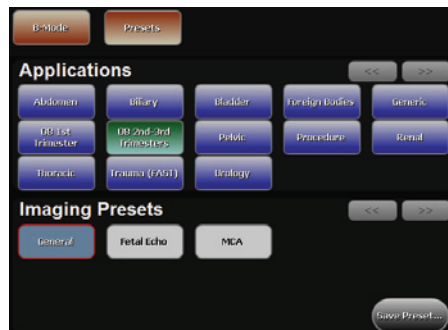

3. Once the system moves to live imaging, adjust the imaging parameters (e.g., **Depth**, **Dynamic Range**, **Gain**, **Sector Size**, etc.) and **TGC** settings.
4. Tap the touch screen **Presets** tab.
5. Tap **Save Preset....**



- When the **Save Preset** dialog is presented, chose the appropriate **Application** under which the new **Preset** will be stored from the **Select Application** drop-down menu.

**SAVE PRESET**

Select Application  
Abdomen

Preset Name

OK Cancel

---

**Note:** If a user-defined **Preset** with the same name already exists, the system will present a message requiring the user to overwrite (**Yes**), save with a new name (**No**) or exit without saving (**Cancel**).

---

- Use the console keyboard to enter a **Preset Name**.
- Select **OK** to save the **Preset** or **Cancel** to exit without saving.
- The user-defined **Preset** will now be available on the **Imaging Presets** page under the selected **Application**.

---

**Note:** Refer to [8.2.1 Presets](#) for more details on **Imaging Presets**.

---

## CHAPTER 5: IMAGING

The Sonix buttons controlling key imaging modes are organized into specific sections on the Operator console (i.e., **2D**, **Color**, **Doppler**, etc.). Refer to **2.2 Operator Console** for layout details.

Additional imaging controls are accessible on the touch screen when a specific imaging mode is active. Touch screen imaging controls are organized by tab for each active imaging modes.

### 5.1 BASIC 2D IMAGING

**2D** or **B-Mode** is the system's default imaging mode. Any time a user toggles out of an imaging mode (other than the combined mode of **Color/PW**) the system will default back to **B-Mode**.

The system's broadband transducers provide a range of imaging **Frequencies**:

- **Harmonics**: artifact reduction (not available with all transducers)
- **Resolution**: highest frequency
- **General**: standard imaging frequency
- **Penetration**: lowest frequency
- **EPI**: greater penetration and improved contrast resolution for the technically difficult patient.

**Note:** *EPI is a licensed option available for use with the C5-2/60 curved array transducer.*

Figure 5-1: 2D/B-Mode Field Locations During Imaging

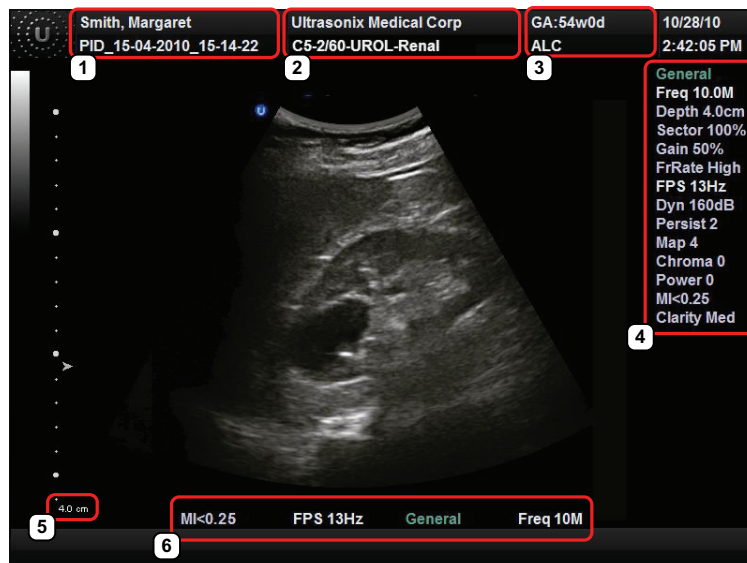
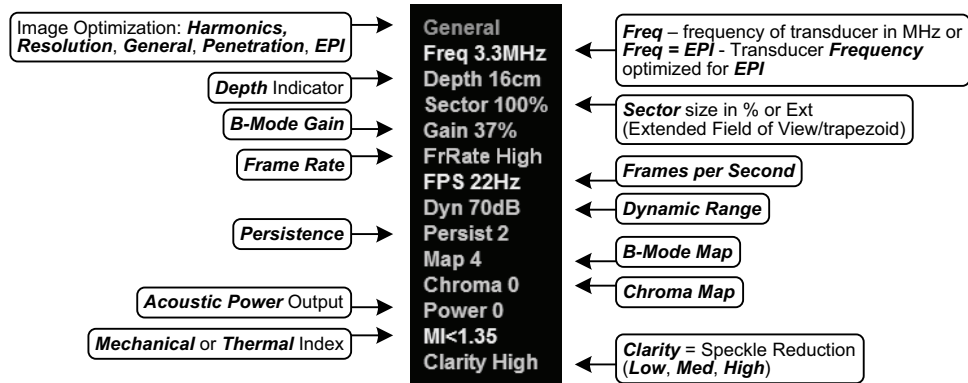













**Table 5-1: 2D/B-Mode Field Locations During Imaging**

1		<ul style="list-style-type: none"> <li>• 1: <b>Patient Name</b> and <b>ID</b></li> <li>• 2: <b>Institution Name</b> and <b>Transducer–Application–Preset</b></li> <li>• 3: <b>GA</b> (for <b>OB</b>), <b>LMP</b> (for <b>Pelvic</b>) and <b>Operator ID</b>.</li> </ul>
2	<b>Patient/Exam Information</b>	
3		<b>Note:</b> Refer to <a href="#">Chapter 4</a> and <a href="#">Chapter 8</a> for more details on <b>Patient/Exam Information</b> .
4	<b>2D/B-Mode Imaging Parameters</b>	Refer to <a href="#">Figure 5-2</a> and <a href="#">Appendix E</a> for details.
<b>Note:</b> If items 5 and 6 exist, then item 4 will not be visible. Refer to <b>Parameters</b> in <a href="#">Table 8-35</a> for more details.		
5	<b>Depth</b>	When <b>Parameters</b> is set to <b>Subset</b> , a <b>Depth</b> value will be placed under the <b>Depth</b> markers.
6	<b>2D/B-Mode Imaging Parameter Subset</b>	When <b>Parameters</b> is set to <b>Subset</b> , only four (4) imaging parameters will be displayed: <b>MI/TI</b> , <b>FPS</b> , <b>Resolution</b> and <b>Freq</b> .

**Figure 5-2: 2D/B-Mode Onscreen Imaging Parameters**



**Table 5-1: 2D/B-Mode Imaging Console Controls**

	Turn to adjust overall <b>Gain</b> . Press to exit other imaging modes and return to <b>2D</b> imaging.
	Press up or down to adjust the transducer <b>Frequency: Penetration, General, Resolution, Harmonics</b> and <b>EPI</b> . <b>Note: The Harmonics setting is not supported by all transducers.</b>
	Press up or down to <b>Zoom</b> the image in or out. Use the trackball to pan the zoomed image. Press <b>[B]</b> to exit <b>Zoom</b> .
	Press up or down to adjust the imaging <b>Depth</b> up or down.
	Press up or down to adjust focal zone position up or down.
	Press once to activate <b>Dual</b> and twice to activate <b>Quad</b> imaging.
	Press to steer the <b>2D</b> beam on linear transducers.
	Turn to adjust <b>Acoustic Power</b> . <b>Note: Pressing the dial will not affect the Index setting.</b>
	<b>Warning: Refer to A.1.1 ALARA Principle and Output Displays.</b>

**Note: Refer to Appendix E for details on touch screen Mode Action and Imaging Parameters buttons.**

The **TGC** slide pods located to the right of the touch screen are used to adjust the **Time Gain Compensation**. Ultrasonix recommends setting the **TGC** slide pods in the center position.

**Note: Press the console [B] button/dial to exit other imaging modes (Color, PW Doppler, M-Mode, Panoramic, etc.) at any time during the imaging session and return to 2D imaging.**

Additional **2D** imaging parameters are available on the touch screen under the **B-Mode** tab.



**To Select/Adjust Touch Screen 2D Imaging Parameters:**

1. Ensure the touch screen **B-Mode** tab is active.
2. Tap the desired imaging parameter on the touch screen, e.g., **Persist(ence)**.
3. Turn the associated touch screen dial to adjust the imaging parameter (e.g., turn dial left to decrease **Persistence** or right to increase **Persistence**).

**To Adjust the Imaging Frequency (Image Optimization):**

1. Press the console  rocker switch.

---

**Note:** To increase the **Frequency** from **General**, press the rocker switch up once for **Resolution** and twice for **Harmonics**. (The latter option is transducer dependant.)

To decrease the **Frequency**, press the rocker switch down once for **Penetration** and twice for **EPI**.

---

**5.1.1 Clarity (Speckle Reduction)**

**Clarity** imaging mode enhances the **2D** image by performing adaptive filtering of the image. It provides improved visibility of real structures with various levels of speckle reduction.

**To Adjust the Clarity (Speckle Reduction) Imaging Mode:**

1. Ensure the touch screen **B-Mode** tab is active.
2. Tap the touch screen **Clarity** button.
3. Turn the associated touch screen dial to adjust the level of speckle reduction.

## 5.1.2 Spatial Compound Imaging

### To Activate Spatial Compound Imaging:

1. Press the console  button.

---

**Notes:**

*Spatial Compound imaging is available as an option with some transducers, but is not available during **Color** imaging.*

*If another mode(s) is selected while in **Compound** imaging (e.g., **Color Mode**), when exiting that mode(s), the **Operator** will be returned to **Compound** imaging, not **B-Mode**.*

---

## 5.1.3 2D Zoom Imaging

### To Activate the Zoom Feature:

1. On a live or frozen image, press the console  rocker switch up or down to the desired level of magnification.
2. Use the trackball to reposition the magnified **FOV**.

---

***Note:** Repositioning of the **Zoom FOV** is only possible after the image has been magnified to a size that is larger than the image field.*

---

3. To exit the **Zoom** feature, press .

## 5.1.4 Dual Imaging Format

Refer to [Split Imaging \(Table 8-39\)](#) for details on configuring the default active image (**Left Side** or **Right Side**) and the **Auto-Switch on Start** setting.

Figure 5-3: Dual Imaging

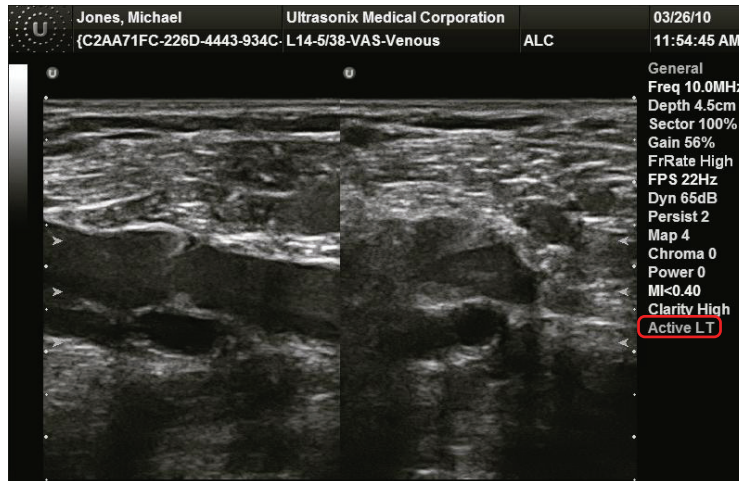









Table 5-2: Dual Imaging

	Indicates <b>Active</b> image:
<b>Active Image</b>	<ul style="list-style-type: none"> <li>• <b>Active LT</b>: left</li> <li>• <b>Active RT</b>: right.</li> </ul>

### To Activate Dual Imaging:

1. With an active **B-Mode** image, press the console  button once.
2. When a live image appears on the left side of the LCD display (**Active LT**), press  to freeze the **Active LT** image and unfreeze (i.e., make active) the **Active RT** image in one step.

**Note:** As an alternative, press  to freeze the right image. Pressing  will then toggle between the frozen images. Press  again at any time to activate the current image.

3. Press  to toggle back and forth between the dual images, freezing the inactive image and unfreezing the newly active image.
4. Press  twice or  to exit **Dual** imaging.

**Note:** **Color Doppler** is available during **Dual** but not **Quad** imaging.



## 5.1.5 Quad Imaging Format

Figure 5-4: Quad Image

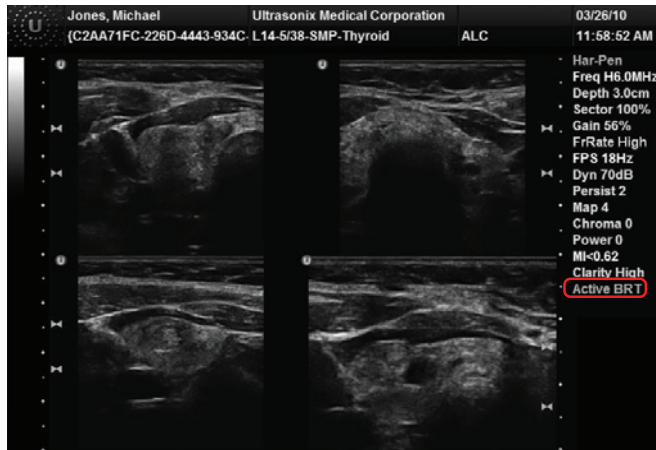









Table 5-3: Quad Imaging

	Indicates <b>Active</b> quadrant:
<b>Active Image</b>	<ul style="list-style-type: none"> <li>• <b>Active ULT</b>: upper left</li> <li>• <b>Active URT</b>: upper right</li> <li>• <b>Active BLT</b>: bottom left</li> <li>• <b>Active BRT</b>: bottom right.</li> </ul>







### To Activate the Quad Imaging Format:

1. With an active **B-Mode** image, press the console  button twice.
2. When a live image appears on the upper left side of the LCD display (**Active ULT**), press  to freeze the **Active ULT** image and unfreeze (i.e., make active) the upper right (**URT**) quadrant in one step.

**Note:** As an alternative, press  to freeze the active image. Press  to move to the next quadrant which will also contain a frozen image. Press  to activate it or  to move to the next quadrant.

3. Press  again to freeze the current image and move to the next quadrant.

**Note:**  toggles through the images sequentially: **ULT, URT, BLT, BRT**.

4. Continue pressing  to move through the four (4) images as required. Depending on the method selected above— only or  and —the images will be active or frozen, respectively.
5. Press  or  to exit **Quad** imaging.

**Note:** **Color Doppler** is available during **Dual** but not **Quad** imaging.

### 5.1.6 Brachytherapy and the BPC8-4/10 Transducer

When the BPC8-4/10 transducer is active and **B-Mode** has been selected, users will be presented with additional Mode Action and Imaging Parameter buttons. These options enable the use of the grid created for **Brachytherapy**.

**Figure 5-5: Brachytherapy Grid Enabled on the Imaging Screen**



---

**Note:** Refer to [Appendix E](#) for details on touch screen Mode Action and Imaging Parameters buttons.

---

### 5.1.7 M-Mode Imaging

When first entering **M-Mode**, all factory supplied **Imaging Presets** will default to the maximum **Zoom** setting.











---

**Note:** This will not affect *user-defined Presets*.

---

During **M-Mode** imaging, the following imaging parameters are available on the touch screen.

**Table 5-4: 2D/B-Mode Imaging Console Controls**

	Turn to adjust overall <b>Gain</b> . Press to exit other imaging modes and return to <b>2D</b> imaging.
	Press up or down to adjust the transducer <b>Frequency: Penetration, General, Resolution, Harmonics</b> and <b>EPI</b> . <b>Note:</b> The <b>Harmonics</b> setting is not supported by all transducers.
	Press up or down to <b>Zoom</b> the image in or out. Use the trackball to pan the zoomed image. Press  to exit <b>Zoom</b> .
	Press up or down to adjust the imaging <b>Depth</b> up or down.
	Press up or down to adjust focal zone position up or down.
	Press once to activate <b>Dual</b> and twice to activate <b>Quad</b> imaging.
	Press to activate <b>M-Mode</b> imaging.
	Press to steer the <b>2D</b> beam on linear transducers.
	Turn to adjust <b>Acoustic Power</b> . <b>Note:</b> Pressing the dial will not affect the <b>Index</b> setting.
	<b>Warning:</b> Refer to <a href="#">A.1.1 ALARA Principle and Output Displays</a> .

---

**Note:** Refer to [Appendix E](#) for details on touch screen Mode Action and Imaging Parameters buttons.

---



**To Activate M-Mode Imaging:**

1. Press the console **[M]** button.
2. A live full screen **2D** image appears with an **M-Mode** cursor.

---

**Note:** Refer to **Layout in Table E-1** and **8.2.19 Imaging Modes** to customize the **M-Mode** display settings and screen layouts.

---

3. Press **(↻)**.
4. Press **[M]** or **[B]** to exit **M-Mode** and return to **2D** imaging.

**To Select/Adjust Touch Screen M-Mode Imaging Parameters:**

1. While in **M-Mode** imaging, ensure the touch screen **M-Mode** tab is active.
2. On the touch screen, tap the desired imaging parameter button to make any required adjustments. (e.g., **MapM** or **ChromaM**).
3. Turn the associated touch screen dial to adjust the imaging parameter.

**5.1.7.1 Anatomic M-Mode Imaging**

**To Activate Anatomic M-Mode Imaging:**

1. Press the console **[M]** button.
2. A live full screen **2D** image appears with an **M-Mode** cursor.

---

**Note:** Refer to **Layout in Table E-1** and **8.2.19 Imaging Modes** to customize the **M-Mode** display settings and screen layouts.

---

3. Press the console **(↻)** button.
4. Tap the touch screen **Anatomic** button.
5. Press **[M]** or **[B]** to exit **M-Mode** and return to **2D** imaging.

**To Select/Adjust Touch Screen Anatomic M-Mode Imaging Parameters:**

1. While in **Anatomic M-Mode** imaging, ensure the touch screen **M-Mode** tab is active.
2. On the touch screen, tap the desired imaging parameter button to make any required adjustments. (e.g., **MapM** or **ChromaM**).
3. Turn the associated touch screen dial to adjust the imaging parameter.

### 5.1.7.2 Color M-Mode Imaging

#### To Activate Color M-Mode Imaging:

1. Press the console **[M]** button.
2. A live full screen **2D** image appears with an **M-Mode** cursor.

---

**Note:** Refer to **Layout in Table E-1** and **8.2.19 Imaging Modes** to customize the **M-Mode** display settings and screen layouts.

---

3. Press the console **(↻)** button.
4. Press the console **[C]** button.
5. Press **[M]** or **[B]** to exit **M-Mode** and return to **2D** imaging.

#### To Select/Adjust Touch Screen Color M-Mode Imaging Parameters:

1. While in **Color M-Mode** imaging, ensure the touch screen **M-Mode** tab is active.
2. On the touch screen, tap the desired imaging parameter button to make any required adjustments. (e.g., **MapM** or **ChromaM**).
3. Turn the associated touch screen dial to adjust the imaging parameter.



## 5.2 COLOR/POWER DOPPLER

**Color Doppler** is used to detect blood flow and determine flow direction. **Power Doppler** is more sensitive to low flow rate in small vessels, but offers no directional information. **Color Power Doppler** is **Power Doppler** with a red/blue color map providing directional flow information.

Figure 5-6: Color Doppler Image

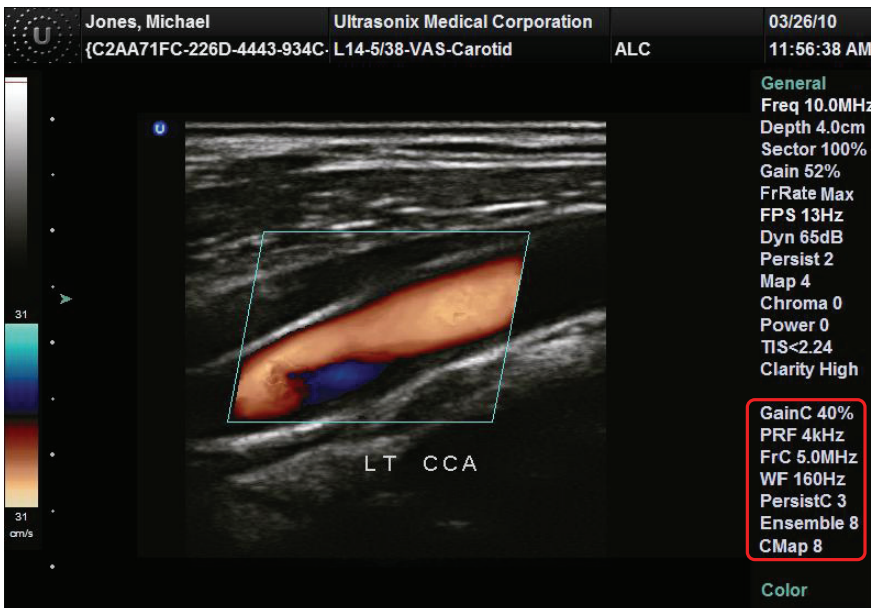
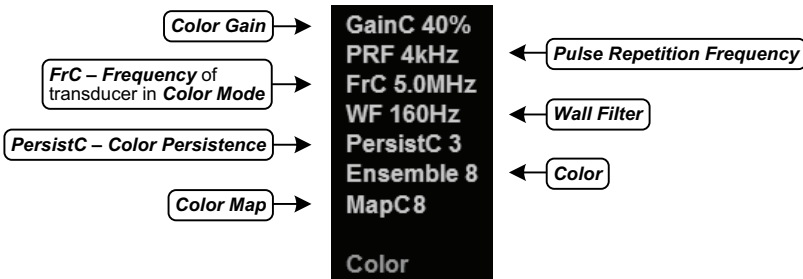





Figure 5-7: Color Doppler Imaging Parameters



**Note:** Refer to [Appendix E](#) for details on touch screen Mode Action and Imaging Parameters buttons.

The key **Color/Power Doppler** imaging controls are located in the upper center position of the operator console.



**Table 5-5: Color Doppler Console Controls**

	Press to select <b>Color Doppler</b> imaging. Turn to adjust <b>Color Gain</b> .
	Press to activate <b>Power Doppler</b> imaging.
<b>WF</b>	Press up or down to adjust the <b>Color Wall Filter</b> higher or lower.
<b>PRF</b>	Press up or down to adjust the <b>Color Doppler Pulse Repetition Frequency</b> up or down.
	Press to <b>Invert</b> the direction of the <b>Color Map</b> .
	Press to <b>Steer</b> the <b>Color ROI</b> box right or left.

Additional **Color/Power Doppler** image optimization controls are available on the touch screen **Color** tab when the **Color** imaging mode is active.

## 5.2.1 Color Doppler Imaging Mode

### To Activate Color Doppler Imaging Mode:

1. Press the console  button.
2. Use the trackball to position the **Color ROI** box to the area of interest.
3. Press  to toggle control of the trackball to resize the **Color ROI** box.
4. Use the trackball to resize the **Color ROI** box or use the touch screen controls to make the horizontal and vertical **Color ROI** box adjustments.

---

**Note:** During multiple mode imaging (e.g., **2D/Color/PW Doppler**) use the  button to toggle control of the trackball for **Color ROI** box positioning, **Color ROI** box resizing and **PW** cursor/Gate positioning. Alternate controls are available on the **Color** tab to resize the **Color ROI** box. The **Color ROI** box moves with the **PW** cursor.

---

5. Press  to exit **Color Doppler** imaging.

### To Select/Adjust Touch Screen Color Imaging Parameters:

1. While in **Color** imaging, ensure the touch screen **Color Mode** tab is active.
2. On the touch screen, tap the desired imaging parameter button to make any required adjustments. (e.g., **PersistC**).
3. Turn the associated touch screen dial to adjust the imaging parameter (e.g., turn dial left to decrease the amount of **Persistence**/turn dial right to increase the amount of **Persistence**).



## 5.2.2 Power Doppler Imaging Mode

### To Activate Power Doppler Imaging Mode (Method 1):

1. Press the console **[PD]** button.
2. Use the trackball to position the **Color Power** ROI box to the area of interest.
3. Press **↖** to toggle control of the trackball to resize the **Color Power** ROI box.
4. Use the trackball to resize the **Color Power** ROI box or use the touch screen controls to make the horizontal and vertical **Color Power** ROI box adjustments.

---

**Note:** During multiple mode imaging (e.g., **2D/Color/PW Doppler**) use the **↖** button to toggle control of the trackball for **Color** ROI box positioning, **Color** ROI box resizing and **PW** cursor/Gate positioning. Alternate controls are available on the **Color** tab to resize the **Color** ROI box. The **Color** ROI box moves with the **PW** cursor.

---

5. Press **[PD]** to exit **Color Doppler** imaging.

### To Activate Power Doppler Imaging Mode (Method 2):

1. While in **Color** imaging, ensure the touch screen **Color Mode** tab is active.
2. Tap the touch screen **Method** button and turn the associated dial to cycle through the options: **Color**, **Power** and **TDI (Tissue Doppler Imaging)**.

---

**Note:** The console options **[PD]** or **[C]** will only be selected (orange) when the selected mode action matches. For example, when **Color** is selected as the **Method**, the console **[C]** button will be selected and the **[PD]** button will be unselected (blue). If **TDI** is selected as the **Method**, both the **[PD]** and **[C]** buttons will be unselected.

---



### 5.2.3 Tissue Doppler Imaging (TDI)

#### To Activate Tissue Doppler Imaging:

1. While in **Color** imaging, ensure the touch screen **Color Mode** tab is active.
2. Tap the touch screen **Method** button and turn the associated dial to cycle through the options: **Color**, **Power** and **TDI**.

---

**Note:** The console options **[PD]** or **[C]** will only be selected (orange) when the selected mode action matches. For example, when **Color** is selected as the **Method**, the console **[C]** button will be selected and the **[PD]** button will be unselected (blue). If **TDI** is selected as the **Method**, both the **[PD]** and **[C]** buttons will be unselected.

---

### 5.2.4 Simultaneous 2D/Color

#### To Activate Split Screen with Simultaneous Live 2D/Color and Live 2D:

1. While in **Color** imaging, ensure the touch screen **Color Mode** tab is active.
2. Tap **Simultaneous 2D Color**.

---

**Note:** The live, **2D** image with **Color** is displayed on the left side of the image field and the same live, **2D** image without **Color** is simultaneously displayed on the right side of the image field. Freezing the image will freeze both sides simultaneously.

**Cine** review will review both sides simultaneously.

---

3. Use the trackball to position the **Simultaneous 2D/Color** ROI box to the area of interest or to resize the **Simultaneous 2D/Color** ROI box.

---

**Note:** Use the  button to toggle control of the trackball for **Color** ROI box positioning, **Color** ROI box resizing and **PW** cursor/**Gate** positioning.

The **Color** ROI box moves with the **PW** cursor.

---

4. Tap **Color Mode** to exit **Simultaneous 2D/Color** and return to **Color** imaging.



### 5.3 PULSED AND CONTINUOUS WAVE DOPPLER (PW AND CW) AND TRIPLEX

**Notes:**



*Triplex is not available when **Cardiac** is selected as the **Application**.*

*ECG is not available on this platform.*

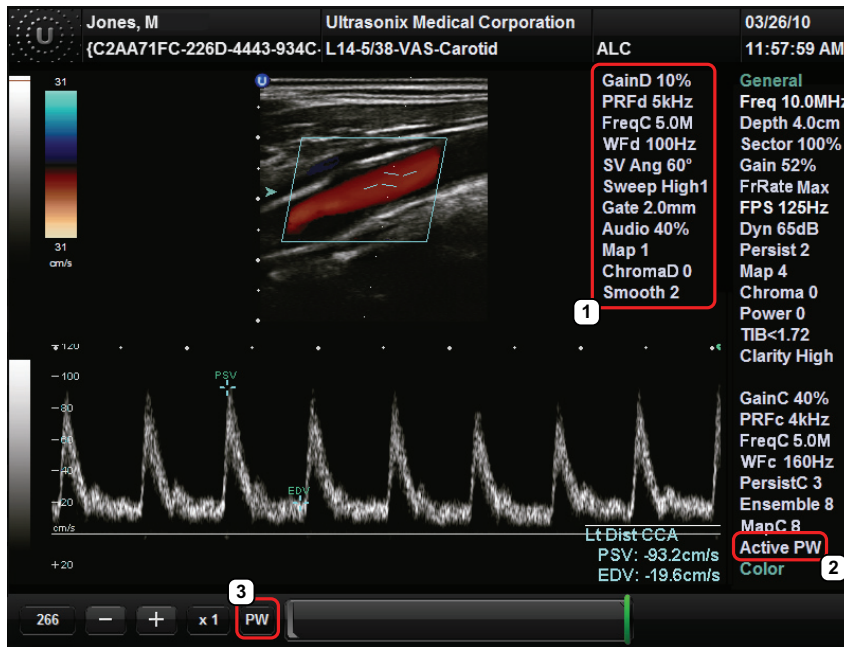
**Figure 5-8: PW Doppler Imaging (Combined with Triplex)**



**Table 5-6: PW Doppler Imaging (Combined with Triplex)**

1 <b>PW Doppler</b> Imaging Parameters	Refer to <a href="#">Figure 5-9</a> and <a href="#">Appendix E</a> for details.
2 <b>Cine Frame</b> Mode	<p>Indicates <b>Cine</b> frames actively available for each imaging mode:</p> <ul style="list-style-type: none"> <li>• <b>PW (Doppler Trace)</b></li> <li>• <b>PW (Doppler Trace)</b></li> <li>• <b>B (2D with and without Color)</b>.</li> </ul> <p>Press  to toggle control between modes.</p>
3 <b>Active</b> Imaging Mode	<p>Indicates active imaging mode(s) when unfrozen:</p> <ul style="list-style-type: none"> <li>• <b>Active PW (Doppler Trace)</b></li> <li>• <b>Active CW (Doppler Trace)</b></li> <li>• <b>Active B (B-Mode or 2D)</b></li> <li>• <b>Active B/PW (Simultaneous 2D and Doppler Trace)</b></li> <li>• <b>Active B/C (2D with Color)</b></li> <li>• <b>Triplex.</b></li> </ul> <p>Press  to toggle control between modes.</p>



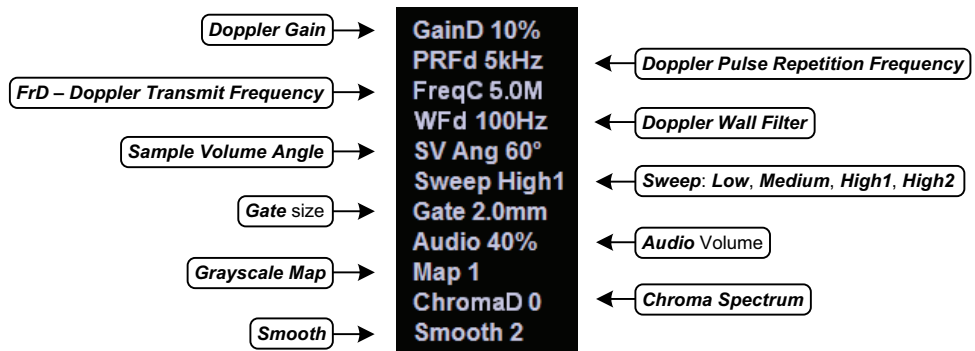



**Figure 5-9: PW/CW Doppler Imaging Parameters**





The key **PW Doppler** imaging controls are positioned to the upper left portion of the operator console:

**Table 5-7: PW/CW Doppler Console Controls**

	Press to activate <b>PW Doppler</b> mode/turn to adjust <b>PW Doppler Gain</b> .
	Press to activate <b>CW Doppler</b> mode.
	Press up or down to adjust the <b>Doppler Trace Baseline</b> up or down.
<b>PRF</b>	Press up or down to adjust the <b>Doppler PRF</b> up or down.
	Press to <b>Invert</b> the direction of the <b>Doppler Trace</b> .
	Press to toggle between +60, -60 and 0 degree <b>Doppler Angle Correct</b> selections. Turn the dial to make angle corrections in 2 degree increments.
	Press to <b>Steer Doppler</b> cursor angle right or left. Also used to steer <b>Color ROI</b> box and <b>2D</b> linear image field.
	Turn to increase/decrease audio volume. <b>Note:</b> <i>The volume control is located on the upper right side of the touch screen.</i>

Additional **PW/CW Doppler** imaging parameters are available on the touch screen to optimize the **Live Doppler Trace**.

**Note:** Refer to [Appendix E](#) for details on touch screen Mode Action and Imaging Parameters buttons.

### 5.3.1 PW Imaging Mode

#### To Activate PW Doppler Imaging Mode:

1. Press the console **PW** button.

---

**Note:** Refer to *Layout* in [Table E-1](#) and [8.2.19 Imaging Modes](#) to customize the **Doppler** display settings and screen layouts.

To adjust the **Sample Volume Gate** size in full screen **2D/PW** cursor, press the console **↻** button and turn the **PW** button/dial.

---

2. Use the trackball to position the **Doppler** cursor/**Gate** to the area of interest.
3. Press the console **↻** button to display a live **Doppler Trace** and a frozen **2D** image/cursor.
4. Press **↻** to toggle back and forth between **PW Trace** and **2D**/cursor.
5. Press **PW** or **B** to exit **PW** imaging mode.

#### To Select/Adjust Touch Screen PW Doppler Imaging Parameters:

1. While in **PW Doppler**, ensure the touch screen **PW Doppler Mode** tab is active.
2. Tap the desired selection (e.g., **Chroma**).
3. Turn the associated touch screen dial to adjust the imaging parameter (e.g., turn dial left to decrease setting/turn dial right to increase setting).



### 5.3.2 CW Imaging Mode

#### To Activate CW Doppler Imaging Mode:

1. Press the console **[CW]** button.

---

**Note:** Refer to **Layout in Table E-1** and **8.2.19 Imaging Modes** to customize the **Doppler** display settings and screen layouts.

---

2. Use the trackball to position the **Doppler** cursor in the area of interest.

---

**Note:** Use the **[PW]** button/dial to control the **CW Gain**.

---

3. Press the console **[D]** button to display a live **Doppler Trace** on the bottom of the image field and a frozen **2D** image/cursor on the top of the image field.
4. Press **[D]** to toggle between **CW Trace** and **2D** cursor both in live or frozen imaging states.
5. Press **[CW]** to return to full screen **2D/CW** cursor.
6. Press **[B]** to exit **CW** imaging mode.

#### To Select/Adjust Touch Screen CW Doppler Imaging Parameters:

1. While in **CW Doppler**, ensure the touch screen **CW Doppler Mode** tab is active.
2. Tap the desired selection (e.g., **GainD**).
3. Turn the associated touch screen dial to adjust the imaging parameter (e.g., turn dial left to decrease setting/turn dial right to increase setting).

### 5.3.3 Triplex Imaging Mode

**Triplex** imaging mode combines live **2D/Color Doppler** with live **PW Doppler** imaging, allowing the user to image with **2D/Color** and **PW Doppler** modes simultaneously.

---

**Caution:** *Triplex* imaging may diminish the quality of the **2D/Color** image and may cause **Doppler** artifacts.

---

**Notes:**

**Triplex** is not available when **Cardiac** is selected as the **Application**.

Refer to **Appendix E** for details on touch screen Mode Action and Imaging Parameters buttons.

---

#### To Activate Triplex Imaging Mode:

---

**Note:** *Triplex* is not available when **Cardiac** is selected as the **Application**.

---

1. Activate **Color** and **Pulsed Doppler** imaging modes.
2. Press the console  button.
3. Tap the touch screen **Triplex** button.

---

**Note:** Once **Triplex** is active, press the console  button to toggle through **Active PW**, **Active B/C** and **Triplex** imaging modes.

---

4. If required, tap **Layout** to move to the appropriate **Split Imaging** selection.

---

**Note:** Refer to **Layout** in **Table E-1** and **8.2.19 Imaging Modes** to customize the display settings and screen layouts.

---

5. Tap **Triplex** again to return to **Duplex** imaging.



**ULTRASONIX**

## **5.4 AUTO-GAIN/B**

*Auto-Gain/B* automatically optimizes image brightness for the following modes:

- *B*
- *Dual/Quad*
- *Compound (Spatial Compounding)*
- *Color*
- *PW Doppler*
- *Triplex.*

**To Initiate Auto-B Functionality:**

1. With an active image in any of the supported modes, press the console **AUTO** button.



## 5.5 ELASTOGRAPHY

*Elastography* is used to measure tissue stiffness.

Figure 5-10: Elastography Imaging

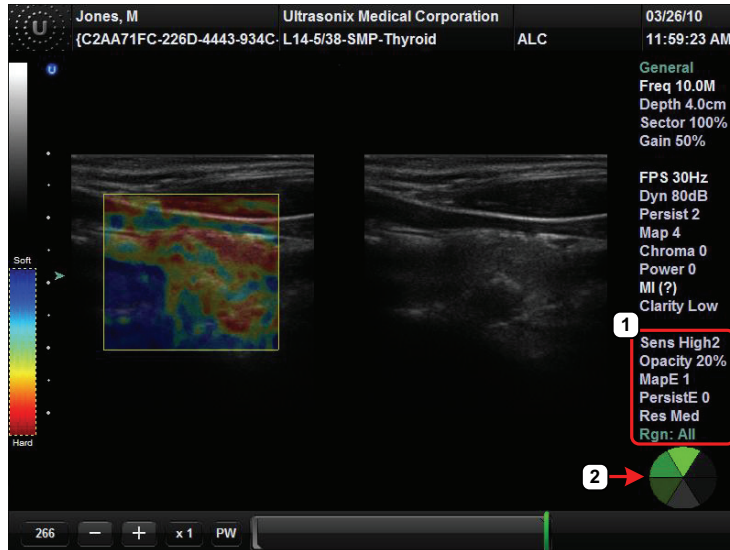
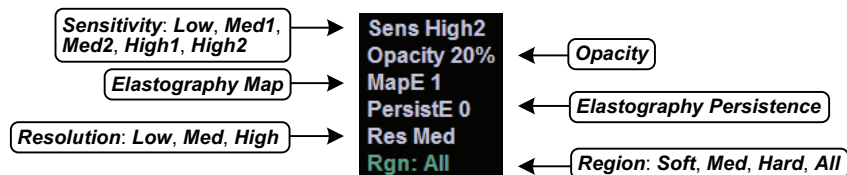

Table 5-8: Elastography Imaging

1	<b>Elastography</b> Imaging Parameters	Refer to <a href="#">Figure 5-11</a> and <a href="#">Appendix E</a> for details.
2	Compression Feedback Indicator	Tracks the amount of pressure being placed on the transducer. When the bright green indicator is at the <u>top</u> , compression has been adjusted to the correct level.

Figure 5-11: Elastography Imaging Parameters





**Table 5-9: Elastography Imaging Console Controls**

	Press to activate <b>Elastography</b> mode.
	Turn to adjust overall <b>Gain</b> . Press to exit other imaging modes and return to <b>2D</b> imaging.
	Press up or down to adjust the transducer <b>Frequency: Penetration, General, Resolution, Harmonics</b> and <b>EPI</b> . <b>Note: The Harmonics setting is not supported by all transducers.</b>
	Press up or down to <b>Zoom</b> the image in or out. Use the trackball to pan the zoomed image. Press  to exit <b>Zoom</b> .
	Press up or down to adjust the imaging <b>Depth</b> up or down.
	Press up or down to adjust focal zone position up or down.
	Press to steer the <b>2D</b> beam on linear transducers.
	Turn to adjust <b>Acoustic Power</b> . <b>Note: Pressing the dial will not affect the Index setting.</b>
	<b>Warning: Refer to <a href="#">A.1.1 ALARA Principle and Output Displays</a>.</b>

**Note:** Refer to [Appendix E](#) for details on touch screen Mode Action and Imaging Parameters buttons.

**To Activate Elastography Imaging Mode:**

1. Ensure a transducer is both connected to the system and currently active.

**Note:** To select the transducer, press the console button.

2. Press the console button.

## 5.6 SonixShine

**SonixShine** mode enhances in-plane needle visibility during needle insertion. Depending on the **Shine Angle** selected, the needle will track from either the left or right side of the image (**Figure 5-10**).

---

**Caution:** Be sure to keep the needle perpendicular to the angle marker.

---



**Note:** **SonixShine** is available only:

- with the L14-5/38 transducer
  - from **B-Mode** and **Compound Imaging**.
- 

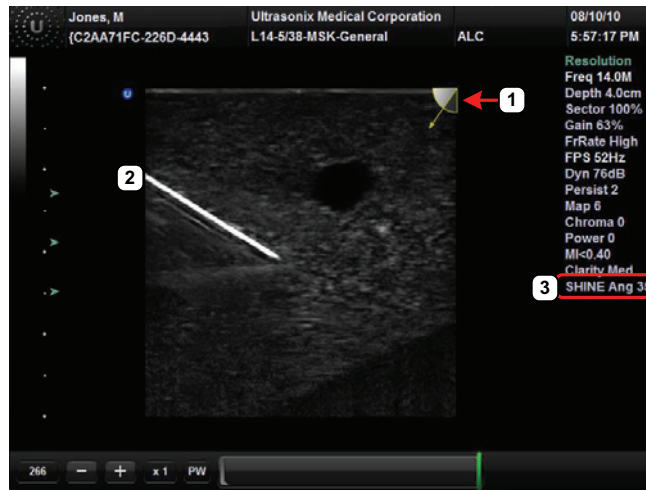
**Figure 5-12: SonixShine Imaging**











**Table 5-10: SonixShine Imaging**

		Marks the <b>Shine Angle</b> .
1	<b>SonixShine Angle Marker</b>	<b>Note:</b> The marker is displayed in the top right corner for positive angles and the top left corner for negative angles.
		Angle range: 15° to 40°.
		Angle range: -40° to -15°.
2	In-Plane Needle	Enhanced visibility of the in-plane needle.
3	<b>Shine Ang</b>	<b>SonixShine Angle</b> imaging parameter.



**Table 5-11: SonixShine Imaging Console Controls**

	<p>Turn to adjust overall <b>Gain</b>.            Press to exit other imaging modes and return to <b>2D</b> imaging.</p>
	<p>Press up or down to adjust the transducer <b>Frequency: Penetration, General, Resolution, Harmonics</b> and <b>EPI</b>.  <b>Note: The Harmonics setting is not supported by all transducers.</b></p>
	<p>Press up or down to <b>Zoom</b> the image in or out. Use the trackball to pan the zoomed image. Press  to exit <b>Zoom</b>.</p>
	<p>Press up or down to adjust the imaging <b>Depth</b> up or down.</p>
	<p>Press up or down to adjust focal zone position up or down.</p>
	<p>Turn to adjust <b>Acoustic Power</b>.  <b>Note: Pressing the dial will not affect the Index setting.</b>   <b>Warning: Refer to <a href="#">A.1.1 ALARA Principle and Output Displays</a>.</b></p>

**Note:** Refer to [Appendix E](#) for details on touch screen Mode Action and Imaging Parameters buttons.

**To Activate SonixShine Imaging:**

1. Ensure **B-Mode** or **Compound Imaging** is active.
2. Tap the touch screen **SonixShine** button.

**To Select/Adjust SonixShine Imaging Parameters:**

1. Ensure **B-Mode** or **Compound Imaging** is active.
2. Tap the touch screen **SonixShine** button.
3. Tap the **Shine Ang** button and the turn the associated dial to set the required angle.
4. Adjust the remaining imaging parameters as required.

## 5.7 SonixGPS



**Warning:** This user manual does not include a comprehensive discussion of the SonixGPS option. For complete details on using SonixGPS, read and follow all instructions and warnings in the most recent SonixGPS User Manual.

**SonixGPS** enables **Operators** to plan, then view the needle route as it enters the patient. Spatial positioning of the needle—with respect to the ultrasound image—is updated in real-time.



**Warnings:**

**SonixGPS** is a guidance system. It is intended to be used only as an aid for qualified, experienced medical personnel in order to verify the correct needle path. Metallic interference, needle deflection, as well as various other factors, will affect the accuracy of tracking the needle.

**Before attempting to use the SonixGPS option, carefully read and follow all warnings, precautions and directions detailed in this manual. In addition to helping ensure safe operation, this will aid the Operator in achieving optimal operating conditions.**

When used under optimal operating conditions by an experienced medical professional, **SonixGPS** can achieve an accuracy rating as high as  $\pm 2$  mm.

Figure 5-13: SonixGPS Imaging

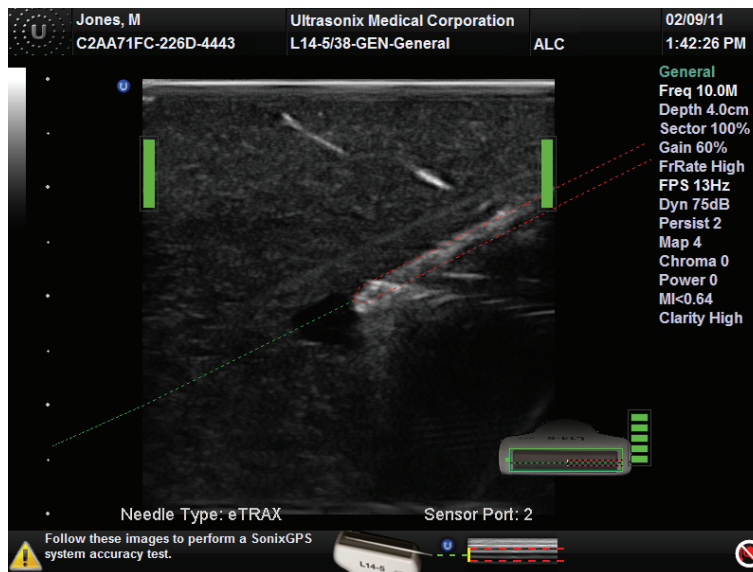

**Warning:** Some **SonixGPS** components may interfere with nearby electrical systems or anyone relying on life-sustaining equipment, such as a pacemaker or defibrillator.





## 5.8 PANORAMIC IMAGING MODE

**Panoramic** imaging enables the user to generate a panoramic view of the **2D** ultrasound image field, which is much wider than the typical transducer field of view.





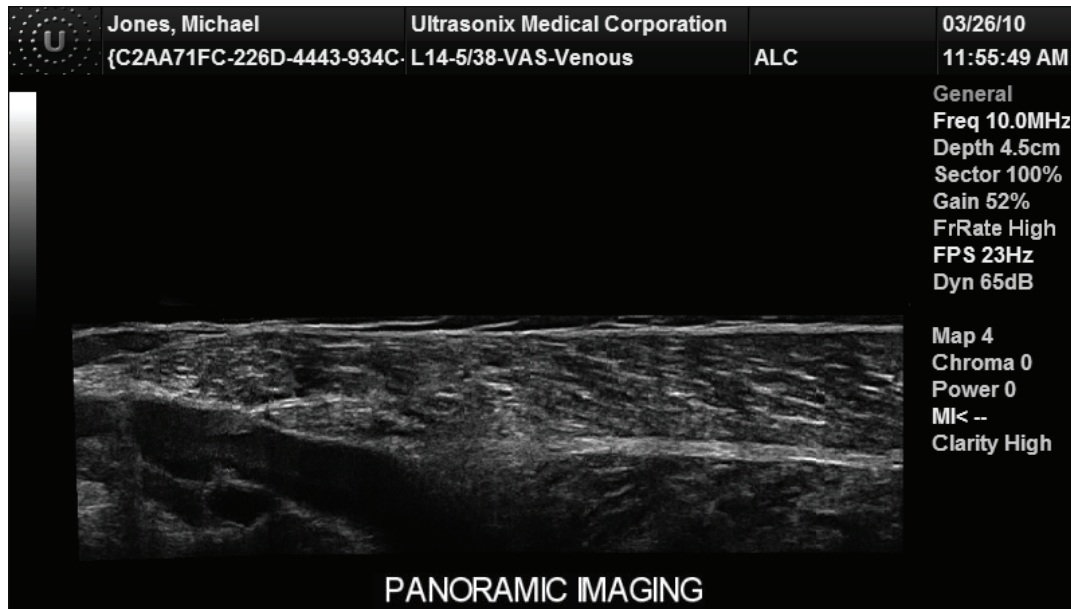



**Panoramic** images are composed of several standard ultrasound images acquired as the transducer is moved along the anatomical area of interest in a direction parallel to the transducer array. The resulting compound or composite image displays a large cross section of the area of interest which can then be viewed, measured, labeled and archived.

Figure 5-14: Panoramic Image



**Warning:** Measurements performed on the acquired **Panoramic** image may be inaccurate as the accuracy of the geometric re-composition is very user-dependent. Measurements performed on the acquired **Panoramic** image should be used for informational purposes only.

**Table 5-12: 2D/B-Mode Imaging Console Controls**

	<p>Turn to adjust overall <b>Gain</b>. Press to exit other imaging modes and return to <b>2D</b> imaging.</p>
	<p>Press up or down to adjust the transducer <b>Frequency: Penetration, General, Resolution, Harmonics</b> and <b>EPI</b>. <b>Note: The Harmonics setting is not supported by all transducers.</b></p>
	<p>Press up or down to <b>Zoom</b> the image in or out. Use the trackball to pan the zoomed image. Press <b>[B]</b> to exit <b>Zoom</b>.</p>
	<p>Press up or down to adjust the imaging <b>Depth</b> up or down.</p>
	<p>Press up or down to adjust focal zone position up or down.</p>
	<p>Press to steer the <b>2D</b> beam on linear transducers.</p>
	<p>Turn to adjust <b>Acoustic Power</b>. <b>Note: Pressing the dial will not affect the Index setting.</b>  <b>Warning: Refer to <a href="#">A.1.1 ALARA Principle and Output Displays</a>.</b></p>

**Note:** Refer to [Appendix E](#) for details on touch screen Mode Action and Imaging Parameters buttons.



### To Activate the Panoramic (Pano) Imaging Mode:

---

**Note:** The **Pano** ROI box can only be vertically resized and/or repositioned.

---

1. Tap the touch screen **Pano** button during live **2D** imaging.
2. A progress bar with the message **Loading Panoramic Tables...** will be presented onscreen.

---

**Note:** This may take a few seconds. The **Panoramic** feature is ready to use when a white **Pano** ROI box appears on the **2D** image and **Pano Ready** appears in the lower left corner of the image field.

---

3. Use the trackball to vertically position the **Pano** ROI box.

---

**Note:** The edge of the **Pano** ROI box will be marked with a solid line.

---

4. Press  to set it.

---

**Note:** The edge of the **Pano** ROI box will change to dotted line.



---

5. Use the trackball to vertically resize the **Pano** ROI box.

---

**Note:** To switch back and forth between positioning (solid line) and resizing (dotted line) the **Pano** ROI box, press the  button.

---

6. To begin acquiring a **Panoramic** image, position the left side of the anatomical area of interest within the **Pano** ROI box.
7. Press the console  button or tap **Pano Start/Stop** on the touch screen to begin the **Panoramic** acquisition.
8. Move the transducer along a path parallel to the transducer array in the area of interest. For best results move the transducer at a slow and steady pace.
9. When a suitable **Pano** image is acquired, press  or  or tap **Pano Start/Stop** on the touch screen.
10. The generated **Panoramic** image appears in the image field.
11. Tap **Pano Exit** to exit **Panoramic** imaging mode and return to **2D** imaging.

---

**Caution:** Measurements performed on the acquired **Panoramic** image may be inaccurate as the accuracy of the geometric re-composition is very user-dependent. Measurements performed on the acquired **Panoramic** image should be used for informational purposes only.

---



## 5.9 SonixDVR RECORDING

Once configured, a **SonixDVR Recording** can be made of any imaging session.

---

**Note:** A physical recording device is not required.

---

Once configured and activated a red recording icon (REC) will flash at the bottom right of the imaging screen and an **MPG** video will be created. All system actions initiated during the recording session will be captured in the **MPG**.

Each time a **SonixDVR Recording** is started/stopped, a message will be displayed in the bottom left of the imaging screen.

---

**Note:** A **SonixDVR Recording** cannot be transferred via **DICOM**. Use the **Image Transfer process (9.3)** to export these files.

---

There are two ways to create a **SonixDVR** recording:

- via **Custom Keys (8.2.13)**, so an **Operator** can start/stop a recording at will
- automatically, via **Capture Settings (8.2.18)**, so a recording starts every time a new exam is initiated.



## 5.10 2D CINE OPTIONS

### 5.10.1 2D Cine Frame Indicators

Figure 5-15: 2D Cine Frame Indicators

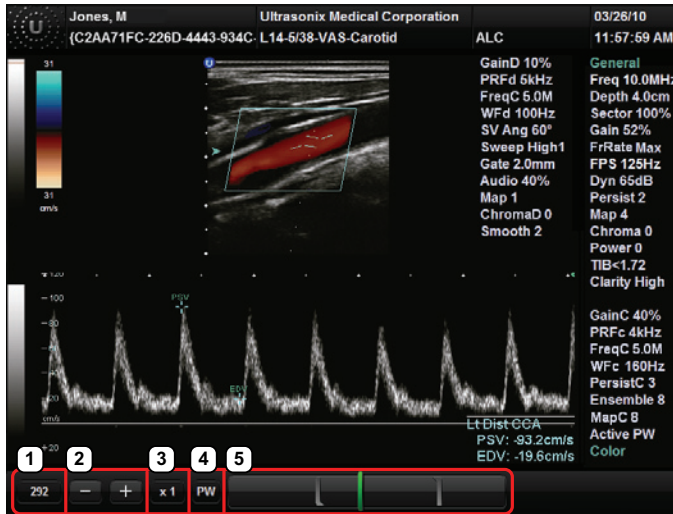

Table 5-13: 2D Cine Frame Indicators

1	<b>Cine Frame</b>	Marks the current <b>Cine</b> frame (number coincides with <b>green</b> marker in 5).
2	<b>Cine Advance/Reverse</b>	Advances (+) or reverses (-) the <b>Cine loop</b> , one frame at a time.
3	<b>Cine Play Speed</b>	Activates <b>Cine Play Speed</b> (1/8, 1/4, 1/2, Full (1) or Double (2)).
4	<b>Active Imaging Cine</b>	Marks the <b>Active</b> imaging <b>Cine</b> . Refer to <a href="#">Table 5-6</a> for more details.
5	<b>Cine Loop Slider</b>	Allows the <b>Operator</b> to select the: <ul style="list-style-type: none"> <li>• start frame</li> <li>• end frame</li> <li>• single (current) frame.</li> </ul> <b>Cine loop</b> start and end markers are gray, while the <b>green</b> marker denotes the current <b>Cine</b> frame (item 1 lists the corresponding frame number). Use the trackball and cursor to drag the start and/or end markers to define <b>Cine loop</b> limits. Once defined, the <b>Cine loop</b> can be saved using <b>Custom Keys (8.2.13)</b> .

**Note:** When an image is frozen, the slider will always be set with the start/end markers to the far left/right with the **green** marker at the end of the loop (far right).

**Note:** Use the trackball and cursor to change any of the settings.

## 5.10.2 2D Cine Options

For details on **4D Cine** options, refer to [5.12.1.1 4D Cine Options](#).

**Figure 5-16: 2D Cine Touch Screen Options**

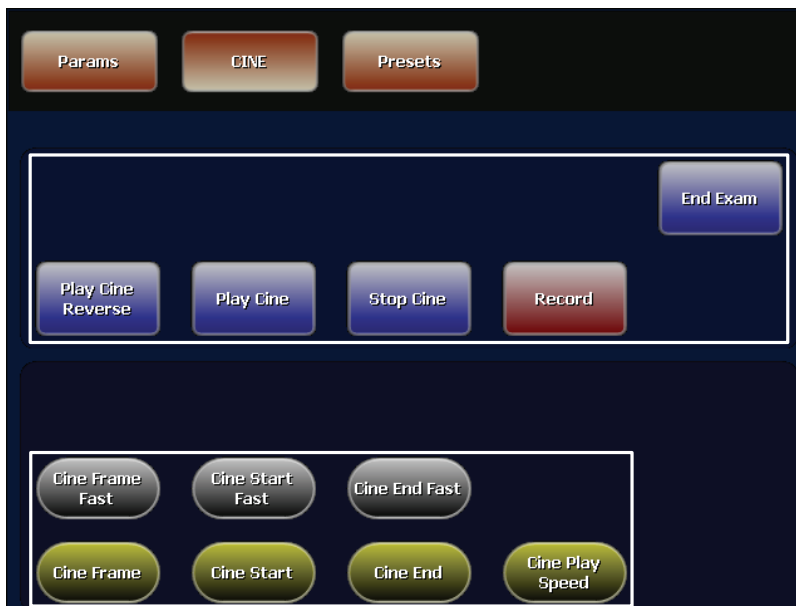

**Table 5-14: Cine Mode Action Buttons (tap to activate)**

<b>End Exam</b>	Tap to end the current exam.
<b>Play Cine Reverse</b>	Select to play the available <b>Cine</b> frames in reverse.
<b>Play Cine</b>	Select to play the available <b>Cine</b> .
<b>Stop Cine</b>	Select to stop the <b>Cine</b> playback.
<b>Record</b>	Tap to store the selected <b>Cine</b> frames to the system or press the appropriate <b>Custom Key</b> button ( <a href="#">8.2.13</a> ).



**Table 5-15: Cine Imaging Parameters (tap to activate, dial/press to adjust/trigger)**

	Tap to activate, then turn the associated dial to trigger the action:
<b>Cine Frame Fast</b> <b>Cine Frame</b>	<ul style="list-style-type: none"> <li>• <b>Cine Frame Fast</b> selects the currently displayed frame and moves 10 frames at a time.</li> <li>• <b>Cine Frame</b> selects the currently displayed frame and moves one (1) frame at a time.</li> </ul>
<b>Cine Start Fast</b> <b>Cine Start</b> <b>Cine End Fast</b> <b>Cine End</b>	<p>When creating a <b>Cine clip</b> from a <b>Cine loop</b>:</p> <ul style="list-style-type: none"> <li>• <b>Cine Start/Cine End</b> selects the start/end frame of the clip, moving one (1) frame at a time.</li> <li>• <b>Cine Start Fast/Cine End Fast</b> selects the start/end frame of the clip, moving 10 frames at a time.</li> </ul>
<b>Cine Play Speed</b>	Tap to activate, then turn the associated dial to select the <b>Cine Play Speed</b> ( $\frac{1}{8}$ , $\frac{1}{4}$ , $\frac{1}{2}$ , Full (1) or Double (2)).

**Notes:**

Changes made to **Depth**, **Gain**, etc., will reset the number of frames available for review or storage.

**Cine loop** storage is a retrospective acquisition.

### 5.10.3 Cine Clip Storage

**To Store a 2D or 2D/Color Cine Clip:**

1. Ensure a suitable image is visible on the LCD display.
2. Press the console  button.
3. If not currently active, tap the touch screen **Cine** tab.

**Note:** Refer to [5.12 Standard and Advanced 3D/4D Imaging](#) for details on capturing a **3D/4D** image.

**To Select/Adjust Touch Screen Cine Controls:**

1. Tap the touch screen **Cine** tab.
2. Tap desired selection (e.g., **Cine Start Fast**).

## 5.10.4 Raw Cine Manipulation

Once saved, a raw **Cine loop** can be edited as if it the exam was still currently active. Any frozen editing option available to an **Operator** during an exam will also be available to manipulate the saved raw **Cine** data (e.g., **Measurements**, imaging parameter changes, etc.).

To save raw **Cine** data for future manipulation, configure a **Custom Key** with the **Record Raw Cine** option (8.2.13).

To access a raw **Cine loop**, open an exiting Patient/exam using the **Exam Management** page **Review** button or via **Exam Review** (Chapter 9).

A raw **Cine loop** thumbnail will be marked with the word **RAW**.

---

**Note:** While there is no time limit on the ability to edit raw **Cine** data, once a **Software Update** is performed (8.2.21), previously existing raw **Cine loops** will cease to be available for manipulation (i.e., raw **Cine loops** can only be saved and edited with the same software version).

---

## 5.10.5 Stored Thumbnail Review

The **Stored Thumbnail Review** is displayed at the bottom of the LCD display.

---

**Note:** **Cine loops** can also be accessed via **Exam Review** (Chapter 9).

---

### To Review a Thumbnail Image/Cine Clip During an Exam:

1. Move the trackball arrow over the desired thumbnail and press the console  button.

---

**Note:** Once the trackball arrow is over a thumbnail, a red **X** will be presented in the top right hand corner. Select the **X** and press  to delete the thumbnail.

---

2. Press  again to return to imaging mode.



### 5.11 FREEHAND 3D IMAGING (ALL NON-4D SONIX TRANSDUCERS)

**Freehand 3D** is designed to enable users to determine the type of imaging (**Parallel** or **Fan**) after an image is acquired.



**Warning:** Measurements performed on an acquired **Freehand 3D** image may be inaccurate as the accuracy of the **Multiplanar Reconstruction** is very user-dependent. Measurements performed on an acquired **Freehand 3D** image should be used for informational purposes only.

Figure 5-17: Freehand 3D Configuration Options

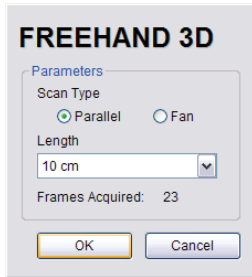

Table 5-16: Freehand 3D Imaging Console Controls

	Press to activate <b>Freehand 3D</b> .
--	--

Table 5-17: Freehand 3D Configuration Options

<b>Scan Type</b>	<b>Parallel</b>	Select <b>Parallel</b> as the <b>Scan Type</b> to measure the <b>Length</b> of a linear path in centimeters.
	<b>Fan</b>	Select <b>Fan</b> as the <b>Scan Type</b> to measure a pivot <b>Angle</b> in degrees.
<b>Length/Angle</b>	When <b>Scan Type = Parallel</b> , the <b>Length</b> selection range is 1 cm to 25 cm, with adjustments available in 1 cm increments.	
	When <b>Scan Type = Fan</b> , the <b>Angle</b> selection range is 5° to 90°, with adjustments available in 5° increments.	
<b>Frames Acquired</b>	Lists the number of <b>Frames Acquired</b> during imaging. These <b>Frames</b> are used to form the <b>Freehand 3D</b> image.	

### To Acquire a Freehand 3D Image:





1. Select the appropriate **Transducer, Application, Preset** combination.

---

**Note:** The **Imaging Preset** selected at this point will provide underlying **2D/B-Mode** imaging parameters. Once the image is acquired and the system moves to **3D** imaging, the **2D/B-Mode** imaging parameters cannot be changed.

If desired, a user-defined **Preset** can be created in order to optimize the **2D/B-Mode** imaging parameters used to acquire a **Freehand 3D** image.

---

2. Press the console  button.
3. Position the transducer to one side of the anatomical area of interest.
4. Press  to begin the acquisition.
5. Move the transducer over the area of interest in either a **Parallel** or **Fan** motion.
6. Press  or  to complete the acquisition.
7. Select the **Freehand 3D Scan Type**.

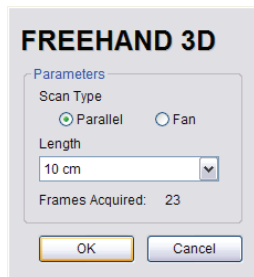

---

**Note:** The **Scan Type** selected should match the motion used to acquire the image: **Parallel** or **Fan**.

---

8. Select the appropriate **Length** or **Angle** setting from the drop-down menu.
9. Select **OK** to complete the configuration.
10. The acquired image will be rendered to the **3D/4D** LCD display in the **A|VR** format.

---

**Note:** Use **Standard 3D/4D** imaging options to optimize the **Freehand 3D Volume** (refer to **5.12.1** for details).

---

11. Press  to exit **Freehand 3D**.



## 5.12 STANDARD AND ADVANCED 3D/4D IMAGING

**Standard** or **Advanced 3D/4D Imaging** are only available to customers who have purchased the relevant license and transducer(s) for this option.

---

**Note:** Only **Standard 3D** imaging options will be available to **Operators using Freehand 3D**.

---

Figure 5-18: 3D/4D Touch Screen Buttons



---

**Note:** A **3D/4D** transducer must be selected in order to access **Standard or Advanced 3D/4D imaging** (i.e., the  button will not be active if a **3D/4D** transducer has not been selected).

---

Figure 5-19: 3D/4D Touch Screen Buttons

- 
- |   |                           |   |
|---|---------------------------|---|
| 1 | Mode Action Buttons       | Refer to <a href="#">Appendix E</a> for details on the specific buttons, including <b>FOV</b> , |
| 2 | Imaging Parameter buttons | <b>Quality</b> and <b>Cut Line</b> .  |
-



Figure 5-20: 3D/4D Imaging Screen with Cut Line Toggled On

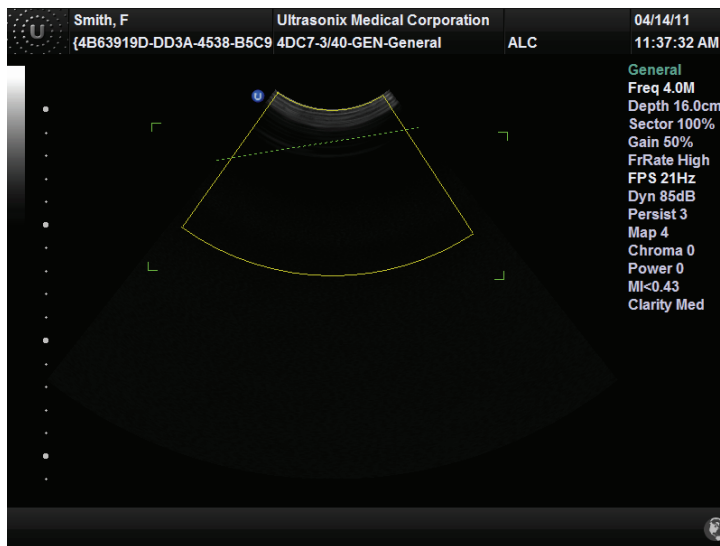

**To Enter Standard or Advanced 3D/4D Imaging:**

1. Ensure a **4D** transducer is connected to the system.

---

**Note:** The **4D** transducer must be inserted into the upper most transducer connection port to ensure proper function.

Only one (1) **4D** transducer can be connected at a time.

Refer to [3.2 Connecting Transducers](#) for connection details.





---

2. Ensure a patient is active.

---

**Note:** Refer to [4.4 Beginning an Exam for a New Patient](#) for details on entering data for a new patient or [4.8.1.1](#) to select an existing patient.

---

3. Press the console  button.
4. Select a **4D** transducer.
5. Select the appropriate underlying **B-Mode Application–Preset** combination.
6. Press the console  button.
7. Set the **FOV**, **Quality** and **Cut Line** as required.
8. Tap the relevant touch screen mode action button: **3D** or **4D**.
9. Use the trackball and console  button to position and adjust the size of the ROI.
10. Press the console  button to begin imaging.

### 5.12.1 3D/4D Touch Screen Layout

3D imaging options are identical to 4D options *once the 4D image has been frozen*.

---

**Note:** Many touch screen options are also available from the LCD display.

---

For details on 3D/4D image acquisition, refer to 5.12.4.

**Figure 5-21: 3D and Frozen 4D Touch Screen Layout**



---

**Note:** Where applicable, the numbering corresponds to [Figure 3-2](#), [Figure 3-3](#), [Table 3-1](#) and [Table 3-2](#). Refer to these sections for more details on general touch screen layout.

**Multislice is not available with Freehand 3D or Standard 3D/4D.**

---



**Table 5-18: 3D (or Frozen 4D) Touch Screen Controls (tap to activate, dial/press to adjust)**

2	<b>Mode Action Buttons</b>	<p>Enable the application of certain actions to an image (e.g., <b>Sculpt...</b>).</p> <hr/> <p><b>Note:</b> Only <b>Reset</b> is available during the acquisition of a <b>4D</b> image.</p> <p>As an alternative to tapping the touch screen <b>Measure</b> button, press the console  button.</p> <p><b>Multislice</b> and <b>Save Volume</b> are not available with <b>Freehand 3D</b> or <b>Standard 3D</b>.</p>
3	<b>Imaging Parameter Buttons</b>	<p>Enable adjustments to be made to the available imaging parameters.</p> <p>Turn/press the relevant touch screen dial to adjust the active imaging parameter.</p> <p>If an imaging parameter button is a pale gray/white color, that particular parameter is currently active (e.g., <b>VR Orient</b>). Turn/press the dial directly to the right of the active button to make adjustments.</p> <hr/> <p><b>Note:</b> To adjust an imaging parameter that is <u>not</u> currently active, tap the desired imaging parameter button then turn/press the dial directly to its right (e.g., <b>Zoom</b>).</p> <p>Imaging parameter availability is based on image type (<b>3D</b> or <b>4D</b>) and the state of image acquisition. For example, <b>FOV (Field of View)</b> and <b>Quality</b> are only available during <b>4D</b> image acquisition, not once the acquired <b>4D</b> image has been frozen).</p>
9	<b>Cine</b>	<p>Tap to access the <b>Cine</b> touch screen.</p> <hr/> <p><b>Note:</b> <b>Cine</b> options are only available when a <b>4D</b> image has been frozen.</p> <p><b>Cine</b> options are not available with <b>Freehand 3D</b> or <b>Standard 3D</b>.</p>
9	<b>Cine Frame Cine Start Cine End</b>	<p>Enable <b>Cine</b> manipulation. These buttons are also available on the <b>Cine</b> touch screen (<a href="#">Table 5-19</a>).</p> <hr/> <p><b>Note:</b> Refer to <a href="#">5.12.1.1</a> for more details on <b>4D Cine</b>.</p>
10	<b>Display Mode Options</b>	<p>ABC VR ABC MPR ROI VR A VR C VR A B C VR</p> <p>Touch screen layout defaults to <b>Display Mode</b> options. Refer to <a href="#">Table 5-21</a> for details on these options.</p> <p>To access <b>Sculpt...</b> and <b>Multislice</b> touch screen layouts, refer to item 2, above.</p> <hr/> <p><b>Note:</b> <b>Display Mode</b> options are also available from the LCD display. For details, refer to <a href="#">5.12.2.1</a>.</p>

### 5.12.1.1 4D Cine Options

The **Cine** button (Table 5-21) is only available if a **4D** image has been frozen.

Figure 5-22: 4D Cine Options

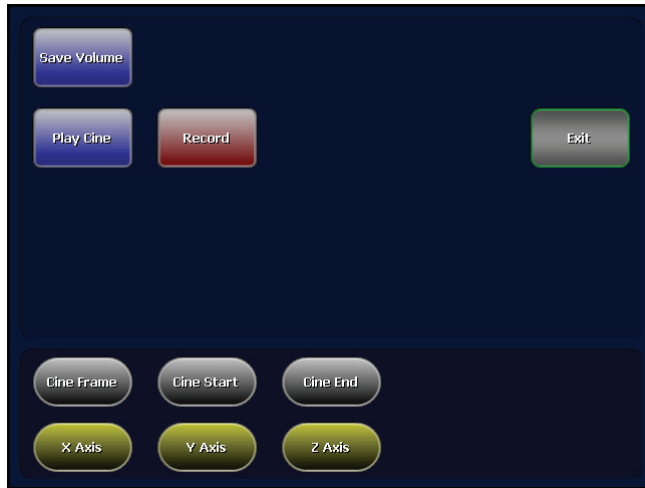





Table 5-19: 4D Cine Options (tap to activate)

<p><b>Save Volume</b></p>	<p>Tap to save the <b>Volume</b> data. This allows <b>Operators</b> to reopen the <b>3D</b> image (and manipulate its settings) during the exam, as long as it remains the <b>Current</b> exam. It can also be reopened later using the <b>Review</b> option on the <b>Exam Management</b> page.</p> <p>Images that have been saved using the <b>Save Volume</b> option will be marked with a <b>3D</b> box icon.</p> 
	<p><b>Note:</b> To access the <b>3D</b> version of the image press the console  button and select the relevant patient/exam from the <b>Patients</b> tab. Select <b>OK</b> to review the exam session. Select the appropriate image from the thumbnails at the bottom of the exam screen and configure the <b>3D</b> image as desired.</p> <p>This option is not available for <b>Freehand 3D</b>.</p>
<p><b>Play/Stop Cine</b></p>	<p>Tap to start or stop the <b>Cine loop</b>.</p>
<p><b>Record</b></p>	<p>Tap to <b>Record</b> a <b>Cine loop</b>.</p>
<p><b>Exit</b></p>	<p>Tap to <b>Exit</b> the <b>Cine</b> touch screen.</p>
<p><b>Cine Frame</b> <b>Cine Start</b> <b>Cine End</b></p>	<p>These buttons can also be used in conjunction with their associated touch screen dial.</p> <p>Use <b>Cine Start</b> and <b>Cine End</b> to mark the beginning and end of a <b>Cine clip</b>.</p> <p><b>Note:</b> To adjust a <b>Cine</b> action button that is not currently active, tap the button to activate it then <u>turn</u> the associated dial to make the required adjustment.</p>

**To Store a 4D Cine:**

1. Ensure a suitable image is visible on the LCD display.
2. Press the console  button.
3. If not currently active, tap the touch screen **Cine** button.



Once an image has been frozen, the **Cine** controls discussed in [Table 5-19](#) are available on the touch screen.

### 5.12.2 3D/4D LCD Display Layout

The LCD display is divided into two (2) major sections:

- imaging on the left
- editing functionality on the right.

---

**Note:** On the LCD display, use the trackball, cursor and  button to change **Display Mode** options. To move a slider to a new position, position the mouse arrow over the slider, press the console  button then use the trackball to move the slider.

---

Figure 5-23: 3D/4D Display Mode LCD Display

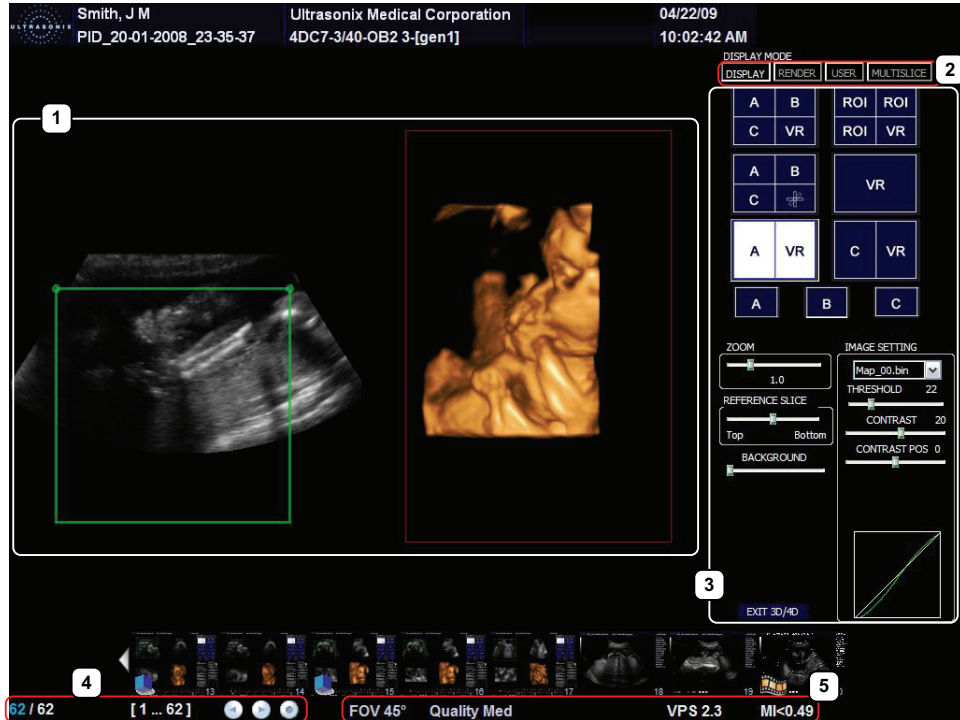

---

**Note:** Multislice is not available with Freehand 3D or Standard 3D/4D.

---

**Table 5-20: 3D/4D LCD Display Options**

1	<b>Imaging</b>	Displays the selected image format.
2	<b>Mode Selection Buttons</b>	Allow the <b>Operator</b> to change between the various <b>3D/4D</b> modes: <b>Display, Render, User</b> and <b>Multislice</b> .  <i>Note: Display and Multislice options are also available from the touch screen.</i>
3	<b>Mode Options and Imaging Parameters</b>	Enable the application of certain actions to an image. For example, in <b>Display Mode</b> , the <b>Operator</b> can select image presentation ( <b>A B C VR</b> ) as well as edit imaging parameters ( <b>Zoom, Map, Threshold</b> , etc) to adjust the image as desired.
4	<b>Cine Frame Indicators</b>	Available only after a <b>4D</b> image has been frozen. Refer to <a href="#">5.12.4.2</a> for details.
5	<b>Additional LCD Display Details</b>	Refer to <a href="#">5.12.3</a> for details.



### 5.12.2.1 3D/4D Display Mode (LCD Display and Touch Screen Options)

Once a **3D** image has been acquired or a **4D** image has been frozen, the following LCD display and touch screen will be presented.

---



**Note:** *Cine controls will be inaccessible (i.e., grayed out) for all 3D images.*

---

Figure 5-24: 3D/4D Display Mode LCD Display



---

**Note:** *On the LCD display, use the trackball, cursor and  button to change **Display Mode** options. To move a slider to a new position, position the mouse arrow over the slider, press the console  button then use the trackball to move the slider. Press  again to anchor the slider in the new position.*

---



**Figure 5-25: 3D/4D Display Mode Touch Screen**



**Table 5-21: 3D/4D Display Mode Options (Touch Screen and/or LCD Display)**

	Displays <b>A</b> , <b>B</b> ( <i>Transverse</i> ) and <b>C</b> ( <i>Coronal</i> ) <b>Plane</b> images with a <b>3D/4D VR</b> ( <i>Volume Rendering</i> ) image and allows the repositioning of both the <b>A</b> , <b>B</b> and <b>C Plane</b> ROI boxes and the <b>MPR Plane</b> intersection point. <b>Operators</b> also have the ability to edit the position of the top line of the ROI box (spline editing).
<b>ABC VR</b>	<b>Note:</b> Refer to the following sections for more details: <a href="#">5.12.6 Spline Editing of 3D/4D Images</a> <a href="#">5.12.7 Repositioning the ROI Box</a> <a href="#">5.12.8 Repositioning the MPR Plane Intersection Point.</a>
	Displays <b>A</b> , <b>B</b> and <b>C Plane</b> images with a <b>3D/4D MPR</b> ( <i>Multiplanar Reconstruction</i> ) image and allows the ROI (on the <b>A</b> , <b>B</b> and <b>C Planes</b> ) to be repositioned. <b>Operators</b> also have the ability to edit the position of the top line of the ROI box (spline editing).
<b>ABC MPR</b>	<b>Note:</b> On the LCD display, <b>MPR</b> is replaced with the symbol  . Refer to the following sections for more details: <a href="#">5.12.6 Spline Editing of 3D/4D Images</a> <a href="#">5.12.7 Repositioning the ROI Box</a> <a href="#">5.12.8 Repositioning the MPR Plane Intersection Point.</a>
	Displays the <b>A Plane</b> image and allows the ROI to be repositioned. <b>Operators</b> also have the ability to edit the position of the top line of the ROI box (spline editing).
<b>A</b>	<b>Note:</b> Refer to the following sections for more details: <a href="#">5.12.6 Spline Editing of 3D/4D Images</a> <a href="#">5.12.7 Repositioning the ROI Box.</a>



<b>ROI VR</b>	<p>Displays <b>A</b>, <b>B</b> and <b>C Plane</b> images along with a <b>3D/4D VR</b> image and allows the repositioning of the <b>A</b>, <b>B</b> and <b>C Plane</b> ROI boxes.</p> <p>Tap the touch screen <b>Reset</b> button to return the repositioned ROI to its original state.</p>
	<p><b>Note:</b> Refer to the following sections for more details:</p> <p><a href="#">5.12.6 Spline Editing of 3D/4D Images</a></p> <p><a href="#">5.12.7 Repositioning the ROI Box.</a></p>
<b>B</b>	<p>Displays the <b>B Plane</b> image and allows the repositioning of the <b>B Plane</b> ROI box.</p> <p><b>Operators</b> also have the ability to edit the position of the top line of the ROI box (spline editing).</p>
	<p><b>Note:</b> Refer to the following sections for more details:</p> <p><a href="#">5.12.6 Spline Editing of 3D/4D Images</a></p> <p><a href="#">5.12.7 Repositioning the ROI Box.</a></p>
<b>A VR</b>	<p>Displays side-by-side, split-screen view of the <b>A Plane</b> image with a <b>3D/4D VR</b> of the image and allows the repositioning of the <b>A Plane</b> ROI box.</p> <p><b>Operators</b> also have the ability to edit the position of the top line of the ROI box (spline editing).</p>
	<p><b>Note:</b> Refer to the following sections for more details:</p> <p><a href="#">5.12.6 Spline Editing of 3D/4D Images</a></p> <p><a href="#">5.12.7 Repositioning the ROI Box.</a></p>
<b>C</b>	<p>Displays the <b>C Plane</b> image and allows the repositioning of the <b>C Plane</b> ROI box.</p> <p><b>Operators</b> also have the ability to edit the position of the top line of the ROI box (spline editing).</p>
	<p><b>Note:</b> Refer to the following sections for more details:</p> <p><a href="#">5.12.6 Spline Editing of 3D/4D Images</a></p> <p><a href="#">5.12.7 Repositioning the ROI Box.</a></p>
<b>C VR</b>	<p>Displays side-by-side, split-screen view of the <b>C Plane</b> image with a <b>3D/4D VR</b> image and allows the repositioning of the <b>C Plane</b> ROI box.</p> <p><b>Operators</b> also have the ability to edit the position of the top line of the ROI box (spline editing).</p>
	<p><b>Note:</b> Refer to the following sections for more details:</p> <p><a href="#">5.12.6 Spline Editing of 3D/4D Images</a></p> <p><a href="#">5.12.7 Repositioning the ROI Box.</a></p>
<b>VR</b>	<p>Displays only the <b>Volume Rendering</b> of the <b>3D/4D</b> image.</p>
<p><b>Note:</b> On the touch screen, tap to activate. On the LCD display, use the trackball, cursor and button to change <b>Display Mode</b> options.</p> <p>All options in this table are available from both the touch screen and the LCD Display.</p>	

**Table 5-22: 3D/4D Touch Screen Mode Action Buttons (tap to activate)**

<b>Save Volume</b>	<p>Tap to save the <b>Volume</b> data. This allows <b>Operators</b> to reopen the <b>3D</b> image (and manipulate its settings) during the exam, as long as it remains the <b>Current</b> exam. It can also be reopened later using the <b>Review</b> option on the <b>Exam Management</b> page.</p> <p>Images that have been saved using the <b>Save Volume</b> option will be marked with a <b>3D</b> box icon.</p> 
	<p><b>Note:</b> To access the <b>3D</b> version of the image tap the touch screen <b>Exam Mgmt</b> button and select the relevant patient/exam from the <b>Patients</b> tab. Select <b>OK</b> to review the exam session. Select the appropriate image from the thumbnails at the bottom of the exam screen and configure the <b>3D</b> image as desired.</p> <p><i>This option is not available for <b>Freehand 3D</b>.</i></p>
<b>Reset</b>	Returns many settings to their defaults, including settings on the various LCD display menus, imaging parameters, etc.
<b>Cine</b>	Tap to access <b>4D Cine</b> options.
<b>Sculpt...</b>	Tap to access <b>Sculpt</b> options.
	<b>Note:</b> Refer to <b>5.12.2.5</b> for more details on <b>Sculpt...</b>
<b>Multislice</b>	Tap to access <b>Multislice</b> options from the touch screen.
	<b>Note:</b> Refer to <b>5.12.2.4</b> for more details on <b>Multislice</b> . <b>Multislice</b> is not available with <b>Freehand 3D</b> or <b>Standard 3D/4D</b> .
<b>Exit</b>	Tap to exit <b>3D/4D</b> imaging.



**Table 5-23: 3D/4D Imaging Parameters (Touch Screen and LCD Display)**

**Note:** The column to the far left indicates where an option is available:

- **TS:** Touch screen only
- **LCD:** LCD display only
- **TS/LCD:** Both the LCD display and touch screen. Note that changes to a setting from the touch screen will be mirrored on the LCD display.

The touch screen **Reset** button applies to all settings in this table.

<b>TS/LCD</b>	<b>Cntrst/Contrast</b>	Adjusts the <b>Cntrst/Contrast</b> settings of the <b>VR</b> on the LCD display. Initially, <b>Cntrst/Contrast</b> adjustments are based on the center of the image. To change this, change the <b>Cntrst Pos/Contrast Pos</b> setting.
<b>TS/LCD</b>	<b>Cntrst Pos/Contrast Pos(ition)</b>	Adjusts the <b>Cntrst Pos/Contrast Pos</b> of the <b>VR</b> on the LCD display. Once moved from the default center position, <b>Cntrst/Contrast</b> adjustments will be centered on the new <b>Cntrst Pos/Contrast Pos</b> setting.
<b>TS/LCD</b>	<b>Zoom</b>	Adjusts the <b>Zoom</b> setting. The range is 0.5 (50%) to 3.0 (300%) in 0.1 (10%) increments.
<b>TS/LCD</b>	<b>Bkgnd/Background</b>	Adjusts the grayscale coloration of the <b>VR Bkgnd/Background</b> on the LCD display.
<b>TS/LCD</b>	<b>Map</b>	Adjusts the coloration of the <b>VR</b> image using pre-defined color <b>Maps</b> . The range for this setting is 0 to 17, inclusive (for all <b>Presets</b> ).
<b>TS/LCD</b>	<b>Thresh/Threshold</b>	Use to suppress image artifacts or noise. This setting has a range of 0 to 100, inclusive, where 0 is no noise suppression and 100 is as much noise suppression as possible. <b>Note:</b> The <b>Dynamic Range</b> of the image will be optimized automatically based on the selected <b>Thresh/Threshold</b> setting.
<b>LCD</b>	<b>Reference Slice</b>	Enables users to choose the position of the <b>Slice</b> to be viewed from the active plane. When in <b>Multislice (5.12.2.4)</b> , the <b>Reference Slice</b> will be highlighted within a green box.
<b>TS</b>	<b>X-axis</b>	Rotates the selected image about the <b>X-axis</b> .
<b>TS</b>	<b>Y-axis</b>	Rotates the selected image about the <b>Y-axis</b> .
<b>TS</b>	<b>Z-axis</b>	Rotates the selected image about the <b>Z-axis</b> .
<b>TS</b>	<b>VR Orient</b>	Sets the <b>Orientation</b> of the <b>VR</b> .

**Note:** Refer to [5.12.1.1](#) for details on **Cine** controls.

### 5.12.2.2 3D/4D Render Mode (LCD Display Options Only)

**Render Mode** enables users to configure image style (grayscale or negative), surface settings (**Smooth**, **X-ray**, etc) and image direction (**Top**, **Bottom**, etc).

---



**Note:** Some **Render Mode** options are available only with **Advanced 3D/4D**. Refer to the individual fields in [Table 5-24](#) for details.

---

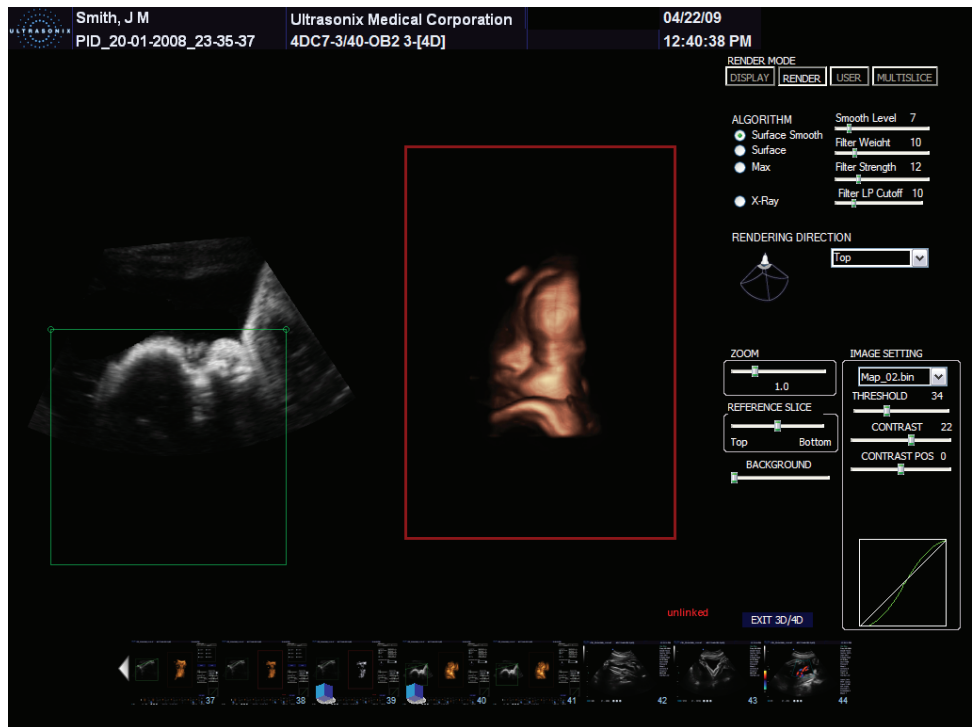
**Figure 5-26: Render Mode LCD Display Options**



---

**Note:** On the LCD display, use the trackball, cursor and  button to change **Render Mode** options. To move a slider to a new position, position the mouse arrow over the slider, press the console  button then use the trackball to move the slider.

---



Table 5-24: Render Mode LCD Display Options

<b>Algorithm</b>	<b>Surface Smooth</b>	Select to smooth the surface rendering of the image in <b>Advanced 3D/4D</b> . <b>Note:</b> This is the default setting for <b>Advanced 3D/4D</b> and is not available in <b>Freehand 3D</b> .
	<b>Surface</b>	<b>Surface</b> rendering of the <b>VR</b> . <b>Note:</b> This is the default setting for <b>Standard 3D/4D</b> .
	<b>Max</b>	Renders voxels with <b>Maximum</b> intensity along the visualization plane.
	<b>X-ray</b>	Provides <b>X-ray</b> -like representation of the <b>Volume</b> model.
	<b>Smooth Level</b>	Adjusts the amount of smoothing applied to <b>Surface Smooth</b> . The range is 0 to 50 in increments of 10, with a default setting of 7. <b>Note:</b> This setting is not available in <b>Freehand 3D</b> .
	<b>Filter Weight</b>	Adjusts sharpness (as applied to <b>Surface Smooth</b> ). The range is 0 to 50 in increments of 10, with a default setting of 12. <b>Note:</b> This setting is not available in <b>Freehand 3D</b> .
	<b>Filter Strength</b>	Adjusts contrast (as applied to <b>Surface Smooth</b> ). The range is 0 to 50 in increments of 10, with a default setting of 12. <b>Note:</b> This setting is not available in <b>Freehand 3D</b> .
	<b>Filter LP (Low Pass) Cutoff</b>	Adjusts the spatial range of the previous three (3) fields: <b>Smooth Level</b> , <b>Filter Weight</b> and <b>Filter Strength</b> . The range is 0 to 50 in increments of 10, with a default setting of 10. A setting of 50 will result in the smallest available spatial range while 0 will result in the greatest range. <b>Note:</b> This setting is not available in <b>Freehand 3D</b> .
<b>Rendering Direction</b>	Selects the direction from which the image is rendered: <b>Front</b> , <b>Back</b> , <b>Left</b> , <b>Right</b> , <b>Top</b> or <b>Bottom</b> .	
<b>Zoom</b>	Adjusts the <b>Zoom</b> setting. The range is 0.5 (50%) to 3.0 (300%) in 0.1 (10%) increments.	
<b>Reference Slice</b>	Enables users to choose the <b>Slice</b> to be viewed from the active plane.	
<b>Background</b>	Adjusts the grayscale coloration of the <b>VR Bkgnd/Background</b> on the LCD display.	



<b>Image Settings</b>	<b>Map</b>	Adjusts the coloration of the active <b>VR</b> using pre-defined color <b>Maps</b> . The range for this setting is 0 to 17, inclusive (for all <b>Presets</b> ).
	<b>Threshold</b>	Use to suppress image artifacts or noise. This setting has a range of 0 to 100, inclusive, where 0 is no noise suppression and 100 is as much noise suppression as possible.  <b>Note:</b> <i>The <b>Dynamic Range</b> of the image will be optimized automatically based on the selected <b>Thresh/Threshold</b> setting.</i>
	<b>Contrast</b>	Adjusts the <b>Contrast</b> settings of the active image(s). Initially, <b>Contrast</b> adjustments are based on the center of the image. To change this, change the <b>Contrast Pos</b> setting. To make this adjustment the new default setting, save it to a <b>3D/4D Preset</b> (refer to <a href="#">5.12.9</a> for details on <b>3D/4D Presets</b> ).
	<b>Contrast Pos(ition)</b>	Adjusts the <b>Contrast Pos</b> of the <b>VR</b> on the LCD display. Once moved from the default center position, <b>Contrast</b> adjustments will be centered on the new <b>Contrast Pos</b> setting.

### 5.12.2.3 3D/4D User Mode (LCD Display Options Only)

**User Mode** enables the users to:

- return system **Presets** to factory defaults
- create/edit user-defined **Presets**
- select a default **Preset**
- load different **Presets** as required.

---



**Note:** There are no **User Mode**-specific touch screen buttons.

---

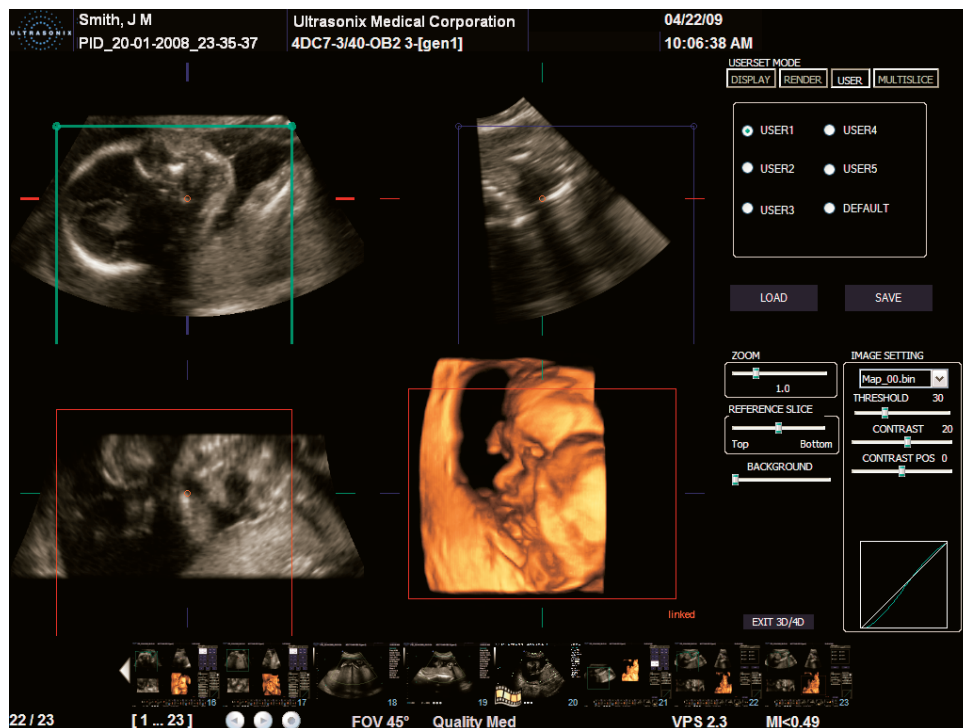
Figure 5-27: User Mode LCD Display



---

**Note:** On the LCD display, use the trackball, cursor and  button to change **User Mode** options. To move a slider to a new position, position the mouse arrow over the slider, press the console  button then use the trackball to move the slider.

---





Table 5-25: 3D/4D User Mode LCD Display Options

<b>User1</b>		
<b>User2</b>		
<b>User3</b>	The five (5) available <b>3D/4D Presets</b> can be reconfigured but they cannot be renamed.	
<b>User4</b>		
<b>User5</b>		
<b>Default</b>		
<b>Default</b>	<b>Default Preset</b> for all images after initial acquisition. If desired, users can convert (save) the settings of one of the five (5) <b>User Presets</b> into the <b>Default Preset</b> (5.12.9.1).	
<b>Load</b>	Allows users to <b>Load</b> a different <b>Preset</b> as required.	
<b>Save</b>	After making changes to one of the three (3) editable <b>Presets</b> ( <b>User3</b> , <b>4</b> , or <b>5</b> ), select the <b>Save</b> button to save the edits as a user-defined <b>Preset</b> .	
<b>Zoom</b>	Adjusts the <b>Zoom</b> setting. The range is 0.5 (50%) to 3.0 (300%) in 0.1 (10%) increments.	
<b>Reference Slice</b>	Enables users to choose the <b>Slice</b> to be viewed from the active plane.	
<b>Background</b>	Adjusts the color of the <b>Background</b> on the LCD display.	
<b>Image Settings</b>	<b>Map</b>	Adjusts the coloration of the active <b>VR</b> using pre-defined color <b>Maps</b> . The range for this setting is 0 to 17, inclusive (for all <b>Presets</b> ).
	<b>Threshold</b>	Use to suppress image artifacts or noise. This setting has a range of 0 to 100, inclusive, where 0 is no noise suppression and 100 is as much noise suppression as possible. <b>Note:</b> The <b>Dynamic Range</b> of the image will be optimized automatically based on the selected <b>Thresh/Threshold</b> setting.
	<b>Contrast</b>	Adjusts the <b>Contrast</b> settings of the active image(s). Initially, <b>Contrast</b> adjustments are based on the center of the image. To change this, change the <b>Contrast Pos</b> setting. To make this adjustment the new default setting, save it to a <b>3D/4D Preset</b> (refer to 5.12.9 for details on <b>3D/4D Presets</b> ).
	<b>Contrast Pos(ition)</b>	Adjusts the <b>Contrast Pos</b> of the <b>VR</b> on the LCD display. Once moved from the default center position, <b>Contrast</b> adjustments will be centered on the new <b>Contrast Pos</b> setting.

### 5.12.2.4 Advanced 3D/4D Multislice Mode (LCD Display and Touch Screen Options)

**Multislice Mode** enables users to select detailed views of individual slices of the **A**, **B** or **C Plane**. These slices can be positioned on the **Horizontal**, **Vertical** or at a user-determined **Angle**.

---

**Note:** If the **Volume Rendering** is active when **Multislice** is entered, the image will default to the **C Plane**.

---

Default entry settings show the **Display Mode** active plane as segment **0** (Table 5-30) with the **Slice** diagram focused on the centre of the image.

---



**Note:** **Multislice** is not available in **Freehand 3D** or **Standard 3D/4D**.

---

Figure 5-28: 3D/4D **Multislice** Mode LCD Display Options



---

**Note:** On the LCD display, use the trackball, cursor and  button to change **Multislice Mode** options. To move a slider to a new position, position the mouse arrow over the slider, press the console  button then use the trackball to move the slider.

---

**Figure 5-29: Advanced 3D/4D Multislice Mode Touch Screen Options**



**Table 5-26:**

**1 Layout**

**2 Slicing**

**Figure 5-30: Advanced 3D/4D Multislice Layout Segments (3x3, 2x2 and 1x2)**

<b>Slice Diagram</b>	-3/xx mm	-2/xx mm	<b>Slice Diagram</b>	0/xx mm	<b>Slice Diagram</b>	0/xx mm
-1/xx mm	-0/xx mm	1/xx mm	1/xx mm	2/xx mm		
2/xx mm	3/xx mm	4/xx mm				

**Note:** Where **xx mm** refers to the number of millimeters the segment is from the center **Slice** of the image. The center **Slice** will always be labeled **0/0.00 mm**.



The measurement will always be to two (2) decimal places.



**Table 5-27: Advanced 3D/4D Multislice Mode Options**

**Note:** The column to the far left indicates where an option is available:

- **TS:** Touch screen only
- **LCD:** LCD display only
- **TS/LCD:** Both the LCD display and touch screen. Note that changes to a setting from the touch screen will be mirrored on the LCD display.

		<p><b>Note:</b> Refer to <a href="#">Table 5-30</a> to determine the meaning of the <b>Layout</b> segments and the order in which they are presented.</p>
TS/LCD	Layout	<p><b>3 by 3</b></p> <p>Displays <b>Multislice Mode</b> images in a <b>3 x 3 Layout</b>. The center <b>Slice</b> (segment <b>0</b>) is both the active image and the plane that was last selected in <b>Display Mode</b>.</p> <p>The top left segment represents the entire image with the <b>Slice</b> data overlaid. The remaining segments show the actual slice data, including position from the center (-3 to 4) and the distance from the distance from the center in millimeters (mm).</p> <p><b>Note:</b> This is the default setting.</p>
		<p><b>2 by 2</b></p> <p>Displays <b>Multislice Mode</b> images in a <b>2 x 2 Layout</b>, with the top, right <b>Slice</b> as the active image.</p>
		<p><b>1 x 2 (Side by Side)</b></p> <p>Displays <b>Multislice Mode</b> images in a <b>1 x 2 Layout</b>, with the right hand <b>Slice</b> as the active image.</p>
		<p><b>1 x 1 (single)</b></p> <p>Displays the <b>Multislice Mode</b> image as a <b>1 x 1 image</b>.</p>
TS/LCD	Slicing	<p><b>Note:</b> Use the trackball to move the cursor into the <b>Slice Diagram</b> and press  to move the center marker.</p>
		<p><b>Vertical Slice</b></p> <p>Slices the image vertically.</p>
		<p><b>Horizontal Slice</b></p> <p>Slices the image horizontally.</p>
		<p><b>Angle Slice</b></p> <p>Allows the <b>Operator</b> to select the <b>Slicing Angle</b> to be applied to the image.</p> <p><b>Note:</b> To set the <b>Angle</b>, use the trackball to move the cursor into the <b>Slice Diagram</b> and press  to set one end of the <b>Angle caliper</b>. Move the cursor to a second position and press  again.</p>
TS/LCD	<b>Previous</b>	Moves the active image to the <b>Previous Slice</b> in the chosen <b>Layout</b> .
TS/LCD	<b>Next</b>	Moves the active image to the <b>Next Slice</b> in the chosen <b>Layout</b> .
TS	<b>Exit Multislice</b>	Exits <b>Multislice</b> .



---

<b>TS/LCD</b>	<b>Space</b>	Sets the <b>Spacing</b> between slices. The range for this option is 5% to 200% in 10% increments. <hr/> <b>Note:</b> <i>The actual measurement (in mm) will be displayed under each slice (Table 5-28).</i> <hr/>
<b>TS/LCD</b>	<b>Zoom</b>	Adjusts the <b>Zoom</b> setting. The range is 0.5 (50%) to 3.0 (300%) in 0.1 (10%) increments.
<b>TS</b>	<b>X-axis</b>	Rotates the selected image about the <b>X-axis</b> .
<b>TS</b>	<b>Y-axis</b>	Rotates the selected image about the <b>Y-axis</b> .
<b>TS</b>	<b>Z-axis</b>	Rotates the selected image about the <b>Z-axis</b> .
<b>TS</b>	<b>VR Orient</b>	Sets the <b>Orientation</b> of the <b>VR</b> .

---

**Note:** *Multislice is not available in Freehand 3D or Standard 3D/4D.*

---

### 5.12.2.5 3D/4D Sculpt (Touch Screen Options Only)

**Sculpt** is used to edit image contents after acquisition.

**Figure 5-31: 3D/4D Sculpt Touch Screen Controls**



**Table 5-28: 3D/4D Sculpt Touch Screen Controls (tap to activate, dial to adjust)**

<b>Lasso Inside</b>	Traces a freehand <b>Lasso</b> around the desired area and deletes all items inside the shape.
<b>Lasso Outside</b>	Traces a freehand <b>Lasso</b> around the desired area and deletes all items outside the shape.
<b>Undo All</b>	Undoes all the edits made to an image at any time within the first 24 hours after the image is saved.
<b>Undo Last</b>	Undoes the edits made to an image at any time within the first 24 hours after the image is saved, one at a time, in reverse order.
<b>Exit Sculpt</b>	Exits <b>Sculpt</b> ...
<b>X-axis</b>	Rotates the selected image about the <b>X-axis</b> .
<b>Y-axis</b>	Rotates the selected image about the <b>Y-axis</b> .
<b>Z-axis</b>	Rotates the selected image about the <b>Z-axis</b> .

**Note:** While in **Sculpt**, use the trackball, cursor and  button to change the various **Mode** options available from the LCD display.

### 5.12.3 Additional 3D/4D LCD Display Details

Once an image has been acquired, the LCD display will have an additional line of information across the bottom of the screen.

**Figure 5-32: Additional 3D/4D LCD Display Details**

FOV 0°	Quality	VPS 0.7	MI<0.53
--------	---------	---------	---------

**Table 5-29: Additional 3D/4D LCD Display Details**

<b>FOV (Field of View)</b>	<p>Adjusts the <b>Field of View (FOV)</b> of the rendered <b>3D/4D</b> image. This setting ranges from 10° to 70° (in 5° increments).</p> <p>Access this setting after pressing the console <b>3D/4D</b> button (<a href="#">Figure 5-18</a>) and before entering <b>3D</b> or <b>4D</b> imaging.</p> <p><b>Note: FOV is used in conjunction with Quality, to auto-calculate Volumes per Second (VPS).</b></p>
<b>Quality</b>	<p>Adjusts image <b>Quality: Low, Medium</b> and <b>High</b>.</p> <p>Access this setting after pressing the console <b>3D/4D</b> button (<a href="#">Figure 5-18</a>) and before entering <b>3D</b> or <b>4D</b> imaging.</p> <p><b>Note: FOV is used in conjunction with Quality, to auto-calculate Volumes per Second (VPS).</b></p>
<b>VPS (Volumes per Second)</b>	<b>VPS</b> is auto-calculated based on the <b>FOV</b> and <b>Quality</b> settings. It cannot be edited.
<b>MI (Mechanical Index)</b>	The <b>MI</b> is displayed for informational purposes only.

### 5.12.4 3D/4D Image Acquisition

**3D** and **4D** images are acquired in similar manners, although the final outcome is different. A **3D** acquisition results in a single **Volume** while a **4D** acquisition results in a **Cine loop**.

Once a **3D** or **4D** image has been acquired, the operator has the ability to edit or optimize the image (5.12.5) using the settings discussed in sections 5.12.2.1 to 5.12.2.5.

**Figure 5-33: Acquisition Diagram**

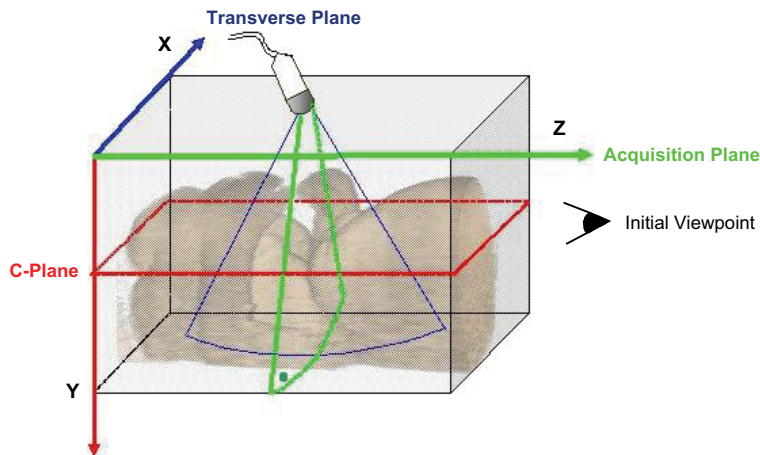

**Figure 5-32** demonstrates the various planes and axis of an acquired **3D** image in its original state. Remember that once an image has been edited or optimized (5.12.5 **Optimization of Acquired Images**), the positions of the planes shown here will have been altered as well.

---

**Note:** *Where applicable, once changes have been made use the touch screen **Reset** button to return the image to its original geometric position and ROI.*

---

For clarity, color is used to highlight the **A**, **B** and **C Planes**.

**Figure 5-34: Image Quadrants**

<b>Green:</b> Acquisition Plane ( <b>A</b> )	<b>Blue:</b> Transverse Plane ( <b>B</b> ) Perpendicular to the Acquisition Plane
<b>Red:</b> Coronal Plane ( <b>C</b> )	<b>Volume Rendering (VR)</b>



### 5.12.4.1 3D Imaging

#### To Acquire a 3D Image with an Ultrasonix 4D Transducer:

1. Ensure a **4D** transducer is connected to the system.

---

**Note:** The **4D** transducer must be inserted into the upper most transducer connection port to ensure proper function.

Only one (1) **4D** transducer can be connected at a time.

Refer to [3.2 Connecting Transducers](#) for connection details.

---

2. Ensure a patient is active.

---

**Note:** Refer to [4.4 Beginning an Exam for a New Patient](#) for details on entering data for a new patient or [4.8.1.1](#) to select an existing patient.

---

3. Press the console  button.

4. Select a **4D** transducer.

5. Select the appropriate underlying **B-Mode Application–Preset** combination.

---

**Note:** If desired, users can select either **OB 1st Trimester** or **OB 2nd–3rd Trimester** as the **Application** then the factory installed **OB4D Preset**.

While this will not affect the actual **3D/4D Presets** available in **4D** mode, it will configure the underlying **2D** imaging parameters.

As an alternative, users can also create their own user-defined **2D Preset (4.9)** to configure the underlying **2D** imaging parameters.

---

6. Press the console  button.

7. Tap the touch screen **3D** mode action button.

8. Position the transducer over the area of interest.

9. Use the trackball and console  button to position and adjust the size of the ROI.

10. Press the console  button to begin the acquisition the **3D Volume**.

---

**Note:** Hold the transducer steady while the image is being acquired.

---

11. The acquired **3D** rendering will be presented on the LCD display in the default format A|VR.



### 5.12.4.2 4D Imaging

#### To Acquire a 4D Image:

1. Ensure a **4D** transducer is connected to the system.

---

**Note:** The **4D** transducer must be inserted into the upper most transducer connection port to ensure proper function.

Only one (1) **4D** transducer can be connected at a time.

Refer to **3.2 Connecting Transducers** for connection details.

---

2. Ensure a patient is active.

---

**Note:** Refer to **4.4 Beginning an Exam for a New Patient** for details on entering data for a new patient or **4.8.1.1** to select an existing patient.

---

3. Press the console  button.

4. Select a **4D** transducer.

5. Select the appropriate underlying **B-Mode Application–Preset** combination.

---

**Note:** If desired, users can select either **OB 1st Trimester** or **OB 2nd–3rd Trimester** as the **Application** then the factory installed **OB4D Preset**.

While this will not affect the actual **3D/4D Presets** available in **4D** mode, it will configure the underlying **2D** imaging parameters.

As an alternative, users can also create their own user-defined **2D Preset (4.9)** to configure the underlying **2D** imaging parameters.

---

6. Press the console  button.



7. Position the transducer over the area of interest.

8. Tap the touch screen **4D** mode action button.

9. Use the trackball and console  button to position and adjust the size of the ROI.

10. Press the console  button to begin the acquisition.

11. Slowly move the transducer over the area of interest.

12. Press the console  or  button to complete the acquisition.

13. The final image of the acquired **4D Cine** file will be presented on the LCD display in the default format **A|VR**.

## 5.12.5 Optimization of Acquired Images

A **3D** or **4D Volume** can only be optimized after it has been acquired. Both the image and its environment can be optimized in several ways, including: **Map**, **Background** and **Threshold**.

For a comprehensive list of options, refer to sections [5.12.2.1](#) to [5.12.2.5](#).

Images saved with the touch screen **Save Volume** option can be accessed for editing during the 24 hours immediately after acquisition.

Select the images from the **3D/4D** LCD display using the trackball and  button or follow the instructions below ([To Select a Saved 3D/4D Volume for Optimization/Editing \(via Exam Management\)](#) :) or [To Select a Saved 3D/4D Volume for Optimization/Editing \(via Exam Review\)](#) :).

---

**Note:** Once 24 hours have passed, the images can be viewed, but not edited.

**Save Volume** is not available for **Freehand 3D** images.

When selecting a saved image for optimization, ensure the original **4D** transducer is connected to the system (i.e., if the original image was acquired with the **4DC-7** transducer, ensure the **4DC-7** transducer is connected to the system).

---

### To Select a Saved 3D/4D Volume for Optimization/Editing (via Exam Management) :

1. Press the console  button.
2. From the **Exam Management** page, select the relevant patient and select **OK**.

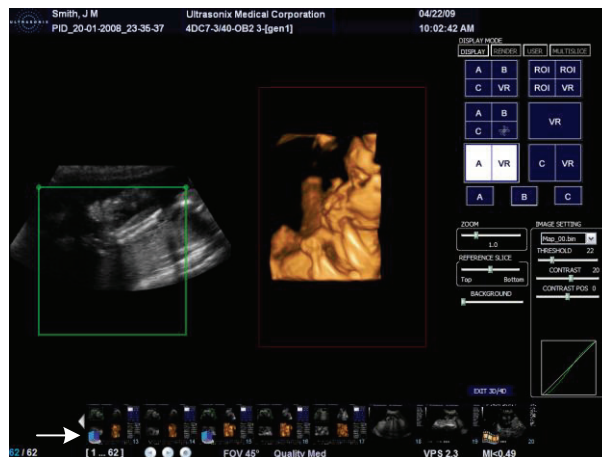



---

**Note:** If there are any images less than 24 hours old that were created using the **Save Volume** method, they will be presented as thumbnails with a box icon. Refer to [Table 5-22](#) for more details on **Save Volume**.

---

3. [Select](#) the desired thumbnail to open the image for editing.

**To Select a Saved 3D/4D Volume for Optimization/Editing (via Exam Review) :**

1. Ensure the relevant Patient is active.
2. Press the console  button.

---

**Note:** Alternatively, press the console  button if it has been configured with the **Programmable Action: Exam Review**. Refer to [8.2.13](#) for details on this **Custom Key** setting.

---

3. Highlight the relevant **Exam** and the associated thumbnails will be displayed onscreen.

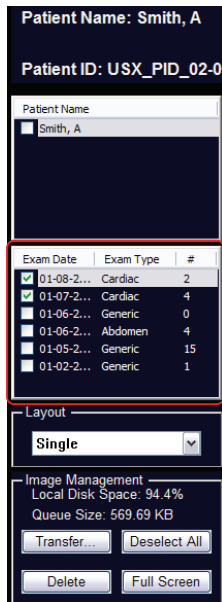

---

**Note:** If there are any images less than 24 hours old that were created using the **Save Volume** method, they will be presented as thumbnails with a box icon. Refer to [Table 5-22](#) for more details on **Save Volume**.

---

4. **Select** on the desired thumbnail to open the image for editing.

## 5.12.6 Spline Editing of 3D/4D Images

Once an image has been acquired, the user has the ability to edit it by changing the layout of the top of the **A (Acquisition)** and/or **B (Transverse) Planes**, enabling users to remove things from the top of the image (spline editing).

This option is available only on single **Volumes** and can be accessed from **Display, Render** and **User Modes**.

Spline editing can be done in two ways, both of which are mirrored across all **Planes** and the **VR**:

- single point redrawing of the top line of the **A** and/or **B Planes**
- multi-point redrawing of the top line of the **A** and/or **B Planes**.

**Figure 5-35: Single Point Spline Editing**

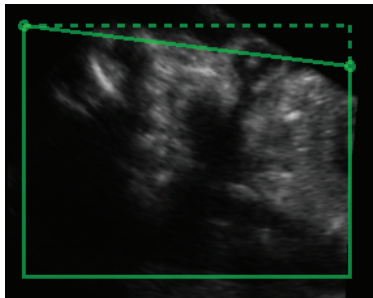

**Figure 5-36: Multi-Point Spline Editing**

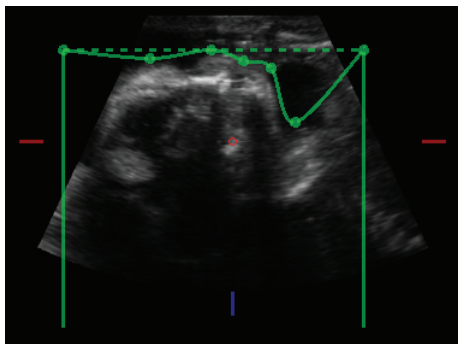



---

**Note:** As the touch screen **Reset** button applies to any changes made, be sure to use **Save Volume** or the relevant **Custom Key** option (1 or 2) to print/save relevant images.

---

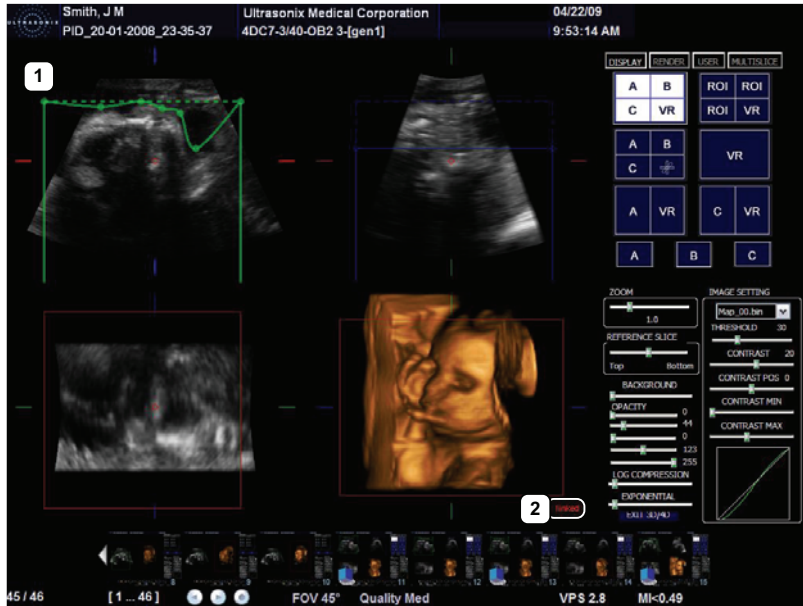
Figure 5-37: 3D or Frozen 4D Image with A Plane Spline Editing



---

**Note:** The **A Plane** ROI box has been moved. Refer to 5.12.7 for details on repositioning the ROI box from the various **Display Modes**.

---

Table 5-30: 3D or Frozen 4D Image with A Plane Spline Editing

- 
- |   |  |
|---|--|
| 1 | Multi-point spline editing in the <b>A Plane</b> . |
| 2 | VR marked as <b>linked</b> .                       |
- 

Depending on the state of the image(s) being displayed, the **VR** will be labeled **linked** or **unlinked**.

A **linked VR** means that at least one **Plane** is visible and is the active image on the LCD display, thus enabling either spline editing or ROI repositioning (5.12.7).

When **unlinked**, the **VR** is the active image.



**To Move the Top Line of a Plane (Single or Multi-Position Spline Editing):**

1. With a **3D** or frozen **4D Volume**, select the relevant **Display Mode: A|B|C|VR, ROI|VR A|B|C|MPPR, A|VR or C|VR**.
2. Place the cursor in the **A, B or C Plane** and press the console  button to activate spline editing for that **Plane**.
3. Move the cursor to the desired place on the top line of the ROI box.

---

**Note:** *The cursor will change to a single arrow.*

---

4. Press  again then move the arrow as required.
5. Press  again to anchor the line in place.
6. Repeat **step 3** to **step 5** as many times as necessary.

---

**Note:** *As the touch screen **Reset** button applies to any changes made, be sure to use **Save Volume** or the relevant **Custom Key** option (1, 2 and ) to print/save relevant images.*

---



## 5.12.7 Repositioning the ROI Box

The ROI box can be repositioned from all *Display Modes* except *VR*.

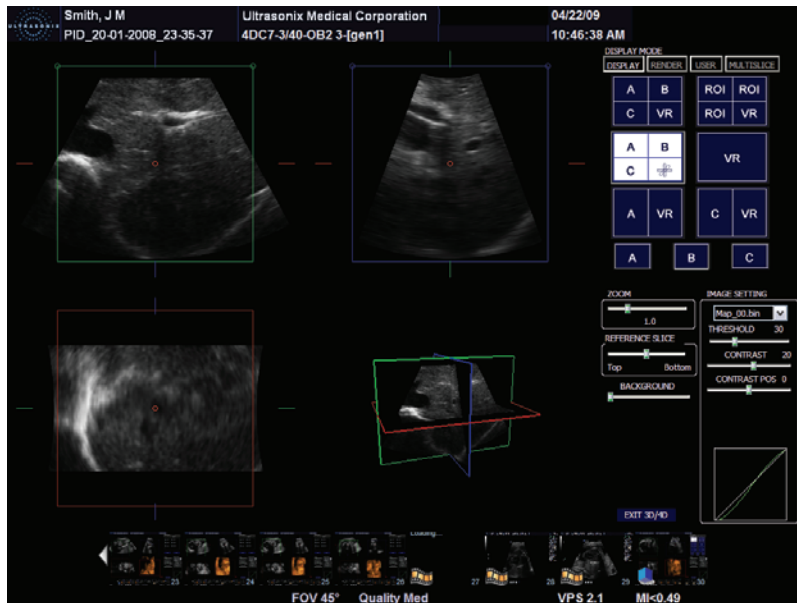
Figure 5-38: A|B|C|VR Image with Repositioned ROI Box



### To Reposition the ROI:

1. With a **3D** or frozen **4D Volume**, select the relevant *Display Mode*.
  2. Place the cursor in the **A**, **B** or **C Plane** and press the console  button to activate the ROI repositioning cursor.
- 
3. Move the cursor to move the ROI box to the desired position.
  4. Press  again to anchor the ROI box in place.
  5. Repeat **step 2** to **step 4** as many times as necessary.

---

**Note:** As the touch screen **Reset** button applies to any changes made, be sure to use **Save Volume** or the relevant **Custom Key** option (1 or 2) to print/save relevant images.

---



### 5.12.8 Repositioning the MPR Plane Intersection Point

The **MPR Plane** intersection point can only be repositioned from **A|B|C|VR** and **A|B|C|MPR**. This is controlled by the presence of a small red circle initially in the center of each **Plane**.

Figure 5-39: Figure 531: MPR Plane Intersection Point

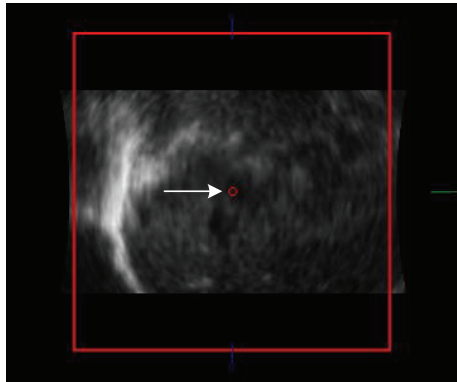

#### To Reposition the MPR Plane Intersection Point:

1. With a **3D** or frozen **4D Volume**, select the relevant **Display Mode**: **A|B|C|VR** or **A|B|C|MPR**.
2. Place the cursor over the red circle in the center of the **A**, **B** or **C Plane** and press the console  button to activate the repositioning cursor.

---

**Note:** Once placed over the red circle, the cursor will change to a cross (+).

---

3. Move the cursor to move the **MPR Plane** intersection point to the desired position.
4. Press  again to anchor the **MPR Plane** intersection point in place.
5. Select **A|B|C|MPR** to check the repositioning.
6. Repeat [step 2](#) to [step 5](#) as many times as necessary until the **MPR Plane** intersection point is in the desired place.

---

**Note:** As the touch screen **Reset** button applies to any changes made, be sure to use **Save Volume** or the relevant **Custom Key** option (1 or 2) to print/save relevant images.

---

## 5.12.9 3D/4D Presets

**Standard** and **Advanced 3D/4D** are delivered with five (5) Factory-installed **3D/4D Presets**. As well as the **2D Preset, OB4D**, for use with the **Applications OB 1st Trimester** or **OB 2nd–3rd Trimester**. This **Preset** is designed to configure the underlying **2D** imaging parameters before the **Operator** enters **3D** or **4D** imaging.

If desired, users can also create their own user-defined **2D Preset(s)** (4.9) to configure the underlying **2D** imaging parameters.

The five (5) **Presets (User1 to User5)** are available through **User Mode (5.12.2.3)** after **3D/4D** image acquisition. The **Default Preset** will always be applied to every image immediately after acquisition. If desired, **User1, 2, 3, 4** or **5** can be saved to the **Default Preset**.

---

**Note:** For details on reconfiguring the **Default Preset**, refer to **5.12.2.2**.

Refer to **5.12.2.3 3D/4D User Mode (LCD Display Options Only)** for more details on **3D4D Presets**.

---

### 5.12.9.1 Selecting a Default 3D/4D User (Preset)

For convenience, Ultrasonix has configured **3D/4D Imaging** to enable the user to select a default **Preset** to be applied to every image immediately after acquisition. If the current **Default Preset** is not appropriate, the user has the option to load a different one (5.12.9.2).

#### To Configure the Default User Preset on Entry:

1. Ensure an image has been acquired.
2. Select **User Mode** on the LCD display.



3. Select the radio button for the desired **Default User Preset** to be defaulted to upon entry.
4. Select **Load**.
5. Select **Default**.
6. Select **Save**.

### 5.12.9.2 User-Defined 3D/4D Presets

While all **Presets** have a pre-defined factory setting, they can be edited to suit the needs of each **Operator**.

#### To Create a User-Defined 3D/4D Preset:

1. Ensure an image has been acquired.
2. Move through the touch screen and LCD display options, making changes as required (refer to [5.12.2.1](#) and [5.12.2.5](#) for details on the available parameters).
3. Select **User Mode** on the LCD display.

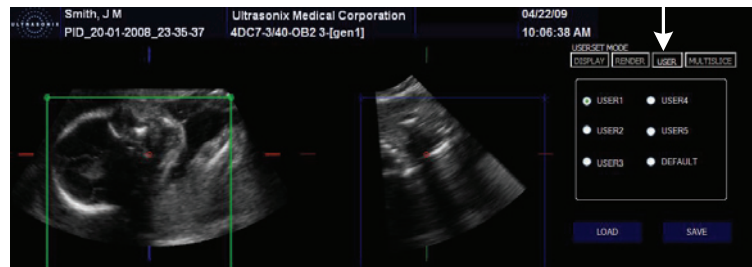

4. Select the radio button for the desired **User Preset**.

---

**Note:** *Ultrasonix does not recommend editing the Preset parameters for Users 1, 2 and 3.*

---

5. To save the parameters of the new **Preset**, select **Save**.



### 5.12.9.3 Loading 3D/4D Presets

In order to apply the parameters of a **Preset**, it must first be loaded. Simply selecting the radio button next to the desired **User Preset** will not apply that **Preset's** parameters to the current image.

#### To Load a User Preset:

1. Ensure an image has been acquired.
2. Select **User Mode** on the LCD display.

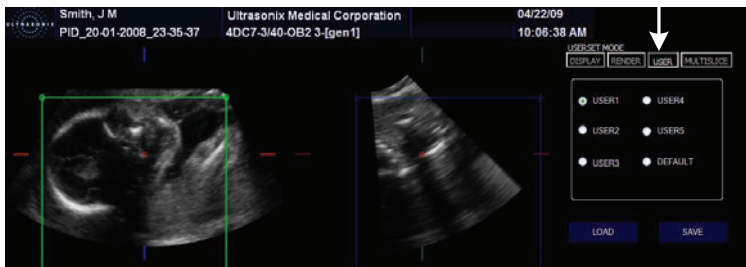

3. Select the radio button for the desired **User Preset**.
4. Select **Load** to activate the selected **Preset**.

#### 5.12.9.4 Resetting Factory Defaults

If desired, an **Operator** can erase all edits to a given **Preset** by resetting it the factory default configuration.

##### To Reset a Preset to Factory Defaults:

1. Ensure an image has been acquired.
2. Select **User Mode** on the LCD display.



3. Select the radio button for the desired **User Preset**.
4. Select **Load**.
5. Tap the touch screen **Reset** button.



**ULTRASONIX**

## CHAPTER 6: CLINICAL ANALYSIS

Measurements provide the user with the functionality to perform clinical analysis on an ultrasound image. They range from simple measurements that calculate **Length**, **Circumference**, **Area**, **Volume**, etc., to **Measurement Packages** that use calculation formulas to determine **Fetal Age**, **Heart Rate**, etc.

The reporting feature takes the **Application**-specific measurement values and generates a **Worksheet/Report** that includes patient and facility information, labeled measurement values and calculation results. Some reports contain auto-generated graphs.

The system provides a wide range of **Application**-specific measurement/calculation packages.

---

**Note:** The availability of measurement/calculation packages is dependant upon a combination of licensed options (8.2.22), currently connected transducers and **Preset** settings (8.2.1).

---

The measurement/calculation package defaults to the **Exam Type/Application** selected. For example, the **Obstetrical** calculation package is the default when an **OB Application** is selected. To access measurements specific to an alternate **Application**, tap the touch screen **Presets...** button and change the **Application-Transducer-Preset** settings as required.

To access **Measurement Packages**, press the console  button.

Figure 6-1: Measurement Packages Touch Screen

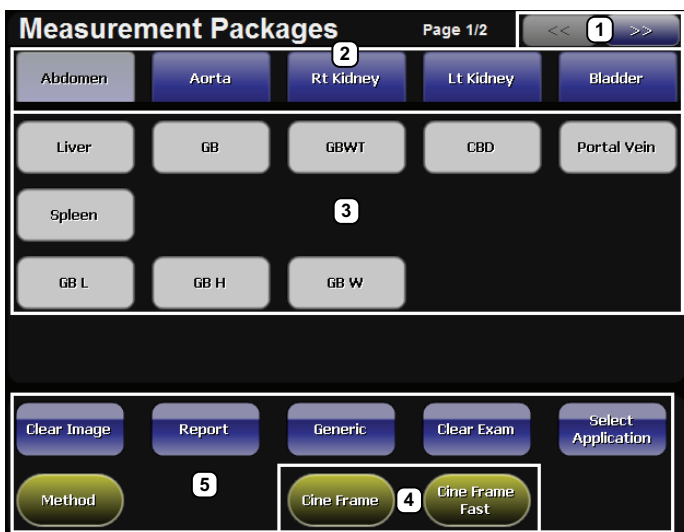

---

**Note:** This example uses the **Application-Transducer-Preset** combination **Abdomen-L14-5/38-Superficial**.











---



Table 6-1: Measurement Packages Touch Screen Options

1	Page selector buttons	Use if more than one page of <b>Measurement Package</b> options exists. If there is only one (1) page available, the selectors will be inaccessible (i.e., grayed out).
2	<b>Measurement Packages</b>	These tabs represent the actual <b>Measurement Packages</b> available for the current <b>Application–Transducer–Preset</b> combination. <b>Note:</b> <i>If the page selector buttons are active, there are more <b>Measurement Packages</b> available than what is visible on the current touch screen.</i>
3	Measurement Options	The specific measurement options available for the active <b>Measurement Package</b> tab.
4	<b>Cine</b> Controls	Standard <b>Cine</b> control buttons. Refer to 5.10 for details on <b>Cine</b> .
5	Measurement Controls	Measurement touch screen control options. Refer to Table 6-2 for more details.

Table 6-2: Console Measurement Buttons

	Initiates/closes the <b>Measurements Package</b> touch screen. On a frozen image with measurements already recorded, press  to remove all the measurements on the frozen image screen. <b>Note:</b> <i>Pressing  does not delete the measurements from the <b>Report</b>.</i>
	Removes measurements from the LCD display (located to the left of the  button). If saved to a <b>Worksheet/Report</b> , it will also remove the measurement from the <b>Report</b> . Continue to press  for each of the measurements to be deleted. <b>Note:</b> <i>To delete a specific measurement when more than one is visible onscreen, move the cursor closest to the measurement to be deleted and press the console  button to select it. Press  to delete it.</i>
	Selects, sets and activates calipers, ellipse, etc.
	Toggles between the calipers prior to finalizing (setting) the measurement.



**Table 6-3: Measurement Packages Touch Screen Controls (tap to activate, dial to adjust)**

<b>Clear Image</b>	Tap to <b>Clear</b> any measurements currently on the image.
	<b>Note:</b> This will not remove the measurements on the <b>Worksheet/Report</b> .
<b>Clear Exam</b>	Tap to <b>Clear</b> all measurements from both the LCD display and the <b>Worksheet/Report</b> .
	<b>Note:</b> Confirm this action when the message <b>Clear Exam? Yes No</b> is presented.
<b>Method</b>	Tap to change measurements types, e.g., from <b>B Distance</b> to <b>Curved Distance</b> . The method selected appears in a message bubble on the lower right corner of the LCD display. Tap as many times as necessary to advance to the desired measurement option.
	<b>Note:</b> Not all measurements have more than one measurement option.
<b>Select Application</b>	Tap to select a different <b>Application</b> .
<b>Generic/Calcs</b>	Tap to move to the <b>Generic/General Application/Preset</b> .
	<b>Note:</b> After tapping <b>Generic</b> , the button name changes to <b>Calcs</b> . This indicates that the system is now using <b>Generic</b> measurements. Tap <b>Calcs</b> to exit <b>Generic</b> measurements and return to standard <b>Measurement Packages</b> .
	<b>Generic</b> measurements are not written to the <b>Worksheet/Report</b> .
<b>Report</b>	Tap to move to the relevant <b>Report (6.8)</b> . Tap <b>Exit</b> to return to <b>Measurement Packages</b> .
	<b>Note:</b> The touch screen will change to the <b>Report Worksheet</b> touch screen. Tap <b>Exit</b> to return to the measurements touch screen.



## 6.1 GENERIC 2D MEASUREMENTS

During imaging, measurements are accessible by pressing the console  button and tapping the desired touch screen tab and measurement.

For the purposes of the following examples, all measurements have been taken using the **Generic** option.

---

**Note:** **Generic** measurements are not written to the **Worksheet/Report**.

---

Once the first version of a measurement has been taken, the relevant touch screen button will be prefaced by (1). If additional versions of that measurement are taken, the number will increment accordingly. Unless the measurement(s) is **Generic**, it will also have been saved to the **Worksheet/Report**.

---

**Note:** *Onscreen measurement labels are placed at or near the location of the first caliper. In order to avoid overlapping measurement labels, whenever possible, take care not to overlap measurement starting points.*



---

### 6.1.1 2D Linear Measurement

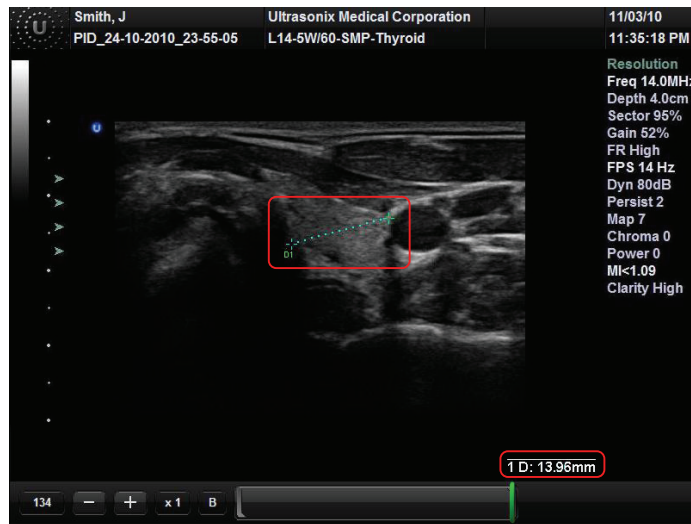
Figure 6-2: 2D Image with Linear Measurement



**To Perform a Linear Measurement:**

1. With a frozen **2D** image, press the console  button.
2. Tap **Generic** then **Distance** (under the **General** tab).
3. Tap **Method** and turn the associated dial to select **Sonix Calcs—Distance set to 'B Distance'**.
4. Use the trackball to position the first caliper.
5. Press  to set the first caliper and activate the second caliper.
6. Use the trackball to position the second caliper.



---

**Note:** Pressing  will toggle control between the calipers enabling either or both to be repositioned.



---

7. Press  to set the measurement and record it onscreen and (for non-**Generic** measurements) to the **Worksheet/Report**.

**To Perform a 2D Curved Distance Measurement:**

1. With a frozen **2D** image, press the console  button.
2. Tap **Generic** then **Distance** (under the **General** tab).
3. Tap **Method** and turn the associated dial to select **Sonix Calcs—Distance set to 'Curved Distance'**.
4. Use the trackball to position the first caliper.
5. Press  to set the first caliper and activate the second caliper.
6. Use the trackball to trace the caliper to the desired position.

---

**Note:** Prior to pressing , use the keyboard **BACKSPACE** key to delete the line. (Each time the **BACKSPACE** key is pressed, another dot in the line is erased.) Alternatively, use the  button (located next to the  button).

---

7. Press  to set the measurement and record it onscreen and (for non-**Generic** measurements) to the **Worksheet/Report**.





## 6.1.2 Area or Circumference Measurement

There are four (4) **Generic** methods of performing the **Area/Circumference** measurement: **Ellipse**, **Continual**, **Point by Point** and **Cross**.

### 6.1.2.1 Ellipse Method Area or Circumference Measurement

#### To Perform an Ellipse Method Area or Circumference Measurement:

1. With a frozen **2D** image, press the console  button.
2. Tap **Generic** then **Area** (under the **General** tab).
3. Tap **Method** and turn the associated dial to select **Sonix Calcs—Area set to 'Ellipse'**.
4. Use the trackball to position the first caliper.
5. Press  to set the first caliper and activate the second caliper.
6. Use the trackball to position the second caliper.
7. Press  to set the second caliper position and activate the **Ellipse** sides.
8. Use the trackball to increase/decrease the sides of the **Ellipse**.

---



**Note:** Pressing  will toggle control between the calipers enabling either or both to be repositioned.

---

9. Press  to set the final caliper position.
10. The **Area** and **Circumference** values are presented on the bottom right of the LCD display.



### 6.1.2.2 Continual Method Area or Circumference Measurement

#### To Perform a Continual Method Area or Circumference Measurement:

1. With a frozen **2D** image, press the console  button.
2. Tap **Generic** then **Area** (under the **General** tab).
3. Tap **Method** and turn the associated dial to select **Sonix Calcs—Area set to 'Continual'**.
4. Use the trackball to position the first caliper.
5. Press  to set the first caliper.
6. Use the trackball to trace the caliper around the desired area.

---

**Note:** If the traced **Area** is not closed (i.e., the caliper start and end positions are not at the same point), the system will automatically fill in the space with a straight line in order to be able to calculate **Area** and **Circumference**.

Prior to pressing  use the keyboard **BACKSPACE** key to delete the dots in the traced line one at a time, in reverse order. Alternatively, use the  button (located next to the  button).



---

7. Press  to set the final caliper position.
8. The **Area** and **Circumference** values are presented on the bottom right of the LCD display.





### 6.1.2.3 Point by Point Area or Circumference Measurement

#### To Perform a Point by Point Method Area or Circumference Measurement:

1. With a frozen **2D** image, press the console  button.
2. Tap **Generic** then **Area** (under the **General** tab).
3. Tap **Method** and turn the associated dial to select **Sonix Calcs—Area set to 'Point by Point'**.
4. Use the trackball to position the first caliper.
5. Press  to set the first caliper.
6. Use the trackball to position the second caliper.
7. Press  to set the second caliper.
8. Use the trackball to position the third caliper.

---





**Note:** Prior to pressing , use the keyboard **BACKSPACE** key to delete the line. (Each time the **BACKSPACE** key is pressed, another dot in the line is erased.) Alternatively, use the  button (located next to the  button).

---



9. Press  to set the final caliper.
10. The system will automatically join the first and last caliper positions in order to calculate the **Area** and **Circumference** and display them onscreen.

#### 6.1.2.4 Cross Area or Circumference Measurement

##### To Perform a Cross Method Area or Circumference Measurement:

1. With a frozen **2D** image, press the console  button.
2. Tap **Generic** then **Area** (under the **General** tab).
3. Tap **Method** and turn the associated dial to select **Sonix Calcs—Area set to 'Cross'**.
4. Use the trackball to position the first caliper.
5. Press  to set the first caliper.
6. Use the trackball to position the second caliper.
7. Press  to set the second caliper.
8. Use the trackball to position the third caliper.
9. Press  to set the third caliper.
10. Use the trackball to position the fourth caliper.

---

**Note:** Prior to pressing , use the keyboard **BACKSPACE** key to delete the line. (Each time the **BACKSPACE** key is pressed, another dot in the line is erased.) Alternatively, use the  button (located next to the  button).

---

11. Press  to set the final caliper.
12. The **Area** and **Circumference** values are presented on the bottom right of the LCD display.



### 6.1.3 Volume Calculation

#### To Perform a Volume Calculation:

---

**Note:** *L (Length) measurements can be performed using either linear (B) or Curved Distance.*

---

1. With a frozen **2D** image, press the console  button.
2. Tap **Generic** then the **Volume** tab to access the **L (Length)**, **H (Height)** and **W (Width)** options.

---

**Note:** *By default, the touch screen Length option will be selected for the first measurement, Height will always be second and Width, last.*

---

3. Tap **Method** and turn the associated dial to select the **L** method: '**B Distance**' or '**Curved Distance**'.
4. Use the track ball to position the first caliper.
5. Press  to set the caliper position and activate the second caliper.
6. Use the trackball to position the second caliper.

---

**Note:** *Pressing  will toggle control between the calipers enabling either or both to be repositioned.*

---

7. Press  to set the second caliper position and complete the measurement.
8. Repeat [step 4](#) through [step 7](#) until all three (3) linear measurements have been completed. The three (3) measurement values with auto-calculated **Volume** results are presented on the bottom right of the LCD display.

---

**Notes:**

*All three (3) measurements must be completed to calculate the **Volume**.*





*Only the three (3) most recent measurements (**L**, **H**, **W** and their **Volume** calculation) will be visible onscreen at any one time.*

---





#### 6.1.4 Percent Diameter Reduction Calculation (% Diam Red)

**To Perform a % Diameter Reduction:**

1. With a frozen **2D** image, press the console  button.
2. Tap **Generic** then **Diam Red** (under the **General** tab).
3. Use the trackball to position the first caliper of the outer measurement.
4. Press  to set the caliper position and activate the second caliper of the outer measurement.
5. Use the trackball to position the second caliper of the outer measurement.
6. Press  to set the second caliper.
7. Use the trackball to position the first caliper of the inner measurement.
8. Press  to set the caliper position and activate the second caliper of the inner measurement.
9. Use the trackball to position the second caliper of the inner measurement.

---

**Note:** Prior to pressing , use the keyboard **BACKSPACE** key to delete the line. (Each time the **BACKSPACE** key is pressed, another dot in the line is erased.) Alternatively, use the  button (located next to the  button).

---

10. Press  to set the second caliper.
11. The resulting **% Diameter Reduction** is presented on the bottom right of the LCD display along with the inner (**I**) and outer (**O**) diameter measurements that were used in the calculation.



### 6.1.5 Percent Area Reduction Calculation (% Area Red)

When combined, the two (2) methods of performing the outer and inner **Area Reduction** measurements—**Ellipse** and **Trace**—result in a total of three (3) options.

**Note:** *The first caliper set is used for the outer measurement of the **Area Reduction** and the second caliper set is used for the inner measurement.*

**Table 6-4: Percent Area Reduction Calculation Methods**

<b>Ellipse/Ellipse</b>	Uses the <b>Ellipse</b> method for both outer and inner measurements.
<b>Ellipse/Trace</b>	Uses the <b>Ellipse</b> method for the outer measurement and the <b>Trace</b> method for the inner measurement.
<b>Trace/Trace</b>	Uses the <b>Trace</b> method for both outer and inner measurements.

#### 6.1.5.1 Ellipse/Ellipse Method of Area Reduction Calculation

##### To Perform an Ellipse/Ellipse Method Area Reduction:



1. With a frozen **2D** image, press the console button.
2. Tap **Generic** then **Area Red** (under the **General** tab).
3. Tap **Method** and turn the associated dial to select **Sonix Calcs—Area Red set to 'Area Reduction Ellipse/Ellipse'**.
4. Use the trackball to position the first caliper of the outer **Ellipse**.
5. Press to set the caliper position and activate the second caliper of the outer **Ellipse**.
6. Use the trackball to position the second caliper.
7. Press to set the second caliper position and activate the outer **Ellipse** sides.
8. Use the trackball to increase/decrease the sides of the outer **Ellipse**.

**Note:** *Pressing will toggle control between the calipers enabling either or both to be repositioned.*

9. Press to complete the outer measurement.
10. Use the trackball to position the first caliper of the inner **Ellipse**.
11. Press to set the caliper position and activate the second caliper of the inner **Ellipse**.
12. Use the trackball to position the second caliper.
13. Press to set the second caliper position and activate the inner **Ellipse** sides.
14. Use the trackball to increase/decrease the sides of the inner **Ellipse**.
15. Press to complete the inner measurement.
16. The resulting **% Area Reduction** is presented on the bottom right of the LCD display along with the inner (**I**) and outer (**O**) measurements that were used in the calculation.

### 6.1.5.2 Ellipse/Trace Method of Percent Area Reduction Calculation



#### To Perform an Ellipse/Trace Method Area Reduction:

1. With a frozen **2D** image, press the console  button.
2. Tap **Generic** then **Area Red** (under the **General** tab).
3. Tap **Method** and turn the associated dial to select **Sonix Calcs—Area Red set to 'Area Reduction Ellipse/Trace'**.
4. Use the trackball to position the first caliper of the outer **Ellipse**.
5. Press  to set the caliper position and activate the second caliper of the outer **Ellipse**.
6. Use the trackball to position the second caliper.
7. Press  to set the second caliper position and activate the outer **Ellipse** sides.
8. Use the trackball to increase/decrease the sides of the outer **Ellipse**.

---

**Note:** Pressing  will toggle control between the calipers enabling either or both to be repositioned.



---

9. Press  to complete the outer measurement.
10. Use the trackball to position the caliper at the start position of the inner **Trace** measurement.
11. Press  to set the second caliper.
12. Use the trackball to trace the caliper around the desired area.
13. Press  to set the second caliper position.
14. The resulting **% Area Reduction** is presented on the bottom right of the LCD display along with the inner (**I**) and outer (**O**) measurements that were used in the calculation.





### 6.1.5.3 Trace/Trace Method of Percent Area Reduction Calculation



#### To Perform a Trace/Trace Method Area Reduction:

1. With a frozen **2D** image, press the console  button.
2. Tap **Generic** then **Area Red** (under the **General** tab).
3. Tap **Method** and turn the associated dial to select **Sonix Calcs—Area Red set to 'Area Reduction Trace/Trace'**.
4. Use the trackball to position the first caliper at the start position of the outer **Trace** measurement.
5. Press  to set the first caliper.
6. Use the trackball to trace the circumference around the desired area.

---

**Note:** Prior to pressing , use the keyboard **BACKSPACE** key to delete the line. (Each time the **BACKSPACE** key is pressed, another dot in the line is erased.) Alternatively, use the  button (located next to the  button).

---

7. Press  to set the **Trace**.
8. Use the trackball to position the second caliper at the start position of the inner **Trace** measurement.
9. Press  to set the second caliper.
10. Use the trackball to trace the circumference the area of interest.
11. Press  to set the second caliper position.
12. The resulting % **Area Reduction** is presented on the bottom right of the LCD display along with the inner (**I**) and outer (**O**) measurements that were used in the calculation.

## 6.2 M-MODE MEASUREMENTS

For the purposes of the following examples, all measurements have been taken using the **Generic** option.



---

**Note:** *Generic measurements are not written to the **Worksheet/Report**.*

---

### 6.2.1 M-Mode Heart Rate Measurement

**To Perform an M-Mode Heart Rate Measurement:**

1. With a frozen **M-Mode** image, press the console  button.
2. Tap **Generic** then **HR** (under the **General** tab).
3. Use the trackball to position the caliper on the **M-Mode Sweep** to the first beat.
4. Press  to set the first cursor and activate a second caliper.
5. Use the trackball to position the second caliper to the next beat.

---

**Note:** *The default **Heart Rate** measurement requires one heart beat. Refer to [8.2.6 Measurements](#) to change the number of beats required for the **HR** calculation.*



*Pressing  will toggle control between the calipers enabling either or both to be repositioned.*

- 
6. Press  to set the measurement.
  7. The **Heart Rate** value is presented on the bottom right of the LCD display.





## 6.2.2 M-Mode Slope Measurement (Time, Distance and Slope)

### To Perform an M-Mode Slope Measurement:

1. With a frozen **M-Mode** image, press the console  button.
2. Tap **Generic** then **Time/Slope** (under the **General** tab).
3. Use the trackball to position the first caliper on the **M-Mode Sweep**.
4. Press  to set the first cursor and activate a second caliper.
5. Use the trackball to position the second caliper to the desired location.
6. Press  to set the measurement.
7. The **Time**, **Distance** and **Slope** values is presented on the bottom right of the LCD display.

## 6.2.3 M-Mode Distance Measurement

### To Perform an M-Mode Distance Measurement:

1. With a frozen **M-Mode** image, press the console  button.
2. Tap **Generic** then **Distance** (under the **General** tab).
3. Tap **Method** and turn the associated dial to select **Sonix Calcs—Distance set to 'M Distance'**.
4. Use the trackball to position the first caliper.
5. Press  to set the second caliper.
6. Use the trackball to position the second caliper.

---

**Note:** Pressing  will toggle control between the calipers enabling either or both to be repositioned.

---

7. Press  to set the second caliper.

---

**Note:** When using the **Cardiac Measurement Package RV/LV (M)**, both diastolic and systolic **M-Mode Distance** measurements must be completed.

---

8. The **Distance** value is presented on the bottom right of the LCD display.

## 6.3 PW/CW DOPPLER MEASUREMENTS

For the purposes of the following examples, all measurements have been taken using the **Generic** option.

---

**Note:** *Generic measurements are not written to the **Worksheet/Report**.*

---

### 6.3.1 Velocity Measurements

**Velocity** measurements can be performed using either a single or double caliper method.

---

**Note:** *Available/visible measurements/calculations depend upon the selections made in [8.2.1.1 Show/Hide Imaging Presets](#) and [8.2.6.2 Show/Hide Applications, Measurement Packages and Measurements](#).*



---

#### To Perform a Single Caliper Velocity Measurement:

---

**Note:** *ECG is not available on this platform.*

---

1. With a frozen **Doppler Trace**, press the console  button.
2. Tap **Generic** then **Velocity** (under the **General** tab).
3. Tap **Method** and turn the associated dial to select **Sonix Calcs—Velocity set to '1 Cal. Velocity'**.
4. Use the trackball to position caliper.
5. Press  to set the caliper.
6. **Velocity** values are presented on the bottom right of the LCD display.

---

**Note:** *If no measurement is selected from the touch panel, a generic **Velocity** measurement value will be displayed depending on the application selected. For example, for **Vascular**, the **Velocity** will be **cm/sec** but for **Cardiac** it may be **m/sec**.*

---





### To Perform a Double Caliper Velocity Measurement:

---

**Note:** *ECG is not available on this platform.*

---

1. With a frozen **Doppler Trace**, press the console  button.
2. Tap **Generic** then **Velocity** (under the **General** tab).
3. Tap **Method** and turn the associated dial to select **Sonix Calcs—Velocity set to '2 Cal. Velocity'**.
4. Use the trackball to position the caliper to the peak velocity. A **Peak Systolic Velocity (PSV)** value is presented on the LCD display.
5. Press  to set the first caliper and activate a second caliper.
6. Use the trackball to position the second caliper.
7. Press  to set the caliper.
8. An **End Diastolic Velocity (EDV)** value with associated **Resistive Index (RI)** and **Systolic/Diastolic Ratio (SD)** is presented on the bottom right of the LCD display.



## 6.3.2 Doppler Manual Trace Measurement

---

**Note:** Available/visible measurements/calculations depend upon the selections made in 8.2.1.1 [Show/Hide Imaging Presets](#) and 8.2.6.2 [Show/Hide Applications, Measurement Packages and Measurements](#).

---

### 6.3.2.1 Doppler Manual Trace Measurement – Continual Method

---



**Note:** To ensure the most accurate results, position the first caliper at the start of the waveform and set the last caliper at end diastole for manual **Doppler Traces**.

---



#### To Perform a Manual Doppler Trace, Using the Continual Method:

1. With a frozen **Doppler Trace**, press the console  button.
2. Tap **Generic** then **Trace** (under the **General** tab).
3. Tap **Method** and turn the associated dial to select **Sonix Calcs—Trace set to 'Spectrum Continual'**.
4. Use the trackball to position the first caliper at the start of the desired **Doppler Waveform**.

---

**Note:** Prior to pressing , use the keyboard **BACKSPACE** key to delete the line. (Each time the **BACKSPACE** key is pressed, another dot in the line is erased.) Alternatively, use the  button (located next to the  button).

---

5. Press  to set the start position.
6. Use the trackball to draw the trace along the desired **Waveform** right up to the point of end diastole.
7. Press **SELECT** to end and set the **Trace**.
8. Press  to end and set the **Trace**.
9. The **Trace** values are presented on the LCD display.



### 6.3.2.2 Doppler Manual Trace Measurement – Point by Point Method

---



**Note:** To ensure the most accurate results, position the first caliper at the start of the waveform and set the last caliper at end diastole for manual **Doppler Traces**.

---



#### To Perform a Manual Doppler Trace, Using the Point by Point Method:

1. With a frozen **Doppler Trace**, press the console  button.
2. Tap **Generic** then **Trace** (under the **General** tab).
3. Tap **Method** and turn the associated dial to select **Sonix Calcs—Trace set to 'Spectrum Point by Point'**.
4. Use the trackball to position the first caliper at the start of the desired **Doppler Waveform**.

---



**Note:** Prior to pressing , use the keyboard **BACKSPACE** key to delete the line. (Each time the **BACKSPACE** key is pressed, another dot in the line is erased.) Alternatively, use the  button (located next to the  button).

---

5. Press  to set the first caliper and activate the second.
6. Use the trackball to position the next trace position.
7. Press  to set the second caliper and activate the third.
8. Use the trackball to position the third caliper at the last trace position.
9. Press  to end and set the **Trace**.
10. The **Doppler Trace** values are presented on the LCD display.

### 6.3.3 Doppler Auto-Trace Measurement (Spectrum Range)

#### To Perform an Auto Doppler Trace (D-Range):

1. With a frozen **Doppler Trace**, press the console  button.
2. Tap **Generic** then **Trace** (under the **General** tab).
3. Tap **Method** and turn the associated dial to select **Sonix Calcs—Trace set to 'Spectrum Range'**.
4. Use the trackball to position the first caliper.
5. Press  to set the first caliper and activate the second.
6. Use the trackball to position the second caliper.

---

**Note:** Pressing  will toggle control between the calipers enabling either or both to be repositioned.

---

7. Press  to set it.

### 6.3.4 Doppler Heart Rate Measurement

#### To Perform a Doppler Heart Rate:

1. With a frozen **Doppler Trace**, press the console  button.
2. Tap **Generic** then **HR** (under the **General** tab).
3. Use the trackball to position the caliper on the **Doppler Trace** to the first beat.

---

**Note:** The default **Heart Rate** measurement requires one heart beat. Refer to [8.2.6 Measurements](#) to change the number of beats required for the **HR** calculation.

---

4. Press  to set the first caliper and activate the second.
5. Use the trackball to position the second caliper to the desired next beat.

---

**Note:** Pressing  will toggle control between the calipers enabling either or both to be repositioned.

---

6. Press  to set the measurement.
7. The **Heart Rate** value is presented on the bottom right of the LCD display.



## 6.4 ELASTOGRAPHY MEASUREMENTS

The *Elastography Strain Ratio* measures the relative stiffness of two (2) regions on the image.

Figure 6-3: Strain Ratio Measurement

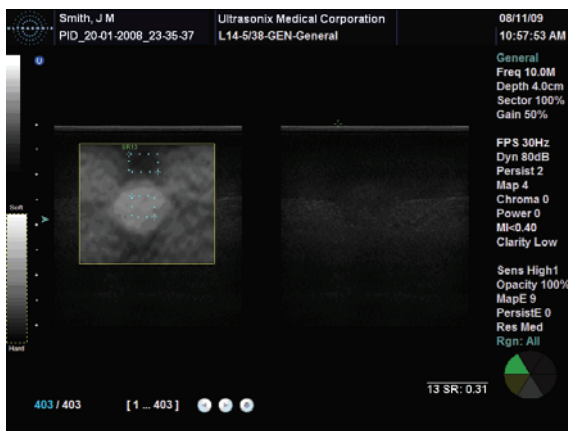





### To Perform an Elastography Strain Ratio Measurement:

---

**Note:** The *Strain Ratio* measurement provided is part of the **General Measurement Package** and therefore will not be saved to the **Report**.

---

1. With a frozen *Elastography* image, press the console  button.
2. Tap **Generic** then **Strain Ratio** (under the **General** tab).
3. Use the trackball to position the first caliper of the first **Strain Ratio** box.
4. Press  to set the caliper position and activate the second caliper of the first **Strain Ratio** box.
5. Use the trackball to position the second caliper of the first **Strain Ratio** box.
6. Press  to set the second caliper and complete the first half of the measurement.
7. Use the trackball to position the first caliper of the second **Strain Ratio** box.
8. Press **SELECT** to set the caliper position and activate the second caliper of the second **Strain Ratio** box.
9. Press  to set the caliper position and activate the second caliper of the second **Strain Ratio** box.
10. Use the trackball to position the second caliper of the second **Strain Ratio** box.
11. Press  to set the second caliper and complete the measurement.
12. Repeat **step 3** to **step 11** as many times as required.

## 6.5 3D/4D MEASUREMENTS



---

**Warning:** Measurements performed on an acquired **Freehand 3D** image may be inaccurate as the accuracy of the **Multiplanar Reconstruction** is very user-dependent. Measurements performed on an acquired **Freehand 3D** image should be used for informational purposes only.

---

## 6.6 OB-SPECIFIC MEASUREMENTS/CALCULATIONS

In the case of multiple fetuses (e.g., twins or triplets), be sure to enter the correct **Fetus #** ([Table 4-4](#)) on the **Exam Management** page. This will ensure that the **Fetus A/B** button will be active in both **OB Measurement Packages** and **Reports** (where **1 = A**, **2 = B**, etc.).



---

**Warning:** In addition to entering the correct **Fetus #** on the **Exam Management** page, be sure to label each **Fetus** using the console **ABC** button.

---



---

**Note:** The **Fetus A/B** button will change based on the number of fetuses entered. For example, for eight (8) fetuses, the button would be **Fetus A/H**. Tap this button as many times as necessary to cycle through to the correct **Fetus #**.

---

Additionally, to ensure that each measurement is labeled correctly (e.g., **A NT**, **B NT**, **F BPD**, where **A**, **B**, **F**, etc., reflect the **Fetus #** for the measurement), after changing the **Fetus #**, always reselect the relevant measurement.



---

### Warnings:

Various factors may affect the accuracy of **Obstetrical** measurements.

Ensure the system **Date/Time** is configured correctly.

Ensure the desired **Obstetrical** calculation author has been selected for each parameter.

In order to record measurements on multiple—but separate—fetuses, enter a **Fetus #** between 2 and 8 (i.e., to activate the **Fetus** toggle button in **OB Measurement Packages** and **Reports** (where **1 = A**, **2 = B**, etc.)).

---

### Notes:

Selection of **OB Doppler** measurements **MCA** (**Middle Cerebral Artery**) and **Umb A** (**Umbilical Artery**) enable a two (2) caliper velocity measurement to be made which displays **PSV**, **EDV**, **RI** and **SD** ratio results. To obtain a **PI** (**Pulsatility Index**) measurement for **MCA** or **Umb A**, select **MCA-PI** or **Umb A-PI** to enable a **Doppler Trace** measurement which displays **PSV**, **EDV**, **RI**, **SD** and **PI** results.

Once the first instance of a measurement has been taken, the relevant touch screen button will be prefaced by (1). If additional versions of that measurement are taken, the number will increment accordingly. Unless the measurement(s) is **Generic**, it will be displayed in the **Report Worksheet**.

---



Figure 6-4: Sample OB-Specific Measurement

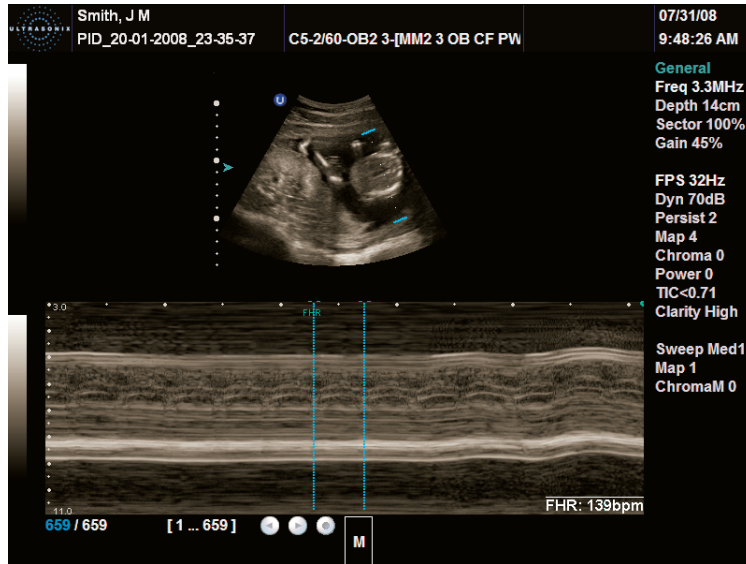

## 6.7 FERTILITY-SPECIFIC MEASUREMENTS/CALCULATIONS

To select the number of follicles to be used in the **Follicle Volume** calculation, refer to **Fertility Cascade #** in **Table 8-10: Measurement Options**.

**Follicle Volumes** are calculated as  $V=(\text{average of all diameters})^3 * \pi/6$ . For example:

- if two (2) diameter measurements (e.g., D1 and D2) are made for a Follicle (e.g., F1) then: Volume of  $F1=((D1+D2)/2)^3 * \pi/6$
- if four (4) diameter measurements (e.g., D1, D2, D3 and D4) are made for a Follicle (e.g., F2), then: Volume of  $F2=((D1+D2+D3+D4)/4)^3 * \pi/6$ .

## 6.8 REPORTS AND WORKSHEETS

**Reports/Worksheets** have been created as an electronic documentation tool. Identifying patient/exam information is included in the **Report** header on every page.

**Applications** are linked to a **Report/Worksheet** that can be viewed/edited during an exam via the touch screen **Report/Worksheet** button. **Worksheets** can also be accessed via the console  button.

---

**Note:** Files saved to a USB storage device during data transfer will be printed to a PDF in the relevant **Patient** directory under **Patientinfo**. Refer to [9.3](#) for more details.

---

**Reports** contain the information from a **Worksheet** but are formatted in a slightly different manner.

Certain aspects (such as measurements) of some **Worksheets** can be edited but only on the same calendar day as they were created. Once the system date rolls past midnight, these fields can no longer be edited. The exception to this is the **Notes** field.

---

**Note:** In order for the **Worksheet** to be available for editing, the **Application** used to create the original **Worksheet** must have a custom **Measurement Package**. For details on the **Applications** that qualify, refer to [8.2.6.2 Show/Hide Applications, Measurement Packages and Measurements](#)).

---

Any measurement that is edited will be marked with an asterisk (\*).



---

**Warning:** Ultrasonix does not endorse user-defined measurements for diagnostic purposes. All user-defined measurements are used at the operator's discretion and risk only.

---

**Note:** The touch screen **Report/Worksheet** button is only available if a patient has been selected.

It is not possible to edit **Calculations**.

---

### 6.8.1 Accessing Reports/Worksheets

During an exam, when in **Measurement Packages**, press/tap the **Report/Worksheet** button at any time to access the current **Report/Worksheet** on the LCD display. While no information can be typed into the open **Report/Worksheet**, using the trackball and  button, certain checkboxes and drop down menu selections can be made. Touch screen options will reflect the fact that a **Report/Worksheet** is now open.

---

**Note:** Only four (4) **Report/Worksheet** touch screen buttons are common to all **Applications**: **Print...**, **Print Default**, **Exit** and **Pages**. The other options will only be available when imaging is underway for the relevant **Application**.

---

**Table 6-5: Console Report/Worksheet Button**

	Initiates/closes the <b>Reporting (Worksheet)</b> touch screen.
---	---



**Table 6-6: Reporting (Report/Worksheet) Touch Screen Options**

<b>Print...</b>	Tap to open the Windows <b>Print</b> dialog. This enables users to configure the print job using the available <b>Print</b> dialog parameters.
<b>Print Default</b>	Tap to send the job to the default printer (if one has been configured).
<b>Exit</b>	Tap to save and close the <b>Report/Worksheet</b> , returning the user to <b>Measurement Packages</b> .
<b>Final Report</b>	Tap to view <b>Final Report</b> layout. <b>Note:</b> <i>This option is available only in <b>Cardiac</b>.</i>
<b>Worksheet</b>	Tap to view the current <b>Worksheet</b> . Edits made to <b>Worksheet Measurements</b> the same calendar day they were taken will be saved and used in final calculations. <b>Note:</b> <i>This option is available only in <b>Cardiac</b>. Any changes to measurements will be auto-calculated within the <b>Worksheet/Report</b>. The actual <b>Calculations</b> cannot be edited. Any measurement that is edited will be marked with an asterisk (*).</i>
<b>Biometrics</b>	Tap to move to the <b>Biometrics</b> page of the <b>Report</b> . <b>Note:</b> <i>This option is available only for <b>OB Applications</b>.</i>
<b>Anatomy</b>	Tap to move to the <b>Anatomy</b> page of the <b>Report</b> . <b>Note:</b> <i>This option is available only for <b>OB Applications</b>.</i>
<b>Pages</b>	Turn the dial directly to the right of <b>Pages</b> to move the <b>Report</b> from page to page.
<b>Graph</b>	Use the <b>Pages</b> button (above) to move to the <b>Graph</b> page of the <b>Report</b> then turn the <b>Graph</b> dial to cycle through the available <b>Graphs</b> .
<b>Fetus A/B to Fetus A/H</b>	Turn the <b>Fetus</b> button dial as many times as necessary to move to the <b>Report</b> for the relevant <b>Fetus</b> (e.g., <b>A, B, C</b> , etc.). <b>Note:</b> <i>This button is only available if <b>Fetus #</b> (Table 4-3) was set to a number other than 1 (options are 1 to 8 which correspond with <b>A to H</b>).</i>
<b>HR</b>	Not available on this platform.

**To Access a Report Worksheet while In Measurement Packages:**

1. With a frozen image, press the console button.
2. Tap **Report** or press .
3. Turn the dial directly to the right of the **Pages** button to move through the pages of the **Report Worksheet**.
4. Use the trackball and button to make any required checkbox or drop-down menu selections.
5. Tap **Exit** to close the **Report Worksheet** or use the trackball and button to select the **X** in the upper right corner.

**Note:** *Exiting the **Report Worksheet** will not end the current exam.*





## 6.8.2 Obstetrics Report

As with other **Reports**, the **OB Report** allows the user to edit/delete measurements, providing the edit/deletion is done on the same calendar day as the measurements were taken.

### To Delete Obstetrical Biometry Measurements from a Worksheet/Report:

**Note:** Report data can only be edited the same calendar day it was created.

1. With a frozen **OB** image, press the console  button.
2. Tap **Report** or press .
3. Tap **Pages** and turn the associated dial until the desired page appears.
4. Use the trackball and  button to insert the cursor at the end of the measurement/data to be deleted.

**Caution:** In the case of two (2) or more fetuses, ensure the correct fetus is selected prior to deleting the **OB** parameter measurement.

**Note:** Only some fields are available for editing.

5. Use the keyboard **BACKSPACE** key and delete the relevant data.
6. Repeat **step 3** to **step 5** as many times as necessary.
7. Tap **Exit** to close the **Report Worksheet** and return to imaging or use the trackball and  button to select the **X** in the upper right corner.

Figure 6-5: Sample Page from an Obstetrical Report Worksheet



Date of Exam: 11/5/2010 Page 1/6  
Exam Type: OB 2nd-3rd Trimesters

Name: Smith, J      Per. Phys. Dr Fred Jones  
Pat. ID: PID\_24 10 2010\_23 55 05      DOB: 12/8/1975      Ref. Phys. Dr Jane Doe  
Indication:      Sex: F      Operator: ALC

LMP: 3/15/2010      GA(LMP): 33w3d      EDD(LMP): 12/20/2010      G:       Ab:   
DOC:      GA(AUA):      EDD(AUA):      P:       Ec:

FFW      Value      Range      Age      Range      Growth  
Hadlock AC(BPD)/FL/HC      39.07g      5.70g      10w2d      Doublet:       <5%

2D Measurements	AUA	Value	m1	m2	m3	Meth.	Age	Range
DPD (Hadlock)		0.07mm	8.19	8.53	7.50	avg		
OFD (HC)		10.27mm	11.19	9.74	9.89	avg		
HC (Hadlock)		29.78mm	30.01	20.04	30.40	avg		
AC (Hadlock)		27.48mm	20.10	30.13	24.14	avg		
FL (Hadlock)		5.83mm	4.70	6.52	6.20	avg		

OB Ratios

FL/DPD      73%      67%-91%      20%      19%-23%

Thumbnail:

### 6.8.3 Vascular Reports

Figure 6-6: Sample Page from a Vascular Report Worksheet

REPORT WORKSHEET		Date of Exam: 8/22/2008		Page 1/4				
		Exam Type: Vascular						
Name	Jones, Michael	Perf. Phys.	Dr Smith					
Pat. ID	USX_PID_23-07-2008_15-22-16	DOB	3/15/1969					
Ref. Phys.	Dr Frank							
Indication		Sex	M		Operator			
			ALC					
Measurements	Value	m1	m2	m3	m4	m5	m6	Meth.
<b>Stenosis D - Rt Prox ICA</b>								
D1	1.04cm	1.04						max
D2	0.38cm	0.38						max
%	63.21%	63.21						max
<b>Rt Carotid - Rt Dist CCA</b>								
PSV	69.6cm/s	69.6						max
EDV	22.3cm/s	22.3						max
<b>Rt Carotid - Rt Prox ICA</b>								
PSV	79.0cm/s	79.0						max
EDV	29.0cm/s	29.0						max

### 6.8.4 Billing and QA Review Report/Worksheet Options

If desired, **Billing** details can be included in the **Billing** section.

---

**Note:** Ensure **Enable QA Review** has been selected (**Table 8-10**).

Any **Report/Worksheet** opened/created during/prior to this setting being selected will not include the **Billing** and **QA** options.

---

**QA Review** enables a **Reviewer** to make note of any **Follow-up Findings**, record their **QA** results, **Agree/Disagree** with the results determined by the **Operator** associated with the exam in question as well as enter any relevant **Notes** they may wish to make.

**Figure 6-7: Billing and QA Review**

**Billing:**

No Attending     
  Attending reviewed / agreed     
  Attending reviewed / disagreed

No US charge     
  US charge #1     
  US charge #2     
  US charge #3

---

**QA Review:**

Follow-up Findings

Adequate US image  Yes     No     
 Accurate Interpretation  Yes     No     
 Exam Results:  Agree     Disagree

TP     TN     FP     FN     TLS

QA Notes:

**Table 6-7: Billing and QA Review Fields**

<b>No Attending</b>	Select if no <b>Attending Physician</b> is present during the exam.
<b>Attending Reviewed/Agreed</b>	Select when an <b>Attending Physician</b> is present during the exam and <b>Agrees</b> with the <b>Operator</b> .
<b>Attending Reviewed/Disagreed</b>	Select when an <b>Attending Physician</b> is present during the exam and <b>Disagrees</b> with the <b>Operator</b> .
<b>No US Charge</b> <b>US Charge #1</b> <b>US Charge #2</b> <b>US Charge #3</b>	The names of these four (4) Ultrasound (US) fields can be edited to reflect billing codes relevant to the <b>Exam Type/Application</b> and/or individual institutions. <b>Note:</b> <i>Ultronix recommends "blanking out" any unused billing code fields.</i>
<b>Follow-up Findings</b>	Enables <b>Reviewers</b> to comment on <b>Follow-up Findings</b> as necessary. <b>Note:</b> <i>This field will accept approximately 75 characters.</i>
<b>Adequate US Image</b>	Accepts a <b>Yes</b> or <b>No</b> answer.
<b>Accurate Interpretation</b>	Accepts a <b>Yes</b> or <b>No</b> answer.
<b>Exam Results</b>	<b>Agree/Disagree</b> Allows <b>Reviewers</b> to <b>Agree/Disagree</b> with the <b>Operator's</b> results.
	<b>TP</b> <b>True Positive</b>
	<b>TN</b> <b>True Negative</b>
	<b>FP</b> <b>False Positive</b>
	<b>FN</b> <b>False Negative</b>
<b>TLS</b> <b>Technically Limited Study</b>	
<b>QA Notes</b>	Enables <b>Reviewers</b> to add whatever comments they feel are necessary. <b>Note:</b> <i>This field will accept approximately 400 characters.</i>



**To Access Billing and QA Review Details:**

1. Press the console  button.
2. Turn the **Pages** dial to move to the relevant page.

**REPORT WORKSHEET** Page 2/2

Name:  Date:  Patient ID:   
Operator ID:  Attending Physician:

Notes:

Billing:  
 No Attending     Attending reviewed / agreed     Attending reviewed / disagreed  
 No US charge     US charge #1     US charge #2     US charge #3

QA Review:  
Follow-up Findings

Adequate US image  Yes     No    Accurate Interpretation  Yes     No    Exam Results:  Agree     Disagree  
 TP     TN     FP     FN     TLS

QA Notes:

---

**Note:** Any **Report/Worksheet** opened/created during/prior to this setting being selected will not include the **Billing** and **QA** options.

---

3. Use the trackball, console keyboard and  button to complete the **Billing** and **QA Review** fields as required.

## CHAPTER 7: TEXT, ANNOTATIONS AND PICTOGRAMS

---

**Text**, **Annotations** and **Pictograms** enable the user to label images prior to image transfer and storage.

---





**Note:** **Annotation** and **Pictogram** options are controlled via [8.2.2](#) and [8.2.3](#), respectively. Refer to [8.2.5](#) for details on global **Annotation** settings.

---

**Text**, **Annotations** and **Text Arrows** can also be added to **3D/4D** images.

---

**Table 7-1: Console Text, Annotation and Pictogram Buttons**

	Turns on/off <b>Application</b> -specific <b>Pictogram</b> graphics. Tap <b>Pictogram</b> and dial through the various icons. <ul style="list-style-type: none"> <li>• trackball positions orientation marker</li> <li>• touch screen <b>Rotate</b> dial pivots orientation marker.</li> </ul>
	Turns on/off <b>Arrow</b> graphic on the image field. Trackball positions and rotates the <b>Arrow</b> graphic.
<b>ABC</b>	Activates the keyboard for <b>Text</b> entry and displays <b>Application</b> -specific <b>Annotation</b> buttons on the touch screen.
	Deletes the most recent <b>Text</b> or <b>Annotation</b> entry. Provides delete character functionality during data entry mode ( <b>Exam Management</b> page).
	Selects/sets onscreen options.



## 7.1 TEXT AND ANNOTATIONS

The system enables users to add **Text** or **Preset Annotations** to the image field. **Annotations** are predefined by **Application** but can also be customized by users (8.2.2). A **Text Arrow** is available as well as an **Auto-Complete** text feature that anticipates the word being entered (8.2.5).

Figure 7-1: Annotations Touch Screen

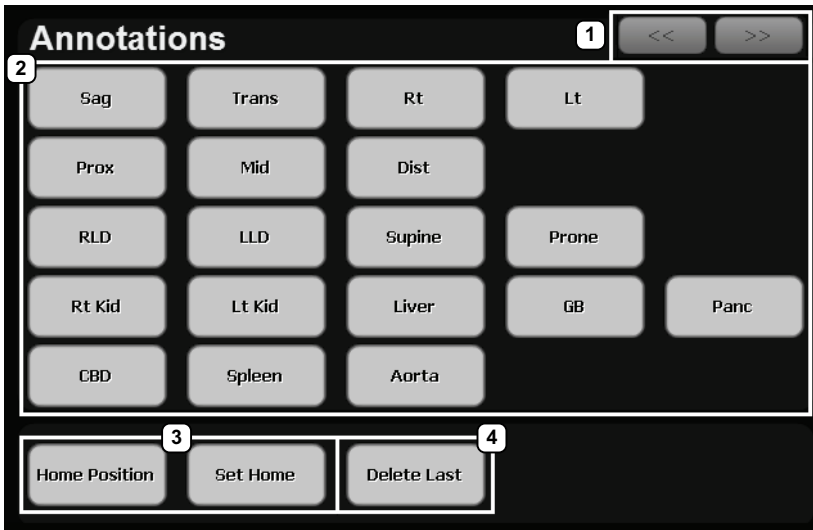

Table 7-2: Annotations Touch Screen

1	<b>Page Selector</b> Buttons	<b>Annotation</b> page selector buttons for use when there are multiple pages of <b>Application</b> -specific <b>Annotations</b> .
2	<b>Annotation</b> Buttons	<b>Application</b> -specific <b>Annotations</b> controlled via 8.2.2 <b>Presets – Annotations</b> .
3	<b>Home Position</b> Buttons	<b>Home Position</b> configuration buttons (common to all <b>Annotations</b> touch screens). <i>Note: Refer to 7.1.1 for details on setting the Home Position.</i>
4	<b>Delete Last</b>	Tap <b>Delete Last</b> (or use the keyboard <b>Backspace</b> key) to remove the letter(s) to the left of the <b>Text</b> cursor.

### To Access the Annotations Touch Screen:

1. Press the console **ABC** button.

### 7.1.1 Set Text Home Position

The **Home Position** button enables users to automatically reposition the cursor to the previously-defined **Text Home Position**. Once a **Text/Annotation** cursor **Home Position** has been set, it will remain until/unless it is reset.

#### To Set the Text Home Position:

1. Press the console **ABC** button.
2. Use the trackball to position the cursor in the desired **Home Position**.
3. Tap **Set Home** to set the **Home Position**.
  
4. Press **ABC** to exit **Text/Annotation** mode.

### 7.1.2 Annotations (Keyboard Text)

#### To Enter Annotation Text:

1. Press the console **ABC** button.
2. A **Text** cursor is presented on the imaging screen.
3. Use the trackball to position the **Text** cursor as required.
4. Use the console keyboard to enter the desired text.

---

**Note:** When the **Auto-Complete** function is active ([8.2.5 Annotations](#)), enter the first letter(s) of the preset word and the rest of the word will be presented in blue. If more than one preset word with the same first letter exists, use the **Tab** key to cycle through all the preset words beginning with that letter. To set the selected preset word, press **Enter** on the keyboard.

---

5. Press **ABC** to exit **Text/Annotation** mode.



### 7.1.3 Application-Specific Annotations

#### To Enter Application-Specific Annotations:

1. Press the console **ABC** button.
2. Once the **Text/Annotation** cursor location is presented on the imaging screen, use the trackball to reposition the cursor as required.
3. Tap the desired **Annotation** from the selection presented on the touch screen.

---

**Note:** To modify the preset **Annotations**, refer to section [8.2.2 Presets – Annotations](#).

---

4. Repeat [step 2](#) and [step 3](#) as many times as required.
5. Press **ABC** to exit **Text/Annotation** mode.

### 7.1.4 Deleting Text/Annotations

#### To Delete All Text/Annotations:

1. Press the console **ABC** button.
2. Press  (below the console **ABC** button) to delete all user-entered Text/Annotations from the image field.

---

**Note:** Alternatively, move the cursor to the desired position and use the keyboard **BACKSPACE** arrow to remove the letter(s) to the left of the **Text** cursor.

To remove the most recently entered **Annotation**, tap **Delete Last** while in the **Annotations** touch screen. Repeating this action will delete each subsequent entry in reverse order.

---

3. Press **ABC** to exit **Text/Annotation** mode.





### 7.1.5 Text Arrows

Operators can enter one (1) or multiple **Text Arrows** on a single image.

If required, Operators can also customize the length of the **Text Arrow** (8.2.5.1).

#### To Enter Text Arrows:

1. Press the console  button.
2. When the arrow appears on the image screen, use the trackball to position/rotate it.
3. Press the console  button to place the positioned arrow on the image.
4. Repeat **step 2** and **step 3** as many times as necessary.
5. Archive the image to save it with the arrows visible.



---

**Note:** To archive, press the console **1** or **2** button, depending on the system's printing setup (as configured in 8.2.13 Custom Keys).

---



6. Press  (below the console **ABC** button) to remove all arrows from the image.

---

**Note:** Once the console  button is pressed—either before or after the **Text Arrows** are added—pressing it again (i.e., unfreezing the image) will remove the **Text Arrows** without having to press .

---

#### To Enter the Customized Text Arrow:

1. Ensure a customized **Text Arrow** has been configured (8.2.5).
2. During imaging, press the console  button.
3. When the arrow appears on the image screen, use the trackball to position the tip of the **Text Arrow**.
4. Press  to lock the **Text Arrow** tip in place on the image.
5. Use the trackball to rotate the tail of the **Text Arrow** so it does not block any of the image.
6. Press  to lock the entire **Text Arrow** tip in place on the image.
7. Repeat **step 2** to **step 6** as many times as necessary.





## 7.2 PICTOGRAMS

**Pictograms** are predefined, **Application**-specific icons that enable users to label the imaging feature. Customizing the availability of specific **Pictograms** is controlled through [8.2.3 Presets – Pictograms](#).

### To Activate a Pictogram:

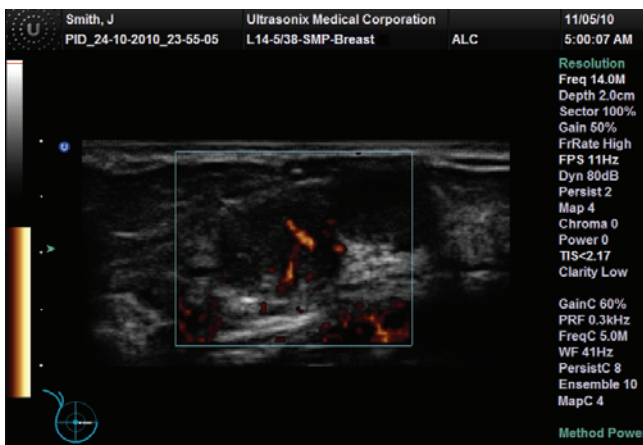
1. Press the console  button.
2. Rotate the associated **Pictogram** dial to move through the various **Pictograms** available.



3. Use the trackball to position the **Pictogram** orientation marker to the desired location on the **Pictogram**.
4. Tap the touch screen **Rotate** button and turn the associated dial to attain the desired position.
5. Press the console  button to set the marker's position and orientation.
6. To adjust the **Pictogram** orientation marker after setting it, move the cursor until it is close to the marker and press  again. Repeat [step 3](#) to [step 5](#) to re-set the marker.

---

**Note:** To hide the **Pictogram** from view, tap the touch screen **Hide** button.

---

## CHAPTER 8: SYSTEM SETUP

---

The various features and settings of the system can be customized via one of the three (3) **System Setup** menus: **User**, **Administrator** and **Service**. Menu-level password protection applies as follows:

- **Users Settings:** no password protection
- **Administrator Settings:** optional password protection
- **Service Settings:** always password protected. Only qualified Ultrasonix Medical Corporation service personnel can access this menu.

To access any of the following functions, press the console  button.

The following tables provide a quick overview of the system's setup menus. Refer to the related sections later in this chapter for details on any particular setup option.

---

**Note:** *Unlicensed and/or inactive Menu options will be inaccessible (i.e., grayed out).*

---

**Table 8-1: User Settings Menu**

<b>Setup</b>	<b>SonixLive</b>	Configure <b>Streaming Video</b> for <b>VLC</b> or <b>Windows Media Player</b> .
	<b>Administrator</b>	Access the <b>Administrator Settings</b> menu.
<b>Support</b>	<b>Remote Support</b>	Access the <b>Remote Support</b> option. <b>Note:</b> <i>Remote Support is configured via <a href="#">8.2.11 Network</a>.</i>
	<b>Chat Support</b>	Access the <b>Chat Support</b> option <b>Note:</b> <i>Chat Support is configured via <a href="#">8.2.11 Network</a>.</i>
	<b>Documentation</b>	View a PDF version of the <b>User Manual</b> on the LCD display.

---

**Note:** *The software version number is displayed across the bottom of this menu.*

---



Table 8-2: Administrator Settings Menu

Application Setup	<b>Presets</b>	View and manage <b>Presets</b> with their associated <b>Annotations</b> , <b>Pictograms</b> , <b>Measurements</b> and <b>Imaging Presets</b> .
	<b>Annotations</b>	Toggle on/off the three (3) global <b>Annotation</b> settings. <b>Note:</b> <i>Customization of Preset-specific Annotations is handled through Presets.</i>
	<b>Measurements</b>	Configure measurement <b>Graphics</b> , <b>Measurement</b> and <b>Worksheet</b> settings.
	<b>Training Tutorials</b>	Download, copy or view training materials in a variety of file formats.
	<b>SonixGPS</b>	Select/deselect <b>SonixGPS</b> needle type.
	<b>Biopsy Guide</b>	Configure <b>Single Guideline Biopsy</b> option.
System Setup	<b>System</b>	Configure/customize basic <b>System Settings</b> : <b>Institution Name</b> , <b>Regional</b> options, <b>Shutdown Options</b> , <b>Auto-Freeze</b> , <b>User Data</b> , <b>Master Volume</b> and <b>Admin Password</b> . Reset system to <b>Factory Defaults</b> .
	<b>Network</b>	Configure settings for: <b>Network</b> ( <b>LAN</b> (Local Area Network) or dialup), <b>TCP/IP</b> (Transmission Control Protocol/Internet Protocol), <b>E-mail</b> and <b>Chat Support</b> . <b>Caution:</b> <i>System networking options are intended for use <u>inside</u> your organization's firewall. Organizations that elect to configure/use the networking functionality provided by Ultrasonix are assuming all liabilities and risks associated with that decision.</i> <b>Note:</b> <i>Dialup access requires an external USB modem. Talk to your local dealer or Ultrasonix Technical Support for details.</i>
	<b>DICOM</b>	Enable and configure <b>DICOM Storage</b> , <b>Print</b> and <b>Worklist</b> .
	<b>Custom Keys</b>	Set the <b>Store</b> , <b>Print</b> , <b>Archive</b> parameters for the console <b>Custom Key</b> buttons ( <b>1</b> , <b>2</b> and  )
	<b>Peripherals</b>	Configure <b>Peripherals</b> : <b>Paper Printer</b> , <b>LCD Display</b> , <b>VCR/Photo</b> , <b>Footswitch</b> , ( <b>Image</b> ) <b>Brightness/Contrast</b> and <b>Touch Screen</b> settings.
	<b>Display</b>	Configure <b>Appearance</b> options for the LCD display.
	<b>Patient</b>	Customize entry of Patient information using a variety of options, including: show/hide fields, create new fields, allow/disallow editing of specific fields, and selection of gender and application defaults.
	<b>Status Bar</b>	Configure which <b>Status Bar</b> icons are visible on the LCD display.
	<b>Capture</b>	Configure <b>Capture Settings</b> for still images, video output and <b>Cine loop</b> storage.
	<b>Imaging Modes</b>	Configure a variety of <b>Imaging Mode</b> options including <b>Split Imaging</b> and <b>Initial Active Display</b> .
System Maintenance	<b>Documentation</b>	<b>Add/Delete</b> user documentation for viewing on the system <b>Note:</b> <i>All documents must be in PDF format.</i>
	<b>Software Updates</b>	Update system software via the Internet or a USB medium.
	<b>Licensing</b>	View and add <b>License</b> details.
	<b>Service...</b>	Access the <b>Service Mode</b> dialog.



**Table 8-3: Service Settings Menu**

---

<b>Service Settings</b>	The system is delivered with this option under <b>Password</b> protection.
	<b>Note:</b> Only qualified Ultronix Medical Corporation service personnel can access this menu.

---

**Note:** Use the trackball and  button to close each menu and exit the menu system, one menu at a time. To exit the entire menu system in one step, press the console **Q** button.

Be sure to save whatever edits are in progress before exiting, otherwise changes may be lost.

---

**To Access the System Menus:**

1. Press the console  button and the **User Settings** menu will be presented.

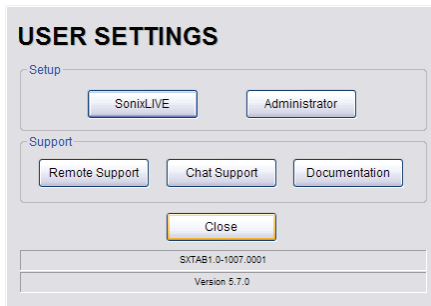



---

**Note:** The **Software Version** number is displayed on the **User Settings** menu.

---

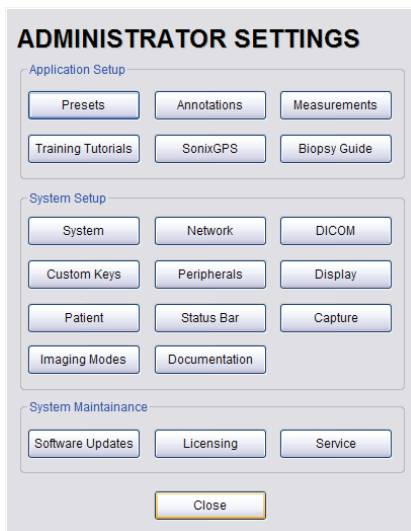
2. From the **User Settings** menu, select **Administrator** to access **Administrator Settings**.



3. From the **Administrator Settings** menu, select **Service...** to access the **Service Mode** dialog.

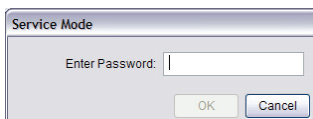

---

**Note:** To exit the entire menu system in one step, press the console  button.

---

## 8.1 USER SETTINGS

### 8.1.1 SonixLive Setup

SonixLive allows remote users to view live imaging as **Streaming Video** using **VLC Media Player** or **Windows Media Player (WMP)**. When both SonixLive and the **Status Bar** icon are activated and **Streaming Video** is underway, the SonixLive icon will appear on the imaging screen (refer to [8.2.17 Status Bar](#) for details on the SonixLive icon).

---

**Note:** Because **Streaming Video** may cause a noticeable decrease in overall system performance, Ultrasonix recommends activating SonixLive only when video streaming is required ([8.1.1.4 Activating/Deactivating SonixLive](#)).

The **VLC Media Player** is freeware available from VideoLAN. The Sonix system is delivered with the server-side software ready for use. Client-side software must be downloaded from the VideoLAN website. Refer to [8.1.1.1 SonixLive and VLC Media Player](#) for details on downloading and setup.

---

Figure 7-1: SonixLive Setup

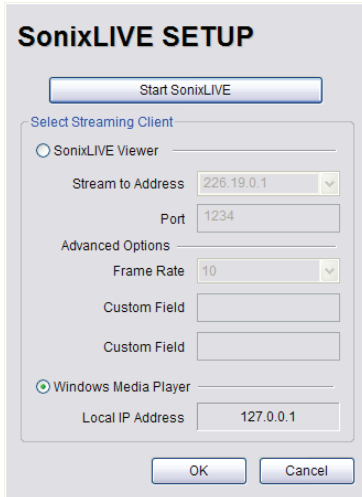

**SonixLIVE SETUP**

Start SonixLIVE

Select Streaming Client

SonixLIVE Viewer

Stream to Address: 226.19.0.1

Port: 1234

Advanced Options

Frame Rate: 10

Custom Field

Custom Field

Windows Media Player

Local IP Address: 127.0.0.1

OK Cancel

---

**Note:** A **Network** connection ([8.2.11](#)) must be configured and active in order to use SonixLive.

---



Table 8-4: SonixLive Settings

		After configuring SonixLive (both for the Sonix system and the receiving PC), use <b>Start/Stop</b> SonixLive to ensure it is running only when necessary.	
<b>Start/Stop SonixLive</b>		<b>Note:</b> Because <b>Streaming Video</b> may cause a noticeable decrease in overall system performance, Ultronix recommends activating SonixLive only when video streaming is required.	
<b>SonixLive Viewer</b>	<b>Stream to Address</b>	Select from the drop-down menu (for multicasting) or type in the relevant <b>Stream to IP Address</b> of the client. Two (2) multicast <b>IP Addresses</b> are provided ( <b>226.19.0.1</b> and <b>226.19.0.2</b> ) for selection from the drop-down menu. If this is not sufficient, use an <b>IP Address</b> from the following range: <b>224.0.0.0</b> to <b>239.255.255.255</b> .	
	<b>Port</b>	The default <b>Stream to Port (1234)</b> should not need to be changed.	
	<b>Advanced Option</b>	<b>Frame Rate</b>	The default <b>Frame Rate</b> is 10 which should be sufficient for most applications. If the setting must be changed, select from the drop-down menu (1–20) or type in the relevant number.
		<b>Custom Field Custom Field</b>	Use these fields for <b>VLC</b> options, e.g., type of encoding.
<b>Windows Media Player</b>		<b>Note:</b> It is not possible to multicast (i.e., broadcast SonixLive to more than one client PC) with the <b>Windows Media Player</b> .	
	<b>Local IP Address</b>	This setting auto-completes using the system's <b>Local IP Address</b> . <b>Note:</b> A <b>Network connection (8.2.11)</b> must be configured and active in order for the <b>Local IP Address</b> to auto-complete.	

**To Access SonixLive Settings:**

1. Press the console  button.
2. Select SonixLive.



### 8.1.1.1 SonixLive and VLC Media Player

#### To Download the VLC Media Player Software for use on the Remote Computer:

---

**Note:** Each remote computer must have a configured copy of the **VLC** software.

---

1. Open the web browser and go to the website: <http://www.videolan.org/vlc/>.
2. Follow the links to download the most recent self-extracting Windows version of the **0.8.6** VLC software.

---

**Note:** The Sonix will only support remote viewing with the **VLC Media Player** on a PC running Windows XP.

When planning to multicast, Ultrasonix recommends downloading the **VLC** software to a USB key to simplify the multi-PC installation process.

---

#### To Install VLC Software on the Remote PC:

1. Open **Windows Explorer** and move to the directory containing the downloaded **VLC** software.
2. Open (or run) the self-extracting **VLC** installation software.
3. When prompted, select **English** as the **Installer Language** and select **OK**.



4. Select **Next** to continue past the **Welcome** screen.

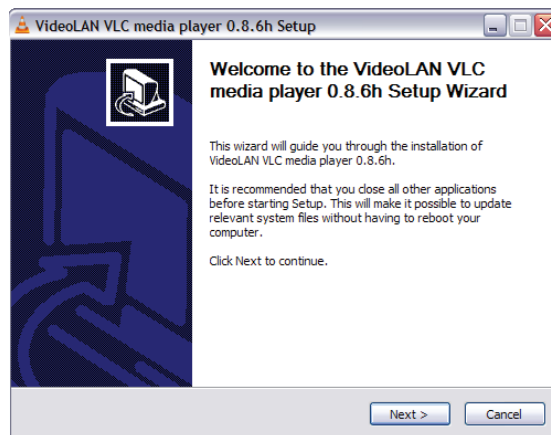

5. Read the **License Agreement** and select **I agree** to continue.

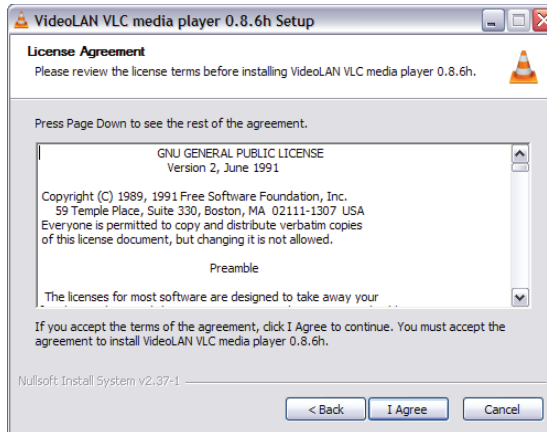

6. On the **Choose Components** dialog, select **Custom** as the type of installation.

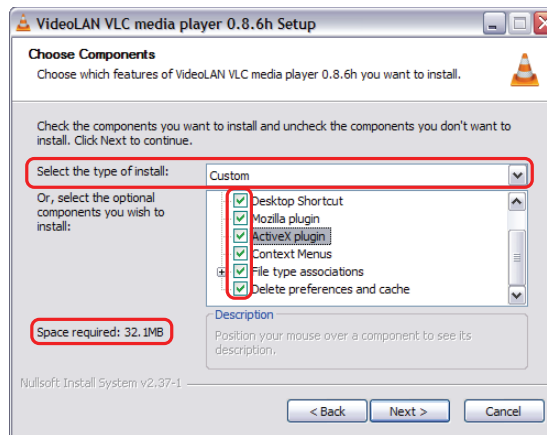

7. Select the checkboxes for all available optional components and select **Next**.

**Note:** Ensure the target PC has enough space to complete the installation.

8. Select **Install** to accept the default Destination Folder and begin the install.

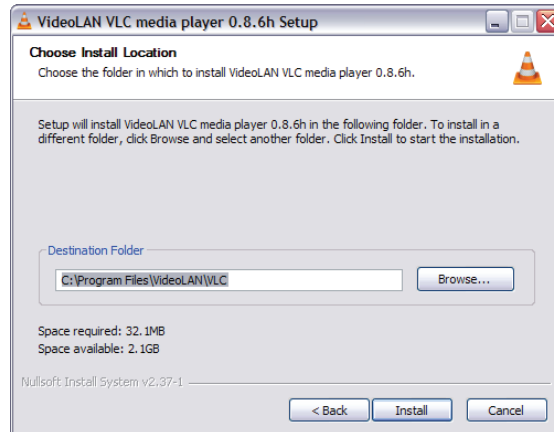

---

**Note:** To change the **Destination Folder** location/name, select **Browse** and follow the instructions.

---

9. When the installation is done, select **Finish**.

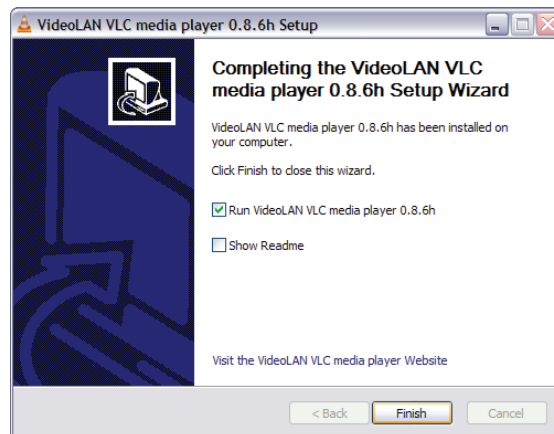

### To Configure VLC Software on the Remote PC:

1. Launch the **VLC Media Player** software.
2. Select the **Settings** menu and select **Preferences....**

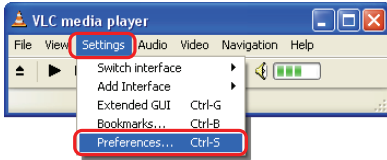

3. Select the + (plus) signs to expand **Video** and **Output modules**.

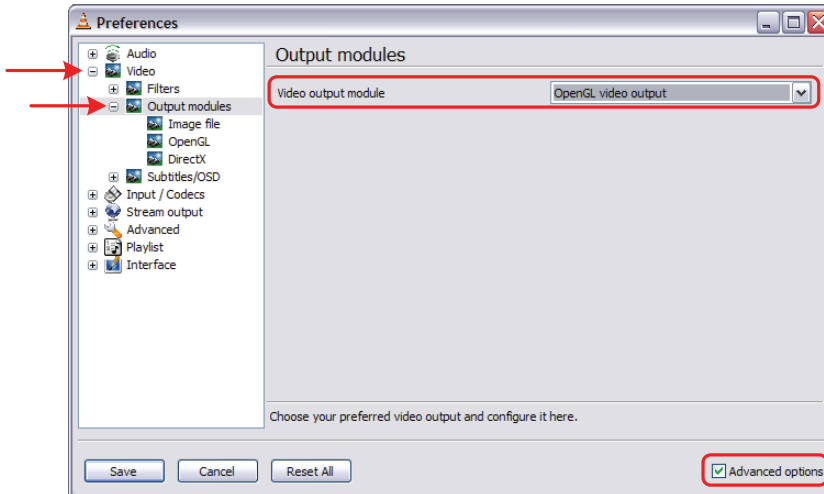

4. Select **Advanced options**.
5. From the **Video output module** drop-down menu select **OpenGL video output**.
6. Select the - (minus) sign to close **Output modules** and **Video**.

7. Select the **+** (plus) sign to expand **Input/Codecs** and **Other codecs**.

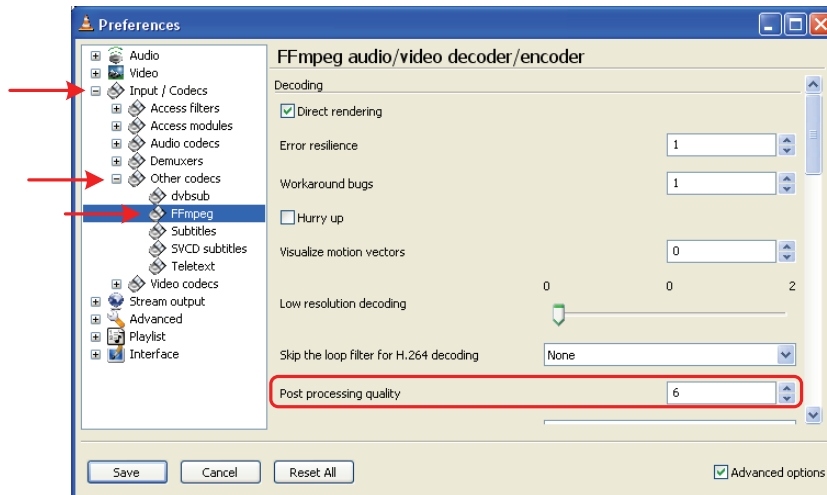

8. Select **FFmpeg**.
9. Set the **Post processing quality** field to **6**.
10. Select **Save**.
11. Select the **Open** button.

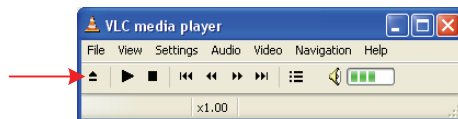

12. Select the **Network** tab.

13. Select the appropriate **UDP/RTP** radio button.

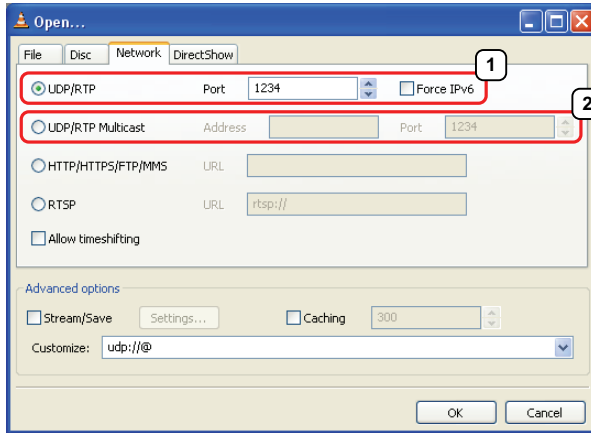

---

**Note:** For unicasting, select (1) **UDP/RTP**.

For multicasting, select (2) **UDP/RTP Multicast** and enter the multicast **IP Address** in the **Address** field.

---

14. Ensure the **Port** is set to **1234**.
15. Select **OK**.

### To Configure SonixLive Streaming Video for VLC Media Player on the Sonix:

1. Press the console  button.
2. Select SonixLive.
3. Select the **SonixLive Viewer** radio button.
4. Select a **Stream to Address** from the drop-down menu or type one in using the keyboard.
5. If required, edit the **Frame Rate**.
6. Select the **Start** SonixLive button.

---

**Note:** Relevant message bubbles will be displayed whenever SonixLive is activated or deactivated.



The SonixLive icon will only be visible if it has been enabled (refer to [8.2.17 Status Bar](#) for more details).

---

7. Select **OK** to accept the changes or **Cancel** to exit without saving.

### 8.1.1.2 SonixLive and Windows Media Player

#### To Configure SonixLive Streaming Video for Windows Media Player on the Sonix:

1. Press the console  button.
2. Select SonixLive.
3. Select the **Windows Media Player** radio button.

---

**Note:** A **Network** connection (8.2.11) must be configured and active in order for the **Local IP Address** to auto-complete.

---

4. Select the **Start** SonixLive button.

---

**Note:** Relevant message bubbles will be displayed whenever SonixLive is activated or deactivated.



The SonixLive icon will only be visible if it has been enabled (refer to 8.2.17 Status Bar for more details).

---

5. Select **OK** to accept the changes or **Cancel** to exit without saving.

**To Configure SonixLive Streaming Video for the Windows Media Player on the Remote Computer:**

---

**Note:** Be sure to have the **SonixLive IP Address** handy before beginning this process.

---

1. After turning on the remote computer, open the **Windows Media Player** program.

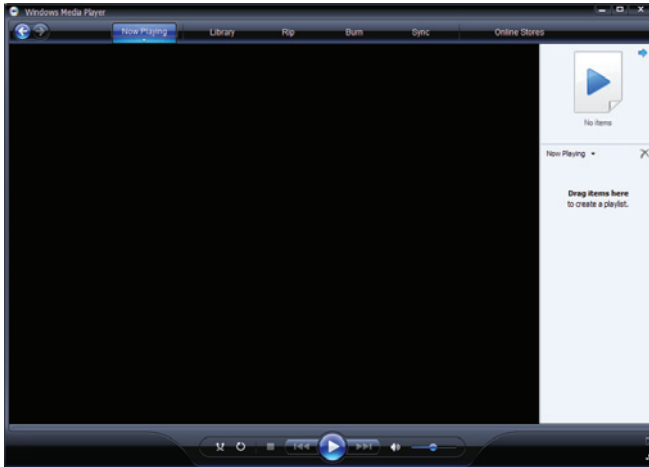

2. With the cursor in the **Title Bar**, right click and select **File > Open URL....**

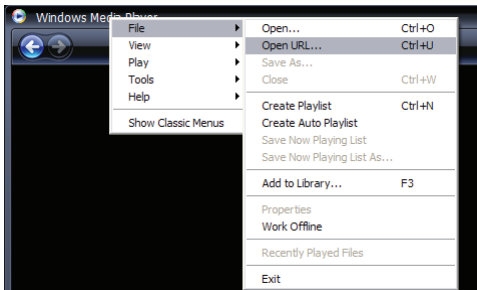

3. In the **Open URL** dialog, enter the **SonixLive IP Address** followed by :8080. For example, if the relevant **IP Address** is 127.0.0.1, type in `http://127.0.0.1:8080`.

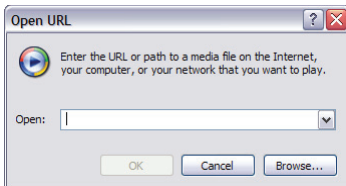

4. Select the **OK** button and the SonixLive video stream will be displayed in the **Windows Media Player**.



### 8.1.1.3 SonixLive Status Bar Settings

**Status Bar** settings apply to both the **VLC** and **Windows Media Players**.

---

**Note:** Refer to [8.2.17 Status Bar](#) for more details on **Status Bar** settings.

---

To Configure SonixLive Status Bar Settings:

1. Press the console  button.
2. Select **Administrator > Status Bar**.

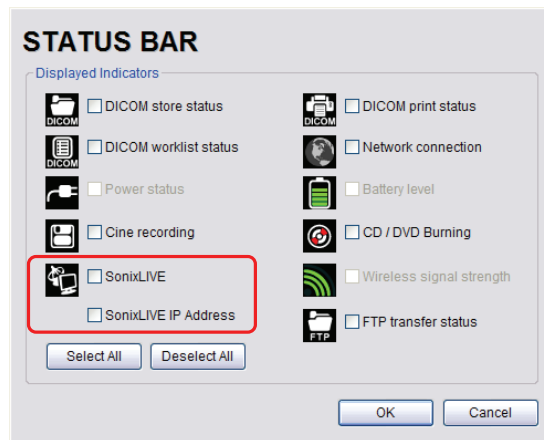

3. Select the SonixLive and **SonixLive IP Address** options.

---

**Note:** Selecting the **SonixLive IP Address** will write the actual **IP Address** to the LCD display. If privacy/security is a concern, do not select this option. To determine the relevant **IP Address**, refer to the **Local IP Address** field in [8.2.11 Network](#).

---

4. Select **OK** to accept the changes or **Cancel** to exit without saving.



#### 8.1.1.4 Activating/Deactivating SonixLive

##### To Activate/Deactivate SonixLive:

---

**Note:** Before activating SonixLive, be sure to:

- install/configure the relevant media player settings ([8.1.1.1](#) or [8.1.1.2](#))
  - enable SonixLive ([8.2.17 Status Bar](#)).
- 

1. Press the console  button.
2. Select SonixLive.
3. Select the **Start/Stop** SonixLive button.

---

**Note:** Relevant message bubbles will be displayed whenever SonixLive is activated or deactivated.



The SonixLive icon will only be visible if it has been enabled (refer to [8.2.17 Status Bar](#) for more details).

---

4. Select **OK** to accept the changes or **Cancel** to exit without saving.

## 8.1.2 Remote Support

**Remote Support** is a licensed option that allows a member of the Ultrasonix Technical Support to view and control the system for diagnostic purposes.

In order to use **Remote Support**, the **Network** must be configured ([8.2.11 Network](#)) and a **PIN** (**Personal Identification Number**) must be obtained from Ultrasonix Technical Support.

---

**Note:** *The PIN is valid for 20 minutes only, so be sure to use it right away.*

**Remote Support** can also be accessed from **QSonix**. Refer to [3.4](#) for details.

---

### To Access Remote Support:

1. Press the console  button.
2. Select **Remote Support**.

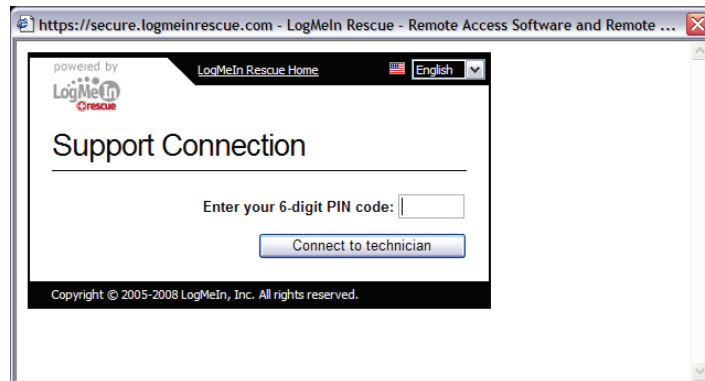

---

**Note:** *If Remote Support does not appear to be available, contact your IT Department and have them check to make sure the network connection is active and the **Remote Support** option has been configured for use.*

---

3. Enter the **PIN** (**Personal Identification Number**) provided by Ultrasonix Technical Support.

---

**Note:** *The PIN is valid for 20 minutes only, so be sure to use it right away.*

---

4. When prompted, select **Download > Run > Run** in order to install the required programs.
5. The system can now be remotely controlled.



### 8.1.3 Chat Support

**Chat Support** enables a real-time discussion with a member of the Ultronix Technical Support team. In order to use **Chat Support**, it must first be configured in [8.2.11 Network](#).

---

**Note:** If **Chat Support** is not available, contact the IT Department and have them check to ensure the network connection is active and that **Chat Support** has been configured for use ([8.2.11.4](#)).

---

#### To Access Live Chat Support:

1. Press the console  button.
2. Select **Chat Support...**

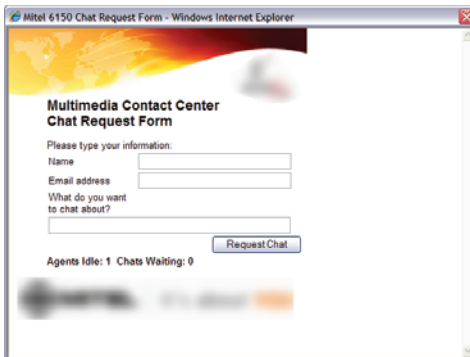

3. If an **Agent** is logged on, use the keyboard to complete the **Chat Request Form**.
4. Select **Request Chat**, then wait while the system connects to the server.
5. When the message **Found available Agent:...** is presented, use the keyboard to enter the inquiry in the **Send** line.

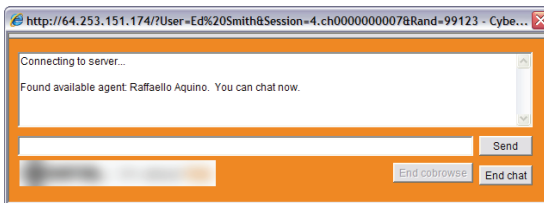

6. Select **Send** to post the message.
7. Select **End Chat** when the chat is complete.
8. Select **Yes** to continue.

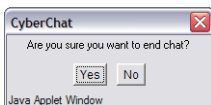

## 8.2 ADMINISTRATOR SETTINGS

**Administrator Settings** allow the system administrator to configure high level **Application** and **System** settings as well as perform certain **System Maintenance** functions.

Typically, the **System** parameters are set during initial installation and only require limited access and adjustment. By default, **Administrator Settings** are not delivered with an active **Password**, however, at their discretion, each institution has the option to apply **Password** protection (8.2.10.1).



**Warning:** *Application parameters should be configured by a qualified medical practitioner.*

Figure 8-2: Administrator Settings Menu



### To Access Administrator Settings:

1. Press the console  button.
2. Select **Administrator** to access the **Administrator Settings** menu.

## 8.2.1 Presets

**Presets Setup** enables users to manage factory default and user-defined **Imaging Presets**.

Each **Preset** can be selected/deselected via the **Presets Setup** options. Refer to [8.2.1.1 Show/Hide Imaging Presets](#) for details on hiding **Presets**.

---

### Notes:

Only the active transducer tree will be expanded upon entry to **Presets Setup**.

**3D/4D Presets** are controlled from within **3D/4D Mode**. Refer to [5.12.9](#) for details.

---

Figure 8-3: Presets Setup

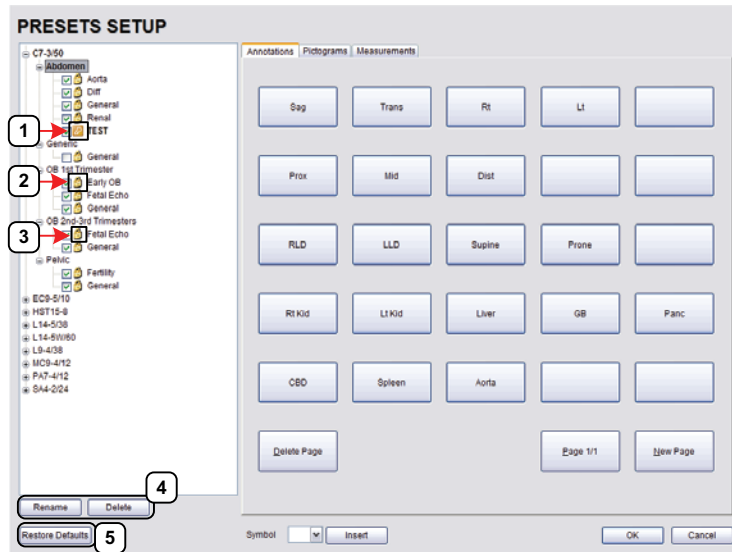

Table 8-5: Presets Setup

1	Key Icon	
2	Lock Icon	
3	<b>Preset</b> Checkbox	
4	<b>Rename</b> and <b>Delete</b>	<b>Note:</b> <i>Rename</i> and <i>Delete</i> are only available if a user-defined <b>Preset</b> has been selected.
5	<b>Restore Defaults</b>	<b>Caution:</b> <i>Restore Defaults</i> restores <b>all Presets Setup</b> changes to their factory settings.

Default settings are locked (as indicated by the lock icon adjacent to the **Preset** name). Additional user-definable aspects of the default settings are available through the three (3) tabs on the **Presets Setup** page: **Annotations**, **Pictograms** and **Measurements**.

User-defined **Presets** are marked with a key icon. These cannot be locked.

The left hand menu displays all currently available **Presets**, both default and user-defined. Each **Application** is delivered with at least one default **Preset**.

#### To Access the Presets Setup Page:

1. Press the console  button.
2. Select **Administrator > Presets**.

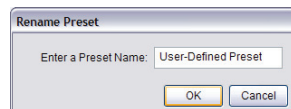

#### To Rename a Previously Created User-Defined Preset:

1. Press the console  button.
2. Select **Administrator > Presets**.
3. Select the user-defined **Preset** to be renamed.
4. Select the **Rename** button.
5. Type a new, unique name in the **Rename Preset** message box.



6. Select **OK** to accept the changes and exit or **Cancel** to exit without saving.

#### To Delete a User-Defined Imaging Preset:

1. Press the console  button.
2. Select **Administrator > Presets**.
3. Select  the user-defined **Preset** to be deleted.
4. Select the **Delete** button.
5. Select **Yes** to confirm the deletion or **No** to cancel the operation.

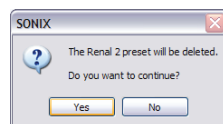

**Note:** The message will specify the name of the user-defined **Preset** selected for deletion.



### 8.2.1.1 Show/Hide Imaging Presets

**Preset** availability can be controlled using its associated checkbox. When selected, as indicated by the presence of the green checkmark, the **Preset** will be available from both the touch screen and **QSonix** (providing the applicable transducer is connected).

To hide **Presets** on the touch screen and in **QSonix**, all versions of that **Preset** must be deselected (i.e., deselect every Preset of the same name under every Application for every transducer).

---

**Note:** The show/hide function applies to both default and user-defined **Presets**.

---

#### To Show/Hide Imaging Presets:

1. Press the console  button.
2. Select **Administrator > Presets**.
3. Select/deselect the relevant checkboxes.

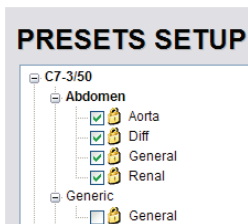

---

**Note:** Deselecting **General** under **C5-2/60-Abdomen** will only hide the **General Preset** when **Abdomen** is selected for the **C5-2/60** transducer.

Deselecting **General** under **Abdomen** for all applicable transducers will hide that **Preset** from view on both the touch screen and in **QSonix**.

---

4. Select **OK** to accept the changes or **Cancel** to exit without saving.



## 8.2.2 Presets – Annotations

The ability to manipulate the text of a specific **Annotation** attached to either a user-defined or default **Presets** is handled through the **Annotations** tab on the **Presets Setup** page. **Annotation** text appears by **Application** on the console touch screen.

**Note:** Refer to 8.2.5 for details on global **Annotation** settings.

Figure 8-4: Presets Setup – Annotations

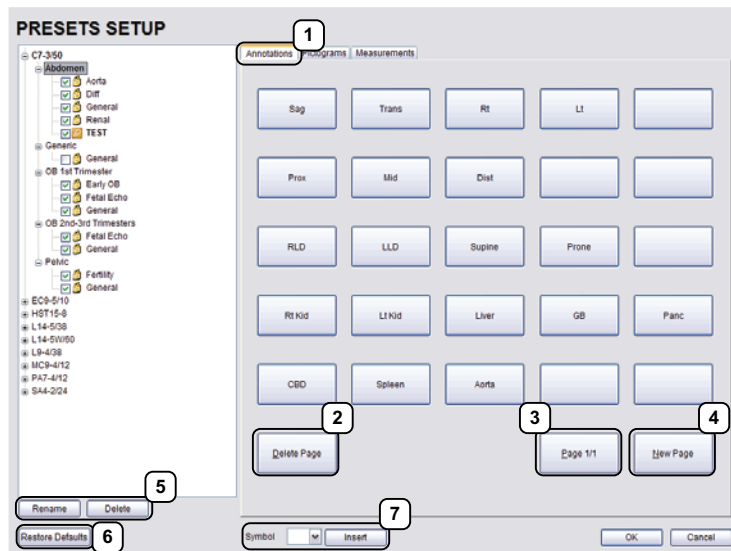

Table 8-6: Presets Setup – Annotations

1	<b>Annotations</b> Tab	
2	<b>Delete Page</b>	
3	Page Selector	
4	<b>New Page</b>	
5	<b>Rename</b> and <b>Delete</b>	<b>Note:</b> <b>Rename</b> and <b>Delete</b> are only available if a user-defined <b>Preset</b> has been selected.
6	<b>Restore Defaults</b>	<b>Caution:</b> <b>Restore Defaults</b> restores <u>all</u> <b>Presets Setup</b> changes to their factory settings.
7	<b>Insert (Symbol)</b>	

**Note:** The order in which **Annotations** are presented is matched on the touch screen during **Text entry (7.1 Text and Annotations)**.



### 8.2.2.1 Modify Annotations



Changes can only be made to the **Annotations** of one **Exam Type/Application** at a time. Additionally, the system allows users to define/change the **Home Position** for the **Annotation** cursor. Once set, whenever the **Home Position** touch screen button is tapped, the **Text** cursor will move directly to that spot.

---

**Note:** Refer to [7.1.1 Set Text Home Position](#) to define the **Text/Annotation** cursor **Home Position**.

---

#### To Modify a Preset's Annotations:

1. Press the console  button.
2. Select **Administrator > Presets**.
3. Highlight the relevant **Preset** from the left hand menu.
4. Select  the relevant **Annotation** space on the right hand side of the LCD display.
5. Use the console keyboard to type in the new **Annotation**.

---

**Note:** If multiple pages of **Annotations** are required, select the **New Page** button as often as necessary to create the desired number of **Annotation** spaces.

Alternatively, if multiple pages already exist, move through them using the onscreen page selection button, making changes as required.

---

6. Press **ENTER** on the keyboard to accept the changes or **ESC** to delete the entry.

## 8.2.3 Presets – Pictograms

The ability to attach/detach specific **Pictograms** to both user-defined and default **Presets** is handled via the **Pictograms** tab in **Presets Setup**. Re-ordering the sequence in which they will appear on the touch screen during a scanning session is managed here as well.

Figure 8-5: Presets Setup – Pictograms

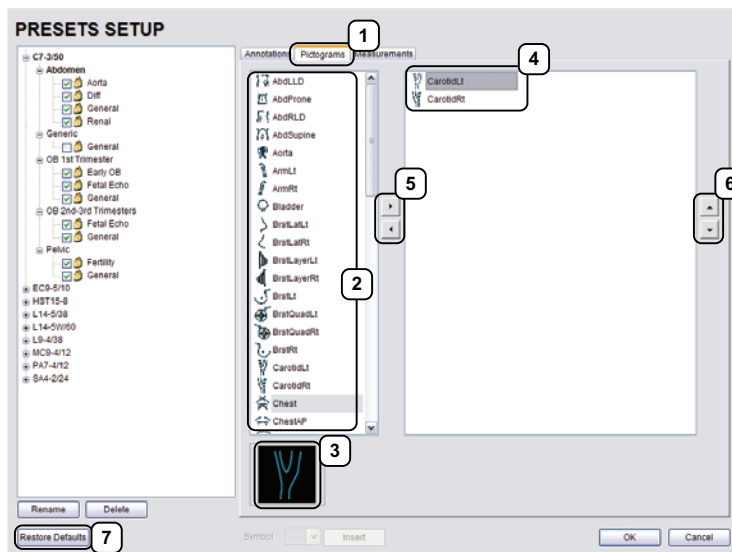



Table 8-7: Presets Setup – Pictograms

1	<b>Pictograms</b> Tab
2	List of available <b>Pictograms</b>
3	List of <b>Pictograms</b> attached to the selected <b>Preset</b>
4	Selected <b>Pictogram</b>
5	<b>Pictogram</b> Selectors
6	<b>Pictogram</b> Order Selectors
7	<b>Restore Defaults</b>
	<b>Caution: Restore Defaults</b> restores <u>all</u> <b>Presets Setup</b> changes to their factory settings.



### 8.2.3.1 Modify the Pictograms Attached to Presets

#### To Add Pictograms to an Imaging Preset:

1. Press the console  button.
2. Select **Administrator > Presets**.
3. On the **Presets Setups** page, select the **Pictograms** tab.
4. Highlight the relevant **Preset** in the left hand column.
5. From the list of available **Pictograms**, highlight the relevant **Pictogram**.
6. Use the right facing selector button to move the item to the list of selected **Pictograms**.
7. Repeat [step 5](#) and [step 6](#) as many times as required.
8. Select **OK** to accept the changes and exit or **Cancel** to exit without saving.

#### To Delete Pictograms from an Imaging Preset:

1. Press the console  button.
2. Select **Administrator > Presets**.
3. On the **Presets Setups** page, select the **Pictograms** tab.
4. Highlight the relevant **Preset** in the left hand column.
5. Highlight the relevant **Pictogram** in the list of selected **Pictograms**.
6. Use the left facing selector button to delete the item from the list of selected **Pictograms**.
7. Repeat [step 5](#) and [step 6](#) as many times as required.
8. Select **OK** to accept the changes and exit or **Cancel** to exit without saving.

#### To Reorder Selected Pictograms Attached to an Imaging Preset:

1. Press the console  button.
2. Select **Administrator > Presets**.
3. On the **Presets Setups** page, select the **Pictograms** tab.
4. Highlight the relevant **Preset** in the left hand column.
5. Highlight the relevant **Pictogram** in the list of selected **Pictograms**.
6. Use the order (up/down) selector buttons to move the item to another place in the list of selected **Pictograms**.
7. Repeat [step 5](#) and [step 6](#) as many times as required.
8. Select **OK** to accept the changes and exit or **Cancel** to exit without saving.

## 8.2.4 Presets – Measurements

Based on *Exam Type*, **Presets – Measurements** allows users to select/deselect the available touch screen **Measurement Package** options. It also enables users to edit the default imaging **Measurement Package** for a specific *Exam Type*.

Figure 8-6: Presets – Measurements

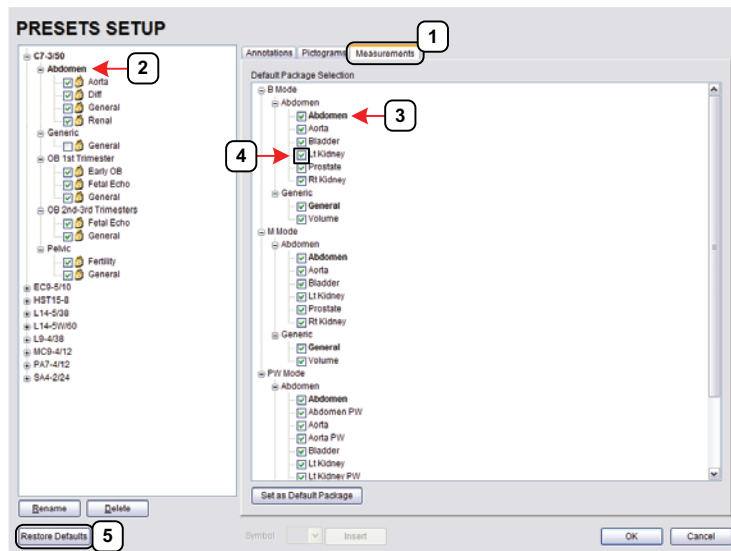



Table 8-8: Presets – Measurements

1	<b>Measurements</b> Tab
2	<b>Exam Type</b>
3	Default Imaging <b>Measurements Package</b> (labelled in bold face type)
4	<b>Measurements</b> checkbox
5	<b>Restore Defaults</b>
	<b>Caution: Restore Defaults restores <u>all</u> Presets Setup changes to their factory settings.</b>



### 8.2.4.1 Modify the Available Touch Screen Measurements Packages

#### To Edit the List of Measurements Packages Available on the Touch Screen:

1. Press the console  button.
2. Select **Administrator > Presets**.
3. On the **Presets Setups** page, select the **Measurements** tab.
4. Highlight the relevant **Exam Type** in the left hand column.
5. From the available **Default Package Selection** list, select/deselect the checkbox for the relevant **Measurements Package**.
6. Repeat [step 4](#) and [step 5](#) as many times as required.
7. Select **OK** to accept the changes and exit or **Cancel** to exit without saving.

#### To Edit the Default Touch Screen Measurements Package:

1. Press the console  button.
2. Select **Administrator > Presets**.
3. On the **Presets Setups** page, select the **Measurements** tab.
4. Highlight the relevant **Exam Type** in the left hand column.
5. From the available **Default Package Selection** list, highlight the desired **Measurements Package**.
6. Select the **Set as Default Package** button.
7. Repeat [step 5](#) and [step 6](#) as many times as required.

---

**Note:** *There can be only one (1) default Measurements Package for each Exam Type.*

---

8. Select **OK** to accept the changes and exit or **Cancel** to exit without saving.

## 8.2.5 Annotations

There are five (5) global **Annotation** settings available.

**Figure 8-7: (Global) Annotations Settings**

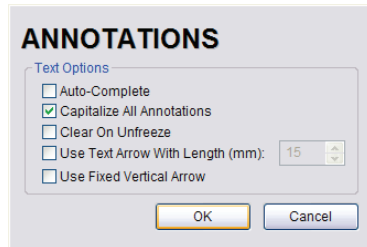

**Table 8-9: (Global) Annotation Settings**

<b>Auto-Complete</b>	<p>Select to automatically fill in a word when the first letter(s) is entered on the LCD display.</p> <p>If more than one <b>Preset</b> begins with the same letter use the <b>Tab</b> key to move through the list or continue typing the <b>Preset</b> name. When enough of the name has been completed in order to jump to the correct entry, the desired <b>Preset</b> name will appear onscreen and can be selected.</p>
<b>Capitalize All Annotations</b>	<p>Select to automatically force the first letter of each word in the <b>Annotation</b> to be typed as an upper case character.</p>
<b>Clear on Unfreeze</b>	<p>Select to automatically clear the <b>Annotations</b> from the image field with unFREEZE. If this option is not selected, the text will remain on the image field until the user deletes it.</p>
<b>Use Text Arrow with Length (mm)</b>	<p>Select to override the standard system <b>Text Arrow</b>. This enables the user to define the <b>Text Arrow</b> length in mm. The range is 5–30 mm with a default setting of 15 mm.</p>
<b>Use Fixed Vertical Arrow</b>	<p>Select to override the standard system <b>Text Arrow</b> with an arrow that is always in a vertical position. When selected, this arrow will use the length setting from the previous field (<b>Use Text Arrow with Length (mm)</b>).</p>

### To Access the Global Annotation Settings Dialog:

1. Press the console  button.
2. Select **Administrator > Annotations**.

**Note:** Refer to **8.2.2 Presets – Annotations** for details on configuring **Preset-specific Annotations**.



### 8.2.5.1 Text Arrow Customization

#### To Customize the Text Arrow:

1. Press the console  button.
2. Select **Administrator > Annotations**.
3. Select **Use Text Arrow with Length (mm)**.

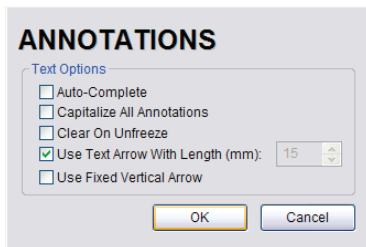

4. Enter the appropriate **Length** in millimeters.
5. Select **OK** to accept the setting and exit or **Cancel** to exit without saving.



## 8.2.6 Measurements

The **Measurements** dialog enables users to customize the onscreen appearance of calipers, caliper labels and certain display details of the measurement/calculation packages. When the touch screen **Measure** button is pressed, **Measurements** are available on the touch screen based on clinical **Application**.

Users are also able to create customized **Measurement Packages** (8.2.6.3 Managing Custom Measurements).

---

**Note:** It is not possible to edit factory-installed **Measurement Packages**.

---

**Figure 8-8: Measurements Settings**

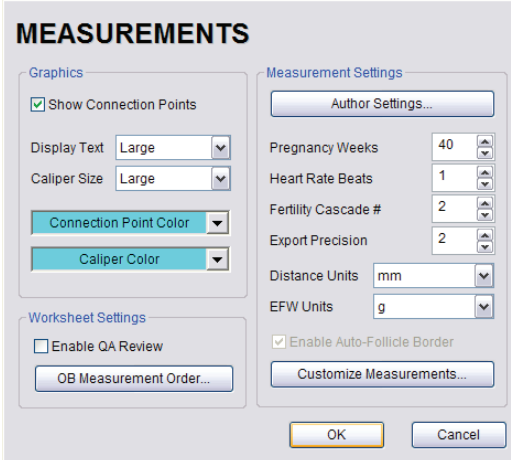



**Warning:** Ultrasonix does not endorse user-defined **Measurements, Calculations and Tables** for diagnostic purposes. All user-defined **Measurements, Calculations and Tables** are used at the **Operator's** discretion and risk only.

---

Table 8-10: Measurement Options

Graphics	<b>Show Connection Points</b>	Select to display the connection points (dotted line) between the linear calipers.
	<b>Display Text</b>	Allows the selection of one (1) of three (3) measurement label font size options: <b>Small</b> , <b>Medium</b> and <b>Large</b> .
	<b>Caliper Size</b>	Allows the selection of one (1) of three (3) caliper size options: <b>Small</b> , <b>Medium</b> and <b>Large</b> .
	<b>Connection Point Color</b>	Allows the selection of the color of the caliper connection points (dots) between the linear calipers. The default is turquoise.
	<b>Caliper Color</b>	Allows the selection of the color of the caliper end points. The default is turquoise.
	<p><b>Caution:</b> Some caliper sizes/colors, font sizes or dot colors may not appear clearly on the image screen, stored image or printed/recorded image. To ensure clear visualization of the caliper, label font and connection points, Ultrasonix recommends setting the caliper graphics to at least <b>Medium</b>.</p> <p><b>Note:</b> To ensure the caliper modifications have been activated, switch imaging modes after exiting the <b>Setup</b> menus.</p>	
Worksheet Settings	<b>Worksheet Settings</b> apply to the <b>Report Worksheet</b> .	
	<b>Enable QA Review</b>	Appends editable <b>Billing</b> and <b>QA Review</b> fields to all <b>Reports</b> . <b>Note:</b> Any <b>Report/Worksheet</b> opened/created during/prior to this setting being selected will <b>not</b> include the <b>Billing</b> and <b>QA</b> options.
	<b>OB Measurement Order...</b>	Allows user to change the order in which <b>OB Measurements</b> are presented on the touch screen, in a <b>Worksheet</b> (onscreen) and in a <b>Report</b> (printed). <b>OB Measurements</b> available for reordering are: <b>BPD, OFD, HC, AC, FL, HL, GS, CRL, NT, YS, CxLength, UL, TL, TTD, CEREB, APTD, FTA, FHR, Umb A, Umb A-PI, MCA</b> and <b>MCA-PI</b> . <b>Note:</b> Refer to <b>Appendix H: Glossary</b> for details on these acronyms.
Measurement Settings	<b>Author Settings...</b>	Refer to <b>Appendix F</b> for a complete list of <b>Author Settings</b> . <b>Note:</b> It is not possible to create user-defined <b>Cardiac</b> tables, nor can factory default tables be modified or deleted.
	<b>Pregnancy Weeks</b>	Defines the number of weeks used to calculate the <b>EDD</b> based on <b>LMP</b> . Range: 35–45 weeks.
	<b>Heart Rate Beats</b>	Number of beats used to measure the <b>HR</b> and <b>FHR</b> on an <b>M-Mode</b> and <b>Doppler Trace</b> . Range: 1–7 beats.
	<b>Fertility Cascade #</b>	Defines the number of times the user must repeat a follicle measurement before the system automatically moves to the next follicle. Range: 1–3 measurements.
	<b>Export Precision</b>	Sets the decimal placement for some types of third party reporting packages. Range: 0–6. The default is 2 decimal places.



<b>Measurement Settings – cont'd</b>	<b>Distance Units</b>	Unit used to display <b>Distance</b> calculation: <b>Use default, <math>\mu\text{m}</math>, cm, in, m or mm.</b> <hr/> <b>Caution:</b> Changing <b>Distance Units</b> during an exam will result in anomalous measurement labeling. <hr/> <b>Note:</b> Use default will use the default set on a per measurement basis in <b>Customize Measurements...</b>
	<b>EFW Units</b>	Unit used to display <b>EFW</b> calculation: <b>g, kg, lbs or oz.</b>
	<b>Enable Auto-Follicle Border</b>	Draws a border around the edges of an <b>Auto-Follicle</b> measurement. By default, this setting is disabled. <hr/> <b>Note:</b> <b>Auto-Follicle</b> is only available on the <b>SonixTouch</b> and will only be accessible if the <b>Auto-Follicle</b> package has been licensed.
	<b>Customize Measurements...</b>	Enables the user to make the following changes to measurements: <ul style="list-style-type: none"> <li>• create custom <b>Measurement Packages</b> and <b>Measurements</b></li> <li>• re-order <b>Measurements</b></li> <li>• show/hide <b>Applications, Measurement Packages</b> and <b>Measurements</b> for the <b>Display/Touch Screen, Worksheet</b> or <b>Report</b>.</li> </ul> <hr/> <b>Note:</b> A <b>Measurement</b> must be performed in order to appear on the <b>Worksheet</b> or <b>Report</b> .
		<b>Warning:</b> <i>Ultronix does not endorse user-defined <b>Measurements, Calculations</b> and <b>Tables</b> for diagnostic purposes. All user-defined <b>Measurements, Calculations</b> and <b>Tables</b> are used at the <b>Operator's</b> discretion and risk only.</i>

**To Access Measurement Settings:**

1. Press the console  button.
2. Select **Administrator > Measurements**.



**To Configure Measurement Graphics:**

1. Press the console  button.
2. Select **Administrator > Measurements**.
3. Configure the **Graphics** settings as required: **Show Connection Points**, **Display Text**, **Caliper Size**, **Connection Point Color** and **Caliper Color**.
4. Select **OK** to accept the settings and exit or **Cancel** to exit without saving.

**To Configure Basic Measurement Settings:**

1. Press the console  button.
2. Select **Administrator > Measurements**.
3. Configure **Pregnancy Weeks**, **Heart Rate Beats**, **Fertility Cascade #**, **Export Precision**, **Distance Units** and **EFW Units** as required.
4. Select **OK** to accept the settings and exit or **Cancel** to exit without saving.

---

**Note:** Refer to [8.2.6.3](#) for details on **Customizing Measurements**.

---

### 8.2.6.1 Managing Worksheet Settings

#### To Enable QA Review Details in Reports/Worksheets:

1. Press the console  button.
2. Select **Administrator > Measurements**.
3. Under **Worksheet Settings**, select the **Enable QA Review** checkbox.

#### To Configure OB Measurement Order:

1. Press the console  button.
2. Select **Administrator > Measurements > OB Measurement Order...**
3. Select an **OB Measurement**.
4. Select the up or down selector button to move the **OB Measurement** to the desired position.

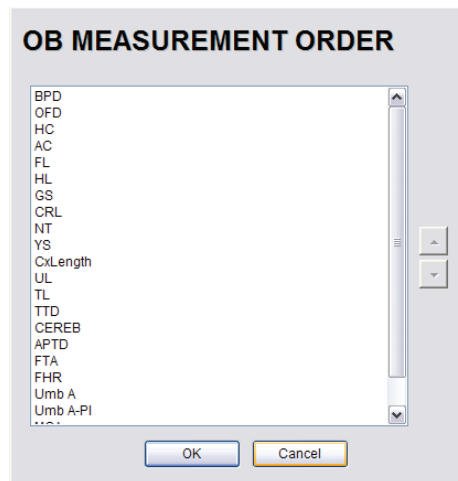

5. Repeat **step 3** and **step 4** as often as necessary to re-order the **OB Measurements** as required.
6. Select **OK** to accept the settings and exit or **Cancel** to exit without saving.



### 8.2.6.2 Show/Hide Applications, Measurement Packages and Measurements

The manner in which the show/hide options are applied have consequences for the availability of **Applications**, **Measurement Packages** and **Measurement** and/or the way in which **Measurement** data is saved:

- hiding an **Application** ensures that the **Application** cannot be accessed/viewed from within the measurement function (i.e., it will not be visible—and therefore not selectable—on the LCD display or the touch screen)
- hiding a **Measurement Package** ensures the **Measurement Package** cannot be used (i.e., it will not be visible—and therefore not selectable—on the LCD display or the touch screen)
- leaving a **Measurement** available on the LCD display and touch screen and selecting only **Visible in Report** ensures it can be used but cannot be viewed on the **Worksheet** during the exam. It will, however, be printed on the **Report**
- leaving a **Measurement** available on the LCD display and touch screen and selecting only **Visible in Worksheet** ensures it can be used and viewed on **the** Worksheet during the exam. It will not, however, be printed on the **Report**.

**Note:** The last two (2) options apply only to Measurements, not Measurement Packages.

Show/hide options apply to both factory-installed and customized measurements.

Figure 8-9: Customize Measurements

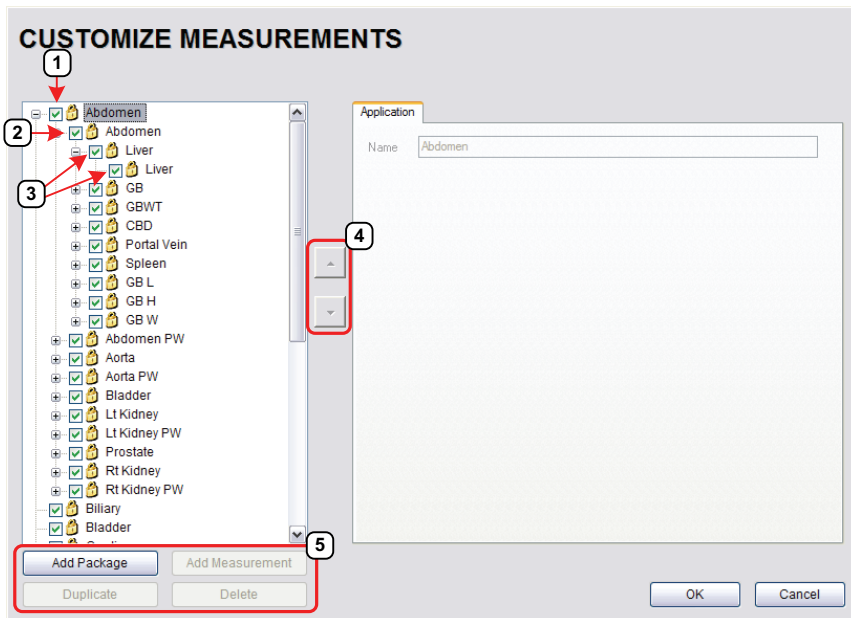
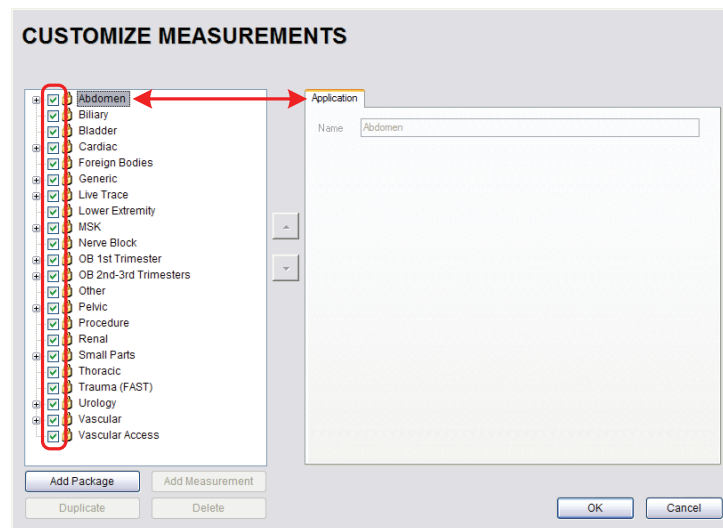

**Table 8-11: Customize Measurements**

1	<b>Application</b> Checkbox
2	<b>Measurement Package</b> Checkbox
3	<b>Measurement</b> Checkboxes
4	<b>Measurement</b> Selectors
5	Action Buttons

**To Show/Hide Applications:**

1. Press the console  button.
2. Select **Administrator > Measurements > Customize Measurements....**
3. To show/hide an **Application** on the LCD display and touch screen (within the measurement function) select/deselect the **Application** checkbox.



4. Repeat [step 3](#) as many times as required.
5. Select **OK** to accept the changes and exit or **Cancel** to exit without saving.



### To Show/Hide Measurement Packages:

1. Press the console  button.
2. Select **Administrator > Measurements > Customize Measurements...**
3. Expand the relevant **Application** tree by selecting the appropriate plus (+) sign (e.g., select the plus (+) sign next to **Abdomen**).
4. To show/hide a **Measurement Package** on the LCD display and touch screen select/deselect the relevant **Measurement Package** checkbox.

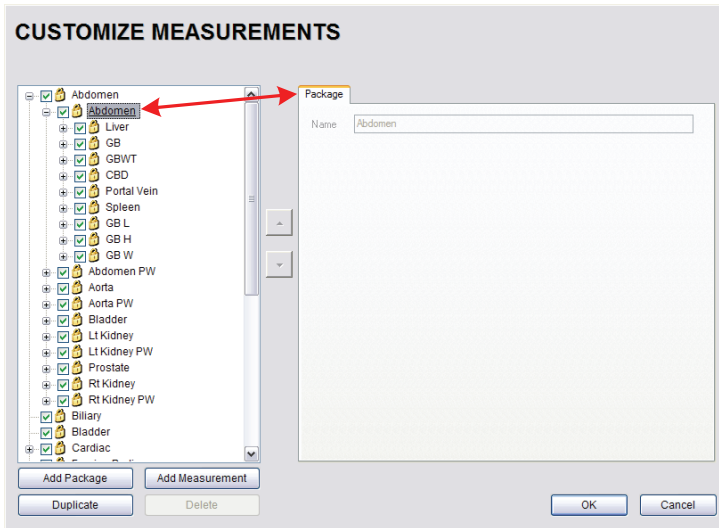

5. Repeat **step 3** and **step 4** as many times as required.
6. Select **OK** to accept the changes and exit or **Cancel** to exit without saving.



**To Show/Hide Measurements:**

1. Press the console  button.
2. Select **Administrator > Measurements > Customize Measurements....**
3. Expand the relevant **Application** tree by selecting the appropriate plus (+) sign (e.g., select the plus (+) sign next to **Abdomen**).

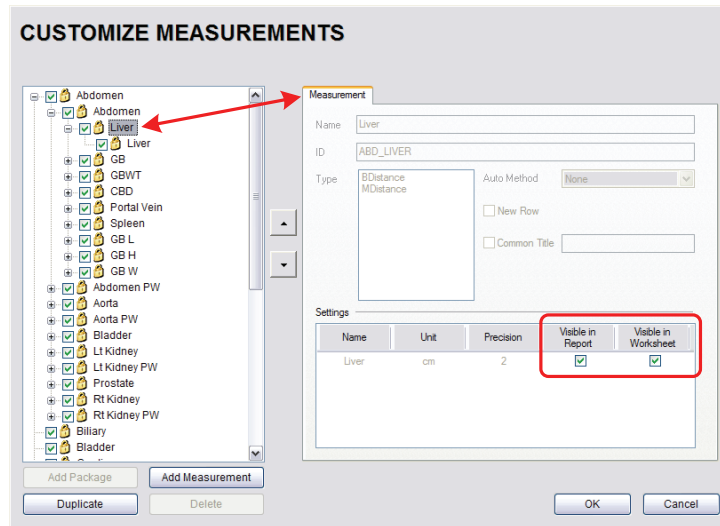

4. Select a measurement from within the **Measurement Package** and the **Visible in Report** and **Visible in Worksheet** options will be presented on the right side of the dialog.
5. Select the appropriate checkbox(es): **Visible in Report** and/or **Visible in Worksheet**.

Name	Unit	Precision	Visible in Report	Visible in Worksheet
Liver	cm	2	<input type="checkbox"/>	<input checked="" type="checkbox"/>

---

**Note:** Additional options will be available for user-created **Measurements**. Refer to [8.2.6.3 Managing Custom Measurements](#) for more details.

---

6. Repeat **step 3** to **step 5** as many times as required.
7. Select **OK** to accept the changes and exit or **Cancel** to exit without saving.

### 8.2.6.3 Managing Custom Measurements

Use **Customize Measurements...** to add/edit/delete user-defined (custom) measurements and **Measurement Packages**.

Figure 8-10: Customize Measurements

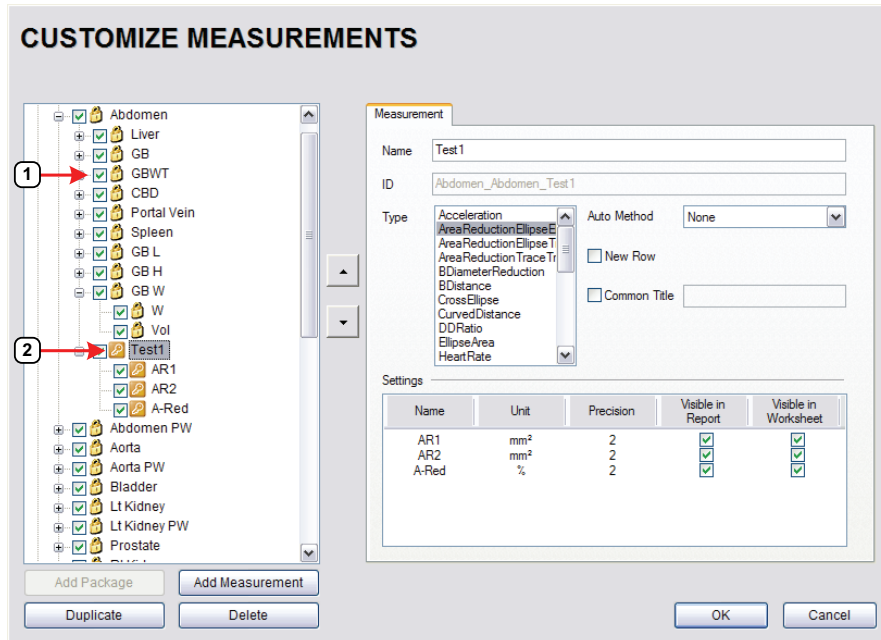

Table 8-12:

- |   |           |
|---|-----------|
| 1 | Lock Icon |
| 2 | Key Icon  |

Default or factory-installed **Measurement Packages** and **Measurements** are locked (as indicated by the associated lock icon) and cannot be edited or deleted.

Customized **Measurements** are marked with a key icon indicating that are user-created and can be edited or deleted.



**Warning:** Ultrasonix does not endorse user-defined **Measurements**, **Calculations** and **Tables** for diagnostic purposes. All user-defined **Measurements**, **Calculations** and **Tables** are used at the **Operator's** discretion and risk only.

**Note:** As it is not possible to edit/delete default **Measurement Packages**, follow the instructions in 8.2.6.2 to hide any unwanted packages from view/use.

**Table 8-13: Customize Measurement Options**

<p><b>Name</b></p>	<p>The <b>Name</b> of the custom measurement.</p> <hr/> <p><b>Note:</b> Place the cursor in this field and use the touch screen keyboard to enter a new <b>Name</b>.</p>
<p><b>ID</b></p>	<p>This is not an editable field. Data in this field is auto-populated and is for information purposes only.</p>
<p><b>Type</b></p> <ul style="list-style-type: none"> <li>Acceleration</li> <li>AreaReductionEllipseEllipse</li> <li>AreaReductionEllipseTrace</li> <li>AreaReductionTraceTrace</li> <li>BDiameterReduction</li> <li>BDistance</li> <li>CrossEllipse</li> <li>CurvedDistance</li> <li>DDRatio</li> <li>EllipseArea</li> <li>HeartRate</li> <li>HipAngle</li> <li>MDiameterReduction</li> <li>MDistance</li> <li>Pisa</li> <li>PointsArea</li> <li>PointsSpectrum</li> <li>RectArea</li> <li>RTSA</li> <li>SimpsonsTrace</li> <li>SpectrumRange</li> <li>Time</li> <li>TimeSlope</li> <li>TraceArea</li> <li>TraceAreaSolid</li> <li>TraceSpectrum</li> <li>Velocity1</li> <li>Velocity2</li> </ul>	<p>Selecting a pre-defined measurement <b>Type</b> will populate the <b>Type</b> attributes—which can be edited within pre-determined parameters.</p> <p>Once a <b>Type</b> has been selected, any attempt to change that <b>Type</b> for the specified measurement will result in an overwrite confirmation message.</p>



<b>Auto-Method</b>	<b>Auto-Method</b> refers to manner in which the system automatically cycles through measurements.
	<b>None</b> There is no pre-selected measurement/caliper auto-selection method.
	<b>Next Measurement</b> When measuring something that requires multiple measurements to create the final measurement (e.g., <b>L</b> , <b>H</b> , <b>W</b> to capture a <b>Volume</b> measurement) this method will automatically move to the next required measurement as each measurement is completed.
	<b>Repeat Measurement</b> Use to keep taking the selected measurement over and over until a new measurement is manually selected on the touch screen.
	<b>Place Caliper for Next Mmt</b> Use to force the system to move sequentially through the measurement options once the first measurement is taken. The first caliper for each sequential measurement will be placed automatically.  <b>Note: This option is for Cardiac only.</b>
<b>New Row</b>	Forces the measurement to wrap to a <b>New Row</b> on the <b>Measurement Packages</b> touch screen.
<b>Common Title</b>	To group a series of measurement together, give each of the relevant measurements a <b>Common Title</b> .  For example, under <b>Abdomen</b> , <b>Abdomen</b> , the three (3) measurements <b>GB L</b> , <b>GB H</b> and <b>GB W</b> , each have the <b>Common Title</b> , <b>GB Vol</b> indicating that these three (3) separate measurements actually form a single measurement: <b>GB Volume</b> .
<b>Settings</b>	<b>Name</b> Options available for the <b>Type</b> chosen (above). If desired, rename the measurement.
	<b>Unit</b> Measurement options available for the <b>Type/Name</b> chosen.  <b>Note: The Unit option is dependant upon the combination of the Type and Name. For example, In and Out Unit options for BDiameterReduction are cm, m, mm, in, ft and µm. But the D-Red Unit options for the same Type are % and ratio.</b>
	<b>Precision</b> Defines the number of decimal places included in a given measurement result.
	<b>Visible in Report</b> Determines whether or not a measurement will be included in a <b>Report</b> . Refer to <b>8.2.6.2</b> for more details.
	<b>Visible in Worksheet</b> Determines whether or not a measurement will be included in a <b>Worksheet</b> . Refer to <b>8.2.6.2</b> for more details.

**To Add a Custom Measurement Package:**

1. Press the console  button.
2. Select **Administrator > Measurements > Customize Measurements....**
3. Expand the relevant **Application** tree by selecting the appropriate plus (+) sign (e.g., select the plus (+) sign next to **Abdomen**).

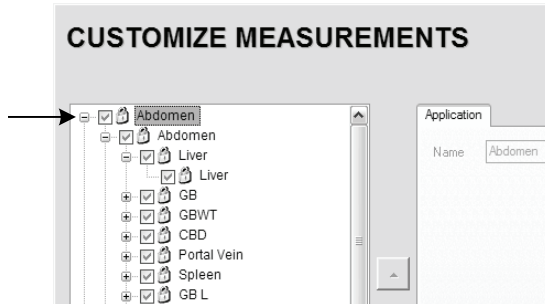

4. Select the **Add Package** button and **pkg1** will be added (alphabetically) to the list of **Measurement Packages**.

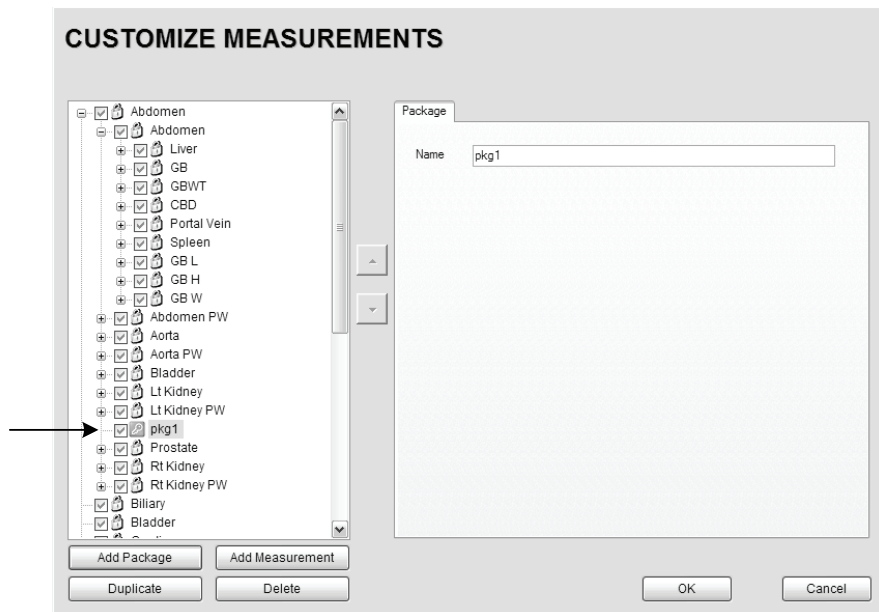



To Add a Custom Measurement:

---

**Note:** *Measurements can be added to both custom and default Measurement Packages.*

---

1. Press the console button.
2. Select **Administrator > Measurements > Customize Measurements....**
3. Expand the relevant **Application** tree by selecting the appropriate plus (+) sign (e.g., select the plus (+) sign next to **Abdomen**).

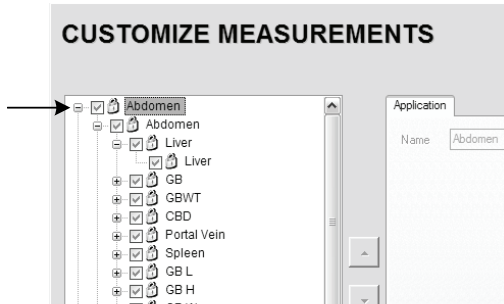

---

**Note:** *If the custom Measurement is to be added a custom Measurement Package, ensure that package has been created.*

---

4. Ensure the relevant **Measurement Package** is selected (e.g., **Abdomen** or **pkg1**).

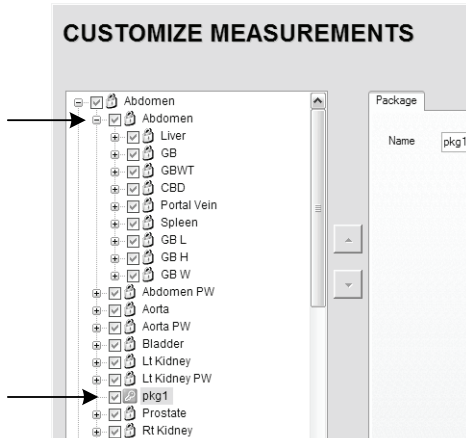

---

**Note:** *If pkg1 is selected, the custom Measurement will be created one level below pkg1. If Abdomen is selected, the custom Measurement will be created at the same level as Abdomen.*

---

5. Select the **Add Measurements** button and mmt1 will be added.

**To Rename a Custom Measurement Package or Measurement:**

1. Press the console  button.
2. Select **Administrator > Measurements > Customize Measurements....**
3. Select the custom **Measurement Package** or **Measurement**.
4. Place the cursor in the **Name** field on the right hand side of the dialog.

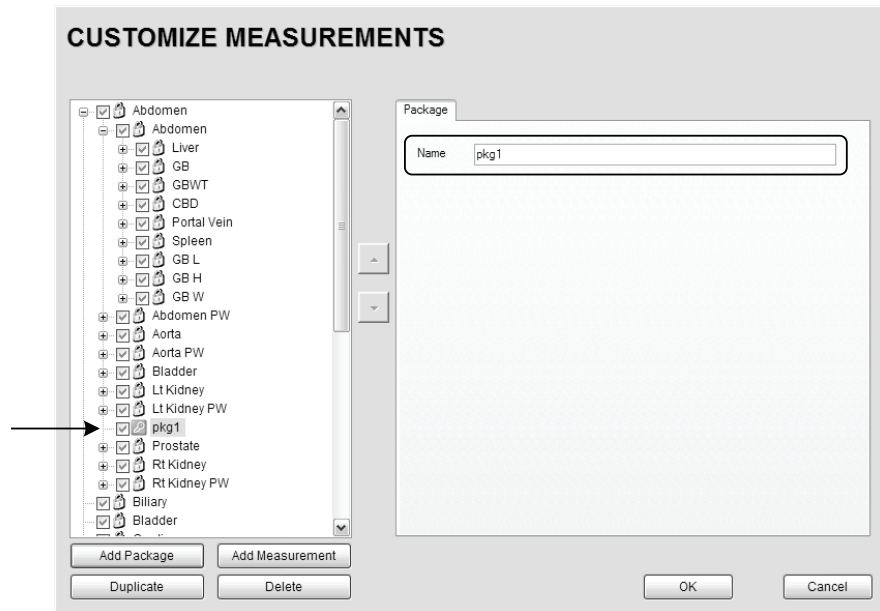

5. Use the touch screen keyboard to erase and type in a new **Measurement Package** or **Measurement Name**.



**To Edit a Custom Measurement:**

1. Press the console button.
2. Select **Administrator > Measurements > Customize Measurements....**
3. Expand the relevant **Application** tree by selecting the appropriate plus (+) sign (e.g., select the plus (+) sign next to **Abdomen**).

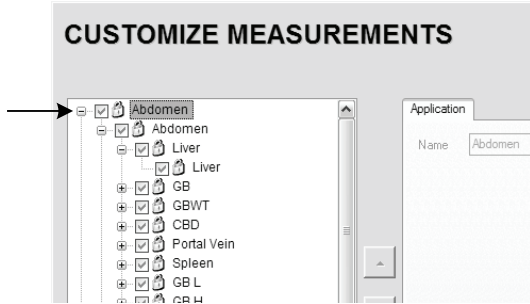

4. Select the custom **Measurement** to be edited.
5. Make the appropriate changes in the **Measurement** tab on the right hand side of the dialog.

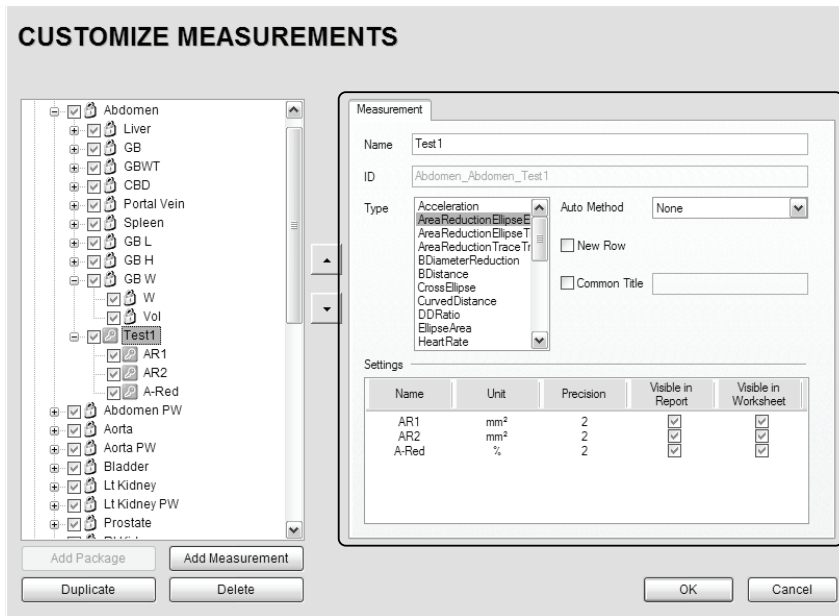

6. Select **OK** to accept the changes and exit or **Cancel** to exit without saving.



**To Delete a Custom Measurement Package or Measurement:**

1. Press the console  button.
2. Select **Administrator > Measurements > Customize Measurements....**
3. Expand the relevant **Application** tree by selecting the appropriate plus (+) sign (e.g., select the plus (+) sign next to **Abdomen**).

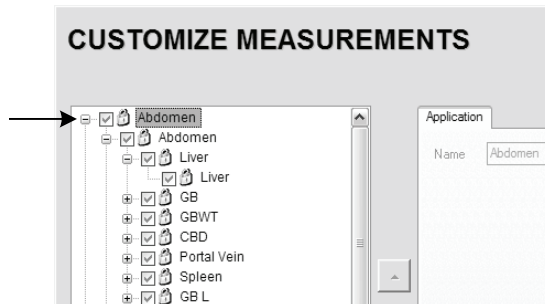

4. Select the custom **Measurement Package** or **Measurement** to be deleted.
5. Select the **Delete** button.
6. Select **Yes** to confirm the deletion or **No** to cancel the operation.

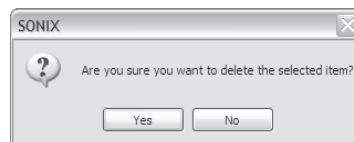



### 8.2.6.4 Reordering Measurements

Figure 8-11: Measurement Packages

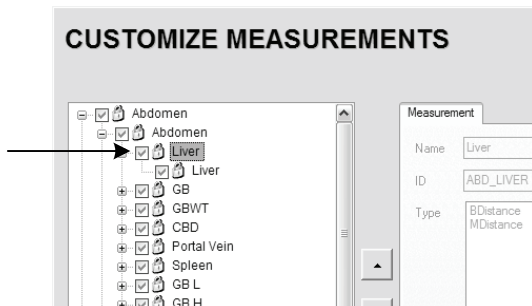

---

**Note:** Only **Measurement Packages** at the level marked in **Figure 8-11** can be reordered.

The reorder option applies to both custom and default **Measurement Packages**.

---

#### To Reorder Measurements:

1. Press the console button.
2. Select **Administrator > Measurements > Customize Measurements....**
3. Expand the relevant **Application** tree by selecting the appropriate plus (+) signs (e.g., select the plus (+) sign next to **Abdomen**).

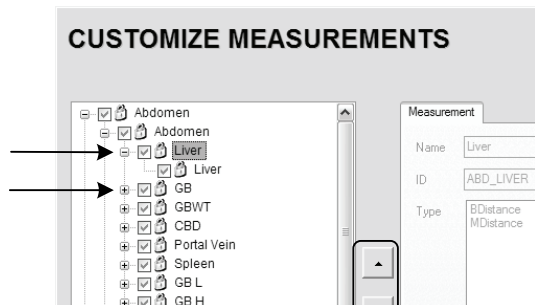

4. Highlight the relevant **Measurement** in the left hand column.
5. Use the (up/down) selector buttons to move the item to another place in the list.
6. Repeat **step 4** and **step 5** as many times as required.
7. Select **OK** to accept the changes and exit or **Cancel** to exit without saving.

### 8.2.6.5 Managing Author Settings

To Select the Cardiac Author:

1. Press the console  button.
2. Select **Administrator > Measurements > Author Settings...**

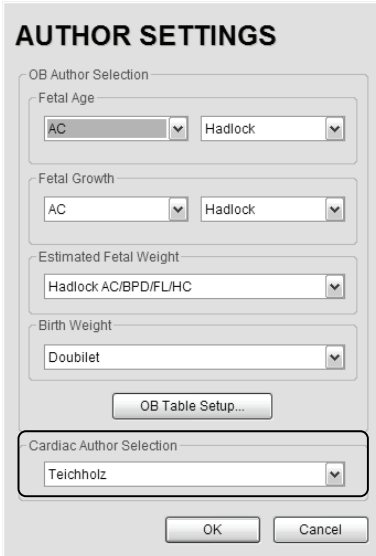

**AUTHOR SETTINGS**

OB Author Selection

Fetal Age

AC Hadlock

Fetal Growth

AC Hadlock

Estimated Fetal Weight

Hadlock AC/BPD/FL/HC

Birth Weight

Doublet

OB Table Setup...

Cardiac Author Selection

Teichholz

OK Cancel

3. Select the **Cardiac Author** from the drop-down menu.

---

**Note:** Refer to [Table F-6 in Appendix F](#) for a complete list of **Cardiac Author Settings**.

---

4. Select **OK** to accept the changes and exit or **Cancel** to exit without saving.



**To Select OB Authors:**

1. Press the console  button.
2. Select **Administrator > Measurements > Author Settings....**

**AUTHOR SETTINGS**

OB Author Selection

Fetal Age

AC Hadlock

Fetal Growth

AC Hadlock

Estimated Fetal Weight

Hadlock AC/BPD/FLHC

Birth Weight

Doubilet

OB Table Setup...

Cardiac Author Selection

Teichholz

OK Cancel

3. Select author/measurement options for **Fetal Age** and **Fetal Growth** from the drop-down menus.
4. Select **Estimated Fetal Weight** and **Birth Weight** authors from the drop-down menus.
5. Select **OK** to accept the changes and exit or **Cancel** to exit without saving.



**Warning:** Various factors may affect the accuracy of **Obstetrical** measurements. Ensure:

- system **Date** and **Time** are configured correctly.
- desired **Obstetrical** calculation author has been selected for each parameter.

## 8.2.6.6 Managing OB Tables



**Warning:** Ultrasonix does not endorse user-defined **Measurements**, **Calculations** and **Tables** for diagnostic purposes. All user-defined **Measurements**, **Calculations** and **Tables** are used at the **Operator's** discretion and risk only.

### To Create New Obstetrical Calculation Authors and Look-up Tables:

1. Press the console  button.
2. Select **Administrator > Measurements > Author Settings... > OB Table Setup....**
3. Select **Create Author**.

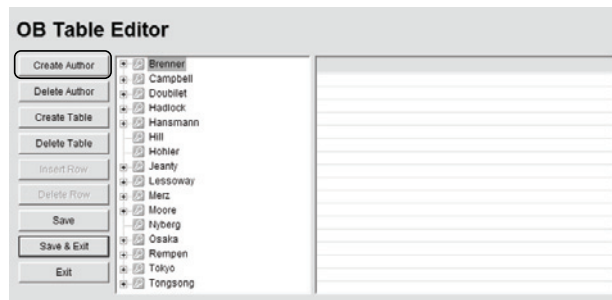

4. Enter a new **Table Author** and select **Create** to save the name to the author list.

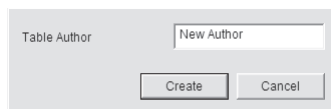

5. Highlight the newly created author and select **Create Table**.



**Note:** Default **Tables** are locked (as indicated by the lock icon adjacent to the **Table** name) and cannot be edited/deleted. User-created **Tables** are marked with a key icon and can be edited/deleted.

- From the **Based on** drop-down menu, select the desired parameter (**BPD**, **HC**, etc.).

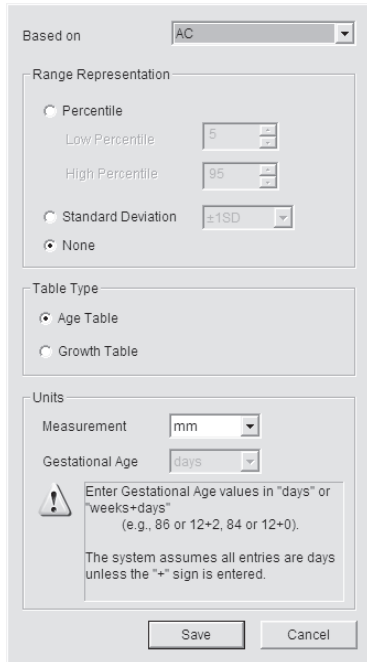

Based on: AC

Range Representation:

- Percentile
  - Low Percentile: 5
  - High Percentile: 95
- Standard Deviation: ±1SD
- None

Table Type:

- Age Table
- Growth Table

Units:

Measurement: mm

Gestational Age: days

**!** Enter Gestational Age values in "days" or "weeks+days" (e.g., 86 or 12+2, 84 or 12+0).  
The system assumes all entries are days unless the "+" sign is entered.

Save Cancel

- Select the desired table **Range Representation**: **Percentile**, **Standard Deviation** or **None**.
- Select the desired **Table Type**: **Age Table** or **Growth Table**.
- From the **Measurement** drop-down menu, select the desired unit: **cm**, **cm<sup>2</sup>**, **g**, **mm**, **mm<sup>2</sup>** or **ratio**.

---

**Note:** **AC** and **HC** are assumed to be **Circumference** measurements.

---

- Select **Save** to accept the changes and return to the **OB Table Editor** or **Cancel** to exit without saving.

**To Enter Data into a New OB table:**

1. Press the console  button.
2. Select **Administrator > Measurements > Author Settings... > OB Table Setup...**
3. Select the newly created **Table** (listed under the user-defined author).

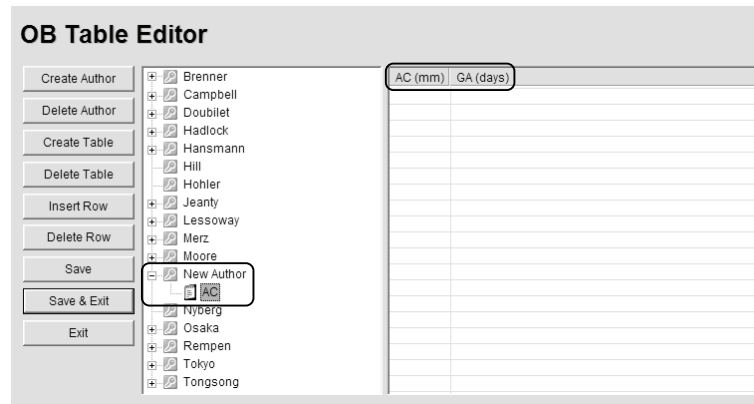

**Note:** The right hand section of the screen will show the columns for the previously-defined **Table** parameters. For example, this **Table** was configured as follows:

**Based on = AC, Range Representation = None, Table Type = Age Table and Measurement = mm.**

4. Enter **Table** data as required. Use **Insert Row** and **Delete Row** buttons to simplify this process.



**Warning:** When entering **Gestational Age** values, use **days** or **weeks+days**:

e.g., 86 (days) = 12+2 (or 12 weeks + 2 days), 84 (days) = 12+0 (or 12 weeks).

The system assumes all entries are in days unless a plus (+) sign is entered, in which case the number is assumed to be in weeks and is converted to the equivalent number of days.

5. Select the **Save & Exit** button to save any newly entered/edited data and exit the page, **Save** to save any newly entered/edited data but remain in the **OB Table Editor** or **Exit** to cancel any newly entered/edited data and exit the page.

## 8.2.7 Training Tutorials

This option enables organizations to load and view a variety of different video, audio or PowerPoint files on the system in order to provide training to their staff.

The training files may be provided by Ultrasonix, but they can also be created by each organization, as long as they are created in one of the accepted digital formats.

**Figure 8-12: Training Tutorials Dialog**

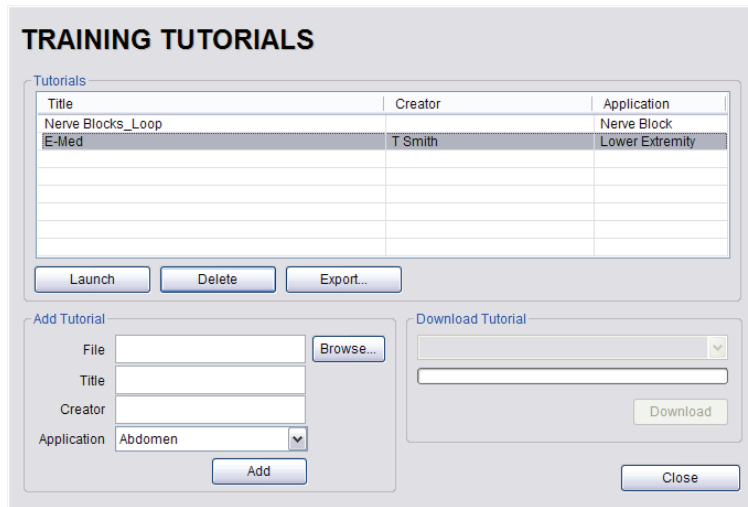

**TRAINING TUTORIALS**

Tutorials

Title	Creator	Application
Nerve Blocks_Loop		Nerve Block
E-Med	T Smith	Lower Extremity

Launch Delete Export...

Add Tutorial

File  Browse...

Title

Creator

Application Abdomen

Add

Download Tutorial

Download

Close

**Table 8-14: Supported Training Tutorial File Formats**

<b>Video</b>	<b>AVI, MPG, MPEG and WMV.</b>
<b>Audio</b>	<b>MP3 and WMA.</b>
<b>PowerPoint</b>	<b>PPT.</b>
	<b>Note: Video files embedded in PowerPoint presentations are not supported.</b>
<b>Adobe® Flash</b>	<b>SWF.</b>



**Table 8-15: Training Tutorial Options**

<b>Tutorials</b>	The <b>Tutorials</b> section lists files that are currently available for viewing.
	<b>Title</b> Lists the <b>Titles</b> of the available <b>Tutorials</b> .
	<b>Creator</b> Lists the <b>Creator</b> of the specific <b>Title</b> .
	<b>Application</b> Lists the <b>Exam Type/Application</b> associated with the specific <b>Title</b> .
	<b>Launch</b> Plays the selected <b>Title</b> .
	<b>Delete</b> Deletes the selected <b>Title</b> .
	<b>Export...</b> Exports the selected <b>Title</b> .
<b>Add Tutorial</b>	<b>Add Tutorial</b> options enable organizations to add user-created <b>Tutorials</b> .
	<b>File</b> Displays the name of the <b>File</b> selected with the <b>Browse</b> button.
	<b>Title</b> Enter a descriptive <b>Title</b> that will immediately reveal the <b>Tutorial's</b> purpose.
	<b>Creator</b> Enter the name of the <b>File's Creator</b> . This might be an individual, an outside company or the name of the host organization.
	<b>Application</b> Select an <b>Application</b> which best describes the clinical relevance of the <b>Tutorial</b> .
	<b>Browse...</b> Enables the user to browse the available drives for a <b>Tutorial</b> file.
	<b>Add</b> Adds the selected <b>Tutorial</b> .
<b>Download</b> Launches the <b>Download</b> sequence for the selected <b>Title</b> .	

### 8.2.7.1 Manipulating Training Tutorials

#### To Download a Training Tutorial from the Network:

1. Press the console  button.
2. Select **Administrator > Training Tutorials**.
3. Select a file from the drop-down menu in the **Download Tutorial** section of the dialog.

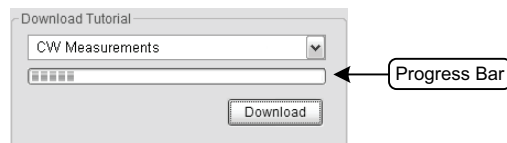

4. Select the **Download** button.
5. Follow the status of the progress bar to see how far along the download is.
6. When the download is complete, the **Title** will be added to the list of available **Tutorials**.



### To Add a Training Tutorial from External Media:

---

**Note:** External media includes USB devices such as a key, drive or CD/DVD reader/writer. When using this type of media, ensure that the relevant item is loaded into the appropriate device before attempting the download.

---

1. Press the console  button.
2. Select **Administrator > Training Tutorials > Browse....**

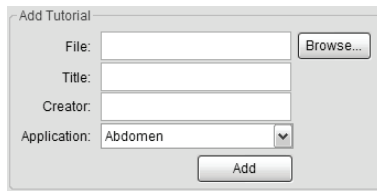

The screenshot shows a dialog box titled "Add Tutorial". It has four input fields: "File:" with a "Browse..." button to its right, "Title:", "Creator:", and "Application:" with a dropdown menu showing "Abdomen". At the bottom right of the dialog is an "Add" button.

3. From the dialog presented, find and select the relevant (file) **Type** and **File** name to be added.
4. Enter a **Title** and **Creator** in the fields provided.
5. Select a clinically relevant **Application** type from the drop-down menu.
6. Select the **Add** button.
7. Once the addition is complete, the **Title** will be added to the list of available **Tutorials**.

---

**Note:** As a precaution, test each file to ensure it displays properly.

---

**To Launch a Training Tutorial:**

1. Press the console  button.
2. Select **Administrator > Training Tutorials**.
3. Highlight a **Title** from the list of **Tutorials**.
4. Select the **Launch** button and the tutorial will be presented on the LCD display.



5. Select the red **X** in the top right corner of the **Tutorial** screen to stop/exit the tutorial.

---

**Notes:**

*If the presentation is in PPT format, press the **Q** button to exit.*

*For files with an audio component, the volume can be adjusted with the audio slide on the right hand side of the tutorial screen. **Master Volume** control is adjusted from the **System Settings** dialog (8.2.10).*

---

## 8.2.8 SonixGPS

Use this option to select the appropriate needle to be used with the **SonixGPS** option.



**Warning:** This user manual does not include a comprehensive discussion of the **SonixGPS** option. For complete details on using **SonixGPS**, read and follow all instructions and warnings in the most recent **SonixGPS** User Manual.

Figure 8-13: SonixGPS Settings

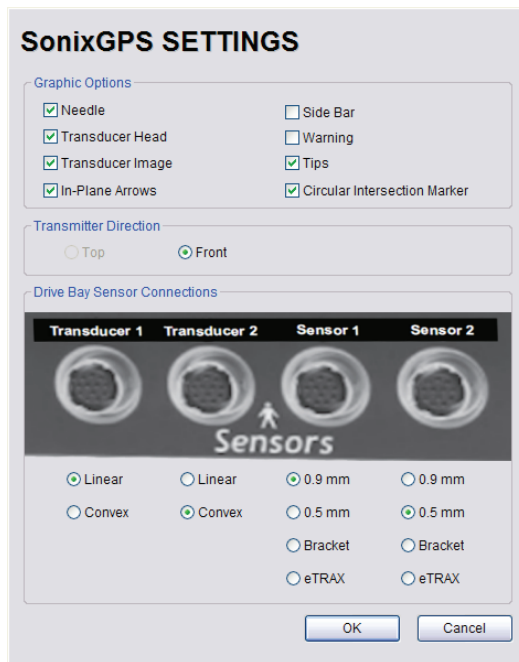

**SonixGPS SETTINGS**





Graphic Options

- Needle
- Transducer Head
- Transducer Image
- In-Plane Arrows
- Side Bar
- Warning
- Tips
- Circular Intersection Marker

Transmitter Direction

- Top
- Front

Drive Bay Sensor Connections

Transducer 1	Transducer 2	Sensor 1	Sensor 2
			
<input checked="" type="radio"/> Linear	<input type="radio"/> Linear	<input checked="" type="radio"/> 0.9 mm	<input type="radio"/> 0.9 mm
<input type="radio"/> Convex	<input checked="" type="radio"/> Convex	<input type="radio"/> 0.5 mm	<input checked="" type="radio"/> 0.5 mm
		<input type="radio"/> Bracket	<input type="radio"/> Bracket
		<input type="radio"/> eTRAX	<input type="radio"/> eTRAX

OK Cancel

## 8.2.9 Biopsy Guide

Users can configure the system with the **Single Guideline Biopsy** option.

Figure 8-14: Biopsy

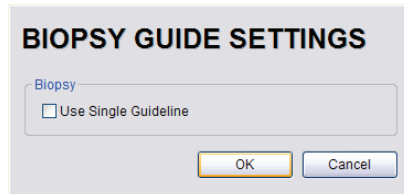



Table 8-16: Biopsy

<b>Use Single Guideline</b>	Select to default to a single <b>Biopsy</b> guideline. When left unselected, the system will use the double line guides.
-----------------------------	--

### To Configure the Biopsy Guide Settings:

1. Press the console  button.
2. Select **Administrator > Biopsy Guide**.
3. Select/deselect the checkbox for **Use Single Guideline**.
4. Select **OK** to accept the changes and exit or **Cancel** to exit without saving.

## 8.2.10 System Settings

**System Settings** are used to configure the **Institution Name**, **Regional** parameters, **Shutdown Options**, **Auto-Freeze**, **Auto-Shutdown**, **User Data** settings and **Admin Password**.

Figure 8-15: System Settings



Table 8-17: System Settings Configuration Options

<b><i>Institution Name</i></b>	Enter the <b><i>Institution Name</i></b> using the keyboard. The text entered here appears at the top of the image field.
<b><i>Insert (Symbol)</i></b>	Enables the insertion of text symbol(s) not available on the keyboard (e.g., punctuation, symbols and letters from other languages).



Regional	Language Settings	<b>Interface Language</b>	Select the desired language for the user interface.
		<b>Keyboard Layout</b>	<p>Select the desired keyboard language.</p> <p>During imaging, tap <b>Shift+Del</b> to toggle access between English and the non-English <b>Keyboard Layout</b> language.</p> <p><b>Note:</b> <i>There is no correlation between <b>Interface Languages</b> and <b>Keyboard Layout</b>. For example, when English is used as the <b>Interface Language</b>, it is possible to select <b>Turkish</b> or <b>Korean</b> as the language for <b>Keyboard Layout</b>.</i></p> <p><i>Additionally, because <b>Keyboard Layout</b> selections are controlled by Windows rather than Ultrasonix, there are many more <b>Keyboard Layouts</b> to choose from than there are <b>Interface Languages</b>.</i></p>
	<b>Internal Settings...</b>		Select country-specific parameters, including <b>Date</b> and <b>Time</b> formats and <b>Number</b> display modes.
	<b>Date/Time...</b>		Configure the actual <b>Date</b> and <b>Time</b> (based on the <b>Date/Time</b> format selected in <b>Internal Settings...</b> ).
Shutdown Options	<b>Confirm Shutdown</b>		Forces the system to request confirmation when powering down.
System Configuration	<b>About</b>		<p>Contains (non-editable) system information, for example, <b>Software Version</b> and <b>ECG Part Number</b> (when applicable).</p> <p><b>Note:</b> <i>ECG is not available on this platform.</i></p>
Auto-Freeze	<b>Enable</b>		Enables <b>Auto-Freeze</b> , which deactivates any transducer that is connected but not currently in use.
	<b>Wait (minutes)</b>		<p>Once <b>Auto-Freeze</b> is enabled, <b>Wait</b> controls the number of minutes a stationary transducer will remain active before <b>Auto-Freeze</b> is triggered. Deactivating/freezing transducer usage will help to prolong its life span.</p> <p>Select a setting of 5 to 120 minutes. The default is <b>Auto-Freeze Enabled</b>, with a 10 minute <b>Wait</b> time.</p> <p><b>Note:</b> <i>To reactivate (or unfreeze) the transducer/imaging session, simply press the console  button.</i></p>
Touch Screen	<b>Enable Customization</b>		Not available on this platform.



User Data	Export	Exports user-configured <b>System Settings</b> to an external storage device (e.g., USB medium).			
		<b>Note:</b> <i>The <b>Export</b> function can also be used to reset all but three (3) <b>User Data</b> options (<b>Settings</b>, <b>System Logs</b> and <b>Licenses</b>) to their factory defaults.</i>			
		<b>Imaging Presets</b>	Exports all user-defined Imaging <b>Preset</b> data.		
		<b>3D/4D Presets</b>	Exports all user-defined 3D/4D <b>Preset</b> data.		
		<b>DICOM Server Configuration</b>	Exports <b>DICOM</b> configuration data.		
		<b>Settings</b>	Exports all user-defined <b>Settings</b> that are not explicitly specified in any other <b>Export</b> option (e.g., <b>DICOM</b> , <b>Network</b> , <b>Peripherals</b> , <b>Patient</b> , <b>ECG HR Precedence</b> , etc).		
		<b>Measurement Order</b>	Exports the <b>Measurement Order</b> data defined under <b>Worksheet Settings</b> on the <b>Measurements</b> dialog.		
		<b>Obstetrical Tables</b>	Exports all user-defined <b>OB Tables</b> .		
		<b>Exam Management Field Lists</b>	Exports all user-defined <b>Exam Management</b> page data (e.g, <b>Attending Physician</b> , <b>Operator ID</b> , etc).		
		Protocols	General	<p><b>Protocols</b> refer to the various specialized applications that can be purchased for use on the SonixTouch (e.g., <b>EMED</b> and, <b>Anesthesia</b>. All other products have only the default <b>General</b> Protocol),).</p> <p>Exporting settings must be done for each separate <b>Protocol</b>.</p> <p><b>Note:</b> <i>Only active <b>Protocols</b> (i.e., <b>Protocols</b> that have been licensed and installed) with changes to default <b>Preset</b>, <b>Measurement</b> and <b>Worksheet</b> settings will be available for <b>Export</b>.</i></p>	
				<b>Preset Assignments</b>	Exports all <b>Preset</b> data as configured under <b>Menu &gt; Administrator &gt; Presets</b> (e.g., <b>Annotations</b> and <b>Pictograms</b> ).
				<b>Measurement Customization</b>	Exports settings defined under <b>Customize Measurements...</b> on the <b>Measurements</b> dialog.
				<b>Worksheets</b>	Exports <b>Worksheet</b> settings.
				<b>Touch Screen Customization</b>	Exports customized touch screen settings (e.g., <b>Favorites</b> ).
				<b>Banners</b>	Not available in this release.
<b>System Logs</b>		Exports copies of all current <b>System Logs</b> .			
		<b>Note:</b> <i>These cannot be imported.</i>			





User Data	Export	<p><b>Licenses</b> Copies existing license settings into licenses.key.</p> <p><b>Note:</b> To re-import licensing details, refer to <a href="#">8.2.22</a>.</p>	
	Import	<p>Imports user-configured <b>System Settings</b> from an external storage device (e.g., USB medium). Settings must have been previously exported from a Sonix system.</p> <p><b>Caution:</b> Ultrasonix does <i>not</i> recommend importing user-defined <b>Presets</b> created with a previous software version as they may not be compatible for use with a more recent software update.</p>	
User Data	Import	<p><b>Imaging Presets</b> Imports all user-defined <b>Imaging Preset</b> data.</p>	
		<p><b>3D/4D Presets</b> Imports all user-defined <b>3D/4D Preset</b> data.</p>	
		<p><b>DICOM Server Configuration</b> Imports <b>DICOM</b> configuration data.</p>	
		<p><b>Settings</b> Imports all user-defined <b>Settings</b> that are not explicitly specified in any other <b>Import</b> option (e.g., <b>DICOM</b>, <b>Network</b>, <b>Peripherals</b>, <b>Patient</b>, <b>ECG HR Precedence</b>, etc).</p>	
		<p><b>Measurement Order</b> Imports the <b>Measurement Order</b> data defined under <b>Worksheet Settings</b> on the <b>Measurements</b> dialog.</p>	
		<p><b>Obstetrical Tables</b> Imports all user-defined <b>OB Tables</b>.</p>	
		<p><b>Exam Management Field Lists</b> Imports all user-defined <b>Exam Management</b> page data (e.g. <b>Attending Physician</b>, <b>Operator ID</b>, etc).</p>	
		<p><b>Protocols</b> refer to the various specialized applications that can be purchased for use on the SonixTouch (e.g., <b>EMED</b>, <b>Anesthesia</b> and <b>General</b>).</p> <p>Importing settings must be done for each separate <b>Protocol</b>.</p> <p><b>Note:</b> Only active <b>Protocols</b> (i.e., <b>Protocols</b> that have been licensed and installed) with <u>previously exported Preset, Measurement and Worksheet settings</u> will be available for <b>Import</b>.</p>	
		General	<p><b>Preset Assignments</b> Imports all <b>Preset</b> data as configured under <b>Menu &gt; Administrator &gt; Presets</b> (e.g., <b>Annotations</b> and <b>Pictograms</b>).</p> <p><b>Note:</b> Presets are <b>Protocol-specific</b>.</p>
			<p><b>Measurement Customization</b> Imports settings defined under <b>Customize Measurements...</b> on the <b>Measurements</b> dialog.</p> <p><b>Note:</b> <b>Measurement Customization</b> is <b>Protocol-specific</b>.</p>
<p><b>Worksheets</b> Imports <b>Worksheet</b> settings.</p> <p><b>Note:</b> <b>Worksheets</b> are only available for the <b>EMED</b>, <b>Anesthesia</b> and <b>Endocrinology Protocols</b>.</p>			
<p><b>Touch Screen Customization</b> Imports customized touch screen settings (e.g., <b>Favorites</b>).</p> <p><b>Note:</b> Available only on SonixTouch and SonixTablet.</p>			
<p><b>Banners</b> Not available in this release.</p>			



<b>User Data</b>	<b>Import</b>	<b>SonixHUB Worksheets</b>	Available only for new <b>Worksheet</b> formats created with <b>SonixHUB</b> . <hr/> <b>Note: SonixHUB Worksheets are Protocol-specific.</b>
		<b>Restore Factory</b>	Resets the system to the default settings installed during manufacturing.
		<b>Master Volume</b>	Controls the master setting for Sonix audio volume.
		<b>Admin Password...</b>	Creates/removes a global, administration level <b>Password</b> in order to protect <b>Administrator Settings</b> configuration.

**To Access System Settings:**

1. Press the console  button.
2. Select **Administrator > System**.

**8.2.10.1 Password Protection**

**To Password Protect Administrator Settings Access:**

1. Press the console  button.
2. Select **Administrator > System > Admin Password...**
3. Enter a **Password** when prompted by the dialog.

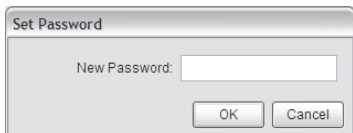

4. Select **OK** to accept the **Password** and exit or **Cancel** to exit without saving.

## 8.2.10.2 Export/Import User Data

### To Export User Data:

1. Connect the external USB storage device on which the **Export** will be saved.
2. Press the console  button.
3. Select **Administrator > System > Export....**
4. Select the item(s) to be exported.

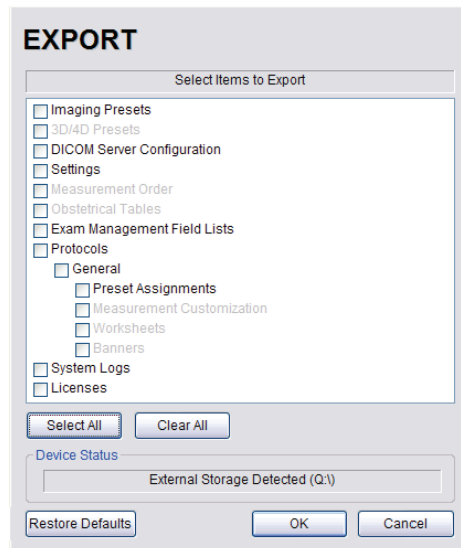

---

**Note:** Use **Select All** to select all items at one time and **Clear All** to clear all checkboxes.

Only active **Protocols** with changes to default **Presets**, **Measurement** and **Worksheet** settings will be available for **Export**.

---

5. Select **OK** to begin the export process or **Cancel** to exit without exporting.
6. If **OK** is selected in the previous step, a completion dialog will be presented when the export process has finished (this will take approximately 15–45 seconds).



### To Import User Data:

---

**Caution:** *Ultrasonix does not recommend importing user-defined **Presets** created with a previous software version as they may not be compatible for use with a more recent software update.*

---

1. Plug the previously-created removable disk (e.g., USB key) into one of the USB ports at the front of the console.
2. Press the console  button.
3. Select **Administrator > System > Import...**
4. Select the item(s) to be imported.

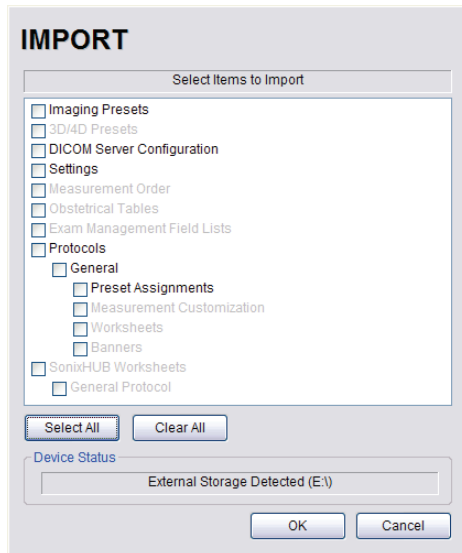

---

**Note:** Use **Select All** to select all items at one time and **Clear All** to clear all checkboxes.

*Only active **Protocols** with changes to default **Presets**, **Measurement** and **Worksheet** settings will be available for **Import**.*

---

5. Select **OK** to begin the import process or **Cancel** to exit without importing.

### 8.2.10.3 Reset User Data Settings to Factory Defaults

#### To Reset User Data:

1. Press the console  button.
2. Select **Administrator > System > Export....**
3. Select the relevant item(s).

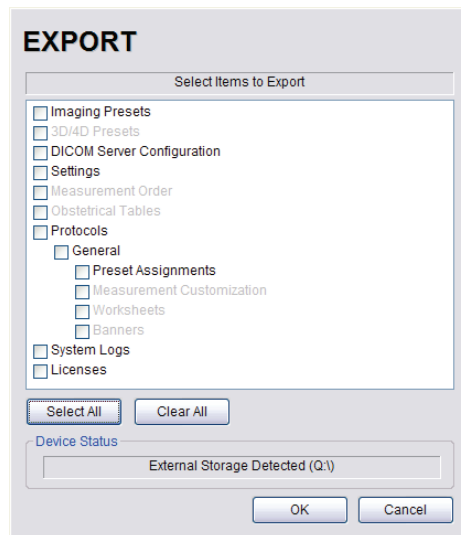

---

**Note:** Factory defaults will be restored to all selected options (except **Settings**, **System Logs** and **Licenses**).

---

4. Select **Restore Defaults**.



## 8.2.11 Network

The **Network** setup dialog allows users to configure the system's network, either through a hard-wired LAN or Dialup connection.

---

**Note:** A dialup connection requires a third-party, USB modem. Contact your dealer or Ultrasonix Technical Support to learn more about this option.

---

**Remote Support** is a licensed option that allows a member of the Ultrasonix Technical Support to view and control the system for diagnostic purposes. Ultrasonix Technical Support will help configure this option should it ever be required.

**Chat Support** enables a real-time discussion with a member of the Ultrasonix Technical Support team.

---

**Caution:** System networking options are intended for use *inside* your organization's firewall. Organizations that elect to configure/use the networking functionality provided by Ultrasonix are assuming all liabilities and risks associated with that decision.

---

Figure 8-16: Network Dialog

**NETWORK**

**Network Setup**

Internet Connection using LAN  
 Dialup Internet Connection

**Account Information**

Phone Number   
User Name   
Password

**Options**

Timeout (seconds)

**Online Support**

Chat Support Enabled

**Local IP Address**

**E-Mail Setup**

Server Address (SMTP)   
Server Port (SMTP)

---

**Note:** A network connection is required to use any of the following: **DICOM**, **Chat Support**, **Remote Support** and **SonixLive**.

---

**Table 8-18: Network Settings**

<b>Network Setup</b>	<b>Internet Connection Using LAN</b>		
	<b>OR</b> Select <b>Internet Connection</b> type: <b>LAN</b> or <b>Dialup</b> .		
	<b>Dialup Internet Connection</b>		
	<b>Account Information</b>	<b>Phone Number</b>	If <b>Dialup</b> was selected in the previous step, enter the telephone number for the <b>Internet Service Provider (ISP)</b> .
		<b>User Name</b>	Enter the <b>User Name</b> for the <b>Dialup ISP</b> account.
		<b>Password</b>	Enter the <b>Password</b> that will protect the <b>Dialup</b> connection to the Internet.
	<b>Timeout (Seconds)</b>	Enter the <b>Timeout</b> limitation (in number of seconds). <b>Note:</b> <i>If the system fails to connect within the prescribed time limit, it will stop trying.</i>	
	<b>Connect</b>	Select to <b>Connect</b> using the <b>Dialup</b> settings.	
	<b>TCP/IP Settings...</b>	Select to configure <b>TCP/IP Settings</b> . Refer to <a href="#">8.2.11.1 Ethernet (LAN) Network Configuration</a> for details.	
	<b>Wireless Settings...</b>	Select to configure <b>Wireless Settings</b> . Refer to <a href="#">8.2.11.3 Wireless Configuration</a> for details.	
<b>Chat Support Enabled</b>	Select this checkbox to enable <b>Chat Support</b> .		
<b>Remote Support</b>	After receiving a <b>PIN (Personal Identification Number)</b> from Ultrasonix, use this option to connect to the Internet. This will allow an Ultrasonix Support technician to remotely access the system to resolve any issues that may have arisen.		
<b>Local IP Address</b>	When using <b>Streaming Video</b> , it is necessary to advise the recipient of the system's <b>Local IP Address</b> . <b>Note:</b> <i>During <b>Streaming Video</b>, this <b>Local IP Address</b> can be accessed temporarily by selecting the <b>Streaming Video</b> icon on the LCD display.</i> <i>For details on <b>Streaming Video</b> and its associated icon, refer to <a href="#">8.1.1 SonixLive Setup</a>.</i> <i>If the system is not connected to a network, instead of a <b>Local IP Address</b>, the field will read <b>No Network Available</b>.</i>		
<b>E-Mail Setup</b>	<b>Server Address</b>	Enter the <b>Outgoing (SMTP) Server Address</b> here.	
	<b>Server Port</b>	Enter the <b>Outgoing Server Port</b> number here.	
<b>Note:</b> <i>Ultrasonix recommends that <b>Network</b> connections be configured using the settings provided by your IT Department.</i>			



### 8.2.11.1 Ethernet (LAN) Network Configuration

#### To Configure an Ethernet (LAN) Connection (If Available):

1. Connect an RJ45 cable to the LAN port located on the Back Connectivity Panel.
2. Press the console  button.
3. Select **Administrator > Network > Internet Connection using LAN.**

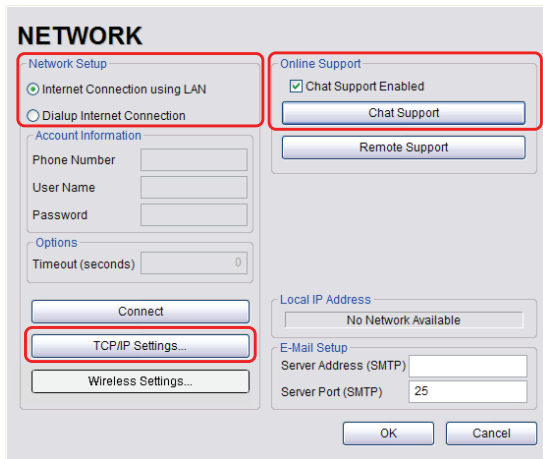

4. Under **Chat Support**, ensure the **Chat Support Enabled** checkbox has been selected.
5. Select **TCP/IP Settings...**
6. Under **General**, select **Obtain an IP address automatically** or **Use the following IP address** and enter the assigned static **IP address**, **Subnet mask**, and **Default gateway**.

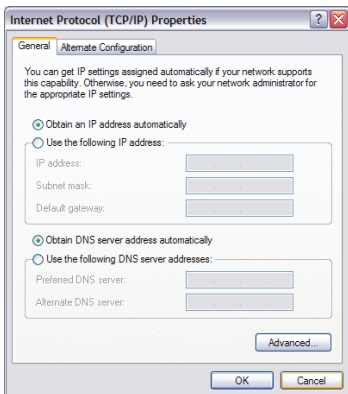

7. Select **OK** and exit the **Menu** system.

---

**Note:** It may be necessary to restart in order for the changes to take affect.

---



### 8.2.11.2 Dialup Network Configuration

---

**Note:** A dialup connection requires a third-party, USB modem. Contact your dealer or Ultrasonix Technical Support to learn more about this option.

---

#### To Configure a Dial-up Connection (If Available):

1. Connect the modem's USB connector to connection point 7.
2. Connect the other end of the modem to a telephone jack in the wall.
3. Press the console  button.
4. Select **Administrator > Network > Dialup Internet Connection**.
5. Under **Chat Support**, ensure the **Chat Support Enabled** checkbox has been selected.
6. Complete the **Account Information** and **Options** sections: **Phone Number**, **Username**, **Password** and **Timeout**.

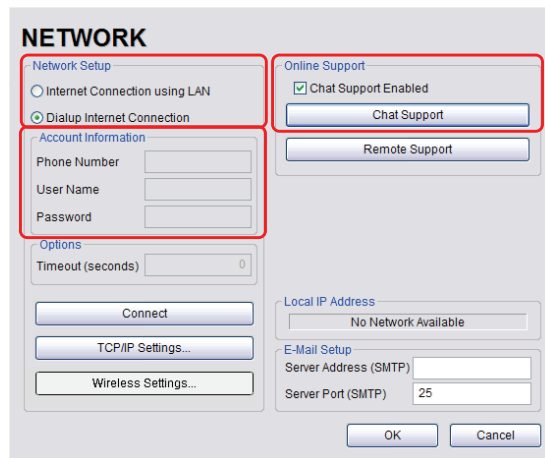

**NETWORK**

**Network Setup**

Internet Connection using LAN

Dialup Internet Connection

**Account Information**

Phone Number

User Name

Password

**Options**

Timeout (seconds)

**Online Support**

Chat Support Enabled

**Local IP Address**

**E-Mail Setup**

Server Address (SMTP)

Server Port (SMTP)

7. Select **OK** and exit the **Menu** system.

---

**Note:** While the system is dialing out, the current dialing status to the ISP will be displayed.

---

### 8.2.11.3 Wireless Configuration

Wireless is only available as a factory-installed option.

**Figure 8-17: Network Configuration Page (Wireless)**

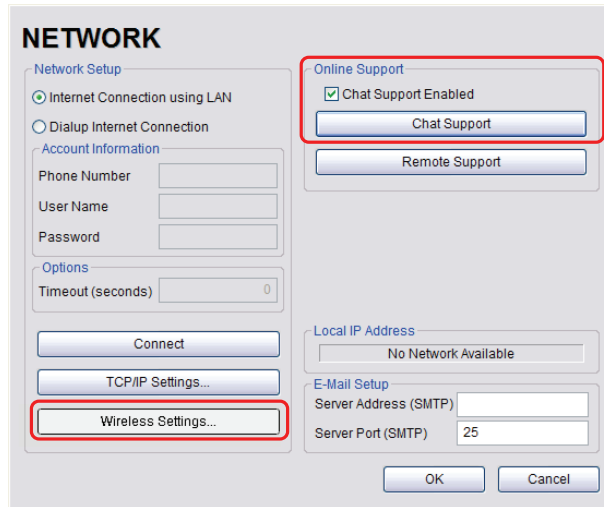

**Figure 8-18: Wireless Network Connection Setup**

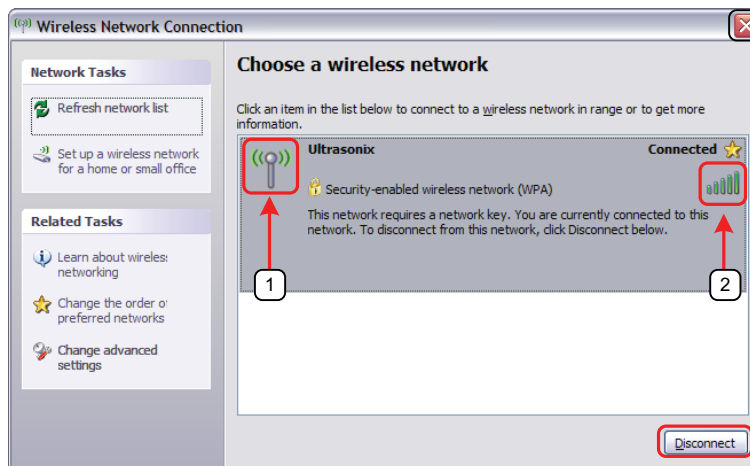

**Table 8-19: Wireless Network Connection Setup**

- 
- |   |                                    |
|---|------------------------------------|
| 1 | Security Indicator                 |
| 2 | Wireless Signal Strength Indicator |
- 

**Notes:**

*Wireless Network Connection options are controlled by MS Windows, not Ultrasonix.*

*Once a secured, wireless network is in place, it will be necessary to obtain the institution's **Network Key** (from the IT department) in order to log in.*

---

**To Configure a Wireless Connection (If Available)**

---

**Notes:**

*When more than one wireless network is available, consult the IT department to determine which one is relevant for SonixSP operations.*

*Do not select the **Chat Support Enabled** checkbox unless an Internet connection is available.*

---

1. Press the console  button.
2. Select **Administrator > Network > Wireless Settings...**
3. Complete the wireless connection following the onscreen directions in the **Wireless Network Connection** dialog.
4. Under **Chat Support**, ensure the **Chat Support Enabled** check box has been selected.

---

**Note:** *Do not select the **Chat Support Enabled** checkbox unless an Internet connection is available.*

---

5. Select **OK** and exit the menu system.



#### 8.2.11.4 Chat Support

**Chat Support** enables a real-time discussion with a member of the Ultrasonix Technical Support team. To access **Chat Support**, refer to [8.1.3](#).

---

**Note:** A network connection is required for **Chat Support**.

---

#### 8.2.11.5 Remote Support

**Remote Support** is a licensed option that allows a member of the Ultrasonix Technical Support to view and control the Sonix for diagnostic purposes.

---

**Note:** A network connection is required for **Remote Support**.

---

To access **Remote Support**, refer to [8.1.2](#) or [3.4](#).

## 8.2.12 DICOM Configuration

The system uses the **Digital Imaging and Communications in Medicine (DICOM)** standard to share medical information with other digital imaging systems. The system, by means of the **DICOM** protocol, communicates with **Storage**, **Print** and **Modality Worklist Service Class Providers**.

---

**Note:** *DICOM Structured Reporting is supported. Refer to [Table 8-21](#) for **Structured Reporting** data transfer options.*

---

Refer to [8.2.11 Network](#) to configure the system for network connectivity.

---

**Note:** *When using a hard-wired network connection, ensure the network is connected via a CAT5 cable at the back of the system. (Check with the local IT Department to ensure that the jack from the wall is live.)*

*When using a wireless network connection, ensure the wireless network is configured properly and that the system has a live wireless connection.*

---

**Figure 8-19: DICOM Configuration**



---

**Note:** *Global Settings for the Local Host apply to DICOM Storage, Print and Worklist.*

---



Table 8-20: DICOM Configuration – Global Settings

Local Host	<b>Station Name</b>	General <b>DICOM Station Name</b> .
	<b>AE Title</b>	<b>AE (Application Entity) Title</b> of the Sonix system.
	<b>IP Address</b>	Unique identifier of the Sonix system (informational only).
	Storage Commitment AE	<b>Port</b>
<b>Listening Port</b>		<b>Listening Port</b> receives incoming <b>Storage Commitment</b> responses ( <b>N-Event</b> ).
Settings	<b>Storage... Print... Worklist...</b>	Use to access specific <b>DICOM Storage, Print</b> and <b>Worklist</b> settings.

To Configure the Global DICOM Settings:

1. Press the console button.
2. Select **Administrator > DICOM**.
3. Configure the global settings as required.

8.2.12.1 DICOM Storage Settings

The **DICOM Storage Settings** dialog offers basic and advanced settings for configuring the system for **DICOM** image storage.

To Configure the DICOM Storage Setting:

1. Press the console button.
2. Select **Administrator > DICOM > Storage**.
3. An onscreen dialog with four (4) tabs will be presented: **AE Configuration, Global Storage Settings, Brightness/Contrast** and **SonixHUB Settings**.
4. Create/select a **Device Name**. Edit the **Application Entity (AE)** settings for the selected **Device**.
5. Repeat **step 4** as many times as required.
6. Configure settings as required.

---

**Note:** In addition to the four (4) tabbed settings options, select the **Settings...** button to access **Storage Settings**.

---

The **DICOM Storage AE Configuration** dialog enables configuration of **AE** properties.

**Figure 8-20: DICOM Storage Settings – AE Configuration**

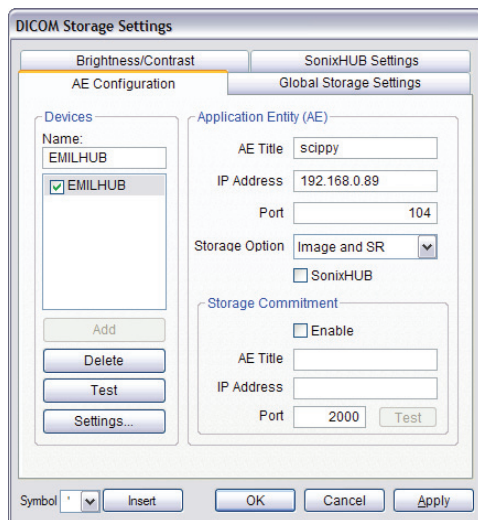

**Table 8-21: DICOM Storage Settings – AE Configuration**

<b>Devices</b>	Use the <b>Devices</b> option to add as many <b>DICOM Storage Servers</b> as required.
	<b>Note:</b> <i>If more than one <b>DICOM Storage Server</b> is configured, during data transfer the <b>Operator</b> has the option of selecting which <b>Storage Server(s)</b> will receive the data (9.3).</i>
	<b>Name</b> Enter/select the <b>Name</b> of an <b>AE Storage Device</b> and populate the four (4) <b>AE</b> fields: <b>Structured Report Only</b> , <b>AE Title</b> , <b>IP Address</b> and <b>Port</b> .
	<b>Add</b> Select to <b>Add</b> the new <b>AE Storage Device</b> .
	<b>Delete</b> Select to <b>Delete</b> the selected <b>AE Storage Device</b> .
	<b>Test</b> Select to send verification request to <b>DICOM Storage Device</b> (ping to verify connection).
<b>Settings...</b> Select to access <b>Storage Settings</b> (Figure 8-21 and Table 8-22).	



<b>Application Entity (AE)</b>		<b>Note:</b> <i>The data entered/edited in the following fields is specific to the selected <b>Device Name</b>.</i>		
		<b>AE Title</b>	<b>AE Title</b> of the <b>Storage SCP</b> .	
		<b>IP Address</b>	Unique identifier of <b>Storage SCP</b> .	
		<b>Port</b>	Listening <b>Port</b> of the <b>Storage SCP</b> .	
		<b>Storage Options</b>	Select the <b>Storage Option</b> to be used during data transfer ( <a href="#">Chapter 9</a> ). <ul style="list-style-type: none"> <li>• <b>Image and SR:</b> transfers both <b>Images</b> and <b>Structured Report</b></li> <li>• <b>Image:</b> transfers only <b>Images</b></li> <li>• <b>SR (Structured Report):</b> transfers only the <b>Structured Report</b>.</li> </ul>	
		<b>SonixHUB</b>	Select to enable/disable <b>SonixHUB</b> . <b>Note:</b> <i>This setting is only available if <b>SonixHUB</b> is licensed.</i>	
		<b>Storage Commitment</b>	<b>Enable</b>	Select to enable <b>Storage Commitment</b> functionality.
			<b>AE Title</b>	<b>AE Title</b> of the <b>Storage Commitment SCP</b> .
			<b>IP Address</b>	Unique identifier of <b>Storage Commitment SCP</b> .
			<b>Port</b>	Listening <b>Port</b> of the <b>Storage Commitment SCP</b> .
<b>Test</b>	Select to send verification request to <b>DICOM Storage Commitment Device</b> (ping to verify connection).			
<b>Insert (Symbol)</b>		Enables the insertion of text symbol(s) not available on the keyboard (e.g., punctuation, symbols and letters from other languages).		



The **DICOM Storage Settings** dialog specifies how images are stored.

**Figure 8-21: DICOM Storage Settings – Storage Settings**

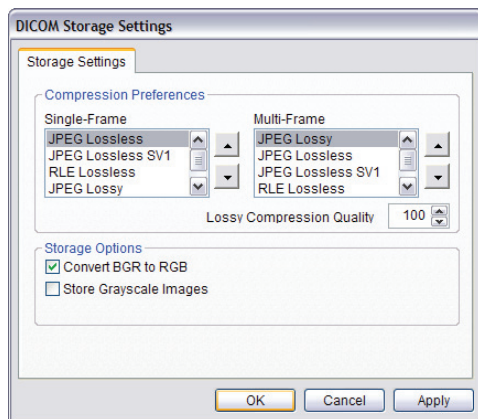
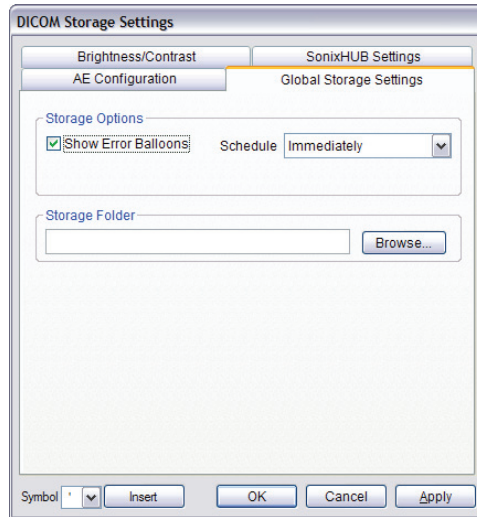

**Table 8-22: DICOM Storage Settings – Storage Settings**

<b>Compression Preferences</b>	<b>Single-Frame</b>	<p><b>JPEG Lossless</b>  <b>JPEG Lossless SV1</b>  <b>RLE Lossless</b>  <b>JPEG Lossy</b>  <b>No Compression</b></p>	<p>Set <b>DICOM</b> image format storage order for single frame images.  <u><b>Note:</b> Refer to the <b>DICOM Standard</b> for details on image formats.</u></p>
	<b>Multi-Frame</b>	<p><b>JPEG Lossy</b>  <b>JPEG Lossless</b>  <b>JPEG Lossless SV1</b>  <b>RLE Lossless</b>  <b>No Compression</b></p>	<p>Set <b>DICOM</b> image format storage order for <b>Cine loops</b>.  <u><b>Note:</b> Refer to the <b>DICOM Standard</b> for details on image formats.</u></p>
		<p><b>Lossy Compression Quality</b></p>	<p>Select the quality (1–100%) of image compression.</p>
<b>Storage Options</b>		<p><b>Convert BGR to RGB</b></p>	<p>Select to swap the color components of the image pixel data—the blue colors are swapped with the red colors.</p>
		<p><b>Store Grayscale Images</b></p>	<p>Select to store images in grayscale format.</p>
	<p><b>Insert (Symbol)</b></p>		<p>Enables the insertion of text symbol(s) not available on the keyboard (e.g., punctuation, symbols and letters from other languages).</p>

The **DICOM Global Storage Settings** dialog specifies global image storage parameters.

**Figure 8-22: DICOM Storage Settings – Global Storage Settings**



**Table 8-23: DICOM Storage Settings – Global Storage Settings**

<b>Storage Options</b>	<b>Show Error Balloons</b>	Select to enable the display of <b>DICOM Storage</b> error messages (e.g., <b>Failed to connect to DICOM</b> ).
	<b>Schedule</b>	Select an auto-transfer setting: <b>End of Exam, Immediate, On Idle</b> .
	<b>Storage Folder</b>	Select the location (local or remote) where the images will be stored.
		<b>Note: If a value is specified, the <i>AE Configuration</i> and <i>Storage Commitment</i> dialogs are disabled—images can not be stored to an <i>SCP</i>.</b>
	<b>Insert (Symbol)</b>	Enables the insertion of text symbol(s) not available on the keyboard (e.g., punctuation, symbols and letters from other languages).

The **DICOM Storage Brightness/Contrast** dialog changes the **Brightness** and **Contrast** settings. These settings are applied to the images that are sent to the **SCP**, not the images stored locally.

The effects of these settings can be seen in the **Before** and **After** images.

**Figure 8-23: DICOM Storage Settings – Brightness/Contrast**

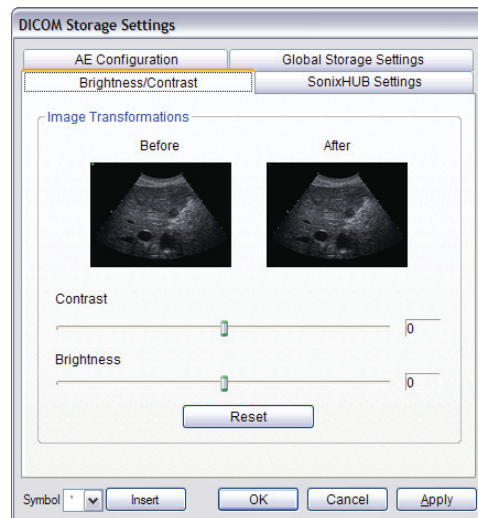

**Table 8-24: DICOM Storage Settings – Brightness/Contrast**

<b>Contrast</b>	Adjusts the level of <b>Contrast</b> applied to the images.
<b>Brightness</b>	Adjusts the level of <b>Brightness</b> applied to the images.
<b>Reset</b>	Resets the values of <b>DICOM Storage Brightness</b> and <b>Contrast</b> back to zero. <i>Note: To adjust the <b>Brightness/Contrast</b> settings, position the trackball arrow over the <b>Brightness</b> or <b>Contrast</b> slider. Press and hold the  button while moving the trackball left or right to the desired position.</i>

The **DICOM SonixHUB Settings** dialog specifies **SonixHUB** parameters.

---

**Note:** These settings are only available if **SonixHUB** is licensed.

---

**Figure 8-24: DICOM Storage Settings – SonixHUB Settings**

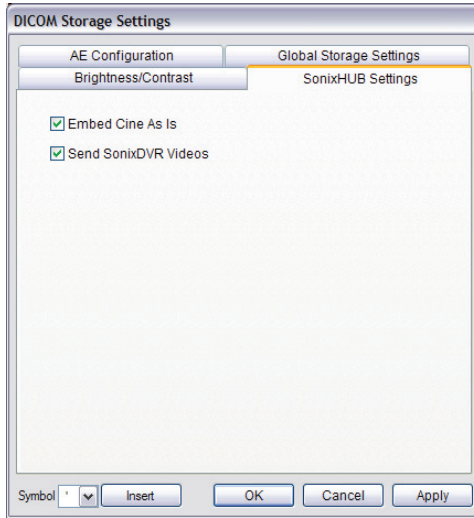

**Table 8-25: DICOM Storage Settings – Global Storage Settings**

<b>Embed Cine As Is</b>	Select to send <b>Cine</b> files in <b>AVI</b> format. When deselected, <b>Cine</b> files will be sent in <b>DICOM</b> format.
<b>Send SonixDVR Videos</b>	Select/deselect in order to include/exclude <b>SonixDVR</b> videos in the <b>SonixHUB</b> transfer.

### 8.2.12.2 DICOM Print Settings

*DICOM Print Settings* offer basic and advanced settings for configuring the system for *DICOM Print*.

#### To Configure DICOM Print Settings:

1. Press the console  button.
2. Select **Administrator > DICOM > Print**.
3. An onscreen dialog with two (2) tabs will be presented: **AE Configuration** and **Brightness/Contrast**.
4. Create/select a **Device Name**. Edit the **Application Entity (AE)** settings for the selected **Device**.
5. Repeat **step 4** as many times as required.
6. Configure **AE Configuration** and **Brightness/Contrast** as required.

---

**Note:** *In addition to the two (2) tabbed settings options, select the **Settings...** button to access **Print Settings** and **Advanced Print Settings**.*

---

The **DICOM Print AE Configuration** dialog enables configuration of **AE** properties.

**Figure 8-25: DICOM Print Settings – AE Configuration**

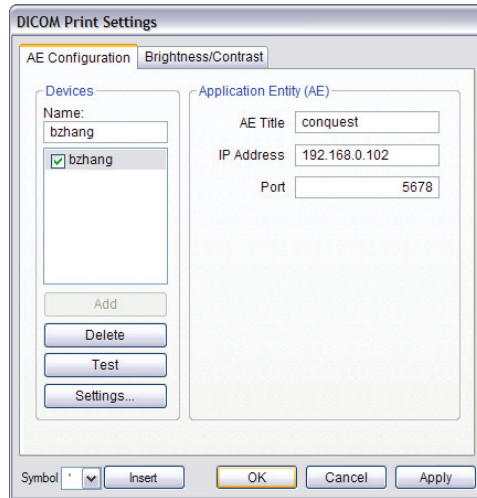
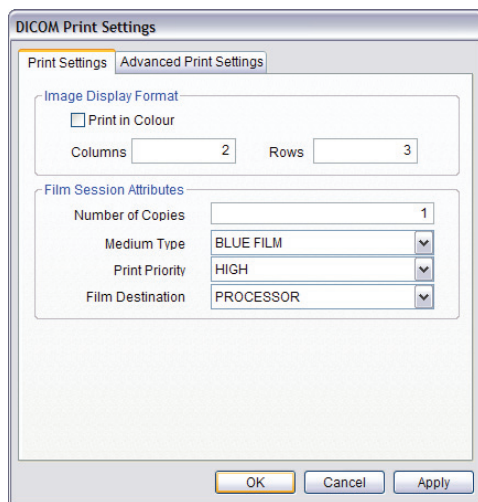

**Table 8-26: DICOM Print Settings – AE Configuration**

<b>Devices</b>		Use the <b>Devices</b> option to add as many <b>DICOM Print Servers</b> as required.
		<b>Note:</b> If more than one <b>DICOM Print Server</b> is configured, during data transfer the <b>Operator</b> has the option of selecting which <b>Print Server(s)</b> will receive the data (9.3).
	<b>Name</b>	Enter/select the <b>Name</b> of an <b>AE Print Device</b> and populate the three (3) <b>AE</b> fields: <b>AE Title</b> , <b>IP Address</b> and <b>Port</b> .
	<b>Add</b>	Select to <b>Add</b> the new <b>AE Print Device</b> .
	<b>Delete</b>	Select to <b>Delete</b> the selected <b>AE Print Device</b> .
	<b>Test</b>	Select to send verification request to <b>DICOM Print Device</b> (ping to verify connection).
	<b>Settings...</b>	Select to access <b>Print Settings</b> (Figure 8-26 and Table 8-27) and <b>Advanced Print Settings</b> (Figure 8-27 and Table 8-28).
<b>Application Entity (AE)</b>		<b>Note:</b> The data entered/edited for the next three (3) fields is specific to the selected <b>Device Name</b> .
	<b>AE Title</b>	<b>AE Title</b> of the <b>Print SCP</b> .
	<b>IP Address</b>	Unique identifier of <b>Print SCP</b> .
	<b>Port</b>	Listening <b>Port</b> of the <b>Print SCP</b> .
<b>Insert (Symbol)</b>		Enables the insertion of text symbol(s) not available on the keyboard (e.g., punctuation, symbols and letters from other languages).

The **DICOM Print Settings** dialog enables configuration of general print properties.

**Figure 8-26: DICOM Print Settings – Print Settings**

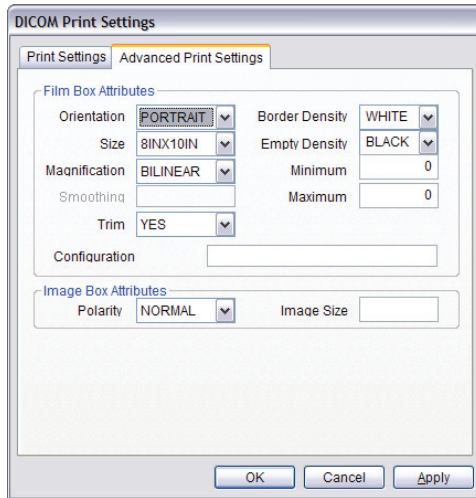

**Table 8-27: DICOM Print Settings – Print Settings**

<b>Image Density Format</b>	<b>Print in Color</b>	Select to print images in color. Deselect to print grayscale (default).
	<b>Columns</b>	Select the number of <b>Columns</b> per page.
	<b>Rows</b>	Select the number of <b>Rows</b> per page.
<b>Film Session Attributes</b>	<b>Number of Copies</b>	Select the <b>Number of Copies</b> of each page to be printed.
	<b>Medium Type</b>	Select the type of medium on which the images will be printed: <b>Paper</b> , <b>Clear Film</b> or <b>Blue Film</b> .
	<b>Print Priority</b>	Select the print job priority: <b>High</b> , <b>Medium</b> or <b>Low</b> .
	<b>Film Destination</b>	Select the location to which the print job will be sent: <b>Processor</b> or <b>Magazine</b> .

The **Advanced Print Settings** dialog enables configuration of advanced printing options.

**Figure 8-27: DICOM Print Settings – Advanced Print Settings**



**Table 8-28: DICOM Print Settings – Advanced Print Settings**

<b>Film Box Attributes</b>	<b>Orientation</b>	Select the <b>Orientation</b> of the print page: <b>Portrait</b> or <b>Landscape</b> .
	<b>Size</b>	Select the <b>Size</b> of the print page.
	<b>Magnification</b>	Select the method of <b>Magnification</b> : <b>Replicate</b> , <b>Bilinear</b> , <b>Cubic</b> or <b>None</b> .
	<b>Smoothing</b>	Select the <b>Smoothing</b> .
		<b>Note:</b> This option is printer-specific and only available if <b>Cubic Magnification</b> is selected in the previous field.
	<b>Trim</b>	Select <b>Yes</b> or <b>No</b> to use a border ( <b>Trim</b> ) on each page.
	<b>Configuration</b>	Enter printer-specific <b>Configuration</b> information.
	<b>Border Density</b>	Select the <b>Border Density</b> : <b>Black</b> or <b>White</b> .
	<b>Empty Density</b>	Select the <b>Empty Density</b> : <b>Black</b> or <b>White</b> .
	<b>Minimum Density</b>	Enter the minimum image density in hundredths of <b>OD (Optical Density)</b> .
<b>Maximum Density</b>	Enter the maximum image density in hundredths of <b>OD</b> .	
<b>Image Box Attributes</b>	<b>Polarity</b>	Select the <b>Polarity</b> : <b>Normal</b> or <b>Reverse</b> .
	<b>Image Size</b>	Enter the printer-specific <b>Image Size</b> in mm.
<b>Insert (Symbol)</b>	Enables the insertion of text symbol(s) not available on the keyboard (e.g., punctuation, symbols and letters from other languages).	



The **DICOM Print Brightness/Contrast** dialog changes the **Brightness** and **Contrast** settings. These settings are applied to the images that are sent to the **SCP**, not to the images stored locally.

The effect of these settings can be seen in the **Before** and **After** images.

**Figure 8-28: DICOM Print Settings – Brightness/Contrast**

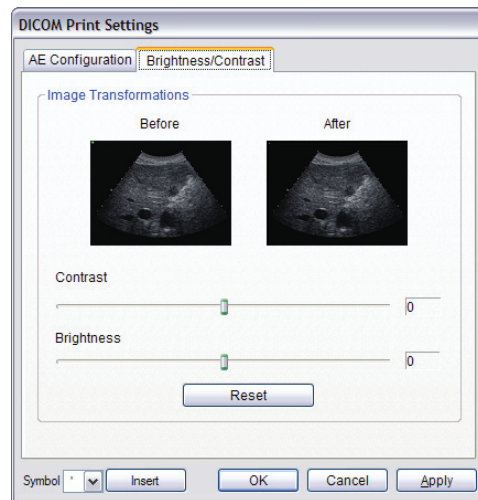

**Table 8-29: DICOM Print Settings – Brightness/Contrast**

<b>Contrast</b>	Adjusts the level of <b>Contrast</b> applied to the images.
<b>Brightness</b>	Adjusts the level of <b>Brightness</b> applied to the images.
<b>Reset</b>	Resets the values of <b>DICOM Print Brightness</b> and <b>Contrast</b> back to zero.  <i>Note: To adjust the <b>Brightness/Contrast</b> settings, position the trackball arrow over the <b>Brightness</b> or <b>Contrast</b> slider. Press and hold the  button while moving the trackball left or right to the desired position.</i>



### 8.2.12.3 DICOM Worklist Settings

*DICOM Worklist Settings* offer advanced settings for configuring the *DICOM Worklist SCU*.

#### To Configure DICOM Worklist Settings:

1. Press the console  button.
2. Select **Administrator > DICOM > Worklist**.
3. Create/select a **Device Name**. Edit the **Application Entity (AE)** settings for the selected **Device**.
4. Repeat **step 3** as many times as required.
5. Configure the dialog as required.

The **DICOM Worklist AE Configuration** dialog enables configuration of **AE** properties.

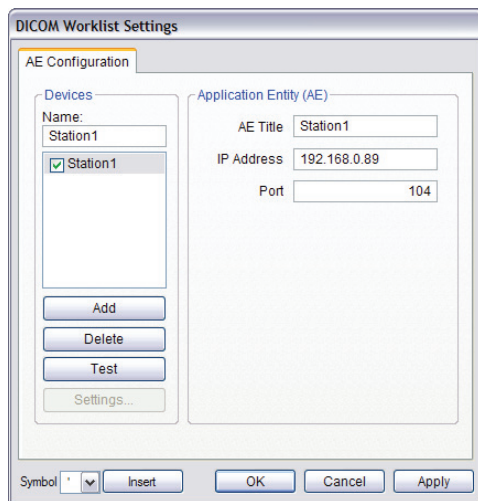

**Figure 8-29: DICOM Worklist Settings – AE Configuration**



**Table 8-30: DICOM Worklist Settings – AE Configuration**

<b>Devices</b>		Use the <b>Devices</b> option to add as many <b>DICOM Worklist Servers</b> as required.
	<b>Name</b>	Enter/select the <b>Name</b> of an <b>AE Worklist Device</b> and populate the three (3) <b>AE</b> fields: <b>AE Title</b> , <b>IP Address</b> and <b>Port</b> .
	<b>Add</b>	Select to <b>Add</b> the new <b>AE Worklist Device</b> .
	<b>Delete</b>	Select to <b>Delete</b> the selected <b>AE Worklist Device</b> .
	<b>Test</b>	Select to send verification request to <b>DICOM Worklist Device</b> (ping to verify connection).
	<b>Settings...</b>	Not available in this release.
<b>Application Entity (AE)</b>		<b>Note:</b> The data entered/edited for the next three (3) fields is specific to the selected <b>Device Name</b> .
	<b>AE Title</b>	<b>AE Title</b> of the <b>Worklist SCP</b> .
	<b>IP Address</b>	Unique identifier of <b>Worklist SCP</b> .
	<b>Port</b>	Listening <b>Port</b> of the <b>Worklist SCP</b> .
	<b>Insert (Symbol)</b>	Enables the insertion of text symbol(s) not available on the keyboard (e.g., punctuation, symbols and letters from other languages).

### 8.2.13 Custom Keys

**Custom Keys** allow users to configure four (4) console buttons: **1**, **2**, , and .

The **Custom Key** setup dialog has a tab that corresponds to each of the **Custom Key** console buttons. Once configured, pressing one of these buttons will produce the defined action.

**Figure 8-30: Custom Keys**

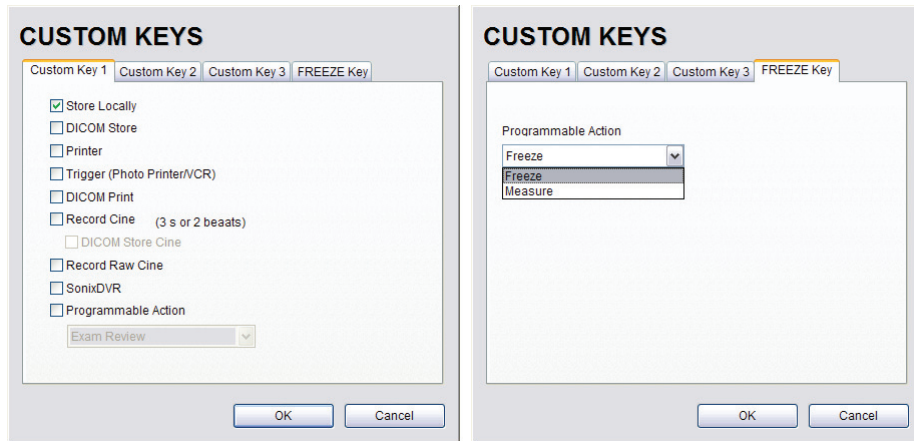

**Table 8-31: Custom Key Settings**

<b>Custom Key 1, Custom Key 2, Custom Key 3</b>	<b>Store Locally</b>	<p>This setting is always selected by default and can only be deselected (or reselected) if all options except <b>Trigger</b> are deselected.</p> <p>When selected, regardless of other settings, images will always be saved to the system's local storage.</p> <p><b>Note:</b> Access locally stored images through the <b>Exam Management</b> page or the touch screen <b>Exam Review</b> button</p>
	<b>DICOM Store</b>	<p>Sends images to a <b>DICOM</b> archive. Refer to <a href="#">8.2.12 DICOM Configuration</a> for more setup details.</p>
	<b>Printer</b>	<p>Sends output to a <b>Paper Printer</b>. Refer to <a href="#">8.2.14 Peripherals</a> for details on printer setup.</p>
	<b>Trigger (Photo Printer/VCR)</b>	<p>Sends a <b>Trigger</b> signal to attached video printers (e.g., <b>Thermal Printer</b>).</p> <p><b>Note:</b> To select <b>Store Locally</b> (above), all other options must be deselected.</p>
	<b>DICOM Print</b>	<p>Sends images to a <b>DICOM</b> printer. Refer to <a href="#">8.2.12 DICOM Configuration</a> for more setup details.</p>



Custom Key 1, Custom Key 2, Custom Key 3, cont'd	Record Cine	Enables the system to be configured to record a <b>Cine loop</b> . Loop duration is configured through <a href="#">8.2.18 Capture Settings</a> .
		<b>DICOM Store Cine</b> Enables the user to send animated <b>DICOM</b> to a <b>DICOM</b> archive ( <a href="#">8.2.12 DICOM Configuration</a> ).
	Record Raw Cine	Saves <b>Cine loops</b> in raw format, enabling future manipulation ( <a href="#">5.10.4 Raw Cine Manipulation</a> ).
	SonixDVR Recording	Enables <b>SonixDVR Recording</b> (i.e., a physical recording device is <u>not</u> required). <b>Note: SonixDVR Recordings cannot be transferred via DICOM. Use the Image Transfer process (9.3) to export these files.</b>
	Programmable Action	Enables the user to configure the <b>Custom Key(s)</b> to one (1) of three (3) specific actions—unrelated to printing.
<b>Exam Review</b> Toggles access between imaging and <b>Exam Review</b> page.		
<b>Measure</b> Activates <b>Measurement Packages</b> touch screen (i.e., achieves the same result as pressing the console <b>Measure</b> button) .		
Report	Toggles access between imaging and current <b>Report</b> (i.e., achieves the same result as tapping the <b>Report</b> button on the <b>Measurement Packages</b> touch screen).	
FREEZE Key Programmable Action	Enables the user to customize the action of the  button.	
	<b>Freeze</b> Toggles access between live and frozen imaging. This setting is the system default.	
	<b>Measure</b> Toggles access between live imaging and the <b>Measurements Package</b> touch screen. This enables the user to determine their preferred workflow.	

**To Configure Custom Keys:**

1. Press the console  button.
2. Select **Administrator > Custom Keys**.
3. Select the desired **Custom Key** tab.
4. Configure the individual **Custom Keys** as required.
5. Select **OK** to accept the changes and exit or **Cancel** to exit without saving.

## 8.2.14 Peripherals

The **Peripherals** setup dialogs enable software configuration for the various peripherals that are approved for connection to the system. For installation details of the specific connections involved, refer to [Chapter 10: Connectivity, Peripherals and Software](#).

Figure 8-31: Peripherals

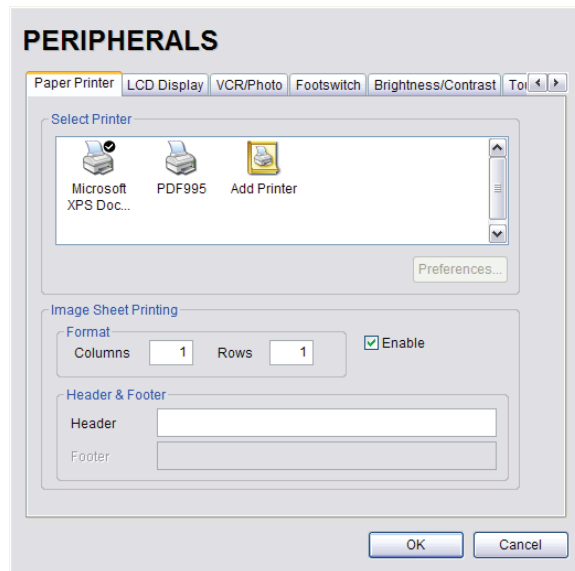

### To Access the Peripherals Dialog:

1. Press the console  button.
2. Select **Administrator > Peripherals**.
3. Select the relevant **Peripherals** dialog tab.

### 8.2.14.1 Paper Printer

The **Paper Printer** dialog is used to configure a laser or inkjet paper printer connected to the system. If the printer is connected via a parallel or USB port, the system will recognize the printer and subsequently list it as a recognized printer in the **Select Printer** section of the dialog.

Figure 8-32: Peripherals – Paper Printer

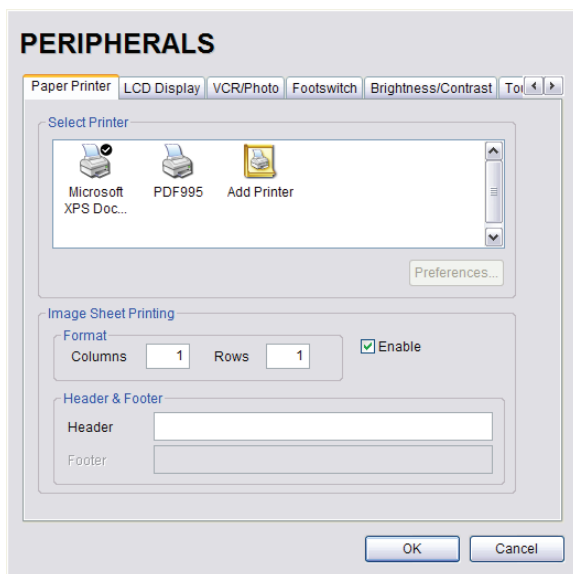



Table 8-32: Paper Printer Settings

<b>Select Printer</b>		Select a <b>Paper Printer</b> from the options presented.
<b>Preferences</b>		Select this button to configure <b>Preferences</b> for the selected printer.
<b>Image Sheet Printing</b>	<b>Format</b>	<b>Columns</b> Select the number of print <b>Columns</b> .
		<b>Rows</b> Select the number of print <b>Rows</b> .
		<b>Enable</b> Select to allow <b>Image Sheet Printing</b> .
	<b>Header &amp; Footer</b>	<b>Header</b> Enter text to be printed in each <b>Header</b> .
<b>Footer</b> <u>Note: This field is always disabled.</u>		



### To Configure the System for a Paper Printer:

1. Press the console  button.
2. Select **Administrator > Peripherals**.
3. Select the **Paper Printer** tab.
4. Select the printer from the list of recognized printers. For multiple printers, press the console  button and select **Set as Default Printer** from the onscreen menu.

---

**Note:** The selected printer can be a network or a local printer and can be configured for specific formats by selecting **Preferences**.

---

5. To select/deselect **Image Sheet Printing** (e.g., **2x3** image sheets), select/deselect the **Enable** box.
6. Enter the number of **Columns** and **Rows** desired in the text boxes provided.
7. To add an optional **Header** to the image sheet (or to supply special commands, as required), enter the desired text in the space provided.

---

**Note:** To configure the console **1, 2** or  button to send images to the default printer, refer to **8.2.13 Custom Keys**.

---

To send partial print pages (e.g., 3 images remaining on a 4 image/sheet format) at the end of an exam, tap the touch screen **End Exam** button.

---



### 8.2.14.2 LCD Display

Adjust the following LCD display settings as required: **Saturation**, **Hue**, **Gamma**, **Brightness**, **Contrast**, **Color Mode** and **Gain (Red, Green and Blue)**.

---



**Note:** Select the **Restore Factory** button to reconfigure **LCD Display** to factory settings.

---

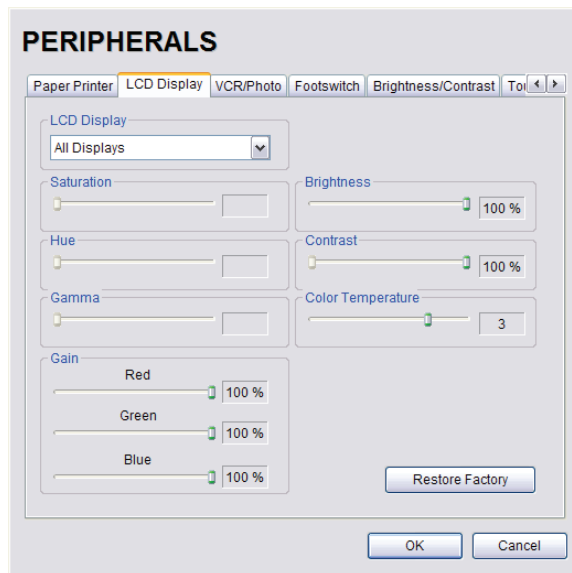
**Figure 8-33: Peripherals – LCD Display**



#### To Adjust the LCD Display Settings:

1. Press the console  button.
2. Select **Administrator > Peripherals**.
3. Select the **LCD Display** tab.
4. Position the trackball arrow over the desired setting slider.
5. Press and hold the  button while moving the trackball to the desired position.
6. Repeat **step 4** and **step 5** as many times as required.
7. Select **OK** to accept the changes and exit or **Cancel** to exit without saving.



### 8.2.14.3 VCR/Photo

Output video includes only the image area (or full screen when a dialog such as the **Exam Management** page or **Image Review** pages are displayed on the screen). The output video does not include the thumbnail images.

Use the **VCR/Photo** dialog to enable/disable the live output video (**Video Out**).

---

**Note:** To create a **SonixDVR Recording** of an exam session, refer to [8.2.13 Custom Keys](#) and/or [8.2.18 Capture Settings](#).

A physical recording device is *not* required for **SonixDVR Recording**. However, the option must be configured in [8.2.13 Custom Keys](#) before an exam session can be recorded to an **MPG** file.

---

Figure 8-34: Peripherals – VCR/Photo

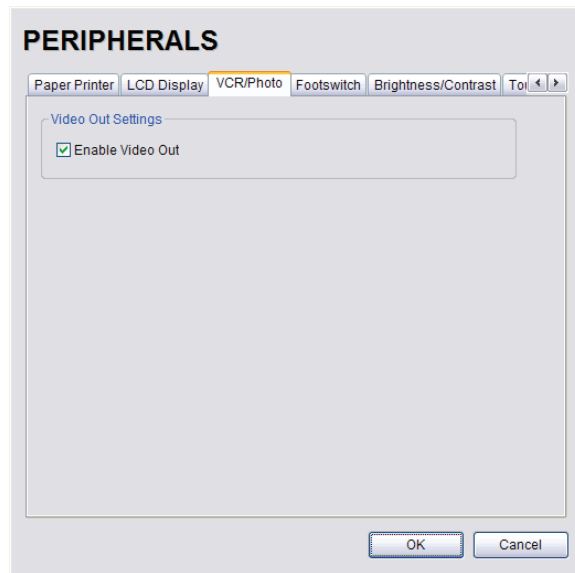

#### To Enable VCR/Photo Functionality:

1. Press the console  button.
2. Select **Administrator > Peripherals**.
3. Select the **VCR/Photo** tab.
4. Select/deselect **Enable Video Out** as required.
5. Select **OK** to accept the changes and exit or **Cancel** to exit without saving.

### 8.2.14.4 Footswitch

The **Footswitch** dialog allows the user to configure the desired operation for as many as three (3) footswitches. There are seven (7) options: **None**, **Print**, **Freeze**, **Quick Cine Record**, **Exam Management**, **Measurement** and **Exam Review**.

Figure 8-35: Peripherals – Footswitch

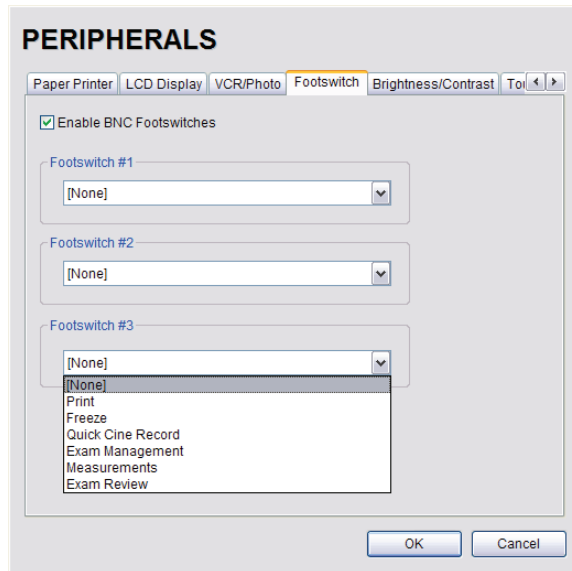

Table 8-33: Footswitch Options

**Enable BNC Footswitches**

<b>Footswitch #1, #2, #3</b>	<b>None</b>	Select the action to be performed when a specific footswitch is pressed.
	<b>Print</b>	
	<b>Freeze</b>	
	<b>Quick Cine Record</b>	
	<b>Exam Management</b>	
	<b>Measurements</b>	
	<b>Exam Review</b>	



**ULTRASONIX**

**To Configure the Footswitch Settings:**

1. Press the console  button.
2. Select **Administrator > Peripherals**.
3. Configure the **Footswitch** options as required.
4. Select **OK** to accept the changes and exit or **Cancel** to exit without saving.

### 8.2.14.5 Brightness/Contrast

The **Brightness/Contrast** dialog allows users to change the **Brightness/Contrast** of images transferred to peripherals to ensure optimum quality.

---

**Note:** The **Brightness/Contrast** values set on this tab are not applied to the image on the screen or images stored to the system.

---

The effects of the **Brightness/Contrast** settings are seen in the **Before** and **After** images.

---



**Note:** Select the **Reset** button to restore **Brightness/Contrast** settings to factory defaults.

---

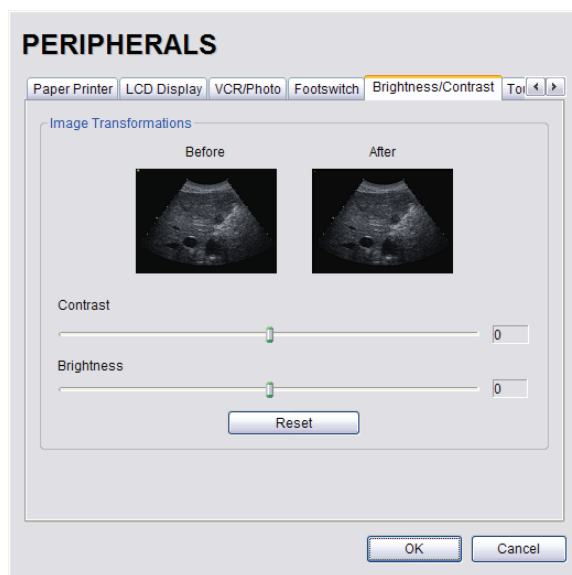
**Figure 8-36: Peripherals – Brightness/Contrast**



#### To Adjust the Brightness/Contrast Settings:

1. Press the console  button.
2. Select **Administrator > Peripherals**.
3. Select the **Brightness/Contrast** tab.
4. Position the trackball arrow over the **Brightness** or **Contrast** slider.
5. Press and hold the  button while moving the trackball to the desired position.
6. Select **OK** to accept the changes and exit or **Cancel** to exit without saving.



### 8.2.14.6 Touch Screen

The **Touch Screen** dialog allows users to change the **Brightness/Contrast** of images transferred to peripherals to ensure optimum quality. The effects of the **Brightness/Contrast** settings are seen in the **Before** and **After** images.

**Note:** The **Brightness/Contrast** values set on this tab are not applied to the image on the screen or images stored to the system.

Figure 8-37: Peripherals – Touch Screen

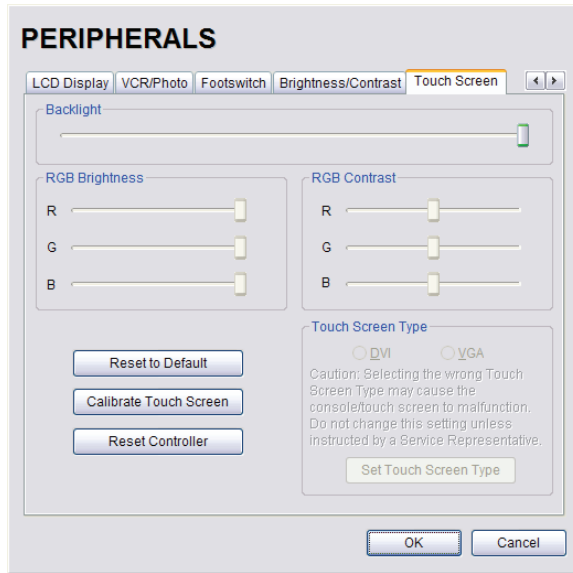



Table 8-34: Touch Screen Settings

<b>Backlight</b>	Adjusts the <b>Backlight</b> intensity.
<b>RGB Brightness</b>	Adjusts the <b>Brightness</b> intensity of the <b>Red</b> , <b>Green</b> and <b>Blue</b> spectrums.
<b>RGB Contrast</b>	Adjusts the <b>Contrast</b> intensity of the <b>Red</b> , <b>Green</b> and <b>Blue</b> spectrums.
<b>Reset to Default</b>	Restores all settings to the factory defaults.
<b>Calibrate Touch Screen</b>	Recalibrates the touch screen.
<b>Reset Controller</b>	Not available in this release.
<b>Touch Screen Type</b>	Not available on this platform.

**To Adjust the Touch Screen Settings:**

1. Press the console  button.
2. Select **Administrator > Peripherals> Touch Screen**.
3. Position the trackball arrow over any of the sliders.
4. Press and hold the  button while moving the trackball to the desired position.
5. Select **Reset to Default** to restore factory settings.
6. Select **OK** to accept the changes and exit or **Cancel** to exit without saving.



### To Calibrate the Touch Screen:

---

**Note:** *The touch screen is very robust so this will not need to be performed often.*

---

1. Press the console  button.
2. Select **Administrator > Peripherals > Touch Screen**.
3. Select **Calibrate** and follow the touch screen prompts.

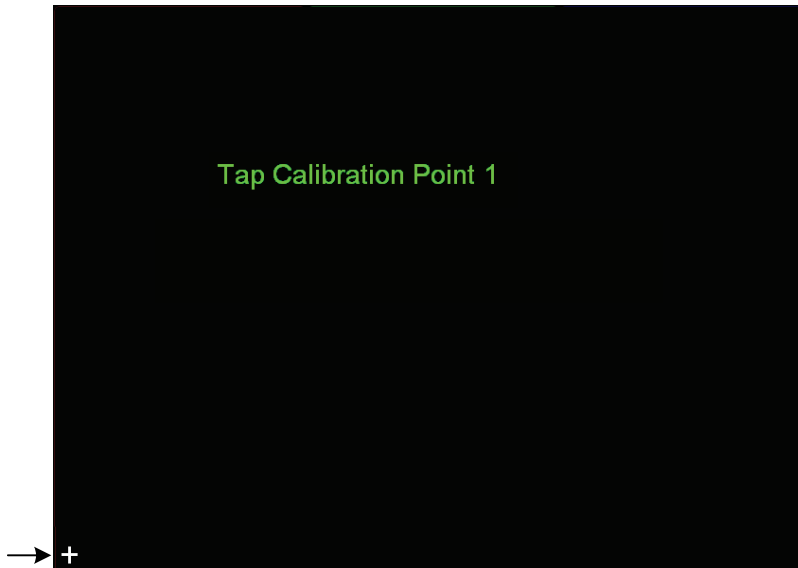

---

**Note:** *Tap the places indicated with a quick, light touch.*

---

4. Once the calibration is complete, select **OK** to exit.



## 8.2.15 Display Settings

*Display Settings* allows users to configure the various LCD display options.

**Figure 8-38: Display Settings**

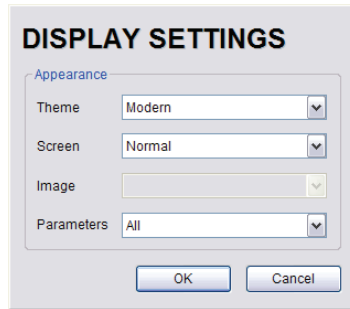

**Table 8-35: Display Settings**

<b>Appearance</b>	<b>Theme</b>	<b>Classic</b> <b>Modern</b>	Configure the basic settings for the LCD display using either <b>Advanced</b> or <b>Classic</b> features.
	<b>Screen</b>	<b>Normal</b> <b>Full</b>	Configure imaging <b>Layout</b> .
	<b>Image</b>	<b>Right</b> <b>Left</b>	Not available on this platform.
	<b>Parameters</b>	<b>All</b> <b>Subset</b>	Configures the system to display <b>All</b> available or a specific <b>Subset</b> of imaging parameters: <b>Subset</b> consists of: <b>MII/TI</b> , <b>FPS</b> , <b>Resolution</b> and <b>Freq</b> (refer to <a href="#">Table E-1</a> for imaging parameter details).  <b>Note:</b> When <b>Subset</b> is selected, a <b>Depth</b> value will be placed under the <b>Depth</b> markers.

### To Configure Display Settings:

1. Press the console  button.
2. Select **Administrator > Display**.
3. Configure **Display Settings** as required.
4. Select **OK** to accept the changes and exit or **Cancel** to exit without saving.

## 8.2.16 Patient Settings

**Patient Settings** allows users to configure options for the **Exam Management** page, the onscreen display of patient data and **EMR Systems**.

The following configuration options are available with the **EMR System EHealthConx**:

- **Operators** must be selected from a predetermined list (see also [3.3.1 Quick Exam Start-Up](#))
- **Worksheets** must be reviewed prior to ending an exam (not relevant to this platform)
- **FTP** transfers are automatically initiated once an exam is ended ([8.2.17 Status Bar](#)).

**Figure 8-39: Patient Settings**

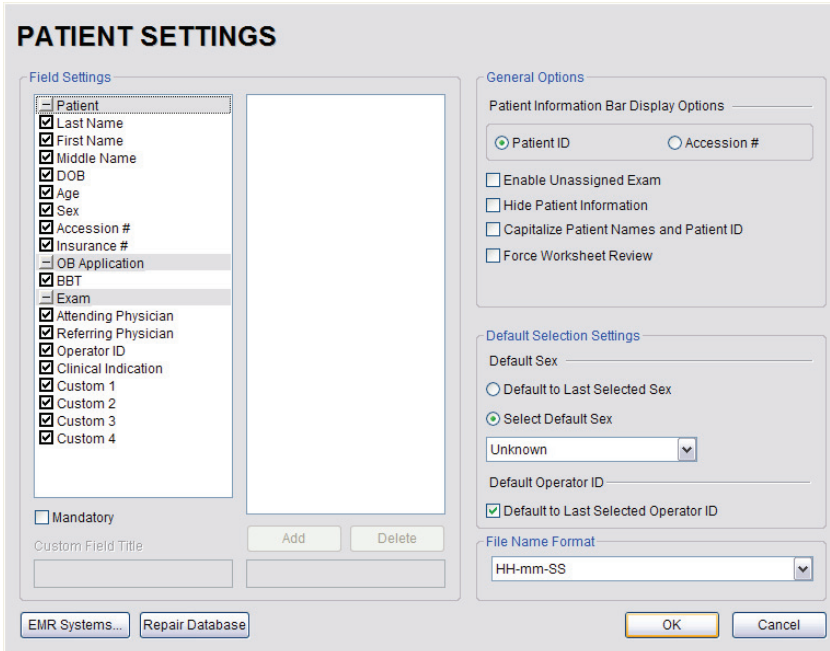

**PATIENT SETTINGS**

**Field Settings**

- Patient
  - Last Name
  - First Name
  - Middle Name
  - DOB
  - Age
  - Sex
  - Accession #
  - Insurance #
- OB Application
  - EBT
  - Exam
    - Attending Physician
    - Referring Physician
    - Operator ID
    - Clinical Indication
    - Custom 1
    - Custom 2
    - Custom 3
    - Custom 4

Mandatory

Custom Field Title

Add Delete

**General Options**

Patient Information Bar Display Options

Patient ID  Accession #

Enable Unassigned Exam

Hide Patient Information

Capitalize Patient Names and Patient ID

Force Worksheet Review

**Default Selection Settings**

Default Sex

Default to Last Selected Sex

Select Default Sex

Unknown

Default Operator ID

Default to Last Selected Operator ID

**File Name Format**

HH-mm-SS

EMR Systems... Repair Database OK Cancel

**Figure 8-40: EMR System Settings and Operators**

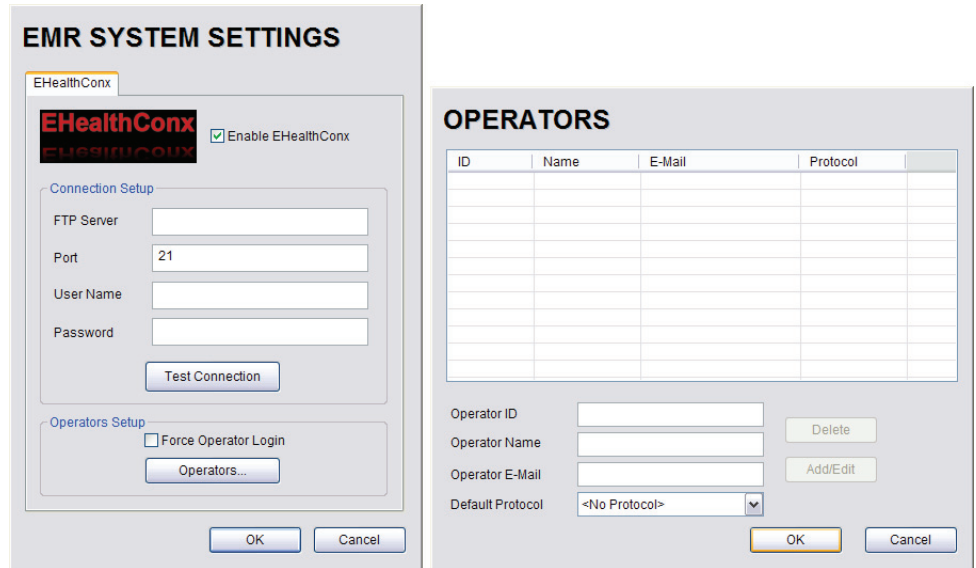

**Table 8-36: Patient Settings**

<b>Field Settings</b>	<p>Select/deselect the <b>Field Setting</b> data entry fields as required. Selected fields will appear on the <b>Exam Management</b> page and, where applicable, in the relevant databases (as described in <a href="#">4.8 Storage/Database Tabs</a>).</p>
	<p><b>Last Name</b>  <b>First Name</b>  <b>Middle Name</b>  <b>DOB</b>  <b>Age</b>  <b>Sex</b>  <b>Accession #</b>  <b>Insurance #</b></p> <p>When selected, these fields will be available under <b>Patient Information (4.1.1)</b>.</p>
	<p><b>BBT</b></p> <p>When selected, <b>BBT</b> will be available under <b>Application Information (4.1.2)</b>.</p> <p><b>Note: BBT is only applicable when the Application is set to OB.</b></p>
<p><b>Note: Users are able to add/edit/delete data in the following fields. Deleting data does not affect existing patients.</b></p> <p>Once deleted, the data can be added again at a later date either here or on the <b>Exam Management page (4.1.3)</b>.</p>	



Field Settings, cont'd	<b>Attending Physician</b> <b>Referring Physician</b> <b>Operator ID</b> <b>Clinical Indication</b>	When selected, these fields will be available under <b>Exam Information (4.1.3)</b> .	
	<b>Custom 1, 2, 3, 4</b>	Use these four (4) user-defined data entry fields to create the desired label in the <b>Field Title</b> text entry box (e.g., Nationality). The customized label appears as one of the data entry fields under <b>Exam Information (4.1.3)</b> .	
	<b>Mandatory</b>	Forces <b>Operators</b> to complete specific Patient data fields.  If an <b>Operator</b> tries to begin an exam using either the <b>Exam Management</b> page or <b>QSonix</b> before all <b>Mandatory</b> fields have been completed, an <b>Input Required</b> message will be presented.	
General Options	<b>General Options</b> control the ability to include/exclude or display/hide certain fields in the Patient Bar on the imaging screen.		
	Patient Information Bar Display Options	<b>Patient ID</b> <b>OR</b> <b>Accession #</b>	The selected option ( <b>Patient ID</b> or <b>Accession #</b> ) will be displayed in the Patient Information Bar along the top of the LCD display during an exam.
	<b>Enable Unassigned Exam</b>		Select/deselect to enable/disable the ability to begin an exam <u>without</u> selecting a patient. Refer to <b>4.5</b> for more details.   <b>Warning:</b> Exams that are assigned to a Patient <u>after</u> images have been saved <b>do not</b> include identifying Patient data (such as <b>Patient ID</b> or <b>Name</b> ).  <i>Organizations that elect to configure/use the <b>Enable Unassigned Exam</b> functionality provided by Ultrasonix are assuming all liabilities and risks associated with that decision.</i>
	<b>Hide Patient Information</b>		Select/deselect to display/hide the Patient Information during an exam.
	<b>Capitalize Patient Names and Patient ID</b>		Select to capitalize all letters in a patient's name or identification number.
<b>Force Worksheet Review</b>		Not relevant to this platform.	



<b>Default Selection Settings</b>	<b>Default Sex</b>	<p>When <b>Default to last selected sex</b> is chosen, opening a fresh <b>Exam Management</b> page will result in the <b>Sex</b> field being populated with the same gender that was selected in the last <b>Exam Management</b> page.</p> <p><b>OR</b></p> <p>When <b>Select default sex</b> is chosen, the user must select a specific <b>Sex</b> from the drop-down menu. The <b>Sex</b> selected will then become the default and be automatically entered in the <b>Sex</b> field of every new patient record that is created. There are four (4) choices available: <b>Female, Male, Other</b> and <b>Unknown</b>.</p>
	<b>Default Operator ID</b>	<p>When <b>Default to last selected Operator ID</b> is chosen, opening a fresh <b>Exam Management</b> page will result in the <b>Operator ID</b> field being populated with the same <b>Operator</b> that was selected in the last <b>Exam Management</b> page.</p> <p><b>Note:</b> <i>This option is especially useful if the same Operator will be using the system for an extended period of time.</i></p>
	<b>File Name Format</b>	
<b>EMR Systems...</b>	Selecting an <b>EMR (Electronic Medical Record) System</b> setting enables that <b>EMR System</b> . It will also enable the configuration/control of <b>Operator IDs</b> .	
	<b>Connection Setup</b>	<p><b>Enable EHealthConx</b> Select/deselect to enable/disable <b>EHealthConx</b>.</p> <p><b>FTP Server Port User Name Password</b> Enter the relevant data as provided by <b>EHealthConx</b>.</p> <p><b>Note:</b> <i>If desired, the FTP (File Transfer Protocol) transfer status icon can be configured to appear on the LCD display during file transfer (8.2.17 Status Bar).</i></p> <p><b>Test Connection</b> After entering the <b>Connection Setup</b> data, select this button to test the <b>FTP</b> connection.</p>
	<b>EHealthConx</b>	<p><b>Note:</b> <i>Operator IDs entered here are specific to EHealthConx, but they will also:</i></p> <ul style="list-style-type: none"> <li>• be used in <b>Quick Exam Start-up (3.3.1)</b> if <b>Force Operator Login</b> was enabled</li> <li>• form part of the list of <b>Operator IDs</b> available from <b>Exam Information (4.1.3)</b>.</li> </ul>
	<b>Operators Setup</b>	<p>Select to force <b>Operators</b> to log in when using <b>QSonix</b>.</p> <p><b>Force Operator Login</b> <b>Note:</b> <i>The Operator ID must have already been entered here using the Operators... option (i.e., they cannot be added during the QSonix process).</i></p>
	<b>Operators...</b>	<p><b>Operator ID</b> Enter the relevant data in each field.</p> <p><b>Operator Name</b> <b>Note:</b> <i>The Operator E-Mail address must be valid as it is used by EHealthConx to identify the Operator involved in each specific exam.</i></p> <p><b>Operator E-Mail</b></p> <p><b>Default Protocol</b></p>



<b>Repair Database</b>	Performs basic database file compression which can improve system performance.
	<b>Caution:</b> <i>This operation is best performed by or under the supervision of a Service Representative.</i>

**To Access the Patient Settings Dialog:**

1. Press the console  button.
2. Select **Administrator > Patient**.

**To Configure Patient Settings:**

1. Press the console  button.
2. Select **Administrator > Patient**.
3. Configure **Patient Settings** as required.
4. Select **OK** to accept the changes and exit or **Cancel** to exit without saving.

**To Create Mandatory Settings:**

1. Press the console  button.
2. Select **Administrator > Patient**.
3. Select the desired **Field Setting** (e.g., **Last Name**).
4. Select the **Mandatory** checkbox.
5. Repeat **step 3** and **step 4** as required.
6. Select **OK** to accept the changes and exit or **Cancel** to exit without saving.

### 8.2.16.1 EMR Settings

#### To Configure EMR System Settings:

1. Press the console  button.
2. Select **Administrator > Patient > EMR Systems,,,.**
3. Select **Enable EHealthConx** and configure the **Connection Setup** options as required.

---

**Note:** *Ultrasonix recommends that **Connection Setup** options be configured using the settings provided by your IT Department.*

---

4. Select **Operators....**
5. Enter the required data in each field and select the **Add/Edit** button.
6. Repeat [step 5](#) as many times as required.
7. Select **OK** to accept the changes and exit or **Cancel** to exit without saving.

## 8.2.17 Status Bar

When **Status** indicators are enabled, the system will present the relevant icons at the bottom right of the LCD display. Read the definitions carefully as not all icons will always be visible—even if the relevant option has been activated.

By default, all **Status Bar** options are unselected.

Figure 8-41: Status Bar

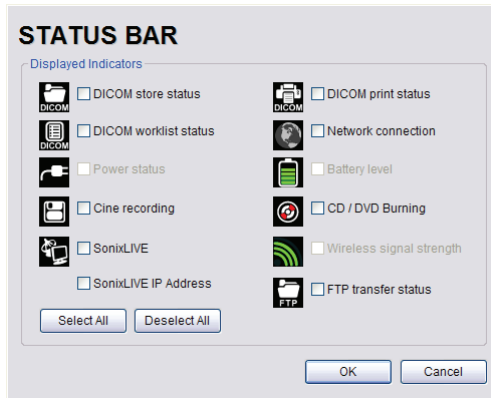





Table 8-37: Status Bar – Displayed Indicators

<p><b>DICOM Store status</b></p>  <p>Active    Success    Failure</p>	<p>Indicates the system is connected to a <b>DICOM Storage</b> server. This icon will be visible for only a short period of time. When a user accesses the <b>DICOM Storage</b> server, the icon will be presented while the operation is underway.</p> <p><b>Note:</b> A <b>Network connection</b> must exist in order to have access to a <b>DICOM network</b>.</p>
<p><b>DICOM Print status</b></p>  <p>Active    Success    Failure</p>	<p>Indicates the system is connected to a <b>DICOM Print</b> device. This icon will be visible for only a short period of time. When the <b>DICOM Print</b> device is in use, the icon will be presented while the job is printing.</p> <p><b>Note:</b> A <b>Network connection</b> must exist in order to have access to a <b>DICOM network</b>.</p>
<p><b>DICOM Worklist status</b></p>  <p>Success    Failure</p>	<p>Indicates the system is connected to a <b>DICOM Worklist</b> server. This icon will be visible only when the <b>DICOM Worklist</b> server is being accessed.</p> <p><b>Note:</b> A <b>Network connection</b> must exist in order to have access to a <b>DICOM network</b>.</p>



---

**Network connection**



Connected    Not Connected

Indicates whether or not a hard-wired network connection is available.

---

**Power status**



Wall Plug    Battery

Specifies the power source in use: **Wall Plug** (AC power) or **Battery** (UPS).

**Note:** If **Battery** power is available, the icon displayed will be the appropriate **Battery level** icon.

*Ultrasonix recommends selecting this option so users will always be aware of the power source in use.*

---

**Battery level**



Displays the approximate amount of **Battery** power remaining.

**Note:** Over time, the level will rise when the system is connected to an AC power source or fall when it is running solely off the UPS battery.

---

**Cine recording**



When **Cine Recording** is underway, this icon will be visible during the recording process.

---

**CD/DVD Burning**



Indicates that a CD or DVD is being burned.

**Note:** The system does not have a built-in CD/DVD player/burner. Refer to System Specifications for details on the recommended USB CD/DVD player/burner.

---

**Wireless signal strength**



Denotes the strength of the wireless signal (%).

**Note:** If a wireless network is not available and active, the relevant icon will not be presented—even if this option is enabled.

---

**SonixLive**



Connected    Not Connected

When SonixLive is activated, the **Connected** icon will be visible on the LCD Display.

---

**SonixLive IP Address**



When **Streaming Video** is underway, selecting the icon will display the **IP Address** at which remote users can view the video.

**Note:** If the relevant staff has been informed of a fixed IP Address, activating this option is unnecessary.

*If a **dynamic IP Address** is used, enable this option to access the address from the LCD display during **Streaming Video**.*

*Alternatively, to maintain data privacy, do not enable this option and direct staff to view the current **Local IP Address** (fixed or dynamic) via **Menu > Administrator > Network** dialog.*



<b>FTP transfer status</b>	If an <b>EMR System</b> is configured, this icon will be visible when the <b>FTP</b> connection is live (refer to <b>EMR Systems...</b> in <b>Table 8-36</b> for more detail).
  Connected    Not Connected	<b>Note:</b> Once an <b>FTP</b> connection is configured under <b>EMR Systems...</b> ( <b>Table 8-36</b> ), ensure the <b>FTP transfer status</b> option is selected.
<b>Select All</b>	Enables the selection of all options in one step.
<b>Deselect All</b>	Enables the deselection of all options in one step.

**To Access Status Bar Indicators:**

1. Press the console  button.
2. Select **Administrator > Status Bar**.

**To Configure Status Bar Indicators:**

1. Press the console  button.
2. Select **Administrator > Status Bar**.
3. Select/deselect **Displayed Indicators** as required.
4. Select **OK** to accept the changes and exit or **Cancel** to exit without saving.

## 8.2.18 Capture Settings

The **Capture Settings** dialog allows the user to select between **Image** and **Full Screen** for image storage and to configure the loop storage record time.

Figure 8-42: Capture Settings

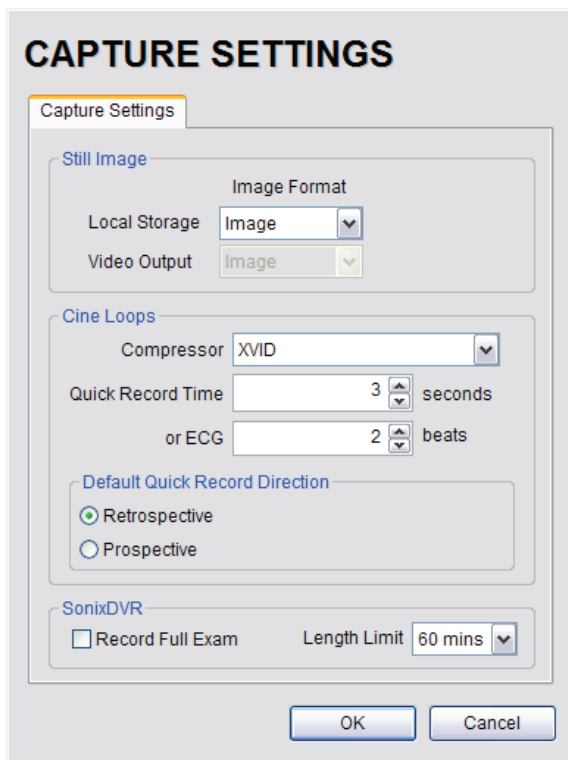

Table 8-38: Capture Settings

<b>Still Image</b>	<b>Local Storage</b>	Select between <b>Full Screen</b> and <b>Image</b> for still image storage. <b>Note:</b> <i>Image</i> includes image field, imaging parameters and patient data bar. <i>Thumbnail</i> images are not included. <i>Full screen</i> includes the entire display, including thumbnails.
	<b>Video Output</b>	Not available in this release.



Cine Loops	<b>Compressor</b>		Select the AVI movie <b>Compressor</b> type. <b>XVID</b> is the default. <b>Caution:</b> This setting should not be changed without a thorough understanding of <b>Compressor types</b> .
	<b>Quick Record Time</b>		Select the <b>Quick Record Time</b> (1 to 30 seconds) for post recording (retrospective acquisition). Refer to <b>8.2.13 Custom Keys</b> to configure the console <b>1, 2</b> or  button for <b>Quick Record</b> . <b>Quick Record</b> is only available for <b>2D</b> or <b>2D/Color</b> imaging. <b>Note:</b> Selecting a longer record time may slow down system performance.
	<b>or ECG (number of (heart) beats)</b>		<b>Cine</b> capture length during an <b>ECG</b> is based on the number heart beats selected here. Refer to <b>8.2.13 Custom Keys</b> to configure the console <b>1, 2</b> or  button. The default setting is <b>2 beats</b> . <b>Note:</b> <b>ECG</b> is not available on this platform.
Cine Loops	Default Quick Record Direction	<b>Retrospective</b>	Select to record history, i.e., the previous <b>X</b> seconds, where <b>X</b> is the number of seconds selected in <b>Quick Record Time</b> .
		<b>Prospective</b>	Select to record the next <b>X</b> seconds, where <b>X</b> is the number of seconds selected in <b>Quick Record Time</b> .
SonixDVR	<b>Note:</b> Refer to <b>5.9 SonixDVR Recording</b> for more details on <b>SonixDVR</b> .		
	<b>Record Full Exam</b>		Select to record every exam from start to finish.
	<b>Length Limit</b>		If <b>Record Full Exam</b> is selected, set the maximum record time for each exam: <b>5, 10, 20, 30, 40, 50</b> or <b>60 minutes</b> . Once the <b>Length Limit</b> is reached, the exam will automatically stop recording and create an MPG file saved to the current Patient/Exam. <b>Note:</b> If the <b>Length Limit</b> is reached before the exam is finished, the recording will end (after being saved to the <b>Patient/Exam</b> ). If additional recording is required, start a <b>MPG</b> using the <b>Custom Key (8.2.13)</b> configured for <b>SonixDVR</b> .

**To Configure Capture Settings:**

1. Press the console button.
2. Select **Administrator > Capture**.
3. Configure **Capture Settings** as required.
4. Select **OK** to accept the changes and exit or **Cancel** to exit without saving.

## 8.2.19 Imaging Modes

The *Imaging Modes* dialog allows the configuration of a variety of *Imaging Mode* options.

Figure 8-43: Imaging Modes and Color Settings

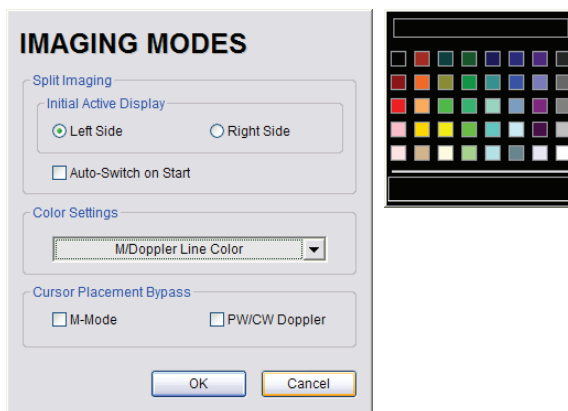





Table 8-39: Imaging Modes

Split Imaging	Initial Active Display	<b>Left Side</b>	When scanning in <b>B-Mode</b> , selecting <b>Left Side</b> will ensure the left image is the active image when the console <b>Dual/Quad</b> button is pressed. <b>Left Side</b> is the default setting.
	Initial Active Display	<b>Right Side</b>	When scanning in <b>B-Mode</b> , selecting <b>Right Side</b> will ensure the right image is the active image when the console <b>Dual/Quad</b> button is pressed.
	Auto-Switch on Start		Selecting this option will ensure that the selected side is active after the console <b>Dual/Quad</b> button is pressed, but then that image will immediately freeze and the active image will move to the opposite side. For example, if <b>Left Side</b> is set as <b>Initial Active Display</b> and <b>Auto-Switch on Start</b> is selected, after pressing the console <b>Dual/Quad</b> button, the <b>Left Side</b> image will be presented as active, then immediately freeze and active imaging will move to the <b>Right Side</b> .
Color Settings		<b>M/Doppler Color Line</b>	Select/edit the <b>M-Mode</b> line color.



<b>Cursor Placement Bypass</b>	<b>M-Mode</b>	<p><b>M-Mode</b> automatically displays the split-screen <b>2D/M-Mode Sweep</b> immediately after <b>M-Mode</b> is activated.</p> <p>Deselecting <b>M-Mode</b> displays a full screen <b>2D</b> image with an <b>M-Mode</b> cursor line immediately after <b>M-Mode</b> is activated.</p> <p> activates the <b>M-Mode Sweep</b>.</p>
	<b>PW/CW Doppler</b>	<p><b>PW/CW Doppler</b> automatically displays the split-screen <b>2D/Doppler Trace</b> immediately after <b>Doppler</b> is activated.</p> <p>Deselecting <b>PW/CW Doppler</b> displays a full screen <b>2D</b> image with the <b>Doppler SV (Sample Volume)</b> cursor immediately after <b>Doppler</b> is activated.</p> <p> activates the <b>Doppler Trace</b>.</p>

**To Configure Imaging Modes:**

1. Press the console  button.
2. Select **Administrator > Imaging Modes**.
3. Configure settings as required.
4. Select **OK** to accept the changes and exit or **Cancel** to exit without saving.
5. If **OK** is selected in **step 4**, a message will be presented.
6. Select **OK** to continue.

## 8.2.20 Documentation Settings

This option enables users to **Add/Delete** user documentation for viewing on the system.

---

**Note:** All documents must be in PDF format.

---

Refer to [3.3.3](#) for details on accessing the PDFs.

**Figure 8-44: Documentation Settings**

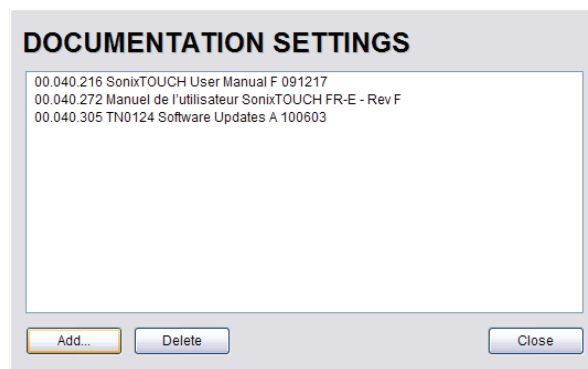



---

**Note:** To view documentation (in PDF format only) on the system, refer to [3.3.3 Documentation Access](#).

---

### To Add a (PDF) Document:

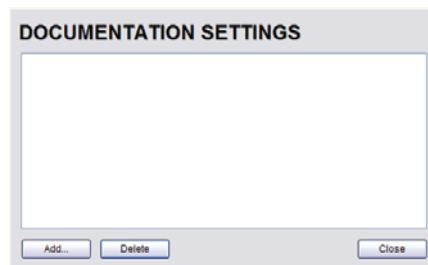
1. Press the console  button.
2. Select **Administrator > Documentation**.



3. Ensure the appropriate media containing the relevant **User Manual** PDF(s) is connected to the system (e.g., a USB key).
4. Select the **Add...** button.

5. Select the **Documentation Location** from the drop-down menu.

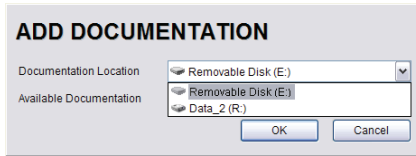

6. Select the relevant PDF from the **Available Documentation** drop-down menu.

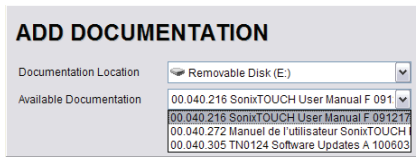

7. Select **OK** and the system will copy the PDF to the system.

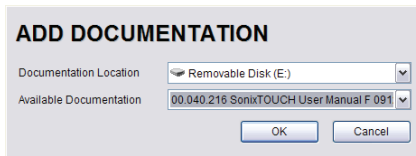



---

**Note:** This may take a few moments, depending on the size of the PDF.

---

8. Repeat [step 4](#) to [step 7](#) as many time as required.

#### To Delete a (PDF) Document:

1. Press the console  button.
2. Select **Administrator > Documentation**.
3. Highlight the PDF to be deleted.

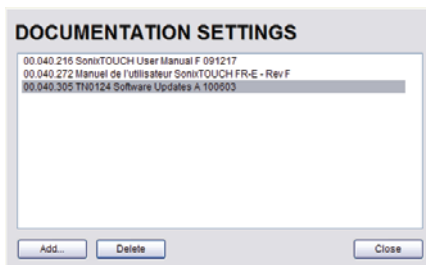

4. Select **Delete**.



## 8.2.21 Software Update

This option allows users to install software updates via the Internet or with a USB key.

---

**Note:** Access to **Software Update** is available only with a valid warranty license.

---

**Figure 8-45: Software Updates**

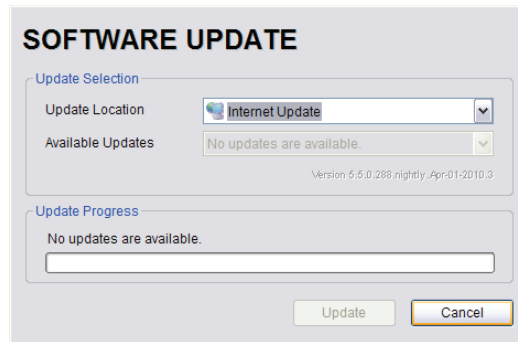

**Table 8-40: Software Updates**

<b>Update Selection</b>	<b>Update Location</b>	<b>Internet Update</b>	If the system is connected to the Internet, an automatic search for available software updates occurs. If successful, the <b>Available Updates</b> drop-down menu auto-populates with the software revisions available for download. The most recent revision is automatically selected but older software revisions may also be available.
		<b>DVD-RAM Drive (E:)</b>	If the update is located on a CD or DVD, it can be accessed via a USB <b>DVD-RAM Drive</b> which can be selected from the <b>Available Updates</b> drop-down menu. <b>Note:</b> <i>SonixTouch, SonixMDP/SP/OP and SonixTablet do not have a built-in CD/DVD player/burner. Refer to System Specifications for details on the recommended USB CD/DVD player/burner.</i>
		<b>Removable Disk</b>	If a removable disk (e.g., USB key or thumb drive) containing the update has been inserted in a USB port on the Front or Back Connectivity Panel, it will be available for selection from the <b>Available Updates</b> drop-down menu.
	<b>Available Updates</b>	Select to choose the appropriate update. Options in this drop-down menu are limited by the selection made in the <b>Update Location</b> drop-down menu.	
<b>Update Progress</b>		Lets the user know when the update is complete or <b>Ready</b> .	



**To Perform a Software Update:**

1. Press the console  button.
2. Select **Administrator > Software Updates**.
3. Select an **Update Location** from the drop-down menu.

---

**Note:** In order to be available in the **Update Location** drop-down menu, the USB key must be inserted prior to selecting the **Software Update** option from the **Administrator Settings** menu.

---

4. Select **Update** to begin the update process or **Cancel** to exit without updating.

---

**Note:** The **Update Progress** bar displays the download progress. Upon completion, the **Software Update** will be auto-installed and the system will restart automatically.

---

## 8.2.22 Licensing

**Licensing** displays the **Options** available on the Sonix system. **Status** and **Expiry** dates (when applicable) of enabled features are also displayed.

Ultrasonix recommends including the *license.key* file in a regular backup, using the **Export** option under **8.2.10 System Settings**.

**Figure 8-46: Licensing**

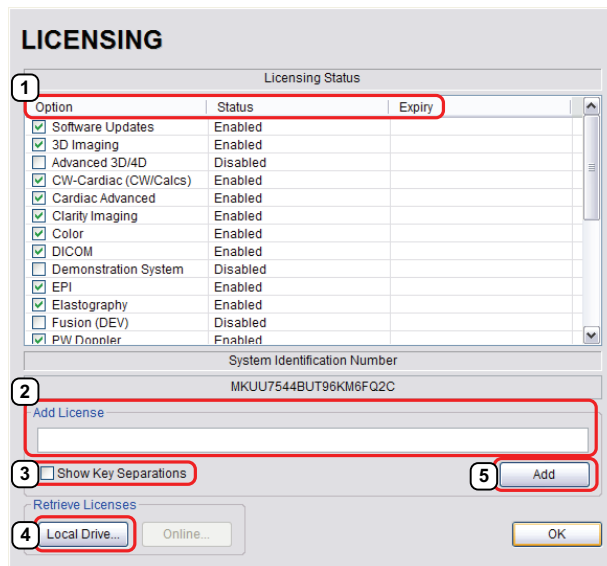

**Note:** *Options that are not licensed at the time of purchase will not be visible in the Licensing dialog. To Enable a new Option, call your local dealer or Ultrasonix Technical Support.*



Table 8-41: Licensing Status

	<b>Enabled</b>	<b>License</b> is <b>Enabled</b> and has more than 30 days remaining.
	<b>Enabled</b> <b>(with Expiry Date)</b>	<b>License</b> is <b>Enabled</b> and will expire in less than 30 days. <b>Note: The exact numbers of days remaining will be listed, e.g., Expires in 27 days.</b>
1	<b>Expired</b>	<b>License</b> was <b>Enabled</b> but is now <b>Expired</b> . <b>Note: To restore an Expired license, call your local dealer or Ultrasonix Technical Support.</b>
	<b>Disabled</b>	<b>Operator</b> has deselected a licensed <b>Option</b> . <b>Note: To Enable the Option, check it then select OK to save and exit.</b>
2	<b>Add License</b> Text Box	When <i>license.key</i> is received in an electronic format that lends itself to the standard copy and paste method, do not select <b>Show Key Separations</b> . Simply copy and paste <i>license.key</i> into <b>Add License</b> .
3	<b>Show Key Separations</b> Checkbox	When entering <i>license.key</i> manually, select <b>Show Key Separations</b> checkbox to enable block-by-block key entry.
4	<b>Local Drive...</b> Button	If <i>license.key</i> is available on the local hard drive, select <b>Local Drive...</b> and choose the appropriate file (*.key) to import/enable the new license.
5	<b>Add License</b> Button	Select to add the license.

**To Access the Licensing Dialog:**

1. Press the console  button.
2. Select **Administrator > Licensing**.

### To Enter a New Licensing Key:

1. Press the console  button.
2. Select **Administrator > Licensing**.
3. Enter the new license key in the **Add License** text box.
4. Select **Add** to add the new license key.
5. Check to ensure the new license has been added then select **Close** to exit the **Licensing** dialog.

### To Re-Import License.key:

---

**Note:** This process presumes the license.key file is stored on a USB device.

---

1. Insert the USB device with license.key file into one of the system's USB drives.
2. Press the console  button.
3. Select **Administrator > Licensing**.
4. Select **Local Drive**.
5. Under the **Look in** drop-down menu, select the relevant drive/device and locate *license.key*.

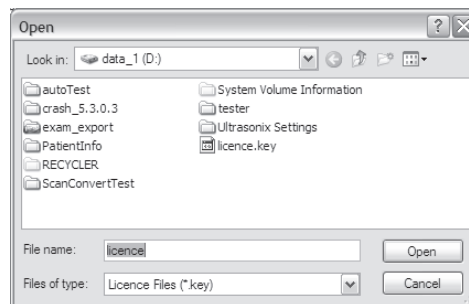

6. Select **Open** to re-import *license.key*.

---

**Note:** If there are any problems, clear all menus, return to the **Licensing** dialog and contact **Ultrasonix Technical Support** for assistance.

---



**ULTRASONIX**

### **8.3 SERVICE MENU**

Access to **Service** is password protected and restricted to certified, Ultronix Service representatives.

## CHAPTER 9: IMAGE STORAGE, REVIEW, TRANSFER AND PRINT

---

The SonixSP includes a (local) patient/exam management system with image storage, review, transfer and print which can be accessed from:

- the **Exam Management** page via the **Review** button. This allows the **Operator** to select one or multiple patients and their associated exam(s)
- a **Custom Key**, providing that **Custom Key** was configured to access the **Exam Review** page (8.2.13)
- the console  button on the main touch screen, which offers access only to the current Patient and their associated exam(s).

### 9.1 IMAGE STORAGE

Each time a new patient is entered into the system, a local file is created for that patient. All saved images and **Cine** clips are stored in the patient file and organized by exam date and type. This image/**Cine** data may be retrieved at any time and transferred to a printer, **DICOM** archive, etc.

Hard drive capacity for patient data storage is at least 160 gigabytes. Depending on the number/type of images involved, the system can store more than 50,000 exams.

---

**Note:** *Ultrasonix recommends regular patient/image file back-up and purging of older patient files stored on the system.*

---





**Figure 9-2: Sample Exam Review Page (Methods 1 and 2)**

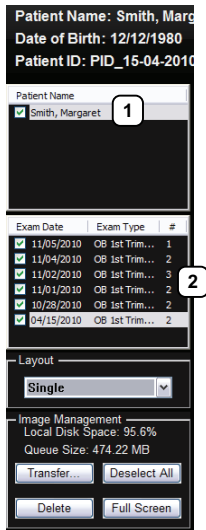

---

**Note:** For methods 1 and 2, images for the current exam will be presented first, but all exams for the current Patient will be available for review.

---

**Table 9-1: Sample Exam Review Page (Methods 1 and 2)**

- 
- |   |   |
|---|---|
| 1 | Current Patient.                        |
| 2 | Multiple exams for the current Patient. |
- 

**To Access the Exam Review Page (Method 1 – Current Patient):**

1. During an exam, press the console **1**, **2** or  button (whichever was configured to access **Exam Review**) to view the images for the current exam.

---

**Note:** Refer to [8.2.13](#) for details on configuring a **Custom Key** to access **Exam Review**.

---

**To Access the Exam Review Page (Method 2 – Current Patient):**

1. During a patient exam, press the console  button.
2. On the **Exam Management** page, select **Review** to view the current exam images.



Figure 9-3: Sample Exam Review Page (Method 3 – with Multiple Patients)

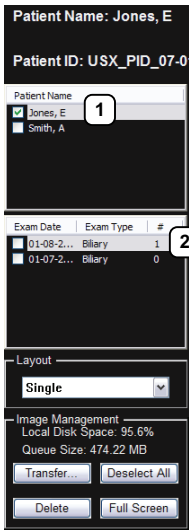

Table 9-2: Sample Exam Review Page (Method 3 – with Multiple Patients)

1	First Patient.
2	Multiple exams for the first Patient.

To Access the Exam Review Page (Method 3 – with Multiple Patients) :

1. During a patient exam, press the console button.
2. Select the **Patient** tab.
3. Select the desired Patient(s) from the **Patient** database.  
**Note:** To select multiple Patients at the same time use the trackball and button in conjunction with the **SHIFT** or **CTRL** keyboard buttons to highlight the relevant Patients.
4. Select **Review** and the **Image Review** page will be presented with the exam files for the selected Patient(s).

Figure 9-4: Exam Review Page



Table 9-3: Exam Review Page

1	Patient data for currently displayed image file.
2	Check Patient and Exam file(s) for image transfer or deletion.
3	
4	Check to select individual images for image transfer or deletion.
5	White arrow indicates more images. The trackball arrow cursor triggers scrolling of thumbnails both to the right and left.



Table 9-4: Exam Review Page

<b>Patient Name</b>	<b>Patient(s)</b> selected from the <b>Exam Management</b> page.
<b>Exam Date/Exam Type</b>	Displays the exam files/images for the <b>Patient</b> selected (above). The number of images and <b>Cine</b> clips stored appears in the far right column of this section.  By default, if only one patient file is listed under <b>Patient Name</b> , the system will display the images from that patient's most recent exam.  If multiple <b>Patients Names</b> are listed, select each of the patients individually to access a list the exam dates for that patient.
<b>Layout</b>	Sets up the image display area: <b>Single, 2x2, 3x3, 4x4, 5x5, 6x6.</b>  <b>Note:</b> The default <b>Layout</b> is <b>Single</b> . However, if the default <b>Layout</b> is changed (e.g., to <b>2x2</b> ), the next time <b>Exam Review</b> is entered the system will default to the last <b>Layout</b> selection (in this example, <b>2x2</b> ).

<b>Image Management</b>	<b>Local Disk Space: %</b>	Lists the amount of available space on the system (where % equals the amount of free space available).
	<b>Queue Size: x Kb</b>	Lists the size of selected items (where x equals the total number of kilobytes in the queue).
	<b>Transfer...</b>	<b>Transfers</b> items to the selected destination.
	<b>Deselect All</b>	<b>Deselects All</b> selected patients/exams.
	<b>Delete</b>	<b>Deletes</b> the selected items from the system hard drive.
	<b>Full Screen</b>	Displays the selected image on a <b>Full Screen</b> .  <b>Note:</b> Press the console  button to exit <b>Full Screen</b> and return to the <b>Exam Review</b> page.

**Note:** Stored **Cine** clips are identified by a small movie symbol on the lower right of the image thumbnail. Once selected, the movie will replay in the **Review** window.



Stored **MPG** files (**SonixVCR Recordings**) are identified by a small **REC** symbol on the lower left of the image thumbnail. Once selected, the **MPG** will replay on the **Review** page.



Raw **Cine loops** (5.10.4) are labelled with the icon **RAW**.



**RAW**

The image thumbnails on the bottom of the screen represent all the available images for the exam under review. To scroll through the thumbnails, use the trackball to move the cursor over to the right or left side of the thumbnails.

**Table 9-5: Exam Review Touch Screen Controls (tap to activate)**

<b>Select All</b>	Tap to <b>Select All</b> patients/patient files/images for image transfer or deletion.
<b>Deselect All</b>	Tap to <b>Deselect All</b> patients/patient files/images marked for image transfer or deletion.
<b>Add Patient</b>	Tap to add the next patient to the queue (selected via checkboxes).
<b>Add Exam</b>	Tap to add the next exam to the queue (selected via checkboxes).
<b>Add Image</b>	Tap to add the next image to the queue (selected via checkboxes).
<b>Transfer...</b>	Tap to initiate image transfer and display the <b>Select Storage Destination</b> page.
<b>Delete...</b>	Tap to <b>Delete</b> the patient(s), patient exam file(s) and/or image(s) selected via checkboxes.
<b>Exit</b>	Tap to <b>Exit</b> the <b>Exam Review</b> page.

**Table 9-6: Exam Review Touch Screen Controls (tap to activate, dial to adjust)**

<b>Image</b>	Tap <b>Image</b> then use the associated touch screen dial to select the image(s) displayed. Dial right to select the next image available. Dial left to select the previous image.
<b>Thumbnail</b>	Tap <b>Thumbnail</b> then use the associated touch screen dial to move through the thumbnail images. Dial right to select the next thumbnail. Dial left to select the previous thumbnail.
<b>Layout</b>	Tap <b>Layout</b> then use the associated touch screen dial to change the display <b>Layout</b> : ( <b>Single</b> , <b>2x2</b> , <b>3x3</b> , etc.).
<b>Exam</b>	Tap <b>Exam</b> then use the associated touch screen dial to page through the list of available exams. Press  to select the highlighted exam file.
<b>Patient</b>	Tap <b>Patient</b> then use the associated touch screen dial to page through the list of available patients. Press  to select highlighted patient.

**Table 9-7: Cine Review Touch Screen Controls (tap to activate, dial to adjust)**

<b>FrmByFrm</b>	Use to select currently displayed frame, one (1) frame at a time.
<b>Speed</b>	Use to select <b>Cine</b> review play speed: 1/8, 1/4, 1/2, Full (1/1) or Double (2/2).

**Figure 9-5: Image Selection/Deselection**

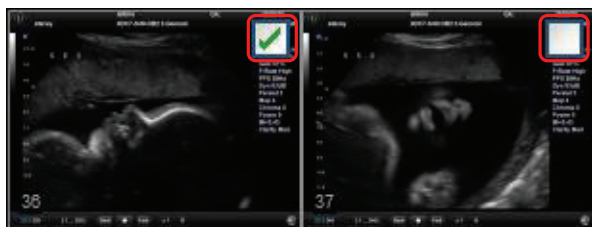



## 9.2.1 Deleting Image(s)/Exam(s)

### To Delete Individual Images:

1. Select the desired patient and exam date to display the images.
2. To select the desired image(s), use the trackball and  button to place a mark in the associated checkbox(es) (as shown in [Figure 9-5](#)).
3. Tap the touch screen **Delete...** button or select **Delete** from the menu on the LCD display.

---

**Note:** Select **Deselect All** to reset the screen and deselect the patient(s), exam(s) and image(s).

---

### To Delete a Complete Exam:

1. Select the desired **Patient** and **Exam Date**.



2. Tap the touch screen **Delete...** button or select **Delete** from the menu on the LCD display.

---

**Note:** Select **Deselect All** to reset the screen and deselect the patient(s), exam(s) and image(s).

---

### 9.3 IMAGE TRANSFER

The image management system enables users to transfer stored images and **Cine** clips to a storage medium: **DICOM** archive or **Printer** or USB medium, etc.

Files saved to a USB storage device (e.g., **[E:] (Removable Device)**) during data transfer will be printed to a PDF in the relevant **Patient** directory under **Patientinfo**.

---

**Notes:**

*To select an entire exam, select the checkbox for the desired exam.*

*To select all exams for a patient, select the checkbox for the desired patient.*

*To select only the desired image(s) open each exam and select the individual checkbox(es) for the desired image(s).*

---

**Figure 9-6: Storage Destination Dialog**



**STORAGE DESTINATION**

DICOM Print Server(s)  
DICOM Storage Server(s)

**Storage Options**

Include Meta-Data       Hide Patient ID

Folder Name: UltrasonixExam

Image Format: PNG

DICOMDIR Profile:

**Transfer Progress**

Save Settings      Send      Close



**Table 9-8: Storage Destination Options**

<b>Storage Destination</b>		<p>All available storage options will be listed here, including all printers currently attached to the system, either locally or via the network: <b>DICOM</b> archive or <b>Printer</b> or USB medium.</p> <p><b>Note:</b> A removable USB device must be connected to the system in order to have it appear in the list of <b>Storage Destinations</b>.</p>	
<b>Storage Options</b>	<b>Include All Patient Data</b>	Creates a backup of images, reports (PDFs) and <b>Cine</b> files (database and measurement data are not included). If multiple patients are selected with this option, all images will generally be exported in one (1) file.	
	<b>Hide Patient ID</b>	Removes Patient information ( <b>Patient Name</b> and <b>ID</b> ) from the image, rendering the data anonymous.	
	<b>Folder Name</b>	<p>Images written to a removable USB device will be written into the <b>Folder Name</b> entered here. The default is <b>UltrasonixExam</b>.</p> <p><b>Note:</b> This field is only available if the selected <b>Storage Destination</b> will create a digital copy of the file e.g., a removable USB device.</p>	
	<b>Image Format</b>		<p>Enables the selection of five (5) different image formats.</p> <p><b>Note:</b> Selecting anything other than the default (<b>PNG</b>) will extend the image transfer time as <b>PNG</b> images will have to be converted to the new format. <b>Bitmap</b> and <b>DICOM</b> images in particular will take significantly more time to transfer.</p>
		<b>PNG</b>	<p><b>Portable Network Graphics</b> image format. This is the default selection.</p> <p>The average <b>PNG</b> image size is 100Kb.</p>
		<b>JPEG</b>	<b>Joint Photographic Experts Group</b> image format.
		<b>Bitmap (BMP)</b>	<p>Converting the image to a <b>Bitmap (BMP)</b> increases the image size as follows:</p> <ul style="list-style-type: none"> <li>800 x 600 <b>Bitmap</b> image = approximately 2Mb</li> <li>1024 x 768 <b>Bitmap</b> image = approximately 3Mb.</li> </ul>
		<b>GIF</b>	<b>Graphics Interchange File or Format</b> image.
		<b>DICOM</b>	<b>DICOM</b> image format.
		<b>DICOMDIR</b>	<p><b>DICOMDIR</b> image format.</p> <p><b>Note:</b> <b>DICOMDIR</b> enables users to copy images to an alternate media if—for whatever reason—it is not possible to transfer the images directly to the <b>DICOM</b> server. They can then be copied to the <b>DICOM</b> server at a later date.</p>
<b>DICOMDIR Profile</b>	Select the appropriate <b>DICOMDIR Profile</b> ( <b>DICOMDIR Profiles</b> are defined in the <b>DICOM Standard</b> .)		
<b>Transfer Progress</b>		<p>Displays the file transfer progress.</p> <p><b>Note:</b> If multiple <b>DICOM Storage</b> or <b>Print Servers</b> have been configured (8.2.12.1 and 8.2.12.2) and <b>DICOM Storage Server(s)</b> or <b>DICOM Print Server(s)</b> is selected as the transfer medium, after selecting <b>Send</b> the <b>Operator</b> will be able to select the specific <b>Server</b> (or set of <b>Servers</b>) to which the data will be transferred.</p>	
<b>Save Settings</b>		Select to save the transfer settings as the default for future use.	
<b>Send</b>		Select to complete the image transfer.	
<b>Close</b>		Select to clear the dialog and exit without transferring the images.	



**To Transfer Patient Exams:**

1. Select the desired **Patient(s)**, **Exam Date** and/or images.

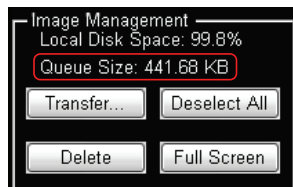

---

**Note:** The amount of space required is listed under **Image Management** as **Queue Size**.

Select **Deselect All** to reset the screen and deselect the patient(s), exam(s) and image(s).

---

2. Select **Transfer....**
3. Select the desired **Storage Destination**.



---

**Note:** All connected Ultrasonix-approved digital storage peripherals will appear in the list of **Storage Destinations**.

If a **DICOM Storage** or **Print Server** is connected, it will also be available for selection.

Files saved to a USB storage device (e.g., [E:] (**Removable Device**)) during data transfer will be printed to a PDF in the relevant **Patient** directory under **Patientinfo**.

---

4. If required, select **Include All Patient Data** and/or **Hide Patient ID**.
5. If required, change the default **Folder Name** (**UltrasonixExam**) using the console keyboard.

---

**Note:** This field is only available if the selected **Storage Destination** will create a digital copy of the file (e.g., a removable USB device).

---



6. Select the desired **Image Format (Default (PNG), JPEG, Bitmap (BMP) or GIF)**.

---

**Note:** *Selecting anything other than the default (PNG) will extend the image transfer time as PNG images will have to be converted to the new format. Bitmap and DICOM images in particular will take significantly more time to transfer.*

---

7. If desired, select **Save Settings** to save the current transfer settings as the default.
8. Select **Send** to transfer the files and/or images or **Close** to exit without transferring.

---

**Notes:**

*If multiple DICOM Storage or Print Servers have been configured (8.2.12.1 and 8.2.12.2) and DICOM Storage Server(s) or DICOM Print Server(s) is selected as the transfer medium, after selecting Send the Operator will be able to select the specific Server (or set of Servers) to which the data will be transferred.*

*The original files will remain unchanged on the local hard drive.*

*The Update Progress bar displays the transfer progress.*

---

## CHAPTER 10: CONNECTIVITY, PERIPHERALS AND SOFTWARE

The system includes a wide range of connectivity features that allow the user to simultaneously connect a variety of peripherals. Refer to [8.2.14 Peripherals](#) and the *SonixSP Service Manual* for further details on peripheral connectivity.



**Warning:** Do not touch the patient and the transducer ports simultaneously.

### 10.1 BACK CONNECTIVITY PANEL

The Back Connectivity Panel can be accessed from the rear of the system. The connectors are routed internally to the System Case Connectivity Panel which enables easy configuration.

**Figure 10-1: SonixMDP/SP/OP Back Connectivity Panel (A)**

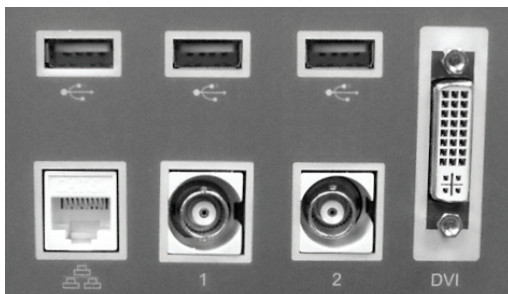

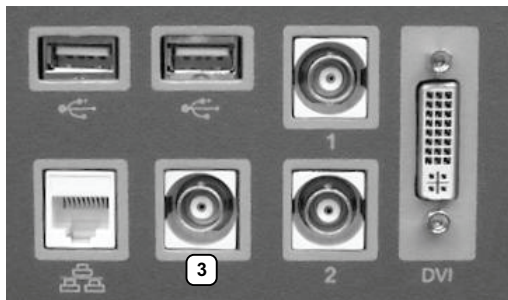

**Figure 10-2: SonixMDP/SP/OP Back Connectivity Panel (B)**





**Table 10-1: Back Connectivity Panels (A and B)**

	USB (x2)	Use to connect Ultrasonix-approved USB devices (e.g., printer, barcode reader, memory stick, etc.).
	LAN	Use to connect the system to a network. This port supports 10Mb/100Mb.
1	BNC (Input) Connector	Connected to the console <b>1</b> button, use to connect an Ultrasonix-approved peripheral (including a Footswitch). <b>Note:</b> <i>The device connected to this BNC is controlled by the settings configured for the console (<b>Custom</b>) <b>1</b> button (refer to <b>8.2.13</b> to configure <b>Custom Keys</b> or to Chapter 8 in the most recent User Manual).</i>
2	BNC (Output) Connector	Connected to the console <b>2</b> button, use to connect an Ultrasonix-approved peripheral. <b>Note:</b> <i>The device connected here is controlled by the settings configured for <b>Custom Key 2</b> (<b>8.2.13</b>).</i>
(3)	BNC (Output) Connector (Back Connectivity Panel B only)	Use to connect a non-USB Black & White (B&W) printer. If this connector is used, it will be controlled by the console ( <b>Custom</b> ) <b>1</b> button and BNC (Input) Connector ( <b>1</b> ) above, will be disabled. <b>Note:</b> <i>If this connector is in use a Footswitch cannot be connected. This connector on Back Connectivity Panel <b>B</b> may or may not be labeled with the number <b>3</b>.</i>
DVI	DVI Connector	Use to connect a second (DVI-compatible) LCD display or television. <b>Caution:</b> <i>Do not plug the extra (DVI-compatible) LCD display into the peripheral receptacle (<b>Figure 10-4</b>).</i> <i>For details on connecting an external TV, refer to <b>10.3.1</b>.</i>

## 10.2 CONSOLE CONNECTIVITY

The system provides two (2) USB ports at the front of the operator console. The USB ports can be used to connect Ultrasonix-approved USB devices such as a USB thumb drive.

**Figure 10-3: Console Connectivity**



## 10.3 ULTRASONIX-APPROVED DEVICES



---

**Warning:** Only Ultrasonix-approved peripheral devices may be connected to the peripheral receptacle.

Refer to the most recent price list to determine the exact make(s)/model(s) of Ultrasonix-approved devices.

---

The following peripherals have been approved for use with the system:

- SONY USB printer
- barcode reader
- USB media (memory stick, external hard drive, etc.).
- dual or triple footswitch
- extra (DVI-compatible) LCD display.

---

**Caution:** Do not plug the extra (DVI-compatible) LCD display into the peripheral receptacle (Figure 10-4).

For details on connecting an external TV, refer to 10.3.1.

---

### 10.3.1 Connecting an External Television to the System

---

**Note:** While a selection of televisions were tested against the following instructions, Ultrasonix cannot guarantee that all TVs will function as an external monitor.

---

The two (2) methods by which an external TV can be connected to the system are:

- via the TV's HDMI (High Definition Multimedia Interface) or DVI input
- via the TV's PC IN connector, providing this connection is either DVI or HDMI.

---

**Caution:** When connecting an external TV, be sure to follow all instructions carefully.

Do not plug the external TV into the peripheral receptacle (Figure 10-4).

---



### 10.3.1.1 Method 1: Via the TV's HDMI or DVI Input

Search the TV manufacturer's user guide to determine whether or not the TV's **HDMI** or **DVI Input** will accept the required signal format.

**Table 10-2: Required Signal Format**

Format	Resolution	V. Frequency
XGA	1024 x 768	60 Hz

Determine the type of connector available on the TV in order to source the correct cable:

- DVI connection > DVI to DVI cable
- HDMI connection > HDMI to DVI cable.

#### To Connect the TV via the DVI Input:

1. With both the TV and the system powered off, connect one end of the DVI cable to **DVI** on the system's Back Connectivity Panel.
2. Connect the other end of the DVI cable to **DVI Input** on the TV.
3. Ensure the TV is plugged in.

---

**Caution:** *Do not plug the external TV into the peripheral receptacle (Figure 10-4).*

---

4. Power on the TV.
5. Power on the system.
6. If necessary, once there is an image on the TV, configure the TV aspect ratio setting to **4:3** (not **16:9**).

#### To Connect the TV via the HDMI Input:

1. With both the TV and the system powered off, connect the DVI end of the cable to **DVI** on the system's Back Connectivity Panel.
2. Connect the HDMI end of the cable to **HDMI Input** on the TV.
3. Ensure the TV is plugged in.

---

**Caution:** *Do not plug the external TV into the peripheral receptacle (Figure 10-4).*

---

4. Power on the TV.
5. Power on the system.
6. If necessary, once there is an image on the TV, configure the TV aspect ratio setting to **4:3** (not **16:9**).

### 10.3.1.2 Method 2: Via the TV's PC IN Connector

Search the TV manufacturer's user guide to determine whether or not the TV's **PC IN** connector will accept the required signal format.

**Table 10-3: Required Signal Format**

Format	Resolution	V. Frequency
XGA	1024 x 768	60 Hz

Determine the type of connector required by the TV's **PC IN** connector in order to source the correct cable:

- DVI connection > DVI to DVI cable
- HDMI connection > HDMI to DVI cable.

#### To Connect the TV via PC IN with a DVI Cable:

1. With both the TV and the system powered off, connect one end of the DVI cable to **DVI** on the system's Back Connectivity Panel.
2. Connect the other end of the DVI cable to **PC In** on the TV.
3. Ensure the TV is plugged in.

---

**Caution:** *Do not plug the external TV into the peripheral receptacle (Figure 10-4).*

---

4. Power on the TV.
5. Power on the system.
6. If necessary, once there is an image on the TV, configure the TV aspect ratio setting to **4:3** (not **16:9**).

#### To Connect the TV via PC IN with an HDMI to DVI Cable:

1. With both the TV and the system powered off, connect the DVI end of the cable to **DVI** on the system's Back Connectivity Panel.
2. Connect the HDMI end of the cable to **PC In** on the TV.
3. Ensure the TV is plugged in.

---

**Caution:** *The external TV may not be plugged into the peripheral receptacle (Figure 10-4).*

---

4. Power on the TV.
5. Power on the system.
6. If necessary, once there is an image on the TV, configure the TV aspect ratio setting to **4:3** (not **16:9**).



**ULTRASONIX**

## 10.4 PERIPHERAL RECEPTACLE

The system is delivered with one peripheral receptacle that is to be used only with Ultrasonix-approved peripheral devices. The connector is clearly labeled ***Only Ultrasonix-approved peripheral devices may be connected to this power receptacle*** and is to be used to connect only Ultrasonix-approved, third-party peripherals to the system.

**Figure 10-4: Peripheral Receptacle Location**

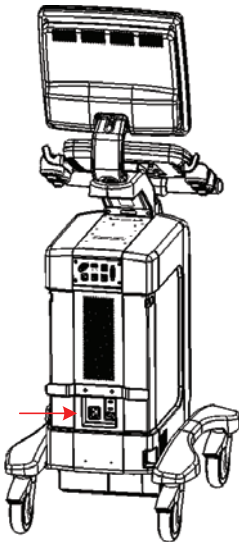



## 10.5 UPS

When the system arrives with the optional UPS installed, the UPS battery will be turned off and may be completely drained of power. During installation, the technician will ensure that the system—and therefore the UPS—is left plugged in, allowing it to completely charge the battery. This will take approximately 6 hours.



### Warnings:

**NEVER** let liquid from any source enter the UPS. Failure to do this may result in accidental **shorts, shocks or electrocutions**.

**DO NOT attempt to service this product yourself.** Attempting to open the UPS may cause exposure to lethal voltages within the unit even when it is apparently not operating and the input wiring is disconnected from the electrical source. Should the UPS require maintenance or replacement, only qualified Ultrasonix Service Technicians may perform service as detailed in the Service Manual.

For UPS and battery service issues, contact Ultrasonix Technical Support.

If the battery is removed from the system, it is the responsibility of the customer to dispose of it in accordance with all local regulations and laws.

### 10.5.1 UPS Circuit Breakers

Access to the UPS circuit breakers is provided via the left side shroud.

**Caution:** The UPS circuit breakers are designed to shut down power to the system only as a last resort. Improper use of the UPS circuit breakers may result in loss of patient data and/or hard drive failure and **may not be covered by the Ultrasonix warranty**.

Figure 10-5: Breaker Types and Locations



**Table 10-4: Breaker Types and Locations**

1	Battery Breaker
2	AC Input Breaker
3	System front

### 10.5.1.1 Determining Whether the UPS Breakers are ON or OFF

To determine whether the breakers are ON or OFF without removing the side shroud, check to see if there is a visible white marking at the top of each breaker. If there is, the breaker is OFF.

If only the Battery Breaker is off, the system will still run as long as it is plugged into a wall outlet. If both breakers are off, the system will not power on.

**Figure 10-6: Breaker Position OFF**



### 10.5.1.2 Turning OFF/Resetting the UPS Breakers

#### To Turn OFF the UPS Breakers:

1. Ensure the system is powered down and the power cord is disconnected from any power source.

**Caution:** Unless a breaker has been tripped, it is important to turn OFF the breakers in the order specified.

*A tripped breaker will be in a central position, rather than ON or OFF. Determine which breaker has been tripped and turn it off first, then turn off the remaining breaker.*

2. Turn **2: AC Input Breaker** to the OFF position.

**Note:** Refer to [Figure 10-5](#) and [Table 10-4](#) to determine the location of each breaker.

3. Turn **1: Battery Breaker** to the OFF position.

### 10.5.1.3 Turning ON the UPS Breakers

#### To Turn ON the UPS Breakers:

1. Plug in the system.
2. Turn **1: Battery Breaker** to the ON position.

---

**Caution:** *It is important to turn the breakers ON in the order specified.*

---

3. Turn **2: AC Input Breaker** to the ON position.



## 10.5.2 Battery Recharge Issues

As a data safety measure, Ultrasonix has configured the UPS alert system to ensure an optimal warning time for UPS battery recharging.



---

**Warnings:**

**NEVER** let liquid from any source enter the UPS. Failure to do this may result in accidental shorts, shocks or electrocutions.

**DO NOT attempt to service this product yourself.** Attempting to open the UPS may cause exposure to lethal voltages within the unit even when it is apparently not operating and the input wiring is disconnected from the electrical source. Should the UPS require maintenance or replacement, only qualified Ultrasonix Service Technicians may perform service as detailed in the Service Manual.

For UPS and battery service issues, contact Ultrasonix Technical Support.

If the battery is removed from the system, it is the responsibility of the customer to dispose of it in accordance with all local regulations and laws.

---

**Caution:** In order to effectively protect exam data for the current patient, pay particular attention to the details in [Table 10-5](#) and [Table 10-6](#), respectively.

---

**Table 10-5: Battery Usage Limitations**

	Ultrasonix does not recommend leaving the system unplugged even when imaging is frozen.
<b>Scanning Time Limit (Active and Frozen Imaging)</b>	<b>Caution:</b> The system should only be unplugged (without shutting down) for the few moments it takes to move it to a new location. <b>Ignoring these instructions may result in data loss and battery failure.</b>
<b>Recharge Time</b>	To fully charge the battery, Ultrasonix recommends keeping the system plugged in continuously for 6 hours. <b>Note:</b> If required, the system can continue to be used while the battery is charging. However, if the system is unplugged and moved during the recharge cycle, it may require more than 6 hours to fully charge.

**Table 10-6: Battery Recharge Alerts**

---

**Note:** The **Battery level** icon will only be visible if it has been enabled (8.2.17).

---

While unplugged, if the battery charge falls below a predetermined level, the system will emit an audible alarm and present the following message on the **Status Bar** (bottom right of the LCD display). Both the message and the alarm will continue so long as the system remains unplugged.

**Alert Level 2**

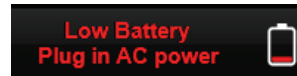

---

**Caution:** To protect patient data and prolong battery life, connect the system to an AC power source immediately.

---

If **Alert Level 2** is ignored (i.e., if the system is not connected to an AC power source), after a predetermined time the tone of the audible alarm will alter and a 120 second (two (2) minute) countdown **Status Bar** will be presented.



If the counter reaches zero (0) before the system is plugged into an AC power outlet, the system will automatically shutdown.

**Alert Level 1**

Before restarting the system, connect the power cord to an AC outlet. If the system is not plugged in before it is turned on, it will simply shut itself down again.

---

**Caution:** Ignoring these instructions may result in data loss and battery failure.

*To fully charge the battery after an **Alert Level 1** automated shutdown, leave the system plugged in continuously for 6 hours. If the charging cycle must be interrupted, Ultrasonix recommends leaving the system plugged in for a minimum of one (1) hour before unplugging it. Once the system has been moved, it should be reconnected to a power source immediately and allowed to continue charging for the full 6 hours.*

*Failure to follow these recommendations may result in premature battery failure which is not covered by the system warranty.*

---



---

**Note:** Battery Recharge Alerts are pre-programmed and cannot be edited or deleted by the user.

---



### 10.5.3 UPS Sleep/Standby Mode

The UPS sleep/standby mode helps to preserve battery integrity.

There are two (2) circumstances under which the UPS will automatically enter sleep/standby mode that will require the user to intervene. If:

- an **Alert Level 1** is ignored, the system is not plugged in to recharge but instead is allowed to countdown the 120 seconds and automatically shut itself down
- the system is powered off and left unplugged for more than 12 hours.

Proper use of the system, as discussed in [2.8.1 UPS Use Model](#) will ensure that neither of these circumstances ever applies.

#### To Wake the UPS from Sleep/Standby Mode:

1. Plug the system in to a power outlet that is known to be working.
2. Press the console **POWER** button for approximately 1 second (a clicking sound may be heard).

---

**Note:** *If the system fails to boot, contact your internal service provider or Ultronix Technical Support.*

---

3. Once the system boots correctly, leave it plugged in and recharging for an uninterrupted period of approximately 6 hours.

---

**Note:** *If desired, the system can be powered off and left plugged in to recharge or it can be used—without being unplugged—during the recharging period.*

---

## 10.6 SonixGPS

The system is delivered with the optional **SonixGPS** attached to the system case.



---

**Warning:** *This user manual does not include a comprehensive discussion of the SonixGPS option. For complete details on using SonixGPS, read and follow all instructions and warnings in the most recent SonixGPS User Manual.*

---

## 10.7 BARCODE READER

A barcode reader is available as an option with the system.

**Figure 10-7: Barcode Reader**



---

**Warnings:**

**USE OF CONTROLS** or adjustments or performance of procedures other than those specified in the manufacturer's User's Guide (delivered with system) may result in hazardous laser light exposure.

**NEVER** attempt to look at the laser beam, even if the barcode reader appears to be non-functional.

**NEVER** point the laser beam in anyone's eyes.

**USE OF OPTICAL** instruments with the laser equipment will increase eye hazard.

**UNDER NO CIRCUMSTANCES** should users or technicians attempt to open or service the laser scanner. Attempting to open the barcode reader may cause exposure to hazardous laser light. Should the barcode reader require maintenance or replacement, contact Ultrasonix Technical Support.

---

**Caution:** *Do not apply ultrasound gel to the barcode reader.*

---



### 10.7.1 Connecting the Barcode Reader

Plug the barcode reader's USB connector into one of the USB ports on the console (10.2). To keep it handy, store the barcode reader in one of the transducer holders.



## 10.8 WIRELESS ADAPTER

Wireless is available only as a pre-installed option.

---

**Caution:** System networking options are intended for use *inside* your organization's firewall. Organizations that elect to configure/use the networking functionality provided by Ultrasonix are assuming all liabilities and risks associated with that decision.

---

---

**Caution:** For details on FCC regulations as they apply to the wireless adapter, please refer to the manufacturer's User Guide included with the system.

---

## 10.9 CONNECTING THE USB FOOTSWITCH (DUAL OR TRIPLE)

Connect the USB footswitch to the Back Connectivity Panel (10.1) and configure it via [8.2.14.4 Footswitch](#).

Figure 10-8: Dual and Triple USB Footswitches





## 10.10 USB PRINTER MOUNTING KIT

Clients wishing to use a USB printer without the peripheral tray have the option of mounting it directly to the system. The printer will be delivered with the mounting plate already attached.

### To Mount the USB Printer Directly to the System:

1. Using the two (2) supplied thumbscrews (1), attach the printer mounting plate to the system.

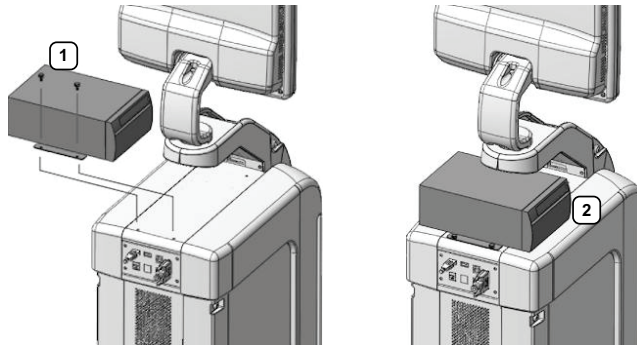



---

**Note:** Ensure the printer front (2) faces in the correct direction.

*If the system order included a USB printer, it will be delivered with the appropriate USB cable already installed.*

---

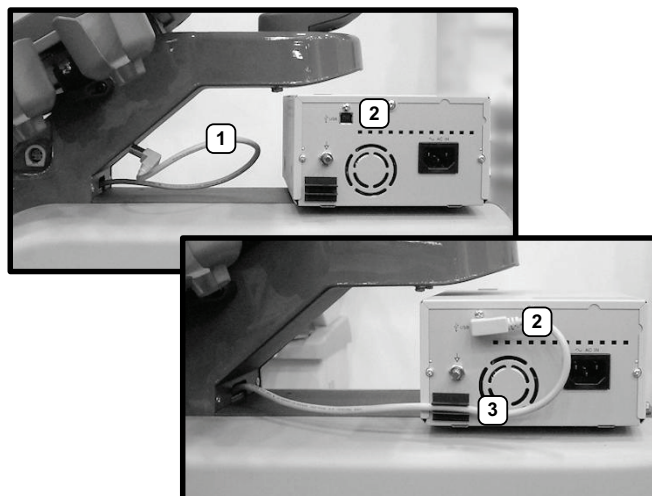
2. Plug the USB cable extending from the system's cable chase (1) into the USB connector on the printer (2).



3. To minimize cable clutter, press the USB cable into the cable retaining clip (3).



## 10.11 PERIPHERAL TRAY

If the system order included the peripheral tray it will come pre-installed—with the exception of the peripheral tray basket. The basket will have to be installed after delivery.

---

**Note:** For best results, Ultrasonix recommends removing the peripheral tray basket before cleaning (D.4.10). This will allow the operator to clean all the various curves and folds in a more effective manner.

If a USB printer has also been installed, it should be removed as well (10.11.1).

The peripheral tray is not available for systems that have **SonixGPS** installed.

---

### To Attach the Peripheral Tray Basket to the Peripheral Tray

1. Using the two (2) sets of supplied nylon washers and thumbscrews, attach the peripheral tray basket to the peripheral tray while the tray is attached to the system.

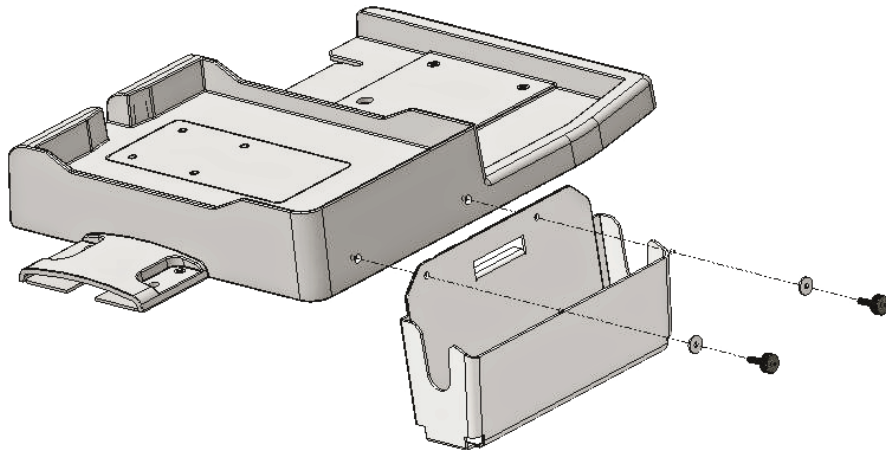

### 10.11.1 USB Printer Mounted on the Peripheral Tray

If the system order included the peripheral tray and a USB printer, the printer will have to be installed after delivery.

---

**Note:** For best results, Ultrasonix recommends removing the USB printer before cleaning (D.4.10) the peripheral tray. This will allow the operator to clean all the various curves and folds in a more effective manner.

---

**Figure 10-9: USB Printer Mounted on the Peripheral Tray**

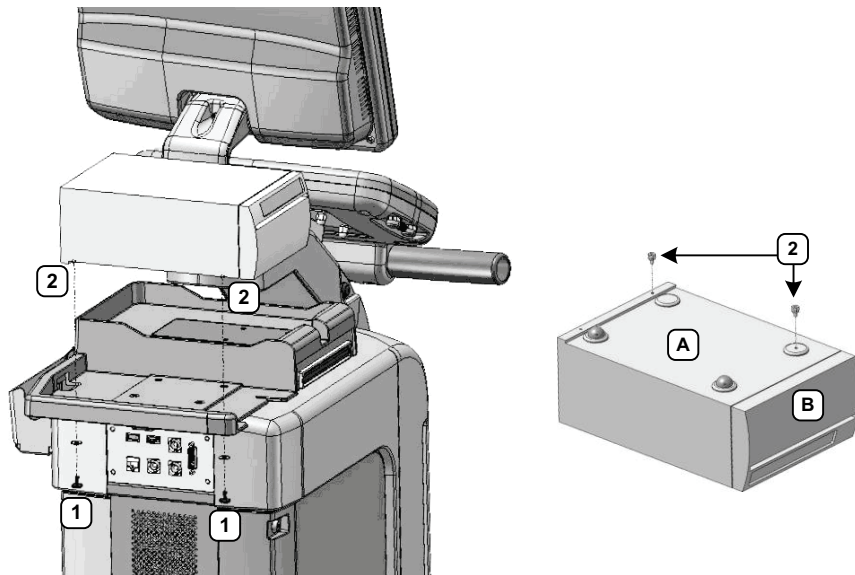

**Table 10-7: USB Printer Mounted on the Peripheral Tray**

---

1	Thumbscrews
2	Threaded Standoffs
A	Printer bottom
B	Printer front

---



### To Attach the Peripheral Tray Basket to the Peripheral Tray

1. From underneath the back of the peripheral tray, fasten the two (2) thumbscrews (1) through the holes provided into the two (2) "threaded standoffs" (2) (already attached to the base of the USB printer).

---

**Note:** Refer to [Figure 10-9](#) and [Table 10-7](#) for a detailed view of the installation.

---

2. The USB (1) and Power cable (2) are pre-installed and will only need to be connected.

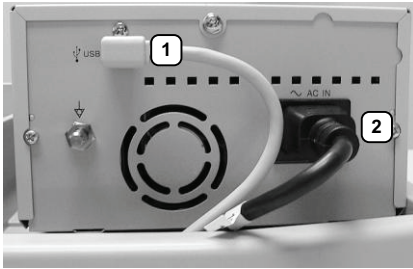

3. To help prevent cable clutter, the power cable is held in place with self-adhesive cable clips with enough slack to connect it to the system. If desired, during use, excess slack in the system power cable can also be secured (1).

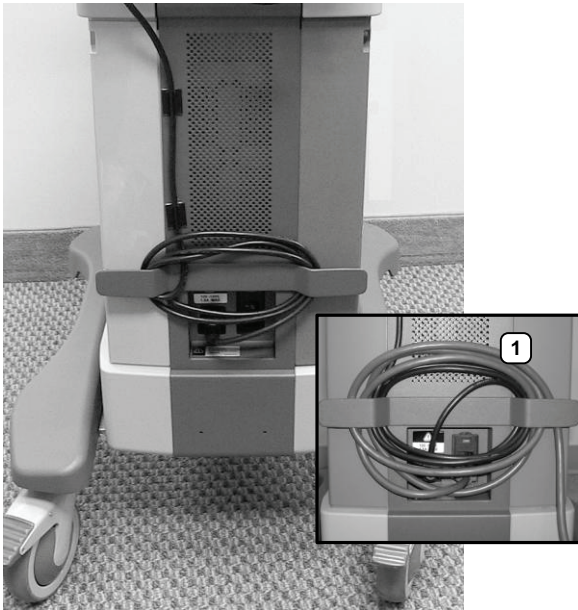

---

**Note:** The system will arrive with the power cable already connected as shown above (1).

---

## 10.12 TRANSDUCER HOLDERS AND CABLE HOOKS

The transducer holders and cable hooks are connected with one (1) simple thumbscrew that is hand-tightened. No tools are required to remove them.

---

**Note:** For best results, Ultrasonix recommends removing the transducer holders and cable hooks before cleaning (D.4.8). This will allow the operator to clean all the various curves and folds in a more effective manner.

---

**Figure 10-10: Transducer Holders and Cable Hooks**

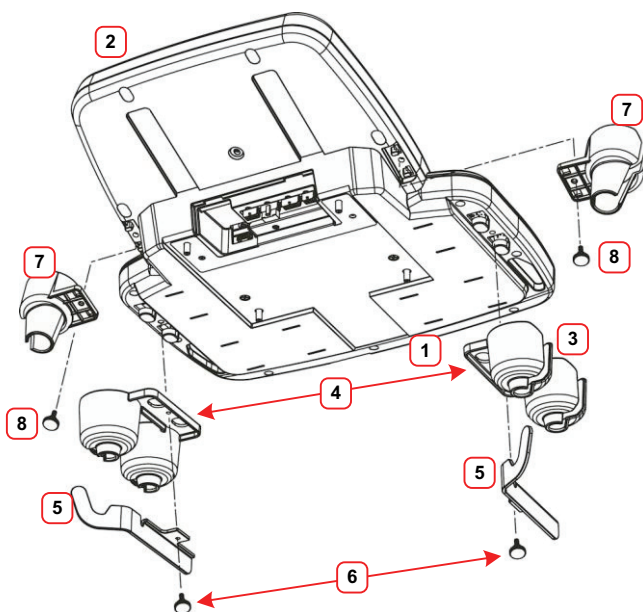

**Table 10-8: Transducer Holders and Cable Hooks**

1	Console Front
2	Console Rear
3	Transducer Holders
4	Connecting Flange for Thumbscrew (faces inward)
5	Cable Hooks (hook faces rear)
6	Thumbscrews (for Cable Hooks)
7	Endocavity Transducer Holders
8	Thumbscrews (for Endocavity Transducer Holders)



### To Remove Transducer Holders and Cable Hooks:

1. Remove all transducers from the transducer holders.
2. Undo the thumbscrews (1) holding the endocavity transducer holders and the ones holding the transducer holder and cable hooks to the console (four (4) in total).

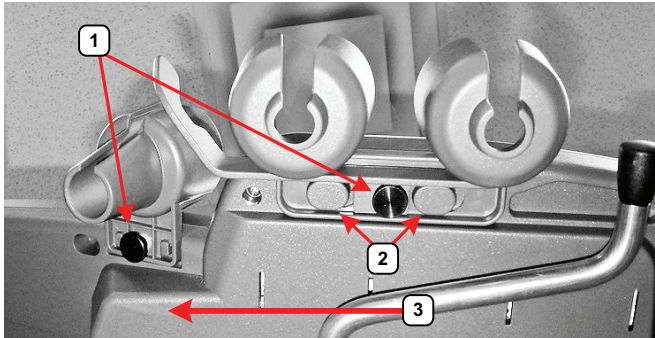

3. Remove the cable hook.
4. The transducer holder is held in place by two (2) tapered mounting flanges (2). Pushing the holder toward the back of the console (3) will loosen it from these flanges, allowing it to be pulled down and removed.

---

**Note:** View from underneath the console.

---

## 10.13 SOFTWARE

### 10.13.1 Anti-Virus Protection

Sonix software includes a 12 month subscription to anti-virus software that is delivered pre-installed and activated.

---

**Caution:** Anti-virus updates will only be available to users with systems connected to the Internet.

---

Users wishing to run their own anti-virus software—or those who do not want to run anti-virus software at all—must disable/uninstall the existing software. Contact your IT department or Ultrasonix Technical Support for more details.

## APPENDIX A: SAFETY

---

### A.1 SAFETY

This section contains important information about the safe use of the Sonix ultrasound system. Much of the information is required by various regulatory agencies and should be read prior to using the Sonix ultrasound system.



---

**Warning:** For safety details on the mTEE8-3/5 transducer, refer to 00.040.314 mTEE8-3/5 User Manual.

---

#### A.1.1 ALARA Principle and Output Displays

The Acoustic Power Output Display for the Sonix ultrasound system meets FDA requirements and the guidance standards set out by AIUM and NEMA: *Standard for Real-Time Display of Thermal and Mechanical Acoustic Output Indices on Diagnostic Ultrasound Equipment*.

The Sonix system provides real-time **Mechanical Index (MI)** and **Thermal Index (TI)** acoustic power output display values depending on the transducer and imaging mode.

- **MI: Mechanical Index (2D imaging)**
- **TIB: Thermal Index – Bone**
- **TIC: Thermal Index – Cranial**
- **TIS: Thermal Index – Soft Tissue.**

#### To Change the Index Value Displayed:

1. Turn the console  dial.
2. Toggle through the **MI**, **TIS**, **TIC** and **TIB** values available depending on the imaging mode.

---

**Note:** The **MI** and **TI** values are displayed to the right of the image field and are updated as changes—which affect the acoustic power output—are made to the system.

---

The ALARA principle, provided by AIUM in *Ultrasound Medical Safety – Implementing ALARA*, guides the ultrasound user on the prudent use of diagnostic ultrasound. Display of the acoustic power output value enables the ultrasound user to better implement the ALARA principle. The ultrasound user can determine the right balance of ultrasound exposure benefits to risks by using acoustic power output levels that are **As Low As Reasonably Achievable (ALARA)**. Without compromising diagnostic quality, patient ultrasound exposure should be kept to a minimum while using the lowest output power possible.



## A.2 BASIC PRECAUTIONS

DO NOT operate the Sonix Ultrasound System in the presence of flammable anesthetics.

NEVER allow water or other liquids onto the keyboard, operator console or interior of the system case.

ALWAYS handle transducers with care. Dropping the transducer or allowing it to strike a hard surface can damage the transducer elements and the acoustic lens. Such a collision can also crack the transducer housing and destroy its electrical safety features.

The device is not intended for ophthalmic use or any use causing the acoustic beam to pass through the eye.

The device is not intended for any application in which the transducer might come in direct contact with brain tissue or the central nervous system.

To avoid the risk of electrical shock, before using the transducer, inspect the transducer face, housing and cable. DO NOT use the transducer if the transducer or cable is damaged.

Failure to repair/replace damaged parts may result in degraded image quality and therefore may impact diagnostic interpretations.

ALWAYS turn off the system before cleaning or changing fuses.

To avoid the risk of electrical shock and fire hazard, inspect the power supply, AC power cord and plug on a regular basis. Ensure they are not damaged.

Follow local governing ordinances and recycling plans regarding disposal or recycling of device components.

Keep the system clean. Carefully follow the procedures described later in this manual for cleaning the system, transducers and cooling fans.

ALWAYS **FREEZE** (❄) the system when not imaging to prevent the transducer from overheating or use the **Auto-Freeze** function to ensure the system freezes after a specified period of inactivity ([8.2.10 System Settings](#)).

Ensure the LCD display and operator console are secure when imaging is being done or when the system is left unattended.

ALWAYS choose the appropriate transducer and parameters for the type of clinical application.

When scanning subjects, always work to use **As Low As Reasonably Achievable** (ALARA) acoustic scanning energies. Refer to [A.1.1 ALARA Principle and Output Displays](#) before using the system. Do not use more than the minimum energy necessary to conduct an ultrasound exam. This is especially necessary where fetal and cephalic scans are being conducted.

DO NOT remove panels or covers from the system.

ALWAYS power the system from a grounded outlet.

Ultronix does not recommend the use of transducer covers/sheaths containing natural rubber latex and talc as these ingredients are known to cause an allergic reaction in some individuals. Refer to *21 CFR 801.437* user labeling for more details on latex use.

DO NOT use transcranial (**TCD**) **Presets** for anything other than transcranial imaging.



Where any transducer (including, but not limited to, an intracavity transducer) is used in a clinical application of a semi-critical nature (including, but not limited to, intraoperative, transrectal, transvaginal, transesophageal, etc.), ensure the transducer is covered with the appropriate STERILE transducer cover/sheath which has received regulatory clearance for use.



---

**Warning:** *The Sonix ultrasound system may produce physiological effects of ultrasound which may cause danger to the patient and operator.*

---

**Cautions:**

*Use of controls or adjustments or performance of procedures other than those specified herein may result in hazardous exposure to ultrasonic energy.*

*Contact Ultrasonix if repairs are needed on the system. Repairs and component maintenance must be carried out by Ultrasonix authorized personnel only.*

---

### A.3 UPS PRECAUTIONS

Refer to [10.5.1](#) for UPS circuit breaker shutdown procedures.



---

**Warnings:**

**NEVER** let liquid from any source enter the UPS. Failure to do this may result in accidental **shorts, shocks or electrocutions**.

**DO NOT attempt to service this product yourself.** Attempting to open the UPS may cause exposure to lethal voltages within the unit even when it is apparently not operating and the input wiring is disconnected from the electrical source. Should the UPS require maintenance or replacement, only qualified Ultrasonix Service Technicians may perform service as detailed in the Service Manual.

*For UPS and battery service issues, contact Ultrasonix Technical Support.*

*If the battery is removed from the system, it is the responsibility of the customer to dispose of it in accordance with all local regulations and laws.*

---

### A.4 SONIXGPS PRECAUTIONS



---

**Warning:** *This user manual does not include a comprehensive discussion of the SonixGPS option. For complete details on using SonixGPS, read and follow all instructions and warnings in the most recent SonixGPS User Manual.*

---



## A.5 SYMBOL DEFINITIONS

Table A-1: System Symbols

Symbol	Location	Meaning
	On serial plate that indicates the serial number and electrical rating.	Alternating current.
	On transducers.	Patient applied part meets the isolation requirements for type B applied part.
	On <b>SonixGPS</b> transmitter and the LCD display during <b>SonixGPS</b> imaging.	Warning: To prohibit entry of a person wearing a pacemaker into an area where the operation of the pacemaker may be negatively influenced or the pacemaker damaged.
	On footswitch (dual or triple).	Indicates compliance with UL 60601-1 and CSA Std C22.2 No. 601.1 standards for medical use.
	On System Label (rear of system) and/or warning/caution labels.	Warning: Dangerous Voltage. Electric Shock Hazard. Do not remove cover or back. Refer servicing to qualified service personnel.
	General warning sign located in a variety of places, including: System Label (rear of system), User Manual and Service Manual.	Warning: Consult accompanying documents. The accompanying explanation will describe a precaution(s) necessary to prevent injury or loss of life.
	On System Label (rear of system).	This product has been tested and meets IEC 60601-1 standards for safety and/or performance, including the applicable standards written or administered by the <i>American National Standards Institute (ANSI)</i> , <i>Underwriters Laboratories (UL)</i> , <i>Canadian Standards Association (CSA)</i> , <i>National Sanitation Foundation (NSF)</i> and others.
	When applicable, the CE Mark is located in a variety of places, including: System Label (rear of system), User Manual and Service Manual.	When affixed to the product, the CE Label testifies to its compliance with Council Directive 93/42/EEC concerning medical devices.
	On System Label (rear of system).	<i>Waste Electrical and Electronic Equipment (WEEE)</i> symbol indicates this device must not be disposed of as unsorted municipal waste. It must be disposed of in accordance with all local laws and regulations. Contact Ultronix Technical Support for more information on the decommissioning of this equipment.

## A.6 ELECTRICAL SAFETY REQUIREMENTS

### A.6.1 System

The SonixSP Ultrasound System is classified in accordance with the IEC 60601–1, the standard for Medical Electrical Equipment as follows.

**Table A-2: System Electrical Safety**

Standard	IEC 60601–1
Type of protection against electrical shock	Class I
Degree of protection against electrical shock	Type BF
Degree of protection against ingress of water	Ordinary



**Warning:** Accessory equipment connected to the analog and digital interfaces must be certified according to their respective IEC standards (e.g., IEC 60950 for data processing equipment and IEC 60601–1 for medical equipment). Furthermore, all configurations shall comply with the system standard IEC 60601–1. Any person who connects additional equipment to the signal input part or signal output part configures a medical system and is therefore responsible for ensuring that the system complies with the requirements of the system standard IEC 60601–1–1. If in doubt, consult Ultrasonix Technical Support.

### A.6.2 Additional Hardware

**Table A-3: SonixGPS Components Electrical Safety**

Standard	EN60601–1
Type of protection against electrical shock	Class I
Degree of protection against electrical shock	Type B Applied Part
Unsuitable for use in the presence of flammable gas	Not AP/APG

**Table A-4: Barcode Reader Electrical Safety**

UL (Underwriter's Laboratory)	UL listed for US and Canada UL 60950 C22.2 No. 60950
Laser Class	CDRH and IEC Laser Class 1 – In accordance with IEC 60825–1:1993 + A1:1997 + A22001 Class 1



## A.7 EMC (ELECTROMAGNETIC COMPATIBILITY) REQUIREMENTS

### A.7.1 System

The SonixSP Ultrasound System has special precautions regarding EMC. Always install and use according to the EMC information provided in the relevant Service Manual.

Portable and mobile RF communications equipment can affect the Sonix Ultrasound System.

Transducer cables must be raised above the ground during scanning.



**Warning:** *The use of accessories, transducers and cables other than those specified by Ultrasonix may result in increased emissions or decreased immunity of the system.*

### A.7.2 Additional Hardware

**Table A-5: SonixGPS Components**

Electromagnetic Compatibility	Class B: FCC Part 15 ICES-003 European Union Directive 89/336/EEC
Operation is subject to these conditions	1. This device may not cause harmful interference, and 2. This device must accept any interference received, including interference that may cause undesired operation.

**Table A-6: Barcode Reader**

Electromagnetic Compatibility	Class B: FCC Part 15 ICES-003 European Union Directive 89/336/EEC
-------------------------------	---

**Table A-7: Footswitch (Dual or Triple)**

Electromagnetic Compatibility	Class B: FCC Part 15 and Industry Canada European Union: En 55022, En 61000-3-1/3, EN 60601-1-2
-------------------------------	--

## A.8 ENVIRONMENTAL CONDITIONS

### A.8.1 System

**Table A-8: System Operating Environment**

Operational Temperature	50° to 104° F (10° to 40° C)
Operational Humidity	30 to 75% relative humidity
Shipping/Storage Conditions	+5° to +122° F (-15° to +50° C)
Shipping/Storage Humidity	10% to 90% (non-condensing)
Shipping/Storage Pressure (kilopascal)	50 kPa to 106 kPa (kilopascal)



**Warning:** Operate in an indoor environment only, free from moisture, flammable liquids, gases, corrosive substances, strong electrical or magnetic fields and equipment that generates high frequency waves.

*Ultrasonix cannot guarantee the proper performance of the system if used in the above-listed conditions.*

### A.8.2 Additional Hardware

**Table A-9: Barcode Reader**

Operating Temperature	32° to 104° F (0° to 40° C)
Storage Temperature	-40° to 140° F (-40° to 60° C)
Humidity	5% to 95% relative humidity, non-condensing
Light Levels	Up to 4842 Lux (footcandles)
Shock	Designed to withstand 1.5 m (5') drops
Contaminants	Sealed to resist airborne particulate contaminants
Ventilation	None required

**Table A-10: Wireless**

Operating Temperature	32° to 104° F (0° to 40° C)
Storage Temperature	-4° to 158° F (-20° to 70° C)
Humidity	80% maximum, non-condensing

**Note:** For more details on the wireless adapter and other peripherals, refer to the manufacturer's User's Guides included with the system.



## **A.9 LIMITING TRANSDUCER SURFACE HEATING**

Ultronix has ensured that the transducer surface temperature in still air does not exceed 50°C and applied on tissue does not exceed 43°C.

Surface heating may be created by transmitting energy on the same area of a transducer at a high rate. This heating may occur, for example, during Pulsed Wave Doppler or Color Doppler imaging. The only Ultronix transducer where this surface heating issue could be an issue is the EC9-5/10 transducer. To limit the surface heating, Sonix software conditions are used to prevent the same area on the transducer from being excited to a rate of less than 100us. Thorough testing has shown no noticeable EC9-5/10 transducer surface heating. For added security the Sonix system high voltage excitation power circuit contains "Polyswitches" that ensure no more than a specified current can be drawn from these high-voltages circuits.

## **A.10 LATEX**

Ultronix does not recommend the use of transducer covers containing natural rubber latex and talc as these ingredients are known to cause an allergic reaction in some individuals. Refer to *21 CFR 801.437* user labeling for more details on latex use.

## APPENDIX B: SYSTEM SPECIFICATIONS

### Notes:

Talk to your Ultrasonix dealer for details on standard and optional features.

Ultrasonix Medical Corporation reserves the right to alter system specifications at any time.

√ – Standard      ◆ – Optional      Ø – Not Available

**Table B-1: System Specifications**

	TAB	TCH	MDP	SP	OP	LGY <sup>5</sup>
<b>CLINICAL APPLICATIONS</b>						
Abdominal	√	√	√	√	√	√
Biliary	√	√	√	√	√	√
Bladder	√	√	√	√	√	√
Cardiac						
<b>Note: Access to <i>Cardiac</i> is controlled through licensing. If <i>CW</i> is not licensed and active, then the <i>Cardiac Application</i> is not available.</b>	◆	◆	√	√	◆	Ø
Foreign Bodies	√	√	√	√	√	√
Generic	√	√	√	√	√	√
Lower Extremities	√	√	√	√	√	√
Musculoskeletal (MSK)	√	√	√	√	√	√
Nerve Block	√	√	√	√	√	√
OB 1st Trimester <sup>1</sup>	√	√	√	√	√	√
OB 2nd–3rd Trimester <sup>1</sup>	√	√	√	√	√	√
Other	√	√	√	√	√	√
Pelvic	√	√	√	√	√	√
Procedure	√	√	√	√	√	√
Renal	√	√	√	√	√	√
Small Parts	√	√	√	√	√	√
Thoracic	√	√	√	√	√	√
Trauma (FAST)	√	√	√	√	√	√
Urology	√	√	√	√	√	√
Vascular	√	√	√	√	√	√
Vascular Access	√	√	√	√	√	√
<b>MEASUREMENTS AND ANALYSIS</b>						
Obstetrical calculation and report package	√	√	√	√	√	√
Abdominal calculation and report package	√	√	√	√	√	√
Gyn/Fertility calculation and report package	√	√	√	√	√	√
Cardiac calculation and report package						
<b>Note: Access to <i>Cardiac</i> calculations is controlled through licensing. If <i>CW</i> is not licensed and active, the <i>Cardiac Application</i>—and therefore the <i>Cardiac</i> calculation and report package—is not available.</b>	◆	◆	√	√	◆	Ø
Vascular calculation and report package	√	√	√	√	√	√
Auto-Follicle calculation and report package	Ø	√	Ø	Ø	Ø	Ø



**ULTRASONIX**

	TAB	TCH	MDP	SP	OP	LGYS <sup>5</sup>
<b>BROADBAND TRANSDUCERS<sup>2</sup></b>						
SA4-2/24 broadband (2–4 MHz), 24 mm, 80.5/90.55" (2.05 m/2.30 m) cable, phased array	◆	◆	◆	◆	◆	∅
EC9-5/10 broadband (5–9 MHz), 10 mm radius, 75" (1.90 m) cable, endocavity microconvex array	◆	◆	◆	◆	◆	◆
C5-2/60 and C5-2/60 GPS broadband (2–5 MHz), 60 mm radius, 75" (1.90 m) cable, curved array	◆	◆	◆	◆	◆	◆
L9-4/38 broadband (4–9 MHz), 38 mm, 75" (1.90 m) cable, linear array	◆	◆	◆	◆	◆	◆
L14-5/38 and L14-5/38 GPS broadband (5–14 MHz), 38 mm, 75" (1.90 m) cable, linear array	◆	◆	◆	◆	◆	∅
L14-5W/60 broadband (5–14 MHz), 60 mm, 75" (1.90 m) cable, wide linear array	◆	◆	◆	◆	◆	∅
HST15-8/20 broadband (10 MHz) 20 mm, 75" (1.90 m) cable, hockey stick linear array	◆	◆	◆	◆	◆	∅
4DC7-3/40 broadband (3–7 MHz), 40 mm radius, 75" (1.90 m) cable, 4D motor-driven electronic curved array	∅	◆	◆	◆	◆	∅
<b>PRESETS</b>						
Default presets	√	√	√	√	√	√
User-defined presets	√	√	√	√	√	√
<b>PHYSICAL CHARACTERISTICS</b>						
Footprint: 53.5 cm x 71 cm (21" x 28") 53.5 cm x 91.5 cm (21" x 36")	∅ ∅	√ ∅	∅ √	∅ √	∅ √	√ ∅
System Size: 45 cm wide x 17 cm deep x 41 cm high (17.7" x 6.9" x 16.1")	√	∅	∅	∅	∅	∅
Weight, with UPS: 88.5 kg (195 lbs) 102 kg (225 lbs) 108 kg (238)	∅ ∅ ∅	√ ∅ ∅	∅ √ ∅	∅ √ ∅	∅ ∅ ∅	∅ ∅ √
Weight, without UPS: 63.6 kg (140 lbs) 77 kg (170 lbs) 75 kg (166 lbs)	∅ ∅ ∅	√ ∅ ∅	∅ √ ∅	∅ √ ∅	∅ √ ∅	∅ ∅ √
System Weight: 15 kg (33 lbs)	√	∅	∅	∅	∅	∅
Power Pack Size: 10.4 cm wide x 40 cm long x 5.8 cm high (4.1" x 15.75" x 2.3")	√	∅	∅	∅	∅	∅
Power Pack Weight: 2.7 kg (5.95 lbs)	√	∅	∅	∅	∅	∅
Height, System (Measured from top of LCD display to floor): Static Position: 137 cm (54") Highest Position: 152.5 cm (60") Lowest Position: 137 cm (54")	∅ ∅ ∅	√ ∅ ∅	∅ √ √	∅ √ √	∅ ∅ ∅	∅ ∅ ∅
Height, System (Measured from top of LCD display to floor): Highest Position: 155 cm (61") Lowest Position: 142 cm (56")	∅ ∅ ∅	∅ ∅ ∅	∅ ∅ ∅	∅ ∅ ∅	∅ ∅ ∅	√ √ ∅
Height, Transport Mode (LCD display folded flat over console): 108 cm (42.5")	∅	√	√	√	√	∅
Tilt, Console (Measured from trackball position to floor): Highest Position: 97.2 cm (38.3") Lowest Position: 78.5 cm (30.9")	∅	√	∅	∅	∅	∅
Tilt/Lift, Console (Combination of tilt and lift, measured from trackball position to floor): Highest Position: 100 cm (39.5") Lowest Position: 82 cm (32.25")	∅	∅	√	√	√	∅
Tilt Angle, Console (Measured by degrees (°) off horizontal position): 0–40° down 0–10° down	∅ ∅	√ ∅	∅ √	∅ √	∅ √	∅ ∅
Swivel Range, Console (Measured by degrees (°) off center position): ± 45°	∅	∅	√	√	√	∅
Tilt Angle, LCD Display (Measured by degrees (°) from the "Transport Mode position): 0 to 115°	∅	√	√	√	√	∅
Swivel Range, LCD Display (Measured by degrees (°) off center position): ± 90°	∅	√	√	√	√	∅
TFT (Active Matrix) LCD display: 17" 19" with SAW (Surface Acoustic Wave) touch screen	∅ √	√ ∅	√ ∅	√ ∅	√ ∅	√ ∅
Touch Screen: 10.4" LCD display with resistive touch screen 8.4" LCD display with resistive touch screen 5.5" LCD display with resistive touch screen	∅ ∅ ∅	√ ∅ ∅	∅ √ ∅	∅ √ ∅	∅ √ ∅	∅ ∅ √





	TAB	TCH	MDP	SP	OP	LGY <sup>5</sup>
Transducer connectors	2	3	3	3	3	3
<b>USER INTERFACE<sup>3</sup></b>						
QSonix Quick Exam Start-up Operator Console Tutorial Remote Support Access <sup>4</sup>	√	√	√	√	√	√
Universal language option	◆	◆	◆	◆	◆	◆
Touch Screen Controls Imaging Parameters (Maps, Persistence, Dynamic Range, PRF, etc.) Mode Actions (Reverse, Invert, Biopsy, Layout, etc.) Cine	√	√	√	√	√	√
Easy-to-use Interface	√	√	√	√	√	√
User-programmable Custom Keys	√	√	√	√	√	√
Text, Annotations, Pictograms, Arrows	√	√	√	√	√	√
<b>CINE MEMORY</b>						
Up to seven (7) minutes of data (Transducer/sector size dependant)	√	√	√	√	√	√
Total available memory: >8,000 fr	√	√	√	√	√	√
<b>REMOTE SUPPORT<sup>4</sup></b>						
Real-time live chat support	√	√	√	√	√	√
Ultronix remote system diagnostic capability	√	√	√	√	√	√
1-Step Software upgrades (CD-ROM or Internet)	√	√	√	√	√	√
<b>STORAGE AND CONNECTIVITY</b>						
DICOM service classes (Print/Store/Worklist)	◆	◆	◆	◆	◆	√
Patient data hard drive storage (at least 160 Gb)	√	√	√	√	√	√
Still image storage (PNG, JPEG, BMP, GIF)	√	√	√	√	√	√
Cine loop storage & trim (AVI)	√	√	√	√	√	√
USB ports 2 on Console, 2 on Back Connectivity Panel 2 on Console, 3 on Back Connectivity Panel 6 on Side Connectivity Panel 2 on Console front	∅ ∅ √ ∅	√ ∅ ∅ ∅	∅ √ ∅ ∅	∅ √ ∅ ∅	∅ √ ∅ ∅	∅ ∅ ∅ √
Built-in Firewall	√	√	√	√	√	√
2 Programmable BNCs for Input/Output	∅	√	√	√	√	√
DVI (Digital video) output	∅	√	√	√	√	∅
USB printer output	√	√	√	√	√	∅
Hard-wired Network (LAN) connection	√	√	√	√	√	√
Wireless Network connection	◆	◆	◆	◆	∅	∅
Streaming video (SonixLive) <sup>4</sup>	◆	◆	◆	◆	∅	◆
<b>PERIPHERALS</b>						
USB printer with direct-to-system mounting kit	◆ ∅	◆ √	◆ √	◆ √	◆ √	∅ ∅
Peripheral Tray, with optional: CD/DVD R/W drive USB Printer	∅ ∅ ∅	◆ ◆ ◆	√ ◆ ◆	◆ ◆ ◆	◆ ◆ ◆	∅ ∅ ∅
UPS (Uninterruptible Power Supply)	∅	◆	◆	◆	∅	∅/∅/◆
Barcode Reader (Pre-programmed to support the following barcode symbologies: UPC, EAN, Interleaved 2 of 5, Codabar, Code 3 of 9, Code 93, Code 128)	◆	◆	◆	◆	∅	◆
Wireless Adapter (802.11b/g compatible)	◆	◆	◆	◆	∅	∅/◆/◆
SonixGPS Hardware	∅	◆	◆	◆	◆	∅
ECG Hardware	∅	◆	◆	∅	∅	∅
USB footswitches (Kinesis, Savant™ Elite™): Triple: (Manufacturer's Part Number: FS30A) (UXID: 00.032.242) Dual: (Manufacturer's Part Number: FS20A) (UXID: 00.032.243)	◆ ◆	◆ ◆	◆ ◆	◆ ◆	◆ ◆	◆ ◆
Hand-held Stylus with Tether (UXID: 00.032.321)	√	∅	∅	∅	∅	∅



**ULTRASONIX**

	TAB	TCH	MDP	SP	OP	LGY <sup>5</sup>
<b>ACCESSORIES</b>						
<b>ULTRASONIX MEDICAL CORPORATION</b>						
<b>SonixGPS Needle Kits and Accessories:</b>						
SonixGPS Vascular Access Starter Kit (contains 1x 00.037.047 and 1x 00.037.041) (UXID: 00.037.050)	∅	◆	◆	◆	◆	∅
SonixGPS 0.9mm Needle Sensor (non-sterile, reusable) (UXID: 00.037.047)	∅	◆	◆	◆	◆	∅
SonixGPS Vascular Access Needle Kits (Single use, Sterile Pack of 10, Ga 17 x 70mm L) (UXID: 00.037.041)	∅	◆	◆	◆	◆	∅
SonixGPS Nerve Block Starter Kit (contains 1x 00.037.048, 1x 00.037.055) (UXID: 00.037.051)	∅	◆	◆	◆	◆	∅
SonixGPS 0.5mm Needle Sensor (non-sterile, reusable) (UXID: 00.037.048)	∅	◆	◆	◆	◆	∅
SonixGPS Nerve Block Needle Kits (Single use, Sterile Pack of 10, Ga 19 x 80mm L) (UXID: 00.037.055)	∅	◆	◆	◆	◆	∅
<b>THIRD PARTY</b>						
<b>SonixGPS™ Needle Kits and Accessories:</b>						
eTRAX™ Needle Starter Kit, Manufactured by CIVCO, Part Number 610-1055 (UXID: 00.037.034)		◆	◆	◆	◆	
Civco eTRAX™ Needle Kit, Manufactured by CIVCO, (Pack of 10), 16GA x 17.7cm (7") and 7.6 tapered to 3.8 x 147cm (3" tapered to 1.5" x 58") CIV-Flex needle cover, Part Number 610-1057 (UXID: 00.037.039)		◆	◆	◆	◆	
Sterile ATEC vacuum-assisted breast biopsy Tracking Bracket, Manufactured by CIVCO, (Pack of 12) Part Number 653-002 (UXID: 00.037.037) (Supported models: 9 gauge Standard, Part Number 0909-20; 12 gauge Standard, Part Number 1209-20; 9 gauge Long, Part Number 0912-20; 12 gauge Long, Part Number 1212-20).		◆	◆	◆	◆	
<b>Note: Only the Tracking Bracket is available from Ultrasonix Medical Corporation. Contact ATEC to purchase the needles.</b>	∅					∅
Sterile Celero vacuum-assisted breast biopsy Tracking Bracket, Manufactured by Civco, (Pack of 12) Part Number 653-001 (UXID: 00.037.036) (Supported model: Celero-12)		◆	◆	◆	◆	
<b>Note: Only the Tracking Bracket is available from Ultrasonix Medical Corporation. Contact Hologic to purchase the needles.</b>						
Non-sterile reusable General Purpose Electromagnetic Sensor driveBAY trakSTAR 8mm, Manufactured by CIVCO, Part Number 610-1066 (UXID: 00.037.035)		◆	◆	◆	◆	
Blue Phantom, Branched 4-Vessel Ultrasound Training Block Model, Part Number BPBV110 (UXID: 00.032.185)		◆	◆	◆	◆	
mTEE8-3/5 Transducer Sheath/Cover Kit with Gel, Applicator and Bite Guard. Manufactured by Palmedic (TOE/TEE kit non-Sterile Part Number: REF 1280-01) UXID: 00.032.189	◆	◆	◆	◆	◆	∅
Recommended ECG Electrode: Kendall Medi-Trace 200 and 230 Foam Electrode	∅	◆	◆	∅	∅	∅
<b>Biopsy Start Kits</b>						
EC9-5/10, Manufactured by Protek, Part Number: 7544 and CIVCO, Part Number: 610-986	◆	◆	◆	◆	◆	◆
C5-2/60, Manufactured by CIVCO, Part Number: 684-003	◆	◆	◆	◆	◆	◆
C5-2/60 and C7-3/50, Manufactured by Protek, Part Number: 7462	◆	◆	◆	◆	◆	◆
L14-5W/60, Manufactured by CIVCO, Part Number: 684-004	◆	◆	◆	◆	◆	∅
L9-4/38, Manufactured by CIVCO, Part Number: 684-005	◆	◆	◆	◆	◆	∅
L14-5/38, Manufactured by CIVCO, Part Number: 684-005	◆	◆	◆	◆	◆	◆
4DEC-5/10, Manufactured by CIVCO, Part Number: 610-666	∅	◆	◆	◆	◆	∅

- 1 Ultrasonix Medical Corporation is not responsible for misdiagnosis from customized measurements.
- 2 Certain transducers may not be available in all markets. Consult your local Ultrasonix Authorized Distributor or Sales Representative to determine availability in your area.
- 3 Specific User Interface options are dependant upon licensed features.
- 4 Where available. Requires Internet connection and ISP.
- 5 Some LGY (Legacy) options are specific to the OP/SP platform, while others apply only to the CEP. If the options are different on the three (3) LGY hardware platforms, then three (3) options will be marked, one each for OP, SP and CEP (e.g., ∅/◆/◆).

## APPENDIX C: TRANSDUCER SPECIFICATIONS

### C.1 TRANSDUCER DISCLAIMER

Certain transducers may not be available in all markets. Consult your local Ultrasonix Authorized Distributor or Sales Representative to determine availability in your area.

### C.2 ACOUSTIC OUTPUT RECORDING TABLES

Below are copies of the **Acoustic Output Reporting Tables for Track 3** for all transducers and all modes (provide data where global maximum displayed index exceeds 1.0).

The following notes apply to **ALL** Acoustic Output Reporting Tables for **ALL** transducers/modes:

- a) This index is not required for this operating mode; see section 4.1.3.1 of the *Standard for real-time display of thermal and mechanical acoustic output indices on diagnostic ultrasound equipment (AIUM/ NEMA 1998b)*
  - b) This probe is not intended for trans-cranial or neonatal cephalic uses
  - c) This formulation for TIS is less than that for an alternate formulation in this mode
- # No data are reported for this operating condition since the global maximum index value is not reported for the reason listed.

**Table C-1: Transducer Model SA4-2/24 (Operating Mode: B)**

Index Label		MI	TIS			TIB	TIC	
			scan	non-scan				
				$A_{aprt} \leq 1$	$A_{aprt} > 1$	non-scan		
Global Maximum Index Value		1.37	(a)	(a)	(a)	(a)	(a)	
Assoc. Acoustic Param.	Pr.3	[MPa]	1.93					
	$W_o$	[mW]		(a)		(a)	(a)	
	min of $[W_s(z_1) : I_{TA,3}(z_1)]$	[mW]			(a)			
	$Z_1$	[cm]			(a)			
	$z_{bp}$	[cm]			(a)			
	$z_{sp}$	[cm]	4.58				(a)	
	$d_{eq}(z_{sp})$	[cm]					(a)	
	$f_c$	[MHz]	2.00	(a)	(a)	(a)	(a)	(a)
	Dim of $A_{aprt}$	X [cm]		(a)	(a)	(a)	(a)	(a)
		Y [cm]		(a)	(a)	(a)	(a)	(a)
Other Information	PD	[µsec]	0.58					
	PRF	[Hz]	31.553					
	$p_r @ PII_{max}$	[MPa]	2.65					
	$d_{eq} @ PII_{max}$	[cm]					(a)	
	Focal Length	FL <sub>X</sub> [cm]		(a)	(a)	(a)		(a)
		FL <sub>Y</sub> [cm]		(a)	(a)	(a)		(a)
$I_{PA,3} @ MI_{max}$	[W/cm <sup>2</sup> ]	0.08						
Operating Control Conditions	Control 1 Depth	800	[mm]					
	Control 2 Focus	46	[mm]					
	Control 3 Gate	-	[mm]					
	Control 4 Preset	ABD-Aorta (SA4-2/20mm) - HarRes						

$$ISPTA.3 [mW/cm^2] = 44.0766$$



**Table C-2: Transducer Model SA4-2/24 (Operating Mode: Color and Power Doppler)**

Index Label		MI	TIS			TIB	TIC	
			scan	non-scan		non-scan		
Global Maximum Index Value		1.01		3.13	(c)	(c)	(a)	4.77
Assoc. Acoustic Param.	Pr.3 [MPa]	1.75						
	W <sub>0</sub> [mW]		219.13	(c)		(a)	324.69	
	min of [W <sub>3</sub> (z <sub>1</sub> ) : I <sub>TA,3</sub> (z <sub>1</sub> )] [mW]				(c)			
	Z <sub>1</sub> [cm]				(c)			
	z <sub>bp</sub> [cm]				(c)			
	z <sub>sp</sub> [cm]	4.02				(a)		
	d <sub>eq</sub> (z <sub>sp</sub> ) [cm]					(a)		
	f <sub>c</sub> [MHz]	3.00	3.00	(c)	(c)	(a)	3.00	
	Dim of A <sub>aprt</sub>	X [cm]	1.63	(c)	(c)	(a)	1.63	
		Y [cm]	1.40	(c)	(c)	(a)	1.40	
Other Information	PD [µsec]	1.26						
	PRF [Hz]	15.282						
	p <sub>r</sub> @P <sub>II</sub> <sub>max</sub> [MPa]	2.65						
	d <sub>eq</sub> @P <sub>II</sub> <sub>max</sub> [cm]					(a)		
	Focal Length	FL <sub>x</sub> [cm]		5.60	(c)	(c)		5.60
		FL <sub>y</sub> [cm]		5.60	(c)	(c)		5.60
I <sub>PA,3</sub> @M <sub>max</sub> [W/cm <sup>2</sup> ]	0.09							
Operating Control Conditions	Control 1 Depth	800	[mm]					
	Control 2 Focus	56	[mm]					
	Control 3 Gate	-	[mm]					
	Control 4 Preset	CAR-Diff (SA4-2/20mm) - Pen						

ISPTA.3 [mW/cm<sup>2</sup>] = 115.098

**Table C-3: Transducer Model SA4-2/24 (Operating Mode: M)**

Index Label		MI	TIS			TIB	TIC	
			scan	non-scan		non-scan		
Global Maximum Index Value		1.37		0.46	(a)	(a)	(a)	1.29
Assoc. Acoustic Param.	Pr.3 [MPa]	1.93						
	W <sub>0</sub> [mW]		48.51	(a)		(a)	88.10	
	min of [W <sub>3</sub> (z <sub>1</sub> ) : I <sub>TA,3</sub> (z <sub>1</sub> )] [mW]				(a)			
	Z <sub>1</sub> [cm]				(a)			
	z <sub>bp</sub> [cm]				(a)			
	z <sub>sp</sub> [cm]	4.58				(a)		
	d <sub>eq</sub> (z <sub>sp</sub> ) [cm]					(a)		
	f <sub>c</sub> [MHz]	2.00	2.00	(a)	(a)	(a)	2.00	
	Dim of A <sub>aprt</sub>	X [cm]	1.63	(a)	(a)	(a)	1.63	
		Y [cm]	1.40	(a)	(a)	(a)	1.40	
Other Information	PD [µsec]	0.58						
	PRF [Hz]	65						
	p <sub>r</sub> @P <sub>II</sub> <sub>max</sub> [MPa]	2.65						
	d <sub>eq</sub> @P <sub>II</sub> <sub>max</sub> [cm]					(a)		
	Focal Length	FL <sub>x</sub> [cm]		4.60	(a)	(a)		4.60
		FL <sub>y</sub> [cm]		4.60	(a)	(a)		4.60
I <sub>PA,3</sub> @M <sub>max</sub> [W/cm <sup>2</sup> ]	0.16							
Operating Control Conditions	Control 1 Depth	800	[mm]					
	Control 2 Focus	46	[mm]					
	Control 3 Gate	-	[mm]					
	Control 4 Preset	ABD-Aorta (SA4-2/20mm) - HarRes						

ISPTA.3 [mW/cm<sup>2</sup>] = 90.7986

**Table C-4: Transducer Model SA4-2/24 (Operating Mode: PW Doppler)**

Index Label		MI	TIS		TIB		TIC	
			scan	non-scan		non-scan		
Global Maximum Index Value		0.22	(a)	1.07	0.8631	1.24	1.10	
Assoc. Acoustic Param.	Pr.3 [MPa]	0.38						
	$W_0$ [mW]		(a)	72.93		72.93	72.93	
	min of $[W_3(z_1) : I_{TA,3}(z_1)]$ [mW]				7.36			
	$Z_1$ [cm]				4.66			
	$Z_{bp}$ [cm]				2.49			
	$z_{sp}$ [cm]	4.66				4.66		
	$d_{eq}(z_{sp})$ [cm]					6.13		
	$f_c$ [MHz]	3.07	(a)	3.07	3.07	3.07	3.07	
	Dim of $A_{aprt}$	X [cm]		(a)	1.54	1.54	1.54	1.54
		Y [cm]		(a)	1.40	1.40	1.40	1.40
Other Information	PD [ $\mu$ sec]	3.06						
	PRF [Hz]	5000						
	$p_r@P_{II_{max}}$ [MPa]	0.63						
	$d_{eq}@P_{II_{max}}$ [cm]					2.77		
	Focal Length	$FL_X$ [cm]		(a)	5.00	5.00		3.07
		$FL_Y$ [cm]		(a)	5.00	5.00		3.07
$I_{PA,3}@MI_{max}$ [W/cm <sup>2</sup> ]	0.02							
Operating Control Conditions	Control 1 Depth	80	[mm]					
	Control 2 Focus	50	[mm]					
	Control 3 Gate	10	[mm]					
	Control 4 Preset	GEN-GEN						

$$ISPTA.3 [mW/cm^2] = 91.68118$$

**Table C-5: Transducer Model SA4-2/24 (Operating Mode: PW+B)**

Index Label		MI	TIS		TIB		TIC	
			scan	non-scan		non-scan		
Global Maximum Index Value		0.22	0.00	1.72	0.8631	0.02	1.77	
Assoc. Acoustic Param.	Pr.3 [MPa]	0.38						
	$W_0$ [mW]		0.07	117.32		117.32	117.32	
	min of $[W_3(z_1) : I_{TA,3}(z_1)]$ [mW]				7.36			
	$Z_1$ [cm]				4.66			
	$Z_{bp}$ [cm]				2.49			
	$z_{sp}$ [cm]	4.66				4.66		
	$d_{eq}(z_{sp})$ [cm]					7.78		
	$f_c$ [MHz]	3.07	3.07	3.07	3.07	3.07	3.07	
	Dim of $A_{aprt}$	X [cm]		1.54	1.54	1.54	1.54	1.54
		Y [cm]		1.40	1.40	1.40	1.40	1.40
Other Information	PD [ $\mu$ sec]	3.06						
	PRF [Hz]	5000						
	$p_r@P_{II_{max}}$ [MPa]	0.63						
	$d_{eq}@P_{II_{max}}$ [cm]					3.52		
	Focal Length	$FL_X$ [cm]		5.00	5.00	5.00		5.00
		$FL_Y$ [cm]		5.00	5.00	5.00		5.00
$I_{PA,3}@MI_{max}$ [W/cm <sup>2</sup> ]	0.03							
Operating Control Conditions	Control 1 Depth	80	[mm]					
	Control 2 Focus	50	[mm]					
	Control 3 Gate	10	[mm]					
	Control 4 Preset	GEN-GEN						

$$ISPTA.3 [mW/cm^2] = 106.3303$$



ULTRASONIX

**Table C-6: Transducer Model SA4-2/24 (Operating Mode: CW Doppler)**

Index Label		MI	TIS			TIB	TIC	
			scan	non-scan				
Global Maximum Index Value		0.06		1.34E-04	1.61E-04	0.0001	2.05E-03	4.81E-04
Assoc. Acoustic Param.	Pr.3 [MPa]	0.07						
	W <sub>0</sub> [mW]		0.02	0.02		0.02	0.02	
	min of [W <sub>3</sub> (z <sub>1</sub> ) : I <sub>TA,3</sub> (z <sub>1</sub> )] [mW]				0.01			
	Z <sub>1</sub> [cm]				3.80			
	Z <sub>bp</sub> [cm]				1.63			
	zsp [cm]	3.80				3.80		
	d <sub>eq</sub> (z <sub>sp</sub> ) [cm]					0.10		
	f <sub>c</sub> [MHz]	1.62	1.62	1.62	1.62	1.62	1.62	
	Dim of A <sub>aprt</sub>	X [cm]		0.66	0.66	0.66	0.66	0.66
		Y [cm]		1.40	1.40	1.40	1.40	1.40
Other Information	PD [µsec]	0.00						
	PRF [Hz]	12500						
	p <sub>r</sub> @PII <sub>max</sub> [MPa]	0.09						
	d <sub>eq</sub> @PII <sub>max</sub> [cm]					0.01		
	Focal Length	FL <sub>x</sub> [cm]		5.00	5.00	5.00		5.00
		FL <sub>y</sub> [cm]		5.00	5.00	5.00		5.00
I <sub>PA,3</sub> @MI <sub>max</sub> [W/cm <sup>2</sup> ]	0.16							
Operating Control Conditions	Control 1 Depth	80	[mm]					
	Control 2 Focus	50	[mm]					
	Control 3 Gate	-	[mm]					
	Control 4 Preset	CAR-Gen						

ISPTA.3 [mW/cm<sup>2</sup>] = 155.3387

**Table C-7: Transducer Model SA4-2/2 (Operating Mode: Triplex (B/Color/PW))**

Index Label		MI	TIS			TIB	TIC	
			scan	non-scan				
Global Maximum Index Value		0.22		0.00	1.72	0.86311	0.02	1.77
Assoc. Acoustic Param.	Pr.3 [MPa]	0.38						
	W <sub>0</sub> [mW]		0.07	117.32		117.32	117.32	
	min of [W <sub>3</sub> (z <sub>1</sub> ) : I <sub>TA,3</sub> (z <sub>1</sub> )] [mW]				0.00			
	Z <sub>1</sub> [cm]				4.66			
	Z <sub>bp</sub> [cm]				2.49			
	zsp [cm]	4.66				4.66		
	d <sub>eq</sub> (z <sub>sp</sub> ) [cm]							
	f <sub>c</sub> [MHz]	3.07	3.07	3.07	3.07	3.07	3.07	
	Dim of A <sub>aprt</sub>	X [cm]		1.54	1.54	1.54	1.54	1.54
		Y [cm]		1.40	1.40	1.40	1.40	1.40
Other Information	PD [µsec]	3.06						
	FPS [Hz]	9						
	PRFd [Hz]	3333						
	p <sub>r</sub> @PII <sub>max</sub> [MPa]	0.63						
	d <sub>eq</sub> @PII <sub>max</sub> [cm]					635.20		
	Focal Length	FL <sub>x</sub> [cm]		5.00	5.00	5.00		5.00
FL <sub>y</sub> [cm]			5.00	5.00	5.00		5.00	
I <sub>PA,3</sub> @MI <sub>max</sub> [W/cm <sup>2</sup> ]	0.02							
Operating Control Conditions	Control 1 Depth	80	[mm]					
	Control 2 Focus	50	[mm]					
	Control 3 Gate	10	[mm]					
	Control 4 Preset	GEN-GEN						

ISPTA.3 [mW/cm<sup>2</sup>] = 68.44

**Table C-8: Transducer Model EC9-5/10 (Operating Mode: B)**

Index Label		MI	TIS		TIB	TIC	
			scan	non-scan			non-scan
Global Maximum Index Value		0.57	(a)	(a)	(a)	(a)	
Assoc. Acoustic Param.	Pr.3 [MPa]	1.40					
	$W_0$ [mW]		(a)	(a)		(a)	
	min of $[W_3(z_1) : I_{TA,3}(z_1)]$ [mW]				(a)		
	$Z_1$ [cm]				(a)		
	$Z_{bp}$ [cm]				(a)		
	$z_{sp}$ [cm]	2.62				(a)	
	$d_{eq}(z_{sp})$ [cm]					(a)	
	$f_c$ [MHz]	6.00	(a)	(a)	(a)	(a)	
	Dim of $A_{aprt}$	X [cm]		(a)	(a)	(a)	(a)
		Y [cm]		(a)	(a)	(a)	(a)
Other Information	PD [ $\mu$ sec]	0.25					
	PRF [Hz]	60.774					
	$p_r@P_{II_{max}}$ [MPa]	2.42					
	$d_{eq}@P_{II_{max}}$ [cm]					(a)	
	Focal Length	FL <sub>X</sub> [cm]		(a)	(a)	(a)	(a)
		FL <sub>Y</sub> [cm]		(a)	(a)	(a)	(a)
$I_{PA,3}@M_{I_{max}}$ [W/cm <sup>2</sup> ]	0.01						
Operating Control Conditions	Control 1 Depth	700	[mm]				
	Control 2 Focus	27	[mm]				
	Control 3 Gate	-	[mm]				
	Control 4 Preset	PEL-General (EC9-5/10mm) - General					

$$ISPTA.3 [mW/cm^2] = 2.88$$

**Table C-9: Transducer Model EC9-5/10 and (Operating Mode: Color and Power Doppler)**

Index Label		MI	TIS		TIB	TIC		
			scan	non-scan			non-scan	
Global Maximum Index Value		0.50	1.35	(a)	(a)	(a)	1.31	
Assoc. Acoustic Param.	Pr.3 [MPa]	1.29						
	$W_0$ [mW]		42.49	(a)		(a)	73.48	
	min of $[W_3(z_1) : I_{TA,3}(z_1)]$ [mW]				(a)			
	$Z_1$ [cm]				(a)			
	$Z_{bp}$ [cm]				(a)			
	$z_{sp}$ [cm]	2.46				(a)		
	$d_{eq}(z_{sp})$ [cm]					(a)		
	$f_c$ [MHz]	6.67	6.67	(a)	(a)	(a)	6.67	
	Dim of $A_{aprt}$	X [cm]		1.00	(a)	(a)	(a)	2.57
		Y [cm]		0.60	(a)	(a)	(a)	0.60
Other Information	PD [ $\mu$ sec]	0.60						
	PRF [Hz]	13.341						
	$p_r@P_{II_{max}}$ [MPa]	2.27						
	$d_{eq}@P_{II_{max}}$ [cm]					(a)		
	Focal Length	FL <sub>X</sub> [cm]		2.70	(a)	(a)		2.70
		FL <sub>Y</sub> [cm]		2.70	(a)	(a)		2.70
$I_{PA,3}@M_{I_{max}}$ [W/cm <sup>2</sup> ]	0.02							
Operating Control Conditions	Control 1 Depth	700	[mm]					
	Control 2 Focus	27	[mm]					
	Control 3 Gate	-	[mm]					
	Control 4 Preset	PEL-General (EC9-5/10mm) - Gen						

$$ISPTA.3 [mW/cm^2] = 10.4397$$



**Table C-10: Transducer Model EC9-5/10 (Operating Mode: M)**

Index Label		MI	TIS			TIB	TIC	
			scan	non-scan				
Global Maximum Index Value		0.57	0.57	(c)	(c)	(c)	0.90	
Assoc. Acoustic Param.	Pr.3 [MPa]	1.40						
	W <sub>0</sub> [mW]		19.96	(c)		(c)	50.56	
	min of [W <sub>3</sub> (z <sub>1</sub> ) : I <sub>TA,3</sub> (z <sub>1</sub> )] [mW]				(c)			
	Z <sub>1</sub> [cm]				(c)			
	Z <sub>bp</sub> [cm]				(c)			
	zsp [cm]	2.62				(c)		
	d <sub>eq</sub> (z <sub>sp</sub> ) [cm]					(c)		
	f <sub>c</sub> [MHz]	6.00	6.00	(c)	(c)	(c)	6.00	
	Dim of A <sub>aprt</sub>	X [cm]		1.00	(c)	(c)	(c)	2.57
		Y [cm]		0.60	(c)	(c)	(c)	0.60
Other Information	PD [µsec]	0.41						
	PRF [Hz]	65						
	p <sub>r</sub> @P <sub>II</sub> max [MPa]	2.42						
	d <sub>eq</sub> @P <sub>II</sub> max [cm]					(c)		
	Focal Length	FL <sub>x</sub> [cm]		2.70	(c)	(c)		2.70
		FL <sub>y</sub> [cm]		2.70	(c)	(c)		2.70
I <sub>PA,3</sub> @MI <sub>max</sub> [W/cm <sup>2</sup> ]	0.01							
Operating Control Conditions	Control 1 Depth	700	[mm]					
	Control 2 Focus	27	[mm]					
	Control 3 Gate	-	[mm]					
	Control 4 Preset	PEL-General (EC9-5/10mm) - HarRes						

ISPTA.3 [mW/cm<sup>2</sup>] = 3.08

**Table C-11: Transducer Model EC9-5/10 (Operating Mode: PW Doppler)**

Index Label		MI	TIS			TIB	TIC	
			scan	non-scan				
Global Maximum Index Value		0.29	(c)	0.40	0.281	1.33	0.48	
Assoc. Acoustic Param.	Pr.3 [MPa]	0.75						
	W <sub>0</sub> [mW]		(c)	12.59		12.59	12.59	
	min of [W <sub>3</sub> (z <sub>1</sub> ) : I <sub>TA,3</sub> (z <sub>1</sub> )] [mW]				7.52			
	Z <sub>1</sub> [cm]				2.42			
	Z <sub>bp</sub> [cm]				0.99			
	zsp [cm]	2.42				2.42		
	d <sub>eq</sub> (z <sub>sp</sub> ) [cm]					2.47		
	f <sub>c</sub> [MHz]	6.67	(c)	6.67	6.67	6.67	6.67	
	Dim of A <sub>aprt</sub>	X [cm]		(c)	0.57	0.57	0.57	0.57
		Y [cm]		(c)	0.60	0.60	0.60	0.60
Other Information	PD [µsec]	1.33						
	PRF [Hz]	6666.7						
	p <sub>r</sub> @P <sub>II</sub> max [MPa]	1.31						
	d <sub>eq</sub> @P <sub>II</sub> max [cm]					-		
	Focal Length	FL <sub>x</sub> [cm]		(c)	(c)	2.70		6.67
		FL <sub>y</sub> [cm]		(c)	(c)	2.70		6.67
I <sub>PA,3</sub> @MI <sub>max</sub> [W/cm <sup>2</sup> ]	0.25							
Operating Control Conditions	Control 1 Depth	700	[mm]					
	Control 2 Focus	27	[mm]					
	Control 3 Gate	20.00	[mm]					
	Control 4 Preset	PEL-General (EC9-5/10mm) - Pen						

ISPTA.3 [mW/cm<sup>2</sup>] = 332.93



**Table C-12: Transducer Model EC9-5/10 (Operating Mode: PW+B)**

Index Label		MI	TIS		TIB	TIC		
			scan	non-scan			non-scan	
Global Maximum Index Value		0.27	0.19	(c)	(c)	0.84		
Assoc. Acoustic Param.	Pr.3 [MPa]	0.70						
	$W_0$ [mW]		5.92	(c)	(c)	47.27		
	min of $[W_3(z_1) : I_{TA,3}(z_1)]$ [mW]				(c)			
	$Z_1$ [cm]				(c)			
	$Z_{bp}$ [cm]				(c)			
	$z_{sp}$ [cm]	2.64				(c)		
	$d_{eq}(z_{sp})$ [cm]					(c)		
	$f_c$ [MHz]	6.67	6.67	(c)	(c)	(c)	6.67	
	Dim of $A_{aprt}$	X [cm]		1.00	(c)	(c)	(c)	2.57
		Y [cm]		0.60	(c)	(c)	(c)	0.60
Other Information	PD [ $\mu$ sec]	1.33						
	PRF [Hz]	19.298						
	$p_r@P_{II_{max}}$ [MPa]	1.28						
	$d_{eq}@P_{II_{max}}$ [cm]					(c)		
	Focal Length	$FL_X$ [cm]		2.70	(c)	(c)	2.70	
		$FL_Y$ [cm]		2.70	(c)	(c)	2.70	
$I_{PA,3}@MI_{max}$ [W/cm <sup>2</sup> ]	0.14							
Operating Control Conditions	Control 1 Depth	700	[mm]					
	Control 2 Focus	26.95	[mm]					
	Control 3 Gate	20	[mm]					
	Control 4 Preset	PEL-General (EC9-5/10mm) - General						

$$ISPTA.3 [mW/cm^2] = 181.00$$

**Table C-13: Transducer Model EC9-5/10 (Operating Mode: Triplex (B/Color/PW))**

Index Label		MI	TIS		TIB	TIC		
			scan	non-scan			non-scan	
Global Maximum Index Value		0.27	0.19	(c)	(c)	0.84		
Assoc. Acoustic Param.	Pr.3 [MPa]	0.70						
	$W_0$ [mW]		5.92	(c)	(c)	47.27		
	min of $[W_3(z_1) : I_{TA,3}(z_1)]$ [mW]				(c)			
	$Z_1$ [cm]				(c)			
	$Z_{bp}$ [cm]				(c)			
	$z_{sp}$ [cm]	2.64				(c)		
	$d_{eq}(z_{sp})$ [cm]					(c)		
	$f_c$ [MHz]	6.67	6.67	(c)	(c)	(c)	6.67	
	Dim of $A_{aprt}$	X [cm]		1.00	(c)	(c)	(c)	1.00
		Y [cm]		0.60	(c)	(c)	(c)	0.60
Other Information	PD [ $\mu$ sec]	1.33						
	FPS [Hz]	7.00						
	PRFd [Hz]	4000						
	$p_r@P_{II_{max}}$ [MPa]	1.28						
	$d_{eq}@P_{II_{max}}$ [cm]					(c)		
	Focal Length	$FL_X$ [cm]		2.70	(c)	(c)	2.70	
$FL_Y$ [cm]			2.70	(c)	(c)	2.70		
$I_{PA,3}@MI_{max}$ [W/cm <sup>2</sup> ]	0.19							
Operating Control Conditions	Control 1 Depth	700	[mm]					
	Control 2 Focus	26.95	[mm]					
	Control 3 Gate	20	[mm]					
	Control 4 Preset	PEL-General (EC9-5 10mm) - General						

$$ISPTA.3 [mW/cm^2] = 249.02$$



ULTRASONIX

**Table C-14: Transducer Model C5-2/60 and C5-2/60 GPS (Operating Mode: B)**

Index Label		MI	TIS		TIB	TIC	
			scan	non-scan			non-scan
Global Maximum Index Value		0.93	(a)	(a)	(a)	(a)	
Assoc. Acoustic Param.	Pr.3 [MPa]	1.48					
	$W_G$ [mW]		(a)	(a)		(a)	
	min of $[W_{.3}(z_1) : I_{TA.3}(z_1)]$ [mW]				(a)		
	$Z_1$ [cm]				(a)		
	$z_{bp}$ [cm]				(a)		
	$z_{sp}$ [cm]	4.56				(a)	
	$d_{eq}(z_{sp})$ [cm]					(a)	
	$f_c$ [MHz]	2.50	(a)	(a)	(a)	(a)	
	Dim of $A_{aprt}$	X [cm]		(a)	(a)	(a)	(a)
		Y [cm]		(a)	(a)	(a)	(a)
Other Information	PD [µsec]	0.71					
	PRF [Hz]	41					
	$p_r@PII_{max}$ [MPa]	2.19					
	$d_{eq}@PII_{max}$ [cm]					(a)	
	Focal Length	FL <sub>x</sub> [cm]		(a)	(a)	(a)	(a)
		FL <sub>y</sub> [cm]		(a)	(a)	(a)	(a)
$I_{PA.3}@MI_{max}$ [W/cm <sup>2</sup> ]	0.02						
Operating Control Conditions	Control 1 Depth	80	[mm]				
	Control 2 Focus	40	[mm]				
	Control 3 Gate	-	[mm]				
	Control 4 Preset	GEN-GEN					

$ISPTA.3 [mW/cm^2] = 67.11$

**Table C-15: Transducer Model C5-2/60 and C5-2/60 GPS (Operating Mode: Color and Power Doppler)**

Index Label		MI	TIS		TIB	TIC		
			scan	non-scan			non-scan	
Global Maximum Index Value		0.83	0.00	(a)	(a)	0.05		
Assoc. Acoustic Param.	Pr.3 [MPa]	1.31						
	$W_G$ [mW]		0.06	(a)		5.84		
	min of $[W_{.3}(z_1) : I_{TA.3}(z_1)]$ [mW]				(c)			
	$Z_1$ [cm]				(c)			
	$z_{bp}$ [cm]				(a)			
	$z_{sp}$ [cm]	4.20				(a)		
	$d_{eq}(z_{sp})$ [cm]					(a)		
	$f_c$ [MHz]	2.50	2.50	(a)	(a)	(a)	2.50	
	Dim of $A_{aprt}$	X [cm]		6.40	(a)	(a)	(a)	6.40
		Y [cm]		1.20	(a)	(a)	(a)	1.20
Other Information	PD [µsec]	1.07						
	PRF [Hz]	6700						
	$p_r@PII_{max}$ [MPa]	1.88						
	$d_{eq}@PII_{max}$ [cm]					(a)		
	Focal Length	FL <sub>x</sub> [cm]		3.00	(a)	(a)	3.00	
		FL <sub>y</sub> [cm]		3.00	(a)	(a)	3.00	
$I_{PA.3}@MI_{max}$ [W/cm <sup>2</sup> ]	0.00							
Operating Control Conditions	Control 1 Depth	80	[mm]					
	Control 2 Focus	40	[mm]					
	Control 3 Gate	-	[mm]					
	Control 4 Preset	GEN-GEN						

$ISPTA.3 [mW/cm^2] = 17.83$

**Table C-16: Transducer Model C5-2/60 and C5-2/60 GPS (Operating Mode: M)**

Index Label		MI	TIS		TIB	TIC		
			scan	non-scan			non-scan	
Global Maximum Index Value		0.93	0.00	A <sub>aprt</sub> ≤1 (a)	A <sub>aprt</sub> >1 (a)	0.21	0.00	
Assoc. Acoustic Param.	Pr.3 [MPa]	1.48						
	W <sub>0</sub> [mW]		0.15	(a)		(a)	(a)	
	min of [W <sub>3</sub> (z <sub>1</sub> ) : I <sub>TA,3</sub> (z <sub>1</sub> )] [mW]					(c)		
	Z <sub>1</sub> [cm]					(c)		
	Z <sub>bsp</sub> [cm]					(a)		
	zsp [cm]	4.56					(a)	
	d <sub>eq</sub> (zsp) [cm]						(a)	
	f <sub>c</sub> [MHz]	2.50	2.50	(a)	(a)	(a)	2.50	
	Dim of A <sub>aprt</sub>	X [cm]		6.40	(a)	(a)	(a)	6.40
		Y [cm]		1.20	(a)	(a)	(a)	1.20
Other Information	PD [μsec]	0.71						
	PRF [Hz]	41						
	p <sub>r</sub> @P <sub>II</sub> max [MPa]	2.19						
	d <sub>eq</sub> @P <sub>II</sub> max [cm]						(a)	
	Focal Length	FL <sub>X</sub> [cm]		3.00	(a)	(a)		3.00
		FL <sub>Y</sub> [cm]		3.00	(a)	(a)		3.00
I <sub>PA,3</sub> @MI <sub>max</sub> [W/cm <sup>2</sup> ]	0.02							
Operating Control Conditions	Control 1 Depth	80	[mm]					
	Control 2 Focus	40	[mm]					
	Control 3 Gate	-	[mm]					
	Control 4 Preset	GEN-GEN						

 ISPTA.3 [mW/cm<sup>2</sup>] = 67.11

**Table C-17: Transducer Model C5-2/60 and C5-2/60 GPS (Operating Mode: PW Doppler)**

Index Label		MI	TIS		TIB	TIC		
			scan	non-scan			non-scan	
Global Maximum Index Value		0.30	(a)	A <sub>aprt</sub> ≤1 1.82	A <sub>aprt</sub> >1 1.29	2.13	1.22	
Assoc. Acoustic Param.	Pr.3 [MPa]	0.48						
	W <sub>0</sub> [mW]		(a)	152.91		152.91	152.91	
	min of [W <sub>3</sub> (z <sub>1</sub> ) : I <sub>TA,3</sub> (z <sub>1</sub> )] [mW]					10.15		
	Z <sub>1</sub> [cm]					2.81		
	Z <sub>bsp</sub> [cm]					4.69		
	zsp [cm]	2.81					2.81	
	d <sub>eq</sub> (zsp) [cm]						10.07	
	f <sub>c</sub> [MHz]	2.50	(a)	2.50	2.50	2.50	2.50	
	Dim of A <sub>aprt</sub>	X [cm]		(a)	6.40	6.40	6.40	6.40
		Y [cm]		(a)	1.20	1.20	1.20	1.20
Other Information	PD [μsec]	5.89						
	PRF [Hz]	12500						
	p <sub>r</sub> @P <sub>II</sub> max [MPa]	0.61						
	d <sub>eq</sub> @P <sub>II</sub> max [cm]						3.88	
	Focal Length	FL <sub>X</sub> [cm]		(a)	4.00	4.00		2.50
		FL <sub>Y</sub> [cm]		(a)	4.00	4.00		2.50
I <sub>PA,3</sub> @MI <sub>max</sub> [W/cm <sup>2</sup> ]	0.16							
Operating Control Conditions	Control 1 Depth	80	[mm]					
	Control 2 Focus	40	[mm]					
	Control 3 Gate	10	[mm]					
	Control 4 Preset	GEN-GEN						

 ISPTA.3 [mW/cm<sup>2</sup>] = 633.22



**Table C-18: Transducer Model C5-2/60 and C5-2/60 GPS (Operating Mode: PW+B)**

Index Label		MI	TIS			TIB	TIC	
			scan	non-scan		non-scan		
				A <sub>aprt</sub> ≤1	A <sub>aprt</sub> >1			
Global Maximum Index Value		0.30	0.00		3.87	1.29	0.12	2.60
Assoc. Acoustic Param.	Pr.3 [MPa]	0.48						
	W <sub>0</sub> [mW]		0.12		325.36		325.36	325.36
	min of [W <sub>3</sub> (z <sub>1</sub> ) : I <sub>TA,3</sub> (z <sub>1</sub> )] [mW]					10.15		
	Z <sub>1</sub> [cm]					2.81		
	Z <sub>bp</sub> [cm]					4.69		
	zsp [cm]	2.81					2.81	
	d <sub>eq</sub> (z <sub>sp</sub> ) [cm]						14.70	
	f <sub>c</sub> [MHz]	2.50	2.50	2.50	2.50	2.50	2.50	2.50
	Dim of A <sub>aprt</sub>	X [cm]		6.40	6.40	6.40	6.40	6.40
		Y [cm]		1.20	1.20	1.20	1.20	1.20
Other Information	PD [µsec]	5.89						
	PRF [Hz]	12500						
	p <sub>r</sub> @P <sub>II</sub> <sub>max</sub> [MPa]	0.61						
	d <sub>eq</sub> @P <sub>II</sub> <sub>max</sub> [cm]						5.66	
	Focal Length	FL <sub>x</sub> [cm]		3.00	3.00	3.00		3.00
		FL <sub>y</sub> [cm]		3.00	3.00	3.00		3.00
I <sub>PA,3</sub> @M <sub>I</sub> <sub>max</sub> [W/cm <sup>2</sup> ]	0.16							
Operating Control Conditions	Control 1 Depth	80	[mm]					
	Control 2 Focus	40	[mm]					
	Control 3 Gate	10	[mm]					
	Control 4 Preset	GEN-GEN						

ISPTA.3 [mW/cm<sup>2</sup>] = 654.59

**Table C-19: Transducer Model C5-2/60 and C5-2/60 GPS (Operating Mode: Triplex (B/Color/PW))**

Index Label		MI	TIS			TIB	TIC	
			scan	non-scan		non-scan		
				A <sub>aprt</sub> ≤1	A <sub>aprt</sub> >1			
Global Maximum Index Value		0.53	0.00		1.67	0.09	0.12	1.12
Assoc. Acoustic Param.	Pr.3 [MPa]	0.83						
	W <sub>0</sub> [mW]		0.10		140.14		140.14	140.14
	min of [W <sub>3</sub> (z <sub>1</sub> ) : I <sub>TA,3</sub> (z <sub>1</sub> )] [mW]					11.71		
	Z <sub>1</sub> [cm]					3.74		
	Z <sub>bp</sub> [cm]					4.69		
	zsp [cm]	3.74					3.74	
	d <sub>eq</sub> (z <sub>sp</sub> ) [cm]						9.27	
	f <sub>c</sub> [MHz]	2.50	2.50	2.50	2.50	2.50	2.50	2.50
	Dim of A <sub>aprt</sub>	X [cm]		6.40	6.40	6.40	6.40	6.40
		Y [cm]		1.20	1.20	1.20	1.20	1.20
Other Information	PD [µsec]	2.46						
	FPS [Hz]	8						
	PRFd [Hz]	3333						
	p <sub>r</sub> @P <sub>II</sub> <sub>max</sub> [MPa]	1.15						
	d <sub>eq</sub> @P <sub>II</sub> <sub>max</sub> [cm]						3.32	
	Focal Length	FL <sub>x</sub> [cm]		3.00	3.00	3.00		3.00
FL <sub>y</sub> [cm]			3.00	3.00	3.00		3.00	
I <sub>PA,3</sub> @M <sub>I</sub> <sub>max</sub> [W/cm <sup>2</sup> ]	0.07							
Operating Control Conditions	Control 1 Depth	80	[mm]					
	Control 2 Focus	40	[mm]					
	Control 3 Gate	10	[mm]					
	Control 4 Preset	GEN-GEN						

ISPTA.3 [mW/cm<sup>2</sup>] = 280.66

**Table C-20: Transducer Model L9-4/38 (Operating Mode: B)**

Index Label		MI	TIS			TIB	TIC	
			scan	non-scan		non-scan		
Global Maximum Index Value		0.60	(a)	(a)	(a)	(a)	(a)	
Assoc. Acoustic Param.	Pr.3 [MPa]	2.62						
	$W_0$ [mW]		(a)	(a)		(a)	(a)	
	min of $[W_3(z_1) : I_{TA,3}(z_1)]$ [mW]				(a)			
	$Z_1$ [cm]				(a)			
	$Z_{bp}$ [cm]				(a)			
	$z_{sp}$ [cm]	2.79				(a)		
	$d_{eq}(z_{sp})$ [cm]					(a)		
	$f_c$ [MHz]	4.77	(a)	(a)	(a)	(a)	(a)	
	Dim of $A_{aprt}$	X [cm]		(a)	(a)	(a)	(a)	(a)
		Y [cm]		(a)	(a)	(a)	(a)	(a)
Other Information	PD [ $\mu$ sec]	1.61						
	PRF [Hz]	55						
	$p_r@P_{II_{max}}$ [MPa]	4.14						
	$d_{eq}@P_{II_{max}}$ [cm]					(a)		
	Focal Length	FL <sub>X</sub> [cm]		(a)	(a)	(a)		(a)
		FL <sub>Y</sub> [cm]		(a)	(a)	(a)		(a)
$I_{PA,3}@M_{I_{max}}$ [W/cm <sup>2</sup> ]	0.56							
Operating Control Conditions	Control 1 Depth	35 [mm]						
	Control 2 Focus	27.5 [mm]						
	Control 3 Gate	- [mm]						
	Control 4 Preset	GEN-General						

$$ISPTA.3 [mW/cm^2] = 98.37$$

**Table C-21: Transducer Model L9-4/38 (Operating Mode: Color and Power Doppler)**

Index Label		MI	TIS			TIB	TIC	
			scan	non-scan		non-scan		
Global Maximum Index Value		0.36	0.00	(a)	(a)	(a)	0.01	
Assoc. Acoustic Param.	Pr.3 [MPa]	0.91						
	$W_0$ [mW]		0.00	(a)		(a)	0.40	
	min of $[W_3(z_1) : I_{TA,3}(z_1)]$ [mW]				(a)			
	$Z_1$ [cm]				(a)			
	$Z_{bp}$ [cm]				(a)			
	$z_{sp}$ [cm]	3.03				(a)		
	$d_{eq}(z_{sp})$ [cm]					(a)		
	$f_c$ [MHz]	6.40	6.40	(a)	(a)	(a)	6.40	
	Dim of $A_{aprt}$	X [cm]		3.84	(a)	(a)	(a)	3.84
		Y [cm]		0.70	(a)	(a)	(a)	0.70
Other Information	PD [ $\mu$ sec]	0.77						
	PRF [Hz]	6700						
	$p_r@P_{II_{max}}$ [MPa]	1.77						
	$d_{eq}@P_{II_{max}}$ [cm]					(a)		
	Focal Length	FL <sub>X</sub> [cm]		3.00	(a)	(a)		3.00
		FL <sub>Y</sub> [cm]		3.00	(a)	(a)		3.00
$I_{PA,3}@M_{I_{max}}$ [W/cm <sup>2</sup> ]	0.00							
Operating Control Conditions	Control 1 Depth	55 [mm]						
	Control 2 Focus	30 [mm]						
	Control 3 Gate	- [mm]						
	Control 4 Preset	GEN-General						

$$ISPTA.3 [mW/cm^2] = 10.6$$



**Table C-22: Transducer Model L9-4/38 (Operating Mode: M)**

Index Label		MI	TIS			TIB	TIC	
			scan	non-scan				
Global Maximum Index Value		0.60		0.00	(a)	(a)	0.10	0.00
Assoc. Acoustic Param.	Pr.3 [MPa]	2.62						
	W <sub>0</sub> [mW]		0.01	(a)		(a)	(a)	
	min of [W <sub>3</sub> (z <sub>1</sub> ) : I <sub>TA,3</sub> (z <sub>1</sub> )] [mW]				(c)			
	Z <sub>1</sub> [cm]				(c)			
	Z <sub>bp</sub> [cm]				(a)			
	zsp [cm]	2.79				(a)		
	d <sub>eq</sub> (z <sub>sp</sub> ) [cm]					(a)		
	f <sub>c</sub> [MHz]	4.77	4.77	(a)	(a)	(a)	4.77	
	Dim of A <sub>aprt</sub>	X [cm]		3.84	(a)	(a)	(a)	3.84
		Y [cm]		0.70	(a)	(a)	(a)	0.70
Other Information	PD [µsec]	1.61						
	PRF [Hz]	62						
	p <sub>r</sub> @P <sub>II</sub> <sub>max</sub> [MPa]	4.14						
	d <sub>eq</sub> @P <sub>II</sub> <sub>max</sub> [cm]					(a)		
	Focal Length	FL <sub>x</sub> [cm]		3.00	(a)	(a)		3.00
		FL <sub>y</sub> [cm]		3.00	(a)	(a)		3.00
I <sub>PA,3</sub> @M <sub>I</sub> <sub>max</sub> [W/cm <sup>2</sup> ]	1.23							
Operating Control Conditions	Control 1 Depth	35	[mm]					
	Control 2 Focus	27.5	[mm]					
	Control 3 Gate	-	[mm]					
	Control 4 Preset	GEN-General						

ISPTA.3 [mW/cm<sup>2</sup>] = 110.89

**Table C-23: Transducer Model L9-4/38 (Operating Mode: PW Doppler)**

Index Label		MI	TIS			TIB	TIC	
			scan	non-scan				
Global Maximum Index Value		0.21		(a)	3.25	1.69	5.50	1.44
Assoc. Acoustic Param.	Pr.3 [MPa]	0.37						
	W <sub>0</sub> [mW]		(a)	106.48		106.48	106.48	
	min of [W <sub>3</sub> (z <sub>1</sub> ) : I <sub>TA,3</sub> (z <sub>1</sub> )] [mW]				6.94			
	Z <sub>1</sub> [cm]				3.41			
	Z <sub>bp</sub> [cm]				2.77			
	zsp [cm]	3.41				3.41		
	d <sub>eq</sub> (z <sub>sp</sub> ) [cm]					6.51		
	f <sub>c</sub> [MHz]	6.40	(a)	6.40	6.40	6.40	6.40	
	Dim of A <sub>aprt</sub>	X [cm]		(a)	3.84	3.84	3.84	3.84
		Y [cm]		(a)	0.70	0.70	0.70	0.70
Other Information	PD [µsec]	2.16						
	PRF [Hz]	6700						
	p <sub>r</sub> @P <sub>II</sub> <sub>max</sub> [MPa]	0.79						
	d <sub>eq</sub> @P <sub>II</sub> <sub>max</sub> [cm]					3.03		
	Focal Length	FL <sub>x</sub> [cm]		(a)	3.50	3.50		6.40
		FL <sub>y</sub> [cm]		(a)	3.50	3.50		6.40
I <sub>PA,3</sub> @M <sub>I</sub> <sub>max</sub> [W/cm <sup>2</sup> ]	0.04							
Operating Control Conditions	Control 1 Depth	55	[mm]					
	Control 2 Focus	35	[mm]					
	Control 3 Gate	10	[mm]					
	Control 4 Preset	GEN-General						

ISPTA.3 [mW/cm<sup>2</sup>] = 176.99

**Table C-24: Transducer Model L9-4/38 (Operating Mode: PW+B)**

Index Label		MI	TIS		TIB	TIC		
			scan	non-scan			non-scan	
Global Maximum Index Value		0.21	0.00	4.73	1.69	0.04	2.10	
Assoc. Acoustic Param.	Pr.3 [MPa]	0.37						
	$W_0$ [mW]		0.06	155.24		155.24	155.24	
	min of $[W_3(z_1) : I_{TA,3}(z_1)]$ [mW]				6.94			
	$Z_1$ [cm]				3.41			
	$Z_{bp}$ [cm]				2.77			
	$z_{sp}$ [cm]	3.41				3.41		
	$d_{eq}(z_{sp})$ [cm]					7.86		
	$f_c$ [MHz]	6.40	6.40	6.40	6.40	6.40	6.40	
	Dim of $A_{aprt}$	X [cm]		3.84	3.84	3.84	3.84	3.84
		Y [cm]		0.70	0.70	0.70	0.70	0.70
Other Information	PD [ $\mu$ sec]	2.16						
	PRF [Hz]	6700						
	$p_r@P_{II_{max}}$ [MPa]	0.79						
	$d_{eq}@P_{II_{max}}$ [cm]					3.66		
	Focal Length	$FL_X$ [cm]		3.00	3.00	3.00		3.00
		$FL_Y$ [cm]		3.00	3.00	3.00		3.00
$I_{PA,3}@MI_{max}$ [W/cm <sup>2</sup> ]	0.05							
Operating Control Conditions	Control 1 Depth	55 [mm]						
	Control 2 Focus	35 [mm]						
	Control 3 Gate	10 [mm]						
	Control 4 Preset	GEN-General						

$$ISPTA.3 \text{ [mW/cm}^2\text{]} = 210.97$$

**Table C-25: Transducer Model L9-4/38 (Operating Mode: Triplex (B/Color/PW))**

Index Label		MI	TIS		TIB	TIC		
			scan	non-scan			non-scan	
Global Maximum Index Value		0.21	0.00	5.40	1.69	0.05	2.40	
Assoc. Acoustic Param.	Pr.3 [MPa]	0.37						
	$W_0$ [mW]		0.07	177.24		177.24	177.24	
	min of $[W_3(z_1) : I_{TA,3}(z_1)]$ [mW]				19.90			
	$Z_1$ [cm]				3.41			
	$Z_{bp}$ [cm]				2.77			
	$z_{sp}$ [cm]	3.41				3.41		
	$d_{eq}(z_{sp})$ [cm]					8.40		
	$f_c$ [MHz]	6.40	6.40	6.40	6.40	6.40	6.40	
	Dim of $A_{aprt}$	X [cm]		3.84	3.84	3.84	3.84	3.84
		Y [cm]		0.70	0.70	0.70	0.70	0.70
Other Information	PD [ $\mu$ sec]	2.16						
	FPS [Hz]	7						
	PRFd [Hz]	4000						
	$p_r@P_{II_{max}}$ [MPa]	0.79						
	$d_{eq}@P_{II_{max}}$ [cm]					2.31		
	Focal Length	$FL_X$ [cm]		3.00	3.00	3.00		3.00
$FL_Y$ [cm]			3.00	3.00	3.00		3.00	
$I_{PA,3}@MI_{max}$ [W/cm <sup>2</sup> ]	0.06							
Operating Control Conditions	Control 1 Depth	55 [mm]						
	Control 2 Focus	35 [mm]						
	Control 3 Gate	10 [mm]						
	Control 4 Preset	GEN-General						

$$ISPTA.3 \text{ [mW/cm}^2\text{]} = 248.85$$



ULTRASONIX

**Table C-26: Transducer Model L14-5/38 and L14-5/38 GPS (Operating Mode: B)**

Index Label		MI	TIS		TIB	TIC	
			scan	non-scan			non-scan
Global Maximum Index Value		0.80	(a)	(a)	(a)	(a)	
Assoc. Acoustic Param.	Pr.3 [MPa]	1.99					
	$W_G$ [mW]		(a)	(a)		(a)	
	min of $[W_{.3}(z_1) : I_{TA.3}(z_1)]$ [mW]				(a)		
	$Z_1$ [cm]				(a)		
	$z_{bp}$ [cm]				(a)		
	$z_{sp}$ [cm]	1.95				(a)	
	$d_{eq}(z_{sp})$ [cm]					(a)	
	$f_c$ [MHz]	6.23	(a)	(a)	(a)	(a)	(a)
	Dim of $A_{aprt}$	X [cm]		(a)	(a)	(a)	(a)
Y [cm]			(a)	(a)	(a)	(a)	
Other Information	PD [µsec]	0.00					
	PRF [Hz]	29					
	$p_r@PII_{max}$ [MPa]	3.03					
	$d_{eq}@PII_{max}$ [cm]					(a)	
	Focal Length	FL <sub>x</sub> [cm]		(a)	(a)	(a)	(a)
		FL <sub>y</sub> [cm]		(a)	(a)	(a)	(a)
$I_{PA.3}@MI_{max}$ [W/cm <sup>2</sup> ]	0.03						
Operating Control Conditions	Control 1 Depth	80	[mm]				
	Control 2 Focus	33	[mm]				
	Control 3 Gate	-	[mm]				
	Control 4 Preset	Gen-Gen (L14-5 38mm) - Pen					

$ISPTA.3 [mW/cm^2] = 66.32$

**Table C-27: Transducer Model L14-5/38 and L14-5/38 GPS (Operating Mode: Color and Power Doppler)**

Index Label		MI	TIS		TIB	TIC	
			scan	non-scan			non-scan
Global Maximum Index Value		0.43	0.00	(a)	(a)	0.02	
Assoc. Acoustic Param.	Pr.3 [MPa]	1.12					
	$W_G$ [mW]		0.01	(a)		1.41	
	min of $[W_{.3}(z_1) : I_{TA.3}(z_1)]$ [mW]				(c)		
	$Z_1$ [cm]				(c)		
	$z_{bp}$ [cm]				(a)		
	$z_{sp}$ [cm]	2.10				(a)	
	$d_{eq}(z_{sp})$ [cm]					(a)	
	$f_c$ [MHz]	6.66	6.66	(a)	(a)	(a)	6.66
	Dim of $A_{aprt}$	X [cm]		3.84	(a)	(a)	3.84
Y [cm]			0.70	(a)	(a)	0.70	
Other Information	PD [µsec]	2.21					
	PRF [Hz]	5000					
	$p_r@PII_{max}$ [MPa]	1.81					
	$d_{eq}@PII_{max}$ [cm]					(a)	
	Focal Length	FL <sub>x</sub> [cm]		3.00	(a)	(a)	3.00
		FL <sub>y</sub> [cm]		3.00	(a)	(a)	3.00
$I_{PA.3}@MI_{max}$ [W/cm <sup>2</sup> ]	0.01						
Operating Control Conditions	Control 1 Depth	80	[mm]				
	Control 2 Focus	33	[mm]				
	Control 3 Gate	-	[mm]				
	Control 4 Preset	Gen-Gen (L14-5 38mm) - Pen					

$ISPTA.3 [mW/cm^2] = 54.12$



**Table C-28: Transducer Model L14-5/38 and L14-5/38 GPS (Operating Mode: M)**

Index Label		MI	TIS		TIB	TIC		
			scan	non-scan			non-scan	
Global Maximum Index Value		0.80	0.00	(a)	(a)	0.00	0.23	
Assoc. Acoustic Param.	Pr.3 [MPa]	1.99						
	$W_0$ [mW]		0.00	(a)		(a)	16.71	
	min of $[W_3(z_1) : I_{TA,3}(z_1)]$ [mW]				(c)			
	$Z_1$ [cm]				(c)			
	$Z_{bp}$ [cm]				(a)			
	$z_{sp}$ [cm]	1.95				(a)		
	$d_{eq}(z_{sp})$ [cm]					(a)		
	$f_c$ [MHz]	6.23	6.23	(a)	(a)	(a)	6.23	
	Dim of $A_{aprt}$	X [cm]		3.84	(a)	(a)	(a)	3.84
		Y [cm]		0.70	(a)	(a)	(a)	0.70
Other Information	PD [ $\mu$ sec]	0.00						
	PRF [Hz]	33						
	$p_r@P_{II_{max}}$ [MPa]	3.03						
	$d_{eq}@P_{II_{max}}$ [cm]					(a)		
	Focal Length	FL <sub>X</sub> [cm]		3.00	(a)	(a)		3.00
		FL <sub>Y</sub> [cm]		3.00	(a)	(a)		3.00
$I_{PA,3}@MI_{max}$ [W/cm <sup>2</sup> ]	0.04							
Operating Control Conditions	Control 1 Depth	80	[mm]					
	Control 2 Focus	33	[mm]					
	Control 3 Gate	-	[mm]					
	Control 4 Preset	Gen-Gen (L14-5 38mm) - Pen						

$$ISPTA.3 [mW/cm^2] = 75.47$$

**Table C-29: Transducer Model L14-5/38 and L14-5/38 GPS (Operating Mode: PW Doppler)**

Index Label		MI	TIS		TIB	TIC		
			scan	non-scan			non-scan	
Global Maximum Index Value		0.39	(a)	0.59	0.37	0.10	0.25	
Assoc. Acoustic Param.	Pr.3 [MPa]	1.02						
	$W_0$ [mW]		(a)	18.54		18.54	18.54	
	min of $[W_3(z_1) : I_{TA,3}(z_1)]$ [mW]				6.14			
	$Z_1$ [cm]				2.40			
	$Z_{bp}$ [cm]				2.77			
	$z_{sp}$ [cm]	2.40					2.40	
	$d_{eq}(z_{sp})$ [cm]						3.00	
	$f_c$ [MHz]	6.67	(a)	6.67	6.67	6.67	6.67	
	Dim of $A_{aprt}$	X [cm]		(a)	3.84	3.84	3.84	3.84
		Y [cm]		(a)	0.70	0.70	0.70	0.70
Other Information	PD [ $\mu$ sec]	1.93						
	PRF [Hz]	5000						
	$p_r@P_{II_{max}}$ [MPa]	1.77						
	$d_{eq}@P_{II_{max}}$ [cm]					0.37		
	Focal Length	FL <sub>X</sub> [cm]		(a)	3.00	3.00		6.77
		FL <sub>Y</sub> [cm]		(a)	3.00	3.00		6.77
$I_{PA,3}@MI_{max}$ [W/cm <sup>2</sup> ]	0.16							
Operating Control Conditions	Control 1 Depth	60	[mm]					
	Control 2 Focus	30	[mm]					
	Control 3 Gate	20	[mm]					
	Control 4 Preset	GEN-General						

$$ISPTA.3 [mW/cm^2] = 622.80$$



**Table C-30: Transducer Model L14-5/38 and L14-5/38 GPS (Operating Mode: PW+B)**

Index Label		MI	TIS		TIB	TIC		
			scan	non-scan				
Global Maximum Index Value		0.39	0.00	0.92	0.37	0.00	0.39	
Assoc. Acoustic Param.	Pr.3 [MPa]	1.02						
	$W_0$ [mW]		0.02	29.03		29.03	29.03	
	min of $[W_3(z_1) : I_{TA,3}(z_1)]$ [mW]				9.61			
	$Z_1$ [cm]				2.40			
	$Z_{bp}$ [cm]				2.77			
	$z_{sp}$ [cm]	2.40				2.40		
	$d_{eq}(z_{sp})$ [cm]					3.76		
	$f_c$ [MHz]	6.67	6.67	6.67	6.67	6.67	6.67	
	Dim of $A_{aprt}$	X [cm]		3.84	3.84	3.84	3.84	3.84
		Y [cm]		0.70	0.70	0.70	0.70	0.70
Other Information	PD [µsec]	1.93						
	PRF [Hz]	5000						
	$p_r@PII_{max}$ [MPa]	1.77						
	$d_{eq}@PII_{max}$ [cm]					0.46		
	Focal Length	FL <sub>X</sub> [cm]		3.00	3.00	3.00		3.00
		FL <sub>Y</sub> [cm]		3.00	3.00	3.00		3.00
$I_{PA,3}@MI_{max}$ [W/cm <sup>2</sup> ]	0.17							
Operating Control Conditions	Control 1 Depth	60	[mm]					
	Control 2 Focus	30	[mm]					
	Control 3 Gate	20	[mm]					
	Control 4 Preset	GEN-General						

$ISPTA.3 [mW/cm^2] = 661.68$

**Table C-31: Transducer Model L14-5/38 and L14-5/38 GPS (Operating Mode: Triplex (B/Color/PW))**

Index Label		MI	TIS		TIB	TIC		
			scan	non-scan				
Global Maximum Index Value		0.39	0.00	0.92	0.37	0.00	0.39	
Assoc. Acoustic Param.	Pr.3 [MPa]	1.02						
	$W_0$ [mW]		0.02	29.03		29.03	29.03	
	min of $[W_3(z_1) : I_{TA,3}(z_1)]$ [mW]				9.61			
	$Z_1$ [cm]				2.40			
	$Z_{bp}$ [cm]				2.77			
	$z_{sp}$ [cm]	2.40				2.40		
	$d_{eq}(z_{sp})$ [cm]					3.76		
	$f_c$ [MHz]	6.67	6.67	6.67	6.67	6.67	6.67	
	Dim of $A_{aprt}$	X [cm]		3.84	3.84	3.84	3.84	3.84
		Y [cm]		0.70	0.70	0.70	0.70	0.70
Other Information	PD [µsec]	1.93						
	FPS [Hz]	4.00						
	PRFd [Hz]	3333						
	$p_r@PII_{max}$ [MPa]	1.77						
	$d_{eq}@PII_{max}$ [cm]					0.93		
	Focal Length	FL <sub>X</sub> [cm]		3.00	3.00	3.00		3.00
FL <sub>Y</sub> [cm]			3.00	3.00	3.00		3.00	
$I_{PA,3}@MI_{max}$ [W/cm <sup>2</sup> ]	0.13							
Operating Control Conditions	Control 1 Depth	60	[mm]					
	Control 2 Focus	30	[mm]					
	Control 3 Gate	20	[mm]					
	Control 4 Preset	GEN-General						

$ISPTA.3 [mW/cm^2] = 521.73$

**Table C-32: Transducer Model L14-5W/60 (Operating Mode: B)**

Index Label		MI	TIS			TIB	TIC	
			scan	non-scan		non-scan		
Global Maximum Index Value		0.32	(a)	(a)	(a)	(a)	(a)	
Assoc. Acoustic Param.	Pr.3 [MPa]	0.82						
	$W_0$ [mW]		(a)	(a)		(a)	(a)	
	min of $[W_3(z_1) : I_{TA,3}(z_1)]$ [mW]				(a)			
	$Z_1$ [cm]				(a)			
	$Z_{bp}$ [cm]				(a)			
	$z_{sp}$ [cm]	3.90				(a)		
	$d_{eq}(z_{sp})$ [cm]					(a)		
	$f_c$ [MHz]	6.60	(a)	(a)	(a)	(a)	(a)	
	Dim of $A_{aprt}$	X [cm]		(a)	(a)	(a)	(a)	(a)
		Y [cm]		(a)	(a)	(a)	(a)	(a)
Other Information	PD [ $\mu$ sec]	0.45						
	PRF [Hz]	34						
	$p_r@PII_{max}$ [MPa]	2.00						
	$d_{eq}@PII_{max}$ [cm]					(a)		
	Focal Length	FL <sub>X</sub> [cm]		(a)	(a)	(a)		(a)
		FL <sub>Y</sub> [cm]		(a)	(a)	(a)		(a)
	$I_{PA,3}@MI_{max}$ [W/cm <sup>2</sup> ]	0.01						
Operating Control Conditions	Control 1 Depth	70	[mm]					
	Control 2 Focus	40	[mm]					
	Control 3 Gate	-	[mm]					
	Control 4 Preset	GEN-General						

$$ISPTA.3 [mW/cm^2] = 22.76$$

**Table C-33: Transducer Model L14-5W/60 (Operating Mode: Color and Power Doppler)**

Index Label		MI	TIS			TIB	TIC	
			scan	non-scan		non-scan		
Global Maximum Index Value		0.16	0.00	(a)	(a)	(a)	0.15	
Assoc. Acoustic Param.	Pr.3 [MPa]	0.41						
	$W_0$ [mW]		0.04	(a)		(a)	13.75	
	min of $[W_3(z_1) : I_{TA,3}(z_1)]$ [mW]				(c)			
	$Z_1$ [cm]				(c)			
	$Z_{bp}$ [cm]				(a)			
	$z_{sp}$ [cm]	4.16				(a)		
	$d_{eq}(z_{sp})$ [cm]					(a)		
	$f_c$ [MHz]	6.60	6.60	(a)	(a)	(a)	6.60	
	Dim of $A_{aprt}$	X [cm]		5.88	(a)	(a)	(a)	5.88
		Y [cm]		0.70	(a)	(a)	(a)	0.70
Other Information	PD [ $\mu$ sec]	0.79						
	PRF [Hz]	6700						
	$p_r@PII_{max}$ [MPa]	1.05						
	$d_{eq}@PII_{max}$ [cm]					(a)		
	Focal Length	FL <sub>X</sub> [cm]		3.00	(a)	(a)		3.00
		FL <sub>Y</sub> [cm]		3.00	(a)	(a)		3.00
	$I_{PA,3}@MI_{max}$ [W/cm <sup>2</sup> ]	0.00						
Operating Control Conditions	Control 1 Depth	70	[mm]					
	Control 2 Focus	45	[mm]					
	Control 3 Gate	-	[mm]					
	Control 4 Preset	GEN-General						

$$ISPTA.3 [mW/cm^2] = 15.67$$



**Table C-34: Transducer Model L14-5W/60 (Operating Mode: M)**

Index Label		MI	TIS			TIB	TIC	
			scan	non-scan				
Global Maximum Index Value		0.32		0.00	(a)	(a)	(a)	0.00
Assoc. Acoustic Param.	Pr.3 [MPa]	0.82						
	W <sub>0</sub> [mW]		0.02	(a)		(a)	(a)	
	min of [W <sub>3</sub> (z <sub>1</sub> ) : I <sub>TA,3</sub> (z <sub>1</sub> )] [mW]				(c)			
	Z <sub>1</sub> [cm]				(c)			
	Z <sub>bp</sub> [cm]				(a)			
	zsp [cm]	3.90				(a)		
	d <sub>eq</sub> (z <sub>sp</sub> ) [cm]					(a)		
	f <sub>c</sub> [MHz]	6.60	6.60	(a)	(a)	(a)	6.60	
	Dim of A <sub>aprt</sub>	X [cm]		5.88	(a)	(a)	(a)	5.88
		Y [cm]		0.70	(a)	(a)	(a)	0.70
Other Information	PD [µsec]	0.45						
	PRF [Hz]	41						
	p <sub>r</sub> @P <sub>II</sub> max [MPa]	2.00						
	d <sub>eq</sub> @P <sub>II</sub> max [cm]					(a)		
	Focal Length	FL <sub>X</sub> [cm]		3.00	(a)	(a)		3.00
		FL <sub>Y</sub> [cm]		3.00	(a)	(a)		3.00
I <sub>PA,3</sub> @MI <sub>max</sub> [W/cm <sup>2</sup> ]	0.01							
Operating Control Conditions	Control 1 Depth	70	[mm]					
	Control 2 Focus	40	[mm]					
	Control 3 Gate	-	[mm]					
	Control 4 Preset	GEN-General						

ISPTA.3 [mW/cm<sup>2</sup>] = 27.45

**Table C-35: Transducer Model L14-5W/60 (Operating Mode: PW Doppler)**

Index Label		MI	TIS			TIB	TIC	
			scan	non-scan				
Global Maximum Index Value		0.16		(a)	1.12	0.48	0.38	0.39
Assoc. Acoustic Param.	Pr.3 [MPa]	0.41						
	W <sub>0</sub> [mW]		(a)	35.70		35.70	35.70	
	min of [W <sub>3</sub> (z <sub>1</sub> ) : I <sub>TA,3</sub> (z <sub>1</sub> )] [mW]				4.52			
	Z <sub>1</sub> [cm]				3.18			
	Z <sub>bp</sub> [cm]				3.43			
	zsp [cm]	3.18				3.18		
	d <sub>eq</sub> (z <sub>sp</sub> ) [cm]					3.82		
	f <sub>c</sub> [MHz]	6.60	(a)	6.60	6.60	6.60	6.60	
	Dim of A <sub>aprt</sub>	X [cm]		(a)	5.88	5.88	5.88	5.88
		Y [cm]		(a)	0.70	0.70	0.70	0.70
Other Information	PD [µsec]	2.20						
	PRF [Hz]	6700						
	p <sub>r</sub> @P <sub>II</sub> max [MPa]	0.84						
	d <sub>eq</sub> @P <sub>II</sub> max [cm]					2.21		
	Focal Length	FL <sub>X</sub> [cm]		(a)	5.00	5.00		6.60
		FL <sub>Y</sub> [cm]		(a)	5.00	5.00		6.60
I <sub>PA,3</sub> @MI <sub>max</sub> [W/cm <sup>2</sup> ]	0.03							
Operating Control Conditions	Control 1 Depth	70	[mm]					
	Control 2 Focus	50	[mm]					
	Control 3 Gate	20	[mm]					
	Control 4 Preset	GEN-General						

ISPTA.3 [mW/cm<sup>2</sup>] = 120.91

**Table C-36: Transducer Model L14-5W/60 (Operating Mode: PW+B)**

Index Label		MI	TIS		TIB	TIC		
			scan	non-scan			non-scan	
Global Maximum Index Value		0.16	0.00	1.94	0.48	0.03	0.67	
Assoc. Acoustic Param.	Pr.3 [MPa]	0.41						
	$W_0$ [mW]		0.00	61.61		61.61	61.61	
	min of $[W_3(z_1) : I_{TA,3}(z_1)]$ [mW]				4.52			
	$Z_1$ [cm]				3.18			
	$Z_{bp}$ [cm]				3.43			
	$z_{sp}$ [cm]	3.18				3.18		
	$d_{eq}(z_{sp})$ [cm]					5.02		
	$f_c$ [MHz]	6.60	6.60	6.60	6.60	6.60	6.60	
	Dim of $A_{aprt}$	X [cm]		5.88	5.88	5.88	5.88	5.88
		Y [cm]		0.70	0.70	0.70	0.70	0.70
Other Information	PD [ $\mu$ sec]	2.20						
	PRF [Hz]	6700						
	$p_r@P_{II_{max}}$ [MPa]	0.84						
	$d_{eq}@P_{II_{max}}$ [cm]					2.90		
	Focal Length	$FL_X$ [cm]		3.00	3.00	3.00		3.00
		$FL_Y$ [cm]		3.00	3.00	3.00		3.00
$I_{PA,3}@MI_{max}$ [W/cm <sup>2</sup> ]	0.03							
Operating Control Conditions	Control 1 Depth	70 [mm]						
	Control 2 Focus	50 [mm]						
	Control 3 Gate	20 [mm]						
	Control 4 Preset	GEN-General						

$$ISPTA.3 [mW/cm^2] = 133.63$$

**Table C-37: Transducer Model L14-5W/60 (Operating Mode: Triplex (B/Color/PW))**

Index Label		MI	TIS		TIB	TIC		
			scan	non-scan			non-scan	
Global Maximum Index Value		0.16	0.00	1.94	0.48	0.03	0.67	
Assoc. Acoustic Param.	Pr.3 [MPa]	0.41						
	$W_0$ [mW]		0.07	61.61		61.61	61.61	
	min of $[W_3(z_1) : I_{TA,3}(z_1)]$ [mW]				3.25			
	$Z_1$ [cm]				3.18			
	$Z_{bp}$ [cm]				3.43			
	$z_{sp}$ [cm]	3.18				3.18		
	$d_{eq}(z_{sp})$ [cm]					5.02		
	$f_c$ [MHz]	6.60	6.60	6.60	6.60	6.60	6.60	
	Dim of $A_{aprt}$	X [cm]		5.88	5.88	5.88	5.88	5.88
		Y [cm]		0.70	0.70	0.70	0.70	0.70
Other Information	PD [ $\mu$ sec]	2.20						
	FPS [Hz]	6						
	PRFd [Hz]	3333						
	$p_r@P_{II_{max}}$ [MPa]	0.84						
	$d_{eq}@P_{II_{max}}$ [cm]					3.42		
	Focal Length	$FL_X$ [cm]		3.00	3.00	3.00		3.00
$FL_Y$ [cm]			3.00	3.00	3.00		3.00	
$I_{PA,3}@MI_{max}$ [W/cm <sup>2</sup> ]	0.02							
Operating Control Conditions	Control 1 Depth	70 [mm]						
	Control 2 Focus	50 [mm]						
	Control 3 Gate	20 [mm]						
	Control 4 Preset	Penetration						

$$ISPTA.3 [mW/cm^2] = 83.64$$



**Table C-38: Transducer Model HST15-8/20 (Operating Mode: B)**

Index Label		MI	TIS			TIB	TIC	
			scan	non-scan		non-scan		
				$A_{aprt} \leq 1$	$A_{aprt} > 1$			
Global Maximum Index Value		0.20	(a)	(a)	(a)	(a)	(a)	
Assoc. Acoustic Param.	Pr.3 [MPa]	0.51						
	$W_0$ [mW]		(a)	(a)		(a)	(a)	
	min of $[W_3(z_1) : I_{TA,3}(z_1)]$ [mW]				(a)			
	$Z_1$ [cm]				(a)			
	$z_{bp}$ [cm]				(a)			
	$z_{sp}$ [cm]	3.32				(a)		
	$d_{eq}(z_{sp})$ [cm]					(a)		
	$f_c$ [MHz]	6.60	(a)	(a)	(a)	(a)	(a)	
	Dim of $A_{aprt}$	X [cm]		(a)	(a)	(a)	(a)	(a)
		Y [cm]		(a)	(a)	(a)	(a)	(a)
Other Information	PD [µsec]	0.34						
	PRF [Hz]	55						
	$p_r @ P_{II_{max}}$ [MPa]	1.10						
	$d_{eq} @ P_{II_{max}}$ [cm]					(a)		
	Focal Length	FL <sub>X</sub> [cm]		(a)	(a)	(a)		(a)
		FL <sub>Y</sub> [cm]		(a)	(a)	(a)		(a)
$I_{PA,3} @ MI_{max}$ [W/cm <sup>2</sup> ]	0.00							
Operating Control Conditions	Control 1 Depth	55	[mm]					
	Control 2 Focus	40	[mm]					
	Control 3 Gate	-	[mm]					
	Control 4 Preset	GEN-General						

$ISPTA.3 [mW/cm^2] = 5.5$

**Table C-39: Transducer Model HST15-8/20 (Operating Mode: Color and Power Doppler)**

Index Label		MI	TIS			TIB	TIC	
			scan	non-scan		non-scan		
				$A_{aprt} \leq 1$	$A_{aprt} > 1$			
Global Maximum Index Value		0.19	0.00	(a)	(a)	(a)	1.10	
Assoc. Acoustic Param.	Pr.3 [MPa]	0.48						
	$W_0$ [mW]		0.03	(a)		(a)	64.75	
	min of $[W_3(z_1) : I_{TA,3}(z_1)]$ [mW]				(a)			
	$Z_1$ [cm]				(a)			
	$z_{bp}$ [cm]				(a)			
	$z_{sp}$ [cm]	3.32				(a)		
	$d_{eq}(z_{sp})$ [cm]					(a)		
	$f_c$ [MHz]	6.60	6.60	(a)	(a)	(a)	6.60	
	Dim of $A_{aprt}$	X [cm]		2.85	(a)	(a)	(a)	2.85
		Y [cm]		0.60	(a)	(a)	(a)	0.60
Other Information	PD [µsec]	0.87						
	PRF [Hz]	10000						
	$p_r @ P_{II_{max}}$ [MPa]	1.03						
	$d_{eq} @ P_{II_{max}}$ [cm]					(a)		
	Focal Length	FL <sub>X</sub> [cm]		4.20	(a)	(a)		4.20
		FL <sub>Y</sub> [cm]		4.20	(a)	(a)		4.20
$I_{PA,3} @ MI_{max}$ [W/cm <sup>2</sup> ]	0.01							
Operating Control Conditions	Control 1 Depth	55	[mm]					
	Control 2 Focus	42	[mm]					
	Control 3 Gate	-	[mm]					
	Control 4 Preset	GEN-General						

$ISPTA.3 [mW/cm^2] = 28.22$

**Table C-40: Transducer Model HST15-8/20 (Operating Mode: M)**

Index Label		MI	TIS		TIB	TIC		
			scan	non-scan			non-scan	
Global Maximum Index Value		0.42	0.00	A <sub>aprt</sub> ≤1 (a)	A <sub>aprt</sub> >1 (a)	(a)	0.32	
Assoc. Acoustic Param.	Pr.3 [MPa]	0.51						
	W <sub>0</sub> [mW]		0.01	(a)		(a)	19.07	
	min of [W <sub>3</sub> (z <sub>1</sub> ) : I <sub>TA,3</sub> (z <sub>1</sub> )] [mW]				(a)			
	Z <sub>1</sub> [cm]				(a)			
	Z <sub>bsp</sub> [cm]				(c)			
	zsp [cm]	3.32				(a)		
	d <sub>eq</sub> (z <sub>sp</sub> ) [cm]					(a)		
	f <sub>c</sub> [MHz]	6.60	6.60	(a)	(a)	(a)	6.60	
	Dim of A <sub>aprt</sub>	X [cm]		2.85	(a)	(a)	(a)	2.85
		Y [cm]		0.60	(a)	(a)	(a)	0.60
Other Information	PD [μsec]	0.34						
	PRF [Hz]	63						
	p <sub>r</sub> @P <sub>II</sub> <sub>max</sub> [MPa]	1.10						
	d <sub>eq</sub> @P <sub>II</sub> <sub>max</sub> [cm]					(a)		
	Focal Length	FL <sub>X</sub> [cm]		4.00	(a)	(a)		4.00
		FL <sub>Y</sub> [cm]		4.00	(a)	(a)		4.00
I <sub>PA,3</sub> @M <sub>I</sub> <sub>max</sub> [W/cm <sup>2</sup> ]	0.00							
Operating Control Conditions	Control 1 Depth	55 [mm]						
	Control 2 Focus	40 [mm]						
	Control 3 Gate	- [mm]						
	Control 4 Preset	GEN-General						

$$ISPTA.3 [mW/cm^2] = 6.3$$

**Table C-41: Transducer Model HST15-8/20 (Operating Mode: PW Doppler)**

Index Label		MI	TIS		TIB	TIC		
			scan	non-scan			non-scan	
Global Maximum Index Value		0.19	(a)	A <sub>aprt</sub> ≤1 0.44	A <sub>aprt</sub> >1 0.22	0.86	0.16	
Assoc. Acoustic Param.	Pr.3 [MPa]	0.61						
	W <sub>0</sub> [mW]		(a)	9.20		9.20	9.20	
	min of [W <sub>3</sub> (z <sub>1</sub> ) : I <sub>TA,3</sub> (z <sub>1</sub> )] [mW]				3.45			
	Z <sub>1</sub> [cm]				1.42			
	Z <sub>bsp</sub> [cm]				2.21			
	zsp [cm]	1.42				1.42		
	d <sub>eq</sub> (z <sub>sp</sub> ) [cm]					2.18		
	f <sub>c</sub> [MHz]	9.98	(a)	9.98	9.98	9.98	9.98	
	Dim of A <sub>aprt</sub>	X [cm]		(a)	2.85	2.85	2.85	2.85
		Y [cm]		(a)	0.60	0.60	0.60	0.60
Other Information	PD [μsec]	1.45						
	PRF [Hz]	12500						
	p <sub>r</sub> @P <sub>II</sub> <sub>max</sub> [MPa]	0.99						
	d <sub>eq</sub> @P <sub>II</sub> <sub>max</sub> [cm]					0.90		
	Focal Length	FL <sub>X</sub> [cm]		(a)	4.00	4.00		9.98
		FL <sub>Y</sub> [cm]		(a)	4.00	4.00		9.98
I <sub>PA,3</sub> @M <sub>I</sub> <sub>max</sub> [W/cm <sup>2</sup> ]	0.28							
Operating Control Conditions	Control 1 Depth	55 [mm]						
	Control 2 Focus	40 [mm]						
	Control 3 Gate	20 [mm]						
	Control 4 Preset	GEN-General						

$$ISPTA.3 [mW/cm^2] = 276.03$$



ULTRASONIX

**Table C-42: Transducer Model HST15-8/20 (Operating Mode: PW+B)**

Index Label		MI	TIS		TIB	TIC		
			scan	non-scan			non-scan	
Global Maximum Index Value		0.19	0.00	0.56	0.22	0.01	0.20	
Assoc. Acoustic Param.	Pr.3 [MPa]	0.61						
	W <sub>0</sub> [mW]		0.00	11.82		11.82	11.82	
	min of [W <sub>3</sub> (z <sub>1</sub> ) : I <sub>TA,3</sub> (z <sub>1</sub> )] [mW]				4.44			
	Z <sub>1</sub> [cm]				1.42			
	z <sub>bp</sub> [cm]				2.21			
	z <sub>sp</sub> [cm]	1.42				1.42		
	d <sub>eq</sub> (z <sub>sp</sub> ) [cm]					2.48		
	f <sub>c</sub> [MHz]	9.98	9.98	9.98	9.98	9.98	9.98	
	Dim of A <sub>aprt</sub>	X [cm]		2.85	2.85	2.85	2.85	2.85
		Y [cm]		0.60	0.60	0.60	0.60	0.60
Other Information	PD [µsec]	1.45						
	PRF [Hz]	12500						
	p <sub>r</sub> @P <sub>II</sub> <sub>max</sub> [MPa]	0.99						
	d <sub>eq</sub> @P <sub>II</sub> <sub>max</sub> [cm]					1.02		
	Focal Length	FL <sub>x</sub> [cm]		3.00	3.00	3.00		3.00
		FL <sub>y</sub> [cm]		3.00	3.00	3.00		3.00
I <sub>PA,3</sub> @MI <sub>max</sub> [W/cm <sup>2</sup> ]	0.28							
Operating Control Conditions	Control 1 Depth	55	[mm]					
	Control 2 Focus	40	[mm]					
	Control 3 Gate	20	[mm]					
	Control 4 Preset	GEN-General						

ISPTA.3 [mW/cm<sup>2</sup>] = 277.21

**Table C-43: Transducer Model HST15-8/20 (Operating Mode: Triplex (B/Color/PW))**

Index Label		MI	TIS		TIB	TIC		
			scan	non-scan			non-scan	
Global Maximum Index Value		0.08	0.00	0.62	0.21	0.01	0.33	
Assoc. Acoustic Param.	Pr.3 [MPa]	0.21						
	W <sub>0</sub> [mW]		0.08	19.75		19.75	19.75	
	min of [W <sub>3</sub> (z <sub>1</sub> ) : I <sub>TA,3</sub> (z <sub>1</sub> )] [mW]				1.18			
	Z <sub>1</sub> [cm]				3.32			
	z <sub>bp</sub> [cm]				2.21			
	z <sub>sp</sub> [cm]	3.32				3.32		
	d <sub>eq</sub> (z <sub>sp</sub> ) [cm]					2.80		
	f <sub>c</sub> [MHz]	6.60	6.60	6.60	6.60	6.60	6.60	
	Dim of A <sub>aprt</sub>	X [cm]		2.85	2.85	2.85	2.85	2.85
		Y [cm]		0.60	0.60	0.60	0.60	0.60
Other Information	PD [µsec]	1.39						
	FPS [Hz]	6						
	PRFd [Hz]	4000						
	p <sub>r</sub> @P <sub>II</sub> <sub>max</sub> [MPa]	0.44						
	d <sub>eq</sub> @P <sub>II</sub> <sub>max</sub> [cm]					3.16		
	Focal Length	FL <sub>x</sub> [cm]		3.00	3.00	3.00		3.00
FL <sub>y</sub> [cm]			3.00	3.00	3.00		3.00	
I <sub>PA,3</sub> @MI <sub>max</sub> [W/cm <sup>2</sup> ]	0.01							
Operating Control Conditions	Control 1 Depth	55	[mm]					
	Control 2 Focus	40	[mm]					
	Control 3 Gate	24.5	[mm]					
	Control 4 Preset	GEN-General						

ISPTA.3 [mW/cm<sup>2</sup>] = 21.51



**Table C-44: Transducer Model 4DC7-3/40 (Operating Mode: B)**

Index Label		MI	TIS		TIB	TIC	
			scan	non-scan			non-scan
Global Maximum Index Value		0.49	(a)	(a)	(a)	(a)	
Assoc. Acoustic Param.	Pr.3 [MPa]	1.05					
	$W_0$ [mW]		(a)	(a)		(a)	
	min of $[W_3(z_1) : I_{TA,3}(z_1)]$ [mW]				(a)		
	$Z_1$ [cm]				(a)		
	$Z_{bp}$ [cm]				(a)		
	$z_{sp}$ [cm]	3.97				(a)	
	$d_{eq}(z_{sp})$ [cm]					(a)	
	$f_c$ [MHz]	4.50	(a)	(a)	(a)	(a)	
	Dim of $A_{aprt}$	X [cm]		(a)	(a)	(a)	(a)
		Y [cm]		(a)	(a)	(a)	(a)
Other Information	PD [ $\mu$ sec]	0.45					
	PRF [Hz]	37					
	$p_r@PII_{max}$ [MPa]	1.94					
	$d_{eq}@PII_{max}$ [cm]					(a)	
	Focal Length	FL <sub>X</sub> [cm]		(a)	(a)	(a)	(a)
		FL <sub>Y</sub> [cm]		(a)	(a)	(a)	(a)
$I_{PA,3}@MI_{max}$ [W/cm <sup>2</sup> ]	0.00						
Operating Control Conditions	Control 1 Depth	90 [mm]					
	Control 2 Focus	40 [mm]					
	Control 3 Gate	- [mm]					
	Control 4 Preset	GEN-General					

$$ISPTA.3 [mW/cm^2] = 9.47$$

**Table C-45: Transducer Model 4DC7-3/40 (Operating Mode: Color and Power Doppler)**

Index Label		MI	TIS		TIB	TIC		
			scan	non-scan			non-scan	
Global Maximum Index Value		0.39	0.00	(a)	(a)	0.01		
Assoc. Acoustic Param.	Pr.3 [MPa]	0.83						
	$W_0$ [mW]		0.01	(a)		0.85		
	min of $[W_3(z_1) : I_{TA,3}(z_1)]$ [mW]				(c)			
	$Z_1$ [cm]				(c)			
	$Z_{bp}$ [cm]				(a)			
	$z_{sp}$ [cm]	5.12				(a)		
	$d_{eq}(z_{sp})$ [cm]					(a)		
	$f_c$ [MHz]	4.50	4.50	(a)	(a)	(a)	4.50	
	Dim of $A_{aprt}$	X [cm]		6.40	(a)	(a)	(a)	6.40
		Y [cm]		1.20	(a)	(a)	(a)	1.20
Other Information	PD [ $\mu$ sec]	1.08						
	PRF [Hz]	5000						
	$p_r@PII_{max}$ [MPa]	1.84						
	$d_{eq}@PII_{max}$ [cm]					(a)		
	Focal Length	FL <sub>X</sub> [cm]		3.00	(a)	(a)	3.00	
		FL <sub>Y</sub> [cm]		3.00	(a)	(a)	3.00	
$I_{PA,3}@MI_{max}$ [W/cm <sup>2</sup> ]	0.00							
Operating Control Conditions	Control 1 Depth	90 [mm]						
	Control 2 Focus	40 [mm]						
	Control 3 Gate	- [mm]						
	Control 4 Preset	GEN-General						

$$ISPTA.3 [mW/cm^2] = 1.76$$



**Table C-46: Transducer Model 4DC7-3/40 (Operating Mode: M)**

Index Label		MI	TIS			TIB	TIC	
			scan	non-scan				
Global Maximum Index Value		0.49	0.00	(a)	(a)	(a)	0.00	
Assoc. Acoustic Param.	Pr.3 [MPa]	1.05						
	W <sub>0</sub> [mW]		0.03	(a)		(a)	(a)	
	min of [W <sub>3</sub> (z <sub>1</sub> ) : I <sub>TA,3</sub> (z <sub>1</sub> )] [mW]				(c)			
	Z <sub>1</sub> [cm]				(c)			
	Z <sub>bp</sub> [cm]				(a)			
	zsp [cm]	3.97				(a)		
	d <sub>eq</sub> (z <sub>sp</sub> ) [cm]					(a)		
	f <sub>c</sub> [MHz]	4.50	4.50	(a)	(a)	(a)	4.50	
	Dim of A <sub>aprt</sub>	X [cm]		6.40	(a)	(a)	(a)	6.40
		Y [cm]		1.20	(a)	(a)	(a)	1.20
Other Information	PD [µsec]	0.45						
	PRF [Hz]	41						
	p <sub>r</sub> @P <sub>II</sub> <sub>max</sub> [MPa]	1.94						
	d <sub>eq</sub> @P <sub>II</sub> <sub>max</sub> [cm]					(a)		
	Focal Length	FL <sub>X</sub> [cm]		3.00	(a)	(a)		3.00
		FL <sub>Y</sub> [cm]		3.00	(a)	(a)		3.00
I <sub>PA,3</sub> @M <sub>I</sub> <sub>max</sub> [W/cm <sup>2</sup> ]	0.00							
Operating Control Conditions	Control 1 Depth	90	[mm]					
	Control 2 Focus	40	[mm]					
	Control 3 Gate	-	[mm]					
	Control 4 Preset	GEN-General						

ISPTA.3 [mW/cm<sup>2</sup>] = 10.5

**Table C-47: Transducer Model 4DC7-3/40 (Operating Mode: PW Doppler)**

Index Label		MI	TIS			TIB	TIC	
			scan	non-scan				
Global Maximum Index Value		0.32	(a)	4.98	2.73	4.03	1.86	
Assoc. Acoustic Param.	Pr.3 [MPa]	0.69						
	W <sub>0</sub> [mW]		(a)	232.23		232.23	232.23	
	min of [W <sub>3</sub> (z <sub>1</sub> ) : I <sub>TA,3</sub> (z <sub>1</sub> )] [mW]				6.22			
	Z <sub>1</sub> [cm]				3.27			
	Z <sub>bp</sub> [cm]				4.69			
	zsp [cm]	3.27				3.27		
	d <sub>eq</sub> (z <sub>sp</sub> ) [cm]					10.87		
	f <sub>c</sub> [MHz]	4.50	(a)	4.50	4.50	4.50	4.50	
	Dim of A <sub>aprt</sub>	X [cm]		(a)	6.40	6.40	6.40	6.40
		Y [cm]		(a)	1.20	1.20	1.20	1.20
Other Information	PD [µsec]	4.08						
	PRF [Hz]	6700						
	p <sub>r</sub> @P <sub>II</sub> <sub>max</sub> [MPa]	1.15						
	d <sub>eq</sub> @P <sub>II</sub> <sub>max</sub> [cm]					5.35		
	Focal Length	FL <sub>X</sub> [cm]		(a)	4.00	4.00		4.50
		FL <sub>Y</sub> [cm]		(a)	4.00	4.00		4.50
I <sub>PA,3</sub> @M <sub>I</sub> <sub>max</sub> [W/cm <sup>2</sup> ]	0.10							
Operating Control Conditions	Control 1 Depth	90	[mm]					
	Control 2 Focus	40	[mm]					
	Control 3 Gate	10	[mm]					
	Control 4 Preset	GEN-General						

ISPTA.3 [mW/cm<sup>2</sup>] = 415.94

**Table C-48: Transducer Model 4DC7-3/40 (Operating Mode: PW+B)**

Index Label		MI	TIS		TIB		TIC	
			scan	non-scan		non-scan		
Global Maximum Index Value		0.32	0.005	5.74	2.73	0.06	2.14	
Assoc. Acoustic Param.	Pr.3 [MPa]	0.69						
	$W_0$ [mW]		0.22	268.04		268.04	268.04	
	min of $[W_3(z_1) : I_{TA,3}(z_1)]$ [mW]				6.22			
	$Z_1$ [cm]				3.27			
	$Z_{bp}$ [cm]				4.69			
	$z_{sp}$ [cm]	3.27				3.27		
	$d_{eq}(z_{sp})$ [cm]					11.68		
	$f_c$ [MHz]	4.50	4.50	4.50	4.50	4.50	4.50	
	Dim of $A_{aprt}$	X [cm]		6.40	6.40	6.40	6.40	6.40
		Y [cm]		1.20	1.20	1.20	1.20	1.20
Other Information	PD [ $\mu$ sec]	4.08						
	PRF [Hz]	6700						
	$p_r@P_{II_{max}}$ [MPa]	1.15						
	$d_{eq}@P_{II_{max}}$ [cm]					5.74		
	Focal Length	$FL_X$ [cm]		3.00	3.00	3.00		3.00
		$FL_Y$ [cm]		3.00	3.00	3.00		3.00
$I_{PA,3}@MI_{max}$ [W/cm <sup>2</sup> ]	0.11							
Operating Control Conditions	Control 1 Depth	90 [mm]						
	Control 2 Focus	40 [mm]						
	Control 3 Gate	10 [mm]						
	Control 4 Preset	GEN-General						

$$ISPTA.3 [mW/cm^2] = 420.8$$

**Table C-49: Transducer Model 4DC7-3/40 (Operating Mode: Triplex (B/Color/PW))**

Index Label		MI	TIS		TIB		TIC	
			scan	non-scan		non-scan		
Global Maximum Index Value		0.32	0.005	5.74	2.73	0.06	2.14	
Assoc. Acoustic Param.	Pr.3 [MPa]	0.69						
	$W_0$ [mW]		0.23			268.04	238.04	
	min of $[W_3(z_1) : I_{TA,3}(z_1)]$ [mW]				26.90			
	$Z_1$ [cm]				3.27			
	$Z_{bp}$ [cm]				4.69			
	$z_{sp}$ [cm]	3.27				3.27		
	$d_{eq}(z_{sp})$ [cm]					11.68		
	$f_c$ [MHz]	4.50	4.50	4.50	4.50	4.50	4.50	
	Dim of $A_{aprt}$	X [cm]		6.40	6.40	6.40	6.40	6.40
		Y [cm]		1.20	1.20	1.20	1.20	1.20
Other Information	PD [ $\mu$ sec]	4.08						
	FPS [Hz]	7						
	PRFd [Hz]	5000						
	$p_r@P_{II_{max}}$ [MPa]	1.15						
	$d_{eq}@P_{II_{max}}$ [cm]					2.76		
	Focal Length	$FL_X$ [cm]		3.00	3.00	3.00		3.00
$FL_Y$ [cm]			3.00	3.00	3.00		3.00	
$I_{PA,3}@MI_{max}$ [W/cm <sup>2</sup> ]	0.13							
Operating Control Conditions	Control 1 Depth	90 [mm]						
	Control 2 Focus	40 [mm]						
	Control 3 Gate	10 [mm]						
	Control 4 Preset	GEN-General						

$$ISPTA.3 [mW/cm^2] = 500.52$$



### C.3 ULTRASOUND INDICATIONS FOR USE TABLES

**TABLE C-50: SONIXSP ULTRASOUND SCANNER  
DIAGNOSTIC ULTRASOUND INDICATIONS FOR USE FORMS**

Intended use: Diagnostic ultrasound imaging or fluid flow analysis of the human body as follows:

Clinical Application	Mode of Operation							
	B	M	PW Doppler	CW Doppler	Color Doppler	Power Doppler	Combine Modes <sup>12</sup>	Other [Notes]
Ophthalmic								
Fetal	◆	◆	◆	◆	◆	◆	◆	◆ [3-8,11]
Abdominal	◆	◆	◆	◆	◆	◆	◆	◆ [3-8,11]
Intraoperative <sup>1</sup>	◆	◆	◆		◆	◆	◆	◆ [3-8]
Intraoperative Neurological	◆	◆	◆		◆	◆	◆	◆ [3-8]
Pediatric	◆	◆	◆	◆	◆	◆	◆	◆ [3-8,11]
Small Organ <sup>2</sup>	◆	◆	◆	◆	◆	◆	◆	◆ [3-6,8,11]
Neonatal Cephalic	◆	◆	◆	◆	◆	◆	◆	◆ [3-6,8,11]
Adult Cephalic (excluding Transcranial)	◆	◆	◆	◆	◆	◆	◆	◆ [3-6,8,11]
Cardiac	◆	◆	◆	◆	◆	◆	◆	◆ [3-6,8]
Transesophageal	◆	◆	◆	◆	◆	◆	◆	◆ [3-6,8]
Transrectal	◆	◆	◆	◆	◆	◆	◆	◆ [3-8,11]
Transvaginal	◆	◆	◆	◆	◆	◆	◆	◆ [3-8,11]
Transurethral								
Transcranial	◆	◆	◆	◆	◆	◆	◆	◆ [3-6,8]
Peripheral Vascular	◆	◆	◆	◆	◆	◆	◆	◆ [3-8,11]
Laparoscopic								
MSK Conventional	◆	◆	◆	◆	◆	◆	◆	◆ [3-8,11]
MSK Superficial	◆	◆	◆	◆	◆	◆	◆	◆ [3-8,11]
Vascular Access (excluding Transcranial)	◆	◆	◆	◆	◆	◆	◆	◆ [3-8,10,11]
Nerve Block	◆	◆	◆	◆	◆	◆	◆	◆ [3-9,11]
Other								

◆ = Cleared for use

**Notes:**

1. Abdominal organs and vascular
2. Breast, Thyroid, Testicle
3. Elastography
4. Panoramic Imaging
5. Compound Imaging
6. Freehand 3D Imaging
7. Live 3D/4D Imaging
8. Imaging for guidance of biopsy
9. Imaging for guidance of nerve block injections
10. Imaging for guidance of central or peripheral lines
11. Volume Navigation/Image Fusion/GPS (available only with the GPS transducer)
12. B/M, B/PW Doppler or CW Doppler, B/C/PW Doppler (Triplex) or CW Doppler (Triplex CW), B/Power Doppler/PW Doppler or CW Doppler, Simultaneous Color Doppler or Power Doppler.

## DIAGNOSTIC ULTRASOUND INDICATIONS FOR USE FORM

**Table C-51: SA4-2/24 Phased Array Transducer**

Intended use: Diagnostic ultrasound imaging or fluid flow analysis of the human body as follows:

Clinical Application	Mode of Operation							
	B	M	PW Doppler	CW Doppler	Color Doppler	Power Doppler	Combined Modes <sup>12</sup>	Other [Notes]
Ophthalmic								
Fetal								
Abdominal	♦	♦	♦	♦	♦	♦	♦	♦ [3-6,8]
Intraoperative <sup>1</sup>								
Intraoperative Neurological								
Pediatric	♦	♦	♦	♦	♦	♦	♦	♦ [3-6,8]
Small Organ <sup>2</sup>								
Neonatal Cephalic	♦	♦	♦		♦	♦	♦	♦ [3-6,8]
Adult Cephalic (excluding Transcranial)	♦	♦	♦	♦	♦	♦	♦	♦ [3-6,8]
Cardiac	♦	♦	♦	♦	♦	♦	♦	♦ [3-6,8]
Transesophageal								
Transrectal								
Transvaginal								
Transurethral								
Transcranial								
Peripheral Vascular								
Laparoscopic								
MSK Conventional								
MSK Superficial								
Vascular Access (excluding Transcranial)								
Nerve Block								
Other								

♦ = Cleared for use

**Notes:**

1. Abdominal organs and vascular
2. Breast, Thyroid, Testicle
3. Elastography
4. Panoramic Imaging
5. Compound Imaging
6. Freehand 3D Imaging
7. Live 3D/4D Imaging
8. Imaging for guidance of biopsy
9. Imaging for guidance of nerve block injections
10. Imaging for guidance of central or peripheral lines
11. Volume Navigation/Image Fusion/GPS (available only with the GPS transducer)
12. B/M, B/PW Doppler or CW Doppler, B/C/PW Doppler (Triplex) or CW Doppler (Triplex CW), B/Power Doppler/PW Doppler or CW Doppler, Simultaneous Color Doppler or Power Doppler.



**ULTRASONIX**

**DIAGNOSTIC ULTRASOUND INDICATIONS FOR USE FORM**

**Table C-52: EC9-5/10 Microconvex Endocavity Radius Transducer**

Intended use: Diagnostic ultrasound imaging or fluid flow analysis of the human body as follows:

Clinical Application	Mode of Operation							
	B	M	PW Doppler	CW Doppler	Color Doppler	Power Doppler	Combined Modes <sup>12</sup>	Other [Notes]
Ophthalmic								
Fetal								
Abdominal								
Intraoperative <sup>1</sup>								
Intraoperative Neurological								
Pediatric								
Small Organ <sup>2</sup>								
Neonatal Cephalic								
Adult Cephalic (excluding Transcranial)								
Cardiac								
Transesophageal								
Transrectal	♦	♦	♦		♦	♦	♦	♦ [3-6,8,11]
Transvaginal	♦	♦	♦		♦	♦	♦	♦ [3-6,8,11]
Transurethral								
Transcranial								
Peripheral Vascular								
Laparoscopic								
MSK Conventional								
MSK Superficial								
Vascular Access (excluding Transcranial)								
Nerve Block								
Other								

♦ = Cleared for use

**Notes:**

1. Abdominal organs and vascular
2. Breast, Thyroid, Testicle
3. Elastography
4. Panoramic Imaging
5. Compound Imaging
6. Freehand 3D Imaging
7. Live 3D/4D Imaging
8. Imaging for guidance of biopsy
9. Imaging for guidance of nerve block injections
10. Imaging for guidance of central or peripheral lines
11. Volume Navigation/Image Fusion/GPS (available only with the GPS transducer)
12. B/M, B/PW Doppler or CW Doppler, B/C/PW Doppler (Triplex) or CW Doppler (Triplex CW), B/Power Doppler/PW Doppler or CW Doppler, Simultaneous Color Doppler or Power Doppler.

## DIAGNOSTIC ULTRASOUND INDICATIONS FOR USE FORM

**Table C-53: C5-2/60 and C5-2/60 GPS Convex Radius Transducer**

Intended use: Diagnostic ultrasound imaging or fluid flow analysis of the human body as follows:

Clinical Application	Mode of Operation							
	B	M	PW Doppler	CW Doppler	Color Doppler	Power Doppler	Combined Modes <sup>12</sup>	Other [Notes]
Ophthalmic								
Fetal	♦	♦	♦		♦	♦	♦	♦ [3-6,8,11]
Abdominal	♦	♦	♦		♦	♦	♦	♦ [3-6,8,11]
Intraoperative <sup>1</sup>								
Intraoperative Neurological								
Pediatric	♦	♦	♦		♦	♦	♦	♦ [3-6,8,11]
Small Organ <sup>2</sup>	♦	♦	♦		♦	♦	♦	♦ [3-6,8,11]
Neonatal Cephalic								
Adult Cephalic (excluding Transcranial)								
Cardiac								
Transesophageal								
Transrectal								
Transvaginal								
Transurethral								
Transcranial								
Peripheral Vascular	♦	♦	♦		♦	♦	♦	♦ [3-6,8,11]
Laparoscopic								
MSK Conventional	♦	♦	♦		♦	♦	♦	♦ [3-6,8,11]
MSK Superficial	♦	♦	♦		♦	♦	♦	♦ [3-6,8,11]
Vascular Access (excluding Transcranial)								
Nerve Block								
Other								

♦ = Cleared for use

**Notes:**

13. Abdominal organs and vascular
14. Breast, Thyroid, Testicle
15. Elastography
16. Panoramic Imaging
17. Compound Imaging
18. Freehand 3D Imaging
19. Live 3D/4D Imaging
20. Imaging for guidance of biopsy
21. Imaging for guidance of nerve block injections
22. Imaging for guidance of central or peripheral lines
23. Volume Navigation/Image Fusion/GPS (available only with the GPS transducer)
24. BB/M, B/PW Doppler or CW Doppler, B/C/PW Doppler (Triplex) or CW Doppler (Triplex CW), B/Power Doppler/PW Doppler or CW Doppler, Simultaneous Color Doppler or Power Doppler.



**ULTRASONIX**

**DIAGNOSTIC ULTRASOUND INDICATIONS FOR USE FORM**

**Table C-54: L9-4/38 Linear Transducer**

Intended use: Diagnostic ultrasound imaging or fluid flow analysis of the human body as follows:

Clinical Application	Mode of Operation							
	B	M	PW Doppler	CW Doppler	Color Doppler	Power Doppler	Combined Modes <sup>12</sup>	Other [Notes]
Ophthalmic								
Fetal	♦	♦	♦		♦	♦	♦	♦ [3-6,8]
Abdominal	♦	♦	♦		♦	♦	♦	♦ [3-6,8]
Intraoperative <sup>1</sup>								
Intraoperative Neurological								
Pediatric	♦	♦	♦		♦	♦	♦	♦ [3-6,8]
Small Organ <sup>2</sup>	♦	♦	♦		♦	♦	♦	♦ [3-6,8]
Neonatal Cephalic	♦	♦	♦		♦	♦	♦	♦ [3-6,8]
Adult Cephalic (excluding Transcranial)	♦	♦	♦		♦	♦	♦	♦ [3-6,8]
Cardiac								
Transesophageal								
Transrectal								
Transvaginal								
Transurethral								
Transcranial								
Peripheral Vascular	♦	♦	♦		♦	♦	♦	♦ [3-6,8]
Laparoscopic								
MSK Conventional	♦	♦	♦		♦	♦	♦	♦ [3-6,8]
MSK Superficial	♦	♦	♦		♦	♦	♦	♦ [3-6,8]
Vascular Access (excluding Transcranial)	♦	♦	♦		♦	♦	♦	♦ [3-6,8,10]
Nerve Block	♦	♦	♦		♦	♦	♦	♦ [3-6,8,9]
Other								

♦ = Cleared for use

**Notes:**

1. Abdominal organs and vascular
2. Breast, Thyroid, Testicle
3. Elastography
4. Panoramic Imaging
5. Compound Imaging
6. Freehand 3D Imaging
7. Live 3D/4D Imaging
8. Imaging for guidance of biopsy
9. Imaging for guidance of nerve block injections
10. Imaging for guidance of central or peripheral lines
11. Volume Navigation/Image Fusion/GPS (available only with the GPS transducer)
12. B/M, B/PW Doppler or CW Doppler, B/C/PW Doppler (Triplex) or CW Doppler (Triplex CW), B/Power Doppler/PW Doppler or CW Doppler, Simultaneous Color Doppler or Power Doppler.



**DIAGNOSTIC ULTRASOUND INDICATIONS FOR USE FORM**

**Table C-55: L14-5/38 and L14-5/38 GPS Linear Transducer**

Intended use: Diagnostic ultrasound imaging or fluid flow analysis of the human body as follows:

Clinical Application	Mode of Operation							
	B	M	PW Doppler	CW Doppler	Color Doppler	Power Doppler	Combined Modes <sup>12</sup>	Other [Notes]
Ophthalmic								
Fetal	♦	♦	♦		♦	♦	♦	♦ [3-6,8,11]
Abdominal	♦	♦	♦		♦	♦	♦	♦ [3-6,8,11]
Intraoperative <sup>1</sup>								
Intraoperative Neurological								
Pediatric	♦	♦	♦		♦	♦	♦	♦ [3-6,8,11]
Small Organ <sup>2</sup>	♦	♦	♦		♦	♦	♦	♦ [3-6,8,11]
Neonatal Cephalic	♦	♦	♦		♦	♦	♦	♦ [3-6,8,11]
Adult Cephalic (excluding Transcranial)	♦	♦	♦		♦	♦	♦	♦ [3-6,8,11]
Cardiac								
Transesophageal								
Transrectal								
Transvaginal								
Transurethral								
Transcranial								
Peripheral Vascular	♦	♦	♦		♦	♦	♦	♦ [3-6,8,11]
Laparoscopic								
MSK Conventional	♦	♦	♦		♦	♦	♦	♦ [3-6,8,11]
MSK Superficial	♦	♦	♦		♦	♦	♦	♦ [3-6,8,11]
Vascular Access (excluding Transcranial)	♦	♦	♦		♦	♦	♦	♦ [3-6,8,10,11]
Nerve Block	♦	♦	♦		♦	♦	♦	♦ [3-6,8,9,11]
Other								

♦ = Cleared for use

**Notes:**

1. Abdominal organs and vascular
2. Breast, Thyroid, Testicle
3. Elastography
4. Panoramic Imaging
5. Compound Imaging
6. Freehand 3D Imaging
7. Live 3D/4D Imaging
8. Imaging for guidance of biopsy
9. Imaging for guidance of nerve block injections
10. Imaging for guidance of central or peripheral lines
11. Volume Navigation/Image Fusion/GPS (available only with the GPS transducer)
12. B/M, B/PW Doppler or CW Doppler, B/C/PW Doppler (Triplex) or CW Doppler (Triplex CW), B/Power Doppler/PW Doppler or CW Doppler, Simultaneous Color Doppler or Power Doppler.



**ULTRASONIX**

**DIAGNOSTIC ULTRASOUND INDICATIONS FOR USE FORM**

**Table C-56: L14-5W/60 Wide Linear Transducer**

Intended use: Diagnostic ultrasound imaging or fluid flow analysis of the human body as follows:

Clinical Application	Mode of Operation							
	B	M	PW Doppler	CW Doppler	Color Doppler	Power Doppler	Combined Modes <sup>12</sup>	Other [Notes]
Ophthalmic								
Fetal	♦	♦	♦		♦	♦	♦	♦ [3-6,8]
Abdominal	♦	♦	♦		♦	♦	♦	♦ [3-6,8]
Intraoperative <sup>1</sup>								
Intraoperative Neurological								
Pediatric	♦	♦	♦		♦	♦	♦	♦ [3-6,8]
Small Organ <sup>2</sup>	♦	♦	♦		♦	♦	♦	♦ [3-6,8]
Neonatal Cephalic	♦	♦	♦		♦	♦	♦	♦ [3-6,8]
Adult Cephalic (excluding Transcranial)	♦	♦	♦		♦	♦	♦	♦ [3-6,8]
Cardiac								
Transesophageal								
Transrectal								
Transvaginal								
Transurethral								
Transcranial								
Peripheral Vascular	♦	♦	♦		♦	♦	♦	♦ [3-6,8]
Laparoscopic								
MSK Conventional	♦	♦	♦		♦	♦	♦	♦ [3-6,8]
MSK Superficial	♦	♦	♦		♦	♦	♦	♦ [3-6,8]
Vascular Access (excluding Transcranial)	♦	♦	♦		♦	♦	♦	♦ [3-6,8,10]
Nerve Block	♦	♦	♦		♦	♦	♦	♦ [3-6,8,9]
Other								

♦ = Cleared for use

**Notes:**

1. Abdominal organs and vascular
2. Breast, Thyroid, Testicle
3. Elastography
4. Panoramic Imaging
5. Compound Imaging
6. Freehand 3D Imaging
7. Live 3D/4D Imaging
8. Imaging for guidance of biopsy
9. Imaging for guidance of nerve block injections
10. Imaging for guidance of central or peripheral lines
11. Volume Navigation/Image Fusion/GPS (available only with the GPS transducer)
12. B/M, B/PW Doppler or CW Doppler, B/C/PW Doppler (Triplex) or CW Doppler (Triplex CW), B/Power Doppler/PW Doppler or CW Doppler, Simultaneous Color Doppler or Power Doppler.

## DIAGNOSTIC ULTRASOUND INDICATIONS FOR USE FORM

**Table C-57: HST15-8/20 Linear Transducer**

Intended use: Diagnostic ultrasound imaging or fluid flow analysis of the human body as follows:

Clinical Application	Mode of Operation							
	B	M	PW Doppler	CW Doppler	Color Doppler	Power Doppler	Combined Modes <sup>12</sup>	Other [Notes]
Ophthalmic								
Fetal								
Abdominal								
Intraoperative <sup>1</sup>								
Intraoperative Neurological	♦	♦	♦		♦	♦	♦	♦ [3-6,8]
Pediatric	♦	♦	♦		♦	♦	♦	♦ [3-6,8]
Small Organ <sup>2</sup>	♦	♦	♦		♦	♦	♦	♦ [3-6,8]
Neonatal Cephalic	♦	♦	♦		♦	♦	♦	♦ [3-6,8]
Adult Cephalic (excluding Transcranial)								
Cardiac								
Transesophageal								
Transrectal								
Transvaginal								
Transurethral								
Transcranial	♦	♦	♦		♦	♦	♦	♦ [3-6,8]
Peripheral Vascular	♦	♦	♦		♦	♦	♦	♦ [3-6,8]
Laparoscopic								
MSK Conventional	♦	♦	♦		♦	♦	♦	♦ [3-6,8]
MSK Superficial	♦	♦	♦		♦	♦	♦	♦ [3-6,8]
Vascular Access (excluding Transcranial)	♦	♦	♦		♦	♦	♦	♦ [3-6,8,10]
Nerve Block	♦	♦	♦		♦	♦	♦	♦ [3-6,8,9]
Other								

♦ = Cleared for use

**Notes:**

1. Abdominal organs and vascular
2. Breast, Thyroid, Testicle
3. Elastography
4. Panoramic Imaging
5. Compound Imaging
6. Freehand 3D Imaging
7. Live 3D/4D Imaging
8. Imaging for guidance of biopsy
9. Imaging for guidance of nerve block injections
10. Imaging for guidance of central or peripheral lines
11. Volume Navigation/Image Fusion/GPS (available only with the GPS transducer)
12. B/M, B/PW Doppler or CW Doppler, B/C/PW Doppler (Triplex) or CW Doppler (Triplex CW), B/Power Doppler/PW Doppler or CW Doppler, Simultaneous Color Doppler or Power Doppler.



**ULTRASONIX**

**DIAGNOSTIC ULTRASOUND INDICATIONS FOR USE FORM**

**Table C-58: 4DC7-3/40 Motorized Convex Radius Transducer**

Intended use: Diagnostic ultrasound imaging or fluid flow analysis of the human body as follows:

Clinical Application	Mode of Operation							
	B	M	PW Doppler	CW Doppler	Color Doppler	Power Doppler	Combined Modes <sup>12</sup>	Other [Notes]
Ophthalmic								
Fetal	♦	♦	♦		♦	♦	♦	♦ [3-8]
Abdominal	♦	♦	♦		♦	♦	♦	♦ [3-8]
Intraoperative <sup>1</sup>								
Intraoperative Neurological								
Pediatric	♦	♦	♦		♦	♦	♦	♦ [3-8]
Small Organ <sup>2</sup>	♦	♦	♦		♦	♦	♦	♦ [3-8]
Neonatal Cephalic								
Adult Cephalic (excluding Transcranial)								
Cardiac								
Transesophageal								
Transrectal								
Transvaginal								
Transurethral								
Transcranial								
Peripheral Vascular								
Laparoscopic								
MSK Conventional	♦	♦	♦		♦	♦	♦	♦ [3-8]
MSK Superficial	♦	♦	♦		♦	♦	♦	♦ [3-8]
Vascular Access (excluding Transcranial)								
Nerve Block								
Other								

♦ = Cleared for use

**Notes:**

1. Abdominal organs and vascular
2. Breast, Thyroid, Testicle
3. Elastography
4. Panoramic Imaging
5. Compound Imaging
6. Freehand 3D Imaging
7. Live 3D/4D Imaging
8. Imaging for guidance of biopsy
9. Imaging for guidance of nerve block injections
10. Imaging for guidance of central or peripheral lines
11. Volume Navigation/Image Fusion/GPS (available only with the GPS transducer)
12. B/M, B/PW Doppler or CW Doppler, B/C/PW Doppler (Triplex) or CW Doppler (Triplex CW), B/Power Doppler/PW Doppler or CW Doppler, Simultaneous Color Doppler or Power Doppler.

## APPENDIX D: MAINTENANCE AND CLEANING

---

### D.1 TRANSDUCERS

#### D.1.1 Guidelines

Ultrasonix recommends inspecting the transducers prior to each use:

- Ensure the transducers are always clean before they are used. There must be no ultrasound gel (from previous imaging), any debris, films or unusual odors present.
- Ensure there are no cracks or other damage to the transducers before they are used. Inspect the transducer surfaces for cracks and feel for cracks with finger tips as well.

Where any transducer (including, but not limited to, an intracavity transducer) is used in a clinical application of a semi-critical nature (including, but not limited to, intraoperative, transrectal, transvaginal, transesophageal, etc.), ensure the transducer is covered with the appropriate STERILE transducer cover/sheath which has received regulatory clearance for use.

#### D.1.2 Ultrasound Coupling Gels

The following ultrasound coupling gels are recommended for use with Ultrasonix transducers:

**Table D-1: Recommended Ultrasound Coupling Gels**

<b>Gel Name</b>	<b>Manufacturer</b>	<b>Address</b>
Aquasonic 100	Parker Laboratories, Inc.	286 Eldridge Road Fairfield, NJ, 07004 USA Ph (800) 631-8888 Fax (973) 276-9510
Clear Image	Sonotech, Inc.	774 Marine Drive Bellingham, WA 98225 USA Ph (360) 671-9121 Fax (360) 671-9024
Echo-Oil®	Echo Ultrasound	R.D.#2. Box 118 Reedsville, PA 17084 USA
Echotrack®	Echo Ultrasound	R.D.#2. Box 118 Reedsville, PA 17084 USA
Ecogel 100& 200	Echo-Med Pharmaceutical Inc.	7050 Bramalea Road Unit C58 Mississauga, ON L5S 1S9 Canada Ph (905) 405-1050 Fax (905) 405-0775



Do not use gels that contain any of the following solutions:

- Acetone
- Methanol
- Denatured ethyl alcohol
- Mineral oil
- Iodine
- Any lotions or gels that contain perfume.

If there are any questions, contact Ultrasonix Medical Corporation.

### D.1.3 General Transducer Maintenance

---

**Cautions:**

*DO NOT drop the transducers.*

*DO NOT hit the transducers against any surface that can dislodge or damage any of the transducer components.*

*DO NOT pinch or kink the transducer cable.*

*DO NOT use a brush to clean the transducer. (Use a soft cloth.)*

*DO NOT immerse the transducer scan head past the first seam in any liquid.*

*DO NOT soak the transducer for extended periods of time.*

*DO NOT rinse or immerse near the strain relief.*

*DO NOT use coupling gels and cleaning agents that have not been recommended by Ultrasonix.*

*DO NOT use sterilization or disinfection methods that have not been recommended by Ultrasonix. Severe damage will result. Contact Ultrasonix if you have any doubt about sterilization or disinfection methods. Use of non-recommended cleaning agents may cause damage to the housing and will void transducer warranties.*

*DO NOT use chemicals such as phenol, benzothonium chloride, pHisoHex, benzoyl peroxide, hydrogen peroxide—commonly found in hospitals or clinics. These chemicals will damage the transducer.*

---

### D.1.3.1 Inspection and Testing

Inspect the transducers prior to each use:

- always ensure the transducers are clean before they are used. There must be no ultrasound gel (from previous imaging), debris, films, or unusual odors present
- ensure there are no cracks or other damage to the transducers before they are used. Inspect the transducer surfaces for cracks and feel for cracks with finger tips as well.

---

***Cautions:***

*DO NOT use transducers if they are found to be cracked, damaged, or broken.*

*DO NOT use the transducer if the transducer cable insulation is damaged, thereby exposing the wiring.*

---

### D.1.3.2 Storing and Packaging

To help avoid contamination, ensure the transducer is clean/disinfected and dry before storing/packing it. Store transducers:

- in one of the transducer holders
- separately, in a protected environment to avoid inadvertent transducer damage
- in the original case (recommended)
- away from direct sunlight, dust and extreme temperatures.

After placing a transducer in its carrying case, wrap the case in bubble wrap and place the wrapped case in a cardboard box.



## D.1.4 General Transducer Cleaning/Disinfecting Recommendations and Warnings

---



### **Warnings:**

*Never sterilize the transducer with sterilization techniques such as autoclave, ultraviolet, gamma radiation, gas, steam, or heat sterilization techniques. Severe damage will result using the above sterilization techniques.*

*Use of precleaning solutions should be restricted to the external transducer face. DO NOT get solution on any other areas or surfaces of the transducer. This includes transducer connectors and contacts.*

*Some chemicals such as phenol, benzothonium chloride, pHisoHex, benzoyl peroxide, hydrogen peroxide are commonly found in clinic and hospital settings, while others are found in antibacterial skin cleaners or lotions. **Use of these chemicals will cause damage to your transducer.***

*Avoid transducer contact with strong solvents such as acetone, freon and other industrial cleansers.*

*Follow all infection control policies and procedures established by your organization, including safety procedures involving personal protective equipment (such as gloves, protective eyewear and protective clothing)*

***DO NOT** use sterilization or disinfection methods that have not been recommended by Ultrasonix. Severe damage will result. Contact Ultrasonix if you have any doubt about sterilization or disinfection methods.*

---



***Warning:** Any transducer suspected of being contaminated with **Creutzfeld Jacob** disease material cannot be cleaned or sterilized.*

*Contact Ultrasonix Medical Corporation to obtain instructions on the proper disposal of these transducers.*

---

*Remove ultrasound transmission gel with a dry or water-moistened soft cloth. It is recommended that transducers are reprocessed as soon as is reasonably practical following use.*

---

### **Cautions:**

*Use only Ultrasonix recommended cleaners/disinfectants ([Table D-2](#) and [Table D-3](#)). They have been tested and determined safe to use on Ultrasonix transducers. Failure to follow these instructions may cause damage and will void transducer warranties.*

*Reprocessing should be completed only by personnel thoroughly trained in proper cleaning/disinfection procedures.*

*Follow all product/manufacture label cleaning and safety instructions.*

*Always verify product expiration dates.*

*Follow all regulatory and manufacturer instructions on product disposal.*

*For complete regulatory information and approval status on the products listed here, refer to the relevant EPA, FDA, Health Canada and CE documentation.*

---

***Note:** Repeated processing has minimal effect on these transducers. End of life is normally determined by wear and damage due to use. Disassembly is not required.*

---



### D.1.5 Cleaning/Disinfecting Non-Invasive Transducers

To prevent biological materials (bioburden) from drying on the equipment, always reprocess transducers as soon as is reasonably practical following use.

**Table D-2: Non-Invasive Cleaning/Disinfecting Agents**

NON-INVASIVE TRANSDUCERS		CLEANING/DISINFECTING AGENTS													
		75% IPA	Alkazyme	Cidex Activated Dialdehyde Solution 14 day	Cidex Plus 28 day	Cidex OPA	Cidezyme	Klenzyme	McKesson Brand	Metrizyme	Milton Disinfecting Liquid	Nuclean	Omnicide – FG2	Steranios 2%	T-spray
MISCELLANEOUS	SA4-2/24				◆	◆				◆					◆
	HST15-8/20			◆	◆	◆	◆								
	4DC7-3/40			◆	◆	◆	◆								
	4DL14-5/38		◆			◆		◆						◆	
GPS	C5-2/60 GPS	◆		◆	◆		◆	◆	◆		◆	◆			◆
	L14-5/38 GPS	◆		◆	◆		◆	◆	◆		◆	◆			◆
LINEAR AND CONVEX	C5-2/60	◆			◆	◆	◆	◆	◆	◆	◆		◆		◆
	C7-3/50	◆			◆	◆	◆	◆	◆	◆	◆		◆		◆
	L9-4/38	◆			◆	◆	◆	◆	◆	◆	◆		◆		◆
	L14-5/38	◆			◆	◆	◆	◆	◆	◆	◆		◆		◆
	L14-5W/60	◆			◆	◆	◆	◆	◆	◆	◆		◆		◆

**Caution:** Use only Ultrasonix recommended cleaners/disinfectants (Table D-2). They have been tested and determined safe to use on Ultrasonix transducers. Failure to follow these instructions may cause damage and will void transducer warranties.



### D.1.5.1 Cleaning Non-Invasive Transducers

Thorough cleaning is essential for successful disinfection. If a transducer is not properly cleaned, any remaining particles (e.g., blood, bodily fluids, dirt) may protect the microorganisms from the disinfection process, rendering it ineffective. Disinfectants overloaded with soil can become contaminated and may themselves become a source for microorganism transmission.

Before cleaning, always remove covers, accessories and attachments.

#### To Clean a Transducer:

1. After every patient exam, wipe the ultrasound transmission gel off the transducer.
2. Wipe the transducer and cable with a soft, dry or water-moistened cloth.
3. Following the manufacturer's instructions, clean the transducer with a recommended cleaning/disinfecting agent from [Table D-2](#).
4. Remove any residue with a soft cloth moistened in water then wipe with a clean, dry cloth.

---

**Caution:** *Do not allow cleaning solutions to air dry on the transducer.*

---

### D.1.5.2 Disinfecting Non-Invasive Transducers

Using a disinfecting agent from the list in [Table D-2](#), follow the manufacturer's instructions to disinfect the transducer.

### D.1.6 Cleaning/Disinfecting Endocavity Transducers

Endocavity transducers are semi-critical medical devices and must be decontaminated using, at a minimum, High Level Disinfection.

Clean and disinfect transducers prior to the first exam and following each exam thereafter.



**Warning:** For instructions on cleaning/disinfecting the mTEE8-3/5 transducer, refer to the most recent Sonix Ultrasound System mTEE8-3/5 User Manual.

**Table D-3: Endocavity Cleaning/Disinfecting Agents**

ENDOCAVITY TRANSDUCERS	CLEANING/DISINFECTING AGENTS			
	Cidex Activated Dialdehyde Solution 14 day	Cidex Plus 28 day	Cidex OPA	Cidezyme
EC9-5/10	◆	◆	◆	◆

**Caution:** Use only Ultrasonix recommended cleaners/disinfectants (Table D-3). They have been tested and determined safe to use on Ultrasonix transducers. Failure to follow these instructions may cause damage and will void transducer warranties.



### To Clean/Disinfect a Transducer:

1. Unplug the transducer.
2. Wash the transducer head and cable with soap and water to remove any protein buildup; however do not rinse or immerse the transducer near the strain relief.
3. Following the manufacturer's instructions, disinfect the transducer with a recommended disinfecting agent from [Table D-3](#).

---

**Note:** *Where any transducer (including, but not limited to, an intracavity transducer) is used in a clinical application of a semi-critical nature (including, but not limited to intraoperative, transrectal, transvaginal, transesophageal, etc.), ensure the transducer is covered with the appropriate STERILE transducer cover/sheath which has received regulatory clearance for use.*

---

4. Wipe with a clean, dry cloth.

---

**Caution:** *Do not allow cleaning solutions to air dry on the transducer.*

---

### D.1.7 Sterilization

Sterilization of transducers is not possible. Follow the instructions for cleaning and disinfection instead:

- Endocavity transducers: [D.1.6](#)
- Non-invasive transducers: [D.1.5.1](#) and [D.1.5.2](#).

---

**Note:** *Where transducers (non-critical and semi-critical medical devices/equipment) cannot withstand sterilization, the FDA recognizes the use of a sterile gel and a sterile transducer cover as an acceptable method of infection control for ultrasound transducers.*

---

## D.2 SHIPPING TRANSDUCERS FOR SERVICE

It is the customer's responsibility to ensure:

- each transducer is disinfected prior to shipping ([D.1.5](#) and [D.1.6](#))
- the transducer is properly packaged for shipment ([D.1.3.2](#))
- all shipping waybills/paperwork is completed as per the relevant regulations and laws.

## D.3 RECOMMENDED FREQUENCY OF HIGH-LEVEL MAINTENANCE PROCEDURES

The frequency of preventive maintenance performed on the system plays a key role in eliminating or extending the periods between downtime due to poor performance or unexpected breakdown. The following table offers recommendations that must be weighed by factors like frequency of use and environmental conditions. In every case, frequent checks of safety-related items are highly recommended.

---

**Note:** *Additional maintenance procedures (covered in the relevant Service Manuals) must be completed by qualified service personnel.*

---

**Table D-4: Maintenance Procedure Frequency**

Test/Clean	Frequency Interval	Task
Transducers	Six (6) months	Check for cracks or bent pins ( <a href="#">D.1 Transducers</a> ).
System Filter	Four (4) months or as required	Check for good air flow without excessive noise.
		Remove and vacuum ( <a href="#">D.4.11 System Filter</a> ).
<b>Note:</b> <i>Filter cleaning frequency is dependant upon usage location. If the system is used in a high traffic area (such as an Emergency Room) filters may require more frequent cleaning.</i>		
System Fans	Six (6) months	Check for good air flow without excessive noise.
Cart	Clean as necessary	The wheels have sealed bearings therefore no lubrication is necessary.

## D.4 CLEANING SYSTEM COMPONENTS

Ultrasonix recommends the following cleaning instructions for all external surfaces, including the cart, cables and connectors.

---

**Cautions:**

*Power off and unplug the system before cleaning.*

*Do not spill or spray water on the controls, transducer connection receptacle, or transducer ports.*

---



## D.4.1 LCD Display and Cabinet

---

**Cautions:**

*Power off and unplug the system prior to cleaning the LCD display.*

*DO NOT apply cleaning solutions directly to any surface of the LCD display or cabinet.*

---

### D.4.1.1 LCD Display Cabinet

Apply a small amount of one of the following recommended cleaning solutions to a soft, non-abrasive cloth and wipe down the cabinet:

- water
- mild detergent (PH level at or near 7) and water solution.

### D.4.1.2 LCD Display Screen

---

**Caution:** *Computer wipes may be used only if they specifically state they are designed for LCD displays.*

---

Apply a small amount of water to a soft, non-abrasive cloth. Stroke the cloth across the display in one direction, moving from the top of the display to the bottom.

- water
- mild detergent (PH level at or near 7) and water solution.

---

**Cautions:**

*DO NOT scratch the LCD display.*

*DO NOT use paper towels to clean the LCD display as they may cause damage and scratches.*

*NEVER use cleaning products containing any of the following on either the cabinet or the screen:*

- *Abrasives*
  - *Acetone*
  - *Alcohol (Ethanol, Methanol or Isopropyl)*
  - *Ammonia*
  - *Benzene*
  - *Solvents*
  - *Wax.*
-

## D.4.2 Touch Screen

---

**Cautions:**

*Power off and unplug the system prior to cleaning the touch screen on the operator console.*

*DO NOT apply the cleaning solution directly to the touch screen.*

*NEVER use cleaning products that contain Ammonia.*

*DO NOT scratch the touch screen.*

*DO NOT use paper towels to clean the console touch screen as they may cause damage and scratches.*

---

Apply a small amount of one of the following recommended cleaning solutions to a soft, non-abrasive cloth:

- water
- 1% isopropyl alcohol.

## D.4.3 Operator Console

---

**Cautions:**

*Power off and unplug the system prior to cleaning the operator console.*

*DO NOT apply cleaning solutions directly to the operator console.*

---

Apply a small amount of one of the following recommended cleaning solutions to a soft, non-abrasive cloth:

- water
- mild detergent (PH level at or near 7) and water solution.

## D.4.4 Power Cord

---

**Cautions:**

*Power off and unplug the system prior to cleaning.*

*DO NOT apply cleaning solutions directly to the power cord.*

---

Apply a small amount of one of the following recommended cleaning solutions to a soft, non-abrasive cloth and wipe the power cord:

- water
- mild detergent (PH level at or near 7) and water solution.



#### D.4.5 Barcode Reader



---

**Warning:** *Disconnect the barcode reader prior to cleaning.*

---

---

**Caution:** *DO NOT apply cleaning solutions directly to the barcode reader.*

---

---

**Note:** *Barcode reader usage should not entail patient contact.*

---

Apply a small amount of one of the following recommended cleaning solutions to a soft, non-abrasive cloth and wipe the barcode reader:

- water
- mild detergent (PH level at or near 7) and water solution.

#### D.4.6 Wireless Adapter (When Connected Externally)



---

**Warning:** *Disconnect the wireless adapter prior to cleaning.*

---

---

**Caution:** *DO NOT apply cleaning solutions directly to the wireless adapter.*

---

---

**Note:** *Wireless adapter usage should not entail patient contact.*

---

Apply a small amount of one of the following recommended cleaning solutions to a soft, non-abrasive cloth and wipe the wireless adapter:

- water
- mild detergent (PH level at or near 7) and water solution.

#### D.4.7 SonixGPS Components



---

**Warning:** *For details on SonixGPS cleaning and maintenance, refer to the most recent SonixGPS User Manual.*

---



#### D.4.8 Transducer Holders and Cable Hooks

---

**Cautions:**

*Power off and unplug the system prior to cleaning.*

*For best results, Ultrasonix recommends removing the transducer holders and cable hooks before cleaning (10.12). This will allow the operator to clean all the various curves and folds in a more effective manner.*

*DO NOT apply cleaning solutions directly to the transducer holders and cable hooks.*

---

Apply a small amount of one of the following recommended cleaning solutions to a soft, non-abrasive cloth and wipe off the transducer holders and cable hooks:

- water
- mild detergent (PH level at or near 7) and water solution.

#### D.4.9 Footswitch (Dual and Triple)

---



**Warning:** *Disconnect the footswitch prior to cleaning.*

---

**Caution:** *DO NOT apply cleaning solutions directly to the footswitch.*

---

Apply a small amount of one of the following recommended cleaning solutions to a soft, non-abrasive cloth and wipe off the footswitch:

- water
- 70% isopropyl alcohol.

**Note:** *Over time, silk-screened graphics may be damaged by the solvent effect of the isopropyl alcohol.*

---



#### D.4.10 Peripheral Tray and Basket

---

**Cautions:**

*Power off and unplug the system prior to cleaning.*

*For best results, Ultrasonix recommends removing the peripheral tray basket before cleaning (10.11). This will allow the operator to clean all the various curves and folds in a more effective manner.*

*DO NOT apply cleaning solutions directly to the peripheral tray basket.*

---

Apply a small amount of one of the following recommended cleaning solutions to a soft, non-abrasive cloth and wipe off the peripheral tray and basket:

- water
- mild detergent (PH level at or near 7) and water solution.

#### D.4.11 System Filter

---

**Cautions:**

*Power off and unplug the system prior to cleaning.*

*Vacuum only. DO NOT apply any liquids to the system filter.*

*Filter cleaning frequency is dependant upon usage location. If the system is used in a high traffic area (such as an Emergency Room), the filter may require more frequent cleaning.*

*Failure to regularly clean the system filter may cause reduced air flow and result in the system overheating. **System failures due to a lack of filter cleaning may not be covered by the Warranty or a Service Contract.***

---

This filter should be cleaned approximately every three (3) to six (6) months. Periodically, the system will present a cleaning reminder message. Always clean the filter when this reminder is presented.

**To Clean the System Filter:**

1. Power off and unplug the system.
2. Gently pull on the two (2) aluminum system filter frame handles until the filter is free of its slot on the right side of the system.



---

**Caution:** *When reinstalling, ensure the filter side faces toward the front of the system and the grid covering the back of the filter faces towards the back.*

---

3. Vacuum thoroughly and reinstall the filter.
4. Plug in and power on the system.



**ULTRASONIX**

## APPENDIX E: MODE ACTION AND IMAGING PARAMETER OPTIONS

---

The following tables ([Table E-1](#) and [Table E-2](#)) describe the available Mode Action and Imaging Parameter buttons for the various platforms and their primary imaging modes.

The specific mix of available Mode Action and Imaging Parameter buttons is dependant upon the combination of:

- mode
- transducer
- licensed options (and its attendant hardware, such as the **SonixGPS**)
- platform (SonixTouch, SonixMDP, SonixSP, SonixOP or SonixTablet)
- frozen/live image.

---

**Note:** Only primary imaging modes are included in the following tables. For details on modes that can be applied in combination (e.g., **Color** and **PW**), refer to all relevant primary modes.

---



Table E-1: Touch Screen Mode Action Buttons (by Imaging Mode)

Mode Action	Description	Imaging Mode								
		B-Mode	M-Mode	Color	PW/CW	Elastography	SonixGPS	Panoramic	SonixShine <sup>1</sup>	
<b>3D</b>	Selects <b>3D</b> imaging. When <b>3D</b> is selected the <b>4D</b> transducer will only scan once (i.e., it will make only a single sweep to create a <b>3D Volume</b> ).	•								
<b>4D</b>	Selects <b>4D</b> imaging. When <b>4D</b> is selected the <b>4D</b> transducer will scan continuously until the console button is pressed or <b>4D</b> is exited. This will create a <b>Cine loop</b> consisting of the individual <b>3D Volumes</b> .	•								
<b>Anatomic</b>	Tap to activate/deactivate <b>Anatomic M-Mode</b> . <b>Note: This is licensed under Cardiac Advanced.</b>		•							
<b>Biopsy</b>	Tap to display <b>Biopsy</b> guidelines. <b>Note: This option is only available for the following transducers: C5-2/60, EC9-5/10, L9-4/38, L145-38 and L14-5W/38.</b> To change the <b>onscreen orientation of the Biopsy Guide</b> , refer to <b>8.2.9 Biopsy Guide</b> . For details on <b>Biopsy</b> use, refer to the instructions included with the <b>Biopsy Starter Kits (Biopsy Starter Kit manufacturers and part numbers are listed under Accessories in Appendix B)</b> .	•	•	•	•	•	•	•	•	•
<b>Color On/Off</b>	Tap to select/deselect <b>Color Doppler</b> imaging.			•						
<b>Cut Line</b>	Tap to toggle the <b>Cut Line</b> on/off. The <b>Cut Line</b> determines what portion of the ROI will be included in the <b>3D/4D Volume</b> . <b>Note: By default, the Cut Line is toggled on for the 4DC7-3/40 transducer and off for the 4DEC9-5/10 transducer.</b> <b>Not available during Freehand 3D.</b>	•								
<b>End Exam</b>	Tap to end the current exam.	•	•	•	•	•	•	•	•	•
<b>Grid On/Off</b>	Toggles the <b>Brachytherapy Grid</b> on and off. <b>Note: To access Brachytherapy, both the BPC8-4/10 transducer and B-Mode must be active.</b>	•						•		
<b>Grid Save</b>	Saves the adjustments made to the <b>Grid</b> using the <b>Brachytherapy</b> Imaging Parameters. <b>Note: To access Brachytherapy, both the BPC8-4/10 transducer and B-Mode must be active.</b>	•							•	



Mode Action	Description	Imaging Mode							
		B-Mode	M-Mode	Color	PW/CW	Elastography	SonixGPS	Panoramic	SonixShine <sup>1</sup>
<b>HD Zoom</b>	<p>Tap to activate <b>HD Zoom</b>. Use the trackball to position the ROI.</p> <p><b>Note:</b> enables ROI resizing with the trackball. Press  again to accept the resized ROI and return to ROI repositioning or  to move directly to imaging. Both <b>HD Zoom</b> and <b>Zoom</b> mode action buttons can be applied to an image.</p>	•	•			•	•		•
<b>Invert</b>	<p>Tap to <b>Invert</b> the image orientation by 180°.</p>	•	•						•
<b>Layout</b>	<p>Tap <b>Layout</b> to cycle through to the next <b>Split Imaging</b> display type. The default is 1:1. The four (4) options are, in order:</p> <p><b>Split 1:1</b> .....½ Imaging Mode – ½ Trace (top/bottom configuration)</p> <p><b>Large Trace</b> .....½ Imaging Mode – ⅓ Trace</p> <p><b>Small Trace</b> .....¾ Imaging Mode – ⅓ Trace</p> <p><b>Side by Side</b> .....½ Imaging Mode – ½ Trace (side by side configuration).</p>	•	•	•	•				
<b>Overlay</b>	<p>Tap to toggle between the side-by-side <b>Comparative</b> image view and the combined or overlaid image view.</p> <p><b>Note:</b> The default view is <b>Comparative</b>.</p>					•			
<b>Pano</b>	<p>Tap to activate <b>Panoramic</b> imaging mode.</p>	•	•	•					•
<b>Pano Cancel</b>	<p>Tap to cancel the current <b>Panoramic</b> acquisition.</p> <p><b>Note:</b> This is not a toggle button.</p>							•	
<b>Pano Exit</b>	<p>Tap to exit <b>Panoramic</b> imaging.</p> <p><b>Note:</b> This is not a toggle button.</p>								•
<b>Pano Start/Stop</b>	<p>Tap to start or stop the <b>Panoramic</b> acquisition.</p>								•
<b>Reverse</b>	<p>Tap to <b>Reverse</b> the image orientation right/left.</p>	•	•						•
<b>Simultaneous 2D/Color-Color Mode</b>	<p>Tap to activate/deactivate <b>Simultaneous 2D/Color</b> (side-by-side split screen):</p> <ul style="list-style-type: none"> <li>• left side: live <b>2D/Color</b></li> <li>• right side: live <b>2D</b>.</li> </ul>			•					•



		Imaging Mode							
Mode Action	Description	B-Mode	M-Mode	Color	PW/CW	Elastography	SonixGPS	Panoramic	SonixShine <sup>1</sup>
<b>SonixGPS</b>	Tap to activate <b>SonixGPS</b> .						•		
<b>Trace On/Off</b>	Tap to activate/deactivate live spectral <b>Doppler Trace</b> display with measurement values.				•				
<b>Triplex</b>	Tap to activate/deactivate <b>Triplex</b> imaging mode. <b>Note: Triplex is only available if both PW and Color have been activated. Once Triplex is active, press the console button to toggle through Active PW, Active B/C and Triplex imaging modes.</b>								•

<sup>1</sup> When licensed (and with the L14-5/38 transducer active in **B-Mode**), the **SonixShine** mode selection button is located on the touch screen with the mode action buttons.



**Table E-2: Touch Screen Imaging Parameters (by Imaging Mode) (Tap to activate and/or dial/press to adjust)**

Imaging Parameter	Description	Imaging Mode							
		B-Mode	M-Mode	Color	PW/CW	Elastography	SonixGPS	Panoramic	SonixShine <sup>1</sup>
<b>Baseline</b>	Adjusts the <b>Color Doppler Baseline</b> : 0.2–6.7kHz.			•					
<b>BaselineC</b>	Adjusts the <b>Color Doppler Baseline</b> .			•					
<b>BaselineD</b>	Adjusts the <b>Doppler Trace Baseline</b> up or down.				•				
<b>Box Height</b>	Adjusts the size of the <b>Color ROI</b> box vertically.			•					
<b>Box Width</b>	Adjusts the size of the <b>Color ROI</b> box horizontally.			•					
<b>Chroma</b>	Adjusts the color <b>Maps</b> overlaying the <b>2D</b> image: 0–7.	•	•	•	•	•	•	•	•
<b>ChromaD</b>	Adjusts the color <b>Map</b> of the <b>Doppler Trace</b> : 0–7.	•			•				
<b>ChromaM</b>	Adjusts the color of the <b>M-Mode Sweep</b> : 0–7.		•						
<b>Clarity</b>	Adjusts the level of speckle reduction: <b>Off, Low, Med, High, Max</b> .	•	•	•	•	•	•	•	•
<b>Cut Angle</b>	Adjusts the angle of the <b>3D/4D Cut Line</b> . <b>Note: Not available during Freehand 3D.</b>	•							
<b>Dyn (Dynamic Range)</b>	Adjusts the overall image contrast resolution in 1 dB increments. Displayed <b>Dynamic Range</b> varies from 15dB to 145dB. Complete system <b>Dynamic Range</b> is 302dB. <b>Note: An increase in dB increases the level of grays displayed.</b>	•	•	•	•	•	•	•	•
<b>Ensemble</b>	Adjusts <b>Color Doppler</b> sensitivity: range 6–16. <b>Note: This adjusts both the FPS and TIS.</b>			•					
<b>Focus #</b>	Adjusts the number of transmit focal zones on the screen. The maximum number of focal zones varies depending on which transducer is selected. <b>Note: Increasing the number of focal zones will reduce the Frame Rate.</b> If desired, enable <b>Auto-Focus</b> by setting the <b>Focus #</b> to 0 (zero). <b>Note: There is no Focus Marker when Auto-Focus is active.</b>	•							•
<b>Focus Span</b>	Adjusts the distance between focal zones.	•							•
<b>FreqC</b>	Adjusts the <b>Frequency</b> of the <b>Color Doppler</b> : 4–6MHz.			•					



Imaging Parameter Description	Imaging Mode						
	B-Mode	M-Mode	Color	PW/CW	Elastography	SonixGPS	Panoramic
<b>Res</b> Adjusts the color <b>Resolution</b> in the ROI box: <b>Low, Med(ium)</b> or <b>High</b> . <b>Note: High sharpens the edges of the ROI the most.</b>					•		
<b>Rgn</b> Adjusts the visible <b>Elastography Region</b> that is overlaid on the <b>2D</b> image based on the selected tissue stiffness: <b>Soft, Med(ium), Hard</b> or <b>All</b> . <b>Note: Region coloration can be adjusted with the Map setting.</b>					•		
<b>Sector</b> Adjusts the image <b>Sector</b> size: 50–100% in 5% increments. <b>Note: Extended Field of View (FOV) and trapezoid imaging if available. Use the trackball to move the sector to different positions.</b>	•	•	•	•	•	•	•
<b>Sens</b> Adjusts transducer <b>Sensitivity</b> depending on the level of compression applied during imaging: <b>Low, Med1, Med2, High1</b> or <b>High2</b> .					•		
<b>SHINE Ang</b> Use to adjust the <b>SonixShine Angle</b> : -40° to -15° or 15° to 40°. The imaging location of the <b>SonixShine</b> angle marker is dictated by the angle selected. When set to a negative angle (-40° to -15°), the angle marker is located in the upper left corner of the image. When set to a positive angle (15° to 40°), it's located in the upper right corner.							•
<b>Smooth</b> Adjusts spectrum smoothing: 1–5.					•		
<b>Sweep</b> Adjusts the <b>Sweep</b> speed of <b>Doppler Trace (Low, Med, High1 and High2)</b> . <b>Note: Not available in CW.</b>		•		•			
<b>WF</b> Adjusts the <b>Wall Filter</b> : 67–3333Hz.			•				
<b>WFc</b> Adjusts the <b>Color WF</b> : 20–1000Hz in 20Hz increments.			•				
<b>WFd</b> Adjusts the <b>Doppler WF</b> : 40–2000Hz in 40Hz increments.					•		
<b>ZoomIM</b> Adjusts the amount of <b>M-Mode</b> magnification. Use the trackball to reposition <b>ZoomIM</b> location.	•						

<sup>1</sup> When licensed, the **SonixShine** mode selection button is located on the touch screen with the mode action buttons.



**ULTRASONIX**

## APPENDIX F: OB AND CARDIAC AUTHORS

---

OB and Cardiac Authors are controlled within **Measurements**.

---

**Note:** For details on **OB Table Setup...** refer to **8.2.6.6 Managing OB Tables**.

---

### To Access Author Settings:

1. Press the console  button.
2. Select **Administrator > Measurements > Author Settings**.



**AUTHOR SETTINGS**

OB Author Selection

Fetal Age

AC Hadlock

Fetal Growth

AC Hadlock

Estimated Fetal Weight

Hadlock AC/BPD/FL/HC

Birth Weight

Doublet

OB Table Setup...

Cardiac Author Selection

Teichholz

OK Cancel



**Table F-1: OB Author Selection – Fetal Age**

<b>Parameter</b>	<b>Authors</b>	<b>Parameter</b>	<b>Authors</b>
<b>AC</b>	BC Women's Hadlock Hansmann Tokyo	<b>FL</b>	BC Women's Hadlock Hansmann Merz Osaka Tokyo
<b>BDN</b>	Jeanty Tongsong	<b>FTA</b>	Osaka
<b>BPD</b>	BC Women's Hadlock Hansmann Osaka Tokyo	<b>GS</b>	Hansmann Nyberg Rempen
		<b>HC</b>	BC Women's Hadlock Hansmann
<b>CEREB</b>	Hill	<b>HL</b>	Jeanty
<b>CRL</b>	BC Women's Hadlock Hansmann Osaka Rempen	<b>OFD</b>	Hansmann
		<b>TL</b>	Jeanty
		<b>TTD</b>	Hansmann
		<b>UL</b>	Jeanty

**Table F-2: OB Author Selection – Fetal Growth**

<b>Parameter</b>	<b>Authors</b>	<b>Parameter</b>	<b>Authors</b>
<b>AC</b>	BC Women's Hadlock Tokyo	<b>FL</b>	BC Women's Hadlock Jeanty Osaka Tokyo
<b>AFI</b>	Moore	<b>FTA</b>	Osaka
<b>BPD</b>	BC Women's Hadlock Osaka Tokyo	<b>HC</b>	BC Women's Hadlock
		<b>HL</b>	Jeanty
<b>CRL</b>	BC Women's Hadlock Osaka	<b>TC</b>	BC Women's

**Table F-3: OB Author Selection – Fetal Growth Ratios**

Parameter	Authors
CI (HC)	Hadlock
FL/AC	Hadlock
FL/BPD	Hohler
FL/HC	Hadlock
HC/AC	Campbell

**Table F-4: OB Author Selection – Estimated Fetal Weight**

Parameter	Authors
EFW	Hadlock (AC/BPD/FL) (AC/BPD/FL/HC) (AC/FL) (AC/FL/HC)
	Hansmann (BPD/TTD) Osaka (BPD/FTA/FL) Tokyo (BPD/APTD/TTD/FL)

**Table F-5: OB Author Selection – Birth Weight**

Parameter	Authors
BW	Brenner Doubilet Hadlock Osaka



**Warning:** *Ultrasonix does not endorse user-defined Measurements, Calculations and Tables for diagnostic purposes. All user-defined Measurements, Calculations and Tables are used at the Operator's discretion and risk only.*

**Table F-6: Cardiac Author Selection**

Parameter	Authors
Volume	Cubed Gibson Teichholz



**ULTRASONIX**





## APPENDIX G: REFERENCES

---

### G.1 OB

- EFW (Hadlock AC/BPD/FL) (Estimated Fetal Weight (Hadlock AC/BPD/FL))  
Hadlock, F., et al. "Estimated of Fetal Weight with the Use of Head, Body, and Femur Measurements, A Prospective Study." *American Journal of Obstetrics and Gynecology*, 151:13 (February 1, 1985), 333-337.
- EFW (Hadlock AC/BPD/FL/HC) (Estimated Fetal Weight (Hadlock AC/BPD/FL/HC))  
Hadlock, F., et al. "Estimated of Fetal Weight with the Use of Head, Body, and Femur Measurements, A Prospective Study." *American Journal of Obstetrics and Gynecology*, 151:13 (February 1, 1985), 333-337.
- EFW (Hadlock AC/FL) (Estimated Fetal Weight (Hadlock AC/FL))  
Hadlock, F., et al. "Estimated of Fetal Weight with the Use of Head, Body, and Femur Measurements, A Prospective Study." *American Journal of Obstetrics and Gynecology*, 151:13 (February 1, 1985), 333-337.
- EFW (Hadlock AC/FL/HC) (Estimated Fetal Weight (Hadlock AC/FL/HC))  
Hadlock, F., et al. "Estimated of Fetal Weight with the Use of Head, Body, and Femur Measurements, A Prospective Study." *American Journal of Obstetrics and Gynecology*, 151:13 (February 1, 1985), 333-337.
- EFW (Hansmann BPD/TTD) (Estimated Fetal Weight (Hansmann BPD/TTD))  
Hansmann, M., et al. *Ultrasound Diagnosis in Obstetrics and Gynecology*. New York: Springer-Verlag, (1986), 154.
- EFW (Osaka BPD/FTA/FL) (Estimated Fetal Weight (Osaka BPD/FTA/FL))  
Osaka University. *Ultrasound in Obstetrics and Gynecology*. (July 20, 1990), 103-105.
- EFW (Tokyo BPD/APTD/TTD/FL) (Estimated Fetal Weight (Tokyo BPD/APTD/TTD/FL))  
Tokyo, Shinozuka, N. FJSUM, et al. "Standard Values of Ultrasonographic Fetal Biometry." *Japanese Journal of Medical Ultrasonics*, 23:12 (1996), 880, Equation 1.

### G.1.1 OB Gestational Age

#### AC (Abdominal Circumference)

- Hadlock, F., et al. "Estimated Fetal Age: Computer-Assisted Analysis of Multiple Fetal Growth Parameters." *Radiology*, 152: (1984), 497-501.
- Hansmann, M., et al. *Ultrasound Diagnosis in Obstetrics and Gynecology*. New York: Springer-Verlag, (1986), 431.
- Lessoway, V A. et al. "Ultrasound Fetal Biometry Charts for a North American Caucasian Population." *Journal of Clinical Ultrasound*, Vol. 26, No 9 (1998), 433-453.
- Tokyo, Shinozuka, N. FJSUM, et al. "Standard Values of Ultrasonographic Fetal Biometry." *Japanese Journal of Medical Ultrasonics*, 23:12 (1996), 885.

#### BND (Binocular Distance)

- Jeanty P, Cantraine F, Cousaert E, Romero R, Hobbins JC. "The Binocular Distance: A New Way to Estimate Fetal Age." *Journal of Ultrasound in Medicine* 3:241, 1984.
- Tongsong T, Wanapirak C, Jesadapornchai S, Tathayathikom E. "Fetal binocular distance as a predictor of menstrual age." *International Journal of Gynecology and Obstetrics* 38:87 1992.

#### BPD (Biparietal Diameter)

- Hadlock, F., et al. "Estimated Fetal Age: Computer-Assisted Analysis of Multiple Fetal Growth Parameters." *Radiology*, 152: 1984), 497-501.
- Hansmann, M., et al. *Ultrasound Diagnosis in Obstetrics and Gynecology*. New York: Springer-Verlag, (1986), 440.
- Lessoway, V A. et al. "Ultrasound Fetal Biometry Charts for a North American Caucasian Population." *Journal of Clinical Ultrasound*, Vol 26, No 9 (1998), 433-453.
- Osaka University. *Ultrasound in Obstetrics and Gynecology*. (July 20, 1990), 98.
- Tokyo, Shinozuka, N. FJSUM, et al. "Standard Values of Ultrasonographic Fetal Biometry." *Japanese Journal of Medical Ultrasonics*, 23:12 (1996), 885.



Cereb (Cerebellum)

Hill, Lyndon, M., et al. "The Transverse Cerebellar Diameter in Estimating Gestational Age in the Large for Gestational Age Fetus." Obstetrics and Gynecology, (June 1990) Vol. 75, No. 6, 981-985 .

CRL (Crown Rump Length)

Hadlock, F., et al. "Fetal Crown-Rump Length: Re-evaluation of Relation to Menstrual Age (5-18 weeks) with High-Resolution, Real-Time Ultrasound." Radiology, 182: (February 1992), 501-505.

Hansmann, M., et al. Ultrasound Diagnosis in Obstetrics and Gynecology. New York: Springer-Verlag, (1986), 439.

Lessoway, V A. et al. "Ultrasound Fetal Biometry Charts for a North American Caucasian Population." Journal of Clinical Ultrasound, Vol. 26, No 9 (1998), 433-453.

Osaka University. Ultrasound in Obstetrics and Gynecology. (July 20, 1990).

Rempen, German Society for Gynecology and Obstetrics, March 1991, Issue 15, Vol 1, pp. 23-28.

EFW (Estimated Fetal Weight)

Brenner, W.E., et al. "A standard of fetal growth for the United States of America." American Journal of Obstetrics and Gynecology, 126: (1976), 555.

Doubilet, Peter M., et al. "Improved Birth Weight Table for Neonates Developed from Gestations Dated by Early Ultrasonography." Journal of Ultrasound in Medicine, 16: (1997), 241-149 .

Hadlock, F., et al. "In Utero Analysis of Fetal Growth: A Sonographic Weight Standard." Radiology, 181: (1991), 129-133.

Osaka University. Ultrasound in Obstetrics and Gynecology. (July 20, 1990), 103-105.

FL (Femur Length)

Hadlock, F., et al. "Estimated Fetal Age: Computer-Assisted Analysis of Multiple Fetal Growth Parameters." Radiology, 152: (1984), 497-501.

Hansmann, M., et al. Ultrasound Diagnosis in Obstetrics and Gynecology. New York: Springer-Verlag, (1986), 431.

Lessoway, V A. et al. "Ultrasound Fetal Biometry Charts for a North American Caucasian Population." Journal of Clinical Ultrasound, Vol. 26, No 9 (1998), 433-453.

Merz, German Society for Gynecology and Obstetrics, March 1991, Issue 15, Vol. 1, pp. 23-28.

Osaka University. Ultrasound in Obstetrics and Gynecology. (July 20, 1990), 101-102.

Tokyo, Shinozuka, N. FJSUM, et al. "Standard Values of Ultrasonographic Fetal Biometry." Japanese Journal of Medical Ultrasonics, 23:12 (1996), 886.

FL/AC Ratio (Femur Length/Abdominal Circumference)

Hadlock, F.P., R.L. Deter, R.B. Harrist, E. Roecker, and S.K. Park. "A Date Independent Predictor of Intrauterine Growth Retardation: Femur Length/Abdominal Circumference Ratio," American Journal of Roentgenology, 141: (November 1983), 979-984.

FL/BPD Ratio (Femur Length/Biparietal Diameter)

Hohler, C.W. & T.A. Quetel. "Comparison of Ultrasound Femur Length and Biparietal Diameter in Late Pregnancy," American Journal of Obstetrics and Gynecology, 141:7 (Dec. 1 1981), 759-762.

FTA (Fetal Trunk Area)

Osaka University. Ultrasound in Obstetrics and Gynecology. (July 20, 1990), 99-100.

GS (Gestational Sac)

Hansmann, M., et al. Ultrasound Diagnosis in Obstetrics and Gynecology. New York: Springer-Verlag, (1986).

Nyberg, D.A., et al. "Transvaginal Ultrasound." Mosby Yearbook, (1992), 76.

Rempen, German Society for Gynecology and Obstetrics, March 1991, Issue 15, Vol. 1, pp. 23-28.

HC (Head Circumference )

Hadlock, F., et al. "Estimated Fetal Age: Computer-Assisted Analysis of Multiple Fetal Growth Parameters." Radiology, 152: (1984), 497-501.

Hansmann, M., et al. Ultrasound Diagnosis in Obstetrics and Gynecology. New York: Springer-Verlag, (1986), 431.

Lessoway, V A. et al. "Ultrasound Fetal Biometry Charts for a North American Caucasian Population." Journal of Clinical Ultrasound, Vol. 26, No 9 (1998), 433-453.



## HL (Humeral Length)

Jeanty P, et al. "Estimation of Gestational Age from Measurements of Fetal Long Bones." Journal of Ultrasound Medicine (1984) 3:75-79.

## OFD (Occipito-Frontal Diameter)

Hansmann, M., et al. Ultrasound Diagnosis in Obstetrics and Gynecology. New York: Springer-Verlag, (1986), 431.

## TL (Tibial Length)

Jeanty, P, et al. "Estimation of Gestational Age from Measurements of Fetal Long Bones." Journal of Ultrasound Medicine (1984) 3:75-79.

## TTD (Transverse Trunk Diameter)

Hansmann, M., et al. Ultrasound Diagnosis in Obstetrics and Gynecology. New York: Springer-Verlag, (1986), 431.

## UL (Ulnar Length)

Jeanty P, et al. "Estimation of Gestational Age from Measurements of Fetal Long Bones." Journal of Ultrasound Medicine (1984) 3:75-79.

## G.1.2 OB Growth Analysis

## AC (Abdominal Circumference)

Hadlock, F., et al. "Estimated Fetal Age: Computer-Assisted Analysis of Multiple Fetal Growth Parameters." Radiology, 152: (1984), 497-501.

Lessoway, V A. et al. "Ultrasound Fetal Biometry Charts for a North American Caucasian Population." Journal of Clinical Ultrasound, Vol. 26, No 9 (1998), 433-453.

Tokyo, Shinozuka, N. FJSUM, et al. "Standard Values of Ultrasonographic Fetal Biometry." Japanese Journal of Medical Ultrasonics, 23:12 (1996).

## AFI (Amniotic Fluid Index)

Moore, T. R., et al. "The amniotic fluid index in normal human pregnancy." American Journal of Obstetrics and Gynecology. (1990) 162: 1168-1173.

## BPD (Biparietal Diameter)

Hadlock, F., et al. "Estimated Fetal Age: Computer-Assisted Analysis of Multiple Fetal Growth Parameters." Radiology, 152: (1984), 497-501.

Lessoway, V A. et al. "Ultrasound Fetal Biometry Charts for a North American Caucasian Population." Journal of Clinical Ultrasound, Vol. 26, No 9 (1998), 433-453.

Osaka University. Ultrasound in Obstetrics and Gynecology. (July 20, 1990), 101-102.

Tokyo, Shinozuka, N. FJSUM, et al. "Standard Values of Ultrasonographic Fetal Biometry." Japanese Journal of Medical Ultrasonics, 23:12 (1996).

## CI (HC) (Cephalic Index (Head Circumference))

Hadlock FP, et al., "Estimating Fetal Age: Effects on Head Shape on BPD," American Journal Roentgen, 1981; 137:83-85.

## CRL (Crown Rump Length)

Hadlock, F., et al. "Fetal Crown-Rump Length: Re-evaluation of Relation to Menstrual Age (5-18 weeks) with High-Resolution, Real-Time Ultrasound." Radiology, 182: (February 1992), 501-505.

Lessoway, V A. et al. "Ultrasound Fetal Biometry Charts for a North American Caucasian Population." Journal of Clinical Ultrasound, Vol 26, No 9 (1998), 433-453.

Osaka University. Ultrasound in Obstetrics and Gynecology. (July 20, 1990) 96, Table 3-3.

## FL (Femur Length)

Hadlock, F., et al. "Estimated Fetal Age: Computer-Assisted Analysis of Multiple Fetal Growth Parameters." Radiology, 152: (1984), 497-501.

Jeanty P., E. et al. "Ultrasonic Evaluation of Fetal Limb Growth." Radiology (1982)143: 751-754.

Lessoway, V A. et al. "Ultrasound Fetal Biometry Charts for a North American Caucasian Population." Journal of Clinical Ultrasound, Vol 26, No 9 (1998), 433-453.

Osaka University. Ultrasound in Obstetrics and Gynecology. (July 20, 1990).

Tokyo, Shinozuka, N. FJSUM, et al. "Standard Values of Ultrasonographic Fetal Biometry." Japanese Journal of Medical Ultrasonics, 23:12 (1996).



FL/HC Ratio (Femur Length/Head Circumference)

Hadlock, F.P., R.B. Harrist, Y. Shah, & S/K. Park. "The Femur Length/Head Circumference Relation in Obstetric Sonography." Journal of Ultrasound in Medicine, 3: (October 1984), 439-442.

FTA (Fetal Trunk Area)

Osaka University. Ultrasound in Obstetrics and Gynecology. (July 20, 1990), 99-100.

HC (Head Circumference)

Hadlock, F., et al. "Estimated Fetal Age: Computer-Assisted Analysis of Multiple Fetal Growth Parameters." Radiology, 152: (1984), 497-501.

Lessoway, V A. et al. "Ultrasound Fetal Biometry Charts for a North American Caucasian Population." Journal of Clinical Ultrasound. Vol 26, No 9 (1998), 433-453.

HC/AC (Head Circumference/Abdominal Circumference)

Campbell S., Thomas Alison. "Ultrasound Measurements of the Fetal Head to Abdomen Circumference Ratio in the Assessment of Growth Retardation," British Journal Obstetrics and Gynaecology, 84: (March 1977), 165-174.

HL (Humeral Length)

Jeanty P., E. et al. "Ultrasonic Evaluation of Fetal Limb Growth." Radiology (1982) 143: 751-754.

TC (Trunk Circumference)

Lessoway, V A. et al. "Ultrasound Fetal Biometry Charts for a North American Caucasian Population." Journal of Clinical Ultrasound. Vol 26, No 9 (1998), 433-453.

## G.2 CARDIAC

AFI (Amniotic Fluid Index)

Rutherford S., et al., "Four Quadrant Assessment of Amniotic Fluid Volume," Journal of Reproductive Medicine, 1987;32:587-589.

AVA (Aortic Valve Area)

Reynolds, Terry. The Echocardiographer's Pocket Reference. 3rd ed., School of Cardiac Ultrasound, Arizona Heart Institute, (2007), 338.

CO (Cardiac Output)

Reynolds, Terry. The Echocardiographer's Pocket Reference. 3rd ed., School of Cardiac Ultrasound, Arizona Heart Institute, (2007), 337, 337-8, 371.

E/A Ratio

Maron, Barry J., et al., "Noninvasive Assessment of Left Ventricular Diastolic Function by Pulsed Doppler Echocardiography in Patients with Hypertrophic Cardiomyopathy", Journal of the American College of Cardiology, 1987, Vol.10, 733-742.

E/E' Ratio

Oh, Seward, and Jamil Tajik, The Echo Manual: Second Edition. Lippincott Williams & Wilkins, 1999, 55.

EDV (End Diastolic Velocity)

Schiller et al., "Recommendations for Quantitation of the Left Ventricle by Two-Dimensional Echocardiography", Journal of the American Society of Echocardiography, Vol 2, No. 5, Sept-Oct 1989, 362.

EF (Ejection Fraction)

Reynolds, Terry. The Echocardiographer's Pocket Reference. 3rd ed., School of Cardiac Ultrasound, Arizona Heart Institute, (2007), 371.

ESV

Schiller et al., "Recommendations for Quantitation of the Left Ventricle by Two-Dimensional Echocardiography", Journal of the American Society of Echocardiography, Vol 2, No. 5, Sept-Oct 1989, 362.

FS (Fractional Shortening)

Reynolds, Terry. The Echocardiographer's Pocket Reference. 3rd ed., School of Cardiac Ultrasound, Arizona Heart Institute, (2007), 371.

IVS FT (Interventricular Septum FT)

Reynolds, Terry. The Echocardiographer's Pocket Reference. 3rd ed., School of Cardiac Ultrasound, Arizona Heart Institute, (2007), 371.



## LV Mass

Oh, Seward, and Jamil Tajik, The Echo Manual: Second Edition. Lippincott Williams & Wilkins, 1999, 41.

Reynolds, Terry. The Echocardiographer's Pocket Reference. 3rd ed., School of Cardiac Ultrasound, Arizona Heart Institute, (2007), 371.

## LVEDV

Belenkie, Israel, et al., "Assessment of Left Ventricular Dimensions and Function by Echocardiography." American Journal of Cardiology, June 1973:31.

Gibson DG, "Estimation of left ventricular size by echocardiography." British Heart Journal, 1973, 35:128.

Teichholz et al, "Problems in Echocardiographic Volume Determinations: Echocardiographic-Angiographic Correlations in the Presence or Absence of Asynergy", American Journal of Cardiology, January 1976, Vol 37, 7 -11.

## LVESV

Belenkie, Israel, et al., "Assessment of Left Ventricular Dimensions and Function by Echocardiography." American Journal of Cardiology, June 1973:31.

Gibson DG, "Estimation of left ventricular size by echocardiography." British Heart Journal, 1973, 35:128.

Teichholz et al, "Problems in Echocardiographic Volume Determinations: Echocardiographic-Angiographic Correlations in the Presence or Absence of Asynergy", American Journal of Cardiology, January 1976, Vol 37, 7 -11.

## LVOT Area (Left Ventricular Outflow Tract Area)

Reynolds, Terry. The Echocardiographer's Pocket Reference. 3rd ed., School of Cardiac Ultrasound, Arizona Heart Institute, (2007), 338.

## LVOT SV (Left Ventricular Outflow Tract SV)

Reynolds, Terry. The Echocardiographer's Pocket Reference. 3rd ed., School of Cardiac Ultrasound, Arizona Heart Institute, (2007), 355.

## Myocardial Thick

Schiller et al., Recommendations for Quantitation of the Left Ventricle by Two-Dimensional Echocardiography, Journal of the American Society of Echocardiography, Vol 2, No. 5, Sept-Oct, 1989, 358-367.

## PISA ERO

Reynolds, Terry. The Echocardiographer's Pocket Reference. 3rd ed., School of Cardiac Ultrasound, Arizona Heart Institute, (2007), 352.

## Qp/Qs

Reynolds, Terry. The Echocardiographer's Pocket Reference. 3rd ed., School of Cardiac Ultrasound, Arizona Heart Institute, (2007), 355.

## RVOT Area (Right Ventricular Outflow Tract Area)

Reynolds, Terry. The Echocardiographer's Pocket Reference. 3rd ed., School of Cardiac Ultrasound, Arizona Heart Institute, (2007), 355.

## RVOT SV (Right Ventricular Outflow Tract SV)

Reynolds, Terry. The Echocardiographer's Pocket Reference. 3rd ed., School of Cardiac Ultrasound, Arizona Heart Institute, (2007), 355.

## RVSP

Reynolds, Terry. The Echocardiographer's Pocket Reference. 3rd ed., School of Cardiac Ultrasound, Arizona Heart Institute, (2007), 333.

## SV

Oh, Seward, and Jamil Tajik, The Echo Manual: Second Edition. Lippincott Williams & Wilkins, 1999, 40.

## VOL (Volume)

Brunn J., Block U., Ruf G., Bos I., Kunze W.P., Scriba P.C. "Volumetric analysis of thyroid lobes by real-time ultrasound". Deutsche Medizinische Wochenschrift 1981;106:1338-40.

## VolFlow (Volume Flow)

Evans, D.H., et. al., Doppler Ultrasound Physics, Instrumentation and Clinical Applications. New York, 1989, Chapter 11, 188-205.



**ULTRASONIX**

## APPENDIX H: GLOSSARY

---

<b>% A Red</b> .....	Percent Area Reduction	<b>AV</b> .....	Aortic Valve
<b>% Area Red</b> .....	Percent Area Reduction	<b>AVA</b> .....	Aortic Valve Area
<b>% D Red</b> .....	Percent Diameter Reduction	<b>AVI</b> .....	Audio Video Interleave
<b>% Diam Red</b> .....	Percent Diameter Reduction	<b>AVm</b> .....	Mean Average Velocity
<b>2D</b> .....	Two Dimensional	<b>AVp</b> .....	Peak Average Velocity
<b>3D</b> .....	Three Dimensional	<b>B/M-Mode</b> .....	2D and M-Mode
<b>4D</b> .....	Four Dimensional (Live 3D)	<b>Base</b> .....	Baseline (i.e., Doppler Baseline)
<b>4DC</b> .....	4D Curved Array Transducer	<b>BBT</b> .....	Basal Body Temperature
<b>Abd</b> .....	Abdomen	<b>BGR</b> .....	Blue Green Red
<b>AC</b> .....	Abdominal Circumference	<b>Blad Wall</b> .....	Bladder Wall
<b>AC</b> .....	Alternating Current (power supply)	<b>BLT</b> .....	Bottom Left
<b>ACC</b> .....	Acceleration	<b>BMP</b> .....	Bitmap
<b>AD</b> .....	Angio Doppler	<b>BNC</b> .....	Bayonet Neill Concelman
<b>Admin</b> .....	Administrative/Administrator	<b>BND</b> .....	Binocular Distance
<b>AE</b> .....	Application Entity (DICOM)	<b>BPD</b> .....	Biparietal Diameter
<b>AFI</b> .....	Amniotic Fluid Index	<b>BPM</b> .....	Beats per Minute
<b>AFV</b> .....	Amniotic Fluid Volume	<b>BRT</b> .....	Bottom Right
<b>AIUM</b> .....	American Institute of Ultrasound in Medicine	<b>BSA</b> .....	Body Surface Area
<b>ALARA</b> .....	As Low As Reasonably Achievable	<b>Calcs</b> .....	Calculations
<b>ANSI</b> .....	American National Standards Institute	<b>Card</b> .....	Cardiology
<b>Ao</b> .....	Aorta	<b>CBD</b> .....	Command Bile Duct
<b>AO/LA</b> .....	Aorta/Left Atrium	<b>CCA</b> .....	Common Carotid Artery
<b>AoV</b> .....	Aortic Valve	<b>CD</b> .....	Compact Disc
<b>AP</b> .....	Anterior Posterior	<b>Cereb</b> .....	Cerebellum
<b>APAD</b> .....	Anterior Posterior Abdominal Diameter	<b>CEREB</b> .....	Cerebellum
<b>APD</b> .....	Anterior Posterior Diameter	<b>CFM</b> .....	Color Flow Mode
<b>APTD</b> .....	Anterior Posterior Thorax Diameter	<b>CI</b> .....	Cardiac Index
<b>AR</b> .....	Area	<b>CI</b> .....	Cephalic Index
<b>Area Red</b> .....	Area Reduction	<b>CIR</b> .....	Circumference
<b>AT</b> .....	Acceleration Time	<b>cm</b> .....	centimeters
<b>AUA</b> .....	Average Ultrasound Age	<b>Cntrst Pos</b> .....	Contrast Position
		<b>CO</b> .....	Cardiac Output



## ULTRASONIX

<b>COR</b> .....	Coronal	<b>F</b> .....	Follicle
<b>CRL</b> .....	Crown Rump Length	<b>FAST</b> .....	Focused Assessment with Sonography in Trauma (Trauma (FAST))
<b>CSA</b> .....	Canadian Standards Association	<b>FDA</b> .....	U.S. Food and Drug Administration
<b>CSA</b> .....	Cross Sectional Area	<b>FHR</b> .....	Fetal Heart Rate
<b>CW</b> .....	Continuous Wave	<b>FL</b> .....	Femur Length
<b>CWD</b> .....	Continuous Wave Doppler	<b>FOV</b> .....	Field Of View
<b>CxLength</b> .....	Cervix Length	<b>FPS</b> .....	Frames per second
<b>DCM</b> .....	DICOM	<b>FR</b> .....	Frame Rate
<b>DEL</b> .....	Delete	<b>FrD</b> .....	Doppler Transmit Frequency
<b>DIAM RED</b> .....	Diameter Reduction	<b>Freq</b> .....	Frequency
<b>DICOM</b> .....	Digital Imaging and Communications in Medicine	<b>Frm</b> .....	Frame
<b>DISP</b> .....	Display	<b>FrRate</b> .....	Frame Rate
<b>DIST</b> .....	Distal	<b>FS</b> .....	Fractional Shortening
<b>Dist</b> .....	Distance	<b>FTA</b> .....	Fetal Trunk Area
<b>DPD</b> .....	Directional Power Doppler	<b>Fwd</b> .....	Forward
<b>DT</b> .....	Deceleration Time	<b>g</b> .....	grams
<b>DVD</b> .....	Digital Video Device	<b>GA</b> .....	Gestational Age
<b>Dyn</b> .....	Dynamic Range	<b>Gb</b> .....	Gigabyte
<b>EC</b> .....	Endocavity	<b>GB</b> .....	Gall Bladder
<b>ECA</b> .....	External Carotid Artery	<b>GBWT</b> .....	Gall Bladder Wall Thickness
<b>ECG</b> .....	Electrocardiogram	<b>Gen</b> .....	General
<b>EDD</b> .....	Estimated Date of Delivery	<b>GIF</b> .....	Graphics Interchange File or Format
<b>EDV</b> .....	End Diastolic Velocity	<b>GS</b> .....	Gestational Sac
<b>EDVPG</b> .....	EDV Pressure Gradient	<b>Gyn</b> .....	Gynecology
<b>EF</b> .....	Ejection Fraction	<b>H</b> .....	Height
<b>EFW</b> .....	Estimated Fetal Weight	<b>HC</b> .....	Head Circumference
<b>EMR</b> .....	Electronic Medical Record	<b>HDMI</b> .....	High Definition Multimedia Interface
<b>Endom Thick</b> .....	Endometrial Thickness	<b>HIPAA</b> .....	Health Insurance Portability & Accountability Act
<b>EMC</b> .....	Electromagnetic Compatibility	<b>HL</b> .....	Humeral Length
<b>EPI</b> .....	Extended Pulse Imaging	<b>HR</b> .....	Heart Rate
<b>EPSS</b> .....	E Point Septal Separation	<b>Hz</b> .....	Hertz
<b>ET</b> .....	Elapsed Time	<b>ICA</b> .....	Internal Carotid Artery
<b>EV</b> .....	Endovaginal		





<b>ICT</b> .....	Intracavity Transducer	<b>MED</b> .....	Medial
<b>in</b> .....	inches	<b>MGr</b> .....	Mean Gradient
<b>IP</b> .....	Internet Protocol	<b>MI</b> .....	Mechanical Index
<b>ISP</b> .....	Internet Service Provider	<b>Min</b> .....	Minimum
<b>IT</b> .....	Information Technology (e.g., IT Department)	<b>M-M</b> .....	Motion Mode
<b>IVS</b> .....	Interventricular Septum	<b>mm</b> .....	millimeters
<b>IVSd</b> .....	Interventricular Septum diastole	<b>MPEG</b> .....	Moving Picture Experts Group
<b>IVSs</b> .....	Interventricular Septum systole	<b>MPG</b> .....	Moving Picture (Experts) Group
<b>JPEG</b> .....	Joint Photographic Experts Group	<b>MPR</b> .....	Multiplanar Reconstruction
<b>Kb</b> .....	Kilobyte	<b>Multi</b> .....	Multiple
<b>kPa</b> .....	Kilopascal	<b>Msk</b> .....	Musculoskeletal
<b>L</b> .....	Length	<b>MV</b> .....	Mean Velocity
<b>LA</b> .....	Long Axis	<b>MV</b> .....	Mitral Valve
<b>LA</b> .....	Left Atrium	<b>Myocardial Thick</b> ..	Myocardial Thickness
<b>LAN</b> .....	Local Area Network	<b>NEMA</b> .....	National Electrical Manufacturers Association
<b>LAT</b> .....	Lateral	<b>NET</b> .....	Network
<b>LCD</b> .....	Liquid Crystal Display	<b>NF</b> .....	Nuchal Fold
<b>LMP</b> .....	Last Menstrual Period	<b>NSF</b> .....	National Sanitation Foundation
<b>LONG</b> .....	Longitudinal	<b>NT</b> .....	Nuchal Thickness
<b>LOV</b> .....	Left Ovary	<b>NTSC</b> .....	National Television Standards Committee
<b>LT</b> .....	Left	<b>OB</b> .....	Obstetrics
<b>LVDd</b> .....	Left Ventricular Diameter diastole	<b>OD</b> .....	Optical Density
<b>LVDs</b> .....	Left Ventricular Diameter systole	<b>OEM</b> .....	Original Equipment Manufacturer
<b>LVET</b> .....	Left Ventricular Ejection Time	<b>OFD</b> .....	Occipital-Frontal Diameter
<b>LVOT</b> .....	Left Ventricular Outflow Tract	<b>OOD</b> .....	Outer Orbital Diameter
<b>LVOTd</b> .....	Left Ventricular Outflow Tract distance	<b>PA</b> .....	Phased Array
<b>LVPWd</b> .....	Left Ventricular Posterior Wall diastole	<b>PAL</b> .....	Phased Alternating Line
<b>LVPWs</b> .....	Left Ventricular Posterior Wall systole	<b>Pano</b> .....	Panoramic Imaging Mode
<b>Max</b> .....	Maximum	<b>Params</b> .....	Parameters
<b>Mb</b> .....	Megabyte	<b>PDF</b> .....	Portable Document Format
<b>MCA</b> .....	Middle Cerebral Artery	<b>Pel</b> .....	Pelvis
<b>MCA- PI</b> .....	Middle Cerebral Artery-Pulsatility Index	<b>Pen</b> .....	Penetration
<b>MEAS</b> .....	Measure	<b>Persist</b> .....	Persistence



## ULTRASONIX

<b>PGr</b> .....	Pressure Gradient	<b>RVDd</b> .....	Right Ventricular Dimension diastole
<b>PHT</b> .....	Pressure Half Time	<b>RVDs</b> .....	Right Ventricular Dimension systole
<b>PI</b> .....	Pulsatility Index	<b>RVOT</b> .....	Right Ventricular Outflow Tract
<b>Picto</b> .....	Pictogram	<b>RVWd</b> .....	Right Ventricular Wall diastole
<b>PIN</b> .....	Personal Identification Number	<b>RVWs</b> .....	Right Ventricular Wall systole
<b>PISA</b> .....	Proximal Isovelocity Surface Area	<b>SA</b> .....	Short Axis
<b>PNG</b> .....	Portable Network Graphics	<b>SAG</b> .....	Sagittal
<b>Pos</b> .....	Position	<b>SAW</b> .....	Surface Acoustic Wave
<b>POS</b> .....	Position	<b>SCP</b> .....	Service Class Provider
<b>PostV Blad</b> .....	Post Void Bladder	<b>SCU</b> .....	Service Class User
<b>PreV Blad</b> .....	Pre Void Bladder	<b>SD</b> .....	Standard Deviation
<b>PRF</b> .....	Pulse Repetition Frequency	<b>SD</b> .....	Systolic/Diastolic Ratio
<b>PROX</b> .....	Proximal	<b>SDK</b> .....	Software Development Kit
<b>PSV</b> .....	Peak Systolic Velocity	<b>SEL</b> .....	Select
<b>PSVPG</b> .....	PSV Pressure Gradient	<b>Sens</b> .....	Sensitivity
<b>PV</b> .....	Peak Velocity	<b>Simult</b> .....	Simultaneous
<b>PV</b> .....	Pulmonary Valve	<b>SMTP</b> .....	Simple Mail Transport Protocol
<b>PW</b> .....	Pulsed Wave Doppler	<b>SonixGPS</b> .....	Sonix Guidance Positioning System
<b>PWD</b> .....	Power Doppler	<b>SV</b> .....	Sample Volume
<b>Q</b> .....	Quadrant (e.g., AFI)	<b>SV</b> .....	Stroke Volume
<b>Qp</b> .....	Pulmonic Blood Flow	<b>SV1</b> .....	Selection Value 1
<b>Qs</b> .....	Systemic Blood Flow	<b>TAD</b> .....	Transverse Abdominal Diameter
<b>Rad</b> .....	Radius	<b>TC</b> .....	Trunk Circumference
<b>Rect</b> .....	Rectangle	<b>TCP</b> .....	Transfer Control Protocol
<b>Res</b> .....	Resolution	<b>TCP/IP</b> .....	Transmission Control Protocol/Internet Protocol
<b>RF</b> .....	Radio Frequency	<b>TFT</b> .....	Thin Film Technology
<b>RGB</b> .....	Red Green Blue	<b>TGC</b> .....	Time Gain Compensation
<b>Rgn</b> .....	Region	<b>THI</b> .....	Tissue Harmonic Imaging
<b>RLE</b> .....	Run Length Encoding	<b>TI</b> .....	Thermal Index
<b>RI</b> .....	Resistive Index	<b>TIB</b> .....	Thermal Index – Bone
<b>ROI</b> .....	Region of Interest	<b>TIC</b> .....	Thermal Index – Cranial
<b>ROV</b> .....	Right Ovary	<b>TIS</b> .....	Thermal Index – Soft Tissue
<b>RT</b> .....	Right	<b>TL</b> .....	Tibia Length
<b>RTSA</b> .....	Real Time Spectrum Analysis		



<b>TDI</b> .....	Tissue Doppler Imaging	<b>US</b> .....	Ultrasound
<b>TRANS</b> .....	Transverse	<b>USB</b> .....	Universal Serial Bus
<b>Transp</b> .....	Transparency	<b>VAC</b> .....	Volts Alternating Current
<b>Trauma (FAST)</b> .....	Trauma (Focused Assessment with Sonography in Trauma)	<b>VCR</b> .....	Video Cassette Recorder
<b>TTD</b> .....	Transverse Trunk Diameter	<b>Vel</b> .....	Velocity
<b>TV</b> .....	Tricuspid Valve	<b>Vol</b> .....	Volume
<b>UI</b> .....	User Interface	<b>VolFlow</b> .....	Volume Flow
<b>UL</b> .....	Ulnar Length	<b>VPS</b> .....	Volumes per Second
<b>UL</b> .....	Underwriter's Laboratory	<b>VR</b> .....	Volume Rendering
<b>ULT</b> .....	Upper Left	<b>VTI</b> .....	Velocity Time Integral
<b>Umb A</b> .....	Umbilical Artery	<b>W</b> .....	Width
<b>Umb A-PI</b> .....	Umbilical Artery- Pulsatility Index	<b>WEEE</b> .....	Waste Electrical and Electronic Equipment
<b>UPS</b> .....	Uninterruptible Power Supply	<b>WF</b> .....	Wall Filter
<b>URL</b> .....	Uniform Resource Locator	<b>WWW</b> .....	World Wide Web
<b>URT</b> .....	Upper Right	<b>YS</b> .....	Yolk Sack



**ULTRASONIX**