

STEP 1: POWER SUPPLIES AND CABLES

CHOOSE FROM MULTIPLE INSTALLATION CASES:

- PLUG INTO AN AC WALL OUTLET
 - VC70, VC80 Series OR VH40 — SLIDE 6
- PLUG INTO THE VEHICLE'S DC POWER
 - VC70 — SLIDE 7-9
 - VH10 OR VC80 Series — SLIDE 10-14

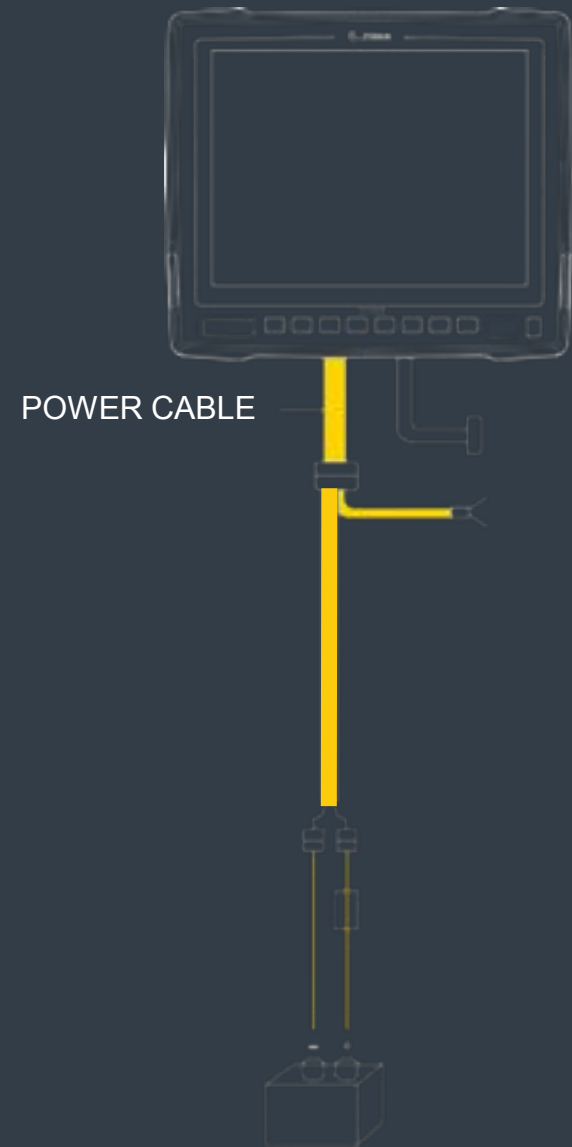

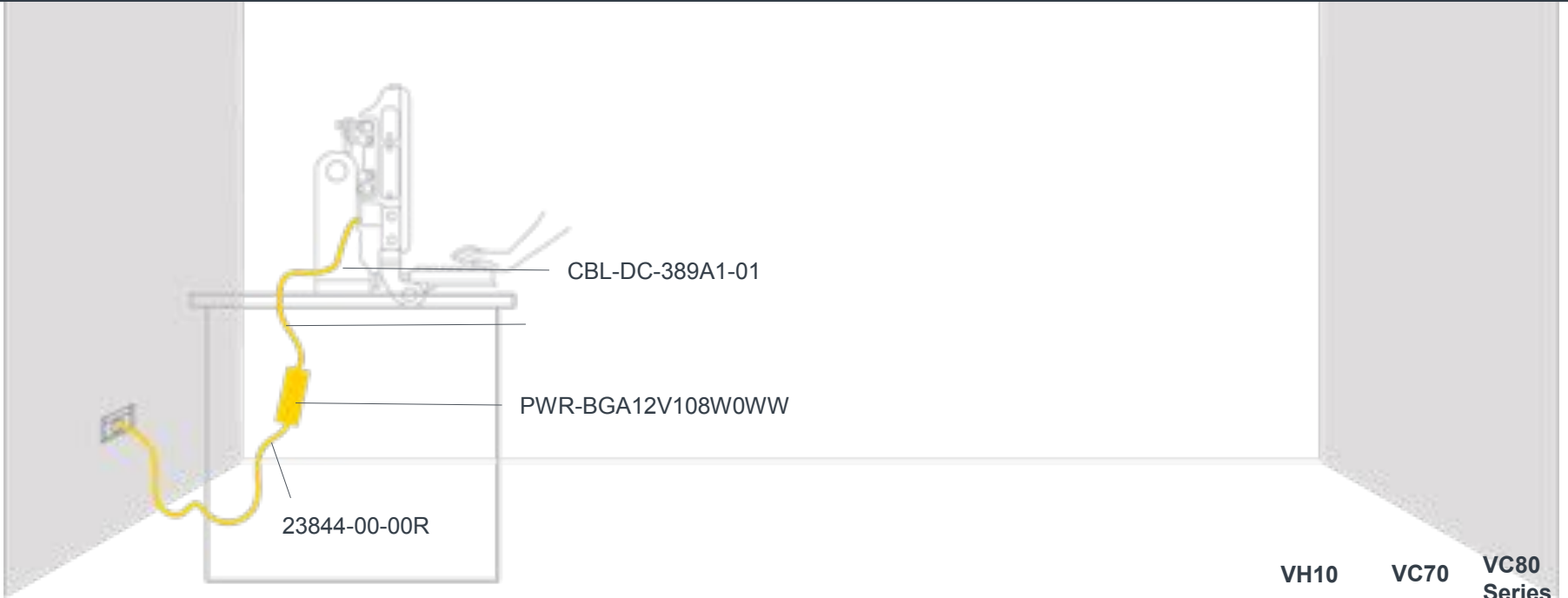

VC70, VC80 Series OR VH10 POWERED BY PLUGGING INTO AN AC WALL OUTLET

		VH10	VC70	VC80 Series
	AC POWER CABLE US AC line cord, 7.5 feet long, grounded, three wire for the AC power supplies PS1450 and PWR-BGA12V108W0WW. Associated Countries: United States.	•	•	•
	AC POWER SUPPLY for VC70 Order country specific 3 wire grounded AC line cord separately.		•	
	DC POWER SUPPLY ADAPTER CABLE for VC70 6.5', required when the PWR-BGA12V108W0WW is used.		•	
	AC POWER SUPPLY for VH10 and VC80 Series 100/240 VAC Power Supply, 12V, 6A, order AC cable separate	•		•

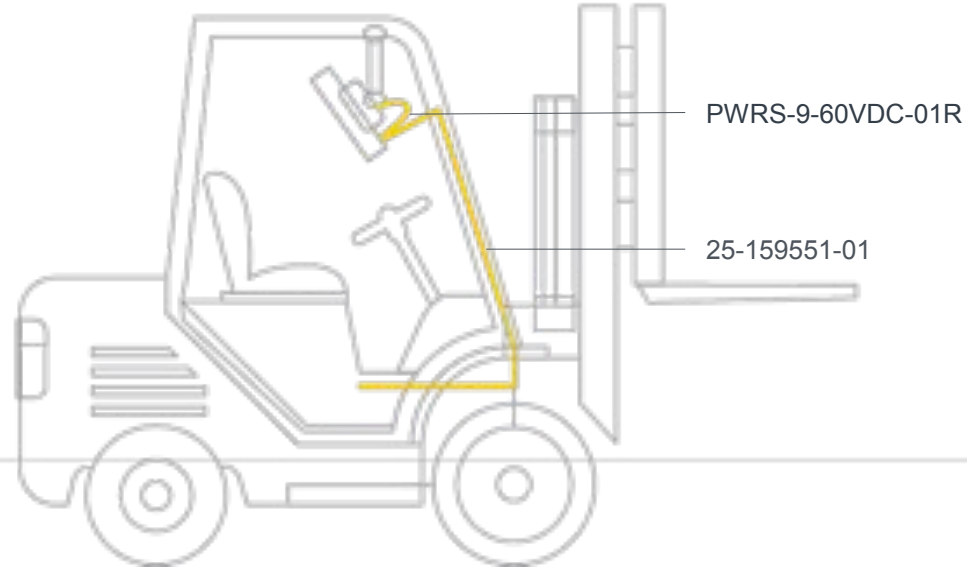

VC70

VEHICLE MOUNT (DC POWER SUPPLY MOUNTED ON THE VC70)

Buy both



DC POWER SUPPLY | ID: PQRS-9-60VDC-01R

External DC Power supply, VC70, 9-60VDC Requires 25-159551-01 fused DC power cable to vehicle battery



DC POWER CABLE | ID: 25-159551-01

Cable, external 9-60V DC power supply to vehicle battery, 10', includes fuse, VC70. Required for the PQRS-9-60VDC-R

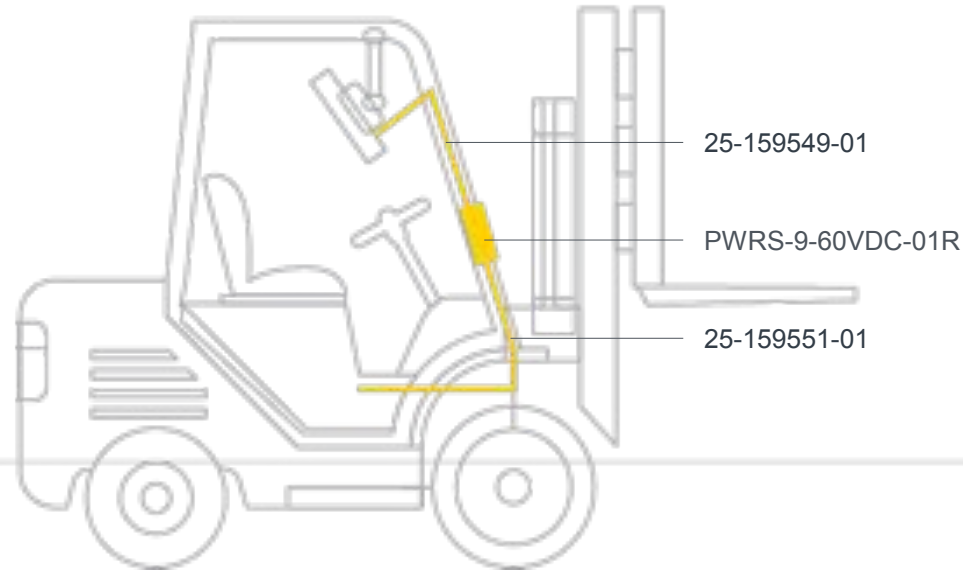

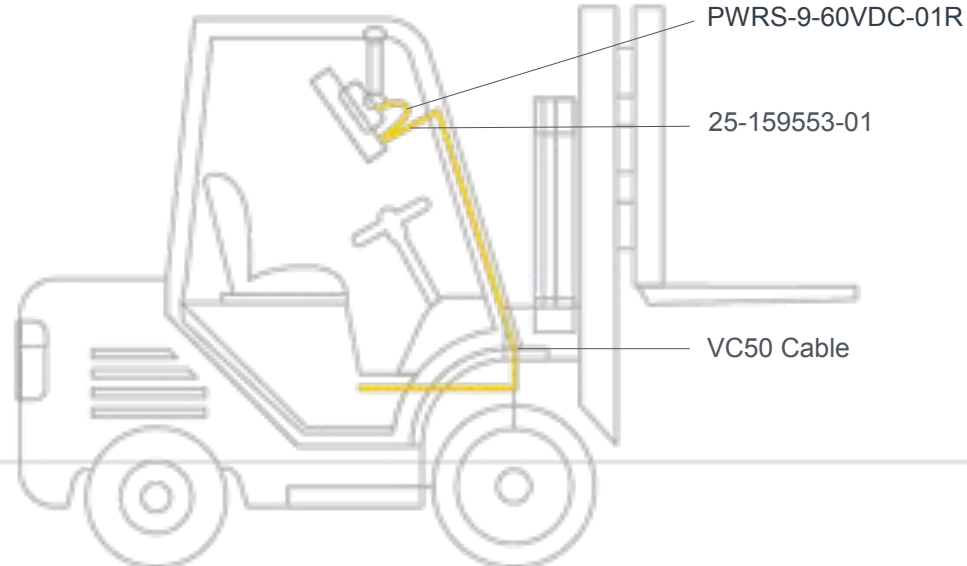

VC70 VEHICLE MOUNT (DC POWER SUPPLY NOT MOUNTED ON THE VC70)

Buy all of these	<p>EXTENSION CABLE ID: 25-159549-01 Cable, external power supply to VC70 extender. 6.5', VC70. Required when the PWRS-9-60VDC-01R is not mounted on the back of the VC70.</p>
	<p>DC POWER SUPPLY ID: PWRS-9-60VDC-01R External DC Power supply, VC70, 9-60VDC Requires 25-159551-01 fused DC power cable to vehicle battery</p>
	<p>DC POWER CABLE ID: 25-159551-01 Cable, external 9-60V DC power supply to vehicle battery, 10', includes fuse, VC70. Required for the PWRS-9-60VDC-R</p>



VC70 **VEHICLE MOUNT (WHEN REPLACING THE VC50 AND REUSING THE VC50 DC POWER CABLE)**

Buy both	 <p>DC POWER SUPPLY ID: PWRS-9-60VDC-01R External DC Power supply, VC70, 9-60VDC Requires 25-159551-01 fused DC power cable to vehicle battery</p>
	 <p>POWER ADAPTER CABLE ID: 25-159553-01 Cable, external power supply to existing VC5090 power cable (25-71919-03R or 25-71919-04R), includes fuses, 2', VC70</p>

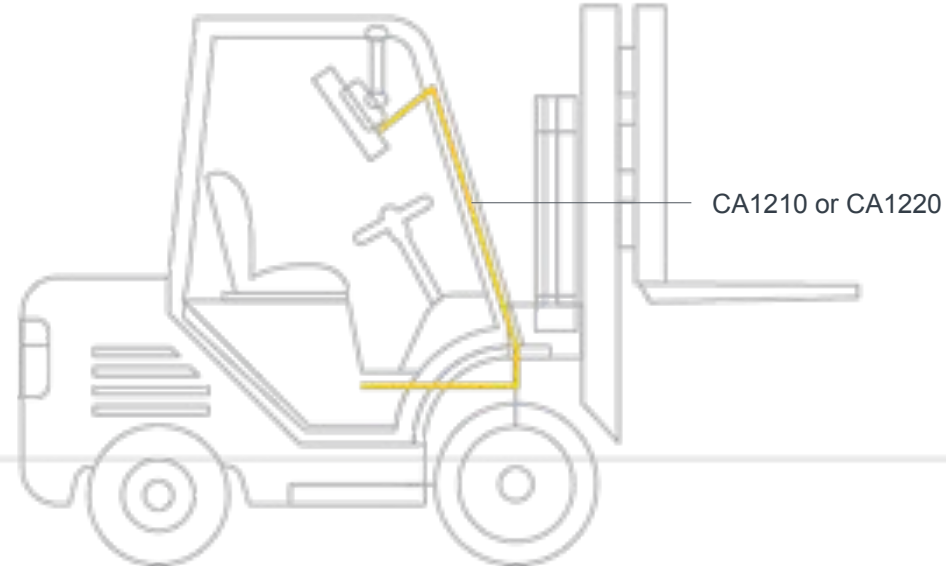

VH10 OR VC80 Series

VEHICLE MOUNT (POWER SUPPLY IS INSIDE THE COMPUTER)

Pick one



DC POWER CABLE | ID: CA1210
Power Extension Cable, DC, 6', waterproof



DC POWER CABLE | ID: CA1220
Power Extension Cable DC, 6', waterproof - Includes Screen Blanking feature

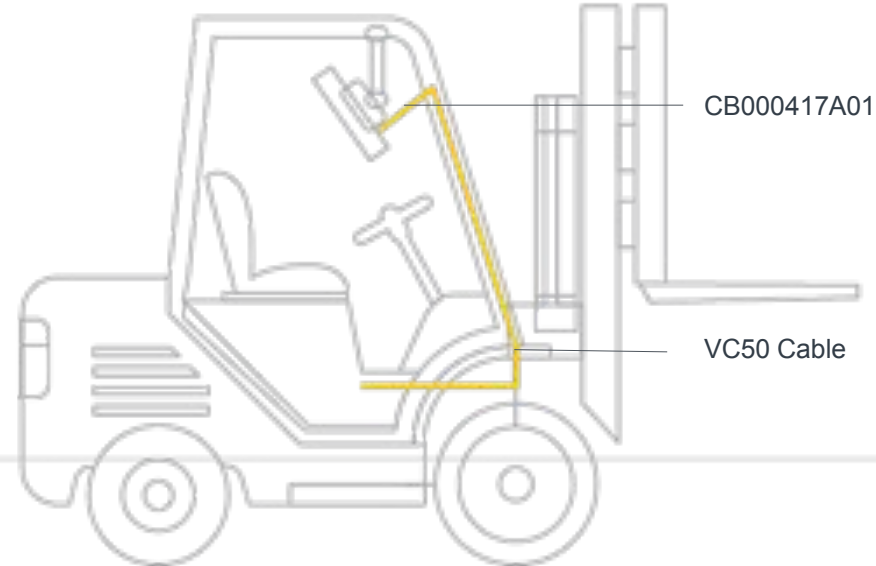

VH10 OR VC80 Series

VEHICLE MOUNT (WHEN REPLACING VC50 AND REUSING THE VC50 DC POWER CABLE)



POWER ADAPTER CABLE | ID: CB000417A01

DC Power Adapter to VC50

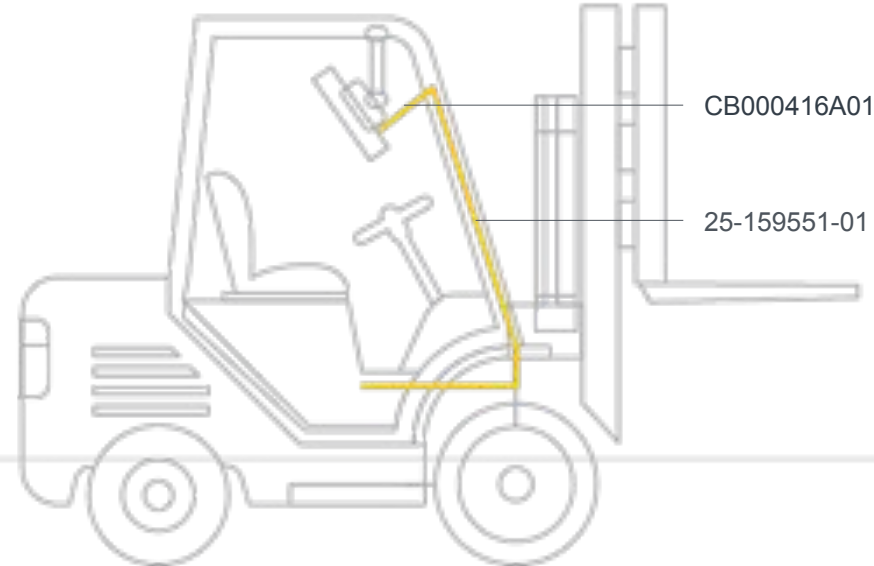

VH10 OR VC80 Series

VEHICLE MOUNT (WHEN REPLACING VC70 AND REUSING THE VC70 DC POWER CABLE)



POWER ADAPTER CABLE | ID: CB000416A01
DC Power Adapter to VC70

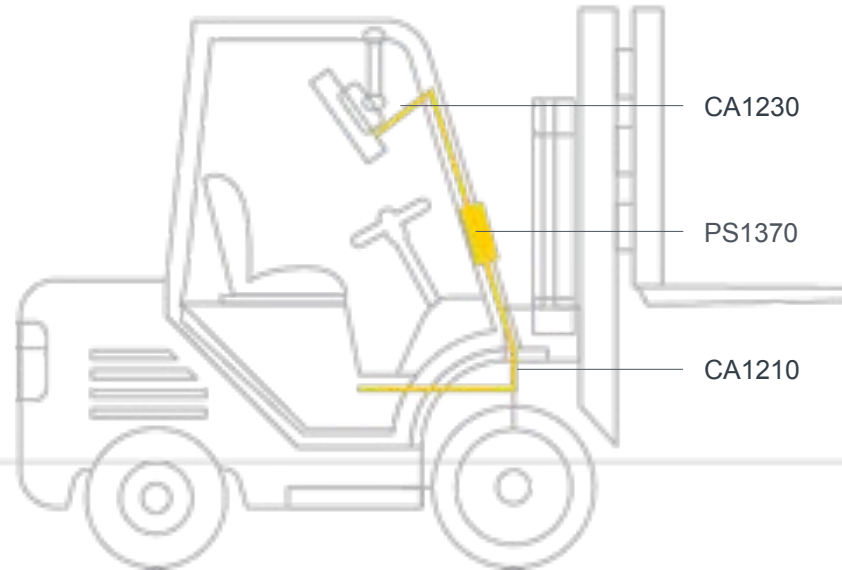

VH10 OR VC80 Series

VEHICLE MOUNT (WITH PRE-REGULATOR TO DECREASE VOLTAGE - FOR TRUCKS WITH BATTERIES GREATER THAN 48V)



DC POWER CABLE | ID: CA1230
DC Power Adapter to VC70



PRE-REGULATOR | ID: PS1370
Pre-Regulator, 19 - 90 VDC in, 15 VDC out, 90 W



DC POWER CABLE | ID: CA1210
Power Extension Cable, DC, 6', waterproof

Buy all three

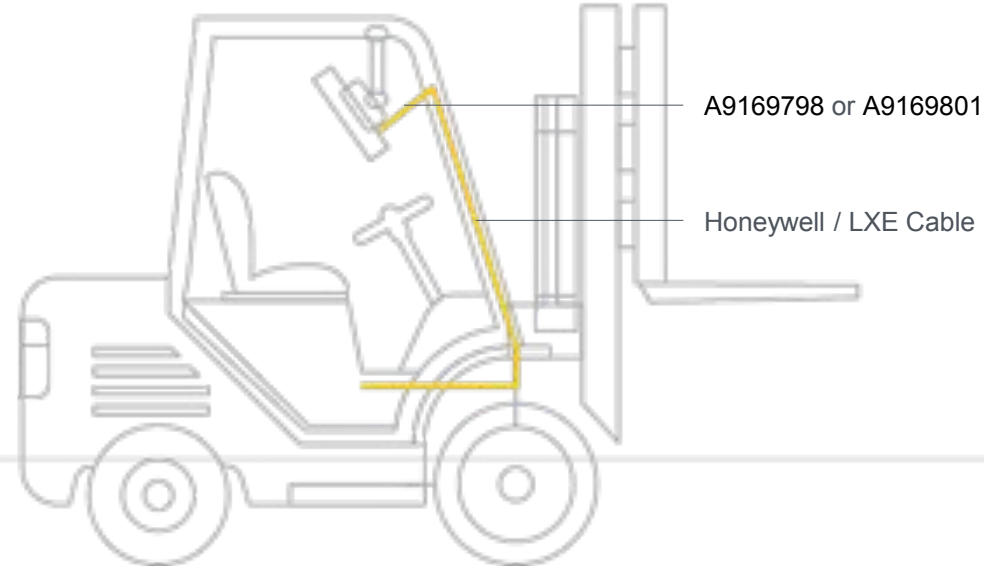

VH10 OR VC80 Series

VEHICLE MOUNT (WHEN REPLACING A HONEYWELL/LXE VC AND REUSING THE DC POWER CABLE)



POWER ADAPTER CABLE | ID: A9169798

Adapter CPC to LXE/Honeywell VX8, VX9, VM1, VM2 AND VM3 DC Power Extension Cable



POWER AND SCREEN BLANKING ADAPTER CABLE | ID: A9169801

Adapter CPC and serial to LXE VX8 and VX9 DC Power Extension and Screen Blanking Cable

STEP 2: MOUNTS

YOUR MOUNTING OPTIONS DEPEND ON YOUR COMPUTER.

FOR THE VH10 AND VC80 Series ——— SLIDES 16
CHOOSE BETWEEN THE FOLLOWING: AND 17

- RAM MOUNT
- QUICK-RELEASE MOUNT
- ADAPTER BRACKET FOR 82XX MOUNTS
- ADAPTER BRACKETS FOR LEGACY VCs

FOR THE VC70, CHOOSE ONE: ——— SLIDE 18

- RAM MOUNT
- U MOUNT
- ADAPTER BRACKET FOR VC50 MOUNT



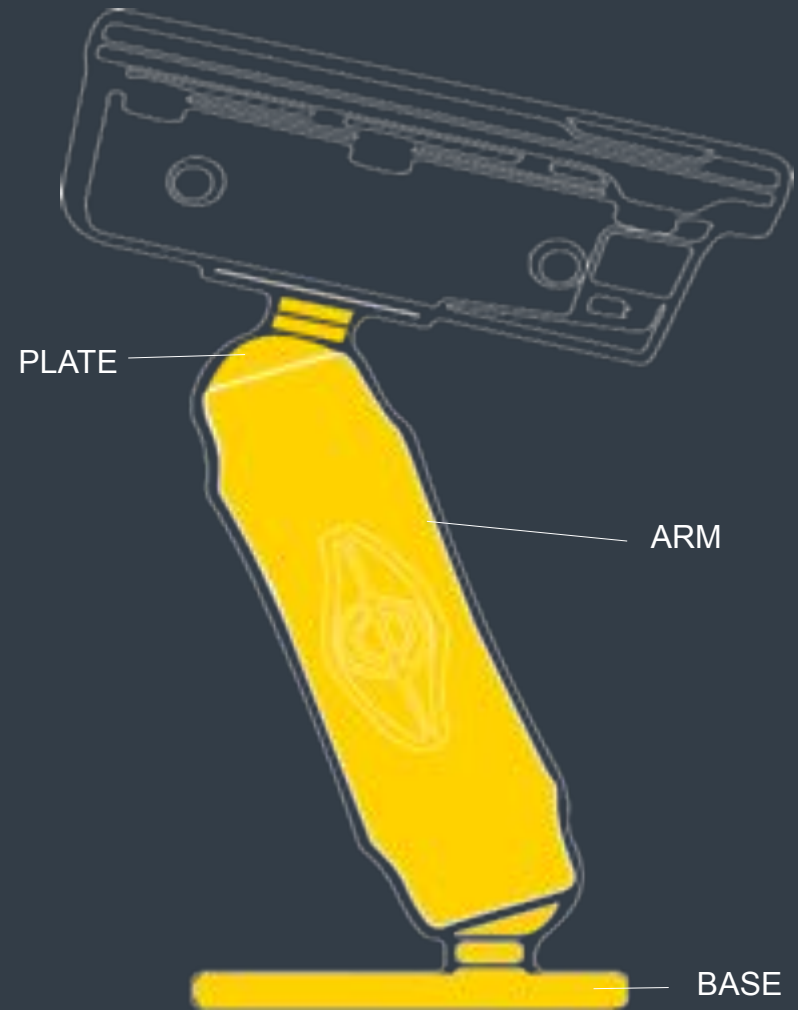

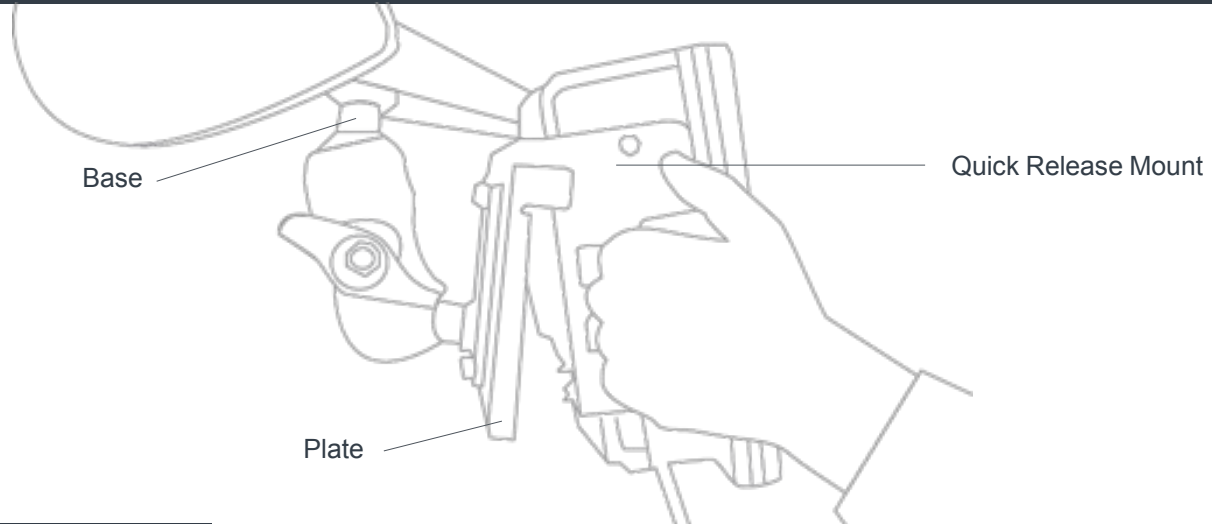
YOU CAN ALSO SELECT A RAM FIXED ——— SLIDE 19
MOUNT BASED ON YOUR VEHICLE THAT
WORKS WITH THE VH10, VC70 , VC80 AND VC80x.





FOR THE VH10 OR VC80 Series

DO YOU NEED A RAM MOUNT, A QUICK RELEASE MOUNT, OR ADAPTERS TO OLD 82XX MOUNTS?

	<p>QUICK RELEASE MOUNT ID: MT4200</p> <p>Quick release mount. Attaches to the side of the computer and includes Mounting Plate (MT4205) that attaches to forklift.</p>
	<p>PLATE ID: MT4205</p> <p>Mounting plate for MT4200, Quick Release Mount, needed if you have one computer for multiple trucks</p>
	<p>ADAPTER BRACKET ID: MT4210</p> <p>Adapter bracket kit for the older 82XX mounts</p>
	<p>PLATE ID: MT3501</p> <p>VESA plate (for 4" or 12" RAM arm), Can also be attached to Quick Release Mount Plate (MT4205)</p>
	<p>BASE ID: MT4510</p> <p>RAM 2"x3" rectangular base with 2.25" rubber ball. Can be attached directly to VH10, VC80 and VC80x</p>

FOR THE VH10 OR VC80 Series
DO YOU REPLACE A LEGACY ZEBRA OR HONEYWELL/LXE VC?

ADAPTER FOR VC50 U-MOUNT
| ID: MNT-VC80-ADPA1-1

The adapter brackets for the VC50 U-Mount can be used to replace a VC50 by a VH10, VC80 or a VC80x and reuse the existing U-Mount.

U-MOUNT, WITH VC70 U-MOUNT HOLE PATTERN
| ID: KT-U-MOUNT-VC80-R

The VC80 Series U-Mount is smaller than the one for the VC50 and has several mounting holes which allow drop-in replacements of VC70, and DLoG U-Mounts. It provides step less tilting of the VC and comes with the VC50 adapters.

ADAPTER FOR HONEYWELL U-MOUNT
| ID: MNT-VC80-ADPB1-1

The adapter brackets for the Honeywell U-Mount can be used to replace a Honeywell/LXE VC by a VH10, VC80 or a VC80x and reuse the existing U-Mount (Honeywell part number VM1010BRKTKIT).

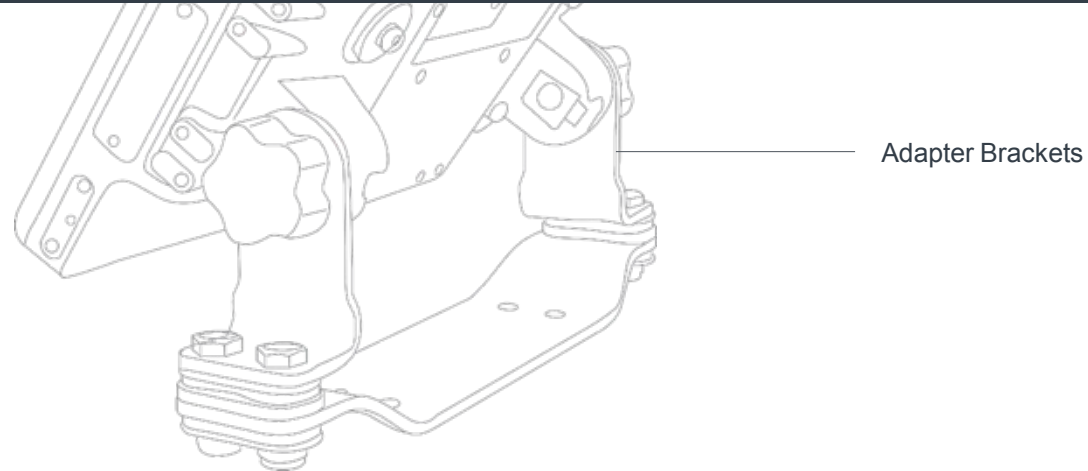

FOR THE VC70

DO YOU NEED A RAM MOUNT, AN U MOUNT, OR ADAPTER BRACKETS TO THE VC50 U MOUNT?



RAM MOUNT

| ID: RAM-D-2461U-MOTO7

RAM bridge with RAM-D-2461U RAM MOUNT, D (2.25") size ball with screws. Including screws to mount the PWRS-9-60VDC-01R External DC Power Supply. Used when replacing equipment already mounted with RAM mounts



RAM MOUNT

| ID: RAM-D-2461U-MOTO7B

RAM-D-2461U RAM MOUNT, D (2.25") size ball with screws. Used when the PWRS-9-60VDC-01R External DC Power Supply has to be mounted away or when AC power supply is used. Used when replacing equipment already mounted with RAM mounts



U MOUNT

| ID: KT-U-MOUNT-VC70-R

U mount, VC70, with mounting hardware



ADAPTER BRACKET | ID: KT-VC50ARM3-VC70-R

2 mount adapter arms for VC50 bracket, 3.5", with bolts











ADAPTER BRACKET | ID: KT-VC50ARM7-VC70-R

2 mount adapter arms for VC50 bracket, 7", with bolts

VC70, VC80 Series & VH10

DEPENDING ON THE VEHICLE, BELOW ARE THE RAM FIXED MOUNTING OPTIONS TO THE COMPUTER AND/OR THE VEHICLE.

	ARM ID: MT4301 RAM mount, 4" arm
	ARM ID: MT4302 RAM mount, 12" arm
	PLATE ID: MT3501 VESA plate (for 4" or 12" RAM arm), Can also be attached to Quick Release Mount Plate (MT4205)
	PLATE ID: MT3502 Round plate (for 4" or 12" RAM arm), Uses smaller footprint than MT3501 VESA Plate
	BASE ID: MT3505 Clamp base (for 4" or 12" RAM arm), 2" max. width
	BASE ID: MT3507 Clamp base (for 4" or 12" RAM arm), 3" max. width
	BASE ID: MT3509 Rail base (for 4" or 12" RAM arm), 1-1/4" to 1-7/8"
	BASE ID: MT3510 Rail base (for 4" or 12" RAM arm), 2" to 2 1/2"
	BASE ID: MT4510 RAM 2"x3" rectangular base with 2.25" rubber ball

STEP 3: SCANNERS



WHEN SHOPPING FOR SCANNER CABLES, CHOOSE BETWEEN COILED OR STRAIGHT FOR YOUR SCANNER AND BETWEEN A RS232 OR USB PLUG.

SCANNER CABLES FOR DS36XX ——— SLIDE 21

SCANNER CABLES FOR LS/DS 34XX/35XX ——— SLIDE 22

SCANNER HOLDERS INCLUDE ——— SLIDE 23

- UNIVERSAL OPTIONS
- SOLUTIONS FOR LS34X8ER AND LS35X8ER
- THERMOTRAZ HEATED

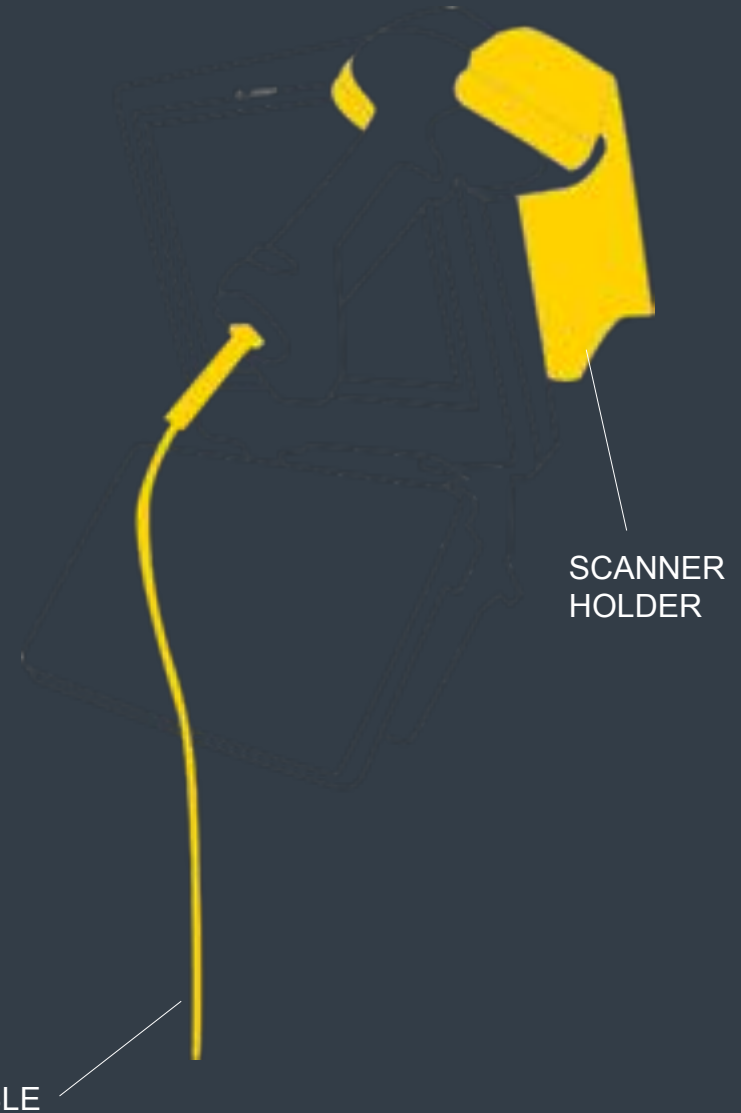





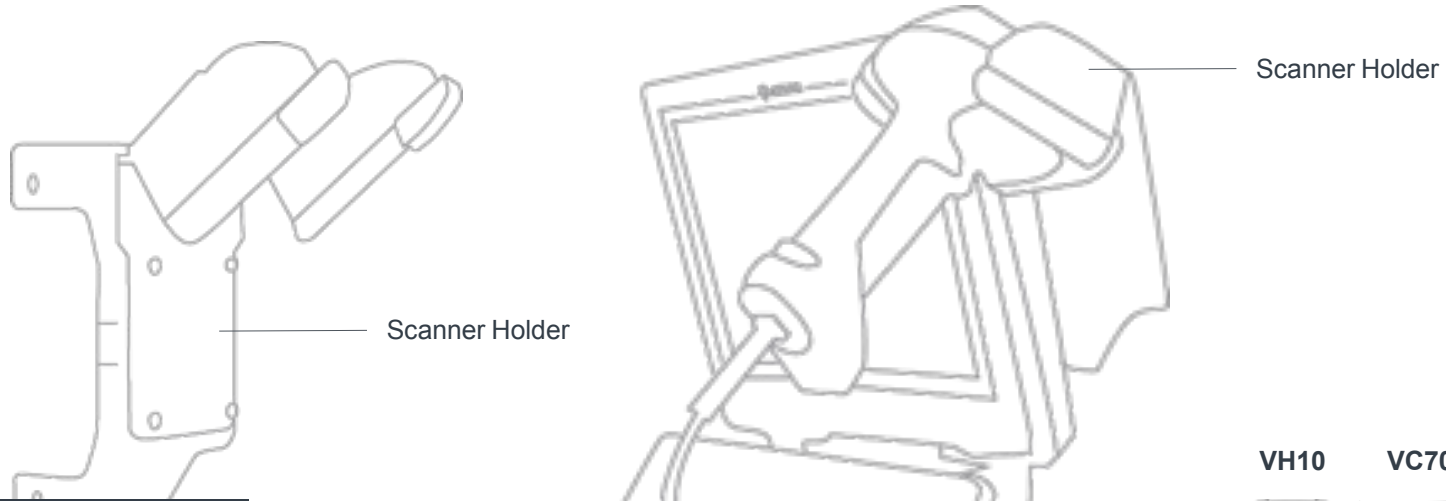





					VH10	VC70	VC80 Series	
DS36XX		SCANNER CABLES						
	RS232 ID: CBA-RF3-C09ZAR Cable - RS232: DB9 Female Connector, 9ft. (2.8m) Coiled, Power Pin 9, TxD on 2, True Converter, -30C					•		
	SHIELDED USB ID: CBA-UF2-C12ZAR Cable - Shielded USB: Series A Locking Connector for VC70, 12', Coiled, -30C					•		
	RS232 ID: CBA-R71-C09ZAR Cable - RS232: DB9 Female Connector, 9ft (2.8m) Coiled, Power Pin 9			•			•	
	RS232 ID: CBA-RF2-C09ZAR Cable - RS232: DB9 Female Connector, 9ft (2.8m) Coiled, Power Pin 9, -30C			•			•	
	SHIELDED USB ID: CBA-U46-S07ZAR Cable - Shielded USB: Series A Connector, 7ft. (2m), Straight, BC 1.2			•			•	
	SHIELDED USB ID: CBA-U47-S15ZAR Cable - Shielded USB: Series A Connector, 15ft. (4.6m), Straight, BC 1.2			•			•	
	SHIELDED USB ID: CBA-UF1-S07ZAR Cable - Shielded USB: Series A Connector, 7ft. (2m), Straight, BC 1.2, -30C			•			•	
LS/DS 34XX/35XX		SCANNER CABLES						
	SHIELDED USB ID: 25-159548-01 Cable - Shielded USB: Series A Locking Connector for VC70, 12', Coiled, -30C					•		
	RS232 ID: CBA-R46-C09ZBR Cable - RS232: DB9 Female Connector, 9ft. (2.8m) Coiled, Power Pin 9, TxD on 2, True Converter					•		
	RS232 ID: CBA-R49-C09ZAR Cable - RS232: DB9 Female Connector, 9ft. (2.8m) Coiled, Power Pin 9, TxD on 2, True Converter, Low Temp -30C					•		
	RS232 ID: CBA-R37-C09ZAR Cable - RS232: DB9 Female Connector, 9ft (2.8m) Coiled, Power Pin 9			•			•	
	USB ID: CBA-U09-C15ZAR Cable - USB: Series A Connector, 15ft. (4.6m) Coiled			•			•	
	SHIELDED USB ID: CBA-U01-S07ZAR Cable - Shielded USB: Series A Connector, 7ft. (2m), Straight, BC 1.2			•			•	
	SHIELDED USB ID: CBA-U10-S15ZAR Cable - Shielded USB: Series A Connector, 15ft. (4.6m), Straight, BC 1.2			•			•	



SCANNER HOLDERS

		VH10	VC70	VC80 Series
	SCANNER HOLDER ID: KT-SCANMNT-VC70-R Mounting holder for the scanner. For LS34x8ER, LS35x8ER. Requires KT-ACCMNT-VC70-R Accessory side mount bracket			
	ACCESSORY MOUNT ID: KT-ACCMNT-VC70-R Accessory side mount bracket		•	
	SCANNER HOLDER ID: 9008951 Thermotrax heated scanner holder with cable management system, 12 Volt, for LS/DS 34xx / 35xx	•	•	•
	SCANNER HOLDER ID: 9008953 Thermotrax heated scanner holder with cable management system, 36-48 Volt, for LS/DS 34xx / 35xx	•	•	•
	SCANNER HOLDER ID: 9008952 Thermotrax heated scanner holder with cable management system, 24 Volt, for LS/DS 34xx / 35xx	•		•
	SCANNER HOLDER ID: KT-SCANMNT-VC80-R Side mounted holder for scanner	•		•

STEP 4: KEYBOARDS



WHILE THE VH10 HAS A BUILT-IN KEYBOARD, THE VC70 AND VC80 Series GIVE YOU MULTIPLE OPTIONS.

VC80 Series KEYBOARDS ————— SLIDE 24

VC70 KEYBOARDS ————— SLIDE 25

IKey KEYBOARDS ————— SLIDE 26

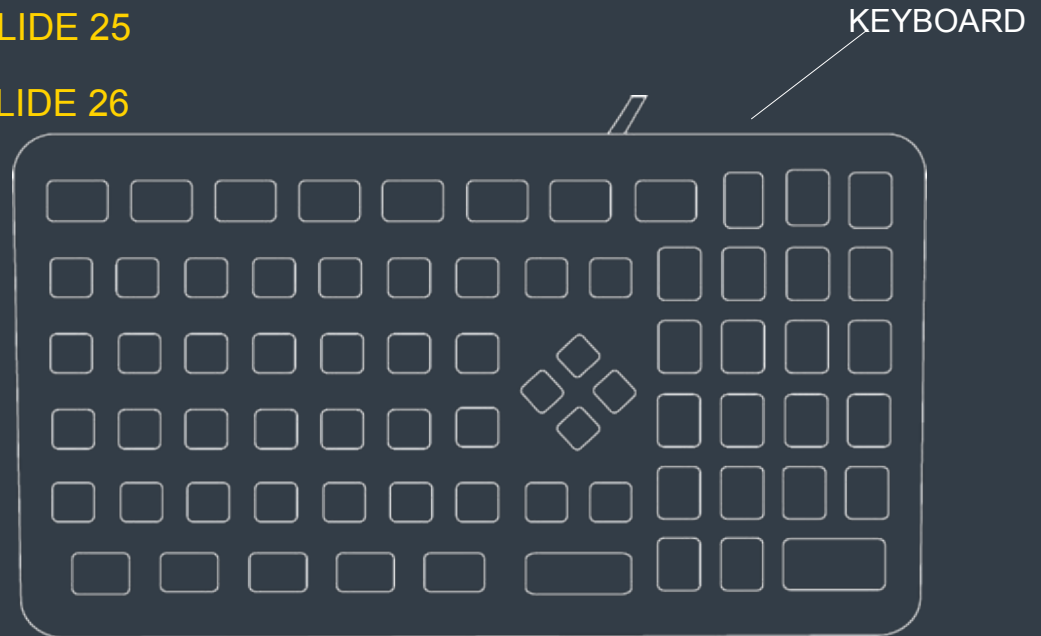

**VC80
Series**

KEYBOARDS, CABLES AND MOUNTING OPTIONS



KEYBOARD | ID: KYBD-AZ-VC-01
VC USB Keyboard AZERTY



KEYBOARD | ID: KYBD-QW-VC80-S-1
USB Keyboard QWERTY with 22 cm cable for VC80/VC80x



KEYBOARD | ID: KYBD-QW-VC80-L-1
USB Keyboard QWERTY with 300 cm cable for VC80/VC80x



KEYBOARD CABLE | ID: CBL-VC80-KBUS1-01
22 cm VC80 Series USB cable for heated Keyboard



KEYBOARD CABLE | ID: CBL-VC80-KBUS2-01
300 cm VC80 Series USB cable for heated Keyboard



KEYBOARD | ID: KYBD-NU-VC70-03R
USB Keyboard QWERTY with 300 cm y-cable for VC70 Freezer



KEYBOARD TRAY | ID: KT-KYBDTRAY-VC70-3
QWERTY/AZERTY Keyboard mounting tray. Includes tilting arms, knobs and screws.



KEYBOARD SIDE MOUNT BRACKET | ID: KT-KYBDMNT-VC70-R
Function/Numeric keypad side mount bracket

VC70
KEYBOARDS, CABLES AND MOUNTING OPTIONS

KEYBOARD | ID: KYBD-AZ-VC-01
 VC USB Keyboard AZERTY



KEYBOARD | ID: KYBD-QW-VC70-S-1
 USB Keyboard QWERTY with 18 cm cable for VC70



KEYBOARD | ID: KYBD-QW-VC70-L-1
 USB Keyboard QWERTY with 300 cm cable for VC70



KEYBOARD | ID: KYBD-QW-VC70F-S-1
 USB Keyboard QWERTY with 37 cm y-cable for VC70 Freezer



KEYBOARD | ID: KYBD-QW-VC70F-L-1
 USB Keyboard QWERTY with 300 cm y-cable for VC70 Freezer



KEYBOARD CABLE | ID: CBL-VC70-KBUS1-01
 18 cm VC70 USB cable for heated Keyboard



KEYBOARD CABLE | ID: CBL-VC70-KBUS2-01
 300 cm VC70 USB cable for heated Keyboard



KEYBOARD CABLE | ID: CBL-VC70-KBUS4-01
 37 cm VC70 USB & RS232 Y-cable for heated Keyboard



KEYBOARD CABLE | ID: CBL-VC70-KBUS4-01
 300 cm VC70 USB & RS232 Y-cable for heated Keyboard



KEYBOARD | ID: KYBD-NU-VC70-03R
 USB Keyboard QWERTY with 300 cm y-cable for VC70 Freezer



KEYBOARD TRAY | ID: KT-KYBDTRAY-VC70-3
 QWERTY/AZERTY Keyboard mounting tray. Includes tilting arms, knobs and screws.



KEYBOARD SIDE MOUNT BRACKET | ID: KT-KYBDMNT-VC70-R
 Function/Numeric keypad side mount bracket

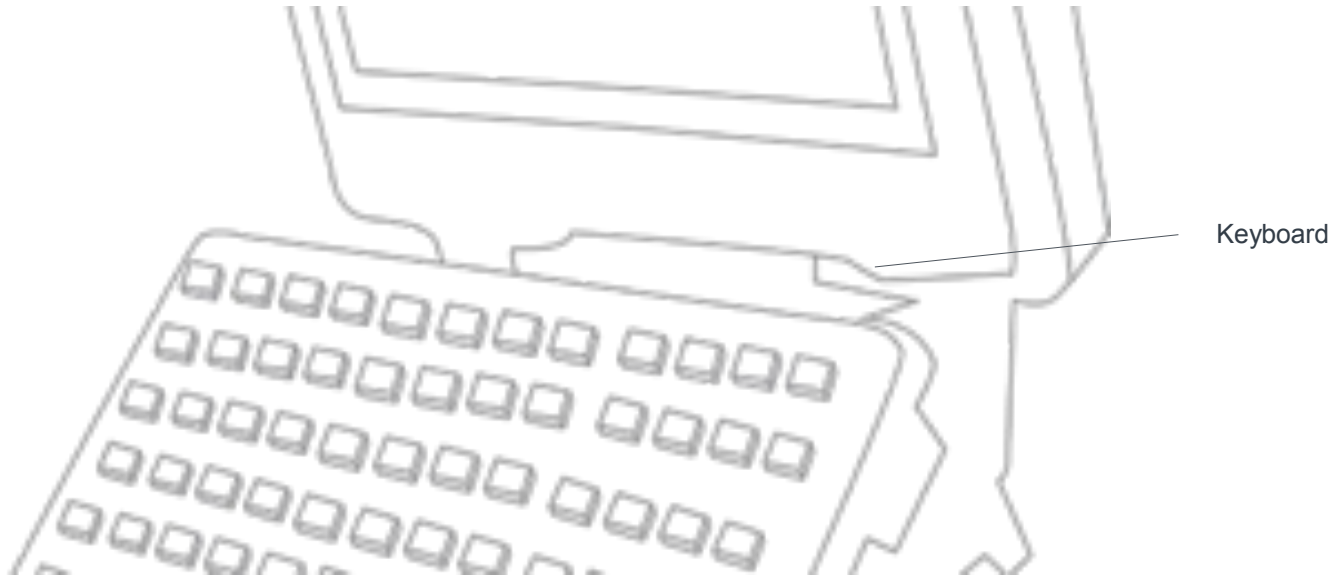

VC70 & VC80 Series

iKey KEYBOARDS



KEYBOARD | ID: 9010376
 iKey Keyboard, English, backlight, USBCable - RS232: DB9 Female Connector, 9ft. (2.8m) Coiled, Power Pin 9, TxD



KEYBOARD | ID: 9010377
 iKey Keyboard, English, color, USB



KEYBOARD | ID: SLK-101-M-USB-3F
 iKey Keyboard, 101 keys (12 Function keys), large numeric pad, backlight, USB

STEP 5: ANTENNAS



YOUR OPTIONS OF ANTENNAS ARE WIDE: ——— SLIDE 28

- WIFI – VC70, VC80 Series & VH10
- NARROWBAND – VH10 ONLY
- GPS – VC80 Series ONLY
- RIGHT-ANGLE ADAPTER FOR INSTALLATIONS WITH LITTLE OVERHEAD SPACE – VC70, VC80 Series & VH10

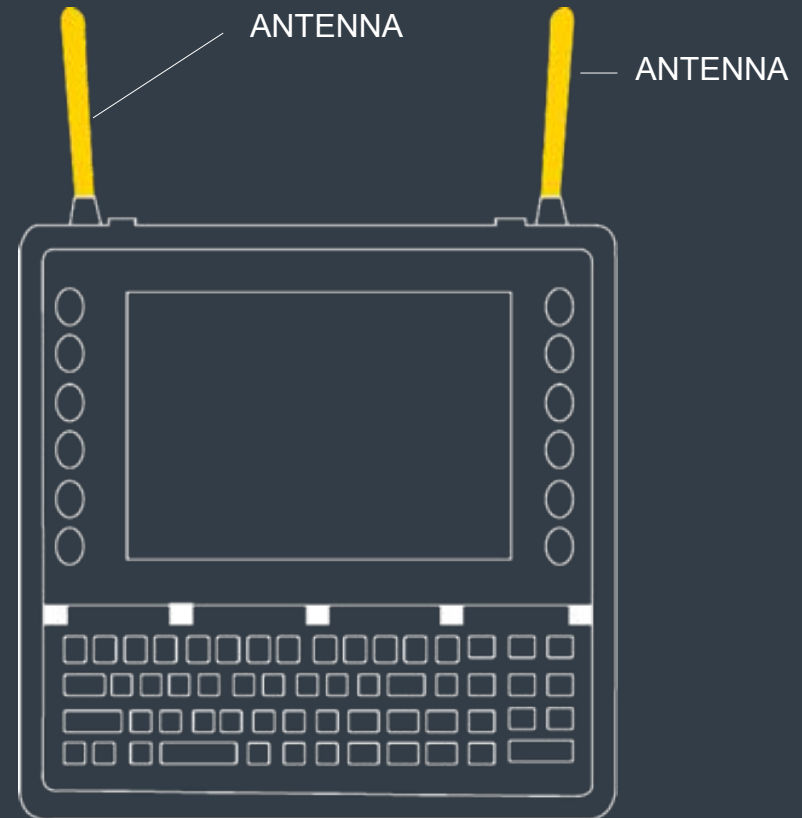

HERE'S A LIST OF ANTENNAS AND CONNECTIVITY FOR YOU TO CHOOSE FROM

ALL VCS

ANTENNAS & CONNECTIVITY FOR WIFI



ANTENNA | ID: 20667-002
Whip antenna (stubby), 802.11 b/g - dipole 2 dBi reverse polarity SMA connector
Antenna, dual band, 802.11 a/b/g/n, 2 dBi, RPSMA connector, magnetic mount, 2.9m, WiFi



ANTENNA | ID: AN2010
Antenna, dual band, 802.11 a/b/g/n, 2 dBi, RPSMA connector, magnetic mount, 2.9m, WiFi



ANTENNA | ID: AN2020
Antenna, 2.4 GHz, 802.11 b/g, 5 dBi, RPSMA connector, magnetic mount, 2.9m



ANTENNA | ID: AN2030
Whip antenna (stubby), dual band, 802.11 a/b/g/n, 2.4GHz 2dBi, 5GHz 3.7 dBi, RPSMA connector, WiFi

VC70

ADAPTERS FOR VC70 TO ATTACH EXTERNAL WIFI ANTENNAS WITH RPSMA CONNECTOR



ADAPTER | ID: RPSMA-RTRPSMA-05R
ANTENNA ADAPTER RPSMA - RTRPSMA, 5-PACK, Required for the VC70 WiFi Antennas



ADAPTER | ID: RPSMA-RTRPSMA-10R
ANTENNA ADAPTER RPSMA - RTRPSMA, 10-PACK, Required for the VC70 WiFi Antennas

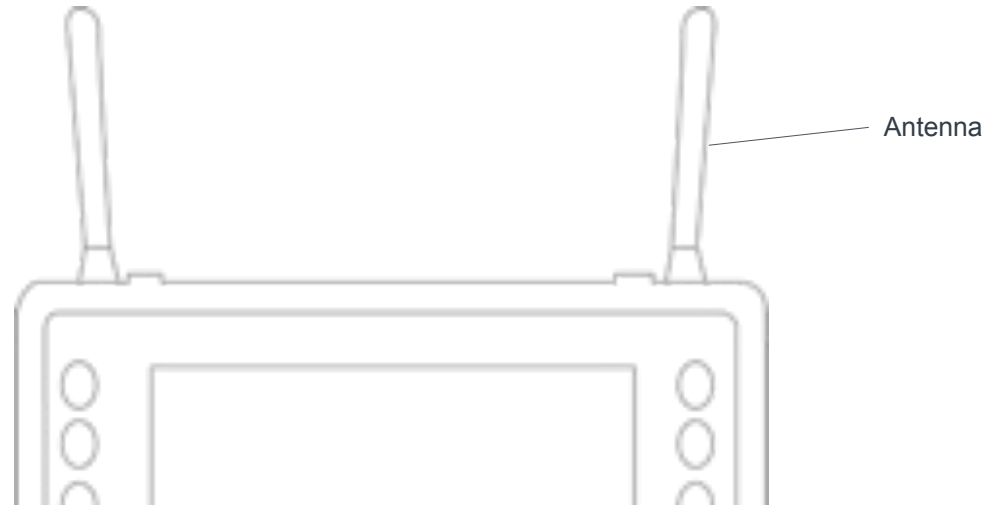

VH10

ANTENNAS & CONNECTIVITY FOR NARROWBAND



ANTENNA | ID: 9009801
Antenna, Narrow Band 1/4 wave, 406-512 MHz 6" NB



MOUNT | ID: 9009792
Mount, Magnetic, for Narrowband, antenna, SMA, 12' cable

VC80 / VC80x

ANTENNA FOR GPS



ANTENNA | ID: RPSMA-RTRPSMA-05R
GNSS antenna, magnetic mount, 2.9 m cable

ALL VCS

RIGHT ANGLE ADAPTER FOR INSTALLATIONS WITH LITTLE SPACE OVERHEAD, ALL VCS



RIGHT ANGLE ADAPTER | ID: AR1000
Right Angle SMA reverse polarity plug-jack Adapter

STEP 6: VOICE









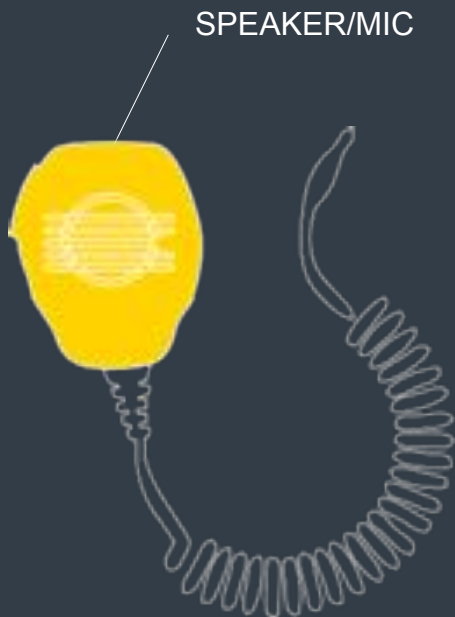



SELECT FROM TURNKEY KITS OR VOICE ACCESSORIES À LA CARTE.

YOUR VOICE OPTIONS — SLIDE 31

- VOICE





VOICE		VH10	VC70	VC80 Series
	MICROPHONE KIT ID: KT-MIC-01R This bundle includes the VC70 External PTT mic, the Motorola HMN1089B Water-resistant Palm Microphone or equivalent and the KT-ACCMNT-VC70-R Accessory Side mount bracket.			
	MICROPHONE ID: HMN1089B Push-To-Talk Hand Microphone, GCAI connector, Water Resistant		•	
	SIDE MOUNT ID: KT-ACCMNT-VC70-R Accessory Side mount bracket		•	
	SPEAKER KIT ID: KT-SPKR-01R This bundle includes the External speaker, the Motorola HSN4039A 13 Watt water-resistant loudspeaker and the 25-159552-01 VC70 external speaker adapter cable.		•	
	SPEAKER ID: HSN4040A External speaker, Motorola HSN4040A 13 Watt water-resistant loudspeaker. Requires 25-159552-01		•	
	INTERFACE CABLE ID: 25-159552-01 Speaker cable adapter, for HSN4040A, VC70. Required to connect the HSN4040A external speaker.		•	
	SPEAKER/MIC ID: M1000 Speaker/Mic with push-to-talk function	•		•

STEP 7: MISCELLANEOUS







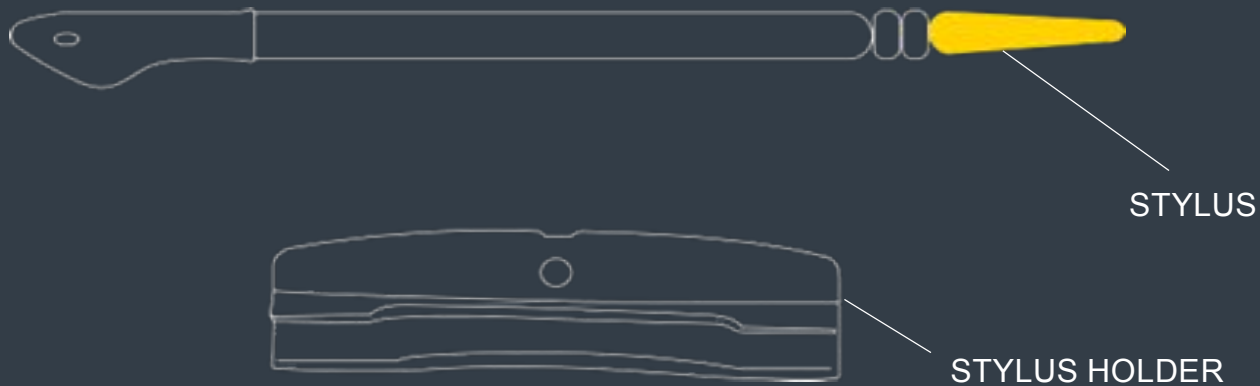



DON'T FORGET TO CONSIDER THESE: ——— SLIDE 33

- STYLUS
- SCREEN PROTECTOR
- CAN BUS CABLE
- USB TO ETHERNET ADAPTER





MISCELLANEOUS		VH10	VC70	VC80 Series
	ID: SL0001 Stylus and Stylus Holder	•	•	•
	ID: VA6200 Screen Protector Pack of 3	•		
	ID: KT-SPRTCT-VC70-05R Screen Protector Pack of 5		•	•
	ID: CA1300 Screen blanking cable (DB9 to open wires)	•		•
	ID: CB-000433-01 CAN Bus Cable (RJ45 to Deutsch)			•
	ID: WA4070 USB to Ethernet Adapter	•		
	ID: 25-159547-01 Cable DB15M to DB9M, for COM2		•	
	ID: SG-VC70-VISR1-01 VC70 Sun Visor mountable with cut out wing.		•	

STEP 8: SERVICE PARTS



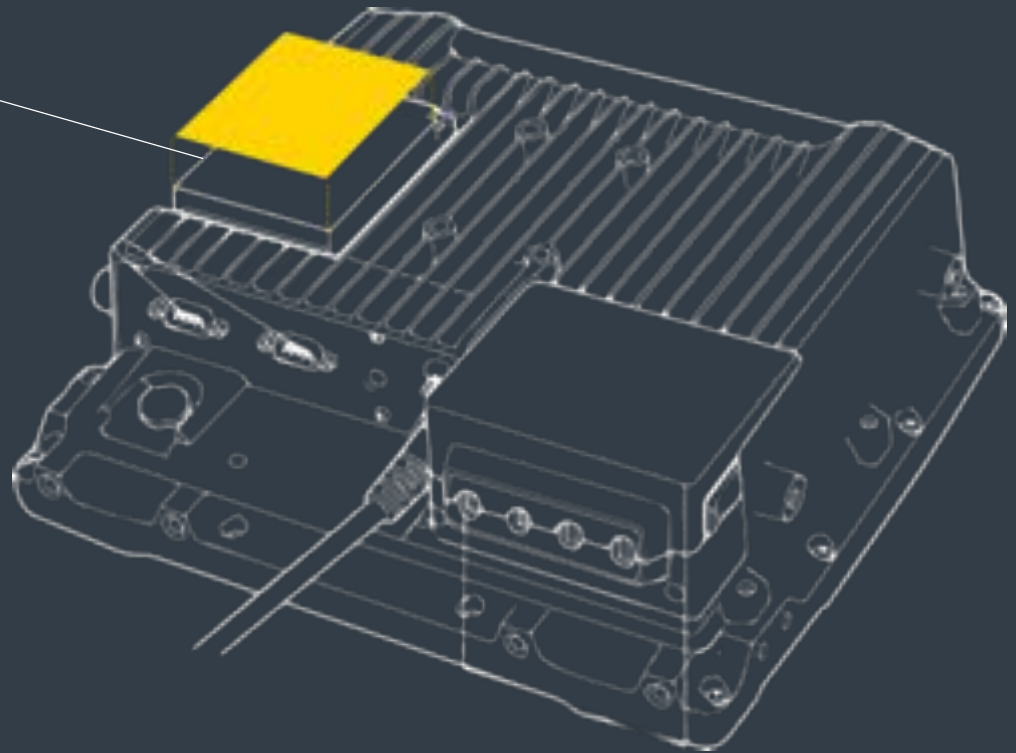

STOCK UP ON THESE ESSENTIAL SPARE PARTS: — SLIDE 35

- TOOL KIT
- KEYPADS
- TOUCH SCREENS
- SPARE BATTERY





SERVICE PARTS		VH10	VC70	VC80 Series
	ID: AL1001 QWERTY Keypad	•		
	ID: AL1002 AZERTY Keypad	•		
	ID: AL2002 Front with standard touch screen and function keys	•		
	ID: AL2002 Front with heated touch screen and function keys	•		
	ID: ST2000 Modular Services Kit	•		•
	ID: KT-VC80-BTRY1-01 Spare Battery			•
	ID: KT-VC80-SCRH1-01 Front with Touch Screen (heated)			•
	ID: KT-VC80-SCRN1-01 Front with Touch Screen (non-heated)			•
	ID: BTRY-VC70IAB00 Spare Battery		•	
	ID: KYBD-QW-VC-01 QWERTY Spare Elastomer for VC USB Keyboard		•	•
	ID: KYBD-AZ-VC-01 AZERTY Spare Elastomer for VC USB Keyboard		•	•