

# **Museum specimens under scrutiny – new insights into the phylogeny of continental molluscs**

Inauguraldissertation  
der Philosophisch-naturwissenschaftlichen Fakultät  
der Universität Bern

vorgelegt von

Beat Ulrich Pfarrer

von Schelten BE

Leiter der Arbeit:  
Prof. Dr. Christian Kropf  
Naturhistorisches Museum Bern

# **Museum specimens under scrutiny – new insights into the phylogeny of continental molluscs**

Inauguraldissertation  
der Philosophisch-naturwissenschaftlichen Fakultät  
der Universität Bern

vorgelegt von

Beat Ulrich Pfarrer

von Schelten BE

Leiter der Arbeit:  
Prof. Dr. Christian Kropf  
Naturhistorisches Museum Bern

Von der Philosophisch-naturwissenschaftlichen Fakultät angenommen.

Originaldokument gespeichert auf dem Webserver der Universitätsbibliothek Bern



This work is licensed under Attribution-NonCommercial-NoDerivatives 4.0 International

Bern, 21.04.2022

Der Dekan  
Prof. Dr. Zoltan Balogh

## You are free to:



- **Share** — copy and redistribute the material in any medium or format

The licensor cannot revoke these freedoms as long as you follow the license terms.

---

## Under the following terms:



- **Attribution** — You must give [appropriate credit](#), provide a link to the license, and [indicate if changes were made](#). You may do so in any reasonable manner, but not in any way that suggests the licensor endorses you or your use.



- **NonCommercial** — You may not use the material for [commercial purposes](#).

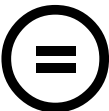

- **NoDerivatives** — If you [remix, transform, or build upon](#) the material, you may not distribute the modified material.

**No additional restrictions** — You may not apply legal terms or [technological measures](#) that legally restrict others from doing anything the license permits.

---

## Notices:

You do not have to comply with the license for elements of the material in the public domain or where your use is permitted by an applicable [exception or limitation](#).

No warranties are given. The license may not give you all of the permissions necessary for your intended use. For example, other rights such as [publicity, privacy, or moral rights](#) may limit how you use the material.

# Table of contents

---

Introduction p 1

Chapter 1 p 5

Pfarrer, B., Rowson, B., Tattersfield, P., & Neubert, E. (2021). Phylogenetic position of African Vitrinidae: Old family groups unraveled. *Journal of Zoological Systematics and Evolutionary Research*, 59(6), 1190-1208.

Chapter 2 p 24

Pfarrer, B., Nekola, J., & Neubert, E. (manuscript to be submitted to *Zootaxa*). Backpacker with little luggage: *Vitrina pellucida* (O. F. Müller, 1774) identified as a species hiking the Holarctic region.

Chapter 3 p 52

Pfarrer, B., Carlevaro, A., Stucki, P., Schwarzer, A., Vicentini, H., & Neubert, E. (submitted to *Hydrobiologia*). New phylogenetic insights from some species of Unionidae out of Switzerland (Bivalvia, Palaeoheterodonta, Unionidae).

Chapter 4 p 89

Bouaziz-Yahiatene, H., Pfarrer, B., Medjdoub-Bensaad, F., & Neubert, E. (2017). Revision of *Massylaea* Möllendorff, 1898 (Stylommatophora, Helicidae). *ZooKeys*, 694, 109–133.

Ezzine, I. K., Dimassi, N., Pfarrer, B., Said, K., & Neubert, E. (2018). New records of the endemic Sicilian land snail species *Marmorana (Murella) muralis* (OF Müller, 1774) from the north of Tunisia (Pulmonata, Gastropoda). *ZooKeys*, 775, 131-147.

Kneubühler, J., Hutterer, R., Pfarrer, B., & Neubert, E. (2019). Anatomical and phylogenetic investigation of the genera *Alabastrina* Kobelt, 1904, *Siretia* Pallary, 1926, and *Otala* Schumacher, 1817 (Stylommatophora, Helicidae). *ZooKeys*, 843, 1–37.



Discussion	p 168
Outlook	p 169
References	p 173
Acknowledgements	p 178
Erklärung	p 179
Curriculum Vitae	p 180

## Introduction

After the arthropods, molluscs represent the second largest phylum in the animal kingdom. Beyond the ice-covered plains of the polar caps, this megadiverse and significant group occupies almost every biome on the planet: from black smokers in the deep sea to estuaries, rocky and sandy shorelines, deserts and rainforests, freshwater lakes and rivers and at the tops of high mountain ridges. The earliest molluscan records date back to the turn of the Ediacaran Period to the Cambrian about 540 million years ago (Maloof *et al.* 2010). Though frequently debated in the last decades, the current species estimate is about 90,000 valid living species, with an equal number of fossil species (MolluscaBase, Jan. 2022). Molluscs have impacted human history, art and culture and have been enriching our diet since prehistoric times (Khan & Liu 2019). Mollusc consumption and export rates vary with different populations and customs. For example, the Food and Agriculture Organization of the United Nations (FAO) reported for the year 2018 a worldwide production of 17.3 million tonnes of shelled molluscs, which represents 56.3 percent of the production of marine and coastal aquaculture. In medicine, the toxins of the Conoidea superfamily, the conopeptides (conotoxins) and teretoxins, have revealed to possess a remarkable diversity of pharmacological function and utility: they circumvent the known abuse of opioids in pain therapy (Bingham *et al.* 2010, 2012; Olivera & Teichert 2007; Verdes *et al.* 2016). On the other hand, snail-borne parasitic diseases (SBPDs) such as schistosomiasis, are still a great concern in Sub-Saharan Africa and in tropical and sub-tropical regions of Southeast Asia as well as in the Caribbean and South America (Peters & Pasvol 2002, Morgan *et al.* 2005). Research is ongoing regarding vector dispersal and the geographical distribution of these diseases (Lu *et al.* 2018).

Due to their limited vagility, terrestrial molluscs are a fitting model for studies addressing colonization and distribution patterns (Scott, 1997). Ecologically, saprophagous terrestrial snails are significant decomposers of organic matter and are thus, vital for the ecological balance of the soil biome (De Oliveira *et al.* 2010). Molluscs act as bioindicators in health and quality assessments of forests (Gheoca *et al.* 2021) as well as in water quality assessments of rivers and lakes, with filtering bivalves as the performing indicators (Shevchuk *et al.* 2021). In addition, molluscs are known for their often bizarre and acrobatic mating practices (Chase & Blanchard 2006; Nitz *et al.* 2010) as well as for their remarkable acts of self-decapitation and regenerative abilities (Mitoh & Yusa 2021). To understand and benefit from these far-reaching dynamics, sound taxonomy and knowledge of phylogenetic relationships is requisite to all endeavors concerning molluscs and mollusc – human interactions.

Traditionally, the study of molluscan phylogeny was based on anatomical and conchological characters such as shell size and shell shape. Usually, bodies and shells are scrutinized for character states, i.e. character states are identified and appraised for their synapomorphic or symplesiomorphic value. This methodology led to the first revision of molluscan taxonomy and phylogeny (see for example Haszprunar, 1988). The now standard use of new generations of DNA sequencing techniques has boosted the quality of molluscan systematics in phylogenetic research (Korábek *et al.* 2019; Neiber *et al.* 2021) The aim of my dissertation is to investigate phylogeographic variation and to study the

dispersal pathways of some of the up to now neglected taxonomic groups (see chapters 1, 2, and 4) as well as to complete gaps in the phylogeography of other groups (see chapter 3).

Museums host large collections of both, dry and ethanol-preserved molluscan specimens whose scientific potential is often underestimated. Increasing quality of DNA capture and the following bioinformatics of DNA fragments convert not only new, but especially old museum samples (given these had been properly curated) to precious research components (Miller *et al.* 2013; Puillandre *et al.* 2012). For example, mummified bodies are proven to be an excellent source for DNA extraction (see chapter 2) while shells can yield enough DNA when sensitive extraction methods are applied (Andree & López 2013; Der Sarkissian *et al.* 2017; Geist *et al.* 2008; Villanea *et al.* 2016). When trying to identify polymorphic species (Rosin *et al.* 2011; Surmacki *et al.* 2013) or species with very few characteristics as in semislugs (Giusti *et al.* 2011) or subterranean microgastropods (Inäbnit *et al.* 2019; Kneubühler *et al.* 2021) conchology has limited power in species delimitation or identification. Mollusc DNA on the other hand, may be difficult to handle, and extraction is paved with numerous obstacles such as the inhibitory effect of mucus-derived polysaccharides on DNA polymerase activity (Sokolov 2000). The composition of mucopolysaccharides may vary from family to family, therefore extraction methods must be thoroughly tested before application. A further problem is caused by the very popular way of euthanizing mollusc specimens by drowning in water, which has proven to be an inappropriate method for later DNA extraction (Kruckenhauser *et al.* 2010; Schander & Hagnell 2003). Other problems include the age of preserved vouchers in museum collections (Jaksch *et al.* 2016), where degradation over time and unsuitable preserving agents damage tissues and fragmentize the DNA. This “highly fragmented DNA” is also known as ancient DNA (aDNA) (Der Sarkissian *et al.* 2017; Pääbo *et al.* 1988; Villanea *et al.* 2016).

In my doctoral work here, I applied DNA sequence data derived from museum specimens of the family Vitrinidae to unravel some taxonomical conundrums in a hitherto neglected group within the malacological community (Chapters 1 and 2). In addition, I resolve phylogenetic problems in Swiss freshwater bivalves (Chapter 3) and introduce new and inexpensive laboratory protocols in conjunction with bioinformatic techniques for recent and ancient mollusc DNA investigations (Chapter 4).

## Chapter 1

A first revision of several African vitrinid species is presented. This study was based on the examination of 46 specimens of Vitrinidae Fitzinger, 1833 mainly from Northeast Africa, the Arabian Peninsula, and the Macaronesian Islands. A specimen collected in the Ethiopian highland of previously unknown species status, turned out to be a relic species of a group that presumably had gone extinct during the late Neogene of Africa. However, this group appears to have evolved to the speciose radiation of Vitrinidae on the Macaronesian Islands. This paper applies genetic methods for the first time in a larger group within this rather neglected family of terrestrial semislugs. The Vitrinidae is characterised by an ongoing tendency towards reduction of the shell. These highly reduced morphological traits constituted

a major problem when resolving the taxonomy and phylogenetic relationships of the included species. Earlier attempts to uncover the relationship of taxa within Vitrinidae by using morphological character states of the shell and soft body anatomy (mainly genital organs) are evaluated and discussed in this paper. The phylogenetic hypotheses hitherto considered valid were tested and refuted by the results of the molecular research. Since they formed the basis of the current phylogenetic system, morphological traits of the genital organs of all available specimens were specifically studied. The main result is that the genital organs of some groups within the Vitrinidae do not show synapomorphic characters especially since many superficially similar traits have evolved in parallel and thus, must be considered homoplasies. Due to low extraction yield and partly fragmented DNA, non-destructive DNA extraction and a redesign of commonly used primers were implemented to assure a yield of highly concentrated DNA with low fragmentation.

## Chapter 2

In this work, the genus *Vitrina* Draparnaud, 1801, from the family Vitrinidae is addressed. *Vitrina pellucida* (O. F. Müller, 1774) has up to now been considered the Central European representative for this genus while *Vitrina* shows a Holarctic distribution pattern with several morphologically very similar species, a problem already pointed out by earlier authors: Hesse (1923) already suspected that the Siberian *Vitrina* species could be conspecific with the European *V. pellucida*, and Forcart (1944) considered the described variants as ecotypes. The result of the investigation is striking in that all specimens from the Holarctic realm revealed almost no genetic differences. The sampling consisted of 93 individuals spanning Europe throughout Siberia to North America. Although the difficulties of conchological and anatomical studies in Vitrinidae prevail, the implication of highly variable genetic markers help to distinguish the selected specimens at species level. Pilsbry (1946) described problems in separating the species of the Nearctic taxa comprising *Vitrina limpida* Gould, 1850, *Vitrina alaskana* Dall, 1905 and *Vitrina angelicae* H. Beck, 1837 from Greenland. Asian taxa were represented by individuals from Siberia and the Kuril Islands, which were considered to be close to *Vitrina exilis* Morelet, 1858 from the southern Kamchatka Peninsula. At least four currently accepted species must be synonymized with *V. pellucida*. This is an interesting example of a rapid expansion of a terrestrial snail species, that developed extraordinary dispersal abilities helping it to invade the northern hemisphere within a few thousands of years, possibly since the Pleistocene. These results suggest that *V. pellucida* uses birds or mammals as vectors for rapid dispersal (Maciorowski *et al.* 2012; Yu *et al.* 2021; Zenzal *et al.* 2017). Another consideration includes dispersal via wind, particularly during strong storms (Ozgo *et al.* 2016). Replication of long gene fragments was challenging in this study, particularly the highly variable ITS1 and ITS2 sequences from very old and mummified material. The morphological study was confounded by shattered shells and hard to access mummified specimens. Designed for this study, a combination of a series of overlapping primer pairs facilitated the production of long gene fragments for the analyses.

## Chapter 3

In this study, selected species of Swiss freshwater bivalves of the family Unionidae Rafinesque, 1820 were investigated and aligned into the modern phylogenetic system of the European unionid fauna. Switzerland possesses a vast hydrological network, providing three major European river basins, the Rhône, the Rhine and the Po with freshwater. Three questions were addressed. First, the distribution pattern of *Anodonta exulcerata* Porro, 1838 in Switzerland. This species was recently recorded in the Swiss part of Lago Maggiore (Froufe *et al.* 2017) and reconstituted as a valid species by Riccardi *et al.* (2020). I show that shell morphology is impossible for distinguishing *Anodonta anatina* (Linnaeus 1758) from *A. exulcerata* while molecular methods work flawlessly for identifying the taxa. Secondly, the identity of the southern and western populations of Swiss *Unio* species has been debatable (Prié & Puillandre 2014). By applying genetic markers, the southern population could be reliably identified as *Unio elongatulus* C. Pfeiffer, 1821 and not *Unio mancus* Lamarck, 1819 as was often purported. This species used to live in north-west Switzerland but has since become recently extinct. This leads to the third question which investigates possible living populations of *U. mancus* in the great lakes and river systems of Switzerland. The genetic analyses using mitochondrial and nuclear markers were performed for 128 specimens from 42 sites in Switzerland. For comparing the Swiss data in a broader geographical context, a selection of sequences from the latest publications (Froufe *et al.* 2017; Klishko *et al.* 2018; Lopes-Lima *et al.* 2021; Marrone *et al.* 2019) was added to the phylogenetic analysis. The results show that *U. mancus* was not found in the 42 sites. However, there may be cryptic populations in the western part of Switzerland such as in the Doubs River drainage system. The dispersal pattern of *U. elongatulus* surprisingly shows that the species overcame the geographical boundaries formed by the Alps and advanced north via the Rhine basin. Finally, the population distribution pattern of *A. anatina* in Switzerland shows that this species splits at least into four subpopulations in the concatenated phylogeny. The taxonomic position of *A. anatina* needs further investigation in the future. This finding enriches and supports previous works concerning *A. anatina* (Froufe *et al.* 2014; Klishko *et al.* 2018).

## Chapter 4

This chapter summarizes my engagement in developing and establishing a wide array of laboratory protocols and bioinformatical procedures within the malacology group at the Natural History Museum in Bern (NMBE). In Bouaziz-Yahiatene *et al.* (2017), a five-marker approach was advised by me to unravel the phylogenetic relationship between *Massylaea* Möllendorff, 1898 and *Eobania* P. Hesse, 1913. A newly modified ITS2 primer pair was developed to molecularly process these North African Helicidae. Consequently, the node values in the phylogenetic tree supported the phylogenetic hypothesis suggested by the anatomical studies. In Ezzine *et al.* (2018), I analysed species boundaries of *Marmorana* (*Murella*) *muralis* (O. F. Müller, 1774) by using Bayesian Inference with MrBayes. In Kneubühler *et al.* (2019), I oversaw MrBayes analyses performed in the HPC cluster at the University of Bern (<http://www.id.unibe.ch/hpc>).

# Phylogenetic position of African Vitrinidae: Old family groups unraveled

Beat Pfarrer<sup>1,2</sup>  | Ben Rowson<sup>3</sup> | Peter Tattersfield<sup>3</sup> | Eike Neubert<sup>1,2</sup>

<sup>1</sup>Department of Invertebrate Animals, Natural History Museum Bern, Bern, Switzerland

<sup>2</sup>Institute of Ecology and Evolution, University of Bern, Bern, Switzerland

<sup>3</sup>Department of Natural Sciences, Amgueddfa Cymru – National Museum Wales, Cardiff, UK

## Correspondence

Beat Pfarrer, Department of Invertebrate Animals, Natural History Museum Bern, Bern, Switzerland.

Email: beat.pfarrer@nmbe.ch

## Abstract

A phylogenetic investigation of genera and species of the semislug family Vitrinidae from Europe, East Africa, Arabia, and Macaronesia is presented. Two mitochondrial markers (*COI* & *16S*) and a set of nuclear markers (*H3* & *ITS2*) were used in maximum likelihood (ML) and Bayesian inference (BI) analyses. The synopsis of DNA sequence data and anatomical data provide a first insight into the phylogenetic relationships of these groups. The existence of major groups comprising European, Macaronesian, and Arabian-African genera is proven, however, their relationship remains unresolved. The sister-group relationship between the Macaronesian radiation and a newly discovered East African genus *Sanettivitrina* nov. gen., perhaps a relic of this radiation, is demonstrated. The separation of the remaining East African Vitrinidae into two clades as hypothesized by earlier authors, viz. *Arabivitrina* Thiele, 1931 and *Calidivitrina* Pilsbry, 1919 could not be confirmed. The hitherto used generic definitions based on genital morphology are not able to explain the existence of at least five lineages in East Africa. Apparently, *Arabivitrina* and *Calidivitrina* morphotypes experienced several parallel losses of genital organ appendices.

## KEYWORDS

Africa, anatomy, Macaronesia, molecular phylogeny, Vitrinidae

## 1 | INTRODUCTION

The family Vitrinidae Fitzinger, 1833 exclusively consists of gastropods in the life form of semislugs with reduced, translucent shells, too small to shelter the complete body of the animal. The family belongs to the superfamily Limacoidea Lamarck, 1801 which includes both snails and slugs (Hausdorf, 2000). The Vitrinidae contains approximately 120 species, with a few widespread taxa in the Holarctic and a considerable number of small-range taxa in the Afrotropics, the Macaronesian Islands, and central Europe (Hausdorf, 2002). North-eastern Africa harbors almost 50 nominal taxa attributed to the family. Their phylogenetic relationships are still insufficiently

explored. Reasons for the still fundamentally unexplored family may lie in the nature of the highly reduced shells of Vitrinidae, from which only a few character states can be retrieved for a phylogenetic analysis. Furthermore, the anatomy of the genital organs offers a number of valuable traits, but due to the fact that in this family no spermatophores are produced, the construction of the male copulatory organ strongly deviates from the classic stylommatophoran bauplan. It also can be misleading if immature specimens were used for the analysis, potentially a problem with small-sized specimens of poorly known species.

After years of remarkable progress in understanding the phylogeny of the Vitrinidae (Alonso et al., 1987; Groh, & Hemmen,

Contributing authors: Ben Rowson (Ben.Rowson@museumwales.sc.uk), Peter Tattersfield (peter@petertat.demon.co.uk), Eike Neubert (eike.neubert@nmbe.ch)

Zoobank link: LSID: <http://zoobank.org/urn:lsid:zoobank.org:pub:C5BEC9BA-9304-479D-A8A9-424C73D0778D>

Online ISSN: 1439-0469

1986; Morales et al., 1988; Schileyko, 1986; Valido et al., 1990, 1993), little has been contributed after the latest hypotheses on Vitrinidae taxonomy (see Alonso et al., 2000; Giusti et al., 2011; Hausdorf, 2002; Schileyko, 2003). The morphological characters used in these leading works could be crucial for any later topology resolution but harbors a potential source of error if characters are not informative or wrongly interpreted. Alonso et al. (2000) evaluated nine morphological characters and their respective states and performed a cladistic analysis of the resulting data matrix. However, they restricted their analysis to five Macaronesian vitrinid taxa, and used another four genera as outgroups. Thus, their results lag behind the broader taxon sampling of the other studies. Schileyko (2003) published a taxonomic treatise over all existing genera, and based his system on an assessment of characters, which did not necessarily follow an evaluation of characters and character states. He subdivided the family into three subfamilies, viz. Plutoniinae, Semilimacinae, and Vitrininae. The phylogenetic hypotheses of Hausdorf (2002) and Giusti et al. (2011) differed in the amount of examined morphological characters (Hausdorf 17 vs. Giusti 25), and the outgroup choice, but both used Maximum Parsimony (MP) as method for the analyses of morphological characters. Although fewer character states were coded in Hausdorf (2002), a clean split between mainland European genera and others was observable. In his discussion, Hausdorf compared the results of his phylogenetic hypothesis with the findings of Schileyko (1986). The subdivisions proposed by Schileyko were not supported: Vitrininae including *Vitrina* (loss of the atrial stimulator) and *Caldivitrina* (loss of the glandula amatoria) was polyphyletic, one taxon falling in a European clade and one in an African clade. Giusti et al. (2011) included more data and varied the outgroup composition resulting in defined data partition sets (DP). In their polytomous DPIII topology, most of the previously accepted groups did not cluster together. Finally, Giusti et al. (2011) rejected all previous classifications of Alonso et al. (2000), Hausdorf (2002), and Schileyko (2003) based on the MP analyses of the DPII and DPIII data trees. It also should be mentioned that neither Hausdorf (2002) nor Giusti et al. (2011) divided the Vitrinidae into subfamilies. The phylogeny of the group is evidently difficult to resolve on morphological grounds alone.

We combine two mitochondrial and two nuclear marker sequences for a deeper understanding of the relationships at the level of genera and subfamilies.

## 2 | MATERIAL & METHODS

The sample consisted of 46 individuals from museums' collections and fresh sampled individuals, preserved in 80% EtOH for later anatomical and genetic analyses. Voucher numbers and GenBank accession numbers are presented in Table 1. Marker sequences are presented in Table 2. The distribution of sampled taxa is displayed in Figure 6.

### 2.1 | Taxon sampling

We sampled as many genera as possible from each biogeographical area, using the nomenclatural type species for each genus where possible. An exception had to be made for *Semilimax semilimax* (J. Férussac, 1802) due to poor preservation, so *Hessemilimax kotulae* (Westerlund, 1883) was used instead. As shown in Table 1 a selection of Macaronesian and mainland European species were chosen from preserved vouchers from the Naturhistorisches Museum der Burgergemeinde Bern (NMBE), the Senckenberg Museum Frankfurt (SMF), the Zoological Collection of the Biology Department, University of the Azores (DBUA), the National Museum of Wales (NMW), the Carnegie Museum of Natural History (CM); the majority of African specimens were also from NMW. To complement mainland Europe and enlarge the test batch, freshly collected specimens from private donors and own collecting trips in the surroundings in Bern, Switzerland were added. Outgroup selection embraced members of other families in the Limacoidea in order to avoid excessive contrasts in the tree resolutions. The selection consisted of *Daudebardia rufa* (Draparnaud, 1805), *Boettgerilla pallens* Simroth, 1912 and *Limax maximus* Linnaeus, 1758.

A GenBank search for previously published Vitrinidae sequences ended with the decision not to use database derived data in this study. Misidentification of species in GenBank can seriously jeopardize the outcome of any phylogenetic analyses. It was preferred to sequence accessible voucher specimens identified by experts in their field in order to guarantee the quality of the results.

In this study, the problem arises that the African vitrinid species have not recently or completely been revised taxonomically. African vitrinid shells cannot be discriminated with certainty from shells of semislugs of the sympatrically existing families Helicarionidae, Ariophantidae, Urocyclidae etc. Thus, several nominal taxa, which even now are only known from shells, are difficult to assign to a family or genus even when they can be identified to species level by comparison to type specimens. In the past, species identified by shells were often allocated to either *Arabivitrina* or *Caldivitrina*, but our results suggest this was often incorrect.

### 2.2 | Anatomy of the genital organs

Preserved animals were dissected under a LEICA stereomicroscope using F.S.T. thin tweezers, and animal and shell (if intact) were studied and compared to all information available from recent literature. The genitalia were removed from the body, the position of the right ommatophore relative to the penial retractor (Giusti et al., 2011) was noted, and afterward the genital situs and further morphological details were investigated. After that, shells, genital situs, and details of the genital organs were photographed under a LEICA M205 C equipped with a LEICA MC190 camera. The multifocal images were processed by using a Leica's in-house software LAS X EDOF (Leica Microsystems).



TABLE 1 Vouchers and GenBank accession numbers

Species	Voucher number	Locality	Latitude	Longitude	Altitude	Gen Bank accession numbers				
						CO1	16S	H3	ITS2	
<i>Boettgerilla pallens</i> Simroth, 1912	NMBE 509975	Switzerland, Grisons, Malix	46.8104	9.5356	1130	-----	MT181329	MT181440	-----	
<i>Limax maximus</i> Linnaeus, 1758	NMBE 561418 NMBE 561417	Switzerland, Bern, Moutier, Eschert Switzerland, Bern, Wabern	47.2754 46.928	7.399 7.4546	596 551	MT181505 MT181504	MT181348 MT181347	MT181462 MT181461	----- MT181387	
<i>Daudebardia rufa</i> (Draparnaud, 1805)	NMBE 561416	Germany, Hessen, Main Taunus, Kelkheim- Eppenhain, Kelkheim Natural Parc	50.1616	8.385	373	MT181499	-----	MT181455	MT181383	
<i>Arabivitrina arabica</i> (Thiele, 1910)	SMF 311601.2	Saudi Arabia, Asir mountain region, Raydah escarpment	18.2039	42.4117	2300	MT181485	MT181323	MT181434	MT181368	
Vitriinae gen. sp. 1	NMW.Z.2019.022.00001A NMW.Z.2019.022.00001B NMW.Z.2019.022.00001D	Sanetti Plateau (site 2) Sanetti Plateau (site 2) Sanetti Plateau (site 2)	6.8491 6.8491 6.8491	39.8927 39.8927 39.8927	4073 4073 4073	MT181511 MT181512 -----	MT181358 ----- MT181357	MT181474 MT181475 -----	MT181394 ----- MT181393	
" <i>Arabivitrina</i> " <i>darnauidi</i> sensu Forcart (L. Pfeiffer, 1857)	NMBE 564353	Ethiopia, Gondar Prov., Semien mts, Sankaber campsite	13.2323	38.0408	3244	MT181486	MT181324	MT181435	MT181369	
<i>Arabivitrina jansseni</i> Neubert, 1998	SMF 311614.1 SMF 311614.2	Saudi Arabia, Asir mountain region, King Khalid descent near Baha Saudi Arabia, Asir mountain region, King Khalid descent near Baha	19.9668 19.9668	41.4855 41.4855	2215 2215	MT181487 -----	MT181325 MT181326	MT181436 MT181437	MT181370 MT181371	
<i>Azorivitrina laxata</i> (Morelet, 1860)	DBUA-00068 DBUA-01377	Portugal, Azores, São Miguel, Algarvia, Ribeira Despe-te-que-suas Portugal, Azores, São Miguel, Abelheira	37.8516 N/A	-25.2221 N/A	100 145	----- -----	MT181327 MT181328	MT181438 MT181439	MT181372 MT181373	
" <i>Caldivitrina</i> " cf. <i>nigrocincta</i> (E. v. Martens, 1897)	NMW.Z.1998.0024.00003	Nou FR, Mbulu Plateau (site IC)	-4.07	35.46	2100	-----	-----	MT181441	MT181374	
" <i>Caldivitrina</i> " <i>ericinellae</i> (d'Ailly, 1910)	NMW.Z.2013.0054.00053	Mt. Kilimanjaro (Podocarpus forest replaced by heathland)	-3.13	37.31	3060	MT181488	MT181330	MT181442	MT181375	
" <i>Caldivitrina</i> " <i>kiboschoensis</i> (d'Ailly, 1910)	NMW.Z.2013.0054.00052A NMW.Z.2013.0054.00052B NMW.Z.2013.0054.00052	Mt. Kilimanjaro (Erica heathland) Mt. Kilimanjaro (Erica heathland) Mt. Kilimanjaro (Erica heathland)	-3.09 -3.09 -3.09	37.31 37.31 37.31	3850 3850 3850	MT181489 MT181490 MT181510	MT181331 MT181332 MT181355	MT181443 MT181444 MT181471	MT181376 MT181377 MT181392	
" <i>Caldivitrina</i> " <i>lactea</i> (Connolly, 1925)	NMW.Z.1998.0018.00001	Castle Forest, Mt. Kenya (siteK3A)	-0.37	37.31	2170	-----	MT181333	MT181445	MT181378	

(Continues)



TABLE 1 (Continued)

Species	Voucher number	Locality	Latitude	Longitude	Altitude	Gen Bank accession numbers			
						CO1	16S	H3	ITS2
<i>Caldivitrina nigrocincta</i> (E. v. Martens, 1897)	NMW.Z.2013.0054.00054A NMW.Z.2013.0054.00054B NMW.Z.2013.0054.00055A NMW.Z.2013.0054.00055B	Mt. Kilimanjaro (Podocarpus forest) Mt. Kilimanjaro (Podocarpus forest) Mt. Kilimanjaro (Podocarpus forest replaced by heathland) Mt. Kilimanjaro (Podocarpus forest replaced by heathland)	-3.18 -3.18 -3.18 -3.18	37.51 37.51 37.44 37.44	2800 2800 2820 2820	MT181491 MT181492 MT181493 MT181494	MT181334 MT181335 MT181336 MT181337	MT181446 MT181447 MT181448 MT181449	MT181379 MT181380 MT181381 MT181382
<i>Caldivitrina ugandensis</i> (Thiele, 1911)	NMBE 564139 NMBE 564140	Kenia, Nyeri, Chania Falls, Aberdare Mts. Kenia, Nyeri, Chania Falls, Aberdare Mts.	-0.45 -0.45	36.17 36.17	3000 3000	MT181495 -----	MT181338 MT181339	MT181450 MT181451	----- -----
<i>Canarivitrina taburientensis</i> (Groh & Valido, 2000)	NMBE 549684 NMBE 549685 NMBE 561419	Spain, Canary Islands, La Palma, Caldera del Taburiente Spain, Canary Islands, La Palma, Roque de Los Cuervos Spain, Canary Islands, La Palma, Garafia	28.6878 28.683 28.7751	-17.9275 -17.8508 -17.9077	1000 1250 1741	MT181496 MT181497 MT181498	MT181340 MT181341 MT181342	MT181452 MT181453 MT181454	----- ----- -----
<i>Eucobresia diaphana</i> (Draparnaud, 1805)	NMBE 2670 NMBE 510118 NMBE 510182	Germany, Merishausen Switzerland, Wallis, Tirtent Switzerland, Varusch, Valle Trubchun	47.7636 46.0579 46.5967	8.6124 7.0012 10.0762	717 1526 2000	MT181500 MT181501 MT181502	MT181343 MT181344 -----	MT181456 MT181457 MT181458	MT181384 ----- MT181385
<i>Insulivitrina lamarckii</i> (A. Férussac, 1821)	NMBE 549704.1	Spain, Canary Islands, Tenerife, Erjos	28.334	-16.7995	950	MT181503	MT181345	MT181459	-----
<i>Madeirovitrina nitida</i> (A. A. Gould, 1847)	NMBE 549667.1 NMBE 549669.1	Portugal, Madeira, Fanal Portugal, Madeira, Ribeiro frio	32.8103 32.7311	-17.1416 -16.8893	1152 1000	MT181506 -----	MT181349 MT181350	MT181463 MT181464	MT181388 -----
<i>Oligolimax annularis</i> (S. Studer, 1820)	EHUMC-2086	Spain, Nafarroa, Beriain	583154	4748921	1450	MT181507	MT181352	MT181468	MT181390
<i>Plutonia atlantica</i> (Morelet, 1860)	DBUA-00599 DBUA-02258	Portugal, Azores, Terceira, Pico Alto Portugal, Azores, São Miguel, Ribeira da Tosquiada	38.7498 37.8015	-27.2165 -25.1466	636 250	MT181508 MT181509	MT181353 MT181354	MT181469 MT181470	----- MT181391
<i>Sanettivitrina scripta</i>	NMW.Z.2019.022.00002A NMW.Z.2019.022.00002B	Sanetti Plateau (site 3) Sanetti Plateau (site 3)	6.8581 6.8581	39.8968 39.8968	4072 4072	MT181513 MT181514	MT181359 MT181360	MT181476 MT181477	MT181395 -----
<i>Hessemilimax kotulae</i> (Westerlund, 1883)	NMBE 4134 NMBE 510137	Switzerland, Pfäffikon, Russikon Switzerland, Grisons Zernez, Val Cluozza	47.4021 46.6587	8.7767 10.1185	620 1835	MT181515 MT181516	MT181361 MT181362	MT181478 MT181479	MT181396 MT181397

(Continues)

TABLE 1 (Continued)

Species	Voucher number	Locality	Latitude	Longitude	Altitude	Gen Bank accession numbers				
						COI	16S	H3	ITS2	
<i>Vitrina pellucida</i> (O. F. Müller, 1774)	NMBE 510181	Switzerland, Varusch, Valle Trubchun	46.5967	10.0762	2000	MT181518	MT181364	MT181481	MT181399	
	NMBE 509708	Switzerland, Bern, Moutier, Eschert	47.2754	7.399	596	MT181517	MT181363	MT181480	MT181398	
	FW 10342	Morocco, Marrakesh-Safi, AlHaouz Province, Imili. S of Aroumd	31.1116	-7.9204	2035	MT181519	MT181365	MT181482	MT181400	
<i>Vitrinobrachium breve</i> (A. Férussac, 1821)	NMBE 549946	Switzerland, Bern, Rüfenacht	46.9241	7.5305	590	MT181521	MT181367	MT181484	MT181402	
	NMBE 549944	Switzerland, Bern, Mettlenweiher	46.9306	7.473	500	MT181520	MT181366	MT181483	MT181401	

Abbreviations: DBUA, Zoological Collection of the Biology Department, University of the Azores; FW, Frank Walther coli; NMB, Naturhistorisches Museum Basel; NMBE, Naturhistorisches Museum der Burgergemeinde Bern; NMW, National Museum of Wales Cardiff; SMF, Senckenberg Museum Frankfurt.

## 2.3 | DNA extraction

Foot muscle snippets, approximately 2 to 5 mm<sup>3</sup> were taken from the specimens with sterile surgical blades in a remote laboratory away from the PCR laboratory under clean conditions. For total genomic DNA extraction, a Qiagen Blood and Tissue Kit (Qiagen cat nr. 69506) in combination with a QIAcube extraction robot (DNeasy Blood Tissue and Rodent tails, standard protocol) was used. A manual extraction in a DNA clean environment by using components of the Qiagen Blood and Tissue Kit were necessary for older specimens. Degradation over time is a persistent concern when working with museum specimens (Jaksch et al., 2016), as was shown by DNA concentration measurements on study specimens by a Qubit 4 Fluorometer (Thermo Fisher Scientific) (Brzobohatá et al., 2017). The decision of including museum specimens is evident: first, expensive collecting trips can be avoided and second, rare or even extinct species can be added to the analysis given that mitochondrial sequences can still be extracted even from old museum specimens (Elias et al., 2007; Puillandre et al., 2012b). Museum voucher specimens also remain accessible to future workers.

## 2.4 | Marker development strategy and primer design

For this study, the following markers were analyzed. Partial sequences of two mitochondrial genes were as follows: (1) the cytochrome c oxidase subunit I gene (*COI*; 710 bp amplicon length); (2) the 16S ribosomal RNA gene (*16S*; 480 bp amplicon length). The two nuclear marker sequences were as follows: (1) a part of the rRNA cluster including part of the 5.8S rRNA gene, the complete internal transcribed spacer 2 and a part of the 28S rRNA gene. The amplicon length of this fragment (hereafter named *ITS2*) was 900 bp. (2) a partial sequence of the histone 3 gene (*H3*; 320 bp amplicon length). (Carmona et al., 2013; Colgan et al., 2007; Gomes et al., 2010; Hausdorf & Sauer, 2009; Neiber et al., 2016; Nekola et al., 2009; Pfenninger et al., 2010; Schultz et al., 2005; Uit de Weerd & Gittenberger, 2013; Wade & Mordan, 2000; Williams & Reid, 2004).

The chosen markers are well known in works covering malacology and possess a useful bandwidth of phylogenetic information (Bouaziz-Yahiatene et al., 2017; Ezzine et al., 2017, 2018). Various primers for each marker gene needed to be used for amplification due to the initial lack of specific Vitrinidae primers and the nature of old museum specimens. *LSU1* and *LSU3* were slightly modified for this work. See Table 2 for primer pairs used in the PCR and sequencing. New primers were designed with the Primer3 V.2.3.4 (Koressaar & Remm, 2007; Untergasser et al., 2012) plugin in Geneious Ver.9.1.8 (Biomatters Ltd.) software package, with additional manual editing.

## 2.5 | PCR amplification

PCRs were conducted with a mix of 12.5 µl of GoTaq G2 HotStart Green Master Mix (Promega M7423), 6.5 µl nuclease

TABLE 2 List of primer pairs used in PCR

Gene	Primer	Sequence (5'-3')	Aprox. amplicon lengths (bp)	References
COI	LCO1490	GGTCAACAAATCATAAAGATATTGG	710	Folmer et al. (1994)
	HCO2198	TAAACTTCAGGGTGACCAAAAAATCA		
	FCOI	ACTCAACGAATCATAAAGATATTGG		Gittenberger et al. (2004)
	ROCI	TATACTTCAGGATGACCAAAAAATCA		
16S	16sF	CGGCCGCTGTTTATCAAAAACAT	480	Palumbi et al. (1991)
	16sR	GGAGCTCCGGTTTGAAGCTCAGATC		
	LR-N-13398 (16Sar)	CGCCTGTTTATCAAA AAC AT		Weigand et al. (2013)
	LR-J-12887 (16Sbr)	CCGGTCTGAAGCTGATCAT		
5.8S-ITS2-28S	LSU-1	CTAGCTGCGAGAATTAATGTGA	900	Wade and Mordan (2000)
	LSU-3	ACTTTCCTCACGGTACTTTG		
	ITS2ModA	GCTTGCGGAGAATTAATGTGAA		This work
	ITS2ModB	GGTACCTTGTTGCTATCGGA		
H3	H3PuIF	GGAGGCAAGGCCCCACGTAARCA	320	Uit de Weerd et al. (2013)
	H3PuIR	TTGGCGTGGATGGCGCACARG		
	H3AD	ATGGCTCGTACCAAGCAGACVGC		Carmona et al. (2013)
	H3BD	ATATCCTTRGGCATRATRGTGAC		

free H<sub>2</sub>O (Sigma-Aldrich, W4502), 1 µl of each primer, and 2 µl template DNA.

The condition for the PCRs were as follows: for COI, the cycling protocol begins with 3 min at 95°C, followed by 35 cycles of 1 min at 95°C, 1 min at 40°C (45°C for FCOI/ROCI) and 1 min at 72°C and finally, 5 min at 72°C. For 16S, the amplification conditions were 3 min at 95°C, followed by 35 cycles of 1 min at 95°C, 1 min at 50°C and 1 min at 72°C, and finally, 5 min at 72°C. For the 16Sar/br primer pair, the conditions were 5 min at 95°C, followed by 34 cycles of 30 s at 95°C, 25 s at 52°C and 45 s at 72°C, and finally, 5 min at 72°C. For ITS2, the cycle conditions were 1 min at 96°C, followed by 35 cycles of 30 s at 94°C, 30 s at 55°C and 1 min at 72°C, and finally, 10 min at 72°C. The PCR conditions for the H3PuIF/R were 3 min at 94°C, followed by 35 cycles of 15 s at 94°C, 30 s at 57°C and 40 s at 72°C, and finally, 1 min at 72°C. For the H3AD/BD pair, 3 min at 95°C, followed by 45 cycles of 45 s at 95°C, 45 s at 50°C and 45 s at 72°C, and finally, 10 min at 72°C. The PCR condition for the new primer pair ITS2ModA and ITS2ModB are virtually the same as for the LSU-1/3 and varies only in the annealing temperature of 43°C.

PCR products were displayed together with a negative control and a 1,000 bp ladder (BenchTop 100 bp DNA Ladder, G8291) in an agarose 1% gel for assessment of quality and primer efficiency. Failures were repeated by applying higher volumes of template and/or changing slightly PCR parameters like temperature or increasing cycles. PCR product purification and sequencing were performed by LGC (LGC Genomics Berlin). Sensitive and old museum specimen sequences were sent for single tube sequencing to Microsynth (Microsynth Balgach Switzerland). A number of unexpected sequence results were checked by reamplification and sequencing or from additional specimens.

## 2.6 | Phylogenetic analyses

Raw sequences were processed and trimmed in Geneious Ver.9.1.8 (Biomatters Ltd.). The MAFFT v.7.222 plugin of Geneious (Katoh & Standley, 2013) was implemented with the L-INS-i algorithm and the 1PAM/k = 2 matrix for alignment of the processed marker sequences. Every generated gene alignment was verified and when needed improved by eye. We excluded positions of unreliable parts of the alignment. Alignment length after editing was as follows (original first MAFFT alignment length in brackets): COI 653 bp (653 bp), 16S 437 bp (462 bp), H3 278 bp (278 bp), and ITS2 with 623 bp (956 bp), summing up to a total of 1991 bp in the concatenated alignment block. The data are downloadable from TreeBASE <http://purl.org/phylo/treebase/phylo/study/TB2:S28034> (Piel et al., 2009; Vos et al., 2012). Test of substitution saturation was assessed by using by Xia's test in DAMBE v.7.058 with default settings (Xia, 2017, 2018; Xia et al., 2003). An editing by applying Gblocks V.0.91b (Castresana, 2000) was suggested with standard settings, which resulted in a reduced size of the alignment: 648 positions, 27% of the original 2349 bp (see Alignment S2). The resulting ML tree (Figure S1) is deposited together with the Alignment S2 in in the supporting information section.

The partition of the 16S and ITS2 fragments was defined for each as a single partition. The protein coding genes COI and H3 fragments were defined each in two partitions: the first two codon positions as one block and the third codon position as a second. Partitionfinder Ver. 2.1 (Lanfear et al., 2016) searched the optimal evolutionary models for the partitions using the corrected Akaike Information Criterion (AICc).

The results of Partitionfinder2 for the assumed partitions suggested GTR+I+G as best fitting model for the analysis in RAxML (Stamatakis, 2006). ML was computed with RAxML by performing

the search for the ML tree and a rapid Bootstrap analysis with 2000 replicates in one single run. Bayesian inference (BI) was performed using Mr Bayes v3.2.2 x64 (Huelsenbeck & Ronquist, 2001; Ronquist & Huelsenbeck, 2003; Ronquist et al., 2012). Partitionfinder2 proposed as optimal evolutionary model GTR+I+G as best fitting model for CO1, 16S, and ITS2 with the exception for the first two codons positions of H3, which was HKY+G and GTR+I for the third codon position of H3, respectively. The Monte Carlo Markov Chain (MCMC) parameter was set as follows: starting with four chains and four separate runs for  $20 \times 10^6$  generations, the temperature set to 0.15, with a tree sampling frequency of 1000 and a burn in of 25%. The effective sample size (ESS) was analyzed by Tracer (Rambaut et al., 2018). The topologies were later displayed on FigTree v1.4.3 (Rambaut, 2012). Both analyses, maximum likelihood and Bayesian inference, were calculated through the UBELIX (<http://www.id.unibe.ch/hpc>), the HPC cluster at the University of Bern.

### 3 | RESULTS

#### 3.1 | Molecular analysis

The substitution saturation assessment for the sequences using Xia's test showed no signs of substantial saturation ( $p = 0.00$ ). Tracer analysis of the separate BI runs showed no anomaly in the ESS scores.

#### 3.2 | Phylogeny

The Bayesian inference tree (BI, Figure 1) shows a similar topology to the Maximum Likelihood tree (ML) (Figure S1). The only differences are to be found in the "*Calidivitrina*" clade where the position of the three main clusters is switched, indicated by asterisks in the nodes.

The family Vitrinidae is monophyletic in both analyses (PP = 1, BS = 78%). Of the selected outgroups, the family Limacidae (*Limax maximus*) is found to be most closely related to the Vitrinidae (PP = 1 BS = 80%). Within the Vitrinidae, there are several major clades of genera, each with a strong biogeographic basis.

The clade of the continental European genera (Figure 1, A1) *Eucobresia* H. B. Baker, 1929, *Vitrina* Draparnaud, 1801, *Oligolimax* P. Fischer, 1878, *Hessemilimax* Schileyko, 1986, and *Vitrinobrachium* Künkel, 1929 is resolved in both analyses (PP = 1, BS = 74%).

The Macaronesian genera (Figure 1, A2) *Azorivitrina* Giusti et al., 2011, *Insulivitrina* P. Hesse, 1923, *Canarivitrina* Valido & Alonso, 2000, *Plutonia* Morelet, 1864 + *Madeirovitrina* Groh & Hemmen, 1986 form a clade strongly supported in both analyses (PP = 1, BS = 83%). Within the clade, highly similar topologies from each tree support subclades of *Azorivitrina* + *Insulivitrina* (PP = 1, BS = 96%), and *Canarivitrina*, *Plutonia* + *Madeirovitrina* (PP = 0.98, BS = 79%). Thus, Azorean and Canarian genera occur in each of these clades. The genera *Plutonia* + *Madeirovitrina* show a sister-group relationship (PP = 0.92, BS = 75%).

Notably, a new African genus from Ethiopia, described here as *Sanettivitrina* nov. gen., is supported as the sister to the entire Macaronesian radiation (PP = 1, BS = 90%). The phylogenetic analyses recovered a clade uniting the Macaronesian + *Sanettivitrina* nov. gen. + the European genera, but without statistic support (PP = 0.75, BS = 50%). However, the support is not strong and the branch leading to this clade is short.

The Arabian and African genera, *Arabivitrina*, "*Calidivitrina*" and Vitrinidae gen. sp. 1, form a clade strongly supported in both analyses (PP = 1, BS = 99%). An African species, "*Calidivitrina*" *kiboschoensis* (d'Ailly, 1910), forms the sister group (Figure 1, B1) to the rest (PP = 0.78, BS = 62%). Neither "*Arabivitrina*" nor "*Calidivitrina*" are restricted to a single clade. The two Arabian species, *Arabivitrina arabica* (Thiele, 1910) (on which the genus *Arabivitrina* is based) + *Arabivitrina jansseni* Neubert, 1998, are sister to one another (PP = 1, BS = 100%), and are nested in a clade (Figure 1, B2) consisting otherwise completely of African taxa (PP = 1, BS = 99%). Thus, the Arabian lineage is monophyletic, the whole clade can be termed an Arabian-African radiation. The next East African clade is presented by the number B3. Differences in position between BI and ML are depicted by an asterisk in Figure 1. "*Arabivitrina*" *darmaudi* sensu Forcart forms a cluster together with Vitrinidae gen. sp. 1 (Figure 1, B3) (PP = 0.97; BS = 65%), "*Calidivitrina*" *ericinellae* (d'Ailly, 1910) clusters together with "*Calidivitrina*" *lactea* (Connolly, 1925) and "*Calidivitrina*" *ugandensis* (Thiele, 1911) (Figure 1, B4) (PP = 0.87; BS = \*). Here, we observe a topological change for "*Calidivitrina*" *lactea* which splits basally causing the asterisk in the ML values. "*Calidivitrina*" *nigrocincta* (E. v. Martens, 1897) and "*Calidivitrina*" cf. *nigrocincta* (E. v. Martens, 1897) form an unsupported group (Figure 1, B5) (PP = 0.58; BS = 17), a position switch for "*Calidivitrina*" cf. *nigrocincta* causes the indicated asterisk at (PP = 0.65; BS = \*).

### 4 | DISCUSSION

#### 4.1 | Phylogeny and topological hypotheses

Comparing the phylogenetic topologies of Hausdorf (2002) and Giusti et al. (2011) with the phylogenetic trees presented here, the molecular tree resolves at least four clades at the base of the Vitrinidae. Due to relatively low node values, their interrelationship is not sufficiently supported. A separation of mainland European genera from the Macaronesian radiation can be found (A subdivided as A1 and A2); the Arabian/African clade (B) subdivided in B1, B2 and B3 is opposite to the European/Macaronesian (A) clade. The current subdivision of the Vitrinidae into two subfamilies is not verified; one alternative could also be a subdivision in three subfamilies. More research and more data (i.e. more specimens) is needed to improve the resolution of the tree.

The early split of *Eucobresia* off the European cluster conflicts with the previous hypotheses of Giusti et al. (2011). In Giusti's system, *Eucobresia diaphana* (Draparnaud, 1805) + *nivalis* + *glacialis* formed part of a polytomy for their DPIII dataset, and in DPII,

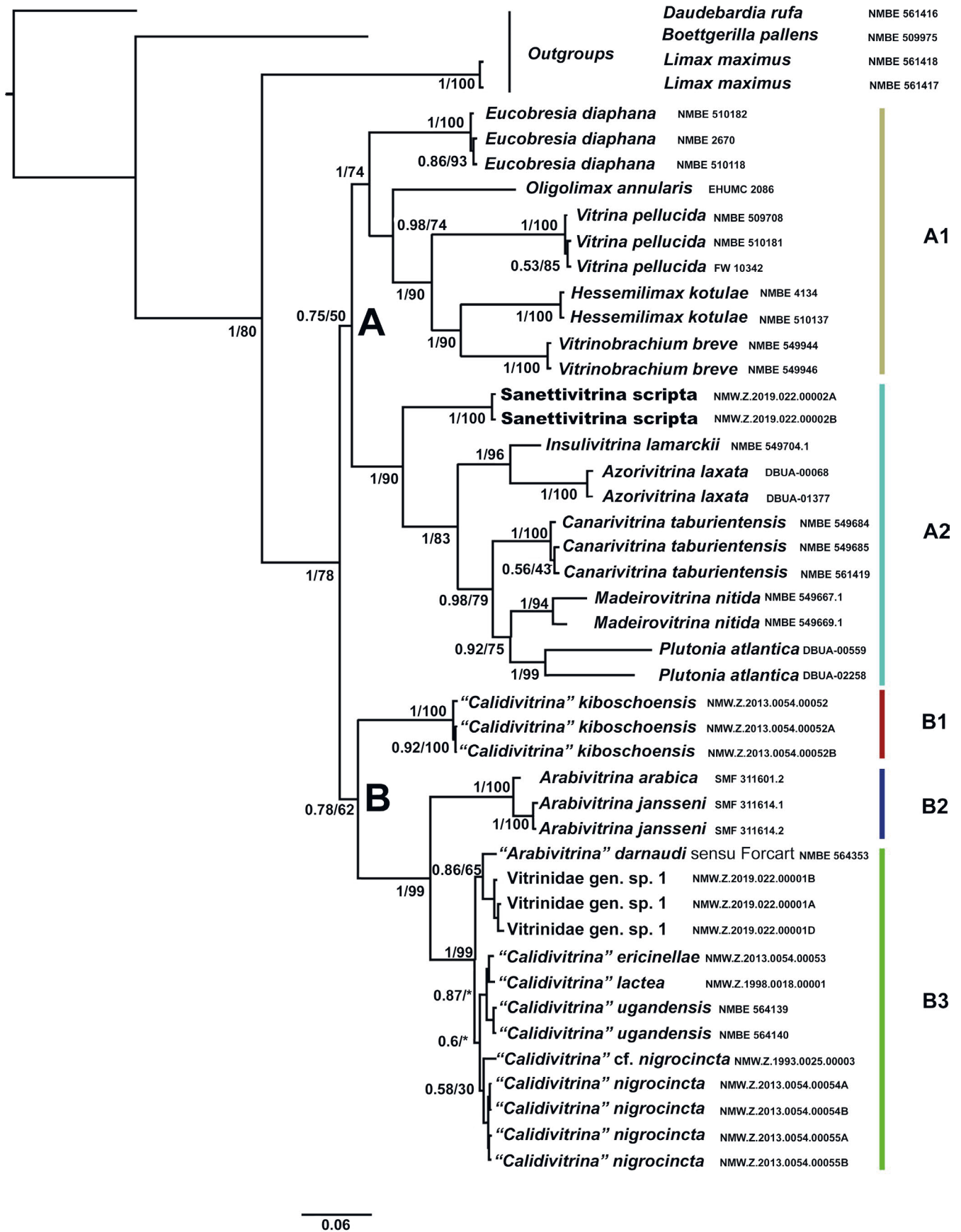

FIGURE 1 Phylogenetic tree obtained by Bayesian inference (BI) based on the analysis of combined CO1, 16S, H3, and ITS2. Posterior probabilities (right) from Bayesian inference and bootstrap support values (left) from maximum likelihood analysis are indicated at the nodes. Asterisks indicate a topological conflict between BI and ML trees (see main text). A = European/Macaronesian clade, B = Arabian/African clade, B1–B3 African lineages



*Eucobresia diaphana* splits off early from all Vitrinidae. In our dataset, *Eucobresia* forms part of the European group. Hausdorf's analysis (Hausdorf, 2002) placed *Eucobresia* between the European and African/Macaronesian clades.

The position of *Oligolimax* is clarified in both our trees it groups with other European genera, while Alonso et al. (2000) postulated it to be a member of other groups, where *Gallandia* (= *Oligolimax*) clustered with *Arabivitrina* and their Macaronesian clade. The position of *Oligolimax* among non-European genera is also observable in the work of Hausdorf (2002), where it was sister group to *Plutonia*. *Oligolimax* definitely forms part of our European clade, although its phylogenetic relationship to *Sardovitrina* needs further investigation when additional species can be sampled.

The Macaronesian clade is represented by two main groups: the *Madeirovitrina nitida* (A. A. Gould, 1847) + *Plutonia atlantica* (Morelet, 1860) + *Canarivitrina taburientensis* (Groh & Valido, 2000) clade versus the *Azorivitrina laxata* (Morelet, 1860) + *Insulivitrina lamarckii* (A. Férussac, 1821) clade. Interestingly, *Azorivitrina laxata* seems to be more closely related to *Insulivitrina lamarckii* than to its geographical neighbour *Plutonia atlantica*. *Canarivitrina taburientensis*, which is a local endemic species from La Palma Island, forms a clade with *Plutonia* and *Madeirovitrina*, representatives of more remote islands of the Macaronesian archipelago. These findings are in conflict with the results of Guisti et al. (2011) in their DPIII tree topology, where *Plutonia atlantica* and *Canarivitrina taburientensis* + *Canarivitrina dianae* (Valido & Alonso, 2000) do not form a clade with the rest of the Macaronesian taxa at all.

These findings reopen questions on the reclassification of the Macaronesian genera made by Alonso et al. (2000). Furthermore, the topology suggests two possible independent colonization events for the Azores by the Vitrinidae from the older Macaronesian Islands, in the last 8 Ma years since the emergence of the Azorean Islands (França et al., 2003). To assess the certainty of the relationships, colonization and generic classification more data is required, which will be implemented in a future publication for the Macaronesian Islands. The newly discovered *Sanettivitrina scripta* nov. gen. nov. sp. stands out being currently the sister group to the remaining taxa in the Macaronesian clade. The split is remarkably distant from the Macaronesian core group, so probably indicates an ancient split-off from a proto-Macaronesian lineage in the Neogene. Actually, the morphology of the genitalia shows a glandula amatoria with a papilla, displaying the genital organs of the *Arabivitrina* type and additionally showing a high anatomical congruency with several Macaronesian genera. This similarity may have been the root for the hypothesis made by Neubert (1998), who postulated a closer relationship between *Arabivitrina* and *Insulivitrina*. This hypothesis is here rejected. Forcart (1959) hypothesized that *Arabivitrina*, *Insulivitrina* and *Phenacolimax* developed independently from ancestor forms; thus, he already observed the phenomenon of convergent evolution in the genital apparatus of the Vitrinidae.

The Arabian/African (B) clade and its subclades B1, B2, and B3 need further attention. All sequenced and dissected specimens are tentatively identified by comparison to the type specimens, where

available. Surprisingly, we only find two basic types of genitalia in the Arabian-African radiation, that is, the *Arabivitrina* type (a huge glandula amatoria present), and the *Calidivitrina* type (glandula amatoria missing), but at least five genetically rather well supported clades in eastern tropical Africa. Unfortunately, we could not include any topotypic specimen of the type species of *Calidivitrina* (Pilsbry, 1919), *Calidivitrina oleosa* (E. v. Martens, 1895) in our study. This means we are unable to determine to which of our clades with the *Calidivitrina* type of genital organs the name could be applied. In Africa, the genera "*Arabivitrina*" and "*Calidivitrina*" are polyphyletic, and yet we have not been able to trace any additional character states in the genital organs that could serve to resolve this problem. Given the fact that we have sequenced only 10 species out of 50 potentially valid African vitrinid species in our study, and large areas of northern Ethiopia and Eritrea remain unknown, the phylogenetic structure of the family in the area seems to be much more complicated than the two-type model of genitalia suggests.

These findings require new criteria of classification for these genera. Independent losses of the glandula amatoria from their common ancestor may have led to this situation today. Both BI/ML trees show five distinguishable lineages as shown in Figure 1.

Lineage B1: contains "*Calidivitrina*" *kiboschoensis* (d'Ailly, 1910). (Figure 2a-d) Genital organs of *Calidivitrina* type, similar to the description of "*C.*" *kiboschoensis* by Hubendick (1953).

Lineage B2: contains the type species of *Arabivitrina*, *Vitrina arabica* Thiele, 1910 and the holotype of *Arabivitrina jansseni* Neubert, 1998. Both cluster together and define the position of the genus *Arabivitrina*. Many other East African taxa inhabiting the Eritrean and Ethiopian area have been allocated to *Arabivitrina*, usually based on anatomical details, and without any genetic data. Lineage B2 is distinct from the East African taxa included in this study, so we currently consider the genus *Arabivitrina* to be restricted to the Arabian Peninsula. *Arabivitrina* genital anatomy is mainly characterized by a large glandula amatoria and a penial glandular torus as defined by Forcart (1957), which was named the major pilaster by Neubert (1998).

Lineage B3: contains several species and is representative for the radiation of the High Simien Mountain range in Ethiopia. The first species displays genital organs of *Arabivitrina* type; our specimen corresponds to the species identified by Forcart (1957: plate 2, Figure 2) as *Phenacolimax* (*Arabivitrina*) *darnaudi* (L. Pfeiffer, 1857); he selected a lectotype for this species in the British Museum from the Cuming collection (Forcart, 1957: 119) (Figure 3a). This specimen only roughly corresponds to our (and Forcart's specimens) (compare Figure 3a and b). The shells differ in the size of the last whorl and the subsutural sculpture. Subsequently, this taxon is called "*Arabivitrina*" *darnaudi* sensu Forcart, 1957, and the original picture of the situs of its genital organs is shown (Figure 3f). It originates from the High Simien area in the Gondar province and displays genital organs of the *Arabivitrina* type. Although anatomically indistinguishable from *Arabivitrina*, the phylogenetic analyses suggest the High Simien specimens' position to be close to the probable *Calidivitrina* clades.

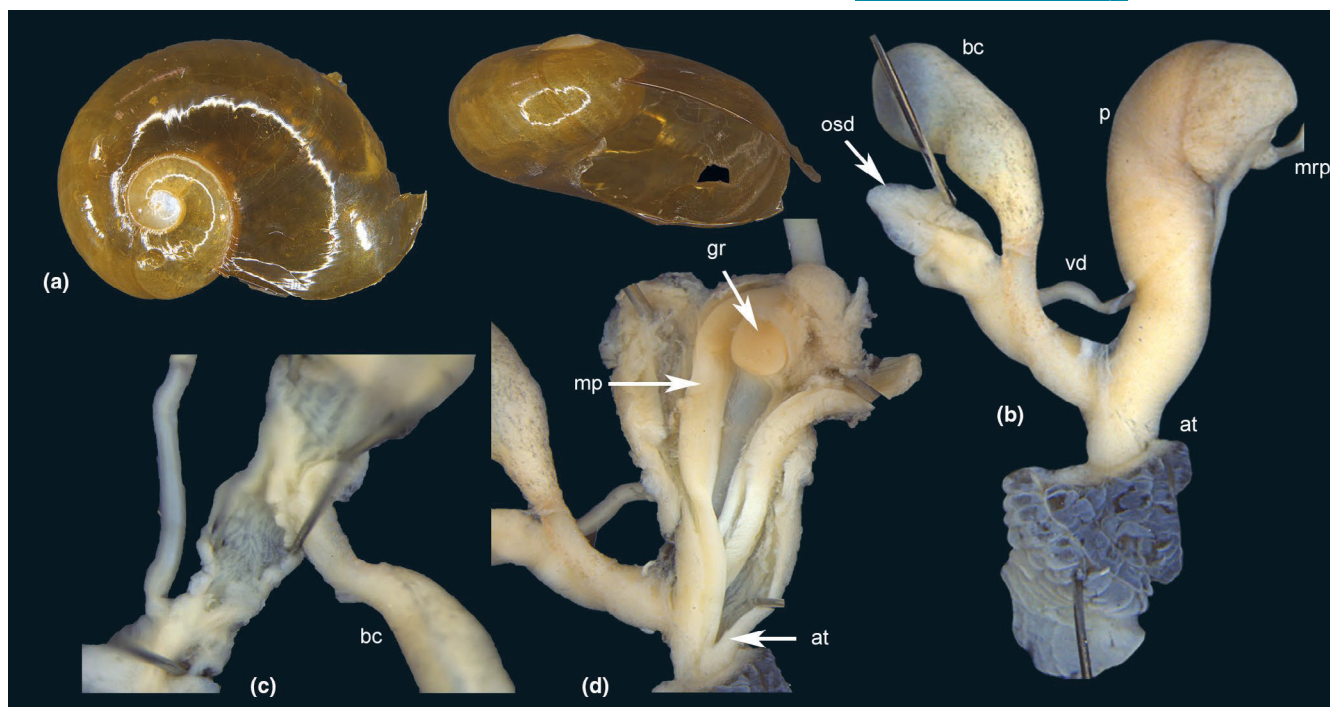

**FIGURE 2** *Calidivitrina*-type of genital organs. (a) "*Calidivitrina*" *kiboschoensis*, NMW.Z.2013.0054.00052, Mt. Kilimanjaro, Erica heathland, shell diameter = 10.2 mm, (b) situs of genital organs, (c) female part of genital organs, (d) 1c penis opened to show internal structures. Abbreviations used: at = atrium; bc = bursa copulatrix; gr = glandular roll; mp = main pilaster; mrp = musculus retractor penis; osd = ovospermiduct; p = penis; vd = vas deferens

An unidentified species Vitrinidae gen. sp. 1 with the *Arabivitrina* type of genital organs forms the sister species to "*Arabivitrina*" *darnaudi* sensu Forcart. It shares the basic genital bauplan of an *Arabivitrina* type but has a rather different shell form and genital appearance from *Phenacolimax* (*Arabivitrina*) *darnaudi* (Figure 3g–j).

The vitrinid radiation of the High Simien was described by Forcart (1957), and embraces two other, conchologically clearly different species, both with genital organs of the *Arabivitrina* type. Comparison of the preserved genital organs on Forcart's slide (NMB 5812) (Figure 3f) from the region of Aostagheb on the south slope of Ambaras, with our examined specimens showed a high congruency in character states: the conical shape of the penis with a knob-shaped tip, the relaxed straight and elongated vagina and the slender glandula amatoria.

The next lineages in B3 comprise specimens from central to east Africa: Uganda, Kenya, and Tanzania. They all share the *Calidivitrina* genital type as described by Pilsbry (1919) for *Calidivitrina oleosa* (E. v. Martens, 1895): a slender elongated vagina, absence of the glandula

amatoria, penis large compared to the vagina, bursa copulatrix prominent. The resolution of the clade consisting of "*Calidivitrina*" cf. *nigrocincta*, "*Calidivitrina*" *lactea*, "*Calidivitrina*" *nigrocincta*, "*Calidivitrina*" *ericinellae*, and "*Calidivitrina*" *ugandensis* is not deep: a clear distinction of the species is possible but the short branch lengths might indicate recent speciation. This newly found lability in the genital morphology may mean that a separation based on morphological traits is even more difficult. Giusti et al. (2011: 351, Figs. 88–90) described in detail the genital organs of a *Calidivitrina* species, which they identified with doubts as *Calidivitrina oleosa*. However, this species was described by E. v. Martens (1895) from the summit of the Ruwenzori Mts. (Congo), which is ca. 300 km away from the locality their specimen came from, Cherangani near Kitale in Kenya. The dissected species may instead be *Calidivitrina variopunctata* Connolly, 1931 or *Calidivitrina baringoensis* E. A. Smith, 1894. Unfortunately, we had no topotypical *Calidivitrina oleosa* available, so the correct identification of the *Calidivitrina* clade remains impossible for the moment.

**FIGURE 3** *Arabivitrina*-type of genital organs. (a–f) *Calidivitrina darnaudi* L. Pfeiffer, 1857. (a) lectotype *Vitrina darnaudi* L. Pfeiffer, 1857, NHMUK 1977.58, shell diameter = 15.4 mm, and original label from the Cuming collection reading "Sennaar interior of Africa, Mon. Darnaud"; (b) "*Arabivitrina*" *darnaudi* sensu Forcart, 1957, High Simien, NMBE 564353, shell diameter = 10.2 mm, (c) situs of genital organs, (d) penis opened to show internal structures, (e) female part of genital organs; (f), original anatomical slide of Forcart (1957: Figure 2), NMB 5182a; (g) Vitrinidae gen. sp. 1, Sanetti Plateau (site 2), shell diameter = 8.6 mm, (j) situs of genital organs, no. 3h penis opened to show internal structures, (i) female part of genital organs. All shells  $\times 5$ , situs  $\times 10$ , details not to scale. Abbreviations used: at = atrium; bc = bursa copulatrix; gr = glandular roll; mp = main pilaster; mrp = musculus retractor penis; osd = ovospermiduct; p = penis; vd = vas deferens

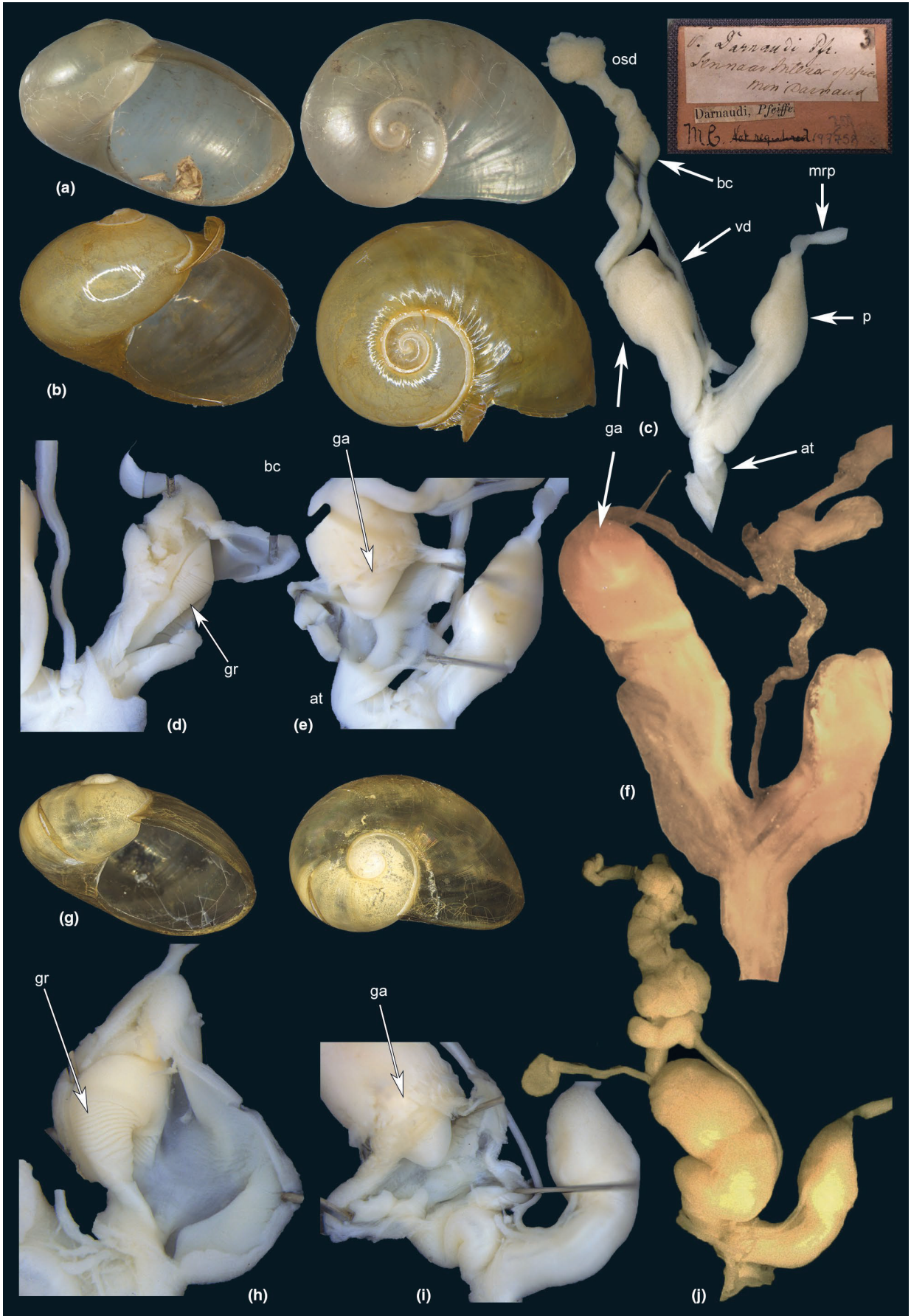



This topology is explained by insufficient observable character states of the genital organs, despite our detailed dissections. We hypothesize that the lineages observed represent multiple genera, each following the one or the other basic type of genital morphology. This means that the reduced *Calidivitrina* type occurs twice, and *Arabivitrina* type three times in the trees if we consider *Sanettivitrina* as an African example of this genital type. Overall, our taxon sampling is too small to resolve the problems at the moment, and more mature and well-preserved specimens collected at the type localities of nominal taxa are needed to find differentiating traits.

## 5 | TAXONOMIC IMPLICATIONS

### *Sanettivitrina* new genus.

ZooBank ID: B61A32CD-AE44-442F-8C47-0846AF0FBFEE.

Type species: *Sanettivitrina scripta* new species.

Diagnosis: As for the type species.

Etymology: From the Sanetti Plateau and the genus *Vitrina* (the “glass” or “vitrine snails”).

### *Sanettivitrina scripta* new species.

Figure 4, Figure 5a-d

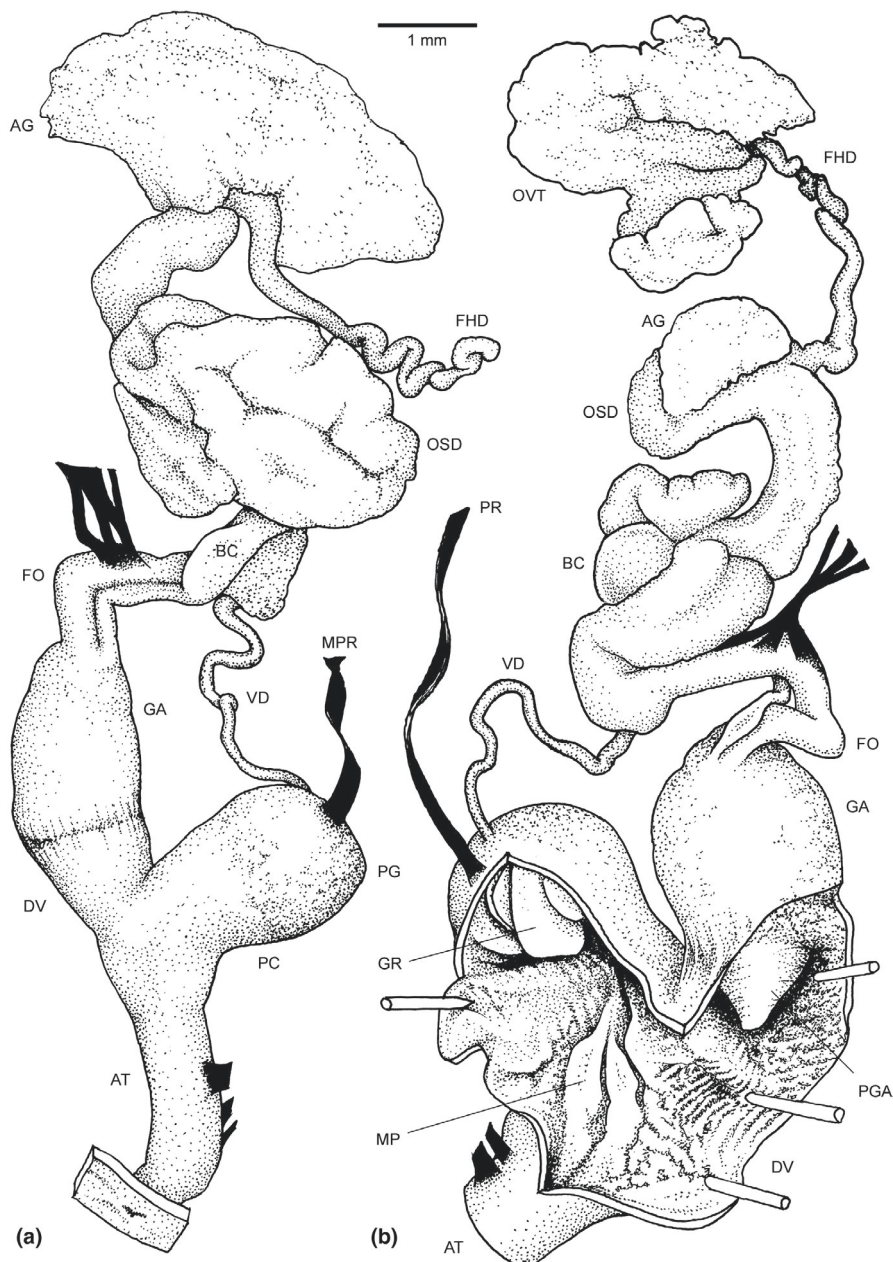

**FIGURE 4** Genital organs of *Sanettivitrina scripta* nov. gen. nov. sp. (a) situs, outer morphology of the genital organs; (b) morphology of male and female lumen. Abbreviations of the genital organs: AG = albumen gland; AT = atrium; BC = bursa copulatrix; DV = distal vagina; FHD = free hermaphroditic duct; FO = free oviduct; GA = glandula amatoria; GR = glandular roll; MP = main pilaster; MRP = musculus retractor penis; OSD = ovospemiduct; OVT = ovotestis; PC = penial complex; PG = penial gland; PGA = papilla of glandula amatoria; VD = vas deferens



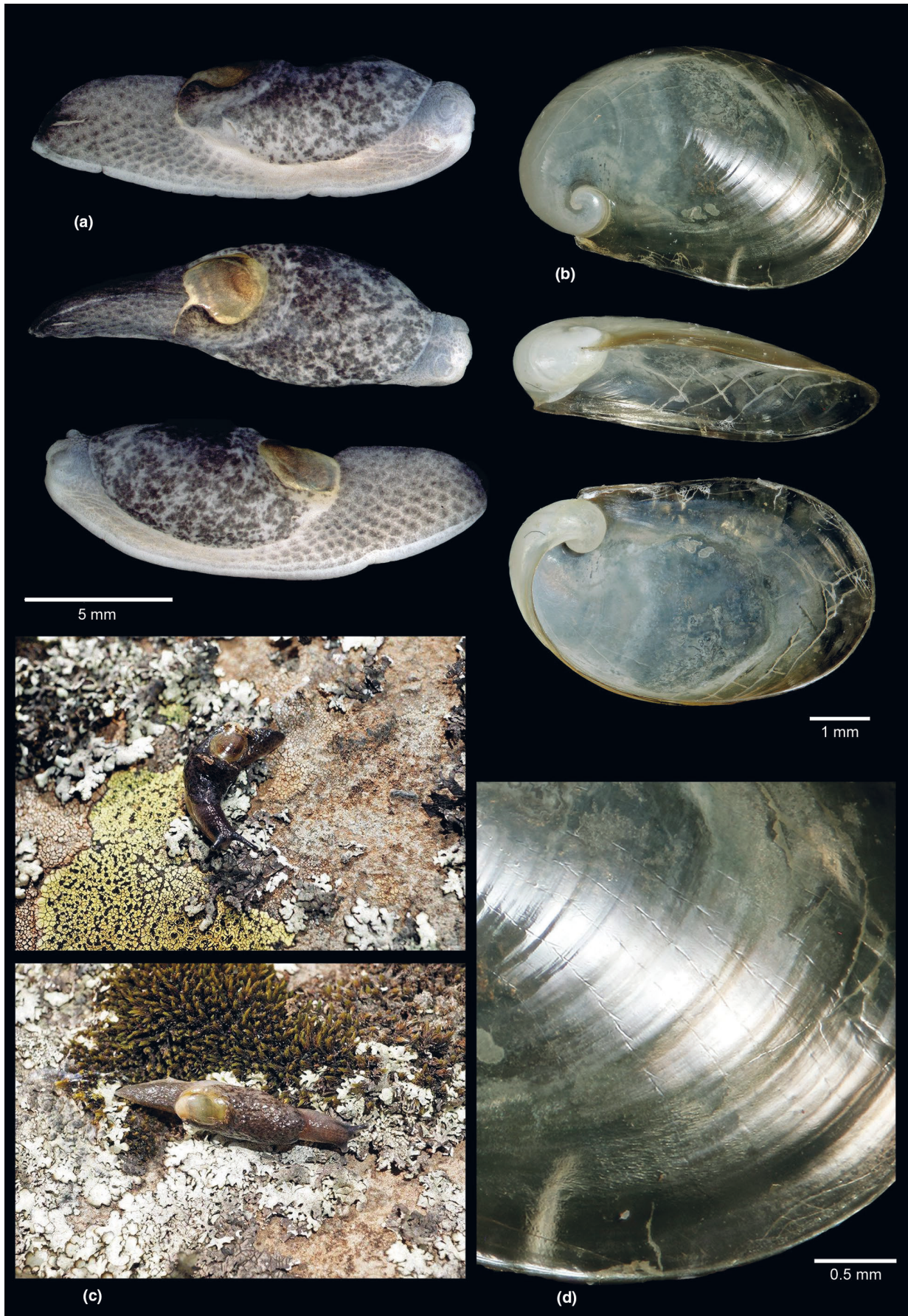

**FIGURE 5** *Sanettivitrina scripta* nov. gen. nov. sp. (a) body of preserved holotype specimen, NMW.Z.2019.022.00002 with mantle lobe covering the lower part of the shell; (b) shell of holotype, shell diameter = 6.0 mm; (c) actively crawling animals in their habitat on lichen; (d) details of upper surface of anterior edge of shell showing the characteristic markings on the shell's surface

Material examined: Holotype (adult animal in ethanol, NMW.Z.2019.022.00002): ETHIOPIA, Bale Mountains National Park, Sanetti Plateau, Afroalpine grassland at 4072 m elevation, 6.85815 N, 39.89685 E (Site 3), 11 December 2015, leg. P. Tattersfield, Awal Mohamed, Fekrudin Kedir. Paratype 1 adult animal in ethanol, NMW.Z.2019.022.00002, data as holotype. Paratype 2 adult animal in ethanol, NMW.Z.2019.022.00002, data as holotype.

**Etymology:** From Latin scripta (writing, papers, or letters), used as a noun in apposition, with reference to the sequences of notch-like marks on the shell.

**Diagnosis:** A strongly limacized vitrinid semislug with a dish-shaped shell of 1.5 whorls, bearing spiral rows of notch-like markings. Genitalia with glandula amatoria and an associated papilla.

**Habitus:** A strongly limacized semislug, approximately 20 mm long when crawling. Shell well-covered by mantle, apex covered by short, spatulate right mantle lobe. Rear of shell covered by anterior part of tail, into which shell and pallial organs substantially sunk. Tail keeled. Pneumostome in posterior quarter of mantle. Head-foot light brown-grey, with tips of tubercles and ommatophores dark blue-grey; mantle blue-grey with dark grey speckles; pallial organs yellowish.

**Shell:** Of 1.5 whorls, dish-shaped, strophostyl, very fragile, corneous, and almost transparent. 6.0–6.2 mm × 4.0–4.4 mm, last whorl occupying 75% of longest shell dimension. Palatal margin weakly mineralized, basal margin with a fringe of periostracum. First whorl with abundant minute pits in spiral sequences. Last whorl with about 10 very delicate spiral sequences of incised notch-like marks (resembling cuneiform script or a bird's footprints) almost reaching the palatal margin.

**Genitalia** (Figure 4a,b): Bursa copulatrix pyriform, duct bound to free oviduct and body wall by muscle strands. Vagina long, proximal half occupied by glandula amatoria (vaginal stimulator) with extensive external glandular covering and conical, muscular papilla internally. Distal half of vagina weakly rugose. Penis (penial complex) club-shaped, shorter than vagina, with sparse glandular covering over about half of external surface. Penial sheath (tunica) absent; vas deferens free, entering penis apically. Penial retractor obtaining from diaphragm, attached to penis apically, near vas deferens. Penis internally with a large proximal glandular roll, flanked by parallel smaller pilasters (alternatively, all could be considered a single, strongly pleated and globular pilaster). Distal penis with pilasters continuing into atrium. Atrium long, tubular, bound to body wall. Right ommatophore retractor passes over penial retractor, but under both penis and vagina (cf. Figure 3 of Giusti et al., 2011).

**Remarks:** This genus is unmistakable in the Afrotropical fauna in its shell shape and sculpture, and body form. The lack of a caudal pore readily distinguishes vitrinid semislugs from Urocyclidae. No remotely similar shells are shown in earlier papers (Jickeli, 1873; v. Martens, 1897; Thiele, 1911, 1933; Hubendick, 1953; Forcart, 1957, 1978; Neubert, 1998; Verdcourt, 2005) or other works. The spoon-shaped and strophostyl shell of fewer than 2.0 whorls is instead superficially similar to non-African taxa, namely the European *Eucobresia*, *Semilimax*, and *Vitrinobrachium* (Welter-Schultes, 2012)

and certain Macaronesian species including the fully limacized *Plutonia atlantica* (Morelet, 1860). The Ethiopian lineage is here shown to be phylogenetically distant from all these. Furthermore, the notch-like markings on the shell have not been noted in any other species of the Vitrinidae.

The genitalia resemble those of several vitrinid genera (including the Afrotropical *Arabivitrina*, the Macaronesian genera, and *Oligolimax*) in having a glandula amatoria with a papilla, and lacking a penial sheath (Hausdorf, 2002, Figure 2g,h,i therein; Giusti et al., 2011). The glandula amatoria is absent from the Afrotropical *Calidivitrina* and in the Palearctic genera with strophostyl shells. The position of the genitalia relative to the ommatophore retractor corresponds to that seen in adult and juvenile *Calidivitrina* and juvenile *Arabivitrina* (see discussion in Giusti et al., 2011). Hubendick (1953) found a glandula amatoria only in *Vitrina neumanni* Thiele, 1933 from southern Ethiopia and in an unidentified Ugandan species later considered an *Arabivitrina* (Forcart, 1978). Forcart (1978) and Verdcourt (2005) reported additional species of *Arabivitrina* from Ethiopia. They were unable to trace Hubendick's Ugandan material, but Hubendick did not mention an unusual shell or body form, features which would have been almost impossible to overlook. The elevated Sanetti Plateau supports a large area of distinctive, isolated, and relatively intact Afroalpine habitat, whose biota includes a number of endemics so it appears the new taxon is endemic to Ethiopia, perhaps even to the plateau itself. Although the shell is not permanently covered by the mantle, the reduced spire, broadened body whorl, and recession of the shell into the tail, are hallmarks of the process of limacization (Solem, 1974). On the genital and biogeographical evidence, the new species could be considered a member of *Arabivitrina* that had undergone further change. However, the phylogenetic results indicate that it is not nested within either *Arabivitrina* or *Calidivitrina* (unlike *Plutonia atlantica*, which is nested in the Macaronesian clade). The extent of limacization in unrelated lineages suggests either multiple instances of limacization, or its widespread reversal. The former is highly plausible since numerous independent cases of limacization are known among the Stylommatophora (Wade et al., 2006). Under the model of Hausdorf (2001), competition with true slugs has influenced vitrinid evolution. Slugs of the families Agriolimacidae and Urocyclidae occur in Ethiopia, but mainly below Afroalpine elevations (Van Goethem, 1977; Wiktor, 2000). If such competition is avoided on the Sanetti Plateau, it could have permitted the limacization of a vitrinid lineage to a greater extent.

## 6 | CONCLUSIONS

In this work, the existence of the split between the European/Macaronesian (A) and Arabian/African (B) clade is visible, but not sufficiently supported by the node values. The previous view of two subfamilies present in the Vitrinidae viz. the Vitrinae and Plutoniinae is not unambiguously corroborated; other concepts may be necessary after addition of more species and specimens in the



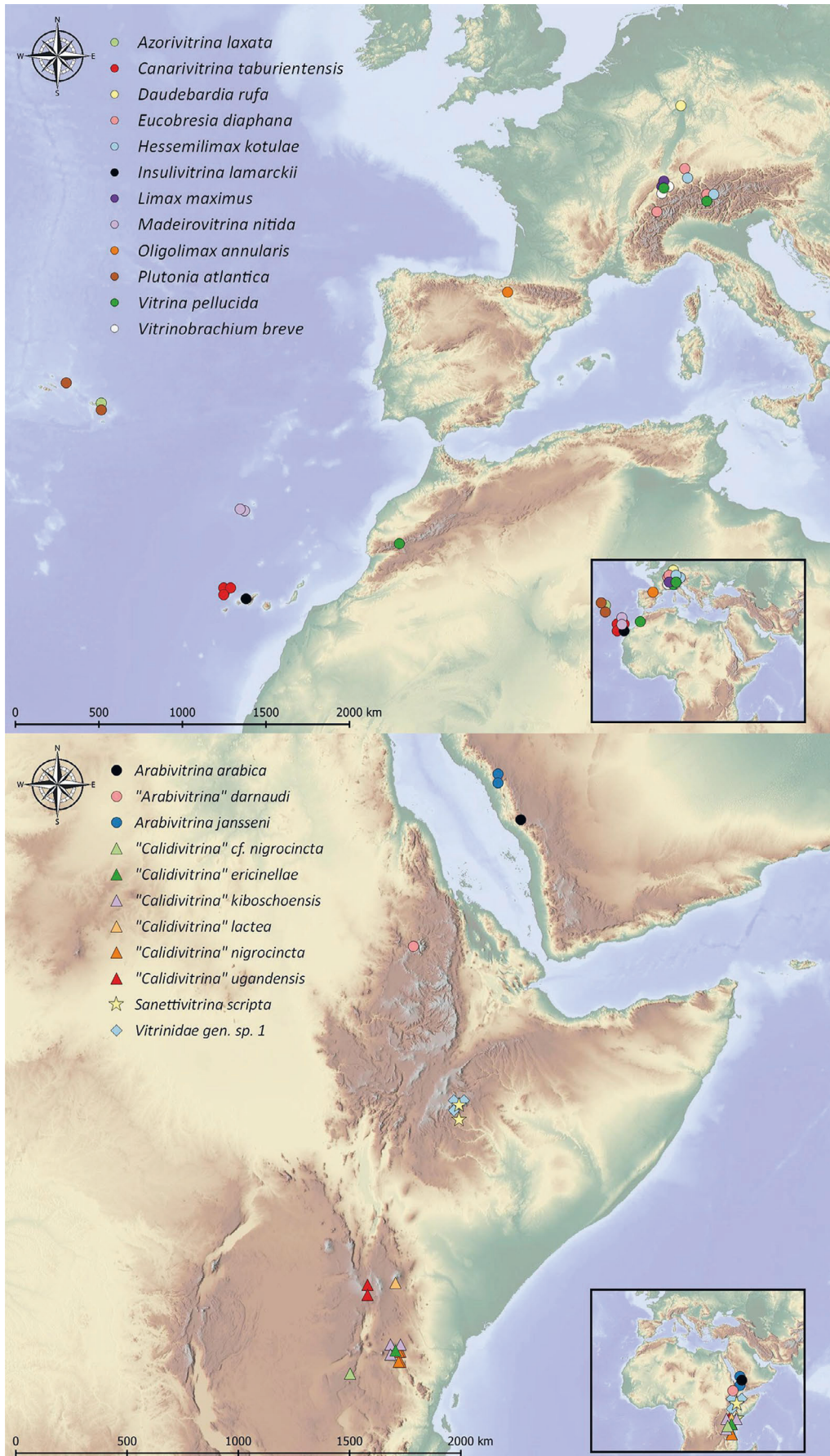

FIGURE 6 Map showing the geographic distribution of all samples included in the study

analysis, and application of more powerful data acquisition methods like Next Generation Sequencing. In contrast to earlier concepts, the position of *Oligolimax* in Vitrininae is corroborated. The phylogenetic hypothesis developed by Giusti et al. (2011) could not be reconfirmed.

Hausdorf postulated (Hausdorf, 2001, 2002) that the Vitrinidae might have originated from a vicariance event in the area between Central Europe and the Near East, defining this region the ancestral area. The biogeographical scenario for the Arabian malacofauna described by Neubert (1998) fits well into this model with a Near Eastern-European ancestral area hypothesis for the Vitrinidae. This hypothesis assumes that in the early Miocene, the ancestor of the Arabian taxa was able to invade Arabia via the Red Sea mountain belt. This was made possible through the *Gomphotherium* landbridge (Harzhauser et al., 2002, 2007; Rögl, 1999), which connected the Eurasian and Afro-Arabian plate. It emerged during the mid-Burdigalian (approx. 18 Ma) and initiated an exchange of European and African animal species. Neubert's hypothesis (Neubert, 1998) is not falsified nor verified by our results, but it may explain the current situation in the Arabian/African (B) clade in Figure 1. The separation of the East African Vitrinidae into two major clades as hypothesized by earlier authors, viz. *Arabivitrina* Thiele, 1931 and *Calidivitrina* Pilsbry, 1919, could not be confirmed. According to the currently available genetic data, *Arabivitrina* is restricted to the Arabian plate (Figure 6). The hitherto used morpho-based generic definitions are not able to explain the existence of at least five genetic lineages. Our data suggest that the central-east African clades (especially lineage B4) are result of a rather young radiation. One possible explanation for our observation on the *Arabivitrina* (Figure 3c) and the *Calidivitrina* (Figure 2b) genital types is that the loss of the glandula amatoria occurred several times in the family. This is surprising, because this simplification deeply changes the organization of the reproductive organs. We expect such a conversion being regulated by several genes rather than by a single gene, which lowers the probability of such a mutation. A similar situation is found within the European Vitrinidae. The genital organ bauplan either displays a fully developed glandula amatoria as seen in *Phenacolimax major* (Férussac, 1807); an intermediate type in the case of *Eucoberesia diaphana* (Draparnaud, 1805); or the genital appendix is absent as displayed in *Vitrina pellucida* (O. F. Müller, 1774). This tendency to reduction of genitalia is obviously occurring in several independent lineages in Europe as well as in Africa.

With a "missing link", *Sanettivitrina scripta* nov. gen. nov. sp., we found evidence for a direct connection of an ancient Macaronesian fauna within the East African fauna. We hypothesize that proto Macaronesian elements dispersed in direction to East Africa. During the late Oligocene to Miocene, the modern Sahara was covered by a Laurasian subtropical flora, harbouring plant genera which are now considered remnants of this era, such as *Dracaena*. Together with wetlands in northern Egypt (Seiffert et al., 2008), a continuous humid belt existed, which may have fostered the dispersal of the Vitrinidae from west to east throughout Saharan Africa. Subsequent climate

changes in the late Pliocene caused the desertification of North Africa. This event drove the Vitrinidae of western North Africa toward extinction, leading to the fragmentation of the Saharan fauna explaining today's disjunct distribution pattern in the recent African Vitrinidae. The direct relationship between the Macaronesian group and the East African genus *Sanettivitrina* nov. gen., as a relic of this radiation, strongly supports this hypothesis.

#### ACKNOWLEDGEMENTS

We are grateful to the following institutions, which supported the project in various ways: the Naturhistorisches Museum der Burgergemeinde Bern (NMBE), the Senckenberg Museum Frankfurt (SMF), the National Museum of Wales, the Cardiff (NMW), the Naturhistorisches Museum Basel (NMB), and the Zoological Collection of the Biology Department, University of the Azores (DBUA) and the curators of these institutions for loan of specimens under their care. We are grateful to the partners in the Ethiopian Insects Project, in particular the Ethiopian Wildlife Conservation Authority and Daniel Wiersbowski, for facilities during the 2015 expeditions. We are also highly indebted to Adrienne Jochum, Marcel Güntert, A.J. de Winter, António M. de Frias Martins, Kees Margy, Luis Javier Chueca, Klaus Groh, Timothy A. Pearce, Ambros Hänggi, Ronald Janssen and Frank Walther who provided us with important key specimens. We are very grateful to Estée Bochud, NMBE, for creating the distribution map, her technical assistance with the stereomicroscope, the imaging software and her helpful comments in image processing. Furthermore, we are very grateful to Seraina Klopffstein, NMB, and Tamara Spasojević, NMBE, for their introduction to and support in the application of MrBayes. We would like to thank all the reviewers involved for their insightful comments on the paper, as these comments led us to an improvement of the work.

#### DATA AVAILABILITY STATEMENT

The data that support the findings of this study are available from the corresponding author upon reasonable request.

#### ORCID

Beat Pfarrer  <https://orcid.org/0000-0002-9702-7968>

#### REFERENCES

- Alonso, M. R., Ibáñez, M., & Morales, P. (1987). La familia Vitrinidae en Canarias. II. Revisión de las especies de La Palma y El Hierro, con descripción de una especie nueva (Gastropoda, Pulmonata). *Archiv Für Molluskenkunde*, 118, 63–76.
- Alonso, M. R., Valido, M. J., Groh, K., & Ibáñez, M. (2000). *Plutonia* (*Canarivitrina*), new subgenus, from the Canary Islands, and the phylogenetic relationships of the subfamily Plutoniinae (Gastropoda: Limacoidea: Vitrinidae). *Malacologia*, 42, 39–62.
- Bouaziz-Yahiatene, H., Pfarrer, B., Medjdoub-Bensaad, F., & Neubert, E. (2017). Revision of *Massylaea* Möllendorff, 1898 (Stylommatophora, Helicidae). *ZooKeys*, 694, 109–133. <https://doi.org/10.3897/zookeys.694.15001>.
- Brzobohatá, K., Drozdová, E., Smutný, J., Zeman, T., & Beňuš, R. (2017). Comparison of suitability of the most common ancient DNA

- quantification methods. *Genetic Testing and Molecular Biomarkers*, 21, 265–271. <https://doi.org/10.1089/gtmb.2016.0197>.
- Carmona, L., Pola, M., Gosliner, T. M., & Cervera, J. L. (2013). A tale that morphology fails to tell: A molecular phylogeny of Aeolidiidae (Aeolidida, Nudibranchia, Gastropoda). *PLoS One*, 8, e63000. <https://doi.org/10.1371/journal.pone.0063000>
- Castresana, J. (2000). Selection of conserved blocks from multiple alignments for their use in phylogenetic analysis. *Molecular Biology and Evolution*, 17, 540–552. <https://doi.org/10.1093/oxfordjournals.molbev.a026334>.
- Colgan, D. J., Ponder, W. F., Beacham, E., & Macaranas, J. (2007). Molecular phylogenetics of Caenogastropoda (Gastropoda: Mollusca). *Molecular Phylogenetics and Evolution*, 42, 717–737. <https://doi.org/10.1016/j.ympev.2006.10.009>.
- Connolly, M. (1925). Notes on African non-marine Mollusca, with descriptions of many new species. *The Annals and Magazine of Natural History*, 15, 457–479.
- Connolly, M. (1931). Descriptions of new non-marine Mollusca from North, South, and Central Africa, with notes on other species. *The Annals and Magazine of Natural History*, 8, 305–321.
- Elias, M., Hill, R. I., Willmott, K. R., Dasmahapatra, K. K., Brower, A. V., Mallet, J., & Jiggins, C. D. (2007). Limited performance of DNA barcoding in a diverse community of tropical butterflies. *Proceedings of the Royal Society B: Biological Sciences*, 274, 2881–2889. <https://doi.org/10.1098/rspb.2007.1035>.
- Ezzine, I. K., Dimassi, N., Pfarrer, B., Said, K., & Neubert, E. (2018). New records of the endemic Sicilian land snail species *Marmorana (Murella) muralis* (O. F. Müller, 1774) from the north of Tunisia (Pulmonata, Gastropoda). *ZooKeys*, 775, 131–147. <https://doi.org/10.3897/zookeys.775.25740>.
- Ezzine, I. K., Pfarrer, B., Dimassi, N., Said, K., & Neubert, E. (2017). At home at least: the taxonomic position of some north African *Xerocrassa* species (Pulmonata, Geomitridae). *ZooKeys*, 712, 1–27. <https://doi.org/10.3897/zookeys.712.13066>.
- Folmer, O., Black, M., Hoeh, W., Lutz, R., & Vrijenhoek, R. (1994). DNA primers for amplification of mitochondrial cytochrome oxidase subunit I from diverse metazoan invertebrates. *Molecular Marine Biology and Biotechnology*, 3(5), 294–299.
- Forcart, L. (1957). Journey to the High Simien (Northern Ethiopia), 1952–3: Three species of Phenacolimax (Gastropoda, Vitrinidae), with notes on the taxonomy of the genus. *Zoological Journal of the Linnean Society*, 43, 113–122. <https://doi.org/10.1111/j.1096-3642.1957.tb02513.x>.
- Forcart, L. (1959). Revision Nordafrikanischer Vitrinidae. *Archiv Für Molluskenkunde*, 88, 1–7.
- Forcart, L. (1978). African distribution of genera and subgenera of the family Vitrinidae (Pulmonata). *Journal of Conchology*, 29, 325–327.
- França, Z., Cruz, J. V., Nunes, J. C., & Forjaz, V. H. (2003). Geologia dos Açores: uma perspectiva actual. *Açoreana*, 10, 11–140.
- Gittenberger, E., Piel, W.H., & Groeneweg, D.S.J. (2004). The Pleistocene glaciations and the evolutionary history of the polytypic snail species *Arianta arbustorum* (Gastropoda, Pulmonata, Helicidae). *Molecular Phylogenetics and Evolution*, 30(1), 64–73. [http://dx.doi.org/10.1016/s1055-7903\(03\)00182-9](http://dx.doi.org/10.1016/s1055-7903(03)00182-9)
- Giusti, F., Fiorentino, V., Benocci, A., & Manganello, G. (2011). A survey of vitrinid land snails (Gastropoda: Pulmonata: Limacoidea). *Malacologia*, 53, 279–363. <https://doi.org/10.4002/040.053.0206>.
- Gomes, S. R., Britto da Silva, F., Mendes, I. L. V., Thomé, J. W., & Bonatto, S. L. (2010). Molecular phylogeny of the South American land slug *Phyllocaulis* (Mollusca, Soleolifera, Veronicellidae). *Zoologica Scripta*, 39, 177–186. <https://doi.org/10.1111/j.1463-6409.2009.00412.x>.
- Groh, K., & Hemmen, J. (1986). Zur Kenntnis der Vitriniden des Madeira-Archipels (Pulmonata: Vitrinidae). *Archiv Für Molluskenkunde*, 116, 183–217.
- Harzhauser, M., Kroh, A., Mandic, O., Piller, W. E., Göhlich, U., Reuter, M., & Berning, B. (2007). Biogeographic responses to geodynamics: a key study all around the Oligo-Miocene Tethyan Seaway. *Zoologischer Anzeiger-A Journal of Comparative Zoology*, 246, 241–256. <https://doi.org/10.1016/j.jcz.2007.05.001>.
- Harzhauser, M., Piller, W. E., & Steininger, F. F. (2002). Circum-Mediterranean Oligo-Miocene biogeographic evolution—the gastropods point of view. *Palaeogeography, Palaeoclimatology, Palaeoecology*, 183, 103–133. [https://doi.org/10.1016/S0031-0182\(01\)00464-3](https://doi.org/10.1016/S0031-0182(01)00464-3).
- Hausdorf, B. (2000). Biogeography of the Limacoidea sensu lato (Gastropoda: Stylommatophora): vicariance events and long-distance dispersal. *Journal of Biogeography*, 27, 379–390. <https://doi.org/10.1046/j.1365-2699.2000.00403.x>.
- Hausdorf, B. (2001). Macroevolution in progress: competition between semislugs and slugs resulting in ecological displacement and ecological release. *Biological Journal of the Linnean Society*, 74, 387–395. <https://doi.org/10.1111/j.1095-8312.2001.tb01400.x>.
- Hausdorf, B. (2002). Phylogeny and biogeography of the Vitrinidae (Gastropoda: Stylommatophora). *Zoological Journal of the Linnean Society*, 134, 347–358. <https://doi.org/10.1046/j.1096-3642.2002.00010.x>.
- Hausdorf, B., & Sauer, J. (2009). Revision of the Helicellinae of Crete (Gastropoda: Hygromiidae). *Zoological Journal of the Linnean Society*, 157, 373–419. <https://doi.org/10.1111/j.1096-3642.2008.00504.x>.
- Hubendick, B. (1953). The relationship of the East African Vitrinae with notes on the taxonomy of *Vitrina*. *Arkiv för Zoologi*, 6, 83–96.
- Huelsenbeck, J. P., & Ronquist, F. (2001). MRBAYES: Bayesian inference of phylogenetic trees. *Bioinformatics*, 17, 754–755. <https://doi.org/10.1093/bioinformatics/17.8.754>.
- Jaksch, K., Eschner, A., Rintelen, T. V., & Haring, E. (2016). DNA analysis of molluscs from a museum wet collection: a comparison of different extraction methods. *BMC Research Notes*, 9, 348. <https://doi.org/10.1186/s13104-016-2147-7>.
- Jickeli, C. F. (1873). Diagnosen neuer Mollusken aus meiner Reiseausbeute. *Malakozoologische Blätter*, 20, 99–108.
- Katoh, K., & Standley, D. M. (2013). MAFFT multiple sequence alignment software version 7: improvements in performance and usability. *Molecular Biology and Evolution*, 30, 772–780. <https://doi.org/10.1093/molbev/mst010>.
- Koressaar, T., & Remm, M. (2007). Enhancements and modifications of primer design program Primer3. *Bioinformatics*, 23, 1289–1291. <https://doi.org/10.1093/bioinformatics/btm091>.
- Lanfear, R., Frandsen, P. B., Wright, A. M., Senfeld, T., & Calcott, B. (2016). PartitionFinder 2: new methods for selecting partitioned models of evolution for molecular and morphological phylogenetic analyses. *Molecular Biology and Evolution*, 34, 772–773. <https://doi.org/10.1093/molbev/msw260>.
- Martens, E. v. (1895). Neue Arten von Landschnecken aus den Gebirgen Ost-Afrikas. *Sitzungsberichte Der Gesellschaft Naturforschender Freunde Zu Berlin*, 18, 120–129.
- Martens, E. v. (1897). Beschalte Weichthiere Deutsch-Ost-Afrikas. In K. Möbius (Ed.), *Deutsch-Ostafrika*. Dietrich Reimer. <https://doi.org/10.5962/bhl.title.12943>
- Morales, P. J., Ibáñez, M., & Alonso, M. R. (1988). La familia Vitrinidae en Canarias III. Tres nuevas especies de La Gomera (Gastropoda: Pulmonata). *Archiv Für Molluskenkunde*, 118, 153–166.
- Morelet, A. (1860). *Iles Açores. Notice sur l'histoire naturelle des Açores suivie d'une description des mollusques terrestres de cet archipel*. Baillière et fils.
- Neiber, M. T., Sagorny, C., & Hausdorf, B. (2016). Increasing the number of molecular markers resolves the phylogenetic relationship of ‘*Cepaea vindobonensis* (Pfeiffer 1828) with *Caucasotachea* Boettger 1909 (Gastropoda: Pulmonata: Helicidae). *Journal of Zoological Systematics and Evolutionary Research*, 54, 40–45. <https://doi.org/10.1111/jzs.12116>.
- Nekola, J. C., Coles, B. F., & Bergthorsson, U. (2009). Evolutionary pattern and process within the *Vertigo gouldii* (Mollusca: Pulmonata,



- Pupillidae) group of minute North American land snails. *Molecular Phylogenetics and Evolution*, 53, 1010–1024. <https://doi.org/10.1016/j.ympev.2009.09.012>.
- Neubert, E. (1998). Annotated checklist of the terrestrial and freshwater molluscs of the Arabian Peninsula with descriptions of new species. *Fauna of Arabia*, 17, 333–461.
- Palumbi, S. R., Martin, A., Romano, S., McMillan, W. O., Stice, L., & Grabowski, G. (1991). *The simple fool's guide to PCR, version 2.0* (p. 45). University of Hawaii.
- Pfeiffer, L. (1857 ["1856"]). Descriptions of fifty – eight new species of Helicea from the collection of H. Cuming, Esq. *Proceedings of the Zoological Society of London*, 24, 324–336.
- Pfenninger, M., Véla, E., Jesse, R., Elejalde, M. A., Liberto, F., Magnin, F., & Martínez-Ortí, A. (2010). Temporal speciation pattern in the western Mediterranean genus *Tudorella* P. Fischer, 1885 (Gastropoda, Pomatiidae) supports the Tyrrhenian vicariance hypothesis. *Molecular Phylogenetics and Evolution*, 54, 427–436. <https://doi.org/10.1016/j.ympev.2009.09.024>.
- Piel, W. H., Chan, L., Dominus, M. J., Ruan, J., Vos, R. A., & Tannen, V. (2009). Treebase v. 2: A database of phylogenetic knowledge. *e-Biosphere*.
- Pilsbry, H. A. (1919). A review of the land mollusks of the Belgian Congo chiefly based on the collections of the American Museum Congo Expedition, 1909–1915. *Bulletin of the American Museum of Natural History*, 40, 1–370.
- Puillandre, N., Bouchet, P., Boisselier-Dubayle, M. C., Brisset, J., Buge, B., Castelin, M., Chagnoux, S., Christophe, T., Corbari, L., Lambourdière, J., & Lozouet, P. (2012b). New taxonomy and old collections: Integrating DNA barcoding into the collection curation process. *Molecular Ecology Resources*, 12, 396–402. <https://doi.org/10.1111/j.1755-0998.2011.03105.x>.
- Rambaut, A. (2012). *FigTree version 1.4.0*. Retrieved from: <http://tree.bio.ed.ac.uk/software/figtree/> (accessed 12 June 2018).
- Rambaut, A., Drummond, A. J., Xie, D., Baele, G., & Suchard, M. A. (2018). Posterior summarization in Bayesian phylogenetics using Tracer 1.7. *Systematic Biology*, 67, 901–904. <https://doi.org/10.1093/sysbio/syy032>.
- Rögl, F. (1999). Mediterranean and Paratethys. Facts and hypotheses of an Oligocene to Miocene paleogeography (short overview). *Geologica Carpathica*, 50, 339–349.
- Ronquist, F., & Huelsenbeck, J. P. (2003). MrBayes 3: Bayesian phylogenetic inference under mixed models. *Bioinformatics*, 19, 1572–1574. <https://doi.org/10.1093/bioinformatics/btg180>.
- Ronquist, F., Teslenko, M., van der Mark, P., Ayres, D. L., Darling, A., Höhna, S., Larget, B., Liu, L., Suchard, M. A., & Huelsenbeck, J. P. (2012). MRBAYES 3.2: Efficient Bayesian phylogenetic inference and model selection across a large model space. *Systematic Biology*, 61, 539–542. <https://doi.org/10.1093/sysbio/sys029>.
- Schileyko, A. A. (1986). Sistema i filogeniya Vitrinidae (Gastropoda Pulmonata). *Trudy Zoologicheskogo Instituta Akademii Nauk SSSR*, 148, 124–157.
- Schileyko, A. A. (2003). Treatise on Recent terrestrial pulmonate molluscs. Part 11. Trigonochlamydidae, Papillodermidae, Vitrinidae, Limacidae, Bielziidae, Agriolimacidae, Boettgerillidae, Camaenidae. *Ruthenica*, 2, 1467–1626.
- Schultz, J., Maisel, S., Gerlach, D., Müller, T., & Wolf, M. (2005). A common core of secondary structure of the internal transcribed spacer 2 (ITS2) throughout the Eukaryota. *RNA*, 11, 361–364. <https://doi.org/10.1261/rna.7204505>.
- Seiffert, E. R., Bown, T. M., Clyde, W. C., & Simons, E. (2008). Geology, paleoenvironment, and age of Birket Qarun locality 2 (BQ – 2), fayum depression, Egypt. In J. G. Fleagle, & C. C. Gilbert (Eds.), *Elwyn Simons: a search for origins* (pp. 71–86). Springer.
- Smith, E. A. (1894). A list of the land and freshwater molluscs collected by Dr. J.W. Gregory in East Africa during his expedition to Mount Kenia with descriptions of a few new species. *Proceedings of the Malacological Society of London*, 1, 163–168. <https://doi.org/10.1093/oxfordjournals.mollus.a064108>.
- Solem, A. (1974). *The shell makers: introducing mollusks*. Wiley-Interscience.
- Stamatakis, A. (2006). RAxML-VI-HPC: maximum likelihood-based phylogenetic analyses with thousands of taxa and mixed models. *Bioinformatics*, 22, 2688–2690. <https://doi.org/10.1093/bioinformatics/btl446>.
- Thiele, J. (1910). Eine arabische Ennea und Bemerkungen über andere Arten. *Sitzungsberichte Der Gesellschaft Naturforschender Freunde Zu Berlin*, 9, 280–284.
- Thiele, J. (1911). Mollusken der deutschen Zentral-Afrika-Expedition. *Wissenschaftliche Ergebnisse Der Deutschen Zentral-Afrika-Expedition, 1907–1908*, 3, 175–214.
- Thiele, J. (1931). *Handbuch der Systematischen Weichtierkunde*. Gustav Fischer.
- Thiele, J. (1933). Die von Oskar Neumann in Abessinien gesammelten und einige andere afrikanische Landschnecken. *Sitzungsberichte Der Gesellschaft Naturforschender Freunde Zu Berlin*, 123, 280–323.
- Uit de Weerd, D. R., & Gittenberger, E. (2013). Phylogeny of the land snail family Clausiliidae (Gastropoda: Pulmonata). *Molecular Phylogenetics and Evolution*, 67, 201–216. <https://doi.org/10.1016/j.ympev.2013.01.011>.
- Untergasser, A., Cutcutache, I., Koressaar, T., Ye, J., Faircloth, B. C., Remm, M., & Rozen, S. G. (2012). Primer3 – new capabilities and interfaces. *Nucleic Acids Research*, 40, e115. <https://doi.org/10.1093/nar/gks596>.
- Valido, M. J., Alonso, M. R., & Ibáñez, M. (1990). La familia Vitrinidae en Canarias. IV. Révision de las especies de Gran Canaria, con descripción de 3 especies nuevas. *Archiv Für Molluskenkunde*, 102, 95–114.
- Valido, M. J., Groh, K., Ibáñez, M., & Alonso, M. R. (1993). La familia Vitrinidae en Canarias V. El género *Guerrina* (Gastropoda: Pulmonata). *Archiv Für Molluskenkunde*, 121, 117–124. <https://doi.org/10.1127/arch.moll/121/1992/117>.
- Van Goethem, J. L. (1977). Révision systématique des Urocyclinae (Mollusca, Pulmonata, Urocyclidae). *Annales Du Musée Royal De L'Afrique Centrale Tervuren, Sciences Zoologiques*, 218, 1–355.
- Verdcourt, B. (2005). A new species of *Vitrina* (Gastropoda, Pulmonata, Vitrinidae) from Kenya with a discussion of the genus in East Africa. *Basteria*, 69, 147–156.
- Vos, R. A., Balhoff, J. P., Caravas, J. A., Holder, M. T., Lapp, H., Maddison, W. P., Midford, P. E., Priyam, A., Sukumaran, J., Xia, X., & Stoltzfus, A. (2012). NeXML: rich, extensible, and verifiable representation of comparative data and metadata. *Systematic Biology*, 61, 675–689. <https://doi.org/10.1093/sysbio/sys025>.
- Wade, C. M., & Mordan, P. B. (2000). Evolution within the gastropod molluscs; using the ribosomal RNA gene-cluster as an indicator of phylogenetic relationships. *Journal of Molluscan Studies*, 66(4), 565–569.
- Wade, C. M., & Mordan, P. B. (2000). Evolution within the gastropod molluscs; using the ribosomal RNA gene-cluster as an indicator of phylogenetic relationships. *Journal of Molluscan Studies*, 66, 565–569. <https://doi.org/10.1093/mollus/66.4.565>.
- Wade, C. M., Mordan, P. B., & Naggs, F. (2006). Evolutionary relationships among the Pulmonate land snail and slugs (Pulmonata, Stylommatophora). *Biological Journal of the Linnean Society*, 87, 593–610. <https://doi.org/10.1111/j.1095-8312.2006.00596.x>.
- Weigand A. M., Jochum A., Slapnik R., Schnitzler J., Zarza E., Klusmann-Kolb A. (2013). Evolution of microgastropods (Ellobioidea, Carychiidae): integrating taxonomic, phylogenetic and evolutionary hypotheses. *BMC Evolutionary Biology*, 13(1), 18. <http://dx.doi.org/10.1186/1471-2148-13-18>
- Welter-Schultes, F. W. (2012). *European non-marine molluscs, a guide for species identification*. Planet Poster Göttingen: Editions.
- Wiktor, A. (2000). Agriolimacidae (Gastropoda: Pulmonata) – a systematic monograph. *Annales Zoologici*, 49, 347–590.

- Williams, S. T., & Reid, D. G. (2004). Speciation and diversity on tropical rocky shores: a global phylogeny of snails of the genus *Echinolittorina*. *Evolution*, 58, 2227–2251. <https://doi.org/10.1554/03-565>.
- Xia, X. (2017). DAMBE6: new tools for microbial genomics, phylogenetics, and molecular evolution. *Journal of Heredity*, 108, 431–437. <https://doi.org/10.1093/jhered/esx033>.
- Xia, X. (2018). DAMBE7: New and improved tools for data analysis in molecular biology and evolution. *Molecular Biology and Evolution*, 35, 1550–1552. <https://doi.org/10.1093/molbev/msy073>.
- Xia, X., Xie, Z., Salemi, M., Chen, L., & Wang, Y. (2003). An index of substitution saturation and its application. *Molecular Phylogenetics and Evolution*, 26, 1–7. [https://doi.org/10.1016/s1055-7903\(02\)00326-3](https://doi.org/10.1016/s1055-7903(02)00326-3).

## SUPPORTING INFORMATION

Additional supporting information may be found online in the Supporting Information section.

**Figure S1.** Phylogenetic tree obtained by Maximum Likelihood (1000 iterations, GTR+I+G), analysis of combined post-Gblocks trimmed CO1, 16S, H3, and ITS2 data. Bootstrap support values from maximum likelihood analysis are indicated at the nodes.

**Alignment S2.** Alignment of 46 sequences in fasta format. Gblocks standard parameters used. New number of positions 648 (27% of the original 2349 positions).

**How to cite this article:** Pfarrer, B., Rowson, B., Tattersfield, P., & Neubert, E. (2021). Phylogenetic position of African Vitrinidae: Old family groups unraveled. *Journal of Zoological Systematics and Evolutionary Research*, 59, 1190–1208. <https://doi.org/10.1111/jzs.12502>



# Backpacker with little luggage: *Vitrina pellucida* (O. F. Müller, 1774) identified as a Holarctic region hiking species

**Beat Pfarrer<sup>1,2</sup>, Jeffrey C. Nekola<sup>3</sup> & Eike Neubert<sup>1,2</sup>**

Addresses of authors:

1 Natural History Museum Bern, Bernastrasse 15, CH-3005 Bern, Switzerland

2 Institute of Ecology and Evolution, University of Bern, CH-3012 Bern, Switzerland

3 Department of Botany and Zoology, Masaryk University, Kotlářská 2, CZ-611 37 Brno, Czech Republic

Corresponding author's E-mail: [beat.pfarrer@nmbe.ch](mailto:beat.pfarrer@nmbe.ch)

Keywords: Vitrinidae, molecular phylogeny, anatomy, Holarctic dispersal

## Abstract

*Vitrina pellucida* (O. F. Müller, 1774) is a well-known member of the glass snail family Vitrinidae Fitzinger, 1833. The Holarctic Realm is inhabited by a number of morphologically rather similar species. This phylogenetic investigation aims at resolving the taxonomic position of *Vitrina pellucida* (O. F. Müller, 1774), *Vitrina limpida* Gould, 1850, *Vitrina alaskana* Dall, 1905, *Vitrina angelicae* (H. Beck, 1837), and *Vitrina exilis* Morelet, 1858. The identity of *Vitrina rugulosa* E. von Martens, 1874 remains unresolved; most records of this species are misidentifications and represent in fact *V. pellucida*. European members of Vitrinidae were added to the analyses as a reference. Two mitochondrial markers (COI & 16S) and a set of nuclear markers (H3, ITS2 and ITS1) were used in a Maximum Likelihood (ML) and Bayesian Inference (BI) analysis. The results demonstrate a remarkably low genetic variation within our Holarctic data set. Subsequently, the nominal taxa listed above have to be synonymized with *V. pellucida*.

## 1 Introduction

Semislugs are gastropods defined by their intermediate bauplan: the shells are so much reduced that the animals are unable to withdraw into their shells. It is considered to constitute an intermediate step between shell bearing snails and shellless slugs. The evolutionary pathway of limacisation can be observed to occur independently in many gastropod families such as Ariophantidae Godwin-Austen, 1888 with the species *Ratnadvipia karui*, Pfeiffer, 1854 (Raheem and Naggs 2006), in the family Pleurodontidae H. von Ihering, 1912 with its only semislug species *Coloniconcha prima* Pilsbry, 1933 (Breure 2010), or in the Palaearctic family Testacellidae, where the slugs carry a small shell remain on the distal tip of their tail.

In the Holarctic realm, the family Vitrinidae Fitzinger, 1833 represents an impressive example of semislug gastropods. These snails can almost hide in their shells like *Phenacolimax major* (A. Férussac, 1807); the opposite can for example be found in species of the genus *Eucobresia* H. B. Baker, 1929. Here, the shell is reduced to 2-2.5 whorls with a decalcified blade of periostracum, and with a large animal unable to withdraw into its shell. The species allocated in this family prefer habitats with low temperatures and a high level of humidity. Such environments can be found in Central and Northern Europe reaching out to the Bering Strait, or in the higher elevated regions of the Alps, the Rocky mountains or the Arabian and Ethiopian highlands (Pfarrer et al. 2021). Reduced shells offer less character states which can make it difficult to identify species. Studies on the morphology of the genital organs can help to circumvent some of these obstacles and uncertainties (Hausdorf 2002, Giusti et al. 2011). However, similar structures of the genital organs do not necessarily represent synapomorphic character states. Pfarrer et al. (2021) found several cases in the Ethiopian Vitrinidae, which lead to a wrong phylogenetic hypothesis, and produced paraphyletic groups.

The genus *Vitrina* Draparnaud, 1801 comprises several nominal taxa distributed all over the Holarctic realm; their phylogenetic relationship remained unclear, and the validity of taxa was frequently disputed. The species display no major conchological and anatomical differences if compared to the oldest species included *V. pellucida*, which is recorded from Europe. In North America, the genus is represented by *V. alaskana*, *V. limpida* and *V. angelicae*, while in the Palaearctic, the morphologically rather similar taxa *V. exilis* and *V. rugulosa* have to be considered.

Hesse (1923) was the first, who remarked that North American and Siberian *Vitrina* species may be conspecific to the “European” *V. pellucida*. In 1944, Forcart explained slight differences in size of the shell and

number of whorls by ecological variation, which could be also apply to size of the shell and the genitalia. Pilsbry (1946) investigated the Nearctic taxa and encountered problems to differentiate between these species. Later, Forcart (1955) re-discussed anatomical and conchological character states of *V. pellucida*, *V. limpida* and *V. angelicae* using data on the genital organs derived from other authors (Soós and Schlesch 1924, Lohmander 1938, Pilsbry 1946). He concluded that the Islandic *V. pellucida* recorded by Lohmander (1938) should be accepted as a subspecies of *V. pellucida* based on a “longer penis” and “differences in the vas deferens”. Furthermore, he regarded *V. limpida* a subspecies of *V. angelicae*. Recently, *V. alaskana* was relegated into the synonymy of *V. pellucida* because of similarity of the reproductive system (Roth and Sadeghian 2006).

*Vitrina exilis* from Kamchatka was rarely treated in literature. Egorov (2011) did not supply any data on its reproductive system, and the sketch drawing of the shell is not informative. The type specimen seems to be lost (Breure et al. 2018). *Vitrina rugulosa*, however, was investigated by Schileyko (1986); Egorov (2011: 10) copied his drawing of the morphology of the genital organs and added some information on the distribution of vitrinid taxa in Russia. The identity of “*V. rugulosa*” sensu auctores is discussed later.

Summarising, the current discussion was not able to satisfyingly conclude on the relationship of these taxa. Our data set contains specimens from a considerable part of the area under discussion and approach this conundrum with genetic methods using four markers (COI, 16S, ITS2, ITS1 and H3).

## 2 Material and Methods

### 2.1 Taxon Sampling

Our sampling consisted of 93 individuals (Fig. 1). As indicated in Supplement 1, a small selection of Central European species was chosen from the voucher collection of the Naturhistorisches Museum Bern (NMBE) for the analyses. Specimens of *V. pellucida*, *V. limpida*, *V. angelicae*, *V. alaskana*, and *V. exilis* were provided by private donors (Adrienne Jochum, Larissa Prozorova, Frank Walther), the Masaryk University (MU), the National Museum of Wales (NMW), Centre for Biodiversity Genomics (CBG), Bulgarian Academy of Sciences (BAS) and the Carnegie Museum (CM). Identifications of the specimens used by the donors were subsequently named “field species”. Almost all samples were mummified but worked in our study. The shells of *V. angelicae* were too damaged for further investigation of the shell characters. The outgroup selection consists of a selection of *Oligolimax annularis* (S. Studer 1820), *Eucobresia diaphana* (Draparnaud, 1805), *Hesseilimax kotulae* (Westerlund, 1883), *Vitrinobrachium breve* (A. Férussac, 1821) and *Limax maximus* Linnaeus, 1758.

#### Abbreviations used

MHB	Natural History Museum Basel
MuPh	Masaryk University, coll. M. Horsak
NMBE	Natural History Museum Bern, Switzerland





Figure 1. Distribution of individuals investigated. Alaskan records were taken from Dall (1905); the record of *V. angelicae* from Greenland follows Forcart (1955); the record of *V. p. islandica* represents unpublished data by M. Horsák from Látrabjarg.

## 2.2 Shell morphology

The morphological characters of shells were investigated by using a LEICA M205 C microscope equipped with a LEICA MC190 camera. The multifocal images were processed by using a Leica's in-house software LAS X EDOF (Leica Microsystems). The main focus was an investigation of details of the protoconch.

## 2.3 DNA extraction

Where possible, foot muscle snippets, of approx. 2 mm<sup>3</sup> size were cut from the specimens with sterile surgical blades in a remote laboratory away from the PCR laboratory under clean conditions. In dried-out mummified specimens, sterile scissors were used to cut tissue samples. A Qiagen Blood and Tissue Kit (Qiagen cat nr. 69506) in combination with a QIAcube extraction robot (DNeasy Blood Tissue and Rodent tails, standard protocol) was used for total genomic extraction. A manual extraction in a DNA clean environment by using components of the Qiagen Blood and Tissue Kit was used for older specimens. Degradation over time is a persistent concern when working with museum specimens (Jaksch et al. 2016). It was documented by DNA concentration measurements on study specimens by using a Qubit 4 Fluorometer (Thermo Fisher Scientific) (Brzobohatá et al. 2017).

## 2.4 Marker development strategy and primer design

For this study, the following markers were chosen. Two mitochondrial gene fragments: the cytochrome c oxidase subunit I gene (COI; 710 bp amplicon length); (2) the 16S ribosomal RNA gene (16S; 480 bp amplicon length). Three nuclear marker: the rRNA cluster 5.8S-ITS2-28S of approx. 900 bp amplicon (partial 5.8S and partial 28S including the complete internal transcribed spacer 2), the internal transcribed spacer 1ITS1 rRNA partial sequence (ITS1; 560 bp amplicon length) and the histone 3 fragment (H3; 320 bp amplicon length) (Palumbi et al. 1991, Folmer et al. 1994, Wade and Mordan 2000, Gittenberger et al. 2004, Pfenninger et al. 2005, Armbruster and Bernhard 2008, Carmona et al. 2013, Uit de Weerd and Gittenberger 2013, Weigand et al. 2013, Nekola et al. 2018)..

These markers were shown to cover a useful bandwidth of phylogenetic information (Wade et al. 2001, Hausdorf and Sauer 2009, Gomes et al. 2010, Pfenninger et al. 2010, Neiber et al. 2016, Bouaziz-Yahiatene et al. 2017, Ezzine et al. 2017, 2018, Nekola et al. 2018, Pfarrer et al. 2021) . A variety of primers for each marker gene were used for amplification due to the age and condition of old museum specimens. Three ITS2 primer pairs have been designed for this work, especially for the highly degraded museum's specimen. Each primer pair covers an average amplicon length of 300 to 320 bp, which can be combined to a whole ITS2 fragment when successfully amplified. The same strategy was applied for COI which resulted in two new primer pairs. Table 2 lists primer pairs used in the PCR and sequencing. New primers were designed with Primer3 V.2.3.4 (Koressaar and Remm 2007, Untergasser et al. 2012) plugin in Geneious Ver.9.1.8 (Biomatters Ltd.) software package and additional manual editing.

Table 2. List of primer pairs used in PCR and sequencing.

Gene	Primer	Sequence (5'-3')	Aprox. Amplicon lengths	Reference
<i>COI</i>	<i>LCO490</i>	GGTCAACAAATCATAAAGATATTGG	710	Folmer et al. 1994
	<i>HCO2198</i>	TAAACTTCAGGGTGACCAAAAAATCA		
	<i>FCOI</i>	ACTCAACGAATCATAAAGATATTGG		Gittenberger et al. 2004
	<i>ROCI</i>	TAACTTCAGGATGACCAAAAAATCA		
	<i>VitCOI_11F</i>	ACAAATCATAAAGATATTGGTACA		This work
	<i>VitCOI_415R</i>	CAAACTACTGAAGCACCAG		
	<i>VitCOI_250F</i>	TGATATAAGATTTCCTCGTA		
	<i>VitCOI_683R</i>	AAAGATGTTGATATAAAATAGG		
<i>16S</i>	<i>16sF</i>	CGGCCGCCTGTTTATCAAAAACAT	480	Palumbi et al. 1991
	<i>16sR</i>	GGAGCTCCGGTTTGAAGCTCAGATC		
	<i>LR-N-13398 (16Sar)</i>	CGCCTGTTTATCAAA AAC AT		Weigand et al. 2013
	<i>LR-J-12887 (16Sbr)</i>	CCGGTCTGAACTCTGATCAT		
<i>ITS1</i>	<i>18s rDNA</i>	TAACAAGGTTTCCGTATGTGAA	650	Armbruster and Bernhard 2008
	<i>LSU1rc</i>	TCACATTAATTCTCGCAGCTAG		
	<i>ITS-1 F</i>	TAACAAGGTTTCCGTAGGTGAA		Pfenninger et al. 2005
	<i>ITS-1 R</i>	GCTGCGTCTTCATCGATGC		
<i>5.8S-ITS2-28S</i>	<i>LSU-1</i>	CTAGCTGCGAGAATTAATGTGA		Wade and Mordan 2000
	<i>LSU-3</i>	ACTTCCCTCACGGTACTTTG		
	<i>ITS2ModA</i>	GCTTGCGGAGAATTAATGTGAA		Pfarrer et al. 2021
	<i>ITS2ModB</i>	GGTACCTTGTTTCGTATCGGA		
	<i>VitITSA_26F</i>	TTGCAGAACACATTGAACAT	300	This work
	<i>VitITSB_540R</i>	AAAGATTCAATCCGAGTCCT		
	<i>VitITSC_342F</i>	GTTCTCGTTGCTGAAGT	320	This work
	<i>VitITSD_778R</i>	ACTGGGGAAATCCTTGTTAG		
	<i>VitITSE_700F</i>	TCAGATCGGACGAGATTAC	300	This work
	<i>VitITSF_1035R</i>	GGACTCGTGCAAGTATTTAG		
<i>H3</i>	<i>H3PulF</i>	GGAGGCAAGGCCACGTAARCA	320	Uit de Weerd and Gittenberger 2013
	<i>H3PulR</i>	TTGGCGTGGATGGCGCACARG		
	<i>H3AD</i>	ATGGCTCGTACCAAGCAGACVGC	320	Carmona et al. 2013
	<i>H3BD</i>	ATATCCTTRGGCATRATRGTGAC		

## 2.5. PCR amplification

PCRs were conducted with a mix of 12.5 µl of GoTaq G2 HotStart Green Master Mix (Promega M7423), 6.5 µl nuclease free H<sub>2</sub>O (Sigma-Aldrich, W4502), 1 µl of each primer and 2 µl template DNA.

The PCR protocol for each marker were applied as follows: for *COI*, 3 min at 95°C, followed by 35 cycles of 1 min at 95°C, 1 min at 40°C (45°C for *FCOI/ROCI*) and 1 min at 72°C and finally, 5 min at 72°C. For *16S* the amplification conditions were 3 min at 95°C, followed 35 cycles of 1 min at 95°C, 1 min at 50°C and 1 min at 72°C, and finally, 5 min at 72°C. For the *16Sar/br* primer pair the conditions were 5 min at 95°C, followed by 34 cycles of 30 s at 95°C, 25 s at 52°C and 45 s at 72°C, and finally, 5 min at 72°C. For *ITS2* the cycle conditions were: 1 min at 96°C, followed 35 cycles of 30 sec at 94°C, 30 sec at 55°C and 1 min at 72°C, and finally, 10 min at 72°C. For the primer pair *ITS2ModA* and *ITS2ModB* the protocol varies for the *LSU-1/3* only in the annealing

temperature of 43°C. The PCR conditions for the *H3PulF/R* were 3 min at 94°C, followed 35 cycles of 15 sec at 94°C, 30 sec at 57°C and 40 sec at 72°C, and finally, 1 min at 72°C. For the *H3AD/BD* pair, 3 min at 95°C, followed 45 cycles of 45 sec at 95°C, 45 sec at 50°C and 45 sec at 72°C, and finally, 10 min at 72°C. The PCR conditions for the new approach of *ITS2* and *COI* sequence generation from highly fragmented DNA is as follows. For the *ITS2* triple primer pair: 2 min at 95°C, followed by 35 cycles of 1 min at 95°C, 1 min at 48°C and 1 min at 72°C, and finally 10 min at 72°C. The *COI* double primer pair needs for each pair an own cycle protocol: for *VitCOI\_11F* & *VitCOI\_415R* 2 min at 95°C, followed 35 cycles of 1 min at 95°C, 1 min at 48.5°C and 1 min at 72°C, and finally, 10 min at 72°C. For *VitCOI\_250F* & *VitCOI\_683R* 2 min at 95°C, followed 35 cycles of 1 min at 95°C, 1 min at 44°C and 1 min at 72°C, and finally, 10 min at 72°C.

PCR products were displayed together with a negative control and a 1000bp ladder (BenchTop 100bp DNA Ladder, G8291) in an agarose 1 % gel for assessment of quality and primer efficiency. Failures were repeated by applying higher volumes of template and/or changing PCR parameters such as temperature or increasing cycles. PCR product purification and sequencing were performed by LGC (LGC Genomics Berlin). Sensitive and old museum specimen sequences were sent for single tube sequencing to Microsynth (Microsynth Balgach Switzerland).

## 2.6 Phylogenetic analyses and species delimitation

The MAFFT v.7.222 plugin (Kato and Standley 2013) of Geneious Ver.9.1.8 (Biomatters Ltd.) was implemented with the L-INS-i algorithm and the 1PAM /  $k = 2$  matrix for alignment generation of the processed marker sequences. Alignment length after secondary manual verification and editing was as follows: COI 654 bp, 16S 436 bp, H3 278 bp, ITS1 689 bp and ITS2 with 919 bp, summing up to a total of 2976 bp length in the concatenated alignment block. ITS1 and ITS2 were left with variable sites which explains the augment in base pair positions due to gap formations in the final alignment. The generated sequence data is downloadable from GenBank, accession numbers are displayed in Table 01.

The alignments for the 16S, ITS1 and ITS2 fragments were defined each as a single partition. The protein coding gene fragments COI and H3 were defined each in two partitions: the first two codon positions as one partition and the third codon position as a second. Partitionfinder Ver. 2.1 (Guindon et al. 2010, Lanfear et al. 2012, 2017) searched the optimal evolutionary models for the partitions using the corrected Akaike Information Criterion (AICc).

The results of Partitionfinder2 for the assumed partitions suggested GTR+G as best fitting model for the analysis in RAxML (Stamatakis 2006). ML was computed with RAxML by performing the search for the ML tree and a rapid Bootstrap analysis with 2000 replicates in one single run. Bayesian Inference (BI) was performed using Mr Bayes v3.2.2 x64 (Huelsenbeck and Ronquist 2001, Ronquist and Huelsenbeck 2003, Ronquist et al. 2012). Partitionfinder2 proposed as optimal evolutionary model GTR+I+G as best fitting model for the first two codons of COI, HKY+G for the third codon of COI and ITS1, GTR+G for 16S and ITS2, GTR+I for the first two codons of H3 and JC+I for the third codon of H3. The Monte Carlo Markov Chain (MCMC) parameter was set as follows: starting with four chains and four separate runs for  $15 \times 10^6$  generations, the temperature set to 0.15, with a tree sampling frequency of 1000 and a burn in of 25 %. The effective sample size (ESS) was analysed by Tracer (Rambaut et al. 2018). An additional Maximum Likelihood (ML) analysis was computed with IQTree (<http://iqtree.cibiv.univie.ac.at/>) (Nguyen et al. 2015, Chernomor et al. 2016, Minh et

al. 2020) with following settings: automated substitution model, performing a standard bootstrap analysis with 100 bootstrap alignments and 1000 replicates for the SH-aLRT (approximate likelihood ratio test (aLRT) and Shimodaira–Hasegawa (SH)) (Guindon et al. 2010, Anisimova et al. 2011). Two additional single gene analyses were performed with the standard settings for ITS1 and ITS2. Tree editing was performed by using FigTree v1.4.3 (Rambaut 2012). Both analyses Maximum Likelihood and Bayesian Inference were calculated through the UBELIX (<http://www.id.unibe.ch/hpc>), the HPC cluster at the University of Bern. For species delimitation the ASAP web tool (Assemble Species by Automatic Partitioning) (<https://bioinfo.mnhn.fr/abi/public/asap/asapweb.html>) (Puillandre et al. 2021) was applied. The settings were: Kimura (K80) (Kimura 1980) substitution model with the settings for the transition/transversion rate ratio (ts/tv) = 2 and the standard advanced options for 10 best partition suggestions for the alignment of the 66 available COI sequences.

### 3. Results

#### 3.1 Shell investigation

The conchological assessment of the character states of the Vitrinidae shells did not show any evident differences in the overall shell shape (Fig. 2). Shell sizes may vary from 3 to 6.5 mm, however, some specimens shown here are not fully adult (Figs 2B, E). There is no general rule that specimens from Arctic areas are always smaller than those from more moderate climate. The shell shape is rather the same; the only observable variation is that some shells may have a little bit more elevated spire than others. The umbilicus is closed and shows a number of spiral periostracum crests internally (Figs 2A, D, H).

Forcart (1955: 162) claimed that the protoconch of *V. angelicae* differs from all other related taxa by “Fehlen der Spiralskulptur auf dem Embryonalgewinde [lack of spiral sculpture on the protoconch]”. Careful examination of the protoconchs of all specimens available yielded no evidence for this observation (Fig. 3). All protoconchs investigated show pits, usually arranged in spiral rows, but sometimes irregularly scattered all over the protoconch surface.

#### 3.2 Species delimitation

The results of the ASAP species delimitation displayed 6 different partitions out of 10 possible partition solutions. These are as follows: *Limax maximus* is represented with 3 individuals. *Hessemilimax kotulae* is recognized with 2 individuals. *Vitrinobrachium breve* is displayed with two individuals as one group. All the three *E. diaphana* are in one partition. Each sample of *O. annularis* is represented in one group. All the *V. pellucida*, *V. limpida*, *V. angelicae*, *V. exilis* and *V. alaskana* specimens are assembled in one group. The results are summarized in Supplement 1.

Figure 2. **A** *V. pellucida*, NMBE 20454, Switzerland, Samnaun, D = 5.2 mm; **B** *V. angelicae*, MHB 3715, Greenland, Sukkertoppen (voucher specimen Forcart (1955)), D = 3.9 mm; **C** *V. alaskana*, NMBE 571038, USA, Sandoval County, Placitas, New Mexico, D = 4.2 mm (sequenced spec.); **D** *V. pellucida islandica*, Holotype MHB 5816, Iceland, Ísafjörður, D = 5.6 mm; **E** *V. limpida*, NMBE 571009, USA, Mahanomen, Dittmer, Minnesota, D = 3 mm (sequenced spec.); **F** *V. pellucida islandica*, coll. Horsak, Iceland, Bjargtangar, Látrabjarg, D = 5.1 mm; **G** *V. exilis*, NMBE 570985, Russia, Ketoi Island, Kuril Archipelago, D = 4.7 mm; **H** “*V. rugulosa*“, coll. Horsak 141, Russia, Southern Altai, Seminski Pereval, D = 6.3 mm; **I** *Oligolimax annularis*, NMBE 20527, Switzerland, Sierre VS, Granges, D = 5 mm. — All shells × 8, phot. E. Bochud.



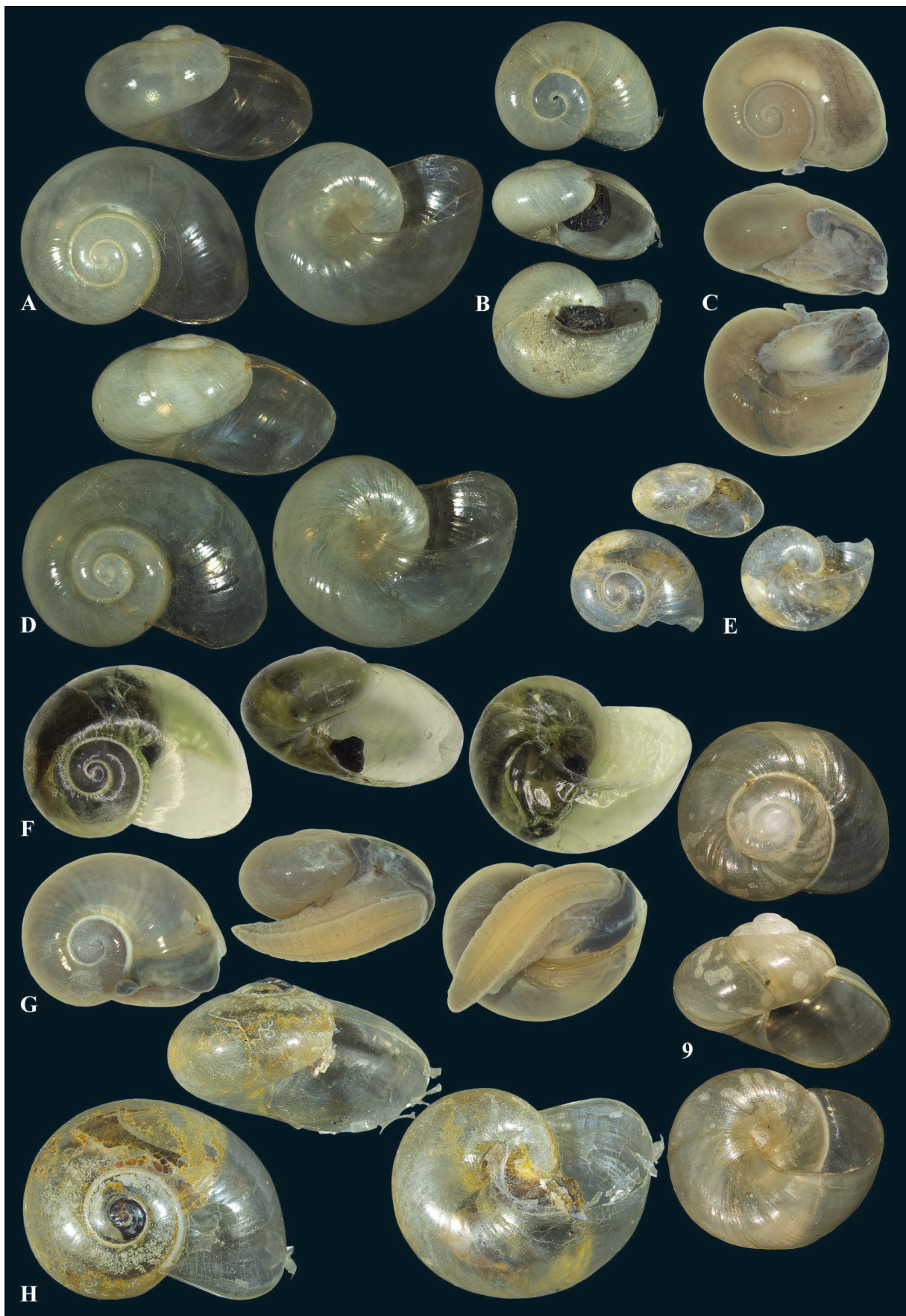



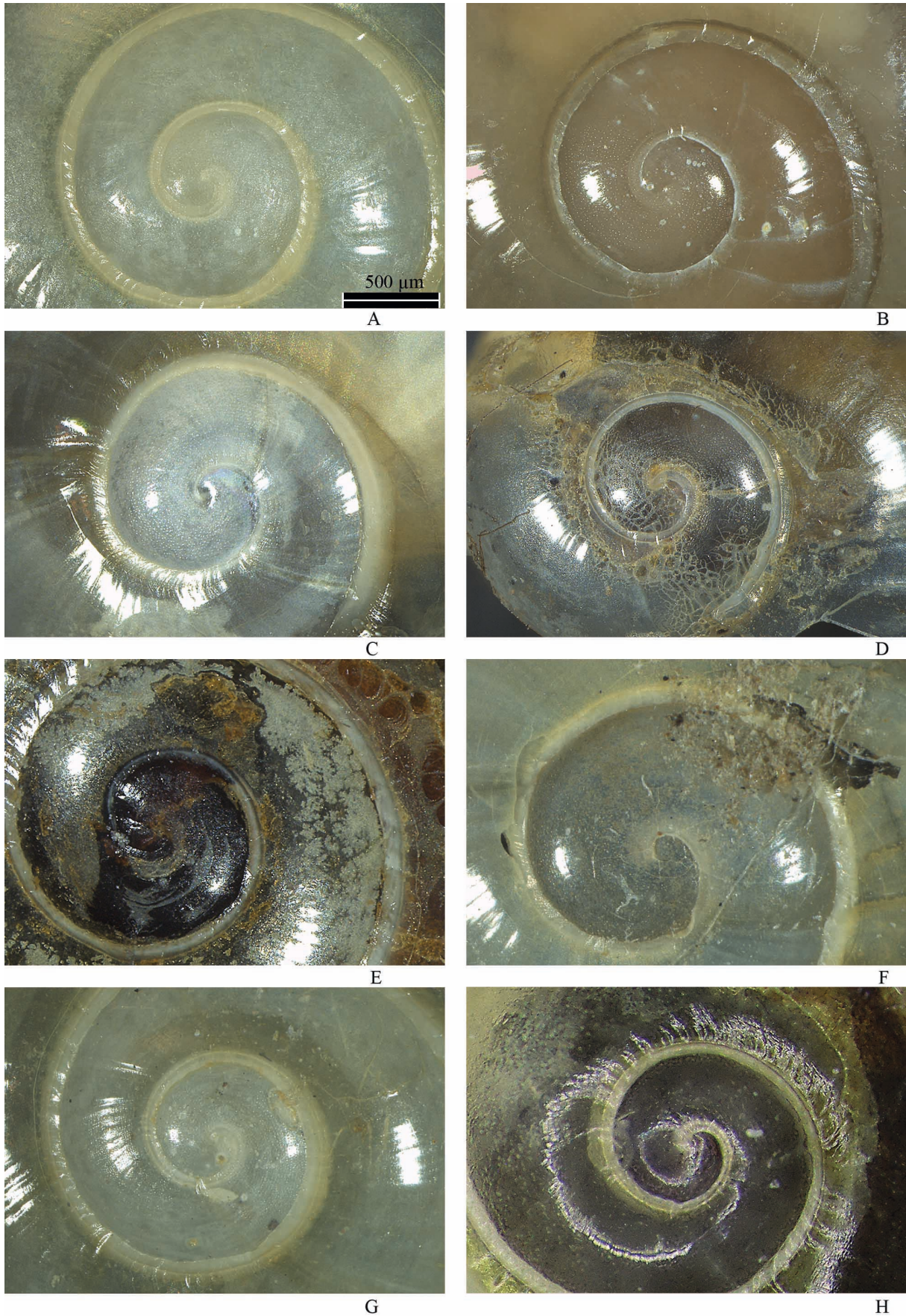

Figure 3. Protoconch sculptures. **A** *V. pellucida*, NMBE 20454; **B** *V. alaskana*, NMBE 571038; **C** *V. exilis*, NMBE 570985; **D** *V. limpida*, NMBE 571009; **E** “*V. rugulosa*”, coll. Horsak 141; **F** *V. angelicae*, MHB 3715; **G** *V. pellucida islandica*, Holotype MHB 5816; **H** ditto, Iceland, Látrabjarg.

### 3.3 Phylogeny

The tree displaying the concatenated genetic data (Fig. 4) is a combination of the Bayesian Inference (BI) displayed at the nodes as posterior probability values (PP) and the Maximum Likelihood analysis (RAxML / IQTree) presented as bootstrap values at the nodes (BS). The nodes are supported in each analysis. The outgroup formed by the three *Limax maximus* specimens is distinctively separated from the monophyletic Vitrinidae group. The *H. kotulae* and *V. breve* lineage is supported with (PP = 1; BS = 100 %, BS = 100 %). *Hessemilimax kotulae* and *V. breve* are separated by (PP = 0.99; BS = 84 %, BS = 76 %). The *O. annularis* group separates with following support values (PP = 0.89; BS = 76 %, BS = 93 %). Here, the different *O. annularis* specimens form a species complex. *Eucobresia diaphana* splits from the *Vitrina* group with (PP = 0.84; BS = 79 %, BS = 47 %). A polytomous group containing *V. pellucida*, *V. alaskana*, *V. limpida*, *V. exilis* and *V. angelicae* marks the larger part of the topology. There is no notable node value or longer branching off to differentiate between single specimens in the greater *Vitrina* clade.

The single ITS1 and ITS2 trees (Fig. 5) show an almost identical topology in respect to the concatenated phylogenetic tree. Differences may be derived from the reduced sample size due to the availability of sound sequences. Here, the ML tree with the standard settings resulted in a support of the *V. pellucida* clade amongst the congeners in the phylogeny (ITS1 BS = 86 % / ITS2 BS = 77 %)



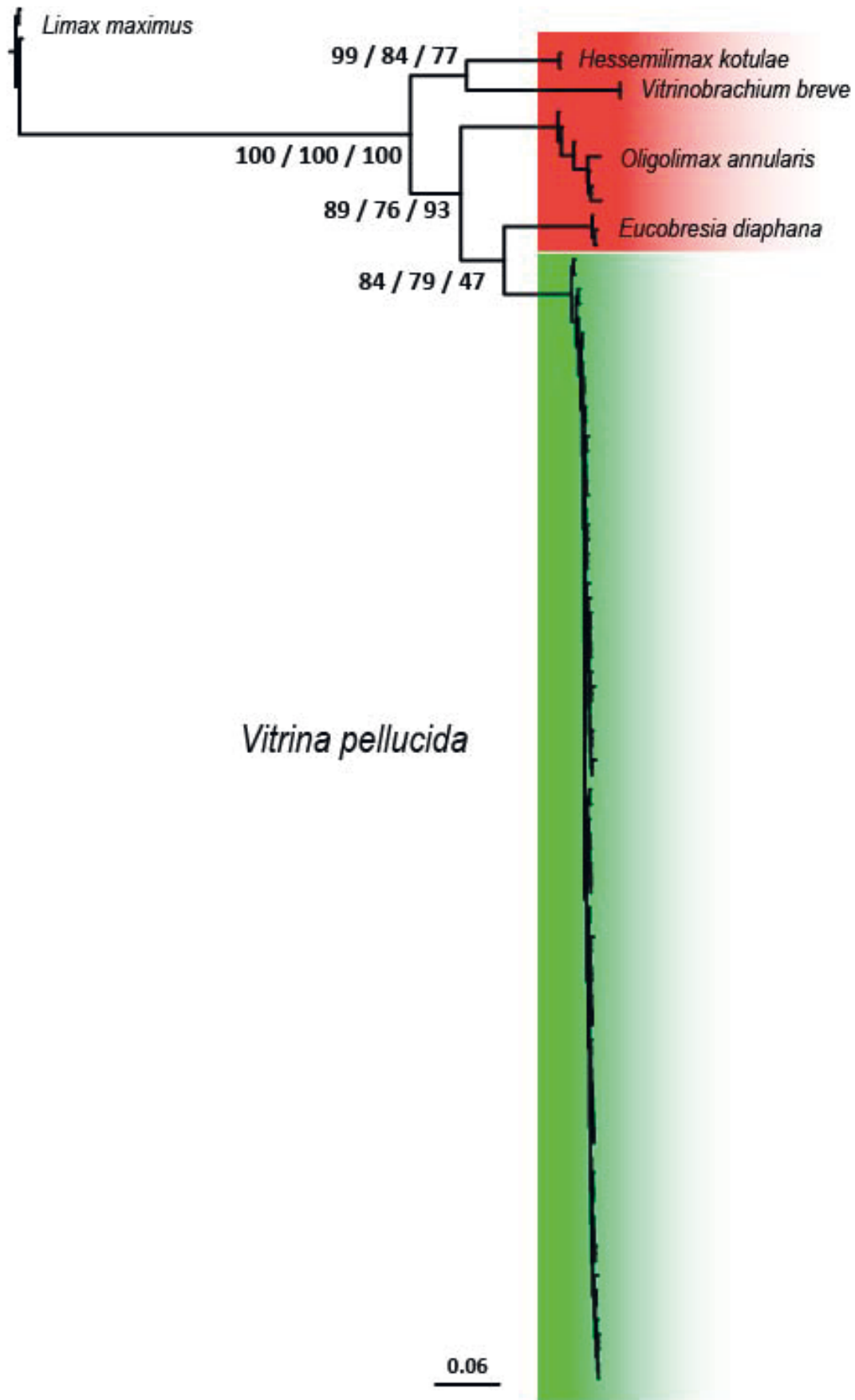

Figure 4. Phylogenetic tree obtained by Bayesian inference (BI) analysis and maximum likelihood (ML) analysis. ML was computed with RAxML and IQTree. Numbers at nodes are posterior probability PP / bootstrap support of RAxML (%) / IQTree (%).

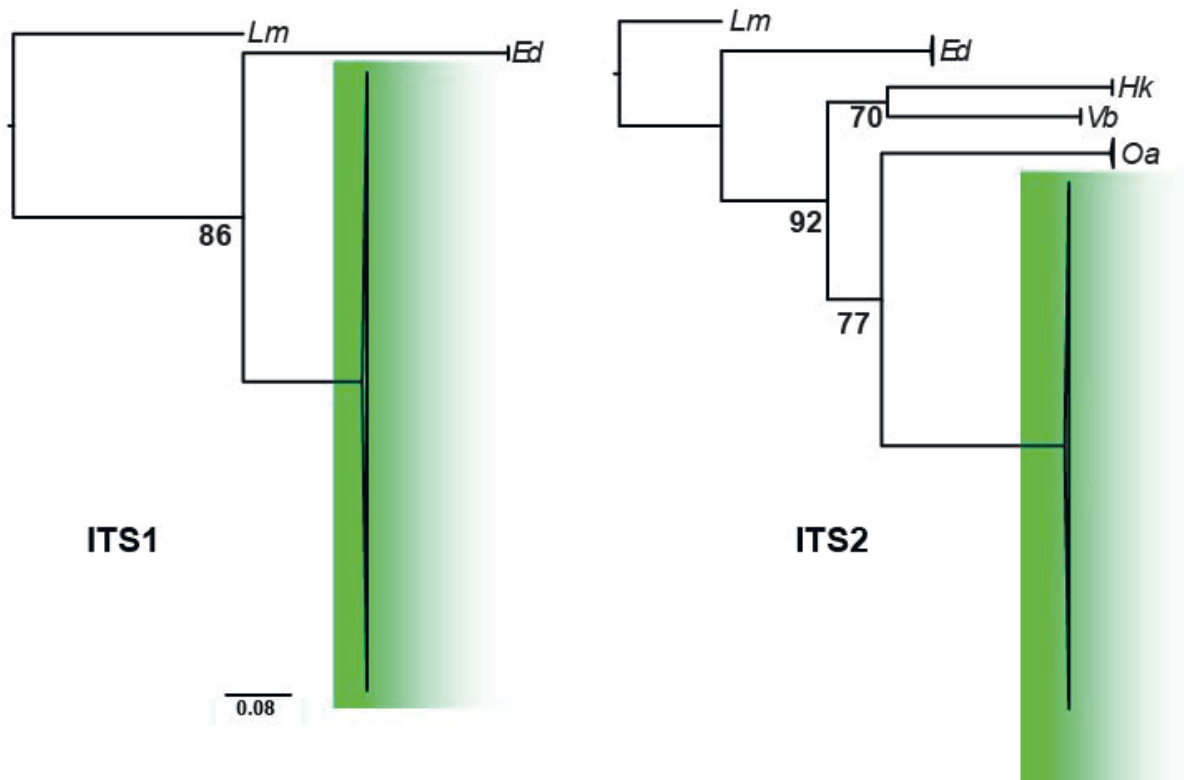

Figure 5. Phylogenetic tree obtained by Maximum likelihood (ML) by IQTree performing a standard bootstrap analysis. Numbers at nodes are indicated as standard bootstrap support (%). Based on the analysis of ITS1 and ITS2 sequence data. Lm = *Limax maximus*, Ed = *Eucobresia diaphana*; Hk = *Hessemilimax kotulae*; Vb = *Vitrinobranchium breve*; Oa = *Oligolimax annularis*.

## 4. Discussion

### 4.1. Morphology

The shells of the specimens presented in the phylogeny, *V. alaskana*, *V. limpida*, *V. angelicae*, “*V. rugulosa*”, *V. pellucida islandica*, and *V. pellucida* do not show any evident differences in the shell morphology. Shells in Vitrinidae are rather poor in character states, which might be due to the ongoing process of limacisation and the loss of relevance of shells. Sysoev and Schileyko (2009) recorded a shell diameter of *V. alaskana* of 10 mm, whereas Pilsbry's (1946) specimens were usually smaller; adult specimens investigate by us reach up to 6.5 mm shell diameter. One frequently discussed feature is the pitting of the protoconch. However, this is a widespread phenomenon in many vitrinid species. Often, the surface of the protoconch is sculptured by a dense pattern of small pits. Next to Forcart (1955), Pilsbry (1946) also remarked on differences in protoconch pitting and used it as a differential character state to discriminate species. It has to be stressed that this is a plesiomorphic character state in the family and does not help for species identification. In all specimens examined, pits could be detected, even in Forcart's specimens of *angelicae*. There are shells, where the pitting is easily recognisable, but often visibility is limited by dried remains of the digestive gland blurring the fine structures on the protoconch shell. It is also a matter of exposure to light and/or light intensity, which may obscure the pitting.

Forcart (1955) considered the specimens from Greenland as a separate species, *V. angelicae* and discriminated it from *pellucida* because of a lower number of whorls, an expanding last whorl, lack of a “spiral sculpture” on the protoconch (see above) and the fact that in his specimens, the vas deferens and the penis were not wrapped in

a sheath of connective tissue. A re-investigation of Forcart's specimens deposited in the Natural History Museum Basel revealed no major differences in the overall shell morphology. The shells are somewhat smaller than usual, and the protoconch is pitted as observed in all other specimens of *pellucida*. Presence or absence of the penial sheath is not indicated in the figures supplied by Forcart (1955, Figs 1–4), who copied the anatomical research of others (in *angelicae*, he used Soós & Schlesch 1924: 97 Abb. 1, (= Maniitsoq)). All his specimens from MHNB from Sukkertoppen are dried out preventing a reappraisal of this feature.

Due to the clear-cut results of the phylogenetic analysis, we shelved investigation of the morphology of genital organs. These are very well known and broadly discussed elsewhere (for example Forcart, 1955; Schileyko, 1986; Giusti et al., 2011). The latter authors also remarked that the general bauplan of the genital organs of *V. angelicae* from Greenland and North America and *V. rugulosa* from Russia is similar to that of *V. pellucida*. Schileyko (1986: 144-145, figs 14, 15) shows the genital organs of both nominal taxa, which display no structural difference. The specimen investigated by Schileyko originates from “southern Altai”, the same area of the specimens sequenced here (Mu Ph141, Altai, Seminski Pereval, Figs 2H, 3E) as *V. pellucida*. All specimens comprised by Shileyko in his material section originate from Russia from Altai westwards towards even Moscow. Later, Egorov (2011) restricts the application of *rugulosa* to “Mountain regions of Central Asia” including the Altai.

*Vitrina rugulosa* was described from” In montibus Kokandensibus prope Karakasuk”, a place we identified in the mountains south of Kokand at 39.804183°N 71.619104°E in the Alaiskyi Ridge (fide Egorov, Fig. on p. 23). The same author shows the distribution of *V. rugulosa* in Central Asia (map 6), and Siberia (map 7). In our investigation, we included two specimens of Vitrinids from the Ferghana Ridge ca. 200 km north of the type locality of *V. rugulosa*, which turned out to be *O. annularis* (Figs 4, 5) in the phylogenetic analysis. We conclude that the specimen investigated by Schileyko in 1986 as *V. rugulosa* was in fact *V. pellucida*. The inclusion of western Russian localities in *V. pellucida* by Egorov (2011, map 1) shows that the original concept of authors concerning *rugulosa* has changed.

The original description by v. Martens is rather inexpressive and could apply to several species of the Vitrinidae; no type specimen(s) could be found so far. We state that neither the shell nor the genital organs of *V. rugulosa* are known since no author including us could investigate topotypic specimens; *rugulosa* could either be *V. pellucida* or *O. annularis*. We herewith treat published *rugulosa* records as “*V. rugulosa*” sensu auctores and considering them as conspecific with *V. pellucida*. The shells of *O. annularis* are rather akin to those of *V. pellucida*. They differ, however, in the more elevated spire of *O. annularis*, the somewhat more rugged (!) surface of the teleoconch, and the less ear-shaped form of the last whorl (Fig. 3I).

## 4.2 Phylogenetic interpretation

The ASAP partitioning helped to assess the species affiliation of the unknown sampled individuals. As it is shown in Supplement 1, field species names were changed accordingly to the species delimitation made by ASAP analysis.

Outgroup and tree structuring taxa cluster as expected, all generic groups are reflected as discrete lineages. However, the investigated nominal taxa of the genus *Vitrina* do not show any intraspecific differences in the molecular phylogeny although they were affiliated to different nominal taxa. By combining the Internal Transcribed Spacers 1 and 2, which are strong markers (Cunningham 1997, Armbruster and Korte 2006, Zhou et

al. 2017, Garzia et al. 2021) especially for the species delimitation in Vitrinidae, the molecular analysis can show a well-defined pattern in the phylogenetic topology. The concatenated phylogenetic tree (Fig. 3) shows a polytomy of all the species of the genus *Vitrina* sampled involved in the investigation. The single gene phylogenetic trees presented in Fig. 4 also show a polytomous topology, which strongly indicates that all individuals in the *Vitrina* clade are to be regarded as conspecific. The ITS1 and ITS2 trees showed no variation. Concluding it can be said that there is no higher variation genetic structure at all as could be expected in a species with a distribution covering the Holarctic realm (Tab. 1 and Fig. 1).

Depending on the group, anatomical studies may provide an effective tool for delimiting genera, sometimes even species. However, in Vitrinidae, such studies can be deceiving, particularly when investigating strongly reduced structures in the reproductive organs. Often enough, similar structures are interpreted as synapomorphic character states leading to a putative stable taxonomic system while ignoring the effect of parallel evolution. This is the case with the African Vitrinidae, which lead to a wrong phylogenetic hypothesis over the years and produced paraphyletic groups as described in Pfarrer et al. (2021). The phylogenetic relationship of *Vitrina* to other vitrinid genera remains to be investigated.

### 4.3 Dispersal of terrestrial snails

Terrestrial snails have limited dispersal abilities, and thus, dispersal of terrestrial snails is a topic of utmost interest in malacology. Terrestrial molluscs move slowly, the activity radius of specimens is rather limited, and in annual species, the individual life span is also a limiting dispersal factor. So, the question of how snails can populate new landscapes, isolated marine Islands or barren landscapes in relatively short time scales is essential.

There are two main vector groups that need to be discussed, i.e. abiotic dispersal vectors, and biotic dispersal vectors. The “rafting” theory postulates transport of terrestrial snails via plants drifting in oceanic currents (Ozgo et al. 2016). Another abiotic dispersal vector may be wind in form of hefty hurricanes (Kirchner et al. 1997). These abiotic factors contrast the biotic dispersal vectors, which are more dynamic and therefore of greater interest in mollusc studies as shown by Gittenberger et al. (2006). Darwin (1859: 385, 397) already studied the immersion of terrestrial snails in salty water, trying to explain in doing so the dispersal to isolated islands, with the conclusion that there may be a biotic factor involved: 'Now it is notorious that land-shells are very easily killed by salt; their eggs, at least such as I have tried, sink in sea-water and are killed by it. Yet there must be, on my view, some unknown, but highly efficient means for their transportal. Would the just hatched young occasionally crawl on and adhere to the feet of birds roosting on the ground, and thus get transported?'

Zoochory comprising endo- and ectozoochory has been described several times. In endozoochory, snails are swallowed by a vector species, transported, and then released with the dung, provided that the species survives the digestive tract of (usually) birds. This passage has been tested by Wada et. al. (2012) using the Japanese white-eye (*Zosterops japonicus* Temminck & Schlegel, 1845) fed with *Tornatellides boeningi* (Schmacker & Boettger, 1891). Some individuals survived, enlarging the activity radius of the micro snail (2.5 mm shell height) enormously, because this bird can fly 300 m per minute! Endozoochory was extensively investigated by Simonová et al. (2016). In this study, a selection of Corvidae, Turdidae, Columbidae and Sturnidae were fed with pulmonate snails up to 17mm length in size. The authors showed that relatively large snails can survive the passage through a bird's digestive system. The survival appeared to be highest in the aviary composed of bird species feeding on grain and seeds rather than animal matter. However, endozoochory presents a major problem

for Vitrinidae as they have no shell to retreat and no massive defensive mucus production which might protect the animals against aggressive digestive enzymes.

Ectozoochory was reported e.g. in mussels adhering to the feet or plumage of aquatic birds enabling them to colonize various ponds or lakes (Prié 2017). In his pond, Darwin (1882) observed bivalves attached on duck feet and on legs of *Dytiscus marginalis* Linnaeus, 1758. Ectozoochory by attachment to the body of a bird, mammal or even insect (Rees 1965) is another possible way for small terrestrial molluscs to disperse (van Leeuwen et al. 2012, Zenzal et al. 2017). Reviewing ectozoochory in birds, Simonová et al. (under preparation) report *V. pellucida* as one of the most observed snail species found in bird feathers during the years 1914 to 2012. The most probable pathway is that *V. pellucida* adheres to the feathers of the vector bird like an ectoparasite using mucus as cohesive with the down feathers. Butot (1977) documented the colonization of north Netherland's coast islands by *V. pellucida*, which took place within just a few years, and the population size was then estimated to encompass several hundred individuals. As colonization by rafting over the North Sea was improbable to impossible due to the salinity of the water (salinity of ca. 1.8%), birds seem to be the only reliable vector species left. In addition to the bird mediated dispersal another possibility of “passive” dispersal is shown by Maciorowski et al. (2012): transport of snails with nest-building material. Small sized snail would be already adhered to tiny leaves and branches and then be dispersed over several kilometres from their possible geographical distribution. Jochum (pers. comm. September 2019) observed *V. pellucida* actively moving towards a backpack after some time of its deposition on a lawn and adhering to it in larger numbers. Optic sensing in terrestrial gastropods is very poor and reduced to differentiation between bright and dark light (Zieger et al. 2009). The enormous distribution of *V. pellucida* over the complete Holarctic range paralleled by an extremely low genetic diversity of even remote populations requires some explanation. We hypothesize that the dispersal was a rapid process which precluded any larger genetic differentiation; the time span available was simply too short. However, what was also needed is obviously the ability to firmly adhere to the plumage of birds or the fur of larger vertebrates. This seems to be a selective advantage over other members of the Vitrinidae: no species within the family shows such an enormous distribution area (and hardly any other terrestrial snail). Probably, attractiveness of a vector species is triggered by tremors provoked by movements of the target animals. After being safely attached in deeper layers of a plumage or a fur, the animals are ready for transport. This probably might have taken place during the Pleistocene, where vast areas were open to long-distance migrators like mammoths, woolly rhino, caribou, other deer species, but also migration birds.

The populations of *V. pellucida* on Greenland and Iceland may also be the product of a man-mediated process. The colonisation of Iceland dates back to the ninth century and that of Greenland a century later. All colonisers have been farmers mainly originating from Norway, where snail specimens might have picked up with vegetables or seeds, and the transported further.



## 4.4 Taxonomic implications

The following list of synonyms contains all taxa, which can be considered conspecific with *V. pellucida*. Remarks on other taxa are added.

### *Vitrina pellucida* (O. F. Müller, 1774)

Figs?

- 1765 *Helix domestica* Strøm, Det Trondheimske Selskab Skrifter 3: 435, pl. VI Fig XV [Norway; nomen oblitum].
- 1774 *Helix pellucida* O. F. Müller, Vermium terrestrium et fluviatilium, seu animalium infusorium, Helminthicorum, et testaceorum, non marinorum, succincta historia, vol 2: 15 [Denmark: Frederiksdal].
- 1812 *Helix limacoides* v. Alten, Systematische Abhandlung über die Erd- und Flußconchylien welche um Augsburg und der umliegenden Gegend gefunden werden: 85, Taf. 11, Fig. 20 [an der Schmutter, einem kleinen Fluss 2 Stunden südlich von Augsburg].
- 1821 *Vitrina beryllina* C. Pfeiffer, Naturgeschichte deutscher Land- und Süßwasser-Mollusken: 47, pl. 3, fig. 1 [...Cassel nicht selten, in dem Bellevuegarten besonders häufig].
- 1837 *Vitrina angelicae* Beck, Index molluscorum praesentis aevi musei principis augustissimi Christiani Frederici: 1 [Grönland, Siuterusak].
- 1850 *Vitrina limpida* A. Gould, Catalogue of shells: 243 [Cape Gourganne, Nipigon Bay, Ontario].
- 1858 *Vitrina exilis* Morelet, Journal de conchyliologie, 7 (1): 8 [aux environs de rétablissement russe de Pétopolowski, Kamtschatka].
- 1861 *Vitrina pfeifferi* Newcomb, Proceedings of the California Academy of Sciences. (1) 2: 92 [Carson Valley Nevada?] non *Vitrina pfeifferi* Deshayes, 1851.
- 1905 *Vitrina alaskana* Dall, Land and fresh water mollusks of Alaska and adjoining regions. In: Alaska. Harriman Alaska Expedition with cooperation of Washington Academy of Sciences vol. 13: 37 [replacement name for *Vitrina pfeifferi* Newcomb, 1861 non *Vitrina pfeifferi* Deshayes, 1851].
- 1955 *Vitrina pellucida islandica* Forcart, Archiv für Molluskenkunde 84 (4/6): 160, Figs 2-3, Taf. 12, Figs 3 & 6 [Iceland, Isarfjördur].

**Distribution:** Holarctic distribution across Eurasia, with records from North Africa (Morocco), East Asia, Kuril, Kamtschatka, Aleute Islands, North America from Alaska to New Mexico; elevation range from sea level up to >3.000 m (Pilsbry 1946, Forcart 1955, own data).

**Remarks:** *Helix domestica*: This is the oldest valid name for *V. pellucida*. However, this name has never been used, we therefore consider it a nomen oblitum; an application to the ICZN for its suppression as suggested by Forcart (1955: 159) is obsolete.

*Helix pellucida*: Forcart (1955) reports that there is no type specimen preserved in the collection of the University of Copenhagen. Therefore, he selected a specimen collected by Mandahl-Barth at the type locality (Frederiksdal, Lyngby, Denmark) as neotype. A reply of the authorities in Copenhagen on the current status is pending, we asked for a picture of the neotype.

*Helix limacoides*: the figures supplied by v. Alten leave no doubt in the identification of his species.

*Vitrina beryllina*: the supplied figures allow synonymising this taxon with *V. pellucida*.

*Vitrina angelicae*: Möller (1842) supplied a short description of the species mainly focusing on the size of lateral appendages (of the animal?!) and the smaller size of the shell.

*Vitrina limpida*: no major differences in shell morphology could be detected; type specimen not researched.

*Vitrina exilis*: This nominal taxon is described from the southern tip of Kamchatka. All our specimens originate from the Kuril Island arc, which is the natural prolongation of this peninsula towards Japan. To our knowledge there are no records for *pellucida* from this country. We consider the specimens from the Kuril Islands as *V. exilis* rendering it a synonym of *pellucida*. Type specimen lost (Breure et al. 2018).

*Vitrina alaskana*: This is a replacement name for *Vitrina pfeifferi* Newcomb, 1861. Thus, the type locality of this taxon is also the type locality of *alaskana*.

*Vitrina pellucida islandica*: there is no evidence for any major genetic or morphological difference to *V. pellucida*. For this reason, we consider *islandica* a synonym of *pellucida*.

*Vitrina rugulosa*:

1874 *Vitrina rugulosa* v. Martens, Sliznyaki (Mollusca). In: A.P. Fedtschenko (ed.), Puteshestvie v Turkestan. Tom II: 7 [Habitat in montibus Kokandensibus prope Karakasuk].

1896 *Vitrina alexandri* Westerlund, Ezhegodnik Zoologicheskogo Muzeya Imperatorskoy Akademii Nauk, 1: 183 [Turkestan, Iskender-kul].

These two nominal vitrinid taxa remain unresolved due to the lack of any specimens. We agree with Schileyko (1986) that *alexandri* is very probably conspecific with *rugulosa*, derived from the original (vague) descriptions. The high-alpine type localities are geographically rather close. Both names probably refer to *O. annularis*.

## 5 Conclusions

The result of our phylogenetic investigation based on genetic analyses implies that the species *V. pellucida* is represented by the following synonymous species; *V. angelicae*, *V. alaskana*, *V. exilis*, and *V. limpida*. The low variation of genetic information, the conservative status of mitochondrial and variable intraspecific nuclear marker (ITS1 and ITS2) is astonishing and strongly suggests that this species complex is in fact just one species. Another interesting finding is that this observed homogeneity is spread overall the Holarctic realm. This can only be explained by a rapid dispersal. Some hypotheses concerning land-snail dispersal are provided. Most probably, long-distance migrating animals like birds and mammals have been acting as vectors during the Pleistocene spreading this species in a very limited timeframe over half of the globe.

## Acknowledgements

We are very grateful to all the contributing collectors for the procured specimen all around the world namely Adrienne Jochum, Larissa Prozorova and Frank Walther. The Masaryk University (MU), the National Museum Cardiff (NMC), Centre for Biodiversity Genomics (CBG), Bulgarian Academy of Sciences (BAS) and the Carnegie Museum (CM) for providing us with collection material for this project. We are very grateful to Estée Bochud, NMBE, for her technical assistance with the stereomicroscope and her helpful comments in image processing. We want to thank Karin Urfer for her help in the laboratory. Many thanks to the team of the UBELIX cluster of Bern for their friendly support and troubleshooting.

## References

- Anisimova M, Gil M, Dufayard J-F, Dessimoz C, Gascuel O (2011) Survey of Branch Support Methods Demonstrates Accuracy, Power, and Robustness of Fast Likelihood-based Approximation Schemes. *Systematic Biology* 60: 685–699. <https://doi.org/10.1093/sysbio/syr041>
- Armbruster GFJ, Korte A (2006) Genomic nucleotide variation in the ITS1 rDNA spacer of land snails. *Journal of Molluscan Studies* 72: 211–213. <https://doi.org/10.1093/mollus/eyi056>
- Armbruster GFJ, Bernhard D (2008) Taxonomic Significance of Ribosomal ITS-1 Sequence Markers in Self-fertilizing Land Snails of Cochlicopa (Stylommatophora, Cochlicopidae). *Zoosystematics and Evolution* 76: 11–18. <https://doi.org/10.1002/mmnz.20000760103>
- Bouaziz-Yahiatene H, Pfarrer B, Medjdoub-Bensaad F, Neubert E (2017) Revision of *Massylaea* Möllendorff, 1898 (Stylommatophora, Helicidae). *ZooKeys* 694: 109–133. <https://doi.org/10.3897/zookeys.694.15001>
- Breure ASH (2010) The rediscovery of a semi-slug: *Coloniconcha prima* Pilsbry, 1933 (Gastropoda, Pleurodontidae) from Hispaniola. *Basteria* 74: 78–86.
- Breure ASH, Audibert C, Ablett JD (2018) Pierre Marie Arthur Morelet (1809-1892) and his contributions to malacology. Leiden, 1–544 pp.
- Brzobohatá K, Drozdová E, Smutný J, Zeman T, Beňuš R (2017) Comparison of Suitability of the Most Common Ancient DNA Quantification Methods. *Genetic Testing and Molecular Biomarkers* 21: 265–271. <https://doi.org/10.1089/gtmb.2016.0197>
- Butot LJM (1977) Vliegende landslakken. De eerste landslakken op een nieuw eiland. *Correspondentieblad NMV* 177: 678–685.
- Carmona L, Pola M, Gosliner TM, Cervera JL (2013) A Tale That Morphology Fails to Tell: A Molecular Phylogeny of Aeolidiidae (Aeolidida, Nudibranchia, Gastropoda). *Badger JH (Ed.). PLoS ONE* 8: 1–13. <https://doi.org/10.1371/journal.pone.0063000>
- Chernomor O, von Haeseler A, Minh BQ (2016) Terrace Aware Data Structure for Phylogenomic Inference from Supermatrices. *Systematic Biology* 65: 997–1008. <https://doi.org/10.1093/sysbio/syw037>
- Cunningham CO (1997) Species Variation within the Internal Transcribed Spacer (ITS) Region of *Gyrodactylus* (Monogenea: Gyrodactylidae) Ribosomal RNA Genes. *The Journal of Parasitology* 83: 215. <https://doi.org/10.2307/3284442>
- Dall WH (1905) Land and fresh water mollusks of Alaska and adjoining regions. in: *Alaska. Harriman Alaska Expedition with cooperation of Washington Academy of Sciences*. vol. 13: i-vii + 1-171.
- Darwin C (1859) *On the origin of species by means of natural selection, or, The preservation of favoured races in the struggle for life*. London: J. Murray. [1st edition].
- Darwin C (1882) On the dispersal of freshwater bivalves. *Nature* 25(649): 529–530.
- Egorov RV (2011) *Treasure of Russian shells*. Vol. 9. Vitrinidae, 33 pp. [4 November]. Moskva (Colus-Doverie).
- Ezzine IK, Pfarrer B, Dimassi N, Said K, Neubert E (2017) At home at least: the taxonomic position of some north African *Xerocrassa* species (Pulmonata, Geomitridae). *ZooKeys* 712: 1–27. <https://doi.org/10.3897/zookeys.712.13066>
- Ezzine IK, Dimassi N, Pfarrer B, Said K, Neubert E (2018) New records of the endemic Sicilian land snail species *Marmorana (Murella) muralis* (O. F. Müller, 1774) from the north of Tunisia (Pulmonata, Gastropoda). *ZooKeys* 775: 131–147. <https://doi.org/10.3897/zookeys.775.25740>
- Folmer O, Black M, Hoeh W, Lutz R, Vrijenhoek R (1994) DNA primers for amplification of mitochondrial cytochrome c oxidase subunit I from diverse metazoan invertebrates. *Molecular Marine Biology and Biotechnology* 3: 294–299.
- Forcart L (1944) Monographie der schweizerischen Vitrinidae (Moll. Pulm.). *Revue Suisse de Zoologie*, 51 (29): 629-678, pl. 2. Genève [December].
- Forcart L (1955) Die nordische Arten der Gattung *Vitrina*. *Archiv für Molluskenkunde*, 84 (4/6): 155-166. Frankfurt am Main [17 October].
- Garzia M, Mariottini P, Salvi D, Furfaro G (2021) Variation and Diagnostic Power of the Internal Transcribed Spacer 2 in Mediterranean and Atlantic Eolid Nudibranchs (Mollusca, Gastropoda). *Frontiers in Marine Science* 8: 811. <https://doi.org/10.3389/fmars.2021.693093>
- Gittenberger E, Piel WH, Groenenberg DSJ (2004) The Pleistocene glaciations and the evolutionary history of the polytypic snail species *Arianta arbustorum* (Gastropoda, Pulmonata, Helicidae). *Molecular Phylogenetics and Evolution* 30: 64–73. [https://doi.org/10.1016/S1055-7903\(03\)00182-9](https://doi.org/10.1016/S1055-7903(03)00182-9)
- Gittenberger E, Groenenberg DSJ, Kokshoorn B, Preece RC (2006) Molecular trails from hitch-hiking snails. *Nature* 439: 409–409. <https://doi.org/10.1038/439409a>
- Giusti F, Fiorentino V, Benocci A, Manganelli G (2011) A Survey of Vitrinid Land Snails (Gastropoda: Pulmonata: Limacoidea). *Malacologia* 53: 279–363. <https://doi.org/10.4002/040.053.0206>
- Gomes SR, Britto da Silva F, Mendes ILV, Thomé JW, Bonatto SL (2010) Molecular phylogeny of the South American land slug *Phyllocaulis* (Mollusca, Soleolifera, Veronicellidae). *Zoologica Scripta* 39: 177–186. <https://doi.org/10.1111/j.1463-6409.2009.00412.x>

Gould AA (1850) Catalogue of shells, with descriptions of new species. In: Agassiz, L., Lake Superior: Its physical character, vegetation, and animals, compared with those of other and similar regions. Boston; Gould, Kendall and Lincoln. pp. 243-245, plate 7..

Guindon S, Dufayard J-F, Lefort V, Anisimova M, Hordijk W, Gascuel O (2010) New Algorithms and Methods to Estimate Maximum-Likelihood Phylogenies: Assessing the Performance of PhyML 3.0. *Systematic Biology* 59: 307–321. <https://doi.org/10.1093/sysbio/syq010>

Hausdorf B (2002) Phylogeny and biogeography of the Vitrinidae (Gastropoda: Stylommatophora). *Zoological Journal of the Linnean Society* 134: 347–358. <https://doi.org/10.1046/j.1096-3642.2002.00010.x>

Hausdorf B, Sauer J (2009) Revision of the Helicellinae of Crete (Gastropoda: Hygromiidae). *Zoological Journal of the Linnean Society* 157: 373–419. <https://doi.org/10.1111/j.1096-3642.2008.00504.x>

Hesse P (1923) Beiträge zur näheren Kenntnis der Familie Vitrinidae. *Archiv für Molluskenkunde* 23: 1–25; 81–115; 129–145, Taf. 1-3 (plate 3 missing).

Huelsenbeck JP, Ronquist F (2001) MRBAYES: Bayesian inference of phylogenetic trees. *Bioinformatics* 17: 754–755. <https://doi.org/10.1093/bioinformatics/17.8.754>

Jaksch K, Eschner A, Rintelen TV, Haring E (2016) DNA analysis of molluscs from a museum wet collection: a comparison of different extraction methods. *BMC Research Notes* 9: 348. <https://doi.org/10.1186/s13104-016-2147-7>

Katoh K, Standley DM (2013) MAFFT Multiple Sequence Alignment Software Version 7: Improvements in Performance and Usability. *Molecular Biology and Evolution* 30: 772–780. <https://doi.org/10.1093/molbev/mst010>

Kimura M (1980) A simple method for estimating evolutionary rates of base substitutions through comparative studies of nucleotide sequences. *Journal of Molecular Evolution* 16: 111–120. <https://doi.org/10.1007/BF01731581>

Kirchner Ch, Krätzner R, Welter-Schultes FW (1997) Flying snails — how far can Truncatellina (Pulmonata: Vertiginidae) be blown over the sea? *Journal of Molluscan Studies* 63: 479–487. <https://doi.org/10.1093/mollus/63.4.479>

Koressaar T, Remm M (2007) Enhancements and modifications of primer design program Primer3. *Bioinformatics (Oxford, England)* 23: 1289–1291. <https://doi.org/10.1093/bioinformatics/btm091>

Lanfear R, Calcott B, Ho SYW, Guindon S (2012) PartitionFinder: Combined Selection of Partitioning Schemes and Substitution Models for Phylogenetic Analyses. *Molecular Biology and Evolution* 29: 1695–1701. <https://doi.org/10.1093/molbev/mss020>

Lanfear R, Frandsen PB, Wright AM, Senfeld T, Calcott B (2017) PartitionFinder 2: New Methods for Selecting Partitioned Models of Evolution for Molecular and Morphological Phylogenetic Analyses. *Molecular Biology and Evolution* 34: 772–773. <https://doi.org/10.1093/molbev/msw260>

van Leeuwen CHA, van der Velde G, van Lith B, Klaassen M (2012) Experimental Quantification of Long Distance Dispersal Potential of Aquatic Snails in the Gut of Migratory Birds. Evans DM (Ed.). *PLoS ONE* 7: e32292. <https://doi.org/10.1371/journal.pone.0032292>

Lohmander H (1938) Landmollusken aus Island. Elanders boktryckeri aktiebolag.

Maciorowski G, Urbańska M, Gierszal H (2012) An example of passive dispersal of land snails by birds - short note. *Folia Malacologica* 20: 139–141. <https://doi.org/10.2478/v10125-012-0010-6>

Martens E von (1874) Sliznyaki (Mollusca). In: A.P. Fedtschenko (ed.), *Puteshestvie v Turkestan*. Tom II. Zoogeograficheskiya Izsledovaniya. Chast I, Vypusk 1. *Izvestiya Imperatorskago Obshchestva Lyubitelei Estestvoznaniya, Antropologii i Etnografii pri Imperatorskom Moskovskom Universitete*, Ser. 5. 11 (1): i-viii, 1-66, pl. 1-3. St.-Peterburg/Moskva [ $< 21$  March]. [summarized by E. von Martens in *Sitzungs-Berichte der Gesellschaft Naturforschender Freunde zu Berlin*, 1874 (5): 43-53. Berlin [ $> 19$  May]].

Minh BQ, Schmidt HA, Chernomor O, Schrempf D, Woodhams MD, von Haeseler A, Lanfear R (2020) IQ-TREE 2: New Models and Efficient Methods for Phylogenetic Inference in the Genomic Era. *Molecular Biology and Evolution* 37: 1530–1534. <https://doi.org/10.1093/molbev/msaa015>

Möller HPC (1842) *Index Molluscorum Groenlandiae*. *Naturhistorisk Tidsskrift* 4: 76–97.

Morelet, A. (1858). *Coquilles terrestres du Kamtchatka*. *Journal de conchyliologie*. 7 (1): 7-22

Müller OF (1774) *Vermium terrestrium et fluviatilium, seu animalium infusorium, Helminthicorum, et testaceorum, non marinorum, succincta historia*. vol 2: I-XXXVI, 1-214, 10 unnumbered pages. Havnicae et Lipsiae, apud Heineck et Faber, ex officina Molleriana.

Neiber MT, Sagorny C, Hausdorf B (2016) Increasing the number of molecular markers resolves the phylogenetic relationship of ‘Cepaea’ vindobonensis (Pfeiffer 1828) with *Caucasotachea Boettger* 1909 (Gastropoda: Pulmonata: Helicidae). *J Zool Syst Evol Res*: 6.

Nekola JC, Chiba S, Coles BF, Drost CA, Proschwitz T von, Horsák M (2018) A Phylogenetic Overview of the Genus *Vertigo* O. F. Müller, 1773 (Gastropoda: Pulmonata: Pupillidae: Vertigininae). *Malacologia* 62: 21–161. <https://doi.org/10.4002/040.062.0104>

Nguyen L-T, Schmidt HA, von Haeseler A, Minh BQ (2015) IQ-TREE: A Fast and Effective Stochastic Algorithm for Estimating Maximum-Likelihood Phylogenies. *Molecular Biology and Evolution* 32: 268–274. <https://doi.org/10.1093/molbev/msu300>



- Ozgo M, Örstan A, Kirschenstein M, Cameron R (2016) Dispersal of land snails by sea storms. *Journal of Molluscan Studies* 82: 341–343. <https://doi.org/10.1093/mollus/eyv060>
- Palumbi S, Martin A, Romano S, McMillan WO, Stice L, Grabowski G (1991) The simple fool's guide to PCR. Dept. of Zoology and Kewalo Marine Laboratory, University of Hawaii. 2.0: 45.
- Pfarrer B, Rowson B, Tattersfield P, Neubert E (2021) Phylogenetic position of African Vitrinidae: Old family groups unraveled. *Journal of Zoological Systematics and Evolutionary Research* 59: 1190–1208. <https://doi.org/10.1111/jzs.12502>
- Pfenninger M, Hrabáková M, Steinke D, Dèpraz A (2005) Why do snails have hairs? A Bayesian inference of character evolution. *BMC Evolutionary Biology* 5: 1–11. <https://doi.org/10.1186/1471-2148-5-59>
- Pfenninger M, Véla E, Jesse R, Elejalde MA, Liberto F, Magnin F, Martínez-Ortí A (2010) Temporal speciation pattern in the western Mediterranean genus *Tudorella* P. Fischer, 1885 (Gastropoda, Pomatiidae) supports the Tyrrenian vicariance hypothesis. *Molecular Phylogenetics and Evolution* 54: 427–436. <https://doi.org/10.1016/j.ympev.2009.09.024>
- Pilsbry HA (1946) Land Mollusca of North America (north of Mexico). Volume II Part 1. The Academy of Natural Sciences of Philadelphia Monographs 2: 1–520.
- Prié V (2017) Naïades et autres bivalves d'eau douce de France. Biotope éditions.
- Puillandre N, Brouillet S, Achaz G (2021) ASAP: assemble species by automatic partitioning. *Molecular Ecology Resources* 21: 609–620. <https://doi.org/10.1111/1755-0998.13281>
- Raheem D, Naggs F (2006) The Sri Lankan endemic semi-slug *Ratnadvipia* (Limacoidea: Ariophantidae) and a new species from southwestern Sri Lanka. *Systematics and Biodiversity* 4: 99–126. <https://doi.org/10.1017/S1477200005001854>
- Rambaut A (2012) FigTree (version 1.4.0). Available at <http://tree.bio.ed.ac.uk/software/figtree/>.
- Rambaut A, Drummond AJ, Xie D, Baele G, Suchard MA (2018) Posterior Summarization in Bayesian Phylogenetics Using Tracer 1.7. Susko E (Ed.). *Systematic Biology* 67: 901–904. <https://doi.org/10.1093/sysbio/syy032>
- Rees WJ (1965) The aerial dispersal of Mollusca. *Journal of Molluscan Studies* 36: 269–282.
- Ronquist F, Huelsenbeck JP (2003) MrBayes 3: Bayesian phylogenetic inference under mixed models. *Bioinformatics* 19: 1572–1574. <https://doi.org/10.1093/bioinformatics/btg180>
- Ronquist F, Teslenko M, van der Mark P, Ayres DL, Darling A, Höhna S, Larget B, Liu L, Suchard MA, Huelsenbeck JP (2012) MrBayes 3.2: Efficient Bayesian Phylogenetic Inference and Model Choice Across a Large Model Space. *Systematic Biology* 61: 539–542. <https://doi.org/10.1093/sysbio/sys029>
- Roth B, Sadeghian PS (2003) Checklist of the land snails and slugs of California. Santa Barbara Museum of Natural History, Santa Barbara, Calif, 81 pp.
- Schileyko AA (1986) Sistema i filogeniya Vitrinidae (Gastropoda Pulmonata). *Trudy Zoologicheskogo Instituta Leningrad* 148: 124–157.
- Simonová J, Simon OP, Kapic Š, Nehasil L, Horsák M (2016) Medium-sized forest snails survive passage through birds' digestive tract and adhere strongly to birds' legs: more evidence for passive dispersal mechanisms. *Journal of Molluscan Studies* 82: 422–426. <https://doi.org/10.1093/mollus/eyw005>
- Soós L, Schlesch H (1924) Notes on some Arctic Mollusca from Greenland. In: *Annales Musei Nationalis Hungarici.* , 94–104.
- Stamatakis A (2006) RAxML-VI-HPC: maximum likelihood-based phylogenetic analyses with thousands of taxa and mixed models. *Bioinformatics* 22: 2688–2690. <https://doi.org/10.1093/bioinformatics/btl446>
- Strøm H (1765) Beskrivelse over Norske insecter, forste stykke. *Det Trondheimske Selskab Skrifter.* 3: 376–439, pl. VI.
- Studer S (1820) Kurzes Verzeichniss der bis jetzt in unserm Vaterlande entdeckten Conchylien. *Naturwissenschaftlicher Anzeiger der Allgemeinen Schweizerischen Gesellschaft für die Gesamten Naturwissenschaften*, 3 (11): 83-90; (12): 91-94. Bern [1 May; 1 June]. [reprinted as a separate work under 2 the title: Systematisches Verzeichniss der bis jetzt bekannt gewordenen Schweizer-Conchylien. Bern (Stämpfli: 32 pp. > 5 April)]
- Sysoev A, Schileyko A (2009) Land snails and slugs of Russia and adjacent countries. Pensoft, Sofia Moscow, 312 pp.
- Uit de Weerd DR, Gittenberger E (2013) Phylogeny of the land snail family Clausiliidae (Gastropoda: Pulmonata). *Molecular Phylogenetics and Evolution* 67: 201–216. <https://doi.org/10.1016/j.ympev.2013.01.011>
- Untergasser A, Cutcutache I, Koressaar T, Ye J, Faircloth BC, Remm M, Rozen SG (2012) Primer3—new capabilities and interfaces. *Nucleic Acids Research* 40: e115–e115. <https://doi.org/10.1093/nar/gks596>
- Wade CM, Mordan PB (2000) Evolution within the gastropod molluscs; using the ribosomal RNA gene-cluster as an indicator of phylogenetic relationships. *Journal of Molluscan Studies* 66: 565–570.
- Wade CM, Mordan PB, Clarke B (2001) A phylogeny of the land snails (Gastropoda: Pulmonata). *Proceedings of the Royal Society of London. Series B: Biological Sciences* 268: 413–422. <https://doi.org/10.1098/rspb.2000.1372>



- Weigand AM, Jochum A, Slapnik R, Schnitzler J, Zarza E, Klusmann-Kolb A (2013) Evolution of microgastropods (Ellobioidea, Carychiidae): integrating taxonomic, phylogenetic and evolutionary hypotheses. *BMC Evolutionary Biology* 13: 18. <https://doi.org/10.1186/1471-2148-13-18>
- Westerlund CA (1896) Neue centralasiatische Mollusken. *Ezhegodnik Zoologicheskogo Muzeya Imperatorskoy Akademii Nauk (Annuaire du Musée Zoologique de l'Académie Impériale des Sciences de Saint-Petersbourg)*. 1: 181-198.
- Zenzal TJ, Lain EJ, Sellers JM (2017) An Indigo Bunting ( *Passerina cyanea* ) Transporting Snails During Spring Migration. *The Wilson Journal of Ornithology* 129: 898–902. <https://doi.org/10.1676/16-182.1>
- Zhou W, Yang H, Ding H, Yang S, Lin J, Wang P (2017) Population genetic structure of the land snail *Camaena cicatricosa* (Stylommatophora, Camaenidae) in China inferred from mitochondrial genes and ITS2 sequences. *Scientific Reports* 7: 15590. <https://doi.org/10.1038/s41598-017-15758-y>
- Zieger MV, Vakoliuk IA, Tuchina OP, Zhukov VV, Meyer-Rochow VB (2009) Eyes and vision in *Arion rufus* and *Deroceras agreste* (Mollusca; Gastropoda; Pulmonata): What role does photoreception play in the orientation of these terrestrial slugs? *Acta Zoologica* 90: 189–204. <https://doi.org/10.1111/j.1463-6395.2008.00369.x>

Supplement 1. Voucher numbers, field species, DNA species ASAP scoring, locality and GenBank accession numbers: Abbreviations: BIOUG, Centre for Biodiversity Genomics; FW, Frank Walther coll; Larissa Prozorova coll; NMBE, Naturhistorisches Museum Bern; NMW, National Museum of Wales; MU, Masaryk University; CBG, Centre for Biodiversity Genomics; BAS, Bulgarian Academy of Sciences; EHUMC, Euskal Herriko Unibertsitatea; CM, Carnegie Museum.

## Gen Bank accession numbers

## locality

ASAP  
partition

## Field species

## DNA species

## Latitude

## Longitude

## Voucher number

## COI

## 16S

## H3

## ITS1

## ITS2

Voucher number	Field species	DNA species	ASAP partition	locality	Latitude	Longitude	COI	16S	H3	ITS1	ITS2
NMBE 571038	<i>Vitrina alaskana</i>	<i>Vitrina pellucida</i>	1	USA	35.2502	-106.4098	OK393824	OK386950	OK431497	OK413297	OK413355
NMBE 571039	<i>Vitrina alaskana</i>	<i>Vitrina pellucida</i>	1	USA	35.2502	-106.4098	OK393825	OK386951	OK431498	OK413298	OK413356
NMBE 571040	<i>Vitrina alaskana</i>	<i>Vitrina pellucida</i>	1	USA	35.2502	-106.4098	OK393826	OK386952	OK431499	OK413299	OK413357
CM 74617a	<i>Vitrina alaskana</i>	<i>Vitrina pellucida</i>	NA	USA	40.3526	-120.8793	-----	OK386967	OK431516	-----	-----
CM 74617b	<i>Vitrina alaskana</i>	<i>Vitrina pellucida</i>	NA	USA	40.3526	-120.8793	-----	OK386968	OK431517	-----	-----
CM 74617c	<i>Vitrina alaskana</i>	<i>Vitrina pellucida</i>	NA	USA	40.3526	-120.8793	-----	-----	OK431518	-----	-----
NMBE 571037	<i>Vitrina alaskana</i>	<i>Vitrina pellucida</i>	NA	USA	35.7588	-105.608	-----	-----	OK431501	OK413300	-----
NMBE 571032	<i>Vitrina alaskana</i>	<i>Vitrina pellucida</i>	1	USA	37.4415	-106.875	OK393827	-----	OK431502	OK413301	-----
NMBE 571022	<i>Vitrina alaskana</i>	<i>Vitrina pellucida</i>	NA	USA	38.8029	-106.374	-----	-----	OK431503	-----	-----
NMBE 571030	<i>Vitrina alaskana</i>	<i>Vitrina pellucida</i>	1	USA	33.498	-105.761	OK393828	-----	OK431504	OK413302	OK413358
NMBE 571034	<i>Vitrina alaskana</i>	<i>Vitrina pellucida</i>	NA	USA	32.4413	-110.784	-----	-----	OK431505	OK413303	-----
NMBE 571029	<i>Vitrina alaskana</i>	<i>Vitrina pellucida</i>	NA	USA	37.0999	-112.549	-----	-----	OK431506	OK413304	OK413359
NMBE 571035	<i>Vitrina alaskana</i>	<i>Vitrina pellucida</i>	1	USA	38.4174	-112.313	OK393829	-----	OK431507	OK413305	-----
NMBE 571023	<i>Vitrina alaskana</i>	<i>Vitrina pellucida</i>	1	USA	38.79	-120.009	OK393830	-----	OK431508	OK413306	-----
NMBE 571025	<i>Vitrina alaskana</i>	<i>Vitrina pellucida</i>	NA	USA	40.7751	-115.336	-----	-----	-----	OK413307	OK413360
NMBE 571024	<i>Vitrina alaskana</i>	<i>Vitrina pellucida</i>	NA	USA	41.8469	-115.429	-----	-----	-----	OK413308	-----

NMBE 571019	<i>Vitrina alaskana</i>	<i>Vitrina pellucida</i>	1	USA	42.5035	-111.276	OK393831	-----	OK431509	OK413309	-----
NMBE 571021	<i>Vitrina alaskana</i>	<i>Vitrina pellucida</i>	1	USA	41.7426	-111.76	OK393832	-----	OK431510	OK413310	-----
NMBE 571026	<i>Vitrina alaskana</i>	<i>Vitrina pellucida</i>	1	Canada	50.647	-117.191	OK393833	-----	OK431511	OK413311	-----
NMBE 571027	<i>Vitrina alaskana</i>	<i>Vitrina pellucida</i>	1	Canada	50.6368	-117.191	OK393834	-----	OK431512	OK413312	-----
NMBE 571036	<i>Vitrina alaskana</i>	<i>Vitrina pellucida</i>	1	USA	34.2168	-116.957	OK393835	-----	OK431513	OK413313	-----
NMBE 571033	<i>Vitrina alaskana</i>	<i>Vitrina pellucida</i>	1	USA	39.3965	-120.186	OK393836	-----	OK431514	OK413314	-----
NMBE 571041	<i>Vitrina alaskana</i>	<i>Vitrina pellucida</i>	1	USA	39.6183	-120.587	OK393837	-----	OK431515	-----	-----
NMBE 571020	<i>Vitrina alaskana</i>	<i>Vitrina pellucida</i>	NA	USA	62.7438	-150.1264	-----	OK386953	OK431500	-----	OK413377
BIOUG15235-B06	<i>Vitrina angelicae</i>	<i>Vitrina pellucida</i>	1	Canada	43.592	-80.2705	OK393838	OK386970	OK431519	OK413315	OK413362
BIOUG12144-A01	<i>Vitrina angelicae</i>	<i>Vitrina pellucida</i>	NA	Canada	53.6579	-112.8339	-----	OK386969	-----	-----	OK413361
NMBE 571012	<i>Vitrina limpida</i>	<i>Vitrina pellucida</i>	1	USA	43.4447	-92.5094	OK393839	OK386971	OK431520	-----	-----
NMBE 571006	<i>Vitrina limpida</i>	<i>Vitrina pellucida</i>	1	USA	48.7354	96.6713	OK393840	OK386972	OK431521	OK413316	OK413363
NMBE 571017	<i>Vitrina limpida</i>	<i>Vitrina pellucida</i>	1	USA	47.6138	-96.1725	OK393841	OK386973	OK431522	OK413317	OK413364
NMBE 571016	<i>Vitrina limpida</i>	<i>Vitrina pellucida</i>	1	USA	48.0069	-96.3035	OK393842	OK386974	OK431523	OK413318	OK413365
NMBE 571005	<i>Vitrina limpida</i>	<i>Vitrina pellucida</i>	1	USA	48.4102	-94.8188	OK393843	OK386975	OK431524	OK413319	OK413366
NMBE 571011	<i>Vitrina limpida</i>	<i>Vitrina pellucida</i>	1	USA	48.3994	-96.5497	OK393844	OK386976	OK431525	OK413320	OK413367
NMBE 571004	<i>Vitrina limpida</i>	<i>Vitrina pellucida</i>	1	USA	46.9832	-96.3194	OK393845	OK386977	OK431526	OK413321	OK413368

NMBE 571013	<i>Vitrina limpida</i>	<i>Vitrina pellucida</i>	1	USA	46.8505	-94.7229	OK393846	-----	OK431527	OK413322	OK413369
NMBE 571002	<i>Vitrina limpida</i>	<i>Vitrina pellucida</i>	1	USA	47.5328	-94.8247	OK393847	OK386978	OK431528	OK413323	OK413370
NMBE 571009	<i>Vitrina limpida</i>	<i>Vitrina pellucida</i>	1	USA	47.4122	-96.0528	OK393848	-----	OK431529	OK413324	-----
NMBE 571018	<i>Vitrina limpida</i>	<i>Vitrina pellucida</i>	1	Canada	50.4135	97.9412	OK393849	OK386979	OK431530	OK413325	OK413371
NMBE 571001	<i>Vitrina limpida</i>	<i>Vitrina pellucida</i>	1	Canada	49.8554	-97.4705	OK393850	OK386980	OK431531	OK413326	-----
NMBE 571003	<i>Vitrina limpida</i>	<i>Vitrina pellucida</i>	1	USA	48.9129	-98.0701	OK393851	OK386981	OK431532	OK413327	OK413372
NMBE 571014	<i>Vitrina limpida</i>	<i>Vitrina pellucida</i>	1	Canada	49.3256	-67.37	OK393852	OK386982	OK431533	OK413328	OK413373
NMBE 571015	<i>Vitrina limpida</i>	<i>Vitrina pellucida</i>	1	Canada	54.8678	-66.6608	OK393853	OK386983	OK431534	OK413329	OK413374
NMBE 571007	<i>Vitrina limpida</i>	<i>Vitrina pellucida</i>	1	Canada	54.6726	-66.6092	OK393854	OK386984	OK431535	OK413330	OK413375
NMBE 571010	<i>Vitrina limpida</i>	<i>Vitrina pellucida</i>	NA	Canada	50.2636	-66.4108	-----	OK386985	OK431536	OK413331	OK413376
NMBE 571008	<i>Vitrina limpida</i>	<i>Vitrina pellucida</i>	NA	USA	45.9077	-84.747	-----	OK386986	-----	OK413332	-----
NMBE 20438	<i>Vitrina pellucida</i>	<i>Vitrina pellucida</i>	1	Switzerland	46.469	9.718	OK393859	OK386991	OK431541	OK413337	-----
NMBE 510181	<i>Vitrina pellucida</i>	<i>Vitrina pellucida</i>	1	Switzerland	46.5967	10.0762	MT181518	MT181364	MT181481	OK413338	MT181399
NMBE 509708	<i>Vitrina pellucida</i>	<i>Vitrina pellucida</i>	1	Switzerland	47.2754	7.399	MT181517	MT181363	MT181480	-----	MT181398
NMBE 570975	<i>Vitrina pellucida</i>	<i>Vitrina pellucida</i>	1	Russia	51.9043	105.102	OK393855	OK386987	OK431537	OK413333	-----
FW 10342	<i>Vitrina pellucida</i>	<i>Vitrina pellucida</i>	1	Morocco	31.1116	-7.9204	MT181519	MT181365	MT181482	OK413339	MT181400
FW 10343	<i>Vitrina pellucida</i>	<i>Vitrina pellucida</i>	1	Morocco	31.1116	-7.9204	OK393860	OK386992	OK431542	OK413340	OK413381



NMBE 570976	<i>Vitrina pellucida</i>	<i>Vitrina pellucida</i>	1	Germany	50.166	8.3889	OK393856	OK386988	OK431538	OK413334	OK413378
NMBE 570977	<i>Vitrina pellucida</i>	<i>Vitrina pellucida</i>	1	Germany	50.166	8.3889	OK393857	OK386989	OK431539	OK413335	OK413379
NMBE 570978	<i>Vitrina pellucida</i>	<i>Vitrina pellucida</i>	1	Germany	50.166	8.3889	OK393858	OK386990	OK431540	OK413336	OK413380
MU PH141	<i>Vitrina rugulosa</i>	<i>Vitrina pellucida</i>	NA	Russia	51.0513	85.6165	-----	OK386996	OK431546	OK413341	-----
MU ZO206	<i>Vitrina pellucida</i>	<i>Vitrina pellucida</i>	NA	Russia	51.1502	86.5102	-----	OK386995	OK431545	-----	-----
MU JD609	<i>Vitrina pellucida</i>	<i>Vitrina pellucida</i>	NA	Russia	53.0367	87.9636	-----	OK386993	OK431543	-----	-----
MU PL253	<i>Vitrina pellucida</i>	<i>Vitrina pellucida</i>	NA	Russia	51.1486	86.505	-----	OK386994	OK431544	-----	-----
NMBE571466	<i>Vitrina pellucida</i>	<i>Vitrina pellucida</i>	NA	Island	65.6434	-22.5381	-----	-----	OM336672	OM326716	OM326718
NMBE 570985	<i>Vitrina exilis</i>	<i>Vitrina pellucida</i>	1	Russia	47.3767	152.4575	OK393865	-----	OK431551	-----	-----
NMBE 570986	<i>Vitrina exilis</i>	<i>Vitrina pellucida</i>	NA	Russia	47.2993	152.5015	-----	OK387001	-----	-----	-----
NMBE 570995	<i>Vitrina exilis</i>	<i>Vitrina pellucida</i>	1	Russia	46.984	152.0207	OK393872	OK387006	OK431557	-----	-----
NMBE 570996	<i>Vitrina exilis</i>	<i>Vitrina pellucida</i>	1	Russia	46.9833	152.0213	OK393873	OK387007	OK431558	-----	-----
NMBE 570998	<i>Vitrina exilis</i>	<i>Vitrina pellucida</i>	1	Russia	45.8033	149.8912	OK393874	OK387008	OK431559	-----	-----
NMBE 570999	<i>Vitrina exilis</i>	<i>Vitrina pellucida</i>	1	Russia	45.7951	149.907	OK393875	OK387009	OK431560	-----	-----
NMBE 570992	<i>Vitrina exilis</i>	<i>Vitrina pellucida</i>	NA	Russia	50.0372	155.3895	-----	-----	OK431554	-----	-----
NMBE 570990	<i>Vitrina exilis</i>	<i>Vitrina pellucida</i>	1	Russia	49.4186	154.6593	OK393867	OK387002	OK431553	OK413343	-----
NMBE 570991	<i>Vitrina exilis</i>	<i>Vitrina pellucida</i>	1	Russia	49.3892	154.8196	OK393868	OK387003	-----	-----	-----

NMBE 570987	<i>Vitrina exilis</i>	<i>Vitrina pellucida</i>	1	Russia	49.1538	154.489	OK393866	-----	OK431552	-----	OK413385
NMBE 570994	<i>Vitrina exilis</i>	<i>Vitrina pellucida</i>	1	Russia	48.782	154.0355	OK393870	OK387004	OK431555	-----	OK413386
NMBE 570982	<i>Vitrina exilis</i>	<i>Vitrina pellucida</i>	1	Russia	50.6533	156.401	OK393871	OK387005	OK431556	OK413344	OK413387
NMBE 570993	<i>Vitrina exilis</i>	<i>Vitrina pellucida</i>	1	Russia	50.6238	156.1345	OK393869	-----	-----	-----	-----
NMBE 570984	<i>Vitrina exilis</i>	<i>Vitrina pellucida</i>	1	Russia	45.1885	148.2572	OK393863	OK386999	OK431549	-----	OK413384
NMBE 570983	<i>Vitrina exilis</i>	<i>Vitrina pellucida</i>	1	Russia	48.95	153.9883	OK393864	OK387000	OK431550	-----	-----
NMBE 571000	<i>Vitrina exilis</i>	<i>Vitrina pellucida</i>	NA	Russia	47.5052	150.8175	-----	-----	OK431561	-----	-----
NMBE 570981	<i>Vitrina sp.</i>	<i>Vitrina pellucida</i>	1	Kazakhstan	49.5285	86.5274	OK393861	OK386997	OK431547	OK413342	OK413382
NMBE 570989	<i>Vitrina sp.</i>	<i>Vitrina pellucida</i>	1	Russia	69.635	31.9792	OK393862	OK386998	OK431548	-----	OK413383
NMBE 549946	<i>Vitrinobrachium breve</i>	<i>Vitrinobrachium breve</i>	2	Switzerland	46.9241	7.5305	MT181521	MT181367	MT181484	OK413346	MT181402
NMBE 549944	<i>Vitrinobrachium breve</i>	<i>Vitrinobrachium breve</i>	2	Switzerland	46.9306	7.473	MT181520	MT181366	MT181483	OK413345	MT181401
NMBE 2670	<i>Eucobresia diaphana</i>	<i>Eucobresia diaphana</i>	3	Germany	47.7636	8.6124	MT181500	MT181343	MT181456	-----	MT181384
NMBE 510118	<i>Eucobresia diaphana</i>	<i>Eucobresia diaphana</i>	3	Switzerland	46.0579	7.0012	MT181501	MT181344	MT181457	OK413295	OK413352
NMBE 510182	<i>Eucobresia diaphana</i>	<i>Eucobresia diaphana</i>	3	Switzerland	46.5967	10.0762	MT181502	OK386942	MT181458	-----	MT181385
NMBE 20538	<i>Hessemilimax kotulae</i>	<i>Hessemilimax kotulae</i>	4	Switzerland	47.4021	8.7767	MT181515	MT181361	MT181478	-----	MT181396
NMBE 510137	<i>Hessemilimax kotulae</i>	<i>Hessemilimax kotulae</i>	4	Switzerland	46.6587	10.1185	MT181516	MT181362	MT181479	-----	MT181397
NMBE 561418	<i>Limax maximus</i>	<i>Limax maximus</i>	5	Switzerland	47.2754	7.399	MT181505	MT181348	MT181462	-----	-----

NMBE 561417	<i>Limax maximus</i>	<i>Limax maximus</i>	5	Switzerland	46.928	7.4546	MT181504	MT181347	MT181461	OK413296	MT181387
NMBE 564039	<i>Limax maximus</i>	<i>Limax maximus</i>	5	Switzerland	46.928	7.454	OK393819	OK386943	-----	-----	-----
EHUMC-2086	<i>Oligolimax annularis</i>	<i>Oligolimax annularis</i>	6	Spain	583154	4748921	MT181507	MT181352	MT181468	-----	MT181390
NMW.Z.1993.0052.00000	<i>Oligolimax annularis</i>	<i>Oligolimax annularis</i>	6	France	44.4241	6.8958	OK393823	OK386949	OK431496	-----	-----
CM 74579	<i>Oligolimax annularis</i>	<i>Oligolimax annularis</i>	6	Turkey	37.67217	29.2824	-----	OK386947	OK431494	-----	OK413353
NMBE 570988	<i>Oligolimax annularis</i>	<i>Oligolimax annularis</i>	6	Kyrgyzstan	42.5707	74.4774	-----	OK386944	OK431492	-----	-----
NMBE 570997	<i>Oligolimax annularis</i>	<i>Oligolimax annularis</i>	6	Kyrgyzstan	42.199	72.9897	OK393820	OK386945	OK431493	-----	-----
BAS CollNo 1653	<i>Oligolimax annularis</i>	<i>Oligolimax annularis</i>	6	Bulgaria	41.3899	23.6083	OK393822	OK386948	OK431495	-----	OK413354
NMBE 571031	<i>Oligolimax annularis</i>	<i>Oligolimax annularis</i>	6	Greece	40.9158	24.0919	OK393821	OK386946	-----	-----	-----

# **New phylogenetic insights on some species of Unionidae from Switzerland (Bivalvia, Palaeoheterodonta, Unionidae)**

**Beat Pfarrer <sup>1,2\*</sup>, Anna Carlevaro <sup>3</sup>, Pascal Stucki <sup>4</sup>, Arno Schwarzer <sup>5</sup>, Heinrich Vicentini <sup>6</sup> & Eike Neubert <sup>1,2\*</sup>**

1 Natural History Museum Bern, Bernastrasse 15, CH-3005 Bern, Switzerland

2 Institute of Ecology and Evolution, University of Bern, CH-3012 Bern, Switzerland

3 Benthos – Büro für Gewässerökologie, Landenbergstrasse 17, CH-8037 Zürich

4 Aquabug, Chemin de la Ramée 6b, 2074 Marin-Epagnier

5 Fröschern 175, CH-4574 Lüsslingen

6 Gewässerökologie, Wasserschöpfli 48, 8055 Zürich

\* corresponding authors: [beat.pfarrer@nmbe.ch](mailto:beat.pfarrer@nmbe.ch); [eike.neubert@nmbe.ch](mailto:eike.neubert@nmbe.ch)

ORCID: [Beat Pfarrer 0000-0002-9702-7968](https://orcid.org/0000-0002-9702-7968)

## Abstract

Switzerland's drainage systems are divided into three major European river basins, i.e. the Po, the Rhône, and the Rhine basins. Until recently 32 species of freshwater mussel species (i.e. belonging to the genera *Anodonta* and *Unio*) were recognized for the country, albeit their identity and number remain uncertain especially, given the recent recognition of *Unio mancus* Lamarck, 1819 from the Rhône in France, and *Unio elongatulus* C. Pfeiffer, 1825 and *Anodonta exulcerata* Porro, 1838 from the Po basin in Italy. In this study, we molecularly assess Swiss populations of freshwater mussels to understand the identity and number of species as well as to characterize their distributions within this geologically differentiated Alpine country. We collected 125 specimens in 42 lakes and rivers representing the three major basins and performed a phylogenetic investigation of the collected specimens using two mitochondrial markers (COI & 16S) and one nuclear marker (28S). COI Haplotype networks are then presented for the identified species. Our new findings show that *Unio elongatulus* inhabits water bodies north of the main Alpine arc. No living populations of *Unio mancus* could be detected in Switzerland. *Anodonta exulcerata* is recorded from two localities north of Lake Maggiore and in the Swiss part of Lake Lugano. *Anodonta anatina* (Linnaeus, 1758) shows genetic differences between southern alpine and northern alpine populations. Our genetic data from Swiss populations of unionid species provides new records and knowledge concerning freshwater mussels from Central Europe and specifically from the Alpine region.

Key words: Unionidae, molecular phylogeny, COI, Swiss lakes, Swiss rivers, conservation



## Declarations

Funding: This project was financed by the BAFU under the contract No. 16.0100.PJ / R354-0347.

Conflicts of interest/Competing interests: no conflicts to report.

Availability of data and material: Sequence data is downloadable from GenBank

(<https://www.ncbi.nlm.nih.gov/genbank/>), species distribution data is downloadable from CSCF database

(<http://www.cscf.ch/cscf/de/home.html>)

Code availability: Not applicable

## Introduction

The hydrogeological network of Switzerland is connected to three major European river basins, i.e. the Po, the Rhône, and the Rhine basin. The latter two rivers have their sources and upper potamic habitats in the Swiss Alps. Both rivers play an important role in the water contribution to large parts of Europe. This makes the area a crucial ecological hub for freshwater flora and fauna, including 32 species of freshwater bivalves. Members of the family Unionidae Rafinesque, 1820 represent the largest freshwater mussels in body size. Unfortunately, public awareness is still practically nonexistent for the water cleansing benefits provided by these remarkable biofilterers.

Swiss naturalists were long fascinated by the autochthonous bivalve fauna; Studer (1789) recorded five species of unionid mussels for Switzerland, and later in 1820, he already listed six species of *Unio*, and two of *Anodonta*. In the following years, Swiss waterbodies were studied by numerous malacologists: Bourguignat (1862) added four *Unio* and eight *Anodonta* species from the Lake Lucerne describing several new species; Brot (1867) discussed the Unionidae living in Lake Geneva, and Godet (1911) reported on the forms of *Unio crassus* Philipsson, 1788 from Lake Neuchâtel. The investigations of all these authors were hindered by an increasingly chaotic system of names assigned to the level of species, subspecies, variety, forms etc., purely based on morphology of shells combined with hypothetical biogeographic consideration. The first to apply a more modern species concept was Schnitter (1922), who revised the unionid species of Switzerland and realised the importance of phenotypic plasticity (Ortmann, 1920), which had been the cause of an overestimation of the number of taxa. Despite this knowledge of the shell plasticity, the classical discrimination of taxa based on conchological characters, was continued for the next 40 years. Haas (1969) hypothesised the existence of hybrids in *U. pictorum* (Linnaeus, 1758) and *U. mancus* after investigating animals with ambiguous shell morphology. Later, enzyme variability analyses by Nagel and Badino (2001) lead to further clarification, rebutting Haas' hypothesis. More advanced genetic methods (COI analysis) generated increasingly more molecular data while ushering Unionidae taxonomy into 21<sup>st</sup> Century assessment standards (Lopes-Lima et al., 2017b; Pfeiffer et al., 2019). Currently, six species of Unionidae are recognized for Switzerland (Lopes-Lima et al., 2017a). Since this last conservation assessment of European freshwater mussels, distinct *Unio* and *Anodonta* species have been recognized around Switzerland. Due to their ecological impact, it is important to monitor their presence in this small Alpine country.

This work's primary aim was prompted by Froufe et al. (2017) upon the recovery of a cryptic species of *Anodonta* in Lake Lugano, northern Italy. This species was formally resurrected under the name *Anodonta exulcerata* Porro, 1838 by Riccardi et al. (2020). Since a section of Lake Lugano overlaps into Switzerland, detecting this species there became important for assessing other Swiss freshwater ecosystems. Unfortunately, the shell morphology of *A. exulcerata* does not allow a distinction from the similar *A. anatina*; however, *A. exulcerata* can be clearly identified using the conventional mitochondrial markers COI and 16S in a molecular phylogenetic analysis.

The second aim of this study is to investigate the *Unio* populations living in the catchment areas that flow into the Mediterranean, and if they have been able to cross the European watershed between the Rhône and the Rhine system? *U. mancus* and *U. elongatulus* were identified as target species. The first species was reported for northern Italy and the Ticino for many decades, however, Prié & Puillandre (2014) confirmed that *U. elongatulus* and *U. mancus* represent two separate species which can be distinguished using COI in a molecular analysis. Froufe et al. (2017) recognized that the historical records for "*U. mancus*" in northern Italy belong to *U. elongatulus*, which is a widespread unionid taxon in the area north of the Apennines to coastal Croatia (Lopes-Lima et al., 2017a).

The third aim of our investigation is to discover if living populations of *U. mancus* exist in the northwestern and central part of Switzerland. The species was reported from the Doubs in the French part of the Jura. The last records of living populations in the Swiss part of the Doubs were reported in 2003 (Rüetschi et al., 2010). The species' known distribution covers Northern, Central and Southern France and Western and Southern Italy together with the Tyrrhenian Islands, Corsica, Sardinia and Sicily. However, a (re?)-dispersal along the Rhône system and potentially also the Doubs is theoretically given, particularly as the French freshwater canal system connects all larger rivers in eastern France. Specimens of *Unio tumidus* Philipsson, 1788 were included to represent the unionid fauna of the lakes in the Central Plateau of Switzerland.

To molecularly assess and delimit the selected Swiss species, we conducted phylogenetic analyses using two mitochondrial (COI, 16S) and one nuclear marker (28S) from 128 specimens culled from Swiss rivers and lakes. We enriched our dataset with sequences of the target species from areas outside Switzerland (Online Resource 1) to illustrate how Swiss species are nested in the larger context. Although a specimen of *U. crassus* was accidentally collected and added to the analysis to differentiate the trees. It was, however, not the target of this investigation.

## Material and methods

### *Taxon Sampling*

Forty-two sites encompassing the major lakes and river systems of the Rhine, Rhône and Po basins were sampled during the years 2018–2020 (Fig. 1). One to eight individuals were collected at each site, resulting in a total of 125 specimens. To meet our research aim, only specimens from the target *Unio* species, i.e. *U. mancus* and *U. elongatulus* and *U. tumidus* were sampled. For *Anodonta* Lamarck, 1799, we included both species, *Anodonta cygnea* (Linnaeus, 1758) and *A. anatina* to detect possible *A. exulcerata*.

The mussels were preserved on site in 100 % ethanol. Preliminary determinations were made at the locality by the diver teams; specimens were then labelled and catalogued. All specimens are stored in 80 % ethanol and preserved in the wet collection of the Natural History Museum Bern, Switzerland. In addition to the Swiss specimens, tissue snippets of 10 unionid specimens from the wet collection of the Senckenberg Museum Frankfurt (SMF), Germany, were added to the study. These snippets were supplied without taxonomic information, acting as a positive control for the extraction and PCR procedure performed in the laboratories at the NMBE (Online Resource 1).

A standardised field protocol was developed in cooperation with the SZKF (info fauna - Schweizerisches Zentrum für die Kartografie der Fauna (SZKF / CSCF)) by the research diver teams. Contained in the field log sheet is a complete set of physical, chemical and environmental data. These data include date, central coordinates, altitude, area searched, water temperature, general information on the dominant substrates and vegetation according to water depth, as well as information on the mussels observed, fish and other biota, with special attention to neozoa. This database will be available via the SZKF portal.

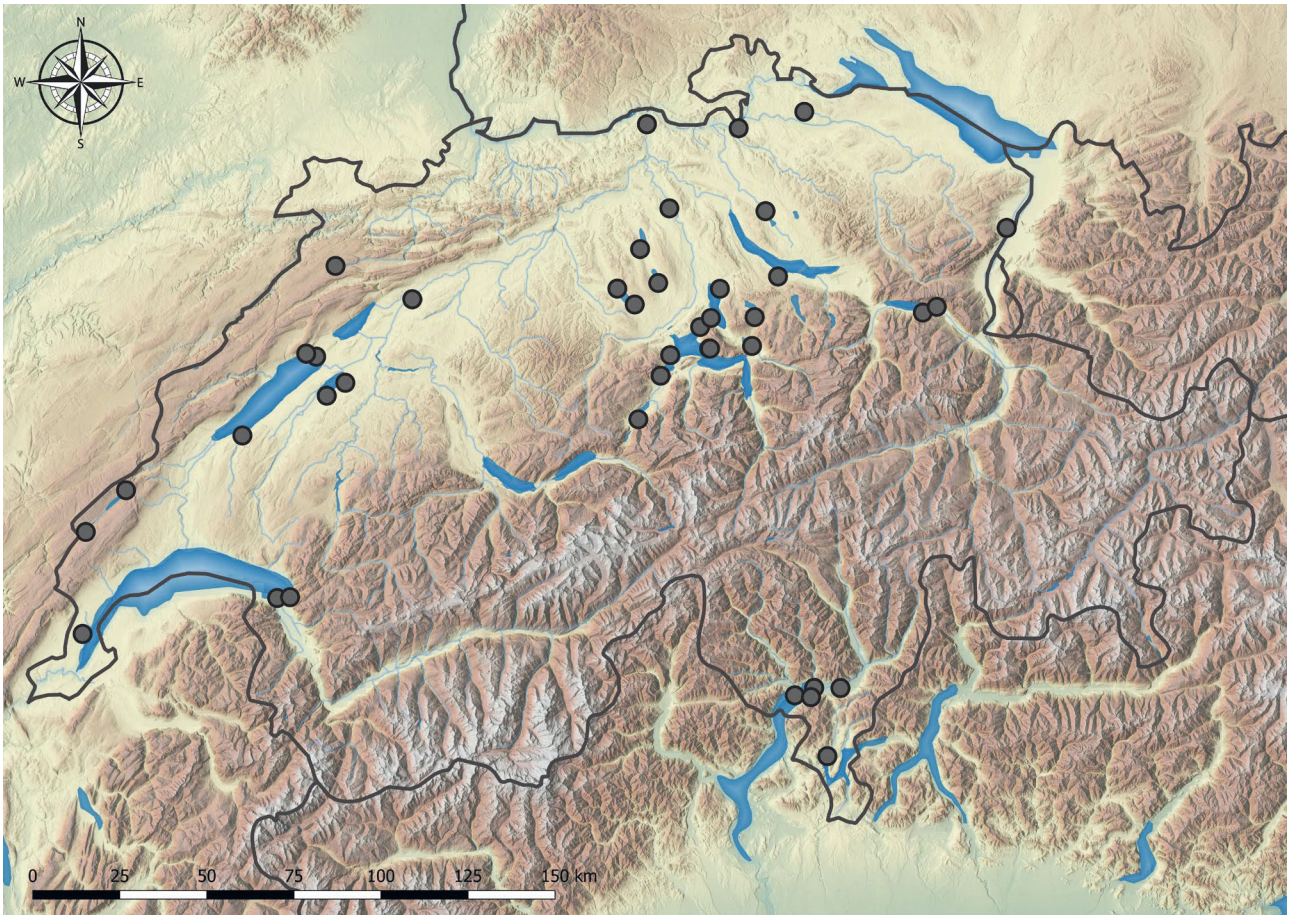

Figure 1. Sampling sites in Switzerland (2018-2020).

### ***DNA extraction, markers description and amplification protocol***

In a separate, sterile laboratory from that where the PCR is conducted, mantle snippets (somatic tissue) of approx. 5 mm<sup>3</sup> size were cut with sterile surgical blades from each specimen. Somatic tissue in Unionidae contains (F) maternal mitochondria, and by clipping tissue from the mantle (F), mitochondria can be harvested (Froufe et al., 2016). Additional snippets were cut and stored for later research. Pre-extraction digestion was performed using the protocol of the Qiagen Blood and Tissue Kit (Qiagen cat. nr. 69506). Subsequent extraction was done by using a QIAcube extraction robot (DNeasy Blood Tissue and Rodent tails, standard protocol). Three markers commonly used in bivalves were selected: (1) the cytochrome c oxidase subunit I gene (COI; 710 bp amplicon length, *LCO22 / HCO700* primer pair) (Froufe et al., 2014); (2) the 16S ribosomal RNA gene (16S; 480 bp amplicon length, *16Sar / 16Sbr* primer pair) (Weigand et al., 2013) and (3) part of the 28S rRNA gene (28S; 810 bp amplicon length, *RD1.3f / RD4b* primer pair) (Whiting, 2002).

The PCR master mix consisted of 12.5 µl of GoTaq G2 HotStart Green Master Mix (Promega M7423), 6.5 µl nuclease free H<sub>2</sub>O (Sigma-Aldrich, W4502). For each reaction, 1 µl of each primer and 2 µl template DNA were added. The PCR protocol for each marker described are as follows: For the *LCO22 / HCO700* (COI) primer pair the thermal regime begins with 3 min at 95°C, followed by 35 cycles of 1 min at 95°C, 1 min at 45°C and 1 min at 72°C and finishes at the end with 5 min at 72°C. For the *16Sar / 16Sbr* (16S) primer pair, the conditions were 5 min at 95°C in the first step, followed by 34 cycles of 30 s at 95°C, 25 s at 52°C and 45 s at 72°C, and finally, 5 min at 72°C. For the



*RD1.3f/ RD4b* (28S) primer pair, the protocol begins with 3 min at 95°C, followed by 45 cycles of 30 sec at 95°C, 45 sec at 50°C and 60 sec at 72°C with a final elongation step of 5 min at 72°C. PCR products were displayed together with a negative control and a 1000bp ladder (BenchTop 100bp DNA Ladder, G8291) in an agarose 1 % gel for assessment of quality and primer efficiency. LGC (LGC Genomics Berlin) performed PCR product purification and sequencing with the above primers. The generated sequence data is downloadable from GenBank (Online Resource

Gene	Primer	Sequence (5 – 3)	approx. amplicon lengths	Reference
COI	<i>LCO22</i>	GGTCAACAAAYCATAARGATATTGG	710	Froufe, 2014
	<i>HCO700</i>	CAGGGTGACCAAAAAAYCA		
16S	<i>LR-N-13398</i> ( <i>16Sar</i> )	CGCCTGTTTATCAAA AAC AT	480	Weigand et al., 2013
	<i>LR-J-12887</i> ( <i>16Sbr</i> )	CCGGTCTGAACTCTGATCAT		
28S	<i>RD1.3f</i>	GGATTCCTYAGTAAGKGC	810	Whiting, 2002
	<i>RD4b</i>	CCTGGTCCGTGTTCAAGAC		

1).Table 1. List of primer pairs used in PCR and sequencing

### ***Phylogenetic analyses and species delimitation***

From the initial 135 specimens, 128 were successfully sequenced for the analyses. The AB1 sequences were processed in Geneious Ver.9.1.8 (Biomatters Ltd.). Every sequence was verified through a BLAST analysis (National Center for Biotechnology Information (NCBI)). Wherever possible, we focused on BLAST results, providing vouchers from the latest publications involving Unionidae e.g., *A. exulcerata* MF414281 (Froufe et al. 2017). For comparing the Swiss data in a broader geographical context, a selection of sequences from the latest publications (Klishko et al., 2018; Froufe et al., 2017; Marrone et al. 2019; Lopes-Lima et al., 2021) were added to the phylogenetic analysis (Online Resource 2). The final sample size for a three-marker approach (COI, 16S, 28S) is 172 and the sample size for the ASAP analysis consisted of 246 COI sequences.

For the alignment, the MAFFT v.7.222 plugin of Geneious (Katoh & Standley, 2013) was implemented. The L-INS-i algorithm and the 1PAM / k=2 matrix chosen for the alignment construction. Every gene alignment was verified and, when needed, improved by excluding positions of unreliable parts of the alignment. The final alignment length after editing was as follows (original first MAFFT alignment length in brackets): COI 654 bp (702 bp), 16S 497 bp (539 bp) and 28S 644 bp (827 bp) summing up to a total of 1795 bp in the concatenated alignment block. The final alignment length for the COI phylogeny was 546 bp. Substitution saturation was assessed by using Xia’s test in DAMBE v.7.058 with default settings (Xia et al., 2003; Xia, 2017, 2018).

Species partitions analysis was performed on the Assemble Species by Automatic Partitioning (ASAP) web tool (<https://bioinfo.mnhn.fr/abi/public/asap/asapweb.html>) (Puillandre et al., 2021), using the Kimura (K80) (Kimura, 1980) substitution model with the settings for the transition/transversion rate ratio (ts/tv) = 2 and the standard advanced options for 5 best partition suggestions for 242 COI sequences, excluding *Potomida littoralis* (Cuvier, 1798), *Microcondylaea bonellii* (Férussac, 1827) and *Sinanodonta woodiana* (I. Lea, 1834) from the analysis.

The protein coding COI fragment was defined in two partitions: the first two codon positions as one partition and the third codon position as a second. Both 16S and 28S alignment data sets were not partitioned and were handled each as a single group for the analyses. The final data block contained 172 individuals. Partitionfinder Ver. 2.1 (Lanfear et al., 2012, 2017) was implemented using the greedy algorithm settings to look for the optimal evolutionary models for the partitions and analysis methods through the corrected Akaike Information Criterion (AICc).

Maximum Likelihood (ML) analysis was computed with RAxML (Stamatakis, 2014) and IQTree (Nguyen et al., 2015; Chernomor et al., 2016; Minh et al., 2020) setting GTR+I+G as substitution model. For RAxML, the settings were set for a rapid bootstrap analysis with 2000 replicates in a single run. For the IQTree analysis a standard bootstrap analysis was performed with the settings of 100 bootstrap alignments and 1000 replicates for the SH-aLRT (approximate likelihood ratio test (aLRT) and Shimodaira–Hasegawa (SH)) (Guindon et al., 2010; Anisimova et al., 2011).

Bayesian Inference (BI) was performed using MrBayes v3.2.2 x64 (Huelsenbeck & Ronquist, 2001; Ronquist & Huelsenbeck, 2003; Ronquist et al., 2012). The substitution model was chosen according to the Partitionfinder definition: the best model for COI and 16S was GTR+I+G and for 28S GTR+G. The settings for the Monte Carlo Markov Chain (MCMC) parameter were as follows: four chains and four separate runs for  $20 \times 10^6$  generations, temperature set to 0.1, with a tree sampling frequency of 1000 and a burn in of 25 %. For convergence diagnostics, Tracer (Rambaut et al., 2018) was implemented to analyse the effective sample size (ESS)

Tree display and editing was performed by using FigTree v1.4.4 (<https://github.com/rambaut/figtree/releases>). MrBayes and RAxML were performed through UBELIX (<http://www.id.unibe.ch/hpc>), the HPC cluster at the University of Bern. The IQTree analysis was performed through the IQ-Tree web server <http://iqtree.cibiv.univie.ac.at/>. The haplotype networks were built with Popart v.1.7 (Leigh & Bryant, 2015) (<http://popart.otago.ac.nz>), using the TCS algorithm (Clement et al., 2002).



## Results

### *Sequence analyses and species delimitation*

Sequence numbers obtained per species are given in Online Resource 1. The substitution saturation assessment for the sequences using Xia's test showed no signs of saturation ( $p = 0.00$ ). Tracer analysis of the BI run showed no anomaly in the ESS scores ( $>200$ ). ASAP suggested one result out of 5 possible partition solutions, it consists of 9 groups in 242 specimens (Online Resource 3).

### *Phylogeny and distribution patterns in Switzerland*

The concatenated phylogenetic tree shown in Fig. 2 is a combination of the Bayesian Inference (BI) and the Maximum Likelihood analysis (RAxML & IQTree) for a dataset of 172 specimens. It shows high support for the clades in the tree topology in that *Unio* and *Anodonta* are monophyletic. The *U. tumidus* clade splits early from the greater *Unio* cluster as shown in Fig 2. The *U. crassus* group splits before the *U. pictorum* / *U. mancus* / *U. elongatulus* cluster. The *Anodonta* clade splits in the three *Anodonta* groups (Fig. 2): *A. exulcerata* is sister group to *A. cygnea*, the *A. anatina* cluster is the counterpart to this group. The topology of the *A. anatina* cluster suggests four branches, with only one being supported by the node values: group A, consisting of Iranoturanic individuals.

The haplotype network for *U. elongatulus* (Fig. 5) shows that the Swiss Rhine population shares the same haplotype as the populations from the Padano-Adriatic basins (Po, Reno) (Marrone et al., 2019). In figure 6, the haplotype network for *A. anatina* shows three distinguishable haplogroups displaying the topology shown in the phylogenetic tree. In figure 7, *Anodonta cygnea* displays one central haplogroup (central European), one Italian / Iberian and two distinct Turkish haplotypes. In figure 8, *A. exulcerata* shows 2 Croatian haplotypes, a central Italian / Swiss haplogroup and an Italian haplotype. The haplotypes with the corresponding sequences are given in Online Resource 4.

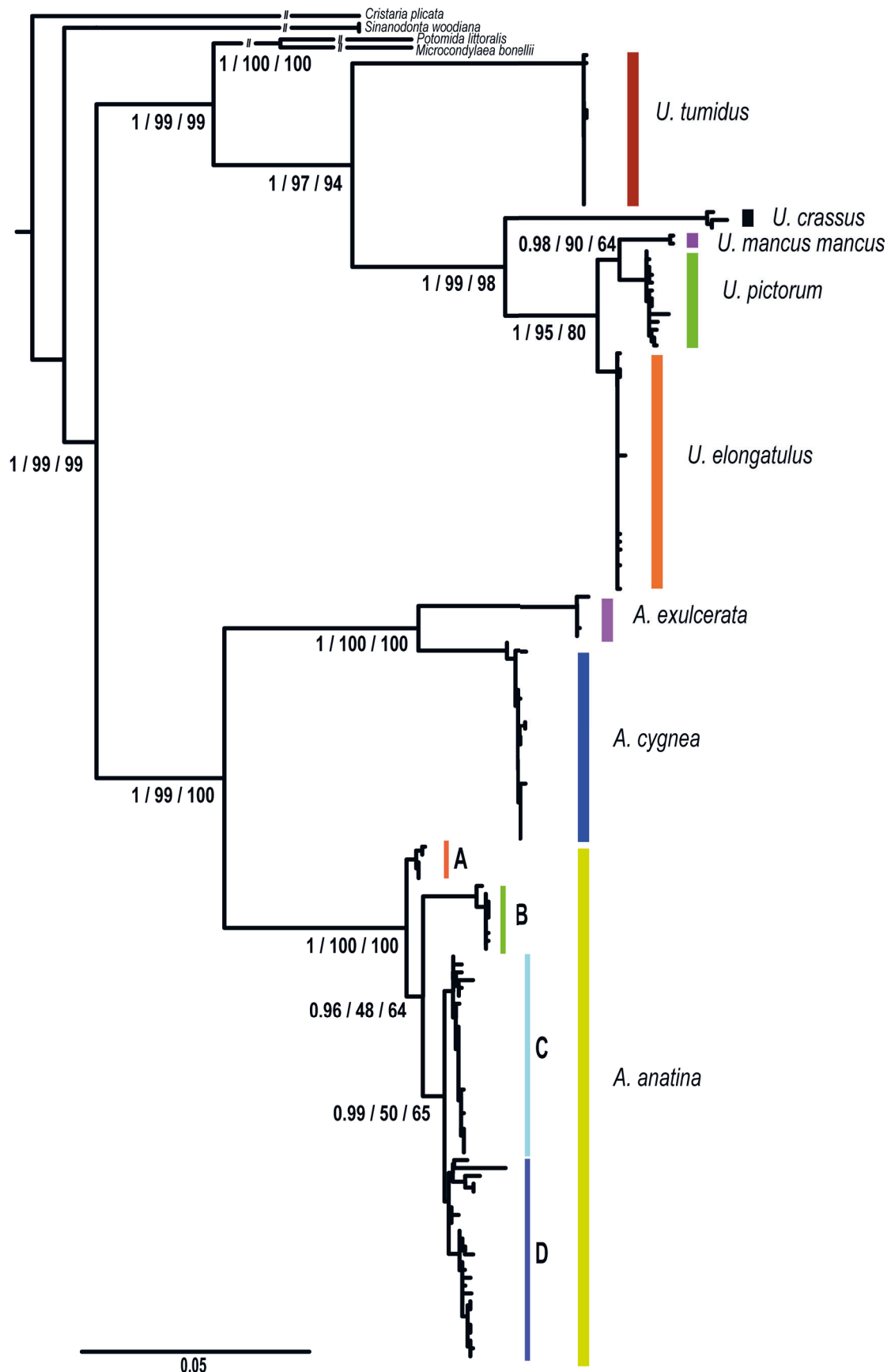

Figure 2. Concatenated phylogenetic tree obtained by Bayesian Inference (BI) analysis and Maximum Likelihood (ML) analysis of three genes (COI, 16S and 28S). ML was computed with RAXML and IQTree performing a standard bootstrap analysis. Support values indicated at the nodes. Subpopulations of *A. anatina* are labelled as A, B, C and D.

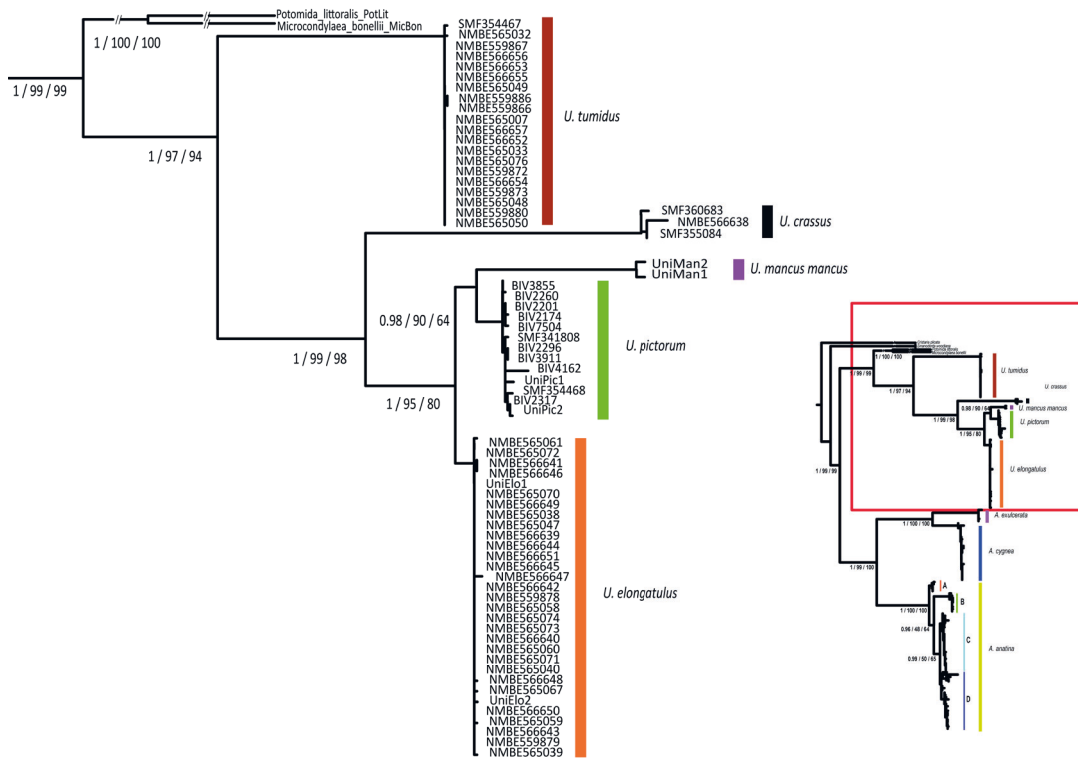

Figure 3. close up of the *Unio* clades in the concatenated phylogenetic tree

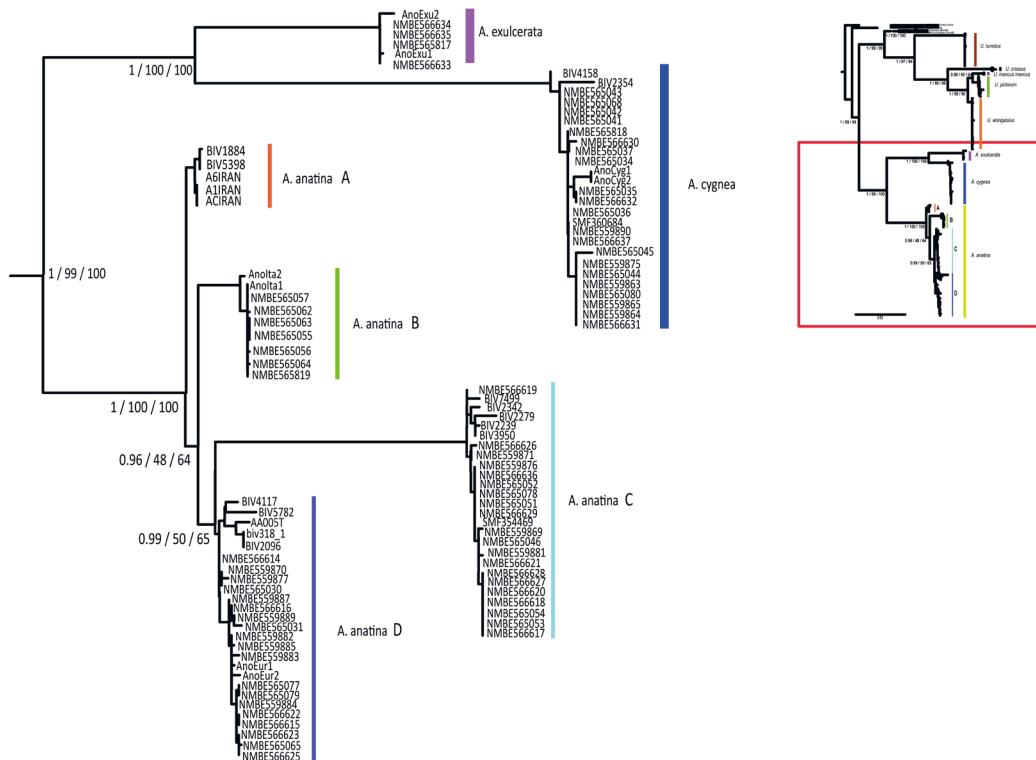

Figure 4. close up of the *Anodonta* clades in the concatenated phylogenetic tree

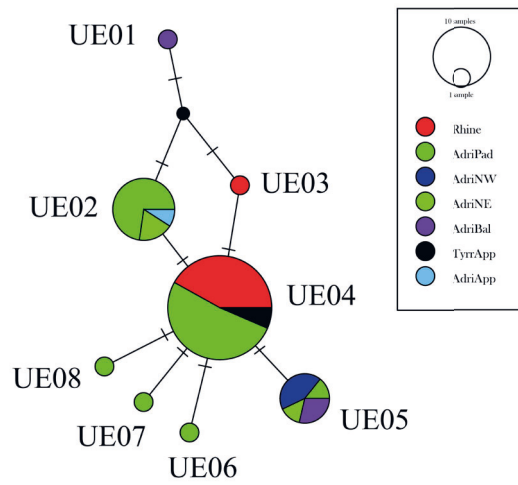

Figure 5. Haplotype network (TCS) *Unio elongatulus*

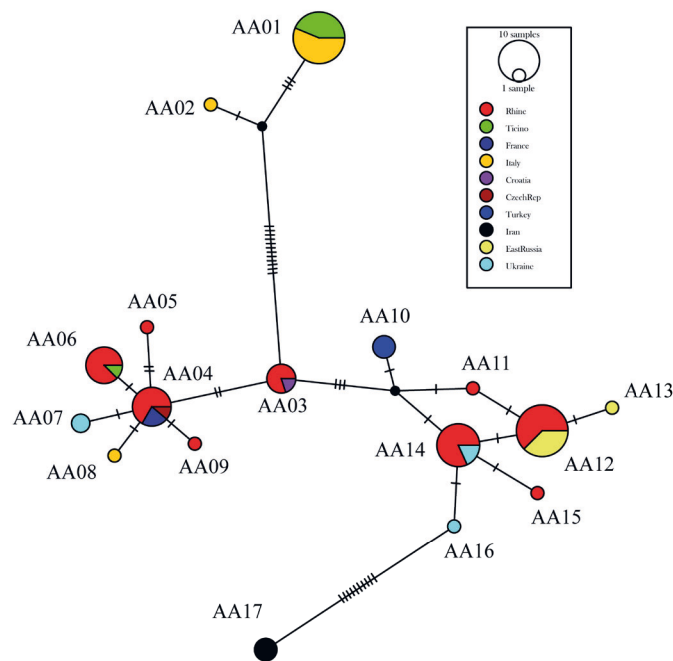

Figure 6. Haplotype network (TCS) *Anodonta anatina*

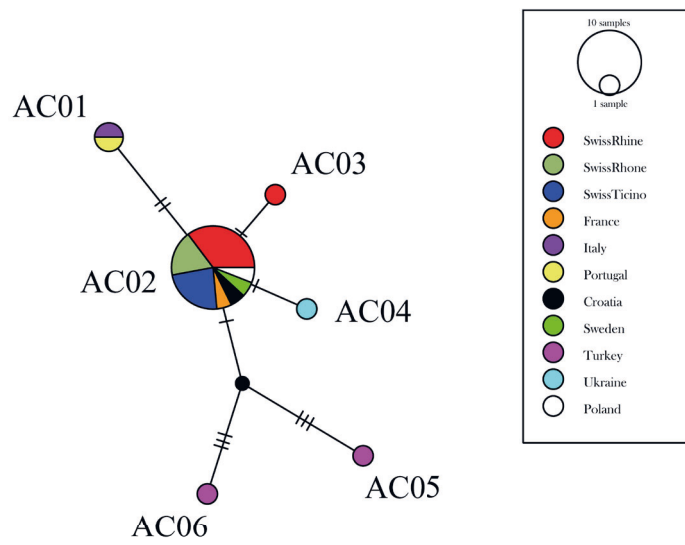

Figure 7. Haplotype network (TCS) *Anodonta cygnea*

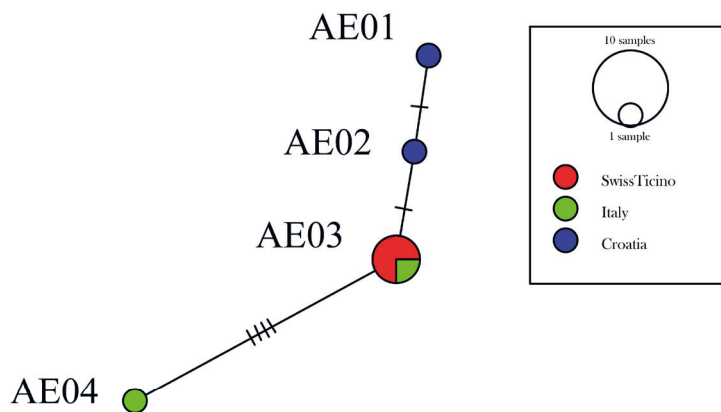

Figure 8. Haplotype network (TCS) *Anodonta exulcerata*



## Discussion

### ***BLAST and ASAP species delimitation***

As stated by Froufe et al. (2017), an identification of species using morphological traits is rather difficult in the genus *Unio*. This pattern is in line with the display of high plasticity witnessed in shell morphology in members of *Anodontini* Rafinesque, 1820 (Zieritz & Aldridge, 2009; Zieritz et al., 2010; Riccardi et al., 2020). This situation is also known for other freshwater bivalves as well e.g. *Hyriidae* Swainson, 1840 (Baker et al., 2003; Yusseppone et al., 2018). The BLAST results and ASAP partitioning facilitates the assignment of the individuals to their respective species identification.

Our investigation could not reveal any living population of *U. mancus* in Switzerland. However, *U. elongatulus* specimens from Switzerland could be confirmed by BLAST. Six specimens were first identified as *U. tumidus* in the field.

*Anodonta exulcerata* specimens however, do occur in the Swiss sampling shown in BLAST. The Swiss population belongs to the Italian haplogroup AE03 (Froufe et al., 2017) (Ticino / Lake Maggiore / Po) as shown in figure 8. Despite the variance displayed in the haplotype network, the ASAP analysis classified all the *A. anatina* individuals to one group. The Ticino population (AA01 and AA02) is geographically and genetically distinct from all other Swiss *A. anatina* populations (Fig. 3). In contrast, the Rhine basin populations form a fragmented pattern throughout the Swiss water systems. The Rhine population shares on the one side, haplotypes with eastern Russian and Ukrainian populations (AA12 and AA144). The west European (AA03, AA04 and AA06) haplogroups include Portuguese, Spanish, French, Czech, Italian and West-Ukrainian specimens. This pattern could be explained by multiple refugia for *A. anatina* during the last glacial periods (Froufe et al., 2014).

The topology in the haplotype network of *A. cygnea* shows a central homogenous haplogroup (AC02). Although the additional sequences used for the haplotype network cover Croatia, Sweden, Poland and France in the haplogroup (AC02), no higher diversity is indicated as observed in *A. anatina*.

### ***Molecular phylogeny***

In the concatenated phylogeny (COI, 16S and 28S) in figure 2, the node splitting *Unio* and *Anodonta* is supported with a posterior probability of BI = 1 and bootstrap values of BS = 99 % and BS = 99 %, with *P. littoralis* and *M. bonelli* changing position close to the *Unio* clade. The Position of *Gonideinae* Ortmann, 1916 is different in Froufe (2017: 3266, fig.7), which is explainable with the greater data set used in the analysis. For the species clades, the topology is coincident with that of Lopes-Lima et al. (2017b), Froufe et al. (2017), Marrone et al. (2019) and Riccardi et al. (2020).

#### *Anodonta exulcerata*:

The haplotype network shows that AnoExu1 (Froufe et al., 2017) forms a haplogroup with the Swiss group, defining it as the Lake Maggiore haplotype. There were no geographical indications on AnuExu1 in Froufe et al. (2017). We identified one additional *A. exulcerata*, NMBE 565817 (Ceresio, Agno Camping) in the concatenated phylogeny. However, due to the missing COI sequence, it was not possible to detect it in the preceding BLAST analysis. The three *A. exulcerata* individuals from Switzerland originate from a rather small pond, Laghetto Demanio in Gudo, which is situated north of Lake Maggiore, upstream of the Ticino River in the Magadino plain. The pond constitutes a remnant tributary before the river was canalized. Thus, the enclosed fauna represents a population isolated from the canalised mainstream- *Anodonta exulcerata* NMBE 565817 originates from Lake Lugano, which is connected via the River Tresa to Lake Maggiore (Fig. 9). Riccardi's (2020: 3, table 1) sampling at Lake Lugano resulted in four *A. cygnea* specimens.

These findings imply that *A. exulcerata* has a wider distribution in the southern Swiss and northern Italian lakes and rivers. Further investigation of the surrounding ponds and tributary remnants could well harbour additional populations warranting future consideration.

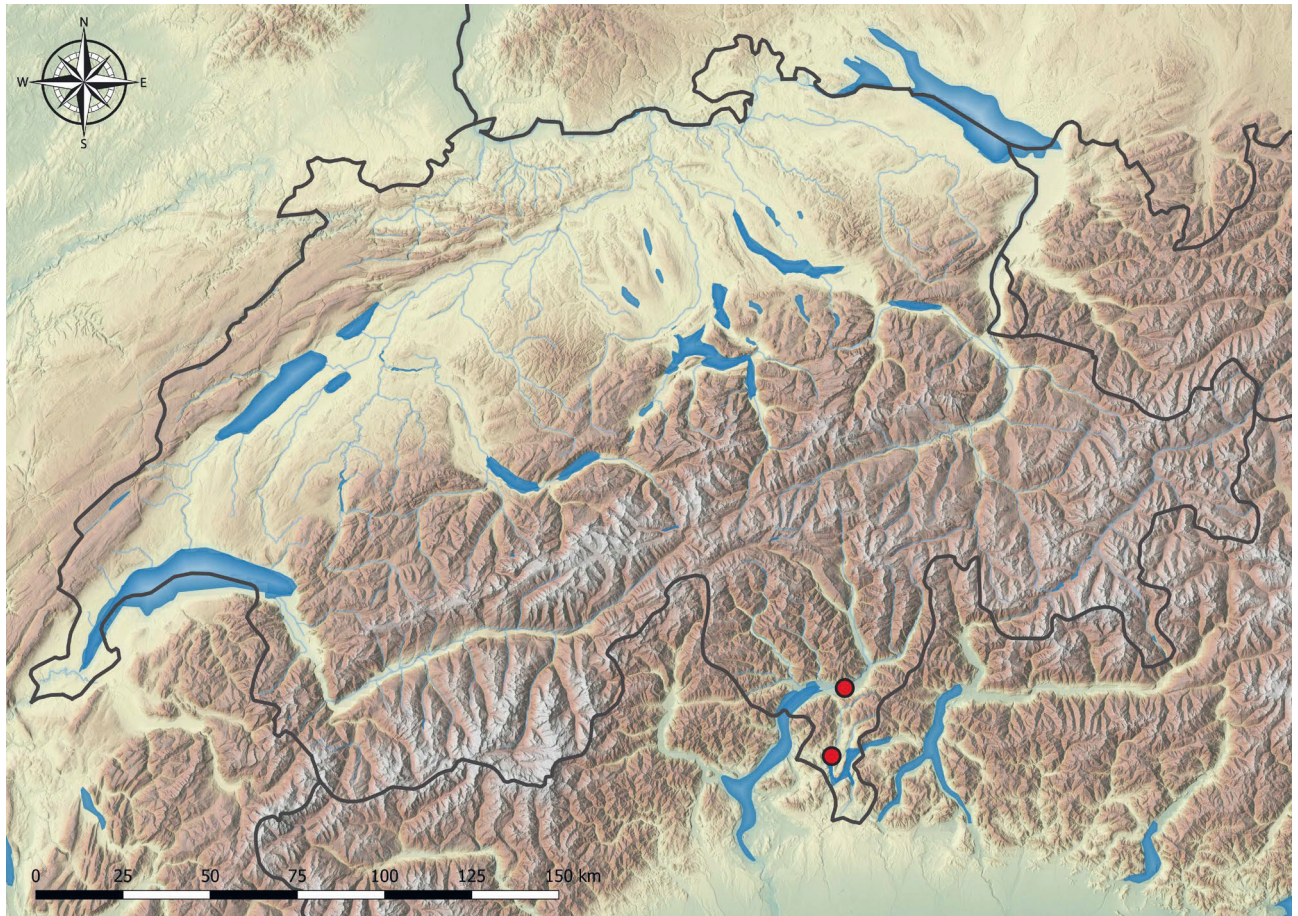

Figure 9. Distribution of *Anodonta exulcerata* in Switzerland

#### *Unio mancus*:

The species has been split into three subspecies: *U. mancus mancus*, *U. mancus requienii* Michaud, 1831 and *U. mancus turtonii* Payraudeau, 1826. Froufe et al. (2017) found that the latter two subspecies only live in affluents of western Italy and considered uniting them into a single subspecies (i.e., *U. mancus turtonii*). In this case, *Unio mancus mancus* is restricted to the western region of France, Pyrenees and eastern Spain. This hypothesis was recently refuted by Marrone et al. (2019) due to anthropogenic influence in the Tyrrhenian drainage basin such that vicariant speciation of *U. mancus requienii* could not be tested. Moreover, the COI haplotype network in Marrone et al. (2019: 347, fig. 3) used a broader COI dataset, showing well-defined haplotypes for all three subspecies. In addition, Prié & Puillandre (2014) show well-supported subspecies clades in figure 2 (COI, 16S, 28S) and in the Online Resource 4 (16S). Despite the same genetic markers, the presented concatenated phylogenetic tree did not show any *U. mancus* from Switzerland. When we revisited their sampling localities at the Swiss Doubs, only old shell fragments and no living *Unio* sp. individuals were found. However, the voucher collection in NMBE houses fresh shells collected in the mid 1980's from the Doubs near St. Ursanne, indicating that the species has recently been exterminated. Additional sampling should focus on Lake Geneva, which potentially harbours this species as well.



*Unio elongatulus*:

The distribution of *U. elongatulus* spans from north of the Apennines to the coastal region of Croatia (Froufe et al., 2017). The new records of *U. elongatulus* north of the Alps extend the northern distribution range of this species (Fig. 10). Moreover, since the populations occur scattered all over central and north-eastern Switzerland, no biogeographical pattern can be detected. This probably results from stocking events of potential host fish species throughout Switzerland. Such human mediated transport can easily move glochidia via infected host fishes northwards over the central Alpine chain. Host fishes for *U. elongatulus* include salmonids, freshwater blennies and cyprinids (Prié et al., 2012). Anthropogenic interference involving similarly infected host fishes with *U. elongatulus* and *S. woodiana* has also been reported in Florence, Italy (Froufe et al. 2017).

Our *U. elongatulus* samples cluster together with the neotype MG967432 from Vipava (= Vipacco) River near Gabria Inferiore (Marrone et al., 2019), thus confirming the correct species identification. The *U. elongatulus* specimens do not show any subclade formations in the single gene and three-marker phylogenetic tree. The haplotype network shows that the Rhine population is part of a haplotype with the Padano - Adriatic basins' specimens (Marrone et al., 2019). Consequently, the entire *U. elongatulus* sampling from Switzerland originates from the southern alpine region. This opens new dispersal possibilities for this species towards Germany via the Rhine River such that the entire Swiss Rhine drainage system can be expected to be populated by *U. elongatulus* in near future.

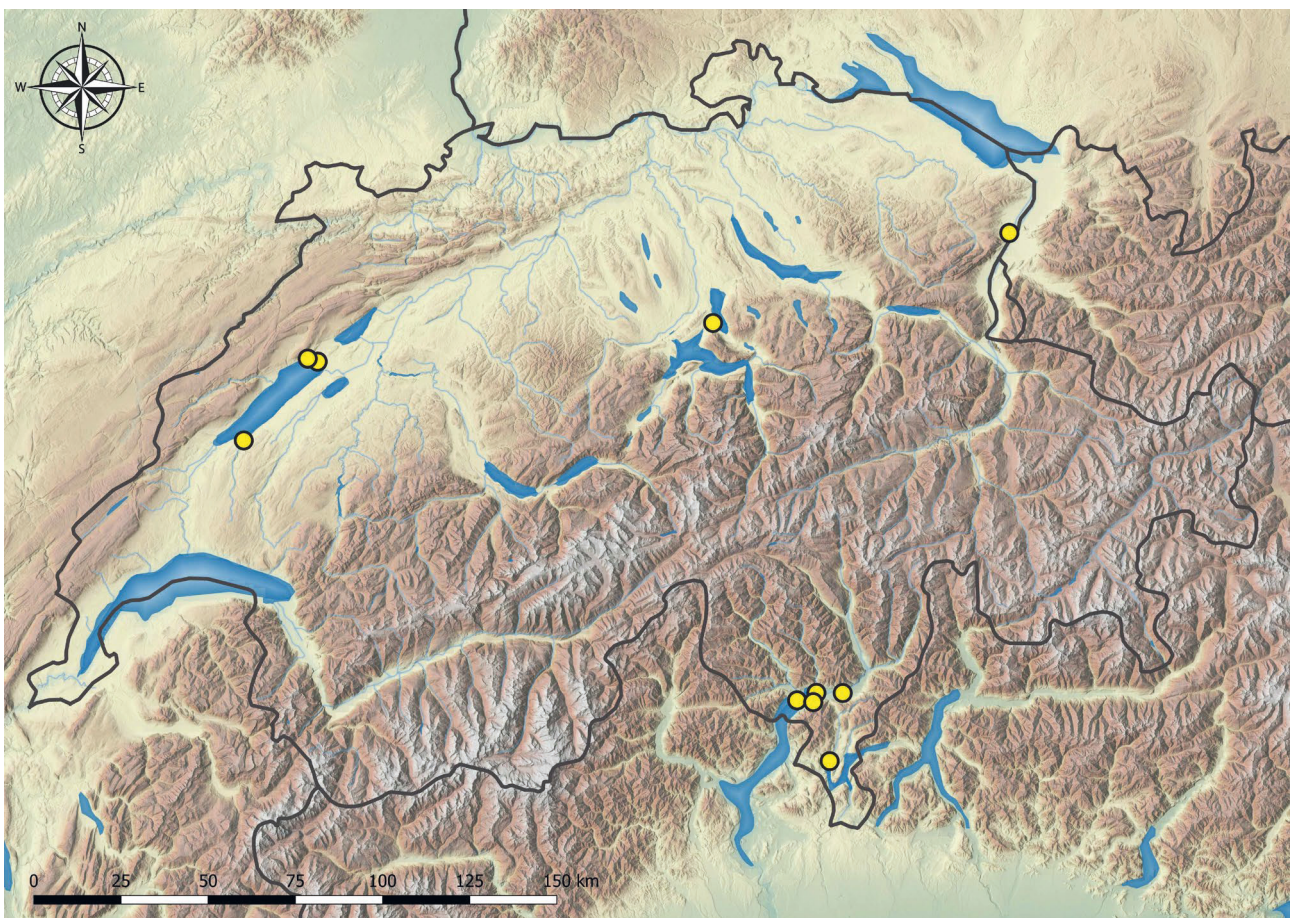

Figure 10. Distribution of *Unio elongatulus* in Switzerland

The non-target taxa for this investigation showed interesting topologies in the phylogenetic analyses. Although not part of the main investigation, they are briefly pointed out here.

#### *Anodonta cygnea:*

The low genetic variation *A. cygnea* observed in the single gene phylogeny and haplotype network does not change with additional molecular data. The clade is still compact and short-branched, which is a contrast to the higher variation shown in *A. anatina*. Possible explanations for this low variability could be that either the distribution of the individuals or certain populations appeared recently or there is anthropogenic distribution involving infected host fish distribution. The haplotype network shows no variation. This may also be an artefact of the sequence choice and certainly requires a larger data set with a broader geographical scope.

#### *Anodonta anatina:*

The *A. anatina* clade indicates a topology with a partitioning into three subclades, but without full support in the node values. The subpopulations in Fig. 4 are congruent with the haplogroups depicted in Fig. 6. The results of the phylogenetic analysis present a similar topology as shown by Froufe (2014: 7, fig. 2), where the main cluster is partitioned into a clade encompassing the Ebro and Adriatic basins, a pan-European clade and the Iberian clades. The partitioning into these clades was to be expected ie. recently, a Transbaikal distribution of *A. anatina* was reported showing the inclusion of Ukrainian and East-Russian individuals into the pan-European *A. anatina* haplogroups (Klishko, 2018). However, partition A, the Turanic partition, is distinctly separated from the main *A. anatina* cluster with high node support in the phylogenetic tree. In the haplotype network, the AA17 haplogroup separates from that of the Ukrainian (AA16) by 10 mutations.

Partition B individuals of *A. anatina* (Lake Maggiore) were labelled during the field work as *Anodonta* sp.. BLAST analysis identified them as closely related to the *A. anatina* specimens, which belong to the biogeographical clade of the Italian / Ebro group (Froufe et al., 2014). In the haplotype network, they form the haplogroup consisting of AA01 and AA02 and are separated by 12 mutations.

Partition C in the *A. anatina* clade consists of the haplotypes AA11 to AA16. The East-Russian individuals originate from the Lake Baikal area. Together with the oriental individuals (AA10), it may be considered the EU-Oriental-Russian group. These specimens were part of the broader EU haplotype group in Klishko (2018: 7, fig.7).

Partition D is represented by the haplotypes AA03 to AA09. Individuals originate from West-Ukraine (AA07) over the Rhine basin into France (AA04), forming the Pan-European group.

By implementing a larger dataset in future investigations, the relationships between the different European groups in the *A. anatina* clade can likely be resolved.

#### *Unio tumidus:*

*Unio tumidus* was chosen to support the structuring of the phylogenetic and ASAP analyses. In the phylogenetic tree it forms a well-defined compact clade, separating *U. tumidus* from *U. crassus* and *U. elongatulus* with high support (BI = 1; BS = 97 %; BS = 94%). Future investigations covering a pan European context will do well to integrate Swiss *U. tumidus* genetic data derived from this work.

## Conclusions

In our study, we present significant genetic data that enhances the known distribution of the family Unionidae in Central European freshwater systems. Of the 120 Swiss individuals, 46 specimens belong to *A. anatina*, 21 to *A.*

*cygnea*, 4 to *A. exulcerata*, 1 to *U. crassus*, 19 to *U. tumidus* and 29 *U. elongatulus*. This information is listed together with the coordinates and GenBank accession numbers in the Online Resource 1.

We show that *Anodonta exulcerata* occurs in southern Switzerland along the River Ticino and is likely to inhabit other lakes and rivers in the area. To adequately assess the distribution of *A. exulcerata*, more lakes in the Tessin region need to be investigated. Although *Unio mancus* was not verified in Switzerland, further investigations are needed in the Swiss Rhône, the Lake Geneva and the Doubs system to detect cryptic populations. We recorded *U. elongatulus* from several sites north of the Alps, which proved to be closely related to those found in northern Italy. This is an alarming finding that has up to now not been reported. As this new invasion of *U. elongatulus* jeopardizes the ecology of the Rhine drainage system, the biome inhabited by indigenous species will drastically change, shifting the IUCN threatened status more towards extinction. In addition, our findings indicate that the *A. anatina* records in Switzerland show a north to south and eastern distribution pattern, and that *Anodonta cygnea* is the second most identified *Anodonta* species in the sampling.

The ecological importance of freshwater bivalves for river and lake systems is evident: being filter feeders, freshwater mussels greatly improve the water quality. A healthy mussel population in a river can retain up to 50 % of the seston (Pusch et al., 2001). The size of the filtered particles differs for example between the species: *A. anatina* and *U. pictorum* retain particle sizes from 4 µm upwards and certain North American species filter particles smaller than 1 µm (Prié, 2017). Therefore, high biodiversity in freshwater mussel populations is a priority. The Red List for the molluscs of Switzerland (Rüetschi et al., 2010) listed a concerning number of large freshwater mussel species as threatened: *Anodonta anatina* VU; *Unio crassus*; *Unio mancus* EN; *Unio pictorum* EN; *Unio tumidus*. Specifically, *Unio crassus* in Switzerland has shown how a once widespread species rapidly suffered population decline since the 1950s. The species became almost extinct due to intensive farming and the introduced muskrat (*Ondatra zibethicus* (Linnaeus, 1766)) (Vicentini & Pfändler, 2001; Vicentini, 2004; Schwarzer & Neubert, 2014; Carlevaro & Stucki, 2020). Today, there are less than ten known live populations of *U. crassus* in Switzerland (Rüetschi et al., 2010). Current measures to protect the highly vulnerable populations of *U. crassus* showed promising results in the Canton of Zürich. One declining population could be stabilized with the method of ex situ infection of host fishes (Vicentini, 2006; Schwarzer, 2021). Despite all efforts, one of the three last known populations in the Canton of Zürich got lost (Isabelle Flöss, personal communication, July 21, 2021). Our scientific investigation widens the knowledge of large, Swiss indigenous freshwater bivalves. The genetic data is paramount for continuing the protection and monitoring of these important mussel species. In light of agricultural pollution, these natural water filters deliver an exceptional ecosystem service. Lastly, the data collected during this study will serve well to improve the classification of unionid taxa recorded in the IUCN Red List for Switzerland (Rüetschi et al., 2010).

## Acknowledgements

We are very grateful to Dr. Francis Cordiality (formerly BAFU) for his generous support at the beginning of the project. Our thanks go to Dr Karl-Otto Nagel (SMF) for supplying additional specimens for research. We are deeply grateful to MSc. Estée Bochud, NMBE, for her technical assistance with the stereomicroscope, her helpful comments in image processing and for creating the distribution map. Furthermore, we are very grateful to Dr. Adrienne Jochum for her technical and intellectual support. We are thankful for Dr. Beatrice Vögeli and Isabelle Flöss (Fachstelle Naturschutz Kanton Zürich) for the information concerning *U. crassus* in the Canton of Zürich. Special thanks goes to the team of the UBELIX cluster of Bern for their amazing, friendly support and troubleshooting. This project was financed by the BAFU under the contract No. 16.0100.PJ / R354-0347.



## References

- Anisimova, M., M. Gil, J.-F. Dufayard, C. Dessimoz, & O. Gascuel, 2011. Survey of Branch Support Methods Demonstrates Accuracy, Power, and Robustness of Fast Likelihood-based Approximation Schemes. *Systematic Biology* 60: 685–699.
- Baker, A. M., C. Bartlett, S. E. Bunn, K. Goudkamp, F. Sheldon, & J. M. Hughes, 2003. Cryptic species and morphological plasticity in long - lived bivalves (Unionoida: Hyriidae) from inland Australia. *Molecular Ecology* 12: 2707–2717.
- Brot, A., 1867: Étude sur les coquilles de la famille des Nayades qui habitent le bassin du Léman. Association zoologique de Léman année 1866, 55 Seiten
- Bourguignat, J. R., 1862: Malacologie du lac des Quatre-Cantons et de ses environs. *Revue et Magasin de Zoologie*, (2) 14 [1862] (11): 430–444, (12): 465–477, pl. 18–21 [pl. 18–19 datées 1863], 15 [1863] (1): 5–26. Paris. [= pp. I–VIII, 9–72, pl. 1–4, Paris (J.-B. BAILLIÈRE), publié tout entier en Novembre 1862.]
- Carlevaro, A., & P. Stucki, (2020). Kurzbericht: genetische Charakterisierung von dreizehn Bachmuschel-Populationen (*Unio crassus*) in der Schweiz.
- Chernomor, O., A. von Haeseler, & B. Q. Minh, 2016. Terrace Aware Data Structure for Phylogenomic Inference from Supermatrices. *Systematic Biology* 65: 997–1008.
- Clement, M., Q. Snell, P. Walke, D. Posada, & K. Crandall, 2002. TCS: estimating gene genealogies. Proceedings 16th International Parallel and Distributed Processing Symposium. IEEE, Ft. Lauderdale, FL: 7 pp, <http://ieeexplore.ieee.org/document/1016585/>.
- Froufe, E., H. M. Gan, Y. P. Lee, J. Carneiro, S. Varandas, A. Teixeira, A. Zieritz, R. Sousa, & M. Lopes-Lima, 2016. The male and female complete mitochondrial genome sequences of the Endangered freshwater mussel *Potomida littoralis* (Cuvier, 1798) (Bivalvia: Unionidae). *Mitochondrial DNA Part A* 27: 3571–3572.
- Froufe, E., M. Lopes-Lima, N. Riccardi, S. Zaccara, I. Vanetti, J. Lajtner, A. Teixeira, S. Varandas, V. Prié, A. Zieritz, R. Sousa, & A. E. Bogan, 2017. Lifting the curtain on the freshwater mussel diversity of the Italian Peninsula and Croatian Adriatic coast. *Biodiversity and Conservation* 26: 3255–3274.
- Froufe, E., C. Sobral, A. Teixeira, R. Sousa, S. Varandas, D. C. Aldridge, & M. Lopes-Lima, 2014. Genetic diversity of the pan-European freshwater mussel *Anodonta anatina* (Bivalvia: Unionoida) based on CO1: new phylogenetic insights and implications for conservation: GENETIC DIVERSITY *ANODONTA ANATINA* EUROPE. *Aquatic Conservation: Marine and Freshwater Ecosystems* 24: 561–574.
- Godet, P., 1911: Contribution à l'histoire naturelle des Najades Suisses. *Unio consetaneus* et ses variétés neuchâtelaises. *Bulletin de la Société Neuchâteloise des Sciences Naturelles*, Bd. 38.

- Guindon, S., J.-F. Dufayard, V. Lefort, M. Anisimova, W. Hordijk, & O. Gascuel, 2010. New Algorithms and Methods to Estimate Maximum-Likelihood Phylogenies: Assessing the Performance of PhyML 3.0. *Systematic Biology* 59: 307–321.
- Huelsenbeck, J. P., & F. Ronquist, 2001. MRBAYES: Bayesian inference of phylogenetic trees. *Bioinformatics* 17: 754–755.
- Katoh, K., & D. M. Standley, 2013. MAFFT Multiple Sequence Alignment Software Version 7: Improvements in Performance and Usability. *Molecular Biology and Evolution* 30: 772–780.
- Kimura, M., 1980. A simple method for estimating evolutionary rates of base substitutions through comparative studies of nucleotide sequences. *Journal of Molecular Evolution* 16: 111–120.
- Klishko, O. K., M. Lopes-Lima, A. E. Bogan, D. V. Matafonov, & E. Froufe, 2018. Morphological and molecular analyses of Anodontinae species (Bivalvia, Unionidae) of Lake Baikal and Transbaikalia. *PLOS ONE* 13: e0194944.
- Lanfear, R., B. Calcott, S. Y. W. Ho, & S. Guindon, 2012. PartitionFinder: Combined Selection of Partitioning Schemes and Substitution Models for Phylogenetic Analyses. *Molecular Biology and Evolution* 29: 1695–1701.
- Lanfear, R., P. B. Frandsen, A. M. Wright, T. Senfeld, & B. Calcott, 2017. PartitionFinder 2: New Methods for Selecting Partitioned Models of Evolution for Molecular and Morphological Phylogenetic Analyses. *Molecular Biology and Evolution* 34: 772–773.
- Leigh, J. W., & D. Bryant, 2015. Popart: full - feature software for haplotype network construction. *Methods in Ecology and Evolution Wiley Online Library* 6: 1110–1116.
- Lopes-Lima, M., R. Sousa, J. Geist, D. C. Aldridge, R. Araujo, J. Bergengren, Y. Bespalaya, E. Bódis, L. Burlakova, D. Van Damme, K. Douda, E. Froufe, D. Georgiev, C. Gumpinger, A. Karatayev, Ü. Kebapçı, I. Killeen, J. Lajtner, B. M. Larsen, R. Lauceri, A. Legakis, S. Lois, S. Lundberg, E. Moorkens, G. Motte, K.-O. Nagel, P. Ondina, A. Outeiro, M. Paunovic, V. Prié, T. von Proschwitz, N. Riccardi, M. Rudzīte, M. Rudzītis, C. Scheder, M. Seddon, H. Şereflişan, V. Simić, S. Sokolova, K. Stoeckl, J. Taskinen, A. Teixeira, F. Thielen, T. Trichkova, S. Varandas, H. Vicentini, K. Zajac, T. Zajac, & S. Zogaris, 2017a. Conservation status of freshwater mussels in Europe: state of the art and future challenges *Biological Reviews* 92: 572–607.
- Lopes-Lima M, Froufe E, Do Tu V, Ghamizi M, Mock KE, Kebapçı Ü, Klishko O, Kovitvadhi S, Kovitvadhi U, Paulo OS, Pfeiffer JM III, Raley M, Riccardi N, Şereflişan H, Sousa R, Teixeira A, Varandas S, Wu X, Zanatta DT, Zieritz A, Bogan AE 2017b. Phylogeny of most species rich freshwater bivalve family (Bivalvia: Unionida: Unionidae): defining modern subfamilies and tribes. *Molecular Phylogenetics and Evolution* 106: 174–191.
- Lopes-Lima, M., M. E. Gürlek, Ü. Kebapçı, H. Şereflişan, T. Yanık, A. Mirzajani, E. Neubert, V. Prié, A. Teixeira, A. Gomes-dos-Santos, D. Barros-García, I. N. Bolotov, A. V. Kondakov, I. V. Vikhrev, A. A. Tomilova, T. Özcan, A. Altun, D. V. Gonçalves, A. E. Bogan & E. Froufe, 2021. Diversity, biogeography, evolutionary relationships, and conservation of Eastern Mediterranean freshwater mussels (Bivalvia: Unionidae). *Molecular Phylogenetics and Evolution* 163: 107261.

- Marrone, F., G. Nardi, S. Cianfanelli, M. Govedič, S. A. Barra, M. Arculeo & M. Bodon, 2019. Diversity and taxonomy of the genus *Unio* Philipsson in Italy, with the designation of a neotype for *Unio elongatulus* C. Pfeiffer (Mollusca, Bivalvia, Unionidae). *Zootaxa* 4545: 339.
- Minh, B. Q., H. A. Schmidt, O. Chernomor, D. Schrempf, M. D. Woodhams, A. von Haeseler, & R. Lanfear, 2020. IQ-TREE 2: New Models and Efficient Methods for Phylogenetic Inference in the Genomic Era. *Molecular Biology and Evolution* 37: 1530–1534.
- Nagel, K.-O., & G. Badino, 2001. Population Genetics and Systematics of European Unionoidea. Ecology and Evolution of the Freshwater Mussels Unionoidea. Springer Berlin Heidelberg, Berlin, Heidelberg, 51–80.
- Nguyen, L.-T., H. A. Schmidt, A. von Haeseler, & B. Q. Minh, 2015. IQ-TREE: A Fast and Effective Stochastic Algorithm for Estimating Maximum-Likelihood Phylogenies. *Molecular Biology and Evolution* 32: 268–274.
- Ortmann, A. E., 1920. Correlation of shape and station in fresh-water mussels (Naiades). *Proceedings of the American Philosophical Society* 59: 269–312.
- Prié, V., 2017. *Naiades et autres bivalves d’eau douce de France*. Biotope éditions.
- Prié, V., N. Puillandre, & P. Bouchet, 2012. Bad taxonomy can kill: molecular reevaluation of *Unio mancus* Lamarck, 1819 (Bivalvia : Unionidae) and its accepted subspecies. 18.
- Prié, V. & N. Puillandre, 2014. Molecular phylogeny, taxonomy, and distribution of French *Unio* species (Bivalvia, Unionidae). *Hydrobiologia*.
- Puillandre, N., S. Brouillet, & G. Achaz, 2021. ASAP: assemble species by automatic partitioning. *Molecular Ecology Resources* 21: 609–620.
- Pusch, M., J. Siefert, & N. Walz, 2001. Filtration and Respiration Rates of Two Unionid Species and Their Impact on the Water Quality of a Lowland River In Bauer, G., & K. Wächtler (eds), *Ecology and Evolution of the Freshwater Mussels Unionoidea*. Springer, Berlin, Heidelberg: 317–326.
- Rambaut, A., A. J. Drummond, D. Xie, G. Baele, & M. A. Suchard, 2018. Posterior Summarization in Bayesian Phylogenetics Using Tracer 1.7. *Systematic Biology* 67: 901–904.
- Riccardi, N., E. Froufe, A. E. Bogan, A. Zieritz, A. Teixeira, I. Vanetti, S. Varandas, S. Zaccara, K.-O. Nagel, & M. Lopes-Lima, 2020. Phylogeny of European Anodontini (Bivalvia: Unionidae) with a redescription of *Anodonta exulcerata*. *Zoological Journal of the Linnean Society* 189: 745–761.
- Ronquist, F., & J. P. Huelsenbeck, 2003. MrBayes 3: Bayesian phylogenetic inference under mixed models. *Bioinformatics* 19: 1572–1574.
- Ronquist, F., M. Teslenko, P. van der Mark, D. L. Ayres, A. Darling, S. Höhna, B. Larget, L. Liu, M. A. Suchard, & J. P. Huelsenbeck, 2012. MrBayes 3.2: Efficient Bayesian Phylogenetic Inference and Model Choice Across a Large Model Space. *Systematic Biology* 61: 539–542.

- Rüetschi, J., P. Stucki, P. Müller, H. Vicentini, & F. Claude, 2010. Rote Liste Weichtiere (Schnecken und Muscheln). Gefährdete Arten der Schweiz, Stand 2010.
- Schwarzer, A., & E. Neubert, 2014. Die Grossmuscheln im Kanton Solothurn, unter besonderer Berücksichtigung der Bachmuschel *Unio crassus* Philipsson 1788. Naturforschende Gesellschaft des Kantons Solothurn, Mitteilungen 10.
- Schwarzer, A. (2021, August 6) Wiederansiedlung der Bachmuschel (*Unio crassus*) im Kanton Aargau – ein Projekt der Sektion Jagd und Fischerei. <https://www.aschwarzer.net/bachmuschel-2>
- Schnitter, H., 1922: Die Najaden der Schweiz mit besonderer Berücksichtigung der Umgebung von Basel. Dissertation Universität Basel, 200 Seiten + Anhang
- Stamatakis, A., 2014. RAxML version 8: a tool for phylogenetic analysis and post-analysis of large phylogenies. *Bioinformatics* 30: 1312–1313.
- Vicentini, H., 2004. Bachmuscheln (*Unio crassus*) in Seen der Schweiz. *Lauterbornia* 50: 31–38.
- Vicentini, H., 2006. Ansiedlungsversuche Bachmuschel (*Unio crassus*) im Kanton Aargau, 2006.
- Vicentini, H., & U. Pfändler, 2001. Die Bachmuschel *Unio crassus* (PHILIPSSON 1788) im Seegraben, Kanton Schaffhausen. *Mitt. Natf. Ges. Schaffhausen* 46: 85–100.
- Studer, S., 1789. Faunula Helvetica. Class VI. Vermes. Ordo III. Testacea. - In: W. Coxe, Travels in Switzerland, in a series of letters to William Melmoth, Esq., Volume III: 384-392. London (T. Cadell in the Strand)
- Studer, S., 1820. Kurzes Verzeichnis der bis jetzt in unserm Vaterlande entdeckten Conchylien. *Naturwissenschaftlicher Anzeiger der Allgemeinen Schweizerischen Gesellschaft für die Gesamten Naturwissenschaften*, 3 (11): 83-90; (12): 91-94. Bern [1 May; 1 June]. [reprinted as a separate work under the title: Systematisches Verzeichniss der bis jetzt bekannt gewordenen Schweizer-Conchylien. Bern (Stämpfli: 32 pp. > 5 April)]
- Weigand, A. M., A. Jochum, R. Slapnik, J. Schnitzler, E. Zarza, & A. Klussmann-Kolb, 2013. Evolution of microgastropods (Ellobioidea, Carychiidae): integrating taxonomic, phylogenetic and evolutionary hypotheses. *BMC Evolutionary Biology* 13: 18.
- Whiting, M. F., 2002. Mecoptera is paraphyletic: multiple genes and phylogeny of Mecoptera and Siphonaptera. *Zoologica Scripta* 31: 93–104.
- Xia, X., 2017. DAMBE6: New Tools for Microbial Genomics, Phylogenetics, and Molecular Evolution. *Journal of Heredity* 108: 431–437.
- Xia, X., 2018. DAMBE7: New and Improved Tools for Data Analysis in Molecular Biology and Evolution. *Molecular Biology and Evolution* 35: 1550–1552.
- Xia, X., Z. Xie, M. Salemi, L. Chen, & Y. Wang, 2003. An index of substitution saturation and its application. *Molecular Phylogenetics and Evolution* 7.

Yusseppone, M. S., F. Márquez, C. M. Luquet, T. Brey, M. C. Ríos de Molina, & I. Rocchetta, 2018. Does shell shape variation play a role in conservation of the long-lived freshwater bivalve *Diplodon chilensis* (Bivalvia, Hyriidae)? *Ecohydrology* 11: e1931.

Zieritz, A., & D. C. Aldridge, 2009. Identification of ecophenotypic trends within three European freshwater mussel species (Bivalvia: Unionoida) using traditional and modern morphometric techniques: ECOPHENOTYPIC TRENDS IN FRESHWATER MUSSELS. *Biological Journal of the Linnean Society* 98: 814–825.

Zieritz, A., J. I. Hoffman, W. Amos, & D. C. Aldridge, 2010. Phenotypic plasticity and genetic isolation-by-distance in the freshwater mussel *Unio pictorum* (Mollusca: Unionoida). *Evolutionary Ecology* 24: 923–938.



## Supplementary Information (SI)

ESM\_1 Voucher numbers, species, ASAP scoring, locality, GenBank accession numbers and Haplotype.

Voucher number	Species / BLAST	ASAP partition	locality	Latitude	Longitude	Gen Bank accession numbers CO1	Gen Bank accession numbers 16S	Gen Bank accession numbers 28S	Haplotype
NMBE 559869	<i>Anodonta anatina</i>	3	Lac de Morat, Muntelier	46.93769	7.12439	OK050190	-----	OK077572	AA12
NMBE 559870	<i>Anodonta anatina</i>	3	Lac Morat, Plage d'Avenches	46.9053	7.0559	OK050192	OK055588	OK077573	AA03
NMBE 559871	<i>Anodonta anatina</i>	3	Lac Morat, Plage d'Avenches	46.9053	7.0559	OK050192	OK055589	OK077574	AA12
NMBE 559876	<i>Anodonta anatina</i>	3	Lac Neuchâtel, St-Blaise	47.0109	6.9806	OK050195	OK055593	OK077578	AA12
NMBE 559877	<i>Anodonta anatina</i>	3	Lac Neuchâtel, Yvonand ancien port	46.8053	6.7456	OK050196	-----	OK077579	AA03
NMBE 559881	<i>Anodonta anatina</i>	3	Zürichsee, Schönenwirt	47.204	8.7169	OK050200	OK055597	OK077582	AA15
NMBE 559882	<i>Anodonta anatina</i>	3	Zürichsee, Schönenwirt	47.204	8.7169	OK050201	OK055598	OK077583	AA04
NMBE 559883	<i>Anodonta anatina</i>	3	Zürichsee, Schönenwirt	47.204	8.7169	OK050202	OK055599	OK077584	AA09
NMBE 559884	<i>Anodonta anatina</i>	3	Greifensee, Bad	47.3669	8.6708	OK050203	OK055600	OK077585	AA06
NMBE 559885	<i>Anodonta anatina</i>	3	Greifensee, Bad	47.3669	8.6708	OK050204	OK055601	OK077586	AA04
NMBE 559887	<i>Anodonta anatina</i>	3	Rhein, Jöslirain	47.573	8.572	OK050206	OK055603	OK077588	AA04
NMBE 559889	<i>Anodonta anatina</i>	3	Rhein, Jöslirain	47.573	8.572	OK050208	OK055605	OK077590	AA04
NMBE 565030	<i>Anodonta anatina</i>	3	Aare, Häfli	47.14706	7.37087	OK050211	-----	OK077593	AA03
NMBE 565031	<i>Anodonta anatina</i>	3	Aare, Häfli	47.14706	7.37087	OK050212	OK055608	OK077594	AA05
NMBE 565046	<i>Anodonta anatina</i>	3	Lac de Morat, Muntelier	46.93769	7.12439	OK050222	-----	OK077607	AA12
NMBE 565051	<i>Anodonta anatina</i>	3	Orbe, Burtignière	46.56192	6.16919	OK050227	OK055626	OK077612	AA12

NMBE 565052	<i>Anodonta anatina</i>	3	Sempachersee, Sempach	47.13397	8.18953	OK050228	OK055627	OK077613	AA12
NMBE 565053	<i>Anodonta anatina</i>	3	Sempachersee, Sempach	47.13397	8.18953	OK050229	OK055628	-----	AA14
NMBE 565054	<i>Anodonta anatina</i>	3	Sempachersee, Sempach	47.13397	8.18953	OK050230	OK055629	OK077614	AA14
NMBE 565055	<i>Anodonta anatina</i>	4	Verbano, Ascona Lido	46.14733	8.77878	OK050231	OK055630	OK077615	AA01
NMBE 565056	<i>Anodonta anatina</i>	4	Verbano, Ascona Lido	46.14733	8.77878	OK050232	OK055631	OK077616	AA01
NMBE 565057	<i>Anodonta anatina</i>	4	Verbano, Ascona Lido	46.14733	8.77878	OK050233	-----	OK077617	AA01
NMBE 565062	<i>Anodonta anatina</i>	4	Verbano, Tenero Lido	46.16648	8.84985	OK050238	OK055636	OK077622	AA01
NMBE 565063	<i>Anodonta anatina</i>	4	Verbano, Tenero Lido	46.16648	8.84985	OK050239	OK055637	OK077623	AA01
NMBE 565064	<i>Anodonta anatina</i>	4	Verbano, Tenero Lido	46.16648	8.84985	OK050240	OK055638	OK077624	AA01
NMBE 565065	<i>Anodonta anatina</i>	3	Verbano, Tenero Lido	46.16648	8.84985	OK050241	OK055639	OK077625	AA06
NMBE 565077	<i>Anodonta anatina</i>	3	Walensee, Untertenzen	47.11356	9.24982	OK050248	OK055649	-----	AA06
NMBE 565078	<i>Anodonta anatina</i>	3	Walensee, Walenstadt	47.12806	9.30104	OK050249	OK055650	OK077634	AA12
NMBE 565079	<i>Anodonta anatina</i>	3	Walensee, Walenstadt	47.12806	9.30104	OK050250	OK055651	OK077635	AA06
NMBE 565819	<i>Anodonta anatina</i>	4	Verbano, Ascona Lido	46.1473	8.7788	OK050253	-----	-----	AA01
NMBE 566614	<i>Anodonta anatina</i>	3	Klingnauer Stausee	47.5829	8.2343	OK050254	-----	OK077639	AA03
NMBE 566615	<i>Anodonta anatina</i>	3	Klingnauer Stausee	47.5829	8.2343	OK050255	-----	OK077640	AA06
NMBE 566616	<i>Anodonta anatina</i>	3	Klingnauer Stausee	47.5829	8.2343	OK050256	OK055654	OK077641	AA04
NMBE 566618	<i>Anodonta anatina</i>	3	Sempachersee, Badi Schenkon LU	47.1737	8.1254	OK050257	OK055655	-----	AA14
NMBE 566619	<i>Anodonta anatina</i>	3	Sempachersee, Badi Schenkon LU	47.1737	8.1254	OK050258	-----	-----	AA14
NMBE 566620	<i>Anodonta anatina</i>	3	Vierwaldstättersee, Lützelau Bad	47.0236	8.4638	OK050259	OK055656	OK077642	AA14

NMBE 566621	<i>Anodonta anatina</i>	3	Vierwaldstättersee, Lützelau Bad	47.0236	8.4638	OK050260	-----	OK077643	AA14
NMBE 566622	<i>Anodonta anatina</i>	3	Vierwaldstättersee, Lützelau Bad	47.0236	8.4638	OK050261	OK055657	OK077644	AA14
NMBE 566623	<i>Anodonta anatina</i>	3	Lauerzersee, Badi Seewen SZ	47.0302	8.6211	OK050262	OK055658	OK077645	AA06
NMBE 566625	<i>Anodonta anatina</i>	3	Lauerzersee, Badi Seewen SZ	47.0302	8.6211	OK050263	OK055659	OK077646	AA12
NMBE 566626	<i>Anodonta anatina</i>	3	Tote Reuss, Fischbach AG	47.3738	8.3169	OK050265	-----	-----	AA11
NMBE 566627	<i>Anodonta anatina</i>	3	Tote Reuss, Fischbach AG	47.3738	8.3169	OK050266	-----	OK077648	AA06
NMBE 566628	<i>Anodonta anatina</i>	3	Ägerisee, Morgarten ZG	47.1024	8.6308	OK050267	OK055661	OK077649	AA14
NMBE 566629	<i>Anodonta anatina</i>	3	Ägerisee, Morgarten ZG	47.1024	8.6308	OK050268	OK055662	OK077650	AA14
NMBE 566630	<i>Anodonta anatina</i>	3	Lac Neuchâtel, St-Blaise	47.0109	6.9806	OK050269	-----	OK077651	AA12
NMBE 566637	<i>Anodonta anatina</i>	NA	Baldeggersee, Baldegg LU	47.1876	8.276	-----	OK055668	-----	NA
SMF 354469	<i>Anodonta anatina</i>	3	Horioff, Oberflorstadt	50.3291	8.871	OK050299	-----	OK077674	AA12
NMBE 559863	<i>Anodonta cygnea</i>	NA	Gouille Marion, Mies	46.3035	6.1575	-----	OK055583	OK077567	NA
NMBE 559864	<i>Anodonta cygnea</i>	NA	Gouille Marion, Mies	46.3035	6.1575	-----	OK055584	OK077568	NA
NMBE 559865	<i>Anodonta cygnea</i>	NA	Gouille Marion, Mies	46.3035	6.1575	-----	OK055585	OK077569	NA
NMBE 559875	<i>Anodonta cygnea</i>	NA	Lac Neuchâtel, St-Blaise	47.0109	6.9806	-----	OK055592	OK077577	NA
NMBE 565037	<i>Anodonta cygnea</i>	NA	Ceresio, Agno Camping	45.99222	8.89857	-----	OK055613	OK077600	NA
NMBE 565041	<i>Anodonta cygnea</i>	NA	Etang sous la Sagne	47.2303	7.0883	-----	OK055617	-----	NA
NMBE 565042	<i>Anodonta cygnea</i>	NA	Etang sous la Sagne	47.2303	7.0883	-----	OK055618	-----	NA
NMBE 565043	<i>Anodonta cygnea</i>	NA	Hallwilersee, Beinwil	47.27235	8.20932	-----	OK055619	OK077604	NA
NMBE 565044	<i>Anodonta cygnea</i>	NA	Lac Brenet, Les Charbonnières	46.6672	6.3172	-----	OK055620	OK077605	NA

NMBE 565068	<i>Anodonta cygnea</i>	NA	Verbano, Tenero Lido	46.1665	8.8498	-----	OK055641	-----	NA
NMBE 566638	<i>Anodonta cygnea</i>	NA	Nussbaumersee, Nussbaumen TG	47.6137	8.8134	-----	OK055669	-----	NA
NMBE 559890	<i>Anodonta cygnea</i>	6	Zugersee, Zug	47.17314	8.50292	OK050209	OK055606	OK077591	AC01
NMBE 565034	<i>Anodonta cygnea</i>	6	Ceresio, Agno Camping	45.99222	8.89857	OK050215	-----	OK077597	AC01
NMBE 565035	<i>Anodonta cygnea</i>	6	Ceresio, Agno Camping	45.99222	8.89857	OK050216	OK055611	OK077598	AC02
NMBE 565036	<i>Anodonta cygnea</i>	6	Ceresio, Agno Camping	45.99222	8.89857	OK050217	OK055612	OK077599	AC02
NMBE 565045	<i>Anodonta cygnea</i>	6	Lac Brenet, Les Charbonnières	46.66733	6.31725	OK050221	OK055621	OK077606	AC02
NMBE 565080	<i>Anodonta cygnea</i>	6	Walensee, Walenstadt	47.12806	9.30104	OK050251	OK055652	OK077636	AC02
NMBE 565818	<i>Anodonta cygnea</i>	6	Ceresio, Agno Camping	45.99222	8.89857	OK050252	OK055653	OK077638	AC02
NMBE 566631	<i>Anodonta cygnea</i>	6	Samersee, Zollhaus OW	46.8459	8.2029	OK050270	OK055663	OK077652	AC03
NMBE 566632	<i>Anodonta cygnea</i>	6	Vierwaldstättersee, Küsnacht SZ	47.0776	8.4301	OK050271	OK055664	OK077653	AC02
NMBE 566633	<i>Anodonta cygnea</i>	6	Vierwaldstättersee, Küsnacht SZ	47.0776	8.4301	OK050272	OK055665	OK077654	AC02
SMF 360684	<i>Anodonta cygnea</i>	6	Großer Woog, Darmstadt	49.87345	8.6709	OK050304	OK055694	OK077679	AC02
NMBE 565817	<i>Anodonta exulcerata</i>	NA	Ceresio, Agno Camping	45.99222	8.89857	-----	-----	OK077637	NA
NMBE 566634	<i>Anodonta exulcerata</i>	8	Laghetto Demanio, Gudo	46.1659	8.9466	OK050273	-----	-----	AE03
NMBE 566635	<i>Anodonta exulcerata</i>	8	Laghetto Demanio, Gudo	46.1659	8.9466	OK050274	OK055666	OK077655	AE03
NMBE 566636	<i>Anodonta exulcerata</i>	8	Laghetto Demanio, Gudo	46.1659	8.9466	OK050275	OK055667	OK077656	AE03
SMF 360685	<i>Sinanodonta woodiana</i>	9	Großer Woog, Darmstadt	49.87345	8.6709	OK050305	OK055695	OK077680	NA
NMBE 566639	<i>Unio crassus</i>	7	Vierwaldstättersee, Weggis Lützelau	47.0234	8.4668	OK050276	-----	-----	NA

SMF 355084	<i>Unio crassus</i>	7	Holchenbach, Rheinbischofsheim	48.653	7.9167	OK050300	OK055691	OK077675	NA
SMF 360683	<i>Unio crassus</i>	7	Gründau, Langenselbold	50.1781	9.0326	OK050303	OK055693	OK077678	NA
NMBE 559878	<i>Unio elongatulus</i>	1	Lac Neuchâtel, Yvonand ancien port	46.8053	6.7456	OK050197	OK055594	OK077580	UE04
NMBE 559879	<i>Unio elongatulus</i>	1	Lac Neuchâtel, St-Blaise	47.0109	6.9806	OK050198	OK055595	-----	UE04
NMBE 565038	<i>Unio elongatulus</i>	1	Ceresio, Agno Camping	45.99222	8.89857	OK050218	OK055614	OK077601	UE04
NMBE 565039	<i>Unio elongatulus</i>	1	Ceresio, Agno Camping	45.99222	8.89857	OK050219	OK055615	OK077602	UE04
NMBE 565040	<i>Unio elongatulus</i>	1	Ceresio, Agno Camping	45.99222	8.89857	OK050220	OK055616	OK077603	UE04
NMBE 565047	<i>Unio elongatulus</i>	1	Lac Neuchâtel, La Tène	47.00336	7.0172	OK050223	OK055622	OK077608	UE04
NMBE 565058	<i>Unio elongatulus</i>	1	Verbano, Ascona Lido	46.14733	8.77878	OK050234	OK055632	OK077618	UE04
NMBE 565059	<i>Unio elongatulus</i>	1	Verbano, Ascona Lido	46.14733	8.77878	OK050235	OK055633	OK077619	UE08
NMBE 565060	<i>Unio elongatulus</i>	1	Verbano, Ascona Lido	46.14733	8.77878	OK050236	OK055634	OK077620	UE04
NMBE 565061	<i>Unio elongatulus</i>	1	Verbano, Ascona Lido	46.14733	8.77878	OK050237	OK055635	OK077621	UE07
NMBE 565067	<i>Unio elongatulus</i>	1	Verbano, Vira	46.14275	8.8382	OK050242	OK055640	OK077626	UE04
NMBE 565070	<i>Unio elongatulus</i>	1	Verbano, Tenero Lido	46.16648	8.84985	OK050243	OK055643	OK077628	UE04
NMBE 565071	<i>Unio elongatulus</i>	1	Verbano, Tenero Lido	46.16648	8.84985	OK050244	OK055644	OK077629	UE04
NMBE 565072	<i>Unio elongatulus</i>	NA	Verbano, Vira	46.14275	8.83819	-----	OK055645	OK077630	NA
NMBE 565073	<i>Unio elongatulus</i>	1	Verbano, Vira	46.14275	8.8382	OK050245	OK055646	OK077631	UE04
NMBE 565074	<i>Unio elongatulus</i>	1	Verbano, Vira	46.14275	8.8382	OK050246	OK055647	OK077632	UE04
NMBE 566640	<i>Unio elongatulus</i>	1	Laghetto Demanio, Gudo	46.1659	8.9466	OK050277	OK055670	OK077657	UE04
NMBE 566641	<i>Unio elongatulus</i>	1	Laghetto Demanio, Gudo	46.1659	8.9466	OK050278	OK055671	OK077658	UE04



NMBE 566617	<i>Unio elongatulus</i>	1	Weither Wichenstein, Oberriet SG	47.3251	9.5585	OK050279	OK055672	OK077659	UE04
NMBE 566642	<i>Unio elongatulus</i>	1	Weither Wichenstein, Oberriet SG	47.3251	9.5585	OK050280	OK055673	OK077660	UE04
NMBE 566643	<i>Unio elongatulus</i>	1	Weither Wichenstein, Oberriet SG	47.3251	9.5585	OK050281	OK055674	-----	UE04
NMBE 566644	<i>Unio elongatulus</i>	1	Weither Wichenstein, Oberriet SG	47.3251	9.5585	OK050282	OK055675	-----	UE04
NMBE 566645	<i>Unio elongatulus</i>	1	Weither Wichenstein, Oberriet SG	47.3251	9.5585	OK050283	OK055676	-----	UE04
NMBE 566646	<i>Unio elongatulus</i>	1	Weither Wichenstein, Oberriet SG	47.3251	9.5585	OK050284	OK055677	-----	UE04
NMBE 566647	<i>Unio elongatulus</i>	1	Zugersee, Immensee, Alte Badi SZ	47.1002	8.47	OK050285	OK055678	OK077661	UE03
NMBE 566648	<i>Unio elongatulus</i>	1	Lac Neuchâtel, La Tène châteaux	47.0034	7.0172	OK050286	OK055679	OK077662	UE04
NMBE 566649	<i>Unio elongatulus</i>	1	Lac Neuchâtel, La Tène châteaux	47.0034	7.0172	OK050287	OK055680	OK077663	UE04
NMBE 566650	<i>Unio elongatulus</i>	1	Lac Neuchâtel, St-Blaise	47.0109	6.9806	OK050288	-----	OK077664	UE04
NMBE 566651	<i>Unio elongatulus</i>	1	Lac Neuchâtel, St-Blaise	47.0109	6.9806	OK050289	-----	-----	UE04
SMF 341808	<i>Unio pictorum</i>	2	Braubach, Dörmigheim	50.1426	8.8247	OK050296	OK055688	OK077671	NA
SMF 354468	<i>Unio pictorum</i>	2	Horloffi, Oberflorstadt	50.3291	8.871	OK050298	OK055690	OK077673	NA
NMBE 559866	<i>Unio tumidus</i>	5	Lac de Morat, Muntelier	46.93769	7.12439	OK050188	OK055586	OK077570	NA
NMBE 559867	<i>Unio tumidus</i>	5	Lac de Morat, Muntelier	46.93769	7.12439	OK050189	OK055587	OK077571	NA
NMBE 559872	<i>Unio tumidus</i>	5	Lac Morat, Plage d'Avenches	46.9053	7.0559	OK050193	OK055590	OK077575	NA

NMBE 559873	<i>Unio tumidus</i>	5	Lac Morat, Plage d'Avenches	46.9053	7.0559	OK050194	OK055591	OK077576	NA
NMBE 559880	<i>Unio tumidus</i>	5	Lac Neuchâtel, St-Blaise	47.0109	6.9806	OK050199	OK055596	OK077581	NA
NMBE 559886	<i>Unio tumidus</i>	5	Greifensee, Bad	47.3669	8.6708	OK050205	OK055602	OK077587	NA
NMBE 565007	<i>Unio tumidus</i>	5	Vierwaldstättersee, Horw	47.00701	8.31999	OK050210	OK055607	OK077592	NA
NMBE 565032	<i>Unio tumidus</i>	5	Aare, Häfpli	47.14706	7.37087	OK050213	OK055609	OK077595	NA
NMBE 565033	<i>Unio tumidus</i>	5	Aare, Häfpli	47.14706	7.37087	OK050214	OK055610	OK077596	NA
NMBE 565048	<i>Unio tumidus</i>	5	Léman, Vieux Rhône	46.39471	6.8733	OK050224	OK055623	OK077609	NA
NMBE 565049	<i>Unio tumidus</i>	5	Léman, Villeneuve port	46.39677	6.92102	OK050225	OK055624	OK077610	NA
NMBE 565050	<i>Unio tumidus</i>	5	Léman, Villeneuve port	46.39686	6.92097	OK050226	OK055625	OK077611	NA
NMBE 565076	<i>Unio tumidus</i>	5	Vierwaldstättersee, Horw	47.00701	8.31999	OK050247	OK055648	OK077633	NA
NMBE 566652	<i>Unio tumidus</i>	5	Alpnachersee, kleine Schlieren	46.9554	8.2848	OK050290	OK055681	OK077665	NA
NMBE 566653	<i>Unio tumidus</i>	5	Alpnachersee, kleine Schlieren	46.9554	8.2848	OK050291	OK055683	OK077666	NA
NMBE 566654	<i>Unio tumidus</i>	5	Alpnachersee, kleine Schlieren	46.9554	8.2848	OK050292	OK055684	OK077667	NA
NMBE 566655	<i>Unio tumidus</i>	5	Klingnauer Stausee	47.5829	8.2343	OK050293	OK055685	OK077668	NA
NMBE 566656	<i>Unio tumidus</i>	5	Klingnauer Stausee	47.5829	8.2343	OK050294	OK055686	OK077669	NA
NMBE 566657	<i>Unio tumidus</i>	5	Klingnauer Stausee	47.5829	8.2343	OK050295	OK055687	OK077670	NA
SMF 354467	<i>Unio tumidus</i>	5	Horloffi, Oberflorstadt	50.3291	8.871	OK050297	OK055689	OK077672	NA

ESM\_2 Additional sequences for haplotype network and phylogenetic analyses

Lopes-Lima et al. 2021																			
Species	River/Lake	Basin	Country	Latitude	Longitude	COI	16S	28S	Code	Voucher									
<i>Anodonta anatina</i>	Arax	Arax	Turkey	39.970694	41.889083	MZ510944	MZ518861	MZ519098	BIV1884	CIIMAR BIV1884									

<i>Anodonta anatina</i>	Kars	Arax	Turkey	40.565836	43.060236	MZ510986	MZ518971	MZ519208	BIV5398	GCMAE K1-3
<i>Anodonta anatina</i>	Euphrates	Euphrates	Turkey	37.379553	38.550085	MZ510989	MZ518984	MZ519221	BIV5782	GCMAE B01-1
<i>Anodonta anatina</i>	Babaeski	Maritsa	Turkey	41.428108	27.098953	MZ510978	MZ518952	MZ519189	BIV4117	GCMAE M24_1
<i>Anodonta anatina</i>	Marjani	Gorganrud	Iran	37.071868	54.65709	MZ510941	MZ518842	MZ519079	ACIRAN	CIIMAR ACIRAN
<i>Anodonta anatina</i>	Gölbashi	Orontes	Turkey	36.496217	36.480722	MZ510936	MZ518839	MZ519076	AA005T	KCMAE AA005T
<i>Anodonta anatina</i>	Muratpaşa	Orontes	Turkey	36.4298	36.3833	MT027826	MT138514	MT138518	BIV318_1	RMBH BIV318_1
<i>Anodonta anatina</i>	Sapanca	Sapanca	Turkey	40.7112838	30.175334	MZ510961	MZ518912	MZ519149	BIV2342	CIIMAR BIV2342
<i>Anodonta anatina</i>	Pasikhan	Anzali	Iran	37.231785	49.46998	MZ510931	MZ518836	MZ519073	A1IRAN	CIIMAR A1IRAN
<i>Anodonta anatina</i>	Pasikhan	Anzali	Iran	37.415918	49.43853	MZ510935	MZ518838	MZ519075	A6IRAN	CIIMAR A6IRAN
<i>Anodonta anatina</i>	Atnos	Susurluk	Turkey	39.416632	28.100681	MZ510970	MZ518937	MZ519174	BIV3950	GCMAE SS11_A1
<i>Anodonta anatina</i>	Kuş	Susurluk	Turkey	40.225219	28.052855	MZ510952	MZ518894	MZ519131	BIV2239	CIIMAR BIV2239
<i>Anodonta anatina</i>	Uluabat	Susurluk	Turkey	40.136279	28.674396	MZ510957	MZ518900	MZ519137	BIV2279	CIIMAR BIV2279
<i>Anodonta anatina</i>	Tersakan	Tersakan	Turkey	36.737379	28.808708	MZ510948	MZ518869	MZ519106	BIV2096	CIIMAR BIV2096
<i>Anodonta anatina</i>	Gökirmak	Gökirmak	Turkey	41.6403	32.3427	MZ510990	MZ518995	MZ519232	BIV7499	GCMAE BK201
<i>Anodonta anatina</i>	Filyos	Filyos	Turkey	41.577354	32.048551	MZ510991	MZ518996	MZ519233	BIV7500	GCMAE BK302
<i>Anodonta cygnea</i>	Çamlıca	Maritsa	Turkey	40.768715	26.514664	MZ510979	MZ518961	MZ519198	BIV4158	GCMAE M34_A_1
<i>Anodonta cygnea</i>	Taşkısığı	Sakarya	Turkey	40.865868	30.405434	MZ510967	MZ518915	MZ519152	BIV2354	CIIMAR BIV2354
<i>Unio pictorum</i>	Gördes	Gediz	Turkey	38.669587	27.979596	MZ511036	MZ518881	MZ519118	BIV2174	CIIMAR BIV2174

<i>Unio pictorum</i>	Karamenderes	Karamenderes	Turkey	39.992947	26.208696	MZ511042	MZ518890	MZ519127	BIV2201	CIIMAR BIV2201
<i>Unio pictorum</i>	Maritsa	Maritsa	Turkey	41.626782	26.581009	MZ511077	MZ518965	MZ519202	BIV4162	GCMAE M48/46_1
<i>Unio pictorum</i>	Sapanca inlet	Sapanca	Turkey	40.716928	30.141743	MZ511056	MZ518906	MZ519143	BIV2317	CIIMAR BIV2317
<i>Unio pictorum</i>	Atnos	Susurluk	Turkey	39.615322	28.066988	MZ511064	MZ518924	MZ519161	BIV3855	GCMAE SS10_J_U1
<i>Unio pictorum</i>	Kuş	Susurluk	Turkey	40.225219	28.052855	MZ511046	MZ518897	MZ519134	BIV2260	CIIMAR BIV2260
<i>Unio pictorum</i>	Simav	Susurluk	Turkey	39.917702	28.166751	MZ511070	MZ518927	MZ519164	BIV3911	GCMAE SS22_2
<i>Unio pictorum</i>	Uluabat	Susurluk	Turkey	40.136279	28.674396	MZ511051	MZ518903	MZ519140	BIV2296	CIIMAR BIV2296
<i>Unio pictorum</i>	Filyos	Filyos	Turkey	41.577354	32.048551	MZ511112	MZ518999	MZ519236	BIV7504	GCMAE BK001

### Froufe et al. 2017

Code	Species	Country	COI	16S	28S
Anolta1	<i>Anodonta anatina</i>	Italy	MF414420	MF414406	MF414392
Anolta2	<i>Anodonta anatina</i>	Italy	MF414421	MF414407	MF414393
AnoEur1	<i>Anodonta anatina</i>	Italy	MF414418	MF414404	MF414390
AnoEur2	<i>Anodonta anatina</i>	Czech Republic	MF414419	MF414405	MF414391
AnoExu1	<i>Anodonta exulcerata</i>	Italy	MF414424	MF414410	MF414396
AnoExu1	<i>Anodonta exulcerata</i>	Italy	MF414425	MF414411	MF414397
AnoCyg1	<i>Anodonta cygnea</i>	Portugal	MF414422	MF414408	MF414394
AnoCyg2	<i>Anodonta cygnea</i>	Italy	MF414423	MF414409	MF414395
UniElo1	<i>Unio elongatulus</i>	Italy	MF414428	MF414414	MF414400
UniElo2	<i>Unio elongatulus</i>	Italy	MF414429	MF414415	MF414401

<i>UniMan1</i>	<i>Unio mancus</i>	Spain	MF414430	MF414416	MF414402
<i>UniMan2</i>	<i>Unio mancus</i>	France	JX046596	KC703431	KC703676
<i>UniPic1</i>	<i>Unio pictorum</i>	France	MF414431	MF414417	MF414403
<i>UniPic2</i>	<i>Unio pictorum</i>	United Kingdom	KC429109	KC429266	KC429447
<i>SinWoo</i>	<i>Sinanodonta woodiana</i>	Italy	MF414427	MF414413	MF414399
<i>PotLit</i>	<i>Potomida littoralis</i>	Portugal	KU946741	KU946112	KU946427

### Froufe et al. 2017

Code	Species	Clade	Population	River Basin	Country	Latitude	Longitude	Haplotype	GenBank
BIV162	<i>Anodonta anatina</i>	European	Drava	Danube	Croatia	45.769702	18.066127	AA1	MF414212
BIV1859	<i>Anodonta anatina</i>	European	Vidourle	Vidourle	France	43.736461	4.142811	AA3	MF414213
BIV1862	<i>Anodonta anatina</i>	European	Vidourle	Vidourle	France	43.736461	4.142811	AA3	MF414214
AA387	<i>Anodonta anatina</i>	Italian	Maggiore	Po	Italy	45.980342	8.644341	AA17	KC583512
C42628	<i>Anodonta cygnea</i>	-----	Ivösjön	-----	Sweden	56.16667	14.833333	AC2	MF414254
AA368	<i>Anodonta cygnea</i>	-----	Balaton	Danube	Hungary	46.75296	17.24607	AC2	MF414253
-----	<i>Anodonta cygnea</i>	-----	Obertrumer	Danube	Austria	47.964985	13.087448	AC2	AF232824
BIV1861	<i>Anodonta cygnea</i>	-----	Vidourle	Vidourle	France	43.736461	4.142811	AC2	MF414270
-----	<i>Anodonta cygnea</i>	-----	Hamrzysko	Biala	Poland	52.831396	16.368745	AC2	GU230748
-----	<i>Anodonta cygnea</i>	-----	Velyki Derevychi	Derevychnka	Ukraine	49.967778	27.605	AC5	JQ253886



BIV130	<i>Anodonta exulcerata</i>	-----	Roški slap	Krka	Croatia	43.854534	16.15537	AE9	MF414301
BIV125	<i>Anodonta exulcerata</i>	-----	Visovac	Krka	Croatia	43.861476	15.980369	AE10	MF414300

### Marrone et al. 2018

Taxon	Accession Number	Country	Hydrographic Area	Hydrographic Basin	River / Lake	Reference
<i>Unio elongatulus</i>	JX046578	Italy	AdriPad	Po	Lake Maggiore	Prié et al., 2012
<i>Unio elongatulus</i>	KU051600	Italy	AdriPad	Po	Lake Mergozzo	Riccardi et al., 2016
<i>Unio elongatulus</i>	KU051605	Italy	AdriPad	Po	Lake Viverone	Riccardi et al., 2016
<i>Unio elongatulus</i>	KU051607	Italy	AdriPad	Po	Lake Candia	Riccardi et al., 2016
<i>Unio elongatulus</i>	KU051610	Italy	AdriPad	Po	Adda river	Riccardi et al., 2016
<i>Unio elongatulus</i>	KU051612	Italy	AdriPad	Po	Lake Endine	Riccardi et al., 2016
<i>Unio elongatulus</i>	KU051616	Italy	AdriPad	Po	Lake Comabbio	Riccardi et al., 2016
<i>Unio elongatulus</i>	KU051618	Italy	AdriPad	Po	Lake Annone	Riccardi et al., 2016
<i>Unio elongatulus</i>	KX399964	Italy	AdriNW	Plave	Lake Cestella	Araujo et al., 2017
<i>Unio elongatulus</i>	KX399968	Italy	AdriNW	Brenta	Boligo canal	Araujo et al., 2017
<i>Unio elongatulus</i>	KX399970	Italy	AdriNE	Isonzo	Versa stream	Araujo et al., 2017
<i>Unio elongatulus</i>	KX399974	Croatia	AdriBal	Zrmanja	Zrmanja river	Araujo et al., 2017
<i>Unio elongatulus</i>	KX399976	Croatia	AdriBal	Bacinska	Lake Bacinska	Araujo et al., 2017
<i>Unio elongatulus</i>	KX399978	Albania	AdriBal	Bojana	Lake Skadar	Araujo et al., 2017

<i>Unio elongatulus</i>	KX399979	Italy	AdriPad	Po	Po River	Araujo et al., 2017
<i>Unio elongatulus</i>	MF414353	Croatia	AdriBal	Krka	Krka river	Froufe et al., 2017
<i>Unio elongatulus</i>	MF414358	Italy	AdriNE	Isonzo	Canal	Froufe et al., 2017
<i>Unio elongatulus</i>	MF414373	Italy	TyrrApp	Arno	Bisenzio river	Froufe et al., 2017
<i>Unio elongatulus</i>	MF414376	Italy	AdriPad	Reno	Lake Castel dell'Alpi	Froufe et al., 2017
<i>Unio elongatulus</i>	MF414380	Italy	AdriPad	Po	Lake Comabbio	Froufe et al., 2017
<i>Unio elongatulus</i>	MF414388	Italy	AdriPad	Po	Lake Mergozzo	Froufe et al., 2017
<i>Unio elongatulus</i>	MG967427	Italy	TyrrApp	Arno	Greve river	Marrone et al., 2019
<i>Unio elongatulus</i> ( <i>Neotype</i> )	MG967432	Italy	AdriNE	Isonzo	Vipacco river	Marrone et al., 2019
<i>Unio elongatulus</i>	MG967436	Italy	AdriApp	Metauro	Metauro river	Marrone et al., 2019
<i>Unio elongatulus</i>	MG967441	Slovenia	AdriNE	Isonzo	Vipava river	Marrone et al., 2019
<i>Unio elongatulus</i>	MG967445	Italy	AdriPad	Po	Chiusella ditch	Marrone et al., 2019

### Klishko et al. 2019

Species	Locality		Country	Code/GenBank
<i>Anodonta anatina</i>	Lake Gusynoye	Russia	BIV3374/MH062766	
<i>Anodonta anatina</i>	Lake Gusynoye	Russia	BIV3375/MH062767	
<i>Anodonta anatina</i>	Lake Schuchje	Russia	BIV3377/MH062768	
<i>Anodonta anatina</i>	Lake Schuchje	Russia	BIV3378/MH062769	
<i>Anodonta anatina</i>	Lake Schuchje	Russia	BIV3379/MH062770	
<i>Anodonta anatina</i>	Lake Schuchje	Russia	BIV3381/MH062771	
<i>Anodonta anatina</i>	Lake Torma	Russia	BIV3382/MH062772	

<i>Anodonta anatina</i>	Lake Torma	Russia	BIV3383/MH062773
<i>Anodonta anatina</i>	Lake Torma	Russia	BIV3384/MH062774
<i>Anodonta anatina</i>	Lake Torma	Russia	BIV3385/MH062775
<i>Anodonta anatina</i>	River Selenga	Russia	BIV3387/MH062776
<i>Anodonta anatina</i>	River Selenga	Russia	BIV3388/MH062777
<i>Anodonta anatina</i>	Lake Big Eravna	Russia	BIV3392/MH062778
<i>Anodonta anatina</i>	Lake Big Eravna	Russia	BIV3393/MH062779
<i>Anodonta anatina</i>	Lake Big Eravna	Russia	BIV3394/MH062780
<i>Anodonta anatina</i>	Lake Big Eravna	Russia	BIV3395/MH062781
<i>Anodonta anatina</i>	Lake Big Eravna	Russia	BIV3397/MH062782
<i>Anodonta anatina</i>	Lake Big Eravna	Russia	BIV3399/MH062783
<i>Anodonta anatina</i>	Lake Baikal	Russia	BIV3401/MH062784
<i>Anodonta anatina</i>	Lake Baikal	Russia	BIV3402/MH062785
<i>Anodonta anatina</i>	Lake Baikal	Russia	BIV3405/MH062786
<i>Anodonta anatina</i>	Lake Baikal	Russia	BIV3406/MH062787
<i>Anodonta anatina</i>	Lake Baikal	Russia	BIV3408/MH062788
<i>Anodonta anatina</i>	Lake Tasey	Russia	BIV0256/MH062765
<i>Anodonta anatina</i>	River Murafa	Ukraine	BIV0201/MH062760
<i>Anodonta anatina</i>	River Revna	Ukraine	BIV0202/MH062761
<i>Anodonta anatina</i>	River Revna	Ukraine	BIV0206/MH062764
<i>Anodonta anatina</i>	Pond in Dinotzky	Ukraine	BIV0204/MH062762
<i>Anodonta anatina</i>	River Suchoy Tashlyk	Ukraine	BIV0205/MH062763
<i>Anodonta anatina</i>	River Vorsakla	Ukraine	BIV0199/MH062759

# ESM\_3 ASAP partitions

Partition 3					
Score: 3					
Proba: 1.413839e-03					
nb groups: 9 (8)					
Group [ 1 ] n: 82 ;id:		Group [ 2 ] n: 23 ;id:		Group [ 7 ] n: 13 ;id:	
Anodonta_anatina_A1IRAN Anodonta anatina isolate A1IRAN		Anodonta_cyanea_140 Anodonta cyanea voucher 140		Unio_pictorum_BIV2174 Unio pictorum isolate BIV2174	
Anodonta_anatina_AGRAN Anodonta anatina isolate AGRAN		Anodonta_cyanea_AA368 Anodonta cyanea isolate AA368		Unio_pictorum_BIV2201 Unio pictorum isolate BIV2201	
Anodonta_anatina_ACIRAN Anodonta anatina isolate ACIRAN		Anodonta_cyanea_AC42628 Anodonta cyanea isolate AC42628		Unio_pictorum_BIV2260 Unio pictorum isolate BIV2260	
Anodonta_anatina_BIV1884 Anodonta anatina isolate BIV1884		Anodonta_cyanea_BIV1861 Anodonta cyanea isolate BIV1861		Unio_pictorum_BIV2296 Unio pictorum isolate BIV2296	
Anodonta_anatina_BIV5398 Anodonta anatina isolate BIV5398		Anodonta_cyanea_NBMBE559863 Anodonta cyanea		Unio_pictorum_BIV3855 Unio pictorum isolate BIV3855	
Anodonta_anatina_AA0051 Anodonta anatina isolate AA0051		Anodonta_cyanea_NBMBE559864 Anodonta cyanea		Unio_pictorum_BIV3911 Unio pictorum isolate BIV3911	
Anodonta_anatina_biv318_1 Anodonta anatina voucher biv318/1		Anodonta_cyanea_SMF362001 Anodonta cyanea		Unio_pictorum_BIV2317 Unio pictorum isolate BIV2317	
Anodonta_anatina_NBMBE559888 Anodonta anatina		Anodonta_cyanea_NBMBE559890 Anodonta cyanea		Unio_pictorum_BIV7504 Unio pictorum isolate BIV7504	
Anodonta_anatina_AnoEur1 Anodonta anatina isolate AnoEur1		Anodonta_cyanea_NBMBE56034 Anodonta cyanea		Unio_pictorum_SMF341808 Unio pictorum	
Anodonta_anatina_AnoEur2 Anodonta anatina isolate AnoEur2		Anodonta_cyanea_NBMBE56036 Anodonta cyanea		Unio_pictorum_SMF354468 Unio pictorum	
Anodonta_anatina_BIV0204 Anodonta anatina isolate BIV0204		Anodonta_cyanea_NBMBE56045 Anodonta cyanea		Unio_pictorum_BiVaToL-204 Unio pictorum voucher BiVaToL-204	
Anodonta_anatina_BIV0205 Anodonta anatina isolate BIV0205		Anodonta_cyanea_NBMBE56080 Anodonta cyanea		Unio_pictorum_UniPic1 Unio pictorum isolate UniPic1	
Anodonta_anatina_BIV1859 Anodonta anatina isolate BIV1859		Anodonta_cyanea_NBMBE56518 Anodonta cyanea			
Anodonta_anatina_BIV1862 Anodonta anatina isolate BIV1862		Anodonta_cyanea_NBMBE56631 Anodonta cyanea		Group [ 8 ] n: 36 ;id:	
Anodonta_anatina_NBMBE559882 Anodonta anatina		Anodonta_cyanea_NBMBE56633 Anodonta cyanea		Unio_mancus_isolate_IT148 Unio mancus isolate IT148	
Anodonta_anatina_NBMBE559885 Anodonta anatina		Anodonta_cyanea_SMF362001 Anodonta cyanea		Unio_mancus_requienii_MNHN-IM-2009-12572 Unio mancus requienii voucher MNHN-IM-2009-12572	
Anodonta_anatina_NBMBE559888 Anodonta anatina		Anodonta_cyanea_NBMBE56630 Anodonta cyanea		Unio_mancus_requienii_MNHN-IM-2009-12581 Unio mancus requienii voucher MNHN-IM-2009-12581	
Anodonta_anatina_NBMBE56616 Anodonta anatina		Anodonta_cyanea_PB15 Anodonta cyanea isolate PB15		Unio_mancus_requienii_MNHN-IM-2009-12605 Unio mancus requienii voucher MNHN-IM-2009-12605	
Anodonta_anatina_NBMBE559883 Anodonta anatina		Anodonta_cyanea_AnoCyg1 Anodonta cyanea isolate AnoCyg1		Unio_mancus_requienii_MNHN-IM-2009-17807 Unio mancus requienii voucher MNHN-IM-2009-17807	
Anodonta_anatina_NBMBE559884 Anodonta anatina		Anodonta_cyanea_AnoCyg2 Anodonta cyanea isolate AnoCyg2		Unio_mancus_requienii_MNHN-IM-2009-21222 Unio mancus requienii voucher MNHN-IM-2009-21222	
Anodonta_anatina_NBMBE56055 Anodonta anatina		Anodonta_cyanea_BIV2354 Anodonta cyanea isolate BIV2354		Unio_mancus_requienii_MNHN-IM-2009-22392 Unio mancus requienii voucher MNHN-IM-2009-22392	
Anodonta_anatina_NBMBE56077 Anodonta anatina		Anodonta_cyanea_BIV4158 Anodonta cyanea isolate BIV4158		Unio_mancus_voucher_MNHN-IM-2009-12708 Unio mancus voucher MNHN-IM-2009-12708	
Anodonta_anatina_NBMBE56079 Anodonta anatina		Group [ 3 ] n: 7 ;id: Anodonta_exulcerata_AnoExu1 Anodonta exulcerata isolate AnoExu1		Unio_mancus_voucher_MNHN-IM-2009-12708 Unio mancus voucher MNHN-IM-2009-12708	
Anodonta_anatina_NBMBE56622 Anodonta anatina		Anodonta_exulcerata_NBMBE56633 Anodonta exulcerata		cytochrome oxidase subunit I gene, partial cds; Unio_mancus_isolate_IT185 Unio mancus isolate IT185	
Anodonta_anatina_NBMBE56623 Anodonta anatina		Anodonta_exulcerata_NBMBE56634 Anodonta exulcerata		Unio_mancus_turtonii_MNHN-IM-2009-12571 Unio mancus turtonii voucher MNHN-IM-2009-12571	
Anodonta_anatina_NBMBE56625 Anodonta anatina		Anodonta_exulcerata_NBMBE56635 Anodonta exulcerata		Unio_mancus_turtonii_MNHN-IM-2009-12725 Unio mancus turtonii voucher MNHN-IM-2009-12725	
Anodonta_anatina_BIV162 Anodonta anatina isolate BIV162		Anodonta_exulcerata_BIV130 Anodonta exulcerata isolate BIV130		Unio_mancus_turtonii_MNHN-IM-2009-12735 Unio mancus turtonii voucher MNHN-IM-2009-12735	
Anodonta_anatina_NBMBE559870 Anodonta anatina		Anodonta_exulcerata_BIV125 Anodonta exulcerata isolate BIV125		Unio_mancus_turtonii_MNHN-IM-2009-12758 Unio mancus turtonii voucher MNHN-IM-2009-12758	
Anodonta_anatina_NBMBE559877 Anodonta anatina		Anodonta_exulcerata_AnoExu2 Anodonta exulcerata isolate AnoExu2		Unio_mancus_turtonii_MNHN-IM-2009-17784 Unio mancus turtonii voucher MNHN-IM-2009-17784	
Anodonta_anatina_NBMBE56618 Anodonta anatina		Group [ 4 ] n: 1 ;id: Cristaria_plicata_IPN_901 Cristaria plicata voucher IPN 90/1		Unio_mancus_voucher_MNHN-IM-2009-12744 Unio mancus voucher MNHN-IM-2009-12744	
Anodonta_anatina_NBMBE56614 Anodonta anatina				Unio_mancus_voucher_MNHN-IM-2009-12753 Unio mancus voucher MNHN-IM-2009-12753	
Anodonta_anatina_NBMBE565031 Anodonta anatina		Group [ 5 ] n: 3 ;id:		Unio_mancus_turtonii_745-Sicily Unio mancus turtonii isolate 745-Sicily	
Anodonta_anatina_BIV0199 Anodonta anatina isolate BIV0199		Unio_crassus_NBMBE566638 Unio crassus		Unio_mancus_voucher_MNHN-IM-2009-12738 Unio mancus voucher MNHN-IM-2009-12738	
Anodonta_anatina_BIV0201 Anodonta anatina isolate BIV0201		Unio_crassus_SMF350084 Unio crassus		Unio_mancus_isolate_UniMan1 Unio mancus isolate UniMan1	
Anodonta_anatina_BIV0206 Anodonta anatina isolate BIV0206		Unio_crassus_SMF360083 Unio crassus		Unio_mancus_voucher_Fw1238-15 Unio mancus voucher Fw1238-15	
Anodonta_anatina_NBMBE565053 Anodonta anatina		Group [ 6 ] n: 58 ;id:		Unio_mancus_voucher_Fw1487-1 Unio mancus voucher Fw1487-1	
Anodonta_anatina_NBMBE565054 Anodonta anatina		Unio_elongatulus_842-Tuscany Unio elongatulus isolate 842-Tuscany		Unio_mancus_voucher_Fw1535-N1 Unio mancus voucher Fw1535-N1	
Anodonta_anatina_NBMBE56617 Anodonta anatina		Unio_elongatulus_IT209 Unio elongatulus isolate IT209		Unio_mancus_mancus_MNHN-IM-2009-12591 Unio mancus mancus voucher MNHN-IM-2009-12591	
Anodonta_anatina_NBMBE56618 Anodonta anatina		Unio_elongatulus_MNHN-IM-2009-12673 Unio elongatulus voucher MNHN-IM-2009-12673		Unio_mancus_mancus_MNHN-IM-2009-17788 Unio mancus mancus voucher MNHN-IM-2009-17788	
Anodonta_anatina_NBMBE56619 Anodonta anatina		Unio_elongatulus_NBMBE559878 Unio elongatulus		Unio_mancus_mancus_MNHN-IM-2009-17815 Unio mancus mancus voucher MNHN-IM-2009-17815	
Anodonta_anatina_NBMBE56620 Anodonta anatina		Unio_elongatulus_NBMBE559879 Unio elongatulus		Unio_mancus_mancus_MNHN-IM-2009-21267 Unio mancus mancus voucher MNHN-IM-2009-21267	
Anodonta_anatina_NBMBE56621 Anodonta anatina		Unio_elongatulus_NBMBE56038 Unio elongatulus		Unio_mancus_mancus_MNHN-IM-2009-21274 Unio mancus mancus voucher MNHN-IM-2009-21274	
Anodonta_anatina_NBMBE56622 Anodonta anatina		Unio_elongatulus_NBMBE56039 Unio elongatulus		Unio_mancus_voucher_Fw1544-N50 Unio mancus voucher Fw1544-N50	
Anodonta_anatina_BIV0256 Anodonta anatina isolate BIV0256		Unio_elongatulus_NBMBE56040 Unio elongatulus		Unio_mancus_mancus_MNHN-IM-2009-12713 Unio mancus mancus voucher MNHN-IM-2009-12713	
Anodonta_anatina_BIV3374 Anodonta anatina isolate BIV3374		Unio_elongatulus_NBMBE56047 Unio elongatulus		Unio_mancus_mancus_MNHN-IM-2009-12715 Unio mancus mancus voucher MNHN-IM-2009-12715	
Anodonta_anatina_BIV3378 Anodonta anatina isolate BIV3378		Unio_elongatulus_NBMBE56058 Unio elongatulus		Unio_mancus_voucher_MNHN-IM-2009-12715 Unio mancus voucher MNHN-IM-2009-12715	
Anodonta_anatina_BIV3382 Anodonta anatina isolate BIV3382		Unio_elongatulus_NBMBE56059 Unio elongatulus		Unio_mancus_mancus_MNHN-IM-2009-21260 Unio mancus mancus voucher MNHN-IM-2009-21260	
Anodonta_anatina_BIV3387 Anodonta anatina isolate BIV3387		Unio_elongatulus_NBMBE56060 Unio elongatulus		Unio_mancus_mancus_MNHN-IM-2009-21293 Unio mancus mancus voucher MNHN-IM-2009-21293	
Anodonta_anatina_BIV3401 Anodonta anatina isolate BIV3401		Unio_elongatulus_NBMBE56067 Unio elongatulus		Group [ 9 ] n: 19 ;id:	
Anodonta_anatina_NBMBE559869 Anodonta anatina		Unio_elongatulus_NBMBE56070 Unio elongatulus		Unio_tumidus_NBMBE559866 Unio tumidus	
Anodonta_anatina_NBMBE559871 Anodonta anatina		Unio_elongatulus_NBMBE56071 Unio elongatulus		Unio_tumidus_NBMBE559886 Unio tumidus	
Anodonta_anatina_NBMBE559876 Anodonta anatina		Unio_elongatulus_NBMBE56073 Unio elongatulus		Unio_tumidus_NBMBE559867 Unio tumidus	
Anodonta_anatina_NBMBE56046 Anodonta anatina		Unio_elongatulus_NBMBE56074 Unio elongatulus		Unio_tumidus_NBMBE559872 Unio tumidus	
Anodonta_anatina_NBMBE56051 Anodonta anatina		Unio_elongatulus_NBMBE566639 Unio elongatulus		Unio_tumidus_NBMBE559873 Unio tumidus	
Anodonta_anatina_NBMBE56052 Anodonta anatina		Unio_elongatulus_NBMBE566640 Unio elongatulus		Unio_tumidus_NBMBE56007 Unio tumidus	
Anodonta_anatina_NBMBE56078 Anodonta anatina		Unio_elongatulus_NBMBE566641 Unio elongatulus		Unio_tumidus_NBMBE56032 Unio tumidus	
Anodonta_anatina_NBMBE56626 Anodonta anatina		Unio_elongatulus_NBMBE566642 Unio elongatulus		Unio_tumidus_NBMBE56033 Unio tumidus	
Anodonta_anatina_NBMBE56629 Anodonta anatina		Unio_elongatulus_NBMBE566643 Unio elongatulus		Unio_tumidus_NBMBE56048 Unio tumidus	
Anodonta_anatina_SMF354463 Anodonta anatina		Unio_elongatulus_NBMBE566644 Unio elongatulus		Unio_tumidus_NBMBE56049 Unio tumidus	
Anodonta_anatina_BIV2239 Anodonta anatina isolate BIV2239		Unio_elongatulus_NBMBE566645 Unio elongatulus		Unio_tumidus_NBMBE56050 Unio tumidus	
Anodonta_anatina_BIV2279 Anodonta anatina isolate BIV2279		Unio_elongatulus_NBMBE566646 Unio elongatulus		Unio_tumidus_NBMBE56076 Unio tumidus	
Anodonta_anatina_BIV3950 Anodonta anatina isolate BIV3950		Unio_elongatulus_NBMBE566648 Unio elongatulus		Unio_tumidus_NBMBE56653 Unio tumidus	
Anodonta_anatina_NBMBE559881 Anodonta anatina		Unio_elongatulus_NBMBE566649 Unio elongatulus		Unio_tumidus_NBMBE56655 Unio tumidus	
Anodonta_anatina_BIV3392 Anodonta anatina isolate BIV3392		Unio_elongatulus_NBMBE566650 Unio elongatulus		Unio_tumidus_NBMBE56656 Unio tumidus	
Anodonta_anatina_BIV2342 Anodonta anatina isolate BIV2342		Unio_elongatulus_SMF355846_2 Unio elongatulus		Unio_tumidus_NBMBE56657 Unio tumidus	
Anodonta_anatina_BIV7499 Anodonta anatina isolate BIV7499		Unio_elongatulus_U71 Unio elongatulus isolate U71		Unio_tumidus_SMF354467 Unio tumidus	
Anodonta_anatina_BIV4117 Anodonta anatina isolate BIV4117		Unio_elongatulus_U81 Unio elongatulus isolate U81			
Anodonta_anatina_BIV5782 Anodonta anatina isolate BIV5782		Unio_elongatulus_U1171 Unio elongatulus isolate U1171			
Anodonta_anatina_AA387 Anodonta anatina isolate AA387		Unio_elongatulus_UniE01 Unio elongatulus isolate UniE01			
Anodonta_anatina_AnoIta1 Anodonta anatina isolate AnoIta1		Unio_elongatulus_UniE02 Unio elongatulus isolate UniE02			
Anodonta_anatina_NBMBE565055 Anodonta anatina		Unio_elongatulus_872-Marche Unio elongatulus isolate 872-Marche			
Anodonta_anatina_NBMBE565056 Anodonta anatina		Unio_elongatulus_BIV3330 Unio elongatulus isolate BIV3330			
Anodonta_anatina_NBMBE565057 Anodonta anatina		Unio_elongatulus_MNHN-IM-2009-12673 Unio elongatulus voucher MNHN-IM-2009-12673			
Anodonta_anatina_NBMBE565062 Anodonta anatina		Unio_elongatulus_MNHN-IM-2009-12673 Unio elongatulus voucher MNHN-IM-2009-12673			
Anodonta_anatina_NBMBE565063 Anodonta anatina		Unio_elongatulus_MNHN-IM-2009-12673 Unio elongatulus voucher MNHN-IM-2009-12673			
Anodonta_anatina_NBMBE565064 Anodonta anatina		Unio_elongatulus_MNHN-IM-2009-12673 Unio elongatulus voucher MNHN-IM-2009-12673			
Anodonta_anatina_NBMBE565069 Anodonta anatina		Unio_elongatulus_MNHN-IM-2009-12673 Unio elongatulus voucher MNHN-IM-2009-12673			
Anodonta_anatina_AnoIta2 Anodonta anatina isolate AnoIta2		Unio_elongatulus_SMF355846_1 Unio elongatulus			
		Unio_elongatulus_874-Tuscany Unio elongatulus isolate 874-Tuscany			
		Unio_elongatulus_876-FVG Unio elongatulus isolate 876-FVG			
		Unio_elongatulus_BIV134 Unio elongatulus isolate BIV134			
		Unio_elongatulus_IT54 Unio elongatulus isolate IT54			
		Unio_elongatulus_MNHN-IM-2009-12673 Unio elongatulus voucher MNHN-IM-2009-12673			
		Unio_elongatulus_U4-Slovenia Unio elongatulus isolate U4-Slovenia			
		Unio_elongatulus_U721 Unio elongatulus isolate U721			
		Unio_elongatulus_U801 Unio elongatulus isolate U801			
		Unio_elongatulus_U881 Unio elongatulus isolate U881			
		Unio_elongatulus_U1161 Unio elongatulus isolate U1161			
		Unio_elongatulus_U1331 Unio elongatulus isolate U1331			
		Unio_elongatulus_NBMBE56059 Unio elongatulus			
		Unio_elongatulus_NBMBE56061 Unio elongatulus			
		Unio_elongatulus_NBMBE56647 Unio elongatulus			
		Unio_elongatulus_US81 Unio elongatulus isolate US81			
		Unio_elongatulus_MNHN-IM-2009-12673 Unio elongatulus voucher MNHN-IM-2009-12673			

## ESM\_4 Haplotype list

Haplotypes of the sequences used in the haplotype network			
Haplotype AC01	Haplotype AC02		
Anodonta_cyanea_AnoCyg1	Anodonta_cyanea_NMBE565034	Haplotype AE01	
Anodonta_cyanea_AnoCyg2	Anodonta_cyanea_NMBE565035	Anodonta_exulcerata_BIV125	
	Anodonta_cyanea_NMBE565036		
Haplotype AC03	Anodonta_cyanea_NMBE565818	Haplotype AE02	
Anodonta_cyanea_NMBE566631	Anodonta_cyanea_NMBE559864	Anodonta_exulcerata_BIV130	
	Anodonta_cyanea_NMBE559865		
Haplotype AC04	Anodonta_cyanea_NMBE559863	Haplotype AE03	
Anodonta_cyanea_PB15	Anodonta_cyanea_SMF360684	Anodonta_exulcerata_NMBE566634	
	Anodonta_cyanea_NMBE565045	Anodonta_exulcerata_NMBE566635	
Haplotype AC05	Anodonta_cyanea_NMBE566632	Anodonta_exulcerata_NMBE566636	
Anodonta_cyanea_BIV2354	Anodonta_cyanea_NMBE566633	Anodonta_exulcerata_AnoExu1	
	Anodonta_cyanea_NMBE565080		
Haplotype AC06	Anodonta_cyanea_NMBE559890	Haplotype AE04	
Anodonta_cyanea_BIV4158	Anodonta_cyanea_BIV1861	Anodonta_exulcerata_AnoExu2	
	Anodonta_cyanea_AC42628		
	Anodonta_cyanea_AA368		
	Anodonta_cyanea_140		
Haplotype AA01	Haplotype AA05	Haplotype AA12	Haplotype AA15
Anodonta_anatina_NMBE565055	Anodonta_anatina_NMBE565031	Anodonta_anatina_SMF354469	Anodonta_anatina_NMBE559881
Anodonta_anatina_NMBE565056		Anodonta_anatina_NMBE559869	
Anodonta_anatina_NMBE565057	Haplotype AA06	Anodonta_anatina_NMBE565046	Haplotype AA16
Anodonta_anatina_NMBE565819	Anodonta_anatina_NMBE559884	Anodonta_anatina_NMBE559871	Anodonta_anatina_BIV0199
Anodonta_anatina_NMBE565062	Anodonta_anatina_NMBE566615	Anodonta_anatina_NMBE559876	
Anodonta_anatina_NMBE565063	Anodonta_anatina_NMBE566623	Anodonta_anatina_NMBE566630	Haplotype AA17
Anodonta_anatina_NMBE565064	Anodonta_anatina_NMBE566624	Anodonta_anatina_NMBE565051	Anodonta_anatina_A1IRAN
Anodonta_anatina_AA387	Anodonta_anatina_NMBE566627	Anodonta_anatina_NMBE565052	Anodonta_anatina_A6IRAN
Anodonta_anatina_AnoIta1	Anodonta_anatina_NMBE565065	Anodonta_anatina_NMBE566625	Anodonta_anatina_ACIRAN
Anodonta_anatina_AA387	Anodonta_anatina_NMBE565077	Anodonta_anatina_NMBE565078	
	Anodonta_anatina_NMBE565079	Anodonta_anatina_BIV0256	
Haplotype AA02		Anodonta_anatina_BIV3374	
Anodonta_anatina_AnoIta2	Haplotype AA07	Anodonta_anatina_BIV3378	
	Anodonta_anatina_BIV0204	Anodonta_anatina_BIV3382	
Haplotype AA03	Anodonta_anatina_BIV0205	Anodonta_anatina_BIV3387	
Anodonta_anatina_NMBE565030		Anodonta_anatina_BIV3401	
Anodonta_anatina_NMBE566614	Haplotype AA08		
Anodonta_anatina_NMBE559870	Anodonta_anatina_AnoEur1	Haplotype AA13	
Anodonta_anatina_NMBE559877		Anodonta_anatina_BIV3392	
Anodonta_anatina_BIV162	Haplotype AA09		
	Anodonta_anatina_NMBE559883	Haplotype AA14	
Haplotype AA04		Anodonta_anatina_NMBE566628	
Anodonta_anatina_NMBE559885	Haplotype AA10	Anodonta_anatina_NMBE566629	
Anodonta_anatina_NMBE566616	Anodonta_anatina_BIV2239	Anodonta_anatina_NMBE566618	
Anodonta_anatina_NMBE559887	Anodonta_anatina_BIV2279	Anodonta_anatina_NMBE566619	
Anodonta_anatina_NMBE559888	Anodonta_anatina_BIV3950	Anodonta_anatina_NMBE566620	
Anodonta_anatina_NMBE559889		Anodonta_anatina_NMBE565053	
Anodonta_anatina_NMBE559882	Haplotype AA11	Anodonta_anatina_NMBE565054	
Anodonta_anatina_AnoEur2	Anodonta_anatina_NMBE566626	Anodonta_anatina_NMBE566622	
Anodonta_anatina_BIV1859		Anodonta_anatina_NMBE566621	
Anodonta_anatina_BIV1862		Anodonta_anatina_BIV0201	
		Anodonta_anatina_BIV0206	
Haplotype UE01	Haplotype UE04		
Unio_elongatulus_MNCN_N1860	Unio_elongatulus_NMBE565038	Haplotype UE05	
	Unio_elongatulus_NMBE565040	Unio_elongatulus_872_Marche	
Haplotype UE02	Unio_elongatulus_NMBE565039	Unio_elongatulus_BIV3330	
Unio_elongatulus_874_Tuscany	Unio_elongatulus_NMBE565047	Unio_elongatulus_MNCN_N168	
Unio_elongatulus_876_FVG	Unio_elongatulus_NMBE566648	Unio_elongatulus_MNCN_N1673	
Unio_elongatulus_BIV134	Unio_elongatulus_NMBE566649	Unio_elongatulus_MNCN_N1677	
Unio_elongatulus_IT54	Unio_elongatulus_NMBE559879	Unio_elongatulus_MNCN_N1854	
Unio_elongatulus_MNCN_N188	Unio_elongatulus_NMBE566650	Unio_elongatulus_MNCN_N1872	
Unio_elongatulus_U4_Slovenia	Unio_elongatulus_NMBE566651		
Unio_elongatulus_U72I	Unio_elongatulus_NMBE559878	Haplotype UE06	
Unio_elongatulus_U80I	Unio_elongatulus_NMBE566640	Unio_elongatulus_U58I	
Unio_elongatulus_U88I	Unio_elongatulus_NMBE566641		
Unio_elongatulus_U116I	Unio_elongatulus_NMBE565058	Haplotype UE07	
Unio_elongatulus_U133I	Unio_elongatulus_NMBE565060	Unio_elongatulus_NMBE565061	
	Unio_elongatulus_NMBE565070		
Haplotype UE03	Unio_elongatulus_NMBE565071	Haplotype UE08	
Unio_elongatulus_NMBE566647	Unio_elongatulus_NMBE565073	Unio_elongatulus_NMBE565059	
	Unio_elongatulus_NMBE565067		
	Unio_elongatulus_NMBE565074		
	Unio_elongatulus_NMBE566617		
	Unio_elongatulus_NMBE566642		
	Unio_elongatulus_NMBE566643		
	Unio_elongatulus_NMBE566644		
	Unio_elongatulus_NMBE566645		
	Unio_elongatulus_NMBE566646		
	Unio_elongatulus_842_Tuscany		
	Unio_elongatulus_IT209		
	Unio_elongatulus_MNHN_IM_2009_12673		
	Unio_elongatulus_U7I		
	Unio_elongatulus_U8I		
	Unio_elongatulus_U117I		



## Revision of *Massylaea* Möllendorff, 1898 (Stylommatophora, Helicidae)

Houria Bouaziz-Yahiatene<sup>1</sup>, Beat Pfarrer<sup>2</sup>,  
Ferroudja Medjdoub-Bensaad<sup>1</sup>, Eike Neubert<sup>2</sup>

**1** *Laboratoire de Production, sauvegarde des espèces menacées et des récoltes. Influence des variations climatiques. Département de Biologie. Faculté des sciences Biologiques et des Sciences Agronomiques. Université Mouloud Mammeri de Tizi-Ouzou. 15000. Algérie* **2** *Natural History Museum of the Burgergemeinde Bern, Bernastr. 15, CH-3005 Berne, Switzerland*

Corresponding author: Eike Neubert ([eike.neubert@nmbe.ch](mailto:eike.neubert@nmbe.ch))

Academic editor: *Ton de Winter* | Received 11 July 2017 | Accepted 8 August 2017 | Published 29 August 2017

<http://zoobank.org/D5786387-3344-4BF1-BF0D-8B12CF666427>

**Citation:** Bouaziz-Yahiatene H, Pfarrer B, Medjdoub-Bensaad F, Neubert E (2017) Revision of *Massylaea* Möllendorff, 1898 (Stylommatophora, Helicidae). ZooKeys 694: 109–133. <https://doi.org/10.3897/zookeys.694.15001>

### Abstract

In this paper some helicoid species from eastern Algeria are investigated using a morphological and molecular approach. The investigation of the genital organs of *M. massylaea* (Morelet, 1851), the type species of the genus *Massylaea* Möllendorff, 1898, showed the same autapomorphic character states as are considered typical for *Eobania* P. Hesse, 1913. These findings are fully supported by the genetic analysis using two mitochondrial and three nuclear markers. Thus, the latter genus has to be considered a synonym of the former. Currently, three species are known to comprise the genus, viz. *M. massylaea*, *M. constantina* (E. Forbes, 1838), and *M. vermiculata* (O. F. Müller, 1774). Several nominal taxa from northern Africa are synonymised with one of the species mentioned here under *Massylaea*. The generic position of the so-called “*Massylaea*” species from the High Atlas Mountains in southern Morocco remains unresolved.

### Résumé

Dans cet article, certaines espèces d’Helicidae de l’est de l’Algérie sont étudiées par une approche morphologique et moléculaire. L’étude des organes génitaux de *M. massylaea* (Morelet, 1851), espèce de type du genre *Massylaea* Möllendorff, 1898, a montré les mêmes caractères autapomorphiques que ceux considérés comme typiques pour *Eobania* P. Hesse, 1913. Ces résultats sont pleinement soutenus par l’analyse génétique utilisant deux marqueurs mitochondriaux et trois nucléaires. Ainsi, ce dernier genre doit être

considéré comme un synonyme de l'ancien. Actuellement, trois espèces sont connues pour comprendre le genre, à savoir *M. massylaea*, *M. constantina* (E. Forbes, 1838) et *M. vermiculata* (O. F. Müller, 1774). Plusieurs taxons nominaux de l'Afrique du Nord sont synonymes avec l'une des espèces mentionnées ici sous *Massylaea*. La position générique des espèces dites «*Massylaea*» des montagnes du Haut Atlas dans le sud du Maroc reste non résolue.

### Keywords

*Massylaea*, *Eobania*, Algeria, Kabylie, revision

### Mots clé

*Massylaea*, *Eobania*, Algérie, Kabylie, révision systématique

## Introduction

The north-eastern part of Algeria, which is called “La Grand Kabylie”, is an area seldom in the focus of malacological research. After the main active period in the second half of the 19<sup>th</sup> century, which culminated in the monumental work of Bourguignat (1863-1864) on Algeria as a whole, and the very detailed list for the Kabylie published by Letournex (1870). Additional information was then supplied by Péchaud (1880), while the activities of Paul Pallary, who dominated the research on Northafrican molluscs after the death of Bourguignat in 1892 focused mainly on north-west Algeria and Morocco. It is the aim of the senior author of this paper to re-activate the malacological research in the area. Consequently, a combination of freshly collected specimens and a reworking of historical collections were chosen to approach this goal. On the long run, the establishment of a modern checklist for the area summarising and implementing the results of the latest research is planned.

Kobelt (1887) listed his findings of *Massylaea* in Algeria under the generalised genus *Helix* as was the use in these times. Later, Möllendorff (1898) established the genus *Massylaea* including the species *Helix massylaea* Morelet, 1851 and *Helix punica* Morelet, 1851 in this new group. Kobelt (1904: 34, etc.) in his biogeographical analysis used this new name for these two species, but erroneously related them with species from the Greek helicoid genus *Codringtonia* Kobelt, 1898 because of a superficially similar shell morphology. However, he also indicated (1904: 100) that particularly *H. punica* could also be considered as an aberrant form of *Alabastrina* Kobelt, 1904. This statement illustrates the uncertainty of how to define the genus, and which species to allocate there. Hesse (1911: 104) cites Pallary, who suggested to place *Helix bailloni* Kobelt, 1888 [from between Tiut und Mograd (= SW Algeria close to the Moroccan border) also under *Massylaea* and adds that this species was also found close to Constantine, the latter being a confusion with the true *M. massylaea*. Latest in 1915, Pallary started to use the name *Massylaea* also for the large and flat helicoid species living in the High Atlas of Morocco southwest of Marrakesch, like for example *Helix rerayana*

Mousson, 1873, a use that pertains until today. In his anatomical work, Hesse (1915) restricted the use of *Massylaea* to species from east Algeria, but included the Westalgerian *Helix soluta* Terver, 1839 [currently *Alabastrina soluta*], although he found considerable differences even in the outer morphology of the genital organs. In the same work, Hesse also investigated *Eobania*, a generic name he had introduced earlier (1913: 13), and which is based on *Helix vermiculata* O. F. Müller, 1774. Interestingly, he already concluded that *Helix constantina* E. Forbes, 1838 belongs to his genus *Eobania*. However, he never noticed the high morphological similarity between *Massylaea* and *Eobania*. Schileyko (2006) listed *Massylaea* without further comment as a group near *Helix* Linnaeus, 1758, with 2-3 species from Tunisia, Algeria and Morocco.

Based on specimens collected by the first author of this paper and supplemented by museum's specimens, a new try to disentangle the unclear taxonomic situation is taken using traits derived from shell morphology, anatomy of the genital organs as well as the results of an analysis of partial sequences of the genes COI, 16S, H3, 28S and ITS2.

## Material and methods

Living specimens as well as empty shells were collected in the Kabylie (eastern Algeria) during the last two years. For subsequent anatomical and molecular analysis, specimens were preserved and stored in 80% ethanol until dissection and DNA extraction. Specimens used in this study (both shells and preserved animals) are housed in the voucher collection of the first author and in the wet collection of the Natural History Museum of the Burgergemeinde Bern. Some of the sequences used in this study were downloaded from GenBank (<https://www.ncbi.nlm.nih.gov>).

First assessments of the shell morphological characters were done by using simple magnifying glasses. Preserved animals were dissected under LEICA M212 stereo microscope using thin tweezers. The genital organs of the specimens were removed from the body, the situs and further morphological details were investigated. After that, shells, genital situs and later details of the genital organs were photographed with a LEICA DFC 425 camera combined with a LEICA M205 C. The multifocal images were processed by using an imaging software (Imagic Switzerland).

## Molecular study

### 1.1. Sampling

The specimens from Algeria used in this study were all collected by H. Bouaziz. Species from outside Algeria originate from the collections of Hutterer, Jochum, and Neubert. Data on sampling sites, voucher numbers, GenBank accession numbers and the identification of the specimens used are compiled in the Table 1.

Table 1. Species data.

Family	Species	Locality	Longitude	Latitude	Voucher	GenBank accession number COI	GenBank accession number 16S	GenBank accession number H3	GenBank accession number 28S	GenBank accession number 5.8S-ITS2-28S
Helicidae	<i>Allognathus (Iberellus) hispanicus hispanicus</i>	Ma 10 km 26 road, Escorca, Mallorca, 31SDE8608			EHUMC-1053	KM592543	KM592633			KM592718
Helicidae	<i>Eobania vermiculata</i>	Makouda, Tizi Ouzou/ Kabylie, DZ	36.7909	4.0659	NMIBE 540544	MF564159	MF564112	MF564174	MF564128	MF564144
Helicidae	<i>Eobania vermiculata</i>	Beach between Agia Napa and Capo Greco, CY	34.9728	34.0427	NMIBE 549959	MF564160	MF564113	MF564175	MF564129	MF564145
Helicidae	<i>Eobania vermiculata</i>	Kusadasi/ Izmir, TR	37.86	27.26	NMIBE 549961	MF564161	MF564114	MF564176	MF564130	MF564146
Helicidae	<i>Helix melanostoma</i>	Kasserine, TN	35.1722	8.8307	NMIBE 520822		MF564115	MF564177	MF564131	MF564147
Helicidae	<i>Helix melanostoma</i>	between Rabieux and Saint-Félix-de-Lodez/ Herault, F	43.6628	3.4409	NMIBE 540550	MF564162	MF564116	MF564178	MF564132	MF564148
Helicidae	<i>Helix vladika</i>	Mokro close to Savnik, MNE	42.95	19.08	NMIBE 23348	MF564163	MF564117	MF564179	MF564133	MF564149
Helicidae	<i>Hemicycla bidentalis</i>	Anaya, Tenerife, Canary Islands			MVHN-2160	KM592619	KJ458528			KJ458615
Helicidae	<i>Masyllaea constantina</i>	Draâ-Ben Khedda/ Tizi Ouzou/ Kabylie, DZ	36.7318	3.9654	NMIBE 534211a	MF564164	MF564118	MF564181	MF564134	MF564150
Helicidae	<i>Masyllaea constantina</i>	Draâ-Ben Khedda/ Tizi Ouzou/ Kabylie, DZ	36.7318	3.9654	NMIBE 534211b	MF564165	MF564119	MF564182	MF564135	MF564151
Helicidae	<i>Masyllaea constantina</i>	Azaghar d'Ait Bouaddou, Bounouh, Tizi Ouzou, DZ	36.5214	3.9425	NMIBE 540542	MF564166	MF564120	MF564183	MF564136	MF564152

Family	Species	Locality	Longitude	latitude	Voucher	GenBank accession number COI	GenBank accession number 16S	GenBank accession number H3	GenBank accession number 28S	GenBank accession number 5.8S-ITS2-28S
Helicidae	<i>Massylaea constantina</i>	Makouda, Tizi Ouzou/ Kabylie, DZ	36.7909	4.0659	NMIBE 540543	MF564167	MF564121	MF564184	MF564137	MF564153
Helicidae	<i>Massylaea constantina</i>	Ighil Bourmi, DZ	36.4872	4.0613	NMIBE 540545	MF564168	MF564122	MF564185	MF564138	MF564154
Helicidae	<i>Massylaea massylaea</i>	Aurès Mountains/ Bama/ Kenchela, DZ			NMIBE 519961	MF564169	MF564123	MF564180	MF564139	
Helicidae	<i>Otala punctata</i>	Tlemcen, DZ			MVHN-2186	KM592621	KJ458545			KJ458628
Helicidae	<i>Otala punctata</i>	Makouda, Tizi Ouzou/ Kabylie, DZ	36.7909	4.0659	NMIBE 534228a	MF564170	MF564124	MF564186	MF564140	MF564155
Helicidae	<i>Otala punctata</i>	Makouda, Tizi Ouzou/ Kabylie, DZ	36.7909	4.0659	NMIBE 534228b	MF564171	MF564125	MF564187	MF564141	MF564156
Helicidae	<i>Theba subdentata subdentata</i>	West of Aoulouz/ Souss-Massa-Draa, MA	30.7094	-8.2683	NMIBE 549949	MF564172	MF564126	MF564188	MF564142	MF564157
Helicidae	<i>Tingitana "decussata"</i>	Montes de Kebbana, Djebel Sebaa Reyal/ Rif, MA	35.0297	-2.6134	NMIBE 549840	MF564173	MF564127	MF564189	MF564143	MF564158



**Table 2.** list of primer pairs used in PCR and sequencing.

Gene	Primer	Sequence	Reference
COI	LCO1490	5'-GGTCAACAAATCATAAAGATATTGG-3'	Folmer et al. 1994
	HCO2198	5'-TAAACTTCAGGGTGACCAAAAAATCA-3'	
16S	16sF	5'-CGGCCGCTGTTTATCAAAAACAT-3'	Palumbi et al. 1991
	16sR	5'-GGAGCTCCGGTTTGAAGTCAGATC-3'	
28S	LSU-2	5'-GGGTTGTTTGGGAATGCAGC-3'	Wade and Mordan 2000
	LSU-4	5'-GTTAGACTCCTTGGTCCGTC-3'	
5.8S-ITS2-28S	LSU-1	5'-CTAGCTGCGAGAATTAATGTGA-3'	Wade and Mordan 2000
	LSU-3	5'-ACTTTCCTCACGGTACTTTG-3'	
5.8S-ITS2-28S	ITS2ModA	5'-GCTTGCGGAGAATTAATGTGAA-3'	This work
	ITS2ModB	5'-GGTACCTTGTTTCGCTATCGGA-3'	
H3	H3AD	5'-ATGGCTCGTACCAAGCAGACVGC-3'	Colgan et al.2013
	H3BD	5'-ATATCCTTRGGCATRATRGTGAC-3'	

## 1.2 DNA extraction, PCR amplification and sequencing

Total genomic DNA was extracted from the foot muscle tissue using Qiagen Blood and Tissue Kit (Qiagen cat nr. 69506) in combination with an QIAcube extraction robot (Protocol 430, DNeasy Blood Tissue and Rodent tails Standard). For this work we decided to use the following markers: Two mitochondrial gene fragments, Cytochrome c oxidase subunit I (COI) of 710 bp length and the 16S ribosomal RNA subunit (16S rRNA) for an approximately 480 base-pair segment. Three nuclear genes: the RNA (rRNA) cluster 5.8S-ITS2-28S of approx. 900 bp length (5.8S and 28S only partial, complete internal transcribed spacer 2), 28S ribosomal RNA partial sequence and the Histone 3 (H3) fragment. Primer pairs used in the PCR and sequencing are listed in Table 2.

PCR mixtures consisted of 12.5 µl of GoTaq G2 HotStart Green Master Mix (Promega M7423), 6.5 µl nuclease free H<sub>2</sub>O (Sigma-Aldrich, W4502), 1 µl of each primer and 2µl template DNA. The 25µl vol. mixtures passed through following listed reaction conditions. For COI, the cycling protocol begins with 3min at 95°C, followed by 35cycles of 1min at 95°C, 1min at 40°C and 1min at 72°C and finally, 5min at 72°C. For 16S the amplification conditions were 3min at 95°C, followed 35 cycles of 1min at 95°C, 1min at 50°C and 1min at 72°C, and finally, 5min at 72°C. ITS-2 and 28S shared the same cycle conditions: 1min at 96°C, followed 35 cycles of 30sec at 94°C, 30sec at 55°C and 1min at 72°C, and finally, 10min at 72°C. For H3, 3min at 95°C, followed 45 cycles of 45sec at 95°C, 45sec at 50°C and 45sec at 72°C, and finally, 10min at 72°C. The PCR condition for the new primer pair ITS2ModA and ITS2ModB are virtually the same as for the LSU-1/3 and varies only in the annealing temperature of 43°C.

The PCR product purification and sequencing was performed by LGC (LGC Genomics Berlin) and difficult/delicate sequences were sent for single tube sequencing to Microsynth (Microsynth Balgach Switzerland).

### 1.3 Phylogenetic analyses

Geneious Ver.9.1.8 (Biomatters Ltd.) was used for Sequence processing and editing. MAFFT v.7.222 plugin of Geneious (Kato and Standley 2013), was used with the default setting and the automated algorithm search setting. We decided defining the 16S fragment, ITS2 and 28S as single data blocks. The protein coding gene CO1 and H3 fragments were defined each in 2 data blocks: the first two codon positions as one block and the third codon position as a second. Partitionfinder Ver. 2.1 (Lanfear et al. 2012) was implemented to search the optimal evolutionary models for the partitions using the corrected Akaike Information Criterion (AICc). From the resulting evolutionary models, GTR +G was chosen for further Maximum Likelihood (ML) analysis. ML inference was computed with RAxML (Stamatakis, 2006), using Geneious's plugin with the rapid bootstrapping setting, the search for the best scoring ML tree and 1000 bootstrapping replicates.

Bayesian Inference (BI) was performed using Mr Bayes v3.2.2 x64 (Huelsenbeck and Ronquist 2001; Ronquist and Huelsenbeck 2003; Ronquist et al. 2012) calculated through the UBELIX (<http://www.id.unibe.ch/hpc>) the HPC cluster at the University of Bern. The nucleotide model was set to 4by4 and a mixed evolution model with G+I rates was chosen, considering this to be the model best suited for the data of the concatenated sequences of 5 different genes (CO1, 16S, H3, ITS2, 28S). The Monte Carlo Markov Chain (MCMC) parameter was set as follow: starting with four chains and four separate runs for 20 × 10<sup>6</sup> generations with a tree sampling frequency of 1000 and a burn in of 25%. Trees were displayed on FigTree v1.4.3 (Rambaut 2012).

Abbreviations of shell measurements: D: shell diameter; H: shell height; PD: peristome diameter; PH: peristome height; W: number of whorls.

### Abbreviations of collections used

<b>EHUMC</b>	Euskal Herriko Unibersitatea Malacological Collection
<b>MHNG-MOLL</b>	Muséum d'Histoire Naturelle Genève, collection Bourguignat, Switzerland
<b>MHNL</b>	Musée des Confluences, Lyon, France
<b>MNHN</b>	Muséum National d'Histoire Naturelle, Paris, France
<b>MVHN</b>	Museo Valenciano de Historia Natural
<b>NMBE</b>	Natural History Museum of the Burgergemeinde Bern, Switzerland
<b>NMSZ</b>	National Museums of Scotland, Edinburgh
<b>SMF</b>	Senckenberg Research Institut, Frankfurt am Main, Germany

## Results

### Molecular study

The p-distances of all markers of different *Massylaea* taxa are supplied as electronic supplementary files. The BI and RAxML analyses of the concatenated data set recovered the genus *Massylaea* and separated it from the *Otala*-clade with a maximal statistical support (Figs 1, 2).

Within *Massylaea*, the separation of species was relatively well supported. Although originating from Algeria, Cyprus and northwestern Turkey, the genetic difference between *vermiculata* populations was very low. In the Bayesian analysis (Fig. 1), the *constantina*-clade, however, detected an irregularity: the node that differentiated NMBE 540542 from NMBE 540545 showed only a low support, although both populations are only separated by a distance of 20 km. In the ML tree (Fig. 2), however, the same branching point was highly supported. In both trees, the position of *M. massylaea* within the clade is beyond any doubt.

Similar problems occurred in the *Otala*-clade. The specimens investigated included a species that is here identified as “*Tingitana decussata* Pallary, 1936”, which clustered within a group of *punctata*. In both trees, the two *punctata*-specimens NMBE 534228a and b had a low support, although they originate from the same population in eastern Algeria.

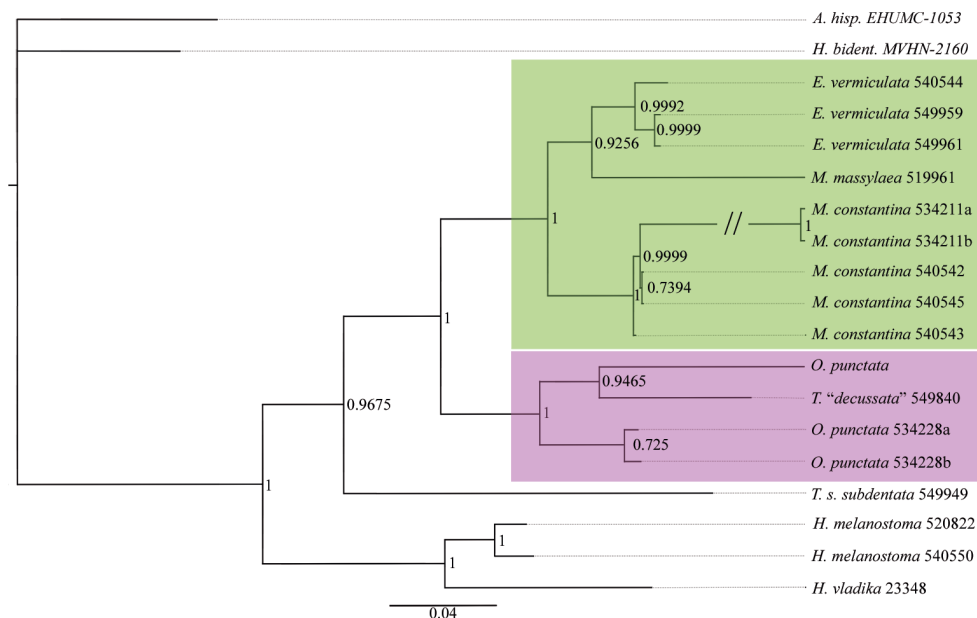

**Figure 1.** Bayesian Inference tree based on concatenated set of sequences (CO1 16S, H3, 28S, ITS2). Number on the nodes refer to posterior probabilities provided by the BI analysis.

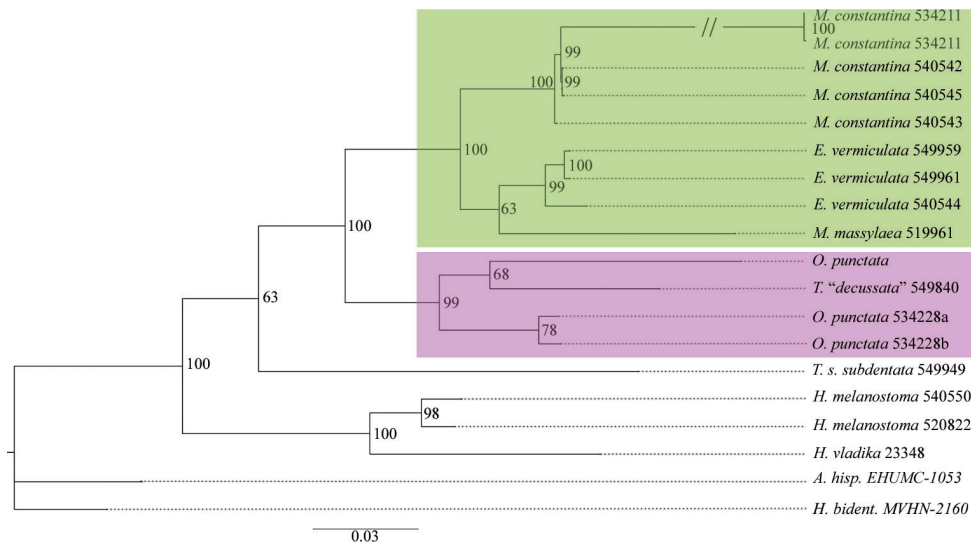

**Figure 2.** Maximum Likelihood (RAxML) tree based on the concatenated dataset (CO1 16S, H3, 28S, ITS2) Number on the nodes represent bootstrap support values from the ML analysis.

### Taxonomic implications

#### Genus *Massylaea* Möllendorff, 1898

*Massylaea* Möllendorff, 1908; *Nachrichtsblatt der Deutschen Malakozologischen Gesellschaft* 30 (9/10): 120.

*Vermiculatiana* Caziot, 1908; *Mémoires de la Société Zoologique de France* 20 (4): 439. Type species (by monotypy): *Helix vermiculata* O.F. Müller, 1774.

*Eobania* Hesse, 1913; *Nachrichtsblatt der Deutschen Malakozologischen Gesellschaft* 45(1): 13. Type species (by monotypy): *Helix vermiculata* O.F. Müller, 1774.

**Type species.** *Helix massylaea* Morelet, 1851 by tautonymy.

**Diagnosis.** Large shells, spire flat to considerably raised, with or without a mal-leate surface structure, aperture without or only with a small labial ridge; penial chamber with a solid “false” penial papilla, epiphallus entering the penial chamber through a laterally situated pore, glandulae mucosae with many subdivided tubules, diverticulum very long.

#### *Massylaea massylaea* (Morelet, 1851)

Figs 3–8

*Helix massylaea* Morelet, 1851; *Journal de Conchyliologie* 2: 354, pl. 9, fig. 1, 2 [La province de Constantine].

- Helix punica* Morelet, 1851; Journal de Conchyliologie 2: 352, pl. 9, fig. 3, 4 [habite la grande plaine de Témoulouk, au sud-est de Constantine].
- Helix massylaea* var. *concolor* Bourguignat, 1863; Malacologie de l'Algérie I: 109, plate 9 fig. 9 [no type locality given].
- Helix massylaea* var. *conoïdea* Bourguignat, 1863; Malacologie de l'Algérie I: 109 [Ouled-Sultan (Deshayes)].
- Helix nitifacta* Bourguignat in Péchaud 1883; Excursions malacologiques dans le nord de l'Afrique de La Calle a Alger, d'Alger a Tanger: 99 [l'Aurès oriental à Aïn-Tamagra, au sud de Khenchala].
- Helix massylaea* var. *zenatia* Kobelt, 1887; Iconographie, (2) 3(1): 3 [Wed Zenati].
- Helix punica* var. *speculatorum* Kobelt, 1887; Iconographie, (2) 3(1): 6, Taf. 63, fig. 320–322 [El Kantara].
- Massylaea* (?) *severinae* Pallary, 1918; Bulletin de la Société d'histoire naturelle d'Afrique du Nord 9(7): 148 [Aïn el Bey (Constantine) (Philippe Thomas)].

**Type specimens.** *massylaea*: 2 syntypes NHMUK 1893.2.4.43.5-6; *concolor*: syntypes MHNG-MOLL 118330/3 (Constantine on label in coll.); *conoïdea*: not found in coll. Bourguignat; *nitifacta*: syntype MHNG-MOLL 118331/1; *zenatia*: not researched; *speculatorum*: not researched; *punica*: 3 syntypes NHMUK 1893.2.4.1240-1242; *severinae*: no type specimens found so far.

**Other records.** Sigus, 36.1202°N 6.7849°E (Hesse 1920: 41); Tebessa, 35.4142°N 8.1010°E (Hesse 1920: 43, sub *punica*).

**Diagnosis.** large grey-yellowish shells with maximum four brown spiral bands, aperture whitish to reddish brown, strong surface sculpture of longitudinal grooves.

**Description.** Shell large, spire depressed to slightly broad conical, basic colour cream grey-yellowish with brown spiral bands; protoconch large (diameter ca. 5 mm), white; teleoconch whorls regularly increasing, with the last whorl considerably expanding before the aperture, rapidly declining at the aperture; suture deep, surface of teleoconch rough, covered by longitudinal, spirally arranged grooves, sometimes intersected by growth riblets and thus producing a pattern of longitudinal rectangles; spiral bands may be fully developed with maximum four spirals, but all variations including complete fusion of spirals may occur; aperture whitish to reddish brown with a thick lip, columellar part of aperture seldom with a ridge; peristome slightly thickened, umbilicus completely covered by a large reflection of the columellar part of aperture.

Genital organs (only the single subadult specimen (NMBE 519961, sequenced specimen) could be investigated, Fig. 3): Penis short, bulbiform; epiphallus reaching twice the length of penis, with the penis retractor muscle inserting in the distal third of epiphallus; tubiform flagellum reaching the length of penis + epiphallus; penial lumen filled with longitudinal fleshy pilasters; penial chamber with a solid penial papilla (pp2, see also Neubert and Bank 2006); epiphallus opening into the penial chamber via a small pore opposite the “false papilla”.

Female part almost undeveloped, the glandulae mucosae only represented by a few small tubules; all other female structures only weakly developed.



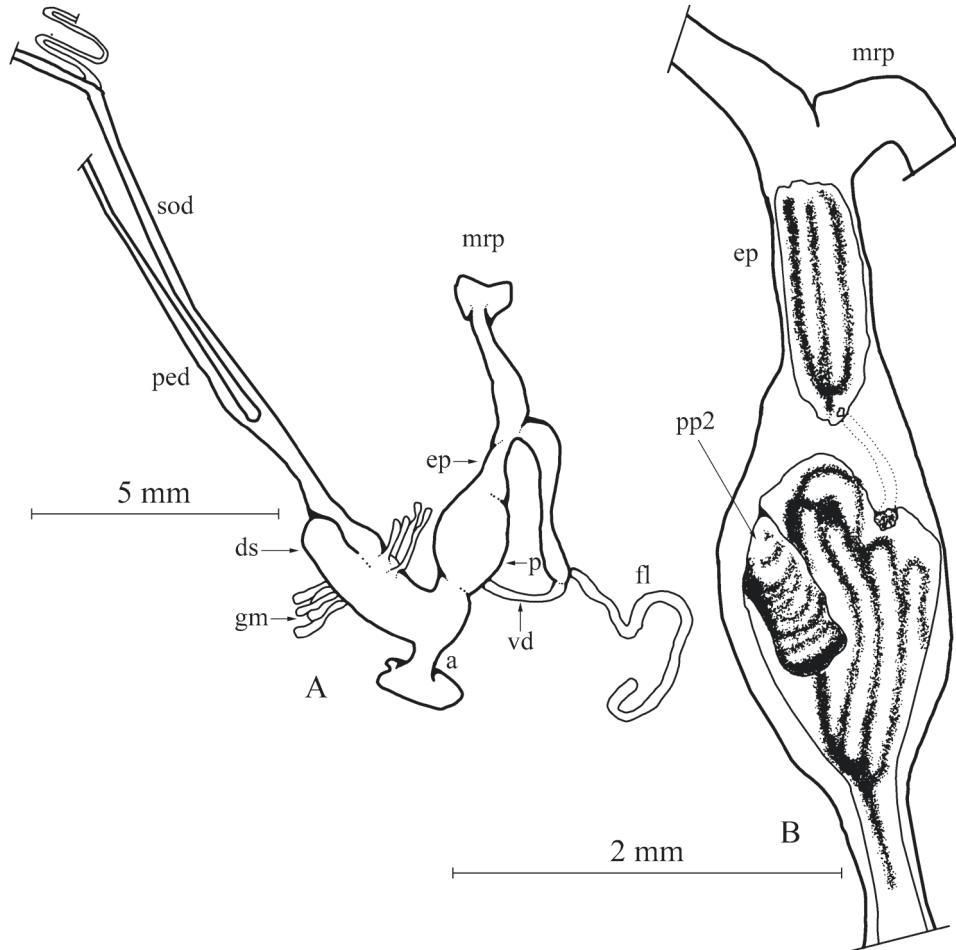

**Figure 3.** *Massylaea massylaea*, morphology of the genital organs; NMBE 519961/1, Aurés Mountains (sequenced specimen). **A** situs of the hermaphroditic genitalis **B** penis opened to show internal structure.

Measurements: Syntype *massylaea*: H = 28.4 mm; D = 40.1 mm; PH = 12.6 mm; PD = 20.5 mm; W = 4.75.

**Distribution.** Kobelt (1887) supplied data on the distribution of both, *massylaea* and *punica*, and stated that they may occur in hundreds of specimens in a single locality. Given the fact that we here consider *punica* a synonym of *massylaea*, this taxon turns out to be one of the most widespread helicoid species in the southern part of the Eastalgerian mountain range covering southwestern parts of the province of Constantine, and parts of the provinces of Biskra and Blida westwards to Schott el Hodna.

Remarks: The variation in shell morphology mainly concerns the elevation of the spire, which may be rather flat to considerably raised. The second character state that varies is the formation, number and colour of the spiral bands. These may be reddish- to chestnut-brown, some may miss completely or in parts, or are fused to form



**Figures 4–8.** *Massylaea massylaea* (Morelet, 1851). **4** syntype *Helix massylaea* NHMUK 1893.2.4.43.5, D = 40.1 mm **5** syntype *Helix punica* NHMUK 1893.2.4.1240, D = 36.8 mm **6** syntype *concolor* MHNG-MOLL 118330, D = 36.9 mm **7** syntype *nitefacta* MHNG-MOLL 118331, D = 35.5 mm **8** NMBE 519961, Aurés Mountains, D = 33.65 mm (sequenced specimen). All figures Neubert, natural size.

a cloudy brownish surface. Although Kobelt (1887: 3) states that his specimens usually had spiral bands he separated one form without spiral bands under the name *zenati*, claiming that this form only occurs at this single locality, from which already Bourguignat named his var. *concolor*. According to the specimens known today, spiral banding is quite stable, but there are all variations seen from five bands to completely unicoloured shells.

Hesse (1920: 43, sub *punica*) reports that he received three specimens of this species from Tunisia “Redyef im südlichen Tunis [= Al Rudayyif, Gafsa]. This record has not been reconfirmed by modern collections and is probably based on a confusion with *vermiculata*.

***Massylaea constantina* (E. Forbes, 1838)**

Figs 9–12

*Helix constantina* E. Forbes, 1838; Annals of Natural History, II: 251, pl. XI, fig. 1 [In waste places among nettles at Bougia].

*Helix cirtae* Terver, 1839; Catalogue des Mollusques...: 11, pl. 1, fig. 1 [Bone].

*Helix constantinae* var. *bifasciata* Bourguignat, 1863; Malacologie de l'Algérie I: 114 [La Calle].

*Helix constantinae* var. *conoidea* Bourguignat, 1863; Malacologie de l'Algérie I: 114, plate 10 fig. 7 [Constantine].

*Helix constantinae* var. *depressa* Bourguignat, 1863; Malacologie de l'Algérie I: 114 [Ouled-Sultan].

*Helix constantinae* var. *maxima* Bourguignat, 1863; Malacologie de l'Algérie I: 114 [Constantine].

*Helix constantinae* var. *minima* Bourguignat, 1863; Malacologie de l'Algérie I: 114 [Bone].

*Helix constantinae* var. *trifasciata* Bourguignat, 1863; Malacologie de l'Algérie I: 114 [La Calle].

**Type specimens.** *constantina*: no type specimens could be identified in the E. Forbes collection in NMSZ; *cirtae*: syntype MHNL 45001107; the type specimens for the varietal names of Bourguignat are not identifiable in his collection.

**Additional specimens.** Ighil Bourmi, 36.4872 4.0613, 1297 m alt., 24.5.2015, Bouaziz, NMBE 540545/1, Makouda, Tizi Ouzou/ Kabylie, 36.7909 4.0659, 440 m alt., 22.3.2015, Bouaziz, NMBE 540543/3, Azaghar, Bounouh, Tizi Ouzou, 36.5214 3.9425, 432 m alt., 26.4.2015, Bouaziz, NMBE 540542/9, Draa Ben Khedaa/ Tizi Ouzou, 36.7318 3.9654, 50 m alt., 6.1.2015, Bouaziz, NMBE 534211/20.

**Diagnosis.** Medium sized shell, teleoconch smooth, and aperture with a raised columellar ridge.

**Description.** Shell medium sized, with a globular or broad conical spire, basic colour white to grey, always with up to five brown spiral bands; protoconch large (diameter ca. 4 mm), white; all teleoconch whorls regularly increasing, with the last whorl rapidly declining at the aperture; suture of moderate depth, surface of teleoconch

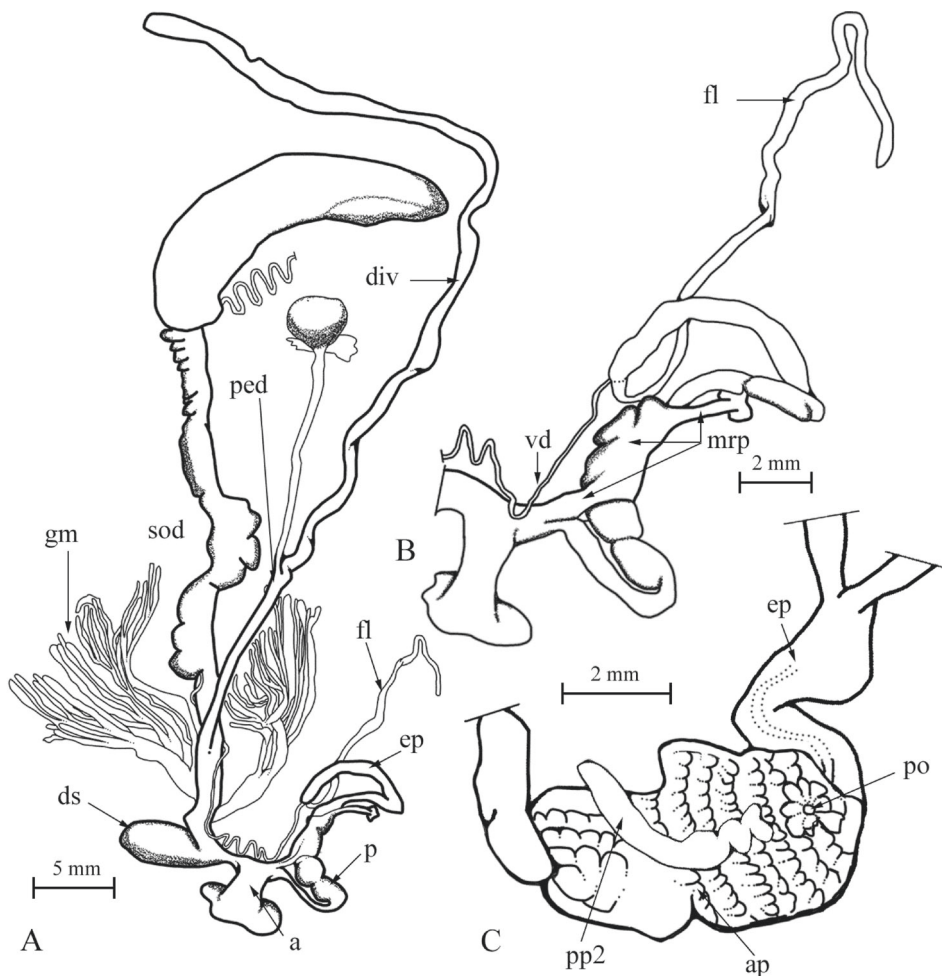

**Figure 9.** Genital organs of *M. constantina*; NMBE 540542, Azaghar; **A** situs **B** outer morphology of male organ **C** interior of penis. Abbreviations used: a = atrium; ap = annular pad; div = diverticulum; ds = dart sac; ep = epiphallus; fl = flagellum; gm = glandulae mucosae; mrp = penial retractor muscle; p = penis; ped = pedunculus; po = pore of penial papilla; pp2 = second penial papilla; sod = spermoviduct; vd = vas deferens.

smooth; usually with five spiral bands with spiral 2+3 often very close or almost merging; aperture always porcelain white with a thick lip, columellar part of aperture with a raised ridge; peristome slightly thickened, umbilicus completely covered by a large reflection of the columellar part of aperture.

Genital organs (Fig. 9A–C): penis subdivided in three parts, with an elongate distal tube connecting to the atrium, and a bilobed muscular proximal part with the internal boundary marked by an annular pad (Giusti et al. 1995); epiphallus longer than penis, enveloped by a strong penial retractor muscle that connects with a fascicle to the atrium, flagellum a long, simple tube; internally, the proximal penial chamber filled by



**Figures 10–12.** *Massylaea constantina* (E. Forbes, 1838). **10** Original figure of E. Forbes, pl. XI, Figure 1 [1839], size adopted to next figure **11** syntype *cirtae* MHNL 45001107, D = 27.2 mm **12** NMBE 534211, Draa Ben Khedaa, D = 30.25 mm. All figures Neubert/Bochud, natural size.

a solid penial papilla (pp2, see also Neubert & Bank 2006); epiphallus opening into the penial chamber via a small pore.

Dart sac opening laterally into the short vagina; glandulae mucosae with two central stems giving rise to at least three subsequent branches with at least 40 tubules; diverticulum branches off in a central position from the pedunculus reaching a length of at least 30 mm.

Measurements: syntype *cirtae*: H = 21.3 mm; D = 27.2 mm; PH = 8.6 mm; PD = 12.9 mm; W = 4.75.

**Distribution.** This species is known from Tizi Ouzou in the Grand Kabylie towards the northern parts of the province of Constantine. In many places it lives in sympatry with *M. vermiculata*.

**Remarks.** This species proved to be quite stable in terms of conchological traits. The number of five spiral bands is very stable as well as the white and smooth teleoconch. Some colour morphs of *M. vermiculata* look quite similar; however, so far all shells of the latter species could be differentiated by presence of the malleate teleoconch surface. This surface structure may be reduced to a small area above and around the aperture, but it is always clearly discernible. It differs from *M. massylaea* by its considerably smaller shell, the high globular spire, and the smooth teleoconch surface.



***Massylaea vermiculata* (O. F. Müller, 1774)**

Figs 13–16

- Helix vermiculata* O. F. Müller, 1774; Vermium terrestrium et fluviatilium 2: 21 [In Italia sabulosis juxta torrentes].
- Helix bonduelliana* Bourguignat, 1863; Mollusques nouveaux, litigieux ou peu connus, fasc. 1: 9, plate 3 figs 1–4 [Province d’Oran].
- Helix vermiculata* var. *albida* Bourguignat, 1863; Malacologie de l’Algérie I: 112, plate 8 fig. 10 [La Calle].
- Helix vermiculata* var. *aspersa* Bourguignat, 1863; Malacologie de l’Algérie I: 112 [Cherchell].
- Helix vermiculata* var. *expallescens* Bourguignat, 1863; Malacologie de l’Algérie I: 112 [Environs d’Alger, Blidah].
- Helix vermiculata* var. *minuta* Bourguignat, 1863; Malacologie de l’Algérie I: 112 [Ile de Galite].
- Helix vermiculata* var. *trizonata* Bourguignat, 1863; Malacologie de l’Algérie I: 112 [Philippeville].
- Helix fleurati* Bourguignat, 1868; Histoire Malacologique de la Régence de Tunis: 12, plate 1 fig. 1–3 [Env. de Tunis (Champs au sud et au sud-est de Tunis, entre un vieux puits espagnol et les collines de Sidi ben Hassen et de la forteresse Bordj el Raïs. Ruines d’Oudena. Ruines d’Utique et de Carthage. non loin de la chapelle Saint-Louis)].
- Helix fleurati* var. *obesa* Bourguignat, 1868; Histoire Malacologique de la Régence de Tunis: 13 [no locality information given].
- Helix fleurati* var. *subcarinata* Bourguignat, 1868; Histoire Malacologique de la Régence de Tunis: 13, plate 1 fig. 4 [no locality information given].
- Helix (Macularia) vermiculata* var. *conoidea* Issel, 1880; Annali del Mus. Civ. di St. Nat. di Genova, Vol. XV: 263 [Sahel, fra Susa e Bir el Buita e fra Susa ed El Gem].
- Helix (Macularia) vermiculata* var. *depressa* Issel, 1880; Annali del Mus. Civ. di St. Nat. di Genova, Vol. XV: 263 [Cartagine].
- Helix (Macularia) vermiculata* var. *minuta* Issel, 1880; Annali del Mus. Civ. di St. Nat. di Genova, Vol. XV: 264 [Is. Galita, Galitone, Aguglia, Gallina (Violante, 1877). Cartagine (Bellucci, 1875)].
- Helix toukriana* Bourguignat in Péchaud, 1883; Excursions malacologiques dans le nord de l’Afrique de La Calle a Alger, d’Alger a Tanger: 37 [hauts plateaux du Sersou, entre Aïn-Toukria et le Nahr-Ouassel, dans la direction de Sebaïn-Aïoun].
- Helix aecouria* Letourneux et Bourguignat, 1887; Prodrome de la malacologie terrestre et fluviatile de la Tunisie: 7 [Environs d’Houmt-Souk dans l’île de Djerba].
- Helix vermiculata* var. *saharica* Kobelt, 1887; Iconographie, (2) 3(1): 9, Taf. 6, fig. 343–345 [Biskra].

**Type specimens.** *bonduelliana*: 1 syntype MHNG-MOLL 118415; *aecouria*: 3 syntypes MHNG-MOLL 118413; *fleurati*: syntypes MHNG-MOLL 118440/7 (Env. de Tunis); *toukriana*: syntype MHNG-MOLL 118487; *saharica*: not researched.

**Diagnosis.** Medium sized shell, teleoconch with a malleate surface sculpture, and aperture with a slightly raised columellar ridge.

**Description.** shell medium sized, with a globular to depressed conical spire, basic colour white to grey, up to five brown spiral bands may be present or completely missing; protoconch large (diameter ca. 4 mm), corneous to white; whorls regularly increasing, the last whorl declining at the aperture; teleoconch suture of moderate depth, surface of teleoconch with a characteristic malleate sculpture (sometimes only present close to the aperture!); spiral bands 2+3 often merging, and bands may fuse to a large brown area on the last whorl before the aperture; aperture usually porcelain white with a thick lip, columellar part of aperture with a raised ridge; peristome slightly thickened, umbilicus completely covered by a large reflection of the columellar part of aperture.

Genital organs (after Giusti et al. 1995; Neubert and Bank 2006; Holyoak and Holyoak 2017): penis clubshaped, bipartite; the bilobed muscular proximal part not visible in outer morphology; epiphallus longer than penis; penial retractor muscle simple, attaching at the boundary of penis and epiphallus; internally, the proximal penial chamber filled by a solid penial papilla, epiphallus opening into the penial chamber via a small pore or on top of a flat papilla.

Dart sac opening laterally into the short vagina; glandulae mucosae with two central stems giving rise to at least three subsequent branches with at least 40 tubules; diverticulum branches off in a central position from the pedunculus surpassing the bursa copulatrix enormously.

**Distribution.** This species is widely recorded throughout Tunisia and eastern Algeria.

**Remarks.** The synonymy list and illustrations only cover synonyms of *M. vermiculata* important for the area from east Algeria and Tunisia. Here, this species inhabits Mediterranean shrublands as well as the wooded hinterland. It also tolerates coastal dunes with salty spray, and semiarid steppes. Holyoak and Holyoak (2017) justify the synonymisation of *constantina* with *vermiculata* with the similar morphology of the genital organs and the wide overlap in shell size and banding pattern. However, in many land-snails, closely related species cannot be differentiated by the morphology of their genital organs. More attention should be paid to the construction of the penis (bilobed muscular proximal part visible from outside or not) and the variability of attaching system of the retractor muscle, which is much larger (and also connects to the atrium) in the specimen of *constantina* than in any *vermiculata* seen so far. The most important character state that separates the species is the absence of any malleation on the shell surface in *constantina*. Additionally, the phenotypic plasticity of the shells of *vermiculata* is markedly contrasted by the congeneric *M. constantina*, which is extremely stable in respect of the spiral banding pattern.

One species mentioned by Kobelt (1887) as a closely related species to his *vermiculata-constantina*-complex is *Helix bonduelliana* Bourguignat, 1863, with the type locality “Province d’Oran” in western Algeria. Kobelt doubts the correctness of this locality, and speculates that it might originate from Tunisia. According to his personal experience in Algeria, *M. vermiculata* reaches the Isser, but does not expand much to the west of this river. The only exception he found was Cherchell west of Algiers,

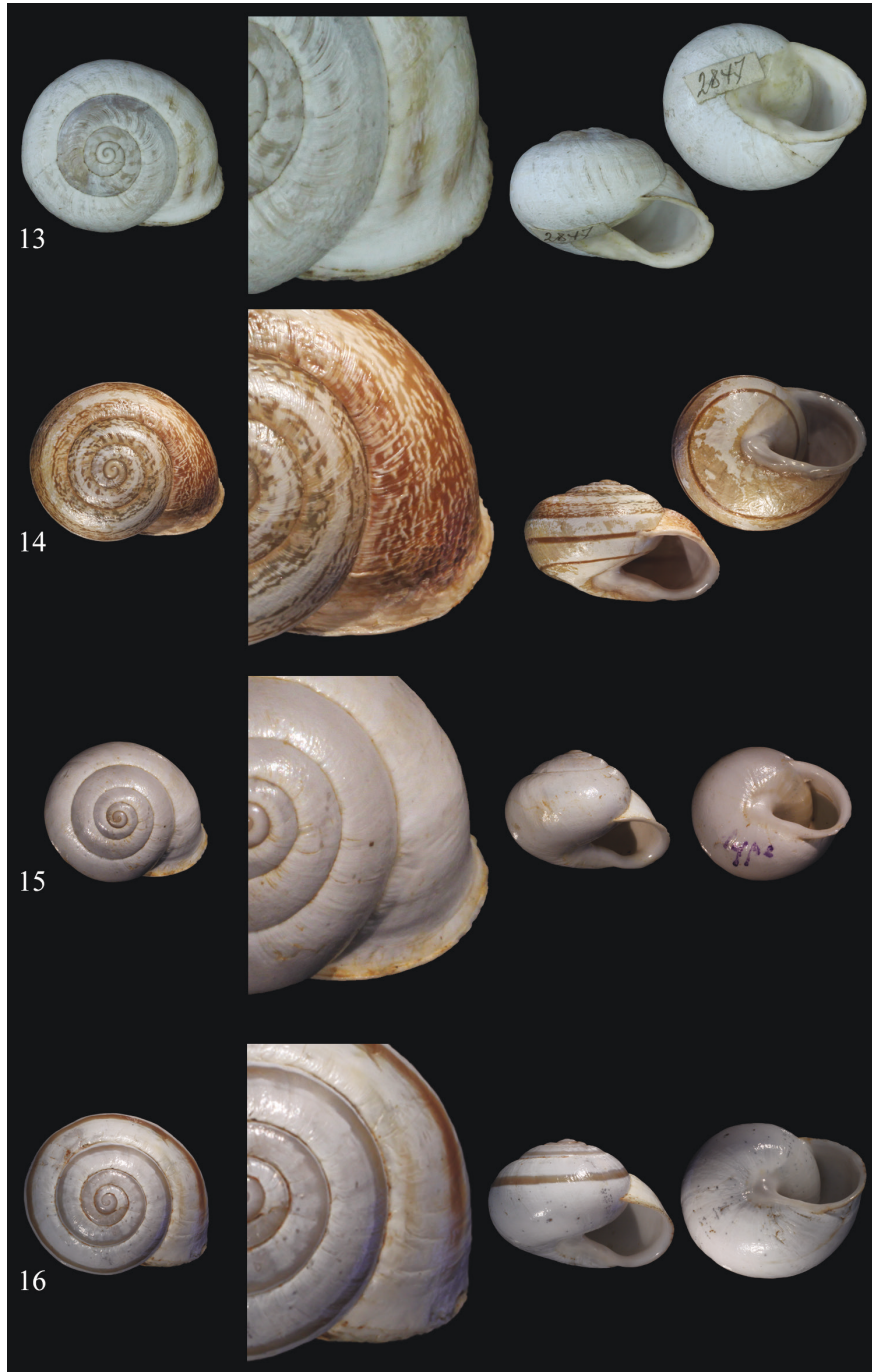

**Figures 13–16.** *Massylaea vermiculata* (O. F. Müller, 1774). **13** syntype *Helix toukriana* MHNG-MOLL 118487, D = 29.7 mm **14** syntype *Helix aecouria* syntype MHNG-MOLL 118413, D = 28.4 mm **15** syntype *Helix fleurati* MHNG-MOLL 118440, D = 23.9 mm **16** *Helix bonduelliana* Bourguignat, 1863 syntype MHNG-MOLL 118415, D = 27.0 mm. — All figures Neubert/Bochud, natural size.

where the species occurred in large numbers, but restricted to and around the harbour, so it can be considered being introduced there. It is not clear how the situation is today along the central and western Algerian coast, but Kobelt's lines can be seen as an information on the natural range of this species in northern Africa. In the same year, Bourguignat (1887: 8) records *H. bonduelliiana* from Ghardimaou (Tunisia) (= MHNG-BBT 118417/3). Bourguignat's collection has another record from "environs de Tunis" under MHNG-MOLL 18416/1. Later, Pallary (1898) mentions his and Debeaux's unsuccessful attempts to recollect the species in Oran. Summarising it can be said that the type locality of *H. bonduelliiana* is apparently wrong, and the specimens are very probably of Tunisian offspring. This nominal taxon fully falls into the colour variation of *M. vermiculata*, which can reach from completely white shells as exemplified by *H. fleurati* (Fig. 15) to the typical morph as seen in *H. aecouria* (Fig. 14). The shell shape, however, is quite stable in most of these forms, and typical for *M. vermiculata*. The synonymisation of *saharica* Kobelt, 1887 needs reconfirmation by study of the type specimens.

## Discussion

The results of our study strongly support the monophyly of the genus *Massylaea*. This is evidenced by traits of the genital organs as well as by the genetic analysis, which is based on two mitochondrial and three nuclear markers.

Although only a subadult specimen of *M. massylaea* was available for investigation, the autapomorphic character states of presence of a "blind" penial papilla in combination with a separate epiphallial pore could clearly be detected (Fig. 3). This type of internal penial construction is also seen in *M. constantina* (Fig. 9) and in *M. vermiculata* (Neubert and Bank 2006). It differs profoundly from other helicoid genera like for example the syntopic *Otala punctata* (O. F. Müller, 1774), which shows the plesiomorphic type of a bipartite penis with two subsequent penial papillae (De Mattia and Mascia 2011).

In the genetic analysis, the *Massylaea*-clade is supported by high bootstrap values (Figs 1, 2). Within the clade, a separation of *M. constantina* from a combined cluster *vermiculata-massylaea* can be seen. The *constantina* population NMBE 534211 shows an enormous number of base-pair substitutions if compared to the other three congeners. The distance matrixes show that the generated 5.8S-ITS2-28S sequence is responsible for the caused deviation. In an ITS2 alignment, the NMBE 534211 population showed a higher variation, often up to 84bp, in the complete second Internal Transcriber Spacer region, in comparison to the congeners. NMBE 534211 from Draâ-Ben Khedda seems to be constituted by a faster evolving population, indicated by the much longer branch reflecting the higher base pair substitutions. We could hypothesize that we probably are witnessing the beginning of a speciation process, but we have to collect more specimen from the complete distribution area to be more conclusive about the existing species boundaries.



**Figure 17.** *Helix boghariensis* Debeaux, 1857 [Rochers en face le village arabe Ksar-el-Boghari]; syntype MNHN IM-2000-31714, D = 34.0 mm. Figure 17 by courtesy of MNHN, Paris, natural size.

The generic name *Massylaea* Möllendorff, 1898 has been widely used for a number of species and thus cannot be treated as a nomen oblitum. It has precedence over *Eobania* Hesse, 1913, and the widespread species *Helix vermiculata* O. F. Müller, 1774, has to be classified under this generic name. Currently, the use of *Massylaea* should be restricted to the three species treated here; the so-called “*Massylaea*” species from the High Atlas Mountains in southern Morocco are widely unknown, and probably form a separate generic entity. At least 12 nominal taxa can be affiliated to this radiation, but species delimitation poses a major problem at the moment.

Already Kobelt (1887) remarked the similarity of *Helix boghariensis* Debeaux, 1857 (syntype Fig. 17), with the *constantina-vermiculata*-group. In fact the shell of this species is close to *M. constantina*, and lacks the teleoconch sculpture of *M. vermiculata*. Kobelt remarked that the type locality Boghar is far from the range of *M. constantina*, which was true at his time. Due to the collections of the senior author we now know that *M. constantina* also inhabits the area of Tizi Ouzou. The distance (as the crow flies) between these localities is about 150 km. From a shell morphological point of view there is no evidence for any major difference between *constantina* and *boghariensis* supporting the separation of the latter as a species in its own rights. This question can only be sorted out by an investigation of animals from Boghar. Holyoak and Holyoak (2017) synonymise this taxon with *E. vermiculata* without further comments.

The enormous radiation of Helicid species and genera in northern Africa is poorly understood and still in a chaotic state, and often complained about like recently in Holyoak and Holyoak (2017). Although not in the centre of the helicoid radiation in northern Africa, our results may contribute to some clarifications like for example in the “*Otala*-clade”. By chance, a specimen of *T. “decussata”* (nomen nudum) could be included in our study. This taxon is conchologically similar to *Archelix minettei* Pallary, 1917 from “Tarzout-du-Guigou”, which is the type species of *Tingitana* Pallary, 1918, a genus used to accommodate a number of helicoid species from all over Morocco. The position of *T. “decussata”* in our concatenated trees (see Figs 1, 2) indicates that *Tingitana* is close to or even identical with *Otala*. This result coincides with Razkin et al. (2015), who found that *T. orientalis* Pallary, 1918 from Berkane clusters within the *Otala* clade. However, it is not clear whether this species is a *Tingitana* in its original sense, or rather a classical *Otala*. Although we have a more clear evidence for a synonymisation of *Tingitana* with *Otala* we still consider this synonymy as premature as



long as evidence through study of anatomical and genetic data of the type species of the genera is supplied. It should be mentioned that the form “*decussata*” lives in the summit area of the Kibdana (leg. R. Hutterer); the population consists exclusively of strongly keeled specimens.

Holyoak and Holyoak (2017) revisited the problems within *Otala* and *Eobania* in northern Africa adding valuable distribution data. However, some details are astonishing. The authors cover the complete distribution area of the genus *Massylaea* and collect (and synonymise) a reasonable number of available species-level names, but completely omit *Helix massylaea* Morelet, 1851! The only reference to the genus is restricted to a note, where it is mentioned as a host of *Helix soluta* Michaud, 1833, perpetuating the erroneous ideas of Kobelt (see introduction). A concept for *Massylaea* is completely missing, and all taxa are lumped under *Eobania vermiculata*. Puzzlingly, the only exception is *Helix punica* (from south of Constantine), which is affiliated by the authors to *Loxana* Pallary, 1899. This genus is based on *Helix beaumiери* Mousson, 1873, which lives in the High Atlas south of Marrakech. It is currently considered to constitute a subgenus of *Alabastrina* Kobelt, 1904; the new concept of *Loxana* is not explained, delimited or justified. Under the same generic name *Loxana*, the enigmatic *Helix rerayana* Mousson, 1873 is treated, a species which originates from the same larger area as *H. beaumiери*, but differs enormously in shell shape, so a congeneric position for these two taxa will require good arguments (which are not supplied in this paper). All names allocated by us to the three accepted taxa under *Massylaea* (and scrutinized by checking and presenting the type specimens), are lumped by Holyoak and Holyoak (2017) under *E. vermiculata*, a concept, which does not comply with our genetic data.

Concluding it can be said that still, the chaos is not fully disentangled, and that the rigorous lumping of taxa is probably not fully supported. We agree with Holyoak and Holyoak (2017: 420) that “it has been taken as axiomatic that the species recognised should be identifiable from morphological characters, of shells, genital anatomy, or both”. But then, prior to any decision taken, the initial point should be the study and presentation of type specimens. This is a major service to other students of the fauna and greatly facilitates the understanding of subsequent decisions made. It could help to clarify the identity of species-level taxa used in genetic studies, and thus constitute a major contribution towards stabilisation of taxonomy and nomenclature.

### Acknowledgements

We are very grateful to Estée Bochud, NMBE, for preparing several of the photos used in this paper. We are very grateful to Jean Mariaux and Emanuel Tardy, MHNG Genève, for providing access to the Bourguignat collection. This contribution could only be realised by support through GBIF.CH (Neufchâtel, Switzerland). Eike Neubert would like to thank R. Janssen for years of access to the collection of SMF, which greatly helped to understand the malacological diversity in Northern Africa. We are very grateful to P. Bouchet, and V. Héros, MNH, Paris, for the permission to use a pic-

ture from the database of MNHN, to Vincent Prié for a specimen of *H. melanostoma* from southern France, to S. Pye for searching for type specimens of *H. constantina* in the collection of the National Museums of Scotland, Edinburgh, and C. Audibert from the Musée des Confluences, Lyon for his interest and valuable support of H. Bouaziz-Yahiatene.

## References

- Bourguignat J-R (1863–1864) Malacologie de l'Algérie ou histoire naturelle des animaux mollusques terrestres et fluviatiles recueillis jusqu'à ce jour dans nos possessions du nord de l'Afrique. — 1: fasc. 1: 1–80, pls I–VIII [May 1863]; fasc. 2: 81–192, pl. IX, X, XIII–XVIII [June 1863]; fasc. 3: 193–294 pls XI, XII, XIX–XXXII [Nov. 1863]; [described species extracted] 2: fasc. 4: 1–144, pl. I–V, VII [Jan. 1864]; fasc. 5: 145–232, pl. VI, VII, IX–XI, XV, XVI, XVIII–XXVI [Apr. 1864]; fasc. 6: I–XII [to be bound prior to fasc. 1] [with replacement pages 9–32 in fasc. 1] 233–380, pls. XII–XIV, XVII [Dec. 1864]. Paris (Challamel aîné).
- Bourguignat J-R (1863–1870) Mollusques nouveaux, litigieux ou peu connus. — Vol. 1 (Première Centurie): Tit. + 324 pp., pls 1–45 (1863–1868); Vol. 2 (inachevée): 1–55, pls 1–4 (1870). Paris (F. Savy, Bouchard-Huzard). Vol. 1: 1<sup>re</sup> décade, 1<sup>er</sup> mars 1863: pp. 1–22, pl. 1–4 [= Revue et Magasin de Zoologie, (2) 15 (3): 100–111, (4): pl. 5–8]; 2<sup>e</sup> décade, 1<sup>er</sup> mai 1863: pp. 23–49, pl. 5–7 [= Revue et Magasin de Zoologie, (2) 15 (5): 179–187, pl. 18–19, (7): 252–261; pl. 7 est supplémentaire dans le livre]; 3<sup>e</sup> décade, 1<sup>er</sup> décembre 1863: pp. 51–82, pl. 8–11; 4<sup>e</sup> décade, mai 1864: pp. 83–130, pl. 12–19; [= Revue et Magasin de Zoologie, (2) 16 (6): 161–179, pl. 11–13, (7): 193–212, pl. 14, (8): pl. 15–16, (9): pl. 17, (11): pl. 18]; 5<sup>e</sup> décade, 1<sup>er</sup> novembre 1865: pp. 131–170, pl. 20–28; [= Revue et Magasin de Zoologie, (2) 17 (11): 337–347, pl. 16–21, (12): pl. 22–24 (1865), 18: (1): 6–23 (1866); l'ordre de quelques planches a été changé: pl. 24 = pl. 23, pl. 25 = pl. 21, pl. 26 = pl. 22, pl. 27 = pl. 20, pl. 28 = pl. 24]; 6<sup>e</sup> décade, 1<sup>er</sup> janvier 1866: pp. 171–198, pl. 29–31; 7<sup>e</sup> décade, 1<sup>er</sup> février 1866: pp. 199–221, pl. 32–34; 8<sup>e</sup> décade, 1<sup>er</sup> décembre 1867: pp. 223–257, pl. 31 [réimpression], pl. 35–38; 9<sup>e</sup> décade, 1<sup>er</sup> septembre 1868: pp. 259–294, pl. 39–41; 10<sup>e</sup> décade, 1<sup>er</sup> décembre 1868: [3] pp. + pp. 295–324 [319–324: Table alphabétique], pl. 42–45. — Vol. 2: 11<sup>e</sup> décade 1<sup>er</sup> janvier 1870: 1–27, pl. 1–2 [= Revue et Magasin de Zoologie, (2) 22 (1): 14–30, pl. 14–15]; 12<sup>e</sup> décade 1<sup>er</sup> février 1870: 29–55, pl. 3–4 [= Revue et Magasin de Zoologie, (2) 22 (3): 87–97, (5): 166–171, pl. 16–17.] [Du vol. 2 a paru seulement une livraison de la 11<sup>e</sup> et 12<sup>e</sup> décade ensemble]
- Bourguignat J-R (1868) Souvenirs d'une exploration scientifique dans le nord de l'Afrique, III. Histoire malacologique de la Régence de Tunis. 36 pp, 1 pl., 2 cartes. Paris (Challamel aîné).
- Caziot E (1908) Compte rendu d'une excursion malacologique dans la partie supérieure de la Vallée de la Roya, et dans le voisinage de la mer, sur la rive droite du Var, près Nice. Mémoires de la Société Zoologique de France 20(4) [1907]: 435–469. [6 June]
- Colgan D, McLauchlan A, Wilson GDF, Livingston SP, Edgecombe GD, et al. (1998) Histone H3 and U2 snRNA DNA sequences and arthropod molecular evolution. Australian Jour-

- nal of Zoology 46: 419–437. <https://doi.org/10.1071/ZO98048> <https://doi.org/10.1071/ZO98048>
- De Mattia W, Mascia F (2011) *Otala punctata* (O. F. Müller, 1774) in Italy. *Iberus* 29(1): 39–46.
- Debeaux O (1857) Catalogue des mollusques vivants observés aux environs de Boghar (Algérie). Recueil trav. Societe d'agriculture d'Agen 8: 317–329.
- Folmer O, Black M, Hoe W, Lutz R, Vrijenhoek R (1994) DNA primers for amplification of mitochondrial cytochrome c oxidase subunit I from diverse metazoan invertebrates. *Molecular Marine Biology and Biotechnology* 3(5): 294–299.
- Forbes E (1838) On the land and freshwater mollusca of Algiers and Bougia. *Annals of Natural History* II: 250–255, pl. XI, XII [plates published in Feb. 1839] <https://doi.org/10.1080/00222933809496670>
- Giusti F, Manganeli G, Schembri, PJ (1995) The non-marine molluscs of the Maltese Islands. Torino, 607 pp.
- Hesse P (1908–1911) In: Rossmässler E A, Iconographie der Land- & Süßwasser-Mollusken mit vorzüglicher Berücksichtigung der europäischen noch nicht abgebildeten Arten, Taf. 421–450 [1909–1911]; Wiesbaden (Kreidel), (2) 14 (5/6): 129–172, Taf. 381–390 [1908]; (2) 16 (1/6): 1–119.
- Hesse P (1913) Neue Funde aus der Umgebung von Philipoppel. *Nachrichtenblatt der Deutschen Malakozoologischen Gesellschaft* 45(1): 12–16.
- Hesse P (1915–1920) In: Rossmässler EA Iconographie der Land- und Süßwasser-Mollusken, mit vorzüglicher Berücksichtigung der europäischen noch nicht abgebildeten Arten. C.W. KREIDEL's Verlag, Berlin & Wiesbaden, (2) 23 (1/2): 1–72, pl. 631–640 [1915]; (2) 23 (3/4): 73–152, pl. 641–650 [1919]; (2) 23 (5/6): 153–262, pl. 651–660 [1920].
- Holyoak DT, Holyoak GA (2017) A revision of the land-snail genera *Otala* and *Eobania* (Gastropoda, Helicidae) in Morocco and Algeria. *Journal of Conchology* 40(6): 419–490.
- Huelsenbeck JP, Ronquist F (2001) MRBAYES: Bayesian inference of phylogeny. *Bioinformatics* 17: 754–755. <https://doi.org/10.1093/bioinformatics/17.8.754>
- Issel A (1880) Molluschi terrestri et d'aqua dolce viventi e fossili. *Annali del Museo Civico di Storia Naturale di Genova* 15: 259–282.
- Kearse M, Moir R, Wilson A, Stones-Havas S, Cheung M, Sturrock S, Buxton S, Cooper A, Markowitz S, Duran C, Thierer T, Ashton B, Mentjies P, Drummond A (2012) Geneious Basic: an integrated and extendable desktop software platform for the organization and analysis of sequence data. *Bioinformatics* 28:1647–1649. <https://doi.org/10.1093/bioinformatics/bts199>
- Kobelt W (1887–1888) In: Rossmässler EA: Iconographie der Land- & Süßwasser-Mollusken mit vorzüglicher Berücksichtigung der europäischen noch nicht abgebildeten Arten. Kreidel, Wiesbaden, (2) 3 (1/2): 1–12, Taf. 61–70 [1887]; (2) 3 (3/4): 13–36, Taf. 71–80 [1887]; (2) 3 (5/6): 37–60, Taf. 81–90 [1888].
- Kobelt W (1904) Register. In: Rossmässler EA: Iconographie der Land- & Süßwasser- Mollusken mit vorzüglicher Berücksichtigung der europäischen noch nicht abgebildeten Arten, Karten, (2) 11: I–XII., 1–342, 6.
- Lanfear R, Frandsen PB, Wright AM, Senfeld T, Calcott B (2016) PartitionFinder 2: new methods for selecting partitioned models of evolution for molecular and morphological

- phylogenetic analyses. *Molecular biology and evolution*. <https://doi.org/10.1093/molbev/msw260>
- Letourneux A, Bourguignat J-R (1887) *Prodrome de la malacologie terrestre et fluviatile de la Tunisie*. Imprimerie nationale, Paris, 1–166. <https://doi.org/10.5962/bhl.title.132280>
- Letourneux A (1870) *Excursions malacologiques en Kabylie et dans le Tell Oriental*. Paris, *Annales de Malacologie* 1: 258–322. [pl. 6]
- Katoh, Misawa, Kuma, Miyata (2002) MAFFT: a novel method for rapid multiple sequence alignment based on fast Fourier transform. *Nucleic Acids Res.* 30: 3059–3066.
- Möllendorff Ov (1898) *Studien zur Zoogeographie von Dr. W. Kobelt. II. Band. Die Fauna der Meridionalen Sub-Region*. C. W. Kreidel, Wiesbaden 898, gr. 8°, 368 pp. *Nachrichtsblatt der Deutschen Malakozoologischen Gesellschaft* 30(9/10): 112–121.
- Morelet A (1851) *Appendice à la conchyliologie de l'Algérie; description d'espèces nouvelles*. Paris, *Journal de Conchyliologie* 2: 351–361.
- Mousson A (1873) *Diagnosen neuer Mollusken aus West-Marokko, von Dr. von Fritsch und Dr. Rein gesammelt*. *Malakozoologische Blätter* 21: 149–157.
- Müller OF (1774) *Vermium terrestrium et fluviatilium, Havniae et Lipsiae*, 2, 214 pp + X; .
- Neubert E, Bank RA (2006) Notes on the species of *Caucasotachea* C. Boettger 1909 and *Lindholmia* P. Hesse 1919, with annotations to the Helicidae (Gastropoda: Stylommatophora: Helicidae). *Archiv für Molluskenkunde, Frankfurt am Main*, 135(1): 101–132; .
- Pallary P (1899) *Deuxième contribution à l'étude de la faune malacologique du Nord-Ouest de l'Afrique. Supplement à «La faune malacologique du Maroc» de A. Morelet*. *Journal de Conchyliologie, Paris* 46 (2) [1898]: 49–170, pl. 5–9. [9 February]
- Pallary P (1915) *Description de quelques mollusques nouveaux du Grand Atlas*. *Bulletin du Muséum Nationale d'Histoire naturelle, Paris*, 21(1): 21–28.
- Pallary P (1917) *Hélicidées nouvelles du Maroc*. *Journal de Conchyliologie* 63(2): 126–141, pl. 5. Paris. [31 August].
- Pallary P (1918) *Diagnoses d'une cinquantaine de mollusques terrestres nouveaux du Nord de l'Afrique*. *Le Bulletin de la Société d'histoire naturelle d'Afrique du Nord* 9(7): 137–152. Alger. [15 July]
- Palumbi S, Martin A, Romano S, McMillan W, Stine O, Grabowski G (1991) *The simple fool's guide to PCR version 2.0* Honolulu, University of Hawaii.
- Péchaud J (1883) *Excursions malacologiques dans le nord de l'Afrique de la Calle a Alger, d'Alger a Tanger. I*, 112 pp.
- Rambaut A (2012) *FigTree v1. 4. Molecular evolution, phylogenetics and epidemiology*. Edinburgh, University of Edinburgh, Institute of Evolutionary Biology.
- Razkin O, Gómez-Moliner BJ, Prieto CE, Martínez-Ortí A, Arrébola JR, Muñoz B, Chueca LJ, Madeira MJ (2015) *Molecular phylogeny of the western Palaearctic Helicoidea (Gastropoda, Stylommatophora)*. *Molecular Phylogenetics and Evolution* 83: 99–117. <https://doi.org/10.1016/j.ympev.2014.11.014>
- Ronquist F, Huelsenbeck JP (2003) *MRBAYES 3: Bayesian phylogenetic inference under mixed models*. *Bioinformatics* 19: 1572–1574. <https://doi.org/10.1093/bioinformatics/btg180>

- Ronquist F, Teslenko M, Van Der Mark P, Ayres DL, Darling A, Höhna S, Larget B, Liu L, Suchard MA, Huelsenbeck JP (2012) MrBayes 3.2: efficient Bayesian phylogenetic inference and model choice across a large model space. *Systematic biology* 61(3): 539–542. <https://doi.org/10.1093/sysbio/sys029>
- Schileyko AA (2006) *Treatise on recent terrestrial pulmonate molluscs. Ruthenica Supplement, Moscow*, 2 13: 1765–1906.
- Stamatakis A (2006) RAxML-VI-HPC: maximum likelihood-based phylogenetic analyses with thousands of taxa and mixed models. *Bioinformatics* 22(21): 2688–2690. <https://doi.org/10.1093/bioinformatics/btl446>
- Terver A-P (1839) *Catalogue des mollusques terrestres et fluviatiles observés dans les possessions françaises au nord de l’Afrique*. Lyon, 40 pp. [4 pl.]
- Wade CM, Mordan PB (2000) Evolution within the gastropod molluscs; using the ribosomal RNA gene-cluster as an indicator of phylogenetic relationships. *Journal of Molluscan Studies* 66: 565–570. <https://doi.org/10.1093/mollus/66.4.565>



## New records of the endemic Sicilian land snail species *Marmorana (Murella) muralis* (O. F. Müller, 1774) from the north of Tunisia (Pulmonata, Gastropoda)

Issaad Kawther Ezzine<sup>1</sup>, Najet Dimassi<sup>1</sup>, Beat Pfarrer<sup>2,3</sup>,  
Khaled Said<sup>1</sup>, Eike Neubert<sup>2,3</sup>

**1** *Laboratoire de génétique, biodiversité et valorisation des bio-ressources, Institut Supérieur de Biotechnologie de Monastir, Avenue Taber Haddad (B.P 74) Monastir 5000, Tunisia* **2** *Natural History Museum Bern, Bernstr. 15, CH-3005 Bern, Switzerland* **3** *Institute of Ecology and Evolution, University of Bern, CH-3012 Bern, Switzerland*

Corresponding author: Issaad Kawther Ezzine ([issaadkawther.ezzine@gmail.com](mailto:issaadkawther.ezzine@gmail.com))

---

Academic editor: M. Haase | Received 12 April 2018 | Accepted 14 June 2018 | Published 19 July 2018

<http://zoobank.org/BDD9E19-9A72-4DB4-91EF-96C485ED8F9A>

---

**Citation:** Ezzine IK, Dimassi N, Pfarrer B, Said K, Neubert E (2018) New records of the endemic Sicilian land snail species *Marmorana (Murella) muralis* (O. F. Müller, 1774) from the north of Tunisia (Pulmonata, Gastropoda). ZooKeys 775: 131–147. <https://doi.org/10.3897/zookeys.775.25740>

---

### Abstract

*Marmorana (Murella) muralis* is known as an endemic species of Sicily Island, which is introduced in many European countries. Here, *M. (M.) muralis* is recorded from the north of Tunisia. In order to confirm the identification of samples collected from several localities, shell morphology, details of genital organs and two mitochondrial markers (COI and 16S) were investigated. The results of the molecular study, as well as the morphological and anatomical studies confirm the identification of all Tunisian samples as *M. (M.) muralis*. The analysis of mitochondrial markers shows a low divergence between Sicilian and Tunisian samples suggesting a recent introduction of *M. (M.) muralis* to the North of Tunisia. The comparison of morphological characters of *M. (M.) muralis* with shell characters of *Murella nicollei* described by Pallary (1926) confirms that the latter should be considered as synonym of *M. (M.) muralis*.

### Keywords

16S, COI, anatomy, *Marmorana (Murella) muralis* morphology, *Murella nicollei*, Sicily, Tunisia

## Résumé

*Marmorana (Murella) muralis* est connue comme une espèce endémique de l'île de Sicile qui est actuellement introduite dans plusieurs pays européens. Dans la présente étude, nous enregistrons la présence de *M. (M.) muralis* dans différentes localités du Nord de la Tunisie. Dans le but de valider l'authenticité des spécimens collectés de différentes localités, la morphologie de la coquille, l'anatomie de l'appareil génital ainsi que deux marqueurs mitochondriaux (COI et 16S) ont été analysés. Les résultats de l'étude moléculaire ainsi que ceux de l'étude morphologique et anatomique confirment qu'il s'agit bien de l'espèce Sicilienne *M. (M.) muralis*. L'analyse des deux marqueurs mitochondriaux montre une faible divergence entre les populations Sicilienne et Tunisienne suggérant ainsi une récente introduction de cette espèce en Tunisie. La comparaison des critères morphologiques de l'espèce *M. (M.) muralis* avec les critères de la coquille de l'espèce *Murella nicollei* décrite par Pallary (1926) confirme que cette dernière doit être considérée comme synonyme de l'espèce *M. (M.) muralis*.

## Mots clés

16S, COI, anatomie, *Marmorana (Murella) muralis*, morphologie, *Murella nicollei*, Sicile, Tunisie

## Introduction

Land snails compose a group of invertebrates which are characterized by low mobility and dispersal capacity. The evolution of morphological characters within land snail species is widely influenced by the environmental and ecological conditions. *Marmorana (Murella) muralis* is an endemic helicid species from Sicily Island, which is characterized by an extremely high variability of shell morphology as well as molecular characters (Fiorentino et al. 2013). It was demonstrated that paleogeographical factors and environmental changes affected the shell morphology of *M. (M.) muralis* in Sicily (Fiorentino et al. 2013). This species was introduced by humans to many other European areas such as Tuscany in Italy, Sardinia, the Balears, Portugal and Bouches-du-Rhône in France. Tunisia is a quite well sampled area as evidenced by Letourneux and Bourguignat (1887), who documented land snails from a plethora of localities. Interestingly, they never recorded the presence of *Marmorana (Murella)* Pfeiffer, 1877 in the area. It was Pallary in 1926, who was the first to describe a *Murella*, *Murella nicollei*, from Tabarka in northwest Tunisia.

Recent sampling efforts by the senior author revealed the presence of a *Marmorana (Murella)* taxon at several localities in the north of Tunisia. The present study aims to 1) identify the samples collected from Tunisia based on morphological and molecular characters, 2) determine the possible origin of each Tunisian population known and 3) clarify the status of *Murella nicollei* Pallary, 1926.

## Materials and methods

Living specimens were collected by hand at several localities in Tunisia during two periods: spring 2014, and winter 2015/2016. Geographic coordinates were recorded using a GPS device. For subsequent molecular analyses, specimens were preserved and stored in 80% ethanol until dissection and DNA extraction.

### **Morphological and anatomical studies**

First assessments of the shell morphological characters were done by using simple magnifying glasses. Preserved animals were dissected under a LEICA M212 stereo microscope using thin tweezers. The genital organs of the specimens were removed from the body, and the outer morphology of the complete hermaphroditic genital organ (situs) and further morphological details were investigated. After that, shells, genital situs, and details of the genital organs were photographed with a LEICA DFC 425 camera combined with a LEICA M205 C stereo microscope. The multifocal images were processed by using Imagic IMS software (Imagic, Switzerland).

### **Molecular study**

Ten specimens of *M. (M.) muralis* collected from northern Tunisia were used in this study. We also included sequences of Italian *M. (M.) muralis* specimens (Fiorentino et al. 2008; Fiorentino et al. 2010; Fiorentino et al. 2013; Neiber and Hausdorf 2015), *M. serpentina* (Férussac, 1821) (Fiorentino et al. 2008, Fiorentino et al. 2010), and *M. cf. globularis* (Philippi, 1836) (Fiorentino et al. 2008) for comparison with our specimens. Almost all cytochrome c oxidase subunit I (COI) haplotypes published by Fiorentino et al. (2013) were included in the study to estimate the divergence between Tunisian and Italian populations. *Macularia sylvatica* (Draparnaud, 1801) and *Macularia niciensis* (Férussac, 1821) were selected as outgroup (Neiber and Hausdorf 2015). All specimens used are listed in Table 1. Sequenced specimens are housed in the voucher collection of the NMBE (Naturhistorisches Museum der Burgergemeinde Bern).

### **DNA extraction, PCR amplification and sequencing**

Total genomic DNA was extracted from foot muscle tissue of each specimen using a standard phenol chloroform method (Estoup et al. 1996). Two mitochondrial gene fragments were chosen for analyses in the present study: cytochrome c oxidase subunit I (COI) of 711 base pairs (bp) length and the gene of the 16S ribosomal RNA subunit (16S rRNA) for an approximately 470–480 bp fragment. Polymerase chain reactions (PCR) were performed in a reaction mixture containing 15 ng of DNA template, 1X reaction buffer (1.5 mM), 0.1 mM of each primer pair, 0.2 mM dNTPs, Taq polymerase (1.25 U) and adjusted till a total volume of 25 µl with DNAase free water/sterilized water (UNIMED) (H<sub>2</sub>O). PCR reactions were run under the following conditions: 3 min at 95 °C, followed by 35 cycles of 1 min at 95 °C, 1 min at 40 °C and 1 min at 72 °C and finally, 5 min at 72 °C for COI. For 16S the amplification conditions were: 3 min at 95 °C, followed by 35 cycles of 1 min at 95 °C, 1 min at 50 °C and 1 min at 72 °C, and finally, 5 min at 72 °C. PCR products were sequenced using automated and standardised ABI 3730 XL sequencing run with a read length up to 1.100 bp (PHRED20 quality) and using the same primers as for the PCR (Table 2).

**Table 1.** Taxa examined in this study: species, localities, voucher, and GenBank accession numbers for COI, and 16S fragments.

Species	Voucher number	Localities	Latitude	Longitude	GenBank accession numbers	
					COI	16S
<i>M. (M.) muralis</i>	NMBE 551462	Manzel Abderrahmen, Bizerte, Tunisia	37.232494°	9.868065°	MG780362	MG774439
<i>M. (M.) muralis</i>	NMBE 551463	Manzel Abderrahmen, Bizerte, Tunisia	37.232494°	9.868065°	MG780363	MG774440
<i>M. (M.) muralis</i>	NMBE 551464	Manzel Abderrahmen, Bizerte, Tunisia	37.232494°	9.868065°	MG780364	MG774441
<i>M. (M.) muralis</i>	NMBE 551454	Manzel Jemil, Bizerte, Tunisia	37.249964°	9.914793°	MG780365	MG774442
<i>M. (M.) muralis</i>	NMBE 551460	Manzel Jemil, Bizerte, Tunisia	37.249964°	9.914793°	MG780366	MG774443
<i>M. (M.) muralis</i>	NMBE 551461	Manzel Jemil, Bizerte, Tunisia	37.249964°	9.914793°	MG780367	MG774444
<i>M. (M.) muralis</i>	NMBE 551465	Haouaria, Nabeul, Tunisia	37.052299°	11.010219°	MG780368	MG774445
<i>M. (M.) muralis</i>	NMBE 551457	Kelibiya, Nabeul, Tunisia	36.838017°	11.115843°	MG780369	MG774446
<i>M. (M.) muralis</i>	NMBE 551458	Kelibiya, Nabeul, Tunisia	36.838017°	11.115843°	–	MG774447
<i>M. (M.) muralis</i>	NMBE 551459	Kelibiya, Nabeul, Tunisia	36.838017°	11.115843°	MG780370	MG774448
<i>M. (M.) muralis</i> [Fiorentino et al. 2010]	FGC 35940	Joppolo, Italy	–	–	EU189905	EU189872
<i>M. (M.) muralis</i> [Fiorentino et al. 2010]	FGC 35948	Marsala, Sicily, Italy	–	–	EU189904	EU189871
<i>M. (M.) muralis</i> [Fiorentino et al. 2010]	FGC 35922	Selinunte, Italy	–	–	EU189907	EU189874
<i>M. (M.) muralis</i> [Fiorentino et al. 2010]	FGC 36598	Fiumedinisi, Sicily, Italy	–	–	GU391370	GU391399
<i>M. (M.) muralis</i> [Neiber and Hausdorf 2015]	MN 503	Lazio, Italy	41.885278°	12.480833°	KR705023	KR704983
<i>M. cf. globularis</i> [Fiorentino et al. 2008]	FGC 35918	Caltabellotta, Sicily, Italy	–	–	EU189919	EU189886
<i>M. (M.) muralis</i> [Fiorentino et al. 2013]	H1	Erice, Sicily, Italy	–	–	JX827102	–
	H2	Erice, Sicily, Italy	–	–	JX827103	–
	H3	Erice, Sicily, Italy	–	–	JX827104	–
	H4	Erice, Sicily, Italy	–	–	JX827105	–
	H5	Erice, Sicily, Italy	–	–	JX827106	–
	H6	Monte Cofano, Sicily, Italy	–	–	JX827107	–
	H8	Erice, Sicily, Italy	–	–	JX827108	–
	H9	Monte Monaco, Sicily, Italy	–	–	JX827109	–
	H10	Erice, Sicily, Italy	–	–	JX827110	–

Species	Voucher number	Localities	Latitude	Longitude	GenBank accession numbers	
					COI	16S
<i>M. (M.) muralis</i> [Fiorentino et al. 2013]	H11	Monte Monaco, Sicily, Italy	–	–	JX827111	–
	H12	Erice, Sicily, Italy	–	–	JX827112	–
	H13	Erice, Sicily, Italy	–	–	JX827113	–
	H14	Monte Monaco, Sicily, Italy	–	–	JX827114	–
	H15	Monte Cofano, Sicily, Italy	–	–	JX827115	–
	H16	Monte Monaco, Sicily, Italy	–	–	JX827116	–
	H17	Monte Monaco, Sicily, Italy	–	–	JX827117	–
	H18	Monte Monaco, Sicily, Italy	–	–	JX827118	–
	H19	Monte Monaco, Sicily, Italy	–	–	JX827119	–
	H20	Monte Monaco, Sicily, Italy	–	–	JX827120	–
	H22	Monte Monaco, Sicily, Italy	–	–	JX827122	–
	H23	Monte Monaco, Sicily, Italy	–	–	JX827123	–
	H24	Monte Monaco, Sicily, Italy	–	–	JX827124	–
	H25	Monte Cofano, Sicily, Italy	–	–	JX827125	–
	H26	Monte Cofano, Sicily, Italy	–	–	JX827126	–
	H27	Monte Cofano, Sicily, Italy	–	–	JX827127	–
	H28	Monte Monaco, Sicily, Italy	–	–	JX827128	–
	H29	Monte Monaco, Sicily, Italy	–	–	JX827129	–
	H30	Monte Monaco, Sicily, Italy	–	–	JX827130	–
	H31	Monte Cofano, Sicily, Italy	–	–	JX827131	–
H32	Monte Cofano, Sicily, Italy	–	–	JX827132	–	
H33	Monte Monaco, Sicily, Italy	–	–	JX827133	–	
H34	Monte Monaco, Sicily, Italy	–	–	JX827134	–	
H35	Monte Monaco, Sicily, Italy	–	–	JX827135	–	
H36	Monte Monaco, Sicily, Italy	–	–	JX827136	–	



Species	Voucher number	Localities	Latitude	Longitude	GenBank accession numbers	
					COI	16S
<i>M. (M.) muralis</i> [Fiorentino et al. 2013]	H37	Monte Monaco, Sicily, Italy	–	–	JX827137	–
	H38	Monte Monaco, Sicily, Italy	–	–	JX827138	–
	H39	Monte Monaco, Sicily, Italy	–	–	JX827139	–
	H40	Monte Monaco, Sicily, Italy	–	–	JX827140	–
	H41	Monte Sparagio, Sicily, Italy	–	–	JX827141	–
	H42	Monte Sparagio, Sicily, Italy	–	–	JX827142	–
	H43	Monte Sparagio, Sicily, Italy	–	–	JX827143	–
	H44	Monte Sparagio, Sicily, Italy	–	–	JX827144	–
	H45	Monte Sparagio, Sicily, Italy	–	–	JX827145	–
	H46	Erice, Sicily, Italy	–	–	JX827146	–
	H47	Erice, Sicily, Italy	–	–	JX827147	–
	H48	Monte Monaco, Sicily, Italy	–	–	JX827148	–
	H50	Erice, Sicily, Italy	–	–	JX827149	–
	H51	Erice, Sicily, Italy	–	–	JX827150	–
	H37	Monte Monaco, Sicily, Italy	–	–	JX827137	–
	H38	Monte Monaco, Sicily, Italy	–	–	JX827138	–
	H39	Monte Monaco, Sicily, Italy	–	–	JX827139	–
	H40	Monte Monaco, Sicily, Italy	–	–	JX827140	–
	H41	Monte Sparagio, Sicily, Italy	–	–	JX827141	–
	H42	Monte Sparagio, Sicily, Italy	–	–	JX827142	–
H43	Monte Sparagio, Sicily, Italy	–	–	JX827143	–	
H44	Monte Sparagio, Sicily, Italy	–	–	JX827144	–	
H45	Monte Sparagio, Sicily, Italy	–	–	JX827145	–	
H46	Erice, Sicily, Italy	–	–	JX827146	–	
H47	Erice, Sicily, Italy	–	–	JX827147	–	
H48	Monte Monaco, Sicily, Italy	–	–	JX827148	–	
H50	Erice, Sicily, Italy	–	–	JX827149	–	

Species	Voucher number	Localities	Latitude	Longitude	GenBank accession numbers	
					COI	16S
<i>M. (M.) muralis</i> [Fiorentino et al. 2013]	H51	Erice, Sicily, Italy	–	–	JX827150	–
	H52	Monte Monaco, Sicily, Italy	–	–	JX827151	–
	H53	Monte Monaco, Sicily, Italy	–	–	JX827152	–
	H54	Monte Monaco, Sicily, Italy	–	–	JX827153	–
	H55	Monte Monaco, Sicily, Italy	–	–	JX827154	–
<i>M. serpentina</i> [Fiorentino et al. 2008]	FGC 35931	Siena, Italy	–	–	EU189932	EU189899
<i>M. serpentina</i> [Fiorentino et al. 2010]	FGC 32381	Sardinia: Casa Cantoniera, Italy	–	–	GU391369	GU391397
<i>Macularia sylvatica</i> [Neiber and Hausdorf 2015]	UB-ZMH-DNA-2843	Schaffhausen Switzerland	47.676389°	8.614722°	KR705039	KR705002
<i>Macularia niciensis</i> [Neiber and Hausdorf 2015]	MN 2370-Hel-218	Provence-Alpes-Côte d'Azur_France	43.700000°	7.241667°	KR705037	KR705000

**Table 2.** List of primers used for PCR and sequencing.

Gene	Name	Sequences	Reference
COI	COIF	5'-ACTCAACGAATCATAAAGATATTGG-3'	Folmer et al. 1994
	COIR	5'-TATACTTCAGGATGACCAAAAAATCA-3'	
16S	16Sar	5'-CGCCTGTTTATCAAAAAACAT-3'	Simon et al. 1994
	16Sbr	5'-CCGGTCTGAACTCTGATCAT-3'	

### Sequence analyses

Forward and reverse sequences were assembled, checked for ambiguities and aligned using the default settings of the ClustalW multiple alignment algorithm as implemented in Bioedit V 7.2.5 (Hall 1999) and trimmed for 655 bp and 414 bp respectively for COI and 16S. Obtained sequences were deposited in GenBank under the accession numbers MG780362-MG780370 and MG774439-MG774448 (Table 1).

Aligned Tunisian and Sicilian sequences were analysed using DnaSP v5.10.01 (Librado and Rozas 2009) to estimate the number of informative sites and nucleotide diversity for each marker. The K2P values were estimated using Mega v.6 (Tamura et al. 2013). The relationships of inferred haplotypes of Tunisian and Italian *M. (M.) muralis* were estimated using the Minimum Spanning Network (MSN) method (Bandelt et al. 1999)

implemented PopART v1.7 (Leigh et al. 2015). Because of lack of sequences available on GenBank, we produced the haplotype network separately for COI and 16S markers.

### Phylogenetic analysis

Concatenated sequences of the two mitochondrial markers were analysed by Bayesian inference of phylogeny. The sequence data was initially partitioned into four partitions: three partitions corresponding to the codon positions of COI and one partition for 16S. Based on the Akaike Information Criterion (AIC), the substitution models F81, K81uf+G, TrN+I and HKY+G were chosen as best models, respectively, for the first, second and third codon positions of COI and for 16S by PartitionFinder v 1.1.1 (Lanfear et al. 2012). For the Bayesian Inference, we used Mr Bayes v3.2.2 (Ronquist and Huelsenbeck 2003) using the partition scheme and substitutions models suggested by PartitionFinder. Four independent runs were conducted for  $10^6$  generations, sampling every 1000. The first 25% trees were discarded as default burn-in and a majority-rule consensus tree was calculated from the remaining trees. Convergence between runs was assessed by comparing the traces using Tracer v1.5 (Rambaut and Drummond 2007). The topology obtained, and the posterior probabilities for each node were displayed with Figtree V1.4.0 (Rambaut 2012).

### Results morphology and anatomy

#### *Marmorana (Murella) muralis* (O. F. Müller, 1774)

**Description.** Shell medium-sized, depressed globular, thick, solid basic colour beige; large protoconch, clear, smooth, consisting of  $1\frac{1}{2}$  whorls; teleoconch consisting of  $3\frac{1}{2}$  slightly flattened whorls, distinctly ribbed; last whorl slightly keeled, larger than the rest whorls, descending towards aperture; aperture sub-spherical; peristome thick, white; suture moderately deep; underside with single interrupted spiral band; moderately ribbed, umbilicus completely covered by the reflected columellar margin (Fig 1).

*Male genital anatomy.* Penis club-shaped, thick; epiphallus as long as penis; retractor muscle inserting into the distal part of the epiphallus; flagellum twice the length of epiphallus; penial papilla elongated, with a slit-like pore on one side.

*Female genital anatomy.* Dart sac simple, well developed, two glandulae mucosae, non-ramified, inserting into the middle part of the vagina near the base of the dart sac; bursa copulatrix and diverticulum inserting into the proximal part of the vagina (Fig. 2).

### Haplotype network and genetic diversity

Among nine Tunisian and 58 Italian partial COI sequences of *M. (M.) muralis* (Fig. 3), 46 distinct haplotypes were found, suggesting an extremely high haplotype diversity ( $H_d = 0.9815$ ) (Fig. 4A). With 45 haplotypes detected, Italian sequences are

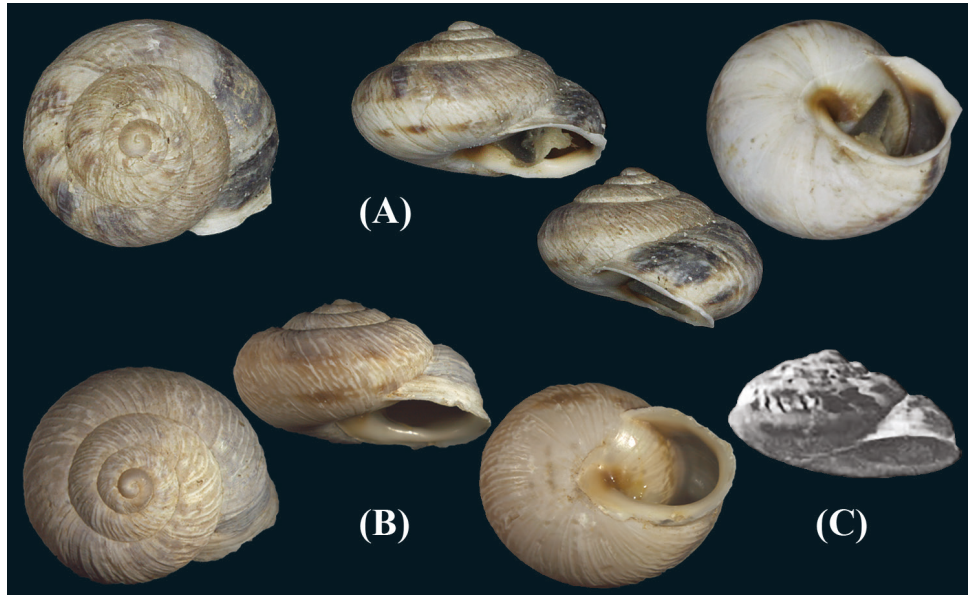

**Figure 1.** *Marmorana (Murella) muralis* (O. F. Müller, 1774) and *Murella nicollei* Pallary, 1926. **A** Menzel Jemil, Bizerte, 17.ii.2015, NMBE 534231, leg. Ezzine, D = 16.79 mm **B** Kelibiya, 10.i.2016, NMBE 551457, leg. Ezzine, D = 16.98 mm. Photographs Bochud & Ezzine **C** *Murella nicollei*, Tabarka. Scale bar: **D** 15.5 mm (copy of the original publication).

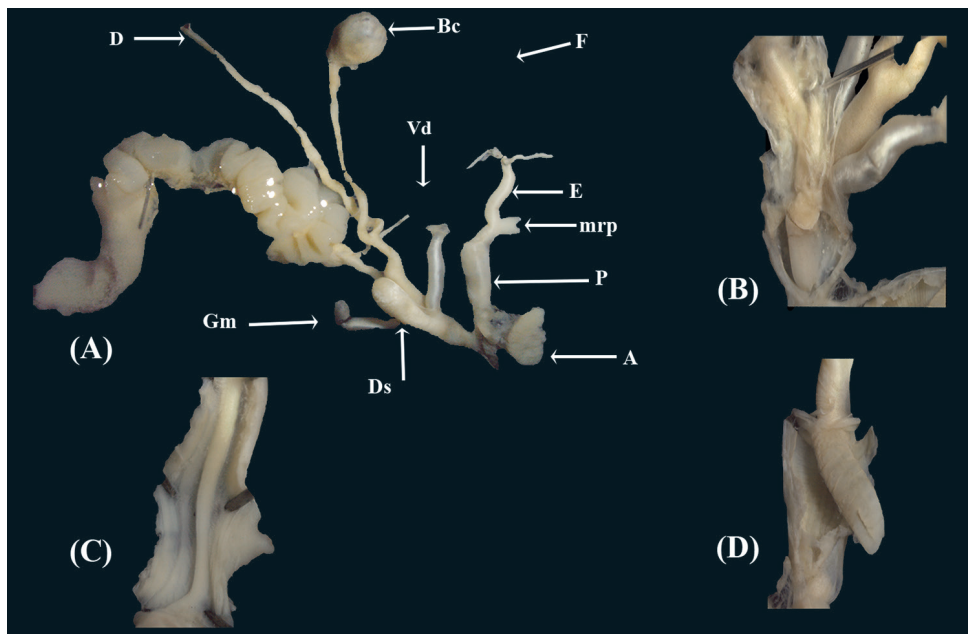

**Figure 2.** Anatomy of genital organs of *Marmorana (Murella) muralis* (Müller, 1774). **A** Situs **B** Details of dart sac **C** Details of epiphallus **D** Penial papilla. Abbreviations: A. atrium, Bc. Bursa copulatrix, D. Diverticulum, Ds. Dart sac, E. Epiphallus, F. Flagellum, Gm. Glandulae mucosae, mrp. Penial retractor muscle, P. Penis, Vd. Vas deferens.

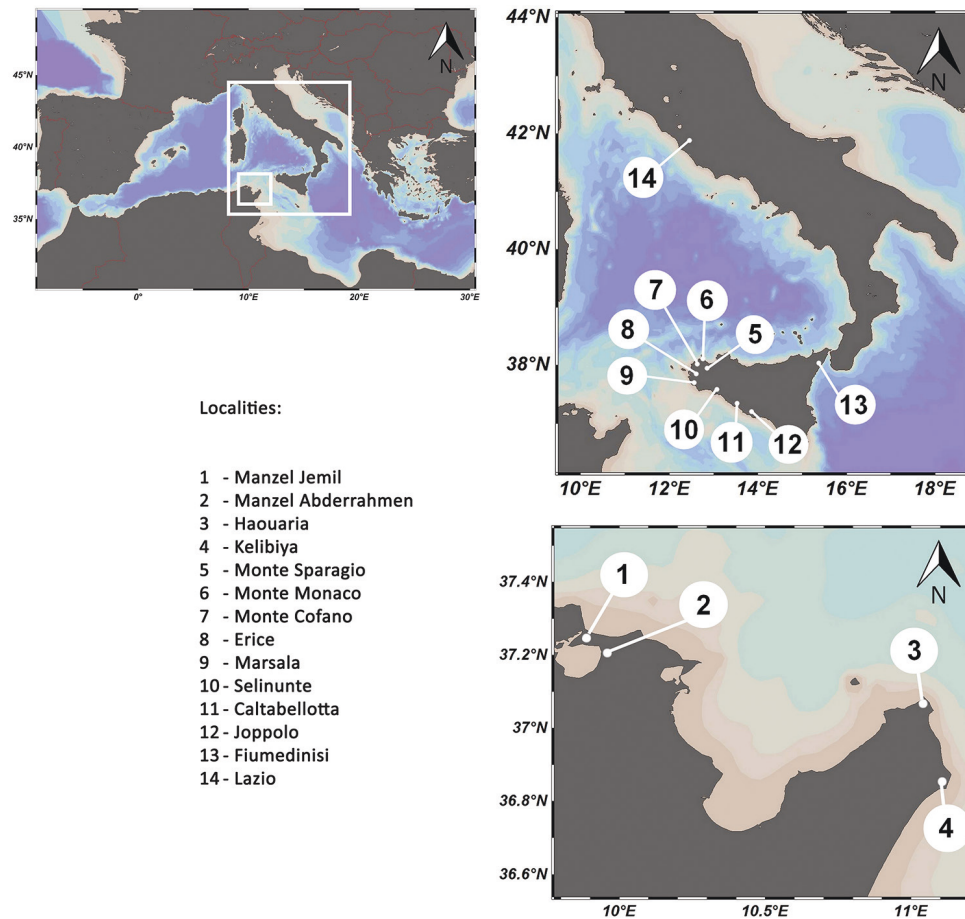

**Figure 3.** Localisation of Tunisian and Italian specimens used in the study.

highly diverse ( $Hd = 0.9903$ ), while only 3 haplotypes were found in Tunisia ( $Hd = 0.5596$ ). The haplotype network therefore suggests a relatively low genetic variability of COI sequences from Tunisian specimens compared to sequences from Italian specimens. Tunisian and Italian specimens share two haplotypes: the first is represented by the COI sequences of the samples collected from Manzel Jemil, Manzel Abderrahmen and the sequence from Selinunte. The second haplotype is represented by the sequence of the sample collected at Haouaria and the sequences H1, H4, and H50 from Erice (Fiorentino et al. 2013). The sequences of the samples collected at Kelibiya represent a unique haplotype that is neither shared with the other specimens from Tunisia nor with any of the specimens from Italy. Within the Tunisian sequences, the highest K2P value (0.078) was recorded between the haplotype of the sequence from Haouaria and the sequences from Kelibiya however; the lowest value (0.01) was reported between the sequences from Kelibiya and those from Manzel Jemil and Manzel Abderrahmen. Between Tunisian and Italian populations, the highest K2P value (0.081) was registered between the sequences from Kelibiya and the



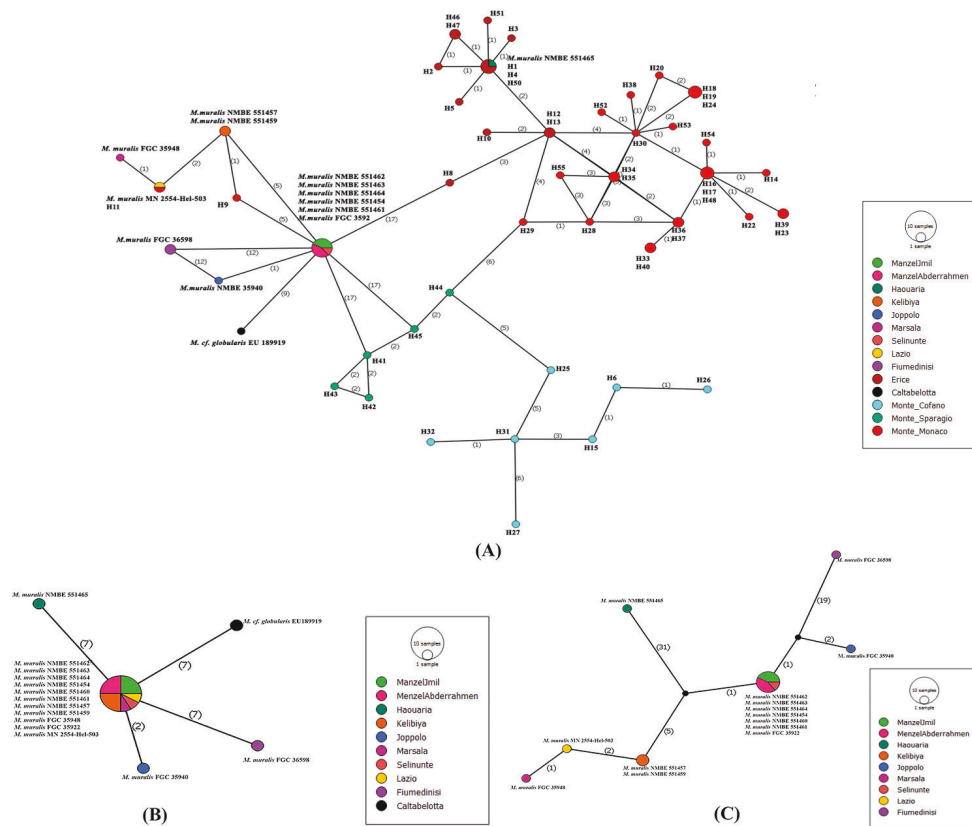

**Figure 4.** Haplotype network showing the relationships among Italian and Tunisian specimens of *M. (M.) muralis*. **A** Haplotype network based on partial COI sequences **B** Haplotype network based on partial 16S sequences **C** Haplotype network based on concatenated partial COI and 16S sequences.

sequences from Erice (H5, H10) and Monte Monaco (H22, H28, H30, H38, H52). The lowest was recorded between the sequence from Haouaria and the sequences H1, H4 and H50 (Fiorentino et al. 2013) on the one hand and the sequences from Manzel Jemil- Manzel Abderrahmen and the sequences from Selinunte on the other hand (Fiorentino et al. 2010). The nucleotide divergence within Tunisian population reached a value of 0.0178 but the divergence was slightly higher (0.0316) within Italian population. Moreover, the divergence between Tunisian and Italian populations reached a value of 0.0353.

The analysis of ten Tunisian and six Italian 16S partial fragments shows five haplotypes suggesting a low haplotype diversity (0.450) (Fig. 4B). Sequences of Italian specimens represent four haplotypes ( $H_d = 0.80$ ), while sequences from Tunisian specimens represent only two haplotypes ( $H_d = 0.20$ ). Tunisian and Italian samples share one haplotype, which was represented by sequences of Tunisian specimens from Kelibiya, Manzel Jemil, Manzel Abderrahmen and sequences of Italian specimens from Lazio, Selinunte and Marsala. The sequences of specimens from Haouaria, Fiumedi-

nisi, Caltabellotta and Joppolo represented four different haplotypes. The maximum value of K2P distance (0.02), within Tunisian sequences, is recorded between the sequence from Haouaria and the rest. While the maximum value recorded between Tunisian and Italian populations is 0.044 between the sequence from Haouaria and the sequences from Fiumedinisi and Caltabellotta. The nucleotide divergence of the 16S partial fragment is remarkably low within Tunisian population (0.00409), as well as, between Tunisian and Italian populations (0.00828).

The analysis of nine Tunisian and six Italian concatenated sequences (COI, 16S) recovered seven different haplotypes among them (Fig. 4. C). One haplotype is shared by Tunisian and Italian populations. The rest is divided into two Tunisian and four Italian haplotypes.

## Phylogeny

The topology, obtained by Bayesian inference based on the concatenated COI and 16S data set was rooted with *Macularia sylvatica* and *Macularia niciensis* as outgroups (Fig. 5). The *Marmorana* species form two opposite clades well supported (PP = 1): The first one is formed by the samples of *M. (M.) serpentina* and the second is formed by both Tunisian and Italian *M. (M.) muralis*. Within the *M. (M.) muralis* clade, *M. cf. globularis* and the *M. (M.) muralis* of Fiumedinisi are situated at the base of the clade with a high value of posterior probability (1–0.93). The rest sequences form three well supported clades. The first is composed by the sequences of Marsala and Lazio, the second is formed by the sequences of Kelibiya, Joppolo, and Selinunte (0.92) and the third clade is formed by the sequences of Manzel Abderrahmen, Manzel Jemil, Haouaria and Erice (0.82).

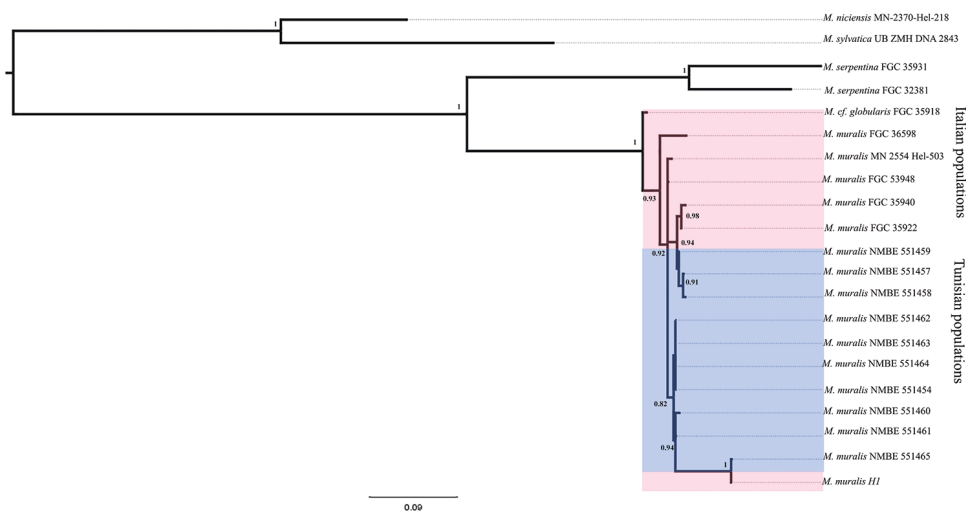

**Figure 5.** Bayesian 50% majority-rule consensus tree based on the analysis of concatenated partial COI and 16S sequences showing the relationships among Tunisian and Italian *Marmorana (Murella) muralis* samples.

## Discussion

### Morphology and anatomy

*Marmorana (Murella) muralis* is known as an endemic species of Sicily but it was introduced to several localities in southern Europe (Fiorentino et al. 2008). The morphological and anatomical characters of the Tunisian samples show the same morphological and genital anatomical traits presented by Fiorentino et al. (2010). Thus, these specimens are here considered to represent *M. (M.) muralis*. In Tunisia, this taxon was first recorded by Pallary (1926: 49, pl. VIII, fig. 9) under the name *Murella nicollei* from Tabarka. The photo of *Murella nicollei* (Fig. 1C) confirms the same shell morphological traits characterizing *M. (M.) muralis*. Thus, we consider *Murella nicollei* Pallary, 1926 to represent synonym of *M. (M.) muralis*. The species was probably introduced by Italian people, who lived in Tabarka for a long time. In fact, Italian people colonised Tabarka since the middle of the XVI century (Valérian 2012). The maximum number of Sicilian people settling in Tunisia was reached in 1891 (De Montety 1937). Since its description, there is no record of this species from Tabarka known to the authors. During the last decade, Tabarka was visited several times by Abbes and Ezzine, but neither empty shells nor living specimens of *M. (M.) muralis* could be found. The extinction of *M. (M.) muralis* in the area could be the result of 1) a negative ecological selection caused by the climatic conditions in Tabarka, or 2) the fragmentation and urbanisation of its habitat by human activities, which easily could reduce the population. Being an alien species to Tabarka it is quite possible that it could not well disperse in the area. As a result, the population is gone extinct. However, despite its extinction in Tabarka, it does well in the other Tunisian localities recorded here. Fiorentino et al. (2013) demonstrated that the shell morphology is highly affected by environmental changes in Sicily Island; the Tunisian populations seem not yet to be influenced by the new environment so far. The absence of any environmental effects on the shell supports the hypothesis that the species was quite recently introduced to the country.

### Network haplotype and genetic diversity

The nucleotide divergence of the COI sequences reaches a maximum value of 0.0316 (3.16%) between Tunisian and Italian populations. This value does not exceed the threshold of intraspecific divergence of land snails (4%) as suggested by Davison (2009), and is comparable to the threshold of 3% suggested by Hebert et al. (2003) to characterize animal species in general. Furthermore, this value is smaller than the intraspecific divergence of the Tunisian *Xerocrassa latastei* reported by Ezzine et al. (2017). The comparison of the nucleotide divergence, the haplotype diversity, and the K2P value between Tunisian and Italian COI sequences shows a high diversity of this marker. The divergence between Tunisian and Italian populations might be the result of the isolation caused by the Mediterranean Sea, which can be considered a geographical barrier causing the restriction of passive gene flow between the two populations.

The analysis of the results obtained by the 16S sequences shows low values of nucleotide divergence, haplotype diversity, and K2P distance between Italian and Tunisian sequences, suggesting a weak diversity of this marker. The comparison of the parameters of the COI and 16S and the haplotype network show that COI is more polymorphic than 16S. COI seems to be suitable to estimate the divergence not only on species but also on population level. The haplotype network of the concatenated data confirms the results obtained by COI and 16S separately and shows that Italian populations are more diversified than the Tunisian ones. This supports the hypothesis of a recent introduction to Tunisia.

The haplotype network of COI sequences shows that the haplotype from Manzel Jemil and Manzel Abderrahmen is similar to the haplotypes from Selinunte and Joppolo, the haplotype from Haouaria is similar to the sequences from Erice, which can be interpreted as a hint to the origin of these particular populations. Interestingly, the haplotype from Kelibiya is unique and not shared with Italian populations. The divergence of the haplotype of Kelibiya may have two reasons: 1) these snails have been introduced from a genetically unknown population on Sicily, or 2) or it could be the result of the isolation of the population inside the castle. In fact, we visited Kelibiya several times, the population seems to be isolated but well adapted to the environment within the castle. The species does not live outside the castle. Geographical isolation is widely accepted to represent the main cause of genetic divergence within a species (Graybeal 1995; Baum and Shaw 1995; Olmstead 1995). However, this is a process that requires many generations and might lead to changes in shell morphology as seen in Sicily. This is not the case here, so we assume that the first hypothesis has a higher probability.

## Phylogeny

The analysis of the topology obtained by the Bayesian Inference method shows that Tunisian specimens form one well supported clade (PP = 1) together with the Italian samples of *M. (M.) muralis* (Fig. 5) and thus proves that the Tunisian samples are conspecific with this species. The topology obtained did not divide the samples used into separate Sicilian and Tunisian clades, and the presence of a Tunisian or Sicilian ancestral clade could not be shown. Additionally, the shell morphology seems not to be affected by the environmental difference between Sicily and Tunisia, as might have been expected in case of a longer presence of the species in Tunisia.

To better understand the population dynamics of this species, more studies including more samples from Tunisia and from Italy will be needed.

## Conclusions

Based on morphological, anatomical, and mitochondrial markers, the present study confirms that the recently collected Tunisian samples of a *Marmorana* species belong

to *M. (M.) muralis*. The absence of this species in the collection of Letourneux and Bourguignat (1887) leads to the hypothesis that the species may have recently been introduced to Tunisia, i.e. earliest after 1887. The first record for the species comes from Tabarka (Pallary 1926), but the species has gone extinct there. The recent populations from Tunisia share some Sicilian haplotypes indicating an origin from Selinunte, Erice and other well-known populations on Sicily; the population from Kelibiyah is more isolated and does not relate to any genetically known population on Sicily. The haplotype networks of the COI, 16S and concatenated fragments prove that Italian populations are more diversified than the Tunisian. The shell morphology of the Tunisian populations is rather homogenous. We therefore conclude that the present distribution pattern is result of a recent anthropogenic introduction of the species in the north of Tunisia, which occurred sometime in the last 90 years. The species has to be considered a neozoon for the Tunisian malacofauna. It has to be emphasized that the development of the hitherto known four populations and their future dispersal in the country need to be observed. The impact of this alien species on the endemic land snail fauna of Tunisia needs serious future monitoring.

### **Acknowledgements**

This work would not have been possible without the input of many people. The senior author is very grateful to Marwa Sidhom and Hela Frih for their help during sampling. We are greatly indebted to Estée Bochud for her support of I. K. Ezzine during her stays at the Natural History Museum in Berne, her technical assistance in the laboratory and photo preparation. I.K. Ezzine was supported by a grant of the Tunisian “Ministère de l’Enseignement Supérieur et de la Recherche Scientifique” and “Université de Monastir” to visit the Natural History Museum of Bern. We are grateful for the valuable comments of one of the reviewers, which increased the quality of our work.

### **References**

- Bandelt H, Forster P, Röhl A (1999) Median-joining networks for inferring intraspecific phylogenies. *Molecular Biology and Evolution* 16(1): 37–48. <https://doi.org/10.1093/oxfordjournals.molbev.a026036>
- Baum DA, Shaw KL (1995) Genealogical perspectives on the species problem. In: *Experimental and Molecular Approaches to Plant Biosystematics*. In: Hoch PC, Stephenson AG (Eds) *Monographs in Systematic Botany from the Missouri Botanical Garden* 53: 289–303.
- Davison A, Blackie RE, Scothern GP (2009) DNA barcoding of stylommatophoran land snails: a test of existing sequences. *Molecular Ecology Resources* 9: 1092–1101. <https://doi.org/10.1111/j.1755-0998.2009.02559.x>
- De Montety H (1937) Les Italiens en Tunisie. In: *Politique étrangère*, n 5. 2<sup>e</sup>année, 409–425. <https://doi.org/10.3406/polit.1937.6318>



- Draparnaud JPR (1801) Tableau des mollusques terrestres et fluviatiles de la France, 116 pp.
- Estoup A, Solignac M, Cornuet JM, Goudet J, Scholl A (1996) Genetic differentiation of continental and island population of *Bombus terrestris* (Hymenoptera: Apidae) in Europe. *Molecular Ecology* 5: 19–31. <https://doi.org/10.1111/j.1365-294X.1996.tb00288.x>
- Ezzine IK, Pfarrer B, Dimassi N, Said K, Neubert E (2017) At home at least: the taxonomic position of some north African *Xerocrassa* species (Pulmonata, Geomitridae). *ZooKeys* 712: 1–27. <https://doi.org/10.3897/zookeys.712.13066>
- Férussac AEJ (1821–1822) Tableaux systématiques des animaux mollusques suivis d'un Pro-drome général pour tous les mollusques terrestres ou fluviatiles vivants ou fossiles. Première partie, Tableaux systématiques généraux, pp. i–xlvi. Deuxième partie, Tableaux particuliers des mollusques terrestres et fluviatiles, Classe des Gastéropodes. 1, Tableau de la famille des limaces, Arthus-Bertrand, Paris, 1–28. 2, Tableau de la famille des limaçons, 1–92. 3, Tableau de la famille des auricules, 93–114. [For details of dates of publication see Kennard A.S., 1942, *Proceedings of the Malacological Society of London* 25(3): 105–110]
- Fiorentino V, Manganelli G, Giusti F, Tiedemann R, Ketmaier V (2013) A question of time: the land snail *Murella muralis* (Gastropoda: Pulmonata) reveals constraints on past ecological speciation. *Molecular Ecology* 22(1): 170–186. <https://doi.org/10.1111/mec.12107>
- Fiorentino V, Salomone N, Manganelli G, Giusti F (2010) Historical biogeography of Tyrrhenian land snails: the *Marmorana-Tyrrheniberus* radiation (Pulmonata, Helicidae). *Molecular Phylogenetics and Evolution*. 55(1): 26–37. <https://doi.org/10.1016/j.ympev.2009.11.024>
- Fiorentino V, Salomone N, Manganelli G, Giusti F (2008) Phylogeography and morphological variability in land snails: the Sicilian *Marmorana* (Pulmonata, Helicidae) *Biological Journal of the Linnean Society* 94(4): 809–823. <https://doi.org/10.1111/j.1095-8312.2008.01023.x>
- Folmer O, Black M, Hoe W, Lutz R, Vrijenhoek R (1994) DNA primers for amplification of mitochondrial cytochrome c oxidase subunit I from diverse metazoan invertebrates. *Molecular Marine Biology and Biotechnology* 3(5): 294–299.
- Graybeal A (1995) Naming species. *Systematic Biology* 44: 237–250. <https://doi.org/10.1093/sysbio/44.2.237>
- Hall TA (1999) BioEdit: a user-friendly biological sequence alignment editor and analysis program for Windows 95/98/NT. *Nucleic Acids Symposium Series* 41: 95–98.
- Hebert PDN, Cywinska A, Ball SL, deWaard JR (2003) Biological identifications through DNA barcodes. *Proceedings of the Royal Society B: Biological Sciences* 270(1512): 313–321. <https://doi.org/10.1098/rspb.2002.2218>
- Lanfear R, Calcott B, Ho SYW, Guindon S (2012) PartitionFinder: combined selection of partitioning schemes and substitution models for phylogenetic analyses. *Molecular Biology and Evolution* 29(6): 1695–1701. <https://doi.org/10.1093/molbev/mss020>
- Leigh JW, Bryant D (2015) POPART: full-feature software for haplotype network construction, *Methods in Ecology and Evolution* 6: 1110–1116. <https://doi.org/10.1111/2041-210X.12410>
- Letourneux A, Bourguignat JR (1887) *Prodrome de la malacologie terrestre et fluviatile de la Tunisie*. Imprimerie nationale, Paris, 166 pp. <https://doi.org/10.5962/bhl.title.132280>

- Librado P, Rozas J (2009) DnaSP v5: A software for comprehensive analysis of DNA polymorphism data. *Bioinformatics* 25: 1451–1452. <https://doi.org/10.1093/bioinformatics/btp187>
- Müller OF (1774) *Vermium terrestrium et fluviatilium, seu animalium infusoriorum, helminthicorum, et testaceorum, non marinorum, succincta historia*. Havniæ (Copenhagen) & Lipsiæ (Leipzig), Heineck & Faber 1: 1–214.
- Neiber MT, Hausdorf B (2015) Molecular phylogeny reveals the polyphyly of the snail genus *Cepaea* (Gastropoda: Helicidae). *Molecular Phylogenetics and Evolution* 93: 143–149. <https://doi.org/10.1016/j.ympev.2015.07.022>
- Olmstead RG, Reeves PA (1995) Evidence for the polyphyly of the Scrophulariaceae based on chloroplast *rbcL* and *ndhF* sequences. *Annals of the Missouri Botanical Garden* 82: 176–193. <https://doi.org/10.2307/2399876>
- Pallary P (1926) Compléments à la faune malacologique de la Berbérie. *Journal de Conchyliologie* 70(1): 1–50. [pl. 1–8]
- Pfeiffer L (1877) Über die systematische Anordnung der Heliceen. *Malakologische Blätter* 24: 1–14.
- Philippi RA (1836) *Enumeratio molluscorum Siciliae cum viventium tum in tellure tertiaria fossilium, quae in itinere suo observavit*. Vol. 1. Schropp, Berlin [Berolini], 267 pp. [plates 1–12] <https://doi.org/10.5962/bhl.title.100735>
- Rambaut A (2012) Fig tree: v 1.4.0 <http://tree.bio.ed.ac.uk/software/figtree/>.
- Rambaut A, Drummond AJ (2007) *Molecular Evolution, Phylogenetics and Epidemiology*, Tracer v.1.5 <http://tree.bio.ed.ac.uk/software/tracer/> (accessed 01.01.13).
- Ronquist F, Huelsenbeck JP (2003) MrBayes 3: Bayesian phylogenetic inference under mixed models. *Bioinformatics* 19: 1572–1574. <https://doi.org/10.1093/bioinformatics/btg180>
- Simon C, Frati F, Beckenbach A, Crespi B, Liu H, Flook P (1994) Evolution, weighting, and phylogenetic utility of mitochondrial gene sequences and a compilation of conserved polymerase chain reaction primers. *Annals of the entomological Society of America* 87(6): 651–701. <https://doi.org/10.1093/aesa/87.6.651>
- Tamura K, Stecher G, Peterson D, Filipski A, Kumar S (2013) MEGA6: Molecular Evolutionary Genetics Analysis version 6.0. *Molecular Biology and Evolution* 30: 2725–2729. <https://doi.org/10.1093/molbev/mst197>
- Valérien D (2012) Gourdin Philippe, Tabarka. *Histoire et archéologie d'un préside espagnol et d'un comptoir génois en terre africaine (xve-xviiiè siècle)*, Rome-Tunis, École française de Rome – Institut national du patrimoine de Tunis, 2008. (Collection de l'École française de Rome, 401). *Revue des mondes musulmans et de la Méditerranée* 130: 1–625.

# Anatomical and phylogenetic investigation of the genera *Alabastrina* Kobelt, 1904, *Siretia* Pallary, 1926, and *Otala* Schumacher, 1817 (Stylommatophora, Helicidae)

Jeannette Kneubühler<sup>1,2</sup>, Rainer Hutterer<sup>3</sup>, Beat Pfarrer<sup>1,2</sup>, Eike Neubert<sup>1,2</sup>

**1** Naturhistorisches Museum der Burggemeinde Bern, 3005 Bern, Switzerland **2** Institute of Ecology and Evolution, University of Bern, 3012 Bern, Switzerland **3** Zoologisches Forschungsmuseum Alexander Koenig, 53113 Bonn, Germany

Corresponding author: Jeannette Kneubühler ([jeannette.kneuebuehler@nmbe.ch](mailto:jeannette.kneuebuehler@nmbe.ch))

---

Academic editor: Ton de Winter | Received 4 January 2019 | Accepted 1 April 2019 | Published 9 May 2019

<http://zoobank.org/4821C74E-C7E8-4866-9BAE-9A03CC46AD16>

---

**Citation:** Kneubühler J, Hutterer R, Pfarrer B, Neubert E (2019) Anatomical and phylogenetic investigation of the genera *Alabastrina* Kobelt, 1904, *Siretia* Pallary, 1926, and *Otala* Schumacher, 1817 (Stylommatophora, Helicidae). ZooKeys 843: 1–37. <https://doi.org/10.3897/zookeys.843.32867>

---

## Abstract

This study presents new insights in the anatomy of genital organs of some large helicid gastropods from northern Africa. The genetic analysis with the markers COI, 16S, H3, and 5.8 S rRNA+ITS2 reveals a high support for *Alabastrina* and *Otala* as separate evolutionary lineages within the Otalini. The position of *Siretia* as another separate lineage within the Otalini is discussed. “*Tingitana minettei decussata*” clusters within the *O. xanthodon* clade and confirms that the genus *Tingitana* can be synonymised with *Otala*. The genus *Alabastrina* differs from all other known genera by possession of a penial appendix. This character state is also found in topotypic *A. tistutensis*. Examination of the twin penial papilla system in *Otala* recovers a reduction of the proximal penial papilla in *O. punctata*. The position of *Helix murcica* as a separate subspecies of *O. lactea* is not supported, and it is here considered to be a synonym of the latter species.

## Keywords

*Alabastrina*, genital anatomy, integrative taxonomy, Morocco, *Otala*, phylogeny, *Siretia*, Spain

## Introduction

Working with the terrestrial molluscs from northern Africa, students are faced with a confusing situation: an enormous number of species- and genus-level taxa are available to arrange the malacodiversity but for many groups a modern treatment is missing. As a result, this important part of the Palaearctic fauna is still in a chaotic state (Rour et al. 2002). The major problem in the Helicidae is the absence of a stable generic concept that is based on recognisable character states. This can be morphological, anatomical, or genetic data. For this reason, we follow the idea of integrative taxonomy and try to draw conclusions based on a synopsis of these types of traits.

Research on the malacofauna of northern Africa was mainly elaborated by three researchers, Bourguignat (1829–1892), Kobelt (1840–1916), and Pallary (1869–1942), who laid a fundament so strict that it is followed more or less until today. This system was more or less supported by P Hesse (1911) by his anatomical research on some groups of Helicidae. His research was the onset of the valorisation of genital morphology as another source of characters and character states. Amongst others, he investigated species, which are treated also in this publication. Unfortunately, Hesse restricted his research to the outer morphology of the genital organs thus missing the highly informative traits found in the lumen. While in the remaining part of the western Palaearctic, taxonomy of terrestrial snails went through a phase of deep changes, northern Africa was left more or less untouched. This situation is currently changing, and several papers were published in the last years which resulted in new data, for example on the Helicidae (Psonis et al. 2013, Neubert 2014, Neubert and Korábek 2015, Walther et al. 2016, Bouaziz-Yahiatene et al. 2017). Recently, Holyoak and Holyoak (2017) published a major paper on the large group of Otalini G Pfeffer, 1930, which has its centre of radiation in the north-west of Africa. In this paper, the authors went through numerous available names and came up with a radical solution following a lumping approach.

The investigation in this study is mainly based on specimens collected by the second author during his excavation campaigns in north-eastern Morocco (Hutterer et al. 2011a, b, 2014). The taxonomic investigation of terrestrial molluscs was part of an archaeological study of various cave sediments in the Rif region (Mikdad et al. 2000).

This study aims to serve as an addition to the recent studies on helicid phylogeny. Due to the restricted number of taxa available in our study, we here can add only some remarks to the ongoing work on the north African Helicidae. Particular emphasis is laid on filling gaps in the knowledge of the anatomy of the genital organs. It has to be stressed that the investigation of this complex of organs should always include the structure of the internal lumina; they certainly help in identifying autapomorphic character states. In addition, we supply new data on shell and anatomical traits, and present a first genetic approach to some of the genera involved using the following markers: cytochrome c oxidase subunit I (COI), 16S rRNA (16S), histone 3 (H3), and partial sequence of 5.8 S rRNA flanking the internal transcribed spacer 2 (ITS2).

## Material and methods

### Specimens investigated

The specimens were collected in Morocco and Algeria between 1998 and 2015. Reference specimens from Spain and Portugal could be included. Detailed sampling locations of the investigated specimens are given in Fig. 1 and Table 1. The voucher number and the GenBank accession numbers for the obtained DNA sequences can be found in Table 1. All specimens used in this study are housed in the Natural History Museum Bern, Switzerland.

Abbreviations of institution:

<b>MHNL</b>	Musée de Confluence, Lyon
<b>MNHN</b>	Museum National d'Histoire Naturelle, Paris
<b>NMBE</b>	Naturhistorisches Museum, Bern
<b>SMF</b>	Research Institute Senckenberg, Frankfurt

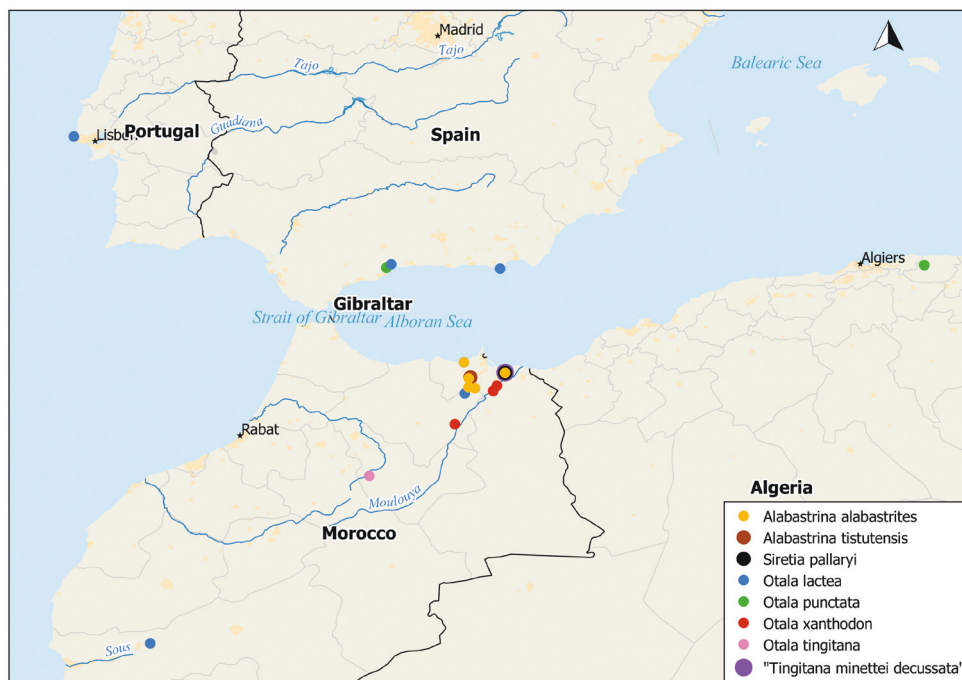

**Figure 1.** Sampling locations of the investigated specimens. This map was produced with QGIS (2016, v2.18.12) using the Natural Earth data set.

**Table 1.** Detailed list of the sampling sites and the GenBank accession numbers of the investigated specimens.

Species	Locality	Latitude	Longitude	Voucher	GenBank accession number COI	GenBank accession number 16S	GenBank accession number H3	GenBank accession number ITS2
<i>Alabastrina alabastrites</i>	Morocco, Montes de Kebdana, Kebdana Mountain/ Rif	35.027N	2.614W	NMBE-549817	MK754458	MK585087	MK728781	MK585111
	Morocco, Rif Jbel Fiztoutine w Hills El Batel	34.938N	3.193W	NMBE-549813	MK754457	MK585086	MK728780	MK585110
	Morocco, Cave Ifri n'Ammar, 20 km SW Berkane	34.782N	3.094W	NMBE-549812	MK754456	MK585085	MK728779	MK585109
	Morocco, Hassi Ouenzga nach Afsou/Oriental	34.796N	3.195W	NMBE-549811	MK754455	MK585084	MK728778	MK585108
	Morocco, Etsedda/Kebdane	35.195N	3.269W	NMBE-549816	MK754459	MK585088	MK728782	MK585112
<i>Alabastrina tistutensis</i>	Morocco, Rif, Tiztoutine, village bouaza	34.955N	3.166W	NMBE-555174	MK754469	MK585099	MK728792	MK585123
<i>Allognathus balearicus</i>	Spain, Mallorca, Escorça	39.822N	2.887E	EHUMC-1051	KR705026	KR704986	no data	no data
<i>Arianta arbustorum</i>	Austria, Upper Austria, Höllengebirge Mts	no data	no data	NHM-109000	KF596871	KF596823	KF596915	no data
<i>Helix melanostoma</i>	Tunisia, Kasserine	35.172N	8.831E	NMBE-540550	MF564162	MF564116	MF564178	no data
	France, between Rabieux and Saint-Félix-de-Lodez/ Herault	43.663N	3.441E	NMBE-520822	MK754471	MF564115	MF564177	no data
<i>Marmorana muralis</i>	Italy, Rome	41.885N	12.481E	MN-2554	KR705023	KR704983	no data	no data
<i>Massylaea constantina</i>	Algeria, Ighil Bourmi	36.487N	4.061E	NMBE-540545	MF564168	MF564122	MF564185	no data
<i>Massylaea vermiculata</i>	Algeria, Makouda, Tizi Ouzou/ Kabylie	36.791N	4.066E	NMBE-540544	MF564159	MF564112	MF564174	no data
<i>Otala lactea</i>	Spain, Finca de la Concepción, N Málaga	36.760N	4.428W	NMBE-554174	MK754463	MK585093	MK728786	MK585117
	Spain, Punta Entinas, W Almería	36.690N	2.694W	NMBE-554175	MK754464	MK585094	MK728787	MK585118
	Spain, Punta Entinas, W Almería	36.690N	2.694W	NMBE-554176	MK754465	MK585095	MK728788	MK585119
	Portugal, W Almoageme/ Sintra Cascais National Park	38.798N	9.485W	NMBE-553246	MK754460	MK585089	MK728783	MK585113
	Morocco, Hassi Ouenzga/ Oriental	34.698N	3.256W	NMBE-555171	MK754452	MK585081	MK728775	MK585105
	Morocco, Hassi Ouenzga/ Oriental	34.698N	3.256W	NMBE-549814	MK754468	MK585098	MK728791	MK585122
	Morocco, West of Aoulouz/ Souss-Massa-Draa	30.709N	8.268W	NMBE-549951	MK754472	MK603015	MK728794	MK602877
	Morocco, Etsedda/Kebdane	35.195N	3.269W	NMBE-545594	MK754448	MK585077	MK728771	MK585101
<i>Otala punctata</i>	Spain, El Tarajal, W Málaga	36.705N	4.506W	NMBE-554171	MK754462	MK585092	MK728785	MK585116
	Spain, El Tarajal, W Málaga	36.705N	4.506W	NMBE-554172	MK754467	MK585097	MK728790	MK585121
	Algeria, Makouda, Tizi Ouzou/ Kabylie	36.745N	4.068E	NMBE-534228	MK754466	MK585096	MK728789	MK585120
<i>Otala iingitana</i>	Morocco, Tarzout de Guigou/ Boulmane, NW Boulmane	33.381N	4.778E	NMBE-510549	no data	no data	no data	no data



Species	Locality	Latitude	Longitude	Voucher	GenBank accession number COI	GenBank accession number 16S	GenBank accession number H3	GenBank accession number ITS2
<i>Otala xanthodon</i>	Morocco, Kebdana, Moulouya valley S Mechraa Elmalh	34.821N	2.745W	NMBE-555169	MK754450	MK585079	MK728773	MK585103
	Morocco, Kebdana, Moulouya valley S Mechraa Elmalh	34.821N	2.745W	NMBE-555170	MK754451	MK585080	MK728774	MK585104
	Kebdana, Moulouya valley below barrage	34.739N	2.803W	NMBE-549825	MK754453	MK585082	MK728776	MK585106
	Kebdana, Moulouya valley below barrage	34.739N	2.803W	NMBE-549826	MK754454	MK585083	MK728777	MK585107
	Morocco, Montes de Kebdana, Kebdana Mountain/ Rif	35.027N	2.614W	NMBE-549841	MK754473	MK603016	MK728795	MK602878
	Morocco, Montes de Kebdana, Djebel Sebaa Reyal/ Rif	35.030N	2.613W	NMBE-549843	MK754474	MK603017	MK728796	MK602879
	Morocco, Guercif, Oued Melloulon/ Taza al-Hoceima	34.207N	3.414W	NMBE-549820	MK754449	MK585078	MK728772	MK585102
<i>Siretia pallaryi</i>	Morocco, Montes de Kebdana, Kebdana Mountain/ Rif	35.027N	2.614W	NMBE-549815	MK754461	MK585090	MK728784	MK585114
<i>Theba subdentata subdentata</i>	Morocco, West of Aoulouz/ Souss-Massa-Draa	30.709N	8.268W	NMBE-549949	MF564172	MF564126	MF564188	no data
<i>"Tingitana minettei decussata"</i>	Morocco, Montes de Kebdana, Djebel Sebaa Reyal/ Rif	35.030N	2.613W	NMBE-549840	MK754470	MK585100	MK728793	MK585124

## Molecular study

For total DNA extraction the Qiagen Blood and Tissue Kit (Qiagen; Hilden, Germany) was used in combination with a QIAcube extraction robot. Ca. 0.5 cm<sup>3</sup> of foot tissue was cut from the foot muscle and placed in a mix of 180 µl ATL buffer and 20 µl Proteinase K. It was then incubated for ca. 4 hours at 56 °C in a heater (Labnet, Vortemp 56, witec AG, Littau, Switzerland). For subsequent DNA extraction the QIAcube extraction robot with the Protocol 430 (DNeasy Blood Tissue and Rodent tails Standard) was used. In this study, two mitochondrial markers (COI and 16S) and two nuclear markers (H3 and 5.8 S rRNA+ITS2) were investigated. PCR mixtures consisted of 12.5 µl GoTaq G2 HotStart Green Master Mix (Promega M7423), 8.5 µl ddH<sub>2</sub>O, 1 µl forward and reverse primer each, and 2 µl DNA template. In Table 2 the used primer pairs for the PCR are listed. Following PCR cycles were used: for COI 2 min at 94 °C, followed by 35 cycles of 1 min at 95 °C, 1 min at 40 °C and 1 min at 72 °C and finally, 5 min at 72 °C; for 16S 5 min at 95 °C, followed by 45 cycles of 30 s at 95 °C, 30 s at 48 °C and 45 s at 72 °C, and finally, 5 min at 72 °C; for H3 3 min at 95 °C, followed 40 cycles of 1 min at 95 °C, 1 min at 42 °C and 1 min at 72 °C, and finally, 10 min at 72 °C, and for 5.8 S rRNA+ITS2 1 min at 96 °C, followed by 45 cycles of 30 s at 94 °C, 30 s at 50 °C and 1 min at 72 °C, and finally, 10 min at 72 °C (SensoQuest Tabcyclet and Techne TC-512,

**Table 2.** Used primer pairs for the two mitochondrial and two nuclear markers.

Gene	Primer	Sequence	Sequence length (bp)	Reference
COI	LCO1490	5'-GGTCAACAAATCATAAAGATATTGG-3'	680	Folmer et al. 1994
	HCO2198	5'-TAAACTTCAGGGTGACCAAAAAATCA-3'		
16S	16S ar	5'-CGC CTG TTT ATC AAA AAC AT-3'	440	Simon et al. 1994
	16S br	5'-CCG GTC TGA ACT CTG ATC AT -3'		
H3	H3AD	5'-ATGGCTCGTACCAAGCAGACVGC-3'	380	Colgan et al. 1998
	H3BD	5'-ATATCCTTRGGCATRATRTGTGAC-3'		
ITS2	ITS2ModA	5'-GCTTGCGGAGAATTAATGTGAA-3'	900	Bouaziz-Yahiatene et al. 2017
	ITS2ModB	5'-GGTACCTTGTTTCGCTATCGGA-3'		

witec AG, Littau, Switzerland). The purification and sequencing of the PCR product was performed by LGC (LGC Genomics Berlin, Germany). Interpretation of Bootstrap values: 70 to 80 = moderate support; 80 to 90 = well supported; > 90 = high support. Bayesian posterior probabilities: values above 0.95 are significant support.

### Phylogenetic analyses

For the phylogenetic analyses sequences obtained from GenBank were included as outgroups: *Arianta arbustorum* (Linnaeus, 1758) (Cadahia et al. 2014), *Marmorana muralis* (OF Müller, 1774), and *Allognathus balearicus* (Rossmässler, 1838) (= *Allognathus hispanicus* (Rossmässler, 1838)) (Neiber and Hausdorf 2015). Additionally, sequences of *Helix melanostoma* Draparnaud, 1801, *Theba subdentata subdentata* (Férussac, 1821), *Masyllaea constantina* (E Forbes, 1838) and *Masyllaea vermiculata* (OF Müller, 1774) from the study of Bouaziz-Yahiatene et al. 2017 were also included as outgroups. These species were selected to identify the phylogenetic placement of the focal taxa investigated in this study.

For sequence processing and editing the software package Geneious v9.1.8 (Biomatters Ltd) was used. The protein-coding gene fragments of COI and H3 were defined in two data blocks. The first two codon positions were defined as one block and the third codon position as a second block. The non-coding regions from 16S and 5.8 S rRNA+ITS2 were defined as a single data block. Partitionfinder-2.1.1 (Lanfear et al. 2012) was applied for searching optimal evolutionary models for the partitions using the corrected Akaike Information Criterion (cAIC). RAxML plug-in for Geneious (Stamatakis 2006) was implemented for computing ML inference, using Geneious' plug-in with rapid bootstrapping setting, the search for the best scoring ML tree and 1500 bootstrapping replicates. Bayesian Inference (BI) was performed using Mr. Bayes v3.2.6 ×64 (Huelsenbeck and Ronquist 2001; Ronquist and Huelsenbeck 2003; Altekar et al. 2004) through the HPC cluster from the University of Bern (<http://www.id.unibe.ch/hpc>). For the concatenated data set, Partitionfinder-2.1.1 was used for finding the optimal evolutionary models for each subset with the model = all function. The Monte Carlo Markov Chain (MCMC) parameter was set as follows: starting with four chains and four separate runs for 20 million generations with a tree sampling frequency of 1000 and a burn in of 25%.

## Anatomical and morphological study

Living animals were killed in boiling water and stored for one day in 80% ethanol. The next day, the ethanol was exchanged and the specimens were stored in the fridge at 5 °C until DNA extraction and dissection. Our experience showed that this procedure maintains the soft tissue and is essential for proper anatomical studies, as well as for the conservation of DNA. The dissection of the snail genitalia took place under a stereomicroscope (Leica MZ12) using thin tweezers and scissors. The genitalia were dissected from the body, spread on a wax bedded bowl, and properly pinned with small needles. The total length of the situs was measured using a calliper (Mitutoyo). Proportions between different parts of the genitalia were estimated using the total situs length as a reference. Additionally, the inner structures of the penis and the epiphallus were investigated. Pictures of the situs were taken with a Leica DFC425 microscope camera using an image-processing program (IMS Client V15Q4, Imagic, Switzerland). The empty shells were imaged using a camera (Canon EOS 50D) in a frontal, lateral, apical, and ventral position. The shell height and shell diameter were measured with perpendicular shell axis with the calliper.

Abbreviations used in the anatomical descriptions and figures:

<b>At</b>	atrium	<b>HD</b>	hermaphroditic duct
<b>AG</b>	albumin gland	<b>MG</b>	mucus glands
<b>AS</b>	atrial stimulator	<b>MRP</b>	musculus retractor penis
<b>BC</b>	bursa copulatrix	<b>PA</b>	penial appendix
<b>BCD</b>	diverticulum of the bursa copulatrix	<b>Pe</b>	penis
<b>D</b>	shell diameter	<b>PF</b>	penial flap
<b>DS</b>	dart sac	<b>PP1</b>	proximal penial papilla
<b>Ep</b>	epiphallus	<b>PP2</b>	distal penial papilla
<b>Fl</b>	flagellum	<b>PS</b>	penis sheath
<b>FO</b>	free oviduct	<b>Va</b>	vagina
<b>H</b>	shell height	<b>VD</b>	vas deferens

## Results

### Phylogenetic results

The RAxML analysis of the concatenated data set (Fig. 2) recovered the genus *Alabastrina* as sister genus to *Siretia* and *Otala*. This node is supported with a ML support value of 90. The species *A. tistutensis* Galindo, 2018 clusters within the five specimens of *A. alabastrites* (Michaud, 1833). The monophyly of *S. pallaryi* (Kobelt, 1909) and *Otala* (and thus the separation of *S. pallaryi* and *Alabastrina*) is highly supported (bootstrap value of 99). The monophyly of *Otala* is not statistically supported (bootstrap value of 61). Within *Otala* we recovered three major clades, i.e., *O. punctata* (OF Müller, 1774), *O. lactea* (OF Müller,

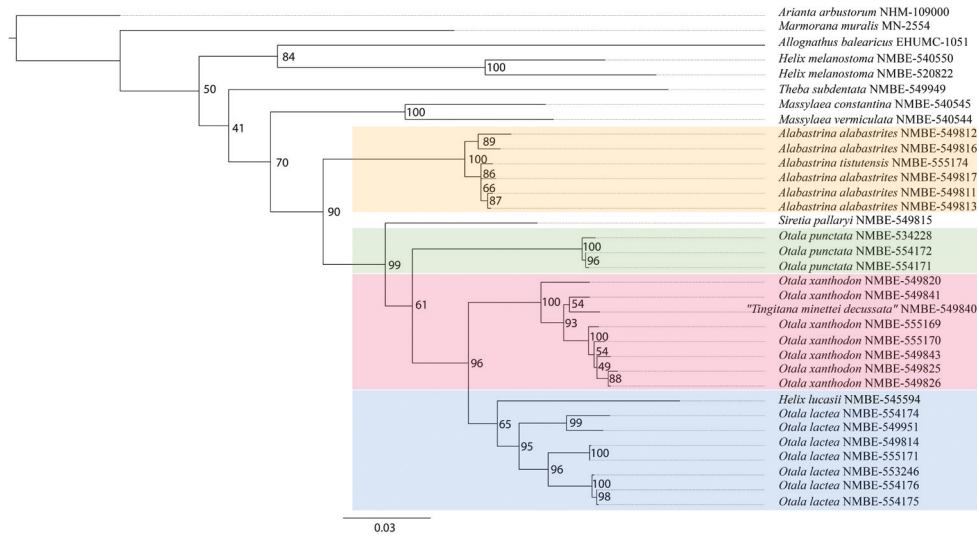

**Figure 2.** Maximum Likelihood (RAxML) tree based on concatenated data set of COI, 16S, H3, and 5.8 S rRNA+ITS2. Numbers represent bootstrap support values from the ML analysis.

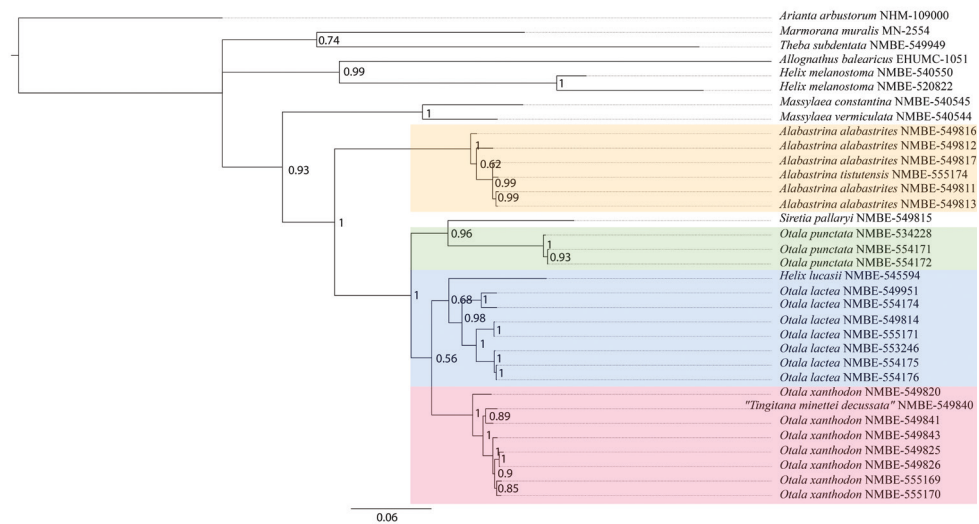

**Figure 3.** Bayesian Inference tree based on concatenated data set of COI, 16S, H3, and 5.8 S rRNA+ITS2. Numbers represent Bayesian posterior probabilities.

1774), and *O. xanthodon* (Anton, 1838). The specimen of "*Tingitana minettei decussata*" (nomen nudum) clusters within the *O. xanthodon* clade. The monophyly of *O. lactea* is not statistically supported (bootstrap value of 65). Within *O. xanthodon* there are some nodes with very low support, especially the node which includes "*Tingitana minettei decussata*" (NMBE 549840). *Otala l. murcica* (Rossmässler, 1854) (NMBE-554175 and NMBE-

554176 in Figs 2, 3) nests within the *O. lactea* clade. Both, the separate mitochondrial and nuclear tree show the same topology as the concatenated tree. They can be found in the supplementary material (Suppl. materials 1, 2).

The Bayesian Inference analysis of the concatenated data set (Fig. 3) recovered the monophyly of *Alabastrina*. This node is statistically supported (posterior probability of 1). The monophyly of *S. pallaryi* and *Otala* and thus the separation of *S. pallaryi* and *Alabastrina* is fully supported. There is no difference in both types of analyses in the *O. lactea* and the *O. xanthodon* clade. The separate mitochondrial and nuclear trees can be found in the supplementary material (Suppl. materials 3, 4).

### Taxonomic accounts

The nomenclature of the parts of the genital organs follows Neubert and Bank (2006) and Neubert (2014). In Table 3, the traits of the genital organs are summarised.

### *Alabastrina* Kobelt, 1904

- 1904 *Alabastrina* Kobelt, in Rossmässler: Iconographie der Land- & Süßwasser-Mollusken, (2) 11: 33, 132, 194 [type species *Helix alabastrites* Michaud, 1833 by OD].
- 1904 *Alabastra* Kobelt, in Rossmässler: Iconographie der Land- & Süßwasser-Mollusken, (2) 11: 100.

Currently, this genus is subdivided in six subgenera (Schileyko 2006). This system is more or less completely based on shell characters and only for a few specimens the morphology of the genital organs has been investigated and published. Schileyko (2006: 1794, fig. 2297B, C) shows the genital organs of *Helix hieroglyphicula* Michaud, 1833, which is the type species of *Michaudia* Pallary, 1926 [by original designation]. In his definition of *Alabastrina* sensu lato, he uses the character state “branches of mucus glands before entering common duct form distinct swellings” (Schileyko 2006: 1792). This interesting trait is not seen in any of the *Alabastrina* species investigated by us. Holyoak and Holyoak (2017: 426, Table 1) relegate *Michaudia* into the synonymy of *Otala*, also based on Schileyko’s figure arguing with the conformity in the structure of

**Table 3.** Traits of genital organs.

	<i>A. alabastrites</i>	<i>A. tistutensis</i>	<i>S. pallaryi</i>	<i>O. lactea</i>	<i>O. punctata</i>	<i>O. xanthodon</i>
relative size of the AS	medium	medium	no data	large	large	large
penial flap	yes	yes	no data	no	no	no
relative size of the Fl	short	short	no data	long	medium	long
relationship BC:BCD	1:1	no data	no data	1.5:2	1:1	1.5:2
no. of penial papillae	1	1	no data	2	1	2
penial appendix	yes	yes	no data	no	no	no

the interior of the proximal penis. The assumption by Schileyko (2006) that *Alabastrina* agrees with *Otala* on the presence of two penial papillae is wrong.

Without further comment, Holyoak and Holyoak (2017) consider *Loxana* Pallary, 1899 a separate genus, follow Razkin et al. (2015) in leaving *Atlasica* Pallary, 1917 as a subgenus of *Alabastrina*, and omit *Lechateliera* Pallary, 1926. Taxon sampling in Razkin et al. (2015) is not sufficient enough to clearly reveal the subgeneric position of *Atlasica*. Based on our anatomical investigation, the genus *Alabastrina* can now be newly characterised using the following traits of the genital organs: Penis with a single penial papilla (PP) with a central pore, distal penis with penial flap (PF), proximal penis with a small penial appendix (PA); epiphallus and flagellum of similar length; mucus glands (MG) multifold, branches very long and slender.

Nomenclatural remark: Kobelt established the names *Alabastra* and *Alabastrina* simultaneously in the register volume of the “Iconographie”. In this work, he presented a register on the “System der palaearktischen Binnenconchylien”, listing a genus group name together with a single species group name (129 ff.). In the second register (171 ff.), he provided a systematically ordered list with information on all taxa ever published in the “Iconographie”, and affiliated these taxa into the new system as outlined before in register 1. Both registers are accompanied by text dealing with zoogeographic considerations and taxonomic remarks.

The name *Alabastra* was used three times exclusively on page 100 (in combination with a species list). The name *Alabastrina* was used on page 33 (zoogeographic context), page 132 (systematic register combined with the species group name *alabastrites*), page 158 (a list of potential members of *Alabastrina* including *alabastrites*), and finally page 194 (amended list of illustrated taxa of *Alabastrina* sensu Kobelt). According to ICZN 24.2.4 we deem Kobelt to act here as First Reviser, because he consequently used the name *Alabastrina* in his registers. We interpret the name *Alabastra* to constitute an erroneous misspelling.

Both genus group names included species lists of differing composition, the name *alabastrites* was always included (loc. cit.). In the first register, the name *Alabastrina* was combined with a single species (p. 132). We consider this act a designation of the type species by the original author (OD); Schileyko’s note on the type species selection (2006: 1792) as “monotypy” is erroneous.

### ***Alabastrina alabastrites* (Michaud, 1833)**

Figs 4–8

1833 *Helix alabastrites* Michaud, Catalogue des testacés vivans envoyés d’Alger par M. Rozet, capitaine au corps royal d’État-Major, au cabinet d’Histoire Naturelle de Strasbourg: 4, figs 6–8 [Oran].

1833 *Helix soluta* Michaud, Catalogue des testacés vivans envoyés d’Alger par M. Rozet, capitaine au corps royal d’État-Major, au cabinet d’Histoire Naturelle de Strasbourg: 3, figs 9, 10 [Oran].



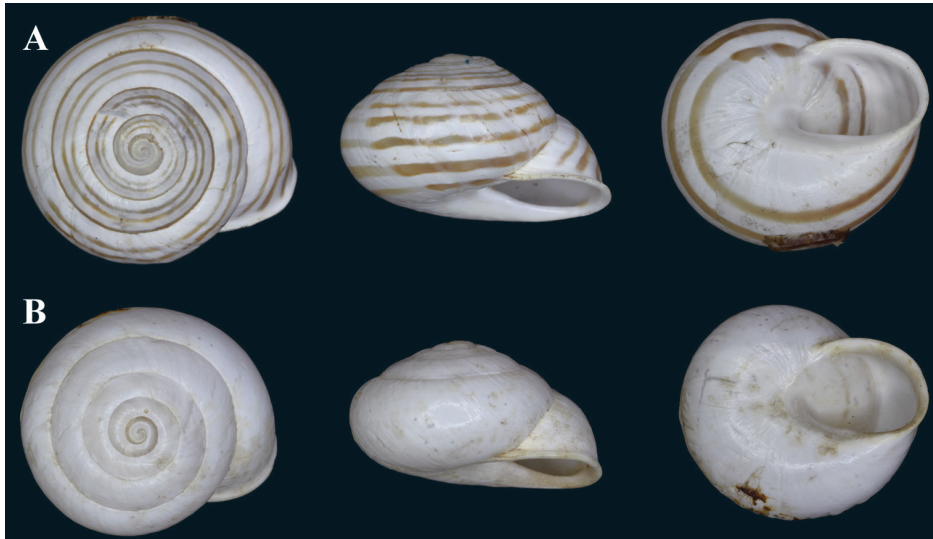

**Figure 4.** *Alabastrina* type specimens. **A** *Helix soluta*, syntype MHNL 45000679, Oran, Algeria, coll. Michaud, D = 24.15 mm **B** *Helix alabastrites*, syntype MHNL 45000690, Oran, Algeria, coll. Michaud, D = 22.48 mm. All photographs by Kneubühler & Neubert, × 1.5.

Type specimens: *Helix alabastrites*: syntype MHNL 45000690; *Helix soluta*: syntype MHNL 45000679.

Specimens examined: for sequenced specimens, see Table 1.

**Description.** The range of the shell diameter of the investigated specimens is between 14.93–22.77 mm and shell height is between 10.85–13.45 mm. The shell of this species is pale and often with dark brown stripes. Some individuals do not show any stripes at all (Figs 4B, 6A). There is none to one tooth found in the aperture.

This species has a rather short flagellum which is a bit shorter than the penis. MG are thin and fragile. The epiphallus goes over into the penial lumen without any penial papilla. Parallel but outside of the epiphallus is a penial appendix found. This penial appendix lies next to the epiphallus and is also covered by the penial sheath. It is blind on one side and opens into the penial lumen on the other side (PA in Fig. 5C, D). From there a huge penial papilla (PP) points towards the atrium. The PP is surrounded by massive muscles. In the atrium is a large atrial stimulator found and a smaller is located at the exit of the penis (PF).

### *Alabastrina tistutensis* Galindo, 2018

2018 *Alabastrina tistutensis* Galindo, Mostra mondiale, Cupra Marittima (2): 22–26.

Type specimen: *Alabastrina tistutensis*: holotype MMM Cupra Marittima (2): 23.

Specimens examined: for sequenced specimen, see Table 1.

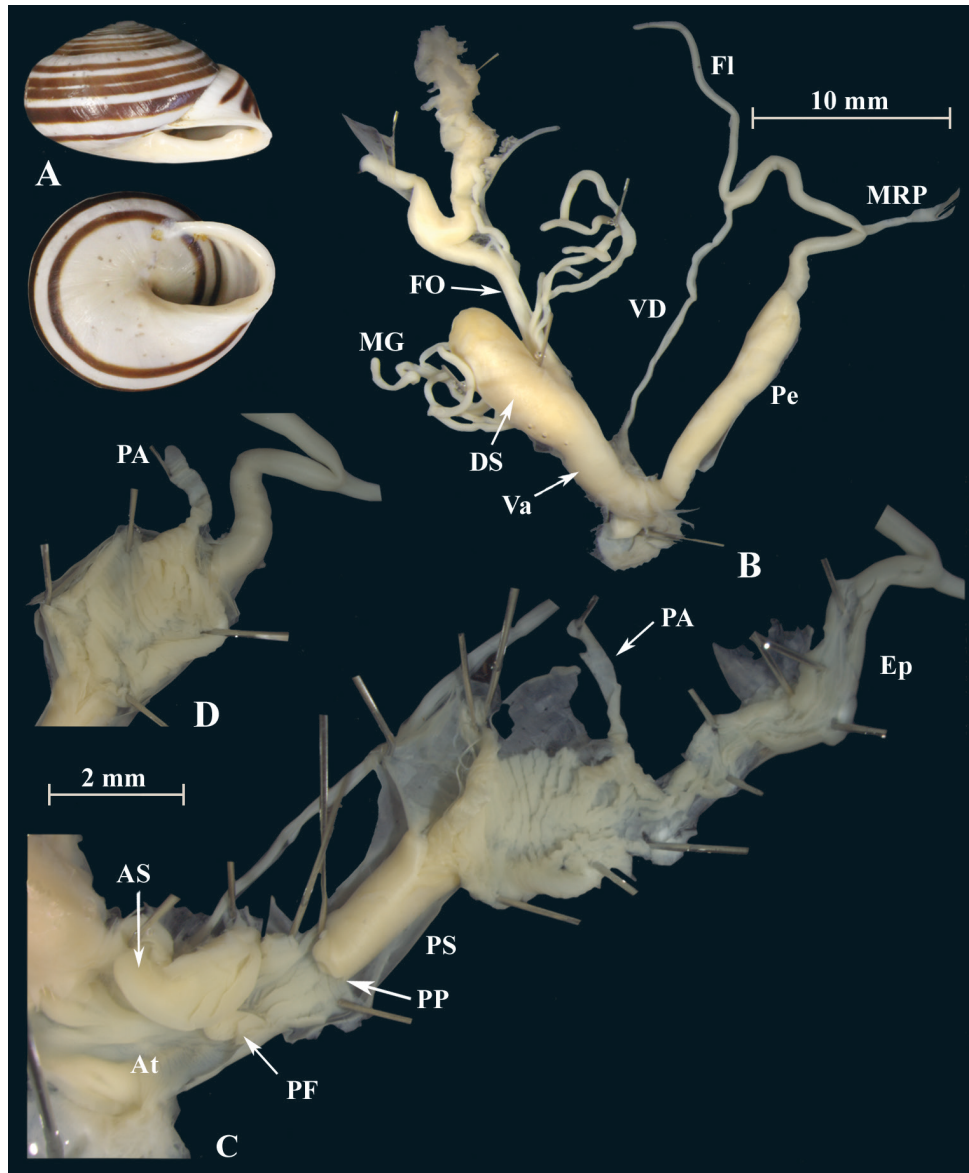

**Figure 5.** *Alabastrina alabastrites* (NMBE 549817), Kibdana Mountain, Morocco; **A** shell **B** situs **C** penis **D** penial lumen; D = 21.91 mm, H = 13.36 mm, situs length 27.57 mm (atrium-flagellum). All photographs by Kneubühler, shell  $\times 1.5$ .

**Description.** The shell is pale and characterised by a sharp keel. The aperture is white with a white lip. The mucus glands (MG) are fragile and slender. The flagellum is slightly shorter than the penis. The epiphallus is characterised by longitudinal tissue ridges and goes over into the penial lumen without any penial papilla. Parallel but outside of the epiphallus is a penial appendix found (PA in Fig. 9C). It is together with the epiphal-

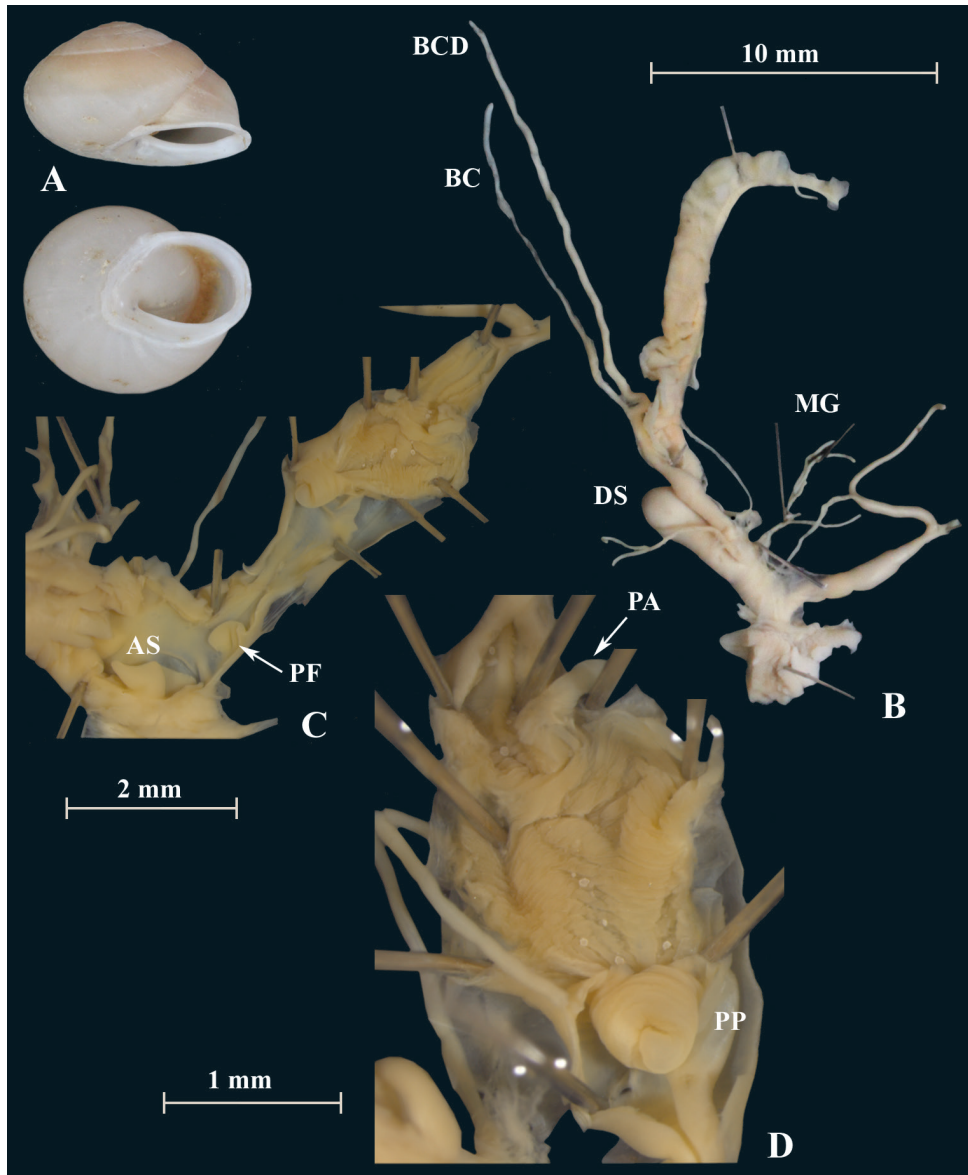

**Figure 6.** *Alabastrina alabastrites* (NMBE 549812), cave Ifri n'Ammar, Morocco; **A** shell **B** situs **C** penis **D** penial lumen; D = 19.72 mm, H = 13.00 mm, situs length 26.27 mm (atrium-BCD). BC lost during dissection. All photographs by Kneubühler, shell  $\times 1.5$ .

lus covered by the penial sheath. The PA is blind on one side and the other side opens into the penial lumen. This species possesses one penial papilla (PP in Fig. 9C) which is slightly smaller than in *A. alabastrites* but it is clearly visible. A large atrial stimulator is found in the atrium and a smaller stimulator is situated in front of the exit of the penis.

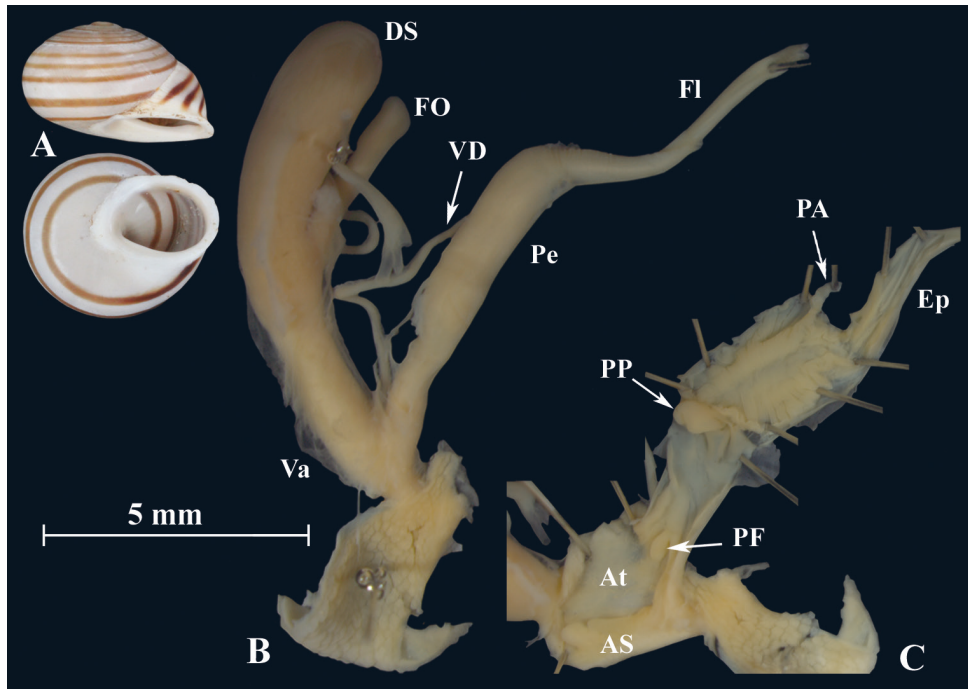

**Figure 7.** *Alabastrina alabastrites* (NMBE 549813), hills El Batel, Morocco; **A** shell **B** situs **C** penis; D = 17.25 mm, H = 10.85 mm, situs length 13.46 mm (atrium-flagellum). Situs is not complete. All photographs by Kneubühler, shell  $\times 1.5$ .

### *Siretia* Pallary, 1926

1926 *Siretia* Pallary, Journal de Conchyliologie, 70: 19.

This genus is characterised by a triangular, toothless aperture, the short upper edge of the shell, its flat form, and by having four dark bands (Pallary 1926). Although *Siretia* has a peculiar shell morphology, Schileyko (2006) considers it as a subgenus of *Alabastrina*. Our phylogenetic analyses reveal it as a separate genus.

### *Siretia pallaryi* (Kobelt, 1909)

Figure 10

1909 *Archelix pallaryi* Kobelt, Nachrichtenblatt der Deutschen Malakozoologischen Gesellschaft, 41 (3): 134 [Tafel im Gebiet der Beni Snassen].

1914 *Archelix pallaryi*, – Kobelt: in Rossmässler: Iconographie der Europäischen Land- & Süßwasser-Mollusken (2) 20: 21, fig. 2790.

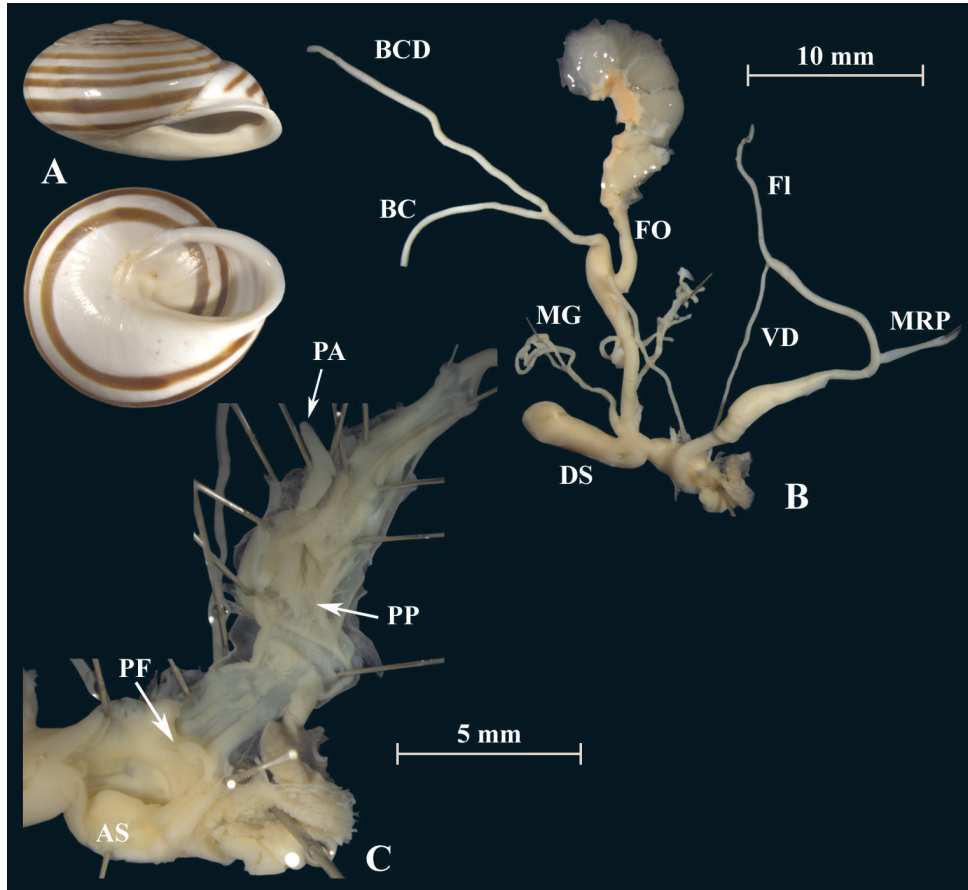

**Figure 8.** *Alabastrina alabastrites* (NMBE 549816), Etsedda/ Kebdana, Morocco; **A** shell **B** situs **C** penis; D = 22.77 mm, H = 13.45 mm, situs length 36.84 mm (atrium-BCD). BC destroyed. All photographs by Kneubühler, shell  $\times 1.5$ .

1926 *Siretia pallaryi*, Journal de Conchyliologie, 70: 19, figs 5, 6, 8.

Type specimen: *Siretia pallaryi*: syntype SMF 75926.

Specimens examined: for sequenced specimen, see Table 1.

**Description.** In Figure 10B, a syntype of *S. pallaryi* from Teforalt (= Taforalt), Morocco (coll. CR Boettger ex Kobelt) is shown. The type specimen is slightly larger than our investigated specimen (Fig. 10A). Both show similar shell morphology and stripe pattern. Unfortunately, our specimen was badly preserved and a juvenile, therefore no proper investigation of the genital organs could be made.

**Remarks.** Holyoak and Holyoak (2017: 446) attribute this species to A Koch. However, in the description Kobelt explicitly mentions “Koch mss”. Therefore, Kobelt is considered the nomenclatural author of this taxon.



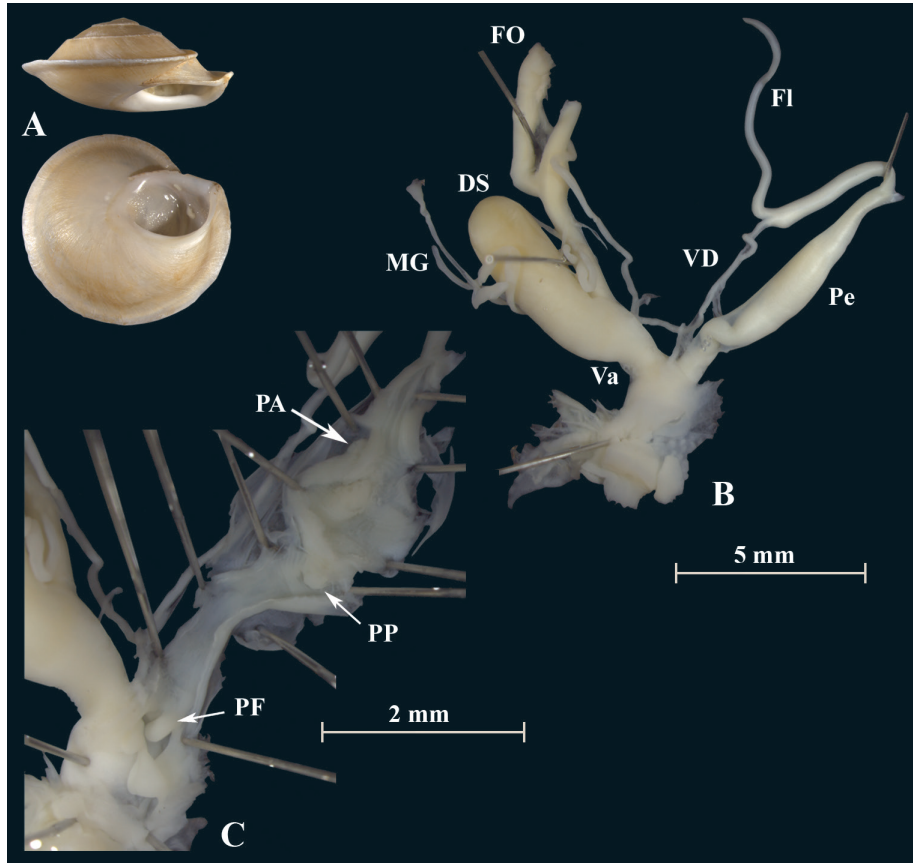

**Figure 9.** *Alabastrina tistutensis* (NMBE 555174), Tiztoutine, Morocco; **A** shell **B** situs **C** penis; D = 19.59 mm, H = 8.74 mm, situs length 13.51 mm (atrium-flagellum). Situs not complete. All photographs by Kneubühler, shell  $\times 1.5$ .



**Figure 10.** **A** *Siretia pallaryi* (NMBE 549815), Kebdana Mountain, Morocco, D = 16.82 mm, H = 8.81 mm; **B** *S. pallaryi* (SMF 75926), Teforalt (= Taforalt), Morocco, coll. CR Boettger, D = 19.38 mm. All photographs by Kneubühler & Neubert,  $\times 1.5$ .



***Otala* Schumacher, 1817**

- 1817 *Otala* Schumacher, Essai d'un nouveau système des habitations des vers testacés: 58, 191 [type species *Helix lactea* OF Müller, 1774, by subsequent designation Pilsbry, 1895: 323].
- 1904 *Otala* (*Dupotetia*) Kobelt: in Rossmässler: Iconographie der Europäischen Land- & Süßwasser-Mollusken (2) 11: 158 [type species *Helix dupotetiana* Terver, 1839 by original designation].
- 1918 *Alabastrina* (*Tingitana*) Pallary, Bulletin de la Société d' Histoire naturelle de l'Afrique du Nord, 9 (7): 145 [type species *Archelix minettei* Pallary, 1917 by monotypy].

This genus was recently revised by Holyoak and Holyoak (2017). After examining several hundreds of specimens from Morocco and Algeria, they distinguish five species within the genus *Otala*, i.e., *O. punctata*, *O. lactea*, *O. xanthodon*, *O. tingitana* (Paladilhe, 1875), and *O. hieroglyphicula* (Michaud, 1833). The species formerly attributed to *Tingitana* Pallary, 1918, and *Dupotetia* Kobelt, 1904 (genera which appeared to have species in the area of the Kebbana) are now lumped under *Otala tingitana*. This lumping approach is supported by the molecular study of Helicoidea by Razkin (2015), who revealed that the genus *Tingitana* is nested within *Otala*. In our phylogenetic analysis we included a specimen of the well-known shell form "*Tingitana minettei decussata*", which clustered within the *O. xanthodon* clade thus supporting the results of Razkin (2015) and Holyoak and Holyoak (2017). More taxon sampling is needed to reveal the phylogenetic relationships within *Otala*.

***Otala lactea* (OF Müller, 1774)**

Figs 11–16

Type specimens: *Helix lucasii*: MNHN IM-2000-31721.

Specimens examined: for sequenced specimens, see Table 1.

**Description.** The shell of *O. lactea* is characterized by a dark aperture. The shell diameter of the investigated specimens ranges between 27.01–40.81 mm and shell height between 15.77–21.75 mm. This species has a large and thick penial tube. It has two distinct penial papillae with each a large central pore. The distal penial lumen between the large tongue-shaped atrial stimulator and the distal penial papilla (PP2) exhibits longitudinal ridges. The distal penial papilla is located ca. 2 mm distally to the atrium. The penial chamber which is bordered by the two penial papillae ranges between 2–4 mm and is characterised by strong annular tissue folds. There is a short transformation zone between the proximal penial papilla (PP1) and the epiphallus. The epiphallus is characterised by longitudinal tissue ridges. The flagellum is ca. 1.5× the length of the penis. The BCD is ca. double in length as the BC, except for the specimen in Figure 13, where they are approximately the same length. The vagina

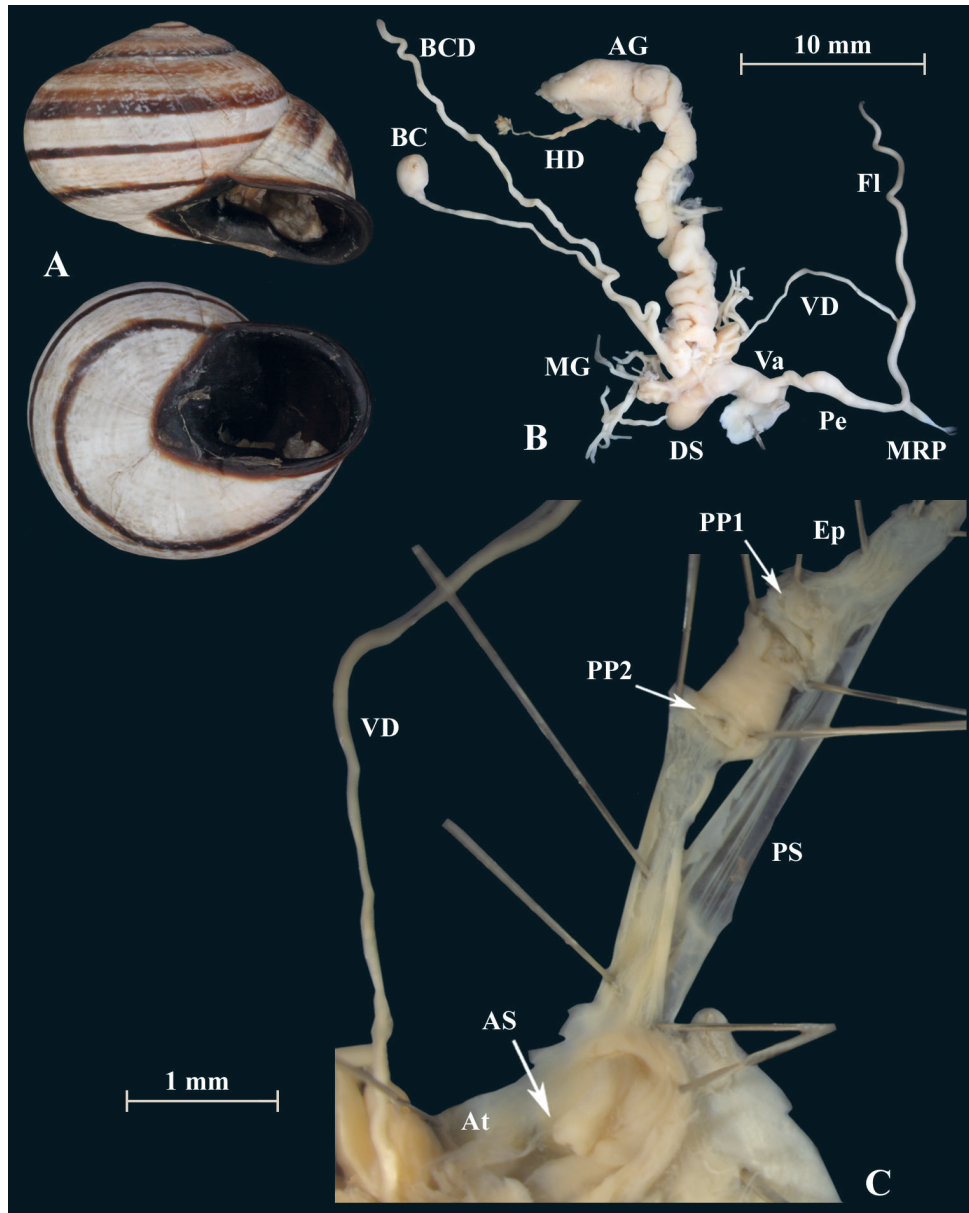

**Figure 11.** *Otala lactea* (NMBE 553246), W Almocageme, Portugal; **A** shell **B** situs **C** penis and atrium; D = 29.82 mm, H = 18.71 mm, situs length 41.34 mm (atrium-BCD). All photographs by Kneubühler, shell  $\times$  1.5.

is stout and short. The MG consist of two massive stems which subdivide into ten smaller branches.

**Remarks.** The analysis includes also specimens of *O. l. murcica* (Fig. 15) from Almería, Spain, which is the type locality. This taxon is characterised by a larger shell and an aperture, which is enlarged and more reflected (Cadevall and Orozco 2016).

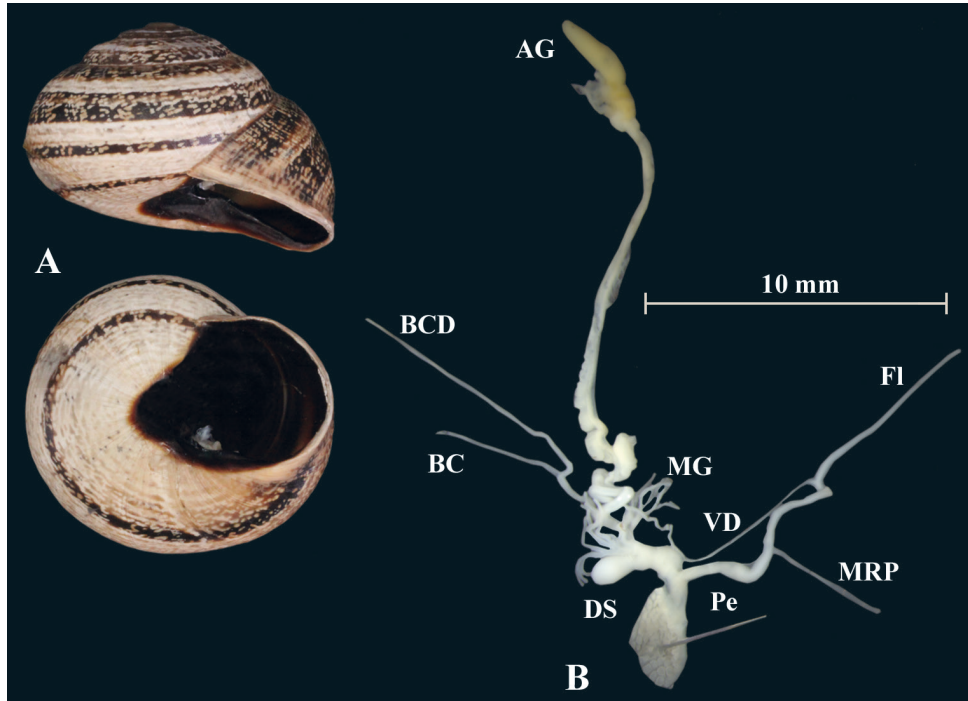

**Figure 12.** *Otala lactea* (NMBE 554174), N Málaga, Spain; **A** shell **B** situs; D = 27.25 mm, H = 18.60 mm, situs length 22.90 mm (atrium-albumin gland); juvenile, BC destroyed. All photographs by Kneubühler, shell  $\times 1.5$ .

The morphology of the genital organs shows no difference to the specimens of *O. lactea* investigated from Portugal or Morocco.

In a small area in north-eastern Morocco, another form of *O. lactea* occurs, namely *Helix lucasii* (Fig. 16D). Our investigation of a specimen from this population revealed some differences in the anatomy of the genital organs (Fig. 16C). The penial chamber is much longer than in the other specimens of *O. lactea*. The length of the penial chamber (PP1-PP2) is 4 mm and the length of the distal penial lumen (PP2-AS) is 1.8 mm. The internal structures differ substantially. Here, the inner walls of this tube are filled by numerous fine transverse ridges arranged in a very dense annular pattern. All other specimens seen so far displayed an irregular network of tissue folds in this section of the penis. Additionally the shell is quite large and flat with a comparatively strong basal tooth or strengthened lip.

### ***Otala punctata* (OF Müller, 1774)**

Figs 17, 18

Specimens examined: for sequenced specimens, see Table 1.

**Description.** The shell is characterized by a white lip and a basal tooth. This species is characterized by a long and thick penial tube. It has a large penial papilla (PP),

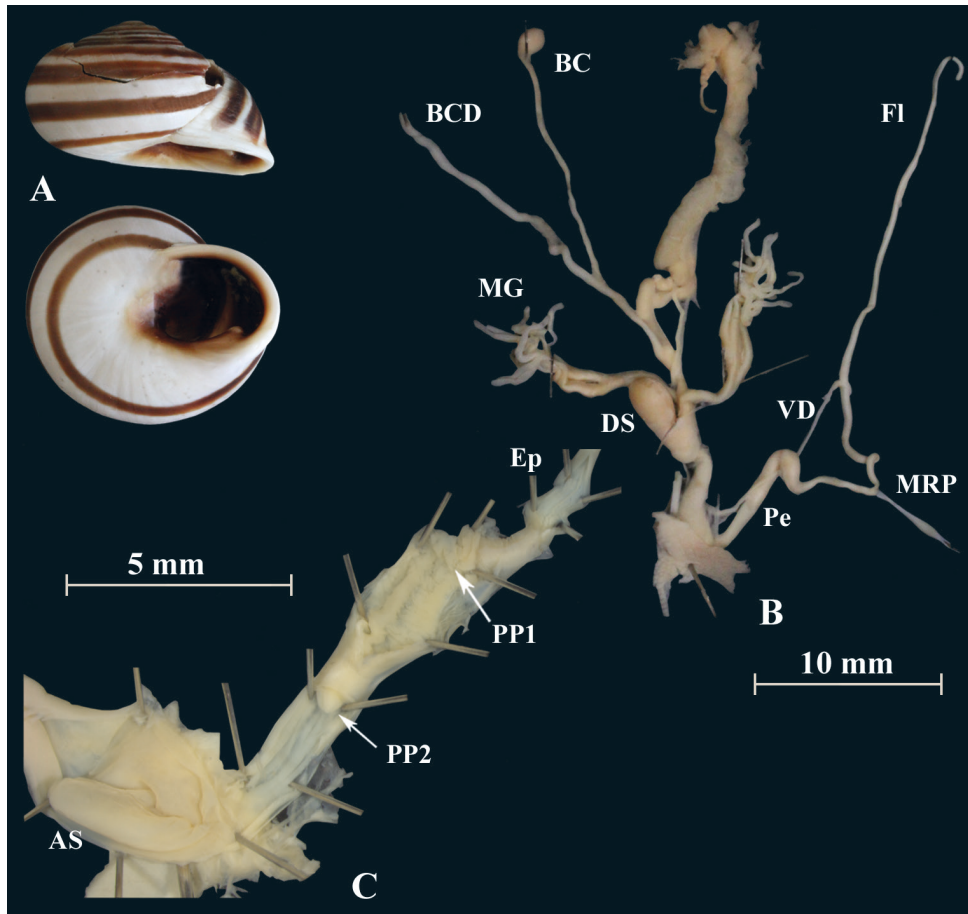

**Figure 13.** *Orala lactea* (NMBE 555171), Hassi Ouenzga/ Oriental, Morocco; **A** shell **B** situs **C** penis and atrium; D = 22.63 mm, H = 14.85 mm, situs length 34.60 mm (atrium-flagellum). All photographs by Kneubühler, shell  $\times 1.5$ .

which is located ca. 2 mm distally to the atrium (Figs 17, 18) with a large central pore. The second proximal penial papilla is reduced and inconspicuous. The distal penial lumen between the atrial stimulator and the penial papilla exhibits a few low longitudinal ridges intersected by many small annular folds. The proximal lumen between penial papilla and epiphallus is filled by a network of irregularly shaped folds and small and large ridges. The epiphallus is characterised by longitudinal tissue ridges with a small transformation zone at the proximal end of the penial lumen. The flagellum has approximately the same length as the penis. The vagina is short and stout. The mucus glands (MG) consist of two massive stems which subdivide into 10–12 smaller subsequent branches. The BCD has approximately the same length as the BC. They are ca.  $3\times$  the length of the flagellum and the penis. The dominant

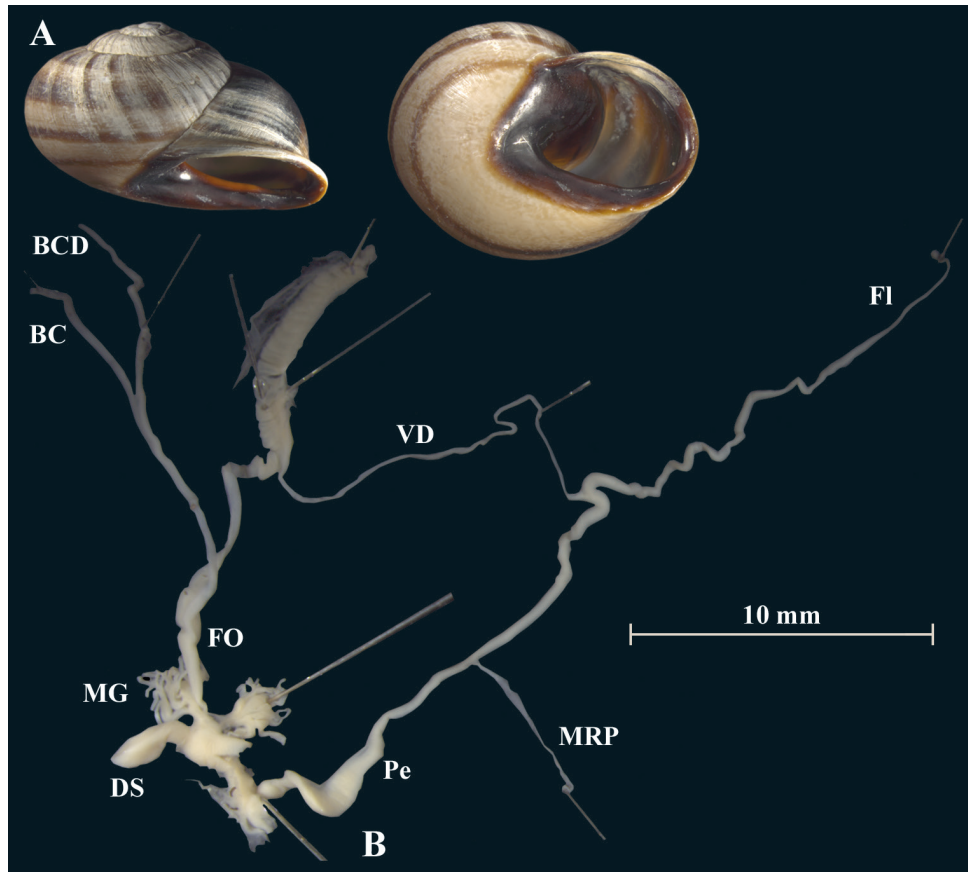

**Figure 14.** *Otala lactea* (NMBE 549951), W Aoulouz, Morocco; **A** shell **B** situs; D = 27.01 mm, H = 15.77 mm, situs length 30.77 mm (atrium-flagellum); juvenile; situs not complete; BC destroyed. All photographs by Kneubühler, shell  $\times 1.5$ .

structure in the atrium is a large, folded stimulator, which was also mentioned by De Mattia and Mascia (2011).

#### *Otala xanthodon* (Anton, 1838)

Figs 19–23

Specimens examined: for sequenced specimens, see Table 1.

**Description.** The shell is characterized by a dark aperture with a white and strongly reverted lip. This species possesses one basal tooth. A palatal tooth is found in some specimens. The shell diameters of the investigated specimens range between 21.47–

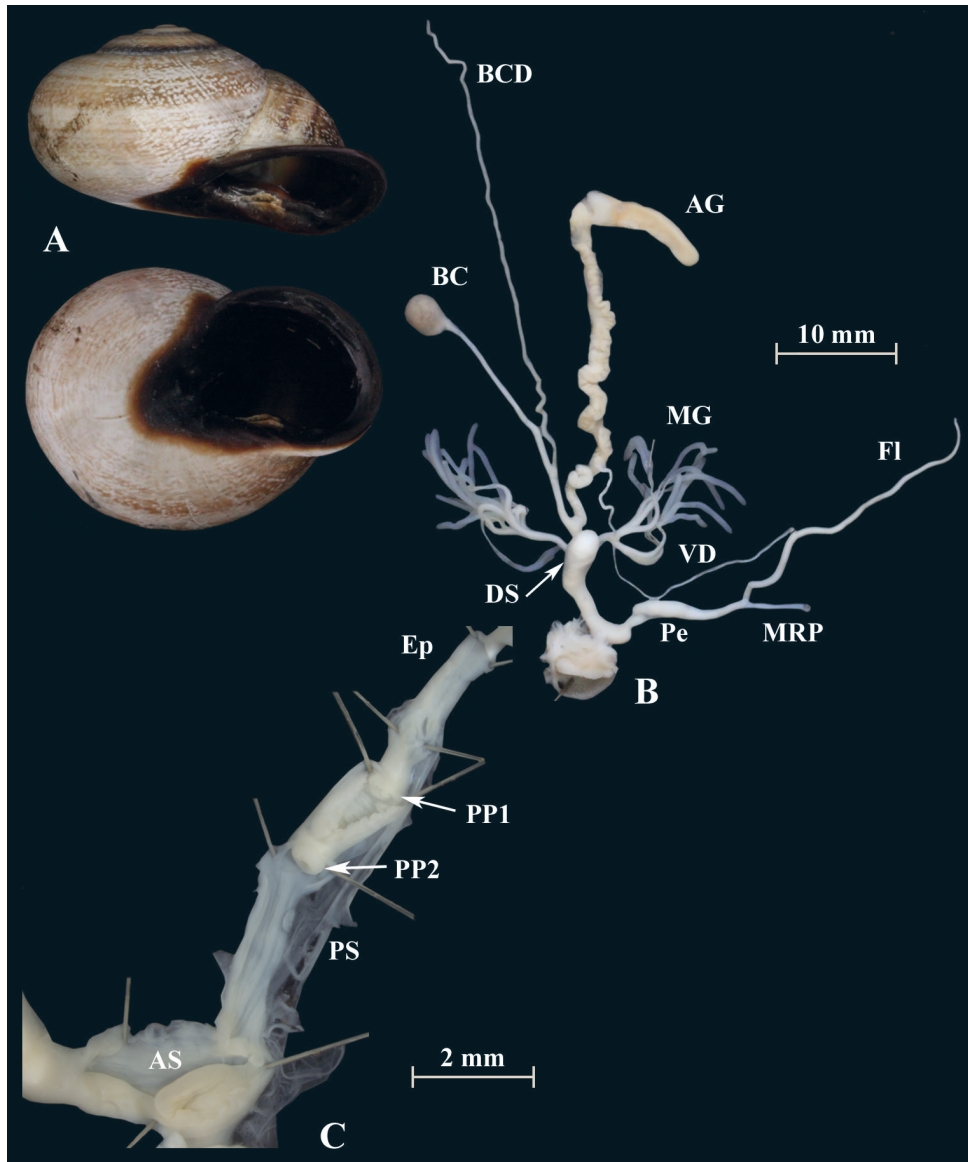

**Figure 15.** *Otala lactea* (NMBE 554175), W Almería, Spain; **A** shell **B** situs **C** penis and atrium; D = 31.89 mm, H = 18.23 mm, situs length 57.86 mm (atrium-BCD). All photographs by Kneubühler, shell  $\times 1.5$ .

27.77 mm and shell height between 13.37–16.04 mm. *Otala xanthodon* has two distinct penial papillae with each a large central pore. The distal penial lumen between the atrial stimulator and the distal penial papilla (PP2) exhibits smooth longitudinal tissue ridges. The penial chamber which is bordered by the two penial papillae is filled by a network of irregularly shaped tissue folds and is ca. 3 mm long. There is a short



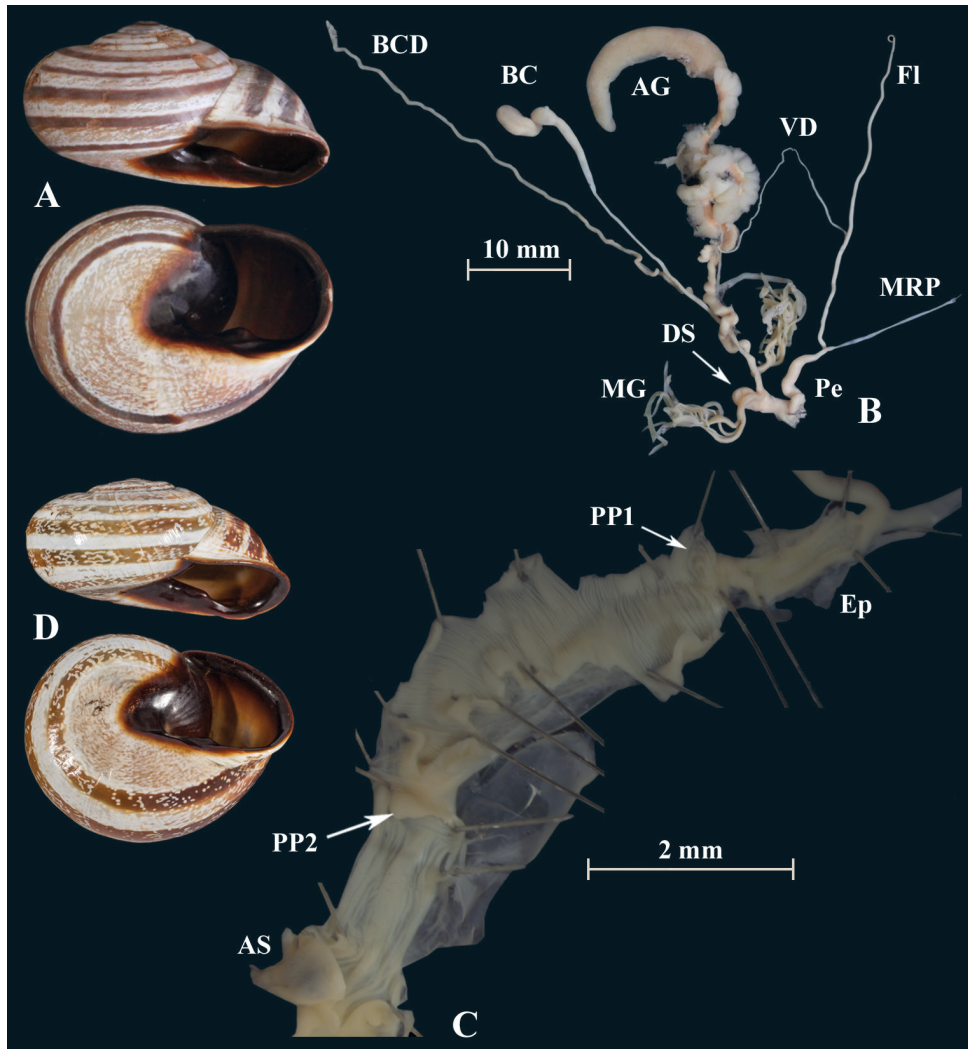

**Figure 16.** *Otala lactea* (NMBE 545594); Etsedda/Kebdana, Morocco; **A** shell **B** situs **C** penis; D = 40.81 mm, H = 21.75 mm, situs length 61.47 mm (atrium-BCD), BC destroyed; **D** *H. lucasii* (syntype MNHN IM-2000-31721), Oran, Algeria, D = 35.4 mm. All photographs by Kneubühler & Neubert, shell original size.

transformation zone between the proximal penial papilla (PP1) and the epiphallus. The epiphallus contains few smooth longitudinal ridges. This species has a large flagellum which is ca. double the length of the penis. The BC is a thin tube and ca. half the length of the BCD. It has two massive mucus glands (MG) which subdivide in four thinner branches of which each again subdivides in two thin branches. The dominant structure in the atrium is a large tongue-shaped stimulator.

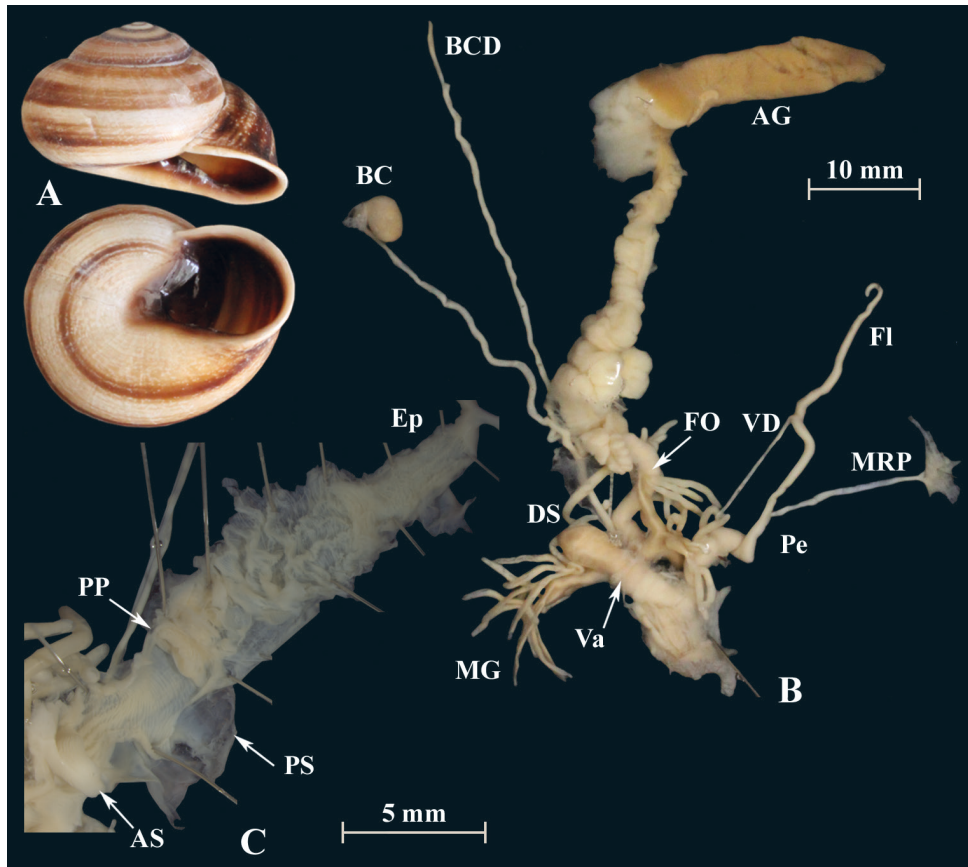

**Figure 17.** *Otala punctata* (NMBE 534228); Makouda, Algeria; **A** shell **B** situs **C** penis; D = 36.02 mm, H = 22.37 mm, situs length 59.77 mm (atrium-BCD). All photographs by Kneubühler, shell original size

**“*Tingitana minettei decussata*”**

Figs 24, 25

Specimens examined: *Otala tingitana* (NMBE 510549); for the sequenced specimen of “*Tingitana minettei decussata*” NMBE 549840, see Table 1.

**Nomenclatorial note:** The name “*decussata* Pallary” is a nomen nudum as already stated by Holyoak and Holyoak (2017: 463). Pallary never made the name available, nor did Llabador (1952). For the latter publication, the provisions of Article 13 ICZN (names published after 1930) rule that every new name must “be accompanied by a description or definition that states in words characters that are purported to differentiate the taxon” or Article 13.1.2. “be accompanied by a bibliographic reference to such a published statement”. No such statements are provided by Llabador. This taxon is well known and often treated as a subspecies of *Tingitana minettei* (Pallary, 1917) (see for example Cossignani 2014). The genus *Tingitana* Pallary, 1918 is synonymised with *Otala* by Holyoak and Holyoak (2017).

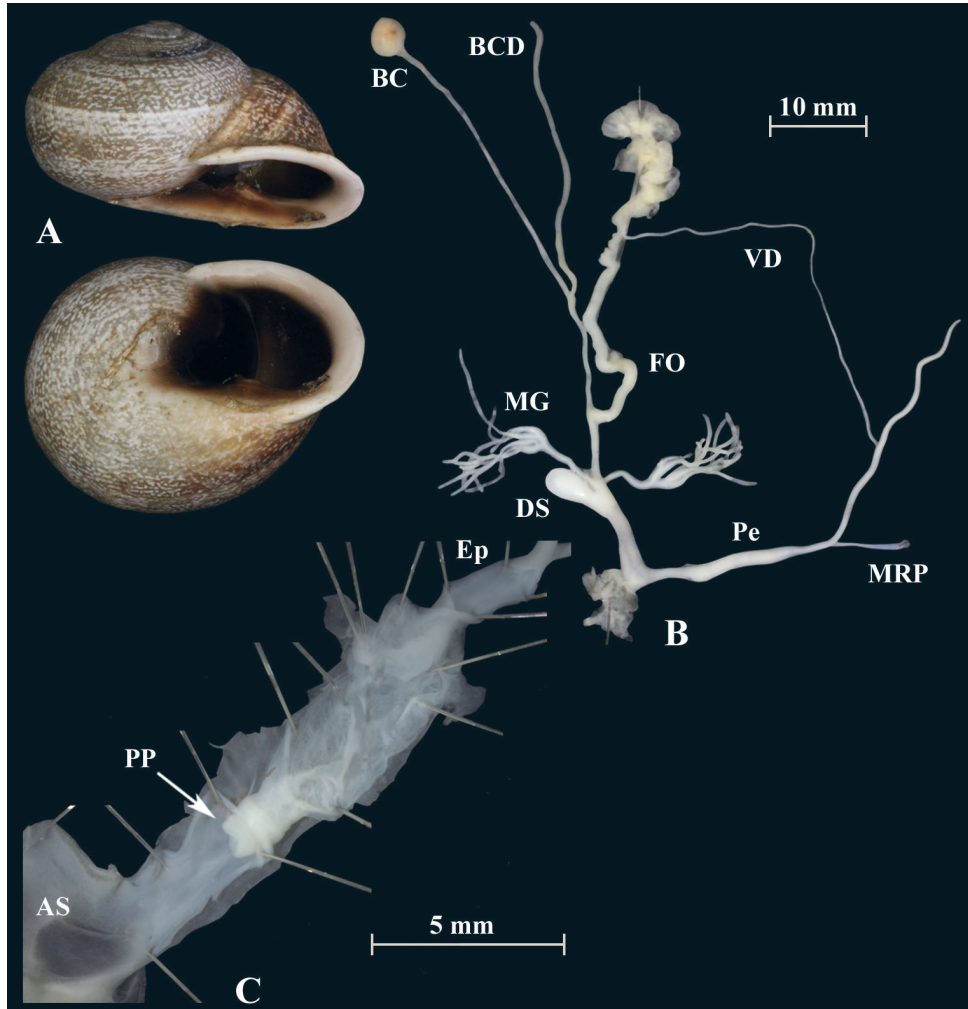

**Figure 18.** *Otala punctata* (NMBE 554171); W Málaga, Spain; **A** shell **B** situs **C** penis; D = 30.30 mm, H = 18.05 mm, situs length 70.10 mm (atrium-BC). All photographs by Kneubühler, shell  $\times 1.5$ .

**Description.** The shells of “*decussata*” are flat and have a sharply keeled last whorl. The aperture is oval and dark brown inside with a white lip and a strong basal tooth. “*Tingitana minettei decussata*” has a network-like sculpture on its surface (Fig. 25). This is in contrast to *Otala tingitana* with a rather smooth surface and a few weakly developed radial ribs. In this species, the interior of the aperture is brighter and the basal tooth conspicuously smaller. Typically, *O. xanthodon* has a smooth shell with evenly rounded whorls and up to three apertural denticles.

The genital organs of “*decussata*” are characterised by two distinct penial papillae, each with a central pore. The distal penial lumen between the atrial stimulator and the distal penial papilla (PP2) is characterised by a network of irregularly shaped folds with

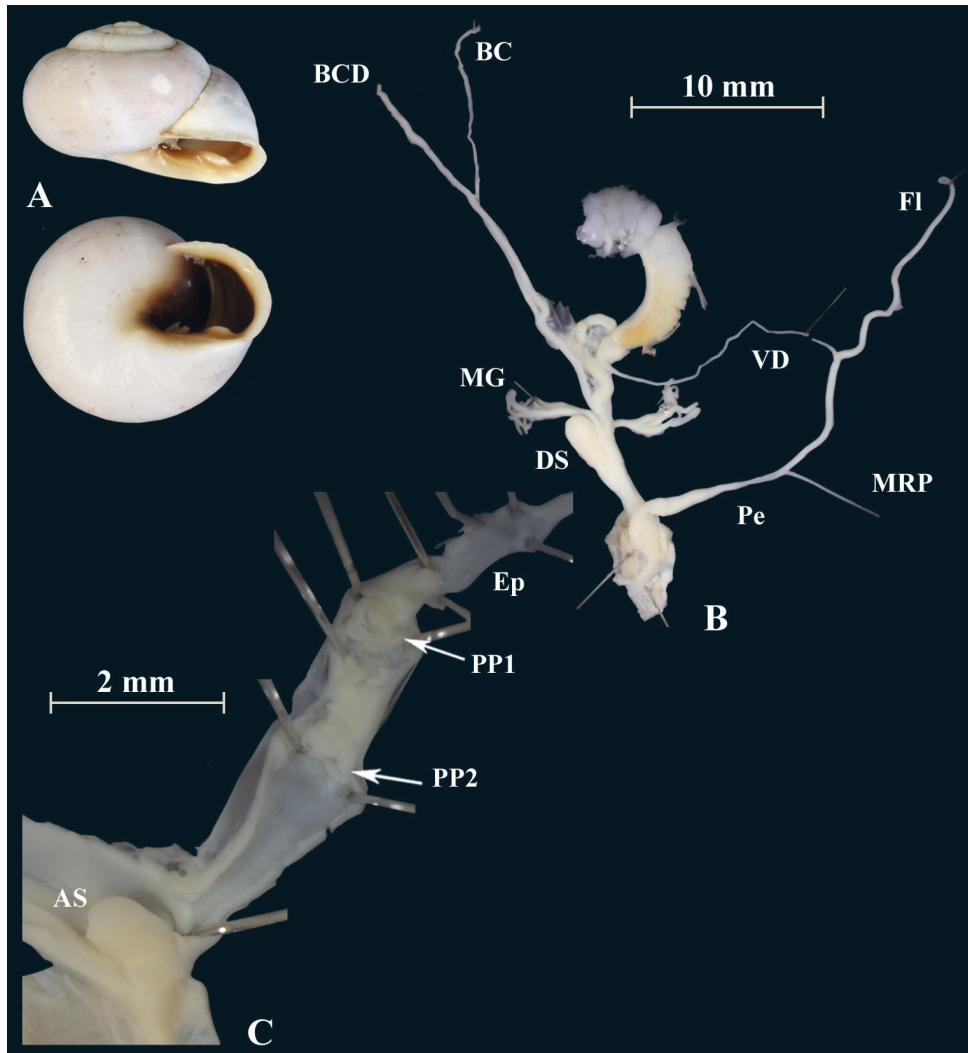

**Figure 19.** *Otala xanthodon* (NMBE 549825), Moulouya, Morocco; **A** shell **B** situs **C** atrium and penis; D = 23.13 mm, H = 14.49 mm, situs length 32.68 mm (atrium-BCD). BC destroyed. All photographs by Kneubühler, shell  $\times 1.5$ .

large and small ridges. The penial chamber exhibits many annular tissue folds and is ca. 3 mm long. Between the proximal penial papilla (PP1) and the epiphallus is a short transformation zone. The epiphallus is characterised by two strong and several smooth longitudinal ridges. The mucus glands consist of two massive stems which subdivide into several thinner branches which again become thinner in the second half. The dominant structure in the atrium is a large tongue-shaped stimulator. There are almost no differences in the inner and outer morphology of the genital organs of “*decussata*” and *O. xanthodon* specimens.

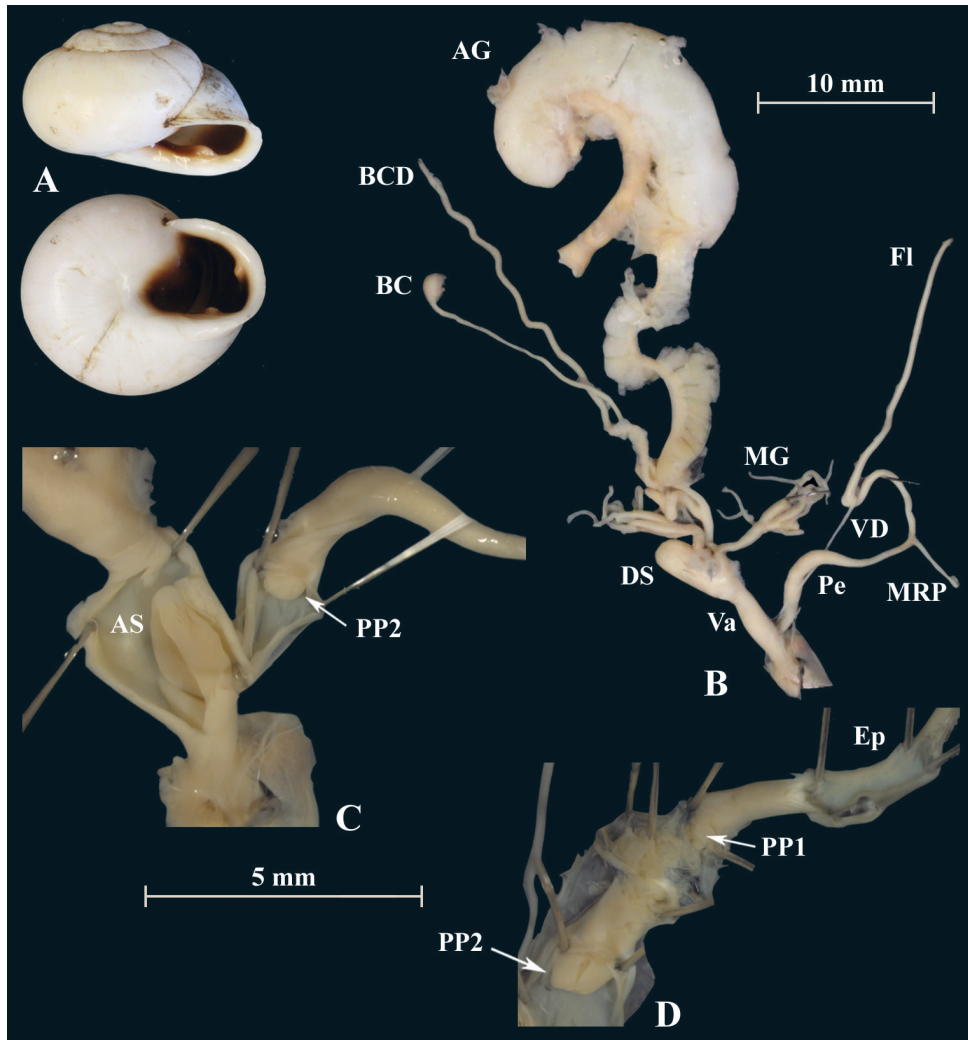

**Figure 20.** *Otala xanthodon* (NMBE 549826), Moulouya, Morocco; **A** shell **B** situs **C** atrium and PP2 **D** penial chamber; D = 21.47 mm, H = 14.22 mm, situs length 37.23 mm (atrium-BCD). All photographs by Kneubühler, shell  $\times 1.5$ .

**Remarks.** According to field observations by R Hutterer, this particular taxon does only occur on top of one mountain in the Kebdana range; comparison with similar specimens illustrated by Cossignani (2014: 109) from Ras el Ma and Tazouta is pending. The distribution area of *O. tingitana/minettei* is far and separated by lowlands, so a position of this taxon as a species in its own right is highly probable. However, as long as topotypic specimens of *O. tingitana* are missing in the genetic analysis, the exact taxonomic position of “*decussata* Pallary” remains unclear. Our results signal a position within or close to *O. xanthodon* rather than to *O. tingitana*.



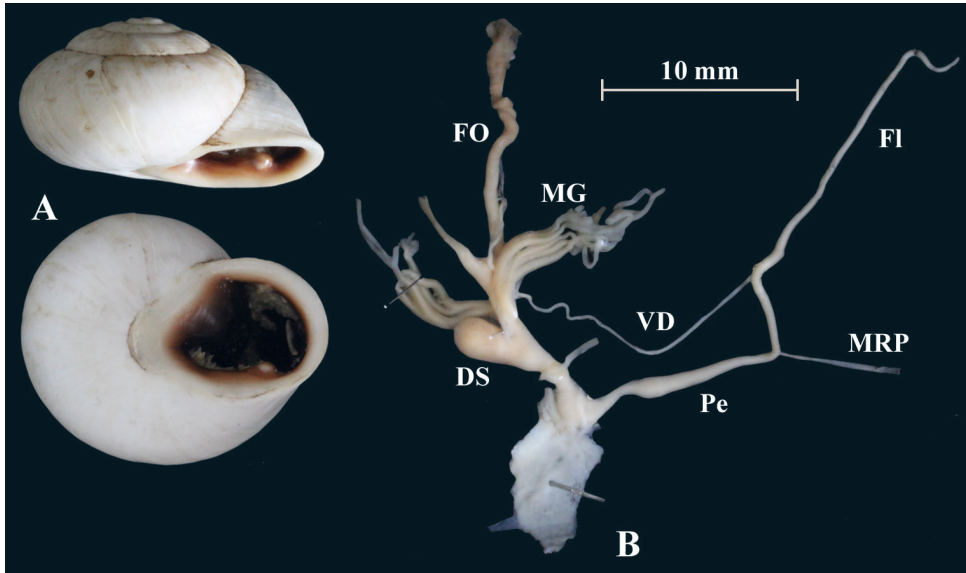
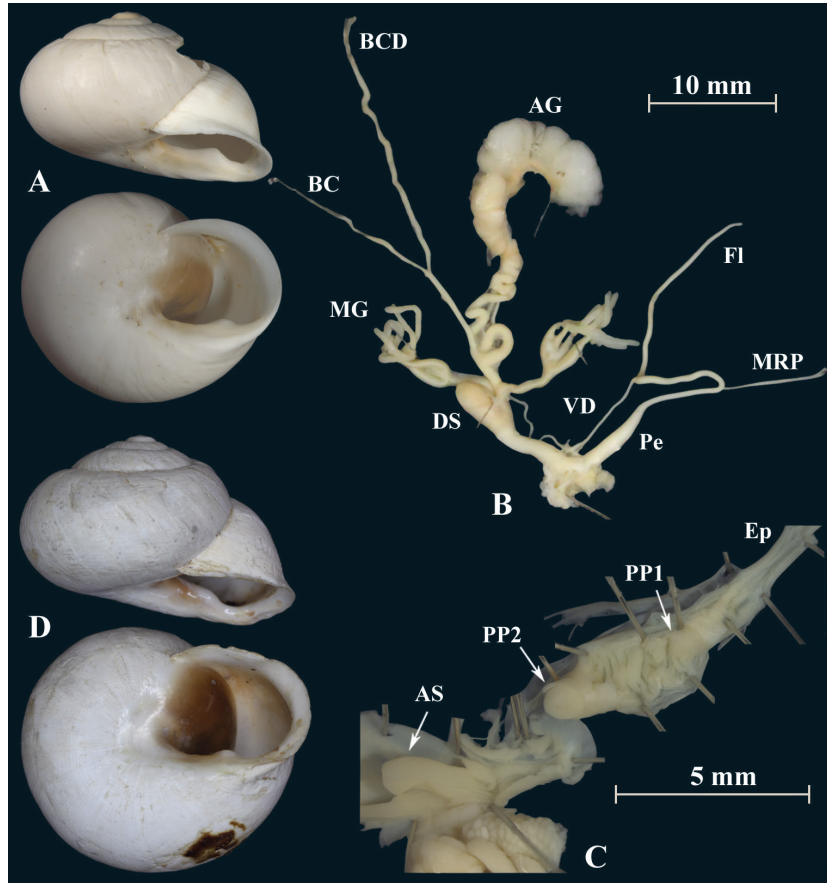

**Figure 21.** *Otala xanthodon* (NMBE 549841), Kebdana Mountain, Morocco; **A** shell **B** situs; D = 26.85 mm, H = 15.74 mm, situs length 33.58 mm (atrium-flagellum). Situs not complete. All photographs by Kneubühler, shell  $\times 1.5$ .



**Figure 22.** *Otala xanthodon*, Kebdana, Moulouya valley, Morocco; **A** shell from *O. xanthodon* (NMBE 555169), D = 22.33 mm, H = 13.61 mm; **B** shell from *O. xanthodon* (NMBE 555170), D = 23.10 mm, H = 13.37 mm. Kebdana, Djebel Sebaa Reyal/ Rif **C** shell from *O. xanthodon* (NMBE 549843), D = 27.77 mm, H = 16.04 mm. All photographs by Kneubühler, shell  $\times 1.5$ .

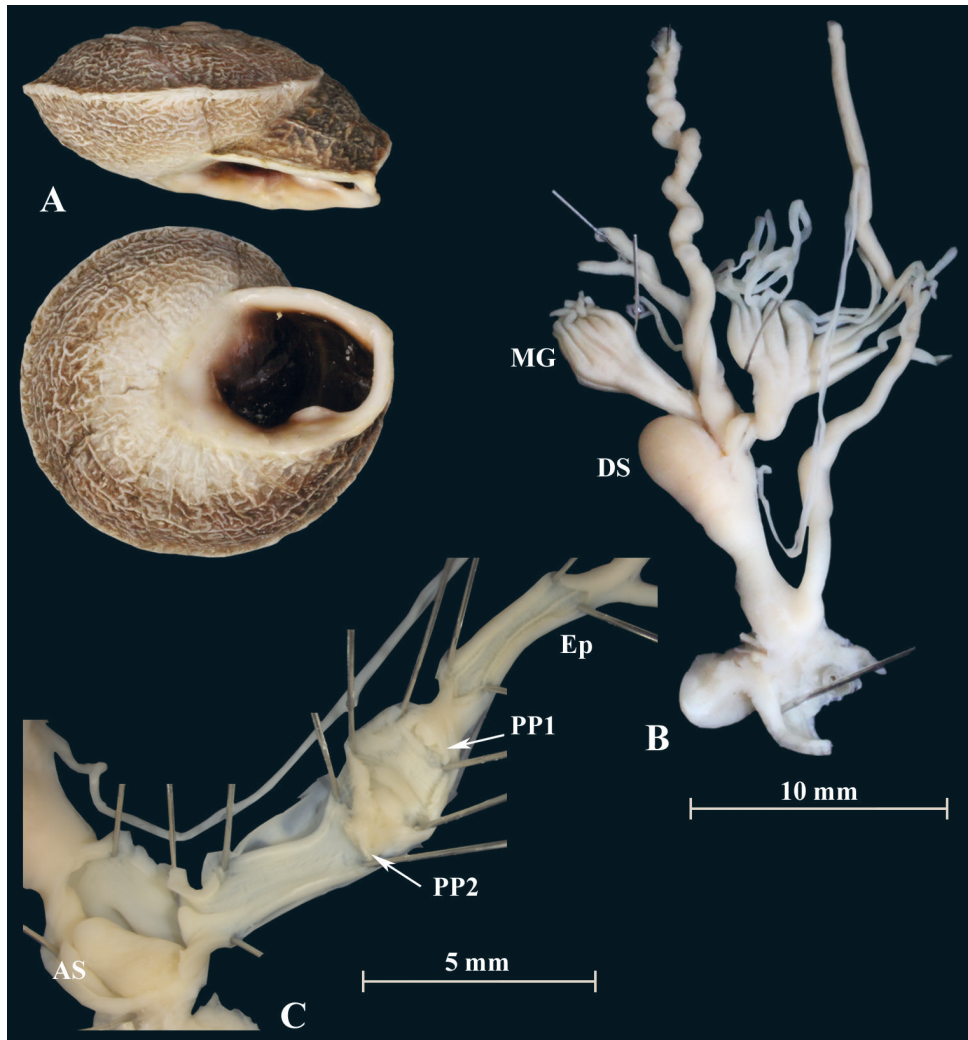



**Figure 23.** *Otala xanthodon* (NMBE 549820), Guercif, Morocco; **A** shell **B** situs **C** atrium and penis; D = 26.74 mm, H = 15.96 mm, situs length 42.81 mm (atrium-BCD), BC destroyed; **D** *Helix zaffarina* Terver, 1839 (syntype MHNL 45001034), Oran, Algeria, coll. Michaud, D = 29.54 mm. All photographs by Kneubühler & Neubert, shell  $\times 1.5$ .



**Figure 24.** *Otala tingitana* (NMBE 510549), Tazout de Guigou, Morocco, D = 27.42 mm, H = 14.38 mm (specimens from the type locality of *Archelix minettei* Pallary, 1917). All photographs by Kneubühler, shell  $\times 1.5$ .



**Figure 25.** “*Tingitana minettei decussata*” (NMBE 549840), Kebdana, Morocco; **A** shell **B** situs **C** atrium and penis; D = 32.45 mm, H = 16.12 mm, situs length 28.84 mm (atrium-flagellum). Situs not complete. All photographs by Kneubühler, shell  $\times 1.5$ .

## Discussion

The results of our study strongly support the monophyly of the genera *Alabastrina* and *Otala* within the tribe Otalini. *Alabastrina alabastrites* is morphologically as well as genetically clearly separated from the genera *Siretia* and *Otala*. All investigated specimens within *Alabastrina* show the unique trait of the presence of a blind penial appendix. This is an anatomical character, which has never been reported before within the Helicidae. The function of this penial appendix is not known. Schileyko’s system which was

based on morphology only, is incorrect as we could demonstrate in our phylogeny that the species *Archelix pallaryi* Kobelt, 1909, which is the type species for the genus *Siretia*, clusters outside the *Alabastrina* clade. We consider this taxon as a separate genus. Anatomical and genetic data for *Helix bailloni* Kobelt, 1888, the type species of *Guilia* Pallary, 1926 also suggest a phylogenetically separate position of this genus (Kneubühler et al. in prep.). The position of *A. tistutensis* within the clade of *A. alabastrites* shows that this extreme local shell form should probably be considered a local subspecies rather than a species in its own rights. Further sampling is necessary to resolve the problem.

The phylogenetic results clearly show that *Siretia* is separated from *Alabastrina*. In the ML analyses *Siretia* forms a lineage separate from *Otala* (Fig. 2; Suppl. materials 1, 2). However, in the Bayesian Inference analyses, *Siretia* clusters within the *Otala* clade (Fig. 3; Suppl. materials 3, 4). Thus, the monophyly of *Otala* is not supported. It cannot be excluded that *Siretia* forms a subgenus or even a synonym of *Otala*. Unfortunately, we cannot present anatomical data for *S. pallaryi* because of the bad preservation of the only specimen we could analyse. More sequence data are necessary to corroborate the monophyly of *Otala* and to resolve the relationships within the *Otala* clade (including *Siretia*). For the time being, *Siretia* is considered here as a separate unit because of the differences in shell shape. Holyoak and Holyoak (2017: 423) regard *Siretia* as a distinct genus within the Otalini.

*Otala lactea* is characterized by a dark aperture, which clearly differentiates it from *O. punctata* with a white aperture. We investigated several populations of *O. lactea* from Morocco, Spain and Portugal and they all cluster together in the phylogenetic analysis. Hesse's (1911) investigations of the outer morphology of the genital organs of *Archelix punctata*, *A. lactea*, and *A. lucasi* showed no difference to our results. In contrast to Holyoak and Holyoak (2017), we could distinguish the species *O. lactea* and *O. punctata* without any doubt by their genital anatomy. *Otala punctata* has one strongly developed penial papilla and a second which is nearly completely reduced, whereas *O. lactea* has two massive and distinct penial papillae. Unfortunately, Holyoak and Holyoak (2017: 425, Table 1) do not describe the form of the proximal verge (PP1 herein) for each species nor do they provide a drawing. This hampers the interpretation of the data known so far and we agree that more detailed study may be necessary for a reliable comparison of species.

We also investigated specimens of *O. l. murcica* from Almería, Spain; from a genetic point of view there is no difference to the remaining specimens of *O. l. lactea*. The two specimens of *O. l. murcica* included in the analyses from the same population (NMBE-554175 and NMBE-554176 in Figs 2, 3) cluster together with the Portuguese specimen of *O. lactea*, which originates close to the type locality of the neotype of *O. lactea* designated by Holyoak and Holyoak (2017: 446). For this reason we conclude that this subspecies has to be considered a synonym of *O. lactea*.

The specimen from Etsedda, Morocco (NMBE-545594 in Figs 2, 3) clusters as the sister lineage of all investigated *O. lactea* specimens. It shows a slightly different shell morphology and genital anatomy (Fig. 16A, B, C). The shells of this population strongly resemble *Helix lucasii* (syntype shown under Fig. 16D). However, the boot-

strap support value for this clade (65) is too low to currently allow the separation as a distinct species or whether it falls within the range of variability of *O. lactea*. More specimens are needed here to corroborate the differences in the anatomical details of the genital organs as well as the separate position on the phylogeny.

“*Tingitana minettei decussata*” clusters within the specimens of *O. xanthodon* but with a low support (Figs 2, 3). The genital organs show strong similarities to other *O. xanthodon* specimens as exemplified by the system of two penial papillae, the short penial chamber, the massive mucus glands, and the large atrial stimulator. However, the shell morphology of this form is clearly different. This could be due to a local adaptation to a rocky habitat since the gastropod shell form is strongly influenced by the substrate the species live on (Goodfriend 1986); specimens with a flat shell can hide more easily in crevices, particularly in limestone. This conflicts with the definition of *Tingitana* by Pallary, who erected this genus for species with a keeled shell. Next to the observation cited above that keeled shells are probably an adaptation to a rocky environment with crevices, juvenile shells of large helicid species often show this phenomenon of a keeled shell (see for example species of *Levantina* Kobelt, 1871, *Codringtonia* Kobelt, 1898, *Isaurica* Kobelt, 1901, etc. (Holyoak and Holyoak 2017)). Consequently, this trait is unsuitable for generic definition; its use even for species delimitation is disputable.

Holyoak and Holyoak (2017) synonymised *H. zaffarina* (a species usually under *Dupotetia*) with *O. xanthodon*. Therefore, we included a specimen that usually would have been identified as *D. zaffarina* in our study (Fig. 23A), and compared the shell with that of the syntype (Fig. 23D). We agree here with the synonymisation of *H. zaffarina* with *O. xanthodon*, because our genetic analyses revealed that this specimen clusters within the specimens of *O. xanthodon*.

## Acknowledgements

We are grateful to Estée Bochud (NMBE Switzerland) for support during the anatomical research and technical advice, José Ahuir Galindo (Málaga, Spain) and Adrienne Jochum (NMBE Switzerland) for providing specimens used in this study. RH is grateful to the support of Deutsches Archäologisches Institut (Bonn) and the Institut National des Sciences de l’Archéologie et du Patrimoine (Rabat). We acknowledge the valuable comments of the reviewers B Hausdorf and MT Neiber (both Hamburg) on an earlier draft of this paper.

## References

- Altekar G, Dwarkadas S, Huelsenbeck JP, Ronquist F (2004) Parallel Metropolis-coupled Markov chain Monte Carlo for Bayesian phylogenetic inference. *Bioinformatics* 20: 407–415. <https://doi.org/10.1093/bioinformatics/btg427>

- Anton HE (1838) Verzeichniss der Conchylien welche sich in der Sammlung von Hermann Eduard Anton befinden. Eduard Anton, Halle, 110 pp. <https://doi.org/10.5962/bhl.title.11509>
- Bouaziz-Yahiatene H, Pfarrer B, Medjdoub-Bensaad F, Neubert E (2017) Revision of *Massylaea* Möllendorff, 1898 (Stylommatophora, Helicidae). *ZooKeys* 694: 109–133. <https://doi.org/10.3897/zookeys.694.15001>
- Cadahia L, Harl J, Duda M, Sattmann H, Kruckenhauser L, Feher Z, Zopp L, Haring E (2014) New data on the phylogeny of *Ariantinae* (Pulmonata, Helicidae) and the systematic position of *Cylindrus obtusus* based on nuclear and mitochondrial DNA marker sequences. *Journal of Zoological Systematics and Evolutionary Research* 52(2): 163–169. <https://doi.org/10.1111/jzs.12044>
- Cadevall J, Orozco A (2016) Caracoles y babosas de la península Ibérica y Baleares. Nueva guías de campo. Omega, Barcelona.
- Colgan D, McLaughlan A, Wilson GDF, Livingston SP, Edgecombe GD (1998) Histone H3 and U2 snRNA DNA sequences and arthropod molecular evolution. *Australian Journal of Zoology* 46: 419–437. <https://doi.org/10.1071/ZO98048>
- Cossignani T (2014) African Landshells. L'informatore Piceno, Ancona.
- De Mattia W, Mascia F (2011) *Otala punctata* (O.F. Müller, 1774) (Stylommatophora: Helicidae) in Italy. *Iberus* 29(1): 39–46.
- Férussac D'Audebard AÉJP, Deshayes GP (1819–1851) Histoire naturelle générale et particulière des mollusques terrestres et fluviatiles, tant des espèces que l'on trouve aujourd'hui vivantes, que des dépouilles fossiles de celles qui n'existent plus; classés d'après les caractères essentiels qui présentent ces animaux et leurs coquilles. J-B Baillière, Paris, 184 pp. [T. 1], 402 pp [T. 2(1)], 1–260, 1–22 [2(2)]. [Atlas 1: 70 pls; Atlas 2: 166 + 5 pls]
- Folmer O, Black M, Hoe W, Lutz R, Vrijenhoek R (1994) DNA primers for amplification of mitochondrial cytochrome c oxidase subunit I from diverse metazoan invertebrates. *Molecular Marine Biology and Biotechnology* 3(5): 294–299.
- Galindo JA (2018) Three new terrestrial gastropod species and two new subspecies from Morocco. *Malacologia, Mostra mondiale, Cupra Marittima* 2: 22–26.
- GenBank (2018) National Center for Biotechnology Information, U.S. National Library of Medicine, Rockville Pike. <https://www.ncbi.nlm.nih.gov/genbank/> [last accessed 17.12.2018]
- Goodfriend GA (1986) Variation in land-snail shell form and size and its causes: a review. *Systematic Zoology* 35(2): 204–223. <https://doi.org/10.2307/2413431>
- Hesse P (1907–1920) Subfamilia Helicinae. In: *Iconographie der Land- & Süßwasser-Mollusken mit vorzüglicher Berücksichtigung der europäischen noch nicht abgebildeten Arten* (2) 14 (1/2): 1–64, pl. 361–370 (13 February 1907); (2) 14 (3/4): 65–128, pl. 371–380 (2 September 1907); (2) 14 (5/6): 129–172 + VII pp., pl. 381–390 (12 September 1908); (2) 16 (1/2): 1–42, pl. 421–430 (23 June 1909); (2) 16 (3/4): 43–66, pl. 431–440 (6 June 1910); (2) 16 (5/6): 67–119 + 5 pp., pl. 441–450 (3 August 1911); (2) 23 (1/2): 1–72, pl. 631–640 (October 1915); (2) 23 (3/4): 73–152, pl. 641–650 (11 November 1919); (2) 23 (5/6): 153–262 + 5 pp., pl. 651–660 (24 November 1920). CW Kreidel, Wiesbaden. [https://doi.org/10.1016/S0033-3506\(09\)80188-1](https://doi.org/10.1016/S0033-3506(09)80188-1)
- Holyoak DT, Holyoak GA (2017) A revision of the land-snail genera *Otala* and *Eobania* (Gastropoda, Helicidae) in Morocco and Algeria. *Journal of Conchology* 42(6): 419–490.



- Huelsenbeck JP, Ronquist F (2001) MRBAYES: Bayesian inference of phylogeny. *Bioinformatics* 17: 754–755. <https://doi.org/10.1093/bioinformatics/17.8.754>
- Hutterer R, Mikdad A, Ripken TEJ (2011a) Species composition and human exploitation of terrestrial gastropods from Taghit Haddouch, an Early Holocene archaeological site in NE Morocco. *Archiv für Molluskenkunde* 140: 57–78. <https://doi.org/10.1127/arch.moll/1869-0963/140/057-075>
- Hutterer R, Eiwanger J, Linstädter J, Mikdad A (2011b) Konsum von Landschnecken im Neolithikum: Neue Daten aus dem östlichen Rif (Marokko). *Beiträge zur Paläoanthropologie und Archäozoologie* 8: 29–34.
- Hutterer R, Linstädter J, Eiwanger J, Mikdad A (2014) Human manipulation of terrestrial gastropods in Neolithic culture groups of NE Morocco. *Quaternary International* 320: 83–91. <https://doi.org/10.1016/j.quaint.2013.12.006>
- Kobelt W (1887–1888). In: Rossmässler EA (Ed.) *Iconographie der Land- & Süßwasser-Mollusken mit vorzüglicher Berücksichtigung der europäischen noch nicht abgebildeten Arten* (2) 3 (1/2): 1–12, pl. 61–70 [15. Apr. 1887]; (2) 3 (3/4): 13–36, pl. 71–80 [6. Oct. 1887]; (2) 3 (5/6): 37–60, pl. 81–90 [10. March 1888]. Kreidel, Wiesbaden.
- Kobelt W (1901–1904) *Iconographie der Land- & Süßwasser-Mollusken mit vorzüglicher Berücksichtigung der europäischen noch nicht abgebildeten Arten* von EA Rossmässler (2) 11: 80–264.
- Kobelt W (1909) Diagnose einer neuen *Archelix*. *Nachrichtenblatt der deutschen Malakozoologischen Gesellschaft* 41(3): 134–135.
- Kobelt W (1914) Rossmässler's *Iconographie der Europäischen Land- & Süßwasser-Mollusken*. (2) 20, 1–24. [pl. 541–552]
- Lanfear R, Frandsen PB, Wright AM, Senfeld T, Calcott B (2016) PartitionFinder 2: new methods for selecting partitioned models of evolution for molecular and morphological phylogenetic analyses. *Molecular Biology and Evolution*. <https://doi.org/10.1093/molbev/msw260>
- Llabador F (1952) Contribution à l'étude de la faune malacologique terrestre et fluviatile du Rif oriental. *Journal de Conchyliologie* 92: 93–142. [pl 5]
- Michaud ALG (1833) *Catalogue des testacés vivans envoyés d'Alger, par M. Rozet (capitaine au corps royal d'état-major), au cabinet d'histoire naturelle des Strasbourg; notice présentée à la Société d'histoire naturelle de la même ville. Mémoires de la Société d'histoire naturelle de Strasbourg*, 1–22.
- Mikdad A, Eiwanger J, Atki H, Ben-Ncer A, Bokbot Y, Hutterer R, Lindstädter J, Moucine T (2000) Recherches préhistoriques et protohistoriques dans le Rif Oriental (Maroc). *Beiträge zur Allgemeinen und Vergleichenden Archäologie* 20: 109–167.
- Müller OF (1774) *Vermium terrestrium et fluviatilium, seu animalium infusoriorum, Helminthicorum et Testaceorum, non marinorum succincta historia. 2. Havinae & Lipsiae*, I–XXXVI [= 1–36] + 1–214. <https://doi.org/10.5962/bhl.title.46299>
- Neiber MT, Hausdorf B (2015) Molecular phylogeny reveals the polyphyly of the snail genus *Cepaea* (Gastropoda: Helicidae). *Molecular Phylogenetics and Evolution* 93: 143–149. <https://doi.org/10.1016/j.ympev.2015.07.022>



- Neubert E (2014) Revision of *Helix* (Linnaeus, 1758) in its eastern Mediterranean distribution area, and reassignment of *Helix godetiana* (Kobelt, 1878) to *Maltzanella* (Hesse, 1917) (Gastropoda, Pulmonata, Helicidae). *Contribution to Natural History* 26: 1–200.
- Neubert E, Bank RA (2006) Notes on the species of *Caucasotachea* C Boettger, 1909 und *Lindholmia* P Hesse, 1919, with annotations to the Helicidae (Gastropoda: Stylommatophora: Helicidae). *Archiv für Molluskenkunde* 135(1): 101–132. <https://doi.org/10.1127/arch.moll/0003-9284/135/101-132>
- Neubert E, Korábek O (2015) Comment on Psonis et al. (2015) Evaluation of the taxonomy of *Helix cincta* (Muller, 1774) and *Helix nucula* (Mousson, 1854); insights using mitochondrial DNA sequence data. *Journal of Natural History* 49: 383–392. <https://doi.org/10.1080/00222933.2015.1021874>
- Paladilhe A (1875) Étude sur les coquilles terrestres et fluviatiles rapportées du Maroc par le Dr. Bleicher. *Revue et Magasin de Zoologie, pure et appliquée* (3<sup>ème</sup> sér.) 3: 75–101. [pl 9]
- Pallary PM (1899) Deuxième contribution à l'étude de la faune malacologique du Nord-Ouest de l'Afrique. Supplement à "La faune malacologique du Maroc" de A Morelet. *Journal de Conchyliologie* 46(2) [1898]: 49–170. [pls 5–9; Paris] [9 February].
- Pallary PM (1917) Hélicidées nouvelle du Maroc. *Journal de Conchyliologie* 63(2): 126–141. [pl 5]
- Pallary PM (1918) Diagnoses d'une cinquantaine de mollusques terrestres nouveaux du Nord de l'Afrique. *Bulletin de la Société d'Histoire naturelle de l'Afrique du Nord* 9(7): 137–152.
- Pallary PM (1926) Compléments à la faune malacologique de la Berbérie. *Journal de Conchyliologie* 70(1): 1–50. [pls 1–8]
- Pallary PM (1936) Deuxième complément a la faune malacologique de la Berbérie. *Journal de Conchyliologie*, 1<sup>er</sup> Trimestre, 32–39.
- Pilsbry HA (1895) *Manual of Conchology, structural and systematic, with illustrations of the species*. By George W Tryon, Jr. Second series: Pulmonata, vol 9. (Helicidae, vol. 7), part 36, frontispiece. Guide to the study of Helices. Conchological Section, Academy of Natural Sciences of Philadelphia, Philadelphia, 161–366. [pls 41–71]
- Pfeffer G (1930) Zur Kenntnis tertiärer Landschnecken. *Geologische und Paläontologische Abhandlungen, Jena (NF)* 17(3): 3–230 (153–380).
- Psonis N, Vardinoyannis K, Mylonas M, Poulakakis N (2013) Evaluation of the taxonomy of *Helix cincta* (Muller, 1774) and *Helix nucula* (Mousson, 1854); insights using mitochondrial DNA sequence data. *Journal of Natural History* 49: 383–392. <https://doi.org/10.1080/00222933.2013.825023>
- Razkin O, Gómez-Moliner BJ, Prieto CE, Martínez-Ortí A, Arrébola R, Muñoz B, Chueca LJ, Madeira MJ (2015) Molecular phylogeny of the western Palearctic Helicoidea (Gastropoda, Stylommatophora). *Molecular Phylogenetics and Evolution* 83: 99–117. <https://doi.org/10.1016/j.ympev.2014.11.014>
- Ronquist F, Huelsenbeck JP (2003) MRBAYES 3: Bayesian phylogenetic inference under mixed models. *Bioinformatics* 19: 1572–1574. <https://doi.org/10.1093/bioinformatics/btg180>
- Rossmässler EA (1854) *Iconographie der Land-und Süßwasser-Mollusken Europa's, mit vorzüglicher Berücksichtigung kritischer und noch nicht abgebildeten Arten*. Hermann Costenoble, Leipzig. Band 3, Heft 1–2, 139 pp. [pl 61–88]

- Rour E, Chahlaoui A, van Goethem JL (2002) Etat actuel des connaissances de la malacofaune terrestre du Maroc. Bulletin de l'Institut Royal des Science Naturelle de Belgique, Biologie, 72: 189–199.
- Schileyko AA (2006) Treatise on recent terrestrial pulmonate molluscs. Part 13. Helicidae, Pleurodontidae, Polygyridae, Ammonitellidae, Oreohelicidae, Thysanophoridae. Ruthenica, Supplement 2, Moscow, 1765–1906.
- Schumacher CF (1817) Essai d'un nouveau système des habitations des vers testacés. Schultz, Copenhagen, [1–3], 1–287. [pls 1–22]
- Simon C, Frati F, Beckenbach A, Crespi B, Liu H, Flook P (1994) Evolution, weighting, and phylogenetic utility of mitochondrial gene sequences and a compilation of conserved polymerase chain reaction primers. Annals of the entomological Society of America 87(6): 651–701. <https://doi.org/10.1093/aesa/87.6.651>
- Stamatakis A (2006) RAxML-VI-HPC: maximum likelihood-based phylogenetic analyses with thousands of taxa and mixed models. Bioinformatics 22(21): 2688–2690. <https://doi.org/10.1093/bioinformatics/btl446>
- Terver AP (1839) Catalogue des mollusques terrestres et fluviatiles, observés dans les possessions françaises au nord de l'Afrique, publié par M Terver. J-B Baillièere, Paris & Savy, Lyon, 1–40. [pls 1–4]
- Walther F, Neiber MT, Hausdorf B (2016) Species complex or complex species? Integrative taxonomy of the land snail genus *Rossmassleria* (Gastropoda, Helicidae) from Morocco and Gibraltar. Systematics and Biodiversity 14: 394–416. <https://doi.org/10.1080/14772000.2016.1150905>

## Supplementary material I

### Maximum Likelihood (RAxML) tree based on mitochondrial data set of COI and 16S

Authors: Jeannette Kneubühler, Rainer Hutterer, Beat Pfarrer, Eike Neubert

Data type: PDF file

Explanation note: Numbers represent bootstrap support values from the ML analysis.

Copyright notice: This dataset is made available under the Open Database License (<http://opendatacommons.org/licenses/odbl/1.0/>). The Open Database License (ODbL) is a license agreement intended to allow users to freely share, modify, and use this Dataset while maintaining this same freedom for others, provided that the original source and author(s) are credited.

Link: <https://doi.org/10.3897/zookeys.843.32867.suppl1>

## **Supplementary material 2**

### **Maximum Likelihood (RAxML) tree based on nuclear data set of H3 and 5.8 S rRNA+ITS2**

Authors: Jeannette Kneubühler, Rainer Hutterer, Beat Pfarrer, Eike Neubert

Data type: PDF file

Explanation note: Numbers represent bootstrap support values from the ML analysis.

Copyright notice: This dataset is made available under the Open Database License (<http://opendatacommons.org/licenses/odbl/1.0/>). The Open Database License (ODbL) is a license agreement intended to allow users to freely share, modify, and use this Dataset while maintaining this same freedom for others, provided that the original source and author(s) are credited.

Link: <https://doi.org/10.3897/zookeys.843.32867.suppl2>

## **Supplementary material 3**

### **Bayesian Inference tree based on mitochondrial data set of COI and 16S**

Authors: Jeannette Kneubühler, Rainer Hutterer, Beat Pfarrer, Eike Neubert

Data type: PDF file

Explanation note: Numbers represent Bayesian posterior probabilities.

Copyright notice: This dataset is made available under the Open Database License (<http://opendatacommons.org/licenses/odbl/1.0/>). The Open Database License (ODbL) is a license agreement intended to allow users to freely share, modify, and use this Dataset while maintaining this same freedom for others, provided that the original source and author(s) are credited.

Link: <https://doi.org/10.3897/zookeys.843.32867.suppl3>

## **Supplementary material 4**

### **Bayesian Inference tree based on nuclear data set of H3 and 5.8 S rRNA+ITS2**

Authors: Jeannette Kneubühler, Rainer Hutterer, Beat Pfarrer, Eike Neubert

Data type: PDF file

Explanation note: Numbers represent Bayesian posterior probabilities.

Copyright notice: This dataset is made available under the Open Database License (<http://opendatacommons.org/licenses/odbl/1.0/>). The Open Database License (ODbL) is a license agreement intended to allow users to freely share, modify, and use this Dataset while maintaining this same freedom for others, provided that the original source and author(s) are credited.

Link: <https://doi.org/10.3897/zookeys.843.32867.suppl4>

## Discussion

During the last 30 years, molluscan phylogeny has undergone major changes as summarised in Bouchet (2017). The traditional evaluation of character states using the shells and the genitalia of molluscs created a phylogenetic system that needs to be supported via genetic research. The application of molecular methods generally shows that homoplastic character states in molluscs are much more widespread than expected. Oftentimes, seeming morphological “synapomorphies” turn out to combine genetically unrelated taxa producing polyphyletic groups.

This was exemplified in Chapter 1 with specimens of Vitrinidae from the Arabian / African clade. These species have traditionally been identified by shells and if available, by genital anatomy such that they were allocated to either *Arabivitrina* Thiele, 1929 or *Calidivitrina* Pilsbry, 1919. The *Arabivitrina* basic genital type, which is defined by a glandula amatoria with a papilla and lacking a penial sheath, could be observed in three non-related clades. On the other hand, the *Calidivitrina* type of genitalia, defined by the absence of a glandula amatoria, is represented in two other non-related lineages. Herein, the results of Giusti et al. (2011), who presented a phylogenetic hypothesis of the Vitrinidae based solely on morphological similarities, could be disproved. However, there are cases where the analysis of shells and genital anatomy deliver congruent results as shown in Chapter 3. Therefore, an important message for future research is that the widespread morpho-based phylogeny in molluscs always requires scrutiny by genetic methods in order to detect cases of parallel evolution.

For the African Vitrinidae, this investigation detected several genera hitherto unknown to science. Moreover, the molecular analyses included Macaronesian taxa as hypothetically closely related groups. This hypothesis was falsified as the African group clearly shows greater affinity to the European clade. However, the discovery of *Sanettivitrina* Pfarrer, Rowson, Tattersfield & Neubert, 2021, a relic taxon on the Ethiopian plateau, showed that this monotypic genus is closely related to the Macaronesian group. Two independent colonization events by Vitrinidae from the older Macaronesian Islands in the last 8 Mya years could be detected for the Azores. Conversely, the scenario for the colonization of the African continent is more complicated. It appears that a probable group of Vitrinidae of unknown origin, dating from the Miocene, inhabited the Saharan belt and went extinct due to the end of the African humid period 5 Kya years ago (Huang *et al.* 2008). In the process, a “disjunct distribution pattern” was left behind. The recent African radiation of Vitrinidae comprises several dozens of species which colonized the continent via the Arabian plate in a second dispersal wave.

This work was contrasted by the investigation of yet another group of vitrinid snails presented in Chapter 2. Here, a rather unique phenomenon required an explanation: a group of presumably closely related species with a presumed individual activity radius of a few meters is distributed over the complete Holarctic realm. Use of the highly variable ITS1 / ITS2 barcoding markers in combination with COI, 16S, and H3 detected an enormous genetic homogeneity in all specimens ranging from Morocco to

Siberia to the North American continent including European *V. pellucida*. As a result, *V. angelicae*, *V. alaskana*, *V. exilis* and *V. limpida* are relegated into synonymy of *Vittrina pellucida*. The genetic homogeneity suggests that the dispersal over the complete northern hemisphere has taken place within a short period of time. This implies that this species may use migrating animals as vectors (Maciorowski *et al.* 2012; Zenzal *et al.* 2017). It is hypothesized in this work that this dispersal occurred during the Pleistocene, whereby the carriers were mainly birds and large mammals.

Another topic addressed in my dissertation is the taxonomic clarification of some problematic species of freshwater bivalves from Switzerland. Using a triple marker approach (COI, 16S and H3), identification problems that can occur in the genus *Unio* could be resolved. Additional records of *Anodonta exulcerata* imply that the species has a wider distribution in the southern Swiss / northern Italian lakes and rivers than hitherto expected. The phylogenetic analysis could not reveal any individual of *Unio mancus* at 42 sites, which means that this species has most probably gone extinct in Switzerland. Interestingly, *Unio elongatulus*, a species native to areas south of the main Alpine divide, is also found in the north Alpine Swiss area. These individuals are part of the Padano – Adriatic basin haplotype network as shown by the comparison with the neotype MG967432 from Vipava, Slovenia (Marrone *et al.*, 2019). Probably mediated by humans, *U. elongatulus* made its way over the Alpine barrier to the north. This fact opens a new perspective for *U. elongatulus* as an invading species, able to disperse in the coming years via the Rhine River towards the North Sea. The haplotype network for *Anodonta cygnea* shows no variation neither does the phylogenetic tree. A permanent gene flow could be the cause for this homogeneity, which might be supported by anthropogenic activity through transport of host fishes infected with parasitic glochidium-larvae of *A. cygnea*. In addition, in the phylogenetic tree and haplotype network for *A. anatina*, a subdivision into four clades could be shown. Parts of this pattern in *A. anatina* were already reported in the molecular investigations of Froufe *et al.* (2014) for the Italian, Iberian and a selection of European individuals. A similar topology, including a Transbaikal distribution, was reported in Klishko *et al.* (2018), which also added genetic *A. anatina* data from western and eastern Europe from previous investigations. The results from Chapter 3 fit into the phylogenetic framework that the aforementioned studies form.

## Outlook

Chapter 1 launches into the research of the Family Vitrinidae by providing various tools e.g., new primers and sequences and the insights of reduced character states that can be misleading, particularly in semislugs. The phylogenetic position of several members of the family is still obscure. Moreover, the separation of the East African Vitrinidae into two major clades as hypothesized by earlier authors, viz. *Arabivitrina* Thiele, 1931 and *Calidivitrina* Pilsbry, 1919, is still to be resolved by future investigations. More and fresh adult specimens from the East African region are to be included in the next investigation. Together with additional variable genetic markers e.g., ITS1 or CytB (Armbruster & Korte 2006; Merritt *et al.* 1998) or mitogenome analyses (Guzmán *et al.* 2021) of the respective species, a realistic approach

nowadays is to enhance the resolution and to increase the support values in the nodes of the phylogenetic reconstructions. Another future project stemming from Chapter 1 is the completion of the phylogeny of Macaronesian Vitrinidae, including clarification of the dispersal pathways within the Macaronesian archipelago. A biogeographic analysis to explore the origin of diversity in the family Vitrinidae is pending.

Chapter 2 presents a historical dynamic concerning the global dispersal of terrestrial snails in conjunction with the genetic homogeneity of *Vitrina pellucida*. The concept that certain terrestrial snails may have a greater dispersal ability than formerly assumed (Rees 1965) is significant for evaluating future environmental and ecological studies. This new knowledge is relevant within the scope of climate change and occurrences of snail-borne parasitic diseases (SBPDs). It additionally serves in explaining the geographical distribution of associated infectious diseases (Lu *et al.* 2018). A thorough taxonomical and phylogenetic study of potential airborne vector-dispersed mollusc taxa is paramount for investigating the geographical distributions of species. The next step would be to extract historical data from voucher specimens in museum collections. These results could provide valuable information about the original populations and therefore sources of SBPDs.

A future behavioral study can be focused on the active or passive “taxis” of possible airborne candidates towards a dispersal vector. Terrestrial gastropods might have developed a strategy (e.g., tremor taxis) to detect probable and effective transport vectors. Finally, the question remains if there is a certain preference in bird species. A combination of ornithological and malacological data would be insightful especially when migratory pathways of birds and terrestrial snails overlap.

In Chapter 3, new sequence data and information on the distribution of the Swiss Unionidae is provided for future research. Firstly, the verification of living populations of *Unio mancus* have acquired priority status due to the results of my investigations here. In the search for “lost populations”, the application of eDNA (environmental DNA) (Thomsen & Willerslev 2015) could be a tool in future surveys of Swiss rivers and lakes as well as have far-reaching uses for other unionid assessments in other water systems. Since established primers for Unionida are already in use (Prié *et al.* 2021), I recommend this effective, non-invasive method for surveying fragile unionid populations. By scanning waterbodies for the target eDNA, a more precise deployment of fishing measures can be guaranteed, and possible surplus fishing of falsely identified taxa can be avoided. The results would do best to encourage initiatives for a possible re-introduction from populations with a similar haplotype composition to the River Doubs. Specifically, a molecular phylogeny incorporating shell DNA from museum collection vouchers to determine autochthonous population genetic structures is required.

Alarming conservation issues have been revealed by this work whereby population dynamics in the river systems are defined by the natural borders formed by the Jura and the Alps and are therefore, bound into corresponding water basins. My findings suggest that human mediated transport of infected host fishes (glochidia) is a probable factor disrupting population structures of some of the Unionidae in Swiss rivers and lakes. Threatening is the invasion of the Adriatic species, *Unio elongatulus*, into the Rhine basin,



which is most likely a result of human mediated transport. Monitoring projects can initiate investigations of adaptation tolerance levels to colder waters as well as keep the limiting dispersal factors of *U. elongatulus* in check.

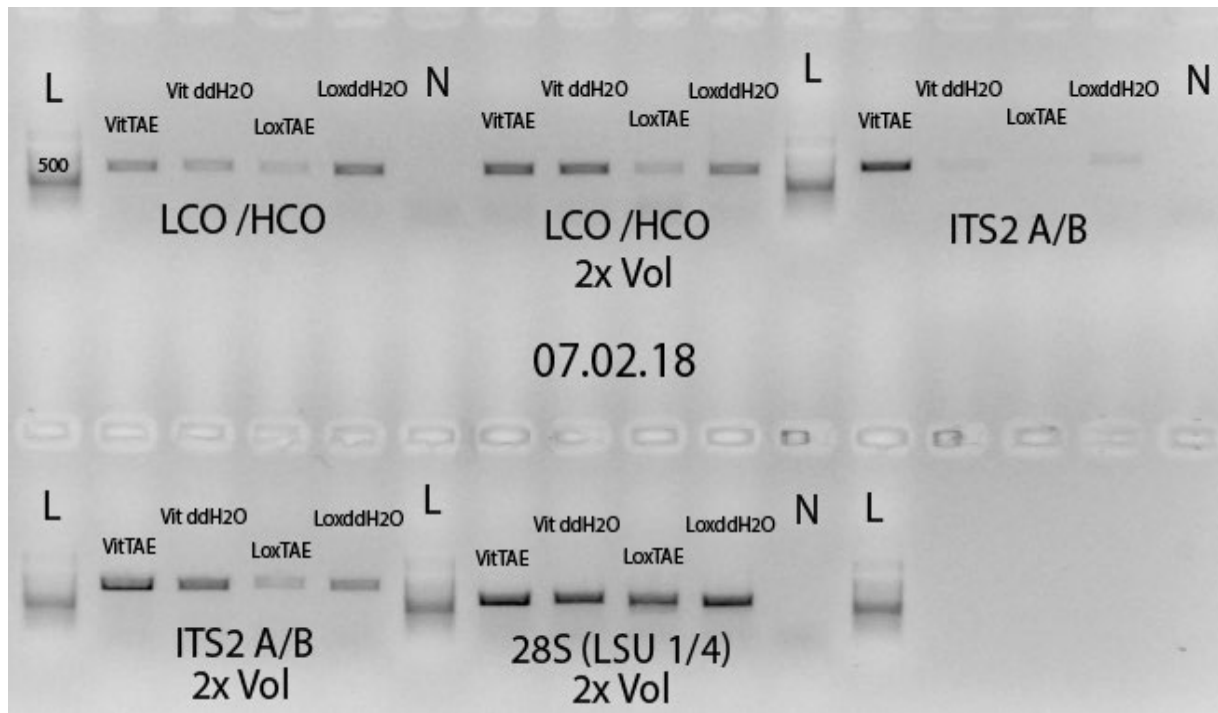

Figure 1 Proof of concept of the new NMBE gastropod shell extraction protocol (Pfarrer, B., Neubert, E., in preparation). L = ladder, N= control group, VitTAE = *Vitrinobracium breve* shell with buffer, *V. breve* with H<sub>2</sub>O; LoxTae = *Loxana* sp. shell with buffer; LoxH<sub>2</sub>O = *Loxana* sp. shell with H<sub>2</sub>O

Chapters 1, 2, 3 and 4 showed that in old specimens and empty shells, DNA extraction poses methodological problems. Subsequently, the question arose how to use the shells as a DNA deposit. Usually, malacologists evaluate empty shells collected in the field or those historically housed in museum collections. Since identification is problematic in many cases, extraction of DNA derived from the calcareous shell matrix is a viable solution. Protocols, which were mainly used on aquatic mollusc shells and published over the last 15 years suggest that shell-extracted DNA must be handled as de facto aDNA, procuring useable fragmented DNA (Geist *et al.* 2008). It is also possible to extract shell derived DNA from at least 50 year-old terrestrial mollusc shells (Andree & López 2013; Villanea *et al.* 2016). In this work, a phenolic extraction was performed. However, the resulting DNA is truncated and the derivable sequences from these fragments are often qualitatively poor. Thus, they must be handled with caution when applied in a sound phylogenetic analysis. Other extraction methods might increase the resolution and information of the phylogenetic tree reconstructions using fragmented DNA. A gentle, non-destructive extraction preserves the shell that can afterwards be reused for morphological analyses. Such an extraction method, combined with next generation sequencing (NGS) e.g., hybridization capture, which is a targeted NGS method that is already applied in aDNA and sedimentary ancient DNA (sedaDNA) science (Armbrecht *et al.* 2021; Knapp & Hofreiter 2010), could give direction to future protocols.

Analyses of shell DNA offer a series of potential applications. For instance, genetic parameters within populations (effective population sizes, genetic variability) and their history (pedigree-analyses, genetic drift and inbreeding) could be assessed by using shells of dead specimens and comparing them with actual parameters of their living relatives. Not only the DNA of the corresponding snails and mussels can be extracted, but also the eDNA which is enclosed in the shell matrix (Der Sarkissian *et al.* 2017). A variety of possibilities become accessible for collating information about the biological diversity, evolutionary history and ecology of a location.

These procedures additionally provide new opportunities to mine data from historical shell vouchers such as those housed in the NMBE (Naturhistorisches Museum Bern) malacological collection. With the NMBE housing shells of approx. 10,000 species, it represents an enormous information potential for future aDNA extractions. Species, which have long gone extinct can provide valuable information in upcoming phylogenetic research. With this objective in mind, I experimented with different extraction methods. Preliminary results (171, Fig. 1) of attempts with 42-year-old shells of Helicidae and Vitrinidae from the museum's collection showed promising results. The extraction was based on a chemical dissolution and different washing steps of the shell pieces with the subsequent extraction in a silica gel based, mini column nucleic acid purification kit. This procedure provides a fast and cheap solution (even for small museums), to extract small DNA fragments from old mollusc shells.

## References

- Andree, K.B. & López, M.A. (2013) Species identification from archived snail shells via genetic analysis: a method for DNA extraction from empty shells. *Molluscan Research* 33, 1–5. <https://doi.org/10.1080/13235818.2012.754141>
- Armbrecht, L., Hallegraeff, G., Bolch, C.J.S., Woodward, C. & Cooper, A. (2021) Hybridisation capture allows DNA damage analysis of ancient marine eukaryotes. *Scientific Reports* 11, 3220. <https://doi.org/10.1038/s41598-021-82578-6>
- Armbruster, G.F.J. & Korte, A. (2006) Genomic nucleotide variation in the ITS1 rDNA spacer of land snails. *Journal of Molluscan Studies* 72, 211–213. <https://doi.org/10.1093/mollus/eyi056>
- Beck, H. (1837) *Index molluscorum praesentis aevi musei principis augustissimi Christiani Frederici*. 1–124 pp. Hafniae [Copenhagen].
- Bingham, J.-P., Andrews, E.A., Kiyabu, S.M. & Cabaltea, C.C. (2012) Drugs from Slugs. Part II – Conopeptide bioengineering. *Chemico-Biological Interactions* 200, 92–113. <https://doi.org/10.1016/j.cbi.2012.09.021>
- Bingham, J.-P., Mitsunaga, E. & Bergeron, Z.L. (2010) Drugs from slugs—Past, present and future perspectives of  $\omega$ -conotoxin research. *Chemico-Biological Interactions* 183, 1–18. <https://doi.org/10.1016/j.cbi.2009.09.021>
- Bouaziz-Yahiatene, H., Pfarrer, B., Medjdoub-Bensaad, F. & Neubert, E. (2017) Revision of *Massylaea Möllendorff, 1898* (Stylommatophora, Helicidae). *ZooKeys* 694, 109–133. <https://doi.org/10.3897/zookeys.694.15001>
- Bouchet, P., Rocroi, J.-P., Hausdorf, B., Kaim, A., Kano, Y., Nützel, A., Parkhaev, P., Schrödl, M. & Strong, E.E. (2017) Revised Classification, Nomenclator and Typification of Gastropod and Monoplacophoran Families. *Malacologia* 61, 1–526. <https://doi.org/10.4002/040.061.0201>
- Chase, R. & Blanchard, K.C. (2006) The snail's love-dart delivers mucus to increase paternity. *Proceedings of the Royal Society B: Biological Sciences* 273, 1471–1475. <https://doi.org/10.1098/rspb.2006.3474>
- Dall, W.H. (1905) *Land and fresh water mollusks of Alaska and adjoining regions*. in: *Alaska. Harriman Alaska Expedition with cooperation of Washington Academy of Sciences*. vol. 13: i-vii + 1-171.
- De Oliveira, T., Hättenschwiler, S. & Tanya Handa, I. (2010) Snail and millipede complementarity in decomposing Mediterranean forest leaf litter mixtures: Snail and millipede interactions. *Functional Ecology* 24, 937–946. <https://doi.org/10.1111/j.1365-2435.2010.01694.x>
- Der Sarkissian, C., Pichereau, V., Dupont, C., Ilsoe, P.C., Perrigault, M., Butler, P., Chauvaud, L., Eiríksson, J., Scourse, J., Paillard, C. & Orlando, L. (2017) Ancient DNA analysis identifies marine mollusc shells as new metagenomic archives of the past. *Molecular Ecology Resources* 17, 835–853. <https://doi.org/10.1111/1755-0998.12679>
- Draparnaud, J.-P.-R. (1801) *Tableau des Mollusques de la France*. Montpellier [Renaud]; Paris [Bossange, Masson et Besson], 1–116 pp.
- Ezzine, I.K., Dimassi, N., Pfarrer, B., Said, K. & Neubert, E. (2018) New records of the endemic Sicilian land snail species *Marmorana (Murella) muralis* (O. F. Müller, 1774) from the north of Tunisia (Pulmonata, Gastropoda). *ZooKeys* 775, 131–147. <https://doi.org/10.3897/zookeys.775.25740>
- Fitzinger, L.J. (1833) Systematisches Verzeichniß der im Erzherzogthume Oesterreich vorkommenden Weichthiere, als Prodom einer Fauna derselben. *Beiträge zur Landeskunde Oesterreichs's unter der Enns* 3, 88-122. Wien.
- Forcart, L. (1944) Monographie der schweizerischen Vitrinidae. (Moll. Pulm.). *Revue suisse de Zoologie* 51, 629–678, pl. 2. Genève [December].

- Froufe, E., Lopes-Lima, M., Riccardi, N., Zaccara, S., Vanetti, I., Lajtner, J., Teixeira, A., Varandas, S., Prié, V., Zieritz, A., Sousa, R. & Bogan, A.E. (2017) Lifting the curtain on the freshwater mussel diversity of the Italian Peninsula and Croatian Adriatic coast. *Biodiversity and Conservation* 26, 3255–3274. <https://doi.org/10.1007/s10531-017-1403-z>
- Froufe, E., Sobral, C., Teixeira, A., Sousa, R., Varandas, S., C. Aldridge, D. & Lopes-Lima, M. (2014) Genetic diversity of the pan-European freshwater mussel *Anodonta anatina* (Bivalvia: Unionoida) based on CO1: new phylogenetic insights and implications for conservation: GENETIC DIVERSITY *ANODONTA ANATINA* EUROPE. *Aquatic Conservation: Marine and Freshwater Ecosystems* 24, 561–574. <https://doi.org/10.1002/aqc.2456>
- Geist, J., Wunderlich, H. & Kuehn, R. (2008) Use of mollusc shells for DNA-based molecular analyses. *Journal of Molluscan Studies* 74, 337–343. <https://doi.org/10.1093/mollus/eyn025>
- Gheoca, V., Benedek, A.M. & Schneider, E. (2021) Exploring land snails' response to habitat characteristics and their potential as bioindicators of riparian forest quality. *Ecological Indicators* 132, 108289.
- Giusti, F., Fiorentino, V., Benocci, A. & Manganelli, G. (2011) A Survey of Vitrinid Land Snails (Gastropoda: Pulmonata: Limacoidea). *Malacologia* 53, 279–363. <https://doi.org/10.4002/040.053.0206>
- Gould, A.A. (1850) Catalogue of shells, with descriptions of new species. In: Agassiz, L., Lake Superior: Its physical character, vegetation, and animals, compared with those of other and similar regions. Boston; Gould, Kendall and Lincoln. pp. 243-245, plate 7.
- Guzmán, L.B., Vogler, R.E. & Beltramino, A.A. (2021) The mitochondrial genome of the semi-slug *Omalonyx unguis* (Gastropoda: Succineidae) and the phylogenetic relationships within Stylommatophora M. S. Brewer (Ed). *PLOS ONE* 16, e0253724. <https://doi.org/10.1371/journal.pone.0253724>
- Haszprunar, G. (1988) On the origin and evolution of major gastropod groups, with special reference to the Streptoneura. *Journal of Molluscan Studies* 54, 367–441.
- Hesse, P. (1913) Zur Kenntnis der Molluskenfauna von Ostrumelien. II. *Nachrichtsblatt der Deutschen Malakozoologischen Gesellschaft* 45, (1): 1-16; 45 (2): 69-74. Frankfurt am Main [27 January; 17 May].
- Hesse, P. (1923) Beiträge zur näheren Kenntnis der Familie Vitrinidae. *Archiv für Molluskenkunde* 23, 1–25; 81–115; 129–145, Taf. 1-3 (plate 3 missing).
- Huang, J., Wang, S., Wen, X. & Yang, B. (2008) Progress in studies of the climate of humid period and the impacts of changing precession in early-mid Holocene. *Progress in Natural Science* 18, 1459–1464. <https://doi.org/10.1016/j.pnsc.2008.05.011>
- Inäbnit, T., Jochum, A., Kampschulte, M., Martels, G., Ruthensteiner, B., Slapnik, R., Nesselhauf, C. & Neubert, E. (2019) An integrative taxonomic study reveals carychiid microsnails of the troglobitic genus *Zospeum* in the Eastern and Dinaric Alps (Gastropoda, Ellobioidea, Carychiinae). *Organisms Diversity & Evolution* 19, 135–177. <https://doi.org/10.1007/s13127-019-00400-8>
- Jaksch, K., Eschner, A., Rintelen, T.V. & Haring, E. (2016) DNA analysis of molluscs from a museum wet collection: a comparison of different extraction methods. *BMC Research Notes* 9, 348. <https://doi.org/10.1186/s13104-016-2147-7>
- Khan, B.M. & Liu, Y. (2019) Marine Mollusks: Food with Benefits: Marine mollusks. *Comprehensive Reviews in Food Science and Food Safety* 18, 548–564. <https://doi.org/10.1111/1541-4337.12429>
- Klishko, O.K., Lopes-Lima, M., Bogan, A.E., Matafonov, D.V. & Froufe, E. (2018) Morphological and molecular analyses of Anodontinae species (Bivalvia, Unionidae) of Lake Baikal and Transbaikalia G. J. Vermeij (Ed). *PLOS ONE* 13, e0194944. <https://doi.org/10.1371/journal.pone.0194944>
- Knapp, M. & Hofreiter, M. (2010) Next Generation Sequencing of Ancient DNA: Requirements, Strategies and Perspectives. *Genes* 1, 227–243. <https://doi.org/10.3390/genes1020227>
- Kneubühler, J., Hutterer, R., Pfarrer, B. & Neubert, E. (2019) Anatomical and phylogenetic investigation of the

- genera *Alabastrina* Kobelt, 1904, *Siretia* Pallary, 1926, and *Otala* Schumacher, 1817 (Stylommatophora, Helicidae). *ZooKeys* 843, 1–37. <https://doi.org/10.3897/zookeys.843.32867>
- Kneubühler, J., Jochum, A., Prieto, C.E. & Neubert, E. (2021) Molecular investigation and description of *Iberozospeum* n. gen., including the description of one new species (Eupulmonata, Ellobioidea, Carychiidae). *Organisms Diversity & Evolution*. <https://doi.org/10.1007/s13127-021-00517-9>
- Korábek, O., Petrussek, A. & Rovatsos, M. (2019) The complete mitogenome of *Helix pomatia* and the basal phylogeny of Helicinae (Gastropoda, Stylommatophora, Helicidae). *ZooKeys* 827, 19–30. <https://doi.org/10.3897/zookeys.827.33057>
- Kruckenhauser, L., Harl, J. & Sattmann, H. (2010) Optimized drowning procedures for pulmonate land snails allowing subsequent DNA analysis and anatomical dissections. *Annalen des Naturhistorischen Museums in Wien: Serie B für Botanik und Zoologie*, 112, 173–175.
- Lamarck, J.B.M. (1819) *Histoire naturelle des animaux sans vertèbres*. Tome 6(1): vi + 343 pp. Paris: published by the author.
- Linnaeus, C. (1758) *Systema Naturae per regna tria naturae, secundum classes, ordines, genera, species, cum characteribus, differentiis, synonymis, locis. Editio decima, reformata [10th revised edition], vol. 1: 824 pp. Laurentius Salvius: Holmiae*. <https://doi.org/10.5962/bhl.title.542>
- Lopes-Lima, M., Gürlek, M.E., Kebapçı, Ü., Şereflişan, H., Yanık, T., Mirzajani, A., Neubert, E., Prié, V., Teixeira, A., Gomes-dos-Santos, A., Barros-García, D., Bolotov, I.N., Kondakov, A.V., Vikhrev, I.V., Tomilova, A.A., Özcan, T., Altun, A., Gonçalves, D.V., Bogan, A.E. & Froufe, E. (2021) Diversity, biogeography, evolutionary relationships, and conservation of Eastern Mediterranean freshwater mussels (Bivalvia: Unionidae). *Molecular Phylogenetics and Evolution* 163, 107261. <https://doi.org/10.1016/j.ympev.2021.107261>
- Lu, X.-T., Gu, Q.-Y., Limpanont, Y., Song, L.-G., Wu, Z.-D., Okanurak, K. & Lv, Z.-Y. (2018) Snail-borne parasitic diseases: an update on global epidemiological distribution, transmission interruption and control methods. *Infectious Diseases of Poverty* 7, 28. <https://doi.org/10.1186/s40249-018-0414-7>
- Maciorowski, G., Urbańska, M. & Gierszal, H. (2012) An example of passive dispersal of land snails by birds - short note. *Folia Malacologica* 20, 139–141. <https://doi.org/10.2478/v10125-012-0010-6>
- Maloof, A.C., Porter, S.M., Moore, J.L., Dudas, F.O., Bowring, S.A., Higgins, J.A., Fike, D.A. & Eddy, M.P. (2010) The earliest Cambrian record of animals and ocean geochemical change. *Geological Society of America Bulletin* 122, 1731–1774. <https://doi.org/10.1130/B30346.1>
- Marrone, F., Nardi, G., Cianfanelli, S., Govedič, M., Barra, S.A., Arculeo, M. & Bodon, M. (2019) Diversity and taxonomy of the genus *Unio* Philipsson in Italy, with the designation of a neotype for *Unio elongatulus* C. Pfeiffer (Mollusca, Bivalvia, Unionidae). *Zootaxa* 4545, 339. <https://doi.org/10.11646/zootaxa.4545.3.2>
- Merritt, T.J.S., Shi, L., Chase, M.C., Rex, M.A., Etter, R.J. & Quattro, J.M. (1998) Universal cytochrome b primers facilitate intraspecific studies in molluscan taxa. *Molecular Marine Biology and Biotechnology* 7, 7–11.
- Miller, J., Beentjes, K., van Helsdingen, P. & IJland, S. (2013) Which specimens from a museum collection will yield DNA barcodes? A time series study of spiders in alcohol. *ZooKeys* 365, 245–261. <https://doi.org/10.3897/zookeys.365.5787>
- Mitoh, S. & Yusa, Y. (2021) Extreme autotomy and whole-body regeneration in photosynthetic sea slugs. *Current Biology* 31, R233–R234. <https://doi.org/10.1016/j.cub.2021.01.014>
- Morelet, A. (1858) Coquilles terrestres du Kamtchatka. *Journal de conchyliologie* 7, 7-22.
- Müller, O.F. (1774) *Vermium terrestrium et fluviatilium, seu animalium infusorium, Helminthicorum, et testaceorum, non marinorum, succincta historia. vol 2: I-XXXVI, 1-214, 10 unnumbered pages. Havniae et Lipsiae, apud Heineck et Faber, ex officina Molleriana.*

- Neiber, M.T., Korábek, O., Glaubrecht, M. & Hausdorf, B. (2021) A misinterpreted disjunction: the phylogenetic relationships of the North African land snail *Gyrostomella* (Gastropoda: Stylommatophora: Helicidae). *Zoological Journal of the Linnean Society*, zlab059. <https://doi.org/10.1093/zoolinnean/zlab059>
- Nitz, B., Falkner, G. & Haszprunar, G. (2010) Inferring Multiple Corsican Limax (Pulmonata: Limacidae) Radiations: A Combined Approach Using Morphology and Molecules. In: M. Glaubrecht (Ed), *Evolution in Action*. Springer Berlin Heidelberg, Berlin, Heidelberg, pp. 405–435.
- Olivera, B.M. & Teichert, R.W. (2007) Diversity of the neurotoxic Conus peptides. *Molecular interventions* 7, 251.
- Pääbo, S., Gifford, J.A. & Wilson, A.C. (1988) Mitochondrial DNA sequences from a 7000-year old brain. *Nucleic Acids Research* 16, 9775–9787. <https://doi.org/10.1093/nar/16.20.9775>
- Pfarrer, B., Rowson, B., Tattersfield, P. & Neubert, E. (2021) Phylogenetic position of African Vitrinidae: Old family groups unraveled. *Journal of Zoological Systematics and Evolutionary Research* 59, 1190–1208. <https://doi.org/10.1111/jzs.12502>
- Pfeiffer, C. (1821) *Naturgeschichte deutscher Land- und Süßwasser-Mollusken*. Weimar. Abt. 1: i-x, 1-134, pls 1-8 [1821]; Abt. 2: i-viii, 1-40, pls 1-8 [1825]; Abt. 3: i-vi, 1-84, pls 1-8 [1828].
- Pilsbry, H.A. (1919) A review of the land mollusks of the Belgian Congo chiefly based on the collections of the American Museum Congo Expedition, 1909-1915. *Bulletin of the American Museum of Natural History*.
- Pilsbry, H.A. (1946) Land Mollusca of North America (north of Mexico). Volume II Part 1. *The Academy of Natural Sciences of Philadelphia Monographs* 2, 1–520.
- Porro, C. (1838) *Malacologia terrestre e fluviale della Provincia Comasca*. Milano: Guglielmini & Redaelli. 132 + [4] (= Autori ed opere citate nello species) pp., pls 1-2. [> July].
- Prié, V. & Puillandre, N. (2014) Molecular phylogeny, taxonomy, and distribution of French Unio species (Bivalvia, Unionidae). *Hydrobiologia* 735, 95–110. <https://doi.org/10.1007/s10750-013-1571-0>
- Prié, V., Valentini, A., Lopes-Lima, M., Froufè, E., Rocle, M., Poulet, N., Taberlet, P. & Dejean, T. (2021) Environmental DNA metabarcoding for freshwater bivalves biodiversity assessment: methods and results for the Western Palearctic (European sub-region). *Hydrobiologia* 848, 2931–2950. <https://doi.org/10.1007/s10750-020-04260-8>
- Puillandre, N., Bouchet, P., Boisselier - Dubayle, M.-C., Brisset, J., Buge, B., Castelin, M., Chagnoux, S., Christophe, T., Corbari, L., Lambourdière, J., Lozouet, P., Marani, G., Rivasseau, A., Silva, N., Terryn, Y., Tillier, S., Utge, J. & Samadi, S. (2012) New taxonomy and old collections: integrating DNA barcoding into the collection curation process. *Molecular Ecology Resources* 12, 396–402. <https://doi.org/10.1111/j.1755-0998.2011.03105.x>
- Rees, W.J. (1965) The aerial dispersal of Mollusca. *Journal of Molluscan Studies* 36, 269–282.
- Riccardi, N., Froufè, E., Bogan, A.E., Zieritz, A., Teixeira, A., Vanetti, I., Varandas, S., Zaccara, S., Nagel, K.-O. & Lopes-Lima, M. (2020) Phylogeny of European Anodontini (Bivalvia: Unionidae) with a redescription of *Anodonta exulcerata*. *Zoological Journal of the Linnean Society* 189, 745–761. <https://doi.org/10.1093/zoolinnean/zlz136>
- Rosin, Z.M., Olborska, P., Surmacki, A. & Tryjanowski, P. (2011) Differences in predatory pressure on terrestrial snails by birds and mammals. *Journal of Biosciences* 36, 691–699. <https://doi.org/10.1007/s12038-011-9077-2>
- Schander, C. & Hagnell, J. (2003) Death by drowning degrades DNA. *Journal of Molluscan Studies* 69, 387–388. <https://doi.org/10.1093/mollus/69.4.387>
- Shevchuk, L., Vasilieva, L., Romaniuk, R. & Pavliuchenko, O. (2021) Species diversity of unionid mussels (Mollusca: Bivalvia: Unionidae) as a bioindicator of the state water environment of river basins of



- Ukraine. *IOP Conference Series: Earth and Environmental Science* 915, 012006. <https://doi.org/10.1088/1755-1315/915/1/012006>
- Sokolov, E.P. (2000) An improved method for DNA isolation from mucopolysaccharide-rich molluscan tissues. *Journal of Molluscan Studies* 66, 573–575. <https://doi.org/10.1093/mollus/66.4.573>
- Surmacki, A., Ożarowska-Nowicka, A. & Rosin, Z.M. (2013) Color polymorphism in a land snail *Cepaea nemoralis* (Pulmonata: Helicidae) as viewed by potential avian predators. *Naturwissenschaften* 100, 533–540. <https://doi.org/10.1007/s00114-013-1049-y>
- Thiele, J. (1929) *Handbuch der systematischen Weichtierkunde*. Jena, Gustav Fischer, 1154 pp.
- Thomsen, P.F. & Willerslev, E. (2015) Environmental DNA – An emerging tool in conservation for monitoring past and present biodiversity. *Biological Conservation* 183, 4–18. <https://doi.org/10.1016/j.biocon.2014.11.019>
- Verdes, A., Anand, P., Gorson, J., Jannetti, S., Kelly, P., Leffler, A., Simpson, D., Ramrattan, G. & Holford, M. (2016) From Mollusks to Medicine: A Venomics Approach for the Discovery and Characterization of Therapeutics from Terebridae Peptide Toxins. *Toxins* 8, 117. <https://doi.org/10.3390/toxins8040117>
- Villanea, F.A., Parent, C.E. & Kemp, B.M. (2016) Reviving Galápagos snails: ancient DNA extraction and amplification from shells of probably extinct endemic land snails. *Journal of Molluscan Studies* 82, 449–456. <https://doi.org/10.1093/mollus/eyw011>
- Yu, T., Neubauer, T.A. & Jochum, A. (2021) First freshwater gastropod preserved in amber suggests long-distance dispersal during the Cretaceous Period. *Geological Magazine* 158, 1327–1334. <https://doi.org/10.1017/S0016756821000285>
- Zenzal, T.J., Lain, E.J. & Sellers, J.M. (2017) An Indigo Bunting (*Passerina cyanea*) Transporting Snails During Spring Migration. *The Wilson Journal of Ornithology* 129, 898–902. <https://doi.org/10.1676/16-182.1>

# Erklärung

gemäss Art. 18 PromR Phil.-nat. 2019

Name/Vorname: Pfarrer Beat

Matrikelnummer: 00-121-202

Studiengang: PhD Ecology and Evolution

Bachelor  Master  Dissertation

Titel der Arbeit: Museum specimens under scrutiny – new insights in the phylogeny of continental molluscs

Leiter der Arbeit: Prof. Dr. Christian Kropf

Ich erkläre hiermit, dass ich diese Arbeit selbständig verfasst und keine anderen als die angegebenen Quellen benutzt habe. Alle Stellen, die wörtlich oder sinngemäss aus Quellen entnommen wurden, habe ich als solche gekennzeichnet. Mir ist bekannt, dass andernfalls der Senat gemäss Artikel 36 Absatz 1 Buchstabe r des Gesetzes über die Universität vom 5. September 1996 und Artikel 69 des Universitätsstatuts vom 7. Juni 2011 zum Entzug des Dokortitels berechtigt ist.

Für die Zwecke der Begutachtung und der Überprüfung der Einhaltung der Selbständigkeitserklärung bzw. der Reglemente betreffend Plagiate erteile ich der Universität Bern das Recht, die dazu erforderlichen Personendaten zu bearbeiten und Nutzungshandlungen vorzunehmen, insbesondere die Doktorarbeit zu vervielfältigen und dauerhaft in einer Datenbank zu speichern sowie diese zur Überprüfung von Arbeiten Dritter zu verwenden oder hierzu zur Verfügung zu stellen.

Bern 22.04.2022

