

UCJV300/150, CJV300 Plus series ID Cut Guide

Congratulations on your purchase of an inkjet printer of MIMAKI (print & cut type). UCJV300/150, CJV300 Plus series This " ID Cut Guide", describes the method for ID cut by using UCJV300/150, CJV300 Plus series and the supplied software. Precautions and predefined settings are also described.

Note

- It is strictly prohibited to write or copy a part or whole of this document without our approval.
- This document has been carefully prepared for your easy understanding, however, please do not hesitate to contact a distributor in your district or our office if you have any inquiry.
- Description contained in this document are subject to change without notice for improvement.
- Due to improvement or change of software, the description of this document could be partially different in specification, for which your understanding is requested.
- With the exception of what is provided for in the warranty provisions of MIMAKI ENGINEERING CO., LTD., we do not assume any liability against the damages (including but not limited to the loss of profit, indirect damage, special damage or other monetary damages) arisen out of the use or failure to use of this product. The same shall also apply to the case even if MIMAKI ENGINEERING CO., LTD. had been notified of the possibility of arising damages in advance. As an example, we shall not be liable for any loss of the media made using this product or indirect damages caused by the product made using this media.
- You can also download the latest operation manual from our website.

FineCut, RasterLink, RasterLink6Plus and CuttingLink are registered trademarks of MIMAKI ENGINEERING CO., LTD.

Adobe Illustrator is a trademark of Adobe Systems Incorporated.

CorelDRAW is a trademark of Corel Corporation.

Microsoft and Windows are registered trademarks of Microsoft Corporation of the U.S.A.

Apple and Macintosh are registered trademarks of Apple Inc. of the U.S.A. and each country.

All brand names and product names are trademarks or registered trademarks of their respective companies.

TABLE OF CONTENTS

Note	1
What is ID cut?	3
ID Cut Procedure	4
Preparation	5
Set up PC.	5
Printing, and ID Cutting	8
Set the media.	8
Print data.	9
ID cut	11
How to handle the following cases.....	12
Troubleshooting	12
Changed CuttingLink - Server.	14
Back up the data of CuttingLink - Server.	14
Migrate CuttingLink - Server.	14
1. Reset initial setting on CuttingLink - Server PC before migration.	14
2. Configure Server on CuttingLink - Server PC to be migrated.	14
3. Register CuttingLink - Server PC on RasterLink6Plus.	14
When to use CuttingLink - Client?	15
How to set CuttingLink - Client	15
Data in the same place is cut twice	16
When you want to ID cut multiple types of data	17

What is ID cut?

It is a function that can cut automatically according to the ID information simply by detecting the ID-contained data. You do not have to output the cut data again after printing the data. (Typically, you need to print the print data and the cut data separately.)

- ID Cut Operation Flow

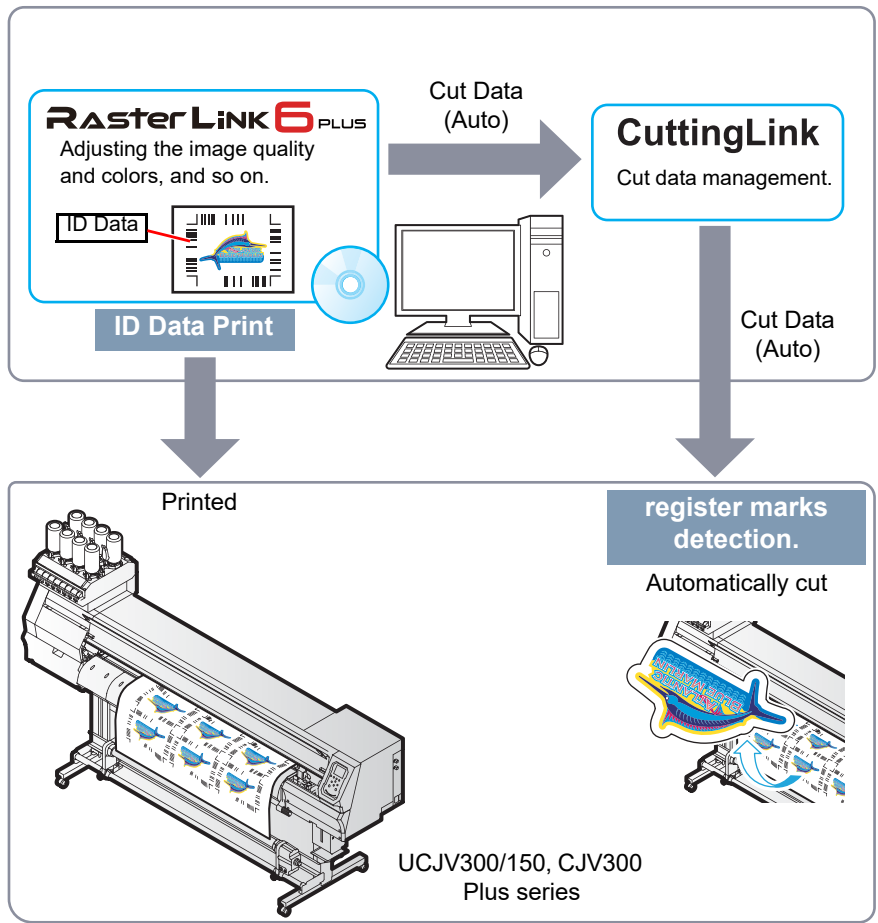

- System configuration

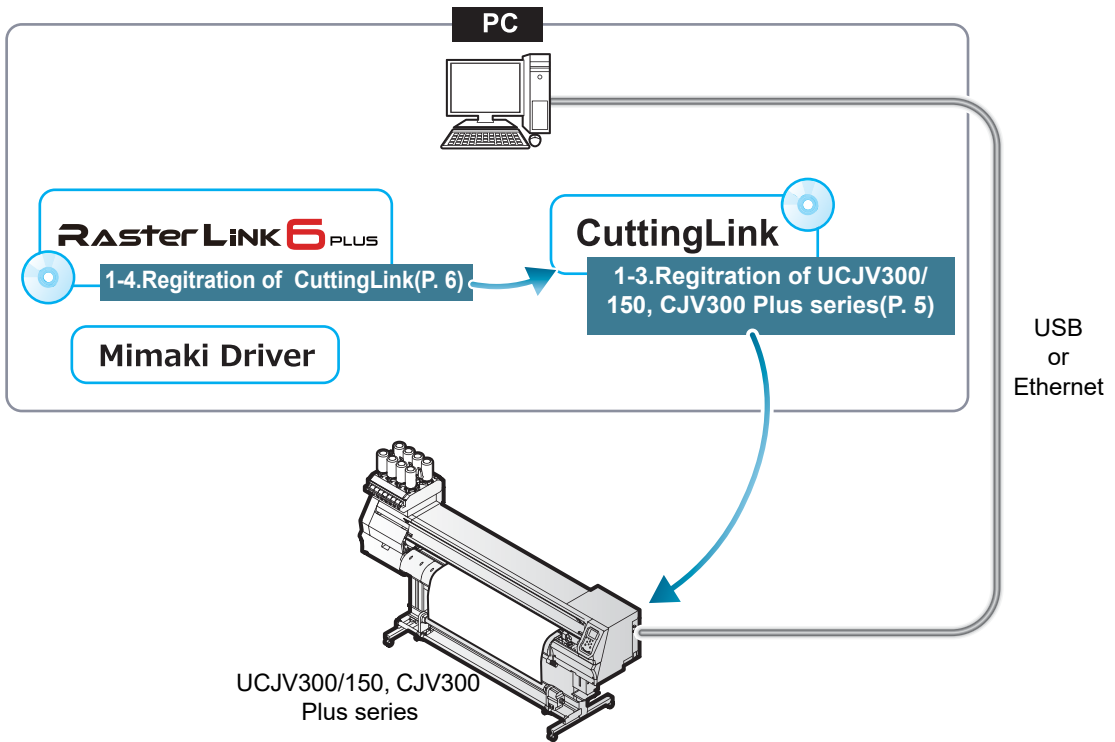

ID Cut Procedure

1. Software / Driver List (P.5)

1. Connect PC and UCJV300/150, CJV300 Plus series with USB or Ethernet. (P.5)
2. Install CuttingLink. (P.5)
3. Register UCJV300/150, CJV300 Plus series with CuttingLink. (P.5)
4. Register CuttingLink with RasterLink6Plus. (P.6)

2. Set the media. (P.8)

1. Set the media onto UCJV300/150, CJV300 Plus series. (P.8)
2. Check if the media margin is sufficient.(P. 8)

3. Print data. (P.9)

1. Start RasterLink6Plus. (P.9)
2. Read the Sample file. (P.9)
3. Add register marks and ID data. (P.9)
4. Select [RIP & Print] or [Immediate Print]. (P.10)
5. Click [Start]. (P.10)
6. Data with ID will be printed. (P.10)

4. ID cut (P.11)

1. Detect the register mark (P.11)
2. The cut data is automatically received and cut. (P.11)

Preparation

You need to prepare UCJV300/150, CJV300 Plus series and the software/Driver before printing or ID cut. If preparations have already been completed, go to "Printing, and ID Cutting" (P.8).

• Software / Driver List

The following software applications are required for ID cut. All software applications are provided by MIMAKI ENGINEERING CO., LTD.

Software/Driver	Description
RasterLink6Plus* ¹ Ver.2.3 or later	Software to receive image data, edit data with various functions, and send plot data to the printer. (supplied with the printer: CD) Refer to the attached RasterLink6Plus Installation Guide for the installation method.
CuttingLink* ¹ Ver.1.1.4 or later	Software to manage ID cut. Download the installer from the Mimaki website(http://mimaki.com/) Refer to the attached " CuttingLink installation " of Raster-Link6Plus Installation Guide for the installation method.
Mimaki Driver	Device driver for using an ink jet printer/cutting plotter from Mimaki Engineering. (supplied with the printer: CD) Refer to the attached Mimaki Driver Installation Guide for the installation method.

*1. When using a version earlier than the specified version, download the upgraded version of the installer from the Mimaki website. (<http://mimaki.com/>)

Set up PC.

1. Connect PC and UCJV300/150, CJV300 Plus series with USB or Ethernet.
2. Install the software/driver.
 - (1) Install Mimaki Driver.
 - (2) Install RasterLink6Plus.
 - (3) Install CuttingLink.
3. Register UCJV300/150, CJV300 Plus series with CuttingLink.
 - (1) Start CuttingLink from the start menu, or double-click the CuttingLink icon created on the desktop to start CuttingLink.
 - The [Initial Setting] screen is displayed.



- (2) On the [Initial Setting] screen, select [CuttingLink-Server], and then click [OK].
- [Data Management] is displayed.

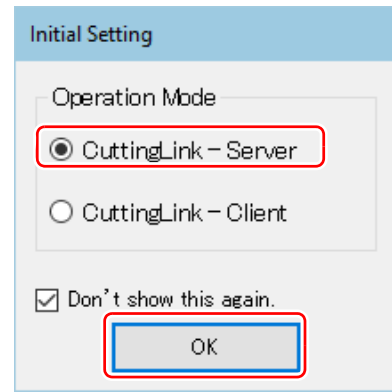

- (3) From the [Tool] menu, select [Cutting Device Manager].

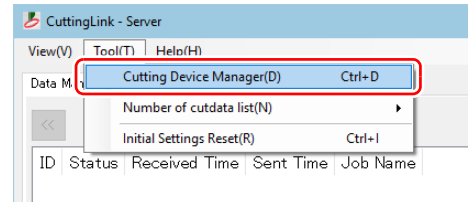

- (4) Select UCJV300/150, CJV300 Plus series in [Available Devices].

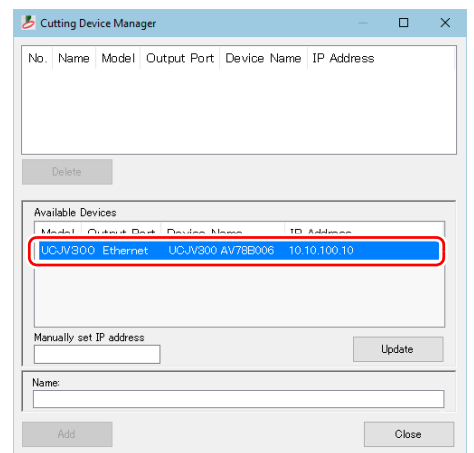

- (5) Enter [Name], and then click [Add].
- UCJV300/150, CJV300 Plus series is added to the list.

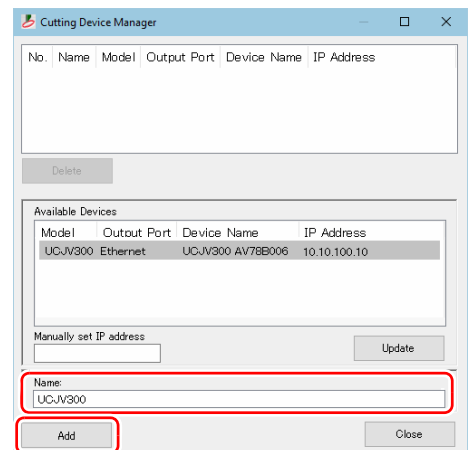

- (6) Click [Close].



- CuttingLink is started automatically when PC starts.

4. Register CuttingLink with RasterLink6Plus.

- Make sure that CuttingLink is running.
- (1) Start RasterLink6Plus.

(2) Select [Option...] from the [Environments] menu in Raster-Link6Plus.

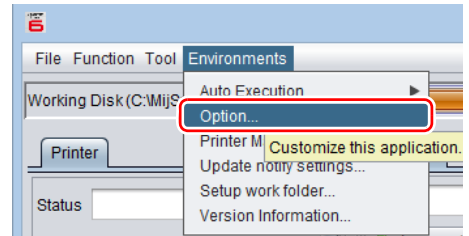

(3) Click the [Communication] tab on the [Option] screen.

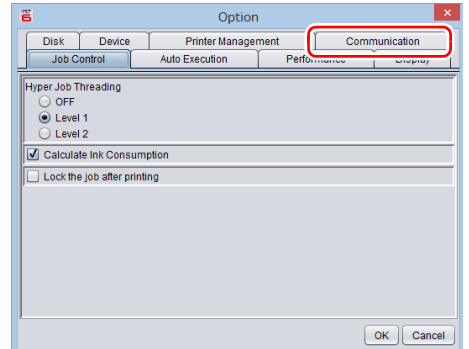

(4) [Setting of ID Cut: Click [Setup] in [Connection destination].
• The [Connection destination setting] screen is displayed.

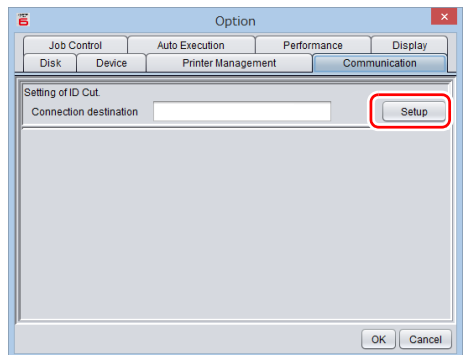

(5) On the [Connection destination setting] screen, select this my computer, and then click [OK].
• The [Connection destination setting] screen is closed.
• On the [Option] screen, "PC name (IP address)" is displayed in [Connection destination].

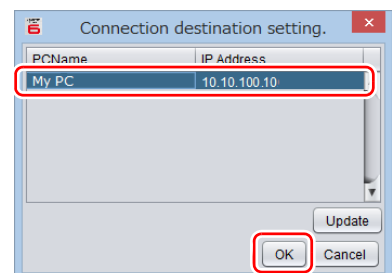

(6) Click [OK] on the [Option] screen.
• Connects with CuttingLink.

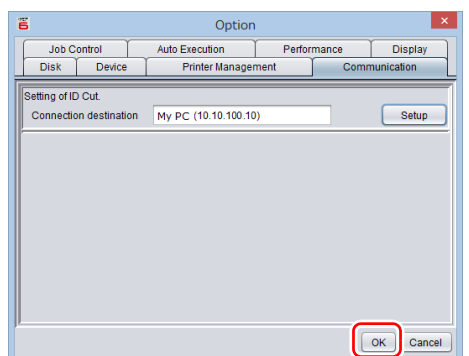

Printing, and ID Cutting

The following shows you how to use and print out the sample data from the attached manual CD. If there is no sample data, create data including illustrations and cut lines.

Important!

- Make sure that you check [P.5 "Preparation"](#) and then print and cut.

Set the media.

For detail, refer to the UCJV300/150, CJV300 Plus series Operation Manual.

If you cut the media rotated by 90, 180, or 270 degrees, set the media margins to the following values at rotated conditions.

- Front end: 110 mm or more
- Left and right ends: 15 mm or more
- Rear end: 110 mm or more
210 mm or more (When copying data with RasterLink6Plus.)

1. Set the media onto UCJV300/150, CJV300 Plus series.
2. Check if the print start position (the origin) is set at 110 mm or more from the media front end, and 15 mm or more from the media right end.
 - Make sure that the width of the media is equal to or larger than [Entire image width (including the register mark) + right 15 mm + left 15 mm].
 - If any of the front / left / right margin is insufficient, the media end may be mistaken as the register mark, which may cause the register mark detection to start earlier.
 - (1) Press the jog key in the local state. Move the luminous point of the LED pointer so that the print start position is 110 mm or more from the media front end, and 15 mm or more from the right end.
 - (2) Press the [ENTER] key.
 - The print start position is changed.
3. Check if the print end position is set at 110 mm or 210 mm (When copying data with RasterLink6Plus.) from the media rear end.
 - Make sure that the length of the media is equal to or larger than [Entire image length (including the register mark) + 110 mm + 110 mm or 210 mm(When copying data with RasterLink6Plus.)].

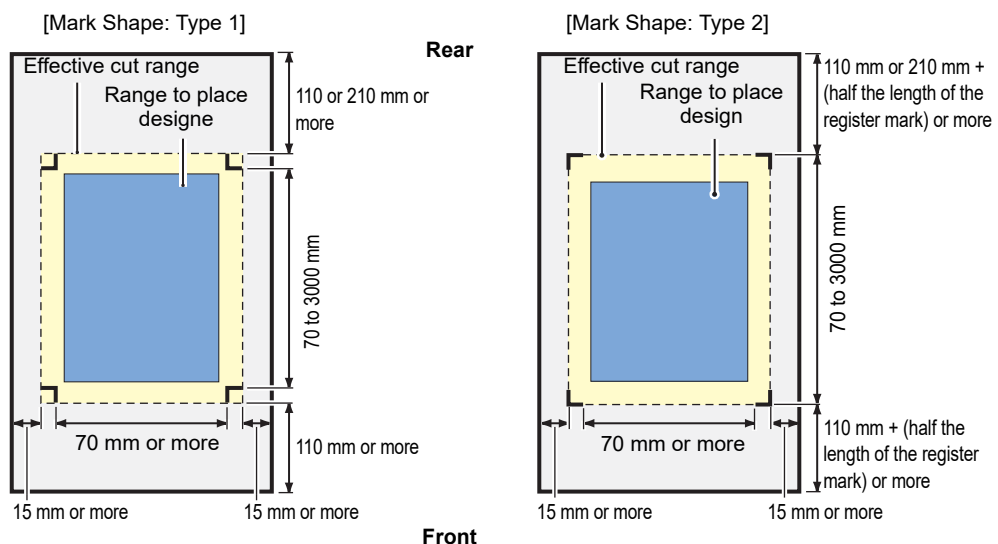

Print data.

1. Start RasterLink6Plus.
2. Set the manual CD to your computer.
 - If there is no sample file, create the sample file with the following procedure and go to step 3.
 - (1) Create "illustration data" and "cut line data".
 - (2) Placing the "illustration data" on the print layer ([Print] attribute: ON) and the "cut line data" on the cut layer ([Print] attribute: OFF).
3. From the [File] menu, select [Open].
 - The [Select file name to print] screen is displayed.
4. Read the Sample file.
 - If there is no sample file, use the data created in step 2.
 - (1) Select the following files on the [Select file name to print] screen, and click [Open].
 - For Windows: "CD drive:\EN\English\
ID Cut_Sample data\sample_mimaki.eps"
 - For Macintosh: "CD drive:\Mac_English\
ID Cut_sample data\sample_mimaki.eps"
 - (2) The sample data is loaded.
 - Sample data is created with RasterLinkTools.
For details on how to create print & cut data, refer to the RasterLink 6Plus Reference guide "RasterLinkTools".
5. Select the read data and click the [General Print] icon  in the function icon list on the right side of the screen.

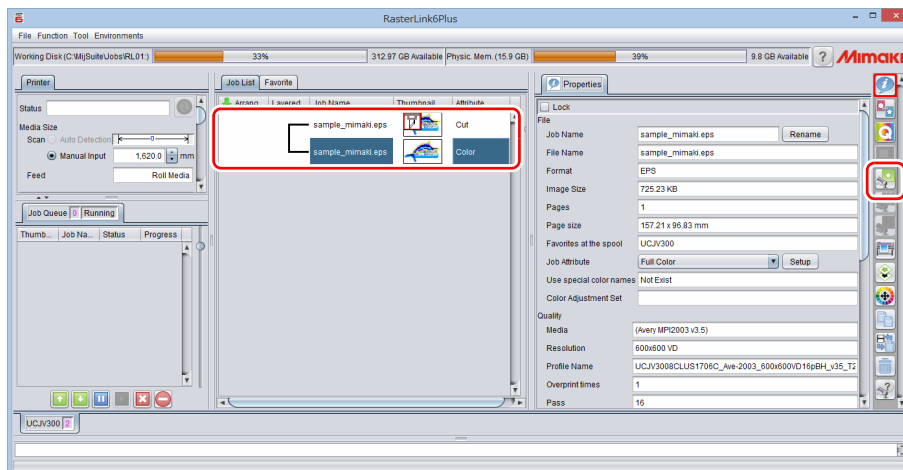

6. Add register marks and ID data.

The conditions under which ID cut is possible are as follows.

 - Mark Shape: [Type 1 

- 9 -

(3) Check [ID Cut].

- Register marks and ID data are added to the data.

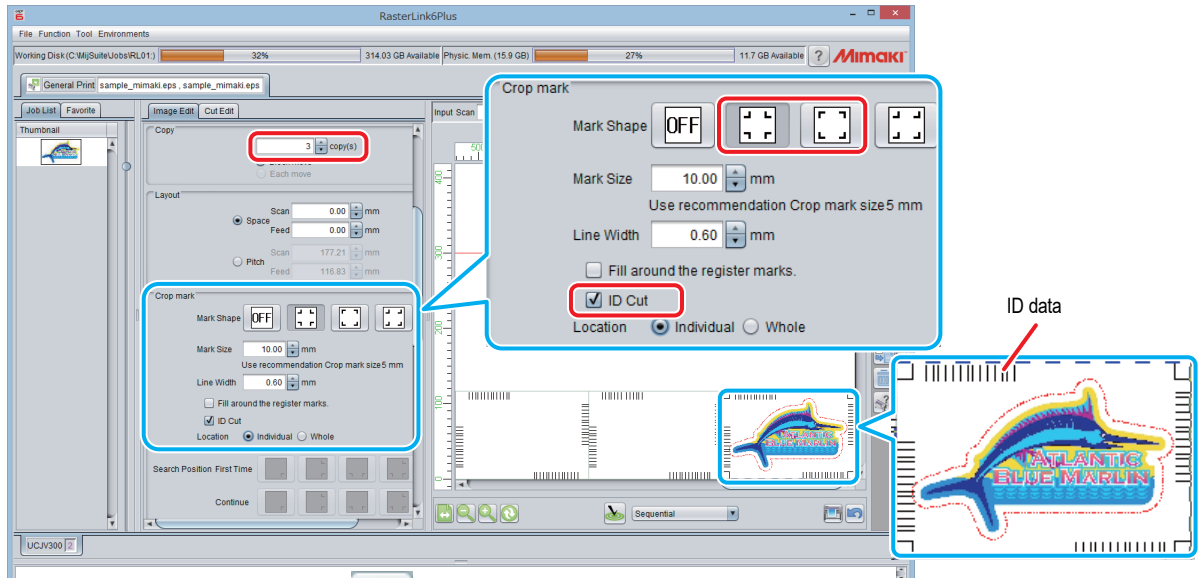

7. Click the Execution icon  in the function icon list on the right side of the screen.
8. Select [RIP & Print] or [Immediate Print].
9. Click [Start].

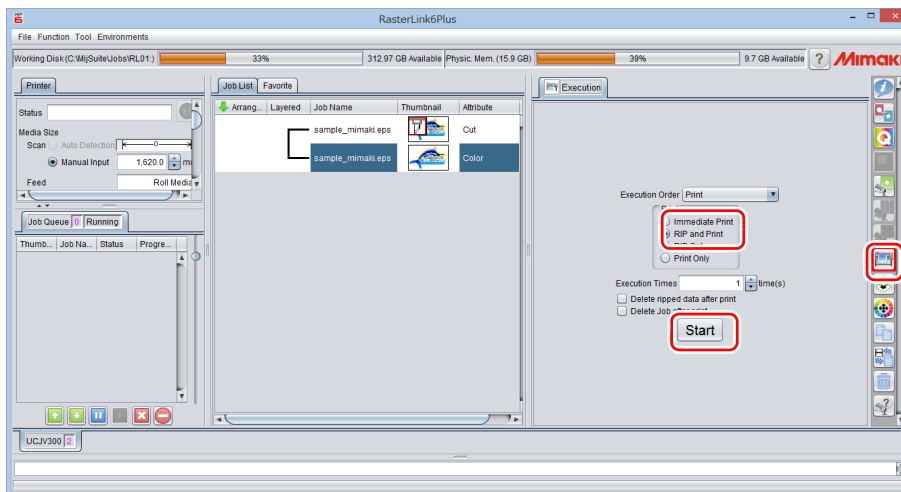

10. Data with ID will be printed.

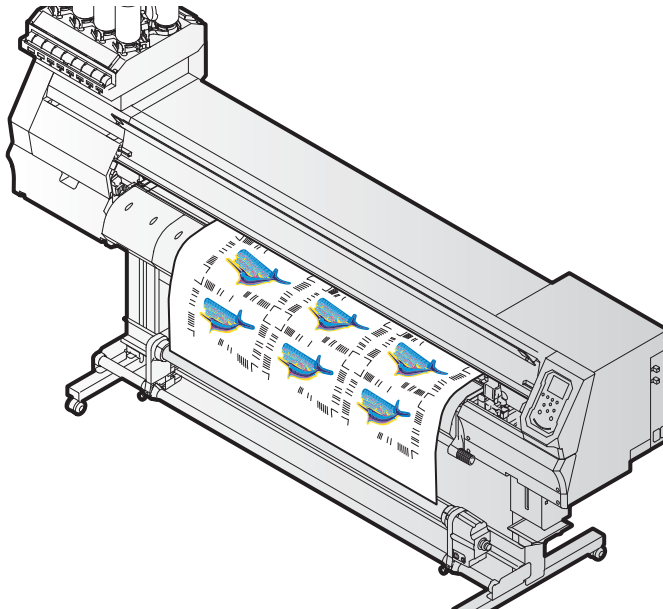

ID cut

1. Detect the register mark

- (1) Press the [SEL] key twice in LOCAL mode.
- (2) Press the [▲][▼] key to select [MARK DETECTION], and press the [ENTER] key.
 - This switches to the mark detection mode.
- (3) Press the [▲][▼][◀][▶] keys to move the luminous point of the LED pointer to the center of the register mark.

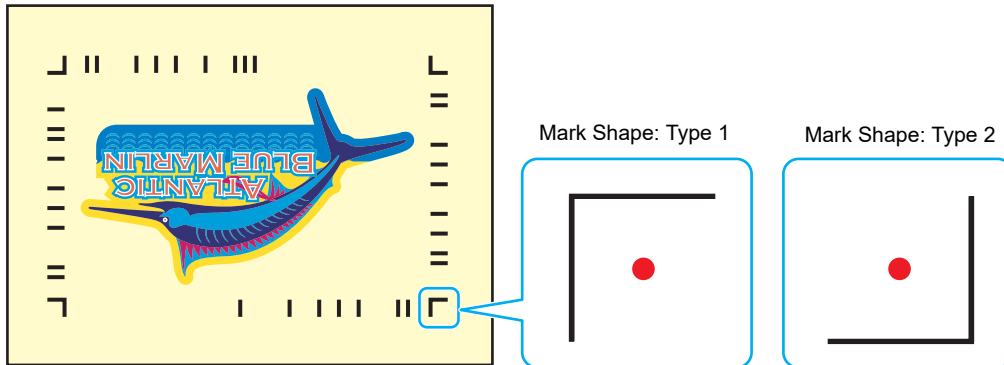

- (4) Press the [ENTER] key.
 - The register mark is detected.
 - The printer is in remote mode.

2. The cut data is automatically received and cut.

How to handle the following cases.

Troubleshooting

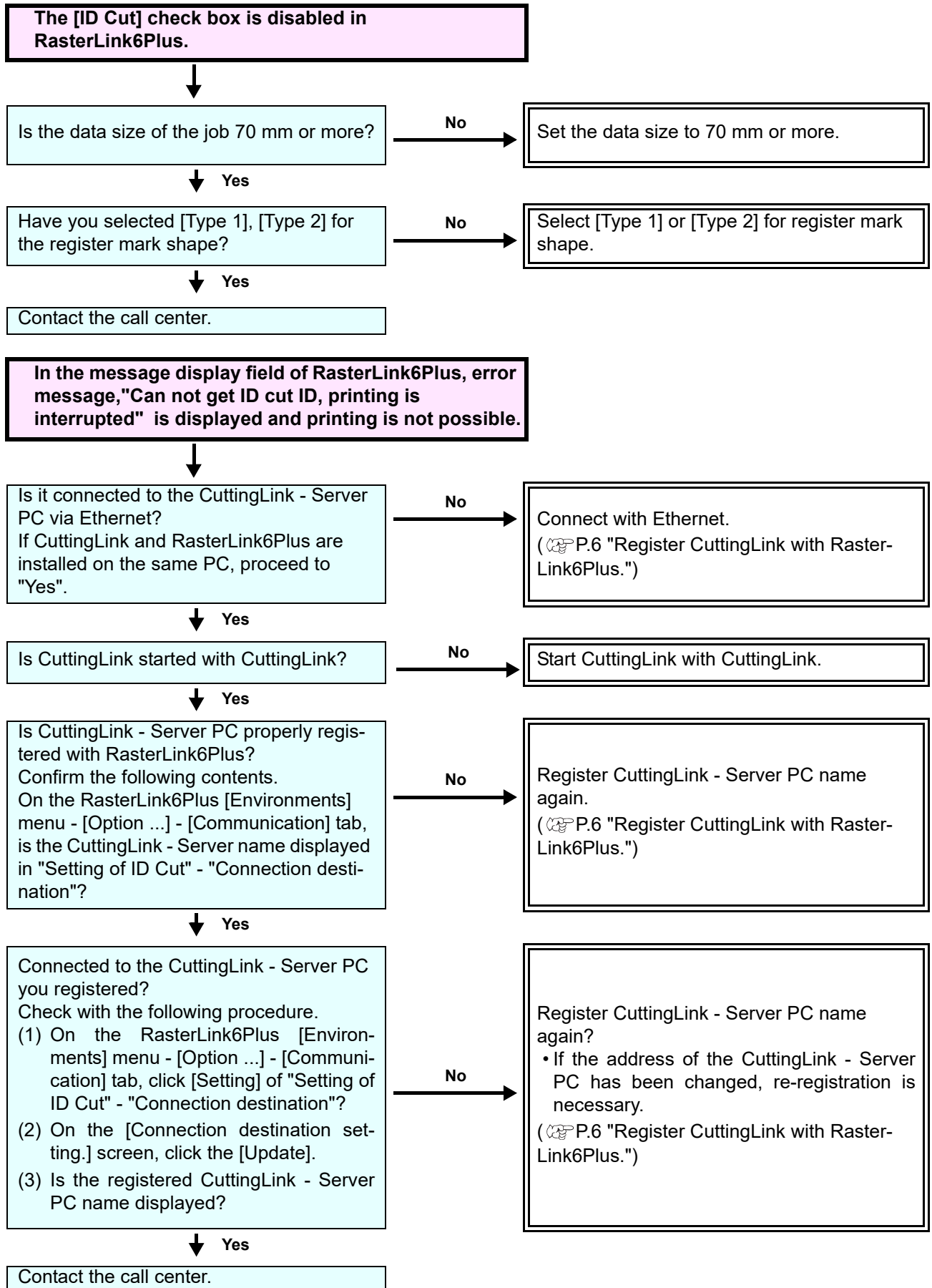

Even if register marks are detected with UCJV300/150, CJV300 Plus series, ID cut is not performed.

Is PC and UCJV300/150, CJV300 Plus series connected via USB or Ethernet?

No

Connect with USB or Ethernet.

Yes

Is UCJV300/150, CJV300 Plus series properly registered in CuttingLink - Server?
Confirm the following contents on the [Cutting Device Manager] tab of CuttingLink - Server.
(1) Is [Output Port] the same as what is physically connected? (USB/Ethernet)
(2) Is the serial number displayed in [Device Name] the same as the serial number of the UCJV300/150, CJV300 Plus series main unit?

No

Register UCJV300/150, CJV300 Plus series with Cutting -Link. (☞ P.5 "Register UCJV300/150, CJV300 Plus series with CuttingLink.")

Yes

Is the ID cut setting correct in UCJV300/150, CJV300 Plus series?
Check the following contents on the operation panel.
• Is [CUTTING] - [MARK DETECTION] - [FORM] and [SIZE] the same as the print register mark data?

No

Set the same register mark shape and size as the print register mark data with UCJV300/150, CJV300 Plus series.

Yes

Contact the call center.

When multiple register marks with different IDs are attached, does not cut continuously.

Is the shape and size of the register mark printed all the same?

No

Make all shapes and sizes of register marks same.

Yes

Are the values for [CUTTING] - [MARK DETECTION] - [DETECT AREA] appropriate on UCJV300/150, CJV300 Plus series?

No

Enter the correct set [cutting] - [register mark detection] - [detection area] with UCJV 300/150. (☞ P.19 "Set the register mark detection area on the operation panel of UCJV300/150, CJV300 Plus series.")

Yes

Contact the call center.

Changed CuttingLink - Server.

Register CuttingLink again with RasterLink6Plus.
(☞ P.6 "Register CuttingLink with RasterLink6Plus.")

Back up the data of CuttingLink - Server.

Back up the following folders.
C:\MimakiTools\CuttingLink\DT

Migrate CuttingLink - Server.

1. Reset initial setting on CuttingLink - Server PC before migration.

1. Back up CuttingLink - Server data.
(☞ P.14 "Back up the data of CuttingLink - Server.")
2. From the [Tool] menu, select [Initial Settings Reset] and click the [OK] button.
3. Exit CuttingLink.

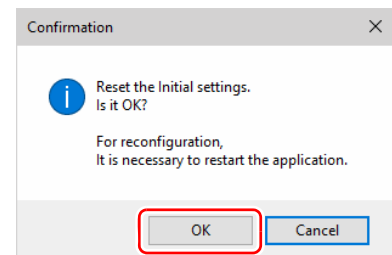

2. Configure Server on CuttingLink - Server PC to be migrated.

1. Install and start CuttingLink.
 - After restarting the PC after installation, CuttingLink will be started automatically.
2. On the [Initial Setting] screen, select [CuttingLink - Server], and then click [OK].
3. Exit CuttingLink.
4. Copy the data backed up on the PC before migration to the folders below.
 - C:\MimakiTools\CuttingLink\DT
5. Start CuttingLink.
6. Register the UCJV300/150, CJV300 Plus series.
(☞ P.5 "Register UCJV300/150, CJV300 Plus series with CuttingLink."(3) to (6))

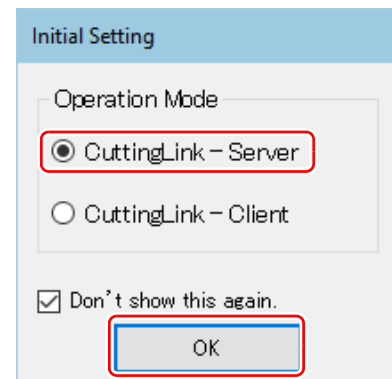

3. Register CuttingLink - Server PC on RasterLink6Plus.

(☞ P.6 "Register CuttingLink with RasterLink6Plus.")

When to use CuttingLink - Client?

CuttingLink - Server can register up to five plotters. As shown below, use Cutting - Client to connect more than 6 plotters.

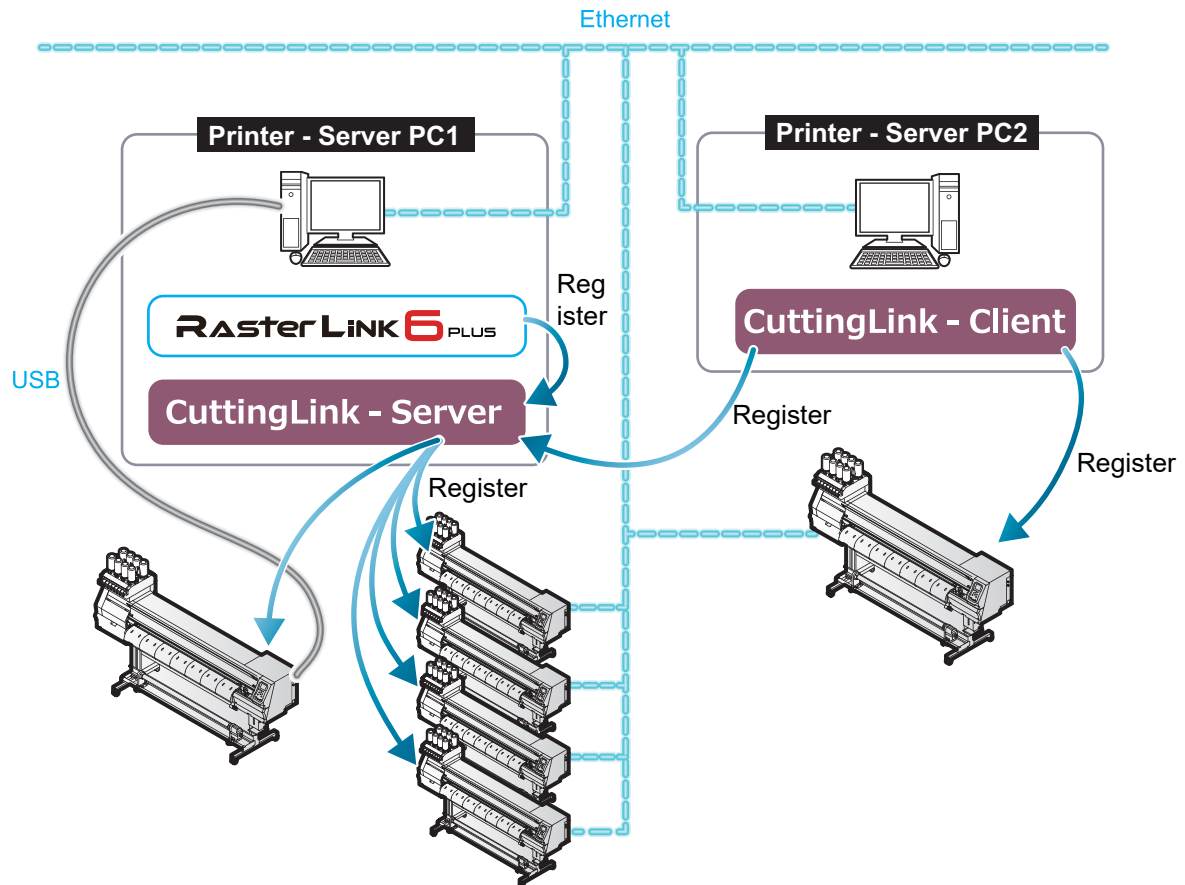

How to set CuttingLink - Client

1. Install CuttingLink on the PC connecting 1st to 5th UCJV300/150, CJV300 Plus series, and set it to CuttingLink - Server. (☞ P.5 "Install CuttingLink." or later)
2. Install CuttingLink on the PC connecting the sixth UCJV300/150, CJV300 Plus series and set it to CuttingLink - Client.
 - (1) Install CuttingLink on the PC to which the plotter is connected and start it.
 - (2) On the [Initial Setting] screen, select [CuttingLink - Client], and then click [OK].

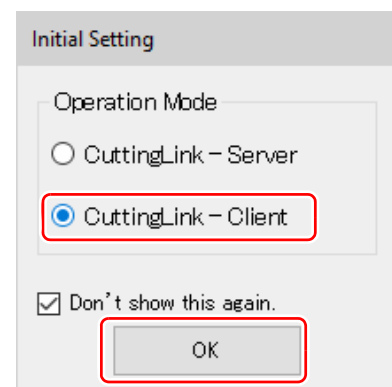

- (3) In the [Connection destination settings] list, select the CuttingLink - Server to connect and click [OK].
- Make sure that CuttingLink - Server is running with CuttingLink - Server PC.
 - If the [Connection destination settings] screen does not appear, select the [Connection destination settings] on the [Tool] menu.
 - If the PC is not displayed, click[Update].

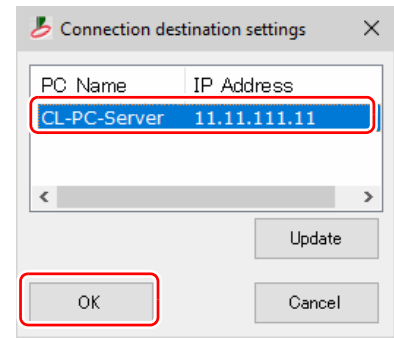

Data in the same place is cut twice

For data of Adobe Illustrator 9 or later to which a transparent effect has been applied, when Print & Cut is executed in RasterLink6Plus, cut data may be cut twice. In such a case, change the settings as follows by using Adobe Illustrator.

- (1) Separate the “Print data” and the “Cut data”, and then move the “Cut data” layer on top.

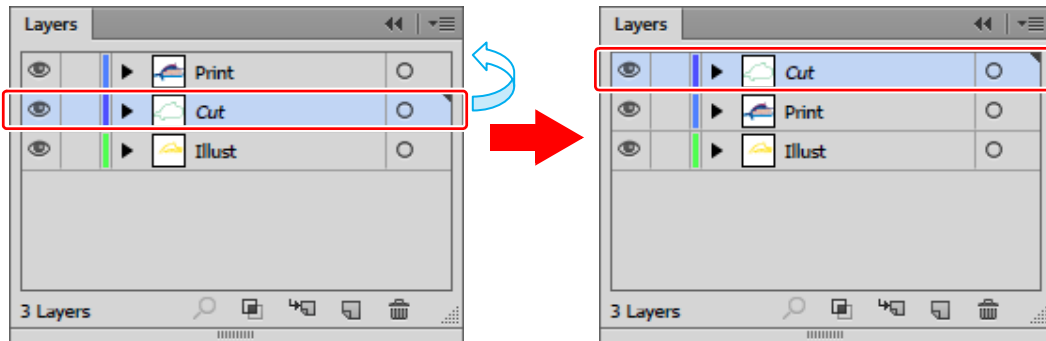

- (2) From the [File] menu, select [Document Setup...].
- (3) On the [Document Setup] dialog, click "Preset" on the right of [Custom...].
- (4) On the [Custom Transparency Flattener Options] dialog, "Convert All Text to Outlines" and set "Convert All Strokes to Outlines" to OFF.

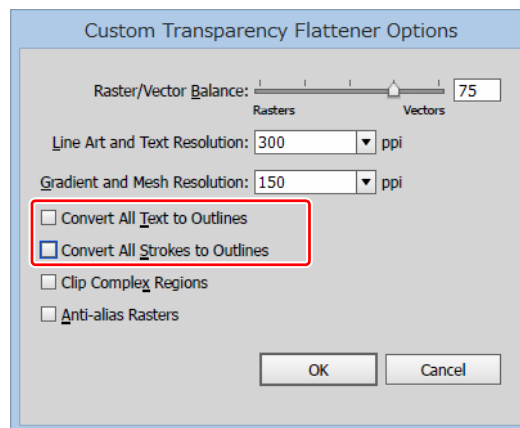

When you want to ID cut multiple types of data

If you print multiple register marks and perform ID Cut, set the same shape and size for all the register marks. If any of the register marks has a different size or shape, the ID Cut is canceled.

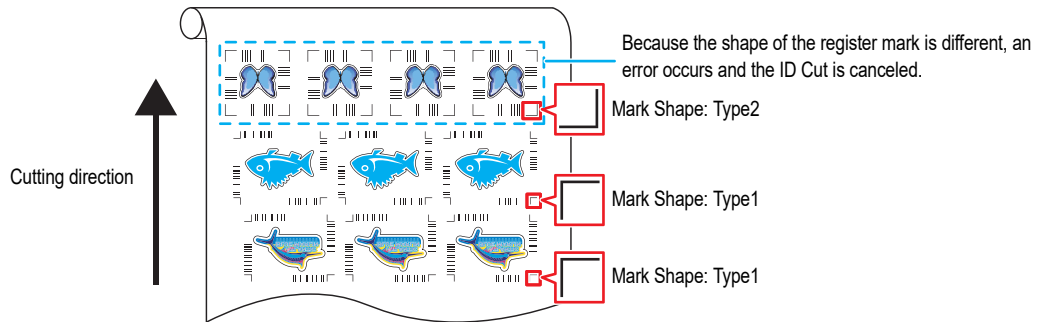

1. Read print & cut data with RasterLink6Plus.

Data size should be more than 70 mm in length and width.

Create print & cut data in the following way.

- Create print data and cut data with Adobe Illustrator / Corel DRAW, and output ID cut without creating and recognizing register marks with FineCut. (Data will be sent automatically to RasterLink6Plus.)

2. Select the data read with RasterLink6Plus and click the [General Print] icon in the function icon list on the right of the screen.

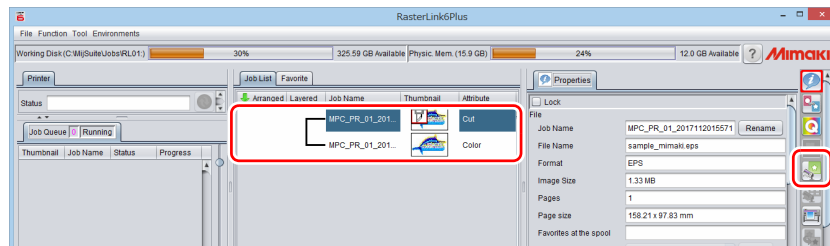

3. Set printing conditions.

(1) Set [Scale].(Arbitrary)

- Scale can not be set for data with ID sent from FineCut.

(2) [Rotation] and [Mirror] are set.(Arbitrary)

(3) Set [Scan] and [Feed] of [Position].(Arbitrary)

- It is unnecessary to set when setting a margin of 10 mm or more.
If not, enter "10 mm" or more in [Scan] and [Feed].

(4) Enter [Copy] number.

(5) Set [Space] or [Pitch] of [Layout].

- When adding register marks, the following values are automatically set for [Space].

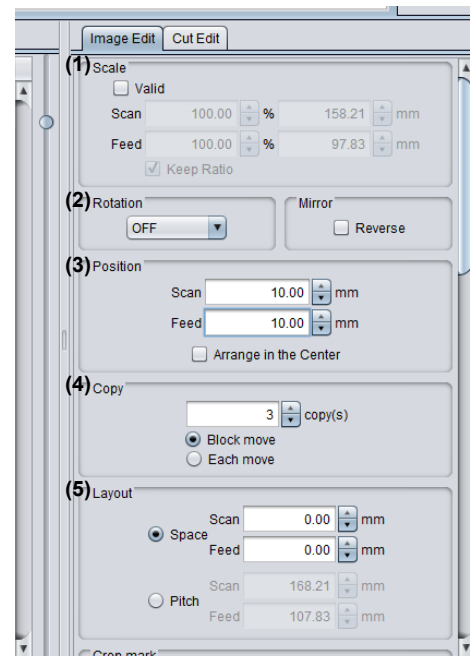

When the register mark shape is [Type1 ]: Register mark size

When the register mark shape is [Type2 ] 0mm



4. Add register marks and ID data.

(1) Select the register mark size.

- [Type1 , [Type2 

(2) Enter the register mark size.

(3) Check [ID Cut].

- Register marks and ID data are added to the data.
- For ID Cut data sent from FineCut, the [ID Cut] check box is already checked. You can not uncheck it.

(4) Select [Location] of register mark.

- Individual: Register marks and ID data are added for each data.
- Whole: Register marks and ID data are added to enclose all copied data.

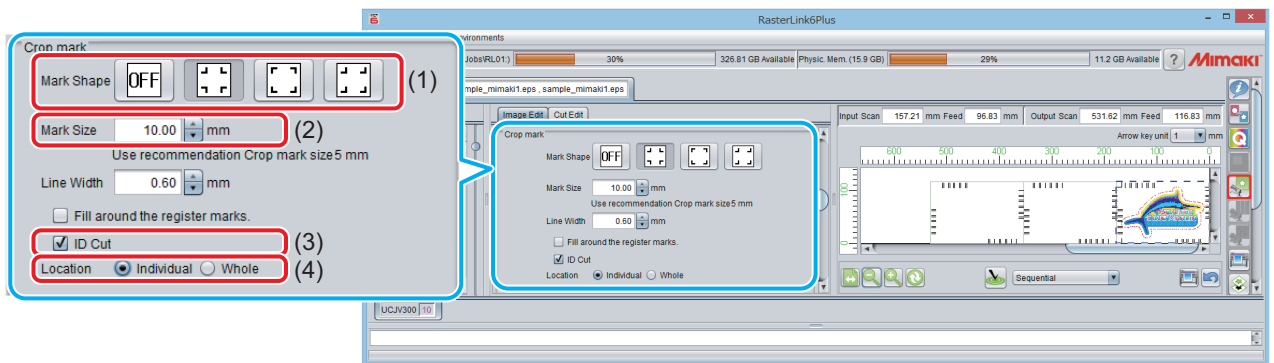

(5) [Offset] is set when [Whole] is selected in (4).

- Offset: Data and margin of register mark

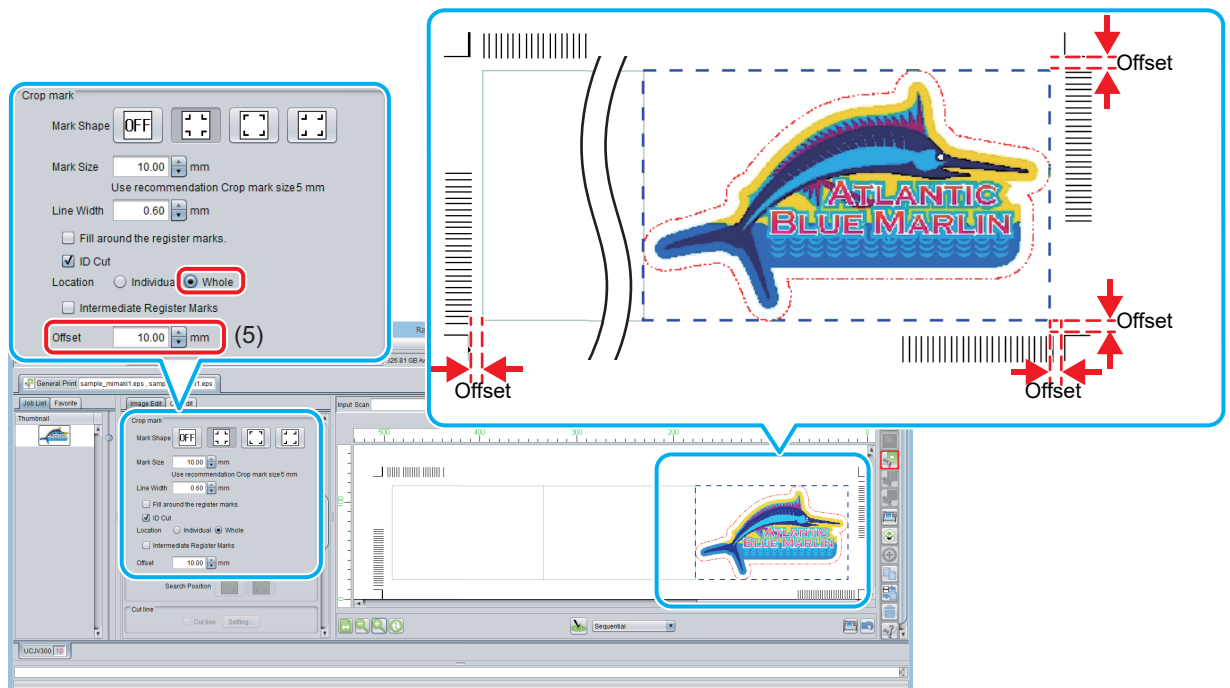

5. Output data with RasterLink6Plus( P.9 "Print data.")

- Data with ID will be printed.

6. Create another data and repeat Step1 to Step5.

7. Set the printed media on UCJV300/150, CJV300 Plus series.

8. Set the register mark detection area on the operation panel of UCJV300/150, CJV300 Plus series.

- (1) Press the [MENU]([FUNC1] key) in LOCAL mode.
- (2) Press [▲][▼] key to select [CUTTING], and press the [ENTER] key.
- (3) Select [MARK DETECTION], and press the [ENTER] key.
- (4) Press the [FUNC3] key.
- (5) Press the [▲][▼] key to set the following items, and press the [ENTER] key.

Item	Value	Set value
DETECT AREA	-	You can configure various settings for the register mark operation.
SCAN DIR.	DEFAULT, 0 cm, 5 cm to the machine width	Configure the detection width for the scanning direction. The register mark is detected while scanning is performed bidirectionally at the set detection width. <ul style="list-style-type: none"> • DEFAULT: The register mark is detected at half the media width. • 0 cm: The register mark is detected only in the feed (media feed) direction. • 5 cm to the machine width: The register mark is detected with the set width.
FEED DIR.	10 to 50 cm	Set the detection distance in the feed (media feed) direction.
OFFSET X	0 to 100 cm	Set the Detection start position after the ID Cut.

- SCAN DIRECTION, FEED DIRECTION, and OFFSET X of [DETECT AREA] are as follows.

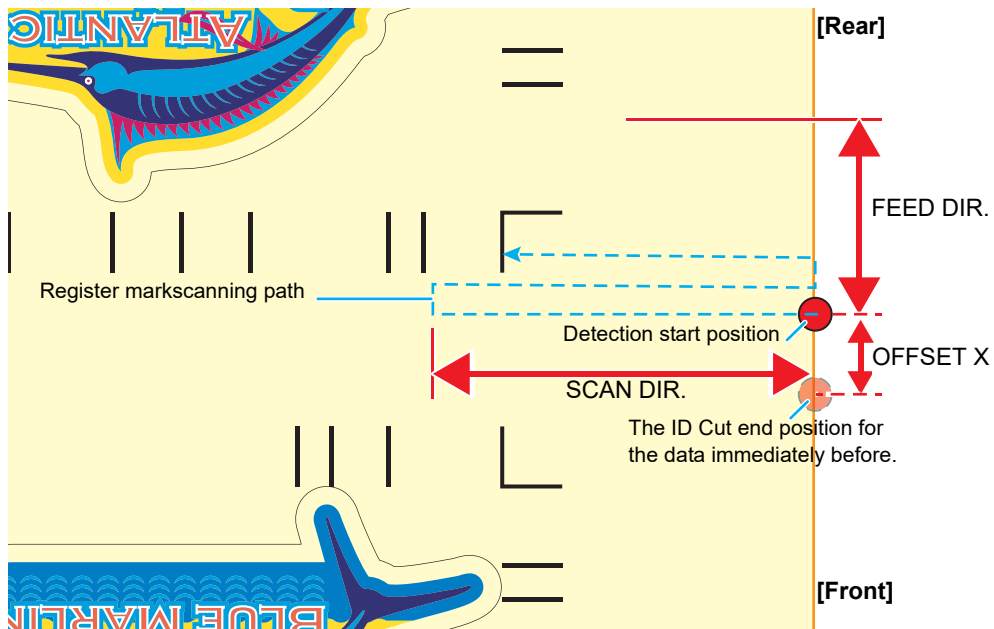

9. Set the printed media.

The register mark is detected in the feed (media feed) direction.

Set the media margins to the following values.

- Front end: 110 mm or more
- Left and right ends: 15 mm or more
- Rear end: 210 mm or more

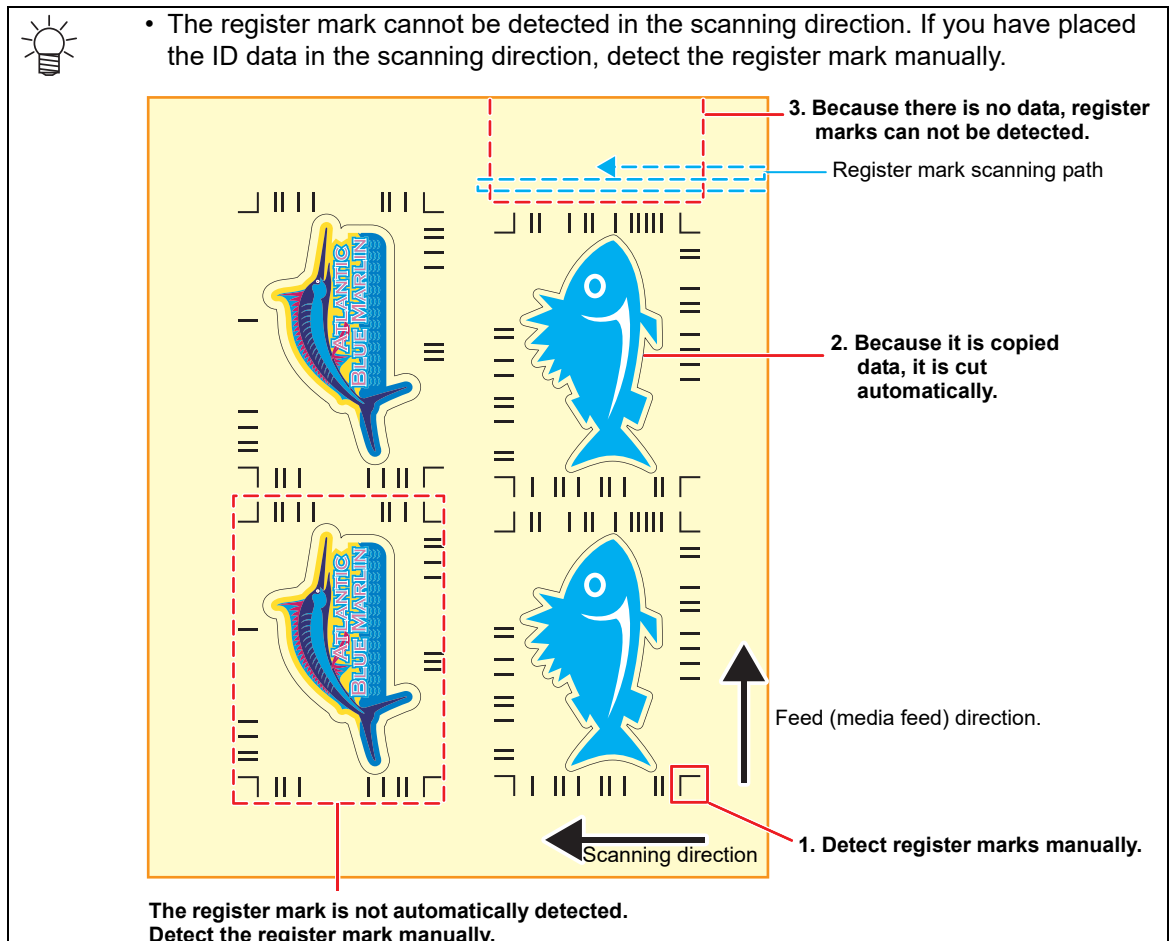
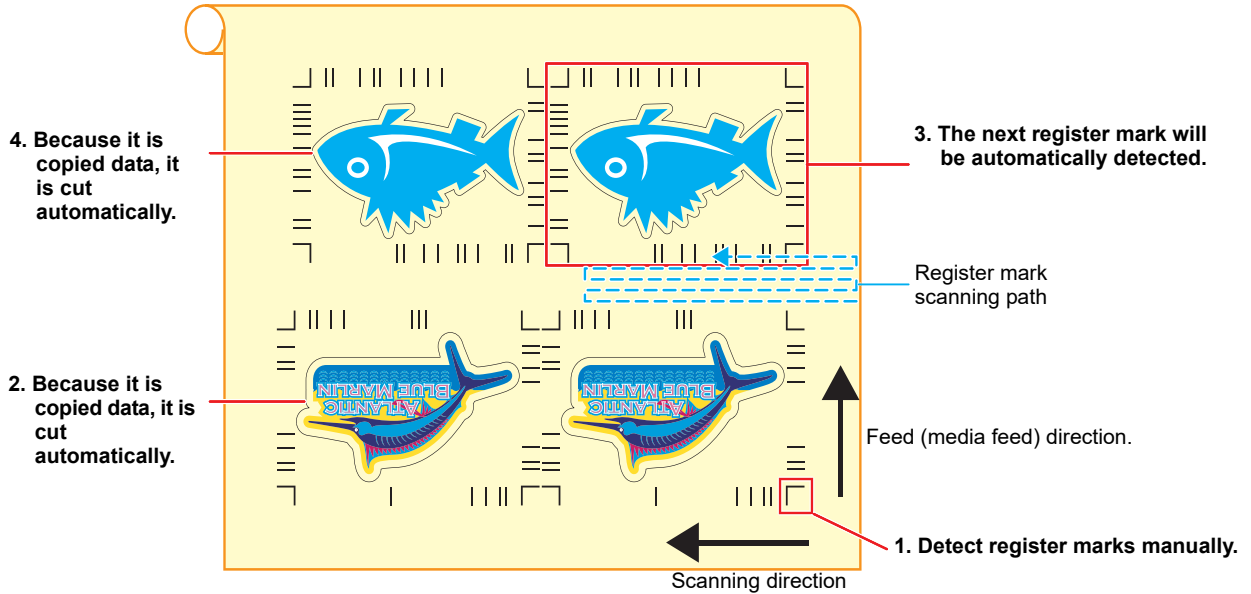

10. Detect the register mark, and then the cut data is automatically received and ID Cut.

- After the ID Cut, the next register mark will be automatically detected.

11. If you have multiple pieces of data, [Auto detection -> ID Cut] is repeated until all pieces of data are finished.

MEMO:

