

Product Catalog



H-S81-HS

Panel

Description of the S81-HS Panel

The H-S81-HS panel is an advanced technological product designed to protect industrial plants and equipment for safety applications. It is characterized by simple configuration and programming, excellent reliability, and system diagnostics.

The S81-HS is similar to a "safety" PLC and it is also configurable and programmable to perform integrated fire detection and fire extinguishing control, gas detection, and technological control functions, in compliance with application and product regulations.

It can interact with other panels of the same type, as well as with supervisory and SCADA systems, through both proprietary and standard protocols, such as Ethernet TCP/IP, Modbus, or OPC server.

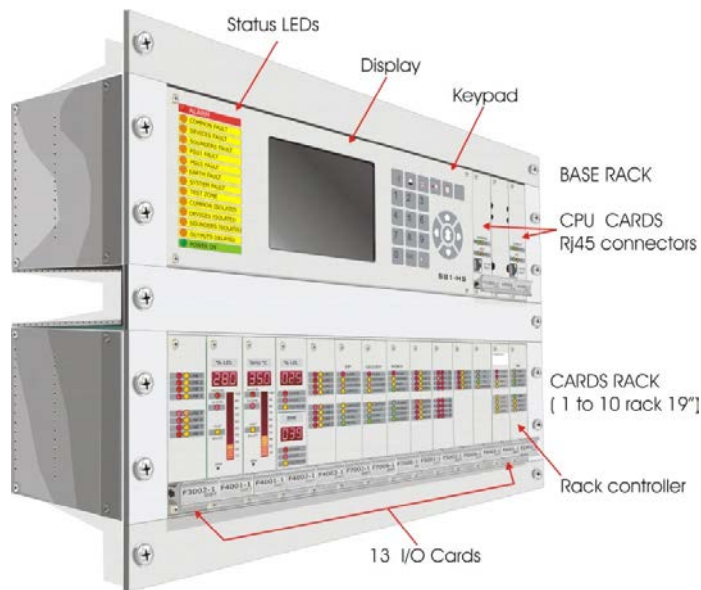

Main Characteristics

- PC configurable with the program ProS81
- Can be managed through a supervisory program
- Can be networked with other panels
- 19" rack modular construction
- From 2 to 10 racks with 13 card slots
- Front plug-in/out cards
- Two CPU's, in hot back-up to one another
- Cards interconnected on redundant bus loop
- Cyclical testing, with automatic simulation of card inputs and outputs
- Automatic monitoring of card and CPU fault
- Automatic and safe disabling of malfunctioning cards
- Hot-swap of cards and CPUs
- High immunity to electromagnetic disturbances.

Reference Standards and Certifications

- IMQ-certified to EN 54-2 and EN 54-4 for fire detection systems
- CPD-certified to EN 12094-1 for fire extinguishing systems
- SIL2 and SIL3 certified to IEC61508 Functional Safety (SIL)
- Gost R and Gost K certified
- UL listed
- AS certified (Australian Standard)
- Certification EU-MED (Marine certification) in progress

Mechanical Construction

The panel, which has a modular structure, is mainly composed of 19"-3HE anodized aluminum racks contained in a cabinet with a swivel rack chassis and an acrylic glass door.

The panel can be composed from a minimum of 2 racks to a maximum of 10 racks according to the application's requirements.

The first rack (base rack) is always necessary and includes one or two CPU's, the display for the operator interface and the keyboard. Any further rack is used to install cards, whose type and quantity depend on specific application requirements.

Each card is terminated either on a DIN rail-mounted electronic-type terminal block (for 4mm² conductors), via a flat cable, or on an electromechanical-type marshaling terminal block, via a cable with plug connector.

In addition to versions tailored to meet specific customer requirements, three standard configurations are available, for the European market, in accordance with the CPD certifications:

H-S81-HS/1R: Base rack + 1 card rack, in wall-mounting cabinet (L=600 H=700 D=400mm)

H-S81-HS/2: Base rack + 2 card racks, in wall-mounting cabinet (L=600 H=1100 D=400mm)

H-S81-HS/10R: Base rack + up to 10 card racks, in self-standing cabinet (L=800 H=2100 D=800mm).

Configuration

One of the most important characteristics of the S81-HS panel is the user-friendly windows-compatible configuration program ProS81, which is simple to use and makes it possible to suit the system to specific application requirements and modifications. With the ProS81 program, it is possible to configure logic association and, or, n of n, and time based, to use on one panel or more connected panels.

Technical Specification Summary:

Mechanical Modularity	
Structure	Self-standing cabinet, with swivel 19"-3H rack chassis and door
Front	Acrylic glass door, lockable
Expansion	By addition of racks, each having 13 card slots
Terminal blocks	On DIN rail
Card installation	Front plug-in
Card replacement	Hot swap (no need for either panel switching off, or intervention on connections and wiring)
Field connection	Through terminal block cards and flat cables (monitored connection)
Card connection	Through serial line on redundant bus managed by FPGA
Direct Control and Interfacing	
4-20 mA inputs	On cards and modules for 4-20 mA inputs
Addressable devices	Total 130 loops, 127 addresses per loop
Detection cards	Specific cards, with self-configuration capability (also to existing detection lines)
Technological controls	Addressable cards and modules on BUS
Commands	Addressable cards and modules on BUS
Automatic fire extinguishing control	Special native cards for this function can control up to 64 extinguishing zones certified to EN 12094-1
Extinguishing controls (directional valves)	Special native cards for this function, with no logic and control limitation
Repeaters	Repeaters with alphanumeric display on addressable bus
Remote control	From PC with IRIDE software and OPC server
Communication protocol	TCP/IP on Ethernet, with communication control
Multi-panel architecture	Ethernet and Modbus, copper or optic fibre, redundant
External SCADA interfacing	Standard MODBUS RTU protocol; proprietary protocol on Ethernet
Electronic Modularity	
Display (LCD)	Liquid crystal, retro illuminated, graphic type, 320 x 240 pixel
Main CPU	Hitachi 32-bit CPU with internal operating system and integrated watch dog
S81-U1002-1 (One or two CPUs)	4 MB Data Memory SRAM + 2 MB Program Memory on Flash Eprom 2 RS232 ports + 1 Ethernet 10/100 base TX port per CPU.
Cards on base rack	- I/O base card and interface S81-T8004 - Display + keyboard and signaling S81-U1006-1 - Base back Plane S81-E2003
Necessary cards on expansion racks and connectors	- S81-E2001-1 Back plane rack (flat cable) - S81-E2001-2 Back plane rack (cable plug) - S81-E2002 Rack controller and internal bus - S81-T8001/T8003 Terminal block module; Cable plug S81-CTT/R - S81-T8006/T8007/T8008 Relay cards
Additional cards on expansion racks (max 9 racks)	- S81-F3002 Eight inputs, conventional detection - S81-F4001 One 4-20 mA analog input - S81-F4002 Two analog inputs - S81-F4003 Eight analog inputs - S81-F5001 Eight 500 mA monitored outputs - S81-F5002 Sixteen open collector outputs - S81-F5003 Eight polarity reversal-monitored outputs - S81-F5004 Four monitored outputs - S81-F6001 Fire extinguishing control (EDC), certified to EN12094-1 - S81-F6002 Special logic control - S81-F7001 Addressable analog loop control DCP (UL) - S81-F7002 Analog addressable loop control, ESP protocol - S81-F7009 Analog addressable loop control, Apollo protocol - S81-F7006 MODBUS RTU card - S81-F7008 Cylinder weighting card with MOD-BIL modules - S81-F7010 Addressable bus control, System Sensor protocol
Power supply	
Feeder	There is the availability of several sizes of feeders 2.5, 4 or 20A and can be paralleled. Certified to EN 54-4, with fault indication in case of main supply failure, battery charger or battery fault, overheating
Battery charger	Can be coupled with feeder Battery charge and aging status monitoring, through microcontroller-processed algorithm; thermal compensation during battery charging; testing button; battery capacity ≤ 110 Ah.

S81-U1006-1

S81 Panel Display

The display card is the interface between the panel and the operator.

It is composed of a liquid crystal, LED back-lit, graphic type, with thirty 52-characters lines, twenty-three keys, and a buzzer.

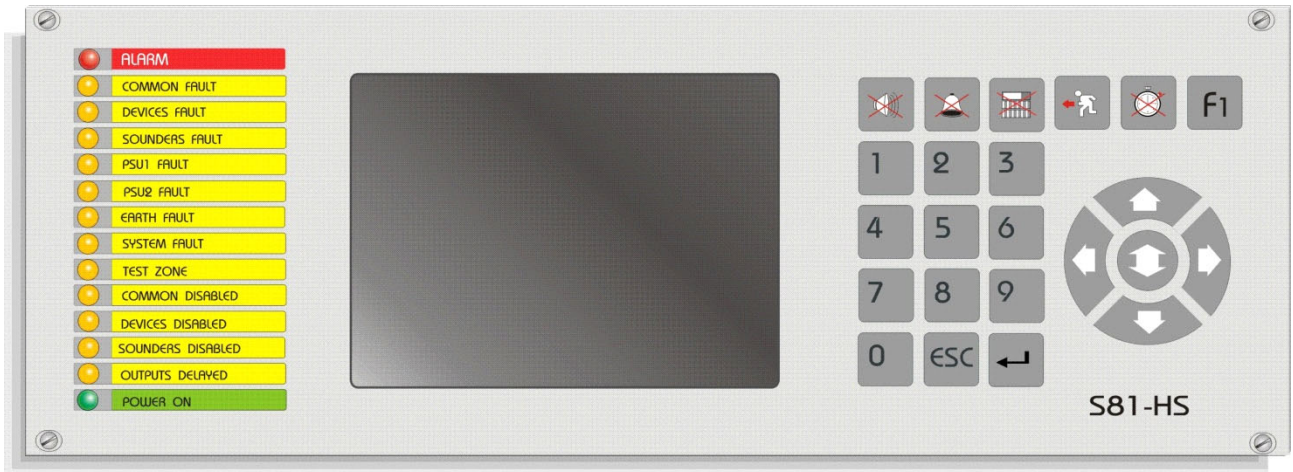

Main Characteristics











- Large display easily visible due to a wide viewing angle
- Displays all panel status conditions and necessary interactive information for the operator
- Display and LED indications are in accordance with the fire fighting standards EN 54-2
- Access to operator functions is subject to different level passwords
- Polycarbonate membrane, with dust and dirt-proof keys.

PANEL AND LED STATUS	ALARM	TEST ZONE	COMMON FAULT	DEVICES FAULT	SOUNDERS FAULT	PSU1 FAULT	PSU2 FAULT	EARTH FAULT	SYSTEM FAULT	COMMON DIS-ABLED	DEVICES DIS-ABLED	SOUNDERS DISABLED	OUTPUTS DELAYED	POWER ON
Normal status	-	-	-	-	-	-	-	-	-	-	-	-	-	⊗
Zone Testing	-	∅	-	-	-	-	-	-	-	-	-	-	-	-
Common fault	-	-	∅	-	-	-	-	-	-	-	-	-	-	-
Card fault	-	-	-	∅	-	-	-	-	-	-	-	-	-	-
Signaling fault	-	-	-	-	∅	-	-	-	-	-	-	-	-	-
Power supply fault	-	-	-	-	-	∅	∅	-	-	-	-	-	-	-
Leakage to earth	-	-	-	-	-	-	-	∅	-	-	-	-	-	-
System fault (CPU)	-	-	-	-	-	-	-	-	∅	-	-	-	-	-
Disabling in progress	-	-	-	-	-	-	-	-	-	⊗	-	-	-	-
Devices disabled	-	-	-	-	-	-	-	-	-	-	⊗	-	-	-
Sounder output disabled	-	-	-	-	-	-	-	-	-	-	-	⊗	-	-
Outputs delayed	-	-	-	-	-	-	-	-	-	-	-	-	⊗	-
Alarm not acknowledged	∅	-	-	-	-	-	-	-	-	-	-	-	-	-
Alarm acknowledged	⊗	-	-	-	-	-	-	-	-	-	-	-	-	-
LED status legend	⊗ = on ∅ = blinking - = off													

Possible Actions Through Keys

OPERATOR'S ACTIONS	Level 1	Level 2 Operator	Level 3 Maintenance
Silencing of panel alarms	OK	OK	OK
Cancellation of control delay	OK	OK	OK
Displaying of alarm and fault status	OK	OK	OK
Silencing and activation of evacuation sounders	-	OK	OK
Include, exclude and reset functions	-	OK	OK
Displaying of event history and exclusions	-	OK	OK
Testing of panel, zones and devices	-	OK	OK
Modification of date and time	-	OK	OK
Access to system configuration functions	-	-	OK
Access to diagnostics functions	-	-	OK

Key Descriptions

ACCESSIBLE FUNCTIONS THROUGH KEYS			
Icon	Meaning	Level	Function
	Panel alarm silencing	1-2-3	Silences panel buzzer
	Sounder alarm silencing	2-3	Silences of general alarm horns in the system
	Panel reset	2-3	Resets all panel and detection line alarms, detectors included
	Evacuation command	2-3	Activates system audible alarms for evacuation
	Delay time setting	1-2-3	Annuls delay time count on active actuators
	Selection cancellation	1-2-3	Back to previous page
	Scroll	1-2-3	Enables display of complete list within operator's cycle menu
	Directions within menus	2-3	Enables navigation in panel access and operation menus
	Numerical keys 0-9	1-2-3	Enable entering passwords and making selections in menus
	Enter	1-2-3	Confirms selection during access operations to panel menus
	Function F1	1-2-3	Varies depending on access level and panel status.

Further Indication

Display rear side LEDs	Function
LD 15	Currently not used
LD 16	Currently not used
Link CPU-A	Communication with CPU-A
Link CPU-B	Communication with CPU-B
Link S81-T8004-1	Communication with card S81-T8004-1

S81-U1002-1

CPU Card

This card is the system's central unit and contains the micro-controller, which processes all the information provided by the other cards of the panel.

In addition to the micro-controller, the card has a flash memory, a buffered static RAM, a watchdog circuit and an Ethernet controller with an RJ 45 Ethernet output connector.

Main Characteristics

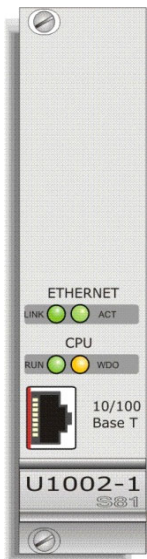

- Can be hot-swapped
- Suitable for applications fault-tolerant up to SIL3 level in accordance with IEC-61508
- Designed to operate in parallel (redundancy)
- Automatic set once the second CPU has been put in
- Micro-controller 25 MHz Renesas (HITACHI) H8-2318
- 4-MB(512K X8) buffered static RAM with lithium battery
- 2-MB expandable flash memory
- Ethernet 10/100 link via RJ 45
- Watchdog external to CPU, for software functional cycle monitoring
- Fault self-check on the hardware
- Built-in clock
- Internal CPLD dedicated to the communication management
- Operating system residing in internal flash memory
- On-line transfer of configuration program
- Front plug-in, with locking screws

Status	LEDs			
	LINK	ACT	RUN	WDO
Linked to LAN	⊗	-	-	-
Communicating	⊗	∅	-	-
CPU active in primary mode			⊗	
CPU active in secondary mode	⊗	-	∅	-
CPU blocked	-	-	-	⊗
Legend	∅ = blinking ⊗ = on - = off			

Operation

The CPU card can be used in either single or redundant configuration with two CPU's operating in parallel. Both CPU's process information from the cards of the panel, but only one (the primary) of the two interacts with them. Once the primary CPU stops operating, the other immediately takes its place without disrupting ongoing operations or losing captured events.

Communication

Thanks to the RJ 45 port located on the CPU, more S81 multifunction panels can be connected to each other or to a supervising PC, via LAN. The panel's interconnection serves to transfer events or information between them. The connection with the supervisor PC allows you to manage the panel from a remote location.

S81-E2002-1

Rack Control Card

This card manages the communications among the rack's cards and the CPU's; it receives data from the CPU and it sorts them among the 13 cards in the rack through 2 different communication channels and vice versa.

Only one card E2002 for each rack is necessary and it has to be placed in the 14th available slot.



Main Features

- Suitable for applications fault-tolerant up to SIL3 level in accordance with IEC-61508
- Allows the interchange of information between the CPUs and the cards in the rack through 13 serial connections (for cards) and 2 BUSES in a loop (for the CPU)
- Can be hot-swapped
- No need of connections to the field
- Communication protocol with Manchester code managed by FPGA
- SMD technology multilayer circuit
- Front plug-in on a 19" rack, with locking screws
- Absorption 20 mA at 24 VDC

Operation

The card is used only to manage the communication between rack and cards and between the racks and the CPUs of the panel.

The communication is redundant and it works on two separate channels, Link A and Link B; in case of interruption on one of the two connections, the panel will work normally, although signaling a fault in communication.

Status conditions	Led indication							
	LINK A		LINK B		RUN	INTERRUPTS CARDS		
	IN	OUT	IN	OUT		FLT 1	FLT 2	FLT 3
Link A active in input	⊗	-	-	-	-	-	-	-
Link A active in output	-	⊗	-	-	-	-	-	-
Link B active in input	-	-	⊗	-	-	-	-	-
Link B active in output	-	-	-	⊗	-	-	-	-
Regular working mode (led blinking)	-	-	-	-	⊗	-	-	-
Interrupt pending from a card	-	-	-	-	-	⊗	-	-
Interrupt pending on link A (CPU A)	-	-	-	-	-	-	⊗	-
Interrupt pending on link B (CPU B)	-	-	-	-	-	-	-	⊗
<i>Legend</i>	⊗=on - = off; --- = not provided							

Configuration

Rack address is defined according to the position of selector placed on the card.

DIP-SW	Rack 1	Rack 2	Rack 3	Rack 4	Rack 5	Rack 6	Rack 7	Rack 8	Rack 9	Rack 10
SW 1-1	OFF	ON	OFF	ON	OFF	ON	OFF	ON	OFF	ON
SW 1-2	OFF	OFF	ON	ON	OFF	OFF	ON	ON	OFF	OFF
SW 1-3	OFF	OFF	OFF	OFF	ON	ON	ON	ON	OFF	OFF
SW 1-4	OFF	OFF	OFF	OFF	OFF	OFF	OFF	OFF	ON	ON

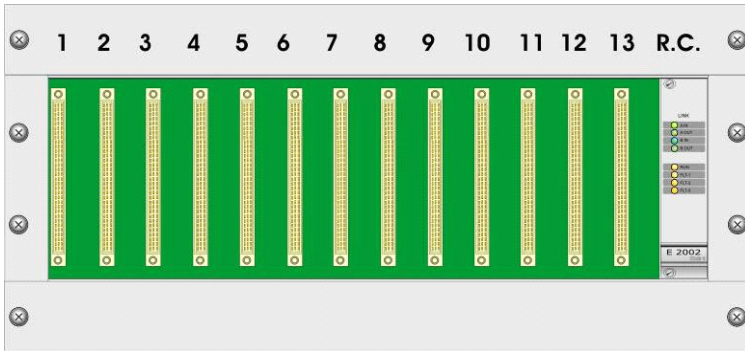

Position of the Card S81-E2002

The Rack Controller card shall be placed only in the last slot on the right of each rack.

The other 13 slots of the rack can be used for all other type of cards.

S81-T8004

Default Input and Output Management Card

This card can manage 10 digital inputs, 16 open collector outputs and one monitored output for fire alarm siren control. In addition, the card checks the ground leakage of the supply voltage.

The S81 T8004 card can be connected with a flexible cable to a S81-T8001 termination card or to an S81-T8007 relay board, to have respectively, 16 open collector or 16 SPDT contact relay outputs.

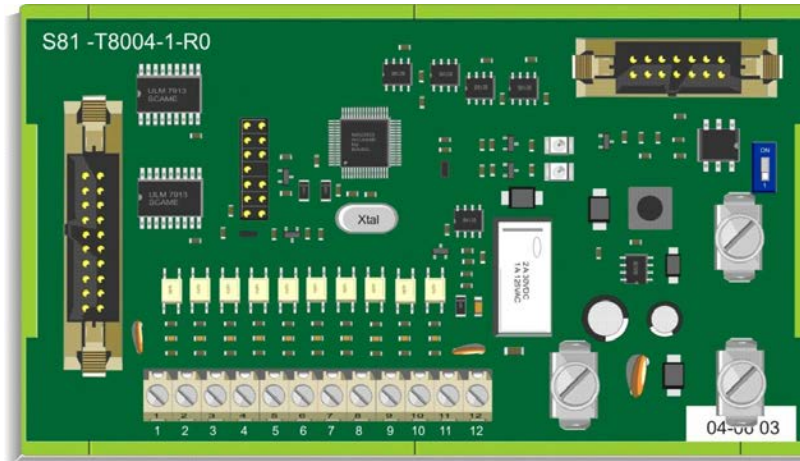

Operation

The S81-T8004 card is to be mounted on a DIN rail so it is normally installed on the panel back plate.

It is connected with the panel display (U-1006) and with a termination card (S81 T8007 or S81-T8001) by means of FLAT cables that can be hot-swapped.

The two LEDs respectively indicate the presence of power supply and the operation of the serial link with the panel display.

Default Outputs Through a T8007-1 or S81-T8001 Card

The S81 panel normally includes an S81-T8007-1 card, which is used to produce the output functions required by the EN 54-2 standard. If, on the other hand, a S81-T8001 termination card is utilized, the outputs have the same functions but are of an Open Collector type.

Some relays are also provided for a normally energized stand-by condition.

Relay (T8007)	Normally energized	Default Outputs	Mode	
			Safety	Security
K1		PREALARM	<input checked="" type="checkbox"/>	
K2		ALARM	<input checked="" type="checkbox"/>	
K3	<input checked="" type="checkbox"/>	FAULT	<input checked="" type="checkbox"/>	
K4		DEVICES DISABLED	<input checked="" type="checkbox"/>	
K5		LOCAL BUZZER	<input checked="" type="checkbox"/>	
K6		SPARE	<input checked="" type="checkbox"/>	<input checked="" type="checkbox"/>
K7	<input checked="" type="checkbox"/>	GENERAL ALARM		<input checked="" type="checkbox"/>
K8	<input checked="" type="checkbox"/>	TAMPER		<input checked="" type="checkbox"/>
K9	<input checked="" type="checkbox"/>	GENERAL FAULT		<input checked="" type="checkbox"/>
K10	<input checked="" type="checkbox"/>	BURGLAR ALARM		<input checked="" type="checkbox"/>
K11		SPARE		
K12	<input checked="" type="checkbox"/>	NORMAL OPERATION	<input checked="" type="checkbox"/>	<input checked="" type="checkbox"/>
K13	<input checked="" type="checkbox"/>	SYSTEM FAULT	<input checked="" type="checkbox"/>	<input checked="" type="checkbox"/>
K14	<input checked="" type="checkbox"/>	POWER SUPPLY FAULT	<input checked="" type="checkbox"/>	<input checked="" type="checkbox"/>
K15	<input checked="" type="checkbox"/>	CPU OR PROCESS FAULT	<input checked="" type="checkbox"/>	<input checked="" type="checkbox"/>
K16	pulsing	PANEL RESET	<input checked="" type="checkbox"/>	<input checked="" type="checkbox"/>

Default Input and Alarm Output

It is a terminal strip, on which panel default inputs and panel outputs to the alarm horn are terminated.

Terminal	Function	Note
Ø M1	Buzzer silencing remote input	N.O. (normally open)
Ø M2	Sounder silencing remote input	N.O.
Ø M3	Panel reset remote input	N.O.
Ø M4	Evacuation command remote input	N.O.
Ø M5	Battery status (supply/charge)	0 VDC (charge)
Ø M6	PSU1 primary supply fault	N.C. (normally closed)
Ø M7	PSU2 secondary supply fault	N.C.
Ø M8	Battery charging status (deep and maintenance)	0 VDC (deep)
Ø M9	Fault external to panel	N.C.
Ø M10	Tamper alarm external to panel	N.C.
Ø M11	Fire alarm siren positive output	250 mA max (monitored line)
Ø M12	Fire alarm siren negative output	250 mA max (monitored line)

NOTE:

When asked, the board S81-T8004 is coupled to the relay card S81-F8007 to make available the repetitions of the central state with voltage-free changeover contacts.

The connection between the two units is carried out simply by using a flat cable-mixed.

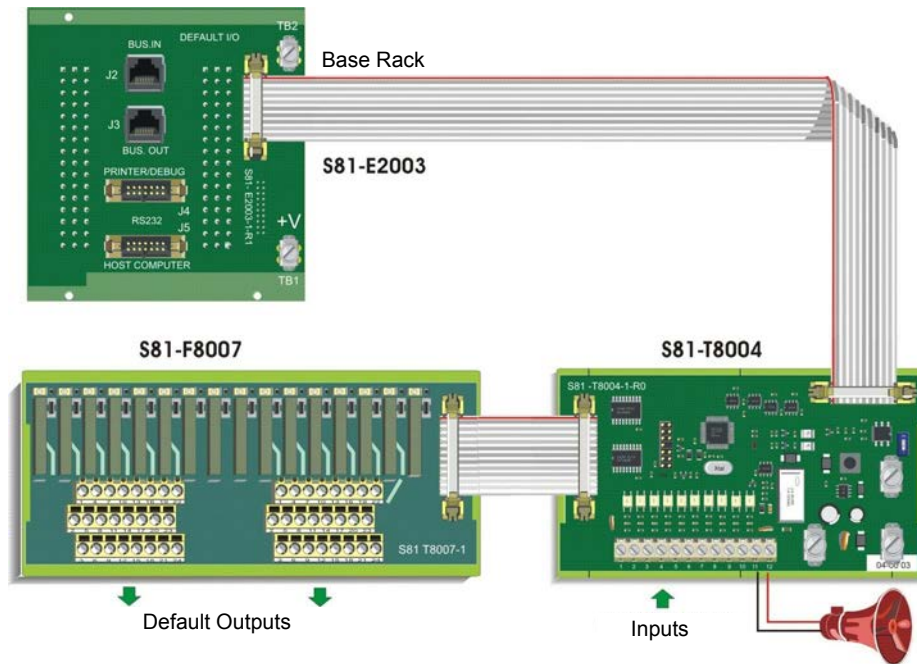

H-S81-HS

Back-Plane Cards for S81 Rack

These cards are used for electric supply and interconnection between S81 cards and the field.

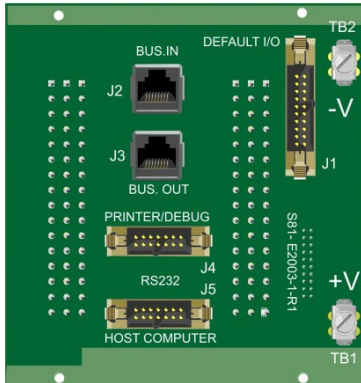

S81-E2003 Back-Plane for Panel Base Rack

- Interface between CPUs and the cards of the system
- Backplane of basic rack of S81 panel HS version
- Prop up connectors for electric supply
- Connector for display
- Connectors for printer and PC serial link
- Completely passive
- RJ45 type BUS connectors, which connect the CPUs and the racks.

S81-E2001-1 Flat Cable Wiring Back-Plane for Card Racks

- Allows the connection between the controller card S81-E2002 and the cards of the rack
- Allows the connection between the cards and the field through flat cable and termination cards
- RJ45 BUS connectors

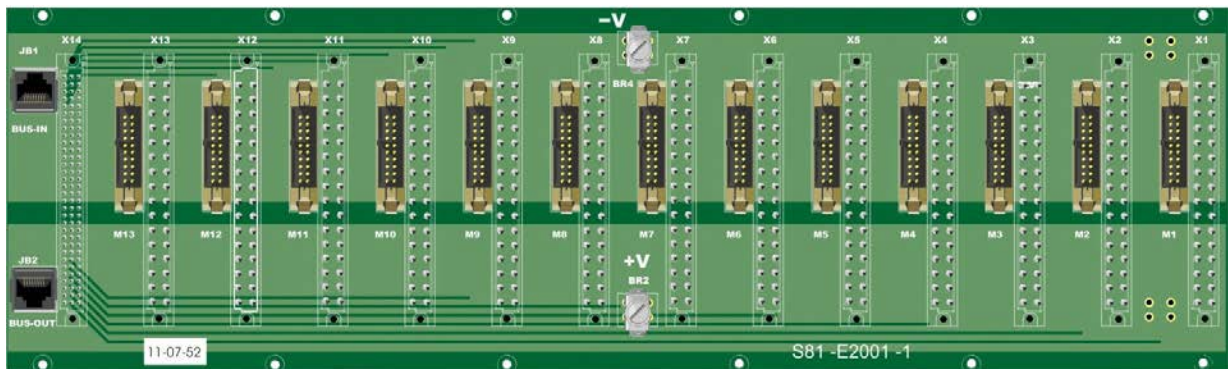

S81-E2001-2 Back-Plane for Plug Cable Connection

- Allows the connection between the controller card and the cards in the rack in safety-related applications and with heavy current loads
- The connection between the cards and the field is carried out via pre-wired cable plugs directly on marshaling terminal box
- RJ45 BUS connectors.

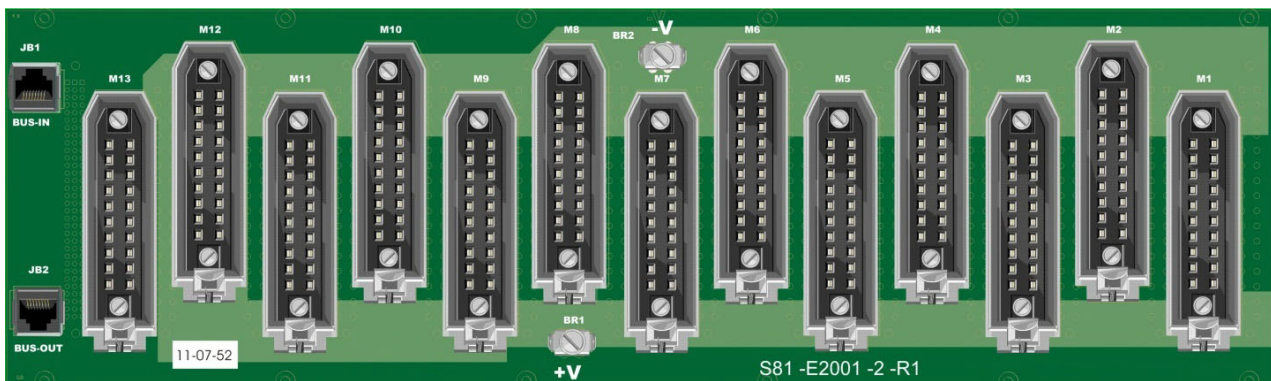

H-S81-HS

Cable Termination

Terminal Block Modules on DIN Rail

T8001-1

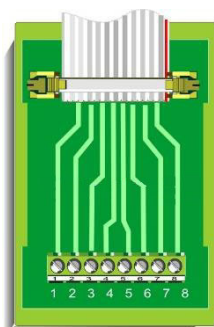

T8003-1

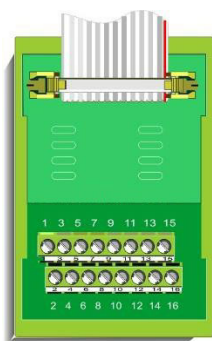

These modules are used in H-S81-HS panels to connect the field devices and they are ready to be fixed on the DIN rail to place on the backplane of the panel.

The connection between the rack and the terminal block is made through flat cable with connectors.

The terminal blocks modules T8001 and T8003 (size 57(L)x77(H)x60(D)mm) have terminal blocks exclusively, while the others also have relays.

The card T8007-2 can be connected with flat cable and with connector.

Type	Terminal blocks
S81-T8007-2	Terminal block with 16 relays
S81-T8006-1	Terminal block with 8 relays
S81-T8008-1	Terminal block with 4 SPDT relays
S81-T8001-1	16 terminals for 4 mm ² cable
S81-T8003-1	8 terminals for 4 mm ² cable

Plug Cable Connectors

S81-CCT4



S81-CCT4R

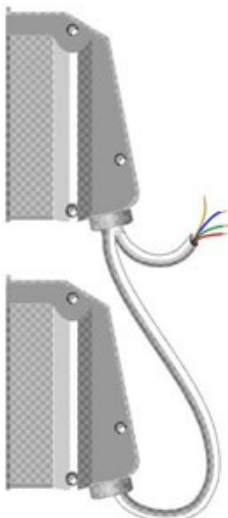

The cables with plug connectors are used for direct connection between the panel cards and the field marshaling terminal blocks. Cables with two connectors are also available (R suffix), which contain the termination and connections necessary for systems with redundant inputs and outputs.

Type	Conductors	Connectors
S81-CCT1	16	Single
S81-CCT1R	16	Double
S81-CCT2	2	Single
S81-CCT2R	2	Double
S81-CCT3	8	Single
S81-CCT3R	8	Double
S81-CCT3R1	8	Double
S81-CCT4	4	Single
S81-CCT4R1	4	Double
S81-CCT6	6	Single
S81-CCT7	8	Single
S81-CCT7R	8	Double

PANEL CARD COMPATIBILITY WITH TERMINAL BLOCK MODULES AND PLUG CABLE CONNECTORS														
Connectors	F3002	F4001	F4002	F4003	F5001	F5002	F5003	F5004	F7001	F7002	F7006	F7008	F7009	F7010
S81-T8001-1	◇					◇	◇							
S81-T8003-1		◇	◇	◇	◇				◇	◇	◇	◇	◇	◇
S81-T8007-2						◇								
S81-T8006-1					◇									
S81-T8008-1							◇							
S81-CCT1	◇					◇	◇							
S81-CCT1R	◇													
S81-CCT2		◇												
S81-CCT2R		◇												
S81-CCT3				◇	◇									
S81-CCT3R				◇	◇									
S81-CCT3R1				◇	◇									
S81-CCT4								◇	◇	◇			◇	◇
S81-CCT4R								◇						
S81-CCT6											◇	◇		
S81-CCT7			◇											
S81-CCT7R			◇											

H-S81-HS Relay Cards

Cable Termination Cards with Relay

These are used in the H-S81-HS panel to manage actuators and power appliances and are directly connected to the base rack S81 or to the S81 card T8001-1.

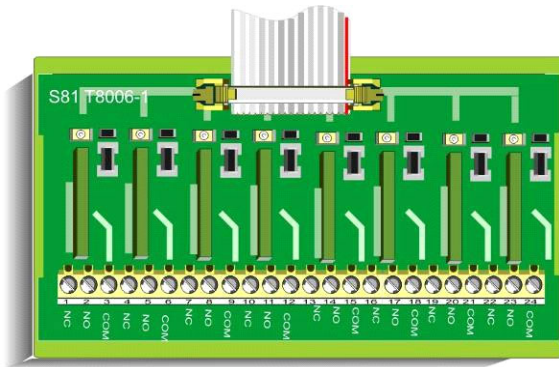

T 8006-1

- Termination block with 8 relays
- Exchange contacts C/ NO /NC
- Contacts 5 to 30 VDC
- DIN rail mounting
- Led for each relay
- Size L 135 x H 77 x D 40 mm

T 8006-1	Relay																										
	K1			K2			K3			K4			K5			K6			K7			K8					
NC = Normally closed NO = Normally open COM = Common	NC	NO	CO	NC	NO	CO	NC	NO	CO	NC	NO	CO	NC	NO	CO	NC	NO	CO	NC	NO	CO	NC	NO	CO	NC	NO	CO
Terminal blocks	1	2	3	4	5	6	7	8	9	10	11	12	13	14	15	16	17	18	19	20	21	22	23	24			

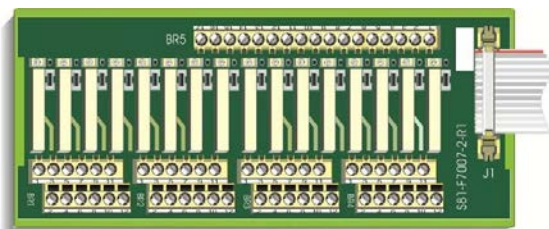

T 8007-2

- Termination block with 16 relays
- Exchange contacts C/ NO /NC
- Contacts 5 to 30 VDC
- Led for each relay
- DIN rail mounting
- Size L 170 x H 77 x D 65 mm
- Enabling relay from flat cable or terminal block

T 8007-2	BR1												BR2														
	K1			K2			K3			K4			K5			K6			K7			K8					
Terminal blocks:	NC	NO	CO	NC	NO	CO	NC	NO	CO	NC	NO	CO	NC	NO	CO	NC	NO	CO	NC	NO	CO	NC	NO	CO	NC	NO	CO
	1	2	3	4	5	6	7	8	9	10	11	12	1	2	3	4	5	6	7	8	9	10	11	12			
NC = Normally closed NO = Normally open COM = Common	BR3												BR4														
	K9			K10			K11			K12			K13			K14			K15			K16					
	NC	NO	CO	NC	NO	CO	NC	NO	CO	NC	NO	CO	NC	NO	CO	NC	NO	CO	NC	NO	CO	NC	NO	CO	NC	NO	CO
	1	2	3	4	5	6	7	8	9	10	11	12	1	2	3	4	5	6	7	8	9	10	11	12			

Activation input	BR5																
Relay	K1	K2	K3	K4	K5	K6	K7	K8	K9	K10	K11	K12	K13	K14	K15	K16	C
Terminal blocks	1	2	3	4	5	6	7	8	9	10	11	12	13	14	15	16	17

Operation

Both cards can be used together with the command card S81 F5002 to convert the open collector outputs in free of tension contacts with 8 or 16 relays.

Through the programming of the S81-T8001, the working status of relays can be set in fix or lashing, energized or non-energized way.

NOTE:

One T8007 card is already supplied with the S81 panel (complete version) and it is used to reproduce the status signaling and the repetitions required by the standard.

In the S81 HS version, this card is connected to the control card S81 T8004.

Cable Termination

Connections with Cable Termination Cards (UL Version)

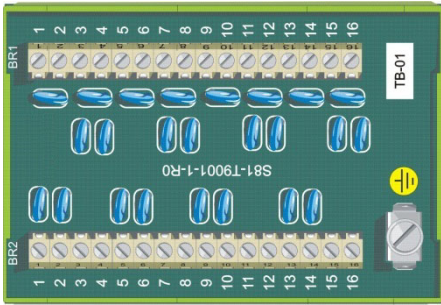

S81-T9001-1

The cable termination cards T900X are used to connect the field devices in the H-S81-HS panel (UL version).

The cable termination cards are arranged for the DIN rail, mounting to the back plate of the panel.

TYPE	Termination blocks
S81-T9001-1	Termination block with 16 contacts
S81-T9002-1	Termination block with 8 contacts
S81-T9003-1	Termination block with 6 contacts
S81-T9004-1	Termination block with 24 contacts
S81-T9005-1	Termination block with 12 contacts

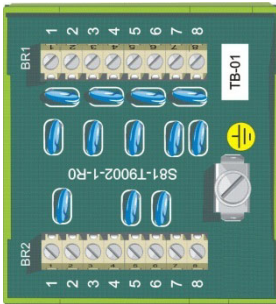

S81-T9002-1

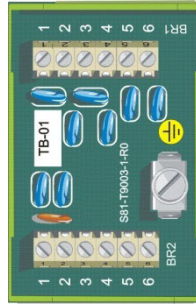

S81-T9003-1

The cards T900X type is used to increase the resistance of the system to over-voltage that might be caused during the connection of devices in some critical applications.

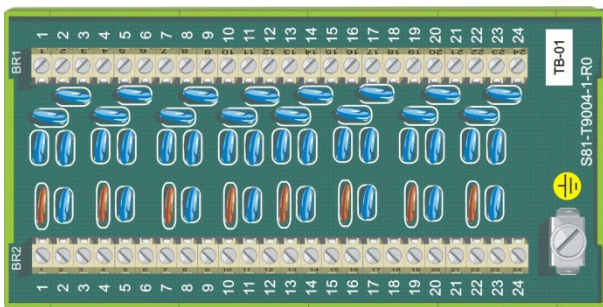

S81-T9004-1

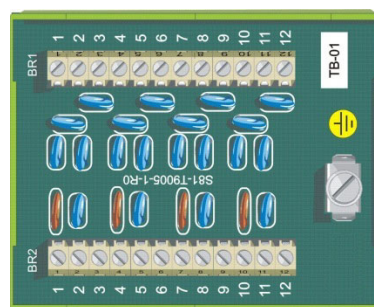

S81-T9005-1

S81-HS PANEL CARD COMPATIBILITY WITH TERMINATION CARDS (UL VERSION)													
Connectors	F3002	F4001	F4002	F4003	F5001	F5002	F5003	F5004	F7001	F7002	F7006	F7008	F7009
S81-T9001-1	◇				◇		◇						
S81-T9002-1								◇					
S81-T9003-2									◇	◇			◇
S81-T9004-1				◇		◇							
S81-T9005-1		◇	◇								◇	◇	

S81-F3002

8-Input Card for Conventional Detection

The S81-F3002 card can manage conventional (non-addressable) detection lines. It is particularly suitable for systems where detection lines are already in place, for cross-line logic control of automatic fire extinguishing systems (for NFPA), or in intrinsic safety systems.



Main Characteristics

- Redundant (note 1)
- Can be hot-swapped (note 2)
- Suitable for applications fault-tolerant up to SIL3 level according to the standards IEC61508
- Double programmable alarm threshold for each line
- Automatic verification and confirmation of the alarm status
- Suitable to various detectors (types and brands)
- Programmable for SAFETY or SECURITY operating mode
- Can manage and control eight lines
- Line inclusion/exclusion through panel keyboard
- Automatic testing of each line every thirty seconds
- Communication management by FPGA
- Internal logic management by micro-controller
- SMD technology multilayer circuit
- Front plug-in on 19" rack, with locking screws

Status	SAFETY Mode		SECURITY Mode	
	Yellow LED	Red LED	Yellow LED	Red LED
Normal	–	–	–	–
Excluded	⊗	–	⊗	–
Fault	∅	–	∅	–
Tampering	---	---	–	∅
Pre-alarm	–	∅	---	---
Alarm	–	⊗	–	⊗
LED status legend	⊗ = on - = off ∅ = blinking --- = not available			

Operation

The F3002-1 card can monitor eight input lines, checking their current variations to get status information. Line status is individually signaled and signaling can be different, depending on selected SAFETY or SECURITY operating mode.

It can be configured to indicate two different alarm thresholds for each line and to apply or not a verification algorithm for alarms. With the configuration, it is possible to define each alarm threshold to adapt it to the actuation threshold (current) of the detector installed.

Through the detection lines, alarm buttons, or voltage-free contacts belonging to the devices that need to monitor, the status can be monitored.

Programmable Parameters Via Software

Status	SAFETY	SECURITY
Normal operating mode	NO/NC	NC
Logic status of the latching/non latching line (note 3)	Latching/Non-latching	Latching
Alarm verification (note 4)	Enabled/Disabled	Disabled
Alarm threshold programmable on 256 levels	Pre-alarm/Alarm	Fixed thresholds
Indication of line short-circuit	Fault/Alarm	Tampering
Audible alarm modalities	Normal/Silent/Buzzer	Normal/Silent

Connection via Termination Module S81-T8001

Connection between the card and the field is basically obtained by interposition of a terminal block module, which is mounted on a DIN rail inside the panel and is connected to the card rack by means of a flat cable with two quick connectors. The electronics-type terminals are suitable for cables having a section area of up to 4 mm².

Connection via Cable Plug S81-CCT1 or S81-CCT1R

Connection between the card and the field is carried out by means of a special cable, provided with a plug-in connector at one of its ends. Cable conductors are wired directly onto a marshaling terminal block, while the connector is plugged into the back side of the rack.

Function		Connection with FLAT CABLE		Connection with PLUG CABLE		
Detection line 1	+	Ø 1	Screw terminal T8001	T8001-1	1	White
	-	Ø 2			2	Brown
Detection line 2	+	Ø 3			3	Green
	-	Ø 4			4	Yellow
Detection line 3	+	Ø 5			5	Grey
	-	Ø 6			6	Pink
Detection line 4	+	Ø 7			7	Blue
	-	Ø 8			8	Red
Detection line 5	+	Ø 9			9	Black
	-	Ø 10			10	Purple
Detection line 6	+	Ø 11			11	Grey/pink
	-	Ø 12			12	Red/blue
Detection line 7	+	Ø 13			13	White/green
	-	Ø 14			14	Brown/green
Detection line 8	+	Ø 15			15	White/yellow
	-	Ø 16			16	Yellow/brown

Connection Example of Detectors to the Card

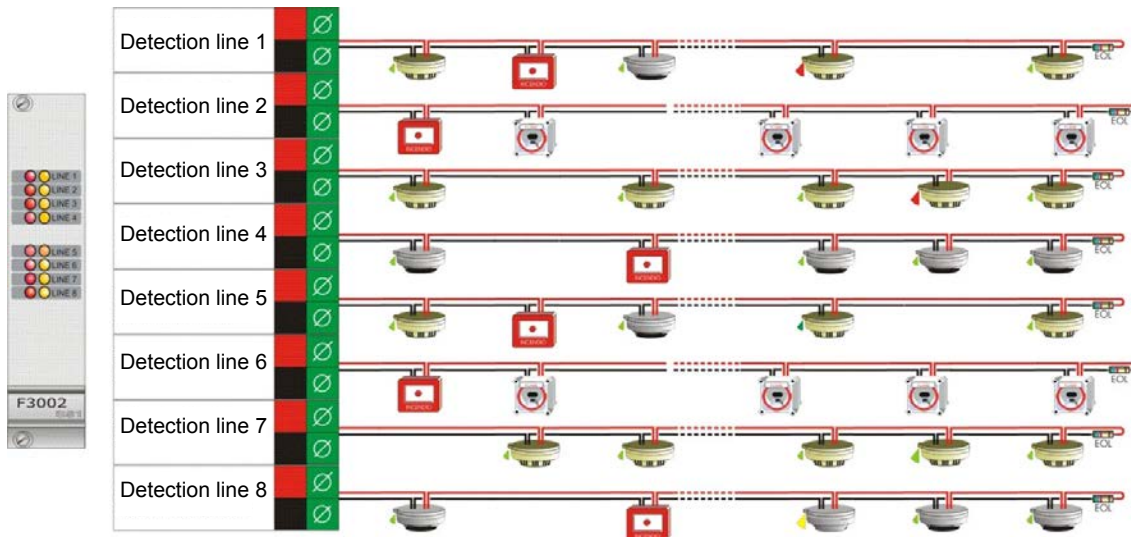

Redundancy (note 1)

In fault-tolerant systems, this card has to be duplicated, i.e. two cards are to be used, which must be installed in two contiguous racks. Each input line from the field has to be connected to both cards and its exclusion is only possible from both of them.

Hot Swap (Note 2)

The card can be removed and replaced without switching off the panel.

Latching Mode (Note 3)

An alarm status persists until reset.

Alarm Verification (Note 4)

Pre-alarm and alarm statuses are taken into consideration only if they validated are by a verification procedure consisting of activated detector voltage drop-down and new checking after 7 seconds.

S81-F4001

Single channel Analog Input card

One 4-21 mA analog input card, with two thresholds that can be set through the panel keyboard. It can manage gas detection systems, as well as level and temperature signal systems.

It can control all the 4-20 mA output transducers normally used for EXPLOSIVE and TOXIC GAS, OXYGEN, TEMPERATURE and LEVEL sensors.

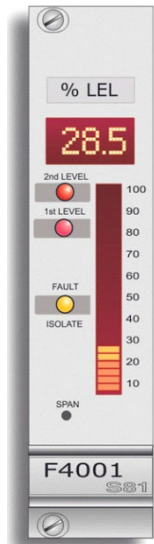

Main Characteristics

- Redundant (Note 1)
- Can be hot-swapped (Note 2)
- Suitable for applications fault-tolerant SIL2 or SIL3 according to the norm IEC61508
- 0-999 display reads engineered values
- Values can be expressed in ppm, LEL%, O2%, mA, °C
- LED bar shows signal trend
- Plastic pocket contains label indicating selected measuring scale
- 4-24 mA input (for fault indication of the sensor)
- Input repetition on 4-20 mA output in terminal block and serial modbus RTU
- Two separately settable alarm thresholds
- Automatic self-testing every 10 seconds
- Communication management by FPGA
- Internal logic management by micro-controller
- Front plug-in on 19" rack, with locking screws

LED Indications

Status	2nd Level	1st Level	Fault	They indicate status
	Red LED	Red LED	Yellow LED	Display
Normal	-	-	-	000 + 999
Line excluded	-	-	⊗	000 + 999
Calibration (span)	⊕	⊕	∅	000 + 3FFF
Fault	-	-	∅	fault code
Pre-alarm	⊗	⊗	-	read value
Alarm	⊗	-	-	read value
LED status legend	⊕ = based on calibration; ⊗ = active; ∅ = blinking; - = off;			

Parameter Configuration Via Software

Parameter	Mode
Normal operating mode	Increasing or decreasing value (up/down)
Logic status of the channel	Latching/Non-latching (Note 3)
Alarm signaling	Normal/Silent/Buzzer only
Analog value repetition on Modbus	Yes/No
Measurement expressed in:	Range:
ppm	0~5; 0~10; 0~15; 0~20; 0~50; 0~100; 0~200; 0~500; 0~999
LEL %	0~100
O ₂ %	0~25; 15~25
mA	4~20
°C	0~100; 0~150; 0~220; 0~300

Calibration

Card calibration can be made directly from panel keyboard, at access level 3. At this level, it is possible to set pre-alarm and alarm thresholds, as well as zero and full scale values, applying a known value sample to sensor input.



Connection Via a Termination Module

Connection between the card and the field is basically obtained by interposition of a terminal block module, which is mounted on a DIN rail inside the panel and is connected to the card rack by means of a flat cable with two quick connectors.

The electronics-type terminals are suitable for cables having a section area of up to 4 mm² and pre-insulated tips should be used.

Connection Via a Cable Plug

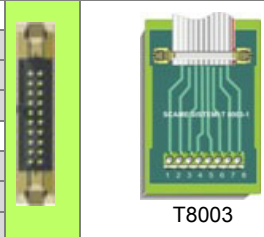
Connection between the card and the field is carried out by means of a special cable, provided with a plug-in connector at one of its ends. Cable conductors are wired directly onto a marshaling terminal block, while the connector is plugged into the back of the rack.

Function		Connection with FLAT CABLE		Connection with PLUG CABLE		
Input Signal	+	1	 T8003	1	White	
---		2		 CCT7	2	---
---		3			3	---
---		4			4	---
Output Signal	+	5			5	Brown
---		6			6	---
---		7			7	---
---		8			8	---

Connection Example of a Sensor and a Repeater

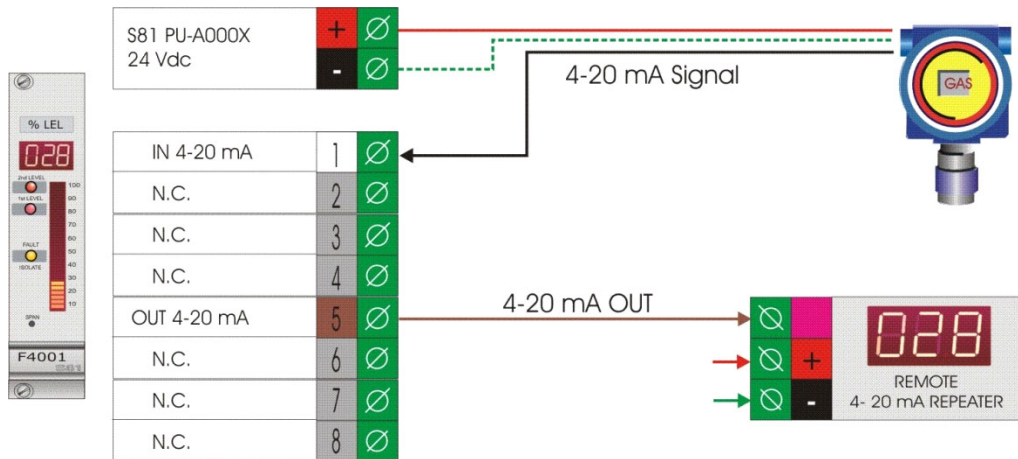

Redundancy (Note 1)

In fault-tolerant systems, this card has to be duplicated, i.e. two cards are to be used, which must be installed in two contiguous racks. Each input line from the field has to be connected to both cards and its exclusion is only possible from both of them.

In redundancy configuration, in order to isolate a device, it will be necessary to isolate both connected channels: moreover, if a supervision software is used (IRIDE), each device will be displayed with 2 different icons.

Hot Swap (Note 2)

The card can be removed and replaced without switching off the panel.

Latching Mode (Note 3)

An alarm status persists until reset.

S81-F4002

Two channel analog input card

Two 4-21 mA analog input card, with two thresholds that can be set through the panel keyboard. It can control all the 4-20 mA output transducers normally used for EXPLOSIVE and TOXIC GAS, OXYGEN, TEMPERATURE and LEVEL sensors.



Main Characteristics

- Redundant (note 1)
- Can be hot-swapped (note 2)
- Suitable for applications fault-tolerant SIL2 and SIL3 in accordance with IEC 61508
- Two separate and independent channels
- Two separately settable alarm thresholds per channel
- Two 0-999 displays read engineered values
- Values can be expressed in ppm, LEL%, O2%, mA, °C
- Transparent plastic pockets to contain labels indicating selected measuring scale
- Two 4-21 mA inputs
- Input repetition on 4-20 mA outputs in terminal block and serial modbus RTU
- Communication management by FPGA
- Internal logic management by micro-controller
- SMD technology multilayer circuit
- Front plug-in on 19" rack, with locking screws

LED Indications

Status	2nd Level	1st Level	Fault	Indication
	Red LED	Red LED	Yellow LED	Display
Normal	-	-	-	000 ÷ 999
Pre-alarm	-	∅	-	Read value
Alarm	⊗	⊗	-	Read value
Channel disabled	-	-	⊗	- - -
Card not configured	-	-	∅	F00
Fault for line opening	-	-	∅	F01
Fault for exceeded range	-	-	∅	F02
Trouble for internal test failure	-	-	∅	F03
Atypical or out-of-range current	-	-	∅	FXX (mA)
Data error in EEPROM	-	-	∅	E00
Threshold value not valid	-	-	∅	E01
Range not supported by card	-	-	∅	E02
Detector being calibrated	-	-	-	CAL
<i>LED status legend</i>				
	⊗ = on	- = off	∅ = blinking	

Parameter Configuration Via Software

Parameter	Mode
Normal operating mode	Increasing or decreasing value (up/down)
Logic status of the latching/non latching channel	Latching/Non-latching (Note 3)
Alarm modality	Normal/Silent/Buzzer only
Analog value repetition on Modbus	Yes/No
Measurement expressed in:	Range:
ppm	0~5; 0~10; 0~15; 0~20; 0~50; 0~100; 0~200; 0~500; 0~999
LEL %	0~100
O ₂ %	0~25; 15~25
mA	4~20
°C	0~100; 0~150; 0~220; 0~300

Calibration

Card calibration can be made directly from panel keyboard, at access level 3. At this level, it is possible to set pre-alarm and alarm thresholds, as well as zero and full scale values, applying a known value sample to sensor input.



Connection Via Terminal Module

Connection between the card and the field is basically obtained by interposition of a terminal block module, which is mounted on a DIN rail inside the panel and is connected to the card rack by means of a flat cable with two quick connectors.

The electronics-type terminals are suitable for cables having a section area of up to 4 mm² and pre-insulated tips should be used.

Connection Via Cable Plug

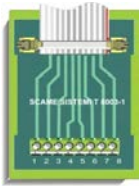
Connection between the card and the field is carried out by means of a special cable, provided with a plug-in connector at one of its ends. Cable conductors are wired directly onto a marshaling terminal block, while the connector is plugged into the back of the rack.

Function		Connection with FLAT CABLE		Connection with PLUG CABLE		
Input signal 1	+	∅ 1	 T8003	1	White	 CCT7
---		∅ 2		2	---	
Input signal 2	+	∅ 3		3	Brown	
---		∅ 4		4	---	
Output signal 1	+	∅ 5		5	Green	
---		∅ 6		6	---	
Output signal 2	+	∅ 7		7	Yellow	
---		∅ 8		8	---	

Connection example of a sensor and a repeater

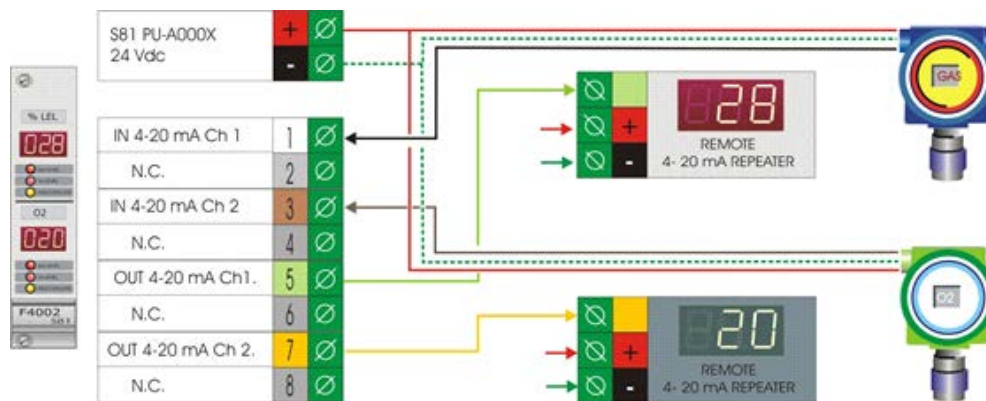

Redundancy (Note 1)

In fault-tolerant systems, this card has to be duplicated, i.e. two cards are to be used, which must be installed in two contiguous racks. Each input line from the field has to be connected to both cards and its exclusion is only possible from both of them.

In a redundant configuration, in order to isolate a device, it will be necessary to isolate both connected channels: moreover, if a supervision software is used (IRIDE), each device will be displayed with 2 different icons.

Hot-Swap (Note 2)

The card can be removed and replaced without switching off the panel.

Latching Mode (Note 3)

An alarm status persists until reset.

S81-F4003

Eight channel Analog Input card

Eight 4-21 mA analog input card, with two thresholds that can be set through the panel keyboard.

It can control all the 4-20 mA output transducers normally used for EXPLOSIVE and TOXIC GAS, OXYGEN, TEMPERATURE and LEVEL sensors.

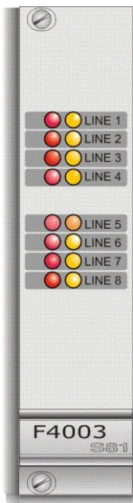

Main Characteristics

- Redundant (note 1)
- Can be hot swapped (note 2)
- Suitable for applications fault-tolerant SIL2 and SIL3 in accordance with IEC 61508
- Eight separate and independent detection channels
- Values can be expressed in ppm, LEL%, O2%, mA, °C
- Eight 4-21 mA inputs
- Repetition of 4-20 mA inputs on modbus RTU
- Two separately settable alarm thresholds per channel
- Communication management by FPGA
- Internal logic management by micro-controller
- SMD technology multilayer circuit
- Front plug-in on 19" rack, with locking screws

LED Indications

Status	Alarm Red LED	Fault Yellow LED
Normal	-	-
Pre-alarm	∅	-
Alarm	⊗	-
Channel disabled	-	⊗
Card not configured	-	∅
Fault for line opening	-	∅
Fault for exceeded range	-	∅
Trouble for internal test failure	-	∅
Atypical or out-of-range current	-	∅
Data error in EEPROM	-	∅
Threshold value not valid	-	∅
Range not supported by card	-	∅
Detector being calibrated	-	-
<i>LED status legend</i> ⊗ = on - = off ∅ = blinking		

Parameter Configuration Via Software

Parameter	Mode
Normal operating mode	Increasing or decreasing value (up/down)
Channel logic status	Latching/Non-latching (note 3)
Alarm modality	Normal/Silent/Buzzer only
Analog value repetition on Modbus	Yes/No
Measurement expressed in:	Range:
ppm	0~5; 0~10; 0~15; 0~20; 0~50; 0~100; 0~200; 0~500; 0~999
LEL %	0~100
O ₂ %	0~25; 15~25
mA	4~20
°C	0~100; 0~150; 0~220; 0~300

Calibration

Card calibration can be made directly from panel keyboard, at access level 3. At this level, it is possible to set pre-alarm and alarm thresholds, as well as zero and full scale values, applying a known value sample to sensor input.

Connection Via a Termination Module

Connection between the card and the field is basically obtained by interposition of a terminal block module, which is mounted on a DIN rail inside the panel and is connected to the card rack by means of a flat cable with two quick connectors. The electronics-type terminals are suitable for cables having a section area of up to 4 mm² and pre-insulated tips should be used.

Connection Via a Cable Plug

Connection between the card and the field is carried out by means of a special cable, provided with a plug-in connector at one of its ends. Cable conductors are wired directly onto a marshaling terminal block, while the connector is plugged into the back of the rack.

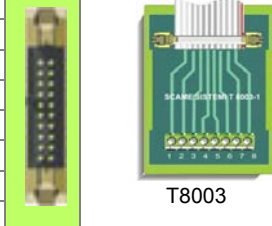
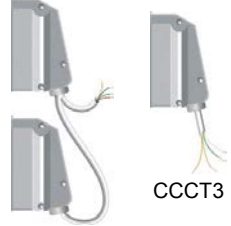
Function		Connection with FLAT CABLE		Connection with PLUG CABLE		
Input signal 1	+	Ø 1	 T8003	1	White	 CCCT3
Input signal 2	+	Ø 2		2	Brown	
Input signal 3	+	Ø 3		3	Green	
Input signal 4	+	Ø 4		4	Yellow	
Input signal 5	+	Ø 5		5	Grey	
Input signal 6	+	Ø 6		6	Pink	
Input signal 7	+	Ø 7		7	Blue	
Input signal 8	+	Ø 8		8	Red	

Connection example of a sensor and a repeater

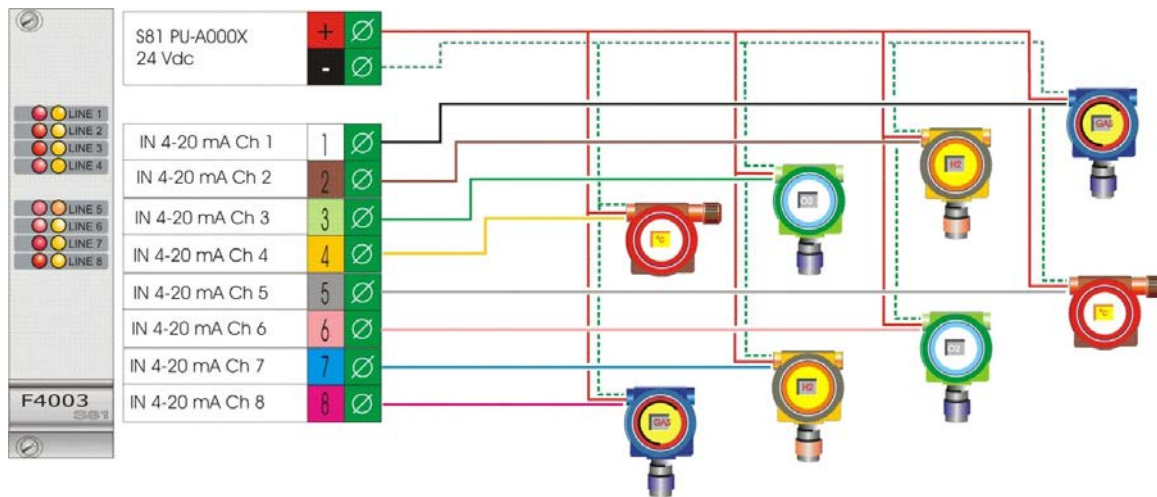

Redundancy (Note 1)

In fault-tolerant systems, this card has to be duplicated, i.e. two cards are to be used, which must be installed in two contiguous racks. Each input line from the field has to be connected to both cards and its exclusion is only possible from both of them.

In redundancy configuration, in order to isolate a device, it will be necessary to isolate both connected channels: moreover, if a supervision software is used (IRIDE), each device will be displayed with 2 different icons.

Hot Swap (Note 2)

The card can be removed and replaced without switching off the panel.

Latching Mode (Note 3)

An alarm status persists until reset.

S81-F5001

8-Monitored Line Control Card

This card has eight 500 mA outputs.

It is particularly suitable for handling automatic fire extinguishing systems, where it can be utilized to control extinguishing agent release and directional valves, or to activate visual-audible alarm devices.



Main Characteristics

- Redundant (note 1)
- Can be hot-swapped (note 2)
- Suitable for applications fault-tolerant SIL2 and SIL3 in accordance with IEC 61508
Temperature testing of DMOS and electronic components
- Functional control of command lines each 2 seconds
500 mA per output
- The card is protected against short circuit, so it is suitable to protect capacitive loads with peak current higher than the nominal value
- Software-configurable output behavior
- Communication management by FPGA
- Internal logic management by micro-controller
- SMD technology multilayer circuit
- Front plug-in on 19" rack, with locking screws

LED Indication on Cards

Status	LEDs	
	Yellow	Red
Normal	-	-
Output disabled	∅	-
Card fault	⊗	-
Line fault	⊗	-
Voltage out of range	⊗	-
Output activated	-	⊗

LED status legend: ⊗ = active; ∅ = blinking; - = off;

Operation

The card performs the tests on individual channels cyclically inverting the signal on the output for a time of about 200 microseconds. In case of a discrepancy between the set signal and the input signal, the system indicates a fault condition. The following fault conditions will be monitored for each output: Open Line, Short to positive, negative to Short, Failure of DMOS device driver, Temperature of the DMOS device drive, power supply outside the allowed limits. All channels are tested during operation every 2 seconds.

Parameter Configuration Via Software

Status	Output	Non-energised	Energised	Period
Normal	Stable a)	⊗		Fixed
	Stable b)		⊗	Fixed
Activated	Stable a)		⊗	(x)
	Stable b)	⊗		(x)
	Delayed		⊗	0-255 s
	Periodical		⊗	0-255 s
	ISA logics (repeaters, lamps)		⊗	(z)
	Sounder logics		⊗	(z)

(x): These statuses persist until logic or operator's reset.

(z): These statuses persist until reset by operator.

Connection Via Relay Card S81-T8006

This card can be connected to an 8-relay board model S81-T8006 by using a flat cable and tray connectors. The card allows the S81-T8006 line monitoring of solenoid relays.

Connection Via Terminal Module

It is possible to use a termination card and the rack S81-E2001-1, which will be connected between them via flat cable.

Connection Via Cable Plug S81-CCT3 or S81-CCT3R

Connection between the card and the field is carried out by means of a special cable, provided with a plug-in connector at one of its ends. Cable conductors are wired directly onto a marshaling terminal block, while the connector is plugged into the back of the rack.

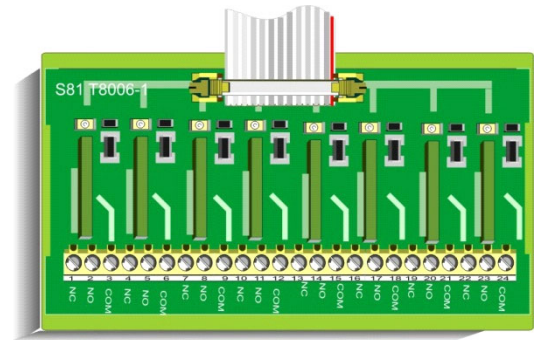

Function	
Output 1	+
Output 2	+
Output 3	+
Output 4	+
Output 5	+
Output 6	+
Output 7	+
Output 8	+

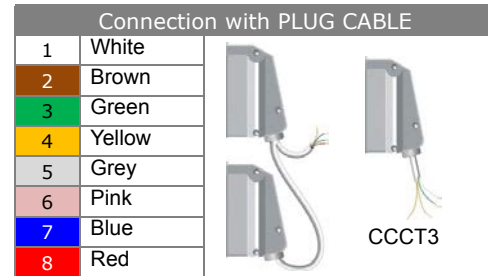
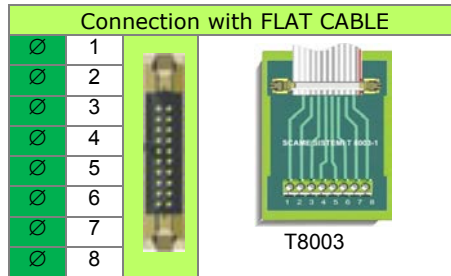

Connection Example of Some Actuators

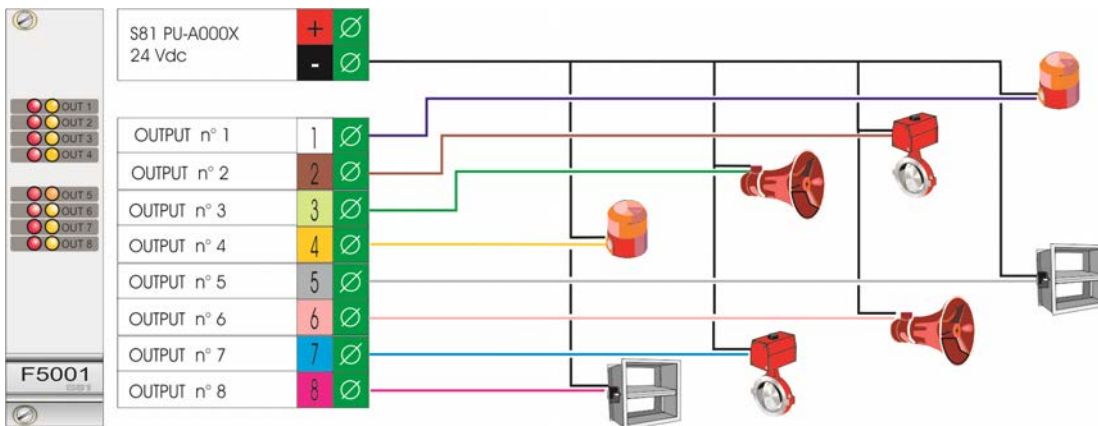

Maximum current

The card is capable of driving resistive or inductive loads with a maximum current of 500mA at 24 VDC. In the case where the card is used to drive filament lamps the maximum power of the load should not exceed 4W.

Redundancy (Note 1)

In fault-tolerant systems, this card has to be duplicated, i.e. two cards are to be used, which must be installed in two contiguous racks. Each input line from the field has to be connected to both cards and its exclusion is only possible from both of them.

Hot-Swap (Note 2)

The card can be removed and replaced without switching off the panel.

S81-F5002

16-Control Channel Card With Open Collector Outputs

The card has 16 non-monitored 250-mA outputs.

It is widely used for controls and direct hardwiring or in conjunction with a 16-relay card (S81-T8007).

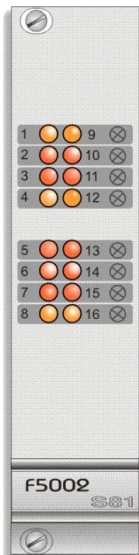

Main Characteristics

- Can be paired with S81 T8007-1 relay card, with contacts free of tension
- Can be paired with S81 T8001-1 termination module or to the S81-CCT1 plug cable, to supply 16 open collector outputs allowed to manage LEDs and non-monitored loads
- Non-redundant
- Hot-swap (note 1)
- 250 mA per output
- Software-configurable operating mode
- Communication management by FPGA
- Internal logic management by micro-controller
- SMD technology multilayer circuit
- Front plug-in on 19" rack, with locking screws

LED Indication on Cards

Status	Outputs 1-8
	Red LED
Channel in normal condition	-
Channel activated	⊗
<i>LED status legend</i>	⊗ = on - = off

Operation

This card effects status and functionality checks, but does not monitor the control channels.

Parameter Configuration Via Software

Parameter	
Activation mode	<ul style="list-style-type: none"> • Steady, normally energised • Steady, normally de-energised • Periodical • Pulsing mode 1 • Pulsing mode 2 • Delayed after activation • Delayed after de-activation • Delayed after enabling • ISA Logic 1A
Period	1 to 255 seconds, in pulsing and periodical mode only
Type of output	normal or sounder

Connection Via Relay Card

The card S81-F5002 can be connected to a 16 relay card S81-T8007-2 through the S81-CCT1 connector wired to terminals BR5 or directly with flat cable connected on J1.

Connection Via Termination Module

This is possible with a backplane of the rack type S81-E2001-1 and flat cable with termination card T8001-1.

Connection Via Cable Plug S81-CCT1

Connection between the card and the field is carried out by means of a wired cable, provided with a plug-in connector connected at the end of the backplane S81-E2001-2.

Cable conductors are wired directly onto a marshaling terminal block, while the connector is plugged into the backside of the rack

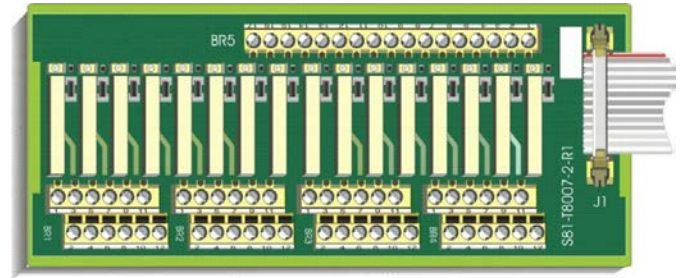

Function	
Command line 1	-
Command line 2	-
Command line 3	-
Command line 4	-
Command line 5	-
Command line 6	-
Command line 7	-
Command line 8	-
Command line 9	-
Command line 10	-
Command line 11	-
Command line 12	-
Command line 13	-
Command line 14	-
Command line 15	-
Command line 16	-
Command line 16	+

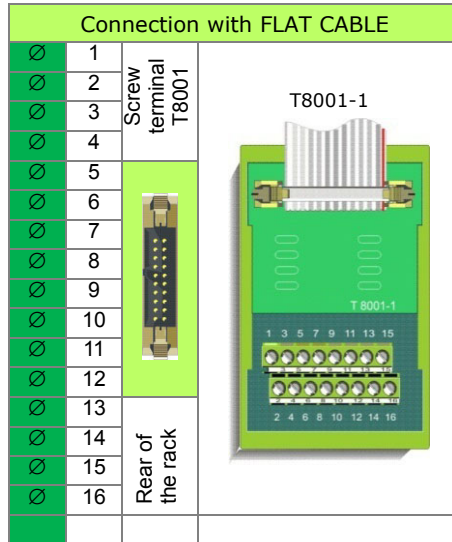

Connection with PLUG CABLE

1	White
2	Brown
3	Green
4	Yellow
5	Grey
6	Pink
7	Blue
8	Red
9	Black
10	Purple
11	Grey/Pink
12	Red/Blue
13	White/Green
14	Brown/Green
15	White/Yellow
16	Yellow/Brown

CCT1

Connection Example of Actuators That Do Not Require Monitoring

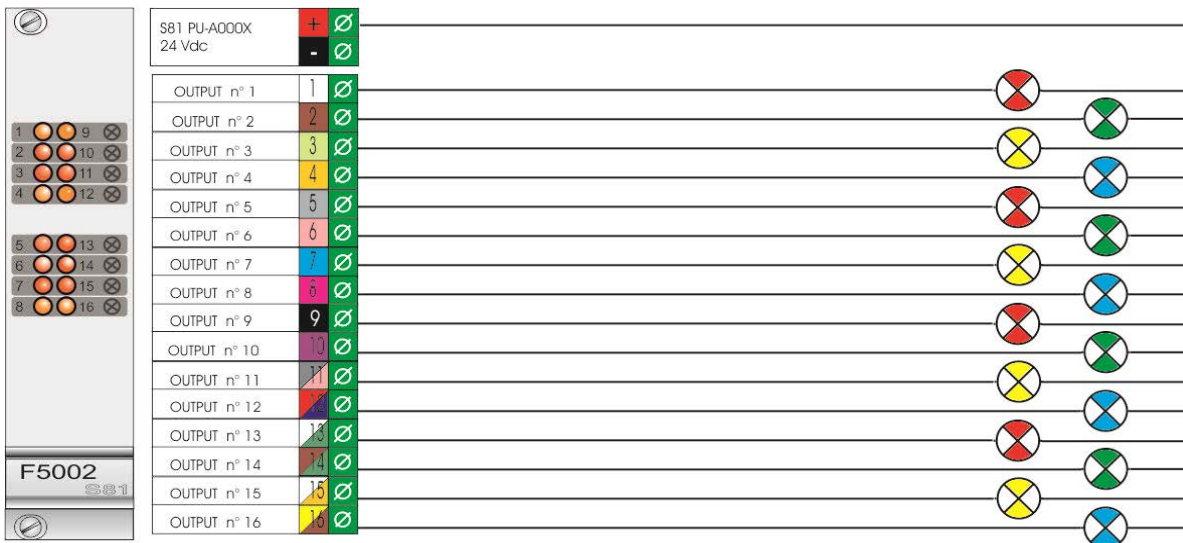

Hot-Swap (Note 1)

The card can be removed and replaced without switching off the panel.

S81-F5003

Alarm Control Card With 8 Output Lines-Monitored Through Polarity Reversal

The eight 500 mA output lines, which the card monitors through reversal of their polarity, are mainly utilized to control actuators. The card is suitable for use in systems that include devices conforming to the NFPA standards, where it can activate the alarm sounders.

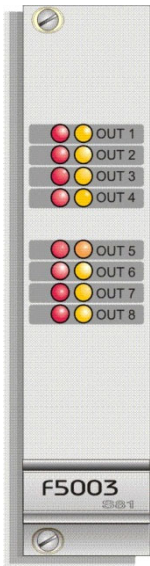

Main Characteristics

- Line monitoring through polarity reversal
- Outputs activated in both steady and pulsing mode
- Can be hot-swapped
- 250 mA available per each command output
- Non redundant (Note 1)
- Temperature testing of DMOS and electronic components
- Software-configurable operating mode
- Communication management by FPGA
- Internal logic management by micro-controller
- SMD technology multilayer circuit
- Front plug-in on 19" rack, with locking screws.
- The card can be connected to S81-T8008 which provides four polarity reversal 2A/24Vdc outputs.

Status	Outputs 1-8	
	Yellow LED	Red LED
Line in normal condition	-	-
Line excluded or disabled	⊗	-
Line in trouble condition	∅	-
Line activated	-	⊗
<i>LED status legend</i> ⊗ = on ∅ = blinking - = off		

Operation

The card periodically performs the test on the single channels by inverting the output signal for duration of about 200 microseconds. In case of discrepancy between configured signal and read signal, the station signals promptly a fault situation. For each single output, the following situations are checked: Line opening, Short-circuit towards positive, Short-circuit towards negative, pilot DMOS device fault, pilot DMOS device overheating, Supply voltage out of admitted limits. All the channels are tested during operation every 2 seconds.

Parameter Configuration Via Software

Parameter	
Activation mode	<ul style="list-style-type: none"> • Steady, normally energized • Steady, normally de-energized • Periodical • Pulsing mode 1 • Pulsing mode 2 • ISA 1A logics • Delayed after activation • Delayed after deactivation • Delayed after enabling
Period	1 to 255 seconds, in pulsing and periodical mode only
Type of output	normal or sounder

Connections

The card F5003 can be connected directly or through the card S81-T8008-1

Function		Connection with FLAT CABLE				Connection with PLUG CABLE	
Command line 1	+	1	2	Screw terminal T8001	T8001-1	1	White
	-	2	3			2	Brown
Command line 1	+	3	4			3	Green
	-	4	5			4	Yellow
Command line 1	+	5	6			5	Grey
	-	6	7			6	Pink
Command line 1	+	7	8			7	Blue
	-	8	9			8	Red
Command line 1	+	9	10			9	Black
	-	10	11			10	Purple
Command line 1	+	11	12			11	Grey/Pink
	-	12	13			12	Red/Blue
Command line 1	+	13	14			13	White/Green
	-	14	15			14	Brown/Green
Command line 1	+	15	16			15	White/Yellow
	-	16				16	Yellow/Brown

Optional Card S81-T8008-1

If the available 500mA per channel are not sufficient, the card can be connected to this module, which provides four polarity reversal 2A/24VDC outputs.

Connection between the card and the module is effected by interposition of an S81/T8001 module or an S81/CCT1 cable plug.

BR1 Terminal Block			
1	2	Positive of 25Vdc electric supply	
2	1	Negative of 25Vdc electric supply	
BR2 Term. Block from card		BR3 Term. Block to field	
1	2	1	2
2	3	2	3
3	4	3	4
4	5	4	5
5	6	5	6
6	7	6	7
7	8	7	8
8		8	

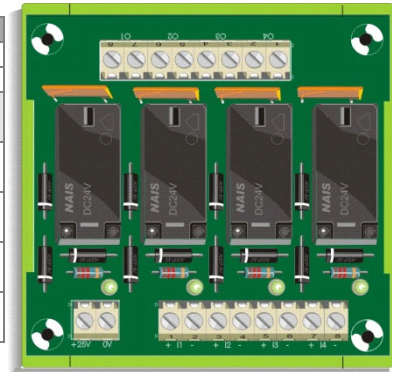

Connection example of actuators managed with polarity reversal

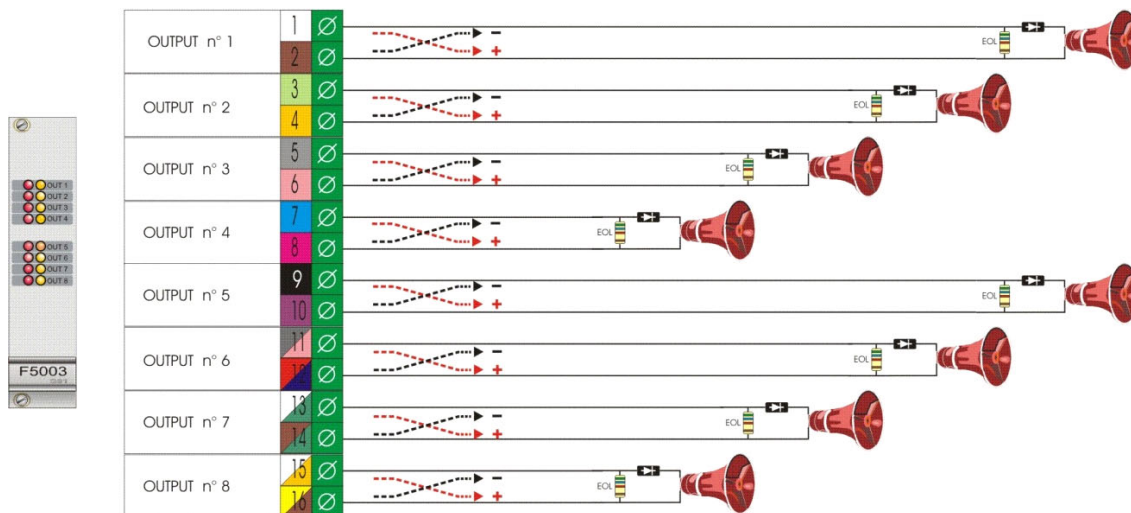

Redundancy (Note 1)

The card cannot be redundant due to the polarity reversal for line monitoring.

S81-F5004

4-Monitored Line Control Card

The four 2A output lines of the card are mainly utilized to control solenoids and heavy loads. The card is particularly suitable to manage automatic fire fighting systems, where it can be used to operate extinguishing agent release solenoid valves, or visual-audible evacuation and alarm devices.

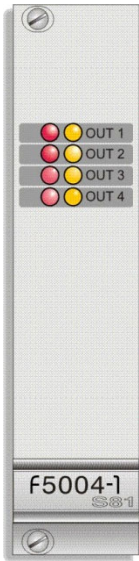

Main Characteristics

- Redundant (note 1)
- Can be hot-swapped (note 2)
- Suitable for application fault-tolerant up to level SIL3 of the standard IEC61508
- Outputs can be paralleled (note 1)
- Line self-testing every 2 seconds
- Continuous monitoring of short/opening/fault condition of pilot circuit
- Internal temperature monitoring of the command device and of the electronic supply
- 2mA per output available for resistive loads
- Can pilot electrically explosive cartridge actuators
- Software-configurable operating mode
- Communication management by FPGA
- Internal logic management by micro-controller
- SMD technology multilayer circuit
- Front plug-in on 19" rack, with locking screws

Status	Outputs 1-4	
	Yellow LED	Red LED
Line in normal condition	-	-
Line excluded or disabled	⊗	-
Line in trouble condition	∅	-
Line activated	-	⊗

LED status legend ⊗ = on ∅ = blinking - = off

Operation

The card cyclically tests each line, by reversing the output signal for about 200 microseconds. In case of discrepancy between setting and reading, the panel provides a fault signal. For each output, the following conditions are monitored: Line opening, Short-circuit towards positive, Short-circuit towards negative, DMOS fault, DMOS overheating, Supply voltage out of range. All lines are automatically tested every 2 seconds.

Parameter Configuration Via Software

Parameter	
Activation mode	<ul style="list-style-type: none"> • Steady, normally energized • Steady, normally de-energized • Periodical • Pulsing mode 1 • Pulsing mode 2 • ISA 1A logics • Delayed after activation • Delayed after deactivation • Delayed after enabling
Period	1 to 255 seconds, in pulsing and periodical mode only
Type of output	normal or sounder

Connection

Warning: Due to required current, only cable plug connection is possible.

Connection between the card and the field is carried out by means of a cable, provided with a plug-in connector at one of its ends.

The other end can be connected to a terminal block to be placed on the back of the rack.

Function	
Output 1	+
Output 2	+
Output 3	+
Output 4	+

Connection with PLUG CABLE	
1	White
2	Brown
3	Green1
4	Yellow

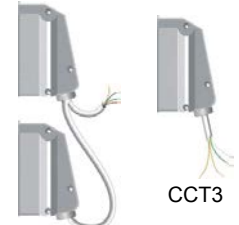

Connection Example of Actuators with Heavy Loads

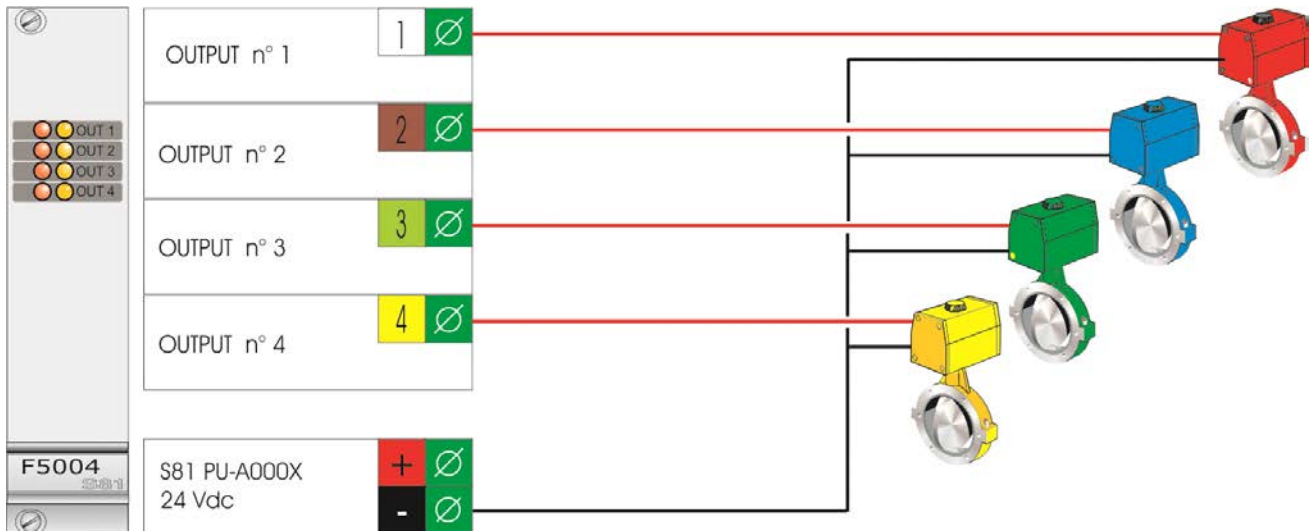

Redundancy (Note 1)

In fault-tolerant systems, this card has to be duplicated, i.e. two cards are to be used, which must be installed in two contiguous racks. Each input line from the field has to be connected to both cards and its exclusion is only possible from both of them.

Hot-Swap (Note 2)

The card can be removed and replaced without switching off the panel.

Warning

In case of normally energized outputs, configure the system to enable hot swap without undesired consequences.

Current per line

Limited to 10 W, in case of connection with filament bulbs.

CARD S81-F6001

Control Card (ECD) for Fire Extinguishing System

This card gathers and deploys the signals and logic associations relating to fire extinguishing control. Using the inputs and outputs managed by the other cards of the S81 panel, it enables system compliance with the EN 12094-1 standard. It does not have physical I/O, but uses inputs and commands managed by other cards of the S81 system.

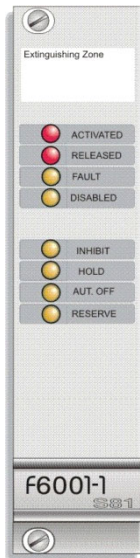

Main Characteristics

- It performs the functions of an ECD (electric control and delay device)
- It is certified by an accredited body to the European C.P.D. Construction Product Directive (Cert. n° 051-CPD-0139/0138/0137)
- It makes the S81 System compliant with EN 12094-1
- It allows building fire extinguishing systems certified SIL2 and SIL3 (IEC 61508)
- LED indication of extinguishing zone status
- It manages 4 virtual inputs (V-IN) and 10 virtual outputs (V-OUT)
- 0-60 second extinguishing control delay is configurable at operator level 3
- Can be hot-swapped (Note 1)
- Communication management by FPGA
- Internal logic management by micro-controller
- SMD technology multilayer circuit
- Front plug-in on 19" rack, with locking screws

Operation

It deploys the inputs and outputs physically located on other cards of the S81 panel using virtual inputs and outputs that are processed, according to pre-configured logics, for extinguishing system control in compliance with regulations.

Zone Status Indication

LED	Function
ACTIVATED	Activated condition
RELEASED	Extinguishing system operated
FAULT	General fault
DISABLED	General disabling
INHIBIT	Emergency stop
HOLD	Emergency hold
AUTOMATIC OFF	Automatic mode excluded
RESERVE	Reserve cylinder bank

Possible Configuration

Each extinguishing zone needs an S81-F6001 card, whatever the number of its sections, while the physical outputs to operate the extinguishing system (actuators, valves, visual/audible alarms, etc.) can be, on S81-F5001 (eight 0.5A channels), S81-F5003 (eight polarity reversal channels) or S81-F5004 (four 2A channels) cards, or addressable modules on BUS.

The inputs from the field (pushbuttons, limit switches, sequence stop, detection) are connected to such cards as the S81-F3002 (eight detection lines) and/or the S81-F7002 loop control cards.

Each extinguishing zone, even in the case of very complex systems, can be configured through the ProS81 program to create logic associations between virtual inputs and outputs (V-IN 1-4; V-OUT 1-10) and physical inputs and outputs.

Virtual Connections

The card deploys the virtual inputs constituted by the output variables from the other panel cards (IN, END) to produce virtual outputs (OUT), which are obtained through software elaboration by internal logic devices.

The virtual outputs generated are input variables to other cards and are used to create special functional logics for fire extinguishing system control.

The right-hand drawing gives an example of an extinguishing zone; note that the input and output devices necessary for the automatic extinguishing are connected to other cards of the system.

In this example the fire detection is performed using two loops routed to allow either a double consent.

Output variables Function	
V1	Manual activation
V2	Automatic actuation (AND)
V3	Automatic actuation excluded
V4	Discharge time extended (Hold)
V5	Extinguishing string inhibition (Abort)
V6	Reserve battery selection
V7	Secondary discharge
V8	Active system input (Flow/PIs)
V9	General anomaly
V10	General disabling
Output variables Function	
V1	Active condition
V2	Main battery start (primary)
V3	Reserve battery start (primary)
V4	Secondary discharge main battery
V5	Secondary discharge reserve battery
V6	Flashing warning alarms
V7	Fix warning alarms

CROSS LINE MADE BY LOOPS

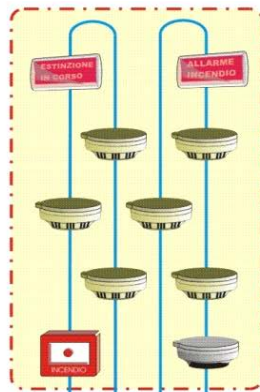

MANUAL SELECTOR AND INDICATORS

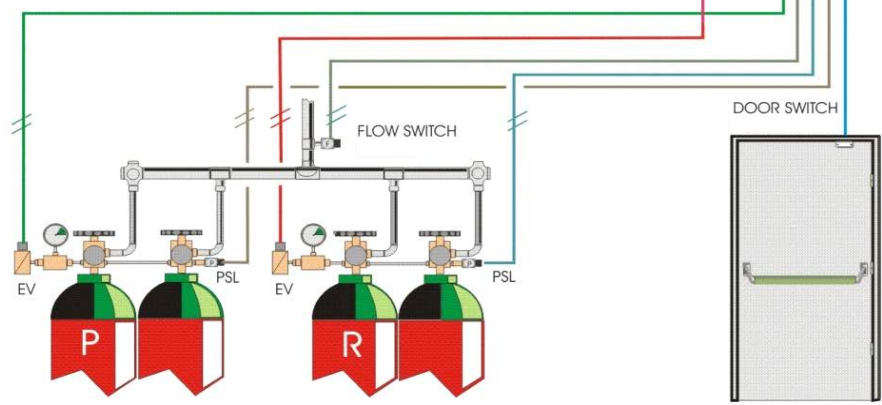
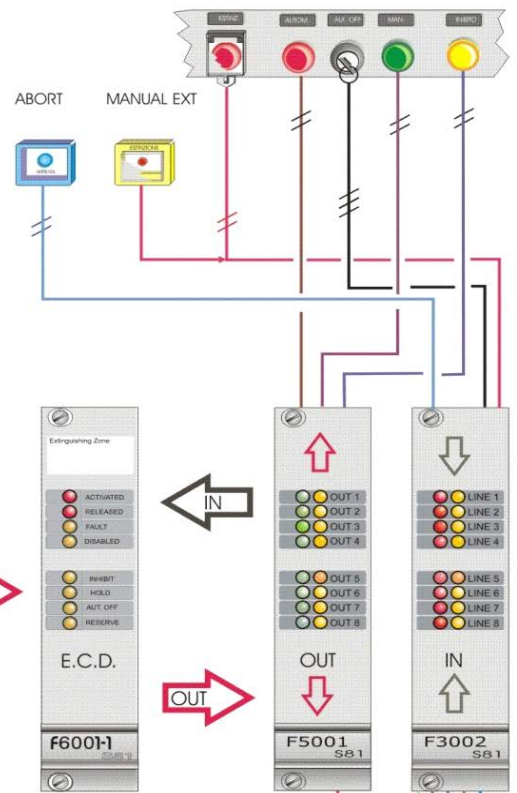

E.C.D.= Electrical automatic control and delay device according to EN 12094-1

Hot-Swap (Note 1)

The card can be removed and replaced without switching off the panel.

CARD S81-F6002

Special Logic Control Card

This card is designed to produce and manage functional logics through flip/flop, toggle and timer devices. Timers can be configured to operate in two modes (A and B).



Main Characteristics

- Operating mode configurable through ProS81 software program
- Up to 100 software logic devices for flip/flop functions of a set/reset type
- Up to 100 software logic devices for “toggle” functions
- Up to 100 software timers individually programmable from 0 to 255 seconds
- Can be hot-swapped
- Communication management by FPGA
- Internal logic management by micro-controller
- SMD technology multilayer circuit
- Front plug-in on 19" rack, with locking screws

Operation

The card deploys the virtual inputs constituted by the output variables from the other panel cards to produce virtual outputs, which are obtained through software elaboration by internal logic devices.

The virtual outputs thus generated are input variables to other cards and are used to create particular functional logics.

Status Indication

LED	Function
F1	Lights up when an input variable to the card is activated
F2	Lights up when an output variable from the card is activated
F3	Blinks when timers are activated
DISABLED	Lights up when an input or an output variable to/from the card is disabled

Configuration

Both the logic devices and the input/output variables are defined during configuration, which is carried out through the ProS81 program.

The logic devices that can be produced by means of this card are the following:

Software Device Configuration				
Type	Variables	Mode	Alarm Delay	Alarm Signaling
Flip Flop	Input/Output	Set/Reset	0-255 seconds	Normal/Silent/Buzzer only
Toggle	Input/Output	In-Out	Not applicable	Normal/Silent/Buzzer only
Timer	Input/Output	Timer A or Timer B	0-255 seconds	Normal/Silent/Buzzer only

Terminal Block Connection

This card has no connection with the field and, therefore, needs no wiring to a terminal block.

Logic Device with Flip-Flop Function - Set/Reset Type

A Set input provides a high output (Q), after a delay time (T).
 The output is zeroed by the front end of the Reset input.
 If Reset occurs within the delay time (T), the output (Q) remains low.

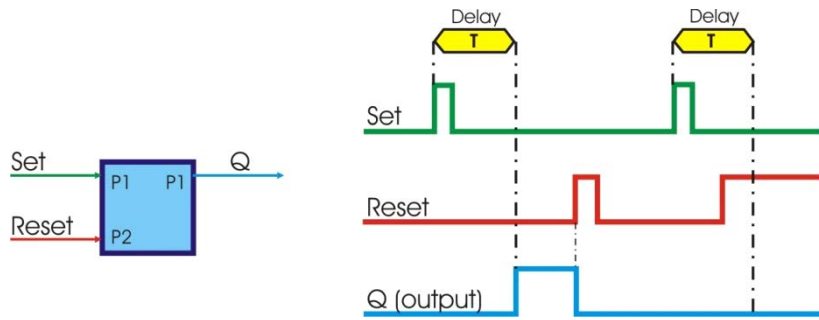

Logic Device with Timer Function - Mode A

The input (In) must remain high, during the set delay time (T), otherwise the output (Out) remains low.
 After the delay time (T), the output (Out) remains high as long as the input (In) is also high.

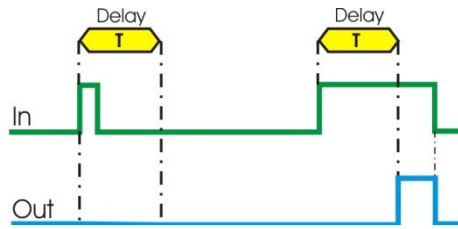

Logic Device with Timer Function - Mode B

The activation of the input (In) increases the output (Out), which remains high for the duration of the set delay time (T), or as long as the input (In) remains active.

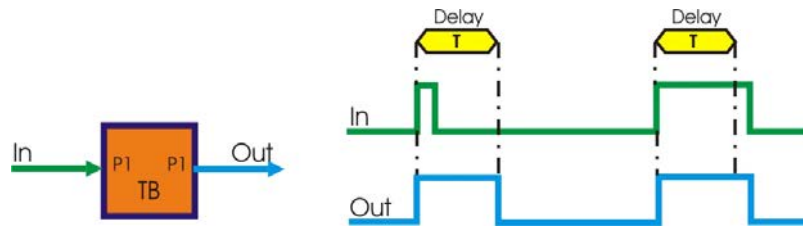

Logic Device with Toggle Function

The activation (on front end) of the input (In) raises the output (Out).
 The next activation of the input (In) zeros the output (Out).

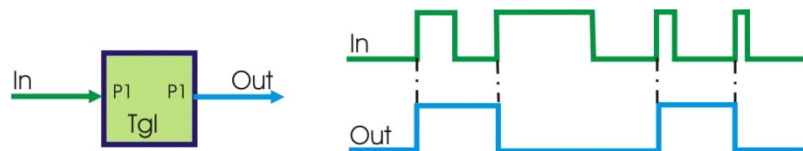

S81-F7006

Modbus Protocol Serial Communications Card

This Modbus RTU Master/Slave protocol communication card provides two independent output ports: one RS485 (Half Duplex) and one RS232.

Main Characteristics

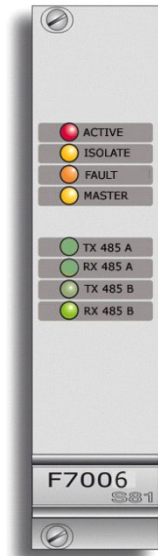

- Non-redundant with double connection (note 1)
- Can be hot-swapped (note 2)
- Modbus RTU protocol
- Master or Slave configuration
- Manages the following variables:
 - 512 Boolean input variables (32x16-bit words)
 - 512 output Boolean variables (32x16-bit words)
 - 130x16-bit analog variables
- Analog variables are related to 4-20 mA input card values
- One RS 232 serial + 1 RS 485 serial line usable simultaneously
- MODBUS address and parameter configuration through two 8-selector dip switches
- Periodical functionality self-testing of card and all connected devices
- Communication management by FPGA
- SMD technology multilayer circuit
- Front plug-in on 19" rack, with locking screws

LED	Status	Indication
ACTIVE	⊗	One input variable is active
DISABLED	⊗	One input or output variable is disabled
FAULT	∅	Communication fault (in Master mode only)
MASTER	∅	Master mode operation
TX RS232	∅	Any transmission from RS232 port
RX RS232	∅	Any receipt on RS232 port
TX RS485	∅	Any transmission from RS485 port
RX RS485	∅	Any receipt on RS485 port
LED status legend		⊗ = on ∅ = blinking

Operation

In MASTER mode, the card is only used for connecting, through the RS 485 port, two peer-to-peer or Master/Slave S81 panels.

In SLAVE mode, the card is used to respond to the requests from an external supervisory system - which may be a PC, a PLC, another panel, a PES, or a SCADA - cyclically interrogating the S81 panel to update its data base.

Further information on card operating mode can be provided, upon request, in a specific document describing the parameters used by the protocol.

Parameter Configuration Via Software

Parameter	
MODBUS address	1 to 255, through 8-selector dip switch SW1
SLAVE mode	address refers to F7006 card
MASTER mode	address refers to SLAVE peripheral to be sent controls
Baud rate settable through SW2 (1-2-3)	1200, 2400, 4800, 9600, 19200, 38400, 57600, 115200
Parity settable through SW2 (4-5)	none, even, odd
RS 485 line terminable with jumper	120 Ohm

Connection Via Termination Module

Connection between the card and the field is basically obtained by interposition of a terminal block module, which is mounted on a DIN rail inside the panel and is connected to the card rack by means of a flat cable with two quick connectors. The electronics-type terminals are suitable.

Connection Via Cable Plug

Connection between the card and the field is carried out by means of a special cable, provided with a plug-in connector at one of its ends. Cable conductors are wired directly onto a marshaling terminal block, while the connector is plugged into the back of the rack or into a DB9 type connector.

Function	
TX DATA RS232	T
RX DATA RS232	R
GND	G
Positive RS485	+
Negative RS485	-
GND	G

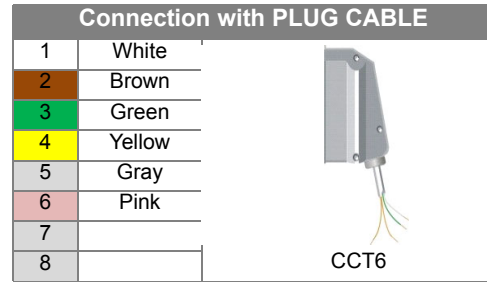
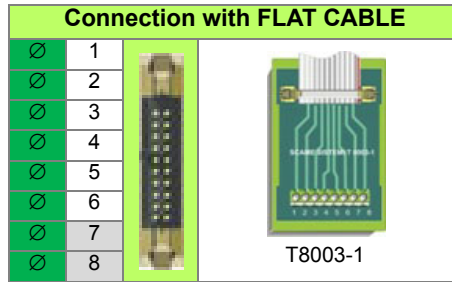

Examples

A T8003-1 terminal block module is used for serial RS232 connection between card and PC or PLC, if any, via a DB9 connector and terminal blocks 1, 2, and 3.

Terminals 4, 5 and 6 are to be used, taking into consideration manufacturer's instructions on cable type and wiring.

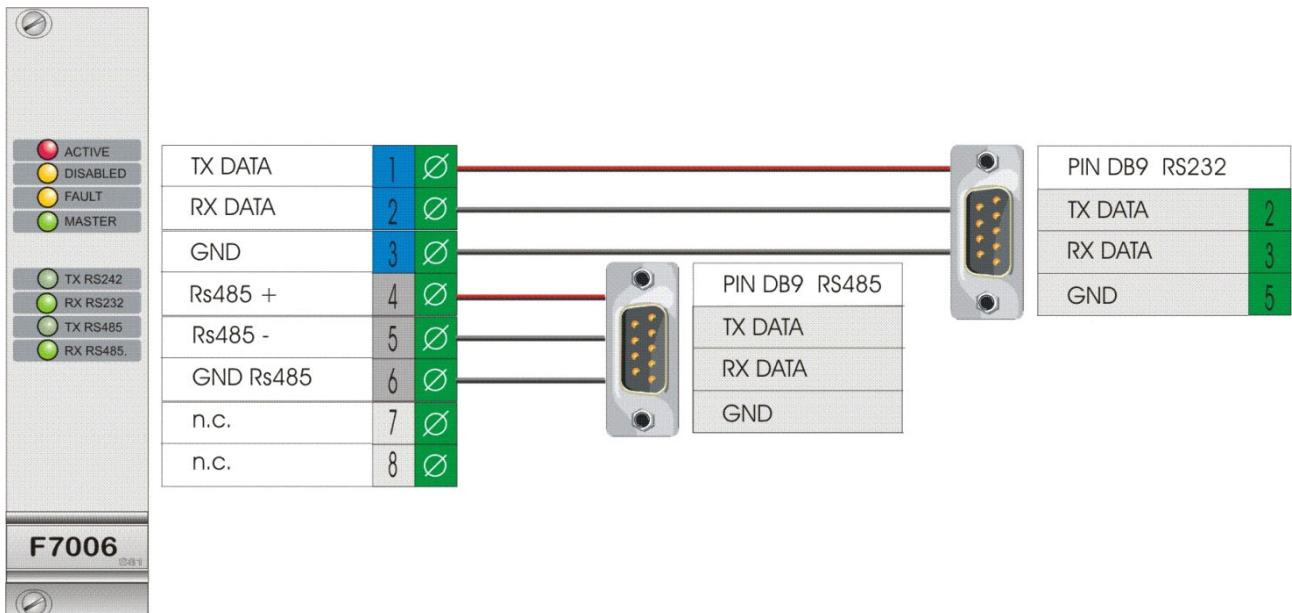

Redundancy (Note 1)

In fault-tolerant systems, this card has to be duplicated, i.e. two cards are to be used, which must be installed in two contiguous racks.

Hot-Swap (Note 2)

The card can be removed and replaced without switching off the panel.

CARD S81-F7001

Analog Addressable Device Control Card DCP Protocol

This card manages the addressable devices that adopt the DCP (Digital Communication Protocol) protocol of HOCHIKI America. A wide range of fire detectors, push buttons, optical-acoustic indicators and input/command modules UL Listed and FM APPROVED are available.

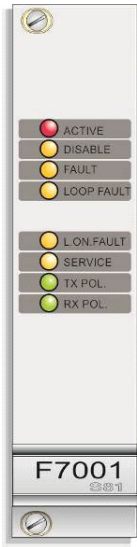

Main Characteristics

- Non redundant (note 1)
- Can be hot-swapped (note 2)
- 127 addresses with 3 I/O channels each
- Loop connection (farthest point at 1500 m)
- Selectable sensitivity of detectors
- Able to control UL Listed and FM Approved devices:
 - Smoke detectors
 - Combined detectors (smoke/temperature)
 - Temperature detectors
 - Short circuit isolators
- Addressable signaling units
- Mini-zone addressable modules
- Addressable push buttons
- Periodic auto-test of the card operation and of all connected devices
- Communication management by FPGA
- Front plug-in on 19" rack, with locking screws

LED Indications

LED	Status	Indication
ACTIVE	⊗	One or more inputs in alarm or active condition
DISABLED	⊗	One input or output disabled
FAULT	∅	Fault condition
LOOP FAULT	∅	Loop short-circuit or opening
LOG ON FAULT	∅	Discrepancy between read and expected devices
SERVICE	∅	Optical smoke detector(s) dirty
TX POL.	∅	Data transmission to devices on loop
RX POL.	∅	Data receipt from devices on loop

Legend: ⊗= led on ; ∅= led blinking

Operations

The card communicates, through the DCP protocol, with all the devices on a loop, periodically polling them or receiving calls (interrupts) from the devices that have detected a status variation. Alarming occurs after the information has been processed, through specific algorithms for the devices; e.g. smoke detectors can provide dynamic alarm thresholds that adjust themselves to compensate for optic sensing element contamination.

Programmable Features

Status conditions	Operations
Normal operating mode	Normally open or normally closed in the normal status
Channel logic status (note 3)	Latching/non latching
Smoke detectors sensibility	predetermined
Alarm thresholds	Input pre-alarm / alarm
Signaling on outputs for alarm	Programmable depending on the type of actuator
Output activation way	Programmable depending on the type of actuator
Time (impulsive and periodic way only)	Programmable depending on the type of actuator
Optical acoustic signals	As for UL864 standard, with synchronization

Connection Via Terminal Module S81-T8001

Connection between the card and the field is basically obtained by interposition of a terminal block module, which is mounted on a DIN rail inside the panel and is connected to the card rack by means of a flat cable with two quick connectors. The electronics-type terminals are suitable for cables having a section area of up to 4 mm².

Connection Via Cable Plug S81-CCT4

Connection between the card and the field is carried out by means of a special cable, provided with a plug-in connector at one of its ends. Cable conductors are wired directly onto a marshaling terminal block, while the connector is plugged into the back of the rack.

Function	
Positive loop out	+
Negative loop out	-
Positive loop in	+
Negative loop in	-
--	
--	
--	
--	

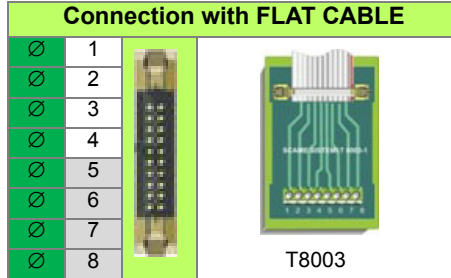

Connection with PLUG CABLE

1	White
2	Brown
3	Green
4	Yellow
5	
6	
7	
8	

CCCT4

Connection example

The connection between the card and the devices takes place through two wires (positive and negative line) which return to the tab forming a ring. This connection is allowed if the devices do not exceed the maximum current allowed for the loop. In case the devices require a separate power supply, this will consist of a further connection of two conductors to carry the positive and negative of the 24 VDC.

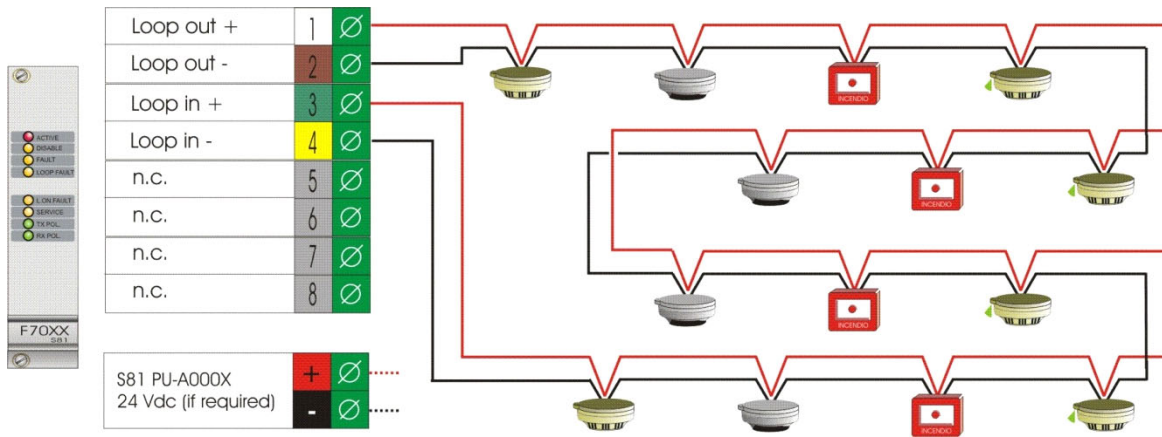

Redundancy (note 1)

The card cannot be redundant because of the intrinsic operation of the serial communication protocol.

Hot-Swap (Note 2)

The card can be removed and replaced without switching off the panel.

Latching Mode (Note 3)

An alarm status persists until reset.

DCP compatibility

This card is compatible with the DCP protocol HOCHIKI AMERICA.

For further information, please visit the internet site of the manufacturer: <http://www.hochikiamerica.com>

As example, below there are some devices of the protocol:



CARD S81-F7002

Analog Addressable Device Control Card - ESP Protocol

Control card for devices that are addressable through the HOCHIKI ESP protocol. SMOKE, TEMPERATURE and COMBINED fire detectors, as well as PUSHBUTTONS and CONTROL MODULES, with monitored and non-monitored lines, are available with the ESP protocol

This type of card is used only for fire fighting system control.

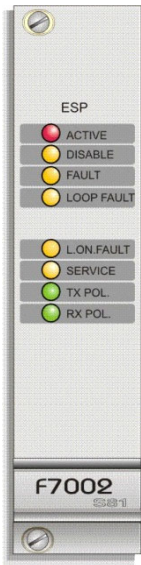

Main Characteristics

- Non-redundant (Note 1)
- Can be hot-swapped (Note 2)
- Up to 127 addresses, 3 channels each
- Loop connection (farthest point at 1500 m)
- Detector sensitivity can be set as HIGH/MEDIUM/LOW
- Can control detectors of the ASX series, certified to EN 54-7 and EN 54-9
 - Smoke detector ALG (photoelectric) and AIE (ionization)
 - Combined detectors (smoke/temperature) ACA-E
 - Temperature detectors ATG-E
 - Short-circuit isolators YBO and YBO-R/SCI (with socket)
 - Addressable sounders CHQ-WS and CHQ-BS (with socket)
 - CHQ-MZ mini-zone, CHQ-R double relay, CHQ-S double input addressable modules
 - MCP-E addressable call points (pushbuttons)
- Periodical functionality self-testing of card and all connected devices
- Communication management by FPGA
- Front plug-in on 19" rack, with locking screws.

LED	Status	Indication
ACTIVE	⊗	One or more inputs in alarm or active condition
DISABLED	⊗	One input or output disabled
FAULT	∅	Fault condition
LOOP FAULT	∅	Loop short-circuit or opening
LOG ON FAULT	∅	Discrepancy between read and expected devices
SERVICE	∅	Optical smoke detector(s) dirty
TX POL	∅	Data transmission to devices on loop
RX POL	∅	Data receipt from devices on loop
<i>LED status legend</i>		⊗ = on ∅ = blinking

Operation

The card communicates, through the ESP protocol, with all the devices on a loop, periodically polling them or receiving calls (interrupts) from the devices that have detected a status variation. Alarming occurs after the information has been processed, through specific algorithms for the devices; e.g. smoke detectors can provide dynamic alarm thresholds that adjust themselves to compensate for optic sensing element contamination.

Parameter Configuration Via Software



Input operating mode	NO/NC
Channel logic status (Note 3)	Latching/Non-latching
Smoke detector sensitivity	High/Medium/Low
Alarm thresholds	Pre-alarm/Alarm
Alarm output	Normal/Silent/Buzzer only
Output activation mode	Steady energised, steady de-energised, periodical, pulsing
Period (pulsing and periodic mode only)	Output settable between 1 and 15 seconds
Tone of sounders on loop	7 different tones settable
Volume of sounders on loop	55 to 98 dBA, settable on 13 steps

Connection Via Termination Module S81-T8001

Connection between the card and the field is basically obtained by interposition of a terminal block module, which is mounted on a DIN rail inside the panel and is connected to the card rack by means of a flat cable with two quick connectors. The electronics-type terminals are suitable for cables having a section area of up to 4 mm².

Connection Via Cable Plug S81-CCT4

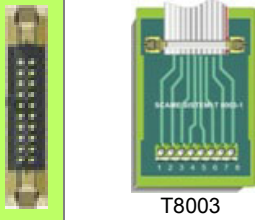
Connection between the card and the field is carried out by means of a special cable, provided with a plug-in connector at one of its ends. Cable conductors are wired directly onto a marshaling terminal block, while the connector is plugged into the back of the rack.

Function		Connection with FLAT CABLE		Connection with PLUG CABLE		
Positive loop out	+	1	 T8003	1	White	 CCCT4
Negative loop out	-	2		2	Brown	
Positive loop in	+	3		3	Green	
Negative loop in	-	4		4	Yellow	
--		5		5		
--		6		6		
--		7		7		
--		8		8		

Connection Examples

The connection between the card and the devices takes place through two wires (positive and negative line) which return to the tab forming a ring. This connection is allowed if the devices do not exceed the maximum current allowed for the loop. In case the devices require a separate power supply, this will consist of a further connection of two conductors to carry the positive and negative of the 24 Vdc.

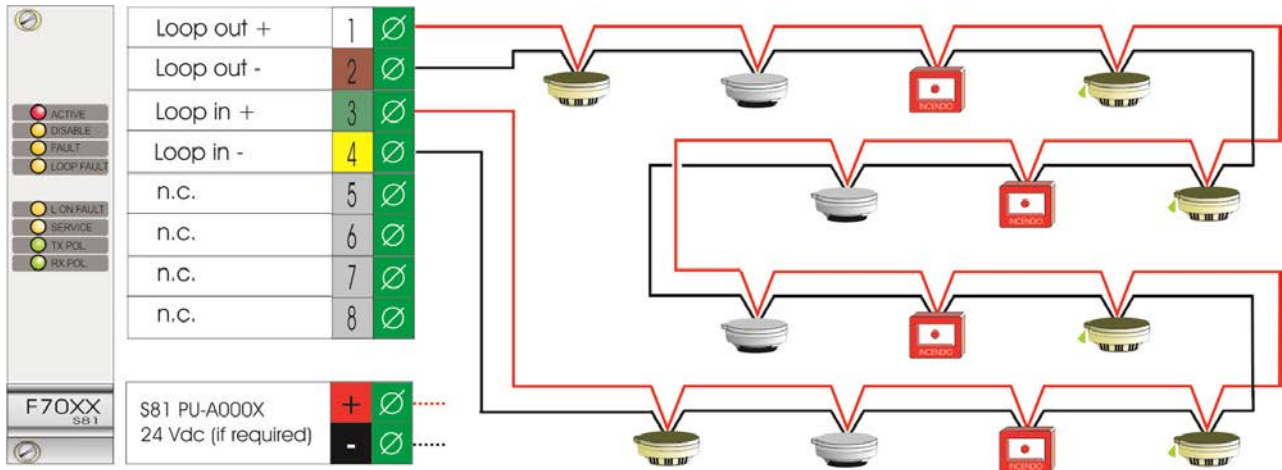

Redundancy (Note 1)

Card redundancy is not possible, due to serial communication protocol.

Hot-Swap (Note 2)

The card can be removed and replaced without switching off the panel.

ESP compatibility

This card is compatible with HOCHIKI's ESP protocol.



CARD S81-F7007

Analog Addressable Device Control Card - SSP Protocol

Control card for SSP (Scame Sistemi Protocol) protocol addressable devices. It can manage up to 127 analogue/digital input addressable modules and control modules. This card must not be used with fire detection systems.

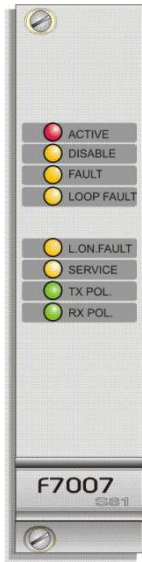

MAIN CHARACTERISTICS

- NON REDUNDANT (Note 1)
- CAN BE HOT SWAPPED (Note 2)
- 127 addresses on SSP protocol
- Serial connection on 1200 m bus
- Serial line can be looped (3000 m max)
- Can control following addressable modules
 - S81-Mod-DI : eight non-monitored inputs
 - S81-Mod-DO : eight non-monitored open collector outputs
 - S81-Mod-AIT : four double balanced inputs, for intruder alarm
 - S81-Mod-AI020 : one 4-20 mA analogue input
 - S81-Mod-AI010 : 1 0-10 V analogue input
 - S81-Mod-DISP : status repeater display (Note 3)
- Periodical functionality self-testing of card and all connected devices
- Communication management by FPGA
- SMD technology multilayer circuit
- Front plug-in on 19" rack, with locking screws.

LED	Status	Indication
ACTIVE	⊗	One or more inputs in alarm or active condition
DISABLED	⊗	One input or output disabled
FAULT	∅	Fault condition
LOOP FAULT	∅	Loop short-circuit or opening
LOG ON FAULT	∅	Discrepancy between read and expected devices
SERVICE	∅	Optical smoke detector(s) dirty
TX POL	∅	Data transmission to devices on loop
RX POL	∅	Receipt of data from devices on loop
<i>LED status legend</i>		⊗ = on ∅ = blinking

OPERATION

The card communicates, through the SSP protocol, with all the devices on a loop, periodically polling them or receiving calls (interrupts) from the devices that have detected a status variation. The analogue input modules can be polled, to show device value reading, either by the operator (from the panel) or by a supervisory program.

PARAMETER CONFIGURATION VIA SOFTWARE

Status	
Input operating mode	NO/NC
Channel logic status (Note 4)	Latching/Non-latching
Analogue module measuring range	See data sheets relevant to addressable devices
Thresholds	Pre-alarm/Alarm
Alarm output	Normal/Silent/Buzzer only
Output activation mode	Steady energised, steady de-energised, periodical, pulsing
Period (pulsing and periodic mode only)	Output settable between 1 and 15 seconds

CONNECTION VIA TERMINATION MODULE

Connection between the card and the field is basically obtained by interposition of a terminal block module, which is mounted on a DIN rail inside the panel and is connected to the card rack by means of a flat cable with two quick connectors. The electronics-type terminals are suitable for cables having a section area of up to 4 mm².

CONNECTION VIA CABLE PLUG

Connection between the card and the field is carried out by means of a special cable, provided with a plug-in connector at one of its ends. Cable conductors are wired directly onto a marshalling terminal block, while the connector is plugged into the backside of the rack.

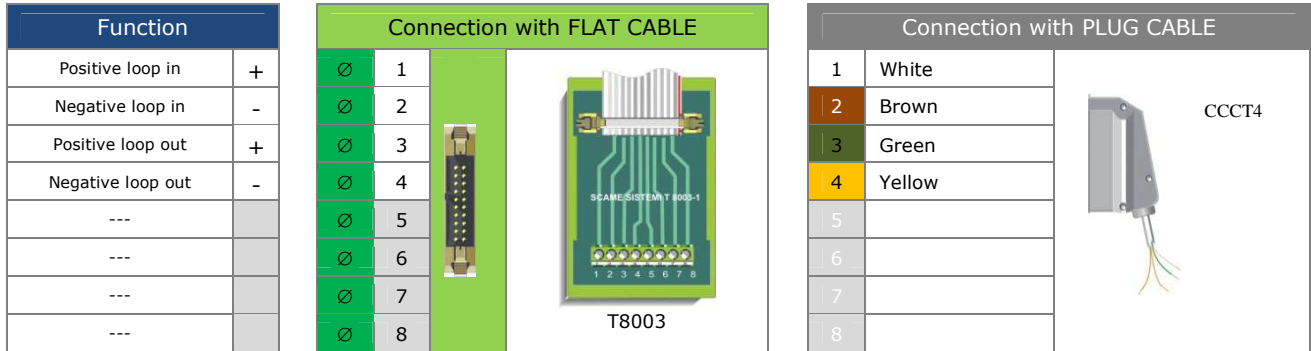

Connection Examples

The connection between the card and devices takes place through two wires (positive and negative line) which return to the tab forming a ring. This connection is allowed if the devices do not exceed the maximum current allowed for the loop. In case the device requires a separate power supply, this will consist of a further connection of two conductors to carry the positive and negative of the 24 Vdc. The bus can also operate without ring closure, in which case a jumper on the terminal board inputs and outputs of the loop.

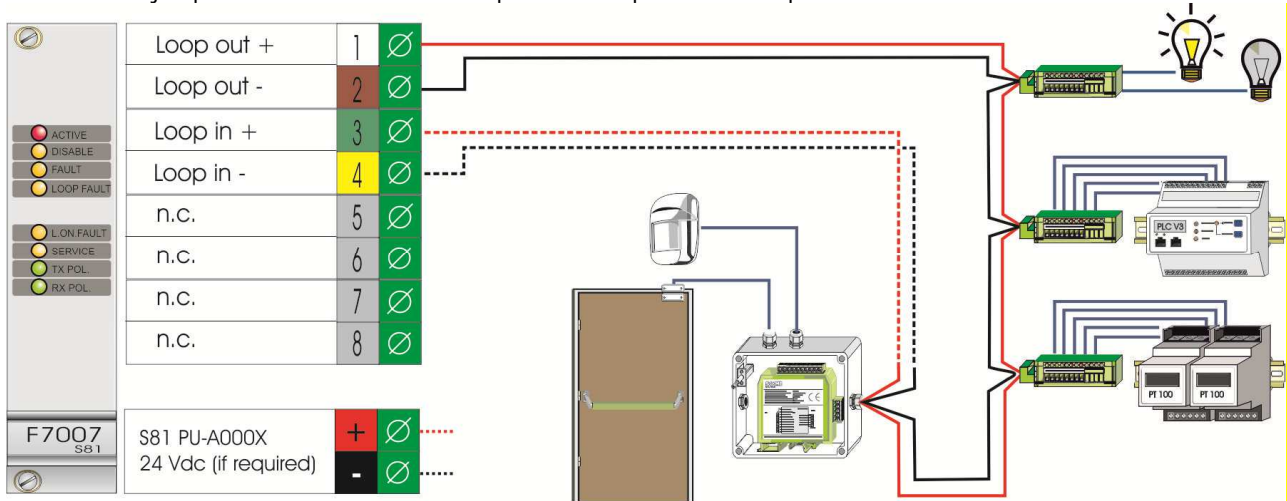

NOTES

Redundancy (Note 1)

Card redundancy is not possible, due to serial communication protocol.

Hot Swap (Note 2)

The card can be removed and replaced without switching off the panel, which would imply system inoperability.

S81-Mod-DISP Status Repeater (Note 3)

The alarm condition remains displayed until reset.

Latching Mode (Note 4)

An alarm status persists until reset.

SSP Compatibility

This card is compatible with SCAME's SSP protocol and with the addressable modules of the series S81 Mod-XXX.

S81-F7009

Analog Addressable Device Control Card Apollo Protocol

Control card for addressable devices that require APOLLO DISCOVERY and XP95 protocols.

With these protocols a wide range of fire detectors, push buttons, optic-acoustic signaling and input/command modules are available.

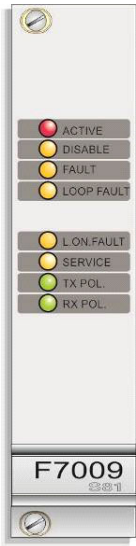

Main Characteristics

- Non redundant (note 1)
- Can be hot-swapped (note 2)
- 127 multichannel addresses
- Loop connection (farthest point at 1500 meters)
- Detector sensitivity selectable during the configuration of the panel
- Sensors certified to EN54 and for marine applications
 - Smoke detectors (photoelectric and ionization)
 - Combine detectors (smoke/temperature)
 - Temperature detectors
 - Short-circuit isolators
 - Addressable sounders
 - Addressable push buttons
 - Wide range of addressable modules with several inputs/outputs
- Sensors and wireless interface units XPander
- Periodical functionality self-testing of card and all connected devices
- SMD technology multilayer circuit
- Front plug-in on 19" rack, with locking screws

LED indication on card

LED	Status	Indication
ACTIVE	⊗	One or more inputs in alarm or active condition
DISABLED	⊗	One input or output disabled
FAULT	∅	Fault condition
LOOP FAULT	∅	Loop short circuit or opening
LOG ON FAULT	∅	Discrepancy between read and expected devices
SERVICE	∅	Optical smoke detector(s) dirty
TX POL.	∅	Data transmission to devices on loop
RX POL.	∅	Data receipt from devices on loop
LED status legend: ⊗ = on ; ∅ = blinking		

Operation

Through two connection and feeder cables, the card communicates with all devices connected on the loop, periodically polling them or receiving calls (interrupt) from the devices that have detected a status variation.

Alarming occurs after the information has been processed, through specific algorithms for the devices; e.g. smoke detectors can provide dynamic alarm thresholds that adjust themselves to compensate for optic sensing element contamination.

Parameter Configuration Via Software

Status	Operations
Operating mode:	NA or NC
Channel logic status (note 3)	Latching/Non-latching
Smoke detectors sensibility	Settable depending on the type of sensor
Thresholds	Settable depending on the type of sensor
Signaling mode on alarm outputs	Normal / Silent/ buzzer only
Output activation mode	Steady energized, steady de-energized, periodical, pulsing
Period (pulsing and periodic mode only)	Output settable between 1 to 15 seconds
Horn tone on the loop	Settable depending on the type of signaling
Horn volume on the loop	Settable depending on the type of horn

Connection Via Termination Module

Connection between the card and the field is basically obtained by interposition of a terminal block module, which is mounted on a DIN rail inside the panel and is connected to the card rack by means of a flat cable with two quick connectors. The electronics-type terminals are suitable for cables having a section area of up to 4 mm².

Connection Via Plug Cable

Connection between the card and the field is carried out by means of a special cable, provided with a plug-in connector at one of its ends. Cable conductors are wired directly onto a marshaling terminal block, while the connector is plugged into the back of the rack.

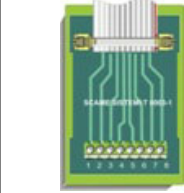
Function		Connection with FLAT CABLE		Connection with PLUG CABLE	
Loop out +	+	Ø 1	 T8003	1	White
Loop out -	-	Ø 2		2	Brown
Loop in +	+	Ø 3		3	Green
Loop in -	-	Ø 4		4	Yellow
--		Ø 5		5	
--		Ø 6		6	
--		Ø 7		7	
--		Ø 8		8	



CCCT4

Connection Example

The connection between the card and devices takes place through two wires (positive and negative line) which return to the tab forming a ring. This connection is allowed if the devices do not exceed the maximum current allowed for the loop. In case the device requires a separate power supply, this will consist of a further connection of two conductors to carry the positive and negative of the 24 VDC.

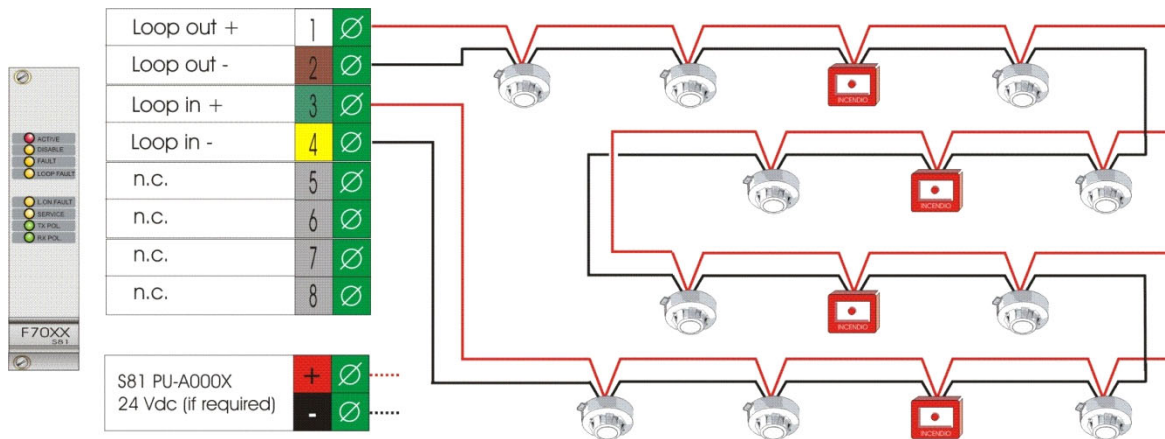

Redundancy (Note 1)

Card redundancy is not possible, due to serial communication protocol.

Hot-Swap (Note 2)

The card can be removed and replaced without switching off the panel.

Latching Mode (Note 3)

An alarm status persists until reset.

Compatibility of Loop Communication Protocol.

This card is compatible with protocols APOLLO DISCOVERY and XP95.

For further information please visit the site of device's manufacturer: <http://www.apollo-fire.co.uk>



S81-F7010

Addressable Device Control Card System Sensor Protocol

Smoke, temperature, combined detectors, push buttons, command modules, and managing modules are available with this protocol.

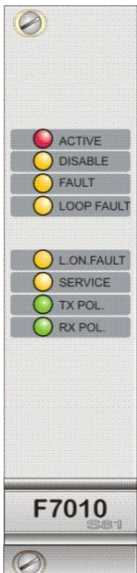

Main Characteristics

- Non redundant (note 1)
- Can be hot-swapped (note 2)
- 99 addresses for sensors and 99 addresses for modules
- Loop connection (farthest point at 1500 meters)
- Detector sensitivity selectable on 5 or 9 levels
- Able to control devices certified according to EN 54-7 e EN 54-9 (CPD).
- Smoke, flame, temperature sensors.
- Combined detectors (smoke/temperature)
- Multi element combined detectors (smoke/temperature/CO/flame)
 - Short-circuit isolators
 - Addressable horns
 - Addressable push buttons
 - Analog interface modules 4-20 mA
 - Sensors
- Periodical functionality self-testing of card and all connected devices
- SMD technology multilayer circuit
- Front plug-in on 19" rack, with locking screws

LED Indication on Card

LED	Status	Indication
ACTIVE	⊗	One or more inputs in alarm or active condition
DISABLED	⊗	One input or output disabled
FAULT	∅	Fault condition
LOOP FAULT	∅	Loop short circuit or opening
LOG ON FAULT	∅	Discrepancy between read and expected devices
SERVICE	∅	Optical smoke detector(s) dirty
TX POL.	∅	Data transmission to devices on loop
RX POL.	∅	Data receipt from devices on loop
LED status legend: ⊗= on ; ∅= blinking		

Operation

Through two connection and feeder cables, the card communicates with all devices connected on the loop, periodically polling them or receiving calls (interrupt) from the devices that have detected a status variation.

Alarming occurs after the information has been processed, through specific algorithms for the devices; e.g. smoke detectors can provide dynamic alarm thresholds that adjust themselves to compensate for optic sensing element contamination.

Parameter Configuration Via Software



Status	Operations
Operating mode:	NA or NC
Channel logic status (note 3)	Latching/Non-latching
Smoke detectors sensibility	5 or 9 settable sensitivity levels
Thresholds	Input in pre-alarm/alarm
Signaling mode	Fire, Supervisory, Gas, Anomaly, Hide, buzzer only
Output activation mode	Steady energized, steady de-energized, periodical, pulsing
Period (pulsing and periodic mode only)	Output settable between 1 to 15 seconds

Connection Via Termination Module

Connection between the card and the field is basically obtained by interposition of a terminal block module, which is mounted on a DIN rail inside the panel and is connected to the card rack by means of a flat cable with two quick connectors. The electronics-type terminals are suitable for cables having a section area of up to 4 mm².

Connection Via Plug Cable

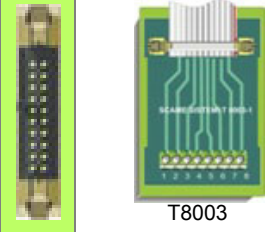
Connection between the card and the field is carried out by means of a special cable, provided with a plug-in connector at one of its ends. Cable conductors are wired directly onto a marshaling terminal block, while the connector is plugged into the back of the rack.

Function		Connection with FLAT CABLE		Connection with PLUG CABLE		
Loop out +	+	1	 T8003	1	White	 CCCT4
Loop out -	-	2		2	Brown	
Loop in +	+	3		3	Green	
Loop in -	-	4		4	Yellow	
--		5		5		
--		6		6		
--		7		7		
--		8		8		

Connection Example

The connection between the card and devices takes place through two wires (positive and negative line) which return to the tab forming a ring. This connection is allowed if the devices do not exceed the maximum current allowed for the loop. In case the device requires a separate power supply, this will consist of a further connection of two conductors to carry the positive and negative of the 24 Vdc.

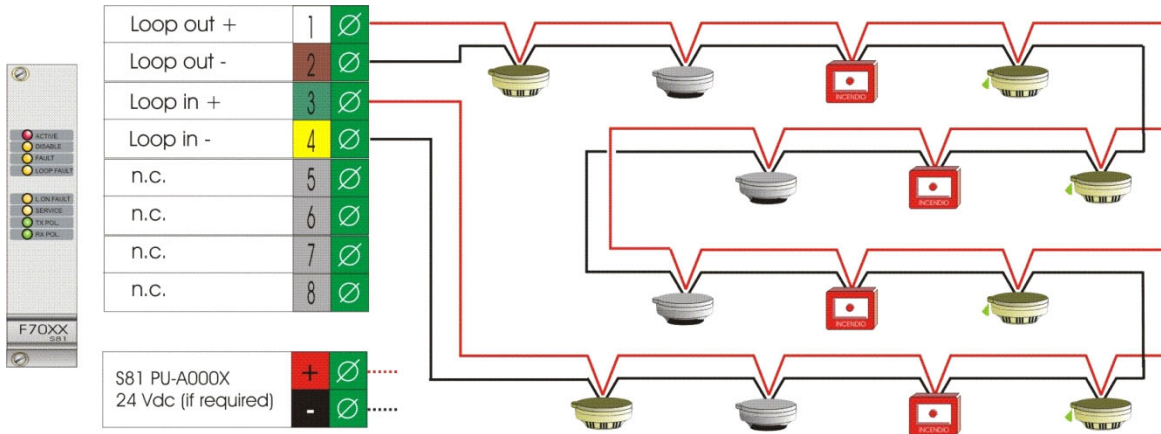

Redundancy (Note 1)

Card redundancy is not possible, due to serial communication protocol.

Hot-Swap (Note 2)

The card can be removed and replaced without switching off the panel.

Latching Mode (Note 3)

An alarm status persists until reset.

Compatibility with protocol System Sensor

This card is compatible with the protocol System Sensor.

For further information please visit the site of addressable device's manufacturer.



S81-F7012-1-UL

Addressable Device Control Card System Sensor Protocol (UL-Listed)

General

The S81-F7012 card controls one SLC loop with System Sensor devices, such as smoke detectors, heat detectors, multi-criteria detectors, control modules, monitor modules, and pull stations. Each loop operates in the CLIP polling protocol and is capable of supporting 99 addressable modules and 99 addressable detectors (any combination of modules and detectors) for a total of 198 points per loop.

LED Indicators on Card

LED	Status	Indication
ACTIVE	⊗	One or more inputs in alarm or active condition
DISABLED	⊗	One input or output disabled
FAULT	∅	Fault condition
LOOP FAULT	∅	Loop short circuit or opening
LOG ON FAULT	∅	Discrepancy between read and expected devices
SERVICE	∅	Optical smoke detector(s) dirty
TX POL.	∅	Data transmission to devices on loop
RX POL.	∅	Data receipt from devices on loop
LED status legend:		⊗= on ; ∅= blinking

Operation

Through two connection and feeder cables, the card communicates with all devices connected on the loop, periodically polling them or receiving calls (interrupt) from the devices that have detected a status variation.

Alarming occurs after the information has been processed, through specific algorithms for the devices; e.g. smoke detectors can provide dynamic alarm thresholds that adjust themselves to compensate for optic sensing element contamination.

Connection Via Plug Cable

Connection between the card and the field is carried out by means of a special cable, provided with a plug-in connector at one of its ends. Cable conductors are wired directly onto a marshaling terminal block, while the connector is plugged into the back of the rack.



FEATURES

- Non redundant due to serial communication protocol
- Can be hot-swapped: removed and replaced without powering off the panel
- 99 addresses for detectors and 99 addresses for modules operating in CLIP protocol
- Loop connection (farthest point at 1500 meters)
- Selectable detector sensitivity
- Controls UL 864-certified devices such as:
 - Multi-criteria detectors (smoke/heat/CO)
 - Short-circuit isolators
 - Addressable smoke detectors
- Addressable heat detectors
- Addressable monitor modules
- Addressable control modules
- Periodic functionality self-test of card and all connected devices
- SMD technology multilayer circuit
- Front plug-in on 19" rack, with locking screws

Function		Connection with PLUG CABLE	
Loop out +	+	1	White
Loop out -	-	2	Brown
Loop in +	+	3	Green
Loop in -	-	4	Yellow
--		5	
--		6	
--		7	
--		8	



CCT4

Connection Example

The connection between the card and devices takes place through two wires (positive and negative line) which return to the tab forming a ring. This connection is allowed if the devices do not exceed the maximum current allowed for the

loop. In case the device requires a separate power supply, this will consist of a further connection of two conductors to carry the positive and negative of the 24 VDC.

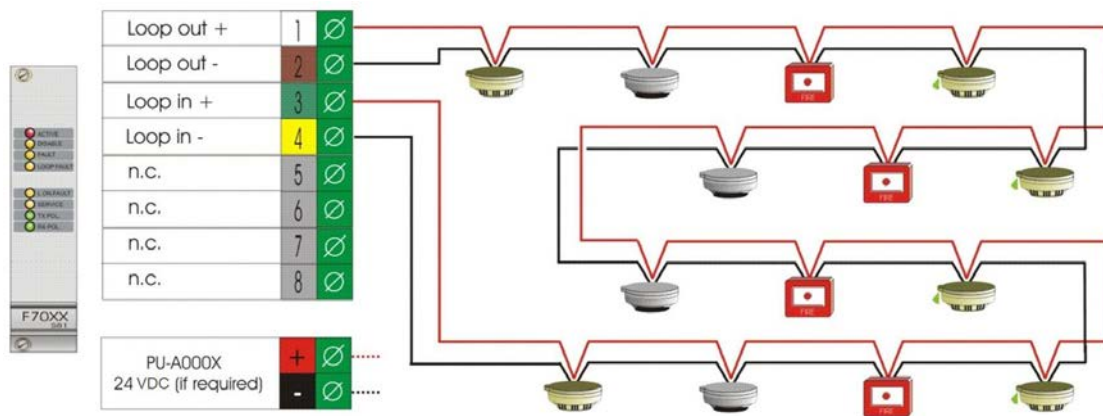

Compatible Devices

- **2251B** Photoelectric Smoke Detector
- **2251BR** Photoelectric Smoke Detector for use with DNR(W) Duct Detector
- **5251B** Fixed Temperature Thermal Detector
- **5251H** High Temperature Thermal Detector
- **5251RB** Rate-of-rise Thermal Detector
- **2251TB** Photoelectric Smoke Detector with Thermal
- **2251TMB** Acclimate Multi-Criteria Smoke Detector
- **2251-COPTIR** Advanced Multi-Criteria Fire Detector
- **HON-12LX** Pull station
- **M502M** Zone Interface Module
- **M500M** Monitor Module
- **M501M** Mini Monitor Module
- **M500DM** Dual Input Monitor Module
- **M500R** Relay Module
- **M500S** Control Module
- **SC-6** Six Supervised Control Module
- **CR-6** Six Relay Control Module
- **CZ-6** Six Conventional Zone Interface Module
- **IM-10** Ten Input Monitor Module
- **ISO-6** Six Isolator Module
- **M500X** Isolator Module
- **B200SR** Sounder Base
- **M500R** Relay Module

System Sensor® is a registered trademark of Honeywell Inc.

This document is not intended to be used for installation purposes. We try to keep our product information up-to-date and accurate. We cannot cover all specific applications or anticipate all requirements. All specifications are subject to change without notice.

PU-A0003-1

Power Unit

This unit is composed of a max 2.5A feeder and an integrated battery charger that supplies two 12V-14Ah batteries.

The batteries are charged separately from the load and, in case of main supply failure or fault, they are switched on to the load immediately, which ensures no interruption.

In normal conditions, the batteries are subject to trickle charging and are checked, every 30 seconds, for their presence and functionality.

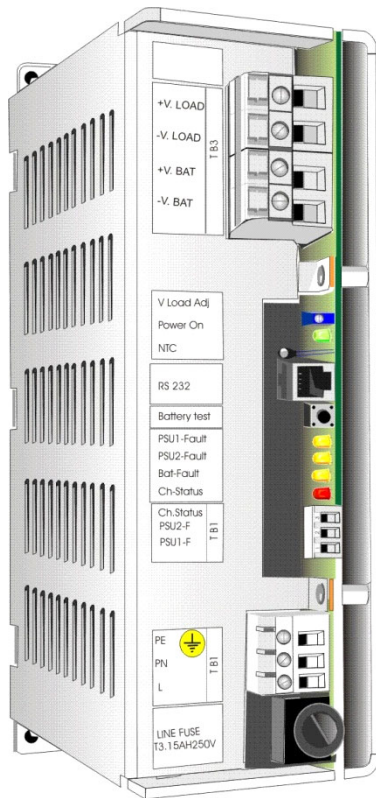

Main Characteristics

- Suitable to build up power supply groups certified to EN 54-4
- Meets the requirements of 54-4:1997/A2:2006
- Check of battery status every 30 seconds
- Input voltage variable between 22 and 28 VDC
- 1.8A available for load (VLOAD) with flat batteries
- Maximum current to batteries electronically limited to 0.7A
- Input supply from 110 to 240 VAC
- LED for indication of battery status
- LED for indication of battery malfunctioning
- Feeder and battery charger malfunctioning LED
- Button for manual battery testing
- RS 232 serial port for programming and control
- OC outputs for repetition of charge status and supply fault
- Efficiency 80%
- Ripple < 100mV pk/pk at maximum current
- Hold-up time on main failure 20 ms
- Dimensions 200 mm x 60 mm x 110 mm (excluding terminals)
- Operating temperature -5 to +50 °C (in open air)
- Mounting on panel back plate
- Can be used with C20 and AFP21 panels.

WIRING OF SUPPLY FROM ELECTRIC main

Terminal Block	Terminal	Name	Function
TB1	M1	L input	Phase (line protected by internal fuse)
	M2	N input	Neutral
	M3	PE	Ground

WIRING FOR STATUS INDICATION

Terminal Block	Terminal	Name	Function
TB2	M1	PSU1-Fault	Primary supply failure output
	M2	PSU2-Fault	Secondary supply failure output
	M3	Charge Status	Charge status repetition output

WIRING TO BATTERIES AND LOAD

Terminal Block	Terminal	Name	Function
TB3	M1	- VBat	Battery negative
	M2	+VBat	Battery positive
	M3	- VLoad	Negative of supply to load
	M4	+VLoad	Positive of supply to load

General Characteristics

Input	110-240 VAC - 50/60 Hz
Maximum current	0.6 A at 240 VAC
Operating temperature	-5 to +50 °C (open air)
Relative humidity	93% (non condensing)
Efficiency	> 83%
Protection	IP20
Dimensions	175mm x 90mm x 55mm
Self Extinguishing	UL94V2
VLOAD voltage	25 VDC (adjustable between 23 and 26 VDC)
VBAT voltage	26.2 to 28.7 VDC (automatically compensated)
VLOAD current	1.8 A (flat batteries)
VLOAD	ripple < 100mV pK-pK at maximum current
Hold-up time on main failure	20 ms at maximum current (with PU-A0005)
Maximum battery current	3A
Maximum battery capacity	14 Ah

Protection

Current to batteries	automatically limited
Current to load	3A fuse (self-restoring)
Other	over voltage, short-circuit, battery polarity reversal

Reference Standards

Product	EN 54-4:1997
CPD Directive	EN 54-4/A2:2006
CE marking	EN50081-2 & EN50082-2 (industrial environment)

**CERTIFIED IN ACCORDANCE WITH EN54-4
A2:2006
(C.P.D. requirements)**

PU-A0004-1

125W, 24 VDC Battery Charger

This is an uninterrupted power supply (UPS) unit, which can control and charge two 12V, 65Ah batteries.

The batteries are charged separately from the load and, in case of main supply fault or failure (PU-A005 or equivalent), they are switched on to the load immediately, which ensures no interruption.

When main supply is restored, the battery charger disconnects the batteries and recharges them, adjusting current depending on temperature.

In normal conditions, the batteries are subject to trickle charging and are checked every 30 seconds for their presence. A complete test is carried out every hour to verify battery efficiency and connections.

Main Characteristics

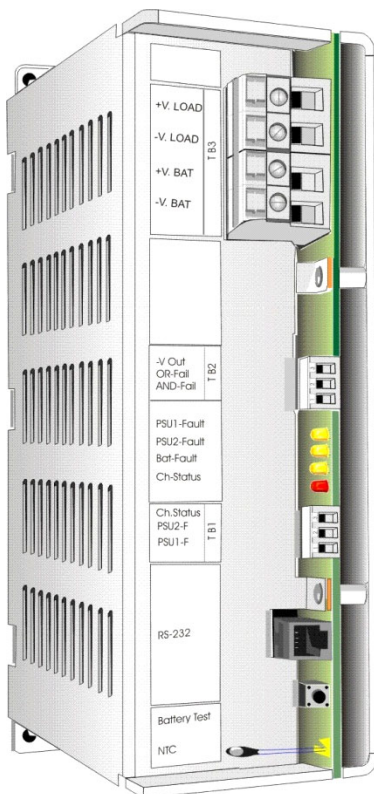

- Uninterrupted power supply (UPS)
- Suitable to build up power supply groups certified to EN 54-4
- Certified to EN 54-4:1997/A2:2006
- Check for battery presence and connections every 30 seconds
- Check for battery efficiency every hour
- Input voltage variable between 22 and 28 VDC
- Maximum current supplied to batteries 4A
- Can control up to four PU-A0005 in parallel
- Protection from battery short-circuits and polarity reversal
- LED for indication of battery charge status
- LED for indication of battery fault
- LED for indication of fault of feeder and battery charger section
- Button for manual battery testing
- RS 232 serial communication port for programming and control
- Efficiency 83%
- Ripple < 100mV pk/pk at maximum current
- Dimensions 200 mm x 60 mm x 110 mm (excluding terminals)
- Operating temperature -5 to +50 °C (in open air)
- Mounting on panel back plate

WIRING OF OPEN COLLECTOR STATUS OUTPUTS

Terminal block	Terminal	Name	Function
TB1	M1	PSU1 Fault	Open collector output for feeder fault
	M2	PSU2 Fault	Open collector output for battery charger fault
	M3	Charge Status	Open collector output for battery status (active during deep charging)

WIRING FOR FEEDER STATUS INDICATION

Terminal block	Terminal	Name	Function
TB2	M1	AND-Fail	Input for failure of all power units
	M2	OR-Fail	Input for failure of one power unit
	M3	-Vout	M1 and M2 input common

WIRING TO BATTERIES AND LOAD

Terminal block	Terminal	Name	Function
TB3	M1	-VBat	Battery negative
	M2	+VBat	Battery positive
	M3	-VLoad	Negative of supply to load
	M4	+VLoad	Positive of supply to load

General Characteristics

Input voltage	22-28 VDC
Maximum current	5 A
Operating temperature	-5 to +50 °C (open air)
Relative humidity	93% (non-condensing)
Efficiency	> 83%
Protection	IP20
Dimensions	200mm x 110mm x 60mm
Self-extinguishing	UL94V2
VBAT voltage	26.2 to 28.7 VDC (automatically compensated)
VBAT current	1/2/4 A (selectable through dip switches)
VBAT ripple	< 100mV pK-pK at maximum current
Hold-up time on main supply failure	20 ms at maximum current (with PU-A0005)
Maximum battery circuit resistance	1.5 ohms
Maximum battery current	65 Ah

Protection

Current to batteries	automatically limited
Current to load	20A fuse
Other	over-voltage, short-circuit, battery polarity reversal

Reference Standards

Product	EN 54-4:1997
CPD Directive	EN 54-4/A2:2006
CE marking	EN50081-2 & EN50082-2 (industrial environment)

**CERTIFIED IN ACCORDANCE WITH EN54-4
A2:2006
(C.P.D. requirements)**

PU-A0005-1

125W AC/DC Converter

This is a universal switching feeder, which can supply a maximum current of 4A at 25 VDC. It is used, with PU-A0004 battery charger, to meet the requirements of the EN54-4 standard. The feeder is provided with a load sharing circuit, which makes it possible to connect up to four feeders in parallel.

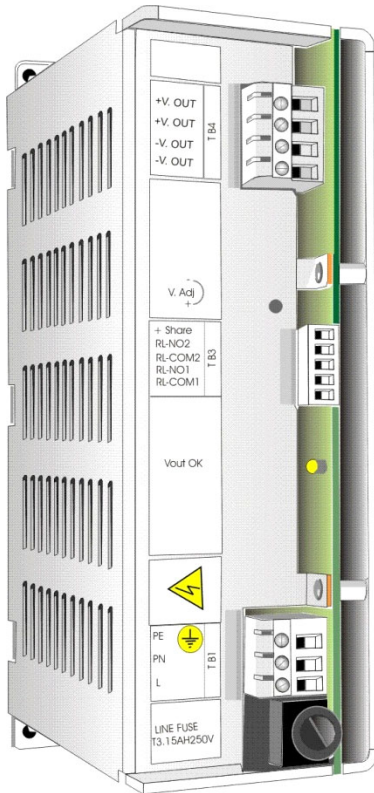

Main Characteristics

- To be used alone or with a PU-A0004 battery charger
- Suitable to build up power supply groups certified to EN 54-4
- Input voltage variable between 110 and 240 VAC
- Input frequency from 50 to 60 Hz
- Maximum continuous current 4A at 24VDC
- Up to 4 feeders in parallel
- Load sharing circuit with Share input
- Protected against short circuit
- LED for fault indication
- Two NO contacts for status repetition
- Ripple < 266mV pk/pk at maximum current
- Stability > 1%
- Efficiency > 80%
- Dimensions 200 mm x 60 mm x 110 mm (excluding terminals)
- Operating temperature -5 to +50 °C (in open air)
- Mounting on panel backplane

WIRING OF INPUT SUPPLY

Terminal Block	Terminal	Name	Function
TB1	M1	L input	Phase (line protected by internal fuse)
	M2	N input	Neutral
	M3	PE	Ground

WIRING OF STATUS AND SHARE SIGNAL REPETITION

Terminal Block	Terminal	Name	Function
TB2	M1	RL-COM1	Status 1 relay common contact
	M2	RL-NO1	Status 1 relay NO contact
	M3	RL-COM2	Status 2 relay common contact
	M4	RL-NO2	Status 2 relay NO contact
	M5	SHARE (+)	Input of synchronization signal for load sharing

WIRING OF OUPUT SUPPLY

Terminal Block	Terminal	Name	Function
TB3	M1	- V OUT	Output voltage negative
	M2	- V OUT	Output voltage negative
	M3	+V OUT	Output voltage positive
	M4	+V OUT	Output voltage positive

General Characteristics

Input voltage	110-240 VAC (-15 to +10%) / 115-250 VDC
Maximum current at 110 VAC	1.6 A
Maximum current at 240 VAC	0.8 A
Operating temperature	-5 to +50 °C (open air)
Relative humidity	93% (non-condensing)
Input voltage frequency	47 to 63 Hz
Power ratio (W/VA)	0.6 (typical)
Efficiency	> 80%
Protection	IP20
Dimensions	200mm x 110mm x 60mm
Self-extinguishing	UL94V2
Insulation between input and output	> 2 Mohm (500 VDC)
Insulation between input and ground	> 2 Mohm (500 VDC)
Insulation between output and ground	> 2 Mohm (500 VDC)
Dielectric strength between input and output	3000 VAC for 1 minute
Dielectric strength between inputs and ground	1500 VAC for 1 minute
Dielectric strength between outputs and ground	1500 VAC for 1 minute

Feeder Section

VLOAD voltage	25 VDC (adjustable between 23 and 26 VDC)
VLOAD current	4 A
VLOAD ripple	<266 mV pK-pK at maximum current

Protection

Line	Fuse T 6.3A H 250V (5x20)
Other	over-voltage, short-circuit

Reference Standards

Product	EN54-4:1997
CE marking	EN50081-2 & EN50082-2 (industrial environment)
Safety	EN60950 (CEI-74-2)

**CERTIFIED IN ACCORDANCE WITH EN54-4
A2:2006
(C.P.D. requirements)**

PU-A0008-1

20A AC/DC Converter - Drawer Type

This is a universal switching feeder, which can supply a maximum 20A current at 25VDC. It is installed in a 19" rack and used in combination with a PU-A009-1 battery charger.

It is provided with a load sharing circuit, which makes it possible to connect up to four feeders in parallel.

It can be hot-swapped.



General Characteristics

Input voltage	110-240 VAC (-15 to +10%) / 115-250 VDC
Maximum current at 110 VAC	1.6 A
Maximum current at 240 VAC	0.8 A
Operating temperature	-5 to +50 C° (in open air)
Relative humidity	93% (non-condensing)
Input voltage frequency	47 to 63 Hz
Power ratio (W/VA)	0.6 (typical)
Efficiency	> 80%
Protection	IP20
Dimensions	200mm x 110mm x 60mm
Self-extinguishing	UL94V2
Insulation between input and output	> 2 M ohm (500 VDC)
Insulation between input and ground	> 2 M ohm (500 VDC)
Insulation between output and ground	> 2 M ohm (500 VDC)
Dielectric strength between input and output	3000 VAC for 1 minute
Dielectric strength between inputs and ground	1500 VAC for 1 minute
Dielectric strength between outputs and ground	1500 VAC for 1 minute

Feeder Section

VLOAD voltage	25 VDC (adjustable between 23 and 26 VDC)
VLOAD current	20 A (25 A max peak current)
VLOAD ripple	< 110 mV pK-pK at maximum current

Protection

Line	fuse T 6.3A H 250V (5x20)
Other	over-voltage, short-circuit

Reference Standards

Product	EN54-4:1997
CE marking	EN50081-2 & EN50082-2 (industrial environment)
Safety	EN60950 (CEI-74-2)

PU-A0009-1

Battery Charger - Drawer Type

This is a UPS converter, which can control and charge two 12VDC (24VDC) batteries having a maximum capacity of 120Ah.

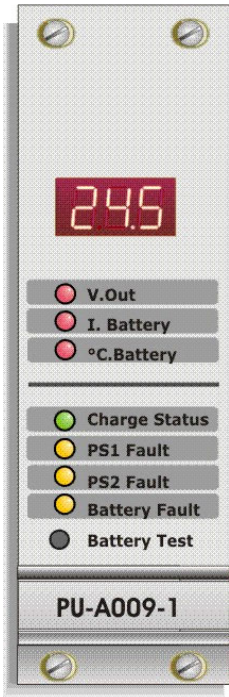

The batteries are charged separately from the load and, in case of main supply fault or failure, they are immediately switched on to the load.

When main supply is restored, the battery charger disconnects the batteries and recharges them, adjusting current according to temperature.

In normal conditions, the batteries are subject to trickle charging and are checked for presence every 30 seconds. Complete testing occurs every hour to verify battery efficiency and connections.



General Characteristics

Input voltage	22-28 VDC
Maximum current	7 A
Operating temperature	-5 to +50 °C (in open air)
Relative humidity	93% (non-condensing)
Efficiency	> 83%
Protection	IP20
Dimensions	128 mm x 40 mm x 250 mm
Self-extinguishing	UL94V2
VBAT voltage	26.2 to 28.7 VDC (automatically compensated)
VBAT current	4/6 A (selectable through dip switches)
VBAT ripple	< 100mV pK-pK at maximum current
Hold-up time on main supply failure	20 ms at maximum current (with PU-A0005)
Maximum battery current	120 Ah

Protection

Current to batteries	automatically limited
Current to load	50A fuse
Other	over-voltage, short-circuit, battery polarity reversal
Low battery	when voltage is 18 VDC, batteries are automatically disconnected from the load

Reference Standards

Product	EN 54-4:1997
CPD Directive	EN 54-4/A2:2006 (CPD requirements)
CE marking	EN50081-2 & EN50082-2 (industrial environment)

**CERTIFIED IN ACCORDANCE WITH EN54-4
A2:2006
(C.P.D. requirements)**

S81Mod-AN

Addressable Module for One Analog Input Control

Addressable circuit for one analog input control 4-20 mA.

Typically suitable to control a gas detector or another analog device on card S81 for addressable loop with customized protocol (upon request).

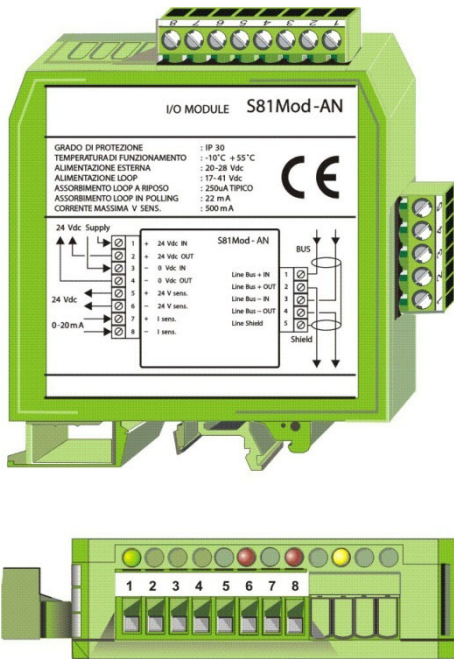

Main Characteristics

- 4- 20 mA input
- 500 mA output for sensor electric supply
- Fault signaling under 4 mA
- Resolution 23,4 uA (10 bit)
- Linearity +/- 1 LSB
- Up to 127 modules for each BUS
- 4 LEDs for status indication
- Customized communication protocol (upon request)
- External supply 22-28 VDC
- Compatible with panels series S81
- Static type addressing
- Programmable through S81-Mod PRG

Information Provided by Module LEDs

Status	LED indication and color							
	Led 1 (Polling)		Led 6 (Pre-alarm)		Led 8 (Alarm)		Led 10 (Fault)	
	Off	On	Off	On	Off	On	Off	On
Normal communication	-	∅	-	-	-	-	-	-
Anomaly condition								⊗
Threshold 1 exceeded	-	-	-	⊗	-	-	-	-
Threshold 2 exceeded	-	-	-	-	-	⊗	-	-
LED status legend	∅ = blinking ⊗ = on; - = off							

POSSIBLE THRESHOLD SETTINGS

Measuring Range	Threshold 1 Pre-alarm	Threshold 2 Alarm	Measuring Range	Threshold 1 Pre-alarm	Threshold 2 Alarm
0-10 ppm	0.0-10.0	0.0-10.0	0-100 %LEL	0-100	0-100
0-20 ppm	0.0-20.0	0.0-20.0	0-25 %O2	0.0-25.0	0.0-25.0
0-50 ppm	0.0-50.0	0.0-50.0	15-25 %O2	15.0-25.0	15.0-25.0
0-100 ppm	0-100	0-100	4-20 mA	4.0-20.0	4.0-20.0
0-200 ppm	0-200	0-200	0-100 °C	0-100	0-100

Operation

This module acts as a remote control unit to connect devices with analog outputs 4-20 mA. The two thresholds can be individually set at the panel.

Wiring Scheme

The BUS will be wired directly to the terminals 1, 2, 3, 4 of the relevant board (4 places terminals), while terminal 5 is intended to give continuity to the shields.

The 24 VDC external supply will be wired to the terminals 1 and 2 (input) and to the terminals 3 and 4 (output) of the I/O board (8 places terminal board), while a 24 VDC output will be available, from terminals 5 and 6, for sensor supply.

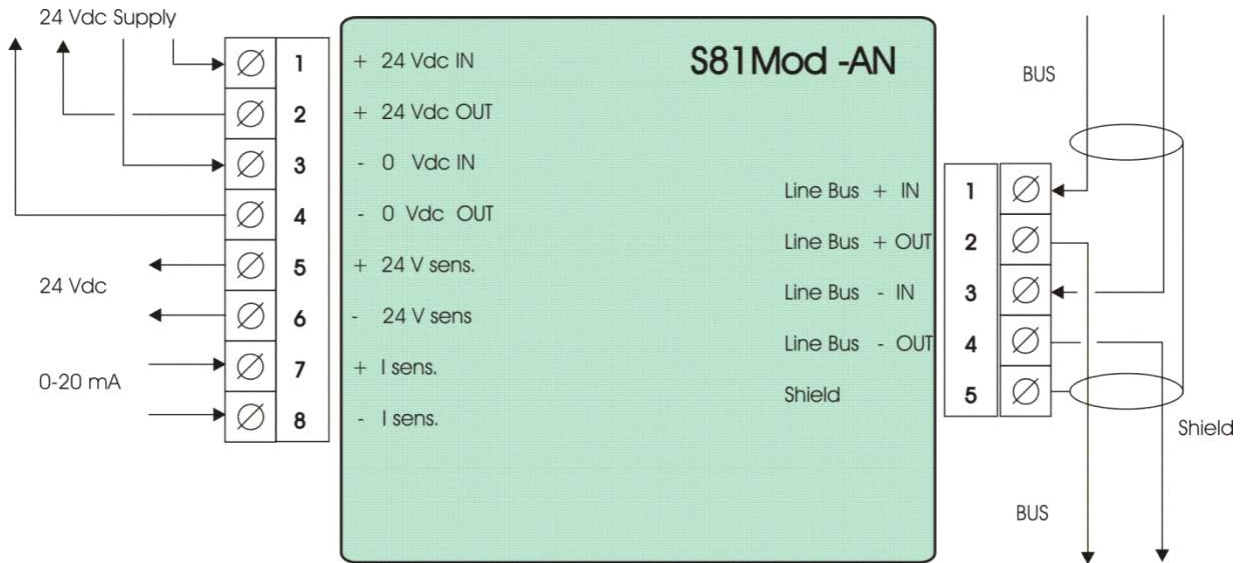

TECHNICAL SPECIFICATIONS

Model	S81Mod-AN	
Product code	S81Mod-AN	
BUS	Loop power supply	17-41 VDC
	Absorption (rest)	250 μ A (typical)
EXTERNAL SUPPLY	Power supply	22 - 28 VDC (nominal 24 VDC)
OUTPUT	Maximum power	500 mA to 24 VDC
INPUT	Signal	0-20 mA
	Resolution	23,4 μ A (10 bit)
	Linearity	+/- 1 LSB
	Impedance	> 47 Ω
Operating temperature	-5 + 50 $^{\circ}$ C	
Maximum humidity (RH%)	95 % non-condensing (*)	
Protection	IP 30 (*)	
Material	ABS	
Color	Green	
Weight	102 g	
Dimensions with terminals and clamp for fitting to DIN rail	(L) 25 mm, (D) 94 mm, (H) 99.5 mm (*)	
Note (*) the module is supposed to be mounted on a DIN rail inside a panel or in a suitably protected junction box		

S81 Mod-Disp

Addressable Status Repeater Module

This module is used as a repeater panel of alarms and/or messages. It can display up to 255 messages, each composed of four 20-character lines. It is commonly controlled, via bus, by the S81 F7007-1 card. However, it can also operate autonomously using its 8 digital inputs. In the latter case there are only 8 possible messages.

It is possible to connect up to 64 modules of this type on each bus. The module is provided with 2 relays, the activation of which can be associated to specific messages.

Message and operating logic programming is carried out, via a PC having an RS232 serial port, by means of a dedicated program. The module is provided with a 3-pole and a 15-pole terminal board, respectively for communication bus and supply/input/output wiring.



Main Characteristics

- Messages displayed on four 20-character lines
- Back-lit alphanumeric display
- Incorporated alarm buzzer
- 255 messages associated with events or panel status
- Serial communication on SSP protocol (S81-F7007 CARD)
- Keyboard with buttons and front in polycarbonate
- 8 digital inputs for direct (no BUS)
- 2 relay outputs can be associated with message

Indications and Controls

	LED	lights up in the presence of at least one active message
	LED	lights up in the presence of at least one active message
	LED	flashes on each polling signal from the control card
	BUTTON	to silence module buzzer
	BUTTON	to acknowledge events
	BUTTON	to manually scroll active messages

S81 Mod-Disp

Module

Mounting

The module is designed for wall mounting (fixing holes on back side), but it can also be installed using the four supports which it is supplied with. The module must be located in easily accessible areas, at a height allowing easy message reading. It shall not be installed outdoors.

Wiring Scheme

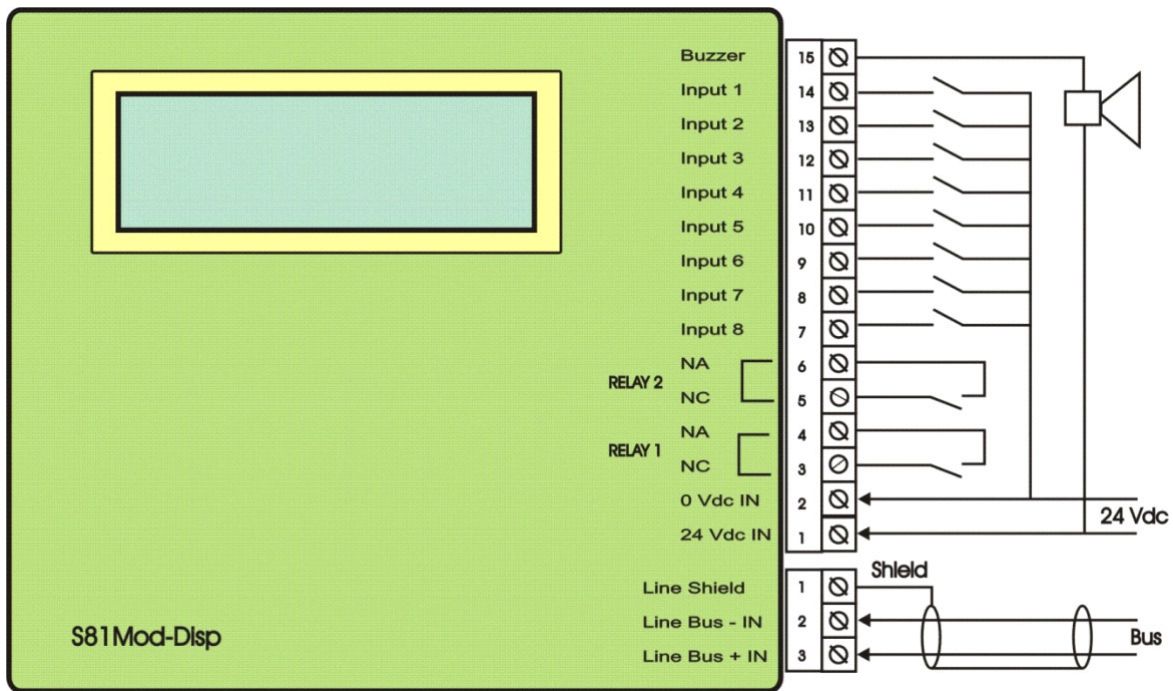

Address Programming

To operate properly, the module must be assigned an address between 1-127 using a special programmer. No more than 64 modules of this type can be mounted on one bus.

TECHNICAL SPECIFICATION		
Model	S81 Mod-Disp	
Part Number	S81 Mod-Disp	
Programmable messages	255, each composed of four 20-character lines	
Bus or loop	Operating voltage	17 to 41 VDC
	Quiescent current	250 μ A (typical)
	Polling current	22 mA \pm 20%
Module	Supply voltage	22 to 28 VDC (nominal 24 VDC)
	Quiescent current	30 mA
	Alarm current	55 mA
Protection	IP 30	
Operating temperature	-5 to +50 °C	
Enclosure material	thermoplastic, black color	
Weight	180 g	
Dimensions	(L) 189 mm x (D) 40 mm x (H) 134 mm	

S81 Mod

Addressable Modules Programmer

Programming circuit useful to configure addresses and verify the functioning of addressable modules series S81Mod manufactured by SCAME Sistemi.







Main Characteristics

- Module address programmer S81Mod
- Alphanumeric visualization on display
- Module address verification
- Functional module test
- Power supply with alkaline battery 9 VDC
- Connector with fast plug in
- Membrane buttons
- Automatic selection of protocol
- Low battery indication
- Compatible with panels series S81 and AFP 21
- Static type address of module

COMPATIBLE MODULES

- S81Mod-AIT
- S81Mod-B
- S81Mod-R
- S81Mod-Z

Buttons and Functions

	BUTTONS	FUNCTIONS
	ON	It is used to turn on the device. The programmer turns off automatically after 30 seconds of non-use
	VERIFY	Reads the set address on module and checks its functionality
	SCROLL UP	Address increase (within programmable addresses)
	SCROLL DOWN	Address decrease
	PROGRAM	Programs the selected address and writes it in the device flash

Indications on Display

- Err = Non connected or fault module (VER); failed address (PRG)
 LOBAT = Low battery
 001 - 127 = Module address

CARD SPECIFICATIONS

Summary Table of Cards for Series S81-HS

Data About the Base Cards for Series S81-HS

CHARACTERISTICS	CPU U-1002	DISPLAY U-1006	E-2003	T8004
Dimensions	25 mm x 150 mm	275 mm x 150 mm	75 mm x 150 mm	138 mm x 78 mm
Indicative weight in grams	90	150	75	180
Stocking temperature	-30 + 80 °C	-30 + 80 °C	-30 + 80 °C	-30 + 80 °C
Operating temperature	-5 + 50 °C	-5 + 50 °C	-5 + 50 °C	-5 + 50 °C
Relative humidity	95% NC	95% NC	95% NC	95% NC
Power supply	From 22 to 29 VDC	From 22 to 29 VDC	From 22 to 29VDC	From 22 to 29 VDC
Card absorption (rest)	70 mA	70 mA	0 mA	100 mA
Absorption for each channel used	NA	10 mA /LED	NA	250 mA (max)
Maximum current for output channel	NA	NA	NA	250 mA
Maximum total absorption	80 mA	180 mA	NA	600 mA
For a complete base, consider:	One CPU =	280 mA	Two CPUs =	380 mA

Data Common to All Rack Cards of Series S81-HS

CHARACTERISTICS	
Dimensions (standard 19" height 3 units)	25 mm width x 150 mm depth
Indicative weight	90 grams
Stocking temperature	-30 + 80 °C
Operating temperature	-5 + 50 °C
Relative humidity	95% non-condensing
Power supply	from 22 to 29 VDC

(Indicative) Absorption at 24VDC of Each Rack Card for the Series S81-HS

INPUT , COMMUNICATION AND SERVICE CARDS	F3002	F4001	F4002	F4003	F7006	E2002
Card absorption (rest) (mA)	18	35	45	70	14	50
Absorption for each channel used (mA)	5	4-16	4-16	4-16	-	-
Maximum current for each output channel (mA)	-	4-21	4-21	-	-	-
Card maximum total absorption (mA)	58	72	120	198	14	20
Indicative absorption (*) to calculate at rest (mA)	58	40	55	110	16	50
COMAND CARDS AND SPECIAL LOGICS	F5001	F5002	F5003	F5004	F6001	F6002
Card absorption (rest) (mA)	35	12	25	35	12	16
Absorption for each channel used (mA)	4	-	4	8	-	-
Maximum current for each output channel (mA)	500	250	250	2000	-	-
Card maximum total absorption (mA)	--	--	--	--	12	16
Indicative absorption (*) to calculate at rest (mA)	67	12	67	67	12	16
LOOP AND COMMUNICATION CARDS	F7001	F7002	F7007	F7009	F7010	F7008
Card absorption (rest) (mA)	90	90	70	90	39	14
Absorption for each channel used (mA)	--	--	--	--	--	10
Maximum supplied current for loop (mA)	400	400	250	400	500	-
Card maximum total absorption (mA)	490	490	320	490	539	334
Indicative absorption (*) to calculate at rest (mA)	300	300	200	300	400	350
Note: (*) to determine the power absorption at rest sum the power absorption at rest of all connected devices						

Overview of Applications

S81-HS Series

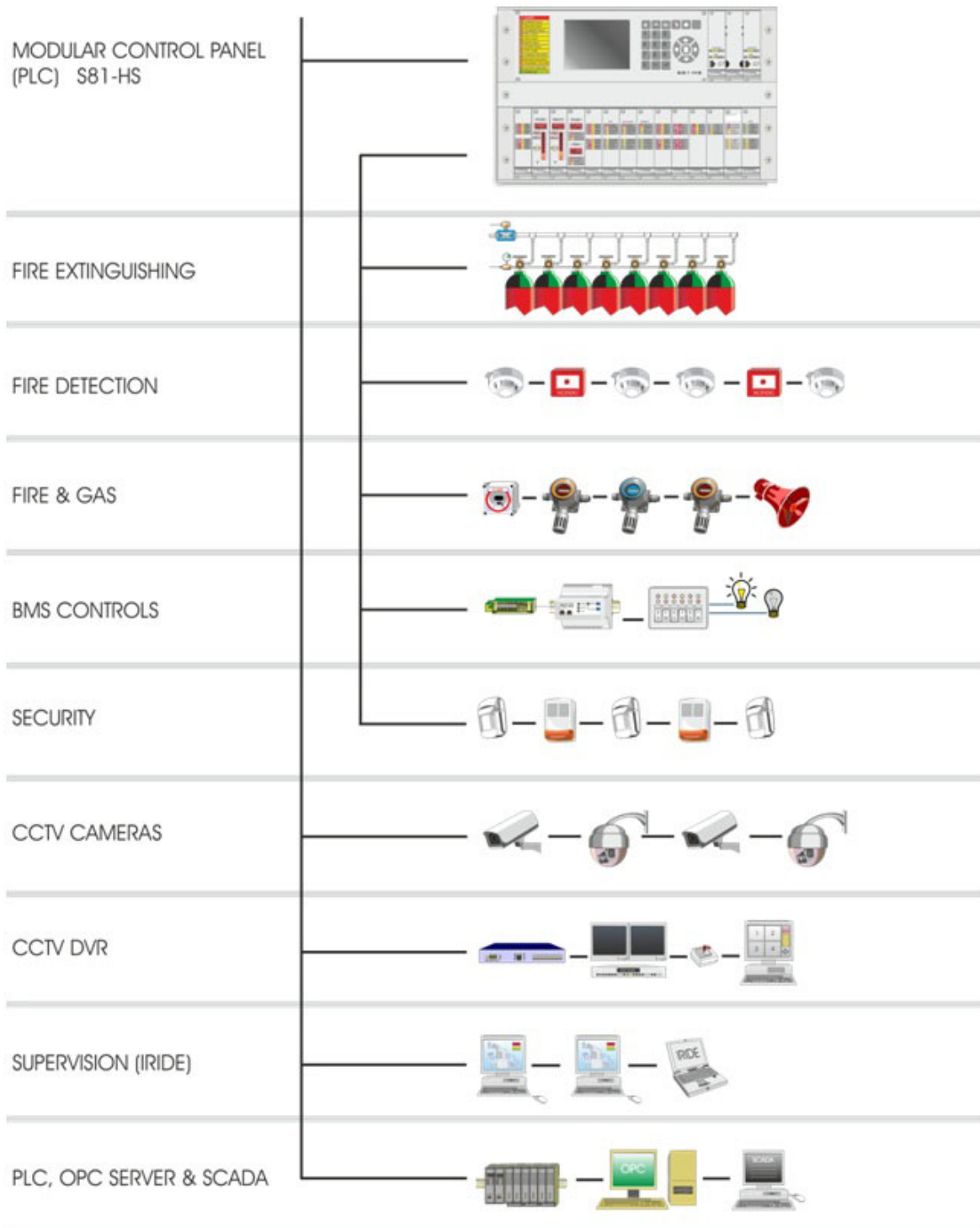

Applications of the H-S81-HS System

The S81-HS system is commonly used in:

- Automatic fire extinguishing control systems in conformity with the Construction Products Directive (CPD);
 - Integrated systems, including fire, and technological control functions;
 - Safety & Security systems, where panels operate as master or slave units, on communication networks (of a fiber optic and fault tolerant type, too) and are connected to DCS or SCADA through Modbus protocol Ethernet and OPC Server;
 - Fire protection systems with special logic programming, also in accordance with the recommendations of the NFPA standard;
 - Gas detection and measurement systems, ATEX-certifiable, capable of interfacing any 4-20 mA output toxic or explosive gas detectors.
- All of these functions can coexist, or be configured to meet specific customer requirements.

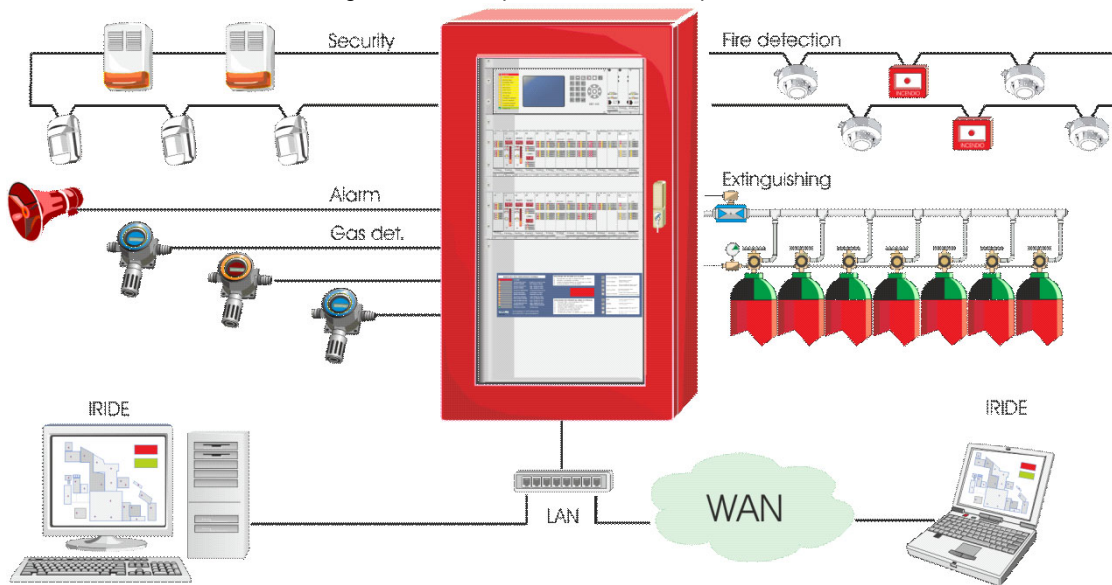

SIL Systems

The S81-HS panel can be used to produce systems certifiable to SIL2 and SIL3, in conformity with the requirements of the applicable regulations that refer to the IEC 61508 and deriving standards.

In these applications, the S81-HS plays the role of logic solver so it represents the core of the system and it can obtain the SIL2 or SIL3 level depending on the redundancy or non-redundancy of some cards.

To reach the expected safety level, the field devices (inputs and outputs) must also be certified accordingly, in addition to the panel.

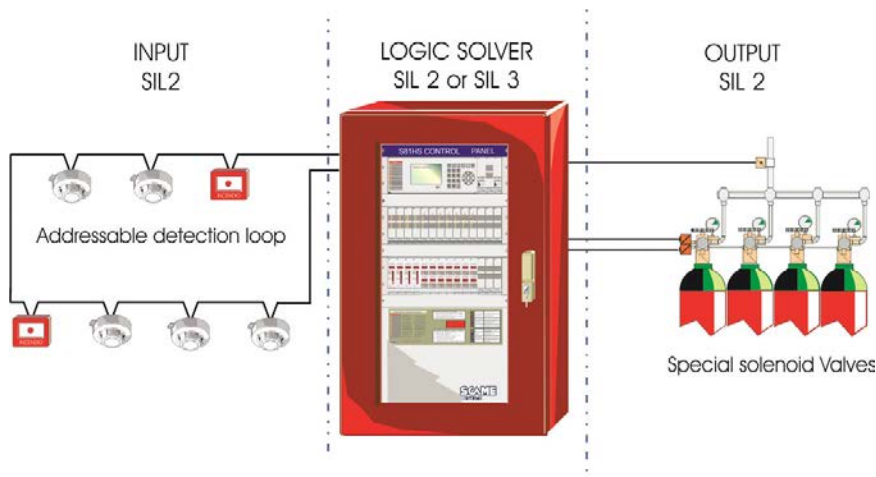

According to the standards, the H-S81-HS panel (or system) can be considered a PES (Programmable Electronic Safety-related system) and can be configured to perform the following safety functions:

- Control and supervision of digital inputs from field devices (conventional detectors, pressure switches, release pushbuttons, selector switches, etc.)
- Control and supervision of analog 4-20mA inputs from field devices (explosive gas, toxic gas, oxygen and heat detectors, etc.)
- Elaboration of logics as a function of input status (including fire extinguishing control to EN12094-1)
- Control and command of actuators (solenoids, relays, etc.).

In the past, certified safety functions were limited only to process applications and gas detection due to the small availability of SIL-certified sensors and actuators on the market. Addressable flame detectors with this certification are now available, as well as automatic fire extinguishing command devices such as solenoids for cylinders, deluge valves and fire monitors.

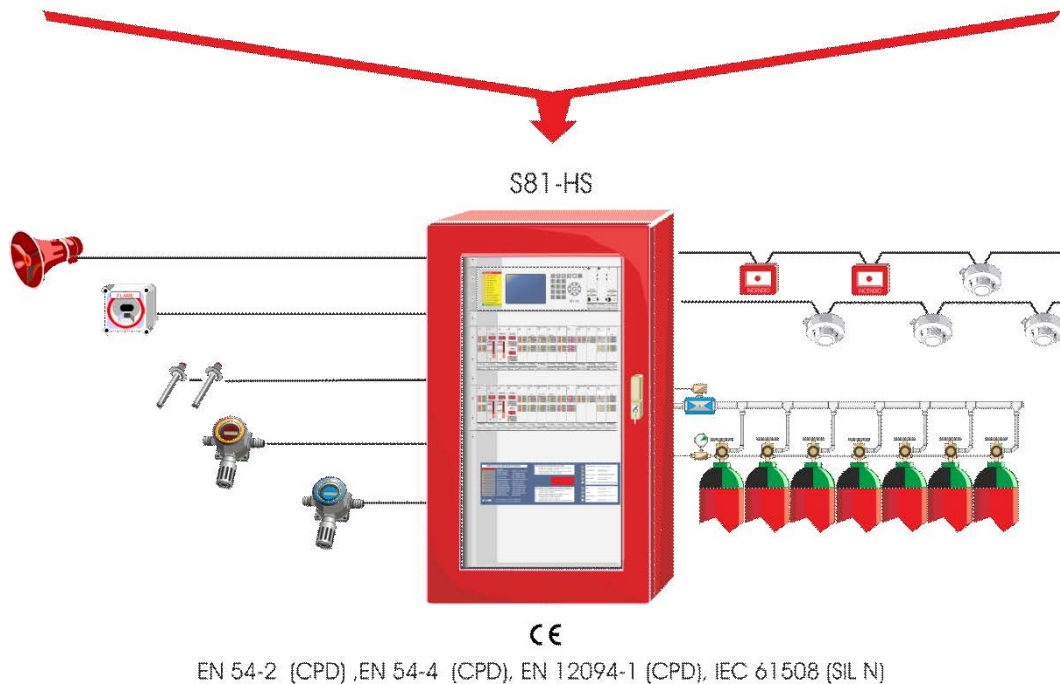
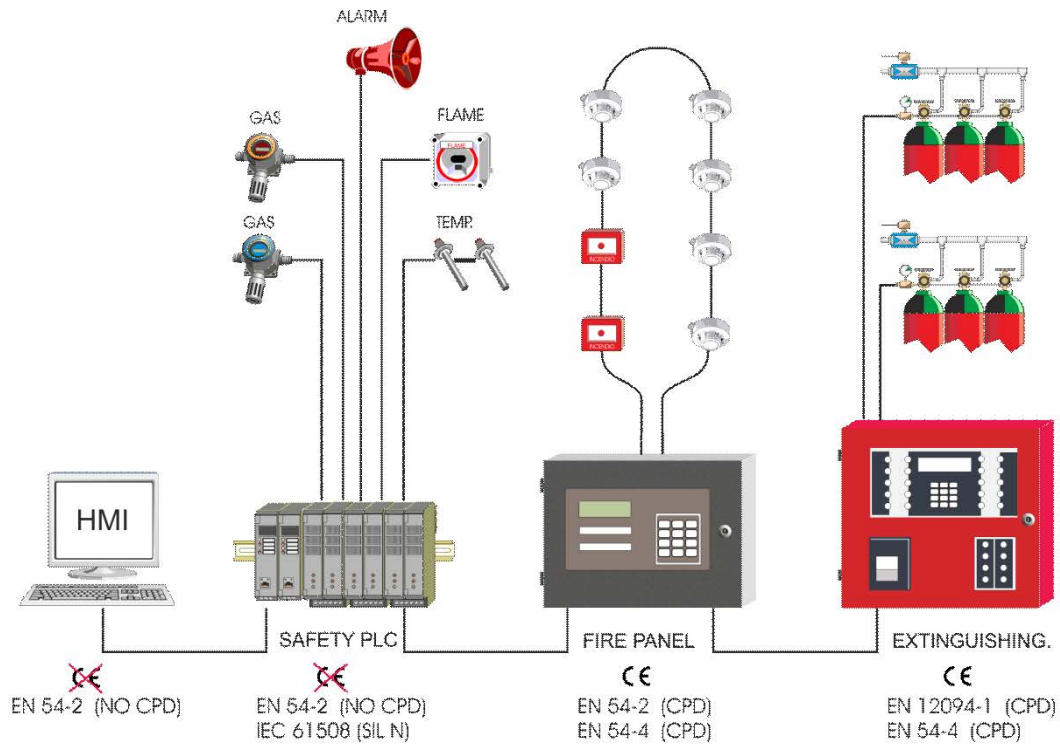

PARTICULAR NOTES FOR SAFETY APPLICATIONS

CPU's shall always be two (redundancy concept).

A SIL-certified S81-HS panel can also contain different cards and perform different functions from those that must be certified to SIL.

The use of Honeywell power units is recommended (feeders & battery chargers), which are certified to EN54-4.

For whole system configuration, refer to S81-HS panel Safety Manual.

Should you have any doubts, please contact Honeywell technical service.

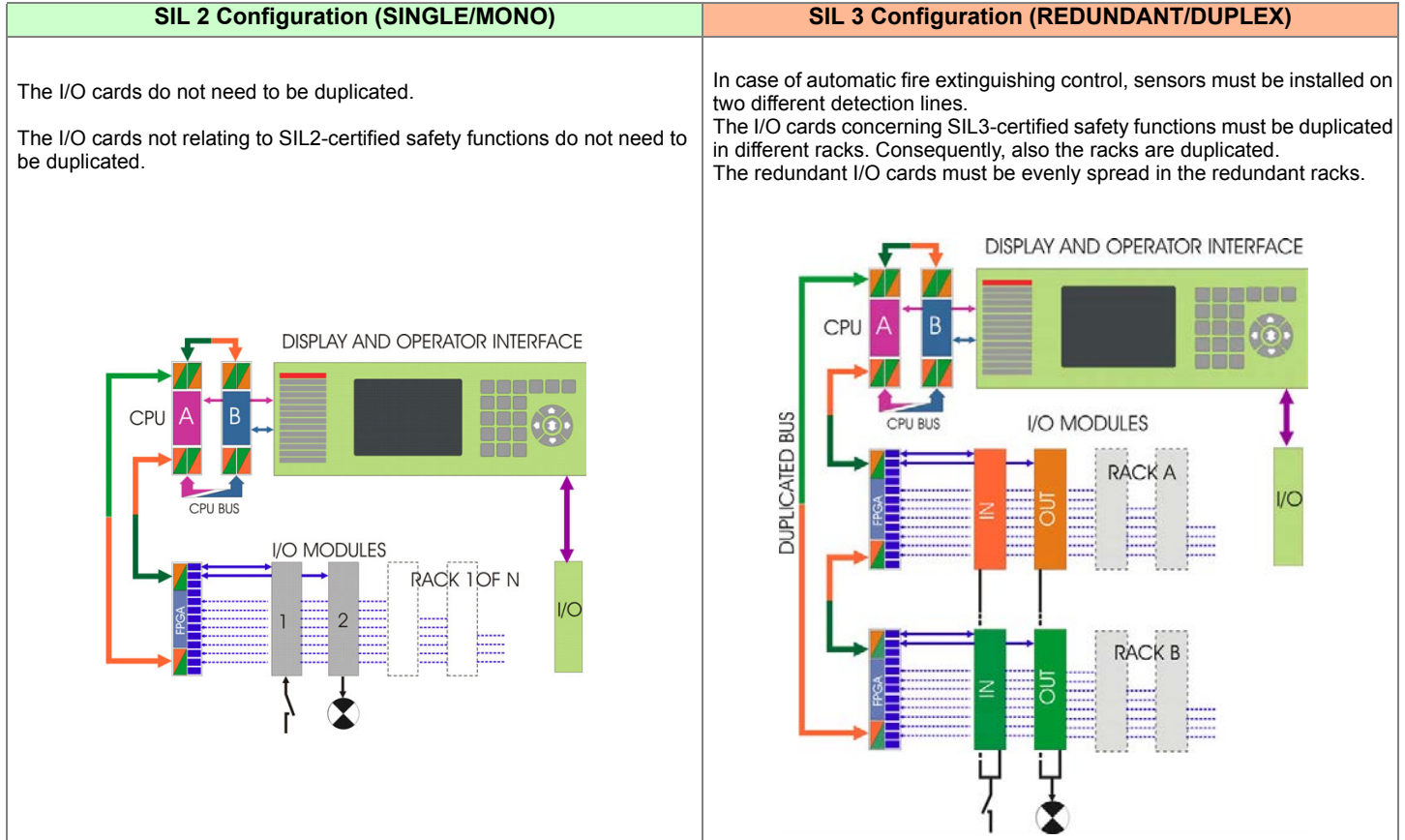

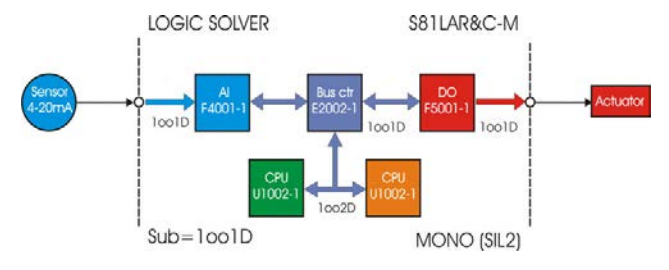
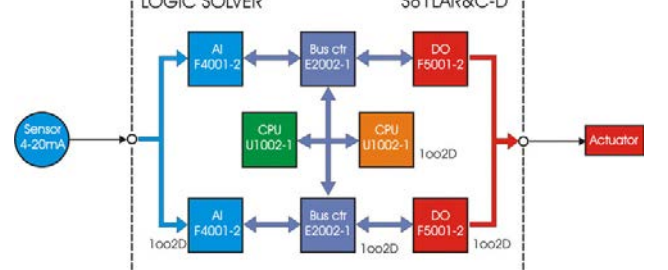
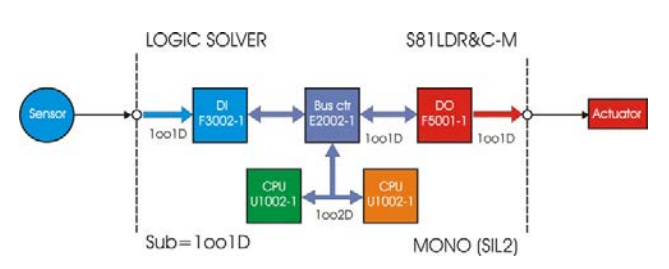
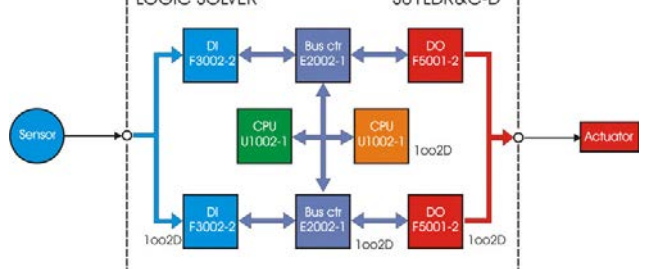
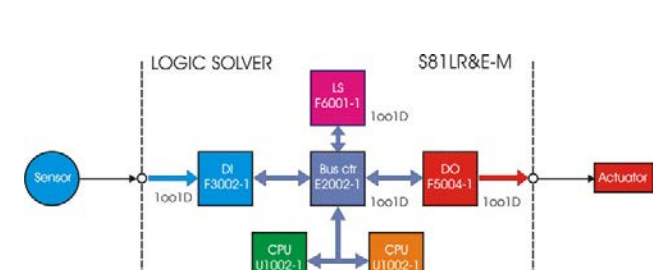
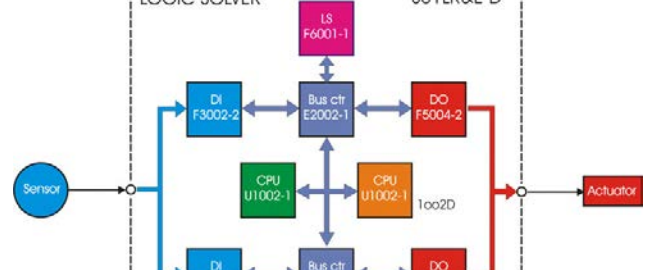
<p>S81LAR&C-M Detection, alarm and control from analogue inputs (typical of gas detectors)</p>	<p>S81LAR&C-D Detection, alarm and control from analogue inputs (typical of gas detection)</p>
 <p>LOGIC SOLVER</p> <p>S81LAR&C-M</p> <p>Sub=1oo1D</p> <p>MONO (SIL2)</p>	 <p>LOGIC SOLVER</p> <p>S81LAR&C-D</p> <p>Sub=1oo2D</p> <p>DUPLEX (SIL3)</p>
<p>S81LDR&C-M Detection, alarm and control from analogue inputs (typical of fire detectors)</p>	<p>S81LDR&C-D Detection, alarm and control from analogue inputs (typical of fire detectors)</p>
 <p>LOGIC SOLVER</p> <p>S81LDR&C-M</p> <p>Sub=1oo1D</p> <p>MONO (SIL2)</p>	 <p>LOGIC SOLVER</p> <p>S81LDR&C-D</p> <p>Sub=1oo2D</p> <p>DUPLEX (SIL3)</p>
<p>S81LDR&C-M Detection and automatic extinguishing control according to the standard EN 12094-1.</p>	<p>S81LDR&C-D Detection and automatic extinguishing control according to the standard EN 12094-1.</p>
 <p>LOGIC SOLVER</p> <p>S81LR&E-M</p> <p>Sub=1oo1D</p> <p>MONO (SIL2)</p>	 <p>LOGIC SOLVER</p> <p>S81LR&E-D</p> <p>Sub=1oo2D</p> <p>DUPLEX (SIL3)</p>

Communication Network

S81-HS is most suitable for use in systems where several panels fully interact on a network, although entirely maintaining their autonomy in respective area control.

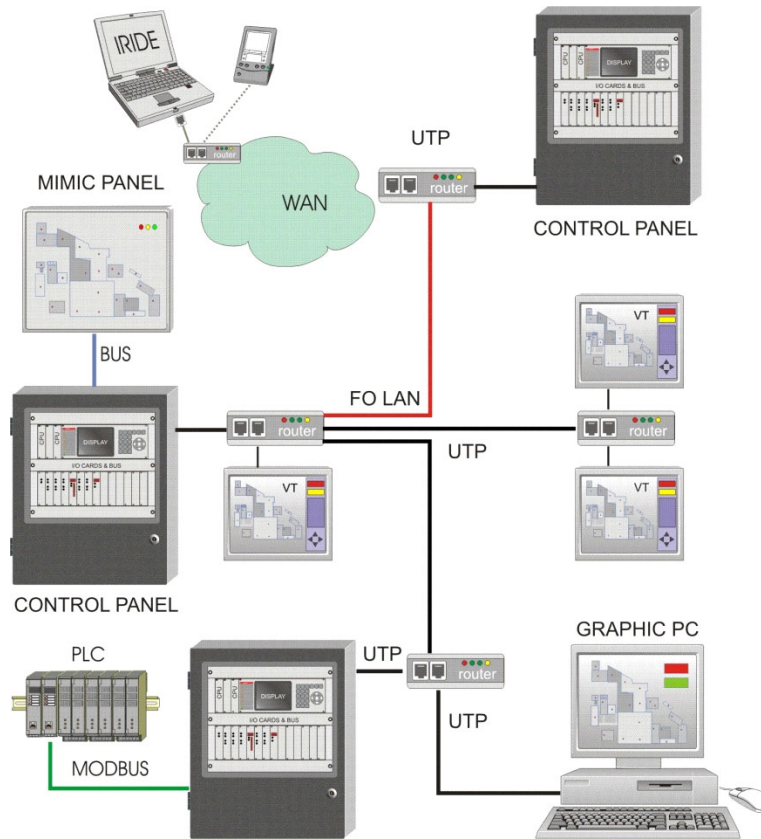

Panels can communicate with supervisory systems on an Ethernet LAN, and with external elements (e.g. DCS, PLC, SCADA systems) via MODBUS RTU.

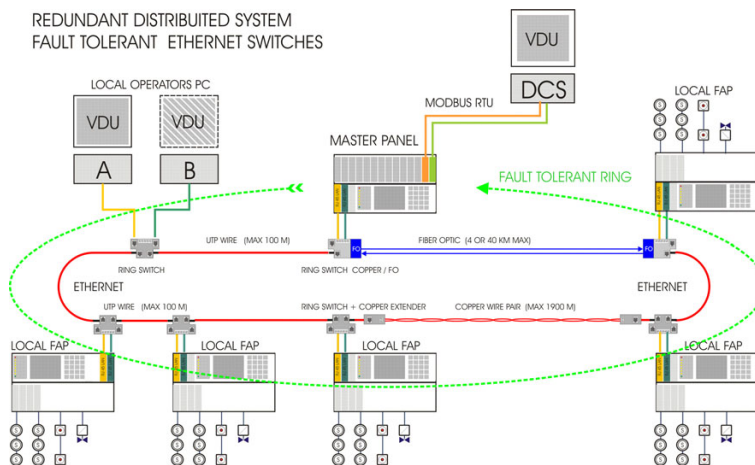

Communication on a network enables the integration of different-vector systems, also including fault-tolerant loop architectures.

SB-AIM Module

The Safety Bus system allows the Fire and Fire & Gas detection and the firefighting control in a unique bus assuring a high safety level. The system is composed by one or two control cards, that are integrated in the panel S81-HS, and up to 64 addressable remote modules installed in the field. The communication between the control cards and the addressable modules is based on an enhanced safety version of CAN protocol (Controller Area Network) with ring architecture to guarantee the best functionality in fault condition and high communication speed.

This module can control eight 4-20mA analog inputs with safety-related functions. All the channels are continuously tested during operation. The following types of transducers can be connected to this board: Explosive gas detectors, Toxic Gas Detectors, Oxygen sensors, Temperature Sensors/detectors, Flame Detectors, 4-20mA generic Sensors/Detectors. Each channel features dedicated terminals to supply 24VDC power to field device. Both communication links are provided with short circuit isolator.

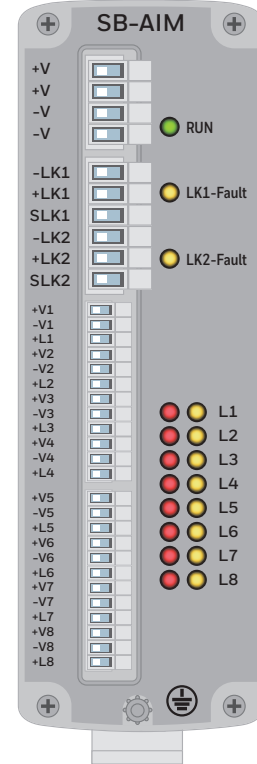

FEATURES & BENEFITS

- Wide area coverage
- Easy addition of IO in existing system
- SIL 2/3, UL, EN, Atex approved installations
- Large capacity of 64 modules/ loop
- Redundant network
- Available with weather proof and explosion proof housing

Visual Indications

The front panel of the module features 19 LEDs that indicate the following conditions:

TAG	COLOR	MODE	CONDITION
RUN	Green	On Solid	Normal operation
		Off	Module failure or no power
LK1-FAULT	Yellow	Off	Communication on Link LK1 present
		Blinking	Link LK1 towards board interrupted
		On Solid	Communication failure on Link LK1
LK2-FAULT	Yellow	Off	Communication on Link LK2 present
		Blinking	Link LK2 towards board interrupted
		On Solid	Communication failure on Link LK2
L1-L8	Red	Off	Channel in Level-1 alarm
		Blinking 1 sec.	Channel in Level-2 alarm
		Blinking 0.5 sec.	Channel in Level-3 alarm (for future use)
		On Solid	Channel in alarm
L1-L8	Yellow	Off	Channel in normal state
		Blinking	Channel fault (module or line)
		On Solid	Channel disabled

Note:
During the startup sequence, the yellow and red LEDs blink 3 times, then the seven red LEDs L1-L7 will go on for 2 seconds to indicate the module address in binary format (L1=1, L2=2, L3=4, L4=8, L5=16, L6=32, L7=64).

At this point, the eight yellow LEDs L1-L8 will begin to blink rapidly until the module is configured by the panel.

SB-AIM Module Technical Specifications

APPLICABLE SAFETY CATEGORY	Up to SIL3
NUMBER OF INPUT CHANNELS	8 individually configurable
ALARM THRESHOLD	2 programmable thresholds (+1 for future use)
MEASURING RANGE	4-20mA
CHANNEL TEST	Continuous
MAX CURRENT FOR EACH POWER SUPPLY	250mA individually protected by self-resetting fuse
POWER SUPPLY VOLTAGE	22-28VDC
CURRENT CONSUMPTION IN STAND BY	105mA
OPERATING TEMPERATURE	-30 / +70 °C
STORAGE TEMPERATURE	-55 / +85 °C
MAX HUMIDITY	0-95% non condensing
PROTECTION RATING	IP30
MOUNTING	T35 DIN rail
DIMENSIONS	53 x 167 x 100 (W x H x D mm)
WEIGHT	Approx. 600g
CONNECTIONS (POWER SUPPLY, LINK)	2.5mm ² removable terminal blocks
CONNECTIONS (ANALOG INPUTS)	1.5mm ² removable terminal blocks
MAX DISTANCE BETWEEN TWO MODULES	500m

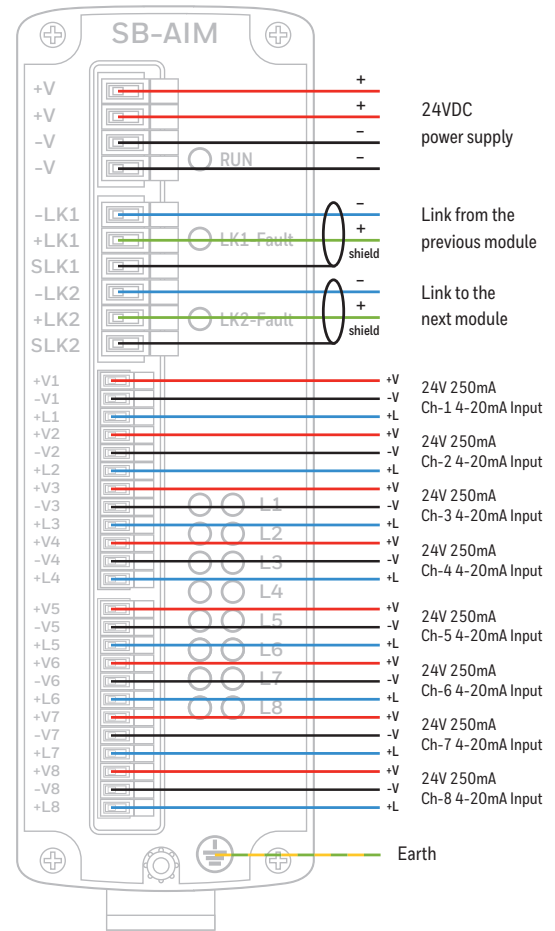

Agency listings and approvals

These listings and approvals apply to the modules specified in this document. In some cases, certain modules or applications may not be listed by certain approval agencies, or listing may be in process. Consult the factory for the latest listing status.

UL Listed UL 864 UL 2017: File No.: S24857
 EN-54 -17, EN 54-18: File No.: 0051-CPR-0449
 SIL 2/3 Certified: File No.: 16-SIL-0010017-02-TIC
 Agency: TUV

SB-ECM Module

This module can control an automatic extinguishing/release system. The module controls 8 supervised inputs with safety-related functions, 4 supervised outputs for controlling solenoid valves (EV) or acoustic/visual (TOA) notification appliances with safety-related functions and 2 supervised outputs for controlling non-safety-related visual (TO) or acoustic/visual (TOA) notification appliances, and a virtual output (V15) used to initiate automatic discharge sequence in embedded mode or logic virtual output in I/O mode.

As to the 8 input channels, the first six are suitable for NO/NC contacts with a max line current of 40mA, while the last two channels are suitable for controlling NO/NC or conventional smoke detector contacts with a max line current of 130mA. As for the 6 output channels, the first four channels are suitable for controlling solenoid valves or visual/acoustic signals with a max current of 500mA and safety-related functions, while the last two channels are suitable for controlling visual/acoustic signals with a max current of 250mA.

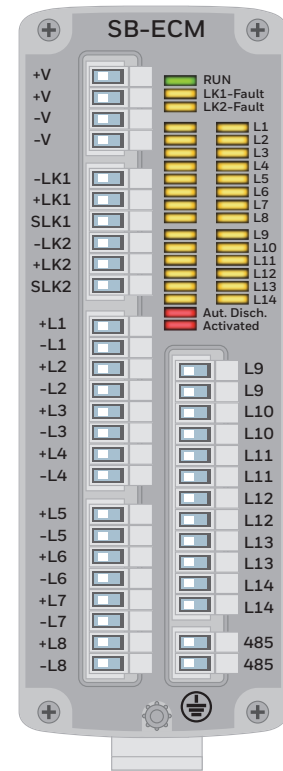

Visual Indications

TAG	COLOR	MODE	CONDITION
RUN	Green	On Solid	Normal operation (Note-a)
		Off	Module failure or no power
LK1-FAULT	Yellow	Off	Communication on Link LK1 present
		Blinking	Link LK1 towards board interrupted
		On Solid	Communication failure on Link LK1
LK2-FAULT	Yellow	Off	Communication on Link LK2 present
		Blinking	Link LK2 towards board interrupted
		On Solid	Communication failure on Link LK2
L1-L8	Red	Off	Channel in normal state
		Blinking	Channel in pre-alarm
		On Solid	Channel in alarm
L1-L8	Yellow	Off	Channel in normal state (Note-b)
		Blinking	Channel fault (module or line)
		On Solid	Channel disabled
L9-L14	Red	Off	Channel inactive
		On Solid	Channel active
L9-L14	Yellow	Off	Channel in normal state
		Blinking	Channel fault (module or line)
		On Solid	Channel disabled
V15	Red	On Solid	V15 variable (automatic discharge) active
		Blinking	Discharge sequence startup (active)
		Off	V15 variable (automatic discharge) inactive
MODE	Green	Off	I/O Mode
		Blinking	Internal logic in progress (only in I/O mode)
		On Solid	Embedded Mode

Note-a:

During the startup sequence, all the LEDs except for the green RUN LED blink 3 times, then the seven red LEDs L1-L7 will go on for 2 seconds to indicate the module address in binary format (L1=1, L2=2, L3=4, L4=8, L5=16, L6=32, L7=64).

At this point, the fourteen yellow LEDs L1-L14 will begin to blink rapidly until the module is configured by the panel.

Note-b:

In Embedded mode the red led L3, indicating the status of the inhibit input, blinks during the discharge sequence inhibition time.

SB-ECM Module Technical Specifications

APPLICABLE SAFETY CATEGORY	Up to SIL3 (excluding output channels 13 and 14)
NUMBER OF INPUT CHANNELS	8 individually configurable
ALARM THRESHOLD FOR INPUT CHANNELS 1-6	2 programmable thresholds from 4 to 35mA
ALARM THRESHOLD FOR INPUT CHANNELS 7-8	2 programmable thresholds from 4 to 120mA
SH. CIRCUIT THRESHOLD FOR INPUT CHANNELS 1-6	Programmable from 4 to 40mA
SH. CIRCUIT THRESHOLD FOR INPUT CHANNELS 7-6	Programmable from 4 to 131mA
OPEN CIRCUIT THRESHOLD FOR INPUT CHANNELS 1-8	≤1mA
INPUT CHANNEL TEST	Performed every 30 seconds
MAX CURRENT FOR OUTPUT CHANNELS 9-12	500 mA
SH. CIRCUIT THRESHOLD FOR OUTPUT CHANNELS 9-12	Current >0.75-1.5 A
OPEN CIRCUIT THRESHOLD FOR OUTPUT CHANNELS 9-12	Current <0.5-9.5 mA
CHANNEL TEST FOR OUTPUTS 9-12	Performed every 3 seconds
MAX CURRENT FOR OUTPUT CHANNELS 13-14	250 mA
FUSE TRIP CURRENT FOR CHANNELS 13-14	>600 mA
POWER SUPPLY VOLTAGE	22-28VDC
CURRENT CONSUMPTION IN STAND BY	135mA
OPERATING TEMPERATURE	-30 / +70 °C
STORAGE TEMPERATURE	-55 / +85 °C
MAX HUMIDITY	0-95% non condensing
PROTECTION RATING	IP30
MOUNTING	T35 DIN rail
DIMENSIONS	53 x 167 x 100 (W x H x D mm)
WEIGHT	Approx. 600g
CONNECTIONS	2.5mm ² removable terminal blocks
MAX DISTANCE BETWEEN TWO MODULES	500m

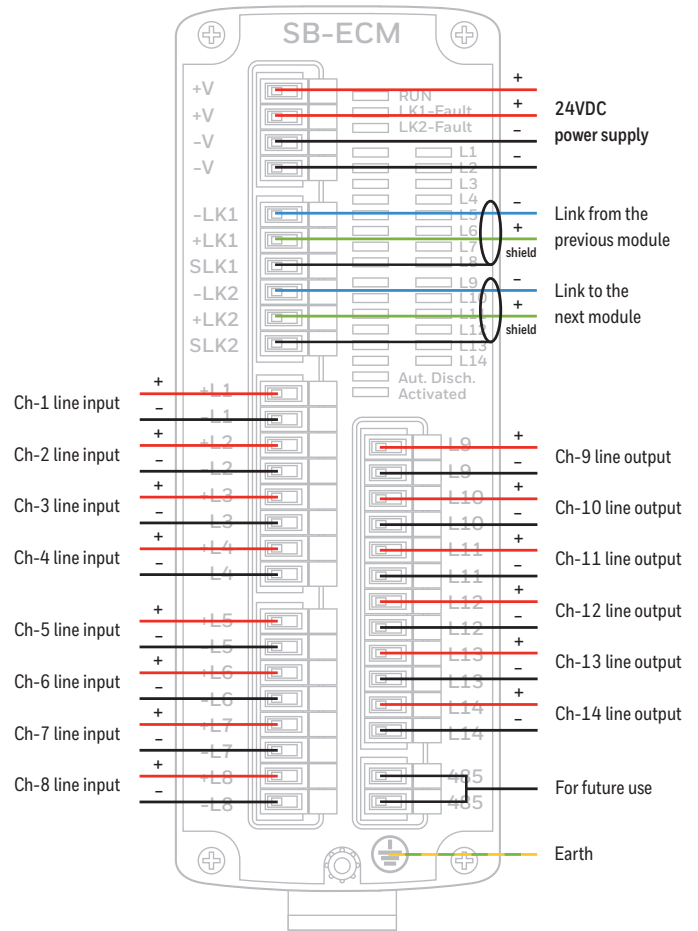

Agency listings and approvals

These listings and approvals apply to the modules specified in this document. In some cases, certain modules or applications may not be listed by certain approval agencies, or listing may be in process. Consult the factory for the latest listing status.

UL Listed UL 864 UL 2017: File No.: S24857
EN-54 -17, EN 54-18: File No.: 0051-CPR-0449
SIL 2/3 Certified: File No.: 16-SIL-0010017-02-TIC
 Agency: TUV

SB-F7011 Module

The Safety Bus system allows the Fire and Fire & Gas detection and the firefighting control in a unique bus assuring a high safety level. The system is composed by one or two control cards, that are integrated in the panel S81-HS, and up to 64 addressable remote modules installed in the field. The communication between the control cards and the addressable modules is based on an enhanced safety version of CAN protocol (Controller Area Network) with ring architecture to guarantee the best functionality in fault condition and high communication speed.

This board manages communication with the I/O modules. It monitors the communication ring and receives all the signals coming from the I/O modules. It can be used in either mono or duplex configuration mode, to increase the system availability.

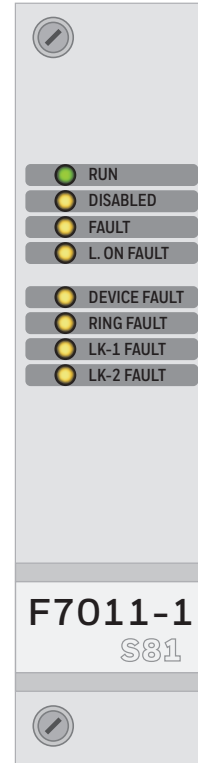









FEATURES & BENEFITS

- Wide area coverage
- Easy addition of IO in existing system
- SIL 2/3, UL, EN, Atex approved installations
- Large capacity of 64 modules/ loop
- Redundant network
- Available with weather proof and explosion proof housing

Visual Indications

The front panel of the board features 8 LEDs that indicate the following conditions:

TAG	COLOR	MODE	CONDITION
RUN	 Green	Off	Board out of order
		Blinking	Board in Slave mode
		On Solid	Board in Master mode
DISABLED	 Yellow	Off	No channel/point disabled
		On Solid	At least one channel/point disabled
FAULT	 Yellow	Off	No line device fault
		Blinking	Line/device Fault
L. ON FAULT	 Yellow	Off	No discrepancy between programmed and detected modules
		Blinking	Discrepancy between programmed and detected modules
DEVICE FAULT	 Yellow	Off	No module failure
		Blinking	Module failure
RING FAULT	 Yellow	Off	No interruption of communication ring
		Blinking	Communication ring interrupted
LK1-FAULT	 Yellow	Off	Communication on Link LK1 present
		Blinking	Communication failure on Link LK1
LK2-FAULT	 Yellow	Off	Communication on Link LK2 present
		Blinking	Communication failure on Link LK2

SB-F7011 Module Technical Specifications

APPLICABLE SAFETY CATEGORY	Up to SIL3 in duplex configuration mode
REDUNDANCY	Yes
MAX NUMBER OF MODULES PER RING	64
POWER SUPPLY VOLTAGE	22-28VDC
CURRENT CONSUMPTION IN STAND BY	80mA
OPERATING TEMPERATURE	-5 / +50 °C
STORAGE TEMPERATURE	-55 / +85 °C
MAX HUMIDITY	0-95% non condensing
MAX DISTANCE IN COPPER BETWEEN THE PANEL AND THE FIRST/LAST MODULE	500m

Agency listings and approvals

These listings and approvals apply to the modules specified in this document. In some cases, certain modules or applications may not be listed by certain approval agencies, or listing may be in process. Consult the factory for the latest listing status.

UL Listed UL 864 UL 2017: File No.: S24857
 EN-54 -17, EN 54-18: File No.: 0051-CPR-0449
 SIL 2/3 Certified: File No.: 16-SIL-0010017-02-TIC
 Agency: TUV

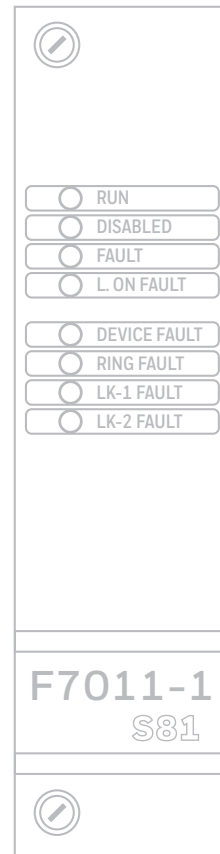

SB-NCM Module

The Safety Bus system allows the Fire and Fire & Gas detection and the firefighting control in a unique bus assuring a high safety level. The system is composed by one or two control cards, that are integrated in the panel S81-HS, and up to 64 addressable remote modules installed in the field. The communication between the control cards and the addressable modules is based on an enhanced safety version of CAN protocol (Controller Area Network) with ring architecture to guarantee the best functionality in fault condition and high communication speed.

This module can control eight 250mA outputs for controlling notification appliances (visual/acoustic signals). The current of the 8 outputs is limited by self-resetting fuses. Line control is carried out by inverting the polarity. This also makes it possible to control electronic devices having low Current consumption in stand by. Note: Line control occurs only when the outputs are inactive. Both communication links are provided with short circuit isolator.

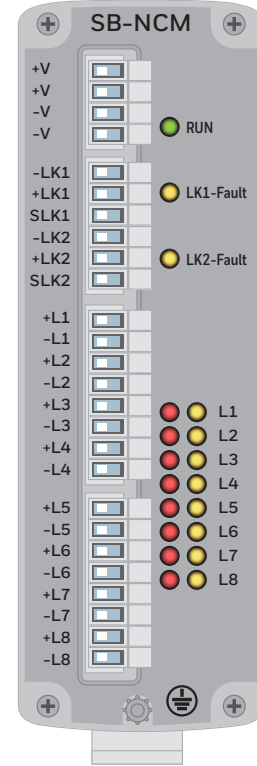

FEATURES & BENEFITS

- Wide area coverage
- Easy addition of IO in existing system
- SIL 2/3, UL, EN, Atex approved installations
- Large capacity of 64 modules/ loop
- Redundant network
- Available with weather proof and explosion proof housing

Visual Indications

The front panel of the module features 19 LEDs that indicate the following conditions:

TAG	COLOR	MODE	CONDITION
RUN	Green	On Solid	Normal operation
		Off	Module failure or no power
LK1-FAULT	Yellow	Off	Communication on Link LK1 present
		Blinking	Link LK1 towards board interrupted
		On Solid	Communication failure on Link LK1
LK2-FAULT	Yellow	Off	Communication on Link LK2 present
		Blinking	Link LK2 towards board interrupted
		On Solid	Communication failure on Link LK2
L1-L8	Red	Off	Channel inactive
		On Solid	Channel active
L1-L8	Yellow	Off	Channel in normal state
		Blinking	Channel fault (module or line)
		On Solid	Channel disabled

Note:
During the startup sequence, the yellow and red LEDs blink 3 times, then the seven red LEDs L1-L7 will go on for 2 seconds to indicate the module address in binary format (L1=1, L2=2, L3=4, L4=8, L5=16, L6=32, L7=64).

At this point, the eight yellow LEDs L1-L8 will begin to blink rapidly until the module is configured by the panel.

SB-NCM Module Technical Specifications

APPLICABLE SAFETY CATEGORY	N/A
MAX CHANNEL CURRENT	250 mA
FUSE TRIP CURRENT	>600 mA
POWER SUPPLY VOLTAGE	22-28VDC
CURRENT CONSUMPTION IN STAND BY	85mA
OPERATING TEMPERATURE	-30 / +70 °C
STORAGE TEMPERATURE	-55 / +85 °C
MAX HUMIDITY	0-95% non condensing
PROTECTION RATING	IP30
MOUNTING	T35 DIN rail
DIMENSIONS	53 x 167 x 100 (W x H x D mm)
WEIGHT	Approx. 600g
CONNECTIONS	2.5mm ² removable terminal blocks
MAX DISTANCE BETWEEN TWO MODULES	500m

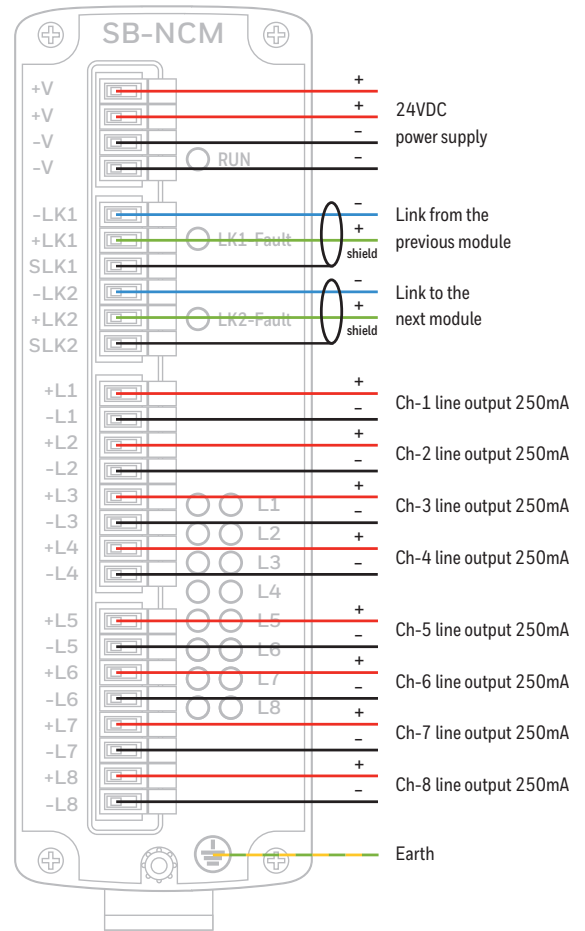

Agency listings and approvals

These listings and approvals apply to the modules specified in this document. In some cases, certain modules or applications may not be listed by certain approval agencies, or listing may be in process. Consult the factory for the latest listing status.

UL Listed UL 864 UL 2017: File No.: S24857
 EN-54 -17, EN 54-18: File No.: 0051-CPR-0449

SB-SCM Module

The Safety Bus system allows the Fire and Fire & Gas detection and the firefighting control in a unique bus assuring a high safety level. The system is composed by one or two control cards, that are integrated in the panel S81-HS, and up to 64 addressable remote modules installed in the field. The communication between the control cards and the addressable modules is based on an enhanced safety version of CAN protocol (Controller Area Network) with ring architecture to guarantee the best functionality in fault condition and high communication speed.

This module can control eight 500mA outputs for controlling solenoid valves or coils in general with safety-related functions. All the channels are tested every 3 seconds during operation. It is possible to connect two channels in parallel to increase load output current. Both communication links are provided with short circuit isolator.

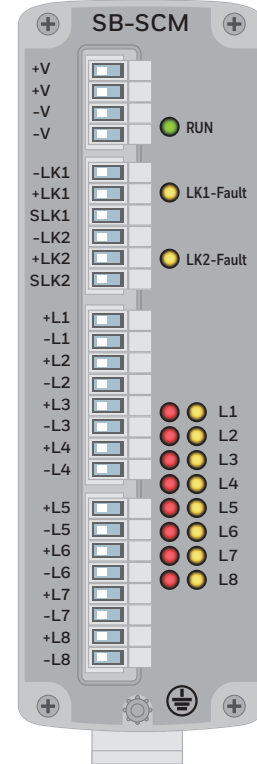

FEATURES & BENEFITS

- Wide area coverage
- Easy addition of IO in existing system
- SIL 2/3, UL, EN, Atex approved installations
- Large capacity of 64 modules/ loop
- Redundant network
- Available with weather proof and explosion proof housing

Visual Indications

The front panel of the module features 19 LEDs that indicate the following conditions:

TAG	COLOR	MODE	CONDITION
RUN	Green	On Solid	Normal operation
		Off	Module failure or no power
LK1-FAULT	Yellow	Off	Communication on Link LK1 present
		Blinking	Link LK1 towards board interrupted
		On Solid	Communication failure on Link LK1
LK2-FAULT	Yellow	Off	Communication on Link LK2 present
		Blinking	Link LK2 towards board interrupted
		On Solid	Communication failure on Link LK2
L1-L8	Red	Off	Channel inactive
		On Solid	Channel active
L1-L8	Yellow	Off	Channel in normal state
		Blinking	Channel fault (module or line)
		On Solid	Channel disabled

Note:
During the startup sequence, the yellow and red LEDs blink 3 times, then the seven red LEDs L1-L7 will go on for 2 seconds to indicate the module address in binary format (L1=1, L2=2, L3=4, L4=8, L5=16, L6=32, L7=64).

At this point, the eight yellow LEDs L1-L8 will begin to blink rapidly until the module is configured by the panel.

SB-SCM Module Technical Specifications

APPLICABLE SAFETY CATEGORY	Up to SIL3
MAX CHANNEL CURRENT	500 mA
SHORT-CIRCUIT THRESHOLD	Current >0.75-1.5 A
OPEN CIRCUIT THRESHOLD	Current <0.5-9.5 mA
CHANNEL TEST	Performed every 3 seconds
POWER SUPPLY VOLTAGE	22-28VDC
CURRENT CONSUMPTION IN STAND BY	95mA
OPERATING TEMPERATURE	-30 / +70 °C
STORAGE TEMPERATURE	-55 / +85 °C
MAX HUMIDITY	0-95% non condensing
PROTECTION RATING	IP30
MOUNTING	T35 DIN rail
DIMENSIONS	53 x 167 x 100 (W x H x D mm)
WEIGHT	Approx. 600g
CONNECTIONS	2.5mm ² removable terminal blocks
MAX DISTANCE BETWEEN TWO MODULES	500m

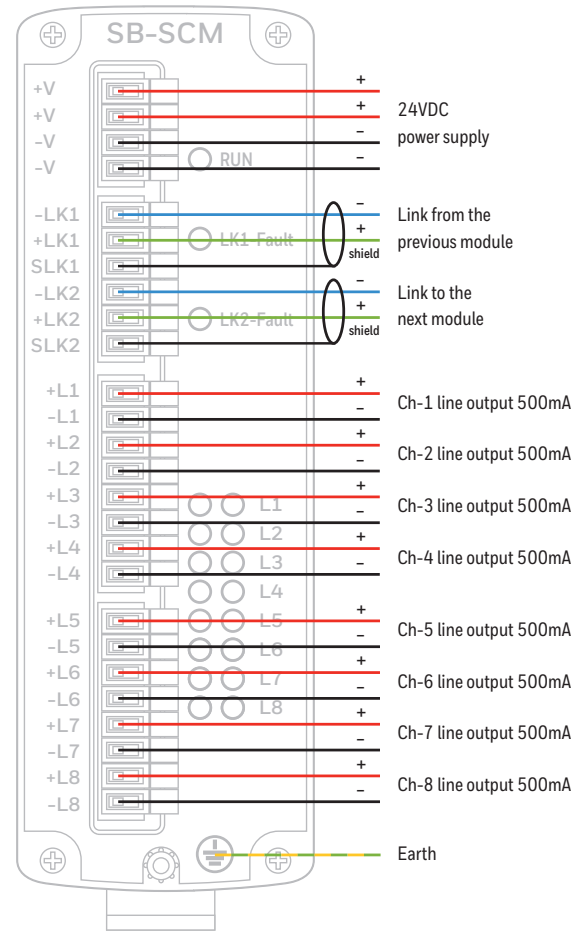

Agency listings and approvals

These listings and approvals apply to the modules specified in this document. In some cases, certain modules or applications may not be listed by certain approval agencies, or listing may be in process. Consult the factory for the latest listing status.

UL Listed UL 864 UL 2017: File No.: S24857
 EN-54 -17, EN 54-18: File No.: 0051-CPR-0449
 SIL 2/3 Certified: File No.: 16-SIL-0010017-02-TIC
 Agency: TUV

SB-SIM Module

The Safety Bus system allows the Fire and Fire & Gas detection and the firefighting control in a unique bus assuring a high safety level. The system is composed by one or two control cards, that are integrated in the panel S81-HS, and up to 64 addressable remote modules installed in the field. The communication between the control cards and the addressable modules is based on an enhanced safety version of CAN protocol (Controller Area Network) with ring architecture to guarantee the best functionality in fault condition and high communication speed.

This module can control eight supervised inputs for conventional sensors or detectors with safety-related functions. All the channels can be individually reset and are tested every 30 seconds during operation. It is used to control conventional fire detectors and NO/NC contacts in general. Both communication links are provided with short circuit isolator.

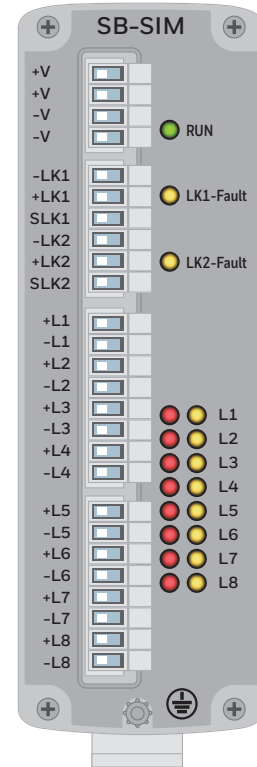

FEATURES & BENEFITS

- Wide area coverage
- Easy addition of IO in existing system
- SIL 2/3, UL, EN, Atex approved installations
- Large capacity of 64 modules/ loop
- Redundant network
- Available with weather proof and explosion proof housing

Visual Indications

The front panel of the module features 19 LEDs that indicate the following conditions:

TAG	COLOR	MODE	CONDITION
RUN	Green	On Solid	Normal operation
		Off	Module failure or no power
LK1-FAULT	Yellow	Off	Communication on Link LK1 present
		Blinking	Link LK1 towards board interrupted
		On Solid	Communication failure on Link LK1
LK2-FAULT	Yellow	Off	Communication on Link LK2 present
		Blinking	Link LK2 towards board interrupted
		On Solid	Communication failure on Link LK2
L1-L8	Red	Off	Channel in normal state
		Blinking	Channel in pre-alarm
		On Solid	Channel in alarm
L1-L8	Yellow	Off	Channel in normal state
		Blinking	Channel fault (module or line)
		On Solid	Channel disabled

Note:
During the startup sequence, the yellow and red LEDs blink 3 times, then the seven red LEDs L1-L7 will go on for 2 seconds to indicate the module address in binary format (L1=1, L2=2, L3=4, L4=8, L5=16, L6=32, L7=64).

At this point, the eight yellow LEDs L1-L8 will begin to blink rapidly until the module is configured by the panel.

SB-SIM Module Technical Specifications

APPLICABLE SAFETY CATEGORY	Up to SIL3
NUMBER OF INPUT CHANNELS	8 individually configurable
ALARM THRESHOLD	2 programmable thresholds from 4 to 120mA
SHORT-CIRCUIT THRESHOLD	Programmable from 4 to 131mA
OPEN CIRCUIT THRESHOLD	1mA
CHANNEL TEST	Performed every 30 seconds
POWER SUPPLY VOLTAGE	22-28VDC
CURRENT CONSUMPTION IN STAND BY	115mA
OPERATING TEMPERATURE	-30 / +70 °C
STORAGE TEMPERATURE	-55 / +85 °C
MAX HUMIDITY	0-95% non condensing
PROTECTION RATING	IP30
MOUNTING	T35 DIN rail
DIMENSIONS	53 x 167 x 100 (W x H x D mm)
WEIGHT	Approx. 600g
CONNECTIONS	2.5mm ² removable terminal blocks
MAX DISTANCE BETWEEN TWO MODULES	500m

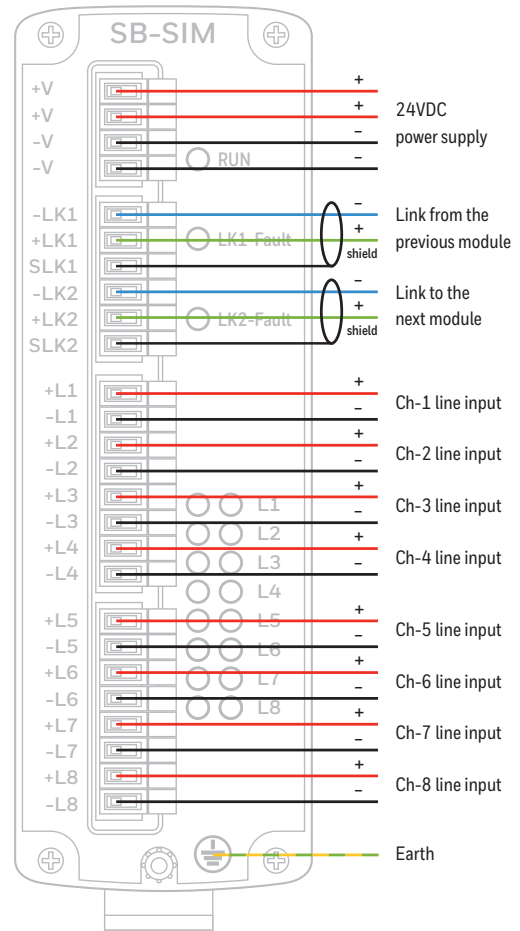

Agency listings and approvals

These listings and approvals apply to the modules specified in this document. In some cases, certain modules or applications may not be listed by certain approval agencies, or listing may be in process. Consult the factory for the latest listing status.

UL Listed UL 864 UL 2017: File No.: S24857
 EN-54 -17, EN 54-18: File No.: 0051-CPR-0449
 SIL 2/3 Certified: File No.: 16-SIL-0010017-02-TIC
 Agency: TUV

SB-SIM/GM Module

The Safety Bus system allows the Fire and Fire & Gas detection and the firefighting control in a unique bus assuring a high safety level. The system is composed by one or two control cards, that are integrated in the panel S81-HS, and up to 64 addressable remote modules installed in the field. The communication between the control cards and the addressable modules is based on an enhanced safety version of CAN protocol (Controller Area Network) with ring architecture to guarantee the best functionality in fault condition and high communication speed.

This module can control eight supervised inputs for conventional sensors or detectors with safety-related functions. All the channels can be individually reset and are tested every 30 seconds during operation. It is used to control conventional fire detectors and NO/NC contacts in general. Both communication links are provided with short circuit isolator.

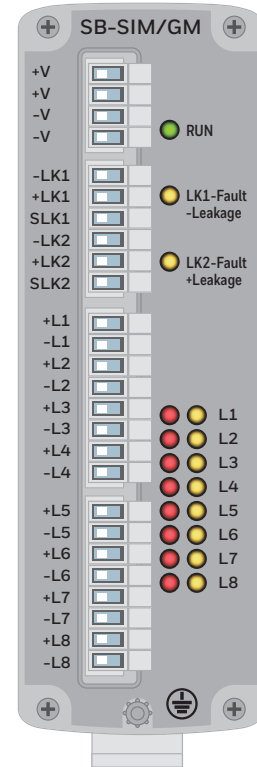

FEATURES & BENEFITS

- Wide area coverage
- Easy addition of IO in existing system
- SIL 2/3, UL, EN, Atex approved installations
- Large capacity of 64 modules/ loop
- Redundant network
- Available with weather proof and explosion proof housing

Visual Indications

The front panel of the module features 19 LEDs that indicate the following conditions:

TAG	COLOR	MODE	CONDITION
RUN	Green	On Solid	Normal operation
		Off	Module failure or no power
LK1-FAULT +LEAKAGE	Yellow	Off	Communication on Link LK1 present
		Blinking	Link LK1 towards board interrupted
		On Solid	Communication failure on Link LK1
LK2-FAULT -LEAKAGE	Yellow	Pulsing on/off	Positive earth leakage
		Off	Communication on Link LK2 present
		Blinking	Link LK2 towards board interrupted
L1-L8	Red	On Solid	Channel in alarm
		Blinking	Channel in pre-alarm
		Off	Channel in normal state
L1-L8	Yellow	Blinking	Channel fault (module or line)
		On Solid	Channel disabled

Note:
During the startup sequence, the yellow and red LEDs blink 3 times, then the seven red LEDs L1-L7 will go on for 2 seconds to indicate the module address in binary format (L1=1, L2=2, L3=4, L4=8, L5=16, L6=32, L7=64).

At this point, the eight yellow LEDs L1-L8 will begin to blink rapidly until the module is configured by the panel.

SB-SIM/GM Module Technical Specifications

APPLICABLE SAFETY CATEGORY	Up to SIL3
NUMBER OF INPUT CHANNELS	8 individually configurable
ALARM THRESHOLD	2 programmable thresholds from 4 to 120mA
SHORT-CIRCUIT THRESHOLD	Programmable from 4 to 131mA
OPEN CIRCUIT THRESHOLD	1mA
CHANNEL TEST	Performed every 30 seconds
POWER SUPPLY VOLTAGE	22-28VDC
CURRENT CONSUMPTION IN STAND BY	115mA
OPERATING TEMPERATURE	-30 / +70 °C
STORAGE TEMPERATURE	-55 / +85 °C
MAX HUMIDITY	0-95% non condensing
PROTECTION RATING	IP30
MOUNTING	T35 DIN rail
DIMENSIONS	53 x 167 x 100 (W x H x D mm)
WEIGHT	Approx. 600g
CONNECTIONS	2.5mm ² removable terminal blocks
MAX DISTANCE BETWEEN TWO MODULES	500m

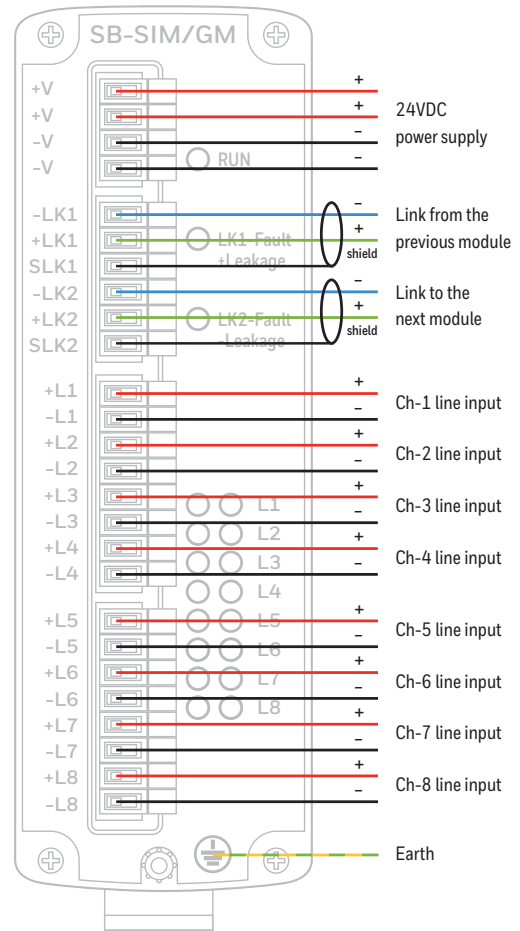

Agency listings and approvals

These listings and approvals apply to the modules specified in this document. In some cases, certain modules or applications may not be listed by certain approval agencies, or listing may be in process. Consult the factory for the latest listing status.

UL Listed UL 864 UL 2017: File No.: S24857
 EN-54 -17, EN 54-18: File No.: 0051-CPR-0449
 SIL 2/3 Certified: File No.: 16-SIL-0010017-02-TIC
 Agency: TUV

Iride

Supervision Software

General Description

Iride is a supervision program that allows computer-based event management through animation and graphic pages. Sites can consist of one or several panels. *Iride* allows management of installation activity without physically moving to it. The *Iride* program can be installed on one or more PCs that will connect to the fire alarm panel with a LAN Ethernet or serial line.

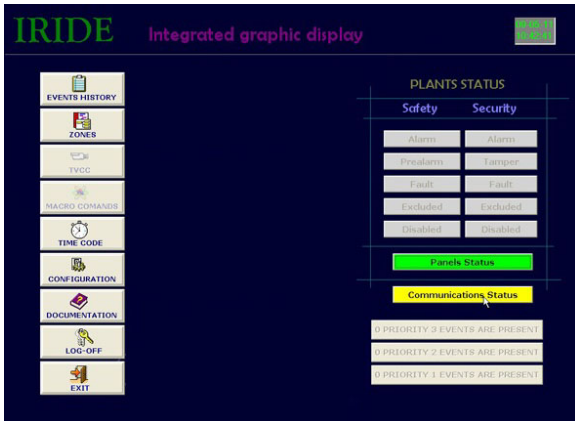

Iride summary home page on the system status

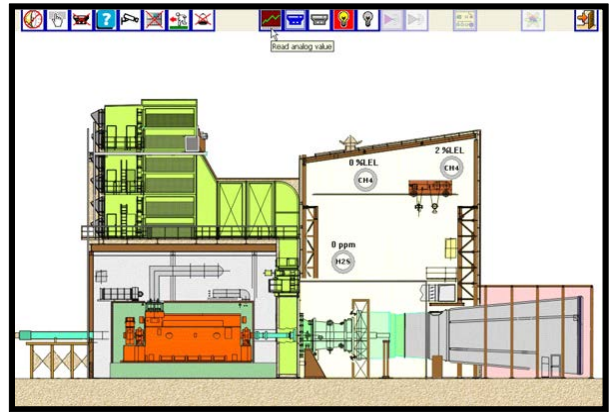

Interactive graphic page with command and display icons

Main Characteristics of the Iride Software

- PC installed (MS Windows)
- H-S81-HS compatible
- Access and configuration with USB protection device
- Connection to the plants through LAN Ethernet or serial line
- Choice of language - English, Spanish, Portuguese, and on request
- Import zone names and entities from panels
- Maps in bitmap format (bmp, jpg, etc.)
- Past events with filter to see and export data
- Online manual



Software Protection

The program is installed through a CD and includes a USB protection device. In order to activate it, a registration on Scame Sistemi database is necessary. The program can still run without the USB device, but only in demo status. Demo status allows events to be seen on the graphic pages, but does not allow any changes to be made.

Iride Configuration

Iride has a simple configuration in order to adapt to the fire and gas installation requirements. From the main panel, the administrator can modify the graphic pages and the fire plant features on the map. Moreover, the administrator can decide all possible actions for each level of access and the graphic pages visible on each PC. In addition to the basic functions, the program *Iride* can also provide some on-demand options such as *Iride Video*, or other customizations bases on the client's needs.

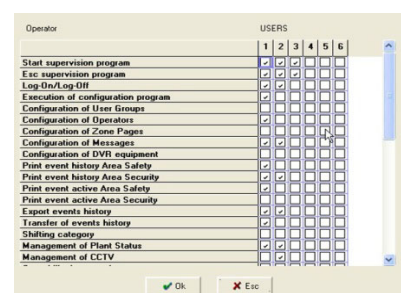
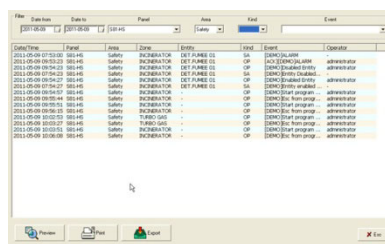
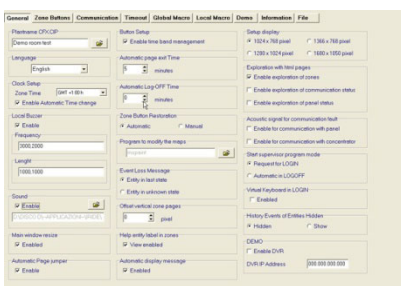

Program Functions		Iride <i>Demo</i>	Iride <i>Base</i>	Iride <i>Video</i>
Connections	USB Dongle:	no	yes	yes
	Connection through serial link		✓	✓
	Connection through LAN (or WAN) Ethernet		✓	✓
Views	Connection to several panels		✓	✓
	Simulation of events to be displayed on graphical maps	✓		
	Visualization of real events on graphical maps		✓	✓
	Summary on the front page of the events and plant status	✓	✓	✓
	Event view of pre-recorded messages for the operator		✓	✓
	On-demand view of analog values of the field devices		✓	✓
	Hierarchical level display of area and zone (optional)		✓	✓
	Graphical map display of video images of cameras			✓
	View events from several panels in the plant		✓	✓
	View the status of the connection among the panels		✓	✓
	Online manual		✓	✓
Event print		✓	✓	
Actions	Allows the acknowledgment of alarms and sirens		✓	✓
	Allows the display of historical events		✓	✓
	Allows the inclusion and exclusion of devices		✓	✓
	Allows control of actuators (lights and sirens) also with macro-commands		✓	✓
Configurations	Configure and save user groups and operators		✓	✓
	Configure and save messages		✓	✓
	Configure and save grouped commands (macro-commands)		✓	✓
	Import, editing and saving of graphics pages		✓	✓
	Edit and save the time slots		✓	✓



Area display with several zones

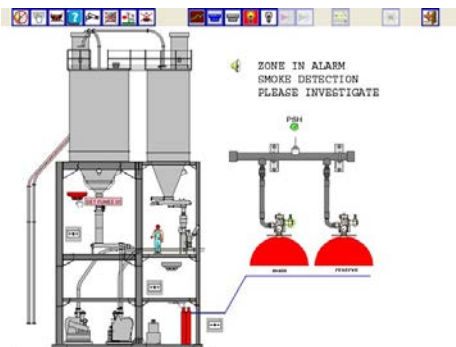

Message display of a detector in alarm

This document is not intended to be used for installation purposes. We try to keep our product information up-to-date and accurate. We cannot cover all specific applications or anticipate all requirements. All specifications are subject to change without notice.

Iride

Configuration Software

General Description

The S81 panel can be programmed using the software ProS81.

The program, which is supplied separately from the panel, can be installed on any PC provided with either a serial port or a link for network connection with the panel to be programmed.

A USB port is also necessary for the protection key that is used to prevent tampering and unauthorized modification after testing.

ProS81 allows the programmer to make the most effective use of panel and hardware modularity. Besides being simple to use, it utilizes video windows including tables and selection menus consistent with both panel composition and desired functions.

Configuration Method

The S81 panel is mainly composed of one basic unit and one or more racks, where cards selected according to the type of system installed are inserted.

Whatever its special function, each card acts as a device connecting and controlling the input (detection) and output (command) field devices.

Once they have been inserted into the racks, the cards must be configured through ProS81 programming to define:

1. characteristics and inputs behavior (sensors)
2. characteristics and outputs behavior (actuators)
3. logic and temporal combinations (rules) determining which outputs are to be activated by status variations of inputs.
4. the assigned zone of each device (input or output) is to be defined, as well as its behavior in stand-by, alarm and fault conditions.

N.	Sensor Name	Card	Rack	Pos	Kind	Chan.	Point	Logic	Mode	Sen
1	Q-DA90025 NH3 DETECTOR	F4002	1	1	*	1	1	R-NA	va-M	*
2	Q-DA90030 NH3 DETECTOR	F4002	1	1	*	2	1	R-NA	va-M	*
3	MANUAL ALARM CALL POINT 1	F3002	1	5	*	1	1	R-NA	AD	*
4	MANUAL ALARM CALL POINT 1	F3002	2	5	*	1	1			
5	A4TW91005 VALVE OPEN	F3002	1	5	*	3	1			
6	A4TW91005 VALVE OPEN	F3002	2	5	*	3	1			
7	A4TW91005 VALVE CLOSE	F3002	1	5	*	4	1			
8	A4TW91005 VALVE CLOSE	F3002	2	5	*	4	1			

1) Definition of inputs

Determination of behavior and time of delay of inputs.
Physical location and addressing of devices.

N.	Output Name	Card	Rack	Pos	Kind	Chan.	Point	Mode	Time	Sec/Min	Sound
1	OPTICAL ACOUSTIC DEVICE 1	F5001	1	8	*	1	1	F-D	0	sec	Y
2	OPTICAL ACOUSTIC DEVICE 1	F5001	2	8	*	1	1	F-D	0	sec	Y
3	A4TW91005 SOLENOIDE	F5001	1	8	*	7	1	F-D	0	sec	N
4	A4TW91005 SOLENOIDE	F5001	2	8	*	7	1	F-C			
5	A4TW91005 SOLENOIDE	F5001	1	8	*	8	1	F-C			
6	A4TW91005 SOLENOIDE	F5001	2	8	*	8	1	F-C			
7	SPOT NH3 PREALARM	F5002	1	10	*	1	1	F-C			
8	SPOT NH3 ALARM	F5002	2	10	*	1	1	F-C			

2) Definition of actuators

Determination of behavior and time of delay of outputs.
Physical location and addressing of devices.

N.	Rule Name	Rule	Entity Group	Group Outputs 1
1	NH3 PREALARM	OR	BS1-2	1,2
2	MANUAL CALL POINT	OR	AS3-4	1,2
3	NH3 ALARM	OR	AS1-2	3,4,5,6
4	EXCLUSION	OR	IS1-8	9
5	EXCLUSION	OR	IO1-6	9
6	VALVE OPEN	OR	AS5-6	10
7	VALVE CLOSE	OR	AS7-8	11
8	VALVE WRONG POSITION	AND	NR6-7	12
9	VALVE FAULT			
10	COMMON FAULT			

3) Definition of rules (operating logics)

It defines the status variations of inputs to determine the activating conditions of outputs.

Possible Configurations

At a general configuration level, it is possible to define:

- Panel and program language
- Panel display parameters
- Panel heading and general information on the type of the panel
- Communication method for panels, PC's and printers
- Panel and supervision PC's IP addresses
- CPU and cards redundancies
- Time-related operation and periodical test functions
- Program and configuration protection parameters.

At panel (and system) functional level, it is possible to configure:

- AND, OR, N/N logic associations relevant to inputs and outputs managed by panel
- Logic associations on other network-connected panels
- Logic associations and events determined by time frame variations.

The logic associations can be configured for a maximum of 300 fire extinguishing zones and technologically controlled zones. Each zone can have 99 inputs, 99 outputs, and 99 logic associations.

Data Validity Control

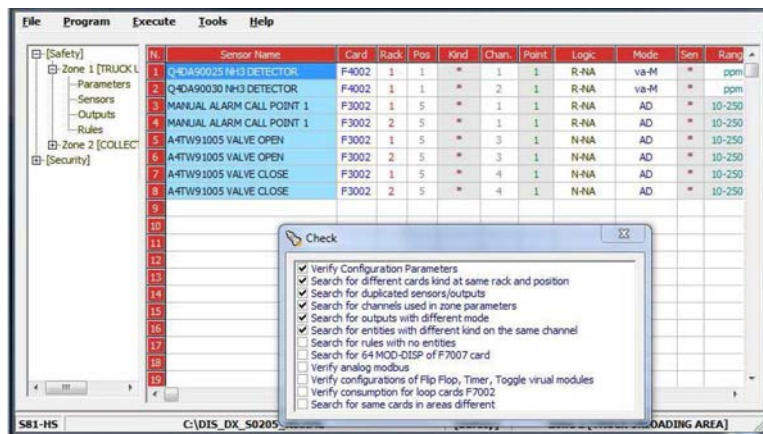

In addition to ancillary functions, the ProS81 configuration program integrates a configuration control utility able to detect and report any syntax or consistency errors during the assignment of addresses and logic attributions.

ProS81 is able to produce a printable page depicting the panel composition.

Program Pack and Protection

The program is supplied on a CD and includes a USB protection key which requires, for its activation, the user's (or installer's) registration in Honeywell's database.

The protection key is necessary as it allows, in combination with the user's (or installer's) password, enabling or disabling panel configuration transmission from and to the PC.

Program Main Characteristics

- PC installation with MS Windows operating system
- Protection of panel configuration with password and USB key
- Connection to panel through serial port or network
- Standard languages is English. Other languages and fonts upon request
- Possibility to configure 300 Safety zones, with 99 sensors, 99 actuators, and 99 rules per zone
- Possibility to configure 999 remote rules for interaction between panels
- Table-type graphic configuration method, with guided drop-down menus and on-line help
- Organization and storage in working folders with a drop-down structure
- Utility for validity control of configuration data
- Graphic display and print of panel configuration
- Graphic display and print of composition of each loop (or bus), with indication of respective consumption
- Table-type display and print of memory occupation by virtual inputs and outputs used for interaction between panels, or setup of logic and particular associations
- Display and print relating to virtual points dedicated to Modbus communication
- Automatic creation of configuration file to be exported to IRIDE supervision program
- Automatic creation of executable program to be exported to panel (S81-HS)
- Programming manual (available directly from program)



C E R T I F I C A T E

Certificate no. 16-SIL-0010017-01-TIC

WE HEREBY CERTIFY THAT

Product description SAFETY PLC - FIRE AND GAS CENTRAL UNIT

Models S81-HS

Manufacturer SCAME SISTEMI S.r.l.
Via Lombardia 5 - 20010 Arluno MI

IS IN COMPLIANCE WITH THE REQUIREMENTS OF THE STANDARDS

IEC 61508 Parts 1÷7:2010

IEC 60079-29-3: 2014

AS RESULT OF THE ASSESSMENT ACCORDING TO THE PROVISION
SET OUT IN THE ABOVE-MENTIONED STANDARDS

Summary Report no. RC-0517-SIL-TIC-PC-0010017-16-02

Expiry date 04.05.2020

Note

This certificate is issued upon the request of the manufacturer as voluntary certification; it does not include the product inspection nor the production surveillance. This certificate is valid for the documents evaluated, as referred in the summary report. This certificate does not allow the manufacturer to use the safety mark of TÜV INTERCERT.

Reggio Emilia, 05.05.2017



Eng. Andrea Vivi
TÜV INTERCERT Certification Body

CERTIFICATE ■ CERTIFICATO ■ ZERTIFIKAT ■ SERTIFIKA ■ CERTIFICADO ■ گواهینامه ■ ΠΙΣΤΟΠΟΙΗΤΙΚΟ ■ 証明書 ■ 証明書 ■ 인증서 ■ شهادة

CERTIFICATE ■ CERTIFICATO ■ ZERTIFIKAT ■ SERTIFIKA ■ CERTIFICADO ■ گواهینامه ■ ΠΙΣΤΟΠΟΙΗΤΙΚΟ



C E R T I F I C A T E

ANNEX to Certificate no. 16-SIL-0010017-01-TIC

Type	B
HFT	<ul style="list-style-type: none"> mono configuration: HFT=0 duplex configuration: HFT=1
Safety functions	<ol style="list-style-type: none"> SF-1: Fire and gas detection and alarm transmission SF-2: Fire and gas detection and shutdown SF-3: Fire and gas detection and extinguishing
Mode of operation	Low Demand Mode

Random failure rates			
Module	λ_{DU} [1/h]	λ_{DD} [1/h]	λ_S [1/h]
S81-U1002	5,02E-07	4,91E-06	4,92E-06
S81-F3002	3,79E-09	2,51E-07	1,25E-09
S81-F4001	1,52E-08	2,05E-07	2,82E-08
S81-F4002	1,50E-08	2,14E-07	2,79E-08
S81-F4003	3,01E-09	3,44E-07	2,68E-09
S81-F5001 (E*)	2,93E-09	3,46E-07	1,71E-09
S81-F5001 (D*)	1,75E-09	1,94E-07	1,55E-07
S81-F5004 (E*)	2,69E-09	3,09E-07	1,67E-09
S81-F5004 (D*)	4,79E-09	1,90E-07	1,33E-07
S81-F6001	2,40E-09	2,00E-07	1,23E-09
S81-F7009	2,05E-08	5,60E-07	5,41E-08
S81-F7002	2,05E-08	5,60E-07	5,41E-08
S81-E2002	2,39E-09	3,04E-07	0,00E+00

E*: Energise to trip / D*: De-energise to trip

Systematic capability	3 (Route 1 _S applied)			
Architectural constraints	Route 1 _H :	Applied	Route 2 _H :	Not applied
	The product can be used in: <ul style="list-style-type: none"> mono configuration: up to SIL 2 duplex configuration: up to SIL 3 			

Remarks:

- For further details, including environmental conditions, limitations of use, lifetime, failure rates traceability, mean repair times, common cause factors and systematic capability constraints, make reference to Safety Manual ST-071-IT.

END OF CERTIFICATE

Reggio Emilia, 05.05.2017

 Eng. Andrea Vivi
 TÜV INTERCERT Certification Body



C E R T I F I C A T E

Certificate no. 16-SIL-0010017-02-TIC

WE HEREBY CERTIFY THAT

Product description DISTRIBUTED I/O SYSTEM
Models SAFETY BUS
Manufacturer SCAME SISTEMI S.r.l.
Via Lombardia 5 - 20010 Arluno MI

IS IN COMPLIANCE WITH THE REQUIREMENTS OF THE STANDARDS

IEC 61508 Parts 1-7:2010

IEC 60079-29-3: 2014

AS RESULT OF THE ASSESSMENT ACCORDING TO THE PROVISION
SET OUT IN THE ABOVE-MENTIONED STANDARDS

Summary Report no. RC-1217-SIL-TIC-PC-0010017-16-04

Expiry date 01.01.2021

Note

This certificate is issued upon the request of the manufacturer as voluntary certification; it does not include the production surveillance.

This certificate does not allow the manufacturer to use the safety mark of TÜV INTERCERT.



Reggio Emilia, 02.01.2018

Eng. Andrea Vivi
TÜV INTERCERT Certification Body



C E R T I F I C A T E

ANNEX to Certificate no. 16-SIL-0010017-02-TIC

Type	B
HFT	<ul style="list-style-type: none"> mono configuration: HFT=0 for each module duplex configuration: HFT=1 for control board S81-F7011-1, HFT=0 for all the other modules
Safety functions	<ol style="list-style-type: none"> SF-1: Fire and gas detection and alarm transmission SF-2: Fire and gas detection and shutdown SF-3: Fire and gas detection and extinguishing
Mode of operation	Low Demand Mode

Random failure rates				
Module	Description	λ_{DU} [1/h]	λ_{DD} [1/h]	λ_S [1/h]
S81-F7011-1	Safety Bus board	7,58E-09	1,88E-06	9,81E-07
SB-SIM, SB-SIM-GM, SB-ECM	Common part	6,83E-09	1,84E-06	9,81E-07
	Input channel	1,78E-10	1,93E-08	0,00E+00
SB-AIM	Common part	6,83E-09	1,84E-06	9,81E-07
	Input channel	1,68E-10	1,74E-08	0,00E+00
SB-SCM (E*)	Common part	6,83E-09	1,84E-06	9,81E-07
	Output channel	8,31E-11	1,54E-08	0,00E+00
SB-SCM (D*)	Common part	5,09E-09	1,40E-06	1,36E-06
	Output channel	1,40E-12	1,39E-10	1,54E-08
SB-ECM (E*)	Common part	6,91E-09	1,87E-06	9,81E-07
	Output channel	8,31E-11	1,54E-08	0,00E+00
SB-ECM (D*)	Common part	5,60E-09	1,45E-06	1,38E-06
	Output channel	1,40E-12	1,39E-10	1,54E-08
CAN Protocol	Safety Bus	1,94E-11	1,92E-09	1,94E-09

E*: Energise to trip / D*: De-energise to trip

Systematic capability	3 (Route 1 _s applied)			
Architectural constraints	Route 1 _H :	Applied	Route 2 _H :	Not applied
	The product can be used up to SIL 3 in mono / duplex configuration			

Remarks:

- For further details, including environmental conditions, limitations of use, lifetime, failure rates traceability, mean repair times, common cause factors and systematic capability constraints, make reference to Safety Manual ST-171-IT.

END OF CERTIFICATE

Reggio Emilia, 02.01.2018

 Eng. Andrea Vivi
 TÜV INTERCERT Certification Body

CERTIFICATE OF COMPLIANCE

Certificate Number 20170320-S24857
Report Reference S24857-20121001
Issue Date 2017-MARCH-20

Issued to: SCAME SISTEMI SRL
VIA LOMBARDIA 5
20010 ARLUNO MI ITALY

**This is to certify that
representative samples of**

CONTROL UNITS, SYSTEM
EMERGENCY ALARM SYSTEM CONTROL UNITS
CONTROL UNITS, RELEASING DEVICE
SEE ADDENDUM PAGE.

Have been investigated by UL in accordance with the
Standard(s) indicated on this Certificate.

Standard(s) for Safety: UL864, Control Units and Accessories for Fire Alarm
Systems
UL2017, General-Purpose Signaling Devices and Systems
Additional Information: See the UL Online Certifications Directory at
www.ul.com/database for additional information

Only those products bearing the UL Certification Mark should be considered as being covered by UL's
Certification and Follow-Up Service.

Look for the UL Certification Mark on the product.

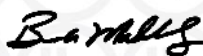

Bruce Mahrenholz, Director North American Certification Program
UL LLC

Any information and documentation involving UL Mark services are provided on behalf of UL LLC (UL) or any authorized licensee of UL. For questions, please
contact a local UL Customer Service Representative at <http://ul.com/aboutul/locations/>



CERTIFICATE OF COMPLIANCE

Certificate Number 20170320-S24857
Report Reference S24857-20121001
Issue Date 2017-MARCH-20

This is to certify that representative samples of the product as specified on this certificate were tested according to the current UL requirements.

UL Fire Alarm and Emergency Signaling Equipment:

Models S81-HS and S81-HS/C control units.

UL Fire Alarm and Emergency Signaling Subassembly:

Models

S81-F3002-1 2-wire initiating circuit module.

S81-F4001-1, S81-F4002-1 and S81-F4003-1 4-20mA initiating circuit modules.

S81-F5001-1, S81-F5004-1 releasing circuit modules.

S81-F5003-1 NAC module.

S81-F5002-1 relay control module.

S81-F6001-1 zone extinguishing module.

S81-F7001-1 and S81-F7012-1 loop control modules.

S81-F7006-1 Modbus protocol module (supplementary use only).

S81-F7011-1 Safety Bus control module.

S81-T8004-1 digital input with output module.

S81-T8007-2 relay module.

S81-T9001-1, S81-T9002-1, S81-T9003-1, S81-T9004-1 and S81-T9005-1 transient suppression modules.

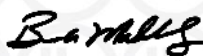

Bruce Mahrenholz, Director North American Certification Program

UL LLC

Any information and documentation involving UL Mark services are provided on behalf of UL LLC (UL) or any authorized licensee of UL. For questions, please contact a local UL Customer Service Representative at <http://ul.com/aboutul/locations/>



CERTIFICATE OF COMPLIANCE

Certificate Number 20170320-S24857
Report Reference S24857-20170317
Issue Date 2017-MARCH-20

Issued to: SCAME SISTEMI SRL
VIA LOMBARDIA 5
20010 ARLUNO MI ITALY

**This is to certify that
representative samples of**

CONTROL UNIT ACCESSORIES, SYSTEM
EMERGENCY ALARM SYSTEM ACCESSORIES
ACCESSORIES, RELEASING DEVICE
SEE ADDENDUM PAGE.

Have been investigated by UL in accordance with the
Standard(s) indicated on this Certificate.

Standard(s) for Safety: UL864, Control Units and Accessories for Fire Alarm
Systems
UL2017, General-Purpose Signaling Devices and Systems
Additional Information: See the UL Online Certifications Directory at
www.ul.com/database for additional information

Only those products bearing the UL Certification Mark should be considered as being covered by UL's
Certification and Follow-Up Service.

Look for the UL Certification Mark on the product.



Bruce Mahrenholz, Director North American Certification Program
UL LLC

Any information and documentation involving UL Mark services are provided on behalf of UL LLC (UL) or any authorized licensee of UL. For questions, please
contact a local UL Customer Service Representative at <http://ul.com/aboutul/locations/>



CERTIFICATE OF COMPLIANCE

Certificate Number 20170320-S24857
Report Reference S24857-20170317
Issue Date 2017-MARCH-20

This is to certify that representative samples of the product as specified on this certificate were tested according to the current UL requirements.

UL Fire Alarm and Emergency Signaling Equipment:

Model Safety Bus System.

UL Fire Alarm and Emergency Signaling Subassembly:

Safety Bus Modules, Model –

SB-AIM analog input module.

SB-ECM extinguishing control module.

SB-NCM notification appliance circuit control module.

SB-SCM solenoid control module.

SB-SIM supervised input module.

SB-SIM-GM supervised input module with ground fault detection.

Enclosures, Model - SB-ENCLT5-UL, SB-ENCLB5-UL.

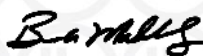

Bruce Mahrenholz, Director North American Certification Program

UL LLC

Any information and documentation involving UL Mark services are provided on behalf of UL LLC (UL) or any authorized licensee of UL. For questions, please contact a local UL Customer Service Representative at <http://ul.com/aboutul/locations/>



Certificate of Constancy of performance

0051 – CPR – 0423

In compliance with Regulation 305/2011/EU of the European Parliament and of the Council of 9 March 2011 (the Construction Products Regulation or CPR), this certificate applies to the construction product

CONTROL AND INDICATING EQUIPMENT WITH INTEGRATED POWER SUPPLY EQUIPMENT

Models: S81-HS/L; S81-HS/1R ; S81-HS/2R and S81-HS/1-10R

Trademark: SCAME SISTEMI

Further characteristics: see Annex

Feature

ELECTRICAL AUTOMATIC CONTROL AND DELAY DEVICE (optional)

Model: S81-F6001-1

Trademark: SCAME SISTEMI

and

ALARM TRANSMISSION AND FAULT WARNING ROUTING EQUIPMENT (optional)

Model: S81-U1002-2

Trademark: SCAME SISTEMI

Produced by:

SCAME SISTEMI S.r.l.

Via Lombardia, 5

20010 Arluno (MI)

In the manufacturing plant:

PI.I0000Y

This certificate attests that all provisions concerning the assessment and verification of constancy of performance and the performances described in Annex ZA of the standards

EN 54-2:1997 + A1:2006

EN 54-4:1997 + A1:2002 + A2:2006

EN 12094-1:2003

EN 54-21:2006

under system **1** are applied and that

the products fulfill all the prescribed requirements set out above.

This certificate cancels and replaces the certificate having the same number and issued on 2015-05-28 and will remain valid as long as the test methods and/or factory production control requirements included in the harmonized standard, used to assess the performance of the declared characteristics, do not change, and the product, and the manufacturing conditions in the plant are not modified significantly.

Milano, 2017-11-10

This certificate was issued by IMQ S.p.A., a notified body according to Regulation 305/2011/EU.
IMQ S.p.A. Identification Number is: 0051.

IMQ
CPR Technical Director
(Ing. V. Baggio)

ANNEX

0051 – CPR – 0423

This devices are Control and indicating equipment intended to be used in automatic detection system and fire alarm

Configuration of control and indicating equipment models S81-HS/L; S81-HS/1R; S81-HS/2R and S81-HS/1-10R

The control and indicating equipment consist of a metal enclosure:

- mod. **S81-HS/L**; (500 mm x 600 mm x 250 mm)
- mod. **S81-HS/1R** (700 mm x 600 mm x 400 mm)
- mod. **S81-HS/2R** (1100 mm x 600 mm x 400 mm)
- mod. **S81-HS/1-10R** (2100 mm x 800 mm x 800 mm)

with IP30 degree of protection, containing:

model **S81-HS/L**

- No. 1 Power supply trademark SCAME SISTEMI, type S81-PU001-2, composed of 2 switching power unit trademark SCAME SISTEMI, type PU-A0005-1;
- No. 1 Battery charger trademark SCAME SISTEMI, type PU-A0004-1;
- No. 2 Allocable batteries rated 12 V – 18 Ah;
- No. 1 Display board type S81-U1006-1;
- No. 1 Display board type S81-U1006-2, used in alternative;
- No. 1 Bus board type S81-E2003-1;
- No. 1 Terminals board type S81-E2004-1

model **S81-HS/1R**

- No. 1 Power supply trademark SCAME SISTEMI, type S81-PU001-1, composed of 1 switching power unit trademark SCAME SISTEMI, type PU-A0005-1;
- No. 1 Battery charger trademark SCAME SISTEMI, type PU-A0004-1;
- No. 2 Allocable batteries rated 12 V – 12 Ah or 12 V – 26 Ah;
- No. 1 Display board type S81-U1006-1;
- No. 1 Display board type S81-U1006-2, used in alternative;
- No. 1 Bus board type S81-E2003-1;
- No. 1 Cable connection board type S81-E2001-2;
- No. 1 Cable connection board type S81-E2001-3;

model **S81-HS/2R**

- No. 1 Power supply trademark SCAME SISTEMI, type S81-PU004-2 composed of 2 switching power unit trademark SCAME SISTEMI, type PU-A0010-1 (One of two switching power unit used as a redundant power unit);
- No. 1 Battery charger unit trademark SCAME SISTEMI, type PU-A0011-1;
- No. 2 Allocable batteries rated 12 V – 40 Ah;
- No. 1 Power supply trademark SCAME SISTEMI, type S81-PU001-2, used in alternative, composed of 2 switching power unit trademark SCAME SISTEMI, type PU-A0005-1;
- No. 1 Battery charger trademark SCAME SISTEMI, type PU-A0004-1, used in alternative;
- No. 2 Allocable batteries rated 12 V – 12 Ah or 12 V – 26 Ah;

- No. 1 Display board type S81-U1006-1;
- No. 1 Display board type S81-U1006-2, used in alternative;
- No. 1 Bus board type S81-E2003-1;
- No. 1 Cable connection board type S81-E2001-2;
- No. 1 Cable connection board type S81-E2001-3;

model S81-HS/1-10R

- No. 1 Power supply trademark SCAME SISTEMI, type S81-PU004-2 composed of 2 switching power unit trademark SCAME SISTEMI, type PU-A0010-1 (One of two switching power unit used as a redundant power unit);
- No. 1 Battery charger unit trademark SCAME SISTEMI, type PU-A0011-1;
- No. 2 Allocable batteries rated 12 V – 40 Ah;
- No. 1 Power supply trademark SCAME SISTEMI, type S81-PU004-3, used in alternative, composed of 3 switching power unit trademark SCAME SISTEMI, type PU-A0010-1 (One of three switching power unit used as a redundant power unit);
- No. 1 Battery charger unit trademark SCAME SISTEMI, type PU-A0011-1;
- No. 2 Allocable batteries rated 12 V – 64 Ah;
- No. 1 Power supply trademark SCAME SISTEMI, type S81-PU004-4, used in alternative, composed of 4 switching power unit trademark SCAME SISTEMI, type PU-A0010-1 (One of four switching power unit used as a redundant power unit);
- No. 1 Battery charger unit trademark SCAME SISTEMI, type PU-A0011-1;
- No. 2 Allocable batteries rated 12 V – 120 Ah;
- No. 1 Power supply trademark SCAME SISTEMI, type S81-PU004-4, used in alternative, composed of 4 switching power unit trademark SCAME SISTEMI, type PU-A0010-1 (Two of four switching power unit used as a redundant power unit);
- No. 1 Battery charger unit trademark SCAME SISTEMI, type PU-A0011-1;
- No. 2 Allocable batteries rated 12 V – 120 Ah;
- No. 1 Power supply trademark SCAME SISTEMI, type S81-PU001-4, used in alternative, composed of 4 switching power unit trademark SCAME SISTEMI, type PU-A0005-1;
- No. 1 Battery charger trademark SCAME SISTEMI, type PU-A0004-1, used in alternative;
- No. 2 Allocable batteries rated 12 V – 26 Ah or 12 V – 65 Ah;
- No. 1 Power supply trademark SCAME SISTEMI, type S81-PU002-2, used in alternative, composed of 2 switching power unit trademark SCAME SISTEMI type PU-A0008-1 (One of two switching power unit used as a redundant power unit);
- No. 1 Battery charger trademark SCAME SISTEMI, type PU-A0009-1, used in alternative;
- No. 2 Allocable batteries rated 12 V – 120 Ah;
- No. 1 Power supply trademark SCAME SISTEMI, type S81-PU002-4, used in alternative, composed of 4 switching power unit trademark SCAME SISTEMI type PU-A0008-1 (Two of four switching power unit used as a redundant power unit);
- No. 1 Battery charger trademark SCAME SISTEMI, type PU-A0009-1, used in alternative;
- No. 2 Allocable batteries rated 12 V – 120 Ah;
- No. 1 Display board type S81-U1006-1;
- No. 1 Display board type S81-U1006-2, used in alternative;
- No. 1 Bus board type S81-E2003-1;
- No. 1 Cable connection board type S81-E2001-2;
- No. 1 Cable connection board type S81-E2001-3;

and fully configurable by following parts (models **S81-HS/L**; **S81-HS/1R**; **S81-HS/2R** and **S81-HS/1-10R**):

- CPU board type S81-U1002-1, mandatory;
- CPU board type S81-U1002-1, mandatory if more than 512 detectors or manual call points are used;
- CPU board type S81-U1002-2, used in alternative. It manage alarm transmission and fault warning routing equipment;
- I/O board type S81-T8004-1, mandatory;
- Relay board type S81-T8007-2, mandatory;
- Control rack board type S81-E2002-1, mandatory;
- Input board type S81-F3002-1, mandatory if loop boards type S81-F7002-1, S81-F7009-1 and S81-7010-1 are not used;
- Input board type S81-F3002-2;
- Input board type S81-F4001-1;
- Input board type S81-F4001-2;
- Input board type S81-F4002-1;
- Input board type S81-F4002-2;
- Input board type S81-F4003-1;
- Input board type S81-F4003-2;
- Solenoid command board type S81-F5001-1;
- Solenoid command board type S81-F5001-2;
- Solenoid command board type S81-F5004-1;
- Solenoid command board type S81-F5004-2;
- Warning device command board type S81-F5003-1, mandatory;
- Output board type S81-F5002-1;
- Extinction command board type S81-F6001-1, up to a maximum of:
 - 2 for the model S81-HS/L,
 - 6 for the model S81-HS/1R,
 - 12 for the model S81-HS/2R,
 - 64 for the model S81-HS/1-101R;
- Loop board type S81-F7002-1, mandatory if input board type S81-F3002-X and loop boards type S81- F7009-1 and S81-F7010-1 are not used;
- Loop board type S81-F7009-1, mandatory if input board type S81-F3002-X and loop boards type S81-F7002-1 and S81-F7010-1 are not used;
- Loop board type S81-F7010-1, mandatory if input board type S81-F3002-X and loop boards type S81-F7002-1 and S81-F7009-1 are not used;
- Loop Safety Bus board type S81-F7011-1;
- Master-Slave board type S81-7006-1;
- Logic board type S81-F6002-1;
- Control board type S81-F7007-1, used to manage the display module type S81-Mod-Disp;
- Balances's control board type S81-F7008-1 (carried out environmental tests, vibration test and EMC tests, only);
- Terminals board type S81-T8006-1;
- Terminals board type S81-T8008-1;
- Terminals board type S81-T9001-1;
- Terminals board type S81-T9002-1;
- Terminals board type S81-T9003-1;

- Terminals board type S81-T9004-1;
- Terminals board type S81-T9005-1;
- Supplementary acoustic local sounder trademark FULLEON LIMITED type FLASHNI FL (*), optional.

NOTE: device marked with (*) is not available for model S81-HS/L

The Control and Indicating Equipment models **S81-HS/L**; **S81-HS/1R**; **S81-HS/2R** and **S81-HS/1-10R** are also provided of the following external devices, optional:

- Remote display module type S81-Mod-Disp, up to 64 maximum;
- Remote Display type S81-RD001-1, up to 10 maximum;
- Remote Display type S81-RD001-2, up to 10 maximum;
- Remote Display type S81-RD001-3, up to 10 maximum, with integrated switching power unit type PU-A0003-1 and 2 allocable batteries rated 12 V – 7.2 Ah;
- Remote Display type S81-RD002-1, up to 10 maximum;
- Remote Display type S81-RD002-2, up to 10 maximum;
- Remote Display type S81-RD002-3, up to 10 maximum, with integrated switching power unit type PU-A0003-1 and 2 allocable batteries rated 12 V – 7.2 Ah;
- Remote input/output device type S81-LEU composed by:
 - Input/output module type SB-ECM;
 - Input module type SB-SIM-GM.

Technical Characteristics

- Number of zone: 1 ÷ 300 (32 detectors and/or manuals call points for each zone)
- Hardware identification of CPU board type S81-U1002-1 and S81-U1002-2: RENESAS, HD64F2318VTE25;
- Firmware identification of CPU board type S81-U1002-1: V2.4.2;
- Firmware identification of CPU board type S81-U1002-2: V3.0.0;
- Hardware identification of extinction command board type S81-F6001-1: TEXAS INSTRUMENT, MSP430F147;
- Firmware identification of extinction command board type S81-F6001-1: V4R4-SP1.

List of optional functions with requirements (EN 54-2)

- 7.8 Output to fire alarm device
- 7.11 Delay to outputs
- 7.12 Co-occurrence detection – Type C
- 8.3 Fault signals from points
- 9.5 Disablement of addressable points
- 10 Test condition

List of optional functions with requirements (EN 12094-1)

- 4.17 Delay of extinguishing signal
- 4.18 Signal representing the flow of extinguishing agent
- 4.20 Emergency hold device
- 4.22 Initiation of secondary flooding
- 4.23 Manual only mode
- 4.24 Triggering signals to equipment within the system
- 4.25 Extinguishing signals to spare cylinders
- 4.26 Triggering of equipment outside the system
- 4.27 Emergency abort device
- 4.30 Activation of alarm devices with different signals

Certificate of Constancy of performance

0051 – CPR – 0449

In compliance with Regulation 305/2011/EU of the European Parliament and of the Council of 9 March 2011 (the Construction Products Regulation or CPR), this certificate applies to the construction product

Input/output device with integrated short-circuit isolator

Model: **SB-SIM ; SB-SIM-GM ; SB-AIM ; SB-ECM ; SB-NCM ; SB-SCM**

Trademark: **SCAME Sistemi**

Other information:
Software version: 1.0

Produced by:

SCAME Sistemi S.r.l.
Via Lombardia 5 – 20010 Arluno (MI)

In the manufacturing plant(s):

PI.I0000Y

This certificate attests that all provisions concerning the assessment and verification of constancy of performance and the performances described in Annex ZA of the standard(s)

EN 54-18:2005
EN 54-17:2005

under system **1** are applied and that

the products fulfill all the prescribed requirements set out above.

This certificate was first issued on 2015-11-06 and will remain valid as long as the test methods and/or factory production control requirements included in the harmonized standard, used to assess the performance of the declared characteristics, do not change, and the product, and the manufacturing conditions in the plant are not modified significantly

IMQ S.p.A.
CPR Technical Director
(Eng. V. Baggio)

Milano, 2015-11-06

This certificate was issued by IMQ S.p.A., a notified body according to Regulation 305/2011/EU.
IMQ S.p.A. Identification Number is: 0051.

Mod. 727CPR-ENG/0

For more information

www.scomesistemi.it

Honeywell Industrial Fire

Via Lombardia 5
20010 Arluno (Milan) Italy
Tel: +39 02 90.379.410
www.honeywell.com

CP | 8 | 04/19
© 2019 Honeywell International Inc.

Honeywell