

**Carrera**<sup>®</sup>



2012



# MOTOR

MOTO

AUTOMOBILI

MOTORIURHEILUA

MOTORSPORT

DEPORTE DEL MOTOR

SPORT MOTOROWY



ORIZADO

MOTOSPORT

# SPORTS

AUTOMOBILISMO

MOTOSPORT



**Carrera**<sup>®</sup>

SPORT AUTOMOBILE



*PARA CASA*

*KOTONA*



*FÜR ZUHAUSE*

**AT HO**

*PÅ HEMMAPLAN  
FOR HJEMMET*

*DO UPRAWIAN*

*VOOR*

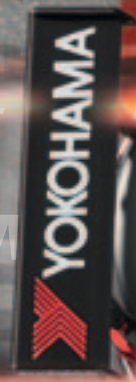

*TIL DERHJEMME*

*NA DOMA*

*ZA DOMA*

**TRA LE PARETI DI CASA**



# ME

THUIS DESPORTO

CHEZ SOI



### ***Carrera – Made for champions!***

*Carrera is all about emotion, passion and is all action with exciting overtaking moves and gripping duels between fathers, sons and grandfathers - for the love of high speed! Carrera is once again in pole position in 2012. Carrera's Red Bull and Ferrari models are further exclusively licensed world champion reproductions in the company's Formula 1 stable.*

*Carrera imports the big screen heroes of the blockbusting movies Disney/Pixar Cars and Spider-Man onto racing tracks and the numerous action features guarantee exciting challenges. The best thing is: Carrera provides wireless freedom around the circuit with the latest 2.4 GHz WIRELESS+ digital radio controlled technology.*

*So with such a great level of equipment fans can look forward to their domestic season in 2012 – and to the 50th year of Carrera in 2013.*

### ***Carrera – Motorsports at home.***

## **Contents**

<b>Carrera</b> <b>DIGITAL 124</b>	10
<b>Carrera</b> <b>TUNING</b>	16
<b>Carrera</b> <b>DIGITAL 132</b>	26
<b>Carrera</b> <b>EVOLUTION</b>	60
<b>Carrera</b> <b>ACCESSORIES</b> <small>Scale 124/132</small>	86
<b>Carrera</b> <b>WIRELESS+))</b>	88
<b>Carrera</b> <b>GO!!!</b>	96
<b>Carrera</b> <b>ACCESSORIES</b> <small>Scale 143</small>	120
<b>Carrera</b> <b>DIGITAL 143</b>	124
<b>Carrera</b> <b>ONLINE</b>	136
<b>Carrera</b> <b>EVENTS · POS</b>	137
<b>Carrera</b> <b>LICENSES</b>	142

**Carrera®**  
DIGITAL 124



**SCALE**  
**1:24**

**Carrera®**  
DIGITAL 132



**SCALE**  
**1:32**

**Carrera**<sup>®</sup>  
EVOLUTION

**Carrera**<sup>®</sup>  
GO!!!

**Carrera**<sup>®</sup>  
DIGITAL 143



SCALE  
1:32





SCALE  
1:43



SCALE  
1:43

### **CARS IN ACTUAL SIZE**

- Carrera high-quality original and detailed printed cars
- Attractive car licences and racing themes
- Digital cars: individually codable and digitally controlled
- Carrera DIGITAL 124: worldwide unique 1:24 scale cars
- Carrera DIGITAL 124/132:  cars with front light (xenon) and rear/brake light\*
- Carrera Evolution:  cars digital upgrade ready\*
- Carrera GO!!!: cars with LED head lights, Ground Light Effect and flashing lights\*

# Carrera® DIGITAL 124

## THE ULTIMATE IN RACING



**CARRERA DIGITAL 124**  
**RACE UP TO 4 DRIVERS**

- Digital racetrack system for teens, adults and hobbyists from 10 years and up
- Pass and change lanes at FULL SPEED with up to 4 cars at the push of a button
- BIG SIZE - tracks and cars scale 1:24
- Cars with front light (xenon) and rear/brake light\*
- Cars compatible with Carrera Exclusiv series
- Unlimited extension possibilities with track material scale 1:24 and further digital accessories

# Carrera® DIGITAL 132

## PASSING ACTION ON MEGA TRACKS

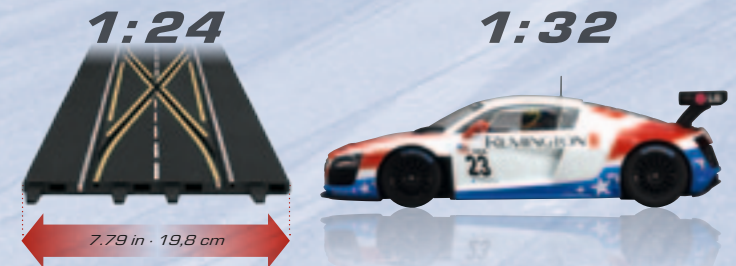

**CARRERA DIGITAL 132**  
**RACE UP TO 6 DRIVERS**

- Digital racetrack system for teens, adults and hobbyists from 8 years and up
- Pass and change lanes at FULL SPEED with up to 6 cars at the push of a button
- Worldwide unique racetrack system combining tracks to race 1:24 and 1:32 scale cars
- Cars with front light (xenon) and rear/brake light\*
- Cars compatible with Carrera Evolution series
- Unlimited extension possibilities with track material scale 1:24 and further digital accessories



# Carrera® EVOLUTION

## RACING ON MEGA TRACKS

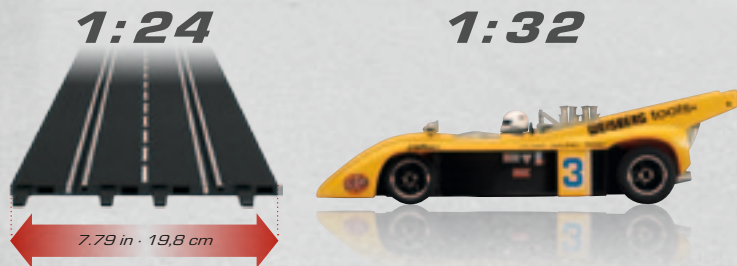

- Analogue racetrack system for teens, adults and hobbyists from 8 years and up
- Unique racetrack system combining tracks to race 1:24 and 1:32 scale cars
- Cars ready for digital upgrade\*
- Track can be expanded from 4-, 6- up to 8-lanes
- Unlimited extension possibilities with track material scale 1:24

# Carrera® GO!!!

## FEEL THE TURBO SPEED



- Analogue racetrack system for kids from 8 years and up
- Through the loop at TURBO SPEED at the push of a button
- Starter system to the Carrera world of racing, scale 1:43
- All basic sets include Turbo Power controllers
- Numerous action features for enhanced racing
- Attractive car licences and racing themes

# Carrera® DIGITAL 143

## THRILLING PASSING ACTION



### CARRERA DIGITAL 143 RACE UP TO 3 DRIVERS

- Digital racetrack system for kids from 8 years and up
- Pass and change lanes at FULL SPEED with up to 3 cars at the push of a button
- Starter system to the Carrera digital world of racing, scale 1:43
- Digital lane change sections in special colour red
- Compatible with Carrera GO!!! action features and accessories



**1:24** **1:24**

- For teens, adults and hobbyists from 10 years and up
- Digital racetrack system allows changing the lane and passing with up to 4 cars
- BIG SIZE - Tracks and cars scale 1:24
- Cars with front light (xenon) and rear/brake light\*
- Cars compatible with Carrera Exclusiv series
- Unlimited extension possibilities with track material scale 1:24 and further digital accessories

**CARRERA DIGITAL 124**

**THE ULTIMATE IN RACING**

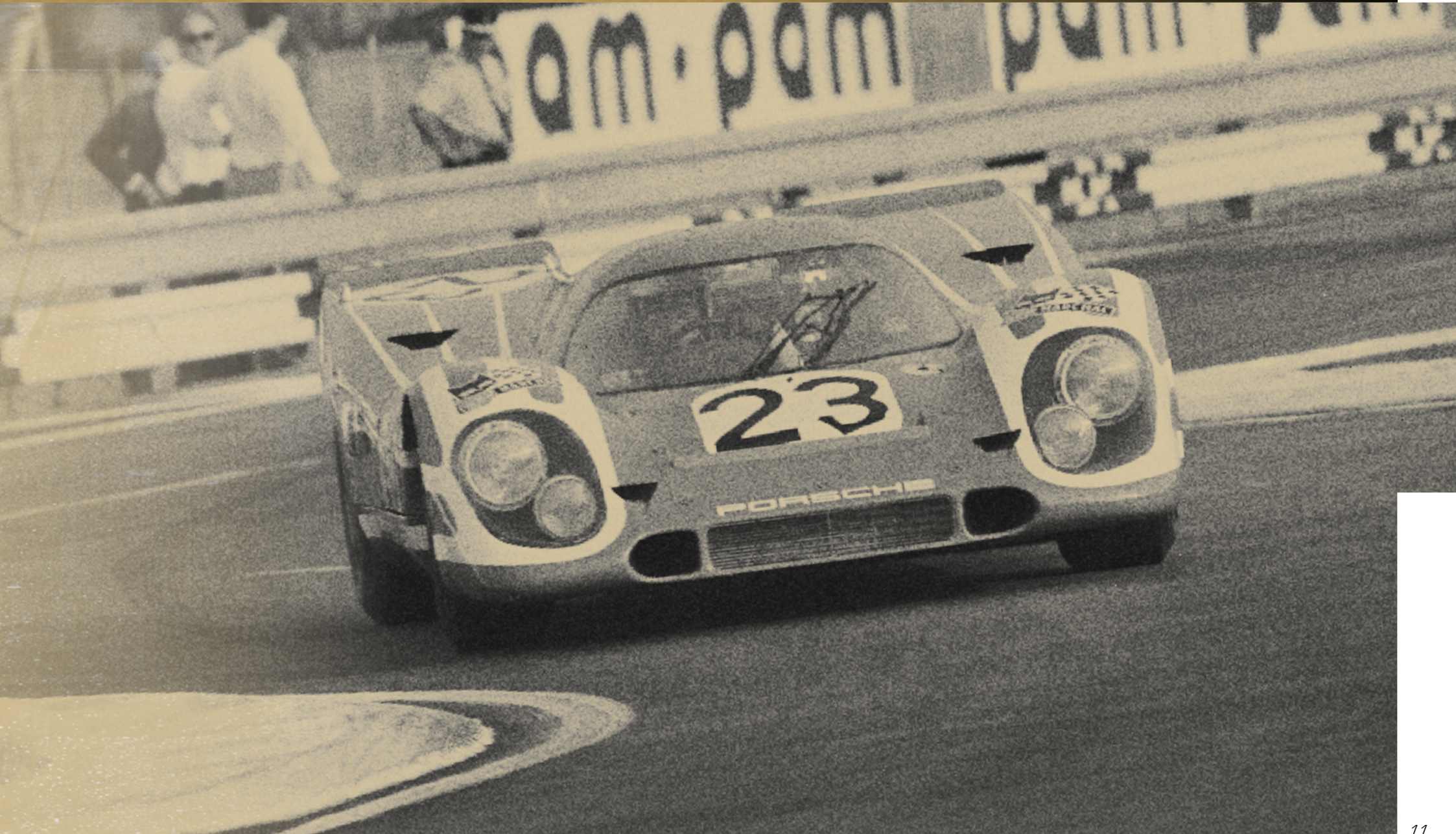

# Carrera® DIGITAL 124

Including Control Unit and  
**Carrera®**  
**WIRELESS+™**  
 For more info - go to:  
[carrera-toys.com/wirelessplus-us](http://carrera-toys.com/wirelessplus-us)



© Bob Heathcote



8.37 x 10.14 ft. 30.51 ft.  
 255 x 309 cm 9,3 m

**NEW**

**CLASSIC SPEED**

Item no. 23609 · L · T  
 Ford GT40 Mk. II "No.2", 1966 · Porsche 917K,  
 J. W. Automotive Engineering "No.2", Daytona 24h 1971



✱ ✱



© Mauro Balaguer

✱ ✱

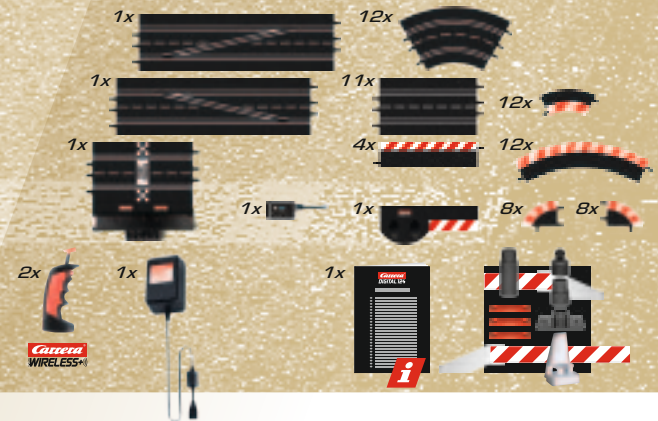

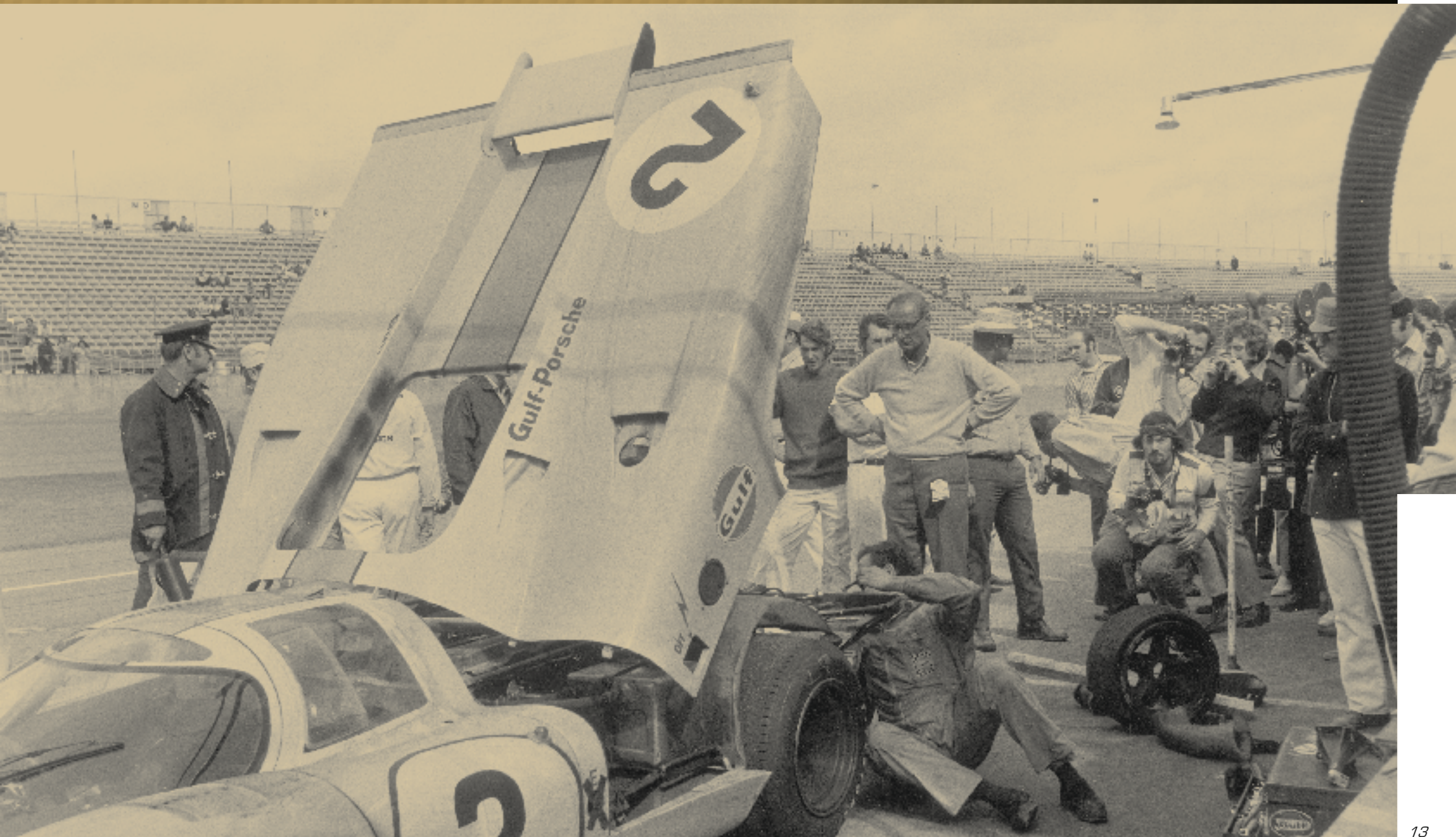

# Carrera® DIGITAL 124

Including Control Unit and  
**Carrera®**  
**WIRELESS+™**  
 For more info - go to:  
[carrera-toys.com/wirelessplus-us](http://carrera-toys.com/wirelessplus-us)



© Darren Pierson



11.75 x 6.20 ft. 26.25 ft.  
 358 x 189 cm 8,0 m

## NEW

**ULTIMATE RACE**  
 Item no. 23610 · B · T  
 Porsche GT3 RSR Team Falken · Audi R8 LMS,  
 Audi Sport Team WRT 24h Spa 2011 "No.33"

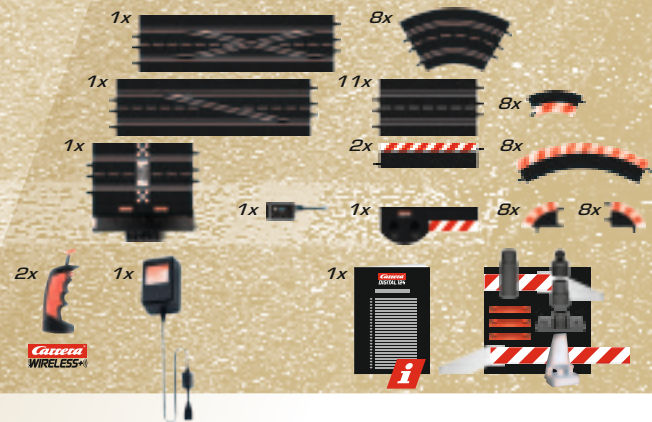

© Lucien Harmegnies





## **CARS WITH INNOVATIVE VEHICLE TECHNOLOGY**

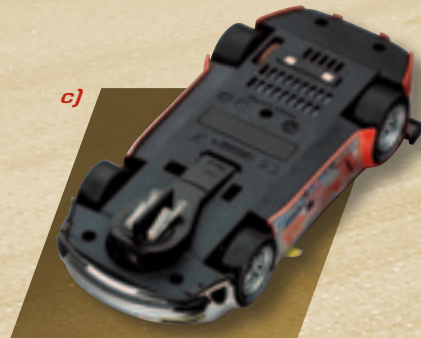
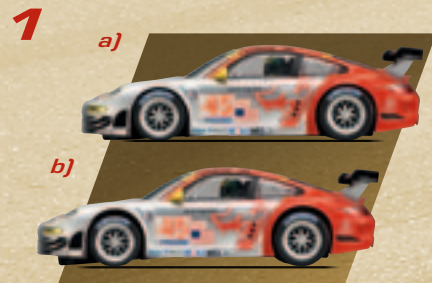

### **1. ADJUSTABLE CAR CHASSIS HEIGHT** (model dependent)

- a) Enlarges the car's distance between the track and the body's front (improves passing high banked curves and crossings).
- b) Standard setting of chassis – for flat track layouts
- c) Automatic track adaptation of the swing arm via swing arm spring.

### **2. REMOVABLE, REPLACEABLE ENGINE TRANSMISSION BLOCK**

Various gear ratios and tyres to alter the top speed, acceleration and braking performance of the cars (model dependent).



**For more information about gear combinations, engines and tyres please refer to:**  
[carrera-toys.com/tuning-us](http://carrera-toys.com/tuning-us)



**NEW**



23774 · B ·   
Audi R8 LMS, Team Phoenix  
24h Nürburgring 2009, "No.98"

**NEW**



23775 · B ·   
Audi Sport Team WRT 24h Spa 2011 "No.33"



23763 · e  
Aston Martin DBR9  
Jetalliance 2008, "No.33"



23747 · e  
Aston Martin DBR9 Aston  
Martin Racing "No.009", 2007



© motorsport.com · Eric Gilbert

23770 · T ·   
Porsche GT3 RSR,  
BMS Scuderia Italia "No.97", 2010

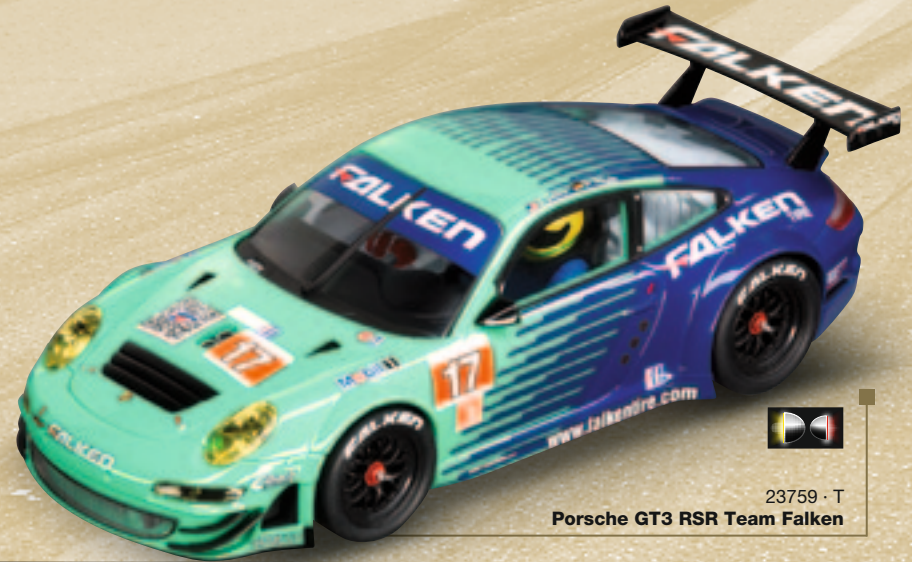

23759 · T  
Porsche GT3 RSR Team Falken

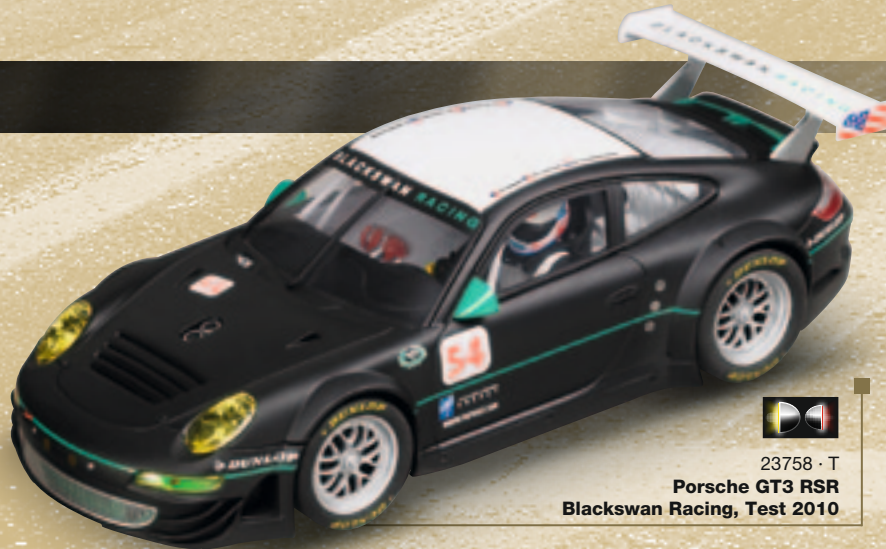

23758 · T  
Porsche GT3 RSR  
Blackswan Racing, Test 2010



23743 · T  
Porsche 997 GT3 RSR Team  
Felbermayr Proton "No.77", 2010

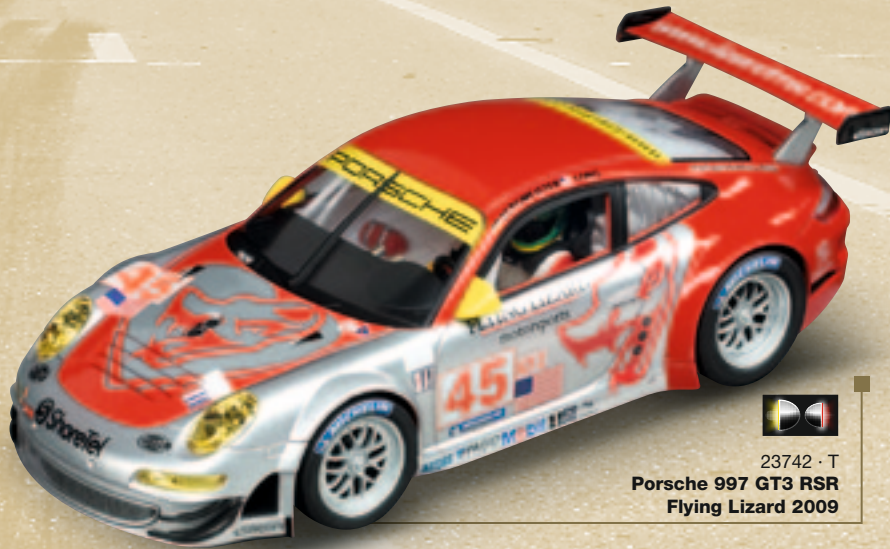

  
23742 · T  
Porsche 997 GT3 RSR  
Flying Lizard 2009



  
23772 · Q ·   
Ferrari 599XX, Ferrari Racing Days "No.88"



  
23757 · Q  
Ferrari 599XX "Homestead 2010"



  
23756 · Q  
Ferrari 599XX  
"As seen at Geneva Motorshow 2009"

**NEW**



23769 · L ·  Preliminary model - Colors/final design subject to change  
**Ford GT40 Mk. II "No.2", 1966**



23762 · L  
**Ford GT40 Mk. II "No.5", 1966**



23746 · L  
**Ford GT40 Mk. II "No.2", 1966**

*More at  
[carrera-toys.com/us/](http://carrera-toys.com/us/)*



23764 - Q  
**Ferrari 250 GTO Second of the GTOs**



© Philippe Hubbert



23715 - Q  
**Ferrari 250 GTO '62 Präsentation**



23761  
Bill Thomas Cheetah



23760  
Bill Thomas Cheetah "No.46",  
Augusta 1964



23744  
Bill Thomas Cheetah  
Vintage GT Challenge



23749 · O  
Maserati 4CL 1500 "No.38",  
Tripoli 1939



23751 · m  
Mercedes-Benz W125 "No.35",  
AVUS 1937



23750 · B  
Auto Union Typ C "No.33", AVUS 1937



**NEW**



23771 · Q ·   
250 GT Berlinetta passo corto  
"Breadvan" 1962, Testcar, Monaco



23755 · Q  
Ferrari 250 GT Berlinetta passo corto  
"Breadvan" 1962 Coppa Gallenga 1965, "No.482"



23754 · Q  
Ferrari 250 GT Berlinetta passo corto  
"Breadvan" 1962 Contemporary Version





© Dave Dyer



23776 · T · Ⓢ

**Porsche 917K, Porsche Salzburg "No.23", 1970**



© Mauro Balaguer



23777 · T · s · Ⓢ

**Porsche 917K, J. W. Automotive  
Engineering "No.2", Daytona 24h 1971**

LIMITED  
EDITION  
2012

*Limited to 999 pieces  
worldwide!*

*For more information on  
LIMITED EDITIONS please visit:  
[carrera-toys.com/limited-us](http://carrera-toys.com/limited-us)*



**1:32** **1:24**

- For teens, adults and hobbyists from 8 years and up
- Digital racetrack system allows changing the lane and passing with up to 6 cars
- Worldwide unique racetrack system combining tracks to race 1:24 and 1:32 scale cars
- Cars with front light (xenon) and rear/brake light\*
- Cars compatible with Carrera Evolution series
- Unlimited extension possibilities with track material scale 1:24 and further digital accessories

**CARRERA DIGITAL 132**  
**PASSING ON MEGA TRACKS**

\* model-specific - Subject to technical and design-related changes. Errors excepted.



# Carrera® DIGITAL 132



© Action Sports Photography



10.17 x 13.12 ft. 32.28 ft.  
310 x 400 cm 9.84 m



### NASCAR DAYTONA 500

Item no. 30153 · C · H · M · c  
NASCAR Chevrolet® Impala Stewart Haas Racing "No.14", 2011 · NASCAR Chevrolet® Impala Stewart Haas Racing "No.39", 2011

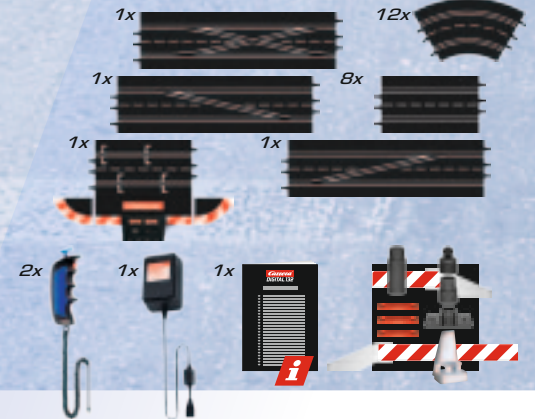



# Carrera® DIGITAL 132

Including Control Unit and

**Carrera®**  
WIRELESS+™

For more info - go to:  
[carrera-toys.com/wireless-plus-us](http://carrera-toys.com/wireless-plus-us)



© Disney/Pixar

10.53 x 4.56 ft. 26.25 ft.  
321 x 139 cm 8,0 m

**NEW**

Disney/Pixar Cars  
"PORTO CORSA CUP"  
Item no. 30159 - w  
Disney/Pixar Cars "Max Schnell"  
"Lightning McQueen" - "Francesco Bernoulli"

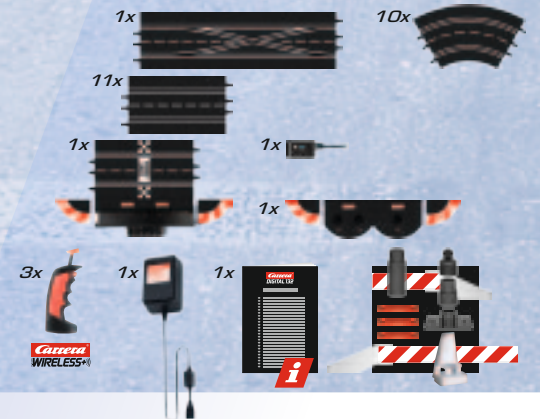



**Carrera**<sup>®</sup>  
**DIGITAL 132**



# Carrera® DIGITAL 132



© motorsportpressebild.de



10.53 x 3.58 ft. 22.64 ft.  
321 x 109 cm 6,9 m

**NEW**

**WORLDWIDE  
EXCLUSIVE LICENCE  
FOR SLOT RACING**



© motorsportpressebild.de

**WORLDWIDE  
EXCLUSIVE LICENCE  
FOR SLOT RACING**



**WORLD F1 CHAMPS**

Item no. 30157 · E · P · Q  
Red Bull RB7 "Sebastian Vettel, No.1"  
Ferrari 150° Italia "Fernando Alonso, No.5"  
Vodafone McLaren Mercedes Race Car 2011

- 1x [Image of a long track section]
- 10x [Image of a curved track section]
- 1x [Image of a track section with a pit lane]
- 6x [Image of a track section with a pit lane]
- 1x [Image of a track section with a pit lane]
- 3x [Image of a power plug]
- 1x [Image of a power plug]
- 1x [Image of a power plug]
- [Image of a slot car chassis]
- [Image of a slot car chassis]





© motorsportpressebild.de



10.53 x 3.58 ft. 22.64 ft.  
321 x 109 cm 6.9 m

**NEW**

**WORLDWIDE  
EXCLUSIVE LICENCE  
FOR SLOT RACING**



© motorsportpressebild.de

**WORLDWIDE  
EXCLUSIVE LICENCE  
FOR SLOT RACING**



**FORMULA ONE DUEL**

Item no. 30162 · E · Q  
Red Bull RB7 "Sebastian Vettel, No.1"  
Ferrari 150° Italia "Fernando Alonso, No.5"

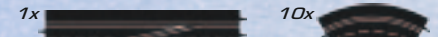

⊕ Preliminary packaging · ⊕ ⊕ Preliminary model - Colors/final design subject to change

# Carrera® DIGITAL 132



© Bob Heathcote



7.97 x 3.58 ft. 17.72 ft.  
243 x 109 cm 5,4 m

**NEW**

### RACING PREDATORS

Item no. 30156 - b  
Shelby Cobra 289 '63, Sebring 12h "No.16"  
Bill Thomas Cheetah, Daytona 24h 1964, "No.14"

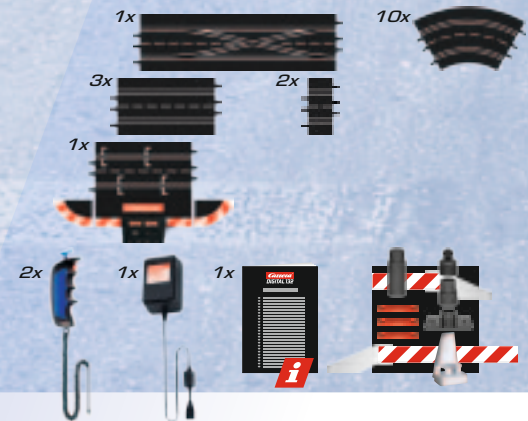

© Eric Gilbert - motorsport.com





11.48 x 5.87 ft. 29.53 ft.  
350 x 179 cm 9.0 m

© bpk - Arthur Grimm



**STREAMLINE**  
Item no. 30151 · B · m  
Auto Union Typ C Stromlinie AVUS 1937  
Mercedes W125 Stromlinie AVUS 1937



Preliminary packaging

# Carrera® DIGITAL 132

Including Control Unit and

**Carrera®**  
WIRELESS+™

For more info - go to:  
[carrera-toys.com/wirelessplus-us](http://carrera-toys.com/wirelessplus-us)



© Langer



11.48 x 5.87 ft. 29.53 ft.  
350 x 179 cm 9,0 m

**NEW**

### LONG RACE

Item no. 30160 · G · m  
Mercedes-Benz SLS AMG GT3 Horn Motorsport "No.32", VLN 2011 · Ferrari 458 Italia GT2 Hankook Team Farnbacher "No.123", 2011

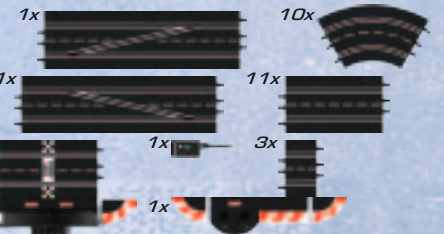

WORLDWIDE  
EXCLUSIVE LICENCE  
FOR SLOT RACING



© mw-sportfoto.de

©



© smp-motorsport-fotos



9.22 x 5.54 ft. 22.64 ft.  
281 x 169 cm 6.9 m

**WORLDWIDE  
EXCLUSIVE LICENCE  
FOR SLOT RACING**



**NEW**

**GT POWER**

Item no. 30161 · Q · m  
Ferrari 458 Italia GT2 Risi Competizione  
"No.062", 2011 · Mercedes-Benz SLS AMG  
GT3, Team Black Falcon, VLN 2011, "No.2"





30590 · H · M · c  
NASCAR Chevrolet® Impala  
Stewart Haas Racing "No.39", 2011



30589 · C · M · c  
NASCAR Chevrolet® Impala  
Stewart Haas Racing "No.14", 2011



30619 · B · c  
Audi R18 "No.1", Spa 1000km



**NEW**



30613 · w ·   
Disney/Pixar Cars "Max Schnell"



© Disney/Pixar



30556 · w  
Disney/Pixar Cars  
"Francesco Bernoulli"



30555 · w  
Disney/Pixar Cars  
"Lightning McQueen"

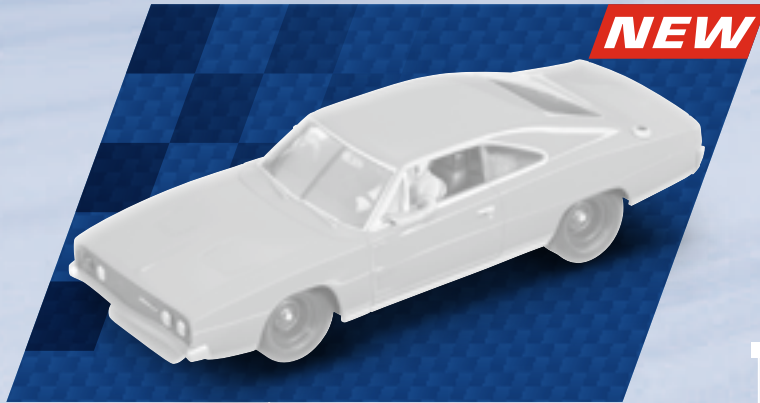

30604 · I ·   
**Dodge Charger 500 "No.22", 1969**



30528 · I  
**Dodge Charger Daytona  
Last Aero Warrior '71, "No.22"**



  
30527 · I · h  
**Dodge Charger SRT8 Petty Promo Car**



30585 · I  
**Dodge Charger Daytona "No.55", 1970**





30586 · S  
Plymouth Superbird "No.02", Riverside '70



30605 · S ·   
Plymouth Superbird "No.8", 1971



30526 · S · h  
Plymouth Superbird "No.40",  
Petty Racing '70



30525 · S · h  
Plymouth Fury '60 "No.43" Richard Petty



*End pipes  
with light  
effect!*

30587 · P  
McLaren M20 "No.3" Interserie, '74



*End pipes  
with light  
effect!*

30573 · P  
McLaren M20 "No.8", '74

*More at  
[carrera-toys.com/us/](http://carrera-toys.com/us/)*

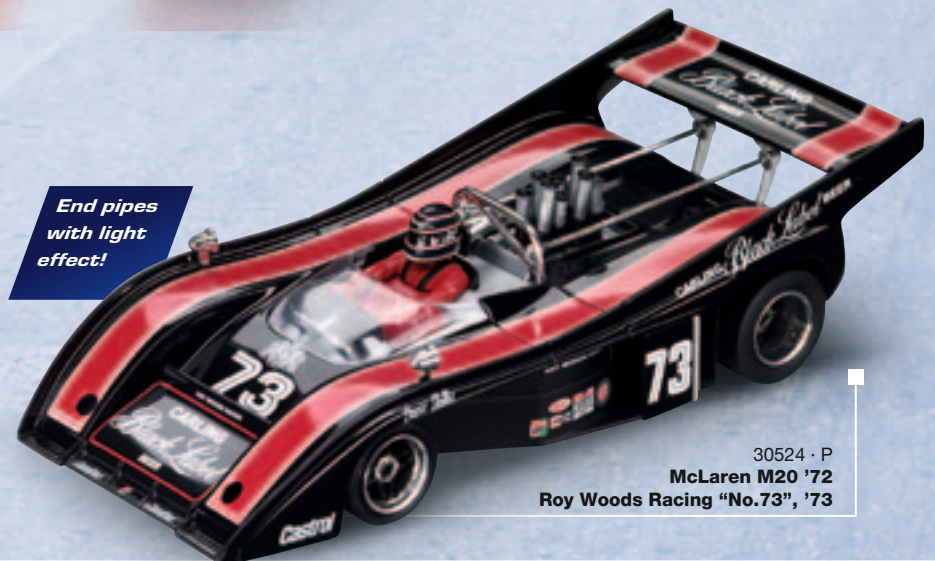

*End pipes  
with light  
effect!*

30524 · P  
McLaren M20 '72  
Roy Woods Racing "No.73", '73



End pipes  
with light  
effect!

30572 · T  
Porsche 917/30 "No.48"



End pipes  
with light  
effect!

30521 · T  
Porsche 917/30 Sunoco  
Porsche Audi "No.6", '73



30550 · p  
Lola T222 "No.51", Laguna Seca '71



30549 · p  
Lola T222 Orwell  
SuperSports Cup, "No.4"



30579 · T  
Porsche 935/78 Joest  
Racing "No.66", DRM Nürburgring '81



30578 · T  
Porsche 935/78 PPG  
Industries "No.09", Riverside '83



30577 · Q  
Ferrari 512 BB LM  
Bellancauto "No.79", 1980



30576 · Q  
Ferrari 512 BB LM  
NART "No.68", Daytona '79



**NEW**



30610 · G ·   
BMW 2002 Touringcar '75, "No.48"



30548 · G  
BMW 2002 "Tuner"



30547 · G  
BMW 2002 "Team Warsteiner", '76



30574 · L  
Ford Capri RS Group 2, 1975



30624 · J · ✖  
**Alfa Romeo GTA Silhouette Race 1**

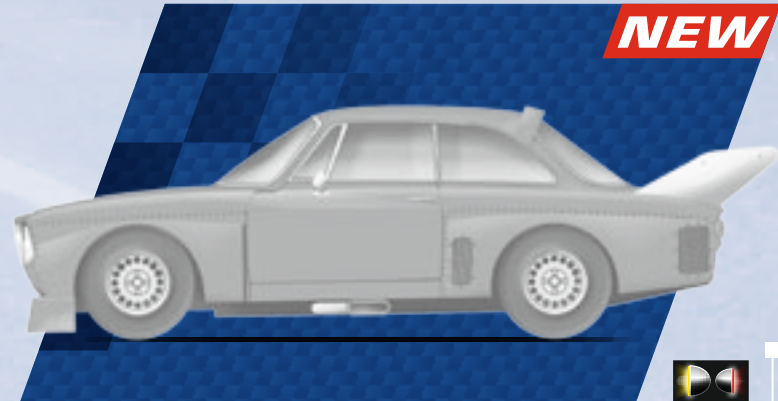

30625 · J · ✖  
**Alfa Romeo GTA Silhouette Race 2**



30615 · G · ✖  
**MINI Countryman WRC "tbd"**



30617 · A · ✖  
**Citroën DS3 WRC "Van Merksteijn, No.20"**



**NEW**

Basisphoto: © Aaron Gee



30620 · b ·

**Shelby Cobra 289 Hardtop Coupe '63, "No.4"**



**NEW**

© Eric Gilbert · motorsport.com



30621 · b ·

**Shelby Cobra 289 '63, Sebring 12h "No.16"**



**NEW**

© Greg Leong



30622 ·

**Bill Thomas Cheetah, Yeakel Racing "No.8"**



**NEW**



30623 ·

**Bill Thomas Cheetah,  
Daytona 24h 1964, "No.14"**







© motorsportpressebild.de

30628 · E ·   
Red Bull RB7 "Sebastian Vettel, No.1"

**NEW**



30626 · Q ·   
Ferrari 150° Italia "Fernando Alonso, No.5"

**NEW**



30599 · P ·   
Vodafone McLaren  
Mercedes Race Car 2011, "No.3"

*With  
flashing  
lights!*



  
30592 · m  
Mercedes SLS AMG "F1™ Safety Car"



30562 · m  
AMG-Mercedes C-DMT 2007 Laureus  
AMG Mercedes 2010 "R.Schumacher"



30561 · m  
AMG-Mercedes C-DMT 2007 Deutsche Post  
AMG Mercedes 2010 "D.Coulthard"



30560 · B  
Audi A4 DTM Audi Sport  
Team Phoenix, "A.Prémat"



30559 · B  
Audi A4 DTM Audi Sport  
Team Abt, "O.Jarvis"



© Rainier Ehrhardt



30606 · Q ·   
**Ferrari 458 Italia GT2 JMW  
 Motorsports "No.66", 2011**



© Hugo Boletto · flickr.com



30607 · Q ·   
**Ferrari 458 Italia GT2 "No.3" GT Open 2011**



30554 · Q  
**Ferrari 458 Italia GT2 Hankook  
 Team Farnbacher "No.123", 2011**



30553 · Q  
**Ferrari 458 Italia GT2 Risi  
 Competizione "No.062", 2011**



© Eric Gilbert - motorsport.com



30609 · T ·   
Porsche GT3 RSR Manthey Racing,  
24h Nürburgring 2011, "No.18"



30567 · m  
Mercedes-Benz SLR McLaren 722 GT  
CBR/TRG Motorsports "No.71" 2009 - USA



30512 · G  
BMW M3 GT2 Rahal  
Letterman Racing "No.92"



30502 · m  
AMG-Mercedes C-Klasse  
DTM 2007 Salzgitter 2008 "J.Green"



30601 · B ·   
Audi R8 LMS Prosperia Team Brinkmann UHC  
Speed ADAC GT Masters, "No.39", 2011



30602 · B ·   
Audi R8 LMS Audi Sport Italia "No.32", 2011



30570 · B ·   
Audi R8 GT LMS Phoenix-Racing,  
ADAC GT Masters 2009, "No.14"



30569 · B ·   
Audi R8 GT LMS  
United Autosports, "No.23"



30611 · m ·   
Mercedes-Benz SLS AMG GT3  
Blackfalcon "No.35" 24h Spa 2011



30612 · m ·   
Mercedes-Benz SLS AMG GT3  
Horn Motorsport "No.32", VLN 2011



30552 · m  
Mercedes-Benz SLS AMG GT3,  
HEICO Motorsport, ADAC GT Masters 2011



30551 · m  
Mercedes-Benz SLS AMG GT3,  
Team Black Falcon, VLN 2011, "No.2"

**NEW**



30608 · Q ·   
Ferrari 599XX Ferrari Racing Days "No.4"



30564 · Q  
Ferrari 599XX  
Paul Ricard 2010, "No.20"



30563 · Q  
Ferrari 599XX  
Nürburgring 2010, "No.97"



30533 · Q  
Ferrari 599XX "Homestead 2010"





Licenses see page 142



30566 · Q  
**Ferrari 458 Italia**



30565 · Q  
**Ferrari 458 Italia**



30539 · Q  
**Ferrari 458 Italia**



30603 · Z ·   
Willys Coupé



30558 · m  
Mercedes W125 Stromlinie AVUS 1937



30557 · B  
Auto Union Typ C Stromlinie AVUS 1937



30542 · m  
Mercedes SLS AMG Coupé



30541 · m  
Mercedes SLS AMG Coupé

LIMITED  
EDITION  
2012

*Limited to 1.999 pieces  
worldwide!*

*For more information on  
LIMITED EDITIONS please visit:  
[carrera-toys.com/limited-us](http://carrera-toys.com/limited-us)*

**1:32** **1:24**

- For teens, adults and hobbyists from 8 years and up
- Analogue racetrack system
- Unique racetrack system combining tracks to race 1:24 and 1:32 scale cars
- Cars ready for digital upgrade \*
- Track can be expanded from 4-, 6- up to 8-lanes
- Unlimited extension possibilities with track material scale 1:24

**CARRERA EVOLUTION**

**RACING ON MEGA TRACKS**



# Carrera® EVOLUTION



© Dave Dyer



6.0 x 2.62 ft.  
183 x 80 cm

13.12 ft.  
4.0 m

**NEW**

### RACING LEGENDS

Item no. 25184 · b  
Shelby Cobra 289 Hardtop Coupe '63, "No.4"  
Bill Thomas Cheetah, Yeakel Racing "No.8"



Basisphoto: © Aaron Gee



© Greg Leong





© Disney/Pixar



6.56 x 2.62 ft. 14.76 ft.  
200 x 80 cm 4.5 m

**NEW**

Disney/Pixar Cars  
**WORLD GRAND PRIX**  
Item no. 25179 - w  
Disney/Pixar Cars "Francesco Bernoulli"  
Disney/Pixar Cars "Lightning McQueen"







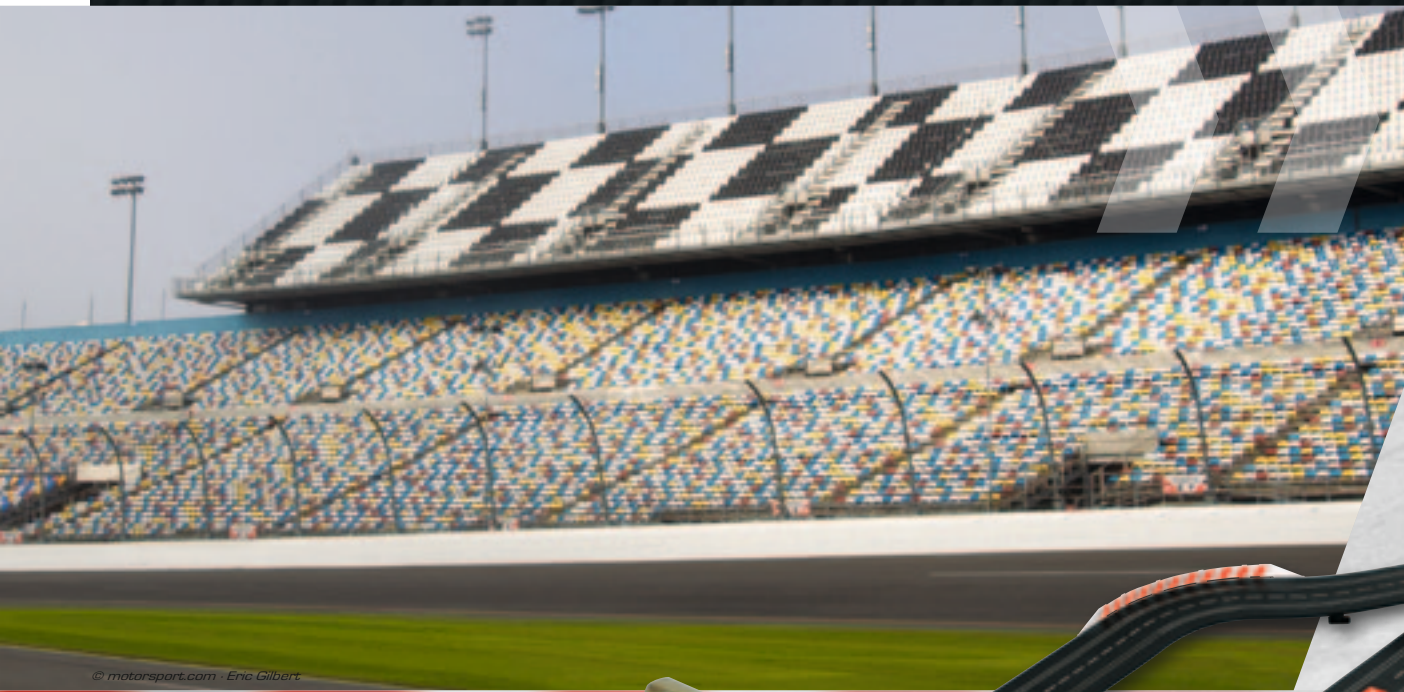

9.58 x 5.54 ft. 24.30 ft.  
292 x 169 cm 7,4 m



**NEW**

**SUPER BIRDS**

Item no. 25186 - I  
Dodge Charger Daytona "No.55", 1970  
Dodge Charger Daytona  
"Last Aero-Warrior" '71, "No.22"





# Carrera® EVOLUTION



© motorsportpressebild.de



6.56 x 2.62 ft. 14.76 ft.  
200 x 80 cm 4.5 m

**NEW**

### GRAND PRIX MASTERS

Item no. 25185 · E · Q  
Red Bull RB7 "Sebastian Vettel, No.1"  
Ferrari 150° Italia "Fernando Alonso, No.5"



**WORLDWIDE  
EXCLUSIVE LICENCE  
FOR SLOT RACING**



**WORLDWIDE  
EXCLUSIVE LICENCE  
FOR SLOT RACING**



© motorsportpressebild.de

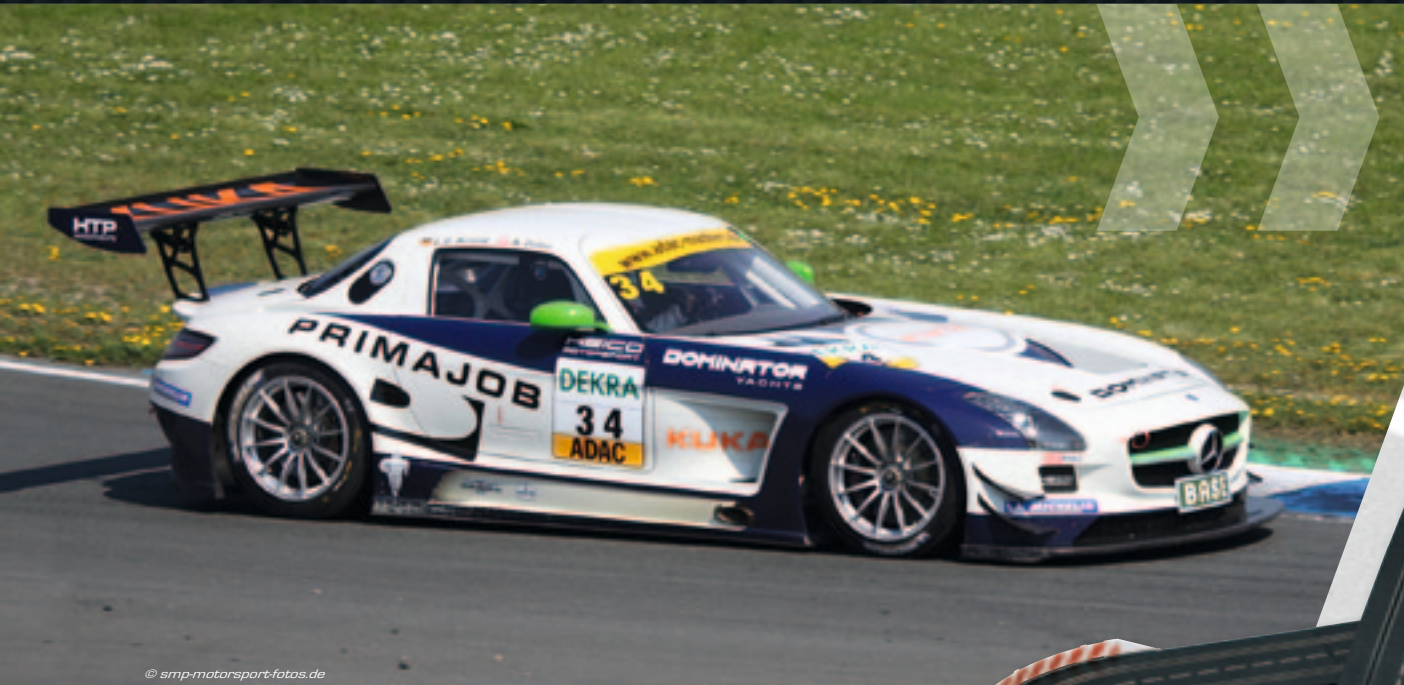

© smp-motorsport-fotos.de



© smp-motorsport-fotos.de



⚠ Preliminary packaging ⚠⚠ Preliminary model - Colors/final design subject to change



7.12 x 4.56 ft. 17.39 ft.  
217 x 139 cm 5.3 m

**NEW**

**SPEED RACE**

Item no. 25187 · A · m  
Mercedes-Benz SLS AMG GT3, HEICO  
Motorsport · Audi R8 LMS Prosperia Team  
Brinkmann UHC Speed "No.39", 2011

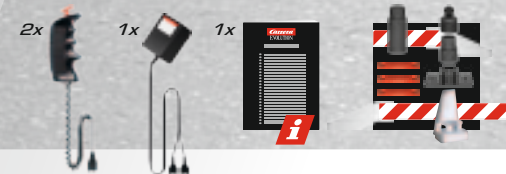



27387 · H · M · c  
NASCAR Chevrolet® Impala  
Stewart Haas Racing "No.39", 2011



27386 · C · M · c  
NASCAR Chevrolet® Impala  
Stewart Haas Racing "No.14", 2011



27410 · B · c  
Audi R18 "No.1", Spa 1000km



© Disney/Pixar

**NEW**



27404 · w · <sup>+</sup>  
Disney/Pixar Cars "Max Schnell"



27354 · w  
Disney/Pixar Cars "Francesco Bernoulli"



27353 · w  
Disney/Pixar Cars  
"Lightning McQueen"



© motorsport.com · Eric Gilbert



**NEW**



27397 · I · ✦  
Dodge Charger 500 "No.22", 1969



27254 · X · ✦  
Plymouth Fury '60 Lee Petty



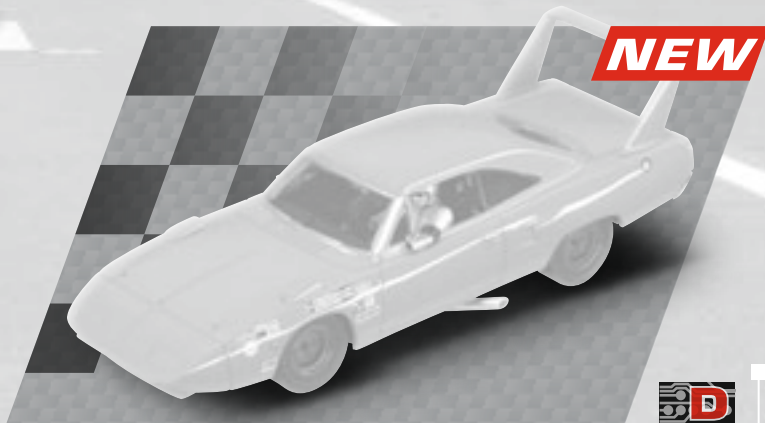

**NEW**



27398 · S · ◉  
**Plymouth Superbird "No.8", 1971**



27330 · S · h  
**Plymouth Superbird "No.40",  
Petty Racing '70**



27329 · S · h  
**Plymouth Fury '60 "No.43" Richard Petty**



27380 · P  
McLaren M20 "No.3" InterSerie, '74



27368 · P  
McLaren M20 "No.8", '74



27367 · T  
Porsche 917/30 "No.48"



27327 · T  
Porsche 917/30 Sunoco  
Porsche Audi "No.6", '73



27352 · p  
Lola T222 "No.51", Laguna Seca '71



27351 · p  
Lola T222 Orwell SuperSports Cup, "No.4"



27372 · T  
Porsche 935/78 PPG  
Industries "No.09", Riverside '83



27371 · Q  
Ferrari 512 BB LM  
NART "No.68", Daytona '79



**NEW**

Basisphoto: © Aaron Gee



27411 · b · \*

**Shelby Cobra 289 Hardtop Coupe '63, "No.4"**



**NEW**

© Eric Gilbert - motorsport.com



27412 · b · \*

**Shelby Cobra 289 '63, Sebring 12h "No.16"**



**NEW**

© Greg Leong



27413 · \*

**Bill Thomas Cheetah, Yeakel Racing "No.8"**



**NEW**



27414 · \*

**Bill Thomas Cheetah,  
Daytona 24h 1964, "No.14"**



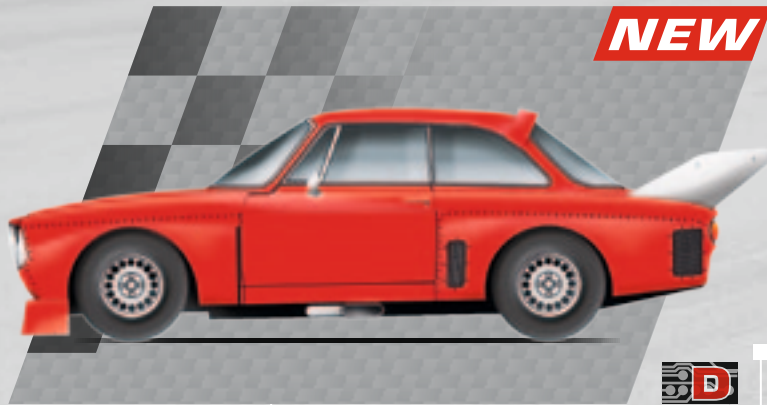

**NEW**



27415 · J ·  **Alfa Romeo GTA Silhouette Race 1**



27369 · L  
**Ford Capri RS Group 2, 1975**



27350 · G  
**BMW 2002 "Tuner"**

**NEW**



27402 · G ·  **BMW 2002 Touringcar '75, "No.48"**

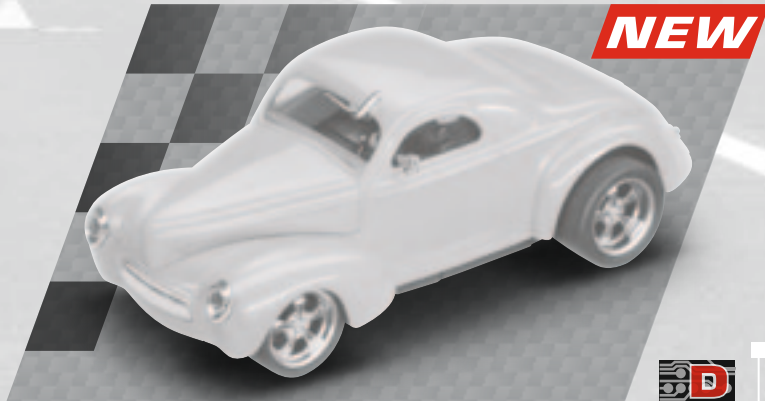

**NEW**



27396 · Z ·   
**Willys Coupé**

© Thomas Brandes · aliens-project.de

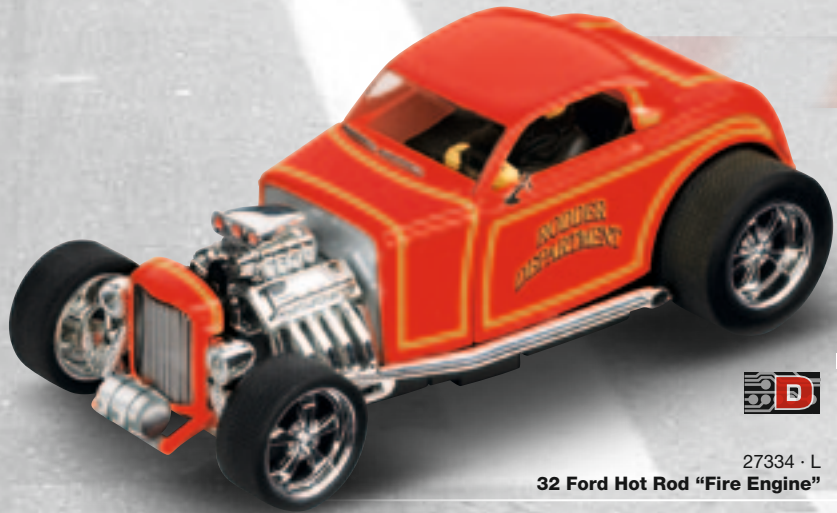

27334 · L  
**32 Ford Hot Rod "Fire Engine"**



27333 · Z  
**41 Willys® Coupé Hot Rod**

**NEW**



27394 · P · ◉  
**Vodafone McLaren  
Mercedes Race Car 2011, "No.3"**

**NEW**



27417 · Q · ◉  
**Ferrari 150° Italia "Fernando Alonso, No.5"**

**NEW**



27419 · E · ◉  
**Red Bull RB7 "Sebastian Vettel, No.1"**

*With  
flashing  
lights!*



27347 · m  
**Mercedes SLS AMG "F1™ Safety Car"**





27405 · G ·   
**MINI Countryman WRC "No.37"**



27407 · A ·   
**Citroën DS3 WRC Sebastian Loeb**

*More at  
[carrera-toys.com/us/](http://carrera-toys.com/us/)*



27395 · B ·   
Audi R8 LMS Prosperia Team Brinkmann UHC  
Speed ADAC GT Masters, "No.39", 2011



27401 · T ·   
Porsche GT3 RSR Manthey Racing,  
24h Nürburgring 2011, "No.18"



27403 · m ·   
Mercedes-Benz SLS AMG GT3  
Blackfalcon "No.35" 24h Spa 2011



27365 · B  
Audi R8 GT LMS  
United Autosports, "No.23"



© Rainier Ehrhardt



27399 · Q ·   
Ferrari 458 Italia GT2 JMW  
Motorsports "No.66", 2011



27384 · Q  
Ferrari 458 Italia GT2 Hankook  
Team Farnbacher "No.123", 2011



27383 · Q  
Ferrari 458 Italia GT2 Risi  
Competizione "No.062", 2011



27319 · G  
BMW M3 GT2 Rahal  
Letterman Racing "No.92"

**NEW**



27400 · Q ·   
Ferrari 599XX Ferrari Racing Days "No.4"



27336 · Q  
Ferrari 599XX "Homestead 2010"



27342 · Q  
Ferrari 458 Italia



27362 · Q  
Ferrari 458 Italia



27345 · m  
Mercedes SLS AMG Coupé



27344 · m  
Mercedes SLS AMG Coupé



27356 · m  
Mercedes W125 Stromlinie AVUS 1937



27355 · B  
Auto Union Typ C Stromlinie AVUS 1937

**Carrera**  
DIGITAL 124

**Carrera**  
DIGITAL 132

**Carrera**  
EVOLUTION

**1:24**

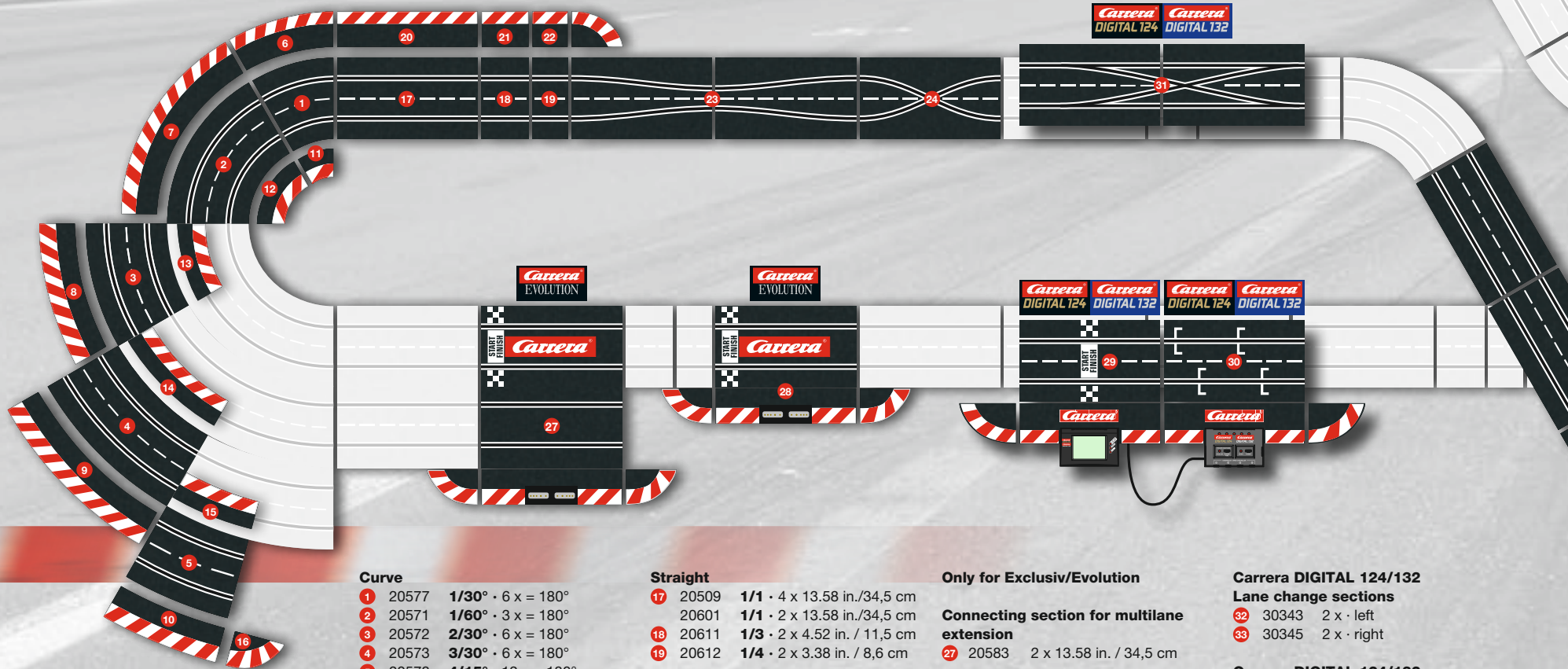

*Flexible 4, 6 or 8-lane track extensions using various high-banked curves and curve radii*

**Curve**

- 1 20577 1/30° · 6 x = 180°
- 2 20571 1/60° · 3 x = 180°
- 3 20572 2/30° · 6 x = 180°
- 4 20573 3/30° · 6 x = 180°
- 5 20578 4/15° · 12 x = 180°

**Outside shoulder for curve**

- 6 20567 1/30° · 6 x
- 7 20561 1/60° · 3 x
- 8 20562 2/30° · 6 x
- 9 20563 3/30° · 6 x
- 10 20568 4/15° · 12 x

**Inside shoulder for curve**

- 11 20590 1/30° · 6 x
- 12 20551 1/60° · 3 x
- 13 20591 2/30° · 6 x
- 14 20592 3/30° · 6 x
- 15 20593 4/15° · 12 x

**End sections outside shoulder**

- 16 20598 1/30° · 4 x

**Straight**

- 17 20509 1/1 · 4 x 13.58 in./34,5 cm
- 20601 1/1 · 2 x 13.58 in./34,5 cm
- 18 20611 1/3 · 2 x 4.52 in. / 11,5 cm
- 19 20612 1/4 · 2 x 3.38 in. / 8,6 cm

**Outside shoulder for straight**

- 20 20560 1/1 · 6 x
- 21 20588 1/3 · 2 x
- 22 20589 1/4 · 2 x

**Chicane**

- 23 20516 2 x 13.58 in. / 34,5 cm

**Lane change section**

- 24 20517 2 x 13.58 in. / 34,5 cm

**Crossing**

- 25 20587 4 x 13.58 in. / 34,5 cm

**Outside shoulder for crossing**

- 26 20597 4 x

**Only for Exclusiv/Evolution**

**Connecting section for multilane extension**

- 27 20583 2 x 13.58 in. / 34,5 cm

**Connecting section**

- 28 20515 13.58 in. / 34,5 cm

**Only for Carrera DIGITAL 124/132**

**Carrera DIGITAL 124/132 Electronic lap counter**

- 29 30342 incl. connecting section and 1 straight

**Carrera DIGITAL 124/132 Black Box**

- 30 30344 1 x

**Carrera DIGITAL 124/132 Double lane change section**

- 31 30347 2 x

**Carrera DIGITAL 124/132 Lane change sections**

- 32 30343 2 x · left
- 33 30345 2 x · right

**Carrera DIGITAL 124/132 Pit Stop Lane**

- 34 30346 1 x

**Carrera DIGITAL 124/132 Track section for pit stop extension**

- 35 30341 1 x

**Carrera DIGITAL 124/132 Outside shoulder for Pit Stop Lane**

- 36 20602 2 end pieces, ascent, straight, descent

**Carrera DIGITAL 124/132 Narrow section**

- 37 30350 left · 4 x

Ⓢ Preliminary model - Colors/final design subject to change

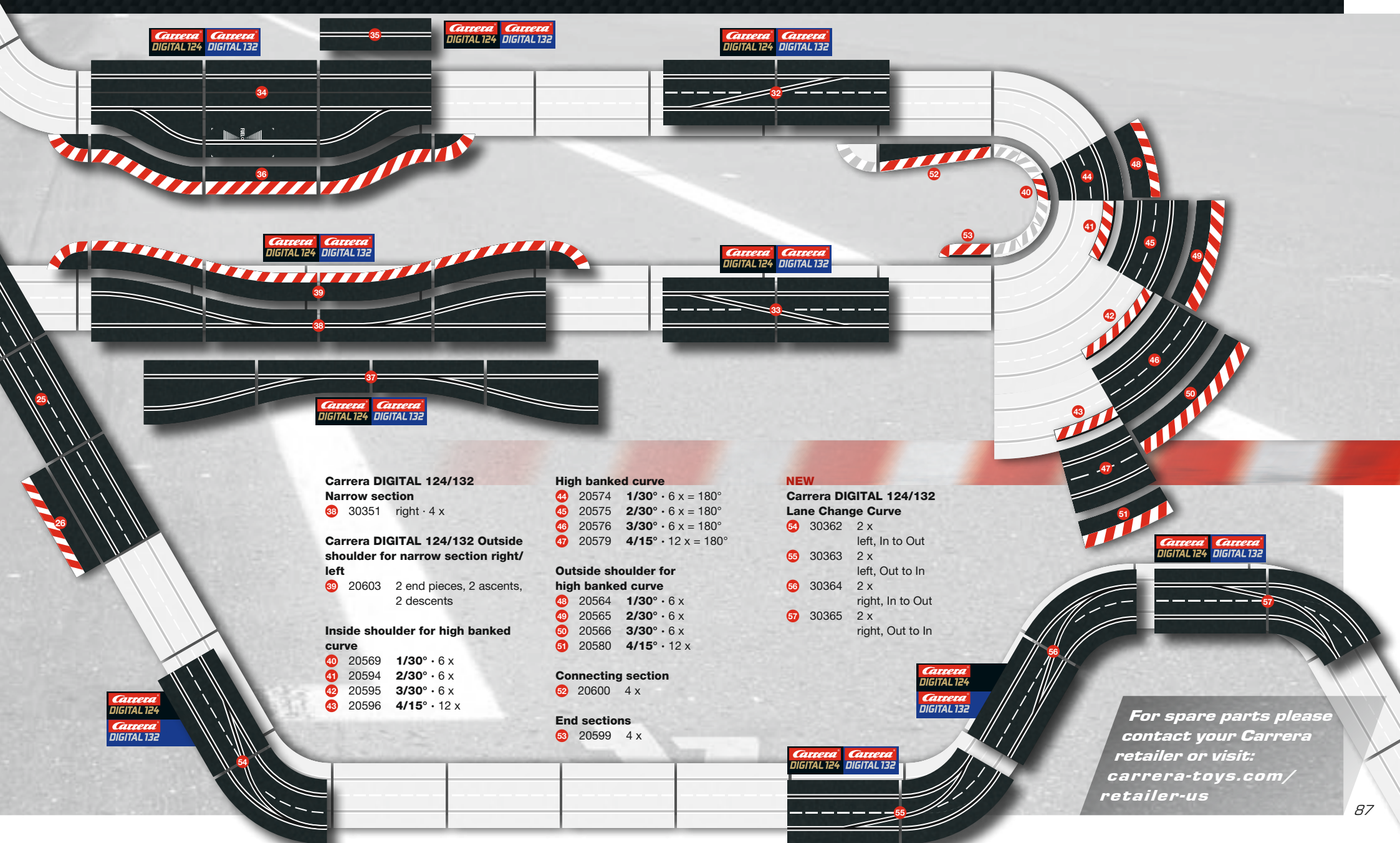

**Carrera DIGITAL 124/132  
Narrow section**

- 38 30351 right · 4 x

**Carrera DIGITAL 124/132 Outside  
shoulder for narrow section right/  
left**

- 39 20603 2 end pieces, 2 ascents,  
2 descents

**Inside shoulder for high banked  
curve**

- 40 20569 **1/30°** · 6 x
- 41 20594 **2/30°** · 6 x
- 42 20595 **3/30°** · 6 x
- 43 20596 **4/15°** · 12 x

**High banked curve**

- 44 20574 **1/30°** · 6 x = 180°
- 45 20575 **2/30°** · 6 x = 180°
- 46 20576 **3/30°** · 6 x = 180°
- 47 20579 **4/15°** · 12 x = 180°

**Outside shoulder for  
high banked curve**

- 48 20564 **1/30°** · 6 x
- 49 20565 **2/30°** · 6 x
- 50 20566 **3/30°** · 6 x
- 51 20580 **4/15°** · 12 x

**Connecting section**

- 52 20600 4 x

**End sections**

- 53 20599 4 x

**NEW**

**Carrera DIGITAL 124/132  
Lane Change Curve**

- 54 30362 2 x  
left, In to Out
- 55 30363 2 x  
left, Out to In
- 56 30364 2 x  
right, In to Out
- 57 30365 2 x  
right, Out to In

*For spare parts please  
contact your Carrera  
retailer or visit:  
carrera-toys.com/  
retailer-us*

**Carrera**<sup>®</sup>  
2.4 GHz WIRELESS+<sup>)))</sup>

Only for

**Carrera**<sup>®</sup>  
DIGITAL 124

**Carrera**<sup>®</sup>  
DIGITAL 132



- 1 2.4 GHz WIRELESS+ Receiver = Receiver
- 2 2.4 GHz WIRELESS+ Speed Controller = Transmitter
- 3 Charging station for 2.4 GHz WIRELESS+ Speed Controller

**NEW**

## **FREEDOM ON THE RACETRACK – WITH 2.4 GHz WIRELESS+**

Experience the joys of wireless racetrack fun for Carrera DIGITAL 124 and Carrera DIGITAL 132 with the new 2.4 GHz WIRELESS+ set-up. This wireless radio signal system uses 2.4-GHz technology and imports even more digital technology onto your Carrera circuit.

A range of up to 15 m allows wireless operation of up to 6 vehicles simultaneously on one circuit. Frequency hopping provides uninterrupted, frequency-independent operation. The powerful Lithium-Polymer power pack provides power for 8 hours of non-stop action – and a fully charged battery can remain charged 20 days on the standby setting. The new 2.4 GHz WIRELESS+ can be used with a Black Box or a Control Unit. The receiver allows signal transmission to 6 different cars and the set is controlled via ultra-light hand-held wireless controls.

The charging stations powering the hand-held controls are incorporated into the track.

The charging stations can be installed in the track layout by linking up to the Adapter Unit or Control Unit.

Experience the new dimension of Carrera car racing with 2.4 GHz WIRELESS+ – radio controlled technology for even more flexibility.

- **2.4 GHz WIRELESS+ technology**
- **Race for up to 6 drivers**
- **Ultra-light, wireless speed controller**
- **Recharger with direct connection to the Carrera circuit**
- **Operating range up to 15 m**
- **Uninterrupted and frequency independent due to frequency hopping**
- **8 hours of non-stop operation**
- **Battery powered with Lithium Polymer power pack**



For more information on  
**CARRERA 2.4 GHz WIRELESS+** go to:  
[carrera-toys.com/wirelessplus-us](http://carrera-toys.com/wirelessplus-us)

**CARRERA 2.4 GHz WIRELESS+ DIGITAL  
RADIO CONTROLLED TECHNOLOGY  
FOR UP TO 6 DRIVERS**

**Carrera**<sup>®</sup>  
2.4 GHz  
**WIRELESS+**

**Carrera Real Racing**



**10109 \* Carrera DIGITAL 124/132 2.4 GHz WIRELESS+ SET DUO**  
2x 2.4 GHz WIRELESS+ Speed Controller, 1x 2.4 GHz WIRELESS+ Receiver, 1x 2.4 GHz WIRELESS+ double charging station, 1 Adapter Unit, 1 Shoulder complement, 1 End sections outside shoulder (left/right), Lithium-polymer battery, instructions



**10110 \* Carrera DIGITAL 124/132 2.4 GHz WIRELESS+ SET SINGLE**  
1x 2.4 GHz WIRELESS+ Speed controller, 1x 2.4 GHz WIRELESS+ Receiver, 1x 2.4 GHz WIRELESS+ single charging station, 1 Adapter Unit, 1 Shoulder complement, 1 End sections outside shoulder (left/right), Lithium-polymer battery, instructions



**10111 \* 2.4 GHz WIRELESS+ Speed  
Controller for Carrera DIGITAL 124/132**  
1x 2.4 GHz WIRELESS+ Speed controller, 1 Exchange  
button, Lithium-polymer battery, instructions

\* Subject to technical changes



# Carrera<sup>®</sup> DIGITAL 124

# Carrera<sup>®</sup> DIGITAL 132

For more information please visit  
[carrera-toys.com/digital124-us](http://carrera-toys.com/digital124-us)  
[carrera-toys.com/digital132-us](http://carrera-toys.com/digital132-us)

## A REAL RACING FEEL AT HOME WITH DIGITAL ACCESSORIES

Experience the Carrera racetrack feeling with our state-of-the-art Carrera DIGITAL 124/132 accessories! The new lap counter offers you real speed thrills with a display including position, fastest lap times and the exact overall time with time difference!

Start your personal training with the special training and racing mode and leave your rivals far behind! The Driver Display combined with the Pit Lane shows each driver his fuel level, the number of pitstops (max. 10) and current race position. The start light triggers the first rush of adrenaline then it's pedal-to-the-metal time.

The new Position Tower means racers always have a race position overview.

### 1 Carrera DIGITAL 124/132 Control Unit

- Possibility to programme:
  - braking performance
  - power (maximum speed)
  - tank capacity
- Pit Stop functions
- Pace Car functions

### 2 Carrera DIGITAL 124/132 Lap Counter

- (only in combination with Control Unit 30352)
- Direct link-up to the Control Unit (no additional track required)
- Stopwatch - also in the pit lane (only with Pit Lane 30356)

- Car position information on the display
- Backlite display for improved legibility
- Position listing, fastest lap, total race time, time gap to the leader.
- Stopwatch times for 6 cars - accurate to 1/1000 sec.
- Training and racing modes
- Racing modes divided into lap and time-based racing
- Lap limit races from 0 to 9999 laps
- Time runs from 00:00'01" to 99:59'59"



**Carrera Real Racing**

*The Control Unit forms  
the basis for great  
digital racing fun*



30352 **Carrera DIGITAL 124/132 Control Unit** · incl. 2 end pieces

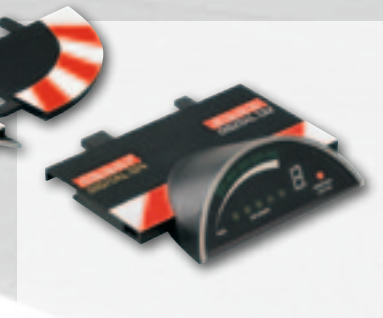

30353 **Carrera DIGITAL 124/132 Driver Display**  
incl. Adapter Unit and 2 end pieces

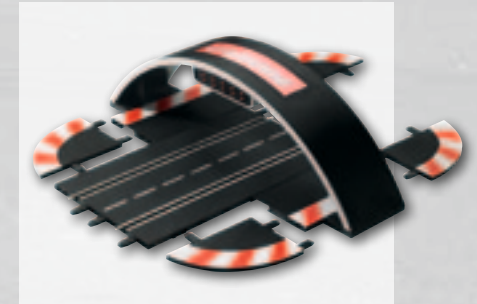

30354 **Carrera DIGITAL 124/132 Startlight**  
incl. Adapter Unit and 2 end pieces left/right

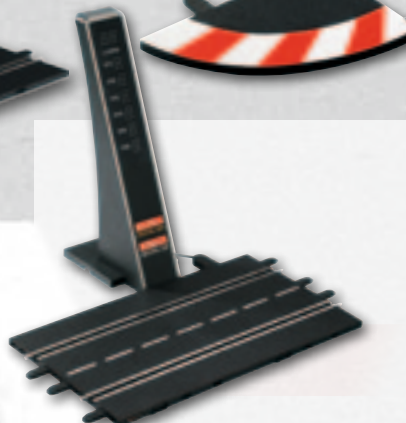

30357 **Carrera DIGITAL 124/132 Position Tower**  
incl. Adapter Unit



30355 **Carrera DIGITAL 124/132 Lap Counter**  
Only in combination with Control Unit 30352



30556 **Carrera DIGITAL 124/132 Pit Lane**  
Only in combination with Control Unit 30352

- 3 Carrera DIGITAL 124/132 Driver Display**  
(Only in combination with Control Unit 30352 and Pit Lane 30356)
- LED-display shows tank capacity and allocation of cars as well as latest race position
  - LED-control display for up to 10 pit stops in the Pit Lane 30356

- 4 Carrera DIGITAL 124/132 Startlight**  
(Only in combination with Control Unit 30352)
- LED-display indicating start sequence

- 5 Carrera DIGITAL 124/132 Position Tower**  
(Only in combination with Control Unit 30352)
- LED-display of latest race position
  - Information on each leading car's laps having been driven



30358 **Carrera DIGITAL 124/132 Shoulder connecting section**  
6.79 in./17,25 cm · incl. shoulder complement (30359), possibility to connect Position Tower 30357

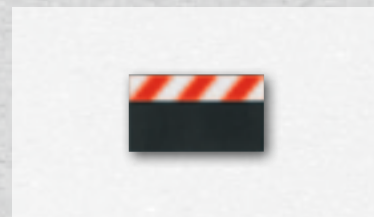

30359 **Carrera DIGITAL 124/132 Shoulder complement** · 6.79 in./17,25 cm

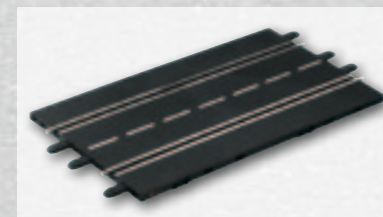

30360 **Carrera DIGITAL 124/132 Adapter Unit** · 13.58 in./34,5 cm · Connecting section for Driver Display 30353, Startlight 30354 and Position Tower 30357



30361 **Carrera DIGITAL 124/132 Pit Stop Adapter Unit** · 13.58 in./34,5 cm · Only in combination with Control Unit 30352 · to retrofit the Pit Stop Lane 30346 for operating the Driver Display 30353

# Carrera® DIGITAL 124

# Carrera® DIGITAL 132

# Carrera® EVOLUTION

For spare parts please contact  
your Carrera retailer or visit:  
[carrera-toys.com/retailer-us](http://carrera-toys.com/retailer-us)

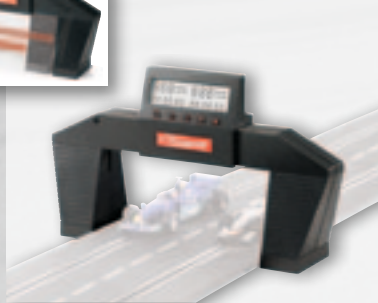
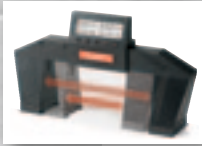

- Records times exactly (1/100 sec.)
- Electronic lap counter for all analogue Carrera racetrack types
- Width adjusts to fit various track sizes
- For two lane operation
- Cars are identified via infrared light barrier
- Time trials from 1 seconds to 99 min.
- Lap races from 1 to 999 laps
- Starting phase with beeping tone starting lights
- False start function
- Battery-operated

71590 **Exclusiv/Evolution/GO!!!**  
**Electronic lap counter**  
4 batteries AA/LR6 (Batteries not included)



30340 **Carrera DIGITAL 124/132**  
**Digital speed controller**  
1 x · with spiral cable



20709 **Evolution**  
**Mechanical speed controller**  
1 x · with spiral cable



20718 **Exclusiv**  
**Electronic speed controller**  
1 x · with spiral cable



30348 **Carrera DIGITAL 132**  
**Speed controller extension set**  
1 x



- Software for race coordination
- For up to 8 drivers with driver and car database



- Only possible in conjunction with the Carrera lap counter 30342 or the control unit 30352 (from X-lap version 1.20) and a PC / notebook.

30349 **Carrera DIGITAL 124/132**  
**PC Unit Software for race coordination**  
PC connection cable, CD with software

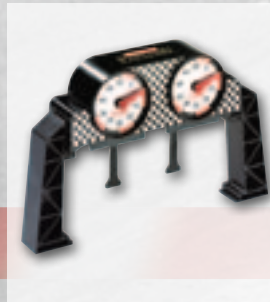

20581 **Exclusiv/Evolution**  
**Mechanical lap counter**

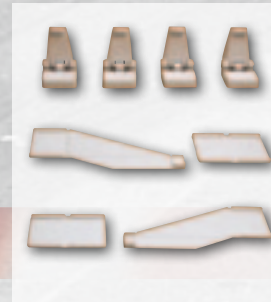

85219 **Guard rail supports** 16 x, **endpiece** 4 x, **guard rail connecting pieces** 2 x



85220 **Guard rail** · 9,84 ft./3 m supports 24 x, **guard rail connecting piece** 6 x, **end piece** 12 x



20760 (USA)  
**Carrera DIGITAL 124**  
**Transformer** 18 V === 54 VA

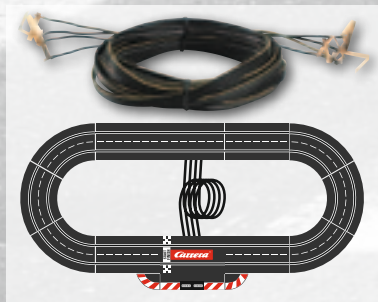

20584 · (16.40 ft./5 m)  
20585 · (32.80 ft./10 m)  
**Additional supply**

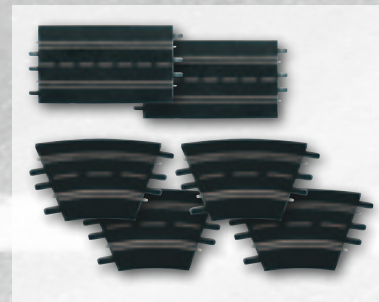

26955 **Carrera DIGITAL 132 · Evolution**  
**Extension Set** · 2 standard straights, 4 curves 1/30°, track section bolts

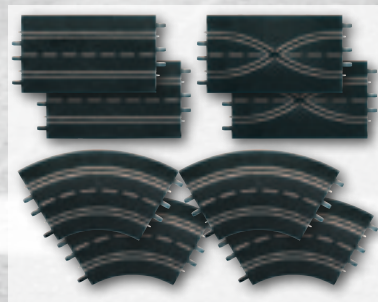

26953 **Carrera DIGITAL 132 · Evolution**  
**Extension Set** · 2 standard straights, 2 lane change sections, 4 curves 1/60°, track section bolts

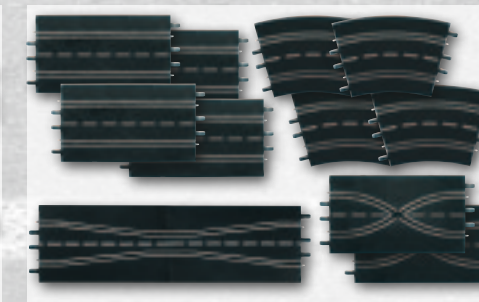

26956 **Carrera DIGITAL 132 · Evolution**  
**Extension Set** · 4 standard straights, 2 lane change sections, 2 chicane, 4 curves 2/30°, track section bolts

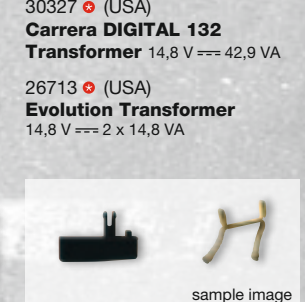

30327 (USA)  
**Carrera DIGITAL 132**  
**Transformer** 14,8 V === 42,9 VA



26713 (USA)  
**Evolution Transformer**  
14,8 V === 2 x 14,8 VA

**Guide keels and double sliding contacts**  
Available for all models

**FAST AND EASY UPGRADE  
FROM ANALOGUE ...**

Easily step into the digital world with the Upgrade Kit for Exclusiv and Evolution and the respective car decoders. After refitting, Exclusiv and Evolution may be digitally operated. Carrera DIGITAL 124 cars compatible with Exclusiv Series (analogue system) and Carrera DIGITAL 132 cars compatible with Evolution Series (analogue system).

**... TO DIGITAL  
RACING FUN!**

The Upgrade Kit can be completed individually with switches, narrow sections, Pit Stop Lane or a lap counter – and nothing can stop you racing digital!



20520 **Upgrade Kit Exclusiv to Carrera DIGITAL 124**  
Carrera DIGITAL 124 Black Box, Adapter for transformer,  
2 Carrera DIGITAL 124 speed controllers



20762 · 20763  
**Digital decoder**



20524 **Adapter**  
for Exclusiv transformer for  
Carrera DIGITAL 124 use



20760 (USA) 18 V === 54 VA  
**Transformer for  
Carrera DIGITAL 124**



26734 · **Upgrade Kit Evolution to Carrera DIGITAL 132** · Carrera DIGITAL 132 Black Box, Carrera DIGITAL 132 Transformer, 2 Carrera DIGITAL 132 speed controllers

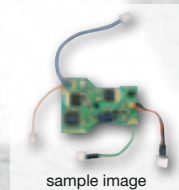

26732 · 26733  
26740 · 26743  
**Digital decoder**

**Carrera**<sup>®</sup>  
**EXCLUSIV**

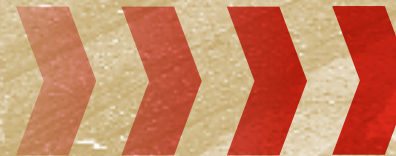

**Carrera**<sup>®</sup>  
**DIGITAL 124**

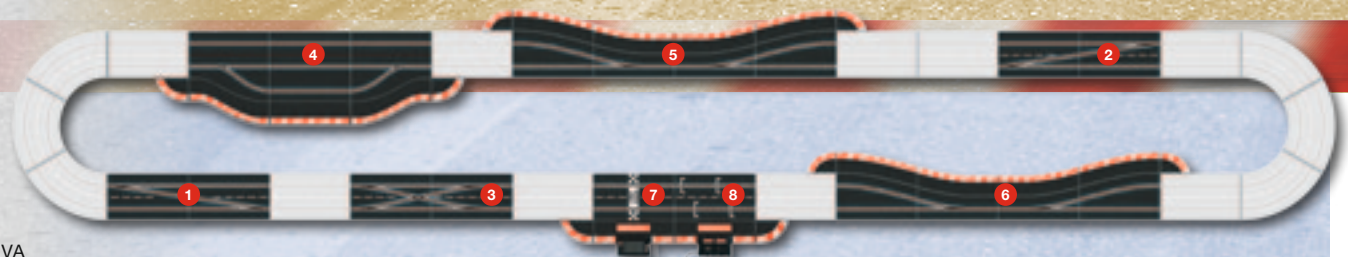

**Carrera**<sup>®</sup>  
**EVOLUTION**



**Carrera**<sup>®</sup>  
**DIGITAL 132**

- 1 Carrera DIGITAL 124/132 Lane change sections · right
- 2 Carrera DIGITAL 124/132 Lane change sections · left
- 3 Carrera DIGITAL 124/132 Double Lane change section
- 4 Carrera DIGITAL 124/132 Pit Stop Lane

- 5 Carrera DIGITAL 124/132 Narrow section · right
- 6 Carrera DIGITAL 124/132 Narrow section · left
- 7 Carrera DIGITAL 124/132 Electronic lap counter
- 8 Carrera DIGITAL 124/132 Black Box

**Carrera**<sup>®</sup>  
DIGITAL 124

**Carrera**<sup>®</sup>  
DIGITAL 132

**Carrera**<sup>®</sup>  
EVOLUTION

**1:32**

**BUILDINGS**

- Modern decoration for the race track
- Buildings can be used as modular system offering numerous combinations and constructions, expandable as much as you like
- Plastic construction kits easy to assemble, decoration stickers enclosed
- Building system consists of stands, press tower, pit stop lane and VIP-floor as top part

**FIGURES**

- Extremely detailed and coloured figures
- Revolving and movable parts of the body



21100 + 21101



21100  
**Grandstand** · Lower part with stairs and roof  
13.8 x 9.4 x 7.9 in. / 34 x 24 x 20 cm\*



21101  
**Grandstand, extension set** · Lower part with separate stairs, 13.8 x 4.7 x 8.3 in. / 34 x 12 x 21 cm\*



21102  
**Press Tower** · 3 stories, incl. double garage  
11.4 x 13.8 x 9.1 in. / 29 x 35 x 23 cm\*



21103  
**Press Tower, extension set** · 1 story, incl. balcony, 13.0 x 3.5 x 9.1 in. / 33 x 9 x 23 cm\*

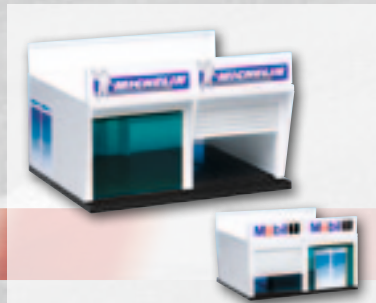

21104  
**Pit stop lane** · 1 double garage incl. signage  
8.1 x 4.3 x 8.7 in. / 20,5 x 11 x 22 cm\*



21105  
**VIP-floor** · 1 top part VIP-floor  
8.1 x 4.3 x 8.7 in. / 20,5 x 11 x 22 cm\*



21119  
**Footbridge** · for two lanes  
18.5 x 6.9 x 3.9 in. / 47 x 17,5 x 10 cm\*



21120  
**Extension set, Footbridge** · for multi-lane extension, 23.6 x 1.6 x 2.4 in. / 60 x 4 x 6 cm\*



21106  
**Set of figures, small assortment**  
5 figures: 3 sitting, 2 standing



21107  
**Set of figures, big assortment**  
15 figures: 12 sitting, 3 standing



21108  
**Set of figures grandstand**  
20 figures sitting



21113  
**Gridgirls**  
5 figures standing



21121  
**Winner's rostrum with set of figures**  
1 winner's tribune, 3 winners, 1 official

For spare parts please contact  
your Carrera retailer or visit:  
[carrera-toys.com/retailer-us](http://carrera-toys.com/retailer-us)



21115  
**Marshals**  
5 figures

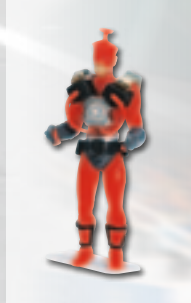

21112  
**Captain Carrera**  
1 figure standing



21114  
**Pit Babes**  
3 leaning, 2 sitting



21111  
**Set of figures, mechanics**  
5 figures (blue/white)



21109  
**Set of figures, mechanics**  
5 figures (Ferrari)



21110  
**Set of figures, mechanics**  
5 figures





 **1:43** **1:43**

- For kids from 8 years and up
- Starter system to the Carrera world of racing, scale 1:43
- All basic sets include Turbo Power controllers
- Numerous action features for enhanced racing
- Attractive car licences and racing themes

**CARRERA GO!!!**  
**FEEL THE**  
**TURBO SPEED**







**Carrera**<sup>®</sup>  
**GO!!!**



© Action Sports Photography



6.10 x 2.53 ft. 17.38 ft.  
186 x 77 cm 5,3 m



**NASCAR - TALLADEGA**

Item no. 62250 · H · C · c  
NASCAR Chevrolet® Impala  
NASCAR Chevrolet® Impala

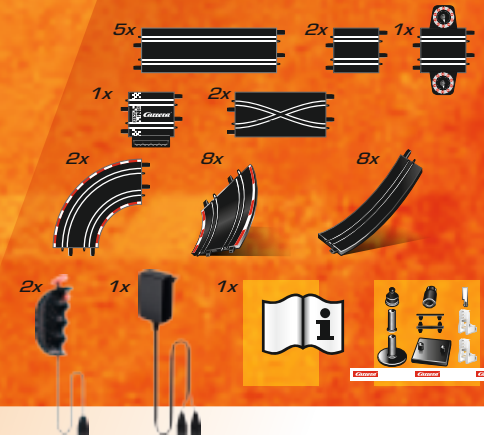



# Carrera® GO!!!



© motorsportpressebild.de



5.74 x 4.00 ft. 20.66 ft.  
175 x 122 cm 6,3 m

**NEW**

**FORMULA COMPETITION**  
Item no. 62272 · E · Q  
Red Bull RB7 "Sebastian Vettel, No.1"  
Ferrari 150° Italia "Fernando Alonso, No.5"

WORLDWIDE  
EXCLUSIVE LICENCE  
FOR SLOT RACING



© motorsportpressebild.de

WORLDWIDE  
EXCLUSIVE LICENCE  
FOR SLOT RACING

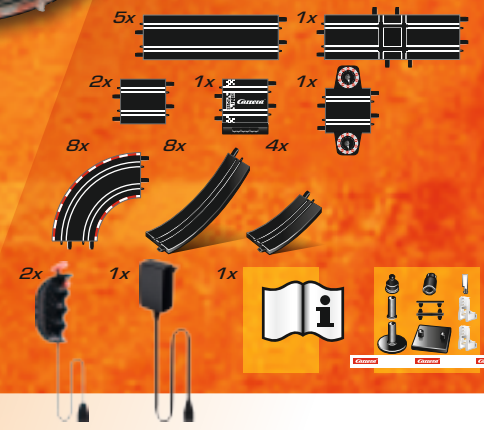



**Carrera**<sup>®</sup>  
**GO!!!**

WORLDWIDE  
EXCLUSIVE LICENCE  
FOR SLOT RACING



© motorsportpressebild.de



6.30 x 1.97 ft.  
192 x 60 cm

17.71 ft.  
5,4 m

**NEW**

**WORLD CHAMPIONS**

Item no. 62278 · E  
Red Bull RB7 "Sebastian Vettel, No.1"  
Red Bull RB7 "Mark Webber, No.2"



⊗ ⊗

⊗ ⊗

WORLDWIDE  
EXCLUSIVE LICENCE  
FOR SLOT RACING



6.30 x 1.97 ft.  
192 x 60 cm

17.71 ft.  
5,4 m

**NEW**

**FERRARI F1 MASTERS**  
Item no. 62280 - Q  
Ferrari 150° Italia "Fernando Alonso, No.5"  
Ferrari 150° Italia "Felipe Massa, No.6"

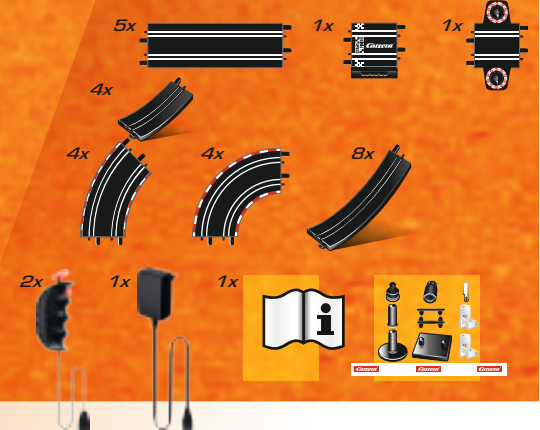

⚠ Preliminary packaging ⚠ Preliminary model - Colors/final design subject to change

**Carrera**<sup>®</sup>  
**GO!!!**



7.12 x 3.90 ft. 18.04 ft.  
217 x 119 cm 5.5 m



**BUGGY ACTION**

Item no. 62243

Dune Buggy

Dune Buggy

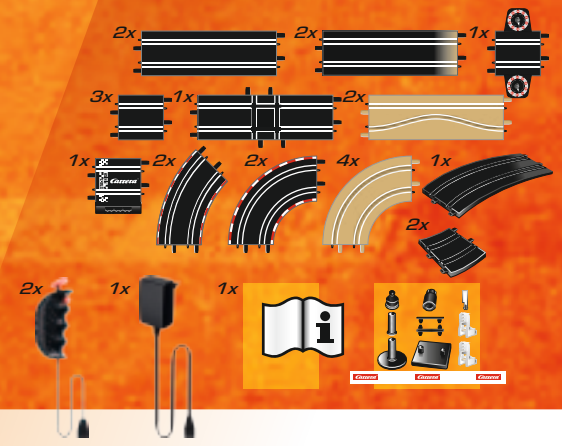





© jamesballardsmith



8,76 x 2,62 ft. 23,62 ft.  
267 x 80 cm 7,2 m

**NEW**



**WORLDWIDE  
EXCLUSIVE LICENCE  
FOR SLOT RACING**

**GT FEVER**  
Item no. 62275 · Q · T  
Ferrari 458 Italia GT2 Risi Competizione  
"No.062", 2011  
Porsche GT3 Cup "Monster FM, U.Alzen"

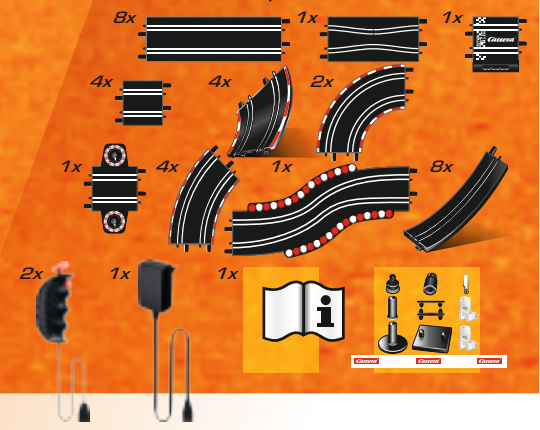

\* Preliminary packaging

**Carrera**<sup>®</sup>  
**GO!!!**



7.12 x 3.90 ft. 17.38 ft.  
217 x 119 cm 5,3 m

**NEW**

Marvel - The Amazing Spider-Man  
**MANHATTAN MADNESS**  
Item no. 62282 - N  
Marvel - The Amazing Spider-Man  
"Spider Racer" - "Lizard Tail Spinner"



⚠ ⚠



⚠ ⚠

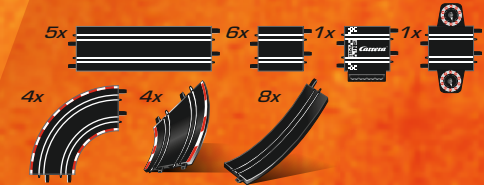

Carrera Carrera Carrera

# THE AMAZING SPIDER-MAN™



**Carrera**<sup>®</sup>  
**GO!!!**



4.89 x 2.79 ft. 11.81 ft.  
149 x 85 cm 3,6 m

**NEW**

Marvel - The Avengers  
**HERO TEAM CHASE**  
Item no. 62283 - X  
"Captain America Stormer"  
"Iron Man Tech Racer"





5.18 x 2.23 ft. 16.08 ft.  
158 x 68 cm 4.9 m

**NEW**

**MARIO KART WII**  
Item no. 62286 - V  
Mario Kart Wii Wild Wing + Mario  
Mario Kart Wii Wild Wing + Luigi™

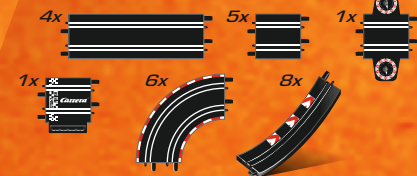

\* Preliminary packaging

**Carrera**<sup>®</sup>  
**GO!!!**



5.18 x 2.23 ft. 16.08 ft.  
158 x 68 cm 4.9 m

**NEW**

Disney/Pixar Cars  
**LONDON RACE AND CHASE**  
Item no. 62277 - w  
Disney/Pixar Cars "Lightning McQueen"  
Disney/Pixar Cars "Security Finn McMissile"

With flashing  
lights!

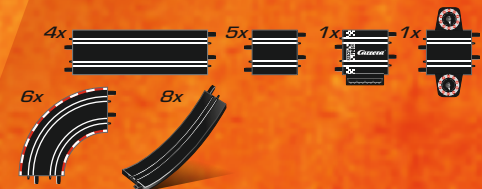



**Carrera**<sup>®</sup>  
**GO!!!**



**Carrera**<sup>®</sup>  
**GO!!!**



**PORTO CORSA**  
INTERNATIONALE



© Disney/Pixar



5.71 x 4.85 ft. 17.71 ft.  
174 x 148 cm 5,4 m



Disney/Pixar Cars  
**PORTO CORSA RACING**  
Item no. 62238 - w  
Disney/Pixar Cars "Lightning McQueen"  
Disney/Pixar Cars "Francesco Bernoulli"

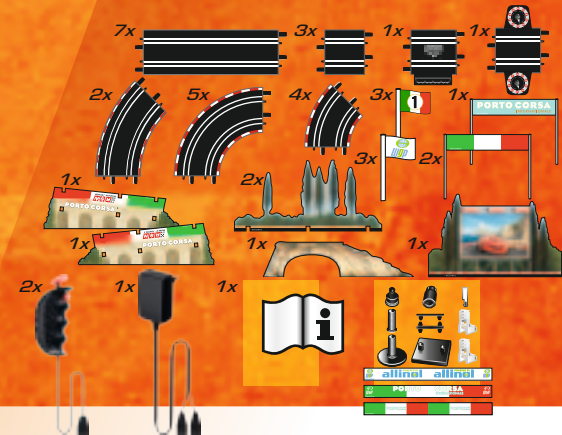





**SpongeBob**  
nickelodeon



6.00 x 2.82 ft. 18.37 ft.  
183 x 80 cm 5.6 m



**SPONGEBOB SQUAREPANTS**

Item no. 62248 - o  
SpongeBob Racer  
Patrick Star Racer

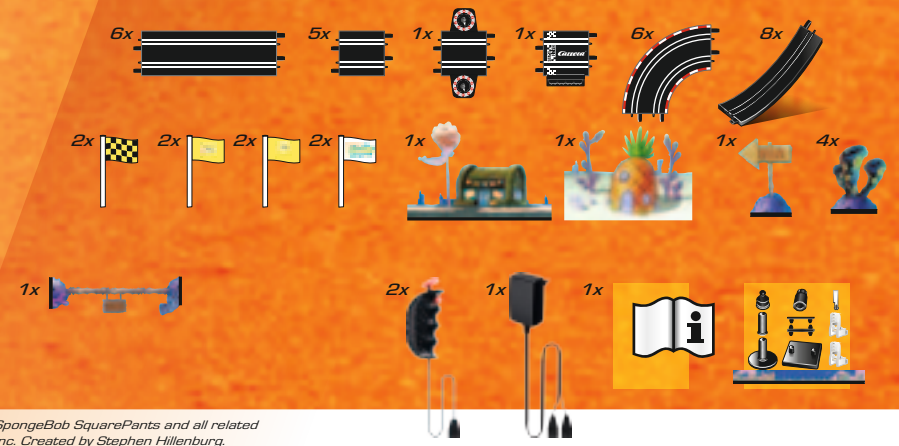

\* Preliminary packaging

© 2012 Viacom International Inc. All Rights Reserved. Nickelodeon, SpongeBob SquarePants and all related titles, logos and characters are trademarks of Viacom International Inc. Created by Stephen Hillenburg.



61201 · C · c  
NASCAR Chevrolet® Impala  
Stewart Haas Racing "No.14", 2011



61202 · H · c  
NASCAR Chevrolet® Impala  
Stewart Haas Racing "No.39", 2011



61203 · d · c · \*  
NASCAR Chevrolet® Impala  
Hendrick Motorsports "No.24", 2011



61204 · i · c · \*  
NASCAR Chevrolet® Impala  
Hendrick Motorsports "No.48", 2011

**NEW**  
With  
flashing  
lights!



61247 · L · \*  
Ford Crown Victoria  
"Police Interceptor"

**NEW**

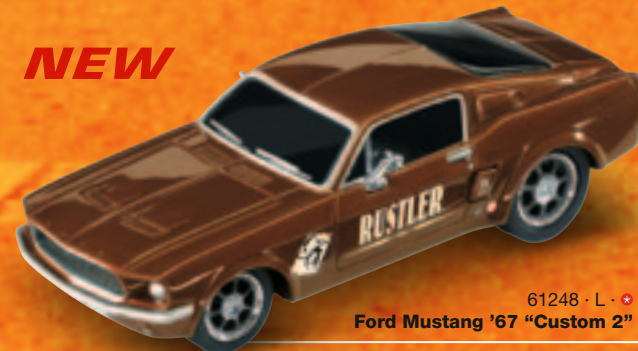

61248 · L · \*  
Ford Mustang '67 "Custom 2"

**NEW**



61236 · E · \*  
**Red Bull RB7**  
"Sebastian Vettel, No.1"



61237 · Q · \*  
**Ferrari 150° Italia**  
"Fernando Alonso, No.5"

**NEW**



61238 · P · \*  
**Vodafone McLaren Mercedes**  
Race Car 2011, "No.3"

**With  
flashing  
lights!**



61180 · m  
**AMG Mercedes SL 63 "Safety Car"**

**NEW**



61243 · \*  
**Dune Buggy**



61232  
**Dune Buggy**



61233  
**Dune Buggy**



© Rainier Ehrhardt

**NEW**

61244 · Q · \*  
**Ferrari 458 Italia GT2**  
 JMW Motorsports "No.66" 2011



61211 · Q  
**Ferrari 458 Italia GT2 Risi**  
 Competizione "No.062", 2011



61212 · Q  
**Ferrari 458 Italia GT2**  
 Hankook Team Farnbacher  
 "No.123", 2011

**NEW**



61245 · Q · \*  
**Ferrari 599XX Ferrari**  
 Racing Days "No.88"



61215 · Q  
**Ferrari 599XX Nürburgring**  
 2010 "No.97"



© fotolia - Jan van Braekhoven

**NEW**

61246 · T · \*  
**Porsche GT3 Cup**  
 "Seyffarth Motorsport"



61216 · T  
**Porsche GT3 Cup**  
 "Monster FM, U.Alzen"



**NEW**



61251 · w ·   
Disney/Pixar Cars  
"Security Finn McMissile"

**With flashing lights!**



61193 · w  
Disney/Pixar Cars  
"Lightning McQueen"



61183 · w  
Disney/Pixar Cars "Mater"



61194 · w  
Disney/Pixar Cars  
"Francesco Bernoulli"



61195 · w  
Disney/Pixar Cars  
"Finn McMissile"



61198 · w  
Disney/Pixar Cars  
"Raoul ÇaRoule"



61199 · w  
Disney/Pixar Cars  
"Max Schnell"



61184 · a  
Disney/Pixar Cars "Sally"

**NEW**



61253 · N · \*  
Marvel - The Amazing  
Spider-Man "Spider Racer"

**NEW**



61254 · N · \*  
Marvel - The Amazing  
Spider-Man "Lizard Tail Spinner"

**NEW**



61255 · X · \*  
Marvel - The Avengers  
"Captain America Stormer"

**NEW**



61256 · X · \*  
Marvel - The Avengers  
"Iron Man Tech Racer"



61230 · o  
SpongeBob Racer



61231 · o  
Patrick Star Racer

**NEW**



61259 · V  
Mario Kart Wii  
Wild Wing + Mario

**NEW**



61260 · V  
Mario Kart Wii  
Wild Wing + Luigi™



61037 · V  
Mario Kart DS  
"Mario B-Dasher"



61038 · V  
Mario Kart DS  
"Wario Brute"



61123 · V  
Mario Kart DS  
"Peach Royale"

More at  
[carrera-toys.com/us/](http://carrera-toys.com/us/)



© Disney / Pixar

61652 · w  
**Disney/Pixar Cars 2 Extension / Car Set "Mater"**  
2 Straight 13.46 in. / 342 mm, 2 Lane change sections, 6 Flags, 3 Banner, 2 Guardrails



© Disney / Pixar

61653 · w  
**Disney/Pixar Cars 2 Extension / Car Set "Francesco Bernoulli"** · 2 Straight 13.46 in. / 342 mm, 2 Lane change sections, 6 Flags, 3 Banner, 2 Guardrails



© Disney / Pixar

61654 · w  
**Disney/Pixar Cars 2 Extension / Car Set "Max Schnell"**  
2 Straight 13.46 in. / 342 mm, 2 Lane change sections, 6 Flags, 3 Banner, 2 Guardrails



© Disney / Pixar

61660 · w · \*  
**Disney/Pixar Cars 2 Extension / Car Set "Security Finn McMissile"** · 2 Straight 13.46 in. / 342 mm, 2 Lane change sections, 6 Flags, 3 Banner, 2 Guardrails



61511 GO!!!  
**Mechanical speed controller**



61537 (USA) GO!!!  
**Transformer**  
14,8 V == 10,4 VA



61530 GO!!! \*  
**Connecting section**



71595 GO!!!  
**Electronic lap counter**  
Battery-operated, 3 batteries AA/LR6 (not included)

- Lap counts from 1 to 99 laps
- Shows best lap times
- Big display
- Winner-fanfare
- Tone signals when crossing the finishing line
- For two lane operation
- Automatically switches off after 3 minutes



**Carrera**<sup>®</sup>  
**DIGITAL 143**

**Carrera**<sup>®</sup>  
**GO!!!**

*For spare parts please contact  
your Carrera retailer or visit:  
[carrera-toys.com/retailer-us](http://carrera-toys.com/retailer-us)*



**71590 GO!!!/Exclusiv/Evolution  
Electronic lap counter**  
Battery-operated, 4 batteries AA/LR6 (not included)

- Records times exactly (1/100 sec.)
- Can be used with all current Carrera racing track product lines
- Adjustable width to suit various track size
- For two lane operation
- Cars are identified via infrared light barrier
- Time trials from 1 seconds to 99 min.
- Lap counts from 1 to 999 laps
- Tone signals when crossing the finishing line
- False start function



**61655  
Lane change curve 1/90°**  
2 x

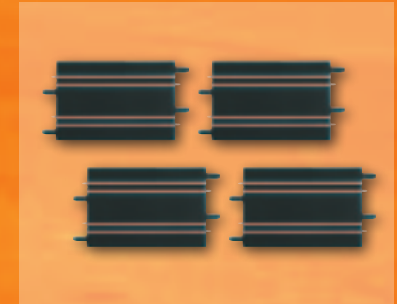

**61656  
Straight 6.73 in. / 171 mm**  
4 x



**61657  
Single-lane bends / Straight section  
extension set** • 8 single-lane bends, 4 single-lane straights  
13.46 in. / 342 mm



**61658  
Straights 3.94 in./100 mm • 4.49 in/114 mm**  
• 3 x Straights 3.94 in./100 mm, 3 x Straights 4.49 in/114 mm



**61659  
See-saw**

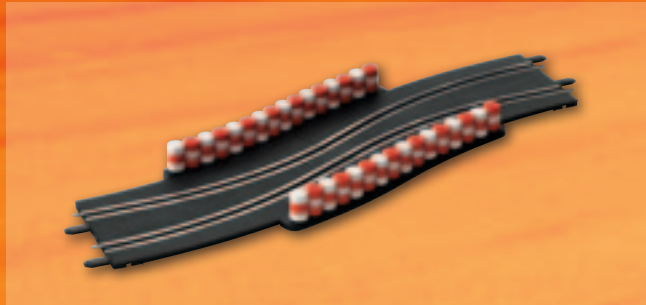

61647  
**Chicane**



61648  
**Single lane circle**



61649  
**Hump track - Bridge**

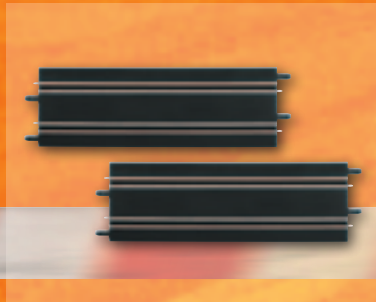

61602  
**Straight 13.46 in. / 342 mm**  
2 x

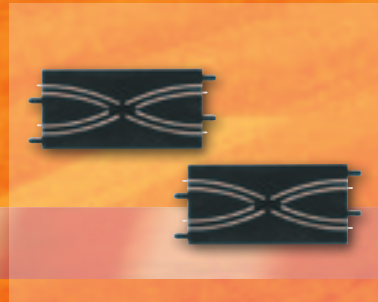

61609  
**Lane change section**  
2 x

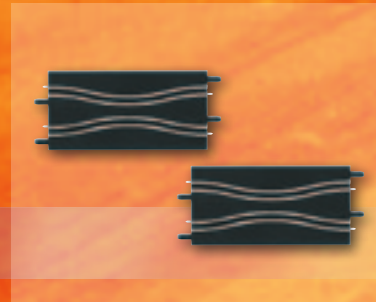

61610  
**Narrow section**  
2 x



61616  
**Junction**



61618  
**Mechanical lane change section**  
left and right



61603  
**Curve 1/90°**  
2 x



61611  
**Curve 1/45°**  
4 x



61612  
**High banked curve 1/45°**  
4 x · incl. supports



61617  
**Curve 2/45°**  
4 x



61646  
**High banked curve 2/45°**  
4 x · incl. supports

For spare parts please contact  
your Carrera retailer or visit:  
[carrera-toys.com/retailer-us](http://carrera-toys.com/retailer-us)



61650  
**Flags**  
10 x

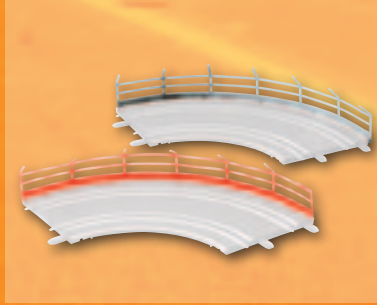

61651  
**Guardrailfence**  
10 x

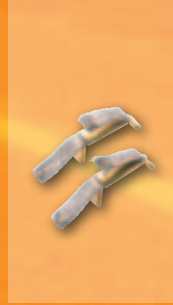

61510  
**Double sliding contact**

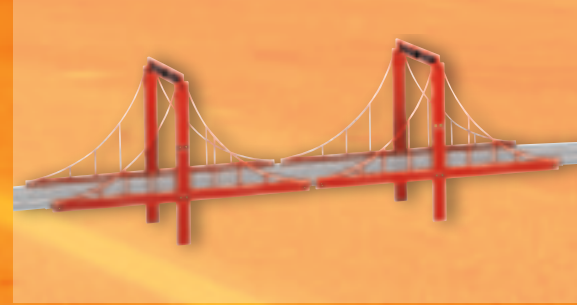

61604  
**Bridge set**  
4 Bridge parts with cross struts

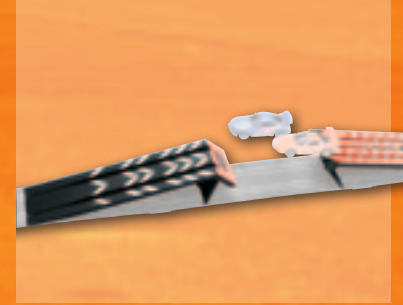

61641  
**Jump ramp**

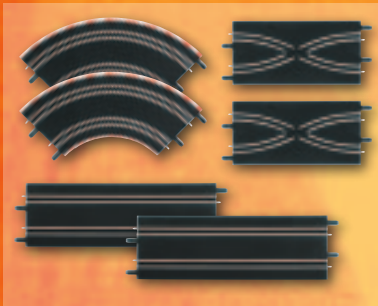

61600  
**Extension set 1** · 2 curves 1/90°, 2 lane change sections, 2 straights 13.46 in./342 mm

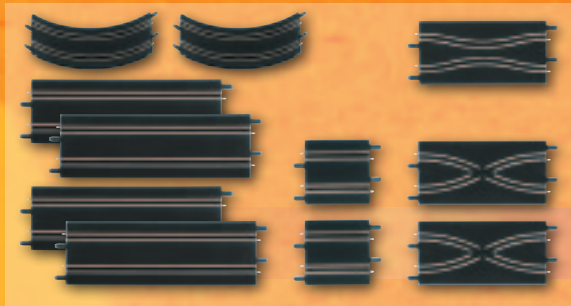

61601  
**Extension set 2** · 4 straights 13.46 in./342 mm, 2 straights 4.48 in./114 mm, 2 Fly Over incl. supports, 1 narrow section, 2 lane change sections

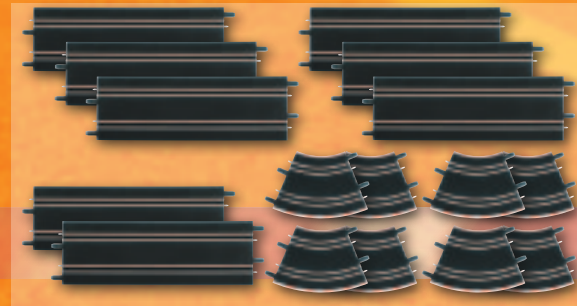

61614  
**Extension set 3** · 8 straights 13.46 in./342 mm, 4 curves 1/45°, 4 high banked curves 1/45° incl. supports

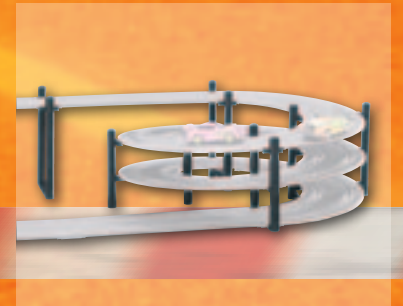

61642  
**3D support**



61645  
**Curve 3/45°**  
4 x



61639  
**Rally curve 1/90°**  
2 x



61640  
**Rallye narrow section**  
2 x



61643  
**Rally extension set** · 2 Rallye curves 1/90°, 2 Rallye narrow sections, 2 crossover straights 13.46 in./342 mm



61613  
**Looping set** · 8 looping sections with supports



**1:43** **1:43**

- For kids from 8 years and up
- Digital racetrack system allows changing the lane and passing with up to 3 cars
- Starter system to the Carrera digital world of racing, scale 1:43
- Digital lane change sections in special colour red
- Compatible with Carrera GO!!! action features and accessories

**CARRERA DIGITAL 143**

**THRILLING PASSING ACTION**



# Carrera® DIGITAL 143



© motorsportpressebild.de



6.40 x 2.46 ft. 18.37 ft.  
195 x 75 cm 5,6 m

**NEW**

### CHAMPIONSHIP RIVALS

Item no. 40015 · E · G · m  
Red Bull RB7 "Sebastian Vettel, No.1" · Ferrari  
150° Italia "Fernando Alonso, No.5" · Vodafone  
McLaren Mercedes Race Car 2011, "No.3"

4x 8x

1x

1x 6x 8x

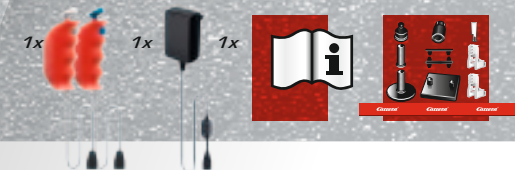

© motorsportpressebild.de

WORLDWIDE  
EXCLUSIVE LICENCE  
FOR SLOT RACING



WORLDWIDE  
EXCLUSIVE LICENCE  
FOR SLOT RACING



# Carrera® DIGITAL 143



© motorsportpressebild.de



7.87 x 4.03 ft. 23.94 ft.  
240 x 123 cm 7,3 m

**NEW**

### SUPER GT

Item no. 40014 · Q · T  
Ferrari 458 Italia GT2  
Porsche GT3 Cup "Monster FM, U. Alzen"

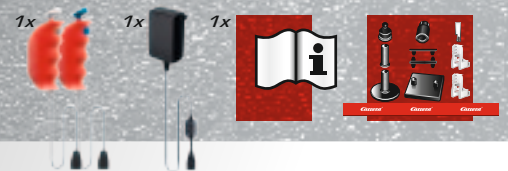

WORLDWIDE  
EXCLUSIVE LICENCE  
FOR SLOT RACING





7.00 x 3.02 ft. 20.66 ft.  
213 x 92 cm 6.3 m

**With flashing lights!**



**POLICE ON PATROL**  
Item no. 40010 · T · m  
AMG Mercedes SL 63 "Polizei"  
Porsche GT3 RS

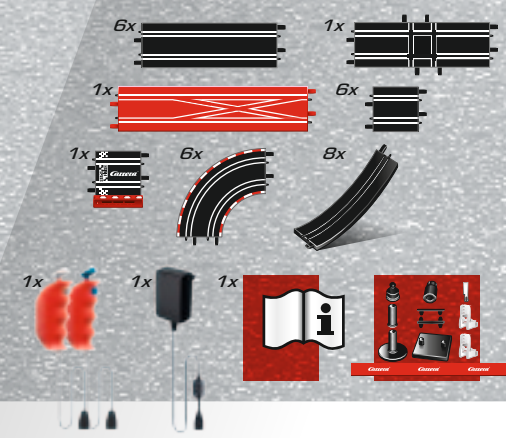

\* Preliminary packaging

# Carrera<sup>®</sup> DIGITAL 143



TM & © 2012 Nintendo. All Rights Reserved.



9.84 x 4.92 ft. 28.54 ft.  
300 x 150 cm 8.7 m



### MARIO KART WII

Item no. 40007 - V  
Mario Kart Wii - Wild Wing + Mario  
Mario Kart Wii - Wild Wing + Luigi™  
Mario Kart Wii - Wild Wing + Peach™

- 12x
- 4x
- 1x
- 1x
- 1x
- 1x
- 4x
- 8x
- 4x
- 1x
- 1x
- 1x
- 
-



41340 · C · c  
NASCAR Chevrolet® Impala  
Stewart Haas Racing "No.14", 2011



41341 · H · c  
NASCAR Chevrolet® Impala  
Stewart Haas Racing "No.39", 2011



41342 · d · c · \*  
NASCAR Chevrolet® Impala  
Hendrick Motorsports "No.24", 2011



41343 · i · c · \*  
NASCAR Chevrolet® Impala  
Hendrick Motorsports "No.48", 2011

More at  
[carrera-toys.com/us/](http://carrera-toys.com/us/)

**NEW**



41364 · Q · \*  
Ferrari 599XX Ferrari  
Racing Days "No.88"



41354 · Q  
Ferrari 599XX  
Nürburgring 2010 "No.97"



© Rainier Ehrhardt

41363 · Q · \*  
Ferrari 458 Italia GT2  
JMW Motorsports "No.66" 2011



41352 · Q  
Ferrari 458 Italia GT2 Risi  
Competizione "No.062", 2011



41353 · Q  
Ferrari 458 Italia GT2  
Hankook Team Farnbacher  
"No.123", 2011



**NEW**

© fotolia - Jan van Broekhoven

41365 · T · \*  
**Porsche GT3 Cup**  
"Seyffarth Motorsport"



41355 · T  
**Porsche GT3 Cup**  
"Monster FM, U.Alzen"

**NEW**



41360 · E · \*  
**Red Bull RB7**  
"Sebastian Vettel, No.1"



**NEW**

© motorsportpressebild.de

41361 · Q · \*  
**Ferrari 150° Italia**  
"Fernando Alonso, No.5"

**NEW**



41362 · P · \*  
**Vodafone McLaren-Mercedes**  
Race Car 2011 "No.3"

**With  
flashing  
lights!**



41334 · m  
**AMG Mercedes SL 63**  
"Safety Car"

**NEW**

**With  
flashing  
lights!**



41366 · L · ✦  
Ford Crown Victoria  
"Police Interceptor"



41319 · V  
Mario Kart Wii -  
Wild Wing + Mario



41320 · V  
Mario Kart Wii -  
Wild Wing + Luigi™



41321 · V  
Mario Kart Wii -  
Wild Wing + Peach™

*For spare parts please contact  
your Carrera retailer or visit:  
[carrera-toys.com/retailer-us](http://carrera-toys.com/retailer-us)*

*More accessories  
see pages 121-123*



42001  
Carrera DIGITAL 143 Black Box



42002  
Carrera DIGITAL 143 Speed Controller



42006 (USA) · 14,8 V === 10,36 VA  
Carrera DIGITAL 143 Transformer



42008  
Carrera DIGITAL 143 Lap counter



42003  
Carrera DIGITAL 143 Switch · left



42004  
Carrera DIGITAL 143 Switch · right

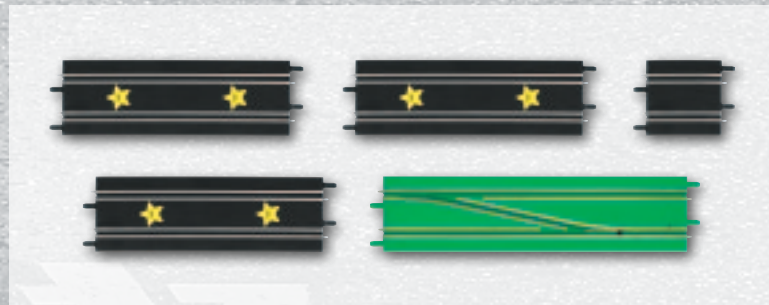

42009  
Carrera DIGITAL 143 Mario Kart Wii Extension set



42010  
Carrera DIGITAL 143  
Double lane change section

### **CARRERA-TOYS.COM – VISIT THE OFFICIAL WEBSITE**

Would you like a complete overview of the Carrera product portfolio and to experience your way across the world of Carrera brands? If so, Carrera's online realm is the place to be! Our official fully up-to-date state of the art website enables guests to import the fascination of motorsport straight into their living rooms.

Discover the myth of Carrera in the Carrera World and make sure you are fully informed about past and future events, and competitions. The 'Carrera Support' section is a quick source of advice on a wide range of issues, and among other things it is possible to download all spare part lists quickly and easily!

Register to receive the Carrera Newsletter for a constant supply of all the latest information on the Carrera brand.



Last website update 2011

## **CARRERA – SIMPLY MORE!**

### **More highlights on [carrera-toys.com](http://carrera-toys.com):**

- **Carrera Dealer Search** - a quick and easy way to find your nearest local official Carrera trader!
- **Carrera Partner Service** - the portal for all Carrera traders and media representatives!
- **Carrera Watchlist** - Note down products and never forget a single item!
- **Carrera decoration sheets and circuit design proposals** - customise your track!
- **Carrera TV** - Check out our internet TV format at [carrera-tv.com](http://carrera-tv.com)!



**Know more:**  
[carrera-toys.com](http://carrera-toys.com)



**Discover more:**  
[facebook.com/  
CarreraofAmerica](http://facebook.com/CarreraofAmerica)



**See more:**  
[youtube.com/  
CarreraHome](http://youtube.com/CarreraHome)



Ferrari Finali Mondiali 2011



VIP Sebastian Vettel in Rankweil

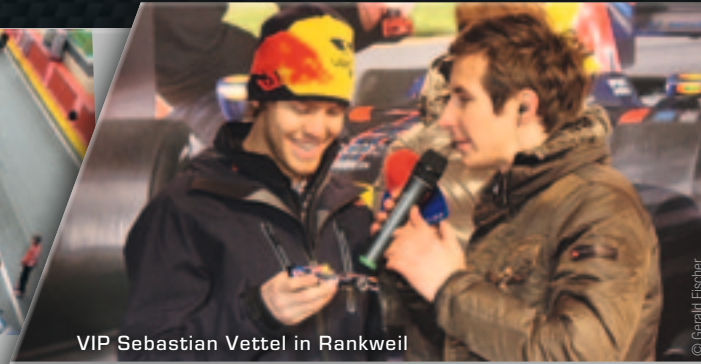

1Live  
Krone 2011



Modell Builders Fair 2011



LeMans 2011



VIP Sebastian Vettel  
in Rankweil

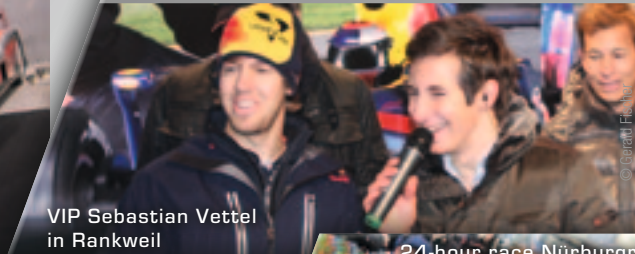

1Live  
Krone 2011



© SOKRATIV



Gaisberg Race Salzburg 2011



24-hour race Nürburgring



Toy Fair Nuremberg 2011



Porsche Sport Driving School



Formula 1 Santander Nürburgring



Press conference  
Stuck³



© Thomas Bönig



© Thomas Bönig



© Thomas Bönig

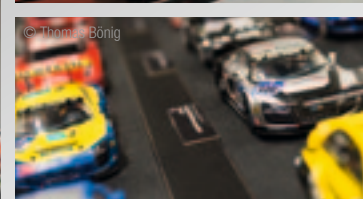

© Thomas Bönig



**Carrera**<sup>®</sup>

**POS**

Our Carrera POS-brand display units enable you to assemble a matching, branded display in order to enhance the impression made by your sales and display areas. Our POS units enable you to create your own perfect POS and display set-up!

For further information on our decoration possibilities please visit [carrera-toys.com/us/partner-service/](http://carrera-toys.com/us/partner-service/)



**POS-BRAND DISPLAY - CUSTOM-BUILD YOUR OWN CARRERA BRANDING SET-UP**



**Customer stopper flag**  
70773 27.6 x 9.8 in. · 70 x 25 cm  
plus fixing magnet



**LCD Screen** · Our LCD 15" screen is ideal for TV spots and product animation. This is a great way of introducing Carrera goods.



**Shelf strips**  
to fix at the shelf front  
70861 39 x 1.1 in. · 99 x 2,8 cm  
70862 48.8 x 1.1 in. · 124 x 2,8 cm



**Lighting box**  
70732 Side panels black mini-perl, rear slot hooks for hanging on existing display unit systems. Compatible with all the main standard shelf systems. Exchangeable backlight foils

## **DESIGN YOUR OWN CARRERA RACE TRACK!**

*You can decorate your show track as you like with grandstands, buildings and figures.  
To learn more about the Carrera show track and possibilities for decorating it, visit our  
homepage [carrera-toys.com/partnerservice](http://carrera-toys.com/partnerservice) or see page 94/95 in the catalogue.  
Orders may only be made through or by retail dealers.  
Delivery time approx. 3 weeks.*



70912  
**Carrera DIGITAL 132  
race track**  
Dimensions assembled:  
13 x 4.6 ft./4,0 x 1,4 m

Wooden plate: three-pieces, track material  
premounted · Two-track including Control  
Unit, 2 Driver Displays, Start light and  
4 vehicles  
Decoration not included.



**RACE TRACK**



69851  
Carrera start- and finish flag of fabric



Carrera fabric  
70488 984.25 x 27.55 in. · 2500 x 70 cm



70418 Carrera fineliner  
70438 Carrera ballpoint pen  
70533 Carrera pencil  
70855 Carrera caps

70770 Carrera kids' caps  
70789 Carrera paper flag  
18620 Carrera neckstrips · red

sample image



Logo plate Carrera  
38.58 x 9.45 in. / 98 x 24 cm:  
70340 Printed both sides - with holes  
70341 Printed both sides - without holes  
Fabric banner  
70434 78.7 x 19.3 in. · 200 x 49 cm  
70435 157.5 x 38.58 in. · 400 x 98 cm



Carrera sticker  
70790 4.72 x 1.18 in. · 12 x 3 cm  
70854 38.58 x 7.87 in. · 98 x 20 cm  
70853 9.64 x 2.36 in. · 24,5 x 6 cm



70567  
Carrera picker arm

Discover even more  
Carrera promotional  
material on our website  
[carrera-toys.com/us/  
partner-service/](http://carrera-toys.com/us/partner-service/)



70901  
**Catalogue 2012**  
Oblong format approx. A4

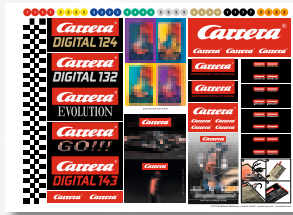

70898  
**Logo sheet self-adhesive**  
Oblong format approx. A4



70905  
**Consumer Folder Box**  
Preliminary model

*For legal reasons, the direct sale of Carrera promotional items to members of the public is forbidden.  
Carrera promotion material may solely be used for Carrera marketing purposes.*



**Carrera Polo Shirt, short-sleeved**  
Men: 18650 (S), 18670 (XXXL),  
30153 - 30157 (M-XXXL)  
Ladies: 18655 (XS), 18656 (S), 18659 (XL),  
70476 - 70478 (M-XL)



**Carrera Polo Shirt, long-sleeved**  
Men: 70470 - 70475 (S-XXXL),  
70775 - 70777 (L-XXL)  
Ladies: 70479 - 70483 (XS-XL)



70721  
**Carrera Dextrose**

70727  
**Carrera balloon**



**Carrera T-Shirts, short-sleeved**  
18621 - 18625 Men (S-XXL)  
18626 - 18630 Ladies (XS-XL)



**Carrera T-Shirts, long-sleeved**  
18631 - 18635 Men (S-XXL)  
18636 - 18640 Ladies (XS-XL)

70828  
**Father-son  
A-board**



## Licenses

### ORIGINAL LICENSES

Detailed, perfect design and highest quality – these standards require a close collaboration with the car industry.

For this reason Carrera is producing their original detailed cars only on basis of license agreements. And that's why the Carrera model might be put on the market before the big original is introduced.

**A**  
With permission of CITROËN.



**B**  
Officially licensed by AUDI AG.

**C**  
The Tony Stewart®, Stewart-Haas Racing™ and #14™ are trademarks of Stewart-Haas Racing and are used under license. Office Depot® and the Office Depot logo are registered trademarks of The Office Club, Inc.

**E**  
Trademarks licensed by Red Bull GmbH/Austria.



**G**  
The BMW logo, the BMW word mark and the BMW model designation are Trademarks of BMW AG and are used under license.

**H**  
The Ryan Newman®, Stewart-Haas Racing™ and #39™ are trademarks of Stewart-Haas Racing and are used under license. Tornos® and the Tornos logo are registered trademarks of Ruiz Food Products, Inc.

**I**  
Dodge, HEMI, vehicle nameplates and trade dress are trademarks of Chrysler Group LLC and used under license by Stadlbauer Marketing + Vertrieb GmbH. © Chrysler Group LLC 2012.



**J**  
Alfa Romeo is a registered trademark licensed by Fiat Group Automobiles S.p.A., a company of Fiat S.p.A. Group.

**K**  
Ford Oval and nameplates are registered trademarks owned and licensed by Ford Motor Company. CASTROL and the CASTROL logos are trademarks of Castrol Limited used under license. The HELIOS and BP, ULTIMATE and the ULTIMATE livery are trademarks of BP p.l.c. used under license. Abu Dhabi and associated marks are registered trademarks owned and licensed by the Abu Dhabi Tourism Authority. Manufactured by Stadlbauer Marketing + Vertrieb GmbH © M-Sport Ltd 2012.



**L**  
Ford Motor Company Trademarks and Trade Dress used under license to Stadlbauer Marketing + Vertrieb GmbH.



**N**  
Spider-Man, the Character TM & © 2012 Marvel Character, Inc. The Amazing Spider-Man, the Movie © 2012 Columbia Pictures Industries, Inc. All Rights Reserved.

**O**  
Maserati is a registered trademark. Under license from Maserati S.p.A.



**P**  
Manufactured under licence from McLaren Racing Limited. 'McLaren' and the McLaren logo are trademarks of McLaren Racing.



**Q**  
Produced under license of Ferrari Spa. FERRARI, the PRANCING HORSE device, all associated logos and distinctive designs are property of Ferrari Spa. The body designs of the Ferrari cars are protected as Ferrari property under design, trademark and trade dress regulations.



**R**  
Hergestellt mit Zustimmung der Peugeot AG.

**S**  
Chrysler, Plymouth, HEMI® and related logos, vehicle model names, and trade dresses are trademarks of Chrysler LLC and are used under license. © Chrysler LLC 2012.



**T**  
Hergestellt mit der Zustimmung der Dr. Ing. h.c.F. Porsche AG.

**V**  
TM & © 2012 Nintendo. All Rights Reserved.

**X**  
TM & © 2012 Marvel & Subs.



**Z**  
Willys® is a trademark of Chrysler LLC and is used under license. ©Chrysler LLC 2012.

**a**  
© Disney/Pixar  
Porsche is a trademark of Porsche.

**b**  
Shelby Cobra 289 are registered trademarks and/or intellectual property of Carroll Shelby and Carroll Shelby Licensing Inc. and are used under license.

**c**  
NASCAR® is a registered trademark of the National Association for Stock Car Auto Racing, Inc.



**d**  
© 2012 HGJ Licensing, LLC. The name, likeness and signature of Jeff Gordon and the likeness of the #24 Drive to End Hunger Chevrolet are used under license granted by HGJ Licensing, LLC.

**e**  
"Aston Martin" and "Aston Martin Racing" and the car design are trademarks/intellectual property rights owned by Aston Martin Lagonda Limited and/or Prodrive Motorsport Limited. All rights reserved. © Aston Martin Lagonda 2012 or such other similar wording as may be agreed by the parties.



ASTON MARTIN

**g**  
The Le Mans and 24 Heures du Mans trademarks are used under license from ACO, Automobile Club de L'Ouest.



**h**  
Richard Petty items licensed by Petty Marketing Company, LLC. The Richard Petty name, signature and silhouette are exclusive trademarks of Petty Marketing Company, LLC.



**i**  
© 2012 HGJ Licensing, LLC. The name, likeness and signature of Jimmie Johnson and the likeness of the #48 Lowe's Chevrolet are used under license granted by HGJ Licensing, LLC.

**m**  
„Mercedes-Benz“, and the design of the enclosed product are subject to intellectual property protection owned by Daimler AG. They are used by Stadlbauer Marketing + Vertrieb GmbH under license.

**n**  
Lee Petty name and/or likeness used under license by Petty Marketing Company, LLC.

**o**  
© 2012 Viacom International Inc. All Rights Reserved. Nickelodeon, SpongeBob SquarePants and all related titles, logos and characters are trademarks of Viacom International Inc. SpongeBob SquarePants created by Stephen Hillenburg.



**q**  
Marken-, Geschmacksmuster- und Urheberrechte werden benutzt mit der Erlaubnis des Inhabers Volkswagen AG.



**r**  
Opel Trademarks licensed to Stadlbauer Marketing + Vertrieb GmbH.

**s**  
Gulf trademark under license from Gulf Oil International Limited.

**w**  
© Disney/Pixar

with front light (xenon) and rear/brake light

With rear lights

digital upgrade ready

# Distributors

## AUSTRIA

**Stadlbauer Marketing +  
Vertrieb GmbH**  
Rennbahn Allee 1  
5412 Puch/Salzburg · Austria  
Phone ++43 662 88 921-0  
Fax ++43 662 88 921-510  
Internet www.carrera-toys.com

## GERMANY

**Stadlbauer Marketing +  
Vertrieb GmbH**  
Rennbahn Allee 1  
5412 Puch/Salzburg · Austria  
Phone ++49 911 7099-0  
Fax ++49 911 7099-119  
Internet www.carrera-toys.com

## USA / CANADA

**Carrera of America Inc.**  
2 Corporate Drive  
Cranbury, NJ 08512, USA  
Phone ++1 609 409 8510  
Fax ++1 609 409 8610  
Email reception@carrera-toys.com

## MEXICO

**Carrera of America Inc.**  
2 Corporate Drive  
Cranbury, NJ 08512, USA  
Phone ++1 609 409 8510  
Fax ++1 609 409 8610  
Email reception@carrera-toys.com

## BENELUX

**Stadlbauer Marketing +  
Vertrieb GmbH**  
Landsheerlaan 33  
NL-6114 MP Susteren  
Phone ++31 46 449 3486  
Fax ++31 46 449 5280  
Email fredhahn@xs4all.nl

## FRANCE

**Stadlbauer Marketing +  
Vertrieb GmbH**  
21 B, Route Nationale  
Domaine de L'Hancardrie  
FR-59320 Ennetieres-En-Weppes  
Phone ++33 3 20 38 48 93  
Fax ++33 3 20 38 48 93  
Email carrera-toys@orange.fr

## SPAIN / PORTUGAL

**Stadlbauer Marketing +  
Vertrieb GmbH**  
Venezuela 3 - 7 Esc. C 6° 3a  
08019 Barcelona  
Spain  
Phone ++34 93 303 63 35  
Fax ++34 93 303 63 35  
Email carrera-toys@telefonica.net

## HUNGARY

**Stadlbauer Kft.**  
Pecz Samu 2/A  
HU-1118 Budapest  
Phone ++361 260 3960  
Fax ++361 260 4266  
Email office@stadlbauer-toys.hu

## POLAND

**Stadlbauer Marketing +  
Vertrieb GmbH**  
Rennbahn Allee 1  
5412 Puch/Salzburg  
Austria  
Phone ++48 22 645 14 20  
Fax ++48 22 645 14 21  
Email office@stadlbauer-toys.pl

## Carrera Distributors

## ARGENTINA

Eurocom S.A.  
Rep. de la India 3067 - 12A  
1425 Buenos Aires  
Argentina  
Phone ++54 11 4803 8777  
Fax ++54 11 4802 6552  
Email eurocomsa@aol.com

## AUSTRALIA

Zimble Pty Ltd.  
169 Perry Street  
Fairfield, Victoria 3078  
Australia  
Phone ++61 3 8481 1000  
Fax ++61 3 9481 1799  
Email sales@zimble.com.au  
Internet www.zimble.com.au

## BRAZIL

Aeromodelli Ltda  
Avenida das Carinás, 550  
Moema - São Paulo - SP  
CEP 04086-011  
Brazil  
Phone ++55 11 5093 0200  
Fax ++55 11 5093 7400  
Email vendas@aeromodelli.com.br  
Internet www.modelo.toys.com.br

## BULGARIA

Ivanchev Ltd.  
78a, Maria Luiza Blvd.  
BG-1202 Sofia  
Phone ++359 283 22020  
Fax ++359 283 22020  
Email kivanchev@del.bg

## CHINA

Shanghai Wowgame  
Commercial Co., Ltd.  
Store 548, 5th Floor,  
353 Plaza, East Nanjing Road,  
Huangpu District, Shanghai, PRC  
Shop Phone ++86 21-3366 6286  
Office Phone ++86 21-5382 1692  
Email eddychan@wowgame.com.cn  
rickychan@wowgame.com.cn

## CZECH REPUBLIC

ConQuest entertainment a.s.  
Hloubetinska 11  
CZ-198 00 Praha 9 - Hloubetin  
Phone ++420 284 000 175  
Fax ++420 284 000 101  
Email radim.kalo@conquest.cz  
Internet www.autodrah.cz

## ESTONIA

Anvol Ltd.  
Madikse 7  
EE-74114 Maardu  
Phone ++372 63 88 100  
Fax ++372 63 88 101  
Email anvol@anvol.ee  
Internet www.anvol.ee

## FINLAND

ToyCenter Oy  
Koivupuistontie 26  
FI-01510 Vantaa  
Phone ++358 9 870 2500  
Fax ++358 9 870 2501  
Email info@toycenter.fi  
Internet www.toycenter.fi

## GREECE

Dionic S.A.  
95 Aristotelous Str.  
Acharnes, 13671 Athens  
Greece  
Phone ++30 210 2419 555 or 513  
Fax ++30 210 2444 389  
Email consumer@dionic.gr  
Internet www.dionicgroup.com

## INDIA

Karma Solutions  
7, Swastik Society, 2A, Pace House  
Vile Parle (W), Mumbai - 400056  
Maharashtra  
India  
Phone ++91 22 26104497  
Fax ++91 22 26104497  
Mobile ++91 9920075400  
Email karmasolutions7@gmail.com  
Internet www.karma-toys.com

## ITALY

Mac Due S.p.A. Società Uninomiale  
Via Raffaello Sanzio, 19  
IT-20852 Villasanta MB  
Phone ++39 039 2058 1  
Fax ++39 039 2058 203  
Email info@macdue.eu

## LEBANON

F. AOUAD  
P.O.Box 1565 Jounieh Lebanon  
Twin Towers Building Blk A  
Sarba High Way  
Jounieh  
Lebanon  
Phone ++961 3 840505  
Fax ++961 9 635473  
Email fawad@dm.net.lb

## NEW ZEALAND

FW Cave Ltd.  
5 Te Kea Place  
PO Box 300-558, Albany  
North Shore City 0752  
Auckland  
New Zealand  
Phone ++64 9 415 7766  
Fax ++64 9 415 7099  
Email sales@fwcave.co.nz  
Internet www.fwcave.co.nz

## RUSSIA

Unitoys Ltd.  
Mnevniky, 7-2  
RU 123308 Moscow  
Phone ++7 495 276 0286  
Fax ++7 499 946 4616  
Email office@unitoys.ru  
Internet www.unitoys.ru

## SERBIA / MONTENEGRO

Cool Play d.o.o.  
Gospodar Jovanova 1  
SRB-11000 Beograd  
Phone ++38111 20 30 353  
Fax ++38111 20 30 352  
Email office@coolplay.rs  
Internet www.coolplay.rs

## SLOVAKIA

Dracik - Duvi s.r.o.  
Brusnicova 7  
SK - 83101 Bratislava  
Phone ++421 2 4594 4626  
Fax ++421 2 4594 4628  
Email dracik@dracik.sk  
Internet www.dracik.sk

## SLOVENIA

Orbico d.o.o.  
Verovskova 72  
SI-1000 Ljubljana  
Phone ++386 1 5886 800  
Fax ++386 1 5886 922  
Internet www.orbico.si

## SOUTH AFRICA

Valid Trade  
4 Northgate Place, Redhill, Durban,  
4051, Kwazulu Natal  
South Africa  
Phone ++27 31 569 1706  
Fax ++27 31 569 1708  
Email valid6@validtrade.co.za

## SOUTH KOREA

JN Corporation  
3 Fl. #304, Oksan Building  
114 Garak-dong, Songpa-Gu  
Seoul, 138-160 Korea  
Phone ++82-70-4195-6602  
Fax ++82-2-576-6601  
Mobile ++82-10-3370-6601  
Email dwjuna@jn-toys.co.kr

## HONG KONG

Chun Lee (China) Industrial Limited  
RM. 1801-5, 18/F., King Palace Plaza,  
52A Sha Tsui Road, Tsuen Wan, N.T.  
Hong Kong  
Email eddychan@yu-lee.com  
Mobile ++852 9103 6679

## SWITZERLAND

Waldmeier AG  
Neustrasse 50  
CH-4623 Neuendorf  
Phone ++41 62 387 98 18  
Fax ++41 62 387 98 20  
Email info@waldmeier.ch  
Internet www.waldmeier.ch

## UKRAINE

Group of Companies "Paritet Service"  
4 Ivana Lepshe blvd  
03680 Kiev, Ukraine  
Phone ++38(044)499-37-07  
Fax ++38(044)499-37-06  
Email info@ps.ua  
Internet www.ps.ua

## UNITED KINGDOM

The Hobby Company Ltd.  
Garforth Place, Knowhill  
Milton Keynes MK5 8PG · UK  
Phone ++44 1908 209 480  
Fax ++44 1908 235 900  
Email enquiries@hobbyco.net  
Internet www.hobbyco.net

## UNITED ARAB EMIRATES

Toyworld Distributor  
P.O. Box 289, Gibca Building  
Al Wahda Street, Sharjah  
United Arab Emirates  
Phone ++971 6 533 7418  
Fax ++971 6 533 6682  
Email toyworld@faisalholding.net

## IMPORTANT!

*This catalogue shows product which is planned to be launched in 2012. The illustrations of this product partly show prototypes or preliminary packaging designs which are marked with "Preliminary model - colors/ final design subject to change" or "Preliminary packaging". These articles may deviate from the production version. Subject to technical and design-related changes. Errors excepted.*

