

# CRUISE REPORT: A12

(Updated OCT 2012)

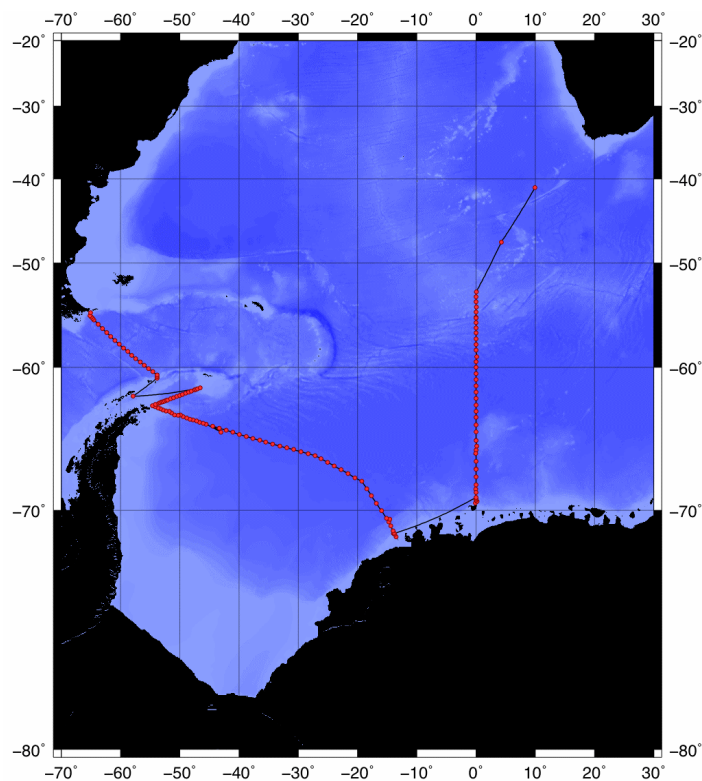

## Highlights

### Cruise Summary Information

WOCE Section Designation	<b>A12</b>
Expedition designation (ExpoCodes)	<b>06AQ20050122</b>
Alias	<b>ANT-XXII/3</b>
Chief Scientists	<b>Eberhard Fahrbach/AWI</b>
Dates	2005 JAN 22 - 2005 APR 06
Ship	<i>R/V POLARSTERN</i>
Ports of call	Cape Town, S. Africa - Punta Arenas, Chile
Geographic Boundaries	41° 8' S 65° 11' W 9° 56' E 71° 28' S
Stations	143
Floats and drifters deployed	40 ARGO floats deployed
Moorings deployed or recovered	3 moorings deployed

Contact Information:

**Eberhard Fahrbach**

Alfred Wegener Institute • Bussestrasse 24 • D-27570 Bremerhaven • (Building F-214) • GERMANY

Tel: +49-471-4831-1820 • FAX: +49-471-4831-1797 • Email: Eberhard.Fahrbach@awi.de

## Links To Select Topics

Shaded sections are not relevant to this cruise or were not available when this report was compiled.

<b>Cruise Summary Information</b>	<b>Hydrographic Measurements</b>
<a href="#">Description of Scientific Program</a>	<b>CTD Data:</b>
<a href="#">Geographic Boundaries</a>	<a href="#">Acquisition</a>
<a href="#">Cruise Track (Figure):</a> <a href="#">PI</a> <a href="#">CCHDO</a>	<a href="#">Processing</a>
<a href="#">Description of Stations</a>	<a href="#">Calibration</a>
<a href="#">Description of Parameters Sampled</a>	<a href="#">Temperature</a> <a href="#">Pressure</a>
<a href="#">Bottle Depth Distributions (Figure)</a>	<a href="#">Salinities</a> <a href="#">Oxygens</a>
<a href="#">Floats and Drifters Deployed</a>	<b>Bottle Data</b>
<a href="#">Moorings Deployed or Recovered</a>	<a href="#">Salinity</a>
	<a href="#">Oxygen</a>
<a href="#">Principal Investigators</a>	<a href="#">Nutrients</a>
<a href="#">Cruise Participants</a>	<a href="#">Carbon System Parameters</a>
	<a href="#">CFCs</a>
<a href="#">Problems and Goals Not Achieved</a>	<a href="#">Helium / Tritium</a>
<a href="#">Other Incidents of Note</a>	<a href="#">Radiocarbon</a>
<b>Underway Data Information</b>	<b>References</b>
<a href="#">Navigation</a> <a href="#">Bathymetry</a>	<a href="#">Nutrients</a>
<a href="#">Acoustic Doppler Current Profiler (ADCP)</a>	<a href="#">CFCs</a>
<a href="#">Thermosalinograph</a>	<a href="#">Carbon System Parameters</a>
<a href="#">XBT and/or XCTD</a>	
<a href="#">Meteorological Observations</a>	<b>Acknowledgments</b>
<a href="#">Atmospheric Chemistry Data</a>	
<b>Data Processing Notes</b>	

---

**ANT-XXII/3**

**2 January 2005 - 6 April 2005  
Cape Town - Punta Arenas**

**Fahrtleiter / Chief Scientist:  
Dr. E. Fahrbach**

**Koordinator / Coordinator:  
Prof. Dr. P. Lemke**



1.	<b>EXPEDITION ANT-XXII/3: Fahrtverlauf und Zusammenfassung</b>	<b>4</b>
	<b>EXPEDITION ANT-XXII/3: cruise narrative and summary</b>	<b>13</b>
2.	<b>Weather conditions</b>	<b>21</b>
3.	<b>Sea ice conditions</b>	<b>25</b>
4.	<b>Large scale processes and decadal variations in the Weddell Sea (Weddell Sea Convection Control, WECCON 2005)</b>	<b>27</b>
5.	<b>Distribution of carbon dioxide in the Weddell gyre</b>	<b>63</b>
6.	<b>Air-sea CO<sub>2</sub> fluxes in the Southern Ocean with CARIOCA buoys</b>	<b>66</b>
7.	<b>Dissolved barium distribution in the Antarctic Circumpolar Current and the Weddell Gyre</b>	<b>67</b>
8.	<b>Automatic detection of marine mammals in the vicinity of RV <i>POLARSTERN</i></b>	<b>68</b>
9.	<b>Introduction to ANDEEP: Antarctic benthic DEEP-sea biodiversity - colonization history and recent community patterns (ANDEEP III)</b>	<b>77</b>
	9.1 <b>Meiobenthos</b>	<b>85</b>
	9.2 <b>Macrobenthos</b>	<b>107</b>
	9.3 <b>Megabenthos</b>	<b>160</b>
	9.4 <b>Depositional Environments</b>	<b>192</b>
10.	<b>Bathymetry</b>	<b>212</b>
11.	<b>Acknowledgements</b>	<b>216</b>
	<b>APPENDIX</b>	<b>217</b>
A.1	<b>Participating Institutions</b>	<b>218</b>
A.2	<b>Cruise Participants</b>	<b>222</b>
A.3	<b>Ship's Crew</b>	<b>224</b>
A.4	<b>Station list</b>	<b>226</b>

---

# 1. EXPEDITION ANT-XXII/3: FAHRTVERLAUF UND ZUSAMMENFASSUNG

Eberhard Fahrbach  
AWI Bremerhaven

Am 22. Januar 2005 um 13:00 Uhr lief FS *Polarstern* von Kapstadt zur Antarktisreise ANT-XXII/3 aus. An Bord waren 57 Fahrtteilnehmer/innen aus 30 Instituten in 10 Ländern. Zunächst führte der Kurs bis  $34^{\circ}11'S$   $14^{\circ}33'E$  nach Westen. Dort wurde der erste Provor-Float ausgesetzt und FS *Polarstern* drehte nach Südwesten. Von nun an bis  $53^{\circ}00.3'S$   $00^{\circ}02.1'E$  folgte der Kurs der Laufbahn des Jason-Satelliten. Mit 80 Expendable Bathythermographs (XBT), die im Abstand von jeweils zwei Stunden geworfen wurden und die Wassertemperatur in den oberen 700 m der Wassersäule messen, dem Thermosalinographen, der Temperatur und Salzgehalt quasi kontinuierlich im Bugstrahlerschacht (6 m) und am Kastenkiel (11 m) misst, und dem Acoustic Doppler Current Profiler (ADCP), der die Meeresströmung vom fahrenden Schiff aus erfasst, fanden ozeanographische Messungen auf der Kurslinie statt, auf der der Jason-Satellit mit einem Altimeter die Auslenkung der Meeresoberfläche misst. Entlang der Kurs-Linie wurden im Rahmen des GOODHOPE-Projekts 9 weitere Provor-Floats (vertikal profilierende Driftkörper) ausgelegt. Ein weiterer Drifter wurde im Rahmen des französischen CARIOCA-Programms ausgebracht. Ferner wurden 2 Bodendruckmesser mit nach oben schauendem Echolot (PIES) aufgenommen und 3 wieder neu ausgelegt. Die Arbeiten des Tiefsee-Biologieprogramms ANDEEP III begannen am 25. Januar bei  $41^{\circ}08'S$   $09^{\circ}55'E$  und einer Wassertiefe von 4725 m im Kapbecken mit einer sedimentprofilierenden Kamera (SPI), 3 Großkastengreifern (GKG), 3 Multicorern (MUC), dem Epibenthoschlitten (EBS) und dem Agassiz-Trawl (AGT). Eine zweite Station erfolgte südwestlich des Meteor-Rückens mit der gleichen Gerätepalette am 28. Januar bei  $47^{\circ}40.0'S$   $04^{\circ}15'E$  in 4560 m Wassertiefe. Das Bathymetrie-Programm fand aufgrund der Auflagen des Umweltbundesamts nur in sehr eingeschränkter Form statt. Auf der Anreise und der Abreise konnte ein Teil des geplanten deutschen Bathymetrie-Programms ausgeführt werden. Es musste bei  $60^{\circ}S$  beendet werden. Südlich davon wurde aufgrund der Auflagen des Umweltbundesamts nur noch das russische Programm ausgeführt.

Bei  $53^{\circ}S$  erreichte FS *Polarstern* den Meridian von Greenwich. Von da an führte der Kurs direkt nach Süden und das ozeanographische Hauptprogramm im Rahmen von WECCON (WEddell Sea Convection CONtrol) wurde mit Messungen mit der CTD-Sonde (conductivity, temperature, depth = Leitfähigkeit, Temperatur, Tiefe) und der Aufnahme und Wiederauslegung von Verankerungen durchgeführt. Auf diesem Schnitt wurden 43 CTD-Messungen in 30 m Abstand ausgeführt. Über stark veränderlicher Topographie wurde der Stationsabstand verringert. Zusätzlich zu den CTD-Messungen wurden Wasserproben genommen, um die Konzentration von gelösten Nährstoffen, Sauerstoff, FCKWs, Barium und  $CO_2$  zu messen. Die FCKW-Proben wurden eingeschweißt und werden im Bremer Institut für Umweltphysik gemessen. Einen wesentlichen Anteil des Programms der physikalischen Ozeanographie stellte die Aufnahme und Auslegung von Verankerungen dar. Auf dem Greenwich-Meridian wurden 8 Verankerungen aufgenommen und 9 ausgelegt. Eine Verankerung konnte

nicht wieder gefunden werden. Bei den Verankerungsarbeiten hat sich das schiffseigene POSIDONIA-System vielfach bewährt. Die genaue Verfolgung des Absinkens bei der Auslegung und des Aufsteigens bei der Aufnahme stellen einen erheblichen Gewinn an Sicherheit für die Wiederaufnahme und Genauigkeit bei der räumlichen Zuordnung der Daten dar. Die Verankerungen enthalten Strömungs-, Temperatur- und Leitfähigkeitsmessgeräte, Schallquellen zur Ortung von Driftkörpern und Eisecholote (upward looking sonar, ULS) zur Messung der Eisdicke. Auf dem Meridian von Greenwich wurden 22 APEX- (Profiling Autonomous Lagrangian Circulation Explorers) und NEMO- (Navigating European Marine Observer) Driftkörper (Floats) ausgebracht. Zur Quantifizierung des Süßwassereintrags durch Eisberge wurden im südlichen Weddellmeer 5 Eisberge mit Satellitensendern ausgestattet, die mit dem Hubschrauber auf Eisbergen abgesetzt wurden.



Abb. 1.1: Karte des Fahrtgebiets und Fahrtroute der FS Polarstern-Reise ANT-XXII/3 vom 22. Januar bis zum 6. April 2005

Fig. 1.1: Map of the area of observations and cruise track during RV Polarstern leg ANT-XXII/3 from 22 January to 6 April 2005

Am 9. Februar wurden bei 67°S die Arbeiten auf dem Meridian von Greenwich unterbrochen, um zur *Neumayer-Station* abzulaufen. Am 25. Januar war das deutsche Polarflugzeug POLAR 4 auf dem Rückflug nach Deutschland bei einer harten Landung an der britischen Station *Rothera* zu Bruch gegangen und konnte den Flug nicht mehr fortsetzen. Dadurch wurde es notwendig, das Expeditionsprogramm der FS *Polarstern* zu ändern. Dabei war zu berücksichtigen, dass der Umweg über *Rothera* ohne zu große Einschnitte für das wissenschaftliche Programm erfolgen sollte. Als erste Möglichkeit der Zeitersparnis wurde die Versorgung der *Neumayer-Station* um einige Tage nach hinten verschoben. Dies brachte einen erheblichen Zeitgewinn mit sich, da das verkürzte Hin- und Zurücklaufen doppelt einging. Ferner wurde die Bergung einer Verankerung östlich der Maudkuppe aus dem Programm genommen. Auf dem Weg zur *Neumayer-Station* wurde am 10. Februar bei 69°30'S 5°23'W eine Amphipodenfalle ausgebracht und in der Nähe ein Hol mit dem Agassiz-Trawl ausgeführt.

Am 11. Januar erreichte FS *Polarstern* bei strahlendem Sonnenschein – nach Auflösung des morgendlichen Seerauchs - die Atkabucht. Schnell war ein passender Anlegeplatz an der Rampe gefunden. In unmittelbarer Nachbarschaft fand auch das südafrikanische Versorgungsschiff SA *Agulhas* einen geeigneten Platz, um Versorgungsgüter und Fahrzeuge von der 227 km entfernten südafrikanischen Station SANAE zu laden. Die Versorgungsaufgaben der FS *Polarstern* konnten zügig durchgeführt und noch am Abend abgeschlossen werden. Etwa 150 Kubikmeter Treibstoff wurde in Tankcontainer für die Station gefüllt. Eine Schneefräse, 16 Container und mehrere Schlitten mit 120 Tonnen Gewicht wurden geladen. Ein Fahrtteilnehmer des SANAP ging von Bord, um in SANAE zu überwintern. Während der Beladung hatten die Fahrtteilnehmer die Gelegenheit, die *Neumayer-Station* zu besuchen. Das wunderbare Wetter brachte viele dazu, den 8 km langen Weg, zumindest in einer Richtung, zu Fuß zurück zu legen. Die Helikopter waren im Einsatz, um Geräte und Personen zu transportieren. Sie waren besonders hilfreich, um die Arbeiten an einer Außenstation in der Nähe der Schelfeiskante durchzuführen. Hier soll in Zukunft mit einem Hydrophon den Geräuschen aus dem Meer gelauscht werden, wobei diese direkt nach Bremerhaven übertragen werden sollen. In der jetzt erreichten Vorstufe werden allerdings erst der automatische Betrieb und die Datenübertragung getestet, die besonders im Winter eine Herausforderung darstellen. Wenn sich das System als zuverlässig erwiesen hat, wird ein Loch durch das Schelfeis gebohrt und das Hydrophon in das Meerwasser darunter versenkt.

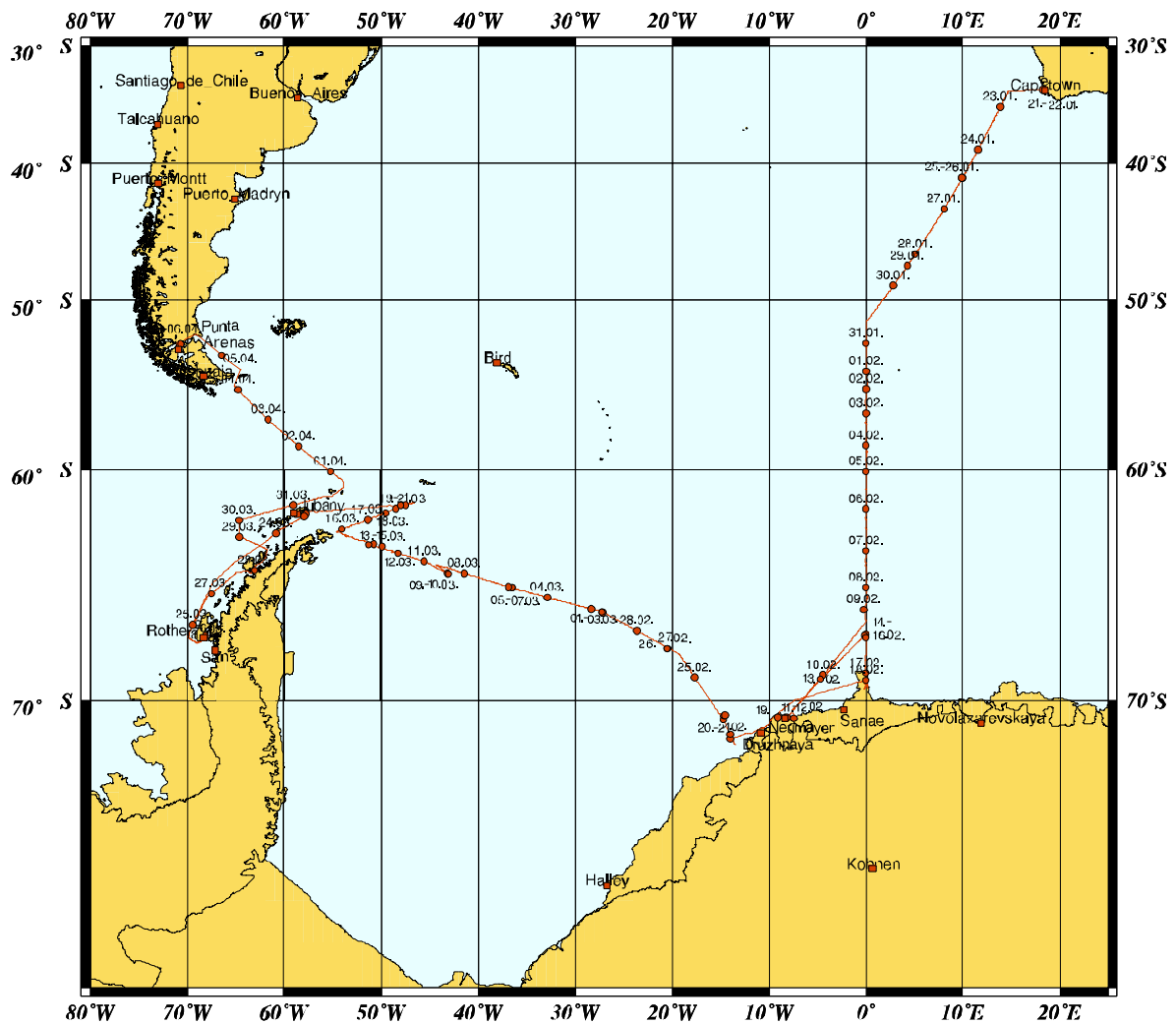
Am frühen Abend waren die Lade- und Pumparbeiten abgeschlossen, und Besatzung und Wissenschaft konnte den sonnigen Abend auf dem Eis mit einer kleinen Feier zu Verabschiedung der Überwinterer genießen. Zu unseren Gästen von der *Neumayer-Station* gesellten sich noch Besatzungsmitglieder der SA *Agulhas* hinzu. Sie mussten mit dem Helikopter abgeholt und wieder zurück gebracht werden, da die SA *Agulhas* nach Abschluss ihrer Ladearbeiten den Eisrand verlassen hatte und nun im freien Wasser der Bucht lag. Weitere Gäste waren die Besatzung der DC3 und eine Gruppe finnischer Forscher, die mit einem Flugzeug der ALCI eingetroffen war. Zusammen mit den deutschen Teilnehmern der Sommerkampagne und den noch an



der Station befindlichen Überwinterern des Vorjahrs sollten alle über die russische *Novolazarewskaya-Station* nach Kapstadt fliegen.

Für den 12. Februar war die Treibstoffübernahme von der *SA Agulhas* geplant, die den zusätzlichen Verbrauch für den Umweg über *Rothera* sicherstellen sollte. Doch das Wetter hatte sich geändert. Der Wind trieb so viel Eis vor die Rampe, dass hier das Tankmanöver nicht wie geplant möglich war. FS *Polarstern* fand im Süden der Bucht einen anscheinend akzeptablen Platz an der Eiskante. Doch auch hier stellte sich heraus, dass die angetriebenen Eisschollen die Betankung nicht erlaubten. Ein weiterer Versuch erfolgte im Osten der Bucht mit Unterstützung durch die Hub-schrauber. Hier schien die Schelfeiskante zuerst dazu geeignet, beide Schiffe parallel zueinander mit der Nase an das Eis zu legen, um so eine sichere Lage zu gewährleisten. Ein Abbruch an der Kante machte aber deutlich, dass auch dies keine sichere Position war. Schließlich erfolgte die Betankung im offenen Wasser. FS *Polarstern* fuhr in langsamer Fahrt voraus, die *SA Agulhas* hinterher. Zuerst wurde eine Leinenverbindung hergestellt, dann ein Schlauch gelegt und schließlich gepumpt. Am späten Abend war die Aktion beendet und FS *Polarstern* hatte 170 Tonnen Treibstoff erhalten. Mit Hornsignalen verabschiedeten sich die beiden Schiffe. FS *Polarstern* lief in Richtung Nordosten ab. Am 13. Februar wurde die Amphipodenfalle, die bei der Anreise ausgelegt worden war, wieder aufgenommen.

Der Schnitt auf dem Meridian von Greenwich wurde am 14. Februar bei 67°30'S mit einer weiteren ANDEEP-Station fortgesetzt, die bis zum 16. Februar dauerte. Mit CTDs, dem Aussetzen von Floats und dem Austausch von Verankerungen erfolgte die Fortsetzung nach Süden. Bei 69°15'S fand am 18. Februar die letzte Station auf dem Greenwich-Meridian-Schnitt in Sichtweite des Fimbul-Schelfeises statt. Bei 69°01'S waren wir das erste Mal auf eine geschlossene Meereisfläche getroffen.

Nach Abschluss der ersten Phase des Programms auf dem Meridian von Greenwich lief FS *Polarstern* nach Westen in Richtung Atkabucht ab. Bei etwa 70°32'S 9°2'W sollten zwei Fischfallen und eine Amphipodenfalle geborgen werden, die vor einem Jahr wegen der Eisverhältnisse nicht aufgenommen werden konnten. Trotz guter Verhältnisse konnte nur eine Fischfalle gefunden werden. Aufgrund des Zustands der geborgenen Falle muss angenommen werden, dass die anderen beiden Fallen durch Korrosion verloren gegangen sind. Der Bergungsversuch einer Verankerung mit Sinkstofffallen bei 70°57'S 10°33'W am 19. Februar war ebenfalls nicht erfolgreich. Hier liegt es nahe, dass diese Verankerung das Opfer eines der zahlreichen Eisberge wurde.

Die zweite Phase der physikalischen und biologischen Arbeiten zwischen Kapp Norvegia und der Nordspitze der Antarktischen Halbinsel begann am 20. Februar bei 71°18'S 13°57'W. Hier lag der Schwerpunkt der tiefseebiologischen Arbeiten mit 9 großen Stationen im Rahmen von ANDEEP III. Vier dieser Stationen fanden am Kontinentalabhang vor Kapp Norvegia in 1040, 2170, 3090 und 4410 m Wassertiefe statt. Dieser Schnitt war am 24. Februar beendet. Die Arbeiten der physikalischen Ozeanographie gingen mit 54 CTD-Stationen in etwa 30 m Abstand und der Auslegung von 3 Verankerungen und 18 Floats weiter. Bei 68°04'S 20°28'W in 4933 m, 66°37'S 27°10'W in 4892 m, 65°34'S 36°31'W in 4802 m und 65°00'S 43°02'W in

4701 m Tiefe fand jeweils eine weitere ANDEEP-Station statt. Am 11. März erreichten wir bei 64°30'S 45°15'W das erste Mal auf der Reise ausgedehnte Meereisfelder, die zeitweise zu einer merklichen Reduzierung der Fahrtgeschwindigkeit führten. Sie waren Teil einer Eiszunge, die sich über dem Kontinentalabhang vom südlichen Weddellmeer bis in das Powellbecken erstreckte. Zwar nahm die Eisbedeckung zum Schelf hin deutlich ab, war aber stärker als in den Satellitenbildern wiedergegeben. Bei 63°41'S 50°44'W erfolgte am 14. März eine weitere ANDEEP-Station. Der westlichste Punkt auf dem Schnitt durch das Weddellmeer wurde am 16. März bei 63°04'S 54°37'W und 440 m Wassertiefe erreicht.

Die verhältnismäßig geringe Eisbedeckung und das sehr ruhige Wetter hatten es ermöglicht, die Arbeiten auf dem Weddellmeer-Schnitt so zügig durchzuführen, dass noch genügend Zeit verblieb, um die als Option geplanten Arbeiten im Powellbecken auszuführen. Sie bestanden aus einem CTD-Schnitt von 63°04'S 54°37'W bis 61°39'S 46°33'W mit 20 Profilen und drei ANDEEP-Stationen in 3405, 2000 und 1180 m Tiefe auf der östlichen Seite des Beckens. Bis 62°02'S 48°45'W mussten die Ausläufer der Eiszunge aus dem Weddellmeer durchquert werden. Auch dieser Abschnitt der Reise konnte unter optimalen Wetterbedingungen zügig durchgeführt werden. Am 21. März waren die Arbeiten im Powellbecken abgeschlossen und *FS Polarstern* lief in die Bransfieldstraße ab. Einen Teil der Strecke mussten wir gegen Westwind der Stärke 8 und den entsprechenden Seegang anfahren.

Allerdings beruhigte sich das Wetter bis zu unserer Ankunft in der Maxwellbucht am 23. März wieder. Am Ufer des angrenzenden Potter Coves liegt die argentinische *Jubany-Station*, der das deutsche *Dallmann-Labor* angeschlossen ist. Obwohl wir deutlich früher als erwartet angekommen waren, waren dort die Vorbereitungen so weit voran geschritten, dass wir die günstigen Wetterbedingungen nutzen und sofort mit den Helikopterflügen zur Beladung beginnen konnten. Neben den Transporten vom *Dallmann-Labor* waren auch Transporte von der von Uruguay betriebenen Station *Base Científica Antártica Artigas* und der russischen Station *Bellingshausen* zur *FS Polarstern* notwendig. Ganz zum Schluss brachten wir noch Teilnehmer der Sommerkampagne nach *Bellingshausen*, wo sie warteten, bis ihr Flug nach Hause abging. Zwei weitere Fahrtteilnehmer, ein argentinischer Bobachter und ein Logistiker des AWI, die uns für den Rest der Reise begleiteten, kamen an Bord. Während dieser Transportaufgaben war es möglich, durch Besuche der Fahrtteilnehmer an mehreren Stationen und von Bewohnern der *Jubany-* und der *Artigas-Stationen* an Bord die freundschaftlichen Beziehungen zu pflegen. Überall wurden wir herzlich empfangen. Während der Nacht und einer Schlechtwetterphase am Vormittag nutzten wir die Zeit, um in der Bransfieldstraße eine weitere ANDEEP-Station in 1995 m Tiefe zu beginnen. Sie wurde nach dem Abschluss der Versorgungsarbeiten fortgesetzt. In der Nacht zum 24. März liefen wir in Richtung der britischen Station *Rothera* ab.

Am 24. März passierten wir Deception-Insel, doch die Insel verbarg sich hinter einer Nebelwand. Die Akustikgruppe nutzte die lange Dampfstrecke, um den Streamer zu schleppen und Walgeräusche aufzunehmen. Die Wetterbedingungen während der Dampfstrecke waren nicht sehr viel versprechend, und wir bereiteten uns auf eine längere Wartezeit vor. Am 25. März erreichten wir die Marguerite-Bucht und lagen

vor *Rothera Point*. Das Wetter hatte sich erstaunlich verbessert. Nachdem schon eine Gruppe britischer Fahrtteilnehmer im Laufe des Tages voraus geflogen war, um lebende Muscheln von *Jubany* nach *Rothera* zu bringen, erfolgte das erste offizielle Zusammentreffen mit unseren britischen Partnern am Abend auf der *FS Polarstern*. Wir hatten den Kapitän der RSS *Ernest Shackleton*, die vor *Rothera* an der Pier lag, und den Stationsleiter zu einem Besuch eingeladen. Auch hier war sofort ein freundschaftliches Verhältnis aufgebaut, und die Aktionen des folgenden Tages konnten ausführlich geplant und vorbereitet werden, bis der Helikopter unsere Gäste bei Einbruch der Dunkelheit wieder zurück brachte. Dann kam schließlich am 26. März der große Tag, auf den unsere ganze Fahrtplanung ausgerichtet werden musste, nämlich die Übernahme der *POLAR 4*. Sie wurde dadurch erschwert, dass die Wassertiefe an der Pier für *FS Polarstern* nicht ausreichend ist und wir das Flugzeug mit Hilfe der RSS *Ernest Shackleton* übernehmen mussten. Wieder verwöhnte uns das Wetter, kein Wind und Sonnenschein schufen optimale Bedingungen. Die RSS *Ernest Shackleton* lud die Tragfläche und den Flugzeugrumpf an der Pier. Dann legten sich *FS Polarstern* und RSS *Ernest Shackleton* 0,85 m von der Pier im offenen Wasser parallel nebeneinander. Die Flugzeugteile konnten in 22 Minuten mit unserem 15-to-Kran auf dem Helikopterdeck der *FS Polarstern* abgestellt werden. Während der Übernahme waren die Fahrtteilnehmer bereits an Land und genossen die britische Gastfreundschaft, die wir am Nachmittag mit einer Einladung auf die *FS Polarstern* zu Bier und Würstchen erwiderten. Am 26. März um 19:00 Uhr liefen wir mit einem weiteren Fahrtteilnehmer, einem Techniker der DLR, der zur Beladung nach *Rothera* gekommen war, an Bord ab. Die Polartaufe und das Osterfest verbrachten wir vom schlechten Wetter geschützt in der Gerlache-Straße auf dem Weg zu den letzten Stationen dieser Reise.

Vom 29. bis zum 31. März fanden bei 63°19'S 64°37'W in 2080 m und bei 62°31'S 64°39'W in 3802 m Tiefe zwei weitere ANDEEP-Stationen statt. Sie waren westlich der Drakestraße und des Hero-Bruchzone im Pazifik gelegen und konnten interessantes Vergleichsmaterial liefern. Den Abschluss der Arbeiten bildete ein CTD-Schnitt durch die östliche Drakestraße entlang des Shackleton-Bruchzone von 60°53'S 53°50'W nach 55°04'S 65°04'W, der am 4. April abgeschlossen war.

Während der gesamten Reise wurden hydroakustische Messungen und Infrarot-Beobachtungen ausgeführt, die zur Weiterentwicklung eines Systems beitragen, das es erlaubt, Warmblüter zu orten. Damit soll ermöglicht werden, in Zukunft die Auflagen des Umweltbundesamts zu erfüllen und unterschiedliche hydroakustische Messverfahren von *FS Polarstern* aus einzusetzen.

Die wissenschaftlichen Arbeiten wurden durch Programme zur Öffentlichkeitsarbeit begleitet, zu dem auch ein Expeditionsmaler gehört, der die Stimmung jeden Tages mit einem Ölbild festhielt. Ferner wurde der Verlauf der Reise auf der AWI-Web-site [eXpeditions site file/ext/www-bhv/Polar/Polarstern/ANT-XXII-3/ExpeditionSummary](http://eXpeditions.site/file/ext/www-bhv/Polar/Polarstern/ANT-XXII-3/ExpeditionSummary), der CeDAMar-site [www.cedamar.org](http://www.cedamar.org) und bei Senckenberg dokumentiert.

Am 6. April 2005 lief *FS Polarstern* um 08:00 Uhr in Punta Arenas ein.

Die Arbeiten der Tiefsee-Biologie sind in das ANDEEP-III-Projekt (ANtarctic benthic DEEP-sea biodiversity: colonization history and recent community patterns) eingebunden, das ein internationales Projekt zur Erforschung der Biologie von Tiefseeorganismen im Scotia- und Weddellmeer darstellt. Das ANDEEP-Projekt wurde ins Leben gerufen, um das Ökosystem Tiefsee im Südlichen Ozean zu charakterisieren. Die Hauptziele sind, den Einfluss der Habitatvielfalt des Meeresbodens auf die biologische Vielfalt zu untersuchen und festzustellen, ob und in welchem Maße das Scotia- und das Weddellmeer Ursprungsgebiete für das Benthos angrenzender Tiefwassergebiete sind. Im Verlaufe von ANDEEP I und II im Sommer 2002 waren bereits mehrere Gebiete im Atlantischen Sektor beprobt worden. In ANDEEP III wurde die Probennahme fortgesetzt und so ein unvergleichbarer Datensatz geschaffen.

Die Tiefsee des Scotia- und des Weddellmeeres gehört zu den am wenigsten untersuchten Gewässern der Weltozeane, und wir wissen nahezu nichts über die dort am und im Boden lebenden Tiere. Erste Ergebnisse von ANDEEP I und II haben Eindrücke über die Artenzusammensetzung und mögliche Wege der Evolution der Tiefseefauna des Südlichen Ozeans vermittelt. ANDEEP III hat unsere bisher gewonnenen Erkenntnisse vertieft, und zwar in einem erweiterten Untersuchungsgebiet, das außer dem Becken des Weddellmeers das Powellbecken, die Bransfieldstraße, die südwestliche Drakestraße und auch das Kapbecken umfasste.

ANDEEP ist eines von zwei Projekten, die den ursprünglichen deutschen Beitrag zu CeDAMar (Census of the Biodiversity of Abyssal Marine Life) leisten. CeDAMar ist ein für zehn Jahre ausgelegtes Projekt, das der Erforschung benthischer Lebensgemeinschaften in den Becken des Atlantiks von Pol zu Pol gewidmet ist und gehört zu dem weltweiten Programm CoML (Census of Marine Life), das 2000 gegründet wurde und bis 2010 dauern soll. Bislang sind Wissenschaftler aus mehr als 70 Nationen beteiligt, die mit standardisierten Methoden Proben nehmen und eine globale Datenbank zusammenstellen, die als frei zugängliche Referenz für spätere Untersuchungen dienen soll. Mit CeDAMar soll versucht werden, Taxonomie und Systematik wieder als zentrale Disziplinen der Biologie zu etablieren. Artbeschreibungen gehören zu den zentralen Aufgaben, die CeDAMar sich gestellt hat.

Um ein möglichst vollständiges Bild über die bodenlebenden Organismen zu erhalten wurden verschiedene Geräte standardisiert eingesetzt. Die CTD für Messungen der Temperatur, des Salzgehalts, der Dichte und der Nährstoffe des Wassers, in dem diese Tiere leben. Mit einer Sedimentprofilkamera (SPI) wurden Organismen und ihre Lebensspuren auf dem Meeresboden anhand von Fotos identifiziert. Ihre Grabspuren und die Korngrößen und Qualität des Sedimentes wurden aufgezeichnet. Die Eindringtiefe des Sauerstoffes in das Sediment wurde gemessen, um zu zeigen, bis in welche Tiefen im Sediment grabende Organismen überhaupt zu erwarten sind. Ein Gerätepark bestehend aus Multicorer, Großkastengreifer, Epibenthoschleppen und Agassiz-Trawl wurde eingesetzt, um Organismen ganz verschiedener Größenklassen zu sammeln und zu bearbeiten, von den kleinsten Formen, die im Sandlückensystem leben bis hin zu den großen Tieren, die man auf den Unterwasserfotos erkennen kann.

Insgesamt wurden 18 ANDEEP-Stationen ausgeführt, bei denen jeweils eine CTD, die SPI, mindestens je zwei GKGs (Großkastengreifer) und zwei MUCs (Multicorer) eingesetzt wurden sowie die geschleppten Geräte, der Epibenthoschlitten und das Agassiz-Trawl. Bei fast allen ANDEEP-Stationen wurde außerdem eine Amphipodenfalle (AT) ausgelegt. Diese Stationen verteilten sich über verschiedene Schnitte. Ein Schnitt wurde entlang des Greenwich-Meridians nach Süden mit je einer Station im Kapbecken, im Agulhasbecken und im nördlichen Weddellmeer-Becken südwestlich der Maudkuppe genommen. Ein weiterer Schnitt mit Stationen in ca. 1000 m, 2000 m, 3000 m und 4000 m Tiefe erfolgte vor Kapp Norvegia in das tiefe Weddellmeer. Ein dritter Schnitt führte durch das tiefe Weddellmeer und bestand aus 5 Stationen, wobei sich eine Station im Ausstrom des Weddellmeer-Bodenwassers befand. Ein weiterer Schnitt aus drei Stationen erfolgte im Powell Becken in 1000 m, 2000 m und 3000 m. Danach wurden noch eine Station in der Bransfieldstraße in 2000 m Tiefe sowie zwei Stationen vor Anvers Island in 2000 und 4000 m Tiefe beprobt.

Das Ziel des WECCON-Programms (Weddell Sea convection control) der physikalischen Ozeanographie besteht darin, die Bedeutung des atlantischen Sektors des Südlichen Ozeans für die großräumigen klimatischen Bedingungen besser zu verstehen. Die Intensität und Struktur der thermohalinen Zirkulation bestimmen die Rolle des Ozeans für das Klima. Im atlantischen Sektor des antarktischen zirkumpolaren Wassergürtels wird die globale Zirkulation durch die Bildung von Antarktischem Bodenwasser beeinflusst. Messungen im Tiefen- und Bodenwasser des Weddellmeeres haben gezeigt, dass sich seine Eigenschaften im Zeitraum der letzten 10 bis 15 Jahren merklich verändert haben. Zum Ende der 80er Jahre fanden eine Erwärmung und Salzgehaltszunahme des von Norden einströmenden Zirkumpolaren Tiefenwassers statt. Im weiteren Verlauf wurde die Temperaturzunahme in den tieferen Schichten des Boden- und Tiefenwassers sichtbar und breitete sich bis in das westliche Weddellmeer aus. Inzwischen ist die Erwärmung im Zirkumpolaren Tiefenwasser des Weddellmeeres zum Stehen gekommen und wurde von einer merklichen Abkühlung gefolgt, im Bodenwasser hält die Erwärmung aber weiter an.

Die Variationen in den verschiedenen Meeresgebieten können hypothetisch als Teile einer längerfristigen Wirkungskette interpretiert werden. Die Wassermassencharakteristik im Weddellmeer hängt vom Zustrom aus dem Antarktischen Zirkumpolarstrom ab. Er erfolgt allerdings nicht nur im östlichen Weddellmeer, wie früher angenommen, sondern auch schon westlich des Meridians von Greenwich. Vermehrter Einstrom kann zur Erwärmung im Weddellmeer führen. Andererseits ist in der Folge der großen Weddell-Polynja der 70er Jahre das Tiefenwasser im Weddellmeer durch Konvektion im offenen Ozean abgekühlt worden und wird nun wieder durch wärmeres ersetzt. Demnach wäre die gegenwärtige Erwärmung eine Reaktion auf ein vorhergehendes Abkühlungsereignis.

Da die Entstehung der großen Weddellmeer-Polynja noch nicht geklärt ist, kann nicht ausgeschlossen werden, dass sie durch Veränderungen im Einstrom von Zirkumpolarem Tiefenwasser ausgelöst wurde, indem die Stabilität der Wassersäule abnahm. Fluktuationen des Einstroms könnten durch die Variation der atmosphärischen An-

triebsbedingungen ausgelöst werden, die z. B. im Rahmen der Antarktischen Zirkumpolaren Welle, des Südlichen Ringmodes oder des Antarktischen Dipols auftreten. Andererseits könnten aber auch lokale Veränderungen der Antriebskräfte im Weddellmeer von Bedeutung sein.

Die Wassermassenformation erfordert, dass warmes, salzreiches Wasser in größerer Tiefe in den antarktischen Bereich einströmt, dort durch Auftrieb in der Antarktischen Divergenz an die Oberfläche kommt und im Kontakt mit der Atmosphäre abgekühlt wird, bis die Dichtezunahme das Absinken ermöglicht. Der Süßwassergewinn durch Niederschlag und durch den Zustrom von Schmelzwasser vom Kontinent, der zum Teil durch das Abbrechen von Eisbergen erfolgt, führt aber zur Dichteabnahme, die erst durch Salzfreesetzung bei der Meereisbildung kompensiert werden muss, bevor die Boden- oder Tiefenwasserbildung einsetzen kann. Daher ist der Salz- oder Süßwasserhaushalt von besonderer Bedeutung.

Im Rahmen globaler Programme haben unsere Messungen das Ziel, einen mittleren Zustand des Weddellmeer-Systems und dessen Veränderlichkeit zu charakterisieren, um über die regionalen Untersuchungen hinaus globale Zusammenhänge zu beschreiben. Ferner sollen die Daten großräumigen Modellrechnungen als südliche Randbedingung dienen und zur Validierung regionaler Modelle herangezogen werden. Da sich gezeigt hat, dass merkliche Veränderungen des Systems über einen Zeitraum von Dekaden erfolgen, erfordert die Untersuchung der Ursachen und der Auswirkungen dieser Fluktuationen Wiederholungsmessungen hoher Qualität über einen entsprechenden Zeitraum.

Die physikalischen Untersuchungen auf hydrographischen Schnitten entlang dem Meridian von Greenwich, durch das Weddellmeer von Kapp Norvegia nach Joinville Island, durch das Powellbecken und über die Drake-Straße wurden durch ein Programm zur Messung von Tracern (FCKWs) erweitert, die zur Wassermassencharakterisierung herangezogen werden. Der Beitrag des atlantischen Sektors des Südpolarmeers als Quelle oder Senke im globalen Kohlenstoffkreislauf wurde in einem Projekt zur Messung von Nährstoffen und den Komponenten des CO<sub>2</sub>-Systems bearbeitet.

Das Ausbringen der Floats erfolgte im Rahmen des internationalen ARGO-Programms, das zum Global Ocean Observing System (GOOS) beiträgt. Ziel des internationalen ARGO-Projekts ist es, permanent ca. 3000 profilierende Floats (Messung von Druck, Temperatur und Salzgehalt) im Weltozean zu unterhalten. Im Rahmen dieses Projekts wurden während der Expedition 40 Floats (10 GOODHOPE, 9 MERSEA und 21 deutsches ARGO) hauptsächlich in Regionen, in denen bisher keine Floatdaten vorhanden waren, ausgelegt. Die 30 AWI-Floats (MERSEA/dt. ARGO) sind alle mit einem Meereis-Erkennungsalgorithmus ausgestattet, um ein Auftauchen zwischen Eisschollen, die die Floats zerstören könnten, zu verhindern. Bis zum 28.03.05 wurden 84 Profile, die sich in sehr guter Übereinstimmung mit in der Nähe liegenden CTD-Messungen befinden, übermittelt.

Die WECCON-Arbeiten fanden im Rahmen des BMBF-Verbundes CLIVAR/marin-2 statt, der im Rahmen des Climate Variability and Predictability (CLIVAR) Programms

---

des World Climate Research Programme (WCRP) der UNESCO angesiedelt ist. Die Untersuchungen bei der Maudkuppe sind im Rahmen des von SCOR (Scientific Committee of Oceanographic Research) betreuten iAnzone Programms zu sehen, das einen Beitrag zum Climate and Cryosphere (CLIC) Programm des WCRP liefert. In diesem Programm ist besonders die Ausbringung der Eisbergsender und der Upward Looking Sonars (ULS) von Bedeutung. Die ULS sind ein Beitrag zum Antarctic Sea Ice Thickness Project (AnSITP). Im Rahmen der internationalen Programme erfolgt besonders enge Zusammenarbeit mit dem Bjerknes Centre in Bergen, Norwegen, das am Verankerungsprogramm beteiligt ist. Die gesamte Expedition ist ein Beitrag zum MARCOPOLI-Programm der Hermann von Helmholtz-Gemeinschaft Deutscher Forschungszentren (HGF) im Rahmen der Arbeitspakete MAR1 und POL2.

## **EXPEDITION ANT-XXII/3: CRUISE NARRATIVE AND SUMMARY**

Eberhard Fahrbach  
AWI Bremerhaven

On 22 January 2005 at 13:00 h local time RV *Polarstern* left Cape Town to the Antarctic cruise ANT-XXII/3 with 57 cruise participants from 30 institutes in 10 countries on board. First we steamed to the west up to 34°11'S 14°33'E. At this location the first Provor float was deployed and RV *Polarstern* turned to the southwest. From now on up to 53°00.3'S 00°02.1'E the course followed to the bottom track of the Jason satellite. With 80 Expendable Bathythermographs (XBT) which were launched every two hours, the water temperature was measured in the upper 700 m of the water column. The thermosalinograph measured temperature and salinity quasi continuously with sensors in the bow thruster tunnel (5 m) and the boxkeel (11 m). An Acoustic Doppler Current Profiler (ADCP) recorded the ocean currents in the upper few hundred meters below the ship. Along its track the Jason satellite observes with its altimeter the sea level elevation. Along the track line 9 Provor floats (vertically profiling floats) were deployed in the context of the GOODHOPE project. A drifting buoy was launched in the framework of the French CARIOCA programme. Two inverted echosounders with bottom pressure sensors (PIES) were recovered and 3 deployed. The activities within the deep-sea biology programme ANDEEP III commenced on 25 January at 41°08'S 09°55'E at a water depth of 4725 m in the Cape Basin with the deployment of a sediment profile imaging camera (SPI), 3 box corers (GKG), 3 multicorers (MUC), the epibenthic sledge (EBS) and the Agassiz trawl (AGT). A second station was done to the southwest of the Meteor Rise with the same sequence of instruments on 28 January at 47°40.0'S 04°15'E in 4560 m water depth. The bathymetry programme had to be significantly reduced due to the restrictions from the Federal Environmental Agency. On the way towards Antarctica and back, north of 60°S a small part of the German bathymetry programme could be done. However, south of 60°S only the Russian Programme could be realised.

At 53°S RV *Polarstern* reached the Greenwich meridian. From now on the course was due south and the main programme in physical oceanography WECCON (WEddell Sea Convection CONtrol) started with measurements with the CTD sonde (conductivity, temperature, depth) and recovery and deployment of moorings. On the Greenwich meridian transect 43 CTD-profiles were measured in a distance of 30 nm. The station distance was reduced when the bottom topography varied considerably. Together with the CTD profiles, water samples were taken to measure the concentrations of dissolved nutrients, oxygen, CFCs, Barium and CO<sub>2</sub>. An essential part of the physical oceanography programme consisted in the recovery and deployment of moorings. On the transect 8 moorings were recovered and 9 deployed. One mooring was lost. The POSIDONIA system of RV *Polarstern* proved to be highly efficient and allowed a precise monitoring of the recovery and deployment process. This improves the safety in respect to the recovery and the quality of data. The moorings contain instruments to measure currents, temperature and conductivity, sound sources to navigate floats and upward looking sonars (ULS) to measure ice draft. On the transect 22 APEX (Profiling Autonomous Lagrangian Circulation Explorers) and NEMO (Navigating European Marine Observer) floats were deployed. To assess the fresh water input by icebergs, 5 bergs were equipped with satellite transmitters which were deployed with the helicopters.

On 9 February at 67°S the scientific work on the Greenwich meridian had to be interrupted and RV *Polarstern* steamed off towards *Neumayer Station*. On 25 January the German polar plane POLAR 4 has had such a hard landing at the British *Rothera Station* on its flight back to Germany that it was not able to continue the flight. Therefore the cruise plan of RV *Polarstern* had to be modified in a way to include a detour to *Rothera* without losses too serious for the scientific programme. The first step in this direction was to delay the supply of *Neumayer Station* by some days to advance farther to the south on the transect before steaming to *Neumayer*. This resulted in significant gain of time since the shortened way to and from the station counted twice. Additionally the recovery of a mooring east of Maud Rise was postponed. On 10 February on the way to *Neumayer Station* an Amphipod trap was deployed at 69°30'S 5°23'W and a haul with the Agassiz trawl was carried out.

On 11 February RV *Polarstern* arrived in Atka Bight in the bright sun after some sea smoke had dissolved. Fast we found an appropriate landing-place at the ice shelf ramp. Little later the South African vessel SA *AGULHAS* landed in close vicinity and loaded material and trucks from the South African station *SANAE* which is 227 km away. The team from the *Neumayer Station*, consisting of summer guests and overwinterers, arrived soon with trucks and goods to start the loading operations. About 150 cubic metres of fuel were filled into the tank containers from the station. A snow mill, sledges and 16 containers, altogether 120 tons were loaded on board. One cruise participant from SANAP left RV *Polarstern* to overwinter at *SANAE*. During the loading activities those of us who had free time were able to visit the *Neumayer Station*. The bright weather allowed many of the visitors to walk at least one way to the station covering a distance of 8 km.

The helicopters were highly demanded to transport persons and goods. In particular they supported the work at an annex of the station near to the ice shelf front from



where a hydrophone shall transmit the noises of the ocean directly to Bremerhaven. The first step which is reached at present was the installation of an automated station with a direct data link. If it proves to work successfully even under harsh winter conditions, a hole will be drilled through the ice shelf and the hydrophone will be lowered into the ocean below.

In the early evening, the loading and pumping operations were successfully finished and crew and scientists from RV *Polarstern* could enjoy the sunny evening with a little party on the ice. The people from the *Neumayer Station* and some crew members from the *SA Agulhas* were our guests. We had to pick them up and to bring them back with our helicopter, since *SA Agulhas* left the ramp after achieving its loading operations and spent the night in open water. Further guests were a group of Finnish scientists and the crew of the DC3 plane from ALCI which brought them from the Finnish station to *Neumayer*. Together with the remaining German members of the summer campaign and former overwinterers, they flew in the night from 12 to 13 February to the Russian *Novolazarevskays* station and from there to Cape Town and back home.

On 12 February we planned to pump additional fuel from the *SA Agulhas* to the RV *Polarstern*. The evening before everything looked easy, but during the night the wind carried an ice field against the ramp so that it was not possible any more to lay there next to each other as during the day before. We searched with RV *Polarstern* for an appropriate alternative location deeper in the bight and thought that we had found one. But when *SA Agulhas* came to the place, it appeared that there as well, there was too much ice. A further attempt, supported by a reconnaissance flight with the helicopter, started on the eastern shore of the bight where *SA Agulhas* had found an appropriate spot. Here both ships should lay stable in parallel with the bows against the ice front and the wind. However, when RV *Polarstern* approached, a significant lump of ice broke from the shelf ice front, giving evidence of its instability. Finally it was decided to transfer the fuel in open water. RV *Polarstern* went in front, *SA Agulhas* followed. Both ships steamed slowly when first ropes were transferred to fix them at a stable distance and then the fuel pipe was lined up between them. Pumping occurred until late in the evening when 170 tons of fuel had been received on RV *Polarstern*. When all the gear was back on board, both ships blew their horns for farewell and RV *Polarstern* left to the northeast back to our transect on the Greenwich meridian. On the way the Amphipod trap was recovered successfully which had been deployed on our way to *Neumayer Station*.

The work on the Greenwich meridian section was continued on 14 February at 67°30'S with another ANDEEP station which lasted until 16 February. With CTD stations, deployment of floats and replacement of moorings the section was continued to the south. The last station on the Greenwich meridian transect was done at 69°15'S on 18 February in sight of the Fimbul Ice Shelf. At 69°01'S we met for the first time a significant ice field.

After having finished the first phase on the Greenwich meridian RV *Polarstern* steamed to the west in the direction of Atka Bight. At 70°32'S 09°02'W two fish traps and an Amphipod trap were to be recovered which had to be left behind a year ago

due to the ice conditions. In spite of good conditions only one fish trap could be recovered. The state of the recovered trap suggested that the other two might have been lost due to corrosion. The attempt to recover a mooring with a sediment trap at 70°57'S 10°33'W at 19 February failed as well. It is possible that it was destroyed by the frequent icebergs in the area.

The second phase of physical oceanography and deep-sea biology stations occurred between Kapp Norvegia and Joinville Island at the northern tip of the Antarctic Peninsula. It began on 20 February at 71° 18'S 13°57'W. The focus of the deep-sea biology programme ANDEEP III was with 9 stations on that transect. Four of these stations were located on the continental slope off Kapp Norvegia in 1040, 2170, 3090 and 4410 m depth. The Kapp Norvegia transect was finished on 24 February. The physical oceanography work continued with 54 CTD stations in approximately 30 nm distance and the deployment of 3 further moorings and 18 floats. At 68°04'S 20°28'W in 4933 m, 66°37'S 27°10'W in 4892 m, 65°34'S 36°31'W in 4802 m and 65°00'S 43°02'W in 4701 m depth further ANDEEP stations were sampled. On 11 March we reached for the first time at 64°30'S 45°15'W an extended ice field which at times slowed down the ship's speed significantly. The ice tongue reached from the southern Weddell Sea along the continental slope up to the Powell Basin. Even though the ice concentration decreased significantly towards the shelf, it was still higher as than displayed by the satellite images. At 63°41'S 50°44'W another ANDEEP station was carried out on 14 March. The westernmost point on the transect across the Weddell Sea was reached on 16 March at 63°04'S 54°37'W and 440 m water depth.

The comparatively light ice conditions and the calm weather allowed to achieve the work in the Weddell Sea so fast that there was still enough time left to realize the work in the Powell Basin included in the plan as an option. There was time for a CTD section from 63°04'S 54°37'W to 61°39'S 46°33'W and three ANDEEP stations, in 3405, 2000 and 1180 m depth at the eastern side of the basin. This part of the cruise as well could be done in favourable weather conditions. Up to 62°02'S 48°45'W the northward extension of the ice tongue from the southern Weddell Sea had to be crossed without remarkable delay. On 21 March the work in Powell Basin was terminated and RV *Polarstern* steamed toward Bransfield Strait and King George Island. During part of the way, we had to go against westerly winds of force 8 and the corresponding waves.

The wind calmed down until we reached Maxwell Bay on 22 March at noontime. The Argentine *Jubany Station*, to which the German *Dallmann Laboratory* is connected, is located at the shore of the adjacent Potter Cove. In spite of being earlier than originally planned, the preparations were sufficiently advanced that we were able to use the good weather and start immediately with the helicopter flights to bring material from the station to RV *Polarstern*. Additionally, material was brought from the Uruguayan station *Base Científica Antártica Artigas* and the Russian *Bellingshausen Station* to RV *Polarstern*. Finally scientists who had spent the summer at the *Dallmann Laboratory* were taken to *Bellingshausen*, where they had to wait for their flights home. Two further cruise participants, an Argentine observer

and an AWI logistic specialist, came on board RV *Polarstern* to join us for the rest of the cruise.

During the time of the transport operations, scientists and crew members from RV *Polarstern* had the occasion to get on shore to enjoy the Argentine hospitality, and some of us were able to visit other stations. Everywhere we were received in a very friendly manner. We invited the crews of the *Jubany Station* and the *Base Científica Antártica Artigas* to a visit of RV *Polarstern* which enforced our friendly relations. During the night and a phase of bad weather, we began a further ANDEEP station in Bransfield Strait. It was finalized after the end of the supply operations.

In the night to 24 March we left for the British *Rothera Station*. In the morning we passed by Deception Island which remained hidden in the fog. The acoustic group used the long steaming routes to tow their streamer in order to record the vocalisations of marine mammals. The weather conditions on the way to *Rothera* were not very promising and we expected a longer waiting period. On the afternoon of 25 March we reached Marguerite Bay and lay off *Rothera Point*. Surprisingly, the weather had improved. During the day a group of British cruise participants were flown ahead to *Rothera* to bring there living mussels from *Jubany*. The first meeting with our British partners occurred in the evening when we invited the captain of the RSS *Ernest Shackleton*, which lay at the Biscoe wharf, and the *Rothera* base commander to a visit on board RV *Polarstern*. A friendly relationship was quickly established and the operations of the coming day could be planned in all detail until the helicopter had to bring back our guests at nightfall. Finally, on 26 March the long expected day for which we had to reschedule our entire cruise was there and we had to load the German plane POLAR4 to be carried back to Punta Arenas. Because near the Biscoe wharf the water depth is not sufficient that RV *Polarstern* could approach close enough, this was not a straight forward task. The loading had to occur with the help of the RSS *Ernest Shackleton*.

Once again, we were spoiled by the weather. No wind and sunshine were optimal conditions not only for the loading but also for the visiting programme. The RSS *Ernest Shackleton* loaded the wing and the fuselage of the plane at the wharf and displaced to RV *Polarstern* which was waiting at a distance of 0.85 nm. Both ships went alongside and within 22 minutes the parts of the plane were picked up by RV *Polarstern* 15-ton crane and set on the helideck. During this operation the cruise participants and the free crew members had started the visit to the station and the adjacent magnificent landscape and enjoyed the British hospitality. During the afternoon, we received the crew members of the RSS *Ernest Shackleton* and the *Rothera Station* on board and could spend a pleasant afternoon together in the friendly and relaxed mood. At 19:00 h we left *Rothera* with a further participant on board, a technician from the DLR who came in to participate at the loading. We steamed well protected against uncomfortable weather conditions through Gerlache Strait towards the last scientific stations during this cruise. On the way we celebrated the polar baptism and spent Easter in front of a well-known picturesque landscape almost completely hidden by snow showers and clouds.

From 29 to 31 March two further ANDEEP stations could be done at 63°19'S 64°37'W in 2080 m and at 62°31'S 64°39'W in 3802 m depth off Anvers Island. The stations were located west of Drake Passage and the Hero Fracture Zone in the Pacific. The last part of the scientific programme was a CTD section with 26 stations across the eastern Drake Passage along the Shackleton Fracture Zone from 60°53'S 53°50'W to 55°04'S 65°04'W, which ended on 4 April.

During the complete cruise hydroacoustic measurements and infrared observations were done to develop a system which allows to detect marine mammals. By this system it is expected to fulfil in future the requirements of the Federal Environmental Agency to apply in future hydroacoustic methods again from RV *Polarstern*.

The scientific programme was accompanied by public relation activities which included an expedition painter who documented the mood of each day by an oil painting. The progress of the cruise was regularly displayed on the AWI eXpeditions site [file/ext/www-bhv/Polar/RVPOLARSTERN/ANT-XXII-3/ExpeditionSummary](http://file/ext/www-bhv/Polar/RVPOLARSTERN/ANT-XXII-3/ExpeditionSummary), the CeDAMar site [www.cedamar.org](http://www.cedamar.org) and the Senckenberg web site.

On 6 April 2005 RV *Polarstern* called at 08:00 h local time to port in Punta Arenas.

The international ANDEEP III project (ANtarctic benthic DEEP-sea biodiversity: colonization history and recent community patterns) aims to investigate the deep-water biology of the Scotia and Weddell Seas from RV *Polarstern*. The ANDEEP programme was established to provide baseline data on the Southern Ocean deep-water ecosystem.

Its main objectives are

- To investigate the influence of seafloor habitat diversity on biodiversity and
- To determine if the Weddell/Scotia Seas are a source for deep-water benthos in other oceans.

Sampling has been undertaken on ANDEEP I & II during 2002 and will be completed during ANDEEP III.

The deeper waters of the Scotia and Weddell Seas are some of the least explored parts of the world's oceans and we know almost nothing about the bottom dwelling animals that inhabit them. First results from ANDEEP I/II have shed some light on the composition and possible evolutionary pathways of the Southern Ocean deep-sea fauna. ANDEEP III will deepen our knowledge gained so far with a somewhat larger geographical scope, spanning not only the Weddell Sea Abyssal Plain and adjacent areas of the Southern Ocean but also the Cape Basin.

ANDEEP is one of the two German pioneering field programmes of CeDAMar (Census of the Biodiversity of Abyssal Marine Life), a ten-year project dedicated to the investigation of benthic communities in abyssal plains in the Atlantic from pole to pole. CeDAMar in turn belongs to the global project CoML (Census of Marine Life) which was launched in 2000 and is planned to run until 2010. Scientists from more

than 70 countries are participating so far, sampling with standardised methods and creating a global database that is designed to provide a benchmark for future research efforts. With taxonomic descriptions of deep-sea species being a major component, CeDAMar is promoting the revival of taxonomy and systematics as important disciplines in biology. ANDEEP will help to provide answers to two basic questions raised by CeDAMar:

How species rich is the deep sea, and how much of the total world species live in the ocean? How large is the area a deep-sea species inhabits?

What factors drive speciation processes in homogeneous environments where ecological factors are uniform over wide distances and therefore have little influence?

Specific objectives of ANDEEP are

- To conduct the first comprehensive survey of megafaunal, macrofaunal and meiofaunal deep-water communities in the Scotia and Weddell Seas and to investigate their similarity at the taxonomic (morphological) and genetic (molecular) levels to the fauna of Atlantic basins and the Antarctic shelf.
- To describe the variety of seafloor habitats in tectonically active and inactive regions and to determine the influence of 'habitat diversity' on species and genetic diversity over a variety of spatial scales.
- To determine the importance of life history strategies and larval biology in influencing species distributional patterns and geographical ranges.
- To investigate the evolutionary processes having resulted in the present biodiversity and distributional/zoogeographical patterns in the Southern Ocean deep sea.
- To investigate the colonisation and exchange processes of the deep-sea fauna, in particular the role of tectonic structures (for example ridges or seamounts).
- To assess the importance of the Antarctic as a region where shallow-water species may enter the deep sea by conducting experimental studies on the pressure and temperature tolerances of shallow and deep-water invertebrate larvae.

The physical oceanography WECCON (Weddell Sea convection control) programme intends to investigate the role of the Weddell Sea in the global climate system. The Antarctic Ocean contributes through atmosphere-ice-ocean interaction processes to the variability of the climate system. The ice cover has a strong control on the albedo and on the ocean-atmosphere heat exchange. At the same time the advective heat supply from the ocean controls the ice cover. Atmosphere-ice-ocean interactions lead to water mass conversion which occurs in the open ocean and on the shelves.

Whereas the shelf processes affect a reservoir limited through the shallow water depth and the cross frontal transports at the shelf edges, open ocean processes can affect deeper layers directly if the stability of the water column is weak. A major contribution of the global deep and bottom water formation occurs in the Weddell Sea. It is controlled by the transport of source waters into the Weddell Sea, processes within the Weddell Sea, and the transport of modified water out of the Weddell Sea.

In the Weddell Sea, Circumpolar Deep Water enters from the north and circulates in intermediate layers within the large scale cyclonic gyre. By upwelling and entrainment heat and salt is transported from that water mass into the surface layers. The vertical transport of heat and salt counteracts to the heat loss and the fresh water gain at the sea surface. The delicate balance controls the stability of the water column. The vertical transports can be significantly affected by vertical flow and enhanced mixing in the vicinity of topographical features like Maud Rise. Even relatively small scale topographical structures have a significant effect on the water flow and mixing due to the generally weak stratification in polar oceans.

Under conditions of a relatively stable water column, shallow open ocean convection represents a preconditioning for the shelf processes through heat extraction and salt redistribution of the source waters which are involved in frontal processes over the continental slope. In the case of relatively unstable conditions, open ocean convection can reach deeper layers and contribute directly to the deep water formation. Unstable conditions enhance the heat transport from the ocean towards the surface to an extent that large areas of the winter sea ice are melted and a open ocean polynya is formed which then allows large heat losses of the ocean increasing the water mass conversion.

Recent observations indicate that the water mass properties of the Warm Deep Water are subject to significant variations. After an initial warming and salinity increase observed until 1996 a cooling followed during the last years which kept on accord to our observations. The variations are most likely due to changes in the inflow from the circumpolar water belt, in combination with changes in the ice-ocean-atmosphere interaction in the Weddell Sea induced by changes in the atmospheric forcing conditions. The time variability of the Antarctic Circumpolar Wave, the Southern Annular Mode, or the Antarctic Dipole might affect the Weddell Sea and generate the observed variations. Whereas the properties of the Weddell Sea Deep Water remained essentially constant, the Weddell Sea Bottom Water was subject to significant changes as well. The warming observed since the late 80s still continues. Since the Warm Deep Water is the source water of bottom water, the variations of the two water masses seem to be related through the formation process.

The deployment of floats occurs in the framework of the international ARGO programme which contributes to the Global Ocean Observing System (GOOS). Aim of the ARGO programme is to maintain ca. 3000 profiling floats (measuring pressure, temperature and salinity) in the global ocean. In the context of this project 40 floats (10 GOODHOPE, 9 MERSEA and 21 German ARGO) were deployed mainly in

areas were up to now no float data exist. The 30 floats owned by AWI (MERSEA/ German ARGO) are all equipped with a sea ice detection algorithm to inhibit them to surface in ice fields where the float might be destroyed. Until 28 March, 84 vertical temperature and salinity profiles were transmitted which are in good agreement with adjacent CTD measurements.

WECCON aims to investigate processes which occur in the Weddell Sea in cooperation with the Bjerknes Centre for Climate Research in Bergen, Norway in the framework of iAnZone, a programme associated to SCOR (Scientific Committee of Oceanographic Research). The cruise occurs in the context of the MARCOPOLI programme of the Hermann von Helmholtz Association of German Research Centres (HGF) as part of work packages MAR1 and POL2. It is a contribution to the Climate Variability and Predictability (CLIVAR) and the Climate and Cryosphere (CliC) projects of the World Climate Research Programme (WCRP). The ULS are a contribution to the Antarctic Sea Ice Thickness Project (AnSITP). The studies of convection in the Weddell Sea and the influence of variations of the inflow from the Antarctic Circumpolar Current on the conditions in the Weddell Sea occur in the framework of the German CLIVAR/marine-2 programme supported by the German Federal Ministry of Education and Research (BMBF).

## 2. WEATHER CONDITIONS

Manfred Gebauer and Hartmut Sonnabend  
DWD Hamburg

When RV *Polarstern* left Cape Town on the 22 January, the wind direction changed from the usually southeast quickly to south accompanied by wind force 3-5 Bft. We were lucky not to be confronted with the stormy "Cape Doctor", an orographic wind system that frequently blows in this area with sometimes 7-8 Bft from southeast. Later, when a small low passed south of us on the 24 January, the wind increased to 7 Bft. During the next days the influence of cyclones passing north of us produced partly rainy and foggy weather and sometimes stormy southeasterly wind. Finally we crossed an extensive high pressure system that often dominates the South Atlantic between 35° S and 50° S.

The ship made headway to southwest accompanied by fresh winds. Finally we reached the area around Bouvet Island, one of the stormiest region of the oceans. And in fact on the 31 January first troughs of a cyclone leaving the Drake Passage eastwards arrived at this area. Caused by the strong pressure gradient between a high near 40°S and the cyclones at 60°S mentioned above the wind blew with 7-9 Bft from West for more than 2 days. Finally the ship proceeded to the south along the Greenwich meridian. As usual in this area between 50°S and 60°S several cyclones passed on their way to the east.

Until 10 February RV *Polarstern* had crossed the Antarctic circle and approached the area near the Antarctic. Finally we arrived at the *Neumayer Station*.

After having done the supply of *Neumayer* the ship stayed in the area north of Dronning Maud Land, e.g. the area where *Neumayer* as well as the station SANAE and among others Kapp Norvegia are situated. North of it the work on the Greenwich meridian continued. On the 15 February a low passed closely north of us and produced northeasterly winds with wind force 8 Bft. Then, RV *Polarstern* moved further south-westwards. Near Kapp Norvegia again a cyclone passed us in the north. There RV *Polarstern* experienced easterly winds with 7 Bft strengthened by orographic effects.

From now on the ship began the crossing of the Weddell Sea in direction of Bransfield Strait. Various low pressure systems passed the Weddell Sea during that time and the weather and wind conditions changed quickly. Mostly we experienced wind forces between 4 and 6 Bft, but sometimes also 7 and 8 Bft (fig. 2.1). From the southern Pacific intensive cyclones had arrived at the Antarctic Peninsula and had born finally in its lee a new cyclone in the western part of the Weddell Sea. In the meantime another cyclone had found a similar way across the Antarctic Peninsula a few days ago. It had intensified when moving to the eastern part of the Weddell Sea. Thus a system of two cyclones often exists at the same time in the Weddell Sea (s. weather analysis of the 13 March, fig. 2.2). Finally *Jubany* was reached on 22 March.

From then on RV *Polarstern* steamed southwards along the western part of the Antarctic Peninsula in direction of *Rothera*. The weather conditions were favourable due to mostly northerly winds. The weather at *Rothera* was initially dominated by intermediate high pressure influence, but finally during leaving the station a new low was arriving accompanied by strongly increasing northerly winds.

The weather conditions during the way back north-eastwards along the Antarctic Peninsula and later in the Bransfield Strait as well on the track across the Drake Passage were dominated by intensive cyclones and its troughs. Visibility and wind conditions changed quickly between calmness and gale-force wind. On 6 April the RV *Polarstern* sailed into harbour at Punta Arenas.



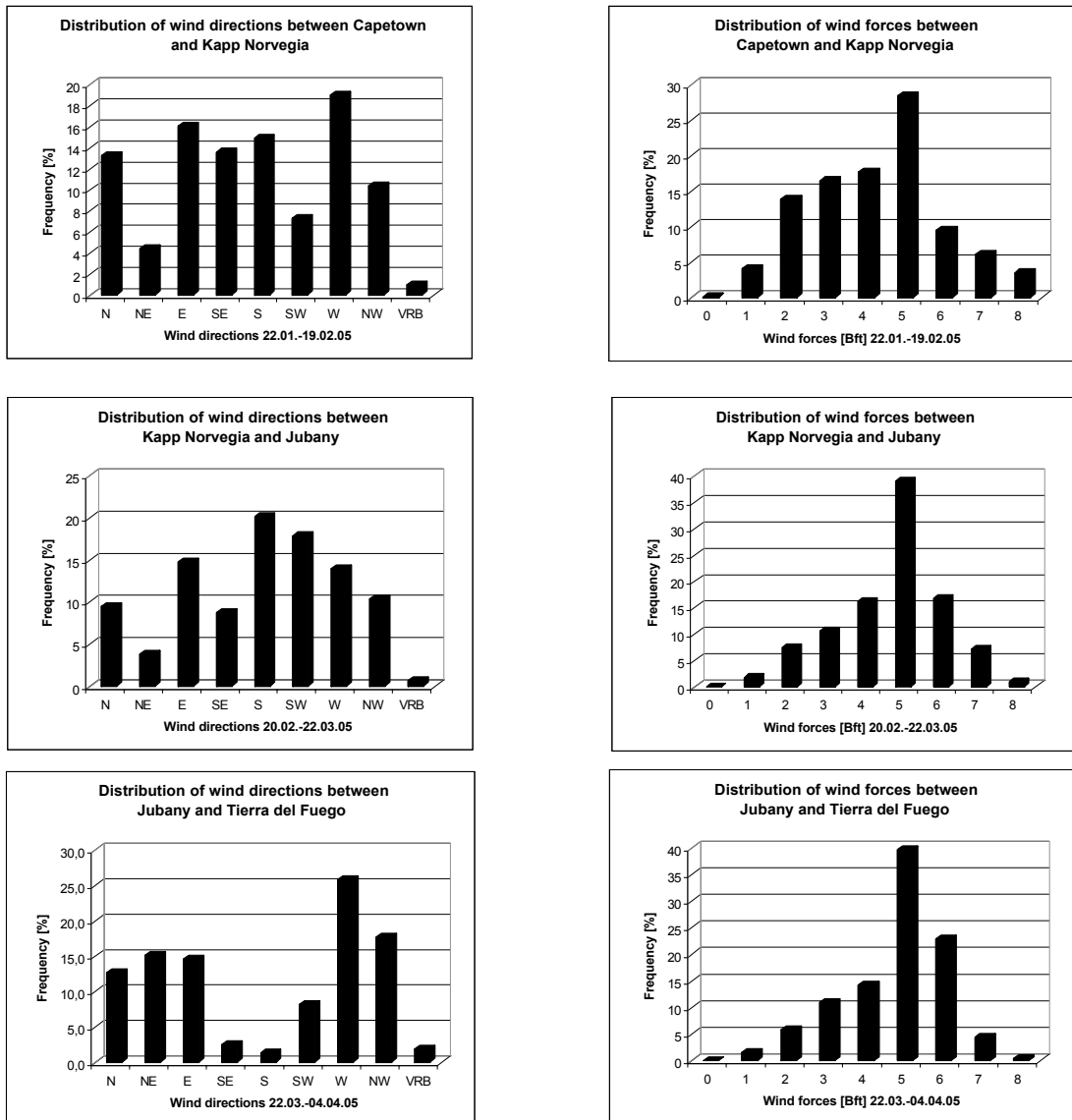

Fig. 2.1: Statistics of wind directions and wind forces during the cruise

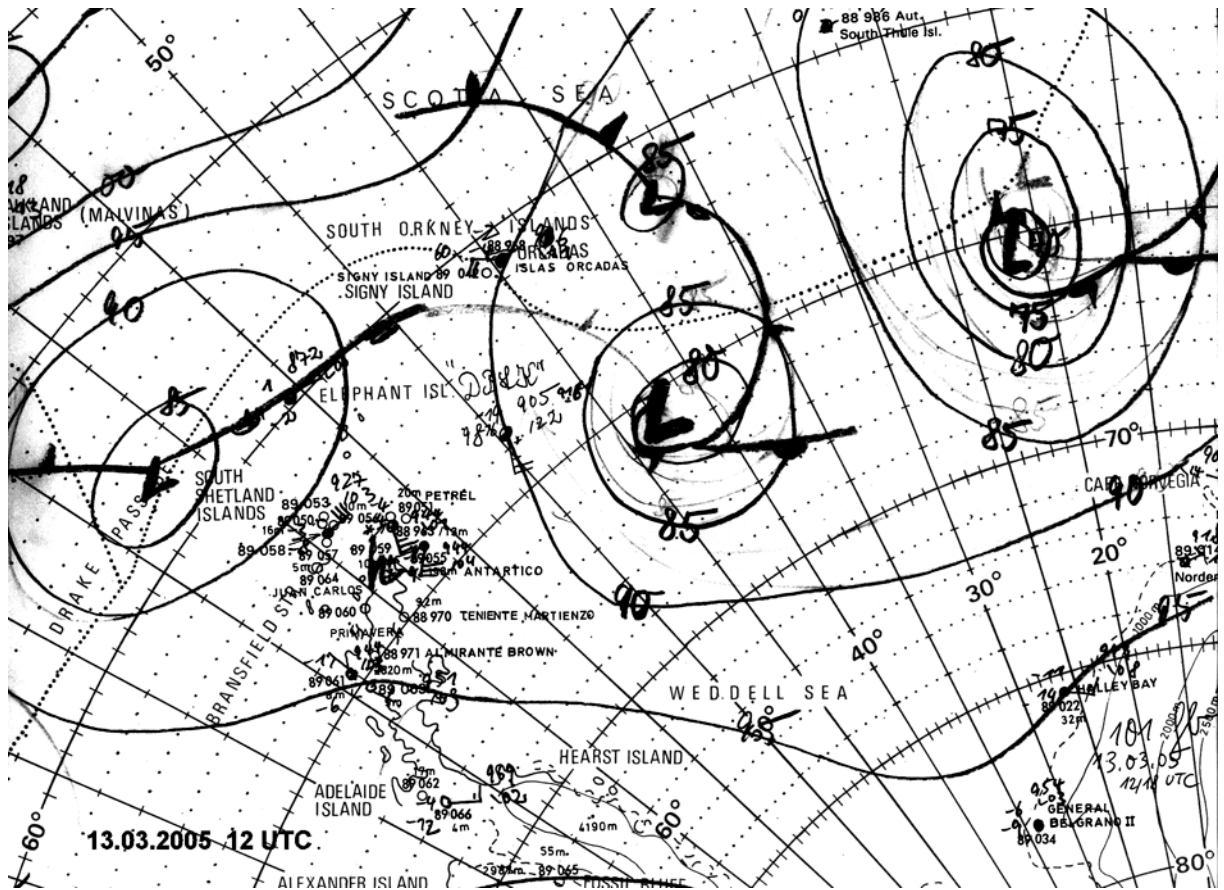

Fig. 2.2: Weather analysis of the 13 March

---

### 3. SEA ICE CONDITIONS

Elin Darelius<sup>2</sup>, Olaf Klatt<sup>1</sup>, Ismael Nunez-Riboni<sup>1</sup>, Michael Planer<sup>1</sup>, Inger Thoma<sup>3</sup>, Ralf Timmermann<sup>1</sup>, Hannelore Witte<sup>1</sup>, Qiang Wang<sup>1</sup>

<sup>1</sup>AWI Bremerhaven  
<sup>2</sup>Bjerknes Centre, Bergen  
<sup>3</sup>IFM-GEOMAR, Kiel

Sea ice observations were conducted on an hourly basis from the bridge of RV *Polarstern*. They are a contribution to the Antarctic Sea Ice Processes and Climate (ASPeCt) programme, which aims at an improved understanding of the role of Antarctic sea ice in the global climate system. The sea ice thickness data collected in this framework form the only circumpolar ice thickness dataset available for the Southern Ocean and have, e.g., recently been used for model validation studies. According to the ASPeCt protocol, total ice concentration, and the thickness, concentration and morphology (ridge height, areal fraction of ridged ice, floe size; snow thickness) of the three dominant ice types within a 1 km radius from the ship were recorded while the ship moved through the pack ice. The observations were complemented by records of sea surface temperature, near-surface air temperature, wind speed and direction, and total cloud cover.

As the cruise was conducted in austral summer, during the time of minimum ice extent, rather little sea ice was encountered. On our way to and from *Neumayer Station* a floe field following the Antarctic Coastal Current was crossed which did not provide a serious obstacle to RV *Polarstern*. The first serious ice field was encountered north of the Fimbul Ice Shelf between 69°01'S and 69°24'S. This ice field was not visible on the ice map derived from satellite data (fig. 3.1). It was dominated by brash and multi-year, heavily deformed floes, which were often broken and had a typical size of not more than 20 m. Concentration of these floes normally amounted to 60%, but at times reached 100% and slowed down the progress. Since air temperatures ranged between -2 and -3° C, only very little sea ice formation in the open water areas occurred. South of this 'ice tongue' the coastal polynya extended about 18 km up to the edge of the Fimbul Ice Shelf.

Thick, multiyear floes (along with several icebergs) were found drifting with the local surface currents in Atka Bay, but total ice coverage was low with only very little fast ice left, so that RV *Polarstern* reached the loading point at the ice shelf edge without difficulty.

The first encounter of an extended sea ice field took place in the northwestern Weddell Sea, i.e. at the western end of the Weddell Sea section at 64°30'S 45°15'W. This ice tongue located over the continental slope reached up to the shelf and from the southern Weddell Sea into the western Powell Basin. We left it at 62°02'S 48°45'W on our section across the Powell Basin to the east. This was not fully consistent with the ice map derived from satellite data (fig. 3.1) which displayed a clear western boundary of that ice tongue. Approaching the Antarctic Peninsula on our Weddell Sea section from the east in a weather situation with mainly south-westerly winds and temperatures below -10°C, we were able to observe the full cycle

of sea ice formation. Grease and frazil ice were followed by large areas of pancake ice, which further to the west consolidated into grey and white first-year ice, along with an increase in the abundance of multi-year floes. It was not uncommon to find floes with a level ice thickness (including a probably significant proportion of ice that has been converted from flooded snow) of more than 2 m. Ridges with a sail height of more than 5 m were observed. Vast floes (i.e. floes of more than 2 km of size) considerably delayed progress.

Further north, in the Powell Basin, the composition and areal coverage of multi-year ice was very similar, but due to the warmer temperatures there, no sea ice formation occurred in the open water areas. Since vast floes were less abundant here than further south, it was possible to keep RV *Polarstern* within leads or areas of relatively thin ice.

South of Adelaide Island, while approaching *Rothera Station*, we crossed a narrow tongue of brash and, later, small floes of decaying multi-year ice. Ice concentration in this area rarely exceeded 10% and always remained below 50%.

All data collected were sent to the ASPeCt database immediately after the cruise.

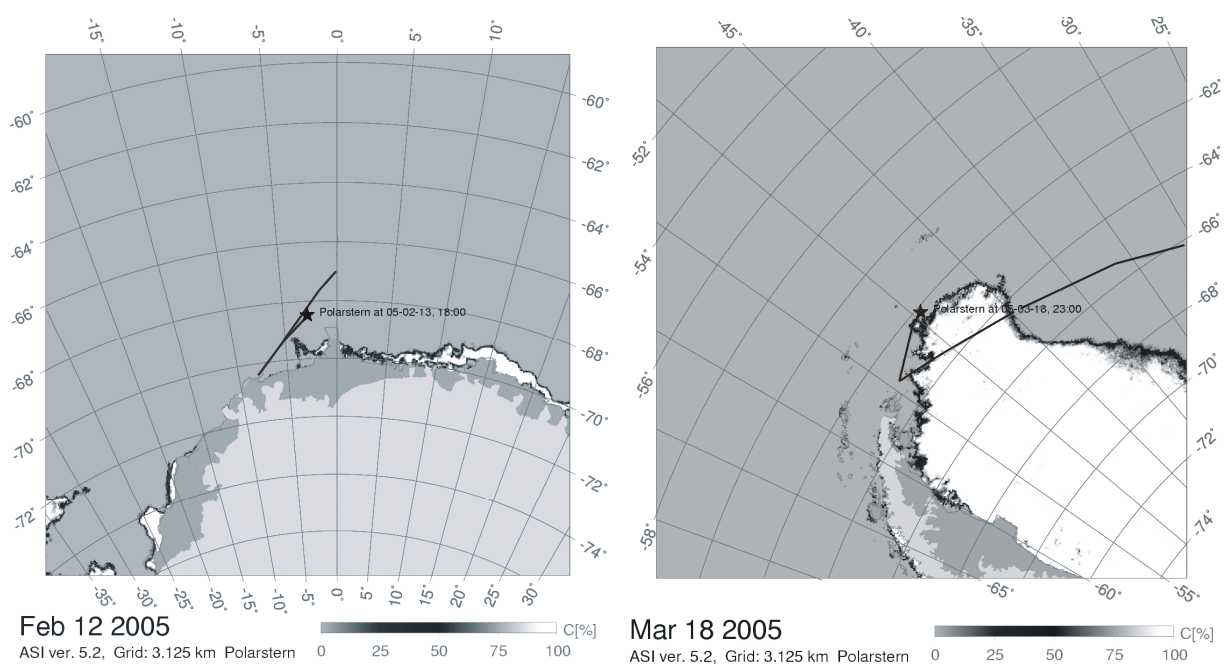

Fig. 3.1: Regional sea ice distribution and relevant parts of cruise track in the vicinity of the Greenwich meridian and in the western Weddell Sea ([www.seaice.de](http://www.seaice.de), Institut für Umweltphysik, University of Bremen, Germany)

---

## 4. LARGE SCALE PROCESSES AND DECADAL VARIATIONS IN THE WEDDELL SEA (WEDDELL SEA CONVECTION CONTROL, WECCON 2005)

Olaf Boebel<sup>1</sup>, Elin Darelius<sup>2</sup>, Eberhard Fahrbach<sup>1</sup>, Olaf Klatt<sup>1</sup>, Matthias Monsees<sup>4</sup>, Ismael Nunez-Riboni<sup>1</sup>, Michael Planer<sup>6</sup>, Gerd Rohardt<sup>1</sup>, Harald Rohr<sup>4</sup>, Inger Thoma<sup>6</sup>, Ralf Timmermann<sup>1</sup>, Qian Wang<sup>1</sup>, Evaline van Weerlee<sup>3</sup>, Hannelore Witte<sup>1</sup>

<sup>1</sup>AWI Bremerhaven

<sup>2</sup>Bjerknes Centre, Bergen

<sup>3</sup>NIOZ, The Netherlands

<sup>4</sup>OPTIMARE, Bremerhaven

<sup>5</sup>IFM-GEOMAR, Kiel

<sup>6</sup>IUP Bremen

### Objectives

The Antarctic Ocean contributes through atmosphere-ice-ocean interaction processes to the variability of the climate system. The ice cover has a strong control on the albedo and on the ocean-atmosphere heat exchange. At the same time the advective heat supply from the ocean controls the ice cover. Atmosphere-ice-ocean interactions lead to water mass conversion which occurs in the open ocean and on the shelves. Whereas the shelf processes affect a reservoir limited through the shallow water depth and the cross frontal transports at the shelf edges, open ocean processes can affect deeper layers directly if the stability of the water column is weak. A major contribution of the global deep and bottom water formation occurs in the Weddell Sea. It is controlled by the transport of source waters into the Weddell Sea, processes within the Weddell Sea, and the transport of modified water out of the Weddell Sea.

In the Weddell Sea, Circumpolar Deep Water enters from the north and circulates in intermediate layers within the large scale cyclonic gyre. By upwelling and entrainment heat and salt is transported from that water mass into the surface layers. The vertical transport of heat and salt counteracts to the heat loss and the fresh water gain at the sea surface. The delicate balance controls the stability of the water column. The vertical transports can be significantly affected by vertical flow and enhanced mixing in the vicinity of topographical features like Maud Rise. Even relative small scale topographical structures have a significant effect on the water flow and mixing due to the generally weak stratification in polar oceans.

Under conditions of a relatively stable water column shallow open ocean convection represents a preconditioning for the shelf processes through heat extraction and salt redistribution of the source waters which are involved in frontal processes over the continental slope. In the case of relatively unstable conditions, open ocean convection can reach deeper layers and contribute directly to the deep water formation. Unstable conditions enhance the heat transport from the ocean towards the surface to an extent that large areas of the winter sea ice are melted and a open ocean polynya is formed which then allows large heat losses of the ocean increasing the water mass conversion.

Recent observations indicate that the water mass properties of the Warm Deep Water are subject to significant variations on decadal time scales. After an initial warming and salinity increase observed up to 1996 a cooling followed during the last years. The variations are most likely due to changes in the inflow from the circumpolar water belt, in combination with changes in the ice-ocean-atmosphere interaction in the Weddell Sea induced by changes in the atmospheric forcing conditions. The time variability of the Antarctic Circumpolar Wave, the Southern Annular Mode or the Antarctic Dipole might affect the Weddell Sea and generate the observed variations. Whereas the properties of the Weddell Sea Deep Water remained essentially constant, the Weddell Sea Bottom Water was subject to significant changes as well. Since the Warm Deep Water is the source water of bottom water, the variations of the two water masses seem to be related through the formation process.

**The detailed objectives of the project are:**

- To determine the variation in water mass properties in the Weddell gyre including the convective area north and west of Maud Rise.
- To determine the variability in characteristics and the amount of the inflowing Circumpolar Deep Water.
- To determine the variability of the structure of the Weddell gyre.
- To determine the effect of variations in the elements of the fresh water budget as sea ice transport and iceberg melt on the stability of the water column.
- To estimate the effect of relative small scale topographic features on horizontal flow regimes and vertical mixing.
- To estimate the potential of abrupt changes.
- To provide a long term data set which can serve to validate numerical models.

The observations will be accompanied by a hierarchy of modelling efforts. High resolution models have to be used to investigate the effect of variations in the atmospheric forcing and the inflow from the north. The effect of the shape of the bottom topography, in particular structures like Maud Rise must be investigated in an ice-ocean interaction model with sufficient horizontal resolution.

WECCON aims to investigate processes which occur in the Weddell Sea in cooperation with the Bjerknes Centre for Climate Research in Bergen, Norway in the framework of iAnZone, a programme associated to SCOR (Scientific Committee of Oceanographic Research). The cruise occurs in the context of the MARCOPOLI programme of the Hermann von Helmholtz Association of German Research Centres (HGF) as part of work packages MAR1 and POL2. It is a contribution to the Climate Variability and Predictability (CLIVAR) and the Climate and Cryosphere (CliC) projects of the World Climate Research Programme (WCRP). The ULS are a contribution to the Antarctic Sea Ice Thickness Project (AnSITP). The deployment of floats occurs in the framework of the international ARGO programme which contributes to the Global Ocean Observing System (GOOS). The study of convection in the Weddell Sea and the influence of variations of the inflow from the Antarctic

Circumpolar Current on the conditions in the Weddell Sea occur in the framework of the German CLIVAR/marine-2 programme supported by the German Federal Ministry of Education and Research (BMBF).

### **Work at sea**

In order to detect regional variations with sufficient time resolution to avoid the effect of aliasing, the observations have to cover at least a decadal time period with sufficient spatial coverage. Furthermore the measurements need sufficient accuracy to assure that even small variations can be distinguished from observational noise. With this background the following works were planned:

### **Recovery and deployment of moorings**

A moored observing system on the Greenwich meridian is maintained since 1996. Current meter moorings were exchanged in 1998 and 1999, 2001 and 2003. Some mooring positions were modified and additional ones were added during this period. During the present leg the moorings deployed in 2002 ([fig. 4.1](#), [4.2](#) and [table 4.1](#)) were recovered and a new set was deployed ([fig. 4.1](#), [4.3](#) and [table 4.2](#)).

The two southernmost moorings covered the area of the coastal current. Westward of Maud Rise there are three moorings equipped with temperature-conductivity recorders from approximately 250 to 750 meters depth to monitor the change in the stratification between the Winter Water and the Warm Deep Water. These data should indicate the potential pre-conditioning for the occurrence of a Polynya. The four northern moorings are at the westward flowing branch of the Weddell Gyre and the transition into the Antarctic Circumpolar Current (ACC). This region is characterized by fronts, which also effect the elevation of the sea surface. Thus bottom pressure recorders in the three northernmost moorings are used to record the change of the sea surface elevation and from these records the meridional shift of the southern boundary of the ACC can be determined. The sea surface elevation was compared with the satellite sea surface height measurements from TOPEX/Poseidon. The stratification can also be derived from a series of temperature-conductivity recorders.

The number of redeployed upward looking sonars (ULS) was reduced from six to four instruments based on the analyzed data which have been gathered so far. The sea ice reached the location of the mooring AWI227 only for a short period. Further on the sea ice thickness did not significantly differ between AWI230 and AWI231 and therefore AWI230 was no longer equipped with an ULS to be able to deploy it in the Weddell Sea proper.

Three RDI Longranger ADCPs were placed in the moorings AWI229, 231 and 232 faced upwards at approximate 350 m depth and can measure the speed of the drifting sea ice too. These additional data combined with the ULS measurements will improve the estimate of the volume transport of sea ice.

The ADCPs have been acoustically calibrated before the cruise to use the backscatter intensity to determine variations of phytoplankton. For this purpose the instrument must record single pings in short intervals. Due to limited memory and battery power the ADCPs in this configuration can only measure for a period of one year. It is planned to exchange these moorings during the coming Antarctic season on cruise ANT-XXIII/2. The other moorings should be exchanged during the Antarctic summer season 2007/2008.

Two sound sources were installed in moorings AWI229 and AWI231 to locate floats. Further details are given in the later section on floats.

All moorings were equipped with an ARGOS satellite transmitter which sends the position to be notified if a mooring would surface unplanned. This has happened with mooring AWI239 on 20 October 2003. RV *Polarstern* recovered the float-package with the ARGOS alarm transmitter on its transit from Cape Town to *Neumayer Station* during ANT-XXI/2. It was assumed that the remaining string may still stay at its location. Therefore the mooring work starts with searching AWI239 using POSIDONIA. No replies were received while staying at the location and during steaming in a 2 nm search circle around the location. Based on the good experiences with POSIDONIA and since the most likely reason for the mooring to disappear is the displacement by an iceberg no attempts to dredge were done.

AWI239 was not redeployed because it was planned to shift the mooring further southwards between AWI238 and AWI228 and AWI239 was continued as a mooring number AWI241; see [fig. 4.1](#) and [4.2](#). This should allow to better resolve the transition from the ACC to the northern part of the Weddell Gyre between AWI238 and AWI228.

With very good weather and sea ice conditions the mooring work was carried out without any serious difficulties. The instruments returned in good conditions. E.g. compared to former recoveries the ULS did not show any scratches resulting from icebergs. The data from the instruments memories were transferred to PC. It was found that one instrument was flooded and another one did not reply. But here is a good chance that the manufacturer is able to retrieve the data; see [table 4.1](#). Apart from the loss of one mooring an outstanding complete dataset was retrieved during this cruise with a data rate of 98% for the recovered moorings. This good result is mainly due to the fact that acoustic current meters which had a high failure rate in the past were no longer used since ANT-XX/2.

A new set of moorings were deployed in the Weddell Sea proper between Kapp Norvegia and Joinville Island ([fig. 4.1](#), [4.4](#) and [table 4.2](#)). They are located at positions where there have been moorings deployed from ANT-VIII/2, 1989 until ANT-XV/4, 1998. The longest lasting records were measured at the mooring sites AWI207, AWI208 and AWI209 showing a continuous increasing temperature of the WSBW in the central Weddell Sea. For this reason these mooring locations were selected to be continued. The instruments were focussed on the WSBW layer. Sea ice draft measurements with ULS were also continued at AWI208 and AWI207. Due to the low current in the centre of the Weddell Gyre a RDI Longranger ADCP was



installed in AWI208 at 300 m depth to support the estimates of the sea ice volume transport. All these moorings were equipped with sound sources at approximately 2000 m depth. An exchange of these moorings will take place during the Antarctic season 2007/2008.

#### **Location and recovering of moored instruments with POSIDONIA**

The POSIDONIA ultra short base line positioning system was used to locate the moorings before sending the release command. After the release POSIDONIA provides the depth and position of the releaser. During this cruise POSIDONIA operated the first time with updated software ABYSS 1.42 which is able to display a history list of the depth and position. This option is very useful in tracking the mooring and finally to get sight of it. POSIDONIA was also used to determine the accurate position when the mooring was deployed with the anchor last. It was found, that the anchor falls almost straight down where it was dropped and did not swing back towards the top in the direction the mooring string was trawled during the deployment.

A problem occurred when mooring AWI208 was deployed and POSIDONIA was started for tracking of the dropped anchor. For this operation POSIDONIA must send an enable command to the POSIDONIA compatible acoustic releaser/transponder. This command will switch the releaser into a mode to communicate with POSIDONIA. Exactly this was done as it was done seven times successfully before. As soon as POSIDONIA received the first replies it showed clearly that the mooring returned to the surface. AWI208 was recovered and an open release hook was found. The releaser was replaced by another one and the mooring was deployed again. This time the POSIDONIA transponder which was placed in the mooring top was used to determine the accurate location instead of repeating to communicate with the release/transponder.

All commands which were transmitted from POSIDONIA were logged. The instrument specific command codes and frequencies were taken from the instrument configuration file which exists for each individual instrument. These files were supplied by the manufacturer. The log-file and the configuration file were checked carefully and no indication was found which could explain the inadvertent release. For a further check the instrument which failed was lowered 100 m deep with a winch and the same procedures were repeated. This time the release did not open the hook as it should be the case.

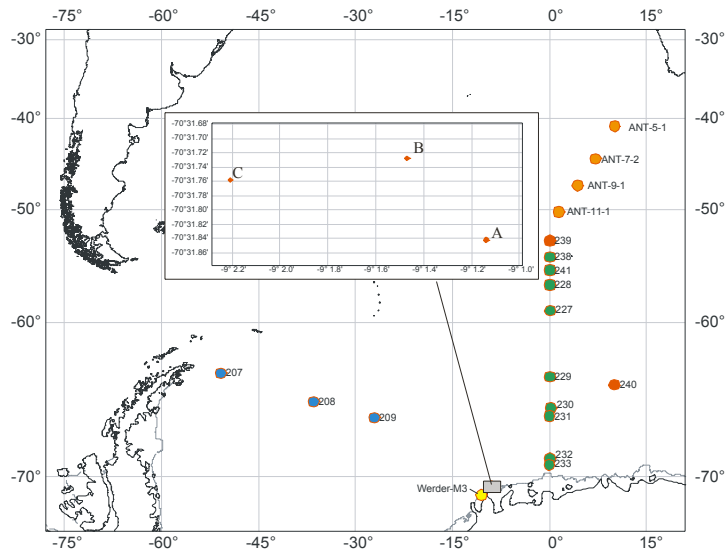

Fig. 4.1: Distribution of moored instruments recovered and deployed during ANT-XXII/3 in the Atlantic sector of the Southern Ocean, along the Greenwich meridian and in the Weddell Sea between Kapp Norvegia and Joinville Island

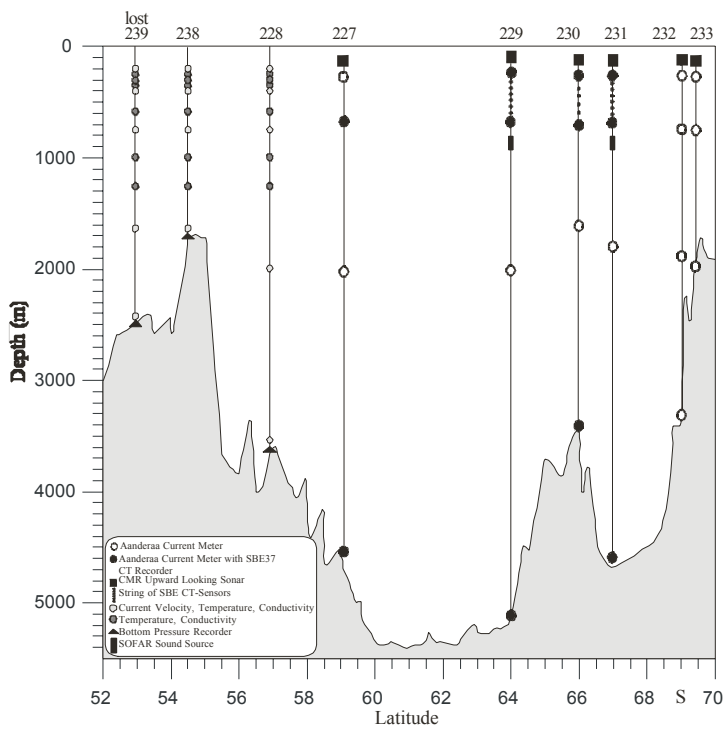

Fig. 4.2: Vertical section along the meridian of Greenwich with the moorings which were recovered. AWI239 was lost completely.

4. LARGE SCALE PROCESSES AND DECADAL VARIATIONS IN THE WEDDELL SEA  
(WEDDELL SEA CONVECTION CONTROL, WECCON 2005)

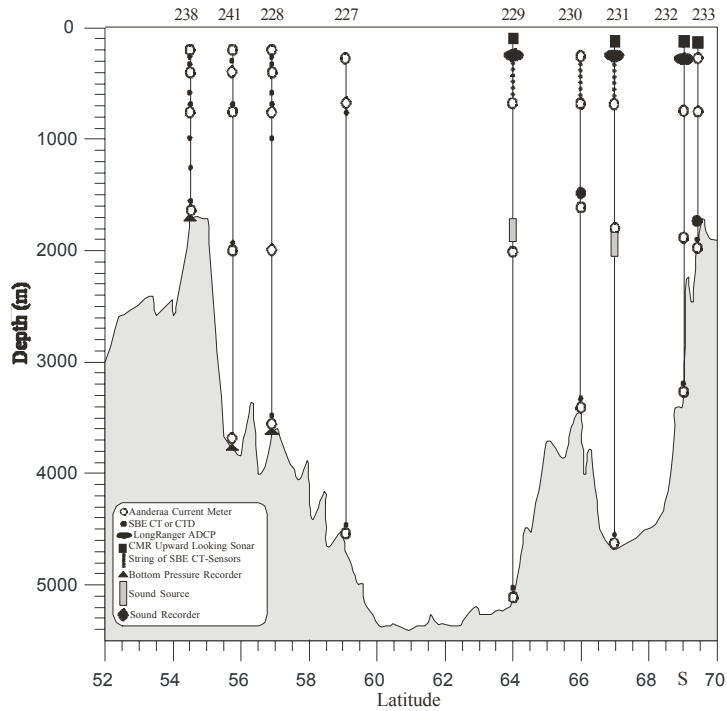

Fig. 4.3: Vertical section along the meridian of Greenwich with the moorings which were deployed. AWI239 was not re-deployed. Instead a new mooring AWI241 was placed further south.

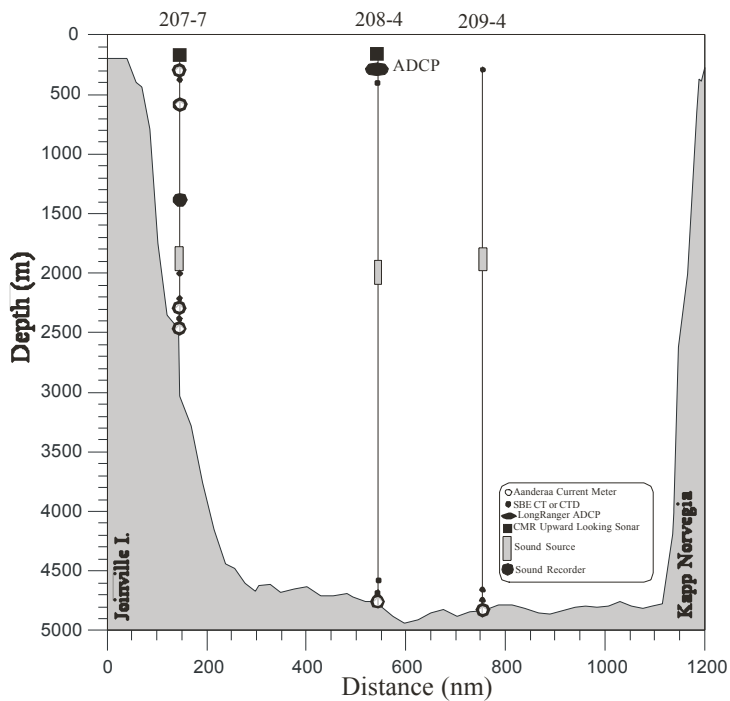

Fig. 4.4: Vertical section along the transect from Kapp Norvegia towards Joinville Island with the moorings which were deployed.

**Table 4.1:** Moorings recovered on the Greenwich meridian

Mooring	Latitude Longitude	Water Depth (m)	Date Time depl-recov.	Type	SN	Depth (m)	Days
AWI233-6	69° 23.66' S 00° 03.98' W	1948	15.12.2002	ULS	49	165	(5)
			22:48	AVTP	8367	237	794
			17.02.2005	AVTPC	8395	738	794
			15:16	SBE37	1604	1891	794
				AVT	10499	1892	794
AWI232-6	68° 59.87' S 00° 00.32' E	3369	16.12.2002	ULS	50	175	(5)
			14:46	AVTP	11887	252	793
			17.02.2005	AVTPC	8396	765	793
			08:00	AVT	10498	1809	793
				SBE37	1605	3314	793
AWI231-5	66° 30.56' S 00° 02.03' W	4542	18.12.2002	ULS	39	178	(5)
			10:55	AVTPC	8400	220	783
			09.02.2005	SBE37	2609	220	783
			08:40	SBE37	211	270	782
				SBE37	2610	320	783
				SBE37	214	370	783
				SBE37	215	420	783
				SBE37PuP3	2392	470	783
				SBE37	220	520	783
				SBE37	222	570	(1)
				SBE37	223	620	783
				SBE37	2234	670	783
				SBE37Pu	2382	720	783
				AVTPC	9215	731	783
				SQ	19/W2	882	(6)
				AVT	9768	1837	783
				SBE37Pu	2383	4492	783
AWI230-4	66° 00.30' S 00° 10.29' E	3477	18.12.2002	RCM 11	133	4498	783
			20:53	ULS	38	177	(5)
			08.02.2005	AVTPC	8401	220	(2)
			16 :14	SBE37Pu	2384	220	782
				SBE37Pu	2385	320	782
				SBE37P3	249	420	782
				SBE37	445	520	782
				SBE37	446	620	782
				SBE37Pu	2386	720	782
				AVTPC	9995	731	782
				RCM 11	134	1627	782
	SBE37Pu	2087	3427	782			
	RCM 11	135	3433	782			

**4.LARGE SCALE PROCESSES AND DECADAL VARIATIONS IN THE WEDDELL SEA  
(WEDDELL SEA CONVECTION CONTROL, WECCON 2005)**

Mooring	Latitude Longitude	Water Depth (m)	Date Time depl-recov.	Type	SN	Depth (m)	Days
AWI229-5	63° 57.23' S 00° 00.21' W	5200	10.12.2002 18:45 07.02.2005 10:37	ULS	38	147	(5)
				AVTP	8402	193	789
				SBE37P3	2387	200	789
				SBE37	250	250	789
				SBE37	448	300	789
				SBE37	449	350	789
				SBE37Pu	2086	400	789
				SBE37PuP3	2393	450	789
				SBE37Pu	2088	500	780
				SBE37Pu	2089	550	789
				SBE37Pu	2090	600	789
				SBE37	2611	700	589
				SBE37 PuP7	1564	750	780
				AVTP	9783	704	789
				SQ	14/W1	859	(6)
				RCM 11	144	2005	789
				SBE37Pu	2388	5150	789
RCM 11	145	5156	789				
AWI227-8	59° 04.20' S 00° 04.47' E	4566	07.12.2002 09:01 04.02.2005 14:12	ULS	41	162	(5)
				AVTPC	10004	274	790
				AVT	3570	704	790
				SBE37PuP3	2395	705	680
				AVT	10503	2011	790
				SBE37Pu	2091	4616	790
				RCM 11	146	4622	790
AWI228-6	56° 57.64' S 00° 01.62' E	3699	04.12.2002 23:00 03.02.2005 09:00	AVTPC	8405	190	791
				SBE16P1	1973	191	791
				SBE37PuP3	2235	241	791
				SBE37Pu	2092	291	791
				SBE37Pu	2093	341	791
				AVTPC	9201	402	791
				SBE37Pu	2391	403	791
				SBE37PuP3	2396	562	791
				AVT	9389	728	791
				SBE37Pu	2094	729	791
				SBE37Pu	2095	979	791
				SBE37PuP7	1565	1227	791
				RCM 11	100	1934	791
				RCM 11	101	3635	791
SBE37Pu	2389	3636	791				
SBE26	276	3699	(5)				

Mooring	Latitude Longitude	Water Depth (m)	Date Time depl-recov.	Type	SN	Depth (m)	Days
AWI238-4	54° 30.63' S 00° 01.81' E	1718	03.12.2002 14:20 01.02.2005 09:43	AVTP	11892	187	790
				SBE16P3	2420	188	790
				SBE37Pu	2096	238	790
				SBE37Pu	2097	288	790
				SBE37Pu	2098	338	790
				AVTP	10491	399	790
				SBE37Pu P3	2236	400	790
				SBE37Pu	2099	570	790
				AVT	9390	745	790
				SBE37Pu P3	2237	746	790
				SBE37Pu	2100	1000	790
				SBE37Pu	2101	1250	790
				RCM 11	102	1651	790
				SBE37Pu	2390	1652	790
				SBE26	257	1718	(5)
				AWI239-3	53° 00.49' S 00° 01.96' E	2483	02.12.2002 18:03
SBE37Pu	2231	241	(3)				
SBE37Pu	2102	291	(3)				
SBE37Pu	2103	341	(3)				
SBE37Pu	2104	391	(3)				
AVT	9401	441	(3)				
SBE37Pu P3	2394	442	(3)				
SBE37Pu	2105	613	(3)				
AVT	9458	797	(3)				
SBE37Pu P3	2238	798	(3)				
SBE37Pu	2233	1043	(3)				
SBE37PuP7	1566	1293	(3)				
RCM 11	103	1793	(3)				
SBE37	2232	1804	(3)				
RCM 11	104	2429	(3)				
SBE26	261	2483	(3)				

Table 4.2: Moorings recovered off Atka Bay

Mooring	Latitude Longitude	Date Time	Water Depth (m)	Type	Depth (m)	Rem.
Trap 1	70° 31.84' S 9° 1.14' W	19.02.05 06:11	306	FT	306	
Trap 2	70° 31.73' S 9° 1.47' W	19.02.05 06:45	308	FT	308	(4)
„Werder M3“	70° 56.67' S 10° 32.13' W	19.02.05 16:21	304	ST	277	(4)
				RCM9	292	(4)

**4.LARGE SCALE PROCESSES AND DECADAL VARIATIONS IN THE WEDDELL SEA  
(WEDDELL SEA CONVECTION CONTROL, WECCON 2005)**

**Table 4.3:** Moorings deployed at the Greenwich meridian

Mooring	Latitude Longitude	Water Depth (m)	Date Time	Type	SN	Depth (m)
AWI233-7	69° 23.60' S 00° 04.29' W	1950	17.02.2005 21:06	ULS	46	150
				AVTP	11890	202
				RCM11	100	699
				SR	W402	1700
				SBE37PuP35	3810	1903
				RCM 11	146	1904
AWI232-7	68° 59.75' S 00° 00.11' W	3370	17.02.2005 12:43	ULS	47	151
				ADCP	5373	375
				AVTPC	10927	752
				AVT	9186	1808
				SBE37	230	3313
				AVT	6854	3314
AWI231-6	66° 30.66' S 00° 01.91' W	4540	09.02.2005 15:47	ULS	56	151
				SBE37PuP3	1237	200
				SBE37	216	300
				ADCP	3813	353
				SBE37	224	400
				SBE37	227	500
				SBE37	229	600
				SBE37P3	242	700
				AVTPC	10928	700
				AVT	9391	1802
				SQ	W2-2	1900
				SBE37	231	4493
				AVT	9180	4494
				AWI230-5	66° 00.66' S 00° 11.28' E	3450
SBE37P3	243	200				
SBE37	233	300				
SBE37	232	400				
SBE37	235	500				
SBE37	236	600				
SBE37PuP35	2721	700				
AVTP	9214	700				
SR	A401	1550				
AVTP	9998	1590				
SBE37	238	3400				
AWI229-6	63° 57.16' S 00° 00.37' W	5200	07.02.2005 15:58	RCM 11	25	3400
				ULS	57	147
				SBE37PuP3	1236	200
				SBE37	240	300
				ADCP	0825	380
				SBE37Pu	435	400
				SBE37Pu	436	500
				SBE37Pu	438	600
				SBE37P3	248	700
				AVT	9769	700
				SQ	W1-2	1814
AVT	9188	2002				
SBE37	439	5153				
AVT	9770	5154				

Mooring	Latitude Longitude	Water Depth (m)	Date Time	Type	SN	Depth (m)				
AWI227-9	59° 04.11' S 00° 04.92' E	4627	04.02.2005 18:39	AVTP	10003	231				
				AVTPC	10926	723				
				SBE37PuP10	1234	724				
				AVT	11937	2019				
				SBE37Pu	1603	4581				
				AVT	9767	4582				
AWI228-7	56° 57.56' S 00° 01.07' E	3700	03.02.2005 16:03	AVTP	9763	191				
				SBE37PuP3	1232	197				
				SBE37	441	247				
				SBE37	442	297				
				SBE37PuP3	1233	347				
				AVTP	10539	401				
				SBE37	447	403				
				SBE37P3	247	582				
				AVTP	8037	747				
				SBE37PuP3	1230	749				
				SBE37	444	998				
				SBE37	440	1247				
				RCM 11	214	2003				
				RCM 11	26	3654				
				SBE37Pu	1607	3656				
AWI241-1	55° 31.94' S 00° 00.05' W	3810	02.02.2005 15 :37	SBE26	257	3700				
				AVTPC	9200	212				
				SBE37P3	246	317				
				AVTP	9785	424				
				AVT	10532	770				
				SBE16P3	245	772				
				RCM 11	216	2017				
				SBE37	269	2000				
				RCM 11	219	3744				
				SBE26	228	3810				
				AWI238-5	54° 30.76' S 00° 01.39' E	1700	01.02.2005	AVTP	10541	201
								SBE16PuP3	1235	208
SBE37P3	244	257								
SBE37	218	306								
SBE37PuP35	2719	356								
AVTP	9211	402								
SBE37PuP35	2720	403								
SBE37	225	573								
AVTP	7727	748								
SBE37PuP35	2722	750								
SBE37PuP35	2723	1000								
SBE37	437	1250								
RCM 11	215	1644								
SBE37PuP35	3811	1646								
SBE26	227	1700								



**4.LARGE SCALE PROCESSES AND DECADAL VARIATIONS IN THE WEDDELL SEA  
(WEDDELL SEA CONVECTION CONTROL, WECCON 2005)**

**Table 4.4:** Moorings deployed along transect from Kapp Norvegia towards Joinville Island

Mooring	Latitude Longitude	Water Depth (m)		Type		Depth (m)
AWI209-4	66° 37.08' S 27° 06.29' W	4860	01.03.2005 10:08	SBE37PuP35	3814	282
				SQ	W4	1840
				SBE16P10	319	4799
				SBE37	226	4848
				RCM 11	101	4849
AWI208-4	65° 37.15' S 36° 23.53' W	4740	05.03.2005 18:31	ULS	42	154
				ADCP	5691	291
				SBE37P3	241	300
				SQ	W5	2014
				SBE37	228	4678
				SBE37Pu	1606	4728
AWI207-6	63° 42.20' S 50° 52.22' W	2500	14.03.2005 2:47	AVT	9182	4729
				ULS	36	148
				AVTP	9193	246
				SBE37PuP35	3812	248
				AVTPC	10929	750
				SR	C403	1457
				SQ	W6	2000
				SBE37	239	2099
				SBE37PuP35	3813	2297
				AVT	10497	2303
				SBE37Pu	2097	2488
				AVT	10496	2489

**Remarks:**

- |   |  |
|---|--|
| (1) Instrument flooded, no data recorded    | (2) Water leakage damaged conductivity |
| (3) Mooring lost                            | (4) Mooring lost                       |
| (5) Full data memory but data not processed | (6) Passive instrument                 |

**Abbreviations:**

- ADCP            RD-Instruments, Self Contained Acoustic Doppler Current Profiler
- AVTCP         Aanderaa Current Meter with temperature, conductivity, and pressure sensor
- AVTP          Aanderaa Current Meter with temperature and pressure sensor
- AVT            Aanderaa Current Meter with temperature sensor
- RCM 11        Aanderaa Doppler Current Meter
- SBE16P#      SeaBird Electronics intern recording CTD measures temperature, conductivity, and pressure, Type: Seacat; P# indicates the depth Rating, e.g. P1 up to 1000psi or P3 up to 3000psi
- ULS            Upward Looking Sonar; Christian Michelsen Research Inc.
- SBE26         SeaBird Electronics to measure the bottom pressure
- SBE37         SeaBird Electronics, Type: MicroCat, to measure temperature and conductivity
- SBE37Pu      SeaBird Electronics, Type: MicroCat, to measure temperature and conductivity including external pump

SBE37PuP#	SeaBird Electronics, Type: MicroCat, to measure temperature and conductivity including external pump and pressure sensor; P# indicates the depth rating, e.g. P3 up to 3000psi or P7 up to 7000psi and P35 for 3500 dbar
SQ	Sound source for SOFAR floats
SR	Sound recorder
ST	Sediment trap
FT	Fish trap

### CTD transects

Moored systems are not able to measure in the near surface layers and can not provide sufficient horizontal resolution. Therefore ship-borne measurements are required. Hydrographic surveys were carried out along the Greenwich meridian, from Kapp Norvegia to the northern end of the Antarctic Peninsula, across the Powell Basin and across Drake Passage with a CTD (Conductivity/Temperature/Depth) probe and a rosette water sampler. Samples were taken for the components of the CO<sub>2</sub> system, oxygen, nutrients, and tracers.

A total number of 143 CTD stations were carried out during the cruise. We used a SBE911plus CTD system in combination with a rosette SBE32 with 24 12-l bottles. To determine the distance to the bottom we used an altimeter from Benthos. In addition to this a transmissiometer from Wetlabs, a SBE43 oxygen sensor from Seabird Electronics and a Dr. Haardt Fluorometer has been used. The water depth was calculated from the CTD measurements and the corresponding altimeter value. Lacking an altimeter value the depth was taken from the ships echo sounder, which has been corrected with the actual sound speed.

The CTD was equipped with two independent CT sensor groups. Each one of them with its own pump to flush the group at a constant flow of water. The oxygen sensor was integrated in the first group. The serial numbers, the type of each sensor and the calibration dates of each device can be taken from tables 4.5 and 4.6.

**Table 4.5:** Serial numbers of the different devices

#### **CTD SBE911plus SN 0561 with rosette SBE 32 SN273**

**Pressure (Type/SN, Cal.-date)**

**Digiquartz 419K-105/SN 75659, 29.10.02**

#### **Sensors in groups:**

	Group 1	Group 2
Pump (Type/SN)	SBE 05T/2878	SBE 05T/XXX
Temperature (Type/SN, Cal.-Date)	SBE 03P/2678, 14.09.04	SBE 03P/2685, 14.09.04
Conductivity (Type/SN, Cal.-Date)	SBE 04C/2446, 19.06.03	SBE 04C/2325, 14.09.04
Oxygen (Type/SN, Cal.-Date)	-	SBE 43/0743, 17.09.04

**Table 4.6:** Additional Sensors:

Sensor	Type	Cal.-date	Analog channel (Voltage)
Altimeter	Benthos SN 189	-	0
Transmissiometer	WET labs C-Star SN CST-267DR	23.07.99	2
Fluorometer	Dr Haardt SN 8060	-	4
Oxygen (Type/SN)	SBE43/0743	17.09.04	6
Temperature (Type/SN)	SBE35/027	07.11.03	-

The salinity is given in Practical Salinity Units (PSU). Salinity samples were analysed with an Autosol salinometer 8400B from Guildline Instruments to check and probably correct the conductivity measurements of the CTD. Therefore 730 samples were taken from depth levels which show no significant gradient in the salinity profile. In this way up to 4 double samples were taken at nearly all deep stations. The salinity measurements were directly compared with the CTD measurements. The water samples were measured in reference to 44 bottles of Standard water batch no P144 ( $k_{15}=0.99987$ ) from 23 September 2003. The difference from the Autosol measurement minus the CTD measurements were calculated and plotted (fig. 4.5). A detailed depth dependence analysis was not carried out. The sensors are known to be well pressure corrected and there was no indication on a deviation. A drift of 0.004 during the cruise was identified for both sensors. Additionally the sensors differed by 0.001. No jumps occurred in the sensor behaviour of the conductivity cells. Deviations from linear drift occurred only around station 63. However, this is due to the salinometer, because one heater lamp did not work during the measurements. A failure of one conductivity cell would have been seen in the comparison of both sensor groups. The external thermometer SBE35 from Seabird Electronics was used to check the temperature probes. Since the thermometer is very accurate, but slow, this was always done when a bottle was closed. The comparison shows no unexpected differences.

A final correction will be carried out after the calibration from the manufacturer. But, the preliminary results show, that the conductivity sensors worked very well during the cruise. One can assume that complicated corrections should not be needed. With respect to these good preliminary results, one should be able to provide salinity values better than  $\pm 0.002$  and temperature values better than  $\pm 0.001$  K.

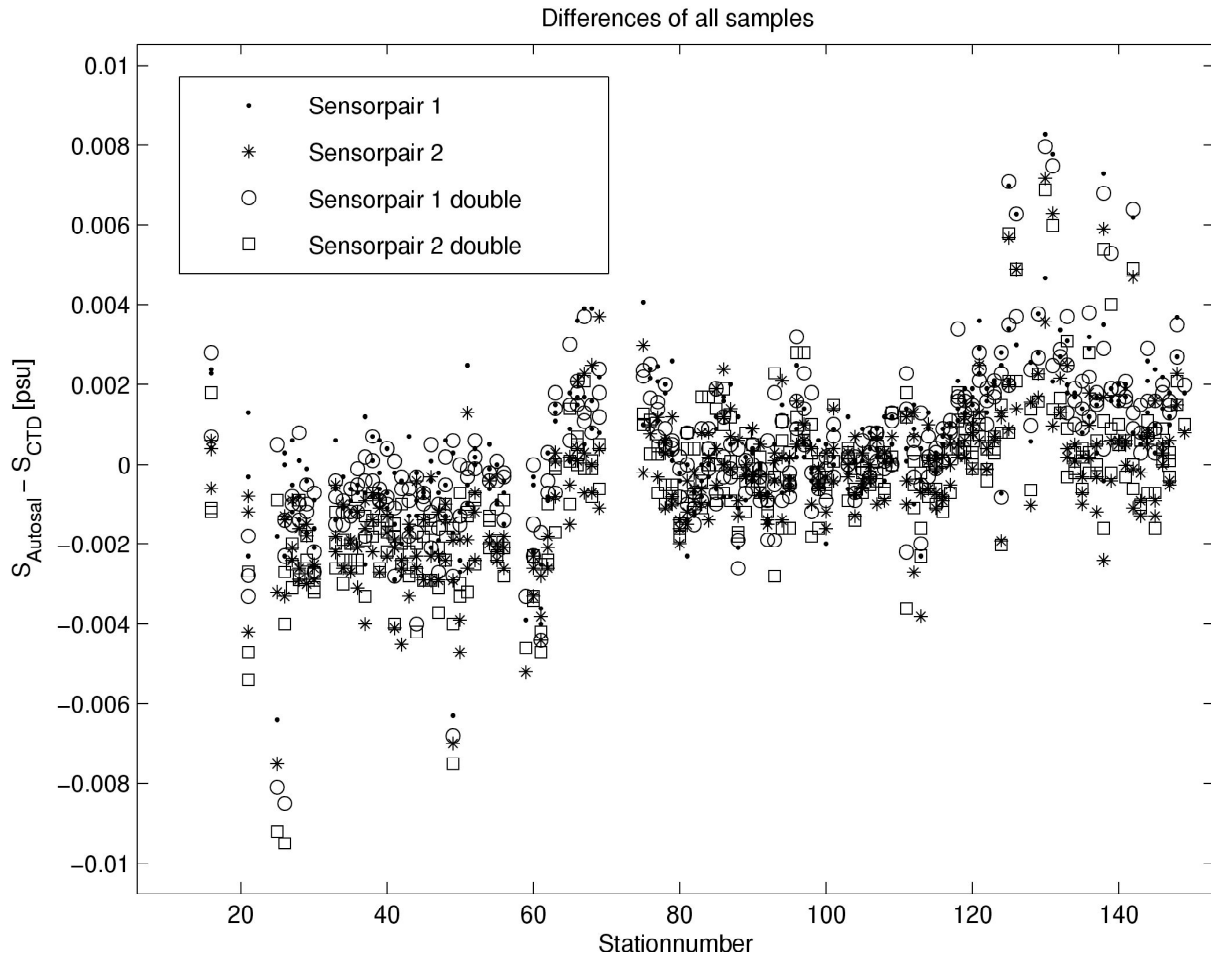

*Fig. 4.5: Differences between the bottle samples and the salinities derived from the CTD sensors for both sensor pair*

The data were directly preliminary processed on board. This processing covers the following steps:

- The conversion and first processing of the data with the Seasoft software from Seabird.
- The conversion of the data into a special data format. At this state the data are linked with meta information, like the station number, water depth.
- The despiking of the data in a graphical editor. The data were rated according to several criteria, like density inversions or outliers in the TS-diagram, to decide if they are deleted or interpolated.
- A comparison of the station with each other, which means from station to station to see if any failures occurred.

The temperature and salinity data are presented as vertical sections in [fig. 4.7](#) to [4.10](#).

## Nutrient measurements

### Methods

A Traacs 800 autoanalyser is used for spectrophotometric determination of the different nutrients using classical methods.

#### Phosphate:

Ortho-phosphate is measured at a wavelength of 880 nm as a blue reduced molybdo-phosphate complex formed at pH 0.9-1.1. Potassiumantimonyltartrate is used as a catalyst and ascorbic acid as the reductant. The method is described in Murphy and Riley (1962).

#### Nitrate and nitrite:

Nitrite can be determined after diazotation with sulfanylamide and N-(1-Naphtyl)-ethylene diammonium dichloride which forms a reddish-purple dye, that is measured at 550 nm. Nitrate is separately reduced first in a copperized Cd-coil using imidazole as a buffer and is then measured as nitrite. The method is fully described by Grasshoff (1983).

#### Dissolved silica:

Measured as a blue reduced siliconmolybdenium complex at 880 nm. Ascorbic acid is used as reductant and oxalic acid is used to prevent interference of phosphate. Described by Strickland and Parsons (1972).

## Sample handling

### CTD rosette

All samples were collected from rosette Niskin bottles after rinsing three times in high density polyethylene sample bottles with a volume of 125 ml. Prior to analysis the samples were stored in the dark at 4°C. Analyses were carried out within 24 hours after sampling for almost all stations.

### Bottom water from the multicorer

A plastic syringe with a volume 10 ml was rinsed twice with water from boxcores or multicores. A filter with 0.2  $\mu\text{m}$  pore size was attached to the syringe and the first 2 ml were used to rinse the disc filter. The filtrate was collected in a polyethylene vial and stored in a refrigerator prior to the analysis.

## Calibration and standards

Calibration curves were produced daily by diluting stock standards in plastic calibration flasks. All calibrated laboratory "glassware" were calibrated at the home lab at NIOZ before the cruise. Depleted aged surface ocean water was used as the diluent for the calibrants and as a baseline for the autoanalyser analysis. As a daily check for the calibration, a lab made cocktail-standard containing all nutrients was

measured with every run. This cocktail was diluted hundredfold in the same ocean water, as a kind of reference standard.

### Performance

For the CTD station 59/8, at which all 24 rosette bottles were fired at the same depth, the precision was estimated to be:

	average ( $\mu\text{M}$ )	standard deviation ( $\mu\text{M}$ )	standard deviation (%)
Silica	136.64	0.43	0.31
Phosphate	2.279	0.009	0.40
Nitrate	33.91	0.06	0.17

For the CTD station 110/12, where the same procedure was followed, the precision was estimated to be:

Silica	135.60	0.89	0.65
Phosphate	2.283	0.016	0.69
Nitrate	33.42	0.08	0.23

All CTD stations were sampled, resulting a total of 2986 water samples (excluding Drake Passage) that were analysed. Additionally, 116 bottom water samples were analysed from 13 stations.

### Oxygen measurements

To calibrate the oxygen profiles that were collected with the optode sensor which is attached to the CTD, 5 samples of water were taken from station 26 to station 171, yielding a total of 665 samples (in shallow stations only 3 or 2 samples were taken). The oxygen was measured according to the manual "WOCE operation and methods" (C.H. Culberson, July, 1991). Immediately after the sampling, the dissolved oxygen was fixed with  $\text{MnCl}_2 \cdot 4\text{H}_2\text{O}$  and  $\text{NaOH} + \text{NaI}$ . Then, the bottles were stored under water to prevent intrusion of air. To measure the dissolved oxygen, sulphuric acid 50% ( $\text{H}_2\text{SO}_4$ ) was added to the samples and a solution of sodium thiosulfate ( $\text{Na}_2\text{S}_2\text{O}_3 \cdot 5\text{H}_2\text{O}$ ) was titrated with a 665 Dosimat Metrohm automatic pipette provided with a transmissometer. Potassium iodate ( $\text{KIO}_3$ ) was used as standard.

Preliminary results of these measurements show a standard deviation of  $0.0158 \text{ ml l}^{-1}$  (less than 1% of the mean oxygen value). The comparison with the oxygen profiles of the CTD was good up to station 55, but the following stations showed that the oxygen sensors tended to drift.

4. LARGE SCALE PROCESSES AND DECADAL VARIATIONS IN THE WEDDELL SEA  
(WEDDELL SEA CONVECTION CONTROL, WECCON 2005)

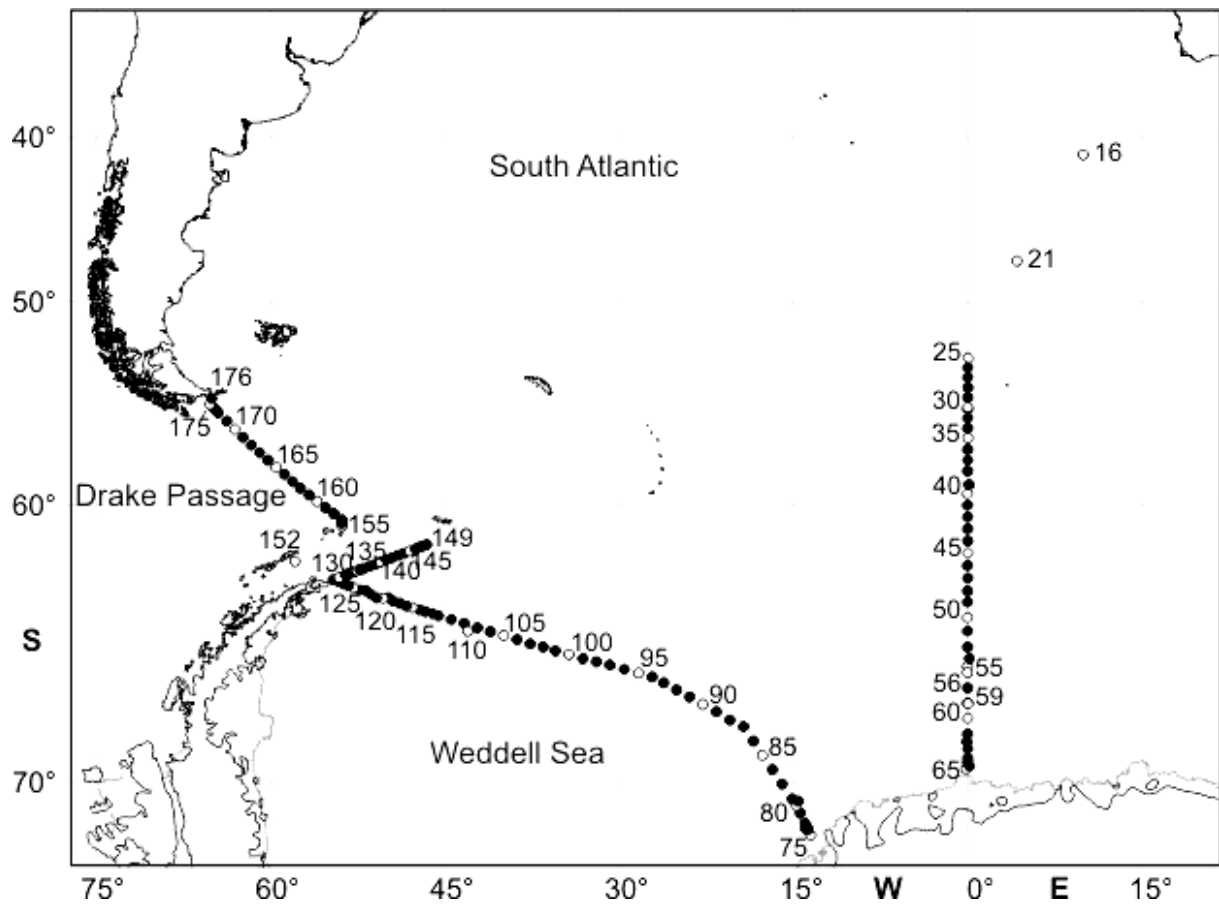

Fig. 4.6.: Map of the location of the CTD stations carried out during ANT-XXII/3. Open circles indicate stations for which the station numbers are displayed

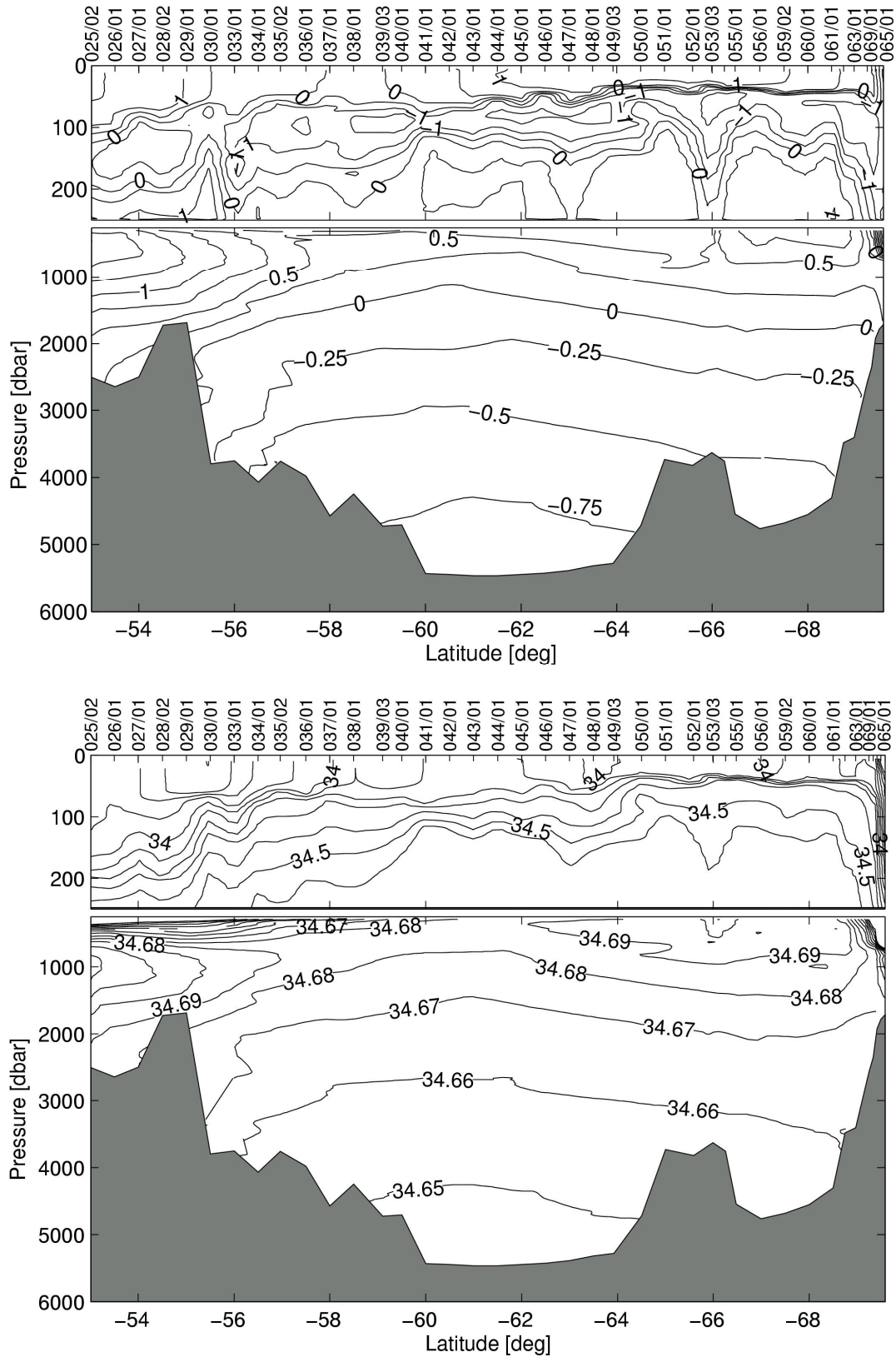

Fig. 4.7: Vertical transect of potential temperature and salinity along the Greenwich meridian



4. LARGE SCALE PROCESSES AND DECADAL VARIATIONS IN THE WEDDELL SEA  
(WEDDELL SEA CONVECTION CONTROL, WECCON 2005)

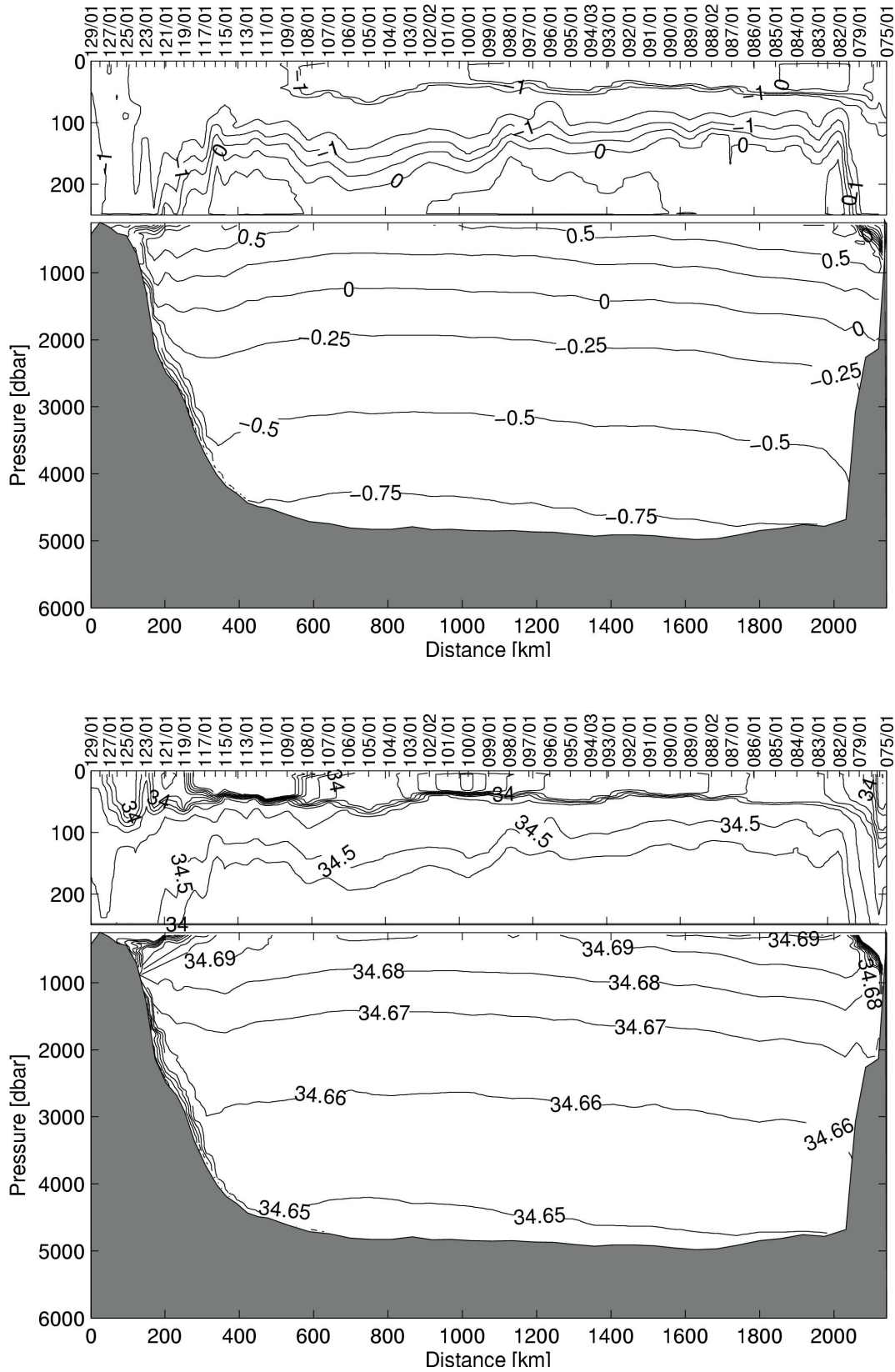

Fig. 4.8: Vertical transect of potential temperature and salinity across the Weddell Sea from Kapp Norvegia (right) to Joinville Island (left)

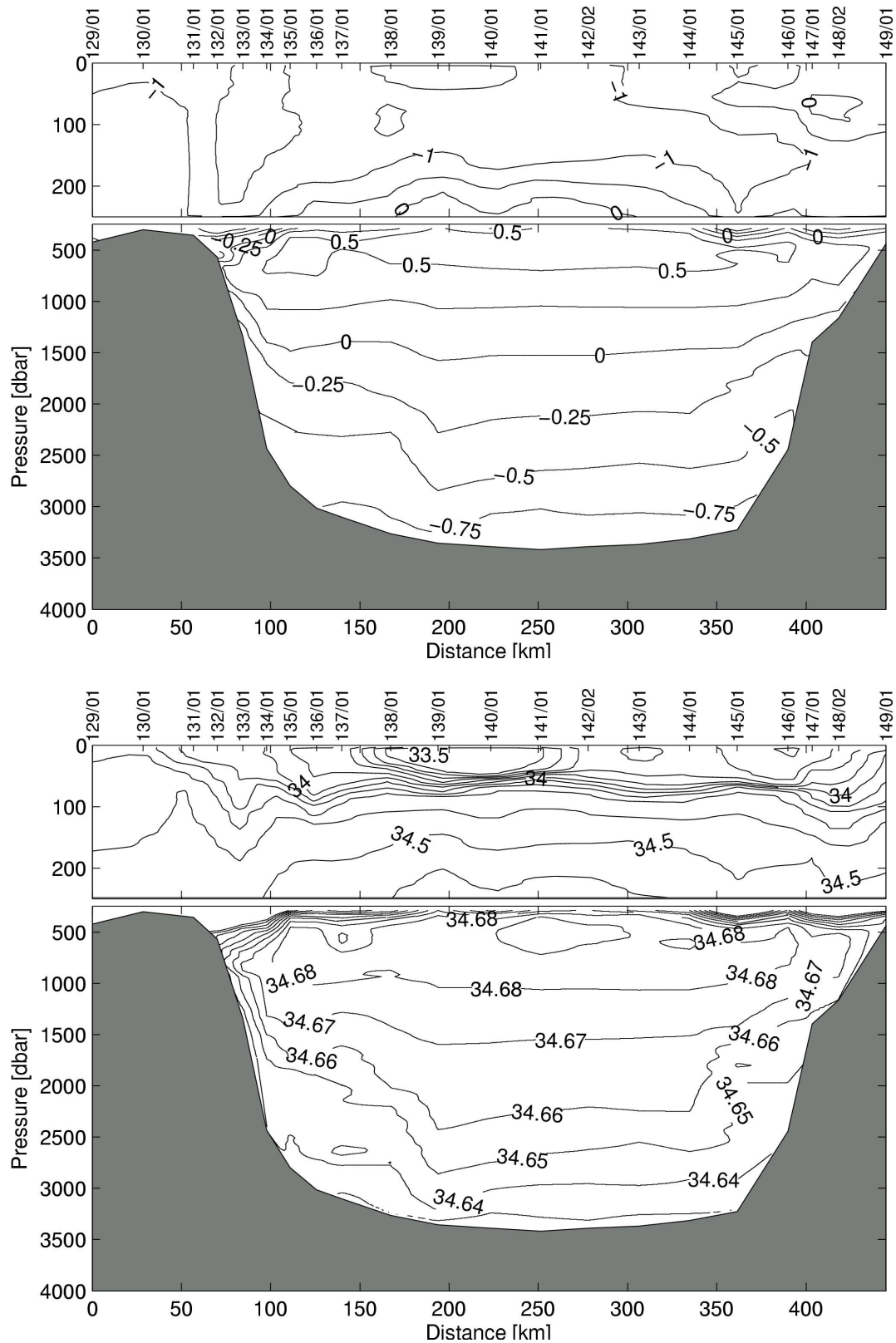

Fig. 4.9: Vertical transect of potential temperature and salinity across the Powell Basin from the South Orkney shelf (right) to Joinville Island (left)

4. LARGE SCALE PROCESSES AND DECADAL VARIATIONS IN THE WEDDELL SEA  
(WEDDELL SEA CONVECTION CONTROL, WECCON 2005)

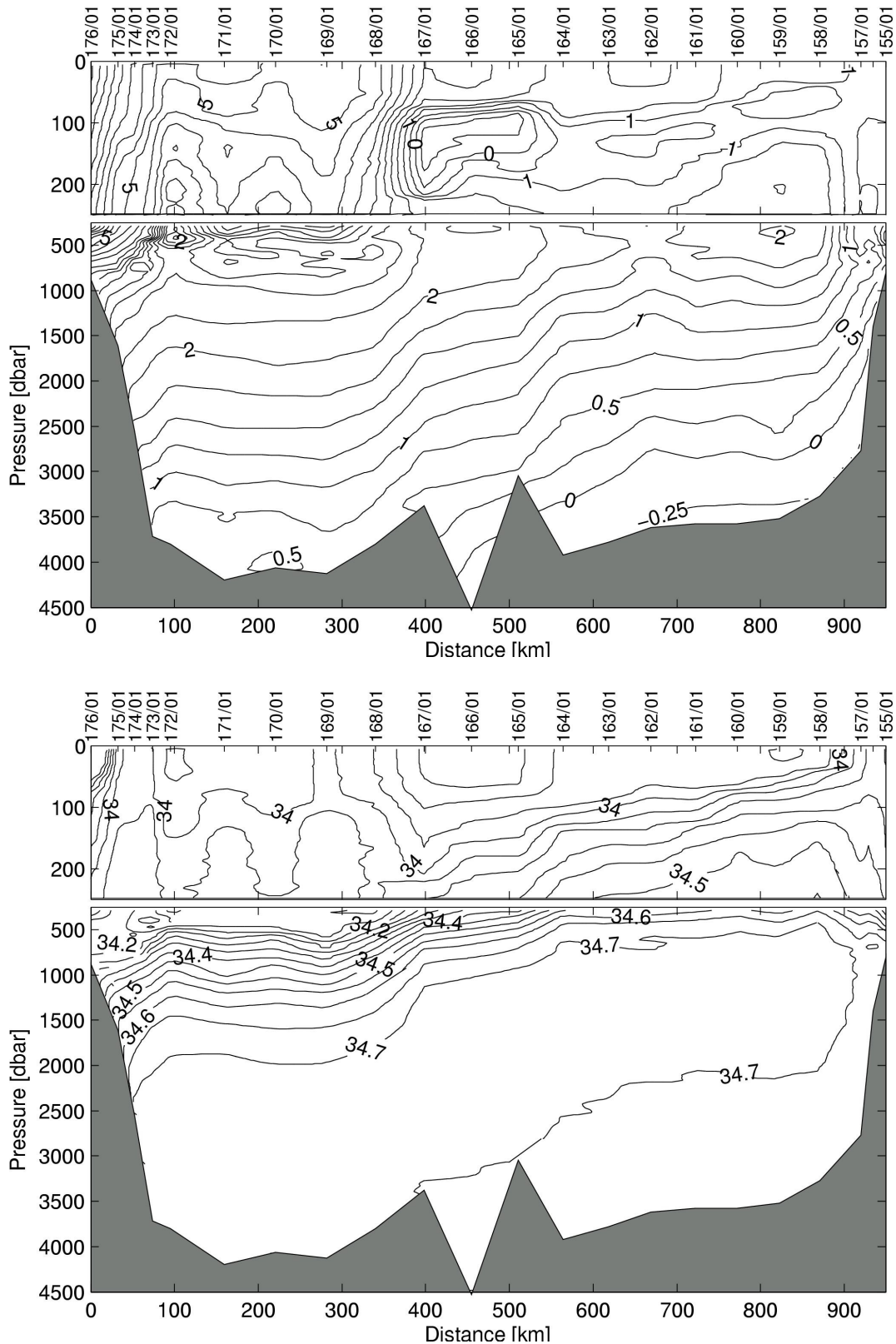

Fig. 4.10: Vertical transect of potential temperature and salinity across the Drake Passage from South America (left) to the Antarctic continent (right)

### Underway measurements

Underway measurements with a vessel mounted 150 kHz-Ocean Surveyor ADCP from RD Instruments and two SBE45 thermosalinographs from Seabird Electronics were conducted along the whole track to supply temperature, salinity and current data at a high spatial resolution (fig. 4.11 and 4.12). The thermosalinographs are mounted in 6 m depth in the bow thruster tunnel (TSB) and in 11 m depth in the keel (TSK). Both instruments were controlled by taking water samples each day which were measured on board with the Autosal 8400B.

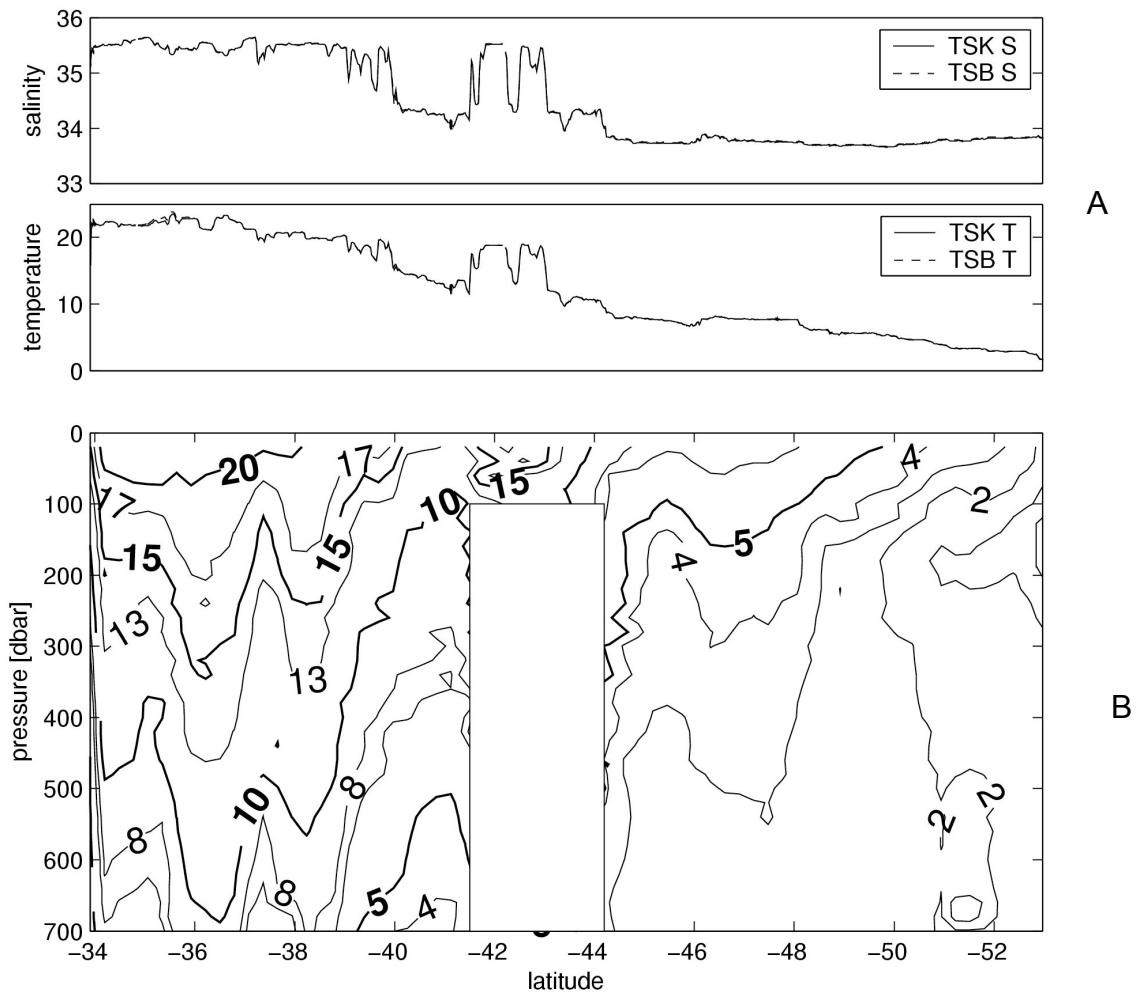

Fig. 4.11: a) Near surface temperature and salinity from the thermosalinograph along the trackline from South Africa (right) to the Antarctic continent (left). b) Vertical transect with XBTs from South Africa (left) to 53°S (right). TSK is solid, TSB is dashed.

4. LARGE SCALE PROCESSES AND DECADAL VARIATIONS IN THE WEDDELL SEA  
(WEDDELL SEA CONVECTION CONTROL, WECCON 2005)

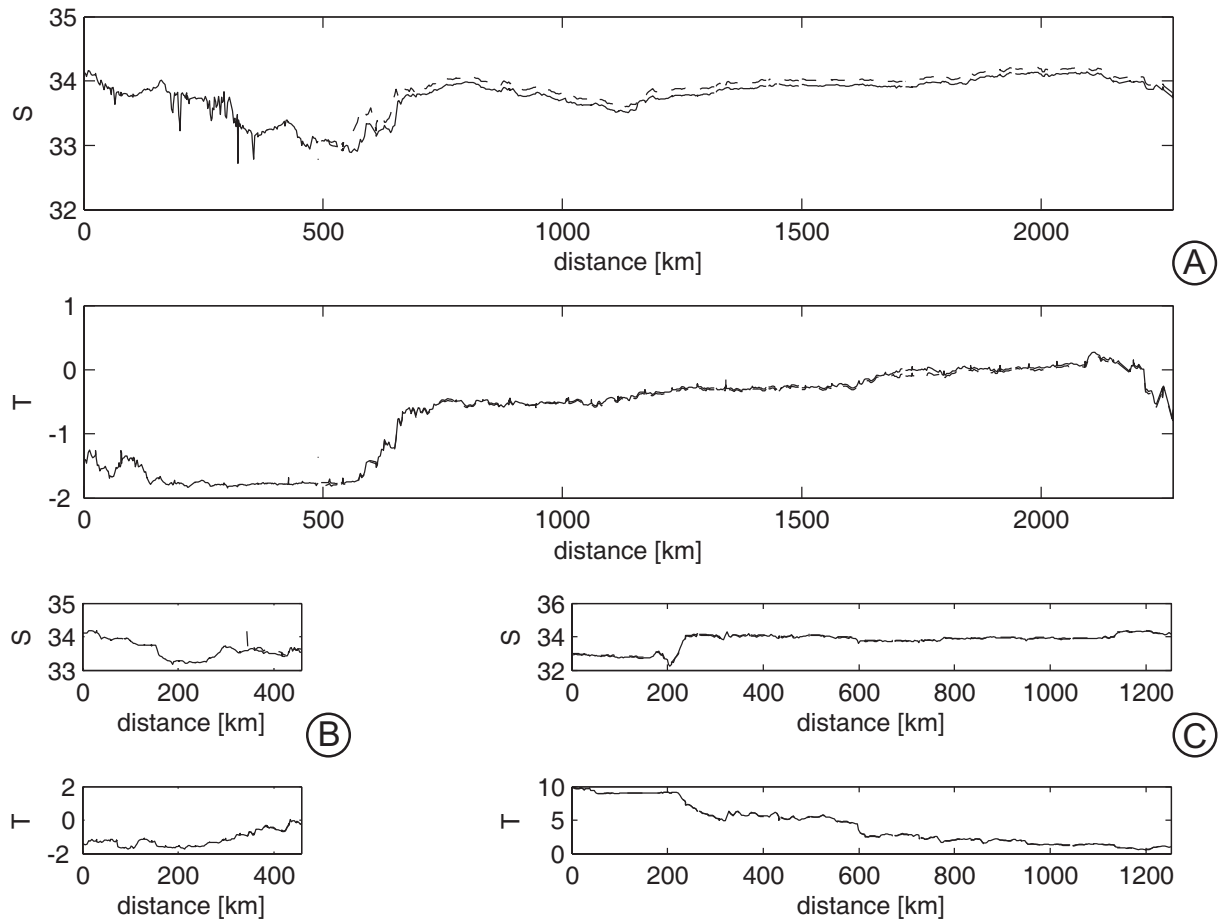

Fig. 4.12: Near surface temperature and salinity from the thermosalinograph (a) across the Weddell Sea from Joinville Island (left) to Kapp Norvegia (right), (b) across the Powell Basin from Joinville Island (left) to the South Orkney shelf (right) and (c) across Drake Passage from South America (left) to the Antarctic continent (right). TSK is solid, TSB is dashed.

### Iceberg tracking

To estimate the fresh water transport by icebergs, 14 satellite tracked transmitters should be deployed but pre-deployment checks displayed in a number of malfunctions. Only five instruments could be brought to operation. One iceberg marker failed after a few days.

The markers determine their position once per day at noon with a GPS receiver. The positions are transmitted via satellite using the ARGOS system. The ARGOS transmitter is switched on for 6 hours once a week, to send the positions from the past seven days. The transmitter's on-time lasts long enough to ensure that all data can be received by CLS in Toulouse, France. This weekly transmission mode was chosen to save CLS service costs. The iceberg markers are designed to operate for up to two years. Due to environmental aspects, the housing is slightly enlarged compared to previous versions. Thus the new markers have positive buoyancy. Markers from melted icebergs are likely to leave the Antarctic Ocean by drifting northwards and being entrained into the Antarctic Circumpolar Current. Tilt sensors are installed to detect when an iceberg begins to capsize. The ARGOS transmitter will switch into a continuous mode as soon as the tilt exceeds a fixed limit.

The markers were deployed on icebergs by helicopter. Fig. 4.13 shows a map with the marked icebergs. The icebergs were chosen along the cruise track with maximum flight distances of 20 nautical miles. Three markers were deployed during the unloading activities at *NEUMAYER*. A digital photograph was taken to describe the shape of the iceberg. The length and width was measured with the GPS, flying along and across the iceberg. The height above sea level is taken from the radar altimeter of the helicopter. [Table 4.7](#) gives a summary of all icebergs marked.

OPTIMARE, Bremerhaven, is assigned to collect the data from CLS via direct computer link and to process and validate the data.

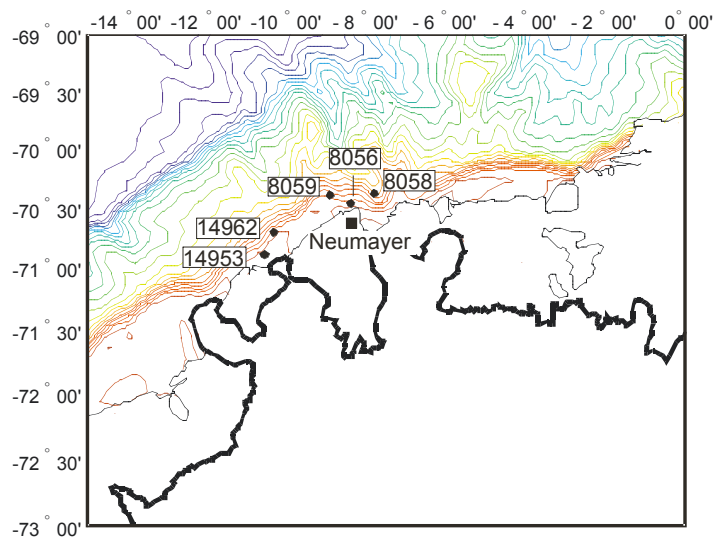

*Fig. 4.13: Map with the location of the marked icebergs. 8056 transmitted for a few days only.*

**Table 4.7:** Deployment of iceberg tracking Argos transmitters

Transmitter					Iceberg			
Argos ID	Date	Time (UTC)	Latitude	Longitude	length (m)	width (m)	Free board (m)	Description
8058	12.02.05	13:07	70°22.740 S	07°49.729 W	401	401	21.5	8058_1.jpg; 8058_2.jpg
8059	12.02.05	13:47	70°24.685 S	08°55.357 W	463	185	30.5	8059_1.jpg; 8059_2.jpg
8056	12.02.05	14:15	70°28.366 S	08°21.641 W	1018	370	27.5	8056.jpg
14962	19.02.05	14:47	70°41.666 S	10°19.549 W	1823	921	49.0	14962_1.jpg; 14962_2.jpg
14953	19.02.05	15:22	70°53.227 S	10°34.668 W	2111	1148	33.5	14953.jpg

### Preliminary results

In spite that final data processing including laboratory calibrations can not be done on board the quality of data is sufficient to provide insight in the progress of the variations in the water mass properties considered during the last 15 years.

The changes of the mean temperature the Warm Deep Water (WDW) and the Weddell Sea Bottom Water (WSBW) continued and proved to be of decadal time scale (fig. 4.14). A temperature increase was observed at the Greenwich meridian since in the late 70ties or early 80ties. It continued until 1996 und since then the warming and cooling by about 0.06°C is comparable. The Weddell Sea Bottom displays an opposite sense of change. At the Greenwich meridian it cooled from the 80ties until 1992.

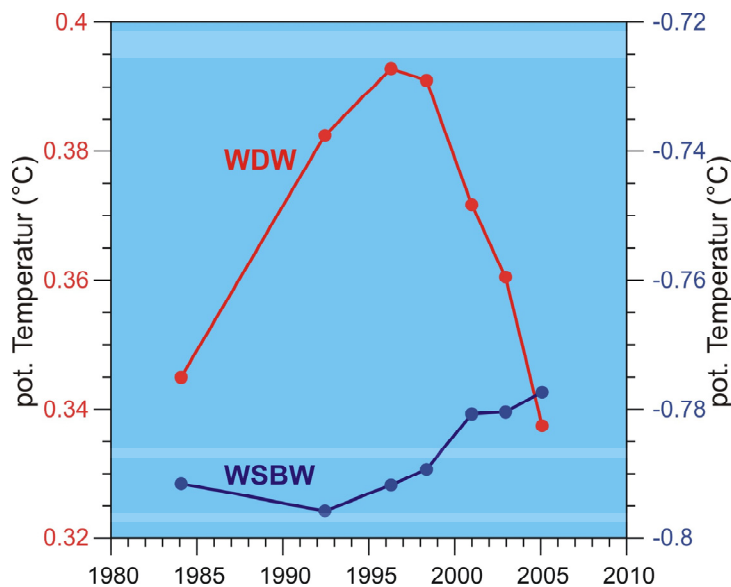

*Fig. 4.14: Time series of mean temperature of the Warm Deep Water (WDW) and the Weddell Sea Bottom Water (WSBW) from CTD sections at the Greenwich meridian*

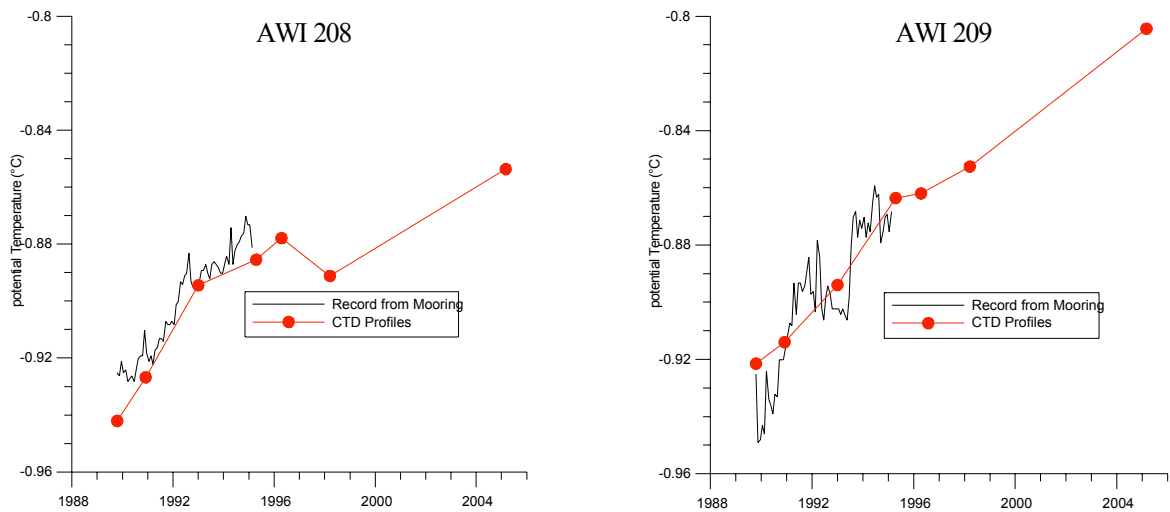

Fig. 4.15: Time series of mean temperature of the Weddell Sea Bottom Water (WSBW) from CTDs and moored instruments in the Weddell Sea proper

Since then it warmed by 0.02°C. However, if one looks on to the local changes the rates are much higher. In the Weddell Sea proper two moorings and CTD profiles indicate a steady temperature increase of 0.08°C from 1989 to 2005 (fig. 4.15). Whereas the warming in the WDW and the WSBW is associated with a salinity increase, the cooling in the WDW occurs with nearly constant salinity (fig. 4.16). The joint increase of temperature and salinity suggests that changes in the inflow cause the variations with a more intense inflow of circumpolar deep water. However the cooling with constant salinity requires heat loss only.

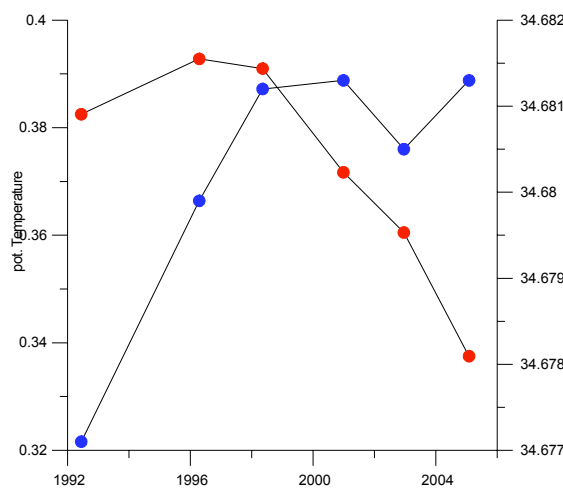

Fig. 4.16: Time series of mean temperature and salinity of the Warm Deep Water (WDW) from CTD sections at the Greenwich meridian



This is consistent with a period of intensive inflow from the ACC up to 1996 and the subsequent relaxation. The warmer and saltier source water induced in increase of temperature and salinity of the newly formed bottom water. The time scale of interaction between WDW and WSBW is longer than a decade and consequently temperature and salinity increase in the WSBW still continues.

### **PIES recovery and deployment**

Pressure Inverted Echo Sounders (PIES) deliver bottom pressure and travel times of sound signals from the bottom to the sea surface, effectively providing a measure of average temperatures, bottom pressure variations and sea surface height. PIES data are used to extract baroclinic and possibly barotropic transport variations within the gap spanned by the PIES array.

As part of the AWI and GOODHOPE programmes to observe the decadal variability of the Antarctic Circumpolar Current (ACC) transport, 2 PIES were recovered and 3 new PIES were deployed across the ACC. The instruments are located on the Jason (previously TOPEX/Poseidon) ground track number 133 (fig. 4.1.7). It thereby complements a PIES array deployed along the same satellite ground track between the South African coast and about 40°S by Deidre Byrne, University of Maine.

**Table 4.8:** PIES recovery. The mooring “PIES ANT-7-1” was previously called “PIES-1, while “PIES ANT-11-1” used to be “PIES-2”. Clock offsets are positive if early with regard to UTC/GMT.

<b>mooring</b>	ANT-7-1 PIES-1	ANT-11-1 PIES-2
<b>station book</b>	PS67/19-1	PS 67/23-169
<b>Sn.</b>	67	69
<b>start date &amp; time [UTC]</b>	26.11.02 18:46:37	28.11.02 16:09:55
<b>launch date &amp; time [UTC]</b>	27.11.02 16:42	29.11.02 21:56
<b>launch latitude &amp; longitude</b>	44°39.75'S 07°05.03'E	50°15.01' S 01°25.00' E
<b>release date &amp; time [UTC]</b>	27.01.05 18:28	30.01.05 18:42
<b>surface date &amp; time [UTC]</b>	27.01.05 20:04	30.01.05 20:18
<b>surface latitude &amp; longitude</b>	44°39.85'S 07°05.53'E	50° 14,50' S 01° 26,14' E
<b>depth [m]</b>	4619	3897
<b>Clock offset</b>	+67 s 05.02.05 09:40	-46 s 30.01.05 21:35:30

**Table 4.9:** PIES deployments. ANT-9-1 used with one of POSIDONIA transponders 392, 391, 390 or 389, match unresolved.

<b>mooring</b>	ANT-5-1	ANT-7-2	ANT-9-1
<b>Station book</b>	PS67/16-12	PS67/19-02	PS67/21-09
<b>Sn</b>	113	135	125
<b>start date &amp; time [UTC]</b>	26.01.05 16:12:56	26.01.05 22:50:59	29.01.05 17:06:12
<b>launch date &amp; time [UTC]</b>	26.01.05 19:20	27.01.05 20:37	30.01.05 02:29
<b>launch latitude &amp; longitude</b>	41°08,04'S 9°56,63'E	44°39,84'S 7°04,93'E	47°39,36'S 4°15,70'E
<b>POSIDONIA: bottom date &amp; time [UTC]</b>	contact lost at 3643 m	27.01.05 21:52	no reception
<b>POSIDONIA: bottom latitude &amp; longitude</b>	-	44° 39,79' S 7° 5,32' E	no reception
<b>POS. ID</b>	387	388	?
<b>depth [m]</b>	4733	4616 4568	4568
<b>PopUp</b>	-	135-1135-2	-
<b>Auto release date &amp; time [UTC]</b>	24.01.09 16:00	25.01.09 16:00	26.01.09 16:00

PIES were released by helicopter. As this procedure was employed for the first time, it will here be described in some detail. The helicopter departed from RV *Polarstern* approximately 2h before dawn, which coincided with the estimated time of arrival of RV *Polarstern* at the PIES mooring site. At the mooring site, first a sonobuoy (courtesy of Forschungsanstalt der Bundeswehr für Wasserschall und Geophysik, Kiel) was dropped from the helicopter to verify the PIES presence and functionality. Circling at about 1000 ft height, the sonobuoy's radio signal was received and visualized using WinRadio and Ishmael software to produce real time spectrograms. The audio signal was monitored using Bose NoiseCancelling Headphones to overcome the helicopters noise. The PIES' 10 minutely pings were clearly discernable in the spectrogram at 12 kHz. The pings' offset with regard to UTC was recorded.

After verification of the PIES presence and activity, the helicopter descended to a height of about 60 ft over water. A transducer was lowered into the water, with a cable and weight preceding the hydrophone to ground the helicopter and onboard electronics before the hydrophone would touch the water. The release code was issued using a Benthos deck unit. While the Benthos deck unit did only sporadically receive acoustic confirmation signals, the respective signals showed up clearly in the spectrograms received by means of the sonobuoy. When the PIES release activity was thus confirmed, the hydrophone was recovered and the helicopter returned to the ship.

When the ship was within short distance from the PIES nominal position, darkness had struck and the PIES flasher became clearly visible in the forward sector. Concurrently, the PIES radio beacon confirmed its position at the sea surface.

Fig. 4.17: Positions of PIES recovery and deployment during ANT-XXII/3. White line: transect and track 133 of TOPEX/Poseidon. Labels east of transect: recovery, labels west of transects: deployment

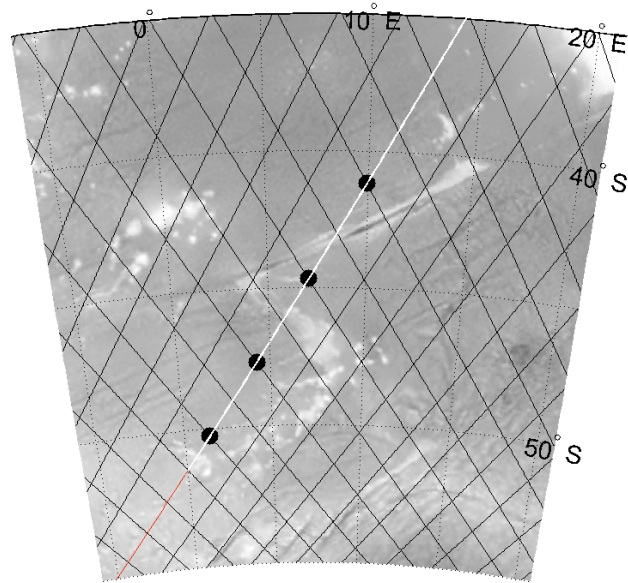

To assist the deployment of PIES and subsequent transport calculations based on the PIES' data, a high resolution bathymetric profile was measured between Cape Town and the Greenwich meridian with the Hydrosweep multi-beam echo sounder (fig. 4.18). The position of PIES ANT-5-1 and PIES ANT-9-2 had to be moved slightly to the north-east (along track 133) to avoid deployment in region of highly variable bottom topography (at the position intended for ANT-9-2 the box corer had tipped).

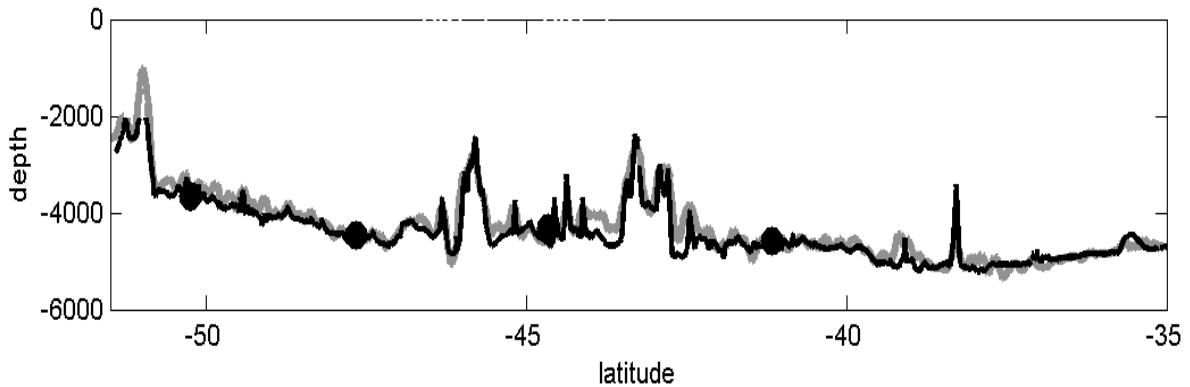

Fig. 4.18: Hydrosweep depth profile (black) along track 133 based on a resolution of 1000 m. Dots indicate PIES positions ANT 5, 7, 9, and 11. The grey curve indicates topography according to Smith and Sandwell TOPEX/Poseidon analysis.

### ARGO float deployments

The international ARGO (Array of Real Time Global Oceanography) project aims to set on the order of 3000 profiling floats into the world ocean, to establish a real-time

operational data stream of mid- and upper (< 2000 m) ocean temperature and salinity profiles. In addition the array will provide the mid-depth oceanic circulation pattern. Since 2001, the AWI contributed about 10 floats annually to this programme. During ANT-XXII/3, however, floats were provided by various programmes: 10 floats from GOODHOPE, 9 floats from MERSEA, and 21 from the German ARGO programme. The instruments were launched at quasi-regular intervals along the cruise track, with preference given to poorly sampled regions and boundary currents (fig. 4.19 and table 4.10). Most of the float launches were preceded by a CTD cast, as indicated in table 4.10.

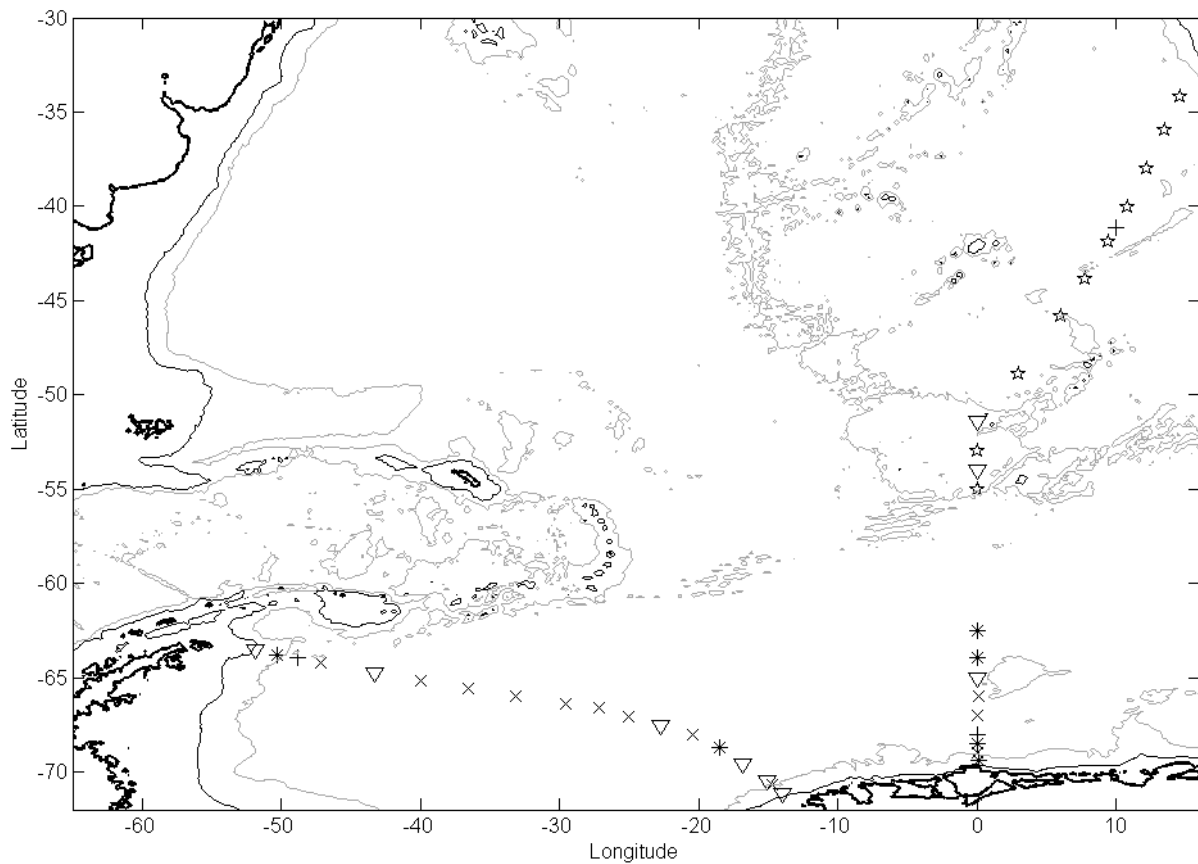

Fig. 4.19: Deployment positions of ARGO floats during ANT-XXII/3. Symbols mark various float types: APEX (\*), APEX with RAFOS option (x), APEX with RAFOS and Optode options (+), NEMO (∇), Provor (star). Contour lines indicate the coast (i.e. land-sea boundary, thick black,) the 1000m isobath (thin black) and the 3000 m isobath (grey).

### APEX floats

A total of 21 APEX floats were launched. Of these, 15 were equipped with RAFOS Navigation System, of which 3 were additionally equipped with an Aanderaa Oxygen Optode 3830 (financed by A. Koertzing, IfM-Geomar Kiel). All APEX floats were equipped with Ice Sensing Algorithm (ISA) set to  $-1.79^{\circ}\text{C}$ . Data from profiles aborted due to ISA are lost. The floats were ballasted to drift at a depth of 800 m and will

**4.LARGE SCALE PROCESSES AND DECADAL VARIATIONS IN THE WEDDELL SEA  
(WEDDELL SEA CONVECTION CONTROL, WECCON 2005)**

acquire profiles from 2000 m up. APEX floats are produced by Webb Research Corporation, USA.

**Table 4.10:** ARGO float launch positions and times. The table indicates various identifiers and possible optional sensors. APEX and NEMO floats were equipped with Ice Sensing Algorithm, set to  $-1.79^{\circ}\text{C}$  for APEX floats and  $-1.75^{\circ}\text{C}$  for NEMO floats ( $-1.79^{\circ}\text{C}$  for NEMO's #1 & 7). Project abbreviations: G = Coriolis GoodHope 3, A = German ARGO, M = MERSEA.

AWI float number	ARGOS-HEX	ARGOS-DEC	Float type and Serial Nr.	RAFOS	Optode	Project	CTD Station	Water depth [m]	Latitude	Longitude	Date (UTC)	Time (UTC)
NA	3CBECAD	46634	OIN03S2061			G	-	4424	34° 10,58' S	14° 33,07' E	23.01.2005	04:45
NA	3CBECBE	46635	OIN03S2062			G	-	4846	35° 57,63' S	13° 28,41' E	23.01.2005	16:10
NA	3CBEC7	46636	OIN03S2063			G	-	5142	38° 0,14' S	12° 9,42' E	24.01.2005	05:25
NA	3CBECD4	46637	OIN03S2064			G	-	4740	40° 1,48' S	10° 45,48' E	24.01.2005	19:05
63	7A794	24222	APEX 1735	+	+	A	16	4700	41°08,21' S	9°56,60' E	26.01.2005	20:47
NA	6F7CEAD	52106	OIN03S2065			G	-	4663	41° 52,27' S	9° 22,82' E	27.01.2005	01:42
NA	6F7CEBE	52107	OIN03S2066			G	-	4485	43° 50,77' S	7° 47,01' E	27.01.2005	14:37
NA	6F7CEC7	5218	OIN03S2066			G	-	4580	45° 49,90' S	6° 2,30' E	28.01.2005	05:30
NA	3CBBF5F	44885	OIN04S201			G	-	4079	48° 55,27' S	2° 55,81' E	30.01.2005	11:35
NA	3CBBFF2	44895	OIN04S202			G	-	2568	52° 59,71' S	0° 1,70' E	31.01.2005	18:53
NA	3CBEC98	46633	OIN04S2060			G	-	1759	55° 00,28' S	0° 1,06' E	01.02.2005	22:45
64	A1936	26724	NEMO 7			A	24	2723	51°25,25' S	0°00,14' E	31.01.2005	05:01
65	A8F8F	10814	NEMO 1			A	27	2431	54°00,08' S	0°00,43' W	01.02.2005	06:02
66	7B0D3	24259	APEX 1846			M	46	5371	62°30,07' S	0°00,53' E	06.02.2005	18:57
67	7B139	24260	APEX 1847			M	49	5199	63°55,04' S	0°00,41' W	07.02.2005	20:30
68	C890C	29220	NEMO 14			A	51	3765	64°59,69' S	0°01,05' E	08.02.2005	07:51
69	79FE4	24191	APEX 1729	+		A	53	3599	65°59,46' S	0°08,38' E	08.02.2005	23:47
70	F7A0C	24195	APEX 1730	+		A	56	4727	67°00,31' S	0°00,11' E	09.02.2005	22:29
71	7A413	24208	APEX 1734	+	+	A	60	4533	67°59,89' S	0°00,24' W	16.02.2005	17:34
72	9246C	9361	APEX 401			M	61	4287	68°30,21' S	0°00,62' W	16.02.2005	23:26
73	79B98	24174	APEX 1727	+		A	63	3410	68°59,75' S	0°00,10' W	17.02.2005	12:45
74	7BA46	24297	APEX 1850			M	67	2000	69°23,58' S	0°04,47' W	17.02.2005	21:11
75	C5B90	29038	NEMO 11			A	78	2154	71°09,15' S	13°58,10' W	21.02.2005	23:40
76	79DDA	24183	APEX 1728	+		A	80	2924	70°40,81' S	14°42,26' W	23.02.2005	05:02
77	C56FE	29019	NEMO 8			A	82	4651	70°28,33' S	15°05,91' W	24.02.2005	18:03
78	C751E	29140	NEMO 13			M	84	4734	69°35,94' S	16°48,90' W	25.02.2005	06:09
79	7B2BE	24266	APEX 1848			M	86	4813	68°43,50' S	18°28,27' W	25.02.2005	18:57
80	7943D	24144	APEX 1723	+		M	88	4933	68°02,00' S	20°28,42' W	27.02.2005	21:36
81	C5B36	29036	NEMO 10			A	90	4890	67°32,74' S	22°46,62' W	28.02.2005	09:55
82	79584	24150	APEX 1729	+		A	92	4847	67°03,74' S	25°02,87' W	28.02.2005	22:00
83	790B4	24130	APEX 1721	+		A	94	4898	66°36,77' S	27°10,17' W	03.03.2005	06:58
84	791AB	24134	APEX 1722	+		A	96	4846	66°21,40' S	29°32,83' W	03.03.2005	20:24
85	7A170	24197	APEX 1732	+		A	99	4825	65°58,39' S	33°07,77' W	04.03.2005	16:03
86	7A123	24196	APEX 1731	+		A	102	4800	65°35,48' S	36°33,26' W	07.03.2005	11:20
87	79B60	24173	APEX 1726	+		A	105	4800	65°10,02' S	39°56,70' W	08.03.2005	04:51
88	C6034	29056	NEMO 12			A	108	4694	64°43,36' S	43°18,83' W	08.03.2005	23:58
89	79B3E	24172	APEX 1725	+		A	114	4292	64°11,44' S	47°10,67' W	12.03.2005	02:48
90	7A185	24198	APEX 1733	+	+	A	117	3707	63°56,76' S	48°48,85' W	13.03.2005	01:54
91	7B78E	24286	APEX 1849			M	121	2725	63°46,57' S	50°16,71' W	13.03.2005	19:14
92	C5ADC	29035	NEMO 9			M	123	1311	63°29,44' S	51°48,65' W	15.03.2005	18:07

**NEMO floats**

A total of 9 NEMO floats (Navigating European Marine Observer) were deployed. NEMO floats were ballasted to a drift depth of 800 m and profile from 1000 m up. NEMO floats are equipped with an adjustable Ice Sensing Algorithm (ISA), set to -1.79°C (#1 & #7) and to -1.75°C for the remaining floats. An interim data storage system (iStore) saves profiles that could not be transmitted due to abortion of the ascend by ISA (implemented for all floats but # 1). For floats #7 & #14 iStore will activate the delayed mode data transfer at the earliest possibility, i.e. at the first successful surfacing after aborted profiles. For all other floats iStore will delay the transmission of aborted profiles to the 15 February – 15 March period (i.e. time of minimal ice concentration). NEMO floats are produced by Optimare, Germany.

**Provor floats**

Provor floats were deployed for S. Speich (University of Brest) as part of the GOODHOPE project, with floats provided courtesy of the Coriolis and ARGO programme. The floats were ballasted to drift at 1000 m depth and to profile from 2000 m up. Provor floats are produced by MARTEC SERPE IESM, France.

**First results of AWI floats (APEX and NEMO)**

During the cruise 30 AWI floats were deployed. Up to date (28.03.05), 28 of these surfaced and transmitted in total 84 profiles. Four floats were launched in high ice concentrations and are not expected to surface during the remainder of this season.

As initial quality check, every first float profile is compared with its corresponding CTD cast. To compensate the effect of internal waves, which induce coupled variation in temperature and salinity, the comparison is performed in  $\theta$ -S-space (fig. 4.20). Assuming temperature to be correct – as recommended by the ARGO delayed mode quality procedures - the differences between the float data and the ship-CTD are approximately 0.0015 in salinity. Even the larger differences of the floats AWI\_0086 and AWI\_0087 fit into the requirements of the ARGO project which aims for an accuracy of 0.005°C for temperature and 0.01 for salinity. The comparison proves the high quality of the float data, at least immediately after the floats' launch.

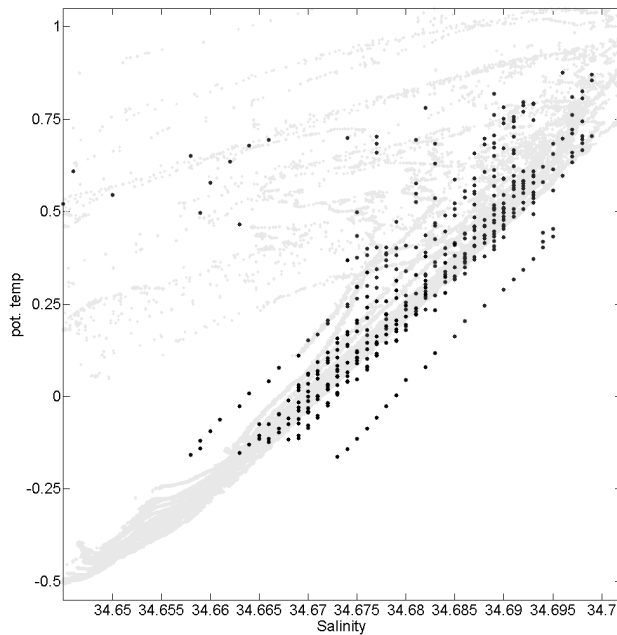

Fig. 4.20: Scatter theta-S diagram of data from each first float profile (black dots) and its corresponding CTD stations (grey dots). Only data deeper than 400m are shown; physically unreasonable outliers were manually excluded from the data.

### Sound Source moorings

The Ranging and Fixing of Sound (RAFOS) technology has been used widely in moderate latitudes to provide high-resolution trajectories of neutrally buoyant floats by means of underwater acoustics. It is based on travel time measurements of a coded sound signal between a moored sound source and the moving float. However, at high latitudes, this technique is expected to work at considerable shorter ranges only. A test experiment started by the AWI in 2002 showed that ranges of about 500 km can be expected in the Weddell Gyre throughout the year with Webb Research RAFOS sources. Based on this experience, an array of 5 sound sources was designed to a) enable location of RAFOS sensor equipped ARGO floats while drifting under ice in the interior Weddell Sea, and b) to provide location for RAFOS floats deployed during MaudNESS, a US lead programme, which will study wintertime convection around Maud Rise during 2005.

**Table 4.11:** Sound sources recovered. The offset of 60 s for W2 needs further verification, as it might be due to offset of the reference (wrist) watch.

site	hull	elec	AWI	Transmission	depth	Lat	Lon
W1	49	14	229-5	00:35	5200	63°57.23'S	0°00.21 W
W2	19	19	231-5	01:05	4542	66°30.56'S	0°02.03 W

site	launch	recover	offset
W1	10.12.2002 18:45	07.02.2005 14:57	08.02.2005 -3s (late)
W2	18.12.2002 10:41	09.02.2005 14:00	10.02.2005 +60s (early)

The test array deployed in 2002 was based on refurbished sources, with some major problems that could only provisionally be fixed in 2002 before shipment. Sound Source 21 showed signs of previous leakage at the high voltage feedthrough, which was mended with Scotch Fill. Sound Sources 19 and 21 could only be addressed through the internal interface and hence could not be vacuum checked before deployment. Sound Source 49/14 had the high voltage feedthrough replaced and spliced to the external cable leading to the transducer. Nevertheless, all three sources functioned flawlessly. Upon recovery, source 49/14 contained a small amount of water, while the stud located on the electronics' side between resonator and battery housing is loose (fig. 4.21). Source 19 was internally dry. Both sources were active at recovery, and the clock offset with respect to GPS time (not UTC/GMT!) was measured by waiting for the next scheduled transmission before switching off the source (table 4.11).

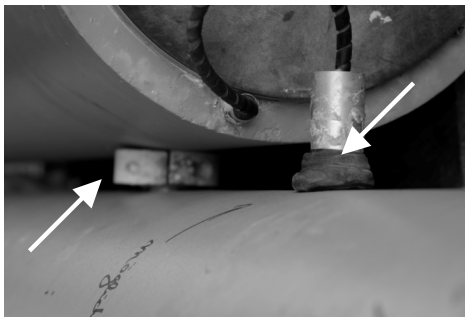

*Fig. 4.21: Photo of source 49 after recovery. The left arrow points to the loose stud, the right arrow to an alternative source of leakage due to a provisional fix prior to launch.*

The new array is intended to provide both acoustic navigation for the Maud Rise region as well as for the interior Weddell Gyre. Hence the sites W1 and W2 were refitted with sources, and 3 more sources were deployed along the Weddell Sea transect. The new sources are manufactured by Tom Rossby and colleagues of the University of Rhode Island and feature a more compact design than the Webb Sources. Their output is slightly lower than that of the Webb Sources. The new design enables deeper deployment depths, which was approximately 2000 m for the five new sound source deployments.

**Table 4.13:** Sound source deployments. All clock offsets 0 seconds.

Location	Source ID	AWI ID	Transmission	depth	depth	latitude	longitude	Launch Date	Launch time
W1-a	15	229-6	00:30	1814	5200	63°57.16' S	00°00.37' W	07.02.05	15:58
W2-b	18	231-6	01:00	1900	4540	66°30.66' S	00°01.91' W	09.02.05	15:43
W4	16	209-4	01:30	1840	4860	66°37.08' S	27°06.29' W	01.03.05	10:08
W5	19	208-4	00:30	2014	4740	65°37.14' S	36°23.53' W	05.03.05	18:31
W6	17	207-6	01:00	2000	2500	63°42.20' S	50°52.22' W	14.03.05	02:47

First results from APEX floats equipped with RAFOS sensors show that the acoustic range of the newly deployed sources is less than of those previously deployed. Whether this is due to a lower source level or due to the sources' deeper deployment



depth (nominally 2000 m instead of 1000 m), or due to a reduced match between signals emitted and expected (by the RAFOS receiver) is, as yet, unclear.

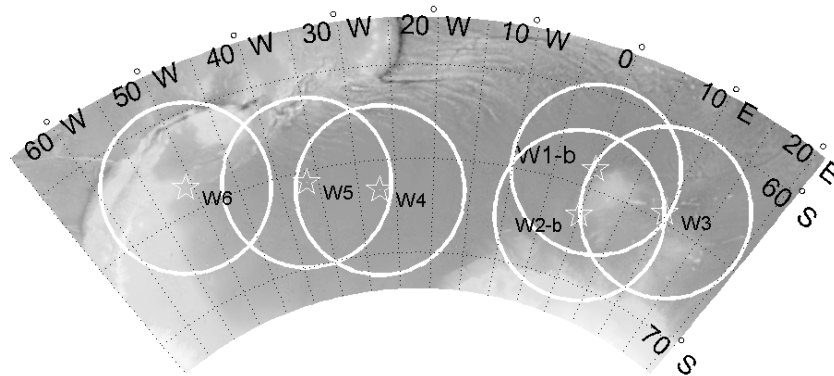

Fig. 4.21: Sound source deployment sites with an assumed acoustic range of 500 km indicated by co-centric circles

## 5. DISTRIBUTION OF CARBON DIOXIDE IN THE WEDDELL GYRE

Mario Hoppema<sup>1</sup> and Rob Middag<sup>2</sup>

<sup>1</sup>AWI Bremerhaven, Germany

<sup>2</sup>NIOZ, The Netherlands

### Objectives

Perturbations of the global carbon cycle, principally by the burning of fossil fuels and changes in land use, have led to a steady rise in atmospheric carbon dioxide (CO<sub>2</sub>) which has the potential to enhance the greenhouse effect, in turn leading to global warming. The world oceans are a main player in the global carbon cycle and, in principle, able to absorb almost all of the excess CO<sub>2</sub>. However, they can only achieve this on time scales which are much longer than those associated with the anthropogenic perturbations. This is related to the typical mixing and residence times of the deep and bottom waters of the oceans, which are of the order of 1000 years. Uptake of atmospheric CO<sub>2</sub> occurs in many regions of the world oceans, but transferring the absorbed CO<sub>2</sub> down the water column into deep layers is hampered by the strong pycnocline separating the upper mixed layer from the deep ocean. Thus studies in areas where major interaction between the deep and the surface ocean occurs, such as the Southern Ocean with the Weddell Sea, are extremely important for increasing our knowledge about CO<sub>2</sub> uptake and its distribution.

While the atmospheric CO<sub>2</sub> increase is well documented, the oceanic increase is hard to monitor due to the high natural variations and the large amount of CO<sub>2</sub>

present in the oceans. Our overall objective is to trace the anthropogenic CO<sub>2</sub> in the deep and surface waters of the Antarctic Ocean and to investigate which factors exert influence on the CO<sub>2</sub> distribution. Substantial progress in these issues can only be made when time series data over sufficiently long times become available. Data from this cruise will extend the longest combined oceanic time-series (since 1984) of CO<sub>2</sub> and transient tracers, hydrography, nutrients and oxygen at the Greenwich meridian. This study is part of the Integrated Project CarboOcean (2005-2009) within the 6th framework programme of the European Union.

### **Work at sea**

CO<sub>2</sub> parameters have been investigated along a section at the Greenwich meridian crossing the eastern Weddell Gyre, and along a section across the Weddell Sea from Kapp Norvegia to Joinville Island near the tip of the Antarctic Peninsula. Additionally, a shorter section across the Powell Basin was sampled. Parameters that were measured are the total inorganic carbon concentration (TCO<sub>2</sub>) and the partial pressure of CO<sub>2</sub> (pCO<sub>2</sub>). Vertical TCO<sub>2</sub> profiles of the entire water column were determined from discrete water samples taken from the rosette sampler. A total of 2374 water samples were analyzed, i.e. at almost all hydrographic stations, where generally a duplicate analysis was done for each sample. Measurements of pCO<sub>2</sub> were carried out in the surface water quasi-continuously from the sailing ship. Additionally, the pCO<sub>2</sub> of marine air was determined every two hours.

TCO<sub>2</sub> was determined by the high-precision coulometric method using an automated sample stripping system. Briefly, a sample of seawater is acidified with phosphoric acid and stripped with high-purity N<sub>2</sub> gas. The extracted CO<sub>2</sub> is, with the N<sub>2</sub> carrier gas, passed through a solution containing ethanolamine and an indicator. This solution is electrochemically back-titrated to its original colour where the amount of coulombs generated is equivalent to the amount of CO<sub>2</sub> in the sample. The measurements were calibrated and corrected against widely used certified reference material for TCO<sub>2</sub> (obtained from Prof. A. Dickson of Scripps Institution of Oceanography, U.S.A.), batches 53 and 66. Two coulometer-extraction systems were used.

Continuous measurements of the pCO<sub>2</sub> in water and marine air were done using an infra-red analyzer (Li-Cor 6252). A continuous water supply is passed through an equilibrator, where every minute the headspace gas is analyzed for its CO<sub>2</sub> content, thus giving pCO<sub>2</sub> in the surface water. Marine air was pumped continuously from the crow's nest into the laboratory and subsampled every two hours. The measurements were calibrated with standard NOAA gases. As the pCO<sub>2</sub> is strongly dependent on temperature changes, final data will only be available after corrections for the temperature increase of the water while flowing from the ship's keel into the lab. Analyses of TCO<sub>2</sub> and online pCO<sub>2</sub> were performed using equipment of Royal Netherlands Institute for Sea Research which was also used at previous cruises in the Weddell Sea by the P.I.

### **Preliminary results**

#### Total carbon dioxide

We cannot as yet present final results for  $\text{TCO}_2$  and  $\text{pCO}_2$ . Some general patterns can be discerned, though. A general feature of the  $\text{TCO}_2$  distribution is that, although the  $\text{TCO}_2$  values in the Southern Ocean surface water are high compared to other surface ocean regions, they are low in comparison with the deep and bottom water. The  $\text{TCO}_2$  minimum in the surface water is due to phytoplankton which utilizes  $\text{CO}_2$ . Below the thermocline, a  $\text{TCO}_2$ -maximum is found, associated with the temperature maximum of the Warm Deep Water. Near the bottom relatively low  $\text{TCO}_2$  values were measured in Weddell Sea Bottom Water. This water mass originates partly from the shelf waters of the Weddell Sea, which are low in  $\text{TCO}_2$ . At the western continental slope bottom water with the lowest  $\text{TCO}_2$  was detected. The bottom water in the Powell Basin has a somewhat higher concentration of  $\text{TCO}_2$  than that at the Antarctic Peninsula.

At two stations calibration casts were done, where all rosette water bottles were fired at the same depth. The depth was chosen to be in a weak gradient of hydrographic parameters. We found that the precision of the coulometric  $\text{TCO}_2$  measurements as determined from the measurements of 12 samples was  $1 \mu\text{mol/kg}$  or better.

#### Partial pressure of $\text{CO}_2$

The measurement of  $\text{pCO}_2$  during the entire cruise resulted in a large, high spatial resolution data set. Mostly modest undersaturation was observed in the area of investigation, which may well be caused by the starting of the cooling of the surface layer in this time of the year. Especially in the eastern Weddell Gyre it was surprising that in those regions where sea ice was found the  $\text{pCO}_2$  values were particularly low, more than  $150 \mu\text{atm}$  below saturation. As this reduction cannot be explained by cooling, this points to relatively recent biological activity in these ice-covered areas (which were not very frequent, though). In the western Weddell Sea, where more sea ice was met, the  $\text{pCO}_2$  did not appear to be so low. The highest  $\text{pCO}_2$  was found in the marginal regions of the Antarctic Peninsula.

---

## 6. AIR-SEA CO<sub>2</sub> FLUXES IN THE SOUTHERN OCEAN WITH CARIOCA BUOYS

Mario Hoppema, Olaf Klatt  
AWI Bremerhaven

This project was carried out for Jacqueline Boutin, Liliane Merlivat (not on board) Laboratoire d'Océanographie Dynamique et de Climatologie (LODYC/CNRS), Paris

### Objectives

This study aims at assessing air-sea CO<sub>2</sub> fluxes and their spatial and temporal variability in the Subantarctic Zone of the Southern Ocean. We concentrate on the Subantarctic Zone for which some evidence exists that it may be a major sink region for atmospheric CO<sub>2</sub>. In order to complement ship measurements, we deployed CARIOCA drifting buoys. CARIOCA buoys measure oceanic CO<sub>2</sub> partial pressure (pCO<sub>2</sub>), temperature, salinity and fluorescence of surface water pumped at 2 m depth. Additionally the buoys measure atmospheric pressure and surface wind-speed. Measurements are transmitted in near-real time via ARGOS. CARIOCA drifters are autonomous instruments with a theoretical lifetime of 1 year.

The ultimate goal of the study is to derive air-sea CO<sub>2</sub> flux monitoring in the Subantarctic Zone of the Southern Ocean by combining in situ and satellite measurements. To achieve this goal, several steps are necessary. In situ and satellite (sea surface temperature and ocean colour) measurements are used to analyse processes controlling observed pCO<sub>2</sub> variability. From this mechanistic understanding, methods for extrapolating pCO<sub>2</sub> at regional scale using satellite measurements are derived. The region under study is divided in biogeochemical provinces characterized by varying dominant factors controlling pCO<sub>2</sub>. Thence empirical relationships between pCO<sub>2</sub>, sea surface temperature and ocean colour established in each province are used to map oceanic pCO<sub>2</sub> at regional scale. The regional air-sea flux is computed using a CO<sub>2</sub> air-sea exchange coefficient derived from satellite wind-speed.

This study is supported by the French national programme PROOF/FLAMENCO2. It is also part of the EU Integrated Project CarboOcean. Since 2002, six CARIOCA drifting buoys have been deployed in the central and eastern Indian Ocean from the *Marion Dufresne* during the 2002 and 2003 OISO campaigns (coll. N. Metz, France) and from the *Tangaroa* during the 2004 SAGE experiment (coll. K. Currie, New Zealand). These 6 buoys monitored pCO<sub>2</sub> in the Subantarctic Zone during a total period of 42 months (2 buoys are still active at sea). The specific objective of deploying new CARIOCA drifters from RV *Polarstern* is to spatially extend CARIOCA measurements towards the central Atlantic Ocean and eventually to the western Indian Ocean, taking advantage of the Antarctic Circumpolar Current (ACC).

---

### **Work at sea**

A CARIOCA buoy has been deployed on the 27 of January 2005 at 43° 50.43'S 7° 47.44'E at an ocean depth of 4486 m by MH and OK, while the buoy data are transmitted to the Paris Laboratory of JB and LM where data processing will be done. The buoy took a northeastern course. On 31 March 2005 it was at 40°06'S, 15°42'E. The pCO<sub>2</sub> measured by the buoy varied during its northeastern course in its first 2 months from about 330 to 365 µatm, which means that in this region the ocean was clearly undersaturated with respect to atmospheric pCO<sub>2</sub> and thus as expected was a sink for atmospheric CO<sub>2</sub>.

## **7. DISSOLVED BARIUM DISTRIBUTION IN THE ANTARCTIC CIRCUMPOLAR CURRENT AND THE WEDDELL GYRE**

Mario Hoppema<sup>1</sup> and Rob Middag<sup>2</sup>

<sup>1</sup>AWI Bremerhaven

<sup>2</sup>NIOZ, The Netherlands

This project was carried out for Stéphanie Jacquet, Frank Dehairs (not on board)  
Vrije Universiteit Brussel

### **Objectives**

Over the last decade it has become increasingly clear that Barium-barite has great potential as a proxy of oceanic export production and paleoproductivity, but in order to have this proxy tool fully operational, further research is needed especially regarding the translocation between particulate and dissolved barium and the oceanic distribution of dissolved Barium (Ba). The particulate Ba distribution in the water column of different subsystems of the Southern Ocean has been documented quite extensively and the relationship with export production and mesopelagic mineralization highlighted (Dehairs et al., 1990; 1992; 1997; Cardinal et al., 2001, 2005). Recently, we also documented further the dissolved Ba distribution in the Southern Ocean (Jacquet et al., 2004, 2005). Efforts were focused on the Indian Ocean (Crozet-Kerguelen Basin and WOCE CIV, A-1 line along 30°E) and the Australian sector (WOCE SR3 line along 145°E). Results indicate that, although hydrodynamic control is predominant, biogeochemical control on dissolved Ba is occasionally detectable, especially in the mesopelagic waters. However, there is need for further documenting the dissolved Ba distribution in the Southern Ocean, especially in the Weddell Gyre, for which very few data exist. RV *Polarstern* expedition XXII/3 offers an excellent opportunity to detail the dissolved Ba distribution in the Weddell Gyre region.

This work is part of the Belcanto II project EV/03/7A ("Assessing the Sensitivity of the Southern Ocean's Biological Carbon Pump to Climate Change"), funded in the framework of the Belgian Federal Science Policy Office programme on Antarctica.

---

### **Work at sea**

During the cruise, 1070 water samples were collected from the rosette by MH and RM. Samples from all through the water column were taken. The sampling was done such that both the Greenwich meridian section and the western Weddell Sea section are well described for dissolved Ba. The samples were acidified with hydrochloric acid on board, and will be transported to the laboratory in Brussels, where they will be analyzed by Isotope Dilution ICP-MS for dissolved Barium by SJ.

## **8. AUTOMATIC DETECTION OF MARINE MAMMALS IN THE VICINITY OF RV *POLARSTERN***

Lars Kindermann, Holger Klinck, Olaf Boebel  
AWI Bremerhaven

### **Objectives**

The ship based detection of marine mammals has a broad range of applications. Population ecologists focussing on whale distributions and migratory patterns are interested in effective methods for conducting marine mammal censuses. Users of hydroacoustic instruments are interested in implementing reliable mitigation methods most effectively, provided adverse reactions of marine mammals to the ship's presence are to be apprehended. Because whales spend considerable periods of time both at the surface as well as submerged, multiple methods need to be employed in parallel to ensure detection regardless of their location. Under water, vocalizing mammals can be detected by passive sonar. Its usefulness, however, is currently compromised by intrinsic vessel noise, which masks particularly low- to mid-frequency vocalizations of the mammals. Near the surface, whales might be recognized by means of their warm blow, which stands out against the cold Antarctic environment.

During ANT-XXII/3, a passive acoustic streamer and two infrared cameras were evaluated for their capability to detect, identify and localize marine mammals in the vicinity of RV *Polarstern*. To compare the ship based passive acoustic data with recordings from an acoustically less disturbed environment, several sonobuoys were deployed by helicopter far from RV *Polarstern* and/or in the acoustic shade of icebergs or islands. Three long term time series of acoustic recordings were started by deploying long term recording devices as part of three oceanographic moorings in the Weddell Sea. Our overall goal of these efforts was a) to test the feasibility of the various detection methods in the context of Antarctic research and b) to collect significant amounts of data to facilitate the development and optimization of automatic pattern recognition algorithms. These – in the long run – shall form the kernel of a fully automated marine mammal detection system.

### Work at sea

**Passive Acoustic Streamer:** Three 10 m long, oil (ISOPAR M) filled streamer sections, each containing 5 hydrophones, were towed at a distance of 200, 500 and 600 m behind the ship (fig. 8.1). They were connected by a steel armed tow cable containing 48 wires. The hydrophone separation within each group was 1.2 m. Hydrophone sensitivity, including a 20 dB preamplifier, was  $-184$  dB re  $1$  V /  $\mu$ Pa, the frequency response 20 Hz to 200 kHz (3 dB points). The streamer was deployed using a dedicated 10 kN, IP 67 protected Nyblad winch, certified to  $-50^{\circ}\text{C}$  and equipped with a slip ring for continuous connection to the electronics in the lab. The winch maintained a hauling speed of 1 m/s, independently of the ship's speed. Deployment and recovery of the streamer lasted about 10 min each and required one scientist and one crew. The analogue signals were conditioned by a 16 channel KEMO VBF40 filter/amplifier with programmable hi/lo-pass settings from 1 Hz to 256 kHz and gains from  $-20$  dB to 90 dB. A studio sound device, RME Fireface, recorded 8 selectable channels at full bandwidth (192 kHz sampling rate and 24 bit resolution) continuously to disk using Steinberg's WaveLab. Data rate was 4.4 MB per second or 15.4 GB per hour. Data was stored in one minute blocks as 'wav' files on exchangeable 500 GB external hard disks, which could host about 30 hours of uncompressed audio each. The data was compressed offline by about 50% using FLAC (Free Lossless Audio Compression) and backed up on 200 GB LTO2 tapes. Some of the remaining 7 channels were fed into devices like click and envelope detectors, computers running online spectrogram displays (Ishmael) and automatic call detection software (IFAW programme suite). For monitoring purposes several channels could be mixed and processed for optimal human perceptibility with Bose NoiseCancelling™ headphones. The maximum certified operating speed of the streamer was 13 kn, though it was used at speed up to 15 kn for extended periods of time. The streamer's maximum operating depth is 60 m, while its survival depth reads 120 m. As the actual depth, measured by depth gauges in each streamer segment, was speed dependent (fig. 8.2) the system had to be recovered when RV *Polarstern* slowed down below a speed of 6 kn. The streamer was deployed regularly between stations during cruising for a total of 2160 nm and 194 h, respectively (table 8.1, fig. 8.3). It was also used under ice-covered conditions as long as RV *Polarstern* could cruise foreseeable with at least 7 kn. During these occasions it was towed several times across ice floes without any damage.

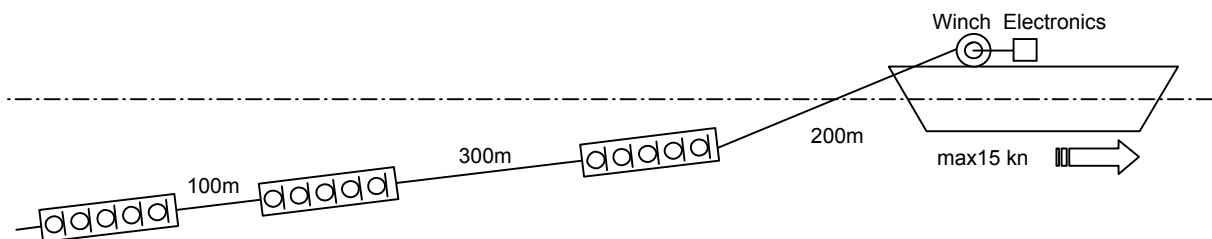

Fig. 8 1: Schematic drawing of the acoustic streamer

Fig 8.2: Streamer depth as a function of tow speed. The markers at zero distance indicate the height of RV Polarstern's working deck.

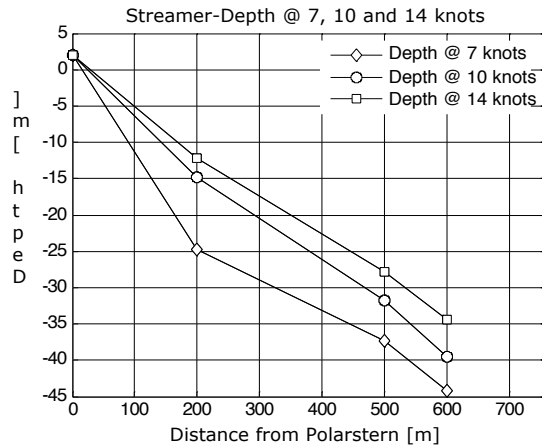

Table 8.1: Streamer Deployments

Deployment			Recovery			Hours	nm
1: 03.02. 16:52	56° 57.84' S	0° 01.61' E	03.02. 20:04	57° 27.45' S	0° 00.07' E	03:12	29.62
2: 05.02. 11:39	60° 01.09' S	0° 00.45' W	05.02. 14:20	60° 28.44' S	0° 00.02' W	02:41	27.35
3: 06.02. 12:51	62° 00.48' S	0° 00.08' W	06.02. 15:36	62° 28.56' S	0° 00.44' W	02:45	28.08
4: 08.02. 13:59	65° 39.14' S	0° 01.33' E	08.02. 15:33	65° 57.47' S	0° 00.06' E	01:34	18.60
5: 13.02. 10:03	69° 24.01' S	5° 09.30' W	13.02. 10:32	69° 21.09' S	5° 00.39' W	00:29	4.29
6: 13.02. 13:30	69° 05.85' S	4° 16.20' W	13.02. 18:40	68° 26.60' S	2° 29.33' W	05:10	55.12
7: 13.02. 19:07	68° 25.39' S	2° 26.29' W	14.02. 01:09	67° 34.02' S	0° 10.61' W	06:02	72.26
8: 18.02. 12:10	69° 15.19' S	0° 00.89' W	19.02. 02:16	70° 14.77' S	8° 24.56' W	14:06	184.05
9: 24.02. 18:12	70° 28.00' S	15° 07.21' W	24.02. 21:08	70° 02.38' S	15° 56.74' W	02:56	30.60
10: 25.02. 12:48	69° 04.55' S	17° 47.97' W	25.02. 15:19	68° 45.57' S	18° 23.30' W	02:31	22.84
11: 27.02. 21:54	68° 00.78' S	20° 31.39' W	28.02. 00:31	67° 48.30' S	21° 32.24' W	02:37	26.07
12: 28.02. 16:15	67° 17.65' S	24° 00.03' W	28.02. 18:50	67° 04.59' S	24° 58.97' W	02:35	26.32
13: 03.03. 13:48	66° 29.08' S	28° 20.75' W	03.03. 17:20	66° 21.81' S	29° 28.82' W	03:32	28.18
14: 04.03. 16:09	65° 58.54' S	33° 08.43' W	04.03. 19:49	65° 51.19' S	34° 13.52' W	03:40	27.56
15: 07.03. 11:44	65° 34.80' S	36° 41.72' W	07.03. 13:51	65° 28.25' S	37° 33.10' W	02:07	22.27
16: 07.03. 17:14	65° 26.92' S	37° 43.28' W	07.03. 19:49	65° 19.21' S	38° 43.55' W	02:35	26.26
17: 08.03. 11:16	65° 00.48' S	41° 08.14' W	08.03. 13:50	64° 52.80' S	42° 08.16' W	02:34	26.55
18: 11.03. 03:38	64° 59.52' S	43° 01.82' W	11.03. 10:25	64° 25.73' S	45° 32.60' W	06:47	72.73
19: 11.03. 17:39	64° 21.53' S	46° 03.97' W	11.03. 19:03	64° 17.58' S	46° 33.90' W	01:24	13.56
20: 15.03. 15:37	63° 32.10' S	51° 36.39' W	15.03. 16:27	63° 28.17' S	51° 50.68' W	00:50	7.49
21: 21.03. 10:19	61° 45.68' S	47° 07.92' W	22.03. 14:31	62° 17.29' S	58° 40.92' W	04:12	326.17
22: 24.03. 03:07	62° 22.45' S	58° 04.20' W	24.03. 09:50	62° 59.62' S	60° 29.45' W	06:43	76.31
23: 24.03. 12:16	63° 09.65' S	60° 53.52' W	25.03. 17:35	67° 41.16' S	68° 11.43' W	29:19	326.48
24: 26.03. 23:49	67° 47.92' S	68° 38.07' W	27.03. 16:00	65° 18.35' S	65° 56.99' W	16:11	162.69
25: 27.03. 18:38	65° 13.12' S	65° 40.25' W	28.03. 00:19	64° 51.42' S	63° 13.56' W	05:41	65.59
26: 28.03. 15:46	64° 31.72' S	62° 28.61' W	29.03. 02:55	63° 18.09' S	64° 36.48' W	11:09	92.63
27: 29.03. 19:00	63° 19.03' S	64° 37.21' W	29.03. 23:57	62° 35.44' S	64° 36.76' W	04:57	43.59
28: 31.03. 01:03	62° 30.89' S	64° 33.62' W	31.03. 23:30	60° 54.84' S	53° 54.45' W	22:27	317.30
Total:						194:46	2160.56



**Infrared Cameras:** Two FLIR ThermoVision A 40 infrared (IR) cameras, contained in protective housings, were mounted on the “Peildeck” of RV *Polarstern*. Each was supplemented by visual video camera. The cameras were connected to two PCs on the bridge via an optical FireWire link, where the image stream was displayed and 5 second long snippets stored every 15 minutes. A video signal of the infrared image could also be displayed on a monitor and could be recorded continuously to video tape. The spatial coverage of each camera was nominally 24° at a resolution of 320 x 240 pixels at 25 frames per second. The computer based system was running since 7 February. Some interruptions occurred, mainly resulting from system crashes due to software or hardware problems, which however, could be fixed during the cruise. The IR image data stream was fed to a Matlab™ based, pattern recognition software, designed to automatically detect whale blows (original version developed DevelLogic, Germany). However, as the detection algorithm had to be developed from only 3 previously recorded IR whale blows, it was considered an experimental setup only, with one of our goals being the multiplication the data base for further developments. Therefore, upon visual sighting of whales by the bridge officers, the acoustic team was summoned to the bridge to supervise the functionality of the camera system. In case of the software not automatically triggering detection, recordings were started manually. On occasion, the ship was turned to bring an animal into focus as the cameras were pointing in a fixed direction. Alternatively and weather permitting, the cameras were pointed manually towards a whale.

**Data Loggers (PODs):** Three autonomous data loggers, PODs (Porpoise Detectors by Chledonia Inc, custom modified for deep water operation) were deployed at three oceanographic moorings (table 8.2). For three years they will record click events in the frequency bands around 9, 22, 41 and 70 kHz which most probably constitute echolocation clicks of toothed whales. The data will only be accessible after recovery of the moorings and will be used to develop a data base of seasonal marine mammal distribution in the Weddell Sea.

**Table 8.2:** POD deployments

POD ID	Mooring ID	Position Lat	Position Lon	Deployment Date	Water Depth	POD Depth
A401	AWI 230-5	66° 00.66' S	00° 11.28' E	08.02.2005 21:00	3450 m	1557 m
B402	AWI 233-7	69° 23.60' S	00° 04.29' W	17.02.2005 21:06	1950 m	1700 m
C403	AWI 207-6	63° 42.20' S	50° 52.22' W	14.03.2005 02:47	2500 m	1457 m

**Sonobuoys:** Using one of RV *Polarstern*'s helicopters, 10 sonobuoys were deployed on 8 independent occasions at considerable distances from the vessel to obtain recordings from an acoustically undisturbed environment (table 8.3). These will be used in comparison with the recordings from the streamer to understand the later's limitations. The sonobuoys (Sparton SSQ 41-B) were kindly provided by the FWG (Forschungsanstalt der Bundeswehr für Wasserschall und Geophysik) and could record and transmit underwater sound for up to 8 hours from a selectable depth of up to 300 m. A Winradio 1550E receiver was used to receive the signals at a distance of

up to 2 to 10 nm. A notebook with a NI DAQPad 5062 AD-converter recorded the sound and provided on line visualization using Ishmael software. In some cases it was possible to land on an iceberg to allow for extended recording times. A total of 10.5 h of helicopter flight time was needed for these measurements which produced 8 hours of recorded sounds.

**Table 8.3:** Sonobuoy Deployments. Buoy #1 was deployed from the ship, buoy #9 was defective.

Buoy #	Date	Start	End	Position		Platform	Minutes
1	25.01.2005	12:22	21:00	41,12435 S	09,93530 E	Ship	518
2	27.01.2005	17:42	18:38	44,64051 S	07,09188 E	Heli	56
3	30.01.2005	18:20	18:56	50,25235 S	01,41073 E	Heli	36
4	16.02.2005	11:36	12:51	67,49902 S	00,00133 E	Heli	75
5	19.02.2005	11:07	11:44	70,52102 S	08,22202 W	Heli	37
6	22.02.2005	16:06	17:02	70,52500 S	14,58500 W	Heli	56
7	15.03.2005	13:23	14:06	63,63500 S	52,22167 W	Heli	43
8	15.03.2005	14:18	15:58	63,43500 S	51,55333 W	Heli	100
9	16.03.2005	---	---	62,48412 S	52,45087 W	Heli	---
10	16.03.2005	15:53	16:28	62,48412 S	52,45087 W	Heli	35
11	25.03.2005	18:42	18:56	69,38358 S	67,70520 W	Heli	14
12	25.03.2005	19:31	19:58	69,23683 S	67,70833 W	Heli	27

**PALAOA:** The Perennial Acoustic Observatory in the Antarctic Ocean. At the shelf-ice border near *Neumayer Station*, an acoustic recording station for underwater sounds is being constructed over the course of two austral seasons. During this cruise's visit to *Neumayer*, parts of the hard- and software were installed and tested. The autonomous energy module and the wireless LAN connection were activated and ice sounds and webcam images are now being transmitted to Bremerhaven continuously. The station is planned to become fully operative in January 2006 after three shelf ice drillings will have been concluded and a hydrophone array will have been placed in the water column below the shelf-ice.

### Preliminary results

Only few whales were detected by the acoustic streamer. 4 sperm whales and one fin whale were clearly audible ([table 8.4](#)). A significant amount of hence unidentified sound events will have to be checked later after processing the recordings in Bremerhaven. The first sperm whale detection and the fin whale were confirmed by visual sighting of the animals from the bridge.

**Table 8.4:** Detections made by means of the acoustic streamer. The fin whale approached the streamer very close at a distance of only a few meters. Sperm whales could be heard at a distance of at least 1.5 kilometres.

No.	Time		Position		Species
1	13.02.2005	16:30	68,7158 S	03,2167 W	Sperm whale
2	15.03.2005	16:09	63,5102 S	52,7857 W	Fin whale
3	31.03.2005	05:31	62,2274 S	62,2805 W	Sperm whale
4	31.03.2005	06:45	62,1488 S	61,6728 W	Sperm whale
5	31.03.2005	07:38	62,0909 S	61,2430 W	Sperm whale

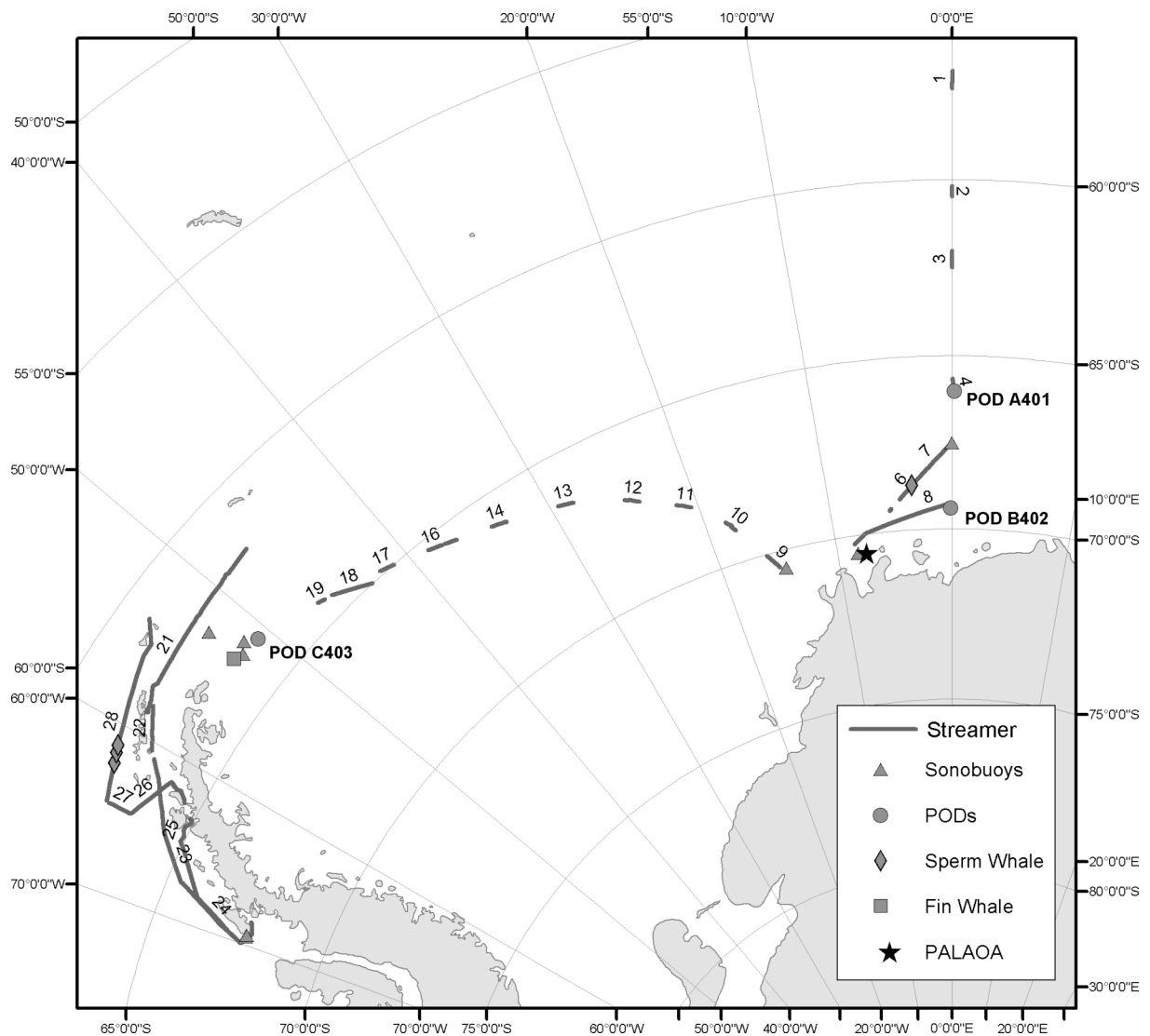

*Fig. 8.3: Map of the Weddell Sea with tracks of streamer deployments, POD mooring sites, sonobuoy drop sites and locations of acoustic whale detections*

The rotation of the propellers produced a non stationary soundscape, which was further influenced by ship movements, waves and bubble clouds which resulted in two opposing effects: Bubbles around the propellers produced loud spikes, while a bubble cloud behind the ship shielded the hydrophones very efficiently from the noise. Hence, typical oscillations between loud and silent phases occurred, which need to be considered when deciding whether detected spikes are sperm whale clicks or cavitation noise induced by the propellers.

The available commercial and free software packages for completely automated detection of underwater vocalizations turned out to be not very efficient when confronted with RV *Polarstern*'s underwater sound background. The further development of specific methods to deal with these conditions is necessary. A major problem is posed by the fact that the spectrum of baleen whale vocalizations overlaps with the frequency range where RV *Polarstern* emits most of its sound energy, so that this unwanted noise cannot be filtered out in the frequency domain. However, considering the geometry of the hydrophone array, a sound from the ship arrives at each hydrophone with specific time lag, different from that of signals from any other direction. The recorded data will help to fit an adaptive sound propagation model for the acoustic emissions of the ship. Part of the noise can then probably be removed which should increase the signal to noise ratio. This might reveal more vocalisations buried within the recorded data and help to build a fully automated detection system.

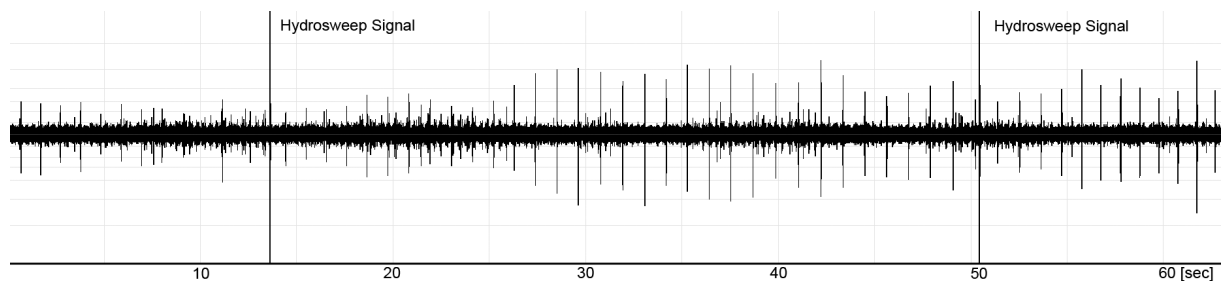

Fig. 8.4: Click train of sperm whale #1 together with Hydrosweep signals. This plot results from band pass filtering the original signal between 5 and 10 kHz.

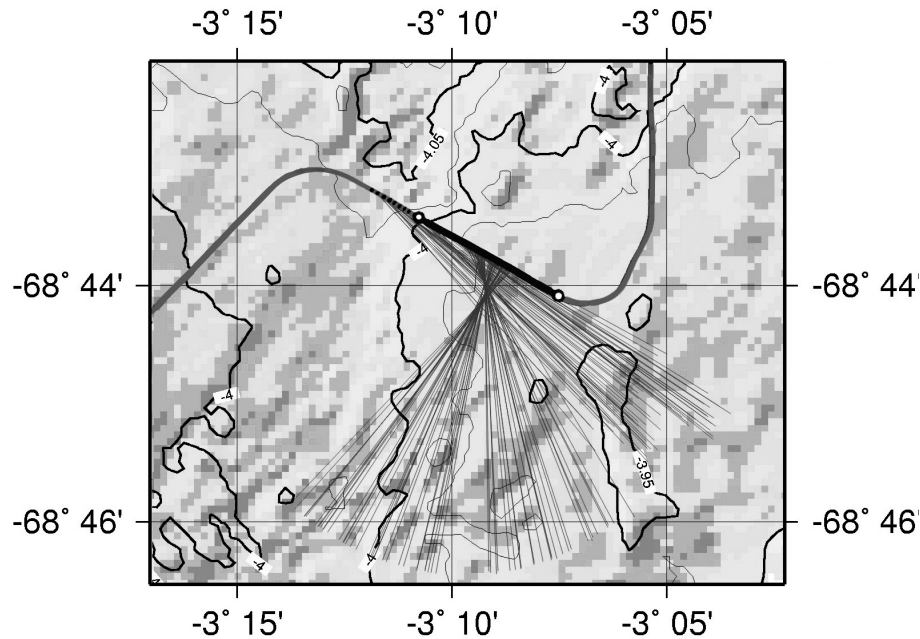

Fig. 8.5: Bearings (projected into 2D, thin black lines) of sperm whale clicks as determined by time of arrival differences from hydrophones of the passive acoustic streamer. The cruise track (thick black line) is superposed to the local bathymetry. This is sperm whale #1 from streamer deployment #6 on 13 February (table 8.4). The first bearings probably do not intersect because the streamer was not yet in a straight line due to a recent course change of RV Polarstern.

The sonobuoy's deployed far enough from RV *Polarstern* recorded several Orca whistles and some lower frequency calls, probably produced by fin whales. However, in most cases, no vocalizations (incl. clicks) were recorded during these periods. In particular, humpback whales remained silent in all cases, even when a hydrophone was placed only few meters away.

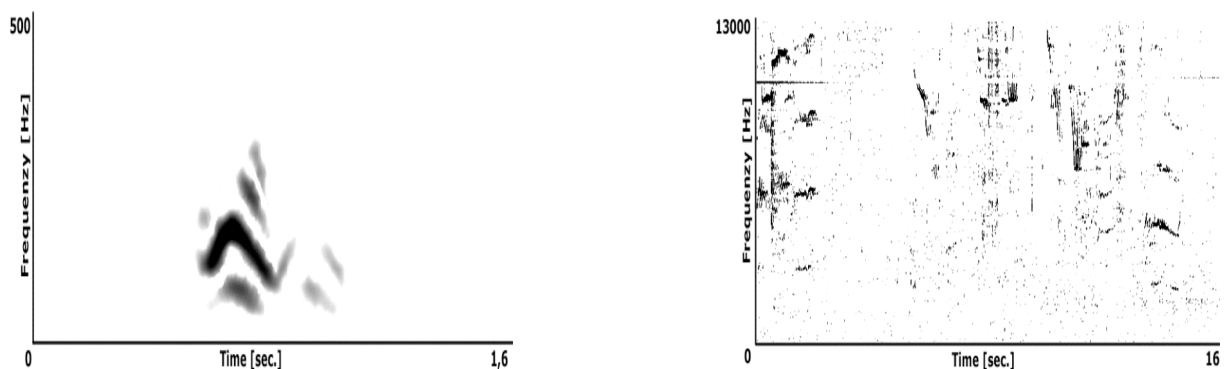
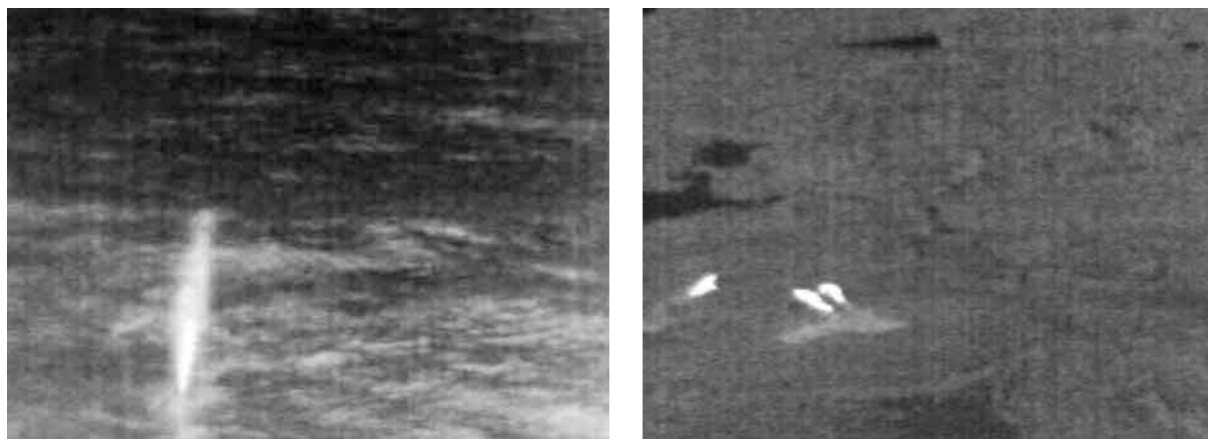

Fig. 8.6: Spectrograms of a fin whale call (left), recorded with the streamer and orca whistles (right), recorded with a sonobuoy

The infrared cameras detected eight whale blows automatically. On most occasions the whales were also observed by humans and could occasionally be identified as humpback and fin whales. Minke whales turned out to be difficult to detect by IR, due

to their relatively small and faint blow. However, in some cases the recordings were started manually and – retrospectively - the minke's blow proved to be just visible. During 11 encounters with single individuals or groups a total number of 41 blow events could be recorded as avi videos. Many false detections were triggered by seals or penguins on ice floes and birds dropping excrements in front of the cameras. Reflected sunrays on waves and ice structures also posed a problem for the pattern recognition algorithm. However, the large amount of data now available will be used to improve the system further.



*Fig. 8.7: Infrared images of a humpback whale blow and three seals on an ice floe*

Additionally, the bridge crew was asked to fill out sighting forms for each whale sighting. From 4 February till 31 March a number of 31 encounters with single individuals or groups were reported by them.



## 9. INTRODUCTION TO ANDEEP:

### ANTARCTIC BENTHIC DEEP-SEA BIODIVERSITY - COLONIZATION HISTORY AND RECENT COMMUNITY PATTERNS (ANDEEP III)

Angelika Brandt<sup>1</sup>, Claude De Broyer<sup>2</sup>,  
Andrew J. Gooday<sup>3</sup>, Brigitte Hilbig<sup>4</sup> and  
Michael R.A. Thomson<sup>5</sup>

<sup>1</sup> Zoological Institute and Zoological  
Museum, Hamburg

<sup>2</sup> Institut Royal des Sciences Naturelles  
de Belgique, Bruxelles

<sup>3</sup> Southampton Oceanographic Centre

<sup>4</sup> Ruhr University of Bochum

<sup>5</sup> Centre for Polar Sciences, School of  
Earth Sciences, University of Leeds

An introduction to ANDEEP was given by Fütterer et al. (2003) for the ANDEEP I & II expeditions, but is elaborated here in order to explain the background to the project and the reports of ANDEEP III (ANT-XXII/3) printed in this volume.

Biodiversity - defined as the variety and variability of genomes, species and populations, communities and ecosystems in space and time - is a central aspect of modern biology, especially in a time of vanishing species and concerns about a "biodiversity crisis". The assessment of Antarctic biodiversity, the understanding of its role in ecosystem functioning, and the requirements for its conservation, are of particular importance in the context of global environmental changes. Biogeography, which is closely linked to biodiversity, describes the geographic distribution of species and taxa in our biosphere and tries to explain patterns of distribution on the background of phylogenetic analyses and historic reconstructions (plate tectonics, palaeontology, palaeoceanography, etc.). Biogeographical research might help to identify the origin of species in certain areas on the basis of their phylogenetic relationships which are investigated using both morphological and molecular techniques. Knowledge of biodiversity and biogeography is absolutely central to any attempt to conserve species and their habitats. Without reliable information about species assemblages and communities, one will not be able to adequately protect the environment and conserve its living organisms. When considering marine biodiversity, we must always remember that roughly three quarters of the earth is ocean, of which less than 10% consists of coastal or shelf areas and more than 90 % is deep sea. The faunas living in this vast area are very poorly known, especially in the Southern Ocean where there has been a notable lack of intensive biological sampling effort. Without doubt, the Antarctic deep-sea harbours many unknown taxa, despite the intensification of Antarctic marine research activities by many nations during the last 20 years.

Modern deep-sea biological research started in the early 60s when Howard Sanders and co-workers postulated, on the basis of samples collected with a fine-meshed epibenthic sledge, that species richness increased with water depth while faunal densities decreased (e.g., Sanders *et al.* 1965, Sanders and Hessler 1969). Since then, attempts to describe and explain patterns of species diversity have become a major goal in deep-sea biological research. On regional (e.g., basin-wide) spatial scales, diversity is influenced by environmental factors such as organic matter fluxes, bottom-water oxygen concentrations, current velocity, and sediment type (Levin *et al.* 2001). There is also evidence for the existence of patterns in biodiversity at larger (global) scales; in particular, an apparent decrease in species richness among a number of taxa from the equator towards the poles (Poore and Wilson 1993, Rex *et al.* 1993; Thomas and Gooday 1996, Rex 1997; Culver and Buzas 2000). In contrast to what is known about the benthos of other deep-sea areas, and especially shelf areas around the Antarctic continent, our knowledge of the Southern Ocean deep-sea faunas is meagre. As in other oceans of the world, the Antarctica deep-sea floor is the largest single benthic habitat, yet it remains the least studied (Clarke & Johnston 2003). In 2002, the ANDEEP I and ANDEEP II expeditions (Brandt & Hilbig 2004) recovered a tremendous number of organisms of all size classes, making it possible for the first time to compare Southern Ocean deep-sea faunas to those collected elsewhere using similar sampling strategies and the same array of gear.

Biodiversity research in Antarctica based on evolutionary biology and biogeography has particular significance because the Antarctic ecosystem is of considerable age. Climatic cooling can be dated back at least to the Oligocene, about 35 million years ago (Clarke and Crame 1992). Because of the antiquity of this ecosystem, Southern Ocean organisms, especially those living on the continental shelf, have had a long time available in which to evolve. This long history may explain the adaptive radiation events observed in many benthic or benthopelagic taxa (e.g., Notothenioidei, Amphipoda, Isopoda, Gastropoda). Watling and Thurston (1989) memorably characterised the Antarctic as an 'evolutionary incubator' for the amphipod family Iphimediidae. These radiation processes, and the long time span available for evolution, probably explain the high degree of endemism that characterises Antarctic communities. However, these generalisations apply specifically to shelf faunas. At the beginning of the ANDEEP project, we did not know whether the biological characteristics of the Antarctic fauna, such as gigantism, late maturity, decreased number of offspring, long life spans etc., also apply to Antarctic deep-sea organisms. The ANDEEP expeditions were carried out in order to address these basic gaps in our knowledge of Antarctic biology.

Another important question concerns the potential faunistic links between South America and Antarctica, and a possibly still on-going faunal exchange, either by island hopping or migration through the deep-sea basins. In other words, does the Antarctic deep sea constitute a barrier or a route of faunal migration between South America and the Antarctic Peninsula? The formation of the Weddell Sea began during Jurassic time (165 million years ago), but a continental link between South America and Antarctica persisted until perhaps 30 million years



ago. Geographical and climatic changes during that time, including intermittent periods of global warming and global sea-level rise and fall, are likely to have influenced the movement of species in and out of the Antarctic region.

The considerations outlined above led us to pursue the following specific objectives during the ANDEEP surveys:

- To conduct the first comprehensive survey of megafaunal, macrofaunal and meiofaunal deep-water communities in the Scotia and Weddell seas.
- To investigate the similarity of the faunas of the Scotia and Weddell Sea at the taxonomic (morphological) and genetic (molecular) levels to the faunas of Atlantic basins, on the one hand, and Antarctic shelf on the other.
- To describe the variety of seafloor habitats in tectonically active and inactive regions and to determine the influence of 'habitat diversity' on species and genetic diversity over a variety of spatial scales.
- To determine the importance of life history strategies and larval biology in influencing species distributional patterns and geographical ranges.
- To investigate the evolutionary processes that have resulted in the present biodiversity and distributional/zoogeographical patterns in the Antarctic deep sea.
- To investigate the colonisation and exchange processes of the deep-sea fauna, in particular the role of tectonic structures (for example ridges or seamounts).

Samples collected during the three ANDEEP expeditions have provided, for the first time, a firm basis for addressing these questions. In a broader sense, ANDEEP may enhance our understanding of some important general issues in deep-sea biology. The project will certainly provide a wealth of new information about the scale and patterns of species diversity in the deep ocean (Etter and Mullineaux 2000; Levin *et al.* 2001), add to our knowledge of deep-sea species ranges and the relationship between local and regional diversity (Stuart and Rex 1994), and may ultimately lead to a better understanding of the origins of faunas inhabiting these remote regions. It has particular relevance to the controversial issue of global (latitudinal) diversity gradients. There is evidence that diversity decreases from the tropics to the poles in some deep-sea taxa. Gradients are particularly pronounced in the Northern Hemisphere, a fact that probably reflects the geologically recent origin of the Arctic Ocean. This hypothesis was first published by Poore and Wilson (1993) and also supported by Rex *et al.* (1993) on the basis of epibenthic sledge samples taken down to 4000 m depth. In a response to the publication of Rex *et al.* (1993), Brey *et al.* (1994) examined diversity gradients in the Southern Hemisphere, using data from the shelf and upper slope of the eastern and southern Weddell Sea. They demonstrated that species richness for bivalves, gastropods, and isopods is comparable to that

found in tropical regions around 20°S. However, the conclusions of Brey *et al.* (1994) are weakened by the fact that they compared Agassiz trawl and box corer data with epibenthic sledge data from Rex *et al.* (1993) and Poore and Wilson (1993). ANDEEP I & II samples and those from ANDEEP III did and will provide a rich source material that can be used in comparison with material collected during DIVA 1 and 2 (Diversity of the Abyssal Atlantic) to test whether or not a latitudinal diversity gradient really exists in the Southern Hemisphere. A more precise and detailed description of latitudinal diversity trends in the deep ocean may help to promote a better understanding of some fundamental controls on patterns of biodiversity in marine ecosystems over geological and ecological time scales.

### **Sampling programme**

Seven potential target areas were selected for the ANDEEP programme (see [figure 9.1](#)). During ANDEEP I (ANT-XIX/2) and ANDEEP II (ANT-XIX/3) target areas 1, 3, 4 (in part) and 6 were investigated (for more details see the cruise report, Fütterer *et al.*, 2003). During ANDEEP III, target areas 2 and 5 were sampled together with a station transect on the Greenwich meridian in the Cape, Agulhas and northern Weddell Sea Basins. It was also possible to sample some additional sites not envisaged in the original cruise programme; these were located on the NE Antarctic Peninsula slope, in the Bransfield Strait, and in the Bellingshausen Sea off Anvers Island.

As in the case of ANDEEP I and II, a variety of sampling gears was used during ANDEEP III to collect animals of all different size classes living in and on the sea floor. A CTD profile of the water column was obtained at the beginning of each biological station. The sediment profile imaging system (SPI) was then deployed in order to obtain still photographs and video footage of the surface of the seafloor and profiles through the sediment-water interface and upper sediment layers. Next, two multicorers (57 mm and 100 mm tube diameter) and two box corers were used to recover sediment samples of different, but well defined surface areas together with the overlying bottom water. The multicorers were used principally for the smallest size fraction, the meiofauna (32-300 µm size range), and for the characterisation of sediment parameters. The box corers were used mainly to sample the macrofauna (size class >300 µm). Two other biological sampling devices were towed across the bottom and obtained material from a much larger but less well-defined area of seafloor. The epibenthic sledge was used for the macrofauna and the Agassiz trawl for the larger animals, the megafauna. Additionally, a baited trap was deployed at the beginning of each ANDEEP station to attract and catch scavenging animals, mainly amphipods, not usually collected by other gears. It was recovered approximately 48 h later at the end of the station work. A brief introduction to the three main sized-based faunal categories follows.

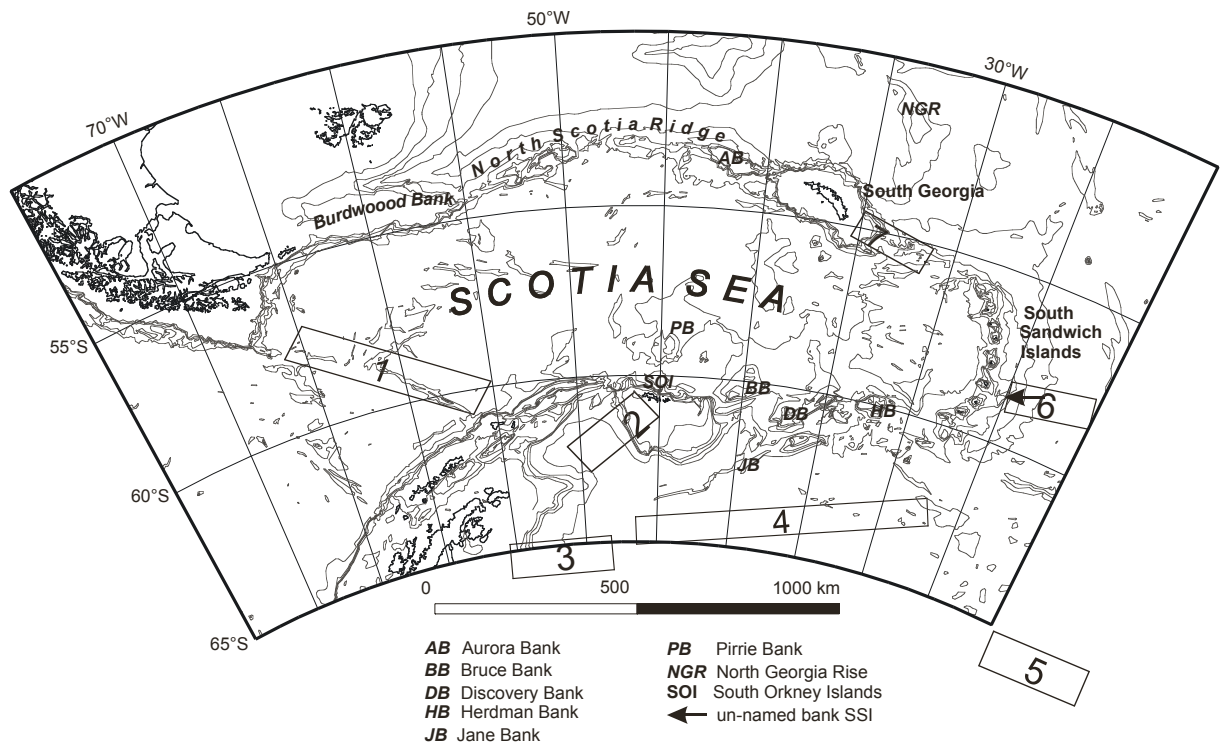

Fig. 9.1: Target areas of the ANDEEP programme

*Meiofauna*. Three meiofaunal groups are particularly abundant in the deep sea - the foraminifera (protistan meiofauna), harpacticoid copepods and nematodes (metazoan meiofauna). These taxa were the main focus of attention for meiofaunal studies during the ANDEEP project. Since the beginning of the 20<sup>th</sup> century, there have been many studies of foraminifera in the Southern Ocean. However, the earlier investigations were qualitative while most later ones were conducted by geologists and concerned the hard-shelled, fossilizable taxa (mainly calcareous) which often constitute a fairly minor component of deep-sea foraminiferal assemblages (Cornelius and Gooday 2004). During ANDEEP II and III, particular attention was paid to the diverse and usually neglected soft-shelled species (e.g., allogromiids, saccamminids, komokiaceans), the vast majority of which are new to science. Many of the much better-known calcareous species in ANDEEP samples also occur in the Northern Hemisphere. For example, *Epistominella arctica*, which is fairly common on the Weddell Abyssal Plain, was first described from the Arctic Ocean. Specimens from these two areas are morphologically identical.

Prior to the ANDEEP expeditions, far less was known about the metazoan meiofauna in the Antarctic deep sea. A handful of papers dealt with meiofauna at the higher taxon level. Two ANDEEP studies focussed on nematodes at the levels of genera (Vanhove *et al.* 2004) and species (Vermeeren *et al.* 2004). These revealed a high diversity, even at generic level, with as many as 40 genera being present in individual samples. Very little was known about harpacticoid copepods at the species level in the Southern Ocean. One new

species was described from ANDEEP II material (Veit-Köhler 2004) and many other new species collected during the second ANDEEP expedition are currently under investigation. Data on the entire metazoan size fraction (32-1000 µm) from the South Sandwich Trench (Vanhove *et al.* 2004) revealed unexpectedly high standing stocks (predominately nematodes), situated above the regression line of meiobenthic abundance against water depth for the World Ocean. In particular, the deepest trench sample (6300 m water depth) yielded unusually high meiofaunal abundances, despite low values for indicators of food availability.

*Macrofauna.* Data from the Southern Ocean deep sea have shown that, in very general terms, the macrofauna does not differ too much in composition at a higher taxonomic level from that of other deep-sea regions of the World oceans. Nevertheless, many, if not most, of the macrofaunal species are new to science. For example, Southern Ocean deep-sea Isopoda show a high degree of endemism, probably due to the negligible sampling effort in the Southern Ocean deep sea in the past. Most important taxa are Polychaeta, Crustacea (Peracarida) and Mollusca (Bivalvia and Gastropoda) (Brandt *et al.* 2004).

The brooding Peracarida were characterised by a high diversity including many rare and new species, and only very few of the species were known from other deep-sea basins (De Broyer *et al.* 2004). By contrast, within the Polychaeta we found many more species that seem to have crossed the barrier between the Southern Ocean and adjacent oceans and, although we do not know the reasons, we assume differences in the biology are responsible (Hilbig 2004). For example, brooding is much less common among polychaetes (at least as far as we know), making larval dispersal a possibility for wide distribution, perhaps together with a particularly high physiological flexibility in coping with large temperature and pressure changes. Data on reproductive stages of some polychaetes suggest that species limited to abyssal depths are reproducing there. Other species with broader depth ranges may be receiving recruits from slope depths.

Our knowledge of the deep-water bivalve fauna of Antarctica is poor. However, the deep-water bivalve fauna sampled during ANDEEP was species rich. This indicates that there is no decline in diversity with depth in Antarctic bivalves, but it does provide evidence for underestimated species richness in deep water because of lack of sampling (Linse 2004).

*Megafauna.* Megafauna was found to be distinctively less diverse than the other two size classes. Most important taxa were Porifera, Mollusca, Echinodermata, and Brachiopoda. Within the Porifera, new Hexactinellida from the deep Weddell Sea are moderately diverse and include 14 species belonging to 12 genera (Janussen *et al.* 2004).

The cephalopod fauna of the Southern Ocean deep sea yielded an unusual and relatively large collection of octopods comprising four species in two genera. One genus was new to science (Allcock *et al.* 2004).

ANDEEP would have never existed without financial and logistic help. We are therefore grateful to the German Science Foundation and all national funding

agencies of the ANDEEP collaborators. Thanks are also due for logistical support to the Alfred-Wegener-Institute for Polar and Marine Research.

### References

- Allcock, A.L., Collins, M. A., Piatkowski, U., & M. Vecchione (2004): *Thaumeledone* and other deep water octopodids from the Southern Ocean. *Deep-Sea Research II*, 51 (14-16): 1883-1903.
- Brandt, A. and Barthel, D. (1995): An improved supra- and epibenthic sledge for catching Peracarida (Crustacea, Malacostraca). *Ophelia* 43 (1): 15–23.
- Brandt, A. and Hilbig, B. (2004): ANDEEP (ANTarctic benthic DEEP-sea biodiversity: colonization history and recent community patterns) - a tribute to Howard L. Sanders. *Deep-Sea Research II*, 51 (14-16): 1457-1919.
- Brandt, A., Brökeland, W., Brix, S. and M. Malyutina (2004): Diversity of Southern Ocean deep-sea Isopoda (Crustacea, Malacostraca) – a comparison with shelf data. *Deep-Sea Research II*, 51 (14-16): 1753-1769.
- Clarke, A. and Crame, J.A. (1992). The Southern Ocean benthic fauna and climate change: a historical perspective. *Philosophical Transactions of the Royal Society of London B* 338: 299–309.
- Clarke, A. and N. M. Johnston (2003): Antarctic marine benthic diversity. *Oceanogr. Mar. Biol.: ann. rev.* 41: 47-114.
- Cornelius, N. and A. J. Gooday (2004): “Live” (stained) deep-sea benthic foraminiferans in the western Weddell Sea: trends in abundance, diversity and taxonomic composition along a depth transect. *Deep-Sea Research II*, 51 (14-16): 1571-1617.
- Culver, S.J. and Buzas, M.A. (2000): Global latitudinal species diversity gradient in deep-sea benthic foraminifera. *Deep-Sea Research*.
- De Broyer, C., Nyssen, F. and P. Dauby (2004): The crustacean scavenger guild in Antarctic shelf, bathyal and abyssal communities. *Deep-Sea Research II*, 51 (14-16): 1733-1752.
- Etter, R.J., Mullineaux, L.S. (2000): Deep-sea communities. In: M.D. Bertness, S. Gaines, M. Hay (Eds) *Marine Ecology*, Sinauer, Sunderland, MA, pp. 367–393.
- Fütterer, D. K. Brandt, A. and G. C. B. Poore (2003): The expeditions Antarktixin XIX/3 and XIX/4 of the Research Vessel *Polarstern* in 2002 (ANDEEP I and II: Antarctic benthic deep-sea biodiversity: colonization history and recent community patterns). *Berichte Polarforsch Meeresforsch.* 470: 1-174.
- Hilbig, B.(2004): Polychaetes of the deep Weddell and Scotia Seas - composition and zoogeographical links. *Deep-Sea Research II*, 51 (14-16): 1817-1827.
- Janussen, D. Tabachnick, K. R. and O. S. Tendal (2004): Deep-sea Hexactinellida (Porifera) of the Weddell Sea. *Deep-Sea Research II*, 51 (14-16): 1857-1883.
- Levin, L.A., Etter, R. J., Rex, M.A., Gooday, A.J., Smith, C. R., Pineda, J., Stuart, C.T., Hessler, R.R. and D. Pawson (2001): Environmental influences on

- regional deep-sea species diversity. *Annual Review of Ecology and Systematics* 200, 32: 51–93.
- Linse, K. (2004): Scotia Arc deep-water bivalves: composition, distribution and relationship to the Antarctic shelf fauna. *Deep-Sea Research II*, 51 (14-16): 1827-1839.
- Poore, G.C.B. and G.D.F. Wilson (1993): Marine species richness (with reply from R.M. May). *Nature* 361: 597–598.
- Rex, M.A.(1997): An oblique slant on deep-sea biodiversity. *Nature* 385: 577–578.
- Rex, M.A., Stuart, C.T., Hessler, R.R., Allen, J.A., Sanders, H.L. and G.D.F. Wilson (1993): Global-scale latitudinal patterns of species diversity in the deep-sea benthos. *Nature* 365: 636–639.
- Sanders, H.L. and R.R. Hessler (1969): Diversity and composition of abyssal benthos. *Science* 166: 1033–1034.
- Sanders, H.L., Hessler, R.R. and G.R. Hampson (1965): An introduction to the study of deep-sea benthic faunal assemblages along the Gay Head-Bermuda transect. *Deep-Sea Research* 12: 845–867.
- Vanhove, S., Vermeeren, H. and A. Vanreusel (2004): Meiofauna towards the South Sandwich Trench (750-6300 m), focus on nematodes. *Deep-Sea Research II*, 51 (14-16): 1665-1689.
- Vermeeren, H., Vanreusel, A. and S. Vanhove, (2004): Species distribution within the free-living marine nematode genus *Dichromadora* in the Weddell Sea and adjacent areas. *Deep-Sea Research II*, 51 (14-16) 1643-1664.
- Veit-Köhler, G. (2004): *Kliopsyllus andeep* sp. n. (Copepoda: Harpacticoida) from the Antarctic deep sea – a copepod closely related to certain shallow-water species. *Deep-Sea Research II*, 51 (14-16): 1629-1643.
- Watling, L. and M.H. Thurston (1989):. Antarctica as an evolutionary incubator: evidence from the cladistic biogeography of the amphipod family Iphimediidae. Pp. 297-313 in Crame, J.A. (ed.), *Origins and evolution of the Antarctic biota*. . Geological Society Special Publication 47.
- Thomas, E., and A.J. Gooday (1996): Cenozoic deep-sea benthic foraminifers: Tracers for changes in oceanic productivity? *Geology* 24: 355-358.

## 9.1 Meiobenthos

### 9.1.1 Introduction to work at sea: Multicorer sampling during ANDEEP III

Armin Rose<sup>1</sup>, Nils Cornelius<sup>2</sup>, Ilse DeMesel<sup>3</sup>, Stacy Doner<sup>4</sup>, Andrew J. Gooday<sup>2</sup>, Annika Henche<sup>1</sup>, John A. Howe<sup>5</sup>, Jereon Ingels<sup>3</sup>, Bhavani E. Narayanaswamy<sup>2</sup>

<sup>1</sup> FIS, Dept. DZMB

<sup>2</sup> Southampton Oceanography Centre

<sup>3</sup> University of Gent

<sup>4</sup> ENSR Marine and Coastal Center, Woods Hole

<sup>5</sup> SAMS

During the ANT-XXII/3 campaign of 'RV *Polarstern*, multicorer and megacorer samples were obtained for several scientific projects which are explained in detail in other contributions to this volume. These two different kinds of gear had to be used in order to ensure comparability of data with earlier expeditions.

Along the transect from Cape Town to *Neumayer*, 3 stations (table 9.1) were sampled quantitatively with a megacorer (MUC10: 95 mm inner tube diameter, fig. 9.2). This gear was used so that data from the present campaign could be compared directly with that from the DIVA 1 (2000) and DIVA 2 (2005) expeditions of RV *Meteor* to the Angola Basin, Northern Cape Basin and Guinea Basin. At all other stations (table 9.1), sampling took place with the smaller multicorer (MUC6: 57 mm inner tube diameter, fig. 9.2) for comparability with the multicorer stations of former ANDEEP I and II campaigns (2002). In general, two (12 out of 18 stations) or three (3 stations) replicate deployments were made at each site. At Stns 78 and 88 on the Kapp Norvegia transect, the multicorer was deployed 4 times in order to provide cores for the meiofaunal incubation experiments (De Mesel & Ingels this volume). At Stn 59, five megacorer deployments were made for the comparison with the DIVA data set (Rose & Henche this volume).

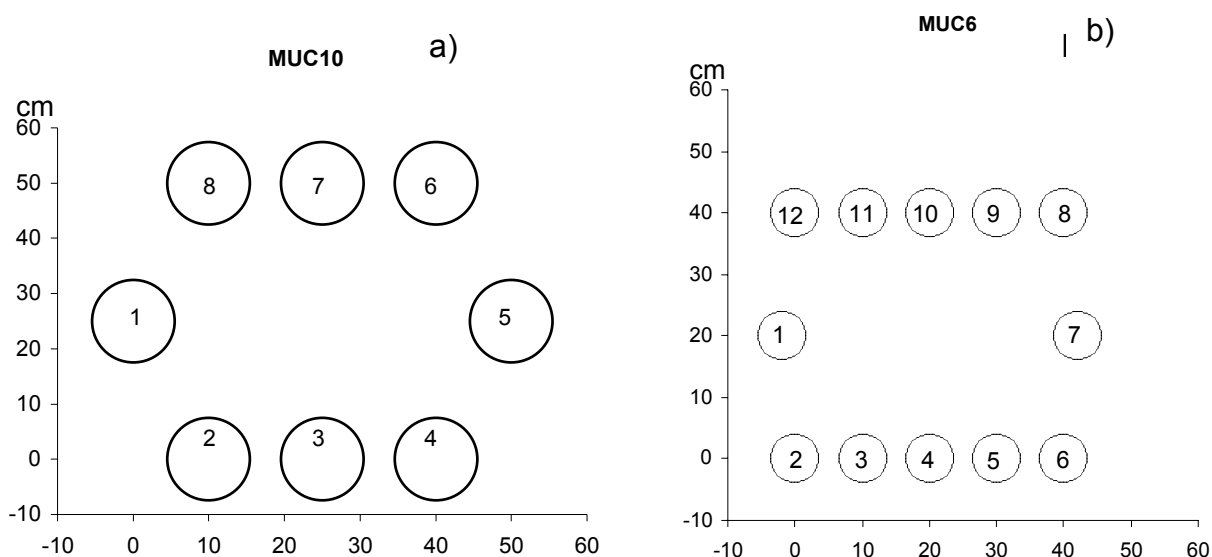

Fig.9.2: Spatial arrangement and assignment of a) megacorer (MUC10), and b) multicorer (MUC6) tube positions

The total number of cores recovered varied between deployments and therefore different numbers were available for the participating scientific projects (table 9.1). To ensure that the best use was made of the samples, cores were shared between certain working groups when possible. Foraminifera and metazoan macrofauna (table 9.1) were sorted at sea soon after sample collection and these cores could therefore be shared during the cruise. For other groups (Nematoda, Harpacticoida, other taxa), cores will be shared later after sorting out major taxa in the institutional labs.

### **Preliminary results**

Nine megacorer and 37 multicorer deployments took place during the ANDEEP III expedition. These provided a total of 392 (64 MUC10 + 328 MUC6) sediment cores. Some were used for the above-mentioned incubation experiment, but most will be analysed for foraminiferal and metazoan meiofauna, metazoan macrofauna, sediment characteristics and other environmental parameters. In the case of the megacorer, 7.1 out of 8 possible tubes (89 %) were filled with sediment on average. The multicorer provided an average of 8.9 out of 12 possible filled tubes (74 %). The overall average core length was about 26 cm. However, the individual core lengths varied widely, from 8 to 60 cm, with sandier sediments on the continental slope (e.g., Stns 150, 151) generally yielding shorter cores. The total surface area of the recovered cores was 1.291 m<sup>2</sup>, while a total sediment volume of 0.378 m<sup>3</sup> was collected with both gears. Although this does not sound impressive, it is more than in most other biological deep-sea expeditions and represents a very substantial addition to the material available for meiofaunal studies from the Southern Ocean.



**Table 9.1:** Deployments of megacorer (MUC10) and multicorer (MUC6) at the ANDEEP III stations (AvgLg = average core length; NeD = nematode morphological diversity analysis; NeM = nematode molecular diversity analysis; NeI = stable isotope analysis; NePFA = lipid analysis; NeE = environmental factors; NeEx = nematode feeding experiment; Har = harpacticoid morphological diversity analysis; For = foraminiferan morphological and molecular diversity analysis; Mac = macrofaunal diversity and community analysis; FoMa = foraminifera/ macrofauna shared cores; Sed = sediment analysis; rem = remains of sediment from failed deployment); further information on the stations in the appendix of this volume.

Station/Dpl.	Wire [m]	Gear	Cores	AvgLg [cm]	NeD	NeM	NeI	NePFA	NeE	NeEx	Har	For	FoMa	Mac	Sed
PS67/016-6	4695	MUC10	7	40.5	0	0	0	0	0	0	3	1	0	2	1
PS67/016-8	4702	MUC10	8	40	0	0	0	0	0	0	3	2	0	3	0
PS67/021-4	4524	MUC10	5	25	0	0	0	0	0	0	2	2	0	1	0
PS67/021-6	4529	MUC10	8	33.5	0	0	0	0	0	0	3	2	0	2	1
PS67/059-4	4590	MUC10	7	29.5	0	0	0	0	0	0	5	0	0	1	1
PS67/059-7	4591	MUC10	7	31.5	0	0	0	0	0	0	5	0	1	1	0
PS67/059-9	4592	MUC10	7	28.5	0	0	0	0	0	0	5	0	1	1	0
PS67/059-11	4588	MUC10	8	18.5	0	0	0	0	0	0	5	2	0	1	0
PS67/059-13	4588	MUC10	7	23.5	0	0	0	0	0	0	5	1	0	1	0
PS67/074-4	1015	MUC6	0	0	0	0	0	0	0	0	0	0	rem	0	0
PS67/074-5	990	MUC6	0	0	0	0	0	0	0	0	0	rem	0	0	0
PS67/078-3	2106	MUC6	12	20	1	0	1	1	1	6	0	1	0	0	1
PS67/078-5	2102	MUC6	12	20	1	0	1	1	1	6	0	1	0	1	0
PS67/078-7	2104	MUC6	12	20	1	0	1	1	1	6	0	1	0	1	0
PS67/078-8	2107	MUC6	11	17	0	1	0	0	0	0	3	2	0	5	0
PS67/080-4	3031	MUC6	7	30	3	0	0	0	1	0	0	1	0	1	1
PS67/080-7	3032	MUC6	5	30.5	2	0	0	0	1	0	0	1	0	1	0
PS67/081-4	4351	MUC6	10	30	3	1	0	0	1	0	0	2	0	2	1
PS67/081-6	4353	MUC6	12	30	3	1	0	0	1	0	1	2	0	4	0
PS67/088-4	4867	MUC6	12	36	1	0	1	1	1	6	0	1	0	0	1
PS67/088-6	4868	MUC6	12	36	1	0	1	1	1	6	0	1	0	1	0
PS67/088-9	4870	MUC6	11	36	1	0	1	1	1	6	0	0	0	1	0
PS67/088-12	4866	MUC6	12	36	1	1	0	0	1	0	3	2	0	4	0
PS67/094-5	4830	MUC6	12	36.5	1	1	0	0	1	0	3	2	0	3	1
PS67/094-7	4830	MUC6	12	37	1	1	0	0	1	0	3	2	0	4	0
PS67/094-9	4831	MUC6	11	32	1	1	0	0	1	0	3	2	0	3	0
PS67/102-7	4738	MUC6	12	34	1	1	0	0	1	0	3	2	0	3	1
PS67/102-9	4738	MUC6	12	38	1	1	0	0	1	0	3	2	0	4	0
PS67/110-4	4637	MUC6	11	35	1	1	0	0	1	0	2	2	0	3	1
PS67/110-6	4628	MUC6	11	37.5	1	1	0	0	1	0	3	2	0	3	0
PS67/121-4	2545	MUC6	3	31	1	0	0	0	0	0	0	0	1	0	1
PS67/121-6	2577	MUC6	11	30	1	1	0	0	1	0	2	2	0	4	0
PS67/142-4	3337	MUC6	7	35	1	1	0	0	1	0	0	1	1	1	1
PS67/142-9	3339	MUC6	4	32	2	0	0	0	0	0	0	1	1	0	0
PS67/150-2	1888	MUC6	10	13	1	1	0	0	1	0	3	1	1	1	1
PS67/150-4	1959	MUC6	6	13.5	1	1	0	0	1	0	0	1	0	2	0
PS67/150-8	1884	MUC6	11	10	1	1	0	0	1	0	5	0	0	3	0
PS67/151-3	1150	MUC6	5	10	2	0	0	0	0	0	0	1	0	1	1
PS67/151-5	1140	MUC6	10	8	2	1	0	0	1	0	1	2	0	3	0
PS67/151-8	1130	MUC6	7	10	2	1	0	0	1	0	1	0	0	2	0
PS67/152-2	1931	MUC6	12	48.5	1	1	0	0	1	0	3	2	0	3	1
PS67/152-4	1931	MUC6	12	50.5	2	0	0	0	1	0	3	2	0	4	0
PS67/153-3	1930	MUC6	0	0	0	0	0	0	0	0	0	0	0	0	0
PS67/153-5	1928	MUC6	12	26	3	0	0	0	1	0	2	2	0	3	1
PS67/154-3	3746	MUC6	7	10	2	0	0	0	1	0	0	1	0	2	1
PS67/154-5	3740	MUC6	2	12.5	1	0	0	0	0	0	0	1	0	0	0
<b>total</b>			<b>392</b>		<b>48</b>	<b>19</b>	<b>6</b>	<b>6</b>	<b>29</b>	<b>36</b>	<b>83</b>	<b>56</b>	<b>6</b>	<b>86</b>	<b>17</b>

### 9.1.2 Diversity and biogeography of deep-sea benthic foraminifera – a combined molecular and morphological approach

Andrew J. Gooday<sup>1</sup>, Tomas Cedhagen<sup>2</sup>, Nils Cornelius<sup>1</sup>

<sup>1</sup>Southampton Oceanography Centre

<sup>2</sup>Department of Marine Ecology, University of Aarhus

#### Introduction and objectives

Foraminifera and closely related large testate (shell-bearing) protists, the xenophyophores and gromiids, are a significant and often visually conspicuous component of the deep-sea meiofauna and macrofauna. In addition to the geologically important and well-known calcareous foraminifera, deep-sea assemblages include substantial numbers of soft-shelled, often single-chambered species, the vast majority of which are undescribed. These frequently overlooked organisms include the allogromiids and saccamminids among the smaller size fraction (meiofauna) and the komokiaceans among the larger size fraction (macrofauna).

Literature records, combined with our own studies on North Atlantic faunas, suggests that many foraminiferal morphospecies have wide geographical ranges in the deep sea. However, whether all of these morphospecies constitute single taxonomic entities at the molecular level over their entire geographical ranges remains an open question. In order to test the general hypothesis that deep-sea foraminiferan species do indeed have cosmopolitan distributions, we will compare ANDEEP species with similar morphospecies collected from Arctic sites during RV *Polarstern* and RRS *James Clarke Ross* cruises later this year. The comparison will combine molecular analyses with conventional morphology-based species descriptions in order to determine whether or not genetic divergence has occurred between widely separated populations of the same morphospecies. An additional objective is to improve knowledge of benthic foraminiferal and gromiid biodiversity by describing some of the many new species and higher taxa collected during the ANDEEP III expedition.

#### Work at sea

Foraminifera, gromiids and xenophyophores were studied during the cruise from all ANDEEP stations. Samples collected with the Agassiz trawl (AGT), epibenthic sledge (EBS), megacorer (MUC10), multicorer (MUC6) and box corer (GKG) were sieved on one or more sieves (mesh sizes 500, 300, 125, 63 µm) and sorted for benthic foraminifera under a binocular microscope. The AT and particularly the EBS samples provided a rich variety of larger species while the core samples yielded mainly smaller species. Many specimens were photographed using a Nikon CoolPix 4500 digital camera attached to a Leica binocular microscope.

A total of 5,566 specimens was assigned either to formally described or informal morphospecies. Of these, 4,526 were fixed in formalin for further morphological analysis and 28 were fixed in glutaraldehyde buffered with sodium cacodylate for ultrastructural examination. The remainder were either fixed in guanidine buffer

(358) or frozen in liquid nitrogen (694) for molecular analyses. This material will form the basis for our planned comparison of Arctic and Antarctic morphospecies. Komokiaceans dominated the sorted specimens and species with saccamminids and tubular agglutinated taxa also representing a substantial proportion of the picked assemblages (table 9.2). Over 1000 photographs of individual specimens or groups of specimens were taken. A total of 341 morphospecies was recognised among this voluminous material. Of these, we were able to assign only 46 (13.5%) to known species. Additional study and better access to taxonomic literature will undoubtedly increase this number, but there must be >200 undescribed species in our sorted material. There was not time to sort all specimens into species and those that were picked from the samples but not examined in detail will certainly include many additional undescribed species.

**Table 9.2:** Proportions of specimens and species belonging to different major groups picked from samples collected using the multicorer, megacorer, box corer, epibenthic sledge and Agassiz trawl. In the case of specimens, separate data are given for total specimens and those to be used for molecular analyses (frozen or fixed in guanidine) and for morphological descriptions (fixed in formalin). Total specimen numbers do not include fragments or mixed collections of several species. Note also that specimens were often picked selectively and it was sometimes impossible to distinguish between live and dead specimens. Except for the final row, all numbers are percentages.

	Specimens			Species
	Total	Molecular	Morphological	
Komoki	33.1	19.6	36.1	22.9
Calcareous	4.76	19.2	1.44	7.62
MAF	8.44	8.65	8.40	6.45
Saccamminid	16.6	13.9	17.2	15.5
Allogromiid	4.31	5.67	4.00	9.67
Tubes	17.1	14.5	17.7	18.8
Other Monothalamous	8.43	7.90	8.55	8.80
Xenophyophores	0.99	0.3	1.15	2.34
Gromiids	6.31	10.2	5.41	7.92
Total numbers	5566	1040	4526	341

In addition to the samples sorted on the ship, two multicores from each station were sliced into layers (0-1, 1-2, 2-3, 3-4, 4-5, 5-7.5, 7.5-10 cm) and fixed in buffered 4% formalin. These will be used for a detailed study of the composition and diversity of foraminiferal assemblages.

### Preliminary results

Shipboard sorting revealed very diverse assemblages of testate protists at all stations. The qualitative data on the 341 morphospecies recognised during the cruise cannot be easily summarised and so we confine ourselves to some remarks about the main groups, a brief account of the gromiid assemblages, and some comments on biogeography. These remarks are based on unstained

material. Particularly in the case of large agglutinated species with thick, opaque test walls, the picked specimens will include a large proportion of dead individuals.

### **General faunal characteristics**

Very large, agglutinated foraminiferans were easily visible on box core surfaces from some continental margin stations, including Stns 78 (*Rhabdammina inaequalis*, *Nodosinum gaussicum*), 80 (*Rhabdammina* sp.), 121 (extremely delicate, undescribed agglutinated tube), 150 (*Rhabdammina discreta*), 152 (*Hormosina normani*, *Hyperammina crassatina* and *R. discreta*), 153 (huge undescribed *Rhabdammina* sp., *N. gaussicum*). These and other large tubular, spherical and multichambered agglutinated foraminiferans often dominated the coarser sample residues at these stations. The other species included the following: *Ammobaculites* spp., *Clavulina communis*, *Cribrostomoides subglobosa*, *C. scitulus*, *Cyclammina cancellata*, *C. orbicularis*, *C. pusillus*, *Hormosinella distans*, *Hyperammina* spp., *Marsipella cylindrica*, *Psammosphaera fusca*, *Reophax* spp. *Rhabdammina* spp., *Vanhoeffenella* spp. However, some of these species also occurred at abyssal sites; for example, *Cyclammina cancellata* in the Agulhas Basin (Stn 21).

Calcareous foraminifera were always less abundant than the agglutinated taxa. The most frequently encountered species were *Epistominella exigua*, *Gyroidina* sp., *Nuttalides umboniferus* and *Oridorsalis umbonatus*. *Nuttalides umboniferus* was fairly common at Stn 21 in the Agulhas Basin. Tiny specimens of *Epistominella exigua* were very common in fluff balls from Stns 102 and 110 on the Weddell Abyssal Plain. Other species were common at particular stations, notably *Bulimina marginata* at Stn 78 off Kapp Norvegia, *Laticarinata pauperata* at Stn 80 off Kapp Norvegia, and a *Cibicides*-like species in the Powell Basin (Stns 150, 151).

Komokiaceans were the most conspicuous faunal component at abyssal plain sites and particularly on the Weddell Abyssal Plain (Stns 88, 94, 102, 110). Almost 80 species were recognised in the ANDEEP samples, many of them new to science. The two most common and widely distributed species were *Septuma* sp (possibly *S. brachyramosa* Kamenskaya) and *Normanina tyloda*. An *Ipoa* species and a second distinct species resembling *Ipoa* were also common on the Weddell Sea transect. These species were characterised by a sparse tubule system without intervening sediment, creating an open, 'bushy' appearance. Compact komokiaceans in which the interstices between the tubules is partly or completely filled with sediment to create a mudball structure were also common on the abyssal plain. These include species of *Edgertonia*, *Reticulum* and *Staphylion*. Komokiaceans were less abundant at the continental slope sites. Here, mudballs and more compact *Septuma*-like species predominated and the delicate 'bushy' komokiaceans were uncommon or absent.

Saccamminids were abundant and diverse, a typical observation in the deep sea. More than 50 species were recognised. All but one of them are believed to

be undescribed and many probably represent new genera. Many are visually very striking. Some species have test walls constructed from plate-like mineral grains which impart a brilliant, silvery or silvery-gold lustre to the surface while others are pure white. Organic-walled allogromiids were less abundant and diverse than the saccamminids. Some of the species recognised belonged to the genera *Nemogullmia* (fairly common at Stn 80 and 121) and *Cylindrogullmia*. Because of their potential phylogenetic importance, brown-walled allogromiids resembling the genera *Nodellum* and *Resigella* were a particular target during this cruise. A few tiny specimens of this type were recovered at Stns 16 (Cape Basin), 21 (Agulhas Basin), 102, 110 (Weddell Sea Abyssal Plain) and preserved for molecular studies.

Xenophyophores, which we include within the foraminifera, were confined to continental margin sites. Plate-like and cylindrical psamminid xenophyophore fragments were fairly common in samples from Stns 59, 78. An intact specimen and several fragments of *Reticulammina* were recovered in a box core from Stn 80 (3000 m) off Kapp Norvegia, probably the most southerly record for a xenophyophore. The final box core of the cruise, from Stn 153 in the Bellingshausen Sea, yielded a dead specimen of a new *Syringamina* species.

### Gromiids

Gromiids (genus *Gromia*) are large testate protists related to the Foraminifera. Until recently, the group was known from a single morphospecies (*Gromia oviformis* – probably a complex of cryptic species) found mainly in coastal habitats around the world. Recently, however, abundant gromiids belonging to a number of spherical, sausage- and grape-shaped morphotypes were discovered at depths between 1000 and 2000 m in the deep Arabian Sea (Gooday *et al.* 2000).

During this cruise, we found many gromiids belonging to a similar variety of morphotypes in samples obtained from continental slope sites in water depths ranging from 1000 to 4400 m. A total of 20 ‘morphospecies’ was tentatively recognised (table 9.3). A smaller, gromiid-like species (no. 211) was present at some of the abyssal stations, but otherwise gromiids were confined to the continental slope. Particularly notable were: 1) a spherical species (no. 254) which was very abundant in the epibenthic sledge haul from Stn 133; 2) a species (no. 143) from Stns 80 and 81 with a test wall divided into honeycomb-like cells - Aranda da Silva *et al.* (submitted) describe a similar wall structure in an Arabian Sea species; 3) a species (no 248) from Stn 121 in which the organic test is sometimes partly enclosed within an agglutinated casing. This new evidence from the Southern Ocean suggests that deep-water gromiids are widespread on continental margins around the world. The occurrence of the cosmopolitan shallow-water species *G. oviformis* in Explorers Cove (McMurdo Sound) (Bowser *et al.* 1996) indicate that these large protists are able to disperse widely.

**Table 9.3:** Occurrence of gromiid morphospecies in the ANDEEP sampling areas. Species are identified by test morphology and, in most cases, a reference number; their recognition on the basis of morphological characteristics is very preliminary. WB = Weddell Basin (Stn 59); NS = NEUMAYER slope (57); CN = Kapp Norvegia transect (74-81); WSAP = Weddell Sea Abyssal Plain (88-110); PS = Antarctic Peninsula slope (121, 133); PB = Powell Basin (142-151); BS = Bransfield Strait (152); AI = slope off Anvers Island, Bellingshausen Sea (153, 154). Gromiids were not noticed in the Cape and Agulhas Basins.

Sampling area Water depth (m)	WB 4550	NS 1820	CN 1025- 4400	WSAP 4600- 4900	PS 1580- 2630	PB 1140- 3400	BS 1930	AI 2100- 3600
76) Carrot-shaped		x				x	x	
120) Grape-shaped			x			x		
73+74) Sausage: thick			x					
Elongate, irregular			x					
143) Grape: honeycomb wall 1			x					
211) Oval: small, brown	x			x				
248) Sausage: agglutinated case					x			
254) Spherical: grey-green					x			
Sausage: granular, grey-violet						x		x
257) Sausage: grey					x	x		
145) Spherical: pale			x		x	x		
Spherical: milky test						x		
Grape: elongate			x			x		
269) Sausage, milky test						x		
263) Sausage, silver grey						x		
Sausage - small, brown								
293) Sausage: fat, rusty							x	
Grape: honeycomb wall 2								x
297) Sausage: pale brown								x
298) Grape: pale, oval								x

### Comments on species biogeography

Little can be said with confidence about biogeographic patterns within the Antarctic region based on information derived from our selective shipboard sorting. Some species are widely distributed across the study area while others are found only at one or two stations; e.g., a distinctive new *Vanhoeffenella* species from Stn 133. However, at a larger geographical scale, it is notable that the majority of the described species recognised in our Southern Ocean samples are well known from the Northern Hemisphere, for example, the upwelling area off NW Africa, the Greenland Norwegian Sea and the Barents Sea. Examples include *Ammolagena clavata*, *Bathysiphon rusticus*, *Cribrostomoides subglobosa*, *C. scitulus*, *Clavulina communis*, *Cyclamina cancellata*, *C. orbicularis*, *Hormosinella distans*, *Hyperammia crassatina*, *Rhabdammina discreta*, *Rh. neglecta* (agglutinated), *Edgertonia floccula*, *E. argillispherula*, *Normanina tyloda* (komokiaceans), *Bulimina marginata*, *Nuttallides umbonatus*, *Epistominella exigua*, *Oridorsalis umbonatus* (calcareous). This list could be expanded substantially. Many of the undescribed komokiaceans are also familiar from areas such as the Porcupine Abyssal Plain in the NE Atlantic. The material collected during this cruise therefore supports the suggestion of Cornelius and Gooday (2004) that the foraminiferal faunas of the bathyal and abyssal Southern Ocean are typical for these habitats and exhibit a close affinity with those from the North Atlantic Ocean.

### Acknowledgements

Cruise participation by AJG and NC was supported by funds from the Core Strategic Project (BICEP) of the George Deacon Division, Southampton Oceanographic Centre (UK). TC was supported by the Danish Research Agency (Project number 95091435).

### References

- Aranda da Silva, A. S. S., Pawlowski, J. and A.J. Gooday (submitted): *Marine Biology*.
- Bowser, S.S., Marko, M., Bernhard, J.M., (1996): Occurrence of *Gromia oviformis* in McMurdo Sound. *Antarctic Journal of the United States*, 31: 122-124.
- Cornelius, N., Gooday, A. J. (2004): Live' (stained) deep-sea benthic foraminiferans in the western Weddell Sea: trends in abundance, diversity and taxonomic composition along a depth transect. *Deep-Sea Research II*, 51: 1571-1617.
- Gooday, A. J., Bowser, S. S. (in press): *Protist*.
- Gooday, A. J., Bett, B. J., Bowser, S. S., Smith, C. R. (2000): A large testate protist, *Gromia sphaerica* sp. nov. (Order Filosea), from bathyal Arabian Sea. *Deep-Sea Research II*, 47: 55-73.

### 9.1.3 Metazoan meiofauna communities in the Antarctic and Subantarctic deep sea

Armin Rose, Annika Henche  
FIS, Dept. DZMB

#### Objectives

Meiofaunal organisms, animals smaller than 1 mm but retained by sieves of 32 (resp. 40 or 63)  $\mu\text{m}$  mesh size, play a major role in Antarctic benthic ecosystems. They are not only important decomposers of detritus. By their often high density they have also a high potential as a food resource for larger organisms.

However, little is known about meiofaunal communities in the Antarctic and Subantarctic deep sea. Former expeditions (ANDEEP I, ANDEEP II) started to improve the situation (some published results for meiofauna: Cornelius & Gooday 2004, Fonseca *et al.* 2004, Gooday & Pawlowski 2004, Gooday *et al.* 2004, Gutzmann *et al.* 2004, Vanhove *et al.* 2004, Veit-Köhler 2004, Vermeeren *et al.* 2004), but had to concentrate on certain regions (see Brandt *et al.* 2004). ANDEEP III was initiated to complement the former ANDEEP I and II programmes in this respect.

One objective was to investigate the diversity of meiofaunal assemblages along gradients and stations in the Antarctic and Subantarctic deep sea, taking into account food availability and other factors. It is of interest which factors correlate strongest with meiofaunal major taxa abundance as well as harpacticoid species diversity. Furthermore, small scale vs. large scale diversity differences in the Antarctic and Subantarctic will be analysed. The results will complement those of former ANDEEP programmes as well as investigations conducted during former EASIZ programmes.

Another important objective was to complement a latitudinal transect along West African deep-sea basins (Angola Basin, Guinea Basin, Northern Cape Basin) taken by the DIVA 1 & 2 expeditions of RV *Meteor* (2000, 2005), towards the Southern Ocean (all DIVA and ANDEEP campaigns are part of CeDAMar (Census of the Diversity of Abyssal Marine Life) which again is part of the CoML (Census of Marine Life)). Therefore, one station in the Southern Cape Basin and another one south of it were sampled twice with a megacorer. A third station in the Weddell Basin was sampled by 5 megacorer deployments. Since the DIVA stations of the latitudinal transect were sampled in the same way (5 or more replicates), it is for the first time possible to receive information on deep-sea meiofaunal diversity at 3 different spatial scales (inter-core, inter-replicate, inter-station) along an equatorial to polar latitudinal transect. The analysis of all these samplings will greatly contribute to the assessment of the overall deep-sea diversity.



### Work at sea

At the transect from Cape Town to NEUMAYER, 3 stations (PS67/16, PS67/21, PS67/59) were sampled quantitatively with a megacorer (MUC10; see Rose *et al.* this volume). This gear had to be taken for comparative purposes, since the same methodology had to be used as with DIVA 1 and 2 expeditions (see objectives). One of these stations (PS67/59, Weddell Basin) was sampled by 5 replicated megacorer hauls, the other stations by 2 replicated hauls each. At all Cape Town to NEUMAYER transect stations the rinse water was sieved with 40 µm mesh size for comparability with DIVA samplings. MUC deployment PS67/21-4 was considered as semi quantitative sampling; the gear came up in a horizontal position due to wire problems, which caused disturbance of the cores.

At Kapp Norvegia, meiofauna was sampled quantitatively at stations PS67/78, PS67/80, and PS67/81. At these and all following stations sampling took place with the smaller multicorer (MUC6; see Rose *et al.* in this volume) and the rinse water was sieved with 32 µm mesh size, for comparability with the multicorer stations of former ANDEEP campaigns.

Furthermore, meiofauna was collected with the MUC6 at the Central Weddell Sea stations PS67/88, PS67/94, PS67/102, PS67/110 and PS67/121, and at stations PS67/142, PS67/150 and PS67/151 in the Powell Basin. Additional stations were sampled in the Bransfield Strait (PS67/152) and west of Anvers Island (PS67/153, PS67/154).

The received MUC cores were sliced at least to 5 cm depth (more layers optional, see table 1), and the upper layer(s) fixed with 5 % formalin on board.

Table 9.4 gives an overview on all MUC samplings that are stored at Senckenberg Research Institute (FIS), Dept. DZMB (Wilhelmshaven, Germany). Most of these, as well as additional samplings that are to be sorted out by RU Ghent (not shown in table 9.4; see De Mesel & Ingels, this volume), will be shared between DZMB (Harpacticoida) and RUG (Nematoda).

All quantitative MUC samplings shown in table 1 (81 cores) will be sorted out and quantified to major taxa level at DZMB after the expedition. The sorted material will be made available to other institutes for systematic, biogeographic and other analysis on request. Harpacticoid copepods will remain at the DZMB for further investigation.

Additional qualitative meiofauna samplings (table 9.4) were taken by sieving (40 µm) water and sediment from elutriated macrofauna cores (formerly sieved with 250 µm) from the MUC6 and MUC10. Further material was taken from the giant box corer (GKG), as well as by sorting out copepods from the epibenthic sledge (EBS) and Agassiz Trawl (AGT). These samplings were fixated with 70-80 % ethanol or 5 % formaldehyde and partly investigated at major taxa level on board.

**Table 9.4:** ANDEEP III deep-sea stations with quantitative, semiquantitative, or qualitative meiofauna samplings to be stored at and investigated by DZMB, Wilhelmshaven (MUC10, MUC6: see Rose *et al.*, this volume; fractions: w = water sieved, w1 = water and first cm, w5 = water and first 5 cm, others = depth in cm); see [fig. 9.2](#) in Rose *et al.* (this volume) for tube positions (Tube #).

Station	Date	Position		Dep.	Gear	Tube	Sample	Fraction(s)
PS67/16-5	25.01.05	41° 07.51' S	9° 56.30' E	4713	GKG	-	qual.	w
PS67/16-6	25.01.05	41° 07.61' S	9° 56.05' E	4695	MUC1 0	1,4,5	quant.	w,1,2,3,5,10, 15
PS67/16-8	25.01.05	41° 07.82' S	9° 56.11' E	4702	MUC1 0	2	quant.	w,1,2,3,5,10, 15
PS67/16-8	25.01.05	41° 07.82' S	9° 56.11' E	4702	MUC1 0	3,6	quant.	w,1,5,10,15
PS67/21-4	29.01.05	47° 40.00' S	4° 15.13' E	4524	MUC1 0	1,5	semiqua nt.	w5,10,15
PS67/21-5	29.01.05	47° 39.37' S	4° 15.65' E	4530	GKG	-	qual.	w
PS67/21-6	29.01.05	47° 39.36' S	4° 15.66' E	4529	MUC1 0	5	quant.	w,1,2,3,5,10, 15
PS67/21-6	29.01.05	47° 39.36' S	4° 15.66' E	4529	MUC1 0	1,4	quant.	w,1,5,10,15
PS67/21-6	29.01.05	47° 39.36' S	4° 15.66' E	4529	MUC1 0	6	qual.	w5
PS67/59-4	14.02.05	67° 30.99' S	0° 00.16' E	4590	MUC1 0	1	quant.	w1,5,10,15
PS67/59-4	14.02.05	67° 30.99' S	0° 00.16' E	4590	MUC1 0	2,3,5,6	quant.	w5
PS67/59-5	14.02.05	67° 29.74' S	0° 01.93' E	4655	EBS	-	qual.	supra-net
PS67/59-6	14.02.05	67° 29.61' S	0° 02.19' E	4655	GKG	-	qual.	surface
PS67/59-7	14.02.05	67° 31.10' S	0° 00.11' E	4572	GKG	-	qual.	surface
PS67/59-7	14.02.05	67° 31.05' S	0° 00.27' E	4591	MUC1 0	2	quant.	w1,5,10,15
PS67/59-7	14.02.05	67° 31.05' S	0° 00.27' E	4591	MUC1 0	3,4,5,6	quant.	w5
PS67/59-7	14.02.05	67° 31.05' S	0° 00.27' E	4591	MUC1 0	8	qual.	w5
PS67/59-9	15.02.05	67° 30.99' S	0° 00.02' E	4592	MUC1 0	7	quant.	w1,5,10,15
PS67/59-9	15.02.05	67° 30.99' S	0° 00.02' E	4592	MUC1 0	2,3,4,8	quant.	w5
PS67/59-11	15.02.05	67° 30.96' S	0° 00.02' E	4588	MUC1 0	5	quant.	w1,5,10,15
PS67/59-11	15.02.05	67° 30.96' S	0° 00.02' E	4588	MUC1 0	4,6,7,8	quant.	w5
PS67/59-13	16.02.05	67° 30.91' S	0° 00.02' E	4588	MUC1 0	8	quant.	w1,5
PS67/59-13	16.02.05	67° 30.91' S	0° 00.02' E	4588	MUC1 0	2,3,4,7	quant.	w5
PS67/59-13	16.02.05	67° 30.91' S	0° 00.02' E	4588	MUC1 0	1,5	qual.	w
PS67/78-5	21.02.05	71° 09.38' S	13° 59.94' W	2102	MUC6	12	qual.	w5
PS67/78-6	21.02.05	71° 09.45' S	14° 00.32' W	2121	GKG	-	qual.	water, surface
PS67/78-8	21.02.05	71° 09.48' S	14° 00.12' W	2107	MUC6	2,4,12	quant.	w5
PS67/78-9	21.02.05	71° 09.39' S	13° 59.30' E	2156	EBS	-	qual.	supra-net
PS67/80-4	22.02.05	71° 09.36' S	13° 58.81' E	2147	EBS	-	qual.	supra-net
PS67/80-4	22.02.05	70° 39.32' S	14° 43.51' W	3031	MUC6	12	qual.	w5
PS67/80-5	22.02.05	70° 39.32' S	14° 43.51' W	3035	GKG	-	qual.	w,surface
PS67/80-7	22.02.05	70° 39.32' S	14° 43.51' W	3032	MUC6	1	qual.	w5

9. INTRODUCTION TO ANDEEP: ANTARCTIC BENTHIC DEEP-SEA BIODIVERSITY

Station	Date	Position		Dep.	Gear	Tube	Sample	Fraction(s)
PS67/80-9	23.02.05	70° 39.07' S	14° 43.36' E	3103	EBS	-	qual.	epi-net
		70° 39.22' S	14° 43.39' E	3102				
PS67/81-4	23.02.05	70° 31.49' S	14° 34.95' W	4351	MUC6	1	qual.	w5
PS67/81-5	23.02.05	70° 31.59' S	14° 35.05' W	4335	GKG	-	qual.	surface
PS67/81-6	23.02.05	70° 31.53' S	14° 35.07' W	4353	MUC6	2	quant.	w5
		70° 32.02' S	14° 35.05' E	4392				
PS67/81-8	24.02.05	70° 32.19' S	14° 35.13' E	4385	EBS	-	qual.	epi-, supra-net
		70° 32.19' S	14° 35.13' E	4385				
PS67/88-5	26.02.05	68° 03.68' S	20° 27.75' W	4872	GKG	-	qual.	surface
PS67/88-6	26.02.05	68° 03.68' S	20° 27.68' W	4868	MUC6	2	qual.	w5
PS67/88-12	27.02.05	68° 03.63' S	20° 27.98' W	4866	MUC6	7	quant.	w1,5,10,15
PS67/88-12	27.02.05	68° 03.63' S	20° 27.98' W	4866	MUC6	8,9	quant.	w1,3,5,10,15
PS67/94-5	01.03.05	66° 37.43' S	27° 09.77' W	4830	MUC6	6	quant.	w5,10,15
PS67/94-5	01.03.05	66° 37.43' S	27° 09.77' W	4830	MUC6	1,5	quant.	w1,3,5,10,15
PS67/94-7	02.03.05	66° 37.37' S	27° 09.78' W	4830	MUC6	10	quant.	w5,10,15
PS67/94-7	02.03.05	66° 37.37' S	27° 09.78' W	4830	MUC6	8,9	quant.	w1,3,5,10,15
PS67/94-9	02.03.05	66° 37.47' S	27° 09.82' W	4831	MUC6	8	quant.	w5,10,15
PS67/94-9	02.03.05	66° 37.47' S	27° 09.82' W	4831	MUC6	9,1	quant.	w1,3,5,10,15
PS67/102-7	06.03.05	65° 34.39' S	36° 31.21' W	4738	MUC6	8	quant.	w5,10,15
PS67/102-7	06.03.05	65° 34.39' S	36° 31.21' W	4738	MUC6	7,9	quant.	w1,3,5,10,15
PS67/102-8	06.03.05	65° 34.37' S	36° 30.93' W	4734	GKG	-	qual.	surface
PS67/102-9	06.03.05	65° 34.40' S	36° 31.07' W	4738	MUC6	7	quant.	w5,10,15
PS67/102-9	06.03.05	65° 34.40' S	36° 31.07' W	4738	MUC6	8,9	quant.	w1,3,5,10,15
PS67/110-4	10.03.05	64° 59.95' S	43° 01.97' W	4627	MUC6	7,12	quant.	w1,3,5,10,15
PS67/110-5	10.03.05	64° 59.97' S	43° 01.97' W	4635	GKG	-	qual.	surface
PS67/110-6	10.03.05	64° 59.98' S	43° 02.00' W	4628	MUC6	4	quant.	w5,10,15
PS67/110-6	10.03.05	64° 59.98' S	43° 02.00' W	4628	MUC6	5,6	quant.	w1,3,5,10,15
PS67/121-6	14.03.05	63° 39.01' S	50° 44.23' W	2577	MUC6	7	quant.	w5,10,15
PS67/121-6	14.03.05	63° 39.01' S	50° 44.23' W	2577	MUC6	12	quant.	w1,3,5,10,15
		63° 34.92' S	50° 41.97' E	2616				
PS67/121-7	14.03.05	63° 34.65' S	50° 41.68' E	2617	AGT	-	qual.	-
		63° 39.01' S	50° 44.23' W	2557				
PS67/12110	15.03.05	63° 39.01' S	50° 44.23' W	2557	GKG	-	qual.	surface
PS67/142-7	18.03.05	62° 11.61' S	49° 29.45' W	3343	GKG	-	qual.	surface
PS67/150-2	20.03.05	61° 48.59' S	47° 27.45' W	1888	MUC6	1,12	quant.	w1,3,5
PS67/150-2	20.03.05	61° 48.59' S	47° 27.45' W	1888	MUC6	2	quant.	w5
PS67/150-3	20.03.05	61° 48.63' S	47° 27.67' W	1897	GKG	-	qual.	surface
PS67/150-8	20.03.05	61° 48.56' S	47° 27.48' W	1884	MUC6	5,6	quant.	w1,3,5
PS67/150-8	20.03.05	61° 48.56' S	47° 27.48' W	1884	MUC6	1	quant.	w5
PS67/150-8	20.03.05	61° 48.56' S	47° 27.48' W	1884	MUC6	10,12	qual.	surface
PS67/151-4	21.03.05	61° 45.50' S	47° 07.57' W	1144	GKG	-	qual.	surface
PS67/151-5	21.03.05	61° 45.55' S	47° 07.52' W	1140	MUC6	11	qual.	surface
PS67/151-8	21.03.05	61° 45.67' S	47° 07.23' W	1130	MUC6	2	qual.	surface
PS67/152-2	23.03.05	62° 19.95' S	57° 54.00' W	1931	MUC6	11,12	quant.	w1,3,5,10,15
PS67/152-2	23.03.05	62° 19.95' S	57° 54.00' W	1931	MUC6	10	quant.	w5,10,15
PS67/152-3	23.03.05	62° 19.98' S	57° 54.02' W	1931	GKG	-	qual.	surface
PS67/152-4	23.03.05	62° 19.98' S	57° 54.00' W	1931	MUC6	7,8	quant.	w1,3,5,10,15
PS67/152-4	23.03.05	62° 19.98' S	57° 54.00' W	1931	MUC6	9	quant.	w5,10,15
PS67/153-4	29.03.05	63° 19.35' S	64° 36.79' W	2032	GKG	-	qual.	surface
PS67/153-5	29.03.05	63° 19.41' S	64° 36.82' W	1928	MUC6	4	quant.	w1,3,5,10,15
PS67/153-5	29.03.05	63° 19.41' S	64° 36.82' W	1928	MUC6	5	quant.	w5,10,15
PS67/154-4	30.03.05	62° 31.46' S	64° 39.42' W	3753	GKG	-	qual.	surface

### **Preliminary results and discussion**

Preliminary results are only available for some qualitative and semiquantitative samplings (table 9.5). Although numbers of specimens are shown for many taxa, these counts will not be representative for the meiofauna community as a whole. Especially for the MUC cores formerly sieved by 250 µm only a very small size fraction of organisms is retained by sieving with 40 µm mesh size (which was done with all qualitative samplings). In contrast, the GKG samplings contain the whole meiofauna size spectrum, but cannot be put in relation to certain quantities of sediment. Nevertheless, the countings may give an impression of the dominance of certain meiofaunal taxa.

Nematodes turned out to be the dominating meiofaunal major taxon in most of the investigated samplings (except for EBS samplings). This is not surprising, since this group is known to dominate the meiofauna in Antarctic deep-sea and shallow-water multicorer, multigrap, and boxcorer samplings (e.g., Dahms *et al.* 1990, Gutzmann *et al.* 2004, Herman & Dahms 1992, Lee *et al.* 2001a, 2001b, Vanhove *et al.* 1995, 1998, 2004).

Copepods are also quite abundant in most samplings, even though they do not reach the same level of dominance as the nematodes. This finding is also consistent with results presented in the literature mentioned above. Cerviniidae were found in most investigated EBS samplings. This was to be expected, since this group is known to occur in supra- and epinet catches (George, pers. comm.).

Less abundant taxa in the samplings were Monobryozoa, Kinorhyncha, Priapulida, Loricifera, Bivalvia, Polychaeta, Tardigrada, Ostracoda, Amphipoda, Cumacea, and Isopoda.

Other major taxa with possible meiofaunal representatives were shown to live in Antarctic waters in literature (e.g., Dahms *et al.* 1990, Vanhove *et al.* 1995, Gutzmann *et al.* 2004), but were yet not found in the few investigated MUC and GKG samplings. These are Porifera, Hydrozoa, Turbellaria, Echinodermata, Tunicata, Gastrotricha, Rotifera, Gastropoda, Halacarida, Tanaidacea, Tantulocarida, Euphausiacea, and Sipunculida.

It is of special interest that the phylum Loricifera, described about 20 years ago (by other authors treated as a class of Aschelminthes) (Kristensen 1983), which was for the first time recorded for the southern hemisphere by Herman & Dahms (1992), and later-on shown to live in the Antarctic deep sea in considerable numbers (Vanhove *et al.* 1995, Gutzmann *et al.* 2004), was for the third time sampled from this habitat during ANT-XXII/3 expedition of RV *Polarstern*.

**Table 9.5:** Metazoan major taxa distribution in some investigated semiquantitative and qualitative samplings during ANDEEP III campaign (p = partim; sq = semiquantitative sampling [rest qualitative samplings]; sup = supra-net; epi = epi-net; w = water sieved).

Region	Cape Town - NEUMAYER		Weddell Sea (Kapp Norvegia)						Weddell Sea (abyssal plain)		
	Gear	MUC10	GKG	MUC6	GKG	EBS	EBS	EBS	EBS	EBS	MUC10
Sampling Station	Sq	W		p	sup	epi	epi	sup	sup	59-7	121-7
MUC Tube #	21-4	21-5	78-5	78-6	78-9	80-9	81-8	81-8	59-5	8	
<b>Bryozoa</b>	+			+							
<b>Nematoda</b>	>> 206	40	87	1076						49	
<b>Kinorhyncha</b>				14							
<b>Priapulida</b>				3							
<b>Loricifera</b>				1							
<b>Bivalvia</b>	1			+							
<b>Annelida</b>	15			16							
<b>Tardigrada</b>				1							
<b>Acari</b>	1										
<b>Ostracoda</b>	4	2	1	+							
<b>Copepoda (adults, copepodids)</b>	76	8	5	153	1	20	12	6	17	6	5
Calanoida	1	1			1	19	11	4	13		5
Harpacticoida:											
Cerviniidae						1	1	2	4		
<i>Pontostratiotes</i> )											
Ectinosomatidae				+							
cf. Harpacticidae	+	+	+	+						+	
cf. Laophontidae	+			+						+	
Paramesochridae											
cf. Tisbidae	+									+	
Nauplii	41	6		81						17	
<b>Amphipoda</b>				1							
<b>Cumacea</b>				1							
<b>Isopoda (total)</b>	1			1							
Cryptoniscidae larva	1										
<b>others</b>	≥ 5			3						10	

**References**

- Brandt, A., De Broyer, C., Gooday, A.J., Hilbig, B. and M.R.A. Thomson (2004): Introduction to ANDEEP (ANtarctic benthic DEEP-sea biodiversity: colonization history and recent community patterns) — a tribute to Howard L. Sanders. - *Deep-Sea Research II*, 51: 1457-1465.
- Cornelius, N. and A.J. Gooday (2004): 'Live' (stained) deep-sea benthic foraminiferans in the western Weddell Sea: trends in abundance, diversity and taxonomic composition along a depth transect. - *Deep-Sea Research II*, 51: 1571-1602.
- Dahms, H.-U., Herman, R. L. and E. Schockaert (1990): Meiobenthos on the Halley Bay and Kapp Norvegia transects. - *Berichte zur Polarforschung* 68: 91-96.
- Fonseca, G., Vanhove, S. and A. Vanreusel (2004): Free-living nematodes from the South Sandwich Trench, with special attention to the biodiversity of the genera *Molgolaimus* and *Manganonema*. - Master's Thesis, Ghent University.
- Gooday, A. J., Holzmann, M., Guiard, J., Cornelius, N. and J. Pawlowski (2004): A new monothalamous foraminiferan from 1000 to 6300m water depth in the Weddell Sea: morphological and molecular characterisation. - *Deep-Sea Research II*, 51: 1603-1616.
- Gooday, A.J. and J. Pawlowski (2004): *Conqueria laevis* gen. & sp. nov., a new soft-walled, monothalamous foraminiferan from the deep Weddell Sea. - *Journal of the Marine Biological Association of the United Kingdom* 84: 919-924.
- Gutzmann, E., Martínez Arbizu, P., Rose, A. and G. Veit-Köhler (2004): Meiofauna communities along an abyssal depth gradient in the Drake Passage. - *Deep-Sea Research II*, 51: 1617-1628.
- Herman, R. L. and H.-U Dahms (1992): Meiofauna communities along a depth transect of Halley Bay (Weddell Sea - Antarctica). - *Polar Biology* 12: 313-320.
- Kristensen, R. M. (1983): Loricifera, a new phylum with Aschelminthes characters from the meiobenthos. - *Zeitschrift für zoologische Systematik und Evolutions-Forschung* 21: 163-180.
- Lee, H. J., Gerdes, D., Vanhove, S. and M. Vincx (2001a): Meiofauna response to iceberg disturbance on the Antarctic continental shelf at Kapp Norvegia (Weddell Sea). - *Polar Biology* 24: 926-933.
- Lee, H.J., Vanhove, S., Peck, L.S. and M. Vincx (2001b): Recolonisation of meiofauna after catastrophic iceberg scouring in shallow Antarctic sediments. - *Polar Biology* 24: 918-925.
- Vanhove, S., Wittoeck, J., Desmet, G., van den Berghe, B., Herman, R.L., Bak, R.M., Nieuwland, G., Vosjan, J.H., Boldrin, A., Rabitti, S. and M. Vincx (1995): Deep-sea meiofauna communities in Antarctica: structural analysis and relation with the environment. - *Marine Ecology Progress Series* 127: 65-76.
- Vanhove, S., Lee, H.J., Beghyn, M., v. Gansbeke, D., Brockington, S. and M. Vincx (1998): The Metazoan Meiofauna in its Biogeochemical environment: The case of an Antarctic Sediment. - *Journal of the Marine Biological Association of the U.K.* 78: 411-434.

- Vanhove, S. Vermeeren, H. and A. Vanreusel (2004): Meiofauna towards the South Sandwich Trench (750–6300 m), focus on nematodes. - Deep-Sea Research II, 51: 1665-1687.
- Veit-Köhler, G. (2004): *Kliopsyllus andeep* sp. n. (Copepoda: Harpacticoida) from the Antarctic deep sea—a copepod closely related to certain shallow-water species. - Deep-Sea Research II, 51: 1629-1641.
- Vermeeren, H., Vanreusel, A. and S. Vanhove (2004): Species distribution within the free-living marine nematode genus *Dichromadora* in the Weddell Sea and adjacent areas. - Deep-Sea Research II, 51: 1643-1664.

#### **9.1.4 Biogeography, diversity and feeding ecology of metazoan meiobenthos in the Antarctic deep-sea, with emphasis on free-living nematodes**

Ilse De Mesel & Jeroen Ingels  
Marine Biology Section – Ghent University

##### **Objectives**

Free-living marine nematodes are generally the most abundant and diverse metazoan component of the meiofauna (32µm - 1mm) in marine environments. In the deep sea they become increasingly important in terms of abundance and species richness in comparison to other taxa.

While the meiobenthic community in shallow Antarctic water has already been studied, the deep-sea fauna of the Southern Ocean is still largely unknown. Until recently, the deepest stations sampled were at 2000 m water depth along a transect off Kapp Norvegia and off Halley Bay. The ANDEEP sampling programme offered a unique opportunity to explore the fauna in bathyal and abyssal Antarctic sediments.

Our aims in the study of the Antarctic deep-sea meiobenthic communities are (1) to get an idea of community composition and biodiversity (alpha diversity) at different depths in the Southern Ocean, (2) to relate the biodiversity patterns and occurrence of genera and species to environmental, bathymetrical and geographical characteristics, (3) to estimate species turn-over (beta diversity) by comparing the communities from the different sites sampled during the ANDEEP campaigns, (4) to compare Antarctic deep-sea diversity with other bathyal and abyssal areas, (5) to perform molecular analysis on some of the dominant taxa in order to get a preliminary idea on the genetic radiation and to compare between different sites and (6) to gain information on the feeding ecology of the benthic community.

##### **Work at sea**

Of the 2 or 3 drops performed at each site (see Rose *et al.*, this volume), generally 3 cores per drop were sliced: one (0-1 cm, 1-3 cm, 3-5 cm, 5-10 cm and 10-15 cm) was preserved on formaldehyde for meiofaunal analysis, one (0-1 cm, 1-2 cm, 2-3 cm, 3-4 cm and 4-5 cm) was preserved in acetone for molecular analysis, and one (0-0.5 cm, 0.5-1 cm, 1-2cm, 2-3 cm, 3-4cm and 4-

5 cm, 5-10 cm and 10-15 cm) was frozen at -30°C and will be used for organic carbon, grain size and pigment analysis.

At the 2000-m station along the Kapp Norvegia transect and station PS67/81 in the Weddell Sea (4700 m) focus was put on the feeding ecology of the benthic fauna. Samples were collected in order to study so called biomarkers (stable isotopes and fatty acids), which allow, to a certain extent, diet reconstruction. Additionally, natural benthic communities were incubated with either <sup>13</sup>C labelled bacteria or <sup>13</sup>C labelled diatoms. After sorting the samples in the laboratory, uptake of the label by different benthic groups can be analysed. We assume a rather diatom based food web in the shallower station, and a more bacterial based one in the deepest station. At each site, 3 drops with the multicorer were performed. From each drop, 4 cores were sliced (0-1 cm, 1-2 cm, 2-3 cm, 3-4 cm and 4- 5cm), of which one was preserved in formaldehyde for community analysis, and three were frozen: one for environmental parameters (organic carbon, grain size, pigments), one for stable isotope analysis and one for fatty acid analysis. From each drop, 6 cores were incubated at 1°C ± 1°C. In total 18 cores were obtained at each depth; half of them were inoculated with <sup>13</sup>C labelled diatoms, the other half with <sup>13</sup>C labelled bacteria. The experiment was run for 14 days, in this period samples were taken 3 times (after 1, 7 and 14 days). At each sampling occasion, 3 replicates (cores) of each treatment were sliced (0-1 cm, 1-2 cm, 2-3cm, 3-4 cm and 4-5 cm) and preserved at -30°C.

### **9.1.5 Morphological and genetic studies on Antarctic Ostracoda**

Simone N. Brandão  
Zoological Institute and Zoological Museum Hamburg

#### **Objectives**

The aims of the present study are:

1. to collect qualitatively the Ostracoda specimens, record the taxa occurring in the sampled area, describing the new ones; 2. to contribute to the knowledge about the ostracod soft-part morphology, by describing the appendages and genitalia of the different taxa; 3. to analyse the possible environmental characteristics influencing their distribution; 4. to compare deep and shallow ostracod faunas around Antarctica; 5 to extract DNA for population and phylogenetic studies (in the last case, of the Infraorder Cypridocopina).

#### **Work at sea**

Because the objective of this work was collecting Ostracoda for both morphological and genetic studies, different chemicals were used to fixate the animals. First, the live specimens sorted from box corer, multicorer, epibenthic sledge and Agassiz trawl samples were preserved in 2.5% glutaraldehyde. This chemical was used, in spite of its high toxicity, because it provides the best results for electron microscopy. For the genetic study, the EBS material was used (fixation in pre-cooled ethanol, see Brandt & Hilbig, this volume). The work



on board also included a preliminary identification of the Ostracoda (see tables 9.6 and 9.7). In addition to the morphological work, the DNA from 24 specimens was extracted for population and phylogenetic analyses (table 9.6).

### **Preliminary Results**

Until now 35 samples provided ostracod specimens: 14 from EBS, 7 from GKG, 4 from multicorer and 10 from the Agassiz Trawl. The material analysed until now consisted on approximately 1000 live specimens and more than 100 empty valves. More than 60 species, contained in at least 16 families are recorded (see tables 9.7 and 9.8). The family Macrocyprididae Müller, 1912 was both the most speciose (8 species) and most abundant (about 30% of the specimens). Together the paraphyletic families Hemicytheridae Puri, 1953 and Tracyleberididae Sylvester-Bradley, 1948 also include approximately 30% of the specimens and at least 14 species. In addition to that, the ANDEEP III material provides the first record of recent species of the Order Platycopida from Antarctica, previously only one platycopid species was recorded from the Mesozoic of King George Island.

When compared to the more than 200 species recorded from the Antarctic shallow waters (Kornicker 1993, Hartmann 1997), the number of species recorded herein is low. On the other hand side, the work in shallow waters has involved until now a much greater effort than the one in the deeper regions. Furthermore, comparing the present results to the only comprehensive publication on live (= with soft parts) deep-sea ostracods, the area sampled herein is much less speciose than the Challenger Plateau (Tasman Sea) and the Campbell Plateau (Southern Ocean), New Zealand, were Jellinek and Swanson (2003) recorded "some 150 species of about 40 genera". It might be related to the fact that the Weddell Sea is a highly oligotrophic region. Similarly, as discussed by Jellinek and Swanson (2003), although most of the previous studies on ostracods involve material collected by corers, the EBS provided more than 86% of the ostracod specimens containing soft parts, suggesting that this gear might be more efficient for sampling ostracods.

Most of the species found in the ANDEEP III material differ from that previously recorded from shallow Antarctic waters (Hartmann 1997), indicating a shift between shallow and deep water fauna around Antarctica. The exceptions are the three shallowest stations (#57, 1812 m; #74, 1408 m, #133, 1582 m), which provided species typical of the Antarctic shelf. This indicates that the depth where the shift on the ostracod fauna occurs might not be shallower than 1800 m. In addition, at least 16 of the species found on ANDEEP III were not present in the ANDEEP I and II material, which indicates that the ostracod species number occurring in the deep Weddell Sea was underestimated before the ANDEEP III cruise.

## References

- Hartmann, G. (1997): Antarctic and subantarctic Podocopa (Ostracoda). *Theses Zoologicae* 26, 1-355.
- Jellinek, T. and M. Swanson (2003): Report on the taxonomy, biogeography and phylogeny of mostly living benthic Ostracoda (Crustacea) from deep-sea samples (Intermediate Water depths) from the Challenger Plateau (Tasman Sea) and Campbell Plateau (Southern Ocean), New Zealand. *Abhandlungen der Senckenbergischen Naturforschenden Gesellschaft* 558, 1-329.
- Kornicker, L.S. (1993): Antarctic and subantarctic Myodocopina (Ostracoda). *Theses Zoologicae* 22, 1-81.

**Table 9.6:** Species found on the samples analysed and their code number

N.	Taxon	N.	Taxon
1	cf. <i>Leguminocythereis</i> sp. 1	85	<i>Abyssocypris</i> sp. 85
2	Trachyleberididae sp. 2	86	Pontocyprididae sp. 86
3	cf. <i>Bradleya</i> sp. 3	87	Xestoleberididae sp. 87
5	<i>Macrosclapha opaca</i> Maddocks, 1990	88	Cytheroidea sp. 88
6	Krithidae spp. 6	89	Myodocopida sp. 89
7	Halocyprida spp. 7	90	Myodocopida sp. 90
8	Platycopida sp. 8	91	cf. Trachyleberididae sp. 91
15	cf. <i>Henryhowella</i> sp. 15	92	cf. Hemicytheridae sp. 92
19	<i>Macromckenziea glaciera</i> Maddocks, 1990	93	cf. <i>Vargula sutura</i> sp. 93
22	<i>Macrosclapha tensa</i> (G. W. Müller, 1908)	94	cf. Hemicytheridae sp. 94
23	Myodocopa spp. 23	95	cf. Hemicytheridae sp. 95
26	Xestoleberididae spp. 26	96	cf. <i>Anchistrocheles</i> sp. 96
31	<i>Macromckenziea</i> sp. nov. 31	97	Cypridinidae sp. 97
36	<i>Macrosclapha turbida</i> (Müller, 1908) (a)	98	Bairdioidea sp. 98
38	<i>Macrosclapha inaequalis</i> (Müller, 1908)	99	Bairdioidea sp. 99
40	Thaumatocyprididae spp. 40	100	Bairdioidea sp. 100
41	Polycopidae spp. 41	101	Bairdioidea sp. 101
46	Cylindroleberididae sp. 46	102	Macrocyprididae sp. 102
49	Cylindroleberididae sp. 49	103	Myodocopa sp. 103
61	cf. Cytherootherinae sp. 61	104	Hemicytheridae sp. 104
64	Sarsiellidae sp. 64		
67	cf. Cytherootherinae sp. 67		
68	Bairdioidea sp. 68		
69	cf. <i>Trachyleberis</i> sp. 69		
71	cf. <i>Bythoceratina</i> sp. 71		
72	Macrocyprididae sp. 72		
74	cf. Pontocyprididae sp. 74		
75	cf. Trachyleberididae sp. 75		
77	cf. Trachyleberididae sp. 77		
79	<i>Leguminocythereis</i> sp. 79		
81	<i>Anchistrocheles</i> sp. 81		
82	Macrocyprididae sp. 82		
83	Hemicytheridae sp. 83		
84	Pontocyprididae sp. 84		





**Table 9.8:** Specimens with DNA extracted

Station	Depth (m)	Specimen
16 - 11	4727	Macrocyprididae sp. 82: (DNA 18, SNB 0115).
74 - 6 - E	1048	<i>Macroscapha turbida</i> : (DNA 1, SNB 0098); (DNA 2, SNB 0099); (DNA 12, SNB 0109). <i>Macroscapha opaca</i> : (DNA 3, SNB 0100); (DNA 5, SNB 0102); (DNA 6, SNB 0103); (DNA 7, SNB 0104); (DNA 11, SNB 0108). <i>Macromckenziea glaciera</i> : (DNA 23, SNB 0120).
78 - 6	2168	Krithidae sp. 6: (DNA 4 SNB 0101).
78 - 8	2165	Krithidae sp. 6 (DNA 0, SNB 0097).
78 - 9 - S	2185	<i>Macroscapha tensa</i> : (DNA 19, SNB 0116); (DNA 20, SNB 0117).
78 - 9	2185	<i>Macroscapha tensa</i> : (DNA 10, SNB 0107).
81 - 8 - E	4420	Macrocyprididae sp. 102: (DNA 21, SNB 0118).
81 - 8 - S	4420	Macrocyprididae sp. 102: (DNA 16, SNB 0113). Macrocyprididae sp. 72: (DNA 17, SNB 0114).
94 - 10	4893	Pontocyprididae sp. 74: (DNA 8 SNB 0105 ). <i>Abyssocypris</i> sp. 85: (DNA 9 SNB 0106).
102 - 13	4818	Bairdioidea sp. 101: (DNA 13, SNB 0110).
110 - 8	4696	Bairdioidea sp. 101: (DNA 14, SNB 0111). Trachyleberididae sp. 83: (DNA 15, SNB 0112).
121 - 7	2603	<i>Macroscapha turbida</i> : (DNA 22, SNB 0119).

## 9.2 Macrobenthos

### 9.2.1 Introduction to work at sea

Angelika Brandt<sup>1</sup>, Brigitte Hilbig<sup>2</sup>

<sup>1</sup>Zoological Institute and Zoological Museum Hamburg

<sup>2</sup>Ruhr University of Bochum

The biodiversity of benthic macroinvertebrates in the Southern Ocean deep sea will be investigated during ANDEEP III on the basis of 19 samples taken with the epibenthic sledge (EBS) (stations PS 67-16-10; -21-7; -59-5; -74-6; -78-9; -80-9; -81-8; -88-8; 94-14, 102-13, 110-8, 121-11, 133-2, 142-5, 150-6, 151-7, 152-6, 153-7, 154-9) and 27 samples taken with the 0.25 m<sup>2</sup>-box corer (GKG).

On most of these stations the following additional gear was employed: CTD, a sediment profile imaging system (SPI), Agassiz trawl (AGT), and the multicorer (MUC). Systematic sampling of the scavenger component of these communities was done by baited amphipod traps (AT) (for details see station list).

## EBS

The epibenthic sledge (EBS) was successfully employed at all 19 stations. While the epibenthic sampler extends from 27 to 60 cm above the seafloor, the suprabenthic sampler (fixed on the top of the epibenthic box; figure 9.3) extends from 100 to 133 cm above the bottom. A plankton net is attached to each sampler, of 0.5 mm mesh size for the epinet and supranet and 0.3 mm for the cod ends. When the sledge touches the seafloor, a shovel fixed to the box door of the epibenthic sampler opens both boxes. The doors are closed mechanically when the sledge leaves the bottom

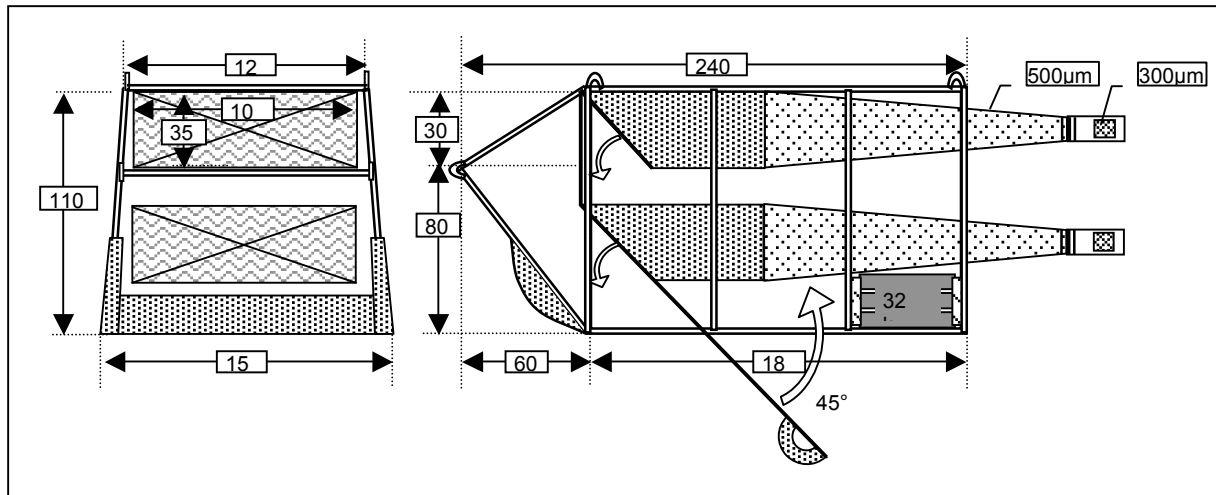

Fig. 9.3: Schematic illustration of the epibenthic sledge (Nils Brenke, University of Bochum)

After lowering with 1 m/sec (ship stops until the EBS reaches the ground, then the ship speed compensates for the lowering in order to lay the wire straight in front of the gear on the ground) to 1.5 cable length to water depth, the sledge was hauled over the ground for 10 min at a mean velocity of 1 kn. Afterwards the ship stopped and holstering was done with  $-0.7$  m/sec until the EBS had left the ground, then it was holstered with  $-1$  m/sec until it reached the deck of RV *Polarstern*. The haul distances were calculated from the time the sledge travelled on the ground while heaving ( $0.7$  m/sec) had to be added after the ship stopped. The tension meter of the winch indicated when the gear left the ground. Haul lengths varied from 1183 to 3488 m; for the comparative analysis the data will be standardised to 1000-m hauls, equivalent to a bottom area of 1000 m<sup>2</sup> sampled by the sledge. In total, 44.852 m<sup>2</sup> ocean bottom were sampled. On deck the complete samples were immediately transferred into pre-cooled 96% ethanol and kept at least for 48 h in  $-20^{\circ}\text{C}$  for DNA extraction. First extractions of DNA have already been done on board. Specimens were partly sorted on board, and sorting will be completed later in the laboratory in the Zoological Museum of the University of Hamburg. Peracarid species will then be sorted and identified.

**GKG**

The box corer (GKG) was successfully, or at least partly successfully, deployed at 15 stations (table 9.9) covering a depth range from roughly 1000 to 4900 m. At approximately 50 m off the bottom, the winch was stopped for about a minute, the wire tension noted, and the box corer was then lowered onto the sea floor at a lower speed, usually 0.5 m/sec, in very soft bottom 0.3 m/sec. The winch was stopped when the wire was slackening and after a very short time on the bottom the box corer was retrieved with 0.5 m/sec, in very soft bottom 0.7 m/sec to create the necessary tension to close the box. At 50 m off the bottom, the winch was again stopped to check the added weight, and if the wire tension indicated a successful sampling it was brought back on deck. In case of no weight increase, it was lowered once again and then pulled back on deck.

Contrary to earlier plans, the vegematic boxes were not used, but the box was deployed undivided and the necessary number of 10x10-cm subcores were pushed into the sample on deck. This method was used to avoid damage of the subcores by dropstones which were present at nearly all locations while taking advantage of the gentle processing facilitated by the usage of subcores. Samples were removed from the box in the following sequence:

**Table 9.9:** Box corer stations and remarks on success and samples achieved

Station	Deployments	Successful	Samples	
			Quantitative	Qualitative
PS67/16	3	2	2	
PS67/21	2	2	2	
PS67/59	3	1		1
PS67/74	2	0	0	
PS67/78	2	2	2	
PS67/80	2	2	2	
PS67/81	2	2	1	1
PS67/88	2	2	2	
PS67/94	3	0	0	
PS67/102	2	2	2	
PS67/110	3	1	1	
PS67/121	3	2	2	
PS67/150	2	2	2	
PS67/151	2	2	2	
PS67/152	2	1		1
PS67/153	2	2	1	1
PS67/154	2	2	2	

- Bacteria: Bruno Danis, University of Ghent and in samples from more than 4000 m depth Gisela Wegener for Jens Harder, University of Bremen (no defined surface area)
- Large Foraminifera visible by naked eye, picked from the surface: Nils Cornelius, SOC (entire surface)

- Macroinfauna to be live sorted: Bhavani Narayanaswamy SAMS and Stacy Doner, ENSR (4 subcores)
- Macroinfauna for quantitative studies: Brigitte Hilbig, RUB and Kari Ellingsen, University of Oslo (10 subcores)
- Sedimentology: John Howe, SAMS (1 subcore of 1 box corer)
- Ostracoda: Simone Brandao, University of Hamburg (1-2 subcores)
- Meiofauna: Annika Henche, DZMB (remaining surface)

### **9.2.2 Biodiversity patterns of deep-water macrofauna in the Antarctic**

Bhavani E. Narayanaswamy<sup>1</sup> and Stacy A. Doner<sup>2</sup>

<sup>1</sup>Scottish Association for Marine Science, Dunstaffnage Marine Laboratory, Oban, Argyll

<sup>2</sup>ENSR Marine and Coastal Center, Woods Hole

#### **Introduction**

Large-scale biodiversity pattern, and the present-day and historical processes causing it, are now thought to be important determinants of high local-scale species richness seen in samples from the deep sea. Although depth related patterns have been detected these vary from site to site. The pattern observed of macrobenthos in the northern hemisphere appears to be absent from that in the southern hemisphere; from preliminary data these basins appear to support as high diversity as that at low latitudes in the northern hemisphere.

We propose to test the following hypothesis:

The benthos of the deep basins of the Antarctic shows taxonomic continuity with the global deep ocean in conjunction with clinal gradients reflecting a source for speciation into other oceans.

There are several major objectives for this project, which in turn will contribute to the overall objectives of the ANDEEP programme.

- 1) To develop data that will help to understand the origins of the deep-sea benthic infauna in relation to the Antarctic shelf and linkages to the deep-sea faunas of the Atlantic and Pacific oceans;
- 2) To test hypotheses proposed to explain high biodiversity in the deep sea;
- 3) To develop data to describe the deep-sea benthic community structure in the Southern Ocean and in particular to compare the shelf, slope and abyssal communities in the ANDEEP areas; and
- 4) To collect samples to understand biological processes including reproduction and larval development of benthic invertebrates.



## **Methods**

### **Sample collection**

A total of 18 stations was sampled during ANDEEP III. For detailed sample collection using the megacorer and multicorer see Rose *et al.* (this volume) and for box corer sample collection see Hilbig *et al.* (this volume). At each deployment four boxcorer subcores were collected and on average 2 multicorer tubes were also collected. The samples were extruded to a depth of 5 cm, cut, and placed into sample carriers. Water overlying each core was filtered through a 250 µm sieve. The samples were refrigerated and kept on ice until elutriation.

### **Elutriation of samples**

A 500-ml distillation flask was used to elutriate each sample. Elutriated water flowed over a 250-µm sieve. The material collected on the sieve was washed carefully into a container after elutriation was completed. The samples were stored in a cool container until sorting could be undertaken. Wet ice was used to keep standing samples cold during this procedure.

### **Sample handling, sorting and observation**

In the laboratory, the specimens retained on the sieve were examined using a Wild M-5 Stereomicroscope equipped with fibre optics. Polychaetes and other invertebrates were picked out and recorded on a datasheet. All polychaetes were examined for the presence of eggs or sperm. Following sorting, the specimens were identified to the lowest possible taxonomic level permitted in the shipboard laboratory. Specimens were immediately preserved in either 10% buffered formalin or cold 90% Ethanol. The latter was used for specimens planned for DNA extraction. Live specimens intended for further observation were set aside prior to the preservation methods mentioned above. All data were entered into a notebook and later transferred to a spreadsheet.

### **Database development**

All data were entered into Excel spreadsheets. Initially data for each sample have been kept separate. As was found for results from ANDEEP II, data will later be manipulated to include some pooling of stations as a result of the low standing stock, species richness and density.

### **Preliminary Results**

Of 18 stations sampled as part of ANDEEP III, 17 yielded fully useable samples from the box corer and multicorer. At the 1000-m station on the Kapp Norvegia transect the multicorer failed to penetrate the sediment and a decision was taken not to deploy the box corer after a preliminary viewing of photographs from the sediment profile imaging camera and Parasound. However, some material remained on the closing plate of the multicorer and was collected by A.J. Gooday and N. Cornelius for foraminiferal analysis. The sorting of this sediment yielded many polychaetes which we were able to use. Of the 17 stations sampled with the corers, a total of 86 useable

subcores from the multicorer/megacorer and 88 from the box corer were elutriated and processed for macrofauna.

A total of 1157 macrofaunal benthic invertebrates were collected (excluding nematodes). The annelids accounted for 57.5%, peracarid crustaceans for 27% and molluscs for 10.5%. The echinoderms and minor phyla accounted for the remaining 5%. There were 38 polychaete families present with the dominant families including: Paraonidae (12.5%), Cirratulidae (10.5%), Spionidae (10%) and Syllidae (5%). The dominant crustaceans were the Tanaidacea and Isopoda.

Samples were also collected from one station situated in the Bransfield Strait and two off Anvers Island. These stations however were not sorted on the ship and will be processed in the laboratory.

### **Acknowledgements**

The first author would like to thank the Trans-Antarctic Association, Scottish Association for Marine Science and J.A. Blake. Logistic and material support for this study was funded by Grant No. OPP-0086665 from the National Science Foundation to James A. Blake, University of Massachusetts. s OPP-0086665. Support for the second author (S. Doner) was provided by Grant No. DEB-0118693 (PEET), also from the National Science Foundation to James A. Blake.

### **9.2.3 Quantitative analysis of soft-sediment macrobenthos community structure**

Kari E. Ellingsen<sup>1</sup> and Brigitte Hilbig<sup>2</sup>

<sup>1</sup> Department of Biology, University of Oslo

<sup>2</sup> Ruhr University of Bochum

### **Objectives**

There is a variety of indices and methods for the measurement of biodiversity (e.g., see Magurran 2004 for an overview). In this project we will emphasise species richness and beta diversity over different spatial scales using similar methods to those used in Ellingsen (2001) and Ellingsen & Gray (2002). The number of species has been the traditional measure of biodiversity in ecological and conservation studies, but the abstract concept of biodiversity as the 'variety of life' cannot be encapsulated by a single measure. Distributions of species and community differences will be taken into account in addition to species richness. The partitioning of species diversity into alpha ( $\alpha$ ), beta ( $\beta$ ) and gamma ( $\gamma$ ) components to characterise different aspects of diversity was first proposed by Whittaker (1960). Here one sample (0.1 m<sup>2</sup>) will be used to describe  $\alpha$ -diversity, while  $\gamma$ -diversity will be computed by merging a number of samples over a larger spatial scale. Most marine studies of species richness have been done on small scales, and there are few studies of diversity at different spatial scales (but see Clarke & Lidgard 2000, Ellingsen & Gray 2002). Beta diversity may be based on ratios of species richness of areas of different sizes, or differences in faunal composition between sites or areas.

Compared with the knowledge of  $\alpha$ -diversity,  $\beta$ -diversity has been far less studied in marine systems (Gray 2000).

During the ANT-XIX/3 and ANT-XIX/4 RV *Polarstern* expeditions in 2002 (ANDEEP I & II) box corer samples were taken from 14 sites in the Scotia and Weddell seas (across the Drake Passage, off Elephant and King George islands, east of the Antarctic Peninsula, east of the South Sandwich Islands, Weddell Sea abyssal plain) using the same procedures as during ANDEEP III. The water depth at these sites ranged from 1166 to 5194 m.

The data from the 29 sites collected during ANDEEP I, II & III will provide a unique possibility to examine patterns of Antarctic deep-sea soft-sediment biodiversity. The main aspects are how biodiversity varies with water depth, geographical location, sediment type and spatial scale.

### Work at sea

For samples intended to be used in quantitative studies of the benthic infauna, well established processing methods were used that have become standard over the last 20 years or so, ensuring comparability of our data with those available in deep-sea literature worldwide. Samples were taken with a Sandia box corer (surface 50 × 50 cm, divided into 10 × 10 cm subcores). The upper 10 cm of sediment were sliced off 10 subcores and gently washed through 300  $\mu$ m-mesh screens, when necessary after pre-softening the samples in buckets with seawater. Samples were fixed in 4% buffered formalin and, as far as time allowed, transferred into 70% ethanol for preservation after a few days. They will be transferred to the German Centre of Marine Biodiversity Research (DZMB) for sorting. All whole animals or anterior fragments will be separated from the sediment, counted, and sent to specialists for identification to species level. Raw data will be generated as number of individuals in a matrix of stations and species. The yet undescribed taxa, typically at least 50% of the sampled fauna, are assigned preliminary names and given to taxonomists for formal description in the framework of CeDAMar. At each site one additional subcore was taken for analyses of sediment grain size. Water depth at the 15 sites ranged from 1880 to 4934 m.

### References

- Clarke, A. and S. Lidgard (2000): Spatial patterns of diversity in the sea: bryozoan species richness in the North Atlantic. *Journal of Animal Ecology* 69: 799-814.
- Ellingsen, K.E. (2001): Biodiversity of a continental shelf soft-sediment macrobenthos community. *Marine Ecology Progress Series* 218: 1-15.
- Ellingsen, K.E. and J.S. Gray (2002): Spatial patterns of benthic diversity – is there a latitudinal gradient along the Norwegian continental shelf? *Journal of Animal Ecology* 71: 373-389.
- Gray, J. S. (2000): The measurement of species diversity: an example from the continental shelf of Norway. *Journal Experimental Marine Biology and Ecology* 250: 23-49.

Magurran, A. E. (2004): Measuring biological diversity. Blackwell Publishing, Oxford  
Whittaker, R. H. (1960): Vegetation of the Siskiyou Mountains, Oregon and California.  
*Ecological Monographs* 30: 279-338.

#### 9.2.4 Spatial patterns of Antarctic deep-sea soft-sediment biodiversity

Kari E. Ellingsen<sup>1</sup>, Angelika Brandt<sup>2</sup>,  
Brigitte Hilbig<sup>3</sup>, Katrin Linse<sup>4</sup> and Andrew  
J. Gooday<sup>5</sup>

<sup>1</sup> Department of Biology, University of Oslo

<sup>2</sup> Zoological Institute and Zoological  
Museum Hamburg

<sup>3</sup> Ruhr University of Bochum

<sup>4</sup> British Antarctic Survey, Natural  
Environmental Research Council,  
Cambridge

<sup>5</sup> Southampton Oceanography Centre

#### Objectives

This project involves post-expedition analyses of benthic deep-sea data from the Atlantic sector of the Southern Ocean (SO). The objectives are to (1) study whether patterns of biodiversity vary with the taxa (protozoan as well as metazoan) or size-group of fauna considered and (2) explain how faunal patterns vary with geographical location, water depth, habitat type and spatial scales.

Using data from ANDEEP I, II and III we aim to examine spatial patterns of benthic biodiversity. The data include organisms from the near bottom water, living on the sediment surface and within the sediment; some data are quantitative and some are qualitative. It is well known that comparative studies of diversity may be problematic due to the use of different sampling procedures, variable sampling effort, analyses at different spatial scales, use of different measures of biodiversity and application of varied statistical analyses (e.g., Arntz *et al.* 1997; Clarke 1992). However, we would like to study whether patterns of biodiversity vary with the taxa or size-groups of fauna considered. In this project we will therefore first examine patterns of biodiversity for each taxonomic group separately and then test if these patterns are different.

Both marine (e.g., deep sea: Grassle & Maciolek 1992; continental shelf: Ellingsen & Gray 2002) and terrestrial studies (Gaston 1994) have shown that rare species (both with regard to abundance and spatial distribution) make up a considerable proportion of the total number of taxa. In this study we will compare the distributional patterns of the different taxonomic groups (polychaetes, isopods, bivalves, gastropods and foraminifera), and test if some sites or areas have higher numbers of rare species, and if the number of rare species at a site is related to habitat characteristics. We will also examine whether species are distributed across the Atlantic sector of the SO or confined to restricted areas of the deep sea and whether the presence or absence of biogeographic patterns is related to body size, as suggested by Finlay, Fenchel and colleagues (e.g., Finlay & Fenchel 2004).

In this project we will emphasise species richness and beta diversity over different spatial scales using similar methods to those used in Ellingsen (2001) and Ellingsen & Gray (2002). Beta diversity can be measured in many different ways (see Magurran 2004 for an overview) and may be based on ratios of species richness of areas of different sizes, or differences in faunal composition between sites or areas. We will also test the relationship between patterns of species richness and beta diversity and geographical location, water depth and habitat type for each of the taxonomic groups.

The sparseness of data from the southern hemisphere, particularly the deep SO, limits our understanding of deep-sea benthic biodiversity patterns at the global scale. Thus a large-scale study of benthic biodiversity and distributional patterns in the SO will provide important new knowledge on patterns of biodiversity in the sea.

### Work at sea

During ANDEEP III box corer, multicorer, epibenthic sledge and Agassiz trawl were used at 18 sites to collect samples of a variety of taxa from the small meiofauna, macrofauna and large-sized epibenthos. At each site a sample was also taken for analysis of sediment properties. The water depth ranged from 1035 to 4934 m. During the ANT-XIX/3 and ANT-XIX/4 RV *Polarstern* expeditions (ANDEEP I and II) in 2002, samples were taken from 22 sites in the Scotia and Weddell seas (across the Drake Passage, off Elephant and King George islands, east of the Antarctic Peninsula, east of the South Sandwich Islands, and on the Weddell Sea abyssal plain) using the same procedures as during ANDEEP III. The water depth at these sites ranged from 774 to 6348 m.

### References

- Arntz, W.E., Gutt, J. and M. Klages (1997): Antarctic marine biodiversity: an overview. In Battaglia B, Valencia J & Walton DWH (eds) *Antarctic Communities: Species, Structure and Survival*. Cambridge University Press, Cambridge, pp 3-14.
- Clarke, A. (1992): Is there a latitudinal diversity cline in the sea? *Trends in Ecology and Evolution* 7: 286-287.
- Ellingsen, K.E. (2001): Biodiversity of a continental shelf soft-sediment macrobenthos community. *Marine Ecology Progress Series* 218: 1-15.
- Ellingsen, K.E. and J.S. Gray (2002): Spatial patterns of benthic diversity – is there a latitudinal gradient along the Norwegian continental shelf? *Journal of Animal Ecology* 71: 373-389.
- Finlay, B. J. and T. Fenchel (2004): *Protist* 155: 237-244.
- Gaston, K. J. (1994): *Rarity*. Chapman and Hall, London.
- Grassle, J.F. and N.J. Maciolek (1992): Deep-sea species richness: regional and local diversity estimated from quantitative bottom samples. *The American Naturalist* 139: 313-341.

Gray, J.S. (2000): The measurement of species diversity: an example from the continental shelf of Norway. *Journal of Experimental Marine Biology and Ecology* 250: 23-49.

Magurran, A.E. (2004): Measuring biological diversity. Blackwell Publishing, Oxford. 256 pp.

### **9.2.5 Phylogeny of deep-sea Asellota (Crustacea, Isopoda) and the colonisation of the deep sea using molecular markers**

Michael J. Raupach

Lehrstuhl für Spezielle Zoologie, Ruhr-Universität Bochum

#### **Objectives**

The Asellota are one of the most numerous and important elements of the deep sea in all oceans (Wolff 1962, Hessler *et al.* 1979, Wägele 1989). However, little is known about their phylogeny (Wägele 1989, Brandt 1999). Numerous deep-sea Asellota were already collected during the ANDEEP I and II-expeditions (2002, ANT-XIX/3+4) (Brandt *et al.* 2003) and preserved for molecular studies while additional shelf taxa were sampled during ANT-XXI/2 (2003/2004) (Raupach 2005). With the already available ssu rDNA sequences we gained in previous projects the new collected specimens will be used to complete the study of the radiation of deep-sea taxa of the Asellota. First results indicate a multiple colonisation of the Antarctic deep sea (Raupach *et al.* 2004). Some families are still missing or only represented by one species in our data set, but several specimens of important genera were sampled during ANDEEP III (e.g. *Vemathambena*, *Xostylus*), helping to complete the data set (see [table 9.10](#)).

#### **Work at sea**

In total, DNA of 406 asellote specimens from 13 different families and at least 40 genera (see [table 9.10](#)) was extracted and purified from several separated legs of the specimens, using the QIAmp Tissue Kit (Qiagen GmbH, Hilden), following the manufacturer's extraction protocol. Most specimens used for DNA extractions of the Asellota were found within the samples of the epibenthic sledge (400 = 98.5%), a much lower number in the catches of the Agassiz trawl (6 = 1.5%). The whole sample of the epibenthic sledge was placed in precooled ethanol 96% directly after sampling to avoid DNA degradation by enzymatic activity. Specimens collected with the Agassiz trawl were transferred into precooled ethanol as fast as possible after sorting and sieving the sample.

In addition, DNA of 25 specimens from other isopod suborders was extracted (see [table 9.11](#)). All amputated animals were preserved in 96% ethanol for future morphological and molecular studies.

All further steps (PCR, DNA sequencing, phylogenetic analysis) will be carried out in the laboratories of the Ruhr-Universität Bochum and the Museum Alexander König in Bonn.

**Table 9.10:** DNA extractions of asellote isopods on board of RV *Polarstern* during ANDEEP III

Family	Genus (number of different species)	Number of DNA extractions
Acanthaspidiidae	<i>Acanthaspidia</i> (4)	7
	<i>Ianthopsis</i> (2)	2
Dendrotiidae	<i>Dendromunna</i> (1)	3
	<i>Dendrotion</i> (1)	1
Echnothambematidae	<i>Vemathambema</i> (1)	1
Haplomunnidae	<i>Haplomunna</i> (1)	1
	<i>Thylakogaster</i> (4)	19
Haploniscidae	<i>Antennuloniscus</i> (3)	15
	<i>Chaulidoniscus</i> (4)	4
	<i>Haploniscus</i> (7)	37
	<i>Hydroniscus</i> (1)	2
	<i>Mastigoniscus</i> (3)	3
Ischnomesidae	<i>Haplomesus</i> (2)	3
	<i>Ischnomesus</i> (1)	2
	<i>Stylomesus</i> (2)	2
Macrostylidae	<i>Macrostylis</i> (2)	2
Mesosignidae	<i>Mesosignum</i> (2)	2
Munnidae	<i>Echinomunna</i> (1)	2
	<i>Munna</i> (1)	2
Munnopsididae	<i>AcanthoCOPE</i> (3)	29
	<i>Bathybadistes</i> (1)	1
	<i>Betamorpha</i> (2)	102
	<i>Disconectes</i> (2)	11
	<i>Echinozone</i> (2)	5
	<i>EuryCOPE</i> (5)	68
	<i>Ilyarachna</i> (1)	19
	<i>Lipomera</i> (1)	2
	<i>Mimocopelates</i> (1)	2
	<i>MunneuryCOPE</i> (1)	2
	<i>Munnopsurus</i> (2)	3
	<i>Storothyngura</i> (2)	2
	<i>Storothyngurella</i> (2)	3
	<i>SyneuryCOPE</i> (3)	33
<i>TytthoCOPE</i> (1)	1	
Nannoniscidae	<i>Nannoniscus</i> (1)	2
Paramunnidae	<i>Paramunna</i> (1)	4
	<i>Pleurogonium</i> (1)	1
Stenetriidae	<i>Tenupedunculus</i> (2)	3
	<i>Stenetrium</i> (1)	1
?	<i>Xostylus</i> (1)	2

**Table 9.11:** DNA extractions of non-asellote isopods on board of RV *Polarstern* during ANDEEP III

Suborder	Family	Genus (number of different species)	Number of DNA extractions
Cymothoida	Dajidae	<i>Zonophryxus</i> (1)	3
	"Cryptoniscid" larvae	? (at least 3)	21
Valvivera	Antarcturidae	<i>Fissarcturus</i>	1

### References

- Brandt, A. (1991): Zur Besiedlungsgeschichte des antarktischen Schelfes am Beispiel der Isopoda (Crustacea, Malacostraca). *Berichte zur Polarforschung*, 98, 246 pp.
- Brandt, A. (1999): On the origin and evolution of Antarctic Peracarida (Crustacea, Malacostraca). *Scientia Marina* 63 (Suppl. 1): 261-274.
- Brandt, A., Brökeland, W., Raupach, M., Strieso, G. and G. Wegener (2003): Investigations on the systematics, zoogeography, and evolution of Antarctic deep-sea isopods (Crustacea, Malacostraca). In: Fütterer D.K., Brandt A., Poore G.C.B. (eds.): *The expeditions ANTARKTIS-XIX/3-4 of the Research Vessel Polarstern in 2002 (ANDEEP I and II: Antarctic benthic deep-sea biodiversity – colonization history and recent community patterns)*. *Berichte zur Polar- und Meeresforschung* 470: 86-87.
- Hessler, R.R., Wilson, G.D.F. and D. Thistle (1979): The deep-sea isopods: a biogeographic and phylogenetic overview. *Sarsia* 64: 67-75.
- Raupach, M.J., Held, C. and J.-W. Wägele (2004): Multiple colonization of the deep sea by the Asellota (Crustacea: Peracarida: Isopoda). *Deep-Sea Research II* 51: 1787-1795.
- Raupach, M.J. (2005): Analysis of Biogeography, Speciation and Biodiversity of Antarctic Asellota (Crustacea: Peracarida: Isopoda) using Molecular Markers. In: *The expedition ANTARKTIS-XXI/2 of the Research Vessel RV Polarstern in 2003/2004*. *Berichte zur Polar- und Meeresforschung*, in press.
- Wägele, J.-W. (1989): Evolution und phylogenetisches System der Isopoda. *Stand der Forschung und neue Erkenntnisse*. *Zoologica* 140: 1-262.
- Wolff, T. (1962): The systematics and biology of bathyal and abyssal Isopoda Asellota. *Scientific Results of the Danish Deep-Sea Expedition Round the World 1950-52*. *Galathea Report*, Volume 6, 320 pp.

### 9.2.6 Dispersal and intraspecific differentiation of selected deep-sea isopods (Crustacea: Asellota) in the Weddell Sea

Michael J. Raupach  
Lehrstuhl für Spezielle Zoologie, Ruhr-Universität Bochum

#### Objectives

Beside the colonisation of the deep sea by the Asellota, another research topic is focused on the genetic differentiation of abyssal asellote populations across the Weddell Sea. A possible model species for genetic differentiation in the deep sea might be *Betamorpha fusiformis* (Barnard, 1920), a Munnopsididae known from



several deep-sea regions in the Atlantic and the Southern Ocean (Thistle & Hessler 1977). During ANDEEP III numerous specimens were sorted out from the epibenthic sledge (EBS) and Agassiz trawl (AGT) samples (table 9.12). In combination with previously collected specimens during the expeditions ANDEEP I and II, a large-scale analysis of population dynamics and genetics of abyssal isopods will be possible.

### Work at sea

In total, DNA of 100 specimens of *Betamorpha fusiformis* from nine different stations has been extracted on board (table 9.12).

**Table 9.12:** Station, depths and number of DNA extractions of *Betamorpha fusiformis* on board of RV *Polarstern* during ANDEEP III

Station	Number of DNA extractions
PS 67/16-10 EBS	8
PS 67/21-7 EBS	6
PS 67/74-6 EBS	4
PS 67/80-9 EBS	3
PS 67/81-8 EBS	1
PS 67/88-8 EBS	2
PS 67/94-11 AGT	2
PS 67/94-14 EBS	5
PS 67/102-13 EBS	12
PS 67/110-8 EBS	57

All further steps (PCR, DNA sequencing, phylogenetic analysis) will be carried out in the laboratories of the Ruhr-Universität Bochum and the Museum Alexander König in Bonn.

### References

Thistle, D. and R.R. Hessler (1977): A revision of *Betamorpha* (Isopoda: Asellota) in the world ocean with three new species. *Zoological Journal of the Linnean Society* 60: 275-295.

### 9.2.7 Investigations on the systematics, zoogeography, and evolution of Antarctic deep-sea isopods (Crustacea, Malacostraca)

Angelika Brandt<sup>1</sup>, Wiebke Brökeland<sup>1</sup>,  
Madhumita Choudhury<sup>1</sup>, Marina  
Malyutina<sup>2</sup>, Michael Raupach<sup>3</sup> and  
Gisela Wegener<sup>1</sup>

<sup>1</sup>Zoological Institute and Zoological  
Museum Hamburg

<sup>2</sup>Institute of Marine Biology, Vladivostok

<sup>3</sup>Ruhr University of Bochum

#### Background and objectives

It is supposed that in the Pliocene and Pleistocene the Antarctic ice shelf never completely eradicated the Antarctic benthic shelf fauna. In the recent geological past Gondwana broke up and Antarctica subsequently isolated. This accompanied by climatic changes involving intermittent periods of global warming and global sea-level changes might have determined faunal zoogeographic ranges, migration processes in and out of the Antarctic, and limits. Extensions of the ice sheet may have enhanced speciation (as demonstrated for the Serolidae and Antarcturidae) on the Antarctic continental shelf, suitably named the Antarctic “diversity pump.”

The abyssal fauna of the Southern Ocean deep sea was not investigated in detail until now. A summary of the few data available, published in widespread taxonomic literature, was published by Brandt (1991). Some new Antarctic Isopoda were described since Brandt's (1991) monograph of the Southern Ocean isopod fauna (e.g., Brandt 1999; Brandt & Malyutina 2002; Kussakin & Vasina 1997, 1998; Kussakin & Rybakov 1995; Malyutina 1997, 1999; 2003; Malyutina & Brandt 2004a, b, c; Mezhev 1992; Park & Wägele 1995; Pirez & Sumida 1997; Teodorczyk & Wägele 1994; Winkler 1992, 1994a, b). Brandt (1991) already indicated that some genera might be cosmopolitan in the deep sea (e.g., *Desmosoma*, *Acanthomunna*, *Munna*, *Munnopsurus*, *Eurycope*, *Disconectes*, *Ilyarachna*, *Echinozone*, *Haploniscus*, *Leptanthura*, a.o.), some, however, are endemic for the Southern Ocean deep sea (e.g., *Acantharcturus*, *Rectarcturus*, *Furcarcturus*, *Fissarcturus*, *Tuberarcturus*, *Antennulosignum*, *Glyptonotus*, *Coulmannia*, *Echinomunna*, *Lionectes*, *Euneognathia*, a.o.) (see Brandt 1991: 101). Closely related to some of these Southern Ocean deep-sea genera are eyeless species or species with rudimentary eyes, whose related shelf species possess well developed eyes and are endemic for the Southern Ocean. The Antarcturidae, for example, occur in the Atlantic deep sea down to >7200 m (Kussakin & Vasina 1993). In these cases we have to conclude submergence into the deep sea from shelf ancestors (Hessler & Thistle 1975). For some Janiroidea, like the families Acanthaspidiidae, Munnidae and Paramunnidae, Brandt (1991) hypothesised polar submergence because the abundant shelf species (genus *Ianthopsis*) possess highly developed eyes. Within the Asellota, the typical shallow-water species which globally thrive on the continental shelves, can also be found at greater depths in the Southern Ocean deep sea [submergence of the Janiridae, Joeropsidae, Stenetriidae, Munnidae (down to 6110 m), Acanthaspididae (down to 7720 m)] which supports the theory of enhanced eurybathy of the Southern Ocean benthic taxa (Brey et al. 1996). Kussakin (1973) was also in favour of the submergence theory of Southern Ocean Isopoda.

Other authors think that the Isopoda have developed in the deep sea *in situ* where they also radiated before they have emerged to the continental shelves, especially in higher latitudes (e.g., Hessler & Thistle 1975; Hessler & Wilson 1983; Wilson & Hessler 1987). In the Southern Ocean many species of the deep-sea suborder Asellota are also represented on the continental shelf. Emergence has been postulated in Antarctica for example for the Munnopsididae, Haploniscidae, Desmosomatidae, Nannoniscidae and Ischnomesidae (Brandt 1991; Wilson 1998; 1999). Brandt (1991) explained that both sub- and emergence can be observed simultaneously. We cannot consider the evolution of the shelf taxa isolated from that of the deep-sea fauna.

It is likely that the deep sea of the Southern Ocean bears a similar importance as a centre for evolution to the Antarctic shelf. The Antarctic shelf is characterized by a high degree of endemism (e.g., Crame 2000) and can be considered as a centre of evolution and radiation for nototheniiform fish (Eastman 2000), isopods (Brandt 1991, Wägele 1994), amphipods (Watling & Thurston 1989) and molluscs (Zinsmeister 1982). Single records support the idea that even in the abyss of the Southern Ocean the evolution of Isopoda has taken place simultaneously and separated from that of the shelf taxa, as illustrated for example for the Haploniscidae by Brökeland (2004) and Raupach (2004). Unpublished results imply that specialisation of populations to certain depths leads to speciation in Antarctica. It is therefore important to compare superficially similar specimens collected in different depths to determine the degree of genetic divergence between populations. Brökeland (2004) described the *Haploniscus cucullus* complex. Species complexes were described for the asellote family Munnopsididae (Eurycopinae) (Wilson 1983a, b; 1987 a, b; 1989) and varying theories about the origin, evolution and speciation of isopod taxa in the deep sea were published (e.g., Brandt 1991; Kussakin 1973; Wägele 1989; Wilson 1987a, b).

In addition to traditional morphological studies, molecular methods have become more and more useful and important tools in modern systematics and have contributed essentially to our understanding of the phylogeny and biogeography of Isopoda, for example the family Serolidae (Held 2000). The importance of molecular analyses as an additional tool to discriminate species in deep-sea biodiversity studies has recently also been stressed by Etter *et al.* (1999) for molluscs. The authors demonstrated that the deep-sea shelters some cryptic species. Sequence data from nuclear and mitochondrial genes can help to determine the population genetics, phylogeny and biogeography of deep-sea isopods of the Southern Ocean. Genetic distances will be used as a proxy for biodiversity. On the basis of these data we aim to develop a method for comparison of these data with species numbers identified by morphologists. The extraction of DNA of selected species was the first and most important step for further molecular studies and has been successful on board. For this treatment it was necessary that the specimens were fixed as soon as possible in cooled ethanol to prevent digestion of the DNA. With the already available ssu rDNA gene sequences gained in previous projects the study on the radiation of deep-sea asellotes will be completed. First results indicate a multiple colonisation of the Antarctic deep sea (Raupach *et al.* 2004). In addition to this, analyses of fast evolving genes (e.g. 16S rRNA, Cytochrome Oxidase I) and high resolution AFLP fingerprints will be used to test if geological structures (ridges, basins) or differences in water

masses and depth are barriers to gene flow, if distant localities harbour different populations or cryptic species, if mere geographical distance correlates with genetic distance, if local radiations occur within deep-sea basins, and if and how the local fauna differs from neighbouring ocean regions. While systematics and phylogenetic work will be done in Hamburg using traditional methods (Dr. Wiebke Brökeland), molecular systematics will be carried out in the laboratories of the Ruhr-Universität Bochum and the Museum Alexander König in Bonn by Dr. Michael Raupach.

The Antarctic shelf is well isolated and the zoogeographic distribution of the 371 isopod species, which show a degree of endemism of 88%, is well documented (Brandt 1991). During the expeditions ANDEEP I&II with RV *Polarstern* from January to April 2002, 317 species of deep-sea Isopoda were sampled and discriminated from 5525 specimens yielded from the epibenthic sledge material of these expeditions. Of these, 277 were new to the area or even to science, 50 were known from adjacent deep-sea areas, and 27 of these from the Southern Ocean (SO), yielding a percentage of 84.7% of deep-sea endemism. During ANDEEP III, questions like the potential origin of Antarctic benthic taxa and colonisation of the deep sea from the Antarctic (submergence versus emergence of species) still remain major objectives especially off the Kapp Norwegia shelf in the deep eastern Weddell Sea. However, the incredible isopod biodiversity reported opens new questions for ANDEEP III like: is the degree of endemism of the SO deep-sea Isopoda really so high, or is this an artefact due to the little knowledge of the isopod faunas of the adjacent deep-sea basins? Which are the dominant isopod taxa in the SO deep-sea, will we find a similar composition of asellote families as during ANDEEP I&II? Are the deep-sea Isopoda widely distributed or patchy? At which depths can we find a shift from the shelf to the deep-sea isopod fauna? (At the 1030 m station – 74-6 – we sampled a typical shelf fauna, indicating that the shelf break must even lie much deeper than that). Is there a northern limit of the SO deep-sea isopod fauna towards the Cape Basin? Have some of the isopod deep-sea families radiated in the SO? Where do the closest relatives of selected taxa live? How can we describe the phylogenetic relationship of some selected and important and speciose families?

Some specific aims of ANDEEP III are

- To expand and deepen insights in the potential origin of Antarctic benthic Isopoda, collected during ANDEEP I and II
- To continue the analysis of evolutionary biology and current community patterns on Southern Ocean deep-sea Isopoda.
- To test whether the present distributions of Isopoda is the result of progressive retractions of the species from a former more cosmopolitan distribution, which was established during Jurassic or Cretaceous periods, when Gondwana was still clustered, or whether these are Gondwanian relicts.
- To analyse whether some taxa of the Isopoda have radiated in the Antarctic because of the extinction of potential competitors (brachyurans), i.e., has the emergence of new, adaptive zones and occurrence of mass extinctions in the Antarctic in the Tertiary opened up previously occupied adaptive zones, and thus provided opportunities for spectacular adaptive radiations?

- To analyse whether the Antarctic deep sea serves as a reservoir of high species diversity within all isopod taxa.
- To investigate whether the Antarctic deep-sea fauna differs from that of the deep sea of the other oceans.
- To analyse whether there is still faunal exchange with the isopod fauna found in the area of the Antarctic Peninsula and the Magellan area or whether there are distinct topographical barriers to migration in and out of Antarctica via the deep sea.
- To analyse whether there is a link between the Antarctic shelf and the deep-sea fauna of the Southern Ocean in present and past.

### **Work at sea**

The sampling procedure referring to the investigations on the Antarctic deep-sea isopods is described in 9.2.1.

### **Preliminary results**

The Asellote family *Haploniscidae* was found in almost all deep-sea EBS-samples sorted on board. It consists of seven genera of which five were found in the samples: *Haploniscus* Richardson, 1908, *Hydrioniscus* Hansen, 1916, *Antennuloniscus* Menzies, 1962, *Mastigoniscus* Lincoln 1985, *Chauliodoniscus* Lincoln, 1985. *Haploniscus* is represented by at least 8 species, which can not be identified so far. Numerous tissues were taken for DNA-extraction.

The genus *Mastigoniscus* was recorded for the first time during ANDEEP I and II and has been sampled as well during ANDEEP III in the Southern Ocean. It was previously known only from the Pacific Ocean with a probable centre of radiation in the Southern Pacific.

Besides the Haploniscidae, most deep-sea isopods sorted so far belonged to the families Munnopsididae, Ischnomesidae, Desmosomatidae, Nannoniscidae, Macrostylidae, Thambematidae, Echinothambematidae, Acanthaspidiidae, Munnidae, Paramunnidae and Haplomunnidae. The most numerous family at each station Munnopsididae (swimming asellots) is represented by at least 7 subfamilies: Ilyarachninae (4 genera, about 10 species), Betamorphinae (2 genera, 4 species), Syneurycopinae (1 genus, 3 species), Acanthocopinae (1 genus, 3 species), Storthyngurinae (5 genera, about 10 species), Lipomeriinae (5 genera, about 10 species), and Eurycopinae (about 10 genera and about 30 species). The last subfamily is the most difficult for identification and its taxonomical structure has to be revised. Numerous tissue samples were taken for DNA extraction.

As the size of the animals usually ranges between 1 and 3 mm, dissections and exact species identification will have to be done later in the laboratory in Hamburg.

Some known species of Isopoda were collected during ANDEEP III.

<b>family</b>	<b>species</b>
Haploniscidae	<i>Haploniscus rostratus</i>
	<i>Haploniscus nondescriptus</i>
	<i>Haploniscus spinifer</i>
	<i>Antennuloniscus armatus</i>
Echinothambematidae	<i>Vemathambema elongata</i>
Munnidae	<i>Echinomunna cf. horrida</i>
Acanthaspidiidae	<i>Tenopedunculus acutum</i>
	<i>lanthopsis cf. nasicornis</i>
	<i>lanthopsis cf. multispinosa</i>
	<i>Acanthaspidia cf. pleuronotus</i>
	<i>Acanthaspidia cf. drygalskii</i>
	<i>Haplomesus aff. corniculatus</i>
Ischnomesidae	<i>Mesosignum cf. weddellensis</i>
Mesosignidae	„Eurycope“ gen. 1 <i>acutitelson</i>
Munnopsididae	„Eurycope“ gen. 1 <i>nodosa</i>
	„Eurycope“ gen. 2 <i>sarsi</i>
	„Eurycope“ gen. 3 <i>ovatum</i>
	<i>Acanthocope annulatus</i>
	<i>Acanthocope galatheae</i>
	<i>Bathybadistes multispinosus</i>
	<i>Betamorpha africana</i>
	<i>Betamorpha fusiformis</i>
	<i>Disconectes vanhoeffeni</i>
	<i>Eurycope glabra</i>
	<i>Ilyarachna triangulata</i>
	<i>Storthyngura antarctica</i>
	<i>Storthyngura elegans</i>
	<i>Storthyngura kussakini</i>
	<i>Storthyngurella menziesi</i>
	<i>Storthyngurella triplispinosa</i>
	Munnopsididae
<i>Sursumura robustissima</i>	
<i>Syneurycope hanseni</i>	
<i>Syneurycope heezeni</i>	
<i>Syneurycope multispina</i>	
	<i>Vanhoeffenura scotia</i>

## References

- Brandt, A. (1991): Zur Besiedlungsgeschichte des antarktischen Schelfes am Beispiel der Isopoda (Crustacea, Malacostraca). *Berichte zur Polarforschung* 98: 1-240.
- Brandt, A., Crame, A., Polz, H. and M. Thomson (1999): Late Jurassic Tethyan ancestry of recent southern high latitude marine isopods (Crustacea, Malacostraca). *Palaeontology* 42 (4): 663-675.
- Brandt, A. and M. Malyutina (2002): *Storthyngura kussakini* sp. nov. from the Southern Ocean. *Mitt. Mus. Nat.kd. Berl., Zool., Reihe 78* (1): 97-107.

- Brey, T., Dahm, C., Gorny, M., Klages, M., Stiller, M. and W. Arntz (1996): Do Antarctic benthic invertebrates show an extended level of eurybathy? *Antarctic Science* 8 (1): 3-6.
- Brökeland, W. (2004): Systematics, zoogeography, evolution and biodiversity of Antarctic deep-sea Isopoda (Crustacea: Malacostraca). Dissertation thesis, Zoological Institute and Museum, University Hamburg: 245 pp.
- Etter, R.J. ; Rex, M.A.; Chase, M.C. and J.M. Quattro (1999): A genetic dimension to deep-sea biodiversity. *Deep-Sea Res. I* 46: 1095-1099.
- Held, C. (2000): Phylogeny and biogeography of serolid isopods (Crustacea, Isopoda, Serolidae) and the use of ribosomal expansion segments in molecular systematics. *Molecular Phylogenetics and Evolution* 15 (2): 165-178.
- Hessler, R.R. and D. Thistle (1975): On the place of origin of deep-sea isopods. *Mar. Biol.* 32: 155-165.
- Hessler, R.R. and G.D.F. Wilson (1983): The origin and biogeography of malacostracan crustaceans in the deep sea. In: Sims, R. W., Price, J. H. and Whalley, P. E. S. (eds.): *The emergence of the biosphere*. Systematic Association 23: 227-254.
- Kussakin, O.G. (1973): Peculiarities of the geographical and vertical distribution of marine isopods and the problem of deep-sea fauna origin. *Marine Biology* 23: 19-34.
- Kussakin, O.G. and G. S. Vasina (1993): Description of *Globalcturus angelikae* gen. et sp. nov., the first Antarctic hadal arcturid from the South Sandwich Trench (Crustacea, Isopoda: Arcturidae). *Zool. Inst. St.Petersb.*, 2: 241-245.
- Kussakin, O. G. and G.S. Vasina (1997): Description of *Globalcturus angelikae* gen. et sp. n., the first Antarctic hadal arcturid from the South Sandwich Trench (Crustacea, Isopoda: Arcturidae). *Zool. Inst. St. Petersburg*. 2: 241-245.
- Kussakin, O.G. and G.S. Vasina (1998): New bathyal and abyssal arcturids from the western Antarctic and Subantarctic (Crustacea: Isopoda: Arcturidae). *Zoosystematica Rossica* 7 (1): 55-75.
- Kussakin, O.G. and A.V. Rybakov (1995). *Protognathia waegelei*, sp. n. (Crustacea, Isopoda, Flabellifera) - a new species of rare and poorly known family Protognathiidae from the Antarctic. *Biologia Morja* 21(1): 21-28.
- Malyutina, M.V. (1997): *Disconectes vanhoeffeni* sp. n., a new species of isopod of the family Munnopsidae from the South Sandwich Trench of the Antarctic. *Russ. J. Marine Biol.* 23 (3): 152-156.
- Malyutina, M.V. (1999): *Storhyngurella*, a new genus of Munnopsidae (Crustacea: Isopoda), with descriptions of three new species from deep-sea basins of the southern hemisphere.
- Malyutina, M. (2003) Revision of *Storhyngura* Vanhöffen, 1914 (Crustacea: Isopoda: Munnopsididae) with descriptions of three new genera and four new species from the deep South Atlantic. *Organisms, Diversity & Evolution* 3, Electr. Suppl. 13: 1– 101.
- Malyutina, M. and A. Brandt (2004a): Antarctic species of the subfamily Storhyngurinae. *Mitt. Mus. Nat.kd. Berl., Zool., Reihe.* 80 (1): 3-32.
- Malyutina, M. and A. Brandt (2004b): *Rectisura menziesi* sp. nov. - a new deep-sea isopod from the Weddell Sea, Southern Ocean (Storhyngurinae: Munnopsididae: Asellota). *Mitt. Hamb. Zool. Mus. Inst.* 101: 237-247.

- Malyutina, M. and A. Brandt (2004c): Acanthocopinae (Crustacea: Isopoda: Munnopsididae) from the Southern Ocean deep sea with the description of *Acanthocope eleganta* sp. nov. ZOOTAXA 550:1-20.
- Mezhov, B.V. (1992): Two new species of the genus *Macrostylis* G.O. Sars, 1864 (Crustacea Isopoda Asellota Macrostylidae) from the Antarctic. *Arthropoda Selecta* 1 (2): 83-87.
- Park, J.-Y. and J.W. Wägele (1995): On a small collection of Valvifera (Crustacea, Isopoda) from the Magellan Strait, with description of *Platidotea magellanica* n. gen. n. sp.. *Bull. Zool. Mus.* 14 (6): 57-99.
- Pirez, A.M. and P.Y.G. Sumida. (1997): The valviferan isopods (Crustacea Peracarida) from Bransfield Strait and adjacent waters, Antarctica. *Ophelia* 46 (1): 11-34.
- Teodorczyk, W. and J.W. Wägele (1994): On Antarctic species of the genus *Munna* Krøyer, 1839 (Crustacea, Isopoda, Asellota, Munnidae). *Bull. Mus. nat. Hist, Paris*, 16: 111-201.
- Raupach, M.J. (2004): Molekulargenetische Analyse von Biogeographie, Speziation und Biodiversität der Asellota (Crustacea: Isopoda) der antarktischen Tiefsee. Dissertation thesis, Fakultät für Biologie, Ruhr-Universität Bochum: 148 pp.
- Raupach, M.J., Held, C. and J.-W. Wägele (2004). Multiple colonization of the deep sea by the Asellota (Crustacea: Peracarida: Isopoda). *Deep-Sea Res II* 51: 1787-1795.
- Wägele, J.-W. (1989): Evolution und phylogenetisches System der Isopoda. Stand der Forschung und neue Erkenntnisse. *Zoologica (Stuttgart)* 140: 1-262.
- Wilson, G.D.F. (1983a): Systematics of a species complex in the deep-sea genus *Eurycope*, with a revision of six previously described species (Crustacea, Isopoda, Eurycopidae). *Bulletin of the Scripps Institution of Oceanography* 25: 1-64.
- Wilson, G.D.F. (1983b): Variation in the deep-sea isopod, *Eurycope iphthima* (Asellota, Eurycopidae): Depth related clines in rostral morphology and in population structure. *Journal of Crustacean Biology* 3: 127-140.
- Wilson, G.D.F. (1987a): The road to the Janiroidea: comparative morphology and evolution of the asellote isopod crustaceans. *Zeitschrift für Zoologische Systematik und Evolutionsforschung* 25: 257-280.
- Wilson, G.D.F. and R. Hessler (1987b): Speciation in the deep sea. *Annual Review of Ecology and Systematics* 18: 185-207.
- Wilson, G.D.F. (1998): Historical influences on deep-sea isopod diversity in the Atlantic Ocean. *Deep-Sea Res. II* 45 (1-3): 279-301.
- Wilson, G.D.F. (1989): A systematic revision of the deep-sea subfamily Lipomerinae of the isopod crustacean family Munnopsidae. *Bulletin of the Scripps Institution of Oceanography* 27: i-xiii, 1-138.
- Winkler, H. (1992): On two Magellanic Munnidae: a new species of *Munna* and *Uromunna nana* (Nordenstam, 1933) (Crustacea: Isopoda: Asellota). *J. nat. Hist* 26(2): 311-326.
- Winkler, H. (1994): Charakterisierung der Isopodenfauna (Crustacea, Malacostraca) des Scotia Bogens aus biogeographischer Sicht: Ein multivariater Ansatz. *Ber. Polarforsch.* 139: 1-196.



### 9.2.8 Biodiversity and zoogeography of Crustacea Peracarida and Polychaeta

Angelika Brandt<sup>1</sup>, Wiebke Brökeland<sup>1</sup>,  
Madhumita Choudhury<sup>1</sup>, Brigitte Hilbig<sup>2</sup>,  
Marina Malyutina<sup>3</sup>,  
Michael Raupach<sup>3</sup> and Gisela Wegener<sup>1</sup>

<sup>1</sup>Zoological Institute and Zoological  
Museum Hamburg  
<sup>2</sup>Institute of Marine Biology, Vladivostok  
<sup>3</sup>Ruhr University of Bochum

#### Objectives

During this study, the zoogeography, and biodiversity of peracarid crustaceans and polychaetes were investigated using an epibenthic sledge. The results will be compared with data from ANDEEP I & II, existing data on the peracarid fauna of the Magellan area, European Northern Seas, and the polychaete fauna of deep-sea regions in the Atlantic and northeastern Pacific oceans.

#### Work at sea

Quantitative and qualitative samples were taken at 22 stations between 750 m and 6348 m in environments with different topographical and sedimentary conditions during ANDEEP I & II. During ANDEEP III samples were taken at 19 stations between 1032 and 4933 m, and haul lengths varied between 711 and 3488 m (table 9.13). These catches covered a trawled area of 44.852 m<sup>2</sup>. For further details please see Macrobenthos, introduction to work at sea.

**Table 9.13:** EBS stations, depth, calculated trawling distance, start and end position

station	depth (m)	trawling distance (m)	long (start)	long (end)	lat (start)	lat (end)
16-10	4720	3198	41°07.55 S	09°55.94 E	09°55.94 E	09°54.85 E
21-7	4577	2923	47°39.87 S	04°15.79 E	47°38.52 S	04°14.94 E
59-5	4655	2878	67°30.75 S	00°00.23 W	67°29.81 S	00°01.94 E
74-6	1032	711	71°18.42 S	13°58.21 W	71°18.33 S	13°57.65 W
78-9	2149	2376	71°09.52 S	14°00.76 W	71°09.34 S	13°58.85 W
80-9	3100	1778	70°38.45 S	14°42.86 W	70°39.18 S	14°43.43 W
81-8	4382	2935	70°31.08 S	14°34.82 W	70°32.23 S	14°34.90 W
88-8	4931	3488	68°03.84 S	20°31.39 W	68°03.64 S	20°27.49 W
94-14	4891	3476	66°39.08 S	27°09.26 W	66°37.16 S	20°10.13 W
102-3	4801	3283	65°33.18 S	36°33.24 W	65°34.32 S	36°31.05 W
110-8	4695	2904	64°59.20 S	43°02.05 W	64°00.91 S	43°02.10 W
121-11	2659	1945	63°38.27 S	50°37.16 W	63°37.31 S	50°38.04 W
133-2	1584	1164	62°46.73 S	53°02.57 W	62°46.33 S	53°04.14 W
142-5	3405	2251	62°11.36 S	49°27.62 W	62°11.36 S	49°29.57 W
150-6	1984	1567	61°49.13 S	47°27.51 W	61°48.52 S	47°28.16 W
151-7	1183	1383	61°45.67 S	47°07.19 W	61°45.42 S	47°08.07 W
152-6	1998	2113	62°20.64 S	57°53.12 W	62°19.91 S	57°53.68 W
153-7	2096	1954	63°19.82 S	64°36.44W	63°19.18 S	64°37.53W
154-9	3803	2525	62°32.52 S	64°39.45W	62°31.31 S	64°38.66W

## Preliminary results

### Peracarida

Peracarida (Amphipoda, Cumacea, Isopoda, Mysidacea, Tanaidacea) is the most successful taxon of Crustacea in the Southern Ocean, with a high percentage of endemic species ( $\approx 90\%$ ) on the Antarctic continental shelf and slope. ANDEEP I & II data on Isopoda have documented that the percentage of endemism is also high for this taxon ( $\approx 85\%$ ) in the Southern Ocean deep sea sampled so far. Before the expedition ANDEEP I & II, knowledge on the composition of Antarctic deep-sea isopods was generally scarce. A comparison of the biodiversity of Southern Ocean deep-sea Isopoda with that of the high-latitude European seas and with the deep sea of the Agulhas, Cape, Angola, and Guinea Basins (ANDEEP I – II; DIVA 1-2) will later contribute to discussions concerning latitudinal biodiversity gradients. Preliminary results from sorting of some ANDEEP III EBS stations are summarised in table 9.14 and [figure 9.4](#).

**Table 9.14:** Peracarid individuals sorted from ANDEEP III stations taken with the EBS

stations	depth	Isopoda	Amphipoda	Cumacea	Tanaidacea	Mysidaceae
16-10	4720	225	88	69	23	2
21-7	4577	69	16	12	5	0
59-5	4655	108	43	11	19	7
74-6	1032	738	1057	984	392	31
78-9	2149	406	416	641	79	19
80-9	3100	616	516	158	27	10
81-8	4382	377	195	50	94	3
88-8	4931	268	94	20	31	0
94-14	4891	92	69	8	4	1
102-13	4801	93	21	4	6	1
110-8	4695	499	55	14	22	3
121-11	2659	375	322	109	87	8
151-7	1183	91	394	60	40	17
<b>Total</b>		3957	3286	2140	829	102

In the ANDEEP III material Isopoda were most abundant, comprising 38 % of the total fauna of Peracarida sorted so far, followed by Amphipoda with 32 %. Cumacea contributed 21 % to the peracarid fauna, Tanaidacea 8 % and Mysidaceae were rare and occurred only with 1 %. Interestingly, we have found very similar results during ANDEEP I & II when Isopoda also dominated with 38 % of the peracarid fauna, followed by Amphipoda, with 32 % as well, Cumacea with 24 %, Tanaidacea with 4 % and Mysidaceae with 2 %.

Fig.9.4 : Total and relative abundance of peracarids sorted from 13 stations

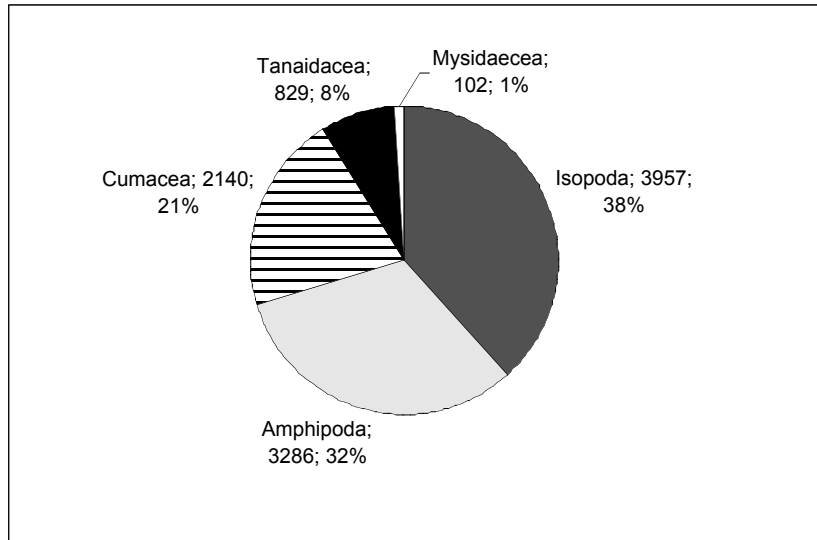

During ANDEEP III 13 stations (epi- and supranet, stations 16, 21, 59, 74, 78, 80, 81, 88, 94, 102, 110, 121 and 151), were sorted on board of RV *Polarstern*. The highest abundance of peracarida was found at station 74 with a depth of 1032 m (fig. 9.4). This station shows a typical shelf composition with respect to the Peracarida and the composition of isopod families. This is also true for station 151, which shows in contrast a lower total abundance of Peracarida. At both stations the Amphipoda are the dominating taxon, followed by the Cumacea and Isopoda; within the Isopoda high numbers of Anthuridae, Munnidae and Paramunnidae were found; these are families which are known to have evolved on the shelf and submerged into the deep sea.

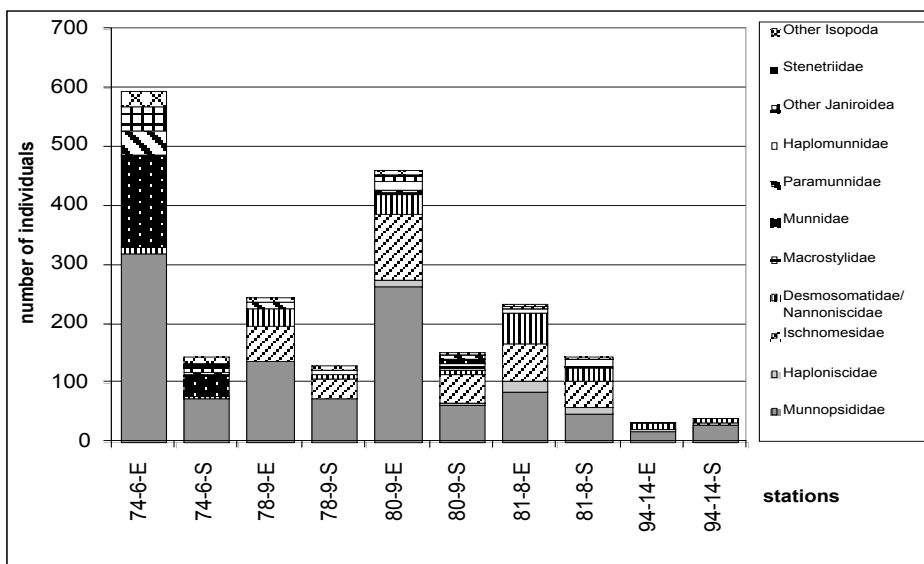

Fig. 9.5: Numbers of individuals of families of Isopoda from the first stations sorted

The Munnopsididae were the most abundant isopod family followed by the Haploniscidae, Ischnomesidae, and Desmosomatidae. Other families, like for example the Nannoniscidae, Macrostylidae, Paramunnidae or Hapломunnidae were much rarer.

In the following figures we present the differences in isopod composition in the epibenthic sledge samples at family level for three stations (figures 9.6-9.8).

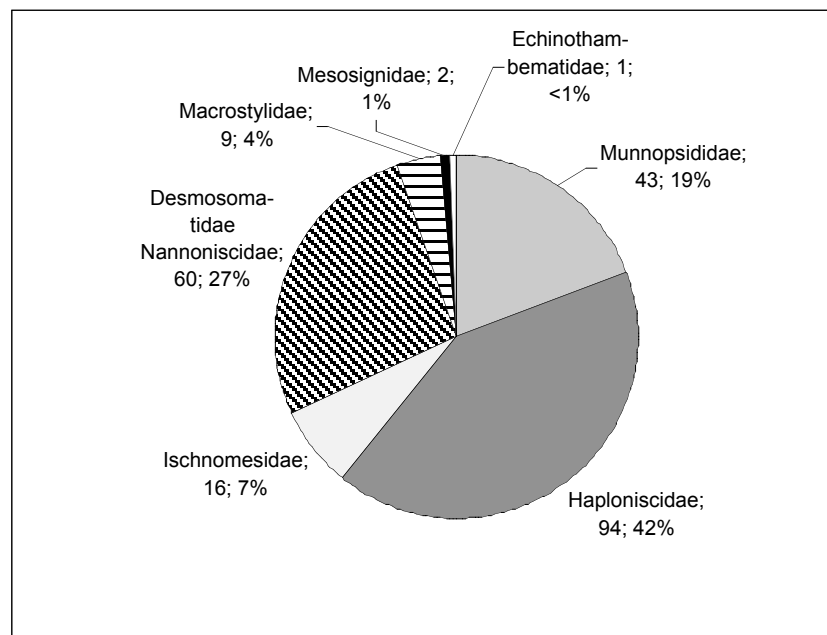

Fig. 9.6: Abundance of isopod families at station 16 in the Cape Basin

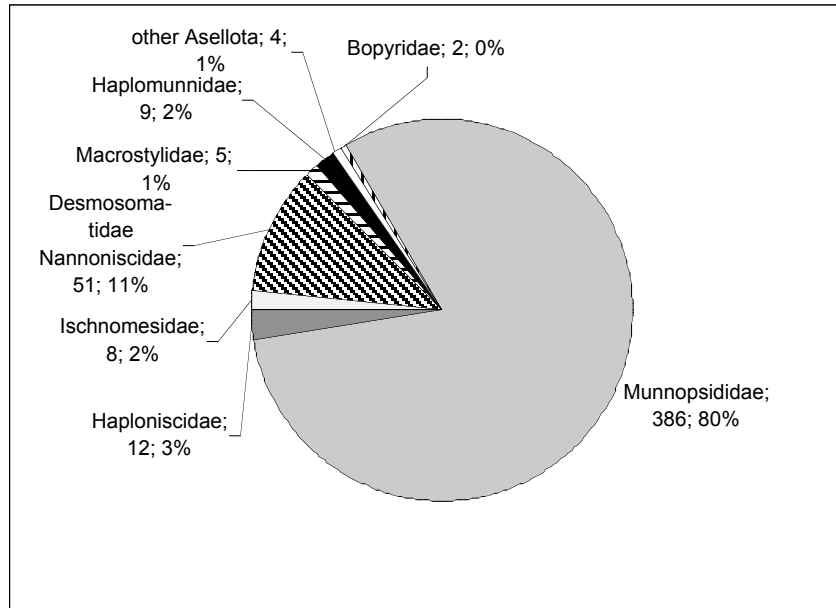

Fig. 9.7: Abundance of isopod families at station 110 in the Weddell Sea

The station in the Cape Basin is characterized by a high number of Haplomiscidae and relatively few Munnopsididae, while all other stations show the typical pattern with higher numbers of Munnopsididae (stations 74 and 110 in the Weddell Sea). The relatively high number of Ischnomesidae at stations 78, 80 and 81 is also remarkable, where this family distinctly exceeds the number of Haplomiscidae, who were completely absent at station 78 and rare at stations 80 and 81.

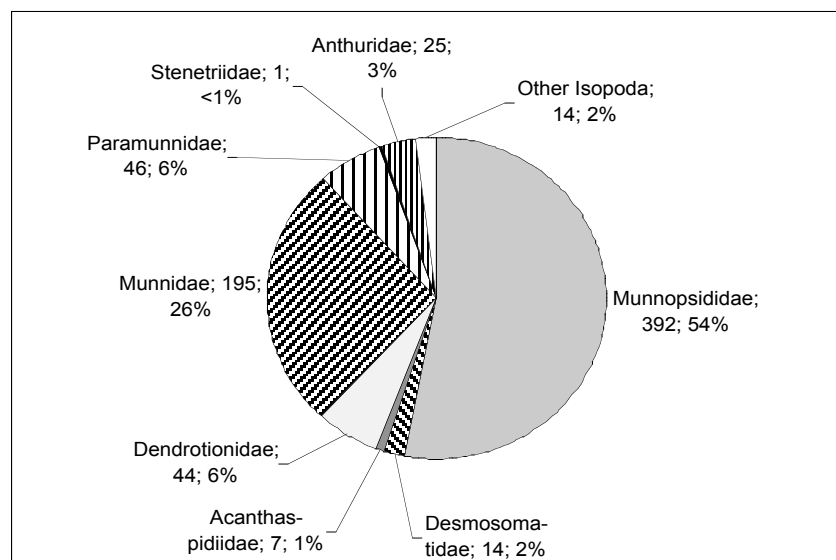

Fig. 9.8: Abundance of isopod families at station 74 off Kapp Norvegia

Typical deep-sea asellote isopods sorted so far belong to the families Munnopsididae (primarily Ilyarachninae, Eurycopinae), Haploniscidae, Ischnomesidae, Desmosomatidae, Munnidae, Acanthaspidiidae, Nannoniscidae, and Macrostylidae. Antarcturidae, Serolidae and Gnathiidae were much rarer.

### Polychaeta

Polychaetes were sorted to family level and enumerated from four stations, including two stations in the Agulhas Basin and two in the Weddell Sea, one at 4600 m and the other at about 1000 m. Not unexpectedly, the total number of individuals was about an order of magnitude lower at all abyssal stations than on the single 1000-m station (Fig. 9.9). In all four samples, a total of 38 families was found. The families can be divided into two groups, those that are generally abundant and ubiquitous and those that are rare and confined to either the shallow or one or more of the deep stations (Figs 9.10, 9.11). In both groups, the variety of families is much higher at 1000 m than at >4000 m, which may be a reflection of the topographical variety of the respective environments. Nonetheless, if diversity is calculated, it is very likely to be considerably higher at the abyssal stations than at the shallow station because of the very low number of individuals at the former among which the species are distributed. Generally, the composition of the fauna at 1000 m resembled that of shallower stations sampled during ANDEEP I and II (2002) and EASIZ II (1998). Large-scale distributional patterns of polychaetes from abyssal depths have to await taxonomic work, i.e., identification to species level and description of new species. One of the major results of ANDEEP I and II was the large increase of true deep-sea species, known to live at abyssal depths and not occurring on the shelf; this number is likely to increase again with the examination of the material collected during ANDEEP III.

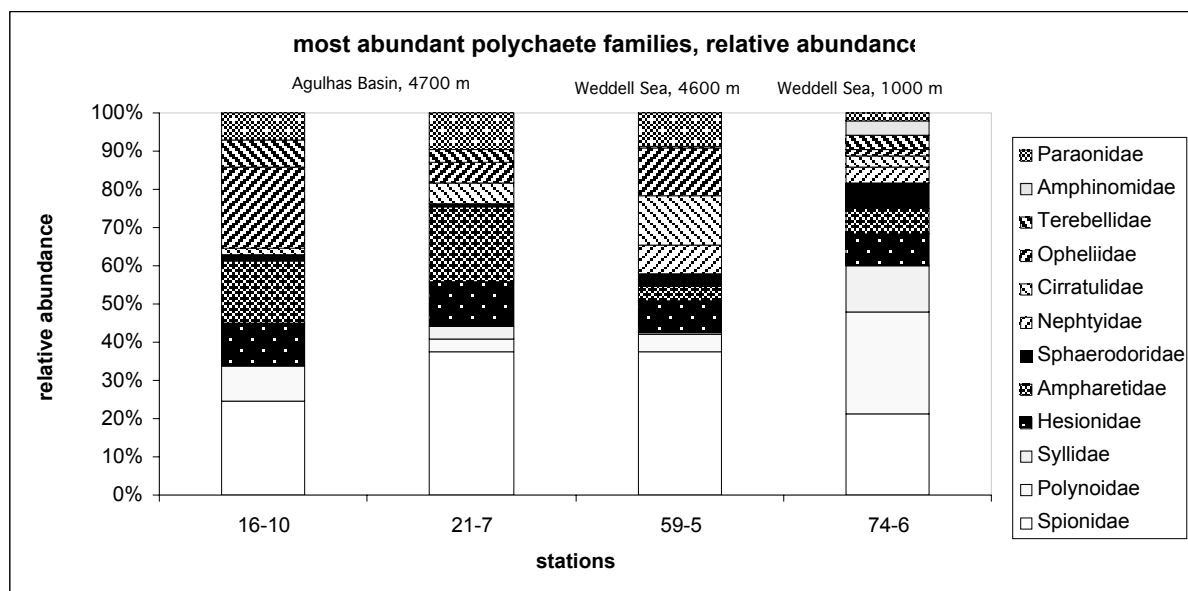

Fig. 9.9: Abundance of most common polychaete families in epibenthic sledge samples from four stations, normalised to 100%

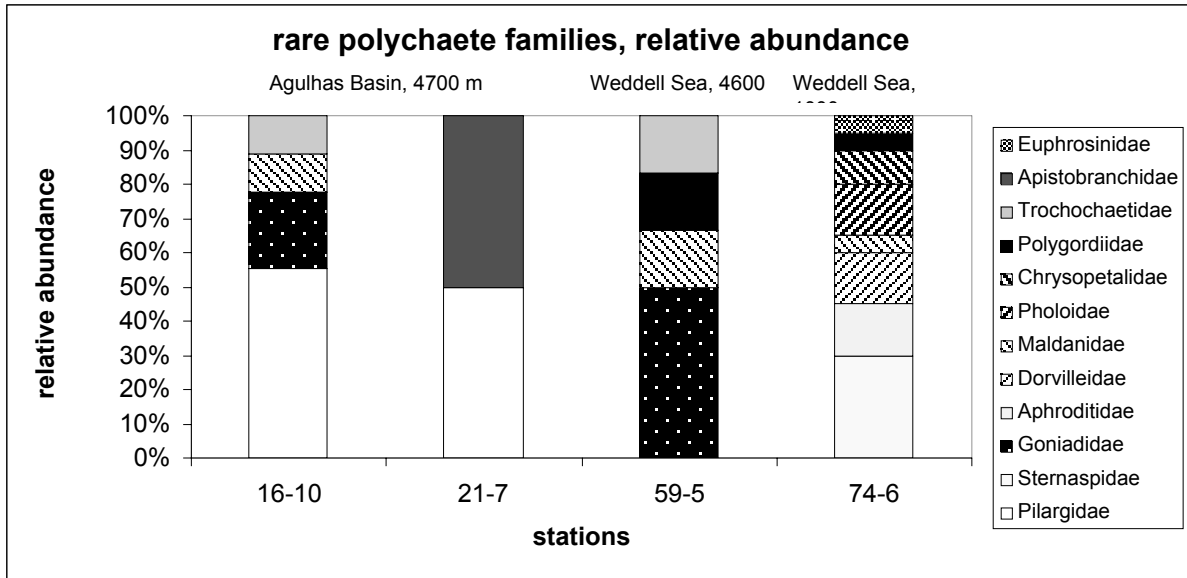

Fig.9.10.: Abundance of rarest polychaete families in epibenthic sledge samples from four stations, normalised to 100%

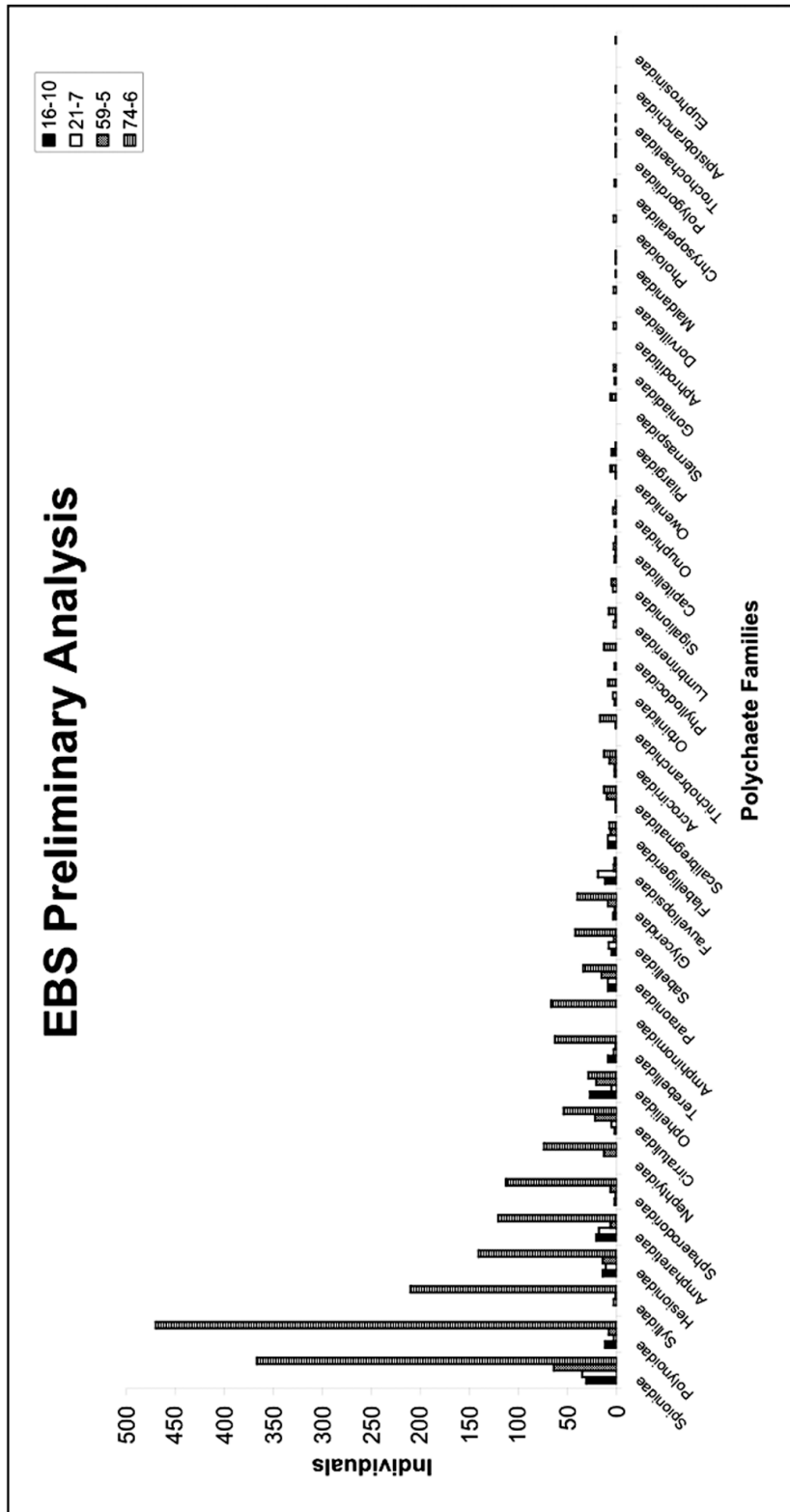

Fig. 9.11: Individuals per polychaete family in the EBS catches



### 9.2.9 Biodiversity, phylogeny and trophodynamics of amphipod crustaceans of the Antarctic deep sea

Claude De Broyer<sup>1</sup>, Bruno Danis<sup>1</sup> & Vincent Hétériér<sup>2</sup>

<sup>1</sup>Royal Belgian Institute of Natural Sciences, Bruxelles

<sup>2</sup>ULB, Brussels

#### Objectives

The ANDEEP I & II cruises in 2002 have revealed an overwhelming biodiversity in different faunal components of the Southern Ocean deep-sea ecosystem. The ANDEEP III expedition was planned to test hypotheses resulting from these data, corroborate results of the previous cruises and seek for the potential origin of some of the taxa which seem to have radiated in the Southern Ocean deep sea like others on the shelf.

The peracarid crustaceans, and in particular the Amphipoda, are known to count among the most speciose animal groups in the Antarctic coastal and shelf communities (De Broyer & Jazdzewski 1996). For the Antarctic deep sea, the ANDEEP I-II results showed that Amphipoda contributed up to 32% of the large material collected by the epibenthic sledge (EBS), just after Isopoda (38%), the usual dominant group in the deep sea (Brandt *et al.* 2004). In terms of species richness, the very limited deep-sea investigations in the Southern Ocean before ANDEEP revealed the presence of only 21 benthic amphipod species below 2000 m, all belonging to relatively primitive families characterized by free-swimming males (Thurston 2001). The successful ANDEEP I-II deep-sea amphipod sampling allowed discovering numerous species belonging to at least 28 different families. The ongoing identification work has already shown a high percentage of unknown species in most families (De Broyer *et al.* 2004; Berge pers. comm.; Thurston pers. comm.).

Concerning the origin of the Antarctic deep-sea fauna, pioneer molecular studies (16s rRNA, 18s rRNA and CO1 data) on polar submergence in Antarctic serolid and arcturid isopods (Held 2000) and Asellota Janiroidea indicated multiple colonisation events of the deep sea from the Antarctic shelf (Raupach *et al.* 2004), all of which occurred independently and may be related to the glaciation history in Antarctica. It is presently unknown if the amphipod crustaceans, which present a different evolutionary history, exhibit similar trends.

Investigations on the trophic role of the rich and diverse amphipod taxocoenosis of the Antarctic shelf have revealed a rather large diversity of trophic types (Dauby *et al.* 2001a, b) and a stable isotope approach (Nyssen *et al.* 2002) and a fatty acid analysis (Graeve *et al.* 2001) confirmed the trophic structure. How far can the trophic structure of the deep-sea benthic communities compare with the shelf communities?

The ANDEEP III project aimed at completing the previous results by pursuing the investigations on:

### 1. Patterns and processes of amphipod biodiversity

- To document species composition and as far as possible ecological traits (e.g. habitats, mode of life) of the Antarctic deep sea amphipod taxocoenoses on latitudinal and bathymetrical scales, and to compare it to the Antarctic shelf fauna and to the fauna of the (south) Atlantic abyssal basins.
- To investigate the determinants of the deep-sea amphipod species richness in comparison to the shelf fauna.
- To contribute by taxonomical material, photographic records, distribution and ecological data to the revision of the Antarctic fauna, the synthesis of its distributional and ecological traits and the preparation of new identification tools by the “Antarctic Amphipodologist Network” (see [www.naturalsciences.be/amphi](http://www.naturalsciences.be/amphi)), and to the SCAR Marine Biodiversity Information Network.

### 2. Molecular phylogeny and phylogeography

- To attempt to establish the phylogeny and phylogeography of selected amphipod taxa (mostly the Lysianassoidea) through parallel molecular and morphological approaches.
- To investigate the role of the Antarctic shelf species pool in the colonisation history of the (Atlantic) deep-sea basins and vice versa.

### 3. Trophodiversity and trophodynamics

- To characterise the dominant trophic types and to determine the trophodynamic role of the Antarctic deep-sea amphipod biocenosis in comparison with the shelf communities.

The trophic approach relies on digestive tract analyses and ethological observations in aquaria. This will be completed by the use of stable isotope (carbon and nitrogen) ratios and fatty acids as amphipod diet tracers to delineate the trophic relationships involving amphipods in Antarctic deep sea food webs.

#### **Work at sea**

Sampling: Amphipods crustaceans were collected from benthic and suprabenthic samples taken at 19 deep-sea stations by using the following gears: epibenthic sledge (EBS), Agassiz trawl (AGT), large box corer (GKG) and autonomous baited trap system (AT). The whole EBS material and selected material from AGT and AT was fixed in cooled ethanol for allowing further DNA analyses.

Sorting and identification: All trap samples, most of the AGT material and part of the EBS material was sorted to the species level and identified as far as time and available documentation permitted.

Photographic documentation: an extensive macro- and micro-photography database focusing on new species was built up during the cruise to feed the existing amphipod database (Ant'phipoda). Over 700 high-quality pictures were taken using either for macrophotography a Nikon D70 (AF 105mm f2.8 Nikkor lense, 2 external electronic flashes (Nikon SB24&SB80),) or for microphotography a Nikon Coolpix 9500 and a Leica binocular microscope.

Selection of material for DNA analyses, bacterial gut content studies, contaminant biokinetics studies, and trophic characterization by stable isotopes was done. DNA extractions were performed on selected species.

Maintenance and observation of living animals: Living amphipods and isopods were kept in different aquaria (of 6 to 30 l) aerated with air bubblers and provided with artificial substrate (nylon gauze). Some ethological observations (mostly on mobility and locomotion mode) were performed as well as systematic gut clearance observations on selected species.

### **Preliminary results**

#### **1. Faunistic survey**

Material collected: Among the collected amphipod specimens, 7297 (Gammaridea and Corophiidea) were sorted.

EBS. Thirteen stations (of 19) provided 3286 specimens. Part of the samples have been sorted to the family level, and in few cases to the genus and species level. The most common families represented were: Ampeliscidae, Corophioidea (mostly Ischyroceridae and Podoceridae, few Caprellidae), Eusiridae, Hyperiopsideae, Lepechinellidae, Liljeborgiidae, Lysianassoidea (adeliellids, Lysianassidae, Uristidae), Melphidippidae, Oedicerotidae, Pardaliscidae, Phoxocephalidae, Stegocephalidae, Stilipedidae, Synopiidae, and Urothoidea.

AGT. Sixteen AGT samples provided 225 specimens from at least 12 families.

GKG. Three specimens were recorded so far (partial results).

AT. Fourteen baited trap deployments allowed collecting 3783 amphipod specimens as well as specimens from 2 cirrolanid isopods ([table 9.15](#)) belonging to 30 species from at least 9 families ([table 9.16](#)). In most cases, these species were not collected by the other gears.

**Table 9.15:** Summary of ANDEEP III trap samples. For the different taxa, numbers indicate the number of species, numbers in parentheses correspond to the number of individuals.

Station	Depth (m)	Soak Time (hrs)	Amphipoda	Isopoda	Mysidacea	Pisces
057 AT	1831	64	4 (108)			
059 AT	4553	30	11 (687)	1 (1)	1 (2)	
074 AT	927	9	6 (132)	1 (11)		
078 AT	2123	17	4 (397)			
080 AT	2880	22	12 (445)			1 (1)
081 AT	4439	28	8 (653)			
088 AT	4934	27	5 (180)			1 (1)
094 AT*	4850	34	4 (65)			
102 AT*	4754	34	4 (23)			
110 AT	4587	27	4 (350)			
142 AT	3337	18	4 (16)			
150 AT	1125	34	5 (714)	1 (82)		
153 AT	2001	15	1 (10)	1 (4)		
154 AT	3689	17	2 (3)			
<b>Total</b>			<b>30 (3783)</b>	<b>2 (98)</b>	<b>1 (2)</b>	<b>1(2)</b>

\* bait in container

**Table 9.16:** List of amphipod and isopod species collected in the baited traps

Species	Stations
<b>AMPHIPODA</b>	
<i>Abyssorchomene plebs</i>	150
<i>Abyssorchomene cf scotianensis</i>	57, 59
<i>Abyssorchomene sp.1</i>	59
<i>Abyssorchomene sp.2</i>	78, 80, 81
<i>Abyssorchomene sp.3</i>	80, 81, 110
<i>Eurythenes gryllus</i>	57, 59, 78, 80, 81, 88, 94, 110, 142
<i>Lepedipecrellid n.gen. n.sp.1</i>	80
<i>Lysianassoidea gen. sp.1</i>	59
<i>Lysianassoidea gen. sp.2</i>	59, 110
<i>Lysianassoidea gen. sp.3</i>	59
<i>Lysianassoidea gen. sp.4</i>	59
<i>Lysianassoidea gen. sp.5</i>	74
<i>Lysianassoidea gen. sp.6</i>	80
<i>Lysianassoidea gen. sp.7</i>	81
<i>Orchomenopsis cf cavimanus</i>	57, 80, 150
<i>Orchomenopsis sp.1</i>	80, 150
<i>Paracallisoma n.sp.1</i>	59, 80, 88, 94, 110, 154
<i>Paralicella cf fusiformis</i>	110
<i>Paralicella sp.1</i>	59, 80, 81, 154
<i>Parschisturella simplex</i>	74, 150
<i>Pseudorchomene cf coatsi</i>	57
<i>Pseudorchomene n.sp.1</i>	150
<i>Stegocephalidae gen.sp.1</i>	78
<i>Stegocephalidae gen.sp.2</i>	88, 94
<i>Stegocephalidae gen.sp.3</i>	81, 110
<i>Stilipedidae gen.sp.1</i>	59
<i>Tryphosinae gen. sp.1</i>	59
<i>Tryphosinae gen.sp. 2</i>	74
<i>Tryphosinae gen.sp. 3</i>	80
<i>Tryphosinae gen.sp. 4</i>	81
<i>Valettiopsis n.sp.1</i>	153
<b>ISOPODA</b>	
<i>Natatolana albinota</i>	150
<i>Natatolana intermedia</i>	74, 153

## 2. Molecular phylogeny and phylogeography

Selected samples for molecular phylogeny studies comprise, in addition to the rich and diverse EBS samples, 34 lysianassoid species (including several new species) belonging to 18 genera and 10 families and 10 species from 5 other amphipod families provided by AGT and AT. Particular attention was paid to the selection of potential cryptic species.

Specimens for molecular analyses were preserved in 96 % cooled ethanol as soon as possible after sampling, preferably live, in order to avoid DNA degradation by enzymatic activity. As a rule, a little part of each specimen was taken for DNA extraction, usually the pereopod 6 as a whole or a part of it, depending of the size of the animal. About 50 DNA extractions and purifications were carried out using QIAamp DNA Mini Kit (Qiagen), from specimens belonging to 44 different morphospecies from 23 genera and 17 families.

All this material will be processed at the Royal Belgian Institute of Natural Sciences (IRSNB), in order to obtain DNA fragment sequences of at least 18S, CO1 and possibly ITS2 genes. These genes have proven to be useful for different phylogenetic levels and to give complementary information.

## 3. Maintenance of living amphipods and isopods and observations of feeding eco-ethology

Living specimens of 11 amphipod and 2 isopod species collected mostly by traps and occasionally by AGT and EBS were kept in a cool container at a temperature of +1°C: the scavenging lysianassoids *Abyssochomene plebs*, *A. scotianensis*, *A. sp.1*, *A. sp.2*, *A. sp.3*, *Orchomenopsis sp.1*, *Eurythenes gryllus*, *Parschisturella simplex*, *Pseudorchomene coatsi*, and *Valettiopsis n.sp.1*, the detritivore *Paraceradocus cf gibber*, and the scavenging cirrolanid isopods *Natatolana intermedia* and *N. albinata*. Some ethological observations (mostly mobility and locomotion mode) were carried out.

## 4. Gut clearance follow-up

Several experiments have been conducted on 3 living crustacean species (*E. gryllus*, *P. simplex*, *N. intermedia*) maintained in cooled aquaria, in order to estimate gut clearance rates. Stomach content analyses were also carried out in order to extend the existing database on Antarctic amphipod feeding habits.

Gut clearance was followed in a total of 40 individuals, at 8 different times (table 9.17). Interesting differences were spotted between the three considered species. At the end of the observations (42 d), the gut content of *E. gryllus* was still important, though well homogenized. Dissection showed that the guts were still relatively full and that the gut content (fish from the baits) had the form of a homogenous white paste. At the end of the experiment (39 d), the gut content of *P. simplex* had almost entirely disappeared, in most individuals. *P. simplex* was found to produce a black oily substance (which has been isolated for further study), which is formed during the

digestion process. Along time, this substance spread through the whole length of the digestive tube. This substance was not found in the other considered species. Finally, individuals of *N. intermedia* showed a very high variability in the digestion process, some individuals having almost emptied their gut at the end of the experiment, while others were still displaying the same content as that of the beginning of the experiment.

In order to quantify the remaining proportion of gut content in the individuals, digital pictures were taken at various intervals. Image analyses software (NIH Image<sup>®</sup>) will be used to measure the variations in gut content along time.

**Table 9.17:** Gut clearance follow-up. Number of individuals considered in the experiment (n) and duration of the experiment.

Species	n	Time (d)
<i>E. gryllus</i>	10	42
<i>P. simplex</i>	20	39
<i>N. intermedia</i>	10	39

### 5. Gut content bacteriology (B. Danis).

At three stations, the gut content of detritus-feeding amphipods was sampled for bacteria population analyses. The study of these samples will bring important information about barophilism in intestinal bacteria from deep-sea organisms, and on their role in the nutrition, which still is not well understood. For details, see Danis in the present cruise report.

### 6. Selected heavy metal levels and biokinetics in deep-sea Antarctic amphipods (B. Danis).

A total of 275 individuals of *Eurythenes gryllus* collected by traps at stations 81, 94 and 102 were immediately frozen for subsequent heavy metal analyses. Amphipods belonging to the species *Abyssorhomene plebs* (Amphipoda, Lysianassidae, n=250) and *Parschisturella simplex* (Amphipoda, Lysianassidae, n=250) were captured using AT at station 150 and kept alive to be sent to the International Atomic Energy Agency facilities (IAEA-MEL, Monaco). For details, see Danis in the present cruise report.

### References

- Brandt, A., Brökeland, W., Brix, S. and M. Maljutina (2004): Diversity of Southern Ocean deep-sea Isopoda (Crustacea, Malacostraca) – a comparison with shelf data. *Deep-Sea Research II*, 51: 1753-1768.
- Dauby, P., Scailteur, Y., Chapelle, G. and C. De Broyer (2001a): Trophic impact of benthic amphipod populations on the eastern Weddell Sea shelf ecosystem (Antarctica). *Polar Biology* 24 (9): 657-662.
- Dauby, P., Scailteur, Y. and C. De Broyer (2001b): Trophic type diversity within the eastern Weddell Sea amphipod community. *Hydrobiologia* 443: 69-86.

- De Broyer, C., Nyssen, F. and P. Dauby (2004): The crustacean scavenger guild in Antarctic shelf, bathyal and abyssal communities. *Deep-Sea Research II*, 51: 1733-1752.
- De Broyer, C. and K. Jazdzewski (1996): Biodiversity of the Southern Ocean: towards a new synthesis for the Amphipoda (Crustacea). *Bolletino del Museo Civico di Storia Naturale di Verona*, 20(2): 547-568.
- Graeve, M., Dauby, P. and Y. Scailteur (2001): Lipid, fatty acids and digestive tract analyses: a powerful combination for estimating feeding modes of Antarctic amphipods. *Polar Biology* 24: 853-862.
- Held, C. (2000): Phylogeny and biogeography of serolid isopods (Crustacea, Isopoda, Serolidae) and the use of ribosomal expansion segments in molecular systematics. *Molecular Phylogenetics and Evolution* 15(2): 165-178.
- Nyssen, F., Brey, T., Lepoint, G., De Broyer, C., Bouquegneau, J.M. and P. Dauby (2002): A stable isotope to the eastern Weddell Sea trophic web: focus on benthic amphipods. *Polar Biol.* 25: 280-287.
- Raupach, M., Held, C. and J.-W. Wägele (2004): Multiple colonization of the deep sea by the Asellota (Crustacea: Peracarida: Isopoda). *Deep-Sea Research II*, 51: 1787-1796.
- Thurston, M.H. (2001): Benthic Gammaridea (Crustacea: Amphipoda) in the deep sea. *Polskie Archiwum Hydrobiologii* 47 (3-4): 353-377.

#### 9.2.10 Selected heavy metal levels and biokinetics in deep-sea Antarctic amphipods

Bruno Danis and Claude De Broyer  
Royal Belgian Institute of Natural Sciences, Bruxelles

##### Background and objectives

Pollution of the ocean by heavy metals such as Co, Zn, Ag, Cu, Pb and Cd is a major environmental problem in many parts of the world (Clark 2001). When reaching marine waters, heavy metals mainly concentrate in the sediments due to their generally low solubility in sea water and their tendency to adsorb onto particles. Sediments therefore constitute the bulk of anthropogenic contaminants in the coastal environment and may be a major source of contamination for numerous organisms living in or close to them (Stebbing et al. 1992, NSTF 1993, Karbe et al. 1994, Alzieu & Michel 1998). Heavy metals reach the environment via natural sources (which account for a background exposure), increased by anthropogenic inputs. To differentiate between natural and anthropogenic metal inputs, which is one of the main objectives in biomonitoring, natural background concentrations of chemicals in organisms and their fluctuations have to be well established (Fialkowski et al. 2000). In this respect, investigations in remote areas such as the Antarctic Ocean are extremely interesting (Bargagli et al. 1996, 1998, Duquesne et al. 2000) because in these areas anthropogenic metal inputs are considered to be of minor importance. Among candidate bioindicator organisms in these areas, amphipods are particularly interesting, being widespread and key components of Antarctic marine ecosystems (Rainbow 1995).

One of the aims of the present study was to determine the concentrations of four heavy metals (Zn, Cd, Cu, and Pb) in sediments and in the widely distributed and abundant amphipod *Eurythenes gryllus*, in order to compare and integrate the information gathered through these two indicators. This information can give an insight in certain biological processes (such as uptake, regulation, elimination, etc.) occurring during life time exposure of the organisms. For this purpose, heavy metal levels will be determined in different organs of *E. gryllus*. This information will be put in relation with heavy metal levels measured in sediments (see Section below).

Investigations on the time course of uptake and loss of metals in organisms are a pivotal step in assessing the potential of test organisms for biomonitoring. Toxicokinetic studies usually focus on the uptake of waterborne heavy metals because this is regarded as the major source for uptake in various organisms (Warnau et al. 1996, 1999; Bustamante et al. 2004). Nevertheless, other sources also have to be considered, such as dietary or sediment uptake.

Another objective of this study is to evaluate the suitability of two Antarctic amphipod species (*Orchomene plebs* and *Parschisturella simplex*) as biomonitors for 4 heavy metals (Co, Zn, Ag, Cd) and 2 anthropogenic radionuclides ( $^{134}\text{Cs}$  and  $^{241}\text{Am}$ ) of environmental concern, and to analyse whether toxicokinetic models can be used as a tool to assess the metal uptake. Sampled organisms will be maintained aboard RV *Polarstern* in controlled conditions, and sent by air transport to the Marine Environment Laboratory (MEL) facilities at the International Atomic Energy Agency (IAEA, Monaco). Prior to experimentation, specimens will be acclimated to laboratory conditions for 1 month (constantly aerated open circuit aquaria (400 l), 34‰,  $1\pm 0.5^\circ\text{C}$ , 24/24 h dark). Antarctic organisms, mainly amphipods, have already been successfully maintained in these facilities for extensive periods of more than one year. Biokinetics will be studied using multi-element exposures with carrier-free or high specific activity radiotracers in order to measure fluxes at realistic contaminant concentrations (Nakamura et al. 1986).

### **Work at sea**

At 5 stations (table 9.18), a total of 275 individuals of *Eurythenes gryllus* (Amphipoda, Lysianassoidea) was collected using autonomous amphipod traps (AT), at depths ranging from 3000 to 4900 m. Specimens were immediately placed in plastic bags and frozen ( $-30^\circ\text{C}$ ) for subsequent heavy metal analyses. To account for possible cross contamination via ingestion of the bait (salmon and herring) used in the traps, subsamples of bait were equally stored for analyses.

Animals destined for contaminant biokinetics studies were captured using AT (Station PS67/150, depth: 1125 m, 34 hrs on bottom). Amphipods belonging to the species *Orchomene plebs* (Amphipoda, Lysianassidae, n=250) and *Parschisturella simplex* (Amphipoda, Lysianassidae, n=250) were kept in aquaria for 16 days until the end of the cruise (30-l aquaria, closed circuit, constant aeration,  $1\pm 0.5^\circ\text{C}$ , 35‰, 24/24 h dark, seawater renewal every second day). For transfer to the International Atomic Energy Agency facilities (IAEA-MEL, Monaco), animals will be packed in strong plastic bags, in seawater, under  $\text{O}_2$ -enriched atmosphere. Plastic bags will be stored



in an isothermic box, together with ice-blocks to keep the ambient temperature as constant as possible during transportation.

**Table 9.18:** *Eurythenes gryllus*. Sampling of individuals for heavy metals analyses in the different stations, using autonomous amphipod traps

Station	Depth (m)	Time at bottom (hrs)	n
PS67/59	4553	30	100
PS67/80	3074	22	25
PS67/81	4439	28	100
PS67/88	4934	27	30
PS67/110	4587	27	20

### Expected results

Heavy metal analyses requiring atomic emission spectrometry (AES), samples (*E. gryllus*) will be processed in the Marine Biology Laboratory (Université Libre de Bruxelles, Belgium), which has a strong expertise in heavy metal analyses in various marine matrixes (viz. biota, sediments). Sediment analyses will be carried out by Dr. John Howe (Scottish Association for Marine Sciences (SAMS), Oban, Scotland).

As all envisaged biokinetics studies require the use of radiotracers, they could not be carried out on board for obvious safety reasons. Experiments will therefore be carried out in the IAEA-Marine Environment Laboratory (Monaco), after a 1-month acclimation period. Depending on the survival rates of the exported animals, heavy metal uptake and loss biokinetics in *O. plebs* and *P. simplex* will be addressed in animals exposed to environmentally realistic concentrations via all possible contamination routes: seawater, sediments and food.

### References

- Alzieu, C. and P. Michel (1998): L'étain et les organoétains en milieu marin. *Biogéochimie et écotoxicologie, Repère océan*, vol. 15. Nantes, France: French Institute for Exploitation of the Sea.
- Bargagli, R., Nelli, L., Ancora, S., and S. Focardi (1996): Elevated cadmium accumulation in marine organisms from Terra Nova Bay (Antarctica). *Polar Biol.* 16: 513–520.
- Bargagli, R., Sanchezhernandez, J.C., Martella, L. and F. Monaci (1998): Mercury, cadmium and lead accumulation in Antarctic mosses growing along nutrient and moisture gradients. *Polar Biol.* 19:316–322.
- Bustamante, P., Teyssié, J.L., Danis, B., Fowler, S.W., Miramand, P., Cotret, O. and M. Warnau (2004): Uptake, transfer and distribution of silver and cobalt in tissues of the common cuttlefish *Sepia officinalis* at different stages of its life cycle. *Mar. Ecol.Prog.Ser.* 269:185-195.
- Clark, R.B. (2001): *Marine pollution*, fifth edition. Oxford University Press, 248 pp.
- Fialkowski, W., Rainbow, P.S., Fialkowska, E. and B.D. Smith (2000): Biomonitoring of trace metals along the Baltic coast of Poland using the sandhopper *Talitrus saltator* (Montagu) (Crustacea: Amphipoda). *Ophelia* 52:183–192.

- Karbe, L., Aletsee, C.D., Diirselen, K., Heyer, U., Kammann, M. and H.J. Kraux (1994): Bioaccumulation and effects of plankton and benthos on the fate of contaminant. In: Sündermann J (ed). *Circulation and fluxes in the North Sea*. Berlin: Springer-Verlag, pp. 556–597.
- Nakamura, R., Nakahara, M., Suzuki, Y. and T. Ueda (1986): Relative importance of food and water in the accumulation of radionuclides by sea urchin *Strongylocentrotus nudus*. *Bulletin of the Japanese Society of Scientific Fisheries* 52:703-710.
- North Sea Task Force (1993): North Sea quality status report. Oslo and Paris commission. London: International Council for the Exploration of the Sea, 346 pp.
- Rainbow, P.S. (1995): Physiology, physicochemistry and metal uptake—a crustacean perspective. *Mar. Pollut. Bull.* 31:55–59.
- Stebbing, A.R.D., Dethlefsen, V. and M. Carr (1992): Biological effects of contaminants in the North Sea. *Mar. Ecol. Prog. Ser.* (special edition) pp 1 – 361 (whole issue).
- Warnau, M., Teyssié, J.L. and S.W. Fowler (1996): Biokinetics of selected heavy metals and radionuclides in the common Mediterranean echinoids *Paracentrotus lividus*: sea water and food exposures. *Mar. Ecol. Prog. Ser.* 141:83-94.
- Warnau, M., Teyssié, J.L. and S.W. Fowler (1999): Biokinetics of radiocobalt in the asteroid *Asterias rubens* : sea water and food exposures. *Mar. Pollut. Bull.* 39:159-164.

### **9.2.11 Metals and microbial communities associated to deep-sea Antarctic sediments**

Bruno Danis  
Royal Belgian Institute of Natural Sciences, Bruxelles

#### **Background and objectives**

Once in the marine environment, many contaminants, including heavy metals, accumulate in sediments (Calmano & Förstner 1996). It is generally agreed that bacteria, as the most abundant sediment organisms, have a major role in the fate of these contaminants (Ford & Ryan 1995). Bacteria may volatilize, precipitate and transform metals into toxic organic derivatives (Calmano & Förstner 1996, Ford & Ryan 1995, Thayer & Brinckman 1984). They can also produce anionic polymers which can in turn complex metals (Ehrlich 1997). According to the type of physico-chemical environment and of microbial metabolism, metals may be released from sediments into the water column. In such cases, marine sediments become a secondary source of pollution leading to the possible contamination of benthic organisms living in their contact, and *in fine* to all the benthic food chain (Calmano & Förstner 1996).

Despite their importance for environmental and human health risks, the interactions between microorganisms and metals are poorly known in marine sediments (Gillan *et*

*al.* 2004). For example, of the three studies which were published about the effects of copper on the genetic diversity of marine microbial communities, only one included sediment communities (Jonas 1989, Webster *et al.* 2001, Gillan 2004). The effects of the other metals on the microbial diversity of sediments are virtually unknown. And, of the few reports that have been published about the effect of metals on bacterial diversity in marine sediments, most of them lack important ecological information such as that offered by 16S rRNA sequencing or *in situ* hybridization (Rasmussen & Sørensen 1998, Frischer *et al.* 2000, Powell *et al.* 2003).

The aim of the present project is to understand the complex interactions between heavy metals and the microorganisms living in deep Antarctic sediments. The microbial communities living at the surface of the sediments will be studied using molecular biology tools (denaturing gradient gel electrophoresis –DGGE– (Muyzer 1999), sequencing, and fluorescent *in situ* hybridization –FISH– (Amann *et al.* 1990)). Bioavailability of the metals (Cd, Pb, Cu, Zn) will be evaluated using HCl extraction and biosensors (Gillan *et al.* 2004, Ivask *et al.* 2002). Mineralogical composition of the sediments and organic matter content will also be determined. All these microbiological data will be collected at each station considered. Multivariate statistics will then be used to determine the importance of metals in the composition and structure of the sediment-associated microbial communities.

### **Work at sea**

Sediments for bacterial analyses were sampled during box corer (GKG) operations, at 16 stations (see GKG report for details). Subcores (first 4 cm) of the sample were taken using 50 ml sterile plastic syringes. Subcores were taken away from the borders of the untouched core, in satisfyingly undisturbed areas. Samples were processed immediately in the dry laboratory on board RV *Polarstern*, using all precautions to avoid bacteriological contamination. Three cryotubes were filled with ca. 1 ml of sediments for DGGE analyses, added with 1 ml 100% ethanol, and stored at -30°C. Three other cryotubes were completely filled with sediments, and immediately deep-frozen in liquid N<sub>2</sub> (-196°C). After 48 hrs, the latter samples were transferred to the cold storage room (-30°C). For FISH analyses, 20 Eppendorf tubes were filled (ca. 1 ml) with sediments and added with 1 ml freshly prepared formaldehyde (4% in filtered seawater (FSW)). Fixation was carried out for 3 h at 4°C. After this period, samples were centrifuged (10,000 RPM, 10', room temp.) and formaldehyde was discarded. Sediments were resuspended in FSW (1 ml) and recentrifuged (10,000 RPM, 10', room temp.). The supernatant was discarded and replaced by 50% ethanol (in FSW). Sediments were resuspended and stored at -30°C.

### **Expected Results**

Bacteriological analyses will imply the use of molecular techniques such as DGGE, FISH, epifluorescence microscopy, DAPI, sequencing, cloning, which could not be performed on board RV *Polarstern*. Therefore, bacteriological samples will be processed on land, in collaboration with Dr. David Gillan, Marine Biology Laboratory (Université Libre de Bruxelles (ULB), Belgium).

All sediment physico-chemical analyses (contaminant levels, granulometry, organic matter) will be carried out by Dr. John Howe (SAMS, Oban, Scotland), and data will be cross-linked using multivariate statistics in order to determine the impact of sediments composition and structure on deep-sea microbial communities.

## References

- Amann, R.I., Binder, B.J., Olson, R.J., Chisholm, S.W., Devereux, R. and D.A. Stahl (1990): Combination of 16S rRNA-targeted oligonucleotide probes with flow cytometry for analyzing mixed microbial populations. *Appl. Environ. Microbiol.* 56:1919-1925.
- Calmano, W. and U. Förstner (eds), (1996): *Sediments and toxic substances*. Springer-Verlag, Berlin, 335 pp.
- Ehrlich, H.L. (1997): Microbes and metals. *Appl. Microbiol. Biotechnol* 48:687-692.
- Ford, T. and D. Ryan (1995): Toxic metals in aquatic ecosystems : a microbiological perspective. *Environ. Health Perspect.* 103 (1):25-28.
- Frischer, M.E., Danforth, J.M., Newton Healy, M.A. and F.M. Saunders (2000): Whole-cell versus total RNA extraction for analysis of microbial community structure with 16S rRNA-targeted oligonucleotide probes in salt marsh sediments. *Appl. Environ. Microbiol.* 66:3037-3043.
- Gillan, D.C. (2004): The effect of an acute copper exposure on the diversity of a microbial community in North Sea sediments as revealed by DGGE analysis – The importance of the protocol. *Mar. Pollut. Bull.* 49:504-513.
- Gillan, D.C., Danis, B., Pernet, P., Joly, G. and P. Dubois (2004): Structure of the sediment-associated microbial communities along a heavy metal contamination gradient in the marine environment. *Appl. Environ. Microbiol.* (in press).
- Ivask, A., Virta, M. and A. Kahru (2002): Construction and use of specific luminescent recombinant bacterial sensors for the assessment of bioavailable fraction of cadmium, zinc, mercury and chromium in the soil. *Soil Biol. Biochem.* 34:1439-1447.
- Jonas, R.B. (1989): Acute copper and cupric ion toxicity in an estuarine microbial community. *Appl. Environ. Microbiol.* 55:43-49.
- Muyzer, G. (1999): DGGE/TGGE a method for identifying genes from natural ecosystems. *Curr. Opin Microbiol.* 2:317-322.
- Powell, S.A., Bowman, J.P., Snape, I. and J.S. Stark (2003): Microbial community variation in pristine and polluted nearshore Antarctic sediments. *FEMS Microbiol. Ecol.* 45:135-145.
- Rasmussen, L.D. and S.J. Sørensen (1998): The effect of longterm exposure to mercury on the bacterial community in marine sediment. *Curr. Microbiol.* 36:291-297.
- Thayer, J.S. and F.E. Brinckman (1984): The biological methylation of metals and metalloids. *Adv. Organometallic Chem.* 20:313-356.
- Webster, N.S., Webb, R.I., Ridd, M.J., Hill, R.T. and A.P. Negri (2001): The effects of copper on the microbial community of a coral reef sponge. *Environ. Microbiol.* 3:19-31.

### 9.2.12 Patterns in phylogeny and biogeography of Antarctic brittle stars (Echinodermata: Ophiuroidea): molecular genetic signatures within the genus *Ophiocten*

Bruno Danis  
Royal Belgian Institute of Natural Sciences, Bruxelles

#### Background and objectives

Brittle stars (Echinodermata: Ophiuroidea) are key elements of benthic ecosystems in Antarctic waters. Despite their general ecological significance, for most species open questions still exist with respect to origin, speciation, taxonomic status and distribution range in relation to biological traits (reproduction mode) and geological history (plate tectonics, climate oscillations). Here, we propose a case study on the abundant and widespread genus *Ophiocten* in order to reconcile patterns in phylogenetic relationship and biogeographic distribution of Arctic, Atlantic and Antarctic species with the course of drastic environmental changes at evolutionary time scales. Molecular methods will be applied to elucidate genetic similarity patterns at both species and population levels. The molecular genetic signatures will be used to deduce the phylogenetic relationships between species and, hence, the course of speciation and colonisation of the polar seas, to solve the taxonomic status of closely related taxa, to track the dispersal routes of meroplanktic larvae and to identify genetically distinct populations.

During the cruise, the genetic study (restricted to regions covered by the ANDEEP III cruise) will include all ophiuroid morphotypes sampled with the Agassiz trawl, prepared for further DNA analyses.

#### Work at sea

Brittle stars were collected in 18 stations using the Agassiz trawl (AGT) (table 9.19). After sieving and sorting of the whole sample, brittle stars were separated in morphotypes, in function of general, spine, and oral plates morphology. A sample of each morphotype (part of an arm) was placed in Eppendorf tubes with 100% ethanol and stored at -30°C for subsequent genetic analyses. Samples (whole organisms) of each morphotypes were fixed in 70% ethanol and placed in plastic vials.

#### Results/expected results

A total of 739 ophiuroid specimens was collected during the cruise using AGT. Results of sampling were roughly analysed using descriptive statistics. Regarding the number of specimens collected and the number of morphotypes, no significant differences or clear trends were found among the stations when considering factors such as depth (fig. 9.12) or substrate quality (mud/rock proportion). When empirically grouping depth in 4 categories (1000-2000 m, 2000-3000 m, 3000-4000 m, 4000-5000 m), no significant differences were found regarding the number of specimens ( $p_{ANOVA}=0.113$ ), but significant differences were found when considering the number of morphotypes ( $p_{ANOVA}=0.001$ ), indicating possible variation of diversity in function of the considered depth category (fig. 9.13).

All brittlestars collected during ANDEEP III cruise will be forwarded to Dr Dieter Piepenburg (Institute for Polar Ecology, University of Kiel), via Dr. Angelika Brandt, for further determination/observation. All DNA analyses will also be carried out by Dr. D. Piepenburg.

**Table 9.19:** Ophiuroid specimens collected with the Agassiz trawl during the ANDEEP III. Distribution of the number of specimens for each morphotype (MT).

Station	MT1	MT2	MT3	MT4	MT5	MT6	MT7	MT8	TOTAL
PS67/016	-	-	-	-	-	-	-	-	100
PS67/021	-	-	-	-	-	-	-	-	50
PS67/057	20	3	1	1					25
PS67/059	5	1	2	1					9
PS67/074	70	30	19	5	1	1	3		129
PS67/078	2	2	1						5
PS67/080	41	17	7	5	6	1	1		78
PS67/081	1	1							2
PS67/088	1								1
PS67/094	7	12							19
PS67/102	2	1	1						4
PS67/110	1	1							2
PS67/121	10	9	3						22
PS67/142	59	8	44	29	10	1	2	1	154
PS67/150	1	1	1	1	1				5
PS67/151	15	2	2	2	1				22
PS67/153	48	3	6	2	2	2	1		64
PS67/154	6	27	11	2	2				48

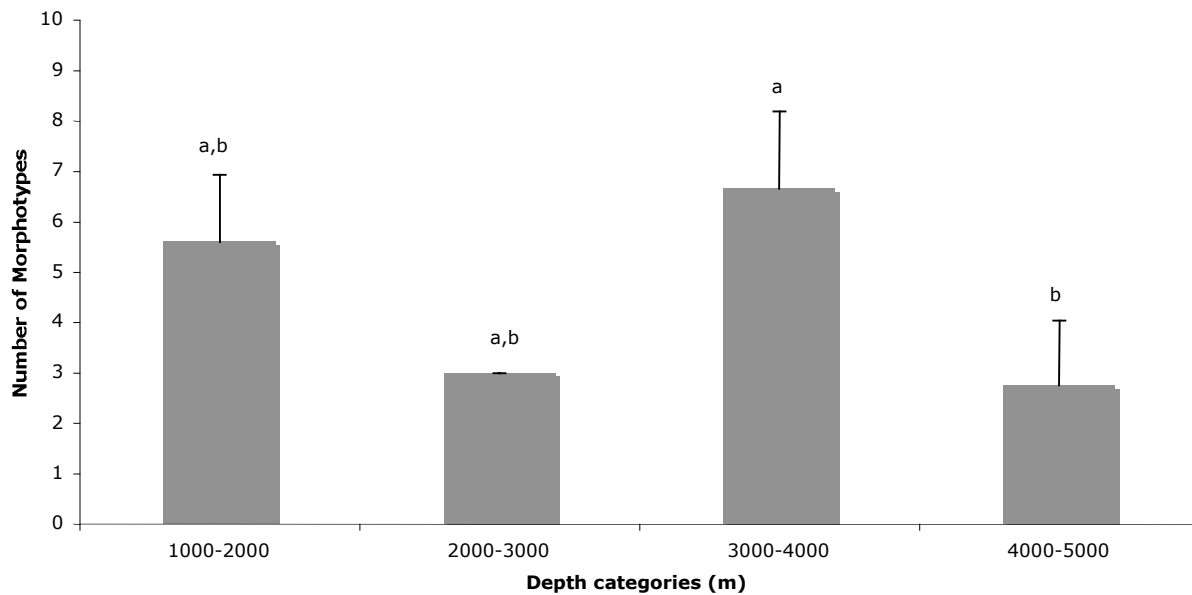

Fig. 9.12: Number of ophiuroid specimens collected with the Agassiz trawl during the ANDEEP III cruise, as a function of depth

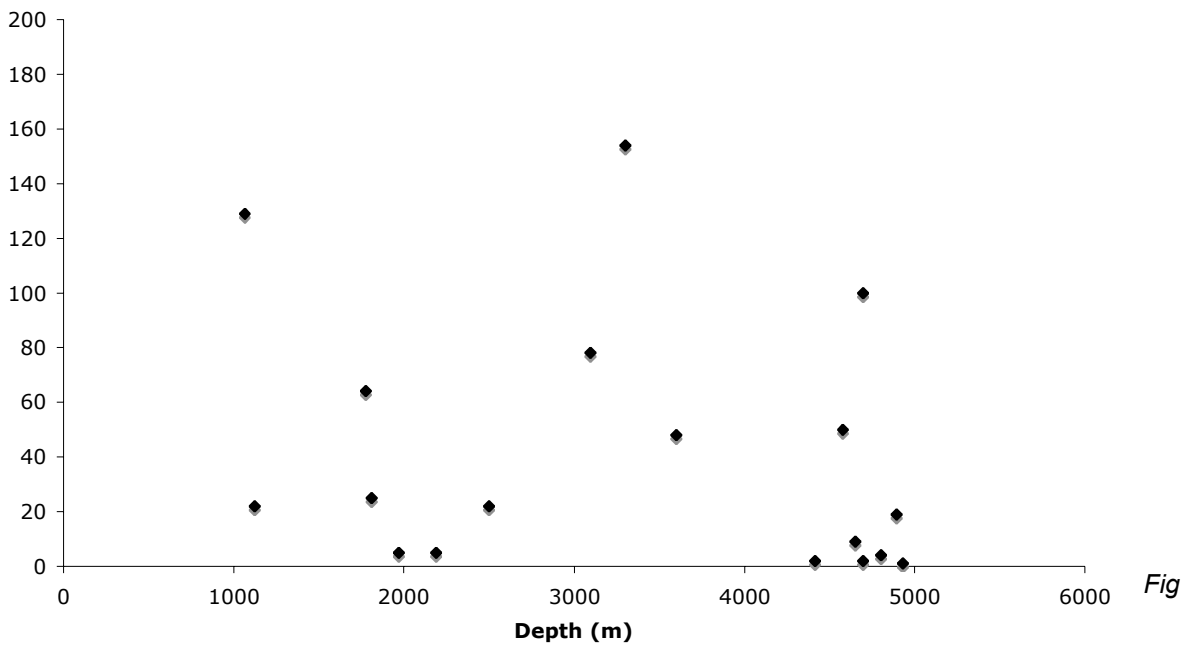

Fig. 9.13: Number of ophiuroid morphotypes (mean±SD), in function of depth categories (m). Histograms sharing the same superscript do not differ significantly ( $r^2=0.05$ )

## Work at sea

### a. Brown sea ice sampling

At station PS67/121, a sample of brown sea ice was taken at sea using a metallic cage. After visual examination, the most densely coloured parts, presumably containing the highest algae concentrations were crushed and separated in 5 plastic bags (ca. 15 l each), before being placed in the cold storage room (-30°C). This sample will be sent to the IAEA facilities to complete the algaetheque. Using cultivation techniques, it will be used in future studies addressing contaminants transfer along Antarctic trophic chains.

### b. Gut content bacteriology

At seven stations, the gut content of various detritivores (Amphipoda, Holothuroidea, Asteroidea) was sampled for bacteria population analyses using DGGE (table 9.20). Animals were carefully dissected with sterilized instruments. The gut was opened and its content transferred to separate cryotubes, in function of the different gut regions. The same procedure as that used for sediment samples was applied for the gut contents (see description in section above). The study of these samples could bring important information about barophilism in intestinal bacteria from deep-sea organisms, and on their nutritious role in the ecosystem, which still is not well understood. Bacterial analyses will be conducted by Dr. David Gillan, ULB (Brussels)

**Table 9.20:** Sampling of bacteria from the gut content of different deposit-feeders during ANDEEP III. (RDT=number of regions of digestive tract; MT=Morphotype; AGT=Agassiz trawl; AT=Amphipod traps; EBS=Epibenthic sledge).

Station	Gear	Taxa	RDT
PS67/16	AGT	Asteroidea	1
PS67/57	AGT	Holothuroidea, MT1	3
		Holothuroidea, MT2	3
PS67/94	AT	Amphipoda	2
PS67/133	EBS	Amphipoda	2
PS67/142	AGT	Echinoidea	3
		Holothuroidea	3
PS67/151	AGT	Echinoidea	3
PS67/153	AGT	Amphipoda	2



### 9.2.13 Mollusca collected during ANDEEP III – preliminary results

Katrin Linse<sup>1</sup>, Enrico Schwabe<sup>2</sup>, Angelika Brandt<sup>3</sup>

<sup>1</sup>British Antarctic Survey, Cambridge

<sup>2</sup>Zoologische Staatssammlung München

<sup>3</sup>Zoologisches Institut und Museum, Universität Hamburg

#### Objectives

The Scotia Sea and the Weddell Sea sector of the Southern Ocean were chosen as the study areas of ANDEEP. During ANDEEP I & II the focus of the sampling was on the Scotia Sea. The break-up of the continental bridge between South America and the Antarctic Peninsula, the development of deep-sea basins and deep-water currents were major events that influenced the evolution of the Antarctic marine benthic fauna. The molluscan material collected on ANDEEP I & II provided an ideal opportunity to study the missing faunal link between the temperate South America (Victor Hensen & Vidal Gomaz cruises; Linse 2002), the South Atlantic deep sea (ANDEEP I & II; Fütterer *et al.* 2003, Linse *et al.* 2003a) and the Antarctic shelf fauna (EPOS, EASIZ; Hain 1989, Brandt *et al.* 1999, Linse *et al.* 2003b, Linse & Cope 2005). First analyses of the mollusc distributions in the Southern Ocean deep sea of the Antarctic Peninsula and Scotia Sea region showed relations to and overlap with the Antarctic shelf fauna but relations to the deep-sea bivalves reported from south off South Africa. ANDEEP III gives us the opportunity to sample deep-sea molluscs from the Cape Basin to Kapp Norvegia and across the Weddell Sea and will throw further light on the evolution and radiation of the present fauna. The stations off Anvers Island (western Antarctic Peninsula) will serve as preliminary and first comparisons to the deep-sea molluscs of the Pacific sector of the Southern Ocean.

The material collected will be the basis for species descriptions, critical taxonomic revisions and zoogeographic analyses. The biodiversity of different molluscan classes will be assessed and latitudinal species diversity gradients will be studied. Studies on the phylogeny and population dynamics of selected taxa, especially taxodont bivalves, trochid gastropods and scaphopods, using traditional and modern methods, may elucidate the role of the Southern Ocean as a centre of radiation for Atlantic taxa and possibly as a continuing portal for colonisation from the Indo-Pacific. These studies may also explain the origin of the recent Southern Ocean molluscan fauna.

#### Work at sea

We sorted and pre-identified Mollusca from 12 (of 19) EBS stations (1000 – 4900 m) as well as from 19 AGT stations (1000 – 4900 m). The material collected by the EBS in Powell Basin, Bransfield Strait and Brabant Island has still to be sorted and identified. To date we have found 186 molluscan morphospecies of six classes and 3801 specimens in the samples from both gears. With 100 morphospecies, gastropods are the dominant group in terms of species numbers followed by bivalves with 60 species. Aplacophoran species were quite common with 1 morphotype of Caudofoveata and 9 morphotypes of Solenogastres. Nine species of scaphopods, five species of cephalopods and one species of polyplacophorans were found. The ratio of 1.66 gastropod to bivalve species is quite interesting bearing in mind that

three times more gastropod species are known from the Southern Ocean than bivalve species. In the samples from ANDEEP I and II this ratio was lower (1.37) and therefore this ratio is not constant for the Southern Ocean deep sea. Hain (1989), Powell (1958) and Egorova (1982) reported ratios for gastropods (G) and bivalves (B) in the range of 1.94-2.94 in their studies on the Antarctic shelf (93 G: 39 B - Weddell Sea, 97 G: 33 B – Enderby Land to Ross Sea, 98 G: 50 B – Davis Sea).

The epibenthic sledge was very efficient in collecting macrobenthic molluscs. To date we have identified 137 species belonging to six molluscan classes and have collected 2426 specimens (table 9.21). With 68 species, gastropods are the dominant group in terms of species numbers followed by bivalves with 50 species. Aplacophoran species were quite common with 1 morphotype of Caudofoveata and 9 morphotypes of Solenogastres. Also nine species of scaphopods were found. Similar to the results from ANDEEP I & II, the species populations seem to be small and very patchy in distribution. Almost two-thirds of all species found, especially gastropod morphospecies, are represented in the material by specimens only found at one or two locations or by single specimens. High numbers of specimens were observed only for *Dacrydium* sp. 2, *Kingiella* cf *sirenkoi*, Thyasiridae sp. 2, *Pulsellum* sp. 1 and *Siphonodentalium* sp..

**Table 9.21:** Molluscan morphospecies collected from the EBS samples

Station	016-10	021-7	059-5	074-6	078-9	080-9	081-8	088-8	094-12	102-13	110-8	133-2-Ü	Sum
<b>Aplacophora</b>													
<b>Solenogastres</b>													
<i>Solenogaster</i> sp. 1	1	1	1			4							7
<i>Solenogaster</i> sp. 2			1	1	2	4					3		11
<i>Solenogaster</i> sp. 3												18	18
<i>Solenogaster</i> sp. 4	1	2	3	5	9	1	2	1					24
<i>Solenogaster</i> sp. 5			4	1	2	3	2			1			13
<i>Solenogaster</i> sp. 6	1			6									7
<i>Solenogaster</i> sp. 7									1				1
<i>Solenogaster</i> sp. 8												5	5
<i>Solenogaster</i> sp. 9												1	1
<b>Caudofoveata</b>													
<i>Falcidens</i> sp.	1	2	1		3	2							9
<b>Monoplacophora</b>													
Monoplacophora sp.						1							1
<b>Gastropoda</b>													
<i>Anatoma euglypta</i>				6			1					41	48
<i>Anatoma</i> sp.							4						4
<i>Balcis</i> cf <i>antarctica</i>												2	2
<i>Balcis</i> cf <i>tumidula</i>				4									4
<i>Balcis</i> sp.				1									1
<i>Brookula</i> sp. 1					1	1						39	41
<i>Brookula</i> sp. 2				3		1							4
<i>Brookula</i> sp. 3					2								2
<i>Brookula</i> sp. 4					1								1

9. INTRODUCTION TO ANDEEP: ANTARCTIC BENTHIC DEEP-SEA BIODIVERSITY

Station	016-10	021-7	059-5	074-6	078-9	080-9	081-8	088-8	094-12	102-13	110-8	133-2-Ü	Sum
Buccinidae juvenil				6									6
<i>Bulla</i> sp.	1												1
<i>Calliotropis pelseneeri rossiana</i>			1									2	3
<i>Calliotropis</i> sp. 1				2									2
<i>Capulus compressus</i>				1									1
<i>Cerithiella lineata</i>				1									1
Cerithiopsidae sp. 1		1											1
<i>Chlanidota</i> sp. 2						1							1
<i>Cylichna</i> sp.												2	2
<i>Diaphana</i> sp. 1				5									5
<i>Diaphana</i> sp. 2					1								1
<i>Diaphana</i> sp. 3												1	1
Eulimidae sp. 1			4										4
Eulimidae sp. 2							1	2		2			5
Pleurobranchiidae sp. 2												1	1
<i>Leptocollonia</i> sp.												2	2
<i>Limacina cf helicina</i>				1								2	3
<i>Liotella</i> sp.												7	7
<i>Lissotesta</i> sp. 1			7	36			1	1		4			49
<i>Lissotesta</i> sp. 2				1									1
<i>Lissotesta</i> sp. 3												1	1
<i>Lissotesta</i> sp. 4							3						3
<i>Lissotesta</i> sp. 5								1				5	6
Littorinidae sp. 2				1	1							4	6
Littorinidae sp. 3				1									1
Littorinidae sp. 4												3	3
Littorinidae sp. 5												1	1
<i>Margarella</i> sp.												13	13
Mesogastropoda sp. 2				2									2
Mesogastropoda sp.3												1	1
<i>Microdiscula</i> sp.												17	17
Naticidae juvenil				1									1
Naticidae sp. 1	1												1
Naticidae sp. 2												1	1
Naticidae sp. 4				2									2
<i>Nothoadmete</i> juvenil				2		1						3	6
<i>Nothoadmete</i> sp. 1				2									2
<i>Nothoadmete</i> sp. 2				1									1
<i>Nothoadmete</i> sp. 3				4									4
<i>Philine</i> sp. 1				2	10								12
<i>Philine</i> sp. 2				1									1
<i>Philine</i> sp. 3			1										1
Pteropod sp. 3												1	1
Pyramidellidae sp.		1	1										2
<i>Sequenzia</i> sp.	1				1								2
<i>Stilapex cf polaris</i>						2							2
<i>Toledonia</i> sp. 1	1												1
<i>Toledonia</i> sp. 2				1									1

Station	016-10	021-7	059-5	074-6	078-9	080-9	081-8	088-8	094-12	102-13	110-8	133-2-Ü	Sum
<i>Torellia cf cornea</i>				1									1
<i>Torellia insignis</i>				1									1
Trochidae sp. 2												1	1
Trochidae sp. 3			2	2			1					1	6
Turbinidae sp. 1						2							2
Turbinidae sp. 2												7	7
Turridae sp. 11				2									2
Turridae sp. 12							1						1
Turridae sp. 2		1											1
<i>Tyaerborgia</i> sp. 1	1											3	4
<i>Tyaerborgia</i> sp. 2												1	1
<b>Bivalvia</b>													
<i>Adacnarca</i> sp. 2			1										1
<i>Adacnarca</i> sp. 3				48									48
<i>Bathyarca sinuata</i>			2								1		3
<i>Cardiomya</i> sp. 1	1												1
<i>Cardiomya</i> sp. 2			5								1		6
<i>Cardiomya</i> sp. 3										2			2
<i>Cuspidaria</i> sp. 1	3	5	3										11
<i>Cuspidaria</i> sp. 2	4		4			2	9				2		21
<i>Cuspidaria</i> sp. 3					4	12	4				1	3	24
<i>Cuspidaria</i> sp. 4								5			2		7
<i>Dacrydium</i> sp. 2			29	19			25	70	15	29	28		215
<i>Ennucula</i> sp.		2											2
<i>Thyasira dearborni</i>				21									21
<i>Kingiella cf sirenkoi</i>	11	3	48		47	5	4	88	26	72	164		468
<i>Limatula</i> (A.) sp. 1		1											1
<i>Limatula</i> (A.) sp. 2				3				11					14
<i>Limatula</i> (A.) sp. 3									1		3		4
<i>Limatula</i> (L.) sp.			1	1				3	1		1		7
<i>Limopsis</i> "Deep I"				1									1
<i>Limopsis</i> juvenil						1							1
<i>Limopsis tenella</i> Antarctica			3								3		6
<i>Limopsis tenella</i> South Africa	1	1											2
Lyonsiidae juvenil				5									5
<i>Malletia</i> sp. 1	1												1
<i>Malletia</i> sp. 2			3										3
<i>Mysella</i> sp.				54									54
<i>Nucula</i> sp.					1								1
Nuculanidae sp. 1	4	6											10
Nuculanidae sp. 2	1	3	10			2	6		2		2		26
Nuculidae juvenil						1							1
Nuculidae sp. 1	1	1											2
Nuculidae sp. 2	5	1											6
Propeamussiidae sp. 1			3				1						4
Propeamussiidae sp. 1						8	7	2	1	2	1		21
Propeamussiidae sp. 1											1		1
<i>Silicula</i> sp.	2												2

Station	016-10	021-7	059-5	074-6	078-9	080-9	081-8	088-8	094-12	102-13	110-8	133-2-Ü	Sum
Taxodont bivalve juvenil	3	10				4						1	18
Taxodont bivalve sp. 1						1				2	2		5
Taxodont bivalve sp. 2	22	1											23
Taxodont bivalve sp. 3	1												1
<i>Thracia meridionalis</i>				1									1
Thyasiridae sp. 1	5												5
Thyasiridae sp. 2		3	13	10	62		4	63	22	20	36		233
Thyasiridae sp. 3									1	6	2		9
Thyasiridae sp. 4							1						1
<i>Waldo</i> sp. 1				9									9
<i>Yoldiella</i> cf <i>ecaudata</i>				21	11							2	34
<i>Yoldiella</i> cf <i>sabrina</i>	12	2			14			7	2	14	42		93
<i>Yoldiella</i> sp. 2	7												7
<i>Yoldiella valettei</i>			7	49	25	1	8					1	91
<b>Scaphopoda</b>													
<i>Cadulus</i> sp. 1	1	2						2					5
<i>Cadulus</i> sp. 2										2	1		3
<i>Dentalium</i> sp.		2											2
<i>Fissidentalium</i> sp. 2			2										2
<i>Fissidentalium</i> sp. 3	1	1			1	1							4
<i>Pulsellum</i> sp. 1			16	8	155	2	1	15	2	12	8		219
<i>Pulsellum</i> sp. 2			1		86			3		2			92
<i>Siphonodentalium</i> sp.		5	5	1	96	9	9		3	5	9	1	143

The AGT catches of ANDEEP III were not as rich as the EBS ones, but still 112 molluscan species and 1384 specimens were collected (table 9.22). Again, with 53 collected species, gastropods were the species richest group, followed by bivalves with 43 species and scaphopods with seven species. Polyplacophorans (1 sp), aplacophorans (3 spp) and cephalopods (5 spp) were scarce and often occurred at one station only. Highlights of the AGT catches were the findings of a large-sized deep-water limpet at station PS67/102-10 and of the second living specimen of *Lyonsiella angelika* at PS67/121-7.

During ANDEEP III only one single specimen of the molluscan class Polyplacophora was discovered. The species of this class are well known from the Weddell Sea (e.g., Götting 1993) and most of the species occurring in this region are circumantarctic. Compared to the results published by Sirenko & Schrödl (2001) of the last ANDEEP expedition, the new finding is noteworthy, as it represents probably a rediscovery of a species, that had fallen into oblivion. The single specimen collected with the AGT on the PS 67/074-7 station (1053-1064 m) was tentatively identified as *Stenosemus simplicissimus* (Thiele, 1906), a species that is so far known from the holotype only, which was collected in the Bellingshausen Sea in 1898 (500 m). The only other species of Polyplacophora that occurs deeper than 1000 m in the Antarctic region, namely *Leptochiton kerguelensis* (Haddon, 1886) reported from the Ross Sea (1335 m) by Dell (1990) may be excluded, as it differs morphologically. Unfortunately the sole recently collected specimen allows no conclusion as to why chitons do not

inhabit the Antarctic deep water. Normally they live on hard substratum, which was also found in high quantity in several other samples. More material and detailed analyses of the abiotic factors would help to get a better understanding of this distribution.

**Table 9.22:** Molluscan morphospecies collected from the AGT samples

	Gear	AGT 1	AGT 2	AGT 3	AGT 4	AGT 5	AGT 6	AGT 7	AGT 8	AGT 9	AGT 10	AGT 11	AGT 12	AGT 13	AGT 14	AGT 15	AGT 16	AGT 17	AGT 18	AGT 19	
Station		016-11	021-8	057-1	059-10	074-7	078-11	080-6	081-9	088-10	094-10	102-10	110-2	121-7	142-6	150-7	151-1	152-7	153-8	154-8	
<b>Aplacophora</b>																					
<b>Solenogastres</b>																					
<i>Solenogaster</i> sp. 2														1							
<i>Solenogaster</i> sp. 3															1						
<b>Caudofoveata</b>																					
<i>Falcidens</i> sp.								1													
<b>Polyplacophora</b>																					
<i>Stenosemus simplicissimus</i>						1															
<b>Gastropoda</b>																					
<i>Brookula</i> sp. 1																5					
<i>Brookula</i> sp. 2			1				1								5						
Buccinidae sp. 1							1														
Buccinidae sp. 2													1								
Cerithiopsidae sp. 1		1																			
<i>Chlanidota</i> sp. 1		1																			
<i>Chlanidota</i> sp. 2							1												1		
<i>Cylichna</i> sp.				69											2						
<i>Diaphana</i> sp. 1							1							1							
Doridacea sp. 1																			1		
Eulimidae sp. 1								1											1		
<i>Cornisepta antarctica</i>				2			1														
<i>Harpovoluta charcoti</i>						1															
<i>Iothia</i> sp.				1																	
Pleurobranchiidae sp. 1		1	1																		
<i>Limacina cf. helicina</i>		74																			
<i>Limacina retroversa</i>		2																			
Limpet sp.												1									
<i>Lissotesta</i> sp. 1				1					1	1	1										
<i>Lissotesta</i> sp. 5															2	2					
Littorinidae sp. 2				14				3													
Littorinidae sp. 3																			2		
Mesogastropoda sp. 1		1																			
<i>Microdiscula</i> sp.																			1		
Naticidae sp. 1			1												1						
Naticidae sp. 3				2																	
<i>Philina</i> sp. 1							1														
Pteropod sp. 1		1																			
Pteropod sp. 2		1	4																		

9. INTRODUCTION TO ANDEEP: ANTARCTIC BENTHIC DEEP-SEA BIODIVERSITY

	Gear	AGT 1	AGT 2	AGT 3	AGT 4	AGT 5	AGT 6	AGT 7	AGT 8	AGT 9	AGT 10	AGT 11	AGT 12	AGT 13	AGT 14	AGT 15	AGT 16	AGT 17	AGT 18	AGT 19
Station		016-11	021-8	057-1	059-10	074-7	078-11	080-6	081-9	088-10	094-10	102-10	110-2	121-7	142-6	150-7	151-1	152-7	153-8	154-8
<i>Seguenzia</i> sp.		3													7					
<i>Toledonia</i> sp. 1		1																		
<i>Torellia</i> cf <i>cornea</i>				1																
<i>Tractolira</i> sp.																1				
Trochidae sp. 1		1													1					
Trochidae sp. 3																1				
<i>Trophon coulmanensis</i>								1												
<i>Trophon drygalskii</i>				1																
<i>Trophon</i> sp.													1							
Turbinidae sp. 1							8													
Turbinidae sp. 2															11					
Turridae sp. 1			1																	
Turridae sp. 10															5					
Turridae sp. 13														3						
Turridae sp. 14																	1			
Turridae sp. 3															2					
Turridae sp. 4															1					
Turridae sp. 5															1					
Turridae sp. 6															1					
Turridae sp. 7				5			1				4	1	1							
Turridae sp. 8				2																
Turridae sp. 9				1																
<i>Tyaerborgia</i> sp. 1		1																		
<i>Volutomitra</i> sp.							1													
<b>Bivalvia</b>																				
<i>Adacnarca</i> sp. 1		3																		
<i>Adacnarca</i> sp. 2																1				
<i>Adacnarca</i> sp. 3						3												1		
<i>Cuspidaria</i> sp. 2											1									
<i>Cuspidaria</i> sp. 3							6													
<i>Dacrydium</i> sp. 1		1																		
<i>Dacrydium</i> sp. 2					1				3	44	4	3				3				
<i>Ennucula</i> sp.			18				18													
<i>Thyasira dearborni</i>															2		7			
<i>Kingiella</i> cf <i>sirenkoi</i>				44	1	4			16	16	12	10	4							
<i>Limatula</i> (A.) sp.1		2																		
<i>Limatula</i> (A.) sp.4																			10	
<i>Limatula</i> (L.) sp.					1				5	1					2					
<i>Limopsis marionensis</i>						2	2													
<i>Limopsis tenella</i> ANT							16		1		8	6		10						
<i>Limopsis tenella</i> SA			5																	
Lucinidae sp. 1		1																		
<i>Lyonsiella angelika</i>														1						
<i>Malletia</i> sp. 1		4																		
<i>Malletia</i> sp. 2															83					
Nuculanidae sp. 1		38	19																	

	Gear		Station																																					
	016-11	AGT 1	021-8	AGT 2	057-1	AGT 3	059-10	AGT 4	074-7	AGT 5	078-11	AGT 6	080-6	AGT 7	081-9	AGT 8	088-10	AGT 9	094-10	AGT 10	102-10	AGT 11	110-2	AGT 12	121-7	AGT 13	142-6	AGT 14	150-7	AGT 15	151-1	AGT 16	152-7	AGT 17	153-8	AGT 18	154-8	AGT 19		
Nuculanidae sp. 2	21	13										3						13		2			2																	
Nuculidae sp. 1	14	5																																						
Nuculidae sp. 2	4																																							
Propeamussiidae sp. 1			2																																					
Propeamussiidae sp. 1																4	9			2																				
Propeamussiidae sp. 1																											2													
<i>Propeamussium</i> sp.																					10																			
<i>Silicula rouchi</i>																											2													
<i>Silicula</i> sp.	2																																							
Taxodont bivalve juvenil	30					2												3				4		1	2															
Taxodont bivalve sp. 1																																								
Taxodont bivalve sp. 2	8	3																																						
Taxodont bivalve sp. 3	1	2																																						
Thyasiridae sp. 1	1																																							
Thyasiridae sp. 2					7			1							3	10	2																							
Thyasiridae sp. 3																											19													
<i>Tindaria</i> sp.		4																																						
<i>Yoldiella cf ecaudata</i>					1			1	9																		30													
<i>Yoldiella cf sabrina</i>	17	10	14												3		4		4	4	20													1						
<i>Yoldiella</i> sp. 2	2																																							
<i>Yoldiella</i> sp. 1	1																																							
<i>Yoldiella valettei</i>					1			8																			1	3												
<b>Scaphopoda</b>																																								
<i>Cadulus</i> sp. 1	1	6																			6																			
<i>Dentalium</i> sp.			16																																					
<i>Fissidentalium</i> sp. 1	1	2																																						
<i>Fissidentalium</i> sp. 3	2	5	1					6												3																				
<i>Pulsellum</i> sp. 1		1	16	1				6	8						4		10	4	31	12																				
<i>Pulsellum</i> sp. 2	3	99						29									2	7								3														
<i>Siphonodentalium</i> sp.	1	2	2					1																				4												
<b>Cephalopoda</b>																																								
Octopodid sp.																									2															
<i>Pareledone</i> sp.				1																																	2			
Teuthoidea sp.1							1																	1																
Teuthoidea sp. 2						1																																		
Squid															1	1											1													



There seems to be no relation between increasing water depth and species or specimen numbers (figures 9.14, 9.15). The species numbers per station are more or less consistent over the depth range from 1050 m to 4900 m when both gears, EBS and AGT, are included. The stations including a cast number show AGT or EBS data (133-2-material above cod end) only.

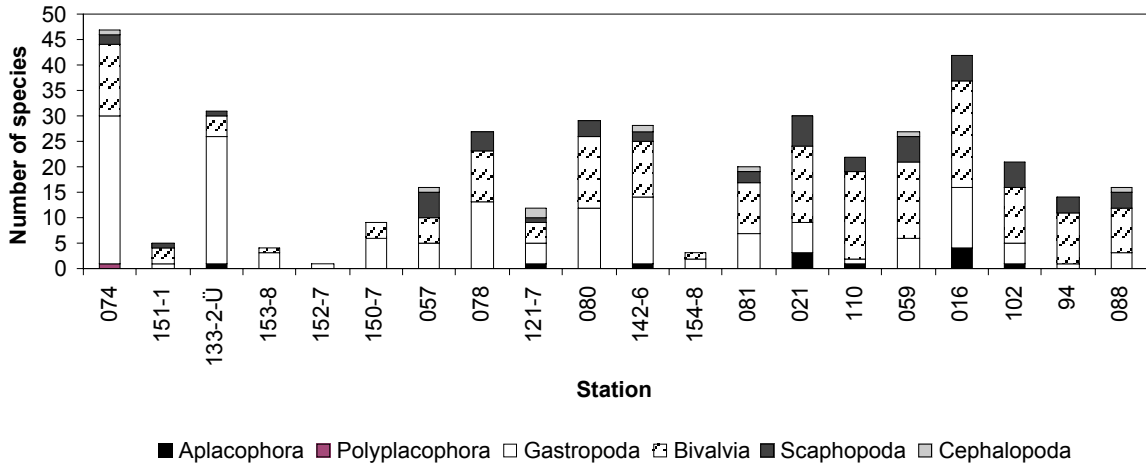

Fig. 9.14: Species – station distribution. Stations are ordered by increasing depth

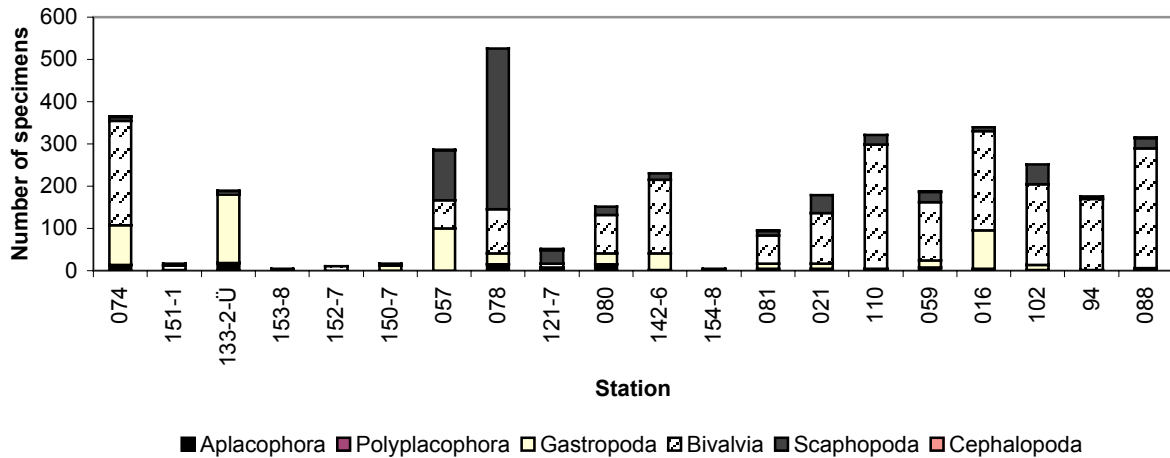

Fig. 9.15: Specimen – station distribution. Stations are ordered by increasing depth

Further DNA extractions were carried out on board on taxodont and limid bivalves. In total 75 nuculanid, limopsid and limid specimens were extracted. PCRs and DNA sequencing will be done in the labs in Cambridge.

## References

- Brandt, A., Hilbig, B., Linse, K. and G. Wegener (1999): Biodiversity and zoogeography of Mollusca, Polychaeta, and Crustacea Peracarida. *Berichte zur Polarforschung* 301: 135-149.
- Dell, R.K. (1990): Antarctic Mollusca with special reference to the fauna of the Ross Sea. *Bulletin of the Royal Society of New Zealand, Wellington* 27 : 1–311.
- Egorova, E.N. (1982): Molluscs from the Davis Sea (the Eastern Antarctic region). Biological results of the Soviet Antarctic expeditions, 7. *Explorations of the Seas, Leningrad*, 26 (34): 1-144.
- Fütterer, D., Brandt, A., and G.C.B Poore (2003): The Expeditions ANTARKTIS-XIX/3-4. *Berichte zur Polar- und Meeresforschung* 470: 1-174.
- Götting, K.-J. (1993): Polyplacophora des Weddell-Meeres und von King George Island, Süd-Shetlands, Antarktis. *Archiv für Molluskenkunde* 122 : 171–187.
- Hain, S. (1989): Beiträge zur Biologie der beschalten Mollusken (Kl. Gastropoda & Bivalvia) des Weddellmeeres, Antarktis. Dissertation. Biology II, Bremen.
- Linse, K. (2002): The shelled Magellanic Mollusca: with special reference to biogeographic relations in the Southern Ocean. *Theses Zoologicae* Vol 74. A.R.A. Ganter Verlag KG, Ruggell, Liechtenstein. 251 pp, 21 plates.
- Linse, K., Schrödl, M., Mc Clain, C. and L. Allcock (2003a): Mollusca in the Antarctic deep sea – preliminary notes on their taxonomy, biogeography and diversity. In: The Expeditions ANTARKTIS-XIX/3-4. D. Fütterer, A. Brandt, G.C.B. Poore (eds). *Berichte zur Polar- und Meeresforschung* 470: 95-101.
- Linse, K., Schrödl, M. and D. Zelaya (2003b): Biodiversity, biogeography and evolution of Magellanic and Antarctic Mollusca. In: The Expedition ANTARKTIS XIX/5 (LAMPOS) of RV *Polarstern* in 2002. W.E. Arntz, T. Brey (eds). *Berichte zur Polar- und Meeresforschung* 462: 19-28.
- Linse, K. and T. Cope (2005): Genetic variability in Antarctic marine organisms. In: Arntz, W.E., Brey, T. (Eds). The expedition ANTARKTIS XXI/2 (BENDEX) of RV *Polarstern* in 2003/2004. *Berichte zur Polar- und Meeresforschung*.
- Powell, A.W.B. (1958): Mollusca from the Victoria-Ross Quadrates of Antarctica. *B.A.N.Z. Antarctic Research Expedition (1929-1931). Reports Series B (Zoology & Botany)*, 6 (9): 165-215.
- Sirenko, B.I. and M. Schrödl (2001): Mollusc biodiversity and ecology. *Berichte zur Polar- und Meeresforschung* 402 : 85–95.

## 9.3 Megabenthos

### 9.3.1 Introduction to work at sea

Katrin Linse<sup>1</sup>, Angelika Brandt<sup>2</sup>

<sup>1</sup>British Antarctic Survey, Cambridge

<sup>2</sup>Zoologisches Institut und Museum, Universität Hamburg

## Work at sea

The large-sized AGT from the AWI (3 m width) was deployed on 19 occasions during ANDEEP III. At the stations PS67/074-7, PS67/078-11 and PS67/081-9 the cod end mesh size was 10 mm while at all other stations an inlet of 500µm mesh size was

inserted to trap smaller sized animals. Allcock et al. (2003) assumed that animals smaller than 10 mm had passed through the wider cod end during ANDEEP I and II. The deployment protocol was standardised. While the AGT was lowered, the ship had to compensate for the wire lowering speed of 1m/sec by steaming with at least 2 kn until the full trawling wire length was put out. The full trawling cable length was 1.5 times the water depth. The net was then trawled at 1 kn for 10 min. With the ship stationary, the AGT was hauled with 0.7 m/sec in order to avoid damaging animals in the net. At station PS67/059-10 the AGT was trawled for 20 min. When the trawl reached the deck, the samples were either sorted straight away to higher taxonomic level or were sieved through 300 µm and 500 µm on deck. If the latter happened, mega- and larger macrobenthos were separated by eye on deck and the remainder in the sieves were fixed in 96% ethanol. After 48 hours the sieve residue was sorted under stereomicroscopes. The different taxa were distributed to the various taxonomists on board being responsible for the taxa.

### 9.3.2 Megabenthos collected by the Agassiz trawl

Katrin Linse<sup>1</sup>, Angelika Brandt<sup>2</sup>, Jens Bohn<sup>3</sup>, Bruno Danis<sup>4</sup>, Claude De Broyer<sup>4</sup>, Vincent Heterier<sup>5</sup>, Brigitte Hilbig<sup>6</sup>, Dorte Janussen<sup>7</sup>, Pablo J. López González<sup>8</sup>, Enrico Schwabe<sup>3</sup>, Michael R.A. Thomson<sup>9</sup>

<sup>1</sup>British Antarctic Survey, Cambridge  
<sup>2</sup>Zoologisches Institut und Museum, Universität Hamburg  
<sup>3</sup>Zoologische Staatssammlung München

<sup>4</sup>Royal Belgian Institute of Natural Sciences, Bruxelles <sup>5</sup>Université Libre de Bruxelles, Laboratoire de Biologie Marine

<sup>6</sup>Lehrstuhl für spezielle Zoologie, Ruhr-Universität Bochum

<sup>7</sup>Forschungsinstitut Senckenberg und Naturmuseum, Frankfurt am Main

<sup>8</sup>Departamento de Fisiología y Zoología, Facultad de Biología, Universidad de Sevilla

<sup>9</sup>School of Earth Sciences, University of Leeds

### Work at sea and preliminary results

In total 19 Agassiz trawl samples were taken, sorted and the taxa were preliminary identified to morphospecies. Numbers of species and specimens were counted to determine the abundance and species richness of major taxonomic groups (tables 9.23-9.26).

#### Cape Town – Atka Bay Transect

Four Agassiz trawls were taken on the way from Cape Town to Atka Bay, the first stations in the Cape Basin (PS67/016-11), in the Agulhas Basin (PS67/021-8), and the later south off Maud Rise (PS67/059-10 and PS67/057-2) (table 9.23). These trawls were taken to detect evidence for biogeographic separation between the South Atlantic African basins and the Southern Ocean Weddell Sea basin.

Echinoderms and molluscs dominated species and specimen numbers in the African Basins. Holothurians accounted for the highest biomass, while ophiuroids and small, less than 5 mm long, bivalves were most numerous. Of special interest in the first two

AGT samples were the occurrences of *Nematocarcinus*, a shrimp genus well known from Antarctic waters, and of deep-sea grenadier and tripod fishes. The AGT samples from the Antarctic basins were dominated by echinoderms, especially holothurians, in biomass and species numbers. Specialties in these two trawls were 40 cm long-legged, giant pycnogonids and two specimens of different deep-sea octopodid species.

#### Kapp Norvegia Transect

Four Agassiz trawls were taken off Kap Norvegia from 1000 m to 4000 m water depths (stations PS67/074-7 to PS67/081-9; [table 9.24](#)). The 1000-m station was characterised by a clean sample that was dominated by hundreds of specimens of *Nematocarcinus*, dozens of ophiuroids, a mid-sized, about 40 cm long pelagic octopus and the only polyplacophoran collected during ANDEEP III. This station revealed also the most diverse sponge fauna with 22 species (65 specimens), including 3 large specimens of the typical shelf genus *Rossella* and also predatory deep-sea sponges of the family Cladorhizidae. At 2000 m and 3000 m the trawl came up filled with mud and rocks, which crushed the collected animals, especially the regular sea urchins, ophiuroids and holothurians. One specimen of *Epimeria* cf. *inermis* was caught at 2000 m, the deepest record for this species. The 4000-m trawl came up nearly empty but had collected some benthic animals as well as a red-spotted, 10 cm long squid.

#### Weddell Sea Transect

On the stations across the Weddell Sea from Kapp Norvegia to Joinville Island (stations PS67/088-10 to PS67/121-7) animals were collected from the abyssal Weddell Sea basin between 4500 and 4900 m and at 2500 m water depth ([table 9.25](#)). The sampled sediment on the eastern side mostly consisted of fine mud, which passed easily through 300 µm sieve meshes, while on the western side the mud was sticky with a high clay content (stations PS67/110-2 and PS67/121-7). Numerous drop stones occurred of which some were colonised by solitaire hydrozoans and sponges. The part of the catch that was sorted by hand on deck was dominated by holothurians and cnidarians of the genera *Umbellula*, *Antipatharia* gen.1, and *Galatheanthemum*, while the residue of the sieved samples contained numerous taxodont and heterodont bivalves. At four stations of the five, solitaire and colonial stalked ascidians similar to the genera *Octacnemus* and *Megalodicopia*, typical deep-sea ascidians, were collected. Megafaunal taxa were low in abundance and biomass, with holothurians, ophiuroids and cnidarians (*Antipatharia*) being the richest ones. Bivalves and scaphopods showed highest species and specimen numbers, followed by isopods, but these taxa can be accounted as macrofaunal elements.

The shallowest station (2500 m) at the western end was the richest and most diverse one ([table 9.26](#)). Next to the taxa that occurred regularly across the deep Weddell Sea, three echinurids, three octopods and several colonial ascidians were found. This station revealed a rich sponge fauna including one of the rare calcareous species and the first complete specimen of the hexactinellid *Malacosaccus coatsi* from the Antarctic. An unexpected find was the occurrence of a ripped-off thallus of the brown, phaeophyt seaweed *Desmarestia*.

### Powell Basin Transect

In the Powell Basin, a deep basin between the shelves of the Antarctic Peninsula and the South Orkney Islands, three AGTs were deployed in about 1000 m, 2000 m and 3000 m depth. The deepest trawl catch (PS67/142-6) was very different to those of comparable depth sampled in the deep Weddell Sea. It was characterised by high biomass, diversity and abundance. At all three stations echinoderms dominated the catch, with high specimen numbers, for all classes (table 4). Various species of a ophiuroids, asteroids and holothurians occurred in the sample and numerous specimens of single species of irregular sea urchins, cidaroid sea urchins, and crinoids. The highlight was one stalked crinoid (*Bathycrinus?*) at PS67/142-6. Further abundant taxa were serolid isopods of the genus *Acanthoserolis*.

### Bransfield Strait and Brabant Island

A further AGT (PS67/152-7) was deployed in deepest part (1988 m) of the Bransfield Strait off King George Island. The trawl contained about 400 l of greenish and orange, anoxic mud. The only fauna collected were epibenthic scale worms, a few deep-water shrimps and limid bivalves as well as a long nemertine (table 9.27).

The AGT was deployed at 2 stations in the vicinity of Brabant Island/ Bellingshausen Sea in about 2000 m and 4000 m. The megafauna at the 2000 m station was dominated by stalked crinoids, more than 250 specimens were collected (table 9.27). The AGT catch from the deeper station was characterised by sessile cnidarians and echinoderms.

For an initial analysis of species and specimen richness of the AGT samples, the different taxa are grouped as follows: Porifera, Cnidaria, Mollusca, Polychaeta, Crustacea, Echinodermata and “others”. The “others” group combines the taxa that occurred with few species only: Ascidiacea, Brachiopoda, Bryozoa, Nemertea, Pisces, Pycnogonida and Sipunculida. The general pattern is a positive correlation between species and specimen richness (fig. 9.16).

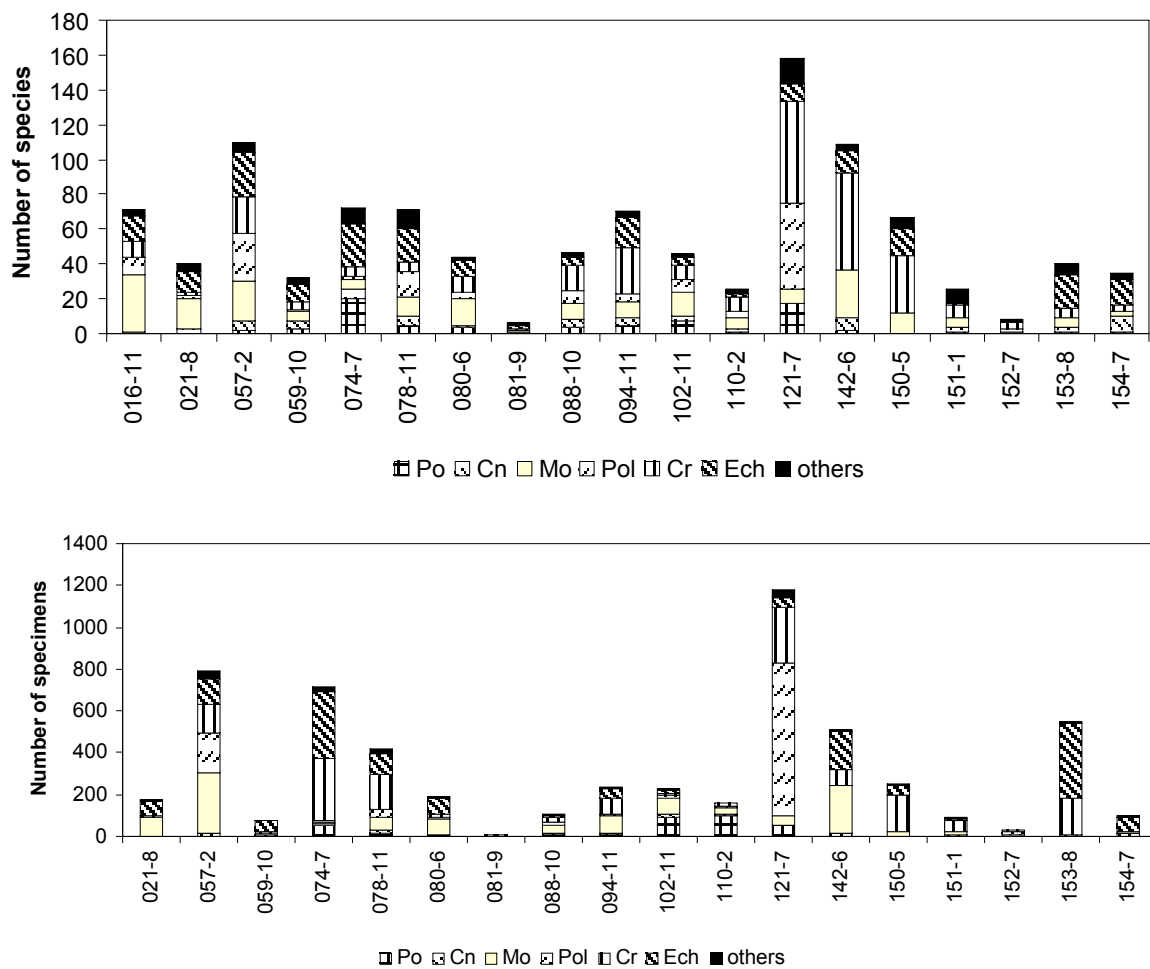

Fig. 9.16: Species and specimen numbers of the AGT stations. Abbreviations: Cn – Cnidaria, Cr – Crustacea, Ech – Echinodermata, Mo – Mollusca, Po – Porifera, Pol – Polychaeta

At stations with high numbers of specimens the number of species was high as well. The stations with the highest species and specimen numbers were PS67/057-2, PS67/074-7 and PS67/121-7. The major six taxa occurred at all stations, but echinoderms, crustaceans and molluscs dominated the diversity. For example station PS67/121-7 accounted for 58 species and 272 specimens of crustaceans and 49 spp/ 727 individuals of polychaetes. The average number of species over all stations were 58, the averaged number of specimens 326.

An effect of the small-sized inner net and cod end has also been observed. Macro- and megafaunal groups like molluscs, crustaceans and polychaetes show higher species and specimen numbers compared to typical megafaunal taxa like sponges, cnidarians and fishes, which are less frequent. But in fact the effect of the small-sized inner net can also be seen in the richness of typically larger faunal elements like sponges. Significantly more small-sized sponge species were collected during this cruise than is normally the case.

The Agassiz trawl samples taken on the five transects during ANDEEP III enable us to compare 1) latitudinal and longitudinal trends of the taxon richness in the Southern Ocean deep-sea basins and 2) bathymetric trends along the slopes of Kapp Norvegia, Powell Basin and Anvers Island. For the detection of latitudinal trends in the species and specimen numbers, the stations from 41°S to 71°S with depths greater than 4000 m (PS67/016-11, PS67/021-8, PS67/110-2, PS67/102-11, PS67/094-11, PS67/059-10, PS67/088-10, PS67/081-9) were compared with each other (fig. 9.17). With the exception of the most northern station PS67/016-11, which is the richest in species and specimen numbers, no sharp latitudinal trend could be detected.

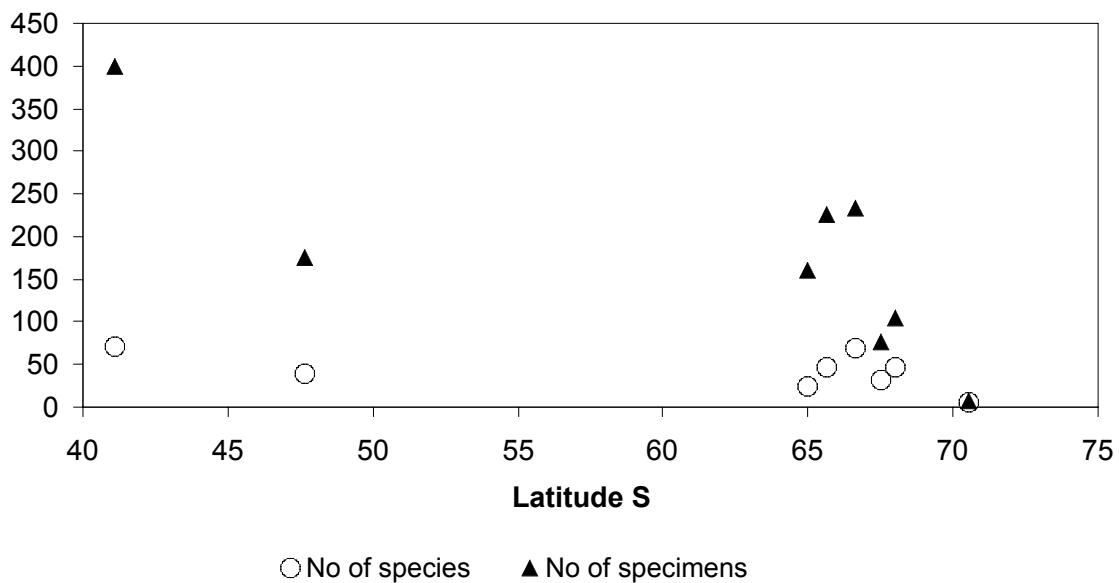

Fig. 9.17: Latitudinal trends

In order to examine longitudinal trends, the stations north of 60°S as well as those shallower than 4000 m were excluded. This left six stations deeper than 4000 m to be compared (from W to E: PS67/110-2, PS67/102-11, PS67/094-11, PS67/088-10, PS67/081-9, PS67/059-10). The results on species and specimen numbers of these stations indicate that the diversity is higher in the middle and western Weddell Sea than at the eastern side (fig. 9.18).

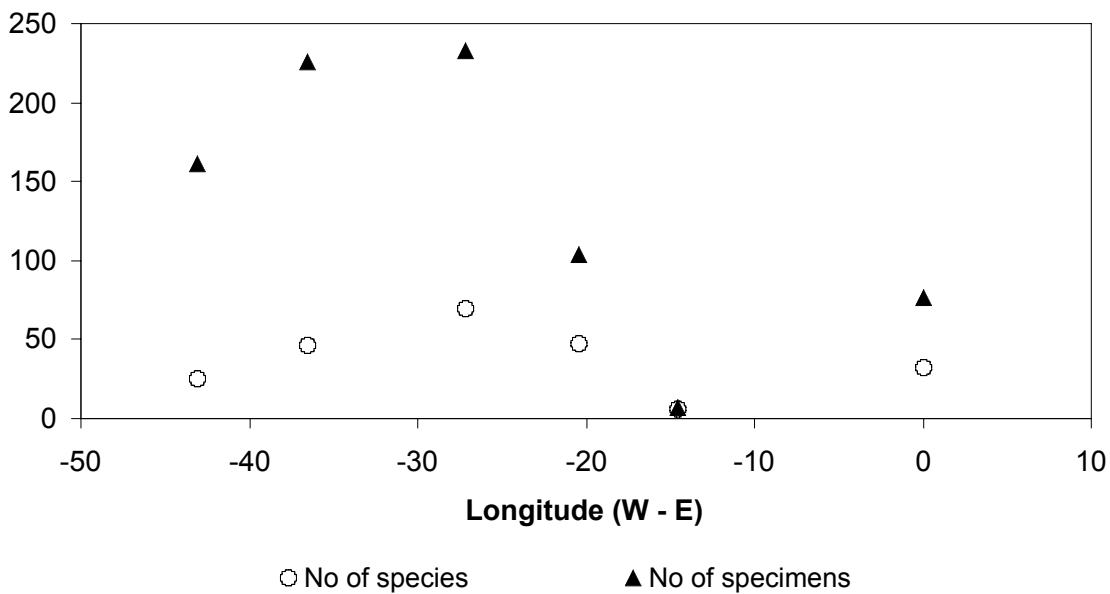

Fig. 9.18: Longitudinal trends

The three transects along the continental slopes of Kapp Norvegia, Powell Basin and Anvers Island will enable us to study and compare bathymetric trends in species richness and abundance. During the cruise the richness of Kapp Norvegia and Powell Basin transects were compared to each other (fig. 9.19). While at Kapp Norvegia species and specimen richness decreased with increasing depth, the opposite trend was observed in the Powell Basin.

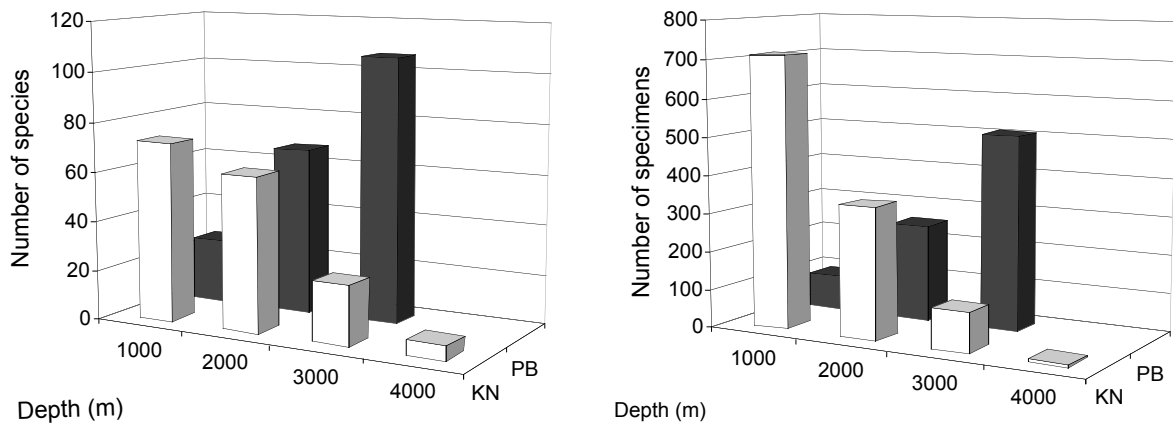

Fig. 9.19: Bathymetric trends in species and specimen numbers at Kapp Norvegia (KN) and Powell Basin (PB)

Comparisons on taxon composition of our recent AGT data with those of ANDEEP I and II (Fütterer *et al.* 2003, Allcock *et al.* 2003) can only be done roughly. Two important changes have occurred to the AGT deployment between the cruises from 2002 and 2005. Then a 1 m wide trawl with 10-mm cod end was used while now a



3 m wide trawl with 500- $\mu$ m cod end was used. Both taxon composition and quantity has increased on the recent cruise. Especially species of sizes less than 10 mm were caught more frequently and in higher specimen numbers. For the megafauna that was collected with both gears now and then, it is noticeable that in the recent samples holothurians and cnidarians are frequent and sometimes even abundant. On the other hand, amphipods that occurred at most of the former stations during ANDEEP I & II were very rare this time. More detailed information on the taxonomic differences between ANDEEP I & II and ANDEEP III will be given in the taxonomic cruise reports (Brandt *et al.*; Bohn, Danis & Heterier; De Broyer *et al.*; Janussen; Linse *et al.*; López González; all this volume).

### References

- Allcock, L., Lockhart, S., Ellingsen, K.E., Mooi, R. And C. De Broyer (2003): Megabenthos. In: The Expeditions ANTARKTIS-XIX/3-4. D. Fütterer, A. Brandt, G.C.B. Poore (eds). *Berichte zur Polar- und Meeresforschung* 470: 91-95.
- Fütterer, D., Brandt, A., and G.C.B. Poore (2003): The Expeditions ANTARKTIS-XIX/3-4. *Berichte zur Polar- und Meeresforschung* 470: 1-174.

**Table 9.23:** Taxon richness Cape Town – Atka Bay transect

		AGT 1	AGT 2	AGT 3	AGT 4
		Station PS67/016-11	PS67/021-8	PS67/057-2	PS67/059-10
		Date 26.01.05	29.01.05	10.02.05	15.02.05
		Depth (m) 4699 - 4694	4578-4579	1812-1822	4654-4647
		Sediment mud	mud	mud	mud, rocks
		Volume (about) 20l	30l	> 200l	50l
Phylum	Class	spp/ind	spp/ind	spp/ind	spp/ind
Porifera		0/0	0/0	2/2	3/3
Cnidaria	Hydrozoa	0/0	0/0	0/0	0/0
	Scyphozoa	0/0	0/0	0/0	0/0
	Anthozoa				
	Alcyonacea (soft cor.)	0/0	0/0	0/0	0/0
	Alcyonacea (gorg.)	0/0	0/0	0/0	0/0
	Pennatulacea	0/0	1/1	0/0	1/2
	Actinaria	1/1	0/1	2/8	1/1
	Corallimorpharia	0/0	0/0	0/0	1/1
	Scleractinia	0/0	0/0	1/6	0/0
	Zoanthidea	0/0	1/1	1/1	0/0
	Ceriantharia	0/0	0/0	2/1	0/0
	Antipatharia	0/0	0/0	0/0	1/3
Nemerteans		1/3	0/0	2/2	0/0
Mollusca	Bivalvia	16/117	10/70	5/67	5/7
	Gastropoda				
	Prosobranchia	7/10	1/1	11/30	0/0
	Opisthobranchia	5/67	1/4	2/70	0/0
	Polyplacophora	0/0	0/0	0/0	0/0
	Scaphopoda	5/6	5/11	4/118	0/0
	Cephalopoda				
	Octopoda	0/0	0/0	1/1	1/1
	Squid	0/0	0/0	0/0	0/0
Annelida	Polychaeta				
	Sedentaria	4/10	1/1	19/137	1/1
	Errantia	6/7	1/6	9/54	0/0
Sipunculida		0/0	0/0	1/21	0/0
Echiurida		0/0	0/0	0/0	0/0
Crustacea	Ostracoda	7/9	0/0	1/3	0/0
	Cirripedia	0/0	0/0	0/0	1/1
	Malacostraca				
	Amphipoda	0/0	0/0	9/29	4/5
	Tanaidacea	0/0	0/0	3/18	1/1
	Cumacea	0/0	0/0	4/39	0/0
	Isopoda	0/0	0/0	8/19	1/2
	Mysidacea	1/6	1/1	1/7	0/0
	Natantia	1/5	0/0	1/20	0/0
Chelicerata	Pycnogonida	0/0	0/0	0/0	1/1
Tentaculata	Bryozoa	1/4	1/2	0/0	0/0
	Brachiopoda	0/0	0/0	1/?	0/0
Echinodermata	Ophiuroidea	3/ca.100	5/ca.50	4/25	4/9
	Asteroidea	2/2	2/5	6/26	2/6
	Echinoidea	1/1	0/0	0/0	0/0
	Regularia				

9. INTRODUCTION TO ANDEEP: ANTARCTIC BENTHIC DEEP-SEA BIODIVERSITY

		AGT 1	AGT 2	AGT 3	AGT 4
		Station PS67/016-11	PS67/021-8	PS67/057-2	PS67/059-10
		Date 26.01.05	29.01.05	10.02.05	15.02.05
		Depth (m) 4699 - 4694	4578-4579	1812-1822	4654-4647
		Sediment mud	mud	mud	mud, rocks
		Volume (about) 20l	30l	> 200l	50l
Phylum	Class	spp/ind	spp/ind	spp/ind	spp/ind
	Irregularia	0/0	0/0	1/1	0/0
	Crinoidea	0/0	0/0	3/4	0/0
	Holothuroidea	9/50	5/16	11/69	4/34
Chordata	Asciacea	0/0	0/0	1/1	1/1
	Pisces	1/1	3/4	1/4	2/2

**Table 9.24:** Taxon richness Kapp Norvegia transect

		AGT 5	AGT 6	AGT 7	AGT 8
		Station PS67/074-7	PS67/078-11	PS67/080-6	PS67/081-9
		Date 20.02.05	21.02.05	22.02.05	24.02.05
		Depth (m) 1066-1063	2191-2146	3095-2970	4413-4351
		Sediment rocks	mud, rocks	mud, rocks	clean
		Volume (about) 50l	>200l	>200l	1l
Phylum	Class	spp/ind	spp/ind	spp/ind	spp/ind
Porifera		20/50	6/15	4/5	0/0
Cnidaria	Hydrozoa	0/0	0/0	0/0	0/0
	Scyphozoa	0/0	0/0	0/0	1/1
	Anthozoa				
	Alcyonacea (soft cor.)	0/0	1/2	0/0	0/0
	Alcyonacea (gorg.)	0/0	2/4	0/0	0/0
	Pennatulacea	1/1	0/0	0/0	0/0
	Actinaria	4/9	0/0	1/1	0/0
	Corallimorpharia	0/0	1/1	0/0	0/0
	Scleractinia	0/0	1/8	0/0	0/0
	Zoanthidea	1/1	0/0	0/0	0/0
	Ceriantharia	0/0	0/0	0/0	0/0
	Antipatharia	0/0	0/0	0/0	0/0
Nemertea		1/5	1/3	0/0	0/0
Mollusca	Bivalvia	2/7	4/20	6/54	0/0
	Gastropoda				
	Prosobranchia	1/1	1/1	9/18	0/0
	Opisthobranchia	0/0	2/2	0/0	0/0
	Polyplacophora	1/1	0/0	0/0	0/0
	Scaphopoda	0/0	4/42	1/8	0/0
	Cephalopoda				
	Octopoda	1/1	0/0	0/0	0/0
	Squid	0/0	0/0	0/0	1/1
Annelida	Polychaeta				
	Sedentaria	2/3	11/26	4/6	0/0
	Errantia	0/0	4/9	0/0	0/0
Sipunculida		0/0	1/6	0/0	0/0

		AGT 5	AGT 6	AGT 7	AGT 8	
		Station PS67/074-7	PS67/078-11	PS67/080-6	PS67/081-9	
		Date 20.02.05	21.02.05	22.02.05	24.02.05	
		Depth (m) 1066-1063	2191-2146	3095-2970	4413-4351	
		Sediment rocks	mud, rocks	mud, rocks	clean	
		Volume (about) 50l	>200l	>200l	1l	
Phylum	Class	spp/ind	spp/ind	spp/ind	spp/ind	
Echiurida		0/0	0/0	0/0	0/0	
Crustacea	Ostracoda	0/0	0/0	1/1	1/1	
	Cirripedia	0/0	0/0	0/0	0/0	
	Malacostraca	Amphipoda	3/4	1/1	0/0	0/0
		Tanaidacea	0/0	0/0	4/4	0/0
		Cumacea	0/0	0/0	0/0	0/0
		Isopoda	3/6	2/6	4/6	0/0
		Mysidacea	1/5	1/3	0/0	0/0
		Natantia	1/290	1/153	0/0	0/0
Chelicerata	Pycnogonida	2/10	0/0	0/0	0/0	
Tentaculata	Bryozoa	3/7	5/5	0/0	0/0	
	Brachiopoda	0/0	1/3	0/0	0/0	
Echinodermata	Ophiuroidea	7/129	3/5	7/78	1/2	
	Asteroidea	5/7	4/9	2/3	1/1	
	Echinoidea	Regularia	0/0	2/14	0/0	0/0
		Irregularia	0/0	1/2	0/0	0/0
	Crinoidea	2/30	0/0	0/0	0/0	
	Holothuroidea	11/149	9/72	0/0	0/0	
Chordata	Ascidiacea	0/0	0/0	2/4	0/0	
	Pisces	3/3	3/3	0/0	1/1	

**Table 9.25:** Taxon richness Weddell Sea transect

		AGT 9	AGT 10	AGT 11	AGT 12	
		Station PS67/088-10	PS67/094-11	PS67/102-11	PS67/110-2	
		Date 27.02.05	02.03.05	06.03.05	09.03.05	
		Depth (m) 4931-4930	4894-4985	4805-4802	4702-4697	
		Sediment mud	mud	mud	mud, rocks	
		Volume (about) 150l	<200l	>300l	>300l	
Phylum	Class	spp/ind	spp/ind	spp/ind	spp/ind	
Porifera		4/4	6/5	7/90	1/100	
Cnidaria	Hydrozoa	1/1	0/0	0/0	0/0	
	Scyphozoa	1/19	1/29	1/38	1/33	
	Anthozoa	Alcyonacea (soft cor.)	0/0	0/0	0/0	0/0
		Alcyonacea (gorg.)	0/0	0/0	0/0	0/0
		Pennatulacea	1/2	1/2	1/3	0/0
		Actinaria	1/2	1/2	1/2	1/1
		Corallimorpharia	0/0	0/0	0/0	0/0

9. INTRODUCTION TO ANDEEP: ANTARCTIC BENTHIC DEEP-SEA BIODIVERSITY

		AGT 9	AGT 10	AGT 11	AGT 12	
		Station PS67/088-10	PS67/094-11	PS67/102-11	PS67/110-2	
		Date	27.02.05	02.03.05	06.03.05	09.03.05
		Depth (m)	4931-4930	4894-4985	4805-4802	4702-4697
		Sediment	mud	mud	mud	mud, rocks
		Volume (about)	150l	<200l	>300l	>300l
Phylum	Class		spp/ind	spp/ind	spp/ind	spp/ind
		Scleractinia	0/0	0/0	0/0	0/0
		Zoanthidea	0/0	0/0	0/0	0/0
		Ceriantharia	0/0	0/0	0/0	0/0
		Antipatharia	1/5	1/2	1/15	1/9
Nemertea			0/0	0/0	0/0	0/0
Mollusca	Bivalvia		7/35	7/86	8/45	4/23
	Gastropoda	Prosobranchia	1/1	1/1	3/6	1/1
		Opisthobranchia	0/0	0/0	0/0	0/0
	Polyplacophora		0/0	0/0	0/0	0/0
	Scaphopoda		1/4	1/2	3/23	1/4
	Cephalopoda	Octopoda	0/0	0/0	0/0	0/0
		Squid	0/0	0/0	0/0	0/0
Annelida	Polychaeta	Sedentaria	4/4	2/3	5/10	4/5
		Errantia	4/9	3/4	2/2	0/0
Sipunculida			0/0	1/2	1/3	0/0
Echiurida			0/0	0/0	0/0	0/0
Crustacea	Ostracoda		2/2	9/27	1/2	1/1
	Cirripedia		0/0	0/0	0/0	0/0
	Malacostraca	Amphipoda	1/5	2/8	1/1	1/1
		Tanaidacea	4/8	1/4	1/1	0/0
		Cumacea	1/1	1/2	1/1	1/1
		Isopoda	6/11	11/30	2/3	5/11
		Mysidacea	0/0	1/2	2/4	0/0
		Natantia	0/0	1/1	0/0	0/0
Chelicerata	Pycnogonida		0/0	0/0	0/0	1/1
Tentaculata	Bryozoa		0/0	0/0	1/5	0/0
	Brachiopoda		0/0	0/0	0/0	0/0
Echinodermata	Ophiuroidea		1/1	2/19	1/2	2/2
	Asteroidea		2/4	6/6	1/1	0/0
	Echinoidea	Regularia	0/0	0/0	0/0	0/0
		Irregularia	0/0	0/0	0/0	0/0
	Crinoidea		0/0	0/0	0/0	0/0
	Holothuroidea		2/2	10/20	3/7	0/0
Chordata	Ascidiacea		2/2	1/1	1/1	0/0
	Pisces		1/1	2/2	0/0	1/1

**Table 9.26:** Taxon richness Western Weddell Sea and Powell Basin transect

		AGT 13	AGT 14	AGT 15	AGT 16
		Station PS67/121-7	PS67/142-6	PS67/150-7	PS67/151-1
		Date	14.03.05	18.03.2005	20.03.2005
		Depth (m)	2618-2620	3403-3403	1978-2020
		Sediment	mud	mud	rocks
		Volume (about)	>500l	> 500l	100l
Phylum	Class	spp/ind	spp/ind	spp/ind	spp/ind
Porifera		17/52	2/3	1/1	1/1
Cnidaria	Hydrozoa	0/0	0/0	0/0	0/0
	Scyphozoa	0/0	1/1	1/1	0/0
	Anthozoa				
	Alcyonacea (soft cor.)	0/0	0/0	0/0	0/0
	Alcyonacea (gorg.)	0/0	1/1	0/0	0/0
	Pennatulacea	0/0	1/1	0/0	0/0
	Actinaria	0/0	4/6	0/0	2/2
	Corallimorpharia	0/0	0/0	0/0	0/0
	Scleractinia	0/0	1/1	0/0	0/0
	Zoanthidea	0/0	0/0	0/0	1/1
	Ceriantharia	0/0	0/0	0/0	0/0
	Antipatharia	0/0	0/0	0/0	0/0
Nemertea		1/1	0/0	0/0	0/0
Mollusca	Bivalvia	4/10	12/184	4/6	3/11
	Gastropoda				
	Prosobranchia	2/4	11/37	7/13	1/3
	Opisthobranchia	0/0	2/3	0/0	0/0
	Polyplacophora	0/0	0/0	0/0	0/0
	Scaphopoda	1/31	2/15	1/4	0/0
	Cephalopoda				
	Octopoda	2/3	0/0	0/0	1/2
	Squid	0/0	1/1	0/0	0/0
Annelida	Polychaeta				
	Sedentaria	39/664			
	Errantia	10/63			
Sipunculida		5/23	1/1	1/1	2/2
Echiurida		1/4	1/1	1/1	1/1
Crustacea	Ostracoda	0/0	1/1	5/5	1/1
	Cirripedia	1/2	1/3	0/0	
	Malacostraca				
	Amphipoda	18/108	25/38	9/12	3/3
	Tanaidacea	14/95	8/31	1/1	1/1
	Cumacea	1/1	2/9	3/5	
	Isopoda	15/67	23/66	12/14	1/1
	Mysidacea	0/0	0/0	2/7	
	Natantia	0/0	0/0	1/133	1/51
Chelicerata	Pycnogonida	3/4	0/0	2/2	3/4
Tentaculata	Bryozoa	3/3	0/0	0/0	0/0
	Brachiopoda	0/0	0/0	0/0	0/0
Echinodermata	Ophiuroidea	3/22	8/148	5/5	5/22
	Asteroidea	2/3	5/50	1/1	1/2
	Echinoidea				
	Regularia	1/10	1/50	1/10	1/33
	Irregularia	1/2	3/57	0/0	0/0
	Crinoidea	0/0	2/>30	1/4	
	Holothuroidea	3/5	7/44	7/22	
Chordata	Ascidiacea	1/2	1/1	1/3	1/1
	Pisces	1/1	1/1	2/4	2/4

**Table 9.27:** Taxon richness Bransfield Strait and Brabant Island/Bellingshausen Sea

		AGT 17	AGT 18	AGT 19
		Station PS67/152-7	PS67/153-8	PS67/154-7
		Date 23.03.2005	38440	37771
		Depth (m) 1997-1998	2069-2108	3813-3801
		Sediment mud	mud	rocks
		Volume (about) > 400l	50l	200l
Phylum	Class	spp/ind	spp/ind	spp/ind
Porifera		0/0	1/1	1/2
Cnidaria	Hydrozoa	0/0	0/0	0/0
	Scyphozoa	0/0	1/1	1/3
	Anthozoa			
	Alcyonacea (soft cor.)	0/0	0/0	0/0
	Alcyonacea (gorg.)	0/0	0/0	2/2
	Pennatulacea	0/0	0/0	2/4
	Actinaria	0/0	2/3	3/4
	Corallimorpharia	0/0	0/0	0/0
	Scleractinia	0/0	0/0	0/0
	Zoanthidea	0/0	0/0	0/0
	Ceriantharia	0/0	0/0	0/0
	Antipatharia	0/0	0/0	1/4
Nemertea		2/3	0/0	0/0
Mollusca	Bivalvia	1/10	1/1	1/2
	Gastropoda			
	Prosobranchia	0/0	3/3	2/3
	Opisthobranchia	0/0	1/1	0/0
	Polyplacophora	0/0	0/0	0/0
	Scaphopoda	0/0	0/0	0/0
	Cephalopoda			
	Octopoda	0/0	0/0	0/0
	Squid	0/0	0/0	0/0
Annelida	Polychaeta			
	Sedentaria	1/4		
	Errantia	1/14		
Sipunculida		0/0	1/1	0/0
Echiurida		0/0	1/1	0/0
Crustacea	Ostracoda	0/0	5/5	0/0
	Cirripedia	0/0	0/0	0/0
	Malacostraca			
	Amphipoda	2/3	11/14	1/1
	Tanaidacea	0/0	1/1	0/0
	Cumacea	0/0	3/5	0/0
	Isopoda	0/0	1/14	1/4
	Mysidacea	0/0	0/0	0/0
	Natantia	1/5	1/138	0/0
Chelicerata	Pycnogonida	0/0	2/6	1/3
Tentaculata	Bryozoa	0/0	0/0	0/0
	Brachiopoda	0/0	0/0	1/1
Echinodermata	Ophiuroidea	0/0	7/64	5/48
	Asteroidea	0/0	7/18	5/13
	Echinoidea			
	Regularia	0/0	0/0	
	Irregularia	0/0	0/0	
	Crinoidea	0/0	1/250	0/0
	Holothuroidea	0/0	4/20	5/8
Chordata	Ascidiacea	0/0	0/0	2/2
	Pisces	0/0	2/2	0/0

### 9.3.3 Collection of Porifera (sponges) during ANDEEP III

Dorte Janussen

Forschungsinstitut und Naturmuseum Senckenberg, Frankfurt

#### Introduction

An up-to-date introduction into the Porifera of the Antarctic deep-sea has been given in earlier publications (Janussen 2003, Janussen *et al.* 2003, Janussen *et al.* 2004). A short review is given here for the understanding of the tasks and preliminary results of this expedition.

The Antarctic shelf sponge fauna is unique. Most famous are the giant sized and probably very old Rossellidae, class Hexactinellida (largest *Rossella* spp. individuals are up to 2 m high and have been calculated to an age of 1515 years, Gatti 2002). According to present knowledge, more than half of the today known species of Antarctic Hexactinellida are endemic, and the genus *Rossella*, except for one species, has been recorded circumantarctically (Barthel & Tendal 1994). Of the Demospongiae, 352 species and 127 genera have been listed mostly from shallow water, of which more than 60 % are endemic to the Southern Ocean and occur circumantarctically, including the Magellan area (Sar a *et al.* 1992). Some 20 species of Antarctic Calcarea have been so far recorded (Koltun 1976), but before the ANDEEP II-expedition, no occurrence of calcareous sponges deeper than 850 m was known (Janussen *et al.* 2003).

During the ANDEEP I and II expeditions 45 poriferan species were collected. These include: --29 species of Demospongiae, 1 new to science and 13 new for the Antarctic. --4 species of Calcarea, 2 (or 3) new to science and 3 new for the Antarctic. --11 species of Hexactinellida, 4 new to science and 5 new for the Antarctic. For the first time, we found calcareous sponges in the Antarctic deep sea: 4 species of the Calcarea, 3 of which are new to science (Janussen *et al.* 2003). However, Calcarea seem to be rare in the Antarctic. For many taxa, we could significantly extend the depth ranges of their occurrences. The distribution and richness of sponges proved to be strongly dependent on depth but also on types of sediment and availability of substrates. Richest and most diverse were the stations 132 and 133, east of the Antarctic Peninsula, where many larger stones were observed in the trawl. To the east towards the South Sandwich Islands, sponge diversity decreased. The bathyal sponge fauna was found to extend very far down the slope: down to about 2500 m we had primarily eurybathic shelf species. However, also a faunal mixture of shallow and deep-sea elements was observed. The abyssal plain (stations 134-139 at about 4000 m depth) exhibits a specific association of deep-sea predatory demosponges and also some hexactinellid species, mostly of the genus *Caulophacus*, well adapted to life on soft bottoms. The abyssal sponge community is fundamentally different from the bathyal one: Whereas most of the bathyal sponges are shelf species, many of which occur only in the Southern Ocean, the abyssal sponge community shows more affinity to the faunas of other deep-sea areas, notably the Atlantic.



Based on the results of the first two ANDEEP expeditions, we set out with the scientific purpose for this ANDEEP III expedition to answer at least some of the following questions:

- How far does the zone of faunal mixture between the bathyal and the abyssal sponge communities extend, and is there a boundary to the true deep-sea fauna?
- Will new sampling confirm a decrease in sponge diversity from W to E in the Weddell Sea?
- Does the poriferan fauna change significantly towards the neighbouring oceans?
- Is “gigantism” a general feature of at least some Antarctic sponge taxa, also in the deep sea?

### **Work at sea**

- Sorting of samples and collection and immediate documentation of deep-sea sponges, fixation for histology, electron microscopy, etc. Freezing samples of sponge tissue for biochemical investigations and molecular biology.
- Preparation and preliminary identifications of gross taxa.

### **Work after return**

- Taxonomical identification and proper description of all species from this new material.
- Research of the bathymetric and zoogeographic distribution of Antarctic deep-sea Porifera including zoogeographic affinities.
- Investigation of the range and phylogenetic significance of morphological variation within the Antarctic Rossellidae (Hexactinellida) by means of mitochondrial and nuclear markers.

### **First results of ANDEEP III**

Sponges were found at all ANDEEP-stations (including AGT #57 and EBS #133), either by the epibenthic sledge (EBS), agassiz trawl (AGT), or both. All together, 386 sponges were collected during this expedition. The following [table](#) gives an overview of the sponge catches by both sampling gears according to stations, including their distribution within the three Poriferan classes. It is remarkable that all catches of the EBS (as far as already sorted out) contained sponges. Some bigger individuals were caught in front of the net, and smaller ones are found within the net together with the other macrofauna.

**Table 9.28:** Distribution of sponge catches, numbers of species and specimens (spp/ind.), according to stations and sponge classes, Hexactinellida, Demospongiae and Calcarea.

Station #	016	021	057	059	074	078	080	081	088	094	102
≅ Depth, m	4695	4578	1820	4650	1065	2180	3050	4400	4930	4890	4805
spp/ind. :											
Hexactinell.				4/4	6/18		2/4		1/1	2/3	4/5
Demospong.	3/4	2/2	2/2	2/3	16/47	10/20	4/4	3/5	4/4	4/4	4/86
Calcarea								1/1			
Total , ssp/ind	3/4	2/2	2/2	6/7	22/65	10/20	6/8	4/6	5/5	6/7	7/91

Station #	110	121	133	142	150	151	152	153	154
≅ Depth, m	4700	2600	1500	3300	1970	1093	1997	1778	3800
spp/ind. :									
Hexactinell.		2/8	4/4	2/3		1/1			1/2
Demospong.	3/100	15/44	3/3		1/1		1/1	1/1	
Calcarea		1/1	1/1						
Total, spp/ind.	3/100	18/53	8/8	2/3	1/1	1/1	1/1	1/1	1/2

Cape Town – Atka Bight transect: At the first two stations (# 016 and # 021, both > 4500 m depth) the AGT yielded no sponges, but the EBS caught several small (1-2 mm) sponges, probably all species of the genus *Asbestopluma* belonging to the deep-sea predatory sponge family Cladorhiszidae. No hexactinellids were collected from these two deep stations. However, both trawl and sledge of station # 021 contained isolated (up to 20 cm long) hexactinellid spicules, proving that some hexactinellids must be there, even if they are probably rare at this locality. At station # 057 the AGT yielded only 2 sponges, both eurybathic shelf species of the family Polymastidae. Station # 59 (at 4650 m water depth) shows a different taxonomic composition: 3 larger Hexactinellida were caught by the AGT, whereas the EBS contained another hexactinellid fragment and 3 *Asbestopluma* specimens.

Kapp Norvegia transect: These 4 stations (074, 078, 080, 081) revealed a highly diverse poriferan fauna. The 1000-m station (074) brought about the maximal number of 22 species (conservative estimate), including 6 rossellide Hexactinellida and 16 species of Demospongiae, mostly eurybathic (Polymastidae, Myxillidae and Halichondridae) normally found in shallower depths, but also including 3 species of the carnivorous Cladorhiszidae taken by EBS. Station 078 (about 2150 m) yielded only Demospongiae, mostly eurybathic, but also 2 cladorhiszide species. The 3000-m station (080) revealed mainly deep-sea species (Hexactinellida and Cladorhiszidae) and only few eurybathic Polymastidae. At station 081 (about 4400 m), no larger sponges were found in the AGT, but 6 very small (1-1.5 mm) specimens were collected by EBS, 5 of which were identified as Cladorhiszidae and 1 belonging to the Calcarea – the first calcarean sponge of this expedition.

Weddell Sea transect: The two deepest stations (088 and 094, both about 4900 m) show different faunal compositions: sta. 88 was poor in megafauna and contained only few demosponges and 1 hexactinellid fragment. Station 094 yielded two hexactinellids of the genus *Caulophacus*, one large *Caulophacus (Oxydiscus) cf. weddelli* (second specimen of this species, the first one was taken at ANDEEP II, sta. 137; Janussen *et al.* 2004) and 4 Demospongiae (Cladorhiszidae and Polymastidae). The stations 102 and 110 (depths 4800 m and 4700 m) again revealed very different sponge faunas: Whereas sta. 102 was rich, including 4 hexactinellids species and 4 species, 85 specimens, of Demospongiae, sta. 110 contained only 2 species of Polymastidae in high numbers (about 100 specimens) and 1 cladorhiszide caught by EBS. High diversity was observed at station 121 with 17 species all together: 2 of Hexactinellida, including 1 very large specimen of the Euplectellidae, identified as *Malacosaccus cf. coatsi* (known so far only from one damaged specimen from the eastern Weddell Sea; Barthel & Tendal 1994), 14 species of Demospongiae, including both eurybathic and cladorhiszide species, and 1 of the Calcarea. Station 133, EBS (still unsorted), also proves to be very rich: From the front of the sledge and from the water above the net, 8 sponge species, 4 Hexactinellida, 3 Demospongiae and 1 Calcarea, were identified

Powell Basin transect: Here the 3000-m, 2000-m and 1000-m stations (142, 150, 151) yielded a highly diverse megafauna. However, the trawl at sta. 142 contained only 3 hexactinellids (2 spp), at sta. 150 it caught 1 demosponge, and at sta. 151 1 hexactinellid was collected. Also the stations in the Drake Passage provided only a few sponges, mostly dead, mud-filled skeletons.

### First conclusions

- All EBS samples contained sponges. The most interesting deep-sea sponges, small Cladorhiszidae and Calcarea were collected by EBS.
- A general observation during the ANDEEP expeditions is the fact that deep-sea stations poor in other megafauna are generally rich in sponges, and *vice versa*.
- The sponge fauna of the deep Weddell Sea differs significantly from that of the adjacent Scotia Sea and Cape Basin: The first is rich in Hexactinellida and larger eurybathic Demospongiae, whereas the latter yielded almost exclusively very small predatory sponges of the family Cladorhiszidae.
- Calcareous sponges are a comparably rare component of the Southern Ocean deep-sea fauna.
- Large Hexactinellida in abyssal samples show that gigantism occurs also in the Southern Ocean deep sea.
- Apparently high species turnover may be a result of the sampling deficiency in the Southern Ocean deep sea.

**References:**

- Barthel, D. and O.S. Tendal (1994): Antarctic Hexactinellida. *Synopsis of the Antarctic benthos* 6: 154 pp.
- Gatti, S. (2002): High Antarctic carbon and silicon cycling – how much do sponges contribute?. *Abstr. VI Int. Sponge Conf. 20.09.-5.10.02*, p. 76, Rapallo.
- Janussen, D. (2003): First report on the deep-sea Porifera from the Northern Weddell Sea and the slope of South Sandwich Trench. *Berichte zur Polarforschung* 470: 104-108.
- Janussen, D., Rapp, H.T. and O.S. Tendal (2003): A myth vanished: Calcareous sponges are alive and well at abyssal depths. *Deep-Sea Newsletter* 32: 17-19.
- Janussen, D. Tabachnick, K.R. and O.S. Tendal (2004): Deep-sea Hexactinellida (Porifera) of the Weddell Sea. *Deep-Sea Research II* 51 (14-16): 1857-1883.
- Koltun, V.M. (1976): Porifera – part I: Antarctic sponges.- B.A.N.Z. *Antarctic Research Exped. Reports, ser. B*, vol. 9: 151-198, Univ. Adelaide.
- Sarà, M., Balduzi, M., Bavastrello, G. And B. Burlando (1992): Biogeographic traits and checklist of Antarctic demosponges. *Polar Biology* 12: 559–585.

**9.3.4 Biodiversity of deep-sea benthic anthozoans during ANDEEP III**

Pablo J. López-González

Departamento de Fisiología y Zoología. Universidad de Sevilla

**Objectives**

Anthozoans are commonly one of the major components in benthic sessile communities in terms of both abundance and diversity (Arntz 1997; Arntz *et al.* 1997; Gili *et al.* 1999), offering a good substrate (e.g. refuge, feeding) to many other benthic mobile animal groups (crustaceans, polychaetes, echinoderms). The Antarctic fauna of anthozoans is still poorly known (Winston 1992, Clark & Johnston 2003), and undescribed genera and species are continuously described (e.g., López-González & Gili 2000, 2001, López-González *et al.* 2002; López-González & Williams 2002; Rodríguez & López-González 2001, 2002, 2003).

Knowledge of the total number of Antarctic and Subantarctic Anthozoan species is still very imprecise, several species-rich genera should be revised, preferably using newly collected material in combination with the type specimens deposited in museums.

Three main explanations have been suggested to explain the origin of recent Antarctic benthic communities: derivation from indigenous fauna components, immigration from the deep sea, or recent dispersal from neighbouring shallow-water areas (Crame 1989, 1994, Clarke 1990, Clark & Crame 1989, 1992). According to preliminary results of the anthozoan fauna from previous EASIZ, ANDEEP and LAMPOS cruises, the Antarctic alcyonaceans apparently include elements derived from all three hypotheses (López-González & Gili 2001), while pennatulaceans are mainly immigrants from the deep sea of surrounding oceans (*Umbellula*,

*Kophobelemnon*) and secondarily from shallow waters (*Pennatula*) (López-González & Williams 2002).

The main objectives on board were: 1. to look for the presence of possible boundaries in the distribution of anthozoans at different taxa levels (family, genus, species) in the deep Weddell Sea, 2. to evaluate the potential origin of the Antarctic anthozoan fauna according to the known distribution of genera/species in this and other biogeographical areas, 3. to identify any undescribed species that might eventually assist with a better understanding of the relationship between Antarctica and other deep-sea and continental shelf areas in the past and present, and 4. to augment the bank of tissues useful for molecular studies (already initiated since EASIZ III).

### **Work at sea**

The material was obtained mainly by Agassiz trawls (AGT), although some additional specimens were also collected by the epibenthic sledge (EBS) and the box corer (GKG). When necessary, individuals or colonies were relaxed by adding menthol crystals to the surface of the sea water, and storing them in the cold room for several hours. Cnidarians were fixed for anatomical studies in buffered 6% formaldehyde in sea water (pH 8-9). Selected specimens of fragments were fixed in 96% ethanol for further molecular studies. All specimens will be preserved in 96% ethanol once in the laboratory.

### **Preliminary results**

The anthozoan material collected during ANDEEP III was obtained from 15 of the 19 AGT hauls carried out. These hauls can be arranged in five transects: Cape Town-Atka Bay (4 hauls), Kapp Norvegia (3 hauls), Weddell Sea (4 hauls), Powell Basin (2 hauls), and north of Anvers Island (2 hauls).

A total of 133 individuals/colonies was identified, although some of them were only present in a fragmentary state, e.g., bases of antipatharians or gorgonians. These specimens were grouped in 36 morphospecies, some of which were identified on board to species level, although most are awaiting further morphological studies in the laboratory, e.g., histological sections, light and electron microscopy. Ten species belonged to the Octocorallia, and 26 to the Hexacorallia. The octocoral classification used here, which is considered to be the most natural currently available, considers only three orders: Helioporacea, Alcyonacea, and Pennatulacea, only the last two are present in the Southern Ocean. Among the octocoral species there were 4 pennatulaceans, and 6 alcyonaceans (1 soft coral, and 5 gorgonians). The hexacoral species consisted of 16 actinarians, 2 scleractinarians, 1 ceriantharian, antipatharians, and 3 zoanthideans. [Table 9.30](#) includes all specimens collected by AGT during the ANDEEP III cruise.

According to the above arrangement of the AGT hauls (see also Linse *et al.* this volume, for the additional characteristics of the transects), the following comments about the diversity and distribution of the anthozoan species can be made:

Cape Town-Atka Bay.- A total of 12 species was collected, five of them in the shallowest station (~1800 m). Station PS67/059-11 is worthy of special mention because of a typical deep-sea species/group composition that will be repeated in the Weddell Sea transect (see below), and an individual attributable to the corallimorpharian species *Corallimorphus profundus*. In the vicinities of the Southern Ocean, this species has been previously reported with certainty only in the Pacific Basin, in latitudes no higher than 60°S (Dunn 1983). No gorgonian colonies were collected on this transect.

Kapp Norvegia.- A total of 10 species was collected. Gorgonians of the families Primnoidae and Isididae (both in PS67/078-11), as well as the species *Umbellula magniflora* (in 74-7), all well represented on the Antarctic shelf, were collected for the first time on this cruise.

Weddell Sea.- This deep-sea transect from the eastern to the western Weddell Sea (4 AGT with a depth range ~ 4700 to 5000 m) is linked to the station 59-11 (final station of the transect Cape Town-Atka Bay). All these stations show a nearly constant species/group composition, as in the deep sea in other oceans: *Galatheanthemum profundale* (Actiniaria), Antipatharia gen.1 (Antipatharia), and *Umbellula cf. thomsoni* (Pennatulacea). These three species have not been found in any previous shelf cruises carried out in the Weddell Sea and near the Antarctic Peninsula (e.g., EASIZ cruises, LAMPOS, BENDEX). Material of the two first species was also collected during ANDEEP II, all in depths > 4000 m. *Galatheanthemum profundale* is well known to occur in Kermadec Trench, and in Antarctic waters between 15° and 130°W (4000-5000 m depth) (Carlgren 1956; Dunn 1983), species of Antipatharia gen.1 and *U. thomsoni* were already reported for the deep Southern Ocean by Pasternak (1961, 1962). None of these species are present in the Antarctic or Subantarctic shelf areas. The genus *Umbellula* is well represented in the Antarctic shelf by two species, *U. magniflora* and *U. lindalhi* (Pasternak 1962; López-González unpubl. data).

Powell Basin.- A total of 10 species was collected. This transect showed a high diversity of actinarians, lacking *G. profundale*, but with deep-sea elements, such as *U. cf. thomsoni* and *Fungiacyathus* sp. Because of the scarcity of data currently available, any discussion of the bathymetric distribution of the anthozoan fauna is tentative, the deeper station is more diverse.

North of Anvers Island.- A total of 10 species was collected, eight of them in the last station. Both stations PS67/153-8 and PS67/154-7 were dominated by actinarians. At the deeper station (PS67/154-7), four specimens of *Umbellula cf. thomsoni* were collected, in this case accompanied by four colonies of Antipatharia gen.2, as well as a single specimen of *Liponema* sp. (Actiniaria), a well know deep-sea species in this area (Dunn, 1983).

Some characteristic features of the anthozoan fauna observed on ANDEEP III are worth of further study: 1. An increase in the diversity of zoanthidean in Antarctic waters. Only one genus, *Parazoanthus*, with a single species *P. antarcticus* Carlgren,

was previously known in the area, and restricted to the shelf (also collected in early shelf cruises such as EASIZ III, LAMPOS, and BENDEX). During this cruise at least two species of *Epizoanthus* were collected. 2. The possible distribution of *Corallimorphus profundus* in deep Antarctic waters. This species can be considered a deep-sea immigrant in Antarctica, and a possible deep-sea circumpolar distribution could be expected. 3. The presence of a homogeneous deep-sea faunal composition across the Weddell Sea in depths ~ 4000 to 5000 m.

### References

- Arntz, W.E. (1997): Investigación antártica en biología marina: situación actual, proyectos internacionales y perspectivas. *Bol.R.Soc.Esp.Hist.Nat.Secc.Biol.* 93: 13-44.
- Arntz, W.E., Gutt, J. And M. Klages (1997): Antarctic marine biodiversity: an overview. In: Battaglia B, Valencia J, Walton DWH (eds) *Antarctic communities, species, structure and survival*. Cambridge University Press, Cambridge, pp 3-14.
- Carlgren, O. (1956): Actiniaria from depth exceeding 6000 metres. *Galathea Rep.* 2: 9-16.
- Clarke. A. (1990): Temperature and evolution. Southern Ocean cooling the Antarctic marine fauna. In: Kerry KR, Hempel G (eds) *Antarctic ecosystems. Ecological change and conservation*. Springer Berlin, pp 9-22.
- Clarke, A. and J.A. Crame (1989): The origin of the Southern Ocean marine fauna. In: Crame J.A. (ed) *Origins and evolution of the Antarctic biota. The Geological Society London* (Geological Society Special Publication 47), pp 253-268.
- Clarke, A. and J.A. Crame (1992): The Southern Ocean benthic fauna and climate change: a historical perspective. *Phil Trans R Soc Lond B* 338: 299-309.
- Clarke, A. and N.M. Johnston (2003): Antarctic marine benthic diversity. *Oceanogr. Mar.Biol. Ann.Rev.* 41: 47-114.
- Crame, J.A. (1989): Origins and evolution of the Antarctic biota. London: *The Geological Society London* (Geological Society Special Publications, 47).
- Crame, J. A. (1994) Evolutionary history of Antarctica. In: Hempel G (ed) *Antarctic science - global concerns*. Springer, Berlin, pp 188-214.
- Dunn, D. (1983): Some Antarctic and sub-Antarctic sea anemones (Coelenterata: Ptychodactiaria and Actiniaria). *Biology of the Antarctic Seas XIV*, Antarctic research series 39, AGU, Washington, D.C., pp. 1-67.
- Gili, J. M., Arntz, W.E., Filipe, P., López, P., Orejas, C., Ros, J. and N. Teixido, (1999): The role of benthic suspension feeders in Antarctic communities. In: The Expedition ANTARKTIS XV/3 (EASIZ II) of RV *Polarstern* in 1998. *Berichte zur Polarforschung* 301: 30-83.
- López-González, P.J. and J.M. Gili (2000): A new octocorallian genus (Cnidaria: Anthozoa) from Antarctic waters. *Polar Biol.* 23: 452-458.
- López-González, P.J. and J.m. Gili (2001): *Rosgorgia inexpectata*, new genus and species of Subergorgiidae (Cnidaria, Octocorallia) from off the Antarctic Peninsula. *Polar Biol.* 24: 122-126.
- López-González, P.J., Gili, J.M. and C. Orejas (2002): A new primnoid genus (Anthozoa: Octocorallia) from the Southern Ocean. *Sci.Mar.* 66(4): 383-397.

- López-González, P.J. and G.C. Williams (2002): A new genus and species of sea pen (Octocorallia: Pennatulacea: Stachyptilidae) from the Antarctic Peninsula. *Invert. Syst.* 16: 919-929.
- Pasternak, F.A. (1961): Pennatularia (Octocorallia) and Antipatharia (Hexacorallia) obtained by the Soviet Antarctic Expedition in 1955-1958. *Trudy Instituta okeanologii, Akademiya Nauk SSSR* 46, 217-230.
- Pasternak, F.A. (1962): Pennatularia of the genus *Umbellula* Cuvier (Coelenterata: Octocorallia) from Antarctic and Subantarctic waters. *Biological Reports of the Soviet Antarctic Expedition* 61, 107-130.
- Rodríguez, E. and P.J. López-González (2001): A new species of *Hormathia* (Actiniaria, Hormathiidae) from the eastern Weddell Sea, Antarctica. *Helgol. Mar. Res.* 55: 116-123.
- Rodríguez, E. and P.J. López-González P. J. (2002): A new species of *Halcampella* (Actiniaria, Halcampoididae) from the eastern Weddell Sea and Antarctic Peninsula. *Sci Mar* 66(1): 43-52.
- Rodríguez, E., López-González (2003): *Stephanthus antarcticus*, a new genus and species of sea anemone (Actiniaria, Haloclavidade) from the South Shetland Islands, Antarctica. *Helgol. Mar. Res.* 57: 54-62.
- Winston, J.E. (1992): Systematics and marine conservation. In Eldredge N (ed) *Systematics, ecology and biodiversity crisis*. Columbia University Press, New York, pp. 144-168.



Table 9.30: Anthozoans collected by Agassiz trawls during ANDEEP III

Transect / area covered	Cape Town- Atka Bay				Kapp Norvegia			Weddell Sea				Powell Basin		N. Anvers Is.	
	16-11	21-8	57-2	59-11	74-7	78-11	80-6	88-11	94-11	102-11	110-2	142-6	151-2	153-8	154-7
Station number	4722-4692	4579-4580	1811-1828	4648-4646	1046-1057	2154-2146	2970-3003	4928-4930	4992-4995	4793-4797	4697-4704	3405-3405	1181-1187	2109-2119	3797-3800
Depth range (m)															
<b>Subclass Octocorallia</b>															
<b>Order Alcyonacea</b>															
<i>Alcyoniidae</i> sp.						2									
<i>Primnoella</i> sp. 1						6									
<i>Primnoella</i> sp. 2												1			
Primnoidae sp.															1
<i>Thouarella</i> sp.															1
Isididae sp.						2									
<b>Order Pennatulacea</b>															
<i>Kophobelemnon</i> sp.		1													
<i>Umbellula</i> sp.				2											1
<i>Umbellula magniflora</i>					1										
<i>Umbellula cf thomsoni</i>								2	2	3		1			3
<b>Subclass Hexacorallia</b>															
<b>Order Alcyonacea</b>															
Actiniaria sp. 1			9												
Actiniaria sp. 2					1										
Actiniaria sp. 3					5										
Actiniaria sp. 4							1								
Actiniaria sp. 5												1			
Actiniaria sp. 6												3			
Actiniaria sp. 7														1	
Actiniaria sp. 8														2	
Actiniaria sp. 9															2
Actinostolidae sp. 1	1											1			
Actinostolidae sp. 2												1			
Actinostolidae sp. 3															1
<i>Bolocera</i> sp.			1										1		
<i>Galatheanthemum profundal</i>				1				2	1	2	1				
<i>Hormatia cf lacunifera</i>													1		
<i>Liponema</i> sp.															1
<b>Order Corallimorpharia</b>															
<i>Corallimorphus cf profundus</i>				1											
<i>Corallimorphus</i> ?						1									
<b>Order Zoanthidea</b>															
<i>Epizoanthus</i> sp.1		1													
<i>Epizoanthus</i> sp.2			1										1		
<i>Epizoanthus</i> sp.3					1										
<b>Order Scleractinia</b>															
<i>Fungiacyathus</i> sp.												2			
<i>Caryophyllia</i> sp.			10			8									

Transect / area covered	Cape Town- Atka Bay				Kapp Norvegia			Weddell Sea				Powell Basin		N. Anvers Is.	
Station number	16-11	21-8	57-2	59-11	74-7	78-11	80-6	88-11	94-11	102-11	110-2	142-6	151-2	153-8	154-7
Depth range (m)	4722-4692	4579-4580	1811-1828	4648-4646	1046-1057	2154-2146	2970-3003	4928-4930	4992-4995	4793-4797	4697-4704	3405-3405	1181-1187	2109-2119	3797-3800
<b>Order Antipatharia</b>				3				5	2	15	9				
Antipatharia gen. 1															
Antipatharia gen. 2															4
<b>Order Ceriantharia</b>															
Ceriantharia sp.			2												
<b>Total number of species</b>	1	2	5	4	4	5	1	3	3	3	2	7	3	2	8
<b>Total number of indiv/colonies</b>	1	2	26	7	8	19	1	9	5	20	10	10	3	3	14

### 9.3.5 The Crinoidea and Holothuroidea (Echinodermata) collected during ANDEEP III

Jens Michael Bohn  
Zoologische Staatssammlung München

#### Objectives

Holothuroidea are an important part of the deep-sea megafauna community because of their abundance, biomass, nutrition and respiration, but the knowledge on deep-sea holothurians in general is quite scarce. Some areas are very well sampled (e.g., the North Atlantic Ocean), while others only have been sampled rarely (e.g., the South Atlantic Ocean or the Southern Ocean). The ANDEEP I-III expeditions for the first time offer the possibility to fill this gap and answer such questions as: (1) What is the composition of the holothurian fauna of this area? (2) What are the relationships of the Antarctic, the South American and the Scotia Arc shelf fauna to the surrounding deep sea? (3) Are there links between the Antarctic deep-sea fauna and the deep-sea fauna of other areas (e.g., South Atlantic Ocean)?

#### Work at sea

During ANDEEP III Crinoidea and Holothuroidea have been collected from four different gears (Agassiz trawl, epibenthic sledge, giant box corer and multicorer, see tables 9.31 and 9.32). The specimens were sorted to species level, specimens in good condition were photographed to document colouration, and all specimens were fixed in ethanol (for molecular studies) or formalin (for histological studies).

#### Preliminary results

(1) Crinoidea (table 9.31). In total, the crinoid fauna was not very diverse. About seven different species have been found during the cruise (five Comatulida, one *Bathycrinus* sp., one *Hyocrinus*). Two of the Comatulida (from shallow station PS 67/074, depth 1060 m) are typical high Antarctic shelf species with a circumantarctic distribution. Remarkable is a new record of a single specimen of *Hyocrinus bethellianus* Thomson, 1876 from the Powell Basin (station PS 67/142-6, 3403 m).

This species seems to have a worldwide distribution, though it is only known from three localities (Southern Ocean: off Kemp Coast, southern Indian Ocean: off Crozet Island, northern Pacific Ocean: off Near Islands) and inhabits a depths from 2915-4636 m (Mironov & Sorokina 1998).

**Table 9.31:** Crinoidea specimens (determined to genus) collected during ANDEEP III with different gears (Agassiz trawl, epibenthic sledge, multi corer). F: fragments

	57-2	59-5	59-10	59-13	74-6	74-7	78-11	80-6	81-8	142-6	150-7	153-7	153-8
Comatulida	2	-	-	1	4, F	30	1	4	1	21	4	-	-
Bathycrinidae	-	F	F	-	-	-	-	-	-	-	-	-	-
<i>Bathycrinus</i>	1	-	-	-	-	-	-	-	-	-	-	1	250
Hyocrinidae	-	-	-	-	-	-	-	-	-	-	-	-	-
<i>Hyocrinus</i>	-	-	-	-	-	-	-	-	-	1	-	-	-

(2) Holothuroidea (table 9.32). The holothurians collected during ANDEEP III are quite diverse, with at least 40 different species belonging to 26 genera. The Elaspodida are dominating with 22 different species, followed by the Apodida with nine species. Several of the species found are well known and have a wide distributional range, e.g. *Psychropotes longicauda* Théel, 1882 (distribution: worldwide, ANDEEP III: 6 stations), and *Scotoplanes globosa* (Théel, 1879) (distribution: Southern Ocean and Indo-Pacific Ocean, ANDEEP III: 3 stations) (all from Hansen 1975). *Kolga hyalina* Danielssen and Koren, 1879 on the other hand seems to be an example for a bipolar species. It is well known from the Arctic Ocean and the North Atlantic, but also has been described from the Southern Ocean (see Hansen 1975). The specimens collected at station PS 67/80-9 are the first record of this species for the Weddell Sea area. New to the Southern Ocean is also *Cherbonniera utriculus* Sibuet, 1974, a small molpadiid holothurian, described from the North Atlantic Ocean, which has recently also been found off the Falkland Islands (Pawson *et al.* 2001). This species has been collected at three ANDEEP III stations (see table 9.32). Also a so far undescribed species of the genus *Labidoplax* which has been found during ANDEEP I off the Antarctic Peninsula (Gebruk *et al.* 2003) seems to have a wide distributional range in the Weddell Sea area, where it has been collected on six ANDEEP III stations (table 9.32).

These very preliminary results show that a detailed study of the holothurian species collected during ANDEEP will contribute much to our understanding of the taxonomy and the zoogeographical relationships of the Antarctic deep-sea holothurians.

**Table 9.32:** Holothuroidea specimens (determined to genus) collected during ANDEEP III with different gears (Agassiz trawl, epibenthic sledge, giant box corer, multi corer)

	16-5	16-7	16-10	16-11	21-7	21-8	57-2	59-5	59-10	70-1	74-6	74-7	78-4	78-6	78-8
Holothuroidea	-	-	-	-	-	2	4	-	2	-	9	9	-	-	-
Cucumariidae	-	-	-	-	-	-	-	-	-	-	-	-	-	-	-
<i>Staurocucumis</i>	-	-	-	-	-	-	13	-	-	-	-	-	-	-	-
Paracucumidae	-	-	-	-	-	-	-	-	-	-	-	-	-	-	-
<i>Crucella</i>	-	-	-	-	-	-	-	-	-	-	18	2	-	-	-
Psolidae	-	-	-	-	-	-	-	-	-	-	22	60	-	-	-
Ypsilothuriidae	-	-	-	-	-	-	-	-	-	-	-	-	-	-	-
<i>Echinocucumis</i>	-	-	-	-	-	-	-	-	-	-	2	-	-	-	-
Synallactidae	-	-	-	10	-	-	9	-	-	-	-	-	-	-	-
<i>Bathyplores</i>	-	-	-	-	-	-	-	-	-	-	-	30	-	-	-
Deimatidae	-	-	-	1	-	-	-	-	-	-	-	-	-	-	-
<i>Deima</i>	-	-	-	1	-	-	-	-	-	-	-	-	-	-	-
Laetmogonidae	-	-	-	-	-	-	-	-	-	-	-	-	-	-	-
<i>Laetmogone</i>	-	-	-	-	-	1	2	-	-	-	-	-	-	-	-
Psychropotidae	-	-	-	-	-	-	-	-	-	-	-	-	-	-	-
<i>Benthodytes</i>	-	-	-	-	-	1	-	-	2	-	-	-	-	-	-
<i>Psycheotrepes</i>	-	-	-	1	-	-	-	-	-	-	-	-	-	-	-
<i>Psychropotes</i>	-	-	-	4	-	4	-	-	1	-	-	-	-	-	-
Elpidiidae	-	-	2	1	2	10	42	2	-	4	-	5	-	-	-
<i>Amperima</i>	-	-	-	-	1	-	-	-	-	-	-	-	-	-	-
<i>Ellipinion</i>	-	-	-	-	-	-	-	-	-	-	-	-	-	-	-
<i>Elpidia</i>	-	-	-	-	3	-	-	15	-	-	1	-	-	-	-
<i>Kolga</i>	-	-	-	-	-	-	-	-	-	-	-	-	-	-	-
<i>Peniagone</i>	-	-	-	-	-	14	-	1	29	-	-	2	-	-	-
<i>Scotoplanes</i>	-	-	-	-	-	-	-	-	-	-	-	-	-	-	-
<i>Rhipidothuria</i>	-	-	-	-	-	-	-	-	-	-	2	38	-	-	-
Molpadiidae	-	-	-	-	-	-	-	-	-	-	-	-	-	-	-
<i>Cherbonniera</i>	-	-	14	-	-	-	-	1	-	-	2	-	-	-	-
<i>Molpadia</i>	-	1	-	24	-	-	-	-	-	-	-	-	-	-	-
Chiridotidae	-	-	-	-	-	-	-	-	-	-	-	-	-	-	-
<i>Chiridota</i>	-	-	-	-	-	-	-	-	-	-	3	-	-	-	-
<i>Paradota</i>	-	-	-	-	-	-	-	-	-	-	-	3	-	-	-
<i>Taeniogyrus</i>	-	-	-	-	-	-	-	-	-	-	1	-	-	-	-
Synaptidae	-	-	-	-	-	-	-	-	-	-	-	-	-	-	-
<i>Labidoplax</i>	-	-	-	-	-	-	1	-	-	-	-	-	1	1	1
<i>Protankyra</i>	1	-	-	8	-	-	-	-	-	-	-	-	-	-	-
Myriotrochidae	-	-	-	-	-	-	-	1	-	-	-	-	-	-	-
<i>Acanthotrochus</i>	-	-	1	-	-	-	-	-	-	-	-	-	-	-	-
<i>Myriotrochus</i>	-	-	-	-	-	-	-	-	-	-	4	-	-	-	-
<i>Prototrochus</i>	-	-	-	-	-	-	-	18	-	-	3	-	1	-	-
Holothuroidea	-	5	2	-	-	4	3	-	1	-	-	10	1	-	2
Cucumariidae	-	-	-	-	-	-	-	-	-	-	-	-	-	-	-
<i>Staurocucumis</i>	-	-	-	-	-	-	-	-	-	-	-	-	-	-	-
Paracucumidae	-	-	-	-	-	-	-	-	-	-	-	-	-	-	-
<i>Crucella</i>	-	-	-	-	-	-	-	-	-	-	-	-	-	-	-
Psolidae	-	1	-	-	-	-	-	-	-	-	-	2	-	-	-
Ypsilothuriidae	-	-	-	-	-	-	-	-	-	-	-	-	-	-	-
<i>Echinocucumis</i>	12	32	-	-	-	-	-	-	15	-	-	1	2	-	3

	16-5	16-7	16-10	16-11	21-7	21-8	57-2	59-5	59-10	70-1	74-6	74-7	78-4	78-6	78-8
Synallactidae	-	-	1	-	-	2	3	2	2	-	-	8	6	16	1
<i>Bathyploetes</i>	-	-	-	-	-	-	-	-	-	-	-	-	-	-	-
Deimatidae	-	-	-	-	-	-	-	-	-	-	-	-	-	-	-
<i>Deima</i>	-	-	-	-	-	-	-	-	-	-	-	-	-	-	-
Laetmogonidae	-	-	-	-	-	-	-	-	-	-	-	-	-	-	-
<i>Laetmogone</i>	-	4	-	1	-	-	-	-	-	-	-	-	-	-	-
Psychropotidae	-	-	-	-	-	-	-	-	-	-	-	-	-	-	-
<i>Benthodytes</i>	-	1	-	-	1	1	-	-	-	-	-	1	-	-	-
<i>Psycheotrepes</i>	-	-	-	-	-	-	-	-	-	-	-	-	-	-	-
<i>Psychropotes</i>	-	-	-	-	-	3	1	1	3	-	-	-	-	-	-
Elpidiidae	4	5	2	-	-	1	-	2	-	2	9	-	-	3	1
<i>Amperima</i>	-	1	-	-	-	2	-	-	-	-	-	-	-	-	-
<i>Ellipinion</i>	-	-	-	-	-	-	-	-	17	-	-	-	-	-	-
<i>Elpidia</i>	3	-	10	1	-	-	-	-	-	-	-	-	-	-	-
<i>Kolga</i>	-	-	108	-	-	-	-	-	-	-	-	-	-	-	-
<i>Peniagone</i>	-	19	6	1	1	6	-	-	1	-	-	-	4	-	1
<i>Scotoplanes</i>	-	-	-	-	-	1	-	-	3	-	-	-	57	-	-
<i>Rhipidothuria</i>	-	-	-	-	-	-	-	-	-	-	-	-	-	-	-
Molpadiidae	-	1	-	-	-	-	-	-	1	-	-	-	1	1	-
<i>Cherbonniera</i>	-	-	-	-	-	-	-	-	-	-	-	-	-	-	-
<i>Molpadia</i>	-	-	-	-	-	-	-	-	-	-	-	-	-	-	-
Chiridotidae	-	-	-	-	-	-	-	-	-	-	-	-	-	-	-
<i>Chiridota</i>	-	-	-	-	-	-	-	-	-	-	-	-	-	-	-
<i>Paradota</i>	-	-	-	-	-	-	-	-	-	-	-	-	1	-	-
<i>Taeniogyrus</i>	-	-	-	-	-	-	-	-	-	-	-	-	-	-	-
Synaptidae	-	-	-	-	-	-	-	-	-	-	-	-	-	-	-
<i>Labidoplax</i>	68	-	1	-	-	-	-	-	-	-	-	-	-	-	-
<i>Protankyra</i>	-	-	-	-	-	-	-	-	-	-	-	-	-	-	-
Myriotrochidae	9	-	-	-	-	-	-	-	-	-	-	-	-	-	-
<i>Acanthotrochus</i>	-	-	-	-	-	-	-	-	-	-	-	-	-	-	-
<i>Myriotrochus</i>	1	3	-	-	-	-	-	-	-	-	-	-	-	-	-
<i>Prototrochus</i>	-	-	1	-	-	-	-	-	-	1	-	-	-	-	-

## References

- Gebruk, A.V., Bohn, J.M. and B.D. Wigham (2003): Antarctic deep-sea holothurians. pp. 115–120 in Fütterer, D.K., Brandt, A. & Poore, G.C.B. The Expeditions ANTARKTIS-XIX/3-4 of Research Vessel *Polarstern* in 2002 (ANDEEP I and II: Antarctic benthic deep-sea biodiversity-colonization history and recent community patterns). *Reports on Polar and Marine Research* 470: 174 pp.
- Hansen, B. (1975): Systematics and Biology of the Deep-Sea Holothurians. Part 1. Elapsipoda. *Galathea Report* 13: 262 pp., 14 pls.
- Mironov, A.N. and O.A. Sorokina (1998): Sea lilies of the order Hyocrinida (Echinodermata, Crinoidea). *Zoologicheskie Issledovaniya* 2: 117 pp.
- Pawson, D.L., Vance, D.J. and C. Ahearn (2001): Western Atlantic sea cucumbers of the order Molpadiida (Echinodermata: Holothuroidea). *Bulletin of the Biological Society of Washington* 10: 311–327.

### 9.3.6 Biodiversity of Antarctic echinoids and their symbionts

Vincent Hétérier

Laboratoire de Biologie Marine, Université Libre de Bruxelles

#### Summary

This project investigates, at different structural and functional levels, the biodiversity of the Antarctic echinoids; it also investigates the symbionts harboured by echinoid hosts. The echinoids constitute an abundant and widely distributed component of the megabenthos of Antarctic communities. Thus far, 79 species of echinoids have been recorded and revisited (David *et al.* in press). Relying on the exploration of new or poorly known Antarctic regions, this study will examine the nature and distribution of echinoid biodiversity, and the associated symbionts of cidaroids.

#### Objectives

##### Biodiversity and evolution of echinoids

A conspicuous and important component of the benthic community is the cidaroid echinoids (colloquially known as pencil-spine sea urchins). The cidaroid assemblage of the Southern Ocean belongs to the subfamily Ctenocidarinae and comprises approximately 21 extant species within five genera. In spite of the suitability of this taxon for studying major biological factors in the Southern Ocean, problems with the systematics of the group require investigation. In the process, many data relating to the evolution of benthic Antarctic faunas can be uncovered. Among the ctenocidarines, the status of taxa at every rank is uncertain. The confusion surrounding the systematics of this group is due in part to a lack of consistent, well-delineated features that can be used to identify unequivocally some species. Morphological techniques, along with advanced molecular analyses of several genes will be used to elucidate the systematics of this group. This will provide, for the first time, well supported data to construct a comprehensive phylogenetic tree. By studying phylogenetic trees one can map the events that signify environmental change, such as alterations in biogeographic and bathymetric distributions, and in reproductive behaviours.

Although the full ranges of these species are poorly known, many have a circumpolar distribution: a remarkable feat for species without dispersive larvae. Generally, the production of pelagic larvae is the dominant mode of development for benthic organisms of the Antarctic. However, there exist a number of speciose clades that protect their brood. The ctenocidarines are one such clade. Brood-protection has been reported in 13 ctenocidarine species to date and suspected in the remaining. How so many brood protecting taxa, such as these urchins, have come to be so diverse in the Antarctic compared to the other areas of the world's oceans is unknown. It has been proposed that the unique oceanographic conditions of the Southern Ocean, afforded by the opening of Drake Passage initiating the Antarctic Circumpolar Current (ACC), have contributed to the radiation of these clades. Indeed, a larger number of brood-protecting benthic invertebrate species are found in the region of the Scotia Arc than in surrounding areas. Through the analysis of the

morphological and molecular phylogenetic trees elucidated for this group, and careful calibration for an accurate timeline, we will be able to reconstruct their evolutionary history. Support for the theory will be gained if the majority of genera are 23 million years old or younger, i.e., if the radiation of this group occurred mainly after the final isolation of Antarctica and the initiation of the ACC.

The proposed cruise track of ANDEEP III covered poorly sampled areas of the Atlantic sector of the Subantarctic sea and, therefore, will greatly enhance the morphology based taxonomy and distribution, as well as the molecule-based phylogeny. Sampling these islands 'downstream' of Drake Passage, and discovering how many, and which, species occur there, will be key to understanding the radiation hypothesis outlined above.

The sampling of these areas, particularly the abyssal biome, will greatly expand the biodiversity data already collated on all the Antarctic echinoids – not just of the cidaroids but also of the other six echinoid families, both regular and irregular, that occur in the Southern Ocean. Investigations of these poorly sampled regions will greatly enhance both taxonomic and biogeographic data. New data collected during the ANDEEP cruises, and taxonomic revisions that result from these collections, will be combined to produce a new edition of the cd-rom database "Antarctic Echinoids" already fully accessible to the scientific community. Digital colour images of live specimens taken during the ANDEEP cruises will be included in this database, allowing easier, and more accurate, identification by the non-specialist.

### **Biodiversity of symbionts in cidaroids**

A crucial problem for marine sessile organisms is the availability of hard substrates on which to settle and attach. This problem is particularly intense when hard substrates are lacking or make up a relatively small portion of the sea floor, a situation well illustrated in the deep sea. As a consequence, competition for living space typically occurs among taxa requiring hard bottom for settlement (Dayton *et al.* 1970). Therefore, any hard substrate (lacking an antifouling substance or mechanism) would rapidly be colonised, regardless of its abiotic or biotic origin. Correlatively, one may expect abundance and diversity of sessile benthos to be increased on soft bottom by the presence of hard supports, even if those are scattered. In that context, cidaroid sea urchins are of particular interest: (1) they occur on soft and hard bottoms, (2) their large pencil-like primary spines are usually densely coated by sessile symbionts and are also colonized by vagile organisms which find adequate microhabitats there (Dearborn & Allen 1972, Dearborn *et al.* 1982, Gutt 1991). This latter feature is related to the absence of an epithelium along the shaft that is instead covered by a polycrystalline layer called the cortex, a unique situation among echinoids (Märkel & Röser 1983). The settlement of ectosymbionts on cidaroid spines could, in theory, lead to an increase of biodiversity in the local environment, particularly the deep sea and Antarctic environments where cidaroids are a prominent taxon on soft substrates from shallow to deep waters. The main aim of this part of the project is to assess the importance of ectosymbiosis regarding cidaroids on deep-sea Antarctic biodiversity. This will be done in close collaboration

between the two teams and will take advantage of the phylogenetic approach being developed on the same urchin clade.

### **Work at sea**

Sea urchins were expected to occur mostly in the Agassiz trawl samples. The first objective was to observe living ectosymbionts kept in aquaria. More particularly, to examine the behavior of vagile ectosymbionts in order to determine specific attraction for a particular host (using Y tube experiments). Unfortunately, no living animals were found in the Agassiz trawl, and consequently no attraction experiments could be carried out. Pictures of the ectosymbionts and of their hosts were taken. After these observations, the animals and their symbionts were preserved in ethanol. When enough individuals had been collected, ten of them were dissected to analyse later the isotopic ratios in the digestive gut and in the gonads. All the tissue samples have been placed in the cold storing room. Dissection was performed for five *Ctenocidaris speciosa* (station PS-67 151-1), for ten *Aporocidaris milleri* (station PS-67 142-6) and for ten irregular sea urchins, *Anterechinus sp* (station PS-67 142-6).

In addition, "classical" samplings and preservations of echinoids and of their load of ectosymbionts have been realized in order to update the biodiversity data (taxonomic and biogeographic) on Antarctic echinoids (so far 81 species of echinoids have been recorded and revisited). Not all species could be identified because some identifications need a cleaning of the test, and in the case where only one specimen was present, the risk of losing the sample was too high.

### **Preliminary results**

The large majority of the echinoids collected with the Agassiz trawl were regular sea urchins (71.4%). Among the regular sea urchins, four cidaroids were collected at station PS67/078-11, 50 at station PS67/142-6, 40 at station PS67/151-1 and two in station PS67/154-7. The cidaroids represented the majority of regular sea urchins in the deep sea, for this sampling (61.6%). Half of the species found were cidaroids.



**Table 9.33:** Summary of the Agassiz trawl samples during ANDEEP III

Station	Location	Depth (m)	Regular sea urchins		Irregular sea urchins	
			N Species	N Specimens	N Species	N Specimens
PS67/016-11	41°07'S - 9°55'E	4699	1	1	0	0
PS67/057-2	69°24'S - 5°19'W	1819	1	11	1	1
PS67/059-10	67°30'S - 0°03'E	4648	1	1	0	0
PS67/074-7	71°18'S - 13°58'W	1055	1	5	1	1
PS67/078-11	71°9'S - 13°59'W	2157	2	9	0	0
PS67/080-6	70°40'S - 14°43'W	3006	1	5	0	0
PS67/081-9	70°32'S - 14°34'W	4390	0	0	1	1
PS67/121-7	63°34'S - 50°41'W	2616	1	10	1	1
PS67/142-6	62°9'S - 49°30'W	3403	1	50	3	57
PS67/150-7	61°48'S - 47°27'W	2007	1	23	0	0
PS67/151-1	61°45'S - 47°07'W	1255	1	40	0	0
PS67/154-7	62°32'S - 64°38'W	3689	1	2	0	0
Total	-	-	12	157	7	62

**Table 9.34:** Echinoid species list for the different Agassiz trawl stations

Station	Species of Regular echinoids	Species of Irregular echinoids
PS67/016-11	<i>Kamptosoma asterias</i>	-
PS67/057-2	<i>Sterechinus Agassiz</i>	?
PS67/059-10	Only fragments	-
PS67/074-7	<i>Pseudechinus sp</i>	?
PS67/078-11	<i>Sterechinus agassiz</i> , <i>Ctenocidaris nutrix</i>	-
PS67/080-6	Only fragments	-
PS67/081-9	-	?
PS67/121-7	<i>Sterechinus sp</i>	?
PS67/142-6	<i>Aporocidaris milleri</i>	<i>Antrechinus sp</i> , <i>Plexechinus sp</i> , <i>Echinosigra amphora</i>
PS67/150-7	<i>Sterechinus sp</i>	-
PS67/151-1	<i>Ctenocidaris speciosa</i>	-
PS67/154-7	<i>Ctenocidaris speciosa</i>	-

## References

- David, B., Chonet, T., Mooi, R. and C. De Ridder (eds) *Antarctic echinoidea*. Synopses of the Antarctic benthos Urban & Fisher Verlag, München (in press).
- Dayton, P.K., Robilliard, G.A. and R.T. Paine (1970): Benthic faunal zonation as a result of anchor ice at McMurdo sound, Antarctica. In : *Antarct. Ecol.*, Holdgate (ed). Academic Press Lond.), 1 : 244-258.
- Dearborn, J.H. and K.W. Allen (1972): Ecological and taxonomic studies of echinoderms, mollusks and fishes from the Antarctic Peninsula. *Antarct. J. U. S.* VII(4): 80-83.
- Deaborn, J.H., Watling, L.E., Edwards, K.C. and D.B. Fratt (1982): Echinoderm biology and general benthic collecting along the Antarctic peninsula. *Antarct. J. U. S.* XVII(5): 162-164.
- Gutt, J. (1991): Are Weddel Sea holothurians typical representative of the Antarctic benthos? *Meeresforsch.* 33: 312-329.
- Märkel, K. and U. Röser (1983): Calcite Resorption in the spine of the Echinoid *Eucidrais tribuloïdes*. *Zoomorph.* 103: 43-58.

## 9.4 Depositional Environments

### 9.4.1 Benthic habitat characterization of physical and biological processes influencing surface sediment structure across the Southern Ocean, Northern Weddell and Bellingshausen Seas, Antarctica: ANDEEP III

Lawrence W. Carpenter and Robert J. Diaz (not on board)

<sup>1</sup>College of William and Mary, Virginia Institute of Marine Science, Gloucester Pt

## Background and objectives

The factors structuring surface sediments, down to 20–30 cm from the sediment-water-interface (SWI), in the deep sea are a combination of physical and biological processes. While physical processes deliver sediment to the sea floor, it is the activities of benthic organisms, or bioturbation, that alter primary physical sedimentary structures and produce secondary structures such as graded beds below the SWI and mounds or pits at the SWI. Surface and near-surface sedimentary structures are then a time-integrated record of recent biological and physical processes, which can be used to evaluate the importance of biology versus physics in structuring the benthic boundary layer Diaz & Carpenter (2003).

In order to characterize the benthic boundary layer, sediment-surface and profile film cameras and video were used. Surface and video cameras have been routinely used in the deep sea to characterise benthic fauna and geological features of the seabed. The use of a sediment profile camera in the deep sea is relatively recent, see Diaz et al. (1995). Rhoads & Cande (1971) initially developed sediment profiling as a means of obtaining in situ data to investigate processes structuring the SWI. The technology of remote ecological monitoring of the sea floor (REMOTS) or sediment profile

imaging (SPI) has encouraged the development of a better understanding of the complexity of sediment dynamics, from both a biological and physical point of view (for shallow water examples see: Rhoads & Germano (1982, 1986), Diaz & Schaffner (1988), Valente et al. (1992), Bonsdorff et al. (1996), Nilsson & Rosenberg (2000), and Rosenberg et al. (2001). This approach to evaluating the SWI and benthic boundary layer can be combined with geochemical and benthic community data to give a holistic view of processes structuring deep-sea surface sediments Diaz & Carpenter (2003).

The primary objective of this project is to document and characterise sediment structures and fabric from the SWI to a depth of 20-30 cm using a combination of surface and sediment -profile cameras (Diaz & Carpenter 2003). Information will be generated on the processes influencing the structure of surficial sediments within a range of stations in the Southern Ocean, Weddell Sea, Powell Basin and the Bellinghausen Sea, that can be linked to biological fauna and geochemical data collected by multicorer and box corer.

Specific questions to be addressed are the same as for ANDEEP I & II:

- (1) what is the relative importance of biological and physical processes in structuring bottom sediments?
- (2) how far into the sediments does bioturbation extend and can mixed layer depth be estimated?
- (3) what faunal components are responsible for major biogenic structures? and
- (4) is small-scale variation (within a station) in sediments, from both biological and physical factors, of the same magnitude as large-scale variation?

In addition to the primary objectives, collaborations have been and will continue to be developed with the other investigators to assist in interpreting patterns on biodiversity and geochemistry. The surface and profile images will provide data on in situ sedimentary and benthic conditions Diaz & Carpenter (2003).

### **Work at sea**

The sediment profile camera comprised of a Benthos deep-sea housing model 3137, a Canon EOS D60 digital camera and a Speedlite 220 EX flash, both of which were controlled by a Canon remote timer TC-80N3. This configuration will image a 15 by 24-cm cross-section of the sediment. A Benthos model 371 utility camera and strobe were attached to the profile camera frame and photographed a 0.7 to 0.8 m<sup>2</sup> area in front of the sediment profile prism. A Sony DCR-TRV10 digital camcorder was placed into a housing and attached to the frame at an oblique angle to image the seabed from 0.4 to 2.0 m away from the edge of the frame (an area of approximately 1 to 2 m<sup>2</sup>). Illumination was provided by 180 white LEDs. At each station the camera system was lowered to the seabed and 12 to 15 replicates collected. 100 kg of lead were attached to the frame to improve prism penetration and frame stability throughout deployment. The profile camera was programmed to take nine pictures during each replicate at 3-second intervals after bottom contact. Data were then written to a SanDisk 1 GB compact flash disc. The surface camera used 400 ASA

Ektachrome. Film was developed onboard RV *Polarstern* and results made available to other investigators.

### Preliminary results

A total of 19 stations was sampled from 25 January to 29 March 2005 (table 9.35). The stations ranged in depth from 1050 m at station PS76-074 to 4870 m at station PS67/094. Station 016 was sampled twice, first on 25 January (016) and again on 26 January (016a) due to equipment failure. Sediment profile images were successfully collected at 16 of the 19 stations sampled, failures were as following; station 016 (minor leak), 016a (over exposed) and 110 (failed memory card). Surface images were successfully collected at 17 of the 19 stations sampled, failures were as follows; 016 - wiring harness and 075 - failed power supply. The video camera successfully collected images at 16 of the 19 stations sampled, failures were as follows; 016 - jammed VT, 016a and 075 - power failure to the isolation timer.

**Table 9.35:** Summary of sediment profile camera, surface camera, and video images collected on ANDEEP III. Notes \* This station was repeated to collect lost data due to equipment failure.

STATION	DEPTH(m)	SPI	SURFACE	VIDEO
016	4732	NO	NO	NO
016a*	4737	NO	YES	NO
021	4560	YES	YES	YES
059	4522	YES	YES	YES
074	1050	YES	NO	NO
078	2105	YES	YES	YES
080	3030	YES	YES	YES
081	4325	YES	YES	YES
088	4870	YES	YES	YES
094	4833	YES	YES	YES
102	4752	YES	YES	YES
110	4645	NO	YES	YES
121	2550	YES	YES	YES
142	3345	YES	YES	YES
150	1955	YES	YES	YES
151	1150	YES	YES	YES
152	1940	YES	YES	YES
153	2030	YES	YES	YES
154	3697	YES	YES	YES

All Ektachrome film were digitized and transferred to CD, and will be available on the Pangaea Data System maintained by the Stiftung Alfred-Wegener-Institut für Polar- und Meeresforschung. Images were labeled with the cruise number, station number, gear code, gear id, image number(s) and depth. For example:

PS67-074-3-SPI-12-2-1050 is the twelfth sediment profile image (SPI) of station PS67-074, which is also the second of three exposures of that replicate and PS67-080-3-SUR-11-3030, is the eleventh surface or plane image (SUR) from station PS67/080.

The video camera recorded the entire time the camera frame was collecting profile and surface images. Upon return to the surface the videotape was removed and reviewed in order to determine the sedimentary characteristics of the bottom and suitability for sampling with the box corer and multicorer. After some initial power-supply issues, the quality of the recorded video was good. Video clips from each station were compiled onto a single mini-DV tape that will be archived at the Alfred-Wegener-Institut für Polar- und Meeresforschung.

The surface camera produced high-resolution images of the bottom over an area of approximately 0.7 to 0.8 m<sup>2</sup> with a resolution of approximately 1 mm. The living positions of many invertebrate species were determined from the surface images. For example, a large ophiuroid was photographed atop a Mn-clast at 2105 m (image PS67-78-9-SUR-08-02). Stations PS67-081 through to 102, exhibited high concentrations of Mn-coated clast on the Weddell Abyssal Plain, see images PS67-81-3-SUR-06-11-4325 and PS67-81-3-SUR-23-34-4325, and a vigorous bottom current was captured by the Video camera at PS67-142. Most surface sediments were dominated by biogenic structures such as mounds, pits and traces with many examples of sedentary and mobile megafauna.

Sediment profile images provided detail on SWI structure and subsurface sediments down to approximately 20 cm. The shallowest prism penetration occurred at station PS67-074 at 1050 m, on the upper continental slope of Kapp Norvegia. Some of the deepest penetrations occurred at stations PS67-152 at 1940 m in the central basin of Bransfield Strait. A detailed description of sediment characterization can be found in Howe (this volume). Completion of image and sedimentological analyses will occur upon return to respective home institutions.

### **Acknowledgements**

This work is supported by a grant from the National Science Foundation.

### **References**

- Bonsdorff, E., Diaz, R.J., Rosenberg, R., Norkko, A. and G.R. Cutter (1996): Characterization of soft-bottom benthic habitats of the Åland Islands, northern Baltic Sea. *Marine Ecology Progress Series* 142: 235–245.
- Diaz, R.J. and L.C. Schaffner (1988): Comparison of sediment landscapes in the Chesapeake Bay as seen by surface and profile imaging. p. 222-240 in: M. P. Lynch and E. C. Krome, eds. *Understanding the estuary; Advances in Chesapeake Bay research*. Chesapeake Research Consortium Publication 129, CBP/TRS 24/88.

- Diaz, R.J., Cutter, G.R. And D.C. Rhoads (1994): The importance of bioturbation to continental slope sediment structure and benthic processes off Cape Hatteras, North Carolina.- *Deep-Sea Research II* 41:719-734.
- Diaz, R.J. and L.W. Carpenter (2003): Depositional environments. *Rep. Polar Marine Res* 470: 120-124.
- Howe, J.A. (2005): Recent sedimentation and geochemistry across the Northern Weddell Sea and adjacent deep-water regions, Antarctica. *Seas, Rep. Polar Marine Res*. (In press).
- Nilsson, H.C. and R. Rosenberg (2000): Succession in marine benthic habitats and fauna in response to oxygen deficiency: analyzed by sediment profile imaging and by grab samples. *Marine Ecology Progress Series* 197: 139-194.
- Rhoads, D.C. and S. Cande (1971): Sediment profile camera for in situ study of organism sediment relations. *Limnology and Oceanography* 16: 110-114.
- Rhoads, D.C. and J.D. Germano (1982): Characterization of organism-sediment relations using sediment profile imaging: an efficient method to remote ecological monitoring on the seafloor (REMOTSsystem). *Marine Ecology Progress Series* 8: 115-128.
- Rhoads, D.C. and J.D. Germano (1986): Interpreting long-term changes in benthic community structure: a new protocol. *Hydrobiologia* 142: 291–308.
- Rosenberg R., Nilsson, H.C. and R.J. Diaz (2001): Response of benthic fauna and changing sediment redox profiles over a hypoxic gradient. *Estuarine Coastal and Shelf Science* 53: 343–350.
- Valente, R.M., Rhoads, D.C., Germano, J.D. and V.J. Cabelli (1992): Mapping of benthic enrichment patterns in Narragansett Bay, Rhode Island.- *Estuaries* 15: 1-17.

#### **9.4.2 Recent sedimentation and geochemistry across the Northern Weddell Sea and adjacent deep-water regions, Antarctica**

John A. Howe

The Scottish Association for Marine Science, Dunstaffnage Marine Laboratory,  
Dunbeg, Oban, Argyll

##### **Introduction and objectives**

Sedimentation within the deep-water basins of the Southern Ocean are fundamentally controlled by basement topography and the oceanographic setting. Topography produces regions of erosion and deposition in response to alongslope bottom current flow and pelagic settling can result from surface oceanographic conditions. Other, perhaps more minor, contributing factors include down-slope resedimentation and iceberg rafting, particularly important closer to the Antarctic margin. Across the region the Antarctic Circumpolar Current (ACC) strongly influences deposition (Pudsey and Howe 1998, Howe and Pudsey 1999, Howe et al. 1997). The current can produce mounded contourite drifts or zones of hemi pelagic drape. Biological productivity is controlled by the position of the Polar Front and by the location of the seasonal sea-ice edges.

Powell Basin, located in northern Weddell Sea, has sediment inputs from both along-slope and down-slope currents. An active field of mud waves is located near the base of the continental slope in water depths of 2800-3100 m. Deposition appears to be maintained by fine-grained sediment supply as a result of the lateral transfer of distal turbidites from the basin floor channels by bottom currents (King et al. 1997; Howe et al. 1998).

During ANDEEP II, two transects were sampled across the north-western Weddell Sea and South Sandwich Forearc, Antarctica. Cores from the base of the Weddell Continental Slope recovered laminated contourites with an uppermost layer of hemipelagites with abundant ice rafted debris, possibly the result of the 1995 Larsen A and 2002 Larsen B ice shelf disintegration. The Weddell Abyssal Plain recovered hemipelagites. The  $^{210}\text{Pb}$  profiles revealed a sedimentation rate of 0.024 cm per year, with the  $^{206}/^{207}\text{Pb}$  isotope ratios suggesting a principle sediment source from ice rafting. The South Sandwich Trench cores recovered both pelagic and turbiditic sediments, interpreted as a region with a high surface biogenic productivity combined with localised downslope mass movements (Howe et al. 2005).

The sedimentary history of the Bellingshausen Sea, in the region of offshore Anvers Island, on the western Antarctic Peninsula, has been described by Rebesco et al. (1997) and Larter et al. (1997). Down slope turbidites are entrained by southwest-flowing Antarctic Bottom Water to produce giant hemi pelagic sediment drifts bisected by channels, which are confined to the lower slope. Eight giant drifts have been identified. The continental rise northwest of Anvers Island contains drifts 1 to 3.

Building upon these previous studies, this project examines the recent sediment history of the deepwater areas of the Southern Ocean from Cape Town, South Africa to the northern Weddell and Bellingshausen Seas, Antarctica. The study aims to examine the depositional environments through the use of sediment texture, structure combined with trace metal (e.g., Ba, U and Mn) and radioisotope ( $^{210}\text{Pb}$ ) geochemistry. The sampling stations focussed on the southern sectors of the South Atlantic (the Agulhas Basin and a minor basin south west of Meteor Rise), the northern and eastern Weddell Sea (including the Powell Basin and the Bransfield Strait) and the Bellingshausen Sea. These regions cover a wide variety of depositional deep-sea environments from mid-latitude sub-tropical to high-latitude slope and abyssal plain settings.

### **Work at sea**

Samples were taken using both the box corer (GKG) and the multicorer. The box corer provided an undisturbed sample enabling later study of sedimentary structures, particle size analysis, x-radiography and magnetic susceptibility. The multicorer provided the sediment slices that will form the basis of further geochemical and radioisotope ( $^{210}\text{Pb}$ ) work. Sediment descriptions were made using the box corer, multicorer and from the video and camera equipment (see Carpenter this volume).

For the methods of the camera system see Carpenter (this volume).

Once the box corer was secured inboard, the visible sediment surface was described. Visual descriptions of the sediment colour, type, texture, structure, level of bioturbation and any appearance of clasts were taken. The box corer was then subsampled using a 10 cm diameter, 60 cm long polyurethane core tube. The core tube was pushed into the sediment, cut, capped and stored in the 4°C cold store onboard RV *Polarstern*. The multicore was extruded and 0.5-2 cm slices taken below the sediment-water interface. The core slice samples were also stored in the 4°C cold store. Smear slides were made from 0.00 cm, 5.00 cm and 10.00 cm below sea floor. These slides were examined using the procedure adopted by the Ocean Drilling Programme (ODP) and based on a pro forma previously used on ANDEEP II.

The criteria used are: acoustic character and geometry (from parasound) sediment sorting, levels of bioturbation, sand/silt/clay content and any bedforms/structures visible (from the camera).

### **Preliminary results: Station Summary and Interpretation**

A summary of each station sediment type and interpretation are presented in table 9.36.

#### **Cape Town – Queen Maud Land transect (Stations 16, 21 and 59)**

PS67/16 4732 m. The Agulhas Basin Abyssal Plain

Parasound profile. The 12.5-km poor quality parasound profile shows a gently dipping, irregular reflective seabed. No internal reflectors were noted.

Sediment description. The sediment is a light yellowish brown mud with a munsell colour of 2.5Y 6/3. The sediment is intensely bioturbated, with some open burrows visible on the surface of box core. Pteropod shells and some calcareous foraminifera are also present. The sediment consists of siliceous biogenic material; diatoms, radiolarians, silicoflagellates and sponge spicules with subordinate calcareous foraminifera. The burrow system Zoophycos is visible in the sliced multicore sections below 20cm depth. Monosulphide is common throughout. The camera shows a bioturbated, pale muddy seabed with abundant fecal traces and little or no bottom-current activity. The sediment is interpreted as a siliceous pelagite (diatomaceous 'ooze'). The environment is very low energy, with sediment supply via surface and intermediate water high biogenic productivity. Pelagites commonly display >30% biogenic material. Pelagic sedimentation rates may be as low as 1-5 mm per 1000 years.

PS67/21 4541 m. The Agulhas Basin, southwest of the Meteor Rise

Parasound profile. An 11-km parasound profile displays a small basin in water depths of 4515-4540 m. Approximately 80 m of acoustic penetration with parallel, well-stratified reflectors are displayed.

Sediment description. The sediment is a light yellowish brown sandy mud, with a Munsell colour of 2.5Y 6/3. Intense bioturbation with common foraminifera, mostly



planktic forms restricted to the top <10 cm. Smear slides show centric diatoms and radiolaria. Abundant lithic clasts 0.5-5 cm angular - sub angular shape are common within the sediment. The composition varied from basalts to high-grade metamorphic and igneous intrusives. The diatoms are dominated by centric forms. Also present are frustules of *Chaetoceras* spp. Some silicoflagellates. The camera showed an intensely bioturbated pale seabed with little or no bottom-current activity. Sediment can be interpreted as a siliceous pelagite (diatomaceous 'ooze' or pelagite). Ice rafting is a possible mechanism for the abundant lithic clasts.

PS67/59 4652 m. Eastern Weddell Abyssal Plain, south of Maud Rise and east of the Sanae Canyon

Parasound profile. A 25-km long parasound profile displays a highly variable seabed and subseabed character. The profile is dominated by a 10-km mound of acoustically irregular to well stratified reflectors with an acoustic penetration of 15 m. A small (<0.5 km) depression is interpreted as a channel. The sampling area contained highly disturbed seabed with chaotic to acoustically transparent reflectors.

Sediment description. The sediment is highly bioturbated olive grey muddy sand with a munsell colour of 5Y 4/2. The fine-medium sands coarsen slightly down-core, and are composed of angular - sub angular quartz with abundant lithic and mineral grains (possible detrital amphibole common). Below 15 cm, in the multicore, are present consolidated 'clasts' of mud (<5 cm). Larger (5-14 cm) consolidated mud clasts were also recovered from the Agazzis trawl. When sectioned and dried these contained abundant Zoophycos trace fossils. Camera shows intensely bioturbated seabed with a weak bottom current and abundant holothurian feeding traces. Sediment can be interpreted as a hemipelagite with sands of a turbiditic origin. This is a depositional environment with a significant downslope sediment input. The Zoophycos trace fossil is described by Bjorlykke (1989) as having a deep, quiet water association, below 200 m on the continental slope and apron. Sediment may derive from Maud Rise to the north or, more likely, from the continental margin to the south. Possibly turbidites are arriving from the Sanae Canyon from the southwest. The highly disturbed seabed visible on the parasound profile is interpreted as a debris flow.

### **Kapp Norvegia transect (Stations 74, 78, 80, and 81)**

PS67/74 1060 m. Eastern Weddell continental slope, Kapp Norvegia

Parasound profile. A short, 2-km parasound profile displays a steep (3°) slope with an acoustically highly reflective seabed. No sediment sample was obtained.

PS67/78 2164 m. Eastern Weddell continental slope, Kapp Norvegia

Parasound profile. A short 2.5-km profile shows a mound of acoustically well stratified reflectors, with an acoustic penetration of over 10 m. The mound is 1.5 km wide and reflectors at its north-eastern flank expand out. The mound is interpreted as a between-channel region of enhanced deposition, possibly a turbidite levee, similar features are noted from parasound to the northeast of the sampling station.

Sediment description. A bioturbated, olive grey sandy mud with a munsell colour of 5Y 4/2. 25 cm below sea floor, a stiff, highly cohesive 10Y 4/1 dark greenish grey sandy mud is present. Angular and sub angular quartz and feldspar dominate the sands with abundant lithic and mineral grains. Centric diatoms and the radiolaria *Eucampia antarctica* are common. Some corroded, planktic carbonate foraminifera are present on the surface. The sediment is interpreted as a hemipelagite. Deposition in a quiet, low energy environment sediment inputs may be from settling in the water column and downslope turbidites from the steep continental margin to the southeast. Channels are visible on the hydrosweep and may indicate some recent downslope activity.

PS67/80 3090 m. Eastern Weddell continental slope, Kapp Norvegia

Parasound profile. A 3.5-km profile extends over the southwestern flank of the Wegener Canyon. The profile begins at the sampling station and displays up to 10 m of acoustic penetration consisting of parallel, well-stratified reflectors. The canyon sides descend in a series of three terraces, displaying a highly reflective to discontinuous, irregular acoustic character. The terraces are up to 30 m and occur in water depths between 3090 and 3150 m.

Sediment description. A bioturbated, foraminiferal-rich, olive grey sandy mud with a munsell colour of 5Y 4/2. Angular to sub angular quartz and feldspar with abundant lithics and minerals comprise the sands. Radiolaria, including *Eucampia antarctica*, and some centric diatoms are common. The camera shows an intensely bioturbated pale seabed with a weak bottom current and abundant feeding and fecal traces. Clasts were common both within the sediment and visible on the sediment surface. A xenophyophore was found on the surface of the box core. Sediment can be interpreted as a hemipelagite. The sampling station lies only 3 km from the southwestern edge of the Wegener Canyon.

PS67/81 4410 m. Eastern Weddell continental slope, Northwest of the mouth of the Wegener Canyon, Kapp Norvegia

Parasound profile. The 11-km profile was obtained to the north of the main sampling station. Here the acoustic character is one of irregular, discontinuous reflectors with an acoustic penetration of about 15 m. Towards the north the seafloor becomes more reflective with a diffusive sub-seafloor acoustic character. The seabed descends in a series of steps to over 4500 m.

Sediment description. The sediment is an olive grey sandy mud with a munsell colour of 5Y 4/2. The sediment is very poorly sorted and contains abundant Mn-coated clasts. The sands consist of angular quartz, lithic and mineral grains. Camera shows seabed with over 70% coverage in Mn-coated clasts and a strong-moderate bottom current. Ophiuroids, crinoids and anemones are all visible on large (>50 cm) Mn-

coated clasts. The sediment can be interpreted as a hemipelagite and a contourite. Sedimentation is the product of a combination of both alongslope resedimentation by bottom currents and settling from the water column. Sediment originally may have derived from the steep continental margin to the southeast and from ice rafting. Manganese derives from oxygen-rich bottom waters and precipitates a crust at a rate of 1 mm per million years (Kennett 1982). The presence of Mn crusts is an indicator of very low sedimentation rates, possibly maintained by the bottom current.

### **Weddell Abyssal Plain transect (Stations 88, 94, 102 and 110)**

PS67/88 4932 m. Weddell Abyssal Plain

Parasound profile. In total, 8 km of parasound data was collected. The profiles display parallel, well-stratified and continuous reflectors with over 25 m of acoustic penetration. A smooth seabed gently dips towards the north.

Sediment description. The sediment is a greyish brown mud with a munsell colour code of 2.5Y 5/2. The sediment is moderately well sorted consisting of angular quartz, lithic and mineral grains. Some minor amounts (10%) of diatoms, notably common centrics and *Eucampia antarctica*, and radiolarian fragments are present. Some organic tubes were observed in smear slides – possibly these are worm tubes. Camera showed a bioturbated seabed with scattered Mn-coated clasts. Some feeding and fecal traces noted. Sediment can be interpreted as a hemipelagite.

PS67/94 4887 m. Weddell Abyssal Plain

Parasound profile. A total of 12 km of parasound data was collected. The profile is oriented NW to this station. The profile displays parallel, well-stratified and continuous reflectors with over 25 m of acoustic penetration, with a smooth seabed.

Sediment description. The sediment is a greyish brown mud with a munsell colour of 2.5Y 5/2. The texture is moderately well sorted with angular quartz, lithic and mineral grains. Some minor amounts (10%) of diatoms are present, notably common centrics and radiolarian fragments. Camera shows bioturbated seabed with some scattered Mn-coated clasts. Some feeding and fecal traces noted. Sediment can be interpreted as a hemipelagite.

PS67/102 4804 m. Weddell Abyssal Plain

Parasound profile. An 8-km profile was obtained steaming NE. The profile displays an asymmetric seabed depression, interpreted as a 50 m deep and 2.5 km wide channel with levee. The acoustic penetration varied from <10 m on the SE side of the channel to over 20 m on the NW levee. This interpretation is suggestive of a downslope flow from the north (i.e., from the Antarctic Peninsula) with enhanced sedimentation due to Coriolis force on the left hand side (NW) of the channel.

Reflectors are discontinuous and chaotic on the SE and floor of the channel becoming parallel, well stratified and continuous within the levee.

Sediment description. The sediment is a greyish brown mud with a munsell colour of 2.5Y 5/2. The texture is a moderately well sorted mud, consisting of angular quartz, lithic and mineral grains. Some minor amounts (10%) of diatoms are present, notably common centrics and radiolarian fragments. The camera shows a bioturbated seabed with some scattered Mn-coated clasts, and some possible sponges. A weak bottom current is visible. The sediment can be interpreted as a hemipelagite. The nearby location of the channel suggests that sediment may also be supplied to the region via downslope turbidity currents. It is not known if this channel is presently active.

PS67/110 4694 m. Weddell Abyssal Plain

Parasound profile. Two long profiles were obtained in this location. A 32-km long profile steaming SW displayed rough, reflective basement topography with isolated basins containing >10 m of parallel, well stratified reflectors. Towards the SE the rougher, reflective basement topography (presumably oceanic basalt from a fracture zone lineament trending NW-SE – possibly extending from the Endurance Ridge) gives way to a smooth, flat-lying seabed with over 30 m of acoustically parallel well-stratified reflectors. A notable acoustically transparent zone occurs approximately 8-10 m below sea floor. These sediments are interpreted as thick sequences of abyssal plain hemipelagites and turbidites with near seafloor exposure of oceanic crust. The final profile, slightly north of former is oriented SE to NW and is 15 km long. The profile displays acoustically parallel well-stratified reflectors with over 30 m of penetration. Towards the NW a minor rise occurs with condensed reflectors over a basement high.

Sediment description. The sediment is a greyish brown mud, with a munsell colour code of 2.5Y 5/2. The sediment is moderately well sorted mud, consisting of angular quartz, lithic and mineral grains. Some minor amounts (10%) of diatoms are present, notably common centrics and some radiolarian fragments. Camera shows bioturbated seabed with some scattered Mn-coated clasts. A weak bottom current is visible. The sediment can be interpreted as a hemipelagite.

### **Powell Basin Transect (Stations 121, 142, 150, 151)**

PS67/121 2609 m. Weddell continental slope, entrance to Powell Basin

Parasound profile. A 23-km profile was obtained from the margin in water depths between 2600 and 2700 m. The profile shows parallel, continuous, well stratified reflectors and a smooth seabed with a gentle slope towards the southeast. Acoustic penetration is >25m, indicating soft, fine-grained sediments.

Sediment description. The sediment is an olive grey mud, with a munsell colour of 5Y 4/2. Minor amounts of sand are present at the core top. The sediment texture is a poorly sorted mud (silt and clay) consisting of angular quartz, lithic and mineral grains, and some minor diatom and radiolarian fragments. Abundant sponge spicules are present in the surface sediment. The camera shows bioturbated seabed with large (20 cm) crater-like burrows and some scattered clasts. The seabed is dusted with phytodetritus. A very weak bottom current is visible on the video. The sediment is interpreted as a hemipelagite.

PS67/142 3408 m Central Powell Basin

Parasound profile. A 6-km profile was obtained from the central Powell Basin, in water depths of 3400 m. The profile shows a smooth seabed with continuous parallel, well stratified reflectors. The acoustic penetration is over 50 m indicating fine-grained, soft sediments. A very bright continuous reflector was noted at 10 m below sea floor. Sediment description. The sediment is an olive grey mud, with a munsell colour of 5Y 4/2. The sediment texture is a moderately well sorted mud with angular quartz, lithic and mineral grains with some minor diatom and sponge spicules. The camera shows bioturbated seabed with large burrows and some scattered clasts. Crag and tail structures around the dropstone clasts and seabed roughening all indicate strong, persistent current activity. A strong bottom current is visible on the video with an estimated current speed of 50-100 cm/sec. The seabed is dusted with phytodetritus. The particles in the water column may indicate an active nepheloid layer. The sediment is interpreted as a contourite, possibly deposited under persistent flow of Weddell Sea Deep Water.

PS67/150 1953 m. Continental slope of the South Orkney Islands, Powell Basin

Parasound profiles (Stations 150 and 151). A single 23-km profile was run upslope, heading NE. The profile initially displayed a bright, reflective seabed with discontinuous, irregular reflectors with >10 m acoustic penetration. The slope towards station 151 consisted of a bright, reflectors with no acoustic penetration. Station 151 displays discontinuous parallel and well stratified reflectors with about 10 m penetration. A distinctive wave-form morphology was noted on the slope sediments, interpreted as being possible bottom current controlled deposition.

Sediment description. The sediment is an olive grey sandy mud with a munsell colour of 5Y 4/2, and consists of poorly sorted sandy mud composed of angular quartz, lithic and mineral grains. Abundant diatoms, radiolarians, silicoflagellates and some foraminiferans are present, especially in the phytodetritus. The sandy muds are very stiff and coherent below about 5 cm. Numerous scattered angular clasts, some larger clasts (>5 cm) are visible on the box core surface. The video camera shows a sandy, coarse-grained sea bed with occasional crater-like burrows and some scattered clasts. No Mn-coating was noted on the clasts. Some clasts are over 1 m in size. The seabed is dusted with abundant phytodetritus. A weak bottom current is visible.

Seabed roughening and small crag and tail structures are common around the clasts. The sediment is interpreted as a contourite. Specifically a sandy silty contourite.

PS67/151 1180 m. Continental slope of the South Orkney Islands, Powell Basin

Sediment description. The sediment is a sandy mud, munsell colour 5Y 4/2 olive, at the surface changing to 5Y 5/1 gray below 10 cm interpreted as a redox layer. The texture is moderately well-sorted. The surface sediment is phytodetritus consisting almost solely of diatom spicules and frustules. The sands consist of angular quartz, lithic and mineral grains. The sandy muds are very stiff and coherent below about 15 cm. Numerous scattered angular clasts, some larger clasts (>5 cm) are present on and throughout the box core sample. The video showed a fine-grained, bioturbated sea bed with some rare scattered clasts. The seabed is covered with abundant phytodetritus. A very weak bottom current is visible. No Mn coating was noted on the clasts possibly indicative of higher sedimentation rates. Sediment can be interpreted as a sandy silty contourite.

### **Bransfield Strait (152)**

PS67/152 1999 m. Central Bransfield Strait

Parasound profile. A 30-km profile was obtained, heading east from Potter Cove, King George Island to the central basin of Bransfield Strait. Reflectors on the slope were bright with little acoustic penetration, interpreted as indicating little or no sediment cover on the steep slope. However below about 1500 m, isolated mounded reflectors occur with about 10 m acoustic penetration, overlying rough basement topography. The base of slope is characterised by a 10-15 m thick mound of chaotic-transparent acoustic character interpreted as a debris flow. East of the mound the acoustic character is one of continuous, parallel and well stratified reflectors with up to 50 m acoustic penetration. This is interpreted a thick, fine-grained sediment fill of the basin floor.

Sediment description. The sediment is a dark greenish grey mud, with a munsell colour on the Gley 1 chart, 10Y 4/1. Monosulphide spots are common throughout the cores. The sediment is poorly sorted, and consists of abundant diatoms and radiolarians. The terrigenous fraction consists of angular quartz, lithic and mineral grains. Clasts are rare. The camera shows a very fine-grained seabed covered with abundant tree-like structures, possibly produced by polychaete worms. No bottom current is visible. The sediment is interpreted as a hemipelagite.

**Bellingshausen Sea, Northwest of Anvers Island (153 & 154)**

PS67/153 2079 m. Northwest of Anvers Island

Parasound profile. A 5-km profile displays a highly reflective seabed on a smooth slope, with little acoustic penetration. This may reflect the sandy slope sediments.

Sediment description. An olive grey sandy mud with a munsell colour of 5Y 4/2. The sediment is poorly sorted with abundant siliceous biogenics, especially diatoms and radiolarians. The terrigenous fraction consists of angular quartz, lithic and mineral grains. Pebble and granule-sized clasts scattered throughout. A slight colour change (darkening to gray) occurs below 10 cm. Large (<2 cm) mineralised burrow found below 21 cm. The multicore displays cohesive (fine-grained) and loose layers (sandier) implying changing sediment inputs or winnowing. Camera shows a medium-grained sea bed covered with crinoids. A weak bottom current is visible. The sediment can be interpreted as a hemipelagite with possible turbidite influences.

PS67/154 3803 m. Northwest of Anvers Island

Parasound profile. An 8.5-km profile displays parallel, well-stratified and continuous reflectors with <15 m acoustic penetration within a mounded seabed morphology. Towards the ESE the seabed descends to 3900 m with a highly reflective, smooth seabed with little acoustic penetration, possibly reflecting coarser-grained slope sediments. At the base of the slope, parallel, well stratified and continuous reflectors are present once again, pinching-out against the base of the continental slope.

Sediment description. A poorly sorted olive grey sandy mud with a munsell colour of 5Y 4/2. The sediment contains abundant siliceous biogenics, diatoms and radiolarians. Some calcareous foraminifera also present in the surface sediment only. The terrigenous fraction consists of angular quartz, lithic and mineral grains. Below 20 cm is an approximately 10 cm thick layer of highly consolidated, stiff and cohesive sandy mud with monosulphidic spots and large (>5 cm) clasts. Below 30 cm occurs a softer, less stiff sandy mud, and the sediment colour changes to munsell Gley 1, 5G 5/1, greenish grey. The camera shows a bioturbated, medium-grained, firm seabed. No bottom current is visible. The sediment is interpreted as presently hemipelagic.

**Acknowledgements**

This work is supported by a grant from the Trans-Antarctic Association.

**References**

- Bjorlykke, K. (1989): *Sedimentary Geology and Petroleum Geology*. Springer-Verlag.
- Howe, J.A., Pudsey, C.J. and A.P. Cunningham (1997): Pliocene-Holocene contourite deposition under the Antarctic Circumpolar Current, western Falkland Trough, south Atlantic Ocean. *Marine Geology* 138: 27-50.

- Howe, J.A., Livermore, R.A. and A. Maldonado (1998): Mudwave activity and current-controlled sedimentation in Powell Basin, northern Weddell Sea, Antarctica. *Marine Geology* 149 (1-4): 229-241.
- Howe, J.A. and C.J. Pudsey (1999): Antarctic Circumpolar Deepwater: a Quaternary palaeoflow record from the northern Scotia Sea, south Atlantic Ocean. *Journal of Sedimentary Research* 64 (4): 847-862.
- Howe, J.A., Shimmield, T.M. and R. Diaz (2005): Deep-water sedimentary environments of the northwestern Weddell Sea and South Sandwich Islands, Antarctica. *Deep-Sea Research II*.
- Kennett, J.P. (1982): *Marine Geology*. Prentice-Hall.
- King, E.C., Leitchenkov, G., Galindo-Zaldivar, J., Maldonado, A. and E. Lodolo (1997): Crustal structure and sedimentation in Powell Basin. In: Barker, P.F. and Cooper, A.K. (Eds) *Geology and seismic stratigraphy of the Antarctic margin, Part 2. Antarctic Research Series Vol. 71: 75-93.*
- Larter, R.D., Rebesco, M., Vanneste, L.E., Gamboa, L.A.P. and P.F. Barker (1997): Cenozoic tectonic, sedimentary and glacial history of the continental shelf west of Graham Land, Antarctic Peninsula. In: Barker, P.F. and Cooper, A.K. (Eds) *Geology and seismic stratigraphy of the Antarctic margin, Part 2. Antarctic Research Series, Vol. 71: 1-27.*
- Pudsey, C. J. and J.A. Howe (1998): Quaternary history of the Antarctic Circumpolar Current: evidence from the Scotia Sea. *Marine Geology* 148 (1-4): 83-112.
- Rebesco, M., Larter, R.D., Barker, P.F., Camerlenghi, A. and L.E.Vanneste (1997): The history of sedimentation on the continental rise west of the Antarctic Peninsula. In: Barker, P.F. and Cooper, A.K. (Eds) *Geology and seismic stratigraphy of the Antarctic margin, Part 2. Antarctic Research Series Vol. 71: 29-49.*



**Table 9.36:** Summary Sediment Data

<b>Station Number</b>	<b>Position (Box core)</b>	<b>Water Depth</b>	<b>General Area</b>	<b>Sediment Type</b>	<b>Interpretation</b>	<b>Comments</b>
PS67/16	41° 8.00'S 09° 56.66'E	4732m	Agulhas Basin	Light Yellowish Brown clay	Siliceous Pelagite	Diatomaceous
PS67/21	47° 39.37'S 04° 15.65'E	4566m	Agulhas Basin, SW of Meteor Rise	Light Yellowish Brown sandy mud	Siliceous Pelagite	Diatomaceous
PS67/59	67° 31.01'S 00° 00.00'W	4650m	Eastern Weddell Abyssal Plain, S. of Maud Rise and E. of Sanae Canyon	Olive Grey muddy sand	Hemipelagite with turbiditic sands	Stiff coherent, sand and abundant consolidated mud clasts with <i>zoophycos</i> traces.
PS67/78	71° 9.49'S 13° 59.92'W	2164m	Eastern Weddell Slope, Kapp Norvegia	Olive Grey sandy mud	Hemipelagite	Dark Greenish Grey stiff sandy mud below 25cm
PS67/80	70° 39.40'S 14° 43.47'W	3086m	Eastern Weddell Slope, Kapp Norvegia, SW of Wegner Canyon	Olive Grey sandy mud	Hemipelagite	Carbonate, Foraminiferal-rich sands at surface.
PS67/81	70° 31.55'S 14° 34.83'W	4410m	Eastern Weddell Continental Slope, NW of the mouth of the Wegener Canyon, Kapp Norvegia	Olive Grey sandy mud with abundant Mn-coated clasts	Contourite	Mn-crusted, active bottom-current.
PS67/88	68° 3.68'S 20° 27.75'W	4933m	Weddell Abyssal Plain	Grayish Brown mud	Hemipelagite	Mn-coated clasts
PS67/94	66° 37.42'S 27° 9.97'W	4887m	Weddell Abyssal Plain	Grayish Brown mud	Hemipelagite	Mn-coated clasts
PS67/102	65° 34.37'S 36° 30.93'W	4803m	Weddell Abyssal Plain	Grayish Brown mud	Hemipelagite	Mn-coated clasts. Channel imaged on Parasound.
PS67/110	64° 59.95'S 43° 1.97'W	4700m	Weddell Abyssal Plain – Revisit of Andeep II 135 Station	Grayish Brown mud	Hemipelagite	Mn-coated clasts

<b>Station Number</b>	<b>Position (Box core)</b>	<b>Water Depth</b>	<b>General Area</b>	<b>Sediment Type</b>	<b>Interpretation</b>	<b>Comments</b>
PS67/121	63° 41.74'S 50° 42.99'W	2621m	Weddell Continental Slope, Entrance to Powell Basin	Olive Gray mud	Hemipelagite	Cratered burrows and phytodetritus present.
PS67/142	62° 11.61'S 49° 29.45'W	3406m	Central Powell Basin	Olive Gray mud	Contourite	Vigorous bottom-current activity >50cm/sec
PS67/150	61° 48.63'S 47° 27.67'W	1956m	SW Continental Slope of the South Orkney Islands, Powell Basin	Olive Gray sandy mud	Contourite	Abundant large clasts. Stiff sandy muds rich in biogenic material.
PS67/151	61° 45.50'S 47° 7.57'W	1181m	SW Continental Slope of the South Orkney Islands, Powell Basin	Olive sandy mud & Gray sandy mud	Contourite	Well-defined Redox layer in the box core at 10cms
PS67/152	62° 19.98'S 57° 54.02'W	1995m	Central Bransfield Strait	Dark Greenish Gray mud	Hemipelagite	Tree-like features on the seafloor. Very soft sediment.
PS67/153	63° 19.35'S 64° 36.79'W	2079m	NW Anvers Island, Bellingshausen Sea	Olive Gray sandy mud	Hemipelagite with turbidites	Crinoids on the seafloor.
PS67/154	62° 31.53'S 64° 39.72'W	3803m	NW Anvers Island, Bellingshausen Sea	Olive Gray sandy mud & Greenish Gray mud	Hemipelagite	Very stiff sandy muds between 20-30cms with monosulphide.

### 9.4.3 Lone-stones

Michael R. A. Thomson

Centre for Polar Sciences, School of Earth Sciences, University of Leeds

#### Introduction

Whilst the collection of rocks in biological sampling equipment (Agassiz trawls in particular) may perhaps sometimes be seriously detrimental to the biological catch, in Antarctic waters it is inevitable. Sea-bed imagery shows that, even in the deepest and most remote parts of the Southern Ocean and Weddell Sea, scattered pebbles and cobbles are present almost everywhere. Given that nearly all occur far away from any possible submarine rock outcrops and lie on thick layers of soft oceanic sediment, any mechanism for the occurrence of such 'lone-stones' has to involve long-distance transport. In a few cases, it may be that they were brought in by debris flows channelled along so-called submarine canyons, but, away from such channels on the abyssal plain, the only possibility is that they were dropped from floating ice and may be referred to specifically as 'drop-stones'. Deep scratches on some clasts, now overgrown with manganese, are a testament to glacial transport. Mechanisms for the incorporation of rock debris into marine sediments by ice-sheets and glaciers are summarised in Thomson (2003).

#### Objectives

Stones in Agassiz trawls were examined and identified by eye to broad lithological categories, with a view to gaining some insight into the ice-covered geology of the hinterland and also the origin of fine clastic material within the sediments. Although it is difficult to distinguish in a hand specimen between, say, mudstones of widely differing ages from different provinces, certain rocks are diagnostic or at least known primarily from only one province. However, it must be borne in mind that the only knowledge of rock types and their distribution on land comes from what can be seen in outcrop, which is considerably less than 1% of the surface of Antarctica. The extent to which the rocks we see in the mountains may extend under the ice is a matter for speculation, and there may even be hidden rock units we do not see at the surface.

#### The lone-stones of ANDEEP III

Weddell Sea and Powell Basin

Ice flowing into the Weddell Sea crosses three major geological provinces:

Province 1- Basement area of Dronning Maud and Coats Lands - mainly Precambrian gneisses (typically 1000 Ma old or older) with local areas of Precambrian and Palaeozoic sedimentary rock (>245 Ma), and areas of Permian sediments intruded by dolerite sheets (e.g. Theron Mountains).

Province 2 – Palaeozoic sedimentary rocks of Pensacola and Ellsworth mountains – Cambrian to Permian (550-245 Ma); in Pensacola Mountains there is also a large intrusion of layered gabbro (Dufek Intrusion).

Province 3 - Volcanic arc of Antarctic Peninsula - volcanic and associated plutonic rocks (mainly 240 to 20 Ma) plus terrestrial and marine sedimentary rocks from flanking basins. There are also very young basaltic rocks (10 Ma) along the

north-eastern coast, and a small area of 1000 Ma gneisses at Haag Nunataks, southernmost Antarctic Peninsula.

Each of these is a potential source for the drop-stones collected in the Weddell Sea region.

Bergs containing rock material derived from the Weddell Sea hinterland will drift around under the influence of the clockwise current known as the Weddell gyre. Thus hauls from close to the Dronning Maud Land coast are likely to be sourced only from East Antarctica. By contrast, drop-stones dredged from north-western Weddell Sea could come from anywhere between western Dronning Maud Land and the Antarctic Peninsula. In particular, many bergs leaving the Weddell Sea move into Powell Basin and commonly accumulate around the South Orkney shelf. Hence a high concentration of varied stones could be expected there. Agassiz trawls made in transit from Cape Town southward to Antarctica, from SW of Meteor Rise (47° 40'S) all probably lie within the influence of the eastern Weddell gyre and are in areas where icebergs transit.

Without a detailed petrological analysis and comparison with the known geology, it is nevertheless not unreasonable to suggest that all rocks obtained on the northern approach to Kapp Norvegia and from the transit across the Weddell Sea can be matched with rock units already known on land. Two rock types stood out in almost every haul: banded white quartz-feldspar and black biotite-amphibolite gneiss, and dark pink indurated sandstones. Several gneisses were garnet bearing and there were rare occurrences of true garnet gneiss, and a distinctive gneiss with blue quartz. Doleritic rocks were commonly present and probably came from the early Jurassic Ferrar Group, related to Gondwana break up. Poorly consolidated, almost white fine grained sediments rich in trace fossils, collected near Maud Rise (PS67/ 059) appear to be of very recent age. Similar rocks were collected from eastern Powell Basin (PS67/1 51) and perhaps both are from young formations *in situ*.

Most of the stones obtained from Powell Basin could be matched with Antarctic Peninsula types, notably deformed mudstone and greywacke from the Trinity Peninsula Group, felsic to andesitic volcanic rocks (Antarctic Peninsula Volcanic Group), sandstones of which one had an Upper Cretaceous ammonite, and basaltic volcanic rocks, some with palagonitic alteration (James Ross Island Volcanic Group). A notable exception was the common occurrence of the white quartz-feldspar gneiss with mafic bands of biotite and amphibole, found in most hauls across the Weddell Sea.

#### Bransfield Strait

Opportunity was taken to sample a site on the floor of the Bransfield Basin en route to *Jubany/Dallmann Station*. Interest in the location lies in the fact that, in addition to Deception Island (an active volcano) and the volcanic remnant of Bridgeman Island, the axis of the basin is occupied by a chain of submarine volcanic edifices, identified on swath bathymetry maps by Graciela et al. (1997). This raised the possibility of the presence of deep-water faunas modified by volcanic activity.

The sea bed at the chosen site was extremely soft with Parasound penetration to 50 m. Sea-bed imagery showed very few lone-stones and only a handful was retrieved by the Agassiz trawl.

### Bellingshausen Sea

Two sites NNE of Anvers Island sampled on the continental slope and the abyssal plain, just south of the Hero Fracture Zone produced rock hauls with many lithological types that might be readily matched with those from the Antarctic Peninsula, notably felsites and andesites from the Antarctic Peninsula Volcanic Group and Tertiary volcanic provinces, the granodiorite-diorite complexes of Mesozoic–mid Cenozoic age, and basaltic volcanic rocks of the late Cenozoic. Distinctive green-coloured schists and phyllites and quartzite sandstones, however, are not so easy to match.

### Manganese coating

With few exceptions, stones were coated with a dark mahogany or even black coating, presumed to be a mixture of manganese and iron oxides, with typically less than one quarter of the stone (that part buried in the sediment) showing a clean rock face. A few pebble-sized stones had a manganiferous coating on all surfaces, suggesting that they had been rolled at some stage. Evidence from manganese nodules suggests growth rates of approximately 3 mm per million years (Broeker & Peng 1982) or 1 to 4 mm per million years (Kennett 1982, p.499). Whilst most of the coatings seen on the drop-stones from the Weddell Sea can only be fractions of a millimetre thick, they nevertheless are likely to have taken hundreds or even thousands of years to build up. Stones from Station PS67/080 (south side of Wegener Canyon) constitute an exception in that several had coatings approaching 1 mm thick. They were further distinguished by the presence of small angular ‘satellite’ stones adhering to one or more faces by limonitic cement. Using even the most conservative of the above growth rates for manganese could suggest that such stones may have been exposed on the sea bed for a hundred thousand years or more.

### Comments

Many stones serve as substrates for a variety of animals, such as foraminifers, corals and anemones, sponges, bryozoans, inarticulate brachiopods, and stalked barnacles and crinoids. Given that the sea-bed consists typically of extremely soft mud, it is a moot point whether such animals could inhabit the deep waters of the Weddell Sea at all, without the presence of drop-stones. Hence, it may be argued that drop-stone accumulations play a significant role in enhancing the diversity of benthic animals in the circum-Antarctic deep sea.

Several hauls were a complete surprise in that they appeared not to reflect the sea-bed as seen by the imaging systems. Thus the largest hauls of rocks were those from Stations PS67/110 and 154, locations where almost no drop stones were visible, and perhaps either the stones lay just under the surface of the sediment or, more likely, the trawl went over a localised dump. As might well be expected, the sea-bed at the mouth of Wegener Canyon has the greatest concentration of stones seen anywhere

---

(> 50% stones to mud) yet the trawl brought back a mere handful of small pebbles, suggesting that it had failed to function properly.

## References

- Broeker, W.S. and T.-H. Peng (1982): *Tracers in the sea*.- Palisades, New York: Lamont Doherty Geological Observatory, Columbia University. 690 pp.
- Graciela, E., Canals, M., Farràn, M.L., Sorribas, J, and R. Pallàs (1997): Central and eastern Bransfield basins (Antarctica) from high-resolution swath bathymetry data. - *Antarctic Science*. 9: 168-180.
- Kennett, J.P. (1982): *Marine Geology*.- Englewood Cliffs, N.J., Prentice Hall. 813 pp.
- Thomson, M.R.A. (2003): 3.4.3 Drop-stones. In: Fütterer, Brandt, A. and Poore, G.C.B. (Eds) The Expeditions ANTARKTIS-XIX/3-4 of the research vessel *Polarstern* in 2002.- *Ber. Polar- Meeresforsch.* 470: 128-130.

## 10. BATHYMETRY

Nathalia Kourentsova<sup>1</sup>, Steffen Gauger<sup>2</sup>

<sup>1</sup>GEOKHI, Moscow

<sup>2</sup>Fielax

### Objectives

The main task of the bathymetric programme was to conduct multibeam (MB) surveys in order to enlarge and, specifically, to densify the data base for mapping the Southern Ocean. The data will in particular be used for the compilation of the new International Bathymetric Chart of the Southern Ocean (IBCSO). The obtained data are further used for geomorphological studies. An important aim was also to evaluate the newly implemented Hydrosweep operation modes HDBE (High Definition Bearing Estimation) and ASLC (Automatic Source Level Control) by comparing the results from this expedition to existing multibeam data from previous surveys.

### Work at sea

During the expedition ANT-XXII/3, 72 days of Hydrosweep DS2 (15.5 kHz) measurements were obtained. The multibeam sonar system was operated in the HDBE softbeam mode, in which the seafloor is represented by 240 single values for water depths, forming a depth profile orthogonal to the ship's long axis. During all surveys a receiving beam coverage of 100° was used. Under optimal operation conditions a horizontal coverage of 2.4 times the water depth can be obtained. For the slant range correction of the sonar beams, the CTD measurements (performed in context of the oceanographic programme) were utilized. In general, the automatic self calibration process is activated when no actual Sound Velocity Profile (SVP) is available for the correction. Throughout the entire expedition the observed depths ranged between 200 m in the shelf regions at the coastal regions of Antarctica and 5600 m in the deep sea.

Continuous MB data recording was performed on the transect along the Greenwich meridian, across the Weddell Sea, and along the Antarctic Peninsula (fig. 1.1 *Polarstern* trackplot of the cruise). Except of three large scale surveys were carried out: One in the area of the Weddell Abyssal Plain and two on the continental slope off Kapp Norvegia and Fimbulisen. However, MB data was recorded along all tracklines of RV *Polarstern* and preprocessed on board.

In general, the Hydrosweep DS-2 system worked reliable and the recorded bathymetric data are of a high quality. Disturbances occurred during ice-breaking and in stormy weather conditions which decreased slightly the data quality and quantity. Erroneous depth values were edited using the Caris HIPS software.

For preparation of bathymetric maps and other visualisations of the seafloor topography, the Generic Mapping Tool (GMT) software was utilized. GMT was also used to determine digital terrain models (DTM) from edited MB-data. DTMs are the base for the derivation of contour line maps, 3D visualizations and the creation of shaded colour coded maps, used for morphological interpretation of the seafloor topography.

The sub-bottom profiling (SBP) system Atlas Parasound DS-2 was used to survey and investigate the sediment structure below the seafloor. In order to achieve a sediment penetration from 5 to 100 m, a parametric signal with a frequency of 4 kHz ( $\pm 150$  Hz) is used. The 4 kHz parametric signal with a beam width of approx.  $4.5^\circ$  is the result of the superimposition of the primary frequencies 18 kHz and 22 kHz by which a penetration of up to 300 m can be achieved under optimal conditions. Large scale high resolution sub-bottom surveys (5 km to 25 km profile length) were performed in the surrounding of each biological sampling site. Figure 10.1 shows an example of a Parasound sediment profile.

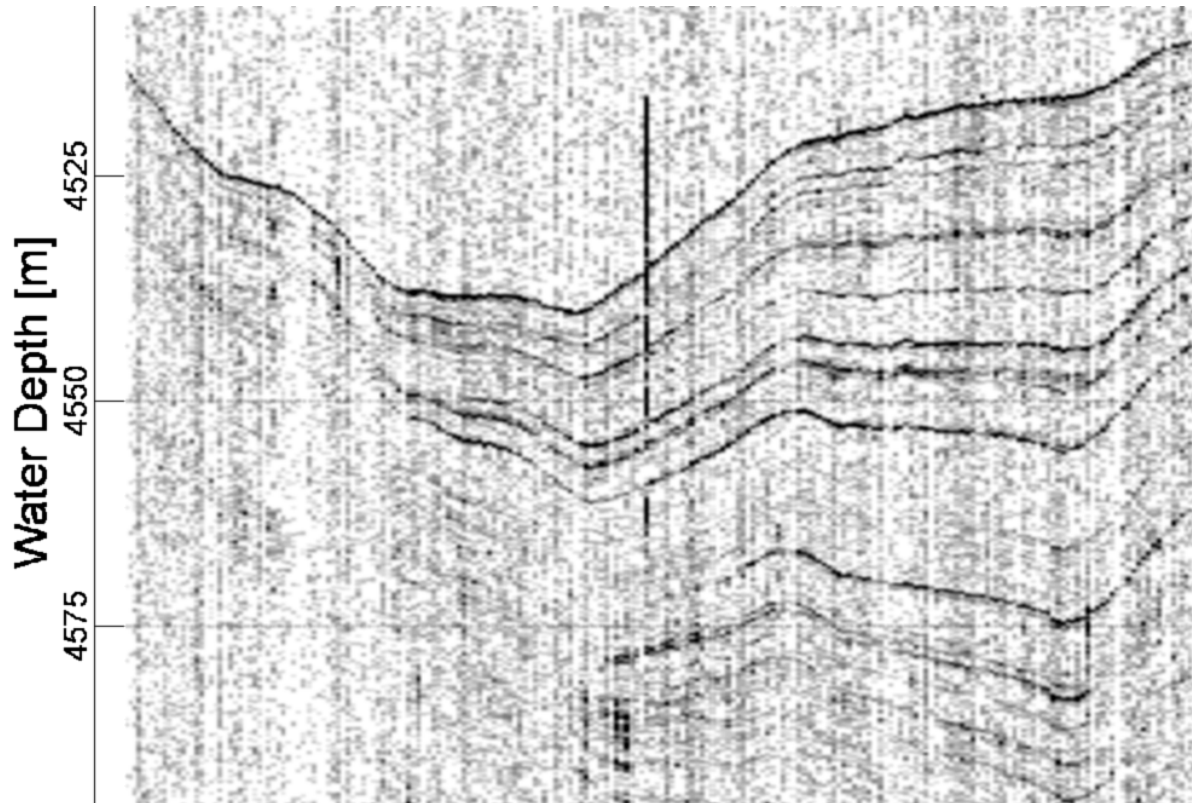

Fig.10.1: Sediment profile at station PS67/21

## Preliminary Results

### Weddell Abyssal Plain – North eastern part

On the transit along the Greenwich meridian two hitherto unknown seamounts with a relative height of more than 1000m were discovered by MB north-east of the slope to the Weddell Abyssal Plain. In the transition area to the Weddell Abyssal Plain a hilly morphology prevailed. Five minor submarine features were surveyed and mapped. Their heights above the surrounding seafloor vary between 150 and 600 m.

### Bungenstock Plateau – North eastern part

The Bungenstock Plateau is located between 69°30'S, 9°00'W and 68°24'S, 4°0'W (cf. [www.ngdc.noaa.gov/mgg/underseafeatures.html](http://www.ngdc.noaa.gov/mgg/underseafeatures.html)) north of the Jelbertisen, Antarctica. East of the Bungenstock Plateau, RV *Polarstern* crossed the Sanae Canyon. The canyon, trending in almost meridional direction, has a steep slope on its western flank and showed a maximum depth of 4400 m

At the central part of the Bungenstock Plateau (69°27'S, 05°21'W) the observed minimum depth was 1750 m which is in good agreement to the AWI BCWS 1:1.000.000. The south-western region of the plateau is also characterized by steep slopes which are carved by distinct deep-sea channels.



### **Antarctic Continental Slope – off Kapp Norvegia**

A short systematic MB survey with four nearly parallel lines was conducted at the medium and upper part of the continental shelf between Kapp Norvegia and Wegener Canyon (fig. 10.2). The water depth varies between 600 and 2300 m. The morphology of this region is characterized by a relatively smooth upper continental shelf between 600 and 1600 m depth, and a topographically well pronounced northern area (1600 to 2300 m depth), which is part of the Wegener Canyon gully system. The morphology of this area is formed by glaciation/de-glaciation processes in conjunction with sediment transports down the continental shelf. The collected MB data is an enlargement of the high resolution bathymetric chart of the Wegener Canyon system.

### **Weddell Abyssal Plain**

The transect across the Weddell Sea was placed parallel to an earlier track of RV *Polarstern* (fig. 1.1). MB data were collected along the profile in order to improve the knowledge about this widely uncharted region of the Southern Ocean and to extend the existing data base. The topography of the central Weddell Sea is relatively smooth and only marked by minor submarine features, s.a. hills and knolls, ranging between several decametres and hundred metres. The maximum depth was encountered with 5076 m at the position of 67°34'S and 22°20'W. The characteristics of the seafloor changed when approaching the foot of the western slope of the Weddell Sea basin south of the Powell Basin at 63°32'S and 51°32'W, where the seafloor gently rises up to 1500 m exhibiting a rather hilly relief.

### **Powell Basin**

Two profiles in nearly E-W direction were placed crossing the Powell Basin. Several submarine hills with relative heights of only few hundred meters were discovered with the MB-system. The greatest depth encountered during this survey in the Powell Basin was 3380 m. A small hill showing a relative height of 350 m and an oval shape trending in meridional direction was discovered in the eastern part of the Powell Basin at location 61°50'S, 48°00'W (see fig. 10.3). This feature is also shown on the Centenary Edition of the GEBCO Digital Atlas 2003 at the same location, but the relative height is 250 m less than the height measured during this expedition.

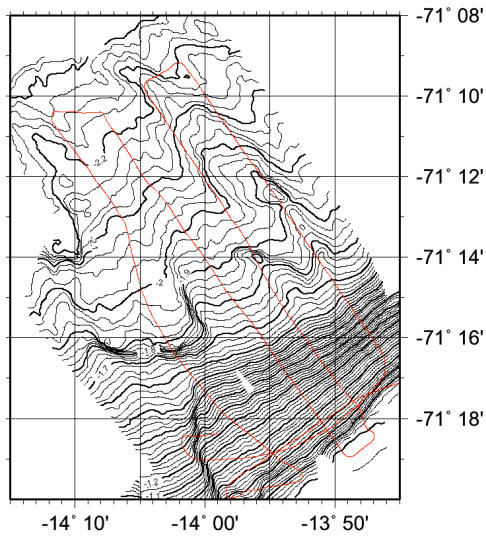

*Fig. 10.2: Bathymetric survey in front of Kapp Norvegia (contour line interval 25 m)*

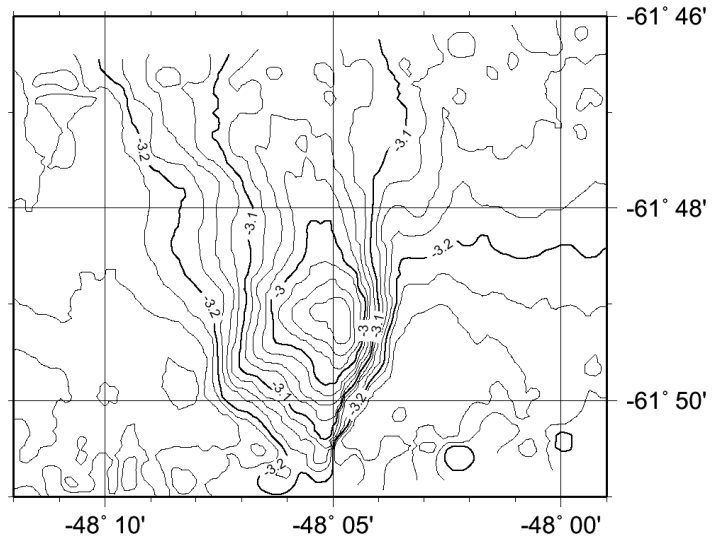

*Fig. 10.3: Unnamed Seamount in Powell Basin (Contour line interval 25 m), who is included in the GEBCO 2003 CE, but 250 m to small*

## 11. ACKNOWLEDGEMENTS

We collected extensive data sets and outstanding samples during the cruise. We achieved all our logistic tasks which to some extent came upon us rather unexpectedly. Part of our success is due to calm weather and optimal ice conditions, but we are aware that, well beyond the excellent technical equipment of RV *Polarstern*, it is the crew who, with their outstanding professionalism, astounding involvement, willingness to help, and warmheartedness made our lives and our work on board so easy and enjoyable. For that we would like to express our heartfelt and sincere thanks to Master Schwarze and his entire crew for another example of the traditionally good cooperation on board. We want to thank as well to all those, even if we are not able to call them all by name, who contributed to the success of the cruise by their support on shore during planning, preparation and while we have been at sea.

## **APPENDIX**

### **A.1 PARTICIPATING INSTITUTIONS**

### **A.2 CRUISE PARTICIPANTS**

### **A.3 SHIP'S CREW**

### **A.4 STATION LIST**

---

## A.1 PARTICIPATING INSTITUTIONS

AWI	Alfred-Wegener-Institut für Polar- und Meeresforschung in der Helmholtz-Gemeinschaft Postfach 120161 27515 Bremerhaven Germany
BAS	British Antarctic Survey High Cross, Madingley Road Cambridge, CB3 0ET UK
DFZ	Department Fisiologia y Zoologia Fac. Biología Avda. Reina Mercedes, 6 41012 Sevilla Spain
DLR	DLR Oberpfaffenhofen Münchener Str. 20 82234 Weßling Germany
DME	Department of Marine Ecology Institute of Biological Sciences University of Aarhus Finlandsgade 14 8200 Aarhus Denmark
DWD	Deutscher Wetterdienst Geschäftsfeld Seeschifffahrt Bernhard-Nocht-Str. 76 20359 Hamburg Germany
ENSR	Marine & Coastal Center 89 Water street Woods Hole, MA 02543 USA
FIELAX	FIELAX Gesellschaft für wissenschaftliche Datenverarbeitung mbH Schifferstraße 10-14 27568 Bremerhaven Germany

---

FIS	Forschungsinstitut Senckenberg Abt. DZMB Südstrand 44 26382 Wilhelmshaven Germany
FSN	Forschungsinstitut Senckenberg und Naturmuseum Sektion Marine Evertibraten I Senckenberganlage 25 60325 Frankfurt am Main Germany
GEOKHI	Vernadsky Institute of Geochemistry and Analytical Chemistry Russian Academy of Sciences 19, Kosygin Street Moscow 119991 Russia
GFI	Geophysical Institute University of Bergen Allegaten 55 5007 Bergen Norway
HeliTransair	HeliTransair GmbH Am Flugplatz 63329 Egelsbach Germany
IFM-GEOMAR	Leibniz-Institut für Meereswissenschaften Düsternbrooker Weg 20 24105 Kiel Germany
IMB	Institute of Marine Biology FEB of RAS Palcheoskogo St. 17 Vladivostok – 41 690041 Russia
IRSN	Royal Belgian Institute of Natural Sciences Rue Vautier, 29 1000 Bruxelles Belgium
IUP	Institut für Umweltphysik Universität Bemen Otto-Hahn-Allee, NW1 D-28334 Bremen, Germany

NIOZ	Koninklijk Nederlands Instituut voor Onderzoek der Zee Department for Marine Chemistry and Geology P.O. Box 59 1790 AB Den Burg The Netherlands
OPTIMARE	Optimare Sensorsysteme AG Am Luneort 15a 27572 Bremerhaven Germany
RUB	Lehrstuhl für spezielle Zoologie Ruhr-Universität Bochum Geb. ND 05/780, Universitätsstr. 150 44780 Bochum Germany
SAMS	Scottish Association for Marine Science Dunstaffnage Marine Lab. Dunbeg, Oban Argyll, PA37 IQA UK
SANAP	Department of Environmental Affairs and Tourism Directorate: Antarctica and Islands 44 Hertzog Boulevard Southern Life Building, 4 <sup>th</sup> floor Foreshore, 8001 South Africa
SIHN	Departamento Oceanografía Servicio de Hidrografía Naval. Argentina
SES	School of Earth Sciences University of Leeds Leeds, LS2 9JT UK
SOC	Southampton Oceanography Centre European Way Southampton, SO14 3ZH UK
UG	Marine Biology University of Gent Krijgslaan 281/S8 9000 Gent Belgium

ULB	Université Libre de Bruxelles Laboratoire de Biologie Marine CP 160/15 50 av. F. D. Roosevelt 1050 Bruxelles Belgium
UO	Institute of Biological Sciences University of Oslo PB 1064 Blindern 0316 Oslo Norway
VIMS	School of Marine Science Virginia Institute of Marine Science College of William & Mary Gloucester Point, Virginia 23062-1346 USA
ZIM	Zoologisches Museum Hamburg Universität Hamburg Martin-Luther-King-Platz 3 20146 Hamburg Germany
ZSM	Zoologische Staatssammlung München Münchhausenstr. 21 81247 München Germany

---

## A.2 CRUISE PARTICIPANTS

Name	Institut/ Institute
Adaro, Martin Pablo Cesar	SIHN since <i>Jubany</i> station
Banda, Gracious	SANAP until <i>Neumayer Station</i>
Boebel, Olaf	AWI
Bohn, Jens	ZSM
Brandt, Angelika	ZIM
Brökeland, Wiebke	ZIM
Carpenter, Lawrence W.	VIMS
Cedhagen, Thomas	DME
Choudhury, Madhumita	ZIM
Cornelius, Nils	SOC
Danis, Bruno	IRSN
Darelius, Elin	GFI
De Broyer, Claude	IRSN
De Mesel, Ilse	UG
Doner, Stacy A.	ENSR
Ellingsen, Kari Elsa	UO
Fahrbach, Eberhard	AWI
Gauger, Steffen	FIELAX
Gebauer, Manfred	DWD
Gooday, Andrew John	SOC
Heinlein, Harald	HeliTransair
Henche, Annika	FIS
Heterier, Vincent	ULB
Hilbig, Brigitte	RUB
Hoppema, Mario	AWI
Howe, John Alexander	SAMS
Ingels, Jeroen	UG
Janussen, Dorte	FSN
Kindermann, Lars	AWI
Klatt, Olaf	AWI
Kleffel, Guido	AWI since <i>Dallmann Laboratory</i>
Klinck, Holger	AWI
Kourentsova, Natalia	GEOKHI
Lahrman, Uwe	HeliTransair
Linse, Katrin	BAS



Name	Institut/ Institute
Lopez Gonzales, Pablo José	DFZ
Malyutina, Marina	IMB
Middag, Rob	NIOZ
Monsees, Matthias	OPTIMARE
Narayanaswamy, Bhavani	SAMS
Nunes Brandao, Simone	ZIM
Nunez Riboni, Ismael	AWI
Planer, Michael	IUP
Raupach, Michael	RUB
Rießbeck, Gerhard	Künstler
Rohardt, Gerd	AWI
Rohr, Harald	OPTIMARE
Rose, Armin	FIS
Schwabe, Enrico	ZSM
Sonnabend, Hartmut	DWD
Stimac, Mihael	HeliTransair
Thoma, Inger	IFM-GEOMAR
Thomson, Michael R.	SES
Timmermann, Ralph	AWI
Wang, Qiang	AWI
Weerlee, van, Evaline	NIOZ
Wegener, Gisela	ZIM
Winter, Stefan	HeliTransair
Witte, Hannelore	AWI
Wolf, Alexander	DLR since <i>Rothera Station</i>

---

### A.3 SHIP'S CREW

Besatzungsliste      Reise ANT XXII/3  
Name of Ship :      POLARSTERN  
Nationality    :      GERMAN  
Cape Town - Punta Arenas

No.	Name	Rank	
01.	Schwarze, Stefan	Master	German
02.	Grundmann, Uwe	1.Offc.	German
03.	Farysch, Bernd	Ch. Eng.	German
04.	Thomas, Rainer	1.Offc./L.	German
05.	Bratz, Herbert	3.Offc.	German
06.	Wunderlich, Thomas	3.Offc.	German
07.	Kapieske, Uwe	Doctor	German
08.	Hecht, Andreas	R.Offc.	German
09.	Erreth Monostori, Gyula	2.Eng.	German
10.	Minzlaff, Hans-Ulrich	2.Eng.	German
11.	Ziemann, Olaf	2.Eng.	German
12.	Kahrs, Thomas	Electron	German
13.	Muhle, Helmut	Electron.	German
14.	Nasis, Ilias	Electron.	German
15.	Scholz, Manfred	Elec.Tech	German
16.	Verhoeven, Roger	Electron.	German
17.	Loidl, Reiner	Boatsw.	German
18.	Reise, Lutz	Carpenter	German
19.	Bäcker, Andreas	A.B.	German
20.	Guse, Hartmut	A.B.	German
21.	Hagemann, Manfred	A.B.	German
22.	Hartwig-Labahn, Andreas	A.B.	German
23.	Schmidt, Uwe	A.B.	German
24.	Vehlow, Ringo	A.B.	German
25.	Winkler, Michael	A.B.	German
26.	Preußner, Jörg	Storek.	German
27.	Elsner, Klaus	Mot-man	German
28.	Grafe, Jens	Mot-man	German
29.	Hartmann,Ernst-Uwe	Mot-man	German
30.	Ipsen, Michael	Mot-man	German
31.	Voy, Bernd	Mot-man	German
32.	Silinski, Frank	Cook	German

33.	Möller, Wolfgang	Cooksmate	German
34.	Völske, Thomas	Cooksmate	German
35.	Jürgens, Monika	1.Stwdess	German
36.	Wöckener, Martina	Stwdss/KS	German
37.	Czyborra, Bärbel	2.Stwdess	German
38.	Gaude, Hans-Jürgen	2.Steward	German
39.	Hu, Guo Yong	2.Steward	China
40.	Huang, Wu-Mei	2.Steward	Taiwan
41.	Silinski, Carmen	2.Stwdess	German
42.	Sun, Yong Sheng	Laundrym.	China
43.	Niehusen, Arne	Trainee	German
44.	Scholl, Christoph	Trainee	German

## A.4 STATION LIST

Station	Date	Time	Latitude	Longitude	Depth	Gear	Remark
12-1	23.01.05	04:45	34°10.58' S	14°33.07' E	4424.6	PFLOAT	deployed
13-1	23.01.05	16:10	35°57.63' S	13°28.41' E	4846.0	PFLOAT	deployed
14-1	24.01.05	05:25	38°0.14' S	12°9.42' E	5142.0	PFLOAT	deployed
15-1	24.01.05	19:05	40°1.48' S	10°45.48' E	4740.0	PFLOAT	deployed
16-1	25.01.05	02:15	41°8.05' S	9°56.44' E	4731.0	CTD/RO	start cast
	25.01.05	03:47	41°7.96' S	9°55.36' E	4712.0		at depth
	25.01.05	05:00	41°7.91' S	9°54.73' E	4690.0		end cast
16-2	25.01.05	05:45	41°8.12' S	9°56.59' E	4732.0	SPI	start cast
	25.01.05	07:10	41°8.12' S	9°56.50' E	4730.0		at depth
	25.01.05	09:01	41°8.44' S	9°56.81' E	4732.0		end cast
16-3	25.01.05	09:25	41°8.00' S	9°56.67' E	4730.0	GKG	start cast
	25.01.05	10:53	41°7.87' S	9°56.66' E	4732.0		at depth
	25.01.05	12:20	41°7.46' S	9°56.35' E	4723.0		end cast
16-4	25.01.05	12:21	41°7.46' S	9°56.33' E	4723.0	SON	start cast
16-5	25.01.05	12:53	41°8.00' S	9°56.69' E	4730.0	GKG	start cast
	25.01.05	14:20	41°7.51' S	9°56.30' E	4723.0		at depth
	25.01.05	15:44	41°7.11' S	9°55.94' E	4712.0		end cast
16-6	25.01.05	16:15	41°7.95' S	9°56.59' E	4732.0	MUC	start cast
	25.01.05	17:45	41°7.61' S	9°56.05' E	4719.0		at depth
	25.01.05	19:09	41°7.25' S	9°54.96' E	4695.0		end cast
16-7	25.01.05	19:45	41°7.99' S	9°56.49' E	4728.0	GKG	start cast
	25.01.05	21:16	41°7.75' S	9°56.06' E	4723.0		at depth
	25.01.05	22:48	41°7.71' S	9°56.33' E	4726.0		end cast
16-8	25.01.05	23:10	41°7.70' S	9°56.34' E	4729.0	MUC	start cast
	26.01.05	00:34	41°7.82' S	9°56.11' E	4726.0		at depth
	26.01.05	02:02	41°7.93' S	9°55.95' E	4722.0		end cast
16-9	26.01.05	02:25	41°8.04' S	9°56.75' E	4737.0	SPI	start cast
	26.01.05	03:59	41°7.70' S	9°55.98' E	4724.0		at depth
	26.01.05	05:51	41°7.17' S	9°55.50' E	4707.0		end cast
16-10	26.01.05	06:37	41°7.77' S	9°56.43' E	4725.0	EBS	start cast
	26.01.05	09:35	41°7.06' S	9°54.88' E	4687.0		start trawling
	26.01.05	09:45	41°6.99' S	9°54.75' E	4669.0		stop trawling
	26.01.05	12:20	41°7.00' S	9°54.75' E	4671.0		end cast
16-11	26.01.05	13:20	41°7.87' S	10°1.96' E	4796.0	AGT	start cast
	26.01.05	15:00	41°7.66' S	9°56.26' E	4727.0		AGT at depth
	26.01.05	15:33	41°7.46' S	9°55.11' E	4699.0		start trawling
	26.01.05	15:43	41°7.42' S	9°54.92' E	4730.0		stop trawling
	26.01.05	18:44	41°6.99' S	9°54.13' E	4619.0		end cast
16-12	26.01.05	19:20	41°8.04' S	9°56.63' E	4733.0	PIES	start deployment
	26.01.05	20:45	41°8.15' S	9°56.54' E	4700.8	PIES	end deployment
	26.01.05	20:47	41°8.21' S	9°56.60' E	4700.3	AFLOAT	deployed
17-65	27.01.05	01:42	41°52.27' S	9°22.82' E	4663.0	PFLOAT	deployed
18-1	27.01.05	14:27	43°50.43' S	7°47.44' E	4486.0	COD	deployed
18-2	27.01.05	14:37	43°50.77' S	7°47.01' E	4485.0	PFLOAT	deployed
19-1	27.01.05	18:28	44°27.21' S	7°15.90' E	4472.0	PIES	released
	27.01.05	20:15	44°39.85' S	7°5.53' E	4619.0	PIES	recovered
19-2	27.01.05	20:37	44°39.84' S	7°4.93' E	4616.0	PIES	start deployment
	27.01.05	21:52	44°39.79' S	7°5.32' E	4585.9	PIES	end deployment
20-1	28.01.05	05:30	45°49.90' S	6°2.30' E	4580.0	PFLOAT	deployed
21-1	28.01.05	18:07	47°39.93' S	4°15.11' E	4557.0	CTD/RO	start cast

Station	Date	Time	Latitude	Longitude	Depth	Gear	Remark
	28.01.05	19:38	47°39.84' S	4°15.68' E	4565.0		at depth
	28.01.05	21:14	47°39.92' S	4°16.02' E	4734.0		end cast
21-2	28.01.05	21:42	47°39.91' S	4°15.20' E	4560.0	SPI	start cast
	28.01.05	23:05	47°39.83' S	4°15.11' E	4558.0		at depth
	29.01.05	01:00	47°40.06' S	4°15.02' E	4558.0		end cast
21-3	29.01.05	01:19	47°39.89' S	4°15.23' E	4564.0	GKG	start cast
	29.01.05	02:41	47°40.05' S	4°14.84' E	4551.0		at depth
	29.01.05	04:04	47°40.30' S	4°14.12' E	4539.0		end cast
21-4	29.01.05	04:30	47°39.95' S	4°15.22' E	4563.0	MUC	start cast
	29.01.05	05:56	47°40.00' S	4°15.13' E	4559.0		at depth
	29.01.05	07:18	47°39.91' S	4°15.14' E	4562.0		end cast
21-5	29.01.05	08:22	47°39.42' S	4°15.49' E	4564.0	GKG	start cast
	29.01.05	09:44	47°39.37' S	4°15.65' E	4566.0		at depth
	29.01.05	11:04	47°39.27' S	4°15.74' E	4576.0		end cast
21-6	29.01.05	11:15	47°39.30' S	4°15.79' E	4569.0	MUC	start cast
	29.01.05	12:41	47°39.36' S	4°15.66' E	4564.0		at depth
	29.01.05	14:07	47°39.47' S	4°16.07' E	4583.0		end cast
21-7	29.01.05	14:29	47°40.53' S	4°16.27' E	4575.0	EBS	start cast
	29.01.05	17:18	47°38.73' S	4°15.20' E	4555.0		start trawling
	29.01.05	17:28	47°38.59' S	4°15.07' E	4552.0		stop trawling
	29.01.05	19:53	47°38.07' S	4°14.93' E	4539.0		end cast
21-8	29.01.05	20:50	47°43.02' S	4°17.62' E	4535.0	AGT	start cast
	29.01.05	22:51	47°39.19' S	4°16.50' E	4578.0		start trawling
	29.01.05	23:01	47°39.03' S	4°16.51' E	4579.0		stop trawling
	30.01.05	01:57	47°38.19' S	4°19.39' E	4581.0		end cast
21-9	30.01.05	02:29	47°39.36' S	4°15.70' E	4568.0	PIES	start deployment
21-9	30.01.05	03:07	47°39.19' S	4°16.10' E	4540.4	PIES	end deployment
22-1	30.01.05	11:35	48°55.27' S	2°55.81' E	4079.0	PFLOAT	deployed
23-1	30.01.05	18:43	49°58.84' S	1°44.56' E	3775.0	PIES	released
	30.01.05	20:50	50°14.50' S	1°26.14' E	3897.0		recovered
24-1	31.01.05	05:01	51°25.25' S	0°0.14' E	2723.0	NFLOAT	deployed
25-1	31.01.05	13:46	53°0.33' S	0°2.11' E	2521.4	MOR	search
25-2	31.01.05	17:00	53°0.49' S	0°1.81' E	2539.0	CTD/RO	start cast
	31.01.05	17:51	53°0.10' S	0°1.99' E	2540.0		at depth
	31.01.05	18:45	52°59.77' S	0°1.87' E	2559.0		end cast
25-3	31.01.05	18:53	52°59.71' S	0°1.70' E	2568.0	PFLOAT	deployed
26-1	31.01.05	22:32	53°30.06' S	0°0.32' E	2690.0	CTD/RO	start cast
	31.01.05	23:27	53°29.99' S	0°0.40' E	2688.0		at depth
	01.02.05	00:24	53°29.99' S	0°0.55' E	2687.0		end cast
27-1	01.02.05	04:16	53°59.83' S	0°0.35' E	2483.0	CTD/RO	start cast
	01.02.05	05:06	53°59.96' S	0°0.23' E	2487.0		at depth
	01.02.05	05:55	54°0.08' S	0°0.28' W	2427.8		end cast
27-2	01.02.05	06:02	54°0.08' S	0°0.43' W	2430.9	NFLOAT	deployed
28-1	01.02.05	09:44	54°30.77' S	0°2.20' E	1767.0	MOR	released
	01.02.05	13:06	54°30.69' S	0°3.71' E	1779.0		recovered
28-2	01.02.05	13:35	54°30.72' S	0°1.93' E	1764.0	CTD/RO	start cast
	01.02.05	14:12	54°30.87' S	0°1.96' E	1763.0		at depth
	01.02.05	14:51	54°31.03' S	0°1.81' E	1725.0		end cast
28-3	01.02.05	14:57	54°31.08' S	0°1.92' E	1712.0	MOR	start deployment
	01.02.05	16:41	54°30.79' S	0°1.29' E	1730.0		end deployment
29-1	01.02.05	21:23	55°0.13' S	0°0.77' E	1722.0	CTD/RO	start cast
	01.02.05	22:03	55°0.08' S	0°1.29' E	1728.0		at depth
	01.02.05	22:41	55°0.26' S	0°1.29' E	1729.0		end cast

Station	Date	Time	Latitude	Longitude	Depth	Gear	Remark
29-2	01.02.05	22:47	55°0.28' S	0°1.06' E	1759.0	PFLOAT	deployed
30-1	02.02.05	06:48	55°30.07' S	0°0.41' E	3775.0	CTD/RO	start cast
	02.02.05	08:01	55°30.30' S	0°0.48' E	3791.0		at depth
	02.02.05	09:10	55°30.60' S	0°0.92' E	3900.0		end cast
31-1	02.02.05	10:12	55°34.11' S	0°0.36' E	3659.0	CTD/RO	start cast
	02.02.05	11:15	55°34.35' S	0°0.97' E	3396.0		at depth
	02.02.05	12:03	55°34.34' S	0°1.57' E	3337.0		end cast
32-1	02.02.05	13:30	55°31.85' S	0°3.96' E	3646.0	MOR	start deployment
	02.02.05	15:37	55°32.03' S	0°0.52' W	3873.0		end deployment
33-1	02.02.05	20:55	56°0.13' S	0°0.00' W	3852.0	CTD/RO	start cast
	02.02.05	22:08	56°0.24' S	0°0.20' E	3771.0		at depth
	02.02.05	23:14	56°0.42' S	0°0.57' E	3663.0		end cast
34-1	03.02.05	03:03	56°29.82' S	0°0.14' E	4097.0	CTD/RO	start cast
	03.02.05	04:19	56°29.80' S	0°0.22' E	4083.0		at depth
	03.02.05	05:30	56°29.84' S	0°0.43' E	4052.0		end cast
35-1	03.02.05	09:00	56°57.60' S	0°0.98' E	3778.0	MOR	released
	03.02.05	10:43	56°57.88' S	0°0.43' E	3811.0	MOR	recovered
35-2	03.02.05	11:08	56°57.69' S	0°1.63' E	3775.0	CTD/RO	start cast
	03.02.05	12:21	56°57.85' S	0°2.41' E	3773.0		at depth
	03.02.05	13:27	56°57.77' S	0°2.92' E	3778.0		end cast
35-3	03.02.05	14:10	56°57.68' S	0°5.51' E	3813.0	MOR	start deployment
	03.02.05	16:04	56°57.62' S	0°0.67' E	3791.0		end deployment
35-4	03.02.05	16:52	56°57.84' S	0°1.61' E	3776.0	STR	start cast
	03.02.05	20:04	57°27.45' S	0°0.07' E	3704.0		end cast
36-1	03.02.05	20:29	57°29.95' S	0°0.26' W	3989.0	CTD/RO	start cast
	03.02.05	21:45	57°30.07' S	0°0.69' W	3976.0		at depth
	03.02.05	22:53	57°30.44' S	0°0.55' W	3975.0		end cast
37-1	04.02.05	02:05	57°59.69' S	0°0.02' W	4562.0	CTD/RO	start cast
	04.02.05	03:30	57°59.76' S	0°0.23' E	4554.0		at depth
	04.02.05	04:45	57°59.62' S	0°0.39' E	4546.0		end cast
38-1	04.02.05	08:08	58°29.89' S	0°0.47' W	4291.0	CTD/RO	start cast
	04.02.05	09:29	58°29.87' S	0°0.40' W	4275.0		at depth
	04.02.05	10:41	58°30.11' S	0°0.62' W	4389.0		end cast
39-1	04.02.05	14:12	59°4.33' S	0°4.56' E	4699.0	MOR	released
	04.02.05	18:39	59°3.96' S	0°4.57' E	4695.0		recovered
39-3	04.02.05	20:15	59°5.86' S	0°7.00' E	4689.0	CTD/RO	start cast
	04.02.05	21:47	59°5.35' S	0°7.75' E	4709.0		at depth
	04.02.05	23:07	59°5.00' S	0°7.47' E	4696.0		end cast
40-1	05.02.05	01:58	59°30.01' S	0°0.49' W	4681.0	CTD/RO	start cast
	05.02.05	03:24	59°30.47' S	0°0.24' W	4690.0		at depth
	05.02.05	04:44	59°30.42' S	0°0.07' W	4686.0		end cast
41-1	05.02.05	08:10	60°0.01' S	0°0.37' W	5379.0	CTD/RO	start cast
	05.02.05	09:52	59°59.87' S	0°0.10' E	5386.0		at depth
	05.02.05	11:25	59°59.92' S	0°0.69' E	5400.0		end cast
41-2	05.02.05	11:39	60°1.09' S	0°0.45' W	5381.0	STR	start cast
	05.02.05	14:20	60°28.44' S	0°0.02' W	5397.0		end cast
42-1	05.02.05	14:43	60°29.95' S	0°0.04' W	5395.0	CTD/RO	start cast
	05.02.05	16:22	60°30.18' S	0°0.16' E	5395.0		at depth
	05.02.05	17:43	60°30.09' S	0°0.38' W	5394.0		end cast
43-1	05.02.05	21:03	60°59.94' S	0°0.25' E	5423.0	CTD/RO	start cast
	05.02.05	22:48	60°59.88' S	0°0.63' W	5421.0		at depth
	06.02.05	00:16	61°0.01' S	0°1.18' W	5415.0		end cast
44-1	06.02.05	03:23	61°29.92' S	0°0.03' W	5415.0	CTD/RO	start cast

Station	Date	Time	Latitude	Longitude	Depth	Gear	Remark
	06.02.05	05:04	61°29.78' S	0°0.35' W	5420.0		at depth
	06.02.05	06:28	61°29.66' S	0°0.68' W	5421.0		end cast
45-1	06.02.05	09:40	61°59.86' S	0°0.19' E	5389.0	CTD/RO	start cast
	06.02.05	11:22	61°59.98' S	0°0.39' E	5391.0		at depth
	06.02.05	12:43	61°59.82' S	0°0.14' W	5391.0		end cast
45-2	06.02.05	12:51	62°0.48' S	0°0.08' W	5392.0	STR	start cast
	06.02.05	15:36	62°28.56' S	0°0.44' W	5371.0		end cast
46-1	06.02.05	15:50	62°29.84' S	0°0.52' W	5368.0	CTD/RO	start cast
	06.02.05	17:29	62°30.14' S	0°0.13' W	5367.0		at depth
	06.02.05	18:51	62°30.06' S	0°0.42' E	5370.0		end cast
47-1	06.02.05	22:07	63°0.05' S	0°0.22' E	5332.0	CTD/RO	start cast
	06.02.05	23:50	62°59.68' S	0°0.23' E	5332.0		at depth
	07.02.05	01:15	62°59.47' S	0°0.28' E	5330.0		end cast
48-1	07.02.05	04:29	63°29.74' S	0°0.09' W	5268.0	CTD/RO	start cast
	07.02.05	06:06	63°29.55' S	0°0.20' E	5266.0		at depth
	07.02.05	07:28	63°29.35' S	0°0.39' E	5265.0		end cast
49-1	07.02.05	10:37	63°57.23' S	0°0.46' W	5198.8	MOR	released
	07.02.05	12:48	63°57.27' S	0°0.40' E	5198.3		recovered
49-2	07.02.05	14:02	63°57.28' S	0°6.23' W	5195.6	MOR	start deployment
	07.02.05	15:57	63°57.27' S	0°0.36' E	5199.4		end deployment
49-3	07.02.05	17:24	63°55.28' S	0°0.22' W	5201.3	CTD/RO	start cast
	07.02.05	19:02	63°55.15' S	0°0.08' W	5202.5		at depth
	07.02.05	20:22	63°55.04' S	0°0.41' W	5201.9		end cast
50-1	07.02.05	23:42	64°29.88' S	0°0.06' W	4650.3	CTD/RO	start cast
	08.02.05	01:11	64°29.86' S	0°0.47' E	4660.5		at depth
	08.02.05	02:27	64°29.92' S	0°0.62' E	4660.7		end cast
51-1	08.02.05	05:33	64°59.79' S	0°0.11' W	3722.6	CTD/RO	start cast
	08.02.05	06:44	64°59.48' S	0°0.40' E	3710.8		at depth
	08.02.05	07:47	64°59.54' S	0°0.64' E	3709.0		end cast
51-2	08.02.05	07:51	64°59.69' S	0°1.05' E	3706.2	NFLOAT	deployed
52-1	08.02.05	11:03	65°35.06' S	0°0.45' W	3831.0	CTD/RO	start cast
	08.02.05	12:14	65°34.93' S	0°0.24' E	3819.0		at depth
	08.02.05	13:24	65°34.86' S	0°0.47' E	3786.3		end cast
52-2	08.02.05	13:59	65°39.14' S	0°1.33' E	3704.0	STR	start cast
	08.02.05	15:33	65°57.47' S	0°9.06' E	3548.0		end cast
53-1	08.02.05	16:14	66°0.26' S	0°10.15' E	3487.6	MOR	released
	08.02.05	17:48	65°59.86' S	0°9.95' E	3528.0		recovered
53-2	08.02.05	19:17	65°59.20' S	0°7.59' E	3643.0	MOR	start deployment
	08.02.05	20:34	66°0.75' S	0°11.50' E	3489.0		end deployment
53-3	08.02.05	21:31	65°59.18' S	0°7.74' E	3616.3	CTD/RO	start cast
	08.02.05	22:42	65°59.25' S	0°7.85' E	3635.0		at depth
	08.02.05	23:43	65°59.26' S	0°7.84' E	3637.0		end cast
54-1	09.02.05	01:33	66°15.42' S	0°0.31' W	3758.0	CTD/RO	start cast
	09.02.05	02:46	66°15.50' S	0°0.19' W	3770.0		at depth
	09.02.05	03:53	66°15.40' S	0°0.53' W	3748.0		end cast
55-1	09.02.05	05:25	66°28.70' S	0°1.97' W	4523.0	CTD/RO	start cast
	09.02.05	06:51	66°28.50' S	0°1.98' W	4529.0		at depth
	09.02.05	08:01	66°28.51' S	0°2.04' W	4530.0		end cast
55-2	09.02.05	08:40	66°30.51' S	0°1.99' W	4548.3	MOR	released
	09.02.05	10:46	66°30.25' S	0°1.29' W	4570.0		recovered
55-3	09.02.05	12:42	66°30.69' S	0°1.78' W	4573.0	MOR	start deployment
	09.02.05	15:49	66°30.66' S	0°1.91' W	4576.0		end deployment
56-1	09.02.05	19:41	66°59.88' S	0°0.26' W	4729.0	CTD/RO	start cast

Station	Date	Time	Latitude	Longitude	Depth	Gear	Remark
	09.02.05	21:12	67°0.06' S	0°0.19' W	4730.0		at depth
	09.02.05	22:24	67°0.26' S	0°0.06' E	4728.0		end cast
57-1	10.02.05	15:10	69°29.92' S	5°23.67' W	1827.0	ATC	deployed
57-2	10.02.05	18:03	69°23.00' S	5°15.05' W	1810.0	AGT	start cast
	10.02.05	18:59	69°24.50' S	5°19.37' W	1819.0		start trawling
	10.02.05	19:09	69°24.62' S	5°19.68' W	1822.0		stop trawling
	10.02.05	20:22	69°24.67' S	5°19.72' W	1823.0		end cast
58-1	13.02.05	06:41	69°29.82' S	5°23.62' W	1829.0	ATC	released
	13.02.05	09:18	69°29.66' S	5°23.32' W	1808.2		recovered
58-2	13.02.05	10:03	69°24.01' S	5°9.30' W	1871.0	STR	start cast
	13.02.05	10:32	69°21.09' S	5°0.39' W	2065.0		end cast
58-3	13.02.05	13:30	69°5.85' S	4°16.20' W	2901.0	STR	start cast
	13.02.05	18:40	68°26.60' S	2°29.33' W	4221.0		end cast
58-4	13.02.05	19:07	68°25.39' S	2°26.29' W	4237.0	STR	start cast
	14.02.05	01:09	67°34.02' S	0°10.61' W	4660.0		end cast
59-1	14.02.05	01:52	67°29.99' S	0°0.10' E	4625.3	ATC	deployed
59-2	14.02.05	02:16	67°30.00' S	0°0.12' W	4625.0	CTD/RO	start cast
	14.02.05	03:45	67°29.91' S	0°0.20' W	4650.0		at depth
	14.02.05	05:00	67°30.22' S	0°0.25' W	4650.0		end cast
59-3	14.02.05	05:37	67°31.03' S	6°0.00' E	4651.0	SPI	start cast
	14.02.05	07:11	67°31.03' S	0°0.14' E	4649.0		at depth
	14.02.05	09:09	67°31.07' S	0°0.17' E	4653.0		end cast
59-4	14.02.05	09:23	67°31.08' S	0°0.25' E	4650.0	MUC	start cast
	14.02.05	10:49	67°30.99' S	0°0.16' E	4652.0		at depth
	14.02.05	12:16	67°31.00' S	0°0.10' E	4649.0		end cast
59-5	14.02.05	12:29	67°31.00' S	0°0.11' E	4650.0	EBS	start cast
	14.02.05	14:35	67°29.74' S	0°1.93' W	4655.0		start trawling
	14.02.05	14:45	67°29.61' S	0°2.19' W	4655.0		stop trawling
	14.02.05	17:30	67°29.85' S	0°3.39' W	4658.0		end cast
59-6	14.02.05	18:08	67°31.07' S	0°0.04' E	4648.0	GKG	start cast
	14.02.05	19:29	67°31.10' S	0°0.11' E	4648.0		at depth
	14.02.05	20:55	67°31.01' S	0°0.23' E	4652.0		end cast
59-7	14.02.05	21:04	67°31.01' S	0°0.22' E	4649.0	MUC	start cast
	14.02.05	22:26	67°31.05' S	0°0.27' E	4654.0		at depth
	14.02.05	23:52	67°30.98' S	0°0.12' E	4649.0		end cast
59-8	15.02.05	00:13	67°31.07' S	0°1.31' E	4649.0	CTD/RO	start cast
	15.02.05	01:09	67°31.06' S	0°0.81' E	4648.0		at depth
	15.02.05	01:50	67°31.05' S	0°0.33' E	4651.0		end cast
59-9	15.02.05	02:43	67°31.03' S	0°0.33' E	4651.0	MUC	start cast
	15.02.05	04:09	67°30.99' S	0°0.02' W	4649.0		at depth
	15.02.05	05:33	67°31.02' S	0°0.21' W	4649.0		end cast
59-10	15.02.05	12:16	67°32.65' S	0°9.65' W	4663.0	AGT	start cast
	15.02.05	14:30	67°30.37' S	0°3.74' E	4648.0		start trawling
	15.02.05	14:50	67°30.27' S	0°4.34' E	4648.0		stop trawling
	15.02.05	17:47	67°30.67' S	0°4.97' E	4649.0		end cast
59-11	15.02.05	19:34	67°31.13' S	0°0.21' W	4650.0	MUC	start cast
	15.02.05	21:01	67°30.96' S	0°0.02' W	4653.0		at depth
	15.02.05	22:27	67°31.02' S	0°0.14' E	4652.0		end cast
59-12	15.02.05	22:49	67°31.01' S	0°0.16' E	4650.0	GKG	start cast
	16.02.05	00:11	67°31.03' S	0°0.11' E	4648.0		at depth
	16.02.05	01:39	67°31.01' S	0°0.02' E	4651.0		end cast
59-13	16.02.05	01:53	67°30.98' S	0°0.00' W	4650.0	MUC	start cast
	16.02.05	03:17	67°30.91' S	0°0.02' W	4652.0		at depth



Station	Date	Time	Latitude	Longitude	Depth	Gear	Remark
	16.02.05	04:41	67°30.80' S	0°0.32' W	4649.0		end cast
59-14	16.02.05	05:17	67°30.89' S	0°0.36' W	4652.0	GKG	start cast
	16.02.05	06:41	67°31.01' S	0°0.00' W	4650.0		at depth
	16.02.05	08:07	67°31.04' S	0°0.27' W	4651.0		end cast
59-15	16.02.05	08:41	67°30.05' S	0°0.04' E	4624.9	ATC	released
	16.02.05	11:14	67°30.08' S	0°0.20' E	4651.0		recovered
60-1	16.02.05	14:39	67°59.98' S	0°0.06' E	4533.0	CTD/RO	start cast
	16.02.05	16:02	68°0.25' S	0°0.22' W	4531.0		at depth
	16.02.05	17:12	67°59.91' S	0°0.18' W	4535.0		end cast
61-1	16.02.05	20:51	68°30.07' S	0°0.68' W	4293.0	CTD/RO	start cast
	16.02.05	22:13	68°30.24' S	0°0.81' W	4291.0		at depth
	16.02.05	23:24	68°30.26' S	0°0.79' W	4289.0		end cast
62-1	17.02.05	01:03	68°44.99' S	0°3.20' W	3503.0	CTD/RO	start cast
	17.02.05	02:10	68°45.12' S	0°3.36' W	3490.0		at depth
	17.02.05	03:15	68°45.11' S	0°3.31' W	3486.0		end cast
63-1	17.02.05	04:51	68°57.92' S	0°0.22' E	3419.0	CTD/RO	start cast
	17.02.05	05:56	68°57.80' S	0°0.31' E	3418.0		at depth
	17.02.05	06:53	68°57.78' S	0°0.67' E	3407.0		end cast
63-2	17.02.05	08:00	68°59.97' S	0°1.18' W	3379.5	MOR	released
	17.02.05	09:54	68°59.28' S	0°2.43' W	3394.5		recovered
63-3	17.02.05	10:44	68°59.72' S	0°0.37' W	3408.3	MOR	start deployment
	17.02.05	12:43	68°59.75' S	0°0.11' W	3413.8		end deployment
64-1	17.02.05	15:16	69°20.59' S	0°4.41' W	2202.6	MOR	released
	17.02.05	18:09	69°22.92' S	0°12.36' W	1935.3		recovered
64-2	17.02.05	19:50	69°23.65' S	0°4.23' W	1967.9	MOR	start deployment
	17.02.05	21:06	69°23.60' S	0°4.33' W	1969.7		end deployment
65-1	18.02.05	01:00	69°34.77' S	0°8.14' W	1718.5	CTD/RO	start cast
	18.02.05	01:33	69°34.59' S	0°7.92' W	1735.0		at depth
	18.02.05	02:11	69°34.63' S	0°7.92' W	1731.4		end cast
66-1	18.02.05	03:48	69°29.54' S	0°9.57' E	1777.0	CTD/RO	start cast
	18.02.05	04:23	69°29.26' S	0°9.29' E	1800.2		at depth
	18.02.05	05:05	69°29.13' S	0°9.56' E	1815.9		end cast
67-1	18.02.05	05:50	69°24.99' S	0°0.02' W	1938.9	CTD/RO	start cast
	18.02.05	06:27	69°24.94' S	0°0.09' E	1945.3		at depth
	18.02.05	07:07	69°24.91' S	0°0.00' E	1939.7		end cast
68-1	18.02.05	07:56	69°20.00' S	0°0.01' E	2356.0	CTD/RO	start cast
	18.02.05	08:44	69°20.01' S	0°0.10' E	2355.8		at depth
	18.02.05	09:28	69°19.99' S	0°0.04' E	2357.4		end cast
69-1	18.02.05	10:24	69°15.00' S	0°0.00' E	2584.0	CTD/RO	start cast
	18.02.05	11:16	69°14.90' S	0°0.00' E	2546.0		at depth
	18.02.05	12:00	69°14.96' S	0°0.08' E	2584.1		end cast
69-2	18.02.05	12:10	69°15.19' S	0°0.89' W	2558.3	STR	start cast
	19.02.05	02:16	70°14.77' S	8°24.56' W	1600.5		end cast
70-1	19.02.05	06:08	70°31.88' S	9°1.49' W	436.9	TRAPF	released
	19.02.05	06:37	70°31.81' S	9°1.40' W	435.6		recovered
71-1	19.02.05	06:45	70°31.80' S	9°1.64' W	438.4	TRAPF	searching
72-1	19.02.05	07:01	70°31.84' S	9°2.18' W	438.1	TRAPF	searching
72-2	19.02.05	07:03	70°31.86' S	9°2.24' W	437.3	TRAPF	searching
72-3	19.02.05	07:05	70°31.90' S	9°2.30' W	438.4	TRAPF	searching
73-1	19.02.05	16:20	70°56.72' S	10°32.50' W	317.2	MOR	searching
74-1	20.02.05	08:10	71°18.26' S	13°57.51' W	1050.0	CTD/RO	start cast
	20.02.05	08:34	71°18.23' S	13°57.67' W	1059.0		at depth
	20.02.05	08:50	71°18.27' S	13°57.72' W	1051.0		end cast

Station	Date	Time	Latitude	Longitude	Depth	Gear	Remark
74-2	20.02.05	09:15	71°17.88' S	13°54.55' W	969.2	ATC	deployed
	20.02.05	09:34	71°18.08' S	13°56.42' W	1017.4		at depth
74-3	20.02.05	10:11	71°18.35' S	13°58.09' W	1051.0	SPI	start cast
	20.02.05	11:00	71°18.28' S	13°57.73' W	1051.0		at depth
	20.02.05	12:21	71°18.29' S	13°57.83' W	1049.0		end cast
74-4	20.02.05	12:31	71°18.31' S	13°57.70' W	1041.0	MUC	start cast
	20.02.05	12:56	71°18.25' S	13°57.82' W	1060.0		at depth
	20.02.05	13:19	71°18.27' S	13°57.63' W	1049.0		end cast
74-5	20.02.05	14:11	71°18.05' S	13°56.23' W	1037.0	MUC	start cast
	20.02.05	14:34	71°18.11' S	13°56.33' W	1035.0		at depth
	20.02.05	14:56	71°18.14' S	13°56.21' W	1022.0		end cast
74-6	20.02.05	15:32	71°18.42' S	13°58.29' W	1053.0	EBS	start cast
	20.02.05	15:50	71°18.42' S	13°58.22' W	1048.0		at depth
	20.02.05	15:58	71°18.35' S	13°57.71' W	1030.0		start trawling
	20.02.05	16:08	71°18.28' S	13°57.31' W	1040.0		stop trawling
	20.02.05	16:39	71°18.46' S	13°58.40' W	1053.0		end cast
74-7	20.02.05	17:09	71°18.89' S	14°0.62' W	1173.0	AGT	start cast
	20.02.05	17:40	71°18.48' S	13°58.55' W	1055.0		start trawling
	20.02.05	17:50	71°18.40' S	13°58.14' W	1047.0		stop trawling
	20.02.05	18:31	71°18.44' S	13°58.10' W	1036.0		end cast
74-8	20.02.05	18:53	71°18.04' S	13°54.77' W	973.7	ATC	released
	20.02.05	19:35	71°18.44' S	13°55.96' W	953.5		recovered
75-1	20.02.05	21:10	71°28.78' S	13°31.25' W	242.8	CTD/RO	start cast
	20.02.05	21:21	71°28.77' S	13°31.64' W	241.2		at depth
	20.02.05	21:32	71°28.75' S	13°31.80' W	242.6		end cast
76-1	20.02.05	22:46	71°20.03' S	13°45.29' W	308.5	CTD/RO	start cast
	20.02.05	22:58	71°20.07' S	13°45.28' W	311.4		at depth
	20.02.05	23:12	71°20.05' S	13°45.39' W	308.2		end cast
77-1	20.02.05	23:47	71°17.04' S	13°50.21' W	948.5	CTD/RO	start cast
	21.02.05	00:08	71°17.01' S	13°50.26' W	962.7		at depth
	21.02.05	00:36	71°17.14' S	13°50.67' W	944.8		end cast
78-1	21.02.05	01:49	71°9.52' S	14°1.18' W	2188.0	ATC	deployed
	21.02.05	02:40	71°9.91' S	14°4.80' W	2194.0		at depth
78-2	21.02.05	02:57	71°9.51' S	14°0.03' W	2168.0	CTD/RO	start cast
	21.02.05	03:42	71°9.47' S	14°0.12' W	2167.0		at depth
	21.02.05	04:25	71°9.46' S	14°0.03' W	2166.0		end cast
78-3	21.02.05	04:35	71°9.48' S	14°0.03' W	2165.0	MUC	start cast
	21.02.05	05:20	71°9.46' S	13°59.97' W	2163.0		at depth
	21.02.05	06:02	71°9.44' S	14°0.05' W	2166.0		end cast
78-4	21.02.05	06:28	71°9.46' S	14°0.00' W	2166.0	GKG	start cast
	21.02.05	07:08	71°9.49' S	13°59.92' W	2164.0		at depth
	21.02.05	07:51	71°9.44' S	13°59.85' W	2163.0		end cast
78-5	21.02.05	08:02	71°9.45' S	13°59.95' W	2169.0	MUC	start cast
	21.02.05	08:48	71°9.38' S	13°59.94' W	2163.0		at depth
	21.02.05	09:29	71°9.44' S	14°0.08' W	2165.0		end cast
78-6	21.02.05	09:48	71°9.46' S	14°0.12' W	2166.0	GKG	start cast
	21.02.05	10:28	71°9.45' S	14°0.32' W	2168.0		at depth
	21.02.05	11:09	71°9.41' S	14°0.30' W	2167.0		end cast
78-7	21.02.05	11:21	71°9.45' S	14°0.05' W	2165.0	MUC	start cast
	21.02.05	12:06	71°9.45' S	14°0.06' W	2165.0		at depth
	21.02.05	12:48	71°9.48' S	14°0.17' W	2168.0		end cast
78-8	21.02.05	13:13	71°9.46' S	14°0.01' W	2164.0	MUC	start cast
	21.02.05	13:55	71°9.48' S	14°0.12' W	2167.0		at depth

Station	Date	Time	Latitude	Longitude	Depth	Gear	Remark
	21.02.05	14:35	71°9.47' S	14°0.15' W	2167.0		end cast
78-9	21.02.05	14:47	71°9.60' S	14°0.05' W	2174.0	SPI	start cast
	21.02.05	15:54	71°9.55' S	14°0.16' W	2172.0		at depth
	21.02.05	17:17	71°9.39' S	13°59.78' W	2161.0		end cast
78-10	21.02.05	17:37	71°9.56' S	14°1.06' W	2186.0	EBS	start cast
	21.02.05	18:35	71°9.39' S	13°59.30' W	2156.0		start trawling
	21.02.05	18:45	71°9.36' S	13°58.81' W	2147.0		stop trawling
78-11	21.02.05	19:23	71°9.37' S	13°58.91' W	2151.0	ATC	released
78-10	21.02.05	19:48	71°9.33' S	13°58.61' W	2147.0	EBS	end cast
78-11	21.02.05	20:35	71°9.60' S	14°2.47' W	2190.0	ATC	recovered
78-12	21.02.05	20:58	71°10.31' S	14°5.66' W	2214.0	AGT	start cast
	21.02.05	21:59	71°9.39' S	13°59.33' W	2157.0		start trawling
	21.02.05	22:09	71°9.35' S	13°58.81' W	2147.0		stop trawling
	21.02.05	23:36	71°9.33' S	13°58.28' W	2143.0		end cast
78-13	21.02.05	23:42	71°9.15' S	13°58.10' W	2145.0	AFLOAT	deployed
79-1	22.02.05	01:44	70°52.56' S	14°23.79' W	2294.0	CTD/RO	start cast
	22.02.05	02:28	70°52.55' S	14°23.89' W	2295.0		at depth
	22.02.05	03:10	70°52.57' S	14°23.84' W	2296.0		end cast
80-1	22.02.05	04:45	70°41.01' S	14°40.11' W	2899.0	ATC	deployed
	22.02.05	05:45	70°40.78' S	14°41.24' W	2928.0		at depth
80-2	22.02.05	06:24	70°39.42' S	14°43.50' W	3090.0	CTD/RO	start cast
	22.02.05	07:23	70°39.45' S	14°43.64' W	3085.0		at depth
	22.02.05	08:19	70°39.42' S	14°43.43' W	3078.0		end cast
80-3	22.02.05	08:22	70°39.42' S	14°43.42' W	3078.0	SPI	start cast
	22.02.05	09:27	70°39.41' S	14°43.54' W	3083.0		at depth
	22.02.05	11:00	70°39.41' S	14°43.47' W	3085.0		end cast
80-4	22.02.05	11:12	70°39.42' S	14°43.50' W	3084.0	MUC	start cast
	22.02.05	12:15	70°39.32' S	14°43.51' W	3093.0		at depth
	22.02.05	13:11	70°39.43' S	14°43.60' W	3092.0		end cast
80-5	22.02.05	13:24	70°39.40' S	14°43.44' W	3088.0	GKG	start cast
	22.02.05	14:20	70°39.40' S	14°43.47' W	3086.0		at depth
	22.02.05	15:19	70°39.30' S	14°43.62' W	3099.0		end cast
80-6	22.02.05	15:54	70°37.09' S	14°42.22' W	3566.0	AGT	start cast
	22.02.05	17:18	70°40.23' S	14°43.78' W	3006.0		start trawling
	22.02.05	17:29	70°40.42' S	14°43.83' W	2978.0		stop trawling
	22.02.05	19:35	70°40.82' S	14°44.24' W	2940.0		end cast
80-7	22.02.05	20:24	70°39.41' S	14°43.43' W	3081.0	MUC	start cast
	22.02.05	21:23	70°39.40' S	14°43.50' W	3088.0		at depth
	22.02.05	22:22	70°39.36' S	14°43.44' W	3090.0		end cast
80-8	22.02.05	22:45	70°39.40' S	14°43.43' W	3084.0	GKG	start cast
	22.02.05	23:44	70°39.40' S	14°43.46' W	3092.0		at depth
	23.02.05	00:37	70°39.45' S	14°43.65' W	3084.0		end cast
80-9	23.02.05	01:06	70°38.42' S	14°42.61' W	3138.0	EBS	start cast
	23.02.05	02:27	70°39.07' S	14°43.36' W	3103.0		start trawling
	23.02.05	02:37	70°39.22' S	14°43.39' W	3102.0		stop trawling
80-10	23.02.05	03:31	70°39.20' S	14°43.42' W	3102.0	ATC	released
80-9	23.02.05	04:10	70°39.24' S	14°43.59' W	3103.0	EBS	end cast
80-10	23.02.05	04:54	70°41.02' S	14°41.82' W	2908.0	ATC	recovered
81-1	23.02.05	06:27	70°30.01' S	14°30.89' W	4497.0	ATC	deployed
81-2	23.02.05	07:02	70°31.50' S	14°34.92' W	4415.0	CTD/RO	start cast
81-1	23.02.05	07:52	70°31.63' S	14°35.00' W	4412.0	ATC	at depth
81-2	23.02.05	08:24	70°31.50' S	14°35.08' W	4413.0	CTD/RO	at depth
	23.02.05	09:30					end cast

Station	Date	Time	Latitude	Longitude	Depth	Gear	Remark
81-3	23.02.05	09:45	70°31.51' S	14°34.77' W	4409.0	SPI	start cast
	23.02.05	11:09	70°31.50' S	14°34.97' W	4411.0		at depth
	23.02.05	13:07	70°31.48' S	14°34.86' W	4410.0		end cast
81-4	23.02.05	13:17	70°31.50' S	14°34.90' W	4412.0	MUC	start cast
	23.02.05	14:39	70°31.49' S	14°34.95' W	4407.0		at depth
	23.02.05	16:01	70°31.49' S	14°34.95' W	4412.0		end cast
81-5	23.02.05	16:14	70°31.59' S	14°34.87' W	4409.0	GKG	start cast
	23.02.05	17:35	70°31.59' S	14°35.05' W	4411.0		at depth
	23.02.05	19:01	70°31.65' S	14°35.10' W	4412.0		end cast
81-6	23.02.05	19:14	70°31.49' S	14°35.31' W	4414.0	MUC	start cast
	23.02.05	20:39	70°31.53' S	14°35.07' W	4413.0		at depth
	23.02.05	22:00	70°31.55' S	14°34.94' W	4411.0		end cast
81-7	23.02.05	22:20	70°31.52' S	14°34.75' W	4409.0	GKG	start cast
	23.02.05	23:41	70°31.49' S	14°34.89' W	4408.0		at depth
	24.02.05	01:01	70°31.55' S	14°34.83' W	4410.0		end cast
81-8	24.02.05	01:20	70°30.85' S	14°34.98' W	4427.0	EBS	start cast
	24.02.05	03:20	70°32.02' S	14°35.05' W	4392.0		start trawling
	24.02.05	03:30	70°32.19' S	14°35.13' W	4385.0		stop trawling
	24.02.05	05:44	70°32.77' S	14°35.15' W	4391.0		end cast
81-9	24.02.05	06:42	70°27.90' S	14°35.77' W	4526.0	AGT	start cast
	24.02.05	08:38	70°32.94' S	14°34.40' W	4390.0		start trawling
	24.02.05	08:48	70°33.15' S	14°34.10' W	4392.0		stop trawling
81-10	24.02.05	11:00	70°33.72' S	14°30.00' W	4449.0	ATC	released
81-9	24.02.05	11:32	70°33.83' S	14°28.62' W	4283.0	AGT	end cast
81-10	24.02.05	13:59	70°30.25' S	14°31.80' W	4448.0	ATC	recovered
82-1	24.02.05	15:29	70°28.09' S	15°6.02' W	4651.0	CTD/RO	start cast
	24.02.05	16:55	70°28.20' S	15°6.23' W	4652.0		at depth
	24.02.05	18:00	70°28.33' S	15°5.97' W	4652.0		end cast
82-3	24.02.05	18:12	70°28.00' S	15°7.21' W	4654.0	STR	start cast
	24.02.05	21:08	70°2.38' S	15°56.74' W	4752.0		end cast
83-1	24.02.05	21:21	70°1.92' S	15°57.75' W	4753.0	CTD/RO	start cast
	24.02.05	22:53	70°1.91' S	15°57.78' W	4754.0		at depth
	25.02.05	00:04	70°1.99' S	15°57.77' W	4754.0		end cast
84-1	25.02.05	03:25	69°35.80' S	16°48.81' W	4731.0	CTD/RO	start cast
	25.02.05	04:55	69°35.85' S	16°48.61' W	4733.0		at depth
	25.02.05	06:06	69°35.90' S	16°48.84' W	4731.0		end cast
84-2	25.02.05	06:09	69°35.94' S	16°48.90' W	4734.0	NFLOAT	deployed
85-1	25.02.05	09:28	69°9.73' S	17°38.48' W	4786.0	CTD/RO	start cast
	25.02.05	10:58	69°9.64' S	17°38.35' W	4782.0		at depth
	25.02.05	12:08	69°9.72' S	17°38.23' W	4781.0		end cast
85-2	25.02.05	12:48	69°4.55' S	17°47.97' W	4789.0	STR	start cast
	25.02.05	15:19	68°45.57' S	18°23.30' W	4801.0		end cast
86-1	25.02.05	16:13	68°43.57' S	18°27.23' W	4813.0	CTD/RO	start cast
	25.02.05	17:42	68°43.58' S	18°28.10' W	4814.0		at depth
	25.02.05	18:53	68°43.51' S	18°28.14' W	4813.0		end cast
87-1	25.02.05	22:18	68°16.06' S	19°17.17' W	4883.0	CTD/RO	start cast
	25.02.05	23:51	68°16.11' S	19°17.33' W	4885.0		at depth
	26.02.05	01:05	68°16.17' S	19°17.46' W	4885.0		end cast
88-1	26.02.05	04:22	68°1.68' S	20°27.75' W	4935.0	ATC	deployed
88-2	26.02.05	05:17	68°3.65' S	20°27.77' W	4932.0	CTD/RO	start cast
88-1	26.02.05	05:58	68°3.70' S	20°27.68' W	4934.0	ATC	at depth
88-2	26.02.05	06:49	68°3.54' S	20°27.95' W	4933.0	CTD/RO	at depth
	26.02.05	08:08	68°3.60' S	20°27.97' W	4933.0		end cast

Station	Date	Time	Latitude	Longitude	Depth	Gear	Remark
88-3	26.02.05	08:14	68°3.59' S	20°27.87' W	4934.0	SPI	start cast
	26.02.05	10:04	68°3.61' S	20°27.78' W	4932.0		at depth
	26.02.05	11:57	68°3.64' S	20°27.76' W	4932.0		end cast
88-4	26.02.05	12:08	68°3.68' S	20°27.88' W	4933.0	MUC	start cast
	26.02.05	13:47	68°3.64' S	20°27.84' W	4932.0		at depth
	26.02.05	15:15	68°3.63' S	20°27.78' W	4933.0		end cast
88-5	26.02.05	15:30	68°3.62' S	20°27.87' W	4932.0	GKG	start cast
	26.02.05	17:01	68°3.68' S	20°27.75' W	4933.0		at depth
	26.02.05	18:32	68°3.73' S	20°27.78' W	4930.0		end cast
88-6	26.02.05	18:42	68°3.71' S	20°27.76' W	4932.0	MUC	start cast
	26.02.05	20:16	68°3.68' S	20°27.68' W	4933.0		at depth
	26.02.05	21:44	68°3.62' S	20°27.87' W	4934.0		end cast
88-7	26.02.05	22:02	68°3.60' S	20°27.89' W	4932.0	GKG	start cast
	26.02.05	23:32	68°3.61' S	20°27.99' W	4934.0		at depth
	27.02.05	01:04	68°3.49' S	20°27.85' W	4931.0		end cast
88-8	27.02.05	01:32	68°3.87' S	20°31.81' W	4929.0	EBS	start cast
	27.02.05	03:48	68°3.66' S	20°27.90' W	4929.0		start trawling
	27.02.05	03:58	68°3.61' S	20°27.52' W	4931.0		stop trawling
	27.02.05	06:33	68°3.58' S	20°27.36' W	4931.0		end cast
88-9	27.02.05	07:00	68°3.70' S	20°27.70' W	4932.0	MUC	start cast
	27.02.05	08:32	68°3.70' S	20°28.05' W	4931.0		at depth
	27.02.05	10:05	68°3.64' S	20°27.72' W	4935.0		end cast
88-11	27.02.05	10:58	68°3.54' S	20°38.33' W	4933.0	AGT	start cast
	27.02.05	13:13	68°3.58' S	20°24.58' W	4930.0		start trawling
	27.02.05	13:23	68°3.57' S	20°24.22' W	4931.0		stop trawling
	27.02.05	16:49	68°3.66' S	20°24.41' W	4929.0		end cast
88-12	27.02.05	17:24	68°3.59' S	20°28.04' W	4931.0	MUC	start cast
	27.02.05	18:58	68°3.63' S	20°27.93' W	4929.0		at depth
88-13	27.02.05	19:32	68°3.68' S	20°27.83' W	4932.0	ATC	released
88-12	27.02.05	20:15	68°3.64' S	20°27.65' W	4933.0	MUC	end cast
88-13	27.02.05	21:28	68°2.00' S	20°28.28' W	4971.0	ATC	recovered
88-14	27.02.05	21:36	68°2.00' S	20°28.42' W	4933.0	AFLOAT	deployed
88-15	27.02.05	21:54	68°0.78' S	20°31.39' W	4937.0	STR	start cast
	28.02.05	00:31	67°48.30' S	21°32.24' W	4939.0		end cast
89-1	28.02.05	00:55	67°47.10' S	21°37.64' W	4940.0	CTD/RO	start cast
	28.02.05	02:27	67°47.10' S	21°37.41' W	4937.0		at depth
	28.02.05	03:48	67°47.20' S	21°37.77' W	4938.0		end cast
90-1	28.02.05	07:01	67°32.75' S	22°46.90' W	4921.0	CTD/RO	start cast
	28.02.05	08:33	67°32.68' S	22°46.82' W	4890.8		at depth
	28.02.05	09:50	67°32.73' S	22°46.81' W	4890.4		end cast
90-2	28.02.05	09:55	67°32.74' S	22°46.62' W	4890.9	NFLOAT	deployed
91-1	28.02.05	13:07	67°18.24' S	23°55.17' W	4861.6	CTD/RO	start cast
	28.02.05	14:39	67°18.22' S	23°55.10' W	4862.0		at depth
	28.02.05	15:52	67°18.26' S	23°55.03' W	4863.9		end cast
91-2	28.02.05	16:15	67°17.65' S	24°0.03' W	4858.0	STR	start cast
	28.02.05	18:50	67°4.59' S	24°58.97' W	4848.2		end cast
92-1	28.02.05	19:07	67°3.76' S	25°2.96' W	4847.3	CTD/RO	start cast
	28.02.05	20:43	67°3.79' S	25°2.92' W	4692.0		at depth
	28.02.05	21:58	67°3.76' S	25°2.95' W	4846.4		end cast
93-1	01.03.05	01:11	66°49.34' S	26°9.98' W	4847.6	CTD/RO	start cast
	01.03.05	02:45	66°49.37' S	26°9.85' W	4845.7		at depth
	01.03.05	04:03	66°49.29' S	26°9.71' W	4826.1		end cast
94-1	01.03.05	07:18	66°34.80' S	27°7.47' W	4866.2	ATC	deployed

Station	Date	Time	Latitude	Longitude	Depth	Gear	Remark
94-2	01.03.05	08:27	66°35.59' S	27°11.60' W	4863.0	MOR	start deployment
94-1	01.03.05	09:00	66°36.28' S	27°9.46' W	4863.0	ATC	at depth
94-2	01.03.05	10:07	66°37.19' S	27°5.79' W	4862.2	MOR	end deployment
94-3	01.03.05	10:58	66°37.40' S	27°9.84' W	4864.2	CTD/RO	start cast
	01.03.05	12:30	66°37.33' S	27°9.78' W	4861.5		at depth
	01.03.05	13:46	66°37.39' S	27°9.80' W	4862.7		end cast
94-4	01.03.05	14:42	66°37.48' S	27°9.48' W	4860.8	SPI	start cast
	01.03.05	16:13	66°37.41' S	27°9.92' W	0.0		at depth
	01.03.05	18:29	66°37.43' S	27°9.88' W	4896.0		end cast
94-5	01.03.05	18:44	66°37.42' S	27°9.73' W	4894.0	MUC	start cast
	01.03.05	20:13	66°37.43' S	27°9.77' W	4894.0		at depth
	01.03.05	21:46	66°37.40' S	27°9.92' W	4862.1		end cast
94-6	01.03.05	22:05	66°37.41' S	27°9.96' W	4891.0	GKG	start cast
	01.03.05	23:31	66°37.40' S	27°9.75' W	4895.0		at depth
	02.03.05	01:04	66°37.37' S	27°9.84' W	4897.0		end cast
94-7	02.03.05	01:24	66°37.37' S	27°9.93' W	4891.0	MUC	start cast
	02.03.05	02:56	66°37.37' S	27°9.78' W	4892.0		at depth
	02.03.05	04:33	66°37.41' S	27°9.93' W	4889.0		end cast
94-8	02.03.05	04:47	66°37.43' S	27°9.84' W	4890.0	GKG	start cast
	02.03.05	06:14	66°37.42' S	27°9.97' W	4887.0		at depth
	02.03.05	07:40	66°37.38' S	27°9.85' W	4893.0		end cast
94-9	02.03.05	07:50	66°37.37' S	27°9.98' W	4893.0	MUC	start cast
	02.03.05	09:22	66°37.47' S	27°9.82' W	4893.0		at depth
	02.03.05	10:53	66°37.46' S	27°9.82' W	4892.0		end cast
94-11	02.03.05	11:43	66°36.08' S	27°18.02' W	4893.0	AGT	start cast
	02.03.05	13:57	66°38.05' S	27°5.90' W	4893.0		start trawling
	02.03.05	14:08	66°38.10' S	27°5.46' W	4894.0		stop trawling
	02.03.05	17:25	66°38.61' S	27°3.33' W	4891.0		end cast
94-12	02.03.05	18:09	66°35.00' S	27°7.20' W	4894.0	ATC	released
	02.03.05	21:04	66°34.94' S	27°7.84' W	4895.0		recovered
94-13	02.03.05	21:33	66°37.39' S	27°9.89' W	4892.0	GKG	start cast
	02.03.05	23:09	66°37.42' S	27°9.79' W	4894.0		at depth
	03.03.05	01:03	66°37.52' S	27°9.75' W	4893.0		end cast
94-14	03.03.05	01:50	66°39.32' S	27°9.08' W	4890.0	EBS	start cast
	03.03.05	04:04	66°37.48' S	27°9.83' W	4892.0		start trawling
	03.03.05	04:14	66°37.37' S	27°9.99' W	4891.0		stop trawling
	03.03.05	06:49	66°36.68' S	27°10.09' W	4895.0		end cast
95-1	03.03.05	11:00	66°29.16' S	28°20.14' W	4872.0	CTD/RO	start cast
	03.03.05	12:30	66°29.14' S	28°20.20' W	4871.0		at depth
	03.03.05	13:42	66°29.18' S	28°20.43' W	4873.0		end cast
95-2	03.03.05	13:48	66°29.08' S	28°20.75' W	4872.0	STR	start cast
	03.03.05	17:20	66°21.81' S	29°28.82' W	4844.0		end cast
96-1	03.03.05	17:40	66°21.45' S	29°32.54' W	4846.0	CTD/RO	start cast
	03.03.05	19:10	66°21.49' S	29°32.84' W	4847.0		at depth
	03.03.05	20:21	66°21.41' S	29°32.75' W	4844.0		end cast
97-1	04.03.05	00:26	66°12.72' S	30°46.86' W	4840.0	CTD/RO	start cast
	04.03.05	01:57	66°12.78' S	30°46.77' W	4844.0		at depth
	04.03.05	03:16	66°12.86' S	30°46.78' W	4843.0		end cast
98-1	04.03.05	07:02	66°5.98' S	31°56.24' W	4820.0	CTD/RO	start cast
	04.03.05	08:33	66°6.00' S	31°56.43' W	4820.0		at depth
	04.03.05	09:46	66°6.01' S	31°56.45' W	4818.0		end cast
99-1	04.03.05	13:04	65°58.34' S	33°7.65' W	4821.0	CTD/RO	start cast
	04.03.05	14:43	65°58.28' S	33°7.61' W	4825.0		at depth

Station	Date	Time	Latitude	Longitude	Depth	Gear	Remark
	04.03.05	15:57	65°58.33' S	33°7.55' W	4825.0		end cast
99-3	04.03.05	16:09	65°58.54' S	33°8.43' W	4828.0	STR	start cast
	04.03.05	19:49	65°51.19' S	34°13.52' W	4822.0		end cast
100-1	04.03.05	20:12	65°50.60' S	34°18.56' W	4819.0	CTD/RO	start cast
	04.03.05	21:42	65°50.59' S	34°18.74' W	4827.0		at depth
	04.03.05	22:57	65°50.59' S	34°18.74' W	4824.0		end cast
101-1	05.03.05	02:43	65°42.94' S	35°29.06' W	4805.0	CTD/RO	start cast
	05.03.05	04:13	65°42.92' S	35°29.25' W	4803.0		at depth
	05.03.05	05:29	65°42.89' S	35°29.51' W	4803.0		end cast
102-1	05.03.05	08:21	65°36.31' S	36°29.91' W	4808.0	ATC	deployed
102-2	05.03.05	08:54	65°34.34' S	36°31.10' W	4804.0	CTD/RO	start cast
	05.03.05	10:24	65°34.36' S	36°31.16' W	4802.0		at depth
102-1	05.03.05	10:30	65°34.34' S	36°31.15' W	4800.0	ATC	at depth
102-2	05.03.05	11:36	65°34.42' S	36°31.26' W	4802.0	CTD/RO	end cast
102-3	05.03.05	12:08	65°35.51' S	36°26.22' W	4799.0	MOR	start deployment
	05.03.05	13:46					end deployment
102-4	05.03.05	14:30	65°38.43' S	36°30.04' W	4796.0	MOR	surfaced
	05.03.05	16:18	65°37.48' S	36°29.96' W	4800.0		recovered
102-5	05.03.05	16:46	65°35.18' S	36°26.61' W	4800.0	MOR	start deployment
	05.03.05	18:31	65°37.72' S	36°22.94' W	4799.0		end deployment
102-6	05.03.05	20:01	65°34.36' S	36°31.02' W	4801.0	SPI	start cast
	05.03.05	21:24	65°34.36' S	36°31.08' W	4802.0		at depth
	05.03.05	23:26	65°34.45' S	36°31.17' W	4800.0		end cast
102-7	05.03.05	23:44	65°34.42' S	36°31.12' W	4802.0	MUC	start cast
	06.03.05	01:13	65°34.39' S	36°31.21' W	4804.0		at depth
	06.03.05	02:42	65°34.35' S	36°31.29' W	4802.0		end cast
102-8	06.03.05	03:03	65°34.42' S	36°31.02' W	4803.0	GKG	start cast
	06.03.05	04:31	65°34.37' S	36°30.93' W	4803.0		at depth
	06.03.05	05:56	65°34.44' S	36°30.84' W	4799.0		end cast
102-9	06.03.05	06:06	65°34.44' S	36°30.86' W	4801.0	MUC	start cast
	06.03.05	07:33	65°34.40' S	36°31.07' W	4804.0		at depth
	06.03.05	09:02	65°34.35' S	36°31.16' W	4802.0		end cast
102-10	06.03.05	09:23	65°34.39' S	36°31.10' W	4802.0	GKG	start cast
	06.03.05	10:52	65°34.34' S	36°31.22' W	4801.0		at depth
	06.03.05	12:18	65°34.41' S	36°31.16' W	4801.0		end cast
102-11	06.03.05	13:07	65°31.29' S	36°36.40' W	4795.0	AGT	start cast
	06.03.05	15:20	65°35.40' S	36°29.00' W	4794.0		start trawling
	06.03.05	15:30	65°35.51' S	36°28.83' W	4797.0		stop trawling
102-12	06.03.05	18:20	65°36.38' S	36°27.48' W	4802.0	ATC	released
102-11	06.03.05	18:41	65°36.42' S	36°27.38' W	4801.0	AGT	end cast
102-12	06.03.05	20:24	65°36.00' S	36°29.89' W	4797.0	ATC	recovered
102-13	06.03.05	20:56	65°33.16' S	36°33.32' W	4822.0	EBS	start cast
	06.03.05	23:06	65°34.32' S	36°31.32' W	4805.0		start trawling
	06.03.05	23:16	65°34.40' S	36°31.07' W	4803.0		stop trawling
	07.03.05	11:18	65°35.43' S	36°33.04' W	4799.0		end cast
102-15	07.03.05	11:44	65°34.80' S	36°41.72' W	4797.0	STR	start cast
	07.03.05	13:51	65°28.25' S	37°33.10' W	4768.0		end cast
103-1	07.03.05	14:12	65°27.42' S	37°39.19' W	4768.0	CTD/RO	start cast
	07.03.05	15:40	65°27.53' S	37°39.34' W	4764.0		at depth
	07.03.05	16:53	65°27.59' S	37°39.14' W	4770.0		end cast
103-2	07.03.05	17:14	65°26.92' S	37°43.28' W	4766.0	STR	start cast
	07.03.05	19:49	65°19.21' S	38°43.55' W	4800.0		end cast
104-1	07.03.05	20:08	65°18.66' S	38°47.67' W	4801.0	CTD/RO	start cast

Station	Date	Time	Latitude	Longitude	Depth	Gear	Remark
	07.03.05	21:38	65°18.63' S	38°47.90' W	4803.0		at depth
	07.03.05	23:00	65°18.63' S	38°48.00' W	4795.0		end cast
105-1	08.03.05	01:56	65°9.87' S	39°56.43' W	4809.0	CTD/RO	start cast
	08.03.05	03:28	65°9.88' S	39°56.26' W	4806.0		at depth
	08.03.05	04:45	65°9.91' S	39°56.53' W	4809.0		end cast
105-2	08.03.05	04:51	65°10.02' S	39°56.70' W	4809.0	AFLOAT	deployed
106-1	08.03.05	08:04	65°1.03' S	41°4.57' W	4760.0	CTD/RO	start cast
	08.03.05	09:34	65°0.94' S	41°4.51' W	4782.0		at depth
	08.03.05	10:47	65°0.80' S	41°3.74' W	4783.0		end cast
106-2	08.03.05	11:16	65°0.48' S	41°8.14' W	4783.0	STR	start cast
	08.03.05	13:50					end cast
107-1	08.03.05	14:19	64°52.54' S	42°11.47' W	4737.0	CTD/RO	start cast
	08.03.05	15:46	64°52.49' S	42°10.70' W	4734.0		at depth
	08.03.05	17:00	64°52.19' S	42°10.57' W	4736.0		end cast
108-1	08.03.05	21:09	64°43.19' S	43°18.89' W	4693.0	CTD/RO	start cast
	08.03.05	22:36	64°43.22' S	43°18.92' W	4695.0		at depth
	08.03.05	23:55	64°43.26' S	43°18.96' W	4695.0		end cast
108-2	08.03.05	23:58	64°43.36' S	43°18.83' W	4694.0	NFLOAT	deployed
109-1	09.03.05	03:17	64°34.56' S	44°25.91' W	4608.0	CTD/RO	start cast
	09.03.05	04:43	64°34.57' S	44°25.85' W	4608.0		at depth
	09.03.05	05:54	64°34.65' S	44°26.20' W	4605.0		end cast
110-1	09.03.05	14:17	64°56.35' S	43°8.02' W	4695.0	ATC	start cast
110-2	09.03.05	14:30	64°56.92' S	43°6.96' W	4700.0	AGT	start cast
	09.03.05	16:35	65°0.79' S	43°0.41' W	4701.0		start trawling
	09.03.05	16:45	65°0.85' S	43°0.25' W	4704.0		stop trawling
	09.03.05	19:44	65°2.00' S	42°58.33' W	4695.0		end cast
110-3	09.03.05	20:34	64°59.96' S	43°2.04' W	4699.0	SPI	start cast
	09.03.05	21:48	64°59.96' S	43°1.99' W	4701.0		at depth
	09.03.05	23:50	64°59.99' S	43°1.96' W	4702.0		end cast
110-4	10.03.05	00:11	64°59.99' S	43°1.94' W	4703.0	MUC	start cast
	10.03.05	01:42	64°59.95' S	43°1.97' W	4700.0		at depth
	10.03.05	03:08	64°60.00' S	43°1.87' W	4700.0		end cast
110-5	10.03.05	03:33	65°0.05' S	43°2.15' W	4700.0	GKG	start cast
	10.03.05	05:00	65°0.00' S	43°2.01' W	4702.0		at depth
	10.03.05	06:28	65°0.06' S	43°1.88' W	4701.0		end cast
110-6	10.03.05	06:38	65°0.04' S	43°1.90' W	4702.0	MUC	start cast
	10.03.05	08:11	64°59.98' S	43°2.00' W	4700.0		at depth
	10.03.05	09:38	65°0.01' S	43°2.01' W	4700.0		end cast
110-7	10.03.05	09:49	65°0.00' S	43°2.00' W	4701.0	GKG	start cast
	10.03.05	11:15	65°0.01' S	43°1.99' W	4700.0		at depth
	10.03.05	12:38	64°59.98' S	43°2.05' W	4697.0		end cast
110-8	10.03.05	13:05	64°58.95' S	43°1.97' W	4701.0	EBS	start cast
	10.03.05	15:20	65°0.52' S	43°2.09' W	4698.0		start trawling
	10.03.05	15:30	65°0.68' S	43°2.16' W	4696.0		stop trawling
	10.03.05	17:52	65°1.44' S	43°2.09' W	4695.0		end cast
110-9	10.03.05	18:49	64°56.43' S	43°8.11' W	4693.0	ATC	released
	10.03.05	20:58	64°56.45' S	43°7.64' W	4699.0		end cast
110-10	10.03.05	21:45	65°0.02' S	43°2.16' W	4703.0	GKG	start cast
	10.03.05	23:14	65°0.02' S	43°1.97' W	4704.0		at depth
	11.03.05	00:39	65°0.07' S	43°1.95' W	4700.0		end cast
110-11	11.03.05	00:56	65°0.05' S	43°2.04' W	4701.0	CTD/RO	start cast
	11.03.05	02:27	65°0.02' S	43°2.01' W	4700.0		at depth
	11.03.05	03:25	65°0.02' S	43°1.94' W	4701.0		end cast



Station	Date	Time	Latitude	Longitude	Depth	Gear	Remark
110-12	11.03.05	03:38	64°59.52' S	43°1.82' W	4703.0	STR	start cast
	11.03.05	10:25	64°25.73' S	45°32.60' W	4486.0		end cast
111-1	11.03.05	10:42	64°25.72' S	45°32.77' W	4486.0	CTD/RO	start cast
	11.03.05	12:08	64°25.67' S	45°32.81' W	4483.0		at depth
	11.03.05	13:22	64°25.46' S	45°32.88' W	4491.0		end cast
112-1	11.03.05	15:02	64°21.38' S	46°4.60' W	4480.0	CTD/RO	start cast
	11.03.05	16:27	64°21.32' S	46°3.80' W	4479.0		at depth
	11.03.05	17:32	64°21.22' S	46°3.21' W	4475.0		end cast
112-2	11.03.05	17:39	64°21.53' S	46°3.97' W	4477.0	STR	start cast
	11.03.05	19:03	64°17.58' S	46°33.90' W	4434.0		end cast
113-1	11.03.05	19:33	64°17.21' S	46°39.08' W	4419.0	CTD/RO	start cast
	11.03.05	21:01	64°16.99' S	46°38.73' W	4420.0		at depth
	11.03.05	22:11	64°16.52' S	46°37.96' W	4419.0		end cast
114-1	12.03.05	00:15	64°12.52' S	47°11.43' W	4292.0	CTD/RO	start cast
	12.03.05	01:37	64°11.84' S	47°10.71' W	4294.0		at depth
	12.03.05	02:44	64°11.44' S	47°10.65' W	4294.0		end cast
115-1	12.03.05	05:07	64°7.83' S	47°45.24' W	4188.0	CTD/RO	start cast
	12.03.05	06:26	64°8.25' S	47°45.10' W	4187.0		at depth
	12.03.05	07:35	64°8.65' S	47°44.40' W	4190.0		end cast
116-1	12.03.05	10:17	64°4.54' S	48°17.23' W	3999.0	CTD/RO	start cast
	12.03.05	11:32	64°3.86' S	48°16.63' W	4013.0		at depth
	12.03.05	12:35	64°3.32' S	48°16.58' W	4021.0		end cast
117-1	12.03.05	23:34	63°58.51' S	48°50.68' W	3744.0	CTD/RO	start cast
	13.03.05	00:49	63°57.52' S	48°49.39' W	3733.0		at depth
	13.03.05	01:51	63°56.80' S	48°48.87' W	3711.0		end cast
118-1	13.03.05	06:23	63°53.23' S	49°26.40' W	3389.0	CTD/RO	start cast
	13.03.05	07:28	63°53.18' S	49°25.46' W	3385.0		at depth
	13.03.05	08:24	63°53.05' S	49°24.27' W	3381.0		end cast
119-1	13.03.05	12:12	63°45.72' S	49°52.83' W	2957.0	CTD/RO	start cast
	13.03.05	13:09	63°44.90' S	49°52.88' W	2943.0		at depth
	13.03.05	13:58	63°44.33' S	49°53.01' W	2927.0		end cast
120-1	13.03.05	17:19	63°47.01' S	50°18.07' W	2716.0	CTD/RO	start cast
	13.03.05	18:13	63°46.89' S	50°17.59' W	2718.0		at depth
	13.03.05	19:11	63°46.59' S	50°16.76' W	2726.0		end cast
121-1	13.03.05	21:32	63°45.67' S	50°53.19' W	2534.0	CTD/RO	start cast
	13.03.05	22:24	63°44.93' S	50°52.58' W	2539.0		at depth
	13.03.05	23:18	63°44.03' S	50°52.39' W	2545.0		end cast
121-2	13.03.05	23:35	63°44.68' S	50°50.75' W	2555.0	MOR	start deployment
	14.03.05	02:47	63°42.20' S	50°52.22' W	2544.0		end deployment
121-3	14.03.05	04:24	63°41.62' S	50°45.45' W	2597.0	SPI	start cast
	14.03.05	05:13	63°41.64' S	50°44.92' W	2602.0		at depth
	14.03.05	07:04	63°41.12' S	50°44.47' W	2606.0		end cast
121-4	14.03.05	07:18	63°41.04' S	50°44.51' W	2606.0	MUC	start cast
	14.03.05	08:08	63°40.99' S	50°44.29' W	2609.0		at depth
	14.03.05	09:00	63°41.09' S	50°44.31' W	2611.0		end cast
121-5	14.03.05	09:28	63°41.07' S	50°44.23' W	2610.0	GKG	start cast
	14.03.05	10:19	63°40.50' S	50°44.37' W	2611.0		at depth
	14.03.05	11:08	63°39.94' S	50°44.52' W	2610.0		end cast
121-6	14.03.05	11:22	63°39.74' S	50°44.48' W	2612.0	MUC	start cast
	14.03.05	12:17	63°39.01' S	50°44.23' W	2618.0		at depth
	14.03.05	13:11	63°38.31' S	50°43.59' W	2627.0		end cast
121-7	14.03.05	14:07	63°37.43' S	50°45.11' W	2603.0	AGT	start cast
	14.03.05	15:15	63°34.92' S	50°41.97' W	2616.0		start trawling

Station	Date	Time	Latitude	Longitude	Depth	Gear	Remark
	14.03.05	15:25	63°34.65' S	50°41.68' W	2617.0		stop trawling
	14.03.05	17:03	63°33.85' S	50°41.12' W	2614.0		end cast
121-8	14.03.05	20:22	63°42.25' S	50°52.25' W	2545.0	MOR	location
121-9	14.03.05	22:00	63°41.94' S	50°43.14' W	2621.0	GKG	start cast
	14.03.05	22:50	63°41.74' S	50°42.99' W	2621.0		at depth
	14.03.05	23:48	63°41.46' S	50°42.79' W	2624.0		end cast
121-10	15.03.05	01:24	63°38.62' S	50°37.67' W	2665.0	EBS	start cast
	15.03.05	02:34	63°37.73' S	50°38.09' W	2663.0		start trawling
	15.03.05	02:44	63°37.55' S	50°38.37' W	2659.0		stop trawling
	15.03.05	04:06	63°36.93' S	50°37.78' W	2658.0		end cast
121-11	15.03.05	04:44	63°36.52' S	50°37.18' W	2658.0	GKG	start cast
	15.03.05	05:32	63°36.19' S	50°37.15' W	2657.0		at depth
	15.03.05	06:28	63°36.02' S	50°37.26' W	2654.0		end cast
122-1	15.03.05	13:02	63°36.79' S	51°24.22' W	2179.0	CTD/RO	start cast
	15.03.05	13:45	63°36.52' S	51°24.03' W	2169.0		at depth
	15.03.05	14:27	63°36.23' S	51°24.00' W	2161.0		end cast
122-2	15.03.05	15:37	63°32.10' S	51°36.39' W	1866.0	STR	start cast
	15.03.05	16:27	63°28.17' S	51°50.68' W	1231.0		end cast
123-1	15.03.05	16:55	63°29.67' S	51°48.14' W	1329.0	CTD/RO	start cast
	15.03.05	17:25	63°29.47' S	51°48.11' W	1327.0		at depth
	15.03.05	18:01	63°29.43' S	51°48.60' W	1314.0		end cast
123-2	15.03.05	18:07	63°29.44' S	51°48.65' W	1311.0	NFLOAT	start cast
124-1	15.03.05	19:53	63°27.94' S	52°18.38' W	741.3	CTD/RO	start cast
	15.03.05	20:11	63°28.04' S	52°18.39' W	743.5		at depth
	15.03.05	20:32	63°28.13' S	52°18.37' W	746.3		end cast
125-1	15.03.05	22:24	63°22.75' S	52°49.32' W	468.1	CTD/RO	start cast
	15.03.05	22:38	63°22.75' S	52°49.69' W	467.0		at depth
	15.03.05	22:53	63°22.81' S	52°50.02' W	468.4		end cast
126-1	16.03.05	00:49	63°17.73' S	53°17.01' W	430.1	CTD/RO	start cast
	16.03.05	01:02	63°17.69' S	53°17.09' W	429.5		at depth
	16.03.05	01:16	63°17.65' S	53°17.18' W	429.8		end cast
127-1	16.03.05	04:25	63°13.69' S	53°41.27' W	334.8	CTD/RO	start cast
	16.03.05	04:36	63°13.71' S	53°41.15' W	338.3		at depth
	16.03.05	04:53	63°13.74' S	53°40.92' W	343.3		end cast
128-1	16.03.05	07:22	63°8.67' S	54°9.04' W	263.2	CTD/RO	start cast
	16.03.05	07:30	63°8.72' S	54°9.05' W	260.9		at depth
	16.03.05	07:40	63°8.76' S	54°9.01' W	261.8		end cast
129-1	16.03.05	09:26	63°3.92' S	54°37.14' W	457.4	CTD/RO	start cast
	16.03.05	09:37	63°3.79' S	54°37.34' W	440.3		at depth
	16.03.05	09:53	63°3.73' S	54°37.54' W	420.9		end cast
130-1	16.03.05	11:33	62°58.12' S	54°5.66' W	319.0	CTD/RO	start cast
	16.03.05	11:44	62°58.09' S	54°5.54' W	318.3		at depth
	16.03.05	11:55	62°58.09' S	54°5.44' W	317.8		end cast
131-1	16.03.05	13:33	62°52.65' S	53°34.36' W	379.8	CTD/RO	start cast
	16.03.05	13:43	62°52.48' S	53°34.14' W	371.4		at depth
	16.03.05	14:00	62°52.33' S	53°33.71' W	355.8		end cast
132-1	16.03.05	14:57	62°50.27' S	53°19.56' W	583.4	CTD/RO	start cast
	16.03.05	15:13	62°50.15' S	53°19.49' W	592.4		at depth
	16.03.05	15:32	62°50.19' S	53°19.60' W	588.5		end cast
133-1	16.03.05	16:54	62°47.54' S	53°3.86' W	1368.0	CTD/RO	start cast
	16.03.05	17:22	62°47.48' S	53°3.75' W	1383.0		at depth
	16.03.05	17:52	62°47.40' S	53°3.82' W	1391.0		end cast
133-2	16.03.05	18:35	62°46.95' S	53°1.72' W	1549.0	EBS	start cast

Station	Date	Time	Latitude	Longitude	Depth	Gear	Remark
	16.03.05	19:17	62°46.49' S	53°3.50' W	1584.0		start trawling
	16.03.05	19:27	62°46.38' S	53°3.98' W	1579.0		stop trawling
	16.03.05	20:13	62°46.23' S	53°4.54' W	1561.0		end cast
134-1	16.03.05	21:21	62°45.36' S	52°48.61' W	2514.0	CTD/RO	start cast
	16.03.05	22:10	62°45.30' S	52°49.02' W	2467.0		at depth
	16.03.05	22:53	62°45.41' S	52°49.17' W	2446.0		end cast
135-1	17.03.05	00:00	62°42.37' S	52°34.52' W	2839.0	CTD/RO	start cast
	17.03.05	00:54	62°42.51' S	52°34.56' W	2823.0		at depth
	17.03.05	01:44	62°42.67' S	52°34.45' W	2808.0		end cast
136-1	17.03.05	02:45	62°39.94' S	52°17.94' W	3042.0	CTD/RO	start cast
	17.03.05	03:43	62°40.05' S	52°17.84' W	3040.0		at depth
	17.03.05	04:39	62°40.07' S	52°17.35' W	3043.0		end cast
137-1	17.03.05	05:39	62°37.36' S	52°2.38' W	3122.0	CTD/RO	start cast
	17.03.05	06:39	62°37.77' S	52°2.03' W	3128.0		at depth
	17.03.05	07:31	62°38.12' S	52°1.48' W	3134.0		end cast
138-1	17.03.05	09:26	62°32.20' S	51°32.33' W	3284.0	CTD/RO	start cast
	17.03.05	10:29	62°32.34' S	51°32.81' W	3283.0		at depth
	17.03.05	11:25	62°32.50' S	51°32.90' W	3282.0		end cast
139-1	17.03.05	13:15	62°27.46' S	51°3.01' W	3373.0	CTD/RO	start cast
	17.03.05	14:20	62°27.48' S	51°2.62' W	3373.0		at depth
	17.03.05	15:27	62°27.49' S	51°2.65' W	3374.0		end cast
140-1	17.03.05	17:40	62°21.58' S	50°31.11' W	3408.0	CTD/RO	start cast
	17.03.05	18:45	62°21.36' S	50°30.10' W	3413.0		at depth
	17.03.05	19:37	62°21.31' S	50°29.65' W	3416.0		end cast
141-1	17.03.05	21:30	62°16.00' S	50°0.76' W	3448.0	CTD/RO	start cast
	17.03.05	22:37	62°15.43' S	50°0.04' W	3437.0		at depth
	17.03.05	23:36	62°15.11' S	49°59.67' W	3438.0		end cast
142-1	18.03.05	01:13	62°12.40' S	49°31.67' W	3411.0	ATC	deployed
142-2	18.03.05	01:39	62°10.93' S	49°32.10' W	3409.0	CTD/RO	start cast
	18.03.05	02:46	62°11.00' S	49°31.80' W	3407.0		at depth
	18.03.05	03:45	62°11.16' S	49°30.89' W	3409.0		end cast
142-3	18.03.05	03:56	62°11.18' S	49°30.61' W	3407.0	SPI	start cast
	18.03.05	05:02	62°11.28' S	49°29.80' W	3405.0		at depth
	18.03.05	06:58	62°11.85' S	49°28.99' W	3407.0		end cast
142-4	18.03.05	07:13	62°11.84' S	49°29.02' W	3407.0	MUC	start cast
	18.03.05	08:18	62°12.02' S	49°27.67' W	3408.0		at depth
	18.03.05	09:26	62°12.11' S	49°26.33' W	3403.0		end cast
142-5	18.03.05	09:46	62°11.65' S	49°27.68' W	3406.0	EBS	start cast
	18.03.05	11:18	62°11.21' S	49°29.40' W	3408.0		start trawling
	18.03.05	11:28	62°11.24' S	49°29.68' W	3405.0		stop trawling
	18.03.05	13:13	62°11.41' S	49°29.87' W	3405.0		end cast
142-6	18.03.05	13:47	62°12.49' S	49°25.17' W	3403.0	AGT	start cast
	18.03.05	15:21	62°9.93' S	49°30.47' W	3403.0		start trawling
	18.03.05	15:31	62°9.80' S	49°30.59' W	3404.0		stop trawling
	18.03.05	17:44	62°9.84' S	49°30.88' W	3406.0		end cast
142-7	18.03.05	18:30	62°11.08' S	49°29.68' W	3406.0	GKG	start cast
	18.03.05	19:31	62°11.61' S	49°29.45' W	3406.0		at depth
	18.03.05	20:37	62°12.12' S	49°28.14' W	3408.0		end cast
142-8	18.03.05	20:43	62°12.18' S	49°28.18' W	3407.0	ATC	released
	18.03.05	22:49	62°12.36' S	49°30.20' W	3413.0		recovered
142-9	18.03.05	23:17	62°11.09' S	49°29.49' W	3408.0	MUC	start cast
	19.03.05	00:20	62°10.67' S	49°28.87' W	3407.0		at depth
	19.03.05	01:30	62°10.36' S	49°28.45' W	3403.0		end cast

Station	Date	Time	Latitude	Longitude	Depth	Gear	Remark
142-10	19.03.05	01:47	62°10.27' S	49°28.28' W	3407.0	GKG	start cast
	19.03.05	02:47	62°10.36' S	49°28.43' W	3405.0		at depth
	19.03.05	03:53	62°10.51' S	49°27.86' W	3408.0		end cast
143-1	19.03.05	05:54	62°5.48' S	49°1.09' W	3395.0	CTD/RO	start cast
	19.03.05	07:00	62°5.75' S	49°0.57' W	3394.0		at depth
	19.03.05	07:56	62°6.05' S	49°0.26' W	3394.0		end cast
144-1	19.03.05	09:54	62°0.39' S	48°30.44' W	3339.0	CTD/RO	start cast
	19.03.05	10:59	62°0.21' S	48°30.45' W	3337.0		at depth
	19.03.05	11:50	62°0.14' S	48°30.53' W	3338.0		end cast
145-1	19.03.05	13:32	61°55.15' S	48°1.95' W	3251.0	CTD/RO	start cast
	19.03.05	14:35	61°55.18' S	48°1.96' W	3250.0		at depth
	19.03.05	15:33	61°55.22' S	48°2.05' W	3249.0		end cast
146-1	19.03.05	17:21	61°49.76' S	47°31.29' W	2528.0	CTD/RO	start cast
	19.03.05	18:09	61°49.76' S	47°30.84' W	2480.0		at depth
	19.03.05	18:51	61°49.52' S	47°30.76' W	2432.0		end cast
147-1	19.03.05	19:43	61°47.21' S	47°16.92' W	1402.0	CTD/RO	start cast
	19.03.05	20:11	61°47.12' S	47°16.64' W	1427.0		at depth
	19.03.05	20:40	61°47.02' S	47°16.45' W	1426.0		at depth
148-1	19.03.05	21:53	61°44.63' S	47°2.15' W	1284.0	ATC	deployed
148-2	19.03.05	22:15	61°44.36' S	47°1.04' W	1202.0	CTD/RO	start cast
	19.03.05	22:41	61°44.40' S	47°1.01' W	1199.0		at depth
	19.03.05	23:03	61°44.27' S	47°1.23' W	1215.0		end cast
149-1	20.03.05	00:40	61°39.45' S	46°32.81' W	464.1	CTD/RO	start cast
	20.03.05	00:54	61°39.51' S	46°32.73' W	466.0		at depth
	20.03.05	01:06	61°39.49' S	46°32.75' W	465.5		end cast
150-1	20.03.05	04:05	61°48.61' S	47°28.38' W	2018.0	SPI	start cast
	20.03.05	04:47	61°48.57' S	47°28.14' W	1982.0		at depth
	20.03.05	06:19	61°48.59' S	47°27.88' W	1967.0		end cast
150-2	20.03.05	06:31	61°48.61' S	47°27.70' W	1956.0	MUC	start cast
	20.03.05	07:10	61°48.59' S	47°27.45' W	1953.0		at depth
	20.03.05	07:51	61°48.56' S	47°27.45' W	1941.0		end cast
150-3	20.03.05	08:05	61°48.58' S	47°27.49' W	1943.0	GKG	start cast
	20.03.05	08:41	61°48.63' S	47°27.67' W	1956.0		at depth
	20.03.05	09:20	61°48.67' S	47°28.25' W	2030.0		end cast
150-4	20.03.05	09:27	61°48.60' S	47°28.34' W	2015.0	MUC	start cast
	20.03.05	10:10	61°48.46' S	47°28.69' W	2017.0		at depth
	20.03.05	10:50	61°48.63' S	47°28.59' W	2048.0		end cast
150-5	20.03.05	11:04	61°48.61' S	47°28.64' W	2045.0	GKG	start cast
	20.03.05	11:46	61°49.08' S	47°28.20' W	2151.0		at depth
	20.03.05	12:27	61°48.96' S	47°28.34' W	2150.0		end cast
150-6	20.03.05	12:50	61°49.20' S	47°27.50' W	1982.0	EBS	start cast
	20.03.05	13:43	61°48.70' S	47°28.04' W	1996.0		start trawling
	20.03.05	13:53	61°48.57' S	47°28.19' W	1993.0		stop trawling
	20.03.05	14:56	61°48.52' S	47°28.38' W	1999.0		end cast
150-7	20.03.05	15:25	61°50.01' S	47°26.53' W	1938.0	AGT	start cast
	20.03.05	16:21	61°48.32' S	47°28.45' W	1970.0		start trawling
	20.03.05	16:31	61°48.20' S	47°28.64' W	1954.0		stop trawling
	20.03.05	17:57	61°48.28' S	47°29.27' W	2022.0		end cast
150-8	20.03.05	18:37	61°48.60' S	47°27.37' W	1940.0	MUC	start cast
	20.03.05	19:14	61°48.56' S	47°27.48' W	1942.0		at depth
	20.03.05	19:55	61°48.49' S	47°27.85' W	1963.0		end cast
151-1	20.03.05	21:25	61°46.21' S	47°6.40' W	1188.0	AGT	start cast
	20.03.05	21:57	61°45.46' S	47°7.57' W	1181.0		start trawling

Station	Date	Time	Latitude	Longitude	Depth	Gear	Remark
	20.03.05	22:07	61°45.34' S	47°7.78' W	1188.0		stop trawling
	20.03.05	22:53	61°45.37' S	47°7.78' W	1188.0		end cast
151-2	20.03.05	23:17	61°45.56' S	47°7.41' W	1179.0	SPI	start cast
	20.03.05	23:40	61°45.58' S	47°7.48' W	1180.0		at depth
	21.03.05	01:00	61°45.64' S	47°7.99' W	1186.0		end cast
151-3	21.03.05	01:14	61°45.58' S	47°7.10' W	1175.0	MUC	start cast
	21.03.05	01:42	61°45.50' S	47°7.50' W	1180.0		at depth
	21.03.05	02:07	61°45.62' S	47°7.51' W	1180.0		end cast
151-4	21.03.05	02:21	61°45.47' S	47°7.67' W	1183.0	GKG	start cast
	21.03.05	02:45	61°45.50' S	47°7.57' W	1181.0		at depth
	21.03.05	03:09	61°45.57' S	47°7.52' W	1180.0		end cast
151-5	21.03.05	03:20	61°45.56' S	47°7.55' W	1180.0	MUC	start cast
	21.03.05	03:44	61°45.55' S	47°7.52' W	1180.0		at depth
	21.03.05	04:08	61°45.55' S	47°7.38' W	1179.0		end cast
151-6	21.03.05	04:27	61°45.56' S	47°7.49' W	1180.0	GKG	start cast
	21.03.05	04:52	61°45.55' S	47°7.56' W	1180.0		at depth
	21.03.05	05:16	61°45.59' S	47°7.40' W	1180.0		end cast
151-7	21.03.05	05:32	61°45.67' S	47°7.18' W	1179.0	EBS	start cast
	21.03.05	06:04	61°45.52' S	47°7.68' W	1182.0		start trawling
	21.03.05	06:14	61°45.42' S	47°8.04' W	1185.0		stop trawling
	21.03.05	06:51	61°45.32' S	47°8.14' W	1187.0		end cast
151-8	21.03.05	07:14	61°45.71' S	47°7.34' W	1181.0	MUC	start cast
	21.03.05	07:37	61°45.67' S	47°7.23' W	1179.0		at depth
	21.03.05	08:02	61°45.56' S	47°7.27' W	1180.0		end cast
151-9	21.03.05	09:37	61°44.74' S	47°2.12' W	1269.0	ATC	recovered
151-10	21.03.05	10:19	61°45.68' S	47°7.92' W	1183.0	STR	start cast
	22.03.05	14:31	62°17.29' S	58°40.92' W	437.7		end cast
152-1	23.03.05	00:46	62°20.06' S	57°54.11' W	1996.0	SPI	start cast
	23.03.05	01:25	62°20.00' S	57°53.98' W	1996.0		at depth
	23.03.05	02:56	62°19.98' S	57°54.01' W	1999.0		end cast
152-2	23.03.05	03:10	62°20.01' S	57°53.99' W	1998.0	MUC	start cast
	23.03.05	03:48	62°19.95' S	57°54.00' W	1996.0		at depth
	23.03.05	04:28	62°19.87' S	57°53.99' W	1998.0		end cast
152-3	23.03.05	04:46	62°20.10' S	57°54.24' W	1998.0	GKG	start cast
	23.03.05	05:25	62°19.98' S	57°54.02' W	1995.0		at depth
	23.03.05	06:06	62°19.88' S	57°53.81' W	1997.0		end cast
152-4	23.03.05	06:17	62°20.16' S	57°54.33' W	1997.0	MUC	start cast
	23.03.05	06:58	62°19.98' S	57°54.00' W	2000.0		at depth
	23.03.05	07:39	62°19.92' S	57°54.05' W	1998.0		end cast
152-5	23.03.05	07:59	62°19.98' S	57°53.88' W	1996.0	GKG	start cast
	23.03.05	08:40	62°19.94' S	57°53.88' W	1996.0		at depth
	23.03.05	09:17	62°19.91' S	57°53.74' W	1997.0		end cast
152-6	23.03.05	09:43	62°20.81' S	57°52.88' W	2001.0	EBS	start cast
	23.03.05	10:41	62°20.11' S	57°53.59' W	1996.0		start trawling
	23.03.05	10:51	62°19.96' S	57°53.78' W	1999.0		stop trawling
	23.03.05	11:54	62°19.80' S	57°53.44' W	1998.0		end cast
152-7	23.03.05	22:27	62°20.89' S	57°50.50' W	2006.0	AGT	start cast
	23.03.05	23:23	62°19.95' S	57°53.73' W	1998.0		start trawling
	23.03.05	23:33	62°19.87' S	57°54.09' W	1998.0		stop trawling
	24.03.05	00:54	62°19.85' S	57°53.87' W	1997.0		end cast
152-8	24.03.05	01:11	62°19.90' S	57°53.72' W	1995.0	CTD/RO	start cast
	24.03.05	01:49	62°19.85' S	57°53.80' W	1997.0		at depth
	24.03.05	02:35	62°19.71' S	57°53.88' W	1997.0		end cast

Station	Date	Time	Latitude	Longitude	Depth	Gear	Remark
152-9	24.03.05	03:07	62°22.45' S	58°4.20' W	1984.0	STR	start cast
	24.03.05	09:50	62°59.62' S	60°29.45' W	66.3		end cast
152-10	24.03.05	12:16	63°9.65' S	60°53.52' W	794.4	STR	start cast
	25.03.05	17:35	67°41.16' S	68°11.43' W	547.2		end cast
152-11	26.03.05	23:49	67°47.92' S	68°38.07' W	250.0	STR	start cast
	27.03.05	16:00	65°18.35' S	65°56.99' W	391.0		end cast
152-12	27.03.05	18:38	65°13.12' S	65°40.25' W	513.0	STR	start cast
	28.03.05	00:19	64°51.42' S	63°13.56' W	281.9		end cast
152-13	28.03.05	15:46	64°31.72' S	62°28.61' W	604.1	STR	start cast
	29.03.05	02:55	63°18.09' S	64°36.48' W	2158.0		end cast
153-1	29.03.05	03:00	63°18.17' S	64°36.57' W	2160.0	ATC	deployed
153-2	29.03.05	03:55	63°19.36' S	64°36.88' W	2087.0	SPI	start cast
	29.03.05	04:40	63°19.38' S	64°36.80' W	2079.0		at depth
	29.03.05	06:10	63°19.37' S	64°36.55' W	2068.0		end cast
153-3	29.03.05	06:36	63°19.34' S	64°36.96' W	2088.0	MUC	start cast
	29.03.05	07:16	63°19.41' S	64°36.77' W	2077.0		at depth
	29.03.05	07:57	63°19.34' S	64°36.78' W	2083.0		end cast
153-4	29.03.05	08:14	63°19.33' S	64°36.87' W	2087.0	GKG	start cast
	29.03.05	08:52	63°19.35' S	64°36.79' W	2079.0		at depth
	29.03.05	09:37	63°19.36' S	64°36.99' W	2092.0		end cast
153-5	29.03.05	09:43	63°19.37' S	64°36.98' W	2090.0	MUC	start cast
	29.03.05	10:22	63°19.41' S	64°36.82' W	2079.0		at depth
	29.03.05	11:04	63°19.39' S	64°37.04' W	2089.0		end cast
153-6	29.03.05	11:16	63°19.43' S	64°36.97' W	2080.0	GKG	start cast
	29.03.05	11:56	63°19.41' S	64°36.85' W	2081.0		at depth
	29.03.05	12:37	63°19.57' S	64°36.87' W	2063.0		end cast
153-7	29.03.05	12:57	63°19.86' S	64°36.37' W	2006.0	EBS	start cast
	29.03.05	13:51	63°19.31' S	64°36.94' W	2092.0		start trawling
	29.03.05	14:01	63°19.15' S	64°37.18' W	2118.0		stop trawling
	29.03.05	15:08	63°19.35' S	64°37.89' W	2102.0		end cast
153-8	29.03.05	15:50	63°21.16' S	64°36.43' W	1766.0	AGT	start cast
	29.03.05	16:48	63°19.21' S	64°37.07' W	2108.0		start trawling
	29.03.05	16:58	63°19.10' S	64°37.13' W	2124.0		stop trawling
153-9	29.03.05	18:40	63°19.03' S	64°37.21' W	2132.0	ATC	recovered
153-10	29.03.05	19:00	63°19.03' S	64°37.21' W	2130.0	STR	start cast
	29.03.05	23:57	62°35.44' S	64°36.76' W	3780.0		end cast
154-1	30.03.05	00:19	62°32.95' S	64°37.66' W	3741.0	ATC	deployed
154-2	30.03.05	00:47	62°31.35' S	64°39.84' W	3801.0	SPI	start cast
	30.03.05	01:54	62°31.50' S	64°39.52' W	3802.0		at depth
	30.03.05	03:47	62°31.49' S	64°39.72' W	3802.0		end cast
154-3	30.03.05	04:08	62°31.47' S	64°39.68' W	3802.0	MUC	start cast
	30.03.05	05:18	62°31.52' S	64°39.64' W	3801.0		at depth
	30.03.05	06:29	62°31.46' S	64°39.54' W	3801.0		end cast
154-4	30.03.05	06:47	62°31.53' S	64°39.69' W	3800.0	GKG	start cast
	30.03.05	07:54	62°31.46' S	64°39.42' W	3802.0		at depth
	30.03.05	09:07	62°31.51' S	64°39.78' W	3799.0		end cast
154-5	30.03.05	09:14	62°31.50' S	64°39.80' W	3797.0	MUC	start cast
	30.03.05	10:22	62°31.55' S	64°39.47' W	3801.0		at depth
	30.03.05	11:35	62°31.49' S	64°39.52' W	3801.0		end cast
154-6	30.03.05	11:48	62°31.51' S	64°39.51' W	3800.0	GKG	start cast
	30.03.05	12:55	62°31.50' S	64°39.54' W	3802.0		at depth
	30.03.05	14:06	62°31.53' S	64°39.72' W	3803.0		end cast
154-7	30.03.05	14:56	62°32.84' S	64°32.19' W	3922.0	AGT	start cast

Station	Date	Time	Latitude	Longitude	Depth	Gear	Remark
	30.03.05	16:39	62°31.37' S	64°40.20' W	3798.0		start trawling
	30.03.05	16:49	62°31.33' S	64°40.52' W	3799.0		stop trawling
	30.03.05	19:17	62°31.40' S	64°42.05' W	3807.0		end cast
154-8	30.03.05	20:31	62°33.46' S	64°37.57' W	3744.0	ATC	recovered
154-9	30.03.05	20:50	62°32.63' S	64°39.47' W	3774.0	EBS	start cast
	30.03.05	22:30	62°31.47' S	64°39.45' W	3804.0		start trawling
	30.03.05	22:40	62°31.36' S	64°39.25' W	3808.0		stop trawling
	31.03.05	00:33	62°31.80' S	64°38.47' W	3812.0		end cast
154-10	31.03.05	01:03	62°30.89' S	64°33.62' W	3914.0	STR	start cast
	31.03.05	23:30	60°54.84' S	53°54.57' W	904.7		end cast
155-1	31.03.05	23:55	60°53.23' S	53°50.45' W	830.8	CTD/RO	start cast
	01.04.05	00:13	60°53.30' S	53°50.36' W	831.2		at depth
	01.04.05	00:33	60°53.38' S	53°50.25' W	832.4		end cast
156-1	01.04.05	01:23	60°45.21' S	53°50.81' W	1636.0	CTD/RO	start cast
	01.04.05	01:53	60°45.42' S	53°51.07' W	1412.0		at depth
	01.04.05	02:20	60°45.61' S	53°51.03' W	1338.0		end cast
157-1	01.04.05	03:12	60°37.16' S	53°50.69' W	2806.0	CTD/RO	start cast
	01.04.05	04:07	60°37.28' S	53°50.50' W	2803.0		at depth
	01.04.05	04:52	60°37.19' S	53°49.84' W	2791.0		end cast
158-1	01.04.05	07:38	60°21.46' S	54°33.59' W	3288.0	CTD/RO	start cast
	01.04.05	08:40	60°21.36' S	54°33.10' W	3287.0		at depth
	01.04.05	09:33	60°21.37' S	54°33.12' W	3288.0		end cast
159-1	01.04.05	12:10	60°5.95' S	55°15.74' W	3524.0	CTD/RO	start cast
	01.04.05	13:17	60°5.90' S	55°16.18' W	3524.0		at depth
	01.04.05	14:14	60°5.85' S	55°16.34' W	3522.0		end cast
160-1	01.04.05	16:50	59°49.50' S	55°58.95' W	3585.0	CTD/RO	start cast
	01.04.05	17:58	59°49.72' S	55°59.54' W	3583.0		at depth
	01.04.05	18:56	59°50.11' S	56°0.89' W	3590.0		end cast
161-1	01.04.05	21:35	59°32.84' S	56°41.05' W	3579.0	CTD/RO	start cast
	01.04.05	22:42	59°33.04' S	56°41.34' W	3579.0		at depth
	01.04.05	23:40	59°33.36' S	56°41.60' W	3579.0		end cast
162-1	02.04.05	02:35	59°15.35' S	57°25.50' W	3621.0	CTD/RO	start cast
	02.04.05	03:43	59°15.19' S	57°25.64' W	3622.0		at depth
	02.04.05	04:45	59°15.35' S	57°25.53' W	3620.0		end cast
163-1	02.04.05	08:13	58°57.49' S	58°5.94' W	3785.0	CTD/RO	start cast
	02.04.05	09:25	58°57.38' S	58°5.72' W	3780.0		at depth
	02.04.05	10:27	58°57.32' S	58°5.90' W	3782.0		end cast
164-1	02.04.05	13:25	58°37.96' S	58°47.68' W	3915.0	CTD/RO	start cast
	02.04.05	14:38	58°38.29' S	58°47.40' W	3920.0		at depth
	02.04.05	15:40	58°38.23' S	58°47.46' W	3922.0		end cast
165-1	02.04.05	18:43	58°19.78' S	59°31.06' W	3266.0	CTD/RO	start cast
	02.04.05	19:42	58°19.86' S	59°30.66' W	3080.0		at depth
	02.04.05	20:32	58°19.82' S	59°30.61' W	3078.0		end cast
166-1	02.04.05	23:43	57°59.52' S	60°13.39' W	4507.0	CTD/RO	start cast
	03.04.05	01:09	57°59.63' S	60°13.30' W	4495.0		at depth
	03.04.05	02:17	57°59.59' S	60°13.68' W	4501.0		end cast
167-1	03.04.05	05:14	57°39.12' S	60°56.07' W	3435.0	CTD/RO	start cast
	03.04.05	06:19	57°38.88' S	60°56.13' W	3385.0		at depth
	03.04.05	07:18	57°38.82' S	60°56.38' W	3368.0		end cast
168-1	03.04.05	10:16	57°18.24' S	61°39.47' W	3793.0	CTD/RO	start cast
	03.04.05	11:28	57°18.16' S	61°39.39' W	3794.0		at depth
	03.04.05	12:28	57°18.18' S	61°39.53' W	3795.0		end cast
169-1	03.04.05	15:22	56°56.19' S	62°21.36' W	4112.0	CTD/RO	start cast

Station	Date	Time	Latitude	Longitude	Depth	Gear	Remark
	03.04.05	16:42	56°55.87' S	62°21.05' W	4100.0		at depth
	03.04.05	17:46	56°55.64' S	62°21.56' W	4104.0		end cast
170-1	03.04.05	20:40	56°33.31' S	63°4.32' W	4044.0	CTD/RO	start cast
	03.04.05	21:54	56°33.08' S	63°5.17' W	4045.0		at depth
	03.04.05	22:56	56°32.91' S	63°5.81' W	4044.0		end cast
171-1	04.04.05	01:38	56°9.68' S	63°45.96' W	4155.0	CTD/RO	start cast
	04.04.05	02:57	56°9.62' S	63°46.17' W	4163.0		at depth
	04.04.05	04:05	56°9.57' S	63°45.87' W	4162.0		end cast
172-1	04.04.05	07:09	55°45.10' S	64°29.50' W	3778.0	CTD/RO	start cast
	04.04.05	08:22	55°44.74' S	64°29.20' W	3795.0		at depth
	04.04.05	09:23	55°44.74' S	64°28.93' W	3796.0		end cast
173-1	04.04.05	10:43	55°36.73' N	64°43.87' E	3684.0	CTD/RO	start cast
	04.04.05	11:51	55°36.50' S	64°43.52' W	3699.0		at depth
	04.04.05	12:51	55°36.52' S	64°43.22' W	3706.0		end cast
174-1	04.04.05	15:33	55°28.13' S	64°57.50' W	2568.0	CTD/RO	at depth
	04.04.05	16:14	55°27.76' S	64°56.79' W	2560.0		start cast
	04.04.05	16:15	55°27.74' S	64°56.74' W	2556.0		end cast
175-1	04.04.05	17:26	55°20.51' S	65°11.44' W	1615.0	CTD/RO	start cast
	04.04.05	18:00	55°20.29' S	65°11.14' W	1618.0		at depth
	04.04.05	18:15	55°20.14' S	65°10.90' W	1626.0		end cast



## CCHDO Data Processing Notes

Date	Person	Data Type	Action	Summary
2010-08-02	<i>Carolina Berys</i>	CTD	Website Update	Available under 'Preliminary/Unprocessed'
		<b>Detailed Notes</b> CTD files submitted by Hannelore Witte on 2008-10-21 available under 'Preliminary/Unprocessed', unprocessed by CCHDO		
2010-08-02	<i>Carolina Berys</i>	Cruise Report	Website Update	Available under 'Preliminary/Unprocessed'
		<b>Detailed Notes</b> Cruise report (in German) downloaded from <a href="http://epic.awi.de/epic/Main?page=abstract&amp;static=yes&amp;language=english&amp;entry_dn=10538">http://epic.awi.de/epic/Main?page=abstract&amp;static=yes&amp;language=english&amp;entry_dn=10538</a> on 2010-08-02 available under 'Preliminary/Unprocessed', unprocessed by CCHDO.		
2010-08-02	<i>Carolina Berys</i>	Cruise ID	Website Update	Created Expocode, data directory
		<b>Detailed Notes</b> I created a new Expocode and cruise entry for A12 2005 [06AQ20050102], and a directory in /data/co2clivar/atlantic/a12/a12_06AQ20050102/.		
2012-07-23	<i>Bob Key</i>	BTL	Submitted	to go online
		<b>Detailed Notes</b> You have the CTD data and a copy (in Ger.) of the cruise report. When you process the CTDOXY values compare the CTD files to the values in the bottle file. The bottle file values are correct, but there were problems with earlier versions of the CTD data having uncalibrated CTDOXY.  I've requested the CFC data for this cruise. If it is submitted, I'll merge and send a new bottle file		
2012-07-30	<i>Carolina Berys</i>	BTL	Website Updated	Available under 'Files as received'
		<b>Detailed Notes</b> File 06AQ20050102.exc.csv containing bottle data, submitted by Bob Key on 2012-07-23, available under 'Files as received', unprocessed by CCHDO.		
2012-08-23	<i>CCHDO Staff</i>	BTL	Website Update	Available under 'Files as received'
		<b>Detailed Notes</b> The following files are now available online under 'Files as received', unprocessed by the CCHDO.  06AQ20050122.exc.csv		
2012-09-17	<i>CCHDO Staff</i>	BTL	Website Update	Available under 'Files as received'
		<b>Detailed Notes</b> The following files are now available online under 'Files as received', unprocessed by the CCHDO.  06AQ20050102.exc.csv		
2012-10-18	<i>Jerry Kappa</i>	CrsRpt	Submitted	PDF version ready to go online
		I've placed 1 new version of the cruise report:  a12_06AQ20050102do.pdf  into the co2clivar/atlantic/a12/a12_06AQ20050122/ directory.  It includes summary pages and CCHDO data processing notes as well as a linked Table of Contents and links to figures, tables and appendices.  It will be available on the cchdo website following the next update script run.		