



Meine Welt.  
Mein Zuhause.  
**2021**

GREEN LIVING

*Mon univers.  
Ma maison.  
Habitat vert*

*My world.  
My home.  
Green living*



**Faire encore mieux, ensemble.**

*EMSA Garten appartient depuis juillet 2020 au leader français du marché : Poétic SAS. Un portefeuille de produits unique, de nouveaux potentiels. Ensemble, nous offrons dès maintenant une variété de produits incomparable : depuis les bacs et pots de base en plastique recyclé jusqu'aux pots et fontaines déclinés en matériaux haut de gamme en passant par des solutions modernes d'agencement des plantes à l'intérieur et à l'extérieur. La variété sans complications.*

**Together even better**

*Since July 2020, EMSA Garden will be part of the French market leader Poétic SAS. Unique portfolio, new potential: Together we now stand for an incomparable product variety: From basic planters made of recycled plastic to state-of-the-art planting solutions for indoors and outdoors to high-quality premium containers and fountains. Versatile & uncomplicated.*

# ZUSAMMEN NOCH BESSER.

EMSA Garten gehört seit Juli 2020 zu dem französischen Marktführer Poétic SAS.

Einzigartiges Portfolio, neue Potenziale und starke Innovationen: Zusammen stehen wir ab sofort für eine unvergleichliche Produktvielfalt. Von Basic-Pflanzgefäßen aus recyceltem Kunststoff über moderne Pflanzlösungen für Indoor & Outdoor bis hin zu hochwertigen Premium Gefäßen und Brunnen. Vielfältig & unkompliziert.



NOUVEAUTÉS  
TENDANCE  
TRENDY NEW ITEMS

# NEUHEITEN IM TREND

## AUTHENTISCHE OBERFLÄCHEN

Täuschend echte Oberflächen im Industrial Design:  
CASA Authentic greift mit Beton- und Cortenstahl-  
Optik den Trend der industriellen Baustoffe auf.  
Für ein modernes Ambiente – Indoor und Outdoor.



CORTEN STEEL

### MATIÈRES AUTHENTIQUES

L'alliance de matières semblant parfaitement authentiques et du design industriel : avec son effet béton et acier Corten, CASA Authentic s'inscrit dans la tendance des matériaux de construction industriels. Pour une ambiance moderne, à l'intérieur comme à l'extérieur.

### AUTHENTIC SURFACES

Deceptively real surfaces in industrial design: CASA Authentic picks up the latest trend of industrial building materials with its concrete and corten steel look. For a modern atmosphere – indoor and outdoor.



CONCRETE

## LANDHAUS

### IRRIGATION EN ÉTÉ

Les températures record et les vagues de chaleur exigent un effort accru pour l'entretien des plantes. Toutefois, la célèbre jardinière de balcon LANDHAUS garantit plus de confort grâce au système d'irrigation AQUA COMFORT qu'elle intègre désormais. Arrosages moins fréquents et croissance optimale garantie !

### WATERING IN THE SUMMER

Record temperatures and heat waves demand greater effort in plant care. The popular LANDHAUS balcony box with the newly integrated AQUA COMFORT watering system provides even greater levels of comfort. Less watering, guaranteed best growth!



# 2

## BEWÄSSERUNG IM SOMMER

Rekordtemperaturen und Hitzewellen erfordern erhöhten Aufwand bei der Pflanzenpflege. Mehr Komfort schafft hingegen der beliebte LANDHAUS Balkonkasten mit neu integriertem AQUA COMFORT Bewässerungssystem. Weniger Gießen, garantiert bestes Wachstum!

## HANA



# 3 LANGLEBIGKEIT

Hochwertiges Material & zeitloses Design – HANA steht für stilvolle Bewässerung. Aus gebürstetem, rostfreien Edelstahl gefertigt, hat sie das Potenzial zum echten Design-Klassiker. Langlebigkeit in ihrer schönsten Form.

### LONGÉVITÉ

*Matériau de haute qualité et design intemporel : HANA est synonyme d'irrigation stylée. Fabriqué en acier inoxydable brossé, il a le potentiel pour devenir un véritable classique du design. La longévité dans toute sa splendeur.*

### DURABILITY

*High quality material & timeless design – HANA stands for stylish watering. Made of brushed, stainless steel, it has the potential to become a true design classic. Durability in its most beautiful form.*

## LOFT



# 4 RETRO LOOK

Die 70er Jahre modern interpretiert: Dezent Farbakzente in Rauchglas-Optik sind voll im Trend. Unsere beliebten LOFT Gießer gibt es jetzt in natürlich anmutenden Rauchglas-Farben. Für den modernen Retrolook.

### LOOK RÉTRO

*Une interprétation moderne des années 1970 : la tendance est aux touches de couleur discrètes avec effet verre fumé. Nos célèbres arrosoirs LOFT sont désormais déclinés en coloris verre fumé empreints de naturalité. Pour un look rétro moderne.*

### RETRO-LOOK

*A modern interpretation of the 70s: Subtle colour accents in smoked glass look are totally in style. Our popular LOFT watering cans are now available in natural-looking smoked glass colours. For the contemporary retro-look.*

# INHALT

## CONTENU / CONTENT

### BEWÄSSERUNG

L'ARROSAGE / WATERING

AQUA COMFORT 9

AQUA PLUS 9

### 01 CASA 10

**NEW** CASA AUTHENTIC 14

CASA COSY 18

CASA MESH 24

CASA MAT & BRILLIANT 30

### **NEW** 02 LANDHAUS 36

### 03 MY CITY GARDEN 58

Pflanzgefäße  
Bac à fleurs / Planter 60

Rankhilfen  
Treillages / Trellis solutions 68

Geländer-Lösungen  
Balustrade / Railing Solution 76

### 04 COUNTRY 84

LAGO 88

BALCONE 90

TERRA GRANDE 92

SIENA NOBILE 94

### 05 FRESH HERBS 96

### 06 Flower Care 102

**NEW** HANA 104

**NEW** LOFT 106

FUCHSIA 110

OASE 116

### 07 Brackets 120

Kastenhalter  
Accroches / Brackets 122

### 08 Add on 126



# WENIGER GIESSEN, GARANTIERT BESTES WACHSTUM

*Arrosages moins fréquents et croissance optimale garantie .  
Less watering, guarantees best growth.*



## AQUA PLUS

- Die Grundausstattung.**
- Drainageplatte gegen Staunässe
  - Großes Wasserreservoir
  - Spezialvlies (funktioniert nach dem Docht-Prinzip, ohne Granulat!)
  - Direkte Bewässerung über das Substrat

- L'équipement de base.**
- Plaque de drainage
  - Réservoir grande capacité
  - Feutre spécial
  - Irrigation directe sur le substrat

- The basic set.**
- Drainage plate
  - Large water tank
  - Special padding
  - Water directly over the substrate

CASA ▶ S. 29  
MY CITY GARDEN ▶ S. 79



## AQUA COMFORT

- Die Vollausstattung.**
- zusätzlich mit Wasserstandsanzeige mit Füllschacht

- L'équipement complet.**
- en plus avec Indicateur de niveau d'eau avec entonnoir

- The full range.**
- additionally with water level indicator with filling chamber

CASA ▶ S. 12  
LANDHAUS ▶ S. 36  
MY CITY GARDEN ▶ S. 58  
LAGO ▶ S. 89  
FRESH HERBS ▶ S. 96





*Un design moderne associé à une irrigation fiable : au-delà de l'exceptionnelle technique d'irrigation mise au point par EMSA, les bacs à plantes CASA séduisent par la netteté de leurs lignes et la modernité de leur aspect, allant du mat au brillant en passant par les structures Mesh et Cosy, sans oublier les matières Authentic, véritables trompe-l'œil.*

*Modern design meets reliable watering: CASA planters convince with their straightforward design and contemporary look combined with the excellent EMSA watering technology: From mat and brilliant to the textures Mesh and Cosy and the deceptively genuine Authentic surfaces.*



# CASA

Modernes Design trifft auf zuverlässige Bewässerung. CASA Pflanzgefäße überzeugen durch klares Design und moderne Optik kombiniert mit der ausgezeichneten EMSA Bewässerungstechnik: Von Mat und Brilliant über die Strukturen Mesh und Cosy bis hin zu den täuschend echten Oberflächen Authentic.

# MODERNES DESIGN, AUSGEZEICHNETE BEWÄSSERUNG.

*Design moderne, irrigation exceptionnelle.  
Modern design, excellent watering.*

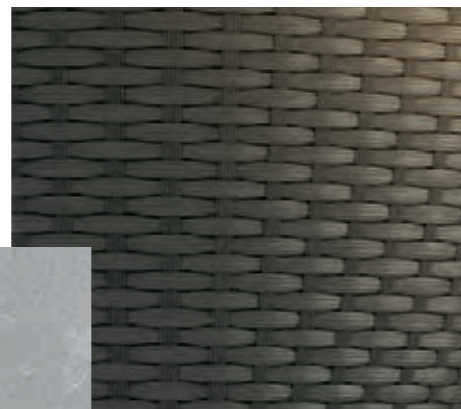
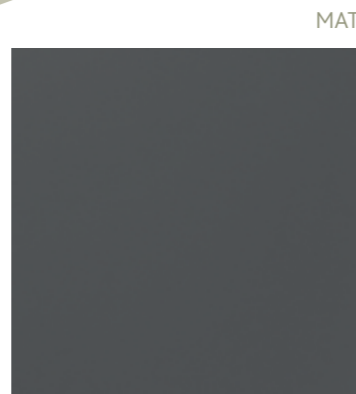
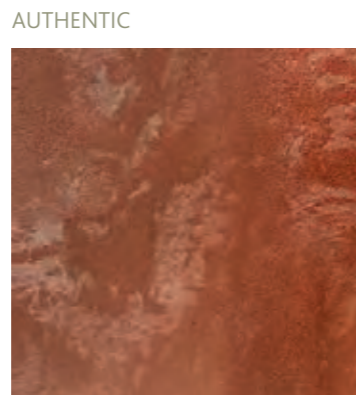

MADE IN GERMANY

## 1. RELEVANTE OBERFLÄCHEN

IMPORTANCE DES FINITIONS PROPOSÉES  
RELEVANT SURFACES

## 2. LANGZEIT-BEWÄSSERUNG

POIGNÉES INTÉGRÉES RETRAIT SIMPLE DES INSERTS  
LONG-TERM IRRIGATION

### „BEWÄSSERT ZUVERLÄSSIG ...“

Inklusive intelligentem Bewässerungssystem: weniger Gießen, keine Staunässe – und die Pflanze nimmt sich genau die Menge Wasser, die sie braucht.

« IRRIGATION FIABLE ... »

Inclus système d'irrigation intelligent : moins d'arrosages, pas d'eau stagnante, et la plante prélève l'exacte quantité d'eau dont elle a besoin.

"RELIABLE WATERING ..."

Including intelligent watering system: less work watering, no waterlogging – and the plant takes exactly the amount of water it needs.



## 3. IN- UND OUTDOOR

- Inkl. Ablauf, kein Aufbohren erforderlich
- Kunststoffschraube mit Dichtring für einfaches Verschließen – ganz ohne Werkzeug

Utilisation simplifiée à l'intérieur et à l'extérieur

- Ouvertures d'écoulement effectuées en usine, le perçage devient inutile
- Nouvelle vis en plastique avec joint d'étanchéité pour une fermeture simple sans outil

indoor & outdoor use

- Supplied with open drainage hole, so no more drilling required
- New plastic screw with sealing ring, making

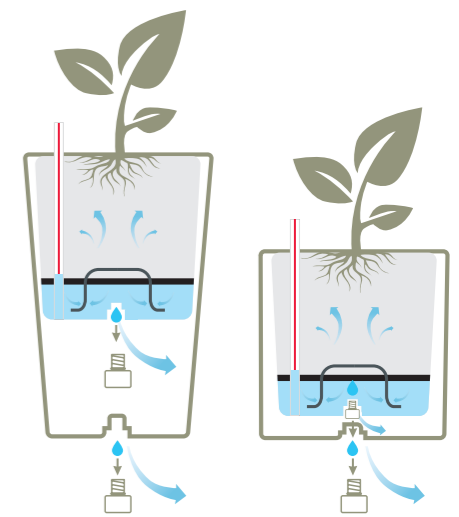

## 4. DURCHDACHTE SYSTEMLÖSUNGEN

Praktischer Pflanzeinsatz. Einfaches Handling durch integrierte Griffmulden.



DES SOLUTIONS INGÉNIERES

Poignées intégrées – Retrait simple des inserts de plantation sans travail de montage supplémentaire.

SOPHISTICATED SYSTEM SOLUTIONS

Integrated recessed handles Make it easy to remove the inserts without any additional assembly effort.





MADE IN GERMANY

NEW

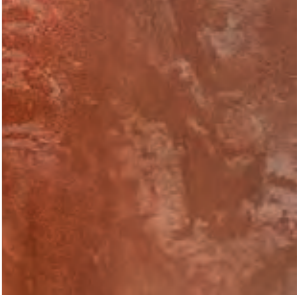

*Moderne. Urban. Authentique. L'alliance de matières semblant parfaitement authentiques et du design industriel : CASA Authentic effet béton et acier Corten pour un style moderne et épuré.*

*Modern. Urban. Authentic. Deceptively real surfaces in Industrial Design - CASA Authentic in concrete and corten steel look for a sharp, modern look.*

Modern. Urban. Authentisch. Täuschend echte Oberflächen im Industrial Design – CASA Authentic in Beton- und Cortenstahl-Optik für einen klaren, modernen Look.

# CASA AUTHENTIC



# CONCRETE & CORTEN STEEL



« Irrigation fiable... »  
"Reliable watering..."

„BEWÄSSERT  
ZUVERLÄSSIG...“

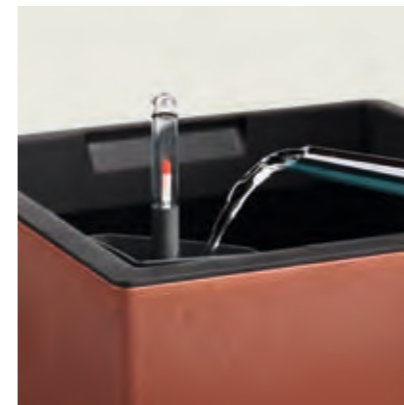

## CASA AUTHENTIC

Säule / Bac à fleurs / Planter

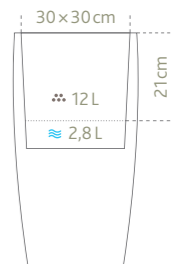

COLOUR	CM <sup>1)</sup>	L <sup>2)</sup> 3)	C-CODE	EAN	VPE <sup>4)</sup>
concrete	30x30x58	≈ 12 ≈ 2,8	BCAUP3058CI	3 1 678 90 0174 13	1
corten steel	30x30x58	≈ 12 ≈ 2,8	BCAUP3058COR	3 1 678 90 0174 20	1



●●●  
MADE IN  
GERMANY

Hochwertige Kunststoffgefäße für Indoor & Outdoor

Des bacs en plastique de haute qualité pour un usage intérieur et extérieur.  
High-quality plastic containers for indoor & outdoor use

1) LxBxH / l x l x h / l x w x h 2) Erdvolumen / Volume de terre / Soil volume  
3) Wasserreservoir / Réservoir d'eau / Water reservoir 4) VPE / UE / Unit

Une réinterprétation de la convivialité et de la matérialité. CASA COSY, la réponse à la tendance en faveur d'une modernité empreinte de sérénité. L'alliance d'un design fort et de la technique d'irrigation éprouvée d'EMSA : le choix idéal aussi bien à l'extérieur qu'à l'intérieur.

Comfort and materiality redefined. CASA COSY: our response to the modern comfort trend. Strong design combined with EMSA's proven watering technology – perfect for indoor and outdoor use.



MADE IN GERMANY



# CASA COSY

Gemütlichkeit und Stofflichkeit neu interpretiert. CASA COSY als Antwort auf den Trend der modernen Geborgenheit. Starkes Design kombiniert mit bewährter EMSA Bewässerungstechnik – ideal für Indoor und Outdoor.



●●●  
MADE IN  
GERMANY



Mit verbessertem Bewässerungs-Kit –  
praktisch eingeschweißt

*Perfectionnement pratique apporté  
au kit d'irrigation qui est maintenant soudé*

*Improved watering kit –  
shrink-wrapped for convenience*



**CASA COSY**  
Blumenkübel / Bac à fleurs / Planter

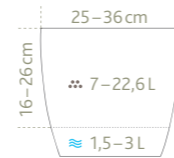

COLOUR	CM <sup>1)</sup>	L <sup>2)</sup> <sup>3)</sup>	C-CODE	EAN	VPE <sup>4)</sup>
white	25×22	≈ 7 ≈ 1,5	PCCO25BL	3 167890 013828	3
	30×27	≈ 12,6 ≈ 2,1	PCCO30BL	3 167890 013859	3
	36×33	≈ 22,6 ≈ 3	PCCO36BL	3 167890 013880	2
granite	25×22	≈ 7 ≈ 1,5	PCCO25GRA	3 167890 013835	3
	30×27	≈ 12,6 ≈ 2,1	PCCO30GRA	3 167890 013866	3
	36×33	≈ 22,6 ≈ 3	PCCO36GRA	3 167890 013897	2
silk grey	25×22	≈ 7 ≈ 1,5	PCCO25GS	3 167890 013842	3
	30×27	≈ 12,6 ≈ 2,1	PCCO30GS	3 167890 013873	3
	36×33	≈ 22,6 ≈ 3	PCCO36GS	3 167890 013903	2



1) Ø×H / Øh / Ø×h 2) Erdvolumen / Volume de terre / Soil volume  
3) Wasserreservoir / Réservoir d'eau / Water reservoir



MADE IN GERMANY



**CASA COSY**  
Würfel / Bac à fleurs / Planter

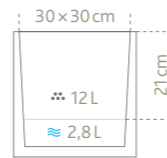

COLOUR	CM <sup>1)</sup>	L <sup>2)</sup> <sup>3)</sup>	C-CODE	EAN	VPE <sup>4)</sup>
white	30x30x31	12 ≈ 2,8	BCCO30BL	3 167890 013958	1
granite	30x30x31	12 ≈ 2,8	BCCO30GRA	3 167890 013965	1
silk grey	30x30x31	12 ≈ 2,8	BCCO30GS	3 167890 013989	1



1) L x B x H / l x l x h / l x w x h 2) Erdvolumen / Volume de terre / Soil volume  
3) Wasserreservoir / Réservoir d'eau / Water reservoir 4) VPE / UE / Unit



**CASA COSY**  
Säule / Bac à fleurs / Planter

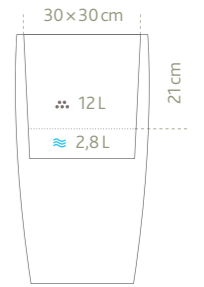

COLOUR	CM <sup>1)</sup>	L <sup>2)</sup> <sup>3)</sup>	C-CODE	EAN	VPE <sup>4)</sup>
white	30x30x58	12 ≈ 2,8	BCCOP3058BL	3 167890 013910	1
granite	30x30x58	12 ≈ 2,8	BCCOP3058GRA	3 167890 013927	1
silk grey	30x30x58	12 ≈ 2,8	BCCOP3058GS	3 167890 013941	1



1) L x B x H / l x l x h / l x w x h 2) Erdvolumen / Volume de terre / Soil volume  
3) Wasserreservoir / Réservoir d'eau / Water reservoir 4) VPE / UE / Unit



# CASA MESH

Hochwertige Oberfläche – clevere Details. Made in Germany

*Finition de haute qualité – détails astucieux. Made in Germany*  
*High-quality finish – ingenious details. Made in Germany*



## CASA MESH

Würfel / Bac à fleurs / Planter

COLOUR	CM <sup>1)</sup>	L <sup>2)</sup> <sup>3)</sup>	C-CODE	EAN	VPE <sup>4)</sup>
white	30×30×31	12 2,8	BCME30BL	3 167890 013996	1
granite	30×30×31	12 2,8	BCME30GRA	3 167890 014009	1
mocca	30×30×31	12 2,8	BCME30MK	3 167890 014016	1

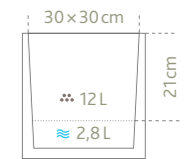

## CASA MESH

Säule / Bac à fleurs / Planter

COLOUR	CM <sup>1)</sup>	L <sup>2)</sup> <sup>3)</sup>	C-CODE	EAN	VPE <sup>4)</sup>
white	30×30×58	12 2,8	BCMEP3058BL	3 167890 014023	1
granite	30×30×58	12 2,8	BCMEP3058GRA	3 167890 014030	1
mocca	30×30×58	12 2,8	BCMEP3058MK	3 167890 014047	1

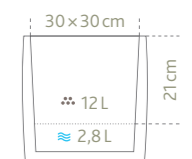

1) L×B×H / l×l×h / l×w×h 2) Erdvolumen / Volume de terre / Soil volume  
 3) Wasserreservoir / Réservoir d'eau / Water reservoir 4) VPE / UE / Unit

●●●  
MADE IN  
GERMANY



« Irrigation fiable... »  
"Reliable watering..."

**„BEWÄSSERT  
ZUVERLÄSSIG...“**



## PERFECT MATCH! DER PASSENDE HALTER ZUM KASTEN.

Accroche de jardinière assortie.  
Matching brackets for window boxes.



### CASA MESH / MY CITY GARDEN Blumenkastenhalter / Accroches / Metal brackets

COLOUR	C-CODE	EAN	VPE <sup>4)</sup>
○ white	SUPJCMEMCGBL	3 167890 1017055	10
● aluminium	SUPJCMEMCGAL	3 167890 1017062	10
● anthracite	SUPJCMEMCGANT	3 167890 1017079	10



**10 / 15,6 L**  
50 cm 75 cm

Großes Pflanzvolumen!  
Grand volume de plantation!  
Generous planting volume!



### CASA MESH

Blumenkasten / Jardinière / Window box

COLOUR	CM <sup>1)</sup>	L <sup>2)</sup> 3)	C-CODE	EAN	VPE <sup>4)</sup>
○ white	50×20×18	≈ 10 ≈ 2,5	JCME50BL	3 167890 014054	5
	75×20×18 <sup>5)</sup>	≈ 15,6 ≈ 4	JCME75BL	3 167890 014061	5
● granite	50×20×18	≈ 10 ≈ 2,5	JCME50GRA	3 167890 014078	5
	75×20×18 <sup>5)</sup>	≈ 15,6 ≈ 4	JCME75GRA	3 167890 014085	5
● mocca	50×20×18	≈ 10 ≈ 2,5	JCME50MK	3 167890 014092	5
	75×20×18 <sup>5)</sup>	≈ 15,6 ≈ 4	JCME75MK	3 167890 014108	5

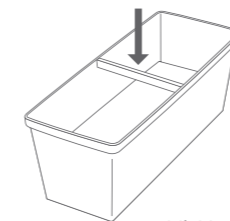

75 cm  
Mit Verstärkungsstrebe

Avec traverse de renfort  
With reinforcement rod



1) LxBxH / l×l×h / l×w×h 2) Erdvolumen / Volume de terre / Soil volume  
3) Wasserreservoir / Réservoir d'eau / Water reservoir 4) VPE / UE / Unit.  
5) Mit Verstärkungsstrebe / Avec traverse de renfort / With reinforcement rod

MADE IN GERMANY



Für mehr Informationen sprechen Sie uns gerne an.

*Veillez contacter votre interlocuteur pour de plus amples informations.  
Please contact your Sales Representative for further information.*

### CASA / CITY

Warenträger / Présentoir / Product displays

CM <sup>1)</sup>	C-CODE	EAN	VPE <sup>4)</sup>
65x70x249	POS002717	3 167890 004031	1
unbestückt / non garni / items not included			

### CASA 30 cm

Bestückungsvorschlag / Proposition de composition / Display suggestion  
80 x Geländertopf / Pot pour balustrade / Railing pot

30x30 cm ○ 20 ● 20 ● 40

### CASA MESH

Geländertopf / Pot pour balustrade / Railing pot

COLOUR	CM <sup>1)</sup>	L <sup>2)</sup> / L <sup>3)</sup>	C-CODE	EAN	VPE <sup>4)</sup>
white	30x30x26	9 0,6	PBCME30BL	3 167890 014122	5
granite	30x30x26	9 0,6	PBCME30GRA	3 167890 014139	5
moCCA	30x30x26	9 0,6	PBCME30MK	3 167890 014146	5



Container proof

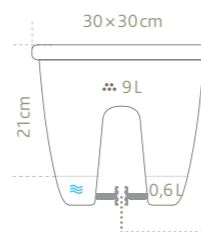
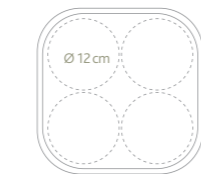

6 cm Ø max. Geländerbreite

Largeur de balustrade max.  
Max. railing width

1) L x B x H / l x l x h / l x w x h 2) Erdvolumen / Volume de terre / Soil volume  
3) Wasserreservoir / Réservoir d'eau / Water reservoir 4) VPE / UE / Unit

\*Quelle: Produkttest CITY Geländertopf mit 60 Testern vom 30.03.-24.05.2015 /  
\*Source: test de produit pour le pot pour balustrade CITY, panel de 60 testeurs du 30 mars au 24 mai 2015 /  
\*Source: Product test - CITY railing pot with 60 testers (30 March - 24 May 2015)

95 %



WEITEREMPFEHLUNG\*  
AUTRE RECOMMANDATION\*  
RECOMMENDATION\*



3-fach überzeugend!  
Triplement séduisant ! / 3-times convincing!

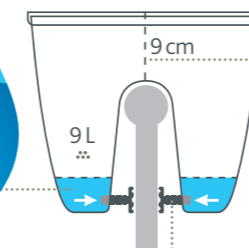

Großes Pflanzvolumen auch im Mittelteil

Grande profondeur de plantation même dans la partie centrale  
Large planting volume also in the centre part

Fixierschraube

Vis de fixation  
Fixing screw



# CASA

## MAT & BRILLIANT

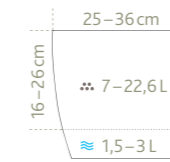

### CASA BRILLIANT

Blumenkübel / Bac à fleurs / Planter

COLOUR	CM <sup>1)</sup>	L <sup>2)</sup> <sup>3)</sup>	C-CODE	EAN	VPE <sup>4)</sup>
white	25x22	≈ 7 ≈ 1,5	PCBR25BL	3 167890 014153	3
	30x27	≈ 12,6 ≈ 2,1	PCBR30BL	3 167890 014160	3
	36x33	≈ 22,6 ≈ 3	PCBR36BL	3 167890 014177	2
granite	25x22	≈ 7 ≈ 1,5	PCBR25GRA	3 167890 014184	3
	30x27	≈ 12,6 ≈ 2,1	PCBR30GRA	3 167890 014191	3
	36x33	≈ 22,6 ≈ 3	PCBR36GRA	3 167890 014214	2
ruby	25x22	≈ 7 ≈ 1,5	PCBR25RU	3 167890 014221	3
	30x27	≈ 12,6 ≈ 2,1	PCBR30RU	3 167890 014238	3
	36x33	≈ 22,6 ≈ 3	PCBR36RU	3 167890 014245	2
silk grey	25x22	≈ 7 ≈ 1,5	PCBR25GS	3 167890 014252	3
	30x27	≈ 12,6 ≈ 2,1	PCBR30GS	3 167890 014269	3
	36x33	≈ 22,6 ≈ 3	PCBR36GS	3 167890 014276	2



Mit verbessertem Bewässerungs-Kit – praktisch eingeschweißt

*Perfectionnement pratique apporté au kit d'irrigation qui est maintenant soudé*

*Improved watering kit – shrink-wrapped for convenience*

### CASA BRILLIANT

Säule / Bac à fleurs / Planter

COLOUR	CM <sup>1)</sup>	L <sup>2)</sup> <sup>3)</sup>	C-CODE	EAN	VPE <sup>4)</sup>
white	30x30x58	≈ 12 ≈ 2,8	BCBRP3058BL	3 167890 014283	1
granite	30x30x58	≈ 12 ≈ 2,8	BCBRP3058GRA	3 167890 014290	1
ruby	30x30x58	≈ 12 ≈ 2,8	BCBRP3058RU	3 167890 014313	1
silk grey	30x30x58	≈ 12 ≈ 2,8	BCBRP3058GS	3 167890 014320	1

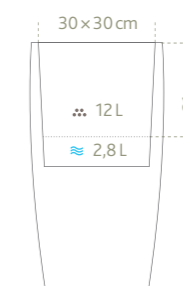

1) Ø×H / Øh / Ø×h 2) Erdvolumen / Volume de terre / Soil volume  
3) Wasserreservoir / Réservoir d'eau / Water reservoir 4) L×B×H / l×x×h / l×w×h





●●●  
MADE IN  
GERMANY



### CASA MAT

Würfel / Bac à fleurs / Planter

COLOUR	CM <sup>1)</sup>	L <sup>2)</sup> <sup>3)</sup>	C-CODE	EAN	VPE <sup>4)</sup>
white	30x30x31	12 2,8	BCMA30BL	3 167890 014337	1
granite	30x30x31	12 2,8	BCMA30GRA	3 167890 014344	1
silk grey	30x30x31	12 2,8	BCMA30GS	3 167890 014368	1

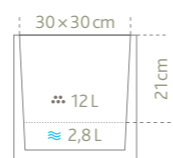

### CASA MAT

Säule / Bac à fleurs / Planter

COLOUR	CM <sup>1)</sup>	L <sup>2)</sup> <sup>3)</sup>	C-CODE	EAN	VPE <sup>4)</sup>
white	30x30x58	12 2,8	BCMAP3058BL	3 167890 014375	1
granite	30x30x58	12 2,8	BCMAP3058GRA	3 167890 014382	1
silk grey	30x30x31	12 2,8	BCMAP3058GS	3 167890 014399	1

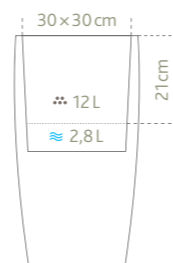

1) L x B x H / l x l x h / l x w x h 2) Erdvolumen / Volume de terre / Soil volume  
3) Wasserreservoir / Réservoir d'eau / Water reservoir 4) VPE / UE / Unit



# POINT OF SALE

Von der Regalplatzierung bis hin zu individuellen, flexiblen Lösungen. Wir beraten Sie gerne!



*Du placement en rayon aux solutions individuelles et flexibles. Nous serons ravis de vous conseiller !*

*From shelf placement to individual, flexible solutions. We would be pleased to advise you!*

Für mehr Informationen sprechen Sie uns gerne an.

*Veillez contacter votre interlocuteur pour de plus amples informations sur le matériel PLV.*

*Please contact your Sales Representative for further information on POS material.*



# SORTIMENTSÜBERSICHT

VUE D'ENSEMBLE DE L'ASSORTIMENT / PRODUCT OVERVIEW

## CASA COSY

○	●	●	25×22 cm	
○	●	●	30×27 cm	
○	●	●	36×33 cm	
○	●	●	30×30×31 cm	
○	●	●	30×30×58 cm	

## CASA MESH

○	●	●	30×30×31 cm	
○	●	●	30×30×58 cm	
○	●	●	75×20×18 cm	
○	●	●	50×20×18 cm	
○	●	●	30×30×26 cm	

## CASA BRILLIANT

○	●	●	●	25×22 cm	
○	●	●	●	30×27 cm	
○	●	●	●	36×33 cm	
○	●	●	●	30×30×58 cm	

## CASA MAT

○	●	●	30×30×31 cm	
○	●	●	30×30×58 cm	

NEW

## CASA AUTHENTIC

●	●	30×30×58 cm	
---	---	-------------	--

white granite mocca ruby silk grey concrete corten steel

# ORIGINAL Landhaus

MADE IN  
GERMANY

*Look unique et irrigation fiable pour une conscience verte. Ce classique arborant son célèbre motif de barrière en bois présente aujourd'hui une durabilité accrue. Fabriqué en plastique recyclé, il intègre désormais une réserve d'eau pour une utilisation particulièrement efficace des précieuses eaux de pluie et d'arrosage.*

*Distinctive appearance & reliable watering for a green conscience. The classic design in popular picket-fence look is now even more sustainable. Made of recycled plastic and now with integrated water reservoir for the particularly efficient use of precious watering and rainwater.*



NEW



- NEU in jedem Landhausblumenkasten:**
- Drainage-Platte gegen Staunässe und als zusätzlicher Wasserspeicher
  - Inkl. wiederverschließbarem Überlauf
  - Mit Wasserstandsanzeiger und Füllschacht

- NOUVEAU pour toutes les jardinières LANDHAUS :**
- Plaque de drainage évitant la stagnation de l'eau et constituant une réserve d'eau supplémentaire
  - Avec trop-plein refermable avec Indicateur de niveau d'eau avec entonnoir

- NEW in every LANDHAUS window box:**
- Drainage plate against waterlogging and as additional water reservoir
  - Incl. reclosable overflow
  - With water level indicator with filling chamber



Unverwechselbare Optik & zuverlässige Bewässerung für ein grünes Gewissen. Der Klassiker in beliebter Lattenzaun-Optik ist jetzt noch nachhaltiger. Aus recyceltem Kunststoff und neu mit integriertem Wasserspeicher für die besonders effiziente Nutzung von kostbarem Gieß- und Regenwasser.



MADE WITH  
**RECYCLED  
PLASTIC**

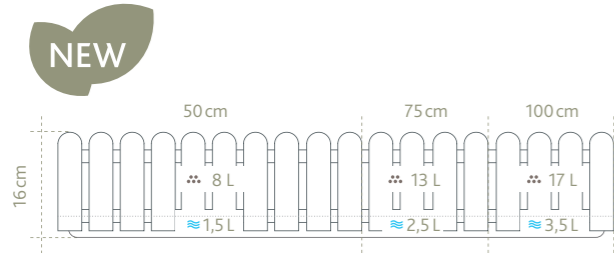

**LANDHAUS BLUMENKASTEN**

Jardinière / Window box

COLOUR	CM <sup>1)</sup>	L <sup>2)</sup>	C-CODE	EAN	VPE <sup>3)</sup>
yellow	50x20x16	8 1,5	JLHAC50J	3 167890 017604	5
	75x20x16	13 2,5	JLHAC75J	3 167890 017680	5
	100x20x16	17 3,5	JLHAC100AN	3 167890 017765	5
green	50x20x16	8 1,5	JLHAC50AN	3 167890 017611	5
	75x20x16	13 2,5	JLHAC75AN	3 167890 017697	5
	100x20x16	17 3,5	JLHAC100AN	3 167890 017765	5
granite	50x20x16	8 1,5	JLHAC50GRA	3 167890 017628	5
	75x20x16	13 2,5	JLHAC75GRA	3 167890 017703	5
	100x20x16	17 3,5	JLHAC100GRA	3 167890 017772	5
silk grey	50x20x16	8 1,5	JLHAC50GS	3 167890 017635	5
	75x20x16	13 2,5	JLHAC75GS	3 167890 017710	5
	100x20x16	17 3,5	JLHAC100GS	3 167890 017789	5
white	50x20x16	8 1,5	JLHAC50BL	3 167890 017642	5
	75x20x16	13 2,5	JLHAC75BL	3 167890 017727	5
	100x20x16	17 3,5	JLHAC100BL	3 167890 017796	5
laurel green	50x20x16	8 1,5	JLHAC50VL	3 167890 017659	5
	75x20x16	13 2,5	JLHAC75VL	3 167890 017734	5
smoky brown	50x20x16	8 1,5	JLHAC50MK	3 167890 017666	5
	75x20x16	13 2,5	JLHAC75MK	3 167890 017741	5
red violet	50x20x16	8 1,5	JLHAC50FR	3 167890 017673	5
	75x20x16	13 2,5	JLHAC75FR	3 167890 017758	5

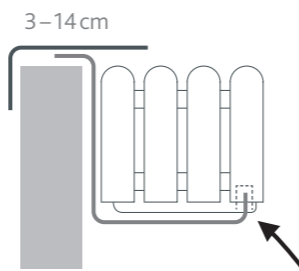

Verdeckte Aufnahme für Blumenkastenhalterung

Dispositif de fixation invisible pour support de jardinière.  
Concealed mount for window box brackets.



**LANDHAUS BLUMENKASTENHALTER**  
Accroches / Metal brackets

COLOUR	C-CODE	EAN	VPE <sup>3)</sup>
white	SUPJLHBL	3 167890 014870	10
aluminium	SUPJLHAL	3 167890 014887	10



**LANDHAUS 75 cm**

1/4 Display bestückt\* / 1/4 Présentoir garni\* / 1/4 Display stand equipped\*

CM <sup>1)</sup>	C-CODE	EAN	VPE <sup>2)</sup>
120x80x105	BOX880	3 167890 017826	1

Bestückung / Composition / Content

35 x Blumenkasten / Jardinière / Window box

● 5 ● 5 ● 5 ● 5 ● 15

**LANDHAUS 50 cm**

1/4 Display bestückt\* / 1/4 Présentoir garni\* / 1/4 Display stand equipped\*

CM <sup>1)</sup>	C-CODE	EAN	VPE <sup>2)</sup>
120x80x105	BOX879	3 167890 017819	1

Bestückung / Composition / Content

55 x Blumenkasten / Jardinière / Window box

● 10 ● 5 ● 5 ● 5 ● 30

**LANDHAUS 50/75 cm Mix**

1/4 Display bestückt\* / 1/4 Présentoir garni\* / 1/4 Display stand equipped\*

CM <sup>1)</sup>	C-CODE	EAN	VPE <sup>2)</sup>
120x80x105	BOX878	3 167890 017802	1

Bestückung / Composition / Content

20 x Blumenkasten 50 cm /  
Jardinière 50 cm / Window box 50 cm

● 5 ● 5 ● 10

20 x Blumenkasten 75 cm /  
Jardinière 75 cm / Window box 75 cm

● 5 ● 5 ● 10

1) L x B x H / l x l x h / l x w x h 2) VPE / UE / Unit

\*Abbildung ähnlich / Semblable à l'illustration / Picture similar



**LANDHAUS KÖRBCHEN**  
*Bac à fleurs / Planter*

COLOUR	CM <sup>1)</sup>	L <sup>2)</sup>	C-CODE	EAN	VPE <sup>3)</sup>
yellow	28×18×14	... 3,5	PALH28J		5
green	28×18×14	... 3,5	PALH28AN		5
silk grey	28×18×14	... 3,5	PALH28GS		5
white	28×18×14	... 3,5	PALH28BL		5
laurel green	28×18×14	... 3,5	PALH28VL		5
smoky brown	28×18×14	... 3,5	PALH28MK		5
red violet	28×18×14	... 3,5	PALH28FR		5



1) L×B×H / l×l×h / l×w×h 2) Erdvolumen / Volume de terre / Soil volume 3) VPE / UE / Unit

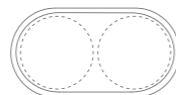
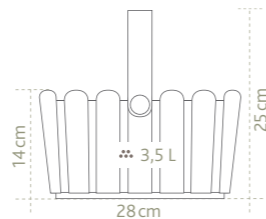

Container proof  
2×Ø 12 cm

**MADE IN GERMANY**

**LANDHAUS FÄSSCHEN**  
*Bac à fleurs / Planter*

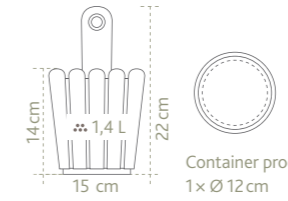

COLOUR	CM <sup>1)</sup>	L <sup>2)</sup>	C-CODE	EAN	VPE <sup>3)</sup>
yellow	15×22	... 1,4	PSULH15J		5
green	15×22	... 1,4	PSULH15AN		5
silk grey	15×22	... 1,4	PSULH15GS		5
white	15×22	... 1,4	PSULH15BL		5
laurel green	15×22	... 1,4	PSULH15VL		5
smoky brown	15×22	... 1,4	PSULH15MK		5
red violet	15×22	... 1,4	PSULH15FR		5



**MADE IN GERMANY**



Für Geländer mit max.  
6 cm Durchmesser

Pour les balustrades d'un diamètre  
max. de 6 cm / For railings with a  
diameter of max. 6 cm (2.36 in.)



**ZUBEHÖRHAKEN GELÄNDER**  
*Crochets pour accessoires / Accessory Hooks*

COLOUR	CONTENT	CM <sup>1)</sup>	C-Code	EAN	VPE <sup>3)</sup>
aluminium	3 St./pc.	7×11	3CRO6AL		10

18/10

1) B×H / l×h / w×h 2) Erdvolumen / Volume de terre / Soil volume  
3) VPE / UE / Unit 4) L×B×H / l×l×h / l×w×h



MADE IN GERMANY

**LANDHAUS JARDINIÈRE**  
Jardinière / Jardinière

COLOUR	CM <sup>1)</sup>	L <sup>2)</sup>	C-CODE	EAN	VPE <sup>3)</sup>
yellow	39x15x19	... 4,3	JLH40J	3 167890 014597	5
green	39x15x19	... 4,3	JLH40AN	3 167890 014603	5
silk grey	39x15x19	... 4,3	JLH40GS	3 167890 014610	5
white	39x15x19	... 4,3	JLH40BL	3 167890 014627	5
laurel green	39x15x19	... 4,3	JLH40VL	3 167890 014641	5
smoky brown	39x15x19	... 4,3	JLH40MK	3 167890 014658	5
red violet	39x15x19	... 4,3	JLH40FR	3 167890 014665	5

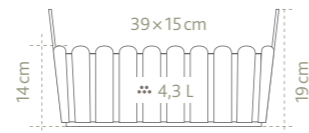

**LANDHAUS BLUMENKÜBEL rund**  
Bac à fleurs ronde / Planter round

COLOUR	CM <sup>2)</sup>	L <sup>3)</sup>	C-CODE	EAN	VPE <sup>4)</sup>
white	30x27	... 11	PLH30BL	3 167890 014917	5

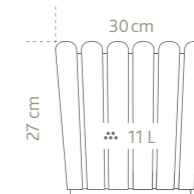

**LANDHAUS BLUMENKÜBEL eckig**  
Bac à fleurs angulaire / Planter rectangular

COLOUR	CM <sup>1)</sup>	L <sup>3)</sup>	C-CODE	EAN	VPE <sup>4)</sup>
white	38x38x31	... 22	BLH38BL	3 167890 014948	3

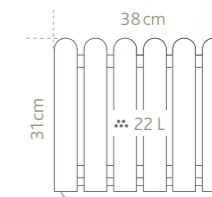

1) LxBxH // l x l x h // l x w x h 2) Erdvolumen / Volume de terre / Soil volume 3) VPE / UE / Unit

1) LxBxH // l x l x h // l x w x h 2) BxH // l x h // w x h 3) Erdvolumen / Volume de terre / Soil volume 4) VPE / UE / Unit

Aufmerksamkeitsstark:  
Original Geländertopf im Topschild  
platziert

Pouvoir d'attraction : bac d'origine placé dans le présentoir  
Eye-catching: original railing pot positioned in the display



**LANDHAUS RAILING POT**

½ Display bestückt / ½ Présentoir garni /  
½ Display stand equipped

CM <sup>1)</sup>	C-CODE	EAN	VPE <sup>3)</sup>
80 x 60 x 110	BOX866	3 1 6 7 8 9 0 0 1 4 9 5 5	1

Content / Composition / Contenuto della confezione

48 x Railing pot  
Pot pour balustrade / Fioriera da ringhiera

● 6 ○ 18 ● 12 ● 12

**LANDHAUS GELÄNDERTOPF**

Warenträger unbestückt / Présentoir non garni /  
Product displays items not included

CM <sup>1)</sup>	C-CODE	EAN	VPE <sup>3)</sup>
65 x 70 x 249	POS002717	3 1 6 7 8 9 6 0 0 4 0 3 1	1

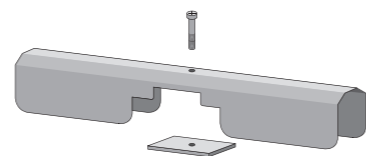

► Rüstsatz für LANDHAUS Geländertopf\*  
Kit pour pot pour balustrade LANDHAUS\*  
Assembly kit for LANDHAUS railing pot\*  
C-Code POS002746

\*Für komplette Bestückung mit LANDHAUS  
Geländertöpfen 4 x Rüstsatz notwendig  
Pour le garnissage complet avec LANDHAUS  
To be filled with LANDHAUS



**9,2L**

Großes Pflanzvolumen  
Grand volume de plantation!  
Generous planting volume!

MADE IN  
GERMANY

**LANDHAUS GELÄNDERTOPF**

Pot pour balustrade / Railing pot

COLOUR	CM <sup>1)</sup>	L <sup>2)</sup>	C-CODE	EAN	VPE <sup>3)</sup>
green	30 x 30 x 21	∞ 4,3	PBLH30AN	3 1 6 7 8 9 0 0 1 4 9 6 2	5
granite	30 x 30 x 21	∞ 4,3	PBLH30GRA	3 1 6 7 8 9 6 0 1 4 9 7 9	5
silk grey	30 x 30 x 21	∞ 4,3	PBLH30GS	3 1 6 7 8 9 0 0 1 4 9 8 6	5
white	30 x 30 x 21	∞ 4,3	PBLH30BL	3 1 6 7 8 9 0 0 1 4 9 9 3	5
laurel green	30 x 30 x 21	∞ 4,3	PBLH30VL	3 1 6 7 8 9 0 0 1 5 0 0 6	5
red violet	30 x 30 x 21	∞ 4,3	PBLH30FR	3 1 6 7 8 9 0 0 1 5 0 1 3	5

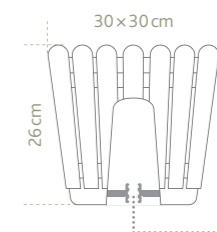
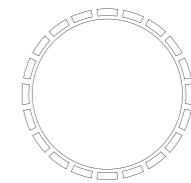

6cm Ø  
max. Geländerbreite

Largeur de balustrade max.  
Max. railing width



1) L x B x H / l x l x h / l x w x h 2) Erdvolumen / Volume de terre / Soil volume 3) VPE / UE / Unit



MADE WITH  
**RECYCLED  
PLASTIC**

# POINT OF SALE

Emotionale Konzepte – attraktiv,  
aufmerksamkeitsstark und leicht zu inszenieren.



Für detaillierte Informationen sprechen  
Sie bitte unseren Verkaufsmitarbeiter an.

*Des concepts émotionnels dans une mise en scène simple, séduisante et génératrice d'achats coup de cœur. Veuillez contacter votre interlocuteur pour de plus amples informations sur le matériel PLV.*

*Emotional concepts – attractive, striking and easy presentation. Please contact your Sales Representative for further information on POS material.*

## SORTIMENTSÜBERSICHT

VUE D'ENSEMBLE DE L'ASSORTIMENT  
PRODUCT OVERVIEW

Kleingefäße / Les petits pots / Small containers

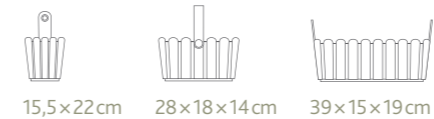

Geländertopf / Pot pour balustrade / Railing pot

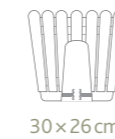

**NEW** Blumenkästen / Jardinières / Window boxes

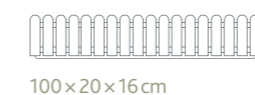
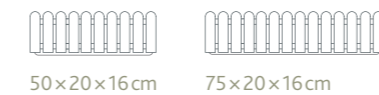

Großgefäße / Grands bacs / Large planters

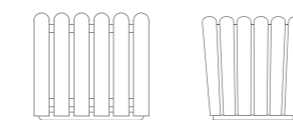

38 x 38 x 31 cm    30 x 27 cm

granite    white    green    silk grey    yellow    laurel green    red violet    smoky brown





Vivre plus vert!  
Live greener!



# VOGELWELT

Materialvorteil Kunststoff. Absolut witterungsbeständig.  
Leicht und gründlich zu reinigen. Unbedenklich für Tier  
und Umwelt: Ohne BPA. 100 % recyclingfähig.  
Vielfach preisgekrönt!

Avantage du matériau plastique. 100 % résistant  
aux intempéries. Légèreté et facilité de nettoyage.  
Sans risque pour les animaux et l'environnement.  
Sans bisphénol A. 100 % recyclable. Récompensé  
par de nombreux prix!

Advantages of plastic. Completely weatherproof.  
Cleans easily and thoroughly. Safe for animals and  
the environment: BPA-free. 100 % recyclable.  
Winner of multiple awards!

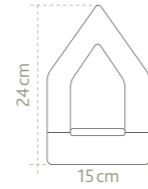

### LANDHAUS FUTTERSILLO

Mangeoire silo pour oiseaux / Bird feed dispenser

COLOUR	CM <sup>1)</sup>	C-CODE	EAN	VPE <sup>2)</sup>
granite	15×10×24	DGLHGRA	3 167890 015020	4
white / granite	15×10×24	DGLHBLGRA	3 167890 015037	4
green	15×10×24	DGLHAN	3 167890 015044	4
antique blue	15×10×24	DGLHBLP	3 167890 015051	4
laurel green	15×10×24	DGLHVL	3 167890 015068	4

Enthält recyceltes Material, ausgenommen transparente Bestandteile  
Contient des matériaux recyclés, sauf les éléments transparents  
Contains recycled material, except transparent components



# 100%



WEITEREMPFEHLUNG\*  
AUTRE RECOMMANDATION\*  
RECOMMENDATION\*

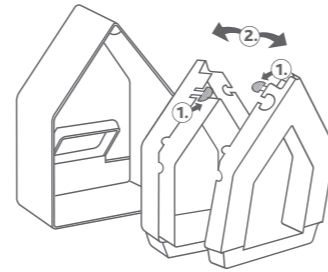

Jederzeit klar im Blick: der Füllstand.  
Immer einfach: schnell aufgefüllt und gereinigt.

Toujours nettement visible : le niveau de remplissage. Extrêmement simple : remplissage et nettoyage rapides.

Filling level is clearly visible at all times. Always easy to use: quick to fill and clean.

## 3 FACH AUSGEZEICHNET!

Triple prime d'excellence!  
Winner of 3 awards!



reddot award 2016 winner



MADE IN GERMANY



En été : utilisable comme bain pour oiseaux ou source supplémentaire de nourriture. En hiver : en y répandant des aliments ou en y mettant des boules de graisse.

In summer: use as a bird bath or for bird feed. In winter: use to feed birds with bird seeds or a fat ball.

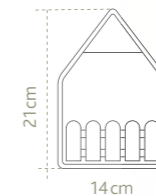

### LANDHAUS FUTTERHAUS

Mangeoire à oiseaux / Bird feeder

COLOUR	CM <sup>1)</sup>	C-CODE	EAN	VPE <sup>2)</sup>
granite	14×15×21	MLHGRA	3 167890 015075	4
green	14×15×21	MLHAN	3 167890 015082	4
antique blue	14×15×21	MLHBLP	3 167890 015099	4
laurel green	14×15×21	MLHVL	3 167890 015105	4
smoky brown	14×15×21	MLHMK	3 167890 015112	4



1) L×B×H / l×l×h / l×w×h 2) VPE / UE / Unit

\*Produktionsumstellung in 2020, Herbst/Winter 2019 noch in alter Aufmachung. / Changement de production en 2020, ancienne présentation encore pour automne / hiver 2019. / Production changeover in 2020; old format still used for autumn / winter 2019.

\*\*Quelle: Produkttest LANDHAUS Futtersilo und LANDHAUS Geländerhalter mit 60 Testern vom 23.01.–26.03.2017 /

\*\*Source : Test de produit de la mangeoire silo LANDHAUS et du support d'accroche sur balustrade LANDHAUS, apanel de 60 testeurs du 23 janvier au 26 mars 2017 /

\*\*Source: product tests carried out by 60 testers on the LANDHAUS bird feed dispenser and LANDHAUS railing bracket between 23 January and 26 March 2017



Doppelter Boden für optimale Belüftung. Besonders hygienisch: leichte und gründliche Reinigung.

*La double base LANDHAUS pour une aération optimale. Particulièrement hygiénique : légèreté et facilité de nettoyage.*

*Double base for optimum ventilation. Remarkably hygienic: easy and thorough cleaning.*

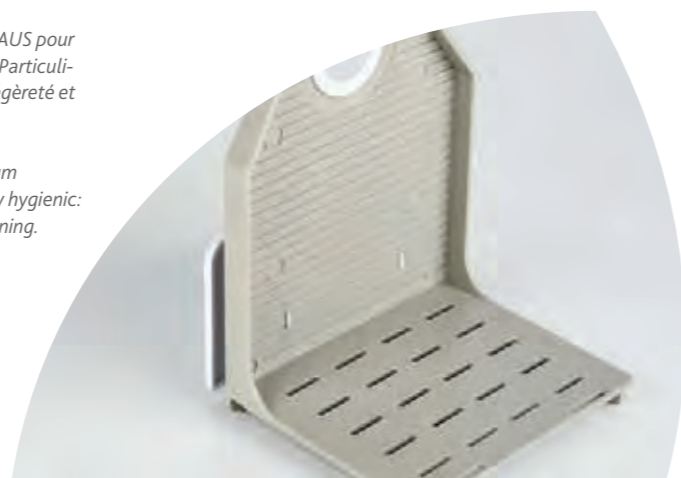

reddot award 2014  
winner



MADE IN  
GERMANY

Ideal für viele **Kleinsingvögel**: Die 3 cm Öffnung.  
Kompetent: Mit **Ornithologen** entwickelt.  
Zuverlässiger **Schutz**: Besonders bei feuchter Witterung.



*Parfaite pour les petits oiseaux chanteurs : l'ouverture de 3 cm. Compétence : produit mis au point avec des ornithologues. Une protection efficace : notamment par temps humide.*

*Perfect for small song birds: 3 cm opening. Expert design: developed in cooperation with ornithologists. Reliable protection: especially in wet weather.*

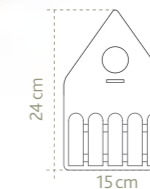

## LANDHAUS NISTKASTEN

Nichoir / Bird House

COLOUR	CM <sup>1)</sup>	C-CODE	EAN	VPE <sup>2)</sup>
 white / granite	15×16×24	NLHBLGRA	3 1 67890 015129	4
 white / green	15×16×24	NLHBLAN	3 1 67890 015136	4
 white / antique blue	15×16×24	NLHBLBP	3 1 67890 015143	4
 silk grey	15×16×24	NLHGS	3 1 67890 015150	4



1) L×B×H / l×l×h / l×w×h 2) VPE / UE / Unit



CONTAINS  
**RECYCLED  
PLASTIC**



Perfekte Lösung für jeden Stadtbalkon!  
Auch für Fallrohre geeignet.

*Solution parfaite pour tous les balcons d'appartements!  
Aussi pour les descentes de gouttières.*

*The perfect solution for every city balcony!  
Also suitable for downpipes.*

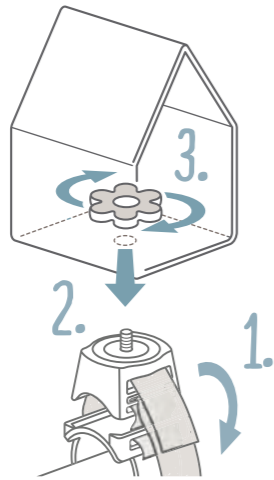

### LANDHAUS GELÄNDERHALTERUNG

Accroche pour balustrade / Railing holder

COLOUR	CM <sup>1)</sup>	C-CODE	EAN	VPE <sup>3)</sup>
anthracite	6×4×4	FXBNLHANT	3 1 6 7 8 9 0 0 1 5 2 2 8	10



1) LxBxH / l×x×h / l×w×h 2) l×w / l×l / B×H 3) VPE / UE / Unit

### LANDHAUS

Einsatz für LANDHAUS Kübel / Insert pour bac à fleurs  
LANDHAUS / Insert for LANDHAUS planter

CM <sup>2)</sup>	C-CODE	EAN	VPE <sup>3)</sup>
31×31	POS002709	3 1 6 7 8 9 0 0 0 3 9 5 9	1

unbestückt / non garni / items not included

Bestückungsvorschlag / Proposition de composition / Display suggestion

16× Stabhalterung / Fixation sur potence / 16× Rod holder

LANDHAUS Kübel sowie Stäbe nicht enthalten / Bac LANDHAUS et tasseaux non inclus / LANDHAUS cube and rods not included



Insert for  
LANDHAUS planter

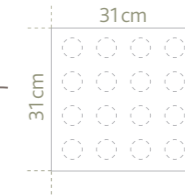

Alle LANDHAUS Vogelprodukte können frei-hängend oder an der Wand montiert werden. Weitere praktische Anbringungsmöglichkeiten finden Sie hier:

*Tous les produits pour oiseaux LANDHAUS peuvent être suspendus ou montés sur un mur. Vous trouverez ici d'autres options de montage pratiques :*

*All LANDHAUS bird products can be hung or mounted on the wall. You'll find more practical mounting options here:*

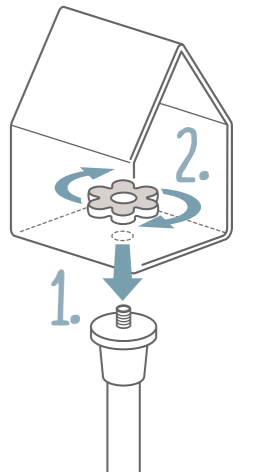
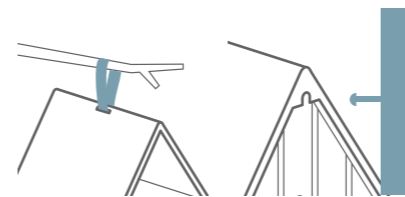

### LANDHAUS STABHALTERUNG

Fixation sur potence / Rod holder

COLOUR	CM <sup>2)</sup>	C-CODE	EAN	VPE <sup>3)</sup>
wood / white	2,5×160	FXPNLHBL	3 1 6 7 8 9 0 0 1 5 2 3 5	10



Inkl. Holzstab / Avec potence en bois / Incl. wooden rod



Des solutions bien pensées, des détails particuliers – MY CITY GARDEN représente l'association astucieuse de bacs à plantes contemporains, de pots à suspendre et de tuteurs pour plantes grimpantes.

Sophisticated solutions with unique details – MY CITY GARDEN is all about the ingenious combination of modern planters, attractive hanging planters and trellises.



# MY CITY GARDEN

Durchdachte Lösungen, besondere Details – MY CITY GARDEN steht für die clevere Kombination von modernen Pflanzgefäßen, attraktiven Hängegefäßen und Rankhilfen. Ideal für das Begrünen von kleinen Flächen – und perfekt aufeinander abgestimmt. Die Antwort auf den Trend des 'Urban Gardening'!



# 100%

★ ★ ★ ★ ★

**WEITEREMPFEHLUNG**  
AUTRE RECOMMANDATION  
RECOMMENDATION

Emsa Produkttest mit MY CITY GARDEN  
Produkten 03.04. – 28.05.2017

Test des produits d'EMSA pour la gamme  
MY CITY GARDEN 3 avril – 28 mai 2017

EMSA product test on MY CITY GARDEN  
products 3 April to 28 May 2017

# IM TREND: ALLES FÜR DEN PERFEKTEN STADTGARTEN

TENDANCE : TOUT POUR UN JARDIN URBAIN PARFAIT  
ON TREND: EVERYTHING FOR THE PERFECT CITY GARDEN

## 1 PFLANZEN

Zeitloses Sortiment der relevantesten Pflanzgefäße für Balkon und Terrasse – mit durchdachten Details.



Assortiment coup de cœur avec système d'agencement.

Compact basic range of timeless planters for balconies and terraces.



Schön bis ins Detail:  
Florales Muster auf den Untersetzern.

Esthétique dans le moindre détail : motif floral sur les soucoupes.  
Beautiful down to the very last detail. Floral pattern on the tray.



## 2 STÜTZEN

Abgestimmte Metalllösungen für die Wandbegrünung und das Gärtnern in der Stadt.

Solutions métalliques harmonisées pour la végétalisation des murs et le jardinage en ville.

Coordinated metal solutions for wall plants and city gardening.

## 3 HELFEN

Schlichte Grundformen, liebevoll designte Produktdetails und viel Zubehör runden das Sortiment ab.

Des formes de base épurées, des détails ajoutés avec amour sur les produits et une grande variété d'accessoires : la gamme est au complet.

Understated basic shapes, carefully designed details and lots of accessories complete the product range.



# BALKON & TERRASSE

BALCON ET TERRASSE  
BALCONY & TERRACE

MADE IN GERMANY



Passender Blumenkasten  
Jardinière standard assortie  
Matching window box

► MY CITY GARDEN BLUMENKASTEN  
MY CITY GARDEN Jardinière  
MY CITY GARDEN WINDOW BOX  
S. 81

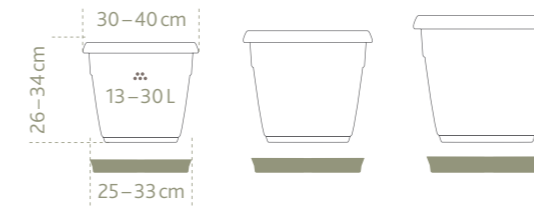

## MY CITY GARDEN

Blumenkübel, eckig / Bac à fleurs, carrée / Planter, rectangular

COLOUR	CM <sup>1)</sup>	L <sup>2)</sup>	C-CODE	EAN	UNIT <sup>4)</sup>
granite	30×30×26	... 13	BMCG30GRA	3 167890 012722	10
	35×35×30	... 20	BMCG35GRA	3 167890 012739	10
	40×40×34	... 30	BMCG40GRA	3 167890 012746	10
light terracotta	30×30×26	... 13	BMCG30TC	3 167890 012753	10
	35×35×30	... 20	BMCG35TC	3 167890 012760	10
	40×40×34	... 30	BMCG40TC	3 167890 012777	10



Untersetzer, eckig / Soucoupe, carrée / Tray, rectangular

CM <sup>2)</sup>	CM <sup>2)</sup>	C-CODE	EAN	UNIT <sup>4)</sup>
30×30	25×25	SBMCG25GRA	3 167890 012814	10
35×35	29×29	SBMCG29GRA	3 167890 012821	10
40×40	33×33	SBMCG33GRA	3 167890 012838	10
30×30	25×25	SBMCG25TC	3 167890 012845	10
35×35	29×29	SBMCG29TC	3 167890 012852	10
40×40	33×33	SBMCG33TC	3 167890 012869	10



## MY CITY GARDEN

¼ Display, unbestückt  
¼ Présentoir, non garni / ¼ Display rack, items not included

Bestückungsvorschlag / Proposition de composition /  
Display suggestion

80× Blumenkübel / Bac à fleurs / Planter					
Ø 30	10	10	Ø 35	20	10
Ø 40	10	10			
80× Untersetzer / Soucoupe / Tray					
Ø 25	10	10	Ø 29	20	10
Ø 33	10	10			

1) L × B × H / l × l × h / l × w × h 2) L × B / l × l / l × w 3) Erdvolumen / Volume de terre / Soil volume 4) VPE / UE / Unit



MADE IN GERMANY



**30/60L**

60 cm 80 cm

Großes Pflanzvolumen!

Grand volume de plantation!  
Generous planting volume!

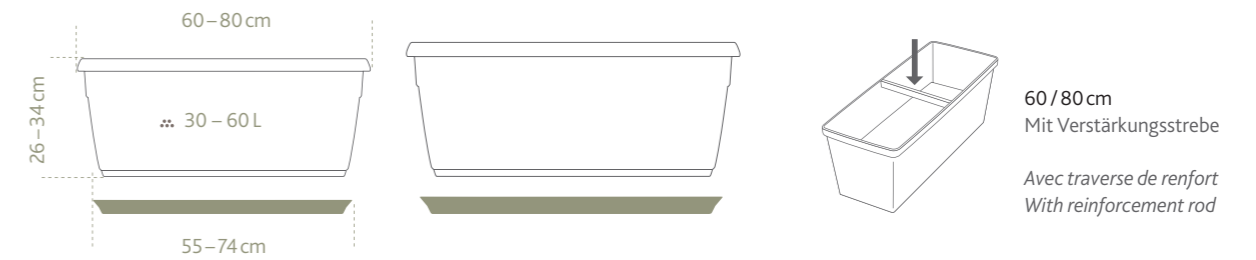

### MY CITY GARDEN

Pflanztrog / Jardinière-auge / Planter, rectangular

COLOUR	CM <sup>1)</sup>	L <sup>3)</sup>	C-CODE	EAN	UNIT <sup>4)</sup>
granite	60x30x26 <sup>5)</sup>	30	JMCG60GRA	3 167890 012890	10
	80x35x34 <sup>5)</sup>	60	JMCG80GRA	3 167890 012906	5
light terracotta	60x30x26 <sup>5)</sup>	30	JMCG60TC	3 167890 012913	10
	80x35x34 <sup>5)</sup>	60	JMCG80TC	3 167890 012920	5

Untersetzer / Soucoupe / Tray

CM <sup>1)</sup>	CM <sup>2)</sup>	C-CODE	EAN	UNIT <sup>4)</sup>
60x30	55x25	SJMCG525GRA	3 167890 012951	10
80x35	74x29	SJMCG7429GRA	3 167890 012968	10
60x30	55x25	SJMCG525TC	3 167890 012975	10
80x35	74x29	SJMCG7429TC	3 167890 012982	10



### MY CITY GARDEN

1/1 Display, unbestückt  
1/1 Présentoir, non garni / 1/1 Rivestimento display,  
1/1 Display rack, items not included

1/1 Display, unbestückt / Proposition de composition /  
Display suggestion

40 x Tröge / Jardinière-auge / Planter  
60x30 ● 10 ● 10 80x35 ● 10 ● 10

40 x Untersetzer / Soucoupe / Tray  
55x25 ● 10 ● 10 74x29 ● 10 ● 10

1) L x B x H / l x l x h / l x w x h 2) L x B / l x l / l x w 3) Erdvolumen / Volume de terre / Soil volume  
4) VPE / UE / Unit 5) Mit Verstärkungsstrebe / Avec traverse de renfort / With reinforcement rod



●●●  
MADE IN  
GERMANY



## MY CITY GARDEN

Blumenkübel, rund / Bac à fleurs, ronde / Planter, round

COLOUR	CM <sup>1)</sup>	L <sup>2)</sup>	C-CODE	EAN	UNIT <sup>3)</sup>
granite	25×20	... 5	PMCG25GRA	3 1 6 7 8 9 0 0 1 3 0 3 3	10
	30×24	... 9	PMCG30GRA	3 1 6 7 8 9 0 0 1 3 0 4 0	10
	40×31	... 20	PMCG40GRA	3 1 6 7 8 9 0 0 1 3 0 5 7	10
	50×40	... 40	PMCG50GRA	3 1 6 7 8 9 0 0 1 3 0 6 4	5
light terracotta	25×20	... 5	PMCG25TC	3 1 6 7 8 9 0 0 1 3 0 7 1	10
	30×24	... 9	PMCG30TC	3 1 6 7 8 9 0 0 1 3 0 8 8	10
	40×31	... 20	PMCG40TC	3 1 6 7 8 9 0 0 1 3 0 9 5	10
	50×40	... 40	PMCG50TC	3 1 6 7 8 9 0 0 1 3 1 0 1	5

Untersetzer, rund / Soucoupe, ronde / Tray, round

CM <sup>4)</sup>	CM <sup>4)</sup>	C-CODE	EAN	UNIT <sup>5)</sup>
25	21	SPMCG21GRA	3 1 6 7 8 9 0 0 1 3 1 5 6	10
30	25	SPMCG25GRA	3 1 6 7 8 9 0 0 1 3 1 6 3	10
40	33	SPMCG33GRA	3 1 6 7 8 9 0 0 1 3 1 7 0	10
50	41	SPMCG41GRA	3 1 6 7 8 9 0 0 1 3 1 8 7	10
25	21	SPMCG21TC	3 1 6 7 8 9 0 0 1 3 1 9 4	10
30	25	SPMCG25TC	3 1 6 7 8 9 0 0 1 3 2 0 0	10
40	33	SPMCG33TC	3 1 6 7 8 9 0 0 1 3 2 1 7	10
50	41	SPMCG41TC	3 1 6 7 8 9 0 0 1 3 2 2 4	10



## MY CITY GARDEN

Warenträger / Présentoir / Product displays

CM <sup>2)</sup>	C-CODE	EAN	UNIT <sup>3)</sup>
110×110×200	POS002716	3 1 6 7 8 9 0 0 0 4 0 2 4	1

unbestückt / non garni / items not included

Bestückungsvorschlag / Proposition de composition / Display suggestion

80x Blumenkübel / Bac à fleurs / Planter

Ø 25 cm: 40      Ø 30 cm: 20      Ø 40 cm: 20  
 ● 20 ● 30      ● 10 ● 10      ● 10 ● 10

120x Untersetzer / Soucoupe / Tray

Ø 21 cm: 40      Ø 25 cm: 40      Ø 33 cm: 40  
 ● 20 ● 30      ● 20 ● 20      ● 20 ● 20



## MY CITY GARDEN

¼ Display, unbestückt

¼ Présentoir, non garni / ¼ Display rack, items not included

Bestückungsvorschlag / Proposition de composition / Display suggestion

140x Blumenkübel / Bac à fleurs / Planter

Ø 25      ● 20 ● 20      Ø 30      ● 20 ● 40  
 Ø 40      ● 20 ● 20

140x Untersetzer / Soucoupe / Tray

Ø 21      ● 20 ● 20      Ø 25      ● 20 ● 40  
 Ø 33      ● 20 ● 20

1) Ø×H/Ø×h/Ø×h 2) L×B×H/L×l×h/l×w×h 3) Erdvolumen / Volume de terre / Soil volume 4) Ø 5) VPE / UE / Unit

# RANKEN

Rank-Lösungen für eine ganz neue Zielgruppe

## TREILLAGES

Des solutions de treillage pour une cible de clientèle toute nouvelle

## VINES

Trellis solutions for a whole new target group



Ideal für Selbstklimmer wie Gurke, Bohne, Kapuziner-kresse u. v. m.

Idéal pour les concombres, cornichons, haricots, capucines, etc.

Perfect for self-clinging climbers such as cucumbers, beans, nasturtiums and much more



## MY CITY GARDEN

Rankgitter breit / Treillage large / Trellis wide

COLOUR CM <sup>1)</sup> C-CODE EAN UNIT <sup>2)</sup>

anthracite 19x92 TSMCG92ANT 3 1 67890 013231 5

Ideal für / idéal pour / ideal for



## MY CITY GARDEN

Rankgitter breit / Treillage large / Trellis wide

COLOUR CM <sup>1)</sup> C-CODE EAN UNIT <sup>2)</sup>

anthracite 19x118 TSMCG118ANT 3 1 67890 013255 5

Ideal für / idéal pour / ideal for

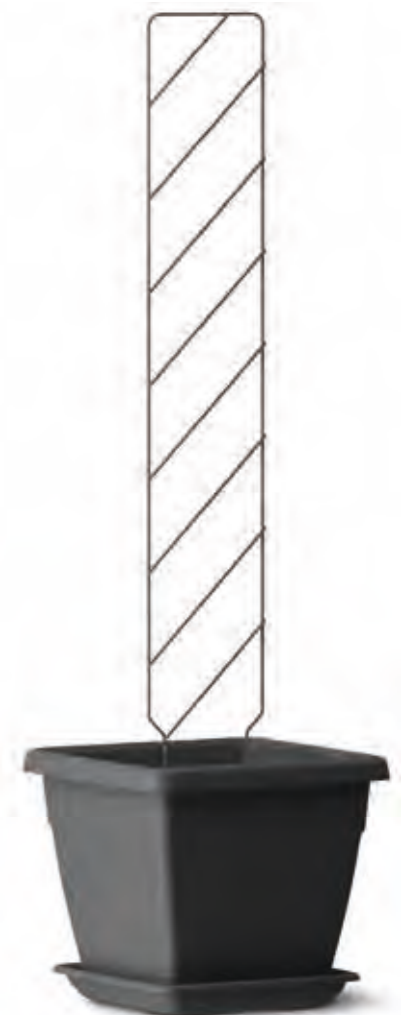
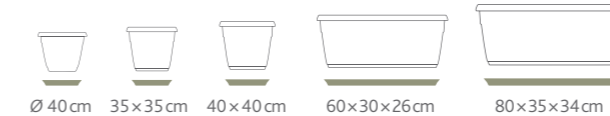

1) BxH / l x h / w x h 2) VPE / UE / Unit

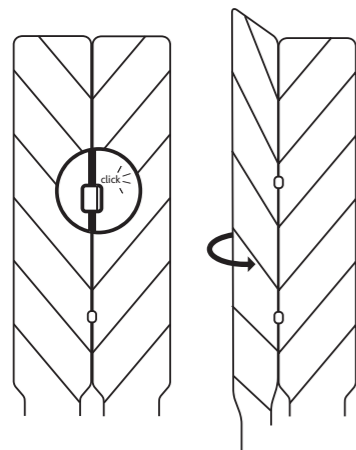

Kombinierbar: Einfach mit beigefügtem Verbindungsclip zusammenklicken oder versetzt im Topf anordnen.

Combinable : fixation par clipsage simple avec le clip de jonction fourni ou plantation en alternance dans le pot.

Combinable: simply click together with the attachment clip included or stagger them inside the pot.



### MY CITY GARDEN

Verbindungsclip / Clip de jonction / Attachment Clip

COLOUR	CONTENT	C-CODE	EAN	UNIT <sup>3)</sup>
anthracite	4 pc.	4CJTANT	3 167890 013279	10



### MY CITY GARDEN

Rankgitter schmal Set \* / Treillage étroit\* / Trellis narrow-set\*

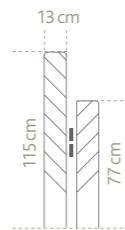

COLOUR	CM <sup>1)</sup>	C-CODE	EAN	UNIT <sup>3)</sup>
anthracite	13x115 13x77	TDMCGANT	3 167890 013286	5

Ideal für / idéal pour / ideal for

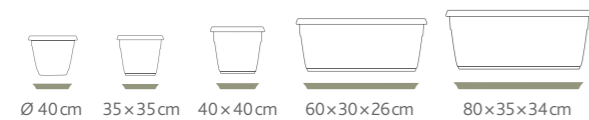

<sup>1)</sup> BxH / l x h / w x h <sup>2)</sup> l x w x h / L x B x H / l x w x h <sup>3)</sup> VPE / UE / Unit  
\* zwei Größen + zwei Verbindungsclips / deux tailles + deux clips de jonction / two sizes + two attachment clips



### MY CITY GARDEN

Pflanzen-schlaufe / Liens pour plantes / Plant ties

COLOUR	CONTENT	CM <sup>2)</sup>	C-CODE	EAN	UNIT <sup>3)</sup>
anthracite	6 pc.	6x5x0,3	6LPMCGANT	3 167890 013316	10
pale green	6 pc.	6x5x0,3	6LPMCGVE	3 167890 013323	10



### MY CITY GARDEN

Pflanzenklammer / Agrafes pour plantes / Plant clips

COLOUR	CONTENT	CM <sup>2)</sup>	C-CODE	EAN	UNIT <sup>3)</sup>
anthracite	4 pc.	6x5x3	4CPMCGANT	3 167890 013330	10
pale green	4 pc.	6x5x3	4CPMCGVE	3 167890 013347	10

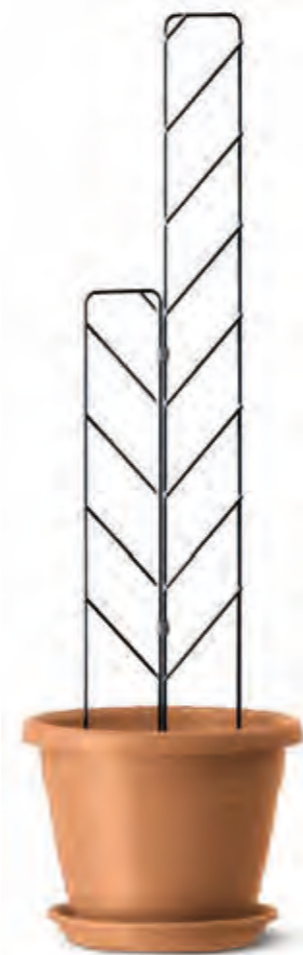

For tomatoes, peppers, sunflowers and much more

Pour les tomates, poivrons ou tournesols, etc.

Per pomodori, peperoni, girasoli ecc.

Sicherer Stand durch Gabelfuß

Pied en fourche pour une insertion stable

Good stability due to fork foot

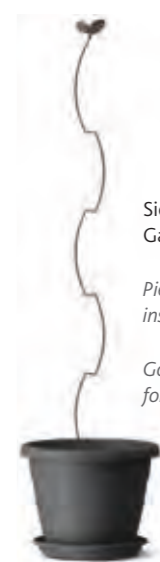

### MY CITY GARDEN

Pflanzstab / Tuteur / Plant rod

COLOUR	CM <sup>1)</sup>	C-CODE	EAN	UNIT <sup>3)</sup>
anthracite	9x153	TU153ANT	3 167890 013309	5

Ideal for / idéal pour / ideale per



9 cm

153 cm

# WAND MUR / WALL



## PERFECT MATCH der passende Haken zum Kübel

le crochet assorti au bac / matching hook  
for the planter

### TOPFHAKEN

Crochets pour pot / plant pot hooks

COLOUR	CONTENT	C-CODE	EAN	UNIT 5)
anthracite	4 pc.	4CROPANT	3 167890 013354	10

20er Kübel = 1 Haken, 40er Kübel = 2 Haken  
20er Bac à fleurs = 1 crochet pour pot, 40er Bac à fleurs =  
2 crochets pour pot / 20er Planter = 1 pot hook, 40er  
Planter = 2 pot hooks



Inkl. angeclipstem Untersetzer  
Avec soucoupe clipsable  
Includes clip-on tray



## MY CITY GARDEN Blumenkübel / Bac à fleurs / Planter

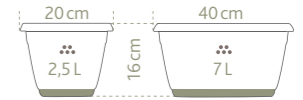

COLOUR	CM 1)	L 4)	C-CODE	EAN	UNIT 5)
granite	20x16	... 2,5	PMCGSC20GRA	3 167890 013392	10
	40x20x16 <sup>2)</sup>	... 7	JMCGSC40GRA	3 167890 013385	5
light terracotta	20x16	... 2,5	PMCGSC20TC	3 167890 013415	10
	40x20x16 <sup>2)</sup>	... 7	JMCGSC40TC	3 167890 013408	5
white	20x16	... 2,5	PMCGSC20BL	3 167890 013439	10
	40x20x16 <sup>2)</sup>	... 7	JMCGSC40BL	3 167890 013446	5
green	20x16	... 2,5	PMCGSC20AN	3 167890 013453	10
	40x20x16 <sup>2)</sup>	... 7	JMCGSC40AN	3 167890 013460	5



Als Rankgitter und zur Aufnahme von  
Blumentöpfen und Zubehör

Comme treillage ou support de pots  
For use as a trellis and to hold planters

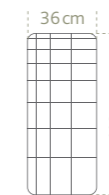

## MY CITY GARDEN WANDGARTEN-RACK SET\*

Lot de treillage mural / Wall trellis set

COLOUR	CM 3)	C-CODE	EAN	UNIT 5)
anthracite	110x36	ENSTMANT	3 167890 013422	5

\* inkl. 4 x Wandhalterungen,  
Schrauben & Dübel für  
massive Wände  
avec 4 supports muraux,  
vis et chevilles /  
includes 4 wall brackets,  
screws & dowels



Inkl. 4 Topfhaken  
Avec 4 crochets pour pot  
Includes 4 plant pot hooks

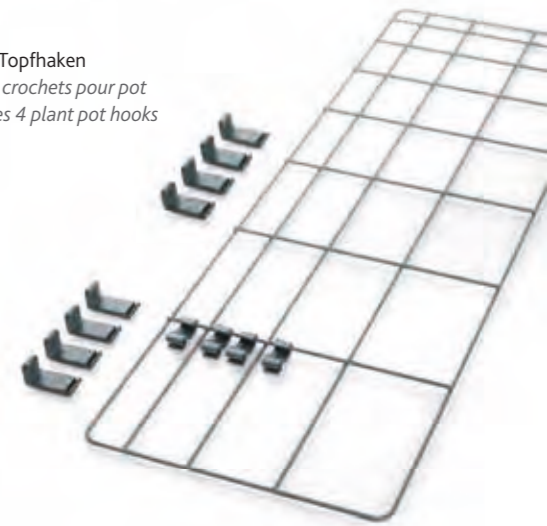

## ZUBEHÖRHAKEN WANDGARTEN-RACK

Crochets pour accessoires / Accessory hooks Wall trellis set

COLOUR	CONTENT	CM 2)	C-CODE	EAN	UNIT 5)
aluminium	3 pc.	6,5x6,5x4	3CRO2AL	3 167890 013477	10

18/10



1) Ø x H / Ø x h / Ø x h 2) L x B x H / L x l x h / L x w x h 3) B x H / l x h / w x h  
4) Erdvolumen / Volume de terre / Soil volume 5) VPE / UE / Unit

# ZAUN

Endlich eine attraktive Lösung für den Großteil aller modernen Gartenzäune, den Doppelstab-Mattenzaun.



## SOLUTION DE CLÔTURE

Enfin une solution attrayante pour la majeure partie de toutes les clôtures de jardin moderne : le grillage rigide.

## FENCE

Finally, an attractive solution for the vast majority of modern garden fences: the double stick mat fence.

## MY CITY GARDEN

Blumenkübel / Bac à fleurs / Planter

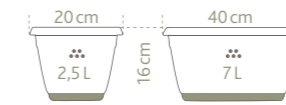

COLOUR	CM <sup>1)</sup>	L <sup>4)</sup>	C-CODE	EAN	UNIT <sup>5)</sup>
● granite	20×16	... 2,5	PMCGSC20GRA	3 1 6 7 8 9 0 0 1 3 3 9 2	10
	40×20×16 <sup>2)</sup>	... 7	JMCGSC40GRA	3 1 6 7 8 9 0 0 1 3 3 8 5	5
● light terracotta	20×16	... 2,5	PMCGSC20TC	3 1 6 7 8 9 0 0 1 3 4 1 5	10
	40×20×16 <sup>2)</sup>	... 7	JMCGSC40TC	3 1 6 7 8 9 0 0 1 3 4 0 8	5
○ white	20×16	... 2,5	PMCGSC20BL	3 1 6 7 8 9 0 0 1 3 4 3 9	10
	40×20×16 <sup>2)</sup>	... 7	JMCGSC40BL	3 1 6 7 8 9 0 0 1 3 4 4 6	5
● green	20×16	... 2,5	PMCGSC20AN	3 1 6 7 8 9 0 0 1 3 4 5 3	10
	40×20×16 <sup>2)</sup>	... 7	JMCGSC40AN	3 1 6 7 8 9 0 0 1 3 4 6 0	5



## MY CITY GARDEN

Topfhaken für Doppelstab-Mattenzäune\* / Crochet spécial « clôture »\* / Special "fence" hooks\*

COLOUR	CONTENT	CM <sup>3)</sup>	C-CODE	EAN	UNIT <sup>5)</sup>
● anthracite	4 pc.	7×11	4CROPLOANT	3 1 6 7 8 9 0 0 1 3 4 9 1	20

\* Ideal für Doppelstab-Mattenzäune, (6/5/6 mm und 8/6/8 mm) / Idéal pour les clôtures en grillage rigide, (6/5/6 mm et 8/6/8 mm) Crochet spécial Clôture\* / Perfect for double stick mat fences, (6/5/6mm and 8/6/8 mm) Special "fence" hooks\*



Inkl. angeclipstem Untersetzer  
Avec soucoupe clipsable  
Includes clip-on tray



40er Kübel = 2 Haken, 20er Kübel = 1 Haken  
40er Bac à fleurs = 2 crochets pour pot,  
20er Bac à fleurs = 1 crochet pour pot /  
40er Planter = 2 pot hooks, 20er Planter = 1 pot hook

# GELÄNDER BALUSTRADE / RAILING

Sicherungsclip  
Clip de sécurité  
Locking clip



anthracite

Farbige Metallhalterung  
Support métallique coloré  
Coloured metal bracket

Kunststoff-Puffer für empfindliche Oberflächen  
Butoir en plastique pour les surfaces facilement rayables  
Plastic buffer for scratch-prone surfaces

Angeclipster Untersetzer  
Soucoupe clipsée  
Clip-on tray

MADE IN GERMANY

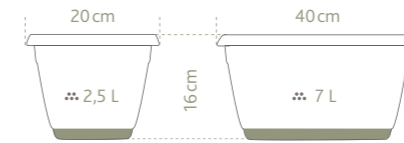

## MY CITY GARDEN

Hängetopf / Pot pour balustrade / Hanging planter

COLOUR	CM <sup>1)</sup>	L <sup>4)</sup>	C-CODE	EAN	UNIT <sup>5)</sup>
white	20×16	2,5	PMCG20BLSCSUP	3 1 6 7 8 9 0 4 0 1 3 5 1 4	8
	40×20×16 <sup>2)</sup>	7	JMCG40BLSCSUP	3 1 6 7 8 9 0 4 0 1 3 5 2 1	4
granite	20×16	2,5	PMCG20GRASCSUP	3 1 6 7 8 9 0 4 0 1 3 5 5 2	8
	40×20×16 <sup>2)</sup>	7	JMCG40GRASCSUP	3 1 6 7 8 9 0 4 0 1 3 5 6 9	4
green	20×16	2,5	PMCG20ANSCSUP	3 1 6 7 8 9 0 4 0 1 3 5 7 6	8
	40×20×16 <sup>2)</sup>	7	JMCG40ANSCSUP	3 1 6 7 8 9 0 4 0 1 3 5 8 3	4
light terracotta	20×16	2,5	PMCG20TCSCSUP	3 1 6 7 8 9 0 4 0 1 3 5 9 0	8
	40×20×16 <sup>2)</sup>	7	JMCG40TCSCSUP	3 1 6 7 8 9 0 4 0 1 3 6 0 6	4

anthracite

anthracite

anthracite

anthracite



## MY CITY GARDEN

¼ Display, unbestückt  
¼ Présentoir, non garni  
¼ Display rack, items not included

Bestückungsvorschlag  
Proposition de composition / Display suggestion

140 × Hängetopf  
Pot pour balustrade / Hanging planter

40×20×16    20    20    20  
Ø 20    24    32    24



## ZUBEHÖRHAKEN GELÄNDER

Crochets pour accessoires / Accessory hooks



COLOUR	CONTENT	CM <sup>3)</sup>	C-CODE	EAN	UNIT <sup>5)</sup>
aluminium	3 pc.	7×11	3CRO6AL	3 1 6 7 8 9 0 4 0 1 3 5 0 7	10

18/10



1) Ø×H/Ø×h/Ø×h 2) L×B×H/L×l×h/l×w×h 3) B×H/l×h/w×h  
4) Erdvolumen / Volume de terre / Soil volume 5) VPE / UE / Unit



MADE IN GERMANY

# 9/21L

30 cm 60 cm

Großes Pflanzvolumen auch im Mittelteil

Grande profondeur de plantation même dans la partie centrale

Large planting volume also in the centre part

Für mehr Informationen sprechen Sie uns gerne an.

*Veuillez contacter votre interlocuteur pour de plus amples informations.  
Please contact your Sales Representative for further information.*

CASA / MY CITY GARDEN  
Warenträger / Présentoir / Product displays

CM <sup>1)</sup>	C-CODE	EAN	UNIT <sup>2)</sup>
65 x 70 x 249	POS002717	3 167890 004031	1
unbestückt / non garni / items not included			

CITY 30er & 60er

Bestückungsvorschlag / Proposition de composition / Display suggestion

Geländertopf / Pot pour balustrade / Railing pot

30 x 30 10 10 10 10

60 x 30 5 5 5 5

CITY 60er

Bestückungsvorschlag / Proposition de composition / Display suggestion

Geländertopf / Pot pour balustrade / Railing pot

60 x 30 10 10 10 10

## MY CITY GARDEN

Geländertopf / Pot pour balustrade / Railing pot

COLOUR	CM <sup>1)</sup>	L <sup>2)</sup> 3)	C-CODE	EAN	UNIT <sup>4)</sup>
white	30 x 30 x 26	9 ≈ 0,6	PBMCG30BL	3 167890 013613	5
	60 x 30 x 26	21 ≈ 1,8	JBMC60BL	3 167890 013620	5
dusty grey	30 x 30 x 26	9 ≈ 0,6	PBMCG30GC	3 167890 013637	5
	60 x 30 x 26	21 ≈ 1,8	JBMC60GC	3 167890 013644	5
granite	30 x 30 x 26	9 ≈ 0,6	PBMCG30GRA	3 167890 013651	5
	60 x 30 x 26	21 ≈ 1,8	JBMC60GRA	3 167890 013668	5
green	30 x 30 x 26	9 ≈ 0,6	PBMCG30AN	3 167890 013675	5
	60 x 30 x 26	21 ≈ 1,8	JBMC60AN	3 167890 013682	5
light terracota	30 x 30 x 26	9 ≈ 0,6	PBMCG30TC	3 167890 013699	5
	60 x 30 x 26	21 ≈ 1,8	JBMC60TC	3 167890 013705	5



3-fach überzeugend!

Triplement séduisant ! / 3-times convincing!

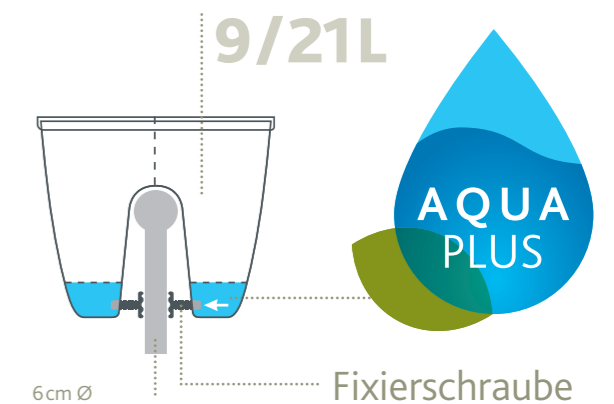

6 cm Ø  
Max. Geländerbreite

Largeur de balustrade max.  
Max. railing width

Fixierschraube

Vis de fixation  
Fixing screw

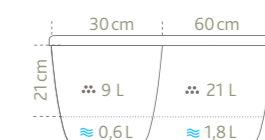

1) L x B x H / l x l x h / L x W x H 2) Erdvolumen / Volume de terre / Soil volume  
3) Wasserreservoir / Réservoir d'eau / Water reservoir 4) VPE / UE / Unit.

\* Quelle: Produkttest CITY Geländertopf mit 60 Testern vom 30.03. – 24.05.2015 /  
Source: Le pot pour balustrade CITY a été soumis à un test produit par 60 testeurs 30.03. – 24.05.2015 /  
Source: Product test CITY railing pot with 60 testers 30.03. – 24.05.2015



# 10/15,6L

50 cm 75 cm

Großes Pflanzvolumen  
Grand volume de plantation!  
Generous planting volume!

●●●  
MADE IN  
GERMANY



« Irrigation fiable... »  
"Reliable watering..."

## „BEWÄSSERT ZUVERLÄSSIG...“

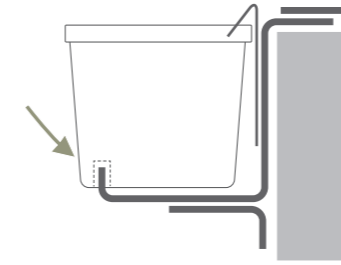

Verdeckte Aufnahme für Blumenkastenhalterung

Dispositif de fixation invisible pour support de jardinière

Concealed mount for window box brackets

- CASA MESH / MY CITY GARDEN, VARIO COMFORT  
Für jeden Kasten die passende Halterung.  
Un système d'accrochage adapté à chaque jardinière.  
The perfect brackets for every box.  
S. 152

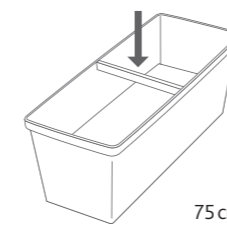

75 cm  
Mit Verstärkungsstrebe

Avec traverse de renfort  
With reinforcement rod



## PERFECT MATCH! DER PASSENDE HALTER ZUM KASTEN.

Accroche de jardinière assortie.  
Matching brackets for window boxes.



MY CITY GARDEN  
Blumenkasten / Jardinière /  
Window box

18 cm	50 x 20 cm	75 x 20 cm
	≈ 10 L	≈ 15,6 L
	≈ 2,5 L	≈ 4 L

COLOUR	CM <sup>1)</sup>	L <sup>2)</sup> 3)	C-CODE	EAN	UNIT <sup>4)</sup>
white	50 x 20 x 18	≈ 10 ≈ 2,5	JMCGRE50BL	3 167890 013712	5
	75 x 20 x 18 <sup>5)</sup>	≈ 15,6 ≈ 4	JMCGRE75BL	3 167890 013729	5
dusty grey	50 x 20 x 18	≈ 10 ≈ 2,5	JMCGRE50GC	3 167890 013736	5
	75 x 20 x 18 <sup>5)</sup>	≈ 15,6 ≈ 4	JMCGRE75GC	3 167890 013743	5
granite	50 x 20 x 18	≈ 10 ≈ 2,5	JMCGRE50GRA	3 167890 013750	5
	75 x 20 x 18 <sup>5)</sup>	≈ 15,6 ≈ 4	JMCGRE75GRA	3 167890 013767	5
light terracotta	50 x 20 x 18	≈ 10 ≈ 2,5	JMCGRE50TC	3 167890 013774	5
	75 x 20 x 18 <sup>5)</sup>	≈ 15,6 ≈ 4	JMCGRE75TC	3 167890 013781	5
green	50 x 20 x 18	≈ 10 ≈ 2,5	JMCGRE50AN	3 167890 013798	5
	75 x 20 x 18 <sup>5)</sup>	≈ 15,6 ≈ 4	JMCGRE75AN	3 167890 013804	5



1) L x B x H / l x l x h / l x w x h 2) Erdvolumen / Volume de terre / Soil volume  
3) Wasservolumen / Réservoir d'eau / Water reservoir 4) VPE / UE / Unit  
5) Mit Verstärkungsstrebe / Avec traverse de renfort / With reinforcement rod



## POINT OF SALE

Von der Idee direkt zur Umsetzung. Alles, was der Kunde für seinen eigenen Nutzgarten braucht, findet er direkt am PoS. Inspirierend. Einfach. Überzeugend.

*Directement de l'idée à la mise en œuvre. Vous trouverez sur votre lieu de vente tout ce dont vous avez besoin pour votre jardin potager. Inspirant. Simple. Séduisant.*

*Straight from the idea to implementation. Everything that the customer needs for his own kitchen garden can be found directly at the PoS. Inspiring. Simple. Impressive.*



### HÄNGEN SUSPENSION / HANGING

## SORTIMENTS- ÜBERSICHT

### VUE D'ENSEMBLE DE L'ASSORTIMENT / PRODUCT OVERVIEW

### STELLEN & HÄNGEN\*

#### POSE & SUSPENSION / POSITIONING & HANGING



36 x 110 cm

### STELLEN

#### POSE / POSITIONING

### STELLEN & RANKEN

#### POSE & TREILLAGE / POSITIONING & ATTACHING CLIMBING PLANTS

	20 x 20 cm					
	40 x 20 cm					
	30 x 30 x 26 cm					
	30 x 60 x 26 cm					
	50 x 20 x 18 cm					
	75 x 20 x 18 cm					
	20 x 16 cm					
	40 x 20 x 16 cm					
	25 x 20 cm					
	30 x 24 cm					
	40 x 31 cm					
	50 x 40 cm					
	30 x 30 x 26 cm					
	35 x 35 x 30 cm					
	40 x 40 x 34 cm					
	60 x 30 x 26 cm					
	80 x 35 x 34 cm					



13 x 115 / 13 x 77 cm /  
19 x 92 cm / 19 x 118 cm /  
9 x 153 cm /

anthracite

white   dusty grey   granite   light terracotta   green

\* Stellen & Hängen mit Topfhaken und Wandgarten-Rack sowie Doppelstabmattenzaun  
\* Position & hang pots with plant pot hooks, wall garden rack and double stick mat fence  
\* Pose et suspension avec crochets pour pot et rack de jardin mural ainsi que pour grillage rigide

Traditionnel. Romantique. Authentique.  
COUNTRY – de véritables classiques du design avec un aspect particulièrement naturel  
Les effets multicolores créent  
l'alliance idéale de l'authenticité et de  
la durabilité. Chaque pièce est unique.

Traditional. Romantic. Authentic.  
COUNTRY – real design classics with a  
natural look. Thanks to multi-colour  
effect, it is the ideal combination of  
authenticity and durability.  
Every piece is unique.



●●●  
MADE IN  
GERMANY



# COUNTRY

Traditionell. Romantisch. Echt.  
COUNTRY – echte Design-Klassiker mit besonders natürlichem Look. Dank Multicolor-Effekt die ideale Verbindung aus Authentizität und Langlebigkeit. Jedes Stück ein Unikat.



► BASIC  
Für jeden Kasten die passende Halterung  
*Un système d'accrochage adapté à chaque jardinière*  
*The perfect brackets for every box*  
S. 124



**MULTICOLOR-EFFEKT –  
JEDES GEFÄSS EIN UNIKAT.**

*Effets multicolores – chaque pot est unique.*  
*Multi-colour-effect – every container is unique.*



**COUNTRY**

Blumenkasten / Jardinière / Window box

COLOUR	CM <sup>1)</sup>	L <sup>2)</sup>	C-CODE	EAN	VPE <sup>3)</sup>
white	50×17×15	.. 9	JCOU50BL	3 1 67890 015792	5
	75×17×15	.. 14	JCOU75BL	3 1 67890 015808	5
green	50×17×15	.. 9	JCOU50V	3 1 67890 015815	5
	75×17×15	.. 14	JCOU75V	3 1 67890 015822	5
brown	50×17×15	.. 9	JCOU50MK	3 1 67890 015839	5
	75×17×15	.. 14	JCOU75MK	3 1 67890 015846	5
anthracite	50×17×15	.. 9	JCOU50ANT	3 1 67890 015860	5
	75×17×15	.. 14	JCOU75ANT	3 1 67890 015860	5
grey	50×17×15	.. 9	JCOU50G	3 1 67890 015877	5
	75×17×15	.. 14	JCOU75G	3 1 67890 015884	5



1) L×H×B / l×l×h // l×w×h 2) Erdvolumen / Volume de terre / Soil volume 3) VPE / UE / Unit



# 10/16/21L

50 cm      75 cm      100 cm

Großes Pflanzvolumen!

Grand volume de plantation!  
Generous planting volume!



► VARIO COMFORT  
Für jeden Kasten die passende Halterung.  
*Un système d'accrochage adapté à chaque jardinière.*  
The perfect brackets for every box.  
S. 123

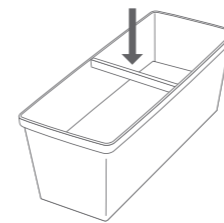

75 und 100 cm  
Mit Verstärkungsstrebe

*Avec traverse de renfort  
With reinforcement rod*

# LAGO



18 cm	50 x 22 cm	75 x 22 cm	100 x 22 cm
	≈ 10 L ≈ 2,1 L	≈ 16 L ≈ 3,3 L	≈ 21 L ≈ 4,6 L

## LAGO

Blumenkasten / Jardinière / Window box

COLOUR	CM <sup>1)</sup>	L <sup>2)</sup>	C-CODE	EAN	VPE <sup>4)</sup>
terracotta	50 x 22 x 18	≈ 10 ≈ 2,1	JLA50TC	3 1 6 7 8 9 0 0 1 5 8 9 1	5
	75 x 22 x 18 <sup>5)</sup>	≈ 16 ≈ 3,3	JLA75TC	3 1 6 7 8 9 0 0 1 5 9 0 7	5
	100 x 22 x 18 <sup>5)</sup>	≈ 21 ≈ 4,6	JLA100TC	3 1 6 7 8 9 0 0 1 5 9 1 4	5
white	50 x 22 x 18	≈ 10 ≈ 2,1	JLA50BL	3 1 6 7 8 9 0 0 1 5 9 2 1	5
	75 x 22 x 18 <sup>5)</sup>	≈ 16 ≈ 3,3	JLA75BL	3 1 6 7 8 9 0 0 1 5 9 3 8	5
	100 x 22 x 18 <sup>5)</sup>	≈ 21 ≈ 4,6	JLA100BL	3 1 6 7 8 9 0 0 1 5 9 4 5	5
dark brown	50 x 22 x 18	≈ 10 ≈ 2,1	JLA50MK	3 1 6 7 8 9 0 0 1 5 9 5 2	5
	75 x 22 x 18 <sup>5)</sup>	≈ 16 ≈ 3,3	JLA75MK	3 1 6 7 8 9 0 0 1 5 9 6 9	5
	100 x 22 x 18 <sup>5)</sup>	≈ 21 ≈ 4,6	JLA100MK	3 1 6 7 8 9 0 0 1 5 9 7 6	5
anthracite	50 x 22 x 18	≈ 10 ≈ 2,1	JLA50ANT	3 1 6 7 8 9 0 0 1 5 9 8 3	5
	75 x 22 x 18 <sup>5)</sup>	≈ 16 ≈ 3,3	JLA75ANT	3 1 6 7 8 9 0 0 1 5 9 9 0	5
	100 x 22 x 18 <sup>5)</sup>	≈ 21 ≈ 4,6	JLA100ANT	3 1 6 7 8 9 0 0 1 6 0 0 3	5



1) L x B x H / l x l x h / l x w x h 2) Erdvolumen / Volume de terre / Soil volume  
3) Wasserreservoir / Réservoir d'eau / Water reservoir 4) VPE / UE / Unit  
5) Mit Verstärkungsstrebe / Avec traverse de renfort / With reinforcement rod

●●●  
MADE IN  
GERMANY

# BALCONE



Besonders dickwandig.  
Absolut formstabil.  
Mit aufwändiger Holz-Imitation.

*A parois particulièrement épaisses.  
Absolument indéformable.  
Avec imitation bois sophistiqué.*

*Particularly thick-walled.  
Absolute shape retention.  
With elaborate wood  
imitation effects.*

	50×17 cm	75×17 cm	100×17 cm
15 cm	∞ 9 L	∞ 13 L	∞ 19 L

## BALCONE

Blumenkasten / Jardinière / Window box

COLOUR	CM <sup>1)</sup>	L	C-CODE	EAN	VPE <sup>2)</sup>
● wooden dark brown	50×17×15	∞ 9	JBA50MK	3 167890 016010	10
	75×17×15	∞ 13	JBA75MK	3 167890 016027	10
	100×17×15	∞ 19	JBA100MK	3 167890 016034	10
○ wooden white	50×17×15	∞ 9	JBA50BL	3 167890 016041	10
	75×17×15	∞ 13	JBA75BL	3 167890 016058	10
	100×17×15	∞ 19	JBA100BL	3 167890 016065	10
● wooden anthracite	50×17×15	∞ 9	JBA50ANT	3 167890 016072	10
	75×17×15	∞ 13	JBA75ANT	3 167890 016089	10
	100×17×15	∞ 19	JBA100ANT	3 167890 016096	10



► BASIC  
Für jeden Kasten die passende Halterung.  
*Un système d'accrochage adapté à chaque jardinière.*  
The perfect brackets for every box.  
S. 124



1) LxBxH / lxlxh / lwxh 2) VPE / UE / Unit



# TERRA GRANDE



## TERRA GRANDE

Blumenkübel / Bac à fleurs / Planter

COLOUR	CM <sup>1)</sup>	L	C-CODE	EAN	VPE <sup>3)</sup>
● terracotta	30×30×25	11	BTG30TC	3 167890 016102	10
	35×35×29	19	BTG35TC	3 167890 016119	10
	40×40×32	27	BTG40TC	3 167890 016126	10
	50×50×39	50	BTG50TC	3 167890 016133	10
	60×60×45	95	BTG60TC	3 167890 016140	5
● anthracite	30×30×25	11	BTG30ANT	3 167890 016157	10
	35×35×29	19	BTG35ANT	3 167890 016164	10
	40×40×32	27	BTG40ANT	3 167890 016171	10
	50×50×39	50	BTG50ANT	3 167890 016188	10
	60×60×45	95	BTG60ANT	3 167890 016195	5

Untersetzer / Soucoupe / Tray

CM <sup>2)</sup>	CM <sup>2)</sup>	C-CODE	EAN	VPE <sup>3)</sup>
30×30	25×25	SBTG25TC	3 167890 016201	10
35×35	29×29	SBTG29TC	3 167890 016218	10
40×40	36×36	SBTG36TC	3 167890 016225	10
-	-	-	-	-
-	-	-	-	-
30×30	25×25	SBTG25ANT	3 167890 016232	10
35×35	29×29	SBTG29ANT	3 167890 016249	10
40×40	36×36	SBTG36ANT	3 167890 016256	10
-	-	-	-	-
-	-	-	-	-

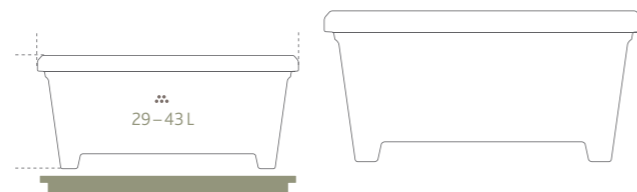

## TERRA GRANDE

Pflanztrog / Bac à fleurs / Planter

COLOUR	CM <sup>1)</sup>	L	C-CODE	EAN	VPE <sup>3)</sup>
● terracotta	60×30×27	29	JTG60TC	3 167890 016263	10
	80×35×30	43	JTG80TC	3 167890 016270	10
● anthracite	60×30×27	29	JTG60ANT	3 167890 016287	10
	80×35×30	43	JTG80ANT	3 167890 016294	10

Untersetzer / Soucoupe / Tray

CM <sup>2)</sup>	CM <sup>2)</sup>	C-CODE	EAN	VPE <sup>3)</sup>
60×30	57×27	SJTG5727TC	3 167890 016300	10
-	-	-	-	-
60×30	57×27	SJTG5727ANT	3 167890 016317	10
-	-	-	-	-



1) L×B×H / l×l×h / l×w×h 2) L×B / L×l / l×w 3) VPE / UE / Unit





# SIENA NOBILE

## SIENA NOBILE

Blumenkübel / Bac à fleurs / Planter



COLOUR	CM <sup>1)</sup>	L	C-CODE	EAN	VPE <sup>2)</sup>
pearl white	26×19	... 5,5	CSN26BL	3 167890 015648	3
	32×24	... 11	CSN32BL	3 167890 015655	3
	38×29	... 22	CSN38BL	3 167890 015662	3
dusty grey	26×19	... 5,5	CSN26GC	3 167890 015679	3
	32×24	... 11	CSN32GC	3 167890 015686	3
	38×29	... 22	CSN38GC	3 167890 015693	3
anthracite	26×19	... 5,5	CSN26ANT	3 167890 015709	3
	32×24	... 11	CSN32ANT	3 167890 015716	3
	38×29	... 22	CSN38ANT	3 167890 015723	3
green	26×19	... 5,5	CSN26AN	3 167890 015730	3
	32×24	... 11	CSN32AN	3 167890 015747	3
	38×29	... 22	CSN38AN	3 167890 015754	3
ruby	26×19	... 5,5	CSN26RU	3 167890 015761	3
	32×24	... 11	CSN32RU	3 167890 015778	3
	38×29	... 22	CSN38RU	3 167890 015785	3



► Präsentationshaken  
Crochet de présentation  
Display hooks  
C-Code 900010 0097



## SIENA NOBILE

Hängeschale / Coupe à suspendre / Hanging planter

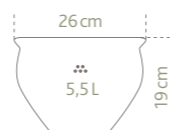

COLOUR	CM <sup>1)</sup>	L	C-CODE	EAN	VPE <sup>2)</sup>
pearl white	26×19	... 5,5	SSN26BL	3 167890 015594	3
dusty grey	26×19	... 5,5	SSN26GC	3 167890 015600	3
anthracite	26×19	... 5,5	SSN26ANT	3 167890 015617	3
green	26×19	... 5,5	SSN26AN	3 167890 015624	3
ruby	26×19	... 5,5	SSN26RU	3 167890 015631	3



Authentisch: wie echte Glasurkeramik

Authentique: l'aspect d'une véritable  
céramique vitrifiée

Authentic: like real glazed ceramics



1) Ø×H/Ø×h/Ø×h 2) VPE/UE/Unit





*Un thème tendance :  
les aromates ! Outre sa parfaite  
fonctionnalité, l'indicateur de  
niveau d'eau original en forme de  
fleur fait du pot à herbes un achat  
coup de cœur et un cadeau idéal.*

*Trend theme herbs! Besides perfect  
functionality, the clever waterlevel  
flower makes the herb pot an ideal  
impulse and gift item.*



# FRESH HERBS

Trendthema Kräuter! Neben perfekter Funktion macht die originelle Wasserstand-Blume den Kräutertopf zum idealen Impuls- und Geschenkartikel.



# FRESH HERBS FOR WEEKS



Selbstbewässerung / Irrigation automatique / Self-watering

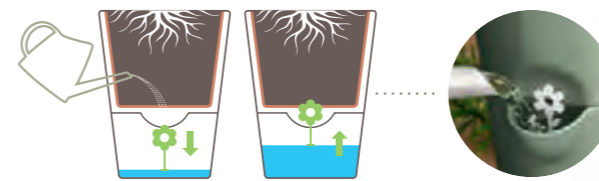

Blume dient als Wasserstandsanzeige  
La fleur sert d'indicateur de niveau d'eau  
The flower is the water-level indicator

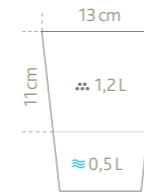

Container proof  
Parfaite pour 1 pots de culture de 12 cm  
Container proof Perfect for 1 x 12 cm pot



Neue, natürliche Farbtöne passend zum aktuellen Einrichtungstrend  
De nouveaux coloris naturels correspondant aux tendances actuelles en matière d'aménagement  
New natural shades in keeping up with the latest decorating trend

## FRESH HERBS SINGLE Kräutertopf / Pot à herbes / Herb pot

COLOUR	CM <sup>2)</sup>	L <sup>3)</sup> / <sup>4)</sup>	C-CODE	EAN	UNIT <sup>5)</sup>
white	13 x 17	≈ 1,2 ≈ 0,5	PFH13BL	3 167890 012609	4
granite	13 x 17	≈ 1,2 ≈ 0,5	PFH13GRA	3 167890 012616	4
green	13 x 17	≈ 1,2 ≈ 0,5	PFH13V	3 167890 012623	4
sage	13 x 17	≈ 1,2 ≈ 0,5	PFH13SA	3 167890 012654	4
silk grey	13 x 17	≈ 1,2 ≈ 0,5	PFH13GS	3 167890 012630	4
sepia rosé	13 x 17	≈ 1,2 ≈ 0,5	PFH13RS	3 167890 012647	4



Keine Direktbepflanzung –  
Docht wird direkt in den  
Kulturtopf gedreht



No direct planting –  
The wick is directly  
turned in the pot



Pas de plantation directe :  
la mèche est enroulée  
directement dans le pot  
de culture



reddot award 2014  
honourable mention

1) L x B x H / l x l x h / l x w x h 2) Ø x H / Ø x h / Ø x h 3) Erdvolumen / Volume de terre / Soil volume  
4) Wasserreservoir / Réservoir d'eau / Water reservoir 5) VPE / UE / Unit

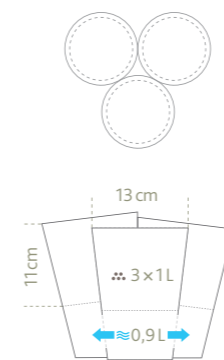

Container proof  
 Perfekt für 3 x 12er Kulturtopf.  
 Parfaite pour 3 pots de culture de 12 cm  
 Container proof Perfect for 3 x 12 cm pot

Platz für 3 Kräutertöpfe –  
 1 großes Wasserreservoir

Accueille 3 pots à herbes –  
 1 grande réservoir d'eau

Space for 3 herb pots –  
 1 large water tank

### FRESH HERBS TRIO

Trio Kräutertopf / Trio de pots à herbes / Trio herb pot

COLOUR	CM <sup>1)</sup>	L <sup>2)</sup> <sup>3)</sup>	C-CODE	EAN	UNIT <sup>5)</sup>
white	27 x 25 x 21	3 x 1 L ≈ 0,9	P3FH13BL	3 1 6 7 8 9 0 1 0 1 2 6 6 1	2
green	27 x 25 x 21	3 x 1 L ≈ 0,9	P3FH13V	3 1 6 7 8 9 0 1 0 1 2 6 7 8	2



### IMPULSKAUF! PLATZIERUNG DIREKT AUF DEM PFLANZTISCH.

Für mehr Informationen sprechen Sie uns gerne an.  
 Achat coup de cœur ! Placement direct sur la table des plantes.  
 Veuillez contacter votre interlocuteur pour de plus amples informations.  
 Impulse buy! Preferred placement on the planting table. Please contact  
 your Sales Representative for further Information.



6 x 3 x

### FRESH HERBS

Bewässerungsset / Kit d'irrigation / Watering set

CONTENT	CM <sup>4)</sup>	C-CODE	EAN	UNIT <sup>5)</sup>
9 pcs.	6 x 9	KITIRFH	3 1 6 7 8 9 0 0 3 5 0 1 1	10



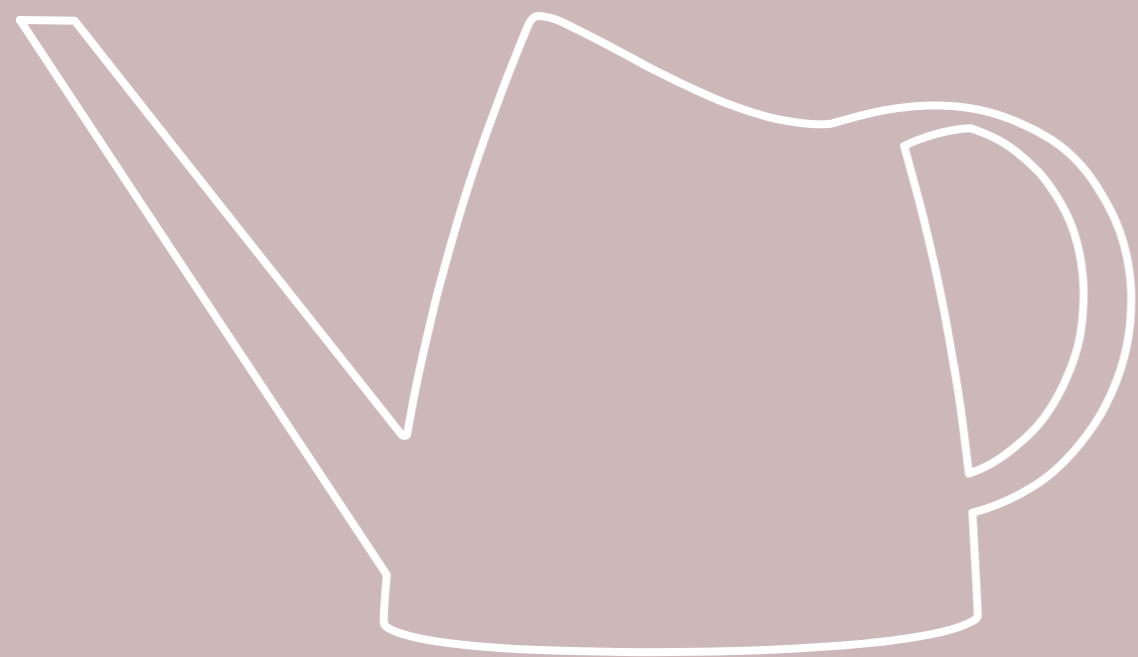

# FLOWER CARE

# FUN



Neue Trendfarben für das moderne Zuhause – perfekt abgestimmt auf die Wohnwelt Ihrer Kunden. Für jeden Anwendungszweck und die Ansprache unterschiedlicher Zielgruppen.

## INDOOR & OUTDOOR

*Nouveaux coloris tendance pour un intérieur moderne – en parfaite harmonie avec l'univers de décoration de vos clients. Pour répondre à chaque type d'utilisation et aux besoins de diverses cibles de clientèle.*

*New trend colours for the modern home – perfectly matched to the living environment of your customers. For every purpose and to address different target groups.*



**NEW**

# LIVING



# LIVING INDOOR

**NEW**

Zeitloses Design, klare Linien. HANA steht für stilvolle und funktionale Bewässerung. Sichtbar platziert, wird sie zu einem dezent-reduzierten Interior-Stück. Mehr als nur ein Gießer.

*Design intemporel, netteté des lignes. HANA est synonyme d'irrigation stylée et fonctionnelle. Placé bien en vue, il s'avère être une pièce de décoration intérieure des plus discrètes. Bien plus qu'un arrosoir.*

*Timeless design, clear lines. HANA stands for stylish and functional watering. Placed in a visible position, it becomes a discreetly reduced interior design piece. More than just a watering can.*



MADE IN GERMANY

Abgesenkte Einfüllöffnung für besonders leichtes und tropffreies Befüllen.

*Ouverture basse pour un remplissage particulièrement simple et sans gouttes.*

*Lowered filling opening for particularly easy and drip-free filling.*



**NEW**

**HANA**

Blumengießer / Arrosoir / Watering can

COLOUR	L	C-CODE	EAN	VPE <sup>1)</sup>
 steel	1,6	AHA1L6IN	3 167890 017383	4
 white	1,6	AHA1L6BL	3 167890 017406	4
 black	1,6	AHA1L6N	3 167890 017390	4

**EDEL STAHL**

Acier inoxydable  
Stainless Steel

18/10

<sup>1)</sup> VPE / UE / Unit

●●●  
MADE IN  
GERMANY

Soft Touch: fühlt sich gut an –  
schont empfindliche Oberflächen.

Soft Touch : agréable au toucher –  
préserve les surfaces délicates.

Soft Touch: feels good and  
protects sensitive surfaces.

touch it.  
love it.



**1,8L**

Grosses Volumen  
Grand volume  
Large volume



AUTHENTIC  
GLOSS



German  
Design Award

SPECIAL  
MENTION 2015



LOFT







Blumengießber / Arrosoir / Watering can

COLOUR	L	C-CODE	EAN	VPE <sup>1)</sup>
 green	1,8	ALO1L8V	3 1 6 7 8 9 0 0 1 6 7 3 7 1	4
 white	1,8	ALO1L8BL	3 1 6 7 8 9 0 0 1 6 7 4 4 1	4
 dusty grey	1,8	ALO1L8GC	3 1 6 7 8 9 0 0 1 6 7 5 1 1	4
 silk grey	1,8	ALO1L8GS	3 1 6 7 8 9 0 0 1 6 7 9 9 1	4
 sepia rose	1,8	ALO1L8RS	3 1 6 7 8 9 0 0 1 6 8 1 2 1	4
 sage	1,8	ALO1L8SA	3 1 6 7 8 9 0 0 1 6 8 3 6 1	4



LOFT

Blumensprüher / Vaporisateur / Sprayer

COLOUR	L	C-CODE	EAN	VPE <sup>1)</sup>
 green	0,7	VLO0L7V	3 1 6 7 8 9 0 0 1 6 7 6 8 1	4
 white	0,7	VLO0L7BL	3 1 6 7 8 9 0 0 1 6 7 7 5 1	4
 dusty grey	0,7	VLO0L7GC	3 1 6 7 8 9 0 0 1 6 7 8 2 1	4
 silk grey	0,7	VLO0L7GS	3 1 6 7 8 9 0 0 1 6 8 0 5 1	4
 sepia rose	0,7	VLO0L7RS	3 1 6 7 8 9 0 0 1 6 8 2 9 1	4
 sage	0,7	VLO0L7SA	3 1 6 7 8 9 0 0 1 6 8 4 3 1	4

<sup>1)</sup> VPE / UE / Unit



Langlebige Messingdüse

Buse en laiton robuste et réglable  
Long-lasting brass nozzle

trend

RAUCHGLAS

TENDANCE : VERRE FUMÉ

TREND: SMOKED GLASS

MADE IN GERMANY

NEW



1,8L

Grosses Volumen  
Grand volume  
Large volume



Langlebige Messingdüse

Buse en laiton robuste et réglable  
Long-lasting brass nozzle



NEW

LOFT SMOKED GLASS

Blumengießler / Verre fumé Arrosoir / Watering can

COLOUR	L	C-CODE	EAN	VPE <sup>1)</sup>
transparent	1,8	ALOFU1L8INC	3 167890 017529	4
smoke	1,8	ALOFU1L8G	3 167890 017536	4
smoky green	1,8	ALOFU1L8VS	3 167890 017543	4
sepia brown	1,8	ALOFU1L8MK	3 167890 017550	4

NEW

LOFT SMOKED GLASS

Blumensprüher / Vaporisateur / Sprayer

COLOUR	L	C-CODE	EAN	VPE <sup>1)</sup>
transparent	0,7	VLOFU0L7INC	3 167890 017567	4
smoke	0,7	VLOFU0L7G	3 167890 017574	4
smoky green	0,7	VLOFU0L7VS	3 167890 017581	4
sepia brown	0,7	VLOFU0L7MK	3 167890 017598	4

<sup>1)</sup> VPE / UE / Unit



### FUCHSIA

¼ Display bestückt / ¼ Présentoir garni /  
¼ Display stand equipped

CM <sup>1)</sup>	C-CODE	EAN	VPE <sup>2)</sup>
60×40×164	BOX890	3 167890 003218	1

40 x Gießler / Arrosoir / Watering can

○ 4 ○ 8 ○ 4 ○ 8 ○ 8 ○ 8

28 x Sprüher / Vaporisateur / Sprayer

○ 4 ○ 4 ○ 4 ○ 4 ○ 4 ○ 8

MADE IN GERMANY



### FUCHSIA TRANSPARENT

Blumengießler / Arrosoir / Watering can

COLOUR	L	C-CODE	EAN	VPE <sup>2)</sup>
○ transp.	1,5	AFUTR1L5INC	3 167890 016324	4
○ transp. sun yellow	1,5	AFUTR1L5J	3 167890 016386	4
○ transp. raspberry red	1,5	AFUTR1L5FR	3 167890 016409	4
○ transp. melon red	1,5	AFUTR1L5PA	3 167890 016423	4
○ transp. lime green	1,5	AFUTR1L5CV	3 167890 016447	4
○ transp. topaz blue	1,5	AFUTR1L5B	3 167890 016331	4

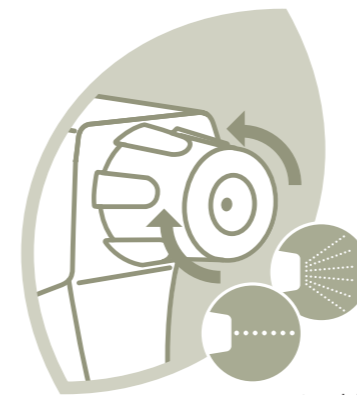

Langlebige Messingdüse

Buse en laiton robuste et réglable  
Long-lasting brass nozzle



### FUCHSIA TRANSPARENT

Blumensprüher / Vaporisateur / Sprayer

COLOUR	L	C-CODE	EAN	VPE <sup>2)</sup>
○ transp.	0,7	VFUTROL7INC	3 167890 016348	4
○ transp. sun yellow	0,7	VFUTROL7J	3 167890 016393	4
○ transp. raspberry red	0,7	VFUTROL7FR	3 167890 016416	4
○ transp. melon red	0,7	VFUTROL7PA	3 167890 016430	4
○ transp. lime green	0,7	VFUTROL7CV	3 167890 016454	4
○ transp. topaz blue	0,7	VFUTROL7B	3 167890 016355	4









1) LxBxH / lxlxh / lxwxh 2) VPE / UE / Unit



MADE IN GERMANY









**FUCHSIA SMOKED GLASS**  
Blumengießßer / Verre fumé Arrosoir / Watering can

COLOUR	L	C-CODE	EAN	VPE <sup>2)</sup>
 transparent	1,5	AFUTR1L5INC	3 167890 016324	4
 amber	1,5	AFUFU1L5AM	3 167890 016461	4
 bottle green	1,5	AFUFU1L5VB	3 167890 016478	4
 smoke	1,5	AFUFU1L5G	3 167890 016485	4
 smoky green	1,5	AFUFU1L5VS	3 167890 016690	4
 sepia brown	1,5	AFUFU1L5MK	3 167890 016713	4



**FUCHSIA SMOKED GLASS**  
Blumensprüher / Vaporisateur / Sprayer

COLOUR	L	C-CODE	EAN	VPE <sup>2)</sup>
 transparent	0,7	VFUTR0L7INC	3 167890 016348	4
 amber	0,7	VFUFU0L7AM	3 167890 016492	4
 bottle green	0,7	VFUFU0L7VB	3 167890 016508	4
 smoke	0,7	VFUFU0L7G	3 167890 016515	4
 smoky green	0,7	VFUFU0L7VS	3 167890 016706	4
 sepia brown	0,7	VFUFU0L7MK	3 167890 016720	4



1) LxBxH // lxlxh // lxwxh 2) VPE / UE / Unit

Langlebige Messingdüse  
Buse en laiton robuste et réglable  
Long-lasting brass nozzle

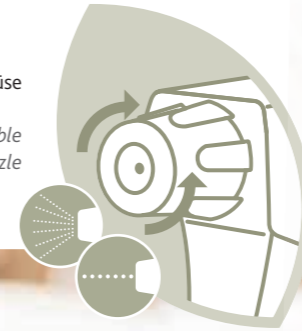

trend

**RAUCHGLAS**

TENDANCE : VERRE FUMÉ  
TREND: SMOKED GLASS



**FUCHSIA**

¼ Display bestückt / ¼ Présentoir garni /  
¼ Display stand equipped

CM <sup>1)</sup>	C-CODE	EAN	VPE <sup>2)</sup>
60x40x164	BOX891	3 167890 003225	1

40x Gießßer / Arrosoir / Watering can  
 8  4  4  8  8  8

28x Sprüher / Vaporisateur / Sprayer  
 8  4  4  4  4  4

●●●●  
MADE IN  
GERMANY

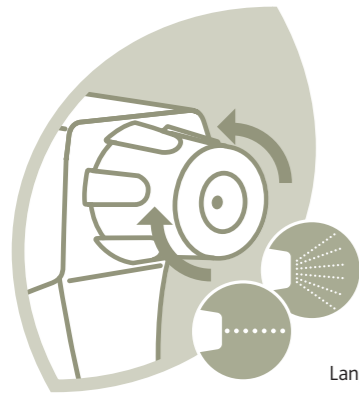

Langlebige Messingdüse

Buse en laiton robuste et réglable  
Long-lasting brass nozzle

### FUCHSIA OPAK

Blumengießßer / Arrosoir / Watering can

COLOUR	L	C-CODE	EAN	VPE <sup>1)</sup>
 turquoise green	1,5	AFUOP1L5TU	3 167890 016546	4
 green	1,5	AFUOP1L5AN	3 167890 016560	4
 light pink	1,5	AFUOP1L5RO	3 167890 016577	4



### FUCHSIA OPAK

Blumensprüher / Vaporisateur / Sprayer



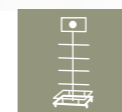

COLOUR	L	C-CODE	EAN	VPE <sup>1)</sup>
 turquoise green	0,7	VFUOP0L7TU	3 167890 016584	4
 green	0,7	VFUOP0L7AN	3 167890 016591	4
 light pink	0,7	VFUOP0L7RO	3 167890 016553	4



► Präsentationsständer /  
Présentoir / Presentation stand  
C-Code POS002764

### FUCHSIA OPAK

Blumengießßer / Arrosoir / Watering can

COLOUR	L	C-CODE	EAN	VPE <sup>1)</sup>
 white	1,5	AFUOP1L5BL	3 167890 016652	4
 crème	1,5	AFUOP1L5CR	3 167890 016669	4
 silk grey	1,5	AFUOP1L5GS	3 167890 016676	4
 anthracite	1,5	AFUOP1L5ANT	3 167890 016683	4



### FUCHSIA OPAK

Blumensprüher / Vaporisateur / Sprayer

COLOUR	L	C-CODE	EAN	VPE <sup>1)</sup>
 white	0,7	VFUOP0L7BL	3 167890 016614	4
 crème	0,7	VFUOP0L7CR	3 167890 016621	4
 silk grey	0,7	VFUOP0L7GS	3 167890 016638	4
 anthracite	0,7	VFUOP0L7ANT	3 167890 016645	4



# OUTDOOR

SCHÖN  
& ROBUST

## 1,5–5,0L

Großes Volumen

*Esthétique & robuste – Grand volume*  
*Beautiful & robust – Large volume*

### OASE

Blumengießser / Arrosoir / Watering can

COLOUR	L	C-CODE	EAN	VPE <sup>1)</sup>
white	1,5	AOA1L5BL	3 167890 016850	6
	3	AOA3BL	3 167890 016867	4
	5	AOA5BL	3 167890 016874	4
granite	1,5	AOA1L5GRA	3 167890 016881	6
	3	AOA3GRA	3 167890 016898	4
	5	AOA5GRA	3 167890 016904	4
silk grey	1,5	AOA1L5GS	3 167890 016911	6
	3	AOA3GS	3 167890 016928	4
	5	AOA5GS	3 167890 016935	4
green	1,5	AOA1L5V	3 167890 016942	6
	3	AOA3V	3 167890 016959	4
	5	AOA5V	3 167890 016966	4
antique blue	1,5	AOA1L5BLP	3 167890 016973	6
	3	AOA3BLP	3 167890 016980	4
	5	AOA5BLP	3 167890 016997	4



### OASE

Blumensprüher / Vaporisateur / Sprayer

L	C-CODE	EAN	VPE <sup>1)</sup>
1	VOA1BL	3 167890 017000	6
1	VOA1GRA	3 167890 017017	6
1	VOA1GS	3 167890 017024	6
1	VOA1V	3 167890 017031	6
1	VOA1BLP	3 167890 017048	6





**MADE IN GERMANY**



Langlebige Messingdüse  
*Buse en laiton robuste et réglable*  
Long-lasting brass nozzle



## FUCHSIA

Tischständer / Présentoir / Table display

CM <sup>2)</sup>	C-CODE	EAN	VPE <sup>3)</sup>
55x127	POS002765	3 167890 004055	1
unbestückt / non garni / items not included			



1. Bestückungsvorschlag / Proposition de composition / Display suggestion

24x Gießler / Arrosoir / Watering can

○ 4 ● 4 ● 4 ● 4 ● 4 ● 4

24x Sprüher / Vaporisateur / Sprayer

○ 4 ● 4 ● 4 ● 4 ● 4 ● 4

2. Bestückungsvorschlag / Proposition de composition / Display suggestion

24x Gießler / Arrosoir / Watering can

○ 4 ○ 4 ○ 4 ○ 4 ○ 4 ○ 4

24x Sprüher / Vaporisateur / Sprayer

○ 4 ○ 4 ○ 4 ○ 4 ○ 4 ○ 4

3. Bestückungsvorschlag / Proposition de composition / Display suggestion

24x Gießler / Arrosoir / Watering can

○ 4 ○ 4 ○ 4 ○ 4 ○ 4 ○ 4

24x Sprüher / Vaporisateur / Sprayer

○ 4 ○ 4 ○ 4 ○ 4 ○ 4 ○ 4

## FUCHSIA

Präsentationsständer / Présentoir / Presentation stand

CM <sup>1)</sup>	C-CODE	EAN	VPE <sup>3)</sup>
80x80x240	POS002764	3 167890 004048	1
unbestückt / non garni / items not included			



1. Bestückungsvorschlag / Proposition de composition / Display suggestion

64x Gießler / Arrosoir / Watering can

● 8 ● 4 ● 8 ○ 12 ● 8 ● 8 ● 8

100x Sprüher / Vaporisateur / Vaporizzatore

● 12 ● 20 ● 12 ○ 20 ● 12 ● 12 ● 12

2. Bestückungsvorschlag / Proposition de composition / Display suggestion

64x Gießler / Arrosoir / Watering can

○ 12 ● 8 ● 12 ● 8 ● 12 ● 12

100x Sprüher / Vaporisateur / Sprayer

○ 20 ● 16 ● 16 ● 16 ● 16 ● 16

3. Bestückungsvorschlag / Proposition de composition / Display suggestion

64x Gießler / Arrosoir / Watering can

○ 12 ● 12 ● 8 ● 12 ● 8 ● 12

100x Sprüher / Vaporisateur / Sprayer

○ 20 ● 16 ● 16 ● 16 ● 16 ● 16

1) LxBxH / lxlxh / lxxwxh 2) lxl / lxl 3) VPE / UE / Unit



## FUCHSIA

1/4 Display bestückt / 1/4 Présentoir garni / 1/4 Display stand equipped

CM <sup>1)</sup>	C-CODE	EAN	VPE <sup>3)</sup>
60x40x164	BOX890	3 167890 003218	1

40x Gießler / Arrosoir / Watering can

○ 4 ○ 8 ○ 4 ○ 8 ○ 8 ○ 8

28x Sprüher / Vaporisateur / Sprayer

○ 4 ○ 4 ○ 4 ○ 4 ○ 4 ○ 8



## FUCHSIA

1/4 Display bestückt / 1/4 Présentoir garni / 1/4 Display stand equipped

CM <sup>1)</sup>	C-CODE	EAN	VPE <sup>3)</sup>
60x40x164	BOX891	3 167890 003225	1

40x Gießler / Arrosoir / Watering can

○ 8 ○ 4 ○ 4 ○ 8 ○ 8 ○ 8

28x Sprüher / Vaporisateur / Sprayer

○ 8 ○ 4 ○ 4 ○ 4 ○ 4 ○ 4

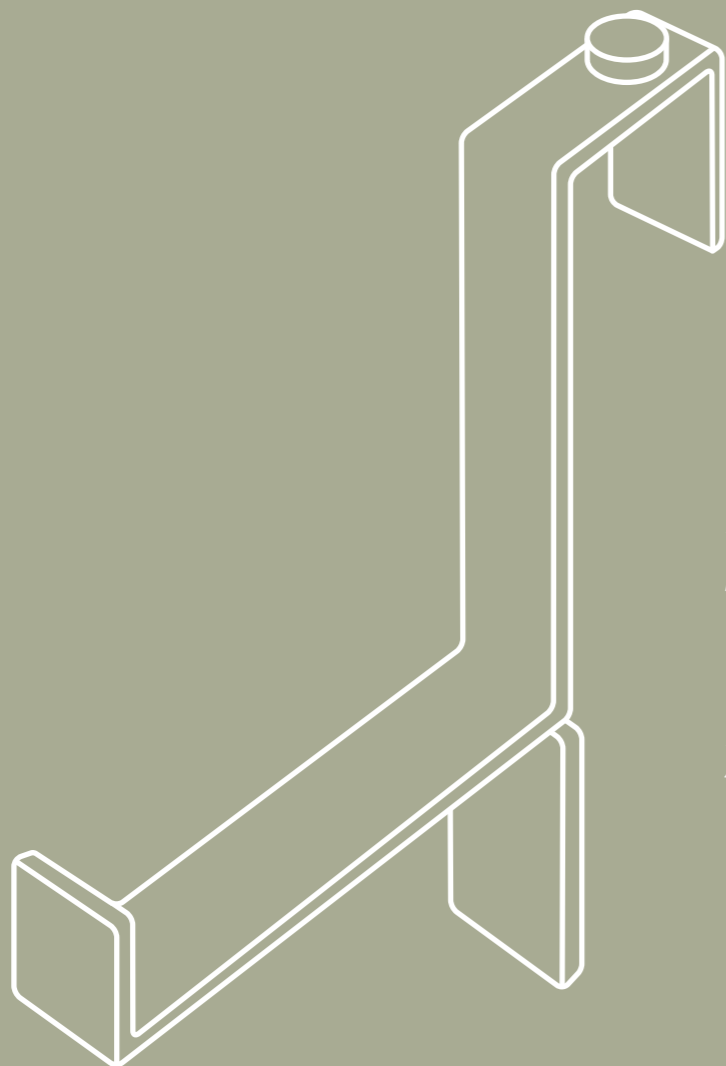

**ACCROCHES**

*Toujours adapté ! Un large assortiment répondant à chaque besoin et orientant le client vers le produit adéquat. Simple pour le client, pratique et facilitant l'achat d'impulsion.*

**METAL BRACKETS**

*It always fits! Extensive assortment for every type of application. Guaranteed more orientation at the PoS. Customer-friendly. Practical. Stimulating.*

# BLUMENKASTEN- HALTER

Immer passend! Umfangreiches Sortiment für jede Anwendung. Garantiert mehr Orientierung am PoS. Kundengerecht. Praktisch. Impulsstark.

\* Abhängig von der Substanz der Mauer / En fonction de la substance du mur / Depends on the make-up of the wall

**VARIO COMFORT 50 kg**



Passend für / Convient aux / Suitable for

- CASA MESH ▶ p.27
- LANDHAUS ▶ p.38
- MY CITY GARDEN ▶ p.81
- COUNTRY ▶ p.87
- LAGO ▶ p.89
- BALCONE ▶ p.90

**VARIO UNIVERSAL 50 kg**



Passend für / Convient aux / Suitable for

- COUNTRY ▶ p.87
- LAGO ▶ p.89
- BALCONE ▶ p.90

**BASIC 25 kg**

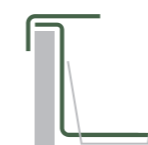

Passend für / Convient aux / Suitable for

- LANDHAUS ▶ p.38
- COUNTRY ▶ p.87
- BALCONE ▶ p.90

**SPECIAL 25 kg**  
Round rail / Balustrade ronde /  
Ringhiera circolare



Passend für / Convient aux / Suitable for

- LANDHAUS ▶ p.38
- COUNTRY ▶ p.87
- LAGO ▶ p.89
- BALCONE ▶ p.90

**SPECIAL 50 kg\***  
Wall / Mur / Muro



Passend für / Convient aux / Suitable for

- LANDHAUS ▶ p.38
- COUNTRY ▶ p.87
- LAGO ▶ p.89
- BALCONE ▶ p.90

**CASA MESH / MY CITY GARDEN 50 kg**



Passend für / Convient aux / Suitable for

- CASA MESH ▶ p.27
- MY CITY GARDEN ▶ p.81

**LANDHAUS 25 kg**

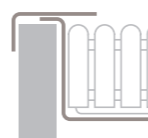

Passend für / Convient aux / Suitable for

- LANDHAUS ▶ p.38
- COUNTRY ▶ p.87
- BALCONE ▶ p.90

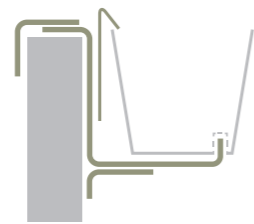
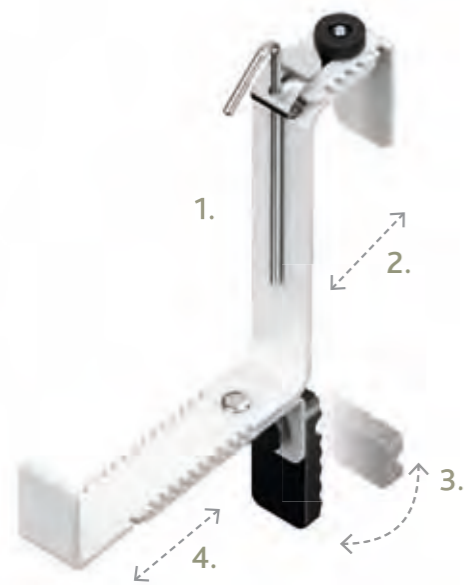

- 1. SPANNMETALL DRÜCKEN, HAKEN RUNTERSCHIEBEN, FERTIG!\***  
Appuyer sur le métal de fixation, pousser le crochet vers le bas, c'est terminé!\*
- 2. FÜR GELÄNDER VON 4–7 CM BREITE**  
Pour balustrades d'une largeur de 4 à 7 cm
- 3. 360° / Ø 10 cm**  
Flexibler Kunststoff-Drehfuß für maximalen Befestigungsradius.
- 4. KOMFORTABLE STUFENRASTUNG – KEIN VERRUTSCHEN MÖGLICH\***

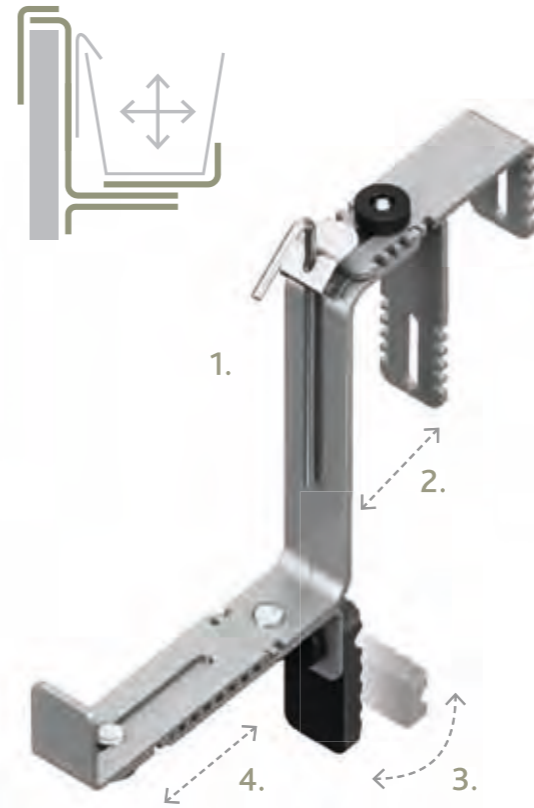

# VARIO COMFORT

- 1. SPANNMETALL DRÜCKEN, HAKEN RUNTERSCHIEBEN, FERTIG!\***  
Appuyer sur le métal de fixation, pousser le crochet vers le bas, c'est terminé!\*
- 2. FÜR RUNDE UND ECKIGE GELÄNDER VON 4–12 CM BREITE**  
Pour balustrades rondes et rectangulaires d'une largeur de 4 à 12 cm
- 3. 360° / Ø 10 cm**  
Flexibler Kunststoff-Drehfuß für maximalen Befestigungsradius.
- 4. KOMFORTABLE STUFENRASTUNG – KEIN VERRUTSCHEN MÖGLICH\***

## IDEAL FÜR VERDECKTE BALKONKASTENHALTERUNG

Idéal pour l'accroche de jardinière masquée  
Perfect for concealed window box brackets



► Passend für  
notamment usages suivants / Suitable for  
CASA MESH and MY CITY GARDEN window-boxes  
S. 27, S. 81



## CASA MESH / MY CITY GARDEN

Blumenkastenhalter / Accroches / Metal brackets

COLOUR	C-CODE	EAN	VPE <sup>2)</sup>
white	SUPJCMEMCGBL	3 167890 017055	10
aluminium	SUPJCMEMCGAL	3 167890 017062	10
anthracite	SUPJCMEMCGANT	3 167890 017079	10



► Universell einsetzbar – u. a. passend für:  
Utilisation universelle, notamment pour les usages suivants :  
Universal use – suitable for:  
CASA MESH, LANDHAUS, MY CITY GARDEN,  
COUNTRY, LAGO, BALCONE  
S. 27, S. 38, S. 81, S. 87, S. 89, S. 90

## VARIO COMFORT

Blumenkastenhalter / Accroches / Metal brackets

COLOUR	C-CODE	EAN	VPE <sup>2)</sup>
white	SUPJVACBL	3 167890 017086	10
aluminium	SUPJVACAL	3 167890 017093	10
anthracite	SUPJVACANT	3 167890 017109	10

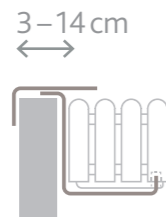

## LANDHAUS

Blumenkastenhalter / Accroches / Metal brackets

COLOUR	C-CODE	EAN	VPE <sup>2)</sup>
white	SUPJLHBL	3 167890 014870	10
aluminium	SUPJLHAL	3 167890 014887	10



► Passend für  
notamment usages suivants / Suitable for  
LANDHAUS window-boxes  
S. 38



## SPEZIELLE REGAL-LÖSUNG UND NACHRÜSTSET AUF ANFRAGE. SPRECHEN SIE UNS AN!

SOLUTION DE RAYONNAGE SPÉCIFIQUE ET KIT D'ADAPTATION SUR DEMANDE. N'HÉSITEZ PAS À NOUS CONTACTER !

SPECIAL SHELF SOLUTION AND RETROFIT KIT ON REQUEST. TALK TO US!

1) LxBxH / l x l x h / l x w x h 2) VPE / UE / Unit  
\* Für Kästen von 14–19 cm Breite. / \* Pour jardinières d'une hauteur de 14 à 19 cm /  
\* For window boxes measuring 14–19 cm in height

# VARIO / BASIC



## VARIO UNIVERSAL

Blumenkastenhalter / Accroches / Metal brackets

COLOUR	C-CODE	EAN	VPE <sup>1)</sup>
white	SUPJVAUNBL	3 167890 017116	10
aluminium	SUPJVAUNAL	3 167890 017123	10
terracotta	SUPJVAUNTC	3 167890 017130	10
dark brown	SUPJVAUNMK	3 167890 017147	10
anthracite	SUPJVAUNANT	3 167890 017154	10

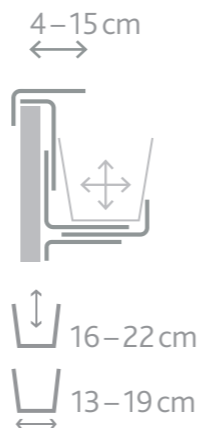

**50 kg**

Tragkraft / Capacité de charge / Load capacity



# SPECIAL

## SPECIAL RUNDGELÄNDER

Blumenkastenhalter / Accroches pour balustrade arrondie / Metal brackets for railings

COLOUR	C-CODE	EAN	VPE <sup>1)</sup>
white	SUPJBALBL	3 167890 017192	10
aluminium	SUPJBALAL	3 167890 017208	10
anthracite	SUPJBALANT	3 167890 017215	10



**25 kg**

Tragkraft / Capacité de charge / Load capacity



Für Standard Rundgeländer bis 4,5 cm geeignet. / Pour les balustrades rondes d'un diamètre max. de 4,5 cm. / Suitable for standard railings up to 4.5 cm



## BASIC

Blumenkastenhalter / Accroches / Metal brackets

COLOUR	C-CODE	EAN	VPE <sup>1)</sup>
white	SUPJVABABL	3 167890 017161	10
aluminium	SUPJVABAAL	3 167890 017178	10
anthracite	SUPJVABAANT	3 167890 017185	10

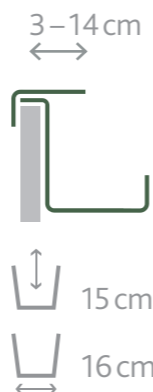

**25 kg**

Tragkraft / Capacité de charge / Load capacity



## SPECIAL MAUER

Blumenkastenhalter / Accroches pour murs / Metal brackets for walls

COLOUR	C-CODE	EAN	VPE <sup>1)</sup>
white	SUPJMBL	3 167890 017222	10
aluminium	SUPJMAL	3 167890 017239	10
anthracite	SUPJMANT	3 167890 017246	10

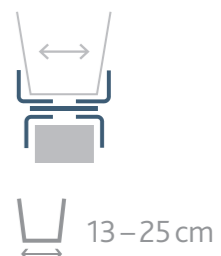

**50 kg**

Tragkraft / Capacité de charge / Load capacity



<sup>1)</sup> VPE / UE / Unit

ERSATZTEILE / SPARE PARTS / ACCESSOIRES

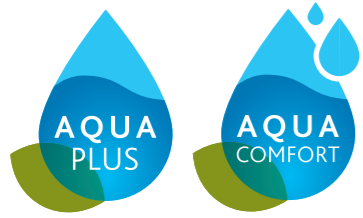

CASA TALL PLANTERS AND CUBES 30 CM

Wasserstandsanzeiger / Indicateur de niveau d'eau / Water level indicator

CM	C-CODE	EAN	UNIT <sup>3)</sup>
34	SP000596	3 167890 035097	6



Füllschacht / Entonnoir de remplissage / Filling chamber

CM	C-CODE	EAN	UNIT <sup>3)</sup>
26	SP000595	3 167890 035080	6



Drainageplatte / Plaque de drainage / Drainage plate

CM	C-CODE	EAN	UNIT <sup>3)</sup>
25x25x6	SP000597	3 167890 035103	6



Pflanzeinsatz / Cache pot / Planting tray

CM <sup>1)</sup>	C-CODE	EAN	UNIT <sup>3)</sup>
30x30x28	SP000598	3 167890 035110	1



Schrauben / Vis / Screws

CONTENT	C-CODE	EAN	UNIT <sup>3)</sup>
2 Stk./pc. /pcs	SP000599	3 167890 035127	6



CASA PLANTER ROUND 25 CM

Bewässerungskit\* / Kit d'arrosage / Watering Set

CM <sup>2)</sup>	C-CODE	EAN	UNIT <sup>3)</sup>
21x6	SP000592	3 167890 035059	1

CASA PLANTER ROUND 30 CM

Bewässerungskit\* / Kit d'arrosage / Watering Set

CM <sup>2)</sup>	C-CODE	EAN	UNIT <sup>3)</sup>
29x6	SP000593	3 167890 035066	1

CASA PLANTER ROUND 36 CM

Bewässerungskit\* / Kit d'arrosage / Watering Set

CM <sup>2)</sup>	C-CODE	EAN	UNIT <sup>3)</sup>
36x6	SP000594	3 167890 035073	1

\* Drainageplatte, Wasserstandsanzeiger, Spezialvlies / Plaque de drainage, Indicateur de niveau d'eau, Feutre spécial / Drainage plate, Water level indicator, Special padding



CASA/CITY RAILING POT 30 CM

Drainageplatte / Plaque de drainage / Drainage plate

CONTENT	C-CODE	EAN	UNIT <sup>3)</sup>
2 Stk./pc. /pcs	SP000601	3 167890 035141	6

CITY RAILING POT 60 CM

Drainageplatte / Plaque de drainage / Drainage plate

CONTENT	C-CODE	EAN	UNIT <sup>3)</sup>
2 Stk./pc. /pcs	SP000602	3 167890 035158	6

CASA/CITY RAILING POT

Schrauben inkl. Abdeckung / Vis avec caches / Screws with covers

CONTENT	C-CODE	EAN	UNIT <sup>3)</sup>
2 Stk./pc. /pcs	SP000603	3 167890 035165	6

CASA MESH / MY CITY GARDEN / LAGO

Wasserstandsanzeiger\* / Indicateur de niveau d'eau / Water level indicator

CM	C-CODE	EAN	UNIT <sup>3)</sup>
22	SP000583	3 167890 034960	6

CASA / MY CITY GARDEN / LAGO

Spezialvlies\*\* / Feutre spécial / Special padding

CM	C-CODE	EAN	UNIT <sup>3)</sup>
200	SP000582	3 167890 034953	6

CASA / CITY / MY CITY GARDEN

Spezialvlies\*\* / Feutre spécial / Special padding

CONTENT	C-CODE	EAN	UNIT <sup>3)</sup>
3 Stk./pc. /pcs à 47 cm	SP000589	3 167890 035028	6

CASA MESH / MY CITY GARDEN

Füllschacht / Entonnoir / Filling chamber

CM	C-CODE	EAN	UNIT <sup>3)</sup>
18	SP000590	3 167890 035035	6

CASA MESH / MY CITY GARDEN

Verstärkungsstreben\* / Traverses de renfort / Reinforcement rods

CONTENT	C-CODE	EAN	UNIT <sup>3)</sup>
20 Stk./pc. /pcs	SP000591	3 167890 035042	1

LAGO

Verstärkungsstreben\* / Traverses de renfort / Reinforcement rods

CONTENT	C-CODE	EAN	UNIT <sup>3)</sup>
20 Stk./pc. /pcs	SP000586	3 167890 034991	1

LAGO

Füllschacht / Entonnoir / Filling chamber

CM	C-CODE	EAN	UNIT <sup>3)</sup>
18	SP000587	3 167890 035004	6

FRESH HERBS

Bewässerungsset / Kit d'irrigation / Watering Set

CONTENT	C-CODE	EAN	UNIT <sup>3)</sup>
9 Stk./pc. /pcs	KITIRFH	3 167890 035011	1

LOFT

Sprühkopf / Tête d'arrosage / Spray head

COLOUR	C-CODE	EAN	UNIT <sup>3)</sup>
grey	SP000600	3 167890 035134	1

FUCHSIA / OASE

Sprühkopf / Tête d'arrosage / Spray head

COLOUR	C-CODE	EAN	UNIT <sup>3)</sup>
black	SP000585	3 167890 034984	1

SIENA NOBILE

Ersatzkette / Chaîne de rechange / Spare chain

C-CODE	EAN	UNIT <sup>3)</sup>
SP000584	3 167890 034977	1

\* für Blumenkästen / pour jardinières / for window boxes  
 \*\* für Blumenkästen und -kübel mit EMSA Langzeitbewässerungssystem / pour jardinières et bacs à fleurs avec le système d'irrigation continue d'EMSA / for window boxes and planters with EMSA long-term watering system  
 \*\*\* für Geländertöpfe / pour pot pour balustrade / for railing pots





Von Basic- bis zu Premium-Pflanzgefäßen und Brunnen stehen wir mit unseren Marken für umfassende Kompetenz – unkompliziert und mit bestem Wachstumspotenzial. Fordern Sie unsere Kataloge an.

**NEW**

# UNSER GANZHEITLICHES PRODUKTANGEBOT.

esteras™ 

ESTERAS. die Freude am Echten.  
Profitieren Sie mit unserer Lifestyle-Marke für hochwertige Pflanzgefäße und Brunnen. Fordern Sie unseren neuen Katalog an.

Oder besuchen Sie uns auch auf [esteras.com](http://esteras.com)

Visitez notre site [esteras.com](http://esteras.com)  
Visit us at [esteras.com](http://esteras.com)



ESTERAS. Le plaisir de l'authentique. Sachez profiter avec notre marque haut de gamme de bacs à plantes et de fontaines décoratives. Demandez notre nouveau catalogue.

ESTERAS. The beauty of authenticity. Benefit from our new lifestyle brand for high-quality planters and fountains. Order our new catalogue.



  
**Poétic**



**Notre vaste gamme de produits.**  
Des pots et bacs de qualité basique aux fontaines haut de gamme, nos marques sont synonymes d'un savoir-faire complet, pour une utilisation simple et un potentiel de croissance optimal. Demandez nos catalogues.

**Our comprehensive product range.**  
From basic to premium planters and fountains, our brands stand for all-round expertise – uncomplicated and with the best growth potential. Order our catalogue.

# INDEX

## PRODUKT

Bewässerungsschlauch	126	Füllschacht	126, 127	Pflanzstab	71	Verbindungsclip	70
Bewässerungsset	101, 127	Futterhaus	51	Pflanztroig	65, 92	Verstärkungsstreben	127
Blumengeißer	105-116	Futtersilo	50	Präsentationsständer	115, 119	Wandgarten-Rack	73
Blumenkasten	27, 38, 81, 87-90	Geländerhalterung	54	Rankgitter	69, 70, 73	Warenträger	28, 44, 66, 78
Blumenkastenhalter	27, 38, 122-125	Geländertopf / Hängetopf	28, 45, 77, 79	Regal	123	Wasserstandsanzeiger	126, 127
Blumenkübel	20, 31, 43, 63, 67, 73, 75, 92, 95	Hängeschale	94	Säule	17, 23, 25, 31, 32	Würfel	22, 25, 32
Blumensprüher	107-116	Jardinière	42	Schrauben	126	Zubehör	126-127
Display	39, 44, 56, 63, 65, 67, 77, 110, 112, 118	Körbchen	40	Spezialvlies	127	Zubehörhaken	41, 73, 77
Drainageplatte	126	Kräutertopf	99	Sprühkopf	127		
Einsatz	55, 126	Nachrüstset	44, 123	Stabhalterung	55		
Ersatzkette	127	Nistkasten	53	Tischständer	119		
Fässchen	41	Pflanzeinsatz	126	Topfhaken	72, 73, 75		
		Pflanzenklammer	71	Trio Kräutertopf	101		
		Pflanzenschlaufe	71	Untersetzer	63-67, 73, 75, 92		

## PRODUIT

Accessoires	126-127	Crochets pour accessoires	41, 73, 77	Liens pour plantes	71	Traverses de renfort	127
Accroche pour balustrade	54	Crochets pour pot	72	Mangeoire à oiseaux	51	Trellage large	69
Accroches	27, 38, 122-125	Crochet spécial	75	Mangeoire silo pour oiseaux	50	Trellage mural	73
Agrafes pour plantes	71	Entonnoir de remplissage	126	Nichoir	53	Trio de pots à herbes	101
Arrosoir	105-116	Feutre spécial	127	Plaque de drainage	126	Tuteur	71
Bac à fleurs	17, 20-25, 31, 32, 40-43, 63, 67, 73-75, 92, 95	Fixation sur potence	55	Pot à herbes	99	Vaporisateur	107-116
Cache pot	126	Indicateur de niveau d'eau	126, 127	Pot pour balustrade	28, 45, 77, 79	Vis	126
Chaîne de rechange	127	Insert	55	Présentoir	28, 39, 44, 56, 63, 65-67, 77, 78, 110, 112, 118, 119		
Clip de jonction	70	Jardinière	27, 38, 42, 65, 81, 87-90	Soucoupe	63-67, 73, 75, 92		
Coupe à suspendre	94	Kit d'arrosage	126	Tête d'arrosage	127		
		Kit d'irrigation	101, 127				

## PRODUCT

Accessories	126-127	Insert	55	Railing holder	54	Trellis	69, 70, 73
Accessory hooks	41, 73, 77	Jardinière	42	Railing pot / Hanging planter	28, 45, 77, 79	Trio herb pot	101
Attachment Clip	70	Metal brackets	27, 38, 122-125	Rod holder	55	Wall trellis	73
Bird feeder	51	Plant clips	71	Screws	126	Watering can	105-116
Bird feed dispenser	50	Plant pot hooks	72	Spare chain	127	Watering set	101, 127
Bird House	53	Plant rod	71	Special hook	75	Water level indicator	126, 127
Display stand	39, 44, 56, 63, 65-67, 77, 78, 110, 112, 118, 119	Plant ties	71	Special padding	127	Window box	27, 38, 81, 87-90
Drainage plate	126	Planter	17, 20-25, 31, 32, 40-43, 63, 65-67, 73, 75, 92, 95	Spray head	127		
Filling chamber	127	Planting tray	126	Sprayer	107-116		
Herb pot	99	Product displays	28, 44, 66, 78	Table display	119		
				Tray	63-67, 73, 75, 92		

## FARBEN / COULEURS / COLOURS

Weiss blanc / white	Cremeweiss crème / creme	Seidengrau gris soie / silk grey	Staubgrau / gris poussiéreux / dusty grey	Granit granit / granite	Anthrazit anthracite / anthracite
Gelb jaune / yellow	Sonnengelb * jaune soleil / sun yellow	Limettengrün * citron vert / lime green	Grün anis / green	Flaschengrün * bouteille verte / bottle green	Rauch * fumée / smoke
Altblau / vieux bleu antique blue	Topasblau * bleu topaze / topaz blue	Türkisgrün / vert turquoise turquoise green	Salbei sauge / sage	Rauchgrün * vert fumé / smoky green	Lorbeergrün vert laurier / laurel green
Terrakotta terre cuite / terracotta	Bernstein * ambre / amber	Braun marron / brown	Sepiabraun * brun sépia / sepia brown	Rauchbraun / brun fumé smoky brown	Mokka moka / mocca
Sepia Rosé rose sépia / sepia rose	Rubinrot rouge rubis / ruby red	Rotviolett rouge violet / red violet	Pink hell rose clair / light pink	Himbeerrot * framboise / raspberry red	Melonenrot * melon / melon red
Cortenstahl corten / corten steel	Aluminium aluminium / aluminum	Stahl acier / steel	Beton béton / concrete	Schwarz noir / black	

\*Transparent / transparent / transparent

## ZEICHEN / SIGNES / SIGNS

Achten Sie auf diese Zeichen. Sie erklären Ihnen in Kurzform die wichtigsten Produktvorteile.

Prêtez attention à ces pictogrammes. Ils vous disent brièvement les principaux avantages du produit.

Look for these signs. They briefly explain the main product benefits.



Produktneuheit / Nouveauté / New product launch



Sicher frostdfest – Das ganze Jahr über im Freien zu verwenden  
Résistance sûre au gel – Utilisable pendant toute l'année à l'extérieur  
Safe, frost-resistant – suitable for outdoor use all year round



Dauerhaft farbecht – UV-beständig für dauerhaft schöne Farben  
Longévité. Couleur durable – Résistant aux UV pour de belles couleurs durables  
Durable, fast colours – UV resistant for long-lasting, beautiful colours



Material  
Matière / Material



Verschlusschraube für den Ablauf  
Vis de fermeture de l'orifice d'écoulement / Screw stopper for drainage hole



Metall  
Métal / Metal



100 % dicht  
100 % hermétique / 100 % leak-proof



Bohren erforderlich  
Perçage nécessaire / Drilling required

Viele Produkte auch im Display erhältlich:  
Beaucoup de produits également disponibles en présentoir:  
Many products also available in display stands:



Warenträger / Présentoir / Presentation stand



1/1 Display / 1/1 Présentoir / 1/1 Display stand



1/2 Display / 1/2 Présentoir / 1/2 Display stand



1/4 Display / 1/4 Présentoir / 1/4 Display stand



Display Box / Présentoir / Display stand



Eine einfache Bohrung genügt.  
Am Boden der meisten Kästen und Kübel befindet sich eine spezielle Vorstanzung, die ganz leicht aufgebohrt werden kann.  
So kann jedes Gefäß wahlweise zum direkten Bepflanzen oder als Übertopf genutzt werden.  
Un simple perçage suffit.  
Au fond de la plupart de nos jardinières et bacs se trouve un poinçon spécial qui peut être percé tout simplement. Ainsi, chaque bac peut facultativement être utilisé pour la plantation ou comme cache-pot.  
Simple drilling operation suffices.  
Most of our window-boxes and tubs have pre-punched pilot holes marked on the bottom, ready for drilling. So each pot can be used either as a flower pot or as a cache-pot



Besonders Formstabil  
Indéformable / Outstanding shape retention



**Poétic**

**Poétic SAS**

38 route de Louhans · 71370 Saint Germain du Plain · Tél. 0033 3 85 42 12 00 · kundenservice@poetic-garden.com · www.poetic-jardin.com

Technische Änderungen/Irrtum vorbehalten. Drucktechnische Farbabweichungen möglich. Dieser Katalog wurde auf FSC zertifiziertem Papier produziert.  
*Sous réserve de modifications techniques. Modifications des couleurs possibles lors de l'impression. Ce catalogue est imprimé sur papier certifié FSC.*  
Subject to technical alterations/error. Printing color deviations possible. This catalogue is printed on FSC-certified paper.

NE002768  
JS-09/20