



# RJ12 and RJ45 Feedthrough Modules

The RJ12 and RJ45 feedthrough modules provide convenient break-out of wiring to terminal blocks.

Modules mount on 35mm DIN rail (part #DN-R35S1) or 15mm DIN rail (part #DN-R15S1).



**ZL-RTB-RJ12**



**ZL-RTB-RJ45**

Specifications		
	Part #	
	ZL-RTB-RJ12	ZL-RTB-RJ45
<b>Price</b>	\$29.00	\$37.50
<b>Pcs/Pkg</b>	1	
<b>Weight (lbs)</b>	0.32	0.45
<b>Description <sup>3</sup></b>	RJ12 Connector to terminal block	RJ45 Connector to terminal block
<b>UL Voltage Rating <sup>1</sup></b>	30VDC	
<b>Maximum Current per Circuit</b>	1A	
<b>Number of Circuits</b>	6	8
<b>Terminal Block Contacts</b>	Copper alloy, tin-lead plated	
<b>Wire Range (Rated Cross Section) <sup>2</sup></b>	12–24 AWG Solid or Stranded Copper Conductor (2.5 mm <sup>2</sup> )	
<b>Wire Strip Length</b>	0.24–0.27 in (6–7 mm)	
<b>Screw Torque</b>	4.4 in·lbs (0.5 N·m)	
<b>Surrounding Temperature Range</b>	32 to 140°F (0 to 60°C)	
<b>Cable/Wire Clearance</b>	0.5 in (12.7 mm) Required	
<b>Mounting Restrictions</b>	None	
<b>Connecting Cables (Sold Separately)</b>	ZL-RJ12-CBL-2, ZL-RJ12-CBL-2P, GS-RJ12-CBL-2, SVC-232RJ12-CBL-2 Click on link: <a href="#">Connection Cable Specifications Tables</a>	Cat5e Cable w/RJ45 connectors
<b>Approvals</b>	File # E200031 UL, cUL, Class 1, Division 2, Groups A,B,C,D Hazardous Locations, CE, EN 61131-2:2007	File # E139594 UL, cUL, CE EN 61131-2:2007

<sup>1</sup> Use Class 2 power supply.

<sup>2</sup> Use conductors rated for 60°/75°C.

<sup>3</sup> Connecting cables are for internal wiring only.



**Note:** See wiring details and dimensional drawings on our Web site at: <http://www.automationdirect.com/static/manuals/ziplinks/ziplinks.html>.

# ZIP LINK™ Module Dimensions

AUTOMATIONDIRECT®

## ZL-RTB-DB09/15/25

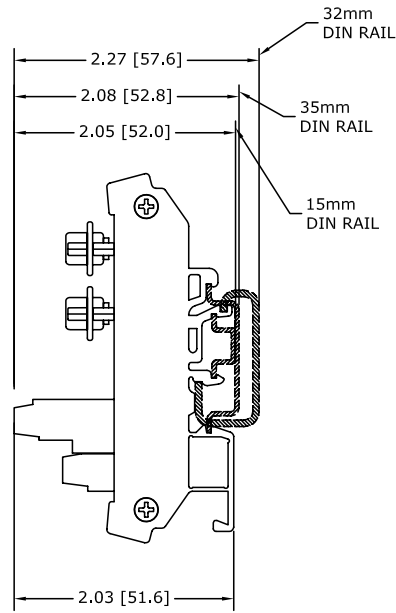
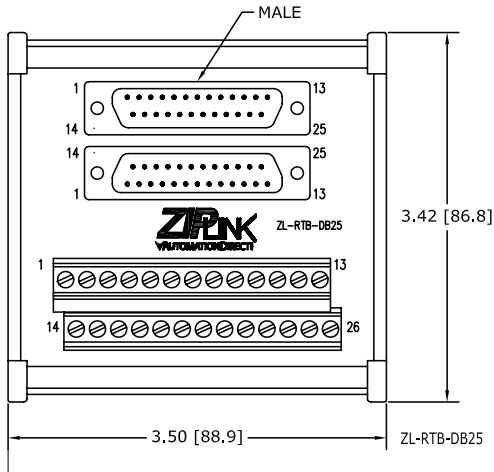

## ZL-RTB-RJ12

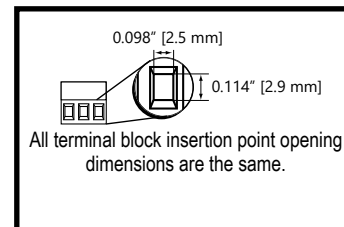
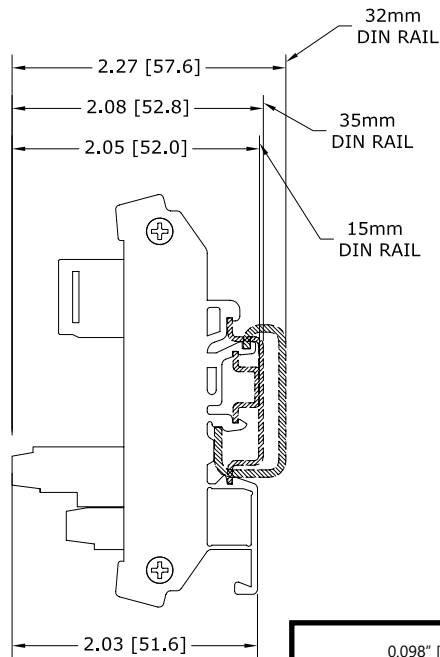
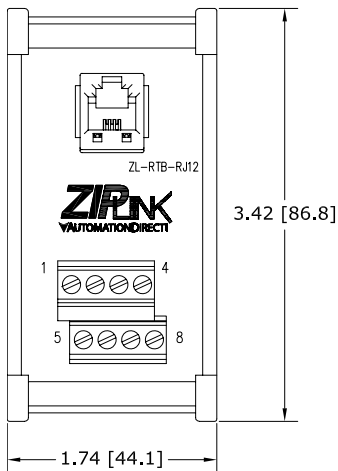

Note: Dimensions shown in Inches [mm]

# ZIP LINK™ Module Dimensions

AUTOMATIONDIRECT

## ZL-RTB-RJ45

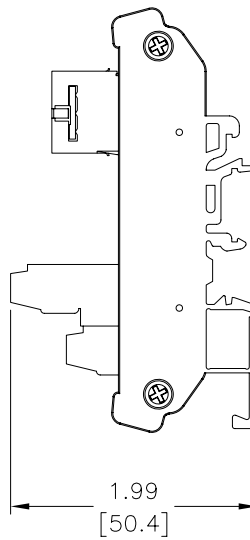
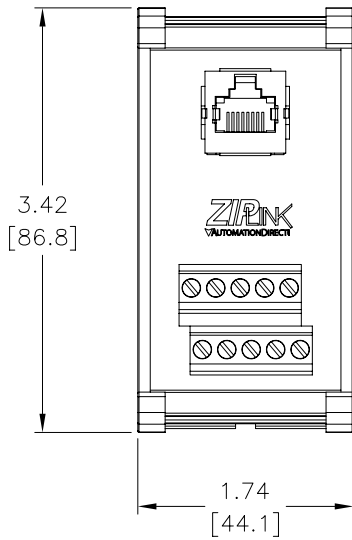

Note: Dimensions shown in Inches [mm]

