



METROLOGIC INSTRUMENTS, INC.

MS9500 Voyager® Series

Single-Line Hand-Held Laser Scanner

Installation and User's Guide



LOCATIONS

CORPORATE HEADQUARTERS

| | | |
|----------------------|---|--|
| North America | Metrologic Instruments, Inc. 90 Coles Road Blackwood, NJ 08012-4683 | Customer Service: 1-800-ID-METRO Tel: 856-228-8100 Fax: 856-228-6673 Email: info@metrologic.com Internet: www.metrologic.com |
|----------------------|---|--|

EUROPEAN HEADQUARTERS

| | | |
|--|--|--|
| Germany, Middle East and Africa | Metrologic Instruments GmbH Dornierstrasse 2 82178 Puchheim b. Munich, Germany | Tel: +49 89 89019 0 Fax: +49 89 89019 200 Email: info@europe.metrologic.com Germany Email: info@de.metrologic.com |
| Spain | Metrologic Eria Ibérica SL Julián Camarillo 29, D-1 Edificio Diapasón 28037 Madrid | Tel: +34 913 272 400 Fax: +34 913 273 829 Email: info@es.metrologic.com |
| Italy | Metrologic Instruments Italia srl Via Emilia 70 40064 Ozzano dell'Emilia (BO) | Tel: +39 0 51 6511978 Fax: +39 0 51 6521337 Email: info@it.metrologic.com |
| France | Metrologic Eria France SA 69 Rue de la Belle Etoile ZI Paris Nord II, BP 50057 95947 – ROISSY CDG CEDEX | Tel: +33 (0) 1 48.63.78.78 Fax: +33 (0) 1 48.63.24.94 Email: info@fr.metrologic.com |
| United Kingdom | Metrologic Instruments UK Limited 58 Tempus Business Centre Kingsclere Road, Basingstoke Hampshire RG21 6XG | Tel: +44 (0) 1256 365900 Fax: +44 (0) 1256 365955 Email: info@uk.metrologic.com |

ASIA

| | | |
|------------------|--|---|
| Singapore | Metrologic Asia (Pte) Ltd No. 8 Kaki Bukit Place 4 th Floor Singapore 416186 | Tel: 65-6842-7155 Fax: 65-6842-7166 Email: info@sg.metrologic.com |
| China | Metro (Suzhou) Technologies Co., Ltd. 221 Xing Hai Street Suzhou Industrial Park Suzhou, China 215021 | Tel: 86-512-62572511 Fax: 86-512-62571517 Email: info@cn.metrologic.com |
| Japan | Metrologic Japan Co., Ltd. Matsunoya Building, 6 Floor 3-14-8 Higashiueno Taitou-Ku, Tokyo 110-0015 Japan | Tel: 81-03-3839-8511 Fax: 81-03-3839-8519 Email: info@jp.metrologic.com |

SOUTH AMERICA

| | | |
|-----------------------|--|---|
| Brazil | Metrologic do Brasil Ltda. Rua da Paz 2059 CEP 04713-002 Chácara Santo Antônio São Paulo, SP, Brasil | Tel: 55-11-5182-8226 Fax: 55-11-5182-8315 Email: info@br.metrologic.com |
| Outside Brazil | Metrologic South America Rua da Paz 2059 CEP 04713-002 Chácara Santo Antônio São Paulo, SP, Brasil | Tel: 55-11-5182-7273 Fax: 55-11-5182-7198 Email: info@sa.metrologic.com |

Copyright

© 2002 by Metrologic Instruments, Inc. All rights reserved. No part of this work may be reproduced, transmitted, or stored in any form or by any means without prior written consent, except by reviewer, who may quote brief passages in a review, or provided for in the Copyright Act of 1976.

Products and brand names mentioned in this document are trademarks of their respective companies.

TABLE OF CONTENTS

| | |
|---|----|
| Introduction..... | 1 |
| Scanner and Accessories..... | 2 |
| Operation Test..... | 4 |
| Installing the Scanner to the Host System | |
| MS9520-00/9/11/14/41 and MS9540-00/9/11/14/41..... | 5 |
| Keyboard Wedge MS9520-47 and MS9540-47..... | 6 |
| Stand Alone Keyboard..... | 7 |
| Installation Notes for USB Interface..... | 8 |
| Disconnection the PowerLink Cable from the Scanner..... | 8 |
| How to Use CodeGate® - MS9540 Series Only..... | 9 |
| Stand Kits..... | 10 |
| Assembling the Stands..... | 11 |
| Scanner Parts..... | 14 |
| Audible Indicators..... | 15 |
| Visual Indicators..... | 16 |
| Failure Modes..... | 18 |
| Programming Modes..... | 19 |
| Upgrading the Flash ROM Firmware..... | 22 |
| Labels..... | 23 |
| Maintenance..... | 23 |
| Depth of Field..... | 24 |
| IR Activation..... | 25 |
| Applications and Protocols..... | 26 |
| Trouble Shooting Guide..... | 27 |
| RS-232 Demonstration Program..... | 31 |
| Design Specifications..... | 32 |
| Default Settings..... | 33 |
| Scanner and Cable Terminations | |
| Scanner Pinout Connections..... | 38 |
| Cable Connector Configurations..... | 40 |
| Limited Warranty..... | 42 |
| Notices..... | 43 |
| Patents..... | 44 |
| Index..... | 45 |

INTRODUCTION

The Voyager® MS9500 Series single-line hand-held scanners include both the MS9520 and MS9540.

The Voyager**CG**® MS9540 features Metrologic's patented CodeGate® technology. CodeGate is an intuitive scanning system that is ideal for all scanning applications, including menu-scanning, point-of-sale, document processing, and inventory control.

CodeGate works hand-in-hand with Metrologic's patented automatic-triggering scheme. Simply present a bar code to the scanner; the high-visibility 650-nanometer laser is automatically activated allowing the user to easily select the bar code to be scanned. Press the CodeGate button and the data is transmitted to the host system.

Equipped with both 'in-stand' and 'out-of-stand' operation, Voyager can be used as both a hand-held and fixed projection scanner. Voyager automatically senses when it is placed in the stand and de-activates the CodeGate button.

If the advantage of CodeGate technology is unnecessary in your application, then the MS9520 is the Voyager of choice. The MS9520 is packed with all of the same features as the MS9540, with the exception of CodeGate.

Metrologic has included many standard features such as: user programmable Flash ROM, PowerLink user-replaceable cables, MetroSet®2 and MetroSelect® configuration, EMI rating of Class B, data editing (parsing) capability using Bits 'n' Pieces®, and a 5-year limited warranty.

| VOYAGER | VOYAGERCG | INTERFACE |
|----------------|------------------|--|
| MS9520 – 00 | MS9540 – 00 | Laser Emulation RS-232 Transmit/Receive |
| MS9520 – 9 | MS9540 – 9 | OCIA |
| MS9520 – 11 | MS9540 – 11 | IBM 468X/469X, RS232-TXD, RXD, RTS, CTS |
| MS9520 – 14 | MS9540 – 14 | RS232 - TXD, RXD, RTS, CTS, DTR, DSR |
| MS9520 – 41 | MS9540 – 41 | RS-232/Light Pen Emulation |
| MS9520 – 47 | MS9540 – 47 | Keyboard Wedge, Stand-Alone Keyboard and RS232 Transmit/Receive |

SCANNER AND ACCESSORIES

| BASIC KIT | |
|-------------------------|---|
| Part # | Description |
| MS9500 | Voyager Series Scanner |
| 00-02561 or 00-02544 | MetroSelect Programming Guide* or MetroSelect Single-Line Programming Guide* |
| 00-02410 | MS9500 Voyager® Series Single-Line Hand Held Laser Scanner Installation and User's Guide |

* Available on the Metrologic website - www.metrologic.com

| OPTIONAL ACCESSORIES | |
|--|---|
| Part # | Description |
| AC to DC Power Transformer- Regulated 5.2VDC @ 650 mA output. | |
| 45-45593 | 120V United States |
| 45-45591 | 220V-240V Continental European |
| 45-45592 | 220V-240V United Kingdom |
| 54-54xxx | PowerLink Cable with built in power jack 2.1m (7') <i>straight</i> cord, short strain relief |
| 53-53xxx | PowerLink Cable with built in power jack 2.7m (9') <i>coiled</i> cord, long strain relief |
| xxx specifies connection to the host. | |
| MX009-2** | MX009 USB Converter Cable |
| MVC** | Metrologic Voltage Converter Cable +12VDC to +5.2VDC or -12VDC to +5.2VDC |
| ** Contact a Metrologic customer service representative for additional information on the MVC and MX009 converter cable series and the host connections available. | |

Other items may be ordered for the specific protocol being used. To order additional items, contact the dealer, distributor or call Metrologic's Customer Service Department at 1-800-ID-METRO or 1-800-436-3876.

SCANNER AND ACCESSORIES

| OPTIONAL ACCESSORIES | |
|-----------------------------|---|
| Part # | Description |
| 54-54002 | Keyboard Wedge PowerLink Cable with Adapter Cable |
| 54-54020 | Stand Alone Keyboard Wedge PowerLink Cable |
| 46-46128 | Free-Standing Stand with Accessories |
| 46-46351 | Hard Mount Accessory Kit (<i>used with kit #46-46128</i>) |
| 46-46433 | Wall Mount Hanger Accessory Kit |

Other items may be ordered for the specific protocol being used. To order additional items, contact the dealer, distributor or call Metrologic's Customer Service Department at 1-800-ID-METRO or 1-800-436-3876.

OPERATIONAL TEST

1. Connect the 10-pin RJ45 male connector into the jack on the Voyager or VoyagerCG. You will hear a 'click' when the connection is made.
2. Connect the L-shaped plug of the power supply into the power jack on the PowerLink cable.
3. Connect the power supply into an AC outlet. Make sure the AC input requirements of the power supply match the AC outlet.

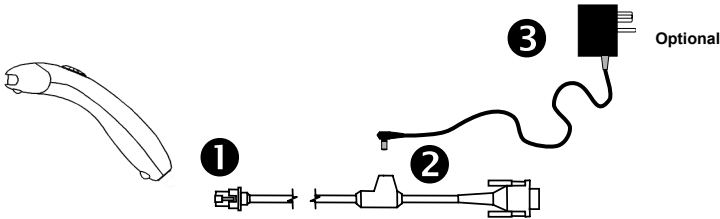

4. When the Voyager is ready to scan, the green LED will turn on, the red LED will flash and the scanner will beep once.



5. Place a bar code in front of the scanning window. The scanner will beep once and flash the red (*default mode only*) LED if the bar code was successfully decoded. For the MS9540, press the CodeGate[®] button to transmit the data. (See page 8.)



Voyager is shipped from the factory programmed with default settings. Refer to the MetroSelect[®] Programming Guide or MetroSet[®] 2's help files for instructions on how to configure the scanner.



MS9520/9540-00 Units Only

All MS9520/9540-00 units leave the factory with *Laser Emulation Mode* enabled. If you recall defaults while re-configuring your scanner the *Laser Emulation Mode* will no longer be enabled. Refer to the *MS9520/9540-00 Laser Emulation Mode* section of the MetroSelect Single-Line Configuration Guide (MLPN 00-02544A) for information on enabling the *Laser Emulation Mode*.



Caution:

To maintain compliance with applicable standards, all circuits connected to the scanner must meet the requirements for SELV (Safety Extra Low Voltage) according to EN 60950.

To maintain compliance with standard CSA C22.2 No. 950/JUL 1950 and norm EN 60950, the power source should meet applicable performance requirements for a limited power source.

INSTALLING THE SCANNER TO THE HOST SYSTEM

MS9520-00/9/11/14/41 AND MS9540-00/9/11/14/41

1. Turn off the host system.
2. Connect the 10-pin RJ45 male connector into the jack on the Voyager or VoyagerCG. You will hear a 'click' when the connection is made.



If the scanner is receiving power from the host system, skip to step #5.

3. Connect the L-shaped plug of the power supply into the power jack on the PowerLink cable.
4. Make sure the AC input requirements of the power supply match the AC outlet. Connect the power supply into an AC outlet. The outlet should be near the equipment and easily accessible.
5. Connect the PowerLink cable to the proper port on the host system.
6. Turn on the host system.

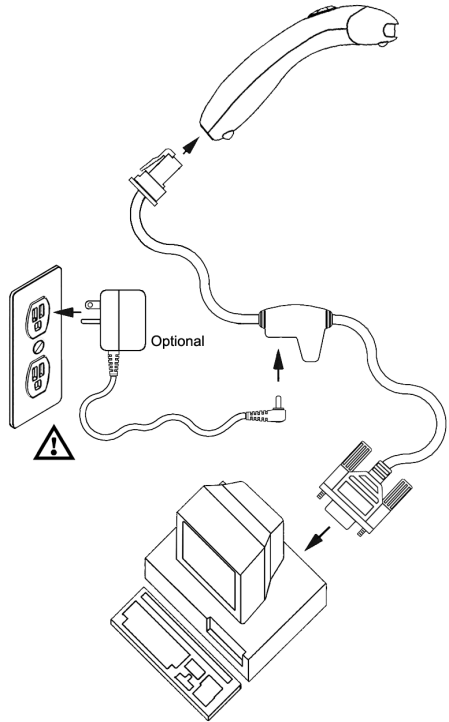

Plugging the scanner into a port on the host system does not guarantee that scanned information will be communicated properly to the host system. The scanner is shipped from the factory programmed with default settings. Please refer to the MetroSelect® Programming Guide (MLPN 00-02544) or MetroSet® 2's help files for instructions on changing the scanner's configuration. In addition, please check that the scanner and host system are using the same communication protocol.



All **MS9520-00/MS9540-00** scanners leave the factory with the *Laser Emulation Mode* enabled. If you *recall defaults* while re-configuring your scanner the *Laser Emulation Mode* will no longer be enabled. Refer to the *MS9520/9540-00 Laser Emulation Mode* section of the MetroSelect Single-Line Configuration Guide (MLPN 00-02544A) for information on enabling the *Laser Emulation Mode*.

Caution:

To maintain compliance with applicable standards, all circuits connected to the scanner must meet the requirements for SELV (Safety Extra Low Voltage) according to EN 60950.



To maintain compliance with standard CSA C22.2 No. 950/JUL 1950 and norm EN 60950, the power source should meet applicable performance requirements for a limited power source.

INSTALLING THE SCANNER TO THE HOST SYSTEM

KEYBOARD WEDGE MS9520-47 AND MS9540-47

1. Turn off the PC.
2. Connect the 10-pin RJ45 male connector into the jack on the Voyager or the VoyagerCG. You will hear a 'click' when the connection is made.
3. Connect the L-shaped plug of the power supply into the power jack on the PowerLink cable.



If the scanner is receiving power from the host system, skip to step #5.

4. Make sure the AC input requirements of the power supply match the AC outlet. Connect the power supply into an AC outlet. The outlet should be near the equipment and easily accessible.
5. Disconnect the keyboard from the PC.
6. The PowerLink cable is terminated with a 5-pin DIN female connector on one end, and a 6-pin mini DIN male on the other. Metrologic will supply an adapter cable with a 5-pin DIN male connector on one end and a 6-pin mini DIN female connector on the other. According to the termination required, connect the appropriate end of the adapter cable to the PowerLink cable, leaving the necessary termination exposed for connecting to the keyboard and the keyboard port on the PC.
7. Connect to the PowerLink cable to the keyboard and the keyboard port on the PC.
8. Power up the PC.

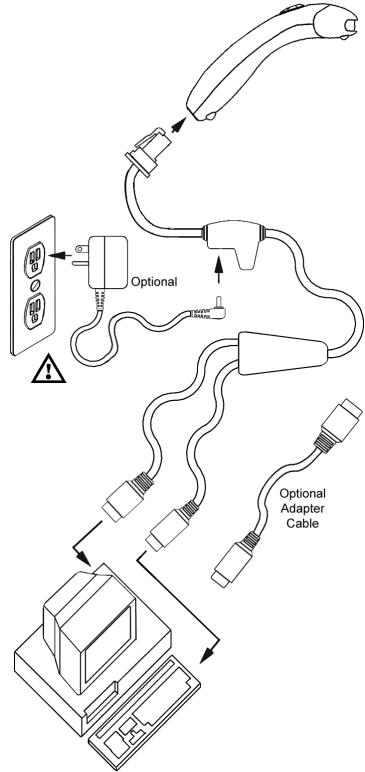

Powering the MS9520-47/MS9540-47 directly from the computer can sometimes cause interference with the operation of the scanner or the computer. Not all computers supply the same current through the keyboard port, explaining why a scanner would work on one computer and not another. Contact a Metrologic Customer Service Representative if you require an external power supply.



Caution:

To maintain compliance with applicable standards, all circuits connected to the scanner must meet the requirements for SELV (Safety Extra Low Voltage) according to EN 60950.

To maintain compliance with standard CSA C22.2 No. 950/UL 1950 and norm EN 60950, the power source should meet applicable performance requirements for a limited power source.

INSTALLING THE SCANNER TO THE HOST SYSTEM

STAND ALONE KEYBOARD

1. Turn off the host system.
2. Connect the 10-pin RJ45 male connector into the jack on the Voyager or VoyagerCG. You will hear a 'click' when the connection is made.
-  **If the scanner is receiving power from the host system, skip to step #5.**
3. Connect the L-shaped plug of the power supply into the power jack on the PowerLink cable.
4. Make sure the AC input requirements of the power supply match the AC outlet. Connect the power supply into an AC outlet. The outlet should be near the equipment and easily accessible.
5. Connect the PowerLink cable to the keyboard port on the host system.
6. Turn on the host system.

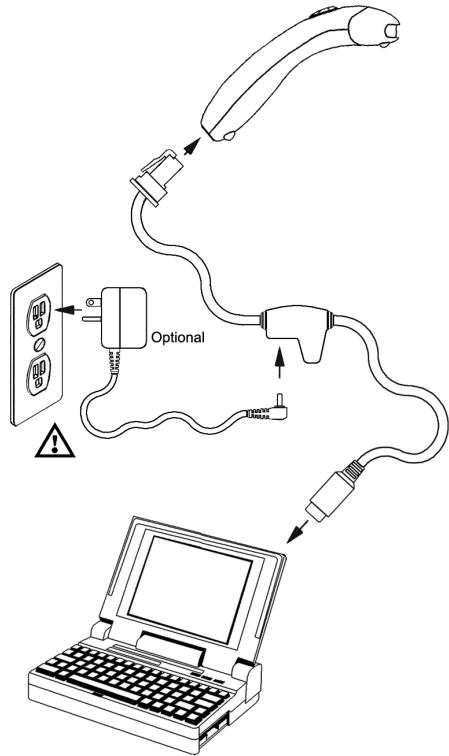

 Powering the MS9520-47/MS9540-47 directly from the computer can sometimes cause interference with the operation of the scanner or the computer. Not all computers supply the same current through the keyboard port, explaining why a scanner would work on one computer and not another. Contact a Metrologic Customer Service Representative if you require an external power supply.

Caution:

To maintain compliance with applicable standards, all circuits connected to the scanner must meet the requirements for SELV (Safety Extra Low Voltage) according to EN 60950.

To maintain compliance with standard CSA C22.2 No. 950/UL 1950 and norm EN 60950, the power source should meet applicable performance requirements for a limited power source.



INSTALLING THE SCANNER TO THE HOST SYSTEM

INSTALLATION NOTES FOR USB INTERFACE

Metrologic's MX009 USB cable is a device that converts serial RS232 formatted data to either USB Keyboard or USB Point-of Sale communication protocol.

Please refer to the *MX009 USB Converter Cable Programming Guide* (MLPN 00-02574A) supplied with your MX009 cable for detailed installation and programming guidelines.

DISCONNECTING THE POWERLINK CABLE FROM THE SCANNER

Before removing the cable from the scanner, Metrologic recommends that the power on the host system is off and the power supply has been disconnected from the PowerLink cable.

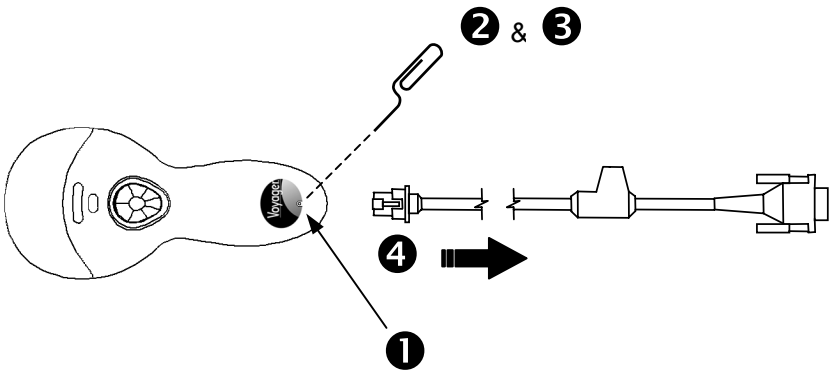

1. Locate the small 'pin-hole' on the top of the unit near the bottom of the Voyager logo.
2. Bend an ordinary paperclip into the shape shown above.
3. Insert the paperclip (or other small metallic pin) into the small 'pin-hole'.
4. You will here a faint 'click'. Pull gently on the strain-relief of the PowerLink cable and it will slide out of the scanner.

HOW TO USE CODEGATE® –MS9540 SERIES ONLY

1 _____

2 

3 



- Auto trigger activates the laser
- Place the laser line on the bar code
- Press the CodeGate button to transmit the data

TWO MODES OF OPERATION

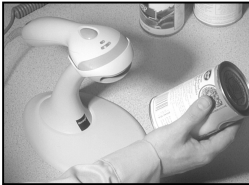

- Auto-trigger while in the stand
- Bar code is automatically decoded and transmitted



- CodeGate activates when removed from the stand
- Bar code data is transmitted when the CodeGate button is pressed

STAND KITS

Free Standing Kits #46-46128

Contains:

- a. Stand (MLPN 36-00454) Qty 1
- b. Apron (MLPN 50-50440) Qty 1
- c. Screw, M3 x 6 mm (MLPN 18-18670)..... Qty 2
- d. Washer, #5 x .5 OD (MLPN 18-18671) Qty 2
- e. Stand Anchor (MLPN 50-50449)..... Qty 1
- f. M3 x 20 mm Set Screw (MLPN 18-18672) Qty 1

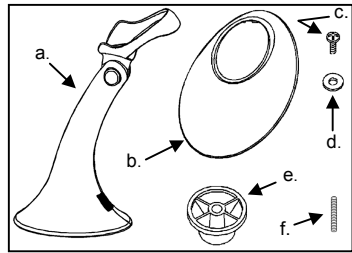

Optional Hard Mount Accessory Kit #46-46351

This kit, used in conjunction with the stand kit (#46-46128), can be used to bolt/hard mount the MS9500 to the countertop.

Contains:

- a. Screw, #8 Round Head (MLPN 18-18057) Qty 4
- b. Base (MLPN 36-36080) Qty 1

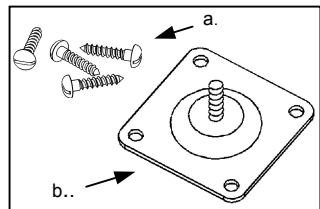

Optional Wall Mount Hanger Accessory Kit #46-46433

Contains:

- a. Screw #8 Round Head (MLPN 18-18057) Qty.2
- b. Wall Mount Hanger (MLPN 18-18057)..... Qty.1

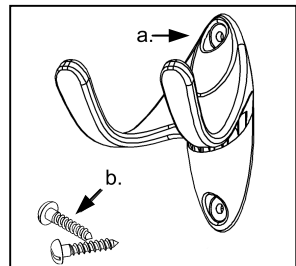

Optional Wall Mount Hanger Kit #46-46508

Contains:

- a. Wall Mount Hanger (MLPN 36-00611) Qty. 1
- b. Wall Mount Base (MLPN 36-00812) Qty. 1
- c. 4.8 x 13 mm, Self Tapping Screw Qty. 2 (MLPN 18-18233)
- d. Double-Sided Adhesive Tape Qty. 1 (MLPN 36-00821)
- e. #8 Wood Screw (MLPN 18-18057) Qty. 2

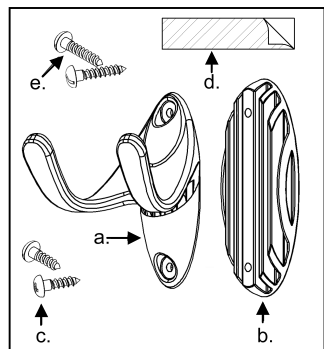

ASSEMBLING THE STANDS

There are 2 options for assembling the stand. The first option allows the stand to be self-supporting and moved freely or placed anywhere on the countertop. The second option is used if the stand will be bolted/hard-mounted to the countertop.

Stand Option 1: Self-supported For use with kit #46-46128

Step 1

Slide the apron (MLPN 50-50440) over the stand (MLPN 36-00454).

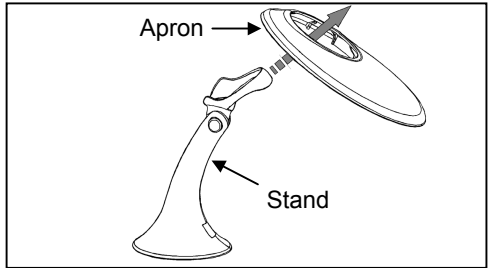

Step 2

Position the stand so it sits under the tab on the apron. Then secure the apron to the stand using the M3 x 6 mm screws (MLPN 18-18670) and the #5 washers (MLPN 18-18671) provided.

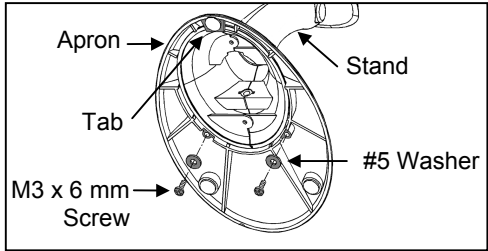

Stand Option 2: Hard-mounted to countertop For use with kit #46-46351

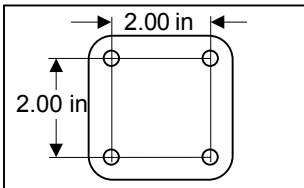

Step 1

Drill four #39 holes in the countertop.

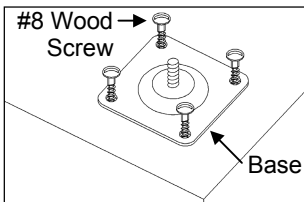

Step 2

Secure the base (MLPN 36-36080) to the countertop with the four #8 wood screws (MLPN 18-18057) provided.

Continued on next page

ASSEMBLING THE STAND (CONTINUED)

Stand Option 2: Hard-mounted to countertop (*continued*) For use with kits #46-46128, #46-46351 and MS951 Stand Replacements

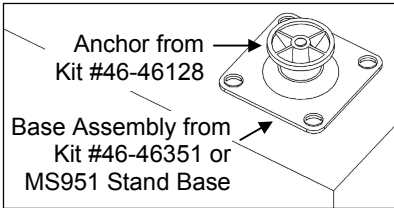

Step 3

Screw the stand anchor (MLPN 50-50449) onto the base assembly until it sits flush.

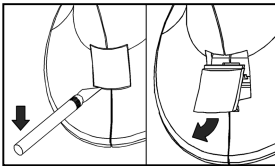

Step 4

Remove the logo plate on the stand by gently using an exacto knife to release the plate hook.

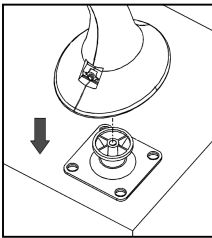

Step 5

Position the stand over the base assembly.

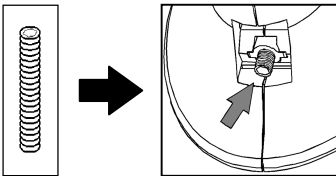

Step 6

Secure the stand to the base assembly by installing and tightening the M3 set screw (MLPN 18-18672) under the logo plate as shown.

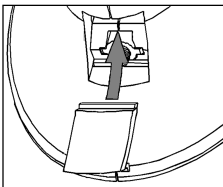

Step 7

Snap the logo plate back into place.

ASSEMBLING THE STAND (CONT.)

Wall Mount, Option 1:

For Kit #46-46433 or
Kit #46-46508

Step 1:

Drill two #39 pilot holes 3.00" apart.

Step 2:

Attach the *Wall Mount Hanger* to the wall with the two #8 wood screws provided.

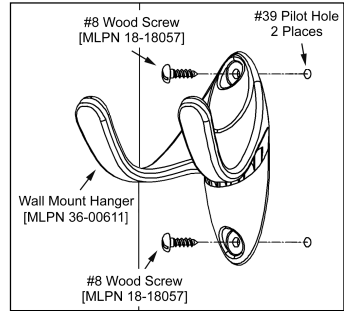

Wall Mount, Option 2:

Kit #46-46508

Step 1:

Attach the *Wall Mount Base* to the *Wall Mount Hanger* with the two 4.8 x 13 mm self-tapping screws.

Step 2:

Remove one side of the protective backing from the double-sided adhesive tape.

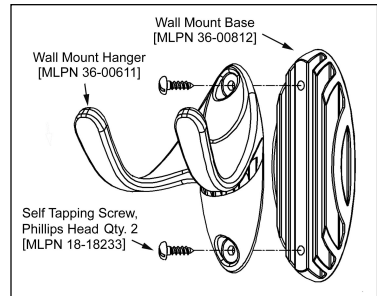

Step 3:

Attach the tape to the back of the *Wall Mount Hanger* as shown.

Step 4:

Remove the protective backing from the double-sided adhesive tape and apply hook to the wall.

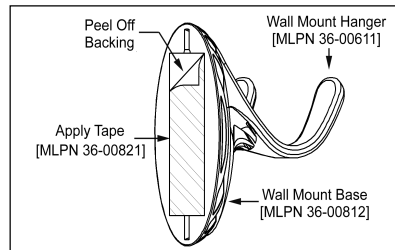

SCANNER PARTS

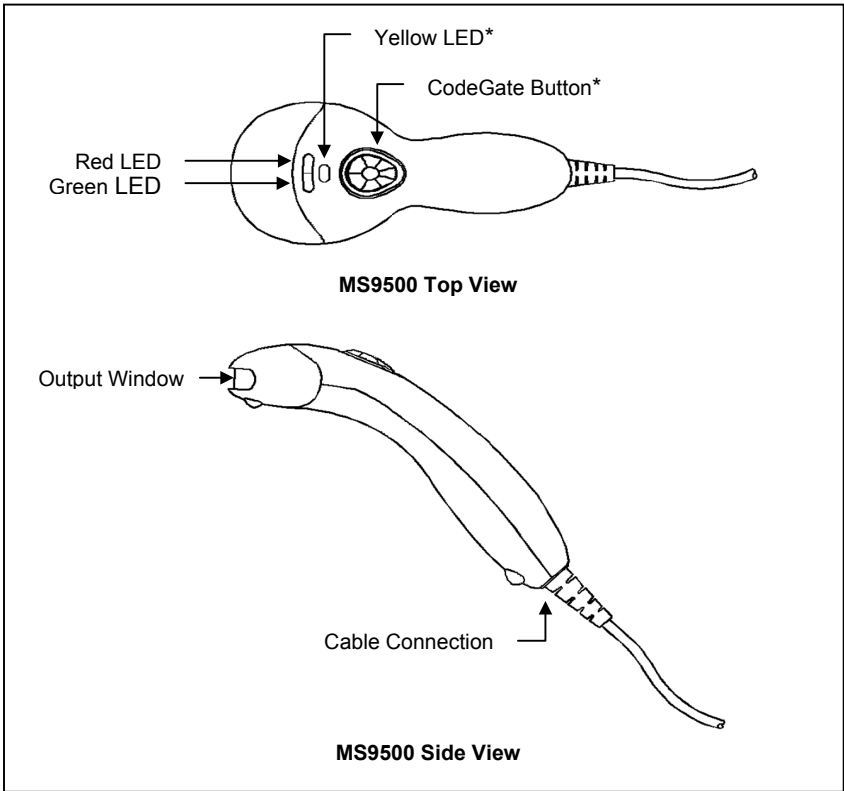

* This feature is not available on the MS9520

AUDIBLE INDICATORS

When the Voyager is in operation, it provides audible feedback. These sounds indicate the status of the scanner. Eight settings are available for the tone of the beep (normal, 6 alternate tones and no tone). To change the tone, refer to the MetroSelect® Single-Line Programming Guide (MLPN 00-02544) or MetroSet®2's help files.



One Beep

When the scanner *first* receives power, the green LED will turn on, then the red LED will flash and the scanner will beep once. (The red LED will remain on for the duration of the beep.) The scanner is ready to scan.

When the scanner *successfully* reads a bar code, the red LED will flash and the scanner beeps once (if programmed to do so). If the scanner does not beep once and the green light does not flash, then the bar code has *not* been successfully read.



Razzberry Tone

This tone is a failure indicator. Refer to "Failure Modes" page 17.

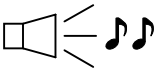

Two Beeps – On Power Up

When there is a Flash ROM upgrade needed, the scanner will beep twice followed by alternating flashing of the green and red LEDs.

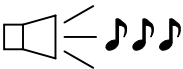

Three Beeps - During Operation

When entering configuration mode, the red LED will flash while the scanner simultaneously beeps three times. The red and green LEDs will continue to flash while in this mode. Upon exiting configuration mode, the scanner will beep three times, and the LEDs will stop flashing.

When configured, 3 beeps can also indicate a communications timeout during normal scanning mode.

When using one-code-programming, the scanner will beep three times (the current selected tone), followed by a short pause then by a high tone and a low tone. This tells the user that the single configuration bar code has successfully configured the scanner.

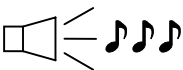

Three Beeps - On Power Up

This is a failure indicator. Refer to "Failure Modes" on page 17.

VISUAL INDICATORS

The MS9540 has three LED indicators (green, red and yellow) located on the head of the scanner. The MS9520 has two LED indicators (green and red) located on the head of the scanner. When the scanner is on, the flashing or stationary activity of the LEDs indicates the status of the current scan and the scanner.



Green, Red & Yellow (MS9540's Only) LEDs are off

The LEDs will not be illuminated if the scanner is not receiving power from the host or transformer.

The scanner is stand-by mode, and CodeGate[®] is enabled. Present a bar code to the scanner and the green LED will turn on when the laser turns on.



Steady Yellow (MS9540's Only)

The CodeGate button is not active. If a bar code is in the scan field, the laser will turn on. The bar code will be decoded and transmitted to the host automatically.



Steady Green

When the laser is active, the green LED is illuminated. The green LED will remain illuminated until the laser is deactivated. (*Default Mode Only*)

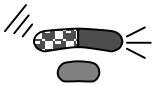

Steady Green and Single Red Flash

When the scanner successfully reads a bar code, the red LED will flash and the scanner will beep once. If the red LED does not flash or the scanner does not beep once, then the bar code has not been successfully read. (*Default Mode Only*)



Steady Green and Steady Red

After a successful scan, the scanner transmits the data to the host device. Some communication modes require that the host inform the scanner when data is ready to be received. If the host is not ready to accept the information, the scanner's red LED will remain on until the data can be transmitted.

VISUAL INDICATORS (CONTINUED)



Alternating Flashing of Green and Red

This indicates the scanner is program mode. A razzberry tone indicates that an invalid bar code has been scanned while in this mode.

The scanner needs to have a Flash ROM upgrade if the alternating flashing of the red and green LEDs occurs during startup and is accompanied by three beeps.

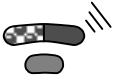

Steady Red, Green off

This indicates the scanner may be waiting for communication from the host.

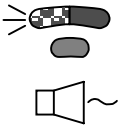

Flashing Green and one Razzberry Tone

This indicates the scanner has experienced a laser sub-system failure. Return the unit for repair to an authorized service center.



Flashing Red and Green with Two Razzberry Tones

This indicates the scanner has experienced a scanning mechanism failure. Return the unit for repair to an authorized service center.

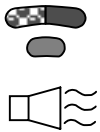

Continuous Razzberry Tone with all LEDs off

If, upon power, the scanner emits a continuous razzberry tone, then the scanner has an experienced an electronic failure. Return the unit for repair to an authorized service center.

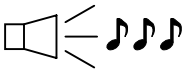

Three Beeps – on power up

If the scanner beeps 3 times on power up then the non-volatile memory (NovRAM) that holds the scanner configuration has failed. If the scanner does not respond after reprogramming, return the scanner for repair to an authorized service center.

PROGRAMMING MODES

The MS9500 Voyager has 3 modes of programming.

➤ **Bar Codes**

Voyager or Voyager CG can be configured by scanning the bar codes located in the MetroSelect® Single-Line Programming Guide (MLPN 00-02544). Please refer to this guide for instructions. This manual can be downloaded for FREE from Metrologic's website (www.metrologic.com).

➤ **MetroSet® 2**

This user-friendly Windows-based configuration program allows you to simply 'point-and-click' at the desired scanner options. This program can be downloaded for FREE from Metrologic' website (www.metrologic.com), or set-up disks can be ordered by calling 1-800-ID-METRO.

➤ **Serial Programming**

This mode of programming is ideal for OEM applications. This mode gives the end-user the ability to send a series of commands using the serial port of the host system. The commands are equivalent to the numerical values of the bar codes located in the MetroSelect Single-Line Programming Guide (MLPN 00-02544).

How does Serial Programming work?

1. Each command sent to the scanner is the ASCII representation of each numeral in the configuration bar code. The entire numeric string is framed with an ASCII [stx] and an ASCII [etx].

EXAMPLE #1:

Command for Disabling Codabar

Command = [stx]100104[etx]

String Sent to Scanner = 02h 31h 30h 30h 31h 30h 34h 03h

(All values are hexadecimal).

2. If the command sent to the scanner is valid, the scanner will respond with an [ack].
3. If the command sent to the scanner is invalid, the scanner will respond with a [nak].

NOTE: If this occurs, the end-user must start over at the very beginning of the configuration sequence. Simply re-transmitting the invalid command will not work, you must start over.

PROGRAMMING MODES (CONTINUED)

4. During programming, the motor and laser turn off. **YOU CANNOT SCAN A BAR CODE WHILE IN SERIAL PROGRAM MODE.**
5. There is a 20 second window between commands. If a 20 second timeout occurs, the scanner will send a [nak] and you must start over.
6. To enter serial program mode, send the following command [stx]999999[etx].
7. To exit serial program mode, send the following command [stx]999999[etx], the scanner will respond with an [ack] followed by 3 beeps.
8. This mode uses the current Baud Rate, Parity, Stop Bits and Data Bits settings that are configured in the scanner. The default settings of the scanner are 9600, Space, 2, 7 respectively. If a command is sent to the scanner to change any of these settings, the change will NOT take effect until after serial program mode is exited.

EXAMPLE #2:

The following example will set the scanner to the factory default settings, Disable Scanning of Code 128 bar codes, change the beeper tone, and add a "G" as a programmable prefix.

| <u>FEATURE</u> | <u>HOST COMMAND</u> | <u>ASCII REPRESENTATION</u> | <u>SCANNER RESPONSE</u> |
|--------------------|---------------------|---------------------------------|-------------------------|
| Enter Program Mode | [stx]999999[etx] | 02h 39h 39h 39h 39h 39h 39h 03h | [ack] or 06h |
| Load Defaults | [stx]999998[etx] | 02h 39h 39h 39h 39h 39h 38h 03h | [ack] or 06h |
| Disable Code 128 | [stx]100113[etx] | 02h 31h 30h 30h 31h 31h 33h 03h | [ack] or 06h |
| Alternate Tone 1 | [stx]318565[etx] | 02h 33h 31h 38h 35h 36h 35h 03h | [ack] or 06h |
| Prog. Prefix #1 | [stx]903500[etx] | 02h 39h 30h 33h 35h 30h 30h 03h | [ack] or 06h |
| Code Byte 0 | [stx]0[etx] | 02h 30h 03h | [ack] or 06h |
| Code Byte 7 | [stx]7[etx] | 02h 37h 03h | [ack] or 06h |
| Code Byte 1 | [stx]1[etx] | 02h 31h 03h | [ack] or 06h |
| Exit Program Mode | [stx]999999[etx] | 02h 39h 39h 39h 39h 39h 39h 03h | [ack] or 06h |

The scanner will beep three times!

The commands sent to the scanner do not include the small superscripted '3' that you see in front of each bar code string in the MetroSelect manual. **THE '3' SHOULD NOT BE SENT, IT IS A CODE TYPE DESIGNATION ONLY!**

As you will note for commands requiring additional bar codes to be scanned (such as prefixes, suffixes, timeouts, etc.), simply send the code bytes in the same order that you would normally scan the bar codes.

PROGRAMMING MODES (CONTINUED)

EXAMPLE #3:

The following example shows the events that occur when an invalid bar code is sent. This sample will load the factory default settings and then set the baud rate to 19200.

| | HOST | | SCANNER |
|--|------------------|---------------------------------|-----------------|
| <u>FEATURE</u> | <u>COMMAND</u> | <u>ASCII REPRESENTATION</u> | <u>RESPONSE</u> |
| Enter Program Mode | [stx]999999[etx] | 02h 39h 39h 39h 39h 39h 39h 03h | [ack] or 06h |
| Load Defaults | [stx]99999:[etx] | 02h 39h 39h 39h 39h 39h 3Ah 03h | [nak] or 15h |
| Invalid command was sent, you must start over! | | | |
| Enter Program Mode | [stx]999999[etx] | 02h 39h 39h 39h 39h 39h 39h 03h | [ack] or 06h |
| Load Defaults | [stx]999998[etx] | 02h 39h 39h 39h 39h 39h 39h 03h | [ack] or 06h |
| 19200 Baud Rate | [stx]415870[etx] | 02h 34h 31h 35h 38h 37h 30h 03h | [ack] or 06h |
| Exit Program Mode | [stx]999999[etx] | 02h 39h 39h 39h 39h 39h 39h 03h | [ack] or 06h |

The scanner will beep three times!

This example illustrates two important points.

First, if an invalid command is sent from the host, the scanner responds with a [nak] and the end-user must start over from the beginning.

Second, if a command is sent to change the Baud Rate, the new baud rate does not take effect until after the end-user exits program mode.

ABBREVIATED ASCII TABLE

| Character | Hex Value | Decimal Value |
|-----------|-----------|---------------|
| [STX] | 02h | 2 |
| [ETX] | 03h | 3 |
| [ACK] | 06h | 6 |
| [NAK] | 15h | 21 |
| 0 | 30h | 48 |
| 1 | 31h | 49 |
| 2 | 32h | 50 |
| 3 | 33h | 51 |
| 4 | 34h | 52 |
| 5 | 35h | 53 |
| 6 | 36h | 54 |
| 7 | 37h | 55 |
| 8 | 38h | 56 |
| 9 | 39h | 57 |

UPGRADING THE FLASH ROM FIRMWARE

The **Meteor** program is a functional component of Metrologic's new line of Flash-based scanners. This program allows the user of a Metrologic scanner to quickly upgrade to a new or custom version of software. It requires the use of a personal computer running under Windows 95 or greater and the use of a communication port. The user merely connects the scanner to a communications port of the PC, launches the **Meteor** program, and blasts off to new software upgrades.

Each MS9500, regardless of the version number or communication protocol, can be upgraded. In other words, all RS232 (-41), keyboard wedge (-47), light pen (-41), laser emulation (-00), OCIA (-9) and IBM 468X/469X (-11) units can be upgraded. To upgrade all units, a power supply and PowerLink cable (MLPN 54-54012) are required.

The upgrades and custom software versions will be supplied by Metrologic in files called Motorola S-record files. These files contain all the information needed to upgrade the scanner. Simply add this file to the working directory or retrieve from its current location.

The program guides the user with its simplistic one click approach. The user must first select the file; once selected and verified, the file is ready to be used in the upgrade. Press the button to upgrade the scanner, the unit will go into a "flash mode" – both the green and red LEDs will be on. The user can follow the progress of the upgrade by watching the screen for details. When the upgrade is complete, the scanner will respond with its normal one beep on power up. If two beeps occur, the scanner did not upgrade properly. (Contact Metrologic for additional details).

LABELS

Each scanner has a label on the back of the unit. This label has the model number, date of manufacture, serial number, CE and caution information. The following is an example of this label:

EVITER TOUTE EXPOSITION-Lumiere laser emis par cette ouverture

AVOID EXPOSURE -Laser light is emitted from this aperture

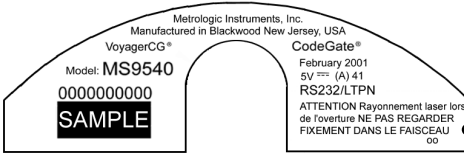

Patent Information-See Manual
 FCC and ICES-003 Information-See Manual
 Warranty VOID if case opened.
 Contains no user serviceable components.
 Complies with 21CFR 1040.10 & 1040.11
 NACH EN60825-1:1994/A11:1996
 5V Ⓜ CE

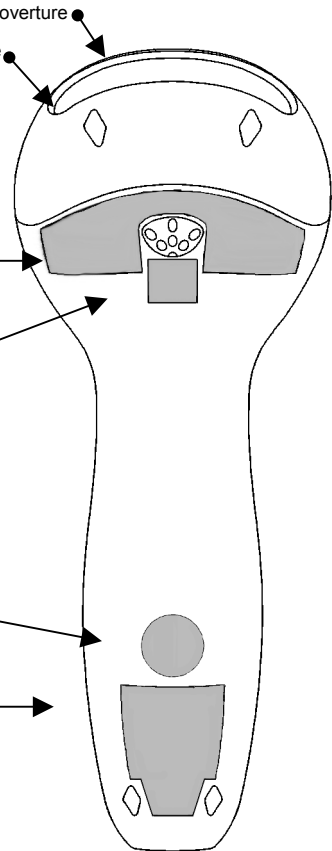

MAINTENANCE

Smudges and dirt can interfere with the proper scanning of a bar code. Therefore, the output window will need occasional cleaning.

1. Spray glass cleaner onto lint free, non-abrasive cleaning cloth.
2. Gently wipe the scanner window.

DEPTH OF FIELD

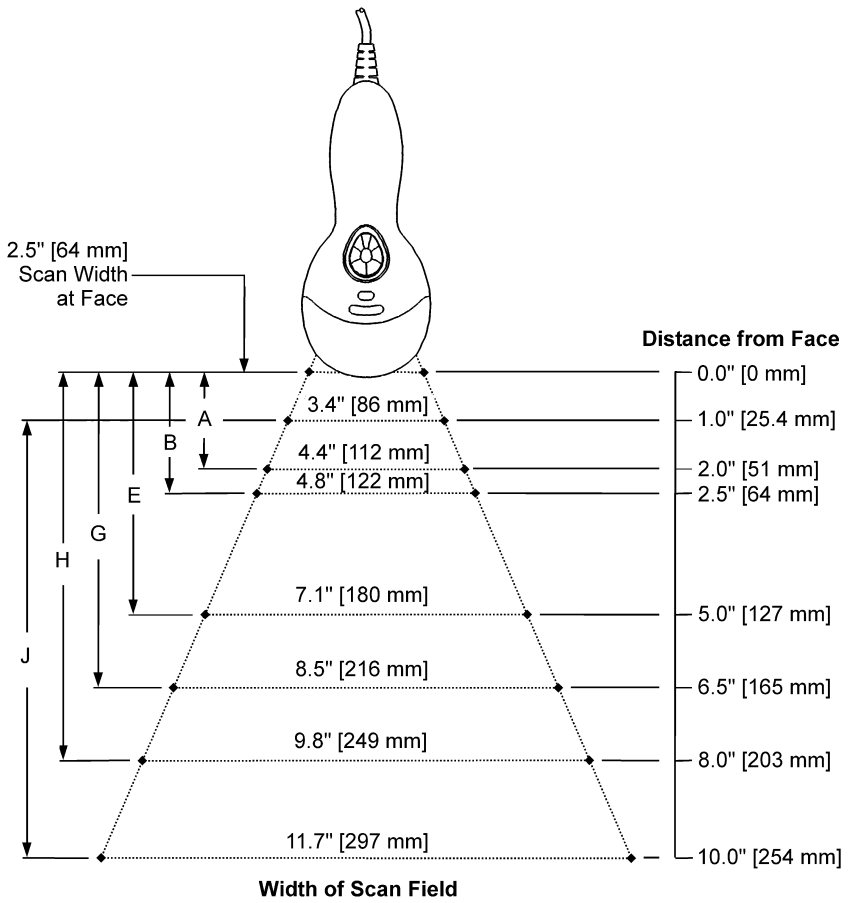

| Minimum Bar Code Element Width | | | | | | | | | | |
|--------------------------------|-----|-----|---|---|-----|---|-----|-----|-----|---|
| | A | B | C | D | E | F | G | H | J | K |
| mm | .13 | .15 | - | - | .19 | - | .25 | .33 | .53 | - |
| mils | 5.2 | 5.7 | - | - | 7.5 | - | 10 | 13 | 21 | - |

IR ACTIVATION

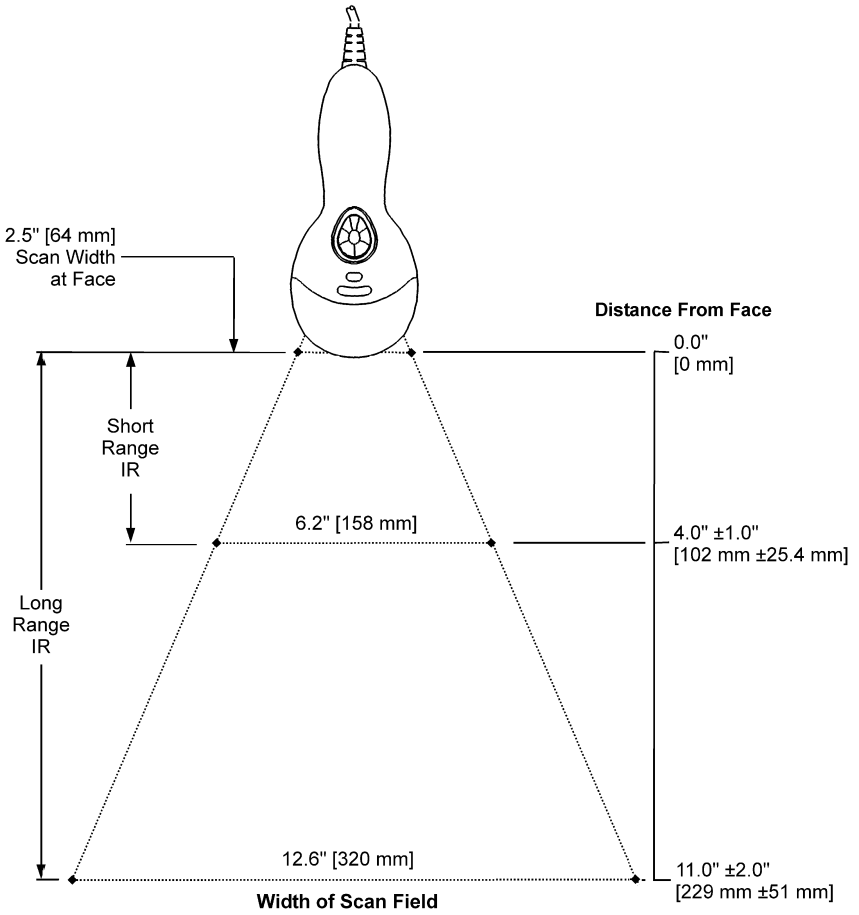

APPLICATIONS AND PROTOCOLS

The model number on each scanner includes the scanner number and factory default communications protocol.

| Scanner | Version Identifier | Communication Protocol(s) |
|------------------|--------------------|--|
| MS9520 MS9540 | 41 | RS-232/Light Pen Emulation |
| MS9520 MS9540 | 47 | Keyboard Wedge, Stand-Alone Keyboard and RS-232 Transmit/Receive |
| MS9520 MS9540 | 9 | OCIA and RS-232 Transmit/Receive |
| MS9520 MS9540 | 11 | IBM 468X/469X, RS232-TXD, RXD, RTS, CTS |
| MS9520 MS9540 | 00 | Laser Emulation and RS-232 Transmit/Receive |
| MS9520 MS9540 | 14 | RS232-TXD, RXD, RTS, CTS, DTR, DSR |

The MS9500 Series Hand-Held Laser Scanner with built-in PC Keyboard Wedge Interface is designed to be used for Keyboard emulation only. Many RS-232 programmable functions available in other Metrologic scanners are also available as keyboard wedge functions.

The following are the most important selectable options specific to the keyboard wedge.

Keyboard Type

- **AT (includes IBM® PS2 models 50, 55, 60, 80)
- XT
- IBM PS2 (includes models 30, 70, 8556)

Keyboard Country Type

- **USA
- German
- Spanish
- Belgium
- Italian
- Swiss
- French
- Japanese
- United Kingdom

**Default setting. Refer to pages 30-34 for default settings. Refer to the MetroSelect® Single-Line Programming Guide (MLPN 00-02544) or MetroSet® 2's help files for information on how to change the default settings.

TROUBLESHOOTING GUIDE

The following guide is for reference purposes only. Contact a Metrologic representative at 1-800-ID-Metro or 1-800-436-3876 to preserve the limited warranty terms.

All Interfaces

| MS9500 Series Troubleshooting Guide | | |
|--|---|--|
| Symptoms | Possible Causes | Solution |
| No LEDs, beep or laser | No power is being supplied to the scanner | Check transformer, outlet and power strip. Make sure the cable is plugged into the scanner. |
| No LEDs, beep, or laser | No power is being supplied to the scanner from host | Some host systems cannot supply enough current to power Voyager. A power supply may be needed. |
| 2 Beeps with alternately flashing LEDs on Power up | Possible ROM failure | Flash ROM Upgrade Required |
| 3 Beeps on power up | Non-volatile RAM failure | Contact a Metrologic Representative, if the unit will not hold the programmed configuration. |
| Continuous razz tone on power up | RAM or ROM failure | Contact a Metrologic Representative, if the unit will not function. |
| Razz tone and green LED flash at power up | VLD failure | Contact a Metrologic Representative |
| Razz tone, red and green LEDs flash at power up | Scanning mechanism failure | Contact a Metrologic Representative |
| Unit scans, Communicates and beeps twice | Same symbol timeout set too short | Adjust same symbol timeout for a longer time. |
| The unit powers up, but does not scan/or beep | Beeper disabled. No tone selected | Enable beeper. Select tone. |

TROUBLESHOOTING GUIDE (CONTINUED)

| Symptoms | Possible Causes | Solution |
|---|--|---|
| The unit powers up, but does not scan and/or beep | Scanning a particular symbology that is not enabled | UPC/EAN, Code 39, interleaved 2 of 5, Code 93, Code 128 and Codabar are enabled by default. Verify that the type of bar code being read has been selected. |
| The unit powers up, but does not scan and/or beep | The scanner has been programmed for a character length lock, or a minimum length and bar code being scanned does not satisfy the programmed criteria | Verify that the bar code that is being scanned falls into the criteria (Typical of Non-UPC/EAN codes) <i>The scanner defaults to a minimum of 3 character bar code.</i> |
| The unit scans a bar code, but locks up after the first scan red LED stays on | The scanner is configured to support some form of host handshaking but is not receiving the signal | If the scanner is setup to support ACK/NAK, RTS/CTS, XON/XOFF or D/E, verify that the host cable and host are supporting the handshaking properly. |
| The unit scans, but the data transmitted to the host is incorrect | The scanner's data format does not match the host system requirements | Verify that the scanner's data format matches that required by the host. Most sure that the scanner is connected to the proper host port. |
| Scanner beeps at some bar codes and NOT for others of the same bar code symbology | The print quality of the bar code is suspect | Check print mode. The type of printer could be the problem. Change print settings. i.e. change to econo mode or high speed. |
| Scanner beeps at some bar codes and NOT for others of the same bar code symbology | The aspect ratio of the bar code is out of tolerance | Check print mode. The type of printer could be the problem. Change print settings. i.e. change to econo mode or high speed. |

TROUBLESHOOTING GUIDE (CONTINUED)

| Symptoms | Possible Causes | Solution |
|---|---|--|
| Scanner beeps at some bar codes and NOT for others of the same bar code symbology | The bar code may have been printed incorrectly | Check if it is a check digit/character/or border problem. |
| Scanner beeps at some bar codes and NOT for others of the same bar code symbology | The scanner is not configured correctly for this type of bar code | Check if check digits are set properly. |
| Scanner beeps at some bar codes and NOT for others of the same bar code symbology | The minimum symbol length setting does not work with the bar code | Check if the correct minimum symbol length is set. |
| The unit scans the bar code but there is no data | Configuration is not correct | Make sure the scanner is configured for the appropriate mode. |
| The unit scans but the data is not correct | Configuration is correct | Make sure that the proper PC type AT, PS2 or XT is selected. Verify correct country code and data formatting are selected. Adjust inter-character delay symptom. |
| The unit is transmitting each character twice | Configuration is not correct | Increase interscan code delay setting. Adjust whether the F0 break is transmitted. It may be necessary to try this in both settings. |

TROUBLESHOOTING GUIDE (CONTINUED)

| Symptoms | Possible Causes | Solution |
|--|--|--|
| Alpha characters show as lower case | Computer is in Caps Lock mode | Enable Caps Lock detect setting of the scanner to detect whether the PC is operating in Caps Lock. |
| Everything works except for a couple of characters | These characters may not be supported by that country's key look up table | Try operating the scanner in Alt mode. |
| Power-up OK and scans OK but does not communicate properly to the host | Com port at the host is not working or configured properly | Check to make sure that the baud rate and parity of the scanner and the communication port match and the program is looking for "RS-232" data. |
| Power-up OK and scans OK but does not communicate properly to the host | Cable not connected to the proper com port | Check to make sure that the baud rate and parity of the scanner and the communication port match and the program is looking for "RS-232" data. |
| Power-up OK and scans OK but does not communicate properly to the host | Cable not connected to the proper com port | Check to make sure that the baud rate and parity of the scanner and the communication port match and the program is looking for "RS-232" data. |
| The host is receiving data but the data does not look correct | The scanner and host may not be configured for the same interface parameters | Check that the scanner and the host are configured for the same interface parameters |
| Characters are being dropped | Inter-character delay needs to be added to the transmitted output | Add some inter-character delay to the transmitted output by using the MetroSelect Single-Line Programming Guide MLPN 00-02544. |

RS-232 DEMONSTRATION PROGRAM

If an RS-232 scanner is not communicating with your IBM compatible PC, key in the following BASIC program to test that the communication port and scanner are working.

This program is for demonstration purposes only. It is only intended to prove that cabling is correct, the com port is working, and the scanner is working. If the bar code data displays on the screen while using this program, it only demonstrates that the hardware interface and scanner are working. At this point, investigate whether the application software and the scanner configuration match.

If the application does not support RS-232 scanners, a software wedge program that will take RS-232 data and place it into a keyboard buffer may be needed. This program tells the PC to ignore RTS-CTS, Data Set Ready (DSR) and Data Carrier Detect (DCD) signals. If the demonstration program works and yours still does not, jumper RTS to CTS and Data Terminal Reading (DTR) to DCD and DSR on the back of your PC.

```
10 CLS
20 ON ERROR GOTO 100
30 OPEN "COM1:9600,S,7,1,CSO,DSO,CD0,LF" AS#1
35 PRINT "SCAN A FEW BAR CODES"
40 LINE INPUT #1, BARCODE$
50 PRINT BARCODE$
60 K$ = INKEY$: IF K$ = CHR$(27) THEN GOTO 32766
70 GOTO 40
100 PRINT "ERROR NO. "; ERR ; "PRESS ANY KEY TO TERMINATE."
110 KK$ = INKEY$: IF KK$ = "" THEN GOTO 110
32766 CLOSE: SYSTEM
32767 END
```

DESIGN SPECIFICATIONS

| OPERATIONAL | |
|--|--|
| Light Source: | Visible Laser Diode 650 nm \pm 10 nm |
| Laser Power: | Less than 1 mW (peak) |
| Depth of Scan Field: | 0 mm – 203 mm (0" – 8") for 0.330 mm (13 mil) bar code at default setting |
| Scan Speed: | 72 scan lines per second |
| Scan Pattern: | Single scan line |
| Minimum Bar Width: | 0.127 mm (5.0 mil) |
| InfraRed Activation: | Long Range: 0 mm – 279 mm \pm 51 mm (0" – 11" \pm 2") Short Range: 0 mm – 102 mm \pm 25 mm (0" – 4" \pm 1") |
| Decode Capability: | Autodiscriminates all standard bar codes for others call a Metrologic service representative |
| System Interfaces: | RS232, PC Keyboard Wedge, Stand-Alone Keyboard, OCIA, IBM 468X/469X, Light Pen Emulation, Laser Emulation, RS232 with DSR |
| Print Contrast: | 35% minimum reflectance difference |
| Number Characters Read: | Up to 80 data characters (Maximum number will vary based on symbology & density) |
| Roll, Pitch, Yaw: | 42°, 68°, 52° |
| Beeper Operation: | 7 tones or no beep |
| Indicators (LED) <i>Default Settings:</i> | Green = laser on, ready to scan; Red = good read; Yellow (MS9540 Only) = CodeGate button is inactive (on). CodeGate button is active (off) |
| MECHANICAL | |
| Length: | 198 mm (7.8") |
| Width: | Handle - 45 mm (1.8"), Head - 78 mm (3.1") |
| Depth: | 40 mm (1.6") |
| Weight: | 149 g (5.25 oz) |
| ELECTRICAL | |
| Input Voltage: | 5VDC \pm 0.25V |
| Power: | Operating = 0.825 W, Standby = 0.600 W |
| Current: | Operating = 165 mA @ 5VDC, Standby = 120 mA @ 5VDC |
| DC Transformers: | Class 2; 5.2V @ 650 mA |
| Laser Class: | CDRH: Class II; EN60825-1:1994/A11:1996 Class 1 |
| EMC: | FCC Class B |
| ENVIRONMENTAL | |
| Temperature: | Operating = 0°C to 40° (32° to 104°F) Storage = -40°C to 60°C (-40°F to 140°F) |
| Humidity: | 5% to 95% relative humidity, non-condensing |
| Light Levels: | Up to 4842 Lux (450 footcandles) |
| Shock: | Designed to withstand 1.5 m (5') drops |
| Contaminants: | Sealed to resist airborne particulate contaminants |
| Ventilation: | None required |

DEFAULT SETTINGS

Many functions of the scanner can be “programmed” – that is, enabled or disabled. The scanner is shipped from the factory programmed to a set of default conditions. The default parameter of the scanner has an asterisk (*) in the charts on the following pages. If an asterisk is not in the default column then the default setting is OFF or DISABLED. Every communication does not support every parameter. If the communication supports a parameter listed in the charts on the following pages, a check mark will appear.

| PARAMETER | DEFAULT | OCIA | RS-232 | LIGHT PEN | IBM 46XX | KBW | LASER EMULATION |
|--------------------------------|---------|------|--------|-----------|----------|-----|-----------------|
| Normal Scan Mode | * | ✓ | ✓ | ✓ | ✓ | ✓ | ✓ |
| Continuous Scan Mode | | ✓ | ✓ | ✓ | ✓ | ✓ | ✓ |
| Blinky Scan | | ✓ | ✓ | ✓ | ✓ | ✓ | ✓ |
| Continuous Blinky Scan | | ✓ | ✓ | ✓ | ✓ | ✓ | ✓ |
| Custom (one shot) Scan | | ✓ | ✓ | ✓ | ✓ | ✓ | ✓ |
| Long-Range In-Stand | * | ✓ | ✓ | ✓ | ✓ | ✓ | ✓ |
| Short-Range In-Stand | | ✓ | ✓ | ✓ | ✓ | ✓ | ✓ |
| Long-Range Out-of-Stand | * | ✓ | ✓ | ✓ | ✓ | ✓ | ✓ |
| Short-Range Out-of-Stand | | ✓ | ✓ | ✓ | ✓ | ✓ | ✓ |
| CodeGate Active In-Stand | | ✓ | ✓ | ✓ | ✓ | ✓ | ✓ |
| CodeGate Inactive In-Stand | * | ✓ | ✓ | ✓ | ✓ | ✓ | ✓ |
| CodeGate Active Out-of Stand | * | ✓ | ✓ | ✓ | ✓ | ✓ | ✓ |
| CodeGate Inactive Out-of Stand | | ✓ | ✓ | ✓ | ✓ | ✓ | ✓ |
| UPC/EAN | * | ✓ | ✓ | ✓ | ✓ | ✓ | ✓ |
| Code 128 | * | ✓ | ✓ | ✓ | ✓ | ✓ | ✓ |
| Code 93 | * | ✓ | ✓ | ✓ | ✓ | ✓ | ✓ |
| Codabar | * | ✓ | ✓ | ✓ | ✓ | ✓ | ✓ |
| Interleaved 2 of 5 (ITF) | * | ✓ | ✓ | ✓ | ✓ | ✓ | ✓ |
| MOD 10 check on ITF | | ✓ | ✓ | ✓ | ✓ | ✓ | ✓ |
| Code 11 | | ✓ | ✓ | ✓ | ✓ | ✓ | ✓ |
| Code 39 | * | ✓ | ✓ | ✓ | ✓ | ✓ | ✓ |
| Full ASCII Code 39 | | ✓ | ✓ | ✓ | ✓ | ✓ | ✓ |

DEFAULT SETTINGS (CONTINUED)

| PARAMETER | DEFAULT | OCIA | RS-232 | LIGHT PEN | IBM 46XX | KBW | LASER EMULATION |
|---------------------------------------|-----------------|------|--------|-----------|----------|-----|-----------------|
| Mod 43 Check on Code 39 | | ✓ | ✓ | ✓ | ✓ | ✓ | ✓ |
| MSI-Plessey 10/10 Check Digit | | ✓ | ✓ | ✓ | ✓ | ✓ | ✓ |
| MSI-Plessey Mod 10 Check Digit | * | ✓ | ✓ | ✓ | ✓ | ✓ | ✓ |
| Paraf Support ITF | | ✓ | ✓ | ✓ | ✓ | ✓ | ✓ |
| ITF Symbol Lengths | Variable | ✓ | ✓ | ✓ | ✓ | ✓ | ✓ |
| Minimum Symbol Length | 3 | ✓ | ✓ | ✓ | ✓ | ✓ | ✓ |
| Symbol Length Lock | None | ✓ | ✓ | ✓ | ✓ | ✓ | ✓ |
| Bars High as Code 39 | * | | | ✓ | | | ✓ |
| Spaces High as Code 39 | | | | ✓ | | | ✓ |
| Bars High as Scanned | | | | ✓ | | | ✓ |
| Spaces High as Scanned | | | | ✓ | | | ✓ |
| DTS/SIEMENS | | ✓ | | | | | |
| DTS/NIXDORF | * | ✓ | | | | | |
| NCR F | | ✓ | | | | | |
| NCR S | | ✓ | | | | | |
| Poll light pen source | | | | ✓ | | | ✓ |
| Beeper tone | Normal | ✓ | ✓ | ✓ | ✓ | ✓ | ✓ |
| Beep/transmit sequence | Before transmit | ✓ | ✓ | ✓ | ✓ | ✓ | ✓ |
| Communication timeout | None | ✓ | ✓ | ✓ | ✓ | ✓ | ✓ |
| Razzberry tone on timeout | | ✓ | ✓ | ✓ | ✓ | ✓ | ✓ |
| Three beeps on timeout | | ✓ | ✓ | ✓ | ✓ | ✓ | ✓ |
| Same symbol rescan timeout 250 msec | | ✓ | ✓ | ✓ | ✓ | ✓ | ✓ |
| Same symbol rescan timeout 375 msec | | ✓ | ✓ | ✓ | ✓ | ✓ | ✓ |
| Same symbol rescan timeout: 500 msec) | | ✓ | ✓ | ✓ | ✓ | ✓ | ✓ |
| Same symbol rescan timeout 625 msec | | ✓ | ✓ | ✓ | ✓ | ✓ | ✓ |

DEFAULT SETTINGS (CONTINUED)

| PARAMETER | DEFAULT | OCIA | RS-232 | LIGHT PEN | IBM 46XX | KBW | LASER EMULATION |
|--|--------------------------|------|--------|-----------|----------|-----|-----------------|
| Same symbol rescan timeout 750 msec | | ✓ | ✓ | ✓ | ✓ | ✓ | ✓ |
| Same symbol rescan timeout 875 msec | * | ✓ | ✓ | ✓ | ✓ | ✓ | ✓ |
| Same symbol rescan timeout: 1000 msec | | ✓ | ✓ | ✓ | ✓ | ✓ | ✓ |
| No Same symbol timeout | | ✓ | ✓ | ✓ | ✓ | ✓ | ✓ |
| Infinite Same symbol timeout | | ✓ | ✓ | ✓ | ✓ | ✓ | ✓ |
| Inter-character delay Program able in 1 msec steps (max 255 msec) | 1 msec 10 msec in KBW | ✓ | ✓ | ✓ | ✓ | ✓ | ✓ |
| Number of scan buffers (maximum) | 4 | ✓ | ✓ | ✓ | ✓ | ✓ | ✓ |
| Transmit UPC-A check digit | * | ✓ | ✓ | ✓ | ✓ | ✓ | ✓ |
| Transmit UPC-E check digit | | ✓ | ✓ | ✓ | ✓ | ✓ | ✓ |
| Expand UPC-E | | ✓ | ✓ | ✓ | ✓ | ✓ | ✓ |
| Convert UPC-A to EAN-13 | | ✓ | ✓ | ✓ | ✓ | ✓ | ✓ |
| Transmit lead zero on UPC-E | | ✓ | ✓ | ✓ | ✓ | ✓ | ✓ |
| Transmit UPC-A number system | * | ✓ | ✓ | ✓ | ✓ | ✓ | ✓ |
| Transmit UPC-A Manufacturer ID# | * | ✓ | ✓ | ✓ | ✓ | ✓ | ✓ |
| Transmit UPC -A Item ID# | * | ✓ | ✓ | ✓ | ✓ | ✓ | ✓ |
| Transmit Codabar Start/Stop Characters | | ✓ | ✓ | | ✓ | ✓ | |
| CLSI Editing (Enable) | | ✓ | ✓ | | ✓ | ✓ | |
| Transmit Mod 43 Check digit on Code 39 | | ✓ | ✓ | | ✓ | ✓ | |
| Transit Mod 10/ITF | | ✓ | ✓ | | ✓ | ✓ | |
| Transmit MSI-Plessey | | ✓ | ✓ | | ✓ | ✓ | |
| Parity | Space | | ✓ | | ✓ | | |
| Baud Rate | 9600 | | ✓ | | | | |
| 8 Data Bits | | | ✓ | | | | |
| 7 Data Bits | * | | ✓ | | | | |
| Stop Bits | 2 | | ✓ | | | | |

DEFAULT SETTINGS (CONTINUED)

| PARAMETER | DEFAULT | OCIA | RS-232 | LIGHT PEN | IBM 46XX | KBW | LASER EMULATION |
|--|---------|------|--------|------------|----------|-----|-----------------|
| Transmit Sanyo ID Characters | | | ✓ | | | ✓ | |
| Nixdorf ID | | | ✓ | | | ✓ | |
| LRC Enabled | | | ✓ | | | ✓ | |
| UPC Prefix | | | ✓ | | | ✓ | |
| UPC Suffix | | | ✓ | | | ✓ | |
| Carriage Return | * | | ✓ | | | ✓ | |
| Line Feed-Disabled by default in KBW | * | | ✓ | | | ✓ | |
| Tab Prefix | | | ✓ | | | ✓ | |
| Tab Suffix | | | ✓ | | | ✓ | |
| "DE" Disable Command | | | ✓ | | | | |
| "FL" Laser | | | ✓ | | | | |
| Enable Command | | | ✓ | | | | |
| DTR Handshaking support | | | ✓ | | | | |
| RTS/CTS Handshaking | | | ✓ | | | | |
| Character | * | | ✓ | | | | |
| Message RTS/CTS | | | ✓ | | | | |
| XON/XOFF Handshaking | | | ✓ | | | | |
| ACK/NAK | | | ✓ | | | | |
| Two Digit Supplements | | ✓ | ✓ | as code 39 | ✓ | ✓ | as code 39 |
| Five Digit Supplements | | ✓ | ✓ | as code 39 | ✓ | ✓ | as code 39 |
| Bookland | | ✓ | ✓ | as code 39 | ✓ | ✓ | as code 39 |
| 977 (2 digit) Supplemental Requirement | | ✓ | ✓ | ✓ | ✓ | ✓ | ✓ |
| Supplements are not Required | * | ✓ | ✓ | ✓ | ✓ | ✓ | ✓ |
| Two Digit Redundancy | * | ✓ | ✓ | ✓ | ✓ | ✓ | ✓ |
| Five digit Redundancy | | ✓ | ✓ | ✓ | ✓ | ✓ | ✓ |

DEFAULT SETTINGS (CONTINUED)

| PARAMETER | DEFAULT | OCIA | RS-232 | LIGHT PEN | IBM 46XX | KBW | LASER EMULATION |
|---|----------|------|--------|------------|----------|-----|-----------------|
| 100 msec to Find Supplement Programmable in 100 msec steps (max 800 msec) | * | ✓ | ✓ | ✓ | ✓ | ✓ | ✓ |
| Coupon Code 128 | | ✓ | ✓ | as code 39 | ✓ | ✓ | as code 39 |
| † Programmable Code Lengths | 7 avail | ✓ | ✓ | ✓ | ✓ | ✓ | ✓ |
| † Code Selects with programmable Code Length Locks | 3 avail | ✓ | ✓ | ✓ | ✓ | ✓ | ✓ |
| Programmable Prefix characters | 10 avail | | ✓ | | | ✓ | |
| Suffix characters | 10 avail | | ✓ | | | ✓ | |
| Prefixes for Individual Code types | | | ✓ | | | ✓ | |
| Editing | | ✓ | ✓ | ✓ | ✓ | ✓ | ✓ |
| Inter Scan-Code delay programmable (100 µsec steps) | 800 µsec | | | | | ✓ | |
| Function/control Key Support | | | | | | | |
| Minimum Element width Programmable in 5.6 µsec steps | 1 msec | | | ✓ | | | ✓ |

† These options are mutually exclusive. One can not be used in conjunction with the other.

Scanner Pinout Connections

The MS9520 and MS9540 scanner interfaces terminate to a 10-pin modular jack. The serial # label indicates the interface enabled when the scanner is shipped from the factory.

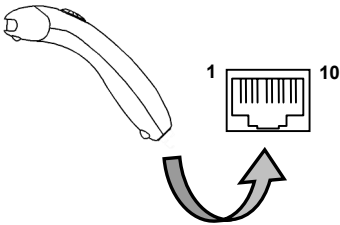

| MS9520-41 & MS9540-41 RS-232C and Light Pen Emulation | |
|--|------------------------|
| Pin | Function |
| 1 | Ground |
| 2 | RS-232 Transmit Output |
| 3 | RS-232 Receive Input |
| 4 | RTS Output |
| 5 | CTS Input |
| 6 | DTR Input/LTPN Source |
| 7 | Reserved |
| 8 | LTPN Data |
| 9 | +5VDC |
| 10 | Shield Ground |

| MS9520-47 & MS9540-47 Keyboard Wedge and Stand-Alone Keyboard | |
|--|------------------------|
| Pin | Function |
| 1 | Ground |
| 2 | RS-232 Transmit Output |
| 3 | RS-232 Receive Input |
| 4 | PC Data |
| 5 | PC Clock |
| 6 | KB Clock |
| 7 | PC +5V |
| 8 | KB Data |
| 9 | +5VDC |
| 10 | Shield Ground |

| MS9520-11 & MS9540-11 IBM 468X/469X | |
|--|------------------------|
| Pin | Function |
| 1 | Ground |
| 2 | RS-232 Transmit Output |
| 3 | RS-232 Receive Input |
| 4 | RTS Output |
| 5 | CTS Input |
| 6 | DTR Input |
| 7 | IBM B-Transmit |
| 8 | IBM A+ Receive |
| 9 | +5VDC |
| 10 | Shield Ground |

Continued next page

SCANNER AND CABLE TERMINATIONS

| MS9520-9 & MS9540-9 OCIA | |
|-------------------------------------|--------------------------------|
| Pin | Function |
| 1 | Ground |
| 2 | RS232 Transmit Output |
| 3 | RS232 Receive Input |
| 4 | RDATA |
| 5 | RDATA Return |
| 6 | Clock In |
| 7 | Clock Out |
| 8 | Clock in Return/Clock out Rtrn |
| 9 | +5VDC |
| 10 | Shield Ground |

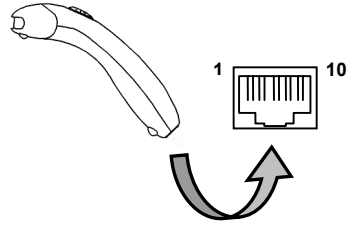



| MS9520-00 & MS9540-00 | |
|----------------------------------|---|
| Pin | Function |
| 1 | Ground |
| 2 | RS232 Transmit Output |
| 3 | RS232 Receive Input |
| 4 | Flip Sense/Start of Scan Output |
| 5 | Proximity Detect/Trigger Emulation Output |
| 6 | Scan/Laser Enable Input |
| 7 | Reserved |
| 8 | Data Out |
| 9 | +5VDC |
| 10 | Shield Ground |

| MS9520-14 & MS9540-14 | |
|----------------------------------|------------------------|
| Pin | Function |
| 1 | Ground |
| 2 | RS-232 Transmit Output |
| 3 | RS-232 Receive Input |
| 4 | RTS Output |
| 5 | CTS Input |
| 6 | DTR Input |
| 7 | Reserved |
| 8 | DSR Out |
| 9 | +5VDC |
| 10 | Shield Ground |

Cable Connector Configurations (Host End)

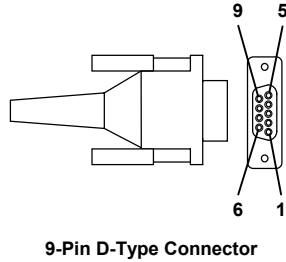
| <p>“Standard” PowerLink cable</p>  | |
|--|---|
| <p>9-pin D-type female connector to the PC</p> | |
| Pin | Function |
| 1 | Shield Ground |
| 2 | RS-232 Transmit Output |
| 3 | RS-232 Receive Input |
| 4 | DTR Input/Light Pen Source |
| 5 | Power/Signal Ground |
| 6 | Light Pen Data <i>(DSR Out for -14 interfaces)</i> |
| 7 | CTS Input |
| 8 | RTS Output |
| 9 | +5VDC |



| <p>Stand Alone Keyboard Power Link Cable</p>  | |
|---|----------------------|
| Pin | Function |
| 1 | PC Data |
| 2 | NC |
| 3 | Power Ground |
| 4 | +5VDC PC Power to KB |
| 5 | PC Clock |
| 6 | NC |



SCANNER AND CABLE TERMINATIONS (CONTINUED)

Cable Connector Configuration

The Keyboard Wedge PowerLink cable [MLPN 53-53002 or 54-54002] is terminated with a 5-pin DIN female connector on one end, and a 6-pin mini DIN male on the other.

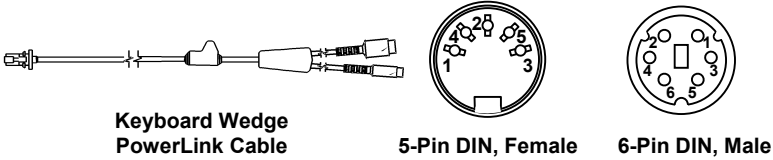

Metrologic will supply an adapter cable with a 5-pin DIN male connector on one end and a 6-pin mini DIN female connector on the other.

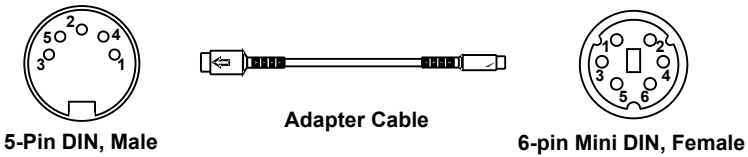

According to the termination required, connect the appropriate end of the adapter cable to the PowerLink cable, leaving the necessary termination exposed for connecting to the keyboard and the keyboard port on the PC. The pin assignments are as follows:

PowerLink Cable

| 5-pin Female DIN | |
|---------------------|----------------|
| Pin | Function |
| 1 | Keyboard Clock |
| 2 | Keyboard Data |
| 3 | No Connect |
| 4 | Power Ground |
| 5 | +5 Volts DC |
| 6-pin Male Mini-DIN | |
| Pin | Function |
| 1 | PC Data |
| 2 | No Connect |
| 3 | Power Ground |
| 4 | +5 Volts DC |
| 5 | PC Clock |
| 6 | No Connect |

Adapter Cable

| 5-pin Male DIN | |
|-----------------------|----------------|
| Pin | Function |
| 1 | PC Clock |
| 2 | PC Data |
| 3 | No Connect |
| 4 | Power Ground |
| 5 | +5 Volts DC |
| 6-pin Female Mini-DIN | |
| Pin | Function |
| 1 | Keyboard Data |
| 2 | No Connect |
| 3 | Power Ground |
| 4 | +5 Volts DC |
| 5 | Keyboard Clock |
| 6 | No Connect |

LIMITED WARRANTY

The MS9500 series scanners are manufactured by Metrologic at its Blackwood, New Jersey, USA facility. The MS9500 series scanners have a five (5) year limited warranty from the date of manufacture. Metrologic warrants and represents that all MS9500 series scanners are free of all defects in material, workmanship and design, and have been produced and labeled in compliance with all applicable US Federal, state and local laws, regulations and ordinances pertaining to their production and labeling.

This warranty is limited to repair, replacement of Product or refund of Product price at the sole discretion of Metrologic. Faulty equipment must be returned to the Metrologic facility in Blackwood, New Jersey, USA or Puchheim, Germany. To do this, contact Metrologic's Customer Service/Repair Department to obtain a Returned Material Authorization (RMA) number.

In the event that it is determined that the equipment failure is covered under the warranty, Metrologic shall, as its sole option, repair the Product or replace the Product with a functionally equivalent unit and return such repaired or replaced Product without charge for service or return freight, whether distributor, dealer/reseller, or retail consumer, or refund an amount equal to the original purchase price.

This limited warranty does not extend to any Product which, in the sole judgement of Metrologic, has been subjected to abuse, misuse, neglect improper installation, or accident, nor any damage due to use or misuse produced from integration of the Product into any mechanical, electrical or computer system. The warranty is void if the case of Product is opened by anyone other than Metrologic's repair department or authorized repair centers.

THIS LIMITED WARRANTY, EXCEPT AS TO TITLE, IS IN LIEU OF ALL OTHER WARRANTIES OR GUARANTEES, EITHER EXPRESS OR IMPLIED, AND SPECIFICALLY EXCLUDES, WITHOUT LIMITATION, WARRANTIES OF MERCHANTABILITY AND FITNESS FOR A PARTICULAR PURPOSE UNDER THE UNIFORM COMMERCIAL CODE, OR ARISING OUT OF CUSTOM OR CONDUCT. THE RIGHTS AND REMEDIES PROVIDED HEREIN ARE EXCLUSIVE AND IN LIEU OF ANY OTHER RIGHTS OR REMEDIES. IN NO EVENT SHALL METROLOGIC BE LIABLE FOR ANY INDIRECT OR CONSEQUENTIAL DAMAGES, INCIDENTAL DAMAGE, DAMAGES TO PERSON OR PROPERTY, OR EFFECT ON BUSINESS OR PROPERTY, OR OTHER DAMAGES OR EXPENSES DUE DIRECTLY OR INDIRECTLY TO THE PRODUCT, EXCEPT AS STATED IN THIS WARRANTY. IN NO EVENT SHALL ANY LIABILITY OF METROLOGIC EXCEED THE ACTUAL AMOUNT PAID TO METROLOGIC FOR THE PRODUCT. METROLOGIC RESERVES THE RIGHT TO MAKE ANY CHANGES TO THE PRODUCT DESCRIBED HEREIN.

North America Headquarters

Metrologic Instruments, Inc.
90 Coles Road
Blackwood, NJ 08012-4683

Customer Service: 1-800-ID-METRO
Tel: 856-228-8100
Fax: 856-228-6673
Email: info@metrologic.com
Website: www.metrologic.com

Germany

Metrologic Instruments GmbH
Dornierstrasse 2
82178 Puchheim b.
Munich, Germany

Tel: 49-89-89019-0
Fax: 49-89-89019-200
Email: info@europe.metrologic.com

NOTICES

Notice

This equipment has been tested and found to comply with the limits for a Class B digital device, pursuant to Part 15 of the FCC rules. These limits are designed to provide reasonable protection against harmful interference in a residential installation. This equipment generates, uses and can radiate radio frequency and, if not installed and used in accordance with the instruction, may cause harmful interference to radio communications. However, there is no guarantee that interference will not occur in a particular installation. If this equipment does cause harmful interference to radio or television reception, which can be determined by turning the equipment off and on, the user is encouraged to try to correct the interference by one or more of the following measures:

- Reorient or relocate the receiving antenna
- Increase the separation between the equipment and receiver
- Connect the equipment into an outlet on a circuit different from that to which the receiver is connected
- Consult the dealer or an experienced radio TV technician for help

Changes or modifications not expressly approved by the party responsible for compliance could void the user's authority to operate the equipment.

Notice

This Class B digital apparatus complies with Canadian ICES-003.

Remarque

Cet appareil numérique de la class B est conforme à la norme NMB-003 du Canada.

Caution

Use of controls or adjustments or performance of procedures other than those specified herein may result in hazardous laser light exposure. Under no circumstances should the customer attempt to service the laser scanner. Never attempt to look at the laser beam, even if the scanner appears to be nonfunctional. Never open the scanner in an attempt to look into the device. Doing so could result in hazardous laser light exposure. The use of optical instruments with the laser equipment will increase eye hazard.

Atención

La modificación de los procedimientos, o la utilización de controles o ajustes distintos de los especificados aquí, pueden provocar una luz de láser peligrosa. Bajo ninguna circunstancia el usuario deberá realizar el mantenimiento del láser del escáner. Ni intentar mirar al haz del láser incluso cuando este no esté operativo. Tampoco deberá abrir el escáner para examinar el aparato. El hacerlo puede conllevar una exposición peligrosa a la luz de láser. El uso de instrumentos ópticos con el equipo láser puede incrementar el riesgo para la vista.

Attention

L'emploi de commandes, réglages ou procédés autres que ceux décrits ici peut entraîner de graves irradiations. Le client ne doit en aucun cas essayer d'entretenir lui-même le scanner ou le laser. Ne regardez jamais directement le rayon laser, même si vous croyez que le scanner est inactif. N'ouvrez jamais le scanner pour regarder dans l'appareil. Ce faisant, vous vous exposez à une rayonnement laser qu'est dangereux. L'emploi d'appareils optiques avec cet équipement laser augmente le risque d'endommagement de la vision.

Achtung

Die Verwendung anderer als der hier beschriebenen Steuerungen, Einstellungen oder Verfahren kann eine gefährliche Laserstrahlung hervorrufen. Der Kunde sollte unter keinen Umständen versuchen, den Laser-Scanner selbst zu warten. Sehen Sie niemals in den Laserstrahl, selbst wenn Sie glauben, daß der Scanner nicht aktiv ist. Öffnen Sie niemals den Scanner, um in das Gerät hineinzusehen. Wenn Sie dies tun, können Sie sich einer gefährlichen Laserstrahlung aussetzen. Der Einsatz optischer Geräte mit dieser Laserausrüstung erhöht das Risiko einer Sehschädigung.

Attenzione

L'utilizzo di sistemi di controllo, di regolazioni o di procedimenti diversi da quelli descritti nel presente Manuale può provocare delle esposizioni a raggi laser rischiose. Il cliente non deve assolutamente tentare di riparare egli stesso lo scanner laser. Non guardate mai il raggio laser, anche se credete che lo scanner non sia attivo. Non aprite mai lo scanner per guardare dentro l'apparecchio. Facendolo potete esporVi ad una esposizione laser rischiosa. L'uso di apparecchi ottici, equipaggiati con raggi laser, aumenta il rischio di danni alla vista.

PATENTS

Patents

“Patent Information

This METROLOGIC product may be covered by one or more of the following US Patents:

US Patent No. 4,958,984; 5,081,342; 5,260,553; 5,340,971; 5,340,973; 5,424,525; 5,468,951; 5,484,992; 5,525,789; 5,528,024; 5,591,953; 5,616,908; 5,627,359; 5,661,292; 5,777,315; 5,789,730; 5,789,731; 5,811,780; 5,825,012; 5,828,048; 5,883,375; 5,886,337; 5,895,907; 5,925,870; 5,925,871; 5,939,698; 6,029,894; D408,532;

4,360,798; 4,369,361; 4,387,297; 4,460,120; 4,593,186; 4,607,156; 4,673,805; 4,736,095; 4,758,717; 4,816,660; 4,845,350; 4,896,026; 4,923,281; 4,933,538; 4,992,717; 5,015,833; 5,017,765; 5,059,779; 5,117,098; 5,124,539; 5,130,520; 5,132,525; 5,140,144; 5,149,950; 5,180,904; 5,200,599; 5,229,591; 5,247,162; 5,250,790; 5,250,791; 5,250,791; 5,250,792; 5,262,628; 5,280,162; 5,280,164; 5,304,788; 5,321,246; 5,324,924; 5,396,053; 5,396,055; 5,408,081; 5,410,139; 5,436,440; 5,449,891; 5,468,949; 5,479,000; 5,532,469; 5,545,889

No license right or sublicense is granted, either expressly or by implication, estoppel, or otherwise, under any METROLOGIC or third party intellectual property rights (whether or not such third party rights are licensed to METROLOGIC), including any third party patent listed above, except for an implied license only for the normal intended use of the specific equipment, circuits, and devices represented by or contained in the METROLOGIC products that are physically transferred to the user, and only to the extent of METROLOGIC’s license rights and subject to any conditions, covenants and restrictions therein.”

Other worldwide patents pending.

INDEX

A
AC Input/Outlet 5, 6, 7
accessories 2
accessories 2
adapter 2
approvals 23
audible 15
autodiscriminates 32

B
bar code 1, 4, 15, 16, 17, 19-21,
23, 24, 28, 29, 32
beep 4, 15, 16, 20-22, 27, 28,
32, 34

C
Cable 2, 3, 30, 40, 41
communication 5, 16, 17, 22,
30, 33
detachable 1, 8
pin assignments 41
powerLink 1, 2, 4, 5, 7, 8, 22,
40, 41
caution 4, 5, 6, 7, 23
CDRH 32
CE 43
codeGate 1, 9, 16, 32, 33
compliance 4, 5, 6, 7, 42, 43
configuration 1, 15, 19, 27, 31,
40, 41
connector 2
current 6, 7, 15, 27, 32
customer Service ii, 3, 42

D
decode Capability 32
default Settings 4, 5, 20, 21, 26
depth of Field 24, 25
detachable 3
disclaimer 42

E
electrical 32

F
failure Indicator(s) 15
failure Modes 15, 18

G
green LED 4, 15, 16, 27

H
host 1-3, 5, 7, 8, 16, 17, 19,
21, 27, 28, 30

I
indicators
audible 15
LED 4, 14, 15, 16, 27, 28, 32
input Voltage 32
installation 42, 43
interfaces 27, 32, 38

K
keyboard Wedge 1, 2

L
labels 23
light Levels 32
light Pen 1, 2, 22, 26, 33, 34-37
light Source 32

M
maintenance 23
meteor 22

N
notices 43

O
OCIA 1, 2
operation 15
output window 14

INDEX

P

parts 2, 14
PC . 5, 22, 26, 29, 30, 32, 38, 40, 41
pin Assignments 41
port 6
power Supply 4, 6, 8, 22, 27
powerLink 5, 7
programming ... 4, 15, 19, 20, 26, 30
programming guide 2

R

razzberry Tone 15, 17, 18, 34
red LED 4, 15, 16, 22, 28
repair 18, 42
RMA 42
RS-232 1, 2, 26, 30, 31, 33-40

S

SELV 4, 5, 6, 7
service 3, 42
specifications 32
stand 2
system interfaces 32

T

termination 6
tones 15, 18
transformers 32
troubleshooting 27, 28, 29, 30

V

ventilation 32
visual 16, 17
voltage 32

W

warranty 42
window 14, 23

April 2002

Printed in the USA



00 - 02410C