



FULL LINE

PRODUCT CATALOG

VOLUME 22



RUGGED. RELIABLE. RESPONSIVE.™



TABLE OF CONTENTS

About Gamber-Johnson	3	Motion Attachments	112
Cradles and Docking Stations	4	ZIRKONA Solutions	122
Console Systems.....	41	Logistic Mounting Systems.....	130
Pedestal Systems.....	78	Material Handling Mounting Systems.....	134
Mobile Workstations	98	Point-of-Sale and Office Solutions.....	154
Vehicle Equipment.....	106		

From humble beginnings as a local wooden furniture manufacturer in Stevens Point, Wisconsin, Gamber-Johnson has developed into the **global go-to partner for equipment mounting products.**



This evolution from producing furniture in 1954 to becoming a 21st-century world leader in mounting equipment for electronics was a natural progression, fostered by a company culture of innovation and continuous improvement.

Today, Gamber-Johnson is still proudly “made in Wisconsin” and manufactures mounting components and systems for laptop and tablet computers, radios, light and siren controls, surveillance cameras, point-of-use kiosks, printers, keyboards and other devices — all meticulously designed to be rugged, reliable, and responsive.

Partnering with major technology manufacturers such as Dell, Getac, Panasonic, Samsung, and Zebra is key to this success. Gamber-Johnson is a trusted name in the industry; long known as the go-to partner for major rugged computer OEMs. With more than 25 patents and counting, the company continues to evolve, creating numerous jobs and meaningful opportunities for community stewardship.

As a pioneer in design innovation — receiving numerous awards and accolades as an industry leader — Gamber-Johnson has been the preferred choice of fleet managers for decades. Gamber-Johnson is a worldwide corporation with subsidiaries around the globe, including Precision Mounting Technologies (PMT) in Calgary. Currently, the company exports to more than 45 countries, with installations in thousands of fleets worldwide. Heroes in police, fire and emergency medical services rely on Gamber products every day in order to better protect and serve.

For these significant contributions to vital industries on a global scale, Gamber-Johnson has received numerous

accolades. These include the 2019 Wisconsin Manufacturer of the Year Award, in the Medium Category recognizing the company’s commitment to business excellence which makes a positive impact on the state of Wisconsin; the President’s “E” and “E” Star Awards, recognizing outstanding contributions and growth to U.S. exports; Wisconsin Governor’s Export Achievement Award, which honors the company’s work in furthering Wisconsin’s global economy; and the Cygnus Innovation Award, acknowledging that the company is at the cutting edge of emerging technologies. Gamber-Johnson has been nominated as Wisconsin Manufacturer of the Year eight times and also received the J.P. Leggett Innovator Award from Leggett & Platt, in addition to being named a “Workplace of Distinction” by Corporate Report Wisconsin.

Gamber-Johnson’s dedication to producing products that are rugged, reliable, and responsive is unparalleled. The Gamber-Johnson name has become synonymous with high quality, rugged products that can withstand even the most extreme situations. These products are guaranteed and reliable, hand tested for perfect performance every single time. With a strong focus on customer service, the Gamber-Johnson brand is responsive: offering custom-designed solutions, lightning-fast production and shipping, and working directly with technology partners to ensure the optimum fit, every time.

From the company’s local origins to its modern-day global impact, Gamber-Johnson has continued pursuing its mission — supporting our heroes and saving the world through a laser-like focus on innovation



CRADLES & DOCKING STATIONS

Find the perfect solution in the form of a docking station, which replicates the computer's ports for full peripheral access, or a cradle that offers the utmost stability for crucial assets. Gamber-Johnson offers a large assortment of docking stations and cradles that support computers from the most trusted rugged manufacturers in the market including: Dell, Getac, Panasonic, Samsung, Zebra, and more.



Getac

DELL LATITUDE RUGGED LAPTOP DOCKING STATION

(Fits Latitude 14 Rugged/Rugged Extreme and Latitude 12 Rugged Extreme Convertible Laptop)

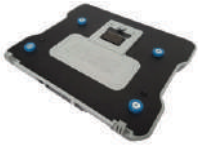

7160-0882-00



7160-0882-00

Item No.	Antenna Pass-Through	Power Supply	Weight	Height	Adjustable Width	Depth
7160-0882-00	No	No - Use LIND Power Supply (7300-0468)	5.6 lbs 2.5 kg	2.4" 6.0 cm	10.7" to 12.9" 27.2 cm to 32.6 cm	12.1" 30.8 cm
7160-0882-03	Triple RF (TNC)	No - Use LIND Power Supply (7300-0468)	5.6 lbs 2.5 kg	2.4" 6.0 cm	10.7" to 12.9" 27.2 cm to 32.6 cm	12.1" 30.8 cm
7170-0551-00	No	Yes - Includes LIND Auto Power Supply	5.6 lbs 2.5 kg	2.4" 6.0 cm	10.7" to 12.9" 27.2 cm to 32.6 cm	12.1" 30.8 cm
7170-0551-03	Triple RF (TNC)	Yes - Includes LIND Auto Power Supply	5.6 lbs 2.5 kg	2.4" 6.0 cm	10.7" to 12.9" 27.2 cm to 32.6 cm	12.1" 30.8 cm

Features

- Compatible with the Dell Latitude 14 Rugged/Rugged Extreme and Latitude 12 Rugged Extreme Convertible Laptop
- Rugged composite/steel construction with black powder coat finish for long-term durability
- Designed with rounded edges to enhance personal safety
- Front-facing USB 2.0 and microphone/AUX ports
- Rear-facing I/O ports, integrated cable strain relief system, and convenient cable management system
- Floating docking connector with alignment tabs – perfectly align the computer with the docking station for a reliable docking connection
- Internal/protected circuit board protects against dirt and dust
- Small footprint - designed to maximize available space inside of vehicle
- Front adjustable mounting brackets; adjust to fit the Latitude 14 Rugged/Rugged Extreme and Latitude 12 Rugged Extreme Convertible Laptop
- Front-facing latch with keyed lock for theft deterrence:
 - Push the latch to open the docking station
 - Insert computer and push latch closed to dock the computer
- VESA 75 mm mounting pattern
- MIL-STD 810G shock/vibration, RoHS, FCC, CE, and SAE J1455 crash certifications
- 3-Year Limited Warranty

Port Replicators

- Serial (2) D-Sub 9 Pin
- Ethernet (1) RJ45
- USB 3.0 (2) 9 Pin
- VGA (1) D-Sub 15 Pin
- HDMI (1) 19 Pin
- RF pass-through (optional) TNC
- Power supply input DC



DELL LATITUDE RUGGED LAPTOP CRADLE

(Fits Latitude 14 Rugged/Rugged Extreme and Latitude 12 Rugged Extreme Convertible Laptop)



7160-0883-00

Item No.	Antenna Pass-Through	Power Supply	Weight	Height	Adjustable Width	Depth
7160-0883-00	No	No - Use LIND Power Supply (7300-0468)	5.6 lbs 2.5 kg	2.4" 6.0 cm	10.7" to 12.9" 27.2 cm to 32.6 cm	12.1" 30.8 cm
7160-0883-03	Triple RF (TNC)	No - Use LIND Power Supply (7300-0468)	5.6 lbs 2.5 kg	2.4" 6.0 cm	10.7" to 12.9" 27.2 cm to 32.6 cm	12.1" 30.8 cm

Features

- Compatible with the Dell Latitude 14 Rugged/Rugged Extreme and Latitude 12 Rugged Extreme Convertible Laptop
- Rugged composite/steel construction with black powder coat finish for long-term durability
- Designed with rounded edges to enhance personal safety
- Small footprint to maximize available space inside of vehicle
- Front adjustable mounting brackets; adjust to fit the Latitude 14 Rugged/Rugged Extreme and Latitude 12 Rugged Extreme Convertible Laptop
- Front-facing latch with keyed lock for theft deterrence:
 - Push the latch to open the docking station
 - Insert computer and push latch closed to dock the computer
- VESA 75 mm mounting pattern
- MIL-STD 810G shock/vibration, RoHS, FCC, CE, and SAE J1455 crash certifications
- 3-Year Limited Warranty

DELL LATITUDE 12 RUGGED TABLET DOCKING STATION

Item No.	Antenna Pass-Through	Power Supply	Weight	Height	Width	Depth
7160-0840-00	No	No - Use LIND Power Supply (7300-0469)	3.6 lbs 1.6 kg	10.4" 26.4 cm	13.0" 33.0 cm	2.9" 7.4 cm
7160-0840-02	Dual RF	No - Use LIND Power Supply (7300-0469)	3.6 lbs 1.6 kg	10.4" 26.4 cm	13.0" 33.0 cm	2.9" 7.4 cm
7170-0552-00	No	Yes - Includes LIND Auto Power Supply	3.6 lbs 1.6 kg	10.4" 26.4 cm	13.0" 33.0 cm	2.9" 7.4 cm
7170-0552-02	Dual RF	Yes - Includes LIND Auto Power Supply	3.6 lbs 1.6 kg	10.4" 26.4 cm	13.0" 33.0 cm	2.9" 7.4 cm



7160-0840-02

Features

- Compatible with the Dell Latitude 12 Rugged tablet
- Steel and composite design for reduced weight and long-term durability
- Designed with rounded edges to enhance personal safety
- Front-facing USB 2.0 and microphone/AUX ports
- Use the tablet stylus and card reader/scanner while the tablet is docked
- The stylus cord, even when placed between the dock and tablet, won't interfere with the tablet's connectivity when docked
- Upward-facing I/O ports, integrated cable strain relief system, and convenient cable management system
- Keyed lock for theft deterrence
- Optional Dual RF antenna pass-through
- VESA 75 mm mounting pattern
- MIL-STD 810G shock/vibration, RoHS, FCC, CE, E-Mark and SAE J1455 crash certifications
- 3-Year Limited Warranty

Port Replicator

- Serial (2) D-Sub 9 Pin
- Ethernet (1) RJ45
- USB 3.0 (2) 9 Pin
- VGA (1) D-Sub 15 Pin
- HDMI (1) 19 Pin
- RF pass-through (optional) TNC
- Power supply input DC



DELL LATITUDE 12 RUGGED TABLET CRADLE

Item No.	Antenna Pass-Through	Power Supply	Weight	Height	Width	Depth
7160-0881-00	No	No - Use LIND Power Supply (7300-0469)	3.6 lbs 1.6 kg	10.4" 26.4 cm	13.0" 33.0 cm	2.9" 7.4 cm



7160-0881-00

Features

- Compatible with the Dell Latitude 12 Rugged tablet
- Steel and composite design for reduced weight and long-term durability
- Designed with rounded edges to enhance personal safety
- Use the tablet stylus and card reader/scanner while the tablet is cradled
- Keyed lock for theft deterrence
- VESA 75 mm mounting pattern
- MIL-STD 810G shock/vibration, RoHS, FCC, CE, E-Mark and SAE J1455 crash certifications
- 3-Year Limited Warranty

DELL LATITUDE 12 CRADLE AND DOCKING STATION ACCESSORIES

Item No.	Description	Placement	Weight	Height	Width	Depth
7300-0468	External 90W LIND Automobile Cigarette Power Adapter	For use with Dell Latitude Rugged Laptop	1.2 lbs 0.5 kg	1.2" 3.0 cm	5.0" 12.7 cm	3.0" 7.6 cm
7300-0469	External 90W LIND Automobile Cigarette Power Adapter	For use with Dell 12 Rugged Tablet	1.2 lbs 0.5 kg	1.2" 3.0 cm	5.0" 12.7 cm	3.0" 7.6 cm
7160-0975	Protective Tablet Cover	For use with Dell Latitude Tablet Docking Station and Cradle		10.0" 25.4cm	13.5" 34.3 cm	3.5" 8.89cm



7160-0975



7160-1247-00

GETAC A140 CRADLE

Item No.	Antenna Pass-Through	Power Supply	Weight	Height	Width	Depth
7160-1247-00	No RF	No - Use Getac External Power Supply (7300-0471)	3.85 lbs 1.74 kg	12.59" 31.9 cm	15.18" 38.5 cm	3.31" 8.4 cm
7160-1247-03	Triple RF	No - Use Getac External Power Supply (7300-0471)	3.85 lbs 1.74 kg	12.59" 31.9 cm	15.18" 38.5 cm	3.31" 8.4 cm

Features

- Designed for the Getac A140 tablet computer
- Getac certified
- Cradle accommodates rotating hand strap (sold separately)
- Designed with rounded edges to enhance personal safety
- Composite/aluminum design for reduced weight and durability
- Access to all tablet control buttons and ports while tablet is cradled
- Optional lock (keyed alike) for theft deterrence
- Easy to use one-handed operation:
 - Insert bottom of computer into the cradle, push top of computer against latch lever until latch engages
 - To remove, push up on latch-button with thumb to disengage and pull computer out of the cradle
- VESA 75 mm mounting pattern
- MIL-STD 810G shock/vibration, RoHS, FCC, and SAE J1455 crash certifications
- 3-Year Limited Warranty



7160-1246-03

GETAC A140 TABLET DOCKING STATION

Item No.	Antenna Pass-Through	Power Supply	Weight	Height	Width	Depth
7160-1246-00	No RF	No - Use Getac External Power Supply (7300-0471)	3.85 lbs 1.74 kg	12.59" 31.9 cm	15.18" 38.5 cm	3.31" 8.4 cm
7160-1246-03	Triple RF	No - Use Getac External Power Supply (7300-0471)	3.85 lbs 1.74 kg	12.59" 31.9 cm	15.18" 38.5 cm	3.31" 8.4 cm
7170-0695-00	No RF	Yes - Includes Getac External Power Supply	4.55 lbs 2.06 kg	12.59" 31.9 cm	15.18" 38.5 cm	3.31" 8.4 cm
7170-0695-03	Triple RF	Yes - Includes Getac External Power Supply	4.55 lbs 2.06 kg	12.59" 31.9 cm	15.1" 38.5 cm	3.3" 8.4 cm

Features

- Designed for the Getac A140 tablet computer
- Getac certified utilizing Getac certified electronics
- Docking station design accommodates rotating hand strap (sold separately)
- Designed with rounded edges to enhance personal safety
- Composite/aluminum design for reduced weight and durability
- Access to all tablet control buttons and ports while tablet is docked
- Upward-facing I/O ports; integrated cable strain relief and cable management system
- Floating docking connector for reliable connectivity in the most rugged environments
- Keyed-alike lock for theft deterrence
- Easy to use one-handed operation:
 - Insert bottom of computer into the docking station, push top of computer against latch lever until latch engages
 - To remove, push up on latch-button with thumb to disengage and pull computer out of the docking station
- VESA 75 mm mounting pattern
- MIL-STD 810G shock/vibration, RoHS, FCC, and SAE J1455 crash certifications
- 3-Year Limited Warranty

Port Replicator

- Getac certified electronics
- Ethernet (1) RJ45
- Serial (1) D-Sub 9 Pin
- USB 2.0 (3) 4 Pin
- USB 3.0 (1) 9 Pin
- VGA (1) D-Sub 9 Pin
- HDMI (1) 19 Pin
- Headphones/Speakers Stereo phone jack
- Microphone Mono phone jack
- RF Pass Through (optional) SMA
- Power Input: 19VDC

GETAC A140 DOCKING STATION AND CRADLE ACCESSORIES

Item No.	Description	Placement	Weight	Height	Width	Depth
7300-0471	Getac 120W Auto Power Adapter, 12-32VDC Input	Use with Getac S410, K120, A140, UX10, and B360 docking stations and cradles	.7 lbs .31 kg	1.2" 3.0 cm	2.6" 6.3 cm	5.1" 12.9 cm
7160-0539	LIND Power Supply Mount	Attaches a LIND power supply between a docking station/cradle and the motion attachment	1.5 lbs .68 kg	5.0" 12.7 cm	10.0" 25.4 cm	1.3" 3.3 cm



7300-0471

GETAC B300 DOCKING CRADLE

Item No.	Power Supply	Weight	Height	Width	Depth
7160-0570-00	No - Use External LIND Auto Adapter (7300-0463)	4.7 lbs 2.1 kg	3.9" 9.9 cm	12.4 31.5 cm	12.3" 31.2 cm

Features

- Compatible with Getac B300 computer
- Getac Certified
- Simple, one-handed, docking mechanism:
- Pull side handle forward to dock
- Unlock the key button to release and undock computer
- Brass locating pins for precise computer placement
- Interlocking mechanism protect computer from damage and prevents engagement until properly mounted
- Keyed lock for theft deterrence
- Composite/steel design creates a lightweight, yet rugged platform for long-term durability
- Gamber-Johnson 2"x 4.09" mounting pattern
- MIL-STD 810G shock/vibration, RoHS, FCC, CE, and SAE J1455 crash certifications
- 3-Year Limited Warranty



GETAC B300 DOCKING STATION

Item No.	Antenna Pass-Through	Power Supply	Weight	Height	Width	Depth
7160-0526-00	NA	Yes - Internal Power Supply	5.2 lbs 2.4 kg	4.9" 12.4 cm	12.4" 31.5 cm	12.3" 31.2 cm
7160-0526-02	Dual RF (TNC)	Yes - Internal Power Supply	5.2 lbs 2.4 kg	4.9" 12.4 cm	12.4" 31.5 cm	12.3" 31.2 cm

Features

- Compatible with Getac B300 computer
- Getac Certified, Getac Certified electronics
- Simple, one-handed, docking mechanism:
- Pull side handle forward to dock
- Unlock the key button to release and undock computer
- Brass locating pins for precise computer placement
- Floating docking connector for reliable docking connection
- Interlocking mechanism protects against connector damage & prevents engagement until properly mounted
- Forward facing ports for low mounting capability, minimal cable strain and minimal swivel resistance
- Power switch with LED light and optional by-pass capability:
- Green LED indicates power to the docking station
- Keyed lock for theft deterrence
- Composite/steel design creates a lightweight, yet rugged platform for long-term durability
- Gamber-Johnson 2"x 4.09" mounting pattern
- MIL-STD 810G shock/vibration, RoHS, FCC, CE, and SAE J1455 crash certifications
- 3-Year Limited Warranty

Port Replicator

- Getac certified electronics
- Ethernet (1) RJ45
- Fully powered USB 3.0 (4) 9 Pin
- Serial (2) D-Sub 9 Pin
- VGA (1) D-Sub 15 Pin
- Headphones/speakers Stereo phono jack
- Microphone Mono phono jack
- RF pass through (Optional) TNC
- Alternate DC power input



7160-0526-00

GETAC B300 DOCKING STATION/CRADLE ACCESSORIES

Item No.	Description	Placement	Weight	Height	Width	Depth
7160-0096	Led Light Assembly	Attaches to the right side of the docking station	0.5 lbs 0.2 kg	17.0" 43.2 cm	3.0" 7.6 cm	1.6" 4.1 cm
7160-0501	Screen Support	Attaches to the right side of the docking station	0.5 lbs 0.2 kg	9.7" 24.6 cm	4.1" 10.4 cm	1.8" 4.6 cm
7160-0398	Trunk Shelf Mounting Plate	Used to raise the Getac B300 Docking Station to provide clearance for cables when mounting to a flat surface (usually trunk applications)	3.6 lbs 1.6 kg	2.3" 5.8 cm	10.25" 26.0 cm	5.5" 14.0 cm



7160-0096

NEW



7160-1432-03

GETAC B360 LAPTOP CRADLE

Item No.	Description	Power Supply	Weight	Height	Width	Depth
7160-1432-00	Getac B360 Laptop Vehicle Cradle (No RF)	No - Use Getac Power Adapter (7300-0471)	4.65 lbs 2.11 kg	2.25" 5.72 cm	14" 35.56 cm	11.5" 29.21 cm
7160-1432-03	Getac B360 Laptop Vehicle Cradle (Tri RF)	No - Use Getac Power Adapter (7300-0471)	4.65 lbs 2.11 kg	2.25" 5.72 cm	14" 35.56 cm	11.5" 29.21 cm
7170-0795-00	Kit Includes: Getac B360 Laptop Vehicle Cradle (No RF), Getac Automotive Power Adapter	Yes - Includes Getac Auto Power Adapter	5.35 lbs 2.42 kg	2.25" 5.72 cm	14" 35.56 cm	11.5" 29.21 cm
7170-0795-03	Kit Includes: Getac B360 Laptop Vehicle Cradle (Tri RF), Getac Automotive Power Adapter	Yes - Includes Getac Auto Power Adapter	5.35 lbs 2.42 kg	2.25" 5.72 cm	14" 35.56 cm	11.5" 29.21 cm

Features

- Designed for the Getac B360 and B360 Pro laptop computers
- Front corner release latch, easily remove the computer by activating the latch
- Access to all computer control buttons and ports while the computer is docked
- Screen support for additional stability (included)
- Available with Tri RF antenna pass-through or No RF. Also available bundled with an automotive power adapter.
- Keyed lock for theft deterrence
- Designed with rounded edges to enhance personal safety
- Composite/steel design for reduced weight and durability
- Easy docking and release:
 - To dock: Align front brackets on dock with pockets on front of computer, slowly rotate back of the computer onto cradle, push down on back of computer until audible click is heard. Computer is cradled.
 - To release: Disengage lock. Push blue release button and rotate back of computer up and pull front of computer away from the cradle.
- VESA 75 mm mounting pattern
- MIL-STD 810G shock/vibration, RoHS, FCC, CE, and SAE J1455 crash certifications
- 3-Year Limited Warranty

NEW



7160-1431-03

GETAC B360 LAPTOP DOCKING STATION

Item No.	Description	Power Supply	Weight	Height	Width	Depth
7160-1431-00	Getac B360 Laptop Vehicle Docking Station (No RF)	No - Use Getac Power Adapter (7300-0471)	4.85 lbs 2.2 kg	2.25" 5.72 cm	14" 35.56 cm	11.5" 29.21 cm
7160-1431-03	Getac B360 Laptop Vehicle Docking Station (Tri RF)	No - Use Getac Power Adapter (7300-0471)	4.85 lbs 2.2 kg	2.25" 5.72 cm	14" 35.56 cm	11.5" 29.21 cm
7170-0789-00	Kit Includes: Getac B360 Laptop Vehicle Docking Station (No RF) + Getac Automotive Power Adapter	Yes - Includes Getac Auto Power Adapter	5.55 lbs 2.51 kg	2.25" 5.72 cm	14" 35.56 cm	11.5" 29.21 cm
7170-0789-03	Kit Includes: Getac B360 Laptop Vehicle Docking Station (Tri RF) + Getac Automotive Power Adapter	Yes - Includes Getac Auto Power Adapter	5.55 lbs 2.51 kg	2.25" 5.72 cm	14" 35.56 cm	11.5" 29.21 cm

Features

- Designed for the Getac B360 and B360 Pro laptop computers
- Getac Certified utilizing Getac Certified electronics
- Floating docking connector with steel guide pins to ensure a reliable connection even in the most rugged environments
- Front corner release latch, easily remove the computer by activating the latch
- Access to all computer control buttons and ports while the computer is docked
- Rear-facing I/O ports; integrated cable strain relief and cable management system
- Screen support for additional stability (included)
- Available with Tri RF antenna pass-through or No RF. Also available bundled with an automotive power adapter.
- Designed with rounded edges to enhance personal safety
- Composite/steel design for reduced weight and durability
- Keyed lock for theft deterrence
- Available with Tri RF antenna pass-through or No RF. Also available bundled with an automotive power adapter.
- Easy docking and release:
 - To dock: Align front brackets on dock with pockets on front of computer, slowly rotate back of the computer onto docking station, push down on back of computer until audible click is heard. Computer is docked.
 - To release: Disengage lock. Push blue release button and rotate back of computer up and pull front of computer away from the dock.
- VESA 75 mm mounting pattern
- MIL-STD 810G shock/vibration, RoHS, FCC, CE, and SAE J1455 crash certifications
- 3-Year Limited Warranty

Port Replicator

- Getac Certified Electronics
- USB 2.0 (1) 4 Pin Rear-Facing, (2) Front-Facing (500mA)
- USB 3.0 (3) 9 Pin Rear-Facing (900mA)
- RS232 Serial (1)
- Ethernet (2) RJ45
- VGA (1) D-Sub 9 Pin
- HDMI (1) 19 Pin
- Power Input 19VDC

GETAC B360 LAPTOP DOCKING STATION ACCESSORIES

Item No.	Description	Placement/Compatibility	Weight	Height	Width	Depth
7110-1332	Screen Support for Getac B360 Laptop Docking Station	Attaches to left or right rear corner of the B360 Docking Station or Cradle	.40 lbs .18 kg	9.0" 22.8 cm	2.12" 5.38 cm	3.75" 9.5 cm
7300-0471	Getac 120W Automotive Power Adapter with Cigarette Lighter Connector; 12-32V Input, Output Voltage 19VDC, Output Current 6.32 Amps to Barrel Connector Plug	Use with Getac S410, K120, A140, UX10, and B360 Docking Stations and Cradles	.7 lbs .31 kg	"5.1" 13 cm	2.6" 6.6 cm	1.2" 3.0 cm

NEW



7110-1332

GETAC EX80 DOCKING STATION

PMT

Item No.	Antenna Pass-Through	Power Supply	Weight	Height	Width	Depth
7300-0143-00	No RF	No	4.2 lbs 1.9 kg	7.6" 19.3 cm	5.7" 14.4 cm	4" 10.1 cm
7300-0143-10	No RF	Yes - Includes LIND Power Adapter	4.3 lbs 1.9 kg	7.6" 19.3 cm	5.7" 14.4 cm	4" 10.1 cm



7300-0143-00

Features

- Integrated Getac EX80 port replicator
- Aircraft-grade aluminum construction perfect for rugged environments and extended use
- Compact, low profile, space-saving design
- Front-facing USB port for ease of use
- Compatible with hand strap for portability
- Integrated cable management system
- Keyed locked for theft deterrence
- Easy, one-handed operation:
 - To dock: Unlock. Lead the bottom of the tablet into the dock using the guide pins for positioning, push the top of the tablet back into the dock until top clamp is fully seated on tablet
 - To release: Unlock. Move the top clamp up and away from the tablet. Gently lift the tablet out of the dock
- VESA 75 mounting pattern
- MIL-STD 810G tested and certified
- 3-Year Limited Warranty

Port Replicator

- Getac certified electronics
- Ethernet (1) RJ45
- USB 2.0 (3) 4 Pin Forward-facing (1), Rear (2)
- Power indicator light
- Power Input: 12VDC

GETAC F110 CRADLE

Item No.	Antenna Pass-Through	Power Supply	Weight	Height	Width	Depth
7160-1009-00	No RF	No - Use LIND External Power Supply (7300-0463)	2.3 lbs 1.04 kg	11.2" 28.6 cm	12.7" 32.3 cm	4.09" 10.3 cm
7160-1009-03	Triple RF	No - Use LIND External Power Supply (7300-0463)	2.3 lbs 1.04 kg	"11.2" 28.6 cm	12.7" 32.3 cm	4.09" 10.3 cm
7170-0669-00	No RF	Yes - Includes External LIND Power Supply	3.3 lbs 1.49 kg	11.2" 28.6 cm	12.7" 32.3 cm	4.09" 10.3 cm
7170-0669-03	Triple RF	Yes - Includes External LIND Power Supply	3.3 lbs 1.49 kg	11.2" 28.6 cm	12.7" 32.3 cm	4.09" 10.3 cm



7160-1009-00

Features

- Designed for the Getac F110 tablet computer
- Getac Certified
- Cradle accommodates mag strip reader and rotating hand strap (sold separately)
- Designed with rounded edges to enhance personal safety
- Composite/aluminum design for reduced weight and durability
- Access to all tablet control buttons and ports while tablet is docked
- Optional lock (keyed alike) for theft deterrence
- Easy to use one-handed operation:
 - Insert bottom of computer into the docking station, push top of computer against latch button until latch engages
 - To remove, push up on latch-button with thumb to disengage and pull computer out of the cradle
- VESA 75 mm mounting pattern
- MIL-STD 810G shock/vibration, RoHS, FCC, and SAE J1455 crash certifications
- 3-Year Limited Warranty



7160-0987-03

GETAC F110 DOCKING STATION

Item No.	Antenna Pass-Through	Power Supply	Weight	Height	Width	Depth
7160-0987-00	No RF	No - Use Lind External Power Supply (7300-0463)	2.6 lbs 1.2 kg	11.2" 28.6 cm	12.7" 32.3 cm	4.09" 10.3 cm
7160-0987-03	Triple RF	No - Use Lind External Power Supply (7300-0463)	2.6 lbs 1.2 kg	11.2" 28.6 cm	12.7" 32.3 cm	4.09" 10.3 cm
7170-0670-00	No RF	Yes - Includes External Lind Power Supply	3.6 lbs 1.63 kg	11.2" 28.6 cm	12.7" 32.3 cm	4.09" 10.3 cm
7170-0670-03	Triple RF	Yes - Includes External Lind Power Supply	3.6 lbs 1.63 kg	11.2" 28.6 cm	12.7" 32.3 cm	4.09" 10.3 cm

Features

- Designed for the Getac F110 tablet computer
- Getac Certified utilizing Getac Certified electronics
- Designed with rounded edges to enhance personal safety
- Composite/aluminum design for reduced weight and durability
- Docking station accommodates mag strip reader and rotating hand strap (sold separately)
- Access to all tablet control buttons and ports while tablet is docked
- Downward-facing I/O ports; integrated cable strain relief and cable management system
- Floating docking connector for reliable connectivity in the most rugged environments
- Optional lock (keyed alike) for theft deterrence
- Easy to use one-handed operation:
 - Insert bottom of computer into the docking station, push top of computer against latch button until latch engages
 - To remove, push up on latch-button with thumb to disengage and pull computer out of the docking station
- VESA 75 mm mounting pattern
- MIL-STD 810G shock/vibration, RoHS, FCC, and SAE J1455 crash certifications
- 3-Year Limited Warranty

Port Replicator

- Getac certified electronics
- Ethernet (1) RJ45
- Serial (2) Power on pin 9 - 1 AMP
- USB 2.0 (3) 4 Pin
- USB 3.0 (1) 9 Pin
- VGA (1) D-Sub 9 Pin
- HDMI (1) 19 Pin
- RF Pass Through (optional) SMA
- Power Input: 19VDC



GETAC F110 CRADLE AND DOCKING STATION ACCESSORIES



7160-0950

Item No.	Description	Placement	Weight	Height	Width	Depth
7300-0463	External LIND Auto Power Adapter with Cigarette Adapter	Use with Getac F110 Docking Stations and Cradles	1.0 lbs 0.45 kg	1.2" 3.0 cm	2.5" 6.4 cm	5.2" 13.2 cm
7160-0539	LIND Power Supply Mount	Attaches a LIND power supply between a docking station/cradle and the motion attachment	1.5 lbs 0.68 kg	5.0" 12.7 cm	10.0" 25.4 cm	1.3" 3.3 cm
7160-0950	10" Universal Tablet Protective Cover	Use with Getac F110 Docking Stations and Cradles	0.4 lbs 0.18 kg	15.0" 38.1 cm	13.0" 33.0 cm	4.0" 10.2 cm
7160-0982	Thermal Tablet Protective Cover	Use with Getac F110 Docking Stations and Cradles	1.15 lbs. 0.52 kg	14.25" 36.2 cm	12.75" 32.4 cm	3.5" 8.9 cm

GETAC K120 TABLET CRADLE



7160-1085-00

Item No.	Antenna Pass-Through	Power Supply	Weight	Height	Width	Depth
7160-1085-00	No RF	No - Use Getac External Power Supply (7300-0471)	3.0 lbs 1.36 kg	11.63" 29.5 cm	13.19" 33.5 cm	4.38" 11.1 cm
7160-1085-03	Triple RF	No - Use Getac External Power Supply (7300-0471)	3.0 lbs 1.36 kg	11.63" 29.5 cm	13.19" 33.5 cm	4.38" 11.1 cm

Features

- Designed for the Getac K120 tablet computer
- Getac certified
- Cradle accommodates rotating hand strap (sold separately)
- Designed with rounded edges to enhance personal safety
- Composite/aluminum design for reduced weight and durability
- Access to all tablet control buttons and ports while tablet is cradled
- Optional lock (keyed alike) for theft deterrence
- Easy to use one-handed operation:
 - Insert bottom of computer into the cradle, push top of computer against latch button until latch engages
 - To remove, push up on latch-button with thumb to disengage and pull computer out of the cradle
- VESA 75 mm mounting pattern
- MIL-STD 810G shock/vibration, RoHS, FCC, and SAE J1455 crash certifications
- 3-Year Limited Warranty

GETAC K120 TABLET DOCKING STATION

Item No.	Antenna Pass-Through	Power Supply	Weight	Height	Width	Depth
7160-1084-00	No RF	No - Use Getac External Power Supply (7300-0471)	3.2 lbs 1.45 kg	11.63" 29.5 cm	13.19" 33.5 cm	4.38" 11.1 cm
7160-1084-03	Triple RF	No - Use Getac External Power Supply (7300-0471)	3.2 lbs 1.45 kg	11.63" 29.5 cm	13.19" 33.5 cm	4.38" 11.1 cm
7170-0694-00	No RF	Yes - Includes Getac External Power Supply	4.2 lbs 1.90 kg	11.63" 29.5 cm	13.19" 33.5 cm	4.38" 11.1 cm
7170-0694-03	Triple RF	Yes - Includes Getac External Power Supply	4.2 lbs 1.90 kg	11.63" 29.5 cm	13.19" 33.5 cm	4.38" 11.1 cm



7160-1084-03

Features

- Designed for the Getac K120 tablet computer
- Getac certified utilizing Getac certified electronics
- Docking station design accommodates rotating hand strap (sold separately)
- Designed with rounded edges to enhance personal safety
- Composite/aluminum design for reduced weight and durability
- Access to all tablet control buttons and ports while tablet is docked
- Upward-facing I/O ports; integrated cable strain relief and cable management system
- Floating docking connector for reliable connectivity in the most rugged environments
- Optional lock (keyed alike) for theft deterrence
- Easy to use one-handed operation:
 - Insert bottom of computer into the docking station, push top of computer against latch button until latch engages
 - To remove, push up on latch-button with thumb to disengage and pull computer out of the docking station
- VESA 75 mm mounting pattern
- MIL-STD 810G shock/vibration, RoHS, FCC, and SAE J1455 crash certifications
- 3-Year Limited Warranty

Port Replicator

- Getac certified electronics
- Ethernet (2) RJ45
- RS232 Serial D-sub 9 pin
- USB 2.0 (3) 4 Pin Forward-facing (2), Rear (1)
- USB 3.0 (3) 9 Pin
- VGA (1) D-Sub 9 Pin
- HDMI (1) 19 Pin
- RF Pass Through (optional) SMA
- Power Input: 19VDC

GETAC K120 DOCKING STATION AND CRADLE ACCESSORIES

Item No.	Description	Placement	Weight	Height	Width	Depth
7300-0471	Getac 120W Auto Power Adapter, 12-32VDC Input	Use with Getac S410, K120, A140, UX10, and B360 Docking Stations and Cradles	.7 lbs .31 kg	1.2" 3.0 cm	2.6" 6.3 cm	5.1" 12.9 cm
7160-0950	10" Universal Tablet Protective Cover	Use with Getac K120 Tablet Docking Station or Cradle	.4 lbs .18 kg	15.0" 38.1 cm	13.0" 33.0 cm	4.0" 10.2 cm
7160-0539	LIND Power Supply Mount	Attaches a LIND power supply between a docking station/cradle and the motion attachment	1.5 lbs .68 kg	5.0" 12.7 cm	10.0" 25.4 cm	1.3" 3.3 cm



7300-0471



7160-1083-00

GETAC K120 NOTEBOOK CRADLE

Item No.	Antenna Pass-Through	Power Supply	Weight	Height	Width	Depth
7160-1083-00	No RF	No - Use Getac External Power Supply (7300-0471)	4.10 lbs 1.85 kg	2.5" 6.5 cm	11.6" 29.5 cm	12.1" 30.7 cm
7160-1083-03	Triple RF	No - Use Getac External Power Supply (7300-0471)	4.10 lbs 1.85 kg	2.5" 6.5 cm	11.6" 29.5 cm	12.1" 30.7 cm

Features

- Designed for the Getac K120 2-in-1 notebook computer
- Getac certified
- Designed with rounded edges to enhance personal safety
- Composite/aluminum design for reduced weight and durability
- Access to all notebook control buttons and ports while the notebook is cradled
- Screen support is included
- Keyed-alike lock for theft deterrence. When notebook is closed and screen is latched, lock will secure the keyboard and the tablet
- Rear corner release button. Easily remove the computer with the push of a button.
- VESA 75 mm mounting pattern
- MIL-STD 810G shock/vibration, RoHS, FCC, and SAE J1455 crash certifications
- 3-Year Limited Warranty

GETAC K120 NOTEBOOK DOCKING STATION



7160-1082-03

Item No.	Antenna Pass-Through	Power Supply	Weight	Height	Width	Depth
7160-1082-00	No RF	No - Use Getac External Power Supply (7300-0471)	4.25 lbs 1.92 kg	2.5" 6.5 cm	11.6" 29.5 cm	12.1" 30.7 cm
7160-1082-03	Triple RF	No - Use Getac External Power Supply (7300-0471)	4.25 lbs 1.92 kg	2.5" 6.5 cm	11.6" 29.5 cm	12.1" 30.7 cm
7170-0693-00	No RF	No - Includes Getac External Power Supply	4.95 lbs 2.24 kg	2.5" 6.5 cm	11.6" 29.5 cm	12.1" 30.7 cm
7170-0693-03	Triple RF	No - Includes Getac External Power Supply	4.95 lbs 2.24 kg	2.5" 6.5 cm	11.6" 29.5 cm	12.1" 30.7 cm

Features

- Designed for the Getac K120 2-in-1 notebook computer
- Getac certified utilizing Getac certified electronics
- Docking Station design accommodates MSR and rotating hand strap (sold separately)
- Designed with rounded edges to enhance personal safety
- Composite/aluminum design for reduced weight and durability
- Access to all notebook control buttons and ports while the notebook is docked
- Forward-facing I/O ports; integrated cable strain relief and cable management system
- Floating docking connector for reliable connectivity in the most rugged environments
- Screen support is included
- Keyed-alike lock for theft deterrence. When notebook is closed and screen is latched, lock will secure the keyboard and the tablet.
- Rear corner release button, easily remove the computer with the push of a button
- VESA 75 mounting pattern
- MIL-STD 810G shock/vibration, RoHS, FCC, and SAE J1455 crash certifications
- 3-Year Limited Warranty

Port Replicator

- Getac certified electronics
- Ethernet (2) RJ45
- RS232 Serial D-sub 9 pin
- USB 2.0 (3) 4 Pin Forward-facing (2), Rear (1)
- USB 3.0 (3) 9 Pin
- VGA (1) D-Sub 9 Pin
- HDMI (1) 19 Pin
- RF Pass Through (optional) SMA
- Power Input: 19VDC

GETAC K120 DOCKING STATION ACCESSORIES



7300-0471

Item No.	Description	Placement	Weight	Height	Width	Depth
7300-0471	Getac 120W Auto Power Adapter, 12-32VDC Input	Use with Getac S410, K120, A140, UX10, and B360 Docking Stations and Cradles	.7 lbs .31 kg	1.2" 3.0 cm	2.6" 6.3 cm	5.1" 12.9 cm
7110-1270	Getac K120 Screen Support	Attaches to the right or left rear corner of the laptop docking station or cradle	.40 lbs. .18 kg	9.0" 22.8 cm	2.12" 5.38 cm	3.75" 9.5 cm

GETAC RX10 DOCKING STATION | LIMITED QUANTITIES AVAILABLE

Item No.	Antenna Pass-Through	Power Supply	Weight	Height	Width	Depth
7160-0760-00	NA	No - Use External LIND Auto Adapter (15110)	2.3 lbs 1.0 kg	10.25" 26.0 cm	11.25" 28.6 cm	2.5" 6.4 cm
7160-0760-03	Triple RF (SMA)	No - Use External LIND Auto Adapter (15110)	2.3 lbs 1.0 kg	10.25" 26.0 cm	11.25" 28.6 cm	2.5" 6.4 cm
7170-0792-00	NA	Yes - Includes External Lind Power Supply	3.3 lbs 1.49 kg	10.25" 26.0 cm	11.25" 28.6 cm	2.5" 6.4 cm
7170-0792-03	Triple RF (SMA)	Yes - Includes External Lind Power Supply	3.3 lbs 1.49 kg	10.25" 26.0 cm	11.25" 28.6 cm	2.5" 6.4 cm



7160-0760-03



7160-0760-03

Features

- Designed for the Getac RX10 tablet computer
- Getac Certified utilizing Getac Certified electronics
- Docking station accommodates barcode scanner, accessory cover, kickstand, and extended battery
- Designed with rounded edges to enhance personal safety
- Composite/aluminum design for reduced weight and durability
- Access to all tablet control buttons and ports while tablet is docked
- Downward-facing I/O ports; integrated cable strain relief and cable management system
- Floating docking connector for reliable connectivity in the most rugged environments
- Optional lock (keyed alike) for theft deterrence
- Easy to use one-handed operation:
 - Insert bottom of computer into the docking station, push top of computer against latch button until latch engages
 - To remove, push up on latch-button with thumb to disengage and pull computer out of the docking station
- VESA 75 mm mounting pattern
- MIL-STD 810G shock/vibration, RoHS, FCC, and SAE J1455 crash certifications
- 3-Year Limited Warranty

Port Replicator

- Getac certified electronics
- Ethernet (1) RJ45
- Serial (1) Power on pin 9 - 1 AMP
- USB 3.0 powered (2) 9 Pin
- RF Pass Through (optional) SMA
- Power supply Input: 19VDC



GETAC RX10 CART MOUNTED DOCKING STATION | LIMITED QUANTITIES AVAILABLE

Item No.	Antenna Pass-Through	Power Supply	Weight	Height	Width	Depth
7160-0760-04	NA	No - Use LIND Power Supply (15110)	2.3 lbs 1.0 kg	10.4" 26.4 cm	11.2" 28.4 cm	3.6" 9.1 cm
7160-0760-05	Triple RF (SMA)	No - Use LIND Power Supply (15110)	2.3 lbs 1.0 kg	10.4" 26.4 cm	11.2" 28.4 cm	3.6" 9.1 cm



7160-0760-05

Features

- Designed for the Getac RX10 tablet computer
- Getac Certified utilizing Getac Certified electronics
- Docking station accommodates barcode scanner, accessory cover, kickstand, and extended battery
- Designed with rounded edges to enhance personal safety
- Composite/aluminum design for reduced weight and durability
- Access to all tablet control buttons and ports while tablet is docked
- Downward-facing I/O ports; integrated cable strain relief and cable management system
- Floating docking connector for reliable connectivity in the most rugged environments
- Optional lock (keyed alike) for theft deterrence
- Ideal for mounting to a wall or medical cart
- Easy to use one-handed operation:
 - Insert bottom of computer into the docking station, push top of computer against latch button until latch engages
 - To remove, push up on latch-button with thumb to disengage and pull computer out of the docking station
- VESA 75 mm mounting pattern
- MIL-STD 810G shock/vibration, RoHS, FCC, and SAE J1455 crash certifications
- 3-Year Limited Warranty

Port Replicator

- Getac certified electronics
- Ethernet (1) RJ45
- Serial (1) Power on pin 9 - 1 AMP
- USB 3.0 powered (2) 9 Pin
- RF Pass Through (optional) SMA
- Power supply Input: 19VDC





7160-0880-00

GETAC RX10H HEALTHCARE TABLET DOCKING STATION | LIMITED QUANTITIES AVAILABLE

Item No.	Antenna Pass-Through	Power Supply	Weight	Height	Width	Depth
7160-0880-00	NA	No - Use LIND Power Supply (7300-0463)	2.3 lbs 1.0 kg	10.4" 26.4 cm	11.2" 28.4 cm	3.6" 9.1 cm
7160-0880-03	Triple RF (SMA)	No - Use LIND Power Supply (7300-0463)	2.3 lbs 1.0 kg	10.4" 26.4 cm	11.2" 28.4 cm	3.6" 9.1 cm

Features

- Designed for the Getac RX10 healthcare tablet computer
- Getac Certified utilizing Getac Certified electronics
- Docking station accommodates barcode scanner, accessory cover, kickstand, and extended battery
- Designed with rounded edges to enhance personal safety
- Composite/aluminum design for reduced weight and durability
- Access to all tablet control buttons and ports while tablet is docked
- Downward-facing I/O ports; integrated cable strain relief and cable management system
- Floating docking connector for reliable connectivity in the most rugged environments
- Optional lock (keyed alike) for theft deterrence
- Ideal for mounting to a wall or medical cart
- Easy to use one-handed operation:
 - Insert bottom of computer into the docking station, push top of computer against latch button until latch engages
 - To remove, push up on latch-button with thumb to disengage and pull computer out of the docking station
- VESA 75 mm mounting pattern
- MIL-STD 810G shock/vibration, RoHS, FCC, and SAE J1455 crash certifications
- 3-Year Limited Warranty

Port Replicator

- Getac certified electronics
- Ethernet (1) RJ45
- VGA (1) D-Sub 15 Pin
- USB 3.0 (1) 9 Pin
- USB 2.0 (3) 4 Pin
- RF Pass Through (optional) SMA
- Power supply Input: 19VDC



7160-0790-03

GETAC S410 DOCKING STATION

Item No.	Antenna Pass-Through	Power Supply	Weight	Height	Width	Depth
7160-0790-00	No	No - Use Getac Power supply (7300-0471)	4.5 lbs 2.0 kg	12.4" 31.5 cm	13.8" 35.1 cm	2.9" 7.4 cm
7160-0790-03	Triple RF (SMA)	No - Use Getac Power supply (7300-0471)	4.5 lbs 2.0 kg	12.4" 31.5 cm	13.8" 35.1 cm	2.9" 7.4 cm
7170-0536	No	Yes - Includes Getac Auto Power Supply	5.2 lbs 2.35 kg	12.4" 31.5 cm	13.8" 35.1 cm	2.9" 7.4 cm
7170-0537	Triple RF (SMA)	Yes - Includes Getac Auto Power Supply	5.2 lbs 2.35 kg	12.4" 31.5 cm	13.8" 35.1 cm	2.9" 7.4 cm

Features

- Compatible with Getac S410 computer
- Getac Certified utilizing Getac Certified electronics
- Rugged composite/aluminum construction with black powder coat finish for long-term durability
- Small footprint designed to maximize available space
- Rear-facing I/O ports, integrated cable strain relief system, and convenient cable management system
- Spring-loaded docking connector to ensure connectivity in the roughest terrain
- Rear hooks and guide pins ensure proper alignment and docking connectivity
- Front-facing docking latch
- Keyed lock for theft deterrence
- Screen support is included with the dock
- Power supply bracket (7120-0736) to attach power supply to the bottom of the dock included with (7170-0536 and 7170-0537)
- VESA 75 mm mounting pattern
- MIL-STD 810G shock/vibration, RoHS, FCC, CE, and SAE J1455 crash certifications
- 3-Year Limited Warranty

Port Replicator

- Getac certified electronics
- Serial (1) D-Sub 9 Pin
- Ethernet (1) RJ45
- USB 3.0 (1) 9 Pin
- USB 2.0 (3) 4 Pin
- VGA (1) D-Sub 15 Pin
- HDMI (1) 19 Pin
- Microphone/speaker
- RF pass-through (optional) SMA
- Power supply input 19V DC



7160-0790-03

GETAC S410 CRADLE

Item No.	Antenna Pass-Through	Power Supply	Weight	Height	Width	Depth
7160-0791-00	No	No - Use Getac Power Supply (7300-0471)	4.5 lbs 2.0 kg	12.4" 31.5 cm	13.8" 35.1 cm	2.9" 7.4 cm
7160-0791-03	Triple RF (SMA)	No - Use Getac Power Supply (7300-0471)	4.5 lbs 2.0 kg	12.4" 31.5 cm	13.8" 35.1 cm	2.9" 7.4 cm
7170-0538	No	Yes - Includes Getac Auto Power Supply	5.2 lbs 2.35 kg	12.4" 31.5 cm	13.8" 35.1 cm	2.9" 7.4 cm
7170-0539	Triple RF (SMA)	Yes - Includes Getac Auto Power Supply	5.2 lbs 2.35 kg	12.4" 31.5 cm	13.8" 35.1 cm	2.9" 7.4 cm



7160-0791-00

Features

- Compatible with Getac S410 computer
- Getac certified
- Rear hooks and guide pins ensure proper alignment
- Small footprint designed to maximize available space
- Front-facing docking latch
- Keyed lock for theft deterrence
- Screen support is included with the dock
- Power supply bracket (7120-0736) to attach power supply to the bottom of the dock included with (7170-0538 and 7170-0539)
- Rugged composite/aluminum construction with black powder coat finish for long-term durability
- VESA 75 mm mounting pattern
- MIL-STD 810G shock/vibration, RoHS, FCC, CE, and SAE J1455 crash certifications
- 3-Year Limited Warranty

GETAC T800 CRADLE

Item No.	Antenna Pass-Through	Power Supply	Weight	Height	Width	Depth
7160-0583-00	NA	No - Use External LIND Auto Adapter (7300-0463)	2.4 lbs 1.1 kg	9.5" 24.1 cm	8.4" 21.3 cm	3.5" 8.9 cm
7160-0583-03	Triple RF (SMA)	No - Use External LIND Auto Adapter (7300-0463)	2.4 lbs 1.1 kg	9.5" 24.1 cm	8.4" 21.3 cm	3.5" 8.9 cm
7170-0246	NA	Yes - Includes External LIND Power Supply	3.4 lbs 1.5 kg	9.5" 24.1 cm	8.4" 21.3 cm	3.5" 8.9 cm
7170-0247	Triple RF (SMA)	Yes - Includes External LIND Power Supply	3.4 lbs 1.5 kg	9.5" 24.1 cm	8.4" 21.3 cm	3.5" 8.9 cm



7160-0583-00

Features

- Designed for the Getac T800 tablet computer
- Getac Certified
- Cradle design accommodates SnapBack, SmartCard & RFID reader and X-Hand Strap (sold separately)
- Designed with rounded edges to enhance personal safety
- Composite/aluminum design for reduced weight and durability
- Access to all tablet control buttons and ports while tablet is docked
- Push and turn lock with key for theft deterrence
- Insert computer then push down and turn lock to close and dock computer
- VESA 75 mm mounting pattern
- MIL-STD 810G shock/vibration, RoHS, FCC, CE, and SAE J1455 crash certifications
- 3-Year Limited Warranty



7160-0565-00

GETAC T800 DOCKING STATION

Item No.	Antenna Pass-Through	Power Supply	Weight	Height	Width	Depth
7160-0565-00	NA	No - Use External LIND Auto Adapter (7300-0463)	2.4 lbs 1.1 kg	9.5" 24.1 cm	8.4" 21.3 cm	3.5" 8.9 cm
7160-0565-03	Triple RF (SMA)	No - Use External LIND Auto Adapter (7300-0463)	2.4 lbs 1.1 kg	9.5" 24.1 cm	8.4" 21.3 cm	3.5" 8.9 cm
7170-0244	NA	Yes - Includes External LIND Power Supply	3.4 lbs 1.5 kg	9.5" 24.1 cm	8.4" 21.3 cm	3.5" 8.9 cm
7170-0245	Triple RF (SMA)	Yes - Includes External LIND Power Supply	3.4 lbs 1.5 kg	9.5" 24.1 cm	8.4" 21.3 cm	3.5" 8.9 cm

Features

- Designed for the Getac T800 tablet computer
- Getac Certified utilizing Getac Certified electronics
- Docking station design accommodates SnapBack, SmartCard & RFID reader and X-Hand Strap (sold separately)
- Designed with rounded edges to enhance personal safety
- Composite/aluminum design for reduced weight and durability
- Access to all tablet control buttons and ports while tablet is docked
- Downward-facing I/O ports; integrated cable strain relief and cable management system
- Floating docking connector for reliable connectivity in the most rugged environments
- Push and turn lock with key for theft deterrence
- Insert computer then push down and turn lock to close and dock computer
- VESA 75 mm mounting pattern
- MIL-STD 810G shock/vibration, RoHS, FCC, CE, and SAE J1455 crash certifications
- 3-Year Limited Warranty



Port Replicator

- Getac certified electronics
- Ethernet (1) RJ45
- Serial (1) D-Sub 9 Pin
- USB 3.0 (2) 9 Pin
- RF Pass Through (optional) SMA
- Power supply Input: 19VDC

GETAC T800 CRADLE AND DOCKING STATION ACCESSORIES



7160-0949

Item No.	Description	Placement/Compatibility	Weight	Height	Width	Depth
7160-0539	LIND Power Supply Mount	Attaches a LIND power supply between a docking station/cradle and the motion attachment	1.5 lbs 0.7 kg	5.0" 12.7 cm	10.0" 25.4 cm	1.3" 3.3 cm
7300-0463	External LIND Automobile Cigarette Power Adapter (Getac T800)	For use with Getac T800 Docking Stations and Cradle	1.0 lb 0.5 kg	1.2" 3.0 cm	2.5" 6.4 cm	5.2" 13.2 cm
7160-0949	8" Universal Tablet Cover	For use with Getac T800 Docking Stations and Cradle	0.2 lbs 0.1 kg	12.5" 31.8 cm	10.5" 26.7 cm	3.5" 8.9 cm
7160-0981	Thermal Tablet Protective Cover	For use with Getac T800 Docking Stations and Cradle	0.95 lbs. 0.43 kg	13.5" 34.3 cm	11.25" 28.6 cm	3.25" 8.3 cm

GETAC UX10 TABLET CRADLE

Item No.	Description	Power Supply	Weight	Height	Width	Depth
7160-1253-00	Getac UX10 Tablet Cradle NO RF (No Electronics)	No - Use Getac Power Adapter (7300-0471)	2.0 lbs 90 kg	9.87 in 25.06 cm	11.25 in 28.57 cm	4.5 in 11.43 cm
7160-1253-03	Getac UX10 Tablet Cradle TRI RF (No Electronics)	No - Use Getac Power Adapter (7300-0471)	2.0 lbs 90 kg	9.87 in 25.06 cm	11.25 in 28.57 cm	4.5 in 11.43 cm
7170-0738-00	Getac UX10 Tablet Cradle NO RF (No Electronics) with Getac Auto Power Adapter	Yes - Includes Getac Auto Power Adapter	2.7 lbs 1.22 kg	9.87 in 25.06 cm	11.25 in 28.57 cm	4.5 in 11.43 cm
7170-0738-03	Getac UX10 Tablet Cradle TRI RF (no electronics) with Getac Auto Power Adapter	Yes - Includes Getac Auto Power Adapter	2.7 lbs 1.22 kg	9.87 in 25.06 cm	11.25 in 28.57 cm	4.5 in 11.43 cm

NEW



7160-1253-03

Features

- Designed for the Getac UX10 tablet computer
- Getac Certified
- Cradle design accommodates the rotating hand strap with the extended battery, or the optional hard handle, RFID reader, smart card reader, and mag stripe reader. (sold separately)
- Designed with rounded edges to enhance personal safety
- Composite/aluminum design for reduced weight and durability
- Keyed lock for theft deterrence
- Easy to use one-handed operation:
 - Insert bottom of computer into cradle, push top of computer against latch button until latch engages
 - To remove, push up on latch-button with thumb to disengage and pull computer out of cradle
- VESA 75 mm mounting pattern
- MIL-STD 810G shock/vibration, RoHS, FCC, CE, and SAE J1455 crash certifications
- 3-Year Limited Warranty

GETAC UX10 TABLET DOCKING STATION

Item No.	Description	Power Supply	Weight	Height	Width	Depth
7160-1252-00	Getac UX10 Tablet Docking Station (NO RF)	No - Use Getac Power Adapter (7300-0471)	2.15 lbs 0.97 kg	9.87 in 25.06 cm	11.25 in 28.57 cm	4.5 in 11.43 cm
7160-1252-03	Getac UX10 Tablet Docking Station (TRI RF)	No - Use Getac Power Adapter (7300-0471)	2.15 lbs 0.97 kg	9.87 in 25.06 cm	11.25 in 28.57 cm	4.5 in 11.43 cm
7170-0696-00	Getac UX10 Tablet Docking Station (NO RF) with Getac 120W Auto Power Adapter	Yes - Includes Getac Auto Power Adapter	2.85 lbs 1.29 kg	9.87 in 25.06 cm	11.25 in 28.57 cm	4.5 in 11.43 cm
7170-0696-03	Getac UX10 Tablet Docking Station (TRI RF) with Getac 120W Auto Power Adapter	Yes - Includes Getac Auto Power Adapter	2.85 lbs 1.29 kg	9.87 in 25.06 cm	11.25 in 28.57 cm	4.5 in 11.43 cm

NEW



7160-1252-03

Features

- Designed for the Getac UX10 tablet computer
- Getac Certified utilizing Getac Certified electronics
- Docking station design accommodates the rotating hand strap with the extended battery, or the optional hard handle, RFID reader, smart card reader, and mag stripe reader. (sold separately)
- Downward-facing I/O ports; integrated cable strain relief and cable management system
- Floating POGO docking connector for reliable docking activation
- Docking tabs align tablet during insertion
- Designed with rounded edges to enhance personal safety
- Composite/aluminum design for reduced weight and durability
- Keyed lock for theft deterrence
- Easy to use one-handed operation:
 - Insert bottom of computer into docking station, push top of computer against latch button until latch engages
 - To remove, push up on latch-button with thumb to disengage and pull computer out of docking station
- VESA 75 mm mounting pattern
- MIL-STD 810G shock/vibration, RoHS, FCC, CE, and SAE J1455 crash certifications
- 3-Year Limited Warranty

Port Replicator

- Getac Certified Electronics
- RS232 Serial (1) D-sub 9 pin
- USB 2.0 (2) 4 Pin Forward-Facing (500mA)
- USB 3.0 (1) 4 Pin Rear-Facing (900mA)
- USB 3.0 (1) 4 Pin Rear-Facing, (1) Fast Charging (1500mA)
- Ethernet RJ45 (1)
- Power Input 19 VDC
- Antenna TRI RF (SMA) (Optional)

NEW



7300-0471

GETAC UX10 TABLET DOCKING STATION ACCESSORIES

Item No.	Description	Power Supply	Weight	Height	Width	Depth
7300-0471	Getac 120W Automotive Power Adapter with Cigarette Lighter Connector; 12-32V Input, Output Voltage 19VDC, Output Current 6.32 Amps to Barrel Connector Plug	Use with Getac S410, K120, A140, UX10, and B360 Docking Station or Cradle	0.7 lbs 0.31 kg	5.1" 13 cm	2.6" 6.6 cm	1.2" 3.0 cm
7160-0950	10" Universal Tablet Protective Cover	Use with Getac UX10 Tablet Docking Station or Cradle	0.4 lbs 0.18 kg	15.0" 38.1 cm	13.0" 33.0 cm	4.0" 10.2 cm
7160-0982	Thermal Tablet Protective Cover	Use with Getac UX10 Tablet Docking Station or Cradle	1.15 lbs. 0.52 kg	14.25" 36.2 cm	12.75" 32.4 cm	3.5" 8.9 cm

GETAC V110 DOCKING STATION



7160-0515-03

Item No.	Antenna Pass-Through	Power Supply	Weight	Height	Width	Depth
7160-0515-00	NA	No - Use External LIND Auto Adapter (7300-0463)	3.8 lbs 1.7 kg	1.4" 3.6 cm	11.6" 29.5 cm	10.75" 27.3 cm
7160-0515-03	Triple RF (SMA)	No - Use External LIND Auto Adapter (7300-0463)	3.8 lbs 1.7 kg	1.4" 3.6 cm	11.6" 29.5 cm	10.75" 27.3 cm
7170-0242	NA	Yes - Includes External LIND Power Supply	4.8 lbs 2.2 kg	1.4" 3.6 cm	11.6" 29.5 cm	10.75" 27.3 cm
7170-0243	Triple RF (SMA)	Yes - Includes External LIND Power Supply	4.8 lbs 2.2 kg	1.4" 3.6 cm	11.6" 29.5 cm	10.75" 27.3 cm

Features

- Designed for the Getac V110 convertible computer
- Getac Certified utilizing Getac electronics
- Front-facing I/O ports, integrated cable strain relief system, and convenient cable management system
- Front safety bracket helps align computer for proper docking connectivity
- Floating POGO pin style docking connector for reliable docking activation
- Built-in stylus holder
- Screen support is included with the docking station
- Rugged aluminum construction
- Push button front latch with keyed lock: Push latch to release the docking connector, insert computer, push latch closed
- VESA 75 mm mounting pattern
- MIL-STD 810G shock/vibration, RoHS, FCC, CE, and SAE J1455 crash certifications
- 3-Year Limited Warranty

Port Replicator

- Getac certified electronics
- Ethernet (1) RJ45
- USB 2.0 (3) 4 Pin
- USB 3.0 (1) 9 Pin
- Serial (2) D-Sub 9 Pin
- VGA (1) D-Sub 15 Pin
- HDMI (1) 19 Pin
- Headphones/Speakers Stereo phono jack
- Microphone Mono phono jack
- RF pass through (optional) SMA
- Power supply input 19V DC



GETAC V110 CRADLE

Item No.	Antenna Pass-Through	Power Supply	Weight	Height	Width	Depth
7160-0568-00	NA	No - Use External LIND Auto Adapter (7300-0463)	3.8 lbs 1.7 kg	1.4" 3.6 cm	11.6" 29.5 cm	10.75" 27.3 cm
7160-0568-03	Triple RF (SMA)	No - Use External LIND Auto Adapter (7300-0463)	3.8 lbs 1.7 kg	1.4" 3.6 cm	11.6" 29.5 cm	10.75" 27.3 cm
7160-0568-04	NA	Yes - Includes External LIND Power Supply	4.8 lbs 2.2 kg	1.4" 3.6 cm	11.6" 29.5 cm	10.75" 27.3 cm
7160-0568-05	Triple RF (SMA)	Yes - Includes External LIND Power Supply	4.8 lbs 2.2 kg	1.4" 3.6 cm	11.6" 29.5 cm	10.75" 27.3 cm

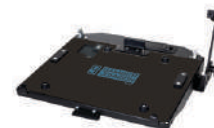

7160-0568-00

Features

- Designed for the Getac V110 convertible computer
- Getac Certified
- Front safety bracket helps align computer
- Built-in stylus holder
- Screen support is included with the docking station
- Rugged aluminum construction
- Push button front latch with keyed lock: Push latch to release rear hooks, insert computer, push latch closed
- VESA 75 mm mounting pattern
- MIL-STD 810G shock/vibration, RoHS, FCC, CE, and SAE J1455 crash certifications
- 3-Year Limited Warranty

GETAC V110 DOCKING STATION/CRADLE ACCESSORIES

Item No.	Description	Placement	Weight	Height	Width	Depth
7160-0539	LIND Power Supply Mount	Attaches a LIND power supply between a docking station/cradle and the motion attachment	1.5 lbs 0.7 kg	5.0" 12.7 cm	10.0" 25.4 cm	1.3" 3.3 cm
7300-0463	External LIND Automobile Cigarette Power Adapter (Getac V110)	For use with the following Getac V110 Docking Stations (7160-0515-00 and 7160-0515-03)	1.0 lbs 0.5 kg	1.2" 3.0 cm	2.5" 6.4 cm	5.2" 13.2 cm



7160-0539



7160-1135-01

GETAC ZX70 CHARGING CRADLE

Item No.	Antenna Pass-Through	Power Supply	Weight	Height	Width	Depth
7160-1135-00	NA	ZX70 Cradle (No Electronics) only Use Auto Power Supply (7300-0441) or Isolated Power Supply (7300-0466 or 7300-0467)	0.90 lbs 0.4 kg	7.6" 19.3 cm	8.8" 22.5 cm	3.1" 7.9 cm
7160-1135-01	NA	ZX70 Charging Cradle (with POGO Pin Connector) Use Auto Power Supply (7300-0441) or Isolated Power Supply (7300-0466 or 7300-0467)	0.90 lbs 0.4 kg	7.6" 19.3 cm	8.8" 22.5 cm	3.1" 7.9 cm
7170-0686-01	NA	ZX70 Charging Cradle with 12V External Automotive Power Adapter	1.91 lbs 0.86 kg	7.6" 19.3 cm	8.8" 22.5 cm	3.1" 7.9 cm
7170-0686-11	NA	ZX70 Charging Cradle with External 12-32VDC Isolated Power Supply for Material Handling	1.91 lbs 0.86 kg	7.6" 19.3 cm	8.8" 22.5 cm	3.1" 7.9 cm
7170-0686-21	NA	ZX70 Charging Cradle with External 20-60VDC Isolated Power Supply for Material Handling	1.91 lbs 0.86 kg	7.6" 19.3 cm	8.8" 22.5 cm	3.1" 7.9 cm

Features

- Designed for the Getac ZX70 tablet computer and backwards compatible with the Getac Z710 computer
- Getac Certified utilizing Getac Certified electronics
- Cradle design accommodates rotating hand strap (sold separately)
- Designed with rounded edges to enhance personal safety
- Composite/aluminum design for reduced weight and durability
- Access to all tablet control buttons and USB port while tablet is cradled
- POGO charging connector for reliable connectivity in the most rugged environments
- Optional lock (keyed alike) for theft deterrence
- Easy to use one-handed operation:
 - Insert bottom of computer into the cradle, push top of computer against latch button until latch engages
 - To remove, push up on latch-button with thumb to disengage and pull computer out of the cradle
- VESA 75 mm mounting pattern
- MIL-STD 810G shock/vibration, RoHS, FCC, and SAE J1455 crash certifications
- 3-Year Limited Warranty

Port Replicator

- Getac certified electronics
- POGO charging connector



7300-0466

GETAC ZX70 CHARGING CRADLE ACCESSORIES

Item No.	Description	Placement	Weight	Height	Width	Depth
7300-0441	Getac 22W Auto Power Adapter	Use with Getac ZX70 Charging Cradle	0.90 lbs 0.4 kg	7.6" 19.3 cm	8.8" 22.5 cm	3.1" 7.9 cm
7300-0466	12-32VDC Material Handling Isolated Power Adapter	Use with Getac ZX70 Charging Cradle	1.01 lbs 0.45 kg	12" 3.0 cm	2.5" 6.3 cm	5.1" 13.0 cm
7300-0467	20-60VDC Material Handling Isolated Power Adapter	Use with Getac ZX70 Charging Cradle	1.01 lbs 0.45 kg	12" 3.0 cm	2.5" 6.3 cm	5.1" 13.0 cm

PANASONIC TOUGHBOOK® A3 TABLET DOCKING STATION

Item No.	Description	Power Supply	Weight	Height	Width	Depth
7160-1416-00	Panasonic Toughbook A3 Tablet Docking Station (NO RF)	No - Use LIND Power Supply (7300-0460)	2.15 lbs 0.98 kg	10.28" 26.11 cm	11.33" 28.78 cm	4.59" 11.66 cm
7160-1416-02	Panasonic Toughbook A3 Tablet Docking Station (DUAL RF)	No - Use LIND Power Supply (7300-0460)	2.15 lbs 0.98 kg	10.28" 26.11 cm	11.33" 28.78 cm	4.59" 11.66 cm
7170-0832-00	Panasonic Toughbook A3 Tablet Docking Station (NO RF) with LIND 90W Auto Power Adapter	Yes - Includes LIND Auto Power Supply	3.37 lbs 1.52 kg	10.28" 26.11 cm	11.33" 28.78 cm	4.59" 11.66 cm
7170-0832-02	Panasonic Toughbook A3 Tablet Docking Station (DUAL RF) with LIND 90W Auto Power Adapter	Yes - Includes LIND Auto Power Supply	3.37 lbs 1.52 kg	10.28" 26.11 cm	11.33" 28.78 cm	4.59" 11.66 cm

NEW



7170-1416-02

Features

- Compatible with the Panasonic Toughbook A3 tablet computer
- Panasonic Toughbook Certified utilizing Panasonic Certified electronics
- Docking station design accommodates the A3 tablet hand strap with the extended battery
- Tablet control buttons and ports are easily accessible while the tablet is docked
- Downward-facing I/O ports for integrated cable strain relief and cable management system
- Dual RF antenna pass through for reliable connectivity
- Designed with rounded edges to enhance personal safety
- Keyed lock for theft deterrence
- Easy to use one-handed operation:
 - Insert bottom of computer into the docking station, push top of computer against latch button until latch engages to secure device
 - To undock and remove, push up on latch-button with thumb to disengage and pull device out of the docking station
- VESA 75 mm mounting pattern
- MIL-STD 810G shock/vibration, RoHS, FCC, CE, and SAE J1455 crash certifications
- 3-Year Limited Warranty

Port Replicator

- Fully Powered USB 2.0 (2)
- Ethernet (1)
- Power Input
- External Antenna Switch

PANASONIC TOUGHBOOK® A3 TABLET CRADLE

Item No.	Description	Power Supply	Weight	Height	Width	Depth
7160-1417-00	Panasonic Toughbook A3 Tablet Cradle (No electronics, NO RF)	No - Use LIND Power Supply (7300-0460)	2.0 lbs .90 kg	10.28" 26.11 cm	11.33" 28.78 cm	4.59" 11.66 cm
7160-1417-02	Panasonic Toughbook A3 Tablet Cradle (No electronics, DUAL RF)	No - Use LIND Power Supply (7300-0460)	2.0 lbs .90 kg	10.28" 26.11 cm	11.33" 28.78 cm	4.59" 11.66 cm
7170-0833-00	Panasonic Toughbook A3 Tablet Cradle (NO RF) with LIND 90W Auto Power Adapter	Yes - Includes LIND Auto Power Supply	3.22 lbs 1.46 kg	10.28" 26.11 cm	11.33" 28.78 cm	4.59" 11.66 cm
7170-0833-02	Panasonic Toughbook A3 Tablet Cradle (DUAL RF) with LIND 90W Auto Power Adapter	Yes - Includes LIND Auto Power Supply	3.22 lbs 1.46 kg	10.28" 26.11 cm	11.33" 28.78 cm	4.59" 11.66 cm

NEW



7160-1417-00

Features

- Compatible with the Panasonic Toughbook A3 tablet computer
- Panasonic Toughbook Certified
- Cradle design accommodates the A3 tablet hand strap with the extended battery
- Tablet control buttons and ports are easily accessible while the tablet is docked
- Downward-facing I/O ports for integrated cable strain relief and cable management system
- Dual RF antenna pass through for reliable connectivity
- Designed with rounded edges to enhance personal safety
- Keyed lock for theft deterrence
- Easy to use one-handed operation:
 - Insert bottom of computer into the cradle, push top of computer against latch button until latch engages to secure device
 - To undock and remove, push up on latch-button with thumb to disengage and pull device out of the cradle
- VESA 75 mm mounting pattern
- MIL-STD 810G shock/vibration, RoHS, FCC, CE, and SAE J1455 crash certifications
- 3-Year Limited Warranty

NEW



7300-0460

PANASONIC TOUGHBOOK® A3 TABLET DOCKING STATION ACCESSORIES

Item No.	Description	Placement/Compatibility	Weight	Height	Width	Depth
7300-0460	LIND Automotive 90W Power Adapter with Bare Wire Lead	Use for the Panasonic Toughbook A3 Docking Station or Cradle	1.22 lbs 0.55 kg	"1.2" 3.04 cm	2.6" 6.6 cm	5.1" 12.95 cm
7160-0454	Universal Adapter Bracket	Attaches between the back of the Panasonic	1.5 lbs 0.7 kg	5.0" 12.7 cm	10.0" 25.4 cm	1.3" 3.3 cm
7160-0950	10" Universal Tablet Protective Cover	Use with Panasonic A3 Tablet Docking Station	0.4 lbs 0.18 kg	15.0" 38.1 cm	13.0" 33.0 cm	4.0" 10.2 cm
7160-0539	LIND Power Adapter Mount	Attaches a LIND Power Adapter between the back of the Panasonic A3 Docking Station and any Gamber-Johnson Motion Attachment	0.9 lbs 0.1 kg	1.0" 2.5 cm	5.0" 12.7 cm	5.0" 12.7 cm
7160-0982	Thermal Tablet Protective Cover	Use with Panasonic Toughbook A3 Docking Stations and Cradles	1.15 lbs. 0.52 kg	14.25" 36.2 cm	12.75" 32.4 cm	3.5" 8.9 cm



7160-1265-02

PANASONIC TOUGHBOOK® 20 LAPTOP DOCKING STATIONS

Item No.	Antenna Pass-Through	Power Supply	Weight	Height	Width	Depth
7160-1265-00	No RF	No - Use LIND Power Supply (7300-0460)	5.0 lbs 2.3 kg	2.5" 6.5 cm	11.6" 29.5 cm	12.1" 30.7 cm
7160-1265-02	Dual RF (TNC)	No - Use LIND Power Supply (7300-0460)	5.0 lbs 2.3 kg	2.5" 6.5 cm	11.6" 29.5 cm	12.1" 30.7 cm
7170-0681-00	No RF	Yes - Includes LIND Auto Power Supply	6.2 lbs 2.8 kg	2.5" 6.5 cm	11.6" 29.5 cm	12.1" 30.7 cm
7170-0681-02	Dual RF (TNC)	Yes - Includes LIND Auto Power Supply	6.2 lbs 2.8 kg	2.5" 6.5 cm	11.6" 29.5 cm	12.1" 30.7 cm

Features

- Designed for the Panasonic Toughbook 20 2-in-1 notebook computer
- Panasonic Toughbook Certified utilizing Panasonic Certified electronics
- Spring-loaded cover protects docking connector when computer is not docked, automatic retracts for superior protection
- Special docking connector pin protection – helps to prevent pin damage by providing additional protection around and in between each docking pin
- Composite/aluminum design for reduced weight and durability
- Designed with rounded edges to enhance personal safety
- Rear-facing I/O ports; integrated cable strain relief and cable management system
- Access to all notebook control buttons and ports while the notebook is docked
- Floating docking connector for reliable connectivity in the most rugged environments
- Optional lock (keyed alike) for theft deterrence
- VESA 75 mm mounting pattern
- MIL-STD 810G shock/vibration, RoHS, FCC, and SAE J1455 crash certifications
- 3-Year Limited Warranty

Port Replicator

- Panasonic certified electronics
- Ethernet (1) RJ4
- Serial (1) D-Sub 9 Pin
- USB 3.0 (2) 9 Pin
- VGA (1) D-Sub 15 Pin
- HDMI (1) 19 Pin
- RF Pass Through (optional) Dual RF (TNC)
- Power Input: 16 VDC

PANASONIC TOUGHBOOK® 20 LAPTOP CRADLE (NO ELECTRONICS)

Item No.	Antenna Pass-Through	Power Supply	Weight	Height	Width	Depth
7160-1265-10	No RF	No - Use LIND Power Supply (7300-0460)	5.0 lbs 2.3 kg	2.5" 6.5 cm	11.6" 29.5 cm	12.1" 30.7 cm

Features

- Designed for the Panasonic Toughbook 20 2-in-1 notebook computer
- Panasonic Toughbook Certified
- Composite/aluminum design for reduced weight and durability
- Designed with rounded edges to enhance personal safety
- Access to all notebook control buttons and ports while the notebook is docked
- Optional lock (keyed alike) for theft deterrence
- VESA 75 mm mounting pattern
- MIL-STD 810G shock/vibration, RoHS, FCC, and SAE J1455 crash certifications
- 3-Year Limited Warranty



PANASONIC TOUGHBOOK® 20 DOCKING STATION ACCESSORIES

Item No.	Description	Placement	Weight	Height	Width	Depth
7300-0460	LIND 90W Auto Power Adapter with Bare Wire Lead	Use for the Panasonic Toughbook 20 Docking Station or Cradle	1.22 lbs 0.55 kg	1.2" 3.04 cm	2.6" 6.6 cm	5.1" 12.95 cm
7300-0459	LIND 90W Auto Power Adapter with Cigarette Lighter Connector	Use for the Panasonic Toughbook 20 Docking Station or Cradle	0.85 lbs 0.38 kg	1.1" 2.79 cm	3.1" 7.8 cm	5.4" 13.7 cm
7110-1275	Screen Support	Attaches to the side of the Toughbook 20 Docking Station or Cradle	0.40 lbs 0.18 kg	8" 20.3 cm	1.5" 3.8 cm	3.25" 8.2 cm



7110-1275

PANASONIC TOUGHBOOK® 20 TRIMLINE™ LAPTOP CRADLE (NO ELECTRONICS)

Item No.	Antenna Pass-Through	Power Supply	Weight	Height	Width	Depth
7300-0190-00	No RF	No - Use LIND Power Adapter (7300-0194)	5.0 lbs 2.2 kg	2.5" 5.6 cm	11.4" 28.96 cm	10.4" 26.4 cm
7300-0190-10	No RF	Yes - Includes LIND Power Adapter	6.4 lbs 2.9 kg	2.5" 5.6 cm	11.4" 28.96 cm	10.4" 26.4 cm

Features

- Designed for the Panasonic Toughbook 20 2-in-1 notebook computer
- Panasonic Toughbook Certified
- CNC machined aluminum construction for rugged reliability
- Space saving and ergonomic design improves safety and comfort
- Patent pending optional screen lock/support arm prevents theft and reduces device wear and tear
- Integrated cable strain relief
- Keyed alike lock for theft deterrence
- Available with power indicator light when purchased with power supply
- Available with or without dual RF pass-through
- Forward facing release and locking mechanism for easy one handed operation:
 - To dock: Position front hooks on the docking station into the front pockets on the keyboard
 - Push down on back of computer until audible click is heard. Computer is docked.
 - To release: Disengage lock. Push front release button and rotate back of computer up and away from the dock
- VESA 75 mm mounting pattern
- MIL-STD 810G shock/vibration, RoHS, FCC, and SAE J1455 crash certifications
- Limited Lifetime Warranty on structural components



7300-0190-10

PANASONIC TOUGHBOOK® 20 TRIMLINE™ LAPTOP DOCKING STATION



7300-0191-22

Item No.	Antenna Pass-Through	Power Supply	Weight	Height	Width	Depth
7300-0191-00	No RF	No - Use LIND Power Adapter (7300-0194)	5.2 lbs 2.3 kg	2.5" 5.6 cm	11.4" 28.96 cm	10.4" 26.4 cm
7300-0191-10	No RF	Yes -Includes LIND Power Adapter	6.6 lbs 3 kg	2.5" 5.6 cm	11.4" 28.96 cm	10.4" 26.4 cm
7300-0191-02	Dual RF (TNC)	No - Use LIND Power Adapter (7300-0194)	5.2 lbs 2.3 kg	2.5" 5.6 cm	11.4" 28.96 cm	10.4" 26.4 cm
7300-0191-12	Dual RF (TNC)	Yes - Includes LIND Power Adapter	6.6 lbs 3 kg	2.5" 5.6 cm	11.4" 28.96 cm	10.1" 25.6 cm
7300-0191-20	No RF	No - Use LIND Power Adapter (7300-0194) - Includes Screen Lock Arm	6.8 lbs 3 kg	4.9" 12.4 cm	12.3" 31.2 cm	10.1" 25.6 cm
7300-0191-30	No RF	Yes - Includes LIND Power Adapter and Screen Lock Arm	8.2 lbs 3.7 kg	4.9" 12.4 cm	12.3" 31.2 cm	10.1" 25.6 cm
7300-0191-22	Dual RF (TNC)	No - Use LIND Power Adapter (7300-0194) - Includes Screen Lock Arm	6.8 lbs 3 kg	4.9" 12.4 cm	12.3" 31.2 cm	10.1" 25.6 cm
7300-0191-32	Dual RF (TNC)	Yes - Includes LIND Power Adapter and Screen Lock Arm	8.2 lbs 3.7 kg	4.9" 12.4 cm	12.3" 31.2 cm	10.1" 25.6 cm

Features

- Designed for the Panasonic Toughbook 20 2-in-1 notebook computer
- Panasonic Toughbook Certified utilizing Panasonic Certified electronics
- CNC machined aluminum construction for rugged reliability
- Space saving and ergonomic design improves safety and comfort
- Patent pending optional screen lock/support arm prevents theft and reduces device wear and tear
- Integrated docking connector protection and safe guards reduce potential of device damage
- Integrated cable strain relief
- Keyed alike lock for theft deterrence
- Available with power indicator light when purchased with power supply
- Available with or without dual RF pass-through
- Forward facing release and locking mechanism for easy one handed operation:
 - To dock: Position front hooks on the docking station into the front pockets on the keyboard
 - Push down on back of computer until audible click is heard. Computer is docked.
 - To release: Disengage lock. Push front release button and rotate back of computer up and away from the dock
- VESA 75 mm mounting pattern
- MIL-STD 810G shock/vibration, RoHS, FCC, and SAE J1455 crash certifications
- Limited Lifetime Warranty on structural components, 3-Year Limited Warranty on electronics

Port Replicator

- Panasonic certified electronics
- Ethernet (1) RJ45
- Serial (1) D-Sub 9 Pin
- USB 3.0 (2) 9 Pin
- VGA (1) D-Sub 15 Pin
- HDMI (1) 19 Pin
- RF Pass Through (optional) Dual RF (TNC)
- Power Input: 16 VDC

PANASONIC TOUGHBOOK® 20 TRIMLINE™ DOCKING STATION ACCESSORIES

Item No.	Description	Placement	Weight	Height	Width	Depth
7300-0192	Toughbook 20 Screen Lock Arm	Attaches to the right side of the docking station	.5 lbs 0.2 kg	4.6" 11.6 cm	1.7" 4.3 cm	1.8" 4.5 cm
7300-0193	Vertical Wall Mount Bracket	Use on a vertical flat surface	2.1 lbs 1 kg	4.1" 10.4 cm	11.9" 30.2 cm	11.1" 28.1 cm
7300-0194	LIND Power Supply with LED	Use with Toughbook 20 Docking Station	1.4 lbs 0.6 kg	1.1" 2.7 cm	3.1" 7.8 cm	5.5" 13.9 cm



7300-0192



7300-0194

PANASONIC TOUGHPAD® FZ-G1 DOCKING STATION

Item No.	Antenna Pass-Through	Power Supply	Weight	Height	Width	Depth
7160-0487-00	No	No - Must use External LIND Auto Adapter (7300-0460)	2.5 lbs 1.1 kg	9.1" 23.1 cm	11.2" 28.4 cm	3.8" 9.7 cm
7160-0487-02	Dual RF (TNC)	No - Must use External LIND Auto Adapter (7300-0460)	2.5 lbs 1.1 kg	9.1" 23.1 cm	11.2" 28.4 cm	3.8" 9.7 cm

Features

- Designed for the Panasonic Toughpad FZ-G1 tablet computer
- Panasonic Toughbook Certified utilizing Panasonic Certified electronics
- Accommodates extended battery, smart card reader, rear hand strap and bumper guards
- Composite/steel design for reduced weight and durability
- Designed with rounded edges to enhance personal safety
- Top-facing I/O ports; integrated cable strain relief and cable management system
- Access to all tablet control buttons and ports while the tablet is docked
- Keyed alike lock for theft deterrence
- VESA 75 mm mounting pattern
- MIL-STD 810G shock/vibration, RoHS, FCC, and SAE J1455 crash certifications
- 3-Year Limited Warranty

Port Replicator

- Panasonic certified electronics
- Ethernet RJ45
- Fully powered USB 3.0 (2) 9 Pin
- Serial (1) D-Sub 9 Pin
- Video (2)
 - VGA D-Sub 15 Pin
 - HDMI 19 Pin
- RF pass-through (optional) TNC
- Power supply input DC



Ports



RF ports



7160-0487-02



PANASONIC TOUGHPAD® FZ-G1 THIN DOCKING STATION

Item No.	Antenna Pass-Through	Power Supply	Weight	Height	Width	Depth
7160-0595-00	No	No - Must use External LIND Auto Adapter (7300-0460)	2.5 lbs 1.1 kg	9.3" 23.6 cm	11.2" 28.4 cm	2.6" 6.6 cm
7160-0595-02	Dual RF (TNC)	No - Must use External LIND Auto Adapter (7300-0460)	2.5 lbs 1.1 kg	9.3" 23.6 cm	11.2" 28.4 cm	2.6" 6.6 cm

Features

- Designed for the Panasonic Toughpad FZ-G1 tablet computer
- Panasonic Toughbook Certified utilizing Panasonic Certified electronics
- Docking Station is designed to perfectly fit the G1 tablet without extra accessories
- Composite/steel design for reduced weight and durability
- Designed with rounded edges to enhance personal safety
- Top-facing I/O ports; integrated cable strain relief and cable management system
- Access to all tablet control buttons and ports while the tablet is docked
- Keyed alike lock for theft deterrence
- VESA 75 mm mounting pattern
- MIL-STD 810G shock/vibration, RoHS, FCC, CE, TUV, E-Mark and SAE J1455 crash certifications
- 3-Year Limited Warranty

Port Replicator

- Panasonic certified electronics
- Ethernet RJ45
- Fully powered USB 3.0 (2) 9 Pin
- Serial (1) D-Sub 9 Pin
- Video (2)
 - VGA D-Sub 15 Pin
 - HDMI 19 Pin
- RF pass-through (optional) TNC
- Power supply input DC



Ports



RF ports



7160-0595-00



7160-0595-02
Side View



PANASONIC TOUGHPAD® FZ-G1 CRADLE

Item No.	Power Supply	Weight	Height	Width	Depth
7160-0490-00	No - Must use External LIND Auto Adapter (7300-0460)	2.5 lbs 1.1 kg	9.1" 23.1 cm	11.2" 28.4 cm	3.8" 9.7 cm

Features

- Designed for the Panasonic Toughpad FZ-G1 tablet computer
- Panasonic Toughbook Certified
- Accommodates extended battery, smart card reader, rear hand strap and bumper guards
- Access to all tablet control buttons and ports while the tablet is cradled
- Composite/steel design for reduced weight and durability
- Designed with rounded edges to enhance personal safety
- Keyed alike lock for theft deterrence
- VESA 75 mm mounting pattern
- MIL-STD 810G shock/vibration, RoHS, FCC, and SAE J1455 crash certifications
- Limited Lifetime Warranty



PANASONIC TOUGHPAD® FZ-G1 THIN TABLET CRADLE

Item No.	Description	Placement	Weight	Height	Width	Depth
7160-0759-00	Panasonic Toughpad FZ-G1 THIN Tablet Cradle (No Electronics, NO RF)	No - Use LIND Power Supply (7300-0460)	2.3 lbs 1.04 kg	9.3" 23.6 cm	11.2" 28.4 cm	2.6" 6.6 cm

Features

- Designed for the Panasonic Toughpad FZ-G1 tablet computer
- Panasonic Toughbook Certified utilizing Panasonic Certified electronics
- Cradle is designed to perfectly fit the G1 tablet does not accommodate extra accessories
- Access to all tablet control buttons and ports while the tablet is cradled
- Composite/steel design for reduced weight and durability
- Designed with rounded edges to enhance personal safety
- Keyed alike lock for theft deterrence
- Easy to use one-handed operation:
 - Insert bottom of computer into the cradle, push top of computer against latch button until latch engages to secure device
 - To remove, push up on latch-button with thumb to disengage and pull device out of the cradle
- VESA 75 mm mounting pattern
- MIL-STD 810G shock/vibration, RoHS, FCC, CE, TUV, E-Mark and SAE J1455 crash certifications
- 3-Year Limited Warranty



7300-0459

PANASONIC TOUGHPAD® FZ-G1 CRADLE AND DOCKING STATION ACCESSORIES

Item No.	Description	Placement	Weight	Height	Width	Depth
7160-0454	Universal Adapter Bracket	Attaches between the back of the Panasonic Toughpad FZ-G1 Docking Stations or Cradles and any Gamber-Johnson Motion Attachment	0.9 lbs 0.1 kg	1.0" 2.5 cm	5.0" 12.7 cm	5.0" 12.7 cm
7160-0539	LIND Power Supply Mount	Attaches a LIND Power Supply between a Docking Station/Cradle and the Motion Attachment	1.5 lbs 0.7 kg	5.0" 12.7 cm	10.0" 25.4 cm	1.3" 3.3 cm
7160-0950	10" Universal Tablet Protective Cover	Use with Panasonic G1 Tablet Docking Station or Cradle	0.4 lbs 0.18 kg	15.0" 38.1 cm	13.0" 33.0 cm	4.0" 10.2 cm
7300-0459	External LIND Automobile Cigarette Power Adapter (Toughpad FZ-G1)	For use with the TabCruzer for Panasonic Toughpad FZ-G1 Docking Stations and Cradles	0.9 lbs 0.4 kg	1.1" 2.8 cm	5.4" 13.7 cm	3.1" 7.9 cm
7300-0460	External LIND Automobile Bare Wire Leads Power Adapter (Toughpad FZ-G1)	For use with the TabCruzer for Panasonic Toughpad FZ-G1 Docking Stations and Cradles	1.2 lbs 0.5 kg	1.0" 2.5 cm	5.0" 12.7 cm	3.0" 7.6 cm
7160-0982	Thermal Tablet Protective Cover	Use with Panasonic FZ-G1 Docking Stations and Cradles	1.15 lbs. 0.52 kg	14.25" 36.2 cm	12.75" 32.4 cm	3.5" 8.9 cm

PANASONIC TOUGHBOOK® L1 TABLET DOCKING STATION

Item No.	Description	Power Supply	Weight	Height	Width	Depth
7160-1314-00	Panasonic Toughbook L1 (NO RF) Tablet Docking Station -THICK Model	No - Use LIND Power Adapter (7300-0443 or 7300-0444)	1.5 lbs 0.68 kg	7.21" 18.31 cm	7.97" 20.24 cm	3.55" 9.0 cm
7160-1314-02	Panasonic Toughbook L1 (DUAL RF) Tablet Docking Station – THICK Model	No - Use LIND Power Adapter (7300-0443 or 7300-0444)	1.5 lbs 0.68 kg	7.21" 18.31 cm	7.97" 20.24 cm	3.55" 9.0 cm
7160-1314-10	Panasonic Toughbook (NO RF) Tablet Docking Station - THIN Model	No - Use LIND Power Adapter (7300-0443 or 7300-0444)	1.5 lbs 0.68 kg	7.21" 18.31 cm	7.97" 20.24 cm	3.03" 7.69 cm
7160-1314-12	Panasonic Toughbook L1 (DUAL RF) Tablet Docking Station – THIN Model	No - Use LIND Power Adapter (7300-0443 or 7300-0444)	1.5 lbs 0.68 kg	7.21" 18.31 cm	7.97" 20.24 cm	3.03" 7.69 cm
7170-0755-00	Panasonic Toughbook L1 (NO RF) Tablet Docking Station -THICK Model with LIND Auto Power Adapter	Yes - Includes LIND Auto Power Supply (7300-0443)	2.2 lbs 0.99 kg	7.21" 18.31 cm	7.97" 20.24 cm	3.55" 9.0 cm
7170-0755-02	Panasonic Toughbook L1 (DUAL RF) Tablet Docking Station – THICK Model with LIND Auto Power Adapter	Yes - Includes LIND Auto Power Supply (7300-0443)	2.2 lbs 0.99 kg	7.21" 18.31 cm	7.97" 20.24 cm	3.55" 9.0 cm
7170-0755-10	Panasonic Toughbook (NO RF) Tablet Docking Station - THIN Model with LIND Auto Power Adapter	Yes - Includes LIND Auto Power Supply (7300-0443)	2.2 lbs 0.99 kg	7.21" 18.31 cm	7.97" 20.24 cm	3.03" 7.69 cm
7170-0755-12	Panasonic Toughbook L1 (DUAL RF) Tablet Docking Station – THIN Model with LIND Auto Power Adapter	Yes - Includes LIND Auto Power Supply (7300-0443)	2.2 lbs 0.99 kg	7.21" 18.31 cm	7.97" 20.24 cm	3.03" 7.69 cm

Features

- Compatible with the Panasonic Toughbook L1 tablet computer
- Panasonic Toughbook Certified utilizing Panasonic Certified electronics
- This docking station is designed to accommodate the L1 tablet's rotating hand strap, large battery, and bar code reader (sold separately)
- Downward-facing I/O ports for integrated cable strain relief and cable management system
- Dual RF antenna pass through for reliable connectivity (optional)
- Access to all tablet control buttons and ports while tablet is docked
- Designed with rounded edges to enhance personal safety
- Keyed lock for theft deterrence
- Easy to use one-handed operation:
 - Insert bottom of handheld into the cradle, push top of the handheld against latch button until latch engages to secure device
 - To undock and remove, push up on latch-button with thumb to disengage and pull device out of the cradle
- AMPS and VESA 75 mm mounting pattern
- MIL-STD 810G shock/vibration, RoHS, FCC, CE, and SAE J1455 crash certifications
- 3-Year Limited Warranty

Port Replicator

- Power input DC 5V 2.0A
- USB 2.0 (1) 500mA
- External antenna switch
- Optional RF (TNC)

NEW



7160-1314-00

PANASONIC TOUGHBOOK® L1 TABLET CRADLE

Item No.	Description	Power Supply	Weight	Height	Width	Depth
7160-1314-04	Panasonic Toughbook L1 Cradle (No Electronics) - THICK Model	No - Use LIND Power Adapter (7300-0443 or 7300-0444)	1.4 lbs 0.63 kg	7.21" 18.31 cm	7.97" 20.24 cm	3.55" 9.0 cm
7160-1314-14	Panasonic Toughbook L1 Cradle (No Electronics) – THIN Model	No - Use LIND Power Adapter (7300-0443 or 7300-0444)	1.4 lbs 0.63 kg	7.21" 18.31 cm	7.97" 20.24 cm	3.03" 7.69 cm

Features

- Compatible with the Panasonic Toughbook L1 tablet computer
- Panasonic Toughbook Certified
- This cradle is designed to accommodate the L1 tablet's rotating hand strap, large battery, and bar code reader (sold separately)
- Access to all tablet control buttons and ports while tablet is docked
- Designed with rounded edges to enhance personal safety
- Keyed lock for theft deterrence
- Easy to use one-handed operation:
 - Insert bottom of computer into the cradle, push top of computer against latch button until latch engages to secure device
 - To undock and remove, push up on latch-button with thumb to disengage and pull device out of the cradle
- AMPS and VESA 75mm mounting pattern
- MIL-STD 810G shock/vibration, RoHS, FCC, CE, and SAE J1455 crash certifications
- 3-Year Limited Warranty

NEW



7160-1314-04

PANASONIC TOUGHBOOK® L1 TABLET DOCKING STATION ACCESSORIES



7400-0023



7300-0444

Item No.	Description	Placement/Compatibility	Weight	Height	Width	Depth
7400-0023	Panasonic Toughbook L1 Enhanced Hand Strap	Attaches to the back of the L1 Tablet	0.6 oz.	6.5"-10.5" 16.5-26.6 cm	1" 2.54 cm	.37" .95 cm
7300-0443	LIND Automotive Power Adapter with Bare Wire Lead; 12-32V input, Output Voltage 5VDC, Output Current 2 AMPS to Barrel Connector Plug	Use for the Panasonic Toughbook L1 Docking Station or Cradle	0.7 lbs 0.31 kg	0.9" 2.28 cm	1.7" 4.3 cm	3.7" 9.3 cm
7300-0444	LIND Automotive Power Adapter with Cigarette Adapter Connection; 12-32V Input, Output Voltage 5VDC, Output Current to Barrel Connector Plug	Use for the Panasonic Toughbook L1 Docking Station or Cradle	0.7 lbs 0.31 kg	0.9" 2.28 cm	1.7" 4.3 cm	3.7" 9.3 cm
7160-0949	8" Universal Tablet Protective Cover	Use with Panasonic Toughbook L1 Tablet Docking Station	0.4 lbs 0.18 kg	12.5" 31.8 cm	10.5" 26.7 cm	3.5" 8.9 cm
7160-0981	Thermal Tablet Protective Cover	Use with Panasonic L1 Tablet Docking Stations and Cradles	0.95 lbs. 0.43 kg	13.5" 34.3 cm	11.25" 28.6 cm	3.25" 8.3 cm

PANASONIC TOUGHPAD® FZ-M1/FZ-B2 DOCKING STATION



7160-0531-00



7160-0531-04 ports

Item No.	Computer	Antenna Pass-Through	Port Replication	Power Supply	Weight	Height	Width	Depth
7160-0531-00	FZ-M1 and FZ-B2	No	Lite	No - Must use External LIND Auto Adapter (7300-0460)	2.5 lbs 1.1 kg	8.1" 20.6 cm	9.6" 24.4 cm	3.6" 9.1 cm
7160-0531-02	FZ-M1 and FZ-B2	Dual RF (TNC)	Lite	No - Must use External LIND Auto Adapter (7300-0460)	2.5 lbs 1.1 kg	8.1" 20.6 cm	9.6" 24.4 cm	3.6" 9.1 cm
7160-0531-03	FZ-M1	No	Full	No - Must use External LIND Auto Adapter (7300-0460)	2.5 lbs 1.1 kg	8.1" 20.6 cm	9.6" 24.4 cm	3.6" 9.1 cm
7160-0531-04	FZ-M1	Dual RF (TNC)	Full	No - Must use External LIND Auto Adapter (7300-0460)	2.5 lbs 1.1 kg	8.1" 20.6 cm	9.6" 24.4 cm	3.6" 9.1 cm

Features

- Designed for the Panasonic Toughpad FZ-M1 and FZ-B2 tablet computer
- Panasonic Toughbook Certified utilizing Panasonic Certified electronics
- Docking Station is available in a Full Port Replication or a Lite Port Replication version
- Docking station accommodates the M1 mag stripe reader and hand strap (sold separately by Panasonic)
- Downward-facing I/O ports; integrated cable strain relief and cable management system
- Access to all tablet control buttons and ports while the tablet is docked
- Insert tablet then push down and turn lock to close and dock tablet
- Composite/steel design for reduced weight and durability
- Designed with rounded edges to enhance personal safety
- Keyed alike lock for theft deterrence
- VESA 75 mm mounting pattern
- MIL-STD 810G shock/vibration, RoHS, FCC, and SAE J1455 crash certifications
- 3-Year Limited Warranty

Full Port Replicator

- Panasonic certified electronics
- Ethernet RJ45
- Fully powered USB 3.0 (2) 9 Pin
- Serial (1) D-Sub 9 Pin
- Video (2)
 - VGA D-Sub 15 Pin
 - HDMI 19 Pin
- RF pass-through (optional) TNC
- Power supply input DC

Lite Port Replicator

- Panasonic certified electronics
- Ethernet RJ45
- Fully powered USB 2.0 (2) 4 Pin
- RF pass-through (optional) TNC
- Power supply input DC

PANASONIC TOUGHPAD® FZ-M1 CRADLE



7160-0543-00

Item No.	Weight	Height	Width	Depth
7160-0543-00	2.3 lbs 1.0 kg	8.1" 20.6 cm	9.6" 24.4 cm	3.6" 9.1 cm

Features

- Designed for the Panasonic Toughpad FZ-M1 and FZ-B2 tablet computer
- Panasonic Toughbook Certified
- Cradle accommodates the M1 mag stripe reader and hand strap (sold separately by Panasonic)
- Access to all tablet control buttons and ports while the tablet is cradled
- Composite/steel design for reduced weight and durability
- Designed with rounded edges to enhance personal safety
- Keyed alike lock for theft deterrence
- Insert tablet then push down and turn lock to close and cradle tablet
- VESA 75 mm mounting pattern
- MIL-STD 810G shock/vibration, RoHS, FCC, and SAE J1455 crash certifications
- Limited Lifetime Warranty

PANASONIC TOUGHPAD® FZ-M1/FZ-B2 CRADLE AND DOCKING STATION ACCESSORIES

Item No.	Description	Placement	Weight	Height	Width	Depth
7160-0539	LIND Power Supply Mount	Attaches a LIND Power Supply between a Docking Station/Cradle and the Motion Attachment	1.5 lbs 0.7 kg	5.0" 12.7 cm	10.0" 25.4 cm	1.3" 3.3 cm
7300-0460	External LIND Automobile Bare Wire Leads Power Adapter (Toughpad FZ-G1)	For use with the TabCruzer for Panasonic Toughpad FZ-M1 Docking Stations and Cradles	1.2 lbs 0.5 kg	1.0" 2.5 cm	5.0" 12.7 cm	3.0" 7.6 cm
16744	8" Universal Tablet Cover	For Use with FZ-M1/FZ-B2 Tablet Docking Station	0.2 lbs 0.1 kg	12.5" 31.8 cm	10.5" 26.7 cm	3.5" 8.9 cm
7160-0981	8" Thermal Tablet Protective Cover	For Use with FZ-M1/FZ-B2 Tablet Docking Station	1.0 lbs 0.4 kg	13.5" 34.3 cm	11.3" 28.6 cm	3.6" 8.3 cm



16744

PANASONIC TOUGHBOOK® N1 RUGGED HANDHELD CRADLE

Item No.	Description	Weight	Height	Width	Depth
7160-0900-00	Charging Cradle, No RF	0.7 lbs 0.3 kg	7.5" 19.1 cm	4.5" 11.4 cm	3.5" 8.9 cm
7160-0901-00	Cradle (No Electronics), No RF	0.7 lbs 0.3 kg	7.5" 19.1 cm	4.5" 11.4 cm	3.5" 8.9 cm

Features

- Designed for the Panasonic Toughbook N1 rugged handheld computer
- Panasonic Toughbook Certified utilizing Panasonic Certified electronics
- Cradle accommodates the N1 extended battery or hand strap (sold separately by Panasonic)
- Access to all computer control buttons and ports while the handheld is cradled
- Designed with rounded edges to enhance personal safety
- Composite/steel design for reduced weight and durability
- Keyed alike lock for theft deterrence
- Compatible with LIND power adapter 7300-0460
- AMPS mounting pattern
- MIL-STD 810G shock/vibration, RoHS, FCC, and SAE J1455 crash certifications
- 3-Year Limited Warranty



7160-0900-00

PANASONIC TOUGHBOOK® N1 POWERED CRADLE ACCESSORIES

Item No.	Description	Placement	Tilt	Swivel	Weight	Height	Width	Depth
7170-0156	Zirkona Mounting Solution Includes Medium Joiner (7110-1235), 4" Extension (14142), Thread Adapter (14145), and Two Round Plates (14144)	Attaches to the back of the Panasonic Toughbook N1 Powered Cradle using the AMPs mounting pattern	Yes	Yes	1.1 lbs 0.5 kg	9.6" 24.4 cm	3.4" 8.6 cm	2.4" 6.1 cm
7300-0460	External LIND Automobile Bare Wire Leads Power Adapter	Use with the Panasonic Toughbook N1 Computer	NA	NA	1.2 lbs 0.5 kg	1.0" 2.5 cm	5.0" 12.7 cm	3.0" 7.6 cm
7160-0993	Zirkona Medium Joiner (7110-1235) with Two Round Mounting Plates (14144)	Attaches to the back of the Panasonic Toughbook N1 using the AMPs mounting pattern	Yes	Yes	0.63 lbs 0.28 kg	4.7" 11.9 cm	2.2" 5.5 cm	2.2" 5.5 cm



7170-0156

NEW



7160-1275-21

PANASONIC TOUGHBOOK® T1 HANDHELD CHARGING CRADLE

Item No.	Description	Power Supply	Weight	Height	Width	Depth
7160-1275-21	Panasonic Toughbook T1 Handheld Charging Cradle	No - Use LIND Power Supply (7300-0445)	.6 lbs .27 kg	7.37" 18.6 cm	3.4" 8.6 cm	1.7" 4.3 cm
7170-0761-21	Panasonic Toughbook T1 Handheld Charging Cradle with LIND Auto Power Adapter	Yes - Includes LIND Auto Power Supply	1.3 lbs .58 kg	7.37" 18.6 cm	3.4" 8.6 cm	1.7" 4.3 cm

Features

- Compatible with the Panasonic Toughbook T1 Handheld computer
- Panasonic Toughbook Certified utilizing Panasonic Certified electronics
- Cradle design accommodates the T1 Handheld's stylus tether and large battery
- Access to all handheld control buttons and ports while the handheld is cradled
- Designed with rounded edges to enhance personal safety
- Keyed alike lock for theft deterrence
- Easy to use one-handed operation:
 - Insert bottom of handheld into the cradle, push top of the handheld against latch button until latch engages to secure device
 - To undock and remove, push up on latch-button with thumb to disengage and pull device out of the cradle
- AMPS mounting pattern
- MIL-STD 810G shock/vibration, RoHS, FCC, CE, and SAE J1455 crash certifications
- 3-Year Limited Warranty

Port Replication

- Micro USB power connection port

NEW



7160-1275-20

PANASONIC TOUGHBOOK® T1 HANDHELD CRADLE

Item No.	Description	Power Supply	Weight	Height	Width	Depth
7160-1275-20	Panasonic Toughbook T1 Handheld Cradle (No Electronics)	No - Use LIND Power Supply (7300-0445)	.6 lbs .27 kg	7.37" 18.6 cm	3.4" 8.6 cm	1.7" 4.3 cm

Features

- Compatible with the Panasonic Toughbook T1 Handheld computer
- Panasonic Toughbook Certified
- Cradle design accommodates the T1 Handheld's stylus tether and large battery
- Access to all handheld control buttons and ports while the handheld is cradled
- Designed with rounded edges to enhance personal safety
- Keyed alike lock for theft deterrence
- Easy to use one-handed operation:
 - Insert bottom of handheld into the cradle, push top of the handheld against latch button until latch engages to secure device
 - To undock and remove, push up on latch-button with thumb to disengage and pull device out of the cradle
- AMPS mounting pattern
- MIL-STD 810G shock/vibration, RoHS, FCC, CE, and SAE J1455 crash certifications
- 3-Year Limited Warranty

NEW



7300-0445

PANASONIC TOUGHBOOK® T1 HANDHELD CHARGING CRADLE ACCESSORIES

Item No.	Description	Placement/Compatibility	Weight	Height	Width	Depth
7300-0445	LIND Automotive Power Adapter with Bare Wire Lead; 12-32V Input, Output Voltage 5VDC, Output Current 2 Amps to Micro USB	Use for the Panasonic Toughbook T1 Cradle	.7 lbs .31 kg	.9" 2.28 cm	1.7" 4.3 cm	3.7" 9.3 cm
7300-0446	LIND Automotive Power Adapter with Cigarette Adapter Connection; 12-32V Input, Output Voltage 5VDC, Output Current 2 Amps to Micro USB	Use for the Panasonic Toughbook T1 Cradle	.7 lbs .31 kg	.9" 2.28 cm	1.7" 4.3 cm	3.7" 9.3 cm
7170-0156	Zirkona Mounting Solution (Includes Medium Joiner (7110-1235), 4" Extension (14142), Threaded Adapter (14145), and Two Round Plates (14144))	Attaches to the back of the T1 Charging Cradle using the AMP's mounting pattern	.63 lbs .28 kg	4.7" 11.9 cm	2.2" 5.5 cm	2.2" 5.5 cm

PANASONIC TOUGHBOOK® 30/31 DOCKING STATION

Item No.	Antenna Pass-Through	Power Supply	Weight	Height	Width	Depth
7160-0318-00	NA	No - Must use External 120W LIND Auto Adapter (7300-0461)	5.1 lbs 2.3 kg	3.9" 9.9 cm	12.4" 31.5 cm	12.3" 31.2 cm
7160-0318-01	Single RF (TNC)	No - Must use External 120W LIND Auto Adapter (7300-0461)	5.1 lbs 2.3 kg	3.9" 9.9 cm	12.4" 31.5 cm	12.3" 31.2 cm
7160-0318-02	Dual RF (TNC)	No - Must use External 120W LIND Auto Adapter (7300-0461)	5.1 lbs 2.3 kg	3.9" 9.9 cm	12.4" 31.5 cm	12.3" 31.2 cm
7160-0318-04	NA	Yes* - Integrated 120W LIND Power Supply	6.0 lbs 2.7 kg	3.9" 9.9 cm	12.4" 31.5 cm	12.3" 31.2 cm
7160-0318-05	Single RF (TNC)	Yes* - Integrated 120W LIND Power Supply	6.0 lbs 2.7 kg	3.9" 9.9 cm	12.4" 31.5 cm	12.3" 31.2 cm
7160-0318-06	Dual RF (TNC)	Yes* - Integrated 120W LIND Power Supply	6.0 lbs 2.7 kg	3.9" 9.9 cm	12.4" 31.5 cm	12.3" 31.2 cm



7160-0318-00



7160-0318-06

Features

- Compatible with Toughbook 30 and 31 computers
- Panasonic Toughbook Certified utilizing Panasonic Certified electronics
- Interlock mechanism protects against connector damage & prevents engagement until properly mounted
- Floating dock connector and brass locating pins for easy docking activation and reliable connectivity
- Forward facing ports for low mounting capability
- Light-weight composite/Steel design, yet rugged platform for long-term durability
- Simple, one-handed, docking mechanism:
 - Pull side handle forward to dock
 - Unlock the key button to release and undock the computer
- Power supply options:
 - Factory integrated 120W LIND power supply - easier installation and service
 - External 120W LIND auto adapter (7300-0461), sold separately
- Side LED indicator light can be used to troubleshoot in the field:
 - Green: All ports are ready to use
 - Orange: USB and LAN ports not functioning or external power is not connected
 - Red: PC is not supported or connection is not made
 - Red (Blinking): Error has occurred in firmware, contact Panasonic Technical Support
 - Not Lit: PC not installed or PC is Off, Standby or Hibernation
- Gamber-Johnson 2" (5.08 cm) x 4.09" (10.38 cm) mounting hole pattern
- MIL-STD 810G shock/vibration, RoHS, FCC, and SAE J1455 crash certifications
- 3-Year Limited Warranty; Optional 4 and 5-Year Extended Warranty available

Note: Panasonic recommends that the Toughbook 30/31 computers should not be "hot docked" into any docking station.

Port Replicator

- Panasonic certified electronics
- Serial (2) D-Sub 9 Pin
- Ethernet (2)
 - USB Ethernet RJ45
 - True Ethernet* RJ45
- USB 2.0 (5) 4 Pin
- External video D-Sub 15 Pin
- Headphones/speakers Stereo phono jack
- Microphone Mono phono jack
- RF pass-through (optional) TNC



* Note: The True Ethernet will not work with a Toughbook 30 computer

120W Internal LIND power supply (optional)

- Operating temperature: -20°C to 50°C (-4° F to 122° F)
- Non-operating (storage) temperature: -40°C to 85°C (-40° F to 185° F)
- Power output to computer from dock = 120 watts (max)
- Input voltage: 12V DC min to 32V DC max systems
- Output voltage: 15.6V DC-16V no load, 14.5V-15.5V full load
- Under voltage protection: 9.5V min to 10.5V max DC
- Over voltage protection: 33V min to 34V max DC
- Output voltage protection: 17V min to 18V max DC
- Automatic temperature reset
- Reverse polarity protection
- Auto shutdown circuit
- Output current limit
- Load dump
- Input fused

PANASONIC TOUGHBOOK® 27/28/29/30/31 CRADLE



Item No.	Port Replicator/Internal Power Supply	Weight	Height	Width	Depth
NP-PAN-CRADLE	No	7.1 lbs 3.2 kg	3.5" - 3.75" 8.9 - 9.5 cm	12.5" 31.8 cm	10.0" 25.4 cm

Features

- Cradle adjusts to securely hold the Panasonic Toughbook 27/28/29/30/31 computers
- Hold-down clips don't interfere with closing the screen
- 90° wing turn closure latch with built-in key lock that allows for quick computer insertion
- Can be used with any Motion Attachment
- Limited Lifetime Warranty

PANASONIC TOUGHBOOK® 27/28/29/30/31 CRADLE ACCESSORIES



7160-0215

Item No.	Description	Placement	Weight	Height	Width	Depth
7160-0215	LED Light Assembly	Attaches to either side of the cradle	0.5 lbs 0.2 kg	17.0" 43.2 cm	2.3" 5.8 cm	1.6" 4.1 cm
7110-0643	Screen Support	Screen Support attaches to either side of the cradle	0.4 lbs 0.2 kg	9.0" 22.9 cm	5.0" 12.7 cm	0.25" 0.6 cm
7160-0539	LIND Power Supply Mount	Attaches a LIND power supply between a docking station/cradle and the motion attachment	1.5 lbs 0.7 kg	5.0" 12.7 cm	10.0" 25.4 cm	1.3" 3.3 cm

PANASONIC TOUGHBOOK® 30/31 DOCKING STATION ACCESSORIES



7160-0096



7160-0398

Item No.	Description	Placement	Weight	Height	Width	Depth
7160-0096	LED Light Assembly	Attaches to the right side of docking station	0.5 lbs 0.2 kg	17.0" 43.1 cm	3.0" 2.6 cm	1.6" 4.1cm
7160-0501	Screen Support	Attaches to the right side of docking station	0.5 lbs 0.2 kg	9.7" 24.6 cm	4.1" 10.4 cm	1.8" 4.6 cm
7160-0398	Trunk Shelf Mounting Plate	Used to raise the Panasonic 30/31 Docking Station to provide clearance for cables when mounting to a flat surface (usually trunk applications)	3.6 lbs 1.6 kg	2.3" 5.8 cm	10.25" 26.0 cm	5.5" 14.0 cm
7160-0496	Integrated 120W LIND Power Supply Kit	Inserts into the dedicated pocket on the underside of docking station. For use with the following Panasonic Toughbook 30/31 Docking Stations (7160-0318-00, 7160-0318-01, 7160-0318-02, 7160-0318-07, 7160-0318-08, 7160-0318-09)	1.0 lbs 0.5 kg	1.0" 2.5 cm	2.0" 5.1 cm	4.5" 11.4 cm
7160-0539	LIND Power Supply Mount	Attaches a LIND power supply between a docking station/cradle and the motion attachment	1.5 lbs 0.7 kg	5.0" 12.7 cm	10.0" 25.4 cm	1.3" 3.3 cm
7300-0461	External 120W LIND Automobile Power Adapter (Toughbook 30 and 31)	For Use with the Following Panasonic Toughbook 30/31 Docking Stations (7160-0318-00, 7160-0318-01, 7160-0318-02, 7160-0318-07, 7160-0318-08, 7160-0318-09)	0.9 lbs 0.4 kg	1.1" 2.8 cm	5.4" 13.7 cm	3.1" 7.9 cm

PANASONIC TOUGHBOOK® 33 LAPTOP DOCKING STATION

Item No.	Antenna Pass-Through	Power Supply	Weight	Height	Width	Depth
7160-0909-00	No	No - Use LIND Power Supply (7300-0461)	6.7 lbs 3.03 kg	3.5" 8.9 cm	14.1" 35.8 cm	13.5" 34.3 cm
7160-0909-02	Dual RF (TNC)	No - Use LIND Power Supply (7300-0461)	6.7 lbs 3.03 kg	3.5" 8.9 cm	14.1" 35.8 cm	13.5" 34.3 cm
7170-0683-00	No	Yes - Includes LIND Auto Power Supply	7.55 lbs 3.42 kg	3.5" 8.9 cm	14.1" 35.8 cm	13.5" 34.3 cm
7170-0683-02	Dual RF (TNC)	Yes - Includes LIND Auto Power Supply	7.55 lbs 3.42 kg	3.5" 8.9 cm	14.1" 35.8 cm	13.5" 34.3 cm



7160-0909-02



7160-0909-02



7160-0909-02

Features

- Compatible only with the Panasonic Toughbook 33 that comes with the premium keyboard option
- Panasonic Toughbook Certified utilizing Panasonic Certified electronics
- Special docking connector pin protection – helps to prevent accidental pin damage by providing additional protection around and in between each docking pin
- Designed with rounded edges to enhance personal safety
- Optional lock (keyed alike) for theft deterrence. When locked, neither the tablet nor the laptop can be removed from the docking station
- Floating docking connector with alignment tabs – perfectly align the computer with the docking station for a reliable docking connection
- Internal/protected circuit board protects against dirt and dust
- Use LIND 120W automobile power adapter (7300-0462) or LIND 120 W power adapter (7300-0461)
- VESA 75 mm mounting pattern
- MIL-STD 810G shock/vibration, RoHS, FCC, CE, and SAE J1455 crash certifications
- 3-Year Limited Warranty

Port Replicator

- Panasonic certified electronics
- Serial D-Sub 9-pin
- VGA (1) D-Sub 9-pin
- USB 2.0 (4) 4 Pin
- USB 3.0 (2) 9 Pin
- HDMI (1) 19 Pin
- Ethernet (2) RJ45
- Antenna switch
- Power supply input 16VDC



PANASONIC TOUGHBOOK® 33 LAPTOP CRADLE

Item No.	Antenna Pass-Through	Power Supply	Weight	Height	Width	Depth
7160-0910-00	No	No - Must use LIND 120W Automobile Power Supply (14650) or LIND 120W Bare Wire Leads Power Supply (7300-0461)	6.7 lbs 3.0 kg	3.5" 8.9 cm	14.1" 35.8 cm	13.5" 34.3 cm



Features

- Compatible only with the Panasonic Toughbook 33 that comes with the premium keyboard option
- Panasonic Toughbook Certified
- Optional lock (keyed alike) for theft deterrence. When locked, neither the tablet nor the laptop can be removed from the docking station
- Designed with rounded edges to enhance personal safety
- Use LIND 120W automobile power adapter (7300-0462) or LIND 120 W power adapter (7300-0461)
- VESA 75 mm mounting pattern
- MIL-STD 810G shock/vibration, RoHS, FCC, CE, and SAE J1455 crash certifications
- 3-Year Limited Warranty

NEW



7300-0387-02

PANASONIC TOUGHBOOK® 33 TRIMLINE™ LAPTOP DOCKING STATION

Item No.	Description	Power Supply	Weight	Height	Width	Depth
7300-0387-00	Panasonic Toughbook 33 TrimLine Laptop Docking Station NO RF	No - Use LIND Power Adapter (7300-0197)	7.75 lbs 3.51 kg	2.8" 7.11 cm	12.5" 31.75 cm	12" 30.48 cm
7300-0387-10	Panasonic Toughbook 33 TrimLine Laptop Docking Station NO RF with LIND Auto Power Adapter	Yes - Includes LIND Auto Power Supply	9.15 lbs. 4.15 kg	2.8" 7.11 cm	12.5" 31.75 cm	12" 30.48 cm
7300-0387-20	Panasonic Toughbook 33 TrimLine Laptop Docking Station NO RF with Screen Lock	No - Use LIND Power Adapter (7300-0197)	8.05 lbs 3.65 kg	2.8" 7.11 cm	12.5" 31.75 cm	12" 30.48 cm
7300-0387-30	Panasonic Toughbook 33 TrimLine Laptop Docking Station NO RF with Screen Lock and LIND Auto Power Adapter	Yes - Includes LIND Auto Power Supply	9.45 lbs 4.28 kg	2.8" 7.11 cm	12.5" 31.75 cm	12" 30.48 cm
7300-0387-02	Panasonic Toughbook 33 TrimLine Laptop Docking Station DUAL RF	No - Use LIND Power Adapter (7300-0197)	7.75 lbs 3.51 kg	2.8" 7.11 cm	12.5" 31.75 cm	12" 30.48 cm
7300-0387-12	Panasonic Toughbook 33 TrimLine Laptop Docking Station DUAL RF with LIND Auto Power Adapter	Yes - Includes LIND Auto Power Supply	9.15 lbs 4.15 kg	2.8" 7.11 cm	12.5" 31.75 cm	12" 30.48 cm
7300-0387-22	Panasonic Toughbook 33 TrimLine Laptop Docking Station DUAL RF with Screen Lock	No - Use LIND Power Adapter (7300-0197)	8.05 lbs 3.65 kg	2.8" 7.11 cm	12.5" 31.75 cm	12" 30.48 cm
7300-0387-32	Panasonic Toughbook 33 TrimLine Laptop Docking Station DUAL RF with Screen Lock and LIND Auto Power Adapter	Yes - Includes LIND Auto Power Supply	9.45 lbs 4.28 kg	2.8" 7.11 cm	12.5" 31.75 cm	12" 30.48 cm

Features

- Compatible with the Panasonic Toughbook 33 2-in-1 computer
- Panasonic Toughbook Certified utilizing Panasonic Certified electronics
- Shutter cover design on connector for protection from external elements
- Docking station can be docked in both laptop and tablet orientation
- Floating connector for reliable docking connection even in the roughest terrain
- Front-facing I/O ports; integrated cable strain relief and cable management system
- Screen support for additional stability (optional)
- Optional tablet screen lock module for added theft deterrence and safety
- Minimal footprint for increased usable cabin space
- Ergonomic design for safety and single hand operation
- Keyed lock for theft deterrence
- Easy docking and release:
 - To dock: Align front brackets on dock with pockets on front of computer, slowly rotate back of the computer onto docking station
 - Push down on back of computer until audible click is heard. Computer is docked.
 - To release: Disengage lock. Push front release button and rotate back of computer up and pull front of computer away from the dock.
- VESA 75 mm mounting pattern
- MIL-STD 810G shock/vibration, RoHS, FCC, CE, and SAE J1455 crash certifications
- Limited Lifetime Warranty on structural components, 3-Year Limited Warranty on electronics

Port Replication

- Serial
- HDMI
- VGA
- Ethernet (2)
- USB 3.0 (2) 900mA
- USB 2.0 Front-facing(2), Bottom-facing(2) 500mA
- Power Input 16VDC
- External Antenna Switch

PANASONIC TOUGHBOOK® 33 TRIMLINE™ LAPTOP CRADLE

Item No.	Description	Power Supply	Weight	Height	Width	Depth
7300-0386-00	Panasonic Toughbook 33 TrimLine Laptop Cradle (No Electronics)	No - Use LIND Power Adapter (7300-0197)	6.8 lbs 3.08 kg	2.8" 7.11 cm	2.5" 31.75 cm	12" 30.48 cm
7300-0386-10	Panasonic Toughbook 33 TrimLine Laptop Cradle (No Electronics) with LIND Auto Power Adapter	Yes - Includes LIND Auto Power Supply	8.2 lbs 3.71 kg	2.8" 7.11 cm	12.5" 31.75 cm	12" 30.48 cm
7300-0386-20	Panasonic Toughbook 33 TrimLine Laptop Cradle (No Electronics) with Screen Lock	No - Use LIND Power Adapter (7300-0197)	7.1 lbs 3.22 kg	2.8" 7.11 cm	12.5" 31.75 cm	12" 30.48 cm
7300-0386-30	Panasonic Toughbook 33 TrimLine Laptop Cradle (No Electronics) with Screen Lock and LIND Auto Power Adapter	Yes - Includes LIND Auto Power Supply	8.5 lbs 3.85 kg	2.8" 7.11 cm	12.5" 31.75 cm	12" 30.48 cm

NEW



7300-0386-00

Features

- Compatible with the Panasonic Toughbook 33 2-in-1 computer
- Panasonic Toughbook certified
- Docking station can be docked in both laptop and tablet orientation
- Screen support for additional stability (optional)
- Optional tablet screen lock module for added theft deterrence and safety
- Minimal footprint for increased usable cabin space
- Ergonomic design for safety and single hand operation
- Keyed lock for theft deterrence
- Easy docking and release:
 - To dock: Align front brackets on dock with pockets on front of computer, slowly rotate back of the computer onto cradle
 - Push down on back of computer until audible click is heard. Computer is cradled.
 - To release: Disengage lock. Push front release button and rotate back of computer up and pull front of computer away from the cradle.
- VESA 75 mm mounting pattern
- MIL-STD 810G shock/vibration, RoHS, FCC, CE, and SAE J1455 crash certifications
- Limited Lifetime Warranty on structural components, 3-Year Limited Warranty on electronics

PANASONIC TOUGHBOOK® 33 TRIMLINE™ LAPTOP DOCKING STATION ACCESSORIES

Item No.	Description	Placement/Compatibility	Weight	Height	Width	Depth
7300-0388-00	Panasonic Toughbook 33 TrimLine Laptop Dock - SCREEN LOCK MODULE	Attaches to Panasonic Toughbook 33 TrimLine Laptop Docking Station or Cradle	.80 lbs .36 kg	3.45" 8.76 cm	3.69" 9.37 cm	1.22" 3.09 cm
7300-0397	Panasonic Toughbook 33 TrimLine Laptop Dock - SCREEN SUPPORT	Attaches to Panasonic Toughbook 33 TrimLine Laptop Docking Station or Cradle	.4 lbs .18 kg	8" 20.32 cm	1.5" 3.81 cm	3.25" 8.26 cm
7300-0197	LIND 120W Automotive Power Adapter with Cigarette Lighter Adapter and Indicator Light	Use with Panasonic Toughbook TrimLine 33 Laptop and Tablet Docking Station or Cradle	1.4 lbs .64 kg	5.5" 13.97 cm	3.1" 7.87 cm	1.1" 2.79 cm

NEW



7300-0388-00



7160-0907-00



7160-0907-00

PANASONIC TOUGHBOOK® 33 TABLET FULL PORT DOCKING STATION

Item No.	Antenna Pass-Through	Power Supply	Weight	Height	Width	Depth
7160-0907-00	No	No - Use LIND Power Supply (7300-0461)	4.2 lbs 1.9 kg	12.5" 31.7 cm	13.25" 33.6 cm	4.5" 11.4 cm
7160-0907-02	Dual RF (TNC)	No - Use LIND Power Supply (7300-0461)	4.2 lbs 1.9 kg	12.5" 31.7 cm	13.25" 33.6 cm	4.5" 11.4 cm
7170-0684-00	No	Yes - Includes LIND Auto Power Supply	5.05 lbs 2.29 kg	12.5" 31.7 cm	13.25" 33.6 cm	4.5" 11.4 cm
7170-0684-02	Dual RF (TNC)	Yes - Includes LIND Auto Power Supply	5.05 lbs 2.29 kg	12.5" 31.7 cm	13.25" 33.6 cm	4.5" 11.4 cm

Features

- Compatible with Panasonic 33 Toughbook
- Panasonic Toughbook Certified utilizing Panasonic Certified electronics
- Accommodates either the Toughbook 33 tablet's hand strap or an additional battery pack
- Can be mounted in horizontal or vertical position
- Internal/protected circuit board protects against dirt and dust
- Floating docking connector for reliable docking connection
- Designed with rounded edges to enhance personal safety
- Optional lock (keyed alike) for theft deterrence
- Optional cradle version (no electronics)
- Use LIND 120W automobile power adapter (7300-0462) or LIND 120 W bare wire leads power adapter (7300-0461)
- Easy to use one-handed operation:
 - Insert bottom of computer into the docking station, push top of computer against latch button until latch engages
 - To remove, push up on latch-button with thumb to disengage and pull computer out of the docking station
- VESA 75 mm mounting pattern
- MIL-STD 810G shock/vibration, RoHS, FCC, CE, and SAE J1455 crash certifications
- 3-Year Limited Warranty

Port Replicator

- Panasonic certified electronics
- Serial (1) D-Sub 9-pin
- VGA (1) D-Sub 9-pin
- USB 2.0 (4) 4 Pin (2) front, (2) rear
- USB 3.0 (2) 9 Pin
- HDMI (1) 19 Pin
- Ethernet (2) RJ45
- Antenna switch
- Power supply input 16VDC

PANASONIC TOUGHBOOK® 33 TABLET LITE PORT DOCKING STATION



7160-0907-06

Item No.	Antenna Pass-Through	Power Supply	Weight	Height	Width	Depth
7160-0907-06	No	No - Use LIND Power Supply (7300-0461)	4.2 lbs 1.9 kg	12.5" 31.7 cm	13.25" 33.6 cm	4.5" 11.4 cm
7160-0907-07	Dual RF (TNC)	No - Use LIND Power Supply (7300-0461)	4.2 lbs 1.9 kg	12.5" 31.7 cm	13.25" 33.6 cm	4.5" 11.4 cm
7170-0685-00	No	Yes - Includes LIND Auto Power Supply	5.05 lbs 2.29 kg	12.5" 31.7 cm	13.25" 33.6 cm	4.5" 11.4 cm
7170-0685-02	Dual RF (TNC)	Yes - Includes LIND Auto Power Supply	5.05 lbs 2.29 kg	12.5" 31.7 cm	13.25" 33.6 cm	4.5" 11.4 cm

Features

- Compatible with Panasonic 33 Toughbook
- Panasonic Toughbook Certified utilizing Panasonic Certified electronics
- Accommodates either the Toughbook 33 tablet's hand strap or an additional battery pack
- Can be mounted in horizontal or vertical position
- Internal/protected circuit board protects against dirt and dust
- Floating docking connector for reliable docking connection
- Designed with rounded edges to enhance personal safety
- Optional lock (keyed alike) for theft deterrence
- Optional cradle version (no electronics)
- Use LIND 120W automobile power adapter (7300-0462) or LIND 120 W bare wire leads power adapter (7300-0461)
- Easy to use one-handed operation:
 - Insert bottom of computer into the docking station, push top of computer against latch button until latch engages
 - To remove, push up on latch-button with thumb to disengage and pull computer out of the docking station
- VESA 75 mm mounting pattern
- MIL-STD 810G shock/vibration, RoHS, FCC, CE, and SAE J1455 crash certifications
- 3-Year Limited Warranty

Port Replicator

- Panasonic certified electronics
- Serial (1) D-Sub 9-pin
- USB 2.0 (4) 4 Pin (2) front, (2) rear
- USB 3.0 (2) 9 Pin
- Ethernet (2) RJ45
- Antenna switch
- Power supply input 16VDC

PANASONIC TOUGHBOOK® 33 TABLET CRADLE

Item No.	Antenna Pass-Through	Power Supply	Weight	Height	Width	Depth
7160-0908-00	No	No - Must use LIND 120W Automobile Power Supply (14650) or LIND 120W Bare Wire Leads Power Supply (7300-0461)	4.2 lbs 1.9 kg	12.5" 31.7 cm	13.25" 33.6 cm	4.5" 11.4 cm
Features <ul style="list-style-type: none"> - Compatible with Panasonic Toughbook 33 computer - Panasonic Toughbook Certified - Accommodates either the Toughbook 33 tablet's hand strap or an additional battery pack - Can be mounted in horizontal or vertical position - Designed with rounded edges to enhance personal safety - Optional lock (keyed alike) for theft deterrence - Use LIND 120W automobile power adapter (7300-0462) or LIND 120 W bare wire leads power adapter (7300-0461) - Easy to use one-handed operation: <ul style="list-style-type: none"> - Insert bottom of computer into the docking station, push top of computer against latch button until latch engages - To remove, push up on latch-button with thumb to disengage and pull computer out of the cradle - VESA 75 mm mounting pattern - MIL-STD 810G shock/vibration, RoHS, FCC, CE, and SAE J1455 crash certifications - 3-Year Limited Warranty 						



PANASONIC TOUGHBOOK® 33 ACCESSORIES

Item No.	Description	Placement	Weight	Height	Width	Depth
7300-0462	LIND 120W Automobile Power Supply	For use with the following Panasonic Toughbook 33 (7160-0908-00, 7160-0907-06, 7160-0907-07, 7160-0907-00, 7160-0907-02, 7160-0909-00, 7160-0909-02, 7160-0909-00)	1.1 lbs 0.5 kg	1.2" 2.9 cm	5.0" 12.7 cm	3.0" 7.6 cm
7300-0461	LIND 120W Bare Wire Leads Power Supply		1.1 lbs 0.5 kg	1.2" 2.9 cm	5.0" 12.7 cm	3.0" 7.6 cm
7110-1214	Screen Support	Attaches to the side of the docking station or cradle	0.4 lbs 0.2 kg	5.0" 12.7 cm	3.5" 8.9 cm	2.1" 5.4 cm



7110-1214



7300-0196-02

PANASONIC TOUGHBOOK® 33 TRIMLINE™ TABLET DOCKING STATION

Item No.	Antenna Pass-Through	Power Supply/Description	Weight	Height	Width	Depth
7300-0196-00	No	No - Use LIND 120W Power Adapter (7300-0197). SLIM TOUGHBOOK 33 TABLET DOCK LITE NPT	6.0 lbs 2.7 kg	10.8" 27.4 cm	12.3" 31.4 cm	3" 7.6 cm
7300-0196-10	No	Yes - Includes LIND 120W Power Adapter. SLIM TOUGHBOOK 33 TABLET DOCK LITE NPT	7.4 lbs 3.4 kg	10.8" 27.4 cm	12.3" 31.4 cm	3" 7.6 cm
7300-0196-02	Yes	No -Use LIND 120W Power Adapter (7300-0197). SLIM TOUGHBOOK 33 TABLET DOCK LITE DPT	6.0 lbs 2.7 kg	10.8" 27.4 cm	12.3" 31.4 cm	3" 7.6 cm
7300-0196-12	Yes	Yes - Includes LIND 120W Power Adapter. SLIM TOUGHBOOK 33 TABLET DOCK LITE DPT	7.4 lbs 3.4 kg	10.8" 27.4 cm	12.3" 31.4 cm	3" 7.6 cm
7300-0196-20	No	No - Use LIND 120W Power Adapter (7300-0197). SLIM TOUGHBOOK 33 TABLET DOCK FULL NPT	6.0 lbs 2.7 kg	10.8" 27.4 cm	12.3" 31.4 cm	3" 7.6 cm
7300-0196-30	No	Yes - Includes LIND Power Adapter. SLIM TOUGHBOOK 33 TABLET DOCK FULL NPT	7.4 lbs 3.4 kg	10.8" 27.4 cm	12.3" 31.4 cm	3" 7.6 cm
7300-0196-22	Yes	No - Use LIND 120W Power Adapter (7300-0197). SLIM TOUGHBOOK 33 TABLET DOCK FULL DPT	6.0 lbs 2.7 kg	10.8" 27.4 cm	12.3" 31.4 cm	3" 7.6 cm
7300-0196-32	Yes	Yes - Includes LIND 120W Power Adapter. SLIM TOUGHBOOK 33 TABLET DOCK FULL DPT	7.4 lbs 3.4 kg	10.8" 27.4 cm	12.3" 31.4 cm	3" 7.6 cm

Features

- Designed for the Panasonic Toughbook 33 tablet computer
- Panasonic Toughbook Certified utilizing Panasonic Certified electronics
- CNC machined aluminum construction for rugged reliability
- Space saving and ergonomic design improves safety and comfort
- Top mounted USB ports allow compatibility with Clam Shell mounts
- Floating protected docking connector for years of reliable connectivity
- Available with power indicator light when purchased with PSU
- Available with or without dual RF pass-through
- Available in "Lite" or "Full" port replication (with or without VGA and HDMI connections)
- Integrated cable strain relief
- Keyed alike lock for theft deterrence
- Easy, one-handed operation:
 - To dock: Unlock. Lead the bottom of the tablet into the dock using the guide pins for positioning.
 - Push the top of the tablet back into the dock. until top clamp is fully seated on tablet
 - To release: Unlock. Move the top clamp up and away from the tablet. Gently lift the tablet out of the dock
- VESA 75 mm mounting pattern
- MIL-STD 810G shock/vibration, RoHS, FCC, and SAE J1455 crash certifications
- Limited Lifetime Warranty on structural components, 3-Year Limited Warranty on electronics

Port Replicator

- Panasonic certified electronics
- Ethernet (2) RJ45
- Serial (1) D-Sub 9 Pin
- USB 3.0 (2) 9 Pin
- USB 2.0 (4) 4 Pin
- HDMI (optional on "Full" dock) 19 Pin
- VGA (optional on "Full" dock) D-Sub 15 Pin
- RF Pass Through (optional) Dual RF (TNC)
- Power Input: 16 VDC

PANASONIC TOUGHBOOK® 33 TRIMLINE™ TABLET CRADLE

Item No.	Antenna Pass-Through	Power Supply	Weight	Height	Width	Depth
7300-0195-00	No	No - Use LIND Power Adapter (7300-0197)	5.9 lbs 2.7 kg	10.8" 27.4 cm	12.3" 31.4 cm	3" 7.6 cm
7300-0195-10	No	Yes - Includes LIND Power Adapter (7300-0197)	7.3 lbs 3.3 kg	10.8" 27.4 cm	12.3" 31.4 cm	3" 7.6 cm



7300-0195-00

Features

- Designed for the Panasonic Toughbook 33 tablet computer
- Panasonic Toughbook Certified
- CNC machined aluminum construction for rugged reliability
- Space saving and ergonomic design improves safety and comfort
- Top mounted USB ports allow compatibility with Clam Shell mounts
- Available with power indicator light when purchased with PSU
- Keyed alike lock for theft deterrence
- Easy, one-handed operation:
 - To dock: Unlock. Lead the bottom of the tablet into the dock using the guide pins for positioning.
 - Push the top of the tablet back into the dock, until top clamp is fully seated on tablet
 - To release: Unlock. Move the top clamp up and away from the tablet. Gently lift the tablet out of the dock
- VESA 75 mm mounting pattern
- MIL-STD 810G shock/vibration, RoHS, FCC, and SAE J1455 crash certifications
- Limited Lifetime Warranty on structural components

PANASONIC TOUGHBOOK® 33 TRIMLINE™ ACCESSORIES

Item No.	Description	Placement	Weight	Height	Width	Depth
7300-0197	LIND 120W Power Supply with LED Indicator	For use with the following Panasonic Toughbook 33 (7300-0196-00, 7300-0196-10, 7300-0196-02, 7300-0196-12, 7300-0196-20, 7300-0196-30, 7300-0196-22, 7300-0196-32, 7300-0203, 7300-0204)	1.4 lbs 0.64 kg	1.1" 7.87 cm	3.1" 2.80 cm	5.5" 13.97 cm



PANASONIC TOUGHBOOK® 55 DOCKING STATION

Item No.	Antenna Pass-Through	Power Supply	Weight	Height	Width	Depth
7160-0577-00	No	No - Must use External LIND Auto Adapter (7300-0461)	5.5 lbs 2.5 kg	3.5" 8.9 cm	13.5" 34.3 cm	11.9" 30.2 cm
7160-0577-02	Dual RF (TNC)	No - Must use External LIND Auto Adapter (7300-0461)	5.5 lbs 2.5 kg	3.5" 8.9 cm	13.5" 34.3 cm	11.9" 30.2 cm
7170-0250	No	Yes - Includes 120W External LIND Auto Adapter	8.5 lbs 3.9 kg	3.5" 8.9 cm	13.5" 34.3 cm	11.9" 30.2 cm
7170-0251	Dual RF (TNC)	Yes - Includes 120W External LIND Auto Adapter	8.5 lbs 3.9 kg	3.5" 8.9 cm	13.5" 34.3 cm	11.9" 30.2 cm



7160-0577-00



7160-0577-00

Features

- Compatible with Panasonic Toughbook 54 and 55
- Panasonic Toughbook Certified utilizing Panasonic Certified electronics
- This docking station accommodates the optional modular expansion area on the Toughbook 54/55 computer
- Rugged composite/steel construction with black powder coat finish for long-term durability
- Special access area for smart card reader makes it easy to insert and eject card
- Spring-loaded plate protects RF connector from damage when computer is not in the docking station. Plate draws back into the docking station when the computer is docked.
- Small footprint - designed to maximize available space inside of vehicle
- Rear-facing I/O ports, integrated cable strain relief system, and convenient cable management system
- Spring-loaded docking connector to ensure connectivity in the roughest terrain
- External antenna switch:
 - Switch set toward outside of dock: Uses exterior antenna
 - Switch set to inside of the dock: Uses laptop antenna
- Front safety bracket and rear corners ensure proper alignment and docking connectivity
- Push button latch with keyed lock for theft deterrence:
 - Push the latch to release the docking connector
 - Insert computer and push latch closed to dock computer
- VESA 75 mm mounting pattern
- MIL-STD 810G shock/vibration, RoHS, FCC, CE, and SAE J1455 crash certifications
- 3-Year Limited Warranty

Port Replicator

- Panasonic certified electronics
- Serial (1) D-Sub 9 Pin
- Ethernet (1) RJ45
- USB 3.0 (2) 9 Pin
- VGA (1) D-Sub 15 Pin
- HDMI (1) 19 Pin
- RF pass-through (optional) TNC
- Power supply input DC



PANASONIC TOUGHBOOK® 55 CRADLE



Item No.	Weight	Height	Width	Depth
7160-0578-00	5.5 lbs 2.5 kg	3.5" 8.9 cm	13.5" 34.3 cm	11.9" 30.2 cm

Features

- Compatible with Panasonic Toughbook 54 and 55
- Panasonic Toughbook Certified
- This cradle accommodates the optional modular expansion area on the Toughbook 54/55 computer
- Rugged composite/steel construction with black powder coat finish for long-term durability
- Special access area for smart card reader makes it easy to insert and eject card
- Small footprint - designed to maximize available space inside of vehicle
- Front safety bracket and rear corners ensure proper alignment and docking connectivity
- Push button latch with keyed lock for theft deterrence:
 - Push the latch to open the cradle
 - Insert computer and push latch closed to cradle the computer
- VESA 75 mm mounting pattern
- MIL-STD 810G shock/vibration, RoHS, FCC, CE, and SAE J1455 crash certifications
- 3-Year Limited Warranty

PANASONIC TOUGHBOOK® 55 CRADLE AND DOCKING STATION ACCESSORIES



7160-0096

Item No.	Description	Placement	Weight	Height	Width	Depth
7160-0096	LED Light Assembly	Attaches to the right side of docking station	0.5 lbs 0.2 kg	17.0" 43.2 cm	3.0" 7.6 cm	1.6" 4.1 cm
7110-1023	Screen Support	Attaches to the right side of docking station	0.5 lbs 0.5 kg	6.5" 16.5 cm	3.5" 8.9 cm	1.7" 4.3 cm
7300-0461	External 120W LIND Automobile Power Adapter (Toughbook 55)	For use with any Gamber-Johnson Panasonic Toughbook 55 Cradle or Docking Station	0.9 lbs 0.4 kg	1.1" 2.8 cm	5.4" 13.7 cm	3.1" 7.9 cm

PANASONIC TOUGHBOOK® 55 TRIMLINE™ LAPTOP DOCKING STATION

Item No.	Description	Power Supply	Weight	Height	Width	Depth
7300-0373-00	Panasonic Toughbook 55 TrimLine Laptop docking station NO RF	No - Use LIND Power Adapter (7300-0197)	8.4 lbs 3.81 kg	3.04" 7.72 cm	14.07" 35.74 cm	12.5" 31.75 cm
7300-0373-02	Panasonic Toughbook 55 TrimLine Laptop docking station DUAL RF	No - Use LIND Power Adapter (7300-0197)	8.4 lbs 3.81 kg	3.04" 7.72 cm	14.07" 35.74 cm	12.5" 31.75 cm
7300-0373-04	Panasonic Toughbook 55 TrimLine Laptop docking station NO RF with LIND auto power adapter	Yes - Includes LIND Auto Power Supply	9.8 lbs 4.44 kg	3.04" 7.72 cm	14.07" 35.74 cm	12.5" 31.75 cm
7300-0373-06	Panasonic Toughbook 55 TrimLine Laptop docking station DUAL RF with LIND auto power adapter	Yes - Includes LIND Auto Power Supply	9.8 lbs 4.44 kg	3.04" 7.72 cm	14.07" 35.74 cm	12.5" 31.75 cm



7300-0373-02

Features

- Compatible with the Panasonic Toughbook 54/55 laptop computer
- Panasonic Toughbook Certified utilizing Panasonic Certified electronics
- Aluminum construction for strength and durability
- Docking connector cover reduces potential damage to critical components
- Floating connector for reliable docking connection even in the roughest terrain
- Rear-facing I/O ports; integrated cable strain relief and cable management system
- Screen support for additional stability (optional)
- Available with dual RF antenna pass through and as a kit with LIND power adapter
- Minimal footprint for increased usable cabin space
- Ergonomic design for safety and single hand operation
- Keyed lock for theft deterrence
- Easy docking and release:
 - To dock: Position front handle on computer into front brackets on dock so pockets on keyboard align with front brackets.
 - Slowly rotate back of the computer onto docking station ensuring that computer stays aligned on the dock.
 - Push down on back of computer until audible click is heard. Computer is docked.
 - To release: Disengage lock. Push front release button and rotate back of computer up and pull front of computer away from the dock.
- VESA 75 mm mounting pattern
- MIL-STD 810G shock/vibration, RoHS, FCC, CE, and SAE J1455 crash certifications
- Limited Lifetime Warranty on structural components, 3-Year Limited Warranty on electronics

Port Replication

- Serial D-sub 9 pin
- HDMI 19 pin
- VGA D-sub 15 pin
- Ethernet RJ45
- Fully powered USB 3.0 (2) 900mA
- Power Input 15.6VDC
- External Antenna Switch

PANASONIC TOUGHBOOK® 55 TRIMLINE™ LAPTOP CRADLE

Item No.	Description	Power Supply	Weight	Height	Width	Depth
7300-0373-90	Panasonic Toughbook 55 TrimLine Laptop Cradle (No Electronics)	No - Use LIND Power Adapter (7300-0197)	8.2 lbs 3.71 kg"	3.04" 7.72 cm	14.07" 35.74 cm	12.5" 31.75 cm
7300-0373-99	Panasonic Toughbook 55 TrimLine Laptop Cradle (No Electronics) with LIND Auto Power Adapter	Yes - Includes LIND Auto Power Supply	9.6 lbs 4.35 kg"	3.04" 7.72 cm"	14.0" 35.74 cm	12.5" 31.75 cm



7300-0373-90

Features

- Compatible with the Panasonic Toughbook 54/55 laptop computer
- Panasonic Toughbook Certified
- Aluminum construction for strength and durability
- Minimal footprint for increased usable cabin space
- Ergonomic design for safety and single hand operation
- Screen support for additional stability (optional)
- Available as a kit with LIND power adapter
- Keyed lock for theft deterrence
- Easy docking and release:
 - To dock: Position front handle on computer into front brackets on cradle so pockets on keyboard align with front brackets.
 - Slowly rotate back of the computer onto cradle ensuring that computer stays aligned on the cradle
 - Push down on back of computer until audible click is heard. Computer is cradled.
 - To release: Disengage lock. Push front release button and rotate back of computer up and pull front of computer away from the cradle
- VESA 75 mm mounting pattern
- MIL-STD 810G shock/vibration, RoHS, FCC, CE, and SAE J1455 crash certifications
- Limited Lifetime Warranty on structural components, 3-Year Limited Warranty on electronics

NEW



7300-0373-50

PANASONIC TOUGHBOOK® 55 TRIMLINE™ LAPTOP DOCKING STATION ACCESSORIES

Item No.	Description	Placement/Compatibility	Weight	Height	Width	Depth
7300-0216	LIND 120W Automotive Power Adapter 11-16VDC with Indicator Light	Use with Panasonic Toughbook TrimLine 33 Laptop and Tablet Docking Station or Cradle	1.4 lbs 0.64 kg	5.5" 13.97 cm	3.1" 7.87 cm	1.1" 2.79 cm
7300-0373-50	Panasonic Toughbook 54/55 TrimLine Laptop Dock - Screen Support	Attaches to the Left Rear Corner of the Docking Station or Cradle	0.4 lbs 0.18 kg	8" 20.32 cm	1.5" 3.81 cm	3.25" 8.26 cm

LIND AUTOMOBILE POWER ADAPTERS FOR PANASONIC TOUGHBOOKS® / TOUGHPADS®



7300-0459



7300-0460



7300-0461



7300-0462

Item No.	Description	Placement	Weight	Height	Width	Depth
7300-0459	External 90W LIND Automobile Power Adapter with Cigarette Lighter Connector	For use with the following Panasonic Docking Stations or Cradles: Toughbook 20, A3, N1, ToughPad FZ-A2, FZ-G1, FZ-M1/B2	1.2 lbs 0.5 kg	1.2" 3.0 cm	5.0" 12.7 cm	3.0" 7.6 cm
7300-0460	External 90W LIND Automobile Power Adapter with Bare Wire Lead	For use with the following Panasonic Docking Stations or Cradles: Toughbook 20, A3, N1, ToughPad FZ-A2, FZ-G1, FZ-M1/B2	1.0 lbs 0.5 kg	1.2" 3.0 cm	5.0" 12.7 cm	3.0" 7.6 cm
7300-0461	External 120W LIND Automobile Power Adapter with Bare Wire Lead	For use with the following Panasonic Docking Stations or Cradles: Toughbook 30/31, 33, 54/55	0.9 lbs 0.4 kg	1.1" 2.8 cm	5.4" 13.7 cm	3.1" 7.9 cm
7300-0462	External 120W LIND Automobile Power Adapter with Cigarette Lighter Connector	For use with the following Panasonic Docking Stations or Cradles: Toughbook 30/31, 33, 54/55	1.0 lbs 0.5 kg	1.1" 2.8 cm	5.4" 13.7 cm	3.1" 7.9 cm
7300-0464	LIND 12-32V Material Handling Isolated Power Adapter with Bare Wire Lead. Output Voltage 15.6Vdc, Output Current 5.5 Amps to Barrel Connector Plug	For use with the following Panasonic Docking Stations or Cradles: Toughpad FZ-A2, G1, M1/B1, Toughbook A3, N1, 20	1.56 lbs. 0.52 kg	1.15" 2.92 cm	9.3" 23.6 cm	3.0" 7.62 cm
7300-0465	LIND 20-60V Material Handling Isolated Power Adapter with Bare Wire Lead. Output Voltage 15.6Vdc, Output Current 5.5 Amps to Barrel Connector Plug	For use with the following Panasonic Docking Stations or Cradles: Toughpad FZ-A2, G1, M1/B1, Toughbook A3, N1, 20	1.56 lbs. 0.52 kg	1.15" 2.92 cm	9.3" 23.6 cm	3.0" 7.62 cm
7300-0417	LIND 72-110V Material Handling Isolated Power Adapter with Bare Wire Lead. Output Voltage 15.6Vdc, Output Current 5.5 Amps to Barrel Connector Plug	For use with the following Panasonic Docking Stations or Cradles: Toughpad FZ-A2, G1, M1/B1, Toughbook A3, N1, 20	1.6 lbs. 0.74 kg	1.15" 2.92 cm	9.3" 23.6 cm	3.0" 7.62 cm
7300-0443	LIND 12-32V Automotive Power Adapter with Bare Wire Lead. Output Voltage 5Vdc, Output Current 2 Amps to Barrel Connector Plug	For use with the following Panasonic Docking Stations or Cradles: Toughbook L1.	0.7 lbs. 0.31 kg	0.9" 2.28 cm	1.7" 4.31 cm	3.7" 9.39 cm
7300-0444	LIND 12-32V Automotive Power Adapter with Cigarette Lighter Connection. Output Voltage 5Vdc, Output Current 2 Amps to Barrel Connector Plug	For use with the following Panasonic Docking Stations or Cradles: Toughbook L1.	0.7 lbs. 0.31 kg	0.9" 2.28 cm	1.7" 4.31 cm	3.7" 9.39 cm
7300-0445	LIND 12-32V Automotive Power Adapter with Bare Wire Lead. Output Voltage 5Vdc, Output Current 2 Amps to Micro USB	For use with the following Panasonic Docking Stations or Cradles: Toughbook T1.	0.7 lbs. 0.31 kg	0.9" 2.28 cm	1.7" 4.31 cm	3.7" 9.39 cm
7300-0446	LIND 12-32V Automotive Power Adapter with Cigarette Lighter Connection. Output Voltage 5Vdc, Output Current 2 Amps to Micro USB	For use with the following Panasonic Docking Stations or Cradles: Toughbook T1.	0.7 lbs. 0.31 kg	0.9" 2.28 cm	1.7" 4.31 cm	3.7" 9.39 cm
7300-0197	LIND 120w Automotive Power Adapter with Cigarette Lighter Connection. Output Voltage 15V, Output Current 8 Amps to Barrel Connector Plug.	For use with the following Panasonic Docking Stations or Cradles: Toughbook 33.	1.4 lbs. 0.64 kg	1.1" 7.87 cm	3.1" 2.8 cm	5.5" 13.9 cm
7300-0455	LIND 12-32V Material Handling Isolated Power Adapter with Bare Wire Lead. Output Voltage 5Vdc, Output Current 2 Amps to Straight Barrel Connector Plug.	For use with the following Panasonic Docking Stations or Cradles: Toughbook L1.	1.35 lbs. 0.61 kg	1.13" 2.86 cm	6.0" 15.24 cm	3.0" 7.62 cm
7300-0456	LIND 20-60V Material Handling Isolated Power Adapter with Bare Wire Lead. Output Voltage 5Vdc, Output Current 2 Amps to Straight Barrel Connector Plug.	For use with the following Panasonic Docking Stations or Cradles: Toughbook L1.	1.35 lbs. 0.61 kg	1.13" 2.86 cm	6.0" 15.24 cm	3.0" 7.62 cm
7300-0483	LIND 72-100V Material Handling Isolated Power Adapter with Bare Wire Lead. Output Voltage 5Vdc, Output Current 2 Amps to Straight Barrel Connector Plug.	For use with the following Panasonic Docking Stations or Cradles: Toughbook L1.	1.35 lbs. 0.61 kg	1.13" 2.86 cm	6.0" 15.24 cm	3.0" 7.62 cm

SAMSUNG GALAXY TAB ACTIVE2/TAB ACTIVE3 DUAL USB DOCKING STATION

Description	Power Supply	Antenna Pass-Through	Weight	Height	Width	Depth
7160-1368-00	Samsung Galaxy Tab Active2/Tab Active3 Dual USB Docking Station with Bare Wire	No	1.1lbs 0.5kg	6.7" 17.1cm	9.3" 23.6cm	1.5" 3.8 cm
7160-1368-20	Samsung Galaxy Tab Active2/Tab Active3 Dual USB Docking Station with Cigarette Lighter Connector	No	1.1lbs 0.5kg	6.7" 17.1cm	9.3" 23.6cm	
7160-1368-30	Samsung Galaxy Tab Active2/Tab Active3 Dual USB Docking Station with MP205 Connector	No	1.1lbs 0.5kg	6.7" 17.1cm	9.3" 23.6cm	
7170-0765-31	Kit Includes: Samsung Galaxy Tab Active2/Tab Active3 Dual USB Docking Station with AC Power Adapter	No	1.1lbs 0.5kg	6.7" 17.1cm	9.3" 23.6cm	
7170-0765-32	Kit Includes: Samsung Galaxy Tab Active2/Tab Active3 Dual USB Docking Station with 12-32V Isolated Power Adapter	Yes	1.1lbs 0.5kg	6.7" 17.1cm	9.3" 23.6cm	
7170-0765-33	Kit Includes: Samsung Galaxy Tab Active2/Tab Active3 Dual USB Docking Station with 20-60V Isolated Power Adapter	Yes	1.1lbs 0.5kg	6.7" 17.1cm	9.3" 23.6cm	
7170-0765-34	Kit Includes: Samsung Galaxy Tab Active2/Tab Active3 Dual USB Docking Station with 70-110V Isolated Power Adapter	Yes	1.1lbs 0.5kg	6.7" 17.1cm	9.3" 23.6cm	

Features

- Designed for the Samsung Galaxy Tab Active2/Tab Active3 rugged tablet with rugged case
- Dual powered USB ports; 1.5A for each port for connecting peripheral devices
- Access to all control buttons, camera, ports and stylus while the tablet is safely docked
- POGO pin connector and internal power supply provides power to charge the Samsung tablet while docked
- Input voltage range is 10V-40V for added power
- Push-button lock with key for theft deterrence
- Composite design for reduced overall weight
- Approximately 4" (101.6 cm) power cable with bare wire end
- Can be mounted on a flat vertical surface
- Simple, one-handed cradle operation:
 - Insert bottom of Samsung tablet into the docking station and push top of the tablet in until the lock engages
 - Push latch button up with your thumb then remove the tablet from the docking station
- VESA 75 mm and AMPS mounting pattern making it easily compatible with Zirkona products and more
- MIL-STD 810G shock/vibration, RoHS, FCC, CE, and SAE J1455 crash certifications
- 3-Year Limited Warranty

Port Replicator

- (2) USB 1.1 1.5A each



SAMSUNG GALAXY TAB ACTIVE2/TAB ACTIVE3 LITE CRADLE

Item No.	Antenna Pass-Through	Weight	Height	Width	Depth
7160-1002-00	Samsung Galaxy Tab Active2/Tab Active3 Lite Cradle (No Electronics)	0.5 lbs 0.2 kg	5.7" 14.5 cm	9.3" 23.5 cm	1.9" 4.8 cm

Features

- Designed for the Samsung Galaxy Tab Active2/Tab Active3 rugged tablet with rugged case
- Has cutouts for providing direct access to your camera, stylus, and USB port while your tablet is safely docked
- Cradle can be mounted on a flat vertical surface
- Optional lock button for theft deterrence and extra tablet security
- Simple, one-handed cradle operation
- Composite design for reduced overall weight
- Includes USB car adapter
- Cradle can be mounted using the VESA 75 mm, M20 threads, and AMPS hole pattern to attach to a Gamber-Johnson system
- MIL-STD 810G shock/vibration, RoHS, FCC, CE, and SAE J1455 crash certifications
- 1 Year Limited Warranty



SAMSUNG GALAXY TAB ACTIVE2/TAB ACTIVE3 LITE CRADLE

NEW



Item No.	Antenna Pass-Through	Weight	Height	Width	Depth
7160-1148-00	Samsung Lite Charging Cradle with Cigarette Lighter Adapter	0.50 lbs 0.22 kg	5.68" 14.5 cm	9.27" 23.5 cm	1.90" 4.8 cm
7160-1148-10	Samsung Lite Charging Cradle with Bare Wire Lead	0.50 lbs 0.22 kg	5.68" 14.5 cm	9.27" 23.5 cm	1.90" 4.8 cm

Features

- Designed for the Samsung Galaxy Tab Active2/Tab Active3 rugged tablet with rugged case
- Direct access to the camera, stylus, and tablet control buttons while the tablet is safely cradled
- VESA 75mm, M20 threads, and AMPS mounting hole patterns, compatible with Zirkona mounting products
- Cradle design is compatible with Samsung's built-in Near Field Communication (NFC); perform tasks with another NFD device without taking the Samsung tablet out of the cradle
- Optional lock for theft deterrence
- Simple, one-handed cradle operation
- Composite design for reduced overall weight
- POGO pin connector with USB-C connector attaches to USB auto power adapter (included)
- MIL-STD 810G shock/vibration, RoHS, FCC, CE, and SAE J1455 crash certifications
- 1 Year Limited Warranty

SAMSUNG GALAXY TAB ACTIVE2/TAB ACTIVE3 DUAL USB DOCKING STATION WITH MOBILITY BUNDLE

NEW



Item No.	Description	Weight	Height	Width	Depth
7170-0765-40	Samsung Galaxy Tab Active2/Tab Active3 Dual USB Docking Station with Mobility Bundle Kit Includes: Samsung Galaxy Tab Active2/Tab Active3 Dual USB Docking Station (7160-1368-00) and Mobility Bundle (7400-0020)	1.1 lbs 0.5 kg	6.7" 17.02 cm	9.3" 23.62 cm	1.5" 3.81 cm

Features

Docking Station

- Dual powered USB ports; 1.5A for each port for connecting peripheral devices
- Access to all control buttons, camera, ports and stylus while the tablet is safely docked
- POGO pin connector and internal power supply provides power to charge the Samsung tablet while docked
- Approximately 40" (101.6 cm) power cable with bare wire end
- Push-button lock with key for theft deterrence
- Composite design for reduced overall weight
- Simple, one-handed cradle operation:
 - Insert bottom of Samsung tablet into the docking station and push top of the tablet in until the lock engages
 - Push latch button up with your thumb then remove the tablet from the docking station
- VESA 75 mm and AMPS mounting patterns
- MIL-STD 810G shock/vibration, RoHS, FCC, CE, and SAE J1455 crash certifications
- 3-Year Limited Warranty

Mobility Bundle

- Quick release handle and shoulder strap for hands-free functionality
- Shoulder strap that loops over the back of the Samsung Tab Active2/Tab Active3 dock while installed
- 1 Year Limited Warranty

Port Replicator

- (2) USB 1.1 1.5A each

SAMSUNG GALAXY TAB ACTIVE2/TAB ACTIVE3 DUAL USB DOCKING STATION WITH Y-STRAP

Item No.	Description	Weight	Height	Width	Depth
7170-0765-41	Samsung Galaxy Tab Active2/Tab Active3 Dual USB Docking Station with Y-Strap Kit Includes: Samsung Galaxy Tab Active2/Tab Active3 Dual USB Docking Station (7160-1368-00) & Y-Strap (7400-0021)	1.1 lbs 0.5 kg	6.7" 17.02 cm	9.3" 23.62 cm	1.5" 3.81 cm
<p>Features</p> <p>Docking Station</p> <ul style="list-style-type: none"> - Dual powered USB ports; 1.5A for each port for connecting peripheral devices - Access to all control buttons, camera, ports and stylus while the tablet is safely docked - POGO pin connector and internal power supply provides power to charge the Samsung tablet while docked - Approximately 40" (101.6 cm) power cable with bare wire end - Push-button lock with key for theft deterrence - Composite design for reduced overall weight - Simple, one-handed cradle operation: <ul style="list-style-type: none"> - Insert bottom of Samsung tablet into the docking station and push top of the tablet in until the lock engages - Push latch button up with your thumb then remove the tablet from the docking station - VESA 75 mm and AMPS mounting patterns - MIL-STD 810G shock/vibration, RoHS, FCC, CE, and SAE J1455 crash certifications - 3-Year Limited Warranty <p>Y-Strap</p> <ul style="list-style-type: none"> - Improved productivity, ergonomics, and convenience - Comfortable and secure portability - Can be used in both portrait and landscape modes - Simply detach the plastic clip on the Y-Strap and drape over the back of the Gamber-Johnson dock when docking - 1 Year Limited Warranty 					
<p>Port Replicator</p> <ul style="list-style-type: none"> - (2) USB 1.1 1.5A each 					



SAMSUNG GALAXY TAB ACTIVE2/TAB ACTIVE3 CHARGING CRADLE KITS

Item No.	Description	Power Supply	Weight	Height	Width	Depth
7160-1313-00	Samsung Galaxy Tab Active2/Tab Active3 Charging Cradle with Power Adapter and Bare Wire Lead	Yes	0.44 lbs 0.2 kg	5.68" 14.43 cm	9.27" 23.55 cm	1.9" 4.83 cm
7160-1313-01	Samsung Galaxy Tab Active2/Tab Active3 Charging Cradle with Power Adapter and Cigarette Lighter Connector	Yes	0.44 lbs 0.2 kg	5.68" 14.43 cm	9.27" 23.55 cm	1.9" 4.83 cm
<p>Features</p> <ul style="list-style-type: none"> - Designed for the Samsung Galaxy Tab Active2/Tab Active3 rugged tablet with rugged case - Access to all control buttons and camera while docked - Cradle design is compatible with Samsung's built-in Near Field Communication (NFC); perform tasks with another NFC device without taking the Samsung tablet out of the cradle - USB-C charging port with integrated cable restraint (to connect to power supply), includes USB-C charging cable with bare wire end - 12-24V power input range to support a wide range of mobile applications - 5V, 3A Max of output - Simple, one-handed operation: <ul style="list-style-type: none"> - Insert bottom of the smartphone into the cradle, push top of the smartphone against top clip until clip engages - To remove, push up on top clip with thumb and pull smartphone out of cradle - AMPs mounting pattern - MIL-STD 810G shock/vibration, RoHS, FCC, CE, and SAE J1455 crash certifications - 3-Year Limited Warranty 						
<p>Port Replicator</p> <ul style="list-style-type: none"> - USB-C Power Input 						



NEW



SAMSUNG GALAXY TAB ACTIVE2/TAB ACTIVE3 CRADLE

Item No.	Description	Weight	Height	Width	Depth
7160-1313-02	Samsung Galaxy Tab Active2/Tab Active3 Cradle	0.44 lbs 0.2 kg	5.68" 14.43 cm	9.27" 23.55 cm	1.9" 4.83 cm

Features

- Designed for the Samsung Galaxy Tab Active2/Tab Active3 rugged tablet with rugged case
- Access to all control buttons and camera while docked
- Cradle design is compatible with Samsung's built-in Near Field Communication (NFC); perform tasks with another NFD device without taking the Samsung tablet out of the cradle
- Minimal design for weight reduction
- Simple, one-handed operation:
 - Insert bottom of the smartphone into the cradle, push top of the smartphone against top clip until clip engages
 - To remove, push up on top clip with thumb and pull smartphone out of cradle
- AMPS mounting pattern
- MIL-STD 810G shock/vibration, RoHS, FCC, CE, and SAE J1455 crash certifications
- 3-Year Limited Warranty



SAMSUNG GALAXY TAB ACTIVE2 POWER PASS THROUGH MODULE KIT

Item No.	Description	Placement	Height	Width	Depth
7160-1023-00	Samsung Power Pass Through Module Kit	Use with Samsung Galaxy Tab Active2 tablets and corresponding docking stations	3.12" 7.9 cm	4.06" 10.3 cm	.12" .30 cm

Features

- Replaces the tablet's battery and allows your tablet to be charged directly from the vehicle's power source using the docking station
- Works with Samsung Galaxy Tab Active2 tablets and docking stations, can also be used with the Samsung Galaxy Tab Active docking station
- Ideal solution when the tablet is intended to be permanently mounted
- **Kit Includes** Power Pass Through Module, Special tablet back cover

Warning: The Power Pass Through Module will not work with old tablets and will not work with other manufacturers products

NEW



SAMSUNG GALAXY TAB ACTIVE2/TAB ACTIVE3 ACCESSORIES

Item No.	Description	Placement	Weight	Height	Width	Depth
7160-1606	Samsung Tab Active2/Tab Active3 Tablet Protective Cover	Secured between Samsung Tab Active2/Tab Active3 Tablet Cradle/Dock and Mount	0.9 lbs 0.4 kg	7.8" 19.8 cm	13.5" 34.3 cm	2.5" 6.4 cm
7160-1607	Thermal Pad Insert Thermal Pad Insert	Velcros into 7160-1606 Samsung Tab Active2/Tab Active3 Protective Cover	0.4 lbs 0.1 kg	1.0" 2.5 cm	21.0" 53.3 cm	0.9" 2.3 cm
7300-0512-3	Samsung Tab Active2/Tab Active3 Replacement Screen	Attaches to existing Samsung Tab Active2/Tab Active3 Protective Cover (7160-1606)	0.1 lbs 0.1 kg	6.9" 17.5 cm	13.5" 34.3 cm	0.2" 0.5 cm

SAMSUNG GALAXY TAB ACTIVE PRO DOCKING STATION

Item No.	Description	Power Adapter Included	Weight	Height	Width	Depth
7160-1418-00	Samsung Galaxy Tab Active Pro Docking Station with Bare Wire Lead	No	1.3 lbs 0.58 kg	8.5" 21.5 cm	10.5" 26.6 cm	2.5" 6.35 cm
7160-1418-20	Samsung Galaxy Tab Active Pro Docking Station with Cigarette Lighter Connector	No	1.3 lbs 0.58 kg	8.5" 21.5 cm	10.5" 26.6 cm	2.5" 6.35 cm
7160-1418-30	Samsung Galaxy Tab Active Pro Docking Station with MP205 Connector	No	1.3 lbs 0.58 kg	8.5" 21.5 cm	10.5" 26.6 cm	2.5" 6.35 cm
7170-0697-00	Samsung Galaxy Tab Active Pro Docking Station with Hand Strap	No	1.3 lbs 0.58 kg	8.5" 21.5 cm	10.5" 26.6 cm	2.5" 6.35 cm
7170-0697-31	Samsung Galaxy Tab Active Pro Docking Station with AC Power Adapter	Yes	1.3 lbs 0.58 kg	8.5" 21.5 cm	10.5" 26.6 cm	2.5" 6.35 cm
7170-0697-32	Samsung Galaxy Tab Active Pro Docking Station with 12-32V Isolated Power Adapter	Yes	1.3 lbs 0.58 kg	8.5" 21.5 cm	10.5" 26.6 cm	2.5" 6.35 cm
7170-0697-33	Samsung Galaxy Tab Active Pro Docking Station with 20-60V Isolated Power Adapter	Yes	1.3 lbs 0.58 kg	8.5" 21.5 cm	10.5" 26.6 cm	2.5" 6.35 cm
7170-0697-34	Samsung Galaxy Tab Active Pro Docking Station with 70-110V Isolated Power Adapter	Yes	1.3 lbs 0.58 kg	8.5" 21.5 cm	10.5" 26.6 cm	2.5" 6.35 cm
7170-0698-00	Samsung Galaxy Tab Active Pro Docking Station with Hand Strap, Rugged Lite Keyboard with Quick Release Keyboard Tray	No	1.3 lbs 0.58 kg	8.5" 21.5 cm	10.5" 26.6 cm	2.5" 6.35 cm
7160-1465-00	Samsung Tab Active Pro Tablet Hand Strap	N/A	0.05 lbs 0.02 kg	0.87" 2.20 cm	10.75" 27.3 cm	3.12 7.92 cm

NEW



7160-1418-00



7160-1418-00



7160-1418-00

Features

- Designed for the Samsung Galaxy Tab Active Pro 10" rugged tablet with rugged case
- Dual powered USB ports; 1.5A for each port for connecting peripheral devices
- 10-40V power input range to support a wide range of mobile applications
- Access to all control buttons, camera, ports and stylus while the tablet is safely docked
- Dock design is compatible with Samsung's built-in Near Field Communication (NFC) allowing users to easily scan NFC cards while the Samsung tablet is in the docking station
- POGO pin connector and internal power supply provides power to charge the Samsung tablet while docked
- Composite design for reduced overall weight
- Can be mounted on a flat vertical surface
- Push-button lock with key for theft deterrence
- Approximately 66" (167.6 cm) power cable with bare wire end
- Simple, one-handed cradle operation:
 - Insert bottom of Samsung tablet into the docking station and push top of the tablet in until the lock engages
 - Push latch button up with your thumb then remove the tablet from the docking station
- VESA 75 mm mounting pattern making it easily compatible with Zirkona products and more
- MIL-STD 810G shock/vibration, RoHS, FCC, CE, and SAE J1455 crash certifications
- 3-Year Limited Warranty

Port Replicator

- (2) USB 2.0 1.5A each

NEW



SAMSUNG GALAXY TAB ACTIVE PRO CRADLE

Item No.	Description	Weight	Height	Width	Depth
7160-1418-90	Samsung Galaxy Tab Active Pro Cradle (No Electronics)	1.1 lbs 0.46 kg	8.5" 21.5 cm	10.5" 26.6 cm	2.5" 6.35 cm

Features

- Designed for the Samsung Galaxy Tab Active Pro 10" rugged tablet with rugged case
- Access to all control buttons, camera, ports and stylus while the tablet is safely docked
- Cradled design is compatible with Samsung's built-in Near Field Communication (NFC) allowing users to easily scan NFC cards while the Samsung tablet is in the docking station
- Composite design for reduced overall weight
- Can be mounted on a flat vertical surface
- Barrel Key lock for theft deterrence
- Simple, one-handed cradle and release operation:
 - Insert bottom of Samsung tablet into the cradle and push top of the tablet in until the lock engages
 - Push latch button up with your thumb then remove the tablet from the cradle
- VESA 75 mm mounting pattern making it easily compatible with Zirkona products and more
- MIL-STD 810G shock/vibration, RoHS, FCC, CE, and SAE J1455 crash certifications
- Lifetime Limited Warranty

NEW



2-IN-1 ATTACHABLE KEYBOARD FOR THE SAMSUNG GALAXY TAB ACTIVE PRO TABLET

Item No.	Description	Weight	Height	Width	Depth
7160-1450-00	2-in-1 Attachable Keyboard for the Samsung Galaxy Tab Active Pro Tablet	1.60 lbs 0.72 kg	1.5" 3.81 cm	10.31" 26.18 cm	7.56" 19.20 cm

Features

- Designed to fit Samsung Galaxy Tab Active Pro Tablet
- Easily connect the tablet to the keyboard; slip the bottom of the tablet into the case and snap the top of the case over the tablet
- Samsung S Pen is accessible when the tablet is docked in the keyboard case
- All the Samsung Tab Active Pro control buttons and rear camera are accessible when the tablet is docked onto the keyboard
- Friction hinge and screen footrest position the tablet at a comfortable viewing angle
- Low-profile ergonomic design for ease of use in a mobile environment
- Rubber feet to prevent slippage
- Integrated center touchpad with right and left mouse buttons
- 76-key keyboard with 12 function keys for custom operation
- Silicone rubber keys with white lettering and a rugged polycarbonate case
- POGO docking connector links the tablet to the keyboard
- USB-C port charges the tablet without having to separate it from the keyboard
- USB- A port to attach a mouse, another peripheral, or flash drive
- Easily connect the tablet to the keyboard; slip the bottom of the tablet into the case and snap the top of the case over the tablet
- Available in US English (7160-1450-00), UK (7160-1450-01), German (7160-1450-02), French (7160-1450-03), Spanish (7160-1450-04), French CA (7160-1450-05), and Thai (7160-1450-06). Contact Gamber-Johnson for other language options.
- Temperature range is -4° F (-20°C) to 140° F (60°C) when operating and -40° F (-40°C) to 185° F (85°C) for storage
- USB-A (2.0) Port: 5V@500mA
- Tablet input power: 5.4V, 1.5A
- MIL-STD 810G shock and vibration specifications, IP54 ingress specifications, Two million actuation per key, FCC CLASS-B (For - Home/Office Use), CE, RoHS, REACH
- 1 Year Limited Warranty (not designed to be vehicle mounted)

NEW



SAMSUNG GALAXY TAB ACTIVE PRO HAND STRAP

Item No.	Description	Weight	Height	Width	Depth
7160-1465-00	Hand Strap	0.05 lbs 0.02 kg	.87" 2.20 cm	10.75" 27.3 cm	3.12" 7.92 cm

Features

- Designed for the Samsung Galaxy Tab Active Pro 10" rugged tablet with rugged case
- Compatible with Gamber-Johnson's Tab Active Pro docking station - easily dock the tablet in the docking station with the hand strap attached
- Hand strap easily slips over the diagonal corners of the tablet
- Cushioned pad for comfort
- 1 Year Limited Warranty

SAMSUNG GALAXY TAB ACTIVE PRO DOCKING STATION KIT

Item No.	Description	Weight	Height	Width	Depth
7170-0698-00	Samsung Galaxy Tab Active Pro Docking Station Kit Kit Includes: Samsung Galaxy Tab Active Pro Docking Station (7160-1418-00), Rugged Lite Keyboard (7160-1449-00), Quick Release Keyboard Cradle (7160-1470-00) and Hand Strap (7160-1465-00)				
7160-1418-00	Samsung Tab Active Pro Docking Station	1.3 lbs .58 kg	8.5" 21.5 cm	10.5" 26.6 cm	2.5" 6.35 cm
7160-1449-00	Rugged Lite Keyboard	1 lbs 0.45 kg	0.68" 1.72 cm	10.31" 26.18 cm	7.12" 18.08 cm
7160-1470-00	Quick Release Keyboard Cradle	0.55 lbs. 0.25 kg	1.01" 2.53 cm	5.5" 13.97 cm	7.35" 18.66 cm
7160-1465-00	Samsung Tab Active Pro Hand Strap	0.05 lbs .02 kg	.87" 2.20 cm	10.75" 27.3 cm	3.12" 7.92 cm

Features

Docking Station

- Dual powered USB ports; 1.5A for each port for connecting peripheral devices
- 10-40V power input range to support a wide range of mobile applications
- Access to all control buttons, camera, ports and stylus while the tablet is safely docked
- POGO pin connector and internal power supply provides power to charge the Samsung tablet while docked
- 3-Year Limited Warranty

Rugged Lite Keyboard

- Integrated center Touchpad with right and left mouse button
- 76-key keyboard with 12 function keys for custom operation
- Supports Windows (XP or Above), Android, Linux, and Mac OS / iOS platforms
- Available in US English (7160-1449-00), UK (7160-1449-01), German (7160-1449-02), French (7160-1449-03), and Spanish (7160-1449-04). Contact Gamber-Johnson for other language options
- Visit gamberjohnson.com for full list of product specifications
- MIL-STD 810G shock/vibration, SAE J1455, RoHS, FCC, CE, REACH
- 1 Year Limited Warranty

Quick Release Keyboard Cradle

- Compatible with Gamber-Johnson USB Mobile Keyboard (7160-1449-00)
- Easily insert or release the USB keyboard:
- Insert bottom of keyboard into tray, match indents in keyboard with hooks on tray, then push top of keyboard into tray and engage latch
- To remove, push latch to disengage and pull keyboard out of computer out of tray
- VESA 75 mm mounting pattern, attaches to most Gamber-Johnson motion attachments
- Black powder coat finish
- Keyboard can be permanently attached to keyboard cradle using two #6 machine screws
- Limited Lifetime Warranty

Hand Strap

- Hand strap easily slips over the diagonal corners of the tablet
- Cushioned pad for comfort
- 1 Year Limited Warranty

NEW



7160-1418-00



7160-1449-00



7160-1470-00



7160-1465-00

GAMBER-JOHNSON'S RUGGED LITE KEYBOARD

Item No.	Description	Weight	Height	Width	Depth
7160-1449-00	Rugged Lite Keyboard	1 lbs 0.45 kg	0.68 in 1.72 cm	10.31 in 26.18 cm	7.12 in 18.08 cm

Features

- Integrated center Touchpad with right and left mouse buttons
- 76-key keyboard with 12 function keys for custom operation
- Low-profile ergonomic design for ease of use in a mobile environment
- Equipped with an emergency key that is configurable and be used to send for emergency help or assistance to dispatch
- Silicone rubber keys with white lettering and a rugged ABS polycarbonate case
- USB Type A male connector (coiled cable) input cable
- Supports Windows (XP or Above), Android, Linux, and Mac OS / iOS platforms
- USB- A port to attach a mouse, another peripheral, or flash drive (USB 2.0 500mA)
- Rubber feet to prevent slippage
- Power: 5Vdc @ <500mA from data cord
- Keyboard is compatible with Gamber-Johnson quick release keyboard cradle (7160-1470-00). Keyboard can be permanently attached to keyboard cradle using two #6 machine screws.
- Available in US English (7160-1449-00), UK (7160-1449-01), German (7160-1449-02), French (7160-1449-03), and Spanish (7160-1449-04). Contact Gamber-Johnson for other language options.
- Temperature range is -4° F (-20°C) to 140° F (60°C) when operating and -40° F (-40°C) to 185° F (85°C) for storage
- Designed to IP54 ingress specifications
- Tested to two million actuation per key
- MIL-STD 810G shock/vibration, SAE J1455, RoHS, FCC, CE, REACH
- 1 Year Limited Warranty

NEW



NEW



QUICK RELEASE KEYBOARD CRADLE

Item No.	Description	Weight	Height	Width	Depth
7160-1470-00	Quick Release Keyboard Cradle	0.55 lbs. 0.25 kg	1.01" 2.53 cm	5.5" 13.97 cm	7.35" 18.66 cm

Features

- Compatible with Gamber-Johnson Rugged Lite Keyboard (7160-1449-00)
- Easily insert or release the Rugged Lite Keyboard:
 - Insert bottom of keyboard into cradle, match indents in keyboard with hooks on cradle, then push top of keyboard into cradle and engage latch
 - To remove, push latch to disengage and pull keyboard out of cradle
- Black powder coat finish
- Keyboard can be permanently attached to keyboard cradle using two #6 machine screws
- VESA 75 mm mounting pattern (#8 mounting studs), attach to most Gamber-Johnson motion attachments
- Limited Lifetime Warranty

NEW



RUGGED LITE KEYBOARD AND QUICK RELEASE KEYBOARD CRADLE KIT

Item No.	Description	Weight	Height	Width	Depth
7170-0817-00	Rugged Lite Keyboard and Quick Release Keyboard Cradle Kit Kit Includes: Rugged Lite Keyboard (7160-1449-00) and Quick Release Keyboard Cradle (7160-1470-00)				
7160-1449-00	Rugged Lite Keyboard	0.25 lbs 0.11 kg	1.01" 2.53 cm	5.5" 13.97 cm	7.35" 18.66 cm
7160-1470-00	Quick Release Keyboard Cradle	1 lbs 0.45 kg	0.56" 1.42 cm	10.31" 26.18 cm	7.12" 18.08 cm

Features

Rugged Lite Keyboard

- Integrated center Touchpad with right and left mouse button
- 76-key keyboard with 12 function keys for custom operation
- Low-profile ergonomic design for ease of use in a mobile environment
- Equipped with an emergency key that is configurable and be used to send for emergency help or assistance to dispatch
- Silicone rubber keys with white lettering and a rugged ABS poly-carbonate case
- USB Type A male connector (coiled cable) input cable
- Supports Windows (XP or Above), Android, Linux, and Mac OS / iOS platforms
- USB- A port to attach a mouse, another peripheral, or flash drive (USB 2.0 500mA)
- Rubber feet to prevent slippage
- Keyboard is compatible with Gamber-Johnson quick release keyboard cradle (7160-1470-00)
- Available in US English (7160-1449-00), UK (7160-1449-01), German (7160-1449-02), French (7160-1449-03), and Spanish (7160-1449-04). Contact Gamber-Johnson for other language options
- 1 Year Limited Warranty

Quick Release Keyboard Cradle

- Compatible with Gamber-Johnson USB Mobile Keyboard (7160-1449-00)
- Easily insert or release the USB keyboard:
 - Insert bottom of keyboard into tray, match indents in keyboard with hooks on tray, then push top of keyboard into tray and engage latch
 - To remove, push latch to disengage and pull keyboard out of computer out of tray
- VESA 75 mm mounting pattern, attaches to most Gamber-Johnson motion attachments
- Black powder coat finish
- Keyboard can be permanently attached to keyboard cradle using two #6 machine screws
- Limited Lifetime Warranty

SAMSUNG GALAXY XCOVER PRO CHARGING CRADLE

Item No.	Description	Weight	Height	Width	Depth
7160-1488-00	Samsung Galaxy XCover Pro Charging Cradle with Bare Wire Lead	0.18 lbs 0.08 kg	7.1" 18.03 cm	3.4" 8.64 cm	1.7" 4.32 cm
7160-1488-10	Samsung Galaxy XCover Pro Charging Cradle with Cigarette Lighter Connector	0.18 lbs 0.08 kg	7.1" 18.03 cm	3.4" 8.64 cm	1.7" 4.32 cm

Features

- Designed for the Samsung Galaxy XCover Pro 6" rugged Smartphone without accessories
- 5-36V power input range to support a wide range of mobile applications
- Access to all control buttons and camera while docked
- Charging cradle design is compatible with Samsung's built-in Near Field Communication (NFC); scan NFC cards while the Samsung phone is in the charging cradle
- POGO pin connector and internal power supply provides power to charge the Samsung phone while docked
- USB-C charging port with integrated cable restraint, includes USB-C charging cable with bare wire end
- Minimal design for weight reduction
- Simple, one-handed operation:
 - Insert bottom of the smartphone into the cradle, push top of the smartphone against top clip until clip engages
 - To remove, push up on top clip with thumb and pull smartphone out of cradle
- USB-C charging port with integrated cable restraint, includes USB-C charging cable with bare wire end
- AMPS mounting pattern
- MIL-STD 810G shock/vibration, RoHS, FCC, CE, and SAE J1455 crash certifications
- 1 Year Limited Warranty

NEW



SAMSUNG GALAXY XCOVER PRO CRADLE

Item No.	Description	Weight	Height	Width	Depth
7160-1488-90	Samsung Galaxy XCover Pro Cradle (No Electronics)	0.18 lbs 0.08 kg	7.1" 18.03 cm	3.4" 8.64 cm	1.7" 4.32 cm

Features

- Designed for the Samsung Galaxy XCover Pro 6" rugged Smartphone without accessories
- Access to all control buttons and camera while docked
- Cradle design is compatible with Samsung's built-in Near Field Communication (NFC); scan NFC cards while the Samsung phone is in the cradle
- Minimal design for weight reduction
- Cradle can be mounted on a flat surface
- Simple, one-handed operation:
 - Insert bottom of the smartphone into the cradle, push top of the smartphone against top clip until clip engages
 - To remove, push up on top clip with thumb and pull smartphone out of cradle
- AMPS mounting pattern
- MIL-STD 810G shock/vibration, RoHS, FCC, CE, and SAE J1455 crash certifications
- 1 Year Limited Warranty

NEW



SAMSUNG DeX HEADS UP VEHICLE KIT

NEW



7170-0757-00



7160-1449-00



7160-1470-00

Item No.	Description	Weight	Height	Width	Depth
7170-0757-00	DeX Heads Up Vehicle Kit Kit Includes: 13.3" Capacitive Touch Screen (7160-1451-00), Rugged USB Hub (7160-1393-00), Rugged Lite Keyboard (7160-1449-00), Quick Release Keyboard Cradle (7160-1470-00), Heads Up Mounting Bracket (18540) and Heads Up Articulating Mount (7110-1237)				
7160-1451-00	13.3" Capacitive Touch Screen	6.65 lbs 3.02 kg	9.94" 25.25 cm	13.75" 34.93 cm	1.57" 3.99 cm
7160-1393-00	Rugged USB Hub	0.25 lbs 0.11 kg	2.05" 5.21 cm	4.36" 11.07 cm	5.62" 14.27 cm
7160-1449-00	Rugged Lite Keyboard	1 lbs 0.45 kg	0.68" 1.73 cm	10.31" 26.19 cm	7.12" 18.08 cm
7160-1470-00	Quick Release Keyboard Cradle	0.55 lbs 0.25 kg	1.01" 2.57 cm	10.31" 26.19 cm	7.35" 18.67 cm
18540	Heads Up Mounting Bracket	0.74 lbs 0.34 kg	0.5" 1.27 cm	12" 30.48 cm	5.75" 14.61 cm
7110-1237	Heads Up Articulating Mount	0.2 lbs 0.09 kg	2.75" 6.99 cm	2.12" 5.38 cm	2.12" 5.38 cm

Features

- Add a compatible Heads Up Smartphone Docking Station (7160-1394-XX) to complete your DeX vehicle solution. Must Order Separately
- Smartphone requires a Rebel Smartphone Case (18551-XX) to be compatible with the smartphone docking station. Must Order Separately.
- Our DeX Heads Up vehicle solution positions the smartphone dock next to the touchscreen where you can use your phone as a secondary screen or a touchpad device
- Screen is 13.3" with a 5-point capacitive touchscreen, high resolution 1920 x 1080, and adjustable brightness (50-1000 nits)
- Mount the 13.3" touchscreen to a Gamber-Johnson close-to-dash mount (7160-1346 or 7160-0822) or tablet display mount (7160-0529 or 7160-0494) for optimal viewing
- The Rugged USB hub provides port replication to connect all peripherals; conceal under the instrument panel, or console box or mounted to the heads up mount bracket
- Rugged Lite Keyboard features an integrated center touchpad with right and left mouse button and 76-key keyboard with 12 function keys for custom operation
- Quick release keyboard cradle allows users to remove keyboard to a different work surface and return to the keyboard mount when complete
- Gamber-Johnson offers several DeX solutions including:
 - The DeX Armrest Vehicle solution that positions the smartphone dock in the vehicle armrest next to the driver where it is out of the way but still accessible
 - The DeX Desktop solution that enable the mobile worker to transition from vehicle to desktop seamlessly
- MIL-STD 810G shock/vibration, SAE J1455, FCC, CE, RCM, RoHS, REACH,
- See individual kit components for warranty details

Note: Visit gamberjohnson.com for full list of product specifications

SAMSUNG DeX HEADS UP VEHICLE KIT WITHOUT KEYBOARD

NEW



7170-0757-01

Item No.	Description	Weight	Height	Width	Depth
7170-0757-01	DeX Heads Up Vehicle Kit without Keyboard Kit Includes: 13.3" Capacitive Touch Screen (7160-1451-00), Rugged USB Hub (7160-1393-00), Heads Up Mounting Bracket (18540) and Heads Up Articulating Mount (7110-1237)				
7160-1451-00	13.3" Capacitive Touch Screen	6.65 lbs 3.02 kg	9.94" 25.25 cm	13.75" 34.93 cm	1.57" 3.99 cm
7160-1393-00	Rugged USB Hub	0.25 lbs 0.11 kg	2.05" 5.21 cm	4.36" 11.07 cm	5.62" 14.27 cm
18540	Heads Up Mounting Bracket	0.74 lbs 0.34 kg	0.5" 1.27 cm	12" 30.48 cm	5.75" 14.61 cm
7110-1237	Heads Up Articulating Mount	0.2 lbs 0.09 kg	2.75" 6.99 cm	2.12" 5.38 cm	2.12" 5.38 cm

Features

- Add a compatible Heads Up Smartphone Docking Station (7160-1394-XX) to complete your DeX vehicle solution. Must Order Separately
- Smartphone requires a Rebel Smartphone Case (18551-XX) to be compatible with the smartphone docking station. Must Order Separately.
- Our DeX Heads Up vehicle solution positions the smartphone dock next to the touchscreen where you can use your phone as a secondary screen or a touchpad device
- Screen is 13.3" with a 5-point capacitive touchscreen, high resolution 1920 x 1080, and adjustable brightness (50-1000 nits)
- Mount the 13.3" touchscreen to a Gamber-Johnson close-to-dash mount (7160-1346 or 7160-0822) or tablet display mount (7160-0529 or 7160-0494) for optimal viewing
- The Rugged USB Hub provides port replication to connect all peripherals; conceal under the instrument panel, or console box or mounted to the heads up mounting bracket
- Gamber-Johnson offers several DeX solutions including:
 - The DeX Armrest Vehicle solution that positions the smartphone dock in the vehicle armrest next to the driver where it is out of the way but still accessible
 - The DeX Desktop solution that enable the mobile worker to transition from vehicle to desktop seamlessly
- MIL-STD 810G shock/vibration, SAE J1455, FCC, CE, RCM, RoHS, REACH,
- See individual kit components for warranty details

Note: Visit gamberjohnson.com for full list of product specifications

SAMSUNG DeX ARMREST VEHICLE SOLUTION KIT

Item No.	Description	Weight	Height	Width	Depth
7170-0760-00	DeX Armrest Vehicle Solution Kit Kit Includes: 13.3" Capacitive Touch Screen (7160-1451-00), Rugged USB Hub (7160-1393-00), Rugged Lite Keyboard (7160-1449-00), Quick Release Keyboard Cradle (7160-1470-00)				
7160-1451-00	13.3" Capacitive Touch Screen	6.65 lbs 3.02 kg	9.94" 25.25 cm	13.75" 34.93 cm	1.57" 3.99 cm
7160-1393-00	Rugged USB Hub	0.25 lbs 0.11 kg	2.05" 5.21 cm	4.36" 11.07 cm	5.62" 14.27 cm
7160-1449-00	Rugged Lite Keyboard	1 lbs 0.45 kg	0.68" 1.73 cm	10.31" 26.19 cm	7.12" 18.08 cm
7160-1470-00	Quick Release Keyboard Cradle	0.55 lbs 0.25 kg	1.01" 2.57 cm	5.5" 13.97 cm	7.35" 18.67 cm

Features

- Add a compatible Armrest Smartphone Dock (7160-1489-XX) to complete your DeX vehicle solution. Must Order Separately
- Smartphone requires a Rebel Smartphone Case (18551-XX) to be compatible with the smartphone docking station. Must Order Separately.
- Our DeX Armrest Vehicle solution positions the smartphone dock in the vehicle armrest next to the driver where it is out of the way but still accessible
- Smartphone Dock can easily be changed to accept a variety of Samsung Galaxy/ DeX compatible smartphones
- Screen is 13.3" with a 5-point capacitive touchscreen, high resolution 1920 x 1080, and adjustable brightness (50-1000 nits)
- Mount the 13.3" touchscreen to a Gamber-Johnson close-to-dash mount (7160-1346 or 7160-0822) or tablet display mount (7160-0529 or 7160-0494) for optimal viewing
- The Rugged USB Hub provides port replication to connect all peripherals; conceal under the instrument panel, or console box or mounted to the heads up mount bracket
- Rugged Lite Keyboard features an integrated center touchpad with right and left mouse button and 76-key keyboard with 12 function keys for custom operation
- Quick release keyboard cradle allows users to remove keyboard and move to a different work surface then return to the keyboard mount when complete
- Gamber-Johnson offers several DeX solutions including:
 - The DeX Armrest Vehicle solution that positions the smartphone dock in the vehicle armrest next to the driver where it is out of the way but still accessible
 - The DeX Desktop solution that enable the mobile worker to transition from vehicle to desktop seamlessly
- MIL-STD 810G shock/vibration, SAE J1455, FCC, CE, RCM, RoHS, REACH,
- See individual kit components for warranty details

Note: Visit gamberjohnson.com for full list of product specifications



SAMSUNG DeX ARMREST VEHICLE SOLUTION KIT WITHOUT KEYBOARD

Item No.	Description	Weight	Height	Width	Depth
7170-0760-01	DeX Armrest Vehicle Solution Kit without Keyboard Kit Includes: 13.3" Capacitive Touch Screen (7160-1451-00), Rugged USB Hub (7160-1393-00)				
7160-1451-00	13.3" Capacitive Touch Screen	6.65 lbs 3.02 kg	9.94" 25.25 cm	13.75" 34.93 cm	1.57" 3.99 cm
7160-1393-00	Rugged USB Hub	0.25 lbs 0.11 kg	2.05" 5.21 cm	4.36" 11.07 cm	5.62" 14.27 cm

Features

- Add a compatible Armrest Smartphone Dock (7160-1489-XX) to complete your DeX vehicle solution. Must Order Separately
- Smartphone requires a Rebel Smartphone Case (18551-XX) to be compatible with the smartphone docking station. Must Order Separately.
- Our DeX Armrest Vehicle solution positions the smartphone dock in the vehicle armrest next to the driver where it is out of the way but still accessible
- Smartphone Dock can easily be changed to accept a variety of Samsung Galaxy/ DeX compatible smartphones
- Screen is 13.3" with a 5-point capacitive touchscreen, high resolution 1920 x 1080, and adjustable brightness (50-1000 nits)
- Mount the 13.3" touchscreen to a Gamber-Johnson close-to-dash mount (7160-1346 or 7160-0822) or tablet display mount (7160-0529 or 7160-0494) for optimal viewing
- The Rugged USB hub provides port replication to connect all peripherals; conceal under the instrument panel, or console box or mounted to the heads up mount bracket
- Gamber-Johnson offers several DeX solutions including:
 - The DeX Armrest Vehicle solution that positions the smartphone dock in the vehicle armrest next to the driver where it is out of the way but still accessible
 - The DeX Desktop solution that enable the mobile worker to transition from vehicle to desktop seamlessly
- Contact Gamber-Johnson for more information about their DeX solution kits and DeX components and accessories
- MIL-STD 810G shock/vibration, SAE J1455, FCC, CE, RCM, RoHS, REACH,
- 1 Year Limited Warranty

Note: Visit gamberjohnson.com for full list of product specifications



NEW



7170-0759-00

SAMSUNG DeX DESKTOP SOLUTION KIT

Item No.	Description	Weight	Height	Width/ Diameter	Depth
7170-0759-00	DeX Desktop Solution Kit Kit Includes: Rugged USB Hub (7160-1393-00), Zirkona 50 mm Extension (14141), Zirkona Thread Adapter (14145), Zirkona Suction Cup (7110-1232), and Zirkona Small Joiner (7110-1234)				
7160-1393-00	Rugged USB Hub	0.25 lbs 0.11 kg	2.05" 5.21 cm	4.36" 11.07 cm	5.62" 14.27 cm
14141	Zirkona 2" (50 mm) Extension	0.05 lbs 0.02 kg	2" 5.08 cm	1" 2.54 cm	
14145	Zirkona Threaded Adapter	0.05 lbs 0.02 kg	1" 2.54 cm	0.77" 1.96 cm	
7110-1234	Zirkona Small Joiner	0.25 lbs 0.11 kg	3.62" 9.19 cm	1.26" 3.20 cm	2.75" 6.99 cm
7110-1232	Zirkona Suction Cup	0.8 lbs 0.36 kg	2" 5.08 cm	4.75" 12.07	

Features

- Dock your mobile smartphone to quickly transform your phone content to a full desktop experience
- Add a compatible Desktop Smartphone Dock (7160-1396-XX) to complete your DeX desktop solution. Must Order Separately
- Smartphone requires a Rebel Smartphone Case (18551-XX) to be compatible with the smartphone docking station. Must Order Separately.
- Includes a USB-C docking connector and a 6" USB-C cable with female connector
- Dock can be changed to be compatible with a different Galaxy phone model
- Utilize USB 3.0 ports to connect to a host of external devices, two fast-charging 3.0 ports
- Mounts to non-porous surfaces for a quick and temporary mount
- Quick-release latch, easy one-hand operation
 - To install: Slide Smartphone with special phone case into docking station until top latch snaps over the top of the phone
 - To release: Push top latch up and away from phone and simultaneously slide phone up and tilt out of case
- Assembly Required
- 3-Year Limited Warranty

Note: Visit gamberjohnson.com for full list of product specifications

NEW



7170-0758-00

RUGGED USB HUB AND HEADS UP MOUNT KIT

Item No.	Description	Weight	Height	Width/ Diameter	Depth
7170-0758-00	Rugged USB Hub and Heads Up Mount Kit Kit Includes: Rugged USB Hub (7160-1393-00), Heads Up Mounting Bracket (18540) and Heads Up Articulating Mount (7110-1237)				
7160-1393-00	Rugged USB Hub	0.25 lbs 0.11 kg	2.05" 5.21 cm	4.36" 11.07 cm	5.62" 14.27 cm
18540	Heads Up Mounting Bracket	0.74 lbs 0.34 kg	0.5" 1.27 cm	12" 30.48 cm	5.75" 14.61 cm
7110-1237	Heads Up Articulating Mount	0.2 lbs 0.09 kg	2.75" 6.99 cm	2.12" 5.38 cm	2.12" 5.38 cm

Features

Rugged USB Hub

- Utilize this multi-port adapter hub to connect devices for a complete mobile office solution or DeX mobile solution
- Supports 4K HD screen expansion for multimedia capabilities
- Gigabit Ethernet port for hassle-free internet connectivity
- Utilize USB 3.0 ports to connect to a host of external devices, two fast-charging 3.0 ports
- USB-C port (fast-charging) to connect a DeX Smartphone Docking Station or other USB-C supported device
- Rugged case with cable restraints and mounting holes; attach to a VESA 75 mm mount or directly to
 - Heads Up Mounting Bracket (18540)
- 3 Year Limited Warranty

Heads Up Mounting Bracket

- Allows users to position their DeX smartphone docking station next to your touchscreen for ideal mobile viewing
- Attaches between the touchscreen and touchscreen mount. Align the slots on the mounting bracket with the VESA 75 mm mounting holes on your touchscreen display to attach the bracket
- Gamber-Johnson offers several DeX solutions including:
 - The DeX Armrest Vehicle solution that positions the smartphone dock in the vehicle armrest next to the driver where it is out of the way but still accessible
 - The DeX Desktop solution that enable the mobile worker to transition from vehicle to desktop seamlessly
- MIL-STD 810G shock/vibration, SAE J1455, FCC, CE, RCM, RoHS, REACH
- Limited Lifetime Warranty

Note: Visit gamberjohnson.com for full list of product specifications

SAMSUNG DeX HEADS UP SMARTPHONE DOCKING STATIONS

Item No.	Description	Weight	Height	Width	Depth
7160-1394-XX	DeX Heads Up Smartphone Docking Stations				
7160-1394-00	Note9 Docking Station without Phone Case	0.3 lbs 0.14 kg	9" 22.86 cm	3.75" 9.53 cm	1.25" 3.18 cm
7160-1394-01	S9+ Docking Station without Phone Case	0.3 lbs 0.14 kg	9" 22.86 cm	3.75" 9.53 cm	1.25" 3.18 cm
7160-1394-02	S9 Docking Station without Phone Case	0.3 lbs 0.14 kg	9" 22.86 cm	3.75" 9.53 cm	1.25" 3.18 cm
7160-1394-03	S10+ Docking Station Without Phone Case	0.3 lbs 0.14 kg	9" 22.86 cm	3.75" 9.53 cm	1.25" 3.18 cm
7160-1394-04	S10 Docking Station without without Phone Case	0.3 lbs 0.14 kg	9" 22.86 cm	3.75" 9.53 cm	1.25" 3.18 cm
7160-1394-05	Note10 Docking Station without Phone Case	0.3 lbs 0.14 kg	9" 22.86 cm	3.75" 9.53 cm	1.25" 3.18 cm
7160-1394-06	Note10+ Docking Station without Phone Case	0.3 lbs 0.14 kg	9" 22.86 cm	3.75" 9.53 cm	1.25" 3.18 cm
7160-1394-07	S10e Docking Station without Phone Case	0.3 lbs 0.14 kg	9" 22.86 cm	3.75" 9.53 cm	1.25" 3.18 cm



Features

- Dock your mobile smartphone to quickly transform your phone to a full desktop experience
- Compatible with a variety of Samsung Galaxy phones (Note 9, Note10, Note10+, S9, S9+, S10, S10+, S10e)
- Includes a USB-C docking connector and a 6" USB-C cable with female connector
- Dock can be changed to be compatible with a different Galaxy phone model
- Quick-release latch for easy one-hand operation
 - To install: Slide Smartphone with special phone case into docking station until top latch snaps over the top of the phone
 - To release: Push top latch up and away from phone and simultaneously slide phone up and tilt out of case
- Smartphone requires a Rebel phone case to be compatible with the smartphone docking station; (18551-00 Note9), (18551-01 S9+), (18551-02 S9), (18551-03 S10+), (18551-04 S10), (18551-05 Note10), (18551-06 Note10+) and (18551-07 S10e).
Must Order Separately.
- MIL-STD 810G shock/vibration, SAE J1455, FCC, CE, RCM, RoHS, REACH,
- 3-Year Limited Warranty

Note: Visit gamberjohnson.com for full list of product specifications

SAMSUNG DeX ARMREST SMARTPHONE DOCKING STATIONS

NEW



7160-1489-XX

Item No.	Description	Weight	Height	Width	Depth
7160-1489-XX	DeX Armrest Smartphone Docking Stations				
7160-1489-00	Note9 Armrest Docking Station without Phone Case	6.4 lbs 2.9 kg	10.25" 26.04 cm	5.25" 13.34 cm	12" 25.4 cm
7160-1489-01	S9+ Armrest Docking Station without Phone Case	6.4 lbs 2.9 kg	10.25" 26.04 cm	5.25" 13.34 cm	12" 25.4 cm
7160-1489-02	S9 Armrest Docking Station without Phone Case	6.4 lbs 2.9 kg	10.25" 26.04 cm	5.25" 13.34 cm	12" 25.4 cm
7160-1489-03	S10+ Armrest Docking Station without Phone Case	6.4 lbs 2.9 kg	10.25" 26.04 cm	5.25" 13.34 cm	12" 25.4 cm
7160-1489-04	S10 Armrest Docking Station without Phone Case	6.4 lbs 2.9 kg	10.25" 26.04 cm	5.25" 13.34 cm	12" 25.4 cm
7160-1489-05	Note10 Armrest Docking Station without Phone Case	6.4 lbs 2.9 kg	10.25" 26.04 cm	5.25" 13.34 cm	12" 25.4 cm
7160-1489-06	Note10+ Armrest Docking Station without Phone Case	6.4 lbs 2.9 kg	10.25" 26.04 cm	5.25" 13.34 cm	12" 25.4 cm
7160-1489-07	S10e Armrest Docking Station without Phone Case	6.4 lbs 2.9 kg	10.25" 26.04 cm	5.25" 13.34 cm	12" 25.4 cm

Features

- Dock your mobile smartphone conveniently under a vehicle armrest where it remains accessible but out of the way
- Compatible with a variety of Samsung Galaxy phones (Note 9, Note10, Note10+, S9, S9+, S10, S10+, S10e)
- Includes a USB-C docking connector and a 6" USB-C cable with female connector
- Dock can be changed to be compatible with a different Galaxy phone model
- Smartphone requires a Rebel Smartphone Case (18551-XX) to be compatible with the smartphone docking station. Must Order Separately.
- Sleek, padded armrest flips up for convenience
- Attaches to any Chevrolet Caprice PPV Console Box, Chevrolet Tahoe Console Box, Dodge Charger Console Box, Dodge Durango SSV Console Box or Ford Police Interceptor Sedan and Utility Console Box via threaded PEM's and hardware
- Heavy gauge steel construction for long-term durability
- Black powdercoat finish for maximum corrosion resistance
- Quick-release latch, easy one-hand operation:
 - To install: Slide Smartphone with special phone case into docking station until top latch snaps over the top of the phone
 - To release: Push top latch down and away from the phone and simultaneously slide phone out and tilt out of case
- MIL-STD 810G shock/vibration, SAE J1455, FCC, CE, RCM, RoHS, REACH
- 3-Year Limited Warranty on electronic components of the Smartphone Docking Station
- Limited Lifetime Warranty on Armrest

Note: Visit gamberjohnson.com for full list of product specifications

SAMSUNG DeX DESKTOP SMARTPHONE DOCKING STATIONS

NEW



7160-1396-XX

Item No.	Description	Weight	Height	Width	Depth
7160-1396-XX	DeX Desktop Smartphone Docking Stations without Phone Case				
7160-1396-00	Note9 Docking Stations without Phone Case	0.3 lbs 0.14 kg	9" 22.86 cm	3.75" 9.53 cm	1.25" 3.18 cm
7160-1396-01	S9+ Docking Stations without Phone Case	0.3 lbs 0.14 kg	9" 22.86 cm	3.75" 9.53 cm	1.25" 3.18 cm
7160-1396-02	S9 Docking Stations without Phone Case	0.3 lbs 0.14 kg	9" 22.86 cm	3.75" 9.53 cm	1.25" 3.18 cm
7160-1396-03	S10+ Docking Stations without Phone Case	0.3 lbs 0.14 kg	9" 22.86 cm	3.75" 9.53 cm	1.25" 3.18 cm
7160-1396-04	S10 Docking Stations without Phone Case	0.3 lbs 0.14 kg	9" 22.86 cm	3.75" 9.53 cm	1.25" 3.18 cm
7160-1396-05	Note10 Docking Stations without Phone Case	0.3 lbs 0.14 kg	9" 22.86 cm	3.75" 9.53 cm	1.25" 3.18 cm
7160-1396-06	Note10+ Docking Stations without Phone Case	0.3 lbs 0.14 kg	9" 22.86 cm	3.75" 9.53 cm	1.25" 3.18 cm
7160-1396-07	S10e Docking Stations without Phone Case	0.3 lbs 0.14 kg	9" 22.86 cm	3.75" 9.53 cm	1.25" 3.18 cm

Features

- Dock your mobile smartphone to quickly transform your phone content to a full desktop experience
- Smartphone requires a Rebel Smartphone Case (18551-XX) to be compatible with the smartphone docking station. Must Order Separately.
- Includes a USB-C docking connector and a 6" USB-C cable with female connector
- Dock can be changed to be compatible with a different Galaxy phone model
- Quick-release latch, easy one-hand operation
 - To install: Slide Smartphone with special phone case into docking station until top latch snaps over the top of the phone
 - To release: Push top latch up and away from phone and simultaneously slide phone up and tilt out of case
- Dock can be changed to be compatible with a different Galaxy phone model
- Easily combine Smartphone dock with Zirkona mounting products to mount on a desktop surface
- 3-Year Limited Warranty

Note: Visit gamberjohnson.com for full list of product specifications

REBEL SMARTPHONE CASE

Item No.	Description	Weight	Height	Width	Depth
18551-XX	DeX Rebel Smartphone Case by Encased is required for most DeX Docking Stations and set ups				
18551-00	Note9 DeX Smartphone Case	0.35 lbs kg	9" 22.86 cm	5" 12.7 cm	1.4" 3.56 cm
18551-01	S9+ DeX Smartphone Case	0.125 lbs kg	9" 22.86 cm	5" 12.7 cm	0.5" 1.27 cm
18551-02	S9 DeX Smartphone Case	0.08 lbs kg	9" 22.86 cm	5" 12.7 cm	0.5" 1.27 cm
18551-03	S10+ DeX Smartphone Case	0.18 lbs kg	9" 22.86 cm	5" 12.7 cm	1.4" 3.56 cm
18551-04	S10 DeX Smartphone Case	0.18 lbs kg	9" 22.86 cm	5" 12.7 cm	1.4" 3.56 cm
18551-05	Note10 DeX Smartphone Case	0.125 lbs kg	9" 22.86 cm	5" 12.7 cm	0.5" 1.27 cm
18551-06	Note10+ DeX Smartphone Case	0.125 lbs kg	9" 22.86 cm	5" 12.7 cm	0.5" 1.27 cm
18551-07	S10e DeX Smartphone Case	0.18 lbs kg	9" 22.86 cm	5" 12.7 cm	1.4" 3.56 cm

NEW



18551-XX

Features

- Required phone case must be used with the Samsung Galaxy Smartphone to be compatible with Gamber-Johnson's DeX Smartphone Docking Stations and solutions
- Designed to fit DeX Compatible Samsung Galaxy phones (Note 9, S9, S9+, Note10, Note10+, S10, S10+, S10e)
- Fully bonded 2-piece structure providing robust dual layer protection with a 10' fall impact rating
- Solid-core frame and a edge-to-edge rubber layer for added impact absorption
- Reinforced corners and a raised front lip offer additional protection
- Responsive easy-press buttons retain the original tactile click and button feel.
- Encased Warranty - Unconditional Lifetime Happiness Guarantee

13.3" CAPACITIVE TOUCH SCREEN

Item No.	Description	Weight	Height	Width	Depth
7160-1451-00	13.3" Capacitive Touch Screen	6.7 lbs 3.04 kg	9.94" 25.25 cm	13.75" 34.93 cm	1.57" 3.99 cm

NEW



7160-1451-00

Features

- Ideal device to extend the use of your DeX optimized smartphone
- Combine this touch screen with a Gamber-Johnson DeX compatible Smartphone Docking Station , Rugged USB Hub (7160-1393-00), and Rugged Lite Keyboard (7160-1449-00) for a complete DeX mobile office solution.
- 13.3" touch screen display, high resolution 1920 x 1080, brightness is 50-1000 nits and is easily adjustable
- Ambient light sensor automatically adjusts screen brightness
- 5-Point multi-touch technology for better accuracy and fluidity (speed) providing greater support for smartphone gesture support
- Blackout button allows screen to be blacked out for privacy or to minimize driver distraction without having to reboot the touch screen
- Brightness and volume buttons enable adjustments to be done right on the touch screen
- Programmable emergency button allows users to send instant notification in case of an emergency
- Sleep mode to reduce power consumption when not in use
- Bottom-facing ports with integrated cable restraint system
- Integrated stereo speakers allow for sound directly from the computing device
- Warm up indicator light easily indicates that the touch screen is powered up
- Anti-glare coating to reduce glare for better visibility
- Includes the following cables: HDMI, USB type B, and power cable with bare wire end
- VESA 75 mm and 100 mm mounting holes
- MIL-STD 810G shock/vibration, SAE J1455, FCC, CE, RCM, RoHS, REACH
- 1 Year Limited Warranty

Note: Visit gamberjohnson.com for full list of product specifications

Port Replicator

- (1) HDMI
- (1) VGA
- (1) USB type C (2A @ 5V) fast charging
- (1) USB type B (for Touch Control)
- (2) USB 3.0 (fast charging 1.5A)
- (1) AUX. out 3.5 mm
- (1) DC input (Barrel Jack)

NEW



7160-1393-00

RUGGED USB HUB

Item No.	Description	Weight	Height	Width	Depth
7160-1393-00	Rugged USB Hub	0.25 lbs 0.11 kg	2.05" 5.21 cm	4.36" 11.07 cm	5.62" 14.27 cm
Features <ul style="list-style-type: none"> - Utilize this multi-port adapter hub to connect devices for a complete mobile office solution or DeX mobile solution - Supports 4K HD screen expansion for multimedia capabilities - Gigabit Ethernet port for hassle-free internet connectivity - Utilize USB 3.0 ports to connect to a host of external devices, two fast-charging 3.0 ports - USB-C port (fast-charging) to connect a DeX smartphone docking station or other USB-C supported devices - Rugged case with cable restraints keeps cable connections secure - Integrated VESA 75 mm mounting pattern, attach to a VESA 75 mm mount or directly to (18540) Heads Up Mounting Bracket - MIL-STD 810G shock/vibration, SAE J1455, RoHS, FCC, CE, REACH - 3-Year Limited Warranty 					
Port Replicator <ul style="list-style-type: none"> - (4) USB 3.0 (2) Fast charging 1.5A - (1) Ethernet RJ45 (Gigabit) - (1) HDMI - (1) USB-C (5V@2A) Fast charging - (1) Power port 					

NEW



18540

HEADS UP MOUNTING BRACKET

Item No.	Description	Weight	Height	Width	Depth
18540	Heads Up Mounting Bracket	0.74 lbs 0.34 kg	0.5" 1.27 cm	12" 30.48 cm	5.75" 14.61 cm
Features <ul style="list-style-type: none"> - Allows users to position their DeX smartphone docking station next to your touchscreen for ideal mobile viewing - Attaches between the touchscreen and touchscreen mount. Align the slots on the mounting bracket with the VESA 75 mm mounting holes on your touchscreen display to attach the bracket - Mount the Rugged USB hub directly to this mounting bracket for easy access to all wiring and network connections - Steel with black powder coat finish - Limited Lifetime Warranty 					

NEW



7110-1237

HEADS UP ARTICULATING MOUNT

Item No.	Description	Weight	Height	Width	Depth
7110-1237	Heads Up Articulating Mount	0.2 lbs 0.09 kg	2.75" 6.99 cm	2.12" 5.38 cm	2.12" 5.38 cm
Features <ul style="list-style-type: none"> - Use this mounting device to position your DeX smartphone docking station (7160-1394-XX) for ideal mobile viewing - Combine the articulating mount with the heads up mounting bracket (18540) to position the articulating mount next to the touchscreen in your vehicle - Anodized aluminum design - Encapsulated ball design for unique and flexible movement - 1 Year Limited Warranty 					

GAMBER-JOHNSON'S RUGGED LITE KEYBOARD

Item No.	Description	Weight	Height	Width	Depth
7160-1449-00	Gamber-Johnson's Rugged Lite Keyboard	1 lbs 0.45 kg	0.68 in 1.72 cm	10.31 in 26.18 cm	7.12 in 18.08 cm

Features

- Integrated center Touchpad with right and left mouse buttons
- 76-key keyboard with 12 function keys for custom operation
- Low-profile ergonomic design for ease of use in a mobile environment
- Equipped with an emergency key that is configurable and be used to send for emergency help or assistance to dispatch
- Silicone rubber keys with white lettering and a rugged ABS polycarbonate case
- USB Type A male connector (coiled cable) input cable
- Supports Windows (XP or Above), Android, Linux, and Mac OS / iOS platforms
- USB- A port to attach a mouse, another peripheral, or flash drive (USB 2.0 500mA)
- Rubber feet to prevent slippage
- Power: 5Vdc @ <500mA from data cord
- Keyboard is compatible with Gamber-Johnson quick release keyboard cradle (7160-1470-00). Keyboard can be permanently attached to keyboard cradle using two #6 machine screws.
- Available in US English (7160-1449-00), UK (7160-1449-01), German (7160-1449-02), French (7160-1449-03), and Spanish (7160-1449-04). Contact Gamber-Johnson for other language options.
- Temperature range is -4° F (-20°C) to 140° F (60°C) when operating and -40° F (-40°C) to 185° F (85°C) for storage
- Designed to IP54 ingress specifications
- Tested to two million actuation per key
- MIL-STD 810G shock/vibration, SAE J1455, RoHS, FCC, CE, REACH
- 1 Year Limited Warranty

NEW



7160-1449-00

QUICK RELEASE KEYBOARD CRADLE

Item No.	Description	Weight	Height	Width	Depth
7160-1470-00	Quick Release Keyboard Cradle	0.55 lbs 0.25 kg	1.01" 2.53 cm	5.5" 13.97 cm	7.35" 18.66 cm

Features

- Compatible with Gamber-Johnson Rugged Lite Keyboard (7160-1449-00)
- Easily insert or release the Rugged Lite Keyboard:
 - Insert bottom of keyboard into cradle, match indents in keyboard with hooks on cradle, then push top of keyboard into cradle and engage latch
 - To remove, push latch to disengage and pull keyboard out of cradle
- Black powder coat finish
- Keyboard can be permanently attached to keyboard cradle using two #6 machine screws
- VESA 75 mm mounting pattern (#8 mounting studs), attach to most Gamber-Johnson motion attachments
- Limited Lifetime Warranty

NEW



7160-1470-00

RUGGED LITE KEYBOARD AND QUICK RELEASE KEYBOARD CRADLE KIT

Item No.	Description	Weight	Height	Width	Depth
7170-0817-00	Rugged Lite Keyboard and Quick Release Keyboard Cradle Kit Kit Includes: Rugged Lite Keyboard (7160-1449-00) and Quick Release Keyboard Cradle (7160-1470-00)				
	Quick Release Keyboard Cradle	0.25 lbs 0.11 kg	1.01" 2.53 cm	5.5" 13.97 cm	7.35" 18.66 cm
	Rugged Lite Keyboard	1 lbs 0.45 kg	0.56" 1.42 cm	10.31" 26.18 cm	7.12" 18.08 cm

Features

Rugged Lite Keyboard

- Integrated center Touchpad with right and left mouse button
- 76-key keyboard with 12 function keys for custom operation
- Low-profile ergonomic design for ease of use in a mobile environment
- Equipped with an emergency key that is configurable and be used to send for emergency help or assistance to dispatch
- Silicone rubber keys with white lettering and a rugged ABS poly-carbonate case
- USB Type A male connector (coiled cable) input cable
- Supports Windows (XP or Above), Android, Linux, and Mac OS / iOS platforms
- USB- A port to attach a mouse, another peripheral, or flash drive (USB 2.0 500mA)
- Rubber feet to prevent slippage
- Keyboard is compatible with Gamber-Johnson quick release keyboard cradle (7160-1470-00)
- Available in US English (7160-1449-00), UK (7160-1449-01), German (7160-1449-02), French (7160-1449-03), and Spanish (7160-1449-04). Contact Gamber-Johnson for other language options
- 1 Year Limited Warranty

Quick Release Keyboard Cradle

- Compatible with Gamber-Johnson USB Mobile Keyboard (7160-1449-00)
- Easily insert or release the USB keyboard:
 - Insert bottom of keyboard into tray, match indents in keyboard with hooks on tray, then push top of keyboard into tray and engage latch
 - To remove, push latch to disengage and pull keyboard out of computer out of tray
- Black powder coat finish
- Keyboard can be permanently attached to keyboard cradle using two #6 machine screws
- VESA 75 mm mounting pattern, attaches to most Gamber-Johnson motion attachments
- Limited Lifetime Warranty

NEW



7170-0817-00

NEW



7160-1299-00

NOTEPAD™ TOUCH UNIVERSAL TABLET CRADLE

Item No.	Description	Adjustable Height	Adjustable Width	Adjustable Depth	Weight	Height	Width	Depth
7160-1299-00	Universal Tablet Cradle	4.5"-7.3" 11.4 -18.5 cm	7.8"-10.9" 19.8-27.6 cm	0.28"-1.12" 0.71-2.8 cm	2.85 lbs 1.29 kg	6.12" 15.54 cm	8.99" 22.8 cm	3.15" 8.00 cm
7160-1299-10	Universal Tablet Cradle	7.0"-9.7" 17.7-24.6 cm	10.0"-13.0" 25.4 -33.0 cm	0.28"-1.12" 0.71-2.8 cm	3.5 lbs 1.58 kg	8.56" 21.74 cm	10.82" 27.48 cm	3.15" 8.00 cm

Features

- Height, width, and depth adjustable to accommodate almost any size tablet computer
- Optional keyed lock for theft deterrence
- Composite/aluminum design for reduced weight and extended durability
- Designed with rounded edges to enhance personal safety
- Easy one-handed operation:
 - Insert bottom of tablet into the cradle, push the top of the tablet against the latch button until latch engages
 - To remove tablet, push up on latch button with thumb and pull tablet from the cradle
- VESA 75 mm and AMPS mounting patterns
- 30 mph crash tested per SAE J1455 standard
- Lifetime Limited Warranty



NOTEPAD™ V CRADLE FOR PANASONIC FZ-Q1 TOUGHPAD

Item No.	Weight	Height	Width	Depth
7160-0862	6.5 lbs 2.9 kg	10.0" 25.4 cm	14.75" 37.5 cm	3.4" 8.6 cm

Features

- Adjustable clips and brackets are pre-set to fit the Panasonic Q1
- Heavy-duty extruded aluminum construction for long-term durability
- Slim form design provides low mounting capabilities
- Special "flanged" side clip design provides superior strength and can be easily adjusted
- T-molded polycarbonate covers hold clips in place during installation for easy height adjustment
- Reversible front and back supports adjust to accommodate varying depths of computers
- Rear support brace is gusseted for added restraint
- 90° wing-turn closure latch allows for fast size adjustments, quick computer insert/removal. Comes with heavy duty key lock (keyed alike) for extra security
- Multiple positions for offset capabilities when used with a Motion Attachment
- Molded polycarbonate end caps ensure the computer is level when in the cradle
- Can be used with optional accessories (screen support, LED light, microphone clip)
- VESA 75 mm mounting pattern
- MIL-STD 810G shock/vibration, RoHS, and SAE J1455 crash certifications
- Limited Lifetime Warranty

UNIVERSAL LAPTOP MOUNT - NOTEPAD™ V

Item No.	Description	Width Adjustable	Depth Adjustable	Thickness Adjustable	Weight	Overall Height	Overall Width	Overall Depth
7160-0250	For use with most Computers (Dell, HP, Sony, Toshiba, Gateway, Samsung, Compaq, Asus, etc.)	Yes - Adjusts to computer widths from 10.6" - 16.5" 26.9 - 41.9 cm	Yes - Adjusts to computer depths from 9.0" - 12.4" 22.9 - 31.5 cm	Yes - Adjusts to computer thickness (Measured with Screen Open) From 0" - 1.5" 0 - 3.8 cm	6.5 lbs 2.9 kg	1.6" 4.1 cm	11.8" to 18.3" 30.0 to 46.5 cm	9.5" 24.1 cm
7160-0250-01	For use with Rugged Computer Laptops that exceed 1.5" in thickness (Panasonic Toughbook 30 and 31, Dell XFR, etc.)	Yes - Adjusts to computer widths from 10.62" - 16.5" 26.9 - 41.9 cm	Yes - Adjusts to computer depths from 9.0" - 12.4" 22.9 - 31.5 cm	Yes - Adjusts to computer thickness (Measured with Screen Open) From 0.12" - 2.0" 0.3 - 5.1 cm	6.5 lbs 2.9 kg	1.6" 4.1 cm	11.8" to 18.3" 30.0 to 46.5 cm	9.5" 24.1 cm
7160-0250-02	For use with computers where the keyboard extends to the left and right edge of the computer	Yes - Adjusts to computer widths from 10.62" - 16.5" 26.9 - 41.9 cm	Yes - Adjusts to computer depths from 9.0" - 12.4" 22.9 - 31.5 cm	Yes - Adjusts to computer thickness (Measured with Screen Open) From 0" - 1.5" 0 - 3.8 cm	6.5 lbs 2.9 kg	1.6" 4.1 cm	11.8" to 18.3" 30.0 to 46.5 cm	9.5" 24.1 cm
7160-0250-03	For use with most computers (Dell, HP, Sony, Toshiba, Gateway, Samsung, Compaq, Asus, etc.), uses Cam Back Clips	Yes - Adjusts to computer widths from 10.62" - 16.5" 26.9 - 41.9 cm	Yes - Adjusts to computer depths from 6.6" - 8.0" 16.8 - 20.3 cm	Yes - Adjusts to computer thickness (Measured with Screen Open) From 0" - 1.5" 0 - 3.8 cm	6.5 lbs 2.9 kg	1.6" 4.1 cm	11.8" to 18.3" 30.0 to 46.5 cm	9.5" 24.1 cm
7160-0402	For use with small computers (Netbooks)	Yes - Adjusts to computer widths from 8.2" - 11.8" 20.82 - 29.97 cm	Yes - Adjusts to computer depths from 7.6" - 9.3" 19.3 - 23.6 cm	Yes - Adjusts to computer thickness (Measured with screen open) From 0" - 1.5" 0 - 3.8 cm	5.5 lbs 2.5 kg	1.6" 4.1 cm	9.6" to 13.2" 24.4 to 33.5 cm	9.5" 24.1 cm
7160-0402-03	For use with small computers (Netbooks and Tablets), uses Cam Back Clips	Yes - Adjusts to computer widths from 8.2" - 11.8" 20.82 - 29.97 cm	Yes - Adjusts to computer depths from 6.6" - 8.0" 16.8 - 20.3 cm	Yes - Adjusts to computer thickness (Measured with Screen Open) From 0" - 1.5" 0 - 3.8 cm	5.5 lbs 2.5 kg	1.6" 4.1 cm	9.6" to 13.2" 24.4 to 33.5 cm	9.5" 24.1 cm

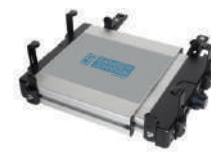

7160-0250



7160-0250-03

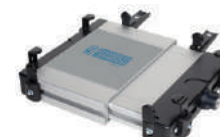

7160-0402



7160-0402-03

Features

- Special "flanged" side clip design provides superior strength and can be easily adjusted they:
 - Are "one-size-fits-all", work with most computers
 - Feature T-molded polycarbonate covers that hold clips in place during installation for easy height adjustment
- Reversible front and back supports adjust to accommodate varying depths of computers
- Rear support brace is gusseted for added restraint
- 90° wing turn closure latch
 - Allows for fast initial size adjustment, quick computer insertions and removal
- Featuring heavy duty key lock (keyed alike)
- Molded polycarbonate end caps ensure that the computer is level when in the cradle
- Can be used with optional accessories to further capabilities in the field
- Adjustable mounting holes allows the computer mount to be offset
- Gamber-Johnson 2" (5.08 cm) x 4.09" (10.38 cm) mounting hole pattern
- MIL-STD 810G shock/vibration, RoHS, and SAE J1455 crash certifications
- Limited Lifetime Warranty

*Note - The NotePad™ V side clips and key lock are designed to securely hold the laptop in the mount and to deter theft, not prevent it. Gamber-Johnson recommends taking your laptop out of the vehicle when not in use.



7120-0587

UNIVERSAL LAPTOP MOUNT - NOTEPAD™ V CLIP PACKAGES

Item No.	Description	Placement	Weight
7120-0519	Tall Clip Package for Use with Rugged Computer Laptops that Exceed 1.5" in Thickness (Panasonic Toughbook 30 and 31, Dell XFR, etc.) <i>Note:</i> Buy this only if you already have a NotePad™ V universal computer mount (7160-0250)	Replaces the Clips on the NotePad V Universal Computer Mount (7160-0250)	0.3 lbs 0.1 kg
7120-0587	Cam Clip Package Used with a Smaller Notebook, Convertible Tablet or Tablet Format <i>Note:</i> Buy this only if you already have a NotePad™ V universal computer mount (7160-0250) or the NotePad™ V-LT universal computer mount (7160-0402)	Replaces the Clips on the NotePad V Universal Computer Mount (7160-0250) or the NotePad V-LT Universal Computer Mount (7160-0402)	0.3 lbs 0.1 kg

UNIVERSAL LAPTOP MOUNT - NOTEPAD™ V ACCESSORIES



7160-0253

Item No.	Description	Placement	Weight	Height	Width	Depth
7160-0251	Screen Support for NotePad V with the Standard Clip Package	Attaches to the Back Right Corner Using Pre-Drilled Slots on the NotePad V Universal Computer Mount (7160-0250, 7160-0250-02 or 7160-0402)	0.5 lbs 0.2 kg	8.75" 22.2 cm	2.5" 6.4 cm	1.5" 3.8 cm
7160-0251-01	Screen Support for NotePad V with the Tall Clip Package	Attaches to the Back Right Corner Using Pre-Drilled Slots on the NotePad V Universal Computer Mount (7160-0250-01)	0.5 lbs 0.2 kg	8.75" 22.2 cm	2.5" 6.4 cm	1.5" 3.8 cm
7160-0252	LED Light Assembly	Attaches to any Corner Using Pre-Drilled Slots on any NotePad V Universal Computer Mount	0.5 lbs 0.2 kg	17.0" 43.2 cm	2.5" 6.4 cm	1.6" 4.1 cm
7160-0253	Microphone Clip	Attaches to any Corner Using Pre-Drilled Slots on any NotePad V Universal Computer Mount	0.2 lbs 0.1 kg	2.1" 5.3 cm	1.5" 3.8 cm	1.0" 2.5 cm
7160-0351	Shock/Vibration Isolator Plate <i>Note:</i> Computer and cradle combined should not exceed 30 lbs	Positioned Between any Motion Attachment and any NotePad V Universal Computer Mount	2.4 lbs 1.1 kg	0.9" 2.3 cm	7.0" 17.8 cm	6.5 16.5 cm
7160-0539	LIND Power Supply Mount	Attaches a LIND Power Supply Between a Docking Station/Cradle and the Motion Attachment	1.5 lbs 0.7 kg	5.0" 12.7 cm	10.0" 25.4 cm	1.3" 3.3 cm

UNIVERSAL TABLET COMPUTER - TABCRUZER® MINI



Item No.	Description	Width Adjustable	Depth Adjustable	Thickness Adjustable	Weight	Overall Height	Overall Width	Overall Depth
7160-0774	For use with most consumer tablet computers (Apple iPad, Samsung Galaxy, Microsoft Surface Pro, etc.)	Yes - Adjusts to tablet widths from 6.9" to 11.2" 17.5 to 28.4 cm	Yes - Adjusts to tablet depths from 4.3" to 8.2" 10.9 to 20.8 cm	Yes - Adjusts to tablet thickness from 0.2" to 0.7" 0.5 to 1.8 cm	1.7 lbs 0.8 kg	2.25" 5.7 cm	9.6" to 12.1" 24.4 to 30.7 cm	8.4" 21.3 cm

Features

- TabCruzer Mini - Universal Tablet Cradle is designed to hold consumer tablet computers
- Slim form design provides low mounting capability
- Side clips are easily adjusted to the proper tablet height and work with most tablets
- Reversible front and back supports adjust to accommodate varying depths of computers
- Rear support brace is gusseted for added restraint
- 90° wing turn closure latch
- Allows for fast initial size adjustment
- Allows for quick computer insertion and removal
- Built-in heavy duty key lock (keyed alike)
- Engineered polycarbonate and steel design for long-term durability
- VESA 75 mm mounting pattern
- MIL-STD 810G shock/vibration, RoHS, FCC, and SAE J1455 crash certifications
- Limited Lifetime Warranty

LINDY USB PORT BLOCKER



7300-0107

Item No.	Description
7300-0107	Pack of 4 USB Blockers and One Combination Key (Blue)
7300-0108	Pack of 10 USB Blockers (Blue)

Features

- Blocks USB ports so that users cannot connect flash drives, MP3 players, and other USB mass storage devices to their computers
- Quick and easy to use

ZEBRA ET50/55 8" AND 10" CRADLE

Item No.	Description	Power Supply	Weight	Height	Width	Depth
7160-0819-00	Zebra ET50/55 8" Cradle (No Electronics)	No - Use LIND Power Adapter (7300-0415)	2.6 lbs 1.2 kg	10" 25.5 cm	9" 22.9 cm	3.4" 8.6 cm
7160-0819-04	Zebra ET50/55 8" Powered Cradle (POGO Pin Charging)	No - Use LIND Power Adapter (7300-0415)	2.6 lbs 1.2 kg	10" 25.5 cm	9" 22.9 cm	3.4" 8.6 cm
7160-0818-00	Zebra 10" Cradle (No Electronics)	No - Use LIND Power Adapter (7300-0415)	2.6 lbs 1.2 kg	10" 25.5 cm	10" 25.5 cm	3.4" 8.6 cm
7160-0818-04	Zebra ET50/55 10" Powered Cradle (POGO Pin Charging)	No - Use LIND Power Adapter (7300-0415)	2.6 lbs 1.2 kg	10" 25.5 cm	10" 25.5 cm	3.4" 8.6 cm



7160-0819-04

Features

- Compatible with Zebra enterprise tablets with the rugged frame option
- Optional power supply input
- Accommodates expansion back of the ET50/55 to easily add accessories like a scanner, hand strap, battery bay, or stylus
- Front camera on ET50/55 accessible when the tablet is in the cradle
- Compatible with Windows or Android operating systems
- Dual latch/locks provide tablet stability and guide pins align the tablet so it's properly placed in the cradle
- VESA 75 mm mounting pattern
- MIL-STD 810G shock/vibration, RoHS, FCC, and SAE J1455 crash certifications
- 3-Year Limited Warranty

ZEBRA ET50/55 8" AND 10" DOCKING STATION

Item No.	Description	Power Supply	Weight	Height	Width	Depth
7160-0860-00	Zebra ET50/55 10" Docking Station	No	2.6 lbs 1.2 kg	10" 25.4 cm	10" 25.4 cm	3.4" 8.6 cm
7160-0861-00	Zebra ET50/55 8" Docking Station	No	2.6 lbs 1.2 kg	10" 25.4 cm	9" 22.9 cm	3.4" 8.6 cm
7170-0529	Zebra ET50/55 8" Docking Station with LIND Automotive Power Adapter	Includes Auto Power Adapter (7300-0415)	2.6 lbs 1.2 kg	10" 25.4 cm	9" 22.9 cm	3.4" 8.6 cm
7170-0522	Zebra ET50/55 8" Docking Station with LIND Material Handling Isolated Power Adapter	Includes LIND 12-32VDC Material Handling Isolated Power Adapter (7300-0466)	2.6 lbs 1.2 kg	10" 25.4 cm	9" 22.9 cm	3.4" 8.6 cm
7170-0523	Zebra ET50/55 8" Docking Station with LIND Material Handling Isolated Power Adapter	Includes LIND 20-60VDC Material Handling Isolated Power Adapter (7300-0467)	2.6 lbs 1.2 kg	10" 25.4 cm	9" 22.9 cm	3.4" 8.6 cm
7170-0528	Zebra ET50/55 10" Docking Station with LIND Automotive Power Adapter	Includes Auto Power Adapter (7300-0415)	2.6 lbs 1.2 kg	10" 25.4 cm	10" 25.4 cm	3.4" 8.6 cm
7170-0520	Zebra ET50/55 10" Docking Station with LIND Material Handling Isolated Power Adapter	Includes LIND 12-32VDC Material Handling Isolated Power Adapter (7300-0466)	2.6 lbs 1.2 kg	10" 25.4 cm	10" 25.4 cm	3.4" 8.6 cm
7170-0521	Zebra ET50/55 10" Docking Station with LIND Material Handling Isolated Power Adapter	Includes LIND 20-60VDC Material Handling Isolated Power Adapter (7300-0467)	2.6 lbs 1.2 kg	10" 25.4 cm	10" 25.4 cm	3.4" 8.6 cm



7160-0860-00

Features

- Compatible with Zebra ET5X series enterprise tablets with the rugged frame option
- Accommodates expansion back of the ET50/55 51/56 to easily add accessories like a scanner, hand strap, battery bay, or stylus
- Front camera on ET50/55 51/56 accessible when the tablet is in the cradle
- Compatible with Windows or Android operating systems
- Dual latch/locks provide stability and guide pins align the tablet so it's properly placed in the cradle
- VESA 75 mm mounting pattern
- MIL-STD 810G shock/vibration, RoHS, FCC, and SAE J1455 crash certifications
- 3-Year Limited Warranty

Port replicator

- Ethernet (1) RJ45
- USB 3.0 (2) 9 Pin
- HDMI (1) 19 Pin
- Serial RS232 D-Sub 9 Pin (1 amp power on pin 9)
- Power supply input



ZEBRA ET 51/56 SLIM 8" FULL PORT REPLICATION TABLET DOCKING STATION

Item No.	Description	Power Supply	Weight	Height	Width	Depth
7160-1506-20	Zebra ET51/56 Series SLIM 8" Full Port Replication Docking Station	Use LIND Power Adapters (7300-0415, 7300-0466, 7300-0467)	2.2 lbs 0.99 kg	8.75" 22.22 cm	9.93" 25.2 cm	3.12" 7.92 cm
<p>Features</p> <ul style="list-style-type: none"> - Designed for the Zebra ET51/56 8" rugged tablet computer with rugged frame - Zebra Certified utilizing Zebra Certified electronics - This dock does not accommodate ET51/56 accessories - Front camera on ET5X accessible when the tablet is in the docking station - Compatible with Windows or Android operating systems - Access to all control buttons and ports while the tablet is safely docked - Bottom-facing I/O ports; integrated cable restraint/cable management system - Guide pins prevent damage to the docking connection when docking the tablet - Composite/aluminum design for reduced weight and extended durability - Designed with rounded edges to enhance personal safety - Keyed lock for security and theft deterrence - Forward facing docking latch/release for easy one-handed operation: <ul style="list-style-type: none"> - Insert bottom of Zebra tablet into the docking station and push top of the tablet until the lock engages - To remove, lift latch to disengage and pull computer out of docking station - VESA 75 mm mounting pattern - MIL-STD 810G shock/vibration, RoHS, FCC, CE, and SAE J1455 crash certifications - 3-Year Limited Warranty <p>Port Replication</p> <ul style="list-style-type: none"> - Zebra Certified Electronics - USB 3.0 (2) 9 pin (900mA) - RS232 Serial (1) Power on pin 9 (825mA) - HDMI (1) 19 pin - Ethernet (1) RJ45 (322 mb/s) - Power Input 12VDC 						

NEW



ZEBRA ET51/56 SLIM 8" TABLET CRADLE

Item No.	Description	Power Supply	Weight	Height	Width	Depth
7160-1506-90	Zebra ET51/56 Series SLIM 8" Cradle (No Electronics)		1.5 lbs 0.68 kg	8.75" 22.22 cm	9.93" 25.2 cm	3.12" 7.92 cm
7160-1506-10	Zebra ET51/56 Series SLIM 8" Charging Cradle	Use LIND Power Adapters (7300-0415, 7300-0466, 7300-0467)	1.6 lbs 0.72 kg	8.75" 22.22 cm	9.93" 25.2 cm	3.12" 7.92 cm
<p>Features</p> <ul style="list-style-type: none"> - Designed for the Zebra ET51/56 8" rugged tablet computer with rugged frame - Zebra Certified - This cradle does not accommodate ET51/56 accessories - Front camera on ET5X accessible when the tablet is in the cradle - Compatible with Windows or Android operating systems - Access to all control buttons and ports while the tablet is safely docked - Guide pins prevent damage to the charging pins when cradling the tablet - Powered POGO pins transfer power to the Zebra tablet (on charging cradle) - Composite/aluminum design for reduced weight and extended durability - Designed with rounded edges to enhance personal safety - Keyed lock for security and theft deterrence - Forward facing docking latch/release for easy one-handed operation: <ul style="list-style-type: none"> - Insert bottom of Zebra tablet into the docking station and push top of the tablet until the lock engages - To remove, lift latch to disengage and pull computer out of cradle - VESA 75 mm mounting pattern - MIL-STD 810G shock/vibration, RoHS, FCC, CE, and SAE J1455 crash certifications - 3-Year Limited Warranty <p>Port Replication</p> <ul style="list-style-type: none"> - Power Input 12VDC (on charging cradle) 						

NEW



71660-1506-10

ZEBRA ET51/56 8" TABLET DOCKING STATION ACCESSORIES

NEW



7300-0467

Item No.	Description	Placement/Compatibility	Weight	Height	Width	Depth
7300-0466	LIND 12-32V Material Handling Isolated Power Adapter for Zebra ET50/51 55/56. Output Voltage 12VDC Output Current 3.5 A.	Use with Zebra ET5X Docking Stations and Cradles	1.01 lbs .46 kg	1.2" 3.0 cm	2.5" 6.35 cm	5.15" 13.08 cm
7300-0467	LIND 20-60V Material Handling Isolated Power Adapter for Zebra ET50/51 55/56. Output Voltage 12VDC Output Current 3.5 A.	Use with Zebra ET5X Docking Stations and Cradles	1.56 lbs .52 kg	1.15" 2.92 cm	3.0" 7.62 cm	9.3" 23.6 cm
7300-0415	LIND 11-16V Automobile Power Adapter for Zebra ET50/51 55/56. Output Voltage 12VDC Output Current 3.5 A.	Use with Zebra ET5X Docking Stations and Cradles	1.01 lbs .46 kg	1.2" 3.0 cm	2.5" 6.35 cm	5.15" 13.08 cm
7160-0949	8" Universal Tablet Protective Cover	Use with Zebra ET51/56 Docking Stations and Cradles	.4 lbs .18 kg	12.5" 31.8 cm	10.5" 26.7 cm	3.5" 8.9 cm

ZEBRA L10 WINDOWS TABLET DOCKING STATION

NEW



7160-1321-05

Item No.	Description	Power Supply	Weight	Height	Width	Depth
7160-1321-00	Zebra L10 Windows Docking Station (No RF)	No - Use LIND Power Adapter (7300-0484)	3.3 lbs 1.49 kg	10.63" 27 cm	11.81" 29.99 cm	3.94" 10 cm
7160-1321-05	Zebra L10 Windows Docking Station (5x RF)	No - Use LIND Power Adapter (7300-0484)	3.75 lbs 1.70 kg	10.63" 27 cm	11.81" 29.99 cm	3.94" 10 cm
7170-0798	Windows Docking Station 5x RF with 12-16V Automotive Power Adapter	Yes - Includes LIND Auto Power Adapter	4.75 2.15 kg	10.63" 27 cm	11.81" 29.99 cm	3.94" 10 cm
7170-0799	Windows Docking Station No RF with 12-16V Automotive Power Adapter	Yes - Includes LIND Auto Power Adapter	4.3 lbs 1.95 kg	10.63" 27 cm	11.81" 29.99 cm	3.94" 10 cm
7170-0800	Windows Docking Station No RF with 20-60V Material Handling Isolated Power Adapter	Yes - Includes LIND Auto Power Adapter	4.86 lbs 2.2 kg	"10.63" 27 cm	11.81" 29.99 cm	3.94" 10 cm
7170-0801	Windows Docking Station NO RF with 72-110V Material Handling Isolated Power Adapter	Yes - Includes LIND Auto Power Adapter	4.86 lbs 2.2 kg	10.63" 27 cm	11.81" 29.99 cm	3.94" 10 cm

Features

- Compatible with the Zebra Windows L10 xPad hard-handle and xSlate tablet computer
- Zebra Certified utilizing Zebra Certified electronics
- Design accommodates the L10 extended battery, smart card/CAC reader module, True Serial (RS232) module, hard handle, soft handle, and shoulder strap
- Sealed docking connector to protect against moisture
- RS232 - power pin 9 (825mA)
- LED indicator lights show that "tablet is docked" and "dock is powered"
- Access door to internal USB 2.0 port provides additional security
- Floating docking connector for reliable docking activation
- Bottom-facing I/O ports; integrated cable restraint/cable management system
- Optional RF pass-through SMA - (WWAN Main, GPS, WWAN Aux, WIFI Main, WIFI Aux)
- Designed with rounded edges to enhance personal safety
- Composite/aluminum design for reduced weight and durability
- Keyed lock for security and theft deterrence
- Forward facing docking latch/release for easy one-handed operation:
 - Insert bottom of computer into docking station, push top of computer in and pull latch forward until latch engages
 - To remove, lift latch to disengage and pull computer out of docking station
- VESA 75 mm and 50 mm x 100 mm mounting patterns
- MIL-STD 810G shock/vibration, RoHS, FCC, CE, and SAE J1455 crash certifications
- 3-Year Limited Warranty

Port Replication

- Zebra Certified Electronics
- USB 3.0 (2) 9 pin (900mA)
- USB 2.0 (2) 4 pin (500 mA)
- USB 2.0 (1) 4 pin (500mA) behind internal access door
- RS232 Serial (1) Power on pin 9 (825mA)
- HDMI (1) 19 pin
- VGA (1) D-sub 9 pin
- Ethernet (1) RJ45 (322 mb/s)
- Microphone
- Headphones / Speakers
- Power Input 19VDC
- Antenna 5x RF (SMA) (optional)

ZEBRA L10 ANDROID TABLET DOCKING STATION

Item No.	Description	Power Supply	Weight	Height	Width	Depth
7160-1453-00	Zebra L10 Android Tablet Docking Station (No RF)	No - Use LIND Power Adapter (7300-0484)	3.3 lbs 1.49 kg	10.63" 27 cm	11.81" 29.99 cm	3.94" 10 cm
7170-0805	Android Docking Station No RF with 90W Auto Power Adapter	Yes - Includes LIND Auto Power Adapter	4.3 lbs 1.95 kg	10.63" 27 cm	11.81" 29.99 cm	3.94" 10 cm
7170-0806	Android Docking Station No RF with 20-60V Isolated Power Adapter	Yes - Includes LIND Auto Power Adapter	4.86 lbs 2.2 kg	10.63" 27 cm	11.81" 29.99 cm	3.94" 10 cm
7170-0807	Android Docking Station No RF with 72-110V Isolated Power Adapter	Yes - Includes LIND Auto Power Adapter	4.86 lbs 2.2 kg	10.63" 27 cm	11.81" 29.99 cm	3.94" 10 cm



Features

- Designed for the Zebra L10 Android Tablet
- Zebra Certified utilizing Zebra Certified electronics
- Accommodates the L10 extended battery, smart card/CAC reader module, True Serial (RS232) module, hard handle, soft handle, and shoulder strap
- Sealed docking connector to protect against moisture
- RS232 - power pin 9 (825mA)
- LED indicator lights show that "tablet is docked" and "dock is powered"
- Access door to internal USB 2.0 port provides additional security
- Floating docking connector for reliable docking activation
- Bottom-facing I/O ports; integrated cable restraint/cable management system
- Composite/aluminum design for reduced weight and extended durability
- Designed with rounded edges to enhance personal safety
- Keyed lock for security and theft deterrence
- Forward facing docking latch/release for easy one-handed operation:
- Insert bottom of computer into docking station, push top of computer in and pull latch forward until latch engages
- To remove, lift latch to disengage and pull computer out of docking station
- VESA 75 mm and 50 mm x 100 mm mounting patterns
- MIL-STD 810G shock/vibration, RoHS, FCC, CE, and SAE J1455 crash certifications
- 3-Year Limited Warranty

Port Replication

- Zebra Certified Electronics
- USB 3.0 (2) 9 pin (900mA)
- USB 2.0 (2) 4 pin (500 mA)
- USB 2.0 (1) 4 pin (500mA) behind internal access door
- RS232 Serial (1) Power on pin 9 (825mA)
- Microphone
- Headphones / Speakers
- Power Input 19VDC

ZEBRA L10 DOCKING STATION ACCESSORIES

Item No.	Description	Placement/Compatibility	Weight	Height	Width	Depth
7110-1292	Cradle NO RF (No Electronics)	Use with Zebra L10 Tablet Docking Station or Combine with Docking Station Module to Build Full Dock	2.07 lbs 0.94 kg	9.7" 24.7 cm	11.8" 30.1 cm	2.99" 7.6 cm
7160-1321-01	Windows Docking Station Module (Converts L10 Cradle to Docking Station)	Use to Convert Zebra L10 Cradle to a Full Windows Docking Station	1.23 lbs 0.55 kg	9.0" 22.86 cm	10" 25.4 cm	3.75" 9.52 cm
7160-1453-01	Android Tablet - Docking Station Module	Use to Convert Zebra L10 Cradle to a Full Android Docking Station	1.23 lbs 0.55 kg	9.0" 22.86 cm	10" 25.4 cm	3.75" 9.52 cm
7300-0484	LIND 12-16V Automobile Power Adapter with Bare Wire Lead. 90W Output Power, 19VDC Output Voltage.	Use with Zebra L10 Tablet Docking Station	1.0 lbs 0.46 kg	1.0" 2.54 cm	3.0" 7.62 cm	5.5" 13.97 cm
7300-0346	LIND 72-110V Isolated Power Adapter with Bare Wire Lead. 90W Output Power, 19VDC Output Voltage.	Use with Zebra L10 Tablet Docking Station	1.56 lbs 0.52 kg	1.15" 2.92 cm	3.0" 7.62 cm	9.3" 23.6 cm
7300-0458	LIND 20-60V Isolated Power Adapter with Bare Wire Lead. 90W Output Power, 19VDC Output Voltage.	Use with Zebra L10 Tablet Docking Station	1.56 lbs 0.52 kg	1.15" 2.92 cm	3.0" 7.62 cm	9.3" 23.6 cm



NEW



ZEBRA ET51/56 2-IN-1 ATTACHABLE KEYBOARD

Item No.	Description	Placement/Compatibility	Weight	Height	Width	Depth
7160-1585-00	2-in-1 Attachable Keyboard for the Zebra ET51/56 Rugged Tablet Computer	Use with the Zebra ET51/56 Tablet Computer	1.80 lbs 0.81 kg	1.5" 3.81 cm	0.31" 26.18 cm	7.56" 19.20 cm
<p>Features</p> <ul style="list-style-type: none"> - Designed for the Zebra ET51/56 Tablet computer without rugged case - Integrated center touchpad with right and left mouse buttons - Convenient carrying handle for easy portability - 76-key keyboard with 12 function keys for custom operation - Silicone rubber keys with white lettering and a rugged polycarbonate case - Docking connector links the tablet to the keyboard - USB- A port to attach a mouse, another peripheral, or flash drive - Easily connect the tablet to the keyboard; slip the bottom of the tablet into the case and snap the top of the case over the tablet - All the Zebra ET51/56 control buttons and rear camera are accessible when the tablet is docked onto the keyboard - Friction hinge and screen footrest position the tablet at a comfortable viewing angle - Low-profile ergonomic design for ease of use in a mobile environment - Rubber feet to prevent slippage - Available in US English (7160-1585-00), UK English (7160-1585-01), German (7160-1585-02), French (7160-1585-03), Spanish (7160-1585-04), French CA (7160-1585-05), Thai (7160-1585-06). Contact Gamber-Johnson for other language options. - MIL-STD 810G shock/vibration, RoHS, FCC, CE - 1 Year Warranty (not designed to be vehicle mounted) 						

NEW



ZEBRA TC8000/TC8300 DOCKING STATION

Item No.	Description	Power Supply	Weight	Height	Width	Depth
7160-1277-02	Zebra TC8000/TC8300 Docking Station	<p>Use LIND Power Adapters: 12-32V Isolated Power Adapter (7300-0466), 20-60V Isolated Power Adapter (7300-0467), 72-110V Isolated Power Adapter (7300-0418)</p>	2.05 lbs 0.93 kg	4.13" 10.49 cm	4.25" 10.8 cm	6.0" 15.24 cm
<p>Features</p> <ul style="list-style-type: none"> - Compatible with both Zebra TC8000 and Zebra TC8300 Handheld Touch Computers - Add additional peripherals by pairing Gamber's Dock with Zebra's USB I/O Hub (sold separately by Zebra) - Requires Zebra USB I/O Hub for charging capabilities - Lightweight, small form factor designed to be resilient and reliable in harsh material handling and enterprise environments - Patented slam latch technology allows single handed operation to effortlessly remove the device - Eliminate daily battery exchanges and device downtime by maintaining charge within your mobile work environment - Reduce costly damages by safely securing your device - Included lock for theft deterrence and extra device security - Offers the ability to utilize the device when secured - Easy one-handed operation: <ul style="list-style-type: none"> - To dock: Insert top of the scanner into the dock at a 45 degree angle until the top of the scanner hits the inside edge of the dock - Lower the handle portion of the scanner into the dock until latch pops over front surface of the scanner - To release: Push the thumb latch to the left and pull outward on the scanner handle - Attach to a Gamber-Johnson mounting system using the AMPS hole pattern - MIL-STD 810G shock/vibration, RoHS, FCC - 1 Year Limited Warranty 						
<p>Port Replication</p> <ul style="list-style-type: none"> - Power Input 12VDC on Zebra I/O Hub)sold separately) 						

ZEBRA TC8000/TC8300 CRADLES

Item No.	Description	Power Supply	Weight	Height	Width	Depth
7160-1277-00	Zebra TC8000/TC8300 Non-Powered Cradle (No Electronics)		1.15 lbs 0.52 kg	4.13" 10.49 cm	4.25" 10.8 cm	6.0" 15.24 cm
7160-1277-01	Zebra TC8000/TC8300 Powered Charging Cradle	Use LIND Power Adapters: 12-32V Isolated Power Adapter (7300-0455), 20-60V Isolated Power Adapter (7300-0456), 72-110V Isolated Power Adapter (7300-0483)	1.30 lbs 0.59 kg	4.13" 10.49 cm	4.25" 10.8 cm	6.0" 15.24 cm

NEW



7160-1277-01

Features

- Compatible with both Zebra TC8000 and Zebra TC8300 Handheld Touch Computers
- Lightweight, small form factor designed to be resilient and reliable in harsh material handling and enterprise environments
- Patented slam latch technology allows single handed operation to effortlessly remove the device
- Eliminate daily battery exchanges and device downtime by maintaining charge within your mobile work environment
- Reduce costly damages by safely securing your device
- Included lock for theft deterrence and extra device security
- Offers the ability to utilize the device when secured
- Easy one-handed operation:
 - To dock: Insert top of the scanner into the dock at a 45 degree angle until the top of the scanner hits the inside edge of the dock
 - Lower the handle portion of the scanner into the dock until latch pops over front surface of the scanner
 - To release: Push the thumb latch to the left and pull outward on the scanner handle
- Attach to a Gamber-Johnson mounting system using the AMPS hole pattern
- MIL-STD 810G shock/vibration, RoHS, FCC
- 1 Year Limited Warranty

ZEBRA TC5X SERIES CRADLES

Item No.	Description	Power Supply	Weight	Height	Width	Depth
7160-1497	Zebra TC5x Non-Powered Cradle (No Electronics)		0.25 lbs 0.11 kg	7.96" 20.21 cm	3.58" 9.09 cm	1.63" 4.14 cm
7160-1497-01	Zebra TC5x Powered Cradle	Use LIND Power Adapters: 12-32V Isolated Power Adapter (7300-0466), 20-60V Isolated Power Adapter (7300-0467), 72-110V Isolated Power Adapter (7300-0418)	0.25 lbs 0.11 kg	7.96" 20.21 cm	3.58" 9.09 cm	1.63" 4.14 cm
7160-1497-02	Zebra TC5x Rugged Hub Adapter Cradle	Use Gamber-Johnson's Rugged Video Adapter Hub (7160-1580) for Power Requirements (8-32VDC) and Port Replication	0.25 lbs 0.11 kg	7.96" 20.21 cm	3.58" 9.09 cm	1.63" 4.14 cm

NEW



7160-1497

Features

- Compatible with the Zebra TC5x Series Handheld Touch Computer (Requires Zebra rugged boot SG-TC5X-EX01-01)
- Cradle accommodates the Zebra TC5x hand strap
- Combine Cradle with Gamber-Johnson's Rugged Video Adapter Hub (7160-1580) to obtain USB charging, communications capabilities, and dual screen capabilities
- Lightweight, small form factor designed to be resilient and reliable in harsh material handling and enterprise environments
- Eliminate daily battery exchanges and device downtime by maintaining charge within your mobile work environment (powered cradle/ rugged hub adapter cradle)
- Reduce costly damages by safely securing your device
- Easy one-handed docking and release operation:
 - To dock: Insert bottom of computer into the cradle, push top of computer into cradle until cradle latch clicks into place in the computer
 - To release: Lift latch to disengage and pull computer out of the cradle
- Attach to a Gamber-Johnson mounting system using the AMPS hole pattern
- MIL-STD 810G shock/vibration, RoHS, FCC
- 1 Year Limited Warranty

NEW



7160-1509

ZEBRA TC7X SERIES CRADLES

Item No.	Description	Placement/Compatibility	Weight	Height	Width	Depth
7160-1509	Zebra TC7x Cradle (No Electronics)		0.25 lbs 0.11 kg	7.12" 18.08 cm	3.56" 9.04 cm	2.0" 5.08 cm
7160-1509-01	Zebra TC7x Powered Cradle	Use LIND Power Adapters: 12-32V Isolated Power Adapter (7300-0466), 20-60V Isolated Power Adapter (7300-0467), 72-110V Isolated Power Adapter (7300-0418)	.25 lbs 0.11 kg	7.12" 18.08 cm	3.56" 9.04 cm	2.0" 5.08 cm
7160-1509-02	Zebra TC7x Rugged Hub Adapter Cradle	Use Gamber-Johnson's Rugged Video Adapter Hub (7160-1580) for Power Requirements (8-32VDC) and Port Replication	0.25 lbs 0.11 kg	7.12" 18.08 cm	3.56" 9.04 cm	2.0" 5.08 cm

Features

- Compatible with the Zebra TC7x Series Handheld Touch Computer
- Cradle accommodates the Zebra TC7x hand strap
- Combine Cradle with Gamber-Johnson's Rugged Video Adapter Hub (7160-1580) to obtain USB charging, communications capabilities, and dual screen capabilities
- Upper cut out enables scanner to be used while the computer is docked
- Lightweight, small form factor designed to be resilient and reliable in harsh material handling and enterprise environments
- Eliminate daily battery exchanges and device downtime by maintaining charge within your mobile work environment
- Reduce costly damages by safely securing your device
- Included lock for theft deterrence and extra device security
- Easy one-handed docking and release operation:
 - To dock: Insert bottom of computer into the cradle, push top of computer into cradle until cradle latch clicks into place in the computer
 - To release: Lift latch to disengage and pull computer out of the cradle
- Attach to a Gamber-Johnson mounting system using the AMPS hole pattern
- MIL-STD 810G shock/vibration, RoHS, FCC
- 1 Year Limited Warranty

RUGGED VIDEO ADAPTER HUB

NEW

Item No.	Description	Placement/Compatibility	Weight	Height	Width	Depth
7160-1580	Rugged Video Adapter Hub	Use with Zebra TC5x Dock (7160-1497-02) or Zebra TC7x Dock (7160-1509-02). Connect Using the 15-pin VGA Connector	0.25 lbs. 0.11 kg	1.6" 4.1 cm	5.8" 14.7 cm	6.4" 16.3 cm

Features

- Compatible with Gamber-Johnson's powered cradle/dock for Zebra's TC5x and TC7x Series Handheld Touch Computer
- Ability to extend or duplicate handheld computer screen to an additional touch capable monitor/screen
- Capable of powering external monitor/screen
- Headphones/speaker jack to connect external audio devices
- MIL-STD 810G shock/vibration, RoHS, FCC
- 1 Year Limited Warranty

Port Replication

- 15-pin VGA input connection
- HDMI (1) 19 pin
- USB 3.0 (3) 9 pin (900mA)

PANORAMA ANTENNAS

Part Number	Description	Cellular	GPS	WiFi	Housing Style	Mount Type	Antenna Connection Type
7300-0158	Sharkfin Style Antenna, GPS + LTE + WiFi	698-960 / 1710-2700MHz	GPS L1 1575	2.4 / 5.0GHz	Sharkfin	Bolt, Panel or Bracket Mount	TNC
7300-0159	Sharkfin Style Antenna, GPS/ GNSS + Dual Cell LTE + WiFi	1562-1612MHz 26dB LNA	2x2MiMo: 698-960 / 1710-3800MHz	2x2MiMo: 2.4 / 5.0GHz	Sharkfin	Bolt, Panel or Bracket Mount	TNC
7300-0160	Sharkfin Style Antenna, GPS + LTE	698-960 / 1710-2700MHz	GPS L1 1575		Sharkfin	Bolt, Panel or Bracket Mount	TNC
7300-0161	Sharkfin Style Antenna, GPS/ GNSS + Dual Cell LTE + WiFi	1562-1612MHz 26dB LNA	2x2MiMo: 698-960 / 1710-3800MHz	2x2MiMo: 2.4 / 5.0GHz	Sharkfin	Bolt, Panel or Bracket Mount	SMA
7300-0162	Sharkfin Style Antenna, GPS + LTE + WiFi	698-960 / 1710-2700MHz	GPS L1 1575	2.4 / 5.0GHz	Sharkfin	Bolt, Panel or Bracket Mount	SMA
7300-0165	Low Profile Antenna, 2G/3G/4G LTE + GPS	698-960/1710-2700MHz	1562-1612		Low Profile Dome	Bolt, Panel or Bracket Mount	SMA
7300-0166	Low Profile Antenna, 2G/3G/4G + GPS	698-960 / 1710-2700MHz	GPS L1 1575		Low Profile Dome	Bolt, Panel or Bracket Mount	TNC
7300-0167	Dashboard/Windshield Mount Antenna, 2G/3G/4G LTE + GPS/ GNSS	698-960 / 1710-2700MHz	1562-1612 26dB LNA		Low Profile Puck	Adhesive, Windshield or Dashboard	SMA
7300-0168	Dashboard/Windshield Mount Antenna, 2G/3G/4G LTE + GPS/ GNSS	698-960 / 1710-2700MHz	1562-1612 26dB LNA		Low Profile Puck	Adhesive, Windshield or Dashboard	TNC
7300-0169	Dashboard/Windshield Mount Antenna, 2G/3G/4G LTE + GPS/ GNSS + WiFi	698-960 / 1710-3800MHz	1562-1612 26dB LNA	2.4 / 5.0GHz	Low Profile Puck	Adhesive, Windshield or Dashboard	SMA
7300-0170	Dashboard/Windshield Mount Antenna, 2G/3G/4G LTE + GPS/ GNSS + WiFi	698-960 / 1710-3800MHz	1562-1612 26dB LNA	2.4 / 5.0GHz	Low Profile Puck	Adhesive, Windshield or Dashboard	TNC
7300-0340	Low Profile Antenna, 2G/3G/4G/5G LTE	698-960 / 1710-3800MHz			Low Profile Tube	Bolt, Panel or Bracket Mount	5 m Cable SMA
7300-0342	Low Profile Antenna, 2G/3G/4G/5G LTE	698-960 / 1710-3800MHz			Low Profile Dome	Bolt, Panel or Bracket Mount	5 m Cable FME
7300-0351	Adhesive Mount Antenna, 2G/3G/4G LTE	698-960 / 1710-2700MHz			Paddle	Adhesive, Windshield or Dashboard	3 m Cable SMA
7300-0352	Adhesive Mount Antenna, 2G/3G/4G LTE	698-960 / 1710-2700MHz			Paddle	Adhesive, Windshield or Dashboard	3 m Cable FME
7300-0361	Low Profile Antenna, 2G/3G/4G LTE with NMO Base	698-960 / 1710-2700MHz			Low Profile Tube	NMO Base	NMO
7300-0362	Low Profile Antenna, 2G/3G/4G LTE + WiFi	698-960 / 1710-2700MHz		2.4 / 5.0GHz	Low Profile Dome	Bolt, Panel or Bracket Mount	TNC
7300-0396	GPS/GNSS Power Divider, Connect 2 GPS/GNSS Receivers to a Single Antenna				Low Profile Rectangle		FME (Male)
7300-0401	Low Profile Panel/Roof Mount WiFi Antenna			2.4 / 5.0GHz	Sharkfin	Bolt, Panel or Bracket Mount	SMA
7300-0405	Ultra Low Profile 3X3 MiMo WiFi Antenna 5 m (17') Flame Retardant CS32			2.4-2.5 / 4.9-6GHz.	Ultra Low Profile	Bolt, Panel or Bracket Mount	5 m Cable Rev Pol SMA Plug
7300-0437	Low Profile WiFi Antenna for LTE, M2M and IOT			2.4 / 5.0GHz	Low Profile	Bolt, Panel or Bracket Mount	N (Female)
7300-0494	Easy Fit Adhesive Mount WiFi Antenna			2.4GHz	Paddle	Adhesive, Windshield or Dashboard	2 m Cable FME

PANORAMA ANTENNA KITS

NEW

Part Number	Description	Cellular	GPS	WiFi	Housing Style	Mount Type	Antenna Connection Type
7300-0347	Single Cell LTE Antenna W/ TNC Connector Kit Includes: Qty (1) Single Cell LTE Antenna (7300-0342), Qty (1) FME to TNC Connector (7300-0343)	698-960 / 1710-3800MHz			Low Profile Dome	Bolt, Panel or Bracket Mount	5 m Cable FME
7300-0400	Low Profile Panel/Roof Mount Wifi Antenna Kit TNC 2.4/5.5GHz Kit Includes: Qty (1) WiFi Antenna 2.4/5.8ghz Low Prof Fin Ant.3m SMA (7300-0401), Qty (1) Cable Assy SMA (Male) - TNC (Male) (7300-0404)			2.4 / 5.0GHz	Sharkfin	Bolt, Panel or Bracket Mount	SMA
7300-0403	Low Profile Panel/Roof Mount WiFi Antenna Kit SMA 2.4/5.5GHz Kit Includes: Qty (1) WiFi Antenna 2.4/5.8GHz Low Prof Fin Ant.3m SMA (7300-0401), Qty (1) Double Shielded Super Low Loss Cable 3M SMA (Male) to SMA (Male) (7300-0402)			2.4 / 5.0GHz	Sharkfin	Bolt, Panel or Bracket Mount	SMA
7300-0439	Low Profile WiFi Antenna Kit with Cable Kit Kit Includes: Qty (1) Low Profile WiFi Antenna 2.4/5.8GHz N Socket - White Antenna (7300-0437), Qty (1) Double Shield Low Loss Cable Assy N (Male) to SMA (Male) (7300-0438)	3.5GHz		2.4 / 5.0GHz	Low Profile	Bolt, Panel or Bracket Mount	N (Female)
7300-0495	Stand Alone Wifi Antenna Kit Kit Includes: Qty (1) Easy Fit Adhesive Mount Wifi Antenna 2.4GHz 2m FME FTTD (7300-0494), Qty (1) TNC (Male) to FME (Male) Coaxial Adapter (7300-0343)			2.4GHz	Paddle	Adhesive, Windshield or Dashboard	2 m Cable SMA

PANORAMA ANTENNA CABLES

NEW

Part Number	Description	Cable Length	TNC Plug	FME Plug
7300-0334	Low Loss Comms Cable Assembly, 5 m, FME (Female) to FME (Female)	5 meter	FME (Female)	FME (Female)
7300-0275	Low Loss Comms Cable Assembly, 5 m, FME (Female) to MINI UHF (Motorola)	5 meter	FME (Female)	Mini UHF (Male)
7300-0277	Low Loss Comms Cable Assembly, 5 m, FME (Female) to PL259 (Kenwood)	5 meter	FME (Female)	PL259
7300-0394	Low Loss Comms Cable Assembly, 5 m, FME (Female) to SMA (Male)	5 meter	FME (Female)	SMA (Male)
7300-0304	Low Loss Comms Cable Assembly, 5 m, FME (Female) to TNC (Male)	5 meter	FME (Female)	TNC (Male)
7300-0189	Low Loss Comms Cable Assembly, 5 m, FME (Male) to SMA (Male)	5 meter	FME (Male)	SMA (Male)
7300-0176	Low Loss Comms Cable Assembly, 5 m, FME (Male) to TNC (Male)	5 meter	FME (Male)	TNC (Male)
7300-0438	Double Shield Low Loss Cable, 5 m, N (Male) to SMA (Male)	5 meter	N (Male)	SMA (Male)
7300-0187	Double Shield Low Loss Cable, 5 m, SMA (Male) to SMA (Female)	5 meter	SMA (Male)	SMA (Female)
7300-0175	Double Shield Low Loss Cable, 5 m, TNC (Male) to SMA (Female)	5 meter	TNC (Male)	SMA (Female)
7300-0402	Double Shielded Super Low Loss Cable, 3 m, SMA (Male) to SMA (Male)	3 meter	SMA (Male)	SMA (Male)
7300-0393	Double Shielded Super Low Loss Cable, 5M, SMA (Male) to N (Female)	5 meter	SMA (Male)	N (Female)
7300-0188	Double Shielded Super Low Loss Cable, 5 m, SMA (Male) to Rev Polarity SMA (Male)	5 meter	SMA (Male)	Rev Pol SMA (Male)
7300-0424	Double Shielded Super Low Loss Cable, 5 m, SMA (Male) to SMA (Male)	5 meter	SMA (Male)	SMA (Male)
7300-0404	Double Shielded Super Low Loss Cable, 5 m, SMA (Male) to TNC (Male)	5 meter	SMA (Male)	TNC (Male)
7300-0343	Coaxial Adapter, TNC (Male) to FME (Male)		TNC (Male)	FME (Male)

PANORAMA ANTENNAS - ANTENNA WHIPS

Part Number	Description	UHF Frequency	VHF Frequency	7/800MHz Frequency Range	LTE Frequencies	Max Power	Pattern	Mount Type / Connection
7300-0278	VHF & UHF / 7/800 & Cellular Diplexer	782-870 MHz	50-210 MHz	700-2700MHz		100W		FME (Male)
7300-0177	NMO Panel Mount Antenna Base, 5 m, FME (Female)							FME (Female)
7300-0303	UHF 1/4 Wave Whip Antenna	450-470MHz				100W	Omni-Directional	M6
7300-0183	UHF 1/4 Wave Whip Antenna	762-870 MHz				100W	Omni-Directional	M6
7300-0267	UHF Gain Whip Antenna	762-870 MHz				60W	Omni-Directional	M6
7300-0269	UHF 1/4 Wave Whip Antenna	450-520MHz				100W	Omni-Directional	M6
7300-0270	UHF Whip Antenna With Gain	450-470MHz				60W	Omni-Directional	M6
7300-0271	VHF 1/4 Gain Whip Antenna		149-159MHz			100W	Omni-Directional	M6
7300-0292	Flexible VHF 1/4 Wave Whip Antenna		155-174MHz			100W	Omni-Directional	M6
7300-0273	Compact Tri-Band VHF/ UHF/7/800MHz Whip Antenna	450-520MHz	150-160MHz	762-800MHz (806-870MHz Fallback)		60W	Omni-Directional	M6
7300-0274	Compact Tri-Band VHF/ UHF/7/800MHz Whip Antenna	450-520MHz	150-160MHz	806-870MHz		60W	Omni-Directional	M6
7300-0395	Compact Flexible Cellular Whip Antenna				698-960MHz / 1710-2170MHz	60W	Omni-Directional	M6

NEW



CONSOLE SYSTEMS

Gamber-Johnson console boxes make the most out of any vehicle's small space in one, customizable solution. These units assist in the organization of the user's most important devices, so the job can be done safely and effectively.



2015-2020 FORD F-150 AND 2017+ SUPER DUTY VERTICAL CONSOLE BOX



Item No.	Description	Seat Configuration	Weight	Height	Width	Depth
7160-0875	Vertical Console Box	Bucket	7.0 lbs 3.2 kg	12.7" 32.3 cm	12.0" 30.5 cm	9.8" 24.9 cm

Features

- Low-profile console mounts under the dash to existing mounting points in vehicle
- 8" (20.3 cm) of opening space to mount devices in console
- Removable lower trim piece for use with HVAC ducts on transmission hump
- Relocate factory USB/AUX input module and OEM 12 volt power port
- One square knock-out for a switch or other accessory and one knock-out for aftermarket 12 volt power port
- Works with both regular, extended, and quad cab model trucks
- Does not work with vehicles with OEM center console
- 2 faceplates filler panels are included
- Fully welded construction for long-term life span
- Limited Lifetime Warranty

2020+ FORD POLICE INTERCEPTOR® UTILITY VEHICLE SPECIFIC CONSOLE BOX

NEW



Item No.	Description	Weight	Height	Width	Length	Depth
7160-1334	Standard Console Box	25 lbs 11.34 kg	17" 43.18 cm	9.2" 23.37 cm	25.94" 65.89 cm	9.8" 24.9 cm

Features

- Vehicle specific console box, easily installed without use of drill for the 2020+ Ford Police Interceptor Utility
- Easily mounts to existing studs in the vehicle (6 locations)
- Includes console box filler wings that go under dash
- Top plate on console allows for mounting a motion attachment or close-to-dash
- Top plate and spreader bar in the middle are removable to easily install the console and run wiring
- Two (2) mounting holes on console top plate made for motion attachments (driver side and passenger side)
- Ships fully assembled (except for console accessories i.e. faceplate, 12V outlets, etc.)
- Three (3) faceplate and three (3) fillers are included per console
- Threaded PEMS on side and rear accommodate arm rests
- Note: Console does not accommodate a 17A rear HVAC control

Vertical Section

- Accommodates 7" (17.78 cm) of mounting space (including OEM relocation panel) or 9" (22.86 cm) NOT including OEM relocation panel

Horizontal Section

- Accommodates 11" (27.94 cm) of mounting space (without internal cup holder)
- Limited Lifetime Warranty

2020+ FORD POLICE INTERCEPTOR® UTILITY LOW-PROFILE CONSOLES

Item No.	Description	Weight	Height	Width	Length	Depth
7160-1446	Low-Profile Console Box	20 lbs 9.1 kg	15" 38.1 cm	8.75" 22.2 cm	26" 66.0 cm	9.8" 24.9 cm
7170-0734-00	Kit Includes: Console Box (7160-1446), and Cup Holder (7160-0846)					
7170-0734-01	Kit Includes: Console Box (7160-1446), Cup Holder (7160-0846), and External Armrest (7160-0429)					
7170-0734-02	Kit Includes: Console Box (7160-1446), Cup Holder (7160-0846), and Printer Armrest (7160-0430)					
7170-0734-03	Kit Includes: Console Box (7160-1446), Cup Holder (7160-0846), and Vertical Surface Mount (14593)					
7170-0734-04	Kit Includes: Console Box (7160-1446), Cup Holder (7160-0846), External Armrest (7160-0429), and Mongoose 9" Locking Slide Arm (7160-0220)					
7170-0734-05	Kit Includes: Console Box (7160-1446), Cup Holder (7160-0846), External Armrest (7160-0429), and 6" Locking Slide Arm (7160-0500)					
7170-0734-06	Kit Includes: Console Box (7160-1446), Cup Holder (7160-0846), External Armrest (7160-0429), and Quad-Motion TS5 (7160-0285)					
7170-0734-07	Kit Includes: Console Box (7160-1446), Cup Holder (7160-0846), External Armrest (7160-0429), and Relocation Panel Kit (15082)					
7170-0734-08	Kit Includes: Console Box (7160-1446), Cup Holder (7160-0846), and Side Mount Armrest (7110-1013)					
7170-0734-09	Kit Includes: Console Box (7160-1446), Cup Holder (7160-0846), Printer Armrest (7160-0430), and Mongoose 9" Locking Slide Arm (7160-0220)					
7170-0734-10	Kit Includes: Console Box (7160-1446), Cup Holder (7160-0846), Printer Armrest (7160-0430), and Quad-Motion TS5 (7160-0285)					
7170-0734-11	Kit Includes: Console Box (7160-1446), Cup Holder (7160-0846), Printer Armrest (7160-0430), and Mongoose 9" Locking Slide Arm with Short Clevis (7160-0928)					
7170-0734-12	Kit Includes: Console Box (7160-1446), Cup Holder (7160-0846), External Armrest (7160-0429), and Mongoose 9" Locking Slide Arm with Short Clevis (7160-0928)					
7170-0734-13	Kit Includes: Console Box (7160-1446), Cup Holder (7160-0846), External Armrest (7160-0429), and Mongoose XE 9" Motion Attachment (7160-1116-09)					
7170-0734-14	Kit Includes: Console Box (7160-1446), Cup Holder (7160-0846), External Armrest (7160-0429), and Mongoose XLE 9" Motion Attachment (7160-1216-09)					
7170-0734-15	Kit Includes: Console Box (7160-1446), Cup Holder (7160-0846), External Armrest (7160-0429), and 6" Locking Slide Arm with Short Clevis (7160-1160)					
7170-0734-16	Kit Includes: Console Box (7160-1446), Cup Holder (7160-0846), External Armrest (7160-0429), and 6" Slide Arm with Short Clevis (7160-0926)					
7170-0734-17	Kit Includes: Console Box (7160-1446), Cup Holder (7160-0846), Printer Armrest (7160-0430), and Mongoose XE 7" Motion Attachment (7160-1116-07)					
7170-0734-18	Kit Includes: Console Box (7160-1446), Cup Holder (7160-0846), Printer Armrest (7160-0430), and Mongoose XLE 9" Motion Attachment (7160-1216-09)					
7170-0734-19	Kit Includes: Console Box (7160-1446), Cup Holder (7160-0846), Printer Armrest (7160-0430), and Mongoose XE 9" Motion Attachment (7160-1116-09)					
7170-0734-20	Kit Includes: Console Box (7160-1446), Cup Holder (7160-0846), Printer Armrest (7160-0430), and Mongoose XLE 7" Motion Attachment (7160-1216-07)					
7170-0734-21	Kit Includes: Console Box (7160-1446), Cup Holder (7160-0846), External Armrest (7160-0429), and Mongoose XE 7" Motion Attachment (7160-1116-07)					
7170-0734-22	Kit Includes: Console Box (7160-1446), Cup Holder (7160-0846), External Armrest (7160-0429), and Mongoose XLE 7" Motion Attachment (7160-1216-07)					
7170-0734-23	Kit Includes: Console Box (7160-1446), Cup Holder (7160-0846), Internal Printer Armrest (7160-1553), and Mongoose XLE 9" Motion Attachment (7160-1216-09)					
7170-0734-24	Kit Includes: Console Box (7160-1446), Cup Holder (7160-0846), and Mongoose XLE 9" Motion Attachment (7160-1216-09)					

NEW



7170-0734-09

Features

- Low profile, vehicle specific console box, easily installed without use of drill for the 2020+ Ford Police Interceptor Utility
- Lowered top plate maintains accessibility to optional rear HVAC controls (Ford 17A ordering option)
- Designed with sloped front for ease of use and accessibility to radio and siren controls
- Easy installation requiring no OEM parts to be removed
- Console sits low between the front seats to create a more comfortable workspace
- Mounting holes on top plate allow for easy installation of desired motion attachments
- Low profile creates desirable egress between seats
- Relocation faceplate for OEM 12V, USB, AUX 12V, and switch knockout included
- Included rear wire cover will meet up directly to Ford 85R if present

Vertical Section

- Accommodates 7" (17.78 cm) of mounting space (including OEM relocation panel) or 9" (22.86 cm) NOT including OEM relocation panel

Horizontal Section

- Accommodates 11" (27.94 cm) of mounting space (without internal cup holder)
- Limited Lifetime Warranty

NEW



7160-1335

2020+ FORD POLICE INTERCEPTOR® UTILITY SHORT CONSOLES

Item No.	Description	Weight	Height	Width	Length	Depth
7160-1335	Short Console Box	22 lbs 9.98 kg	15.5" 39.37 cm	9" 22.86 cm	27.87" 70.79 cm	9.8" 24.9 cm
7170-0735-00	Kit Includes: Console Box (7160-1335), and Cup Holder (7160-0846)					
7170-0735-01	Kit Includes: Console Box (7160-1335), Cup Holder (7160-0846), and Heavy-Duty Armrest (MCS-ARMREST)					
7170-0735-02	Kit Includes: Console Box (7160-1335), Cup Holder (7160-0846), and Printer Armrest with DS (7160-1403)					
7170-0735-04	Kit Includes: Console Box (7160-1335), Cup Holder (7160-0846), Heavy-Duty Armrest (MCS-ARMREST), and Mongoose 9" Locking Slide Arm with Short Clevis (7160-0928)					
7170-0735-05	Kit Includes: Console Box (7160-1335), Cup Holder (7160-0846), Heavy-Duty Armrest (MCS-ARMREST), and 6" Locking Slide Arm with Short Clevis (7160-1160)					
7170-0735-06	Kit Includes: Console Box (7160-1335), Cup Holder (7160-0846), Heavy-Duty Armrest (MCS-ARMREST), and Mongoose XE 7" Motion Attachment (7160-1116-07)					
7170-0735-07	Kit Includes: Console Box (7160-1335), Cup Holder (7160-0846), Heavy-Duty Armrest (MCS-ARMREST), and Mongoose XLE 7" Motion Attachment (7160-1216-07)					
7170-0735-08	Kit Includes: Console Box (7160-1335), Cup Holder (7160-0846), Heavy-Duty Armrest (MCS-ARMREST), and Mongoose XLE 9" Motion Attachment (7160-1216-09)					
7170-0735-09	Kit Includes: Console Box (7160-1335), Cup Holder (7160-0846), Heavy-Duty Armrest (MCS-ARMREST), and Mongoose XE 9" Motion Attachment (7160-1116-09)					
7170-0735-10	Kit Includes: Console Box (7160-1335), Cup Holder (7160-0846), Printer Armrest with DS (7160-1403), and Mongoose XE 7" Motion Attachment (7160-1116-07)					
7170-0735-11	Kit Includes: Console Box (7160-1335), Cup Holder (7160-0846), Printer Armrest with DS (7160-1403), and Mongoose XE 9" Motion Attachment (7160-1116-09)					

Features

- Compact, vehicle specific console box, easily installed without use of drill for the 2020+ Ford Police Interceptor Utility
- Horizontal mounting space is shortened to increase accessibility to gun mounts and equipment
- Lowered top plate maintains accessibility to optional rear HVAC controls (Ford 17A ordering option)
- Easy installation requiring no OEM parts to be removed
- Console sits low between the front seats to create a more comfortable workspace
- Relocation faceplate for OEM 12V, USB, AUX 12V, and switch knockout included

Mounting Space

- 10" (25.4 cm) vertical section, 4.5" (11.43 cm) horizontal section
- Limited Lifetime Warranty

NEW



2020+ FORD POLICE INTERCEPTOR® UTILITY FULL DEPTH CONSOLES

Item No.	Description	Weight	Height	Width	Length	Depth
7160-1477	Full Depth Console Box	41.25 lbs 18.71 kg	15.69" 39.85 cm	11.55" 29.34 cm	31.15" 79.12 cm	9.8" 24.9 cm
7170-0822-00	Kit Includes: Console Box (7160-1477), Cup Holder (7160-0846), Side Mount Armrest (7110-1013), and Side Mount (7160-1522)					
7170-0822-01	Kit Includes: Console Box (7160-1477), Cup Holder (7160-0846), Side Mount Armrest (7110-1013), and 5" Center-Mounted Complete Upper Pole (7160-0177)					

Features

- Full depth, vehicle specific console box, easily installed without use of drill for the 2020+ Ford Police Interceptor Utility
- Full depth console box accommodates one-piece radios and controls
- Easy installation requiring no OEM parts to be removed
- OEM 12V/USB relocation, switch knockout, and 12V knockout included with no loss of mounting space
- Padded armrest flips up for convenience

Mounting Space

- Kit (7170-0822-00) features 8" (20.32 cm) of front mounting space and 14.5" (36.83 cm) of rear mounting space
- Kit (7170-0822-01) features 5" (12.7 cm) of front mounting space and 14.5" (36.83 cm) of rear mounting space
- Limited Lifetime Warranty

2020+ FORD POLICE INTERCEPTOR® UTILITY IN-CONSOLE PRINTER MOUNT

Item No.	Description	Weight	Height	Width	Length	Depth
7160-1543	In-Console Printer Mount	6.25 lbs 2.83 kg	3.5" 8.89 cm	11.71" 29.74 cm	11.97" 30.4 cm	9.8" 24.9 cm

Features

- Easily installs in the 2020+ Ford Police Interceptor Utility Full Depth Console
- Lockable lid safely secures the Brother PocketJet PJ-600/700 series printers
- Printer and paper can be quickly accessed with the push of a button
- Includes USB extension wire with 90 degree plug
- Limited Lifetime Warranty

NEW



2015-2020 FORD F-150, 2017+ F-250-550, AND 2018+ FORD EXPEDITION WIDE BODY CONSOLES

Item No.	Description	Weight	Height	Width	Length	Depth
7160-1256	Console Box	25 lbs 11.34 kg	16" 40.64 cm	14" 35.56 cm	30" 76.2 cm	9.8" 24.9 cm
7170-0727-00	Kit Includes: Console Box (7160-1256), and Cup Holder (7160-0846)					
7170-0727-01	Kit Includes: Console Box (7160-1256), and Cup Holder (7160-0846), and External Armrest (7160-0429)					
7170-0727-02	Kit Includes: Console Box (7160-1256), and Cup Holder (7160-0846), and Printer Armrest (7160-0430)					
7170-0727-03	Kit Includes: Console Box (7160-1256), and Cup Holder (7160-0846), and Side Mount Armrest (7110-1013)					

Features

- Wide body, vehicle specific console box, easily installed without use of drill for the 2015-2020 Ford F-150, 2017+ F-250-550, and 2018+ Ford Expedition
- Sloped front and horizontal section create a vehicle specific look and feel
- Simple and fast install not requiring any drilling as the console is specific to vehicle and uses existing mounting points saving time and money
- Cutouts on passenger, top, back side of console for 12V outlets and other accessories create freedom to locate items effectively and to user preferences
- Push-button locking storage compartment with one (1) rectangular cutout and one (1) 12V outlet cutout
- Threaded PEMS for various items for quickly mounting various accessories (mic clips, rear arm rest, side arm rest)

Vertical Section

- 8" (20.32 cm) of mounting space
- Designed to house full-size devices and accessories
- Vertical plate holding devices can be turned 180° and reinstalled to mount devices away from driver, if desired

Horizontal Section

- 12" (30.48 cm) of mounting space or 7.5" (19.05 cm) of mounting space after internal cup holder
- Locking pocket designed to hold various items (locking pocket opening dimension: 4" (10.16 cm) W X 12" (30.48 cm) L X 8" (20.32 cm) H)
- Front angled portion of horizontal plate features a micro switch knockout and regular switch knockout if lighting is necessary in the pocket
- Limited Lifetime Warranty

NEW



NEW



2015-2020 FORD F-150 NARROW CONSOLES

Item No.	Description	Weight	Height	Width	Length	Depth
7160-1452	Narrow Console Box	22 lbs 9.98 kg	16" 40.64 cm	14.5" 36.83 cm	30" 76.2 cm	9.8" 24.9 cm
7170-0829-00	Kit Includes: Console Box (7160-1452), and Cup Holder (7160-0846)					
7170-0829-01	Kit Includes: Console Box (7160-1452), and Cup Holder (7160-0846), and External Armrest (7160-0429)					
7170-0829-02	Kit Includes: Console Box (7160-1452), and Cup Holder (7160-0846), and Printer Armrest (7160-0430)					
7170-0829-03	Kit Includes: Console Box (7160-1452), and Cup Holder (7160-0846), and Side Mount Armrest (7110-1013)					
Features						
<ul style="list-style-type: none"> - Narrow body, vehicle specific console box, easily installed without use of drill for the 2015-2020 Ford F-150v - Narrowed width creates extra clearance for seat belts and gun holsters - Simple and fast install not requiring any drilling as the console is specific to vehicle and uses existing mounting points saving time and money - Sloped front increases accessibility to radios and controls - Includes 8" (20.32 cm) of angled mounting space and 12" (30.48 cm) of horizontal mounting space - Limited Lifetime Warranty 						

NEW



2017+ F-250-550 SUPER DUTY VEHICLE SPECIFIC CONSOLES

Item No.	Description	Weight	Height	Width	Length	Depth
7160-1326	Console Box	26 lbs 11.79 kg	16" 40.64 cm	14" 35.56 cm	30" 76.2 cm	9.8" 24.9 cm
7170-0728-00	Kit Includes: Console Box (7160-1326), and Cup Holder (7160-0846)					
7170-0728-01	Kit Includes: Console Box (7160-1326), and Cup Holder (7160-0846), and External Armrest (7160-0429)					
7170-0728-02	Kit Includes: Console Box (7160-1326), and Cup Holder (7160-0846), and Printer Armrest (7160-0430)					
7170-0728-03	Kit Includes: Console Box (7160-1326), and Cup Holder (7160-0846), and Side Mount Armrest (7110-1013)					
Features						
<ul style="list-style-type: none"> - Wide body, vehicle specific console box, easily installed without use of drill for the 2017+ F-250-550 Super Duty - Sloped front and horizontal section create a vehicle specific look and feel - Simple and fast, no-drill install as the console is specific to vehicle using existing mounting points saving you time and money - Cutouts on passenger, top, back side of console for 12V outlets and other accessories create freedom to locate those items effectively - Push-button locking storage compartment with one (1) rectangular cutout and one (1) 12V outlet cutout - Threaded PEMS and studs for various items for quickly mounting various accessories (mic clips and arm rests) - Ships with filler panel wings assembled 						
Vertical Section						
<ul style="list-style-type: none"> - 8" (20.32cm) of mounting space - Designed to house full-size devices and accessories - Three (3) 12V outlet cutouts and three (3) switch cutouts on face of vertical section - Console ships with vertical plate turned 180° in order to mount full length devices away from driver while still utilizing the 4X4 shifter on the floor 						
Horizontal Section						
<ul style="list-style-type: none"> - 12" (30.48 cm) of mounting space or 7.5" (19.05 cm) of mounting space after internal cup holder - Designed to house full-size devices and accessories - Locking pocket designed to hold various items (locking pocket opening dimension: 8" (20.32 cm) H x 4" (10.16 cm) W x 12" (30.48 cm) - Limited Lifetime Warranty 						

2021+ CHEVROLET TAHOE WIDE BODY CONSOLE BOX

Item No.	Description	Weight	Height	Width	Length
7160-1566	Wide Body Console Box	35 lbs 15.88 kg	13.5" 34.29 cm	14.54" 36.93 cm	28.66" 72.8 cm
7170-0848-00	Kit includes: Console Box (7160-1566), Side Mount Armrest (7110-1013), and Cup Holder (7160-0846)				
7170-0848-01	Kit includes: Console Box (7160-1566), Side Mount Armrest (7110-1013), Cup Holder (7160-0846), and Mongoose 9" XE Motion Attachment (7160-1116-09)				
7170-0848-02	Kit includes: Console Box (7160-1566), Side Mount Armrest (7110-1013), Cup Holder (7160-0846), and Mongoose 9" Locking Slide Arm with Short Clevis (7160-0928)				
7170-0848-03	Kit includes: Console Box (7160-1566), Printer Armrest (7160-0430), Cup Holder (7160-0846), and Mongoose 9" Locking Slide Arm with Short Clevis (7160-0928)				
7170-0848-04	Kit includes: Console Box (7160-1566), Side Mount Armrest (7110-1013), Cup Holder (7160-0846), and Mongoose 9" XLE Motion Attachment (7160-1216-09)				
7170-0848-05	Kit includes: Console Box (7160-1566), Side Mount (14593), and Cup Holder (7160-0846)				
7160-1566-01	Wide Body Console Box with Internal Printer Mount	40 lbs 18.14 kg	13.5" 34.29 cm	14.54" 36.93 cm	28.66" 72.8 cm
7170-0864-00	Kit includes: Console Box with Internal Printer Mount (7160-1566-01), Side Mount Armrest (7110-1013), and Cup Holder (7160-0846)				
7170-0864-01	Kit includes: Console Box with Internal Printer Mount (7160-1566-01), Side Mount Armrest (7110-1013), Cup Holder (7160-0846), and Mongoose 9" XE Motion Attachment (7160-1116-09)				
7170-0864-02	Kit includes: Console Box with Internal Printer Mount (7160-1566-01), Side Mount Armrest (7110-1013), Cup Holder (7160-0846), and Mongoose 9" Locking Slide Arm with Short Clevis (7160-0928)				
7170-0864-03	Kit includes: Console Box with Internal Printer Mount (7160-1566-01), Side Mount Armrest (7110-1013), Cup Holder (7160-0846), and Mongoose 9" XLE Motion Attachment (7160-1216-09)				
7170-0864-04	Kit includes: Console Box with Internal Printer Mount (7160-1566-01), Side Mount (14593), and Cup Holder (7160-0846)				
Features					
<ul style="list-style-type: none"> - Wide body, vehicle specific console box, easily installed without use of drill for the 2021+ Chevrolet Tahoe - Wide body design maximizes mounting space - Push-button locking storage compartment keeps valuables safe and includes one rectangular cutout and one 12V outlet cutout - Simple and fast, no-drill install as the console is specific to vehicle using existing mounting points saving you time and money - Computer and devices can be easily mounted to the 3-hole pattern on either driver or passenger side - Includes three 12 volt plug knock-outs, three USB power ports, and two mic mount locations 					
Vertical Section					
<ul style="list-style-type: none"> - 8" (20.32cm) of mounting space for 7160-1566 - 3" (7.62cm) of mounting space for 7160-1566-01 					
Horizontal Section					
<ul style="list-style-type: none"> - 12" (30.48 cm) of mounting space or 7.5" (19.05 cm) of mounting space after internal cup holder - Limited Lifetime Warranty 					

NEW



7160-1566

NEW



7160-1566-01

2019+ CHEVROLET SILVERADO 1500 / 2019+ GMC SIERRA 1500 LEG KIT (W/ NEW BODY STYLE)

NEW



7160-1325



7170-0784-07

Item No.	Description	Weight	Height	Width	Depth
7160-1325	Leg Kit	3.2 lbs 1.4 kg	See features	See features	See features
7170-0784-00	Kit Includes: Leg Kit (7160-1325) and Console Box (7160-0548)				
7170-0784-01	Kit Includes: Leg Kit (7160-1325), Console Box (7160-0548), Cup Holder (7160-0846), and Side Mount Armrest (7110-1013)				
7170-0784-02	Kit Includes: Leg Kit (7160-1325), Console Box (7160-0548), and Wire Chase Assembly (7110-1024)				
7170-0784-03	Kit Includes: Leg Kit (7160-1325), Console Box (7160-0548), Cup Holder (7160-0846), Side Mount Armrest (7110-1013), and Wire Chase Assembly (7110-1024)				
7170-0784-04	Kit Includes: Leg Kit (7160-1325), Console Box (7160-0548), Cup Holder (7160-0846), Side Mount Armrest (7110-1013), Wire Chase Assembly (7110-1024), and Mongoose 9" Locking Slide Arm (7160-0220)				
7170-0784-05	Kit Includes: Leg Kit (7160-1325), Console Box (7160-0548), Cup Holder (7160-0846), Side Mount Armrest (7110-1013), and Mongoose 9" Locking Slide Arm (7160-0220)				
7170-0784-06	Kit Includes: Leg Kit (7160-1325), Console Box (7160-0548), Cup Holder (7160-0846), Side Mount Armrest (7110-1013), and 6" Locking Slide Arm (7160-0500)				
7170-0784-07	Kit Includes: Leg Kit (7160-1325) and Console Box (7160-0548), and Cup Holder (7160-0846)				
	Front Legs		1.5" 3.8 cm	3" 7.6 cm	5" 12.7 cm
	Rear Legs		2.3" 5.7 cm	2" 5.1 cm	6.5" 16.5 cm
<p>Features</p> <ul style="list-style-type: none"> - Low profile, vehicle specific console box and leg kit for the 2019+ Chevrolet Silverado 1500 - Leg kit easily attaches to the sides of the transmission hump - Will NOT fit in 2019 Chevrolet Silverado 1500 CLASSIC/GMC Sierra 1500 CLASSIC. For those vehicles please see 7160-0509 - Works with our 23" (58.42 cm) (7160-0086) and 29" (73.66 cm) (7160-0085) top plates only - Does not work with trucks with OEM center console with shifter <p>Vertical Section</p> <ul style="list-style-type: none"> - Vertical Section accommodates 7.5" (19.05 cm) of mounting space <p>Horizontal Section</p> <ul style="list-style-type: none"> - Horizontal Section accommodates 7" (17.78 cm) of mounting space including internal cup holder - Horizontal Section accommodates 11.5" (29.21 cm) of mounting space excluding internal cup holder <p>- Limited Lifetime Warranty</p>					

2011-2020 DODGE CHARGER CONSOLES - LONG

Item No.	Description	Seat Configuration	Weight	Height	Width	Depth
7160-0326	Vehicle Specific Console Only	Bucket	18 lbs 8.2 kg	10.1" 25.7 cm	14.14" 35.9 cm	35.66" 90.6 cm
7170-0137-00	Kit Includes: Console Box (7160-0326) and a Cup Holder (7160-0846)					
7170-0137-01	Kit Includes: Console Box (7160-0326), a Cup Holder (7160-0846), and an Arm Rest (7160-0429)					
7170-0137-02	Kit Includes: Console Box (7160-0326), a Cup Holder (7160-0846), and a Printer Arm Rest (7160-0430)					
7170-0137-03	Kit Includes: Console Box (7160-0326), a Cup Holder (7160-0846), Vertical Surface Mount (14594), and a Hardware Bag (7120-0593)					
7170-0137-04	Kit Includes: Console Box (7160-0326), a Cup Holder (7160-0846), Arm Rest (7160-0429), and a Mongoose Motion Attachment (7160-0220)					
7170-0137-05	Kit Includes: Console Box (7160-0326), a Cup Holder (7160-0846), Arm Rest (7160-0429), and a 6" Locking Slide Arm (7160-0500)					



7170-0137-01



7170-0137-02



7170-0137-04

Features

- Low profile vehicle specific console for the Dodge Charger
- Attaches to the Dodge Charger without the need to order a separate top plate, five fasteners for mounting the console
- A removable top plate and center plate for easy radio installation and wire routing
- Ships with molded dash filler panels that give the box a sleek appearance that blends in with the car's aesthetics
- Five, 12 Volt knock-outs (4 on the back and 1 on driver side)
- USB and MP3 knock-outs from stock console, relocated on passenger side
- Computer can be mounted offset towards the passenger or on the 3-bolt pattern closer to the driver
- Box will ship fully assembled (except accessories)
- Fully welded construction for long term product life span
- 3 faceplates and 3 filler panels are included
- Console box is not compatible with legacy Dodge Chargers

Horizontal, Low Profile Section

- Accommodates 4 to 6 devices (13.5" of mounting space) without an internal cup holder or 1 to 2 devices (9.0" (22.9 cm) of mounting space) with an internal cup holder
- Has a mounting space height range of 3.6" (9.1 cm) to 5.67" (14.4 cm)
- Designed to house remote or control head devices and accessories

Vertical, Angled Section

- Accommodates 1 to 3 full sized devices (7.5" (19 cm) of mounting space)
- Limited Lifetime Warranty

2011-2020 DODGE CHARGER CONSOLES - SHORT

Item No.	Description	Seat Configuration	Weight	Height	Width	Depth
7160-0353	Vehicle Specific Console Only	Bucket	17.5 lbs 7.9 kg	10.1" 25.7 cm	14.14" 35.9 cm	32.6" 82.8 cm
7170-0564-00	Kit Includes: Console Box (7160-0353) and a Cup Holder (7160-0486)					
7170-0564-01	Kit Includes: Console Box (7160-0353), a Cup Holder (7160-0846), and an Arm Rest (7160-0429)					
7170-0564-02	Kit Includes: Console Box (7160-0353), a Cup Holder (7160-0846), and a Printer Arm Rest (7160-0430)					
7170-0564-03	Kit Includes: Console Box (7160-0353), a Cup Holder (7160-0846), Vertical Surface Mount (14594), and a Hardware Bag (7120-0593)					
7170-0564-04	Kit Includes: Console Box (7160-0353), a Cup Holder (7160-0846), Arm Rest (7160-0429), and a Mongoose Motion Attachment (7160-0220)					
7170-0564-05	Kit Includes: Console Box (7160-0353), a Cup Holder (7160-0846), Arm Rest (7160-0429), and a 6" Locking Slide Arm (7160-0500)					



7160-0353



7170-0564-02



7170-0564-04

Features

- Low profile vehicle specific console for the Dodge Charger
- Attaches directly to the Dodge Charger without the need to order a separate top plate, five fasteners for mounting the console allows for easy installation
- A removable top plate and center plate for easy radio installation and wire routing
- Ships with molded dash filler panels that give the box a sleek appearance that blends in with the car's aesthetics
- Five 12 volt knock-outs, USB and MP3 knock-outs from stock console relocated on passenger side
- Computer can be mounted either offset towards the passenger or on the 3-bolt pattern closer to the driver
- Box will ship fully assembled (except accessories)
- Fully welded construction for long term product life span
- 3 faceplates and 3 filler panels are included
- Console box is not compatible with legacy Dodge Chargers

Horizontal, Low Profile Section

- Accommodates 10.0" (25.4 cm) of mounting space or 5.5" (14.0 cm) mounting space with cup holder and is designed to house radio control heads and accessories

Vertical, Angled Section

- Accommodates 1 to 3 full sized devices (7.5" (19 cm) of mounting space)
- Limited Lifetime Warranty

NEW



2019+ NEW BODY STYLE RAM 1500 LEG KIT

Item No.	Description	Weight	Height	Width	Depth
7160-1383	Leg Kit	6 lbs 2.72 kg	See features	See features	See features
	Front Legs		2.75" 6.99 cm	1.86" 4.72 cm	13.13" 33.35 cm
	Rear Legs		4.57" 11.61 cm	1.86" 4.72 cm	12.13" 30.81 cm

Features

- Four (4) slotted holes allow for fine tuning the console alignment between front seats
- Works with our 29" and 23" top plates as well as the 7160-0548 console box
- Uses same seat bolts used for the center seat for ease of install
- Limited Lifetime Warranty



DODGE CHARGER CONSOLE BOX WITH 12.1" IN-DASH DISPLAY

Item No.	Description	Seat Configuration	Weight	Height	Width	Depth
7160-0877	Vehicle Specific Console Only	Bucket	12 lbs 5.4 kg	5.1" 13 cm	9.0" 22.9 cm	20.75" 52.7 cm

Features

- Heavy gauge steel, fully welded construction for long-term durability
- Low profile vehicle specific console
- Mounts to existing mounting points in vehicle
- 19" (48.3 cm) opening to mount devices in console
- No need to relocate HVAC, radio, 12 VDC power ports, and AUX/USB inputs
- Four 12 volt knock-outs on back side of the console
- Mounting on the front passenger side for keyboard tray using the vertical surface mount, upper pole, and Motion Attachment (14593)
- Mount for armrest is located on the back of the console box
- Maximum depth in console is 5.25" (13.3 cm)
- 3 faceplates and 3 filler panels included
- Ships fully assembled
- Limited Lifetime Warranty

Note: For RAM Classic Body see 7160-0422 and 7160-0985

NEW



7170-0721-01

2018-2020 DODGE DURANGO CONSOLES

Item No.	Description	Weight	Height	Width	Depth
7160-1047	Console Box	30.0 lbs 13.6 kg	12.0" 30.5 cm	9.0" 22.9 cm	32.0" 81.3 cm
7170-0721-00	Kit Includes: Console Box (7160-1047) and Cup Holder (7160-0846)				
7170-0721-01	Kit Includes: Console Box (7160-1047), Cup Holder (7160-0846), and External Armrest (7160-0429)				
7170-0721-02	Kit Includes: Console Box (7160-1047), Cup Holder (7160-0846), and Printer Armrest (7160-0430)				

Features

- Low profile, vehicle specific console box, easily installed without use of drill for the 2018-2020 Dodge Durango
- Easily mounts directly to the transmission hump without requiring a Leg Kit or MCS Top Plate
- Designed with a removable center brace for easy radio installation and wire routing
- Ships with dash filler panels giving the console box a sleek appearance that blends in with the car's aesthetics
- Threaded PEM's provided for rear mounted armrest to the console
- Includes one 12 Volt and two switch knock-outs located on shifter faceplate

Vertical Section

- Angled section accommodates 5" (12.7 cm) of mounting space and is designed to house radio control heads and accessories

Horizontal Section

- Section accommodates 13" (33.02 cm) of mounting space and is designed to house radio control heads and accessories
- With traction control faceplate users have 7.5" (19.05 cm) of mounting internal height
- With traction control faceplate users have 10" (25.4 cm) of mounting space
- With traction control faceplate and internal cup holder users have 5.5" (13.97 cm) of mounting space
- Designed to house full sized devices and accessories
- Limited Lifetime Warranty

VEHICLE SPECIFIC CONSOLE BOX ACCESSORIES

The table below shows the compatibility of the accessories that are designed to work with the vehicle specific console boxes. For more detailed information and images please visit our website.



14422



7110-1001



7110-1013



7160-0429



7160-0430



7110-1201



7160-0464



7160-0524

Item No.	Description	Chevrolet Caprice Console (2014+)	Chevrolet Tahoe Console (2007-2014)	Chevrolet Tahoe/Silverado Console (2015+)	Dodge Charger Console (2011+)	Dodge Durango Console (2014+)	Ford Sedan PI Console (2012+)	Ford Utility PI Console (2012+)	Ford Transit 2015+	Utility Specific Box
13791	LIND Factory Set Shut Down Timer			Yes						Yes
13792	LIND Adjustable Shut Down Timer			Yes						Yes
14422	Charger USB/ Phone Jack/ 12 Volt Relocation Filler Panel				Yes					
15250	Tahoe USB/MP3/SD Card Reader/Factory 12 Volt Relocation Filler Panel			Yes						Yes
17100	Ford Transit Upfitter Switches Relocation								Yes	
7110-1001	Interior Armrest				Yes		Yes	Yes		
7110-1013	Side Armrest	Yes	Yes	Yes	Yes					Yes
7110-1024	Tahoe Wiring Chase			Yes						
7160-0110	Power Distribution Block			Yes						Yes
7160-0313	Power Distribution Block With Negative Bus			Yes						Yes
7160-0429	Exterior Armrest	Yes	Yes	Yes	Yes	Yes	Yes	Yes		Yes
7160-0430	Exterior Brother Printer Armrest	Yes	Yes	Yes	Yes	Yes	Yes	Yes		Yes
7160-0464	Tahoe Passenger Side Accessory Mounting Box		Yes	Yes						Yes
7110-1201	Tahoe Side Panels <i>Note: can't be used with wiring chase packages (7160-0548-02 and 7160-0548-03)</i>			Yes (Tahoe only)						Yes
7160-0524	Exterior Break Away Armrest	Yes	Yes	Yes	Yes	Yes	Yes	Yes		Yes
7160-0847	Universal Heavy-Duty Cupholder <i>Note: can't be used with exterior armrests</i>			Yes						Yes
15082	Rocker Switch And Cigarette Knockout Panel	Yes	Yes	Yes	Yes	Yes	Yes	Yes	Yes	Yes
15083	Rocker Switch Knockout Panel	Yes	Yes	Yes	Yes	Yes	Yes	Yes	Yes	Yes

2020+ FORD POLICE INTERCEPTOR® UTILITY ON-DASH MOUNT

Item No.	Description	Weight	Height	Width	Depth
7160-1346	On-Dash Mount	11.62 lbs 5.27 kg	16" 40.64 cm	15" 38.1 cm	22" 55.88 cm
7160-1346-01	On-Dash Mount with 3" Extension Arm	12.5 lbs 5.67 kg	16" 40.64 cm	15" 38.1 cm	25" 63.5 cm

Features

- On-Dash Mount for the 2020+ Ford Police Interceptor Utility installs quickly and brings tablets and displays into better view
- Mounts to the OEM dash as well as to the top of the console for a secure mount
- Interchangeable lower legs for a universal fit
- Lower legs wrap around the top of the console without obstructing access to vehicle controls
- Drilling not required for easy installation
- One-handed operation to twist and tilt your tablet for easy viewing
- Limited Lifetime Warranty

NEW



2020+ FORD POLICE INTERCEPTOR® UTILITY CLOSE-TO-DASH MOUNT

Item No.	Description	Weight	Height	Width	Depth
7160-1337	Close-To-Dash Mount	6.85 lbs 3.11 kg	13" 33.02 cm	6" 15.24 cm	7.88" 20.00 cm
7160-1337-01	Close-To-Dash Mount with 3" Extension Arm	6.85 lbs 3.11 kg	13" 33.02 cm	6" 15.24 cm	7.88" 20.00 cm

Features

- Rugged close-to-dash mounting solution for the 2020+ Ford Police Interceptor Utility
- Works with tablets and convertible laptop docking stations
- Easily mounts to the top of the console box using the 3-hole pattern
- Pair with one of our Mongoose motion attachments for added flexibility
- Limited Lifetime Warranty

Note: Compatible only with Gamber-Johnson product lines

NEW



FORD F-150 (2015-2020), F-250 TO F-550 SUPER DUTY (2017+), EXPEDITION (2018+), AND CHEVROLET TAHOE (2021+)

Item No.	Placement
7160-1010	Ford F-150 (2015-2020), F-250 to F-550 Super Duty (2017+), Expedition (2018+), and Chevrolet Tahoe (2021+)

Features

- Fully welded construction for long term product life span
- Low profile, ergonomic, vehicle specific mount
- Works with tablets and convertible laptops docking stations
- Mounts to the top of Gamber-Johnson console box (7160-0894, 7160-0896, 7160-0899, 7160-0911, 7160-0970 console boxes and their related kits)
- Mounts to Gamber-Johnson mobile workstation radio platforms (7170-0581-03, 7170-0581-04, 7170-0563-03, 7170-0563-04, 7170-0125-01)
- Securely mounts to the side of the side and top of the console box utilizing the existing two side bolts and 3-hole pattern
- Allows use of the 3-bolt hole pattern for use with motion device for keyboard separate from the tablet or convertible computer
- Allows for viewing of the device from both driver and passenger seat - about 90° of rotation - with one hand
- 3" link allows for movement and proper placement of device mounted on the Clevis
- Allows for complete access of the dash control on the vehicle
- Limited Lifetime Warranty

Note: To adjust your computer, display, or device higher use the offset adapter bracket (7160-0872)



2011-2020 DODGE CHARGER CLOSE-TO-DASH MOUNT



Item No.	Placement	Weight	Height	Width	Depth
7160-0820	On the Dodge Charger Console Box	5.25 lbs 2.4 kg	10.5" 26.7 cm	11.5" 29.2 cm	5.5" 14 cm

Features

- Low profile, ergonomic, vehicle specific mount
- Sleek and small design so you can easily access both your tablet and electronics
- Easy install - no need to remove the dashboard
- Rugged steel construction with black powder coat finish for long-term durability
- Features a Clevis to twist and tilt your tablet for easier viewing from the driver and passenger seat
- Stabilization foot helps reduce vibration
- Works with tablets, convertible laptops, mounting displays, and other devices
- Black powder coat finish, heavy-gauge metal construction, and fully welded for long-term durability
- Recommended solutions: 7160-1449-00, 7160-0757, 7160-0220, and 7160-0500
- Limited Lifetime Warranty

Note: To adjust your computer, display, or device higher use the offset adapter bracket (7160-0872)

2015-2020 CHEVY TAHOE CLOSE-TO-DASH MOUNT



Item No.	Placement	Weight	Height	Width	Depth
7160-0822	On the Chevy Tahoe Console Box	6 lbs 2.7 kg	13.5" 34.3 cm	14.25" 36.2 cm	8.25" 21 cm

Features

- Low profile, ergonomic, vehicle specific mount
- Sleek and small design so you can easily access both your tablet and electronics
- Easy install - no need to remove the dashboard
- Rugged steel construction with black powder coat finish for long-term durability
- Supports up to 14 lbs (6.4 kg)
- Features a Clevis to twist and tilt your tablet for easier viewing from the driver and passenger seat
- Stabilization foot helps reduce vibration
- Works with tablets, convertible laptops, mounting displays, and other devices
- Recommended solutions: 7160-1449-00, 7160-0757, 7160-0220, and 7160-0500
- Limited Lifetime Warranty

Note: To adjust your computer, display, or device higher use the offset adapter bracket (7160-0872)

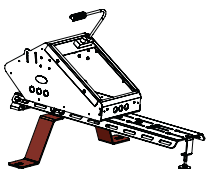

STEP 1:
Select the leg kit for your type of vehicle.

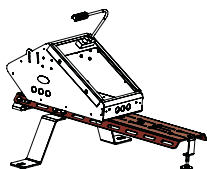

STEP 2:
Select the top plate that best fits your equipment needs. Keep in mind the number of radios and accessories you will need to mount.

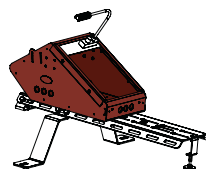

STEP 3:
Select the console box that best fits your equipment needs.

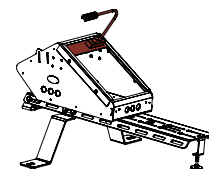

STEP 4:
Select the accessories that fit your equipment needs.

CONSOLE BOX VEHICLE LEG KITS

Item No.	Placement	Seat Configuration	Drilling Required	Weight
7160-0088	On Top of the Transmission Hump	Bucket	No - Attaches to the Existing Studs on top of the Transmission Hump: Dodge Charger (2006-2018), Dodge Magnum (2006-2008)	4.6 lbs 2.1 kg
7160-0422	On Top of the Transmission Hump	Bucket	No - Attaches to the Existing Studs on top of the Transmission Hump: Ram 1500-5500 Retail Models (2011-2018), Ram 1500-5500 SSV Models (2012-2018)	7.2 lbs 3.3 kg
7160-0164	On Top of the Transmission Hump	Bucket	No - Requires Removal of the Center Seat and Attaches to the Seat Mounting Points: Ford F-150 (2009-2014)	4 lbs 1.8 kg
7160-0555	On Top of the Transmission Hump	Bucket	No - Attaches to the Existing Studs on top of the Transmission Hump: Ford F-150 Aluminum Body (2015+), Super Duty (2017+)	6.8 lbs 3.1 kg
7160-0084	On Both Sides of the Transmission Hump	Bucket	No - Attaches to the Inboard Seat Bolts of the Driver and Passenger Seat: Ford Expedition (2007-2017)	9.9 lbs 4.5 kg
7160-0301	On Top of the Transmission Hump	Bucket	No - Attaches to Inboard Driver and Passenger Side Seat Studs: Ford F-250 to F-750 Super Duty (2011-2016)	12 lbs 5.4 kg
7160-0552	Attaches to the Mounting Points on the Side of the Transmission Hump	Bucket	No - Attaches to the Mounting Points on Side of the Transmission Hump: Ford Transit (2015-2018)	4.8 lbs 2.2 kg
7160-0509	On Top of the Transmission Hump	Bucket	No - Attaches to the Existing Studs on top of the Transmission Hump: Chevy Tahoe 2015-2020, Yukon XL 2015-2020, Silverado 2500/3500 2015-2019, GMC Sierra 1500 2015-2018, Sierra 2500/3500 2015-2019	7.2 lbs 3.3 kg
7160-0575	Attaches to the Mounting Points on the Side of the Transmission Hump	Bucket	No - Attaches to the Mounting Points on Side of the Transmission Hump: Chevrolet Express Van (2010+), GMC Savana (2010+)	15.1 lbs 6.8 kg
7110-0350	On Both Sides of the Transmission Hump	Bucket	Yes - Drilling is Required: Universal - All Vehicles	1.2 lbs .5 kg
7160-0545	Attaches to Inboard Driver and Passenger Side Seat Studs	Bucket	No - Attaches to Seat Studs on the Freightliner M2 106 and 112 (2012+) Only Works with Large Workstation. Top Plates (7160-0085/0086) will not Work with Leg Kit.	19.76 lbs 9.0 kg
7160-0971	On Both Sides of Transmission Up (7160-0971)	Bucket (7160-0971)	No - Attaches to Seat Studs and Driver and Passenger Seats. Works with Top Plates (7160-0085/0086) (7160-0971) Leg Kit - Freightliner M2 for Top Plate Mounting	22.3 lbs 10.1 kg
7160-0985	On Top of Transmission Hump (7160-0985)	Bucket (7160-0985)	No - Attaches to Brackets used for the Center Seat Option (7160-0985) Ram 1500-5500 (2011+) with Center Seat Leg Kit, 2011-2018 and 2019 Classic	3.18 lbs 1.44 kg each leg

STEP 1

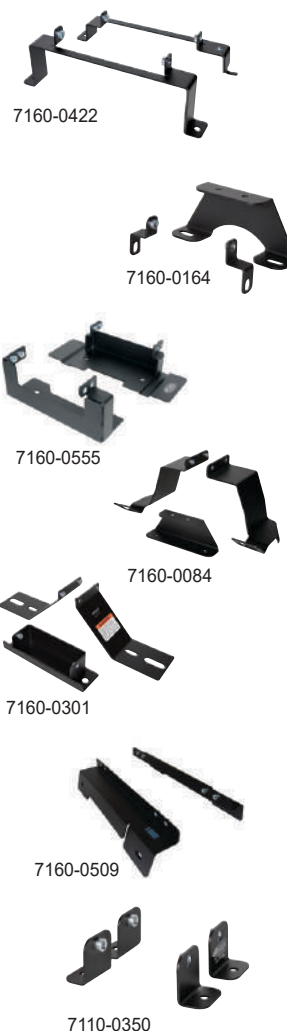

STEP 2



7160-0086

CONSOLE BOX TOP PLATES

Item No.	Description	Placement	Seat Configuration	Drilling Required	Weight	Width	Depth
7160-0086	Short Console Box Top Plate	Any Console Box Vehicle Leg	Bucket	No - Console box Vehicle Legs attach to pre-drilled holes alongside Console Box Top Plate	9.9 lbs 4.5 kg	8.0" 20.3 cm	23.0" 58.4 cm
7160-0085	Long Console Box Top Plate	Any Console Box Vehicle Leg	Bucket	No - Console box Vehicle Legs attach to pre-drilled holes alongside Console Box Top Plate	12.4 lbs 5.6 kg	8.0" 20.3 cm	29.0" 73.7 cm

Features:

- Wider design allows the console box to be offset towards the passenger for added space
- Wider plate adds additional space to mount additional accessories
- Provides three (3) options for computer mount placement (offset towards driver, center or offset towards passenger side)
- Fills up space between the seats giving a cleaner appearance
- Limited Lifetime Warranty

STEP 3



MCS-EPIC13

EPIC CONSOLE BOXES

Item No.	Placement	Seat Configuration	Drilling Required	No. of Devices	Weight	Exterior Height	Exterior Width	Exterior Depth	Interior Depth
MCS-EPIC9	On any Console Box Top Plate (7160-0086 or 7160-0085)	Bucket	No	2 to 4	8.8 lbs 4 kg	7.5" to 11.5" 19 to 29.2 cm	9.0" 22.9 cm	9.0" 22.9 cm	7.0" 17.8 cm
MCS-EPIC13	On any Console Box Top Plate (7160-0086 or 7160-0085)	Bucket	No	4 to 6	12.1 lbs 5.5 kg	8.75" to 12.0" 22.2 to 30.5 cm	9.0" 22.9 cm	13.0" 33 cm	11.0" 27.9 cm
MCS-EPIC17	On any Console Box Top Plate (7160-0086 or 7160-0085)	Bucket	No	6 to 8	15.0 lbs 6.8 kg	8.75" to 12.0" 22.2 to 30.5 cm	9.0" 22.9 cm	17.0" 43.2 cm	15.0" 38.1 cm

Features

- Rounded-edges for sleek appearance and passenger safety
- Two-piece flexible design allows for 36 ht/angle combinations (18 ht/angle combination for MCS-EPIC9)
- 12 knockout panels and multiple cutouts for cigarette adapters (10 knockout panels in MCS-EPIC9)
- Cutout pattern for light mount on each side and large cutout holes in bottom and on both sides for wiring access
- Pre-drilled sidewall & bottom slots for convenient mounting; Mounting holes align with many competitive top plates
- 2 faceplates and 2 filler panels are included with MCS-EPIC 9
- 3 faceplates and 3 filler panels are included with MCS-EPIC 13 and MCS-EPIC 17
- Limited Lifetime Warranty

ERGONOMIC CONSOLE BOX



Item No.	Placement	Seat Configuration	Drilling Required	No. of Devices	Weight	Height	Width	Depth	Interior Depth
MCS-ERGOBOX12	On any Console Box Top Plate (7160-0086 or 7160-0085)	Bucket	No	3 to 5 (10" (25.4 cm) of Mounting Space)	10.0 lbs 4.5 kg	9.5" 24.1 cm	9.0" 22.9 cm	13.0" 33 cm	10.9" 27.7 cm

Features

- Rounded-edges for sleek appearance and passenger safety
- May be mounted towards the dash to create space between the seats for other equipment or easier passenger side exit
- Enclosed design enables communication equipment to be stored securely and safely
- Available computer mounting bracket (MCS-COMBRKT) for added versatility
- Mounting holes align with many competitive top plates
- 3 faceplates and 3 filler panels are included
- Limited Lifetime Warranty

LOW PROFILE ERGONOMIC CONSOLE BOX

Item No.	Placement	Seat Configuration	Drilling Required	No. of Devices	Weight	Height	Width	Depth	Interior Depth
7160-0237	On any Console Box Top Plate (7160-0086 or 7160-0085)	Bucket	No	3 to 5 (10" (25.4 cm) of Radio Mounting Space)	17.8 lbs 8.1 kg	8.5" 21.6 cm	8.8" 22.2 cm	21.8" 55.3 cm	10.98" 27.9 cm

Features

- Ergonomically designed console box that provides two mounting positions for motion devices on the top of the console box
- Reduced height allows the console to be positioned closer to the dash
- Top plate can be removed during installation for better access to electronics
- Large cutout on top plate allows for easy access to wiring
- Two piece flexible design allows for many height and angle combinations
- 9 Knockout panels for cigarette adapters
- Large cutout holes on bottom for wiring access
- Pre-drilled sidewall and bottom slots for convenient mounting
- Pre-drilled holes for use with any Gamber-Johnson cup holder
- Rounded edges for sleek appearance
- 3 faceplates and 3 filler panels are included
- Limited Lifetime Warranty



13" LOW PROFILE ERGONOMIC CONSOLE BOX

Item No.	Placement	Seat Configuration	Drilling Required	No. of Devices	Weight	Height	Width	Depth	Interior Depth
7160-0333	On any Console Box Top Plate (7160-0086 or 7160-0085)	Bucket	No	3 to 5	17.8 lbs 8.1 kg	8.5" 21.6 cm	9.1" 23 cm	13.3" 33.8 cm	10.7" 27.2 cm

Features

- Ergonomically designed console box that provides two mounting positions for motion devices on the top of the console box
- Reduced height allows the console to be positioned closer to the dash
- Top plate can be removed during installation for better access to electronics
- Two piece flexible design allows for many height and angle combinations
- 9 Knockout panels for cigarette adapters
- Large cutout holes on bottom for wiring access
- Pre-drilled sidewall and bottom slots for convenient mounting
- Pre-drilled holes for use with any Gamber-Johnson cup holder
- Rounded edges for sleek appearance
- 3 faceplates and 3 filler panels are included
- Limited Lifetime Warranty



LOW PROFILE CONSOLE BOX

Item No.	Placement	Seat Configuration	Drilling Required	No. of Devices	Weight	Height	Width	Depth	Interior Depth
MCS-LOWBOX	On any Console Box Top Plate (7160-0086 or 7160-0085)	Bucket	No	4 to 5 (12" (30.5 cm) of Control Head Mounting Space)	12 lbs 5.4 kg	4" (10.1 cm) (Low End) to 6" (15.2 cm) (High End)	9.0" 22.9 cm	14.0" 35.6 cm	12.1" 30.7 cm

Features

- May be mounted towards the dash of any vehicle creating added space between the seats for other equipment
- Low-profile design sits flush or slightly below the seats allowing ample space for an emergency passenger side exit
- Enclosed design enables communication equipment to be stored securely and safely
- Available computer mounting bracket (MCS-COMBRKT) for added versatility
- Mounting holes align with many competitive top plates
- 3 faceplates and 3 filler panels are included
- Limited Lifetime Warranty



25" UNIVERSAL CONSOLE BOX

Item No.	Placement	Seat Configuration	Drilling Required	Weight	Height	Width	Depth
7160-0770	On any Console Top Plate (7160-0086 or 7160-0085)	Bucket	No	22.5 lbs 10.2 kg	8.36" to 11.36" 21.2 to 28.9 cm	8.75" 22.2 cm	8.75" 22.2 cm

Features

- 24.5" (62.23 cm) of straight mounting space plus 0.5" (1.3 cm) of overlap space to allow faceplates to fit flush
- Designed to house full sized devices and accessories
- Height adjustable with no side gaps in the console, ranges from 8.36" (21.2 cm) to 11.36" (28.9 cm)
- Angle adjustable at any height, ranges from 0° to 9°
- Adjustable support bracket in the center to strengthen the console box, along with fixed gussets in the bottom
- Can accommodate a power distribution block or LIND shut-down timer on the Front Plate
- Can accommodate most console box accessories including armrests, exterior cup holder, side pocket, DS-138 etc.
- Side pole mount (DS-138, sold separately) is angle adjustable to keep the pole vertical
- Rear armrest can be angle adjusted by using spacers on the bottom two bolts
- Three mounting locations on the side of the box for a mic clip or adjustable mic clip (7160-0826)
- Six 12V knockout panels for cigarette adapters
- Fully welded construction for long term product life span
- Box will ship fully assembled (except for accessories)
- 3 faceplates and 3 filler panels are included
- Limited Lifetime Warranty



UNIVERSAL CONSOLE BOX WITH SLOPED FRONT



7160-0896



7170-0579-05

Item No.	Description	Seat Configuration	Weight	Height	Width	Depth	Interior Depth
7160-0896	Universal Console Box Only with Sloped Front	Bucket	19.5 lbs 8.9 kg	11.0" 27.9 cm	9.0" 22.8 cm	24.8" 62.9 cm	12.1" 30.7 cm
7170-0579-00	Kit Includes: Console Box (7160-0896) and Cup Holder (7160-0846)						
7170-0579-01	Kit Includes: Console Box (7160-0896), Cup Holder (7160-0846) and Armrest (7110-1013)						
7170-0579-02	Kit Includes: Console Box (7160-0896), Cup Holder (7160-0846) and Printer Armrest (7160-0430)						
7170-0579-04	Kit Includes: Console Box (7160-0896), Cup Holder (7160-0846), Armrest (7110-1013), and Mongoose Motion Attachment (7160-0220)						
7170-0579-05	Kit Includes: Console Box (7160-0896), Cup Holder (7160-0846), Armrest (7110-1013), and 6" Locking Slide Arm Motion Attachment (7160-0500)						

Features

- Low profile universal console box with a sloped front mounting area
- Designed to work with top plate/tunnel plate and leg kits
- Horizontal section has 11.5" (29.2 cm) mounting space to hold full-sized devices and accessories
- Vertical angled section has 7.5" (19.1 cm) to hold 1 to 2 full-size devices
- Two 12 volt plug knockouts located on passenger side
- Knockout for USB/AUX input module or dual USB power port on passenger side
- Front plate underneath dash has placement for power distribution block or LIND shut-down timer
- Opening on sides of console box for audio output devices to be mounted behind
- Ships assembled (except for accessories)
- Mounting space for armrests on back and sides, side document pocket, and standard mic clip
- Limited Lifetime Warranty

SHORT UNIVERSAL CONSOLE BOX WITH SLOPED FRONT



7160-0899



7170-0578-00

Item No.	Description	Weight	Height	Width	Depth
7160-0899	Short Universal Console Box Only with Sloped Front	15.8 lbs 7.2 kg	10.9" 27.6 cm	17.8" 45.1 cm	8.8" 22.2 cm
7170-0578-00	Kit Includes: Console (7160-0899) and Cup Holder (7160-0847)				

Features

- Low profile universal console with a sloped mounting area
- Designed to work with to the top plate (7160-0085 or 7160-0086) and leg kits
- Computer can be centered offset towards the passenger or closer to the driver
- Fully welded construction for long-term life span
- 3 faceplates and 3 filler panels included
- Box ships fully assembled (except for accessories)
- Add an armrest that mounts off the top plate
- Limited Lifetime Warranty

Horizontal Low Profile Section

- Has 4.5" (11.4 cm) of mounting space for an internal cup holder, accessories, or devices
- Designed to house full sized devices and accessories

Vertical Angled Section

- Accommodates 1 to 2 full sized devices 7.5" (19.1 cm) of mounting space
- PEMs for mounting a mic clip (7120-0723) on both sides
- Knockout for the USB/AUX input module (16648) or dual USB power port (15371) located on the passenger side
- Side vented openings for air flow or mounting a speaker inside the box
- Front plate of console underneath the dash has placement area for a power distribution block or a LIND shut-down timer

NOTE: Universal consoles and universal sloped consoles require a leg kit and top plate.

WIDE BODY CONSOLE BOXES

Item No.	Description	Placement	Weight	Height	Width	Depth
7160-0894	Wide Body Console Only	On the 29" Console Box Top Plate (7160-0085)	26.4 lbs 12.0 kg	10.9" 27.6 cm	11.8" 30.1 cm	24.8" 62.9 cm
7170-0567-00	Kit Includes: Wide Body Console (7160-0894), Internal Cup Holder (7160-0846), and Pocket (7160-0924)					
7170-0567-01	Kit Includes: Wide Body Console (7160-0894), Internal Cup Holder (7160-0846), Break-Away Armrest (7160-0524), and Pocket (7160-0924)					
7170-0567-02	Kit Includes: Wide Body Console (7160-0894), Internal Cup Holder (7160-0846), Brother Printer Armrest (7160-0430), and Pocket (7160-0924)					
7170-0567-03	Kit Includes: Wide Body Console (7160-0894), Internal Cup Holder (7160-0846), Vertical Surface Mount, and Pocket (7160-0924)					
7170-0567-04	Kit Includes: Wide Body Console (7160-0894), Internal Cup Holder (7160-0846), Break-Away Armrest (7160-0524), Mongoose Motion Attachment (7160-0220), and Pocket (7160-0924)					
7170-0567-05	Kit Includes: Wide Body Console (7160-0894), Internal Cup Holder (7160-0846), and 6" Locking Slide Arm (7160-0500)					



7160-0894

Features

- Low profile universal console with a sloped mounting area
- Designed to work with the top plate and leg kits
- Two 12 volt plug knockouts located on passenger side wall and 1 knockout for switches, dual USB power ports, battery voltage display, data/mic jack, or USB/AUX input module extension
- PEMs for mounting mic clip (7120-0723) on both sides
- Side vented openings for air flow or mounting a speaker inside the console box
- PEMs on back of the console box for mounting external cup holder (7160-0847) or either MCS armrest (7160-0429) or MCS printer armrest (7160-0430)
- Front plate of console under the dash area has placement for a power distribution block or a LIND shut-down timer using pre-configured mounting holes
- Box ships fully assembled (except for accessories)
- Computer can be mounted offset towards the passenger or on the 3-bolt pattern closer to the driver
- Fully welded construction for long-term life span
- 3 faceplates and 3 filler panels included
- Limited Lifetime Warranty

Horizontal Low Profile Section

- Mounting space length of 11.5" (29.2 cm)
- Designed to house full sized devices and accessories
- Additional 2"/5.1 cm area to accommodate a pocket, two inch faceplates for switches or power ports, or a smaller device

Vertical Angled Sections

- Accommodates 1 to 2 full sized devices or faceplates (5" (12.7 cm) mounting space)
- Two 12 volt plug knockouts located on top passenger side and two knockouts for switches, dual USB power ports, battery voltage display, data/mic jack, or USB/AUX input module extension

WIDE BODY CONSOLE BOXES

Item No.	Description	Weight	Height	Width	Length
7160-1460	Wide Body Universal Console Box	28.12 lbs 12.76 kg	10.88" 27.64 cm	11.83" 30.05 cm	27.25" 69.22 cm

NEW



Features

- Low profile, universal console with a sloped mounting area
- 8" (20.32 cm) of mounting space in angled section, 11.5" (29.21 cm) of mounting space in horizontal section to accommodate multiple devices
- Designed to work with truck top plate and leg kits (Chevy Tahoe and Silverado, Ford F-150, 250+, Expeditions, Dodge Ram)
- Side vented openings for air flow or mounting a speaker inside the console box
- Box ships fully assembled (except for accessories) for convenience
- Fully welded construction for long-term life span
- Limited Lifetime Warranty

STEP 4



7160-1034



7160-1035

GAMBER-JOHNSON TO ZIRKONA ADAPTER PLATE

Item No.	Placement	Weight	Height	Width	Depth
7160-1034	Gamber-Johnson to Zirkona Adapter Plate - Pedestal / Vehicle Base	0.75 lbs 0.34 kg	0.8" 1.9 cm	3.0" 7.6 cm	3.0" 7.6 cm
7160-1035	Gamber-Johnson to Zirkona Adapter Plate - Console 3-Bolt	0.5 lbs 0.2 kg	1.8" 4.5 cm	3.0" 7.6 cm	3.0" 7.6 cm

Features

- Black Powdercoat finish for maximum corrosion resistance
- Heavy gauge steel construction for long-term durability
- Threaded mounting to work with the Zirkona parts
- Studs easily align with Gamber-Johnson 3-hole pattern
- Mounting hardware provided with adapter

CONSOLE BOX FILLER PANELS



3130-0156

Item No.	Description	Placement	Weight	Height	Width	Depth
3130-0152	1/2" blank filler panel	On top of any console box	0.10 lbs 0.04 kg	0.50" 1.3 cm	8.7" 22.1 cm	0.075" 0.2 cm
15130	3/4" blank filler panel	On top of any console box	0.15 lbs 0.06 kg	0.75" 109 cm	8.7" 22.1 cm	0.075" 0.2 cm
3130-0153	1.0" blank filler panel	On top of any console box	0.20 lbs 0.09 kg	1.0" 2.5 cm	8.7" 22.1 cm	0.075" 0.2 cm
18492	1.5" blank filler panel	On top of any console box	0.17 lbs 0.08 kg	1.5" 3.81 cm	8.7" 22.1 cm	0.075" 0.2 cm
3130-0154	2.0" blank filler panel	On top of any console box	0.30 lbs 0.1 kg	2.0" / 5 cm	8.7" 22.1 cm	0.075" 0.2 cm
18901	2.5" blank filler panel	On top of any console box	0.35 lbs 0.16 kg	2.5" 6.35 cm	8.7" 22.1 cm	0.075" 0.2 cm
3130-0155	3.0" blank filler panel	On top of any console box	0.40 lbs 0.2 kg	3.0" 7.6 cm	8.7" 22.1 cm	0.075" 0.2 cm
19814	3.5" blank filler panel	On top of any console box	0.63 lbs 0.29 kg	3.5 in 8.89 cm	8.7" 22.1 cm	0.075" 0.2 cm
3130-0156	4.0" blank filler panel	On top of any console box	0.50 lbs 0.2 kg	4.0" 10.2 cm	8.7" 22.1 cm	0.075" 0.2 cm

Features

- Fills space in console boxes not occupied by equipment
- Limited Lifetime Warranty

CIGARETTE KNOCKOUT FILLER PANEL



Item No.	Description	Placement	Weight	Height	Width	Depth
3130-0361	2.0" Cigarette Knockout Filler Panel	On Top of any Console Box	0.4 lbs 0.2 kg	2.0" 5.1 cm	8.7" 22.1 cm	0.075" 0.2 cm

Features

- Three holes for mounting the cigarette receptacle (7160-0063)
- Limited Lifetime Warranty

CIGARETTE LIGHTER ADAPTER KIT



Item No.	Description	Placement	Weight	Height	Diameter
7160-0063	Cigarette Lighter Adapter Kit	On the side of any Console Box or with 2.0" Cigarette Knockout Filler Panel (3130-0361)	0.05 lbs 0.02 kg	2.5" 6.4 cm	1.12" 2.8 cm

Features

- **Kit Includes** one (1) RoHS compliant 12 volt receptacle, wire kit and cap
- Limited Lifetime Warranty

ROCKER SWITCH/DUAL USB PORT KNOCKOUT FILLER PANELS

Item No.	Description	Placement	Weight	Height	Width	Depth
15082	3 Rocker Switch/Dual Usb Port and 3 Cigarette Knockout Panel	On any Console Box	0.36 lbs 0.2 kg	2.0" 5.1 cm	8.7" 22.1 cm	0.08" 0.2 cm
15083	6 Rocker Switch/Dual Usb Port Knockout Panel		0.36 lbs 0.02 kg	2.0" 5.1 cm	8.7" 22.1 cm	0.08" 0.2 cm

Features

- Knockouts work with rocker switches (7160-0516 or 7160-0517), cigarette receptacle (7160-0063) or dual USB port (15371)
- Knockout panels ship without holes knocked out
- Limited Lifetime Warranty



15082

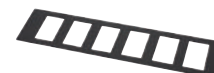

15083

OFFSET ADAPTER BRACKET

Item No.	Description	Placement	Weight	Height	Width	Depth
7160-0872	Offset Adapter Bracket	Compatible with many items including the Dodge Charger, Ford PI Utility, and Chevy Tahoe Close-to-Dash Mounts, and Ford PI Utility and Sedan On-Dash Mount	1.3 lbs 0.6 kg	6.5" 16.5 cm	5.0" 12.7 cm	0.75" 1.9 cm
7160-1015	9.5" Offset Adapter Bracket					

Features

- Mounts to the Gamber-Johnson Clevis in the VESA 75 mm hole pattern with 4 PEM studs in plate
- Black powder coat finish for maximum corrosion resistance
- Hardware provided for mounting plate
- Using the VESA 75 mm pattern, can adjust device 1" to 2" (2.5 to 5.1 cm) above the Clevis
- Using the Gamber-Johnson hole pattern, can adjust device 1" to 3" (2.5 to 7.6 cm) above the Clevis
- Limited Lifetime Warranty



7160-0872



7160-1015

STANDARD LOCKBOX ARMRESTS

Item No.	Description	Weight	Width	Height	Depth
7160-1000	Armrest Only	9.9 lbs 4.5 kg	6.5" 16.5 cm	10.35" 26.3 cm	10.8" 27.4 cm
7170-0607-01	Armrest with Vertical Surface Mount	9.9 lbs 4.5 kg	6.5" 16.5 cm	11.5" 29.3 cm	10.8" 27.4 cm
7170-0607-02	Armrest with Short Lower Pole (DS-LOWER-5)	9.9 lbs 4.5 kg	6.5" 16.5 cm	10.5" 26.7 cm	10.8" 27.4 cm
7170-0607-03	Armrest with Tall Lower Pole (DS-LOWER-7)	9.9 lbs 4.5 kg	6.5" 16.5 cm	12.5" 31.8 cm	10.8" 27.4 cm

Common Features

- Black powder coat finish for maximum corrosion resistance
- Heavy gauge steel construction for long-term durability
- Convenient flip-up lockbox and armrest
- Flip-up lid allows for access to storage area
- Lid has latch-lock combination with easy latching
- Locking is done with barrel key
- Armrest pad adjusts about 1" backwards and 2" forward
- Armrest pad slides over latch - lock mechanism to help conceal it
- Interior storage area lined with padding to protect items and reduce noise
- Limited Lifetime Warranty



7160-1000



7170-0607-01

BREAKAWAY LOCKBOX ARMRESTS



7160-1017



7170-0608-02

Item No.	Description	Weight	Width	Height	Depth
7160-1017	Armrest Only	10.9 lbs 4.9 kg	6.5" 16.5 cm	11.4" 29.0 cm	10.8" 27.4 cm
7170-0608-01	Armrest with Vertical Surface Mount	12.2 lbs 5.5 kg	6.5" 16.5 cm	12.6" 32.1 cm	10.8" 27.4 cm
7170-0608-02	Armrest with Short Lower Pole (DS-LOWER-5)	11.9 lbs 5.4 kg	6.5" 16.5 cm	11.6" 29.5 cm	10.8" 27.4 cm
7170-0608-03	Armrest with Tall Lower Pole (DS-LOWER-7)	12.2 lbs 5.5 kg	6.5" 16.5 cm	13.6" 34.6 cm	10.8" 27.4 cm

Common Features

- Black powder coat finish for maximum corrosion resistance
- Heavy gauge steel construction for long-term durability
- Convenient flip-up lockbox and armrest
- Lockbox and armrest swivels 100° from driver
- Flip-up lid allows for access to storage area
- Lid has latch-lock combination with easy latching
- Locking is done with barrel key
- Armrest pad adjusts about 1" backwards and 2" forward
- Armrest pad slides over latch - lock mechanism to help conceal it
- Interior storage area lined with padding to protect items and reduce noise
- Limited Lifetime Warranty

HEAVY-DUTY ARMREST



MCS-ARMREST5



7160-0525

Item No.	Placement	Height Adjustment	Weight	Height	Width	Depth
MCS-ARMREST	Regular Armrest with 9" Lower Tube	2.5" (6.4 cm) Adjustment Above the Lip of Lower Tube	6.10 lbs 2.8 kg	11.5" 29.2 cm	5.25" 13.3 cm	10.0" 25.4 cm
MCS-ARMREST5	Regular Armrest with 5" Lower Tube	1.6" (4.1 cm) Adjustment Above the Lip of Lower Tube	5.5 lbs 2.5 kg	8.15" 14 cm	5.25" 13.3 cm	10.0" 25.4 cm
7160-0525	Break Away Armrest with 9" Lower Tube	2.5" (6.4 cm) Adjustment Above the Lip of Lower Tube	7.0 lbs 3.2 kg	11.5" 29.2 cm	5.25" 13.3 cm	10.0" 25.4 cm

Common Features

- Attaches to any console box top plate, the MCS-ARMREST5 is recommended for the Dodge Charger vehicle
- Sturdy design for additional support
- Height adjustable
- Padded armrest flips up for convenience
- Limited Lifetime Warranty

Break Away Armrest Features

- Armrest pad slides forwards 2" (5.1 cm) for a comfortable armrest position
- Armrest swivels 100° from the driver to help minimize injury to the driver when in a side impact situation
- Both the slide and the swivel offer an adjustable tension feature

BROTHER ARMREST PRINTER MOUNT



Item No.	Placement	Height Adjustment	Weight	Height	Width	Depth
7160-0006	On top of any Console Box Top Plate or any Flat Stable Surface	1.6" (4.1 cm) Adjustment Above Lip of Lower Tube	11.25 lbs 5.1 kg	15.0" - includes 5" pole 38.1 cm - includes 12.7 cm pole	5.5" 14 cm	11.6" 29.5 cm

Features

- Convenient flip-up armrest and printer mount all in one
- For use with the following Brother printers: PocketJet 200, 3, 6, 7, II, 3 Plus, 6 Plus, 7 and 7 Plus (NiMH battery only)
- Mount holds printer and paper roll in separate lockdown trays
- Paper roll is enclosed to protect from dirt and dust
- The cover latches shut and can be used with a padlock for extra security
- Indicator lights and on/off button are easy to see and accessible when the cover is closed
- Paper deflector prevents paper from curling up and jamming
- Cable strain relief protects connector interface on the printer engine from damage
- Printer can be easily removed from the mount for use outside of the vehicle
- Paper feeds out the side towards the driver (paper and printer not included)
- Limited Lifetime Warranty

INTERNAL MOUNT PRINTER ARMREST

Item No.	Placement	Weight	Height	Width	Depth
7160-1553	Internal Printer Armrest	11.50 lbs. 5.2 kg	14.0" 35.6 cm	5.25" 13.3 cm	11.6" 29.5 cm

Features

- Designed to accommodate the following Brother printers: PocketJet 200, PocketJet 3, PocketJet 6, PocketJet 7, PocketJet II, PocketJet 3 Plus, and PocketJet 6 Plus (NiMH battery only)
- Internal mount creates clearance at back of the console for easy retrieval of weapons or equipment
- Convenient flip-up armrest and printer mount all in one
- Mount holds printer and paper roll in separate locked trays
- Indicator lights and on/off button are easily visible and accessible when the cover is closed
- Paper and printer not included
- Limited Lifetime Warranty

NEW



EXTENDED PANEL ARMREST

Item No.	Placement	Weight	Height	Width	Depth
7160-0375	On top of most Gamber-Johnson Console Box and Vehicle Specific Consoles Boxes	1.3 lbs 0.6 kg	2.0" 5.1 cm	8.7" 22.1 cm	4.75" to 5.5" 12.1 cm to 14 cm

Features

- Padded, height adjustable faceplate armrest
- Perfect for vehicle specific consoles or vehicles that have space constraints
- Limited Lifetime Warranty



ADJUSTABLE CUPHOLDER (SINGLE AND DOUBLE)

Item No.	Placement	Weight	Height	Width	Depth
MCS-CUP	Attaches to Pre-Drilled Holes on either end of any Console Box	2.4 lbs 1.1 kg	4.0" 10.2 cm	9.75" 24.8 cm	6.0" 15.2 cm
MCS-CUP2	Attaches to Pre-Drilled Holes on either end of any Console Box	2.4 lbs 1.1 kg	4.0" 10.2 cm	9.75" 24.8 cm	6.0" 15.2 cm

Features

- Hold one (MCS-CUP) or two (MCS-CUP2) cups and compatible with most cup sizes
- No drilling is required
- Limited Lifetime Warranty



UNIVERSAL HEAVY-DUTY CUPHOLDER (DOUBLE)

Item No.	Placement	Weight	Height	Width	Depth
7160-0847	Attaches to Pre-Drilled Holes on either end of any Console Box	2.8 lbs 1.3 kg	3.2" 8.1 cm	8.75" 22.2 cm	4.5" 11.4 cm

Features

- Holds two cups and compatible with most cup sizes
- No drilling is required
- Limited Lifetime Warranty



INTERNAL MOUNTED CUPHOLDER (DOUBLE)

Item No.	Placement	Weight	Height	Width	Depth
7160-0846	Inserts into any Console Box	0.5 lbs 0.2 kg	4.5" 11.4 cm	8.63" 21.9 cm	3.4" 8.6 cm

Features

- Holds two cups; compatible with most cup sizes
- No drilling is required
- Limited Lifetime Warranty



ROCKER SWITCHES



Item No.	Description	Placement	Weight	Height	Width	Depth
7160-0516	Rocker Switch (ON/OFF/ON) - 4 Contacts (Ground, Input, 2 Outputs)	With Rocker Switch Filler Panels (15082 or 15083)	0.09 lbs 0.04 kg	2.05" 5.2 cm	0.96" 2.4 cm	1.93" 4.9 cm
7160-0517	Rocker Switch (ON/OFF) - 3 Contacts (Ground, Input, Output)	With Rocker Switch Filler Panels (15082 or 15083)	0.09 lbs 0.04 kg	2.05" 5.2 cm	0.96" 2.4 cm	1.93" 4.9 cm
7160-0540	Rocker Switch (Momentary ON/OFF) - 2 Contacts (Input and Output)	With Rocker Switch Filler Panels (15082 or 15083)	0.09 lbs 0.04 kg	2.05" 5.2 cm	0.96" 2.4 cm	1.93" 4.9 cm

Features

- Red LED light is visible when switch is in the "ON" position
- Rated for 20 AMPS and 12 volts DC
- Limited Lifetime Warranty

POWER DISTRIBUTION BLOCK



Item No.	Description	Placement	Drilling Required	Weight	Height	Width	Depth
7160-0110	6 Circuit Power Distribution Block	Can be positioned in any convenient location	Yes	0.42 lbs 0.02 kg	1.5" 3.8 cm	3.63" 9.2 cm	3.30" 8.4 cm

Features

- 6 circuit block without a negative bus
- Tin-plated copper busses and fuse clips give 30 AMPS rating per circuit
- Accepts ATO and ATC fast acting blade fuses
- Maximum amperage per circuit: 30 / maximum amperage per block: 100 / maximum voltage rating: 32 volts DC
- Lifetime Limited Warranty

POWER DISTRIBUTION BLOCK WITH NEGATIVE BUS



Item No.	Description	Placement	Drilling Required	Weight	Height	Width	Depth
7160-0313	6 Circuit Power Distribution Block with Negative Bus	Can be positioned in any convenient location	Yes	0.42 lbs 0.2 kg	1.5" 3.8 cm	3.63" 9.2 cm	3.30" 8.4 cm

Features

- 6 independent ground connections on to a ground bus and separate master ground bus connection
- Tin-plated copper busses and fuse clips give 30 AMPS rating per circuit
- Accepts ATO and ATC fast acting blade fuses
- Maximum amperage per circuit: 30 / maximum amperage per block: 100 / maximum voltage rating: 32 volts DC
- Lifetime Limited Warranty

MOBILE MOUNTS VEHICLE POWER DISTRIBUTION UNITS (VPDU)



7300-0039



7300-0040

Item No.	Description	Continuous Power Circuits	USB Ports	Height	Weight	Width	Depth
7300-0039	Standard VPDU (MM-VPDU-1011)	1	0	1.0" 29.2 cm	1.5" 3.8 cm	4.25" 10.8 cm	6.5" 16.5 cm
7300-0040	VPDU with Dual USB Output (MM-VPDU-1014)	1	2	1.0" 14 cm	2.25" 5.7 cm	4.25" 10.8 cm	6.5" 16.5 cm
7300-0041	Accessory Power Distribution Unit (MM-APDU)	7	0	2.1" 29.2 cm	1.75" 4.4 cm	7.25" 18.4 cm	11.25" 28.6 cm

Features

- Dip switch settable time delay from 15 seconds to 8 hours (constant 'on' is also available)
- Voltage cutoff: low - 10.5 volts/ high - 18.0 volts / Loads up to 50 AMPS total
- LED display indicates time delay and status
- Automatic activation by seeking battery voltage
- Optional activation by wiring to ignition sense point
- Four circuits controlled by timer with override switch for 15 minutes of on-demand operation
- LED lights over operative state of fuse positions
- Reverse polarity protected
- 3 Year Limited Warranty by Mobile Mounts

DUAL USB PORT

Item No.	Description	Placement	Weight	Height	Width	Depth
15371	Dual USB Port (Two 2.1 amp Ports)	With Rocker Switch/Dual USB Port Filler Panels (15082 or 15083)	0.25 lbs 0.1 kg	1.8" 4.6 cm	1.0" 2.5 cm	1.7" 4.4 cm



Features

- Quick and easy way to recharge electronic devices in a vehicle
- Output: 5 VDC, 4.2 AMPS total / Input: 11-16 VDC
- Lifetime Limited Warranty

KUSSMAUL DATA PORT/MICROPHONE EXTENSION RJ45 MODULE

Item No.	Description	Placement	Weight	Height	Width	Depth
16649	Standard RJ 45 Connection	Standard Switch Knockout	0.25 lbs 0.1 kg	1.7" 4.3 cm	1.0" 2.5 cm	1.7" 4.4 cm



Features

- Works for a data port or microphone extension
- Warranty by Kussmaul Electronics

KUSSMAUL AUTO MINI BATTERY VOLTAGE DISPLAY MODULE

Item No.	Description	Placement	Weight	Height	Width	Depth
16650	Display Voltage in a Digital Format	Standard Switch Knockout	0.25 lbs 0.1 kg	1.7" 4.3 cm	1.0" 2.5 cm	1.7" 4.4 cm



Features

- Works for monitoring a second battery voltage or main battery in a remote location
- Displays voltage in a digital format to 1 decimal point
- Input voltage 10-15 volts DC / current draw is 0.04 AMPS max
- Warranty by Kussmaul Electronics

2-INCH POCKET IN WIDE-BODY

Item No.	Placement	Weight	Height	Width	Depth
7160-0924	Works with any Gamber-Johnson Console Box	1.05 lbs 0.48 kg	1.50" 3.81 cm	8.62" 21.90 cm	2.15" 5.46 cm



Features

- Heavy gauge steel construction for long-term durability
- Black powder coat finish for maximum corrosion resistance
- Ideal for holding pens, keys, and other miscellaneous items
- Padded on bottom of pocket to help sound dampening and cushioning
- Limited Lifetime Warranty

TALL INTERIOR POCKET



Item No.	Placement	Weight	Height	Width	Depth
MCS-POCKET3	Works with any Gamber-Johnson Console Box	2.4 lbs 1.1 lg	3.0" 7.6 cm	7.25" 18.4 cm	6.06" 15.4 cm

Features

- Ideal for holding pens, keys and other miscellaneous items
- Lifetime Limited Warranty

4.5" X 2" (11.4 X 5.1 CM) POCKET WITH KNOCKOUT



Item No.	Placement	Weight	Height	Width	Depth
16298	Can be fitted with any Gamber-Johnson or Vehicle Specific Console Box	1.7 lbs 0.75 kg	2.0" 5.1 cm	8.6" 21.9 cm	2.0" 5.1 cm

Features

- Interior dimensions: 7.1" (18.1 cm) W x 4.5" (11.3 cm) H x 2.0" (5.1 cm) D
- Ideal for holding pens, keys, and other miscellaneous items
- Knockout on bottom of the pocket and outside corner for dual USB power port
- Heavy gauge steel and powder coat finish for long term durability and maximum corrosion resistance
- Limited Lifetime Warranty

SHORT INTERIOR POCKET



7160-0597

Item No.	Placement	Weight	Height	Width	Depth
7160-0332	Works with any Gamber-Johnson Console Box, Low Profile Box (MCS-LOWBOX), or any Vehicle Specific Console Box	1.9 lbs 0.9 kg	3.0" 7.6 cm	8.6" 21.8	3.3" 8.4 cm
7160-0597	Works with any Gamber-Johnson Console Box, Low Profile Box (MCS-LOWBOX), or any Vehicle Specific Console Box	2.8 lbs 1.3 kg	6.0" 15.2 cm	8.6" 21.8 cm	3.26" 8.3 cm

Features

- Ideal for holding pens, keys and other miscellaneous items
- Drain holes located in the bottom of the pocket
- Lifetime Limited Warranty

LOCKING INTERIOR POCKET



7160-0388



7160-0389

Item No.	Placement	Weight	Height	Width	Depth
7160-0388	Tall Locking Pocket Works with any Gamber-Johnson Console Box	3.9 lbs 1.8 kg	3.5" 8.9 cm	8.6" 21.8 cm	6.1" 15.5 cm
7160-0389	Short Locking Pocket Fits any Epic Console Box, Console Box, Low Profile Box (MCS-LOWBOX), or any Vehicle Specific Console Box	3.1 lbs 1.4 kg	6.3" 16 cm	8.6" 21.8 cm	3.1" 7.9 cm

Features

- Locking lid with barrel key lock
- Ideal for weapons, keys and other miscellaneous items
- Lifetime Limited Warranty

LOCKING POCKET WITH SLAM LATCH

Item No.	Description	Placement/Compatibility	Weight	Height	Width	Depth
7160-1555	Locking Pocket with Slam Latch	Short Locking Pocket fits any EPIC Console Box, Console Box, Low Profile Box (MCS-LOWBOX), or any Vehicle Specific Console Box	3.9 lbs 1.8 kg	3" 7.62 cm	8.6" 21.8 cm	6" 15.24 cm

Features

- Lid latches in place without the need to locking
- Lid features a tubular slam push button lock for added security
- Ideal for securing keys and other miscellaneous items
- Limited Lifetime Warranty

NEW



3-INCH DISPOSABLE GLOVE DISPENSER

Item No.	Placement	Weight	Height	Width	Depth
7160-0952	Inserts into any Gamber-Johnson Console Box	2.05 lbs 0.93 kg	3.0" 7.6 cm	8.63" 21.8 cm	3.0" 7.6 cm

Features

- Dispenser has removable lid
- Lid has opening for removal of gloves or filling up the dispenser
- Lifetime Limited Warranty



MICROPHONE CLIP PANEL

Item No.	Placement	Weight	Height	Width	Depth
MCS-MICPLT	On top of any Console Box	0.5 lb 0.2 kg	2.25" 5.7 cm	8.7" 22.1 cm	1.0" 2.5 cm

Features

- Heavy gauge steel construction for long-term durability
- Black powder coat finish for maximum corrosion resistance
- Can hold up to three microphone clips
- Spacer provided to raise clip for easier use
- Microphone clip sold separately (9000-0053)
- Lifetime Limited Warranty



ADJUSTABLE MICROPHONE CLIP

Item No.	Placement	Weight	Height	Width	Depth
7160-0826	Attaches to pre-drilled holes on the 25" Universal Console Box or by drilling to any Console Box	1.0 lbs 0.5 kg	7.51" 19.1 cm	1.45" 3.7 cm	2.50" 6.4 cm

Features

- Can be positioned either over or away from radios
- Heavy gauge steel construction for long-term durability
- Height adjustable, range of 2.5" (6.4 cm)
- No drilling is required for 25" universal console box, drilling is required for other console boxes
- Lifetime Limited Warranty



RAIL-MOUNTED MICROPHONE CLIP

Item No.	Placement	Weight	Height	Width	Depth
MCS-EPICMIC	Attaches to pre-drilled Holes on either end of any Console Box	0.8 lbs 0.4 kg	2.25" 5.7 cm	1.75" 4.4 cm	1.50" 3.8 cm

Features

- Can be positioned either over or away from radios
- No drilling is required
- Lifetime Limited Warranty



PROTECTOR SERIES - POWER DISTRIBUTION CENTERS FUSE PANELS

NEW



7300-0053

Item No.	Description	Placement	Output	Weight	Height	Width
7300-0053	Protector Fuse Panel, 100 AMP, 6 Outputs, Screw Term (AFS #PD-B6)	Trunk, Console or Anyplace Multiple Fused Circuits are Needed	6 100 AMP	0.08 lbs 0.04 kg		
7300-0027	Protector Fuse Panel, 11 Outputs Split (AFS #PD-B11)	Trunk, Console or Anyplace Multiple Fused Hot, Timed or Ignition Circuits are Needed	6 100 AMP 5 40 AMP	0.11 lbs 0.05 kg		
7300-0054	Protector Fuse Panel, 100 AMP, 12 Outputs, Screw Term (AFS #PD-B12)	Trunk, Console or Anyplace Multiple Fused Circuits are Needed	12 100 AMP	0.11 lbs 0.05 kg	8.6" 21.8 cm	6" 15.24 cm

PROTECTOR SERIES - DELAY SHUT DOWN TIMERS AND ACCESSORIES

NEW



7300-0056

Item No.	Description	Weight
7300-0023	Pigtail and Connector for DR38 Series Timers (00-1705)	0.01 lbs 0 kg
7300-0056	75 AMP Relay with Relay Control Connector (SK-1550)	1 lbs 0.45 kg

INSTALLATION KITS

NEW

Item No.	Description
7300-0295	Installation Kit for DVT-04 Series Products. 4' Wire Outputs with Ground Stud (AFS # IK4-VT04)

INSTALLER BASE HARNESSES

NEW

Item No.	Description	Placement	Weight
7300-0059	Vehicle Sense, Right Spot Light, and Rebroadcast (A)	Right Spot Light	1 lbs 0.45 kg
7300-0060	Sync Option, Provides Common Sync Wire at Each Lighthouse (S)	Sync Wire Provided for All Lighting Wire Options in the Harness	1 lbs 0.45 kg
7300-0061	2nd 100 Watt Siren Speaker, Wire Pair from Siren to Speaker (2)	Under Hood to Switchbox Location	1 lbs 0.45 kg
7300-0062	Low Frequency Siren, 3 Wires from Siren to Speakers (L)	Under Hood to Switchbox Location	1 lbs 0.45 kg
7300-0063	Warning Lights at European/Front Marker Light Locations (E)	Driver and Passenger	1 lbs 0.45 kg
7300-0064	Side Mirror Warning Lights (M)	Driver and Passenger Side	1 lbs 0.45 kg
7300-0065	Mid-Ship Lights at the B or C Pillar (B)	Driver and Passenger Side	1 lbs 0.45 kg
7300-0066	Radio Power, 20 AMP, 10 Gauge (X)	Front Battery to Console	1 lbs 0.45 kg
7300-0067	Radio Power, 20 AMP, 10 Gauge (Y)	Front Battery to Trunk Tray	1 lbs 0.45 kg
7300-0068	Radio Power, 20 AMP, 10 Gauge (Z)	Rear Battery to Console	1 lbs 0.45 kg
7300-0069	Radio Power, 20 AMP, 10 Gauge (W)	Rear Battery to Trunk Tray - Braided	1 lbs 0.45 kg

FUSE PANELS - POWER DISTRIBUTION - TIMERS

Item No.	Description	Placement	Output	Weight	Height	Width	Length
7300-0053	Protector Fuse Panel, 100 Amp, 6 Outputs, Screw Term (AFS #PD-B6)	Trunk, Console or anyplace multiple fused circuits are needed	6 (100 Amp)	0.08 lbs 0.04 kg			
7300-0027	Protector Fuse Panel, 11 Outputs Split (AFS #PD-B11)	Trunk, Console or anyplace multiple fused hot, timed or ignition circuits are needed	6 (100 Amp), 5 (40 Amp)	0.11 lbs 0.05 kg			
7300-0054	Protector Fuse Panel, 100 Amp, 12 Outputs, Screw Term (AFS #PD-B12)	Trunk, Console or anyplace multiple fused circuits are needed	12 (100 Amp)	0.11 lbs 0.05 kg			
7300-0023	Pigtail and Connector for DR38 Series Timers (AFS #00-1705)			0.01 lbs 0 kg			
7300-0056	75 Amp Relay with Relay Control Connec-tor (AFS #SK-1550)			1 lbs 0.45 kg			
7300-0335	Power 12 Distribution Center, 6 Timed Circuits on Timer 1 and 6 Timed Circuits on Timer 2, 100 Amp Total Load, 30 Amp Max per Circuit. Voltage Monitoring (AFS # P12-T6T6)			2.04 lbs 0.93 kg	1.25 in 3.18 cm	5.57 in 14.15 cm	10 in 25.4 cm
7300-0357	Fuse Expansion Panel, 5 Outputs, 60 Amp Load, M5 Input, #6 Terminal Strip Outputs (AFS # FXP-05)"		5 (60 Amp)				
7300-0353	Combined Timer Fuse Panel, Voltage Monitoring Delay Timer, 75 Amp Load, Eight Fused Outputs, 4 hot, 4 Timed, 30 Amp Max. per Output, Low Voltage Cut Off at 11 VDC or 11.75 VDC, Time Delay, and Over Voltage Cut-Off at 18 VDC (AFS # CTF-B4T4)			0.2 lbs 0.09 kg	1.12 in 2.84 cm	2.07 in 5.26 cm	7.25 in 18.42 cm
7300-0354	Combined Timer Fuse Panel, Voltage Monitoring Delay Timer, 75 Amp Load, Six Fused Outputs, 30 Amp Max. per Output, Low Voltage Cut Off at 11 VDC or 11.75 VDC, Time Delay, and Over Voltage Cut-Off at 18 VDC (AFS # CTF-T6)		6 (75 Amp)	0.2 lbs 0.09 kg	1.12 in 2.84 cm	2.07 in 5.26 cm	7.25 in 18.42 cm
7300-0280	Dual Voltage Timer, 75 Amp Load, 4 Timed Outputs, 2 Battery Hot Outputs, Low Voltage Cut Off at 11 VDC or 11.75 VDC, Time Delay, and Over Voltage Cut-Off at 18 VDC - Custom Software Load: Ignition Input Optional (AFS # DVT-04io)			0.8 lbs 0.36 kg	1.6 in 4.06 cm	3.5 in 8.89 cm	7 in 17.78 cm

NEW



7300-0357

NEW



7300-0335

NEW



7300-0353

NEW



7300-0280

RADIO POWER HARNESSES: STAND ALONE POWER AND GROUND CABLES

Item No.	Description	Placement	Weight
7300-0066	Radio Power, 20 AMP, 10 Gauge (X)	Front Battery to Console	1 lbs 0.45 kg
7300-0067	Radio Power, 20 AMP, 10 Gauge (Y)	Front Battery to Trunk Tray	1 lbs 0.45 kg
7300-0068	Radio Power, 20 AMP, 10 Gauge (Z)	Rear Battery to Console	1 lbs 0.45 kg
7300-0069	Radio Power, 20 AMP, 10 Gauge (W)	Rear Battery to Trunk Tray - Braided	1 lbs 0.45 kg

NEW

LIND POWER SUPPLY MOUNTING BRACKET ASSEMBLY



Item No.	Placement	Weight	Height	Width	Depth
7160-0936	Attaches to any Console Box or a Flat Surface	3.5 lbs 1.6 kg	5.0" 12.7 cm	9.6" 24.4 cm	3.0" 7.6 cm

Features

- Designed to hold a LIND power supply or a power supply that is 5.5" (13.97 cm) H x 3" (7.62 cm) W x 1" (2.54 cm) D
- Lifetime Limited Warranty

COMPUTER MOUNTING BRACKET



Item No.	Placement	Weight	Height	Width	Depth
MCS-COMBRKT	Attaches to pre-drilled holes on each side of the Ergonomic Console Boxes (MCS-ERGOBOX12, 71600237, 7160-0333) or the Low Profile Box (MCS-LOWBOX)	3.5 lbs 1.6 kg	5.0" 12.7 cm	9.6" 24.4 cm	3.0" 7.6 cm

Features

- Keeps computer low in vehicle and out of the air bag zone
- Computer can be mounted in the center or offset
- Lifetime Limited Warranty

SIDE EXTENSION MOUNTING PLATE



Item No.	Description	Placement	Weight	Height	Width	Depth
7160-0106	Side Extension Mounting Plate	Attaches to pre-drilled holes along side of any new Console Box Top Plate (7160-0085 or 7160-0086)	1.0 lbs 0.5 kg	1.5" 3.8 cm	5.0" 12.7 cm	3.65" 9.3 cm

Features

- Provides an offset mounting surface for any complete DS pole assembly or lower tube assembly
- Lifetime Limited Warranty

BROTHER POCKETJET 7 AND POCKETJET 7 PLUS PRINTER ACCESSORIES



14331

Item No.	Description
14331	Power Car Adapter - Wired 14' for use with PocketJet 3, 3 Plus, 6, 6 Plus, 7, 7 Plus Printers
14332	USB Cable - 4' for use with PocketJet 3, 3 Plus, 6, 6 Plus, 7, 7 Plus Printers

BROTHER ARMREST PRINTER MOUNT



Item No.	Placement	Drilling Required	Weight	Height	Width	Depth
7160-0006	On top of any Console Box Top Plate or any flat stable surface	No - Attaches to any Console Box Top Plate	11.3 lbs 5.1 kg	15.0" - includes 5" pole 38.1 cm - includes 12.7 cm pole	5.5" 14.0 cm	11.6" 29.5 cm

Features

- Convenient flip-up armrest and printer mount all in one
- For use with the following Brother printers:

PocketJet 200	PocketJet 3	PocketJet 6	PocketJet 7
PocketJet II	PocketJet 3 Plus	PocketJet 6 Plus (NiMH battery only)	PocketJet 7 Plus
- Mount holds printer and paper roll in separate lockdown tray
- Paper roll is enclosed to protect from dirt and dust
- The cover latches shut and can be used with a padlock for extra security
- Indicator lights and on/off button are easy to see and accessible when the cover is closed
- Paper deflector prevents paper from curling up and jamming
- Cable strain relief protects connector interface on the printer engine from damage
- Printer can be easily removed from the mount for use outside of the vehicle
- Paper feeds out the side towards the driver (paper and printer not included)
- Lifetime Limited Warranty

BROTHER POCKETJET SERIES MOUNT

Item No.	Placement	Description	Weight	Height	Width	Depth	Misc
7160-0126	Secures to the Rack-to-Post Platform (DS-74 or DS-74-L), then secured to any Lower Tube, Vehicle Base with a Welded Pole or onto any flat, stable surface	Printer/Paper Roll Housing with Optional Bolt-on Cable Strain Relief	2.3 lbs 1.0 kg	3.25" 8.3 cm	12.25" 31.1 cm	5.25" 13.3 cm	Holds Printer and Paper Roll in Separate Trays Cable Strain Relief Protects Connector Interface on the Printer Engine from Damage



Features

- For use with the following Brother printers:
 PocketJet 200 PocketJet 3 PocketJet 6 PocketJet 7
 PocketJet II PocketJet 3 Plus PocketJet 6 Plus (NiMH battery only) PocketJet 7 Plus
- Mount holds printer and paper roll in separate lockdown tray
- New wire draw latch provides a secure fit to reduce vibration noise
- Bolt-on cable restraint provide cable management options if desired
- There is no drilling required if mounting to a rack-to-post (DS-74 or DS-74-L), otherwise drilling is required for most other applications
- Gamber-Johnson mounting hole pattern
- Paper roll is enclosed to protect from prolonged exposure to direct sunlight
- Paper roll cut-out allows for vertical orientation as well as horizontal orientation
- Printer can be easily removed from the mount for use outside of the vehicle
- Paper and printer not included
- Lifetime Limited Warranty

BROTHER RUGGEDJET PRINTER MOUNT

Item No.	Placement	Weight	Height	Width	Depth
7160-0425	Secures to the Rack-to-Post Platform (DS-74 or DS-74-L), any Lower Pole, Vehicle Base with a Welded Pole or onto any flat stable surface	2.2 lbs 1.0 kg	2.1" to 3.4" 5.3 to 8.6 cm	12.5" to 14.6" 31.8 to 37.1 cm	7.6" to 8.9" 19.3 to 22.6 cm



Features

- Bracket allows the Brother RuggedJet™ RJ-4030 or RJ-4040 mobile printer to be mounted in a vertical or horizontal orientation
- Optional removable cable restraint
- Allows installation of paper roll while mounted
- Works with Brother's optional card reader
- This is not a quick release mount
- Lifetime Limited Warranty

CANON i70/i80/i90/i100 AND HP100/HP450/HP460/HP470 PRINTER MOUNT

Item No.	Placement	Drilling Required	Weight	Height	Width	Depth
7160-0392	Attaches to Pre-Drilled Holes on Rack-to-Post Platform (DS-74 or DS-74-L)	No - If Using a Rack-to-Post Platform (DS-74 or DS-74-L)	2.2 lbs 1.0 kg	2.1" to 3.4" 5.3 to 8.6 cm	12.5" to 14.6" 31.8 to 37.1 cm	7.6" to 8.9" 19.3 to 22.6 cm



Features

- Universal printer mount designed to be used with Canon i70/i80/i90/i100 and HP100/450/460/470 printers
- Adjustable side brackets allows the printer to be firmly seated
- Printer mount can be used with or without the optional battery pack
- For extra protection against shock and vibration, an isolator plate (7160-0351) is recommended
- Lifetime Limited Warranty



CODE 3 MASTERCON SIREN FULL FACEPLATE

Item No.	Placement	Weight	Height	Width	Depth
7160-0337	Works with any Gamber-Johnson Console Box and the Code 3 MasterCon Siren	0.6 lbs 0.3 kg	3.5" 8.9 cm	8.6" 21.8 cm	3.3" 8.4 cm

Features

- Designed for use with the Code 3 MasterCom siren control
- Full Faceplate secures the Code 3 MasterCom siren control into any Gamber-Johnson console box
- Interior mounting dimensions: 6.78" (17.2 cm) W x 2.78" (7.1 cm) H
- Lifetime Limited Warranty



CODE 3 XCEL SIREN BOX FULL FACEPLATE

Item No.	Placement	Weight	Height	Width	Depth
7160-0569	Works with any Gamber-Johnson Console Box and the Code 3 Xcel Siren Box	0.45 lbs 0.2 kg	3.0" 7.6 cm	8.60" 21.8 cm	2.83" 7.2 cm

Features

- Designed for use with the Code 3 Xcel siren box
- Full Faceplate secures the Code 3 Xcel siren box into any Gamber-Johnson console box
- Interior mounting dimensions: 6.36" (16.2 cm) W x 2.70" (6.9 cm) H
- Lifetime Limited Warranty



CODE 3 Z3 SERIES FULL FACEPLATE

Item No.	Placement	Weight	Height	Width	Depth
11511	Works with any Gamber-Johnson Console Box and the Code 3 Z3 Series	0.67 lbs 0.3 kg	3.38" 8.6 cm	8.63" 21.8 cm	0.89" 2.3 cm

Features

- Designed for use with the Code 3 Z3 series
- Full Faceplate secures the Code 3 Z3 series into any Gamber-Johnson console box
- Lifetime Limited Warranty



EF JOHNSON 5300 ES SERIES MOBILE RADIO/EF JOHNSON LIGHTNING CONTROL HEAD FULL FACEPLATE

Item No.	Placement	Weight	Height	Width	Depth
7160-0406	Works with any Gamber-Johnson Console Box and the EF Johnson 5300 ES Series Mobile Radio/EF Johnson Lightning Control Head	0.5 lbs 0.2 kg	3.0" 7.6 cm	8.62" 21.9 cm	3.58" 9.1 cm

Features

- Designed for use with the EF Johnson 5300 ES series mobile radio/EF Johnson lightning control head
- Full Faceplate secures the EF Johnson 5300 ES series mobile radio/EF Johnson lightning control head into any Gamber-Johnson console box
- Interior mounting dimensions: 7.19" (18.3 cm) W x 2.11" (5.4 cm) H
- Lifetime Limited Warranty



FEDERAL SIGNAL E-Q2B/PREMIUM VISION/SMARTSIREN FULL FACEPLATE

Item No.	Placement	Weight	Height	Width	Depth
3130-0237	Works with any Gamber-Johnson Console Box and the Federal Signal e-Q2B/Premium Vision/SmartSiren Control	0.7 lbs 0.3 kg	3.25" 8.3 cm	8.62" 21.9 cm	0.88" 2.2 cm

Features

- Designed for use with the Federal Signal e-Q2B/Premium Vision/SmartSiren control
- Full Faceplate secures the Federal Signal e-Q2B/Premium Vision/SmartSiren into any Gamber-Johnson console box
- Lifetime Limited Warranty

FEDERAL SIGNAL SMART SIREN/PLATINUM FULL FACEPLATE

Item No.	Placement	Weight	Height	Width	Depth
7160-0338	Works with any Gamber-Johnson Console Box and the Federal Signal Smart Siren/Platinum	0.65 lbs 0.3 kg	4.25" 10.8 cm	8.62" 21.9 cm	1.2" 3 cm
Features - Designed for use with the Federal Signal Smart Siren/Platinum - Full Faceplate secures the Federal Signal Smart Siren/Platinum into any Gamber-Johnson console box - Interior mounting dimensions: 6.86" (17.4 cm) W x 3.31" (8.4 cm) H - Lifetime Limited Warranty					



FEDERAL SIGNAL SIGNALMASTER CONTROLLER SERIES FACEPLATE

Item No.	Placement	Weight	Height	Width	Depth
15359	Works with any Gamber-Johnson Console Box	0.25 lbs 0.2 kg	2.0" 5.1 cm	8.6" 21.8 cm	2.75" 7.0 cm
Features - Allows for an easy mounting solution in Gamber-Johnson console boxes - Allows for about 1" (2.5 cm) of adjustability up and down - Interior mounting dimensions: 6.2" (15.7 cm) W x 1.5" (3.8 cm) H - Lifetime Limited Warranty					



FENIEX 4200 CONTROLLER/SIREN FULL FACEPLATE

Item No.	Placement	Weight	Height	Width	Depth
15360	Works with any Gamber-Johnson Console Box and the Fenix 4200 Controller/Siren	0.32 lbs 0.15 kg	4.0" 10.16 cm	8.62" 21.8 cm	0.80" 2.0 cm
Features - Allows for an easy mounting solution in Gamber-Johnson console boxes - Allows for about 1" (2.5 cm) of adjustability up and down - Interior mounting dimensions: 6.2" (15.7 cm) W x 1.5" (3.8 cm) H - Lifetime Limited Warranty					



HARRIS M7300/M7200, M/A COM M803, OPENSKY CH-103 FULL FACEPLATE

Item No.	Placement	Weight	Height	Width	Depth
7160-0523	Works with any Gamber-Johnson Console Box and the Harris M7300	0.42 lbs 0.2 kg	3.0" 7.6 cm	8.62" 21.9 cm	2.58" 6.6 cm
Features - Designed for use with the Harris M7300 radio - Full Faceplate secures the Harris M7300 radio into any Gamber-Johnson console box - Interior mounting dimensions: 6.94" (17.6 cm) W x 2.4" (6.1 cm) H - Lifetime Limited Warranty					



HARRIS UNITY XG-100M CONTROL HEAD FULL FACEPLATE

Item No.	Placement	Weight	Height	Width	Depth
7160-0432	Works with any Gamber-Johnson Console Box and the Harris Unity XG-100M Control Head	0.40 lbs 0.2 kg	4.50" 11.4 cm	8.62" 21.9 cm	1.88" 4.8 cm
Features - Designed for use with the Harris Unity XG-100M control head - Full faceplate secures the Harris Unity XG-100M control head into any Gamber-Johnson console box - Interior mounting dimensions: 7.09" (18 cm) W x 3.44" (8.7 cm) H - Lifetime Limited Warranty					



ICOM ID-5100 CONTROL HEAD FULL FACEPLATE



Item No.	Placement	Weight	Height	Width	Depth
16082	Works with any Gamber-Johnson Console Box and the ICOM ID-5100 Control Head	0.44 lbs 0.2 kg	3.5" 8.9 cm	8.62" 21.9 cm	0.71" 1.8 cm

Features

- Designed for use with the ICOM ID-5100 control head
- Full Faceplate secures the ICOM ID-5100 control head into any Gamber-Johnson console box
- Allows use of magnet mounting from ICOM for ease of removing control head
- Interior mounting dimensions: 7.13" (18.1 cm) W x 3.19" (8.1) cm H
- Lifetime Limited Warranty

ICOM IC-2730 CONTROL HEAD FULL FACEPLATE



Item No.	Placement	Weight	Height	Width	Depth
16328	Works with any Gamber-Johnson Console Box and the ICOM IC-2730 Control Head	0.4 lbs 0.2 kg	3.0" 7.6 cm	8.62" 21.9 cm	0.5" 1.3 cm

Features

- Designed for use with the ICOM ID-2730 control head
- Allows to be mounted with PEM's on back side of control head
- Allows use of magnet mounting option from ICOM for ease of removing control head
- Interior mounting dimensions: 5.88" (14.9 cm) W X 2.00" (5.1 cm) H
- Lifetime Limited Warranty

ICOM A120 RADIO (AIR BAND) / IC-F5061 FACEPLATE



Item No.	Placement	Weight	Height	Width	Depth
16437	Works with any Gamber-Johnson Console Box	0.3 lbs 0.2 kg	2.5" 6.4 cm	8.6" 21.8 cm	2.75" 7.0 cm

Features

- Allows for easy mounting solution in Gamber-Johnson console box
- Mounts using mounting points on the side of the radio
- About 1" (2.5 cm) adjustability up and down
- Interior mounting dimensions: 6.38" (16.2 cm) W x 1.75" (4.4 cm) H
- Lifetime Limited Warranty

KENWOOD NX-5000 SERIES RADIO AND STANDARD CONTROL HEAD FACEPLATE



Item No.	Placement	Weight	Height	Width	Depth
17170	Works with any Gamber-Johnson Console Box and the Kenwood NX-5000 Series Radio and Standard Control Head	0.4 lbs 0.18 kg	3.0" 7.6 cm	8.62" 21.8cm	3.0" 7.6 cm

Features

- Designed for use with the Kenwood NX-5000 Series Radio and Standard Control Head
- Full faceplate secures the Kenwood NX-5000 Series Radio and Standard Control Head into any Gamber-Johnson console
- Interior mounting dimensions: 6.75" (17.1 cm) W x 1.95" (5.0 cm) H
- Lifetime Limited Warranty

KENWOOD NX-700/NX-800/TK-7180/TK-8180/MPT SERIES RADIO FULL FACEPLATE



Item No.	Placement	Weight	Height	Width	Depth
16030	Works with any Gamber-Johnson Console Box and the Kenwood NX-700/NX-800/TK-7180/TK-8180/MPT Series Radio	0.36 lbs 0.2 kg	2.5" 6.4 cm	8.62" 21.9 cm	3.27" 8.3 cm

Features

- Designed for use with the Kenwood NX-700/NX-800/TK-7180/TK-8180/MPT series radio
- Full Faceplate secures the Kenwood NX-700/NX-800/TK-7180/TK-8180/MPT series radio into any Gamber-Johnson console box
- Interior mounting dimensions: 6.38" (16.2 cm) W x 1.75" (4.4 cm) H
- Lifetime Limited Warranty

KENWOOD TK-790 RADIO FULL FACEPLATE

Item No.	Placement	Weight	Height	Width	Depth
7160-0466	Works with any Gamber-Johnson Console Box and the Kenwood TK-790 Radio	0.50 lbs 0.2 kg	3.0" 7.6 cm	8.62" 21.9 cm	3.25" 8.3 cm

Features

- Designed for use with the Kenwood TK-790 radio
- Full faceplate secures the Kenwood TK-790 radio into any Gamber-Johnson console box
- Interior mounting dimensions: 7.32" (18.6 cm) W x 2.39" (6.1 cm) H
- Lifetime Limited Warranty



KENWOOD TK-980 AND TK-981 RADIO FULL FACEPLATE

Item No.	Placement	Weight	Height	Width	Depth
7160-0465	Works with any Gamber-Johnson Console Box and the Kenwood TK-980 and TK-981 Radio	0.40 lbs 0.2 kg	2.0" 5.1 cm	8.62" 21.9 cm	2.72" 6.9 cm

Features

- Designed for use with the Kenwood TK-980 and TK-981 radios
- Full faceplate secures the Kenwood TK-980 and TK-981 radios into any Gamber-Johnson Console box
- Interior mounting dimensions: 5.53" (14 cm) W x 1.61" (2.9 cm) H
- Lifetime Limited Warranty



L3 MOBILE-VISON FLASHBACK3 VIDEO RECORDER FULL FACEPLATE

Item No.	Placement	Weight	Height	Width	Depth
7160-0522	Works with any Gamber-Johnson Console Box and the L3 Communication Flashback3	0.38 lb 0.2 kg	3.0" 7.6 cm	8.62" 21.9 cm	2.43" 6.2 cm

Features

- Designed for use with the L3 Communication Flashback3 In-Car Digital Video Recorder
- Full Faceplate secures the L3 Communication Flashback3 into any Gamber-Johnson console box
- Interior mounting dimensions: 6.94" (17.6 cm) W x 2.44" (6.2 cm) H
- Lifetime Limited Warranty



MOTOROLA 8 BUTTON DEK FULL FACEPLATE

Item No.	Placement	Weight	Height	Width	Depth
7160-0459	Works with any Gamber-Johnson Console Box and the Motorola 8 Button DEK (Single)	0.25 lbs 0.1 kg	2.0" 5.1 cm	8.62" 21.9 cm	1.75" 4.4 cm
7160-0462	Works with any Gamber-Johnson Console Box and the Motorola 8 Button DEK (Dual)	0.50 lbs 0.2 kg	3.5" 8.9 cm	8.62" 21.9 cm	1.75" 4.4 cm

Features

- Designed for use with the Motorola 8 Button DEK (single or dual)
- Full faceplate secures the Motorola 8 Button DEK (single or dual) into any Gamber-Johnson console box
- Interior mounting dimensions for Motorola 8 Button DEK (Single): 6.56" (16.9 cm) W x 1.28" (3.3 cm) H
- Interior mounting dimensions for Motorola 8 Button DEK (Dual): 6.56" (16.7 cm) W x 2.56" (6.5 cm) H
- Lifetime Limited Warranty



7160-0462

MOTOROLA APX 09/6500/7500/8500 FULL FACEPLATE

Item No.	Placement	Weight	Height	Width	Depth
7160-0267	Works with any Gamber-Johnson Console Box and the Motorola APX 09/6500/7500/8500 Integrated Control Head	0.80 lb 0.4 kg	8.0" 20.3 cm	8.62" 21.9 cm	1.68" 4.3 cm

Features

- Designed for use with the Motorola APX 09/6500/7500/8500 integrated control head
- Full faceplate secures the Motorola APX 09/6500/7500/8500 into any Gamber-Johnson console box
- Interior mounting dimensions: 7.53" (19.1 cm) W x 7.06" (17.9 cm) H
- Lifetime Limited Warranty





MOTOROLA CDM SERIES RADIO FULL FACEPLATE

Item No.	Placement	Weight	Height	Width	Depth
7160-0467	Works with any Gamber-Johnson Console Box and the Motorola CDM Series Radio	0.40 lbs 0.2 kg	3.0" 7.6 cm	8.62" 21.8 cm	3.60" 9.1 cm

Features

- Designed for use with the Motorola CDM series radio
- Full faceplate secures the Motorola CDM series radio into any Gamber-Johnson console box
- Interior mounting dimensions: 6.96" (17.7 cm) W x 2.36" (56 cm) H
- Lifetime Limited Warranty



MOTOROLA PM1500 SERIES RADIO FULL FACEPLATE

Item No.	Placement	Weight	Height	Width	Depth
7160-0538	Works with any Gamber-Johnson Console Box and the Motorola PM1500 Series Radio	0.35 lbs 0.2 kg	3.0" 7.6 cm	8.62" 21.9 cm	1.79" 4.5 cm

Features

- Designed for use with the Motorola PM1500 series radio
- Full faceplate secures the Motorola PM1500 series radio into any Gamber-Johnson console box
- Interior mounting dimensions: 7.26" (18.4 cm) W x 2.36" (6 cm) H
- Lifetime Limited Warranty



MOTOROLA XPR 5550/6550 FULL FACEPLATE

Item No.	Placement	Weight	Height	Width	Depth
7160-0587	Works with any Gamber-Johnson Console Box and the Motorola XPR 5550/6550 Control Head and Full Radio	0.32 lbs 0.1 kg	2.5" 6.4 cm	8.62" 21.9 cm	3.36" 8.5 cm

Features

- Designed for use with the Motorola XPR 5550/6550 control head and full radio
- Full faceplate secures the Motorola XPR 5550/6550 control head and full radio into any Gamber-Johnson console box
- Interior mounting dimensions: 6.7" (17.1 cm) W x 2.10" (5.3 cm) H
- Lifetime Limited Warranty



MOTOROLA XTL 2500/5000, APX 6500/7500/8500 FULL FACEPLATE

Item No.	Placement	Weight	Height	Width	Depth
7160-0321	Works with any Gamber-Johnson Console Box and the Motorola XTL 2500/5000 and Apex 6500/7500/8500 Control Head Radio	0.35 lbs 0.2 kg	3.0" 7.6 cm	8.62" 21.9 cm	1.51" 3.8 cm
7160-0322	Works with any Gamber-Johnson Console Box and the Motorola XTL 2500/5000 and Apex 6500/7500/8500 Full Sized Radio	0.50 lbs 0.2 kg	3.0" 7.6 cm	8.62" 21.9 cm	3.58" 9.1 cm

Features

- Designed for use with the Motorola XTL 2500/5000 and APX 6500/7500/8500 models 02/05/07 control head and full sized radio
- Full faceplate secures the Motorola XTL 2500/5000 into any Gamber-Johnson console box
- Interior mounting dimensions: 7.06" (17.9 cm) W x 2.08" (5.3 cm) H
- Lifetime Limited Warranty



PANASONIC ARBITRATOR MK3 VPU FULL FACEPLATE

Item No.	Placement	Weight	Height	Width	Depth
16071	Works with any Gamber-Johnson Console Box and the Panasonic Arbitrator MK3 VPU	0.33 lbs 0.1 kg	4.0" 10.2 cm	8.62" 21.9 cm	1.00" 2.5 cm

Features

- Designed for use with the Panasonic Arbitrator MK3 VPU
- Full faceplate secures the Panasonic Arbitrator MK3 VPU into any Gamber-Johnson console box
- Interior mounting dimensions: 7.07" (18 cm) W x 3.39" (8.6 cm) H
- Lifetime Limited Warranty



RELM BK KNG M FULL FACEPLATE

Item No.	Placement	Weight	Height	Width	Depth	Interior Dimensions
15344	Works with any Gamber-Johnson Console Box and the Relm BK KNG M Control Head	0.31 lbs 0.1 kg	3.0" 7.6 cm	8.62" 21.9 cm	1.33" 3.4 cm	6.13" W x 2.25" H 15.6 cm W x 5.7 cm H
15348	Works with any Gamber-Johnson Console Box and the Relm BK KNG M Full Radio	0.34 lbs 0.2 kg	3.0" 7.6 cm	8.62" 21.9 cm	2.83" 7.2 cm	6.5" W x 2.42" H 16.2 cm W x 6.1 cm H



15344

Features

- Designed for use with the Relm BK KNG M control head and full sized radio
- Full faceplate secures the Relm BK KNG M control head and full sized radio into any Gamber-Johnson console box
- Lifetime Limited Warranty

SOUNDOFF SIGNAL 380 CONTROL HEAD FULL FACEPLATE

Item No.	Placement	Weight	Height	Width	Depth
14619	Works with any Gamber-Johnson Console Box and the SoundOff Signal 380 Control Head	0.7 lbs 0.3 kg	3.50" 8.9 cm	8.62" 21.9 cm	0.88" 2.2 cm



Features

- Designed for use with the Sound Off Signal 380 control head
- Full faceplate secures the Sound Off Signal 380 control head into any Gamber-Johnson console box
- Lifetime Limited Warranty

SOUNDOFF SIGNAL ETSP990, BOOKING BR-990 SERIES SWITCH PANEL FULL FACEPLATE

Item No.	Placement	Weight	Height	Width	Depth
16331	Works with any Gamber-Johnson Console Box and the SoundOff Signal ETSP990 Switch Panel	0.31 lbs 0.1 kg	3.0" 7.6 cm	8.62" 21.9 cm	0.50" 1.3 cm



Features

- Designed for use with the SoundOff signal switch panel
- Full faceplate secures the SoundOff Signal ETSP990 switch panel into any Gamber-Johnson console box
- Works with mounting points on back side of switch panel
- Interior mounting dimensions: 6.50 (16.5 cm) W x 2.63" (6.7 cm) H
- Lifetime Limited Warranty

SOUNDOFF SIGNAL NERGY 400 SERIES FULL SIREN FACEPLATE

Item No.	Placement	Weight	Height	Width	Depth
17133	Works with any Gamber-Johnson Console Box and the SoundOff Signal nERGY 400 Series Full Siren	0.25 lbs 0.11 kg	3.5" 8.89 cm	8.62" 21.8 cm	2.5" 6.35 cm



Features

- Designed for use with the SoundOff Signal nERGY 400 Series Full Siren - both buttons and knobs
- Full faceplate secures the SoundOff Signal nERGY 400 Series Full Siren into any Gamber-Johnson console
- Allows for about 1" or adjustability up and down
- Interior mounting dimensions: 7.38 (18.75 cm) W x 2.88 (7.32 cm) H
- Lifetime Limited Warranty

TAIT TM8100/8200 SERIES FULL FACEPLATE

Item No.	Placement	Weight	Height	Width	Depth
15343	Works with any Gamber-Johnson Console Box and the Tait TM8100/8200 Series	0.48 lbs 0.2 kg	3.0" 7.6 cm	8.62" 21.9 cm	3.23" 8.2 cm



Features

- Designed for use with the Tait TM8100/8200 series
- Full faceplate secures the Tait TM8100/8200 series into any Gamber-Johnson console box
- Interior mounting dimensions: 6.33" (16.1 cm) W x 2.13" (5.4 cm) H
- Lifetime Limited Warranty

UNIDEN MOBILE SCANNERS FULL FACEPLATE



Item No.	Placement	Weight	Height	Width	Depth
7160-0528	Works with any Gamber-Johnson Console Box and the Uniden Mobile Scanners	0.46 lbs 0.2 kg	3.0" 7.6 cm	8.62" 21.9 cm	3.65" 9.3 cm

Features

- Designed for use with the Uniden mobile scanners models: BCT15 (X), BCD996 (T & XT), UBC800XLT and BCD536HP
- Full faceplate secures the Uniden mobile scanners into any Gamber-Johnson console box
- Interior mounting dimensions: 7.28" (18.5 cm) W x 2.25" (5.7 cm) H
- Lifetime Limited Warranty

WHELEN 295SLSA1 SIREN FULL FACEPLATE



Item No.	Placement	Weight	Height	Width	Depth
15377	Works with any Gamber-Johnson Console Box and the Whelen 295SLSA1 Siren	0.3 lbs 0.1 kg	3.0" 7.6 cm	8.62" 21.9 cm	1.58" 4 cm

Features

- Designed for use with the Whelen 295SLSA1 siren
- Full faceplate secures the Whelen 295SLSA1 siren into any Gamber-Johnson console box
- Interior mounting dimensions: 5.97" (15.2 cm) W x 2.40" (6.1 cm) H
- Lifetime Limited Warranty

WHELEN 295SLSA6 FULL FACEPLATE



Item No.	Placement	Weight	Height	Width	Depth
17041	Works with any Gamber-Johnson Console Box and the Whelen 295SLSA6 Siren with Switches	0.5 lbs 0.23 kg	4.0" 10.16 cm	8.62" 21.8 cm	2.5" 6.35 cm

Features

- Designed for use with the Whelen 295SLSA6 siren with 6 switches
- Full faceplate secures the Whelen 295SLSA6 siren into any Gamber-Johnson console
- Allows for about 1.75" (4.45 cm) of adjustability up and down
- Interior mounting dimensions: 5.94" (15.09 cm) W x 3.19" (8.1 cm) H
- Lifetime Limited Warranty

WHELEN PCC8R 8 BUTTON LIGHT CONTROLLER FACEPLATE



Item No.	Placement	Weight	Height	Width	Depth
15087	Works with any Gamber-Johnson Console Box and the Whelen PCC8R 8 Button Light Controller	0.55 lbs 0.2 kg	3.0" 7.6 cm	8.62" 21.9 cm	0.08" 0.2 cm

Features

- Designed for use with the Whelen PCC8R 8 button light controller
- Faceplate secures the Whelen PCC8R 8 button light controller into any Gamber-Johnson console box
- Lifetime Limited Warranty

WHELEN CENCOM GOLD/SOUNDOFF 380 LIGHT AND SIREN, nERGY 400 SERIES REMOTE SIREN FULL FACEPLATE

Item No.	Placement	Weight	Height	Width	Depth
7160-0339	Works with any Gamber-Johnson Console Box and the Whelen CenCom Gold or SoundOff 380Light/Siren Controls	0.50 lbs	4.0"	8.62"	1.33"

Features

- Designed for use with the Whelen CenCom Gold or SoundOff 380 light/siren controls and nERGY 400 series remote siren
- Full Faceplate secures the Whelen CenCom Gold or SoundOff 380 light/siren controls into any Gamber-Johnson console box
- Interior mounting dimensions: 6.66" (19.9 cm) W x 3.44" (8.7 cm) H
- Lifetime Limited Warranty



YAESU FT-7900 / FT-8800R / FT-8900R / FTM-100D / FTM-400D RADIO BODY FULL FACEPLATE

Item No.	Placement	Weight	Height	Width	Depth
16327	Works with any Gamber-Johnson Console Box and Yaesu FT-7900 / FT-8800R / FT-8900R / FTM-100D / FTM-400D Series Radio	0.3 lbs 0.1 kg	2.5" 57.2 cm	8.62" 21.9 cm	2.5" 6.3 cm

Features

- Designed for use with Yaesu FT-7900 / FT-8800R / FT-8900R / FTM-100D / FTM-400D-radio body
- Works with mounting points on the radio
- Control head has to be detached to put faceplate on the radio, then reattached
- Interior mounting dimensions: 5.63" (14.3 cm) W x 1.5" (3.8 cm) H
- Lifetime Limited Warranty



YAESU FTM-100DR CONTROL HEAD ONLY FULL FACEPLATE

Item No.	Placement	Weight	Height	Width	Depth
16329	Works with any Gamber-Johnson Console Box and Yaesu FTM-100DR Control Head	0.75 lbs 0.3 kg	4.0" 10.1 cm	8.62" 21.9 cm	1.25" 3.2 cm

Features

- Designed for use with Yaesu FTM-100DR control head
- Works with mounting points on the radio
- Work with GPS receiver on top of control head
- Interior mounting dimensions: 5.5" (14 cm) W x 2.38" (6 cm) H (angled)
- Lifetime Limited Warranty



YAESU FT-857 RADIO FULL FACEPLATE

Item No.	Placement	Weight	Height	Width	Depth
16330	Works with any Gamber-Johnson Console Box and Yaesu FT-857 Radio	0.35 lbs 0.2 kg	2.5" 6.4 cm	8.62" 21.9 cm	2.5" 6.4 cm

Features

- Designed for use with Yaesu FT-857 radio
- Works with mounting points on the radio
- Control head has to be detached to put on faceplate on the radio, then reattached
- Interior mounting dimensions: 6.13" (15.6 cm) W x 1.75" (4.4 cm) H (angled)
- Lifetime Limited Warranty



FACEPLATE ORDERING INSTRUCTIONS (Every order number includes a pair of faceplates)

1. Note the manufacturer and the model name of the equipment to be installed, then locate your equipment in the guide.
2. Use the part number listed in the Item No. column.
3. Should Gamber-Johnson's dimensions not correspond with your equipment or you do not find your equipment listed, please make a copy of the dimensions worksheet (above), fill it out and fax it to us at 1-800-934-3577. We will help you find a faceplate which will work with your equipment.



CAN'T FIND YOUR DEVICE? VISIT OUR WEBSITE AT WWW.GAMBERJOHNSON.COM FOR A FULL LISTING.

	HEIGHT	WIDTH	ITEM NO.		HEIGHT	WIDTH	ITEM NO.
911EP Orion DIRECTOR (ORITD4)	1.3"/3.2 cm	6.5"/16.5 cm	7140-0374	D & R RDS-RK	2.4"/6.1 cm	6.6"/16.77 cm	7140-0364
911EP Orion ELITE (ORIEL4)	1.3"/3.2 cm	6.5"/16.5 cm	7140-0374	Eagle Radar	1.75"/4.4 cm	6.5"/16.5 cm	7140-0370
911EP Orion STANDARD (ORISD4)	1.3"/3.2 cm	6.5"/16.5 cm	7140-0374	EF Johnson 242-7610	1.6"/4.1 cm	5.5"/14 cm	7140-0272
Able 2 05-5300	2.75"/7 cm	6.0"/15.2 cm	7140-0312	EF Johnson 53SL ES	2.00"/5 cm	7.0"/17.8 cm	7140-0443
Able 2 05-6040	2.0"/5 cm	6.0"/15.2 cm	7140-0318	Emtrac, Traffic Pre-Empron System	2.8"/7.1 cm	6.5"/16.5 cm	7140-0362
Able 2 Sho-Me 30-2100 / 30.2108 / 30-2200 SIRENS	2.3"/5.7 cm	6.0"/15.2 cm	7140-0316	Ericsson EDACS Orion Scanner	2.5"/6.4 cm	7.3"/18.5 cm	7140-0439
Able 2 Sho-Me-05-600 siren	2.3"/5.7 cm	7.1"/18.1 cm	7140-0441	Ericsson GE 34A4210P D	2.00"/5 cm	6.0"/15.2 cm	7140-0318
Able 2 Sho-Me-05-600 Switch Box	2.3"/5.7 cm	6.0"/15.2 cm	7140-0316	Ericsson M7100 (Orion)	2.4"/6.1 cm	6.9"/17.5 cm	7140-0439
Able 2 Sho-Me-5-5540	2.3"/5.7 cm	6.0"/15.2 cm	7140-0316	Federal Signal Light Control Model SMC5 (331105)	1.5"/3.8 cm	6.1"/15.5 cm	7140-0322
Able2 Chameleon Traffic Director Control	1.3"/3.2 cm	6.0"/15.2 cm	7140-0322	Federal FIRECOM 3000A	1.69"/4.3 cm	6.1"/15.5 cm	7140-0317
ADI AR-146	1.6"/4.1 cm	5.5"/14 cm	7140-0271	Federal FIRECOM 3000C	1.5"/3.8 cm	6.1"/15.5cm	7140-0322
Alinco DR-06T	1.6"/4.1 cm	5.5"/14 cm	7140-0271	Federal MS-4000	1.5"/3.8 cm	5.5"/14 cm	7140-0272
Alinco DR-590	2.0"/5.1 cm	6.0"/15.2 cm	7140-0318	Federal PA - 200, PA-300, PA-400	2.4"/6.1 cm	6.1"/15.5 cm	7140-0315
Applied Concepts Stacker Radar	1.8"/4.6 cm	5.5"/14 cm	7140-0271	Federal PA-15	2.75"/7 cm	5.3"/13.5 cm	7140-0237
Bee Doppler Radar Model 36 Series A	2.4"/6.1 cm	6.0"/15.2 cm	7140-0315	Federal PA630 P640	3.0"/7.6 cm	6.9"/17.5 cm	7140-0385
Bendix/King EMH5990A	2.1"/5.3 cm	6.0"/15.2 cm	7140-0317	Federal Signal SignalMaster SMC 5 Lightbar Controller 331105	1.5"/3.8 cm	6.1"/15.5 cm	7140-0322
Bendix/King EMV	2.1"/5.3 cm	6.0"/15.2 cm	7140-0317	Federal Signal SS-700 Siren/PA	2.5"/6.4 cm	6.0"/15.2 cm	7140-0364
Bendix/King GMH (RELM / BK Radio)	2.1"/5.3 cm	6.0"/15.2 cm	7140-0317	Federal Signal UTMD Delta	2.4"/6.1 cm	6.5"/16.5	7140-0364
BK DMH5992X	2.1"/5.3 cm	6.0"/15.2 cm	7140-0317	Federal SW-300, SW400SS, SW400SSJ, SW 400S&L	2.2"/5.6 cm	6.1"/15.5 cm	7140-0316
Brooking BR960	2.0"/5.1 cm	6.3"/16 cm	7140-0343	Fenix 4200 (control head)	3.5"/8.9 cm	6.8"/17.3 cm	7140-0881
Carson SA 400	2.5"/6.4 cm	6.1"/15.5 cm	7140-0314	Galls 5 Function Switch Panel SE080	2.0"/5.1 cm	6.3"/16.0 cm	7140-0343
Carson SC407 Siren Box 407A Siren	2.9"/7.4 cm	6.1"/15.5 cm	7140-0312	Galls 6 Function Switch Panel SE081	2.1"/5.3 cm	6.3"/16.0 cm	7140-0342
Carson SC-409	2.8"/7.1 cm	6.1"/15.5 cm	7140-0312	Galls 6 Function Switch Panel SE082	2.0"/5.1 cm	6.3"/16.0 cm	7140-0342
Cobra 148 GTL	2.4"/6.1 cm	7.9"/20 cm	7140-0440	Galls 6 Function Switch Panel SE103	2.0"/5.1 cm	5.0"/12.7 cm	7140-0218
Cobra 18 Ultra	2.1"/5.3 cm	6.1"/15.5 cm	7140-0442	Galls 9 Function Switch Panel SE104	2.0"/5.1 cm	5.0"/12.7 cm	7140-0218
Cobra 18 WX ST II	1.9"/4.8 cm	6.5"/16.5 cm	7140-0369	Galls Siren Box SK053 (is Code 3 Mastercom)	2.75"/7 cm	6.7"/17.0 cm	7140-0362
Cobra 25 LTD	2.1"/5.3 cm	6.3"/16 cm	7140-0342	Galls SK155	2.5"/6.4 cm	6.0"/15.2 cm	7140-0314
Cobra 29 LTD Classic	2.3"/5.7 cm	7.3"/18.5 cm	7140-0441	Galls Street Thunder 240	2.5"/6.4 cm	6.0"/15.2 cm	7140-0314
Cobra 29 LX & 29 LX BT	2.325"/5.7 cm	7.3"/18.5 cm	7140-0441	Galls Street Thunder Deluxe Full Feature Siren SK125 / ST240	2.0"/5.1 cm	5.8"/14.7 cm	7140-0218
Cobra 29 WX NW BT	2.6"/6.6 cm	7.3"/18.5 cm	7140-0438	Galls Switch Box J-SE041	2.2"/5.6 cm	6.1"/15.5 cm	7140-0316
Cobra 29 WX NWST Mobile CB	2.3"/5.7 cm	7.3"/18.5 cm	7140-0441	Galls XL 100 Street Thunder - OLD	2.5"/6.4 cm	6.0"/15.2 cm	7140-0314
Code 3 3892L6M /3892L4H Siren/Light Control (MasterCom B)	2.8"/7.1 cm	6.5"/16.5 cm	7140-0362	Galls XL 200 Switch Box	2.5"/6.4 cm	6.5"/16.5 cm	7140-0364
Code 3 3942M/3942L4H/ 3942L6H/3944L4H (MasterCom B)	2.8"/7.1 cm	6.5"/16.5 cm	7140-0362	Galls XL 300 Street Thunder	2.1"/5.3 cm	6.3"/16.0 cm	7140-0342
Code 3 Model 430 6 Switchbox	2.2"/5.5 cm	6.1"/15.4 cm	7140-0316	Galls XL 400 Street Thunder	2.5"/6.4 cm	6.5"/16.5 cm	7140-0364
Code 3 415 Series Rocker Switch Control Panels	2.5"/6.4 cm	6.5"/16.5 cm	7140-0364	GE 344A4210P2	2.0"/5.1 cm	6.0"/15.2 cm	7140-0318
Code 3 Arrowstick PSE (Model - NASLCH2)	1.25"/3.2 cm	6.5"/16.5 cm	7140-0374	GE Ericsson Mrk Vehicle Charger	2.4"/6.1 cm	7.1"/18.0 cm	7140-0440
Code 3 ArrowStik	2.00"/5 cm	6.5"/16.5 cm	7140-0368	GE Ericsson (MA/Comm) KMC300	2.2"/5.6 cm	7.1"/18.0 cm	7140-0442
Code 3 Mastercom B (3892/ 3892L6M/3892L6)	2.8"/7.1 cm	6.5"/16.5 cm	7140-0362	GE Ericsson M7100 (Orion)	2.4"/6.1 cm	6.9"/15.5 cm	7140-0439
Code 3 Narrowstick	1.5"/3.9 cm	6.6"/16.8 cm	7140-0371	GE FMD Radio/Recessed	2.9"/7.4 cm	7.4"/18.8 cm	7140-0436
Code 3 Stealth 518	1.5"/3.8 cm	6.0"/15.2 cm	7140-0322	GE Marc MDX, NPH-20	2.2"/5.6 cm	7.2"/18.3 cm	7140-0441
Code 3 V-CON 3600 Series	2.25"/5.7 cm	6.5"/16.5 cm	7140-0864	GE MDX Remote	2.2"/5.6 cm	7.2"/18.3 cm	7140-0441
Code 3 V-CON 3672L4	2.25"/5.7 cm	6.5"/16.5 cm	7140-0864	GE MLS II	2.5"/6.4 cm	7.0"/17.8 cm	7140-0439
Code 3 V-CON 3692	2.25"/5.7 cm	6.5"/16.5 cm	7140-0864	GE Monogram MGM-148	2.0"/5.1 cm	6.0"/15.2 cm	7140-0318
Code 3 V-CON 3692L4	2.25"/5.7 cm	6.5"/16.5 cm	7140-0864	GE MPR Controller & Charger	3.0"/7.6 cm	7.0"/17.8 cm	7140-0385
Code 3 V-CON 3696 series	2.25"/5.7 cm	6.5"/16.5 cm	7140-0864	GE MVS	2.25"/5.7 cm	7.1"/18.0 cm	7140-0441
CPI SV100	1.5"/3.8 cm	5.5"/14 cm	7140-0272	GE Orion	2.0"/5.1 cm	7.1"/18.0 cm	7140-0443
				GE Orion Mobile EDACS Scan Model	2.5"/6.4 cm	7.0"/17.8 cm	7140-0439

CONSOLE SYSTEMS | FACEPLATES GUIDE

	HEIGHT	WIDTH	ITEM NO.		HEIGHT	WIDTH	ITEM NO.
GE PAE 5610 or GE ORION REMOTE HEAD	2.4"/6.1 cm	6.9"/17.5 cm	7140-0440	Kenwood TK7180	1.7"/4.3 cm	6.3"/16.0 cm	7140-0345
GE Phoenix	2.6"/6.6 cm	7.4"/17.8 cm	7140-0438	Kenwood TK730	2.4"/6.1 cm	7.1"/18.0 cm	7140-0440
GE PMH4SD	2.25"/5.7 cm	7.1"/18.0 cm	7140-0441	Kenwood TK7360	1.7"/4.3 cm	6.3"/16.0 cm	7140-0345
GE S-900 w/light	2.0"/5.1 cm	6.6"/16.8	7140-0368	Kenwood TK7360 HV	1.8"/4.6 cm	6.3"/16.0 cm	7140-0345
GE S-990 Remote Head	1.6"/4.1 cm	6.6"/16.8	7140-0371	Kenwood TK760H	1.5"/3.8 cm	5.5"/14.0 cm	7140-0272
Genesis I Radar	1.75"/4.4 cm	6.50	7140-0370	Kenwood TK780	1.6"/4.1 cm	5.5"/14.0 cm	7140-0271
HARRIS M5300 Series Radio & Control Head	2.4"/6.1 cm	7.0"/17.8 cm	7140-0439	Kenwood TK790	2.4"/6.1 cm	7.1"/18.0 cm	7140-0440
HARRIS M7100 Series Radio & Control Head	2.4"/6.1 cm	7.0"/17.8 cm	7140-0439	Kenwood TK8102	1.7"/4.3 cm	6.3"/16.0 cm	7140-0345
HARRIS M7100 (Orion)	2.4"/6.1 cm	6.9"/17.5 cm	7140-0439	Kenwood TK8150	2.0"/5.1 cm	7.0"/17.8 cm	7140-0443
HARRIS M7200 Series Radio & Control Head	2.4"/6.1 cm	7.0"/17.8 cm	7140-0439	Kenwood TK8160	1.7"/4.3 cm	6.3"/16.0 cm	7140-0345
HARRIS M7300 Series CONTROL HEAD	2.4"/6.1 cm	7.0"/17.8 cm	7140-0439	Kenwood TK8180	1.7"/4.3 cm	6.3"/16.0 cm	7140-0345
Icom F420	1.5"/3.8 cm	5.5"/14.0 cm	7140-0272	Kenwood TK830	2.4"/6.1 cm	6.9"/17.5 cm	7140-0440
Icom 207	1.5"/3.8 cm	5.5"/14.0 cm	7140-0272	Kenwood TK8360HU	1.8"/4.6 cm	6.3"/16.0 cm	7140-0345
Icom 521	1.5"/3.8 cm	5.5"/14.0 cm	7140-0272	Kenwood TK840	1.5"/3.8 cm	5.5"/14.0 cm	7140-0272
Icom A-110	1.9"/4.8 cm	5.8"/15.0 cm	7140-0318	Kenwood TK840	1.5"/3.8 cm	5.5"/14.0 cm	7140-0272
Icom F1020	2.0"/5.1 cm	6.0"/15.2 cm	7140-0318	Kenwood TK860	1.6"/4.1 cm	5.5"/14.0 cm	7140-0271
Icom F-122	1.6"/4.1 cm	5.9"/15.0 cm	7140-0321	Kenwood TK863G	1.5"/3.8 cm	5.5"/14 cm	7140-0272
Icom F220	2.0"/5.1 cm	6.0"/15.2 cm	7140-0318	Kenwood TK863G	1.5"/3.8 cm	5.5"/14 cm	7140-0272
Icom F2721D	1.5"/3.8 cm	5.5"/14.0 cm	7140-0272	Kenwood TK880	1.6"/4.1 cm	5.5"/14 cm	7140-0271
Icom F320	1.5"/3.8 cm	5.5"/14.0 cm	7140-0272	Kenwood TK890	2.4"/6.1 cm	6.9"/17.5 cm	7140-0440
Icom F521	1.6"/4.1 cm	5.6"/14.2 cm	7140-0271	Kenwood TK940	1.5"/3.8 cm	5.5"/14 cm	7140-0272
Icom F621	1.6"/4.1 cm	5.6"/14.2 cm	7140-0271	Kenwood TK980	1.5"/3.8 cm	5.5"/14 cm	7140-0272
Icom IC-1010	2.0"/5.1 cm "	6.0"/15.2 cm	7140-0318	Kenwood TM-261	1.5"/3.8 cm	5.5"/14 cm	7140-0272
Icom IC-1020	2.0"/5.1 cm	6.0"/15.2 cm	7140-0318	Kenwood TM-271	1.7"/4.3 cm	6.3"/16 cm	7140-0345
Icom IC-2300H Radio	1.6"/4.1 cm	5.5"/14.0 cm	7140-0271	Kenwood TM-641A	2.0"/5.1 cm	5.9"/15 cm	7140-0318
Icom IC-2720	1.5"/3.8 cm	5.5"/14.0 cm	7140-0272	Kenwood TM-741A	2.0"/5.1 cm	5.9"/15 cm	7140-0318
Icom IC-2800	1.5"/3.8 cm	5.5"/14.0 cm	7140-0272	Kenwood TM-742A	2.0"/5.1 cm	5.9"/15 cm	7140-0318
Icom IC-F121 also IC-F221-A	1.5"/3.8 cm	6.0"/15.2 cm	7140-0322	Kenwood TM-942A	2.0"/5.1 cm	5.9"/15 cm	7140-0318
Icom IC-F5061	1.6"/4.1 cm	5.9"/15.0 cm	7140-0321	Kenwood TM-V7	1.5"/3.8 cm	5.5"/14 cm	7140-0272
Icom IC-F5220D	1.6"/4.1 cm	5.9"/15.0 cm	7140-0321	Kenwood TM-V71A	1.7"/4.3 cm	5.5"/14 cm	7140-0271
Icom IC-F606ID	1.6"/4.1 cm	5.9"/15.0 cm	7140-0321	Kustom Signal Eyewitness G3 (not the best solution but the only solution)	2.1"/5.3 cm	6.5"/16.5 cm	7140-0839
Icom IC-F6220D	1.6"/4.1 cm	5.9"/15.0 cm	7140-0321	Kustom Signal Golden Eagle	1.75"/4.4 cm	6.5"/16.5 cm	7140-0370
Icom IC-F65061	1.8"/4.6 cm	6.4"/16.3 cm	7140-0345	Kustom Signal Pro 1000DS	1.75"/4.4 cm	6.5"/16.5 cm	7140-0370
Icom IC-V800 Radio	2.0"/5.1 cm	6.0"/15.2 cm	7140-0318	L3 Mobile Vision FLASHBACK 2	2.0"/5.1 cm	5.9"/15 cm	7140-1036
Icom ID-880H	1.6"/4.1 cm	5.9"/15.0 cm	7140-0322	L3 Mobile Vision FLASHBACK 3	2.4"/6.1 cm	6.9"/17.5 cm	7140-0440
Icom IG R100	1.9"/4.8 cm	5.9"/15.0 cm	7140-0293	Light Switch PNL	2.5"/6.4 cm	6.5"/16.5 cm	7140-0364
Icom V100	2.0"/5.1 cm	6.3"/16.0 cm	7140-0393	M/A Com D28LPX - M7100	2.0"/5.1 cm	6.9"/17.5"	7140-0393
Johnson 8615B	2.0"/5.1 cm	6.5"/12.7 cm	7140-0368	M/A Com M7300 Radio	2.0"/5.1 cm	7.0"/17.8 cm	7140-0443
Johnson 9755 Multi-N	2.3"/5.7 cm	7.0"/17.8 cm	7140-0441	M/A Com Panther 500M	2.25"/5.7 cm	7.0"/17.8 cm	7140-0441
Johnson Summit Trunk	2.1"/5.3 cm	7.1"/18.0 cm	7140-0442	MA/Comm M7100 (Orion)	2.4"/6.1 cm	6.9"/17.5 cm	7140-0439
Kenwood 7150	2.0"/5.1 cm	7.1"/18.0 cm	7140-0443	Maxon SM 4450SC	2.0"/5.1 cm	6.0"/15.2 cm	7140-0318
Kenwood 862	1.5"/3.8 cm	5.6"/14.2 cm	7140-0272	Midland 2 piece	2.1"/5.3 cm	7.1"/18 cm	7140-0442
Kenwood KCH-4	2.3"/5.7 cm	7.0"/17.8 cm	7140-0441	Midland 70-0002	2.6"/6.6 cm	7.4"/18.7 cm	7140-0438
Kenwood NX700	1.8"/4.6 cm	6.3"/16.0 cm	7140-0345	Midland 70-1394B	2.25"/5.7 cm	7.4"/18.7 cm	7140-0441
Kenwood NX800	1.8"/4.6 cm	6.3"/16.0 cm	7140-0345	Midland 70-340B	2.6"/6.6 cm	7.5"/19 cm	7140-0438
Kenwood NX800K	1.7"/4.3 cm	6.3"/16.0 cm	7140-0345	Midland 77-116	1.5"/3.8 cm	6.0"/15.2 cm	7140-0322
Kenwood TK 6110	2.0"/5.1 cm	6.3"/16.0 cm	7140-0343	Midland 77-155	2.25"/5.7 cm	6.0"/15.2 cm	7140-0316
Kenwood TK5710	2.4"/6.1 cm	7.0"/17.8 cm	7140-0440	Midland LMM4115D	2.0"/5.1 cm	7.0"/17.8 cm	7140-0443
Kenwood TK5710	2.4"/6.1 cm	7.1"/18.0 cm	7140-0440	Midland Syntech II (Dash)	2.25"/5.7 cm	7.25"/18.4 cm	7140-0441
Kenwood TK5720/5820	1.8"/4.6 cm	6.3"/16.0 cm	7140-0345	Mixer, MFG unknown	3.5"/8.9 cm	6.1"/15.5 cm	7140-0306
Kenwood TK5810	2.4"/6.1 cm	7.0"/17.8 cm	7140-0440	Motorola 067W	2.0"/5.1 cm	7.0"/17.8 cm	7140-0443
Kenwood TK601	2.6"/6.6 cm	7.3"/18.5 cm	7140-0438	Motorola 4009 CB	2.5"/6.4 cm	7.0"/17.8 cm	7140-0439
Kenwood TK690	2.4"/6.1 cm	7.1"/18.0 cm	7140-0440	Motorola 800 MHZ GTX	1.75"/4.4 cm	6.6"/16.8 cm	7140-0370
Kenwood TK7102	1.7"/4.3 cm	6.3"/16.0 cm	7140-0345	Motorola AM300	2.0"/5.1 cm	7.0"/17.8 cm	7140-0443
Kenwood TK7150	2.0"/5.1 cm	7.0"/17.8 cm	7140-0443	Motorola APX 6500 (05 Control head) Full Radio	2.0"/5.1 cm	7.0"/17.8 cm	7140-1034
Kenwood TK7160	1.7"/4.3 cm	6.3"/16.0 cm	7140-0345	Motorola APX 7500 (05 Control head) Full Radio	2.0"/5.1 cm	7.0"/17.8 cm	7140-1034
Kenwood TK7160H	2.0"/5.1 cm	7.0"/17.8 cm	7140-0443				

FACEPLATES GUIDE | CONSOLE SYSTEMS

	HEIGHT	WIDTH	ITEM NO.
Motorola Astro	2.0"/5.1 cm	7.0"/17.8 cm	7140-0906
Motorola Astro 800	2.0"/5.1 cm	7.0"/17.8 cm	7140-0906
Motorola Astro MHLN6432E	2.0"/5.1 cm	7.0"/17.8 cm	7140-0443
Motorola Astro Spectra W7 Control head	2.0"/5.1 cm	7.1"/18 cm	7140-1004
Motorola Astro Spectra W9 Control head	3.4"/8.6 cm	6.5"/16.5 cm	7140-1010
Motorola CDM 1250	2.0"/5.1 cm	6.5"/16.5 cm	7140-0368
Motorola CDM 1250	2.4"/6.1 cm	7.0"/17.8 cm	7140-0440
Motorola CDM 1550	2.0"/5.1 cm	6.5"/16.5 cm	7140-0368
Motorola CDM 1550	3.4"/8.6 cm	7.0"/17.8 cm	7140-0440
Motorola CDM 750	2.0"/5.1 cm	6.5"/16.5 cm	7140-0368
Motorola CDM 750	2.4"/6.1 cm	7.0"/17.8 cm	7140-0440
Motorola CM200	1.7"/4.3 cm	6.67"/17 cm	7140-0370
Motorola CM300	1.7"/4.3 cm	6.67"/17 cm	7140-0370
Motorola DEK / SIREN Control Box	1.25"/3.2 cm	6.5"/16.5 cm	7140-0374
Motorola E-4	2.0"/5.1 cm	7.0"/17.8 cm	7140-0443
Motorola GM300	2.0"/5.1 cm	7.0"/17.8 cm	7140-0443
Motorola Handi-Talkie Charger NTN8660A	3.5"/8.9 cm	3.5"/8.9 cm	7140-0556
Motorola HCN 1019A	2.0"/5.1 cm	6.75"/17.1 cm	7140-0393
Motorola HCN 1052B Maratrac Remote HD ADV. A-7	3.4"/8.6 cm	6.5"/16.5 cm	7140-1010
Motorola HCN 1089A Maratrac (Astro)	3.4"/8.6 cm	6.5"/16.5 cm	7140-1010
Motorola HLN 1241C, HLN 1241B, HLN333	1.25"/3.2 cm	6.5"/16.5 cm	7140-0374
Motorola HLN 1260	1.25"/3.2 cm	6.5"/16.5 cm	7140-0374
Motorola HLN 3333B	1.25"/3.2 cm	6.5"/16.5 cm	7140-0374
Motorola LCS 2000	1.7"/4.3 cm	6.6"/16.8 cm	7140-0370
Motorola M1225	1.75"/4.4 cm	6.6"/16.8	7140-0370
Motorola M1550	2.9"/7.4 cm	7.4"/18.7 cm	7140-0436
Motorola Maratrac A7 Head	3.6"/9.1 cm	6.5"/16.5 cm	7140-1010
Motorola Maratrac HCN 4034	2.0"/5.1 cm	5.75"/14.6 cm	7140-0318
Motorola Maratrac W-9	3.6"/9.1 cm	6.5"/16.5 cm	7140-1010
Motorola Maxar 80	2.5"/6.4 cm	5.6"/14.2 cm	7140-0364
Motorola Maxon SM4000	2.0"/5.1 cm	6.0"/15.2 cm	7140-0318
Motorola Maxtrac	2.0"/5.1 cm	7.0"/17.8 cm	7140-0443
Motorola MCS 2000 - Control Head MODEL I	2.4"/6.1 cm	7.3"/18.5 cm	7140-0440
Motorola MCS 2000 - Control Head MODEL II & III	2.4"/6.1 cm	5.0"/12.7 cm	7140-1031
Motorola MCS 2000 - MODEL I, II, & III	1.75"/4.4 cm	6.6"/16.8 cm	7140-0370
Motorola MCX 1000	2.0"/5.1 cm	6.9"/17.5 cm	7140-0443
Motorola MD1H Remote	2.25"/5.7 cm	7.25"/18.4 cm	7140-0441
Motorola NLN4368A	3.0"/7.6 cm	7.25"/18.4 cm	7140-0435
Motorola P200 Charger	3.0"/7.6 cm	7.25"/18.4 cm	7140-0435
Motorola PM1500	2.5"/6.4 cm	7.25"/18.4 cm	7140-0439
Motorola PM1500 Remote Head only	2.6"/6.6 cm	7.1"/18 cm	7140-0438
Motorola PM400	1.7"/4.3 cm	6.7"/17 cm	7140-0370
Motorola Radius / GM 300	2.0"/5.1 cm	7.0"/17.8 cm	7140-0443
Motorola SM120 / SM50 Radius	1.7"/4.3 cm	6.6"/16.8 cm	7140-0370
Motorola Spectra A-4 Remote (double bend) B7	2.0"/5.1 cm	5.7"/14.5 cm	7140-1004
Motorola Spectra A-5 Astro/W7 W5 W4	2.0"/5.1 cm	7.0"/17.8 cm	7140-0443
Motorola Spectra C-7	2.0"/5.1 cm	5.7"/14.5 cm	7140-1004
Motorola Spectra C-9 HCN1073D	3.2"/8.1 cm	6.5"/16.5 cm	7140-1010
Motorola Spectra DA5KM	2.0"/5.1 cm	7.0"/17.8 cm	7140-0442
Motorola Spectra/W9	3.6"/9.1 cm	6.5"/16.5 cm	7140-1010
Motorola Syntor Radio	2.25"/5.7 cm	6.0"/15.2 cm	7140-0316

	HEIGHT	WIDTH	ITEM NO.
Motorola Syntor X9000 (same as spectra, astro-ctrl head only)	3.4"/8.6 cm	6.5"/16.5 cm	7140-1010
Motorola TLN 3042A	1.25"/3.2 cm	6.3"/16 cm	7140-0374
Motorola VRM 850	1.9"/4.8 cm	6.6"/16.8 cm	7140-0370
Motorola Wildcard	1.25"/3.2 cm	6.0"/15.2 cm	7140-0374
Motorola XPR 4500	2.0"/5.1 cm	7.0"/17.8 cm	7140-1034
Motorola XPR 5000 Series	2.0"/5.1 cm	7.0"/17.8 cm	7140-1034
Motorola XTL 1500	2.0"/5.1 cm	7.0"/17.8 cm	7140-1034
Motorola XTL 2500	2.0"/5.1 cm	7.0"/17.8 cm	7140-1034
Motorola XTL 5000	2.0"/5.1 cm	7.0"/17.8 cm	7140-1034
Opticom Model 2100 & 2101	1.6"/4.1 cm	5.4"/13.7 cm	7140-0271
Panasonic Arbitrator Camera Head	2.0"/5.1 cm	7.0"/17.8 cm	7140-0443
Power call Siren - 6 Adam	2.5"/6.4 cm	6.4"/16.3 cm	7140-0364
Public Safety Equip. Lite Switch Box	2.1"/5.3 cm	6.3"/16 cm	7140-0342
Pyramid SVR200 Series Vehicular Repeater	1.1"/2.8 cm	5.3"/13.5 cm	7140-0249
Radio Shack CCS	2.0"/5.1 cm	7.0"/17.8 cm	7140-0443
Radio Shack PRO 2046 & 2051	2.0"/5.1 cm	7.1"/18 cm	7140-0443
Radio Shack Pro 2066	2.1"/5.3 cm	7.1"/18 cm	7140-0442
Radio Shack PRO 2066	2.0"/5.1 cm	7.4"/18.7 cm	7140-0443
Radio Shack PRO 2067	2.0"/5.1 cm	6.75"/17.1 cm	7140-0393
Radio Shack Pro MD2 800	2.1"/5.3 cm	7.1"/18 cm	7140-0442
Radio Shack TRC-474	1.5"/3.8 cm	5.5"/14 cm	7140-0272
Radio Shack TRC-487	1.5"/3.8 cm	5.6"/14.2 cm	7140-0272
Radio Shack TRC-496	2.0"/5.1 cm	7.25"/18.4 cm	7140-0443
Radio Shack TRC519	1.6"/4.01 cm	5.6"/14.2 cm	7140-0271
Realistic HTX100	2.5"/6.4 cm	7.4"/18.7 cm	7140-0439
Realistic TRC-418 CB	1.6"/4.1 cm	5.4"/13.7 cm	7140-0271
Realistic TRC-423	2.0"/5.1 cm	5.9"/14.9 cm	7140-0318
Realistic TRC-435	1.5"/3.8 cm	5.5"/14 cm	7140-0272
Realistic TRC-482	2.0"/5.1 cm	5.9"/14.9 cm	7140-0318
Regency Lo Band Radio	2.5"/6.4 cm	6.5"/16.5 cm	7140-0364
Regency R1600 Scanner	1.75"/4.4 cm	6.3"/16 cm	7140-0345
Regency RH2510	2.8"/7.1 cm	6.5"/16.5 cm	7140-0362
Regency WH2516	2.1"/5.3 cm	6.0"/15.2 cm	7140-0317
Relm MS2000	2.1"/5.3 cm	6.0"/15.2 cm	7140-0317
Relm RM800	2.0"/5.1 cm	6.75"/17.1 cm	7140-0443
Relm RMV50 & V50R	1.75"/4.4 cm	6.5"/16.5 cm	7140-0370
Roadmaster	2.5"/6.4 cm	6.1"/15.5 cm	7140-0314
Ronton LC1000	2.0"/5.1 cm	6.75"/17.1 cm	7140-0443
Signal Vehicle SB4020	2.5"/6.4 cm	6.1"/15.5 cm	7140-0314
Signal Vehicle SB4040	2.1"/5.3 cm	4.75"/12.1 cm	7140-0317
Signal Vehicle SS700	2.5"/6.4 cm	6.5"/16.5 cm	7140-0364
Sound Off 380 ML (Multi-Function)	2.4"/6.1 cm	6.4"/16.3 cm	7140-0439
Sound Off 400 Series Sirens (nERGY 400 Series)	2.6"/6.6 cm	7.1"/18 cm	7140-0438
Sound Off 700 Series	2.1"/5.3 cm	6.3"/16 cm	7140-0342
Sound Off Directional Arrowswitch	1.75"/4.4 cm	6.6"/16.8 cm	7140-0370
Sound Off ETSA481(2)CSP (400 Series - nERGY)	2.6"/6.6 cm	7.0"/17.8 cm	7140-0438
Sound Off ETSA481CSR (400 Series - nERGY)	2.6"/6.6 cm	7.0"/17.8 cm	7140-0438
Sound Off ETSP990 & ETSP993	2.6"/6.6 cm	7.0"/17.8 cm	7140-0438
Standard Vertex	1.75"/4.4 cm	6.4"/16.3 cm	7140-0345
Star Signal Warning Systems TD77-2	1.5"/3.8 cm	6.0"/15.2 cm	7140-0322
Star Signal Siren Model LCS770	2.9"/7.4 cm	6.0"/15.2 cm	7140-0312
Star Signal Siren Model SS650 - Economy	2.0"/5.1 cm	6.0"/15.2 cm	7140-0318
Star Signal Siren Model SS670	2.0"/5.1 cm	6.0"/15.2 cm	7140-0318

	HEIGHT	WIDTH	ITEM NO.
Star Signal Siren Model SS700	2.4"/6.1 cm	6.0"/15.2 cm	7140-0315
Star SignalSiren Model SS652	2.0"/5.1 cm	6.0"/15.2 cm	7140-0318
Steven R Jennings Siren	3.5"/8.9 cm	6.1"/15.5 cm	7140-0306
SVP SA-500	2.1"/5.3 cm	6.1"/15.5 cm	7140-0317
SVP SB4020	2.25"/5.7 cm	6.1"/15.5 cm	7140-0316
SVP SS-700	2.5"/6.4 cm	6.5"/16.5 cm	7140-0364
SVP Star SB4020	2.5"/6.4 cm	6.5"/16.5 cm	7140-0364
Tait T2020	2.0"/5.1 cm	6.2"/12.7 cm	7140-0393
Tait TM8255	2.8"/7.1 cm	7.2"/18.3 cm	7140-0436
Tele Tec	3.0"/7.6 cm	7.3"/18.5 cm	7140-0435
Tomar 940 & Tomar 940 amp	3.6"/9.1 cm	7.0"/17.8 cm	7140-0435
TSD Generation S1CMCI & S2GMC1	1.6"/4.1 cm	6.1"/15.5 cm	7140-0321
Uniden 780 XLT	2.4"/6.1 cm	6.9"/17.5"	7140-0440
Uniden BC350A	2.0"/5.1 cm	5.0"/12.7 cm	7140-0218
Uniden BC350C	2.0"/5.1 cm	5.0"/12.7 cm	7140-0218
Uniden BC355C	2.0"/5.1 cm	5.0"/12.7 cm	7140-0218
Uniden BC355N	2.0"/5.1 cm	5.0"/12.7 cm	7140-0218
Uniden BC700A	2.4"/6.1 cm	6.9"/17.5 cm	7140-0440
Uniden BCT7	2.6"/6.6 cm	5.5"/14 cm	7140-0271
Uniden BCT8	2.0"/5.1 cm	6.9"/17.5"	7140-0443
Uniden BCT8 scanner	2.4"/6.1 cm	7.0"/18 cm	7140-0439
Uniden Bearcat 400XLT	2.8"/7.1 cm	5.4"/13.7 cm	7140-0237
Uniden Bearcat Scan BCT15	2.2"/5.6 cm	7.2"/18.3 cm	7140-0441
Uniden Bearcat Scan BCT15X	2.2"/5.6 cm	7.2"/18.3 cm	7140-0441
Uniden CB Radio PC 76XL	2.1"/5.3 cm	7.25"/18.4 cm	7140-0442
Uniden FML 600C	2.5"/6.4 cm	7.25"/18.4 cm	7140-0439
Uniden HR-2510 & HR-2600	2.5"/6.4 cm	7.4"/18.7 cm	7140-0439
Uniden Mobile Scanner - BCD536 HP	2.2"/5.6 cm	7.25"/18.4 cm	7140-0442
Uniden Mobile Scanner - BCD996	2.2"/5.6 cm	7.25"/18.4 cm	7140-0442
Uniden PC68 Elite CB	2.1"/5.3 cm	6.3"/16 cm	7140-0342
Uniden PC78 Elite CB Radio	2.2"/5.6 cm	7.3"/18.5 cm	7140-0441
Uniden PRO 538W	2.0"/5.1 cm	6.75"/17.1 cm	7140-0443
Uniden PRO Series PC68XL	2.1"/5.3 cm	7.1"/18 cm	7140-0442
Uniden SMH5250T	2.2"/5.6 cm	6.0"/15.2 cm	7140-0317
Uniden SMR Base Station	2.5"/6.4 cm	6.0"/15.2 cm	7140-0314
Uniden SMU4525	2.0"/5.1 cm	6.1"/15.5 cm	7140-0318
Uniden UTMD Delta	2.5"/6.4 cm	6.5"/16.5 cm	7140-0364
Unitrol 480K w/switch pack	3.0"/7.6 cm	4.9"/12.4 cm	7140-0710
Unitrol Touchmaster (UTM4)	2.5"/6.4 cm	6.5"/16.5 cm	7140-1001
Vertex Standard (Yaesu) VX-2100	1.8"/4.6 cm	6.5"/16.5 cm	7140-0369
Vertex Standard (Yaesu) VX-2200	1.8"/4.6 cm	6.5"/16.5 cm	7140-0369
Vertex Standard (Yaesu) VX-4500	1.8"/4.6 cm	6.5"/16.5 cm	7140-0369
Vertex Standard (Yaesu) VX-4600	1.8"/4.6 cm	6.5"/16.5 cm	7140-0369
Watchguard DVR (4RE)	1.7"/4.3 cm	7.2"/18.3 cm	7140-0445
Whelen 295HFSA1	2.5"/6.4 cm	6.0"/15.2 cm	7140-0314
Whelen 295HFSA5	2.5"/6.4 cm	6.0"/15.2 cm	7140-0314
Whelen 295HFSA6	2.5"/6.4 cm	6.0"/15.2 cm	7140-0314
Whelen 295SDA Series	3.5"/8.9 cm	6.9"/17.5"	7140-0881
Whelen 295SL100	2.5"/6.4 cm	6.0"/15.2 cm	7140-0314
Whelen 295SLSA1	2.5"/6.4 cm	6.0"/15.2 cm	7140-0314
Whelen 295SLSA1 Siren	2.5"/6.4 cm	6.0"/15.2 cm	7140-0314
Whelen 295SLSC1 Siren	2.5"/6.4 cm	6.0"/15.2 cm	7140-0314
Whelen Cencom (head only) Sapphire (CCSRN36)	3.5"/8.9 cm	6.9"/17.5"	7140-1037
Whelen Cencom Gold (head only) Sapphire (CCSRN3)	3.5"/8.9 cm	6.9"/17.5"	7140-1037
Whelen Epsilon Siren EPSL259	3.25"/8.3 cm	5.9"/15 cm	7140-0283

	HEIGHT	WIDTH	ITEM NO.
Whelen HSF4	3.1"/7.9 cm	5.9"/15 cm	7140-0284
Whelen MGC032	2.5"/6.4 cm	6.0"/15.2 cm	7140-0314
Whelen MPC01	3.1"/7.9 cm	5.9"/15 cm	7140-0284
Whelen PCC10W	2.25"/5.7 cm	6.0"/15.2 cm	7140-0816
Whelen PCC6W	2.25"/5.7 cm	6.0"/15.2 cm	7140-0316
Whelen PCC9	2.1"/5.3 cm	6.0"/15.2 cm	7140-0317
Whelen PCCHD-2	2.1"/5.3 cm	6.1"/15.5 cm	7140-0317
Whelen PCCS9N1	3.5"/8.9 cm	6.9"/17.5"	7140-0306
Whelen PCCS9R	2.0"/5.1 cm	6.1"/15.5 cm	7140-0318
Whelen PCDS-9 and PCDS-9R Barlight Head	2.0"/5.1 cm	6.0"/15.2 cm	7140-0318
Whelen TACTRL12	2.1"/5.3 cm	6.1"/15.5 cm	7140-0317
Whelen Traffic Advisor	2.0"/5.1 cm	5.9"/15 cm	7140-0318
Whelen WS-2100	2.5"/6.4 cm	6.0"/15.2 cm	7140-0314
Whelen WS295HFS5	3.4"/8.6 cm	6.0"/15.2 cm	7140-0307
Whelen WS295HFS6	3.4"/8.6 cm	6.0"/15.2 cm	7140-0307
Whelen WS295HFSA6	3.4"/8.6 cm	6.0"/15.2 cm	7140-0307
Whelen WS-295-HF-Sinc Siren Head (295HFSA1)	2.5"/6.4 cm	6.0"/15.2 cm	7140-0314
Whelen WS295SLS6	3.4"/8.6 cm	6.0"/15.2 cm	7140-0307
Whelen WS295SLSA6	3.4"/8.6 cm	6.0"/15.2 cm	7140-0307
Yaesu FT-5100	1.5"/3.8 cm	5.5"/14 cm	7140-0272
Yaesu FT-7800R	1.8"/4.6 cm	6.1"/15.5 cm	7140-0369
Yaesu FT-7900R	1.8"/4.6 cm	6.1"/15.5 cm	7140-0369
Yaesu FT-8100	1.6"/4.1 cm	5.5"/14 cm	7140-0271
Yaesu Vertex	1.5"/3.8 cm	5.6"/14.2 cm	7140-0272
Yaesu Vertex VX 7200	2.4"/6.1 cm	7.0"/17.8 cm	7140-0440
Yaesu Vertex FTL 2011	2.0"/5.1 cm	6.3"/16.0 cm	7140-0343
Yaesu Vertex FTL-7011	2.0"/5.1 cm	6.3"/16.0 cm	7140-0343
Yaesu Vertex VX2100	1.7"/4.3 cm	6.5"/16.5 cm	7140-0370
Yaesu Vertex VX4000U - VX6000	2.4"/6.1 cm	7.0"/17.8 cm	7140-0440
Yaesu Vertex VX4200	2.4"/6.1 cm	7.0"/17.8 cm	7140-0440
Yaesu Vertex VX-7200-DO-50	1.7"/4.3 cm	6.5"/16.5 cm	7140-0370
Yaesu FT-100	2.0"/5.1 cm	6.5"/16.5 cm	7140-0368
Yaesu FT-100D	2.1"/5.3 cm	6.3"/16.0 cm	7140-0342
Yaesu High Band	1.6"/4.1 cm	5.5"/14.0 cm	7140-0271
Yaesu Vertex 4000	2.4"/6.1 cm	7.7"/19.6 cm	7140-0439
Yaesu Vertex VX 5500 (remote head only)	2.4"/6.1 cm	7.0"/17.8 cm	7140-0440



PEDESTAL SYSTEMS

Pedestal systems are an ideal option for vans and trucks that have small console areas, which do not allow adequate space for mounting. With an innovative design and sturdy construction, these products offer maximum reliability, but save on space.



The vehicle base and leg guide makes it easy to identify which vehicle base and leg are compatible with your vehicle. If there is not a vehicle base listed or if you can't find a particular make, model or year on the chart, please contact our sales department at 1-800-456-6868 or at sales@gamberjohnson.com. For the most up-to-date product information, visit our website at www.gamberjohnson.com.

Make	Model	Year	No Drilling Required	Page	Drilling Required	Page	Vehicle Legs (MCS)	Page	
Chevrolet	1500 C/K - 4WD-SELECTOR ON HUMP ONLY	1994-1999					7110-0350	51	
	1500/2500/3500 C/K	1999-2006 & 2007 classic body style	DS-122	W			7160-0160	51	
	1500/2500/3500 C/K	2007-2009	DS-144	82			7160-0160	51	
	Avalanche	2002-2006	DS-122	W			7160-0160	51	
	Avalanche	2007-2013	DS-144	82			7160-0160	51	
	Caprice	2011-2013	7160-0381	W					
	Caprice	2014-2017	7160-0532	83					
	Colorado	2004-2012	7160-0114	W			7160-0249	W	
	Colorado	2015-2018	7160-0556	83					
	Equinox	2007-2009				7160-0185	92	7110-0350	51
	Equinox	2010-2017	7160-0572	83					
	Express Van	1995-2009	7160-0133	82			7110-0350	51	
	Express Van	2010-2018	7160-0248	82			7110-0350	51	
	G-Series Van	1995-2009	7160-0133	82			7110-0350	51	
	G-Series Van	2010-2018	7160-0248	82			7110-0350	51	
	Impala	2006-2013 & 2015-2016 PPV only	7160-0055	W			7160-0121	W	
	Impala (civilian model)	2014-2018	7160-0520	W					
	Malibu	2006-2012	7160-0222	W					
	Malibu	2013-2017	7160-0520	W					
	Malibu	2017-2018	7160-0969	W					
	Silverado	1999-2006 & 2007 classic body style	DS-122	W			7110-0350	51	
	Silverado	2007 New Body Style-2014	DS-144	82			7160-0160	51	
	Silverado (1500 models)	2014-2018	7160-0510	83			7160-0509	51	
	Silverado 4500/5500	2019	7160-0510	83			7160-0509	51	
	Suburban	2000-2006	DS-122	W	7160-0185	92	7160-0160	51	
	Suburban	2007 new body style-2014	DS-144	82			7160-0160	51	
	Suburban	2015-2018	7160-0510	83			7160-0509	51	
	Tahoe	2000-2006	DS-122	W	7160-0185	92	7160-0160	51	
	Tahoe	2007 new body style-2014	DS-144	82			7160-0160	51	
	Tahoe	2015-2018	7160-0510	83			7160-0509	51	
	Uplander	2005-2009				7160-0185	92	7110-0350	51
	Chrysler	Aspen	2007-2009	DS-132	W			7110-0350	51
Town & Country		2008-2016	7160-0116	W			7110-0350	51	
Dodge	Caravan	2008-2017	7160-0116	W			7110-0350	51	
	Grand Caravan	2008-2018	7160-0116	W			7110-0350	51	
	Ram C/V	2012-2017	7160-0116	W			7110-0350	51	
	Charger	2006					7160-0088	51	
	Charger	2007-2010	7160-0008	W			7160-0088	51	
	Charger	2011-2018	7160-0329	84			7160-0088	51	
	Dakota	1997-2004 & 2007-2011	7160-0013	W			7110-0350	51	
	Dakota	2005				7160-0185	92	7110-0350	51
	Durango	2011-2018	7160-0323	84					
	Durango	1997-2003	7160-0013	W			7110-0350	51	
	Magnum	2006					7160-0088	51	
	Magnum	2007-2008	7160-0008	W			7160-0088	51	
	Nitro	2007-2011	DS-148	W					
	ProMaster	2014-2018	7160-0527	85					
	Ram 1500	2002-2018	7160-0182	84					
	Ram 1500	2011-2018					7160-0422	51	
	Ram 2500/3500	2003-2018	7160-0182	84					
Ram 2500/3500	2011-2018					7160-0422	51		
Ram 4500/5500	2007-2018	7160-0182	84						
Ram 4500/5500	2011-2018					7160-0422	51		
Sprinter	2004-2009	7160-0036	90			7110-0350	51		
Freightliner	Sprinter (w/ bucket seats)	2004-2015	7160-0036	90			7110-0350	51	
	M2 106	2012-2018	7160-0544	92			7160-0545	51	
	M2 112	2012-2018	7160-0544	92			7160-0545	51	
	Universal	ALL YEARS			DS-146	93	7110-0350	51	
Ford	Crown Victorial Police Interceptor	1991-2011	7160-0234	87			7160-0117	W	
	Police Interceptor - Sedan	2012-2018	7160-0350	88			7160-0413	51	
	Police Interceptor - Utility	2012-2018	7160-0350	88			7160-0413	51	
	Escape	2002-2012	DS-140	W			7110-0350	51	
	Escape	2013-2018	7160-0451	85					
	E-Series Van	1995-2005	7160-0133	82			7110-0350	51	
	E-Series Van	2006-2014	7160-0090	86			7110-0350	51	
	E-Series - cut aways	2006-2018	7160-0090	86			7160-0350	88	
	Excursion	2000-2005	7160-0045	86					
	Excursion Limited	2000-2005				7160-0185	92		
	Expedition	1997-2006	DS-112	W			7110-0350	51	
	Expedition	2007-2017	7160-0046	86			7160-0084	51	

W = Web Listing Only

Make	Model	Year	No Drilling Required	Page	Drilling Required	Page	Vehicle Legs (Console box)	Page
	Explorer	1995-2001	DS-118	W			7110-0350	51
	Explorer	2002-2010	DS-114	W			7110-0350	51
	Explorer	2011-2018	7160-0350	88				
	Explorer Sport Track	2007	DS-114	W			7110-0350	51
	F-150	1997-2003	DS-112	W			7110-0054	W
	F-150 Heritage	2004	DS-112	W				
	F-150 (new body style)	2004-2014	DS-124	89				
	F-150 (aluminum body)	2015-2018	7160-0554	89			7160-0555	51
	F-150	2004-2008					7160-0076	W
	F-150	2009-2014					7160-0164	51
	F-250 Light Duty	1997-2004	DS-112	W			7110-0054	W
	F-250, F-350, F-450, F-550, F-750 Super Duty	1999-2010 AUTOMATICS ONLY	7160-0045	86				
	F-250, F-350, F-450, F-550, F-750 Super Duty	2011-2016	7160-0281	87			7160-0301	51
	F-650, F-750 Super Duty	2017-2018	7160-0281	87			7160-0301	51
	F-250, F350, F450, F550 Super Duty	2017	7160-0554	89			7160-0555	51
	Five Hundred	2005-2007	7160-0009	W			7110-0350	51
	Flex	2009 -2018			7160-0185	92		
	Focus	2007			7160-0185	92		
	Freestyle	2005-2007	7160-0009	W			7110-0350	51
	Fusion/Lincoln MKZ	2007-2012	7160-0244	W			7110-0350	51
	Fusion	2013-2018	7160-0260	87			7110-0350	51
	Ranger	1993-2011	DS-118	W			7110-0350	51
	Taurus	2000-2007			7160-0185	92	7110-0350	51
	Taurus/Taurus-X	2008-2018	7160-0350	88			7110-0350	51
	Transit Connect	2011-2013	7160-0245	W				
	Transit Connect	2014-2018	7160-0536	88				
	Transit	2015-2018	7160-0537	88			7160-0552	51
GMC	1500/2500/3500 C/K	1999-2006 & 2007 classic body style	DS-122	W			7160-0160	51
	1500/2500/3500 C/K	2007 - 2009	DS-144	82			7160-0160	51
	Canyon	2004-2012	7160-0114	W			7160-0249	W
	Canyon	2015-2018	7160-0556	83				
	G-Series Van	1995-2009	7160-0133	82			7110-0350	51
	G-Series Van	2010-2018	7160-0248	82			7160-0575	51
	Savana	1995-2009	7160-0133	82			7110-0350	51
	Savana	2010-2018	7160-0248	82			7110-0350	51
	Sierra	2000-2006 & 2007 classic body style	DS-122	W			7160-0160	51
	Sierra	2007 new body style-2014	DS-144	82			7160-0160	51
	Sierra 1500	2014-2018	7160-0510	83			7160-0509	51
	Sierra 2500/3500/HD	2015-2018	7160-0510	83			7160-0509	51
	Yukon/Yukon XL	2007 new body style-2014	DS-144	82			7160-0160	51
	Yukon/Yukon XL	2000-2006	DS-122	W	7160-0185	92	7160-0160	51
	Yukon/Yukon XL	2015-2018	7160-0510	83			7160-0509	51
International	Universal	ALL YEARS			DS-146	93	7110-0350	51
	Durastar 4300 / 7300 Series Trucks	2002-2018	7160-0198	128			7160-0403	101
Jeep	Commander	2007			7160-0185	92		
	Compass	2007-2016			7160-0185	92		
	Grand Cherokee	2007-2010			7160-0185	92		
	Grand Cherokee	2011-2018	7160-0323	84				
	Liberty	2002-2012	DS-148	W				
	Patriot	2007-2017			7160-0185	92		
Mercedes	Sprinter	2004-2018	7160-0036	96			7110-0350	51
	Metris	2016+	7160-0036	96			7110-0350	51
Nissan	Pathfinder	2009-2018			7160-0185	92	7110-0350	51
	Titan	2009-2018			7160-0185	92	7110-0350	51
	NV Van	2011-2018	7160-0342	90			7110-0350	51
	NV200 Van	2010-2018	7160-0557	90				
Semi-Truck / Class 8	International	2005-2018	7160-0198	128				
	Freightliner	2005-2018	7160-0198	128				
	Peterbilt	2005-2018	7160-0198	128				
	Kenworth	2005-2018	7160-0198	128				
	Volvo	2005-2018	7160-0198	128				
	Mack	2005-2018	7160-0198	128				
	Sterling	2005-2010	7160-0198	128				
	Western Star Day Cab	2005-2018	7160-0198	128				
Class 6/7	Freightliner M2 Business Class	2010-2018	7160-0544	92			7160-0549	W
Sterling	Bullet 4500-5500	2008	7160-0182	84			7110-0350	51
	Universal	ALL YEARS			DS-146	93	7110-0350	51
Toyota	Tacoma	2005-2018	DS-150	90				
	Tundra	2007-2018	7160-0062	W			7110-0350	51
	Highlander	2007-2013	DS-150	90				

W = Web Listing Only

2018+ CHEVY TRAVERSE/GMC ACADIA VEHICLE BASE



Item No.	Placement	Drilling Required	Recommended Solution	Weight	Height	Width	Length
7160-1397	Vehicle Base	No	Lower Tube: DS-LOWER-9 Upper Pole: 7160-0178 Support Brace: 7160-0230	6 lbs 2.7 kg	8.25" 20.96 cm	7.22" 18.33 cm	19.5" 49.53 cm

Features

- Designed specifically for the 2018+ Chevy Traverse/GMC Acadia for a secure, custom fit
- Uses existing seat bolts so drilling is not required
- Limited forward seat travel
- Can be used with factory (OEM) console
- Includes the DS-STEP to help position the mount closer to the driver and providing more room for the passenger
- For extra stability a support brace (7160-0230) is strongly recommended
- Tubes and motion attachments sold separately
- Limited Lifetime Warranty

2019+ CHEVROLET SILVERADO 1500/ 2019+ GMC SIERRA 1500 (NEW BODY STYLE) / 2021+ CHEVROLET TAHOE VEHICLE BASE



Item No.	Placement	Drilling Required	Recommended Solution	Weight	Height	Width	Length
7160-1332	Vehicle Base	No	Lower Tube: DS-LOWER-9 Upper Pole: 7160-0178 Support Brace: 7160-0230	10.1 lbs 4.58 kg	8.3" 21 cm	8.5" 21.6 cm	22.5" 57.2 cm
7170-0783-01	Kit Includes: Vehicle Base (7160-1332), the Recommended Pole Solution as Stated Above, and the Mongoose 9" Locking Slide Arm (7160-0220)						
7170-0783-02	Kit Includes: Vehicle Base (7160-1332), the Recommended Pole Solution as Stated Above, and the Mongoose 9" Locking Slide Arm with Short Clevis (7160-0928)						
7170-0783-03	Kit Includes: Vehicle Base (7160-1332), the Recommended Pole Solution as Stated Above, and the Mongoose XE 9" Motion Attachment (7160-1116-09)						
7170-0783-04	Kit Includes: Vehicle Base (7160-1332), the Recommended Pole Solution as Stated Above, and the Mongoose XLE 9" Motion Attachment (7160-1216-09)						

Features

- Vehicle specific pedestal base and kits for the 2019+ Chevrolet Silverado 1500 / 2019+ GMC Sierra 1500 (New Body Style) / 2021+ Chevrolet Tahoe
- Attaches to the passenger side seat using the front seat bolts under the seat rails so drilling is not required
- Angled step (included with base) can adjust to help position the pole system closer towards the console
- For extra stability a support brace (7160-0230) is strongly recommended
- Limited seat movement forward
- Will NOT fit in 2019 Chevrolet Silverado 1500 CLASSIC/GMC Sierra 1500 CLASSIC. See product 7160-0510
- Limited Lifetime Warranty

CHEVROLET EXPRESS AND GMC SAVANNA VAN VEHICLE BASE



Item No.	Placement	Seat Configuration	Drilling Required	Recommended Solution	Weight	Height	Width	Depth
7160-0248	Passenger Side Inner Front and Back Seat Studs	Bucket	No - Attaches to Seat Studs: Chevrolet/GMC G-Series Van (2010+) Chevrolet Express Van (2010+) GMC Savana Van (2010+)	Lower Tube: Included with Base Upper Pole: 7160-0178 Motion Attachment: 7160-0220 <i>Motion attachment and poles ordered separately</i>	8.1 lbs 3.7 kg	19.85" 50.4 cm	15.0" 38.1 cm	9.31" 23.6 cm

7170-0140 **Kit Includes:** Vehicle Base and the Recommended Pole Solution as Stated Above. No Substitutions. For More Detailed Information Please Visit our Website.

Features

- Won't interfere with passenger leg space
- Bracket mounted to pole gusset allows for additional attachment to seat frame
- Base works with most existing work boxes
- Limited Lifetime Warranty

CHEVY SILVERADO/TAHOE/SUBURBAN/YUKON/YUKON XL, GMC SIERRA 1500/2500/3500/HD

Item No.	Placement	Seat Configuration	Drilling Required	Recommended Solution	Weight	Height	Width	Depth
7160-0510	Attaches to Inboard and Outboard Passenger Side Seat Hooks	Bucket/ Split Bench	No - Attaches to Seat Hooks: GM Silverado/Sierra 1500 (2014-2018) GM Silverado/Sierra 2500/3500 HD (2015-2019) GM Tahoe/Yukon (2015-2020) GM Silverado 4500/5500/6500 (2018+)	Lower Tube: DS-LOWER-9 Upper Pole: 7160-0178 Support Brace: 7160-0230 Motion Attachment: 7160-0220 <i>Motion attachment and poles ordered separately</i>	13.5 lbs 6.1 kg	7.2" 18.3 cm	20.7" 52.6 cm	15.4" 39.1 cm



7170-0214 **Kit Includes:** Vehicle Base and the Recommended Pole Solution as Stated Above. No Substitutions. For More Detailed Information Please Visit our Website.

Features

- Will not interfere with levers or factory installed console
- One offset universal mounting step (DS-STEP) is already included with this vehicle base. However, additional offset universal mounting steps can be ordered to stack on top of each other if needed.
- For extra stability a support brace (7160-0230) is recommended
- Limited Lifetime Warranty

Note: - Rearward travel of the passenger seat is not affected, however there is limited forward seat travel
- Will not work with Chevrolet 3500 with PTO, the recommended base is 7160-0185

2016+ CHEVY TRAX VEHICLE BASE

Item No.	Placement	Drilling Required	Recommended Solution	Weight	Height	Width	Length
7160-0855	Vehicle Base	No	Lower Tube: DS-LOWER-9 Upper Pole: 7160-0178 Support Brace: 7160-0230	7.75 lbs. 3.4 kg	4.80" 12.20 cm	8.75" 22.23 cm	18.50" 46.99 cm



Features

- Easy to install, vehicle specific base for the 2016+ Chevy Trax
- DS-STEP built into the base
- Base attaches to inboard and outboard passenger side seat rails
- Forward seat movement is affected – little to no movement
- Base bolts to passenger side seat rails in existing holes. Seat does NOT have to be removed
- Limited Lifetime Warranty

2018+ CHEVY EQUINOX/GMC TERRAIN VEHICLE BASE

Item No.	Placement	Drilling Required	Recommended Solution	Weight	Height	Width	Length
7160-1322	Vehicle Base	No	Lower Tube: DS-LOWER-9 Upper Pole: 7160-0178 Support Brace: 7160-0230	6 lbs 2.7 kg	8.25" 20.96 cm	6.5" 16.51 cm	19.5" 49.53 cm



Features

- Vehicle specific base for the 2018+ Chevy Equinox/GMC Terrain creates a secure, custom fit
- Easily mounts to existing seat bolts without requiring drilling
- Can be used in conjunction with the OEM center console
- Offset riser brings pedestal system closer to center console maximizing leg room for the passenger
- While this doesn't impact rearward travel of the passenger seat, forward seat travel is limited
- Limited Lifetime Warranty

CHEVY COLORADO AND GMC CANYON VEHICLE BASE

Item No.	Placement	Seat Configuration	Drilling Required	Recommended Solution	Weight	Height	Width	Depth
7160-0556	Attaches to Inboard and Outboard Passenger Side Seat Hooks	Bucket	No - Attaches Seat Hooks: Chevrolet Colorado (2015+) Gmc Canyon (2015+)	Lower Tube: DS-LOWER-9 Upper Pole: 7160-0178 Support Brace: 7160-0230 Motion Attachment: 7160-0500 <i>Motion attachment and poles ordered separately</i>	12.68 lbs 5.7 kg	6.88" 17.5 cm	18.44" 46.8 cm	13.66" 34.7 cm



Features

- Installs in minutes with no drilling required
- Angled step moves pole away from passenger leg space
- Will not interfere with levers or factory installed consoles
- One offset universal mounting step (DS-STEP) is already included with this vehicle base. However, additional offset universal mounting steps can be ordered to stack on top of each other if needed
- Limited Lifetime Warranty

DODGE RAM AND STERLING BULLET VEHICLE BASE



Item No.	Placement	Seat Configuration	Drilling Required	Recommended Solution	Weight	Height	Width	Depth
7160-0182	Passenger Side on the Floor, Under Seat	Bucket/Bench	No - Attaches to Seat Studs: Dodge Ram 1500-5500 (2002-2019) Classic Body	Lower tube: DS-LOWER-7 Upper pole: 7160-0178 Support brace: 7160-0230 Motion Attachment: 7160-0220 <i>Motion attachment and poles ordered separately</i>	4.1 lbs 1.9 kg	3.58" 9.1 cm	18.25" 46.4 cm	5.08" 12.9 cm
7170-0136	Kit Includes: Vehicle base and the recommended pole solution as stated above. No substitutions. For more detailed information please visit our website.							

Features

- Will not interfere with levers or factory installed consoles
- An offset universal mounting step (DS-STEP) may be ordered separately to move the pole away from passenger leg space
- For extra stability a support brace (7160-0230) is recommended
- Limited Lifetime Warranty

Note: 1) If your Dodge Ram has a factory installed console and/or manual shift on the floor, the recommended pole solution is DS-LOWER-13, QADJ-UPPER-M, 7160-0230 and 7160-0284. That solution is not available in a kit.
2) If your Sterling Bullet has a factory installed console and/or manual shift on the floor, the recommended pole solution is DS-LOWER-9, QADJ-UPPER-L, 7160-0230 and 7160-0750 (CLEVIS). That solution is not available in a kit.

2019+ NEW BODY STYLE RAM 1500 TRANSMISSION HUMP BASE



Item No.	Placement	Drilling Required	Recommended Solution	Weight	Height	Width	Length
7160-1382	Vehicle Base	No	Lower Tube: DS-LOWER-9 Upper Pole: 7160-0178 Support Brace: 7160-0230	8.75 lbs 3.97 kg	4.00" 10.16 cm	5.00" 12.70 cm	16.50" 41.91 cm
7170-0771	Kit Includes: Vehicle Base (7160-1382), the Recommended Pole Solution as Stated Above, and the RAM 1500-5500 Support Brace Bracket (7160-1391)						

Features

- Easy to install, vehicle specific transmission hump base and kit for the 2019+ New Body Style RAM 1500
- Simple design sits on top of mounting legs of center seat using the OEM hardware
- Spacers to go in-between the transmission hump base and OEM legs are included with the base
- A metal covering mounts underneath the base providing coverage of exposed vehicle metal and helps keeps small items from falling under OEM carpet
- An offset riser is included to help with positioning your mount to the desired location
- Three (3) sets of mounting holes to place the lower pole
- Limited Lifetime Warranty

2019+ NEW BODY STYLE RAM 1500 VEHICLE BASE



Item No.	Placement	Drilling Required	Recommended Solution	Weight	Height	Width	Length
7160-1324	Vehicle Base	No	Lower Tube: DS-LOWER-13 Upper Pole: 7160-0178 Support Brace: 7160-0230	7.8 lbs 3.54 kg	6.63" 16.83 cm	6.5" 16.51 cm	19.75" 50.165 cm
7170-0770	Kit Includes: Vehicle base (7160-1324), the Recommended Pole Solution as Stated Above, the RAM 1500-5500 Support Brace Bracket (7160-1391), and the Mongoose 9" Locking Slide Arm with Short Clevis (7160-0928)						

Features

- Designed specifically for the 2019+ New Body Style RAM 1500 for a secure, custom fit
- Attaches to the passenger side seat using the front seat bolts under the seat rails
- Angled step (included with base) can adjust to help position the pole system closer towards the console
- For extra stability a support brace (7160-0230) is strongly recommended
- Pedestal system does impact forward motion of passenger seat
- Limited Lifetime Warranty

2011+ DODGE DURANGO AND JEEP GRAND CHEROKEE VEHICLE BASE

Item No.	Placement	Drilling Required	Recommended Solution	Weight	Height	Width	Length
7160-0323	Vehicle Base	No	Lower Tube: DS-LOWER-9 Upper Pole: 7160-0178 Support Brace: 7160-0230	9.11 lbs 4.1 kg	5.87" 14.9 cm	18.85" 47.9 cm	9.22" 23.4 cm
7170-0841-00	Kit Includes: Vehicle Base (7160-0323) and the Recommended Pole Solution as Stated Above						
7170-0841-01	Kit Includes: Vehicle Base (7160-0323), the Recommended Pole Solution as Stated Above, and the Mongoose 9" Locking Slide Arm (7160-0220)						
7170-0841-02	Kit Includes: Vehicle Base (7160-0323), the Recommended Pole Solution as Stated Above, and the Mongoose 9" Locking Slide Arm with Short Clevis (7160-0928)						
7170-0841-03	Kit Includes: Vehicle Base (7160-0323), the Recommended Pole Solution as Stated Above, and the Mongoose XE 9" Motion Attachment (7160-1116-09)						



Features

- Easy to install, vehicle specific pedestal base and kits for the 2011+ Dodge Durango and Jeep Grand Cherokee
- Angled step moves pole away from passenger leg space
- Will not interfere with levers or factory installed consoles
- One offset universal mounting step (DS-STEP) is already included with this vehicle base. However, additional offset
- universal mounting steps can be ordered to stack on top of each other if needed
- For extra stability a support brace (7160-0230) is strongly recommended
- Limited Lifetime Warranty

DODGE CHARGER VEHICLE BASE

Item No.	Placement	Seat Configuration	Drilling Required	Recommended Solution	Weight	Height	Width	Depth
7160-0329	Attaches to Inboard and Outboard Passenger Side Seat Studs	Bucket	No - Attaches to Seat Studs: Dodge Charger (2011-2020)	Lower Tube: DS-LOWER-13 Upper Pole: 7160-0178 Support Brace: 7160-0230 Motion Attachment: 7160-0220 <i>Motion attachment and poles ordered separately</i>	10.5 lbs 4.8 kg	3.2" 8.1 cm	20.3" 51.6 cm	9.6" 24.4 cm
7170-0138	Kit Includes: Vehicle Base and the Recommended Pole Solution as Stated Above. No Substitutions. For More Detailed Information Please Visit our Website.							



Features

- Base works with both the Police and Street model Dodge Charger
- Can be used with factory installed console
- For extra stability a support brace (7160-0230) is recommended
- Limited Lifetime Warranty

FORD ESCAPE , DODGE CALIBER, DODGE JOURNEY, JEEP PATRIOT/COMPASS VEHICLE BASE

Item No.	Placement	Seat Configuration	Drilling Required	Recommended Solution	Weight	Height	Width	Depth
7160-0451	Attaches to Inboard and Outboard Passenger Side Seat Studs	Bucket	No- Drilling is Recommended but Not Required: Ford Escape (2013-2019) Dodge Caliber (2007-2012) Dodge Journey (2015+) Jeep Patriot (2007+) Jeep Compass (2007+)	Lower Tube: DS-LOWER-13 Upper Pole: 7160-0178 Support Brace: 7160-0230 Motion Attachment: 7160-0500 <i>Motion attachment and poles ordered separately</i>	5.0 lbs 2.3 kg	1.68" 4.3 cm	17.0" 43.2 cm	7.5" 19.1 cm
7170-0233	Kit Includes: Vehicle Base and the Recommended Pole Solution as Stated Above. No Substitutions. For More Detailed Information Please Visit our Website.							



Features

- Won't interfere with passenger leg space
- For extra stability a support brace (7160-0230) is recommended
- Limited Lifetime Warranty

Note: This base will not work with the Offset Universal Mounting Step (DS-STEP)

RAM PROMASTER CITY VEHICLE BASE



Item No.	Placement	Seat Configuration	Drilling Required	Recommended Pole Solution	Weight	Height	Width	Depth
7160-0553	Attaches to Inboard and Outboard Passenger Side Seat Studs	Bucket	No - Attaches to Seat Studs: Ram ProMaster City (2015+)	Lower Tube: DS-LOWER-9 Upper Pole: 7160-0178 Support Brace: 7160-0230 Motion Attachment: 7160-0500 <i>Motion attachment and poles ordered separately</i>	11.2 lbs 5.1 kg	8.18" 20.8 cm	19.0" 48.3 cm	10.55" 26.8 cm
7170-0500	Kit Includes: Vehicle Base and the Recommended Pole Solution as Stated Above. No Substitutions. For More Detailed Information Please Visit our Website.							

Features

- Installs in minutes with no drilling required
- Angled step moves pole away from passenger leg space
- Will not interfere with levers or factory installed consoles
- One offset universal mounting step (DS-STEP) is already included with this vehicle base. However, additional offset universal mounting steps can be ordered to stack on top of each other if needed
- Multiple mounting slots allow for flexible positioning of the offset universal mounting step
- Limited Lifetime Warranty

RAM PROMASTER VEHICLE BASE



Item No.	Placement	Seat Configuration	Drilling Required	Recommended Pole Solution	Weight	Height	Width	Depth
7160-0527	Attaches to Inboard and Outboard Passenger Side Seat Studs	Bucket/ Split Bench	No - Attaches to Seat Studs: Ram ProMaster (2014+)	Lower Tube: DS-LOWER-7 Upper Pole: 7160-0178 Support Brace: 7160-0231 Motion Attachment: 7160-0500 <i>Motion attachment and poles ordered separately</i>	7.1 lbs 3.2 kg	5.1" 13 cm	22.5" 57.2 cm	4.8" 12.2 cm
7170-0239	Kit Includes: Vehicle Base and the Recommended Pole Solution as Stated Above. No Substitutions. For More Detailed Information Please Visit our Website.							

Features

- One offset universal mounting step (DS-STEP) is already included with this vehicle base. However, additional offset universal mounting steps can be ordered to stack on top of each other if needed
- For extra stability a support brace (7160-0230) is recommended
- Limited Lifetime Warranty

JEEP COMPASS 2017+ VEHICLE BASE



Item No.	Placement	Seat Configuration	Drilling Required	Recommended Pole Solution	Weight	Height	Width	Depth
7160-1028	Attaches to Inboard and Outboard Passenger Side Seat Rails	Bucket/ Split Bench	No - Attaches to Seat Studs: Jeep Compass (2017+)	Lower Tube: DS-LOWER-9 Upper Pole: 7160-0178 Support Brace: 7160-0230 Motion Attachment: 7160-0500 <i>Motion attachment and poles ordered separately</i>	7.9 lbs 3.6 kg	4.5" 11.4 cm	16.1" 41.0 cm	10.8" 27.3 cm

Features

- Installs in minutes with no drilling required
- Riser (included) bolts on to base for added height and moves pole closer to the center of the vehicle
- Support brace recommended (7160-0230)
- Limited Lifetime Warranty

2020+ FORD POLICE INTERCEPTOR® UTILITY VEHICLE BASE

Item No.	Placement	Drilling Required	Recommended Solution	Weight	Height	Width	Length
7160-1336	Vehicle Base	No	Lower Tube: DS-LOWER-9 Upper Pole: 7160-0178 Support Brace: 7160-0230	10.5 lbs 4.76 kg	7.83" 19.89 cm	10.46" 26.57 cm	14.60" 37.08 cm
7170-0814-00	Kit Includes: Vehicle Base (7160-1336) and the Recommended Solution as Stated Above						
7170-0814-01	Kit Includes: Vehicle Base (7160-1336), the Recommended Solution as Stated Above, and the Mongoose 9" Locking Slide Arm (7160-0220)						
7170-0814-02	Kit Includes: Vehicle Base (7160-1336), the Recommended Solution as Stated Above, and the Mongoose 9" Locking Slide Arm with Short Clevis (7160-0928)						
7170-0814-03	Kit Includes: Vehicle Base (7160-1336), the Recommended Solution as Stated Above, and the Mongoose XE 9" Motion Attachment (7160-1116-09)						



Features

- Vehicle specific pedestal base and kits for the 2020+ Ford Police Interceptor Utility creates a secure, custom fit
- Quickly install this base utilizing the front passenger seat bolts
- Vehicle base positions the lower pole of the computer mount closer to the transmission hump to provide more room by the passenger
- Includes an offset riser is included with the base to position the computer mount closer to the center
- Works around the HVAC duct that runs under the passenger seat
- Designed to not interfere with factory OEM console or seat levers
- Limited Lifetime Warranty

2020+ FORD ESCAPE VEHICLE BASE

Item No.	Placement	Drilling Required	Recommended Solution	Weight	Height	Width	Length
7160-1493	Vehicle Base	No	Lower Tube: DS-LOWER-9 Upper Pole: 7160-0178 Support Brace: 7160-0230	7.5 lbs 3.4 kg	6.25" 15.88 cm	15" 38.1 cm	10.45" 26.54 cm
7170-0836-00	Kit Includes: Vehicle Base (7160-1493) and the Recommended Solution as Stated Above						
7170-0836-01	Kit Includes: Vehicle Base (7160-1493), the Recommended Solution as Stated Above, and the Mongoose 9" Locking Slide Arm (7160-0220)						
7170-0836-02	Kit Includes: Vehicle Base (7160-1493), the Recommended Solution as Stated Above, and the Mongoose 9" Locking Slide Arm with Short Clevis (7160-0928)						
7170-0836-03	Kit Includes: Vehicle Base (7160-1493), the Recommended Solution as Stated Above, and the Mongoose XE 9" Motion Attachment (7160-1116-09)						



Features

- Designed specifically for the 2020+ Ford Escape for a secure, custom fit
- Easily attaches to the passenger side seat rails
- Angled step (included with base) conveniently positions the pole system closer towards the console for ease of use
- Will not interfere with factory OEM console or seat levers
- Black powder coat finish for maximum corrosion resistance
- Heavy gauge steel construction for long-term durability
- Limited Lifetime Warranty

2019+ FORD RANGER VEHICLE BASE

Item No.	Placement	Drilling Required	Recommended Solution	Weight	Height	Width	Length
7160-1379	Vehicle Base	No	Lower Tube: DS-LOWER-9 Upper Pole: 7160-0178 Support Brace: 7160-0230	8 lbs 3.63 kg	4" 10.16 cm	12.2" 30.98 cm	16.22" 41.20 cm
7170-0782-01	Kit Includes: Vehicle Base (7160-1379), the Recommended Solution as Stated Above, and the 6" Locking Slide Arm (7160-0500)						
7170-0782-02	Kit Includes: Vehicle Base (7160-1493), the Recommended Solution as Stated Above, and the 6" Locking Slide Arm with Short Clevis (7160-1160)						



Features

- Designed specifically for the 2019+ Ford Ranger for a secure, custom fit
- Vehicle base uses existing OEM bolts for a quick and easy install
- Additional holes created to allow guide pin on seat rail
- Positions the lower pole closer to the transmission hump to be as out of the way as possible
- Stable and rugged platform for your computer mount in your mobile office
- While this doesn't impact rearward travel of the passenger seat, forward seat travel is limited
- Limited Lifetime Warranty

FORD E-SERIES VAN CUTAWAY CHASSIS VEHICLE BASE



Item No.	Placement	Seat Configuration	Drilling Required	Recommended Solution	Weight	Height	Width	Depth
7160-0090	Passenger Side Inner Front and Back Seat Studs	Bucket	No - Attaches to Seat Studs: Ford E-Series Van (2006+)	Lower Tube: Included with Base Upper Pole: 7160-0178 Motion Attachment: 7160-0220 <i>Motion attachment and poles ordered separately</i>	9.5 lbs 4.3 kg	19.25" 18.8 cm	16.75" 42.5 cm	8.3" 21.1 cm
7170-0130	Kit Includes: Vehicle Base and the Recommended Pole Solution as Stated Above. No Substitutions. For More Detailed Information Please Visit our Website.							
Features <ul style="list-style-type: none"> - Won't interfere with passenger leg space - Bracket mounted to pole gusset allows for additional attachment to seat frame - Base works with most existing work boxes - Limited Lifetime Warranty <p><i>Note:</i> Works with the 2015-2017 model year cutaway versions</p>								

FORD FUSION VEHICLE BASE



Item No.	Placement	Seat Configuration	Drilling Required	Recommended Solution	Weight	Height	Width	Depth
7160-0260	Attaches to Inboard and Outboard Passenger Side Seat Studs	Bucket	No - Attaches to Seat Studs: Ford Fusion (2013+)	Lower tube: DS-LOWER-9 Upper pole: 7160-0178 Support brace: 7160-0230 Motion Attachment: 7160-0500 <i>Motion attachment and poles ordered separately</i>	6.9 lbs 3.1 kg	5.43" 13.8 cm	19.0" 48.3 cm	4.36" 11.1 cm
7170-0234	Kit Includes: Vehicle Base and the Recommended Pole Solution as Stated Above. No Substitutions. For More Detailed Information Please Visit our Website.							
Features <ul style="list-style-type: none"> - Angled step moves pole away from passenger leg space - Can be used with factory installed console - One offset universal mounting step (DS-STEP) is already included with this vehicle base. However, additional offset universal mounting steps can be ordered to stack on top of each other if needed. - For extra stability a support brace (7160-0230) is recommended - Limited Lifetime Warranty 								

FORD TRANSIT CONNECT VEHICLE BASE



Item No.	Placement	Seat Configuration	Drilling Required	Recommended Pole Solution	Weight	Height	Width	Depth
7160-0536	Passenger Side on the Floor, Under Seat	Bucket	No - Attaches to Seat Studs: Ford Transit Connect (2014+)	Lower Tube: DS-LOWER-9 Upper Pole: 7160-0178 Support Brace: 7160-0230 Motion Attachment: 7160-0500 <i>Motion attachment and poles ordered separately</i>	3.35 lbs 1.5 kg	4.46" 11.3 cm	5.81" 14.8 cm	4.30" 10.9 cm
7170-0238	Kit Includes: Vehicle Base and the Recommended Pole Solution as Stated Above. No Substitutions. For More Detailed Information Please Visit our Website.							
Features <ul style="list-style-type: none"> - For extra stability, a support brace (7160-0230) is recommended - Limited Lifetime Warranty 								

FORD TRANSIT VEHICLE BASE / 2016+ MERCEDES BENZ METRIS VAN

Item No.	Placement	Seat Configuration	Drilling Required	Recommended Pole Solution	Weight	Height	Width	Depth
7160-0537	Attaches to Inboard and Outboard Passenger Side Seat Studs	Bucket/ Split Bench	No - Attaches to Seat Studs: Ford Transit (2015+)	Lower Tube: DS-LOWER-9 Upper Pole: 7160-0178 Support Brace: 7160-0231 Motion Attachment: 7160-0500 <i>Motion attachment and poles ordered separately</i>	4.75 lbs 2.2 kg	1.18" 3 cm	23.0" 58.4 cm	4.21" 10.7 cm
7170-0226	Kit Includes: Vehicle Base and the Recommended Pole Solution as Stated Above. No Substitutions. For More Detailed Information Please Visit our Website.							
Features - For extra stability, a support brace (7160-0230) is recommended - Limited Lifetime Warranty								



FORD F150 ALUMINUM BODY/FORD F250 - F550/FORD EXPEDITION 2018+ VEHICLE BASE

Item No.	Placement	Seat Configuration	Drilling Required	Recommended Pole Solution	Weight	Height	Width	Depth
7160-0554	Passenger Side on the Floor, Under the Seat	All	No - Attaches to Seat Studs: Ford F-150 Aluminum Body (2015-2020) Super Duty F250-F550 (2017+) Ford Expedition (2018+)	Lower Tube: DS-LOWER-9 Upper Pole: 7160-0178 Support Brace: 7160-0230 Motion Attachment: 7160-0220 <i>Motion attachment and poles ordered separately</i>	6.7 lbs 3 kg	6.48" 16.5 cm	17.68" 44.9 cm	7.27" 18.5 cm
7170-0236	Kit Includes: Vehicle Base and the Recommended Pole Solution as Stated Above. No Substitutions. For More Detailed Information Please Visit our Website.							
Features - Installs in minutes with no drilling required - Angled step moves pole away from passenger leg space - Will not interfere with levers or factory installed consoles - One offset universal mounting step (DS-STEP) is already included with this vehicle base. However, additional offset universal mounting steps can be ordered to stack on top of each other if needed - Limited Lifetime Warranty								



FORD F150 ALUMINUM BODY AND SUPER DUTY F250 - F550 VEHICLE BASE

Item No.	Placement	Seat Configuration	Drilling Required	Recommended Pole Solution	Weight	Height	Width	Depth
7160-1046	Attaches to Front Center Seat Bolts on Transmission Hump	Bucket/ Split Bench	No - Attaches to Seat Studs: Ford F-150 (2015-2020) Super Duty F250-F550 (2017+)	Lower Tube: DS-LOWER-9 Upper Pole: 7160-0178 Support Brace: 7160-0230 Motion Attachment: 7160-0220 <i>Motion attachment and poles ordered separately</i>	8.5 lbs 3.9 kg	2.8" 12.5 cm	12.5" 31.8 cm	12.6" 32.1 cm
7170-0640-01	Kit Includes: Vehicle Base with Support Brace (7160-0230)							
7170-0640-02	Kit Includes: Vehicle Base with Support Brace (7160-0230) and Lower Tube (DS-LOWER-9)							
7170-0640-03	Kit Includes: Vehicle Base with Support Brace (7160-0230), and Lower Tube (DS-LOWER-13)							
Features - Installs in minutes with no drilling required - Removable support foot on the driver's side for truck with manual 4x4 shift lever on the floor - Support brace recommended (7160-0230) - Two pole mounting positions on base - Base includes bracket that secures the vehicle end of the support brace under the dash to a OEM mounting point - Limited Lifetime Warranty								



SPRINTER VAN BASE



Item No.	Placement	Seat Configuration	Drilling Required	Recommended Solution	Weight	Height	Width	Depth
7160-0036	Secured Between the Passenger Seat Base and Seat Bolts	Bucket	No - Attaches Between Seat Base and Seat Studs: Dodge Sprinter (2004-2009) Freightliner Sprinter (2004-2015) Mercedes Sprinter (2004-2018)	Lower Tube: DS-LOWER-5 Upper Pole: QADJ-UPPER-M5 Support Brace: 7160-0231 Motion Attachment: 7160-0284 <i>Motion attachment and poles ordered separately</i>	10.13 lbs 4.6 kg	5.88" 14.7 cm	24.12" 61.3 cm	7.0" 17.8 cm
7170-0501	Kit Includes: Vehicle Base and the Recommended Pole Solution as Stated Above. No Substitutions. For More Detailed Information Please Visit our Website.							
Features - For extra stability a Support Brace (7160-0231) is recommended - Limited Lifetime Warranty								

2019+ NISSAN FRONTIER BASE



Item No.	Placement	Drilling Required	Recommended Solution	Weight	Height	Width	Length
7160-1412	Vehicle Base	No	Lower Tube: DS-LOWER-9 Upper Pole: 7160-0178 Support Brace: 7160-0230	7.94 lbs 3.60 kg	6.25" 15.9 cm	7.5" 19.0 cm	19" 48.3 cm
Features - Vehicle specific pedestal base for the 2019+ Nissan Frontier creates a custom fit - Vehicle base uses existing OEM bolts for a quick and easy install without drilling - Positions the lower pole closer to the transmission hump to be as out of the way as possible - Stable and rugged platform for your computer mount in your mobile office - While this doesn't impact rearward travel of the passenger seat, forward seat travel is limited - Limited Lifetime Warranty							

NISSAN NV VEHICLE BASE



Item No.	Placement	Seat Configuration	Drilling Required	Recommended Solution	Weight	Height	Width	Depth
7160-0342	Passenger Side on the Floor, Under Seat Rails	Bucket	No - Attaches to Seat Studs: Nissan NV (2011+)	Lower Tube: DS-LOWER-13 Upper Pole: 7160-0178 Support Brace: 7160-0230 Motion Attachment: 7160-0220 <i>Motion attachment and poles ordered separately</i>	6.6 lbs 3 kg	4.0" 10.2 cm	20.8" 52.8 cm	10.0" 25.4 cm
7170-0502	Kit Includes: Vehicle Base and the Recommended Pole Solution as Stated Above. No Substitutions. For More Detailed Information Please Visit our Website.							
Features - Can be used with factory installed console - For extra stability a support brace (7160-0230) is recommended - Limited Lifetime Warranty								

CHEVY CITY EXPRESS 2017, CHEVY VOLT, NISSAN NV200 VEHICLE BASE

Item No.	Placement	Seat Configuration	Drilling Required	Recommended Solution	Weight	Height	Width	Depth
7160-0557	Attaches to Inboard and Outboard Passenger Side Seat Studs	Bucket/ Split Bench	No - Attaches to Seat Studs: Chevrolet City Express (2015+) Chevrolet Volt (2010+) Nissan NV200 (2010+)	Lower Tube: DS-LOWER-13 Upper Pole: 7160-0178 Support Brace: 7160-0230 Motion Attachment: 7160-0500 <i>Motion attachment and poles ordered separately</i>	7.15 lbs 3.2 kg	4.48" 11.4 cm	18.14" 14.1 cm	7.15" 18.2 cm



7170-0503 **Kit Includes:** Vehicle base and the Recommended Solution as Stated Above. No Substitutions. For More Detailed Information Please Visit our Website.

Features

- Can be used with factory installed console
- For extra stability, a support brace (7160-0230) is recommended
- Rearward travel of the passenger seat is not affected, however there is limited forward seat travel
- Limited Lifetime Warranty

2019+ TOYOTA RAV4 VEHICLE BASE

Item No.	Placement	Drilling Required	Recommended Solution	Weight	Height	Width	Length
7160-1514	Vehicle Base	No	Lower Tube: DS-LOWER-7 Upper Pole: 7160-0178 Support Brace: 7160-0230	7.34 lbs 3.33 kg	4.5" 11.43 cm	7.15" 18.16 cm	20.14" 51.16 cm
7170-0824-00	Kit Includes: Vehicle Base (7160-1514) and the Recommended Solution as Stated Above						
7170-0824-01	Kit Includes: Vehicle Base (7160-1514), the Recommended Solution as Stated Above, and the Mongoose 9" Locking Slide Arm (7160-0220)						
7170-0824-02	Kit Includes: Vehicle Base (7160-1514), the Recommended Solution as Stated Above, and the Mongoose 9" Locking Slide Arm with Short Clevis (7160-0928)						
7170-0824-03	Kit Includes: Vehicle Base (7160-1514), the Recommended Solution as Stated Above, and the Mongoose 9" Locking Slide Arm with Short Clevis (7160-0928)						
7170-0824-04	Kit Includes: Vehicle Base (7160-1514), the Recommended Solution as Stated Above, and the 6" Locking Slide Arm (7160-0500)						



Features

- Designed specifically for the 2019+ Toyota RAV4 for a secure, custom fit
- Easily mounts to existing seat bolts without the use of drilling
- Can be used in conjunction with the OEM center console
- Offset riser brings pedestal system closer to center console maximizing leg room for the passenger
- While this doesn't impact rearward travel of the passenger seat, forward seat travel is limited
- Limited Lifetime Warranty

TOYOTA TACOMA VEHICLE BASE

Item No.	Placement	Seat Configuration	Drilling Required	Recommended Solution	Weight	Height	Width	Depth
DS-150	Passenger Side on the Floor, Under Seat	Bucket/ Bench	No - Attaches to Seat Studs: Toyota Tacoma (2005+)	Lower Tube: DS-LOWER-7 Upper Pole: QUADJ-UPPER-M Support Brace: 7160-0230 Motion Attachment: 7160-0284 <i>Motion attachment and poles ordered separately</i>	8.5 lbs 3.9 kg	4.2" 10.7 cm	18.5" 47 cm	7.0" 17.8 cm



Features

- Will not interfere with levers or factory installed console
- Angled step moves pole away from passenger leg space
- One offset universal mounting step (DS-STEP) is already included with this vehicle base. However, additional offset universal mounting steps can be ordered to stack on top of each other if needed.
- Limited Lifetime Warranty

UNIVERSAL SUPPORT PLATE



Item No.	Placement	Seat Configuration	Drilling Required	Weight	Height	Width	Depth
7160-0190	Under the vehicle in conjunction with the DS-52 and DS-57 Vehicle Bases only	All	Yes	4.91 lbs 2.2 kg	0.52" 1.3 cm	8.0" 20.3 cm	8.0" 20.3 cm

Features

- Underbody support plate provides stability to the DS-52 and DS-57 and distributes the clamping load across the vehicle body
- Underbody support plate can be installed in two configurations:
 - Bolts with threads up (plate will remain fixed position if the vehicle base is removed)
 - Bolts with threads down (plate will disengage when the vehicle base is removed)
- PEM nuts are used in order to reduce installation time and can be installed by a single individual
- Holes in center of plate allows installer to thread twine or wire and pull plate up to the underbody
- Limited Lifetime Warranty

Note: Before drilling holes through a vehicle floor pan, inspect the drill locations for wiring, exhaust pipes, drive train components, fuel lines and hydraulic lines.

FLAT FLOOR/HIGH SEAT UNIVERSAL BASE



Item No.	Placement	Seat Configuration	Drilling Required	Pole	Height Adjustability	Weight	Height	Width	Depth
DS-52	Flat floor	All	Yes - Any vehicle with a flat floor	Lower Tube Included with Base <i>Upper Pole ordered separately</i>	Yes - 18.5" - 23.5" (46.9 - 59.7 cm) Depending on Upper Pole Selected	8.1 lbs 3.67 kg	18.25" 46.4 cm	8.0" 20.3 cm	8.0" 20.3 cm

Features

- Solution for vehicle with high seats - vans, stepvans and trucks
- Limited Lifetime Warranty

UNIVERSAL HORIZONTAL SURFACE BASE



Item No.	Placement	Seat Configuration	Drilling Required	Pole	Weight	Height	Width	Depth
DS-56	Flat, Horizontal Surface	All	Yes	N/A - Attaches to Motion Attachment	2.0 lbs 0.9 kg	0.75" 1.9 cm	6.0" 15.2 cm	6.0" 15.2 cm

Features

- Solution for any vehicle where mounting floor space is limited
- Provides low rise for mounting on storage boxes or engine covers
- Limited Lifetime Warranty

UNIVERSAL FLAT FLOOR BASE



Item No.	Placement	Seat Configuration	Drilling Required	Pole	Height Adjustability	Weight	Height	Width	Depth
DS-57	Flat Floor	All	Yes - Any vehicle with a flat floor	Lower Tube Included with Base <i>Upper Pole ordered separately</i>	Yes - 14.25" - 19.25" (36.2 - 48.9 cm) Depending on Upper Pole Selected	5.35 lbs 2.4 kg	14.0" 35.6 cm	8.0" 20.3 cm	8.0" 20.3 cm

Features

- Solution for vehicle with high seats - vans, stepvans and trucks
- Limited Lifetime Warranty

UNIVERSAL PORTABLE BASE



Item No.	Placement	Seat Configuration	Drilling Required	Weight	Height	Width	Depth
7160-0033	On Passenger Seat	All	No	5.7 lbs 2.6 kg	5.0" 12.7 cm	14.0" 35.6 cm	16.0" 40.6 cm

Features

- Light-weight aluminum for reduced overall weight
- Uses the passenger seat to firmly secure the base into the vehicle
- Design can easily be used with any vehicle
- Can be used with any Motion Attachment and computer cradle to make a universal computer mounting solution
- Provides a platform to mount portable equipment (computers, printers, scanners, etc...)
- Limited Lifetime Warranty

PASSENGER-SIDE VEHICLE BASE

Item No.	Placement	Seat Configuration	Drilling Required	Pole	Weight	Height	Width	Depth
7160-0185	Passenger Side on the Floor	Bucket/Bench	Yes	Ordered Separately	7.5 lbs 3.4 kg	5.75" 14.6 cm	22.88" 58.1 cm	5.25" 13.3 cm

Features

- Won't interfere with levers or factory installed 1/2 consoles located on transmission hump
- Will not work with full factory installed console or 4WD lever on transmission hump
- Won't interfere with passenger leg space
- Limited Lifetime Warranty



FREIGHTLINER M2 106/107 VEHICLE BASE

Item No.	Placement	Seat Configuration	Drilling Required	Recommended Pole Solution	Weight	Height	Width	Depth
7160-0544	Attaches to Inboard and Outboard Passenger Side Seat Studs	Bucket	No - Attaches to Seat Studs: Freightliner M2 106 (2012+) Freightliner M2 112 (2012+)	Lower Tube: DS-LOWER-9 Upper Pole: 7160-0178 Support Brace: 7160-0230 Motion Attachment: 7160-0220 <i>Motion Attachment and Poles Ordered Separately</i>	9.6 lbs 4.4 kg	9.49" 24.1 cm	20.27" 21.5 cm	11.27" 28.6 cm

Features

- For extra stability, a support brace (7160-0230) is recommended
- Limited Lifetime Warranty



FLAT VERTICAL SURFACE BASE

Item No.	Placement	Seat Configuration	Drilling Required	Pole	Height Adjustability	Weight	Height	Width	Depth
DS-53	Flat, Vertical Surface	All	Yes	Lower Tube Included with Base, Upper Pole Ordered Separately	Yes - 13.25" - 18.25" (33.6 - 46.4 cm) Depending on Upper Pole Selected	4.2 lbs 1.9 kg	13.0" 33 cm	2.0" 5.1 cm	8.0" 20.3 cm

Features

- Can be mounted to engine covers, consoles and "dog houses"
- Two back-up mounting strips included
- Limited Lifetime Warranty



UNIVERSAL VERTICAL BASE

Item No.	Placement	Seat Configuration	Drilling Required	Pole	Height Adjustability	Weight	Height	Width	Depth
DS-138	Flat, Vertical Surface	All	Yes - Backing Plate Provided to System Strength	Lower Tube Included with Base Upper Pole Ordered Separately	Yes - 7.75" - 12.75" (19.7 - 32.4 cm) Depending on Upper Pole Selected	2.4 lbs 1.1 kg	7.5" 19.5 cm	3.0" 7.6 cm	1.25" 3.2 cm

Features

- Ideal for mounting communication equipment to engine cover, consoles and "dog houses"
- Limited Lifetime Warranty

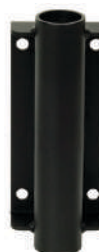

UNIVERSAL VEHICLE BASE FOR INTERNATIONAL, FREIGHTLINER, AND STERLING TRUCKS

Item No.	Placement	Seat Configuration	Drilling Required	Pole	Weight	Height	Width	Depth
DS-146	Flat Floor to the Bench Seat	Bench	Yes - Attaches to Seat Frame and Drilled into the Vehicle Floor of the International, Freightliner or Sterling	Ordered separately	8.0 lbs 3.6 kg	11.0" - 15.23" 27.9 - 38.7 cm	5.0" 12.7 cm	13.39" 34 cm

Features

- Universal design can be used in International, Freightliner, Sterling and other large trucks with a bench style seat
- Several mounting holes on top of the vehicle base allows for flexible positioning of computer mounting system
- Limited Lifetime Warranty





3" CENTER-MOUNTED COMPLETE POLES

Item No.	Placement	Height Adjustability	Weight	Height	Width	Depth
DS-POLE-CTR	Any Console Box Top Plate or Vehicle Base Without a Welded Pole	No - Welded Pole	3 lbs 1.4 kg	4.7" 11.8 cm	3.0" 7.6 cm	3.0" 7.6 cm
Features - Specifically designed for low profile computer mounting in the Dodge Charger/Magnum police vehicle - A low profile Motion Attachment (LOWSWIVEL) is recommended for use in the Dodge Charger/Magnum police vehicle - Hardware for attaching to console box top plates included - Is not compatible with the following vehicle bases (DS-52, DS-53, DS-56, DS-57, DS-100, DS-138, 7160-0090, 7160-0116, 7160-0133, 7160-0198, or 7160-0248) - Limited Lifetime Warranty Key dimension - Affects overall height of equipment						



LOWER TUBES

Item No.	Placement	Height Adjustability	Weight	Height	Width	Depth
DS-LOWER-5	Any Console Box Top Plate or Vehicle Base Without a Welded Pole	Yes - From 5.0" - 7.0" (12.7 - 17.8 cm) Adjustment Includes Upper Pole	1.5 lbs .7 kg	5.0" 12.7 cm	3.0" 7.6 cm	3.0" 7.6 cm
DS-LOWER-7	Any Console Box Top Plate or Vehicle Base Without a Welded Pole	Yes - From 7.0" - 9.0" (17.8 - 22.9 cm) Adjustment Includes Upper Pole	1.8 lbs .8 kg	7.0" 17.8 cm	3.0" 7.6 cm	3.0" 7.6 cm
DS-LOWER-9	Any Console Box Top Plate or Vehicle Base Without a Welded Pole	Yes - From 9.0" - 14.25" (22.9 - 36.2 cm) Adjustment Includes Upper Pole	2.1 lbs 1 kg	9.0" 22.9 cm	3.0" 7.6 cm	3.0" 7.6 cm
DS-LOWER-13	Any Console Box Top Plate or Vehicle Base Without a Welded Pole	Yes - From 13.0" - 18.25" (33 - 46.4 cm) Adjustment Includes Upper Pole	2.65 lbs 1.2 kg	13.0" 33 cm	3.0" 7.6 cm	3.0" 7.6 cm
Features - Hardware for attaching to console box top plates included - Is not compatible with the following vehicle bases (DS-52, DS-53, DS-56, DS-57, DS-100, DS-138, 7160-0090, 7160-0116, 7160-0133, 7160-0198, or 7160-0248) - Limited Lifetime Warranty Key dimension - Affects overall height of equipment						



7160-0178

CENTER UPPER TUBES

Item No.	Placement	Height Adjustability	Weight	Height	Width	Depth
7160-0177	Inserts Into: - Any Gamber-Johnson Lower Tube - Vehicle Base that has a Welded Lower Tube	Allows 0.38" to 5.76" (1 - 7 cm) Adjustment Above Lip of Lower Tube	2.8 lbs 1.3 kg	6.22" 18.3 cm	4.31" 10.9 cm	3.0" 7.6 cm
7160-0178	Inserts Into: - 9" Lower Tube (DS-LOWER-9) - 13" Lower Tube (DS-LOWER-13) - Vehicle Base that has a Welded Lower Tube	Allows 0.38" to 5.76" (1 - 7 cm) Adjustment Above Lip of Lower Tube	3.2 lbs 1.5 kg	9.22" 26 cm	4.31" 10.9 cm	3.0" 7.6 cm
Features - Allows for closer mounting to the dash when off-set adjustability is not needed - Less stress on the vehicle mounting equipment as weight is centered on the pole - Wrench is needed for loosening, tightening and height adjustment - Limited Lifetime Warranty						

STANDARD-ADJUSTABLE UPPER POLES

Item No.	Placement	Height Adjustability	Weight	Height	Width	Depth
DS-UPPER	Inserts Into: - 7" Lower Tube (DS-LOWER-7) - 9" Lower Tube (DS-LOWER-9) - 13" Lower Tube (DS-LOWER-13) - Vehicle Base that has a Welded Lower Tube	Allows 0.38" - 5.76" (1 - 14.6 cm) Adjustment Above Lip of Lower Tube	2.6 lbs 1.2 kg	8.00" 20.3 cm	3.5" 8.9 cm	5.8" 14.7 cm
DS-UPPER-M	Inserts Into: - 7" Lower Tube (DS-LOWER-7) - 9" Lower Tube (DS-LOWER-9) - 13" Lower Tube (DS-LOWER-13) - Vehicle Base that has a Welded Lower Tube	Allows 0.38" - 5.76" (1 - 14.6 cm) Adjustment Above Lip of Lower Tube	3.3 lbs 1.5 kg	8.00" 20.3 cm	3.5" 8.9 cm	8.0" 20.3 cm
DS-UPPER-L	Inserts Into: - 7" Lower Tube (DS-LOWER-7) - 9" Lower Tube (DS-LOWER-9) - 13" Lower Tube (DS-LOWER-13) - Vehicle Base that has a Welded Lower Tube	Allows 0.38" - 5.76" (1 - 14.6 cm) Adjustment Above Lip of Lower Tube	4.1 lbs 1.9 kg	8.00" 20.3 cm	3.5" 8.9 cm	12.0" 30.5 cm
Features - Any Motion Attachment can be mounted on top of these upper poles. - Wrench is needed for left/right rotational adjustments and height adjustments - Limited Lifetime Warranty						
Key dimension - Determines how far equipment extends away from pole						



DS-UPPER-M

QUICK-ADJUSTABLE UPPER POLES

Item No.	Placement	Height Adjustability	Weight	Height	Width	Depth
QADJ-UPPER-S	Inserts Into: - 7" Lower Tube (DS-LOWER-7) - 9" Lower Tube (DS-LOWER-9) - 13" Lower Tube (DS-LOWER-13) - Vehicle Base that has a Welded Lower Tube	Allows 0.38" - 5.76" (1 - 14.6 cm) Adjustment Above Lip of Lower Tube	3.1 lbs 1.4 kg	8.25" 21 cm	3.5" 8.9 cm	5.8" 14.7 cm
QADJ-UPPER-M	Inserts Into: - 7" Lower Tube (DS-LOWER-7) - 9" Lower Tube (DS-LOWER-9) - 13" Lower Tube (DS-LOWER-13) - Vehicle Base that has a Welded Lower Tube	Allows 2.18" - 5.76" (5.5 - 14.6 cm) Adjustment Above Lip of Lower Tube	3.3 lbs 1.5 kg	8.25" 21 cm	3.5" 8.9 cm	8.0" 20.3 cm
QADJ-UPPER-L	Inserts Into: - 7" Lower Tube (DS-LOWER-7) - 9" Lower Tube (DS-LOWER-9) - 13" Lower Tube (DS-LOWER-13) - Vehicle Base that has a Welded Lower Tube	Allows 2.18" - 5.76" (5.5 - 14.6 cm) Adjustment Above Lip of Lower Tube	4.1 lbs 1.9 kg	8.25" 21 cm	3.5" 8.9 cm	12.0" 30.5 cm
Features - Any Motion Attachment can be mounted on top of these upper poles. - Convenient lever controls left/right rotational adjustments and height adjustments. Wrench is not needed for adjustments. - Set-collar can be used to stabilize height while rotational adjustments are made - Limited Lifetime Warranty						
Key dimension - Determines how far equipment extends away from pole						



QADJ-UPPER-M



LOW PROFILE BRACKET

Item No.	Placement	Weight	Height	Width	Depth
ABF-KIT	Any Vehicle Base Without a Welded Pole	0.8 lbs 0.4 kg	1.5" 3.8 cm	3.0" 7.6 cm	6.6" 16.8 cm

Features

- Positions equipment low to the floor
- Hardware for attaching to console box top plates included
- Is not compatible with the following vehicle bases (DS-52, DS-53, DS-56, DS-57, DS-100, DS-138, 7160-0090, 7160-0116, 7160-0133, 7160-0198, or 7160-0248)
- Limited Lifetime Warranty



DS-74



DS-74-L

RACK-TO-POST PLATFORMS

Item No.	Placement	Weight	Height	Width	Depth
DS-74	Secures to any Lower Tube	1.9 lbs 0.9 kg	4.0" 10.2 cm	3.0" 7.6 cm	6.0" 15.2 cm
DS-74-L	Secures to any Lower Tube	2.6 lbs 1.2 kg	3.56" 9 cm	3.0" 7.6 cm	9.38" 23.8 cm

Features

- Provides additional mounting surface for radios, printers and other equipment
- Two muffler clamps are included for securing to pole
- Pre-drilled holes for use with the following printer mounts (7160-0126, 7160-0392 or 7160-0507)
- Limited Lifetime Warranty

SUPPORT BRACES



7160-0230

7160-0231

Item No.	Placement	Weight	Width	Depth
7160-0230	Pole Clamp Attaches to the Lower Tube, Flattened Surface on Opposite End Secures to Vehicle Floor, Console or Dash	1.1 lbs 0.5 kg	2.3" 5.8 cm	10.3" to 16.3" 26.1 - 41.4 cm
7160-0231	Pole Clamp Attaches to the Lower Tube, Flattened Surface on Opposite End Secures to Vehicle Floor, Console or Dash	1.5 lbs 0.7 kg	2.3" 5.8 cm	10.3" to 35.3" 4.7 - 16 cm

Features

- Designed for ease of installation
- Telescoping design allows for precise length adjustment without drilling into the pole
- Includes durable aluminum pole clamp that prevents catch points
- Increases the mounting system rigidity in rugged driving environments
- Limited Lifetime Warranty



MOBILE WORKSTATION

Featuring a locking storage area for supplies and electronics as well as a platform to mount devices, mobile workstations are ideal for military, government, and utility vehicles.



MOBILE WORKSTATIONS

MOBILE WORKSTATION BOXES



7160-0947



7160-0941



7160-0968

Item No.	Placement	Description	Weight	Height	Width	Depth
7160-0947	Attaches to the floor, between the seats of most vans & trucks	Small workstation box	37.2 lbs 16.9 kg	13.0" 33.0 cm	11.5" 29.2 cm	18.8" 47.8 cm
7160-0941	Attaches to the floor, between the seats of most vans & trucks	Large workstation box	55 lbs 24.9 kg	15.0" 38.1 cm	15.5" 39.4 cm	17.4" 44.2 cm
7160-0968	Attaches to the floor, between the seats of most vans & trucks	Small 9" tall workstation box	25.6 lbs 11.6 kg	9.5" 24.1 cm	12.0" 30.5 cm	16.3" 41.3 cm

Workstation Features

- Heavy gauge steel construction for long-term durability
- Contains locking storage for supplies and devices
- Includes on file holder bracket that can be mounted on either wall or inside the box
- Larger handle to allow easy opening or closing of the door
- Mounting holes on the front accommodates computer mounting brackets or platform
- Includes exterior pocket for binder that can be mounted on back or either side
- Wire access cutouts in box for passing wires into or out of it
- Clip board spring for securing notepads or papers to the top of the workstation box
- Mounting point on the side of the box for legs or Chevy van leg kit
- Can be used with any of the MCS leg kit and top plate
- Limited Lifetime Warranty

WORK TRUCK CONSOLE WITH FILE BOX, CUPHOLDER, AND ARMREST



Item No.	Placement	Weight	Height	Width	Depth
7170-0125	On the 29" console box top plate (7160-0085)	37 lbs 16.8 kg	11.0" to 13.4" 27.9 to 34 cm	9.23" 23.4 cm	32.06" 81.4 cm

Features

- Locking storage for hanging standard file folders, supplies, or other devices
- Armrest can be positioned closer to the driver or passenger during installation
- 9" (22.86 cm) of mounting space with the internal cupholder and is designed to work with both full sized radios and radio control heads
- Mounting holes on the right side of the console for vertical surface mount (DS-138) for computer mounting (sold separately)
- Box attaches to console box top plate
- Sold as a package and there are no substitutions. Includes internal cupholder, break away armrest, and console box top plate
- 3 faceplates and 3 filler panels are included
- Limited Lifetime Warranty

SHORT UNIVERSAL SLOPED CONSOLE BOX KIT WITH FILE BOX, CUP HOLDER, ARMREST, AND TOP PLATE



Item No.	Placement	Weight	Height	Width	Depth
7170-0125-01	On the 29" console box top plate (7160-0085)	46.3 lbs 21.2 kg	12.4" 31.5 cm	9.5" 24.1 cm	30.9" 78.5 cm

Features

- Contains locking storage for supplies and devices
- File box has accommodations for hanging file folders on inside of box
- Large handle for opening and closing file box lid
- Mounting holes on lid for two armrests - one armrest comes with the kit
- Lid opens past 90° for better access to the inside of the box
- Clip board sprint secures notepads or papers to the top of the workstation box
- Lock of file box is incorporated into the latch
- Mounting slots on bottom of the box for mounting to top plate (7160-0085) is part of the kit
- Mounting for 3-4 devices in the front console
- Dual removable cup holders with pen holders
- Limited Lifetime Warranty

VEHICLE LEG KIT

Item No.	Placement	Seat Configuration	Drilling Required	Mounting Locations	Weight	Height	Width	Depth
7160-0403	Attaches to inboard driver and passenger side seat studs	Bucket	No - attaches to seat studs: International 4300/7300 Work Truck (2011-2013)	3	24.0 lbs 10.9 kg	2.75" 7 cm	34.5" 87.6 cm	18.75" 57.6 cm
7160-0545	Attaches to inboard driver and passenger side seat studs	Bucket	No - attaches to seat studs: Freightliner M2 106 (2012+) Freightliner M2 112 (2012+)	2	19.6 lbs 8.9 kg	7.11" 18.1 cm	33.44" 84.9 cm	19.30" 49 cm

Features

- Vehicle leg kit allows workstations, storage or console boxes to be mounted between the seats of the vehicle
- Multiple mounting locations on the strut channel for various positions for mounting equipment
- Compatible with air ride seats
- Limited Lifetime Warranty



7160-0403



7160-0545

SHORT UNIVERSAL SLOPED FRONT CONSOLE BOX

Item No.	Placement	Weight	Height	Width	Depth
7160-0899	On the 29" console box top plate (7160-0085)	15.8 lbs 7.2 kg	10.9" 27.6 cm	17.8" 45.1 cm	8.8" 22.2 cm

Features

- Low profile universal console with a sloped mounting area
- Designed to work with the top plate and leg kits
- Computer can be mounted offset towards the passenger or closer to the driver
- Fully welded construction for long-term life span
- 3 faceplates and 3 filler panels included
- Box ships fully assembled (except for accessories)
- Add an armrest that mounts off the top plate

Horizontal low profile section:

- Has 4.5" (11.4 cm) of mounting space for an internal cup holder, accessories, or devices
- Designed to house full sized devices and accessories

Vertical angled section:

- Accommodates 1 to 2 full sized devices 7.5" (19.1 cm) of mounting space
- PEMs for mounting a mic clip (7120-0723) on both sides
- Knockout for the USB/AUX input module (16648) or dual USB power port (15371) located on the passenger side
- Side vented openings for air flow or mounting a speaker inside the box
- Front plate of console underneath the dash has placement area for a power distribution block or a LIND shut-down timer
- Limited Lifetime Warranty



WIDE BODY CONSOLE BOXES



7160-0894

Item No.	Description	Placement	Weight	Height	Width	Depth
7160-0894	Wide body console only	On the 29" console box top plate (7160-0085)	26.4 lbs 12.0 kg	10.9" 27.6 cm	11.8" 30.1 cm	24.8" 62.9 cm
7170-0567-00	Kit Includes: Wide Body Console (7160-0894), Internal Cup Holder (7160-0846), And Pocket (7160-0924)					
7170-0567-01	Kit Includes: Wide Body Console (7160-0894), Internal Cup Holder (7160-0846), Break-Away Armrest (7160-0524), and Pocket (7160-0924)					
7170-0567-02	Kit Includes: Wide Body Console (7160-0894), Internal Cup Holder (7160-0846), Brother Printer Armrest (7160-0430), and Pocket (7160-0924)					
7170-0567-03	Kit Includes: Wide Body Console (7160-0894), Internal Cup Holder (7160-0846), Vertical Surface Mount, and Pocket (7160-0924)					
7170-0567-04	Kit Includes: Wide Body Console (7160-0894), Internal Cup Holder (7160-0846), Break-Away Armrest (7160-0524), Mongoose Motion Attachment (7160-0220), and Pocket (7160-0924)					
7170-0567-05	Kit Includes: Wide Body Console (7160-0894), Internal Cup Holder (7160-0846), and 6-Inch Locking Slide Arm (7160-0500)					

Features

- Low profile universal console with a sloped mounting area
- Designed to work with the top plate and leg kits
- Two 12 volt plug knockouts located on passenger side wall and 1 knockout for switches, dual USB power ports, battery voltage display, data/mic jack, or USB/AUX input module extension
- PEMs for mounting mic clip (7120-0723) on both sides
- Side vented openings for air flow or mounting a speaker inside the console box
- PEMs on back of the console box for mounting external cup holder (7160-0847) or either MCS armrest (7160-0429) or MCS printer armrest (7160-0430)
- Front plate of console under the dash area has placement for a power distribution block or a LIND shut-down timer using pre-configured mounting holes
- Box ships fully assembled (except for accessories)
- Computer can be mounted offset towards the passenger or on the 3-bolt pattern closer to the driver
- Fully welded construction for long-term life span
- 3 faceplates and 3 filler panels included

Horizontal low profile section

- Mounting space length of 11.5" (29.2 cm)
- Designed to house full sized devices and accessories
- Additional 2" (5.1 cm) area to accommodate a pocket, two inch faceplates for switches or power ports, or a smaller device

Vertical angled sections

- Accommodates 1 to 2 full sized devices or faceplates, 5" (12.7 cm) of mounting space
- Two 12 volt plug knockouts located on top passenger side and two knockouts for switches, dual USB power ports, battery voltage display, data/mic jack, or USB/AUX input module extension
- Limited Lifetime Warranty

WORKSTATION CONSOLE BOX WITH 3" AND 5" MOUNTING OPENINGS



7160-0970

Item No.	Placement	Description	Weight	Height	Width	Depth
7160-0970	Mounts directly to the front of the small workstation box	Small workstation radio platform	19.5 lbs 8.9 kg	10.9" 27.6 cm	11.5" 29.2 cm	15.5" 39.5 cm

Features

- Low profile, universal console with sloped front mounting area
- Designed to work with top plate/tunnel plate and leg kits
- PEM's for mounting mic clip (7120-0723) or Magnetic Mic (17040) on both sides
- Access door on passenger side of console for accessing fuse power distribution block tray, like power distribution block with negative bus (7160-0313)
- Side vented openings for air flow or mounting a speaker inside the console box
- Front plate of console (underneath dash area) has placement for a power distribution block or LIND shut-down timer using pre-configured mounted holes
- Computer can be center mounted in two locations: off-set towards the passenger on the 3-bolt hole pattern closer to the driver for easy articulation
- Cutouts located on outside area of the console box to pass cables through for use with small workstation (no legs)
- Fully welded construction for long term product life span
- Box ships fully assembled with 3 faceplates and 3 filler panels. No accessories included.

Horizontal, low profile section:

- Has a 3" (7.62 cm) mounting opening for device like control heads or device less than 4.5" (11.43 cm) in length
- Two knockouts for switches, dual USB power ports, battery voltage display, data/mic jack or USB/AUX input module extension

Vertical, angled section:

- Has 5" (12.7 cm) of mounting space to accommodate 1 to 2 full-sized devices or faceplates.
- Two 12-volt plug knockouts, located on passenger side and two knockouts for switches, dual USB power ports, battery voltage display, data/mic jack or USB/AUX input module extension
- Limited Lifetime Warranty

RADIO PLATFORMS

Item No.	Placement	Description	Weight	Height	Width	Depth
7160-0945	Mounts directly to the front of the large workstation box	Large workstation radio platform	16.0 lbs 7.2 kg	13.3" 33.8 cm	14.3" 36.3 cm	12.9" 32.8 cm
7160-0967-01	Mounts directly to the front of the small 9-inch workstation box	9-inch small radio platform	16.0 lbs 7.2 kg	11.5" 29.2 cm	14.3" 36.2 cm	12.2" 31.1 cm
7160-0967-02	Mounts directly to the front of the small 9-inch workstation box	9-inch small radio platform with single cup holder, 4x4 level indent	15.97 lbs 7.24 kg	11.5" 29.2 cm	4.3" 36.2 cm	12.2" 31.1 cm

Features

- 5" (12.7 cm) for radio or other device mounting area
- Computer mounting off the top of the radio platform via the 3-bolt hole pattern
- Removable single up and pen holder for easy cleaning (7160-0966, 7160-0945, and 7160-0967-02 only)
- One knockout for switches or other accessories like USB charging or battery voltage monitoring
- Cigarette jack power port knockout
- Grill pattern on each side of the platform for mounting a speaker behind
- Mounting point on both sides for a standard mic clip (7120-0723) or Magnetic Mic (17040)
- Limited Lifetime Warranty



7160-0945



7160-0967-01



7160-0967-02

COMPUTER PLATFORMS

Item No.	Placement	Description	Weight	Height	Width	Depth
7160-0964	Mounts directly to the front of the small workstation box	Small workstation computer platform	6.5 lbs 2.9 kg	9.4" 23.9 cm	11.5" 29.2 cm	8.8" 22.4 cm
7160-0963	Mounts directly to the front of the large workstation box	Large workstation computer platform	8.0 lbs 3.6 kg	11.4" 29.0 cm	15.0" 38.1 cm	8.5" 21.6 cm

Features

- Three mounting positions via the 3-bolt hole pattern for motion devices
- Two mounting positions on either side of the platform for a short pole via the 4-bolt holes
- Limited Lifetime Warranty



7160-0964



7160-0963

ARMREST FOR SMALL MOBILE WORKSTATION LID

Item No.	Placement	Weight	Height	Width	Depth
7160-0893	Mounts to workstation lid either by holes in lid or drilling own holes	1.4 lbs 0.2 kg	1.9" 4.8 cm	3.3" 8.3 cm	11.0" 27.9 cm

Features

- Sleek padded armrest for comfort
- Sturdy for additional support
- Black powder coat finish on a metal bracket and heavy gauge steel construction for long-term durability
- Limited Lifetime Warranty



7160-0893

WORKSTATION CONSOLE BOX SHELF

Item No.	Placement	Weight	Height	Width	Depth
7160-0920	Mounts to the front of the small console box (7160-0899)	7.0 lbs 3.2 kg	5.9" 15.0 cm	14.3" 36.3 cm	14.2" 36.1 cm

Features

- Black powder coat finish for maximum corrosion resistance
- Heavy gauge steel construction for long-term durability
- Designed to Work with the Large Workstation only
- Bolts on to the front of the using PEM's
- Works on smaller console box (7160-0899)
- Limited Lifetime Warranty



7160-0920

WORKSTATION KITS WITH MOUNTING LEGS



7170-0581-00



7170-0563-00

Item No.	Placement	Description	Weight	Height	Width	Depth
7170-0563-00	Attaches to the floor, between the seats of most vans and trucks	Small workstation box with mounting legs	43.1 lbs 19.5 kg	15.0" 38.1 cm	11.5" 29.2 cm	18.0" 45.7 cm
7170-0581-00	Attaches to the floor, between the seats of most vans and trucks	Large workstation with mounting legs	65 lbs 29.5 kg	16.0" 40.6 cm	16.0" 40.6 cm	19.0" 48.3 cm

Features

- Contains locking storage for supplies and devices
- Includes one file folder bracket that can be mounted on either wall on the inside on the box
- Larger handle for easier opening and closing of the door
- Mounting holes on the front accommodates computer mounting brackets or platform
- Includes exterior pocket for binder that can be mounted on back or either side
- Wire access cutouts in box for passing wires into or out of it
- Clip board spring secures notepad or papers to the top of the workstation box
- Mounting point on the side of the box for legs or Chevy van leg kit
- Mounting slots in bottom of the box for mounting to top plate or the Freightliner and the International truck leg kits
- Can be used with any of the workstation leg kits or a leg kit and top plate
- Limited Lifetime Warranty

WORKSTATION KIT WITH MOUNTING LEGS AND VERTICAL SURFACE MOUNT



7170-0563-01



7170-0581-01

Item No.	Placement	Description	Weight	Height	Width	Depth
7170-0563-01	Attaches to the floor, between the seats of most vans and trucks	Small workstation with mounting legs and vertical surface mount	45.5 lbs 7.0 kg	15.0" 38.1 cm	11.5" 29.2 cm	19.2" 48.8 cm
7170-0581-01	Attaches to the floor, between the seats of most vans and trucks	Large workstation with mounting legs and vertical surface mount	65 lbs 29.5 kg	16.0" 40.6 cm	16.0" 40.6 cm	19.0" 48.3 cm

Features

- Contains locking storage for supplies and devices
- Includes one file folder bracket that can be mounted on either wall on the inside of the box
- Larger handle to allow easy opening or closing of door
- Mounting holes on the front accommodates computer mounting brackets or platform
- Vertical surface mount on front of the workstation for mounting computers or tablets with Gamber-Johnson upper pole and motion device
- Includes exterior pocket for binder that can be mounted on back or either side
- Wire access cutouts in box for passing wires into or out of it
- Clip board spring secures notepads or papers to the top of the workstation box
- Mounting point on the side of box for legs or Chevy van leg kit
- Mounting slots in bottom of the box for mounting to top plate or the Freightliner and International truck leg kits
- Can be used with any of the workstation leg kits or a leg kit and top plate
- Limited Lifetime Warranty

WORKSTATION WITH MOUNTING LEGS AND COMPUTER PLATFORM



7170-0563-02



7170-0581-02

Item No.	Placement	Description	Weight	Height	Width	Depth
7170-0563-02	Attaches to the floor, between the seats of most vans and trucks	Small workstation with mounting legs and computer platform	49.6 lbs 22.5 kg	15.0" 38.1 cm	11.5" 29.2 cm	26.8" 68.1 cm
7170-0581-02	Attaches to the floor, between the seats of most vans and trucks	Large workstation with mounting legs and computer platform	70 lbs 31.8 kg	16.0" 40.6 cm	16.0" 40.6 cm	25.9" 65.8 cm

Features

- Locking storage for supplies and devices
- Contains locking storage for supplies and devices
- Includes one file folder bracket that can be mounted on either wall on the inside of the box
- Large handle for easy opening and closing of the door
- Mounting holes on the front accommodates computer mounting brackets or platform
- Computer mounting platform on front of workstation for mounting computers or tablets
- Includes exterior pocket for binder that can be mounted on back or either side
- Wire access cutouts in box for passing wires into or out of it
- Clip board spring for securing notepads or papers to the top of the workstation box
- Mounting point on the side of box for legs or Chevy van leg kit
- Mounting slots in bottom of the box for mounting to top plate or the Freightliner and International truck leg kits
- Can be used with any of the workstation leg kits or a leg kit and top plate
- Limited Lifetime Warranty

WORKSTATION KIT WITH MOUNTING LEGS AND RADIO PLATFORM

Item No.	Placement	Description	Weight	Height	Width	Depth
7170-0581-03	Attaches to the floor, between the seats of most vans & trucks	Large workstation with mounting legs	78 lbs 35.4 kg	18.6" 47.2 cm	16.0" 40.6 cm	30.3" 77.0 cm

Features

- Contains locking storage for supplies and devices
- Includes one file folder bracket that can be mounted on either wall on the inside on the box
- Larger handle for easier opening and closing of the door
- Mounting holes on the front accommodates computer mounting brackets or platform
- Includes exterior pocket for binder that can be mounted on back or either side
- Radio platform on front for mounting computers or tablets, radios, light controllers, and switch or DC power outlets
- Wire access cutouts in box for passing wires into or out of it
- Clip board spring secures notepad or papers to the top of the workstation box
- Mounting point on the side of the box for legs or Chevy van leg kit
- Mounting slots in bottom of the box for mounting to top plate or the Freightliner and the International truck leg kits
- Can be used with any of the workstation leg kits or a leg kit and top plate
- Limited Lifetime Warranty



7170-0563-03



7170-0581-03

WORKSTATION KIT WITH LONG TOP PLATE, CONSOLE BOX, AND DUAL ARMREST

Item No.	Placement	Description	Weight	Height	Width	Depth
7170-0563-04	Attaches to the floor, between the seats of most vans and trucks	Small workstation box with mounting legs	76.6 lbs 34.8 kg	12.1" 30.7 cm	11.5" 29.2 cm	34.3" 87.1 cm
7170-0581-04	Attaches to the floor, between the seats of most vans and trucks	Large workstation with mounting legs	88.5 lbs 40.1 kg	16.0" 40.6 cm	16.0" 40.6 cm	33.0" 83.8 cm

Features

- Contains locking storage for supplies and devices
- Includes one file folder bracket that can be mounted on either wall on the inside on the box
- Larger handle for easier opening and closing of the door
- Mounting holes on the front accommodates computer mounting brackets or platform
- Mounting ledge for mounting off the front of the workstation for a small console box
- Workstation console box provides for radio, safety light controller, and computer mounting along with switches, DC power ports, and dual cup holders
- Includes exterior pocket for binder that can be mounted on back or either side
- Radio platform on front for mounting computers or tablets, radios, light controllers, and switch or DC power outlets
- Wire access cutouts in box for passing wires into or out of it
- Clip board spring secures notepad or papers to the top of the workstation box
- Mounting point on the side of the box for legs or Chevy van leg kit
- Mounting slots in bottom of the box for mounting to top plate or the Freightliner and the International truck leg kits
- Can be used with any of the workstation leg kits or a leg kit and top plate
- Limited Lifetime Warranty



7170-0563-04



7170-0581-04

WORKSTATION 4-INCH LED LIGHT STRIP ASSEMBLY

Item No.	Placement	Weight	Height	Width	Depth
7160-0978	Attaches to the console box top plate	0.3 lbs 0.1 kg	0.4" 1.0 cm	0.6" 1.4 cm	4.0" 10.2 cm

Features

- LED light can be wired for red or white light
- Comes with ON-OFF switch and has LED in it for ON indication if desired
- Assembly comes with connectors for the switch and connectors for any wire extension need
- Three leads, 9" (22.9 cm) long, from LED for hooking up power through supplied switch:
 - Ground: black wire
 - White light: white wire
 - Red light: red wire
- New redesigned workstation boxes have mounting built in for the LED light strip and cut-outs
- Old style workstation boxes do not have mounting for LED light or switch - installer will have to mount in their own
- LED and switch has a 90 Day Warranty
- Limited Lifetime Warranty



7160-0978

REMOVABLE INTERIOR TRAY FOR SMALL WORKSTATION

Item No.	Placement	Weight	Height	Width	Depth
7160-0986	Attaches to the inside of the small workstation box	3.3 lbs 1.5 kg	1.9" 4.8 cm	10.5" 26.7 cm	5.6" 14.3 cm

Features

- Black powder coat finish on metal bracket
- Heavy gauge steel construction for long-term durability
- Brackets mount on the inside wall of small workstation boxes (new workstation boxes have pre-drilled holes, old boxes will have to be field drilled)
- Tray secures to mounting brackets with supplied hardware
- Tray has handle to be lifted out of box
- Limited Lifetime Warranty



7160-0986



VEHICLE EQUIPMENT

Safeguard your assets with Gamber-Johnson vehicle equipment including push bumpers, partitions, window guards and gun mounts. These products offer rugged construction, quick and easy installation, and our limited lifetime warranty.



NEW



2020+ FORD POLICE INTERCEPTOR® UTILITY PUSH BUMPER

Item No.	Description	Weight	Height	Width	Depth
7170-0736-01	Steel Push Bumper with Standard Bar	78 lbs 35.38 kg	29" 73.7 cm	34.8" 88.4 cm	11" 33.02 cm
7170-0736-02	Steel Push Bumper with Light Bar	78 lbs 35.38 kg	29" 73.7 cm	34.8" 88.4 cm	12" 33.02 cm
7170-0736-03	Aluminum Push Bumper with Standard Bar	30 lbs 13.61 kg	29" 73.7 cm	34" 86.4 cm	13" 33.02 cm
7170-0736-04	Aluminum Push Bumper with Light Bar	30 lbs 13.61 kg	29" 73.7 cm	34" 86.4 cm	13" 33.02 cm

Features

- Rugged aluminum and steel push bumpers for the 2020+ Ford Police Interceptor Utility
- Designed with additional mounting space to easily mount sirens or lights in the middle or top of the flat cross bar
- Uses powder coated steel brackets to provide protection against corrosion and adds additional strength
- Product includes all necessary hardware for a quick, seamless install
- Front upright protectors are preinstalled before being shipped for added convenience
- Includes highly reflective Gamber-Johnson label for increased visibility
- Minor fascia modification required when installing
- Limited Lifetime Warranty

NEW



2015-2020 FORD F-150 PUSH BUMPER

Item No.	Description	Weight	Height	Width	Depth
7170-0787-01	Steel Push Bumper with Standard Bar	85 lbs 38.56 kg	33" 83.8 cm	37.5" 95.3 cm	10" 25.4 cm
7170-0787-02	Steel Push Bumper with Light Bar	85 lbs 38.56 kg	33" 83.8 cm	37.5" 95.3 cm	10" 25.4 cm
7170-0787-03	Aluminum Push Bumper with Standard Bar	50 lbs 22.68 kg	33" 83.8 cm	37.5" 95.3 cm	10" 25.4 cm
7170-0787-04	Aluminum Push Bumper with Light Bar	50 lbs 22.68 kg	33" 83.8 cm	37.5" 95.3 cm	10" 25.4 cm

Features

- Rugged aluminum and steel push bumpers for the 2015+ Ford F-150
- Designed with a flat cross bar for easy mounting of lights, sirens or additional equipment
- Uses powder coated steel brackets to help with protection against corrosion
- Product includes all necessary hardware for a quick, seamless install
- Front upright protectors are preinstalled before being shipped for added convenience
- Highly reflective Gamber-Johnson label for maximum visibility
- Minor fascia modification required when installing
- Limited Lifetime Warranty

2021+ CHEVROLET TAHOE PUSH BUMPER

Item No.	Description	Weight	Height	Width	Depth
7170-0849-00	Steel Push Bumper with Standard Bar	78 lbs 35.38 kg	29" 73.7 cm	34" 86.4 cm	14" 35.56 cm
7170-0849-01	Steel Push Bumper with Light Bar	78 lbs 35.38 kg	29" 73.7 cm	34" 86.4 cm	14" 35.56 cm
7170-0849-02	Aluminum Push Bumper with Standard Bar	30 lbs 13.61 kg	29" 73.7 cm	34" 86.4 cm	14" 35.56 cm
7170-0849-03	Aluminum Push Bumper with Light Bar	30 lbs 13.61 kg	29" 73.7 cm	34" 86.4 cm	14" 35.56 cm



Features

- Rugged aluminum and steel push bumpers for the 2021+ Chevrolet Tahoe
- Designed with additional mounting space to easily mount sirens or lights in the middle or top of the flat cross bar
- Uses powder coated steel brackets to provide protection against corrosion and adds additional strength
- Product includes all necessary hardware for a quick, seamless install
- Front upright protectors are preinstalled before being shipped for added convenience
- Includes highly reflective Gamber-Johnson label for increased visibility
- Minor fascia modification required when installing
- Limited Lifetime Warranty

2011-2020 DODGE CHARGER PUSH BUMPER

Item No.	Description	Weight	Height	Width	Depth
7170-0649-01	Steel Push Bumper with Standard Bar	62 lbs. 28.12 kg	34" 86.36 cm	29" 73.66 cm	18" 45.72 cm
7170-0649-02	Steel Push Bumper with Light Bar	62 lbs. 28.12 kg	34" 86.36 cm	29" 73.66 cm	18" 45.72 cm
7170-0649-03	Aluminum Push Bumper with Standard Bar	40 lbs. 18.14 kg	29" 73.7 cm	34" 86.4 cm	18" 45.7 cm
7170-0649-04	Aluminum Push Bumper with Light Bar	40 lbs. 18.14 kg	29" 73.7 cm	34" 86.4 cm	18" 45.7 cm



Features

- Rugged aluminum and steel push bumpers for the 2011-2020 Dodge Charger
- Bumper with top bar weighs only 18 lbs (8.16 kg) without sacrificing durability
- Allows for mounting sirens or lights on flat cross bar in middle and a light cross bar at the top for additional placement opportunities
- Uses powder coated steel brackets to help with protection against corrosion strength attaching to vehicle
- Easy alignment process with all of the necessary hardware to install
- Some minor fascia modification required when installing. See installation guide for details
- Front upright protectors come pre-installed
- Highly reflective Gamber-Johnson label for maximum visibility
- Limited Lifetime Warranty

NEW



2020+ FORD POLICE INTERCEPTOR® UTILITY WINDOW BARS

Item No.	Description	Weight	Height	Width	Depth
7160-1411	Steel Window Bars	27 lbs 12.25 kg	15" 38.1 cm	36.975" 93.9 cm	2.75" 7.0 cm

Features

- Rugged and reliable steel window bars for the 2020+ Ford Police Interceptor Utility
- Steel window bars provide protection while still allowing visibility
- Redesigned to feature a LED mounting hole pattern for easy light installation
- Black powder coat finish for maximum corrosion resistance
- Fully welded construction for maximum strength and reliability
- Sold as a pair for both driver and passenger side
- Limited Lifetime Warranty

NEW



2020+ FORD POLICE INTERCEPTOR® UTILITY MESH WINDOW GUARDS

Item No.	Description	Weight	Height	Width
7160-1338	Mesh Window Guards	7 lbs 3.18 kg	13.65" 34.67 cm	34.75" 88.27 cm

Features

- Protective steel mesh window guards for the 2020+ Ford Police Interceptor Utility
- Metal mesh window guards for rear driver and passenger side windows
- Mesh provides protective coverage while still allowing visibility
- Self-tapping screws are used to fasten to window frame of door
- Constructed of 14 gauge steel for added strength and durability
- LED mounting locations on lower front corners for easy lighting installation
- Sold as a pair for both driver and passenger side
- Limited Lifetime Warranty

NEW



2021+ CHEVROLET TAHOE WINDOW BARS

Item No.	Description	Weight	Height	Width	Depth
7160-1558	Steel Window Bars	24 lbs 10.89 kg	19.43" 49.35 cm	37.25" 94.62 cm	0.92" 2.34 cm

Features

- 1/2" (1.27 cm) welded steel bars
- Black powder coat finish for long-term durability
- LED mounting locations on lower front corners
- Comes as a pair for both driver and passenger side
- Works ONLY with OEM door panels
- Limited Lifetime Warranty

NEW



2021+ CHEVROLET TAHOE POLY WINDOW GUARDS

Item No.	Description	Weight	Height	Width	Depth
7160-1560	Poly Window Guards	24 lbs 10.89 kg	19.43" 49.35 cm	37.25" 94.62 cm	0.92" 2.34 cm

Features

- Rugged and reliable Poly Window Guards for the 2021+ Chevrolet Tahoe
- Scratch resistant Poly Window Guards provide protection while still allowing visibility
- Includes mounting holes for the Universal Light Bracket (7160-1594)
- Black powder coat finish on the frame for maximum corrosion resistance
- Sold as a pair for both driver and passenger side
- Limited Lifetime Warranty

2011-2020 DODGE CHARGER WINDOW BARS

Item No.	Placement	Configuration	Drilling Required	Weight	Height	Width	Depth
7160-1141	Attaches to window frame of door	2011-2020 Dodge Charger Window Bars	Yes - drill holes for #10 X 1/2" sheetmetal screws	10 lbs per side	13.5" 34.3 cm	32" 7 cm	2.75" 81.3 cm



Features

- 1/2" (1.27 cm) welded steel bars
- Black powder coat finish for long-term durability
- LED mounting locations on lower front corners
- Comes as a pair for both driver and passenger side
- Works ONLY with OEM door panels
- Limited Lifetime Warranty

2011-2020 DODGE CHARGER MESH WINDOW GUARDS

Item No.	Placement	Description/Configuration	Drilling Required	Weight	Height	Width	Depth
7160-1139	Attaches to window frame of door	2011-2020 Dodge Charger Mesh Window Guards	Yes - drill holes for #10 X 1/2" sheetmetal screws	11.5 lbs per side	13.5" 34.3 cm	32" 81.3 cm	.62" 1.6 cm



Features

- 14 GA Steel Mesh
- Black powder coat finish for long-term durability
- Comes as a pair for both driver and passenger side
- Works ONLY with OEM door panels
- Limited Lifetime Warranty

2015-2020 FORD F-150 WINDOW BARS

Item No.	Description	Weight	Height	Width	Depth
7160-1415	Steel Window Bars	33 lbs 14.97 kg	19" 48.3 cm	32" 81.3 cm	3" 7.6 cm

NEW

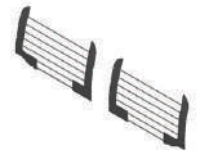

Features

- Rugged and reliable steel window bars for the 2015-2020 Ford F-150
- Steel window bars provide protection while still allowing visibility
- Fully welded construction for maximum strength and reliability
- LED mounting locations on lower front corners for easy lighting installation
- Black powder coat finish for long-term durability and maximum corrosion resistance
- Sold as a pair for both driver and passenger side
- Limited Lifetime Warranty

2015-2020 FORD F-150 MESH WINDOW GUARDS

Item No.	Description	Weight	Height	Width	Depth
7160-1405	Mesh Window Guards	30 lbs 13.61 kg	20" 50.8 cm	32" 81.3 cm	0.62" 1.6 cm

NEW



Features

- Protective steel mesh window guards for the 2015-2020 Ford F-150 Mesh Window Guards
- Mesh provides protective coverage while still allowing visibility
- Constructed of 14 gauge steel for added strength and durability
- LED mounting locations on lower front corners for easy lighting installation
- Black powder coat finish for long-term durability and maximum corrosion resistance
- Sold as a pair for both driver and passenger side
- Limited Lifetime Warranty

NEW



2020+ FORD POLICE INTERCEPTOR® UTILITY PASSENGER PARTITION

Item No.	Description	Weight	Height	Width	Depth
7160-1376	Poly Passenger Partition	95 lbs 43.09 kg	48" 121.92 cm	54.6" 138.68 cm	16.5" 41.91 cm

Features

- Poly passenger partition designed for the 2020+ Ford Police Interceptor Utility provides safety while maintaining visibility through the rear window
- Includes filler panels for main partition to separate the officer from the rear passenger area
- Foam padding around edge of hoop helps seal area between officer and rear passenger area
- Foot wells mount easily under the front seats to create a tight seal allowing for easy cleaning
- Frees up area behind passenger seat creating additional usable space for mounting various electronics
- Width does not include filler panels for around outside of hoop
- Length includes seat foot well depth
- Limited Lifetime Warranty

NEW



2020+ FORD POLICE INTERCEPTOR® UTILITY CARGO PARTITION - MESH

Item No.	Description	Weight	Height	Width	Depth
7160-1387-02	Mesh Cargo Partition	65 lbs 29.48 kg	35.9" 91.19 cm	54.5" 138.43 cm	9.8" 24.89 cm

Features

- Easy to install, mesh cargo partition for the 2020+ Ford Police Interceptor Utility creates a safe divide between cargo equipment and rear passenger
- Steel mesh allows for air movement while still providing clear visibility through rear-view mirror
- Includes filler panels designed to surround the main partition to help seal off the cargo area from any unwanted objects going in or coming out
- Includes four simple mounting points for easy installation
- Flat panel allows for mounting of different fuse panels and various equipment
- Width does not include filler panels for around outside of hoop
- Length includes top and bottom brackets
- Limited Lifetime Warranty

NEW



2015-2020 FORD F-150 PASSENGER PARTITION

Item No.	Description	Weight	Height	Width	Length
7160-1402	Poly Passenger Partition	95 lbs 43.09 kg	48" 121.92 cm	54.6" 138.68 cm	16.5" 41.91 cm

Features

- Poly passenger partition designed for the 2015-2020 Ford F-150 provides safety while maintaining visibility through the rear window
- Includes filler panels for main partition to separate the officer from the rear passenger area
- Foam padding around edge of hoop helps seal area between officer and rear passenger area
- Foot wells mount easily under the front seats to create a tight seal allowing for easy cleaning
- Frees up area behind passenger seat creating additional usable space for mounting various electronics
- Width does not include filler panels for around outside of hoop
- Length includes seat foot well depth
- Limited Lifetime Warranty

NEW



2011-2020 DODGE CHARGER PASSENGER PARTITION

Item No.	Description	Weight	Height	Width	Length
7160-1138	Poly Passenger Partition	95 lbs 43.09 kg	48" 121.92 cm	54.6" 138.68 cm	16.5" 41.91 cm

Features

- Passenger partition with a poly center window designed for a secure fit in the 2011-2020 Dodge Charger
- Includes filler panels for main partition to separate the officer from the rear passenger area
- Foam padding around edge of hoop helps seal area between officer and rear passenger area
- Foot wells mount easily under the front seats to create a tight seal allowing for easy cleaning
- Frees up area behind passenger seat creating additional usable space for mounting various electronics
- Width does not include filler panels for around outside of hoop
- Length includes seat foot well depth
- Limited Lifetime Warranty

2021+ CHEVROLET TAHOE PASSENGER PARTITION

Item No.	Description	Weight	Height	Width	Length
7160-1556	Poly Passenger Partition	100 lbs 45.36 kg	49.82" 126.54 cm	63.18" 160.48 cm	8.7" 22.1 cm

Features

- Poly passenger partition designed for the 2021+ Chevrolet Tahoe provides safety while maintaining visibility through the rear window
- Includes filler panels for main partition to separate the officer from the rear passenger area
- Foam padding around edge of hoop helps seal area between officer and rear passenger area
- Foot wells mount easily under the front seats to create a tight seal allowing for easy cleaning
- Frees up area behind passenger seat creating additional usable space for mounting various electronics
- Limited Lifetime Warranty

NEW



2021+ CHEVROLET TAHOE CARGO PARTITION - MESH

Item No.	Description	Weight	Height	Width	Length
7160-1557	Mesh Cargo Partition	90 lbs 40.82 kg	45.46" 115.47 cm	59.75" 151.77 cm	2.85" 7.24 cm (does not include rear support rod)

Features

- Easy to install, mesh cargo partition for the 2021+ Chevrolet Tahoe creates a safe divide between cargo equipment and rear passenger
- Includes filler panels designed to surround the main partition, securing gear and equipment in the cargo area
- Flat panel allows for mounting of different fuse panels and various equipment
- Includes three simple mounting points for easy installation
- Full width bottom mounting bracket adds stability to the partition
- Limited Lifetime Warranty

NEW





GUN MOUNTS

Item No.	Placement	Weight	Height	Width	Length	Depth
7160-1097-01	Single Weapon Gun Mount	7.0 lbs. 3.2 kg	33.0" 83.8 cm	n/a	n/a	5.5" 13.97 cm
7160-1097-02	Dual Weapon Gun Mount	10.2 lbs. 4.6 kg	33.0" 83.8 cm	n/a	n/a	

Features

- Features the universal Santa Cruz SC-6 lock to secure a variety of weapon styles and sizes
- Dual channel system allows full adjustability of lock heads and butt plates
- Sliding mounting brackets provide great adaptability to horizontal or vertical installations
- Universal butt plate fits most weapons
- Black powder coat and anodized finish for maximum corrosion resistance
- Limited Lifetime Warranty

2020+ FORD POLICE INTERCEPTOR® UTILITY FLIP UP STORAGE TRAY

Item No.	Description	Weight	Height	Width	Depth
7160-1480	Equipment Trunk Tray	68 lbs 30.84 kg	7" 17.78 cm	47.5" 120.65 cm	28.12" 71.42 cm



Features

- Flip-up storage tray designed specifically for the 2020+ Ford Police Interceptor Utility for a rugged and reliable fit
- Upper and lower level trays provide ample equipment mounting space
- Provides easy access to equipment for installing and servicing
- Two shocks enable the upper tray to stay open without the use of a latch
- Each shock has a load rating of 100 lbs
- Installation requires minimal modification to OEM parts, maintaining vehicle crash rating
- 3" (7.62 cm) of clearance between lower and upper trays
- Limited Lifetime Warranty

2011-2020 DODGE CHARGER TRUNK SHELF

Item No.	Description	Weight	Height	Width	Depth
7160-0336	Upper Shelf	18.0 lbs 8.2 kg	10.1" 25.7 cm	14.01" 35.6 cm	35.66" 90.6 cm
7160-0020	Lower Shelf	25.0 lbs 11.3 kg	3.76" 9.6 cm	32.50" 82.6 cm	20.0" 50.8 cm

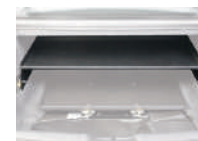

Features

- Easy to install, vehicle specific equipment trays for the 2011-2020 Dodge Charger
- Constructed of strong, lightweight aluminum alloy
- Lower tray slides on heavy-duty ball bearing slides and can latch securely in the closed position
- Provides easier access and safe mounting of the spare tire
- Spare tire tie down bolt and nut are provided with tray
- Will accommodate either a full size or compact spare tire
- Available mounting space for Upper Shelf 37.75" x 18.5" (95.9 cm x 47.0 cm)
- Available mounting space for Lower Shelf 32.0" x 19.75" (81.3 cm x 50.2 cm)
- Limited Lifetime Warranty

EQUIPMENT STORAGE BOX FOR ELECTRONICS

Item No.	Description	Weight	Height	Width	Depth
7160-1048	SUV Equipment Storage	47.5 lbs. 21.5 kg	18.0" 45.7 cm	38.0" 96.5 cm	6.0" 15.2 cm



Features

- Removable mounting tray on back wall
- Removable front door panel
- Dual keyed lockable latches
- Mounting holes in the back wall to mount to rear cage
- Brackets for raising the box off the floor
- Ventilation holes for air flow. Vent covers can be replaced with 80 mm case face - customer supplied.
- Six knockouts for cable entry into box - 2" (5 cm) diameter, 2 on each side and 2 on the bottom
- Limited Lifetime Warranty

TRUNK BOX

Item No.	Description	Weight	Height	Width	Depth
7160-1498	Lockable Storage Box	64.5 lbs. 29.26 kg	12.87" 32.69 cm	36.4" 92.46 cm	26.82" 68.12 cm
7160-1515	2020+ Ford Police Interceptor Utility Trunk Box Leg Kit	14 lbs 6.35 kg	20" 50.8 cm	15" 38.1 cm	54" 137.16 cm



Features

- Lockable storage box for equipment
- Easily mounts to Gamber-Johnson cargo partition
- Can be used with or without partition for flexibility of install
- Vehicle specific leg kit creates a customized fit
- Limited Lifetime Warranty





MOTION ATTACHMENTS

Gamber-Johnson's motion attachments are one of the key components needed to mount a docking station or cradle to give users the flexibility desired. The motion attachment allows for tilting, swiveling, rotating, and locking to ensure safety and ergonomic use in a mobile office environment. From laptops to tablets, our wide range of devices help perfect the right solution.



NEW



7160-1116-07

MONGOOSE® XE WITH CLEVIS

Item No.	Description	Placement/Compatibility	Weight	Height	Width	Depth
7160-1116-07	7" (17.78 cm) Motion Attachment	Center Console or Center Upper Pole	5.5 lbs 2.49 kg	3.5" 8.89 cm	5.5" 13.97 cm	8.38" 21.29 cm
7160-1116-09	9" (22.86 cm) Motion Attachment	Center Console or Center Upper Pole	5.68 lbs 2.58 kg	3.5" 8.89 cm	5.5" 13.97 cm	10.38" 26.37 cm
7160-1116-12	12" (30.48 cm) Motion Attachment	Center Console or Center Upper Pole	6.1 lbs 2.58 kg	3.5" 8.89 cm	5.5" 13.97 cm	13.38" 33.99 cm
7160-1116-15	15" (38.1 cm) Motion Attachment	Center Console or Center Upper Pole	6.8 lbs 3.08 kg	3.5" 8.89 cm	5.5" 13.97 cm	6.5" 41.91 cm

Features

- Color touch points for quick adjustments
- Sleek, low profile design
- Effortless positioning for user for user
- Newly designed braking system allows for secure positioning at roughly every inch
- Trolley can quickly and easily be pushed to the secure position for when vehicle is in motion
- Front pivot control lever locks arm in secure positions every 21°
- Attachment allows for computer/keyboard use between both driver and passenger position
- Clevis can be positioned on center on pivot portion of motion attachment for stowing device out of the way when not in use
- Attaches to any center upper or console top plate with the 3-hole pattern
- Clevis contains following hole patterns: VESA 75 mm, AMPS, NEC, and Gamber-Johnson 2x4
- MIL STD 810G, Mechanical Shock 20G and 40G, Tested to 30,000 Cycles
- Limited Lifetime Warranty

NEW

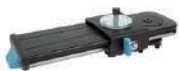

7160-1210-12

MONGOOSE® XE WITH 3/8" STUD

Item No.	Description	Placement/Compatibility	Weight	Height	Width	Depth
7160-1210-07	7" (17.78 cm) Motion Attachment	Center Console or Center Upper Pole	3.85 lbs 1.75 kg	3" 7.62 cm	5.5" 13.97 cm	8.38" 21.29 cm
7160-1210-09	9" (22.86 cm) Motion Attachment	Center Console or Center Upper Pole	4.05 lbs 1.88 kg	3" 7.62 cm	5.5" 13.97 cm	10.38" 26.37 cm
7160-1210-12	12" (30.48 cm) Motion Attachment	Center Console or Center Upper Pole	4.45 lbs 2.02 kg	3" 7.62 cm	5.5" 13.97 cm	13.38" 33.99 cm
7160-1210-15	15" (38.1 cm) Motion Attachment	Center Console or Center Upper Pole	5.05 lbs 2.29 kg	3" 7.62 cm	5.5" 13.97 cm	16.5" 41.91 cm

Features

- Color touch points for quick adjustments
- Sleek, low profile design
- Effortless positioning for user
- Newly designed braking system allows for secure positioning at roughly every inch
- Trolley can quickly and easily be pushed to the secure position for when vehicle is in motion
- Front pivot control lever locks arm in secure positions every 21°
- Attachment allows for computer/keyboard use between both driver and passenger position
- Clevis can be positioned on center on pivot portion of motion attachment for stowing device out of the way when not in use
- Attaches to any center upper or console top plate with the 3-hole pattern
- Clevis or tablet display bracket mounts to the 3/8" stud (sold separately)
- MIL STD 810G, Mechanical Shock 20G and 40G, Tested to 30,000 Cycles
- Limited Lifetime Warranty

MONGOOSE® XLE WITH CLEVIS

Item No.	Description	Placement/Compatibility	Weight	Height	Width	Depth
7160-1216-07	7" (17.78 cm) Motion Attachment	Center Console or Center Upper Pole	5.6 lbs 2.54 kg	3.5" 8.89 cm	5.5" 13.97 cm	8.38" 21.29 cm
7160-1216-09	9" (22.86 cm) Motion Attachment	Center Console or Center Upper Pole	5.8 lbs 2.63 kg	3.5" 8.89 cm	5.5" 13.97 cm	10.38" 26.37 cm
7160-1216-12	12" (30.48 cm) Motion Attachment	Center Console or Center Upper Pole	6.2 lbs 2.81 kg	3.5" 8.89 cm	5.5" 13.97 cm	13.38" 33.99 cm
7160-1216-15	15" (38.1 cm) Motion Attachment	Center Console or Center Upper Pole	6.8 lbs 3.08 kg	3.5" 8.89 cm	5.5" 13.97 cm	16.5" 41.91 cm

NEW



7160-1216-09

Features

- Color touch points for quick adjustments
- Sleek, low profile design
- Effortless positioning for user
- Newly designed braking system allows for secure positioning at roughly every inch
- Trolley can quickly and easily be pushed to the secure position
- Front pivot control lever locks arm in secure positions every 21°
- Attachment allows for computer/keyboard use between both driver and passenger position
- Clevis can be positioned on center on pivot portion of motion attachment for stowing device out of the way when not in use
- Attaches to any center upper or console top plate with the 3-hole pattern
- Designed to work with the Independent Display bracket assembly (7110-1305 and 7110-1306)
- 7" (17.78 cm) and 9" (22.86 cm) lengths recommended for cars and SUVs
- 12" (30.48 cm) and 15" (38.10 cm) lengths recommended for pickups and larger trucks
- Trolley plate is extended to provide 4" (10.16 cm) of additional length
- Clevis contains following hole patterns: VESA 75 mm, AMPS, NEC, and Gamber-Johnson 2x4
- MIL STD 810G, Mechanical Shock 20G and 40G, Tested to 30,000 Cycles
- Limited Lifetime Warranty

MONGOOSE® XLE WITH 3/8" STUD

Item No.	Description	Placement/Compatibility	Weight	Height	Width	Depth
7160-1220-07	7" (17.78 cm) Motion Attachment	Center Console or Center Upper Pole	3.95 lbs 1.79 kg	3" 7.62 cm	5.5" 13.97 cm	8.38" 21.29 cm
7160-1220-09	9" (22.86 cm) Motion Attachment	Center Console or Center Upper Pole	4.15 lbs 1.88 kg	3" 7.62 cm	5.5" 13.97 cm	10.38" 26.37 cm
7160-1220-12	12" (30.48 cm) Motion Attachment	Center Console or Center Upper Pole	4.55 lbs 2.06 kg	3" 7.62 cm	5.5" 13.97 cm	13.38" 33.99 cm
7160-1220-15	15" (38.1 cm) Motion Attachment	Center Console or Center Upper Pole	5.15 lbs 2.34 kg	3" 7.62 cm	5.5" 13.97 cm	16.5" 41.91 cm

NEW



7160-1220-15

Features

- Color touch points for quick adjustments
- Sleek, low profile design
- Effortless positioning for user
- Newly designed braking system allows for secure positioning at roughly every inch
- Trolley can quickly and easily be pushed to the secure position for when vehicle is in motion
- Front pivot control lever locks arm in secure positions every 21°
- Attachment allows for computer/keyboard use between both driver and passenger position
- Clevis can be positioned on center on pivot portion of motion attachment for stowing device out of the way when not in use
- Attaches to any center upper or console top plate with the 3-hole pattern
- Clevis or tablet display bracket mounts to the 3/8" stud (sold separately)
- MIL STD 810G, Mechanical Shock 20G and 40G, Tested to 30,000 Cycles
- Limited Lifetime Warranty

NEW



MONGOOSE® XLE WITH 3/8" STUD

Item No.	Description	Placement/Compatibility	Weight	Height	Width	Depth
7110-1305	Mongoose XLE Independent Display Bracket for Gamber-Johnson	Rear Pivot Portion of Mongoose XLE for Tablet Display Bracket	1.65 lbs 0.75 kg	4" 10.16 cm	3" 7.62 cm	3.88" 9.34cm

Features

- Mounts over top of the pivot point of the Mongoose XLE creating a smaller footprint
- 3/8" stud accommodates both Gamber-Johnson VESA 75 mm Tablet Displays (7160-0761 and 7160-0831)
- Tight fit with the foam pad allows for vibration dampening of tablet display portion
- Motion attachment and tablet display are independent from each other to allow stationary viewing
- Does NOT include bearing hardware
- Limited Lifetime Warranty

NEW



MONGOOSE® XLE INDEPENDENT DISPLAY BRACKET FOR ZIRKONA

Item No.	Description	Placement/Compatibility	Weight	Height	Width	Depth
7110-1306	Mongoose XLE Independent Display Bracket for Zirkona	Rear Pivot Portion of Mongoose XLE for Tablet Display with Zirkona	1.8 lbs 0.82 kg	3.5" 8.89 cm	3" 7.62 cm	3.88" 9.34cm

Features

- Mounts over top of the pivot point of the Mongoose XLE creating a smaller footprint
- M20 threads adapts to a Zirkona Tablet display for use with smaller tablets
- Tight fit with the foam pad allows for vibration dampening of tablet display portion
- Motion attachment and tablet display are independent from each other to allow stationary viewing
- Does NOT include bearing hardware
- Limited Lifetime Warranty

TABLET DISPLAY MOUNT

Item No.	Tilt	Swivel	Weight	Height	Width	Depth
7160-0494	Display can be Tilted Down 160° Away From the Dash	Display can be Swiveled 60° Right/60° Left	3.85 lbs 1.7 kg	8.42" to 10.3" (21.4 to 26.2 cm) <i>Entire mounting system will determine overall height</i>	5.5" 14 cm	5.75" 14.6 cm
7160-0529	Display can be Tilted Down 160° Away From the Dash	Display can be Swiveled 60° Right/60° Left	4.0 lbs 1.7 kg	10.3" to 12.7" (26.2 to 32.3 cm) <i>Entire mounting system will determine overall height</i>	5.5" 14 cm	5.75" 14.6 cm

Features

- The tablet display mount can be placed on any Gamber-Johnson upper pole, the Mongoose (7160-0220) or 3-hole pattern found on a console system (ordered separately) allowing flexibility in how you want to adapt the tablet in a vehicle
- Display mount can easily be tilted down 160° away from the dashboard, providing easy access to the controls on the instrument panel
- Display mount can be swiveled 60° right/60° left for optimal viewing positioning
- Display mount is height adjustable to accommodate the various sizes of tablet computers and docking stations
- Can be used with the quick release keyboard tray for Motion Attachment (7160-0498) and one of the following Motion Attachments to make a sliding keyboard:
 - Quad-Motion TS3 (7160-0284)
 - Quad-Motion TS5 (7160-0285)
 - Mongoose (7160-0427), Mongoose XE (7160-1210-XXv), Mongoose XLE (7160-1220-XX)
 - 6" locking slide arm (7160-0514) with 3/8" stud
- Display mount can be used with any tablet or tablet docking station that has an AMPS, NEC, Gamber-Johnson or VESA 75 mm hole pattern
- Limited Lifetime Warranty



7160-0494



7160-0529

TABLET DISPLAY MOUNT KITS WITH KEYBOARD

Item No.	Included in Kit	Weight	Height	Width	Depth
7170-0217	Tablet Display Mount (7160-0494), 6" Locking Slide Arm with 3/8" Stud (7160-0514), Quick Release Keyboard Tray (7160-0498), 3/8" Clevis Motion Attachment (7160-1008)	13.0 lbs 5.9 kg	10.0 - 12.0" 25.4 - 30.5 cm <i>Entire mounting system will determine overall height</i>	12.88" 32.7 cm	11.25" 28.6 cm
7170-0217-01	Tall Tablet Display Mount (7160-0529), 6" Locking Slide Arm with 3/8" Stud (7160-0514), Quick Release Keyboard Tray (7160-0498), 3/8" Clevis Motion Attachment (7110-1008)	13.15 lbs 5.96 kg	11.89 - 14.4" 30.2 - 36.58 cm <i>Entire mounting system will determine overall height</i>	12.88" 32.7 cm	11.25" 28.6 cm

Features

- The Tablet Display Mount Kit can be placed on any Gamber-Johnson Upper Pole or 3-hole pattern found on a MCS Console System (ordered separately) allowing flexibility in how you want to adapt the tablet in a vehicle
- Display Mount can easily be tilted down 160° away from the dashboard. The downward tilt helps provide easy access to the controls on the instrument panel
- Display Mount can be swiveled 360° for optimal viewing positioning
- Display Mount is height adjustable to accommodate the various sizes of tablet computers and docking stations
- Heavy gauge steel construction for long-term durability
- Black powder coat finish for maximum corrosion resistance
- Display Mount can be used with any tablet or tablet docking station that has an AMPS, NEC, Gamber-Johnson or VESA 75 mm hole pattern
- Limited Lifetime Warranty



7170-0217



7170-0217

TABLET DISPLAY MOUNT KITS WITH KEYBOARD



7170-0218



7170-0219



7170-0219-01



7170-0513-01

Item No.	Included in Kit	Weight	Height	Width	Depth
7170-0218	Tablet Display Mount (7160-0494), Mongoose with 3/8" Stud (7160-0427), Clevis (7110-1008), Keyboard (7160-0498)	14.5 lbs 6.6 kg	9.88" to 11.75" (25.1 to 29.8 cm) <i>Entire mounting system will determine overall height</i>	12.88" 32.7 cm	13.62" 34.6 cm
7170-0218-01	Tall Tablet Display Mount (7160-0529), Mongoose with 3/8" Stud (7160-0427), Clevis (7110-1008), Keyboard (7160-0498)	14.7 lbs 6.6 kg	11.77" to 14.5" (29.9 to 36.8 cm) <i>Entire mounting system will determine overall height</i>	12.88" 32.7 cm	13.62" 34.6 cm
7170-0219	Tablet Display Mount (7160-0494), Quad-Motion TS5 (7160-0285), Clevis (7110-1008), Keyboard (7160-0498)	12.0 lbs 5.4 kg	8.38" to 10.25" (21.3 to 26 cm) <i>Entire mounting system will determine overall height</i>	12.88" 32.7 cm	11.18" 28.4 cm
7170-0219-01	Tall Tablet Display Mount (7160-0529), Quad-Motion TS5 (7160-0285), Clevis (7110-1008), Keyboard (7160-0498)	12.2 lbs 5.5 kg	10.27" to 12.65" (26.1 to 32.1 cm) <i>Entire mounting system will determine overall height</i>	12.88" 32.7 cm	11.18" 28.4 cm
7170-0513	Tablet Display Mount (7160-0494), Quad-Motion TS5 (7160-0285), Keyboard (7160-0857)	9.4 lbs 4.3 kg	8.38" to 10.25" (21.2 to 26 cm) <i>Entire mounting system will determine overall height</i>	7.40" 18.8 cm	13.27" 33.7 cm
7170-0513-01	Tall Tablet Display Mount (7160-0529), Quad-Motion TS5 (7160-0285), Keyboard (7160-0857)	9.5 lbs 4.3 kg	10.27" to 12.65" (26 to 32.1 cm) <i>Entire mounting system will determine overall height</i>	7.40" 18.8 cm	13.27" 33.7 cm

INDEPENDENT TABLET DISPLAY MOUNT BASE



Item No.	Placement	Weight	Height	Width	Depth
7160-0758	Attaches to the Top Bracket of the Independent Tablet Display Mount (7160-0761) and can be Placed on any Upper Pole, Complete Pole, Center Pole, 3-Hole Pattern Found on a MCS Console System	4.0 lbs 1.8 kg	5.2" - 6.8" 13.2 cm - 17.3 cm	3.0" 7.6 cm	4.5" 11.43 cm

Features

- Independent Tablet Display Mount Base is height adjustable to accommodate the various sizes of tablet computers and docking stations heights
- Base can be used in conjunction with the Mongoose (7160-0220) and the Independent Tablet Display Bracket (7160-0761) to form a solution
- Base attaches to any Gamber-Johnson upper pole or 3-hole pattern found on the MCS console system (ordered separately)
- Limited Lifetime Warranty

INDEPENDENT TABLET DISPLAY MOUNT



Item No.	Placement	Tilt	Rotate	Weight	Height	Width	Depth
7160-0761	Attaches to the Base of the Independent Tablet Display Mount (7160-0758) and to any Tablet Display or Gamber-Johnson Tablet Docking Station with a VESA 75 mm Mounting Hole Pattern	Yes - Total of 53°	360°	2.6 lbs 1.6 kg	9.2" 23.4 cm	4.2" 10.67 cm	5.65" 14.35 cm

Features

- Attaches to the base of the Independent Tablet Display Mount (7160-0758)
- Has four mounting positions that allow the tablet display or tablet docking station to be positioned at the optimal viewing height
- Bracket can be tilted down 160° away from the dash to provide easy access to the controls on the instrument panel
- Docks and Cradles mounted using any 75 mm hole pattern position
- Limited Lifetime Warranty

TALL INDEPENDENT TABLET DISPLAY MOUNT

Item No.	Description	Placement	Weight	Height	Width	Depth
7160-0831	Tall Independent Tablet Display Mount	Attaches to the Base of the Independent Tablet Display Mount (7160-0758) and to any Tablet Display or Gamber-Johnson Tablet Docking Station with a VESA 75 mm Mounting Hole Pattern	2.75 lbs 1.25 kg	12" 30.48 cm	4.2" 10.6 cm	6.02" 15.29 cm



Features

- Taller display bracket helps to increase visibility of screen for driver
- Works best with tablet docks with downward facing ports (i.e. Panasonic Toughbook 33 Tablet docks and cradles)
- Bracket can be tilted down 160° to help with better access around the dock
- Great display bracket to use with Mongoose XLE Independent Display Bracket (7110-1305)
- Multiple VESA 75 mm mounting holes to get the ideal height during install
- Limited Lifetime Warranty

FOLD-UP TABLET AND KEYBOARD MOUNT

Item No.	Description	Placement	Weight	Height	Width	Depth
7160-1445	Tablet and Keyboard Mount / Keyboard Tray Works with Mountable Keyboards and the Quick-Release Keyboard Tray (7160-0857)	Attaches to any 3/8" stud	3.95 lbs 1.79 kg	9.25" 23.5 cm	6.58" 16.71 cm	12.67" 32.18 cm



Features

- Fold-up your keyboard when not in use to make the dock and keyboard mounted compact
- Swivel and/or telescope the keyboard and display together for easy viewing and operation
- Ratcheting handles (2) for swift adjustment of keyboard and display
- Ratcheting handles can also be installed on either side of mount depending on the use case
- Includes friction bearing hardware bag to mount to the center hole located in the 3-hole pattern
- Keyboard and display can tilt to operator's desired position
- Display can tilt to help avoid unwelcome glare
- Bottom portion features three (3) 3/8" holes allowing the user different positions to mount on motion device
- VESA 75 mm threaded PEMS permits the ability to mount to anything that contains VESA 75 mm holes (i.e. clevis' and universal adapter 7160-0454)
- Keyboard contains VESA 75 mm, VESA 50 mm, AMPS, and NEC hole patterns to accommodate various mountable keyboards
- Display features 4 different VESA 75 mm positions to accommodate different size tablet docks and cradles
- Limited Lifetime Warranty

INDEPENDENT ROTATION TABLET DISPLAY MOUNT KIT

Item No.	Included in Kit	Weight	Height	Width	Depth
7170-0514	Independent Tablet Display Mount (7160-0761), Mount Base (7160-0758), Mongoose Motion Attachment (7160-0427), Short Clevis with Handle (7160-0783), Low Profile Quick Release Keyboard Tray (7160-0857)	15.0 lbs 6.8 kg	14.4 - 16.0" 36.6 - 40.6 cm	7.5" 19.1 cm	14.4" 36.6 cm
7170-0514-01	Tall Independent Tablet Display Mount (7160-0831), Mount Base (7160-0758), Mongoose Motion Attachment (7160-0427), Short Clevis with Handle (7160-0783), Low Profile Quick Release Keyboard Tray (7160-0857)	15.15 lbs 6.87 kg	17.4" - 19" 44.20 cm - 48.26cm	7.5" 19.05 cm	14.4" 36.58 cm



Features

- Can be mounted on either a Gamber-Johnson upper pole or directly to a console box (mission control system) with a 3-hole pattern
- Rotate the tablet and keyboard independent of each other
- Quick release keyboard comes with built-in optional heavy-duty key lock to keep the keyboard from being removed
- Can be tilted up to 160° down from the dashboard so you have access to controls on the instrument panel
- Has four mounting positions to accommodate various sizes of tablets and docking stations
- Can be used with any tablet or tablet docking station with a VESA 75mm hole pattern
- Tall Independent Rotation Tablet Display Mount Kit (7170-0514-01) is taller to accommodate different tablet docks and offer more height
- Limited Lifetime Warranty

VESA 75 MM & GAMBER-JOHNSON HOLE PATTERN CLEVIS



7160-0750



7160-0775



7160-0776

Item No.	Description	Placement	Tilt	Swivel	Weight	Height	Width	Depth
7160-0750	Standard	Any Upper Pole, Compatible Pole, Center Pole, Low Profile Bracket, or Directly to any Flat Surface	Yes - Up to 90° fore/ 26° aft	Yes - 360°	2.2 lbs 1 kg	2.17" 5.5 cm	8.18" 20.8 cm	4.4" 11.2 cm
7160-0775	Short	Any Upper Pole, Compatible Pole, Center Pole, Low Profile Bracket, or Directly to any Flat Surface	Yes - Up to 45° fore	Yes - 360°	2.2 lbs 1 kg	1.47" 3.7 cm	7.23" 18.4 cm	4.05" 10.3 cm
7160-0776	Tall	Any Upper Pole, Compatible Pole, Center Pole, Low Profile Bracket, or Directly to any Flat Surface	Yes - Up to 90° fore/30° aft	Yes - 360°	3.0 lbs 1.4 kg	5.71" 14.5 cm	7.23" 18.4 cm	4.4" 11.2 cm

Features

- Built in swivel function allows Clevis to be mounted on any flat, rigid surface.
- When mounted to a 3-hole pattern the built in swivel function gives the user more flexibility of the Clevis positioning during installation.
- Top locknut allows the clevis to be fixed in position
- Lever provides a secure clamping force when tilted
- Clevis works with the following hole patterns: VESA 75 mm, Gamber-Johnson 2x4, NE, AMPS
- Limited Lifetime Warranty

3/8" HOLE WITH VESA 75MM & GAMBER-JOHNSON HOLE PATTERN CLEVIS



Item No.	Placement	Tilt	Swivel	Weight	Height	Width	Depth
7110-1200	Any Upper Pole, Compatible Pole, Center Pole, Low Profile Bracket. Has a 3/8" Center Hole for 360° Rotation. Is Recommended to be Used With 3/8" Stud Motion Attachments (7160-0427, 7160-0514, 7160-1210-XX OR 7160-1220-XX Motion Attachments).	Yes - Up to 90° fore/ 26° aft	Yes - 360°	2.2 lbs 1 kg	2.4" 6.1 cm	8.18" 20.8 cm	4.40" 11.2 cm

Features

- Allows for increased tilt capabilities of 45° forward and 360° swivel
- Riveted design allows for smoother tilt movement
- Clevis can mount on any Gamber-Johnson console box, pole or flat, rigid surface
- Provide 360° swivel function for improved ergonomic positioning within the vehicle
- Rear fastening stud allows the Clevis to be locked in a fixed position
- Lever provides a secure clamping force when tilted
- Heavy gauge steel construction for long-term durability
- Black powdercoat finish for maximum corrosion resistance
- Clevis contains following hole patterns: VESA 75 mm, AMPS, NEC, and Gamber-Johnson 2x4
- Limited Lifetime Warranty

SHORT CLEVIS W/HANDLE



Item No.	Description	Placement	Weight	Height	Width	Depth
7160-0783	Short Clevis w/Handle	Attaches to any 3-Hole Pattern to Attach Docks, Cradles, Keyboards	2 lbs 0.91 kg	1.47" 3.73 cm	7.23" 18.36 cm	4.05" 10.29 cm

Features

- Allows for increased tilt capabilities of 45° forward and 360° swivel
- Riveted design allows for smoother tilt movement
- Clevis can mount on any Gamber-Johnson console box, pole or flat, rigid surface
- Provide 360° swivel function for improved ergonomic positioning within the vehicle
- Rear fastening stud allows the Clevis to be locked in a fixed position
- Lever provides a secure clamping force when tilted
- Heavy gauge steel construction for long-term durability
- Black powdercoat finish for maximum corrosion resistance
- Clevis contains following hole patterns: VESA 75 mm, AMPS, NEC, and Gamber-Johnson 2x4
- Limited Lifetime Warranty

LOWSWIVEL VESA 75 MM & GAMBER-JOHNSON HOLE PATTERN

Item No.	Placement	Tilt	Swivel	Weight	Height	Width	Depth
LOWSWIVEL	Any Upper Pole, Compatible Pole, Center Pole, Low Profile Bracket	No	Yes - 360°	1.4 lbs 0.6 kg	1.94" 4.9 cm	5.25" 13.3 cm	3.68" 9.3 cm
7160-0762	Any Upper Pole, Compatible Pole, Center Pole, Low Profile Bracket. Has a 3/8" Center Hole for 360° Rotation. Is Recommended to be used with 3/8" Stud Motion Attachments (7160-0427 or 7160-0514)	No	Yes - 360°	0.35 lbs 0.2 kg	1.67" 4.2 cm	5.25" 13.3 cm	3.68" 9.3 cm
7160-0268	Any Upper Pole, Compatible Pole, Center Pole, Low Profile Bracket	No - Motion Attachment has a fixed angle of 10°	Yes - 360°	1.4 lbs 0.6 kg	2.52" 6.4 cm	5.25" 13.3 cm	3.65" 9.3 cm
7160-0436	Any Upper Pole, Compatible Pole, Center Pole, Low Profile Bracket. Has a 3/8" Center Hole for 360° Rotation. Is Recommended to be used with 3/8" Stud Motion Attachments (7160-0427 or 7160-0514)	No - Motion Attachment has a fixed angle of 10°	Yes - 360°	0.36 lbs 0.2 kg	2.52" 6.4 cm	5.25" 13.3 cm	3.65" 9.3 cm

Features

- Provides a low profile for mounting equipment
- Clevis works with the following hole patterns: VESA 75 mm, Gamber-Johnson 2x4, NEC, AMPS
- Limited Lifetime Warranty



LOWSWIVEL



7160-0268



7160-0436

MINI-CLEVIS

Item No.	Placement	Tilt	Swivel	Weight	Height	Width	Depth
7160-0162	Any Upper Pole, Compatible Pole, Center Pole, Low Profile Bracket	Yes - Up to 72° fore/40° aft	Yes - up to 60° right/ 60° left	1.04 lbs 0.5 kg	2.62" 6.7 cm	5.16" 13.1 cm	3.13" 8 cm

Features

- Designed to work with smaller handheld devices (rugged and non-rugged)
- Will hold devices up to 3.5 lbs (1.6 kg)
- Ratcheting lever allows for easy tilting adjustment
- Clevis works with the following hole patterns: NEC, AMPS
- Limited Lifetime Warranty



6" ARTICULATING ARM WITH VESA 75 MM & GAMBER-JOHNSON HOLE PATTERN

Item No.	Placement	Tilt	Swivel	Rotate	Weight	Height	Width	Depth
7160-0497	Any Upper Pole, Compatible Pole, Center Pole, Low Profile Bracket or the Universal Portable Base (7160-0033)	Yes - Up to 90° fore/26° aft	Yes - 360°	Yes - 360°	4.24 lbs 1.9 kg	5.63" 14.3 cm	7.29" 18.5 cm	9.35" 23.7 cm

Features

- Marine-grade aluminum to help prevent rusting
- Can tilt, swivel, pull-out and rotate equipment 360° to virtually any position for optimal computer placement
- Extends 6" bringing equipment close to the user
- Recommended for use with universal portable base (7160-0033)
- Clevis works with the following hole patterns: VESA 75 mm, Gamber-Johnson 2x4, NEC, AMPS
- Limited Lifetime Warranty



6" LOCKING SLIDE ARMS WITH VESA 75MM & GAMBER-JOHNSON HOLE PATTERN



7160-0500



7160-1160



7160-0502

Item No.	Placement	Motion Attachment Included	Tilt	Rotate	Slide	Weight	Height	Width	Depth
7160-0500	Any Upper Pole, Compatible Pole, Center Pole, Low Profile Bracket, or Directly to any Flat Surface	Yes - includes a standard Clevis	Yes - Up to 90° fore/ 26° aft	Motion Attachment - 360° Entire Arm - 360° can lock at every 15°	Yes - Up to 5.5" fore/aft	4.9 lbs 2.2 kg	4.59" 11.7 cm	7.23" 18.4 cm	9.39" 23.9 cm
7160-1160	Any Upper Pole, Complete Pole, Center Pole, Low Profile Bracket, Gamber-Johnson Console Box via 3-Hole Pattern or Directly to any Flat Surface	Yes - includes a Short Clevis	Yes - Up to 45°	Motion Attachment - 360° Entire Arm - 360° can lock at every 15°	Yes - Up to 5.5" fore/aft	5.2 lbs 3.1 kg	3.9" 9.9 cm	7.2" 18.4 cm	9.39" 23.9 cm
7160-0502	Any Upper Pole, Compatible Pole, Center Pole, Low Profile Bracket, or Directly to any Flat Surface	Yes - includes a Lowswivel	No - Motion Attachment has a fixed angle of 10°	Motion Attachment - 360° Entire Arm - 360° can lock at every 15°	Yes - Up to 5.5" fore/aft	4.7 lbs 2.1 kg	3.94" 9.6 cm	5.25" 13.3 cm	8.69" 22.1 cm

Features

- The entire arm can rotate around 360° with locking points every 15°
 - To rotate the arm simply pull the front lever out, rotate to desired position and then release the lever
- Locking slide arm can slide up to 5.5" from the center of the pole
- Clevis Motion Attachment (7160-0500):
 - Tilt capabilities:
 - 90° forward allows for tablets to be easily mounted
 - 26° aft movement
 - Riveted design allows for smoother tilt movement
- Lowswivel Motion Attachment (7160-0502):
 - Tilt capabilities:
 - Fixed 10° angle for low profile mounting solution
- Clevis contains VESA 75 mm and Gamber-Johnson 2X4
- Limited Lifetime Warranty

6" LOCKING SLIDE ARM WITH 3/8" STUD



7160-0514

Item No.	Placement	Motion Attachment Included	Tilt	Rotate	Slide	Weight	Height	Width	Depth
7160-0514	Any Upper Pole, Compatible Pole, Center Pole, Low Profile Bracket, or Directly to any Flat Surface	No - must use Motion Attachment (7110-1200 or 7160-0436)	No	Entire Arm - 360° can lock every 15°	Yes - Up to 5.5" fore/aft	3.63 lbs 1.6 kg	2.43" 6.2 cm	3.66" 9.3 cm	8.74" 22.2 cm

Features

- The entire arm can rotate around 360° with locking points every 15°
 - To rotate the arm simply pull the front lever out, rotate to desired position and then release the lever
- Locking slide arm can slide up to 5.5" from the center of the pole
- Designed to be used with the Gamber-Johnson Clevis with a 3/8" hole (7110-1200) or lowswivel with a 3/8" hole (7160-0436)
- Limited Lifetime Warranty

QUAD-MOTION ATTACHMENTS WITH VESA 75 MM & GAMBER-JOHNSON HOLE PATTERN



7160-0284

Item No.	Placement	Tilt	Swivel	Slide	Weight	Height	Width	Depth
7160-0284	Any Upper Pole, Compatible Pole, Center Pole, Low Profile Bracket, or Directly to any Flat Surface	Yes - up to 90° fore/ 26° aft	Motion Attachment - 360° Entire Arm - Up to 60° right / 60° left	Yes - Up to 3.5" fore/aft	4.66 lbs 2.1 kg	4.16" 10.6 cm	7.23" 18.4 cm	7.91" 20.1 cm
7160-0285	Any Upper Pole, Compatible Pole, Center Pole, Low Profile Bracket, or Directly to any Flat Surface	Yes - up to 90° fore/ 26° aft	Motion Attachment - 360° Entire Arm - Up to 60° right / 60° left	Yes - Up to 5.0" fore/aft	4.88 lbs 2.2 kg	4.16" 10.6 cm	7.23" 18.4 cm	9.50" 24.13 cm

Features

- Two separate pivot points allow for swiveling, sliding, swiveling again and tilting computer to ideal location
- Maximum range of motion allows for comfortable use by both driver and passenger
- Adjustments can be made easily by turning the quick adjustment knob and moving the equipment in the desired position
- Improved sliding plate for smoother forward and backward motion
- Clevis works with the following hole patterns: VESA 75 mm, Gamber-Johnson 2x4, NEC, AMPS
- Limited Lifetime Warranty

6" SLIDE ARM WITH 3/8" STUD

Item No.	Placement	Tilt	Swivel	Slide	Weight	Height	Width	Depth
7160-0782	Any Upper Pole, Complete Pole, Center Pole, Low Profile Bracket, the Universal Portable Base (7160-0033), or any Flat Surface	No - Must Use Motion Attachment (7110-1200 or 7160-0436)	Motion Attachment - 360° Entire Arm - 360°	Yes - Up to 5.0" (12.7 cm) fore/aft	3.05 lbs 1.38 kg	4.0" 10.2 cm	3.63" 9.22 cm	7.91" 20.1 cm



Features

- Can be mounted directly to a flat surface or on any Upper Pole, Center Pole, Low Profile Bracket, Gamber-Johnson console box via 3-hole pattern
- Designed to be used with the Gamber-Johnson Clevis with a 3/8" hole (7110-1200) or lowswivel with a 3/8" hole (7160-0436)
- The entire arm can rotate around 360°
- Maximum range of motion allows for comfortable use by both driver and passenger
- Heavy gauge steel construction for long-term durability
- Black powder coat finish for maximum corrosion resistance
- Limited Lifetime Warranty

6" SLIDE ARM WITH SHORT CLEVIS

Item No.	Placement	Tilt	Swivel	Slide	Weight	Height	Width	Depth
7160-0926	Any Upper Pole, Complete Pole, Center Pole, Low Profile Bracket, the Universal Portable Base (7160-0033), or any Flat Surface	Yes - Up to 45°	Motion Attachment - 360° Entire Arm - 360°	Yes - up to 5.0" (12.7 cm) fore/aft	4.73 lbs 2.15 kg	3.9" 9.9 cm	7.23" 18.4 cm	7.91" 20.1 cm



Features

- Can be mounted directly to a flat surface or on any Upper Pole, Center Pole, Low Profile Bracket, Gamber-Johnson console box via 3-hole pattern
- The entire arm can rotate around 360°
- Two separate pivot points allow for swiveling, sliding, swiveling again, and tilting computer to ideal location
- Maximum range of motion allows for comfortable use by both driver and passenger
- Heavy gauge steel construction for long-term durability
- Black powder coat finish for maximum corrosion resistance
- Clevis works with the following hole patterns: VESA 75 mm, Gamber-Johnson 2x4, NE, AMPS
- Limited Lifetime Warranty

MONGOOSE® - 9" LOCKING SLIDE ARM WITH VESA 75 MM & GAMBER-JOHNSON HOLE PATTERN

Item No.	Placement	Motion Attachment Included	Tilt	Rotate	Weight	Height	Width	Depth
7160-0220	Any Upper Pole, Compatible Pole, Center Pole, Low Profile Bracket, or Directly to any Flat Surface	Yes - Includes a Standard Clevis	Yes - Up to 90° fore / 26° aft	Motion Attachment - 360° Entire Arm - 360° can lock every 15°	6.9 lbs 3.1 kg	4.64" 11.8 cm	7.23" 18.4 cm	11.34" 28.8 cm



Features

- Design is protected by US Patent Number 8,511,629
- The entire arm can rotate around 360° with locking points every 15°
- To rotate the arm simply pull the front lever out, rotate to desired position and then release the lever
- Locking slide arm can telescope 9" to 13" from the center of the pole and allows you to simply push the computer back to the retracted position and it automatically locks into place
- Heavy duty, spring loaded steel, side pin was tested to 50,000+ cycles
- Clevis works with the following hole patterns: VESA 75 mm, Gamber-Johnson 2x4, NEC, AMPS
- Limited Lifetime Warranty

MONGOOSE® - 9" LOCKING SLIDE ARM WITH SHORT CLEVIS



Item No.	Placement	Motion Attachment Included	Tilt	Rotate	Weight	Height	Width	Depth
7160-0928	Any Upper Pole, Complete Pole, Center Pole, Low Profile Bracket, Gamber-Johnson Console Box via 3-Hole Pattern or Directly to any Flat Surface	Yes - Includes a Short Clevis	Yes - Up to 45°	Motion Attachment - 360° Entire Arm - 360° can lock at every 15°	3.63 lbs 1.65 kg	2.43" 6.17 cm	3.66" 9.30 cm	8.74" 22.20 cm

Features

- Design is protected by US Patent Number 8,511,629
- The entire arm can rotate around 360° with locking points at every 15°
- To rotate the arm simply pull the front lever out, rotate to desired position and then release the lever
- Locking slide arm can telescope 9" to 13" from the center of the pole and utilizes the industry first "slam and lock" technology that allows you to simply push the computer back to the retracted position and it automatically locks into place
- Heavy duty, spring loaded steel, side pin was tested to 50,000+ cycles
- Can be mounted directly to a flat surface or on any Upper Pole, Center Pole, Low Profile Bracket, Gamber-Johnson console box via 3-hole pattern
- Two threaded inserts added to the back of the Mongoose to attach the Tablet Display Mount (7160-0494 or 7160-0529)
- Heavy gauge steel construction for long-term durability
- Black powder coat finish for maximum corrosion resistance
- Limited Lifetime Warranty

MONGOOSE® - 9" LOCKING SLIDE ARM WITH 3/8" STUD



Item No.	Placement	Motion Attachment Included	Tilt	Rotate	Weight	Height	Width	Depth
7160-0427	Any Upper Pole, Compatible Pole, Center Pole, Low Profile Bracket, or Directly to any Flat Surface	No - Must use Motion Attachment (7110-1200 or 7160-0436)	No	Entire Arm - 360° can lock every 15°	5.2 lbs 2.4 kg	4.0" 10.2 cm	4.0" 10.2 cm	12.0" 30.5 cm

Features

- Design is protected by US Patent Number 8,511,629
- The entire arm can rotate around 360° with locking points every 15°
 - To rotate the arm simply pull the front lever out, rotate to desired position and then release the lever
- Locking slide arm can telescope 9" to 13" from the center of the pole and allows you to simply push the computer back to the retracted position and it automatically locks into place
- Heavy duty, spring loaded steel, side pin was tested to 50,000+ cycles
- Designed to be used with the Gamber-Johnson Clevis with 3/8" hole (7110-1200) or low swivel with 3/8" hole (7160-0436)
- Limited Lifetime Warranty

15" LOCKING SWING ARM WITH STANDARD CLEVIS



Item No.	Placement	Motion Attachment Included	Tilt	Rotate	Weight	Height	Width	Depth
7160-0341	Any Upper Pole, Compatible Pole, Center Pole, Low Profile Bracket, or Directly to any Flat Surface	Yes - Includes a standard Clevis	Yes - Up to 90° fore/26° aft	Motion Attachment - 360° Entire Arm - 360° can lock every 15°	5.9 lbs 2.7 kg	3.59" 9.1 cm	7.23" 18.4 cm	14.50" 36.8 cm

Features

- The entire arm can rotate around 360° with locking points every 15°
 - To rotate the arm simply pull the front lever out, rotate to desired position and then release the lever
- Ideal for work trucks and vans
- Clevis works with the following hole pattern: VESA 75 mm, Gamber-Johnson 2x4, NEC, AMPS
- Limited Lifetime Warranty

UNIVERSAL ADAPTER

Item No.	Placement	Weight	Height	Width	Depth
7160-0454	Between any Screen/Display or Docking Station with a VESA 75 mm or 100 mm, NEC, AMPS, Havis, Jotto, or PMT Hole Pattern and any Gamber-Johnson Motion Attachment	0.85 lbs 0.4 kg	0.97" 2.5 cm	5.0" 12.7 cm	5.0" 12.7 cm

Features

- Adapter plate can be mounted to flat surfaces
- Built-in cable restraint tie for service loops
- Adapter plate includes PEMs for easy installation
- Compatible with screens/displays or docking station that utilize the VESA 75 mm or 100 mm, NEC, AMPS, Havis, Jotto, or PMT hole pattern and allows you to attach the Gamber-Johnson standard hole pattern
- Limited Lifetime Warranty



VESA 75 MM TO GAMBER-JOHNSON ADAPTOR PLATE

Item No.	Placement	Weight	Height	Width	Depth
7160-0794	Between any Screens/Monitors or Docking Stations with VESA 75 mm Hole Pattern to Gamber-Johnson Older Motion Attachments with the Gamber-Johnson 2x4 Hole Pattern	0.8 lbs 0.36 kg	4.0" 10.2 cm	5.0" 12.7 cm	0.75" 1.9 cm

Features

- Adapter can be used with screens/monitors or docking stations that have threaded stud or threaded inserts
- Mounts between the device and the motion attachment
- Hardware provided for mounting plate to motion attachment, use hardware from screens/monitors or docking stations to mount to adapter plate
- Compatible with screens/monitors or docking stations that utilize the VESA 75 mm hole pattern and allow you to attach to the older Gamber-Johnson motion attachments with the 2x4 hole pattern
- Limited Lifetime Warranty





Zirkona

Our Zirkona product line features an innovative, encapsulated jointer that allows users to rotate their small, lightweight devices (up to 11 pounds depending on the jointer) to the best possible position. This unique flexibility makes it possible to quickly adapt to nearly any application so that the user has an ergonomically correct position and minimal time is wasted fidgeting with repetitive adjustments. Knowing your technology is as secure as it is accessible makes Zirkona the ideal go-to solution.



BUILDING SOLUTIONS WITH ZIRKONA

Device Plate: Available in several mounting designs for unique device adaption, the device plate securely holds your light-weight device in place to complete the Zirkona solution.

Joiner: Our unique encapsulated joiner allows users to rotate their small, lightweight devices easily and effortlessly. Available in two styles (traditional and two-down) and three different sizes to give users increased flexibility for a variety of payloads.

Extension and Adapter (Optional Components): Extensions and adapters allow users to build the most desired solution for their needs. Available in a variety of extension lengths and configurations these pieces of the Zirkona product line are the key to customizability.

Base Plate: Our wide variety of base plates gives your Zirkona solution the structural integrity it needs to withstand even the most extreme situations.

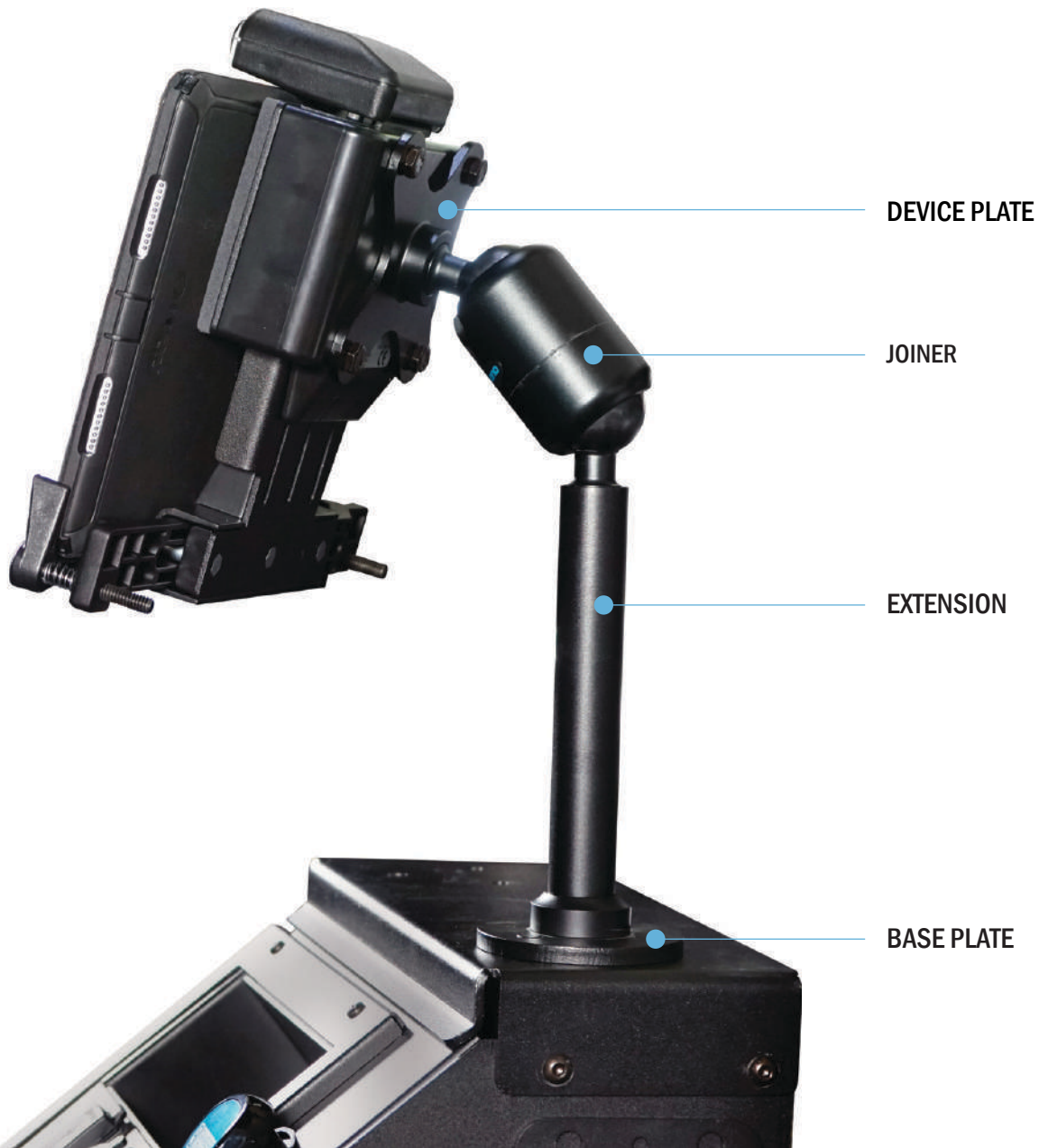

ZIRKONA SALES CASE

Ensure you have all the most popular Zirkona components on hand to create your own customizable solution for any opportunity that comes your way. This case (7160-1200) includes 22 individual Zirkona components to mix, match and build.

- | | |
|--|--|
| 1. VESA 75 mm AMPS Assembly (7110-1240) | 12. 12" (300 mm) Sleeve (17463) |
| 2. VESA 75 mm and 100 mm Plate (14140) | 13. Height-Adjustable Pole (7110-1230) |
| 3. VESA 75 mm Plate (14139) | 14. 6" (150 mm Extension) (14143) |
| 4. Threaded Adapter (14145) | 15. AMPS Quick-Release Plate (7110-1225) |
| 5. Large Joiner (7110-1236) | 16. Diamond Plate Clamp (7110-1226) |
| 6. Suction Cup Mount (7110-1232) | 17. AMPS Round Plate (14144) |
| 7. Medium 2-Down Joiner with Brake (7110-1259) | 18. Diamond Plate Pipe Clamp (7110-1231) |
| 8. Medium Joiner (7110-1235) | 19. Chair Rail Mount (7110-1229) |
| 9. Small Joiner (7110-1234) | 20. Vertical Surface Mount (7110-1228) |
| 10. 2" (50 mm) Extension (14141) | 21. Surface/Pole Mount (7160-0440) |
| 11. 4" (100 mm) Extension (14142) | 22. Extension Adapter (17467) |

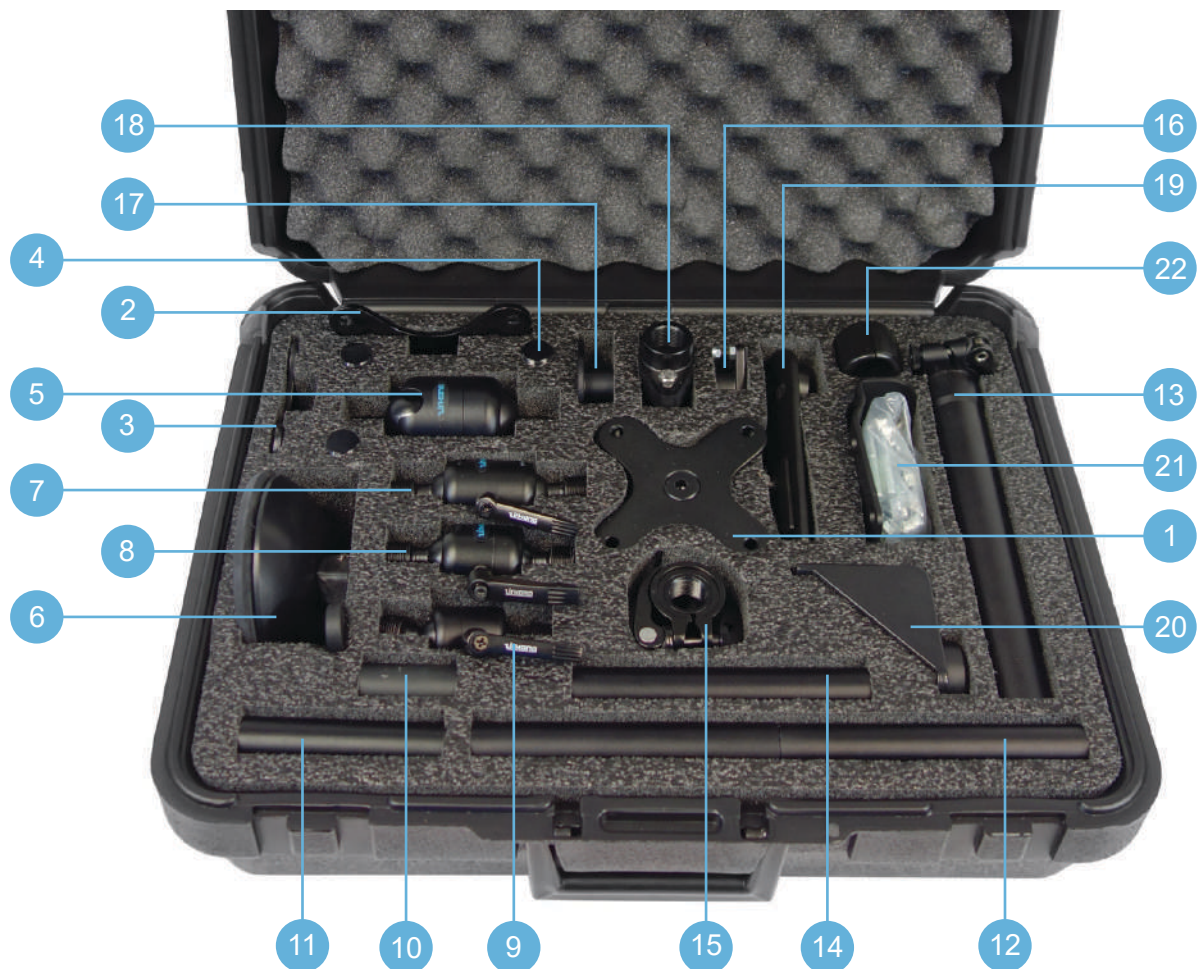

ZIRKONA AMPS ROUND PLATE



Item No.	Description	Placement/Compatibility	Weight	Height	Depth/ Diameter
14144	AMPS Round Plate	Attaches to any Joiner or Male Threaded Adapter (14145)	3.62" 9.19 cm	2.75" 6.99 cm	1.26" 3.20 cm diameter

Features

- Easily threads onto a male threaded adapter or joiner using M20 threads
- Holes accommodate up to M6 and 1/4-20 size hardware
- Works great on smaller tablet cradles and docks such as: Samsung Tab Active2/Tab Active3, Gamber-Johnson NotePad Touch, Panasonic Toughbook F1/N1, Toughbook L1, Toughbook T1, Zebra L10 and more
- Can also be utilized as a base in your mount for a smaller footprint
- Recommend use of Loctite® 9460, 9461, or 9466 on all M20 size threads (Loctite not included)
- Contains AMPS and NEC Hole Patterns
- 1 Year Limited Warranty

ZIRKONA VESA 75 MM AND VESA 100 MM PLATES



14139



14140

Item No.	Description	Placement/Compatibility	Weight	Height	Width	Depth
14139	VESA 75 mm Plate	Attaches to any Joiner or Male Threaded Adapter (14145)	0.2 lbs 0.09 kg	0.55" 1.4 cm	3.75" 9.53 cm	3.75" 9.53 cm
14140	VESA 100 mm Plate	Attaches to any Joiner or Male Threaded Adapter (14145)	0.25 lbs 0.11 kg	0.55" 1.4 cm	4.75" 12.07 cm	4.75" 12.07 cm

Features

- Easily threads onto a male threaded adapter or joiner using M20 threads
- Holes accommodate up to M6 and 1/4-20 size hardware
- Works great on smaller tablet cradles, docks, and monitors including, but not limited to: Samsung Tab Active2, Gamber-Johnson's NotePad Touch and TabCruzer Mini, Getac's F110, ZX70, UX10, RX10, T800, Panasonic's Toughbook G1, Toughbook L1, and Zebra L10
- Can also be utilized as a base in your mount for a strong base given the wider stance
- Recommend use of Loctite® 9460, 9461, or 9466 on all M20 size threads (Loctite not included)
- Contains VESA 75 mm hole pattern (14139) and VESA 75 mm, 100 mm hole patterns (14140)
- 1 Year Limited Warranty

ZIRKONA VESA 75 MM DECORATIVE PLATE



Item No.	Description	Placement/Compatibility	Weight	Height	Width	Depth/ Diameter
17238	Decorative Plate - VESA 75 mm	Use as a Base Plate or Device Plate	0.25 lbs 0.45 kg	0.75" 1.90 cm	4" 10.16 cm	4" 10.16 cm

Features

- Easily threads onto a male threaded adapter or joiner using M20 threads
- Holes accommodate up to M6 and 1/4-20 size hardware
- Works great on smaller tablet cradles, docks, and monitors including, but not limited to: Samsung Tab Active2, Gamber-Johnson's NotePad Touch and TabCruzer Mini, Getac's F110, ZX70, UX10, RX10, T800, Panasonic's Toughbook G1, Toughbook L1, and Zebra L10
- Can also be utilized as a base in your mount for a strong base given the wider stance
- Contours on the base offer a more finished look to your mounting solution
- Base can also be used on the device end
- Recommend use of Loctite® 9460, 9461, or 9466 on all M20 size threads (Loctite not included)
- Contains VESA 75 mm hole pattern
- 1 Year Limited Warranty

ZIRKONA LIGHT-DUTY WALL MOUNT BASE

Item No.	Description	Placement/Compatibility	Weight	Height	Width	Depth/ Diameter
7110-1227	Light-Duty Wall Mount	Attaches to Walls / Accepts Any Joiner or Male Threaded Adapter (14145)	0.7 lbs 0.32 kg	5" 12.70 cm	2.125" 5.40 cm	3" 7.62 cm (includes handle)

Features

- Pivot pin features the M20 threads allowing the user to use any joiner or extension pole with threaded adapter making the mount versatile
- Threads on top of pivot pin is created for a set screw for secondary thread locking
- Ratchet handle on front allows for adjustability to raise or turn the pivot pin while still being able to lock down
- Made of anodized aluminum making it a light-weight, clean solution
- Recommend use of Loctite® 9460, 9461, or 9466 on all M20 size threads (Loctite not included)
- 1 Year Limited Warranty



ZIRKONA UNIVERSAL WALL MOUNT

Item No.	Description	Placement/Compatibility	Weight	Height	Width	Depth/ Diameter
7110-1228	Universal Wall Mount	Attaches to Walls / Accepts Any Joiner or Male Threaded Adapter (14145)	0.60 lbs 0.27 kg	3.25" 8.25 cm	1.69" 4.29 cm	3" 7.62 cm

Features

- Bracket is gusseted for extra strength
- 3 available mounting holes
- Add an extension, joiner, and adapter plate for a complete solution (Requires 14145 threaded adapter or joiner)
- Black powder coat finish for maximum corrosion resistance
- Recommend use of Loctite® 9460, 9461, or 9466 on all M20 size threads (Loctite not included)
- 1 Year Limited Warranty



ZIRKONA SEAT RAIL BASE

Item No.	Description	Placement/Compatibility	Weight	Height	Width	Depth/ Diameter
7110-1229	Seat Rail	Attaches Inside Passenger Side Seat Rail / Most Seat Rails (does NOT work with powered seats)	1.1 lbs 0.05 kg	1.1" 2.79 cm	2" 5.08 cm	5.88" 14.94 cm

Features

- Fits most seat rails to provide additional mounting capabilities for products
- Sturdy steel construction for increased durability
- Pair with telescoping mount (7110-1230) and desired joiner/plate combination for your vehicle mounting needs
- Requires Threaded Adapter (14145)
- A component of Zirkona's interactive, fully-customizable, mounting solution
- Recommend use of Loctite® 9460, 9461, or 9466 on all M20 size threads (Loctite not included)
- Does NOT work with powered seats
- 1 Year Limited Warranty



ZIRKONA QUICK-RELEASE BASES

Item No.	Description	Placement/Compatibility	Weight	Height	Width	Depth/ Diameter
7110-1225	AMPS Quick Release Base	Attaches to Any Flat Surface / Accepts Any Joiner or the Male Threaded Adapter (14145)	0.30 lbs 0.14 kg	1.25" 3.18 cm	N/A	2.5" 6.35 cm
7110-1263	VESA 75 mm Quick Release Base	Attaches to Any Flat Surface / Accepts Any Joiner or the Male Threaded Adapter (14145)	0.60 lbs 0.27 kg	1.75" 4.45 cm	3.5" 8.89 cm	3.5" 8.89 cm

Features

- Inner sleeve contains roll pin in order to push, twist, and secure the mount in place before clamping
- Grooves in base help align the roll-pin to help keep sleeve in place even when clamp is open
- Padding inside base creates tension between the sleeve and base to reduce vibration and eliminate rattling
- Constructed of anodized aluminum making it light-weight yet durable
- Can be utilized as a base plate or device plate
- Recommend use of Loctite® 9460, 9461, or 9466 on all M20 size threads (Loctite not included)
- Available in either AMPS/NEC base or VESA 75 mm base
- 1 Year Limited Warranty

NEW



7110-1225

NEW



7110-1263

ZIRKONA SUCTION CUP



Item No.	Description	Placement/Compatibility	Weight	Height	Width	Depth/ Diameter
7110-1232	Zirkona Suction Cup	Mounts on Windows or Flat Surfaces	0.80 lbs 0.36 kg	2" 5.08 cm	N/A	4.75" 12.07 cm

Features

- Mounts to non-porous surfaces for a quick and temporary mount
- New material is less susceptible to cold and heat
- Simple push and clamp secures the suction cup to the surface
- M20 threads matches to any joiner or the 14145 threaded adapter
- Recommend use of Loctite® 9460, 9461, or 9466 on all M20 size threads (Loctite not included)
- 1 Year Limited Warranty

ZIRKONA MAGNETIC MOUNT



Item No.	Description	Placement/Compatibility	Weight	Height	Width	Depth/ Diameter
7160-1113	Magnetic Base	Mounts to Magnetic Surfaces	0.44 lbs 0.20 kg	1.18" 2.99 cm	2.88" 7.31 cm	2.88" 7.31 cm

Features

- Easily mount the magnetic base on any flat metal surface and plane
- Each magnet has 120 lbs (54.43 kg) of pull force for a total of 360 lbs (163.29 kg) of pull force
- Works with the Zirkona product line for light weight cell phones or tablets up to 4 lbs (1.81 kg)
- Works with Zirkona parts to customize your configuration
- Can be used to for temporary mounting of a device
- Constructed of anodized aluminum making it light-weight yet durable
- Has 3 magnets for securing the mounting plate via the NEC hole pattern
- Recommend use of Loctite® 9460, 9461, or 9466 on all M20 size threads (Loctite not included)
- 1 Year Limited Warranty

ZIRKONA PIPE CLAMP - SMALL 2" (50 MM)

NEW



Item No.	Description	Placement/Compatibility	Weight	Height	Width	Depth/ Diameter
7110-1223	Zirkona Pipe Clamp - Small 2" (50 mm)	Works on Any Stable Pipe or post Ranging from 0.25" (0.64 cm) to 1" (2.5 cm)	0.25 lbs 0.11 kg	2.38" 6.05 cm	1.5" 3.81 cm	2.5" 6.35 cm

Features

- Mounts into tight spaces while providing great strength
- Rubber inserts help to stabilize and reduce vibration
- Works great for mounting a small tablet or smartphone
- Same threads as all Zirkona items making the solution simple to build
- Stainless hardware made for more extreme environments
- Recommend use of Loctite® 9460, 9461, or 9466 on all M20 size threads (Loctite not included)
- 1 Year Limited Warranty

ZIRKONA PIPE CLAMP

NEW



Item No.	Description	Placement/Compatibility	Weight	Height	Width	Depth/ Diameter
7110-1231	Zirkona Pipe Clamp	Use on Pipe from .5" (1.27 cm) to 1.69" (4.29 cm) in Diameter or Square Posts up to 1.44" (3.66 cm) in Width	0.30 lbs 0.14 kg	3.75" 9.53 cm	1.25" 3.18 cm	2.38" 6.05 cm

Features

- Rubber inserts provide extra gripping power
- Threaded connector accepts a variety of Zirkona components
- Made of anodized aluminum and rubber
- Recommend use of Loctite® 9460, 9461, or 9466 on all M20 size threads (Loctite not included)
- 1 Year Limited Warranty

ZIRKONA DIAMOND PLATE - SMALL

Item No.	Description	Placement/Compatibility	Weight	Height	Width	Depth/ Diameter
7110-1226	Diamond Plate	Mounts to Any Flat Surface Vertical or Horizontal	0.11 lbs 0.05 kg	0.82" 2.09 cm	2.43" 6.16 cm	1.31" 3.33 cm



Features

- Designed to mount to a flat surface in either vertical or horizontal position
- Great for mounting in locations with limited space
- Comes with an M5 threaded stud mounting plate for surfaces with 3/8" thick material
- M5 threaded stud mounting plate can be removed so that the base can be secured down by itself with a longer hardware (not supplied) or directly in the material
- Recommended to be used to secure small accessory equipment utilizing the Zirkona joiner to forklifts - ex. fans, lights, scanners, cell phones, tablets and more
- Constructed of anodized aluminum making it light-weight yet durable
- Recommend use of Loctite® 9460, 9461, or 9466 on all M20 size threads (Loctite not included)
- 1 Year Limited Warranty

ZIRKONA BEAM MOUNT

Item No.	Description	Placement/Compatibility	Weight	Height	Width	Depth/ Diameter
7110-1274	Beam Mount	Clamps to Square Metal Tubes and Posts	0.5 lbs 0.23 kg	2.25" 5.72 cm	2.5" 6.35 cm	5.25" 13.33 cm

NEW



Features

- Four (4) set screws and four bolts to accommodate mounting to virtually any flat surface edge
- Constructed of heavy-duty steel for a strong mounting base
- M20 threads screwed right to base for easy Zirkona solution installation
- Bracket with four (4) PEMs can be turned to accommodate thinner or thicker surfaces
- Set screws dig into the mounting surface creating a stable base for your solution
- Requires 13 mm socket/wrench and 4 mm hex key for installation
- Best suited to work with metal
- Recommend use of Loctite® 9460, 9461, or 9466 on all M20 size threads (Loctite not included)
- 1 Year Limited Warranty

4" DIAMOND PLATE MOUNT

Item No.	Description	Placement/Compatibility	Weight	Height	Width	Depth/ Diameter
7160-1235	4" Diamond Plate Mount	Clamps Around Square and Rectangular Posts for Mounting Zirkona	1.8 lbs 0.82 kg	4.68" 11.89 cm	2.5" 6.35 cm	5.75" 14.61 cm



Features

- Mounts to various thickness of posts
- Allows for flexibility in mounting in different position, such as overhead and other locations
- Designed to be easily mounted by any installer
- Small form factor for smaller tablet and other smaller devices
- Recommend use of Loctite® 9460, 9461, or 9466 on all M20 size threads (Loctite not included)
- See Material Handling Section for complete solutions
- 1 Year Limited Warranty

ZIRKONA MARINE MOUNTING PLATE



Item No.	Description	Placement/Compatibility	Weight	Height	Width	Depth/ Diameter
18322	Marine Mounting Plate	Typically Mounts on a Boat to Mount a Fish Finder or Chart Plotter	0.4 lbs 0.18 kg	0.56" 1.43 cm	2" 5.08 cm	6.25" 15.88 cm

Features

- Multiple hole patterns to accommodate various fish finders/chart plotters
- M20 threads attaches to any joiner as well as the 14145 threaded adapter to help make the right solution
- Requires the use of the device bracket for installation
- Small footprint when installed
- When utilized with a quick-release base, your device can easily be removed from your boat or kayak when not in use
- Anodized aluminum for a rust-free mount
- Recommend use of Loctite® 9460, 9461, or 9466 on all M20 size threads (Loctite not included)
- 1 Year Limited Warranty

Recommended Solutions

- Zirkona Quick Release Round Plate (7110-1225)
- Zirkona Large Joiner Only (7110-1236)
- Marine Bracket (18322)

ZIRKONA AMPS ROUND PLATE



Item No.	Description	Placement/Compatibility	Weight	Height	Depth/ Diameter
14144	AMPS Round Plate	Attaches to any Joiner or Male Threaded Adapter (14145)	0.08 lbs 0.04 kg	0.55" 1.4 cm	2.38" 6.05 cm

Features

- Easily threads onto a male threaded adapter or joiner using M20 threads
- Holes accommodate up to M6 and 1/4-20 size hardware
- Works great on smaller tablet cradles and docks such as: Samsung Tab Active2 and Tab Active3, Gamber-Johnson NotePad Touch, Panasonic FZ F1/N1, FZ-L1, FZ-T1, Zebra L10 and more
- Can also be utilized as a base in your mount for a smaller footprint
- Recommend use of Loctite® 9460, 9461, or 9466 on all M20 size threads (Loctite not included)
- Contains AMPS and NEC Hole Patterns
- 1 Year Limited Warranty

ZIRKONA VESA 75 MM AND VESA 100 MM PLATES



14139



14140

Item No.	Description	Placement/Compatibility	Weight	Height	Width	Depth/ Diameter
14139	VESA 75 mm Plate	Attaches to any Joiner or Male Threaded Adapter (14145)	0.2 lbs 0.09 kg	0.55" 1.4 cm	3.75" 9.53 cm	3.75" 9.53 cm
14140	VESA 100 mm Plate	Attaches to any Joiner or Male Threaded Adapter (14145)	0.25 lbs 0.11 kg	0.55" 1.4 cm	4.75" 12.07 cm	4.75" 12.07 cm

Features

- Easily threads onto a male threaded adapter or joiner using M20 threads
- Holes accommodate up to M6 and 1/4-20 size hardware
- Works great on smaller tablet cradles, docks, and monitors including, but not limited to: Samsung Tab Active2, Gamber-Johnson's NotePad Touch and TabCruzer Mini, Getac's F110, ZX70, UX10, RX10, T800, Panasonic's FZ-G1, FZ-L1, and Zebra L10
- Can also be utilized as a base in your mount for a strong base given the wider stance
- Recommend use of Loctite® 9460, 9461, or 9466 on all M20 size threads (Loctite not included)
- Contains VESA 75 mm hole pattern (14139) and VESA 75 mm, 100 mm hole patterns (14140)
- 1 Year Limited Warranty

ZIRKONA QUICK-RELEASE BASES

Item No.	Description	Placement/Compatibility	Weight	Height	Width	Depth/ Diameter
7110-1225	AMPS Quick Release Base	Attaches To Any Flat Surface / Accepts Any Joiner or the Male Threaded Adapter (14145)	0.30 lbs 0.14 kg	1.25" 3.18 cm	N/A	2.5" 6.35 cm
7110-1263	VESA 75 mm Quick Release Base	Attaches To Any Flat Surface / Accepts Any Joiner or the Male Threaded Adapter (14145)	0.60 lbs 0.27 kg	1.75" 4.45 cm	3.5" 8.89 cm	3.5" 8.89 cm



Features

- Inner sleeve contains roll pin in order to push, twist, and secure the mount in place before clamping
- Grooves in base help align the roll-pin to help keep sleeve in place even when clamp is open
- Padding inside base creates tension between the sleeve and base to reduce vibration and eliminate rattling
- Constructed of anodized aluminum making it light-weight yet durable
- Can be utilized as a base plate or device plate
- Recommend use of Loctite® 9460, 9461, or 9466 on all M20 size threads (Loctite not included) (Not Included)
- Available in either AMPS/NEC base or VESA 75 mm base
- 1 Year Limited Warranty

ZIRKONA VESA 75 MM DECORATIVE PLATE

Item No.	Description	Placement/Compatibility	Weight	Height	Width	Depth/ Diameter
17238	Decorative Plate - VESA 75 mm	Use as a Base Plate or Device Plate	0.25 lbs 0.45 kg	0.75" 1.90 cm	4" 10.16 cm	4" 10.16 cm



Features

- Easily threads onto a male threaded adapter or joiner using M20 threads
- Holes accommodate up to M6 and 1/4-20 size hardware
- Works great on smaller tablet cradles, docks, and monitors including, but not limited to: Samsung Tab Active2, Gamber-Johnson's NotePad Touch and TabCruzer Mini, Getac's F110, ZX70, UX10, RX10, T800, Panasonic's FZ-G1, FZ-L1, and Zebra L10
- Can also be utilized as a base in your mount for a strong base given the wider stance
- Contours on the base offer a more finished look to your mounting solution
- Base can also be used on the device end
- Recommend use of Loctite® 9460, 9461, or 9466 on all M20 size threads (Loctite not included)
- Contains VESA 75 mm hole pattern
- 1 Year Limited Warranty

ZIRKONA DIAMOND PLATE - SMALL

Item No.	Description	Placement/Compatibility	Weight	Height	Width	Depth/ Diameter
7110-1226	Diamond Plate	Mounts to Any Flat Surface Vertical or Horizontal	0.11 lbs 0.05 kg	0.82" 2.09 cm	2.43" 6.16 cm	1.31" 3.33 cm



Features

- Designed to mount to a flat surface in either vertical or horizontal position
- Great for mounting in locations with limited space
- Comes with an M5 threaded stud mounting plate for surfaces with 3/8" (0.95 cm) thick material
- M5 threaded stud mounting plate can be removed so that the base can be secured down by itself with a longer hardware (not supplied) or directly in the material
- Recommended to be used to secure small accessory equipment utilizing the Zirkona joiner to forklifts - ex. fans, lights, scanners, cell phones, tablets and more
- Constructed of anodized aluminum making it light-weight yet durable
- Recommend use of Loctite® 9460, 9461, or 9466 on all M20 size threads (Loctite not included)
- 1 Year Limited Warranty

ZIRKONA STANDARD JOINERS



7110-1235

Item No.	Description	Placement/Compatibility	Weight	Height	Width	Depth
7110-1234	Small Joiner Holds up to 3 lbs (1.4 kg)	Inserts into any M20 Female Threads including Extensions, Device Plates, and Base Plates	0.25 lbs 0.11 kg	3.62" 9.19 cm	2.75" 6.99 cm	1.26" 3.20 cm
7110-1235	Medium Joiner Holds up to 6 lbs (2.8 kg)	Inserts into any M20 Female Threads including Extensions, Device Plates, and Base Plates	0.45 lbs 0.20 kg	4" 10.16 cm	3.38" 8.59 cm	1.54" 3.91 cm
7110-1236	Large Joiner Holds up to 11 lbs (5.0 kg)	Inserts into any M20 Female Threads including Extensions, Device Plates, and Base Plates	0.95 lbs 0.43 kg	5" 12.7 cm	3.88" 9.86 cm	2.05" 5.21 cm

Features

- All axes range of motion in X axis (left/right), Y axis (front/back) and Z axis (up/down)
- Multi-configurable and easily paired with extension tubes of various lengths work to achieve desired reach
- Quick adjust handle for easy adjustment to position the device
- Encapsulated ball design offers theft deterrence
- All metal construction (anodized aluminum) will not deform or degrade
- Small joiner holds up to 3 lbs (1.4 kg)
- Medium Joiner holds up to 6 lbs (2.8 kg)
- Large Joiner holds up to 11 lbs (5.0 kg)
- Recommend use of Loctite® 9460, 9461, or 9466 on all M20 size threads (Loctite not included)
- 1 Year Limited Warranty

ZIRKONA TWO-DOWN JOINERS

NEW



7110-1259

Item No.	Description	Placement/Compatibility	Weight	Height	Width	Depth
7110-1259	Medium 2-Down Joiner Holds up to 6 lbs(2.8 kg)	Inserts into any M20 Female Threads including Extensions, Device Plates, and Base Plates	0.5 lbs 0.23 kg	4.5" 11.43 cm	3.38" 8.58 cm	1.54" 3.91 cm
7110-1260	Large 2-Down Joiner Holds up to 11 lbs (5.0 kg)	Inserts into any M20 Female Threads including Extensions, Device Plates, and Base Plates	0.95 lbs 0.43 kg	5.5" 13.97 cm	3.88" 9.86 cm	2" 5.08 cm

Features

- Two notches (2-down) on each end and 180° from each other help create the "Z" shape for a more flexible solution
- Unique internal braking system allows the user to adjust mount with ease while not having the device fall (weight restrictions apply)
- All axes range of motion in X axis (left/right), Y axis (front/back) and Z axis (up/down)
- Multi-configurable and easily paired with extension tubes of various lengths work to achieve desired reach
- Ultra-smooth movement when positioning your device
- Quick adjust handle for easy adjustment to position the device
- Encapsulated ball design offers theft deterrence
- All metal construction (anodized aluminum) will not deform or degrade
- Medium 2-down joiner holds up to 6 lbs (2.8 kg)
- Large 2-down joiner holds up to 11 lbs (5.0 kg)
- Recommend use of Loctite® 9460, 9461, or 9466 on all M20 size threads (Loctite not included)
- 1 Year Limited Warranty

ZIRKONA 6" DOG-BONE JOINER

NEW



Item No.	Description	Placement/Compatibility	Weight	Height	Width	Depth
7110-1330	6" Medium 2-Down Joiner with Center Swivel Holds up to 6 lbs (2.8 kg)	Inserts into any M20 Female Threads including Extensions, Device Plates, and Base Plates	1 lbs 0.45 kg	5" 12.7 cm	2.35" 5.97 cm	8.90" 22.61 cm

Features

- Extendable length giving users the ability to create several different configurations
- Both ends swivel to allow for unique mounting positions and flexibility
- To set mounting position, simply tighten two (2) set screws in place
- Unique internal braking system allows the user to adjust mount with ease while not having the device fall (weight restrictions apply)
- Adapts to various Zirkona bases and plates to offer countless configurations to create an ideal custom mounting solution
- To set mounting position, simply tighten two (2) set screws in place
- All metal construction (anodized aluminum) will not deform or degrade
- 6" Medium 2-Down Joiner with Center Swivel holds up to 6 lbs (2.8 kg)
- Recommend use of Loctite® 9460, 9461, or 9466 on all M20 size threads (Loctite not included)
- 1 Year Limited Warranty

ZIRKONA EXTENSIONS

Item No.	Description	Placement/Compatibility	Weight	Height	Depth/ Diameter
14141	2" (50 mm) Extension	Accepts any M20 Male Thread size such as Threaded Adapter (14145) and any Joiner	0.05 lbs 0.02kg	2" 5.1 cm	1" 2.54 cm
14142	4" (100 mm) Extension	Accepts any M20 Male Thread size such as Threaded Adapter (14145) and any Joiner	0.45 lbs 0.20 kg	4" 10.2 cm	1" 2.54 cm
14143	6" (150 mm) Extension	Accepts any M20 Male Thread size such as Threaded Adapter (14145) and any Joiner	0.95 lbs 0.43 kg	6" 15.24 cm	1" 2.54 cm
17463	12" (300 mm) Extension	Accepts any M20 Male Thread size such as Threaded Adapter (14145) and any Joiner	0.5 lbs 0.23 kg	4.5" 11.43 cm	1" 2.54 cm



14142

Features

- Extends your mount 2" (50 mm), 4" (100 mm), 6" (150 mm) or 12" (300 mm) for better positioning
- Both ends are threaded with M20 threads
- Threads allow for either a joiner or male threaded adapter
- 1 Year Limited Warranty

*Note: Extensions should be used on base end of mount, not device end as the later would reduce the payload of the joiner

ZIRKONA DOUBLE MOUNT

Item No.	Description	Placement/Compatibility	Weight	Height	Width	Depth
7110-1312	Double Mount	Accepts any M20 Male Thread size such as Threaded Adapter (14145) and any Joiner	0.35 lbs 0.16kg	1.25" 3.18 cm	1.5" 3.81 cm	8" 20.32 cm

NEW



Features

- Two M20 threads are 6.25" (15.88 cm) apart on center
- Works well for either a side-by-side or top-bottom solution
- All-Aluminum construction to help make the solution light-weight
- Gives users the ability to mount two devices on one pole system
- Recommend use of Loctite® 9460, 9461, or 9466 on all M20 size threads (Loctite not included)
- 1 Year Limited Warranty

ZIRKONA SUPPORT BRACES

Item No.	Description	Placement/Compatibility	Weight	Height	Width	Depth/ Diameter
7160-1340	Support Brace - Short	Attaches to Height Adjustable Pole (7110-1230)	1.1 lbs 0.5 kg	N/A	1.5" 3.81 cm	10.3" - 16.3" 26.16 - 41.40 cm
7160-1341	Support Brace - Long	Attaches to Height Adjustable Pole (7110-1230)	1.4 lbs 0.64 kg	N/A	1.5" 3.81 cm	30.38" - 36" 77.17 cm - 91.44 cm

NEW



Features

- Telescoping design allows for precise length adjustment without drilling into pole
- Small clamp in middle locks the desired length in place
- Larger clamp has a rubber overmold to grip the adjustable pole
- Increases the mounting system rigidity
- Low-profile clamp reduces bulk to mount
- Does NOT work with Gamber-Johnson poles
- Limited Lifetime Warranty

ZIRKONA HEIGHT-ADJUSTABLE POLE

Item No.	Description	Placement/Compatibility	Weight	Height	Width	Depth
7110-1230	Height-Adjustable Pole	Attaches inside passenger side seat rail / most seat rails (does NOT work with powered seats)	0.85 lbs 0.39 kg	9.25" 23.49 cm	N/A	1.25" 3.17 cm



Features

- Wider end accepts the 14145 threaded adapter giving the ability to mount to most base plates
- Expands from 9.25" (23.49 cm) - 15.75" (40cm)
- Pair with Zirkona Seat Rail (7110-1229), choice of joiner and device plate for your vehicle mounting solution (Requires 14145 threaded adapter)
- A component of Zirkona's interactive, fully-customizable, mounting solution
- Recommend use of Loctite® 9460, 9461, or 9466 on all M20 size threads (Loctite not included)
- 1 Year Limited Warranty

ZIRKONA MALE THREADED ADAPTER



Item No.	Description	Placement/Compatibility	Weight	Height	Width	Depth/ Diameter
14145	Threaded Adapter	Inserts into Any Base Plate and Extension	0.05 lbs 0.02 kg	1" 2.54 cm	N/A	0.77" 1.96 cm

Features

- Solid aluminum, fully threaded adapter easily threads into an extension pole, base, or height-adjustable pole
- Adapter is invisible when assembled into a mount giving the mount a clean look
- Constructed of anodized aluminum making it light-weight yet durable
- A required component when using an extension and/or base plate
- Recommend use of Loctite® 9460, 9461, or 9466 on all M20 size threads (Loctite not included)
- 1 Year Limited Warranty

ZIRKONA TUBE/SLEEVE MOUNT

NEW



Item No.	Description	Placement/Compatibility	Weight	Height	Width	Depth/ Diameter
17467	Tube/Sleeve Mount	Slides ver Any Extension Tube or 1" (2.54 cm) Tube to Add Another Mounting Opportunity or Articulation Point	0.25 lbs 0.11 kg	2.75" 6.98 cm	1.46" 3.70 cm	1.25" 3.18 cm

Features

- Smoothly slides over any extension tube or 1" (2.54 cm) tube to add an additional device
- Mounts perpendicular to the extension
- Requires at least two (2) 1" (2.54 cm) tubes in order to mount
- Black powder-coated die-cast aluminum for durability
- Recommend use of Loctite® 9460, 9461, or 9466 on all M20 size threads (Loctite not included)
- 1 Year Limited Warranty

GAMBER-JOHNSON TO ZIRKONA ADAPTER PLATE



Item No.	Description	Placement/Compatibility	Weight	Height	Width	Depth/ Diameter
7160-1035	Gamber-Johnson to Zirkona Adapter - 3-Hole	Attaches to the 3-Hole Pattern	0.5 lbs 0.23 kg	1.8" 4.5 cm	3" 7.6 cm	3" 7.6 cm

Features

- Threaded mounting to work with the Zirkona parts
- Three stud mounting to align with the Gamber-Johnson 3-hole pattern
- Great alternative base when going from a rugged laptop to a small rugged or non-rugged tablet
- Pair with 14145 threaded adapter and desired extension, joiner and device plate to create a mini-pedestal on top of a Gamber-Johnson console
- Heavy gauge steel construction for long-term durability.
- Black powdercoat finish for maximum corrosion resistance.
- Mounting hardware provided with adapter
- Recommend use of Loctite® 9460, 9461, or 9466 on all M20 size threads (Loctite not included)
- 1 Year Limited Warranty

ZIRKONA FAN ADAPTER PLATE

NEW



Item No.	Description	Placement/Compatibility	Weight	Height	Width	Depth/ Diameter
7160-1342	Fan Adapter	Attaches to AMPS/NEC Hole Pattern Plate (14144) to Mount Fans on Forklifts	0.3 lbs 0.14 kg	0.63" 1.6 cm	N/A	2.75" 6.99 cm

Features

- Quick and easy no-drill installation designed to be used with a variety of fans
- Adapts fan to any competitor product with the NEC hole pattern
- Includes mounting hardware
- Powder-coated steel plate offers rigidity and strength
- 1 Year Limited Warranty

Recommended Solution

- Kit: Forklift Fan Mounting Bracket (7170-0774)
- 4" Diamond Plate with Large Joiner and Zirkona AMPS/NEC Plate (7160-1261)
- OR
- Kit: Forklift Fan Mounting Bracket (7170-0774)
- 4" Diamond Plate with Medium Joiner and Zirkona AMPS/NEC Plate (7160-1171)

ZIRKONA THREADED PIVOT PIN

Item No.	Description	Placement/Compatibility	Weight	Height	Width	Depth/ Diameter
18834	Threaded Pivot Pin	Inserts into any Base Plate and Extension	0.15 lbs 0.07 kg	1.25" 3.18 cm	N/A	2" 5.05 cm

Features

- Two M20 threads perpendicular from each other offers a strong, 90° angle to mount
- M5 threads on top of threaded pivot pin to allow for set screw to lock threads instead of Loctite® 9460, 9461, or 9466
- M20 threads attaches to any joiner as well as the 14145 threaded adapter with extension for a customized solution
- Requires the use of the device bracket for installation
- Anodized aluminum for a rust-free mount
- Recommend use of Loctite® 9460, 9461, or 9466 on all M20 size threads (Loctite not included)
- 1 Year Limited Warranty

Recommended Solution

- Seat Rail (7110-1229)
- Threaded Adapter (14145)
- Two-Down Medium Joiner with Brake (7110-1259)
- VESA 75 mm Device Plate (14139)
- Height-Adjustable Pole (7110-1230)
- Threaded Pivot Pin (18834)
- Zirkona Support Brace (7160-1340)

NEW



ZIRKONA GARMIN ADAPTER

Item No.	Description	Placement/Compatibility	Weight	Height	Width	Depth/ Diameter
17476	Garmin GPS Adatper	Attaches to any Joiner and Garmin p/n 010-11983-02	0.1 lbs 0.05 kg	1.19" 3.02 cm	N/A	1.16" 2.86 cm

Features

- Garmin adapter fixes to the back of most Garmin GPS devices
- M20 threads accommodates either the 14145 threaded adapter or any Zirkona joiner
- Suction cup option needs to be removed for adapter to work
- Set screw on side locks the adapter to the M20 threads
- Constructed of black plastic
- Does NOT include Garmin p/n 010-11983-02
- 1 Year Limited Warranty

Recommended Solution

- Magnetic Base (7160-1113)
- Small Joiner (7110-1234)
- Garmin Adapter (17476)

NEW



ZIRKONA FEMALE THREADED ADAPTER

Item No.	Description	Placement/Compatibility	Weight	Height	Width	Depth/ Diameter
17394	Female Threaded Adapter	Accepts any Joiner or Male Threaded Adapter (14145) and Mounts to Any Flat and Strong Surface	0.1 lbs 0.05 kg	0.5" 1.27 cm	N/A	1.44" 3.66 cm

Features

- M20 threads accommodates either the Threaded Adapter (14145) or any Joiner
- Two threads on bottom side take M6 hardware for minimal installing and mounting (hardware not included)
- Works great for small devices such as smartphones, GPS, and small tablets
- Anodized aluminum for a rust-free mount
- May require some drilling
- 1 Year Limited Warranty

NEW



ZIRKONA PIVOT JOINT - M20

NEW



Item No.	Description	Placement/Compatibility	Weight	Height	Width	Depth/ Diameter
7110-1327	Pivot Joiner - M20	Inserts into Any Base Plate and Extension	0.1 lbs 0.05 kg	0.75" 1.91 cm	N/A	3.5" 8.89 cm

Features

- Pivot joint locks every 30° providing a strong mount at whichever angle
- Male M20 threads adapts to any extension or base
- Ratcheting handle can adjust to position handle in desired location
- Works great for a more fixed angle mount
- Requires a base plate and extension in order to be used in mounting solution
- Recommend use of Loctite® 9460, 9461, or 9466 on all M20 size threads (Loctite not included)
- 1 Year Limited Warranty

Recommended Solutions

- Multi-Function Pivot Mount, 2" Extension, AMPS Mounting Plate with Back Plate (7160-1385)
- Multi-Function Pivot Mount, 2" Extension, VESA 75 mm Mounting Plate with Back Plate (7160-1385-01)

MONGOOSE® XLE INDEPENDENT DISPLAY BRACKET FOR ZIRKONA

NEW



Item No.	Placement/Compatibility	Weight	Height	Width	Depth/ Diameter
7110-1306	Rear pivot portion of Mongoose XLE for Tablet Display with Zirkona	1.8 lbs 0.82 kg	3.5" 8.89 cm	3" 7.62 cm	3.88" 9.34 cm

Features

- Mounts over top of the pivot point of the Mongoose XLE creating a smaller footprint
- M20 threads adapts to a Zirkona Tablet display for use with smaller tablets
- Designed to apply pressure on the motion attachment using a foam pad for vibration dampening
- Motion attachment and tablet display are independent from each other to allow stationary viewing
- Limited Lifetime Warranty

ZIRKONA WELDED POLE ADAPTER

NEW



Item No.	Placement/Compatibility	Weight	Height	Width	Depth/ Diameter
7110-1326	Any Gamber-Johnson Pedestal System or Use on Pipe Up to 1.75" (4.4 cm) in Diameter	1.2 lbs 0.54 kg	3" 7.62 cm	3" 7.62 cm	3" 7.62 cm

Features

- Quickly add a second device to a Gamber-Johnson pole system using the Zirkona system
- Two (2) metal clamps and welded design helps ensure strength
- No removal of parts is needed; adapts to existing Gamber-Johnson pedestal mounts or pipe diameter 1.13" to 1.75"
- Cost-effective part when adding a new, secondary device
- Recommend use of Loctite® 9460, 9461, or 9466 on all M20 size threads (Loctite not included)
- 1 Year Limited Warranty

ZIRKONA WELDED VEHICLE BASE ADAPTER

NEW



Item No.	Description	Placement/Compatibility	Weight	Height	Width	Depth/ Diameter
7110-1325	Welded Vehicle Base Adapter	Any Gamber-Johnson Vehicle Base	1 lbs 0.45 kg	3" 7.62 cm	0.88" 2.24 cm	3" 7.62 cm

Features

- Easily switch from a Gamber-Johnson pole system to a Zirkona system
- Welded design helps ensure strength in the light-duty pedestal mount
- Gamber-Johnson vehicle base removal is not necessary; cutting down on removal and install time for the rest of the mount
- New or old hardware can be utilized
- Cost-effective part when looking at a new mount
- Recommend use of Loctite® 9460, 9461, or 9466 on all M20 size threads (Loctite not included)
- 1 Year Limited Warranty

ZIRKONA FAN ADAPTER PLATE

Item No.	Description	Placement/Compatibility	Weight	Height	Width	Depth/ Diameter
7160-1342	Fan Adapter	Attaches to AMPS/ NEC Hole Pattern Plate (14144) to Mount Fans on Forklifts	0.3 lbs 0.14 kg	0.63" 1.6 cm	N/A	2.75" 6.99 cm

Features

- Quick and easy no-drill installation designed to be used with a variety of fans
- Adapts fan to any competitor product with the NEC hole pattern
- Includes mounting hardware
- Powder-coated steel plate offers rigidity and strength
- 1 Year Limited Warranty

Recommended Solution

- Kit: Forklift Fan Mounting Bracket (7170-0774)
- 4" Diamond Plate with Large Joiner and Zirkona AMPS/NEC Plate (7160-1261)
OR
- Kit: Forklift Fan Mounting Bracket (7170-0774)
- 4" Diamond Plate with Medium Joiner and Zirkona AMPS/NEC Plate (7160-1171)

NEW



7160-1342



7170-0774

ZIRKONA DIAMOND PLATE MOUNT

Item No.	Description	Placement/Compatibility	Maximum Payload Capacity	Weight	Height	Width	Depth
7160-1171	Zirkona, 4" Diamond Plate with Medium Joiner and AMPs Plate	Up to 4" Wide Overhead Crossmember, Rectangular or Roll Form Profile	Vibration Environment 6 lbs (1.4 kg) Static Environment 33 lbs (15 kg)	2.2 lbs 1.0 kg	2.5" 6.4 cm	4.7" 12.0 cm	5.8" 14.6 cm

Features

- Small form factor for smaller tablets and other small devices
- Large range of motion and quick adjust lever to effortlessly move to a desired position
- Designed to be quickly and easily installed without the need for drilling
- Mounting hole patterns include AMPs and NEC
- 1 Year Limited Warranty



DOG-BONE JOINER MOUNTS

Item No.	Description	Placement/Compatibility	Maximum Payload Capacity	Weight	Height	Width	Depth
7160-1466	Zirkona, 4" Diamond Plate with 6" Medium Dog-Bone and AMPs Plate	Up to 4" Wide Overhead Crossmember, Rectangular or Roll Form Profile	Vibration Environment 6 lbs (1.4 kg) Static Environment 33 lbs (15 kg)	3.3 lbs 1.5 kg	6.0" 15.2 cm	5.0" 12.7 cm	9.5" 24.1 cm
7160-1466-01	Zirkona, 4" Diamond Plate with 6" Medium Dog-Bone and VESA 75 mm Plate	Up to 4" Wide Overhead Crossmember, Rectangular or Roll Form Profile	Vibration Environment 6 lbs (1.4 kg) Static Environment 33 lbs (15 kg)	3.3 lbs 1.5 kg	6.0" 15.2 cm	5.0" 12.7 cm	9.5" 24.1 cm

Features

- Small form factor with an extended reach for smaller tablets and other small devices
- Two quick adjust levers increase range of motion and positioning
- Unique internal braking system allows the user to adjust the mount with ease while not having the device fall (weight restrictions apply)
- Designed to be quickly and easily installed without the need for drilling
- 1 Year Limited Warranty

NEW



7160-1466



7160-1466-01

LARGE JOINER MOUNTS



7160-1261



7160-1261-01

Item No.	Description	Placement/Compatibility	Maximum Payload Capacity	Weight	Height	Width	Depth
7160-1261	Zirkona, 4" Diamond Plate with Large Joiner and AMPs Plate	Up to 4" Wide Overhead Crossmember, Rectangular or Roll Form Profile	Vibration Environment 11 lbs (5.0 kg) Static Environment 55 lbs (25 kg)	2.7 lbs 1.2 kg	2.5" 6.4 cm	5.7" 14.4 cm	5.8" 14.6 cm
7160-1261-01	Zirkona, 4" Diamond Plate with Large Joiner and VESA 75 mm Plate	Up to 4" Wide Overhead Crossmember, Rectangular or Roll Form Profile	Vibration Environment 11 lbs (5.0 kg) Static Environment 55 lbs (25 kg)	2.8 lbs 1.3 kg	2.5" 6.4 cm	5.7" 14.4 cm	5.8" 14.6 cm

Features

- Easy to install mounting solution with no drilling required and ample adjustability to accommodate operator comfort and ease of use
- Small form factor for smaller tablets and other small devices
- Large range of motion and quick adjust lever to effortlessly move to a desired position
- Options for various mounting hole patterns include AMPs, NEC, and VESA 75 mm
- 1 Year Limited Warranty

COMPONENTS



7160-1235

Item No.	Description	Placement/Compatibility	Maximum Payload Capacity	Weight	Height	Width	Depth
7160-1235	Zirkona, 4" Diamond Plate Mount	Up to 4" Wide Overhead Crossmember, Rectangular or Roll Form Profile	N/A	1.8 lbs 0.8 kg	4.7" 12.0 cm	2.5" 6.4 cm	5.8" 14.6 cm

Features

- For use with individual Zirkona products such as Joiners and Extensions
- Allows for creating a unique mount for smaller tablets and other small devices
- Designed to be quickly and easily installed without the need for drilling
- 1 Year Limited Warranty

ZIRKONA POLE/TUBE MOUNTS LARGE JOINER WITH 3/4" TO 1-7/8" SIZE RANGE

NEW



7160-1367



7160-1367-01

Item No.	Description	Placement	Attributes	Weight	Height	Width	Depth
7160-1367	Zirkona 3/4" to 1-7/8" Pole Mount with AMPs Plate	Cylindrical Pole/Tube Ranging Between 3/4" and 1-7/8"	Vibration Environment 11 lbs (5.0 kg) Static Environment 55 lbs (25 kg)	2.9 lbs 1.3 kg	3.7" 9.4 cm	5.2" 13.2 cm	6.3" 15.9 cm
7160-1367-01	Zirkona 3/4" to 1-7/8" Pole Mount with VESA 75 mm Plate	Cylindrical Pole/Tube Ranging Between 3/4" and 1-7/8"	Vibration Environment 11 lbs (5.0 kg) Static Environment 55 lbs (25 kg)	3.0 lbs 1.4 kg	3.7" 9.4 cm	5.2" 13.2 cm	6.3" 15.9 cm

Features

- Mounts to any size cylindrical poles, handles, or tubular style overhead guard legs varying between 3/4" (1.91 cm) and 1-7/8" (4.76 cm) in diameter
- Easy to install mounting solution with no drilling required and ample adjustability to accommodate operator comfort and ease of use
- Small form factor for smaller tablets and other small devices
- Options for various mounting hole patterns include AMPs/NEC and VESA 75 mm
- 1 Year Limited Warranty

LARGE JOINER WITH 3/4" TO 1-7/8" SIZE RANGE AND QUICK RELEASE DEVICE PLATE

Item No.	Description	Placement	Attributes	Weight	Height	Width	Depth
7160-1367-02	Zirkona 3/4" to 1-7/8" Pole Mount with AMPs Quick Release Plate	Cylindrical Pole/Tube Ranging Between 3/4" and 1-7/8"	Vibration Environment 11 lbs (5.0 kg) Static Environment 55 lbs (25 kg)	3.5 lbs 1.56 kg	3.9" 9.9 cm	4.7" 11.9 cm	6.8" 17.3 cm
7160-1367-03	Zirkona 3/4" to 1-7/8" Pole Mount with VESA 75 mm Quick Release Plate	Cylindrical Pole/Tube Ranging Between 3/4" and 1-7/8"	Vibration Environment 11 lbs (5.0 kg) Static Environment 55 lbs (25 kg)	3.7 lbs 1.68 kg	3.9" 9.9 cm	5.5" 13.8 cm	7.1" 18.0 cm

Features

- Mounts to any size cylindrical poles, handles, or tubular style overhead guard legs varying between 3/4" (1.91 cm) and 1-7/8" (4.7625 cm) in diameter
- Easy to install mounting solution with no drilling required to decrease install times and improve vehicle up-times
- Quick release device plate to easily remove small tablets or devices
- Options for various mounting hole patterns include AMPs/NEC and VESA 75 mm
- 1 Year Limited Warranty

NEW



7160-1367-02



7160-1367-03

LARGE JOINER WITH 2" TO 3" SIZE RANGE

Item No.	Description	Placement	Attributes	Weight	Height	Width	Depth
7160-1356	Zirkona 2" to 3" Pole Mount with AMPs Plate	Cylindrical Pole/Tube Ranging Between 2" and 3"	Vibration Environment 11 lbs (5.0 kg) Static Environment 55 lbs (25 kg)	2.2 lbs 1.0 kg	3.7" 9.4 cm	5.2" 13.2 cm	6.3" 15.9 cm
7160-1356-01	Zirkona 2" to 3" Pole Mount with VESA 75 mm Plate	Cylindrical Pole/Tube Ranging Between 2" and 3"	Vibration Environment 11 lbs (5.0 kg) Static Environment 55 lbs (25 kg)	2.3 lbs 1.1 kg	3.7" 9.4 cm	5.2" 13.2 cm	6.3" 15.9 cm

Features

- Mounts to any size cylindrical poles or tubular style overhead guard legs varying between 2" (5.08 cm) and 3" (7.62 cm) in diameter
- Easy to install mounting solution with no drilling required and ample adjustability to accommodate operator comfort and ease of use
- Small form factor for smaller tablets and other small devices
- Options for various mounting hole patterns include AMPs/NEC and VESA 75 mm
- 1 Year Limited Warranty

NEW



7160-1356



7160-1356-01

DOG-BONE JOINER WITH 3/4" TO 1-7/8" SIZE RANGE

Item No.	Description	Placement	Attributes	Weight	Height	Width	Depth
7160-1533	Zirkona 3/4" to 1-7/8" Pole Mount with 6" Medium Dog-Bone and AMPs Plate	Cylindrical Pole/Tube Ranging Between 3/4" and 1-7/8"	Vibration Environment 6 lbs (1.4 kg) Static Environment 33 lbs (15 kg)	3.5 lbs 1.6 kg	3.9" 9.8 cm	4.7" 11.9 cm	10.1" 25.7 cm
7160-1533-01	Zirkona 3/4" to 1-7/8" Pole Mount with 6" Medium Dog-Bone and VESA 75 mm Plate	Cylindrical Pole/Tube Ranging Between 3/4" and 1-7/8"	Vibration Environment 6 lbs (1.4 kg) Static Environment 33 lbs (15 kg)	3.5 lbs 1.6 kg	3.9" 9.8 cm	4.7" 11.9 cm	10.1" 25.7 cm

Features

- Mounts to any size cylindrical poles or tubular style overhead guard legs varying between 3/4" (1.91 cm) and 1-7/8" (4.76 cm) in diameter
- Unique internal braking system allows the user to adjust the mount with ease while not having the device fall (weight restrictions apply)
- Two quick adjust levers increase range of motion and positioning
- Includes 6" Medium Dog-Bone Joiner with options for AMPs/NEC and VESA 75 mm mounting hole patterns
- 1 Year Limited Warranty

NEW



7160-1533



7160-1533-01

DOG-BONE JOINER WITH 2" TO 3" SIZE RANGE

NEW



7160-1531



7160-1531-01

Item No.	Description	Placement	Attributes	Weight	Height	Width	Depth
7160-1531	Zirkona 2" to 3" Pole Mount with 6" Medium Dog-Bone and AMPs Plate	Cylindrical Pole/Tube Ranging Between 2" and 3"	Vibration Environment 6 lbs (1.4 kg) Static Environment 33 lbs (15 kg)	2.8 lbs 1.3 kg	2.4" 6.0 cm	5.2" 13.2 cm	9.8" 25.0 cm
7160-1531-01	Zirkona 2" to 3" Pole Mount with 6" Medium Dog-Bone and VESA 75 mm Plate	Cylindrical Pole/Tube Ranging Between 2" and 3"	Vibration Environment 6 lbs (1.4 kg) Static Environment 33 lbs (15 kg)	2.8 lbs 1.3 kg	3.9" 9.8 cm	5.2" 13.2 cm	9.8" 25.0 cm

Features

- Mounts to any size cylindrical poles or tubular style overhead guard legs varying between 2" (5.08 cm) and 3" (7.62 cm) in diameter
- Unique internal braking system allows the user to adjust the mount with ease while not having the device fall (weight restrictions apply)
- Two quick adjust levers increase range of motion and positioning
- Includes 6" Medium Dog-Bone Joiner with options for AMPs/NEC and VESA 75 mm mounting hole patterns
- 1 Year Limited Warranty

ZIRKONA POCKET MOUNTS

NEW



7170-0788



7170-0796

Item No.	Description	Placement	Weight	Height	Width	Depth
7170-0788	Zirkona 4" Diamond Mount with Scanner Pocket	Up to 4" Wide Crossmember, Rectangular or Roll Form Profile	5.2 lbs 2.4 kg	3.5" 8.9 cm	6.0" 15.2 cm	13.0 33.0 cm
7170-0796	Zirkona 2" to 3" Pole Mount with Scanner Pocket	Cylindrical Pole/Tube Ranging Between 2" and 3"	4.6 lbs 2.2 kg	3.5" 8.9 cm	5.5" 13.8 cm	15" 38.1 cm

Features

- Designed to be an easily equipped, no drilling required, solution to reduce installation times and labor costs
- Large range of motion and quick adjust lever to effortlessly move to a desired position
- Adjustable pocket with a range of 3.5" (8.89 cm) to 4.5" (11.43 cm) in width and set at 2.5" (6.35 cm) tall
- 1 Year Limited Warranty

ZIRKONA POCKET MOUNTS

NEW



Item No.	Description	Placement	Weight	Height	Width	Depth
7170-0764	Zirkona Pistol Grip Scanner Mount Kit	Up to 4" Wide Crossmember, Rectangular or Roll Form Profile	4.1 lbs 1.8 kg	2.6" 6.6 cm	4.3" 10.8 cm	15.7" 39.9 cm

Features

- Padded tray to support most wireless handheld barcode scanners
- Offers the ability to utilize the device while cradled
- Designed to be an easily equipped solution with no drilling required to reduce installation times and labor costs
- Large range of motion and quick adjust lever to effortlessly move to a desired position
- 1 Year Limited Warranty

ZIRKONA FOR BIG RIGS PIVOT MOUNT

Item No.	Description	Placement	Weight	Height	Width	Depth
7160-1132	Zirkona Pivot Arm with 2" Extension and AMPs/NEC Plate	Attach to Dash or Flat Vertical Surface	2.5 lbs 1.1 kg	4.6" 11.6 cm	8.0" 20.3 cm	2.3" 5.7 cm
7160-1132-01	Zirkona Pivot Arm with 2" Extension and VESA 75 mm Plate	Attach to Dash or Flat Vertical Surface	2.6 lbs 1.2 kg	4.6" 11.6 cm	8.0" 20.3 cm	2.3" 5.7 cm
7160-1132-04	Zirkona Pivot Arm with 2" Extension and VESA 100 mm Plate	Attach to Dash or Flat Vertical Surface	2.7 lbs 1.3 kg	4.6" 11.6 cm	8.0" 20.3 cm	2.3" 5.7 cm
7160-1132-02	Zirkona Pivot Arm with 4" Extension and AMPs/NEC Plate	Attach to Dash or Flat Vertical Surface	2.6 lbs 1.2 kg	4.6" 11.6 cm	10.0" 25.4 cm	2.3" 5.7 cm
7160-1132-03	Zirkona Pivot Arm with 4" Extension and VESA 75 mm Plate	Attach to Dash or Flat Vertical Surface	2.7 lbs 1.3 kg	4.6" 11.6 cm	10.0" 25.4 cm	2.3" 5.7 cm
7160-1132-05	Zirkona Pivot Arm with 4" Extension and VESA 100 mm Plate	Attach to Dash or Flat Vertical Surface	2.8 lbs 1.4 kg	4.6" 11.6 cm	10.0" 25.4 cm	2.3" 5.7 cm

Features

- Back plate included for additional weight distribution to reduce the risk of damaging the dash
- Large range of motion and quick adjust lever to effortlessly move to a desired position
- Drilled solution allows devices to be mounted in the most convenient position for the user
- 1 Year Limited Warranty

NEW



7160-1132



7160-1132-01



7160-1132-03

MULTI-FUNCTION PIVOT MOUNT

Item No.	Description	Placement	Weight	Height	Width	Depth
7160-1385	Zirkona Multi-Function Pivot Arm with 2" Extension and AMPs/NEC Plate	Attach to Dash, Flat Surface, or OEM Specific Dash Mounts	1.3 lbs 0.6 kg	3.0" 7.6 cm	8.9" 22.5 cm	3.0" 7.6 cm
7160-1385-01	Zirkona Multi-Function Pivot Arm with 2" Extension and VESA 75 mm Plate	Attach to Dash, Flat Surface, or OEM Specific Dash Mounts	1.4 lbs 0.6 kg	3.0" 7.6 cm	8.9" 22.5 cm	3.0" 7.6 cm
7160-1385-02	Zirkona Multi-Function Pivot Arm with 4" Extension and AMPs/NEC Plate	Attach to Dash, Flat Surface, or OEM Specific Dash Mounts	1.4 lbs 0.6 kg	3.0" 7.6 cm	10.9" 27.6 cm	3.0" 7.6 cm
7160-1385-03	Zirkona Multi-Function Pivot Arm with 4" Extension and VESA 75 mm Plate	Attach to Dash, Flat Surface, or OEM Specific Dash Mounts	1.5 lbs 0.7 kg	3.0" 7.6 cm	10.9" 27.6 cm	3.0" 7.6 cm
7160-1385-04	Zirkona Multi-Function Pivot Arm with 6" Extension and AMPs/NEC Plate	Attach to Dash, Flat Surface, or OEM Specific Dash Mounts	1.5 lbs 0.7 kg	3.0" 7.6 cm	12.9" 32.8 cm	3.0" 7.6 cm
7160-1385-05	Zirkona Multi-Function Pivot Arm with 6" Extension and VESA 75 mm Plate	Attach to Dash, Flat Surface, or OEM Specific Dash Mounts	1.6 lbs 0.8kg	3.0" 7.6 cm	12.9" 32.8 cm	3.0" 7.6 cm

Features

- Back plate included for additional weight distribution to reduce the risk of damaging the dash
- Push and twist quick release base and multiple quick adjust handles in order to optimize device position and provide easy removal
- Utilized as a drilled solution to virtually mount anywhere or adapts to Gamber-Johnson OEM Specific Dash Mounts to perfectly align with your mounting needs
- No need to fight installing extra hardware with an easy to install back plate
- 1 Year Limited Warranty

NEW



7160-1385-01



7160-1385-02



7160-1385-03

DOG-BONE MEDIUM JOINER MOUNTS

Item No.	Description	Placement	Weight	Height	Width	Depth
7160-1410	Zirkona 6" Medium Dog-Bone Joiner with AMPs/NEC Plate	Attach to Dash, Flat Surface, or OEM Specific Dash Mounts	1.3 lbs 0.6 kg	5.0" 12.7 cm	9.0" 22.9 cm	3.0" 7.6 cm
7160-1410-01	Zirkona 6" Medium Dog-Bone Joiner with VESA 75 mm Plate	Attach to Dash, Flat Surface, or OEM Specific Dash Mounts	1.4 lbs 0.6 kg	5.0" 12.7 cm	9.0" 22.9 cm	3.0" 7.6 cm

Features

- Back plate included for additional weight distribution to reduce the risk of damaging the dash
- Utilized as a drilled solution to virtually mount anywhere or adapts to Gamber-Johnson OEM Specific Dash Mounts to perfectly align with your mounting needs
- Large range of motion and quick adjust lever to effortlessly move to a desired position
- No need to fight installing extra hardware with an easy to install back plate
- 1 Year Limited Warranty

NEW



7160-1410



7160-1410-01

MEDIUM JOINER MOUNTS



7160-1179-01



7160-1240-01

Item No.	Description	Maximum Payload Capacity*	Weight	Height	Width
7160-1179	Zirkona Medium Joiner with VESA 75 mm Plate	Vibration Environment 6 lbs (1.4 kg) Static Environment 33 lbs (15 kg)	1.3 lbs 0.6 kg	3.2" 8.1 cm	4.4" 11.2 cm
7160-1179-01	Zirkona Medium Joiner with VESA 75 mm Plate and Back Plate	Vibration Environment 6 lbs (1.4 kg) Static Environment 33 lbs (15 kg)	1.4 lbs 0.6 kg	3.2" 8.1 cm	4.4" 11.2 cm
7160-1240	Zirkona Medium Joiner with AMPs/NEC Plate	Vibration Environment 6 lbs (1.4 kg) Static Environment 33 lbs (15 kg)	1.4 lbs 0.6 kg	3.2" 8.1 cm	4.4" 11.2 cm
7160-1240-01	Zirkona Medium Joiner with AMPs/NEC Plate and Back Plate	Vibration Environment 6 lbs (1.4 kg) Static Environment 33 lbs (15 kg)	1.5 lbs 0.7 kg	3.2" 8.1 cm	4.4" 11.2 cm

Features

- Attaches to dash, flat surface, or OEM Specific Dash Mounts
- Utilized as a drilled solution to virtually mount anywhere or adapts to Gamber-Johnson OEM Specific Dash Mounts to perfectly align with your mounting needs
- Large range of motion and quick adjust lever to effortlessly move to a desired position
- Products with back plate adds additional weight distribution to reduce the risk of damaging the dash
- 1 Year Limited Warranty

*Note: Extensions will decrease maximum payload capacity. Visit gamberjohnson.com for more details

MEDIUM JOINER EXTENDED MOUNTS



7160-1180-01



7160-1239-01

Item No.	Description	Maximum Payload Capacity*	Weight	Height	Width
7160-1180	Zirkona Medium Joiner with 2" Extension and VESA 75 mm Plate	Vibration Environment 6 lbs (1.4 kg) Static Environment 33 lbs (15 kg)	1.5 lbs 0.7 kg	3.2" 8.1 cm	6.4" 11.2 cm
7160-1180-01	Zirkona Medium Joiner with 2" Extension, VESA 75 mm Plate, and Back Plate	Vibration Environment 6 lbs (1.4 kg) Static Environment 33 lbs (15 kg)	1.6 lbs 0.7 kg	3.2" 8.1 cm	6.4" 11.2 cm
7160-1239	Zirkona Medium Joiner with 2" Extension and AMPs/NEC Plate	Vibration Environment 6 lbs (1.4 kg) Static Environment 33 lbs (15 kg)	1.4 lbs 0.7 kg	3.2" 8.1 cm	6.4" 11.2 cm
7160-1239-01	Zirkona Medium Joiner with 2" Extension, AMPs/NEC Plate, and Back Plate	Vibration Environment 6 lbs (1.4 kg) Static Environment 33 lbs (15 kg)	1.5 lbs 0.7 kg	3.2" 8.1 cm	6.4" 11.2 cm

Features

- Attaches to dash, flat surface, or OEM Specific Dash Mounts
- Utilized as a drilled solution to virtually mount anywhere or adapts to Gamber-Johnson OEM Specific Dash Mounts to perfectly align with your mounting needs
- Added extension brings the device closer to the user or creates easier access to other necessary switches and functions
- Large range of motion and quick adjust lever to effortlessly move to a desired position
- Products with back plate adds additional weight distribution to reduce the risk of damaging the dash
- 1 Year Limited Warranty

*Note: Extensions will decrease maximum payload capacity. Visit gamberjohnson.com for more details

TWO-DOWN SUCTION CUP PHONE MOUNT

Item No.	Description	Placement	Weight	Height	Width	Depth/ Diameter
7170-0856	Phone Mount with Suction Cup	Any Flat, Smooth, Non-Porous Surface	1.02 lbs 0.46 kg	7" 17.78 cm	4.66" 11.84 cm	4.66" 11.84 cm

Features

- Keep your phone or small device in clear view for GPS or charging your device
- Suction cup has strong grip with the help of a handle to clamp
- Phone cradle holds a wide variety of phones and devices with up to 3.5" (8.89 cm) of expanding clamps
- The medium 2-down joiner with brake allows for easy, one-handed adjustment
- Provides a quick, light-weight and temporary solution for mounting your device
- Includes: (1) Two-down medium joiner with brake, (1) Suction cup, and (1) Phone cradle
- 1 Year Limited Warranty



6" FLAT SURFACE PHONE MOUNT

Item No.	Description	Placement	Weight	Height	Width	Depth/ Diameter
7170-0857	Flat Surface Phone Mount	Mounts on Dashes and Other Flat And Stable Surfaces	0.98 lbs 0.44 kg	14.5" 36.83 cm	3" 7.62 cm	3" 7.62 cm

Features

- Use your dash for a better place to put your phone
- Four (4) simple drilled holes into the dash provide a strong support when accompanied with the backer plate
- Pivot Joint allows for any desired angle
- Phone cradle holds a wide variety of phones and devices with up to 3.5" (8.89 cm) of expanding clamps
- The medium 2-down joiner with brake allows for easy, one-handed adjustment
- 6" (150 mm) extension allows for longer reach
- Includes: (1) Medium 2-down joiner, (1) AMPS Backer Plate, (1) Pivot Elbow, (1) 6" extension, (1) Phone cradle, and (1) AMPS Backer Plate Hardware Bag
- 1 Year Limited Warranty



ZIRKONA STANDARD CLAMP PHONE MOUNT

Item No.	Description	Placement	Weight	Height	Width	Depth/ Diameter
7170-0858	Standard Clamp Phone Mount	Use on Round Tubes from 0.5" (1.27 cm) to 1.69" (4.29 cm) in Diameter or Square Posts up to 1.44" (3.66 cm) in Width	0.9 lbs 0.41 kg	9.66" 24.54 cm	3.5" 8.89 cm	3.5" 8.89 cm

Features

- Standard clamp mounts around posts up to 1.69" (4.29 cm) giving you flexibility on what and where to mount your solution
- Rubber spacers in the clamp help provide grip to whatever surface it's in contact with
- Phone Cradle holds a wide variety of phones and devices up to 3.5" (8.89 cm) of expanding clamps
- The medium 2-down joiner with brake allows for easy, one-handed adjustment
- Clamping allows for a clean, no drilling required option for your device
- Includes: (1) Phone Cradle, (1) Medium 2-down joiner, and (1) standard size clamp
- 1 Year Limited Warranty



ZIRKONA SMALL CLAMP PHONE MOUNT

Item No.	Description	Placement	Weight	Height	Width	Depth/ Diameter
7170-0859	Small Clamp Phone Mount	Works on Any Handlebars, Stable Pipe or Post Ranging from 0.5" (0.64 cm) to 1" (2.5 cm)	0.9 lbs 0.41 kg	8.25" 20.96 cm	3.5" 8.89 cm	3.5" 8.89 cm

Features

- Small clamp is ideal for handlebars or anywhere space is needed
- Shorter hardware helps keep catch points to a minimum while still holding your device
- Phone cradle holds a wide variety of phones and devices with up to 3.5" (8.89 cm) of expanding clamps
- The medium 2-down joiner with brake allows for easy, one-handed adjustment
- Clamping allows for a clean, no drilling required option for your device
- Includes: (1) Phone Cradle, (1) Medium 2-down joiner, and (1) small size clamp
- 1 Year Limited Warranty



UNIVERSAL HEADS UP PHONE CRADLE MOUNT



Item No.	Description	Placement	Weight	Height	Width	Depth/ Diameter
7170-0758-01	Heads Up Phone Mount	Phone Cradle Fits Most Smart Phones. Heads Up Display Fits Between Most Docks and Cradles and Clevis.	1.5 lbs 0.68 kg	4.5" 11.43 cm	12.5" 31.75 cm	5" 12.7 cm

Features

- Mount your phone to the left or right of your tablet or laptop dock for easy reach
- Keeps your phone up and out of the way
- Mounting plate positions between the dock/cradle and the clevis/tablet display using the VESA 75 mm hole pattern
- Slotted holes allow for the bracket and Zirkona mount to be adjusted for different size docks and cradles
- Universal phone cradle uses Zirkona to allow for better positioning to the user using the small short joiner
- Includes: (1) Heads Up Mounting Bracket, (1) Zirkona Female Threaded Adapter, (1) Phone Cradle, (1) medium short joiner, and (1) hardware bag
- Limited Lifetime Warranty on Heads UP Display Bracket
- 1 Year Limited Warranty on Zirkona pieces
- 1 Year Limited Warranty on phone cradle

ZIRKONA SCREW BASE CELL PHONE HOLDER



Item No.	Description	Placement	Weight	Height	Width	Depth/ Diameter
7160-0995-00	Cell Phone Holder	In Strong Flat Surface, Most Cell Phones and Similar Sized Devices	0.5 lbs 0.2 kg	4.63" 11.76 cm	2.63" - 4.5" 6.68 cm - 11.43 cm	4.38" 11.13 cm

Features

- Easy to install on a console box
- Features a Zirkona joiner with 360° rotation so you can position the phone to any viewing angle
- Phone cradle expands to 3.5" (8.9 cm)
- Foldable legs provide extra support for your phone
- One button quick release, no need to expand the cradle sides with your hands
- Works in either portrait or landscape orientation
- Phone cradle can be easily removed from the joiner and base, and be attached to any Zirkona mounting bracket
- Fits most smartphones including:
 - Apple iPhone: 6s, 6s Plus, 7, 7 Plus, 8, 8 Plus, X, XS
 - Samsung Galaxy: Note 8, Note 8 Plus, Note 9, S7, S8, S9, S10, S10+, S20, S20 Ultra, A8, A8 Plus, J2
 - LG: V30, G6
 - Google: Pixel 2, Pixel 2XL
 - HTC: U11
- 1 Year Limited Warranty

ZIRKONA MAGNETIC BASE CELL PHONE HOLDER



Item No.	Description	Placement	Weight	Height	Width	Depth/ Diameter
7160-0996-00	Cell Phone Holder	Any Magnetic Surface	0.5 lbs 0.2 kg"	4.63" 11.76 cm	2.63" - 4.5" 6.68 cm - 11.43 cm	4.38" 11.13 cm

Features

- Handsfree display for small handhelds
- Easy to install on a console box
- Powerful neodymium magnet has 105 lbs of pull force so your phone will stay in place
- Features a Zirkona joiner with 360° rotation so you can position the phone to any viewing angle
- Phone cradle expands to 3.5" (8.9 cm)
- Foldable legs provide extra support for your phone
- One button quick release, no need to expand the cradle sides with your hands
- Works in either portrait or landscape orientation
- Phone cradle can be easily removed from the joiner and base, and be attached to any Zirkona mounting bracket
- Fits most smartphones including:
 - Apple iPhone: 6s, 6s Plus, 7, 7 Plus, 8, 8 Plus, X, XS
 - Samsung Galaxy: Note 8, Note 8 Plus, Note 9, S7, S8, S9, S10, A8, A8 Plus, J2
 - LG: V30, G6
 - Google: Pixel 2, Pixel 2XL
 - HTC: U11
- 1 Year Limited Warranty

ZIRKONA MEDIUM JOINER WITH TWO ROUND PLATES

Item No.	Description	Placement/Compatibility	Weight	Height	Width	Depth/ Diameter
7160-0993	Medium Joiner with Two Round Plates	Mounts To Any Flat and Stable Surface. May Require Drilling. Holds Devices with AMPs or NEC.	0.63 lbs 0.29 kg	4.75" 12.06 cm	2.25" 5.72 cm	2.25" 5.72 cm

Features

- All axes range of motion in X axis (left/right), Y axis (front/back) and Z axis (up/down)
- Quick adjust handle for easy adjustment to position device
- Ships assembled and glued
- Anodized aluminum with black finish making it lightweight but durable
- Maximum weight limit: 6.0 lbs (2.8 kg) in a vibration/mobile environment or 33 lbs (15 kg) in a static/no vibration environment
- Includes: (1) Medium Joiner and (2) AMPS Round Plates
- May require drilling
- 1 Year Limited Warranty



ZIRKONA MEDIUM JOINER WITH TWO VESA 75 MM MOUNTING PLATES

Item No.	Description	Placement/Compatibility	Weight	Height	Width	Depth/ Diameter
7160-0865	Medium Joiner with Two VESA 75 mm Plates	Mounts To Any Flat and Stable Surface. May Require Drilling. Holds Devices with VESA 75 mm Hole Pattern.	0.80 lbs 0.36 kg	5.75" 14.61 cm	4.88" 12.40 cm	4.88" 12.40 cm

Features

- All axes range of motion in X axis (left/right), Y axis (front/back) and Z axis (up/down)
- Quick adjust handle for easy adjustment to position device
- Ships assembled and glued
- Anodized aluminum with black finish making it lightweight but durable
- Maximum weight limit: 6.0 lbs (2.8 kg) in a vibration/mobile environment or 33 lbs (15 kg) in a static/no vibration environment
- Includes: (1) Medium Joiner and (2) VESA 75 mm Plates
- May require drilling
- 1 Year Limited Warranty



ZIRKONA MEDIUM JOINER 2" (50 MM) WITH AMPS AND VESA 75 MM PLATES

Item No.	Description	Placement/Compatibility	Weight	Height	Width	Depth/ Diameter
7160-0779	Medium Joiner 2" with AMPS and VESA 75 mm Plates	AMPs Plates Mount To Any Flat and Stable Surface. May Require Drilling. Holds Devices with VESA 75 mm Hole Pattern.	0.75 lbs 0.34 kg	6.5" 16.51 cm	4.88" 12.40 cm	4.88" 12.40 cm

Features

- All axes range of motion in X axis (left/right), Y axis (front/back) and Z axis (up/down)
- Extension tube for extra height off mounting surface
- Quick adjust handle for easy adjustment to position device
- Ships assembled and glued
- Anodized aluminum with black finish making it lightweight but durable
- Maximum weight limit: 6.0 lbs (2.8 kg) in a vibration/mobile environment or 33 lbs (15 kg) in a static/no vibration environment
- Includes: (1) Medium Joiner, (1) VESA75 mm Plate, (1) AMPS Round Plate, (1) Threaded Adapter, and (1) 2" (50 mm) extension
- AMPS round mounting plate provides two standard mounting hole patterns; AMPS and NEC
- Device plate is VESA 75 mm
- May require drilling
- 1 Year Limited Warranty



ZIRKONA MEDIUM JOINER 4" (100 MM) KIT WITH ROUND PLATES



Item No.	Description	Placement/Compatibility	Weight	Height	Width	Depth/ Diameter
7170-0156	Medium Joiner 4" (100 mm) Kit with AMPS Round Plates	AMPS Plates Mounts to Any Flat and Stable Surface. May Require Drilling. Holds Devices with AMPS/NEC Hole Pattern.	1.05 lbs 0.5 kg	9.64" 24.4 cm	3.38" 8.6 cm	2.38" 6.1 cm

Features

- All axes range of motion in X axis (left/right), Y axis (front/back) and Z axis (up/down)
- Extension tube for extra height off mounting surface
- Quick adjust handle for easy adjustment to position device
- Ships unassembled - Recommend use of Loctite® 9460, 9461, or 9466 on all M20 size threads (Loctite not included)
- Anodized aluminum with black finish making it lightweight but durable
- Maximum weight limit: 6.0 lbs (2.8 kg) in a vibration/mobile environment or 33 lbs (15 kg) in a static/no vibration environment
- Kit includes: (1) Medium Joiner, (2) AMPS Round Plate, (1) Threaded Adapter, and (1) 4" (100 mm) Extension
- AMPS round mounting plate provides two standard mounting hole patterns; AMPS and NEC
- May require drilling
- 1 Year Limited Warranty

ZIRKONA MEDIUM JOINER, ROUND MOUNTING PLATE AND FEMALE THREADED ADAPTER KIT



Item No.	Description	Placement/Compatibility	Weight	Height	Width	Depth/ Diameter
7170-0691	Medium Joiner, Round Mounting Plate and Female Threaded Adapter Kit	Threaded Adapter Mounts to Any Flat and Stable Surface. May Require Drilling. Holds Devices with AMPS/NEC Hole Pattern.	0.57 lbs 0.26 kg	2.38" 6.05 cm	3.5" 8.89 cm	4.5" 11.43 cm

Features

- Ideal for holding light weight devices, like cell phones, GPS's, small displays or small light weight tablets
- Kit allows for mounting on a solid surface with the Female Threaded Adapter (17394), like metal, aluminum, wood, or thicker rigid plastic
- M6 hardware required for mounting Female Threaded Adapter. Hardware not provided.
- Medium joiner allows for the device to be mounted in a position for easy viewing.
- Anodized aluminum with black finish making it lightweight but durable
- Kit includes: (1) Medium Joiner, (1) AMPS Round Plate, (1) Female Threaded Adapter
- AMPS round mounting plate provides two standard mounting hole patterns; AMPS and NEC
- May require drilling
- Ships unassembled - Recommend use of Loctite® 9460, 9461, or 9466 on all M20 size threads (Loctite not included)
- 1 Year Limited Warranty

SMALL ZIRKONA POLE MOUNT

Item No.	Description	Placement/Compatibility	Weight	Height	Width	Depth/ Diameter
7170-0594	Pole Mount	Use on pipe from .5" (1.27 cm) to 1.69" (4.29cm) in diameter or square posts up to 1.44" (3.66 cm) in width	1 lbs 0.45 kg	5.25" 13.3 cm	3.75" 9.5 cm	3.75" 9.5 cm

Features

- Great for mounting small handheld devices used in material handling or and static environment
- Pipe/channel clamp fits pipe from 0.59" (1.5 cm) to 1.18" (3.0 cm) diameter
- Articulated joiner with tension handle – position display for the proper viewing angle
- VESA 75mm mounting adapter – fits most displays
- 100mm extension (included) to increase the range of operation
- Anodized aluminum with black finish
- **Kit Includes:** (1) 7160-0440 Pole Clamp, (1) 7110-1234 Small Joiner, (1) 14142 100 mm Extension, (1) 14145 Threaded Adapter, and (1) 14139 VESA 75 mm Device Plate
- Recommend use of Loctite® 9460, 9461, or 9466 on all M20 size threads (Loctite not included)
- Assembly required
- 1 Year Limited Warranty

NEW



MEDIUM ZIRKONA POLE MOUNT

Item No.	Description	Placement/Compatibility	Weight	Height	Width	Depth/ Diameter
7170-0593	Pole Mount	Use on pipe up to 1.75" (4.4 cm) in diameter	1.12 lbs 0.54 kg	11.75" 29.85 cm	3.75" 9.53 cm	5" 12.7 cm

Features

- Great for mounting small handheld devices used in material handling or and static environment
- Pipe/channel clamp (fits pipe up to 1.75 in (4.4 cm) diameter pipe)
- Articulated connector with tension handle - position display to the proper angle for best viewing
- VESA 75mm mounting adapter – fits most displays
- Clamp is made of steel with black powder coat finish
- Articulated connector is made of anodized aluminum with black finish 100mm extension (included) to increase the range of operation
- **Kit Includes:** (1) 7160-0440 Pole Clamp, (1) 7110-1235 Medium Joiner, (1) 14145 Threaded Adapter, (1) 14142 100 mm Extension, and (1) 14139 VESA 75 mm Device Plate
- Assembly required
- 1 Year Limited Warranty

NEW



ZIRKONA POLE CLAMP

Item No.	Description	Placement/Compatibility	Weight	Height	Width	Depth/ Diameter
7160-0440	Pole Clamp	Use on pipe up to 1.75 (4.4 cm) in diameter	0.5 lbs 0.23 kg	4.12" 10.46 cm	2.75" 6.99 cm	1.87" 4.75 cm

Features

- Designed to be used with light-weight devices such as smart phones and handhelds
- Allows Zirkona products to be mounted to poles
- Mounts to poles using tube clamps
- Compatible with poles 1.13" (2.87 cm) to 1.75" (4.45 cm) in diameter
- Compatible with medium and small Zirkona Joiners as well as the 14145 threaded adapter and extensions
- Fastens to bracket through threaded hole and secured using a jam nut
- Hardware bag includes tube clamps and jam nut
- Recommend use of Loctite® 9460, 9461, or 9466 on all M20 size threads (Loctite not included)
- 1 Year Limited Warranty



ZIRKONA WELDED POLE ADAPTER

Item No.	Description	Placement/Compatibility	Weight	Height	Width	Depth/ Diameter
7110-1326	Welded Pole Adapter	Any Gamber-Johnson Pedestal System or use on pipe up to 1.75" (4.4 cm) in diameter	1.2 lbs 0.54 kg	3" 7.62 cm	3" 7.62 cm	3" 7.62 cm

Features

- Quickly add a second device to a Gamber-Johnson pole system using the Zirkona system
- Welded design provides greater strength for larger devices such as tablets
- Two (2) metal clamps and welded design helps ensure strength
- No removal of parts is needed; adapts to existing Gamber-Johnson pedestal mounts or pipe diameter 1.13" (2.87 cm) to 1.75" (4.45 cm)
- Cost-effective part when adding a new, secondary device
- Recommend use of Loctite® 9460, 9461, or 9466 on all M20 size threads (Loctite not included)
- 1 Year Limited Warranty

NEW





TabCruzer® MINI ZIRKONA SHORT DESKTOP MOUNT KIT

Item No.	Description	Placement/Compatibility	Weight	Height	Width	Depth/Diameter
7170-0604	Desktop Mount Kit Kit Includes: TabCruzer Mini (7160-0774) and Zirkona Short Desktop Mount (7110-1240)	Any Flat and Stable Surface/Cradle Holds Most Consumer Grade Tablets	1.7 lbs 0.8 kg	5.75" 14.61 cm	9.6" - 12.1" 24.4 cm - 30.7 cm	8.4" 21.3 cm

Features

- **TabCruzer Mini Universal Tablet Cradle** is designed to hold a variety of consumer tablet computers
 - Adjusts to tablet widths from 6.9" (17.5 cm) to 11.2" (28.4 cm)
 - Adjusts to tablet depths from 4.3" (10.9 cm) to 8.2" (20.8 cm)
 - Adjusts to tablet thickness from 0.2" (0.5 cm) to 0.7" (1.8 cm)
 - Side clips are easily adjusted to the proper tablet height and work with most tablets
 - Reversible front and back supports adjust to accommodate varying depths of computers
 - 90° wing turn closure latch with built-in key lock
 - Limited Lifetime Warranty
- **Zirkona Short Desktop Mount** is a simple universal mounting solution for small tablets and handhelds
 - Stands 3.5" high with round mounting base and VESA 75 mm mounting plate
 - Articulated joiner with tension handle - position display for the proper viewing angle
 - Anodized aluminum with black finish
 - Dimensions: 3.5" (8.9 cm) H x 3.75" (9.5 cm) W x 3.75" (9.5 cm) D
 - Weight: 0.90 lbs (0.41 kg)
 - VESA 75 mm mounting adapter, fits most displays
 - Recommend use of Loctite® 9460, 9461, or 9466 on all M20 size threads (Loctite not included)
 - 1 Year Limited Warranty



TabCruzer® ZIRKONA HEIGHT ADJUSTABLE DESKTOP MOUNT AND CRADLE

Item No.	Description	Placement/Compatibility	Weight	Height	Width	Depth/Diameter
7170-0602	Desktop Mount Kit Kit Includes: TabCruzer Mini (7160-0774) and Zirkona Height-Adjustable Mount (7170-0587)	Any Flat and Stable Surface/Cradle Holds Most Consumer Grade Tablets	3.3 lbs 1.5 kg	21.25" 14.61 cm	9.6" - 12.1" 24.4 cm - 30.7 cm	8.4" 21.3 cm

Features

- **TabCruzer Mini Universal Tablet Cradle** is designed to hold consumer tablet computers:
 - Adjusts to tablet widths from 6.9" (17.5 cm) to 11.2" (28.4 cm)
 - Adjusts to tablet depths from 4.3" (10.9 cm) to 8.2" (20.8 cm)
 - Adjusts to tablet thickness from 0.2" (0.5 cm) to 0.7" (1.8 cm)
 - Side clips are easily adjusted to the proper tablet height and work with most tablets
 - Reversible front and back supports adjust to accommodate varying depths of computers
 - 90° wing turn closure latch with built-in key lock
 - Limited Lifetime Warranty
- **Zirkona Height-Adjustable Mount** allows users to adjust their device to their desired viewing position
 - Base is 4" (10.6 cm) W x 0.75" (1.9 cm) H
 - Adjustable pole is 9.25" (23.5cm) H and has the ability to span 9.25" (23.5 cm) - 15.75" (40.0 cm)
 - Tension handle locks pedestal at the proper height
 - Articulated joiner with tension handle - position display for the proper viewing angle
 - Anodized aluminum with black finish
 - Dimensions: 12.5" - 19.0" (31.8 cm - 48.3 cm) H x 4.0" (10.2 cm) W x 4.0" (10.2 cm) D
 - Weight: 1.60 lbs. (0.7 kg)
 - VESA 75 mm mounting adapter, fits most displays
 - Recommend use of Loctite® 9460, 9461, or 9466 on all M20 size threads (Loctite not included)
 - 1 Year Limited Warranty

ZIRKONA HEIGHT ADJUSTABLE DESKTOP MOUNT WITHOUT CRADLE

Item No.	Description	Placement	Weight	Height	Width	Depth/ Diameter
7170-0587	Desktop Mount Kit without Cradle Kit Includes: Decorative base (17238), Threaded Adapter (14145), Height-Adjustable Pole (7110-1230), Large Joiner (7110-1236), and VESA 75 mm Device Plate (14139)	Any Flat and Stable Surface	1.6 lbs 0.73 kg	15.5" - 19" 39.4 cm - 48.3 cm	4" 10.16 cm	4" 10.16 cm
Features <ul style="list-style-type: none"> - Permanent workstation mounting solution with decorative base - Articulated joiner with tension handle to position display for the proper viewing angle - Tension handle locks pedestal at the desired height - Base is 4" (10.6 cm) W x 0.75" (1.9 cm) H - Adjustable pole is 9.25" (23.5cm) H and has the ability to span 9.25" (23.5 cm) - 15.75" (40.0 cm) - Anodized aluminum with black finish - VESA 75 mm mounting adapter, fits most displays - Assembly required - Recommend use of Loctite® 9460, 9461, or 9466 on all M20 size threads (Loctite not included) - 1 Year Limited Warranty 						



ZIRKONA HEIGHT ADJUSTABLE SUCTION CUP DESKTOP MOUNT

Item No.	Description	Placement	Weight	Height	Width	Depth/ Diameter
7170-0588	Desktop Mount Kit without Cradle Kit Includes: Suction Cup (7110-1232), Threaded Adapter (14145), Height-Adjustable Pole (7110-1230), Small Joiner (7110-1234), and VESA 75 mm Device Plate (14139)	Any Flat and Stable Surface / Part of Zirkona Robust Product Line	2.15 lbs 0.98 kg	13.25" - 19.75" 33.7 cm - 50.2 cm	4.5" 11.4 cm	4.5" 11.4 cm
Features <ul style="list-style-type: none"> - A great temporary workstation mounting solution for a display or tablet - Suction cup takes only seconds to install or re-position - Articulated joiner with tension handle to position display for the proper viewing angle - Tension handle locks pedestal at the desired height - Adjustable pole is 9.25" (23.5cm) H and has the ability to span 9.25" (23.5 cm) - 15.75" (40.0 cm) - Anodized aluminum with black finish - VESA 75 mm mounting adapter, fits most displays - Assembly required - Recommend use of Loctite® 9460, 9461, or 9466 on all M20 size threads (Loctite not included) - 1 Year Limited Warranty 						



ZIRKONA HEIGHT ADJUSTABLE EXTENDING DESKTOP MOUNT



Item No.	Description	Placement/Compatibility	Weight	Height	Width	Depth/ Diameter
7170-0590	Desktop Mount Kit without Cradle Kit Includes: Robust Base (7110-1316), Dual Articulating Arm (7110-1246), 2-Down Medium Joiner (7110-1259) and VESA 75/100 mm Device Plate (14140)	Any Flat and Stable Surface / Part of Zirkona Robust Product Line	5.35 lbs 2.4 kg	16" - 24" 40.6 cm - 61 cm	10" - 16.5" 25.4 cm - 41.9 cm	4" 10.2 cm

Features

- Add flexibility to your desktop or workstation without a large footprint
- Dual pivoting arms help adjust your device to the right height and reach to each user
- Designed for single monitor or docking station use
- Base is 4" (10.6 cm) W x 0.75" (1.9 cm) H
- Articulating arm is 16" (40.6cm) H and has the ability to span 16" (40.6 cm) - 24" (61.0 cm) from main pedestal
- Tension handles lock pedestal height and articulated arms in place
- Articulated joiner with tension handle - position display for the proper viewing angle
- Tension handles lock pedestal height and articulated arms in place
- Articulated joiner with tension handle - position display for the proper viewing angle
- Anodized aluminum and steel with black powder coat finish
- VESA 75/100mm adapter plate (14140)
- Assembly required
- Recommend use of Loctite® 9460, 9461, or 9466 on all M20 size threads (Loctite not included)
- 1 Year Limited Warranty

ZIRKONA DUAL ARTICULATING ARM WITH MEDIUM JOINER



Item No.	Description	Placement/Compatibility	Weight	Height	Width	Depth/ Diameter
7110-1246	Dual Articulating Arm with 2-Down Medium Joiner	Desktop or Wall Application for a Large Display, Tablet, or Docking Station When Additional Adjustability is Needed.	3.70 lbs 1.68 kg	16" - 24" 40.64 cm - 60.96 cm	17" 43.18 cm (Fully Extended)	1.56 3.96 cm (Largest Pole)

Features

- Dual Articulating Arm mounts to either Desktop Base (7110-1316) or Wall Mount Base (17246) providing a great solution for your monitor and workspace
- Add flexibility to your desktop or workstation without a large footprint
- Dual pivoting arms help adjust your device to the right height and reach to each user
- Designed for single monitor or docking station use
- Tension handles lock pedestal height and articulated arms in place
- Articulated joiner with tension handle - position display for the proper viewing angle
- Includes hardware to attach to base
- Base pedestal and inside pedestal with extended arm is constructed of steel
- Height-adjustable pedestal 16" (40.6 cm) - 24" (61.0 cm)
- Articulating arm extend 16.5" (41.91 cm) from the main pedestal
- Outside extended arm constructed of anodized aluminum
- Recommend use of Loctite® 9460, 9461, or 9466 on all M20 size threads (Loctite not included)
- 1 Year Limited Warranty

ZIRKONA ROBUST 75 MM SURFACE MOUNT



Item No.	Description	Placement/Compatibility	Weight	Height	Width	Depth/ Diameter
7110-1316	Robust 75 mm Surface Mount	Any Flat and Stable Surface / Part of Zirkona Robust Product Line	0.95 lbs 0.43 kg	3.75" 9.52 cm	4.25" 10.8 cm	4.25" 10.8 cm

Features

- Zirkona Dual Articulating Arm attaches over the pedestal portion the mount (See 7110-1246)
- Includes pole mounting hardware
- Small yet strong base to reduce footprint on your desktop or workstation
- 4" (10.16cm) mounting base for Zirkona robust mount provides a strong platform for your tablet or monitor
- Made of steel construction with black powder coat finish
- Hole pattern measures 75 mm for a wider mounting platform
- Note: Does not contain M20 threads
- 1 Year Limited Warranty

ZIRKONA LIGHT-DUTY WALL MOUNT BASE

Item No.	Description	Placement/Compatibility	Weight	Height	Width	Depth/ Diameter
7110-1227	Light-Duty Wall Mount	Attaches to Walls / Accepts Any Joiner or Male Threaded Adapter (14145)	0.7 lbs 0.32 kg	5" 12.70 cm	2.125" 5.40 cm	3" 7.62 cm (includes handle)
<p>Features</p> <ul style="list-style-type: none"> - Pivot pin features the M20 threads allowing the user to use any joiner or extension pole with threaded adapter making the mount versatile - Threads on top of pivot pin is created for a set screw for secondary thread locking - Ratchet handle on front allows for adjustability to raise or turn the pivot pin while still being able to lock down - Made of anodized aluminum making it a light-weight, clean solution - Recommend use of Loctite® 9460, 9461, or 9466 on all M20 size threads (Loctite not included) - 1 Year Limited Warranty 						



ZIRKONA UNIVERSAL WALL MOUNT

Item No.	Description	Placement/Compatibility	Weight	Height	Width	Depth/ Diameter
7110-1228	Universal Wall Mount	Attaches to Walls / Accepts Any Joiner or Male Threaded Adapter (14145)	0.60 lbs 0.27 kg	3.25" 8.25 cm	1.69" 4.29 cm	3" 7.62 cm
<p>Features</p> <ul style="list-style-type: none"> - Bracket is gusseted for extra strength - Add an extension, joiner, and adapter plate for a complete solution (Requires Threaded Adapter (14145) or joiner) - Black powder coat finish for maximum corrosion resistance - Three (3) holes for mounting to a strong and stable surface - Recommend use of Loctite® 9460, 9461, or 9466 on all M20 size threads (Loctite not included) - 1 Year Limited Warranty 						



ZIRKONA ROBUST WALL MOUNT BRACKET

Item No.	Description	Placement/Compatibility	Weight	Height	Width	Depth/ Diameter
17246	Universal Wall Mount	Attaches to Walls / Use with Zirkona Dual Articulating Arm (7110-1246)	2.15 lbs 0.98 kg	6" 15.24 cm	4" 10.16 cm	5" 12.70 cm
<p>Features</p> <ul style="list-style-type: none"> - Vertical surface mounting base for Zirkona Robust Mounts provides a strong platform for your tablet or monitor - Base is 4" (10.6 cm) W x 0.75" (1.9 cm) H - Four (4) holes for mounting to a strong and stable surface - Extends 4.62" (11.74 cm) from the wall - Zirkona Dual Articulating Arm attaches over the pedestal portion the bracket (See 7110-1246) - Made of steel construction and black powder coat finish - Use with Zirkona Dual Articulating Arm to create a complete solution - Note: Does NOT contain M20 threads - 1 Year Limited Warranty 						

NEW



TabCruzer® MINI ROTATING WALL MOUNT KIT



Item No.	Kit Description	Weight	Height	Width	Depth
7170-0603	Universal Cradle Rotating Wall Mount Kit Includes: Pole Clamp (7160-0440), Zirkona Medium Joiner (7110-1235), Threaded Adapter (14145), 100 mm Extension (14142), VESA 75 mm Adapter Plate (14139)	1.2 lbs 0.5 kg	7.0" 17.8 cm	3.75" 9.5 cm	6.0" 15.2 cm

TabCruzer Mini Features

- TabCruzer Mini - Universal Tablet Cradle is designed to hold consumer tablet computers:
- Adjusts to tablet widths from 6.9" to 11.2" (17.5 - 28.4 cm)
- Adjusts to tablet depths from 4.3" to 8.2" (10.9 - 20.8 cm)
- Adjusts to tablet thickness from 0.2" to 0.7" (0.5 - 1.8 cm)
- Side clips are easily adjusted to the proper tablet height and work with most tablets
- Reversible front and back supports adjust to accommodate varying depths of computers
- 90° wing turn closure latch with built-in key lock
- Limited Lifetime Warranty

Kit features

- Wall mount solution for a small display, tablet, or handheld device
- 4.25" x 1.87" (12.1 cm x 4.7 cm) mounting plate with 1.4" x 3.7" (3.5 cm x 9.5 cm) hole pattern
- 3" (7.6 cm) arm rotates 180° and can be raised or lowered 1.5" (3.8 cm), tension handle locks the arm in place
- Tension handle allows you to position the display at the proper angle then tighten handle to keep it in place
- See individual product for warranty details

ZIRKONA QUICK RELEASE WALL MOUNT



Item No.	Description	Weight	Height	Width	Depth
7170-0592	Mount Easily Attaches to any Flat Surface and Allows you to Quickly Remove or Attach your Display from the Wall Mount	0.9 lbs 0.4 kg	4.5" 11.4 cm	5.5" 14.0 cm	1.1" 2.8 cm

Features

- Easy installation - one half attaches to the surface and the other half attaches to the device
- 2.5" (6.4 cm) diameter base with NEC and AMPS mounting hole pattern
- Adjustable tension lever that can attach or release in seconds
- Surface distance to VESA mounting adapter is approximately 2" (5.1 cm)
- Anodized aluminum with black finish
- Assembly required
- VESA 75 mm mounting adapter plate attaches to most devices
- Limited Lifetime Warranty

ZIRKONA LIGHT DUTY ROTATING WALL MOUNT



Item No.	Description	Weight	Height	Width	Depth
7170-0595	Light Duty Rotating Wall Mount Kit Includes: Zirkona Small Joiner (7110-1234), Wall Mount with Swing Arm (7110-1227), VESA 75 mm Adapter Plate (14139)	1.1 lbs 0.5 kg	4.8" 12.1 cm	1.9" 4.7 cm	7.5" 19.1 cm

Features

- Wall mount solution for a small display, tablet, or handheld device
- 4.25" x 1.87" (12.1 cm x 4.7 cm) mounting plate with 1.4" x 3.7" (3.5 cm x 9.5 cm) hole pattern
- 3" (7.6 cm) arm rotates 180° and can be raised or lowered 1.5" (3.8 cm), tension handle locks the arm in place
- Tension handle allows you to position the display at the proper angle and keep it in place
- Made of rugged black anodized aluminum
- Add a 50 mm, 100 mm, or 150 mm extension to increase the range of operation
- Assembly required
- VESA 75 mm mounting adapter fits most displays
- See individual product for warranty details

ZIRKONA TALL STATIONARY WALL MOUNT

Item No.	Description	Weight	Height	Width	Depth
7170-0596	Tall Stationary Wall Mount Kit Includes: Wall/Ceiling Mounting Bracket (17245), Threaded Adapter (14145), 100 mm Extension Tube (14142), Zirkona Small Joiner (7110-1234), VESA 75 mm adapter plate (14139)	1.3 lbs 0.6 kg	10.0" 25.4 cm	3.8" 9.5 cm	4.1" 10.5 cm
Features - Easy to install by mounting to a wall or other solid surface - 3.3" x 1.7" x 2.9" (8.3 cm x 4.3 cm x 7.3 cm) steel mounting bracket - 100 mm extension used to increase the range of operation - more can be used if necessary - Tension handle allows you to position the display at the proper angle then tighten handle to keep it in place - Black anodized aluminum and powder coat finish - Assembly required - VESA 75 mm mounting adapter fits most displays - See individual product for warranty details					



ZIRKONA HEIGHT ADJUSTABLE EXTENDING WALL MOUNT

Item No.	Description	Weight	Height	Width	Depth
7170-0597	Height Adjustable Extending Wall Mount Kit Includes: Wall Mount (17246), Dual Articulating Arms with Adjustable Height and Zirkona Medium Joiner (14141), VESA 75/100 mm Adapter Plate (14140)	6.6 lbs 3.0 kg	16.0" to 24.0" 40.6 cm to 61.0 cm	10.0" to 16.5" 25.4 cm to 41.9 cm	4.0" 10.2 cm
Features - Wall mount solution for a large display or tablet - 4" x 5" (10.2 cm x 12.7 cm) steel base with 3" x 4" (7.6 cm x 10.2 cm) mounting hole pattern - Articulated joiner with tension handle allows you to position the display at the proper angle and keep it in place - Anodized aluminum and steel black finish - Assembly required - VESA 75/100 mm mounting adapter fits most displays - See individual product for warranty details					



ZIRKONA DUAL ARTICULATING ARM WITH MEDIUM JOINER

Item No.	Description	Placement/Compatibility	Weight	Height	Width	Depth/ Diameter
7110-1246	Dual Articulating Arm with 2-Down Medium Joiner (7110-1259)	Desktop or Wall Application for a Large Display, Tablet, or Docking Station When Additional Adjustability is Needed	3.70 lbs 1.68 kg	16" - 24" 40.64 cm - 60.96 cm	17" 43.18 cm (Fully Extended)	1.56 3.96 cm (Largest Pole)
Features - Dual Articulating Arm mounts to either Desktop Base (7110-1316) or Wall Mount Base (17246) providing a great solution for your monitor and workspace - Add flexibility to your desktop or workstation without a large footprint - Dual pivoting arms help adjust your device to the right height and reach to each user - Designed for single monitor or docking station use - Tension handles lock pedestal height and articulated arms in place - Articulated joiner with tension handle - position display for the proper viewing angle - Includes hardware to attach to base - Base pedestal and inside pedestal with extended arm is constructed of steel - Height-adjustable pedestal 16" - 24" (40.6 cm - 61.0 cm) - Articulating arm extend 16.5" (41.91 cm) from the main pedestal - Outside extended arm constructed of anodized aluminum - Recommend use of Loctite® 9460, 9461, or 9466 on all M20 size threads (Loctite not included) - 1 Year Limited Warranty						



ZIRKONA MEDIUM JOINER WITH TWO ROUND PLATES



Item No.	Description	Placement	Weight	Height	Width	Depth/ Diameter
7160-0993	Medium Joiner with Two Round Plates	Mounts to Any Flat and Stable Surface. May Require Drilling. Holds Devices with AMPS or NEC.	0.63 lbs 0.29 kg	4.75" 12.06 cm	2.25" 5.72 cm	2.25" 5.72 cm

Features

- All axes range of motion in X axis (left/right), Y axis (front/back) and Z axis (up/down)
- Quick adjust handle for easy adjustment to position device
- Ships assembled and glued
- Anodized aluminum with black finish making it lightweight but durable
- Maximum weight limit: 6.0 lbs (2.8 kg) in a vibration/mobile environment or 33 lbs (15 kg) in a static/no vibration environment
- Includes: (1) Medium Joiner and (2) AMPS Round Plates
- May require drilling
- 1 Year Limited Warranty

ZIRKONA MEDIUM JOINER WITH TWO VESA 75 MM MOUNTING PLATES



Item No.	Description	Placement	Weight	Height	Width	Depth/ Diameter
7160-0865	Medium Joiner with Two VESA 75 mm Plates	Mounts to Any Flat and Stable Surface. May Require Drilling. Holds Devices with VESA 75 mm Hole Pattern.	0.80 lbs 0.36 kg	5.75" 14.61 cm	4.88" 12.40 cm	4.88" 12.40 cm

Features

- All axes range of motion in X axis (left/right), Y axis (front/back) and Z axis (up/down)
- Quick adjust handle for easy adjustment to position device
- Ships assembled and glued
- Anodized aluminum with black finish making it lightweight but durable
- Maximum weight limit: 6.0 lbs (2.8 kg) in a vibration/mobile environment or 33 lbs (15 kg) in a static/no vibration environment
- Includes: (1) Medium Joiner and (2) VESA 75 mm Plates
- May require drilling
- 1 Year Limited Warranty

ZIRKONA MEDIUM JOINER 2" (50 MM) WITH AMPS AND VESA 75 MM PLATES



Item No.	Description	Placement	Weight	Height	Width	Depth/ Diameter
7160-0779	Medium Joiner 2" with AMPS and VESA 75 mm Plates	AMPS Plates Mounts to Any Flat and Stable Surface. May Require Drilling. Holds Devices with VESA 75 mm Hole Pattern.	0.75 lbs 0.34 kg	6.5" 16.51 cm	4.88" 12.40 cm	4.88" 12.40 cm

Features

- All axes range of motion in X axis (left/right), Y axis (front/back) and Z axis (up/down)
- Extension tube for extra height off mounting surface
- Quick adjust handle for easy adjustment to position device
- Ships assembled and glued
- Anodized aluminum with black finish making it lightweight but durable
- Maximum weight limit: 6.0 lbs (2.8 kg) in a vibration/mobile environment or 33 lbs (15 kg) in a static/no vibration environment
- Includes: (1) Medium Joiner, (1) VESA75 mm Plate, (1) AMPS Round Plate, (1) Threaded Adapter, and (1) 2" (50 mm) extension
- AMPS round mounting plate provides two standard mounting hole patterns; AMPS and NEC
- Device plate is VESA 75 mm
- May require drilling
- 1 Year Limited Warranty

ZIRKONA MEDIUM JOINER 4" (100 MM) KIT WITH ROUND PLATES

Item No.	Description	Placement	Weight	Height	Width	Depth/ Diameter
7170-0156	Medium Joiner 4" (100 mm) Kit with AMPS Round Plates	AMPS Plates Mounts to Any Flat and Stable Surface. May Require Drilling. Holds Devices with AMPS/NEC Hole Pattern.	1.05 lbs 0.5 kg	9.64" 24.4 cm	3.38" 8.6 cm	2.38" 6.1 cm

Features

- All axes range of motion in X axis (left/right), Y axis (front/back) and Z axis (up/down)
- Extension tube for extra height off mounting surface
- Quick adjust handle for easy adjustment to position device
- Ships unassembled - Recommend use of Loctite® 9460, 9461, or 9466 on all M20 size threads (Loctite not included)
- Anodized aluminum with black finish making it lightweight but durable
- Maximum weight limit: 6.0 lbs (2.8 kg) in a vibration/mobile environment or 33 lbs (15 kg) in a static/no vibration environment
- Includes: (1) Medium Joiner, (2) AMPS Round Plate, (1) Threaded Adapter, and (1) 4" (100 mm) extension
- AMPS round mounting plate provides two standard mounting hole patterns; AMPS and NEC
- May require drilling
- 1 Year Limited Warranty



ZIRKONA MEDIUM JOINER, ROUND MOUNTING PLATE AND FEMALE THREADED ADAPTER KIT

Item No.	Description	Placement	Weight	Height	Width	Depth/ Diameter
7170-0691	Medium Joiner, Round Mounting Plate and Female Threaded Adapter Kit	Threaded Adapter Mounts to Any Flat and Stable Surface. May Require Drilling. Holds Devices with AMPS/ NEC Hole Pattern.	0.57 lbs 0.26 kg	2.38" 6.05 cm	3.5" 8.89 cm	4.5" 11.43 cm

Features

- Ideal for holding light weight devices, like cell phones, GPS's, small displays or small light weight tablets
- Kit allows for mounting on a solid surface with the Female Threaded Adapter (17394), like metal, aluminum, wood, or thicker rigid plastic
- M6 hardware required for mounting Female Threaded Adapter. Hardware not provided.
- Medium joiner allows for the device to be mounted in a position for easy viewing.
- Anodized aluminum with black finish making it lightweight but durable
- Includes: (1) Medium Joiner, (1) AMPS Round Plate, (1) Female Threaded Adapter
- AMPS round mounting plate provides two standard mounting hole patterns; AMPS and NEC
- May require drilling
- Ships unassembled - Recommend use of Loctite® 9460, 9461, or 9466 on all M20 size threads (Loctite not included)
- 1 Year Limited Warranty



MAXIMUM PAYLOAD CAPACITY

Determining the correct size joiner for your set up is essential for designing the perfect mounting solution for your needs. Each joiner has a specified weight rating, in both static and vibration environments, to help ensure your device will mount as intended and standup in harsh environments for the long haul. To learn more about our entire Zirkona offering visit gamberjohnson.com/Zirkona.



	Small Joiner	Medium Joiner	Large Joiner	Medium 2-Down Joiner	Large 2-Down Joiner	6" Medium 2-Down Joiner
	Item No. 7110-1234	Item No. 7110-1235	Item No. 7110-1236	Item No. 7110-1259	Item No. 7110-1260	Item No. 7110-1330
VIBRATION ENVIRONMENT	Holds up to 3 lbs / 1.4 kg	Holds up to 6 lbs / 2.8 kg	Holds up to 11 lbs / 5.0 kg	Holds up to 6 lbs / 2.8 kg	Holds up to 11 lbs / 5.0 kg	Holds up to 6 lbs / 2.8 kg
STATIC ENVIRONMENT	Holds up to 22 lbs / 10 kg	Holds up to 33 lbs / 15 kg	Holds up to 55 lbs / 25 kg	Holds up to 33 lbs / 15 kg	Holds up to 55 lbs / 25 kg	Holds up to 33 lbs / 15 kg

- **Warning:** Extension tube will lower the overall payload rating of the joiner. The longer the extension pole, the lower the overall rating for the joiner.
- Lower the maximum payload by 20% for every 2" (50 mm) of extension tube.
Example: 6" (150 mm) extension = reduce maximum payload by 60%
- **Note:** Neither the 12" (300 mm) tube nor the small joiner should be used for mounting TV screens.





LOGISTIC MOUNTS

Gamber-Johnson's logistic products bundled with a tablet or hand-held computer offer a safe and ergonomic solution when on the road for ultimate peace of mind. Our numerous cradle options offer all-day charging capabilities and our mounts are easy to install and provide a sturdy platform for a variety of devices.



MON | JUN 06

Log Form Sign DVIR

	M	1	2	3	4	5	6	7	8	9	10	11	N	1	2	3	4	5	6	7	8	9	10	11	M
OFF																									
SB																									
D																									
ON																									

12.75
00.00
07.25
04.00

OFF 12:00 AM PST | 4 hr 45 min | San Francisco, CA

Edit ON 4:45 AM PST | 1 hr 45 min | San Francisco, CA Pre-Trip

D 6:30 AM PST | 4 hr 30 min | San Francisco, CA Load Pickup

GAMBER
JOHNSON

FREIGHTLINER CASCADIA DASH MOUNT

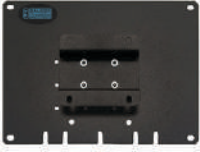

Item No.	Description	Placement	Weight	Height	Width	Depth
7160-1124	2018 Freightliner Cascadia Dash Mount with Offset Bracket	Replaces Existing Dash Plate	3.0 lbs 7.6 kg	7.1" 18.1 cm	9.8" 24.8 cm	2.8" 7.1 cm

Features

- No drilling required solution preventing damage to the dash
- Cigarette power adapter included (attached to the back side of the mount) for easy power access
- Several wire routing options to conceal wires for a clean and professional finished install
- Includes a 1" (2.5 cm) offset adapter plate from AMPs to VESA 75 mm
- Large plate with multiple VESA 75 mm and AMPs hole patterns for multiple options of product placement
- Limited Lifetime Warranty

FREIGHTLINER CASCADIA DASH MOUNT

NEW



Item No.	Description	Placement	Weight	Height	Width	Depth
7160-1124-01	2018 Freightliner Cascadia Dash Mount	Replaces Existing Dash Plate	1.8 lbs 0.8 kg	7.1" 18.1 cm	9.8" 24.8 cm	0.2" 0.5 cm

Features

- No drilling required solution preventing damage to the dash
- Several wire routing options to conceal wires for a clean and professional finished install
- Large plate with multiple VESA 75 mm and AMPs hole patterns for multiple options of product placement
- Limited Lifetime Warranty

FREIGHTLINER CASCADIA DASH MOUNT

NEW



Item No.	Description	Placement	Weight	Height	Width	Depth
7160-1124-02	2018 Freightliner Cascadia Dash Mount with Offset Bracket and without Power Adapter	Replaces Existing Dash Plate	2.7 lbs 6.9 kg	7.1" 18.1 cm	9.8" 24.8 cm	1.2" 3.1 cm

Features

- No drilling required solution preventing damage to the dash
- Several wire routing options to conceal wires for a clean and professional finished install
- Includes a 1" (2.5 cm) offset adapter plate from AMPs to VESA 75 mm
- Large plate with multiple VESA 75 mm and AMPs hole patterns for multiple options of product placement
- Limited Lifetime Warranty

FREIGHTLINER M2 DASH MOUNT

NEW



Item No.	Description	Placement	Weight	Height	Width	Depth
7160-1301	Freightliner M2 Dash Mount	Attaches to Temperature Control Panel	1.2 lbs 0.5 kg	9.0" 22.9 cm	5.0" 12.8 cm	2.3" 5.9 cm

Features

- Designed specifically for the Freightliner M2 to eliminate the need for drilling additional holes into the dash
- Designed for mounting multiple small devices from the same mount
- Maintains access to temperature control knobs and stays clear of other dials and switches
- Utilizes AMPs mounting hole pattern, best suited for mounting Gamber-Johnson's Zirkona solutions and tilt mounts
- Limited Lifetime Warranty

INTERNATIONAL PROSTAR DIN MOUNT

Item No.	Description	Placement	Weight	Height	Width	Depth
7160-1168	International ProStar Semi-Truck Pocket Mount	Attaches within DIN Pocket	1.5 lbs 0.7 kg	3.1" 7.8 cm	5.0" 12.7 cm	2.8" 7.0 cm

Features

- Designed to be drilled into the double DIN pocket within the dash, bringing the mount closer to the dash
- Tilt capabilities to easily adjust your tablet or device and give drivers comfort and ease of viewing
- Utilizes AMPs mounting hole pattern, best suited for mounting Gamber-Johnson's Zirkona solutions and tilt mounts
- Limited Lifetime Warranty



INTERNATIONAL LT DASH MOUNT

Item No.	Description	Placement	Weight	Height	Width	Depth
7160-1243	International LT Dash Mount with Tilting Bracket	Replaces Existing Dash Plate	1.9 lbs 0.8 kg	4.8" 12.1 cm	9.1" 23.2 cm	2.6" 6.5 cm

Features

- No drilling required solution preventing damage to the dash
- Tilt capabilities to easily adjust your tablet or device and give drivers comfort and ease of viewing
- Mounts device closer to the dash so drivers can easily access switches, dials, or other electronics without interference
- Provides USB and cigarette power adapter knockouts for easy charging access (USB and cigarette adapters sold separately)
- Utilizes AMPs and VESA 75 mm mounting hole patterns to adapt to devices
- Limited Lifetime Warranty



INTERNATIONAL LT DASH MOUNT

Item No.	Description	Placement	Weight	Height	Width	Depth
7160-1243-01	International LT Dash Mount with Phone Mount	Replaces Existing Dash Plate	1.5 lbs 0.7 kg	4.8" 12.1 cm	9.1" 23.2 cm	5.5" 14.0 cm

Features

- Make and model specific solution and intended to eliminate the need for drilling additional holes into the dash
- Provides USB and cigarette power adapter knockouts for easy charging access (USB and cigarette adapters sold separately)
- Large range of motion and quick adjust lever to effortlessly move to a desired position
- Dash plate provides multiple AMPs hole patterns for placement of the phone mount
- 1 Year Limited Warranty on Zirkona products and phone holder
- Limited Lifetime Warranty on dash plate



INTERNATIONAL LT DASH MOUNT

Item No.	Description	Placement	Weight	Height	Width	Depth
7160-1243-02	International LT Dash Mount	Replaces Existing Dash Plate	1.8 lbs 0.8 kg	4.8" 12.1 cm	9.1" 23.2 cm	0.5" 1.3 cm

Features

- No drilling required solution preventing damage to the dash
- Provides USB and cigarette power adapter knockouts for easy charging access (USB and cigarette adapters sold separately)
- Utilizes AMPs mounting hole pattern, best suited for mounting Gamber-Johnson's Zirkona solutions and tilt mounts
- Limited Lifetime Warranty

NEW



NEW

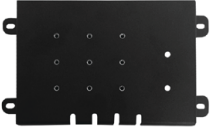

KENWORTH T680/T880 DASH MOUNT

Item No.	Description	Placement	Weight	Height	Width	Depth
7160-1283	Kenworth T680/T880 Dash Mount	Replaces Existing Dash Plate	1.2 lbs 0.5 kg	5.7" 14.2 cm	9.8" 24.8 cm	0.7" 1.7 cm

Features

- Designed specifically for the Kenworth T680/T880 to eliminate the need for drilling additional holes into the dash
- Cigarette power adapter included (attached to the back side of the mount) for easy power access
- Several wire routing options to conceal wires for a clean and professional finished install
- Utilizes AMP's mounting hole pattern, best suited for mounting Gamber-Johnson's Zirkona solutions and tilt mounts
- Limited Lifetime Warranty

NEW



KENWORTH T680/T880 DASH MOUNT

Item No.	Description	Placement	Weight	Height	Width	Depth
7160-1283-01	Kenworth T680/T880 Dash Mount with Tilting Bracket	Replaces Existing Dash Plate	1.2 lbs 0.5 kg	5.7" 14.2 cm	9.8" 24.8 cm	0.7" 1.7 cm

Features

- Designed specifically for the Kenworth T680/T880 to eliminate the need for drilling additional holes into the dash
- Cigarette power adapter included (attached to the back side of the mount) for easy power access
- Several wire routing options to conceal wires for a clean and professional finished install
- Utilizes AMP's and VESA 75 mm mounting hole patterns to adapt to devices
- Limited Lifetime Warranty

NEW



PETERBILT 579 DASH MOUNT

Item No.	Description	Placement	Weight	Height	Width	Depth
7160-1295	Peterbilt 579 Dash Mount	Attaches Over Parking Brake and Air Supply Knobs	0.7 lbs 0.3 kg	6.6" 16.7 cm	5.7" 14.5 cm	1.5" 3.8 cm

Features

- No drilling required solution preventing damage to the dash
- Mount is designed to prevent interference with other functions from the dash
- Utilizes AMP's mounting hole pattern, best suited for mounting Gamber-Johnson's Zirkona solutions and tilt mounts
- Limited Lifetime Warranty

NEW



PETERBILT 389 DASH MOUNT

Item No.	Description	Placement	Weight	Height	Width	Depth
7160-1302	Peterbilt 389 Dash Mount	Replaces 2 Unused/Spare Switches that are Side by Side	0.4 lbs 0.2 kg	2.5" 6.4 cm	2.5" 6.4 cm	0.3" 0.6 cm

Features

- No drilling required solution preventing damage to the dash
- Mounts device and maintains access to switches, dials, or other electronics without interference
- Utilizes AMP's mounting hole pattern, best suited for mounting Gamber-Johnson's Zirkona solutions
- Limited Lifetime Warranty

VOLVO VNL SWITCH PANEL MOUNT



Item No.	Description	Placement	Weight	Height	Width	Depth
7160-1177	Volvo VNL Switch Panel Mount (2017 and Older)	Attaches in Switch Plate	0.4 lbs 0.2 kg	2.3" 5.7 cm	2.4" 6.1 cm	2.4" 6.1 cm

Features

- Designed specifically for Volvo Semi-Trucks to eliminate the need for drilling additional holes into the dash
- Utilizes AMP's mounting hole pattern, best suited for mounting Gamber-Johnson's Zirkona solutions
- Limited Lifetime Warranty

PIVOT MOUNTS



Item No.	Description	Maximum Payload Capacity*	Weight	Height	Width	Depth
7160-1132	Zirkona Pivot Arm with 2" Extension and AMPs/NEC Plate	Vibration Environment 6 lbs / 1.4 kg Static Environment 33 lbs / 15 kg	2.5 lbs 1.1 kg	4.6" 11.6 cm	2.3" 5.7 cm	8.0" 20.3 cm
7160-1132-01	Zirkona Pivot Arm with 2" Extension and VESA 75 mm Plate	Vibration Environment 6 lbs / 1.4 kg Static Environment 33 lbs / 15 kg	2.6 lbs 1.2 kg	4.6" 11.6 cm	2.3" 5.7 cm	8.0" 20.3 cm
7160-1132-04	Zirkona Pivot Arm with 2" Extension and VESA 100 mm Plate	Vibration Environment 6 lbs / 1.4 kg Static Environment 33 lbs / 15 kg	2.7 lbs 1.3 kg	4.6" 11.6 cm	2.3" 5.7 cm	8.0" 20.3 cm
7160-1132-02	Zirkona Pivot Arm with 4" Extension and AMPs/NEC Plate	Vibration Environment 6 lbs / 1.4 kg Static Environment 33 lbs / 15 kg	2.6 lbs 1.2 kg	4.6" 11.6 cm	2.3" 5.7 cm	10.0" 25.4 cm
7160-1132-03	Zirkona Pivot Arm with 4" Extension and VESA 75 mm Plate	Vibration Environment 6 lbs / 1.4 kg Static Environment 33 lbs / 15 kg	2.7 lbs 1.3 kg	4.6" 11.6 cm	2.3" 5.7 cm	10.0" 25.4 cm
7160-1132-05	Zirkona Pivot Arm with 4" Extension and VESA 100 mm Plate	Vibration Environment 6 lbs / 1.4 kg Static Environment 33 lbs / 15 kg	2.8 lbs 1.4 kg	4.6" 11.6 cm	2.3" 5.7 cm	10.0" 25.4 cm
7160-1132-06	Zirkona Pivot Arm with 6" Extension and AMPs/NEC Plate	Vibration Environment 6 lbs / 1.4 kg Static Environment 33 lbs / 15 kg	2.7 lbs 1.3 kg	4.6" 11.6 cm	2.3" 5.7 cm	12.0" 30.5 cm
7160-1132-07	Zirkona Pivot Arm with 6" Extension and VESA 75 mm Plate	Vibration Environment 6 lbs / 1.4 kg Static Environment 33 lbs / 15 kg	2.8 lbs 1.4 kg	4.6" 11.6 cm	2.3" 5.7 cm	12.0" 30.5 cm
7160-1132-08	Zirkona Pivot Arm with 6" Extension and VESA 100 mm Plate	Vibration Environment 6 lbs / 1.4 kg Static Environment 33 lbs / 15 kg	2.9 lbs 1.5 kg	4.6" 11.6 cm	2.3" 5.7 cm	12.0" 30.5 cm



7160-1132

NEW

NEW

NEW



7160-1132-03

NEW

NEW



7160-1132-06

NEW

NEW

Features

- Attaches to dash or flat vertical surface
- Back plate adds additional weight distribution to reduce the risk of damaging the dash
- Large range of motion and quick adjust lever to effortlessly move to a desired position
- Drilled solution allows devices to be mounted in the most convenient position for the user
- 1 Year Limited Warranty

Note: Extensions will decrease maximum payload capacity. Visit gamberjohnson.com for more details



MULTI-FUNCTION PIVOT MOUNTS

NEW



7160-1385-01



7160-1385-02



7160-1385-03

Item No.	Description	Maximum Payload Capacity*	Weight	Height	Width	Depth
7160-1385	Zirkona Multi-Function Pivot Arm with 2" Extension and AMPs/NEC Plate	Vibration Environment 6 lbs / 1.4 kg Static Environment 33 lbs / 15 kg	1.3 lbs 0.6 kg	3.0" 7.6 cm	3.0" 7.6 cm	8.9" 22.5 cm
7160-1385-01	Zirkona Multi-Function Pivot Arm with 2" Extension and VESA 75 mm Plate	Vibration Environment 6 lbs / 1.4 kg Static Environment 33 lbs / 15 kg	1.4 lbs 0.6 kg	3.0" 7.6 cm	3.0" 7.6 cm	8.9" 22.5 cm
7160-1385-02	Zirkona Multi-Function Pivot Arm with 4" Extension and AMPs/NEC Plate	Vibration Environment 6 lbs / 1.4 kg Static Environment 33 lbs / 15 kg	1.4 lbs 0.6 kg	3.0" 7.6 cm	3.0" 7.6 cm	10.9" 27.6 cm
7160-1385-03	Zirkona Multi-Function Pivot Arm with 4" Extension and VESA 75 mm Plate	Vibration Environment 6 lbs / 1.4 kg Static Environment 33 lbs / 15 kg	1.5 lbs 0.7 kg	3.0" 7.6 cm	3.0" 7.6 cm	10.9" 27.6 cm
7160-1385-04	Zirkona Multi-Function Pivot Arm with 6" Extension and AMPs/NEC Plate	Vibration Environment 6 lbs / 1.4 kg Static Environment 33 lbs / 15 kg	1.5 lbs 0.7 kg	3.0" 7.6 cm	3.0" 7.6 cm	12.9" 32.8 cm
7160-1385-05	Zirkona Multi-Function Pivot Arm with 6" Extension and VESA 75 mm Plate	Vibration Environment 6 lbs / 1.4 kg Static Environment 33 lbs / 15 kg	1.6 lbs 0.7 kg	3.0" 7.6 cm	3.0" 7.6 cm	12.9" 32.8 cm

Features

- Attaches to dash, flat surface, or OEM Specific Dash Mounts
- Back plate adds additional weight distribution to reduce the risk of damaging the dash
- Push and twist quick release base and multiple quick adjust handles in order to optimize device position and provide easy removal
- Utilized as a drilled solution to virtually mount anywhere or adapts to Gamber-Johnson OEM Specific Dash Mounts to perfectly align with your mounting needs
- No need to install extra hardware with an easy to install back plate
- 1 Year Limited Warranty

Note: Extensions will decrease maximum payload capacity. Visit gamberjohnson.com for more details

DOG-BONE MOUNTS



NEW



7160-1410



7160-1410-1

Item No.	Description	Maximum Payload Capacity*	Weight	Height	Width	Depth
7160-1410	Zirkona 6" Medium Dog-Bone Joiner with AMPs/NEC Plate	Vibration Environment 6 lbs / 1.4 kg Static Environment 33 lbs / 15 kg	1.3 lbs 0.6 kg	5.0" 12.7 cm	5.0" 12.7 cm	9.0" 22.9 cm
7160-1410-01	Zirkona 6" Medium Dog-Bone Joiner with VESA 75 mm Plate	Vibration Environment 6 lbs / 1.4 kg Static Environment 33 lbs / 15 kg	1.4 lbs 0.6 kg	5.0" 12.7 cm	5.0" 12.7 cm	9.0" 22.9 cm

Features

- Attaches to dash, flat surface, or OEM Specific Dash Mounts
- Back plate adds additional weight distribution to reduce the risk of damaging the dash
- Utilized as a drilled solution to virtually mount anywhere or adapts to Gamber-Johnson OEM Specific Dash Mounts
- Large range of motion and quick adjust lever to effortlessly move to a desired position
- No need to install extra hardware with an easy to install back plate
- 1 Year Limited Warranty

Note: Extensions will decrease maximum payload capacity. Visit gamberjohnson.com for more details.

MEDIUM JOINER MOUNTS



Item No.	Description	Maximum Payload Capacity*	Weight	Height	Width	Depth
7160-1179	Zirkona Medium Joiner with VESA 75 mm Plate	Vibration Environment 6 lbs / 1.4 kg Static Environment 33 lbs / 15 kg	1.3 lbs 0.6 kg	3.2" 8.1 cm	3.2" 8.1 cm	4.4" 11.2 cm
7160-1179-01	Zirkona Medium Joiner with VESA 75 mm Plate and Back Plate	Vibration Environment 6 lbs / 1.4 kg Static Environment 33 lbs / 15 kg	1.4 lbs 0.6 kg	3.2" 8.1 cm	3.2" 8.1 cm	4.4" 11.2 cm
7160-1240	Zirkona Medium Joiner with AMPs/NEC Plate	Vibration Environment 6 lbs / 1.4 kg Static Environment 33 lbs / 15 kg	1.4 lbs 0.6 kg	3.2" 8.1 cm	3.2" 8.1 cm	4.4" 11.2 cm
7160-1240-01	Zirkona Medium Joiner with AMPs/NEC Plate and Back Plate	Vibration Environment 6 lbs / 1.4 kg Static Environment 33 lbs / 15 kg	1.5 lbs 0.7 kg	3.2" 8.1 cm	3.2" 8.1 cm	4.4" 11.2 cm

Features

- Attaches to dash, flat surface, or OEM Specific Dash Mounts
- Utilized as a drilled solution to virtually mount anywhere or adapts to Gamber-Johnson OEM Specific Dash Mounts to perfectly align with your mounting needs
- Large range of motion and quick adjust lever to effortlessly move to a desired position
- Products with back plate adds additional weight distribution to reduce the risk of damaging the dash
- 1 Year Limited Warranty

Note: Extensions will decrease maximum payload capacity. Visit gamberjohnson.com for more details.



7160-1179



7160-1179-01



7160-1240



7160-1240-01

MEDIUM JOINER EXTENDED MOUNTS



Item No.	Description	Maximum Payload Capacity*	Weight	Height	Width	Depth
7160-1180	Zirkona Medium Joiner with 2" Extension and VESA 75 mm Plate	Vibration Environment 6 lbs / 1.4 kg Static Environment 33 lbs / 15 kg	1.5 lbs 0.7 kg	3.2" 8.1 cm	3.2" 8.1 cm	6.4" 11.2 cm
7160-1180-01	Zirkona Medium Joiner with 2" Extension, VESA 75 mm Plate, and Back Plate	Vibration Environment 6 lbs / 1.4 kg Static Environment 33 lbs / 15 kg	1.6 lbs 0.7 kg	3.2" 8.1 cm	3.2" 8.1 cm	6.4" 11.2 cm
7160-1239	Zirkona Medium Joiner with 2" Extension and AMPs/NEC Plate	Vibration Environment 6 lbs / 1.4 kg Static Environment 33 lbs / 15 kg	1.4 lbs 0.7 kg	3.2" 8.1 cm	3.2" 8.1 cm	6.4" 11.2 cm
7160-1239-01	Zirkona Medium Joiner with 2" Extension, AMPs/NEC Plate, and Back Plate	Vibration Environment 6 lbs / 1.4 kg Static Environment 33 lbs / 15 kg	1.5 lbs 0.7 kg	3.2" 8.1 cm	3.2" 8.1 cm	6.4" 11.2 cm

Features

- Attaches to dash, flat surface, or OEM Specific Dash Mounts
- Utilized as a drilled solution to virtually mount anywhere or adapts to Gamber-Johnson OEM Specific Dash Mounts to perfectly align with your mounting needs
- Added extension brings the device closer to the user or creates easier access to other necessary switches and functions
- Large range of motion and quick adjust lever to effortlessly move to a desired position
- Products with back plate adds additional weight distribution to reduce the risk of damaging the dash
- 1 Year Limited Warranty

Note: Extensions will decrease maximum payload capacity. Visit gamberjohnson.com for more details.



7160-1180



7160-1180-01



7160-1239



7160-1239-01

TILT MOUNT



Item No.	Description	Maximum Payload Capacity*	Weight	Height	Width	Depth
7160-1262	Tilting Mount for Semi-Trucks	Attach to Dash, Flat Surface, or OEM Specific Dash Mounts	0.9 lbs 0.4 kg	4.2" 10.7 cm	3.8" 9.5 cm	2.1" 5.2 cm

Features

- Utilized as a drilled solution to mount virtually anywhere or adapts to Gamber-Johnson OEM Specific Dash Mounts to perfectly align with your mounting needs
- Tilt and set features to easily adjust the tablet or device for comfortable use by the driver
- Designed for close-to-dash mounting
- AMPs and VESA 75 mm mounting hole patterns to easily adapt electronic devices
- Limited Lifetime Warranty

SEMI-TRUCK BASE



Item No.	Description	Maximum Payload Capacity*	Weight	Height	Width	Depth
7160-0198	Universal Day Cab and Over the Road Sleeper, Semi-Truck Base	Attaches Under Passenger Side Standard Bucket and Air Ride Seats	25.5 lbs 11.6 kg	19.1" 48.5 cm	18.8" 47.6 cm	26.3" 66.8 cm

Features

- Compatible with most Class 8 Day Cab and Over the Road Sleeper Semi-Trucks
- For full list of vehicle compatibility visit product page 7160-0198 on gamberjohnson.com
- Allows egress to the back of the sleeper cab
- Does not interfere with standard floor shift
- Support Brace (7160-0231) is highly recommended and can be bolted directly to the vehicle base
- Pole can be rotated in four positions in order to adjust to cab configurations and driver ergonomics
- Limited Lifetime Warranty

Note: This base will not work with International trucks with an integrated air conditioning system under the seat

SEMI-TRUCK PEDESTAL KIT



Item No.	Description	Placement	Weight	Height	Width	Depth
7170-0580	Universal Day Cab and Over the Road Sleeper, Semi-Truck Pedestal Kit Kit Includes: Universal Day Cab and Over the Road Sleeper Semi-Truck Base (7160-0198), 7" Center-Mounted Upper Pole (7160-0178), Mongoose-9" Locking Slide Arm (7160-0220), and Long Support Brace (7160-0231)	Attaches Under Passenger Side Standard Bucket and Air Ride Seats	37.1 lbs 16.8 kg	18.9" to 24.4" 48.0 cm to 61.9 cm	26.5" 67.4 cm	26.3" 66.8 cm

Features

- Compatible with most Class 8 Day Cab and Over the Road Sleeper Semi-Trucks
- For full list of vehicle compatibility visit product page 7170-0580 on gamberjohnson.com
- Mongoose motion attachment lets you rotate, tilt, telescope 9" to 13" closer to you and lock your device to any desired position
- Allows egress to the back of the sleeper cab
- Does not interfere with standard floor shift
- Limited Lifetime Warranty

Note: This base will not work with International trucks with an integrated air conditioning system under the seat



MATERIAL HANDLING

Securely mount your electronic devices (laptops, VMU's, tablets) and accessories (keyboards, mobile scanners, printers, and safety lights) to your lift vehicle utilizing Gamber-Johnson material handling solutions. Built and designed to be as rugged as the environment they work in.



SINGLE CLAM SHELLS



7160-0357



7160-0370

Item No.	Description	Placement	Movement Capabilities	Weight	Height	Width	Depth
7160-0357	Clam Shell with Small Plate	1.5" to 2.5" Rectangular Guard Leg Roll Form Brackets Horizontal and Vertical Extensions	Tilt - 160° Total Rotation - None	4.0 lbs 1.8 kg	4.6" 11.7 cm	6.3" 15.9 cm	5.1" 13.0 cm
7160-0370	Clam Shell with Large Plate	2.5" to 5.0" Rectangular Guard Leg	Tilt - 160° Total Rotation - None	5.8 lbs 2.6 kg	4.6" 11.7 cm	6.8" 17.3 cm	5.3" 3.4 cm

Features

- Designed to be quickly and easily installed without the need for drilling
- Quick adjust lever to effortlessly tilt to a desired position
- Multiple mounting hole patterns including AMPs, NEC, and VESA 75 mm to support various Gamber-Johnson devices and other peripherals
- Limited Lifetime Warranty

DUAL CLAM SHELLS



7160-0366



7160-0367

Item No.	Description	Placement	Movement Capabilities	Weight	Height	Width	Depth
7160-0366	Dual Clam Shell with Small Plate	1.5" to 2.5" Rectangular Guard Leg Roll Form Brackets Horizontal and Vertical Extensions	Clevis Tilt - 90° fore / 26° aft Clam Shell Tilt - 160° Total Clevis Rotation - 180°	6.2 lbs 2.8 kg	9.8" 24.8 cm	7.3" 18.4 cm	7.0" 25.3 cm
7160-0367	Dual Clam Shell with Large Plate	2.5" to 5.0" Rectangular Guard Leg	Clevis Tilt - 90° fore / 26° aft Clam Shell Tilt - 160° Total Clevis Rotation - 180°	8.0 lbs 3.6 kg	9.8" 24.8 cm	8.3" 21.0 cm	7.1" 18.1 cm

Features

- Designed to be quickly and easily installed without the need for drilling
- Quick adjust lever to effortlessly tilt to a desired position
- Allows additional rotation capabilities for added flexibility and ergonomic positioning
- Multiple mounting hole patterns including AMPs, NEC, and VESA 75 mm to support various Gamber-Johnson devices and other peripherals
- Limited Lifetime Warranty

DUAL CLAM SHELLS WITH ARTICULATING ARM



7160-0420



7160-0421

Item No.	Description	Placement	Movement Capabilities	Weight	Height	Width	Depth
7160-0420	Dual Clam Shell with Articulating arm and Small Plate	1.5" to 2.5" Rectangular Guard Leg Roll Form Brackets Horizontal and Vertical Extensions	Clevis Tilt - 90° fore / 26° aft Clam Shell Tilt - 160° Total Clevis Rotation - 180° Articulating Arm Rotation - 240°	8.0 lbs 3.6 kg	10.1" 25.7 cm	7.4" 18.8 cm	10.0" 25.4 cm
7160-0421	Dual Clam Shell with Articulating arm and Large Plate	2.5" to 5.0" Rectangular Guard Leg	Clevis Tilt - 90° fore / 26° aft Clam Shell Tilt - 160° Total Clevis Rotation - 180° Articulating Arm Rotation - 240°	9.8 lbs 4.4 kg	10.1" 25.7 cm	6.6" 16.8 cm	10.1" 25.7 cm
7160-1505	Fixed Base, Clamshell with Articulating Arm and Large Plate	2.5" to 5.0" Rectangular Guard Leg	Clevis Tilt - 90° fore / 26° aft Clevis Rotation - 180° Articulating Arm Rotation - 240°	8.0 lbs 3.6 kg	9.8" 24.8 cm	8.3" 21.0 cm	7.1" 18.1 cm

Features

- Designed to be quickly and easily installed without the need for drilling
- Quick adjust lever to effortlessly tilt to a desired position
- Articulating arm allows greater positioning capabilities and brings the device closer to the user
- Multiple mounting hole patterns including AMPs, NEC, and VESA 75 mm to support various Gamber-Johnson devices and other peripherals
- Limited Lifetime Warranty

NEW



7160-1505

FLAT SURFACE MOUNT

Item No.	Description	Placement	Weight	Height	Width	Depth
7160-1105	Flat Surface Mount	Flat Surface	7.5 lbs 3.4 kg	6.3" 15.9 cm	6.5" 3.4 kg	6.5" 3.4 kg



Features

- Drilled solution for any flat surface application
- Compatible with Gamber-Johnson lower poles and motion attachments
- Backer plate included to provide added support on thin surface applications
- Multiple mounting hole patterns including AMPs, NEC, and VESA 75 mm to support various Gamber-Johnson devices and other peripherals
- Limited Lifetime Warranty

MAGNETIC SURFACE MOUNT

Item No.	Description	Placement	Movement Capabilities	Weight	Height	Width	Depth
7160-1258	Flat Surface Magnet Mount with Clevis	Magnetic Flat Surface	Tilt - 90° fore / 26° aft Clevis Rotation - 360°	7.5 lbs 3.4 kg	6.3" 15.9 cm	6.5" 3.4 kg	6.5" 3.4 kg

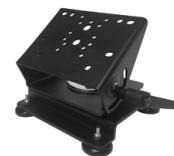

Features

- Base magnets allow a quick way to mount and dismount to any flat magnetic surface
- Quick adjust lever to effortlessly tilt to a desired position
- Multiple mounting hole patterns including AMPs, NEC, and VESA 75 mm to support various Gamber-Johnson devices and other peripherals
- Limited Lifetime Warranty

CLEVIS WITH ARTICULATING ARM

Item No.	Description	Placement	Movement Capabilities	Weight	Height	Width	Depth
7160-0356	Clevis with Articulating Arm	Attaches to Clam Shells (7160-0357, 7160-0370, 7160-0371) or 3/8" Bolt Clearance Hole	Tilt - 90° fore / 26° aft Clevis Rotation - 180° Articulating Arm Rotation - 240°	4.2 lbs 1.9 kg	3.5" 8.9 cm	8.2" 20.8 cm	6.6" 16.8 cm



Features

- Quick adjust lever to effortlessly tilt to a desired position
- Articulating arm allows greater positioning capabilities and brings the device closer to the user
- Multiple mounting hole patterns including AMPs, NEC, and VESA 75 mm to support various Gamber-Johnson devices and other peripherals
- Limited Lifetime Warranty

SECONDARY CLAM SHELL

Item No.	Description	Placement	Movement Capabilities	Weight	Height	Width	Depth
7160-0371	Secondary Clam Shell	Attaches to Clam Shells (7160-0357, 7160-0370) or 3/8" Bolt Clearance Hole	Tilt - 160° Total Rotation - None	1.7 lbs 0.78 kg	4.6" 11.7 cm	6.0" 15.2 cm	5.2" 13.1 cm



Features

- Quick adjust lever to effortlessly tilt to a desired position
- Hardware included to lock into a fixed position
- Multiple mounting hole patterns including AMPs, NEC, and VESA 75 mm to support various Gamber-Johnson devices and other peripherals
- 1 Year Limited Warranty



MEDIUM JOINER MOUNT



Item No.	Description	Placement	Maximum Payload Capacity	Weight	Height	Width	Depth
7160-1171	Zirkona, 4" Diamond Plate with Medium Joiner and AMPs Plate	Up to 4" Wide Overhead Crossmember, Rectangular or Roll Form Profile	Vibration Environment - 6 lbs / 1.4 kg Static Environment - 33 lbs / 15 kg	2.2 lbs 1.0 kg	2.5" 6.4 cm	4.7" 12.0 cm	5.8" 14.6 cm

Features

- Small form factor for smaller tablets and devices
- Large range of motion and quick adjust lever to effortlessly move to a desired position
- Designed to be quickly and easily installed without the need for drilling
- Mounting hole patterns include AMPs and NEC
- 1 Year Limited Warranty



DOG-BONE JOINER MOUNTS

NEW



7160-1466

Item No.	Description	Placement	Maximum Payload Capacity	Weight	Height	Width	Depth
7160-1466	Zirkona, 4" Diamond Plate with 6" Medium Dog-Bone and AMPs Plate	Up to 4" Wide Overhead Crossmember, Rectangular or Roll Form Profile	Vibration Environment - 6 lbs / 1.4 kg Static Environment - 33 lbs / 15 kg	3.3 lbs 1.5 kg	6.0" 15.2 cm	5.0" 12.7 cm	9.5" 24.1 cm
7160-1466-01	Zirkona, 4" Diamond Plate with 6" Medium Dog-Bone and VESA 75 mm Plate	Up to 4" Wide Overhead Crossmember, Rectangular or Roll Form Profile	Vibration Environment - 6 lbs / 1.4 kg Static Environment - 33 lbs / 15 kg	3.3 lbs 1.5 kg	6.0" 15.2 cm	5.0" 12.7 cm	9.5" 24.1 cm

Features

- Small form factor with an extended reach for smaller tablets and devices
- Two quick adjust levers increase range of motion and positioning
- Unique internal braking system allows the user to adjust the mount with ease while not having the device fall (weight restrictions apply)
- Designed to be quickly and easily installed without the need for drilling
- 1 Year Limited Warranty

NEW



7160-1466-01



LARGE JOINER MOUNTS



7160-1261

Item No.	Description	Placement	Maximum Payload Capacity	Weight	Height	Width	Depth
7160-1261	Zirkona, 4" Diamond Plate with Large Joiner and AMPs Plate	Up to 4" Wide Overhead Crossmember, Rectangular or Roll Form Profile	Vibration Environment - 11 lbs / 5.0 kg Static Environment - 55 lbs / 25 kg	2.7 lbs 1.2 kg	2.5" 6.4 cm	5.7" 14.4 cm	5.8" 14.6 cm
7160-1261-01	Zirkona, 4" Diamond Plate with Large Joiner and VESA 75 mm Plate	Up to 4" Wide Overhead Crossmember, Rectangular or Roll Form Profile	Vibration Environment - 11 lbs / 5.0 kg Static Environment - 55 lbs / 25 kg	2.8 lbs 1.3 kg	2.5" 6.4 cm	5.7" 14.4 cm	5.8" 14.6 cm

Features

- Easy to install mounting solution with no drilling required and ample adjustability to accommodate operator comfort and ease of use
- Ideal for small form factor tablets and devices
- Large range of motion and quick adjust lever to effortlessly move to a desired position
- Options for various mounting hole patterns include AMPs, NEC, and VESA 75 mm
- 1 Year Limited Warranty



7160-1466-01



COMPONENTS



Item No.	Description	Placement	Weight	Height	Width	Depth
7160-1235	Zirkona, 4" Diamond Plate Mount	Up to 4" Wide Overhead Crossmember, Rectangular or Roll Form Profile	1.8 lbs 0.8 kg	4.7" 12.0 cm	2.5" 6.4 cm	5.8" 14.6 cm

Features

- For use with individual Zirkona products such as joiners and extensions
- Creates an unique mount for smaller tablets and other small devices
- Designed to be quickly and easily installed without the need for drilling
- 1 Year Limited Warranty

ROLL FORM BRACKETS

Item No.	Description	Placement	Weight	Height	Width	Depth
7160-0418	Yale/Hyster and Crown Roll Formed Pillar Bracket	Roll Formed Guard Leg for OEM Specific Forklifts	2.7 lbs 1.2 kg	4.7" 12 cm	5.8" 14.8 cm	2.3" 5.7 cm
7160-0814	Toyota, Jungheinrich, and CAT Roll Formed Pillar Bracket	Roll Formed Guard Leg for OEM Specific Forklifts	2.7 lbs 1.2 kg	4.7" 12 cm	6.8" 17.3 cm	2.0" 5.1 cm
7160-0815	Linde Roll Formed Pillar Bracket	Roll Formed Guard Leg for OEM Specific Forklifts	2.7 lbs 1.2 kg	4.7" 12 cm	5.8" 14.8 cm	1.1" 2.8 cm
7160-1542	CLARK Roll Formed Pillar Bracket	Roll Formed Guard Leg for OEM Specific Forklifts	2.7 lbs 1.2 kg	4.7" 12 cm	5.7" 14.4 cm	3.3" 8.4 cm

Features

- Designed to perfectly fit OEM specific forklifts
- Creates a solid and secure point to adapt Gamber-Johnson's Clam Shell Mounts
- Limited Lifetime Warranty



NEW



ROLL FORM KITS

Item No.	Description	Placement	Weight	Height	Width	Depth
7170-0705	Yale/Hyster and Crown Roll Formed Pillar Mount Kit Kit Includes: Roll Formed Bracket (7160-0418) and Dual Clam Shell with Articulating Arm (7160-0420)	Roll Formed Guard Leg for OEM Specific Forklifts	10.7 lbs 4.8 kg	10.1" 25.7 cm	7.4" 18.8 cm	12.4" 31.5 cm
7170-0706	Toyota, Jungheinrich, and CAT Roll Formed Pillar Mount Kit Kit Includes: Roll Formed Bracket (7160-0814) and Dual Clam Shell with Articulating Arm (7160-0420)	Roll Formed Guard Leg for OEM Specific Forklifts	10.7 lbs 4.8 kg	10.1" 25.7 cm	7.4" 18.8 cm	12.1" 30.7 cm
7170-0707	LINDE Roll Formed Pillar Mount Kit Kit Includes: Roll Formed Bracket (7160-0815) and Dual Clam Shell with Articulating Arm (7160-0420)	Roll Formed Guard Leg for OEM Specific Forklifts	10.7 lbs 4.8 kg	10.1" 25.7 cm	7.4" 18.8 cm	11.2" 28.4 cm

Features

- Designed to perfectly fit OEM specific forklifts
- Articulating arm allows greater positioning capabilities and brings the device closer to the user
- Creates a solid and secure point to adapt Gamber-Johnson's Clam Shell Mounts
- Kitted mounting solutions for ease of ordering
- Limited Lifetime Warranty

NEW



NEW



NEW



POLE/TUBE MOUNTS

Item No.	Description	Placement	Weight	Height	Width	Depth
7160-0561	Guard Leg 2" to 3" Tube Clamp	Cylindrical Pole/Tube Ranging Between 2" and 3"	3.8 lbs 1.7 kg	5.3" 13.3 cm	3.4" 8.6 cm	10.0" 25.4 cm
7170-0703	Forklift Pole Mount Kit Kit Includes: Guard Leg 2" to 3" Tube Clamp (7160-0561) and Dual Clam Shell with Articulating Arm (7160-0420)	Cylindrical Pole/Tube Ranging Between 2" and 3"	12.0 lbs 5.4 kg	10.1" 25.7 cm	11.0" 27.9 cm	10.1" 25.7 cm

Features

- Configure an optimal solution to fit any size cylindrical pole or tubular style profiles varying between 2" (5.08 cm) and 3" (7.62 cm) in diameter
- Improved, no drilling required, mounting solution for enhanced ease of installation
- Adaptable to support various Gamber-Johnson mounts to securely mount an assortment of devices and peripherals
- Limited Lifetime Warranty



NEW





LARGE JOINER WITH 3/4" TO 1-7/8" SIZE RANGE

NEW



7160-1367

NEW



7160-1367-01

Item No.	Description	Placement	Maximum Payload Capacity	Weight	Height	Width	Depth
7160-1367	Zirkona 3/4" to 1-7/8" Pole Mount with AMPs Plate	Cylindrical Pole/ Tube Ranging between 3/4" and 1-7/8"	Vibration Environment - 11 lbs / 5.0 kg Static Environment - 55 lbs / 25 kg	2.9 lbs 1.3 kg	3.7" 9.4 cm	5.2" 13.2 cm	6.3" 15.9 cm
7160-1367-01	Zirkona 3/4" to 1-7/8" Pole Mount with VESA 75 mm Plate	Cylindrical Pole/ Tube Ranging between 3/4" and 1-7/8"	Vibration Environment - 11 lbs / 5.0 kg Static Environment - 55 lbs / 25 kg	3.0 lbs 1.4 kg	3.7" 9.4 cm	5.2" 13.2 cm	6.3" 15.9 cm

Features

- Mounts to any size cylindrical poles, handles, or tubular style overhead guard legs varying between 3/4" (1.9 cm) and 1-7/8" (4.76 cm) in diameter
- Easy to install mounting solution with no drilling required and ample adjustability to accommodate operator comfort and ease of use
- Ideal for small form factor devices
- Options for various mounting hole patterns include AMPs/NEC and VESA 75 mm
- 1 Year Limited Warranty

LARGE JOINER WITH 3/4" TO 1-7/8" SIZE RANGE AND QUICK RELEASE DEVICE PLATE



NEW



7160-1367-02

NEW



7160-1367-03

Item No.	Description	Placement	Maximum Payload Capacity	Weight	Height	Width	Depth
7160-1367-02	Zirkona 3/4" to 1-7/8" Pole Mount with AMPs Quick Release Plate	Cylindrical Pole/ Tube Ranging Between 3/4" and 1-7/8"	Vibration Environment - 11 lbs / 5.0 kg Static Environment - 55 lbs / 25 kg	3.5 lbs 1.56 kg	3.9" 9.9 cm	4.7" 11.9 cm	6.8" 17.3 cm
7160-1367-03	Zirkona 3/4" to 1-7/8" Pole Mount with VESA 75 mm Quick Release Plate	Cylindrical Pole/ Tube Ranging Between 3/4" and 1-7/8"	Vibration Environment - 11 lbs / 5.0 kg Static Environment - 55 lbs / 25 kg	3.7 lbs 1.68 kg	3.9" 9.9 cm	5.5" 13.8 cm	7.1" 18.0 cm

Features

- Mounts to any size cylindrical poles, handles, or tubular style overhead guard legs varying between 3/4" (1.9 cm) and 1-7/8" (4.76 cm) in diameter
- Easy to install mounting solution with no drilling required to decrease install times and improve vehicle up-times
- Quick release device plate to easily remove small tablets or devices
- Options for various mounting hole patterns include AMPs/NEC and VESA 75 mm
- 1 Year Limited Warranty

LARGE JOINER WITH 2" TO 3" SIZE RANGE



NEW



7160-1356

NEW



7160-1356-01

Item No.	Description	Placement	Maximum Payload Capacity	Weight	Height	Width	Depth
7160-1356	Zirkona 2" to 3" Pole Mount with AMPs Plate	Cylindrical Pole/ Tube Ranging Between 2" and 3"	Vibration Environment - 11 lbs / 5.0 kg Static Environment - 55 lbs / 25 kg	2.2 lbs 1.0 kg	3.7" 9.4 cm	5.2" 13.2 cm	6.3" 15.9 cm
7160-1356-01	Zirkona 2" to 3" Pole Mount with VESA 75 mm Plate	Cylindrical Pole/ Tube Ranging Between 2" and 3"	Vibration Environment - 11 lbs / 5.0 kg Static Environment - 55 lbs / 25 kg	2.3 lbs 1.1 kg	3.7" 9.4 cm	5.2" 13.2 cm	6.3" 15.9 cm

Features

- Mounts to any size cylindrical poles or tubular style overhead guard legs varying between 2" (5.08 cm) and 3" (7.62 cm) in diameter
- Easy to install mounting solution with no drilling required and ample adjustability to accommodate operator comfort and ease of use
- Ideal for small form factor devices
- Options for various mounting hole patterns include AMPs/NEC and VESA 75 mm
- 1 Year Limited Warranty

DOG-BONE JOINER WITH 3/4" TO 1-7/8" SIZE RANGE



Item No.	Description	Placement	Maximum Payload Capacity	Weight	Height	Width	Depth
7160-1533	Zirkona 3/4" to 1-7/8" Pole Mount with 6" Medium Dog-Bone and AMPs Plate	Cylindrical Pole/ Tube Ranging Between 3/4" and 1-7/8"	Vibration Environment - 6 lbs / 1.4 kg Static Environment - 33 lbs / 15 kg	3.5 lbs 1.6 kg	3.9" 9.8 cm	4.7" 11.9 cm	10.1" 25.7 cm
7160-1533-01	Zirkona 3/4" to 1-7/8" Pole Mount with 6" Medium Dog-Bone and VESA 75 mm Plate	Cylindrical Pole/ Tube Ranging Between 3/4" and 1-7/8"	Vibration Environment - 6 lbs / 1.4 kg Static Environment - 33 lbs / 15 kg	3.5 lbs 1.6 kg	3.9" 9.8 cm	4.7" 11.9 cm	10.1" 25.7 cm

Features

- Mounts to any size cylindrical poles, handles, or tubular style overhead guard legs varying between 3/4" (1.9 cm) and 1-7/8" (4.76 cm) in diameter
- Unique internal braking system allows the user to adjust the mount with ease while not having the device fall (weight restrictions apply)
- Two quick adjust levers increase range of motion and positioning
- Includes 6" Medium Dog-Bone Joiner with options for AMPs/NEC and VESA 75mm mounting hole patterns
- 1 Year Limited Warranty

NEW



7160-1533

NEW



7160-1533-01

DOG-BONE JOINER WITH 2" TO 3" SIZE RANGE



Item No.	Description	Placement	Maximum Payload Capacity	Weight	Height	Width	Depth
7160-1531	Zirkona 2" to 3" Pole Mount with 6" Medium Dog-Bone and AMPs Plate	Cylindrical Pole/ Tube Ranging Between 2" and 3"	Vibration Environment - 6 lbs / 1.4 kg Static Environment - 33 lbs / 15 kg	2.8 lbs 1.3 kg	2.4" 6.0 cm	5.2" 13.2 cm	9.8" 25.0 cm
7160-1531-01	Zirkona 2" to 3" Pole Mount with 6" Medium Dog-Bone and VESA 75 mm Plate	Cylindrical Pole/ Tube Ranging Between 2" and 3"	Vibration Environment - 6 lbs / 1.4 kg Static Environment - 33 lbs / 15 kg	2.8 lbs 1.3 kg	3.9" 9.8 cm	5.2" 13.2 cm	9.8" 25.0 cm

Features

- Mounts to any size cylindrical poles or tubular style overhead guard legs varying between 2" (5.08 cm) and 3" (7.62 cm) in diameter
- Unique internal braking system allows the user to adjust the mount with ease while not having the device fall (weight restrictions apply)
- Two quick adjust levers increase range of motion and positioning
- Includes 6" Medium Dog-Bone Joiner with options for AMPs/NEC and VESA 75 mm mounting hole patterns
- 1 Year Limited Warranty

NEW



7160-1531

NEW



7160-1531-01

HORIZONTAL EXTENSION

Item No.	Description	Placement	Weight	Height	Width	Depth
7160-0363	Horizontal Extension Bar	1.5" to 5.0" Rectangular Guard Leg	6.8 lbs 3.1 kg	4.4" 11.1 cm	19.0" 48.3 cm	1.2" 3.0 cm

Features

- Allows positioning of devices up to 15" (38.1 cm) horizontally from the inside of the guard leg
- Creates a solid and secure point to adapt various Gamber-Johnson's mounts
- Allows for multiple system configurations based on the style of forklift and computer configuration.
- Limited Lifetime Warranty



7160-0363

SHORT OVERHEAD GUARD MOUNTS



Item No.	Description	Placement	Movement Capabilities	Weight	Height	Width	Depth
7160-0585	Short Overhead Guard Mount with Clevis	Attaches Directly to Overhead Guard	Clam Shell Tilt - 160° Total Clam Shell Rotation - 360°	5.6 lbs 2.5 kg	5.6" 14.2 cm	10.0" 25.4 cm	5.6" 14.2 cm
7160-0586	Short Overhead Guard Mount with Dual Clevis	Attaches Directly to Overhead Guard	Clevis Tilt - 90° fore / 26° aft Rotation - 360°	7.9 lbs 3.6 kg	7.5" 3.6 kg	10.0" 25.4 cm	10.8" 27.4 cm

Features

- Provides a reduced profile in order to bring devices closer to the overhead guard and out of an operators direct view
- Great solution to mount peripherals such as radios
- Multiple mounting hole patterns including AMPs, NEC, and VESA 75 mm to support various Gamber-Johnson devices and other peripherals
- Limited Lifetime Warranty

EXTENDED OVERHEAD GUARD MOUNT



Item No.	Description	Placement	Movement Capabilities	Weight	Height	Width	Depth
7160-0368	Extended Overhead Guard Mount with Clevis	Attaches Directly to Overhead Guard	Clevis Tilt - 90° fore / 26° aft Clevis Rotation - 360°	9.7 lbs 4.4 kg	13.2" 33.4 cm	10.0" 25.4 cm	5.6" 14.2 cm

Features

- Provides an 8" (20.32 cm) extension from the overhead guard in order to bring devices closer to the user
- Multiple mounting hole patterns including AMPs, NEC, and VESA 75 mm to support various Gamber-Johnson devices and other peripherals
- Limited Lifetime Warranty

OVERHEAD BAR MOUNTS



Item No.	Description	Placement	Movement Capabilities	Weight	Height	Width	Depth
7160-1156	Overhead Bar Mount	Attaches to Crossmember of Overhead Guard	Clevis Tilt - 90° fore / 26° aft Clevis Rotation - 360°	4.8 lbs 2.2 kg	10.0" 25.4 cm	7.5" 19.1 cm	7.0" 17.8 cm
7160-1156-01	Tall Overhead Bar Mount	Attaches to Crossmember of Overhead Guard	Clevis Tilt - 90° fore / 26° aft Clevis Rotation - 360°	6.7 lbs 3.0 kg	14.0" 35.6 cm	7.5" 19.1 cm	7.0" 17.8 cm

Features

- Provides ergonomic tilt and rotation options to position device
- Quick adjust lever to effortlessly tilt to desired position
- Allows for flexibility in mounting in different positions overhead
- Multiple mounting hole patterns including AMPs, NEC, and VESA 75 mm to support various Gamber-Johnson devices and other peripherals
- Limited Lifetime Warranty

VERTICAL EXTENSION AND KIT



Item No.	Description	Placement	Weight	Height	Width	Depth
7160-0856	Vertical Extension Bar	Attaches to Crossmember of Overhead Guard	8.8 lbs 4.0 kg	4.4" 11.1 cm	31.0" 78.7 cm	1.2" 3.0 cm
7170-0704	Overhead Guard Extension Kit Kit Includes: Vertical Extension Bar (7160-0856) and Dual Clam Shell with Articulating Arm (7160-0420)	Attaches to Crossmember of Overhead Guard	16.8 lbs 7.6 kg	10.1" 25.7 cm	31.0" 78.7 cm	10.1" 25.7 cm

Features

- Allows positioning of devices up to 27" (68.58 cm) vertically from the top of the overhead guard
- Creates a solid and secure point to adapt various Gamber-Johnson's mounts
- Allows for multiple system configurations based on the style of forklift and computer configuration
- Limited Lifetime Warranty

LINDE CAB MOUNT

Item No.	Description	Placement	Weight	Height	Width	Depth
7160-1103	Linde E30 Latch Mounting Bracket	Attaches to Linde E30 Cab Latch	2.5 lbs 1.1 kg	4.8" 12.2 cm	8.3" 21.1 cm	1.5" 3.8 cm

Features

- Designed to perfectly fit the Linde E30 forklift with a cab
- Can be mounted in conjunction with various Gamber-Johnson mounts to allow movement and adjustability of the device
- Allows you to mount a computer or device in a small cab space without interfering with the driver and line of vision
- Limited Lifetime Warranty



TOYOTA CAB MOUNTS

Item No.	Description	Placement	Weight	Height	Width	Depth
7160-1151	Toyota Cab Latch Mount for Electronic Hydraulics	Attaches to Toyota Right Side Cab Latch	3.5 lbs 1.6 kg	5.8" 14.6"	8.5" 21.5 cm	2.8" 7.0 cm
7160-1233	Toyota Cab Mount	Attaches to Toyota Guard Leg	3.0 lbs 1.4 kg	4.7" 11.9 cm	9.0" 22.9 cm	1.7" 4.3 cm

Features

- Designed to perfectly fit Toyota forklifts with cabs
- Can be mounted in conjunction with various Gamber-Johnson mounts to allow movement and adjustability of the device
- Allows you to mount a computer or device in a small cab space without interfering with the driver and line of vision
- Limited Lifetime Warranty



7160-1151



7160-1233

YALE/HYSTER CAB MOUNTS

Item No.	Description	Placement	Weight	Height	Width	Depth
7160-1109	Yale/Hyster Electric Forklift Bracket	Attaches to Yale/Hyster Guard Leg (Models with Electric Hydraulics)	5.0 lbs 2.3 kg	16.5" 41.9 cm	7.3" 40.6 cm	2.2" 5.6 cm
7160-1278	Yale/Hyster 40-70 Cab Mount	Attaches to Yale/Hyster Guard Leg	5.7 lbs 2.6 kg	19.0" 48.3 cm	7.3" 40.6 cm	2.2" 5.6 cm

Features

- Designed to perfectly fit Yale/Hyster forklifts with cabs
- Can be mounted in conjunction with various Gamber-Johnson mounts to allow movement and adjustability of the device
- Allows you to mount a computer or device in a small cab space without interfering with the driver and line of vision
- Limited Lifetime Warranty



7160-1109



NEW

7160-1278

NEW



OVEHEAD GUARD

Item No.	Description	Placement	Weight	Height	Width	Depth
7160-1425	Overhead Guard Cab Mount	Attaches Directly to Overhead Guard with a Cab	10.1 lbs 4.6 kg	11.0" 27.9 cm	5.5" 14.0 cm	12.3" 31.1 cm

Features

- Quick and easy installation with no drilling required for decreased install times and increased vehicle up-time
- A multitude of positioning configurations for optimal operator access
- A universal solution adaptable to various overhead guard types with cabs
- Features the Gamber-Johnson Clevis for mounting any device utilizing standard AMPs, NEC, or VESA 75 mm universal hole patterns
- Limited Lifetime Warranty

CAB CLAMP BRACKET ADAPTER



Item No.	Description	Placement	Weight	Height	Width	Depth
7160-1096	Clamp Bracket Adapter	Adapts to Various Gamber-Johnson Mounts	2.8 lbs 1.3 kg	5.2" 13.3 cm	6.4" 16.2 cm	1.6" 4.1 cm

Features

- Can be mounted in conjunction with various Gamber-Johnson mounts to allow movement and adjustability of the device
- Use one or two clamp brackets to hold the adapter in place
- Limited Lifetime Warranty

CROWN PALLET RIDER MOUNT



Item No.	Description	Placement	Weight	Height	Width	Depth
7160-0889	Crown PE4500 Pallet Rider Mount	Attaches Between Battery and Steering Column	6.2 lbs 2.8 kg	18.3" 46.4 cm	6.4" 16.1 cm	1.9" 4.8 cm

Features

- Designed specifically for the Crown PE4500 Pallet Rider for an exact fit
- Compatible with any Gamber-Johnson upper poles
- Some drilling may be required
- Limited Lifetime Warranty

RAYMOND PALLET RIDER MOUNT



Item No.	Description	Placement	Weight	Height	Width	Depth
7160-1144	Raymond 8400 Pallet Rider Mount	Attaches Between Battery and Steering Column	10.8 lbs 4.9 kg	8.3" 21.1 cm	16.0" 40.6 cm	6.7" 16.9 cm

Features

- Designed specifically for the Raymond 8400 Pallet Rider for an exact fit
- Adaptable to support various Gamber-Johnson mounts to securely mount an assortment of devices and peripherals
- No drilling required for installation
- Limited Lifetime Warranty

TABLET KEYBOARD MOUNT

Item No.	Description	Placement	Compatibility	Weight	Height	Width	Depth
7160-0799	Tablet Keyboard Mount	Attaches Between Dock and Mounting Solution	Attaches Utilizing VESA 75 mm or Gamber-Johnson Hole Patterns	4.3 lbs 1.9 kg	6.1" 15.5 cm	5.8" 14.7 cm	10.0" 25.4 cm
7160-1323	Honeywell VMU Keyboard Mount	Attaches Between Dock and Mounting Solution	Attaches Utilizing AMPs Universal Hole Pattern	4.3 lbs 1.9 kg	6.1" 15.5 cm	5.8" 14.7 cm	10.0" 25.4 cm

Features

- Designed to hold the keyboard in a standard horizontal position directly under the device
- Quick adjust tension handle secures the keyboard tray and allows for optimal positioning and stowing capabilities
- Keyboard mounting hole patterns:
 - AMPs (2 mounting locations)
 - 2.5" (6.35 cm) x 2.5" (6.35 cm) (2 mounting locations)
 - VESA 75 mm
 - 2" (5.08 cm) x 7" (17.78 cm) Honeywell
- Limited Lifetime Warranty



7160-0799



7160-1323

VERTICAL KEYBOARD MOUNT

Item No.	Description	Placement	Compatibility	Weight	Height	Width	Depth
7160-1257	Vertical Tablet Keyboard Mount	Attaches Between Dock and Mounting Solution	Attaches Utilizing VESA 75 mm or Gamber-Johnson Hole Patterns	3.8 lbs 1.7 kg	11.3" 28.6 cm	5.0" 12.7 cm	9.6" 24.5 cm
7160-1357	Honeywell VMU Vertical Keyboard Mount	Attaches Between Dock and Mounting Solution	Attaches Utilizing AMPs Universal Hole Pattern	3.8 lbs 1.7 kg	11.3" 28.6 cm	5.0" 12.7 cm	9.6" 24.5 cm

Features

- Designed to hold the keyboard in a vertical position directly under the device
- Quick adjust tension handle secures the keyboard tray and allows for optimal positioning
- Keyboard mounting hole patterns:
 - AMPs (2 mounting locations)
 - 2.5" (6.35 cm) X 2.5" (6.35 cm) (2 mounting locations)
 - VESA 75 mm
 - 2" (5.08 cm) x 7" (17.78 cm) Honeywell
- Limited Lifetime Warranty



7160-1257



7160-1357

FIXED KEYBOARD MOUNT

Item No.	Description	Placement	Compatibility	Weight	Height	Width	Depth
7160-1157	Fixed Tablet Keyboard Mount	Attaches Between Dock and Mounting Solution	Attaches Utilizing VESA 75 mm or Gamber-Johnson Hole Patterns	4.5 lbs 2.0 kg	9.0" 22.9 cm	9.6" 24.4 cm	8.9" 22.6 cm

Features

- Designed to hold the keyboard in a standard horizontal position directly under the device
- Positions keyboard at a fixed 20° angle
- Keyboard mounting hole patterns:
 - AMPs (2 mounting locations)
 - 2.5" (6.35 cm) x 2.5" (6.35 cm) (2 mounting locations)
 - VESA 75 mm
 - 2" (5.08 cm) X 7" (17.78 cm) Honeywell
- Limited Lifetime Warranty



TABLET KEYBOARD OFFSET KIT

Item No.	Description	Placement	Weight	Height	Width	Depth
7170-0644	Tablet Keyboard Mount with 75 mm Offset Kit Includes: 7160-0799 Tablet Keyboard Mount and 7160-1040 VESA 75 mm Offset Bracket	Attaches Between Gamber-Johnson and Tablet Keyboard Mounts	5.1 lbs 2.3 kg	6.1" 15.5 cm	5.8" 14.7 cm	10.0" 25.4 cm

Features

- Ability to offset keyboard mount slightly lower to be compatible with larger devices
- Compatible with any Gamber-Johnson Clam Shell or Clevis
- Keyboard mounting hole patterns:
 - AMPs (2 mounting locations)
 - 2.5" (6.35 cm) x 2.5" (6.35 cm) (2 mounting locations)
 - VESA 75 mm
 - 2" (5.08 cm) x 7" (17.78 cm) Honeywell
- Limited Lifetime Warranty



INDEPENDENT KEYBOARD MOUNTS



7160-0550



7160-0584

Item No.	Description	Placement	Weight	Height	Width	Depth
7160-0550	Independent Keyboard Mount V1	1.5" to 2.5" Rectangular Guard Leg or Mates with Clam Shells	3.0 lbs 1.4 kg	3.8" 9.7 cm	5.1" 13.0 cm	14.0" 35.6 cm
7160-0584	Independent Keyboard Mount V2	1.5" to 2.5" Rectangular Guard Leg or Mates with Clam Shells	3.0 lbs 1.4 kg	3.8" 9.7 cm	5.1" 13.0 cm	14.0" 35.6 cm

Features

- Central articulating arms are simply switched between the two versions (V1 Shown)
- Designed to position and hold the keyboard independent of device
- Quick adjust tension handle secures keyboard angle and allows for optimal positioning
- Keyboard mounting hole patterns:
 - AMPs
 - VESA 75 mm
- Limited Lifetime Warranty

LOW PROFILE KEYBOARD MOUNT



Item No.	Description	Placement	Movement Capabilities	Weight	Height	Width	Depth
7160-0984	Low Profile Tablet Keyboard Bracket	Attaches to Gamber-Johnson Clam Shell Products	Clevis Tilt - 90° fore / 26° aft Clevis Rotation - 180° Articulating Arm Rotation - 240°	6.8 lbs 3.1 kg	14.6" 37.0 cm	6.2" 15.8 cm	9.4" 23.7 cm

Features

- Articulating arm allows keyboard to be tucked in closer to the device for a slimmer profile
- Compatible with any Gamber-Johnson Clam Shell or Clevis
- Keyboard mounting hole patterns:
 - AMPs
 - VESA 75 mm
- Limited Lifetime Warranty

RUGGED LITE KEYBOARD MOUNT



NEW

Item No.	Description	Placement	Compatibility	Weight	Height	Width	Depth
7160-1474	Fixed Rugged Lite Keyboard Mount	Attaches to Gamber-Johnson Clam Shell Products	Rugged Lite Keyboard (7160-1499-00)	1.1 lbs 0.5 kg	1.0" 2.5 cm	9.6" 24.4 cm	7.7" 19.6 cm

Features

- VESA 75 mm mounting pattern in order to attach to variety of Gamber-Johnson motion attachments
- Limited Lifetime Warranty

NUMERIC KEYPAD BRACKETS



7160-0859



7160-1165



7160-1486

Item No.	Description	Placement	Movement Capabilities	Weight	Height	Width	Depth
7160-0859	iKey Numeric Keypad Bracket	Attaches Between Dock and Mounting Solution	Fixed Mount Ability to Orient on Both Sides	1.1 lbs 0.5 kg	12.0" 30.5 cm	4.0" 10.2 cm	2.5" 6.2 cm
7160-1165	Zebra Numeric Keypad Bracket	Attaches Directly to the Bottom of Gamber-Johnson's Zebra 8" and 10" Docks	Fixed Mount	0.6 lbs 0.3 kg	2.9" 7.3 cm	1.8" 4.5 cm	8.0" 20.3 cm
7160-1486	Tablet Pivoting AMPs Mount	Attaches Between Dock and Mounting Solution	Adjustable Tilt Mount Ability to Orient on Both Sides	1.8" 0.8 kg	3.5" 8.9 cm	13.0" 32.8 cm	4.0" 10.2 cm

Features

- Places keypad ergonomically for the users comfort and ease of usability
- AMPs hole pattern allows capability to secure iKey's Mobile Numeric Pad (7300-0106) to your Gamber-Johnson dock
- Limited Lifetime Warranty

iKEY KEYBOARDS

Item No.	Description	Features	Weight
7300-0028	Rechargeable Bluetooth® Keyboard for Windows 8 (BT-80-02)	Fully Sealed, IP68 Case, Bluetooth® Wireless Technology, Windows 8 Integrated Hot Keys, VESA Mounting Pattern	1.2 lbs 0.5 kg
7300-0029	Rechargeable Bluetooth® Keyboard for Windows/Android (BT-80-03)	Fully Sealed, IP65 Case, Bluetooth Wireless Technology, Red LED Backlit Keys, VESA Mounting Pattern	1.2 lbs 0.5 kg
7300-0031	Backlit Keyboard with Integrated Touchpad (FT-88-911-TP)	12 Function Keys, 88-Key Functionality, Integrated Backlighting, Integrated Touchpad, Mobile Mounting Holes, One-Touch Emergency Key	2.3 lbs 1.0 kg
7300-0032	SkinnyBoard™ Mobile Keyboard with Touchpad (SB-87-TP-M)	12 Function Keys, Red Backlit Keys, Integrated Touchpad, Silicone Rubber, VESA Mounting Pattern, Ultra-Thin Design	1.4 lbs 0.6 kg
7300-0033	SkinnyBoard™ Mobile Keyboard (SB-87-TP)	IP65 Case, 12 Function Keys, Fully Sealed, Integrated Touchpad, Silicone Rubber, Red LED Backlit Keys, USB Connectivity, Ultra-Thin Design	1.4 lbs 0.6 kg
7300-0034	Mountable Keyboard with Touchpad (SL-86-911-TP)	86-Key Functionality, Fn Key for Secondary Legend Flexibility, Integrated Touchpad, Meets NEMA 4X (IP65) Specifications, One-Touch Emergency Key, Red Backlit Keys	2.3 lbs 1.0 kg
7300-0035	OEM Keyboard for Public Safety (SL-86-911-USB)	86-Key Functionality, Fn Key for Secondary Legend Flexibility, Integrated Touchpad, Meets NEMA 4X (IP65) Specifications, One-Touch Emergency Key, Red Backlit Keys	2.0 lbs 0.9 kg
7300-0036	Mobile Backlit keyboard with HulaPoint II™ (SLK-79-M)	12 Function Keys, Integrated HulaPoint II™ Pointing Device, Mobile Mounting Holes, Red Backlit Keys, USB and PS/2 Configurations Available	1.0 lb 0.5 kg
7300-0037	Bluetooth-Compatible Keyboard with Touchpad (BT-80-TP)	Wireless Industrial Keyboard, Fully-Sealed Keyboard - Meets NEMA 4X Specifications, Silicone Rubber Keypad and ABS Polycarbonate Case, Submersible and Easy to Clean with Disinfectants, Compact Design and Internal Bluetooth Module, Red LED Backlighting	1.2 lbs 0.5 kg
7300-0038	Full Travel Keyboard with Attachment Versatility (IK-TR-88)	12 Function Keys, 88-Key Functionality, Integrated Backlighting, Integrated Touchpad, Mobile Mounting Holes, One-Touch Emergency Key	2.0 lbs 0.9 kg
7300-0113	Dual Connectivity Slim Keyboard (BT-870-TP)	Meets NEMA 4X Specifications, Silicone Rubber Keypad, Rugged ABS Polycarbonate Case, Red Backlit Keys, Bluetooth Wireless Technology	2.0 lbs 0.9 kg
7300-0171	Mobile Backlit Keyboard with Force Sensing Resistor (SLK-79-FSR)	12 Function Keys, Integrated Force Sensing Resistor Pointing Device, Red Backlit Keys, APMS Hole Pattern, USB and PS/2 Keyboard/Pointer, 3' Single-Cable USB	1.0 lbs 0.45 kg
7300-0301	Mobile Keyboard with Numeric Keypad (SK-101-M-USB)	12 Function Keys, 10-Key Numeric Pad, Compact Slim Design, Wired USB Connection	2.0 lbs 0.9 kg
7300-0312	Small Footprint Keyboard with Oversized Keys (DP-72-USB)	72-Key Functionality, 8 Function Keys, Lightweight ABS Polycarbonate Case, Wired USB Connection	2.0 lbs 0.9 kg
7300-0106	Mobile Numeric Number Pad (IK-18-USB)	ABS Polycarbonate, Built-In AMPs Mounting Holes, IP 65 Water-Resistant, Backlit (Green), Wired USB Connection	0.4 lbs 0.18 kg



7300-0033



7300-0037



7300-0171



7300-0301



7300-0312



7300-0106

HANDHELD SCANNER MOUNTS

NEW



7160-1306

NEW



7160-1306-01

Item No.	Description	Placement	Weight	Height	Width	Depth
7160-1306	Scanner Pocket Mount with Small Back Plate	1.5" to 2.5" Rectangular Guard Leg Roll Form Brackets Horizontal and Vertical Extensions	5.2 lbs 2.4 kg	2.5" 6.4 cm	4.5" 11.4 cm	6.0" 15.2 cm
7160-1306-01	Scanner Pocket Mount with Large Back Plate	2.5" to 5.0" Rectangular Guard Leg	7.1 lbs 3.2 kg	2.5" 6.4 cm	4.5" 11.4 cm	6.0" 15.2 cm

Features

- Designed to be orientated inside, outside, or inline with the overhead guard leg
- Tilt adjustability provides ergonomic comfort and ease of use
- Adjustable pocket with a range of 3.5" (8.89 cm) to 4.5" (11.43 cm) in width and set at 2.5" (6.35 cm) tall
- Compatible with most handheld computers and scanners
- Limited Lifetime Warranty

MAGNETIC POCKET MOUNT

NEW



Item No.	Description	Placement	Weight	Height	Width	Depth
7160-1259	Flat Surface Magnet Mount with Scanner Holder	Magnetic Flat Surface	5.6 lbs 2.5 kg	7.8" 19.8 cm	6.4" 16.2 cm	6.0" 15.2 cm

Features

- Designed to eliminate any unnecessary drilling
- Base magnets allow a quick way to mount and dismount to any flat metal surface
- Adjustable pocket with a range of 3.5" (8.89 cm) to 4.5" (11.43 cm) in width and set at 2.5" (6.35 cm) tall
- Tilt adjustability provides ergonomic comfort and ease of use
- Limited Lifetime Warranty

ZIRKONA POCKET MOUNTS

zirkona

NEW



7170-0788

NEW



7170-0796

Item No.	Description	Placement	Weight	Height	Width	Depth
7170-0788	Zirkona 4" Diamond Mount with Scanner Pocket	Up to 4" Wide Crossmember, Rectangular or Roll Form Profile	5.2 lbs 2.4 kg	3.5" 8.9 cm	6.0" 15.2 cm	13.0 33.0 cm
7170-0796	Zirkona 2" to 3" Pole Mount with Scanner Pocket	Cylindrical Pole/Tube Ranging Between 2" and 3"	4.6 lbs 2.2 kg	3.5" 8.9 cm	5.5" 13.8 cm	15" 38.1 cm

Features

- Designed to be an easily equipped, no drilling required, solution to reduce installation times and labor costs
- Large range of motion and quick adjust lever to effortlessly move to a desired position
- Adjustable pocket with a range of 3.5" (8.89 cm) to 4.5" (11.43 cm) in width and set at 2.5" (6.35 cm) tall
- 1 Year Limited Warranty

PISTOL GRIP MOUNT

zirkona

NEW



Item No.	Description	Placement	Weight	Height	Width	Depth
7170-0764	Zirkona Pistol Grip Scanner Mount Kit Kit Includes: Zirkona 4" Diamond Plate with Large Joiner and AMPs Plate (7160-1261) and Pistol Grip Scanner Bracket (7160-1380)	Up to 4" Wide Crossmember, Rectangular or Roll Form Profile	4.1 lbs 1.8 kg	2.6" 6.6 cm	4.3" 10.8 cm	15.7" 39.9 cm

Features

- Padded tray to support most wireless handheld barcode scanners
- Offers the ability to utilize the device while cradled
- Designed to be an easily equipped solution with no drilling required to reduce installation times and labor costs
- Large range of motion and quick adjust lever to effortlessly move to a desired position
- 1 Year Limited Warranty

OFFSET TABLET MOUNTS

Item No.	Description	Placement	Weight	Height	Width	Depth
7160-1389	Scanner Pocket Tablet Mount	Attaches Between Dock and Mounting Solution	3.3 lbs 1.5 kg	6.2" 15.6 cm	4.0" 10.2 cm	13.3" 33.7 cm
7160-1486	Tablet Pivoting AMPs Mount	Attaches Between Dock and Mounting Solution	1.8 lbs 0.8 kg	3.5" 8.9 cm	12.9" 32.8 cm	4.0" 10.2 cm

Features

- Designed to eliminate any unnecessary drilling
- Tilt adjustability provides ergonomic comfort and ease of use
- Ability to orient on both sides of Gamber-Johnson docks/cradles
- Multiple mounting hole patterns including VESA 75 mm and AMPs for compatibility to various Gamber-Johnson docks/cradles and forklift mounting solutions
- Limited Lifetime Warranty

NEW



7160-1389

NEW



7160-1486

FIXED SCANNER MOUNT

Item No.	Description	Placement	Weight	Height	Width	Depth
7160-0854	Barcode Scanner/Mobile Computer Mount	1.5" to 2.5" Rectangular Guard Leg Roll Form Brackets Horizontal and Vertical Extensions	3.0 lbs 1.4 kg	7.2" 18.3 cm	5.0" 12.7 cm	6.9" 17.5 cm

Features

- Securely holds most wired or wireless handheld barcode scanners
- Mounts directly to rectangular overhead guard legs that are 1.5" (3.81 cm) to 2.5" (6.35 cm) wide
- Limited Lifetime Warranty



SCANNER REEL MOUNT

Item No.	Description	Placement	Weight	Height	Width	Depth
7300-0302	Retractable Scanner Reel	Attaches to Cable Reel Hanger (7160-1319)	1.0 lbs 0.5 kg	5.1" 13.0 cm	4.5" 11.4 cm	2.5" 6.4 cm

Features

- Capable of holding 1.5 lbs (.6 kg) to 3 lbs (1.4 kg)
- Retracts to 6 feet with a 100,000 cycle rating
- Designed to be compatible with most handheld scanning devices
- Contains an end stop to assist in mitigating damage to devices

NEW



HANDHELD SCANNER INDIVIDUAL BRACKETS

Item No.	Description	Placement	Compatibility	Weight	Height	Width	Depth
7160-1319	Cable Reel Hanger	Attaches to Crossmember of Overhead Guard	Commonly used with 7300-0302 Retractable Scanner Reel	1.0 lbs 0.5 kg	3.5" 8.9 cm	1.4" 3.5 cm	2.0" 5.1 cm
7160-1380	Pistol Grip Scanner Bracket	Attaches to Mount Utilizing AMPs Hole Pattern	Commonly used with Zirkona Mounting Solutions	1.4 lbs 0.6 kg	2.6" 6.6 cm	4.3" 10.8 cm	10.0" 25.4"
7160-1433	Scanner Pocket with AMPs Adapter Bracket	Attaches to Mount Utilizing AMPs Hole Pattern	Commonly used with 7160-1486 Tablet Pivoting AMPs Mount	0.4 lbs 0.2 kg	1.3" 3.4 cm	5.9" 14.9 cm	3.0" 7.6 cm
7160-1485	Zebra FLB3678 Cradle Adapter	Attaches to Mount Utilizing AMPs Hole Pattern	Commonly used with Zirkona Mounting Solutions	2.7 lbs 1.2 kg	3.5" 8.9 cm	4.0" 10.2 cm	8.0" 20.3 cm

Features

- Limited Lifetime Warranty

NEW



7160-1319

NEW



7160-1380

NEW



7160-1433

NEW



7160-1485

PRINTER BRACKETS



7160-0888



7160-0817



7160-1473

Item No.	OEM	Printer Model	Compatibility	Weight	Height	Width	Depth
7160-0785	Datamax O'Neil (Honeywell)	MP Compact 4 Mark II	Attaches to Mount Utilizing VESA 75 mm Hole Pattern	1.0 lbs 0.5 kg	0.5" 1.3 cm	5.0" 12.7 cm	4.0" 10.2 cm
7160-0888	Datamax O'Neil (Honeywell)	RL4	Attaches to Mount Utilizing VESA 75 mm Hole Pattern	3.3 lbs 1.5 kg	9.1" 23.2 cm	7.8" 19.9 cm	4.2" 10.8 cm
7160-0867	Intermec	PB42	Attaches to Mount Utilizing VESA 75 mm Hole Pattern	1.6 lbs 0.7 kg	0.1" 0.3 cm	7.0" 17.8 cm	9.0" 22.7 cm
7160-0817	Zebra	ZQ630 QLN420	Attaches to Mount Utilizing AMPs Hole Pattern	0.5 lbs 0.2 kg	1.0" 2.5 cm	6.0" 15.2 cm	4.0" 10.2 cm
7160-1053	Zebra	ZQ520	Attaches to Mount Utilizing AMPs Hole Pattern	0.5 lbs 0.2 kg	0.8" 2.1 cm	3.2" 8.0 cm	3.7" 9.4 cm
7160-1473	Zebra	ZQ620	Attaches to Mount Utilizing AMPs Hole Pattern	0.3 lbs 0.1 kg	2.1" 5.3 cm	5.0" 12.7 cm	3.7" 9.4 cm

Features

- Adapts to a variety of Gamber-Johnson and Zirkona mounts
- Designed to not impede paper feed, printer ports or power connections
- Limited Lifetime Warranty

SAFETY LIGHT BRACKETS



7160-0610

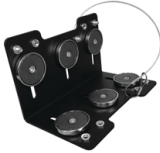

7160-0850

Item No.	OEM	Printer Model	Compatibility	Weight	Height	Width	Depth
7160-0610	Single Light Bracket	Attaches to Crossmember of Overhead Guard	Adapts any Light with Hardware up to 3/8"	3.8 lbs 1.7 kg	5.4" 13.7 cm	2.0" 5.1 cm	3.6" 9.2 cm
7160-0850	Magnetic Redline Light Mount	Attaches to Crossmember of Overhead Guard or Rectangular Guard Leg	Adapts to a Variety of Industry Redline Lights	1.5 lbs 0.7 kg	3.7" 9.4 cm	3.7" 9.4 cm	6.0" 15.2 cm

Features

- Improve workplace safety by mounting a visual indicator to lift vehicles to know when they are approaching
- No need for custom brackets with our mounts that accommodate multiple profiles
- Limited Lifetime Warranty



7160-1342



7160-1588



7170-0774

FAN MOUNTS



Item No.	Description	Placement	Weight	Height	Width	Depth
7160-1342	Fan Adapter Plate	Attaches to Mount Utilizing NEC Hole Pattern	0.3 lbs 0.1 kg	2.8" 7.0 cm	2.8" 7.0 cm	0.6" 1.6 cm
7160-1588	Maradyne 4 Hole Fan Mount	Up to 4" Wide Overhead Crossmember, Rectangular or Roll Form Profile	2.7 lbs 1.2 kg	2.5" 6.4 cm	5.7" 14.4 cm	5.8" 14.7 cm
7170-0774	Fan Mounting Bracket Kit Kit Includes: Fan Adapter Plate (7160-1342) and Zirkona, 4" Diamond Plate with Large Joiner and AMPs Plate (7160-1261)	Up to 4" Wide Overhead Crossmember, Rectangular or Roll Form Profile	3.0 lbs 1.4 kg	2.8" 7.0 cm	5.7" 14.4 cm	5.7" 14.4 cm

Features

- Quick and easy installation with no drilling required for decreased install times
- Rugged lightweight solution to withstand the toughest material handling environments
- Limited Lifetime Warranty

ANTENNA MOUNT



Item No.	Description	Placement	Weight	Height	Width	Depth
7160-1303	Antenna Bracket	Attaches to Vertical or Horizontal Surfaces or Crossmembers	1.9 lbs 0.8 kg	3.5" 8.9 cm	7.2" 18.2 cm	4.0" 10.2 cm

Features

- Two antenna mounting configurations give the flexibility to mount the bracket vertically or horizontally
- Multiple mounting locations and included backplate to adapt to multiple surfaces or profiles
- 7/8" mounting hole to accommodate varying mounting bolt sizes
- Limited Lifetime Warranty

CUP HOLDER MOUNTS

Item No.	Description	Placement	Maximum Payload Capacity	Weight	Height	Width	Depth
7160-1297	Forklift Cup Holder Bracket	Attaches to Mount Utilizing AMPs Hole Pattern	N/A	1.7 lbs 0.8 kg	3.3" 8.5 cm	4.5" 11.4 cm	5.3" 13.3 cm
7170-0720	Forklift Cup Holder Bracket with 4" Diamond Plate and Medium Joiner	Up to 4" Wide Rectangular or Roll Form Profile	Vibration Environment 6 lbs / 1.4 kg Static Environment 33 lbs / 15 kg	3.9 lbs 1.8 kg	4.5" 11.4 cm	3.3" 8.5 cm	10.0" 25.4 cm

Features

- Designed to hold many cup sizes to meet operators needs and can hold up to 6 lbs (2.7 kg)
- Cup holder is made with plastic, and is removable for ease of clean up should there be any spills
- Additional spot to stow away a pen or pencil
- Limited Lifetime Warranty

NEW



7160-1297

NEW



7170-0720

RUGGED CLIPBOARD

Item No.	Description	Placement	Weight	Height	Width	Depth
7160-1526	Rugged Clipboard	Attaches to Mount Utilizing VESA 75mm Hole Pattern	2.4 lbs 1.1 kg	12.3" 31.1 cm	9.0" 22.9 cm	1.3" 3.3 cm

Features

- 14 gauge steel provides a robust surface for writing and daily tasks
- 12.25" (31.11 cm) x 9" (22.86 cm) writing surface to accommodate standard writing tablets, paper size, and notebooks
- Standard clip to secure documents
- Composite writing surface for guaranteed ease of writing even on the thinnest sheets
- VESA 75 mm mounting studs provide an effortless way to adapt to Zirkona mounting solutions
- Limited Lifetime Warranty

NEW



7160-1526

TABLET PROTECTIVE COVERS

Item No.	Description	Placement	Weight	Height	Width	Depth
7160-0949	Universal 8" Tablet Protective Cover	Secured Between Tablet Cradle/Dock and Mount	1.0 lbs 0.4 kg	13.5" 34.3 cm	11.3" 28.6 cm	3.3" 8.3 cm
7160-0950	Universal 10" Tablet Protective Cover	Secured Between Tablet Cradle/Dock and Mount	1.2 lbs 0.5 kg	14.3" 36.2 cm	12.8" 32.4 cm	3.5" 8.9 cm
7160-0975	Dell Tablet Protective Cover	Secured Between Dell Latitude 12 Rugged Tablet Cradle/Dock and Mount	1.2 lbs 0.5 kg	10.0" 25.4 cm	13.5" 35.3 cm	3.5" 8.9 cm
7160-1606	Samsung Tab Active 2 Tablet Protective Cover	Secured Between Samsung Tab Active2 Tablet Cradle/Dock and Mount	0.9 lbs 0.4 kg	7.8" 19.8 cm	13.5" 34.3 cm	2.5" 6.4 cm

Features

- Rolla glass vinyl with cold crack resistants to -20° F (-29° C)
- Materials are water, UV, and dust resistant
- Allows easy screen visibility and full touch screen functionality
- Compatible with Gamber-Johnson keyboard mount (7160-0799)
- Velcro seals around cables and cords
- Limited Lifetime Warranty

NEW



7160-1606



7160-0982

THERMAL PROTECTIVE COVERS

Item No.	Description	Placement	Compatibility	Weight	Height	Width	Depth
7160-0981	8" Thermal Tablet Protective Cover	Secured Between Tablet Cradle/Dock and Mount	Fits Most 8" Tablets with Cradle/Dock	1.0 lbs 0.4 kg	13.5" 34.3 cm	11.3" 28.6 cm	3.3" 8.3 cm
7160-0982	10" Thermal Tablet Protective Cover	Secured Between Tablet Cradle/Dock and Mount	Fits Most 10" Tablets with Cradle/Dock	1.2 lbs 0.5 kg	14.3" 36.2 cm	12.8" 32.4 cm	3.5" 8.9 cm

Features

- Rolla glass vinyl with cold crack resistants to -20° F (-29° C)
- Materials are water, UV, and dust resistant
- Allows easy screen visibility and full touch screen functionality
- Compatible with Gamber-Johnson keyboard mount (7160-0799)
- Activates when temperatures reach below 40° F (4.5° C)
- Provides consistent temperature to maintain tablet functionality
- Velcro seals around cables and cords
- Requires a 12 Volt power source
- Limited Lifetime Warranty

NEW



7160-1607

THERMAL PAD INSERT

Item No.	Description	Placement	Weight	Height	Width	Depth
7160-1607	Thermal Pad Insert	Velcros into 7160-1606 Samsung Tab Active2 Protective Cover	0.4 lbs 0.2 kg	1.0" 2.5 cm	21.0" 53.3 cm	0.9" 2.3 cm

Features

- Easy to remove or insert into 7160-1606 Samsung Tab Active2 Protective Cover
- Activates when temperatures reach below 40° F (4.5° C)
- Provides consistent temperature to maintain tablet functionality
- Requires a 12 Volt power source



17617

NEW

REPLACEMENT SCREENS

Item No.	Description	Placement	Weight	Height	Width	Depth
17617	8" Thermal Cover Replacement Screen	Attaches to Existing Thermal Protective Cover with Velcro	.1 lbs 0.1 kg	7.0" 17.8 cm	10.3" 26.2 cm	0.2" 0.5 cm
17616	10" Thermal Cover Replacement Screen	Attaches to Existing Thermal Protective Cover with Velcro	.2 lbs 0.1 kg	9.0" 22.9 cm	11.8" 30.0 cm	0.2" 0.5 cm
7300-0512-3	Samsung Tab Active 2 Replacement Screen	Attaches to Existing Samsung Tab Active2/ Tab Active3 Protective Cover (7160-1606)	.1 lbs 0.1 kg	6.9" 17.5 cm	13.5" 34.3 cm	0.2" 0.5 cm

Features

- Rolla glass vinyl with cold crack resistants to -20° F (-29° C)
- Allows easy screen visibility and full touch screen functionality
- Materials are water, UV, and dust resistant
- Limited Lifetime Warranty

NEW



7300-0414

SCREEN BLANKING SOLUTIONS

Item No.	Description	Placement	Compatibility	Weight	Height	Width	Depth
7300-0414	Accelerometer with USB Cable	Attaches with USB Plug to any Dock or Device	Requires IPC VuLock™ Software	0.2 lbs 0.1 kg	0.5" 1.3 cm	1.0" 2.5 cm	15.0" 38.1 cm
7300-0434	IPC VuLock™ Software	N/A	Android or Windows (7.0 and 10.0) Compatible	N/A	N/A	N/A	N/A

Features

- Prevent drivers from using their device while in motion
- Specific tamper proof brackets to conceal the accelerometer
- Simple installation
- Limited Lifetime Warranty

SCREEN BLANKING MOUNTS

Item No.	Description	Placement	Compatibility	Weight	Height	Width	Depth
7160-1111	Dell and Panasonic Tamper Proof Bracket with Accelerometer	Attaches Between Dock and Mounting Solution	Specifically Designed for Dell Latitude 12 Rugged Tablet Dock and Panasonic FZ-G1 Dock	1.2 lbs 0.5 kg	7.9" 20.1 cm	5.9" 15.0 cm	0.8" 2.0 cm
7160-1146	Zebra Tamper Proof Bracket with Accelerometer	Attaches Between Dock and Mounting Solution	Specifically Designed for Zebra ET50/51/55/56 Docks	0.9 lbs 0.4 kg	9.8" 24.9 cm	6.2" v15.7 cm	1.6" 4.1 cm

Features

- Prevent drivers from using their device while in motion
- Specific tamper proof brackets to conceal the accelerometer
- Simple installation
- Limited Lifetime Warranty

NEW



7160-1111

NEW



7160-1146

FORKLIFT WIRING KIT

Item No.	Description	Attributes	Weight	Height	Width	Depth
7300-0482	Forklift Wiring Kit	12 Gauge (AWG) Wire 15 Amp Fuse	1.2 lbs 0.5 kg	0.3" 0.8 cm	12" 30.8 cm	0.8" 2.0 cm

Features

- 15 feet of 12 gauge (AWG) wire (red and black) for handling longer wire runs and varied power applications
- In line 15 amp fuse protects your device from over voltage
- Quick connects for attaching 12 gauge wire to 18 gauge power supply wires
- (10) 12-inch zip ties for ease of installation
- For non material handling applications, a 12 gauge wire at 15ft long can handle a 30 amp fuse
- Limited Lifetime Warranty

NEW



7300-0482

LINDY USB PORT BLOCKER

Item No.	Description	Includes
7300-0107	LINDY USB Port Blocker with Key	Pack of 4 Blocks and 1 Key
7300-0108	LINDY USB Port Blockers	Pack of 10 Blockers Requires Key

Features

- Physically blocks USB ports from connecting USB flash drives and other mass storage devices
- Quick and easy to use
- Limited Lifetime Warranty



7300-0107



7300-0108

NEW



7160-1333

POWER SUPPLY MOUNT

Item No.	Description	Attributes	Weight	Height	Width	Depth
7160-1333	Power Supply Clamp	Attaches to Overhead Guard or Guard Leg	1.7 lbs 0.8 kg	0.5" 1.3 cm	2.5" 6.4 cm	5.8" 14.6 cm

Features

- No drilling required with when mounting so no damage to the surface during installation
- Keeps power supply block secured and easily accessible for serviceability
- Mountable on surfaces up to 4" (10.16 cm) wide
- Limited Lifetime Warranty

ISOLATED POWER SUPPLIES

NEW

NEW

NEW

NEW

NEW

NEW

NEW

NEW

Item No.	OEM	Device Model	Input Voltage Range	Weight	Height	Width	Depth
7300-0470	Dell	Latitude 12 Rugged Tablet	12-32VDC	1.6 lbs 0.5 kg	1.2" 2.9 cm	9.3" 23.6 cm	3.0" 7.6 cm
7300-0429	Dell	Latitude 12 Rugged Tablet	20-60VDC	1.6 lbs 0.5 kg	1.2" 2.9 cm	9.3" 23.6 cm	3.0" 7.6 cm
7300-0430	Dell	Latitude 12 Rugged Tablet	72-110VDC	1.6 lbs 0.5 kg	1.2" 2.9 cm	9.3" 23.6 cm	3.0" 7.6 cm
7300-0431	DT Research	DT313	12-32VDC	1.6 lbs 0.5 kg	1.2" 2.9 cm	9.3" 23.6 cm	3.0" 7.6 cm
7300-0432	DT Research	DT313	20-60VDC	1.6 lbs 0.5 kg	1.2" 2.9 cm	9.3" 23.6 cm	3.0" 7.6 cm
7300-0433	DT Research	DT313	72-110VDC	1.6 lbs 0.5 kg	1.2" 2.9 cm	9.3" 23.6 cm	3.0" 7.6 cm
7300-0413	Getac	A140 F110 K120 T800	12-32VDC	1.6 lbs 0.5 kg	1.2" 2.9 cm	9.3" 23.6 cm	3.0" 7.6 cm
7300-0412	Getac	A140 F110 K120 T800	20-60VDC	1.6 lbs 0.5 kg	1.2" 2.9 cm	9.3" 23.6 cm	3.0" 7.6 cm
7300-0466	Getac	ZX70	12-32VDC	1.0 lbs 0.5 kg	1.2" 3.0 cm	5.2" 13.1 cm	2.5" 6.4 cm
7300-0467	Getac	ZX70	20-60VDC	1.0 lbs 0.5 kg	1.2" 3.0 cm	5.2" 13.1 cm	2.5" 6.4 cm
7300-0418	Getac	ZX70	72-110VDC	1.0 lbs 0.5 kg	1.2" 3.0 cm	5.2" 13.1 cm	2.5" 6.4 cm
7300-00407	HP	Visit LIND Electronics Website for Entire Listing	20-60VDC	2.2 lbs 1.0 kg	1.2" 2.9 cm	9.3" 23.6 cm	3.0" 7.6 cm
7300-0464	Panasonic	Toughbook A2 Toughpad FZ-G1 Toughpad FZ-M1/B2 Toughbook N1 Toughpad FZ-X1-E1	12-32VDC	1.6 lbs 0.5 kg	1.2" 2.9 cm	9.3" 23.6 cm	3.0" 7.6 cm
7300-0465	Panasonic	Toughbook A2 Toughpad FZ-G1 Toughpad FZ-M1/B2 Toughbook N1 Toughpad FZ-X1-E1	20-60VDC	1.6 lbs 0.5 kg	1.2" 2.9 cm	9.3" 23.6 cm	3.0" 7.6 cm

Features

- Continuous stable power output specifically made to adapt to material handling vehicles
- Output short circuit and overcurrent protection
- Internal over temperature protection
- Sealed and potted in aluminum extrusions to withstand the harshest operating environments
- Contact LIND Power Supplies for warranty details

ISOLATED POWER SUPPLIES CON'T

Item No.	OEM	Device Model	Input Voltage Range	Weight	Height	Width	Depth
7300-0417	Panasonic	Toughbook A2 Toughpad FZ-G1 Toughpad FZ-M1/B2 Toughbook N1 Toughpad FZ-X1-E1	72-110VDC	1.6 lbs 0.5 kg	1.2" 2.9 cm	9.3" 23.6 cm	3.0" 7.6 cm
7300-0455	Panasonic	Toughbook L1	12-32VDC	1.4 lbs 0.6 kg	1.2" 2.9 cm	6.0" 15.2 cm	3.0" 7.6 cm
7300-0456	Panasonic	Toughbook L1	20-60VDC	1.4 lbs 0.6 kg	1.2" 2.9 cm	6.0" 15.2 cm	3.0" 7.6 cm
7400-0015	Panasonic	Toughbook L1	72-110VDC	1.4 lbs 0.6 kg	1.2" 2.9 cm	6.0" 15.2 cm	3.0" 7.6 cm
7300-0473	Samsung	Tab Active 2 Tab Active Pro	20-60VDC	1.6 lbs 0.5 kg	1.2" 2.9 cm	9.3" 23.6 cm	3.0" 7.6 cm
7300-0466	Zebra	ET50/51 ET55/56 TC8000 with Zebra I/O Hub TC8300 with Zebra I/O Hub	12-32VDC	1.0 lbs 0.5 kg	1.2" 3.0 cm	5.2" 13.1 cm	2.5" 6.4 cm
7300-0467	Zebra	ET50/51 ET55/56 TC8000 with Zebra I/O Hub TC8300 with Zebra I/O Hub	20-60VDC	1.0 lbs 0.5 kg	1.2" 3.0 cm	5.2" 13.1 cm	2.5" 6.4 cm
7300-0418	Zebra	ET50/51 ET55/56 TC8000 with Zebra I/O Hub TC8300 with Zebra I/O Hub	72-110VDC	1.0 lbs 0.5 kg	1.2" 3.0 cm	5.2" 13.1 cm	2.5" 6.4 cm
7300-0457	Zebra	L10	12-32VDC	1.6 lbs 0.5 kg	1.2" 2.9 cm	9.3" 23.6 cm	3.0" 7.6 cm
7300-0458	Zebra	L10	20-60VDC	1.6 lbs 0.5 kg	1.2" 2.9 cm	9.3" 23.6 cm	3.0" 7.6 cm
7300-0346	Zebra	L10	72-110VDC	1.6 lbs 0.5 kg	1.2" 2.9 cm	9.3" 23.6 cm	3.0" 7.6 cm
7300-0455	Zebra	TC8000 TC8300 (Powered Cradles Only)	12-32VDC	1.4 lbs 0.6 kg	1.2" 2.9 cm	6.0" 15.2 cm	3.0" 7.6 cm
7300-0456	Zebra	TC8000 TC8300 (Powered Cradles Only)	20-60VDC	1.4 lbs 0.6 kg	1.2" 2.9 cm	6.0" 15.2 cm	3.0" 7.6 cm
7300-0483	Zebra	TC8000 TC8300 (Powered Cradles Only)	72-110VDC	1.4 lbs 0.6 kg	1.2" 2.9 cm	6.0" 15.2 cm	3.0" 7.6 cm

NEW
NEW
NEW
NEW

NEW
NEW
NEW
NEW
NEW
NEW

Features

- Continuous stable power output specifically made to adapt to material handling vehicles
- Output short circuit and overcurrent protection
- Internal over temperature protection
- Sealed and potted in aluminum extrusions to withstand the harshest operating environments
- Contact LIND Power Supplies for warranty details

NEW



UNIVERSAL ISOLATED POWER SUPPLIES

Item No.	Compatibility	Input Voltage Range	Weight	Height	Width	Depth
7300-0452	Universal	12-32VDC	1.4 lbs 0.6 kg	1.2" 2.9 cm	6.0" 15.2 cm	3.0" 7.6 cm
7300-0453	Universal	20-60VDC	1.4 lbs 0.6 kg	1.2" 2.9 cm	6.0" 15.2 cm	3.0" 7.6 cm
7300-0454	Universal	72-110VDC	1.4 lbs 0.6 kg	1.2" 2.9 cm	6.0" 15.2 cm	3.0" 7.6 cm

Features

- Protect and power your consumer grade devices with 5 VDC maximum output
- Supports up to two USB compatible devices with 4 AMPS of maximum output
- Sealed and potted in aluminum extrusions to withstand the harshest operating environments
- Continuous stable power output specifically made to adapt to Material Handling vehicles
- Contact LIND Power Supplies for warranty details



NON-ISOLATED POWER SUPPLIES FOR PROTECTIVE THERMAL COVERS

Item No.	Compatibility	Output	Input Voltage Range	Weight	Height	Width	Depth
7300-0449	8" Thermal Tablet Protective Cover (7160-0981) 10" Thermal Tablet Protective Cover (7160-0982) Samsung Tab Active 2 Thermal Tablet Protective Cover (TBD) Datamax O'Neil (Honeywell) MP Compact 4 Mark II Thermal Protective Cover Kit (7170-0605)	Voltage - 12VDC Current - 10 Amps	24VDC	0.6 lbs 0.3 kg	2.9" 7.4 cm	2.9" 7.4 cm	1.3" 3.3 cm
7300-0450	8" Thermal Tablet Protective Cover (7160-0981) 10" Thermal Tablet Protective Cover (7160-0982) Samsung Tab Active 2 Thermal Tablet Protective Cover (TBD) Datamax O'Neil (Honeywell) MP Compact 4 Mark II Thermal Protective Cover Kit (7170-0605)	Voltage - 12VDC Current - 10 Amps	36/48VDC	0.6 lbs 0.3 kg	2.9" 7.4 cm	2.9" 7.4 cm	1.3" 3.3 cm

Features

- Sealed and potted in aluminum shell to withstand the harshest operating environments
- Non-Isolated, constant voltage design
- IP67 waterproof rating
- 1 Year Limited Warranty



POINT-OF-SALE & OFFICE SOLUTIONS

Our point-of-sale and office solution options range from fixed to mobile and are perfectly suited to fit a variety configurations and needs. Mobile options improve the customer experience, while fixed mounts create the ideal working environment that is safe, secure, and reliable.



NEW



PAYMENT STAND FOR IPAD MINI (W/SWIVEL)

Item No.	Description	Weight	Height	Width	Depth
7160-1401-02	Payment Stand for iPad Mini (w/Swivel)	9.68 lbs 4.39 kg	8" 20.32 cm	7.38" 18.75 cm	1" 2.54 cm

Features

- Swivels 180° for added usability
- Designed with a 45° angle for usability
- Textured black powder coat to keep a clean, smudge-free look
- Designed featuring a 1.25" (3.18 cm) open hole for easy cable management
- Compatible with iPad Mini Series 1-4
- Can be secured mount on a counter top with 1/4-20 screws
- Tamper resistant assembly
- Hardware kit included for installer convenience
- Limited Lifetime Warranty

NEW



PAYMENT STAND FOR IPAD MINI (NO SWIVEL)

Item No.	Description	Weight	Height	Width	Depth
7160-1401-01	Payment Stand for iPad Mini (No Swivel)	9.68 lbs 4.39 kg	8" 20.32 cm	7.38" 18.75 cm	1" 2.54 cm

Features

- Designed with a 45° angle for usability
- Textured black powder coat to keep a clean, smudge-free look
- Designed featuring a 1.25" (3.18 cm) open hole for easy cable management
- Compatible with iPad Mini Series 1-4
- Can be secured mount on a counter top with 1/4-20 screws
- Tamper resistant assembly
- Hardware kit included for installer convenience
- Limited Lifetime Warranty

NEW



PAYMENT STAND FOR IPAD 10.2 (NO SWIVEL)

Item No.	Description	Weight	Height	Width	Depth
7160-1583-01	Payment Stand for iPad 10.2 (No Swivel)	6.3 lbs 2.86 kg	10.5" 26.67 cm	13.2" 33.53 cm	7.3" 18.54 cm

Features

- Designed with a 45° angle for usability
- Textured black powder coat to keep a clean, smudge-free look
- Contains a 1.25" (3.18 cm) open hole for cable management
- Compatible with iPad 10.2
- Can be secured mount on a counter top with 1/4-20 screws or adhesive
- Hardware kit included for easy assembly
- Pair with other accessories such as cash drawers and barcode scanners
- Limited Lifetime Warranty

NEW



PAYMENT STAND FOR IPAD 10.2 (W/SWIVEL)

Item No.	Description	Weight	Height	Width	Depth
7160-1583-02	Payment Stand for iPad 10.2 (w/Swivel)	11 lbs 4.99 kg	10.5" 26.67 cm	13.2" 33.53 cm	7.3" 18.54 cm

Features

- Swivels 180 Degrees for added usability
- Designed with a 45° angle for usability
- Textured black powder coat to keep a clean, smudge-free look
- Contains a 1.25" (3.18 cm) open hole for cable management
- Compatible with iPad 10.2
- Can be secured mount on a counter top with 1/4-20 screws or adhesive
- Hardware kit included for easy assembly
- Pair with other accessories such as cash drawers and barcode scanners
- Limited Lifetime Warranty

STAND FOR IPAD 10.2 (NO SWIVEL)

Item No.	Description	Weight	Height	Width	Depth
7160-1581-01	Stand for iPad 10.2 (No Swivel)	6.3 lbs 2.86 kg	10.5" 26.67 cm	13.2" 33.53 cm	7.3" 18.54 cm
Features <ul style="list-style-type: none"> - Designed with a 45 degree angle for usability - Textured black powder coat to keep a clean, smudge-free look - Contains a 1.25" (3.18 cm) open hole for cable management - Compatible with iPad 10.2 - Can be secured mount on a counter top with 1/4-20 screws or adhesive - Hardware kit included for easy assembly - Pair with other accessories such as cash drawers and barcode scanners - Limited Lifetime Warranty 					

NEW



STAND FOR IPAD 10.2 (W/SWIVEL)

Item No.	Description	Weight	Height	Width	Depth
7160-1581-02	Stand for iPad 10.2 (w/Swivel)	11 lbs 4.99 kg	10.5" 26.67 cm	13.2" 33.53 cm	7.3" 18.54 cm
Features <ul style="list-style-type: none"> - Swivels 180° for added usability - Designed with a 45° angle for usability - Textured black powder coat to keep a clean, smudge-free look - Contains a 1.25" (3.18 cm) open hole for cable management - Compatible with iPad 10.2 - Can be secured mount on a counter top with 1/4-20 screws or adhesive - Hardware kit included for easy assembly - Pair with other accessories such as cash drawers and barcode scanners - Limited Lifetime Warranty 					

NEW



EQUINOX LUXE™ 8500i LOW SWIVEL STAND

Item No.	Description	Weight	Height	Width
7160-1310	Equinox LUXE 8500i Low Swivel Stand	1.60 lbs 0.73 kg	1.31" 3.33 cm	7.81" 19.84 cm
Features <ul style="list-style-type: none"> - Swivels 120° for added usability - Cable strain relief to reduce other cable interference and keep point-of-sale area clean and organized - Designed featuring an open hole base for easy cable management - Can be mounted to a surface up to 1" (2.54 cm) thick. For thicker surfaces, longer 1/4-20 flat head screws are required. - Black powder coat finish for maximum corrosion resistance and long term durability - Hardware kit included for installer convenience - PCI Compliant - Limited Lifetime Warranty 				

NEW



EQUINOX LUXE™ 8500i SHORT CLEVIS STAND

Item No.	Description	Weight	Height	Width
7160-1311	Equinox LUXE 8500i Short Clevis Stand	1.75 lbs 0.79 kg	1.31" 3.33 cm	5.31" 13.49 cm
Features <ul style="list-style-type: none"> - Swivels 120° for added usability - Cable strain relief to reduce other cable interference and keep point-of-sale area clean and organized - Designed featuring an open hole base for easy cable management - Can be mounted to a surface up to 1" (2.54 cm) thick. For thicker surfaces, longer 1/4-20 flat head screws are required. - Black powder coat finish for maximum corrosion resistance and long term durability - Hardware kit included for installer convenience - PCI Compliant - Limited Lifetime Warranty 				

NEW



HEIGHT ADJUSTABLE DESKTOP MOUNT



Item No.	Description	Weight	Height	Width	Depth
7170-0587	Desktop Mount Kit without Cradle Kit Includes: Decorative Base (17238), Threaded Adapter (14145), Height-Adjustable Pole (7110-1230), Large Joiner (7110-1236) and VESA 75 mm Device Plate (14139)	1.6 lbs 0.73 kg	15.5" - 19" 39.4 cm - 48.3 cm	4" 10.16 cm	4" 10.16 cm

Features

- Permanent workstation mounting solution with decorative base
- Articulated joiner with tension handle to position display for the proper viewing angle
- Tension handle locks pedestal at the desired height
- Base is 4" (10.6 cm) W x 0.75" (1.9 cm) H
- Adjustable pole is 9.25" (23.5cm) H and has the ability to span 9.25" - 15.75" (23.5 cm - 40.0 cm)
- Anodized aluminum with black finish
- VESA 75 mm mounting adapter, fits most displays
- Assembly required
- Recommend use of Loctite® 9460, 9461, or 9466 on all M20 size threads (Loctite not included)
- 1 Year Limited Warranty

HEIGHT ADJUSTABLE SUCTION CUP DESKTOP MOUNT



Item No.	Kit Description	Weight	Height	Width	Depth
7170-0588	Desktop Mount Kit without Cradle Kit Includes: Suction Cup (7110-1232), Threaded Adapter (14145), Height-Adjustable Pole (7110-1230), Small Joiner (7110-1234), and VESA 75 mm Device Plate (14139)	2.15 lbs 0.98 kg	13.25" - 19.75" 33.7 cm - 50.2 cm	4.5" 11.4 cm	4.5" 11.4 cm

Features

- A great temporary workstation mounting solution for a display or tablet
- Suction cup takes only seconds to install or re-position
- Articulated joiner with tension handle to position display for the proper viewing angle
- Tension handle locks pedestal at the desired height
- Adjustable pole is 9.25" (23.5cm) H and has the ability to span 9.25" - 15.75" (23.5 cm - 40.0 cm)
- Anodized aluminum with black finish
- VESA 75 mm mounting adapter, fits most displays
- Assembly required
- Recommend use of Loctite® 9460, 9461, or 9466 on all M20 size threads (Loctite not included)
- 1 Year Limited Warranty

HEIGHT ADJUSTABLE EXTENDING DESKTOP MOUNT



Item No.	Kit Description	Weight	Height	Width	Depth
7170-0590	Desktop Mount Kit without Cradle Kit Includes: Robust Base (7110-1316), Dual Articulating Arm (7110-1246), 2-Down Medium Joiner (7110-1259) and VESA 75/100 mm Device Plate (14140)	5.35 lbs 2.4 kg	16" - 24" 40.6 cm - 61 cm	10" - 16.5" 25.4 cm - 41.9 cm	4" 10.2 cm

Features

- Add flexibility to your desktop or workstation without a large footprint
- Dual pivoting arms help adjust your device to the right height and reach to each user
- Designed for single monitor or docking station use
- Base is 4" (10.6 cm) W x 0.75" (1.9 cm) H
- Articulating arm is 16" (40.6cm) H and has the ability to span 16" - 24" (40.6 cm - 61.0 cm) from main pedestal
- Tension handles lock pedestal height and articulated arms in place
- Articulated joiner with tension handle - position display for the proper viewing angle
- Anodized aluminum and steel with black powder coat finish
- Assembly required
- VESA 75/100mm adapter plate (14140)
- Recommend use of Loctite® 9460, 9461, or 9466 on all M20 size threads (Loctite not included)
- 1 Year Limited Warranty

TILT AND SWIVEL DESKTOP MOUNT

Item No.	Description	Weight	Height	Width	Depth
7170-0586	Low Tilt/Swivel Desktop Mount Kit Includes: Low Tilt Base (DS-56) and Low Clevis (7160-0775)	4.0 lbs 1.8 kg	2.8" 7.0 cm	7.5" 19.1 cm	6.0" 15.2 cm
7170-0585	Tall Tilt/Swivel Desktop Mount Kit Includes: Tall Base (DS-56) and Tall Clevis (7160-0776)	5.0 lbs 2.3 kg	5.9" 14.9 cm	7.5" 19.1 cm	6.0" 15.2 cm

Features

- Ideal "close-to-surface" mounting solution with viewing-angle adjustment
- Easy installation with heavy-duty mounting base
- Can be mounted on a horizontal or vertical surface
- 360° rotation
- Adjustable tilt with tension handle (45° forward tilt)
- Steel with black powder coat finish for maximum corrosion resistance
- VESA 75 mm Gamber-Johnson 2x4, NEC, and AMPS mounting patterns
- Assembly required
- Limited Lifetime Warranty



7170-0586



7170-0585

TabCruzer® MINI SHORT DESKTOP MOUNT KIT



Item No.	Description	Weight	Height	Width	Depth
7170-0604	Desktop Mount Kit Kit Includes: TabCruzer Mini (7160-0774) and Zirkona Short Desktop Mount (7110-1240)	1.7 lbs 0.8 kg	5.75" 14.61 cm	9.6" - 12.1" 24.4 cm - 30.7 cm	8.4" 21.3 cm

Features

- TabCruzer Mini - Universal Tablet Cradle is designed to hold a variety of consumer tablet computers
- Adjusts to tablet widths from 6.9" to 11.2" (17.5 - 28.4 cm)
- Adjusts to tablet depths from 4.3" to 8.2" (10.9 - 20.8 cm)
- Adjusts to tablet thickness from 0.2" to 0.7" (0.5 - 1.8 cm)
- Side clips are easily adjusted to the proper tablet height and work with most tablets
- Reversible front and back supports adjust to accommodate varying depths of computers
- 90° wing turn closure latch with built-in key lock
- Limited Lifetime Warranty
- Zirkona Short Desktop Mount is a simple universal mounting solution for small tablets and handhelds
- Stands 3.5" high with round mounting base and VESA 75 mm mounting plate
- Articulated joiner with tension handle - position display for the proper viewing angle
- Anodized aluminum with black finish
- Dimensions: 3.5" (8.9 cm) H x 3.75" (9.5 cm) W x 3.75" (9.5 cm) D
- Weight: .90 lbs (0.41 kg)
- VESA 75 mm mounting adapter, fits most displays
- Recommend use of Loctite® 9460, 9461, or 9466 on all M20 size threads (Loctite not included)
- 1 Year Limited Warranty



SHORT MEDIUM JOINER WITH VESA 75 MM MOUNTING PLATE



Item No.	Description	Weight	Height	Width	Depth
7110-1240	A Simple Universal Mounting Solution for Small Tablets and Handhelds	0.6 lbs 0.3 kg	3.5" 8.9 cm	3.8" 9.5 cm	3.8" 9.5 cm

Features

- Round mounting base with VESA 75 mm mounting plate
- Articulating joiner with tension handle to position display for the proper viewing angle
- Anodized aluminum with black finish
- VESA 75 mm mounting adapter fits most displays
- 1 Year Product Warranty



TabCruzer® MINI DESKTOP MOUNT KIT



Item No.	Description	Weight	Height	Width	Depth
7170-0589	Universal Small Tablet Desktop Mount Kit Kit Includes: TabCruzer Mini (7160-0774) and Display Base (16434)	2.2 lbs 1.0 kg	13.0" to 17.0" 33.0 cm to 43.2 cm	9.0" 22.9 cm	6.3" 15.9 cm

Features

- TabCruzer Mini Universal Tablet Cradle is designed to hold consumer tablet computers:
- Adjusts to tablet widths from 6.9" to 11.2" (17.5 - 28.4 cm)
- Adjusts to tablet depths from 4.3" to 8.2" (10.9 - 20.8 cm)
- Adjusts to tablet thickness from 0.2" to 0.7" (0.5 - 1.8 cm)
- Side clips are easily adjusted to the proper tablet height and work with most tablets
- Reversible front and back supports adjust to accommodate varying depths of computers
- 90° wing turn closure latch with built-in key lock
- Movable mount
- Assembly required
- Limited Lifetime Warranty

TabCruzer® MINI HEIGHT ADJUSTABLE DESKTOP KIT



Item No.	Description	Weight	Height	Width	Depth
7170-0602	Desktop Mount Kit Kit Includes: TabCruzer Mini (7160-0774) and Zirkona Height-Adjustable Mount (7170-0587)	3.3 lbs 1.5 kg	21.25" 14.61 cm	9.6" - 12.1" 24.4 cm - 30.7 cm	8.4" 21.3 cm

Features

- TabCruzer Mini Universal Tablet Cradle is designed to hold consumer tablet computers:
- Adjusts to tablet widths from 6.9" to 11.2" (17.5 - 28.4 cm)
- Adjusts to tablet depths from 4.3" to 8.2" (10.9 - 20.8 cm)
- Adjusts to tablet thickness from 0.2" to 0.7" (0.5 - 1.8 cm)
- Side clips are easily adjusted to the proper tablet height and work with most tablets
- Reversible front and back supports adjust to accommodate varying depths of computers
- 90° wing turn closure latch with built-in key lock
- Limited Lifetime Warranty
- Zirkona Height-Adjustable Mount allows users to adjust their device to their desired viewing position
- Base is 4" (10.6 cm) W x 0.75" (1.9 cm) H
- Adjustable pole is 9.25" (23.5cm) H and has the ability to span 9.25" - 15.75" (23.5 cm - 40.0 cm)
- Tension handle locks pedestal at the proper height
- Articulated joiner with tension handle - position display for the proper viewing angle
- Anodized aluminum with black finish
- Dimensions: 12.5" - 19.0" (31.8 cm - 48.3 cm) H x 4.0" (10.2 cm) W x 4.0" (10.2 cm) D
- Weight: 1.60 lbs. (0.7 kg)
- VESA 75 mm mounting adapter, fits most displays
- Recommend use of Loctite® 9460, 9461, or 9466 on all M20 size threads (Loctite not included)
- 1 Year Limited Warranty

SECURE TABLET KIOSK FOR IPAD 10.2

NEW



Item No.	Description	Weight	Height	Width	Depth
7160-1617	Secure Tablet Kiosk for iPad 10.2	15.8 lbs 7.17 kg	7 in 17.78 cm	15 in 38.1 cm	11 in 27.94 cm

Features

- A locking tablet or iPad kiosk to mount on a wall or surface
- Easy-open access with secure key lock and padlock bar (padlock not included) for additional security
- Easily cleaned and disinfected
- Ample room inside for cables and peripherals
- Kiosk positions the tablet on a 30° angle that creates the perfect viewing angle on both surface and wall mount kiosk installations, creating easily accessible secure tablet experiences in retail, healthcare, hospitality, tourism and many other industries
- Mount over electric wall plate for easy power routing
- Side panels for future expansion options including adding payment devices
- Limited Lifetime Warranty

HEAVY DUTY EXTENDING WALL MOUNTS

Item No.	Description	Weight	Height	Width	Depth
7170-0583-00	Heavy Duty Wall Mount with Standard Clevis Kit Includes: Dual Articulating Arm with Standard Clevis (7160-0976) and Wall Bracket (7160-0863)	1.1 lbs 0.5 kg	4.75" 12.4 cm	1.9" 4.7 cm	7.5" 19.1 cm
7170-0583-01	Heavy Duty Wall Mount with Low Clevis Kit Includes: Dual Articulating Arm with Low Clevis (7160-0977) and Wall Bracket (7160-0863)	5.8 lbs 2.6 kg	10.4" 26.3 cm	7.2" 18.3 cm	16.5" 41.9 cm

Features

- Wall mount solution for a large display, tablet, or laptop
- 3" W x 6" H (7.6 cm x 15.3 cm) wall bracket with 3.25" (8.3 cm) mounting platform
- Dual articulating arm extends 15" (38.1 cm) for pivot to vertical mounting plate and arm rotates 360°
- Articulating arm folds to bring the device closer to the wall
- Adjustable tilt with tension handle, 90° forward, 26° backward, tilt mechanism rotates 360°
- Assembly required
- VESA 75 mm, Gamber-Johnson 2x4, NEC, and AMPS mounting pattern to fit most displays
- Limited Lifetime Warranty



7170-0583-01

HEAVY DUTY ROTATING WALL MOUNT KIT

Item No.	Description	Weight	Height	Width	Depth
7170-0598	Heavy-Duty Rotating Wall Mount Kit Includes: Single Articulating Arm (7160-0497) and Wall Bracket (7160-0863)	5.7 lbs 2.6 kg	7.6" 19.4 cm	7.2" 19.3 cm	9.0" 22.9 cm

Features

- Wall mount solution for a large display, tablet, or laptop
- 3" W x 6" H (7.6 cm x 15.3 cm) wall bracket with 3.25" (8.3 cm) mounting platform
- Dual articulating arm extends 15" (38.1 cm) for pivot to vertical mounting plate and arm rotates 360°
- Articulating arm folds to bring the device closer to the wall
- Adjustable tilt with tension handle, 90° forward, 26° backward, tilt mechanism rotates 360°
- Assembly required
- VESA 75 mm, Gamber-Johnson 2x4, NEC, and AMPS mounting pattern to fit most displays
- Limited Lifetime Warranty



ZIRKONA LIGHT DUTY ROTATING WALL MOUNT



Item No.	Description	Weight	Height	Width	Depth
7170-0595	Light Duty Rotating Wall Mount Kit Includes: Zirkona Small Joiner (7110-1234), Wall Mount with Swing Arm (7110-1227), VESA 75 mm Adapter Plate (14139)	1.1 lbs 0.5 kg	4.8" 12.1 cm	1.9" 4.7 cm	7.5" 19.1 cm

Features

- Wall mount solution for a small display, tablet, or handheld device
- 4.25" x 1.87" (12.1 cm x 4.7 cm) mounting plate with 1.4" x 3.7" (3.5 cm x 9.5 cm) hole pattern
- 3" (7.6 cm) arm rotates 180° and can be raised or lowered 1.5" (3.8 cm), tension handle locks the arm in place
- Tension handle allows you to position the display at the proper angle and keep it in place
- Made of rugged black anodized aluminum
- Add a 50 mm, 100 mm, or 150 mm extension to increase the range of operation
- Assembly required
- VESA 75 mm mounting adapter fits most displays
- See individual product for warranty details





TabCruzer® MINI ROTATING WALL MOUNT KIT



Item No.	Kit Description	Weight	Height	Width	Depth
7170-0603	Universal Cradle Rotating Wall Mount Kit Includes: Pole Clamp (7160-0440), Zirkona Medium Joiner (7110-1235), Threaded Adapter (14145), 100 mm Extension (14142), VESA 75 mm Adapter Plate (14139)	1.2 lbs 0.5 kg	7.0" 17.8 cm	3.75" 9.5 cm	6.0" 15.2 cm

TabCruzer Mini Features

- TabCruzer Mini - Universal Tablet Cradle is designed to hold consumer tablet computers:
- Adjusts to tablet widths from 6.9" to 11.2" (17.5 - 28.4 cm)
- Adjusts to tablet depths from 4.3" to 8.2" (10.9 - 20.8 cm)
- Adjusts to tablet thickness from 0.2" to 0.7" (0.5 - 1.8 cm)
- Side clips are easily adjusted to the proper tablet height and work with most tablets
- Reversible front and back supports adjust to accommodate varying depths of computers
- 90° wing turn closure latch with built-in key lock
- Limited Lifetime Warranty

Kit features

- Wall mount solution for a small display, tablet, or handheld device
- 4.25" x 1.87" (12.1 cm x 4.7 cm) mounting plate with 1.4" x 3.7" (3.5 cm x 9.5 cm) hole pattern
- 3" (7.6 cm) arm rotates 180° and can be raised or lowered 1.5" (3.8 cm), tension handle locks the arm in place
- Tension handle allows you to position the display at the proper angle then tighten handle to keep it in place
- See individual product for warranty details



ZIRKONA TALL STATIONARY WALL MOUNT



Item No.	Description	Weight	Height	Width	Depth
7170-0596	Tall Stationary Wall Mount Kit Includes: Wall/ceiling Mounting Bracket (17245), Threaded Adapter (14145), 100 mm Extension Tube (14142), Zirkona Small Joiner (7110-1234), VESA 75 mm adapter plate (14139)	1.3 lbs 0.6 kg	10.0" 25.4 cm	3.8" 9.5 cm	4.1" 10.5 cm

Features

- Easy to install by mounting to a wall or other solid surface
- 3.3" x 1.7" x 2.9" (8.3 cm x 4.3 cm x 7.3 cm) steel mounting bracket
- 100 mm extension used to increase the range of operation - more can be used if necessary
- Tension handle allows you to position the display at the proper angle then tighten handle to keep it in place
- Black anodized aluminum and powder coat finish
- Assembly required
- VESA 75 mm mounting adapter fits most displays
- See individual product for warranty details



ZIRKONA HEIGHT ADJUSTABLE EXTENDING WALL MOUNT



Item No.	Description	Weight	Height	Width	Depth
7170-0597	Height Adjustable Extending Wall Mount Kit Includes: Wall Mount (17246), Dual Articulating Arms with Adjustable Height and Zirkona Medium Joiner (14141), VESA 75/100 mm Adapter Plate (14140)	6.6 lbs 3.0 kg	16.0" to 24.0" 40.6 cm to 61.0 cm	10.0" to 16.5" 25.4 cm to 41.9 cm	4.0" 10.2 cm

Features

- Wall mount solution for a large display or tablet
- 4" x 5" (10.2 cm x 12.7 cm) steel base with 3" x 4" (7.6 cm x 10.2 cm) mounting hole pattern
- Articulated joiner with tension handle allows you to position the display at the proper angle and keep it in place
- Anodized aluminum and steel black finish
- Assembly required
- VESA 75/100 mm mounting adapter fits most displays
- See individual product for warranty details



ZIRKONA QUICK RELEASE WALL MOUNT



Item No.	Description	Weight	Height	Width	Depth
7170-0592	Mount Easily Attaches to any Flat Surface and Allows you to Quickly Remove or Attach Your Display from the Wall Mount	0.9 lbs 0.4 kg	4.5" 11.4 cm	5.5" 14.0 cm	1.1" 2.8 cm

Features

- Easy installation - one half attaches to the surface and the other half attaches to the device
- 2.5" (6.4 cm) diameter base with NEC and AMPS mounting hole pattern
- Adjustable tension lever that can attach or release in seconds
- Surface distance to VESA mounting adapter is approximately 2" (5.1 cm)
- Anodized aluminum with black finish
- Assembly required
- VESA 75 mm mounting adapter plate attaches to most devices
- Limited Lifetime Warranty



FULL LINE
PRODUCT
CATALOG
VOLUME 22

RUGGED. RELIABLE. RESPONSIVE.