



Retail lamp program 2014/2015

Light is OSRAM



OSRAM GmbH

Head Office

Marcel-Breuer-Strasse 6

80807 Munich

Germany

Phone +49 (0)89-6213-0

Fax +49 (0)89-6213-20 20

www.osram.com

Retail lamp program
2014/2015



Contents

Quality and innovation	04	LED lamps	24
Market and trends	06	LIGHTIFY™	30
Implementation of EU standards	08	LED lamps in classic shapes	32
Phase-out and alternatives	10	LED spotlights and reflectors	38
Sustainability	12	LED SubstiTUBE® Value	44
Product range and segmentation	14	LED special lamps	45
Consumer guide	15		
Packaging	16	Halogen lamps	50
polePOSITION® Advanced Shop System	18	Halogen lamps in classic shapes with screw bases	54
Secondary placements	20	Halogen high voltage pin or plug base lamps	62
New media	22	Halogen low voltage pin or plug base lamps	71
		Compact fluorescent lamps	82
		Classic bulb shaped compact fluorescent lamps	86
		Spiral and ring shaped compact fluorescent lamps	92
		Compact fluorescent lamps with stick shape	99
		Intelligent compact fluorescent lamps	103
		Compact fluorescent lamps with plug base	106
		Fluorescent lamps	114
		Fluorescent lamps T8	118
		Fluorescent lamps T5	121
		Fluorescent lamps with special shapes	126
		Fluorescent lamps for special applications	129
		Starters	131
		Incandescent lamps and special lamps	132
		Spot lamps	134
		Decorative incandescent lamps	136
		Special incandescent lamps	138
		Lamps with ultraviolet and infrared radiation	142
		Vehicle lamps	144
		LED product range	150
		Gas discharge headlamps	161
		Halogen headlamps	163
		Signal lamp range	169
		Motorcycle lamp range	172
		Spare lamp kit	175

OSRAM is your perfect partner for light

As THE integrated lighting expert and premium provider, OSRAM plays a leading role in the lighting market. With state-of-the-art technology, best brand quality, appealing prices and professional sales support, we are your perfect partner in the lighting business, both now and in the future.



A focus on light

The OSRAM brand has been standing for innovative and sustainable light for more than 100 years. Today we are one of the world's leading manufacturers of light. We cover the complete value-added chain with our portfolio, ranging from LED chips, modules, components, lamps, luminaires and light management systems to comprehensive, customer-specific lighting solutions and complex project business.

Quality is the trump card

Energy efficiency, long life, diversity, price-performance ratio and light quality: OSRAM has a wealth of convincing arguments to support your successful lighting business. Many lamps are also produced in Europe, and this tendency is increasing. Another trump card to impress your customers.

Conforming with standards

Global "lighting regulations" and especially European ones have become more stringent, and target the widespread use of energy-efficient light sources. All OSRAM products already meet all legal standards and regulations in the respective countries from the start.

Highly effective sales support

Attractive packaging, attention-grabbing POS media, extensive online and printed materials as well as simple and effective consumer guidance: OSRAM not only knows the best way to produce ideal light – we are also experts on how to market it professionally. You can always depend on our support.



OSRAM is designing the future of light.

The global lighting market is currently undergoing fundamental change. Regulatory changes are speeding up development and the introduction of semi-conductor-based products (SSL), while the demand for traditional products is falling. At the same time, falling prices for LED components and products, particularly in the field of general illumination, have increased the attraction of more widespread use in many market segments. Technological change also offers major opportunities for growth and new solutions for our customers.

Our innovative, tailor-made solutions for the entire spectrum of lighting create added value for our customers all around the world. As the only globally-active, pure lighting group with a strong brand, we are the leading player on the market and set standards in our industry. We also improve people's quality of life through light.

Our product range includes vertically-integrated products and solutions along the entire chain of added lighting value, from light sources - including lamps, components and optical semiconductors - through control gears and other illumination components to complete luminaires, light management systems and lighting solutions, as well as added value services. OSRAM is THE integrated lighting expert.

In keeping with the slogan "Light is OSRAM," we provide lighting solutions for all areas of life. With this approach, the OSRAM brand supports customers in all highly diverse areas of life: At home, during educational and professional activities, in public spaces, during leisure time, and with all forms of mobility. In addition to covering topics such as energy efficiency, OSRAM products and solutions also fulfill further aspects of light usage such as the ability to concentrate and a sense of well-being.

LED is best – and best with OSRAM

OSRAM is starting the next lighting season with a revised and complete ErP-compliant portfolio. Whether halogen, compact fluorescent or LED technology: Innovative lamps from OSRAM always sets new standards. This makes you perfectly equipped for the continuously increasing demand for efficient and sustainable lighting solutions.



Comparison of lamp shape popularity

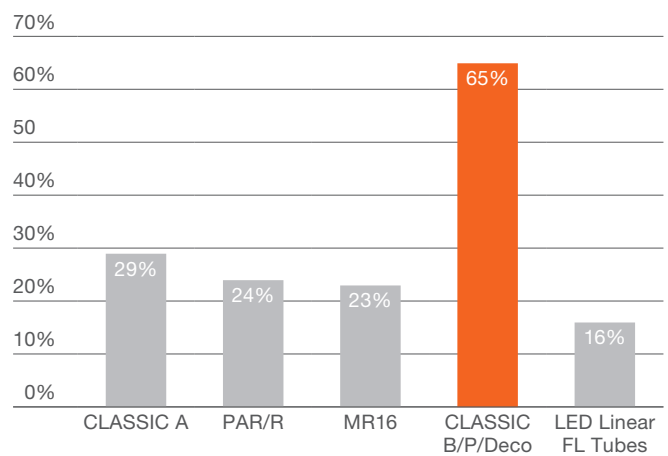

LED lamp shapes: average annual growth 2011–2016 (EU market units)
Source: Strategies Unlimited, 2012

LED lamps will be a megatrend for years to come

Over 95% growth rate from 2011 to 2012¹, a forecast share of LED lamps in the total lamp market of approx. 45% in the year 2016 and even 70% in 2020² speaks for itself. It is not only statutory regulations that are gradually phasing out inefficient light sources contributing towards this, but more and more consumers are now themselves recognizing the advantages of LED.

Efficient traditional lamps still lead the way

The greatest demand worldwide for energy-efficient lamps comes from offices, shops, retail and, above all, private residential use. Currently traditional technologies such as halogen lamps are still benefiting from this, but in five years time at the latest, LED lamps will represent the largest share³.

Classic lamp shapes are the most popular

Traditional lamp shapes across various technologies are especially popular. OSRAM reflects this trend with an especially wide product range, and particularly with “CLASSIC” LED lamps, provides you with the widest retrofit lamp portfolio in the market at the moment⁴.

¹ Source: GfK figures 2012

^{2,3} Source: McKinsey & company – Lighting the Way

⁴ Based on lamp types and wattages

A complete portfolio for your success

OSRAM is not only the leader in the LED sector, but also continues to dominate traditional lamp technologies. As a result, we are your best possible partner in the transition to LED, while making sure that your customers find the right lighting solution for virtually any application and to suit all tastes.



OSRAM halogen lamps

- The better “incandescent lamp”:
CLASSIC ECO SUPERSTAR
- Warm color temperature
- HALOGEN ECO as a further development of halogen technology

OSRAM compact fluorescent lamps

- Energy-efficient
- Various color temperatures
- Compact design

OSRAM LED lamps

- Long lifespan
- Energy-efficient
- Dimmable¹
- Standard shapes, bases and wattages

OSRAM fluorescent lamps

- Long lifespan
- Energy-efficient
- A wide range with many shapes and light colors

Everything speaks for OSRAM and your lighting success

- Lamp portfolio with outstanding price-performance ratio
- A focus on innovative, energy-efficient technologies
- Continuous optimization of the lamp portfolio
- One of the leading companies for LED lamps
- A strong partner in continuously changing market conditions
- A pure light manufacturer with genuine brand quality and expertise
- Specific application know-how
- Reliable and future-proof products

¹ Selected types. LED lamps can be operated with a wide variety of commercially-available dimmers; details and results of compatibility tests can be found at www.OSRAM.com/dim and in the additional technical product information sheets linked there.

Innovative and in line with regulations

European regulations for the environmentally-friendly design of energy-relevant products (ErP) continue to make themselves felt on the lighting market. For example, the implementation measure 244/2009 among other things has led to phasing out the incandescent lamp. Currently and in the next few years, implementation directive 1194/2012 is becoming particularly relevant. With the 874/2012 directive, a new regulation on energy consumption labeling comes into force for electrical lamps and luminaires.



Ecodesign regulation: EU 1194/2012

The implementation measure takes place in three stages. For the first time, minimum requirements will apply for the efficiency and functionality of lamps with directional light and of LED modules, and for the functionality of non-directional LED lamps. The aim of the directive is to remove inefficient products from the market and to specify supplementary quality criteria.

The innovative OSRAM lamp portfolio completely meets the legal requirements for efficiency and quality and, in most cases, even exceeds them.

Regulation for energy labeling: EU 874/2012

The most efficient products should be promoted using explicit information. Among other things, the energy efficiency index (EEI) has been expanded: Classes A+ and A++ for even more efficient lamps have been added, while classes F and G have been removed. The classes have also been redefined so that non-directional high-voltage halogen lamps have now been assigned Class D (formerly Class C). These products continue to comply with the ecological design directive, but no longer conform to the Class C labeling.

OSRAM complies with all legal labeling and information obligations on lamp and luminaire packaging.

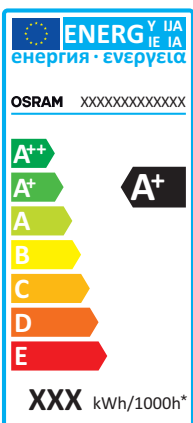

← Energy efficiency class

Continuous innovation and further developments influence our product design to the same extent as legal efficiency and quality criteria. This enables OSRAM to provide you with an improved, more comprehensive and completely standard-compliant lamp product range for your successful lighting business in the light year 2014/2015 and beyond.











For detailed information on current laws and regulations:
www.OSRAM.com/erp

*As the nominal operating period of a lamp is approx. 1,000 hours per year, this data allows simple calculation of annual energy costs (printed kWh value × electricity cost/kWh = annual energy costs of the corresponding lamp).











The entire range of improved light

Phasing out standard incandescent lamps as specified by the EU has been in full swing since 2009, and over the coming years, further inefficient lamps will follow step by step. The following table shows the alternatives that OSRAM is already offering. You will find the respective so-called phase-out year of affected lamps in the appropriate place on the product pages.

Halogen lamps with pin or plug bases

Product phased out by September 2014		Halogen alternative from fall 2014		LED alternative	
	4008321202246 OSRAM HALOPAR 16 STAR FL 20W 230V GU10 10XB LI2	in preparation	OSRAM HALOPAR 16 STAR FL 20W 230V GU10 10XB LI2 2.000h		4052899910331 LED STAR PAR16 20 36° 2700 K (6xBLI1)
	4008321918666 OSRAM HALOPAR 16 STAR 20W 240V GU10 10XB LI2	in preparation	OSRAM HALOPAR 16 STAR 20W 240V GU10 10XB LI2 2.000h		
	4008321997661 OSRAM HALOPAR 16 ECO STAR 28W 230V GU10 10XB LI1		4008321929037 OSRAM HALOPAR 16 ECO SUPERSTAR 28W 230V GU10 10XB LI1		4008321882653 LED SUPERSTAR PAR16 35 36° ADV 2700 K (6xBLI1)
	4008321445117 OSRAM HALOPAR 16 35W 230V GU10 10XB LI3 VALUE	—	—		
	4008321200365 OSRAM HALOPAR 16 STAR FL 35W 230V GU10 10XB LI2	in preparation	OSRAM HALOPAR 16 STAR FL 35W 230V GU10 10XB LI2 2.000h		
	4008321226587 OSRAM HALOPAR 16 STAR 35W 240V GU10 10XB LI2	in preparation	OSRAM HALOPAR 16 STAR 35W 240V GU10 10XB LI2 2.000h		
	4008321200501 OSRAM HALOPAR 16 STAR FL 40W 230V E14 10XB LI2	in preparation	OSRAM HALOPAR 16 STAR FL 40W 230V E14 10XB LI2 2.000h	—	—
	4008321918642 OSRAM HALOPAR 16 STAR FL 40W 240V E14 10XB LI2	in preparation	OSRAM HALOPAR 16 STAR FL 40W 240V E14 10XB LI2 2.000h	—	—
	4008321997685 OSRAM HALOPAR 16 ECO STAR 40W 230V GU10 10XB LI1		4008321204356 OSRAM HALOPAR 16 ECO SUPERSTAR 40W 230V GU10 10XB LI1		4008321882714 LED SUPERSTAR PAR16 50 36° ADV 2700 K (6xBLI1)
	4008321200426 OSRAM HALOPAR 16 STAR FL 50W 230V GU10 10XB LI2	in preparation	OSRAM HALOPAR 16 STAR FL 50W 230V GU10 10XB LI2 2.000h		
	4008321445131 OSRAM HALOPAR 16 FL 50W 230V GU10 10XB LI3 VALUE	—	—		
	4008321226563 OSRAM HALOPAR 16 STAR FL 50W 240V GU10 10XB LI2	in preparation	OSRAM HALOPAR 16 STAR FL 50W 240V GU10 10XB LI2 2.000h		
	4008321200242 OSRAM HALOPAR 16 STAR FL 50W 230V E27 10XB LI1	in preparation	OSRAM HALOPAR 16 STAR FL 50W 230V E27 10XB LI1 2.000h	—	—
	4008321207999 OSRAM HALOPAR 30 SUPERSTAR FL 75W 230V E27 15X1	—	—	—	—

Spot lamps with incandescent lamp technology

Product phased out by September 2014		Halogen alternative from autumn 2014		LED alternative	
	4050300004815 CONCENTRA SPOT R39 30W 230V E14 25X1	—	—	—	—
	4050300118529 CONCENTRA SPOT R39 30W 230V E14 10XBL1	—	—	—	—
	4050300118505 CONCENTRA SPOT R50 25W 230V E14 10XBLI2		4008321984975 CLASSIC ECO SUPERSTAR R50 20W 230V E1410XBL1	—	—
	4050300312811 CONCENTRA SPOT R50 25W 230V E14 5X5X1		4008321984852 CLASSIC ECO SUPERSTAR R50 20W 230V E14 20X1	—	—
	4050300118482 CONCENTRA SPOT R50 40W 230V E14 10XBLI2		4008321916334 CLASSIC ECO SUPERSTAR R50 30W 230V E1410XBL1	—	—
	4050300148489 CONCENTRA SPOT R50 40W 230V E14 14X2		4008321670953 64542R63 ECO 30W 230V E27 20X1 SST OSRAM	—	—
	4050300302263 CONCENTRA SPOT R50 40W 240V E14 5X5X1		4008321758583 64542R63 ECO 30W 240V E27 20X1 SST OSRAM		4052899920477 LED STAR R50 40 30° 2700K E14 (6xBLI1)
	4050300322315 CONCENTRA SPOT R50 40W 230V E14 5X5X1		4008321670953 64542R63 ECO 30W 230V E27 20X1 SST OSRAM	—	—
	4050300909431 CONCENTRA SPOT R50 40W 230V E14 20XBLI4		4008321916334 CLASSIC ECO SUPERSTAR R50 30W 230V E1410XBL1	—	—
	4008321163516 CONCENTRA SPOT R50 60W 230V E14 25X1		4008321984869 CLASSIC ECO SUPERSTAR R50 46W 230V E14 20X1	—	—
	4050300312767 CONCENTRA SPOT R63 25W 230V E27 25X1		—	—	—
	4050300023397 CONCENTRA SPOT R63 40W 240V E27 5X5X1		4008321758583 CLASSIC ECO SUPERSTAR R63 30W 240V E27 20X1		4052899920491 LED STAR R50 40 30° 2700K E27 (6xBLI1)
	4050300093055 CONCENTRA SPOT R63 40W 230V E27 10XBLI1		4008321984999 CLASSIC ECO SUPERSTAR R63 30W 230V E2710XBL1	—	—
	4050300310640 CONCENTRA SPOT R63 40W 230V E27 25X1		4008321670953 CLASSIC ECO SUPERSTAR R63 30W 230V E27 20X1	—	—
	4050300562537 CONCENTRA SPOT R63 40W 230V E27 24X2		4008321670953 CLASSIC ECO SUPERSTAR R63 30W 230V E27 20X1	—	—
	4050300941509 CONCENTRA SPOT R63 40W 220V E27 5X5X1		4008321670953 CLASSIC ECO SUPERSTAR R63 30W 230V E27 20X1	—	—
	4050300023380 CONCENTRA SPOT R63 60W 240V E27 5X5X1		4008321229342 CLASSIC ECO SUPERSTAR R63 46W 240V E27 20X1	—	—
	4050300093826 CONCENTRA SPOT R63 60W 230V E27 10XBLI1		4008321916358 CLASSIC ECO SUPERSTAR R63 46W 230V E2710XBL1		4052899920491 LED STAR R50 40 30° 2700K E27 (6xBLI1)
	4050300323275 CONCENTRA SPOT R63 60W 230V E27 25X1		4008321212139 CLASSIC ECO SUPERSTAR R63 46W 230V E27 20X1	—	—
	4050300562551 CONCENTRA SPOT R63 60W 230V E27 24X2		4008321212139 CLASSIC ECO SUPERSTAR R63 46W 230V E27 20X1	—	—
	4050300941530 CONCENTRA SPOT R63 60W 220V E27 5X5X1		4008321212139 CLASSIC ECO SUPERSTAR R63 46W 230V E27 20X1	—	—
	4050300066042 CONCENTRA SPOT R80 40W 240V E27 25X1		—	—	—
	4050300066059 CONCENTRA SPOT R80 60W 240V E27 25X1		4052899054431 CLASSIC ECO SUPERSTAR R80 46W 230V E27 FS1	—	—
	4050300066066 CONCENTRA SPOT R80 75W 240V E27 25X1		4052899054479 CLASSIC ECO SUPERSTAR R80 57W 230V E27 FS1	—	—



Sustainability is the guiding principle

As one of the world's largest lamp manufacturers, OSRAM has a great responsibility towards people and the environment. The company, with its long and proud history, is aware of this role, and all of its activities are guided by a philosophy of sustainability.

Environmental protection in all sectors

As an expert in integrated light, OSRAM has dedicated itself to developing energy-efficient products, systems and solutions. This means that we have not only aligned our business activities to protecting the climate, but also help our customers to make savings in their energy costs. Implementing total environmental protection also means living the principle of sustainability and acting in an environmentally-friendly, innovative and responsible manner, from product development through to recycling. In addition to the development of energy-saving products, this also includes research into and selecting the most environmentally-friendly raw materials, reducing production waste as far as possible, using environmentally-friendly packaging and implementing energy efficiently in all production processes.

Set your sights on the future!

Consistent transition to modern, efficient light sources is inevitable, and with OSRAM you are optimally prepared for this, since OSRAM offers you and your customers high-quality, future-proof alternatives to conventional lamps suitable for almost any application. And the best thing is: The transition is not only good for the environment, but will also pay dividends to you and your customers.



For more information about OSRAM sustainability:
www.osram.com/global-care

Great diversity and clear structure

Whether halogen, compact fluorescent or LED lamps: OSRAM impresses in all sectors with a wide range of shapes, base variants, wattages and light colors. So as not to lose the overview with this wide range on offer, we have clearly structured the spectrum of products.



Outstanding brand quality – in two quality levels: SUPERSTAR and STAR

Categorizing in two general quality and power levels applies to compact fluorescent, halogen and LED lamps from OSRAM, i.e. all lamp technologies that provide modern alternatives to the incandescent lamp. This means: Your customers can now find the right lamp for any luminaire, any application and for all needs.

- SUPERSTAR stands for light sources with innovative features and a long lifespan. In their respective technologies, for consumers they are the best choice for lighting comfort and quality.
- STAR stands for high quality at a favorable price, and is a good choice in terms of light comfort and lifespan.

OSRAM lamp range (replacement for conventional incandescent and halogen lamps)

CLASSIC ECO
SUPERSTAR

OSRAM DULUX®
SUPERSTAR

LED
SUPERSTAR

HALOGEN ECO
SUPERSTAR

OSRAM
DULUXSTAR®

LED
STAR

HALOGEN ECO
STAR

HALOGEN
STAR

Rapid orientation with comparable wattages

Your customers know how bright a 60 watt incandescent lamp shines for example, and are now searching for alternatives with the same luminosity. To help them locate these alternatives, OSRAM has now introduced new wattages for CLASSIC ECO SUPERSTAR, OSRAM DULUX® SUPERSTAR and LED SUPERSTAR that correspond to the familiar wattages of traditional incandescent lamps.

True comparability with incandescent lamps thanks to new wattages

When consumers look for alternatives to incandescent lamps, they start with the classic wattages: 25 W, 40 W, 60 W, 75 W, 100 W, 150 W. However, as a general rule, the alternatives only “theoretically” correspond to incandescent lamps.

For example, from a mathematical perspective, an 18 W halogen lamp replaced a 20 W incandescent lamp and a 70 W halogen lamp replaced a 93 W incandescent lamp – except that these lamps never existed and never will.

OSRAM now ensures genuine comparability with the new lamp wattages. This achieves more transparency at the point of sale and makes it easier for consumers to quickly find their desired product.

Incandescent lamp	▶ OSRAM CLASSIC ECO SUPERSTAR	Energy efficiency class
25 W	▶ 20 W	D
40 W	▶ 30 W	D
60 W	▶ 46 W	D
75 W	▶ 57 W	D
100 W	▶ 77 W	D
150 W	▶ 116 W	D

All CLASSIC ECO SUPERSTAR halogen lamps are directly comparable to incandescent lamps with the traditional “rounded” wattages – and all have energy efficiency class D.

Incandescent lamp	▶ OSRAM DULUX® SUPERSTAR (CLASSIC A, B, P, Globe, Micro Twist, Nano Twist, Stick)	Energy efficiency class
25 W	▶ 5–6 W	A
40 W	▶ 7–9 W	A
60 W	▶ 12–14 W	A
75 W	▶ 15–17 W	A
100 W	▶ 21–23 W	A

All OSRAM DULUX® SUPERSTAR compact fluorescent lamps (except the DULUX® SUPERSTAR intelligent multi-talents) are directly comparable with incandescent lamps that have traditional, “rounded” wattages.

Incandescent lamp	▶ OSRAM LED SUPERSTAR/ STAR CLASSIC	Energy efficiency class
15 W	▶ 2 W	A+
25 W	▶ 4 W	A+
40 W	▶ 6 W	A+
60 W	▶ 10 W	A+
75 W	▶ 12 W	A+

The power consumption required to replace a classic incandescent lamp wattage varies with LED lamps. The reason: The number of light diodes varies for different lamp types.

Consumer friendly and typical of the brand

Whether LED, halogen or compact fluorescent lamps: OSRAM displays its products in an especially appealing and convincing way with modern, consumer-friendly packaging design. The clear design with intelligent color coding and self-explanatory icons enables your customers to quickly find the lamp they are looking for.

LED lamps will be a megatrend for years to come

The attractive, modern packaging designs immediately communicate the quality and the innovative content of OSRAM LED lamps. All important information can be recognized and understood at a glance. Your customers can see the whole product, even though it is completely enclosed and thus ideally protected. In the interests of environmental protection, the plastic content of the packaging has also been reduced as far as possible.

The graphical layout has been slightly modified to comply with all the information obligations of the ErP regulations. To achieve even better shelf utilization, the blister boxes for the various classic and reflector lamps have been made even smaller.



Orientation at a glance: The lamp packaging

- 1 Wattage of the lamp and wattage of the comparable lamp
- 2 Lumen value, large and clear
- 3 Lifespan of the lamp clearly shown
- 4 Energy efficiency class of the lamp
- 5 Bulb shape and base clearly visible
- 6 Emphasis on the added value of the lamp
- 7 Clear presentation of technical features
- 8 Clear indication of the energy savings of the lamp
- 9 Light color easily identifiable
- 10 Base description
- 11 Beam angle

Back page:

- Type and order reference
- Guarantee in years for certain types of lamp
- Lifespan compared to standard light sources
- Clearly presented technical value table
- Lamp dimensions

Perfect packaging

The clear design communicates all the important information and creates clear differentiation to other product groups, such as compact fluorescent lamps or halogen lamps. Both types of packaging are suitable for hanging or standing presentation.











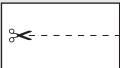









Different quality levels within a technology product range are easy to identify due to packaging structure and color design.

Greater transparency

The directive for product safety has been standardizing safety requirements for products across Europe since 2004. For consumers this means more safety and transparency. OSRAM provides safety information on its

products, packaging and instruction leaflets to comply with obligations arising from this directive. Given the large number of languages spoken within the EU, pictograms are used instead of written text. After all, OSRAM has always given the health and safety of consumers top priority.

	Open the packaging		Disconnect the luminaire from the power before relamping		Lamp with UV filter
	Read the enclosed leaflet before use		Switch off vehicle headlights before relamping		Operation with shattered outer bulbs not allowed
	Keep away from children		Only use in lamps with protective cover		Inner temperature range
	Fit by gripping the integrated control casing, not the glass lamp section		Lamp cannot be dimmed		Special lamp, not suitable for use in household environments
	Do not touch the lamp with bare fingers		Lamp can be continuously dimmed		Lamp with limited dimming. For more detailed information about compatible dimmers: www.OSRAM.com/dim
	Do not throw away with household waste		Caution: Hot		
	Only for indoor use		Protect against splashes		

Selection of pictograms used by OSRAM: Not all originate from the product safety directive; some are used for better understanding and for clarification purposes.

It's simple: more light, more sales!

The decline in the use of incandescent lamps and the emergence of alternative, future-proof lighting technology has led to a change in the way your customers search for lamps at the point of sale. With the redesign of its intelligent shop system, OSRAM has taken this factor into account. polePOSition® Advanced is now more modern, more clearly designed and even more user-friendly.





Turning lamps into highlights: OSRAM displays

Advanced technologies, greater efficiency: The innovative OSRAM product range offers many highlights. Not only does it meet your customers' needs, it also has the ability to stimulate new lighting desires. This is why high-profile secondary shop displays with emotional motifs supplement the OSRAM shelving perfectly.





Visible everywhere: Sales support with apps, social media and OSRAM.com

Sources of digital information such as the Internet, apps and social media are becoming ever more popular. The main website is not the only place that OSRAM presents itself and its products in a highly modern and convincing way. Whether it's Facebook, Twitter, YouTube or mobile apps: OSRAM is visible everywhere and always keeps your customers up-to-date in terms of light – and therefore also up-to-date with your lighting business.



OSRAM Light Finder app

Your customers can find exactly the right lamps and luminaires for their homes with the free OSRAM Light Finder app. The app enables them to configure LED, halogen and energy-saving lamps, and also to virtually test OSRAM luminaires.

www.OSRAM.com/lightfinder-app

OSRAM Innovation News

The latest news from OSRAM research. Via newsletter approximately every two months. The newsletter provides background information about the latest technologies, and details the most recent findings from the OSRAM research laboratories.

www.OSRAM.com/innovation



OSRAM Vehicle Light app

Whether it's for cars, trucks or motorcycles: With the free OSRAM Vehicle Light app, your customers can locate precisely the right lamp for their vehicle, ranging from dipped and full-beam headlights to indicator and brake lights and reversing lights.

www.OSRAM.com/vehicle-light-app

OSRAM catalogs

Information even more quickly: In the future you can download selected brochures and catalogs without having to search according to specific products – simplicity itself with one central link.

www.OSRAM.com/downloads



OSRAM LED LIGHT@DAY app

The OSRAM LED LIGHT@DAY daytime running light transforms all cars into a highlight with regard to safety and design. With the innovative and free app, your customers interactively experience the advantages of LED daytime running light.

www.OSRAM.com/highlights-mobile-app



OSRAM in the social web

OSRAM is of course present on all important social media channels. This is how we make the theme of light interesting for younger target groups as well, while achieving more popularity and familiarity for the OSRAM brand.

www.facebook.com/OSRAM

www.youtube.com/OSRAM

www.twitter.com/OSRAMcom



Company | Press | Career | Sustainability | Investor Relations

OSRAM

Applications | Products | Tools & Services | News & Knowledge

News & Knowledge: [LED lamps from OSRAM - the big product push](#)

LED lamps: the big product offensive for more energy efficiency and less costs

OSRAM is entering the new lighting season with a comprehensively extended LED lamp portfolio - a total of around 550 different cutting edge LED lamp types, including brand new products and updates of familiar top sellers. Implemented consistently on all lamps: the greatest possible energy efficiency, quality and durability. Guaranteed future for dealers and users.

A wide product portfolio, good light and performance values together with an impressive price performance ratio

LED lamps by OSRAM are characterised by their enormous product range. Various types of bases and shapes of lamps - from screw and plug bases via high-voltage and low-voltage versions up to reflector lamps, and classic round-based lamp shapes - are within our range. They are therefore ideally suited to both commercial and private use.

All information for the lighting professional

All information for the end user

LED lamps by OSRAM: usable for almost all applications

Thanks to the broad range of OSRAM products, LED lamps are the ideal solution in many different cases - for new installations or as a replacement for classic incandescent lamps, compact fluorescent lamps or halogen lamps, and for FR fluorescent lamps. Whether for private or commercial use, for example in restaurants and hotels: LED lamps.

LED > Innovative, efficient, flexible

News & Knowledge: LED Home

LED news
Always up to date with LED news from OSRAM

EU Directive on Eco-Design

News & Knowledge: EU Directive on Eco-Design

Products, technical data & information

Videos, pictures, products & information





LED lamps

An efficient and durable replacement for standard incandescent, halogen and fluorescent lamps: With innovative LED lamps from OSRAM you provide your customers with modern alternatives for bright and energy-saving lighting. Practical LED lamps for special applications complete the product range.

LIGHTIFY™	30	
Classically shaped LED lamps	32	
LED spotlights and reflectors	38	
LED SubstiTUBE® Value	44	
LED special lamps	45	

LED lamps for almost everything and everyone

Thanks to a unique selection of wattages, lights colors, shapes and base variants, your customers can find their perfect lighting solutions in the OSRAM LED lamp range for almost all applications and needs.



Four OSRAM LED lamp categories

Dividing the product range into four unique categories helps your customers to identify optimal LED lamp alternatives.

OSRAM LED SUPERSTAR

Dimmable¹ high-tech LED lamps for demanding requirements

- Lifespan of up to 25 years²
- Outstanding efficiency of up to 81 lumens per watt
- Good color rendering of $R_a \geq 80$
- Only slight variations in color from lamp to lamp
- Special patented OSRAM optic for all clear lamps
- Made in Germany from autumn 2014:
OSRAM LED SUPERSTAR CLASSIC A40/A60

OSRAM LED STAR

Premium LED lamps for versatile daily use

- Lifespans of up to 15 years²
- Good color rendering of $R_a \geq 80$
- Special patented OSRAM optic for all clear lamps
- Made in Germany from autumn 2014:
OSRAM LED STAR CLASSIC A40/A60

OSRAM LED STAR special lamps

High quality LED lamps for special purposes

OSRAM SubstiTUBE® Value

LED lamps as the modern alternative to T8 fluorescent lamps in CCG luminaires

- Up to 66 % energy savings when compared to a 1.5 m T8 fluorescent lamp
- Lifespan up to 30 years²
- Full brightness without warm-up phase and flicker
- Quick, simple and safe replacement with no rewiring

¹ LED lamps can be operated with a wide variety of commercially-available dimmers; details and results of compatibility tests can be seen at www.osram.com/dim and in the additional technical product information sheets linked there.

² Corresponds to an average lifespan of 15,000/25,000/30,000 hrs with daily operation of approx. 2.7 hrs.



Three light colors – your customers have the choice

From cozy and warm to cool and clinical: With Warm White, Cool White and Cool Daylight (SubstiTUBE® Value), OSRAM LED lamps always offer the right light color.



OSRAM LED Lamps - for less than 10 Euros RRP

Innovative technology and the best branded quality at attractive prices: With an RRP of less than 10 Euros for all OSRAM LED STAR CLASSIC A40/A60, CLASSIC B, CLASSIC P, PAR16, MR16 and SPECIAL T26, OSRAM sets a new standard in branded LED lamps. This will allow you in the future to also convince LED-skeptical and particularly price-sensitive customers.

Unique guarantee

- Four year guarantee on LED SUPERSTAR lamps³
- Three year guarantee on LED STAR lamps³



www.osram.com/guarantee

















www.osram.com/guarantee

³ You can find the detailed guarantee terms at www.osram.com/guarantee

The product range at a glance

CLASSIC A

Base	Repl. for	SUPERSTAR	Page 32	STAR	Page 33
E27	40 W	LED SUPERSTAR CLASSIC A40, WW/CW, clear sparkling/frosted, 6 W		LED STAR CLASSIC A40, WW/CW, clear/frosted, 6 W	
					
	60 W	LED SUPERSTAR CLASSIC A60, WW/CW, clear sparkling/frosted, 10 W		LED STAR CLASSIC A60, WW/CW, clear/frosted, 10 W	
					
	75 W	LED SUPERSTAR CLASSIC A75, WW, frosted, 12 W		LED STAR CLASSIC A75, WW, frosted, 12 W	
					

CLASSIC B

Base	Repl. for	SUPERSTAR	Page 34	STAR	Page 35
E14	15 W	—		LED STAR CLASSIC B15, WW, clear, 2 W	
	25 W	LED SUPERSTAR CLASSIC B25, WW, clear sparkling/frosted, 4 W		LED STAR CLASSIC B25, WW/CW, clear/frosted, 4 W	
					
	40 W	LED SUPERSTAR CLASSIC B40, WW, clear sparkling/frosted, 6 W		LED STAR CLASSIC B40, WW, clear/frosted, 6 W	
					

CLASSIC P

Base	Repl. for	SUPERSTAR	Page 36	STAR	Page 37
E14	15 W	—		LED STAR CLASSIC P15, WW, clear, 2 W	
	25 W	LED SUPERSTAR CLASSIC P25, WW, clear sparkling/frosted, 4 W		LED STAR CLASSIC P25, WW/CW, clear/frosted, 4 W	
					
	40 W	LED SUPERSTAR CLASSIC P40, WW, clear sparkling/frosted, 6 W		LED STAR CLASSIC P40, WW, clear/frosted, 6 W	
					
E27	15 W	—		LED STAR CLASSIC P15, WW, clear, 2 W	
	25 W	LED SUPERSTAR CLASSIC P25, WW, clear sparkling/frosted, 4 W		LED STAR CLASSIC P25, WW/CW, clear/frosted, 4 W	
					
	40 W	LED SUPERSTAR CLASSIC P40, WW, clear sparkling/frosted, 6 W		LED STAR CLASSIC P40, WW, clear/frosted, 6 W	
					

¹ from fall 2014

² LED lamps can be operated with a wide variety of commercially-available dimmers; details and results of compatibility tests can be seen at www.osram.com/dim and in the additional technical product information sheets linked there.



Reflector

Base	Repl. for	SUPERSTAR	pages 38, 40	STAR	pages 39, 41–43
GU10	20W	—		LED STAR PAR16 20 36°, WW, 1.6W	
	35W	LED SUPERSTAR PAR16 35, 36°, WW/CW, 3.6W		LED STAR PAR16 35, 36°, WW/CW, 3.9W	
	50W	LED SUPERSTAR PAR16 50, 36°, WW/CW, 5.3W		LED STAR PAR16 50, 36°, WW/CW, 5.5W	
	—	—		LED STAR PAR16 120° 270/450, WW, 4/6.5W	
GU5.3	20W	LED SUPERSTAR MR16 20, 36°, WW/CW, 3.7W		LED STAR MR16 20, 36°, WW/CW, 3.5W	
	35W	LED SUPERSTAR MR16 35, 36°, WW/CW, 5.9W		LED STAR MR16 35, 36°, WW/CW, 5.6W	
GU4	20W	—		LED STAR MR11 20, 30°, WW, 3.7W	
E27	40W	—		LED STAR R50 40, WW/CW, 3.9W	
E14	40W	—		LED STAR R50 40, WW/CW, 3.9W	

Special lamps

Base	Repl. for	LEDInestra®/STAR	pages 45–47
S14s	25W	LEDInestra® 6W advanced, WW, frosted, 6W	  
	60W	LEDInestra® 9W advanced, WW, frosted, 9W	  
S14d	25W	LEDInestra® 6W advanced, WW, frosted, 6W	  
	60W	LEDInestra® 9W advanced, WW, frosted, 9W	  
T26/ E14	15W	LED STAR SPECIAL T26, WW/CW, frosted, 1.4W	
PIN G9	15W	LED STAR PIN, WW, frosted, 1.9W	
G4	10W	LED STAR SPECIAL G4, WW, clear, 2.1W	

Tube-shaped lamps

Base	Repl. for	SubstiTUBE®	page 44
G13	600 mm	SubstiTUBE® Value 600 mm, WW/CW/DL, frosted, 8W	
	1200 mm ¹	SubstiTUBE® Value 1200 mm, WW/CW/DL, frosted, 20W	
	1500 mm ¹	SubstiTUBE® Value 1500 mm, WW/CW/DL, frosted, 22W	

³ T8 fluorescent lamp

OSRAM LIGHTIFY™: Make your home intelligent

Light was never so enriching, helpful, individual and networked ... and lighting was never so much fun as it is now. OSRAM LIGHTIFY™ brings the future of light into your home: Intelligent, networked solutions that adapt at any time to your desires and lifestyle. And more easily than you could ever believe.

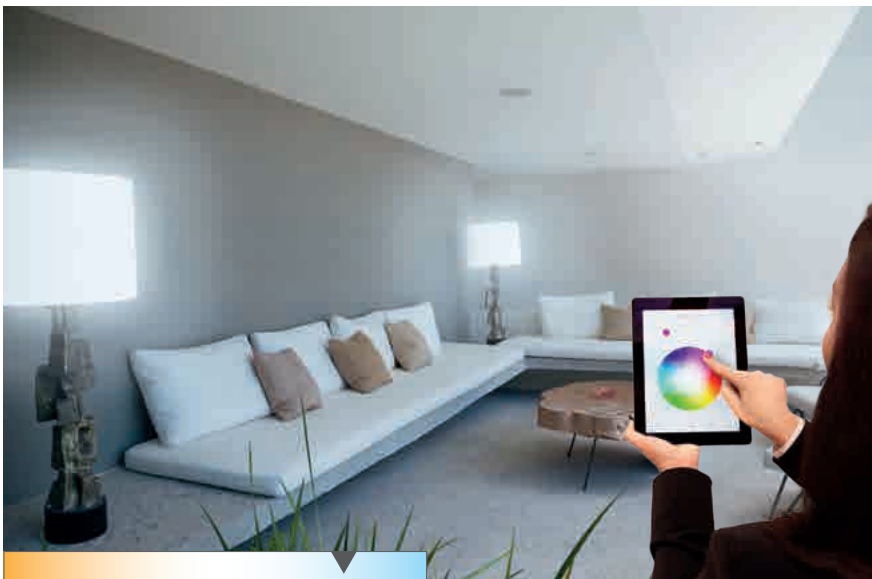

Light that enriches your life

More comfort, a greater feeling for safety and less energy consumption! Would you like to conveniently and flexibly control your lighting? Would you like to give the impression that you're at home even when you're away? Or would you like to protect the environment and cut your electricity costs? OSRAM LIGHTIFY™ enables you to get the very best from your lighting system in every way.



Nothing but radiant joy

Let your creativity run free! Play with your light, try new ideas out and surprise with really great effects – magic up a big smile onto the faces of friends and family.



Your very personal light

Light that sets itself entirely to your needs: A little bit brighter or darker? Cooler or warmer white?¹ Perhaps a touch of color?¹ Once thought and it's already done! After you've created the perfect lighting scene you can simply save it, for loading again whenever you want. Or you simply plan your whole day in advance.



Light that connects

OSRAM LIGHTIFY™ makes it possible: Inter-connect your light sources. Or share the light atmosphere that ideally expresses your mood with your friends! You always stay flexible, because LIGHTIFY™ can be controlled with several smart phones or tablet PCs while on the road or at home.

Light in all its aspects

Simply adapt your light to the time of day – or to reflect your own desired mood: Comfortable warm white, motivating cool white, soothing blue, activating red, invigorating orange.¹ Anything is possible.

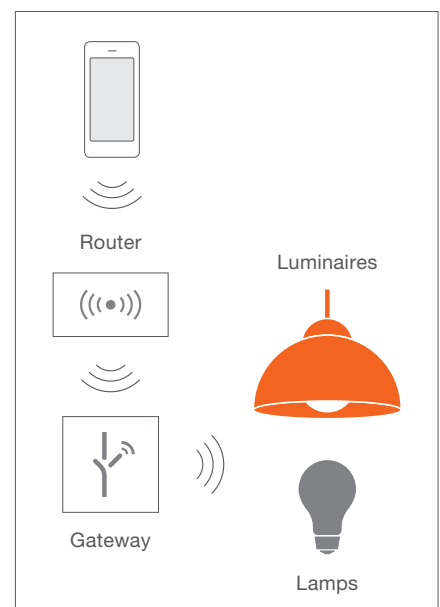

¹ Optional depending on product

OSRAM LIGHTIFY™

Also
luminaires
available

New



With LIGHTIFY™ it's all about you, your desires and needs. To achieve this, several components work in unison: Innovative lamps and luminaires that can be dimmed, that can modify your light from cool to warm white and that illuminate in various colors¹ according to your moods and

wishes. LIGHTIFY™ light sources are wirelessly networked via a gateway, they can be combined with LIGHTIFY™ luminaires, and integrated wirelessly into existing WLAN systems to be controlled via smart phone or tablet PC.

Item name	No.	t [h] ²	W ³	lm ⁴	cd ⁵		kWh/1000h		K		d [mm]	l [mm]	b [mm]	h [mm]			Order code (EAN)
LIGHTIFY Classic A60 TW	(1)	20000	10	810	—	A+	10	Tunable White	2700–6500	frosted	60	110	—	—	1	4	4052899926165
LIGHTIFY Classic A60 RGBW	(2)	20000	10	810	—	A+	10	RGBW	2000–6500	frosted	60	110	—	—	1	4	4052899926097
LIGHTIFY PAR16 50 GU10 TW	(3)	20000	6	350	850	A+	6	Tunable White	2700–6500	—	50	58	—	—	1	4	4052899926103
LIGHTIFY Gateway	(4)	90000	5	—	—	—	5	—	—	—	—	60	60	80	1	4	4052899926172

The major benefits at a glance:

- Individual and flexible modification of lighting to your needs
- Convenient, simple operation via smart phone or tablet PC
- Wireless networking of all components
- Comfortable planning in advance of complete daytime sequences
- Simulates your occupancy with light even when you are not at home
- Energy consumption overview
- Highly simple installation
- Can be flexibly expanded to include up to 50 light sources

See more detailed information about LIGHTIFY™: www.osram.com/lightify



OSRAM LIGHTIFY™ App:
Download for free from fall 2014



Apple and the Apple logo are trademarks of Apple Inc., registered in the U.S. and other countries. App Store is a service mark of Apple Inc.



¹ Optional depending on product

² Average lifespan

³ Maximum consumption; standby consumption ≤ 0.5W

⁴ Maximum luminous flux

⁵ Maximum luminous intensity

OSRAM LED SUPERSTAR CLASSIC A



Standard	LED SUPERSTAR	Electricity cost savings/year ¹
40W	→ 6W	9.52 €
60W	→ 10W	14.00 €
75W	→ 12W	17.64 €



Dimmable² LED lamp for demanding requirements with a lifespan of up to 25 years³ and a four-year guarantee⁴. Patented OSRAM optic for all clear versions. As CLASSIC

A40 with the size of a traditional incandescent lamp. All-round light with a beam angle of 300°. OSRAM LED lamps – Made in Germany from fall 2014⁵.

Item name														Order code (EAN)
LED SUPERSTAR CLASSIC A40	(1)	25000	6	470	A+	6	Warm White	2700	clear sparkling	55	97	1	4	4052899149243
LED SUPERSTAR CLASSIC A40	(2)	25000	6	470	A+	6	Warm White	2700	frosted	55	97	1	4	4052899148697
LED SUPERSTAR CLASSIC A40	(2)	25000	6	470	A+	6	Cool White	4000	frosted	55	97	1	4	4052899148642
LED SUPERSTAR CLASSIC A60	(3)	25000	10	806	A+	10	Warm White	2700	clear sparkling	60	110	1	4	4052899913813
LED SUPERSTAR CLASSIC A60	(4)	25000	10	806	A+	10	Warm White	2700	frosted	60	110	1	4	4052899911222
LED SUPERSTAR CLASSIC A60	(4)	25000	10	806	A+	10	Cool White	4000	frosted	60	110	1	4	4052899149571
LED SUPERSTAR CLASSIC A75	(5)	25000	12	1055	A+	12	Warm White	2700	frosted	62	116	1	4	4052899153738

¹ Basis: Electricity cost € 0.28/kWh and 1,000 hours operating time per year.
² LED lamps can be operated with a wide variety of commercially-available dimmers; details and results of compatibility tests can be seen at www.osram.com/dim and in the additional technical product information sheets linked there.
³ Corresponds to an average lifespan of 25,000 hours with daily operation of approx. 2.7 hours.

⁴ Find the detailed guarantee terms at: www.osram.com/guarantee
⁵ LED SUPERSTAR CLASSIC A40/A60, from fall 2014
⁶ Average lifespan
⁷ LED SUPERSTAR CLASSIC A40 clear sparkling, winner lighting design 2014
⁸ LED SUPERSTAR CLASSIC A40/A60



OSRAM LED STAR CLASSIC A



LED lamps



Standard	LED STAR	Electricity cost savings/year ¹
40W	→ 6W	9.52 €
60W	→ 10W	14.00 €
75W	→ 13W	17.36 €



LED lamp with an outstanding price-performance ratio and a lifespan of up to 15 years² and 3-year guarantee³. The CLASSIC A40 comes in the size of a traditional incandes-

cent lamp. OSRAM LED lamps – Made in Germany from fall 2014⁴.

Item name	No.	t[h] ⁵	W	lm	A+	kWh/1000h	Color	K	Light	d [mm]	h [mm]	Box	Order code (EAN)	
LED STAR CLASSIC A40	(1)	15000	6	470	A+	6	Warm White	2700	clear	55	97	1	6	4052899149458
LED STAR CLASSIC A40	(2)	15000	6	470	A+	6	Warm White	2700	frosted	55	97	1	6	4052899147904
LED STAR CLASSIC A40	(2)	15000	6	470	A+	6	Cool White	4000	frosted	55	97	1	6	4052899147881
LED STAR CLASSIC A60	(3)	15000	10	806	A+	10	Warm White	2700	clear	60	110	1	6	4052899149267
LED STAR CLASSIC A60	(4)	15000	10	806	A+	10	Warm White	2700	frosted	60	110	1	6	4052899149229
LED STAR CLASSIC A60	(4)	15000	10	806	A+	10	Cool White	4000	frosted	60	110	1	6	4052899149281
LED STAR CLASSIC A75	(5)	15000	13	1055	A+	12	Warm White	2700	frosted	60	115	1	6	4052899926622
LED STAR CLASSIC A75	(5)	15000	13	1100	A+	12	Cool White	4000	frosted	60	115	1	6	4052899152076

¹ Basis: Electricity cost € 0.28/kWh and 1,000 hours operating time per year.
² Corresponds to an average lifespan of 15,000 hours with daily operation of approx. 2.7 hours.
³ Find the detailed guarantee terms at www.osram.com/guarantee

⁴ LED STAR CLASSIC A40/A60, from fall 2014
⁵ Average lifespan



OSRAM LED SUPERSTAR CLASSIC B



Standard	LED SUPERSTAR	Electricity cost savings/year ¹
25 W	→ 4 W	5.88 €
40 W	→ 6 W	9.52 €



Dimmable² LED lamp for demanding requirements with a lifespan of up to 25 years³ and a four-year guarantee⁴. Patented OSRAM optic for all clear versions.

All CLASSIC B lamps with unique, slender design. OSRAM LED lamps – designed in Germany.

Item name														Order code (EAN)
E14 – blister box														
LED SUPERSTAR CLASSIC B25	(1)	25000	4	250	A+	4	Warm White	2700	clear sparkling	38	105	1	6	4008321979261
LED SUPERSTAR CLASSIC B25	(2)	25000	4	250	A+	4	Warm White	2700	frosted	38	105	1	6	4008321994011
LED SUPERSTAR CLASSIC B40	(1)	20000	6	470	A+	6	Warm White	2700	clear sparkling	38	105	1	6	4052899900899
LED SUPERSTAR CLASSIC B40	(2)	20000	6	470	A+	6	Warm White	2700	frosted	38	105	1	6	4052899904415

¹ Basis: Electricity cost € 0.28/kWh and 1,000 hours operating time per year.
² LED lamps can be operated with a wide variety of commercially-available dimmers; details and results of compatibility tests can be seen at www.osram.com/dim and in the additional technical product information sheets linked there.

³ Corresponds to an average lifespan of 25,000 hours with daily operation of approx. 2.7 hours.
⁴ Find the detailed guarantee terms at www.osram.com/guarantee
⁵ Average lifespan



OSRAM LED STAR CLASSIC B



LED lamps



Standard	LED STAR	Electricity cost savings/year ¹
15W	→ 2W	3.64 €
25W	→ 4W	5.88 €
40W	→ 6W	9.52 €



LED lamp with an outstanding price-performance ratio and a lifespan of up to 15 years² and 3-year guarantee³. All CLASSIC B lamps with a unique, slender design.

OSRAM LED CLASSIC B25 and B40 lamps – designed in Germany.

Item name	No.	t [h] ⁴	W	lm	Energy label icon	kWh/1000h	Color bar	K	Light icon	d [mm]	h [mm]	Base icon	Order code (EAN)
-----------	-----	--------------------	---	----	-------------------	-----------	-----------	---	------------	--------	--------	-----------	------------------

E14 – blister

LED STAR CLASSIC B15	(1)	15000	2	136	A+	2	Warm White	2700	clear	35	92	1	6	4052899911253
LED STAR CLASSIC B25	(2)	15000	4	250	A+	4	Warm White	2700	frosted	38	105	1	6	4052899913615
LED STAR CLASSIC B25	(3)	15000	4	250	A+	4	Warm White	2700	clear	38	105	1	6	4052899913622
LED STAR CLASSIC B25	(2)	15000	4	250	A+	4	Cool White	4000	frosted	38	105	1	6	4052899146396
LED STAR CLASSIC B40	(3)	15000	6	470	A+	6	Warm White	2700	clear	38	105	1	6	4052899911970
LED STAR CLASSIC B40	(2)	15000	6	470	A+	6	Warm White	2700	frosted	38	105	1	6	4052899911987

E14 wind gust – blister

LED STAR CLASSIC BA25	(4)	15000	3.8	250	A+	4	Warm White	2700	clear	38	123	1	6	4052899926646
LED STAR CLASSIC BA40	(5)	15000	6.7	470	A+	7	Warm White	2700	clear	38	132	1	6	4052899926653

¹ Basis: Electricity cost € 0.28/kWh and 1,000 hours operating time per year.

² Corresponds to an average lifespan of 15,000 hours with daily operation of approx. 2.7 hours.









³ Find the detailed guarantee terms at www.osram.com/guarantee

⁴ Average lifespan



OSRAM LED SUPERSTAR CLASSIC P











Standard	LED SUPERSTAR	Electricity cost savings/year ¹
25 W   →	4 W  	5.88 €
40 W   →	6 W  	9.52 €



Dimmable² LED lamp for demanding requirements with a lifespan of up to 25 years³ and a four-year guarantee⁴. Patented OSRAM optic for all clear versions.

All CLASSIC P lamps with unique, compact design. OSRAM LED lamps – designed in Germany.

Item name														Order code (EAN)
E27 – blister box														
LED SUPERSTAR CLASSIC P25	(1)	25000	4	250	A+	4	Warm White	2700	clear sparkling	43	80	1	6	4008321992376
LED SUPERSTAR CLASSIC P25	(2)	25000	4	250	A+	4	Warm White	2700	frosted	43	80	1	6	4052899911420
LED SUPERSTAR CLASSIC P40	(1)	20000	6	470	A+	6	Warm White	2700	clear sparkling	43	80	1	6	4052899904422
LED SUPERSTAR CLASSIC P40	(2)	20000	6	470	A+	6	Warm White	2700	frosted	43	80	1	6	4052899900912
E14 – blister box														
LED SUPERSTAR CLASSIC P25	(3)	25000	4	250	A+	4	Warm White	2700	clear sparkling	43	82	1	6	4008321980380
LED SUPERSTAR CLASSIC P25	(4)	25000	4	250	A+	4	Warm White	2700	frosted	43	82	1	6	4052899911406
LED SUPERSTAR CLASSIC P40	(3)	20000	6	470	A+	6	Warm White	2700	clear sparkling	43	82	1	6	4052899904439
LED SUPERSTAR CLASSIC P40	(4)	20000	6	470	A+	6	Warm White	2700	frosted	43	82	1	6	4052899900905

¹ Basis: Electricity cost € 0.28/kWh and 1,000 hours operating time per year.
² LED lamps can be operated with a wide variety of commercially-available dimmers; details and results of compatibility tests can be seen at www.osram.com/dim and in the additional technical product information sheets linked there.

³ Corresponds to an average lifespan of 25,000 hours with daily operation of approx. 2.7 hours.
⁴ Find the detailed guarantee terms at www.osram.com/guarantee
⁵ Average lifespan



OSRAM LED STAR CLASSIC P



LED lamps



Standard	LED STAR	Electricity cost savings/year ¹
15W	2W	3.64 €
25W	4W	5.88 €
40W	6W	9.52 €



LED lamp with an outstanding price-performance ratio and a lifespan of up to 15 years² and 3-year guarantee³. All CLASSIC P lamps with unique, compact design.

OSRAM LED P25 and P40 lamps – designed in Germany.

Item name	No.	t[h] ⁴	W	lm	Energy label icon	kWh/1000h	Color bar	K	Light icon	d [mm]	l [mm]	Box icon	Order code (EAN)
-----------	-----	-------------------	---	----	-------------------	-----------	-----------	---	------------	--------	--------	----------	------------------

E27 – blister

LED STAR CLASSIC P15	(1)	15000	2	136	A+	2	Warm White	2700	clear	45	80	1	6	4052899911277
LED STAR CLASSIC P25	(2)	15000	4	250	A+	4	Warm White	2700	frosted	43	80	1	6	4052899913677
LED STAR CLASSIC P25	—	15000	4	250	A+	4	Warm White	2700	clear	43	80	1	6	4052899913684
LED STAR CLASSIC P25	(2)	15000	4	250	A+	4	Cool White	4000	frosted	43	80	1	6	4052899146457
LED STAR CLASSIC P40	(3)	15000	6	470	A+	6	Warm White	2700	clear	43	80	1	6	4052899911956
LED STAR CLASSIC P40	(2)	15000	6	470	A+	6	Warm White	2700	frosted	43	80	1	6	4052899911949

E14 – blister

LED STAR CLASSIC P15	(4)	15000	2	136	A+	2	Warm White	2700	clear	45	80	1	6	4052899911260
LED STAR CLASSIC P25	(5)	15000	4	250	A+	4	Warm White	2700	frosted	43	82	1	6	4052899913646
LED STAR CLASSIC P25	(6)	15000	4	250	A+	4	Warm White	2700	clear	43	82	1	6	4052899913653
LED STAR CLASSIC P25	(5)	15000	4	250	A+	4	Cool White	4000	frosted	43	82	1	6	4052899146426
LED STAR CLASSIC P40	(6)	15000	6	470	A+	6	Warm White	2700	clear	43	82	1	6	4052899911963
LED STAR CLASSIC P40	(5)	15000	6	470	A+	6	Warm White	2700	frosted	43	82	1	6	4052899911932

¹ Basis: Electricity cost €0.28/kWh and 1,000 hour operating time per year.

² Corresponds to an average lifespan of 15,000 hours with daily operation of approx. 2.7 hours.

³ Find the detailed guarantee terms at www.osram.com/guarantee

⁴ Average lifespan



OSRAM LED SUPERSTAR PAR16

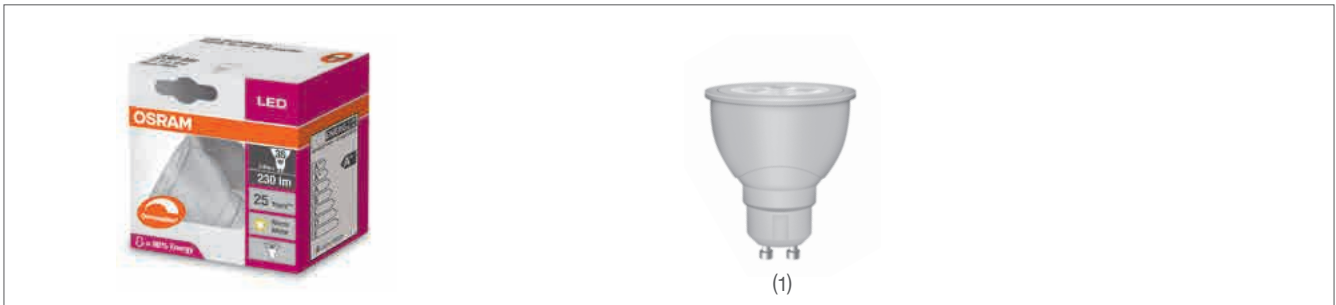

Standard	LED SUPERSTAR	Electricity cost savings/year ¹
35 W	→ 3.6 W	8.79 €
50 W	→ 5.3 W	12.52 €



Dimmable² LED reflector lamp for demanding requirements with a lifespan of up to 25 years³ and a 4-year guarantee⁴.

A genuine high voltage halogen lamp replacement with very low energy consumption. Homogeneous OSRAM design.

Item name	No.	t [h] ⁵	W	lm	cd	Beam angle	Energy class	kWh/1000h	Color	K	d [mm]	l [mm]	Weight	Quantity	Order code (EAN)
-----------	-----	--------------------	---	----	----	------------	--------------	-----------	-------	---	--------	--------	--------	----------	------------------

GU10 – blister box

LED SUPERSTAR PAR16 35	(1)	25000	3.6	230	600	36	A+	4	Warm White	2700	50	58	1	6	4008321882653
LED SUPERSTAR PAR16 35	(1)	25000	3.6	230	600	36	A+	4	Cool White	4000	50	58	1	6	4008321882684
LED SUPERSTAR PAR16 50	(1)	25000	5.3	350	850	36	A+	6	Warm White	2700	50	58	1	6	4008321882714
LED SUPERSTAR PAR16 50	(1)	25000	5.3	350	850	36	A+	6	Cool White	4000	50	58	1	6	4008321882745

¹ Basis: Electricity cost € 0.28/kWh and 1,000 hours operating time per year.

² LED lamps can be operated with a wide variety of commercially-available dimmers; details and results of compatibility tests can be seen at www.osram.com/dim and in the additional technical product information sheets linked there.

³ Corresponds to an average lifespan of 25,000 hours with daily operation of approx. 2.7 hours.

⁴ Find the detailed guarantee terms at www.osram.com/guarantee

⁵ Average lifespan





OSRAM LED STAR PAR16

LED lamps

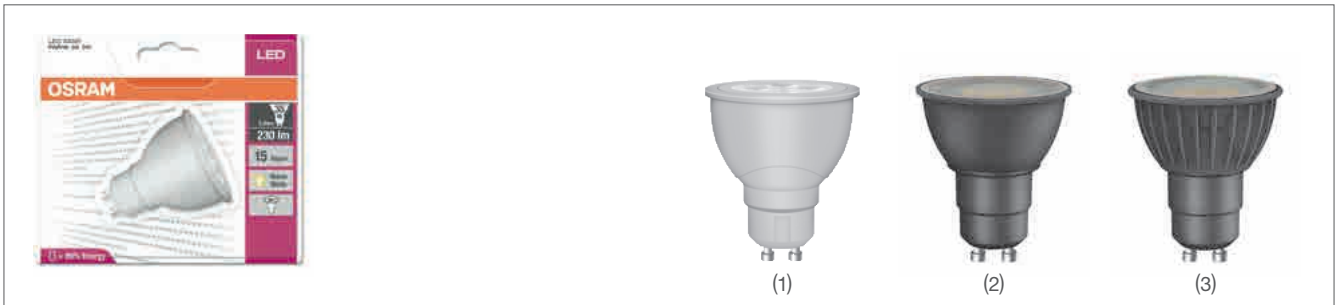

Standard	LED STAR	Electricity cost savings/year ¹
20W	→ 1.6W	5.15 €
35W	→ 3.9W	8.71 €
50W	→ 5.5W	12.46 €



LED reflector lamps for various applications: The versions with 36° beam angle are especially suitable for accent lighting, and the versions with 120° angle emit especially wide distribution light for more planar lighting⁵. Both ver-

sions replace standard high voltage halogen lamps with significantly less energy consumption¹. Lifespan up to 15 years² and 3-year guarantee³.

Item name	No.	t [h] ⁴	W	lm	Beam angle	Energy class	kWh/1000h	Color	K	d [mm]	h [mm]	Weight	Order code (EAN)
-----------	-----	--------------------	---	----	------------	--------------	-----------	-------	---	--------	--------	--------	------------------

GU10 – blister

LED STAR PAR16 20	(1)	15000	1.6	110	36	A++	2	Warm White	2700	50	58	1	6	4052899910331
LED STAR PAR16 35	(1)	15000	3.9	230	36	A+	4	Warm White	2700	50	58	1	6	4052899910348
LED STAR PAR16 35	(1)	15000	3.9	230	36	A+	4	Cool White	4000	50	58	1	6	4052899928954
LED STAR PAR16 50	(1)	15000	5.5	350	36	A+	6	Warm White	2700	50	58	1	6	4052899910355
LED STAR PAR16 50	(1)	15000	5.5	350	36	A+	6	Cool White	4000	50	58	1	6	4052899928961
LED STAR PAR16 120° 270	(2)	15000	4	270	120	A+	4	Warm White	2700	50	58	1	6	4052899921924
LED STAR PAR16 120° 450	(3)	15000	6.5	450	120	A+	4	Warm White	2700	50	58	1	6	4052899921931

¹ Basis: Electricity cost € 0.28/kWh and 1,000 hours operating time per year.

² Corresponds to an average lifespan of 15,000 hours with daily operation of approx. 2.7 hours.

³ Find the detailed guarantee terms at www.osram.com/guarantee

⁴ Average lifespan

⁵ Not suitable for accent lighting



OSRAM LED SUPERSTAR MR16

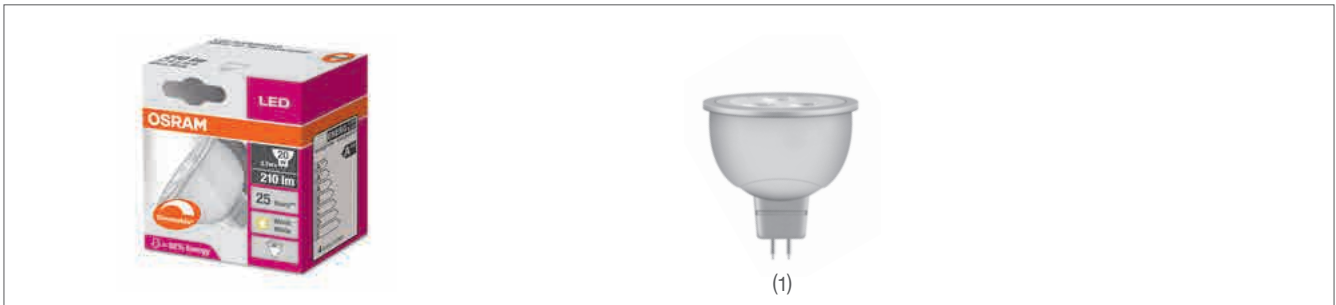

Standard	LED SUPERSTAR	Electricity cost savings/year ¹
20 W	→ 3.7 W	4.56 €
35 W	→ 5.9 W	8.15 €



Dimmable² LED reflector lamp for demanding requirements with a lifespan of up to 25 years³ and a 4-year guarantee⁴.

A genuine low voltage halogen lamp replacement with very low energy consumption. Homogeneous OSRAM design.

Item name	No.	t [h] ⁵	W	lm	cd	Beam angle	Energy class	kWh/1000h	Color	K	d [mm]	l [mm]	Weight	Order code (EAN)
-----------	-----	--------------------	---	----	----	------------	--------------	-----------	-------	---	--------	--------	--------	------------------

GU5.3 – blister box

LED SUPERSTAR MR16 20	(1)	25000	3.7	210	558	36	A+	4	Warm White	2700	51	50	1	6	4008321882264
LED SUPERSTAR MR16 20	(1)	25000	3.7	220	558	36	A+	4	Cool White	4000	51	50	1	6	4008321882295
LED SUPERSTAR MR16 35	(1)	25000	5.9	350	877	36	A	6	Warm White	2700	51	50	1	6	4008321882349
LED SUPERSTAR MR16 35	(1)	25000	5.9	400	877	36	A+	6	Cool White	4000	51	50	1	6	4008321882370

¹ Basis: Electricity cost € 0.28/kWh and 1,000 hours operating time per year.

² LED lamps can be operated with a wide variety of commercially-available dimmers; details and results of compatibility tests can be seen at www.osram.com/dim and in the additional technical product information sheets linked there.

³ Corresponds to an average lifespan of 25,000 hours with daily operation of approx. 2.7 hours.

⁴ Find the detailed guarantee terms at www.osram.com/guarantee

⁵ Average lifespan



OSRAM LED STAR MR16



LED lamps

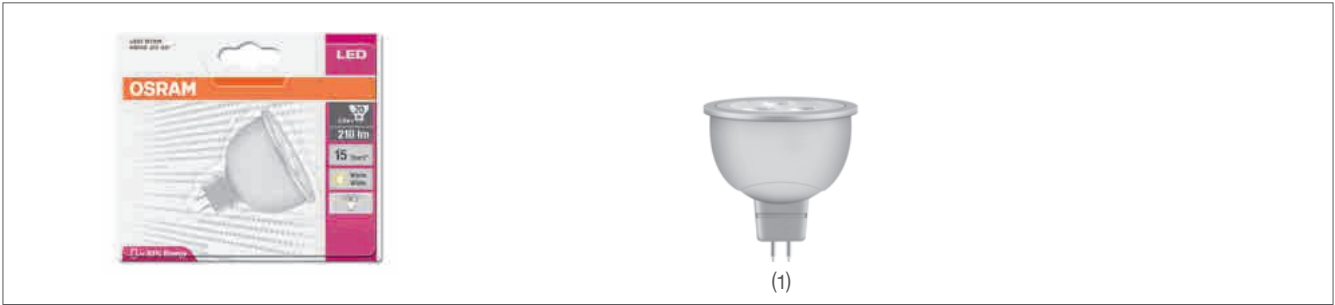

Standard	LED STAR	Electricity cost savings/year ¹
20 W	→ 3.5 W	4.62 €
35 W	→ 5.6 W	8.23 €



An extremely efficient LED reflector lamp with an outstanding price/performance ratio. Replaces standard MR16 low voltage halogen reflector lamps with 20 and

35 W. Beam angle of 36° for classic accent lighting. Life-span up to 15 years² and 3-year guarantee³.

Item name	No.	t [h] ⁴	W	lm	°	Energy Class	kWh/1000h	Color	K	d [mm]	l [mm]	h [mm]	Order code (EAN)
-----------	-----	--------------------	---	----	---	--------------	-----------	-------	---	--------	--------	--------	------------------

GU5.3 – blister

LED STAR MR16 20	(1)	15000	3.5	210	36	A+	4	Warm White	2700	50	51	1	6	4052899910386
LED STAR MR16 20	(1)	15000	3.5	220	36	A+	4	Cool White	4000	50	51	1	6	4052899928978
LED STAR MR16 35	(1)	15000	5.6	350	36	A+	6	Warm White	2700	50	51	1	6	4052899910393
LED STAR MR16 35	(1)	15000	5.6	400	36	A+	6	Cool White	4000	50	51	1	6	4052899928985

¹ Basis: Electricity cost € 0.28/kWh and 1,000 hours operating time per year.
² Corresponds to an average lifespan of 15,000 hours with daily operation of approx. 2.7 hours.
³ Find the detailed guarantee terms at www.osram.com/guarantee

⁴ Average lifespan



OSRAM LED STAR MR11

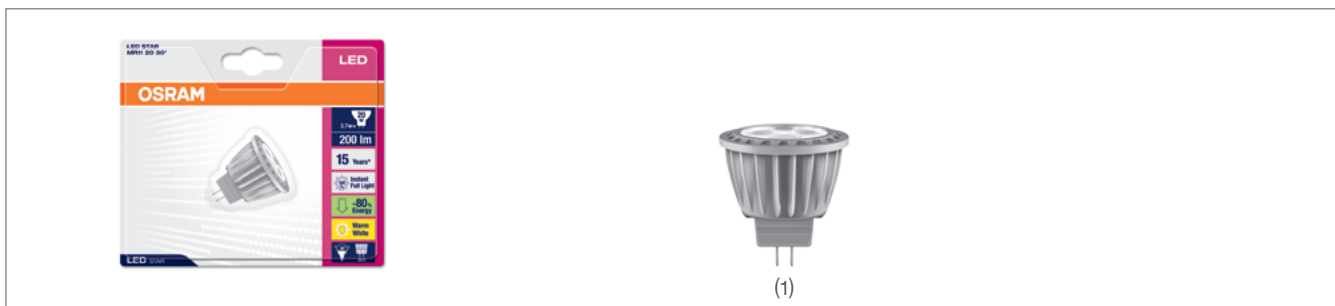

Standard	LED STAR	Electricity cost savings/year ¹
20 W	→ 3.7 W	4.56 €



LED reflector lamp for space-saving applications thanks to compact design. Replaces standard MR11 low voltage

halogen reflector lamps with 20W. Lifespan up to 15 years² and three-year guarantee³.

Item name														Order code (EAN)
GU4 – blister LED STAR MR11 20	(1)	15000	3.7	200	30	A+	4	Warm White	2700	34.7	39	1	6	4052899910416

¹ Basis: Electricity cost € 0.28/kWh and 1,000 hours operating time per year.
² Corresponds to an average lifespan of 15,000 hours with daily operation of approx. 2.7 hours.
³ Find the detailed guarantee terms at www.osram.com/guarantee

⁴ Average lifespan



OSRAM LED STAR R50



LED lamps



Standard	LED STAR	Electricity cost savings/year ¹
40W	3.9W	10.11 €



LED reflector lamp with two screw base versions for replacing standard incandescent or halogen reflector lamps. With high luminous intensity and various light colors for

sophisticated lighting. Lifespan up to 15 years² and 3-year guarantee³.

Item name	No.	t [h] ⁴	W	lm	Beam angle	Energy class	kWh/1000h	Color	K	d [mm]	L [mm]	Weight	Order code (EAN)
-----------	-----	--------------------	---	----	------------	--------------	-----------	-------	---	--------	--------	--------	------------------

E27 – blister

LED STAR R50 40	(1)	15000	3.9	196	30	A+	4	Warm White	2700	50	85	1	6	4052899920491
LED STAR R50 40	(1)	15000	3.9	200	30	A+	4	Cool White	4000	50	85	1	6	4052899920507

E14 – blister

LED STAR R50 40	(2)	15000	3.9	196	30	A+	4	Warm White	2700	50	85	1	6	4052899920477
LED STAR R50 40	(2)	15000	3.9	200	30	A+	4	Cool White	4000	50	85	1	6	4052899920484

¹ Basis: Electricity cost € 0.28/kWh and 1,000 hours operating time per year.
² Corresponds to an average lifespan of 15,000 hours with daily operation of approx. 2.7 hours.
³ Find the detailed guarantee terms at www.osram.com/guarantee

⁴ Average lifespan



OSRAM SubstiTUBE® Value

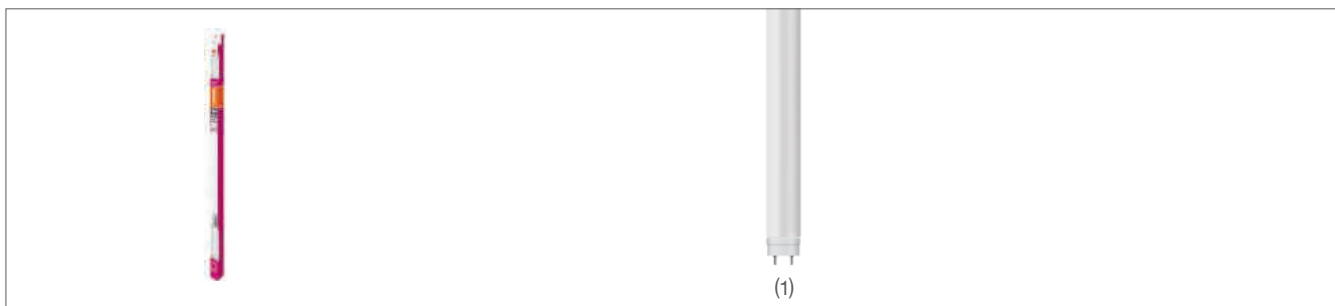

Repl. for ¹	LED SubstiTUBE® Value	Electricity cost savings/year ²
600 mm →	8W	up to 5.32 €
1200 mm →	20W	up to 7.00 €
1500 mm →	22W	up to 12.60 €



SubstiTUBE® Value enables standard T8 fluorescent lamps to be replaced as quick as a flash. Electricity consumption is also significantly reduced without having to forego pleasantly warm, homogeneous light. A further benefit compared to traditional T8 fluorescent lamps: Complete

brightness is available immediately after switching on, and without any flickering. SubstiTUBE® Value is suitable for replacing T8 fluorescent lamps used in luminaires equipped with magnetic ballasts, so-called CCGs.

Item name	No.	t[h] ³	W	lm	Beam angle	Energy class	kWh/1000h	Color	K	Light type	Ø [mm]	L [mm]	Box	Order code (EAN)
-----------	-----	-------------------	---	----	------------	--------------	-----------	-------	---	------------	--------	--------	-----	------------------

G13 – blister box

SubstiTUBE Value 600 mm	(1)	30000	8	650	160	A	11	Warm White	3000	frosted	27.5	600	1	4	4052899922280
SubstiTUBE Value 600 mm	(1)	30000	8	750	160	A	11	Cool White	4000	frosted	27.5	600	1	4	4052899922297
SubstiTUBE Value 600 mm	(1)	30000	8	750	160	A	11	Cool Daylight	6500	frosted	27.5	600	1	4	4052899922303
SubstiTUBE Value 1200 mm	(1)	30000	20	1500	150	A	25	Warm White	3000	frosted	27.5	1200	1	4	4052899922310
SubstiTUBE Value 1200 mm	(1)	30000	20	1700	150	A	25	Cool White	4000	frosted	27.5	1200	1	4	4052899922327
SubstiTUBE Value 1200 mm	(1)	30000	20	1700	150	A	25	Cool Daylight	6500	frosted	27.5	1200	1	4	4052899922334
SubstiTUBE Value 1500 mm	(1)	30000	22	1800	150	A	27	Warm White	3000	frosted	27.5	1500	1	4	4052899922341
SubstiTUBE Value 1500 mm	(1)	30000	22	2000	150	A	27	Cool White	4000	frosted	27.5	1500	1	4	4052899922358
SubstiTUBE Value 1500 mm	(1)	30000	22	2000	150	A	27	Cool Daylight	6500	frosted	27.5	1500	1	4	4052899922365

¹ T8 fluorescent lamp
² Basis: Electricity price € 0.28/kWh and 1,000 hours operating time per year, dependent on control gear loss.
³ Average lifespan



OSRAM LEDinestra®

New

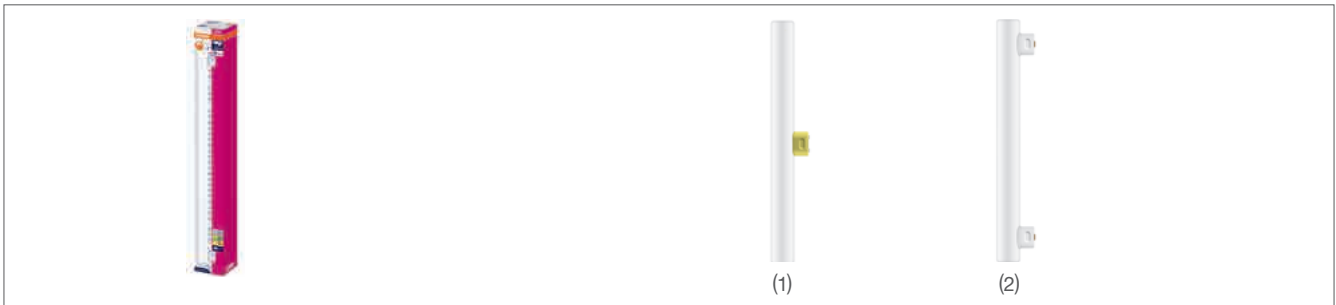

Standard	LEDinestra®	Electricity cost savings/year ¹
25 W	→ 6 W	5.32 €
60 W	→ 9 W	14.28 €

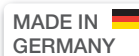

The ideal replacement product for standard tubular incandescent lamps, with significantly lower energy consumption and a lifespan of up to 20 years² and a 4-year guarantee³.

Especially good for mirror lighting: Without UV and IR components in the light beam, good color rendering, dimmable⁴.

Item name



No.

t [h]⁵

W



lm



A



kWh/1000h



K



K



d [mm]



h [mm]



1



5



1



5



1



5

Order code (EAN)

S14s – blister box

LEDinestra 6W advanced	(1)	20000	6	250	A	6	Warm White	2700	frosted	29	300	1	5	4052899110311
LEDinestra 9W advanced	(2)	20000	9	450	A	9	Warm White	2700	frosted	29	500	1	5	4008321979193

S14d – blister box

LEDinestra 6W advanced	(1)	20000	6	250	A	6	Warm White	2700	frosted	29	300	1	5	4052899110335
LEDinestra 9W advanced	(2)	20000	9	450	A	9	Warm White	2700	frosted	29	500	1	5	4008321979216

¹ Basis: Electricity cost € 0.28/kWh and 1,000 hours operating time per year.

² Corresponds to an average lifespan of 20,000 hours with daily operation of approx. 2.7 hours.

³ Find the detailed guarantee terms at www.osram.com/guarantee

⁴ LED lamps can be operated with a wide variety of commercially-available dimmers; details and results of compatibility tests can be seen at www.osram.com/dim and in the additional technical product information sheets linked there.

⁵ Average lifespan



OSRAM LED STAR SPECIAL T26

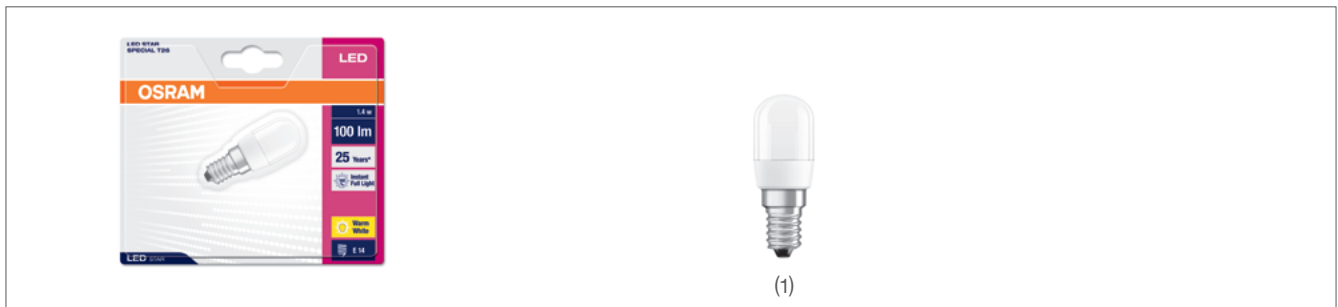

LED lamp with extremely compact design for use in refrigerators or sewing machines, or for accent lighting. Very

low energy consumption and a lifespan of up to 15 years¹ and 3-year guarantee². Shockproof and vibration-proof.

Item name

No.
 t [h]³
 W
 lm

 kWh/1000h

 K

 d [mm]
 l [mm]

 Order code (EAN)

E14 – blister

SPECIAL T26 15	(1)	15000	1.4	100	A++	2	Warm White	2700	frosted	23.5	63	1	20	4052899907096
SPECIAL T26 15	(1)	15000	1.4	100	A++	2	Cool White	5500	frosted	23.5	63	1	20	4052899907133

¹ Corresponds to an average lifespan of 15,000 hours with daily operation of approx. 2.7 hours.

² Find the detailed guarantee terms at www.osram.com/guarantee

³ Average lifespan



OSRAM LED STAR SPECIAL G4



LED lamps

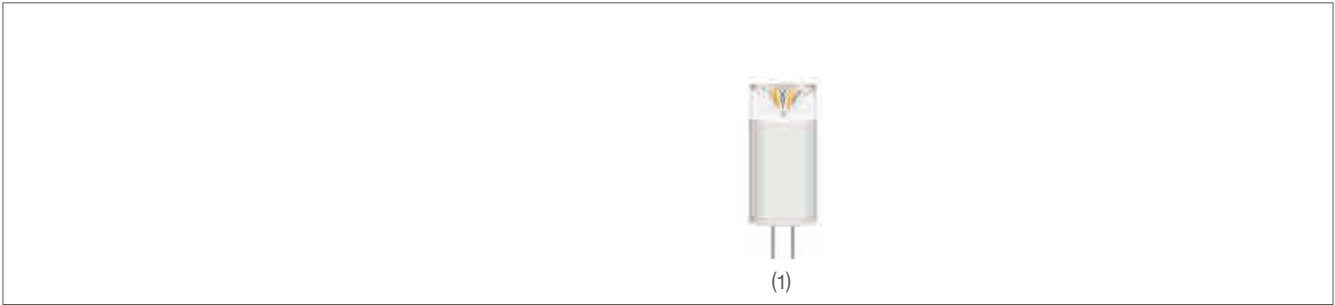

LED lamp with extremely compact construction for use in compact luminaires or for designing starlight canopy

ceilings. Very low energy consumption and a lifespan of up to 15 years¹ and 3-year guarantee².

Item name	No.	t [h] ³	W	lm	Energy class	kWh/1000h	Color	K	Light type	d [mm]	l [mm]	h [mm]	W [mm]	Order code (EAN)
G4 – blister														
SPECIAL G4	(1)	15000	2.1	140	A+	3	Warm White	2700	clear	14	36	1	6	4052899196469

¹ Corresponds to an average lifespan of 15,000 hours with daily operation of approx. 2.7 hours.
² Find the detailed guarantee terms at www.osram.com/guarantee
³ Average lifespan



OSRAM LED STAR PIN

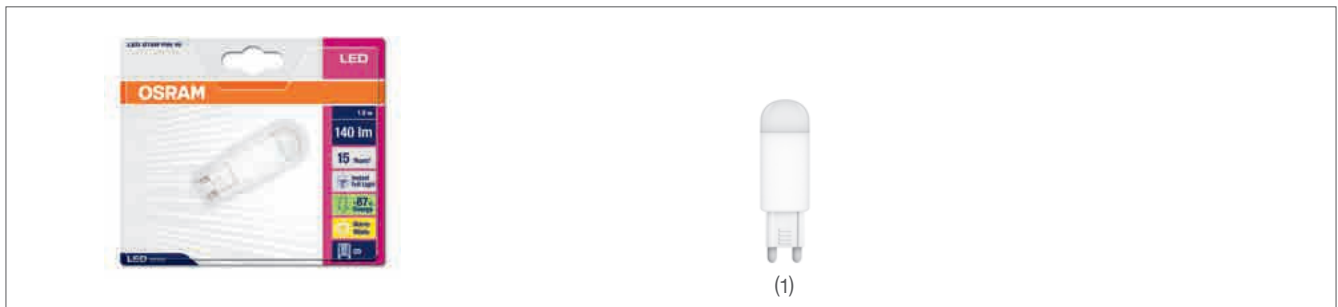

LED lamp for atmospheric accent lighting in living rooms and party cellars. Significantly less heat development and distinctly longer replacement intervals compared to the

standard reference product. Very low energy consumption and a lifespan of up to 15 years¹ and 3-year guarantee².

Item name	No.	t [h] ³	W	lm	A+	kWh/1000h		K		d [mm]	l [mm]			Order code (EAN)
G9 – blister														
LED STAR PIN	(1)	15000	1.9	140	A+	2	Warm White	3000	frosted	18	57.8	1	6	4052899920606

¹ Corresponds to an average lifespan of 15,000 hours with daily operation of approx. 2.7 hours.
² Find the detailed guarantee terms at www.osram.com/guarantee
³ Average lifespan







Halogen lamps

Brilliant quality of light, a constant luminous intensity and natural color rendering ($R_a = 100$) are typical of halogen lamps. However HALOGEN ECO lamps from OSRAM have an additional decisive advantage: Thanks to their high quality inert gas xenon and other technical modifications, they are more durable than standard incandescent and halogen lamps.

Classically shaped halogen lamps with a screw base 54



Halogen high voltage pin or plug base lamps 62



Halogen low voltage pin or plug base lamps 71



A wide product range with brilliant quality

Even more ECO variants with top brand quality: The OSRAM range of halogen lamps offer a strong sales argument. The clear segmentation helps your customers to quickly find their way around the point of sale and locate precisely the right lamp without the need for assistance.



Classically shaped halogen lamps with a screw base

CLASSIC ECO SUPERSTAR halogen lamps from OSRAM with an E14 or E27 screw base offer all the benefits of incandescent lamp light and more besides.

- 100% light immediately
- 100% dimmable
- Up to twice the lamp lifespan compared to standard incandescent lamps

Halogen lamps with pin or plug base

OSRAM offers high quality halogen lamps with pin or plug bases for all requirements and in three quality grades.

- HALOGEN ECO SUPERSTAR: The resource-saving halogen lamps for your most discerning customers – with brilliant light and up to twice the lifespan of ECO STAR lamps
- HALOGEN ECO STAR: The resource-saving halogen lamps for your cost-conscious customers – with brilliant light and up to twice the lifespan of standard halogen lamps
- HALOGEN STAR: For your cost-conscious customers – in practical twin packs



Brilliant benefits: OSRAM halogen lamps refute any prejudice

Many false assumptions about halogen lamps go round and can be easily refuted when advising customers – particularly with modern halogen lamps from OSRAM.

“Are halogen lamps only available with plug bases?”

Whether for bedside lights, large table lamps or uplighters: OSRAM halogen lamps with screw bases provide optimal light in a wide array of familiar luminaire designs.

“Halogen lamps get especially hot”

HALOGEN ECO lamps from OSRAM do not get any hotter than standard incandescent lamps. The innovative design of the inner bulb (burner) limits the outward radiation of heat from the filament. This means that the outer lamp bulb does not get as hot.

“Halogen lamps always need a transformer”

Halogen lamps from OSRAM are available for high voltage and low voltage applications. High voltage lamps are suitable for direct operation on the mains power supply (230V). Only low voltage lamps with operating voltages of 6V, 12V or 24V need to be connected to a transformer.

“Halogen lamps produce a cold light.”

HALOGEN ECO lamps from OSRAM create the same pleasant lighting atmosphere as conventional incandescent lamps.

“Halogen lamps are less environmentally-friendly”













Halogen lamps from OSRAM do not contain mercury. The lamps can be disposed in the household waste without problems.

“Halogen lamps cannot be dimmed.”

All halogen lamps from OSRAM can be continuously dimmed – from 100% to 0%.

OSRAM CLASSIC ECO SUPERSTAR A bulb shaped



Standard	CLASSIC ECO SUPERSTAR
25W 	→ 20W 
40W 	→ 30W 
60W 	→ 46W 
75W 	→ 57W 
100W 	→ 77W 
150W 	→ 116W 



Direct replacement for standard incandescent lamps in existing wattages with equally outstanding light quality.

Available from 20 to 116 W with E27 screw base and a lifespan of up to 2 years¹.

Item name												Order code (EAN)
-----------	---	---	---	---	---	---	---	---	---	---	---	------------------

E27 – clear – 230 V – blister

CLASSIC A ECO 20 W	(1)	2000	20	235	D	20	2700	55	97	1	10	4008321928351
CLASSIC A ECO 30 W	(1)	2000	30	405	D	30	2700	55	97	1	10	4008321916273
CLASSIC A ECO 46 W	(1)	2000	46	700	D	46	2700	55	97	1	10	4008321916297
CLASSIC A ECO 57 W	(1)	2000	57	915	D	57	2800	55	97	1	10	4008321928375
CLASSIC A ECO 77 W	(1)	2000	77	1320	D	77	2800	55	97	1	10	4008321928399
CLASSIC A ECO 116 W	(1)	2000	116	2135	D	116	2800	55	97	1	10	4008321928412







E27 – clear – 230 V – folding box

CLASSIC A ECO 20 W	(1)	2000	20	235	D	20	2700	55	97	1	20	4008321927163
CLASSIC A ECO 30 W	(1)	2000	30	405	D	30	2700	55	97	1	20	4008321211828
CLASSIC A ECO 46 W	(1)	2000	46	700	D	46	2700	55	97	1	20	4008321212078
CLASSIC A ECO 57 W	(1)	2000	57	915	D	57	2800	55	97	1	20	4008321927187
CLASSIC A ECO 77 W	(1)	2000	77	1320	D	77	2800	55	97	1	20	4008321927200
CLASSIC A ECO 116 W	(1)	2000	116	2135	D	116	2800	55	97	1	20	4008321928153

¹ Corresponds to an average lifespan of 2,000 hours with daily operation of approx. 2.7 hours.

OSRAM CLASSIC ECO SUPERSTAR B candle shaped



Standard	CLASSIC ECO SUPERSTAR
25 W 	→ 20 W 
40 W 	→ 30 W 
60 W 	→ 46 W 



Direct replacement for standard candle-shaped incandescent lamps in existing wattages with equally outstanding light quality. Available in 20, 30 and 46 W with E14 screw

base, in 30 and 46 W with E27 screw base and a lifespan of up to 2 years¹.

Item name	No.	t [h]	W	lm	Energy label icon	kWh/1000h	K	d [mm]	l [mm]	Box icon	Blister icon	Order code (EAN)
-----------	-----	-------	---	----	-------------------	-----------	---	--------	--------	----------	--------------	------------------

E14 – clear – 230 V – blister

CLASSIC B ECO 20 W	(1)	2000	20	235	D	20	2700	35	104	1	10	4008321928511
CLASSIC B ECO 30 W	(1)	2000	30	405	D	30	2700	35	97	1	10	4008321916310
CLASSIC B ECO 46 W	(1)	2000	46	700	D	46	2700	35	104	1	10	4008321928535

E14 – clear – 230 V – folding box

CLASSIC B ECO 20 W	(1)	2000	20	235	D	20	2700	35	104	1	20	4008321927286
CLASSIC B ECO 30 W	(1)	2000	30	405	D	30	2700	35	97	1	20	4008321212153
CLASSIC B ECO 46 W	(1)	2000	46	700	D	46	2700	35	104	1	20	4008321927309

E27 – clear – 230 V – folding box

CLASSIC B ECO 30 W	(2)	2000	30	405	D	30	2700	35	99	1	20	4008321984883
CLASSIC B ECO 46 W	(2)	2000	46	700	D	46	2700	35	99	1	20	4008321984890

¹ Corresponds to an average lifespan of 2,000 hours with daily operation of approx. 2.7 hours.

OSRAM CLASSIC ECO SUPERSTAR BW twisted candle



Standard CLASSIC ECO SUPERSTAR

40 W → 30 W

60 W → 46 W



Direct replacement for standard twisted candle-shaped incandescent lamps in existing wattages with equally

outstanding light quality. Available from 30 and 46 W with E14 screw base and a lifespan of up to 2 years¹.

Item name Order code (EAN)

E14 – clear – 230 V – blister

Item name	No.	t [h]	W	lm	Eco	kWh/1000h	K	d [mm]	l [mm]	Box	Blister	Order code (EAN)
CLASSIC BW ECO 30 W	(1)	2000	30	405	D	30	2700	35	104	1	10	4008321928597
CLASSIC BW ECO 46 W	(1)	2000	46	700	D	46	2700	35	104	1	10	4008321985019













E14 – clear – 230 V – folding box

Item name	No.	t [h]	W	lm	Eco	kWh/1000h	K	d [mm]	l [mm]	Box	Blister	Order code (EAN)
CLASSIC BW ECO 30 W	(1)	2000	30	405	D	30	2700	35	104	1	20	4008321927385
CLASSIC BW ECO 46 W	(1)	2000	46	700	D	46	2700	35	104	1	20	4008321984906

¹ Corresponds to an average lifespan of 2,000 hours with daily operation of approx. 2.7 hours.

OSRAM CLASSIC ECO SUPERSTAR P round shaped



Standard	CLASSIC ECO SUPERSTAR
25 W   →	20 W  
40 W   →	30 W  
60 W   →	46 W  



Halogen lamps

Direct replacement for standard round incandescent lamps in existing wattages with equally outstanding

light quality. Available in 20, 36 and 46 W with E14/E27 screw base and a lifespan of up to 2 years¹.

Item name	No.	t [h]	W	lm	Base	kWh/1000h	K	d [mm]	l [mm]	h [mm]	Order code (EAN)	
E14 – clear – 230 V – blister												
CLASSIC P ECO 20 W	(1)	2000	20	235	D	20	2700	45	77	1	10	4008321928672
CLASSIC P ECO 30 W	(1)	2000	30	405	D	30	2700	45	77	1	10	4008321928696
CLASSIC P ECO 46 W	(1)	2000	46	700	D	46	2700	45	77	1	10	4008321928719
E27 – clear – 230 V – blister												
CLASSIC P ECO 20 W	(2)	2000	20	235	D	20	2700	45	74	1	10	4008321952745
CLASSIC P ECO 30 W	(2)	2000	30	405	D	30	2700	45	74	1	10	4008321952769
CLASSIC P ECO 46 W	(2)	2000	46	700	D	46	2700	45	74	1	10	4008321952783
E14 – clear – 230 V – folding box												
CLASSIC P ECO 20 W	(1)	2000	20	235	D	20	2700	45	77	1	20	4008321927446
CLASSIC P ECO 30 W	(1)	2000	30	405	D	30	2700	45	77	1	20	4008321927460
CLASSIC P ECO 46 W	(1)	2000	46	700	D	46	2700	45	77	1	20	4008321927484
E27 – clear – 230 V – folding box												
CLASSIC P ECO 20 W	(2)	2000	20	235	D	20	2700	45	74	1	20	4008321927569
CLASSIC P ECO 30 W	(2)	2000	30	405	D	30	2700	45	74	1	20	4008321927583
CLASSIC P ECO 46 W	(2)	2000	46	700	D	46	2700	45	74	1	20	4008321927606

¹ Corresponds to an average lifespan of 2,000 hours with daily operation of approx. 2.7 hours.

OSRAM HALOLUX® T ECO SUPERSTAR TUBULAR

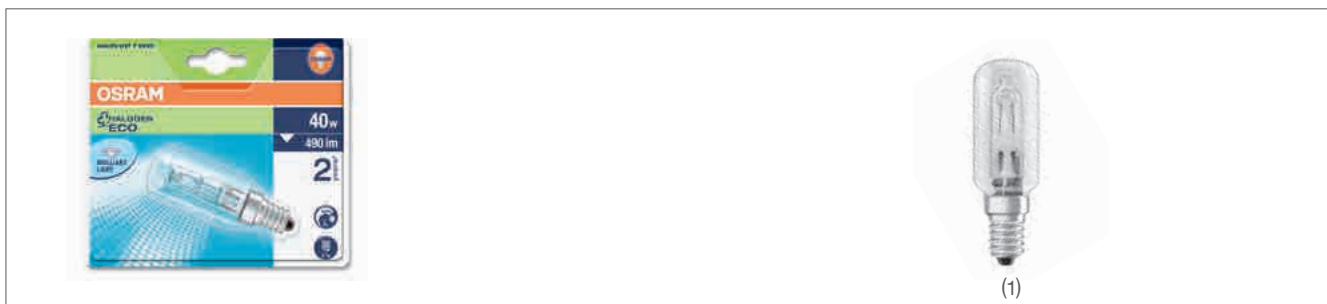

Direct replacement for standard incandescent lamps in existing wattages with equally outstanding light quality. Compact dimensions make this lamp suitable for refrige-

rator lighting. Available in 40 and 60 W with E14 screw base and a lifespan of up to 2 years¹.

Item name



Order code
(EAN)







E14 – clear – 230 V – blister

Item name	No.	t [h]	W	lm	D	kWh/1000h	K	d [mm]	l [mm]	Blister	Order code (EAN)	
HALOLUX T ECO 40 W	(1)	2000	40	490	D	40	2700	26	80	1	10	4008321204486
HALOLUX T ECO 60 W	(1)	2000	60	820	D	60	2700	26	80	1	10	4008321204509

¹ Corresponds to an average lifespan of 2,000 hours with daily operation of approx. 2.7 hours.

OSRAM CLASSIC ECO SUPERSTAR R50



Standard	CLASSIC ECO SUPERSTAR
25 W 	→ 20 W 
40 W 	→ 30 W 
60 W 	→ 46 W 



Halogen lamps

Direct replacement for standard spot incandescent lamps in existing wattages with equally outstanding light quality.

Available in 20, 30 and 46 W with E14 screw base and a lifespan of up to 2 years¹.

Item name	 No.	 t [h]	 W	 cd	 lm			 kWh/1000h	 K		 d [mm]	 l [mm]		 Order code (EAN)
-----------	---	---	---	--	--	---	---	---	---	---	--	--	---	--

E14 – 30° – 230V – blister

HALOGEN SPOT R50 ECO 20 W	(1)	2000	20	510	90	D	20	2700	30	50	87	1	10	4008321984975
HALOGEN SPOT R50 ECO 30 W	(1)	2000	30	410	170	D	30	2700	30	50	87	1	10	4008321916334
HALOGEN SPOT R50 ECO 46 W	(1)	2000	46	510	290	D	46	2700	30	50	87	1	10	4008321984982

E14 – 30° – 230V – folding box

HALOGEN SPOT R50 ECO 20 W	(1)	2000	20	510	90	D	20	2700	30	50	87	1	20	4008321984852
HALOGEN SPOT R50 ECO 30 W	(1)	2000	30	410	170	D	30	2700	30	50	87	1	20	4008321212115
HALOGEN SPOT R50 ECO 46 W	(1)	2000	46	510	290	D	46	2700	30	50	87	1	20	4008321984869

¹ Corresponds to an average lifespan of 2,000 hours with daily operation of approx. 2.7 hours.

OSRAM CLASSIC ECO SUPERSTAR R63



Standard CLASSIC ECO SUPERSTAR

40 W → 30 W

60 W → 46 W



Direct replacement for standard spot incandescent lamps in existing wattages with equally outstanding light quality.

Available in 30 and 46 W with E27 screw base and a life-span of up to 2 years¹.

Item name No. t [h] W cd lm kWh/1000h K ° d [mm] l [mm] Order code (EAN)

E27 – 30° – 230 V – blister

HALOGEN SPOT R63 ECO 30 W	(1)	2000	30	410	180	D	30	2700	30	63	105	1	10	4008321984999
HALOGEN SPOT R63 ECO 46 W	(1)	2000	46	765	300	D	46	2700	30	63	105	1	10	4008321916358

E27 – 30° – 230 V – folding box

HALOGEN SPOT R63 ECO 30 W	(1)	2000	30	410	180	D	30	2700	30	63	105	1	20	4008321670953
HALOGEN SPOT R63 ECO 46 W	(1)	2000	46	765	300	D	46	2700	30	63	105	1	20	4008321212139

¹ Corresponds to an average lifespan of 2,000 hours with daily operation of approx. 2.7 hours.



OSRAM CLASSIC ECO SUPERSTAR R80



Standard	CLASSIC ECO SUPERSTAR
60W	→ 46W
75W	→ 57W
100W	→ 77W



Halogen lamps

Direct replacement for standard spot incandescent lamps in existing wattages with equally outstanding light quality.

Available in 46, 57 and 77 W with E27 screw base and a lifespan of up to 2 years¹.

Item name														Order code (EAN)
-----------	--	--	--	--	--	--	--	--	--	--	--	--	--	------------------

E27 – 50° – 230V – blister

HALOGEN SPOT R80 ECO 46 W	(1)	2000	46	—	300	D	46	2700	30	80	116	1	10	4052899054455
HALOGEN SPOT R80 ECO 57 W	(1)	2000	57	—	370	D	57	2800	30	80	116	1	10	4052899054493
HALOGEN SPOT R80 ECO 77 W	(1)	2000	77	—	580	D	77	2800	30	80	116	1	10	4052899054530

E27 – 50° – 230V – folding box

HALOGEN SPOT R80 ECO 46 W	(1)	2000	46	—	300	D	46	2700	30	80	116	1	20	4052899054431
HALOGEN SPOT R80 ECO 57 W	(1)	2000	57	—	370	D	57	2800	30	80	116	1	20	4052899054479
HALOGEN SPOT R80 ECO 77 W	(1)	2000	77	—	580	D	77	2800	30	80	116	1	20	4052899054516

¹ Corresponds to an average lifespan of 2,000 hours with daily operation of approx. 2.7 hours.

OSRAM HALOLINE® ECO SUPERSTAR



Standard		HALOGEN ECO SUPERSTAR
60W	→	48W
100W	→	80W
150W	→	120W
200W	→	160W
300W	→	230W
500W	→	400W



Slim tubular halogen lamp with light as brilliant as conventional standard halogen lamps, for direct 1:1 replacement.

Available from 48 to 400 W with R7s base and a lifespan of up to 2 years¹.

Item name	No.	t [h]	W	lm		kWh/1000h	K	d [mm]	l [mm]			Order code (EAN)
-----------	-----	-------	---	----	--	-----------	---	--------	--------	--	--	------------------

R7s – 74.9 mm – 230V – blister

HALOLINE ECO SUPERSTAR 48 W	(1)	2000	48	750	C	48	2800	12	75	1	10	4008321977571
HALOLINE ECO SUPERSTAR 80 W	(1)	2000	80	1400	D	80	2950	12	75	1	10	4008321928955
HALOLINE ECO SUPERSTAR 120 W	(1)	2000	120	2250	C	120	2950	12	75	1	10	4008321928931

R7s – 114.2 mm – 230V – blister

HALOLINE ECO SUPERSTAR 120 W	(2)	2000	120	2250	D	120	2900	12	115	1	10	4008321977656
HALOLINE ECO SUPERSTAR 160 W	(2)	2000	160	3100	C	160	2900	12	115	1	10	4008321977731
HALOLINE ECO SUPERSTAR 230 W	(2)	2000	230	5000	C	230	2950	12	115	1	10	4008321202673
HALOLINE ECO SUPERSTAR 400 W	(2)	2000	400	9000	C	400	3000	12	115	1	10	4008321202697

¹ Corresponds to an average lifespan of 2,000 hours with daily operation of approx. 2.7 hours.

OSRAM HALOPIN® ECO SUPERSTAR

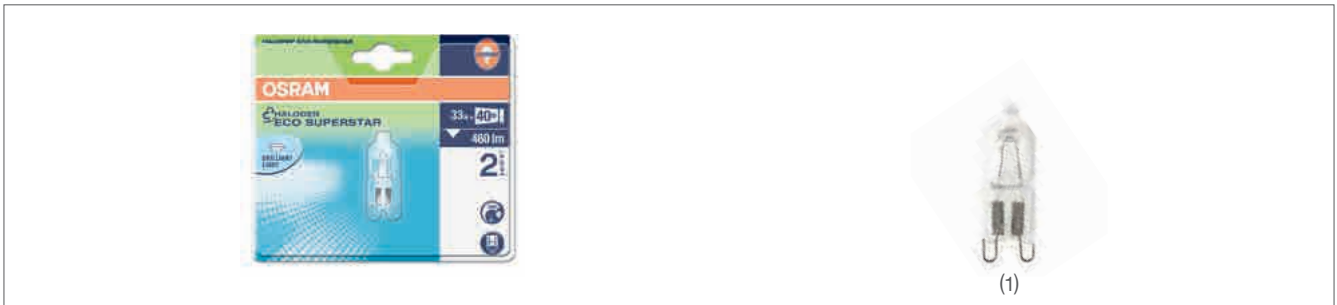

Standard		HALOGEN ECO SUPERSTAR
25 W	→	20 W
40 W	→	33 W
60 W	→	48 W



Compact halogen lamp that generates light as brilliant as that provided by conventional standard halogen lamps, suitable for direct 1:1 replacement. For modern luminaires

without protective cover in compliance with IEC 60598. Available in 20, 33 and 48 W with G9 base and a lifespan of up to 2 years¹.

Item name	No.	t [h]	W	lm	Base	kWh/1000h	K	d [mm]	l [mm]	h [mm]	Order code (EAN)
-----------	-----	-------	---	----	------	-----------	---	--------	--------	--------	------------------

G9 – clear – 230V – blister

HALOPIN ECO SUPERSTAR 20 W	(1)	2000	20	235	D	20	2700	14	43	1	10	4008321945136
HALOPIN ECO SUPERSTAR 33 W	(1)	2000	33	460	D	33	2700	14	43	1	10	4008321204547
HALOPIN ECO SUPERSTAR 48 W	(1)	2000	48	740	D	48	2800	14	43	1	10	4008321945198

¹ Corresponds to an average lifespan of 2,000 hours with daily operation of approx. 2.7 hours.

OSRAM HALOPIN® oven lamp

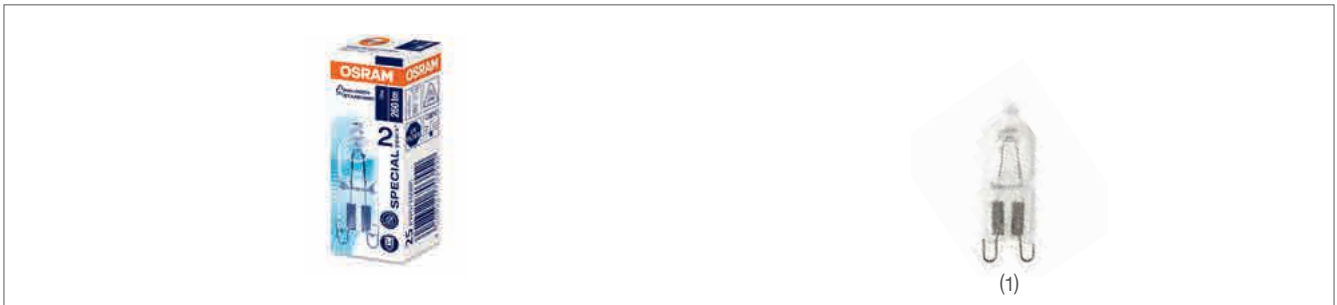

Compact dimensions make this the ideal lamp for use in ovens.

Item name	No.	t [h] ¹	W	lm	□	□	K	d [mm]	l [mm]	□	□	Order code (EAN)
G9 – clear – 230 V – folding box												
HALOPIN oven 25 W	(1)	2000	25	260	D	25	2700	14	43	1	20	4008321703552
HALOPIN oven 40 W	(1)	2000	40	490	D	40	2700	14	43	1	20	4008321703576

¹ Average lifespan at room temperature, higher temperatures may reduce average lifespan

OSRAM DECOPIN® STAR

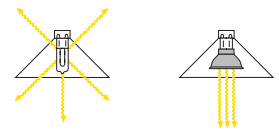
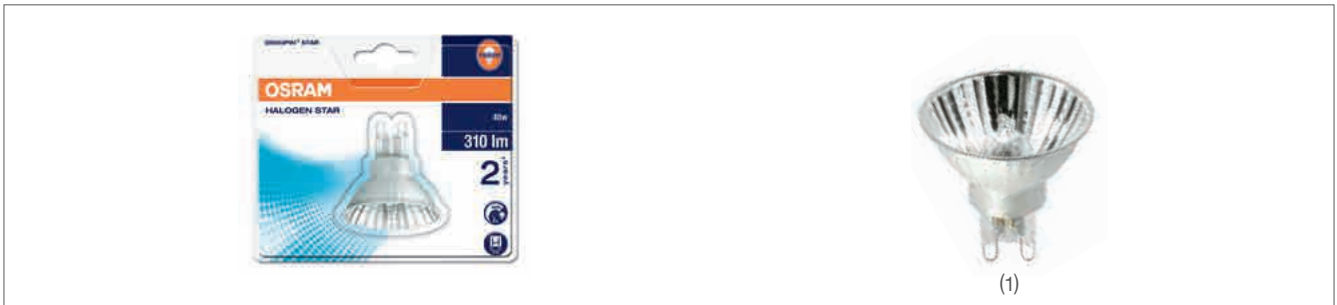

Extremely compact high voltage reflector lamp. Available in 40 W with G9 base and a lifespan of up to 2 years¹.

Item name	No.	t [h]	W	cd	lm	D	kWh/1000 h	K	°	d (mm)	l (mm)	Quantity	Order code (EAN)
G9 – 40° – 220–240 V – blister													
DECOPIN STAR 40 W	(1)	2000	40	550	310	D	40	2700	40	41,5	43	1	10 4008321202260

¹ Corresponds to an average lifespan of 2,000 hours with daily operation of approx. 2.7 hours.

OSRAM HALOPAR® 16 ECO SUPERSTAR



Standard HALOGEN ECO SUPERSTAR

35W → 30W

50W → 42W



Attractive reflector lamp that generates light as brilliant as that provided by conventional standard halogen lamps, suitable for direct 1:1 replacement. Available in 30 and 42 W with GU10 base and a lifespan of up to 2 years¹.

Item name



Order code (EAN)

GU10 – 30° – 230V – blister

HALOPAR 16 ECO SUPERSTAR 28 W	(1)	2000	30	570	200	D	30	2800	30	51	55	1	10	4008321929037
HALOPAR 16 ECO SUPERSTAR 40 W	(1)	2000	42	900	300	D	42	2800	30	51	53	1	10	4008321204356

¹ Corresponds to an average lifespan of 2,000 hours with daily operation of approx. 2.7 hours.

OSRAM HALOPAR® 16 ECO STAR

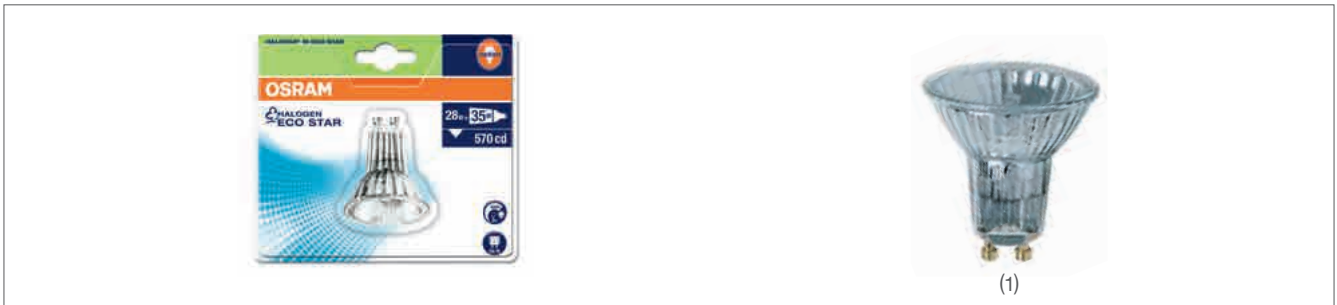

Standard HALOGEN ECO STAR

35W → 28W

50W → 40W



Reflector lamp with a lifespan of up to 1 year¹. Available in 28 and 40W with GU10 base.

Item name No. t [h] W cd lm kWh/1000h K d [mm] l [mm] Order code (EAN)

GU10 – 30° – 230V – blister

HALOPAR 16 ECO STAR 28 W ²	(1)	1000	28	570	200	D	28	2700	30	51	55	1	10	4008321997661
HALOPAR 16 ECO STAR 40 W ²	(1)	1000	40	900	300	D	40	2700	30	51	55	1	10	4008321997685

¹ Corresponds to an average lifespan of 1,000 hours with daily operation of approx. 2.7 hours.

² Phase-out September 2014. Find more information in this catalog on pages 8–11 or at www.osram.com/erp

OSRAM HALOPAR® 16 STAR



Available from 20 to 50W with GU10 base and a lifespan of up to one year¹ or in 40W with E14 screw base and a lifespan of up to 2 years¹.

Item name



Order code (EAN)

E14 – aluminum – 35° – 230V – twin blister

HALOPAR 16 STAR 40 W ²	(1)	1000	40	650	250	D	40	2800	35	51	73	2	20	4008321200501
-----------------------------------	-----	------	----	-----	-----	---	----	------	----	----	----	---	----	---------------

GU10 – aluminum – 35° – 230V – twin blister

HALOPAR 16 STAR 20 W ²	(2)	1000	20	230	80	D	20	2700	35	51	53	2	20	4008321202246
HALOPAR 16 STAR 35 W ²	(2)	1000	35	450	230	D	35	2700	30	51	58	2	20	4008321200365
HALOPAR 16 STAR 50 W ²	(2)	1000	50	650	300	D	50	2800	35	51	58	2	20	4008321200426

¹ Corresponds to an average lifespan of 1,000 hours with daily operation of approx. 2.7 hours.

² Phase-out September 2014. Find more information in this catalog on pages 8–11 or at www.osram.com/erp. Successor with 2,000 hours in development

OSRAM HALOPAR® 20 STAR

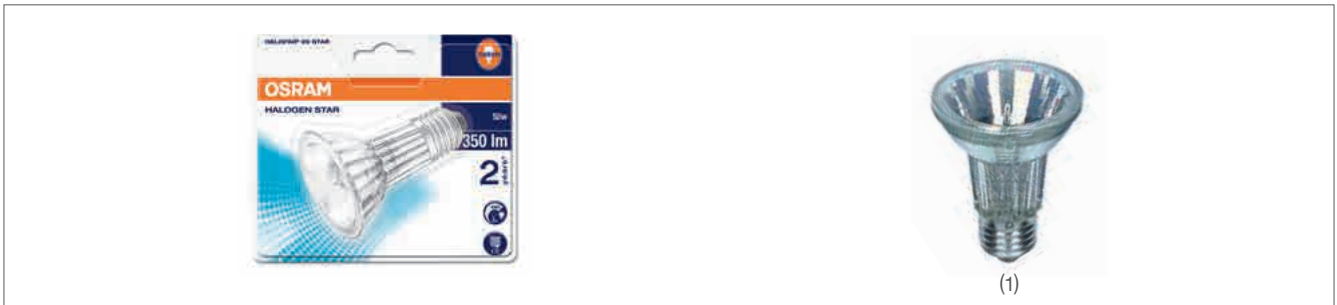

Reflector lamp with a lifespan of up to 2 years¹. Available in 50 W with E27 base.

Item name



E27 – 30° – 230 V – blister

HALOPAR 20 STAR 50 W	(1)	2000	50	1000	350	D	50	2800	30	64,5	90	1	10	4008321200242
----------------------	-----	------	----	------	-----	---	----	------	----	------	----	---	----	---------------

OSRAM HALOPAR® 30 STAR

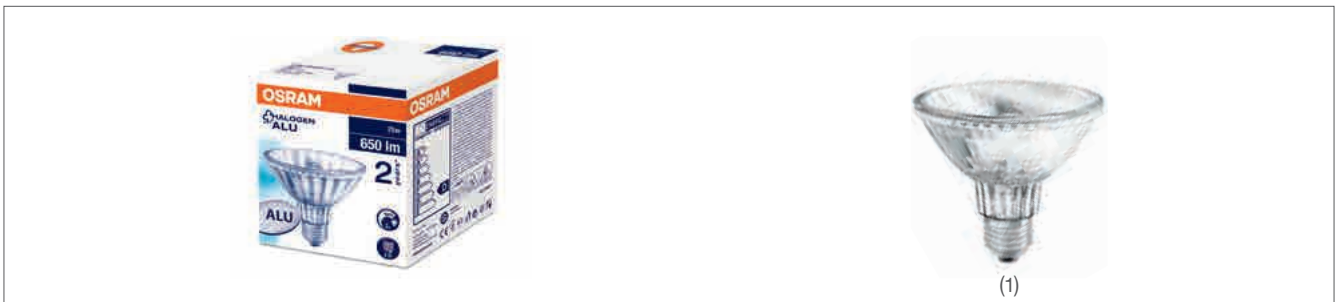

Reflector lamp with a lifespan of up to 2 years¹. Available in 75 W with E27 base.

Item name



E27 – 30° – 230 V – folding box

HALOPAR 30 STAR 75 W	(1)	2000	75	2200	650	D	75	2900	30	97	91	1	15	4050300338484
----------------------	-----	------	----	------	-----	---	----	------	----	----	----	---	----	---------------

¹ Corresponds to an average lifespan of 2,000 hours with daily operation of approx. 2.7 hours.

OSRAM HALOPAR® 38 FLOOD

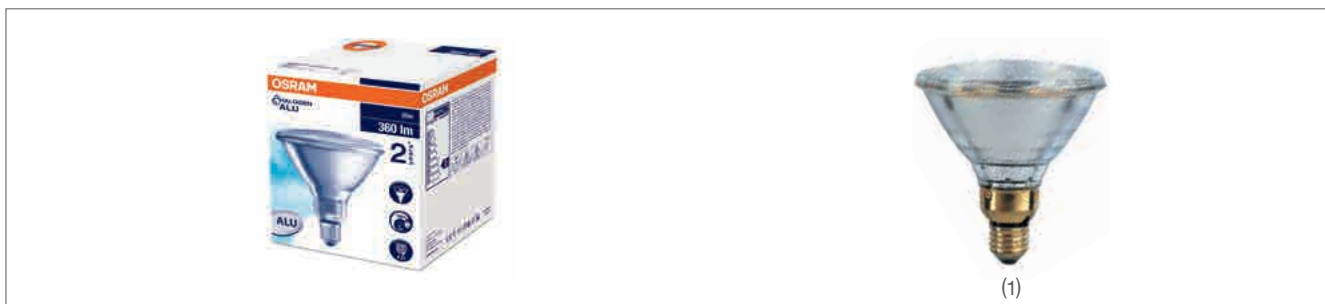

Direct replacement for standard PAR 38 FLOOD spotlight lamps with equally outstanding light quality. Available in

50, 75 and 100 W with E27 screw base and a lifespan of up to 2 years¹.

Item name



Order code (EAN)

E27 – 30° – 220–240V – folding box

Item name	No.	t [h]	W	cd	lm	Beam angle	kWh/1000h	K	Beam angle	d [mm]	h [mm]	Height	Width	Order code (EAN)
HALOPAR38 50 W FLOOD	(1)	2000	50	1200	360	D	50	2700	30	123	139	1	12	4008321380364
HALOPAR38 75 W FLOOD	(1)	2000	75	2400	550	D	75	2800	30	123	139	1	12	4008321380340
HALOPAR38 100 W FLOOD	(1)	2000	100	3100	900	D	100	2900	30	123	134	1	12	4008321372062

OSRAM HALOPAR® 38 SPOT

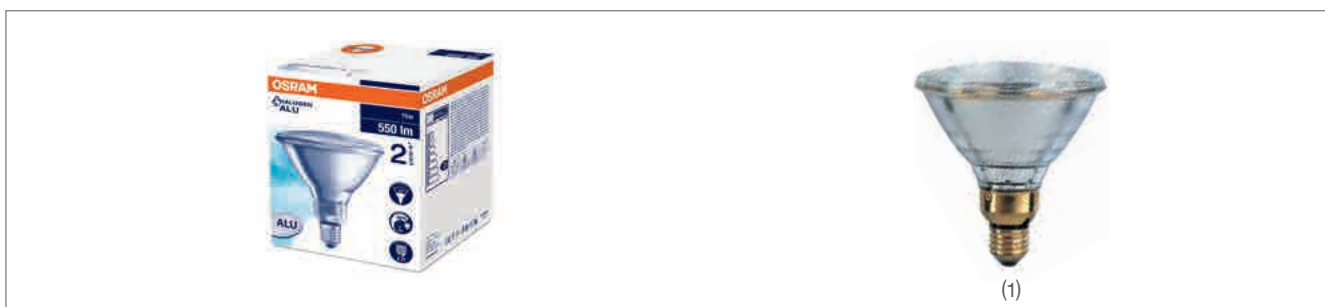

Direct replacement for standard PAR 38 SPOT spotlight lamps with equally outstanding light quality. Available in

75 W with E27 screw base and a lifespan of up to 2 years¹.

Item name



Order code (EAN)

E27 – 12° – 240V – folding box

Item name	No.	t [h]	W	cd	lm	Beam angle	kWh/1000h	K	Beam angle	d [mm]	h [mm]	Height	Width	Order code (EAN)
HALOPAR38 75 W SPOT	(1)	2000	75	7200	550	D	75	2800	12	123	139	1	12	4008321380401

¹ Corresponds to an average lifespan of 2,000 hours with daily operation of approx. 2.7 hours.

OSRAM DECOSTAR® 35 ECO STAR



Standard HALOGEN ECO STAR

20W → 14W

35W → 25W



Halogen lamps

Reflector lamp with a lifespan of up to 2 years¹. Available in 14 and 25 W with GU4 pin base.

Item name													Order code (EAN)	
GU4 – WFL – 36° – 12V – blister														
DECOSTAR 35 ECO STAR 14W	(1)	2000	14	400	160	B	15	2800	36	35	40	1	10	4008321997623
DECOSTAR 35 ECO STAR 25 W	(1)	2000	25	1000	340	B	27	2900	36	35	40	1	10	4008321997647

¹ Corresponds to an average lifespan of 2,000 hours with daily operation of approx. 2.7 hours.

OSRAM DECOSTAR® 35 STAR

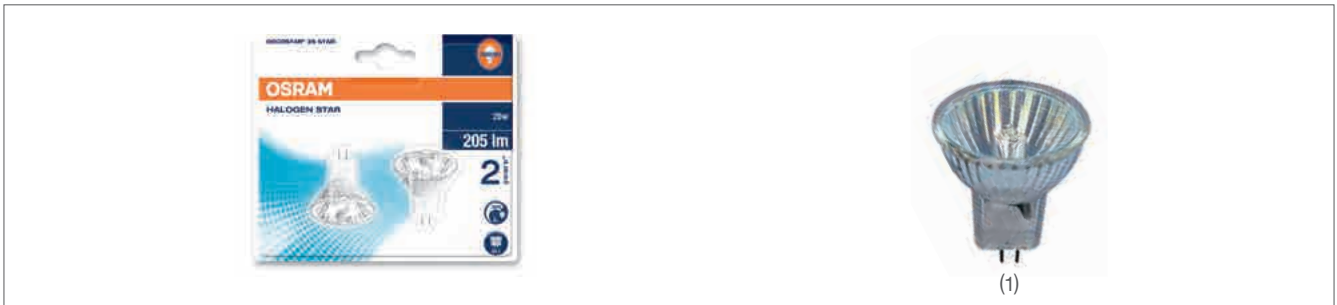

Reflector lamp with a lifespan of up to 2 years¹. Available in 20 and 35 W with GU4 pin base.

Item name



Order code (EAN)







GU4 – WFL – 36° – 12V – twin blister

DECOSTAR 35 STAR 20 W	(1)	2000	20	580	205	B	22	2800	36	35	42	2	20	4008321200266
DECOSTAR 35 STAR 35 W	(1)	2000	35	1000	430	B	38	2900	36	35	42	2	20	4008321200303

¹ Corresponds to an average lifespan of 2,000 hours with daily operation of approx. 2.7 hours.

OSRAM DECOSTAR® 51 ECO SUPERSTAR



Standard	HALOGEN ECO SUPERSTAR
20 W  → 14 W 	
35 W  → 25 W 	
50 W  → 35 W 	



Reflector lamp that generates strong accentuated light as brilliant as that provided by conventional standard halogen lamps, suitable for direct 1:1 replacement. Available in 14,

25 and 35 W with GU5.3 pin base and a lifespan of up to 4 years¹.

Item name	 No.	 t [h]	 W	 cd	 lm		 kWh/1000 h	 K		 d [mm]	 l [mm]			Order code (EAN)
-----------	---	---	---	--	--	---	--	---	---	--	--	---	---	------------------

GU5.3 – WFL – 36° – 12V – blister

DECOSTAR 51 ECO SUPERSTAR 14 W	(1)	4000	14	480	180	B	15	2800	36	51	45	1	10	4008321931863
DECOSTAR 51 ECO SUPERSTAR 25 W	(1)	4000	25	1000	370	B	27	2900	36	51	45	1	10	4008321202734
DECOSTAR 51 ECO SUPERSTAR 35 W	(1)	4000	35	1450	550	B	38	3000	36	51	45	1	10	4008321202710

¹ Corresponds to an average lifespan of 4,000 hours with daily operation of approx. 2.7 hours.

OSRAM DECOSTAR® 51 ECO STAR



Standard HALOGEN ECO STAR

20 W  → 14 W 

35 W  → 25 W 

50 W  → 35 W 



Reflector lamp with a lifespan of up to 2 years¹. Available in 14, 25 and 35 W with GU5.3 pin base.

Item name



Order code (EAN)

GU5.3 – WFL – 36° – 12V – blister

Item name	No.	t [h]	W	cd	lm	Beam angle	kWh/1000h	K	Beam angle	d [mm]	l [mm]	Height	Width	Order code (EAN)
DECOSTAR 51 ECO STAR 14 W	(1)	2000	14	380	180	B	15	2800	36	51	46	1	10	4008321990242
DECOSTAR 51 ECO STAR 25 W	(1)	2000	25	800	340	B	27	3000	36	51	46	1	10	4008321990266
DECOSTAR 51 ECO STAR 35 W	(1)	2000	35	1150	540	B	38	3000	36	51	46	1	10	4008321997609

¹ Corresponds to an average lifespan of 2,000 hours with daily operation of approx. 2.7 hours.

OSRAM DECOSTAR® 51 STAR

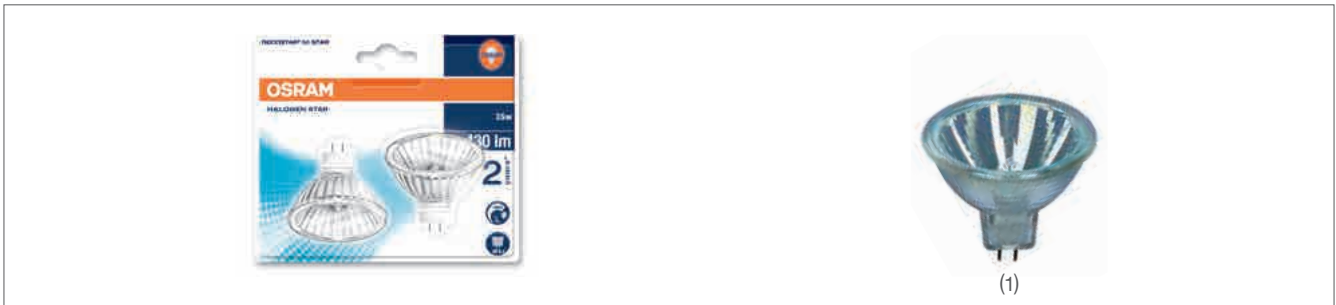

Reflector lamp with a lifespan of up to 2 years¹. Available in 20, 35 and 50 W with GU5.3 pin base and different light emission angles.

Item name



GU5.3 – SP – 10° – 12V – twin blister

Item name	No.	t [h]	W	cd	lm	Beam	kWh/1000 h	K	Beam angle	d [mm]	l [mm]	Base	Order code (EAN)	
DECOSTAR 51 STAR 20 W	(1)	2000	20	3000	210	B	22	2800	10	51	45	2	20	4008321200464
DECOSTAR 51 STAR 35 W	(1)	2000	35	6200	430	B	38	2900	10	51	46	2	20	4008321200488
DECOSTAR 51 STAR 50 W	(1)	2000	50	9000	680	B	53	3000	10	51	46	2	20	4008321200525

GU5.3 – WFL – 36° – 12V – twin blister

Item name	No.	t [h]	W	cd	lm	Beam	kWh/1000 h	K	Beam angle	d [mm]	l [mm]	Base	Order code (EAN)	
DECOSTAR 51 STAR 20 W	(1)	2000	20	480	210	B	22	3000	36	51	45	2	20	4008321200389
DECOSTAR 51 STAR 35 W	(1)	2000	35	1000	430	B	38	2900	36	51	46	2	20	4008321200402
DECOSTAR 51 STAR 50 W	(1)	2000	50	1450	680	B	53	2950	36	51	46	2	20	4008321200440

¹ Corresponds to an average lifespan of 2,000 hours with daily operation of approx. 2.7 hours.

OSRAM HALOSPOT® 111 ECO SUPERSTAR

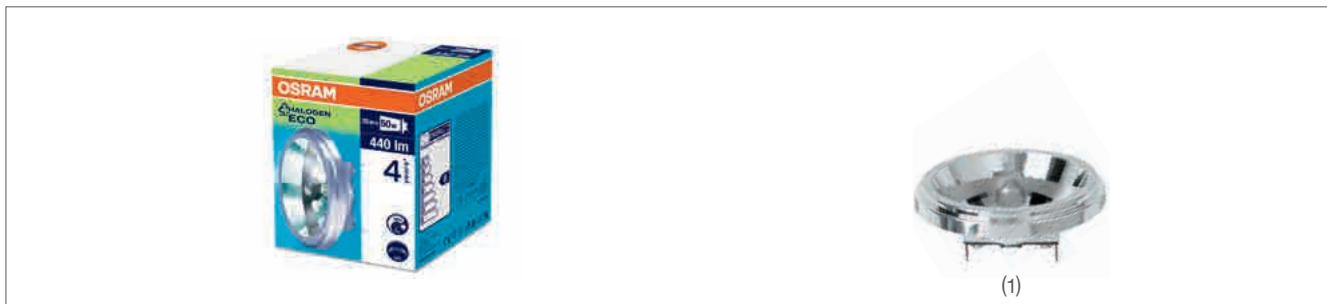

Standard HALOGEN ECO SUPERSTAR

50W  → 35W 

**HALOGEN
ECO**



Powerful lighting package that generates light as brilliant as that provided by conventional standard halogen lamps,

suitable for direct 1:1 replacement. Available in 35 W with G53 pin base and a lifespan of up to 4 years¹.

Item name



Order code (EAN)

G53 – FL – 24° – 12V – folding box

HALOSPOT 111 ECO SUPERSTAR 35 W (1) 4000 35 4200 440 B 38 2900 24 111 58 1 6 4008321201201

¹ Corresponds to an average lifespan of 4,000 hours with daily operation of approx. 2.7 hours.

OSRAM HALOSTAR® ECO SUPERSTAR

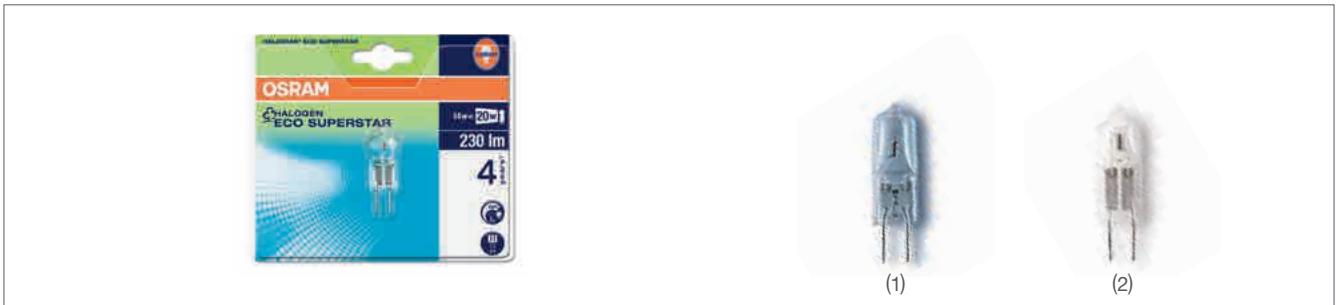

Standard		HALOGEN ECO SUPERSTAR
10 W	→	7 W
20 W	→	14 W
35 W	→	25 W
50 W	→	35 W



Halogen lamps

Almost point-shaped light source that generates light as brilliant as standard halogen lamps, suitable for direct 1:1 replacement. Available in 25 and 35 W with GY6.35 pin

base, in 7 and 14 W with G4 base and with a lifespan of up to 4 years¹.

Item name	No.	t [h]	W	lm	E-41	kWh/1000h	K	d [mm]	l [mm]	Order code (EAN)
-----------	-----	-------	---	----	------	-----------	---	--------	--------	------------------

G4 – clear – 12V – blister

HALOSTAR ECO SUPERSTAR 7 W	(1)	4000	7	95	C	8	2700	10	33	1	10	4008321963208
HALOSTAR ECO SUPERSTAR 14 W	(1)	4000	14	230	C	15	2800	10	33	1	10	4008321932655









GY6.35 – clear – 12V – blister

HALOSTAR ECO SUPERSTAR 25 W	(2)	4000	25	440	C	27	2900	12	44	1	10	4008321204387
HALOSTAR ECO SUPERSTAR 35 W	(2)	4000	35	670	C	38	3000	12	44	1	10	4008321204400

¹ Corresponds to an average lifespan of 4,000 hours with daily operation of approx. 2.7 hours.

OSRAM HALOSTAR® ECO STAR



Standard	HALOGEN ECO STAR
10W 	→ 7W 
20W 	→ 14W 
35W 	→ 25W 
50W 	→ 35W 



Lamp with point-based light and a lifespan of up to 2 years¹. Available in 25 and 35W with GY6.35 pin

base and 7 and 14 W with G4 base.

Item name	 No.	 t [h]	 W	 lm	 E [lm/W]	 kWh/1000h	 K	 d [mm]	 l [mm]		 Order code (EAN)
-----------	---	---	---	--	--	---	---	--	--	---	--

G4 – clear – 12V – blister

HALOSTAR ECO STAR 7 W	(1)	2000	7	95	C	8	2700	9	33	1	10	4008321990167
HALOSTAR ECO STAR 14 W	(1)	2000	14	230	C	15	2700	9	33	1	10	4008321990181

GY6.35 – clear – 12V – blister

HALOSTAR ECO STAR 25 W	(2)	2000	25	440	C	27	2700	11	44	1	10	4008321990204
HALOSTAR ECO STAR 35 W	(2)	2000	35	670	C	38	2700	11	44	1	10	4008321990228

¹ Corresponds to an average lifespan of 2,000 hours with daily operation of approx. 2.7 hours.

OSRAM HALOSTAR® STAR

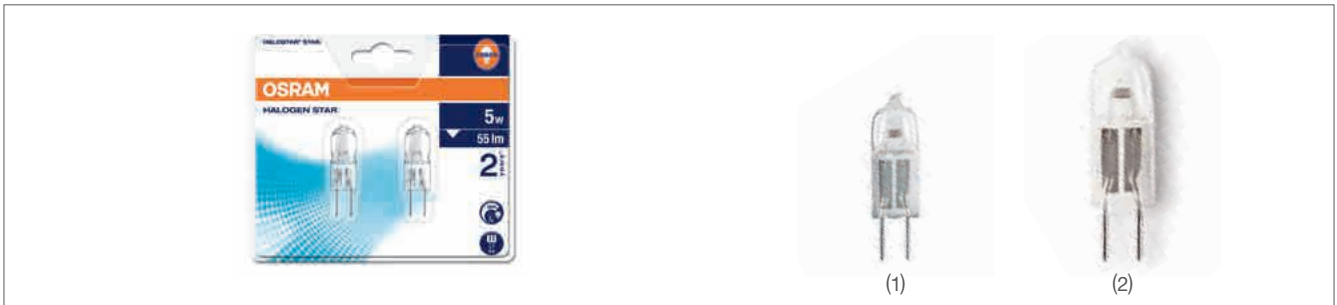

Lamp with point-based light and a lifespan of up to 2 years¹.
Available in 5 to 50 W with G4 or GY6.35 pin base.

Item name

Order code
(EAN)

G4 – clear – 12V – Duo-blister

Item name	No.	t [h]	W	lm	B	kWh/1000h	K	d [mm]	l [mm]	h [mm]	V [mm³]	Order code (EAN)
HALOSTAR STAR 5 W	(1)	2000	5	55	B	6	2700	10	33	2	20	4008321201799
HALOSTAR STAR 10 W	(1)	2000	10	140	C	11	2800	10	33	2	20	4008321201812
HALOSTAR STAR 20 W	(1)	2000	20	320	C	22	2800	10	33	2	20	4008321201836

GY6.35 – clear – 12V – Duo-blister

HALOSTAR STAR 35 W	(2)	2000	35	600	C	38	2900	12	44	2	20	4008321201874
HALOSTAR STAR 50 W	(2)	2000	50	910	C	53	3000	12	44	2	20	4008321202161

¹ Corresponds to an average lifespan of 2,000 hours with daily operation of approx. 2.7 hours.

OSRAM HALOSTAR® oven lamp

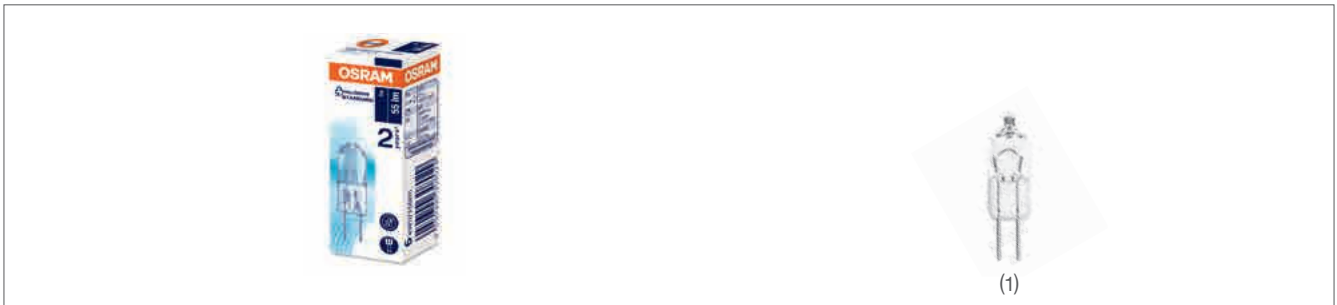

Compact dimensions make this the ideal lamp for use in ovens.

Item name



Order code (EAN)

G4 – clear – 12V – folding box

Item name	No.	t [h] ¹	W	lm	E	kWh/1000h	K	d [mm]	l [mm]	mm	mm	Order code (EAN)
HALOSTAR oven 5 W	(1)	1000	5	60	C	6	2700	10	31	1	40	4050300308029
HALOSTAR oven 10 W	(1)	2000	10	140	C	11	2800	10	31	1	40	4050300308081
HALOSTAR oven 20 W	(1)	2000	20	320	C	22	2800	12	31	1	40	4050300308050

¹ Average lifespan at room temperature, higher temperatures may reduce average lifespan





Compact fluorescent lamps

Economy, quality of light, convenience: The innovative OSRAM compact fluorescent lamps prove their worth across the board and are much more than simply a replacement for standard incandescent lamps. And the best thing is: Thanks to the wide OSRAM product range, your customers will be able to find the right lamp for the most challenging requirements, luminaires and applications.

Compact fluorescent lamps with standard bulb shape 86



Compact fluorescent lamps with spiral shape and ring shape 92



Compact fluorescent lamps with stick shape 99



Intelligent compact fluorescent lamps 103



Compact fluorescent lamps with pin base 106



Compact fluorescent lamps

Wide variety – simple choice

All of OSRAM’s compact fluorescent lamps have two things in common: High energy savings and high product quality. In addition, the range is enormous – from Micro Twist to Globe, from Warm Comfort Light to Cool Daylight, from 5 to 30 Watts. Thanks to clear segmentation, your customers will still be able to find the right lamp quickly.



OSRAM DULUX® SUPERSTAR – innovative performance characteristics and long lifespan

- Average lamp lifespan of up to 10 years¹
- 3-year guarantee²
- Selected types with Quick light technology
- With Warm Comfort Light

OSRAM DULUXSTAR® – high quality at a favorable price

- Average lamp lifespan of 6 years¹
- In many shapes and wattages, light colors and base variants

OSRAM DULUX® SUPERSTAR – intelligent all-rounder for special tasks

- All-rounders like SENSOR, DIM or FACILITY
- Rapid luminous flux ramp-up thanks to Quick light technology
- Average lamp lifespan of up to 20 years¹



OSRAM DULUX® lamps with Quick light achieve their full output twice as quickly as conventional energy-saving lamps.



Lamps with this symbol can withstand frequent on/off switching and are suitable for lighting installations with motion sensors or automatic power-off function.



Lamps with this symbol switch on automatically when it gets dark and switch off again in daylight.



Lamps with this symbol can be continuously dimmed (from 7% to 100%) after switching on.

¹ Corresponds to an average lifespan of 6,000/10,000/20,000 hrs with daily operation of approx. 2.7 hrs.
² Detailed guarantee conditions at www.osram.com/guarantee



**OSRAM compact fluorescent lamps:
Strong arguments to counter outdated views**

Energy saving lamps don't have a good reputation. Unjustified: OSRAM's modern compact fluorescent lamps easily refute the repeated criticism leveled at this technology group.

“Compact fluorescent lamps produce a cold light.”

OSRAM compact fluorescent lamps can generate any light that your customers wish to have, for example to create a warm light environment, the Warm Comfort Light, which looks similar to a standard bulb.

“Compact fluorescent lamps take a long time to reach their full brightness.”

Thanks to the new QUICK light technology, many OSRAM DULUX® SUPERSTAR lamps now shine brightly in an instant.

“Compact fluorescent lamps are large, are strangely shaped, and don't fit every luminaire.”

Small, large, stylish or designed to look like a standard bulb – OSRAM compact fluorescent lamps are available in all shapes and sizes. The latest example: OSRAM DULUXSTAR® Mini Twist and OSRAM DULUX® SUPERSTAR Micro Twist are now even more compact and attractive, thanks to the optimized spiral design.

“Compact fluorescent lamps can't be dimmed.”

OSRAM DULUX® SUPERSTAR DIM can be continuously dimmed between 7 and 100%. They fit into virtually any luminaire that has a suitable incandescent lamp dimmer. For more information, see: www.osram.com/dim.

“Compact fluorescent lamps are difficult to dispose of.”

The compact fluorescent lamp has a very long lifespan, but if it should fail at some point, recycling it is really easy. OSRAM has established recycling systems in cooperation

with other manufacturers in Europe to dispose of compact fluorescent and LED lamps in an environmentally-friendly manner and in accordance with EU legislation. In Germany, this is done by Lightcycle GmbH. For more information, refer to: www.lightcycle.de or page 13 of this catalog.

“Compact fluorescent lamps are a health risk.”

OSRAM compact fluorescent lamps comply with international requirements and are well below the prescribed limit values, often even 100 times lower.

“Compact fluorescent lamps contain too much mercury.”







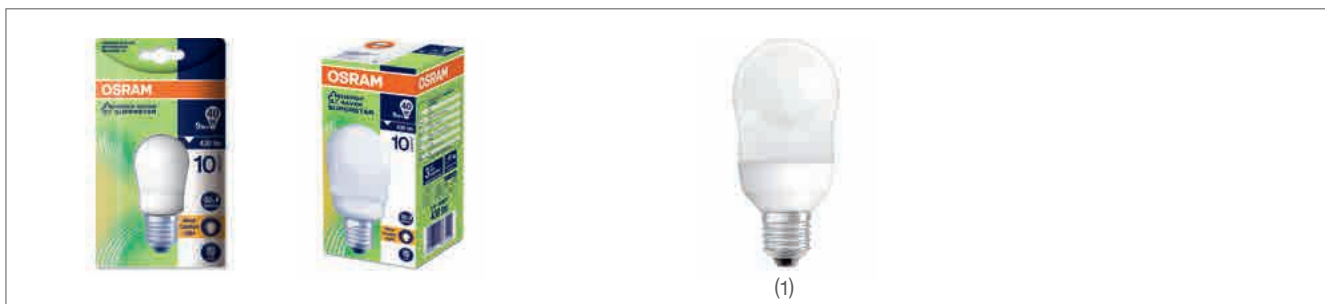

In OSRAM compact fluorescent lamps, the mercury content is considerably lower than specified by the EU Guideline RoHS. This small amount does not pose any appreciable threat to people or the environment and is not released during operation. For more information, go to: www.osram.com/mercury.



Lighting sets the mood and your customers have the choice: The range of light colors offered by OSRAM compact fluorescent lamps stretches from energizing, near-daylight Cool Daylight, through Cool White and Warm White/INTERNA up to the cozy Warm Comfort Light.

OSRAM DULUX® SUPERSTAR CLASSIC A



Standard	DULUX® SUPERSTAR	Electricity cost savings/year ¹
40W  → 9W 		8.68 €
60W  → 14W 		12.88 €
75W  → 17W 		16.24 €
100W  → 23W 		21.56 €



Lifespan up to 10 years² and 3-year guarantee³. Available from 9 to 23 W with screw base E27.

Item name	 No.	 t [h] ⁴	 W	 lm		 kWh/1000h		 K	 d max. [mm]	 l [mm]			Order code (EAN)
-----------	---	--	---	--	---	---	---	---	---	--	---	---	------------------

E27 – eco-blister

DULUX SUPERSTAR Classic A 9W	(1)	10000	9	430	A	9	Warm Comfort Light	2500	57	111	1	6	4008321667250
DULUX SUPERSTAR Classic A 14W	(1)	10000	14	740	A	14	Warm Comfort Light	2500	61	123	1	6	4008321655288
DULUX SUPERSTAR Classic A 17W	(1)	10000	17	970	A	17	Warm Comfort Light	2500	71	140	1	6	4008321687425
DULUX SUPERSTAR Classic A 23W	(1)	10000	23	1390	A	23	Warm Comfort Light	2500	80	158	1	6	4008321986429

E27 – folding box

DULUX SUPERSTAR Classic A 9W	(1)	10000	9	430	A	9	Warm Comfort Light	2500	57	111	1	10	4008321667229
DULUX SUPERSTAR Classic A 14W	(1)	10000	14	740	A	14	Warm Comfort Light	2500	61	123	1	10	4008321655264
DULUX SUPERSTAR Classic A 17W	(1)	10000	17	970	A	17	Warm Comfort Light	2500	71	140	1	10	4008321687401
DULUX SUPERSTAR Classic A 23W	(1)	10000	23	1390	A	23	Warm Comfort Light	2500	80	158	1	10	4008321986412

¹ Basis: Electricity costs 0.28 €/kWh and 1,000 hours operating time per year.

² Corresponds to an average lifespan of 10,000 hours with daily operation of approx. 2.7 hours.

³ In case of a fault, the lamp will be replaced, provided it was not used for commercial purposes.







www.osram.com/guarantee

⁴ Average lifespan



OSRAM DULUXSTAR® CLASSIC A



Standard	DULUXSTAR®	Electricity cost savings/year ¹
48 W 	→ 11 W 	10.36 €
65 W 	→ 15 W 	14.00 €
86 W 	→ 20 W 	18.48 €



Lifespan up to 6 years². Available from 11 to 20W with screw base E27.

Item name													Order code (EAN)
-----------	---	---	---	---	---	---	---	---	---	---	---	---	------------------

E27 – eco-blister

DULUXSTAR Classic A 11W	(1)	6000	11	550	A	11	Warm White	2700	57	117	1	6	4008321989802
DULUXSTAR Classic A 15W	(1)	6000	15	820	A	15	Warm White	2700	66	137	1	6	4008321989819
DULUXSTAR Classic A 20W	(1)	6000	20	1152	A	20	Warm White	2700	71	152	1	6	4008321989833

E27 – folding box





DULUXSTAR Classic A 11W	(1)	6000	11	550	A	11	Warm White	2700	57	117	1	10	4008321942593
DULUXSTAR Classic A 15W	(1)	6000	15	820	A	15	Warm White	2700	66	137	1	10	4008321942616
DULUXSTAR Classic A 20W	(1)	6000	20	1152	A	20	Warm White	2700	71	152	1	10	4008321954701

¹ Basis: Electricity costs 0.28 €/kWh and 1,000 hours operating time per year.
² Corresponds to an average lifespan of 6,000 hours with daily operation of approx. 2.7 hours.
³ Average lifespan

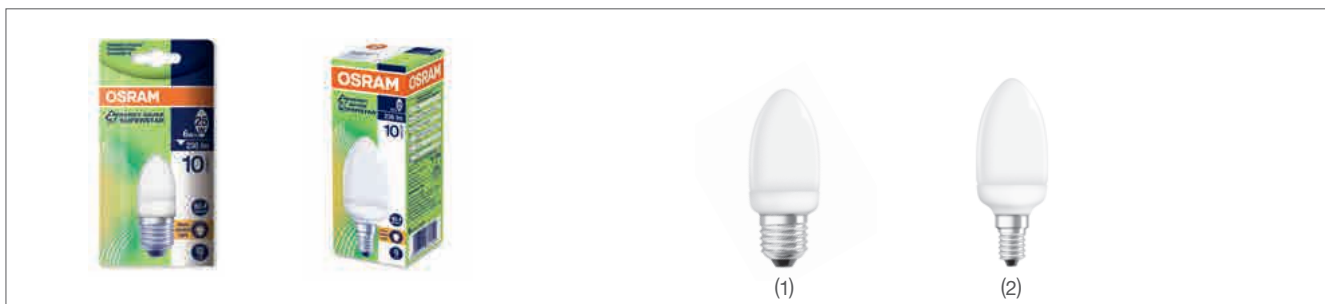

OSRAM DULUX® SUPERSTAR CLASSIC B



Standard	DULUX® SUPERSTAR	Electricity cost savings/year ¹
25 W 	→ 6 W 	5.32 €
40 W 	→ 9 W 	8.68 €



Lifespan up to 10 years² and 3-year guarantee³. Available in 6 W and 9 W with E27 and E14 screw base.

Item name													Order code (EAN)
-----------	---	---	---	---	---	---	---	---	---	---	---	---	------------------

E27 – eco-blister

DULUX SUPERSTAR Classic B 6W	(1)	10000	6	235	A	6	Warm Comfort Light	2500	37	95	1	8	4008321665775
DULUX SUPERSTAR Classic B 9W	(1)	10000	9	430	A	9	Warm Comfort Light	2500	42	109	1	10	4008321946652

E27 – folding box

DULUX SUPERSTAR Classic B 6W	(1)	10000	6	235	A	6	Warm Comfort Light	2500	37	95	1	10	4008321665713
DULUX SUPERSTAR Classic B 9W	(1)	10000	9	430	A	9	Warm Comfort Light	2500	42	109	1	10	4008321946645

E14 – eco-blister

DULUX SUPERSTAR Classic B 6W	(2)	10000	6	235	A	6	Warm Comfort Light	2500	37	98	1	8	4008321665805
DULUX SUPERSTAR Classic B 9W	(2)	10000	9	430	A	9	Warm Comfort Light	2500	42	110	1	10	4008321946638

E14 – folding box

DULUX SUPERSTAR Classic B 6W	(2)	10000	6	235	A	6	Warm Comfort Light	2500	37	98	1	10	4008321665744
DULUX SUPERSTAR Classic B 9W	(2)	10000	9	430	A	9	Warm Comfort Light	2500	42	110	1	10	4008321946621

¹ Basis: Electricity costs 0.28 €/kWh and 1,000 hours operating time per year.

² Corresponds to an average lifespan of 10,000 hours with daily operation of approx. 2.7 hours.

³ In case of a fault, the lamp will be replaced, provided it was not used for commercial purposes.





www.osram.com/guarantee

⁴ Average lifespan

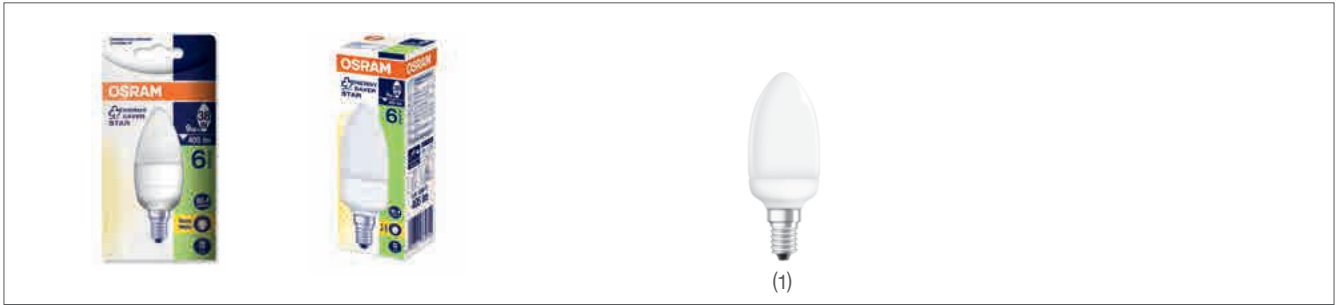

OSRAM DULUXSTAR® CLASSIC B



Standard	DULUXSTAR®	Electricity cost savings/year ¹
25 W 	→ 6 W 	5.32 €
40 W 	→ 9 W 	8.68 €



Lifespan up to 6 years². Available in 6 and 9 W with E27 screw base.

Item name													Order code (EAN)
-----------	---	---	---	---	---	---	---	---	---	---	---	---	------------------

E14 – eco-blister

DULUXSTAR Classic B 6W	(1)	6000	6	235	A	6	Warm White	2700	37	98	1	8	4052899011571
DULUXSTAR Classic B 9W	(1)	6000	9	430	A	9	Warm White	2700	42	110	1	10	4008321997845

E14 – folding box

DULUXSTAR Classic B 6W	(1)	6000	6	235	A	6	Warm White	2700	37	98	1	10	4052899011519
DULUXSTAR Classic B 9W	(1)	6000	9	430	A	9	Warm White	2700	42	110	1	10	4008321374899

¹ Basis: Electricity costs 0.28 €/kWh and 1,000 hours operating time per year.
² Corresponds to an average lifespan of 6,000 hours with daily operation of approx. 2.7 hours.
³ Average lifespan



OSRAM DULUX® SUPERSTAR CLASSIC P

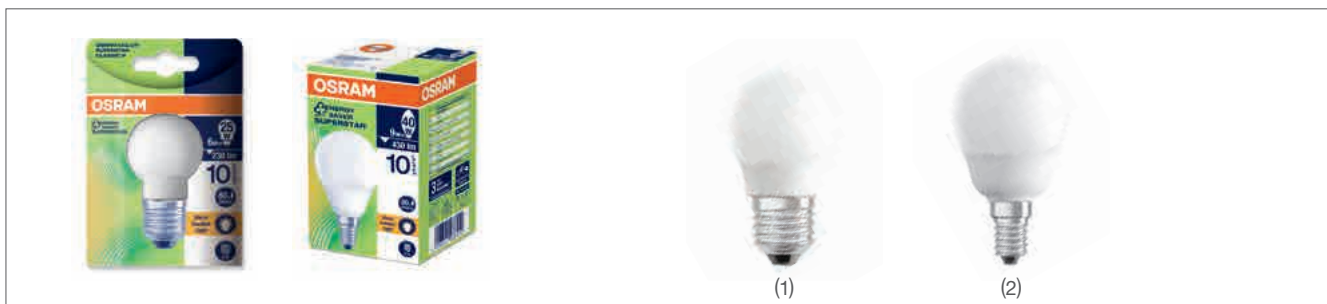

Standard	DULUX® SUPERSTAR	Electricity cost savings/year ¹
25 W	→ 6 W	5.32 €
40 W	→ 9 W	8.68 €



Lifespan up to 10 years² and 3-year guarantee³. Available in 6 W and 9 W with E27 and E14 screw base.

Item name													Order code (EAN)
-----------	--	--	--	--	--	--	--	--	--	--	--	--	------------------

E27 – eco-blister

DULUX SUPERSTAR Classic P 6W	(1)	10000	6	235	A	6	Warm Comfort Light	2500	46	82	1	8	4008321666345
DULUX SUPERSTAR Classic P 9W	(1)	10000	9	430	A	9	Warm Comfort Light	2500	56	98	1	8	4008321986467

E27 – folding box

DULUX SUPERSTAR Classic P 6W	(1)	10000	6	235	A	6	Warm Comfort Light	2500	46	82	1	10	4008321666307
DULUX SUPERSTAR Classic P 9W	(1)	10000	9	430	A	9	Warm Comfort Light	2500	56	98	1	10	4008321986443

E14 – eco-blister

DULUX SUPERSTAR Classic P 6W	(2)	10000	6	235	A	6	Warm Comfort Light	2500	46	85	1	8	4008321666321
DULUX SUPERSTAR Classic P 9W	(2)	10000	9	430	A	9	Warm Comfort Light	2500	56	100	1	8	4008321986450

E14 – folding box

DULUX SUPERSTAR Classic P 6W	(2)	10000	6	235	A	6	Warm Comfort Light	2500	46	85	1	10	4008321666321
DULUX SUPERSTAR Classic P 9W	(2)	10000	9	430	A	9	Warm Comfort Light	2500	56	100	1	10	4008321986450

¹ Basis: Electricity costs 0.28 €/kWh and 1,000 hours operating time per year.

² Corresponds to an average lifespan of 10,000 hours with daily operation of approx. 2.7 hours.

³ In case of a fault, the lamp will be replaced, provided it was not used for commercial purposes.





www.osram.com/guarantee

⁴ Average lifespan

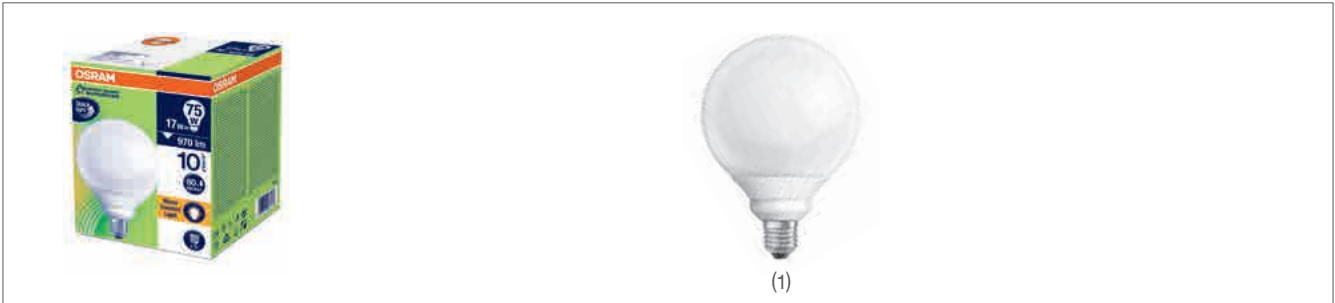













OSRAM DULUX® SUPERSTAR GLOBE



Standard	DULUX® SUPERSTAR	Electricity cost savings/year ¹
60 W  → 14 W 		12.88 €
75 W  → 17 W 		16.24 €



Lifespan up to 10 years² and 3-year guarantee³. Rapid luminous flux ramp-up thanks to Quick light technology. Available in 14 and 17 W with E27 screw base.

Item name	 No.	 t [h] ⁴	 W	 lm		 kWh/1000h		 K	 d max. [mm]	 l [mm]			Order code (EAN)
E27 – folding box													
DULUX SUPERSTAR Globe 14W	(1)	10000	14	740	A	14	Warm Comfort Light	2500	119	170	1	10	4008321943873
DULUX SUPERSTAR Globe 17W	(1)	10000	17	970	A	17	Warm Comfort Light	2500	119	170	1	10	4008321986436









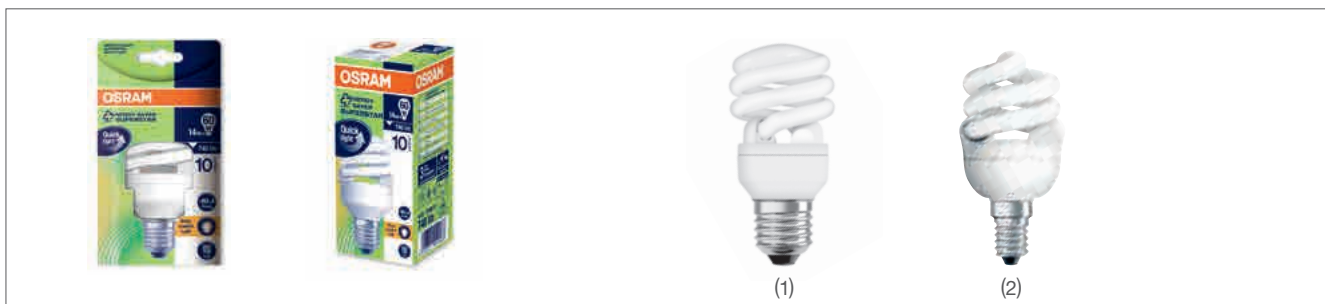

¹ Basis: Electricity costs 0.28 €/kWh and 1,000 hours operating time per year.
² Corresponds to an average lifespan of 10,000 hours with daily operation of approx. 2.7 hours.
³ In case of a fault, the lamp will be replaced, provided it was not used for commercial purposes.

www.osram.com/guarantee
⁴ Average lifespan



OSRAM DULUX® SUPERSTAR MICRO TWIST



Standard	DULUX® SUPERSTAR	Electricity cost savings/year ¹
40W 	→ 7W 	9.24 €
60W 	→ 12W 	13.44 €
75W 	→ 15W 	16.80 €
100W 	→ 21W 	22.12 €
115W 	→ 24W 	25.48 €



www.osram.com/guarantee

Lifespan up to 10 years² and 3-year guarantee³. Rapid luminous flux ramp-up thanks to Quick light technology.

Available from 7 to 24 W with E27 and E14 screw base. Choice of two different light colors.

Item name	 No.	 t [h] ⁴	 W	 lm		 kWh/1000h		 K	 d max. [mm]	 l [mm]			Order code (EAN)
-----------	---	--	---	--	---	---	---	---	---	--	---	---	------------------

E27 – eco-blister

DULUX SUPERSTAR Micro Twist 7W	(1)	10000	7	430	A	7	Warm Comfort Light	2500	43	89	1	8	4008321949196
DULUX SUPERSTAR Micro Twist 7W	(1)	10000	7	430	A	7	Cool White	4000	43	89	1	8	4008321954145
DULUX SUPERSTAR Micro Twist 12W	(1)	10000	12	740	A	12	Warm Comfort Light	2500	48	97	1	6	4008321949240
DULUX SUPERSTAR Micro Twist 12W	(1)	10000	12	740	A	12	Cool White	4000	48	97	1	6	4008321954329
DULUX SUPERSTAR Micro Twist 15W	(1)	10000	15	970	A	15	Warm Comfort Light	2500	48	103	1	6	4008321985798
DULUX SUPERSTAR Micro Twist 15W	(1)	10000	15	970	A	15	Cool White	4000	48	103	1	6	4008321985828
DULUX SUPERSTAR Micro Twist 21W	(1)	10000	21	1400	A	21	Warm Comfort Light	2500	57	109	1	6	4008321949288
DULUX SUPERSTAR Micro Twist 21W	(1)	10000	21	1400	A	21	Cool White	4000	57	109	1	6	4008321954404
DULUX SUPERSTAR Micro Twist 24W	(1)	10000	24	1650	A	24	Warm Comfort Light	2500	57	118	1	6	4052899912342
DULUX SUPERSTAR Micro Twist 24W	(1)	10000	24	1650	A	24	Cool White	4000	57	118	1	6	4052899912366

¹ Basis: Electricity costs 0.28 €/kWh and 1,000 hours operating time per year.

² Corresponds to an average lifespan of 10,000 hours with daily operation of approx. 2.7 hours.

³ In case of a fault, the lamp will be replaced, provided it was not used for commercial purposes.

www.osram.com/guarantee

⁴ Average lifespan



Item name	 No.	 t [h] ¹	 W	 lm		 kWh/1000h		 K	 d max. [mm]	 l [mm]			Order code (EAN)
-----------	---	--	---	--	---	---	---	---	---	--	---	---	------------------

E27 – folding box

DULUX SUPERSTAR Micro Twist 7W	(1)	10000	7	430	A	7	Warm Comfort Light	2500	43	89	1	10	4008321948953
DULUX SUPERSTAR Micro Twist 7W	(1)	10000	7	430	A	7	Cool White	4000	43	89	1	10	4008321948960
DULUX SUPERSTAR Micro Twist 12W	(1)	10000	12	740	A	12	Warm Comfort Light	2500	48	97	1	10	4008321949066
DULUX SUPERSTAR Micro Twist 12W	(1)	10000	12	740	A	12	Cool White	4000	48	97	1	10	4008321949073
DULUX SUPERSTAR Micro Twist 15W	(1)	10000	15	970	A	15	Warm Comfort Light	2500	48	103	1	10	4008321985774
DULUX SUPERSTAR Micro Twist 15W	(1)	10000	15	970	A	15	Cool White	4000	48	103	1	10	4008321985811
DULUX SUPERSTAR Micro Twist 21W	(1)	10000	21	1400	A	21	Warm Comfort Light	2500	57	109	1	10	4008321949141
DULUX SUPERSTAR Micro Twist 21W	(1)	10000	21	1400	A	21	Cool White	4000	57	109	1	10	4008321949158
DULUX SUPERSTAR Micro Twist 24W	(1)	10000	24	1650	A	24	Warm Comfort Light	2500	57	118	1	10	4052899912311
DULUX SUPERSTAR Micro Twist 24W	(1)	10000	24	1650	A	24	Cool White	4000	57	118	1	10	4052899912328

E14 – eco-blister

DULUX SUPERSTAR Micro Twist 7W	(2)	10000	7	430	A	7	Warm Comfort Light	2500	43	93	1	8	4008321949189
DULUX SUPERSTAR Micro Twist 7W	(2)	10000	7	430	A	7	Cool White	4000	43	93	1	8	4008321954084
DULUX SUPERSTAR Micro Twist 12W	(2)	10000	12	740	A	12	Warm Comfort Light	2500	48	97	1	6	4052899912298
DULUX SUPERSTAR Micro Twist 12W	(2)	10000	12	740	A	12	Cool White	4000	48	97	1	6	4052899912304

E14 – folding box

DULUX SUPERSTAR Micro Twist 7W	(2)	10000	7	430	A	7	Warm Comfort Light	2500	43	93	1	10	4008321948922
DULUX SUPERSTAR Micro Twist 7W	(2)	10000	7	430	A	7	Cool White	4000	43	93	1	10	4008321948939
DULUX SUPERSTAR Micro Twist 12W	(2)	10000	12	740	A	12	Warm Comfort Light	2500	48	97	1	10	4052899912274
DULUX SUPERSTAR Micro Twist 12W	(2)	10000	12	740	A	12	Cool White	4000	48	97	1	10	4052899912281

¹ Average lifespan

OSRAM DULUXSTAR® MINI TWIST

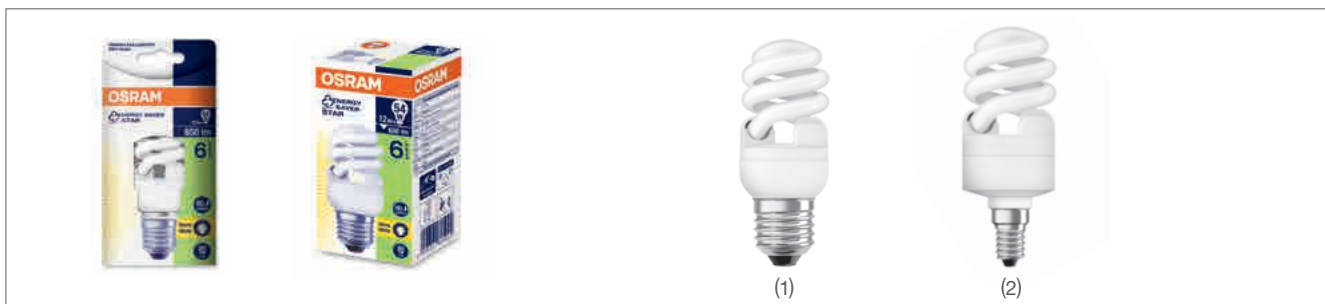

Standard	DULUXSTAR®	Electricity cost savings/year ¹
54W	→ 12W	11.76 €
70W	→ 15W	15.40 €
94W	→ 20W	20.72 €
112W	→ 23W	24.92 €



Lifespan up to 6 years². Available from 12 to 23W with E27 and E14 screw base. Choice of two different light colors.

Item name	No.	t [h] ³	W	lm	lm/W	kWh/1000h	Color	K	d max. [mm]	l [mm]	Weight	Order code (EAN)
-----------	-----	--------------------	---	----	------	-----------	-------	---	-------------	--------	--------	------------------

E27 – eco-blister

DULUXSTAR Mini Twist 12W	(1)	6000	12	650	A	12	Warm White	2700	41	102	1	8	4008321989581
DULUXSTAR Mini Twist 12W	(1)	6000	12	650	A	12	Cool Daylight	6500	41	102	1	8	4008321989611
DULUXSTAR Mini Twist 15W	(1)	6000	15	900	A	15	Warm White	2700	41	106	1	6	4008321989635
DULUXSTAR Mini Twist 15W	(1)	6000	15	900	A	15	Cool Daylight	6500	41	106	1	6	4008321989642
DULUXSTAR Mini Twist 20W	(1)	6000	20	1300	A	20	Warm White	2700	54	111	1	6	4008321989666
DULUXSTAR Mini Twist 20W	(1)	6000	20	1300	A	20	Cool Daylight	6500	54	111	1	6	4008321989673
DULUXSTAR Mini Twist 23W	(1)	6000	23	1600	A	23	Warm White	2700	54	119	1	6	4008321989697
DULUXSTAR Mini Twist 23W	(1)	6000	23	1600	A	23	Cool Daylight	6500	54	119	1	6	4008321989703

¹ Basis: Electricity costs 0.28 €/kWh and 1,000 hours operating time per year.
² Corresponds to an average lifespan of 6,000 hours with daily operation of approx. 2.7 hours.
³ Average lifespan



Item name	 No.	 t [h] ¹	 W	 lm		 kWh/1000h		 K	 d max. [mm]	 l [mm]			Order code (EAN)
-----------	---	--	---	--	---	---	---	---	---	--	---	---	------------------

E27 – folding box

DULUXSTAR Mini Twist 12W	(1)	6000	12	650	A	12	Warm White	2700	41	102	1	10	4008321605924
DULUXSTAR Mini Twist 12W	(1)	6000	12	650	A	12	Cool Daylight	6500	41	102	1	10	4008321628503
DULUXSTAR Mini Twist 15W	(1)	6000	15	900	A	15	Warm White	2700	41	106	1	10	4008321605986
DULUXSTAR Mini Twist 15W	(1)	6000	15	900	A	15	Cool Daylight	6500	41	106	1	10	4008321628534
DULUXSTAR Mini Twist 20W	(1)	6000	20	1300	A	20	Warm White	2700	54	111	1	10	4008321606013
DULUXSTAR Mini Twist 20W	(1)	6000	20	1300	A	20	Cool Daylight	6500	54	111	1	10	4008321628565
DULUXSTAR Mini Twist 23W	(1)	6000	23	1600	A	23	Warm White	2700	54	119	1	10	4008321606044
DULUXSTAR Mini Twist 23W	(1)	6000	23	1600	A	23	Cool Daylight	6500	54	119	1	10	4008321628596

E14 – eco-blister

DULUXSTAR Mini Twist 12W	(2)	6000	12	650	A	12	Warm White	2700	41	106	1	8	4008321989598
DULUXSTAR Mini Twist 12W	(2)	6000	12	650	A	12	Cool Daylight	6500	41	106	1	8	4008321989604





E14 – folding box

DULUXSTAR Mini Twist 12W	(2)	6000	12	650	A	12	Warm White	2700	41	106	1	10	4008321605955
DULUXSTAR Mini Twist 12W	(2)	6000	12	650	A	12	Cool Daylight	6500	41	106	1	10	4008321628473
DULUXSTAR Mini Twist 15W	(2)	6000	15	900	A	15	Warm White	2700	41	110	1	10	4052899915732

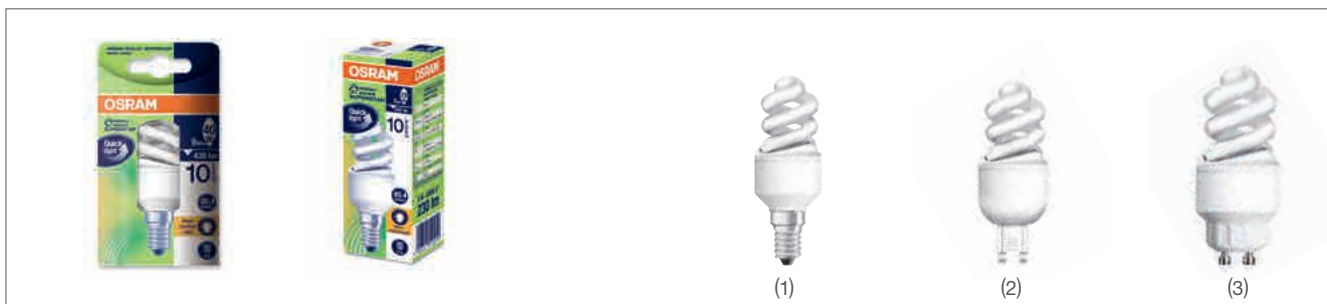
¹ Average lifespan

OSRAM DULUX® SUPERSTAR NANO TWIST



Standard	DULUX® SUPERSTAR	Electricity cost savings/year ¹
25 W 	→ 5 W 	5.60 €
40 W 	→ 9 W 	8.68 €



www.osram.com/guarantee

Lifespan up to 10 years² and 3-year guarantee³. Rapid luminous flux ramp-up thanks to Quick light technology.

Available in 5 and 9 W with screw base E14 or pin base G9 and GU10. Choice of two different light colors.

Item name	 No.	 t [h] ⁴	 W	 lm		 kWh/1000h		 K	 d max. [mm]	 l [mm]			Order code (EAN)
-----------	---	--	---	--	---	---	---	---	---	--	---	---	------------------

E14 – eco-blister

DULUX SUPERSTAR Nano Twist 5W	(1)	10000	5	230	A	5	Warm Comfort Light	2500	33	90	1	10	4008321508850
DULUX SUPERSTAR Nano Twist 5W	(1)	10000	5	230	A	5	Cool White	4000	33	90	1	10	4008321510945
DULUX SUPERSTAR Nano Twist 9W	(1)	10000	9	430	A	9	Warm Comfort Light	2500	33	102	1	10	4008321509031
DULUX SUPERSTAR Nano Twist 9W	(1)	10000	9	430	A	9	Cool White	4000	33	102	1	10	4008321511065

E14 – folding box

DULUX SUPERSTAR Nano Twist 5W	(1)	10000	5	230	A	5	Warm Comfort Light	2500	33	90	1	10	4008321510914
DULUX SUPERSTAR Nano Twist 5W	(1)	10000	5	230	A	5	Cool White	4000	33	90	1	10	4008321508898
DULUX SUPERSTAR Nano Twist 9W	(1)	10000	9	430	A	9	Warm Comfort Light	2500	33	102	1	10	4008321511034
DULUX SUPERSTAR Nano Twist 9W	(1)	10000	9	430	A	9	Cool White	4000	33	102	1	10	4008321509062

G9 – eco-blister

DULUX SUPERSTAR Nano Twist 5W	(2)	10000	5	230	A	5	Warm Comfort Light	2500	33	88	1	10	4008321956101
DULUX SUPERSTAR Nano Twist 5W	(2)	10000	5	230	A	5	Cool White	4000	33	88	1	10	4008321510761
DULUX SUPERSTAR Nano Twist 9W	(2)	10000	9	430	A	9	Warm Comfort Light	2500	33	101	1	10	4008321956910
DULUX SUPERSTAR Nano Twist 9W	(2)	10000	9	430	A	9	Cool White	4000	33	101	1	10	4008321510884

¹ Basis: Electricity costs 0.28 €/kWh and 1,000 hours operating time per year.













² Corresponds to an average lifespan of 10,000 hours with daily operation of approx. 2.7 hours.

³ In case of a fault, the lamp will be replaced, provided it was not used for commercial purposes.

www.osram.com/guarantee

⁴ Average lifespan



Item name	 No.	 t [h] ¹	 W	 lm		 kWh/1000h		 K	 d max. [mm]	 l [mm]			Order code (EAN)
GU10 – eco-blister													
DULUX SUPERSTAR Nano Twist 5W	(3)	10000	5	230	A	5	Warm Comfort Light	2500	33	83	1	10	4008321549037
DULUX SUPERSTAR Nano Twist 5W	(3)	10000	5	230	A	5	Cool White	4000	33	83	1	10	4008321549006
DULUX SUPERSTAR Nano Twist 9W	(3)	10000	9	430	A	9	Warm Comfort Light	2500	33	96	1	10	4008321549259
DULUX SUPERSTAR Nano Twist 9W	(3)	10000	9	430	A	9	Cool White	4000	33	96	1	10	4008321549334

¹ Average lifespan



OSRAM DULUX® SUPERSTAR CIRCOLUX®



Standard	DULUX® SUPERSTAR	Electricity cost savings/year ¹
112W	→ 24W	24.64 €



www.osram.com/guarantee

Ring-shaped, particularly bright lamp, ideal for pendant luminaires. Lifespan up to 8 years² and 3-year guarantee³.

Rapid luminous flux ramp-up thanks to Quick light technology. Available in 24 W with screw base E27.

Item name

E27 – folding box

DULUX SUPERSTAR Circolux 24W	(1)	8000	24	1600	A	24	Warm White	2700	231	82	1	4	4008321662224
------------------------------	-----	------	----	------	---	----	------------	------	-----	----	---	---	---------------











¹ Basis: Electricity costs 0.28 €/kWh and 1,000 hours operating time per year.
² Corresponds to an average lifespan of 8,000 hours with daily operation of approx. 2.7 hours.
³ In case of a fault, the lamp will be replaced, provided it was not used for commercial purposes.

www.osram.com/guarantee
⁴ Average lifespan



OSRAM DULUX® SUPERSTAR STICK



Standard	DULUX® SUPERSTAR	Electricity cost savings/year ¹
40W  → 8W 		8.96 €
60W  → 14W 		12.88 €
75W  → 17W 		16.24 €
100W  → 23W 		21.56 €
130W  → 30W 		28.00 €



Lifespan up to 10 years² and 3-year guarantee³. Rapid luminous flux ramp-up thanks to Quick light technology.

Available from 8 to 30W with E27 and E14 screw base. Choice of two different light colors.

Item name	 No.	 t [h] ⁴	 W	 lm		 kWh/1000h		 K	 d max. [mm]	 l [mm]			Order code (EAN)
-----------	---	--	---	--	---	---	---	---	---	--	---	---	------------------

E27 – eco-blister

DULUX SUPERSTAR 8W	(1)	10000	8	430	A	8	Warm Comfort Light	2500	43	112	1	8	4008321071101
DULUX SUPERSTAR 14W	(1)	10000	14	740	A	14	Warm Comfort Light	2500	44	135	1	8	4008321071897
DULUX SUPERSTAR 14W	(1)	10000	14	740	A	14	Cool White	4000	44	135	1	8	4008321319173
DULUX SUPERSTAR 17W	(1)	10000	17	970	A	17	Warm Comfort Light	2500	46	151	1	8	4008321072047
DULUX SUPERSTAR 17W	(1)	10000	17	970	A	17	Cool White	4000	46	151	1	8	4008321945907
DULUX SUPERSTAR 23W	(1)	10000	23	1400	A	23	Warm Comfort Light	2500	52	176	1	6	4008321986870
DULUX SUPERSTAR 23W	(1)	10000	23	1400	A	23	Cool White	4000	52	176	1	6	4008321986894
DULUX SUPERSTAR 30W	(1)	10000	30	1910	A	30	Warm Comfort Light	2500	58	195	1	6	4008321948915

¹ Basis: Electricity costs 0.28 €/kWh and 1,000 hours operating time per year.

² Corresponds to an average lifespan of 10,000 hours with daily operation of approx. 2.7 hours.

³ In case of a fault, the lamp will be replaced, provided it was not used for commercial purposes.

www.osram.com/guarantee

⁴ Average lifespan



Item name	 No.	 t [h] ¹	 W	 lm		 kWh/1000h		 K	 d max. [mm]	 l [mm]			Order code (EAN)
-----------	---	--	---	--	---	---	---	---	---	--	---	---	------------------

E27 – folding box

DULUX SUPERSTAR 8W	(1)	10000	8	430	A	8	Warm Comfort Light	2500	43	112	1	10	4008321063205
DULUX SUPERSTAR 8W	(1)	10000	8	430	A	8	Cool White	4000	43	112	1	10	4008321361752
DULUX SUPERSTAR 14W	(1)	10000	14	740	A	14	Warm Comfort Light	2500	44	135	1	10	4008321063298
DULUX SUPERSTAR 14W	(1)	10000	14	740	A	14	Cool White	4000	44	135	1	10	4008321319159
DULUX SUPERSTAR 17W	(1)	10000	17	970	A	17	Warm Comfort Light	2500	46	151	1	10	4008321063441
DULUX SUPERSTAR 17W	(1)	10000	17	970	A	17	Cool White	4000	46	151	1	10	4008321945891
DULUX SUPERSTAR 23W	(1)	10000	23	1400	A	23	Warm Comfort Light	2500	52	176	1	10	4008321986863
DULUX SUPERSTAR 23W	(1)	10000	23	1400	A	23	Cool White	4000	52	176	1	10	4008321986887
DULUX SUPERSTAR 30W	(1)	10000	30	1910	A	30	Warm Comfort Light	2500	58	195	1	10	4008321181213
DULUX SUPERSTAR 30W	(1)	10000	30	1910	A	30	Cool White	4000	58	195	1	10	4008321181237

E14 – eco-blister

DULUX SUPERSTAR 8W	(2)	10000	8	430	A	8	Warm Comfort Light	2500	43	115	1	8	4008321071835
--------------------	-----	-------	---	-----	---	---	--------------------	------	----	-----	---	---	---------------

E14 – folding box



DULUX SUPERSTAR 8W	(2)	10000	8	430	A	8	Warm Comfort Light	2500	43	115	1	10	4008321063236
DULUX SUPERSTAR 8W	(2)	10000	8	430	A	8	Cool White	4000	43	115	1	10	4008321361721

¹ Average lifespan

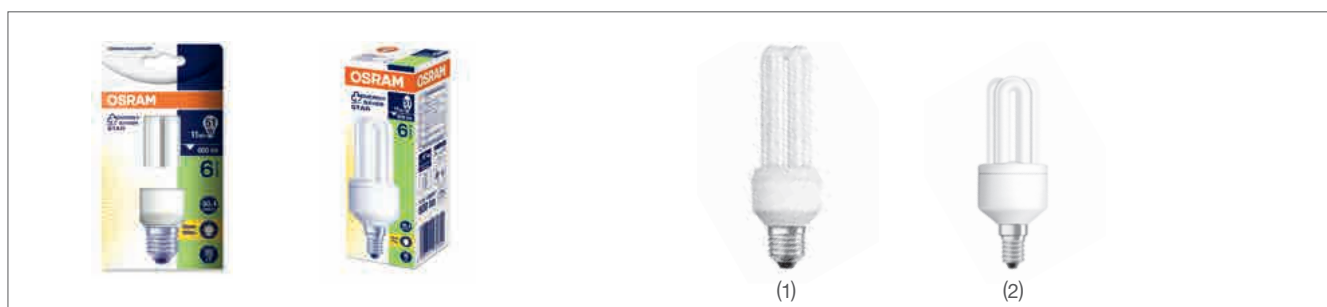

OSRAM DULUXSTAR® STICK



Standard	DULUXSTAR®	Electricity cost savings/year ¹
49 W  → 11 W 		10.64 € (Cool Daylight)
51 W  → 11 W 		11.20 € (Warm White)
68 W  → 15 W 		14.84 € (Cool Daylight)
70 W  → 15 W 		15.40 € (Warm White)
86 W  → 20 W 		18.48 € (Cool Daylight)
91 W  → 20 W 		19.88 € (Warm White)



Compact fluorescent lamps

Lifespan up to 6 years². Available from 11 to 20 W with E27 and E14 screw base. Choice of two different light colors.

Item name	 No.	 t [h] ³	 W	 lm		 kWh/1000h		 K	 d max. [mm]	 l [mm]			Order code (EAN)
-----------	---	--	---	--	---	---	---	---	---	--	---	---	------------------

E27 – eco-blister

DULUXSTAR 11W	(1)	6000	11	600	A	11	Warm White	2700	43	119	1	8	4008321989741
DULUXSTAR 11W	(1)	6000	11	570	A	11	Cool Daylight	6500	43	119	1	8	4008321989758
DULUXSTAR 15W	(1)	6000	15	900	A	15	Warm White	2700	43	135	1	6	4008321989765
DULUXSTAR 15W	(1)	6000	15	870	A	15	Cool Daylight	6500	43	135	1	6	4008321989772
DULUXSTAR 20W	(1)	6000	20	1170	A	20	Warm White	2700	49	154	1	6	4008321989789
DULUXSTAR 20W	(1)	6000	20	1120	A	20	Cool Daylight	6500	49	154	1	6	4008321989796

¹ Basis: Electricity costs 0.28 €/kWh and 1,000 hours operating time per year.
² Corresponds to an average lifespan of 6,000 hours with daily operation of approx. 2.7 hours.
³ Average lifespan



Item name	 No.	 t [h] ¹	 W	 lm		 kWh/1000h		 K	 d max. [mm]	 l [mm]			Order code (EAN)
-----------	---	--	---	--	---	---	---	---	---	--	---	---	------------------

E27 – folding box

DULUXSTAR 11W	(1)	6000	11	600	A	11	Warm White	2700	43	119	1	10	4008321363794
DULUXSTAR 11W	(1)	6000	11	570	A	11	Cool Daylight	6500	43	119	1	10	4008321360724
DULUXSTAR 15W	(1)	6000	15	900	A	15	Warm White	2700	43	135	1	10	4008321363824
DULUXSTAR 15W	(1)	6000	15	870	A	15	Cool Daylight	6500	43	135	1	10	4008321360779
DULUXSTAR 20W	(1)	6000	20	1170	A	20	Warm White	2700	49	154	1	10	4008321363855
DULUXSTAR 20W	(1)	6000	20	1120	A	20	Cool Daylight	6500	49	154	1	10	4008321360847

E14 – eco-blister

DULUXSTAR 11W	(2)	6000	11	600	A	11	Warm White	2700	43	122	1	8	4008321989727
DULUXSTAR 11W	(2)	6000	11	570	A	11	Cool Daylight	6500	43	122	1	8	4008321989734

E14 – folding box





DULUXSTAR 11W	(2)	6000	11	600	A	11	Warm White	2700	43	122	1	10	4008321989840
DULUXSTAR 11W	(2)	6000	11	570	A	11	Cool Daylight	6500	43	122	1	10	4008321618078

¹ Average lifespan

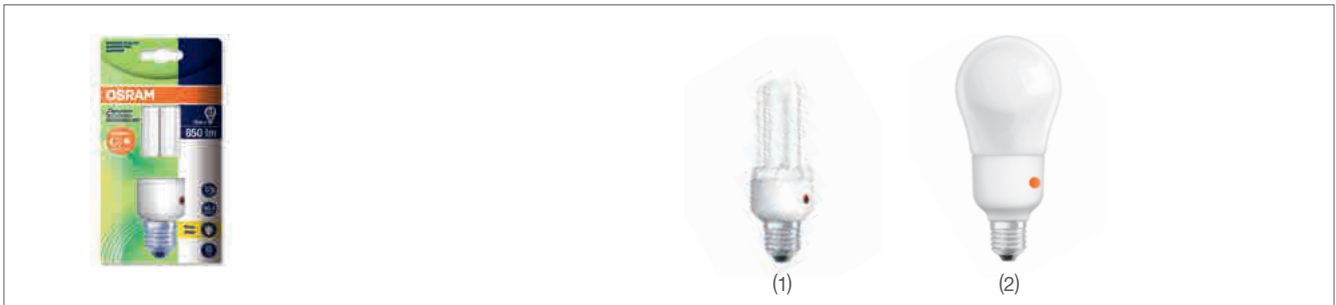













OSRAM DULUX® SUPERSTAR SENSOR



Standard	DULUX® SUPERSTAR	Electricity cost savings/year ¹
51 W  → 11 W 		11.20 €
67 W  → 15 W  		14.56 €



Lifespan up to 10 years² and 3-year guarantee³. Switches on and off automatically depending on the ambient brightness. Rapid luminous flux ramp-up thanks to Quick light technology.

Item name													Order code (EAN)
E27 – eco-blister													
DULUX SUPERSTAR SENSOR 11W	(1)	10000	11	600	A	11	Warm White	2700	45	126	1	8	4008321986986
DULUX SUPERSTAR SENSOR 15W	(1)	10000	15	850	A	15	Warm White	2700	45	132	1	8	4008321987068
DULUX SUPERSTAR SENSOR Classic A 15W	(2)	10000	15	850	A	15	Warm White	2700	78	158	1	6	4052899916630





¹ Basis: Electricity costs 0.28 €/kWh and 1,000 hours operating time per year.
² Corresponds to an average lifespan of 10,000 hours with daily operation of approx. 2.7 hours.
³ In case of a fault, the lamp will be replaced, provided it was not used for commercial purposes.

www.osram.com/guarantee
⁴ Average lifespan



OSRAM DULUX® SUPERSTAR DIM















Standard	DULUX® SUPERSTAR	Electricity cost savings/year ¹
69 W  → 16 W 		14.84 €
83 W  → 18 W 		18.20 €



Continuously dimmable from 100% to 7% with most standard trailing-edge phase dimmers. Rapid luminous flux start-up thanks to Quick light technology (excluding

Classic A). Extra long lifespan of up to 20 years² (Classic A up to 10 years²) and 3 years guarantee³.

Item name													Order code (EAN)
E27 – eco-blister													
DULUX SUPERSTAR DIM Classic A 16W	(1)	10000	16	880	A	16	Warm Comfort Light	2500	78	163	1	6	4008321953520
DULUX SUPERSTAR DIM 18W	(2)	20000	18	1100	A	18	Warm Comfort Light	2500	52	161	1	6	4008321953452

¹ Basis: Electricity costs 0.28 €/kWh and 1,000 hours operating time per year.

² Corresponds to an average lifespan of 20,000/10,000 hours with daily operation of approx. 2.7 hours.

³ In case of a fault, the lamp will be replaced, provided it was not used for commercial purposes.





www.osram.com/guarantee

⁴ Average lifespan

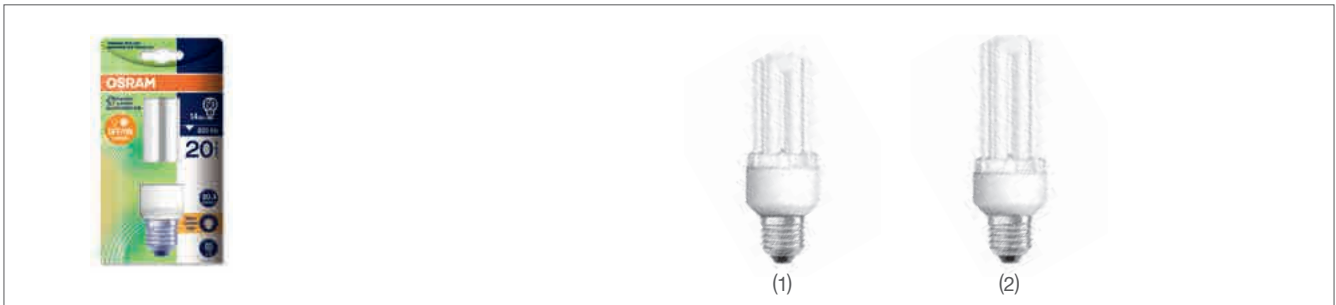

OSRAM DULUX® SUPERSTAR FACILITY















Standard	DULUX® SUPERSTAR	Electricity cost savings/year ¹
64 W  → 14 W 		14.00 €
80 W  → 18 W 		17.36 €



Lifespan up to 20 years² and 3-year guarantee³. Can be switched extremely often, thanks to heavy-duty switching resistance, making it ideally suited to lighting installations

with motion sensors or automatic power-off function. Rapid luminous flux ramp-up thanks to Quick light technology.

Item name													Order code (EAN)
E27 – eco-blister													
DULUX SUPERSTAR FACILITY 14 W	(1)	20000	14	800	A	14	Warm Comfort Light	2500	45	126	1	8	4050300946245
DULUX SUPERSTAR FACILITY 18 W	(2)	20000	18	1050	A	18	Warm Comfort Light	2500	45	140	1	8	4008321997807

¹ Basis: Electricity costs 0.28 €/kWh and 1,000 hours operating time per year.
² Corresponds to an average lifespan of 20,000 hours with daily operation of approx. 2.7 hours.
³ In case of a fault, the lamp will be replaced, provided it was not used for commercial purposes.

www.osram.com/guarantee
⁴ Average lifespan



OSRAM DULUX® T PLUS



LUMILUX® INTERNA (827): Warm, atmospheric light for relaxing surroundings.

LUMILUX® Cool White (840): Natural white light for a fresh, inspiring ambiance.

Item name



Order code (EAN)

GX24d base – folding box

Item name	No.	t (h) ¹	W	lm	Energy efficiency class	kWh/1000h	Color temperature (K)	Base type	l max. (mm)	Height (mm)	Packaging	Order code (EAN)	
DULUX T Plus 13 W	(1)	8000	13	900	A	16	LUMILUX Cool White	4000	GX24d-1	90	1	10	4050300446905
DULUX T Plus 18 W	(1)	10000	18	1200	A	22	LUMILUX INTERNA	2700	GX24d-2	101	1	10	4050300333502
DULUX T Plus 18 W	(1)	10000	18	1200	A	22	LUMILUX Cool White	4000	GX24d-2	101	1	10	4050300333465
DULUX T Plus 26 W	(1)	10000	26	1800	A	32	LUMILUX INTERNA	2700	GX24d-3	116	1	10	4050300342085
DULUX T Plus 26 W	(1)	10000	26	1800	A	32	LUMILUX Cool White	4000	GX24d-3	116	1	10	4050300342047

¹ Average lifespan



OSRAM DULUX® T/E PLUS

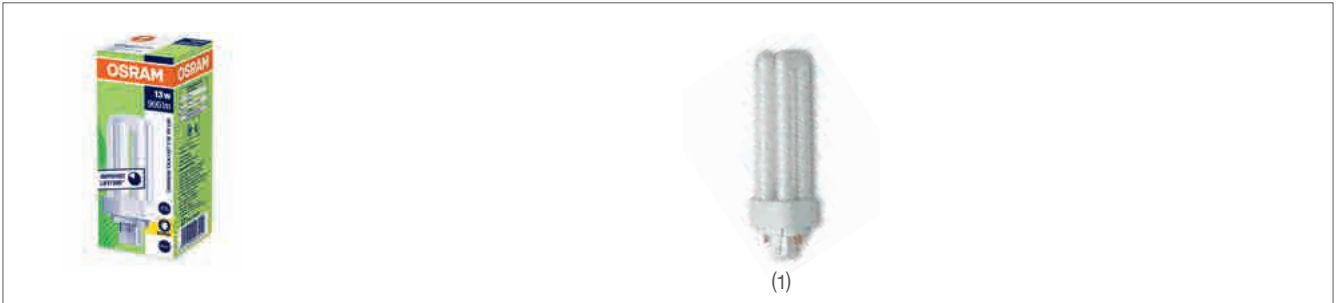

LUMILUX® INTERNA (827): Warm, atmospheric light for relaxing surroundings.

LUMILUX® Cool White (840): Natural white light for a fresh, inspiring ambiance.

Item name



Order code (EAN)

GX24q base – folding box

Item name	No.	t [h] ¹	W	lm	A	kWh/1000h	Color	K	Base	l max. [mm]	Box	Order code (EAN)
DULUX T/E Plus 13 W	(1)	13000	13	900	A	16	LUMILUX INTERNA	2700	GX24q-1	90	1	10 4050300447001
DULUX T/E Plus 13 W	(1)	13000	13	900	A	16	LUMILUX Cool White	4000	GX24q-1	90	1	10 4050300446967
DULUX T/E Plus 18 W	(1)	13000	18	1200	A	22	LUMILUX INTERNA	2700	GX24q-2	101	1	10 4050300342269
DULUX T/E Plus 18 W	(1)	13000	18	1200	A	22	LUMILUX Cool White	4000	GX24q-2	101	1	10 4050300342221
DULUX T/E Plus 26 W	(1)	20000	26	1800	A	31	LUMILUX INTERNA	2700	GX24q-3	116	1	10 4050300342320
DULUX T/E Plus 26 W	(1)	20000	26	1800	A	31	LUMILUX Cool White	4000	GX24q-3	116	1	10 4050300342283
DULUX T/E Plus 32 W	(1)	20000	32	2400	A	38	LUMILUX INTERNA	2700	GX24q-3	132	1	10 4050300348605
DULUX T/E Plus 32 W	(1)	20000	32	2400	A	38	LUMILUX Cool White	4000	GX24q-3	132	1	10 4050300348568
DULUX T/E Plus 42 W	(1)	20000	42	3200	A	51	LUMILUX INTERNA	2700	GX24q-4	153	1	10 4050300425665
DULUX T/E Plus 42 W	(1)	20000	42	3200	A	51	LUMILUX Cool White	4000	GX24q-4	153	1	10 4050300425627

¹ Average lifespan



OSRAM DULUX® D

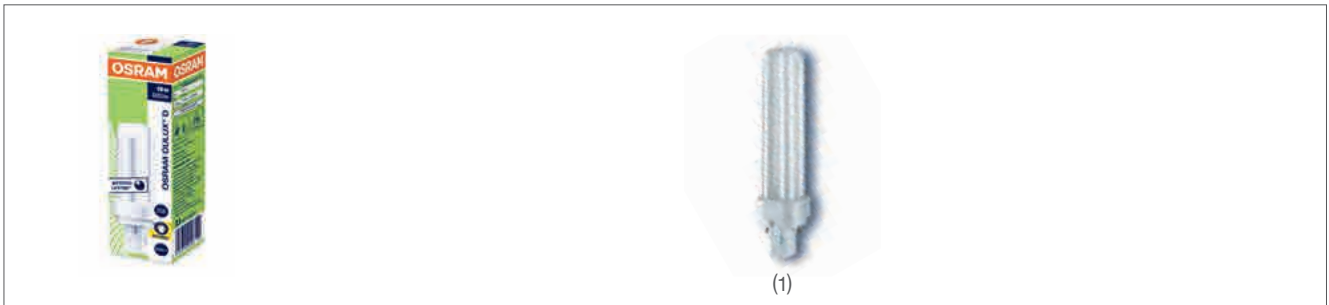

LUMILUX® INTERNA (827): Warm, atmospheric light for relaxing surroundings.

LUMILUX® Cool White (840): Natural white light for a fresh, inspiring ambiance.

Item name	No.	t(h) ¹	W	lm	E	kWh/1000h		K		l max. [mm]			Order code (EAN)
-----------	-----	-------------------	---	----	---	-----------	--	---	--	-------------	--	--	------------------

G24d base – folding box

DULUX D 10 W	(1)	10000	10	600	A	13	LUMILUX INTERNA	2700	G24d-1	87	1	10	4050300008110
DULUX D 10 W	(1)	10000	10	600	A	13	LUMILUX Cool White	4000	G24d-1	87	1	10	4050300010595
DULUX D 13 W	(1)	10000	13	900	A	16	LUMILUX INTERNA	2700	G24d-1	115	1	10	4050300008127
DULUX D 13 W	(1)	10000	13	900	A	16	LUMILUX Cool White	4000	G24d-1	115	1	10	4050300010625
DULUX D 18 W	(1)	10000	18	1200	A	22	LUMILUX INTERNA	2700	G24d-2	130	1	10	4050300011462
DULUX D 18 W	(1)	10000	18	1200	A	22	LUMILUX Cool White	4000	G24d-2	130	1	10	4050300012056
DULUX D 26 W	(1)	10000	26	1800	A	31	LUMILUX INTERNA	2700	G24d-3	149	1	10	4050300011912
DULUX D 26 W	(1)	10000	26	1800	A	31	LUMILUX Cool White	4000	G24d-3	149	1	10	4050300012049

¹ Average lifespan



OSRAM DULUX® D/E

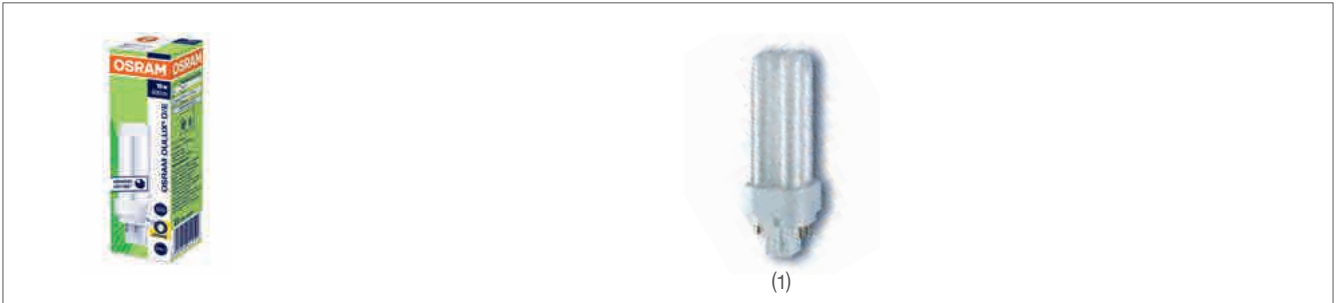

LUMILUX® INTERNA (827): Warm, atmospheric light for relaxing surroundings.

LUMILUX® Cool White (840): Natural white light for a fresh, inspiring ambiance.

Item name



Order code (EAN)

G24q base – folding box

Item name	No.	t(h) ¹	W	lm	A	kWh/1000h	Color	K	Beam angle	l max. [mm]	Box height	Quantity	Order code (EAN)
DULUX D/E 10 W	(1)	20000	10	600	A	11	LUMILUX INTERNA	2700	G24q-1	87	1	10	4050300012124
DULUX D/E 10 W	(1)	20000	10	600	A	11	LUMILUX Cool White	4000	G24q-1	87	1	10	4050300017587
DULUX D/E 13 W	(1)	20000	13	900	A	14	LUMILUX INTERNA	2700	G24q-1	115	1	10	4050300012131
DULUX D/E 13 W	(1)	20000	13	900	A	14	LUMILUX Cool White	4000	G24q-1	115	1	10	4050300017594
DULUX D/E 18 W	(1)	20000	18	1200	A	20	LUMILUX INTERNA	2700	G24q-2	130	1	10	4050300012148
DULUX D/E 18 W	(1)	20000	18	1200	A	20	LUMILUX Cool White	4000	G24q-2	130	1	10	4050300017617
DULUX D/E 26 W	(1)	20000	26	1800	A	29	LUMILUX INTERNA	2700	G24q-3	149	1	10	4050300012230
DULUX D/E 26 W	(1)	20000	26	1800	A	29	LUMILUX Cool White	4000	G24q-3	149	1	10	4050300020303

¹ Average lifespan



OSRAM DULUX® S

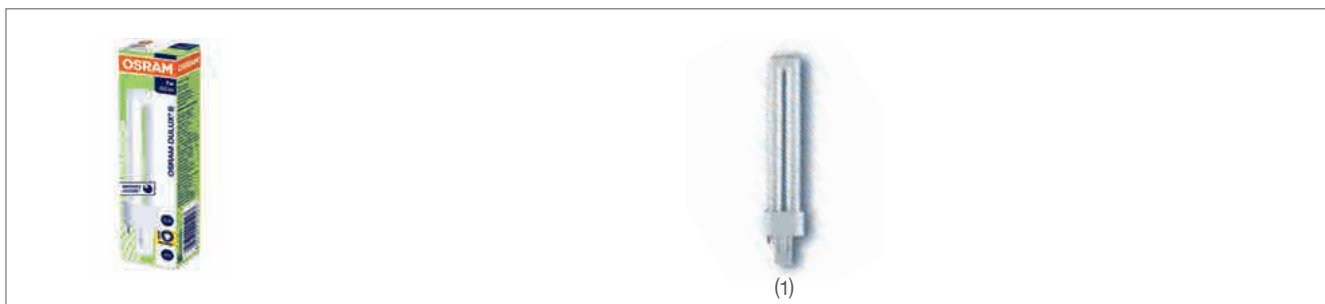

LUMILUX® INTERNA (827): Warm, atmospheric light for relaxing surroundings.

LUMILUX® Cool White (840): Natural white light for a fresh, inspiring ambiance.

Item name No. t (h)¹ W lm kWh/1000h K l max. [mm] Order code (EAN)

G23 base – folding box

DULUX S 5 W	10000	5	250	A	7	LUMILUX INTERNA	2700	G23	85	1	10	4050300006130
DULUX S 7 W	10000	7	400	A	9	LUMILUX INTERNA	2700	G23	114	1	10	4050300005997
DULUX S 7 W	10000	7	400	A	9	LUMILUX Cool White	4000	G23	114	1	10	4050300010571
DULUX S 9 W	10000	9	600	A	11	LUMILUX INTERNA	2700	G23	144	1	10	4050300006000
DULUX S 9 W	10000	9	600	A	11	LUMILUX Cool White	4000	G23	144	1	10	4050300010588
DULUX S 11 W	10000	11	900	A	15	LUMILUX INTERNA	2700	G23	214	1	10	4050300006017
DULUX S 11 W	10000	11	900	A	15	LUMILUX Cool White	4000	G23	214	1	10	4050300010618
DULUX S 9 W	10000	9	400	B	11	Red (60)	red	G23	144	1	10	4050300015927
DULUX S 9 W	10000	9	800	A	11	Green (66)	green	G23	144	1	10	4050300015934
DULUX S 9 W	10000	9	200	B	12	Blue (67)	blue	G23	144	1	10	4050300015941

G23 base – eco-blister

DULUX S 7 W	10000	7	400	A	9	LUMILUX INTERNA	2700	G23	114	1	10	4050300006086
-------------	-------	---	-----	---	---	-----------------	------	-----	-----	---	----	---------------

¹ Average lifespan



OSRAM DULUX® S/E

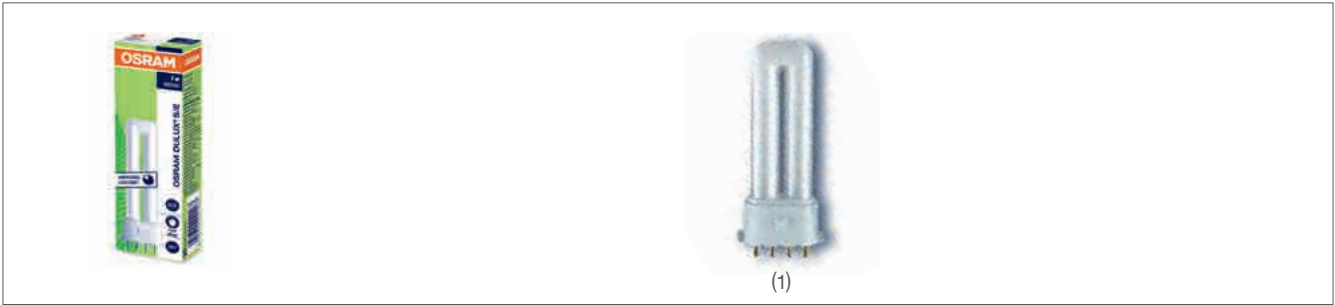

LUMILUX® INTERNA (827): Warm, atmospheric light for relaxing surroundings.

LUMILUX® Cool White (840): Natural white light for a fresh, inspiring ambiance.

Item name No. t(h)¹ W lm kWh/1000h K l max. [mm] Order code (EAN)

2G7 base – folding box

DULUX S/E 7 W	(1)	20000	7	400	A	9	LUMILUX INTERNA	2700	2G7	114	1	10	4050300017648
DULUX S/E 7 W	(1)	20000	7	400	A	9	LUMILUX Cool White	4000	2G7	114	1	10	4050300020167
DULUX S/E 9 W	(1)	20000	9	600	A	11	LUMILUX INTERNA	2700	2G7	144	1	10	4050300017655
DULUX S/E 9 W	(1)	20000	9	600	A	11	LUMILUX Cool White	4000	2G7	144	1	10	4050300020174
DULUX S/E 11 W	(1)	20000	11	900	A	15	LUMILUX INTERNA	2700	2G7	214	1	10	4050300017662
DULUX S/E 11 W	(1)	20000	11	900	A	15	LUMILUX Cool White	4000	2G7	214	1	10	4050300020181

¹ Average lifespan



OSRAM DULUX® L

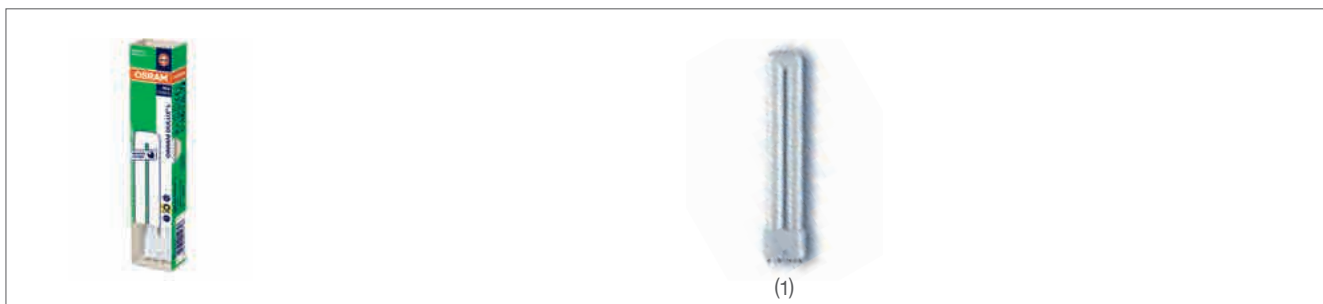

LUMILUX® INTERNA (827): Warm, atmospheric light for relaxing surroundings.

LUMILUX® Cool White (840): Natural white light for a fresh, inspiring ambiance.

Item name No. t [h]¹ W lm kWh/1000h K l max. [mm] Order code (EAN)

2G11 base – folding box

DULUX L 18 W	(1)	20000	18	1200	A	20	LUMILUX INTERNA	2700	2G11	217	1	10	4050300010748
DULUX L 18 W	(1)	20000	18	1200	A	20	LUMILUX Cool White	4000	2G11	217	1	10	4050300010724
DULUX L 24 W	(1)	20000	24	1800	A	27	LUMILUX INTERNA	2700	2G11	317	1	10	4050300010779
DULUX L 24 W	(1)	20000	24	1800	A	27	LUMILUX Cool White	4000	2G11	317	1	10	4050300010755
DULUX L 36 W	(1)	20000	36	2900	A	40	LUMILUX INTERNA	2700	2G11	411	1	10	4050300010809
DULUX L 36 W	(1)	20000	36	2900	A	40	LUMILUX Cool White	4000	2G11	411	1	10	4050300010786
DULUX L 40 W	(1)	20000	40	3500	A+	44	LUMILUX INTERNA	2700	2G11	533	1	10	4050300322285
DULUX L 40 W	(1)	20000	40	3500	A+	44	LUMILUX Cool White	4000	2G11	533	1	10	4050300279909
DULUX L 55 W	(1)	20000	55	4800	A+	61	LUMILUX INTERNA	2700	2G11	533	1	10	4050300315881
DULUX L 55 W	(1)	20000	55	4800	A+	61	LUMILUX Cool White	4000	2G11	533	1	10	4050300295879
DULUX L 80 W	(1)	20000	80	6500	A	88	LUMILUX Cool White	4000	2G11	565	1	10	4050300665481

¹ Average lifespan





Compact fluorescent lamps



Fluorescent lamps

Fluorescent lamps are among the most widely used light sources in the world. Innovative lamps such as LUMILUX® from OSRAM are available in a wide range of shapes that offer a wide spectrum of design options. Some of the advantages of fluorescent lamps include a high luminous efficiency, long service life, superior reliability and low energy consumption. With various light colors, your customers are always able to select precisely the right lamp from the complete OSRAM range for their individual lighting requirements.

T8 fluorescent lamps 118



T5 fluorescent lamps 121

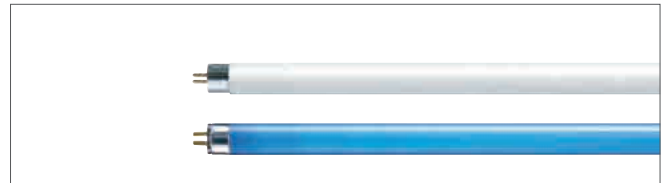

Fluorescent lamps with special shapes 126



Fluorescent lamps for special applications 129



Starters 131



For a wide spectrum of applications and requirements

With the OSRAM light colors ACTIVE DAYWHITE for natural daylight and RELAX WARMWHITE for atmospheric home lighting, the right light color is available for a wide range of applications. The OSRAM portfolio also includes colored fluorescent lamps for creative and decorative lighting solutions. The special light colors BIOLUX® and FLUORA® are especially suitable for keeping small animals or for stimulating plant growth.

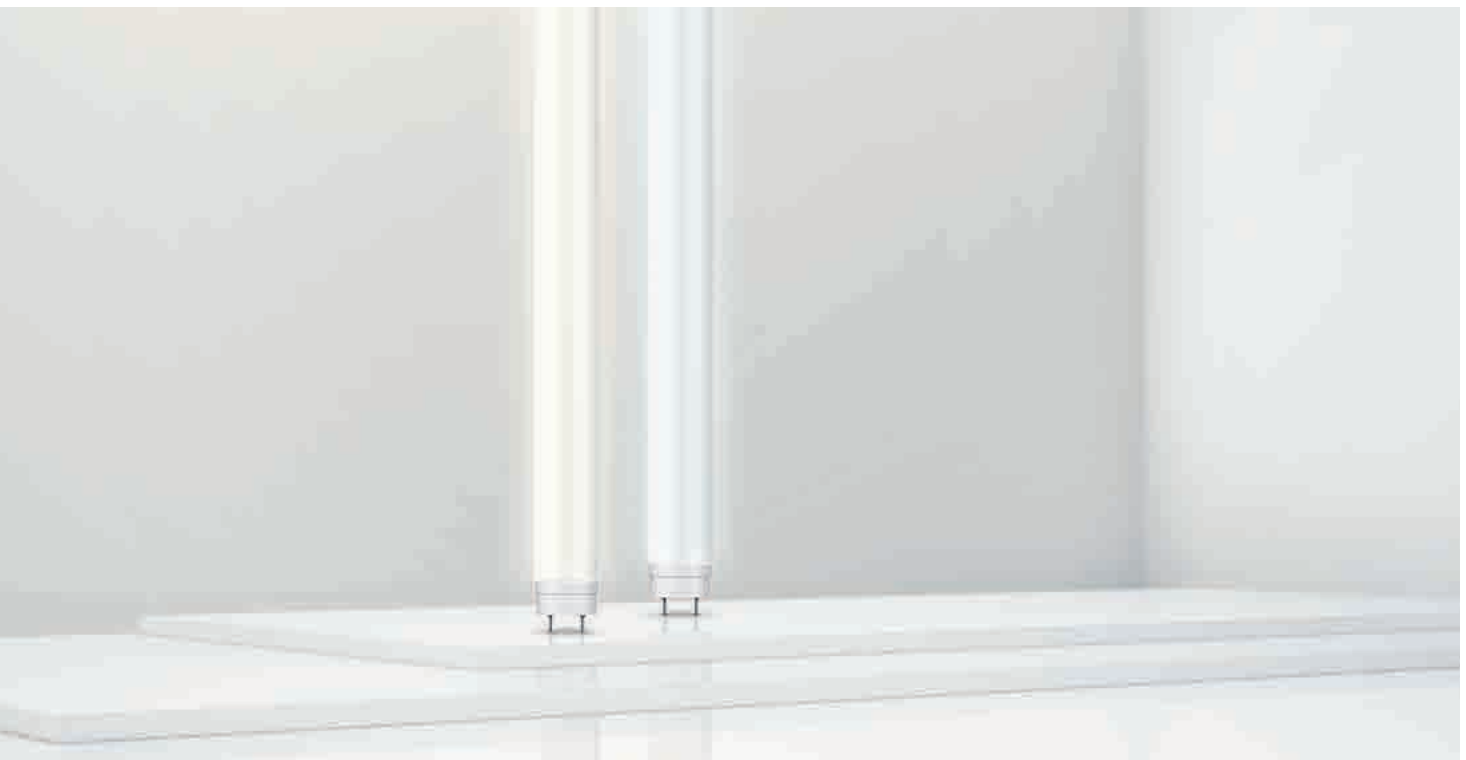

ACTIVE DAYWHITE – light color 840

- Natural white, glare-free light can be combined well with daylight
- Outstanding for public spaces and playrooms



RELAX WARMWHITE – light color 827

- Cosy and atmospheric light, but still bright
- The ideal selection for all living space and bedrooms



Cool Daylight – light color 865

- Light similar to daylight
- Ideal for lighting private work areas





Fluorescent lamp light in all shapes:

T8, T5, circular and U-shaped lamps

OSRAM fluorescent lamps are characterized by a long service life, low power consumption and an excellent price-performance ratio. The well proven lamp technology includes T5 double capped fluorescent lamps (Ø 16 mm), T8 double capped fluorescent lamps (Ø 26 mm) as well as lamps in special shapes (circular and U-shaped).

- T8 double capped fluorescent lamps provide a low-cost solution for both commercial and private use and are also available with special light colors
- T5 double capped fluorescent lamps feature high efficiency and long lifespans
- Circular lamps distribute light with high uniformity due to their shape
- U-shaped lamps are especially suitable for space-saving and low-cost lighting concepts

Animals and plants:

Fluorescent lamps for special applications

- BIOLUX® with light color 965 is perfect for lighting enclosures for small animals
- FLUORA® with light color 77 is ideal for healthy plant growth



Safe, durable, reliable:

High-quality starters from OSRAM

OSRAM offers a full range of modern brand name starters for operating fluorescent lamps on conventional ballasts. The LONGLIFE and DEOS® Safety starter ranges are characterized by above-average quality, economy and reliability.

- Starters in genuine brand quality from OSRAM
- Safe, durable, reliable, and standard-compliant
- 2 starter families: LONGLIFE and DEOS® Safety starters
- Switching life: from ≥ 10,000 to ≥ 60,000 switching operations

Fluorescent lamps

T8 RELAX WARMWHITE

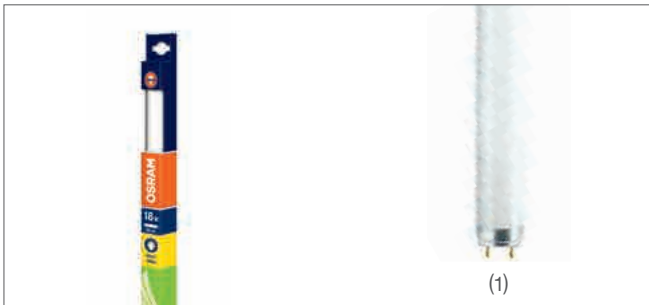

Warm, atmospheric light for relaxing surroundings.

Item name



Order code (EAN)

G13 – 26 mm – LUMILUX® Warm White (827) – folding box

Item name	Lightbulb icon	Average lifespan t[h]¹	Power W	Lumen lm	Energy efficiency E	Energy consumption kWh/1000h	Color temperature K	Maximum length l1 max. [mm]	Packaging icon	Order code icon	Order code (EAN)
T8 RELAX L 15 W	(1)	20000	15	950	B	19	2700	438	1	10	4050300325613
T8 RELAX L 16 W	(1)	20000	16	1250	A	20	2700	720	1	10	4050300325637
T8 RELAX L 18 W	(1)	20000	18	1350	A	22	2700	590	1	10	4050300325675
T8 RELAX L 30 W	(1)	20000	30	2400	A	36	2700	895	1	10	4050300325651
T8 RELAX L 36 W	(1)	20000	36	3350	A	42	2700	1200	1	10	4050300325699
T8 RELAX L 58 W	(1)	20000	58	5200	A	67	2700	1500	1	10	4050300325712

¹ Average lifespan



T8 ACTIVE DAYWHITE



Natural white light for a fresh, inspiring ambiance.

Item name



Order code
(EAN)

G13 – 26 mm – LUMILUX® Cool White (840) – folding box

Item name	No.	t[h] ¹	W	lm ²	A	kWh/1000h	K	l max. [mm]	l	Quantity	Order code (EAN)
T8 ACTIVE L 15 W	(1)	20000	15	950	B	19	4000	438	1	10	4008321064325
T8 ACTIVE L 16 W	(1)	20000	16	1250	A	20	4000	720	1	10	4008321064301
T8 ACTIVE L 18 W	(1)	20000	18	1350	A	22	4000	590	1	10	4050300336800
T8 ACTIVE L 30 W	(1)	20000	30	2400	A	36	4000	895	1	10	4050300336947
T8 ACTIVE L 36 W	(1)	20000	36	3350	A	42	4000	1200	1	10	4050300336763
T8 ACTIVE L 58 W	(1)	20000	58	5200	A	67	4000	1500	1	10	4050300336787

¹ Average lifespan
² Max. luminous flux at 25 °C



T8 colored fluorescent lamps

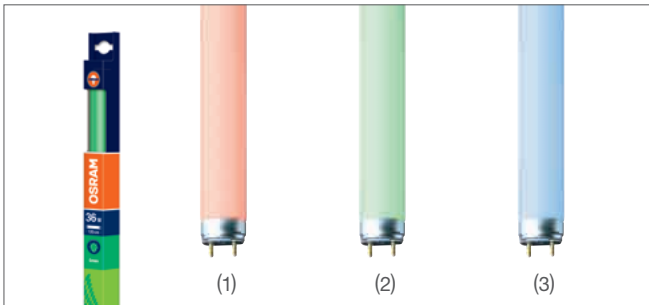

Item name



t [h]¹

W

lm²



kWh/1000h



l max. [mm]



Order code (EAN)

G13 – 26 mm – folding box

T8 colored fluorescent lamp, red	(1)	20000	36	2400	B	43	red	1200	1	10	4008321938060
T8 colored fluorescent lamp, yellow	—	20000	36	2300	B	43	yellow	1200	1	10	4008321938008
T8 colored fluorescent lamp, green	(2)	20000	36	4400	A+	42	green	1200	1	10	4008321938022
T8 colored fluorescent lamp, blue	(3)	20000	36	900	C	45	blue	1200	1	10	4008321938046

¹ Average lifespan
² Max. luminous flux at 25 °C



T5 RELAX WARMWHITE



Warm, atmospheric light for relaxing surroundings.

Item name	No.	t [h] ¹	W	lm ²	lm ³ _{35°C}		kWh/1000h	K	l1 max. [mm]			Order code (EAN)
G13 – 16 mm – LUMILUX® Warm White (827) – folding box												
T5 short RELAX L8W	(1)	10000 ¹	8	430	—	A	9	2700	288	1	10	4050300336961
T5 short RELAX L 13W	(1)	10000 ¹	13	950	—	A	15	2700	517	1	10	4050300325750
T5 HE RELAX 14 W	(1)	24000	14	1200	1350	A+	16	2700	549	1	10	4008321916020
T5 HE RELAX 21 W	(1)	24000	21	1900	2100	A+	23	2700	849	1	10	4008321912138
T5 HE RELAX 28 W	(1)	24000	28	2600	2900	A+	31	2700	1149	1	10	4008321916044

¹ Average lifespan with ECG operation
² Max. luminous flux at 25 °C
³ Max. luminous flux at 35 °C







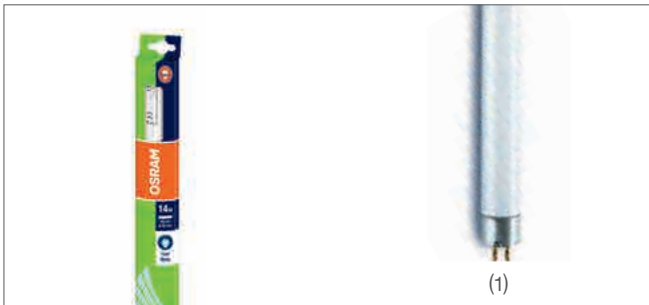





Fluorescent lamps

T5 ACTIVE DAYWHITE



Natural white light for a fresh, inspiring ambiance.

Item name	 No.	 t [h] ¹	 W	 lm ²	 lm ³ _{35°C}		 kWh/1000h	 K	 t ₁ max. [min]			Order code (EAN)
G5 – 16 mm – LUMILUX® Cool White (840) – folding box												
T5 short ACTIVE L 8 W	(1)	10000 ¹	8	430	—	A	9	4000	288	1	10	4008321067241
T5 short ACTIVE L 13 W	(1)	10000 ¹	13	950	—	A	15	4000	517	1	10	4008321067210
T5 HE ACTIVE 14 W	(1)	24000	14	1200	1350	A+	16	4000	549	1	10	4008321916013
T5 HE ACTIVE 21 W	(1)	24000	21	1900	2100	A+	23	4000	849	1	10	4008321912114
T5 HE ACTIVE 28 W	(1)	24000	28	2600	2900	A+	31	4000	1149	1	10	4008321916037

¹ Average lifespan with ECG operation
² Max. luminous flux at 25 °C
³ Max. luminous flux at 35 °C



T5 BASIC



The low-cost fluorescent lamp.

Item name



Order code (EAN)

G5 – 16 mm – Cool White (840) – folding box

Item name	No.	t[h]¹	W	lm²	A	kWh/1000h	K	l max. [mm]	Lamp icon	Box icon	Order code (EAN)
T5 short BASIC L 6 W	(1)	10000	6	270	A	7	4000	212	1	10	4008321025050
T5 short BASIC L 8 W	(1)	10000	8	385	A	9	4000	288	1	10	4008321025081
T5 short BASIC L 13 W	(1)	10000	13	830	A	15	4000	517	1	10	4008321025524

¹ Average lifespan with ECG operation
² Max. luminous flux at 25 °C



T5 High Efficiency RGB

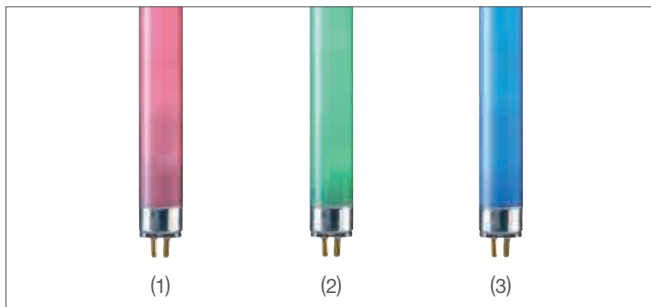

T5 HE High Efficiency with high red, green and blue color saturation.

Item name



Order code (EAN)

G5 – 16 mm – red/green/blue – folding box

Item name	t [h]	W	lm	lm 35°C	Energy efficiency	kWh/1000h	Color	l max. [mm]	Box	Stack of boxes	Order code (EAN)	
T5 HE 14W red	(1)	24000	14	930	970	A	16	red	549	1	10	4008321170705
T5 HE 21W red	(1)	24000	21	1500	1550	A	24	red	849	1	10	4008321170682
T5 HE 28W red	(1)	24000	28	2100	2200	A	31	red	1149	1	10	4008321161840
T5 HE 35W red	(1)	24000	35	2650	2800	A	39	red	1449	1	10	4008321133458
T5 HE 14W green	(2)	24000	14	1550	1600	A+	15	green	549	1	10	4008321170729
T5 HE 21W green	(2)	24000	21	2500	2650	A+	23	green	849	1	10	4008321170743
T5 HE 28W green	(2)	24000	28	3500	3700	A+	31	green	1149	1	10	4008321161864
T5 HE 35W green	(2)	24000	35	4450	4700	A+	39	green	1449	1	10	4008321161925
T5 HE 14W blue	(3)	24000	14	300	330	B	16	blue	549	1	10	4008321170781
T5 HE 21W blue	(3)	24000	21	500	540	B	24	blue	849	1	10	4008321170804
T5 HE 28W blue	(3)	24000	28	700	750	B	31	blue	1149	1	10	4008321161888
T5 HE 35W blue	(3)	24000	35	875	950	B	39	blue	1449	1	10	4008321161949

¹ Average lifespan
² Max. luminous flux at 25°C
³ Max. luminous flux at 35°C



T5 High Output RGB

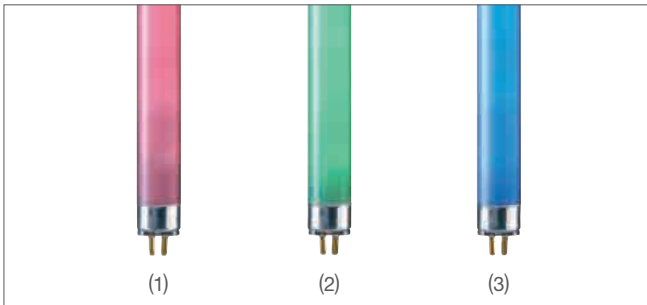

T5 HO High Output with high red, green and blue color saturation.

Item name



Order code
(EAN)

G5 – 16 mm – red/green/blue – folding box

Item name	No.	t [h]	W	lm	lm 35°C	A	kWh/1000h	Color	l max. [mm]	Box	Stack	Order code (EAN)
T5 HO 24W red	(1)	24000	24	1500	1650	A	25	red	549	1	10	4008321171009
T5 HO 39W red	(1)	24000	39	2450	2700	A	42	red	849	1	10	4008321170989
T5 HO 54W red	(1)	24000	54	3300	3650	A	60	red	1149	1	10	4008321170965
T5 HO 80W red	(1)	24000	80	4525	5000	A	88	red	1449	1	10	4008321161963
T5 HO 24W green	(2)	24000	24	2500	2750	A+	25	green	549	1	10	4008321170941
T5 HO 39W green	(2)	24000	39	4100	4470	A+	42	green	849	1	10	4008321170927
T5 HO 54W green	(2)	24000	54	5550	6050	A+	60	green	1149	1	10	4008321170903
T5 HO 80W green	(2)	24000	80	7650	8300	A+	88	green	1449	1	10	4008321161987
T5 HO 24W blue	(3)	24000	24	525	670	B	25	blue	549	1	10	4008321170880
T5 HO 39W blue	(3)	24000	39	850	1075	B	42	blue	849	1	10	4008321170866
T5 HO 54W blue	(3)	24000	54	1150	1475	B	60	blue	1149	1	10	4008321170842
T5 HO 80W blue	(3)	24000	80	1550	2025	B	88	blue	1449	1	10	4008321162007

¹ Average lifespan
² Max. luminous flux at 25°C
³ Max. luminous flux at 35°C



Circular T5 FC



Ideal for circular and square luminaires. Emits harmonious light.

Item name



Order code (EAN)

2GX13 – 16 mm – LUMILUX® INTERNA (827) – folding box

Item name	No.	t[h] ¹	W	lm	Energy efficiency class	kWh/1000h	K	d [mm]	Height [mm]	Packaging	Order code (EAN)
Circular lamp T5 FC 22 W	(1)	12000	22	1800	A+	25	2700	230	1	12	4050300646237
Circular lamp T5 FC 40 W	(1)	12000	40	3400	A+	44	2700	305	1	12	4050300646251
Circular lamp T5 FC 55 W	(1)	12000	55	4200	A	61	2700	305	1	12	4050300646275

2GX13 – 16 mm – LUMILUX® Cool White (840) – folding box

Item name	No.	t[h] ¹	W	lm	Energy efficiency class	kWh/1000h	K	d [mm]	Height [mm]	Packaging	Order code (EAN)
Circular lamp T5 FC 22 W	(1)	12000	22	1800	A+	25	4000	230	1	12	4050300528465
Circular lamp T5 FC 40 W	(1)	12000	40	3400	A+	44	4000	305	1	12	4050300528526
Circular lamp T5 FC 55 W	(1)	12000	55	4200	A	61	4000	305	1	12	4050300528588

¹ Average lifespan



Circular T9 C



Ideal for circular and square luminaires. Emits harmonious light.

Item name No. t[h]¹ W lm kWh/1000h K d [mm] Order code (EAN)

G10q – 29 mm – LUMILUX® INTERNA (827) – folding box

Circular lamp T9 C 22 W	(1)	9000	22	1350	A	25	2700	216	1	12	4008321581068
Circular lamp T9 C 32 W	(1)	9000	32	2250	A	36	2700	305	1	12	4008321581129

G10q – 29 mm – LUMILUX® Cool White (840) – folding box

Circular lamp T9 C 22 W	(1)	9000	22	1350	A	25	4000	216	1	12	4008321581082
Circular lamp T9 C 32 W	(1)	9000	32	2250	A	36	4000	305	1	12	4008321581143
Circular lamp T9 C 40 W	(1)	9000	40	3200	A	44	4000	406	1	12	4050300014845

G10q – 29 mm – LUMILUX® Cool Daylight (865) – folding box

Circular lamp T9 C 40 W	(1)	9000	40	3070	A	44	6500	406	1	12	4008321960139
-------------------------	-----	------	----	------	---	----	------	-----	---	----	---------------

¹ Average lifespan



U-shaped



For space-saving luminaires in kitchens and offices.

Item name	 No.	 t [h] ¹	 W	 lm		 kWh/1000h	 K	 l max. [mm]			Order code (EAN)
-----------	---	--	---	--	---	---	---	---	---	---	------------------

2G13 – 26 mm – LUMILUX® Warm White (830) – folding box

U-shaped lamp L 18 W	(1)	13000	18	1350	A	20	3000	310	1	24	4008321959904
U-shaped lamp L 36 W	(1)	13000	36	3350	A+	41	3000	670	1	12	4008321959911
U-shaped lamp L 58 W	(1)	13000	58	5250	A+	65	3000	765	1	12	4008321959041

2G13 – 26 mm – LUMILUX® Cool White (840) – folding box

U-shaped lamp L 18 W	(1)	13000	18	1350	A	20	4000	310	1	24	4008321469168
U-shaped lamp L 36 W	(1)	13000	36	3350	A+	41	4000	670	1	12	4008321469182
U-shaped lamp L 58 W	(1)	13000	58	5250	A+	65	4000	765	1	12	4008321469205

¹ Average lifespan



T8 SPEZIAL BIOLUX®



Lamp with very good color rendering, also suitable for lighting enclosures for small animals.

Item name



t[h]¹

W

lm²



kWh/1000h



l_f max.
[mm]



Order code
(EAN)

G13 – 26 mm – BIOLUX® (965) – folding box

Item name	t[h] ¹	W	lm ²	Base	kWh/1000h	Color rendering	l _f max. [mm]	Box	Order code (EAN)	
T8 BIOLUX L 18 W	(1)	20000	18	1000	B	22	BIOLUX 590	1	10	4050300937939
T8 BIOLUX L 30 W	(1)	20000	30	1600	B	36	BIOLUX 895	1	10	4050300937946
T8 BIOLUX L 36 W	(1)	20000	36	2300	B	43	BIOLUX 1200	1	10	4050300937977
T8 BIOLUX L 58 W	(1)	20000	58	3700	B	68	BIOLUX 1500	1	10	4050300938004

¹ Average lifespan
² Max. luminous flux at 25 °C



T8 SPECIAL FLUORA®



Promotes healthy plant growth.

Item name



Order code (EAN)

G13 – 26 mm – FLUORA® (77) – folding box

Item name	Light bulb icon	Average lifespan [h]	Power [W]	Lumen [lm]	Energy efficiency [kWh/1000h]	Color temperature	Maximum length [mm]	Packaging	Order code (EAN)	
T8 FLUORA L 18 W	(1)	20000	18	550	B	23	FLUORA 590	1	10	4050300325798
T8 FLUORA L 30 W	(1)	20000	30	1000	B	37	FLUORA 895	1	10	4050300325453
T8 FLUORA L 36 W	(1)	20000	36	1400	B	44	FLUORA 1200	1	10	4050300325774
T8 FLUORA L 58 W	(1)	20000	58	2250	B	69	FLUORA 1500	1	10	4050300325811

¹ Average lifespan









STARTERS



For the safe, rapid and gentle ignition of fluorescent lamps operated on conventional ballasts. With self-extinguishing insulating housing and anti-interference capacitor, VDE approved and protection rating II. DEOS® safety starters

also offer other valuable advantages for ensuring that lamps start safely and operate reliably.

Item name	 No.	 W	 d [mm]	 H max. [mm]			Order code (EAN)
Blister							
DEOS ST 171	(1)	36...65	22	40.3	1	10	4050300 421544
ST 111	(1)	4...65; 80	22	40.3	2	20	4050300 064000
ST 151 ¹	(1)	4...22	22	40.3	2	20	4050300 092638

¹ For series operation of two 4 to 22W fluorescent lamps.





Incandescent lamps and special lamps

ErP legislation has ensured that the old-timers among lamps are now fully obsolete. Excluded from the ban are special lamps and initially, various spotlights. OSRAM continues to offer these products in proven quality.

Spot lamps 134	
Decorative incandescent lamps 136	
Special incandescent lamps 138	
Lamps with ultraviolet and infrared radiation 142	

SPOT R39



Item name	No.	W	cd		kWh/1000h	K	d [mm]	l [mm]			Order code (EAN)
E14 – 40° – blister											
SPOT R39 30 W ¹	(1)	30	180	E	30	2700	39	68	1	10	4050300118529
E14 – 40° – box											
SPOT R39 30 W ¹	(1)	30	180	E	30	2700	39	68	1	25	4050300004815

SPOT R50



Item name	No.	W	cd		kWh/1000h	K	d [mm]	l [mm]			Order code (EAN)
E14 – 30° – blister											
SPOT R50 25 W ¹	(1)	25	210	E	25	2700	50	85	2	20	4050300118505
SPOT R50 40 W ¹	(1)	40	410	E	40	2700	50	85	2	20	4050300118482
E14 – 30° – box											
SPOT R50 25 W ¹	(1)	25	210	E	25	2700	50	85	2	28	4050300148465
SPOT R50 40 W ¹	(1)	40	410	E	40	2700	50	85	2	28	4050300148489

¹ Phase-out September 2014. Find more information in this catalog on pages 8–11 or at www.osram.com/erp

SPOT R63



Item name



W

cd



kWh/1000h

K

d [mm]

l [mm]



Order code (EAN)

E27 – 30° – blister

Item name	No.	W	cd	Energy efficiency	kWh/1000h	K	d [mm]	l [mm]	Blister pack	Box	Order code (EAN)
SPOT R63 40 W ¹	(1)	40	430	E	40	2700	63	104	1	10	4050300093055
SPOT R63 60 W ¹	(1)	60	960	E	60	2700	63	104	1	10	4050300093826

E27 – 30° – box

SPOT R63 40 W ¹	(1)	40	430	E	40	2700	63	104	2	48	4050300562537
SPOT R 63 60 W ¹	(1)	60	960	E	60	2700	63	104	2	48	4050300562551

SPOT R80

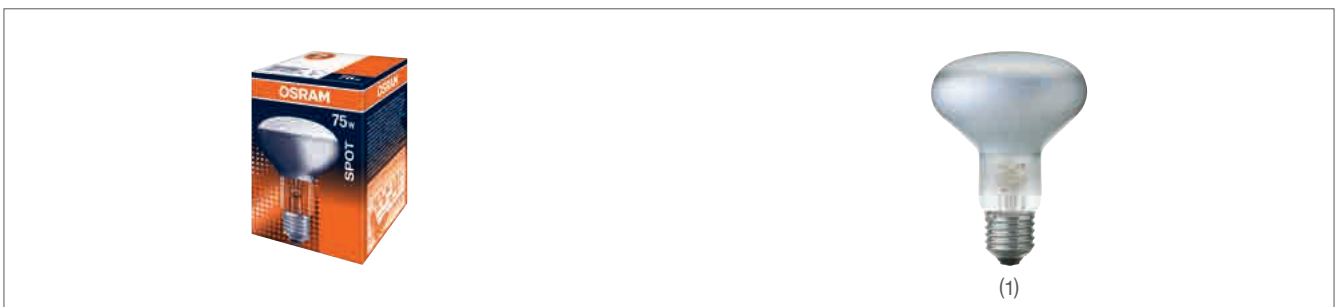

Item name



W

cd



kWh/1000h

K

d [mm]

l [mm]



Order code (EAN)

E27 – 50° – box

SPOT R80 40 W ^{1,2}	(1)	40	150	E	40	2700	80	115	1	25	4050300066042
SPOT R80 60 W ^{1,2}	(1)	60	460	E	60	2700	80	115	1	25	4050300066059
SPOT R80 75 W ^{1,2}	(1)	75	345	E	75	2700	80	115	1	25	4050300066066

¹ Phase-out September 2014. Find more information in this catalog on pages 8–11 or at www.osram.com/erp
² Only available for 240V. Also suitable for 230V applications.

DECOR COLOR A bulb shape



Item name



W

lm



kWh/1000h

K



d [mm]



l [mm]

Order code (EAN)

E27 – box

Item name	No.	W	lm	Energy efficiency	kWh/1000h	K	d [mm]	l [mm]	Order code (EAN)
DECOR A BLUE 11 W	(1)	11	—	E	11	2700	55	94	1 35 4008321545862
DECOR A GREEN 11 W	(2)	11	—	E	11	2700	55	94	1 35 4008321545893
DECOR A ORANGE 11 W	(3)	11	—	E	11	2700	55	94	1 35 4008321545916
DECOR A RED 11 W	(4)	11	—	E	11	2700	55	94	1 35 4008321545824
DECOR A YELLOW 11 W	(5)	11	—	E	11	2700	55	97	1 35 4008321480910

DECOR COLOR P round shape



Item name



No.

W

lm



kWh/1000h

K



d [mm]



l [mm]

Order code
(EAN)

E14 – box

Item name	No.	W	lm	Energy efficiency	kWh/1000h	K	d [mm]	l [mm]	Box icon	Stack icon	Order code (EAN)
DECOR P BLUE 11 W	(1)	11	—	E	11	2700	45	74	1	35	4008321545787
DECOR P GREEN 11 W	(2)	11	—	E	11	2700	45	74	1	35	4008321545800
DECOR P RED 11 W	(3)	11	—	E	11	2700	45	74	1	35	4008321545763
DECOR P YELLOW 11 W	(4)	11	—	E	11	2700	45	74	1	35	4008321480910

SPECIAL MIRROR A GOLD/SILVER

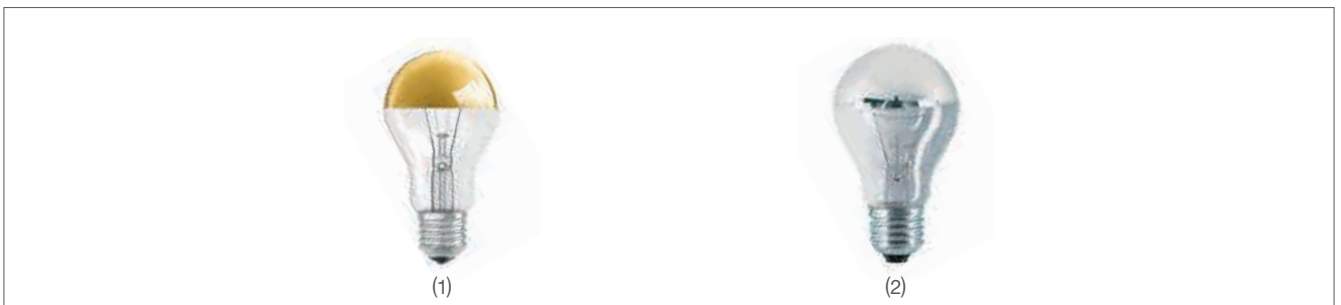

Item name



W

lm



kWh/1000h

K

d [mm]

l [mm]



Order code (EAN)

E27 – box

Item name	No.	W	lm	Energy efficiency	kWh/1000h	K	d [mm]	l [mm]	Box	Stack	Order code (EAN)
SPECIAL MIRROR A GOLD 40 W	(1)	40	330	E	40	2700	60	97	1	30	4050300001050
SPECIAL MIRROR A GOLD 60 W	(1)	60	570	E	60	2700	60	97	1	30	4050300001067
SPECIAL MIRROR A SILVER 60 W	(2)	60	570	E	60	2700	60	97	1	30	4050300309651
SPECIAL MIRROR A SILVER 100 W	(2)	100	1180	E	100	2700	60	123	1	30	4050300312705

SPECIAL MIRROR P GOLD/SILVER



Item name



W

lm



kWh/1000h

K

d [mm]

l [mm]

Order code
(EAN)

E14 – box

SPECIAL MIRROR P GOLD 25 W	—	25	170	E	25	2700	45	78	1	35	4050300001104
SPECIAL MIRROR P GOLD 40 W	—	40	330	E	40	2700	45	78	1	35	4050300001111
SPECIAL MIRROR P SILVER 25 W	(1)	25	170	E	25	2700	45	78	1	35	4050300001081
SPECIAL MIRROR P SILVER 40 W	(2)	40	330	E	40	2700	45	78	1	35	4050300002224

Oven lamp P round shaped/T pygmy shaped

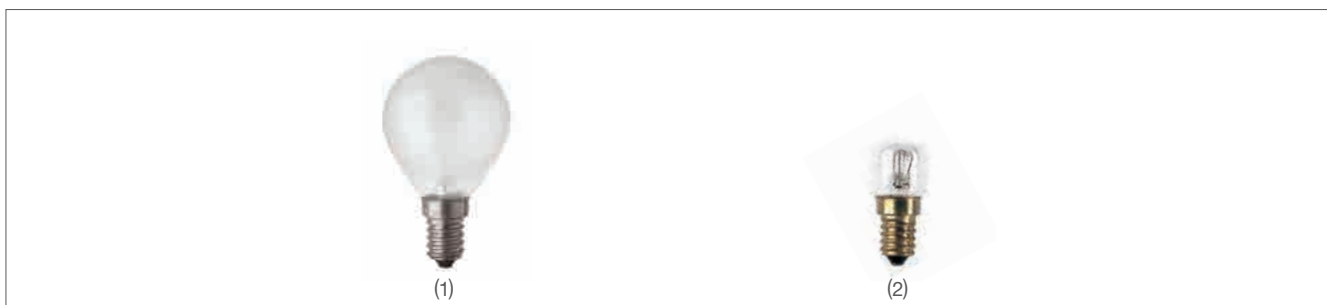

Item name	No.	W	lm	Energy class	kWh/1000h	K	d (mm)	l (mm)	Box height (mm)	Box width (mm)	Order code (EAN)
E14 – frosted – box											
P bulb oven 300° 40 W	(1)	40	400	E	40	2700	45	74	1	50	4050300008486
E14 – clear – blister											
T bulb oven 300° 15 W	(2)	15	85	E	15	2700	22	50	1	10	4050300065052
E14 – clear – box											
T bulb oven 300° 15 W	(2)	15	85	E	15	2700	22	50	1	100	4050300003108

Refrigerator lamp/sewing machine lamp T pygmy shaped











Item name	No.	W	lm	g	kWh/1000h	K	d [mm]	l [mm]	g	g	Order code (EAN)
E14 – clear – blister											
T bulb 16/54 15 W	(1)	15	100	E	15	2700	16	54	1	10	4050300092928
E14 – frosted – box											
T bulb 26/57 15 W	(2)	15	110	E	15	2700	26	57	1	99	4050300003085
T bulb 26/57 25 W	(2)	25	190	E	25	2700	26	57	1	100	4050300323596
E14 – clear – box											
T bulb 26/57 15 W	(3)	15	110	E	15	2700	26	57	1	100	4050300310282
T bulb 26/57 25 W	(3)	25	190	E	25	2700	26	57	1	100	4050300309637

Incandescent and special lamps

OSRAM ULTRA-VITALUX® UV spotlight



High-performance UV lamp for technical applications from terraristics to curing, luminous exposure and materials testing. Not for exposing people to radiation.¹

Item name									Order code (EAN)
E27 – 30° – 230 V – box									
ULTRA-VITALUX	(1)	300	13,6	3	127	185	1	6	4008321543929

¹ Safety information: Because of the high amount of heat generated, OSRAM ULTRA-VITALUX® spotlights should only be operated in suitable appliances. Protect the lamps against moisture and splashes. This appliance is not a medical product. In accordance with EN 60335-2-27, OSRAM ULTRA-VITALUX® is not approved for human





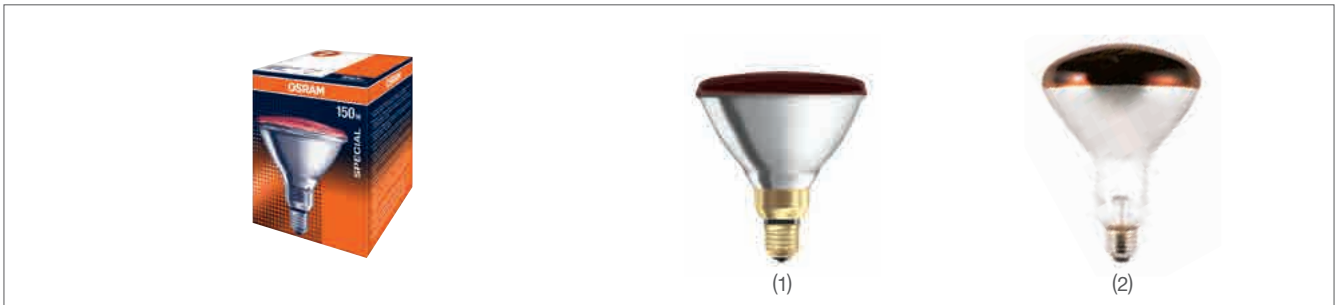

radiation therapy.
² After 1 hour.



THERATHERM® infrared heat lamp



Infrared heat lamps with high irradiance, long lifespan and full heat output as soon as the lamp is switched on.

Item name	 No.	 W	 d [mm]	 l [mm]			Order code (EAN)
E27 – rot – box							
THERATHERM PAR38	(1)	150	124	136	1	12	4008321 392213
THERATHERM R125	(2)	250	125	185	1	12	4008321 507099

¹ Safety information: Consult your doctor if you have medical problems. Because of the high heat produced, you may only use THERATHERM® spotlights in suitable, heat-resistant appliances! Protect lamps (made from soft glass) against moisture and splashes!



Vehicle lamps

Modern vehicle lighting makes special demands on lamps, in summer and winter, all day and all night. It's no wonder then that the OSRAM brand with its know-how and experience in this field inspires the highest level of trust with customers.

LED product range	150	
Gas discharge headlamps	161	
Halogen headlamps	163	
Signal lamp product range	169	
Motorcycle lamp product range	172	
Spare lamp kit	175	

Get your sales into gear: OSRAM vehicle lamps

OSRAM continuously sets new standards with outstanding product ideas, such as LED LIGHT@DAY®, the upgrade daytime running light with a uniform LED light surface, or NIGHT BREAKER® UNLIMITED, probably the most powerful automotive halogen light in the world.



The latest technology and top quality

The innovative vehicle lamp product range from OSRAM appeals to both design-conscious and performance-oriented vehicle drivers, and will give a new boost to your light business.

Especially impressive: OSRAM Performance automotive lamps

Performance automotive lamps from OSRAM lead the way in the car lighting sector with their powerful light. Various lamp technologies and product lines offer your customers a precise selection of lamps closely corresponding to their personal needs.

Especially stylish: OSRAM design automotive lamps

OSRAM design headlamps are not just optimized in terms of luminous efficacy, but are also a visual highlight. They are the first choice for design-aware drivers seeking a modern look and stylish effects for their vehicle, for example with blue light instead of standard light. There are also many new and appealing alternatives for interior lighting, for example LED retrofit lamps and LED solutions for ambient lighting.



“Automotive Special” on the OSRAM website

Now with interesting content, tools and services, the automotive sector of the OSRAM website gains even more importance. Whether you want powerful and stylish lighting, the latest trends or news hot off the press: The “Automotive Special” offers your customers a wealth of information and possibilities for automotive lighting to keep them up-to-date – simply by clicking on the “news and knowledge” area on the OSRAM home page.

OSRAM is the first choice for passenger car light applications. Our customers include major international companies in the automotive industry. For years now, they have trusted in light solutions which meet ever increasing safety requirements and which can hold their own providing the highest quality and performance standards.

Pure horsepower for your sales success: professional OSRAM support

OSRAM makes a wide range of tools and advertising materials available to you which guarantee optimum advice, attractive product presentation and a better incentive to buy at the POS. Continuous ad placements and online marketing from OSRAM also ensure additional professional sales support.

Innovative sales solutions for the POS

Whether modular shelving systems, LCD displays ready for delivery or impressive beamer racks, OSRAM provides active customer communication with its innovative sales solutions and optimal product presentations at your POS.

Even more flexible and easier to setup: The POS shelving system

A new, modern shelving display emphasizes the premium quality that is OSRAM. The modular design allows flexible and individual use of every component. This makes for perfect presentations at the POS for both small and large shelf placements. A highlight is the information board available optionally with a demo tool bracket, communicating all the important information for finding the right lamp. Customers can see at a glance the various characteristics of the lamp, such as more light output, blue light or a longer lifespan. The vertical structure helps to provide a better visual orientation.



Attractive packaging and transparent information

OSRAM vehicle lamps have especially appealing packaging that also communicates all important information and features in a clear, understandable and honest way.

LC displays

Information, advice and entertainment: The LC displays upgrade your sales space and encourage spontaneous purchases. As stand-alones or in combination with free secondary placements, LC displays are even noticed by the most inattentive of customers.

Interactive tools for computers and smartphones

Whether it is useful information in the carlightblog, a vehicle lamp adviser, installation videos for new products or mobile apps for iPhone or Android: Your customers are kept completely up to date on car lighting with interactive OSRAM tools.



Carlightblog

What is the difference between halogen, xenon and LED light? How can I equip my car with daytime running lights? How are headlights set correctly? The carlightblog provides the answers to these and many other questions.

Beamer rack

Experiencing quality live is the most convincing sales argument. Halogen, xenon, LED: Demo tools enable a direct comparison of luminous intensity and specific impressions of light from various headlamps. This allows your customers to see the complete range of product benefits at a glance.



Vehicle spare lamp list

Whether it is for cars, trucks and motorcycles: This tool enables your customers to find lamps, dipped beam, full beam, fog lights, indicator lights and much more for these vehicles.



Installation videos

Easy and understandable: OSRAM installation videos show your customers how new products, for example Light@Day daytime running lights, are installed correctly and professionally.



More effective sales aids

- Displays and secondary placement – for both eye-catching and high quality product presentation, neatly arranged and providing clear information
- Counter displays – ideal in tight spaces, attracting attention and practical
- Floor display – for presenting the entire product range
- Additional extras such as wobblers and shelf stoppers – perfect eye-catchers

“Vehicle Light” mobile app

Being mobile is crucial, and with the OSRAM “Vehicle Light” app for iPhone and Android smartphones, your customers can also find precisely the right lamps for their vehicle types while they are on the go.

OSRAM LED LIGHT@DAY®

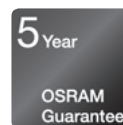

Dynamic design and optional styling light function – with no visible LED lights points: OSRAM LED LIGHT@DAY® is the first upgradable daytime running light with a uniform LED light surface. Thanks to its high protection rating (IP69K), a

car wash is no problem. Suitable for many vehicle models, with easy installation. Low power consumption, dimmable and with a 5-year guarantee¹.

Item name	No.	ECE	W	V	Color	Beam	Box	Stack	Order code (EAN)
LED daytime running light – 12V									
LED LIGHT@DAY / LEDDRL101	(1)	—	15	12	6000	—	1	2	4008321673152
LED LIGHT@DAY (Clamp15) / LEDDRL101 CL 15	(2)	—	15	12	6000	—	1	2	4052899054622

¹ Details at www.osram.com/am-guarantee

OSRAM LEDriving®



An angular appearance and a modern, dotted diode effect give the LED daytime running light an especially dynamic look. Thanks to the simple design and specific lamp shape a simple installation is also possible in tight bumpers.

Suitable for many vehicle models. Low power consumption, dimmable and with a three year guarantee¹.

Item name									Order code (EAN)
LED daytime running light – 12V									
LEDriving PX-5 / LEDDRL301	(1)	—	13.5	12	5200	—	1	5	4052899000070
LEDriving PX-4 / LEDDRL401	(2)	—	13.5	12	6000	—	1	4	4008321781215





¹ Details at www.osram.com/am-guarantee

OSRAM LEDriving® FOG



The innovative, dimmable LED fog light with daytime running light functionality emits uniform light with no visible

LED points. Low power consumption and automatic operation thanks to intelligent control. 5-year guarantee¹.

Item name	 No.								Order code (EAN)
LED fog light – 12V									
LEDriving FOG / LEDFOG101	(1)	—	7/12	12	6000	—	1	4	4008321890566

¹ Details at www.osram.com/am-guarantee

OSRAM LEDriving® Retrofits Premium



Lamps for a wide variety of applications in vehicle interiors¹. Up to 80 % lower power consumption compared to standard lamps. Perfect LED light based on the latest

diffuser material: Uniform light distribution with no point lighting. Simple, rapid replacement for easy upgrading. 5-year OSRAM guarantee².

Item name Order code (EAN)

LEDriving® Retrofits Premium – 12V – double blister

Item name									Order code (EAN)
LEDriving W5W 4000K / 2850WW-02B	(1)	—	1	12	Warm White	W2.1x9.5d	2	10	4008321657633
LEDriving W5W 6000K / 2850CW-02B	(1)	—	1	12	Cool White	W2.1x9.5d	2	10	4008321657657
LEDriving W5W BLUE / 2850B-02B	(1)	—	1	12	Ice Blue	W2.1x9.5d	2	10	4008321875549
LEDriving W5W YELLOW / 2855YE-02B	(1)	—	1	12	Amber	W2.1x9.5d	2	10	4008321875600

Item name Order code (EAN)

LEDriving® Retrofits Premium – 12V – blister

Item name									Order code (EAN)
LEDriving C5W 4000K / 6498WW-01B	(2)	—	1	12	Warm White	SV8.5-8	2	10	4008321658159
LEDriving C5W 6000K / 6498CW-01B	(2)	—	1	12	Cool White	SV8.5-8	2	10	4008321658173

Item name Order code (EAN)

LEDriving® Retrofits Premium – 12V – double blister

Item name									Order code (EAN)
LEDriving T4W 4000K / 3850WW-02B	(3)	—	1	12	Warm White	BA9s	2	10	4008321657893
LEDriving T4W 6000K / 3850CW-02B	(3)	—	1	12	Cool White	BA9s	2	10	4008321658111

¹ Only authorized for off-road use when used as exterior lighting. Use on public highways will lead to cancellation of the vehicle's operating license and will invalidate your insurance.
² Details at www.osram.com/am-guarantee

OSRAM LEDriving® Retrofits Standard



Lamps for a wide variety of applications in vehicle interiors¹. rapid replacement for easy upgrading. 3-year guarantee². Uniform light distribution without spot lighting. Simple,

Item name



Order code (EAN)

LEDriving® Retrofits Standard – 12V – double blister

Item name	Light bulb icon with 'No.'	ECE	W	V	Color bar	Beam spread icon	Blister pack icon	Box icon	Order code (EAN)
LEDriving W5W 6000K / 2880CW-02B	(1)	—	1	12	Cool White	W2.1x9.5d	2	10	4052899067820
LEDriving W5W 6700K / 2880SW-02B	(1)	—	1	12	Sky White	W2.1x9.5d	2	10	4052899067844

¹ Only authorized for off-road use when used as exterior lighting. Use on public highways will lead to cancellation of the vehicle's operating license and will invalidate your insurance.

² Details at www.osram.com/am-guarantee

OSRAM LEDriving® Canbus Control Unit

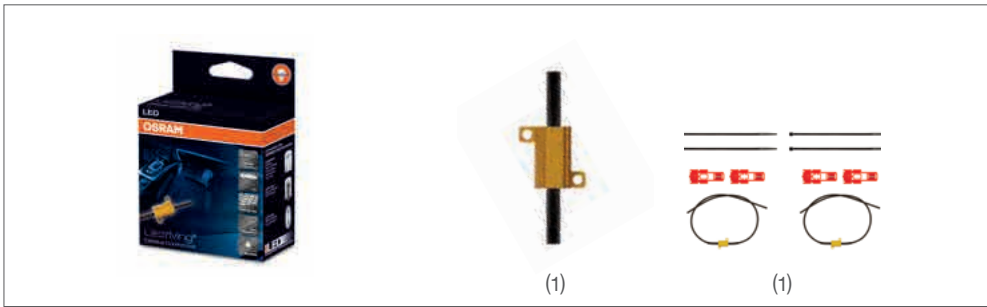

Improved light management, no error messages from the on-board computer, and no negative effects on light intensity or the thermal management of the LED solution. The accessory set for use with LED retrofit lamps is suit-

able for all vehicle types with CAN bus control systems for lighting¹. Simple installation, connecting clips included, 3-year guarantee².

Item name



Order code (EAN)

LEDriving® Canbus Control Unit – 12V – blister

LEDriving Canbus Control Unit / LEDCBCTRL101	(1)	—	5	12	—	—	2	20	4052899090873
--	-----	---	---	----	---	---	---	----	---------------

¹ Only authorized for off-road use when used as exterior lighting. Use on public highways will lead to cancellation of the vehicle's operating license and will invalidate your insurance.
² Details at www.osram.com/am-guarantee

OSRAM LEDambient® Door Entrance Ledge

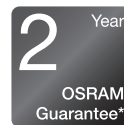
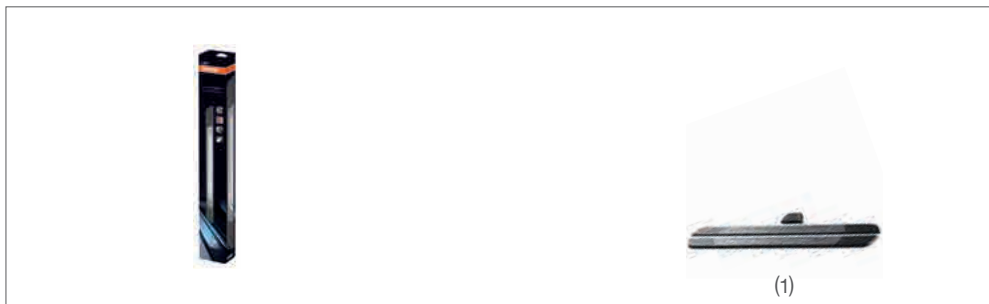

LED door entrance lighting for a more comfortable ambience inside the vehicle. Seven color varieties of your choice in four adjustable brightness levels ensure a maximum number of individualization options. Wireless tech-

nology enables simple and intuitive control of the modules via remote control. Easy and quick installation thanks to magnetic fastening. 2-year guarantee¹.

Item name



Order code (EAN)

LEDambient® Styling Lights

LEDambient Door Entrance Ledge / WAL DEL101	(1)	—	—	2.8–4.2	RGB Multicolor	—	1	2	4052899074903
---	-----	---	---	---------	----------------	---	---	---	---------------

¹ Details at www.osram.com/am-guarantee

OSRAM LEDambient® Wallwasher, Spotlight & Light Guide



LED lighting for atmospheric and uniform illumination of the vehicle interior. Various modules enable diverse applications and the stylish design harmonizes ideally with the vehicle interior. Seven color varieties of your choice and

four adjustable brightness levels. Wireless technology, control via remote control. 2-year guarantee¹.

Item name									Order code (EAN)
LEDambient® Styling Lights									
LEDambient Wallwasher, Spotlight & Light Guide / 510269 WAL INT 101	(1)	—	—	2.8–4.2	RGB Multicolor	—	1	2	4052899074927





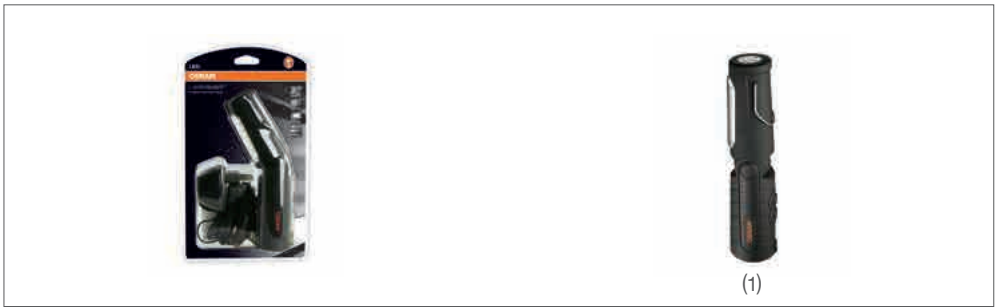



¹ Details at www.osram.com/am-guarantee

OSRAM LEDinspect® Foldable Inspection Lamp



An LED work light with a compact design for hands-free work based on a magnet and hook. Durable LEDs with high light intensity ensure outstanding illumination.

No batteries required, rechargeable via 220V adapter and 12V cigarette lighter. 2-year guarantee¹.

Item name	 No.	 ECE	 W	 V					Order code (EAN)
LEDinspect® Inspection Lights									
LEDinspect Foldable Inspection Lamp / LEDIL301	(1)	—	—	12/24	—	—	1	10	4052899009592

¹ Details at www.osram.com/am-guarantee

OSRAM LEDinspect® Mini Inspection Lamp



2 Year
OSRAM
Guarantee*

24 + 3 LED

Compact battery-operated LED work light. 3 AAA batteries included in the scope of delivery. Outstanding illumination

due to long-life LEDs with high light intensity. Hands-free work based on magnet and hook. 2-year guarantee¹.

Item name



ECE

W

V



Order code
(EAN)

LEDinspect® Inspection Lights

LEDinspect Mini Inspection Lamp / LEDIL302	(1)	—	—	12/24	—	—	1	24	4052899009578
--	-----	---	---	-------	---	---	---	----	---------------









¹ Details at www.osram.com/am-guarantee

OSRAM ONYX COPILOT®



LED reading light for the vehicle interior. Individual alignment thanks to gooseneck and pleasantly warm and glare-free light. Mounted to the cigarette lighter. Supply voltage:

12 V and 24 V. Standard plug in compliance with ISO 4165 and SAE J563.

Item name	 No.								Order code (EAN)
LED Copilot									
ONYX Copilot M / ONYX M	(1)	—	—	12/24	—	—	1	4	4052899011250
ONYX Copilot M-7 / ONYX M-7	(1)	—	—	12/24	—	—	1	4	4052899077270

¹ Details at www.osram.com/am-guarantee

OSRAM XENARC® COOL BLUE® INTENSE



The blue effect in headlamps is normally achieved with a special coating, but this reduces the light level. OSRAM XENARC® COOL BLUE® INTENSE achieves its intensely

bright and unusually contrast-rich blue due to a special filling system only – thus emitting up to 20 % more light^{1,2}.

Item name



Order code
(EAN)

Headlight lamp – 12V – blister

XENARC COOL BLUE INTENSE / 66240CBI-HCB	(1)	D2S	35	—	—	P32d-2	2	20	4008321588883
---	-----	-----	----	---	---	--------	---	----	---------------

¹ Compared to xenon lamps with a conventional coating

² We recommend having XENARC® relamping carried out by a qualified mechanic.

OSRAM XENARC® NIGHT BREAKER® UNLIMITED



The most powerful xenon automotive light in the world with up to 70 % more light¹. In addition to this, the light cone is up to 20 m longer, with up to 5 % whiter light compared to xenon headlamps¹. Ideal for a comfortable drive².

Item name



ECE

W

V



Order code (EAN)

Headlight lamp – 12V – blister

XENARC NIGHT BREAKER UNLIMITED / 66240XNB-HCB	(1)	D2S	35	—	—	P32d-2	2	20	4052899047105
---	-----	-----	----	---	---	--------	---	----	---------------

¹ Compared to xenon lamps with a conventional coating

² We recommend having XENARC® relamping carried out by a qualified mechanic.

OSRAM NIGHT BREAKER® UNLIMITED

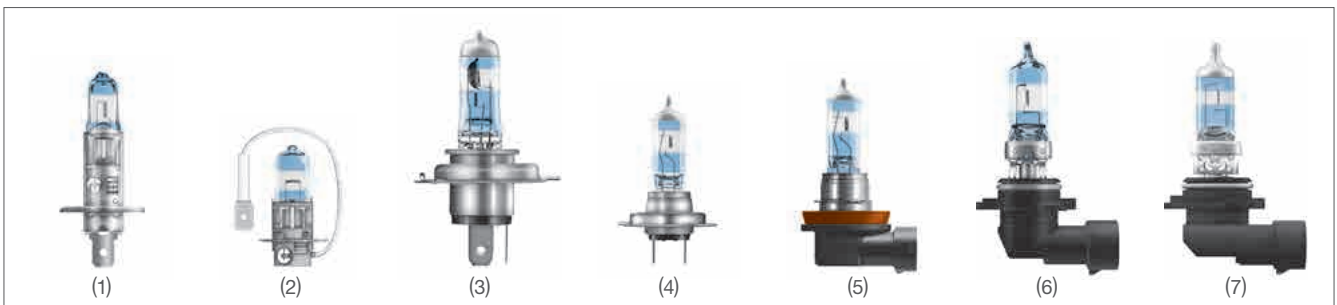
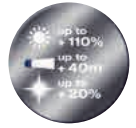

The most powerful OSRAM halogen automotive lamp achieves up to 110% more light on the road¹, a light cone up to 40m longer¹ and up to 20% whiter light¹. Optimal

for more time to react – obstacles and hazards can be identified earlier. A striking design with patented blue ring coating for glare-free light.

Item name



No.

ECE

W

V



Order code (EAN)

Headlight lamp – 12V – blister

NIGHT BREAKER UNLIMITED / 64150NBU-01B	(1)	H1	55	12	—	P14.5s	1	10	4052899016781
NIGHT BREAKER UNLIMITED / 64151NBU-01B	(2)	H3	55	12	—	PK22s	1	10	4052899016729
NIGHT BREAKER UNLIMITED / 64193NBU-01B	(3)	H4	60/55	12	—	P43t	1	10	4052899017177
NIGHT BREAKER UNLIMITED / 64210NBU-01B	(4)	H7	55	12	—	PX26d	1	10	4052899017047
NIGHT BREAKER UNLIMITED / 64211NBU-01B	(5)	H11	55	12	—	PGJ19-2	1	10	4052899016804

Headlight lamp – 12V – double blister

NIGHT BREAKER UNLIMITED / 64150NBU-02B	(1)	H1	55	12	—	P14.5s	2	20	4052899016743
NIGHT BREAKER UNLIMITED / 64193NBU-02B	(3)	H4	60/55	12	—	P43t	2	20	4052899017191
NIGHT BREAKER UNLIMITED / 64210NBU-02B	(4)	H7	55	12	—	PX26d	2	20	4052899017023

Headlight lamp – 12V – duo box

NIGHT BREAKER UNLIMITED / 64150NBU-HCB	(1)	H1	55	12	—	P14.5s	2	20	4052899016286
NIGHT BREAKER UNLIMITED / 64193NBU-HCB	(3)	H4	60/55	12	—	P43t	2	20	4052899017214
NIGHT BREAKER UNLIMITED / 64210NBU-HCB	(4)	H7	55	12	—	PX26d	2	20	4052899017061
NIGHT BREAKER UNLIMITED / 9005NBU-HCB	(6)	HB3	60	12	—	P20d	2	20	4052899030756
NIGHT BREAKER UNLIMITED / 9006NBU-HCB	(7)	HB4	51	12	—	P22d	2	20	4052899030817

¹ Compared to standard halogen lamps

OSRAM COOL BLUE® INTENSE



The headlamp for the bluest legally-compliant halogen light in a stylish xenon look – with up to 20% more light¹. OSRAM COOL BLUE® INTENSE achieves high luminous

flux for a daylight-like, high-contrast lighting effect. A modern design with a silver dome (H4/H7/H11/HB4). Available for all headlight functions.

Item name



Order code (EAN)

Headlight lamp – 12V – blister

COOL BLUE INTENSE H1 / 64150CBI-01B	(1)	H1	55	12	—	P14.5s	1	10	4008321655424
COOL BLUE INTENSE H4 / 64193CBI-01B	(2)	H4	60/55	12	—	P43t	1	10	4008321651280
COOL BLUE INTENSE H7 / 64210CBI-01B	(3)	H7	55	12	—	PX26d	1	10	4008321651563

Headlight lamp – 12V – double blister

COOL BLUE INTENSE H1 / 64150CBI-02B	(1)	H1	55	12	—	P14.5s	2	20	4008321655448
COOL BLUE INTENSE H4 / 64193CBI-02B	(2)	H4	60/55	12	—	P43t	2	20	4008321651303
COOL BLUE INTENSE H7 / 64210CBI-02B	(3)	H7	55	12	—	PX26d	2	20	4008321651372

Headlight lamp – 12V – duo box

COOL BLUE INTENSE H1 / 64150CBI-HCB	(1)	H1	55	12	—	P14.5s	2	20	4008321650719
COOL BLUE INTENSE H4 / 64193CBI-HCB	(2)	H4	60/55	12	—	P43t	2	20	4008321650733
COOL BLUE INTENSE H7 / 64210CBI-HCB	(3)	H7	55	12	—	PX26d	2	20	4008321650757
COOL BLUE INTENSE H11 / 64211CBI-HCB	(4)	H11	55	12	—	PGJ19-2	2	20	4008321650771
COOL BLUE INTENSE HB3 / 9005CBI-HCB	(5)	HB3	60	12	—	P20d	2	20	4008321660282
COOL BLUE INTENSE HB4 / 9006CBI-HCB	(6)	HB4	51	12	—	P22d	2	20	4008321660305

Additional lamp – 12V – double blister

COOL BLUE INTENSE / 2825HCBI-02B	(7)	W5W	5	12	—	W2.1x9.5d	2	20	4008321650870
----------------------------------	-----	-----	---	----	---	-----------	---	----	---------------

¹ Compared to standard halogen lamps

OSRAM SILVERSTAR® 2.0

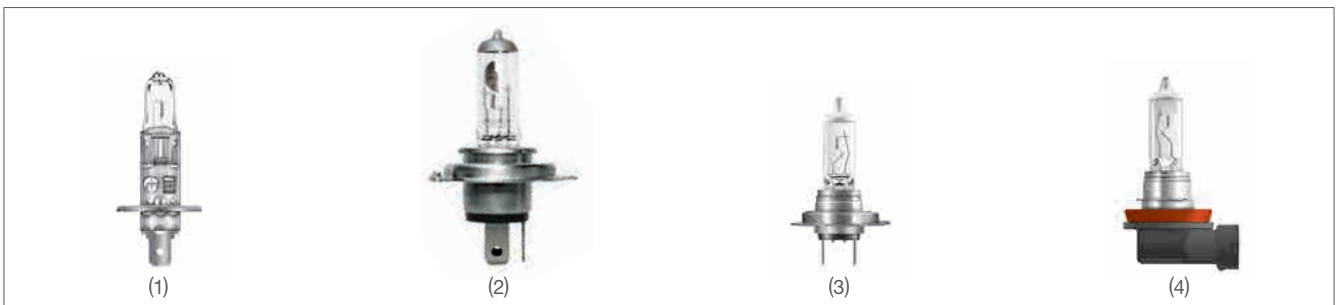

Headlamps for high demands in terms of safety, performance and pricing. OSRAM SILVERSTAR® 2.0 achieves up to 60 % more light¹, a light cone extended by up to 20m¹ and up to double the lifespan². This enables hazards to be

identified more quickly, and drivers can respond earlier and better. A modern design with silver dome (H4/H7/H11) for use in clear glass headlights.

Item name	No.	ECE	W	V					Order code (EAN)
Headlight lamp – 12V – blister									
SILVERSTAR 2.0 / 64150SV2-01B	(1)	H1	55	12	—	P14.5s	1	10	4008321785855
SILVERSTAR 2.0 / 64193SV2-01B	(2)	H4	60/55	12	—	P43t	1	10	4008321785961
SILVERSTAR 2.0 / 64210SV2-01B	(3)	H7	55	12	—	PX26d	1	10	4008321786715
Headlight lamp – 12V – double blister									
SILVERSTAR 2.0 / 64150SV2-02B	(1)	H1	55	12	—	P14.5s	2	20	4008321785899
SILVERSTAR 2.0 / 64193SV2-02B	(2)	H4	60/55	12	—	P43t	2	20	4008321785985
SILVERSTAR 2.0 / 64210SV2-02B	(3)	H7	55	12	—	PX26d	2	20	4008321786739
Headlight lamp – 12V – duo box									
SILVERSTAR 2.0 / 64150SV2-HCB	(1)	H1	55	12	—	P14.5s	2	20	4008321785893
SILVERSTAR 2.0 / 64193SV2-HCB	(2)	H4	60/55	12	—	P43t	2	20	4008321786005
SILVERSTAR 2.0 / 64210SV2-HCB	(3)	H7	55	12	—	PX26d	2	20	4008321786753
SILVERSTAR 2.0 / 64211SV2-HCB	(4)	H11	55	12	—	PGJ19-2	2	20	4008321787187

¹ Compared to standard halogen lamps
² Compared to predecessor

OSRAM ULTRA LIFE

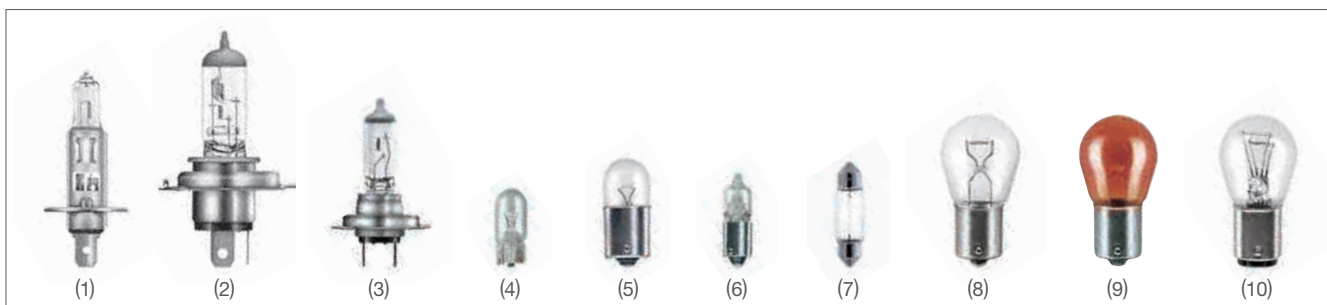

Ideal for frequent drivers thanks to a long lifespan, and up to three times more durable than standard halogen lamps. 3-year guarantee on headlight lamps¹. Available as head-

lamps, styling and parking lights, indicator lights, brake lights, fog lights and tail lights. A modern design with silver dome (H4/H7), ideal for use in clear glass headlights.

Item name



Order code (EAN)

Headlight lamp – 12V – blister

ULTRA LIFE / 64150ULT-01B	(1)	H1	55	12	—	P14.5s	1	10	4008321416100
ULTRA LIFE / 64193ULT-01B	(2)	H4	60/55	12	—	P43t	1	10	4008321416124
ULTRA LIFE / 64210ULT-01B	(3)	H7	55	12	—	PX26d	1	10	4008321416087









Headlight lamp – 12V – double blister

ULTRA LIFE / 64150ULT-02B	(1)	H1	55	12	—	P14.5s	2	20	4008321416315
ULTRA LIFE / 64193ULT-02B	(2)	H4	60 /55	12	—	P43t	2	20	4008321416339
ULTRA LIFE / 64210ULT-02B	(3)	H7	55	12	—	PX26d	2	20	4008321416292

Headlight lamp – 12V – duo box

ULTRA LIFE / 64150ULT-HCB	(1)	H1	55	12	—	P14.5s	2	20	4008321416162
ULTRA LIFE / 64193ULT-HCB	(2)	H4	60 /55	12	—	P43t	2	20	4008321416186
ULTRA LIFE / 64210ULT-HCB	(3)	H7	55	12	—	PX26d	2	20	4008321416148









¹ Details at www.osram.com/am-guarantee

Item name	 No.								Order code (EAN)
Additional lamp – 12V – double blister									
ULTRA LIFE / 2825ULT-02B	(4)	W5W	5	12	—	W2.1x9.5d	2	20	4008321415189
ULTRA LIFE / 5007ULT-02B	(5)	R5W	5	12	—	BA15s	2	20	4008321415202
ULTRA LIFE / 5008ULT-02B	(5)	R10W	10	12	—	BA15s	2	20	4008321415226
ULTRA LIFE / 64132ULT-02B	(6)	H6W	6	12	—	BAX9s	2	20	4008321415325
ULTRA LIFE / 6418ULT-02B	(7)	C5W	5	12	—	SV8.5-8	2	20	4008321415240
ULTRA LIFE / 7506ULT-02B	(8)	P21W	21	12	—	BA15s	2	20	4008321415141
ULTRA LIFE / 7507ULT-02B	(9)	PY21W	21	12	—	BAU15s	2	20	4008321415165
ULTRA LIFE / 7528ULT-02B	(10)	P21/5W	21/5	12	—	BAY15d	2	20	4008321415288

OSRAM ORIGINAL



Original spare parts with OEM quality. Headlights and fog lights featuring highly reliable quality with an outstanding price-performance ratio.

Item name	 No.	 ECE	 W	 V					Order code (EAN)
Headlight lamp – 12 V – blister									
ORIGINAL / 64150-01B	(1)	H1	55	12	—	P14.5s	1	10	4050300925264
ORIGINAL / 64151-01B	(2)	H3	55	12	—	PK22s	1	10	4050300925349
ORIGINAL / 64193-01B	(3)	H4	60 /55	12	—	P43t	1	10	4050300925127
ORIGINAL / 64210-01B	(4)	H7	55	12	—	PX26d	1	10	4050300925202
ORIGINAL / 64211-01B	(5)	H11	55	12	—	PGJ19-2	1	10	4008321171252
ORIGINAL / 9005-01B	(6)	HB3	60	12	—	P20d	1	10	4008321171214
ORIGINAL / 9006-01B	(7)	HB4	51	12	—	P22d	1	10	4008321171238
ORIGINAL / 64183-01B	(8)	R2	45/40	12	—	P45t	1	10	4050300925400

OSRAM DIADEM®/DIADEM® CHROME



OSRAM DIADEM®

Modern and attractive signal lighting as a supplement to halogen and xenon headlamps. An opalizing surface based on the latest interference coating. Ideal for indicator lights

with clear covers. The lamps only light up red or yellow when in operation, and with a discrete blue shimmer when switched off.

Item name									Order code (EAN)
-----------	--	--	--	--	--	--	--	--	------------------

Additional lamp – 12V – double blister

DIADEM / 7507LDA-02B	(1)	PY21W	21	12	—	BAU15s	2	20	4050300925486
----------------------	-----	-------	----	----	---	--------	---	----	---------------









Auxiliary lamp – 12V – blister

DIADEM / 7508LDR-01B	(2)	PR21W	21	12	—	BAW15s	1	10	4008321376848
DIADEM / 7538LDR-01B	(3)	PR21/5W	21	12	—	BAW15d	1	10	4008321376862

OSRAM DIADEM® CHROME

Signal lamps with an exclusive design. The lamps only light up yellow when in operation, and are almost invisible when switched off. A chrome surface thanks to a combi-

nation of the latest interference coating and absorber coating. Ideal for indicator lights with clear covers.

Item name	 No.	 ECE	 W	 V					Order code (EAN)
Additional lamp – 12V – double blister									
DIADEM CHROME / 7507DC-02B	(4)	PY21W	21	12	—	BAU15s	2	20	4008321972774
DIADEM CHROME / 2827DC-02B	(5)	WY5W	5	12	—	W2.1x9.5d	2	20	4008321972750

OSRAM ORIGINAL

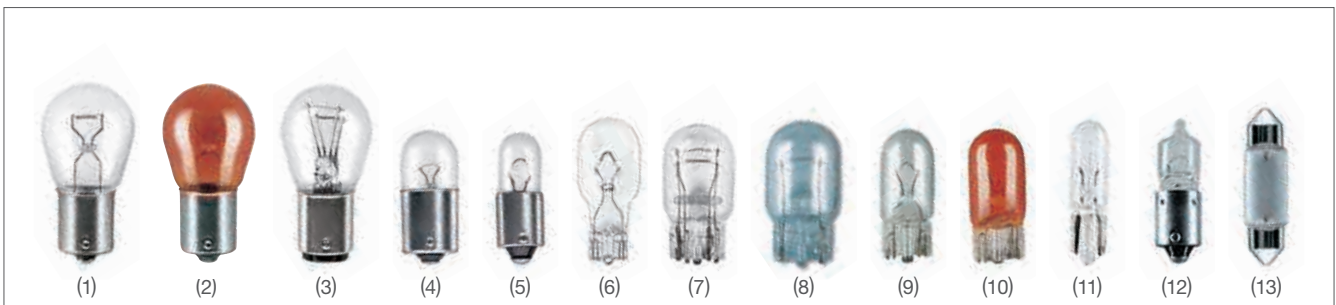

Original spare parts with OEM quality. The wide range of products (styling lights, parking lights, indicator lights, brake lights, tail lights, numberplate and side styling lights)

feature reliable quality combined with an excellent price-performance ratio.

Item name



No.

ECE

W

V

Order code
(EAN)

Additional lamp – 12V – double blister

ORIGINAL / 7506-02B	(1)	P21W	21	12	—	BA15s	2	20	4050300925448
ORIGINAL / 7507-02B	(2)	PY21W	21	12	—	BAU15s	2	20	4050300925462
ORIGINAL / 7225-02B	(3)	P21/4W	21	12	—	BAZ15d	2	20	4050300925547
ORIGINAL / 7528-02B	(3)	P21/5W	21	12	—	BAY15d	2	20	4050300925523
ORIGINAL / 5007-02B	(4)	R5W	5	12	—	BA15s	2	40	4050300925585
ORIGINAL / 5008-02B	(4)	R10W	10	12	—	BA15s	2	20	4050300925608
ORIGINAL / 3893-02B	(5)	T4W	4	12	—	BA9s	2	20	4050300647609
ORIGINAL / 921-02B	(6)	W16W	16	12	—	W2.1x9.5d	2	20	4008321349507
ORIGINAL / 7515-02B	(7)	W21/5W	21 /5	12	—	W3x16q	2	20	4008321662262
ORIGINAL / 7505-02B	(8)	W21W	21	12	—	W3x16d	2	20	4008321349521
ORIGINAL / 2825-02B	(9)	W5W	5	12	—	W2.1x9.5d	2	20	4050300925684
ORIGINAL / 2821-02B	(9)	W3W	3	12	—	W2.1x9.5d	2	20	4050300925745
ORIGINAL / 2827-02B	(10)	WY5W	5	12	—	W2.1x9.5d	2	20	4008321149411
ORIGINAL / 2721-02B	(11)	—	1,2	12	—	W2x4.6d	2	20	4050300925769
ORIGINAL / 2722-02B	(11)	—	2	12	—	W2x4.6d	2	20	4050300925783
ORIGINAL / 64111-02B	(12)	—	5	12	—	BA9s	2	20	4050300647258
ORIGINAL / 6411-02B	(13)	C10W	10	12	—	SV8.5-8	2	20	4050300925646
ORIGINAL / 6418-02B	(13)	C5W	5	12	—	SV8.5-8	2	20	4050300925622
ORIGINAL / 6438-02B	(13)	—	10	12	—	SV8.5-8	2	20	4008321185389

OSRAM NIGHT RACER® PLUS

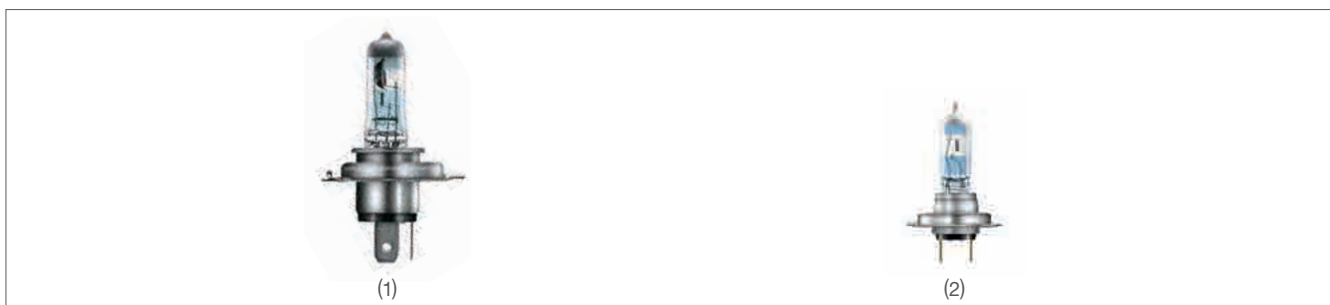
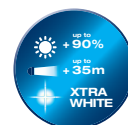

Motorcycle headlamp for particularly discerning drivers, with up to 90% more light on the road¹ for maximum visibility, more time to react and maximum safety. A light

cone up to 35 m longer¹ and up to 10% whiter light¹. Vibration-resistant technology.







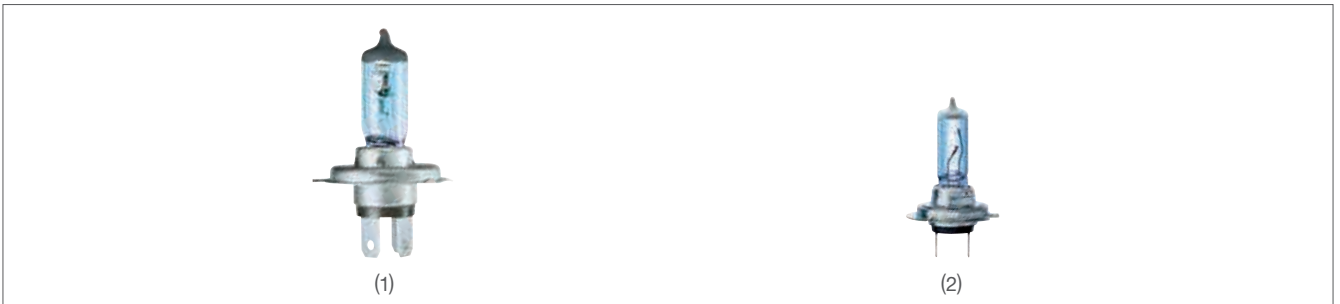

Item name	No.	ECE	W	V						Order code (EAN)
Headlight lamp – 12 V – blister										
NIGHT RACER PLUS / 64193NRP-01B	(1)	H4	60 /55	12	—	P43t	1	10		4008321626998
NIGHT RACER PLUS / 64210NRP-01B	(2)	H7	55	12	—	PX26d	1	10		4008321626974
Headlight lamp – 12 V – double blister										
NIGHT RACER PLUS / 64193NRP-02B	(1)	H4	60/55	12	—	P43t	2	20		4008321977533
NIGHT RACER PLUS / 64210NRP-02B	(2)	H7	55	12	—	PX26d	2	20		4008321623546

¹ Compared to standard halogen lamps

OSRAM X-RACER®



Motorcycle headlamps with blueish white light and a xenon look. Up to 20% more light than standard halogen lamps. Bright light means pleasant light for drivers. The twin pack contains a lamp for immediate replacement and a spare lamp as a reserve for on the road.

Item name	 No.	 ECE	 W	 V					Order code (EAN)
Headlight lamp – 12 V – double blister									
X-RACER / 64193XR-02B	(1)	H4	60/55	12	—	P43t	2	20	4008321395719
X-RACER / 64210XR-02B	(2)	H7	55	12	—	PX26d	2	20	4008321395696

HS1 OSRAM SILVERSTAR®

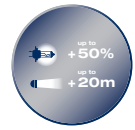

Plenty of light at a reasonable price, especially for scooters. Up to 50% more light¹ and a light cone extended by up to 20 m¹. This makes hazards identifiable earlier and give you more time to react.

Item name



Order code (EAN)

Headlight lamp – 12V – blister

SILVERSTAR / 64185SVS-01B	(1)	HS1	35/35	12	—	PX43t	1	10	4008321650610
---------------------------	-----	-----	-------	----	---	-------	---	----	---------------

¹ Compared to standard halogen lamps

OSRAM MINIBOX



Complete spare lamp sets in OEM quality. Each spare lamp kit contains one headlamp, the same set of the five most important automotive auxiliary lamps and also a set of three

flat fuses. The MINIBOX has an ergonomic shape and features an exclusive design.

Item name



ECE



Order code
(EAN)

Spare lamp box – 12V

MINIBOX / CLKM H1	(1)	H1	Halogen main headlamp	1	10	4050300875217
MINIBOX / CLKM H4	(2)	H4	Halogen main headlamp	1	10	4050300873398
MINIBOX / CLKM H7	(3)	H7	Halogen main headlamp	1	10	4050300876375

Alphabetical product index

C	
CLASSIC ECO SUPERSTAR A bulb shaped	54
CLASSIC ECO SUPERSTAR B candle shaped	55
CLASSIC ECO SUPERSTAR BW twisted candle	56
CLASSIC ECO SUPERSTAR P round shaped	57
CLASSIC ECO SUPERSTAR R50	59
CLASSIC ECO SUPERSTAR R63	60
CLASSIC ECO SUPERSTAR R80	61
COOL BLUE® INTENSE	164
D	
DECOPIN® STAR	65
DECOR COLOR A bulb shaped	136
DECOR COLOR P round shaped	137
DECOSTAR® 35 ECO STAR	71
DECOSTAR® 35 STAR	72
DECOSTAR® 51 ECO STAR	74
DECOSTAR® 51 ECO SUPERSTAR	73
DECOSTAR® 51 STAR	75
DIADEM®/DIADEM® CHROME	169
DULUXSTAR® CLASSIC A	87
DULUXSTAR® CLASSIC B	89
DULUXSTAR® MINI TWIST	94
DULUXSTAR® STICK	101
DULUX® D	108
DULUX® D/E	109
DULUX® L	112
DULUX® S	110
DULUX® S/E	111
DULUX® SUPERSTAR CIRCOLUX®	98
DULUX® SUPERSTAR CLASSIC A	86
DULUX® SUPERSTAR CLASSIC B	88
DULUX® SUPERSTAR CLASSIC P	90
DULUX® SUPERSTAR DIM	104
DULUX® SUPERSTAR FACILITY	105
DULUX® SUPERSTAR GLOBE	91
DULUX® SUPERSTAR MICRO TWIST	92
DULUX® SUPERSTAR NANO TWIST	96
DULUX® SUPERSTAR SENSOR	103
DULUX® SUPERSTAR STICK	99
DULUX® T PLUS	106
DULUX® T/E PLUS	107
H	
HALOLINE® ECO SUPERSTAR	62
HALOLUX® T ECO SUPERSTAR TUBULAR	58
HALOPAR® 16 ECO STAR	67
HALOPAR® 16 ECO SUPERSTAR	66
HALOPAR® 16 STAR	68
HALOPAR® 20 STAR	69
HALOPAR® 30 STAR	69
HALOPAR® 38 FLOOD	70
HALOPAR® 38 SPOT	70
HALOPIN® ECO SUPERSTAR	63
HALOPIN® oven lamp	64
HALOSPOT® 111 ECO SUPERSTAR	76
HALOSTAR® ECO STAR	78
HALOSTAR® ECO SUPERSTAR	77
HALOSTAR® oven lamp	80
HALOSTAR® STAR	79
HS1 OSRAM SILVERSTAR®	174
L	
LED LIGHT@DAY®	150
LED SUPERSTAR CLASSIC A	32
LED SUPERSTAR CLASSIC B	34
LED SUPERSTAR CLASSIC P	36
LED SUPERSTAR MR16	40
LED SUPERSTAR PAR16	38
LED STAR CLASSIC A	33
LED STAR CLASSIC B	35
LED STAR CLASSIC P	37
LED STAR MR11	42
LED STAR MR16	41
LED STAR PAR16	39
LED STAR PIN	48
LED STAR R50	43
LED STAR SPECIAL G4	47
LED STAR SPECIAL T26	46
LEDambient® Door Entrance Ledge	156
LEDambient® Wallwasher, Spotlight & Light Guide	157
LEDinestra®	45
LEDinspect® Foldable Inspection Lamp	158
LEDinspect® Mini Inspection Lamp	159
LEDiving®	151
LEDiving® Canbus Control Unit	155
LEDiving® FOG	152
LEDiving® Retrofits Premium	153
LEDiving® Retrofits Standard	154
LIGHTIFY™ Classic A60 RGBW	31
LIGHTIFY™ Classic A60 TW	31
LIGHTIFY™ Gateway	31
LIGHTIFY™ PAR16 50 GU10 TW	31
M	
MINIBOX	175
N	
NIGHT BREAKER® UNLIMITED	163
NIGHT RACER® PLUS	172
O	
ONYX COPILOT®	160
ORIGINAL halogen headlight lamps	168
ORIGINAL signal lamps	171
Oven lamp P round shaped/T pygmy shaped	140

R	
Refrigerator lamp/sewing machine lamp T pygmy shaped	141
Ringform T5 FC	126
Ringform T9 FC	127

S	
SILVERSTAR® 2.0	165
SPECIAL MIRROR A GOLD/SILVER	138
SPECIAL MIRROR P GOLD/SILVER	139
SPOT R39	134
SPOT R50	134
SPOT R63	135
SPOT R80	135
STARTER	131
SubstiTUBE® Value	44

T	
T5 ACTIVE DAYWHITE	122
T5 BASIC	123
T5 High Efficiency RGB	124
T5 High Output RGB	125
T5 RELAX WARMWHITE	121
T8 ACTIVE DAYWHITE	119
T8 colored fluorescent lamps	120
T8 RELAX WARMWHITE	118
T8 SPEZIAL BIOLUX®	129
T8 SPEZIAL FLUORA®	130
THERATHERM® infrared heat lamp	143

U	
U-shaped	128
ULTRA LIFE	166
ULTRA-VITALUX® UV spotlight	142

X	
X-RACER®	173
XENARC® COOL BLUE® INTENSE	161
XENARC® NIGHT BREAKER® UNLIMITED	162

Overview EAN codes

EAN barcodes for efficient planning

LED lamps

LIGHTIFY™	179
Classically shaped LED lamps	179
LED spotlights and reflectors	181
LED SubstiTUBE® Value	181
LED special lamps	182

Halogen lamps

Classically shaped halogen lamps with a screw base	182
Halogen high voltage pin or plug base lamps	184
Halogen low voltage pin or plug base lamps	185

Compact fluorescent lamps

Compact fluorescent lamps with standard bulb shape	186
Compact fluorescent lamps with spiral shape	187
Compact fluorescent lamps with ring shape	189
Compact fluorescent lamps with stick shape	189
Intelligent compact fluorescent lamps	190
Compact fluorescent lamps with pin base	190

Fluorescent lamps

T8 fluorescent lamps	192
T5 fluorescent lamps	192
Fluorescent lamps with special shapes	193
Fluorescent lamps for special applications	194
Starters	194

Incandescent lamps and special lamps

Spotlight	194
Decorative incandescent lamps	195
Special incandescent lamps	195
Lamps with ultraviolet and infrared radiation	196

Vehicle lamps

LED product range	196
Gas discharge headlamps	197
Halogen headlamps	197
Signal lamp product range	198
Motorcycle lamp product range	199
Spare lamp kit	199

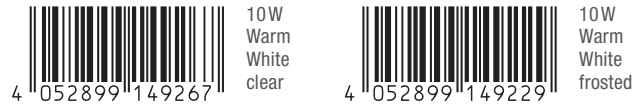
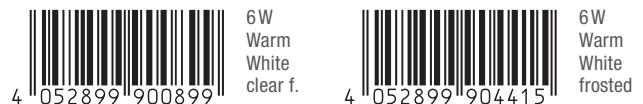

LIGHTIFY™**LIGHTIFY™ Classic A60 TW (see catalog page 31)****LIGHTIFY™ Classic A60 RGBW (see catalog page 31)****LIGHTIFY™ PAR16 50 GU10 TW (see catalog page 31)****LIGHTIFY™ Gateway (see catalog page 31)****Classically shaped LED lamps****OSRAM LED SUPERSTAR CLASSIC A (see catalog page 32)****E27, blister-Box, LED SUPERSTAR CLASSIC A40****E27, blister-Box, LED SUPERSTAR CLASSIC A60****E27, blister-Box, LED SUPERSTAR CLASSIC A75****OSRAM LED STAR CLASSIC A (see catalog page 33)****E27, blister, LED STAR CLASSIC A40****E27, blister, LED STAR CLASSIC A60****E27, blister, LED STAR CLASSIC A75****OSRAM LED SUPERSTAR CLASSIC B (see catalog page 34)****E14, blister box, LED SUPERSTAR CLASSIC B25****E14, blister box, LED SUPERSTAR CLASSIC B40**

OSRAM LED STAR CLASSIC B (see catalog page 35)

E14, blister, LED STAR CLASSIC B15

	2 W Warm White clear
4 052899 911253	

E14, blister, LED STAR CLASSIC B25

	4 W Warm White frosted		4 W Warm White clear
4 052899 913615		4 052899 913622	

	4 W Cool White frosted
4 052899 146396	

E14, blister, LED STAR CLASSIC B40

	6 W Warm White clear sp.		6 W Warm White frosted
4 052899 911970		4 052899 911987	

E14 wind gust, blister, LED STAR CLASSIC BA25

	3.8 W Warm White clear
4 052899 926646	

E14 wind gust, blister, LED STAR CLASSIC BA40

	6.7 W Warm White clear
4 052899 926653	

OSRAM LED SUPERSTAR CLASSIC P (see catalog page 36)

E27, blister box, LED SUPERSTAR CLASSIC P25

	4 W Warm White clear sp.		4 W Warm White frosted
4 008321 992376		4 052899 911420	

E27, blister box, LED SUPERSTAR CLASSIC P40

	6 W Warm White frosted		6 W Warm White clear sp.
4 052899 900912		4 052899 904422	

E14, blister box, LED SUPERSTAR CLASSIC P25

	4 W Warm White clear sp.		4 W Warm White frosted
4 008321 980380		4 052899 911406	

E14, blister box, LED SUPERSTAR CLASSIC P40

	6 W Warm White frosted		6 W Warm White clear sp.
4 052899 900905		4 052899 904439	

OSRAM LED STAR CLASSIC P (see catalog page 37)

E27, blister, LED STAR CLASSIC P15

	2 W Warm White clear
4 052899 911277	

E27, blister, LED STAR CLASSIC P25

	4 W Warm White frosted		4 W Warm White clear
4 052899 913677		4 052899 913684	

	4 W Cool White frosted
4 052899 146457	

E27, blister, LED STAR CLASSIC P40

	6 W Warm White clear sp.		6 W Warm White frosted
4 052899 911956		4 052899 911949	

E14, blister, LED STAR CLASSIC P15

	2 W Warm White clear
4 052899 911260	

E14, blister, LED STAR CLASSIC P25

	4 W Warm White frosted		4 W Warm White clear
4 052899 913646		4 052899 913653	

	4 W Cool White frosted
4 052899 146426	

E14, blister, LED STAR CLASSIC P40

	6 W Warm White clear sp.		6 W Warm White frosted
4 052899 911963		4 052899 911932	

LED spotlights and reflectors

OSRAM LED SUPERSTAR PAR16 (see catalog page 38)

GU10, blister box, LED SUPERSTAR PAR16 35

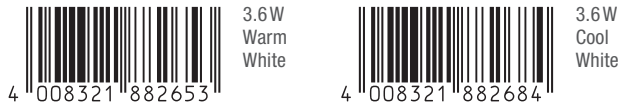

GU10, blister box, LED SUPERSTAR PAR16 50

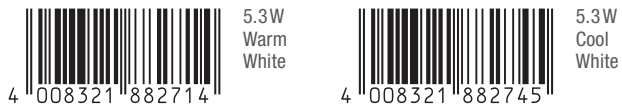

OSRAM LED STAR PAR16 (see catalog page 39)

GU10, blister, LED STAR PAR16 20



GU10, blister, LED STAR PAR16 35

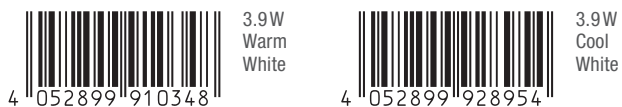

GU10, blister, LED STAR PAR16 50

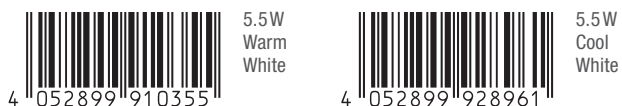

GU10, blister, LED STAR PAR16 120



OSRAM LED SUPERSTAR MR16 (see catalog page 40)

GU5.3, blister box, LED SUPERSTAR MR16 20

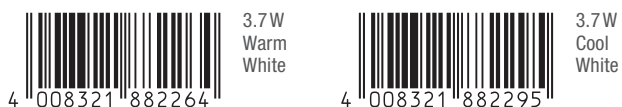

GU5.3, blister box, LED SUPERSTAR MR16 35

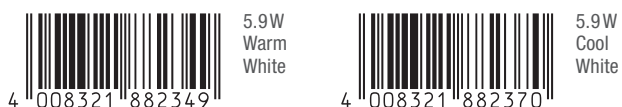

OSRAM LED STAR MR16 (see catalog page 41)

GU5.3, blister, LED STAR MR16 20

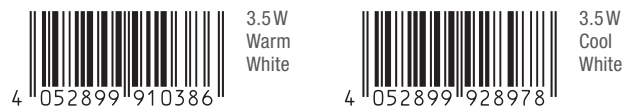

GU5.3, blister, LED STAR MR16 35

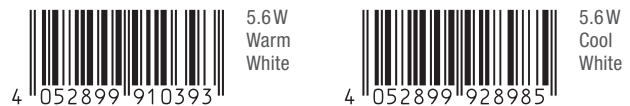

OSRAM LED STAR MR11 (see catalog page 42)

GU4, blister, LED STAR MR11 20



OSRAM LED STAR R50 (see catalog page 43)

E27, blister, LED STAR R50 40

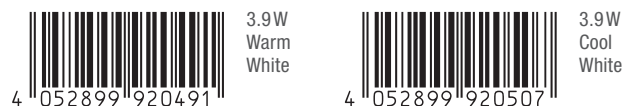

E14, blister, LED STAR R50 40

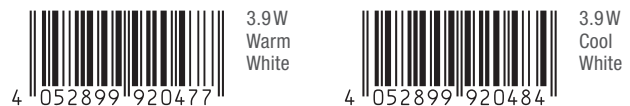

LED SubstiTUBE® Value

OSRAM SubstiTUBE® Value (see catalog page 44)

G13, blister box, SubstiTUBE® Value 590 mm

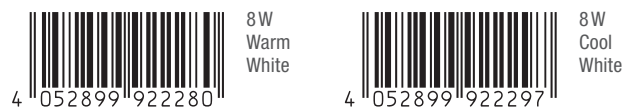

G13, blister box, SubstiTUBE® Value 1200 mm



G13, blister box, SubstiTUBE® Value 1500 mm

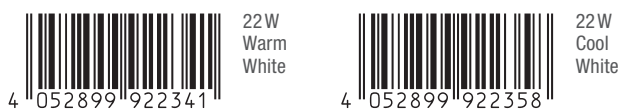

LED special lamps

OSRAM LEDinestra® (see catalog page 45)

S14s, blister box, LEDinestra®



S14d, blister box, LEDinestra®



OSRAM LED STAR SPECIAL T26 (see catalog page 46)

E14, blister, SPECIAL T26 15



OSRAM LED STAR SPECIAL G4 (see catalog page 47)

G4, blister, SPECIAL G4



OSRAM LED STAR PIN (see catalog page 48)

G9, blister, LED STAR PIN



Classically shaped halogen lamps with a screw base

OSRAM CLASSIC ECO SUPERSTAR A bulb shaped (see catalog page 54)

E27, clear, 230V, blister, CLASSIC A ECO



E27, clear, 230V, folding box, CLASSIC A ECO



OSRAM CLASSIC ECO SUPERSTAR B candle shaped (see catalog page 55)

E14, clear, 230V, blister, CLASSIC B ECO



E14, clear, 230V, folding box, CLASSIC B ECO



E27, clear, 230V, folding box, CLASSIC B ECO**OSRAM CLASSIC ECO SUPERSTAR BW twisted candle**
(see catalog page 56)**E14, clear, 230V, blister, CLASSIC BW ECO****E14, clear, 230V, folding box, CLASSIC BW ECO****OSRAM CLASSIC ECO SUPERSTAR P round shaped**
(see catalog page 57)**E14, clear, 230V, blister, CLASSIC P ECO****E27, clear, 230V, blister, CLASSIC P ECO****E14, clear, 230V, folding box, CLASSIC P ECO****E27, clear, 230V, folding box, CLASSIC P ECO****OSRAM HALOLUX® T ECO SUPERSTAR TUBULAR**
(see catalog page 58)**E14, clear, 230V, blister, HALOLUX T ECO****OSRAM CLASSIC ECO SUPERSTAR R50** (see catalog page 59)**E14, 30°, 230V, blister, HALOGEN SPOT R50 ECO****E14, 30°, 230V, folding box, HALOGEN SPOT R50 ECO****OSRAM CLASSIC ECO SUPERSTAR R63** (see catalog page 60)**E27, 30°, 230V, blister, HALOGEN SPOT R63 ECO****E27, 30°, 230V, folding box, HALOGEN SPOT R63 ECO**

OSRAM CLASSIC ECO SUPERSTAR R80 (see catalog page 61)

E27, 50°, 230 V, blister, HALOGEN SPOT R80 ECO



E27, 50°, 230 V, folding box, HALOGEN SPOT R80 ECO



Halogen high voltage pin or plug base lamps

OSRAM HALOLINE® ECO SUPERSTAR (see catalog page 62)

R7s, 74.9 mm, 230 V, blister, HALOLINE ECO SUPERSTAR



R7s, 114.2 mm, 230 V, blister, HALOLINE ECO SUPERSTAR



OSRAM HALOPIN® ECO SUPERSTAR (see catalog page 63)

G9, clear, 230 V, blister, HALOPIN ECO SUPERSTAR



OSRAM HALOPIN® oven lamp (see catalog page 64)

G9, clear, 230 V, folding box, HALOPIN oven

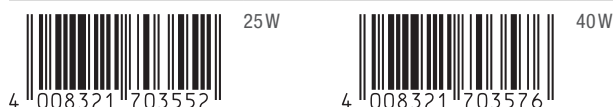

OSRAM DECOPIN® STAR (see catalog page 63)

G9, 40°, 220–240 V, blister, OSRAM DECOPIN® STAR



OSRAM HALOPAR® 16 ECO SUPERSTAR (see catalog page 66)

GU10, 30°, 230 V, blister, HALOPAR 16 ECO SUPERSTAR



OSRAM HALOPAR® 16 ECO STAR (see catalog page 67)

GU10, 30°, 230 V, blister, HALOPAR 16 ECO STAR

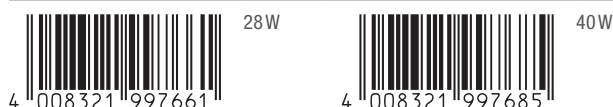

OSRAM HALOPAR® 16 STAR (see catalog page 68)

E14, Alu, 35°, 230 V, twin blister, HALOPAR 16 STAR



GU10, Alu, 35°, 230 V, twin blister, HALOPAR 16 STAR

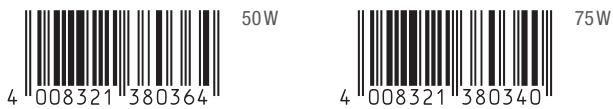
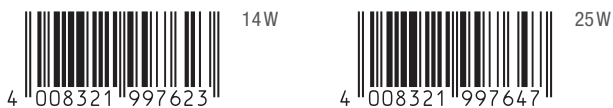

OSRAM HALOPAR® 20 STAR (see catalog page 69)**E27, 30°, 230V, blister, HALOPAR 20 STAR****OSRAM HALOPAR® 30 STAR (see catalog page 69)****E27, 30°, 230V, folding box, HALOPAR 30 STAR****OSRAM HALOPAR® 38 FLOOD (see catalog page 70)****E27, 30°, 220-240V, folding box, HALOPAR® 38 FLOOD****OSRAM HALOPAR® 38 SPOT (see catalog page 70)****E27, 12°, 240V, folding box, HALOPAR® 38 SPOT****Halogen low voltage pin or plug base lamps****OSRAM DECOSTAR® 35 ECO STAR (see catalog page 71)****GU4, WFL, 36°, 12V, blister, DECOSTAR® 35 ECO STAR****OSRAM DECOSTAR® 35 STAR (see catalog page 72)****GU4, WFL, 36°, 12V, twin blister, DECOSTAR® 35 STAR****OSRAM DECOSTAR® 51 ECO SUPERSTAR (see catalog page 73)****GU5.3, WFL, 36°, 12V, blister, DECOSTAR® 51 ECO SUPERSTAR****OSRAM DECOSTAR® 51 ECO STAR (see catalog page 74)****GU5.3, WFL, 36°, 12V, blister, DECOSTAR® 51 ECO STAR****OSRAM DECOSTAR® 51 STAR (see catalog page 75)****GU5.3, SP, 10°, 12V, twin blister, DECOSTAR® 51 STAR****GU5.3, WFL, 36°, 12V, twin blister, DECOSTAR® 51 STAR****OSRAM HALOSPOT® 111 ECO SUPERSTAR (see catalog page 76)****G53, FL, 24°, 12V, folding box**

OSRAM HALOSTAR® ECO SUPERSTAR (see catalog page 77)

G4, clear, 12V, blister, HALOSTAR ECO SUPERSTAR

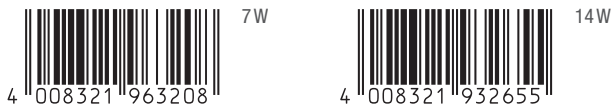

GY6.35, clear, 12V, blister, HALOSTAR ECO SUPERSTAR

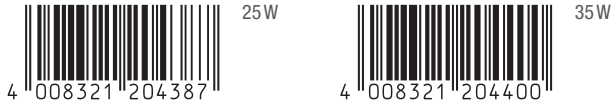

OSRAM HALOSTAR® ECO STAR (see catalog page 78)

G4, clear, 12V, blister, HALOSTAR ECO STAR

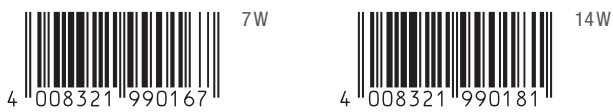

GY6.35, clear, 12V, blister, HALOSTAR ECO STAR

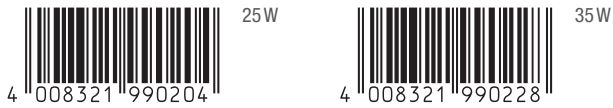

OSRAM HALOSTAR® STAR (see catalog page 79)

G4, clear, 12V, twin blister, HALOSTAR STAR

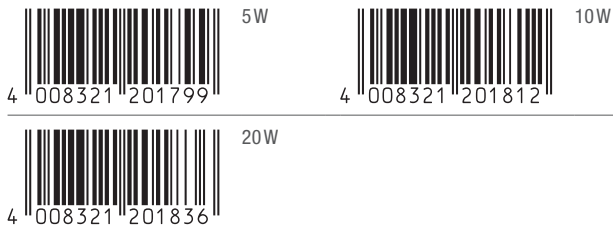

GY6.35, clear, 12V, twin blister, HALOSTAR STAR

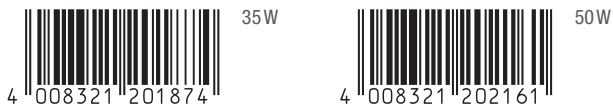

OSRAM HALOSTAR® oven lamp (see catalog page 80)

G4, clear, 12V, folding box, HALOSTAR oven



Compact fluorescent lamps with standard bulb shape

OSRAM DULUX® SUPERSTAR CLASSIC A (see catalog page 86)

E27 – eco-blister



E27 – folding box



OSRAM DULUXSTAR® CLASSIC A (see catalog page 87)

E27 – eco-blister



E27 – folding box



OSRAM DULUX® SUPERSTAR CLASSIC B (see catalog page 88)

E27 – eco-blister



E27 – folding box



E14 – eco-blister



E14 – folding box

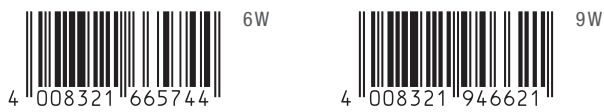

OSRAM DULUXSTAR® CLASSIC B (see catalog page 89)

E14 – eco-blister



E14 – folding box

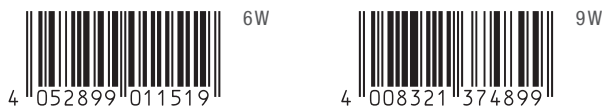

OSRAM DULUX® SUPERSTAR CLASSIC P (see catalog page 90)

E27 – eco-blister

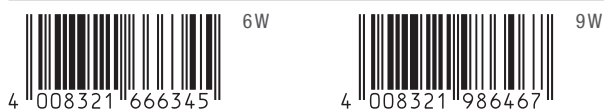

E27 – folding box

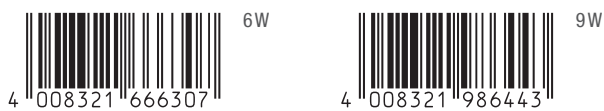

E14 – eco-blister

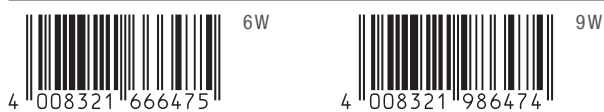

E14 – folding box



OSRAM DULUX® SUPERSTAR GLOBE (see catalog page 91)

E27 – folding box



Compact fluorescent lamps with spiral shape

OSRAM DULUX® SUPERSTAR MICRO TWIST (see catalog page 92/93)

E27 – eco-blister



E27 – folding box



E14 – eco-blister

 4 008321 949189	7 W Warm Comfort Light	 4 008321 954084	7 W Cool White
 4 052899 912298	12 W Warm Comfort Light	 4 052899 912304	12 W Cool White

E14 – folding box

 4 008321 948922	7 W Warm Comfort Light	 4 008321 948939	7 W Cool White
 4 052899 912274	12 W Warm Comfort Light	 4 052899 912281	12 W Cool White

OSRAM DULUXSTAR® MINI TWIST
(see catalog page 94/95)

E27 – eco-blister

 4 008321 989581	12 W Warm White	 4 008321 989611	12 W Cool Daylight
 4 008321 989635	15 W Warm White	 4 008321 989642	15 W Cool Daylight
 4 008321 989666	20 W Warm White	 4 008321 989673	20 W Cool Daylight
 4 008321 989697	23 W Warm White	 4 008321 989703	23 W Cool Daylight

E27 – folding box

 4 008321 605924	12 W Warm White	 4 008321 628503	12 W Cool Daylight
 4 008321 605986	15 W Warm White	 4 008321 628534	15 W Cool Daylight
 4 008321 606013	20 W Warm White	 4 008321 628565	20 W Cool Daylight
 4 008321 606044	23 W Warm White	 4 008321 628596	23 W Cool Daylight

E14 – eco-blister

 4 008321 989598	12 W Warm White	 4 008321 989604	12 W Cool Daylight
---	-----------------------	--	--------------------------

E14 – folding box

 4 008321 605955	12 W Warm White	 4 008321 628473	12 W Cool Daylight
 4 052899 915732	15 W Warm White		

OSRAM DULUX® SUPERSTAR NANO TWIST
(see catalog page 96/97)

E14 – eco-blister

 4 008321 508850	5 W Warm Comfort Light	 4 008321 510945	5 W Cool White
 4 008321 509031	9 W Warm Comfort Light	 4 008321 511065	9 W Cool White

E14 – folding box

 4 008321 510914	5 W Warm Comfort Light	 4 008321 508898	5 W Cool White
 4 008321 511034	9 W Warm Comfort Light	 4 008321 509062	9 W Cool White

G9 – eco-blister

 4 008321 956101	5 W Warm Comfort Light	 4 008321 510761	5 W Cool White
 4 008321 956910	9 W Warm Comfort Light	 4 008321 510884	9 W Cool White

GU10 – eco-blister

 4 008321 549037	5 W Warm Comfort Light	 4 008321 549006	5 W Cool White
 4 008321 549259	9 W Warm Comfort Light	 4 008321 549334	9 W Cool White

Compact fluorescent lamps with ring shape

OSRAM DULUX® SUPERSTAR CIRCOLUX®
(see catalog page 98)

E27 – folding box



Compact fluorescent lamps with stick shape

OSRAM DULUX® SUPERSTAR STICK (see catalog page 99/100)

E27 – eco-blister



E27 – folding box



E14 – eco-blister



E14 – folding box



OSRAM DULUXSTAR® STICK (see catalog page 101/102)

E27 – eco-blister



E27 – folding box



E14 – eco-blister



E14 – folding box



Intelligent compact fluorescent lamps

OSRAM DULUX® SUPERSTAR SENSOR (see catalog page 103)

E27 – eco-blister

 11W	 15W
4 008321 986986	4 008321 987068
 Classic A 15W	
4 052899 916630	

OSRAM DULUX® SUPERSTAR DIM (see catalog page 104)

E27 – eco-blister

 Classic A 16W	 18W
4 008321 953520	4 008321 953452

OSRAM DULUX® SUPERSTAR FACILITY (see catalog page 105)

E27 – eco-blister

 14W	 18W
4 050300 946245	4 008321 997807

Compact fluorescent lamps with pin base

OSRAM DULUX® T PLUS (see catalog page 106)

GX24d base – folding box

 13W Cool White	 18W INTERNA
4 050300 446905	4 050300 333502
 18W Cool White	 26W INTERNA
4 050300 333465	4 050300 342085
 26W Cool White	
4 050300 342047	

OSRAM DULUX® T/E PLUS (see catalog page 107)

GX24q base – folding box

 13W INTERNA	 13W Cool White
4 050300 447001	4 050300 446967
 18W INTERNA	 18W Cool White
4 050300 342269	4 050300 342221
 26W INTERNA	 26W Cool White
4 050300 342320	4 050300 342283
 32W INTERNA	 32W Cool White
4 050300 348605	4 050300 348568
 42W INTERNA	 42W Cool White
4 050300 425665	4 050300 425627

OSRAM DULUX® D (see catalog page 108)

G24d base – folding box

 10W INTERNA	 10W Cool White
4 050300 008110	4 050300 010595
 13W INTERNA	 13W Cool White
4 050300 008127	4 050300 010625
 18W INTERNA	 18W Cool White
4 050300 011462	4 050300 012056
 26W INTERNA	 26W Cool White
4 050300 011912	4 050300 012049

OSRAM DULUX® D/E (see catalog page 109)**G24q base – folding box**

 4 050300 012124	10W INTERNA	 4 050300 017587	10W Cool White
 4 050300 012131	13W INTERNA	 4 050300 017594	13W Cool White
 4 050300 012148	18W INTERNA	 4 050300 017617	18W Cool White
 4 050300 012230	26W INTERNA	 4 050300 020303	26W Cool White

OSRAM DULUX® S (see catalog page 110)**G23 base – folding box**

 4 050300 006130	5W INTERNA	 4 050300 005997	7W INTERNA
 4 050300 010571	7W Cool White	 4 050300 006000	9W INTERNA
 4 050300 010588	9W Cool White	 4 050300 006017	11W INTERNA
 4 050300 010618	11W Cool White	 4 050300 015927	9W Red
 4 050300 015934	9W Green	 4 050300 015941	9W Blue









G23 base – eco-blister

 4 050300 006086	7W INTERNA
--	---------------

OSRAM DULUX® S/E (see catalog page 111)**2G7 base – folding box**

 4 050300 017648	7W INTERNA	 4 050300 020167	7W Cool White
 4 050300 017655	9W INTERNA	 4 050300 020174	9W Cool White
 4 050300 017662	11W INTERNA	 4 050300 020181	11W Cool White

OSRAM DULUX® L (see catalog page 112)**2G11 base – folding box**

 4 050300 010748	18W INTERNA	 4 050300 010724	18W Cool White
 4 050300 010779	24W INTERNA	 4 050300 010755	24W Cool White
 4 050300 010809	36W INTERNA	 4 050300 010786	36W Cool White
 4 050300 322285	40W INTERNA	 4 050300 279909	40W Cool White
 4 050300 315881	55W INTERNA	 4 050300 295879	55W Cool White
 4 050300 665481	80W Cool White		

T8 fluorescent lamps

T8 RELAX WARMWHITE (see catalog page 118)

G13 – 26 mm – LUMILUX® Warm White (827) – folding box

 15W	 16W
 18W	 30W
 36W	 58W

T8 ACTIVE DAYWHITE (see catalog page 119)

G13 – 26 mm – LUMILUX® Cool White (840) – folding box

 15W	 16W
 18W	 30W
 36W	 58W

T8 colored fluorescent lamps (see catalog page 120)

G13 – 26 mm – folding box

 red	 yellow
 green	 blue

T5 fluorescent lamps

T5 RELAX WARMWHITE (see catalog page 121)

G13 – 16 mm – LUMILUX® Warm White (827) – folding box

 8W	 13W
 14W	 21W
 28W	

T5 ACTIVE DAYWHITE (see catalog page 122)

G5 – 16 mm – LUMILUX® Cool White (840) – folding box

 8W	 13W
 14W	 21W
 28W	

T5 BASIC (see catalog page 123)

G5 – 16 mm – Cool White (840) – folding box

 6W	 8W
 13W	

T5 High Efficiency RGB (see catalog page 124)

G5 – 16 mm – red/green/blue – folding box

 14W red	 21W red
 28W red	 35W red
 14W green	 21W green

 28 W green	 35 W green
 14 W blue	 21 W blue
 28 W blue	 35 W blue

T5 High Output RGB (see catalog page 125)

G5 – 16 mm – red/green/blue – folding box

 24 W red	 39 W red
 54 W red	 80 W red
 24 W green	 39 W green
 54 W green	 80 W green
 24 W blue	 39 W blue
 54 W blue	 80 W blue

Fluorescent lamps with special shapes

Circular T5 FC (see catalog page 126)

2GX13 – 16 mm – LUMILUX® INTERNA (827) – folding box

 22 W	 40 W
 55 W	

2GX13 – 16 mm – LUMILUX® Cool White (840) – folding box

 22 W	 40 W
 55 W	

Circular T9 FC (see catalog page 127)

G10q – 29 mm – LUMILUX® INTERNA (827) – folding box

 22 W	 32 W
---	--

G10q – 29 mm – LUMILUX® Cool White (840) – folding box

 22 W	 32 W
 40 W	

G10q – 29 mm – LUMILUX® Cool Daylight (865) – folding box

 40 W	
---	--

U-shaped (see catalog page 128)

2G13 – 26 mm – LUMILUX® Warm White (830) – folding box

 18 W	 36 W
 58 W	

2G13 – 26 mm – LUMILUX® Cool White (840) – folding box

 18 W	 36 W
 58 W	

Fluorescent lamps for special applications

T8 SPEZIAL BIOLUX® (see catalog page 129)

G13 – 26 mm – BIOLUX® (965) – folding box

 18W	 30W
4 050300 937939	4 050300 937946
 36W	 58W
4 050300 937977	4 050300 938004

T8 SPEZIAL FLUORA® (see catalog page 130)

G13 – 26 mm – FLUORA® (77) – folding box

 18W	 30W
4 050300 325798	4 050300 325453
 36W	 58W
4 050300 325774	4 050300 325811

Starters

STARTER (see catalog page 131)

Blister

 DEOS ST 171	 ST 111
4 050300 421544	4 050300 064000
 ST 151	
4 050300 092638	

Spot lamps with incandescent lamp technology

SPOT R39 (see catalog page 134)

E14 – 40° – blister

 30W
4 050300 118529

E14 – 40° – folding box

 30W
4 050300 004815

SPOT R50 (see catalog page 134)

E14 – 30° – blister

 25W	 40W
4 050300 118505	4 050300 118482

E14 – 30° – folding box

 25W	 40W
4 050300 148465	4 050300 148489

SPOT R63 (see catalog page 135)

E27 – 30° – blister

 40W	 60W
4 050300 093055	4 050300 093826

E27 – 30° – folding box

 40W	 60W
4 050300 562537	4 050300 562551

SPOT R80 (see catalog page 135)

E27 – 50° – folding box

 40W	 60W
4 050300 066042	4 050300 066059
 75W	
4 050300 066066	

Decorative incandescent lamps

DECOR COLOR A bulb shape (see catalog page 136)

E27 – folding box

 blue 4 008321 545862	 green 4 008321 545893
 orange 4 008321 545916	 red 4 008321 545824
 yellow 4 008321 480910	

DECOR COLOR P round shape (see catalog page 137)

E14 – folding box

 blue 4 008321 545787	 green 4 008321 545800
 red 4 008321 545763	 yellow 4 008321 480910

Special incandescent lamps

SPECIAL MIRROR A GOLD/SILVER (see catalog page 138)

E27 – folding box

 40W Gold 4 050300 001050	 60W Gold 4 050300 001067
 60W Silver 4 050300 309651	 100W Silver 4 050300 312705

SPECIAL MIRROR P GOLD/SILVER (see catalog page 139)

E14 – folding box

 25W Gold 4 050300 001104	 40W Gold 4 050300 001111
 25W Silver 4 050300 001081	 40W Silver 4 050300 002224

Oven lamp P round shaped/T pygmy shaped (see catalog page 140)

E14 – frosted – folding box

 40W 4 050300 008486

E14 – clear – blister

 15W 4 050300 065052

E14 – clear – folding box



 15W 4 050300 003108

Refrigerator lamp/sewing machine lamp T pygmy shaped (see catalog page 141)

E14 – clear – blister

 15W 4 050300 092928
--

E14 – frosted – folding box

 15W 4 050300 003085	 25W 4 050300 323596
---	--

E14 – clear – folding box

 15W 4 050300 310282	 25W 4 050300 309637
---	--

Lamps with ultraviolet and infrared radiation

OSRAM ULTRA-VITALUX® UV spotlight (see catalog page 142)

E27 – 30° – 230V – folding box



4 008321 543929

THERATHERM® infrared heat lamp (see catalog page 143)

E27 – red – folding box



4 008321 392213

150W
PAR38



4 008321 507099

250W
R125

LED vehicle lamps

OSRAM LED LIGHT@DAY® (see catalog page 150)

LED daytime running light – 12V



4 008321 673152

LEDDR
101



4 052899 054622

LEDDR
101 CL 15

OSRAM LEDDriving® (see catalog page 151)

LED daytime running light – 12V



4 052899 000070

LEDDR
301



4 008321 781215

LEDDR
401

OSRAM LEDDriving® FOG (see catalog page 152)

LED fog light – 12V



4 008321 890566

LEDFOG
101

OSRAM LEDDriving® Retrofits Premium (see catalog page 153)

LEDDriving® Retrofits Premium – 12V – twin blister



4 008321 657633

2850
WW-02B



4 008321 657657

2850
CW-02B



4 008321 875549

2850
B-02B



4 008321 875600

2855
YE-02B

LEDDriving® Retrofits Premium – 12V – blister



4 008321 658159

6498
WW-01B



4 008321 658173

6498
CW-01B

LEDDriving® Retrofits Premium – 12V – twin blister



4 008321 657893

3850
WW-02B



4 008321 658111

3850
CW-02B

OSRAM LEDDriving® Retrofits Standard (see catalog page 154)

LEDDriving® Retrofits Standard – 12V – twin blister



4 052899 067820

2880
CW-02B



4 052899 067844

2880
SW-02B

OSRAM LEDDriving® Canbus Control Unit (see catalog page 155)

LEDDriving® Canbus Control Unit – 12V – blister



4 052899 090873

LED
CBCTRL
101

OSRAM LEDambient® Door Entrance Ledge (see catalog page 156)

LEDambient® Styling Lights



4 052899 074903

WAL
DEL101

OSRAM LEDambient® Wallwasher, Spotlight & Light Guide (see catalog page 157)

LEDambient® Styling Lights



4 052899 074927

510269
WAL INT
101

OSRAM LEDinspect® Foldable Inspection Lamp (see catalog page 158)

LEDInspect® Inspection Lights



4 052899 009592

LEDIL301

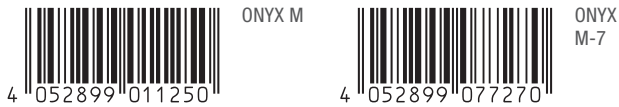
OSRAM LEDinspect® Mini Inspection Lamp
(see catalog page 159)**LEDinspect® Inspection Lights****OSRAM ONYX COPILOT®** (see catalog page 160)**LED Copilot****Gas discharge headlamps****OSRAM XENARC® COOL BLUE® INTENSE**
(see catalog page 161)**Headlight lamp – 12V – blister****OSRAM XENARC® NIGHT BREAKER® UNLIMITED**
(see catalog page 162)**Headlight lamp – 12V – blister****Halogen headlamps****OSRAM NIGHT BREAKER® UNLIMITED**
(see catalog page 163)**Headlight lamp – 12V – blister****Headlight lamp – 12V – twin blister****Headlight lamp – 12V – duo box****OSRAM COOL BLUE® INTENSE** (see catalog page 164)**Headlight lamp – 12V – blister****Headlight lamp – 12V – twin blister****Headlight lamp – 12V – duo box**

Additional lamp – 12V – twin blister



OSRAM SILVERSTAR® 2.0 (see catalog page 165)

Headlight lamp – 12V – blister

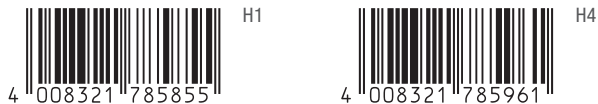

Headlight lamp – 12V – twin blister

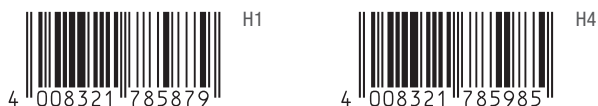

Headlight lamp – 12V – duo box

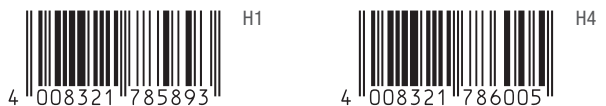

OSRAM ULTRA LIFE (see catalog page 166/167)

Headlight lamp – 12V – blister



Headlight lamp – 12V – twin blister

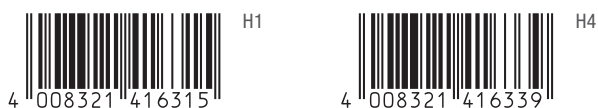

Headlight lamp – 12V – duo box

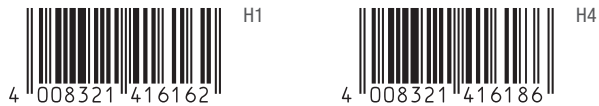

Additional lamp – 12V – twin blister

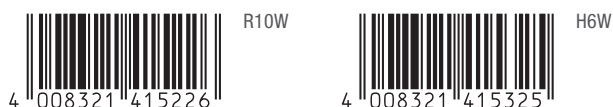
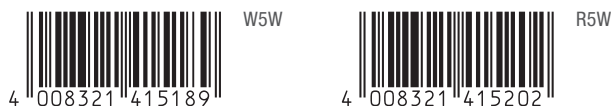

OSRAM ORIGINAL (see catalog page 168)

Headlight lamp – 12V – blister

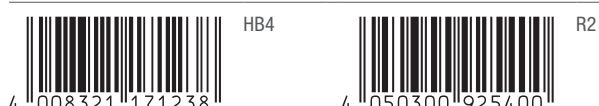
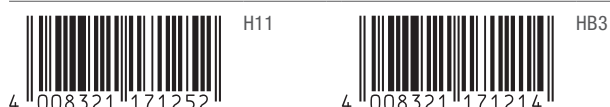
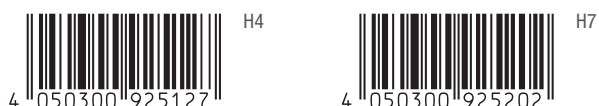
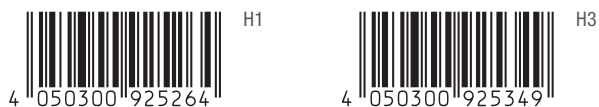

Signal lamp product range

OSRAM DIADEM®/DIADEM® CHROME (see catalog page 169/170)

Additional lamp – 12V – twin blister

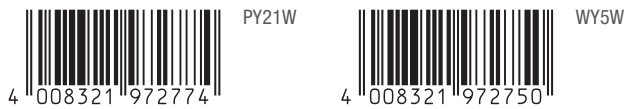
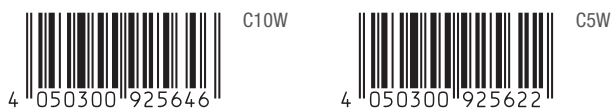
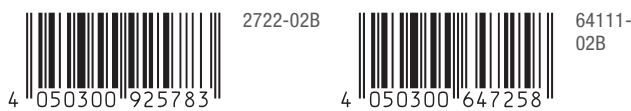
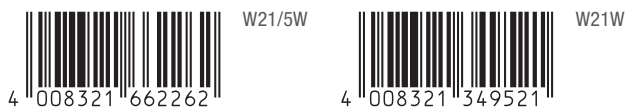
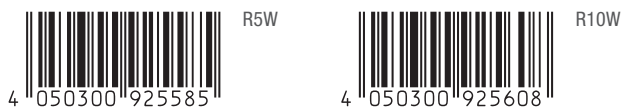
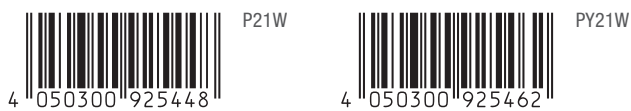
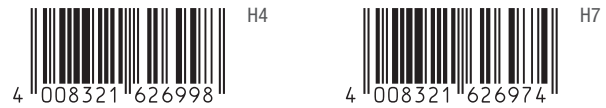
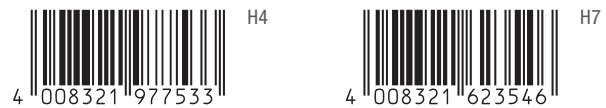
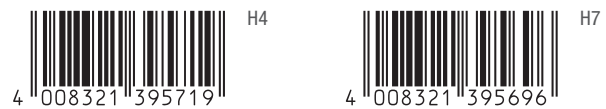

Additional lamp – 12V – blister**Additional lamp – 12V – twin blister****OSRAM ORIGINAL (see catalog page 171)****Additional lamp – 12V – twin blister****Motorcycle lamp product range****OSRAM NIGHT RACER® PLUS (see catalog page 172)****Headlight lamp – 12V – blister****Headlight lamp – 12V – twin blister****OSRAM X-RACER® (see catalog page 173)****Headlight lamp – 12V – twin blister****HS1 OSRAM SILVERSTAR® (see catalog page 174)****Headlight lamp – 12V – blister****Spare lamp kit****OSRAM MINIBOX (see catalog page 175)****Spare lamp box – 12V**

Any manipulation of our products or packaging, including but not limited to modification, reworking or restamping, is prohibited and infringes our registered trademark rights. Such modifications may impair the technical properties of our products, destroy them or cause consequential damage or injury, for which OSRAM cannot under any circumstances be held responsible.

For more information on our products go to:

www.osram.de

www.osram.com

Printed on paper treated with
chlorine-free bleach.

Printed in Germany.

Subject to change without notice. Errors and omission
excepted. The pictures in the catalog are for illustration
purposes only.

LAMPS