

## Product Catalogue



# New Products in 2012

SMS 17807 NF and SMS 171607 NF  
from page 22



SUS 21 F  
from page 60



SMA 8 F  
from page 62



SpaceBox VAM 5/10  
from page 122



VAM 420 NG DVB-T  
from page 138



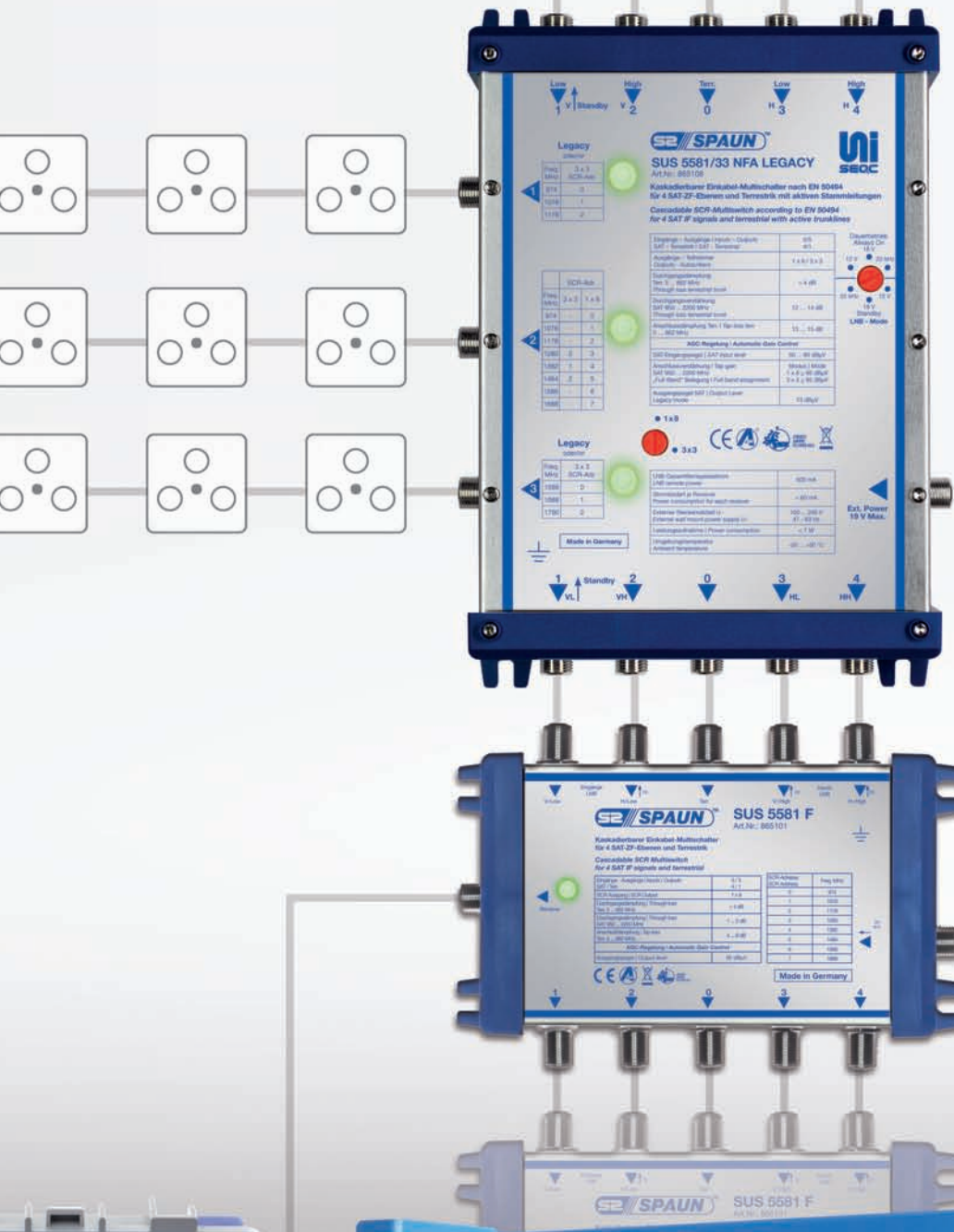

SUS 5581 F  
 SUS 5581 FA  
 SUS 5541 F  
 SUS 5541 FA  
 SUS 4481 F  
 SUS 4441 F  
 from page 58



SPAROS SAT HD DVB-C  
 SPAROS SAT HD DVB-T  
 from page 144



BluBox 8/16/32  
 from page 116

# High-Quality and Future-Proof ... distribution components made by SPAUN

## What makes SPAUN products so reliable?

- 98 % in-house production and development
- Made in Germany
- Using most modern SMT machines
- Energy saving switch-mode power supplies made by SPAUN
- 100 % computer-aided testing (CAT)
- Mechanical components made by SPAUN
- In-house EMC measurement possibilities
- Standby functionality

## Key benefits of SPAUN system components:

- Fast and trouble-free installation
- Outstanding signal quality
- Minimal failure rate
- Fast and accommodating help in service case
- Technical hotline free of charge
- Excellent cost-performance ratio
- 5 years warranty for specialist shops and wholesalers \*



\* according to our General Terms and Conditions

SPAUN multiswitches and home amplifiers are equipped with energy saving switch-mode power supplies.

Power supplies made by SPAUN indicate a high level of efficiency (low power consumption) and high tolerance ranges regarding the scope of input voltage.

All SPAUN multiswitches have a well thought out standby concept since many years. When all satellite receivers connected to the multiswitch are switched off the SAT-IF amplifier and the LNB supply voltage is shut down.

The power consumption of the device drops considerably which relieves the yearly power bill. The receipt of terrestrial programs with activated standby function is still possible.

The new housing concept allows the installer:

- Flexible installation position of the multiswitches
- Greater utilisation of the available space
- Even more extended life time of the switch-mode power supply as a result of an improved cooling-effect



SPAUN designs and produces all mechanical components in-house with focus on optimal EMC-results as well as great mechanical stability and thermal conductivity.

Easy installation due to intelligent housing concept.

## !/? Frequently Asked Questions (FAQ)

### What does SAT-CR mean?

SAT-CR stands for **S**atellite **C**hannel **R**outer.

This technology enables the delivery of broadcast programs to multiple users over a single coaxial cable.

This standard allows a tree architecture instead of the standard star architecture which is commonly used in the SAT-IF distribution. SAT-CR technology enables to connect up to 8 receivers on a single coaxial cable. Compared with headends SAT-CR allows to receive the entire channel offer of up to two satellite positions.

There are no limitations.

### How can I install the SUS 5581/33 NF(A) LEGACY?

The SUS 5581/33 NF(A) LEGACY can be used as a stand-alone device or within a cascadable system. This makes a mixed system possible with SAT-CR devices and common cascadable multiswitches (for instance SMK 55xx3 Fx). The launch amplifier of a cascadable system remote powers the devices via terrestrial trunkline (SBK 5502/03, NFx). If you use the SUS 5581/33 NF(A) LEGACY as a stand-alone device you can use the wall socket power supply which is included in scope of delivery.

### Why does the SUS 5581/33 NF(A) LEGACY have two different operating modes?

The SUS 5581/33 NF(A) LEGACY allows to switch between two different operation modes:

In position 1x8 (1 output, 8 receivers) up to 8 receivers can be connected in series on a single coaxial cable.

In position 3x3 (1 output, 3 receivers) up to 9 receivers can be connected to three outputs each three receivers.

In the 1x8 operating mode, the two unused outputs can be used as conventional multiswitch outputs (Legacy mode).

### What kind of sockets shall I use for the SUS 5581/33 NF(A) LEGACY?

Generally, the SPAUN SUS 5581/33 NF(A) LEGACY can be used in combination with all available wall through sockets which have a DC-power pass. In order to obtain the best performance of a SAT-CR system we recommend to use the UNiSockets. These sockets are available with optimized through loss for the use with the SPAUN UNiSEqC product line.

### How can the SUS 21 F be used?

With the SUS 21 F it is possible to connect 2 receivers or one PVR (Dual Tuner) receiver through a single coaxial cable. It is necessary that the connected receivers support the SAT-CR command set according to EN 50494. The signals from max. 2 SAT position (8 SAT IF signals) and terrestrial can be received. For instance if the SUS 21 F is used in combination with a SMS 17089 NF the user can receive the first two satellite positions (8 SAT IF signals, positions A & B). The positions C and D (SAT IF signals from 9 to 16) are not available. The input jacks of the SUS 21 F have margin of 20 mm therefore the SUS 21 F can be directly connected to almost all available SPAUN multiswitches. Naturally the SUS 21 F can be also combined with non SPAUN devices. The Universal AC Adapter SNG 18/1000 can be used to feed the system if the used receiver is not able to power the distribution system.

### Which cable lengths can be used?

This question cannot be generally answered. However, there are factors that must be considered in principle and based on these factors it is also possible to determine whether a desired cable length can be realized or not.

For the calculation the following specifications are needed: The attenuation of the used coaxial cable at 2000 MHz. A typical value for a standard 7mm coaxial cable is approx. 30dB/100m. SPAUN's SPOAX cable is a high quality cable and has an excellent attenuation of 27.8 dB/100m at a frequency of 2150 MHz. Furthermore, the signal level from the LNB is required (typically 78 dB $\mu$ V). Finally, the technical specifications of the used multiswitch are needed to do the calculation.

#### Example:

The LNB provides a signal level of 78 dB $\mu$ V. The distance from the LNB to the multiswitch (SMS 51603 NF) is 30 m. This cable length indicate an attenuation of approx. 9 dB. Therefore the input level of the SMS 51603 NF should be approx. 69 dB $\mu$ V. The SMS 51603 NF has a gain of 9 dB so we can reach an output level of 78 dB $\mu$ V. The signal level at the sockets should be at least 55 dB $\mu$ V. This means that we have a signal budget of 78 dB $\mu$ V - 55 dB $\mu$ V = 23 dB $\mu$ V. A budget of 23 dB $\mu$ V is equivalent to a cable length of 70m and additionally the used TV socket outlet (ASE 5 F).

### What are the differences in terrestrial transmission between the different SPAUN multiswitches?

SPAUN offers three different solutions for the terrestrial transmission:

#### First version:

The terrestrial path has an active forward path in the frequency range of 85 ... 862 MHz and a passive return path in the range of 5 ... 65 MHz. It is possible to use triple-play applications (Premium Class SMS 5xx03 NF series)

#### Second version:

The terrestrial path is completely passive in the frequency range from 5 ... 862 MHz. It is also possible to use triple-play applications but without amplification in forward path (Light Class SMS 5xx07 NF series)

#### Third version:

The terrestrial path is completely active terrestrial stage and has a fixed frequency range from 47 ... 862 MHz. It is not possible to use triple-play applications (Standard Class SMS 5xx08 NF series)

### What's the functionality of the LNB supply voltage mode switch?

Several SPAUN products have a switch which allows to adjust the supply voltage of the connected LNBS.

#### There are three possible modes:

**12 V:** All 4 SAT-IF inputs supply a voltage of 12 volts. This setting is necessary to run a Quattro LNB.

**18 V:** The vertical SAT IF inputs supply 14 volts and the horizontal SAT IF inputs supply 18 volts.

**22 kHz:** The vertical SAT IF inputs supply 14 volts and the horizontal SAT IF inputs supply 18 volts. Additionally the two High-Band inputs are modulated with a 22 kHz tone. With this setting the use of a QUAD LNB (included multiswitch) is possible.

# Table of contents

Article	Page
ABE 1/10 P	157
ABE 1/15 P	157
ABE 2/10 P	157
ABE 2/15 P	157
ABE 4/10 P	157
ABE 4/15 P	157
ABE 6/15 P	157
AIW-1	167
AMR U/Set	164
ASD 210	161
ASE 203	161
ASE 5 F	162
ASR 75/Set	164
AZR 131130/10 F	155
AZR 171170/10 F	155
AZR 171170/15 F	155
AZR 172170/10 F	155
AZR 172170/15 F	155
AZR 55250/10 F	156
AZR 5550/10 F	156
AZR 5550/15 F	156
AZR 5550/20 F	156
AZR 99290/10 F	155
AZR 99290/15 F	155
AZR 9990/10 F	155
BluBox 16	116
BluBox 32	117
BluBox 16 PAL	120
BluBox 8	116
BluCard 8	118
DCF 500/Set	165
DCR 75/Set	164
DCV 4	137
DMK 55122 F	74
DMK 55162 F	74
DMK 5582 F	74
DMS 51202 NF	64
DMS 51602 NF	64
DMS 5802 NF	64
EDKL 1/Set	164
EW 4	164
EW 5	164
EW 6	164
FCS-53/Set	166
FCZ-1	167
FKS-53/Set	166
FKZ-1	167
FMP 30	134
FSW 30 F	150
FSW 40 F	150
FSW 5 F	150
GBK 5500 WBP	78
GBV 3809 U	91
GMS 51209 WBP	77
GMS 51609 WBP	77
GMS 5809 WBP	77
GTS 525 WB	79
GZR 5550/15 WB	80
HLV 40/30 FPE	127
HLV 40/65 FPE	127
HNF 30 URP	129
HNV 20 U	130
HNV 30 UPE	129
HNV 30/30 UPE	128
HNV 30/65 UPE	128
HNV 32/65 DPE	126

LE 2200	154
LE 862 F	154
MBV 420 PF	132
MBV 429 PF	132
MBV 435 PF	132
MBW 410 F	133
MediaSocket 410	163
MediaSocket 414	163
MediaSocket 419	163
MSS 5 F	163
NV 5523 NF	68
NVF 115 F	93
NVF 120 F	94
NVF 5522 SR	68
PS 2200 F	152
SAR 12 F	88
SAR 212 WSG	88
SAR 411 WSG	88
SAR 422 WSG	86
SAZ 8 NFI	97
SBK 131309 NF	32
SBK 171709 NF	26
SBK 4416 NF	72
SBK 5501 NFI	66
SBK 5502 NF	66
SBK 5503 NFI	66
SBK 5509 NF	66
SBK 9935 NF	42
SBK 9965 NF	42
SDE 4415/5 F	152
SDE 4420/5 F	152
SEW 121 F	151
SEW 122 F	151
SEW 123 F	151
SFV 2/Set	165
SG 22 F	152
SHP 45	151
SLA 10 F	96
SLE 4420/6 F	153
SLR 2200 F	153
SMA 8 F	62
SMF 790	135
SMK 13089 F	34
SMK 13089 FA	34
SMK 13129 F	34
SMK 13129 FA	34
SMK 13169 F	34
SMK 13169 FA	34
SMK 13169 FA	34
SMK 17089 F	28
SMK 17089 FA	28
SMK 17129 F	28
SMK 17129 FA	28
SMK 17169 F	28
SMK 17169 FA	28
SMK 55123 F	70
SMK 55123 FA	71
SMK 55163 F	70
SMK 55163 FA	71
SMK 55243 F	70
SMK 55243 FA	71
SMK 5543 F	70
SMK 5543 FA	71
SMK 5583 F	70
SMK 5583 FA	71
SMK 99129 F	45
SMK 99169 F	45
SMK 9969 F	45

SMK 9989 F	45
SMR 210 F	90
SMR 410 F	90
SMR 9210 F	90
SMS 13089 NF	30
SMS 17089 NF	24
SMS 171607 NF	22
SMS 17807 NF	22
SMS 2212 F	83
SMS 287 F	84
SMS 41209 WBP	76
SMS 41609 WBP	76
SMS 4447 F	73
SMS 4487 F	73
SMS 51203 NF	48
SMS 51207 NF	52
SMS 51208 NF	50
SMS 51603 NF	48
SMS 51607 NF	52
SMS 51808 NF	50
SMS 52208 NF	50
SMS 52403 NF	48
SMS 5547 UI	55
SMS 5587 UI	55
SMS 5603 NF	48
SMS 5607 NF	52
SMS 5608 NF	50
SMS 5803 NF	48
SMS 5807 NF	52
SMS 5808 NF	50
SMS 91607 NF	36
SMS 92407 NF	36
SMS 93207 NF	36
SMS 9807 NF	36
SMS 9949 NFI	40
SMS 9982 NFI	38
SMS 9987 U	35
SMS 9989 U	35
SNG 12/2000	150
SNG 14/1000	150
SNG 18/1000	150
SODE X FC/PC	19
SODE X SC/APC	19
SOK FC/PC	18
SOK SC/APC	18
SOP 4/X SC/APC	19
SOP X FC/PC	19
SOP X SC/APC	19
SORx 1310607 NF	17
SORx 1310607/1 NF	17
SOTx 1310607 NF	16
SOV X FC/PC	18
SOV X SC/APC	18
SpaceBox VAM 10	122
SpaceBox VAM 5	122
SPAROS 609 CA HD	140
SPAROS 611 CA HD	140
SPAROS BC	143
SPAROS Upgrades	143
SPAROS Case	143
SPAROS SAT HD	144
SPAROS SAT HD DVB-C	144
SPAROS SAT HD DVB-T	144
SPAROS WIFI	143
SPOAX 111 LS0H	166
SPOAX 111 PVC	166

SPOAX 95 LS0H	166
SPOAX 95 PVC	166
SUR 211 WSG	89
SUR 420 WSG	87
SUS 21 F	60
SUS 4441 F	58
SUS 4481 F	58
SUS 5541 F	58
SUS 5541 NFA	58
SUS 5581 F	58
SUS 5581 NFA	58
SUS 5581/33 NF LEGACY	56
SUS 5581/33 NFA LEGACY	56
SVA 4 F	97
SVA 8 F	97
SVF 10 F	96
SVF 128 F	94
SVF 20 F	96
SVF 20 LE	96
SVN 231 F	92
TAR 5	135
TP 216	146
UNISocket 310	162
UNISocket 314	162
UNISocket 318	162
UNITap	158
VAM 420 NG DVB-T	138
VAM 420 NG PAL	137
VBE 2 P	159
VBE 2 PD	159
VBE 3 PD	159
VBE 4 P	159
VBE 4 PD	159
VBE 6 PD	159
VBE 8 PD	159
VFM 25 F	134
VTS 13213	158
VTS 17217	158
VTS 525	158
VTS 929	158
WS 90 F	164
ZFR 75 DC/Set	165
ZMR 75 DC/Set	165
ZSR 75 F/Set	165
ZSV 2 S/Set	165
ZVK 250 F/Set	165
ZVK 500 F/Set	165





**Optical Distribution** ..... from page 15

Optical



**SAT IF Distribution** ..... from page 21

SAT IF



**Headends** ..... from page 115

Headends



**CATV Distribution** ..... from page 125

CATV



**Terrestrial Distribution** ..... from page 131

Terrestrial



**Measurement** ..... from page 139

Measurement



**Accessories** ..... from page 149

Accessories



**Annex** ..... from page 168

Annex

# Impressions

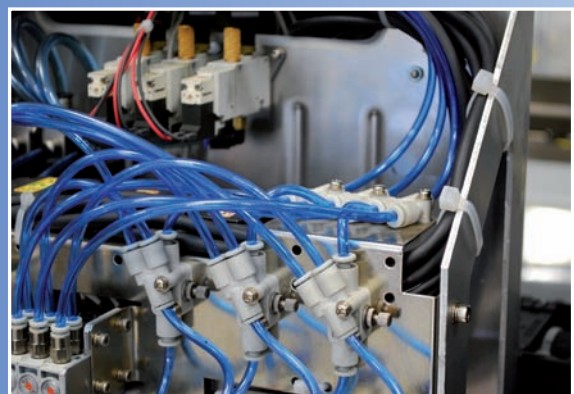
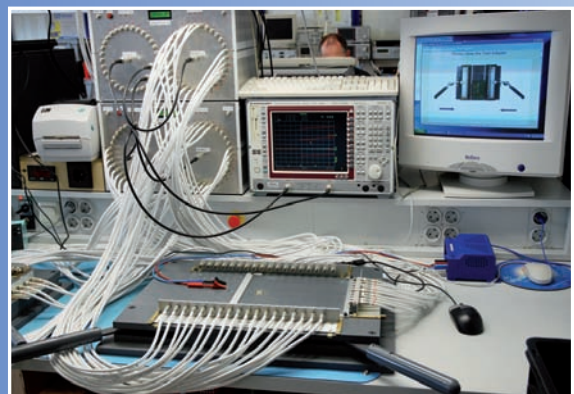

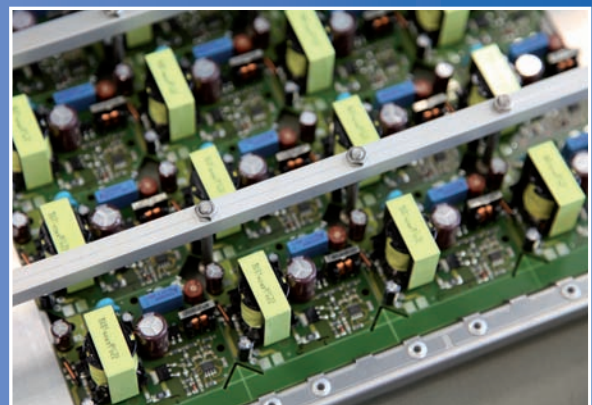
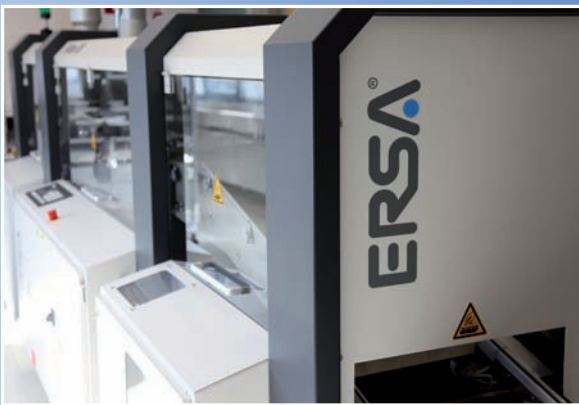

# Electromagnetic Shielding (EMC)



All SPAUN products comply with EN 50083-2, 50117-X and 60966-2-X regarding electromagnetic shielding.

This is evidenced by this registered A-Class symbol.



With CE labeling SPAUN confirms the conformity of the corresponding products with the following standards EN 60728-11, EN 50083-2 and EN 60065.



## Declaration of Conformity

We hereby inform you about our compliance in accordance with regulation (EC) No 1907/2006 (REACH), Article 33. SPAUN electronic is a manufacturer of products according to the above regulation and a “downstream user” of small quantities and therefore not subject to registration.

SPAUN provides only non-chemical products. These include no substances according to REACH Article 7 which has the intention to release under normal or reasonably foreseeable conditions of use.

Information about the ingredients are based on the information provided by the suppliers of SPAUN electronic. Accordingly, based on our current knowledge there are no substances in our products of more than 0.1% by mass, which are called in the candidate list (SVHC) of the European Chemicals Agency (ECHA).

This list (available under <http://echa.europa.eu>) is monitored from time to time by SPAUN electronic.

# RoHS ✓

## Declaration of Conformity

For implementing the RoHS directive also all suppliers were involved. The corresponding compliance certification are available.

Thus, we hereby confirm that all of SPAUN electronic GmbH & Co. KG manufactured products correspond to the EU Directive 2002/95/EC from 01/06/2006.

This is another contribution of SPAUN on environmental protection.



## WEEE Directive

WEEE-Reg.-Nr. DE 18925686

By the European WEEE directive 2002/96/EC (Waste Electrical and Electronic Equipment directive) the recycling of waste in consumer electronics is controlled. The symbol indicates that a product according to the WEEE 2002/96/EC and national laws must be disposed of with household waste.

The required measures for WEEE have been on time in 2005 fully completed and implemented. To demonstrate compliance with our obligations under the WEEE registration number we were following assigned: WEEE-Reg.-No. DE 18925686.

This is another contribution of SPAUN on environmental protection.



By the CE marking SPAUN electronic confirms the conformity of products with the respective applicable standards EN 60728-11, EN 50083-2 and EN 60065.



SPAUN electronic is contractor of the Interseroh system „detecting, sorting and recycling of packaging of the authorized electrical industry“ (transport packaging).

The disposal of sales packaging takes place via a participation in the Interseroh dual system as well as the industry solution Interseroh.

The Interseroh registration is confirmed with manufacturer number **80412**.

## Custom Power on Demand

SPAUN multiswitches are provided with energy saving switch-mode power supplies made by SPAUN Power GmbH.

SPAUN Power GmbH is specialized in development and production of custom-built switch-mode power supplies "Made in Germany". When it comes to reliability in application and to precision in manufacturing, switch-mode power supplies made by SPAUN are the right decision. Shareholder Friedrich Spaun the founder of SPAUN electronic a worldwide leading enterprise in the area of SAT-IF distribution technology has almost 40 years experience in development and production of electronic components, especially in the area of high-frequency technology.

The philosophy of Friedrich Spaun, consistent quality and reliability reflects in modern production and development facilities. These facilities are equipped with the latest EMC measurement equipment, RoHS compliant SMD assembly and soldering lines. Database supported automated testing tools for function and overvoltage tests and an ESD protected manufacturing cycle are indispensable conditions to ensure reliability. We support you from consulting and development to production maturity and beyond. We take pleasure in growing according to the increasing demands of our customers.

### 8 reasons why the switch-mode power supplies of SPAUN Power are that reliable:

- Almost 40 years of know-how in development and mass production of electronic components
- Development and production in Germany
- Using high-quality electronic assemblies
- 100% quality – each switch-mode power supply is tested
- Extensive control of incoming raw material
- Complete ESD protected manufacturing process
- In-house EMC laboratory
- Database supported testing systems

Please visit our website:



# Optical Systems

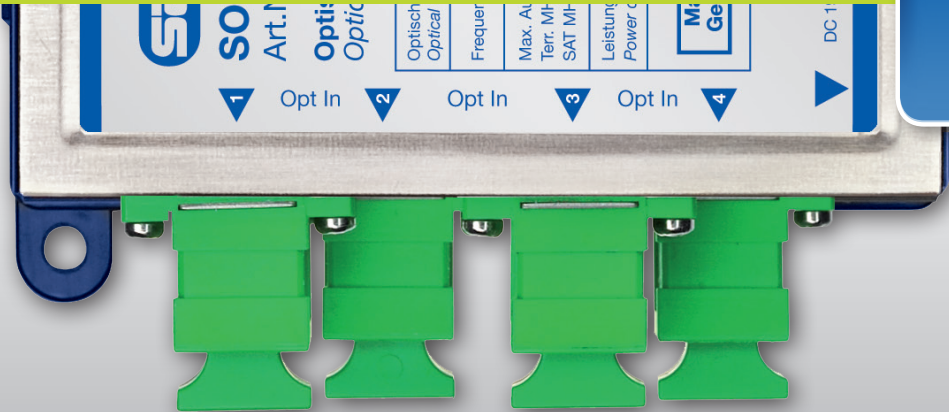

## TABLE OF CONTENTS

Optical Transmitter.....	from page 16
Optical Receiver .....	from page 17
Optical Accessories .....	from page 18

## Optical Transmitter

SOTx 1310607 NF



- Single-mode DFB-Laser
- Optical output power: +6 dBm
- Integrated amplifier-stages using Splitband Technology for terrestrial and SAT IF signals
- Level adjuster for terrestrial and SAT IF (0...-12 dB)
- Bias current to LNB possible (Quattro or QUAD)
- 5 dB slope pre-compensation for the SAT IF range
- Optical connector: SC/APC 8°
- LED operation display
- Through innovative mounting frame stackable

Model Art. No.	SOTx 1310607 NF 815000
EAN	4040326150009
Inputs Outputs	1 F connector 1 optical
Connector	SC/APC
Frequency range	47 ... 2200 MHz
Optical wavelength	1310 nm
Optical output power	6 dBm
Gain 47 ... 862 MHz 950 ... 2200 MHz	14 dB 16 ... 21 dB
Input level max. terr. 47 ... 862 MHz 60 dB IMA <sub>3</sub> / EN 60728-3	95 dB $\mu$ V
Input level max. SAT 950 ... 2200 MHz 35 dB IMA <sub>3</sub> / EN 60728-3	95 dB $\mu$ V
Level adjuster	0 ... -12 dB
LNB Bias current	400 mA
Wall power supply SNG 18/1000	100 ... 240 V, 47 – 63 Hz DC 18V / 1000 mA
Power consumption	6 W
Ambient temperature	-20 ... +50°C
Dimensions in mm	70 x 120 x 50

## Application diagram

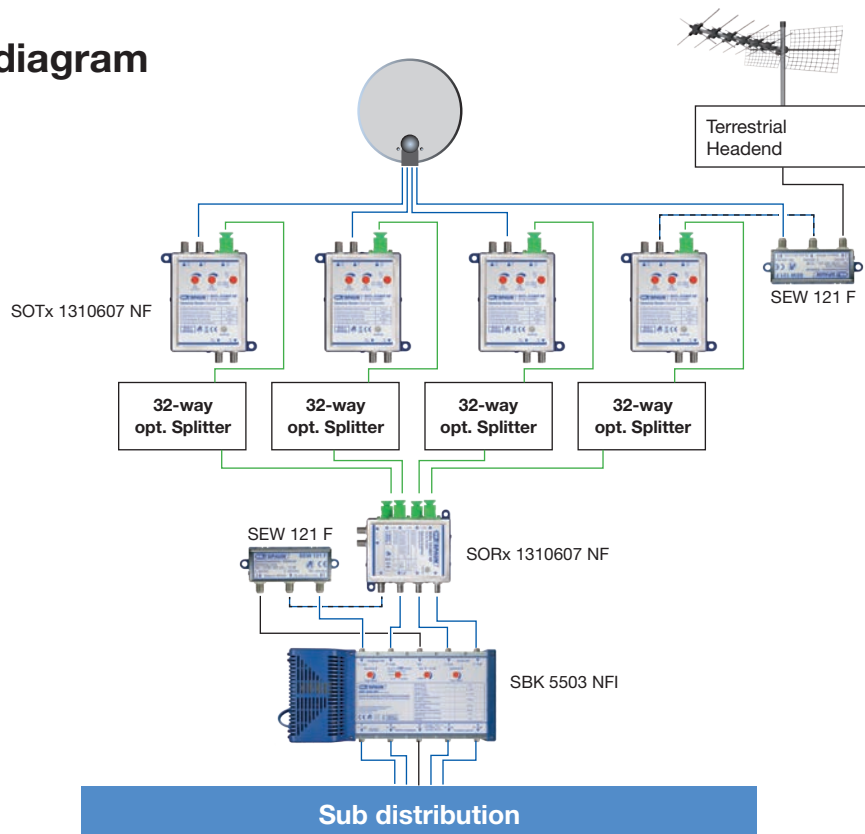



# Optical Receiver

SORx 1310607 NF, SORx1310607/1 NF

Optical

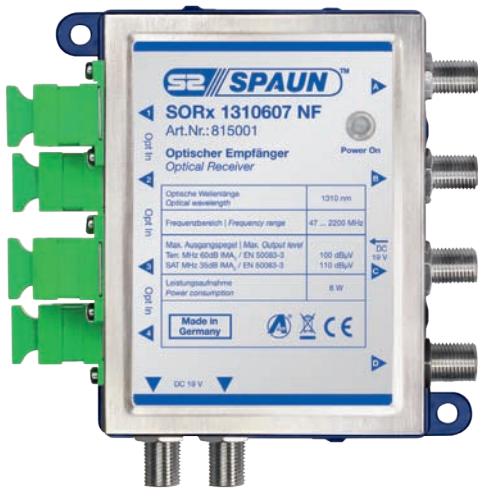

- 4-way / 1-way receiver in a compact housing
- High output power level by using a Push-Pull output stage
- Input sensitivity in the range of 0 ... -12 dBm
- Remote power for the receiver possible through the Coax outputs
- Optional remote current with SNG 18/1000 wall power supply (not in the scope of delivery)
- Optical connector: SC/APC 8°
- LED operation display
- SORx 1310607/1 NF has just one optical input

Model Art. No.	SORx 1310607 NF 815001	SORx 1310607/1 NF 814999
EAN	4040326150016	4040326149997
Inputs	4 optical	1 optical
Outputs	4 F connectors	1 F connectors
Connector	SC / APC	
Frequency range	47 ... 2200 MHz	
Optical wavelength	1310 ... 1550 nm	
Optical input power max.	0 dBm	
Optical input power min.	-12 dBm	
Output level max. terr. 47 ... 862 MHz 60 dB IMA <sub>3</sub> / EN 60728-3	100 dBμV	
Output level max. 950 ... 2200 MHz 35 dB IMA <sub>3</sub> / EN 60728-3	110 dBμV	
Power consumption	6 W	
Ambient temperature	-20 ... +50°C	
Dimensions (mm)	100 x 100 x 50	

## Optical Splitter

SOV 1/2 SC/APC, SOV 1/3 SC/APC, SOV 1/4 SC/APC, SOV 1/8 SC/APC, SOV 1/16 SC/APC, SOV 1/32 SC/APC  
SOV 1/2 FC/PC, SOV 1/3 FC/PC, SOV 1/4 FC/PC, SOV 1/8 FC/PC, SOV 1/16 FC/PC, SOV 1/32 FC/PC



- Useable for a wavelength of 1310 and 1550 nm
- Low insertion loss
- Optical connector: SC/APC 8° and FC/PC
- Compact design

Model Art. No.	SOV 1/2 SC/APC 815002	SOV 1/3 SC/APC 815003	SOV 1/4 SC/APC 815004	SOV 1/8 SC/APC 815005	SOV 1/16 SC/APC 815019	SOV 1/32 SC/APC 815020
EAN	4040326150023	4040326150030	4040326150047	4040326150054	4040326150191	4040326150207
Optical Wavelength	1310 & 1550 nm					
Connector	SC/APC both sides					
Input - Output	1:2	1:3	1:4	1:8	1:16	1:32
Typical insertion loss 1*	3,2 dB	4,9 dB	6,3 dB	9,5 dB	12,5 dB	15,8 dB
Insertion loss 1* max.	4,3 dB	6,2 dB	7,4 dB	10,7 dB	13,9 dB	17,2 dB
Equality	0,5 dB	0,6 dB	0,8 dB	1,0 dB	1,4 dB	1,6 dB
Optical output isolation	50 dB					

Model Art. No.	SOV 1/2 FC/PC 815035	SOV 1/3 FC/PC 815036	SOV 1/4 FC/PC 815037	SOV 1/8 FC/PC 815038	SOV 1/16 FC/PC 815039	SOV 1/32 FC/PC 815040
EAN	4040326150351	4040326150368	4040326150375	4040326150382	4040326150399	4040326150405
Optical Wavelength	1310 & 1550 nm					
Connector	FC/PC both sides					
Input - Output	1:2	1:3	1:4	1:8	1:16	1:32
Typical insertion loss 1*	3,2 dB	4,9 dB	6,3 dB	9,5 dB	12,5 dB	15,8 dB
Insertion loss 1* max.	4,3 dB	6,2 dB	7,4 dB	10,7 dB	13,9 dB	17,2 dB
Equality	0,5 dB	0,6 dB	0,8 dB	1,0 dB	1,4 dB	1,6 dB
Optical output isolation	50 dB					

1\* without connectors

## Optical Coupler

SOK SC/APC, SOK FC/PC

Optical coupler for universal purposes

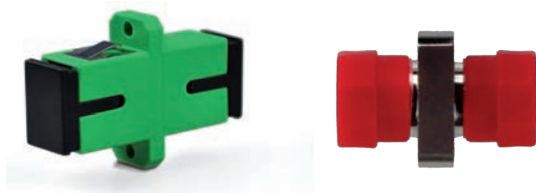

Model Art. No.	SOK SC/APC 815006	SOK FC/PC 815027
EAN	4040326150061	4040326150276
Connector	SC/APC	FC/PC

## Optical Attenuation Unit

SODE 3 SC/APC, SODE 6 SC/APC, SODE 10 SC/APC, SODE 15 SC/APC  
 SODE 3 FC/PC, SODE 6 FC/PC, SODE 10 FC/PC, SODE 15 FC/PC



To level out an optical transmission network normally an attenuation unit is used. These units should prevent damages to an optical network in case that too much light energy will be feeded to the sensitive receiver diodes.

Model Art. No.	SODE 3 SC/APC 815015	SODE 6 SC/APC 815016	SODE 10 SC/APC 815013	SODE 15 SC/APC 815017
EAN	4040326150155	4040326150162	4040326150139	4040326150179
Loss	3 dB	6 dB	10 dB	15 dB
Connector	SC/APC	SC/APC	SC/APC	SC/APC
Optical Wavelength	1310 & 1550 nm			

Model Art. No.	SODE 3 FC/PC 815028	SODE 6 FC/PC 815029	SODE 10 FC/PC 815021	SODE 15 FC/PC 815031
EAN	4040326150283	4040326150290	4040326150214	4040326150313
Loss	3 dB	6 dB	10 dB	15 dB
Connector	FC/PC	FC/PC	FC/PC	FC/PC
Optical Wavelength	1310 & 1550 nm			

## Optical Patch Cable

SOP 1 SC/APC, SOP 2 SC/APC, SOP 4 SC/APC,  
 SOP 1 FC/PC, SOP 2 FC/PC, SOP 4 FC/PC  
 SOP 4/20 SC/APC, SOP 4/100 SC/APC, SOP 4/500 SC/APC

Optical patch cable with one fibre



Model Art. No.	SOP 1 SC/APC 815007	SOP 2 SC/APC 815008	SOP 4 SC/APC 815009	
EAN	4040326150078	4040326150087	4040326150094	Further lengths on demand
Length	1 m	2 m	4 m	
Fibre type	Singlemode	Singlemode	Singlemode	
Connector	SC/APC	SC/APC	SC/APC	



Model Art. No.	SOP 1 FC/PC 815032	SOP 2 FC/AP 815033	SOP 4 FC/PC 815034	
EAN	4040326150320	4040326150337	4040326150344	Further lengths on demand
Length	1 m	2 m	4 m	
Fibre type	Singlemode	Singlemode	Singlemode	
Connector	FC/PC	FC/PC	FC/PC	

Optical patch cable with 4 fibres



Model Art. No.	SOP 4/20 SC/APC 871457	SOP 4/100 SC/APC 871455	SOP 4/500 SC/APC 871456	
EAN	4040326714577	4040326714553	4040326714560	Further lengths on demand
Length	20 m	100 m	500 m	
Fibre type	Singlemode	Singlemode	Singlemode	
Connector	SC/APC	SC/APC	SC/APC	

## Application diagram

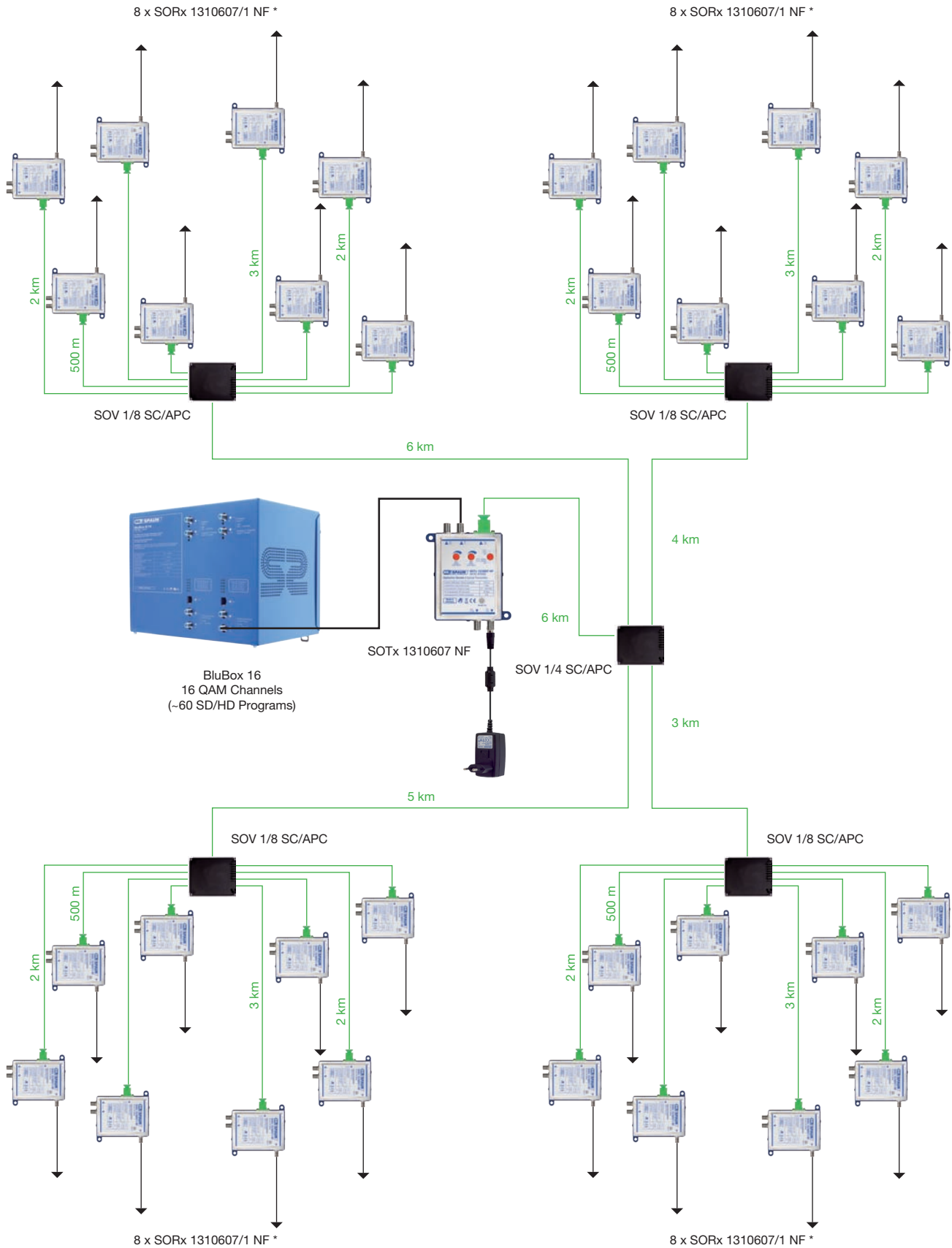

\* In this application diagram, all optical receivers SORx 1310607/1 NF require an external power supply (SNG 18/1000, Art. No.: 832114)

# SAT IF Distribution



## TABLE OF CONTENTS

17 Inputs .....	from page 22
13 Inputs .....	from page 30
9 Inputs .....	from page 35
5 Inputs .....	from page 48
UNiSEqC SCR System acc. to EN 50494 .....	from page 56
Wideband multiswitches .....	from page 75
2 Inputs.....	from page 83
SAT Antenna relay .....	from page 86
Power SAT IF Amplifier .....	from page 91

**Light-Class**

**Compact Multiswitch with active terrestrial 17 in 8 and 16**

SMS 17807 NF, SMS 171607 NF

SAT IF



**Energy Saver!**  
Standby Function and  
Switch-Mode Power Supply



**Energy Saver!**  
Standby Function and  
Switch-Mode Power Supply



**For 8 and 16 subscribers.**

Both devices feature more than 16 active SAT IF inputs and an active terrestrial input. The SMS 17807 NF offers 8 subscriber outputs and the SMS 171607 NF has 16 subscriber outputs. Both devices are supplied with an integrated energy-saving switched-mode power supply and the typical SPAUN Standby function.

**SAT IF:**

- Can be used with Quattro (12V) or QUAD LNBS (22 kHz)
- A special amplifier / filter design improves the intermodulation properties of the compact multiswitch considerably
- The high selective input filter guarantees that interference products of the LNBS cannot drive the amplifiers into saturation
- The multiswitch supports standby mode. The SAT IF amplifiers and the LNB remote voltage are only active when at least one receiver feeds a remote voltage to its multiswitch outlet.

**Terrestrial:**

- Active Forward Path (85 ... 862 MHz)
- Passive Return Path from 5 ... 65 MHz for the use of interactive signals (Triple Play)

**Miscellaneous:**

- Standby function
- Ground clamp

Model Art. No.		SMS 17807 NF 842500	SMS 171607 NF 842501
EAN		4040326425008	4040326425015
Inputs SAT / terrestrial		17 16 / 1	
Outputs / receiver		8	16
Tap loss Terr. passive: 5 ... 65 MHz		17 ... 19 dB	22 ... 24 dB
Tap loss Terr. active: 85 ... 862 MHz		4 ... 2 dB	8 ... 4 dB
Tap gain SAT IF: 950 ... 2200 MHz		-3 ... 3 dB	-5 ... 0 dB
Output level max. 85 ... 862 MHz 60 dB IMA <sub>3</sub> / EN 60728-3		92 dB $\mu$ V	88 dB $\mu$ V
Output level max. 950 ... 2200 MHz 35 dB IMA <sub>3</sub> / EN 60728-3		95 dB $\mu$ V	95 dB $\mu$ V
Selection	SAT / terrestrial	> 40 dB	
	Terrestrial / SAT	> 40 dB	
Isolation	Switching isolation	> 35 dB	
	Receiver / receiver	> 35 dB	
Mains power supply V~		100 ... 240 V / 47 - 63 Hz	
Power consumption Terrestrial active/SAT active + LNB		< 5 W	< 8 W
Power consumption SAT standby		< 2 W	< 2 W
LNB remote current		1200 mA	
LNB single port current		300 mA	
Current consumption from receiver		< 20 mA	
Ambient temperature		-20 ... +50 °C	
Dimensions (mm)		240 x 266 x 68	318 x 266 x 68

## Premium-Class

# Cascadable Multiswitch 17 in 8

SMS 17089 NF



The SMS 17089 NF multiswitch received the ratings „Ausgezeichnet“ (=“excellent“) and „Sehr gut“ (=“very good“) in the comparative tests of the professional journals Digital Fernsehen and SATVISION.

SAT IF



**Energy Saver!**  
Standby Function and Switch-Mode Power Supply



Useable as standalone switch for 8 subscribers; for cascading with SMK 17xx9 F (A); as post amplifier or to terminate a cascadable system.

### SAT IF:

- Synchronous level adjuster for each SAT IF system
- LNB supply voltage selectable for the use of Quattro (12V) or QUAD LNBS (22 kHz)

### Terrestrial:

- The terrestrial input is passive and return path compatible with the possibility of a 18 V (250 mA) remote current in both directions for an amplifier.

### Miscellaneous:

- Selective standby function:  
If all subscribers only watch TV programmes of SAT system A only the appropriate LNB is supplied with power. The internal logic turns off the power supply of all other LNBS as well as that of the integrated amplifiers.  
This process results in significant energy savings!
- Ground clamp

LED control:

- green = active
- yellow = standby
- red = DC error

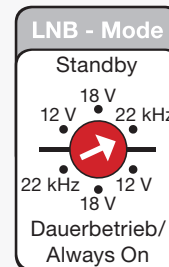

LNB supply voltage selectable, for Quattro or QUAD-LNB

Standby or normal operation modes selectable for SAT reception

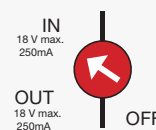

Supply voltage selectable 0 V / 18 V

-10dB



Synchronous level adjuster for each SAT IF system



17 DC-decoupled terminating resistors are shipped with the SMS 17089 NF to terminate the trunk lines.  
**ZFR 75 DC /Set (Art.No.: 871511)**



Model Art. No.	SMS 17089 NF 842425
EAN	4040326424254
Inputs / outputs SAT / Terrestrial	17 / 17 16 / 1
Outputs / subscribers	8
Tap loss Terr. 5 ... 862 MHz	20 ... 23 dB
Tap gain SAT: 950 ... 2200 MHz	-3 ... 3 dB
Loss trunkline Terr. 5 ... 862 MHz	5 dB
Gain trunkline SAT: 950 ... 2200 MHz	18 ... 21 dB
Output level max. SAT 950 ... 2200 MHz 35 dB IMA <sub>3</sub> / EN 60728-3	110 dB $\mu$ V
Rejection SAT / Terrestrial Terrestrial / SAT	> 35 dB > 40 dB
Isolation Trunk / trunk	> 30 dB
Isolation Receiver / receiver	> 28 dB
Mains power supply V~	100 ... 240 V / 47 – 63 Hz
Power consumption Terrestrial 18 V / 250 mA + LNB max.	< 23 W
Power consumption Terrestrial 0 V + LNB max.	< 26 W
Power consumption Standby / Terrestrial 18 V / 250 mA	< 8 W
Power consumption Terrestrial 0 V	< 3 W
LNB remote current	1,2 A
Single port current	300 mA
Remote current Terrestrial	18 V / 250 mA
Current consumption from receiver	25 mA
Ambient temperature	-20 ... +50 °C
Dimensions (mm)	490 x 211 x 56

## Power-Class

# Power Launch Amplifier for large distribution networks / 17 inputs

SBK 171709 NF

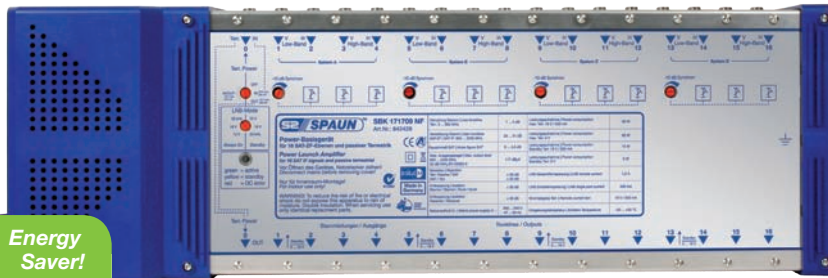

Standby Function and  
Switch-Mode Power Supply

### Power Launch Amplifier for cascading with SMK 17x9 F (A)

#### SAT IF:

- Synchronous level adjuster for each SAT IF system
- A special amplifier / filter design improves the intermodulation properties of the launch amplifier considerably
- The high selective input filter guarantees that interference products of the LNBS cannot drive the amplifiers into saturation
- An additional output filter ensures that intermodulation products and noise effects do not degrade the terrestrial signal

#### Terrestrial:

- The terrestrial input is passive and return path compatible with the possibility of a 18 V (250 mA) remote current in both directions for an amplifier.

#### Miscellaneous:

- Selective standby function:  
If all subscribers only watch TV programmes of SAT system A, only the appropriate LNB is supplied with power. The internal logic turns off the power supply of all other LNBS as well as that of the integrated amplifiers.  
This process results in significant energy savings!
- Ground clamp



17 DC-decoupled terminating resistors are shipped with the SMS 17089 NF to terminate the trunk lines.

**ZFR 75 DC /Set (Art.No.: 871511)**

LED control:

- green = active
- yellow = standby
- red = DC error

#### LNB - Mode

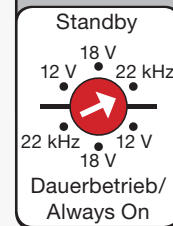

LNB supply voltage selectable for Quattro or QUAD-LNB.

Standby or normal operation modes selectable for SAT reception

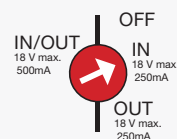

Supply voltage selectable 0 V / 18 V

synchronous  
-10dB



Synchronous level adjuster for each SAT IF system

Model Art. No.		SBK 171709 NF 842428
EAN		4040326424285
Inputs / outputs SAT / Terrestrial		17 / 17 16 / 1
Loss Terr.: 5 ... 862 MHz		1 ... 3 dB
Gain SAT IF: 950 ... 2200 MHz		25 ... 31 dB
Noise figure SAT		9 ... 4,5 dB
Output level max. 950 ... 2200 MHz 35 dB IMA <sub>3</sub> / EN 60728-3		117 dB $\mu$ V
Rejection	Terrestrial passive / SAT	> 45 dB
	SAT / Terrestrial	> 40 dB
Isolation Trunk / trunk		> 30 dB
Power supply V~		100 ... 240 V / 47 – 63 Hz
Power consumption Terr. 18 V / 500 mA + LNB max.		62 W
Power consumption Terr. 0 V + LNB max.		50 W
Power consumption Standby / terr. 18 V / 500 mA		18 W
Power consumption Standby / Terr. 0 V		5 W
LNB remote current		1,6 A
Single port current		400 mA
Remote current Terrestrial		18 V / 500 mA
Ambient temperature		-20 ... +50 °C
Dimensions (mm)		540 x 170 x 100

SAT IF

## Premium-Class

### Cascadable Multiswitches 17 in 8, 12, 16

SMK 17xx9 F and SMK 17xx9 FA (active)

SAT IF



SMK 17129 F multiswitch received the rating of „sehr gut“ = “excellent”



For 8, 12 or 16 subscribers as passive SMK 17xx9 F and as active model SMK 17xx9 FA available.



Only useable in combination with the cascadable multiswitch **SMS 17089 NF** or launch amplifier **SBK 171709 NF**.

Model Art. No.	SMK 17089 F 842423	SMK 17129 F 842426	SMK 17169 F 842424	SMK 17089 FA 842469	SMK 17129 FA 842470	SMK 17169 FA 842471
EAN	4040326424230	4040326424261	4040326424247	4040326424698	4040326424704	4040326424711
Inputs / outputs SAT / Terrestrial	17 / 17 16 / 1					
Frequency range	5 ... 862 MHz and 950 ... 2200 MHz					
Outputs / subscribers	8	12	16	8	12	16
Through loss terr. trunk	6 dB	6 dB	6 dB	6 dB	6 dB	6 dB
Through loss SAT trunk	2 ... 5 dB	3 ... 7 dB	3 ... 7 dB	2 ... 5 dB	3 ... 7 dB	3 ... 7 dB
Tap loss terr.	22 ... 25 dB	25 ... 27 dB	27 ... 29 dB	22 ... 25 dB	25 ... 27 dB	27 ... 29 dB
Tap loss SAT	20 ... 19 dB	22 ... 20 dB	22 ... 20 dB	7 ... 0 dB	7,5 ... 2 dB	7 ... 1 dB
Current consumption from receiver	max. 25 mA			max. 75 mA		
Output level max. 950 ... 2200 MHz 35 dB IMA <sub>3</sub> / EN 60728-3	-	-	-	110 dBμV	110 dBμV	110 dBμV
Isolation trunk / trunk	> 30 dB	> 30 dB	> 30 dB	> 30 dB	> 30 dB	> 30 dB
Isolation receiver / receiver	> 30 dB	> 30 dB	> 30 dB	> 30 dB	> 30 dB	> 30 dB
DC-pass through Trunkline 0; 2 ... 16 *	1 A					
Ambient temperature	-20 ... +50 °C					
Dimensions (mm)	425 x 130 x 40	425 x 210 x 40	425 x 210 x 40	426 x 130 x 40	425 x 210 x 40	425 x 210 x 40

\* Selective Standby mode. Activation via trunk lines 1, 5, 9 and 13.

# SPOAX - The *premium* SAT IF Cables

**NEW** New Installer Prices



**SPOAX - Don't call it Coax!**

## Premium-Class

# Cascadable Multiswitch 13 in 8

SMS 13089 NF



Useable as standalone switch for 8 subscribers; for cascading with SMK 13xx9 F (A); as post amplifier or to terminate a cascadable system.

### SAT IF:

- Synchronous level adjuster for each SAT IF system
- LNB supply voltage selectable for the use of 12V, Quattro (18V) or QUAD LNBS (22 kHz)
- The cascadable multiswitches are delivered with 13 DC-decoupled terminating resistors to terminate the unused trunk lines

### Terrestrial:

- Passive Return Path from 5 ... 65 MHz for the use of interactive signals (Triple Play)
- Active Forward Path from 85 ... 862 MHz
- InGap-HBT Push-Pull output stage

### Miscellaneous:

- Selective standby function:  
If all subscribers only watch TV programmes of SAT system A, only the appropriate LNB is supplied with power. The internal logic turns off the power supply of all other LNBS as well as that of the integrated amplifiers  
This process results in significant energy savings
- Ground clamp

### LED control:

- green = active
- yellow = standby
- red = DC error

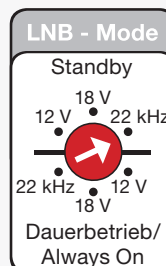

LNB supply Voltage selectable for Quattro- or QUAD-LNBS

Standby or normal operation modes selectable for SAT reception

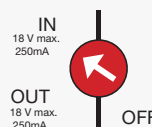

Supply voltage selectable  
0 V / 18 V

Synchron  
-10dB



Synchronous level adjuster for each SAT IF system



13 DC-decoupled terminating resistors are shipped with the SMS 13089 NF to terminate the trunk lines.  
**ZFR 75 DC /Set (Art.No.: 871511)**

Model Art. Nr.	SMS 13089 NF 842430
EAN	4040326424308
Inputs / outputs SAT / Terrestrial	13 / 13 12 / 1
Outputs / subscribers	8
Tap gain Terr. 85 ... 862 MHz	5 dB
Tap loss Terr. Return Path 5 ... 65 MHz	18 ... 20 dB
Tap gain SAT: 950 ... 2200 MHz	0 ... 4 dB
Gain trunkline SAT: 950 ... 2200 MHz	20 ... 21 dB
Loss trunkline Terr. Return Path 5 ... 65 MHz	5 dB
Gain trunkline Terr.: 85 ... 862 MHz	20 dB
Output level max. Terr. 85 ... 862 MHz 60 dB IMA <sub>3</sub> / EN 60728-3	103 dB $\mu$ V
Output level max. SAT 950 ... 2200 MHz 35 dB IMA <sub>3</sub> / EN 60728-3	110 dB $\mu$ V
Rejection SAT / terrestrial Terrestrial / SAT	> 35 dB > 40 dB
Isolation Trunk / trunk	> 30 dB
Isolation Receiver / receiver	> 28 dB
Mains power supply V~	100 ... 240 V / 47 – 63 Hz
Power consumption Terrestrial 18 V / 250 mA + LNB max.	< 22 W
Power consumption Terrestrial 0 V + LNB max.	< 21 W
Power consumption Standby / terr. 18 V / 250 mA	< 8 W
Power consumption Terr. 0 V	< 7 W
LNB remote current	900 mA
Single port current	300 mA
Remote current terrestrial	18 V / 250 mA
Current consumption from receiver	25 mA
Ambient temperature	-20 ... +50 °C
Dimensions (mm)	430 x 211 x 56

## Power-Class

# Power Launch Amplifier for large distribution networks / 13 inputs

SBK 131309 NF

SAT IF

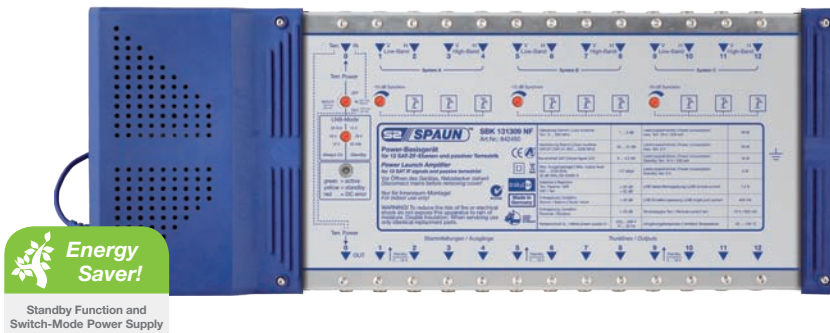

Standby Function and  
Switch-Mode Power Supply

### Power Launch Amplifier for cascading with SMK 13xx3 F(A).

#### SAT IF:

- The power launch amplifier features 12 SAT IF trunkline inputs and outputs in total for reception and distribution of 4 SAT IF signals of each SAT system A, B and C
- To ensure logical allocation of the IF signals according to the DiSEqC circuit criteria, the IF signals must be connected to the power launch amplifier according to the marking on the unit
- All IF amplifiers feature an integrated 6 dB slope. Each SAT system features a synchronous level controller. Thus an adjustment of different signals up to 10 dB is possible.

#### Terrestrial:

- The terrestrial input is return path compatible. Supply voltage selectable in both directions: 0 V / 18 V (500 mA)

#### Miscellaneous:

- Selective standby function:  
If all subscribers only watch TV programmes of SAT system A, only the appropriate LNB is supplied with power. The internal logic turns off the power supply of all other LNBs as well as that of the integrated amplifiers.  
This process results in significant energy savings
- Ground clamp



13 DC-decoupled terminating resistors are shipped with the SBK 131309 NF to terminate the trunk lines.  
**ZFR 75 DC /Set (Art.No.: 871511)**

#### LED control:

- green = active
- yellow = standby
- red = DC error

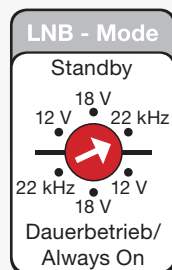

LNB supply voltage selectable for Quattro or QUAD-LNB:

Standby or normal operation modes selectable for SAT reception

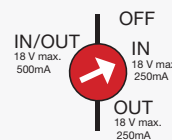

Supply voltage selectable 0 V / 18 V

synchronous  
-10dB



Synchronous level adjuster for each SAT IF system



Model Art. No.	SBK 131309 NF 842450	
EAN	4040326424506	
Inputs / outputs SAT / terr.	13 / 13 12 / 1	
Loss Terr.: 5 ... 862 MHz	1 ... 3 dB	
Gain SAT IF: 950 ... 2200 MHz	25 ... 31 dB	
Noise figure SAT	9 ... 4,5 dB	
Output level max. 950 ... 2200 MHz 35 dB IMA <sub>3</sub> / EN 60728-3	117 dB $\mu$ V	
Rejection	Terrrestrial passive / SAT	> 45 dB
	SAT / terrestrial	> 40 dB
Isolation Trunk / trunk	> 30 dB	
Power supply V~	100 ... 240 V / 47 – 63 Hz	
Power consumption max terr. 18 V / 500 mA	50 W	
Power consumption Terr. 0 V + LNB max.	40 W	
Power consumption Standby / terr. 18 V / 500 mA + LNB	18 W	
Power consumption Standby / terr. 0 V	5 W	
LNB remote current	1,2 A	
Single port current	400 mA	
Remote current terrestrial	18 V / 500 mA	
Ambient temperature	-20 ... +50 °C	
Dimensions (mm)	460 x 170 x 100	

## Premium-Class

# Cascadable Multiswitches 13 in 8, 12, 16

SMK 13xx9 F and SMK 13xx9 FA (active)

SAT IF



For 8, 12 or 16 subscribers as passive SMK 13xx9 F and as active model SMK 13xx9 FA available.



Only useable in combination with launch amplifier **SBK 131309 NF** or with the cascadable multiswitch **SMS 13089 NF**.

Model Art. No.	SMK 13089 F 842466	SMK 13129 F 842467	SMK 13169 F 842468	SMK 13089 FA 842472	SMK 13129 FA 842473	SMK 13169 FA 842474
EAN	4040326424667	4040326424674	4040326424681	4040326424728	4040326424735	4040326424742
Inputs / outputs SAT / terr.	13 / 13 12 / 1					
Frequency range	5 ... 862 MHz and 950 ... 2200 MHz					
Outputs / subscribers	8	12	16	8	12	16
Through loss terr. trunk	6 dB	6 dB	6 dB	6 dB	6 dB	6 dB
Through loss SAT trunk	2 ... 5 dB	3 ... 7 dB	3 ... 7 dB	2 ... 5 dB	3 ... 7 dB	3 ... 7 dB
Tap loss terr.	22 ... 25 dB	25 ... 27 dB	27 ... 29 dB	22 ... 25 dB	25 ... 27 dB	27 ... 29 dB
Tap loss SAT	20 ... 19 dB	22 ... 20 dB	22 ... 20 dB	3 ... -1 dB	4 ... 1 dB	4 ... 1 dB
Output level max. 950 ... 2200 MHz 35 dB IMA <sub>3</sub> / EN 60728-3	-	-	-	110 dBμV	110 dBμV	110 dBμV
Current consumption from receiver max.	25 mA			75 mA		
Isolation trunk / trunk	> 30 dB	> 30 dB	> 30 dB	> 30 dB	> 30 dB	> 30 dB
Isolation receiver / receiver	> 30 dB	> 30 dB	> 30 dB	> 30 dB	> 30 dB	> 30 dB
DC-pass through trunkline 0; 2 ... 16 *	1 A					
Ambient temperature	-20 ... +50 °C					
Dimensions (mm)	345 x 130 x 40	345 x 210 x 40	345 x 210 x 40	345 x 130 x 40	345 x 210 x 40	345 x 210 x 40

\* Selective Standby mode. Activation via trunk lines 1, 5, 9.

# UniSystem - Flexible Multiswitch System 9 in 8

SMS 9989 U, SMS 9987 U

9 DC-decoupled terminating resistors are shipped with the SBK 131309 NF to terminate the trunk lines.  
**ZFR 75 DC /Set (Art.No.: 871511)**



**Optional:**  
Universal AC Adapter **SNG 18/1000 (Art. No.: 832114)**  
in combination with Line Power Injection Filter **FSW 30 F (Art. No.: 815018)**

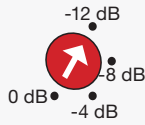

Each receiver output has an integrated switchable level shifting (except SMS 9987 U)

SAT IF

## For 8 ... 16 SAT IF signals.

The UniSystem multiswitches can be used as stand-alone devices or can be cascaded with themselves for an easy extension of the number of subscribers. The UniSystem is extendable to up to 16 SAT IF levels.

### Special features:

- After the SAT IF signal has been decoupled by microstripline directional couplers, it is amplified for each receiver output, which produces a tap loss of 3 ... +1 dB

### Possible applications:

- As a single multiswitch for 8 SAT IF signals
- In „piggyback“ mode in conjunction with a multiswitch relay extensible for 16 SAT IF signals. The wall mounting frame supplied is designed to support also the „piggyback“ assembly
- The master outputs also facilitate cascading, so that the number of receivers can be increased. Without amplifying the signal, it is possible (depending on cable quality and length) to feed up to 24 receiver

Model Art. No.	SMS 9989 U 842432	SMS 9987 U 842439
EAN	4040326424322	4040326424391
Inputs / outputs SAT / terr.	9 / 9 8 / 1	
Frequency range	5 ... 862 MHz and 950 ... 2200 MHz	
Outputs / receivers	8	
Through loss Terr.	6 dB	
Through loss SAT	2 ... 5 dB	
Tap loss Terr.	24 dB	
Tap gain SAT	-3 ... +1 dB	
Input level SAT max.	85 dB $\mu$ V	
Output level SAT A ... H max.	86 dB $\mu$ V	
Switching Isolation	> 26 dB	
Rejection Receiver / Receiver	> 26 dB	
Current from receiver max.	95 mA	
DC-pass per trunkline	1 A	
Ambient temperature	-20 ... +50 °C	
Dimensions (mm)	225 x 146 x 32	

## Light-Class

# Compact Multiswitch with active terrestrial 9 in 8, 16, 24, 32

SMS 9807 NF, SMS 91607 NF, SMS 92407 NF, SMS 93207 NF



For 8, 16, 24 and 32 subscribers.

### SAT IF:

- Can be used with Quattro (12V) or QUAD LNBS (22 kHz)
- A special amplifier / filter design improves the intermodulation properties of the compact multiswitch considerably
- The high selective input filter guarantees that interference products of the LNBS cannot drive the amplifiers into saturation

### Terrestrial:

- Active Forward Path (85 ... 862 MHz)
- Passive Return Path from 5 ... 65 MHz for the use of interactive signals (Triple Play)

### Miscellaneous:

- The multiswitch supports standby mode.  
The SAT IF amplifiers and the LNB remote voltage are only active when at least one receiver feeds a remote voltage to its multiswitch outlet
- Ground clamp



Model Art. No.		SMS 9807 NF 842495	SMS 91607 NF 842496	SMS 92407 NF 842498	SMS 93207 NF 842499
EAN		4040326424957	4040326424964	4040326424988	4040326424995
Inputs SAT / terrestrial		9 / 1			
Outputs / receiver		8	16	24	32
Tap loss Terr. passive: 5 ... 65 MHz		17 ... 19 dB	22 ... 24 dB	24 ... 26 dB	25 ... 27 dB
Tap loss Terr. active: 85 ... 862 MHz		4 ... 2 dB	8 ... 4 dB	8 ... 5 dB	9 ... 6 dB
Tap gain SAT IF: 950 ... 2200 MHz		-3 ... 3 dB	-5 ... 0 dB	-5 ... 2 dB	-6 ... 0 dB
Output level max. 85 ... 862 MHz 60 dB IMA <sub>3</sub> / EN 60728-3		92 dB $\mu$ V	88 dB $\mu$ V	92 dB $\mu$ V	90 dB $\mu$ V
Output level max. 950 ... 2200 MHz 35 dB IMA <sub>3</sub> / EN 60728-3		95 dB $\mu$ V	95 dB $\mu$ V	95 dB $\mu$ V	95 dB $\mu$ V
Selection	SAT / terrestrial	> 40 dB			
	Terrestrial / SAT	> 40 dB			
Isolation	Switching isolation	> 35 dB			
	Receiver / receiver	> 35 dB			
Mains power supply V~		100 ... 240 V / 47 - 63 Hz			
Power consumption Terrestrial active/SAT active + LNB		< 5 W	< 6 W	< 7 W	< 8 W
Power consumption SAT standby		< 3 W	< 3 W	< 3 W	< 3 W
LNB remote current		600 mA			
LNB single port current		300 mA			
Current consumption from receiver		< 20 mA			
Ambient temperature		-20 ... +50 °C			
Dimensions (mm)		230 x 211 x 56	330 x 211 x 56	410 x 211 x 56	490 x 211 x 56

SAT IF

## Premium-Class Cascadable Multiswitch 9 in 8 SMS 9982 NFI

SAT IF



For 8 subscribers.

### SAT IF:

- SAT IF amplifiers with precompensating 6 dB slope
- IF selection logic:  
Using the analogue control signals 14 / 18 V, 0 / 22kHz and ToneBurst or the DiSEqC commands Polarity, Band and Position
- The multiswitches support a standby mode. The SAT IF amplifiers and the LNB remote voltage are only active when at least one receiver feeds a remote voltage to its multiswitch outlet
- The multiswitches support DiSEqC 2.0. That means bidirectional communication between receiver and multiswitch is possible

### Terrestrial:

- Terrestrial input selectable active/passive
- Return path for the use of interactive signals (Triple Play)

### Miscellaneous:

- Standby function
- Ground clamp

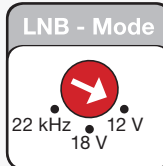

LNB supply voltage selectable for Quattro or QUAD-LNB



This adjuster allows the reduction of the terrestrial signal and the extension of the return path



Level adjuster for each IF input to adjust different input levels



9 DC-decoupled terminating resistors are shipped with the SMS 99X2 NF to terminate the trunk lines.  
**ZFR 75 DC /Set (Art.No.: 871511)**

Model Art. No.	SMS 9982 NFI 842257	
EAN	4040326422571	
Inputs / outputs SAT / terrestrial	9 / 9 8 / 1	
Outputs / subscribers	8	
Tap loss Terr.: passive 5 ... 862 MHz	18 ... 21,5 dB	
Tap gain Terr.: active 47 ... 862 MHz	3.5 ... 0,5 dB	
Tap gain SAT: 950 ... 2200 MHz	-2.5 ... 6,5 dB	
Loss trunk lines Terr.: passive 5 ... 862 MHz	5,5 dB	
Gain trunk lines Terr.: active 47... 862 MHz	18 dB	
Gain trunk lines SAT IF: 950 ... 2200 MHz	13 ... 17 dB	
Noise figure terrestrial	< 7 dB	
Noise figure SAT	< 7 dB	
Output level max. 47 ... 862 MHz 60 dB IMA <sub>3</sub> / EN 60728-3	105 dB $\mu$ V	
Output level max. 950 ... 2200 MHz 35 dB IMA <sub>3</sub> / EN 60728-3	109 dB $\mu$ V	
Rejection	Terr. passive / SAT	> 26 dB
	Terr. active / SAT	> 30 dB
	SAT / terr.	> 36 dB
Isolation Trunk / trunk	> 30 dB	
Isolation Receiver / receiver	> 28 dB	
Mains power supply V~	100 ... 240 V / 47 – 63 Hz	
Power consumption max. terr. 18 V / 250 mA + LNB	27 W	
Power consumption max. terr. 0 V + LNB	20 W	
Power consumption Standby / terr. 18 V / 250 mA	6 W	
Power consumption Standby / terr. 0 V	3 W	
LNB remote current	800 mA	
Single port current	400 mA	
Current consumption from receiver	25 mA	
Ambient temperature	-20 ... +50 °C	
Dimensions (mm)	330 x 211 x 56	

SAT IF

## Light-Class

# Cascadable Multiswitch 9 in 4

SMS 9949 NFI

SAT IF



**Energy Saver!**  
Standby Function and  
Switch-Mode Power Supply



As standalone switch for 4 subscribers; for cascading with SMK 99xx F; as post amplifier or to terminate a cascadable system.

### SAT IF:

- Standby mode, even with cascaded sub devices SMK 99x9 F, activation via trunkline
- A special amplifier / filter design improves the intermodulation properties of the multiswitch considerably
- The multiswitch supports DiSEqC 2.0. That means bidirectional communication between receiver and multiswitch is possible
- Can be used with Quattro (12 V) or QUAD LNBS (22 kHz)

### Terrestrial:

- Return path compatible
- Remote power over terrestrial for active cascade components 18 V / 150 mA

### Miscellaneous:

- The SMS 9949 NFI provides improved maximum output level as well as an increased gain of the SAT IF trunk lines
- 8 SAT IF inputs and 1 passive terrestrial input, 4 receiver outputs and 9 trunkline outputs



9 DC-decoupled terminating resistors are shipped with the SMS 9949 NFI to terminate the trunk lines.

**ZFR 75 DC /Set (Art.No.: 871511)**



Model Art. No.	SMS 9949 NFI 842431	
EAN	4040326424315	
Inputs / outputs SAT / terrestrial	9 / 9 8 / 1	
Outputs / subscribers	4	
Tap loss terr.: 5 ... 862 MHz	16 ... 18 dB	
Tap gain SAT: 950 ... 2200 MHz	-3 ... 2,5 dB	
Loss trunk lines terr.: 5 ... 862 MHz	4,5 ... 6 dB	
Gain trunk lines SAT IF: 950 ... 2200 MHz	15 dB	
Output level max. 950 ... 2200 MHz 35 dB IMA <sub>3</sub> / EN 60728-3	116 dB <sub>μ</sub> V	
Selection	terr. / SAT	> 35 dB
	SAT / terr.	> 35 dB
Isolation trunk / trunk	> 30 dB	
Isolation Receiver / receiver	> 35 dB	
Mains power supply V~	100 ... 240 V / 47 - 63 Hz	
Power consumption + LNB	< 8,5 W	
Power consumption standby	< 2 W	
LNB remote current	500 mA	
Single port current	250 mA	
Current consumption from receiver	25 mA	
Ambient temperature	-20 ... +50 °C	
Dimensions (mm)	340 x 130 x 56	

## Power-Class

# Launch Amplifier for large distribution networks / 9 inputs

SBK 9935 NF, SBK 9965 NF

SAT IF



Standby Function and  
Switch-Mode Power Supply

### Launch- and post amplifier for cascading with SMK 99xx F.

#### SAT IF:

- A special amplifier / filter design improves the intermodulation properties of the launch amplifiers considerably
- The high selective input filter guarantees that interference products of the LNBS can not drive the amplifiers into saturation
- An additional output filter ensures that intermodulation products and noise effects do not degrade the terrestrial signal

#### Terrestrial:

- **Forward path:**  
Terrestrial amplifier with pre emphasis
- **Return path:**  
Selectable: off, passive, active  
Gain selectable: 20, 15, 10 or 5 dB
- CATV compatible
- Push pull technology
- Level adjuster range: 0 ... -15 dB

#### Miscellaneous:

- Selective standby function:  
If all subscribers only watch TV programmes of SAT system A, only the appropriate LNB is supplied with power. The internal logic turns off the power supply of all other LNBS as well as that of the integrated amplifiers.  
This process results in significant energy savings.
- Ground clamp

#### LED control:

- green = active
- yellow = standby
- red = DC error

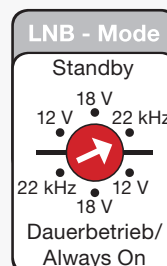

LNB supply voltage  
selectable for  
Quattro or QUAD-LNB

Standby or normal operation  
modes selectable for SAT  
reception

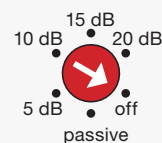

Return path: selectable: off,  
passive, active. Gain selectable:  
20, 15, 10 or 5 dB



Level adjuster for each  
SAT IF signals 0 ... -10 dB



9 DC-decoupled terminating resistors are  
shipped with the SBK 99x5 NF to termi-  
nate the trunk lines.  
**ZFR 75 DC /Set (Art.No.: 871511)**

Model Art. No.	SBK 9935 NF 842379	SBK 9965 NF 842400
EAN	4040326423790	4040326424001
Inputs / outputs SAT / terrestrial	9 / 9 8 / 1	
Return path loss terr. passive: 5 ... 30 MHz	-2,5 dB	-
Return path loss terr. passive: 5 ... 65 MHz	-	-2,5 dB
Return path gain terr. active: 5 ... 30 MHz	5, 10, 15, 20 dB	-
Return path gain terr. active: 5 ... 65 MHz	-	5, 10, 15, 20 dB
Gain terr. 47 ... 862 MHz	26 ... 30 dB	-
Gain terr. 85 ... 862 MHz	-	26 ... 30 dB
Gain SAT IF: 950 ... 2200 MHz	27 ... 31 dB	27 ... 31 dB
Noise figure Terrestrial	< 7 dB	< 7 dB
Noise figure return path Terrestrial	6 dB	6 dB
Noise figure SAT	< 5,5 dB	< 5,5 dB
Output level Return path 5 ... 30 MHz max. 60 dB IMA <sub>3</sub> / EN 60728-3	110 dB $\mu$ V	-
Output level Return path 5 ... 65 MHz max. 60 dB IMA <sub>3</sub> / EN 60728-3	-	110 dB $\mu$ V
Output level 47... 862 MHz max. 60 dB IMA <sub>3</sub> / EN 60728-3	116 dB $\mu$ V	-
Output level 85 ... 862 MHz max. 60 dB IMA <sub>3</sub> / EN 60728-3	-	116 dB $\mu$ V
Output level 950 ... 2200 MHz max. 35 dB IMA <sub>3</sub> / EN 60728-3	117 dB $\mu$ V	117 dB $\mu$ V
Rejection	Terrestrial active / SAT	> 42 dB
	SAT / terrestrial	> 40 dB
Isolation Trunk / trunk	$\geq$ 35 dB	
Mains power supply V~	100 ... 240 V / 47 – 63 Hz	
Power consumption Terrestrial active / SAT active	55 W	
Power consumption standby	< 15 W	
LNB remote current	1 A	
Single port current	500 mA	
Ambient temperature	-20 ... +50 °C	
Dimensions (mm)	445 x 190 x 100	

SAT IF

# VAM 420 NG PAL / DVB-T

The *premium* Audio/Video Conversion

## VAM 420 NG DVB-T

Conversion of two A/V- signals into a COFDM modulated signal



## VAM 420 NG PAL

Adjacent channel capable conversion of two A/V signals into an analogue PAL signal

## Standard-Class

# Cascadable Multiswitch 9 in 6, 8, 12, 16

SMK 9969 F, SMK 9989 F, SMK 99129 F, SMK 99169 F

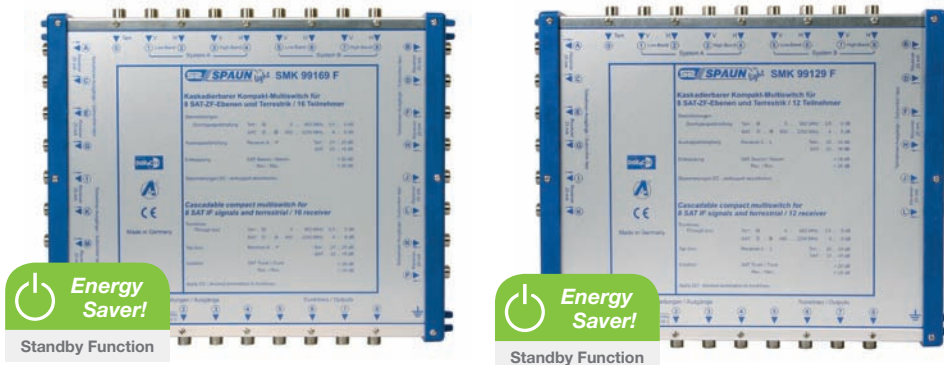

SAT IF

For 6, 8, 12 or 16 subscribers.

### SAT IF:

- **IF selection logic:**  
Using the analogue control signals 14 / 18 V, 0 / 22 kHz and ToneBurst or the DiSEqC commands Polarity, Band and Position

### Terrestrial:

- Passive, return-path capable terrestrial

### Miscellaneous:

- Standby function (trunkline 1)
- Ground clamp

**!** Only useable in combination with cascadable multiswitches **SMS 99xx NFx** or launch amplifiers **SBK 99xx NF**.

Model Art. No.	SMK 9969 F 842382	SMK 9989 F 842383	SMK 99129 F 842409	SMK 99169 F 842410
EAN	4040326423820	4040326423837	4040326424094	4040326424100
Inputs / outputs SAT / terr.	9 / 9 8 / 1			
Outputs / subscribers	6	8	12	16
Through loss terr. trunk	3,5 ... 4,5 dB	3,5 ... 4,5 dB	3,5 ... 5 dB	3,5 ... 5 dB
Through loss SAT trunk	2 ... 4,5 dB	2 ... 4,5 dB	4 ... 8 dB	4 ... 8 dB
Tap loss terr.	18 ... 21 dB	18 ... 21 dB	22 ... 24 dB	22 ... 25 dB
Tap loss SAT	18 ... 15 dB	18 ... 15 dB	20 ... 16 dB	20 ... 16 dB
Current consumption from receiver max.	25 mA			
Isolation trunk / trunk	> 30 dB	> 30 dB	> 30 dB	> 30 dB
Isolation receiver / receiver	> 30 dB	> 30 dB	> 30 dB	> 30 dB
DC-pass through Trunkline 0; 2 ... 8 *	1 A			
Ambient temperature	-20 ... +50 °C			
Dimensions (mm)	265 x 130 x 40	265 x 130 x 40	265 x 211 x 40	265 x 211 x 40

\* Standby mode. Activation via trunkline 1.

## Find the right Multiswitch for your application:

### Premium-Class SMS 5xx03 NF

#### Features:

- Passive return path for interactive applications (Triple Play)
- Active CATV compatible forward path including InGaP Push-Pull output stage
- Level adjuster (0 ... -12dB) for the terrestrial forward path
- High max. SAT output level (102 bis 108 dB $\mu$ V; 35 db IMA3 EN 60728-3)
- Synchronous level adjuster for Low- and High Band (0...-12dB)
- By using sharp cut-off input filter a perfect selection performance is reached: Terr./SAT > 40 dB; SAT/Terr. > 45 dB
- A high receiver/receiver isolation is reached by using the latest directional coupler technology: Isolation > 36 dB/VHF; > 32 dB/UHF
- Short circuit proof, energy saving switch-mode power supplies with standby functionality
- LNB supply voltage selectable for Quattro or QUAD LNB
- Premium series with 6, 8, 12, 16 or 24 subscriber outputs.

### Standard-Class SMS 5xx08 NF

#### Features:

- Fixed terrestrial frequency range of 47... 862 MHz
- Active terrestrial stage with a tap loss between 3 and 10 dB (depends to the unit)
- Specific pre filter technology allows a selection performance of Terr./SAT > 30dB; SAT/Terr. > 30dB
- A high receiver/receiver isolation is reached by using the latest directional coupler technology: Isolation > 36 dB/VHF; > 32 dB/UHF
- Short circuit proof, energy saving switch-mode power supplies with standby functionality
- LNB supply voltage selectable for Quattro or QUAD LNB
- Standard series with 6, 8, 12, 18, or 22 subscriber outputs

### Light-Class SMS 5xx07 NF

#### Features:

- Passive terrestrial signal distribution in the frequency range of 5 ... 862 MHz
- Tap loss for the terrestrial path between 20 and 25 dB (depends on the unit)
- Selection performance from > 26 dB for Terr./SAT and SAT/Terr.
- Receiver/receiver isolation > 26dB
- Short circuit proof, energy saving switch-mode power supplies with standby functionality
- LNB supply voltage for Quattro or QUAD LNB
- Standard series with 6, 8, 12 and 16 subscriber outputs

## The **Light** Class 5 in 6, 8, 12, 16

- Economically priced
- High performance
- 5 years warranty
- Made in Germany



## Premium-Class

### Compact Multiswitch with active terrestrial, 5 in 6, 8, 12, 16 and 24

SMS 5603 NF, SMS 5803 NF, SMS 51203 NF, SMS 51603 NF, SMS 52403 NF

SAT IF



**Energy Saver!**  
Standby Function and  
Switch-Mode Power Supply

For 6, 8, 12, 16 or 24 subscribers.

#### SAT IF:

- The new SAT IF amplifiers assure high output levels. Depending on the unit the max. output level according to EN 60728-3 differs between 102 and 108 dB $\mu$ V.
- Synchronous Level Adjuster for Low- and High Band (0...-12dB)
- This multiswitch series has an integrated standby functionality. If all connected receivers are switched off, the LNB supply voltage and the  $U_B$  of the SAT IF amplifiers will also be switched off
- The SAT IF amplifiers have a slope correction of 6dB
- LNB supply voltage selectable for Quattro or QUAD LNB

#### Terrestrial:

- Based on a new terrestrial concept the Premium Class multiswitches are coming with a passive return path for interactive applications (Triple Play)
- Active CATV compatible forward path including InGaP Push-Pull output stage
- By using sharp cut-off input filter a perfect selection performance will be reached:  
Terrestrial/SAT > 40 dB and SAT/Terrestrial > 45 dB
- The high Receiver/Receiver Isolation will be reached by using the latest directional coupler technology  
> 36dB/VHF and > 32 dB/UHF
- Level Adjuster (0...-12dB) for the terrestrial forward path

#### Miscellaneous:

- Standby function
- Ground clamp

#### LNB - Mode

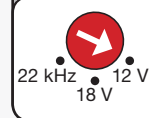

LNB supply voltage selectable for Quattro- or QUAD-LNB



This adjuster allows the reduction of the terrestrial signal



Synchronous Level Adjuster for Low- and High Band



Model Art. No.		SMS 5603 NF 842479	SMS 5803 NF 842480	SMS 51203 NF 842481	SMS 51603 NF 842482	SMS 52403 NF 842489
EAN		4040326423790	4040326424803	4040326424810	4040326424827	4040326424896
Inputs SAT / Terrestrial		5 4 / 1				
Outputs / subscribers		6	8	12	16	24
Tap loss Terr. passiv: 5 ... 65 MHz		16 ... 19 dB	16 ... 19 dB	18 ... 22 dB	21 ... 23 dB	26 ... 28 dB
Tap gain Terr. aktiv: 85 ... 862 MHz		10 ... 12 dB	10 ... 12 dB	9 ... 11 dB	8 ... 10 dB	4 ... 6 dB
Tap gain SAT IF: 950 ... 2200 MHz		5 ... 11 dB	6 ... 12 dB	4 ... 10 dB	3 ... 9 dB	0 ... 6 dB
Output level max. 85 ... 862 MHz 60 dB IMA <sub>3</sub> / EN 60728-3		93 dBμV	93 dBμV	90 dBμV	88 dBμV	84 dBμV
Output level max. 950 ... 2200 MHz 35 dB IMA <sub>3</sub> / EN 60728-3		108 dBμV	108 dBμV	106 dBμV	105 dBμV	102 dBμV
Selection	SAT / terrestrial	> 45 dB				
	Terrestrial / SAT	> 40 dB				
Rejection	Switching isolation	> 35 dB				
	Receiver/ receiver	> 36 dB/VHF, > 32 dB/UHF, > 35 dB/SAT				
Mains power supply V~		100 ... 240 V / 47 - 63 Hz				
Power consumption Terrestrial active/SAT active + LNB		< 10 W				
Power consumption SAT standby		< 5 W				
Current consumption LNB max.		500 mA				
Current consumption from each receiver		55 mA				
Ambient temperature		-20 ... +50 °C				
Dimensions (mm)		240 x 130 x 56	260 x 130 x 56	300 x 130 x 56	340 x 130 x 56	420 x 130 x 56

SAT IF

## Standard-Class

# Compact Multiswitch with active terrestrial 5 in 6, 8, 12, 18, 22

SMS 5608 NF, SMS 5808 NF, SMS 51208 NF, SMS 51808 NF, SMS 52208 NF

SAT IF



SMS 5808 NF multiswitch received the rating „sehr gut“ = „excellent“ and is winner of the DigitalFernsehen comparative test

For 6, 8, 12, 18 or 22 subscribers.

### SAT IF:

- Special amplifier- and filter concept to improve the intermodulation quality of the multiswitch
- Steep pre-filter to suppress outband distortions from LNBs
- LNB supply voltage selectable for Quattro- and QUAD-LNB
- Standby- or normal operation mode selectable  
The SAT IF amplifiers and the LNB remote voltage are only active when at least one receiver feeds a remote voltage to its multiswitch outlet
- Amplifier stages with > 5 dB slope

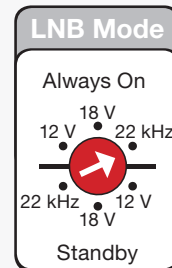

LNB supply voltage switch for Quattro- or QUAD-LNB

Standby or normal operation mode selectable for SAT reception

### Terrestrial:

- Active terrestrial from 47 ... 862 MHz
- Active terrestrial stage with an tap loss between 3 and 10 dB (depends on the device)

### Miscellaneous:

- Ground clamp
- Standby function

Model Art. Nr.		SMS 5608 NF 842444	SMS 5808 NF 842445	SMS 51208 NF 842443	SMS 51808 NF 842441	SMS 52208 NF 842442	
EAN		4040326424445	4040326424452	4040326424438	4040326424414	4040326424421	
Inputs SAT / Terrestrial		5 4 / 1					
Outputs / subscribers		6	8	12	18	22	
Tap loss Terrestrial: 47 ... 862 MHz		0 ... 2 dB	1 ... 0 dB	8 ... 9 dB	9 ... 11 dB	9 ... 11 dB	
Tap gain SAT IF: 950 ... 2200 MHz		-4 ... 1 dB	-4 ... 1 dB	-4 ... 1 dB	-4 ... 0 dB	1-12 -5...1 dB	13-22 -6...-3 dB
Output level max. 47 ... 862 MHz 60 dB IMA <sub>3</sub> / EN 60728-3		83 dB $\mu$ V					
Output level max. 950 ... 2200 MHz 35 dB IMA <sub>3</sub> / EN 60728-3		93 dB $\mu$ V					
Selection	Terrestrial / SAT:	$\geq 30$ dB					
	SAT / Terrestrial:	$\geq 30$ dB					
Rejection	Isolation	$\geq 30$ dB					
	Receiver / receiver:	$> 36$ dB/VHF, $> 32$ dB/UHF, $> 30$ dB/SAT					
Mains power supply V~		100 ... 240 V / 47 - 63 Hz					
Power consumption SAT active + LNB		10 W			11 W		
Power consumption SAT standby		3,5 W			4,5 W		
Current consumption LNB max.		300 mA					
Current consumption from each receiver		40 mA					
Ambient temperature		-20 ... +50 °C					
Dimensions (mm)		220 x 130 x 56	260 x 130 x 56	280 x 130 x 56	340 x 130 x 56	380 x 130 x 56	

## Light-Class

### Compact Multiswitch 5 in 6, 8, 12, 16

SMS 5607 NF, SMS 5807 NF, SMS 51207 NF, SMS 51607 NF

SAT IF



For 6, 8, 12, or 16 subscribers.

#### SAT IF:

- Special amplifier- / filter concept to improve the intermodulation quality of the multiswitch
- Integrated 22 kHz-generator  
→ suitable for Quattro and QUAD-LNB
- Due to a new design concept the units offer a high output level

#### Terrestrial:

- Passive terrestrial stage in the frequency range of 5 ... 862 MHz
- Suitable for digital inputs

#### Miscellaneous:

- Ground clamp
- Excellent price / performance ratio
- Standby function

Model Art. No.	SMS 5607 NF 815014	SMS 5807 NF 842462	SMS 51207 NF 842463	SMS 51607 NF 842464
EAN	4040326150146	4040326424629	4040326424636	4040326424643
Inputs SAT / terrestrial	5 4 / 1			
Outputs / subscribers	6	8	12	16
Tap loss Terrestrial: 5 ... 862 MHz	20 dB	21 ... 16 dB	24 ... 20 dB	25 ... 21 dB
Tap gain SAT IF: 950 ... 2200 MHz	-2 ... -1 dB	-1 ... 5 dB	-2 ... 4 dB	-4 ... 2 dB
Mains supply V~	100 ... 240 V / 47 - 63 Hz			
Power consumption + LNB	5 W	7 W	8,5 W	10 W
Power consumption Standby	< 1 W			
LNB supply current max.	350 mA			
Output level max. 950 ... 2200 MHz 35 dB IMA <sub>3</sub> / EN 60728-3	102 dB $\mu$ V	102 dB $\mu$ V	100 dB $\mu$ V	100 dB $\mu$ V
Current consumption from each receiver	10 mA			
Isolation receiver / receiver: Terrestrial / SAT	$\geq$ 26 dB			
Ambient temperature	-20 ... +50 °C			
Dimensions (mm)	194 x 90 x 52	220 x 132 x 56	260 x 132 x 56	300 x 132 x 56

SAT IF

# Uni SYSTEM

## The UniSystem

The UniSystem is receiver-powered and extendable to up to 16 SAT IF levels.

The multiswitches can be used as stand-alone devices or can be cascaded with themselves for an easy extension of the number of subscribers.

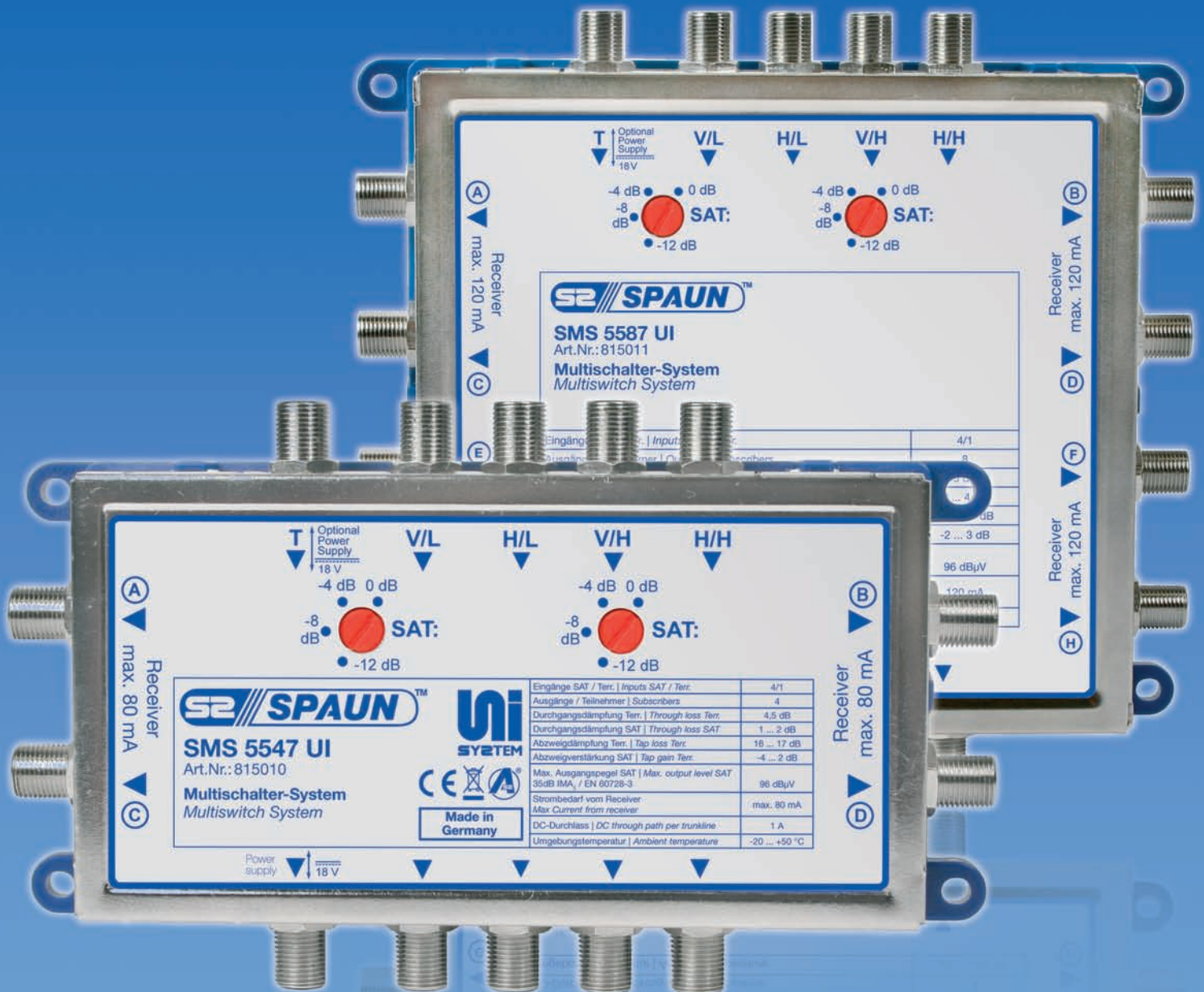

# UniSystem - Flexible Multiswitch System 5 in 4, 8

SMS 5547 UI, SMS 5587 UI

The multiswitch comes with 5 DC-decoupled terminating resistors to terminate the trunk lines. **ZFR 75 DC (Art. No.: 871511)**



**Optional:**  
Universal AC Adapter **SNG 18/1000 (Art. No.: 832114)**  
in combination with Line Power Injection Filter **FSW 30 F (Art. No.: 815018)**

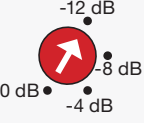

Output level selectable for left and right subscriber outputs

## For 4 ... 16 SAT IF signals.

The UniSystem multiswitches can be used as stand-alone device or can be cascaded with themselves for an easy extension of the number of subscribers. The UniSystem is extendable to up to 16 SAT IF levels.

## SAT IF:

- After the SAT signal has been decoupled by microstripline directional couplers, it is amplified for each receiver output, which produces a tap gain of -4 ... 2 dB. (SMS 5547 UI)

## Possible applications:

- As a single multiswitch for 4 SAT IF signals
- In „piggyback“ mode in conjunction with a multiswitch relay extensible for 8, 12 or 16 SAT IF signals. In addition to the wall mounting frame, the „piggyback“ assembly also includes an adapter frame in delivery
- The master outputs also facilitate cascading, so that the number of receivers can be increased. Without amplifying the signal, it is possible (depending on cable quality and length) to feed up to 24 receiver

Model Art. No.	SMS 5547 UI 815010	SM 5587 UI 815011
EAN	4040326150108	4040326150115
Inputs SAT / terrestrial	5 4 / 1	
Frequency range	5 ... 862 MHz and 950 ... 2200 MHz	
Outputs / receivers	4	8
Through loss terrestrial	4,5 dB	4,5 dB
Through loss SAT	1 ... 2 dB	2 ... 4 dB
Tap loss Terrestrial	16 ... 17 dB	20 ... 21 dB
Tap gain SAT	-4 ... 2 dB	-6 ... 0 dB
Output level max. 950 ... 2200 MHz 35 dB IMA <sub>3</sub> /EN 60728-3	96 dB $\mu$ V	
Switching Isolation	> 26 dB	
Rejection Receiver / Receiver	> 26 dB	
Current from receiver max.	80 mA	120 mA
DC-pass current per trunkline	1 A	
Ambient temperature	-20 ... +50 °C	
Dimensions (mm)	160 x 95 x 32	160 x 146 x 32

SAT IF



## Premium-Class

### UniSEqC Single Cable System 5 in 3x3 or 1x8 according to EN 50494

SUS 5581/33 NF LEGACY, SUS 5581/33 NFA LEGACY

SAT IF

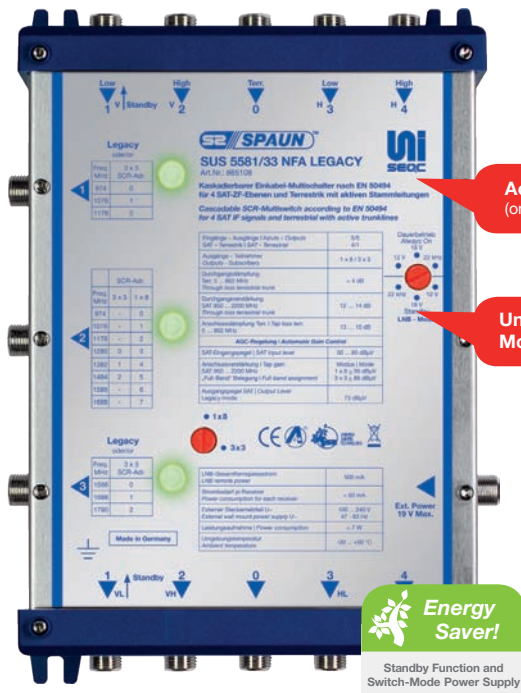

Active SAT trunk lines  
(only SUS 5581/33 NFA LEGACY)

Unused outputs in Legacy  
Mode (1x8)

Energy  
Saver!

Standby Function and  
Switch-Mode Power Supply

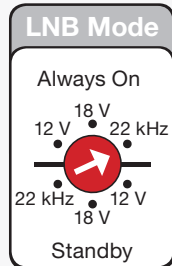

LNB supply voltage  
switch for Quattro- or  
QUAD-LNB

1 x 8

Output mode switch:



• 1 x 8 (1 output with 8 receiver)

(Legacy Mode for unused outputs)

• 3 x 3

• 3 x 3 (3 outputs with 3 receiver)

### Tech Hint

The device has an internal protection circuit to shut down if no DiSEqC command according to EN 50494 is sent. The use of special TV socket outlets with such a protection circuit is not necessary.

The new Premium product SUS 5581/33 NF LEGACY offers users pure single-cable operation according to EN 50494, with an option of 1x8 or 3x3 subscribers. With the 1x8 operating mode, the two unused outputs are now also available as pure "legacy outputs". This means that the device can also be used as a conventional multiswitch.

Thanks to the SUS 5581/33 NFA LEGACY design, the device additionally boasts active SAT trunk lines. This allows the realisation of cost-effective cascade distribution systems that operate without a base amplifier in good reception conditions.

#### SAT IF:

- SCR multiswitch for the distribution of 4 SAT IF positions and terrestrial by one output to max. 8 receiver or by 3 outputs to max. 3 receiver
- Active SAT trunk lines (only SUS 5581/33 NFA LEGACY)
- In the 1x8 operating mode, the two unused outputs can be used as standard multiswitch outputs (Legacy mode)
- The selection of the SAT IF position is affected by the receiver through a specific DiSEqC™ command according to EN 50494
- No limitation on transponder reception
- LNB-Mode selectable to use a Quattro- or a QUAD-LNB
- All subscriber outputs are automatic gain controlled
- Multipurpose LED status notification
- Delivery including wall power supply SNG 18/1000

#### Terrestrial:

- The terrestrial input is passive
- The reception of the terrestrial signal is also possible

#### LED:

Meaning	LED
Remote voltage 13 V	green
Valid command being executed	green flashing
Short circuit	red
Remote voltage 5 .. 10 V	red flashing
Remote voltage > 15 V	orange
Band	orange flashing

- when the SAT-receivers are switched off
- Remote power over terrestrial trunkline possible

#### The multiswitch provides 2 operation modes:

1. The input signals are feeded in one output. On this output the connection of max. 8 receiver is possible. The two unused outputs can be used as conventional multiswitch outputs (Legacy Mode).
2. By switching to the second operation mode, the input signals will be feeded into 3 outputs. On each output the connection of max. 3 receiver is possible



Model Art. No.	SUS 5581/33 NF LEGACY 865109 <span style="color: red; font-weight: bold;">NEW</span>			SUS 5581/33 NFA LEGACY 865108 <span style="color: red; font-weight: bold;">NEW</span>		
	EAN	4040326651094			4040326651087	
Inputs SAT / terrestrial	5 4 / 1			5 4 / 1		
Through loss Terr. 5 ... 862 MHz	< 4 dB			< 4 dB		
Through loss SAT 950 ... 2200 MHz	1 ... 2,5 dB			-		
Through gain SAT 950 ... 2200 MHz	-			12 ... 14 dB		
Tap loss Terr. 5 ... 862 MHz	13 ... 15 dB			13 ... 15 dB		
Isolation	≥ 35 dB					
<b>Automatic Gain Control</b>						
SAT input level	65 ... 95 dBμV			50 ... 80 dBμV		
SAT Output level (Legacy Mode)	73 dBμV			73 dBμV		
Output level SAT 950 ... 2200 MHz „Full-band“ assignment	Mode: 1 x 8 ≥ 95 dBμV 3 x 3 ≥ 82 dBμV			mode: 1 x 8 ≥ 95 dBμV 3 x 3 ≥ 82 dBμV		
Mains supply V~	incl. power supply 100 ... 240 V / 47 – 63 Hz			incl. power supply 100 ... 240 V / 47 – 63 Hz		
Power consumption	< 7 W			< 7 W		
Receiver Frequency / SCR-Address	Frequency MHz	3 x 3 SCR-Adr.	1 x 8 SCR-Adr.	Frequency MHz	3 x 3 SCR-Adr.	1 x 8 SCR-Adr.
Receiver 1	974	0	0	974	0	0
Receiver 2	1076	1	1	1076	1	1
Receiver 3	1178	2	2	1178	2	2
Receiver 4	1280	0	3	1280	0	3
Receiver 5	1382	1	4	1382	1	4
Receiver 6	1484	2	5	1484	2	5
Receiver 7	1586	0	6	1586	0	6
Receiver 8	1688	1	7	1688	1	7
Receiver 9 (3 outputs only)	1790	2	-	1790	2	-
LNB remote current	500 mA			500 mA		
Current consumption for each receiver	< 60 mA			< 60 mA		
Ambient temperature	-20 ... +50 °C			-20 ... +50 °C		
Dimensions (mm)	185 x 131 x 40			185 x 131 x 40		

### Tech Hint



We recommend to use of the SUS series in combination with our specially adapted „UNISocket“ DC through sockets with a low through loss (UNISocket 310, 314, 318) and the UNITap.



## UNiSEqC Single Cable System 4/5 in 1x4 or 1x8 according to EN 50494

SUS 5541 F, SUS 5541 NFA, SUS 5581 F, SUS 5581 NFA, SUS 4441 F, SUS 4481 F



SAT IF



Active SAT trunk lines  
(only SUS 5541 NFA and SUS 5581 NFA)



Optional:  
Universal AC Adapter  
SNG 18/1000  
(Art. No.: 832114)

Wall power supply is included in scope of delivery of SUS 5581 NFA and SUS 5541 NFA

Energy Saver!  
Standby Function and Switch-Mode Power Supply

### Cascadable SCR multiswitch according to EN 50494 for the reception of 4 SAT IF signals and terrestrial\*.

The Light Class products SUS 5581 NF and SUS 5581 NFA are a logical consequence of the Premium Class product SUS 5581/33 NF LEGACY. These products are based on the same top-quality technology as the Premium product, but do not feature an option for switching in respect of subscriber outputs.

The SUS 5581 NFA is equipped with active SAT trunk lines. The SUS 5541 NF and SUS 5541 NFA variants offer a good alternative where only 4 subscribers are required per coaxial cable. The two models SUS 4481 NF and 4441 NF (either for 1x8 or 1x4 subscribers) are available where no terrestrial transmission is required.

#### SAT IF:

- The selection of the SAT IF position is affected by the receiver through a specific DiSEqC™ command according to EN 50494
- No limitation on transponder reception
- Quattro LNB capable
- All subscriber outputs are automatic gain controlled
- Multipurpose status LED notification
- F input for optional wall power supply (SNG 18/1000, Art.No. 832114)

#### Terrestrial\*:

- The terrestrial input is passive
- The reception of the terrestrial signal is also possible when the SAT-receivers are switched off

### Tech Hint

The device has an internal protection circuit to shut down if no DiSEqC command according to EN 50494 is sent. The use of special TV socket outlets with such a protection circuit is not necessary.

### LED signal indication:

Meaning	LED
Remote voltage 13 V	green
Valid command being executed	green flashing
Short circuit	red
Remote voltage 5 .. 10 V	red flashing
Remote voltage > 15 V	orange
Band	orange flashing

#### SUS 5541 NFA, SUS 5581 NFA:

- Like SUS 5541 F and SUS 5581 F but with an active SAT trunkline gain

#### SUS 4441 F, SUS 4481 F:

- Receiver powered SCR multiswitch for the distribution of 4 SAT IF positions through one output onto four or eight receivers.

\* not SUS 4441 F and SUS 4481 F

Model Art. No.	SUS 5541 F 865100 <sup>NEW</sup>	SUS 5541 NFA 865102 <sup>NEW</sup>	SUS 5581 F 865101 <sup>NEW</sup>	SUS 5581 NFA 865103 <sup>NEW</sup>	SUS 4441 F 865105 <sup>NEW</sup>	SUS 4481 F 865106 <sup>NEW</sup>
EAN	4040326651001	4040326651025	4040326651018	4040326651032	4040326651056	4040326651063
Inputs SAT / terrestrial	5 / 5 4 / 1	5 / 5 4 / 1	5 / 5 4 / 1	5 / 5 4 / 1	4 / 4 4 / -	4 / 4 4 / -
Through loss Terr. 5 ... 862 MHz	< 4 dB	< 4 dB	< 4 dB	< 4 dB	-	-
Through loss SAT 950 ... 2200 MHz	1 ... 2 dB	-	1 ... 2 dB	-	1 ... 2 dB	1 ... 2 dB
Through gain SAT 950 ... 2200 MHz	-	12 ... 14 dB	-	12 ... 14 dB	-	-
Tap loss Terr. 5 ... 862 MHz	4 ... 6 dB	4 ... 6 dB	4 ... 6 dB	4 ... 6 dB	-	-
Isolation	≥ 35 dB					
<b>Automatic Gain Control</b>						
SAT input level	65 ... 95 dBμV	50 ... 80 dBμV	65 ... 95 dBμV	50 ... 80 dBμV	65 ... 95 dBμV	65 ... 95 dBμV
Output level SAT 950 ... 2200 MHz „Full-band“ assignment	95 dBμV	95 dBμV	95 dBμV	95 dBμV	95 dBμV	95 dBμV
Mains supply V~	Optional SNG 18/1000 100 ... 240 V / 47 – 63 Hz	Includes SNG 18/1000 100 ... 240 V / 47 – 63 Hz	Optional SNG 18/1000 100 ... 240 V / 47 – 63 Hz	Includes SNG 18/1000 100 ... 240 V / 47 – 63 Hz	Optional SNG 18/1000 100 ... 240 V / 47 – 63 Hz	Optional SNG 18/1000 100 ... 240 V / 47 – 63 Hz
Power consumption	-	< 7 W	-	< 7 W	-	-
Receiver Frequency / SCR-Address	Frequenz MHz	Frequenz MHz	Frequenz MHz	Frequenz MHz	Frequenz MHz	Frequenz MHz
Receiver 1	974	974	974	974	1210	1210
Receiver 2	1076	1076	1076	1076	1420	1315
Receiver 3	1178	1178	1178	1178	1680	1420
Receiver 4	1280	1280	1280	1280	2040	1550
Receiver 5			1382	1382		1680
Receiver 6			1484	1484		1800
Receiver 7			1586	1586		1920
Receiver 8			1688	1688		2040
LNB remote current	-	300 mA	-	300 mA	-	-
Current consumption for each receiver	< 230 mA	< 40 mA	< 320 mA	< 40 mA	< 230 mA	< 320 mA
Ambient temperature	-20 ... +50 °C	-20 ... +50 °C	-20 ... +50 °C	-20 ... +50 °C	-20 ... +50 °C	-20 ... +50 °C
Dimensions (mm)	140 x 92 x 38	140 x 92 x 38	140 x 92 x 38	140 x 92 x 38	140 x 92 x 38	140 x 92 x 38

**SAT IF**

### Tech Hint



We recommend to use of the SUS series in combination with our specially adapted „UNISocket“ DC through sockets with a low through loss (UNISocket 310, 314, 318) and the UNITap.

# UNiSEqC Single Cable System 2 in 1x2 according to EN 50494

SUS 21 F



SAT IF



**Optional:**  
Universal AC Adapter  
**SNG 18/1000 (Art. No.: 832114)**

Model Art. No.	SUS 21 F 865104
EAN	4040326651049
Inputs	2
SAT Input Level	65 ... 95 dBµV
Tap loss Terr 5 ... 862 MHz	2 dB
SAT Output Level	82 dBµV
Isolation	≥ 35 dB
Current consumption max. + LNB	130 mA
Ambient temperature	-20 ... +50 °C
Dimensions (mm)	39 x 107 x 26

Another innovation is the SUS 21 F, which enables two receivers or a dual tuner receiver (PVR) to be connected via a single coaxial connection. The device is simply plugged onto a conventional multiswitch. For this, the SUS 21 F uses two subscriber outputs of the multiswitch or of a QUAD LNB, which serve as its input signals. A single coaxial cable can then be led into the dwelling, and used to supply either two separate receivers or a PVR (dual tuner) receiver. The receivers used must however support the single-cable protocol as per EN 50494. The SUS 21 F is supplied with power via the receiver, or via a mains adapter where required (optionally available).

### SCR frequencies:

SCR-Address	Frequency
1	1076 MHz
2	1178 MHz

### LED signal indication:

Meaning	LED
Remote voltage 13 V	green
Valid command being executed	green flashing
Short circuit	red
Remote voltage 5 .. 10 V	red flashing
Remote voltage > 15 V	orange
Band	orange flashing

### SAT IF:

- SCR multiswitch for the distribution of up to 8 SAT IF signals and terrestrial.
- The selection of the SAT IF position is affected by the receiver through a specific DiSEqC™ command according to EN 50494
- No limitation on transponder reception
- All subscriber outputs are automatic gain controlled
- Multipurpose LED status notification
- F-input for optional wall power supply (SNG 18/1000, Art.Nr.: 832114)
- The SUS 21 F has a jack distance of 20 mm and can be therefore directly connected to almost every SPAUN multiswitch/cascade.

### Terrestrial:

- The terrestrial signal (FM, DVB-T, CATV) is looped through
- The reception of the terrestrial signal is also possible when the SAT-receivers are switched off

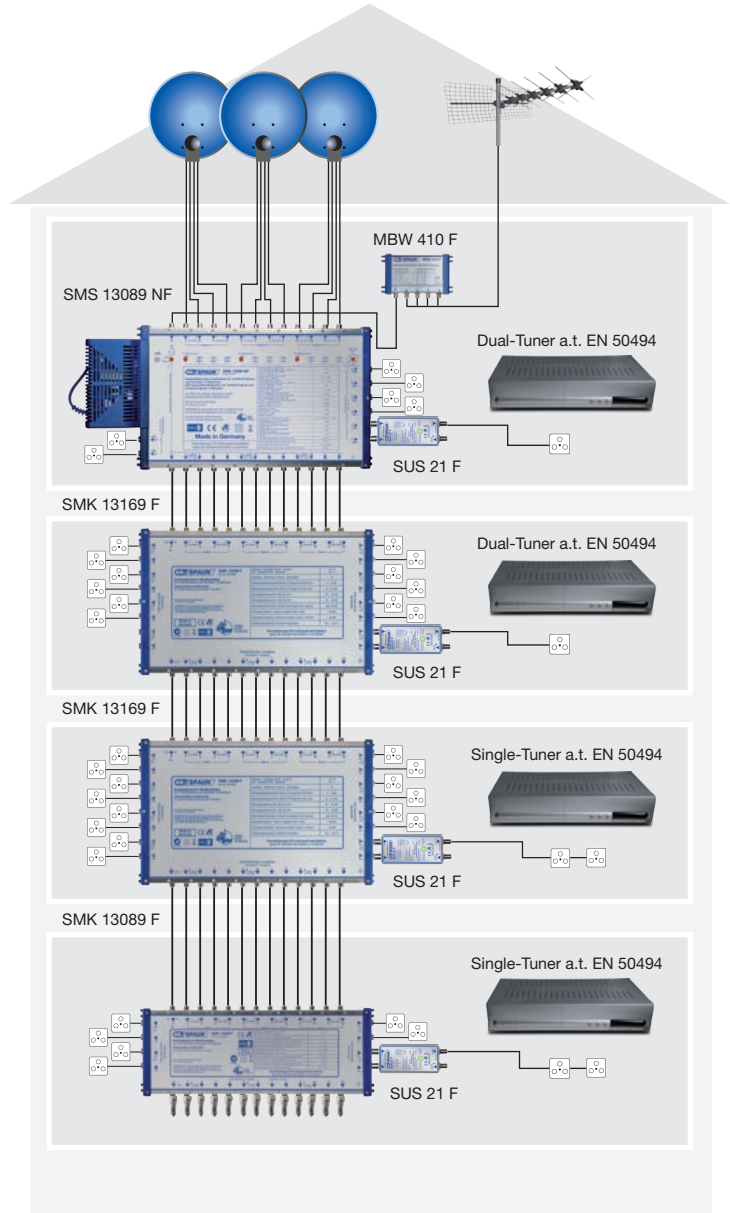
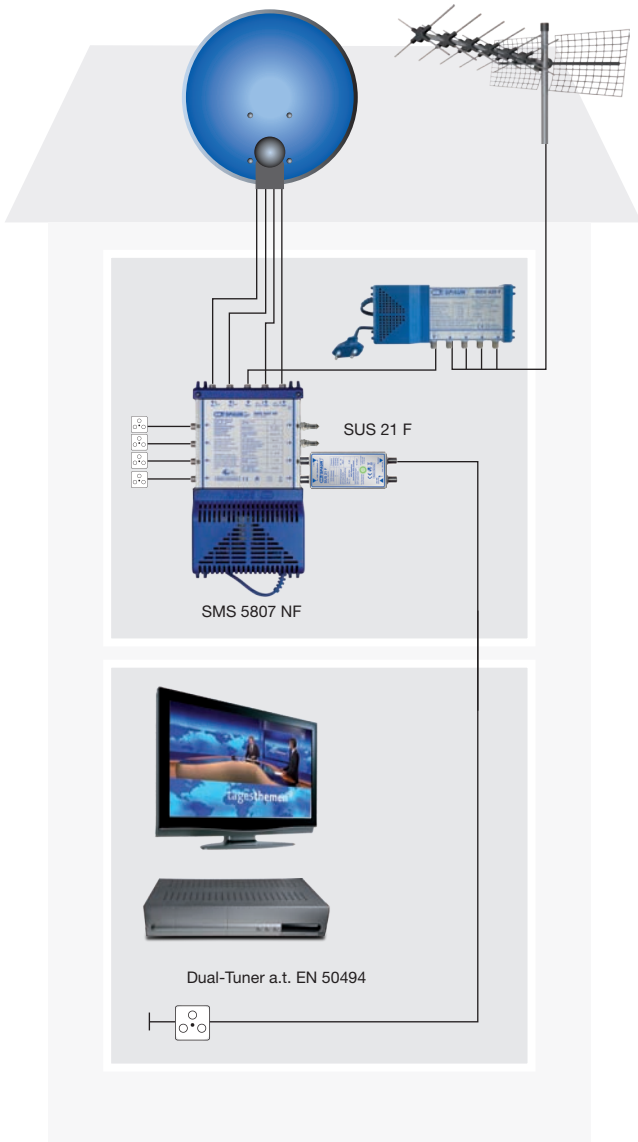

SAT IF

**!** In the above application diagram just the first two SAT positions (A und B) are transmitted from the SUS 21 F.



## UNiSEQ Socket filter for Single Cable System according to EN 50494 SMA 8 F

SAT IF



Model Art. No.	SMA 8 F 865107
EAN	4040326651070
Inputs/Outputs	1/1
Through loss	1 dB
Ambient temperature	-20 ... +50 °C
Dimensions (mm)	61 x 49 x 19

NEW

For the first time ever, SPAUN is offering a socket attachment in the SMA 8 F, which significantly reduces the susceptibility to interference in single-cable distribution systems. The SMA 8 F can be mounted on any commercially available single-cable antenna socket. The product can be programmed in such a manner that only permitted instruction sequences reach the distribution system from the receiver, thereby preventing interferences caused by

use of a receiver that does not comply with EN 50494 or a receiver that has been incorrectly programmed. No PC or programmer is required for programming the SMA 8 F. Any specialist can perform the programming by using switching logic.

### Application example SUS 5581/33 NF(A) LEGACY:

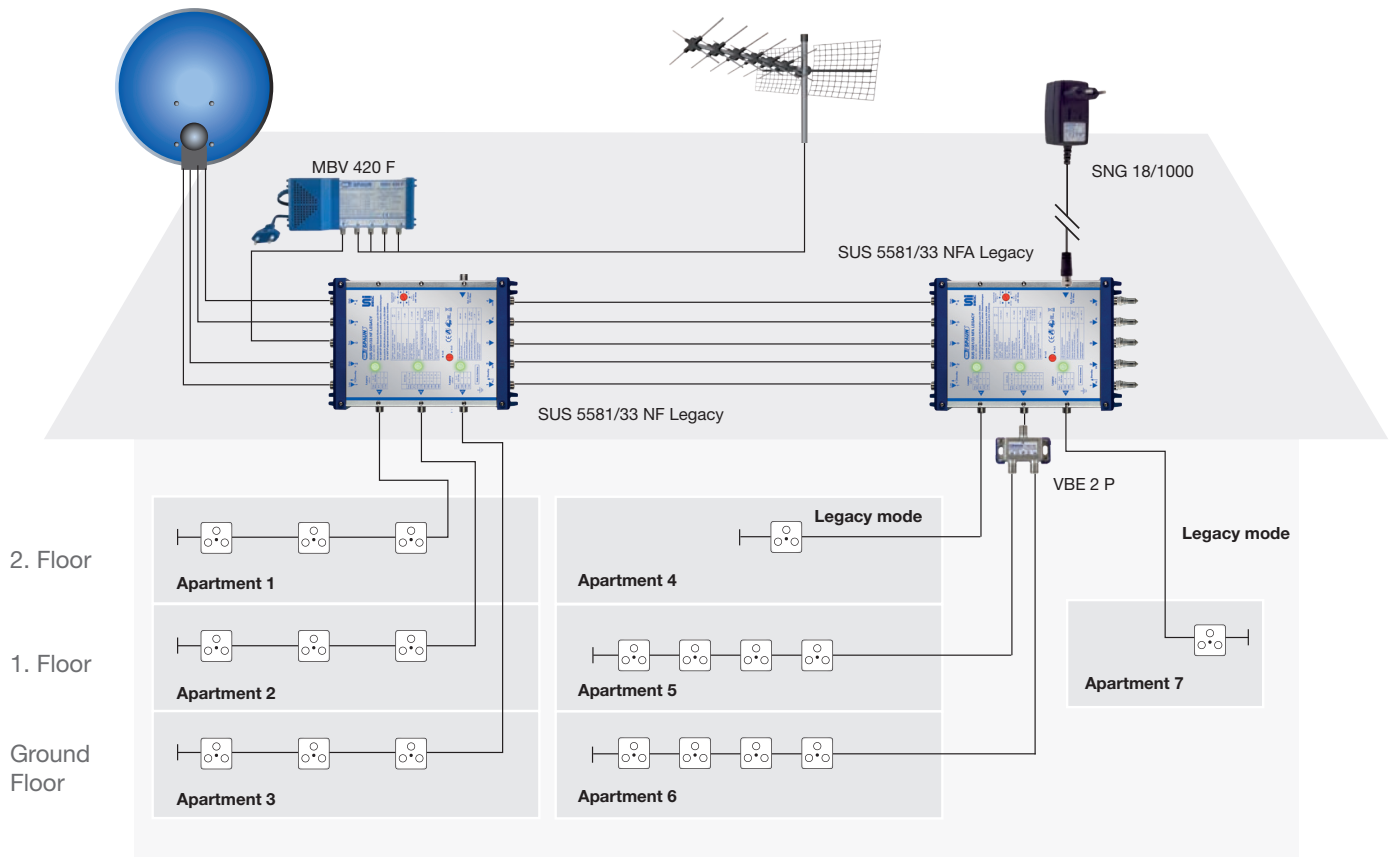

**NEW**

## The new *premium* UNiSEqC Single Cable System according to EN 50494

- With output mode switch for 3x3 or 1x8 receiver
- Useable as common multiwitch (1x8) through Legacy Mode
- As stand-alone solution or for use within a cascadable system
- AGC controlled output level
- Multipurpose LED
- Delivery incl. wall power supply (SNG 18/1000)

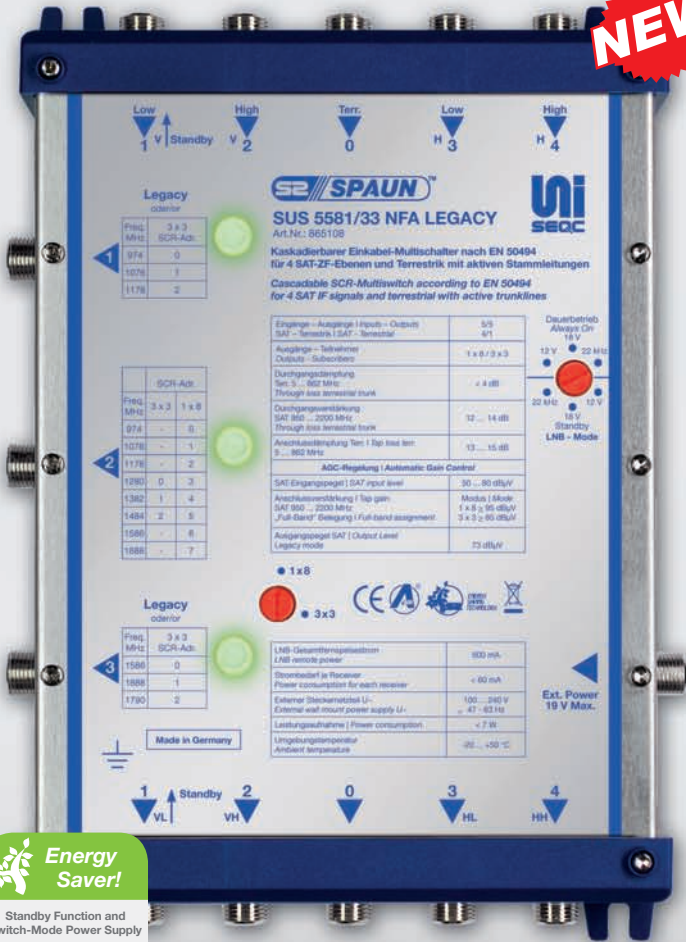

**UNISocket 318**  
Through loss: **1,5 dB**

## Premium-Class

# Compact Multiswitch with active terrestrial 5 in 8, 12, 16

DMS 5802 NF, DMS 51202 NF, DMS 51602 NF



**Energy Saver!**  
Standby Function and Switch-Mode Power Supply



For 8, 12 or 16 subscribers.

### SAT IF:

- A special amplifier / filter design improves the intermodulation properties of the multiswitch considerably
- The high selective input filter guarantees that interference products of the LNBs cannot drive the amplifiers into saturation
- LNB supply voltage selectable. Twin-, SMATV- and universal twin LNBs can be connected
- The multiswitches support a standby mode. The SAT IF amplifiers and the LNB remote voltage are only active when at least one receiver sends a voltage to its multiswitch outlet
- Amplifier has precompensating  $\geq 5$  dB slope

### Terrestrial:

The multiswitches are return path compatible.

- Push-pull technology
- With the integrated variable attenuator active or passive distribution can be selected. In active mode too high input levels can be decreased by 0...10 dB
- Turned to max. attenuation the amplifier is bypassed and turned off. The passive distribution is return path compatible (5 ... 862 MHz)

### Miscellaneous:

- Energy saving switch-mode power supply; short circuit proof
- Standby function
- Ground Clamp

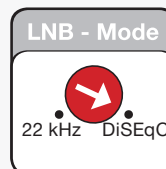

LNB supply voltage selectable



In active mode too high input levels can be decreased by 0 ... 10 dB

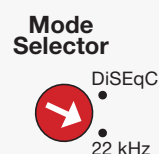

Switching logic to select analogue or DiSEqC switching criterias



Model Art. No.	DMS 5802 NF 842393	DMS 51202 NF 842408	DMS 51602 NF 842407
EAN	4040326423936	4040326424087	4040326424070
Inputs SAT / Terrestrial	5 4 / 1		
Outputs / Subscribers	8	12	16
Tap loss Terr. passive: 5 ... 862 MHz	17 ... 20 dB	21 ... 25 dB	21 ... 23 dB
Tap gain Terr. active: 47 ... 862 MHz	4 dB	-2 ... 0 dB	-2 ... 0 dB
Tap gain SAT IF: 950 ... 2200 MHz	-6 ... 2 dB	2.5 ... -4 dB	2 ... -4 dB
Output level max. 47 ... 862 MHz 60 dB IMA <sub>3</sub> / EN 60728-3	90 dB $\mu$ V	88 dB $\mu$ V	86 dB $\mu$ V
Output level max. 950 ... 2200 MHz 35 dB IMA <sub>3</sub> / EN 60728-3	92 dB $\mu$ V	90 dB $\mu$ V	88 dB $\mu$ V
Isolation Rec. / Rec.: Terrestrial: / SAT:	$\geq 24$ dB		
Mains power supply V~	100 ... 240 V / 47 - 63 Hz		
Power consumption Terrestrial active/SAT active	26 W		
Power consumption Terrestrial passive/SAT active	20 W		
Power consumption Terrestrial active/SAT standby	6,5 W		
Power consumption Terrestrial passive/SAT standby	2,5 W		
LNB remote current	500 mA		
LNB single port current	500 mA		
Current consumption for each receiver	70 mA		
Ambient temperature	-20 ... +50 °C		
Dimensions (mm)	300 x 130 x 52	380 x 130 x 52	380 x 130 x 52

## Launch Amplifier for large distribution networks / 5 Inputs

SBK 5501 NFI, SBK 5502 NF, SBK 5503 NFI, SBK 5509 NF

### To be used in:

- SMATV systems
- Star distribution networks

### SAT IF:

- Amplifiers have precompensating 4 dB slope
- The SAT IF amplifier units are equipped with two filters: one at the input and one at the output to perform good noise rejection and good out-of-band immunity
- LNB supply voltage selectable (except SBK 5501 NFI)
- Only SBK 5502 NF: Separate level attenuator for each SAT IF input
- Only SBK 5503 NFI: Synchronous level adjuster for each low- and high-band to adjust different input levels by 0 ... 10 dB

### Terrestrial:

#### SBK 5501 NFI: Light-Class

- Passive return path compatible terrestrial.
- 18 V / 200 mA remote power for the active cascades (SMK 55xx3 FA)

#### SBK 5502 NF: Standard-Class

- With the integrated variable attenuator too high input levels can be decreased by 0 ... 10 dB in active mode or the stage could be switched into passive mode (5 ... 862 MHz)
- Push-Pull-Technology

#### SBK 5503 NFI: Power-Class

- Passive return path (5 ... 65 MHz)
- CATV compatible forward path in Push-Pull-Technology
- With the integrated variable attenuator too high input levels can be decreased by 0 ... 10 dB

### Miscellaneous:

- Standby function
- Ground Clamp

Remote supply for one post amplifier (except SBK 5501 NFI):

- SBK 5502 NF one NVF 5522 SR
- SBK 5503 NFI one NVF 5522 SR

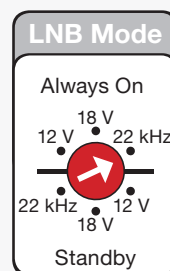

Only SBK 5502 NF and SBK 5503 NFI:  
LNB supply voltage switch for Quattro- or QUAD-LNB

Standby or normal operation mode selectable for SAT reception

SBK 5502 NF / -8dB  
SBK 5503 NFI / -10dB  
SBK 5509 NF / -8dB

Synchronous level adjuster for each low- and high-band to adjust different input levels



5 DC-decoupled terminating resistors are shipped with the SBK 55xx NFI to terminate the trunk lines.  
**ZFR 75 DC/Set (Art.No: 871511)**

Model Art. No.	SBK 5502 NF 842389	SBK 5503 NFI 842488	SBK 5509 NF 842420	SBK 5501 NFI 842437
EAN	4040326423899	4040326424889	4040326424209	4040326424377
Inputs / Outputs SAT / Terrestrial	5 / 5 4 / 1			
Loss Terr. passive: 5 ... 862 MHz	3,5 dB	-	3,5 dB	2 dB
Loss Terr. passive: 5 ... 65 MHz	-	4 dB	-	-
Gain Terr. active: 47 ... 862 MHz	22 dB	-	-	-
Gain Terr. active: 85 ... 862 MHz	-	27 ... 30 dB	-	-
Gain SAT IF: 950 ... 2200 MHz	19 ... 23 dB	24 ... 30 dB	19 ... 23 dB	21 ... 25 dB
Output level max. 47 ... 862 MHz 60 dB IMA <sub>3</sub> / EN 60728-3	109 dB $\mu$ V	118 dB $\mu$ V	-	-
Output level max. 950 ... 2200 MHz 35 dB IMA <sub>3</sub> / EN 60728-3	110 dB $\mu$ V	118 dB $\mu$ V	110 dB $\mu$ V	110 dB $\mu$ V
Rejection	Terrestrial active / SAT	> 30 dB	> 50 dB	-
	Terrestrial passive / SAT	> 30 dB	-	> 22 dB
	SAT / Terrestrial	> 35 dB	> 55 dB	> 22 dB
Isolation Trunkline / trunkline	$\geq$ 30 dB			$\geq$ 26 dB
Mains power supply V~	100 ... 240 V / 47 - 63 Hz			
Power consumption Terrestrial active/SAT active + LNB	15 W	15,5 W	-	-
Power consumption Terr. passive/SAT active + LNB	11 W	-	11 W	13,5 W
Power consumption Terrestrial active/SAT standby	7 W	9 W	-	-
Power consumption Terrestrial passive/SAT standby	3 W	-	-	< 1 W
LNB remote current	600 mA	600 mA	400 mA	12 V / 350 mA
Total single port current	400 mA	500 mA	400 mA	12 V / 350 mA
Current for post amplifier max.	18 V / 650 mA	18 V / 1 A	-	-
Ambient temperature	-20 ... +50 °C			
Dimensions (mm)	220 x 130 x 52	300 x 130 x 52	220 x 130 x 52	195 x 90 x 52

## Post Amplifier for Cascaded Distribution Systems

NV 5523 NF, NVF 5522 SR

SAT IF



With the integrated variable attenuator; active or passive distribution can be selected

NVF 5522 SR / -8dB  
NV 5523 NF / -10dB



Synchronous level adjuster for all SAT IF amplifiers

### SAT IF:

- SAT IF amplifier with precompensating slope
- Synchronous level adjuster for all SAT IF amplifiers

### Terrestrial:

- Terrestrial amplifier made for CATV using push-pull technology
- With the integrated variable attenuator active or passive distribution can be selected
- In active mode too high input levels can be decreased by 0 ... 10 dB
- Turned to max. attenuation the amplifier is bypassed and turned off. The passive distribution is return path compatible (5 ... 862 MHz)

### Miscellaneous:

- NV 5523 NF energy saving switch-mode power supply
- DC-pass: trunk 0, 2 ... 4 - 1 A each
- Ground clamp

### Tech Hint

When planning, please take into consideration that the post amplifier NVF 5522 SR can only be supplied by the launch amplifiers SBK 5502 NF or SBK 5503 NF1.

For connections between SBK 5501 NF1 / SBK 5502 NF and cascade please use **ZSV 2 S/Set (set of 5 pcs., Art. No. 871508)**

and for connections between SBK 5503 NF1 and cascade please use **ZVK 250 F/Set. (set of 5 pcs., Art. No. 871505)** or **ZVK 500 F/Set. (set of 5 pcs., Art. No. 871507)**



Model Art. No.		NVF 5522 SR 814219	NV 5523 NF 814110
EAN		4040326142196	4040326141106
Inputs / Outputs SAT / Terrestrial		5 / 5 4 / 1	
Loss Terr. passive: 5 ... 862 MHz		4 dB	
Gain Terr. active: 47 ... 862 MHz		22 dB	15 ... 18 dB
Gain SAT IF: 950 ... 2200 MHz		15 ... 18 dB	13 ... 18 dB
Noise figure Terrestrial		7 dB	16 ... 8,5 dB
Noise figure SAT		7,5 ... 5 dB	10 ... 8 dB
Output level max. 47 ... 862 MHz 60 dB IMA <sub>3</sub> / EN 60728-3		108 dBμV	115 dBμV
Output level max. 950 ... 2200 MHz 35 dB IMA <sub>3</sub> / EN 60728-3		110 dBμV	115 dBμV
Rejection	Terrestrial active / SAT	> 22 dB	> 30 dB
	Terrestrial passive / SAT	> 20 dB	> 35 dB
	Terrestrial / SAT	> 30 dB	> 30 dB
Isolation Trunkline / trunkline		≥ 26 dB	≥ 35 dB
Mains power supply V~		-	100 ... 240 V / 47 - 63 Hz
Power consumption Terrestrial active/SAT active		-	15 W
Power consumption Terrestrial passive/SAT active		-	10 W
Power consumption Terrestrial active/SAT standby		-	< 8 W
Power consumption Terrestrial passive/SAT standby		-	< 3 W
DC-pass max. Trunkline 0; 2; 3 und 4		1 A	
Ambient temperature		-20 ... +50 °C	
Dimensions (mm)		145 x 130 x 39	300 x 150 x 32

SAT IF

## Cascadable Multiswitch 5 in 4, 8, 12, 16, 24

SMK 5543 F, SMK 5583 F, SMK 55123 F, SMK 55163 F, SMK 55243 F

SAT IF



For 4, 8, 12, 16 or 24 subscribers.

- Return path compatible
- The SAT IF polarity selection is controlled by remote voltage,  $< 14\text{ V} \cong \text{vert.}$  /  $> 16\text{ V} \cong \text{hor.}$  and the 22 kHz tone provided by the receiver
- Standby control on trunkline 1
- Ground clamp

**Only useable in combination with launch amplifier SBK 55xx Nfx**

Model Art. No.	SMK 5543 F 842490	SMK 5583 F 842491	SMK 55123 F 842492	SMK 55163 F 842493	SMK 55243 F 842494
EAN	4040326424902	4040326424919	4040326424926	4040326424933	4040326424940
Inputs / outputs SAT / Terrestrial	5 / 5 4 / 1				
Outputs / subscribers	4	8	12	16	24
Through loss terrestrial	4 dB	5 dB	6 ...5 dB	6 ...5 dB	6 ...5 dB
Through loss SAT	1 ... 1,5 dB	1,5 ... 3 dB	2 ... 4 dB	2 ... 6 dB	3 ... 7 dB
Tap loss terrestrial	18 ... 19 dB	20 ... 21 dB	25 ... 23 dB	25 ... 24 dB	28 dB
Tap loss SAT	22 ... 18 dB	22 ... 18 dB	22 ... 18 dB	21 ... 17 dB	23 ... 20 dB
Switching isolation	$\geq 30\text{ dB}$				
Isolation trunkline / trunkline	$> 30\text{ dB}$				
Isolation receiver / receiver	$\geq 30\text{ dB}$				
DC-pass max. Trunkline 0; 2; 3 and 4	1 A				
Current consumption for each receiver max.	20 mA				
Ambient temperature	$-20 \dots +50\text{ }^\circ\text{C}$				
Dimensions (mm)	90 x 140 x 40	145 x 130 x 40	185 x 130 x 40	225 x 130 x 40	305 x 130 x 40

# Cascadable Multiswitch (active) 5 in 4, 8, 12, 16, 24

SMK 5543 FA, SMK 5583 FA, SMK 55123 FA, SMK 55163 FA, SMK 55243 FA



Stand-alone capable

Energy Saver!  
Standby Function



**Optional:**  
Universal AC Adapter  
**SNG 18/1000 (Art. No.: 832114)**  
Switch-mode power supply  
V~: 100 ... 240 / 47 - 63 Hz

Maximum trunkline input level of the active cascade is 83 ... 77 dB $\mu$ V.

## For 4, 8, 12, 16 or 24 subscribers.

- Return path compatible
- The SAT IF polarity selection is controlled by remote voltage, < 14 V  $\cong$  vert. / > 16 V  $\cong$  hor. and the 22 kHz tone provided by the receiver
- Ground clamp
- Active Terrestrial in the range between 85 ... 862 MHz
- Active SAT IF stage
- SMK 5583 FA, SMK 55123 FA, SMK 55163 FA, SMK 55243 FA have a DC jack for remote power, if the Launch Amplifier would not provide remote power voltage
- LED operation display (not on SMK 5543 FA)
- The supply of the active terrestrial via trunkline 0 (18 V / 90 mA), from the launch amplifier or the optional remote power supply

## Terrestrial:

- Active terrestrial (85 ... 862 MHz) / passive return path

SAT IF

Model Art. No.	SMK 5543 FA 842484	SMK 5583 FA 842486	SMK 55123 FA 842418	SMK 55163 FA 842419	SMK 55243 FA 842487
EAN	4040326424841	40403264248652	4040326424186	4040326424193	4040326424872
Inputs / outputs SAT / terrestrial	5 / 5 4 / 1				
Outputs / subscribers	4	8	12	16	24
Through loss terrestrial	4 dB	5 dB	6 ... 5 dB	6 ... 5 dB	6 ... 5 dB
Through loss SAT	1 ... 1,5 dB	1 ... 2,5 dB	1.5 ... 3,5 dB	2 ... 5 dB	3 ... 7,5 dB
Tap loss terrestrial 5 ... 65 MHz	20 ... 21 dB	21 ... 22 dB	22 ... 23 dB	26 ... 27 dB	27 ... 28 dB
Tap loss terrestrial 85 ... 862 MHz	6 ... 3 dB	5 ... 4 dB	5 ... 3 dB	10 ... 6 dB	10 ... 6 dB
Tap gain SAT 950 ... 2200 MHz	2 ... 7 dB	0 ... 6 dB	0 ... 6 dB	0 ... 6 dB	0 ... 6 dB
Output level max. Terrestrial 85...862 MHz 60 dB IMA <sub>3</sub> / EN 60728-3	92 dB $\mu$ V	92 dB $\mu$ V	90 dB $\mu$ V	88 dB $\mu$ V	86 dB $\mu$ V
Output level max. SAT 950...2200 MHz 35 dB IMA <sub>3</sub> / EN 60728-3	95 dB $\mu$ V	95 dB $\mu$ V	95 dB $\mu$ V	95 dB $\mu$ V	95 dB $\mu$ V
Switching isolation	$\geq$ 30 dB				
Isolation trunkline / trunkline	> 30 dB				
Isolation receiver / receiver	$\geq$ 30 dB				
DC-pass max. Trunkline 0; 2; 3 and 4	1 A				
Current consumption for each receiver max.	75 mA				
Ambient temperature	-20 ... +50 °C				
Dimensions (mm)	90 x 140 x 40	145 x 130 x 40	185 x 130 x 40	225 x 130 x 40	305 x 130 x 40

## SPAUN Mini

### Launch Amplifier with 4 SAT IF inputs

SBK 4416 NF



SAT IF

#### Launch Amplifier for SMS 44xx F

##### SAT IF:

- LNB supply voltage can be switched off (by using the included decoupled terminating resistor) to use unit as inline amplifier

##### Miscellaneous:

- Including external wall power supply **SNG 18/1000** (18V/1A)
- Wall mounting adapter included

Model Art. No.	SBK 4416 NF 842502
EAN	4040326425022
Inputs / Outputs	4 / 4
Gain SAT-ZF 950...2200 MHz	15 ... 20 dB
Noise figure	9 ... 5,5 dB
Output level max. 950...2200 MHz 35 dB IMA <sub>3</sub> /EN 60728-3	112 dBμV
Isolation Trunk/Trunk	> 35 dB
LNB remote current	12 V/400 mA
Mains power supply V~	incl. wall power supply 100 ... 240 V / 47 - 63 Hz
Power consumption	< 4 W
Ambient temperature	-20 ... +50 °C
Dimensions (mm)	90 x 71 x 27



## SPAUN Mini

### Cascadable Multiswitch / stand-alone Multiswitch 4 in 4, 8

SMS 4447 F, SMS 4487 F



SAT IF

For 4 and 8 subscribers.

#### SAT IF:

- Cascadable multiswitch
- Also useable as receiver powered stand-alone device
- For Quattro LNB only

#### Miscellaneous:

- Wall mounting adapter included
- Useable without mains power

Model Art. No.	SMS 4447 F 842475	SMS 4487 F 842476
EAN	4040326424759	4040326424766
Inputs / Outputs	4 / 4	4 / 8
Through loss	<2 dB	<3 dB
Tap gain	0 ... 5 dB	-3 ... 2 dB
Output level max. 950 ... 2200 MHz 35 dB IMA <sub>3</sub> /EN 60728-3	95 dB $\mu$ V	
Switching isolation	$\geq 26$ dB	
Isolation trunk / trunk rec. / rec.	$\geq 35$ dB $\geq 26$ dB	
Current from receiver max.	75 mA	
Ambient temperature	-20 ... +50 °C	
Dimensions (mm)	90 x 71 x 27	90 x 113 x 27

## Cascadable Multiswitches 5 in 8, 12, 16

DMK 5582 F, DMK 55122 F, DMK 55162 F

SAT IF



**Energy Saver!**  
Standby Function



For 8, 12 or 16 subscribers.

- Return path compatible
- Switching logic to select analogue or DiSEqC switching criterias, especially adapted to digital receivers

Miscellaneous:

- Ground clamp

**Only useable in combination with launch amplifier SBK 55xx NFx.**



Mode	Select
1	Band
2	Position
3	Option / DiSEqC
4	Band 22 kHz / no DiSEqC

Model Art. No.	DMK 5582 F 842395	DMK 55122 F 842436	DMK 55162 F 842433
EAN	4040326423950	4040326424360	4040326424339
Inputs / Outputs SAT / Terrestrial		5 / 5 4 / 1	
Outputs / subscribers	8	12	16
Through loss terrestrial	6 dB	5 ... 6 dB	5 ... 6 dB
Through loss SAT	2 ... 4,5 dB	4 ... 7,5 dB	5 ... 9 dB
Tap loss terrestrial	20 ... 18 dB	23 ... 26 dB	25 ... 26 dB
Tap loss SAT	18 ... 15 dB	18 ... 15,5 dB	18.5 ... 16,5 dB
Switching isolation		> 26 dB	
Isolation trunkline / trunkline		> 30 dB	
Isolation receiver / receiver		26 dB	
DC-pass max. trunkline 0; 2; 3 and 4		1 A	
Current consumption for each receiver max.		60 mA	
Ambient temperature		-20 ... +50 °C	
Dimensions (mm)	140 x 153 x 38	130 x 240 x 38	130 x 240 x 38

## Wideband Devices for DirecTV™ Applications

# NEW



## Wideband Multiswitches 4 in 12, 16

SMS 41209 WBP, SMS 41609 WBP

SAT IF



Model Art. No.	SMS 41209 WBP 842446	SMS 41609 WBP 842447
EAN	4040326424469	4040326424476
Inputs SAT	4	
Outputs / Subscribers	12	16
Tap gain SAT IF: 250 ... 2200 MHz	- 2 ... 7 dB	
Output level max. 250 ... 2200 MHz 35 dB IMA <sub>3</sub> / EN 60728-3	- 14 dBm	
Isolation of taps	> 26 dB	
max. LNB supply current	400 mA	
Current consumption from each receiver	50 mA	
Ambient temperature	-4 ... 122 °F	
Dimensions (inch)	8.31 x 5.71 x 1.54	
External power supply SNG 18/1000	100 ... 240 V, 47 - 63 Hz DC 18 V / 1000 mA	

### For 12 and 16 subscribers.

- Wideband device designed for DirecTV™ applications
- For the distribution of the new HD channel signals in Ka/Ku bands
- All wideband switches can be used as a standalone device or as active terminating tap in a cascable system
- Especially for DirecTV™ 5 LNB system
- Remote Power Supply to LNB
- To power the wideband multiswitch and the DirecTV™ 5 LNB please use our wall power supply **SNG 18/1000** included in delivery

Application example	① 14 V	② 18 V	③ 14 V + 22 kHz	④ 18 V + 22 kHz
<b>Stack Plan</b>				
Ka-Low	99° L	99° R	103° L	103° R
Ku	101° L	101° R	119° L	110° / 119° R
Ka-High	99° L	99° R	103° L	103° R
<b>SAT IF frequencies</b>				
Ka-Low	250 ... 750 MHz			
Ku	950 ... 1450 MHz			
Ka-High	1650 ... 2150 MHz			

## Wideband Multiswitches 5 in 8, 12, 16

GMS 5809 WBP, GMS 51209 WBP, GMS 51609 WBP



Model Art. No.	GMS 5809 WBP 842461	GMS 51209 WBP 842452	GMS 51609 WBP 842453
EAN	4040326424612	4040326424520	4040326424537
Inputs SAT/Terrestrial	5 4 / 1		
Outputs / Subscribers	8	12	16
Tap loss Terr.: 5 ... 160 MHz	20 ... 22 dB		
Tap gain SAT IF: 250 ... 2200 MHz	2 ... 6 dB	- 7 ... 2 dB	
Output level max. 250 ... 2200 MHz 35 dB IMA <sub>3</sub> / EN 60728-3	- 13 dBm		
Isolation of taps	> 26 dB		
LNB supply current max.	400 mA		
Current consumption from each receiver	50 mA		
Ambient temperature	-4 ... 122 °F		
Dimensions (inch)	6.14 x 6.02 x 1.46	9.29 x 6.02 x 1.46	
External power supply SNG 18/1000	100 ... 240 V, 47 - 63 Hz DC 18 V / 1000 mA		

SAT IF

### For 8, 12 and 16 subscribers.

- Wideband device designed for DIRECTV™ applications
- in die-cast metal housing
- For the distribution of the new HD channel signals in Ka/Ku bands
- All wideband switches can be used as a standalone device or as active terminating tap in a cascadable system
- Especially for DIRECTV™ 5 LNB
- To power the wideband multiswitch and the DIRECTV™ 5 LNB please use our wall power supply **SNG 18/1000** included in delivery

Application example	① 14 V	② 18 V	③ 14 V + 22 kHz	④ 18 V + 22 kHz
<b>Stack Plan</b>				
Ka-Low	99° L	99° R	103° L	103° R
Ku	101° L	101° R	119° L	110° / 119° R
Ka-High	99° L	99° R	103° L	103° R
<b>SAT IF frequencies</b>				
Ka-Low	250 ... 750 MHz			
Ku	950 ... 1450 MHz			
Ka-High	1650 ... 2150 MHz			

## Launch Amplifier for large distribution networks 4 SAT IF inputs

GBK 5500 WBP

SAT IF

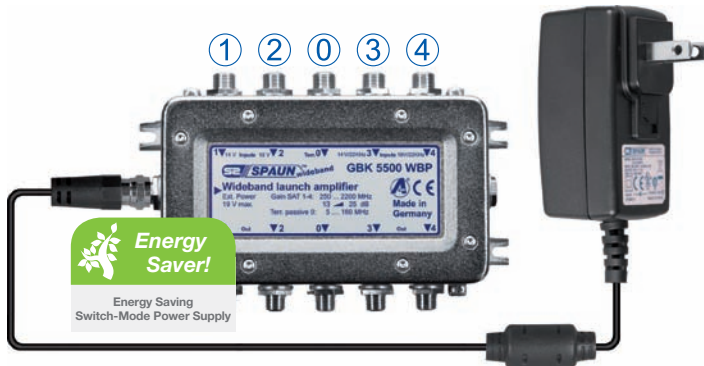

Model Art. No.	GBK 5500 WBP 842451
EAN	4040326424513
Inputs SAT / terrestrial	5 4 / 1
Outputs / subscribers	5
Tap gain Terr.: 5 ... 160 MHz	- 2 dB
Tap gain SAT IF: 250 ... 2200 MHz	13 ... 22 dB
Output level max. 250 ... 2200 MHz 35 dB IMA <sub>3</sub> / EN 60728-3	4.25 dBm
Isolation of taps	> 26 dB
LNB supply current max.	450 mA
Ambient temperature	-4 ... 122 °F
Dimensions (inch)	3.75 x 6.02 x 1.46
External power supply SNG 18/1000	100 ... 240 V, 47 - 63 Hz DC 18 V / 1000 mA

- Wideband device designed for DirecTV™ applications
- For the distribution of the new HD channel signals in Ka/Ku bands
- Terrestrial: passive injection
- SAT IF: Amplifiers precompensating 9 dB slope
- Wall power supply **SNG 18/1000** included in delivery



5 DC-decoupled terminating resistors are shipped with the GBK 5500 WBP to terminate the trunk lines.  
**ZFR 75 DC /Set (Art.No.: 871511)**

Application example	① 14 V	② 18 V	③ 14 V + 22 kHz	④ 18 V + 22 kHz
<b>Stack Plan</b>				
Ka-Low	99° L	99° R	103° L	103° R
Ku	101° L	101° R	119° L	110° / 119° R
Ka-High	99° L	99° R	103° L	103° R
<b>SAT IF frequencies</b>				
Ka-Low	250 ... 750 MHz			
Ku	950 ... 1450 MHz			
Ka-High	1650 ... 2150 MHz			

# Penta Splitter Terrestrial + SAT for Wideband Distribution Systems

GTS 525 WB



Model Art. No.	GTS 525 WB 842233
EAN	4040326422335
Inputs SAT / terrestrial	5 4 / 1
Outputs / subscribers	2 x 5
Through loss Terr.: 5 ... 160 MHz	5 dB
Through loss SAT IF: 250 ... 2200 MHz	6 dB
Isolation Input / input	> 26 dB
Isolation Output terrestrial:	> 20 dB
Isolation Output SAT:	> 15 dB
Isolation of taps	> 26 dB
LNB supply current max.	450 mA
DC-pass max.	30 V / 1 A
Ambient temperature	-4 ... 122 °F
Dimensions (inch)	6.14 x 6.02 x 1.46

SAT IF

The Penta splitter GTS 525 WB reduces the installation expenditure of distribution networks substantially as it combines five two-way splitters in one device.

That means: the RF energy of the terrestrial trunkline and the four SAT IF trunk lines are distributed in each case on two trunk lines.

Each trunkline has a separate DC-pass, which is connected with the respective output ports. It is possible to supply a post amplifier from the trunkline to each output.

Easy installation just one device instead of five. It is possible to connect the GTS 525 WB direct to the GMS 5x09 WBP multiswitch series by using quick-connector ZSV 2/SET.

Application example	① 14 V	② 18 V	③ 14 V + 22 kHz	④ 18 V + 22 kHz
<b>Stack Plan</b>				
Ka-Low	99° L	99° R	103° L	103° R
Ku	101° L	101° R	119° L	110° / 119° R
Ka-High	99° L	99° R	103° L	103° R
<b>SAT IF frequencies</b>				
Ka-Low	250 ... 750 MHz			
Ku	950 ... 1450 MHz			
Ka-High	1650 ... 2150 MHz			

## Penta Taps Terr. + SAT with Direction Coupler for Wideband Distribution Systems

GZR 5550/15 WB

SAT IF



Model Art. No.	GZR 5550/15 WB 841155
EAN	4040326411551
Inputs SAT / terrestrial	5 4 / 1
Outputs / subscribers	2 x 5
Through loss Terr.: 5 ... 160 MHz	3 dB
Through loss SAT: 250 ... 2200 MHz	5 dB
Tap loss Terr.: 5 ... 160 MHz	10 dB
Tap loss SAT IF: 250 ... 2200 MHz	15 ... 13 dB
Isolation Trunk / trunk	> 26 dB
Trunk / tap	> 26 dB
Tap / tap	> 26 dB
DC-pass max.	max. 30 V / 1 A
Ambient temperature	-4 ... 122 °F
Dimensions (inch)	6.14 x 6.02 x 1.46

The tap GZR 5550/15 WB is equipped with 5 trunk lines and 5 tap outlets. There are 1 terrestrial and 4 SAT IF.

Easy installation just one device instead of five.

It is possible to connect the GZR 5550/15 WB directly to the GMS 5xx09 WBP multiswitch series by using quick-connector ZSV 2/Set.

The trunk line DC path is linked to the tap outlet. This offers remote power to a line powered post amplifier at any location.

Application example	① 14 V	② 18 V	③ 14 V + 22 kHz	④ 18 V + 22 kHz
<b>Stack Plan</b>				
Ka-Low	99° L	99° R	103° L	103° R
Ku	101° L	101° R	119° L	110° / 119° R
Ka-High	99° L	99° R	103° L	103° R
<b>SAT IF frequencies</b>	250 ... 750 MHz 950 ... 1450 MHz 1650 ... 2150 MHz			



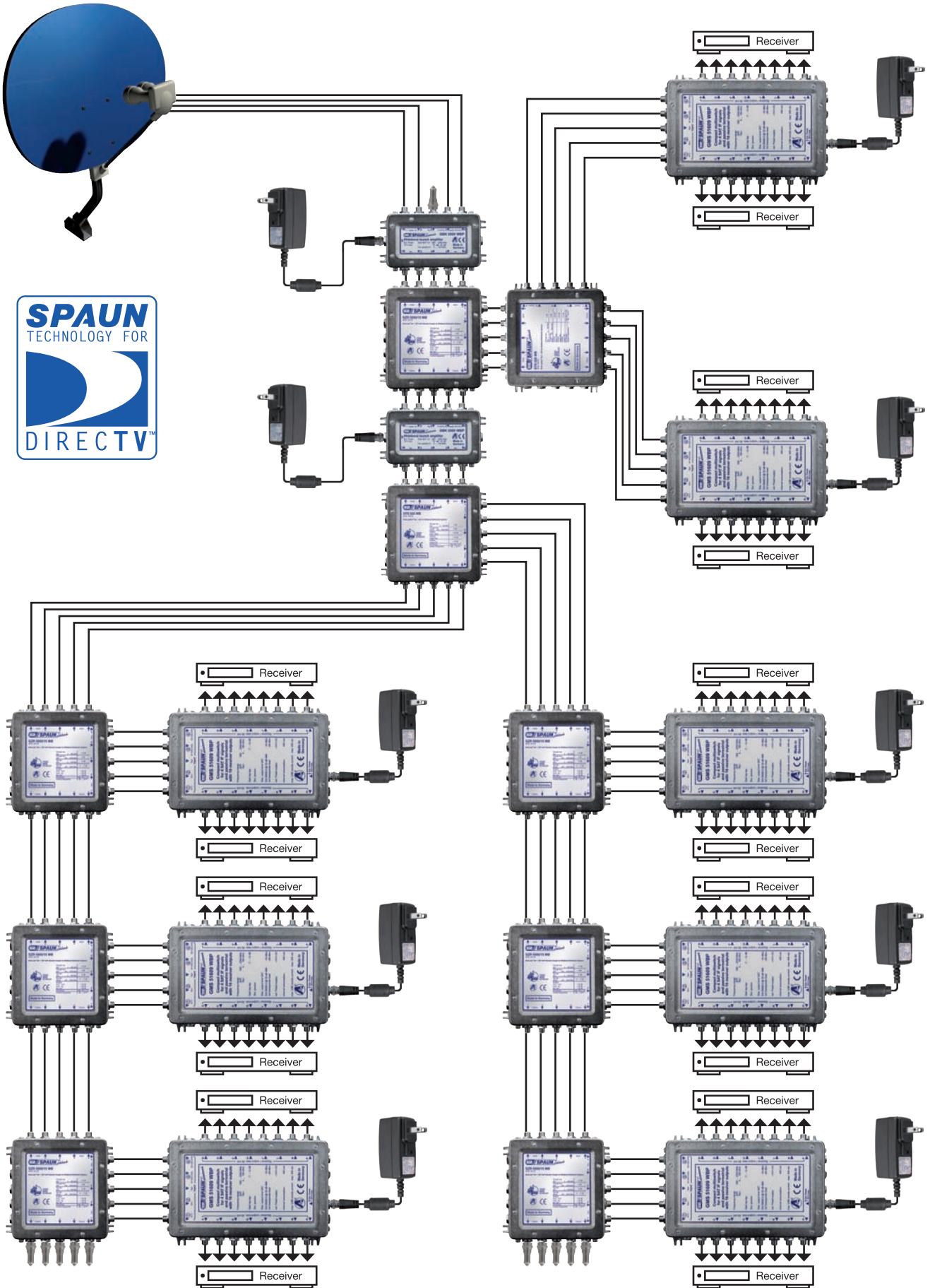

4 SAT IF signals for 128 subscribers



# The UNiSEQC Product Family according to EN 50494



## SMA 8 F

Innovative socket filter for SCR systems to filter wrong receiver configurations which is an effective solution to reduce the susceptibility to interference of SCR distribution systems.

Page 62

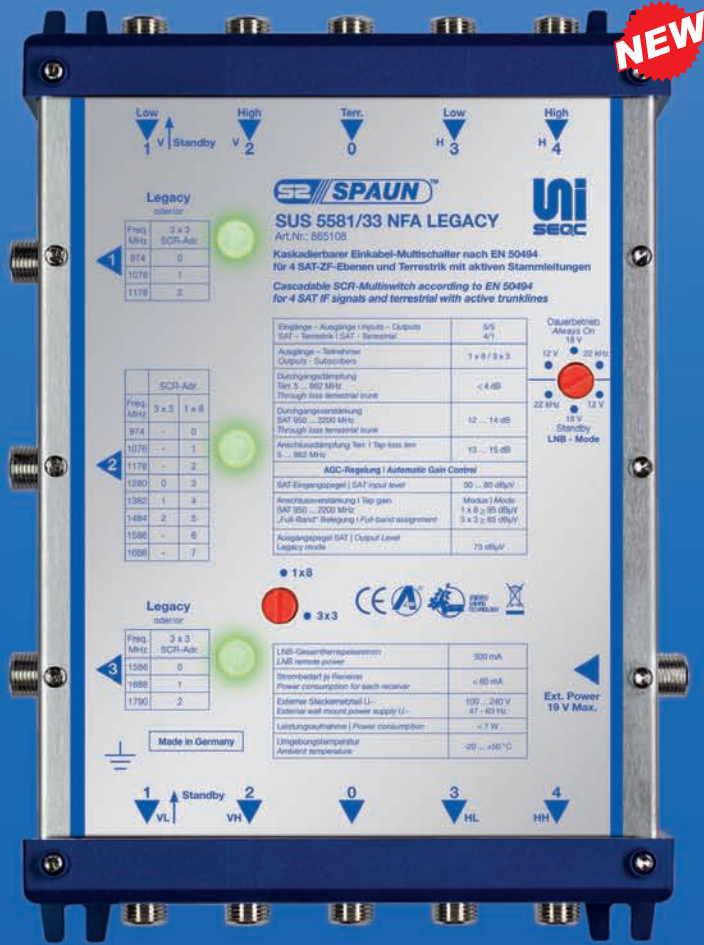

## SUS 5581/33 NF(A) LEGACY

Single cable multiswitch 5 in 1x8 or 3x3 receiver, switchable. By using mode 1x8 the two unused outputs can be used as conventional multiswitch outputs.

Page 56



## SUS 55x1 F(A) and SUS 44x1 F

Cost-effective, cascading single cable multiswitch 4/5 in 1x4 or 1x8 either receiver powered or with an optional wall power supply.

Page 58



## SUS 21 F

As plug on solution for a standard multiswitch to combine two subscriber outputs onto one coaxial line.

Page 60

# Cascadable Multiswitch 2 in 12

SMS 2212 F



For 12 subscribers.

- Remote powered by satellite receiver
- The IF polarity selection is controlled by the remote voltage, < 14 V  $\cong$  vert. / > 16 V  $\cong$  hor. provided by the receiver

Model Art. No.	SMS 2212 F 842344
EAN	4040326423448
Inputs / outputs	2 / 2
Outputs / subscribers	12
Through loss: SAT IF: 950 ... 2200 MHz	0 dB
Tap loss: SAT	0 dB
35 dB IMA <sub>2</sub> / EN 60728-3	86 dB $\mu$ V
35 dB IMA <sub>3</sub> / EN 60728-3	94 dB $\mu$ V
Isolation Receiver / receiver	$\geq$ 23 dB
Isolation Trunkline / trunkline	$\geq$ 30 dB
Noise figure	7 dB
Current consumption	75 mA
Capacity (IF ports) max.	500 mA
Ambient temperature	-20 ... +50 °C
Dimensions (mm)	145 x 130 x 39

SAT IF



## Compact Multiswitch 2 in 8

SMS 287 F



Model Art. No.	SMS 287 F 842497
EAN	4040326423417
Inputs	2
Outputs / Subscribers	8
Through gain: SAT IF: 950 ... 2200 MHz	0 ... 3 dB
Output level max. 35 dB IMA <sub>3</sub> / EN 60728-3	98 dBμV
Isolation Receiver / receiver	≥ 26 dB
Noise figure	7 dB
Current consumption	-
Current consumption from each receiver	75 mA
Capacity (IF ports) max.	500 mA
Ambient temperature	-20 ... +50 °C
Dimensions (mm)	90 x 139 x 38

### For 8 subscribers.

- Remote powered by the satellite receiver
- Compact multiswitches for distribution of 2 SAT IF for 8 subscribers. The IF polarity selection is controlled by the remote voltage, < 14 V ≅ vert. / > 16 V ≅ hor. provided by the receiver

### Tech Hint

In case that there is no mains connection at the mounting place, or multi-dwelling projects own no operating cost-counter, a receiver fedded multiswitch is the best choice. When using receiver fedded multiswitch-systems, it is important to make sure that there is sufficient feeding voltage for the current consumption of the multiswitch and the LNBS of the external unit.

This applies especially to PC-Cards for satellite reception. Please adhere to the corresponding data of the devices. The overload of a power supply can have a negative impact on the durability of the receiver.

The receiver-powered UniSystem multiswitches are remote powered via the coaxial cable. The power supply is also used to supply the LNBS.

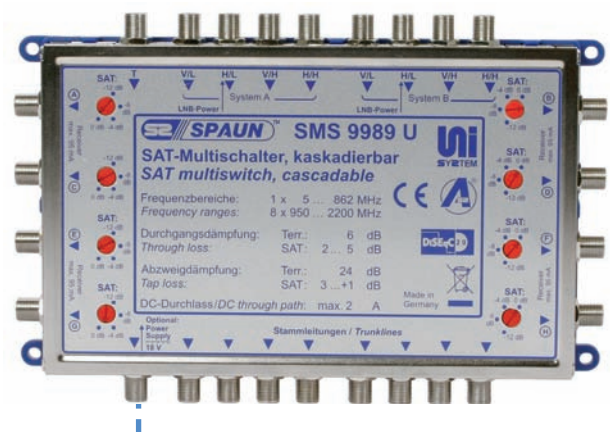

Universal AC Adapter  
**SNG 18/1000 (Art. No.: 832114)**  
in combination with Line Power  
Injection Filter **FSW 30 F (Art.  
No.: 815018)**

# BluBox 32

## Professional Headend 32 x DVB-S(2) into QAM

In the area of head-end technology, SPAUN is extending its range of products to include the BluBox 32. This head-end enables up to 32 DVB-S(2) transponders to be converted to 32 QAM transponders.

The BluBox 32 is based on the proven BluBox 8/16 technology. Redundant switched-mode power supplies ensure high reliability here as well. The entire technology is accommodated in a lockable 19-inch housing, which is also suitable for wall mounting by means of the wall brackets included in the scope of delivery. No special software is required for configuring the head-end; a PC with Internet browser and network connection is the only prerequisite.

- 32 x DVB-S(2) (QPSK/8PSK) into DVB-C (QAM)
- For the reception of up to 240 TV programs SD/HD and up to 120 Radio programs
- Compact dimensions and high energy efficiency
- LNB control with 14/18 V + 22 kHz or DiSEqC
- Configuration via LAN/IP
- Complete processing of the transport streams possible
- All 32 output channels can be placed individually in the spectrum
- Two individual input ports
- Redundant power supply
- 19" or wall mounting



## SAT Antenna Relay

SAR 422 WSG

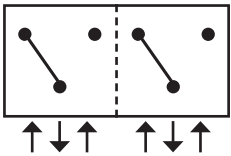

### SAT IF:

- To be used in SMATV systems
- Continuation of the 22 kHz tone and the DiSEqC command
- For two TWIN LNBs onto two receivers
- The satellite system (east / west) is selected using the DiSEqC command "Position" or the analogue Tone-Burst

Model Art. No.	SAR 422 WSG 871426
EAN	4040326714263
Inputs / Outputs	4/2
Outdoor case	✓
Frequency range	950 ... 2200 MHz
Through loss max.	2 dB
Switching isolation	> 35 dB
Isolation relays / relays	> 30 dB
DC-pass per trunkline max.	600 mA
System switching using DiSEqC-commands	Position
Current from receiver max.	2 x 25 mA
Ambient temperature	-20 ... +50 °C
Dimensions (mm)	124 x 112 x 40

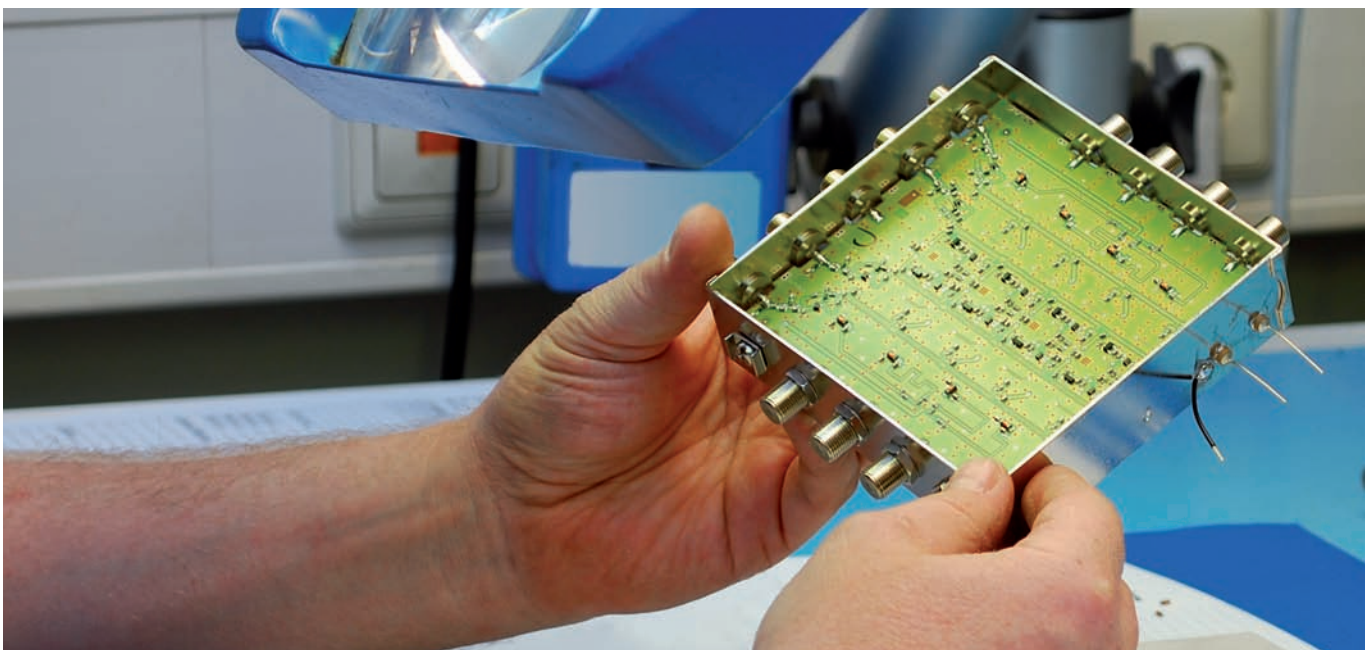

# SAT Antenna Relay

SUR 420 WSG

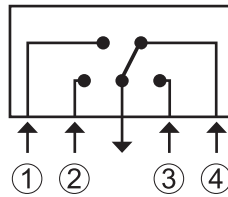

**! DiSEqC 1.1 / 2.1 receiver required!**

To be used as „uncommitted“ switch.

- For individual reception systems
- Continuation of the 22 kHz tone and the DiSEqC command
- To multiplex four down lead cables
- Cascadable for up to 256 IF signals

SAT IF

MODE Selector	SMATV	START Byte	ADDRESS Byte	COMMAND Byte	DATA Byte	Mode 1	Mode 2	Mode 3
<ul style="list-style-type: none"> <li>• Mode 1</li> <li>• Mode 2</li> <li>• Mode 3</li> </ul>	1	E0	18	39	F0	Input 1	Input 1	Input 1
	2	E0	18	39	F1	Input 2		
	3	E0	18	39	F2	Input 3	Input 2	
	4	E0	18	39	F3	Input 4		
	5	E0	18	39	F4	Input 1	Input 3	Input 2
	6	E0	18	39	F5	Input 2		
	7	E0	18	39	F6	Input 3	Input 4	
	8	E0	18	39	F7	Input 4		
	9	E0	18	39	F8	Input 1	Input 1	Input 3
	10	E0	18	39	F9	Input 2		
	11	E0	18	39	FA	Input 3	Input 2	
	12	E0	18	39	FB	Input 4		
	13	E0	18	39	FC	Input 1	Input 3	Input 4
	14	E0	18	39	FD	Input 2		
	15	E0	18	39	FE	Input 3	Input 4	
	16	E0	18	39	FF	Input 4		

Model Art. No.	SUR 420 WSG 871417
EAN	4040326714171
Inputs / Outputs	4/1
Outdoor case	✓
Through loss max.	2,5 dB
Switching isolation terrestrial	> 40 dB
Switching isolation SAT	> 26 dB
DC-pass per trunkline max.	500 mA
System switching using DiSEqC-commands	Uncommitted
Current from receiver max.	60 mA
Ambient temperature	-20 ... +50 °C
Dimensions (mm)	124 x 112 x 40

## SAT Antenna Relay

SAR 411 WSG, SAR 212 WSG



For two Single SAT LNBS onto one receiver (SAR 212 WSG)  
For four Single SAT LNBS onto one receiver (SAR 411 WSG)

- To be used in SMATV systems and for down lead cables
- Continuation of the 22 kHz tone and the DiSEqC command
- To multiplex two or four down lead cables
- The satellite system (east / west) is selected using the DiSEqC command "Position" or the analogue Tone-Burst

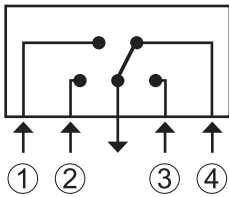

SPAUN SAR 411F relay received the rating „gut“=“good“ in the SATVISION comparative test



SPAUN SAR 411F relay received the rating „sehr gut“=“excellent“

Model Art. No.	SAR 411 WSG 871432	SAR 212 WSG 871430
EAN	4040326714324	4040326714300
Inputs / Outputs	4/1	2/1
Outdoor case	optional (WSG 94) ✓	optional (WSG 94) ✓
Frequency range	950 ... 2200 MHz	
Through loss max.	2 dB	1,5 dB
Switching isolation	> 26 / typ. 30 dB	> 30 / typ. 40 dB
DC-pass per trunkline max.	500 mA	500 mA
System switching using DiSEqC-commands	Option, Position	Position
Current from receiver max.	36 mA	30 mA
Ambient temperature	-20 ... +50 °C	
Dimensions (mm)	94 x 73 x 26	64 x 73 x 26

## SAT Antenna Relay

SAR 12 F

To multiplex two SAT IF systems.

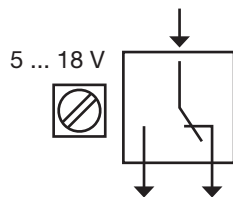

Model Art. No.	SAR 12 F 871406
EAN	4040326714065
Inputs / Outputs	1/2
Outdoor case	optional
Frequency range	47 ... 2200 MHz
Through loss	0,8 dB
Switching isolation Terr.	> 40 dB
Switching isolation SAT	> 25 dB
DC-pass per trunkline max.	500 mA
Control voltage	5 ... 18 V
Control current	< 0,5 ... 1,5 mA
Current from receiver max.	35 mA
Ambient temperature	-20 ... +50 °C
Dimensions (mm)	105 x 82 x 38



# SAT Antenna Relay

## SUR 211 WSG

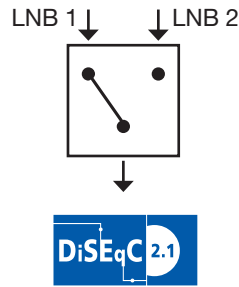

- To be used in SMATV systems and down lead cables
- Continuation of the 22 kHz tone and the DiSEqC command
- Mode selector to choose the switching commands type

SAT IF

MODE Selector	SMATV	Option	Satellite Position System	Polarisation	Band	START Byte	ADDRESS Byte	COM-MAND Byte	DATA Byte	switch setting			
										1 <sup>st</sup> Uncommitted	Position	Option	
1 <sup>st</sup> Uncommitted Switch  Position (TonBurst) Option (nur DiSEqC)	1	A	A	Vert.	Low	E0	00*/18**	38*/39**	F0	LNB 1	LNB 1		
	2				High	E0	00*/18**	38*/39**	F1	LNB2			
	3			Hor.	Low	E0	00*/18**	38*/39**	F2	LNB1			
	4				High	E0	00*/18**	38*/39**	F3	LNB2			
	5		B	Vert.	Low	E0	00*/18**	38*/39**	F4	LNB1			LNB 2
	6				High	E0	00*/18**	38*/39**	F5	LNB2			
	7			Hor.	Low	E0	00*/18**	38*/39**	F6	LNB1			
	8				High	E0	00*/18**	38*/39**	F7	LNB2			
	9	B	C	Vert.	Low	E0	00*/18**	38*/39**	F8	LNB1	LNB 2		
	10				High	E0	00*/18**	38*/39**	F9	LNB2			
	11			Hor.	Low	E0	00*/18**	38*/39**	FA	LNB1			
	12				High	E0	00*/18**	38*/39**	FB	LNB2			
	13		D	Vert.	Low	E0	00*/18**	38*/39**	FC	LNB1			
	14				High	E0	00*/18**	38*/39**	FD	LNB2			
	15			Hor.	Low	E0	00*/18**	38*/39**	FE	LNB1			
	16				High	E0	00*/18**	38*/39**	FF	LNB2			

\* Committed, \*\* Uncommitted

Model Art. No.	SUR 211 WSG 871437
EAN	4040326714379
Inputs / Outputs	2/1
Outdoor case	✓
Frequency range	5 ... 2200 MHz
Through loss max.	1 dB
Switching isolation Terrestrial	> 40 dB
Switching isolation SAT	> 26 dB
DC-pass per trunkline max.	500 mA
System switching using DiSEqC-commands	1 <sup>st</sup> Uncommitted, Option, Position
Current from receiver max.	35 mA
Ambient temperature	-20 ... +50 °C
Dimensions (mm)	90 x 112 x 40

## UniSystem - Multiswitch Relay

SMR 410 F, SMR 210 F, SMR 9210 F

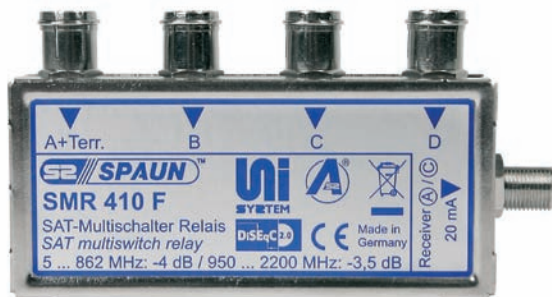

For 8 ... 16 SAT IF signals.

For combining the signal of 2, 3 or 4 SAT systems and terrestrial path on one subscriber output. The relays have to be connected on the right and left subscriber side of the UniSystem multiswitches.

SMR 210 F for connection of 2 satellites, such as 2x SMS 5547 UI

SMR 410 F for connection of 3-4 satellites, such as 3x SMS 5587 UI

SMR 9210 F for connection of 4 satellites such as SMS 9987 U or SMS 9989 U

Model Art. No.	SMR 410 F 871436	SMR 210 F 871435	SMR 9210 F 871438
EAN	4040326714362	4040326714355	4040326714386
Inputs SAT / terrestrial	4	2	
Frequency range	5 ... 862 MHz and 950 ... 2200 MHz		
Outputs / receivers	1	1	
Combination of SAT systems	2 ... 4	2	4
Through loss terrestrial	4 dB	3 dB	
Through loss SAT	3,5 dB	3 dB	
System switching using DiSEqC-commands	Option and Position	Position	Option
Current from receiver max.	20 mA		
Ambient temperature	-20 ... +50 °C		
Dimensions (mm)	102 x 54 x 22	80 x 54 x 22	

### Tech Hint

Please note our accessories program:

DC-decoupled terminating resistors are included in delivery. Furthermore we provide SAT attenuation devices for balancing the different signal levels between the SAT systems and the ground clamp, suitable for all F-jacks.



# Power-Class Power SAT IF Amplifier

GBV 3809 U

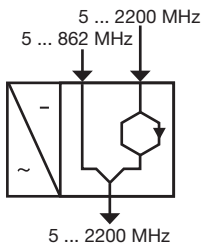

For large distribution networks or long cable runs.

- Wideband output
- LED operation display
- suitable for SCR systems according to EN 50494

### Input 1:

- Passive terrestrial
- Active SAT IF with extremely high output level
- Splitband technology

### Input 2:

- Useable as headend- or CATV line amplifier

Model Art. No.	GBV 3809 U 814112	
EAN	4040326141120	
Inputs / Outputs	2 / 1	
Gain: SAT IF: 950 ... 2200 MHz	25 ... 30 dB or 35 ... 40 dB	
Noise figure SAT	8 dB	
Input 1 5 ... 862 MHz Terrestrial passive 950 ... 2200 MHz SAT active	-1 ... -6 dB	
Input 2 5 ... 862 MHz Terrestrial passive	-1 ... -4 dB	
Output level max. 950 ... 2200 MHz 35 dB IMA <sub>2</sub> / EN 60728-3	125 dBμV	
Output level max. 950 ... 2200 MHz 35 dB IMA <sub>3</sub> / EN 60728-3	125 dBμV	
Rejection	Terrestrial / SAT	≥ 25 dB
	SAT / Terrestrial	≥ 35 dB
Level adjusting range / SAT	0 ... -10 dB	
Slope correction range / SAT	0 ... -12 dB	
Mains power supply V~	100 ... 240 V / 47 - 63 Hz	
Power consumption + LNB	9,5 W	
LNB supply voltage	12 / 18V, 350 mA	
Ambient temperature	-20 ... +50 °C	
Dimensions (mm)	250 x 190 x 77	

SAT IF

**LNB - Mode**

18 V • OFF

12 V •

OFF • 18 V

• 12 V + 22kHz

• 18 V + 22kHz

LNB supply voltage selectable

35 ... 40 dB

25 ... 30 dB

Gain selectable

-12 dB

-10 dB

Integrated level adjuster and slope correction

## Mains Powered SAT IF Amplifier

SVN 231 F



**Energy Saver!**  
Energy Saving  
Switch-Mode Power Supply

**Suitable for SCR systems  
according to EN 50494**

**With active terrestrial feed.**

### SAT IF:

- LNB remote power (18 V / 400 mA)
- Integrated level adjusting
- Integrated slope adjusting
- Suitable for SCR systems according to EN 50494

### Terrestrial:

- Integrated level adjusting

### Miscellaneous:

- Splitband technology
- Useable as Inline amplifier  
(Continuation of the 22 kHz tone and the DiSEqC™ command)

Model Art. No.	SVN 231 F 814118	
EAN	4040326141182	
Outputs	1	
Inputs terrestrial / SAT	1 / 1	
Gain		
Terr.: 47 ... 862 MHz	20 dB	
Gain		
SAT IF: 950 ... 2150 MHz	30 dB	
Noise figure	5 dB	
Output level max. 47 ... 862 MHz 60 dB IMA <sub>3</sub> / EN 60728-3	108 dBμV	
Output level max. 950 ... 2150 MHz 35 dB IMA <sub>3</sub> / EN 60728-3	111 dBμV	
Rejection	Terrestrial / SAT	≥ 25 dB
	SAT / terrestrial	≥ 35 dB
Level adjusting range	0 ... -10 dB	
Slope correction range / SAT	0 ... -12 dB	
Mains power supply V~	100 ... 240 V / 47 - 63 Hz	
Power consumption	12 W	
Ambient temperature	-20 ... +50 °C	
Dimensions (mm)	250 x 190 x 77	



The SVN 231 F received the TELE satellite AWARD from the international magazine TELE satellite in March 2010

### Operation Mode

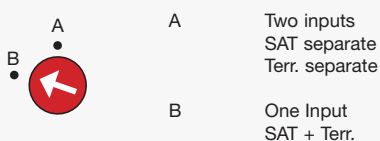

### DC Power Supply 18 V

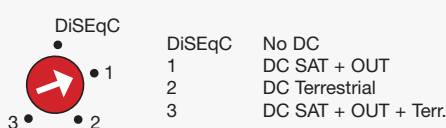

### Level adjuster

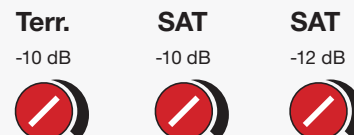

### Slope correction



# Remote Powered Post Amplifier

NVF 115 F



47 ... 862 / 950 ... 2300 MHz

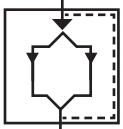

47 ... 2300 MHz

Model Art. No.	NVF 115 F 814117
EAN	4040326141175
Inputs / Outputs	1 / 1
Gain Terr.: 47 ... 862 MHz	7 ... 10 dB
Gain SAT IF: 950 ... 2300 MHz	10 ... 15 dB
Noise figure	5 dB
Output level max. 47 ... 862 MHz 60 dB IMA <sub>3</sub> / EN 60728-3	106 dBμV
Output level max. 950 ... 2300 MHz 35 dB IMA <sub>3</sub> / EN 60728-3	112 dBμV
Power supply	14 ... 20 V / 200 mA
DC-pass per trunkline max.	1 A
Ambient temperature	-20 ... +50 °C
Dimensions (mm)	150 x 90 x 35

SAT IF

### For terrestrial and SAT IF.

- Splitband technology
- Wideband in- and output
- Continuation of the 22 kHz tone and the DiSEqC command

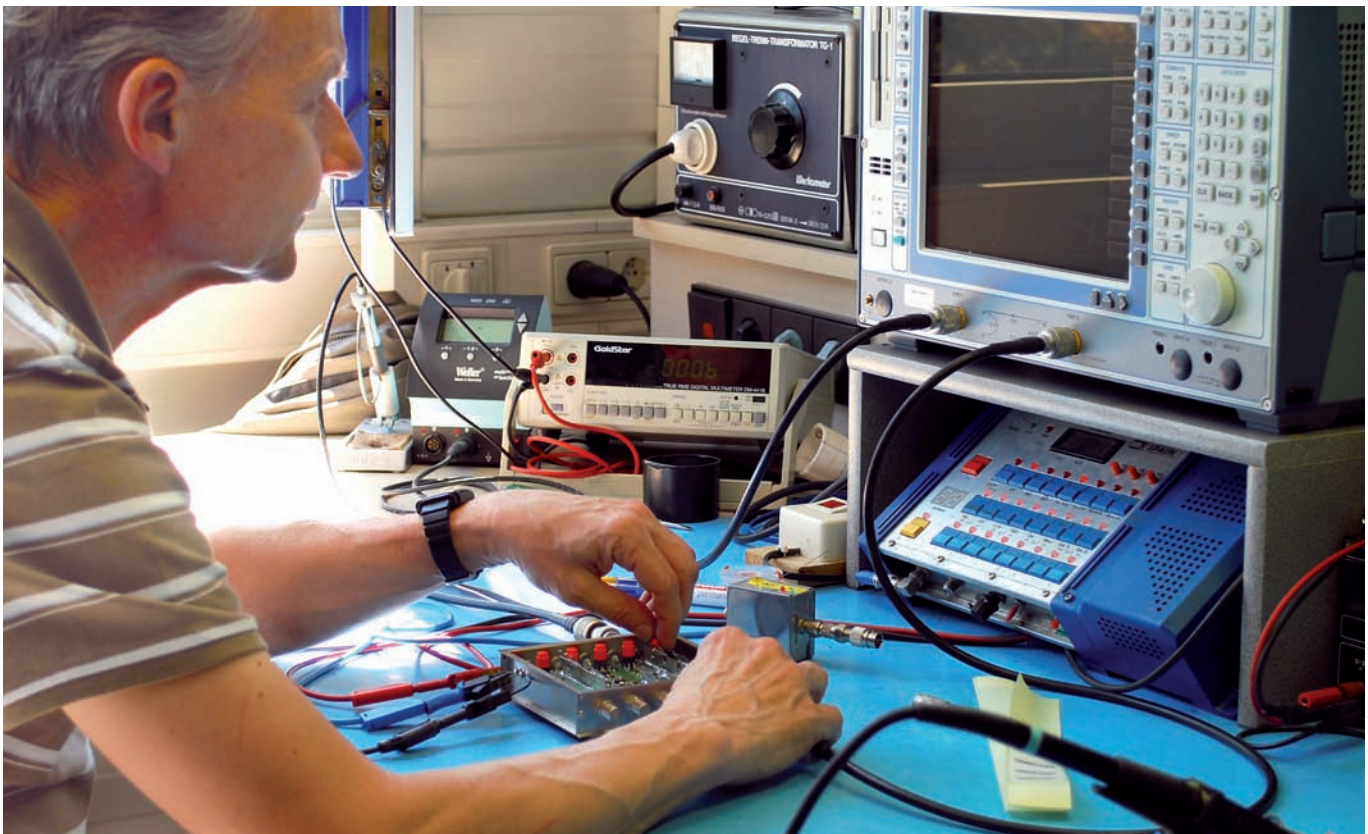

## Remote Powered Post Amplifier

NVF 120 F



For terrestrial and SAT IF.

- Splitband technology
- Wideband in- and output
- Continuation of the 22 kHz tone and the DiSEqC command

Please note the frequency range of 5 ... 160 MHz and 250 ... 2200 MHz

Model Art. No.	NVF 120 F 814115
EAN	4040326141151
Inputs / Outputs	1 / 1
Gain Terr.:	5 ... 160 MHz 7 ... 10 dB
Gain SAT IF:	250 ... 2200 MHz 12 ... 20 dB
Noise figure	6 dB
Output level max. 5 ... 160 MHz 35 dB IMA <sub>3</sub> / EN 60728-3	108 dB $\mu$ V
Output level max. 250 ... 2200 MHz 35 dB IMA <sub>3</sub> / EN 60728-3	106 dB $\mu$ V
Power supply	14 ... 20 V / 120 mA
DC-pass per trunkline	max. 1 A
Ambient temperature	-4 ... 122 °F
Dimensions (inch)	5.9 x 3.5 x 1.4

## Remote Powered SAT IF Amplifier

SVF 128 F



- Continuation of the 22 kHz tone and the DiSEqC command
- Integrated level adjuster
- Integrated precompensating slope

Model Art. No.	SVF 128 F 814207
EAN	4040326142073
Frequency range	950 ... 2200 MHz
Inputs / Outputs	1 / 1
Gain	21 ... 28 dB
Noise figure	4,5 ... 2,5 dB
Output level max. 950 ... 2200 MHz 35 dB IMA <sub>3</sub> / EN 60728-3	110 dB $\mu$ V
Power supply	10,5 ... 20 V / 200 mA
DC-pass per trunkline max.	600 mA
Ambient temperature	-20 ... +50 °C
Dimensions (mm)	77 x 49 x 33

# How much may it be?



## We have multiswitches in all sizes!

**SPAUN** // **electronic** <sup>TM</sup>



## Remote Powered SAT IF Amplifiers

SVF 10 F, SVF 20 F, SVF 20 LE



- All DC through paths are both 22 kHz tone and DiSEqC capable
- Perfect to compensate loss of long LNB down lead cables due to precompensating slope of SAT IF amplifier

### Only SVF 20 LE

- An integrated high-pass filter suppresses undesirable LNB intermodulation products in the frequency range below 950 MHz

Model Art. No.	SVF 10 F 814210	SVF 20 F 814208	SVF 20 LE 814209
EAN	4040326142103	4040326142080	4040326142097
Frequency range	950 ... 2200 MHz		
Inputs / Outputs	1 / 1		
Gain	9 ... 10 dB	20 dB	13 ... 20 dB
Noise figure	6,5 ... 3,5 dB	6 ... 3 dB	8 ... 5 dB
Output level max. 35 dB IMA <sub>2</sub> / EN 60728-3	112 dBµV		
Output level max. 35 dB IMA <sub>3</sub> / EN 60728-3	112 dBµV		
Power supply	11,5 ... 20 V / 55 mA	11,5 ... 20 V / 95 mA	
DC-pass per trunkline max.	1 A		
Ambient temperature	-20 ... +50 °C		
Dimensions (mm)	35 x 72 x 21		

## Active Slope Equalizer

SLA 10 F



With integrated slope precompensation and gain

- Continuation of the 22 kHz tone and the DiSEqC command

Model Art. No.	SLA 10 F 871317
EAN	4040326713174
Frequency range	950 ... 2200 MHz
Inputs / Outputs	1 / 1
Gain	5 ... 10 dB
Noise figure	8 ... 5 dB
Output level max. 35 dB IMA <sub>2</sub> / EN 60728-3	112 dBµV
Output level max. 35 dB IMA <sub>3</sub> / EN 60728-3	112 dBµV
Power Supply	11,5 ... 20 V / 50 mA
DC-pass per trunkline max.	1 A
Ambient temperature	-20 ... +50 °C
Dimensions (mm)	35 x 72 x 21



## Active SAT IF Distribution

SAZ 8 NFI



Distribution of one SAT IF input signal onto 8 trunk lines.

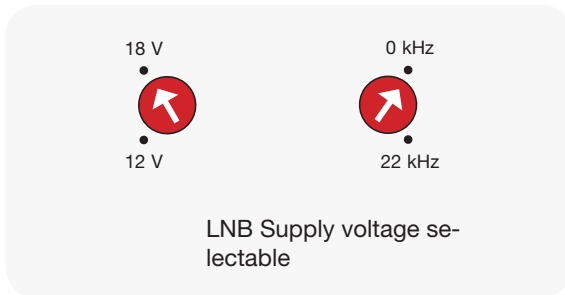

Model Art. No.	SAZ 8 NFI 841301
EAN	4040326413012
Frequency range	950 ... 2200 MHz
Inputs / Outputs	1 / 9
Gain trunk tap	16 dB 3 ... 8 dB
Noise figure	8 ... 5 dB
Output level max. 35 dB IMA <sub>2</sub> / EN 60728-3	108 dBμV
Output level max. 35 dB IMA <sub>3</sub> / EN 60728-3	106 dBμV
Isolation	> 30 dB
Mains power supply V~	100 ... 240 V / 47 - 63 Hz
Power consumption	8 W
LNB remote current	300 mA
Ambient temperature	-20 ... +50 °C
Dimensions (mm)	105 x 90 x 35

SAT IF

## Active SAT IF Distribution

SVA 4 F, SVA 8 F

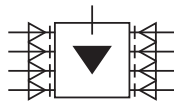
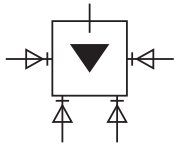

Distribution of one SAT IF signal onto 4 or 8 trunk lines.

- DC-pass from all output ports via diodes
- Unused outputs must be terminated

Model Art. No.	SVA 4 F 842103	SVA 8 F 850002
EAN	4040326421031	4040326500026
Frequency range	950 ... 2200 MHz	
Inputs / Outputs	1 / 4	1 / 8
Gain	1 dB	- 3 dB
Output level max. 35 dB IMA <sub>3</sub> / EN 60728-3	106 dBμV	102 dBμV
Power supply	10,5 ... 20 V / 40 mA	10,5 ... 20 V / 40 mA
DC-pass per trunkline max.	500 mA	500 mA
Ambient temperature	-20 ... +50 °C	-20 ... +50 °C
Dimensions (mm)	105 x 90 x 35	145 x 131 x 40



2 Single LNB into one download

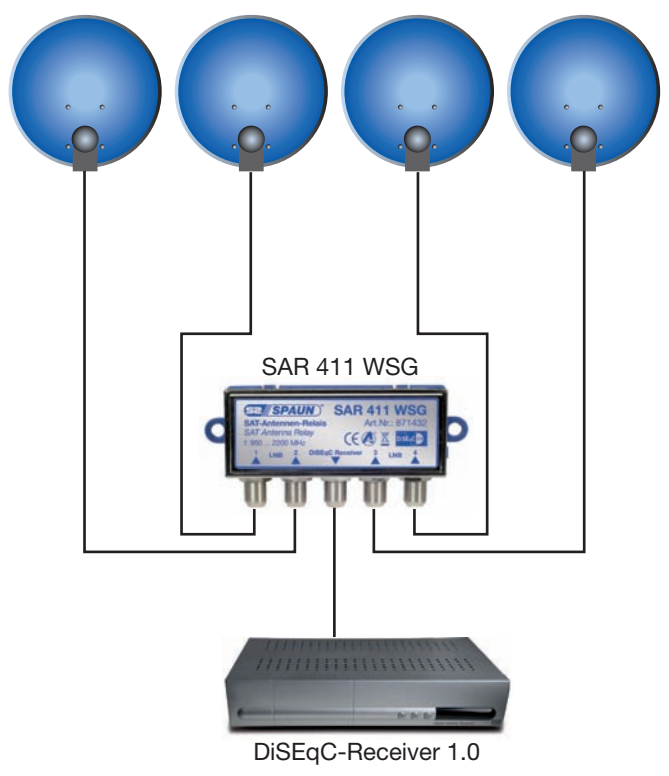

4 Single LNB into one download

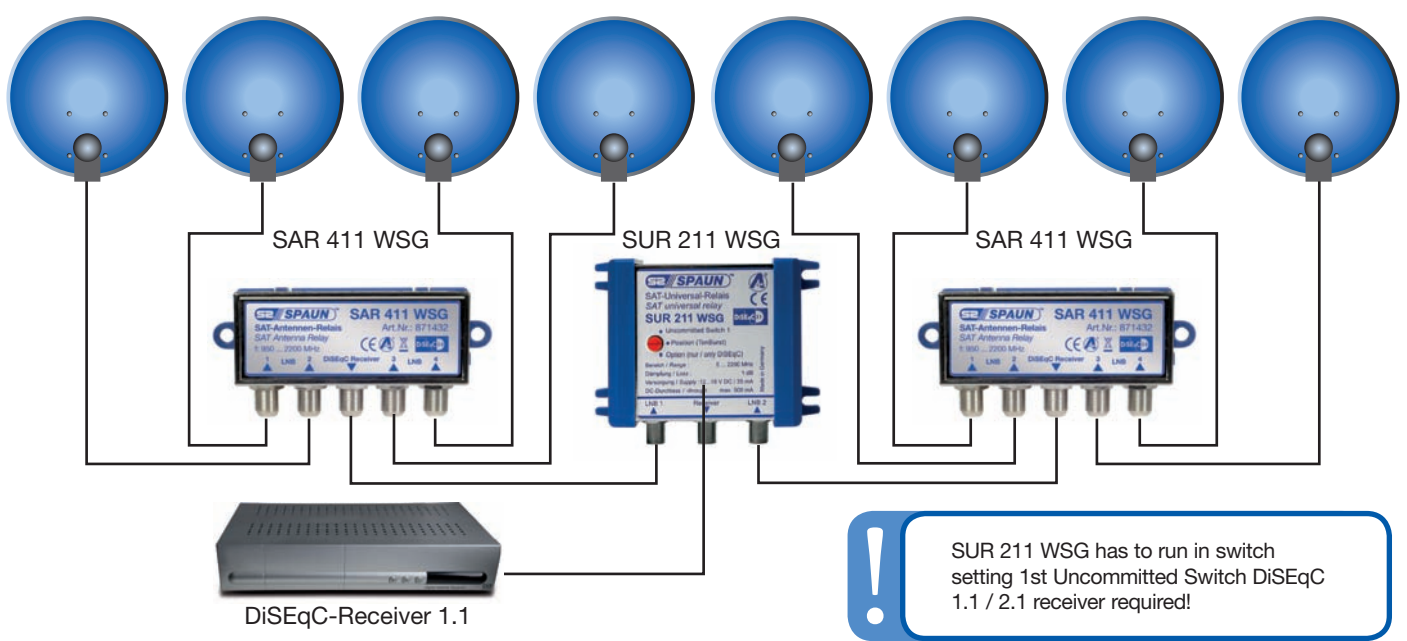

8 Single LNB into one download

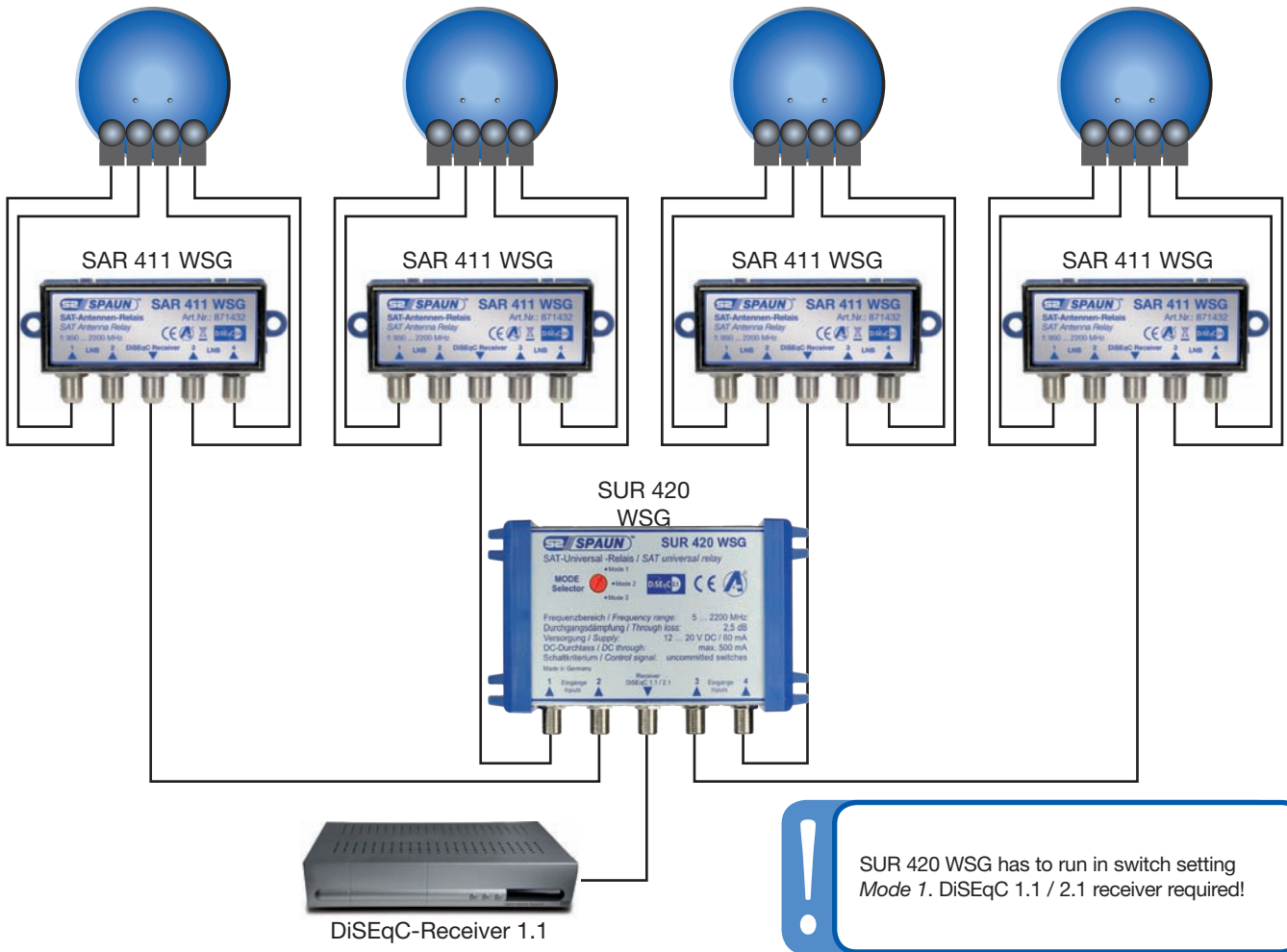

SAT IF

! SUR 420 WSG has to run in switch setting *Mode 1*. DiSEqC 1.1 / 2.1 receiver required!

16 Single LNB into one download

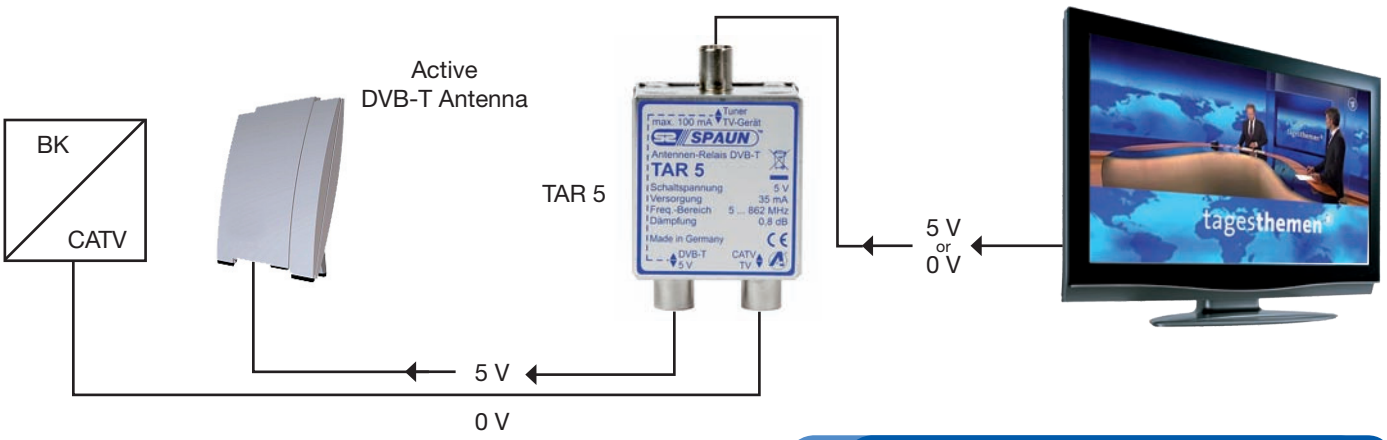

DVB-T reception and CATV into one download

! When using a non DC capable DVB-T antenna you have to install a DC blocker **DCF 500/Set** to the DVB-T antenna.

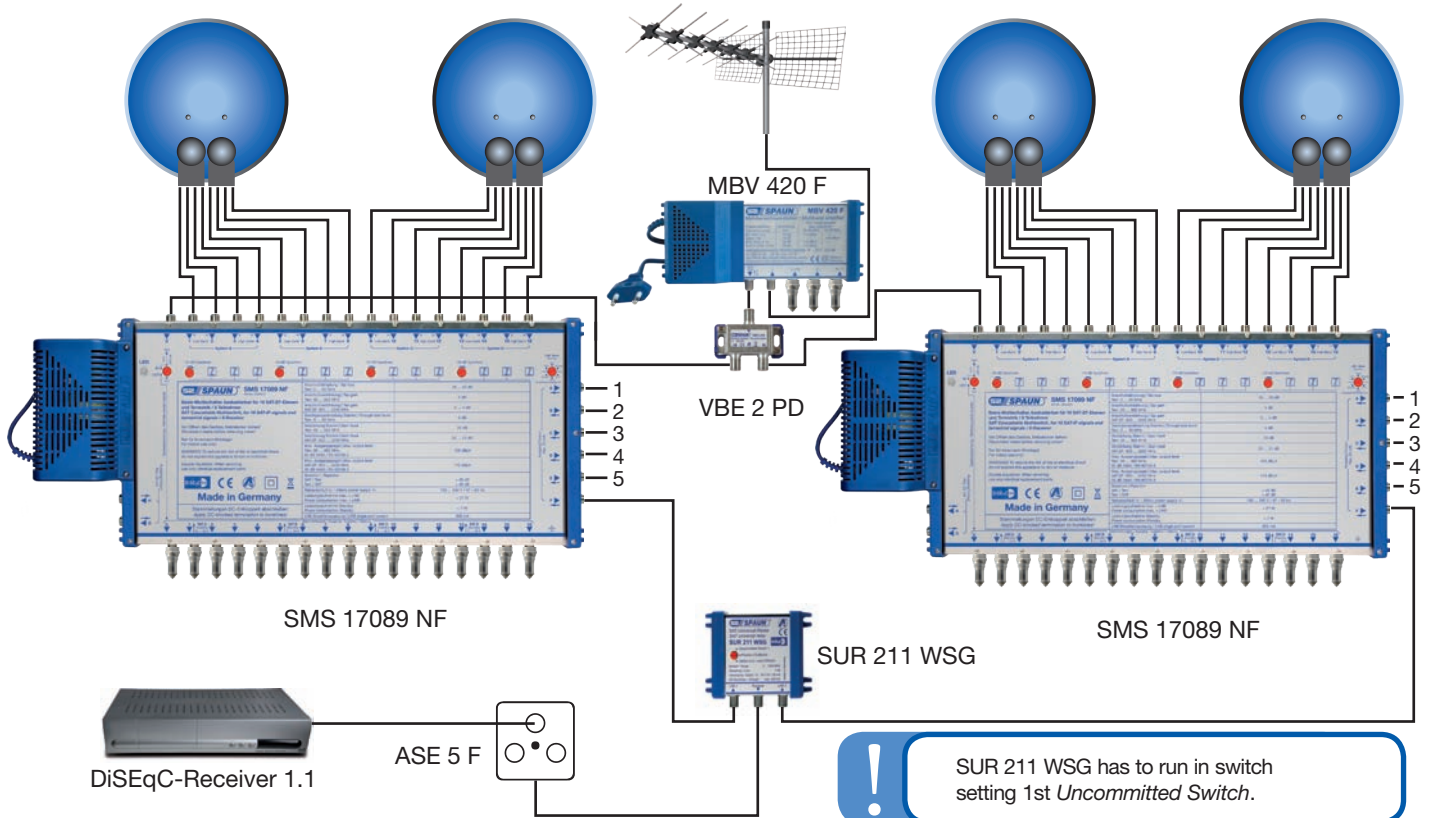

8 SAT positions (32 SAT IF signals) and terrestrial for 8 subscribers

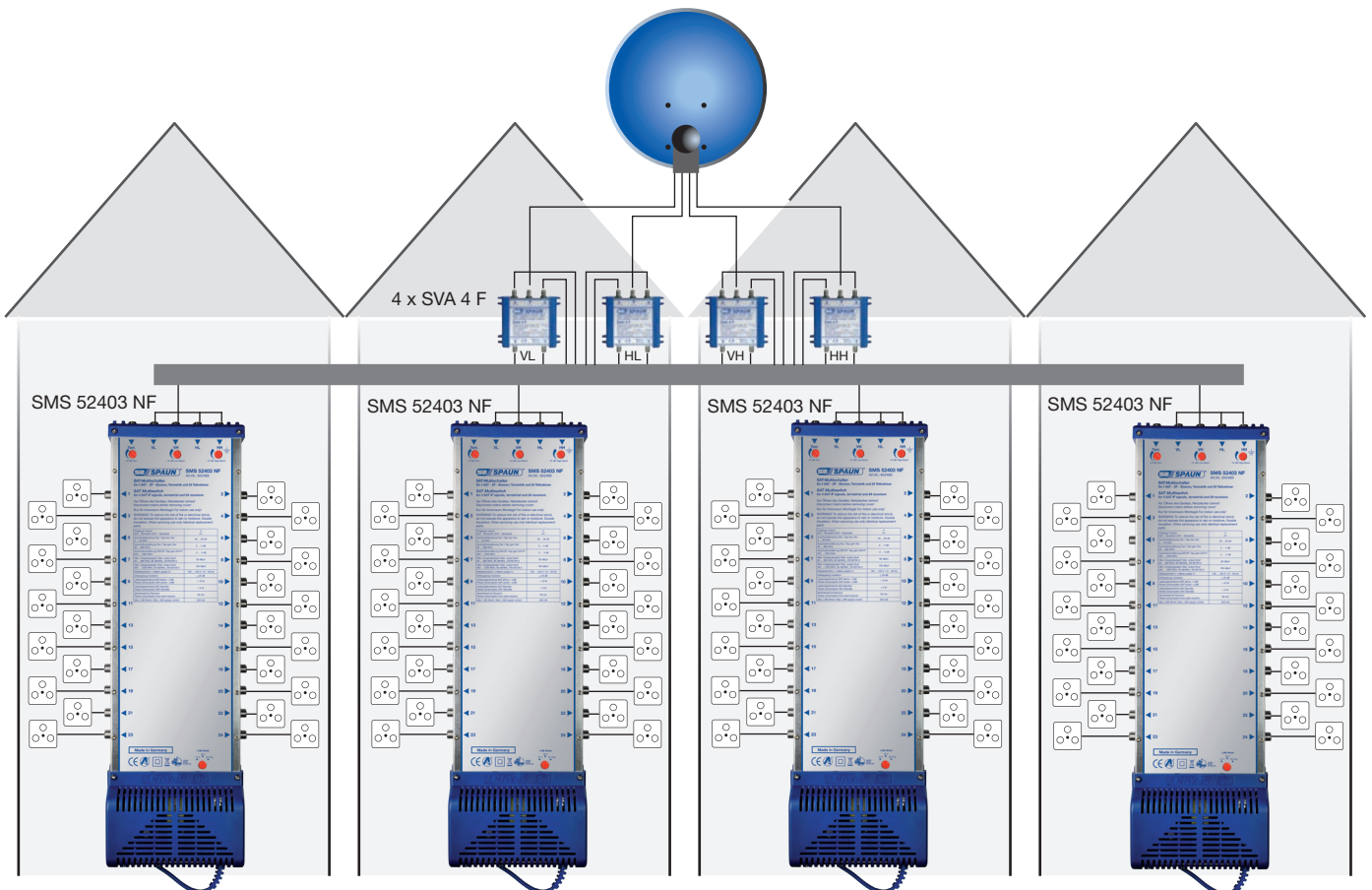

1 SAT position (4 SAT IF signals) for 4 x 24 subscribers

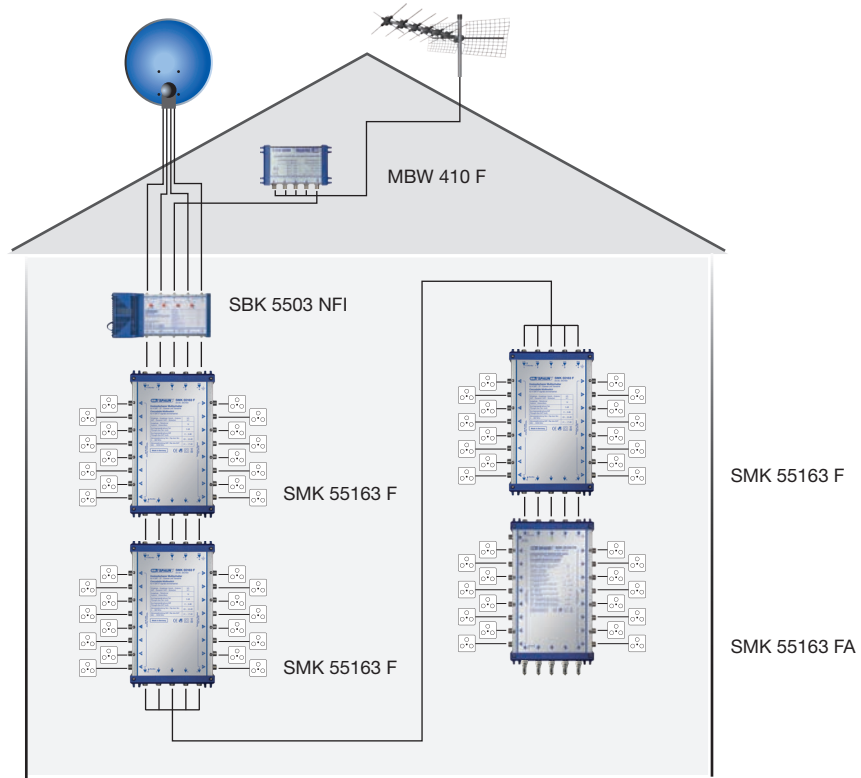

1 SAT position (4 SAT IF signals) and terrestrial for 64 subscribers, decentral distribution

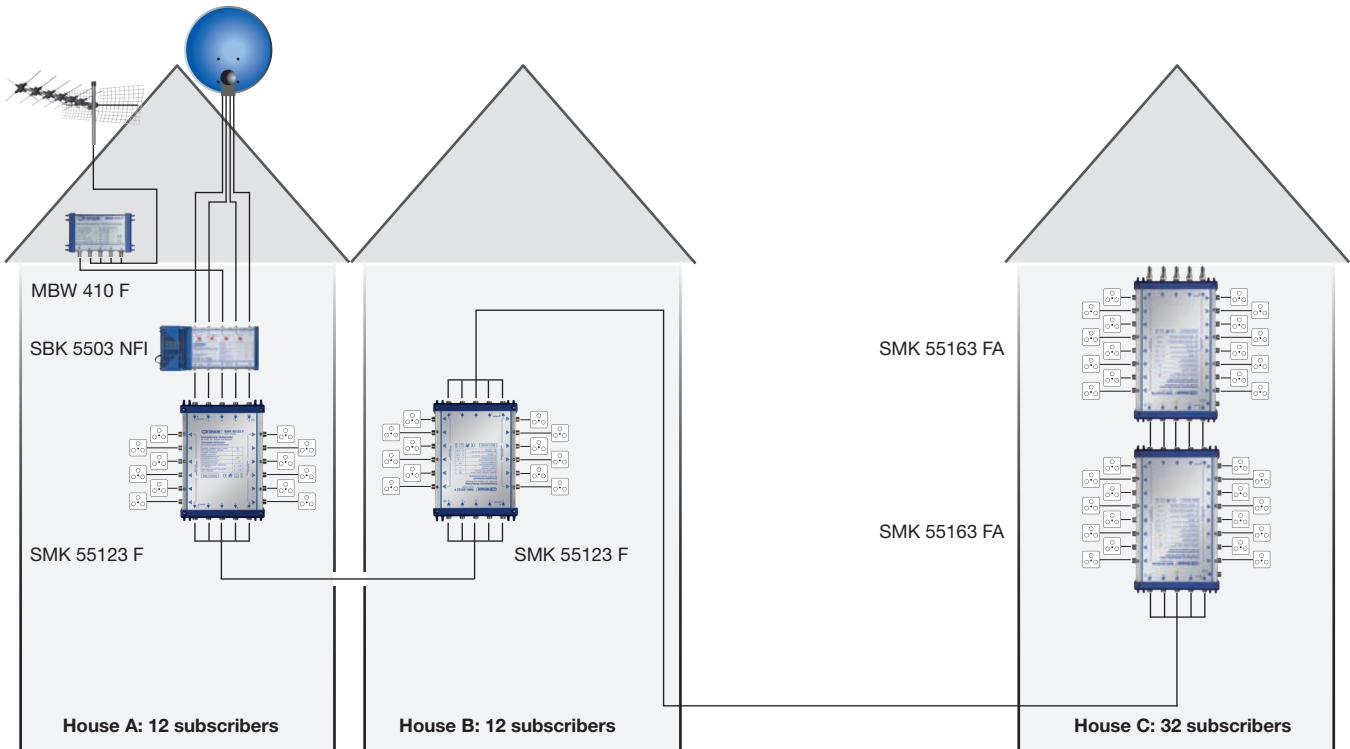

1 SAT position (4 SAT IF signals) and terrestrial for 56 subscribers, decentral distribution (3 houses)

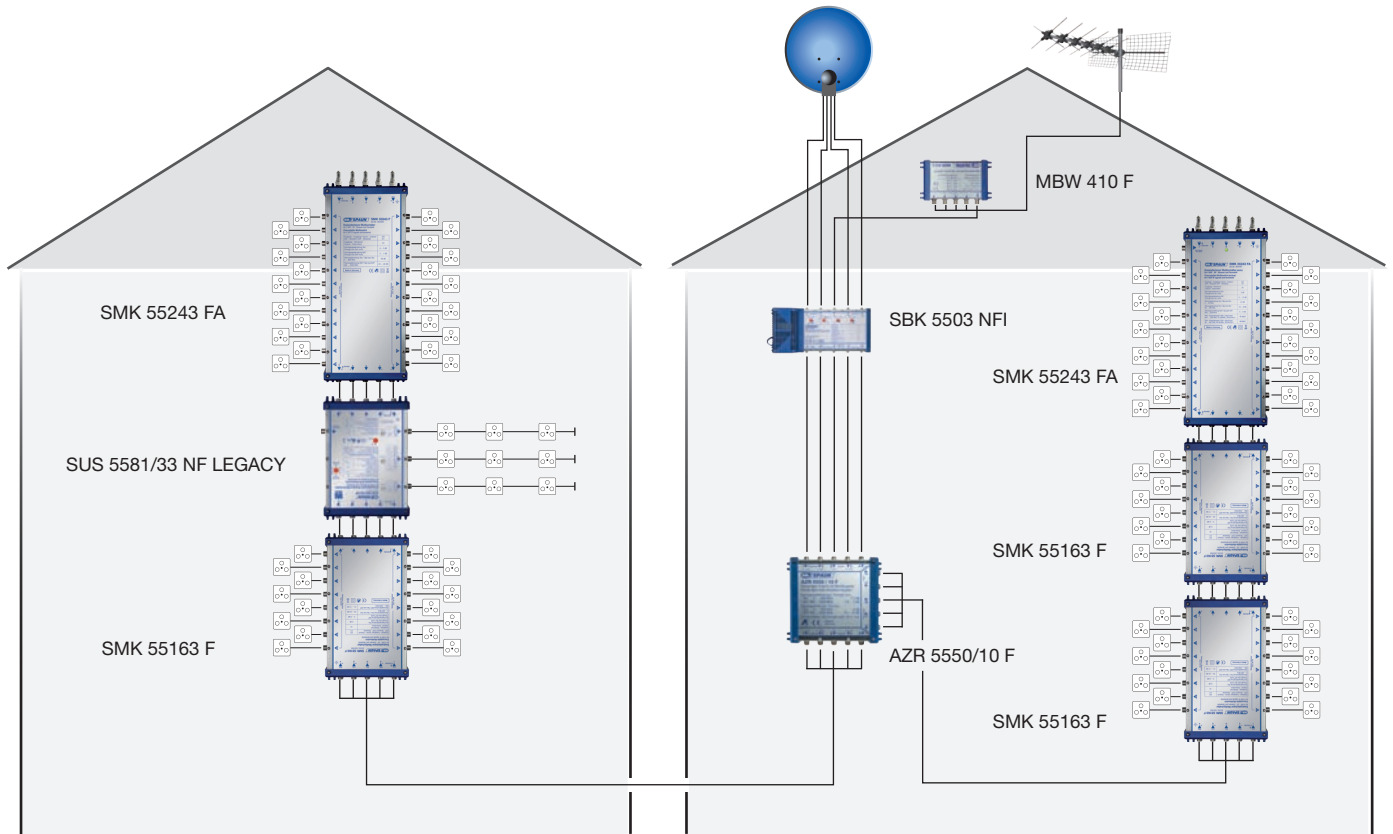

1 SAT position (4 SAT IF signals) and terrestrial for 105 subscribers, decentral distribution (2 houses) with SCR system integration

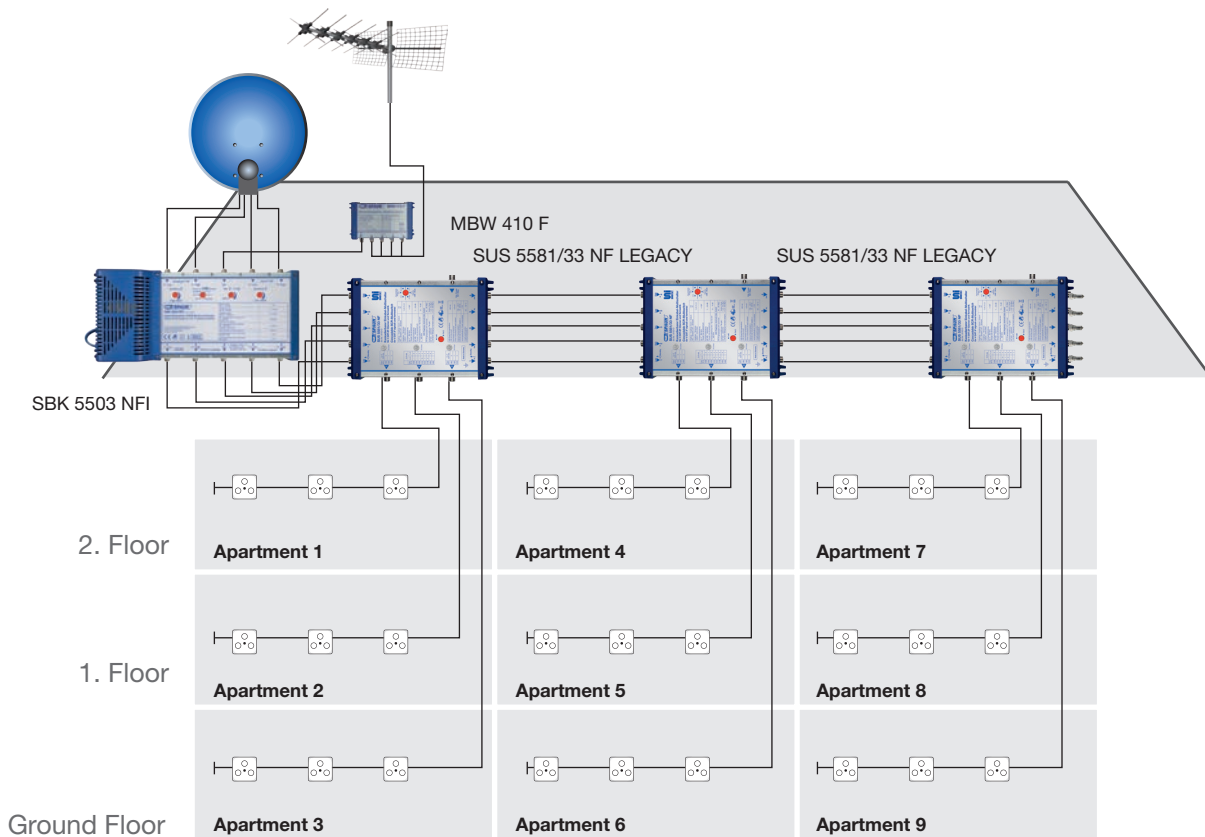

house = star distribution apartments = tree structure

SCR system with 1 SAT position (4 SAT IF signals) and terrestrial for 27 subscribers, decentral distribution (9 apartments)

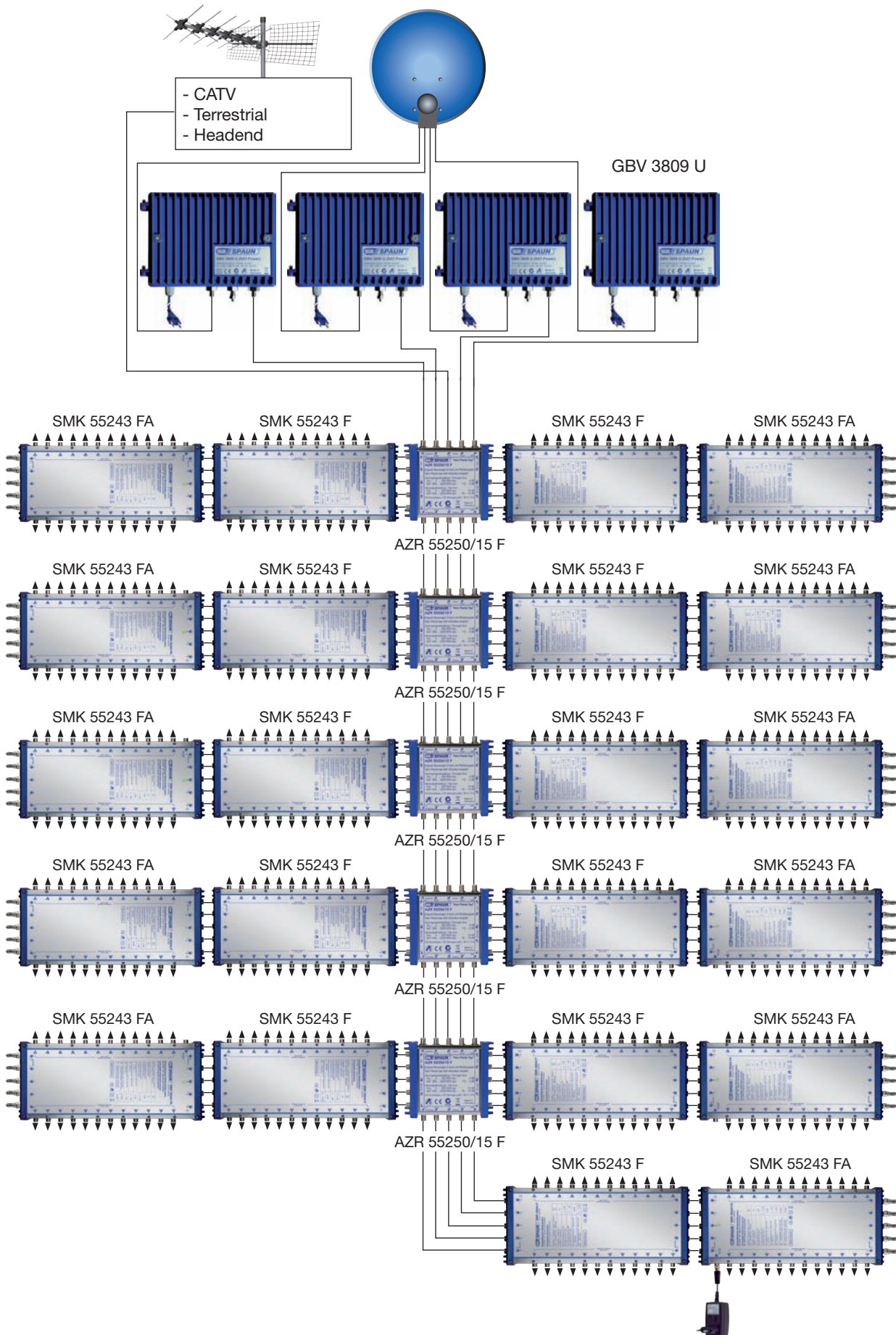

1 SAT position (4 SAT IF signals) and terrestrial for 528 subscribers, decentral distribution

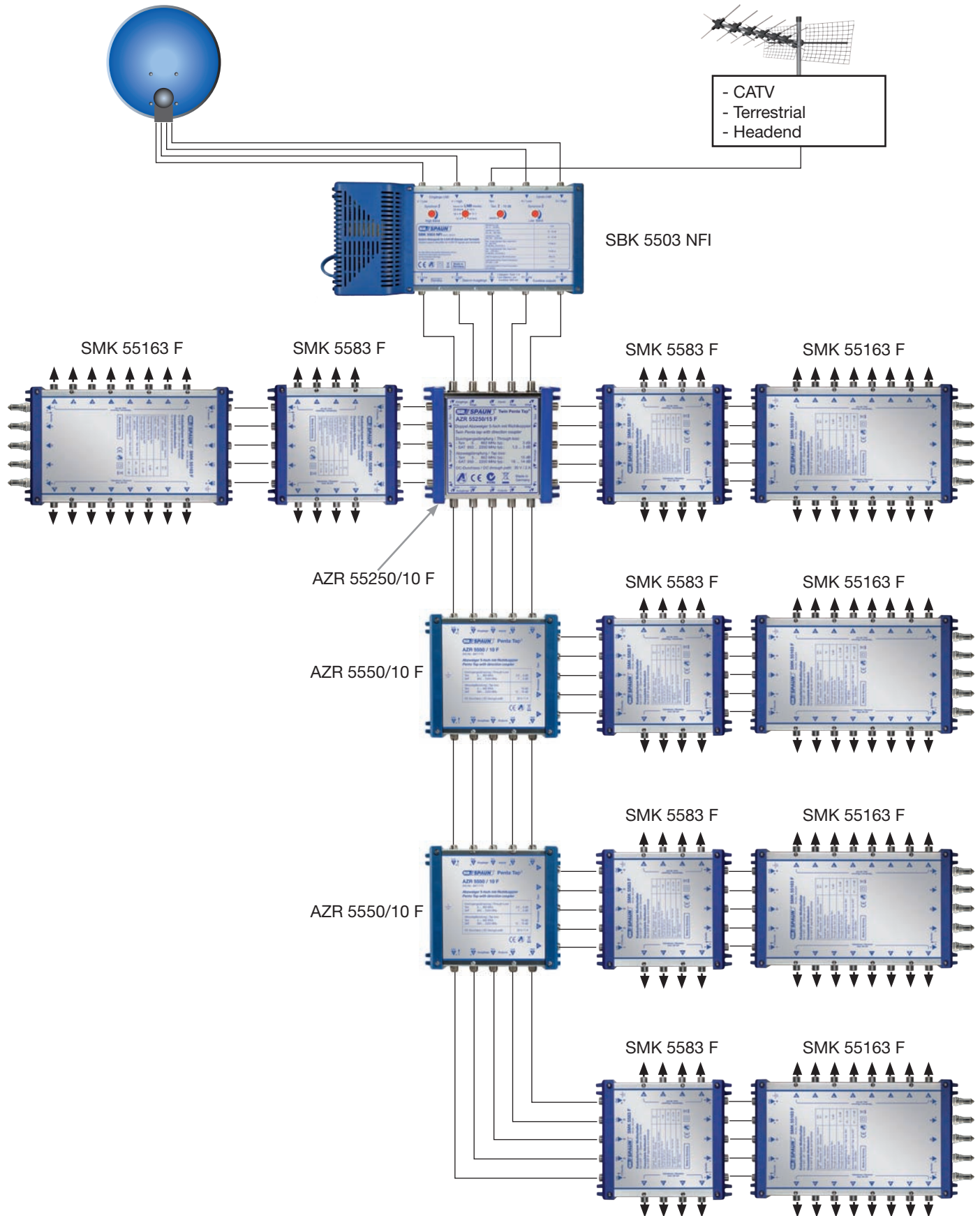

1 SAT position (4 SAT IF signals) and terrestrial for 120 subscribers, decentral distribution



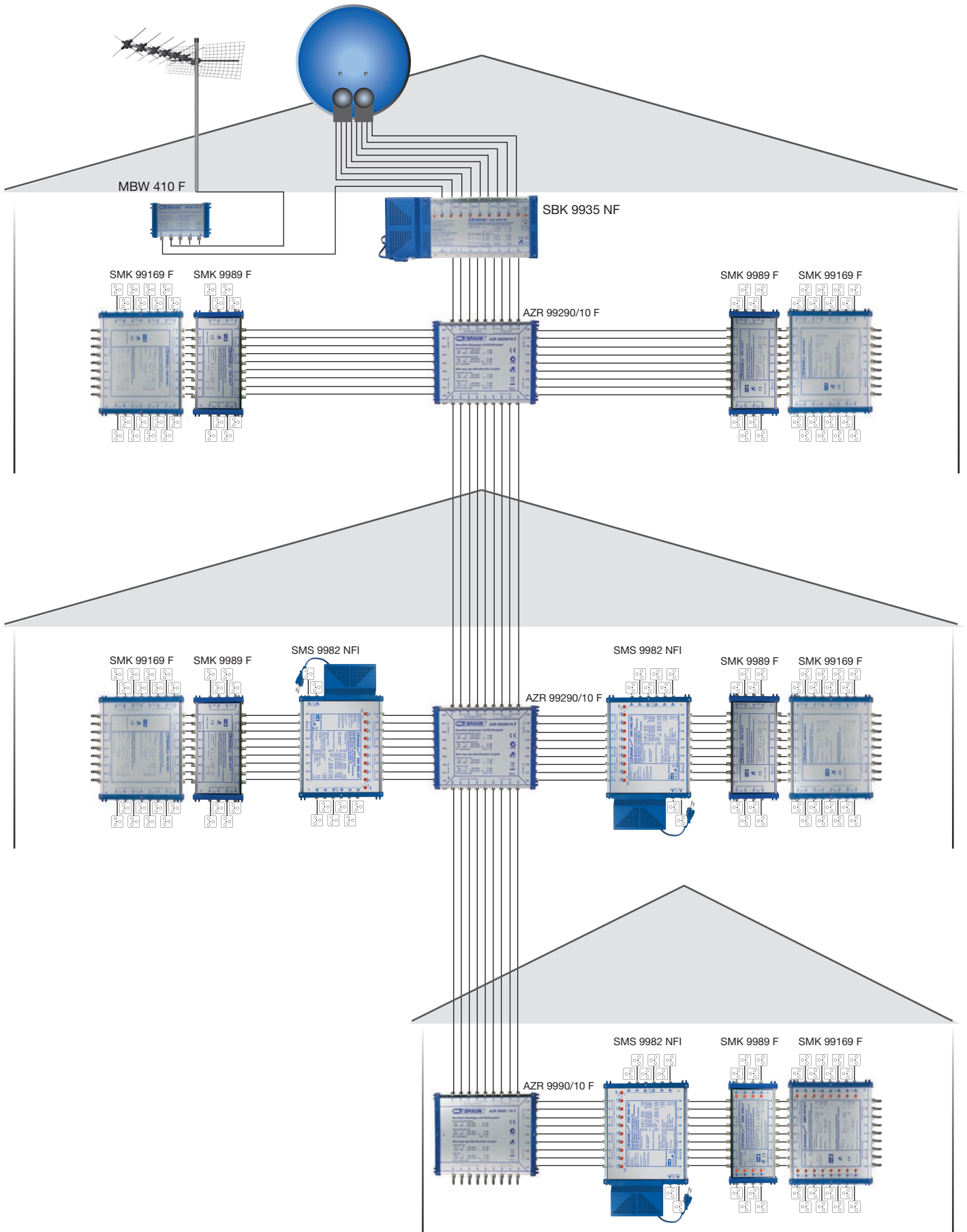

SAT IF

2 SAT positions (8 SAT IF signals) and terrestrial for 144 subscribers, decentral distribution (3 houses)

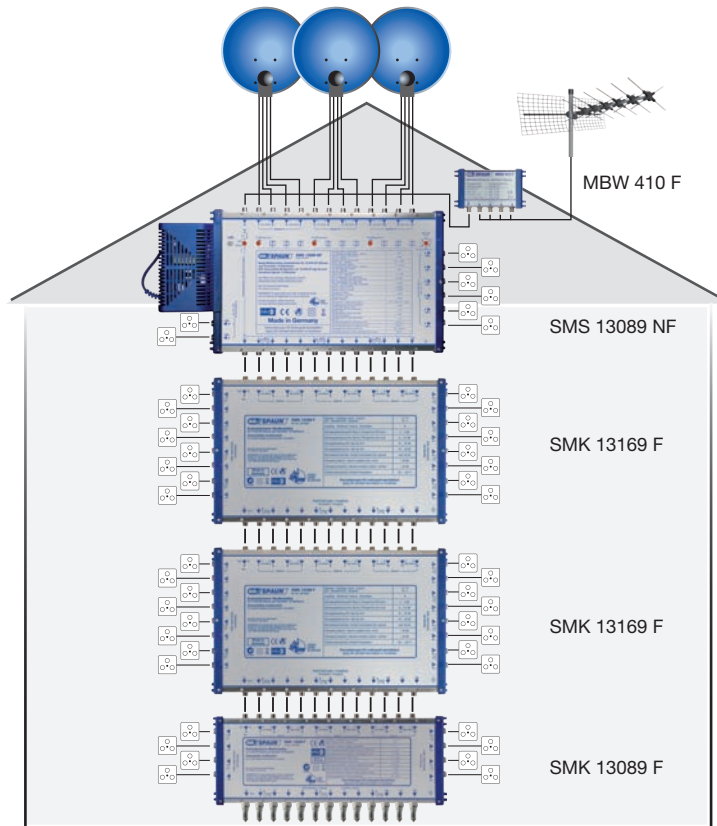

3 SAT positions (12 SAT IF signals) and terrestrial for 48 subscribers

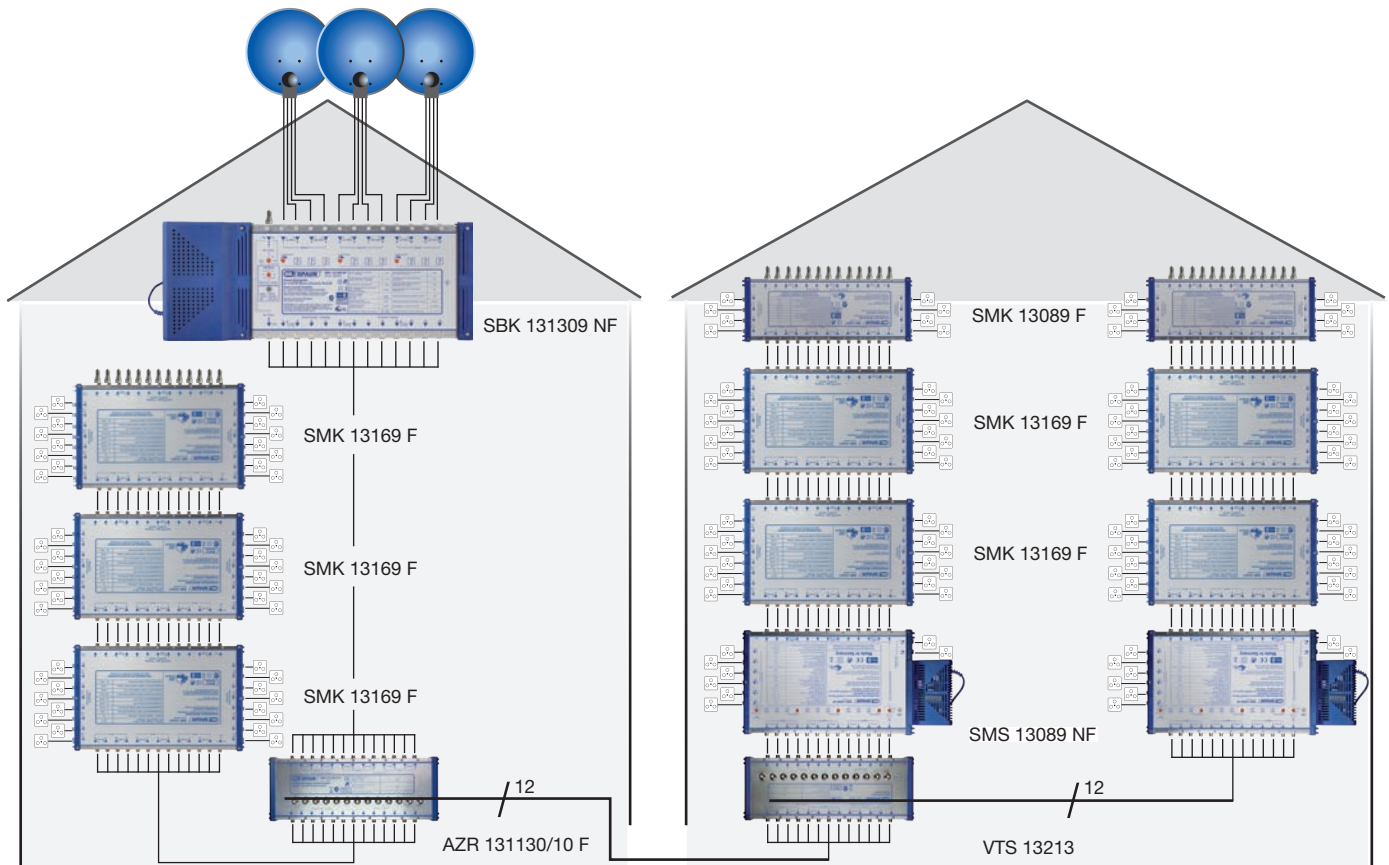

3 SAT positions (12 SAT IF signals) for 144 subscribers, decentral distribution (2 houses)

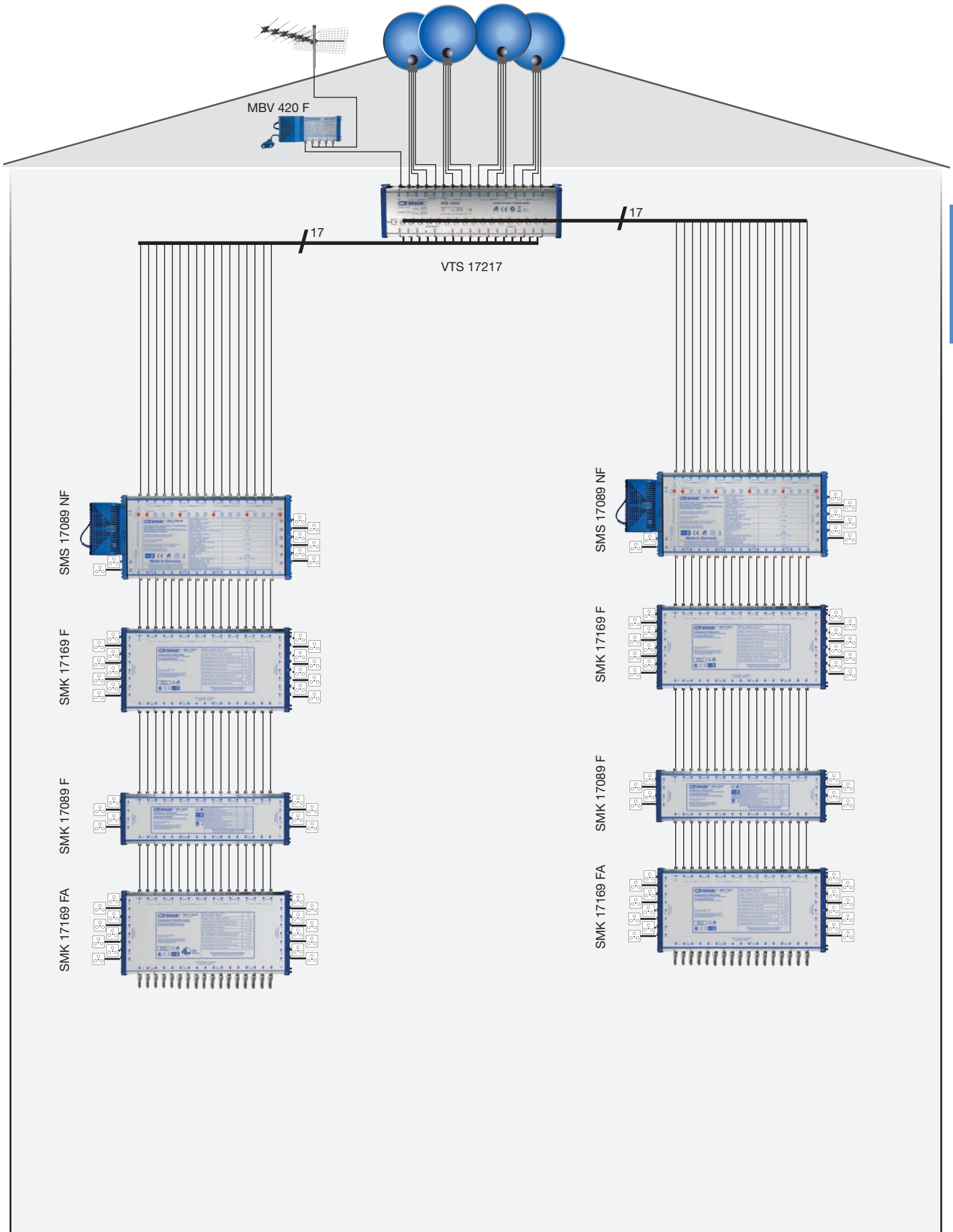

SAT IF

4 SAT positions (16 SAT IF signals) and terrestrial for 96 subscribers

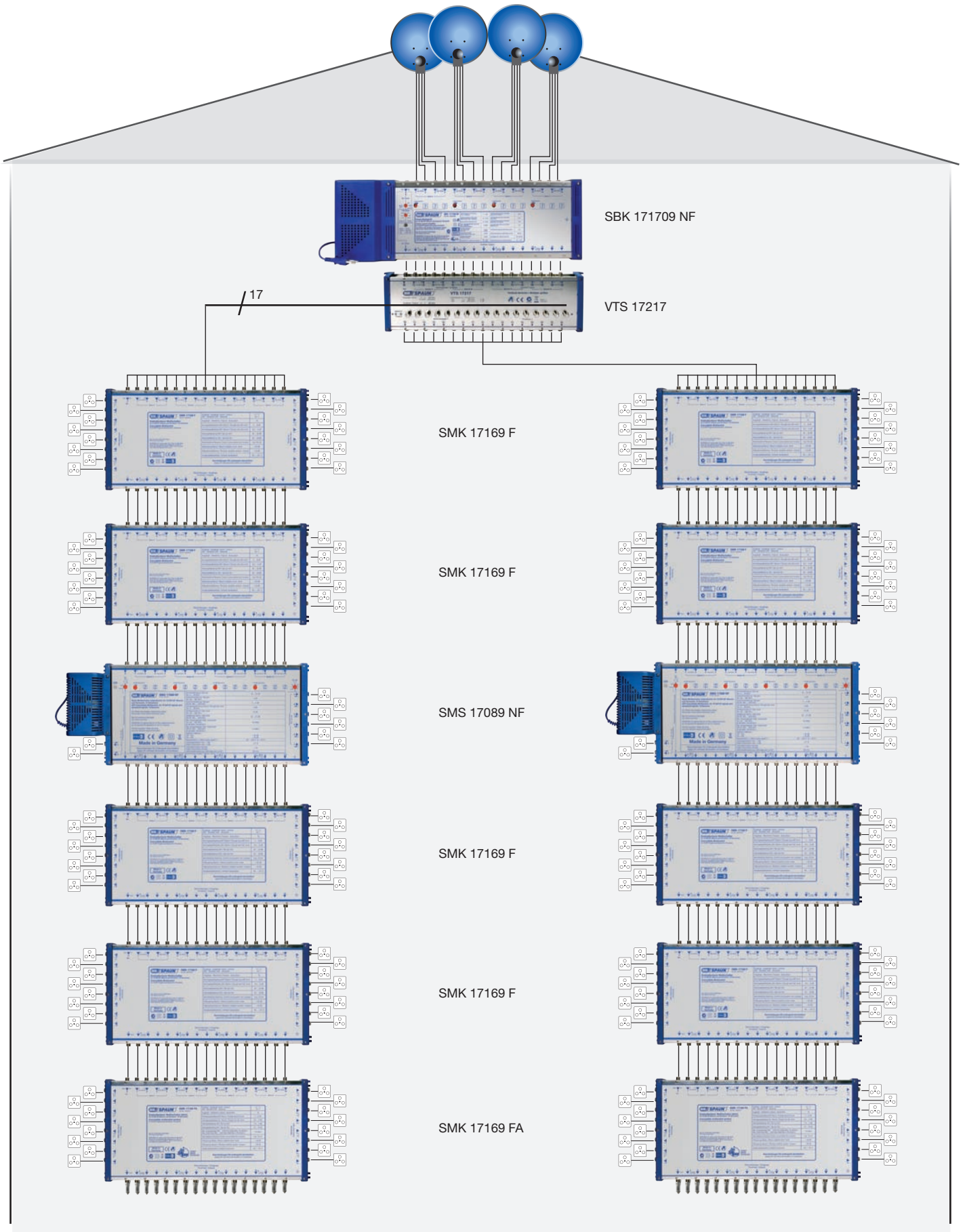

4 SAT positions (16 SAT IF signals) for 176 subscribers, with active cascades

Input level 78 dB $\mu$ V

SBK 4416 NF

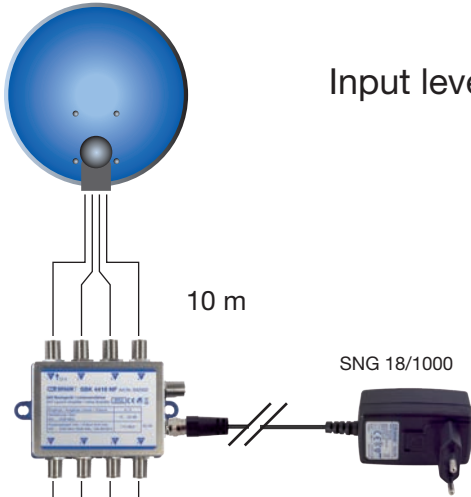

10 m

SNG 18/1000

**50 m**

SMS 4487 F



Subscriber distance  
40 - 80 m

5 m

SMS 4487 F



Subscriber distance  
30 - 60 m

5 m

SMS 4487 F



Subscriber distance  
10 - 50 m

= ASE 5 F

Only in combination with SPOAX cable

SMS 4487 F

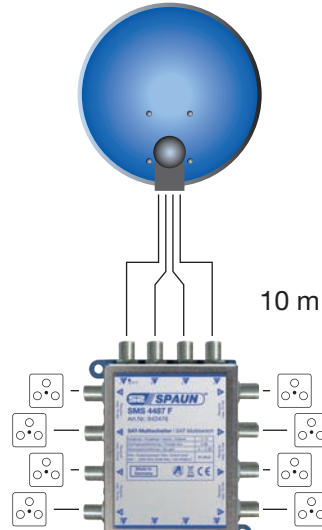

10 m

Subscriber distance  
20 - 60 m

SMS 4487 F



1 m

Subscriber distance  
10 - 50 m

SMS 4487 F



1 m

Subscriber distance  
5 - 40 m

= ASE 5 F

Only in combination with SPOAX cable  
**No mains power necessary**

Input level 78 dB $\mu$ V

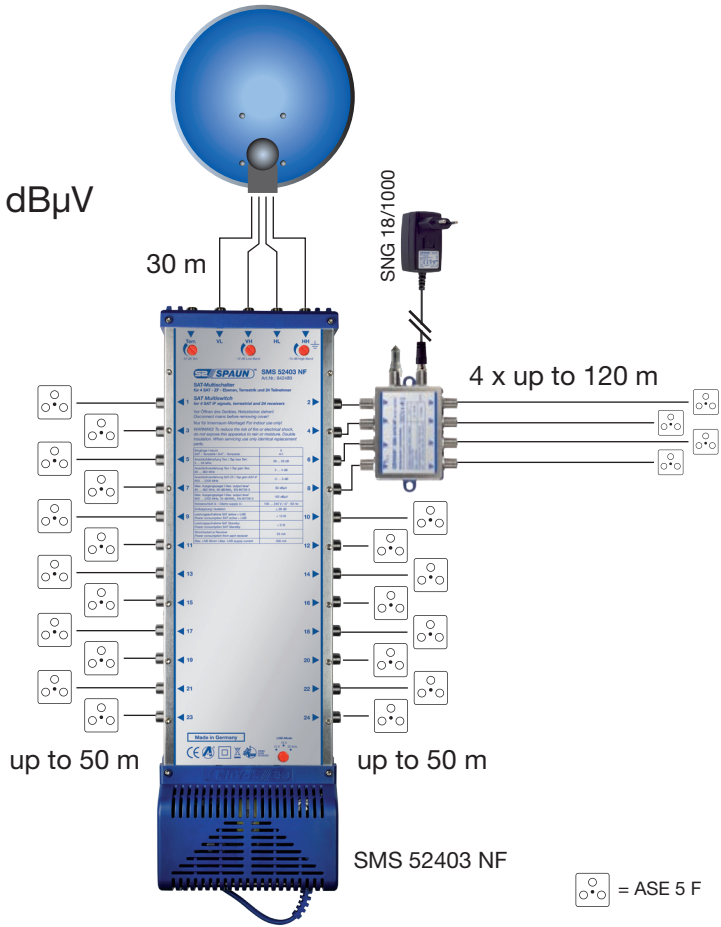

Only in combination with SPOAX cable

Input level 78 dB $\mu$ V  
No mains power necessary

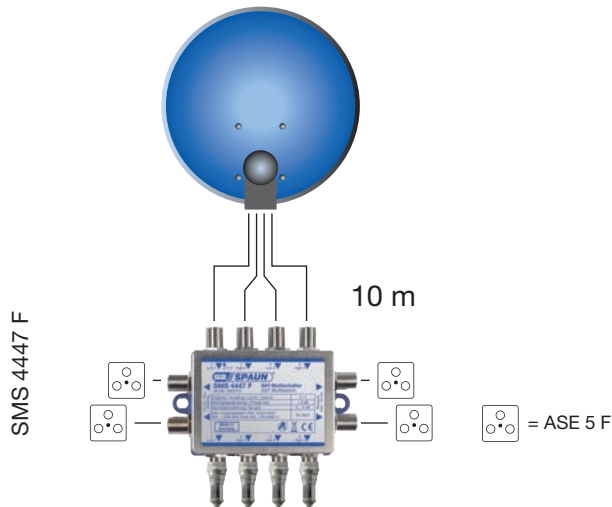

Subscriber distances of 20 - 70 m  
Only in combination with SPOAX cable

# uni SYSTEM

**Features:**

- Extendable for further subscribers and SAT signals
- No mains power supply required
- Compact dimensions
- Terrestrial path included

**Available relay types:**

- SMR 210 F  
for 2 SAT Positions
- SMR 410 F  
for 3-4 SAT Positions
- SMR 9210 F  
for 4 SAT Positions

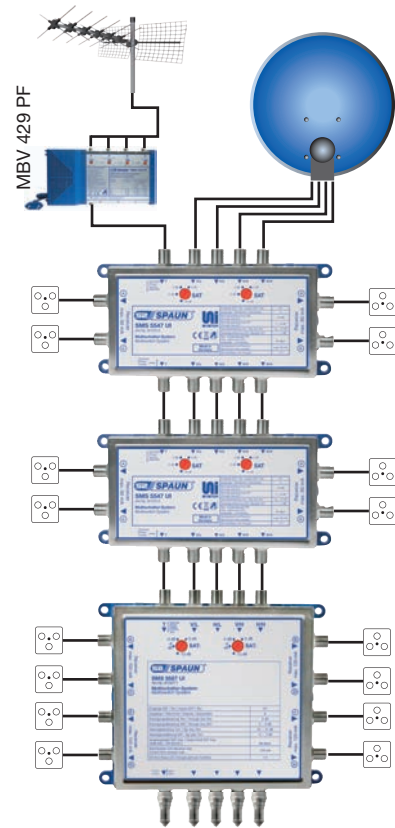

SAT IF

4 SAT IF signals with passive terrestrial for 16 subscribers

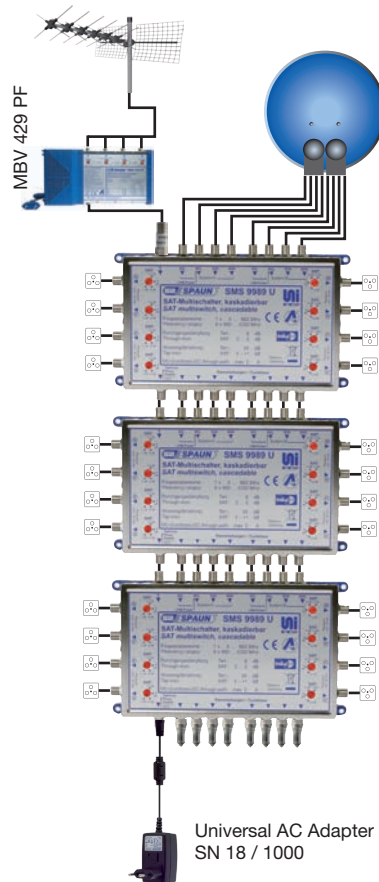

8 SAT IF signals with passive terrestrial for 24 subscribers

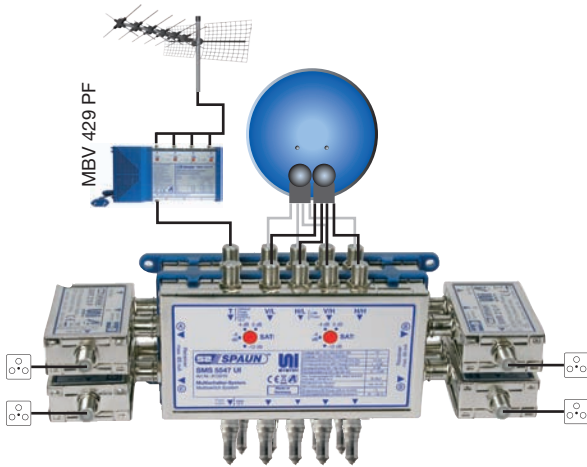

8 SAT IF signals with passive terrestrial for 4 subscribers

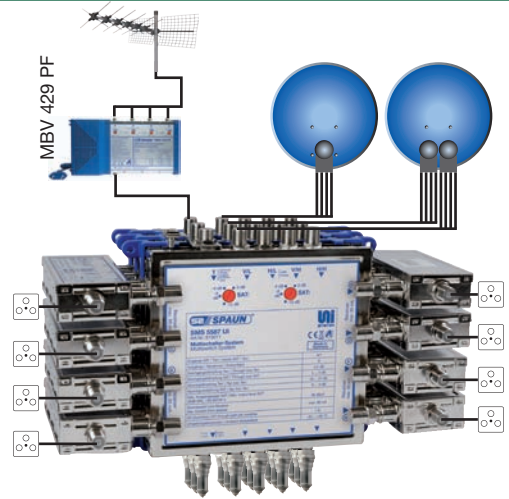

12 SAT IF signals with passive terrestrial for 8 subscribers

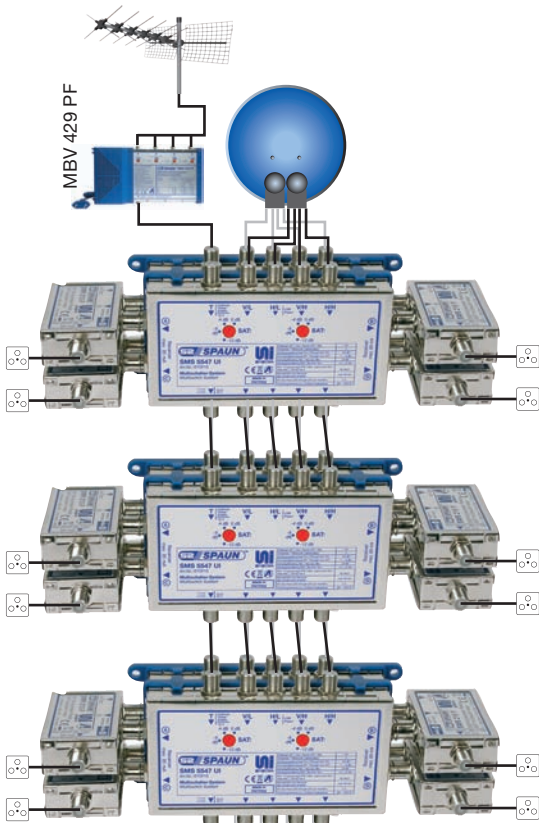

Extension



8 SAT IF signals with passive terrestrial for 12 to 20 subscribers

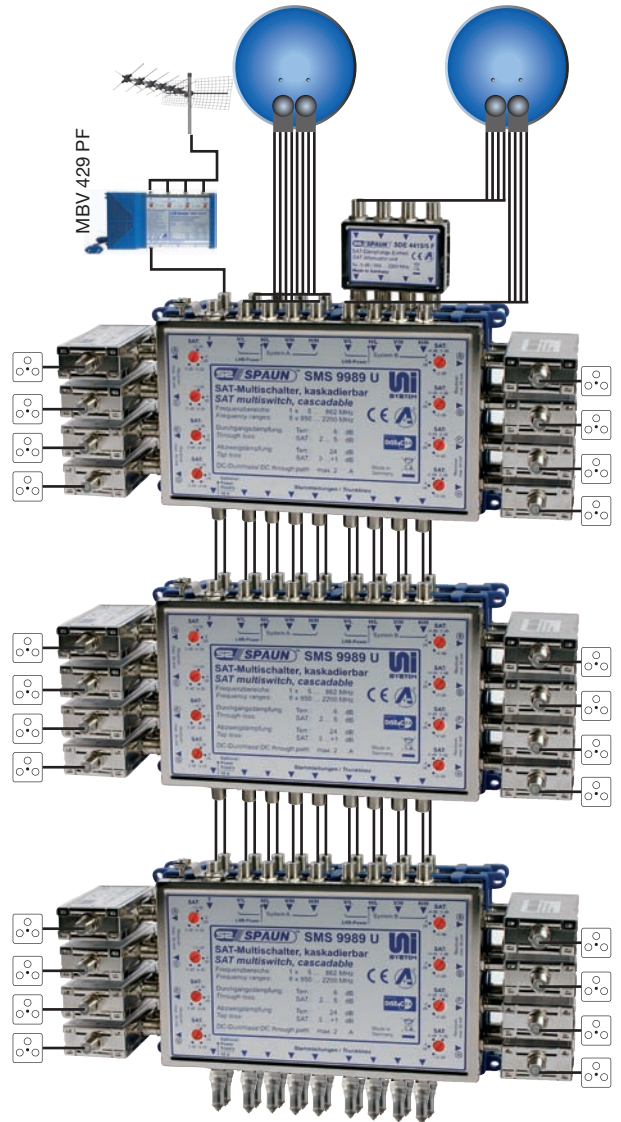

16 SAT IF signals with passive terrestrial for 24 subscribers



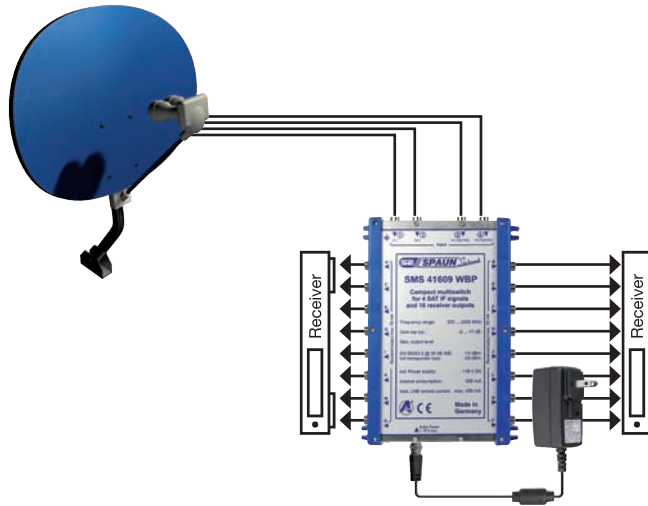

SAT IF

4 SAT IF signals for 16 subscribers

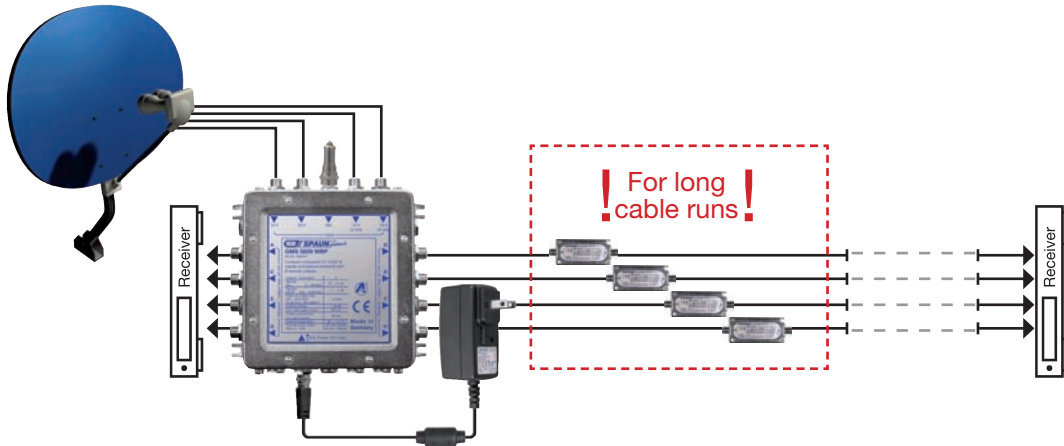

4 SAT IF signals for 8 subscribers with long cable runs

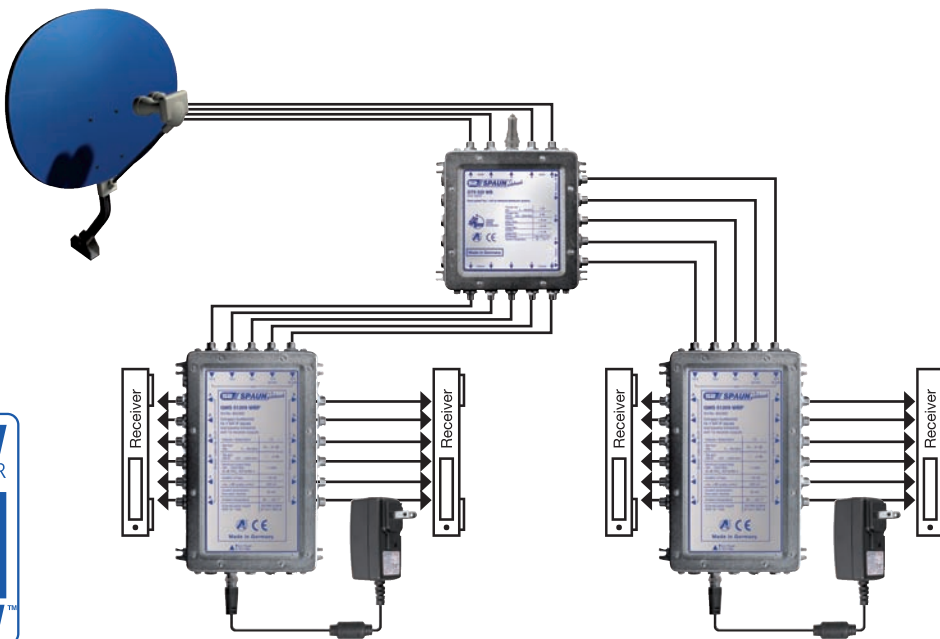

4 SAT IF signals for 24 subscribers

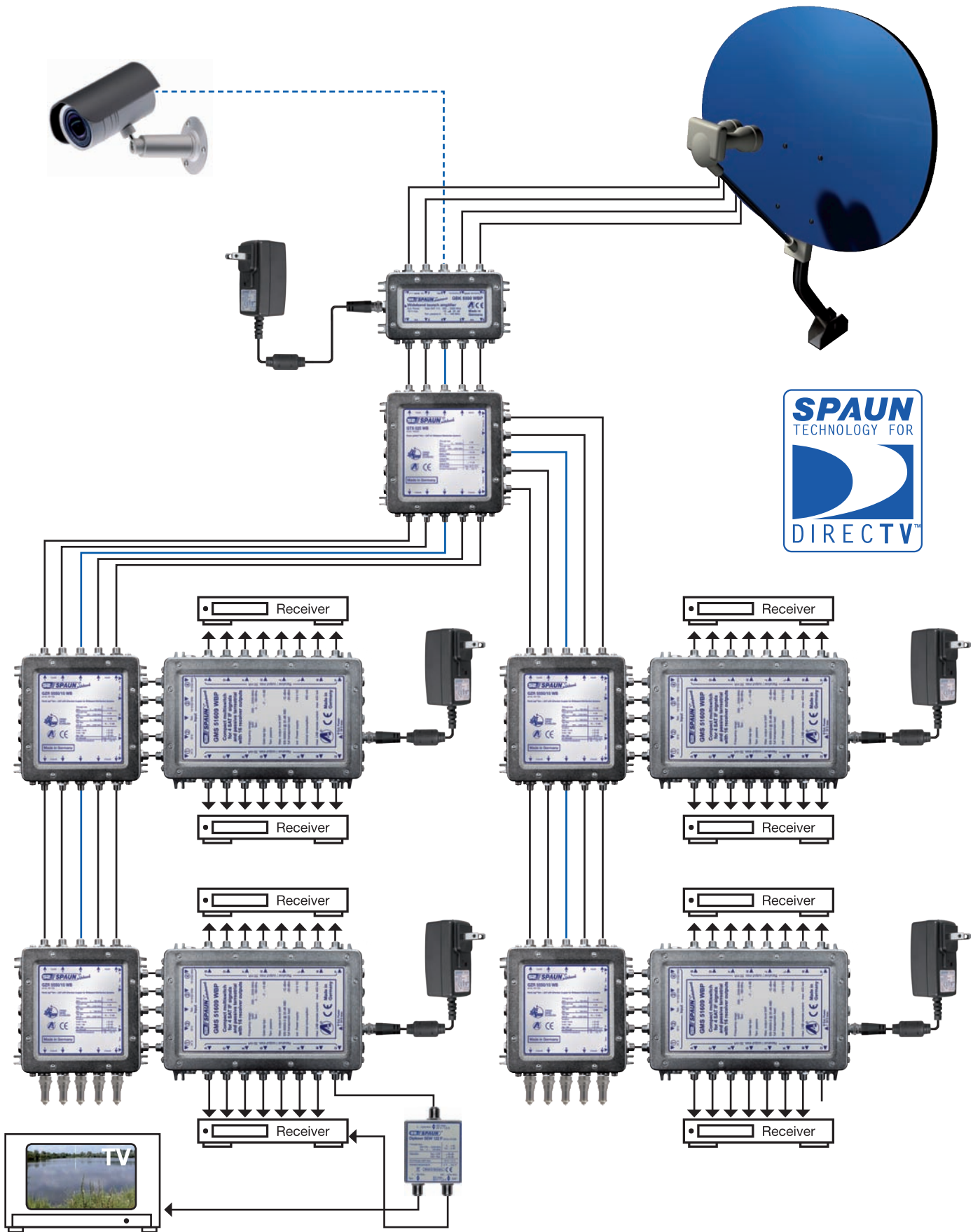

4 SAT IF signals for 64 subscribers (AV signal in addition)

# Headends



## TABLE OF CONTENTS

<b>BluBox DVB-S(2) into QAM Compact Headends</b> .....	from page 116
<b>BluBox DVB-S into PAL Headend</b> .....	from page 120
<b>Audio/Video Modulator System</b> .....	from page 122

## Compact Headend 8 / 16 x DVB-S(2) into QAM

BluBox 8 / 16



- 8 / 16 x DVB-S(2) (QPSK/8PSK) into DVB-C (QAM)
- For the reception of up to 60 / 120 TV programs SD/HD and up to 30 / 60 Radio programs
- Compact dimensions and high energy efficiency
- LNB control with 14/18 V + 22 kHz or DiSEqC
- Configuration via LAN/IP
- Complete processing of the transport streams possible
- All 8 / 16 output channels can be placed individually in the spectrum
- Two individual input ports
- Redundant power supply
- **BluBox 8 is upgradeable to 16 transponders (using BluCard 8 x DVB-S(2) -> QAM)**



Headends

Model Art. No.		BluBox 8 821626	BluBox 16 821629	
EAN		4040326216262	4040326216293	
Transponders		8 (+8 optional)	16	
SAT IF Input	Frequency range	950 ... 2150 MHz		
	AFC range	1 MHz		
	AGC level range	64 ... 94 dB $\mu$ V		
	Through loss	$\leq$ 2,5 dB		
	LNB supply voltage	14 / 18 V (400 mA), DiSEqC 1.0		
Demodulator / Decoder	DVB-S	Modulation	QPSK (EN 300 421)	
		Symbol rate	1 ... 45 MSps	
		Code rate (Viterbi)	1/2, 2/3, 3/4, 5/6, 7/8	
	Signal processing	ETS 300 421 (DVB-S)		
	DVB-S(2)	Modulation	QPSK, 8PSK (EN 302 307)	
		Symbol rate	2 ... 47 MSps (QPSK); 2 ... 31,5 MSps (8PSK)	
		Code rate (LDPC)	QPSK = 1/4, 1/3, 2/5, 1/2, 3/5, 2/3, 3/4, 4/5, 5/6, 8/9, 9/10 8 PSK = 3/5, 2/3, 3/4, 5/6, 8/9, 9/10	
Signal processing		ETS 302 307 (DVB-S2)		
QAM-Output	Symbol rate	1,0 ... 7,2 MSps		
	QAM Constellation	16, 32, 64, 128, 256 QAM (EN 300 429)		
	Output level max.	85 dB $\mu$ V		
	Sum level setting	1 dB ( $\pm$ 3dB)		
	Individual level setting	0,5 dB ( $\pm$ 3dB)		
	Channel allocation	adjacent channel compatible (IEDGE)		
	Connectors	F-Jack, 75 $\Omega$ (IEC 60169-2)		
	Through Loss	1 dB		
Output frequency range	47 ... 862 MHz			
Switch-mode power supply (redundant)	Mains power supply V~	100 ... 240 V / 47 ... 63 Hz		
	Power consumption max.	85 W + LNB		
	DC output voltage	12 V		
	Current drain max.	8 A		
	Ambient temperature	-10 ... +55°C		
Dimensions (mm)		330 x 286 x 246		

# Professional Headend 32 x DVB-S(2) into QAM

BluBox 32



- 32 x DVB-S(2) (QPSK/8PSK) into DVB-C (QAM)
- For the reception of up to 240 TV programs SD/HD and up to 120 Radio programs
- Compact dimensions and high energy efficiency
- LNB control with 14/18 V + 22 kHz or DiSEqC
- Configuration via LAN/IP
- Complete processing of the transport streams possible
- All 32 output channels can be placed individually in the spectrum
- Two individual input ports
- Redundant power supply
- 19" or wall mounting

Model Art. No.		BluBox 32 821631	
EAN		4040326216316	
Transponders		16	
SAT IF Input	Frequency range	950 ... 2150 MHz	
	AFC range	1 MHz	
	AGC level range	64 ... 94 dB $\mu$ V	
	Through loss	$\leq$ 2,5 dB	
	LNB supply voltage	14 / 18 V (400 mA), DiSEqC 1.0	
Demodulator / Decoder	DVB-S	Modulation	QPSK (EN 300 421)
		Symbol rate	1 ... 45 MSps
		Code rate (Viterbi)	1/2, 2/3, 3/4, 5/6, 7/8
		Signal processing	ETS 300 421 (DVB-S)
	DVB-S(2)	Modulation	QPSK, 8PSK (EN 302 307)
		Symbol rate	2 ... 47 MSps (QPSK); 2 ... 31,5 MSps (8PSK)
		Code rate (LDPC)	QPSK = 1/4, 1/3, 2/5, 1/2, 3/5, 2/3, 3/4, 4/5, 5/6, 8/9, 9/10 8 PSK = 3/5, 2/3, 3/4, 5/6, 8/9, 9/10
Signal processing	ETS 302 307 (DVB-S2)		
QAM-Output	Symbol rate	1,0 ... 7,2 MSps	
	QAM Constellation	16, 32, 64, 128, 256 QAM (EN 300 429)	
	Output level max.	85 dB $\mu$ V	
	Sum level setting	1 dB ( $\pm$ 3dB)	
	Individual level setting	0,5 dB ( $\pm$ 3dB)	
	Channel allocation	adjacent channel compatible (IEDGE)	
	Connectors	F-Jack, 75 $\Omega$ (IEC 60169-2)	
	Through Loss	1 dB	
Output frequency range	47 ... 862 MHz		
Switch-mode power supply (redundant)	Mains power supply V~	100 ... 240 V / 47 ... 63 Hz	
	Power consumption max.	138 W + LNB	
	DC output voltage	12 V	
	Current drain max.	16 A	
	Ambient temperature	-10 ... +55°C	
Dimensions (mm)		486 x 361 x 265	

## BluBox Upgrade Card 8 x DVB-S(2) into QAM

BluCard 8 x DVB-S(2) -> QAM



Model Art. No	BluCard 8 x DVB-S(2) -> QAM 821627
EAN	4040326216279
Transponders	8 (Please refer to datasheet of BluBox 8 / 16)



Headends

### Screenshots of the BluCard Web-Interface

#### Satellite selection Basic mode

**IN**

LNB control:

SAT selection:

---

**IN/OUT**

Mode:

LNB control:

SAT selection:

No.	Name	DownlinkInput	Programs	
1	DVB-S	11719	IN	11719H SID 0x64,
2	SKY	11758	IN	.. 60er/70er,
3	betarese	11797	IN	x, 11797H SID 0xdab,
4	ARD	11836	IN	Bayerisches FS Nord,
5	DVB-S	11875	IN	11875H SID 0xfbd,
6	SKY	11914	IN	Discovery HD,
7	ZDFvisior	11953	IN	3sat, DKULTUR, DLF,
8	SKY	11992	IN	Disney Cinemagic HD,
9	SKY	12031	IN	Big Brother, Blue
10	DVB-S	12070	IN	12070H SID 0x888,
11	ARD	12109	IN	ARD-Data-1,
12	x	12148	IN	.. .. 12148H SID
13	RTL	12187	IN	RTL Television, Super
14	Globecas	12226	IN	EuroNews, Eurosport
15	ARD	12265	IN	1LIVE, 1LIVE diggi,
16	SKY	12304	IN	.. .. HUMAX
17	CANALDI	12343	IN	538 Juize, Animal
18	SKY	12382	IN	.. BM Nights HD 1, BM
19	ARD	12421	IN	Einsfestival HD,
20	BetaDigit	12460	IN	.. 1-2-3.tv, 12460H
21	Canal dig	12515	IN	BNR Nieuwsradio, BVN,
22	ProSiebe	12544	IN	9Live, kabel eins,
23	SES	12603	IN	ASTRA SDT,
24	MEDIA	12633	IN	123Damenwahl,
25	ORS	12662	IN	Arion OTA1, AUSTRIA
26	ORF	12692	IN	AlphaCrypt, ATV,
27	TV	12721	IN	2BE, Acht, Dorcel TV.,
28	TDA	12539	IN	A3, ADMINISTRA.IT, Al
29	FT	12577	IN	Boing, Boomerang,
30	DVB-S	12616	IN	12616H SID 0x2c80,
31	ARABSAT	12654	IN	ADDOUNIA TV,
32	DVB-S	12731	IN	12731H SID 0x2b5f,
33	ARD	10744	IN/OUT	arte, EinsExtra,
34	BetaDigit	10773	IN/OUT	ANIXE HD, VOD 24,
35	BetaDigit	10832	IN/OUT	.. .. 10832H SID
36	TVP	10861	IN/OUT	TV Polonia, TVP HD,
37	SES	11023	IN/OUT	AB Channel, Radio
38	OrangeS	11170	IN/OUT	Boing, KidsCo,
39	ORF	11302	IN/OUT	ORF1 HD, ORF2 HD,
40	ZDFvisior	11361	IN/OUT	arte HD, Das Erste HD,
41	ProSiebe	11464	IN/OUT	kabel eins HD,

- Channel 1
- Channel 2
- Channel 3
- Channel 4
- Channel 5
- Channel 6
- Channel 7
- Channel 8
- Input
- System
- Power
- Connection

118

www.spaun.com

## Screenshots of the BluCard Web-Interface

**SAT Selection**

Astra 19,2 Degree East

**LNB with multi-switch**

Count of input lines: 2 (IN and IN/OUT)

OK

**Quattro LNB**

Input (IN): High / Horizontal

Input (IN/OUT): Low / Horizontal

OK

- Channel 1
- Channel 2
- Channel 3
- Channel 4
- Channel 5
- Channel 6
- Channel 7
- Channel 8
- Input
- System
- Power
- Connection

No.	Tp name	Downlink	Input	Program	SID	Mode
1	DVB-S	11719	IN	> SES ASTRA	S 38 (442000 kHz)	123
2	SKY	11758	IN	> CANALDIGITAL	S 39 (450000 kHz)	12148H SID 0xf8a3978
3	betarese	11797	IN	> Canal digitaal	S 40 (458000 kHz)	12148H SID 0xf913985
4	ARD	11836	IN	> SKY	S 41 (466000 kHz)	12148H SID 0xf953989
5	DVB-S	11875	IN	> BetaDigital	21 (474000 kHz)	12148H SID 0xf963990
6	SKY	11914	IN	> Globecast	22 (482000 kHz)	12148H SID 0xf973991
7	ZDFvisior	11953	IN	> x	23 (490000 kHz)	12148H SID 0xf983992
8	SKY	11992	IN	> SKY	24 (498000 kHz)	12148H SID 0xfa14001
9	SKY	12031	IN			12148H SID 0xfa34003
10	DVB-S	12070	IN			12148H SID 0xfab4011
11	ARD	12109	IN			12148H SID 0xfb74023
12	x	12148	IN			12148H SID 0xfb94025
13	RTL	12187	IN			Alpenländer TVX70
14	Globecast	12226	IN			ANTENNE BAYERN 170
15	ARD	12265	IN			ERF Radio 161
16	SKY	12304	IN			GOD Channel 774
17	CANALDI	12343	IN			HOPE Channel 71
18	SKY	12382	IN			ROCK ANTENNE 160
19	ARD	12421	IN			sunshine live 169
20	BetaDigit	12460	IN			BData4 3975
21	Canal dig	12515	IN			Beauty TV 54
22	ProSiebe	12544	IN			Channel21 769
23	SES	12603	IN			JML Shop 514
24	MEDIA	12633	IN			MediaShop- Meine 775
25	ORS	12662	IN			RNF 768
26	ORF	12692	IN			Sky Sport Austria 53
27	TV	12721	IN			YAVIDO 765
28	TDA	12539	IN			
29	FT	12577	IN			
30	DVB-S	12616	IN			
31	ARABSAT	12654	IN			
32	DVB-S	12731	IN			
33	ARD	10744	IN/OUT			
34	BetaDigit	10773	IN/OUT			
35	BetaDigit	10832	IN/OUT			
36	TVP	10861	IN/OUT			
37	SES	11023	IN/OUT			
38	OrangeS	11170	IN/OUT			
39	ORF	11302	IN/OUT			
40	ZDFvisior	11361	IN/OUT			
41	ProSiebe	11464	IN/OUT			

Load new program list

- Channel 1
- Channel 2
- Channel 3
- Channel 4
- Channel 5
- Channel 6
- Channel 7
- Channel 8
- Input
- System
- Power
- Connection

## Headend 16 x DVB-S into PAL

BluBox 16 PAL



Cost-effective and compact headend system for the conversion of DVB-S into PAL for small hotels and residential homes, equipped with 8 TWIN cards for the conversion to 16 analogue programs, configuration via LAN/IP

- 16 x DVB-S into PAL
- Input collector with 4 ports
- 19" mounting or wall mounting
- High energy efficiency
- LNB control with 0/14 V
- Configuration via LAN/IP
- Redundant power supply

Model Art. No	BluBox 16 PAL 821631
EAN	4040326216316
Inputs	4
Input frequency range	950 ... 2150 MHz
SAT input level	40 ... 74 dBμV
Output frequency range	47 ... 862 MHz
SAT output level	typ. 90 dBμV
TV standard	B/G, L, I, DK
LNB remote power	0 / 14 V
Power consumption	55 W
Ambient temperature	-10 ... +50°C
Dimensions (in mm)	486 x 361 x 265



## Application diagram BluBox 8 / 16

### Headend & optical distribution for large networks

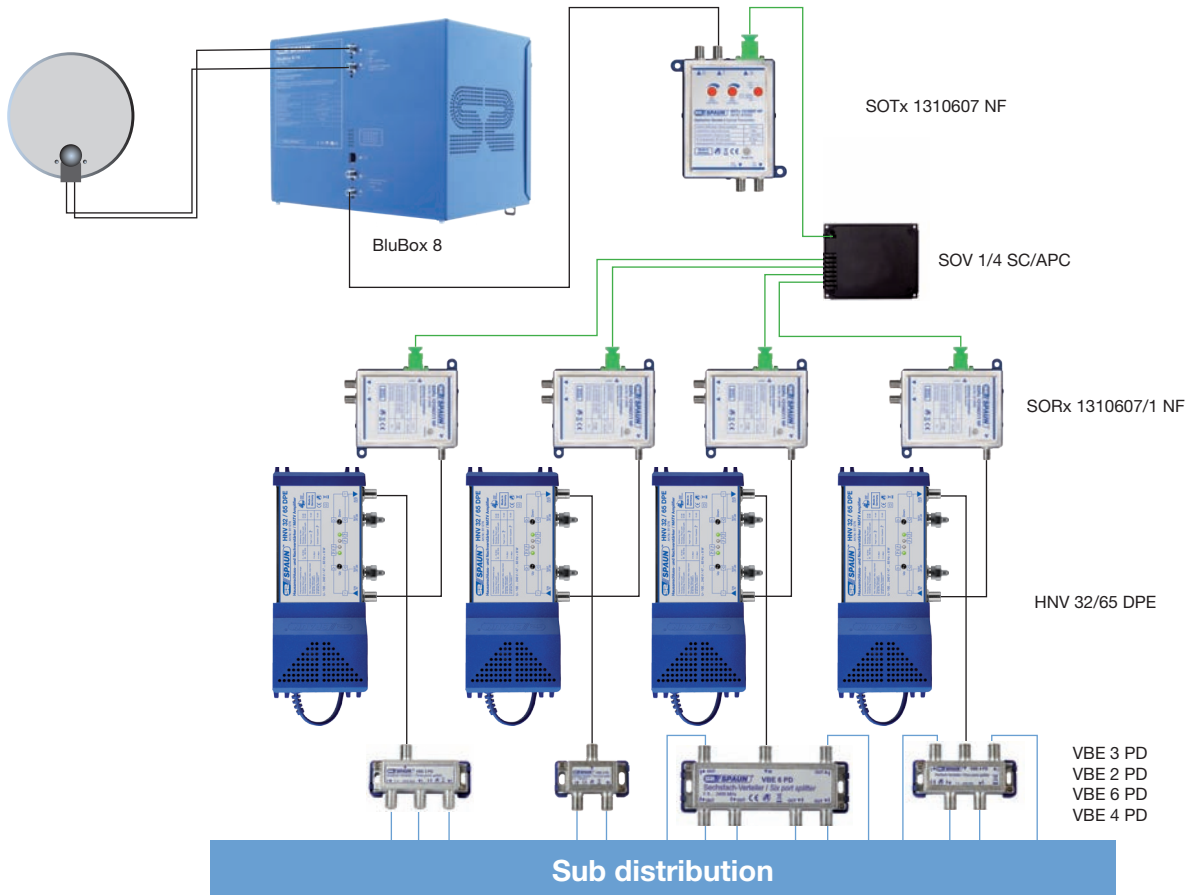

Headends

### Cascading of the BluBox for the reception of up to 240 TV programmes and up to 120 Radio programmes

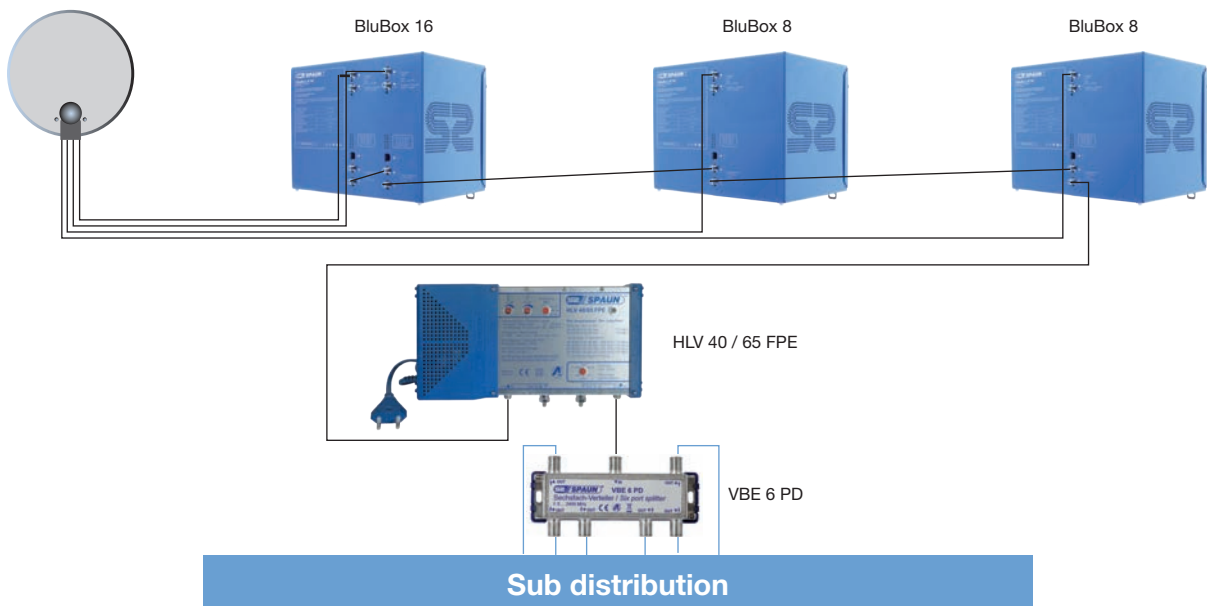

## Audio/Video Modulator System

SpaceBox VAM 5, SpaceBox VAM 10



- Compact headend system for 19" mounting
- For use between video camera and the TV
- Wide range of applications in the private or commercial sector
- The modulator output is adjacent channel compatible
- It is either a wall or DIN rail mounting possible
- Internal test pattern generator can be activated by function key
- Possibility to connect an additional terrestrial signal

### Video feed of:

- Event programs in hotels or guesthouses
- Digital TV programs via DVB receiver
- Information channels in large CATV systems

Stand-alone modulator  
VAM 420 NG PAL, s. page 137

Also available as AV Converter  
into DVB-T, s. page 138

Model Art. No.		SpaceBox VAM 5 865001	SpaceBox VAM 10 865002
EAN		4040326650011	4040326650028
Video-/Audio-Inputs		10 / 10	20 / 20
Frequency range		110 ... 862 MHz	110 ... 862 MHz
TV standard		B/G/D/K/I/L/Au	B/G/D/K/I/L/Au
RF output	Input impedance	75 Ω BNC female	75 Ω BNC female
	Output level	82 ... 86 dBμV + 2dB	78 ... 82 dBμV + 2dB
	Output level adjusting range	0 ... -6 dB (in 1 dB steps)	0 ... -6 dB (in 1 dB steps)
	Spurious level IMD2/IMD3	<-60 dB	<-60 dB
	C/N ratio	≥ 55 dB	≥ 55 dB
	Output impedance	75 Ω	75 Ω
	Return loss	≤ 10 dB	≤ 10 dB
	Connector type RF	F	F
	Connector type audio, video	RCA socket	RCA socket
Video	Input level	1± 0,1 Vp-p	1± 0,1 Vp-p
	Input impedance	RCA 75 Ω	RCA 75 Ω
	S/N ratio	≥ 55 dB	≥ 55 dB
Audio	Frequency range	40 Hz ... 15 kHz	40 Hz ... 15 kHz
	Input impedance	> 10 kΩ	> 10 kΩ
	Preemphasis	50 μs	50 μs
	Audio level adjusting range	+6 ... -6 dB (in 2 dB steps)	+6 ... -6 dB (in 2 dB steps)
	Audio signal / noise ratio FM (fm=1kHz:+f=50 kHz)	≥ 50 dB	≥ 50 dB
	Audio signal / noise ratio AM (fm=1kHz:m=60%)	≥ 47 dB	≥ 47 dB
Power	Supply voltage	100 ... 240 V / 47 - 63 Hz	100 ... 240 V / 47 - 63 Hz
	Current consumption	< 38 W	< 70 W
	Ambient temperature	0 ... +50 °C	0 ... +50 °C
Dimensions (mm)		483 x 276 x 266	483 x 276 x 266

# Application Example SpaceBox VAM 10

Up to 20 Audio/Video signals and terrestrial

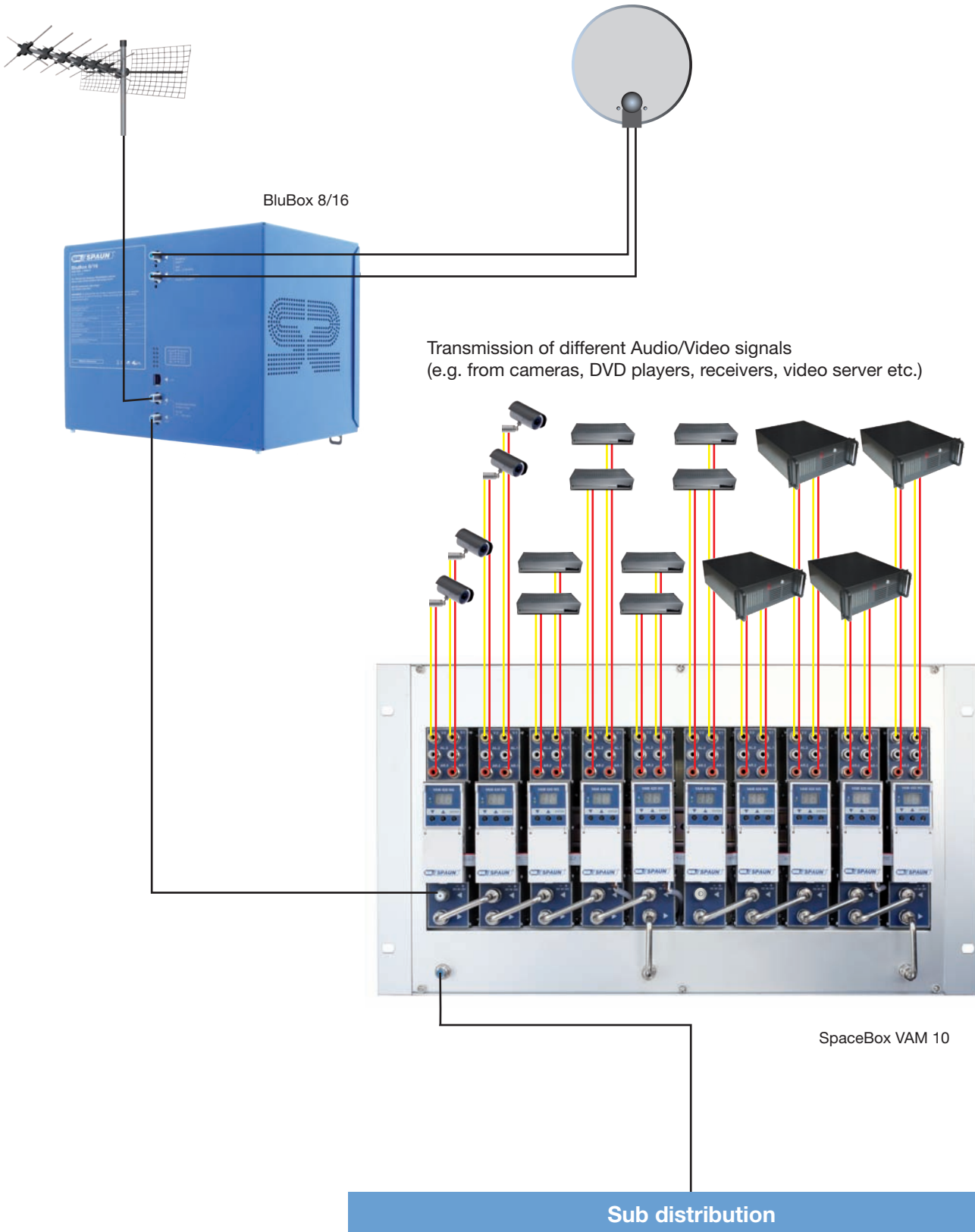

Headends

## Application diagram BluBox 8 / 16

BluBox 8 / 16

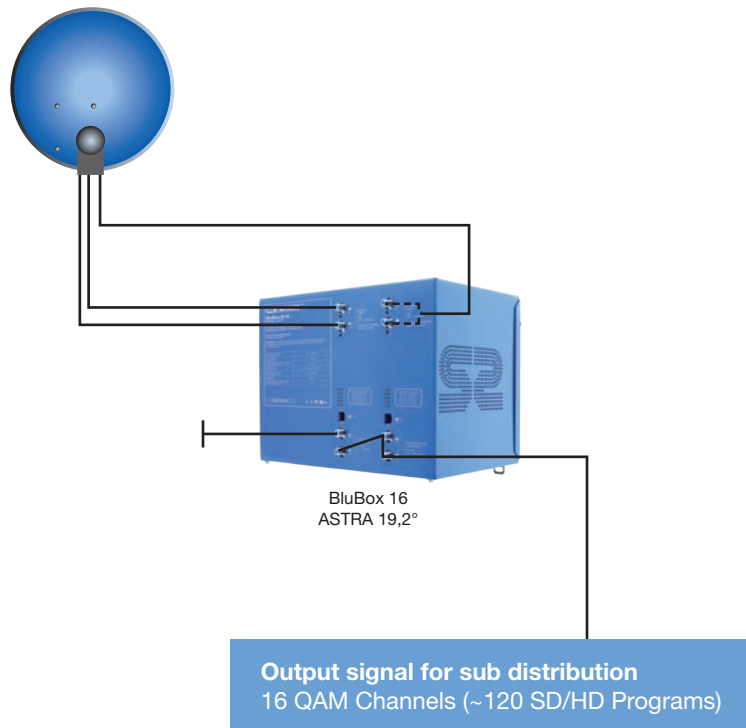
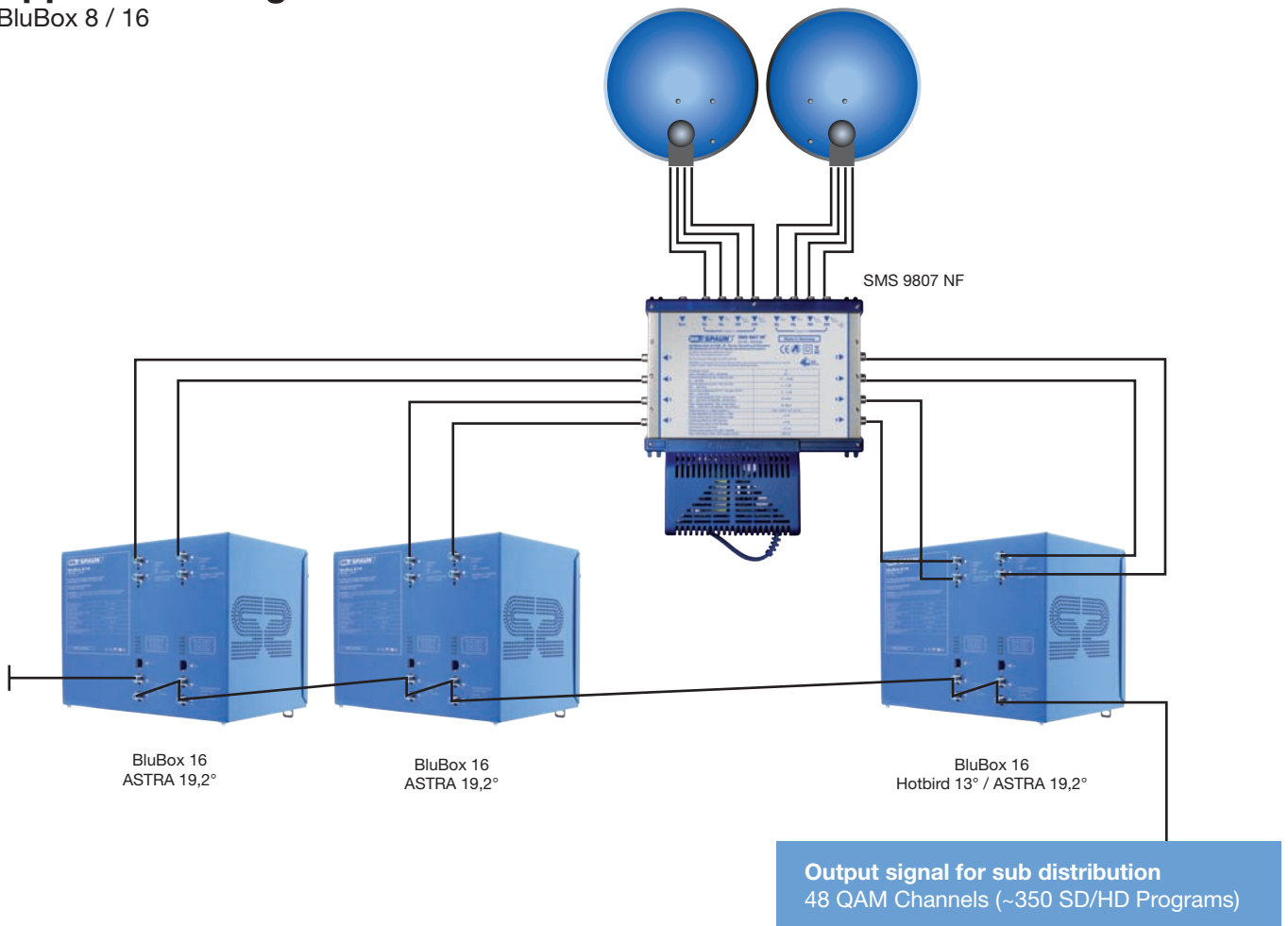

# BK / CATV

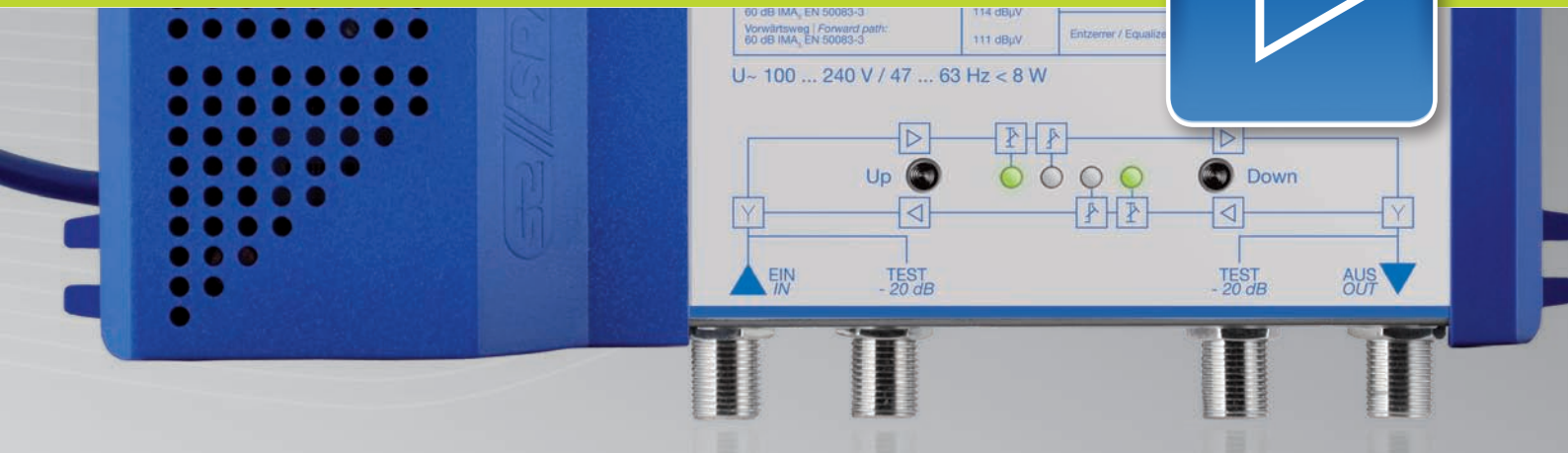

## TABLE OF CONTENTS

Home distribution amplifier.....	from page 126
----------------------------------	---------------

## Line Amplifier and Home Distribution Amplifier

HNV 32/65 DPE



Digital signal level adjuster (1 dB steps) for level and slope correction (forward and return path).

- Complete solution with an integrated forward path amplifier, return path amplifier, digital actuators
- 4 LEDs showing the digital level adjustment
- Two buttons for easy configuration with integrated key-lock option against unauthorised manipulation
- Test ports (-20 dB) at input and output
- Developed in accordance with the KDG 1-Classification TS 140: Class C

Model Art. No.	HNV 32/65 DPE 811276
EAN	4040326112762
Inputs / Outputs	1 / 1
Screening attenuation	> 85 dB
Gain (return path) 5 ... 65 MHz	25 dB
Gain (forward path) 85 ... 862 MHz	32 dB
Output level return path 5 ... 65 MHz 60 dB IMA <sub>3</sub> / EN 60728-3	max. 114 dB $\mu$ V
Output level return path 85 ... 862 MHz 60 dB IMA <sub>3</sub> / EN 60728-3	max. 111 dB $\mu$ V
Level adjusting range	0 ... -15 dB (1 dB Steps)
Slope correction range	0 ... -15 dB (1 dB Steps)
Noise figure	< 8 dB
Mains power supply V~	100 ... 240 V / 47 - 63 Hz
Power consumption	< 8 W
Ambient temperature	-20 ... +50 °C
Dimensions (mm)	194 x 86 x 52

# CATV and Line Amplifier

HLV 40/30 FPE, HLV 40/65 FPE



- Active and passive return path
- For medium sized distribution systems
- External test ports (-30 dB) at input and output
- LED indicator for power supply
- Metal / plastic housing for indoor mounting
- Protection class IP 20

0 ... -12 dB

Integrated attenuator and slope control

0 ... -16 dB

Multiple functionality

**Return path**

15 dB

10 dB ● 20 dB

5 dB ● off

passiv

Return path selectable:  
off - passive - active.

**Forward path**

20 dB

30 dB

40 dB

Gain selectable:  
20, 15, 10 or 5 dB

CATV

Model Art. No.	HLV 40/30 FPE 813128	HLV 40/65 FPE 813129
EAN	4040326131282	4040326131299
Inputs / Outputs	1 / 1	1 / 1
Screening factor	> 85 dB	> 85 dB
Gain	47 ... 862 MHz / 40, 30, 20 dB	85 ... 862 MHz / 40, 30, 20 dB
Return path gain	5 ... 30 MHz / 20, 15, 10, 5 dB	5 ... 65 MHz / 20, 15, 10, 5 dB
Output level return path 60 dB IMA <sub>3</sub> / EN 60728-3	max. 110 dBμV	max. 110 dBμV
Output level forward path 60 dB IMA <sub>3</sub> / EN 60728-3	max. 113 dBμV	max. 113 dBμV
Level adjusting range	0 ... -12 dB	0 ... -12 dB
Slope correction range	0 ... -16 dB	0 ... -16 dB
Noise figure	8 ... 9 dB	8 ... 9 dB
Noise figure return path	5 ... 7 dB	5 ... 7 dB
Mains power supply V~	100 ... 240 V / 47 - 63 Hz	100 ... 240 V / 47 - 63 Hz
Power consumption max.	13 W	13 W
Ambient temperature	-20 ... +50 °C	-20 ... +50 °C
Dimensions (mm)	260 x 130 x 52	260 x 130 x 52

## MATV and Home Distribution Amplifier

HNV 30/30 UPE, HNV 30/65 UPE



**Energy Saver!**  
Energy Saving  
Switch-Mode Power Supply



**Optional:**  
Universal AC Adapter  
**SNG 18/1000** (Art. No.: 832114)  
in combination with Line Power  
Injection Filter **FSW 30 F** (Art.  
No.: 815018)

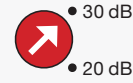

• 30 dB  
• 20 dB  
Two-step  
forward gain



0 ... -12 dB

Integrated attenuator and  
slope control



0 ... -15 dB

- Passive return path
- For medium sized distribution systems
- Metal / plastic housing for indoor mounting
- Protection class IP 20
- Remote power through In- or Output possible

Model Art. No.	HNV 30/30 UPE 811267	HNV 30/65 UPE 811268
EAN	4040326112670	4040326112687
Inputs / Outputs	1 / 1	1 / 1
Screening factor	> 85 dB	> 85 dB
Gain	47 ... 862 MHz / 30 or 20 dB	85 ... 862 MHz / 30 or 20 dB
Output level forward path 60 dB IMA <sub>3</sub> / EN 60728-3	max. 108 dBμV	max. 108 dBμV
Level adjusting range	0 ... -12 dB	0 ... -12 dB
Slope correction range	0 ... -15 dB	0 ... -15 dB
Noise figure	< 7 dB	< 7 dB
Mains power supply V~	100 ... 240 V / 47 - 63 Hz	100 ... 240 V / 47 - 63 Hz
Remote powering	15 ... 20 V / 210 mA	15 ... 20 V / 210 mA
Power consumption	< 4 W	< 4 W
Ambient temperature	-20 ... +50 °C	-20 ... +50 °C
Dimensions (mm)	194 x 86 x 52	194 x 86 x 52



# MATV and Home Distribution Amplifiers

HNV 30 UPE, HNF 30 URP



- For MATV and CATV systems
- Protection class IP 20
- Remote powering on input and output side (only HNF 30 URP)

**Optional:**  
 Universal AC Adapter  
**SNG 18/1000** (Art. No.: 832114)  
 in combination with Line Power  
 Injection Filter **FSW 30 F** (Art.  
 No.: 815018)

• 30 dB  
 • 20 dB  
 0 ... -12 dB  

 0 ... -15 dB  
 Integrated attenuator and  
 slope control

**Tech-Hint HNF 30 URP**

The remote power is available on the input- and output side. This has the advantage that another remote powered amplifier can be supplied with voltage. On ports where it is not desired, a **DCF 500** (set of 2 pcs. Art.No.: 871506) must be used.

CATV

Model Art. No.	HNV 30 UPE 811269	HNF 30 URP 811304
EAN	4040326112694	4040326113042
Inputs / Outputs	1 / 1	1 / 1
Screening factor	> 85 dB	> 85 dB
Gain 47 ... 862 MHz	30 or 20 dB	30 or 20 dB
Output level max. 60 dB IMA <sub>3</sub> / EN 60728-3	max. 108 dBμV	max. 108 dBμV
Level adjusting range	0 ... -12 dB	0 ... -12 dB
Slope correction range	0 ... -15 dB	0 ... -15 dB
Noise figure	< 7,5 dB	< 7 dB
Mains power supply V~	100 ... 240 V / 47 - 63 Hz	15 ... 20 V / 210 mA
Power consumption	< 4 W	-
Ambient temperature	-20 ... +50 °C	-20 ... +50 °C
Dimensions (mm)	194 x 86 x 52	138 x 83 x 52

## MATV and Home Distribution Amplifiers

HNV 20 U

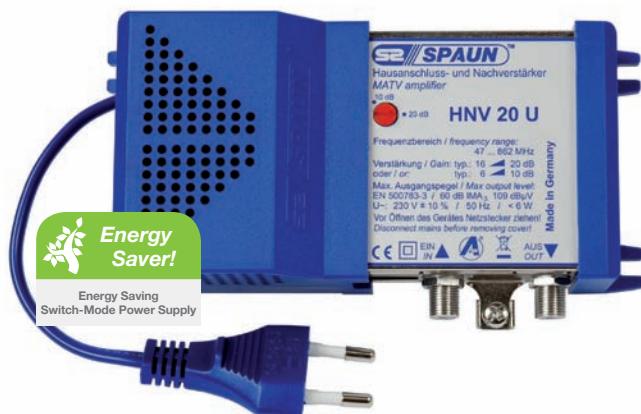

• 10 dB  
• 20 dB

Forward gain:  
10 or 20 dB

- For MATV and CATV systems
- Slope precompensating
- Protection class IP 20

CATV

Model Art. No.	HNV 20 U 811273
Inputs / Outputs	1 / 1
Screening factor	> 85 dB
Gain 47 ... 862 MHz	20 or 10 dB
Output level 60 dB IMA <sub>3</sub> / EN 60728-3	max. 109 dBμV
Noise figure	< 8.5 dB
Slope precompensating	4 dB
Mains power supply V~	230 V / 50 Hz
Power consumption	< 4 W
Ambient temperature	-20 ... +50 °C
Dimensions (mm)	160 x 86 x 52

# Terrestrial



## TABLE OF CONTENTS

Multiband Amplifiers .....	from page 132
Multiband Diplexer .....	from page 133
FM-Amplifier .....	from page 134
FM-Band-Pass .....	from page 134
LTE Stop Band Filter .....	from page 135
Terrestrial Antenna-Relay .....	from page 135
Audio/Video-Modulators .....	from page 137

## Multiband Amplifiers

MBV 420 F, MBV 429 PF, MBV 435 PF



- Selective input frequency range
- Optimized for reception of DVB-T (DTT)
- Ground clamp
- Protection class IP 20

### MBV 429 PF + MBV 420 F

- Remote powering possible via output

### MBV 435 PF

- LED operation display
- Interstage technology  
The low noise amplifier will be bypassed at the maximum attenuation of 15 dB

	<b>Light Class</b>	<b>Standard Class</b>	<b>Premium Class</b>
Model Art. No.	MBV 420 F 812117	MBV 429 PF 812118	MBV 435 PF 812116
EAN	4040326121177	4040326121184	4040326121160
Inputs / Outputs	4 / 1		
Gain B I	10 dB	30 dB	35 dB
Gain FM	10 dB	30 dB	35 dB
Gain B III	20 dB	30 dB	35 dB
Gain B IV/V	20 dB	30 dB	35 dB
Noise figure B I	4,5 dB	5 ... 6 dB	5 dB
Noise figure FM	6 dB	5 ... 6 dB	4 dB
Noise figure B III	4,5 dB	5 ... 6 dB	4 dB
Noise figure B IV/V	6 dB	7 dB	4 dB
Output level 60 dB IMA <sub>2</sub> / EN 60728-3	max. 103 dBμV	max. 114 dBμV	max. 116 dBμV
Output level 66 dB KMA / EN 60728-5	max. 112 dBμV	max. 114 dBμV	max. 117 dBμV
Level adjusting range FM	-	0 ... -15 dB	0 ... -15 dB
Level adjusting range B I, B III, B IV/V	-	0 ... -10 dB	0 ... -15 dB
Mains supply V~	230 V~ / 50Hz	100 ... 240 V / 47 - 63 Hz	230 V~ / 50Hz
Remote powering	15 ... 24 V / 370 mA	15 ... 20 V / 460 mA	-
Power consumption	< 5 W	< 8 W	< 12 W
Ambient temperature	- 20 ... + 50 °C		
Dimensions (mm)	194 x 82 x 52	260 x 130 x 52	300 x 130 x 52

# Multiband Diplexer

MBW 410 F



Model Art. No.	MBW 410 F 871110
EAN	4040326711101
Inputs / Outputs	4 / 1
Through loss B I	1,5 dB
Through loss UKW	1 dB
Through loss B III	1,5 dB
Through loss B IV/V	2 dB
Ambient temperature	- 20 ... + 50 °C
Dimensions (mm)	140 x 82 x 38

- Selective input frequency range
- Preferably, as a supplement for components with a active terrestrial input (multiband amplifiers, multiswitches or launch amplifiers)

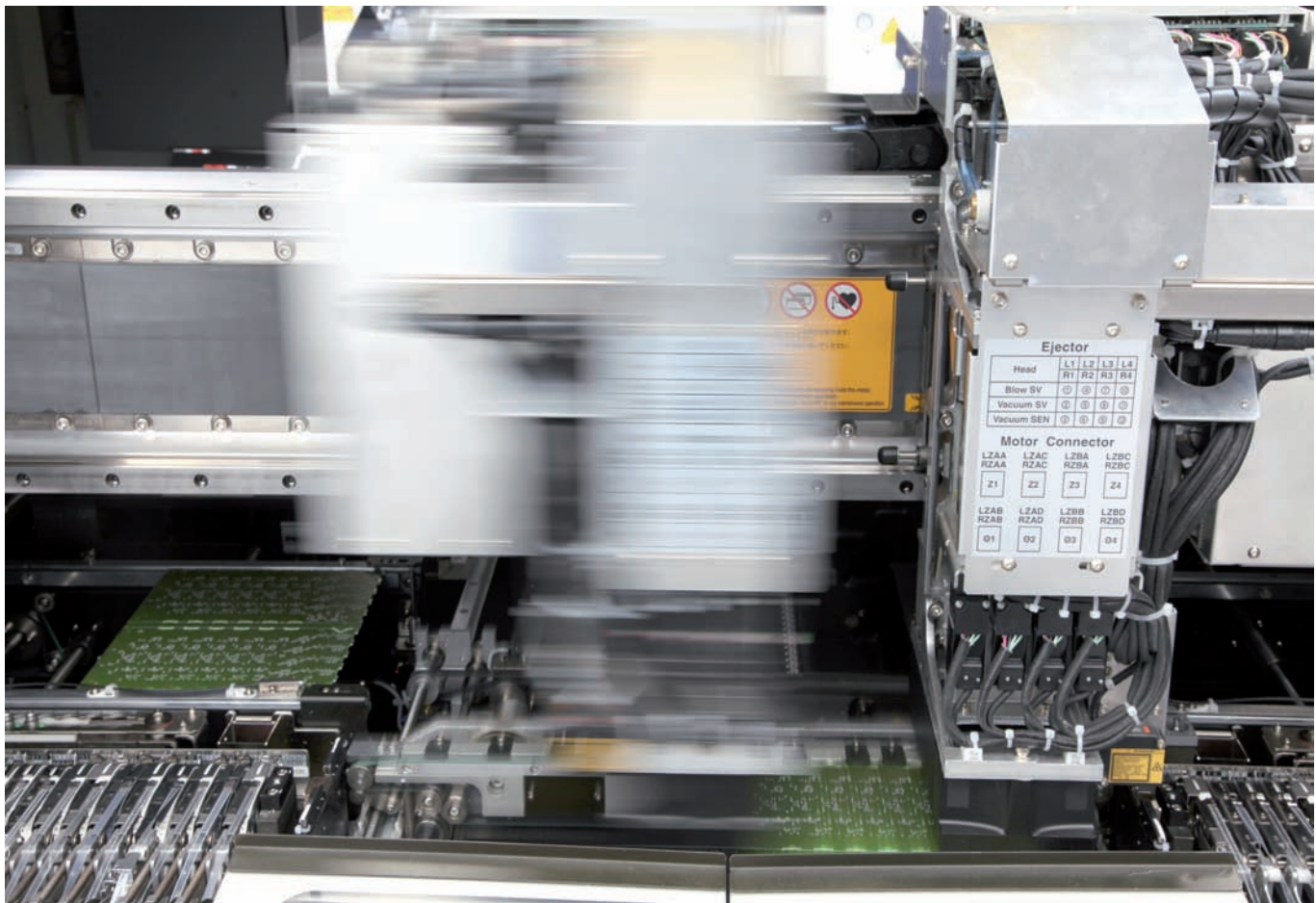

Terrestrial

## FM Amplifier

VFM 25 F



Model Art. No.	VFM 25 F 810202
EAN	4040326102022
Inputs / Outputs	1 / 1
Frequency range	87,5 ... 108 MHz
Gain	25 dB
60 dB KMA / EN 60728-5	115 dB $\mu$ V
Level adjusting range	0 ... -10 dB
Noise figure	5 dB
Mains supply V~	230 V / 50 Hz
Power consumption	< 4 W
Ambient temperature	-20 ... +50 °C
Dimensions (mm)	160 x 86 x 52

Preferably, as a supplement for components with a wideband terrestrial input.

- Ground clamp
- Protection class IP 20

## FM Band-Pass

FMP 30



Model Art. No.	FMP 30 871202
EAN	4040326712023
Inputs / Outputs	1 / 1
Frequency range	87,5 ... 108 MHz
Through loss	1 dB
Selection	30 dB
Ambient temperature	-20 ... +50 °C
Dimensions (mm)	77 x 49 x 30

Selective reception of FM channels. Preferably, as a supplement for components with a wideband terrestrial input.

### Tech-Hint

Broadband antennas may never be directly connected with the non-selective terrestrial input of a multiswitch or CATV amplifier, as adjacent frequencies of radio and TV services may interfere.

## LTE Stop Band Filter

SMF 790



Model Art. No.	SMF 790 871304
EAN	4040326713044
Stop band	822 ... 1000 MHz
Selektion	typ. 50 dB
Through band	5 ... 790 MHz
Through loss	typ. 1 dB
Dimensions (mm)	75, 25 Ø

The SMF 790 is needed to block the LTE signals above 790 MHz. This prevents that LTE signals pass the terrestrial range below 790 MHz and interfere the reception of such as DVB-T.

## Terrestrial Antenna Relay

TAR 5



Model Art. No.	TAR 5 871433
EAN	4040326714331
Inputs / Outputs	1 / 2
Frequency range	5 ... 862 MHz
Through loss	0,8 dB
Remote voltage	5 V
DC-pass max.	500 mA
Current consumption max.	35 mA
Ambient temperature	-20 ... +50 °C
Dimensions (mm)	75 x 47 x 30

Terrestrial

To multiplex a CATV- and a (active) DVB-T antenna.  
Switching is done automatically by the remote power.

Note: it is necessary for the functionality of the TAR 5 that the TV has an output of 5 V as a switching criteria (DVB-T).

Relay recommended by:

**LOEWE.**



## ENERGY SAVING TECHNOLOGY

**SPAUN** multiswitches are equipped with energy saving switch-mode power supplies. Switch-mode power supplies made by **SPAUN** feature a high effectiveness (low power consumption) with a wide range of tolerance of input voltage.

Furthermore, the switch-mode power supplies reduce the transport weight, save precious raw materials (lower copper content in comparison with transformers) and allow a standby function with a very low power consumption.

Since many years **SPAUN** multiswitches are using a energy saving standby concept developed by **SPAUN**. In case of inactivity of all connected receivers the multiswitch switches the the SAT-IF amplifier and the LNB remote supply voltage off.

The power consumption of the device falls considerably and the electricity bill is released. The reception of terrestrial programs are still possible even after activating the standby function.

Recommended by well-known international certifiers (e.g. UL) **SPAUN** switch-mode power supplies garant safety and reliability.



## Audio/Video-Modulator

VAM 420 NG PAL



- Stand-alone audio/video modulator into PAL
- For use between video camera and the TV
- Wide range of applications in the private or commercial sector
- The modulator output is adjacent channel compatible
- Wall or DIN rail mounting possible
- Internal test pattern generator can be activated by function key
- Possibility to connect an additional terrestrial signal

### Video feed of:

- Event programs in hotels or guesthouses
- Digital TV programs via DVB receiver
- Information channels in large CATV systems

Model Art. No.		VAM 420 NG PAL 821705
EAN		4040326217054
Video-/Audio-Inputs		2 / 2
Frequency range		110 ... 862 MHz
TV standard		B/G/D/K/I/L/Au
RF output	Input impedance	75 Ω BNC female
	Output level	max. 90 dBμV
	Output level adjusting range	0 ... -6 dB (by 1 dB step)
	Spurious level IMD2/IMD3	<-60 dB
	C/N ratio	≥ 55 dB
	Output impedance	75 Ω
	Return loss	≤ 10 dB
	Connector type RF	F
	Connector type audio, video	RCA socket
Video	Input level	1± 0,1 Vp-p
	Input impedance	RCA 75 Ω
	S/N ratio	≥ 55 dB
Audio	Frequency range	40 Hz ... 15 kHz
	Input impedance	> 10 kΩ
	Preemphasis	50 μs
	Audio level adjusting range	+6 ... -6 dB (by 2 dB step)
	Audio signal / noise ratio FM (fm=1kHz: +f=50 kHz)	≥ 50 dB
	Audio signal / noise ratio AM (fm=1kHz:m=60%)	≥ 47 dB
Power	Supply voltage	12V ± 1V
	Current consumption	430 mA
	Ambient temperature	0 ... +50 °C
Dimensions (mm)		196 x 106 x 35

Terrestrial

## DC Link Cable

DCV 4



Model Art. No.	DCV 4 821707
EAN	4040326217078



## Audio/Video Modulator

VAM 420 NG DVB-T



- Stand-alone Audio/Video modulator into DVB-T
- Twin input for two independent AV sources
- Wide range of applications in the private or commercial sector
- The modulator output is adjacent channel compatible
- Wall or DIN rail mounting possible
- Internal test pattern generator can be activated by function key
- Possibility to connect an additional terrestrial signal

### Video feed of:

- Event programs in hotels or guesthouses
- Digital TV programs via DVB receiver
- Information channels in large CATV systems



Model Art. No.	VAM 420 NG DVB-T 821708	
EAN	4040326217085	
Video-/Audio-Inputs	2 / 2	
Frequency range	110 ... 862 MHz	
TV standard	B/G/D/K/I/L/Au	
HF Ausgang	Input impedance	75 Ω BNC female
	Output level	85 dBμV + 2dB
	Output level adjusting range	0 ... 15,5 dB (in 0,5 dB steps)
	C/N ratio	≥ 50 dB
	Output impedance	75 Ω
	Return loss	≥ 10 dB
	Connector type RF	F
	Connector type audio, video	RCA
Video	Input level	1± 0,1 Vp-p
	Input impedance	RCA 75 Ω
Audio Processing	Encoding	ISO /IEC11172-3 (MPEG1 audio) layer 2 compliant
	Sample Rate	44,1 kHz
	Compressed bit rate	256 Kbps
	Audio Mode	Stereo
Video Processing	Encoding	ISO/IEC13818-2 MPEG-2 MP@ML
	Resolution	720 x 576 (at 25 fps), 720 x 480 (at 30 fps)
	Frame rate	25 max. PAL, SECAM, 30 max. NTSC
	Compressed system bit rate	2...9 Mbps
Modulation	MER	≥ 35 dB
	Modulation	QPSK, QAM 16, QAM 64
	Channel Bandwidth	7/8 MHz
	GUARD Interval	1/4, 1/8, 1/16, 1/32
Power	Supply voltage	12V ± 1V
	Current consumption	650 mA
	Ambient temperature	0 ... +50 °C
Dimensions (mm)		196 x 106 x 48

Terrestrial

# Measurement



## TABLE OF CONTENTS

SPAROS 609, 611 Analyzers .....	from page 140
SPAROS Accessories .....	from page 143
SPAROS SAT HD .....	from page 144
DiSEqC Test Tools .....	from page 146

## The SPAROS Family

SPAROS 611 CA HD, SPAROS 609 CA HD

No matter if you have to do analogue or digital measurements, the SPAROS-family assists you with all advanced functions to do your job fast and reliable.

An uncomplicated control concept enables a simple and fast navigation over direct access function keys.

The innovative SPAROS-family has been designed with special water-repellent buttons, as well as an extraordinary large 7" LCD color screen in 16:9 wide-screen format.

The weight of the SPAROS including battery and a rugged carrying bag is only 2,1 kg. It can be transported therefore – due to the very compact dimensions and low weight - comfortable.

The Li-Ion battery provides a long operating time, with an estimated duration of 3 hours. After reloading of approx. 1 hour an uncharged SPAROS is already operational through its intelligent charging electronics.

With an optional mobile charger the unit can be also charged in the car.

Both devices can be upgraded with DVB-T(2).



SPAROS 611 CA HD

### SPAROS 611 CA HD – TV SIGNAL ANALYZER

The Top-unit of the SPAROS-family offers, together with the already known functions of the 609-series, the following features:

- Constellation diagram for all DVB standards
- The “expert-mode” within the spectrum analysis provides the operator with an extensive analysis of the signal
- Terrestrial frequency range from 5 ... 865 MHz
- DiSEqC-Monitor
- Display of video data rate



SPAROS 609 CA HD

### Included in scope of delivery:

- SPAROS TV signal analyzer
- Water-repellent rugged carrying bag
- USB cable
- Printed quick guide
- USB-Stick with
  - Extensive operating manual (PDF)
  - SPS 609 PC Software
  - SpaunSat Software
- Adapter F-Coupler / F-Coupler
- AC/DC power unit



Model Art. No.	SPAROS 609 CA HD 850021	SPAROS 611 CA HD 850022
EAN	4040326500217	4040326500224
LCD Display Dimensions	7"	7"
Aspect ratio	16:9 Widescreen	16:9 Widescreen
<b>Signal measurements of</b>		
DVB-S2 (HDTV)	✓	✓
DVB-S	✓	✓
DVB-C	✓	✓
DVB-T / H	✓	✓
Analogue TV	✓	✓
FM with Sound	✓	✓
Return path measuring (from 5 MHz)	-	✓
<b>Display of</b>		
Analogue terrestrial	✓	✓
Digital TV FTA (MPEG2)	✓	✓
Digital TV with CA-Modul (MPEG2)	✓	✓
Digital TV FTA (MPEG4 H.264)	✓	✓
Digital TV with CA-Modul (MPEG4 H.264)	✓	✓
Spectrum analyser	✓	✓
Expert-Mode	-	✓
Constellation diagram	only DVB-S/S2	all DVB modes
SAT identification	✓	✓
EXPLORER function	✓	✓
DVB-T Echo-Measuring	✓	✓
Data-Logger-Function (long term measuring)	✓	✓
Automated measuring protocols	✓	✓
Measuring data memory (screenshots)	✓	✓
Acoustic signal for antenna adjustment	✓	✓
DiSEqC-Control 1.0 / 1.1 / 1.2	✓	✓
SCR single cable switching commands	✓	✓
Ethernet	RJ45	RJ45
PC-Interface	USB	USB
Software	SPS-609, SpaunSat	SPS-609, SpaunSat
Mains or battery operation	✓	✓
Li-Ion Battery (operating time circa 3 h)	✓	✓
Weight (incl. Battery and carrying bag)	2.1 kg	2.1 kg
Warranty	24 month (battery 6 month)	24 month (battery 6 month)
Dimensions (in mm)	205 x 90 x 290	

## Screenshots SPAROS 609 / 611

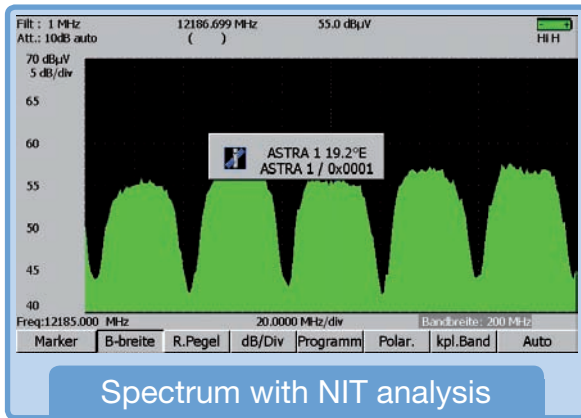

Messplan 6 (ASTRA KOMP)

Programm # : 0 (DIGITAL+)

#	Freq.	Stand.	Pegel	C/N	BERI	BERo	UNC/PER	MER
0	10788.000	DVB-S	62.3	13.0	3.5E-6	<5E-9	<9E-6	14.8
1	10744.000	DVB-S	66.3	14.3	<1E-7	<5E-9	<9E-6	15.8
2	11739.000	DVB-S	68.4	16.3	2.2E-5	<5E-9	<9E-6	13.4
3	11720.000	DVB-S	65.8	17.3	<1E-7	<5E-9	<9E-6	15.0
4	11318.000	DVB-S	65.0	13.6	7.9E-4	<5E-9	<9E-6	11.3
5	11303.000	DVB-S2	69.6	12.9	6.1E-3	<5E-9	<9E-6	13.0
6	12207.000	DVB-S	73.5	11.2	7.3E-5	<5E-9	<9E-6	12.8
7	12188.000	DVB-S	71.3	14.0	<1E-7	<5E-9	<9E-6	15.0
8	11686.000	DVB-S	64.2	15.0	7.1E-4	<5E-9	<9E-6	11.4
9	11671.000	DVB-S	69.1	15.9	<1E-7	<5E-9	<9E-6	15.6
10	12699.000	DVB-S	70.6	12.5	2.5E-5	<5E-9	<9E-6	13.5

Reset Löschen Liste Sortier -> USB Init.

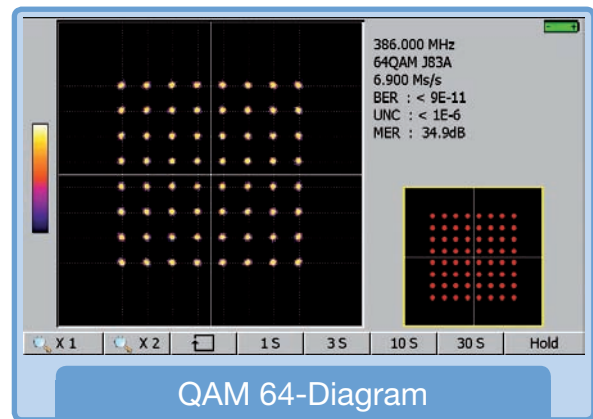
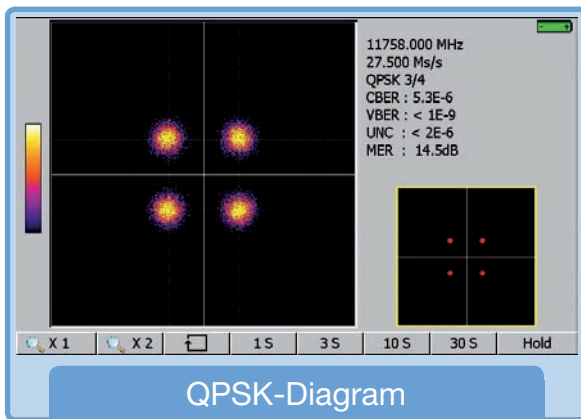
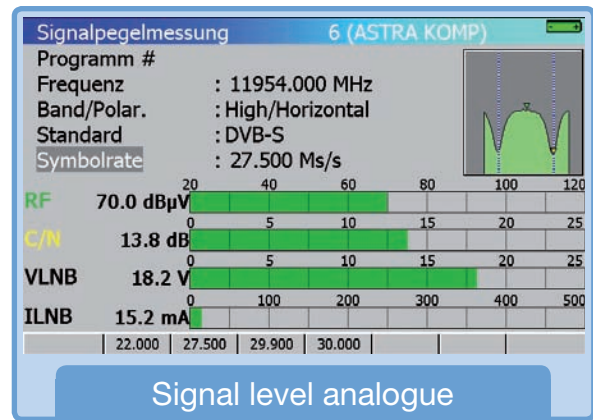
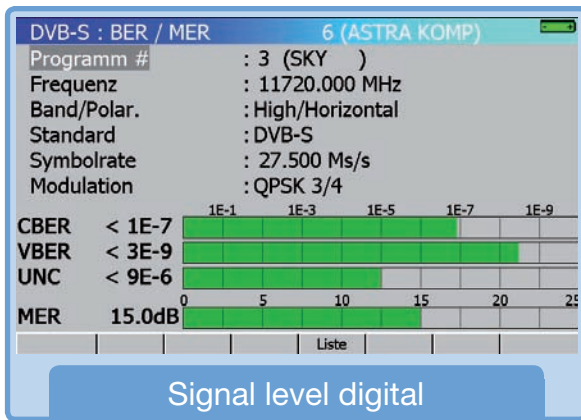

Parameter 6 (ASTRA KOMP)

Speicherbank # : 6 (ASTRA KOMP)

Frequenzband LNB - DiSEqC

Grenzwerte LNB Spannung : Auto

Zusatztext LO1 Frequenz : 9750.000 MHz, LO2 Frequenz : 10600.000 MHz

#	Name	Band Auswahl	Polar Auswahl	nd	Pol.
0	DIGITAL	0/22kHz	13/18V	w	Vert.
1	ARD			w	Hor.
2	VIACOM			gh	Vert.
3	SKY			gh	Hor.
4	DIGITAL			w	Vert.
5	SES ASTI			w	Hor.
6	CANALSA			gh	Vert.
7	RTL			gh	Hor.
8	DIGITAL			w	Vert.

Nein ToneBurst 0/22kHz DiSEqC Pos A Pos B Pos C Pos D

LNB-DiSEqC™

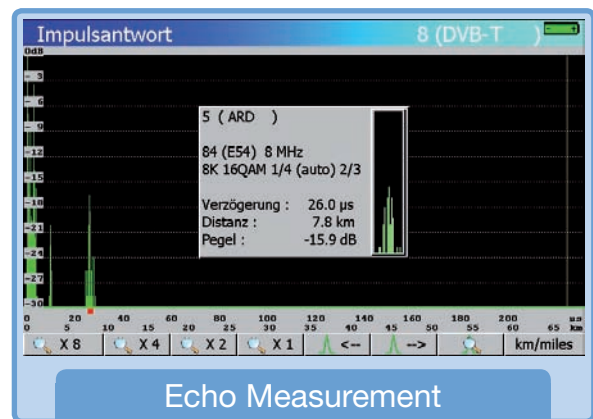

## SPAROS Upgrades

SPAROS HD-Upgrade  
SPAROS DVB-T2-Upgrade

Please note that not all devices are upgradable.

Under the following number, you can check the possibility of an upgrade of your SPAROS 6XX device:

Phone: +49 7731 / 8673-18

Email: [hotline@spaun.de](mailto:hotline@spaun.de)

Model Art. No.	SPAROS HD-UPGRADE 871522	SPAROS DVB-T2-UPGRADE 871528
EAN	4040326715222	4040326715284
Available for	SPAROS 609	SPAROS 609 CA HD SPAROS 611 CA HD
Additional functionality	DVB-S2 FTA-Display	DVB-T2 Measuring and FTA-Display

## SPAROS Tool Case

SPAROS CASE  
for SPAROS 609 CA HD and SPAROS 611 CA HD

This practical tool bag offers additional storage. The tool bag will be fixed directly by using four rivets on the device.

Model Art. No.	SPAROS Case 871525
EAN	4040326715253



## SPAROS WiFi Option

SPAROS WIFI  
for SPAROS 609 CA HD and SPAROS 611 CA HD

### Wireless LAN Option

With this option it is possible to measure WLAN-networks using the SPAROS.

The set includes a wireless USB adapter plus a practical cable extension with a pedestal incl. extension cord.

Model Art. No.	SPAROS WIFI 871526
EAN	4040326715260



## SPAROS Mobile Charger

SPAROS BC  
for SPAROS 609 CA HD, SPAROS 611 CA HD and SPAROS SAT HD

### For the cigarette car lighter

With this mobile charger it is possible to charge the SPAROS series through the cigarette lighter of a vehicle.

Model Art. No.	SPAROS BC 871527
EAN	4040326715276





# SPAROS SAT HD Analyzer

SPAROS SAT HD, SPAROS SAT HD DVB-T, SPAROS SAT HD DVB-C



### Robust and easy to use

With only five function keys on the keypad, you have direct access to the various menus. The robust plastic housing is designed for mobile use and to protect all the sensitive components of the device.

### Measurement Range

The SPAROS SAT HD is also capable of measurements in DVB-S and DVB-S2. In addition, also QPSK and 8PSK modulations are supported.

**NEW** SPAROS SAT HD DVB-T is also capable of measurements in DVB-T.

**NEW** SPAROS SAT HD DVB-C is also capable of measurements in DVB-C.

### Fast Check SAT-Mode

All devices offer a fast CheckSAT mode for the alignment of satellite antennas through visual and audio information to reduce the time required effort.

### High quality color LCD

On the bright and 4.3" (10.8 cm) LCD TFT display all measurements and FTA TV channels (MPEG-2 and MPEG-4) are shown.

### USB-interface

The whole series comes with two USB ports for the transfer of measurement results to the computer. In addition, firmware updates can be installed through this interface.

### General Features:

- High quality and bright display 4.3"
- MPEG4-display and measuring
- SCR single cable control commands according to EN 50494
- DiSEqC control
- Spectrum analysis
- Robust, impact-resistant plastic housing
- Splash-resistant keypad



Measurement

## Screenshots

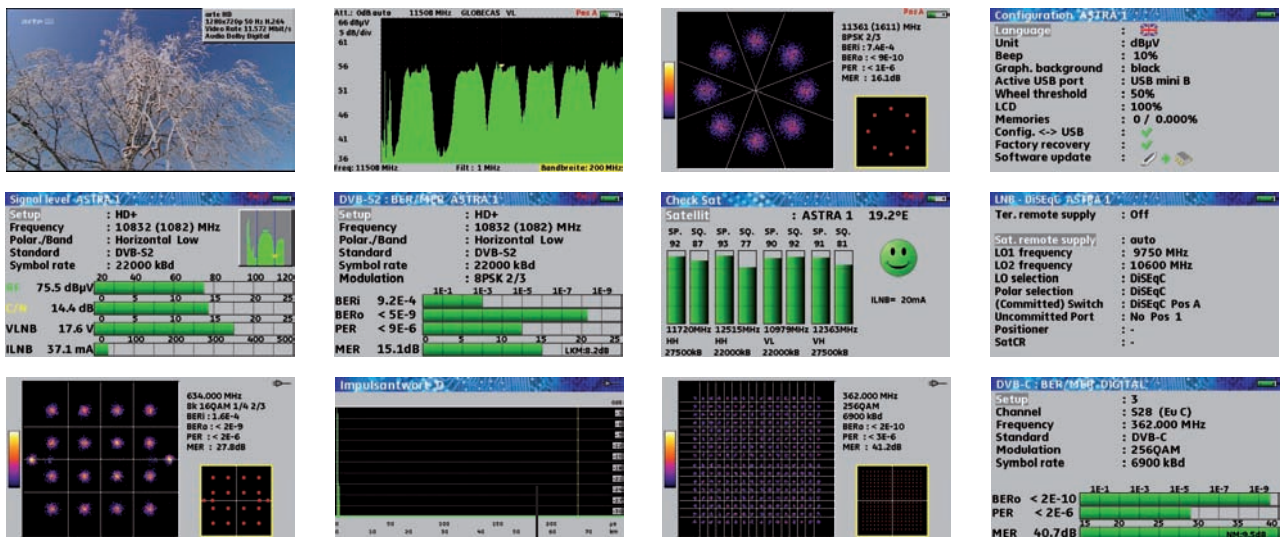

ONLY SPAROS SAT HD DVB-T

ONLY SPAROS SAT HD DVB-C



Model Art. No.	SPAROS SAT HD 850023	SPAROS SAT HD DVB-T 850024	SPAROS SAT HD DVB-C 850025
EAN	4040326500231	4040326500248	4040326500255
LCD / screen size	4.3"	4.3"	4.3"
Image format	16:9 Widescreen	16:9 Widescreen	16:9 Widescreen
<b>Signal measuring of</b>			
DVB-S2 (HDTV)	✓	✓	✓
DVB-S	✓	✓	✓
DVB-T	-	✓	-
DVB-C	-	-	✓
Analogue SAT	✓	✓	✓
<b>Display of</b>			
Digital TV FTA (MPEG2)	✓	✓	✓
Digital TV FTA (MPEG4 H.264)	✓	✓	✓
Spectrum analyzer	✓	✓	✓
Constellation diagram	✓	✓	✓
SAT identification	✓	✓	✓
Automatic measurement protocols	✓	✓	✓
Measurementdata memory (Screenshots)	✓	✓	✓
Signal for antenna alignment	✓	✓	✓
DiSEqC control1.0/1.1/1.2	✓	✓	✓
SCR single cable switching commands	✓	✓	✓
PC interface	USB A, USB mini B	USB A, USB mini B	USB A, USB mini B
AC or battery operation possible	✓	✓	✓
Lithium-Ionen-Battery (duration > 2 hours)	✓	✓	✓
Power supply	100 - 240 V, 15V / 1A	100 - 240 V, 15V / 1A	100 - 240 V, 15V / 1A
Weight (incl. battery and protection case)	1,5 kg	1,5 kg	1,5 kg
Ambient temperature	-5 ... +45 °C	-5 ... +45 °C	-5 ... +45 °C
Warranty	24 month (Battery 6 month)	24 month (Battery 6 month)	24 month (Battery 6 month)
Dimensions (mm)	200 x 190 x 100	200 x 190 x 100	200 x 190 x 100

## DiSEqC-Monitor

TP 216

Useful test tool and Bus-Monitor to ease systematic troubleshooting in distribution networks and for function check.

- Loads and terminations of the networks do not change by using the test tool

### New features:

- Address indicator
- Identification of the reply from the target device by DiSEqC 2.0 commands
- Display of transmission errors
- Test jack for LNB-Power and voltage

Model Art. No.	TP 216 871521
EAN	4040326715215
Frequency range	5 ... 2200 MHz
Through loss	2 dB
Test jack	-20 dB
DC-pass max.	600 mA
Power requirements	10 ... 20 V DC / 70 mA
Ambient temperature	-20 ... +50 °C
Dimensions (mm)	77 x 90 x 31

## Function List

No.	DiSEqC™ commands	Option		Monitor	Voltage	22 kHz continous tone	ToneBurst	Bus			Monitor
		A	B					<15V	>15V	22 kHz	
1	E21038F0	on	off	Vert. L.A.	13	0	0	on	off	off	Vert. L.A.
2	E21038F2	on	off	Hor. L.A.	18	0	0	off	on	off	Hor. L.A.
3	E21038F1	on	off	Vert. H.A.	13	1	0	on	off	on	Vert. H.A.
4	E21038F3	on	off	Hor. H.A.	18	1	0	off	on	on	Hor. H.A.
5	E21038F4	on	off	Vert. L.B.	13	0	1	on	off	off	Vert. L.B.
6	E21038F6	on	off	Hor. L.B.	18	0	1	off	on	off	Hor. L.B.
7	E21038F5	on	off	Vert. H.B.	13	1	1	on	off	on	Vert. H.B.
8	E21038F7	on	off	Hor. H.B.	18	1	1	off	on	on	Hor. H.B.
9	E21038F8	off	on	Vert. L.A.							
10	E21038FA	off	on	Hor. L.A.							
11	E21038F9	off	on	Vert. H.A.							
12	E21038FB	off	on	Hor. H.A.							
13	E21038FC	off	on	Vert. L.B.							
14	E21038FE	off	on	Hor. L.B.							
15	E21038FD	off	on	Vert. H.B.							
16	E21038FF	off	on	Hor. H.B.							

No.	Address Byte	Address LEDs			
		10	14	15	18
1	10	on	off	off	off
2	14	off	on	off	off
3	15	off	off	on	off
4	18	off	off	off	on
5	optional	on	on	on	on

Measurement

### Tech-Hint

By sending the DiSEqC-commands E00002, the Standby-LED turns on and by sending the Power-On command E00003 the Standby-LED turns off.

If the receiver sends DiSEqC 2.0 commands, the target devices have to confirm the reception of these commands. The reply of the target device will be displayed by the Reply-LED (9).

A transmission error in the DiSeqC-Protocol will be displayed by the LED „Parity-Error“ (10).

## Functions Of DiSeqC-Monitor TP 216

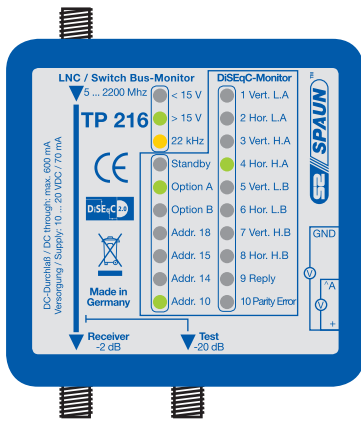

The receiver sends the DiSeqC command Option A, Position A and Horizontal High-Band.

Address 10 contains the command for all switching components like multiswitches, corresponding relays or LNBS for the execution of the receiver commands.

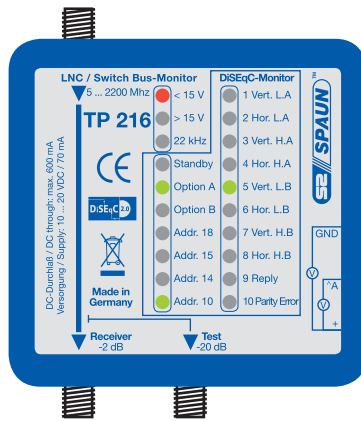

The receiver sends the DiSeqC command Option A, Position B and Vertical Low-Band.

Address 10 contains the command for all switching components like multiswitches, corresponding relays or LNBS for the execution of the receiver commands.

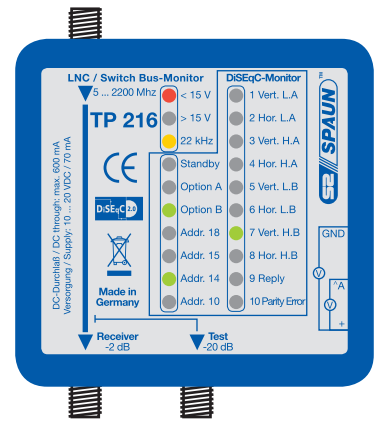

The receiver sends the DiSeqC command Option B, Position B and Vertical High-Band.

Address 14 solely responds to a multiswitch.

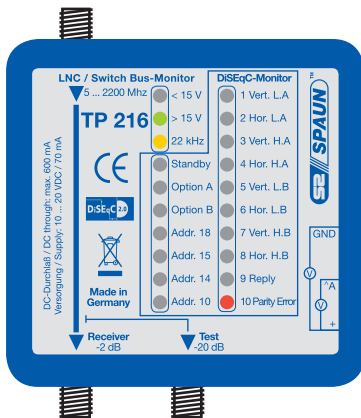

A transmission error in the DiSeqC-Protocol will be displayed by the LED „Parity-Error“.



### Tech-Hint

You have the possibility to check the voltage and the current consumption (indirect current metering) of a LNB, relays or a multiswitch when loaded in combination with a multimeter.

In addition to that it is possible to meter the level at the test jack, less 20 dB, at normal operation, by using a suitable antenna measuring set.

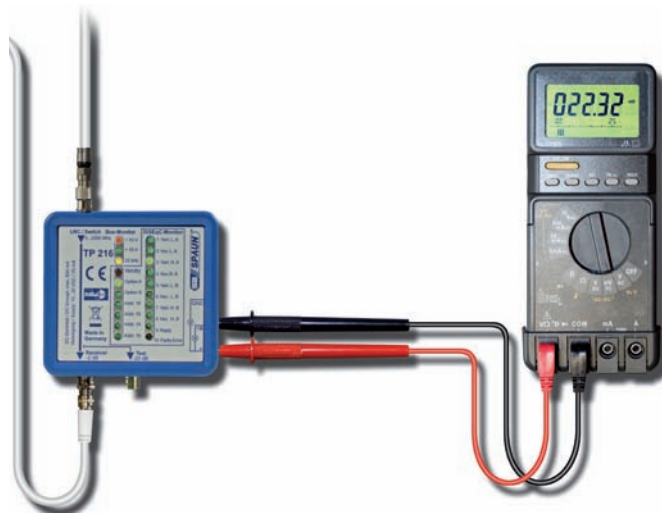

# POWER SAT IF Amplifier

For major distribution networks and long cable runs

- Aluminum die cast housing
- Energy saving switch-mode power supply
- Extremely high output level
- Splitband technology
- Protection class IP 54 in combination with suitable connectors
- F-Jacks optional with PG 11



ENERGY  
SAVING  
TECHNOLOGY

# Accessories

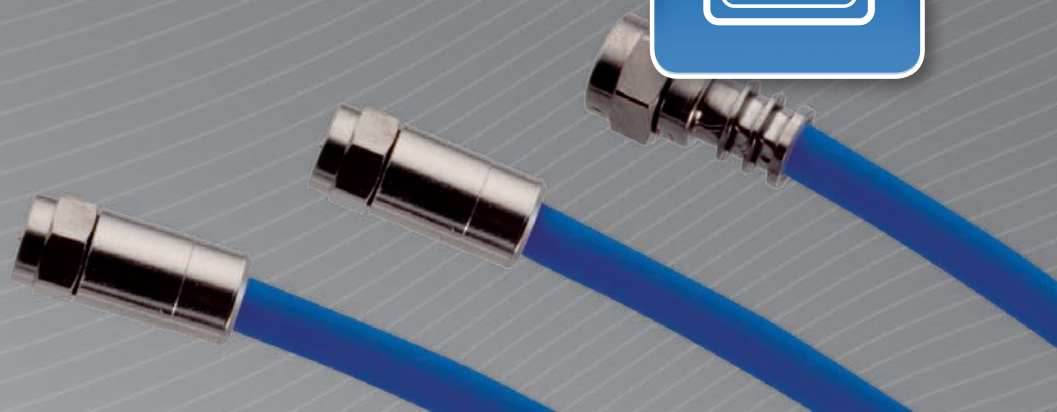

## TABLE OF CONTENTS

<b>Power Supply</b> .....	from page 150
<b>RF Accessories</b> .....	from page 151
<b>Taps</b> .....	from page 155
<b>Splitters</b> .....	from page 158
<b>TV Socket Outlets (CATV)</b> .....	from page 161
<b>TV Socket Outlets (SMATV)</b> .....	from page 162
<b>Multimedia Sockets (SAT)</b> .....	from page 163
<b>Mounting Accessories</b> .....	from page 164
<b>Coaxial Cable</b> .....	from page 166
<b>Mounting Tools</b> .....	from page 167
<b>Annex</b> .....	from page 168

**NEW**

## Universal AC Adapter

SNG 12/2000, SNG 14/1000, SNG 18/1000



To supply SPAUN components which are designed for an external voltage supply.

- International adapters
- Meets EU Directive 2005/32/EG

Model Art. No.	SNG 18/1000 832114	SNG 14/1000 832116	SNG 12/2000 832115
EAN	4040326321140	4040326321164	4040326321157
Mains power supply V~	100 ... 240 V / 47 – 63 Hz	100 ... 240 V / 47 – 63 Hz	100 ... 240 V / 47 – 63 Hz
Power consumption (unloaded)	≤ 0,3 W	≤ 0,3 W	≤ 0,3 W
Remote voltage	18 V	14 V	12 V
Total current	1 A	1 A	2 A
Ambient temperature	0 ... 40 °C	0 ... 40 °C	0 ... 40 °C

## Line Power Injection Filter

FSW 5 F, FSW 30 F, FSW 40 F

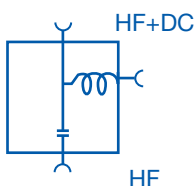

To add or remove remote power.

### Applications:

- Remote powering of amplifiers (HNV, SVF, NVF, MBV)
- To bypass non DC resistant RF components

Model Art. No.	FSW 5 F 871315	FSW 30 F 815018	FSW 40 F 871333
EAN	4040326713150	4040326150184	4040326713334
Frequency range	5 ... 2200 MHz	5 ... 2200 MHz	5 ... 2200 MHz
Through loss max.	1 dB	1 dB	1 dB
DC-pass	1 A	1 A	1 A
Remote power voltage max.	30 V	30 V	20 V
Ambient temperature	-20 ... +50 °C	-20 ... +50 °C	-20 ... +50 °C
Dimensions (mm)	40 x 74 x 21	40 x 74 x 21	40 x 74 x 21

## Diplexer

SEW 121 F, SEW 122 F, SEW 123 F



- To combine / separate the terrestrial and SAT IF signals
- DC-pass for LNB remote power

**SEW 122 F:**  
Please note the frequency range of  
5 ... 160 MHz and 250 ... 2200 MHz

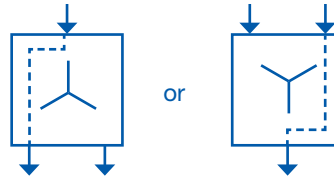

Model Art. No.	SEW 121 F 871108	SEW 122 F 871439	SEW 123 F 871109
EAN	4040326711088	4040326714393	4040326711095
Frequency range	5 ... 862 MHz 950 ... 2200 MHz	5 ... 160 MHz 250 ... 2200 MHz	5 ... 862 MHz 950 ... 2200 MHz
Through loss SAT Terr.	1.5 dB 2,5 ... 1,5 dB	2 ... 1 dB 0,5 ... 2 dB	1.5 dB 0,5 ... 2 dB
Rejection Terr./SAT SAT/Terr.	≥ 32 dB ≥ 32 dB	≥ 40 dB ≥ 40 dB	≥ 30 dB ≥ 30 dB
DC-pass max.	20 V / 1 A		
Ambient temperature	-20 ... +50 °C		
Dimensions (mm)	101 x 46 x 18	102 x 46 x 18	52 x 53 x 17



For wall or mast mounting: please use UV resistant outdoor case type **WSG 94** (only available for SEW 121 F) (Art.No.: 872009)

## SAT High Pass Filter

SHP 45

- To remove IM interferences caused by the LNB in the terrestrial frequency range



Model Art. No.	SHP 45 871203
EAN	4040326712030
Frequency range	950 ... 2200 MHz
Through loss	2,5 ... 1,5 dB
Rejection SAT/Terr.	> 45 dB
DC-pass	max. 1 A
Ambient temperature	-20 ... +50 °C
Dimensions (mm)	35 x 74 x 21

## 22 kHz Generator

SG 22 F



- To generate a continuous 22 kHz tone
- RF connectors:  
Input: F-Jack (male)  
Output: F-Connector (female)  
for direct connection

Model Art. No.	SG 22 F 871419
EAN	4040326714195
Frequency range	950 ... 2200 MHz
Through loss	1 dB
Supply voltage	10 ... 20 V / 17 mA
DC-pass	max. 500 mA
Ambient temperature	-20 ... +50 °C
Dimensions (mm)	35 x 74 x 21

## SAT Attenuator Unit

SDE 4415/5 F, SDE 4420/5 F



To decrease too strong RF levels of one SAT system.

- In order to increase the usability of this attenuator unit, it has this built-in F-male / F-female connectors

Model Art. No.	SDE 4415/5 F 871319	SDE 4420/5 F 871320
EAN	4040326713198	4040326713204
Frequency range	950 ... 2200 MHz	
Loss/fix	each jack 5 dB	
DC-pass	max. 1 A	
Ambient temperature	-20 ... +50 °C	
Jack distance (mm)	15	20
Dimensions (mm)	62 x 64 x 21	77 x 64 x 21

### Tech Hint

Please note that the SAT attenuator units have different jack distances. Thus the attenuator unit **SDE 4415/5 F** with a jack distance of 15mm is suitable e.g. for the multiswitches **SMS 9989 U**, **SMS 9807 NF**, **SMS 91607 NF**, **SMS 92407 NF**, **SMS 93207 NF** and the attenuator unit **SDE 4420/5 F** with a jack distance of 20mm e.g. for the multiswitch **SMS 9949 NFI**.



## Level Adjuster

PS 2200 F

To vary RF levels.



Model Art. No.	PS 2200 F 871312
EAN	4040326713129
Frequency range	0,15 ... 2200 MHz
Through loss Terr.	0,5 dB
Through loss SAT	1 ... 2 dB
Attenuation range	0 ... -20 dB
DC-pass	max. 1 A
Ambient temperature	-20 ... +50 °C
Dimensions (mm)	77 x 49 x 30



## SAT Slope Equalizer Unit

SLE 4420/6 F

To compensate the slope of distribution networks.



Model Art. No.	SLE 4420/6 F 871321
EAN	4040326713211
Frequency range	950 ... 2200 MHz
Through loss	max. 1,5 dB
Slope control (fixed value)	-6 dB
DC-pass	max. 1 A
Ambient temperature	-20 ... +50 °C
Dimensions (mm)	77 x 64 x 21

### Tech Hint

The slope equalizer unit **SLE 4420/6 F** has built-in F-male / F-female connectors. The unit is designed for a direct connection with multiswitches with 20 mm F-connector distance, e.g.: multiswitch **SMS 9949 NFI**.

## SAT Slope Equalizer Unit

SLR 2200 F

To compensate the slope of distribution networks.



Model Art. No.	SLR 2200 F 871316	
EAN	4040326713167	
Through loss max.	1,5 dB	
Loss	950 MHz 2200 MHz	14 dB 3 dB
Slope control / variation range	0 ... -12 dB	
DC-pass	max. 1 A	
Supply	11 ... 20 V DC / 5 mA	
Ambient temperature	-20 ... +50 °C	
Dimensions (mm)	35 x 74 x 21	



## Slope Equalizer for SAT and Terrestrial

LE 2200



To compensate the slope of distribution networks.

Model Art. No.	LE 2200 871318
EAN	4040326713181
Frequency range	5 ... 2200 MHz
Through loss max.	1,5 dB
Loss	47 MHz 862 MHz 2200 MHz
	12 dB 10 dB 2 dB
Slope control (fixed value)	-10 dB
DC-pass	max. 1 A
Ambient temperature	-20 ... +50 °C
Dimensions (mm)	35 x 74 x 21

## Terrestrial Slope Equalizer

LE 862 F

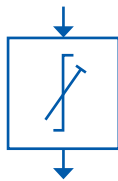

To compensate the slope of distribution networks.  
F jack / F connector for direct connection.

Model Art. No.	LE 862 F 871311
EAN	4040326713112
Frequency range	47 ... 862 MHz
Through loss	1 dB
Slope control / variation range	-1 ... -18 dB
Ambient temperature	-20 ... +50 °C
Dimensions (mm)	77 x 49 x 30



For DC compatibility use **DCF 500 (Art.No. 871506)**.

### Tech Hint

Slope equalizer will be used in distribution networks where long cable runs cause a higher through loss in the upper frequency range.

Slope equalizer compensate this higher through loss by having a higher loss in the lower frequency range compared to the upper frequency range.

SPAUN offers different slope equalizer as adjustable and non-adjustable models for the terrestrial- and the SAT range, to give an installer the possibility, to customize every installation individually corresponding to the distribution network.

## Tap

AZR 171170/10 F, AZR 171170/15 F, AZR 172170/10 F, AZR 172170/15 F, AZR 131130/10 F  
 AZR 9990/10 F, AZR 9990/15 F, AZR 99290/10 F, AZR 99290/15 F



- To install large digital distribution networks with multiple supply lines, these devices reduce the installation cost significantly
- For each tap series, there are two different models with different tap loss
- The terrestrial line is return path compatible. The trunk line DC path is linked to the tap outlet

Model Art. No.		AZR 171170/10 F 841134	AZR 171170/15 F 841135	AZR 172170/10 F 841136	AZR 172170/15 F 841137
EAN		4040326411346	4040326411353	4040326411360	4040326411377
Inputs SAT / Terrestrial		16/1			
Outputs SAT / Terrestrial		16/1 + 16/1		16/1 + 16/1 + 16/1	
Frequency range		5 ... 862 MHz and 950 ... 2200 MHz			
Tap loss tap 1	Terr.	11 dB	15 dB	10 dB	15 dB
	SAT	13 ... 10 dB	18 ... 15 dB	14 ... 10 dB	18 ... 15 dB
Tap loss tap 2	Terr.	-	-	10 dB	15 dB
	SAT	-	-	14 ... 10 dB	18 ... 15 dB
Through loss trunk	Terr.	3,5 dB	2,5 dB	4 dB	3,5 dB
	SAT	1,5 dB	1,5 dB	3 dB	3 dB
Isolation	Trunkline/trunkline	26 dB			
	Trunkline/tap	26 dB			
	Tap/tap	26 dB			
DC-pass max.		30 V / 1 A			
Ambient temperature		-20 ... +50 °C			
Dimensions (mm)		426 x 132 x 46			

Model Art. No.		AZR 131130/10 F 850020	AZR 9990/10 F 841131	AZR 99290/10 F 841153	AZR 99290/15 F 841154
EAN		4040326500200	4040326411315	4040326411537	4040326411544
Inputs SAT / terrestrial		12/1	8/1		
Outputs SAT / terrestrial		12/1 + 12/1	8/1 + 8/1	8/1 + 8/1 + 8/1	
Frequency range		5 ... 862 MHz and 950 ... 2200 MHz	5 ... 862 MHz und 950 ... 2200 MHz		
Tap loss tap 1	Terr.	10 dB	11 dB	10 dB	15 dB
	SAT	11 dB	14 ... 10 dB	13 ... 10 dB	18 ... 15 dB
Tap loss tap 2	Terr.	-	-	10 dB	15 dB
	SAT	-	-	13 ... 10 dB	18 ... 15 dB
Through loss trunk	Terr.	2,5 dB	< 3,5 dB	6 dB	6 dB
	SAT	1,5 dB	< 1 ... 2,5 dB	2 ... 4 dB	2 ... 4 dB
Isolation	Trunkline/trunkline	26 dB	26 dB		
	Trunkline/tap	26 dB	26 dB		
	Tap/tap	26 dB	26 dB		
DC-pass max.		30 V / 1 A	30 V / 1 A		
Ambient temperature		-20 ... +50 °C	-20 ... +50 °C		
Dimensions (mm)		345 x 132 x 48	264 x 211 x 39		

## Tap

AZR 5550/10 F, AZR 5550/15 F, AZR 55250/10 F



**Penta Tap®**  
**Twin Penta Tap®**

- The installation expenditure of major distribution networks can be reduced substantially. Easy installation, just one device instead of five
- The trunk line DC path is also linked to the tap outlets. This offers remote power to post amplifier in tap lines

Model Art. No.		AZR 5550/10 F 841113	AZR 5550/15 F 841114	AZR 5550/20 F 841115	AZR 55250/10 F 841151
EAN		4040326411131	4040326411148	4040326411155	4040326411513
Inputs SAT / terrestrial		4/1			
Outputs SAT / terrestrial		4/1 + 4/1			4/1 + 4/1 + 4/1
Frequency range		5 ... 862 MHz und 4x 950 ... 2200 MHz			
Tap loss Tap 1	Terr.	10 dB	16 dB	20 ... 17,5 dB	10 dB
	SAT	13 ... 10 dB	19 ... 15 dB	24 ... 20 dB	14 ... 10 dB
Tap loss Tap 2	Terr.	-	-	-	10 dB
	SAT	-	-	-	14 ... 10 dB
Through loss trunk	Terr.	2,5 ... 4 dB	1 ... 2 dB	0,5 ... 1,5 dB	4 ... 5 dB
	SAT	1 ... 2 dB	1 ... 2 dB	1 ... 2 dB	1,5 ... 3 dB
Isolation	Trunkline / trunkline	26 dB			
	Trunkline / tap	26 dB			
	Tap / tap	26 dB			
DC-pass max.		30 V / 1 A			
Ambient temperature		-20 ... +50 °C			
Dimensions (mm)		145 x 130 x 39			

## Tap

ABE 1/10 P, ABE 1/15 P, ABE 2/20 P, ABE 2/15 P, ABE 4/10 P, ABE 4/15 P, ABE 6/15 P

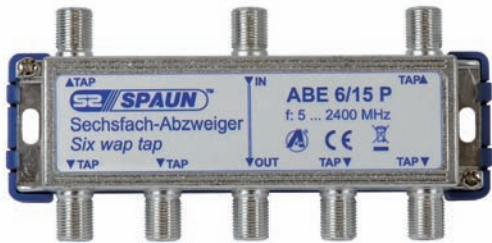

- To tap ports from a trunkline
- CATV compatible
- Remote power passes only through trunkline
- Unused trunkline output must be terminated
- Die cast metal housing protection class IP 54 (using suitable connectors)

Model Art. No.	ABE 1/10 P 841138	ABE 1/15 P 841139	ABE 2/10 P 841141	ABE 2/15 P 841142	ABE 4/10 P 841147	ABE 4/15 P 841148	ABE 6/15 P 841150
EAN	4040326411384	4040326411391	4040326411414	4040326411421	4040326411476	4040326411483	4040326411506
Tap	1-way		2-way		4-way		6-way
Tap loss							
5 ... 40 MHz	11 dB	15 dB	11 dB	15 dB	10,5 dB	15 dB	15,5 dB
40 ... 1000 MHz	10 dB	15 dB	11 dB	15 dB	11,5 dB	15 dB	16 dB
1000 ... 2400 MHz	10 dB	15 dB	11 dB	15 dB	13 dB	15,5 dB	18 dB
Through loss trunk							
5 ... 40 MHz	2,0 dB	1,5 dB	3,5 dB	3 dB	5 dB	3 dB	4 dB
40 ... 1000 MHz	2,5 dB	1,5 dB	4,5 dB	3 dB	5 dB	3,5 dB	4,5 dB
1000 ... 2400 MHz	3,2 dB	2,2 dB	4,5 dB	4 dB	6 dB	5 dB	7 dB
Ambient temperature	-20 ... +50 °C						
Dimensions (mm)	56 x 50 x 28		78 x 50 x 28				122 x 58 x 29



## UNiTap

UNiTap



- Suitable for SAT-CR applications
- DC-pass in all directions

Model Art. No.	UNiTap 841156
EAN	4040326411568
Tap	1-way
Frequency range	5 ... 2400 MHz
Insertion loss	typ. 2 dB
Tap loss	typ. 10 dB
Ambient temperature	-20 ... +50 °C
Dimensions (mm)	55 x 48 x 27

## Splitter

VTS 17217, VTS 13213, VTS 929, VTS 525



- To build large digital distribution systems with multiple supply lines, the splitters reduce the installation expenditures substantially. This means, the RF signal of the terrestrial trunkline and the 16/12/8/4 SAT IF trunkline is divided in each case into two trunklines. Each trunkline has a separate DC-pass, which is connected with the respective output ports.

### Penta Splitter®

Model Art. No.	VTS 17217 842222	VTS 13213 850019	VTS 929 842221	VTS 525 842218
EAN	4040326422229	4040326500194	4040326422212	4040326422182
Inputs SAT / Terrestrial	16/1	12/1	8/1	4/1
Outputs SAT / Terrestrial	16/1 + 16/1	12/1 + 12/1	8/1 + 8/1	4/1 + 4/1
Frequency range	5 ... 682 MHz and 950 ... 2200 MHz			
Through loss	Terr. 4 dB SAT 5 dB	4 dB 5 dB		4,5 dB 5 dB
Isolation	Input / Input	> 26 dB		
	Output / Output Terr.	> 20 dB		
	Output / Output SAT	> 15 dB		
DC-pass max.	30 V / 1 A			
Ambient temperature	-20 ... +50 °C			
Dimensions (mm)	426 x 132 x 46	345 x 132 x 48	264 x 211 x 39	145 x 130 x 46

# Splitter

VBE 2 P, VBE 2 PD, VBE 3 PD, VBE 4 P, VBE 4 PD, VBE 6 PD, VBE 8 PD



- To split signals into 2 – 8 outputs
- CATV compatible
- Return loss and isolation meets the requirements of the EN 60728-4/ class A
- Die cast metal housing protection class IP 54 (using suitable connectors)
- DC-pass from all output ports via diodes
- Feature VBE 2 P and VBE 4 P: Remote power pass in all directions

Model Art. No.	VBE 2 P 842223	VBE 4 P 842234	VBE 2 PD 842224	VBE 3 PD 842226	VBE 4 PD 842228	VBE 6 PD 842230	VBE 8 PD 842232
EAN	4040326422236	4040326422342	4040326422243	4040326422267	4040326422281	4040326422304	4040326422328
Tap	2-fach	4-fach	2-fach	3-fach	4-fach	6-fach	8-fach
Through loss							
5 ... 40 MHz	4,5 dB	8,5 dB	4,5 dB	7,5 dB	8,5 dB	11,5 dB	12 dB
40 ... 1000 MHz	4,5 dB	9 dB	5 dB	8 dB	9 dB	13 dB	14 dB
1000 ... 2400 MHz	5 dB	11 dB	6,2 dB	10,5 dB	11 dB	16,5 dB	16 dB
Return loss							
5 ... 40 MHz	18 dB	22 dB	18 dB	20 dB	22 dB	22 dB	22 dB
40 ... 1000 MHz	20 dB	20 dB	20 dB	20 dB	20 dB	21 dB	21 dB
1000 ... 2400 MHz	20 dB	20 dB	20 dB	20 dB	20 dB	20 dB	20 dB
DC-pass max.	30 V / 1 A		30 V / 1 A				
Ambient temperature	-20 ... +50 °C		-20 ... +50 °C				
Dimensions (mm)	56 x 50 x 28	78 x 50 x 28	56 x 50 x 28	78 x 50 x 28		122 x 58 x 29	

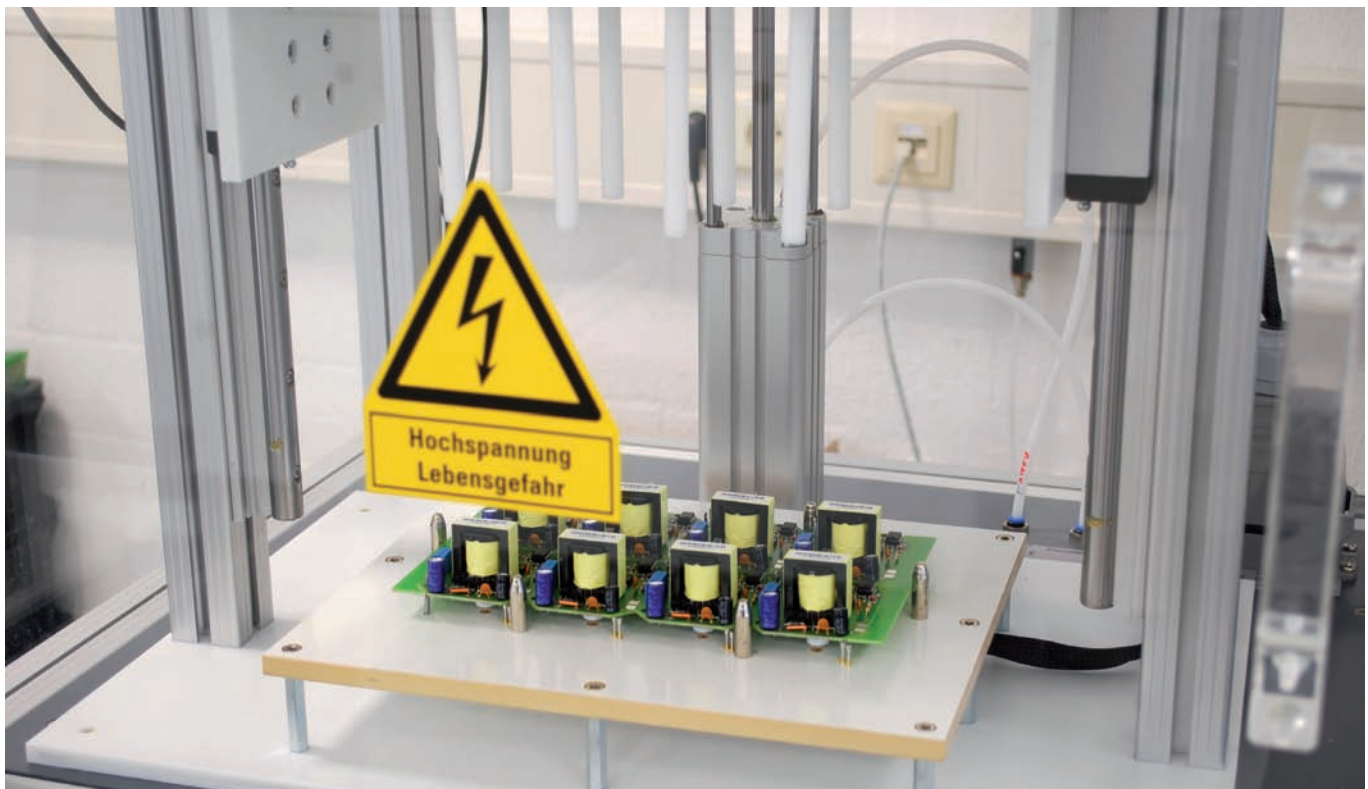

Accessories

# BluBox 16 PAL

## Headend 16 x DVB-S into PAL

The new BluBox 16 PAL is an interesting solution for care homes and small guesthouses in particular. This headend is easy to operate, offers exceptional value for money and is pre-programmed with numerous application options. The headend is supplied with 8 QPSK in PAL TWIN modules (Master/Slave), which allows for conversion of up to 16 TV programmes.

- 16 x DVB-S into PAL
- Input collector with 4 ports
- 19" mounting or wall mounting
- High energy efficiency
- LNB control with 0/14 V
- Configuration via LAN/IP
- Redundant power supply





## TV Socket Outlets (CATV)

ASE 203, ASD 210



Stubline Socket  
ASE 203

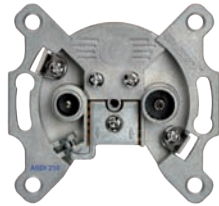

Through Socket  
ASD 210

- To be used in CATV networks or terrestrial distribution systems
- For surface and flush-mounting with screw and claw-fixing
- With nearly all installation programs combinable (DIN 45330)
- Delivery without hole cover

Model Art. No.	ASE 203 850016	ASD 210 821104
EAN	4040326500163	4040326211045
Type	Stubline Socket	Through Socket
Frequency range	5 ... 862 MHz	
Frequency range TV	5 ... 862 MHz	
Frequency range FM	5 ... 108 MHz	
Insertion loss IN - TV	3 dB ± 0,5 dB	10 dB ± 1 dB
Insertion loss IN - FM	6 dB ± 0,5 dB	12 dB ± 1 dB
Through loss	-	2,5 dB ± 0,5 dB
Isolation TV - FM	25 dB	
Screening factor	> 85 dB, Class A	
Ambient temperature	-20 ... +50 °C	



## TV Socket Outlets (SMATV)

ASE 5 F, UNiSocket 310, UNiSocket 314, UNiSocket 318



Stubline Socket  
ASE 5 F

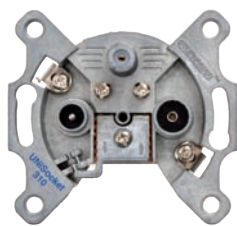

Through Socket  
UNiSocket 310



Through Socket  
UNiSocket 314



Through Socket  
UNiSocket 318

- **Specifically optimized for usage with SPAUN SCR systems**
- To be used in SMATV networks
- For selective separation of the broadband frequency range 5 ... 2250 MHz
- For surface and flush-mounting with screw and claw-fixing
- With nearly all installation programs combinable (DIN 45330)
- Delivery without hole cover

Model Art. No.	ASE 5 F 850006	UNiSocket 310 852106	UNiSocket 314 852107	UNiSocket 318 852108
EAN	4040326500064	4040326521069	4040326521076	4040326521083
Type	Stubline Socket	Through Socket	Through Socket	Through Socket
Frequency range SAT	950 ... 2250 MHz			
Frequency range TV	5 ... 862 MHz	5 ... 68 MHz & 118 ... 862 MHz		
Frequency range FM	5 ... 139 MHz	87,5 ... 108 MHz		
Tap loss IN - SAT	2 dB ± 0,5 dB	10 dB ± 2 dB	14 dB ± 2 dB	18 dB ± 2 dB
Tap loss IN - TV	2,5 dB ± 0,5 dB	10 dB ± 2 dB	14 dB ± 2 dB	18 dB ± 2 dB
Tap loss IN - FM	6 dB ± 0,5 dB	10 dB ± 2 dB	14 dB ± 2 dB	18 dB ± 2 dB
Through loss	-	typ. 3 dB	typ. 2 dB	typ. 1,5 dB
Isolation TV - SAT	25 dB			
Isolation FM - SAT	22 dB			
Isolation TV - FM	20 dB			
Screening factor	> 85 dB, Class A			
SAT power pass	max. 1 A			
Ambient temperature	-20 ... +50 °C			

## Multimedia Sockets (SAT)

MSS 5 F, MediaSocket 410, MediaSocket 414, MediaSocket 419



Stubline Socket  
MSS 5 F



Through Socket  
MediaSocket 410

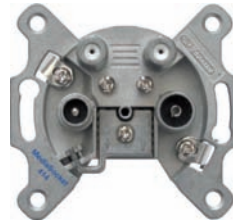

Through Socket  
MediaSocket 414



Through Socket  
MediaSocket 419

- To be used in SMATV networks combined with multimedia application
- Separate data port for connecting a cable modem
- For surface and flush-mounting with screw and claw-fixing
- With nearly all installation programs combinable (DIN 45330)
- Delivery without hole cover

Model Art. No.	MSS 5 F 852112	MediaSocket 410 852109	MediaSocket 414 852110	MediaSocket 419 852111
EAN	4040326521120	4040326521090	4040326521106	4040326521113
Type	Stubline Socket	Through Socket	Through Socket	Through Socket
Frequency range SAT	950 ... 2250 MHz			
Frequency range TV	87,5 ... 862 MHz			
Frequency range FM	87,5 ... 862 MHz			
Frequency range Data	5 ... 862 MHz			
Tap loss IN - SAT	3 dB ± 0,5 dB	10 dB ± 2,5 dB	14 dB ± 2,5 dB	19 dB ± 2,5 dB
Tap loss IN - TV	4 dB ± 2 dB	10 dB ± 2,5 dB	14 dB ± 2,5 dB	19 dB ± 2,5 dB
Tap loss IN - FM	8 dB ± 2 dB	10 dB ± 2,5 dB	14 dB ± 2,5 dB	19 dB ± 2,5 dB
Tap loss IN - Data	9 dB ± 2,5 dB	10 dB ± 2,5 dB	14 dB ± 2,5 dB	19 dB ± 2,5 dB
Through loss	-	5 ... 1750 MHz = typ. 6,5 dB 1750 ... 2250 MHz = typ. 8 dB	5 ... 1750 MHz = typ. 5 dB 1750 ... 2250 MHz = typ. 7 dB	5 ... 1750 MHz = typ. 6 dB 1750 ... 2250 MHz = typ. 6,5 dB
Isolation TV - SAT	25 dB			
Isolation FM - SAT	22 dB			
Isolation TV - FM	20 dB			
Screening factor	> 85 dB, Class A			
SAT power pass	max. 1 A			
Ambient temperature	-20 ... +50 °C			

## Surface Mount Assembly Kit

AMR U/Set



- For TV socket outlets according to DIN 45330
- Can be used with all SPAUN SMATV- and CATV sockets
- Includes of surface frame, frame, and 2 -, 3 - and 4-hole cover
- Color: RAL 9010 pure white

Modell Art. Nr.	AMR U/Set 850005
EAN	4040326500057

## Terminating Resistors

ASR 75/Set, DCR 75/Set

Model Art. No.	ASR 75/Set 871512	DCR 75/Set 871513
EAN	4040326715123	4040326715130
Dimensions (mm)	18,5 , 3,5 Ø	18,5 , 3,5 Ø



Terminating resistors 75 Ω



Terminating resistors 75 Ω for  
UNISocket 310 / 314 / 318,  
MediaSocket 410 / 414 / 419,  
DC decoupled

## Earth Bonding Bars

EW4, EW5, EW6

- Space between jacks: 20 mm
- Including mounting screws



Model Art. No.	EW 4 852113	EW 5 852114	EW 6 852115
EAN	4040326521137	4040326521144	4040326521151
Connectors	4	5	6
Dimensions (mm)	77 x 45 x 30	97 x 45 x 30	117 x 45 x 30

## Ground Clamp

EDKL 1 / Set



- Suitable for all F-jacks, especially for the grounding of the UniSystem devices
- For equipotential bounding with 4 mm<sup>2</sup>

Set = 5 pcs. (sales unit)

Model Art. No.	EDKL 1/Set 872013
EAN	4040326720134
Dimensions (mm)	35 x 14,5 x 2

## Elbow Connector

WS 90 F / Set



Set of 4 pcs.

Model Art. No.	WS 90 F 871502
EAN	4040326715024
Screening attenuation	> 90 dB

## DC Blocker

DCF 500/Set



Set of 2 pcs.

Model Art. Nr.	DCF 500/Set 871506
EAN	4040326715062
Impedance	75 Ω
Through loss trunk	Terr. SAT < 0,5 dB < 0,5 dB
Voltage max.	50 V
Dimensions (mm)	33, 12 Ø

## DC-Decoupled Terminating Resistor

ZFR 75 DC/Set, ZMR 75 DC/Set



Set of 2 pcs.

Model Art. No.	ZMR 75 DC/Set 871514	ZFR 75 DC/Set 871511
EAN	4040326715147	4040326715116
Impedance	75 Ω	75 Ω
Voltage	max. 30 V	max. 30 V
Dimensions (mm)	27, 12 Ø	27, 12 Ø

## Non DC-Decoupled Terminating Resistor

ZSR 75 F/Set

Set of 5 pcs.



Model Art. No.	ZSR 75 F/Set 871501
EAN	4040326715017
Impedance	75 Ω
Voltage	0 V
Dimensions (mm)	12,5 Ø

## Push On 'F' male Coupler

ZSV 2 S/Set



Set of 5 pcs.

Model Art. No.	ZSV 2 S/Set 871508
EAN	4040326715086
Through loss trunk	Terr. SAT 0,2 dB 0,4 dB
Dimensions (mm)	29, 12 Ø

## Push On 'F' female Coupler

SFV 2/Set

Set of 2 pcs.

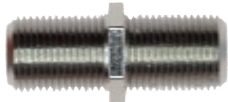

Modell Art. Nr.	SFV 2/Set 872616
EAN	4040326726167
Through loss	Terr. SAT 0,2 dB 0,4 dB
Dimensions (mm)	29, 12 Ø

## RF Link Cables

ZVK 500 F/Set , ZVK 250 F/Set



Set of 5 pcs.

Model Art. No.	ZVK 250 F/Set 871505	ZVK 500 F/Set 871507
EAN	4040326715055	4040326715079
Impedance	75 Ω	
Through loss trunk	Terr. SAT 0,5 dB 1 dB	
Dimensions (mm)	250	500
Diameter (mm)	6	

## Antenna Coaxial Cable

SPOAX 111, SPOAX 95

- Darkblue external sheath
- Meter marking
- Lead and silicone free
- Conform with EN 50117-2-4, CEI20-35, CEI20-11, RoHS



Model External coating (material) Art. No.		SPOAX 111		SPOAX 95	
		PVC 860020	LS0H 860022	PVC 860010	LS0H 860012
EAN		4040326600207	4040326600221	4040326600108	4040326600122
Outdoor mounting		-	✓	-	✓
Indoor mounting		✓	✓	✓	✓
Flame retardant		-	✓	-	✓
Material data	1. Inner conductor	Copper (CU) 1.13 mm (17 Ω /km)			
	2. Bend protection	pigmented Polyethylene with black Carbon (PEC)			
	3. Insulation (Dielectric)	foamed antiaging Polyethylene (PEE) 4.9 mm			
	4. Bend protection	pigmented Polyethylene with black Carbon (PEC)			
	5. Tape	Aluminum / Polyester / Aluminum (AL/PET/AL) 100%			
	6. Braid	tinned Copper wire (CU-SN) 5,6 mm			
	7. Tape	Aluminum / Polyester (AL/PET) 100%		-	
	8. Sheath	6,7 mm			
Capacitance		52 pF/m (+/- 2)			
Nominal impedance		75 Ω (+/- 3)			
Attenuation dB / 100 m	5 MHz	1,0 dB			
	50 MHz	3,6 dB			
	200 MHz	8,0 dB			
	300 MHz	9,5 dB			
	470 MHz	12,4 dB			
	860 MHz	16,8 dB			
	1000 MHz	18,0 dB			
	1750 MHz	24,9 dB			
	2150 MHz	27,8 dB			
	2500 MHz	29,5 dB			
3000 MHz	33,0 dB				
Return loss	20 ... 470 MHz	> 30 dB			
	470 ... 1500 MHz	> 28 dB			
	1500 ... 2500 MHz	> 24 dB			
Screening attenuation		> 110 dB		> 95 dB	
Velocity ratio		85 %			
Bending radius in mm max. one-time / repeated		20 / 50			
Copper weight		24,5 kg/km		22 kg/km	
Total weight		55 kg/km		51 kg/km	
Mounting temperature		-20° - 70°			
Packing		250 m boxed with unwinder			

\* EN 50265  
EN 50266  
EN 50267  
EN 50268  
ASTM D2565

suitable for  
outdoor use  
(no laying in  
the ground)

## F-Connectors

FKS 53, FCS 53

Model Art. No.	FKS 53/Set (Compression) 872600	FCS 53/Set (Crimp) 872610
EAN	4040326726006	4040326726105
Screening attenuation	> 90 dB	> 90 dB
Packing unit	50 pcs	50 pcs

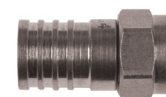
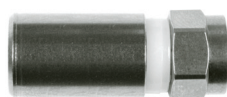

## Compression Pliers

FKZ-1

Compression pliers with 3 compression adapters for FKS 53/Set (compression connector).

- Parallel track path
- Robust metal worked design with efficient transmission for good effort-compression ratio

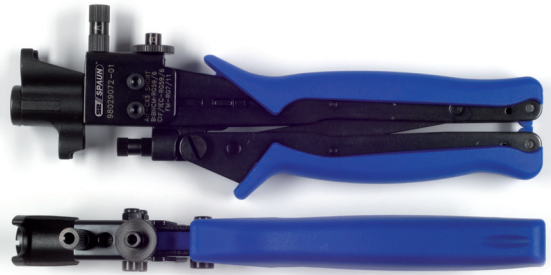

Model Art. No.	FKZ-1 872500
EAN	4040326725009

## Crimp Pliers

FCZ-1

Crimp pliers for crimp connector FCS-53/Set.

- Robust metal worked design
- Adjustable track
- Use with crimp connector in size 3.7 and 5.3 without switching the cap



Model Art. No.	FCZ-1 872501
EAN	4040326725016

## Rotary Cable Stripper

AIW-1

Rotary cable stripper for nearly all kinds of mini coaxial cables as well as RG 6, RG 59 and RG 58.

- Different settings for cut- and stripper blades
- Incl. hex key wrench for adjustment
- Fixcross for easy adjustment of cable diameter
- Depth stop for optimal cable cutback



Model Art. No.	AIW-1 872502
EAN	4040326725023

### Project reference 1

A satellite system with 4 satellite position and a total of 256 TV socket outlets.

In a technical service room which is located next to the antenna park the signal is modulated from coax to fibre optic and is distributed to 6 locations with different cable distances from 130 up to 400 m. From each location a further sub-distribution to the various buildings is made with distances between 20 and approximate 110m.

By using our active and passive multiswitch technology, we are able to realize such a distribution system with a large number of outlets but with a small number of additional inline amplifiers.

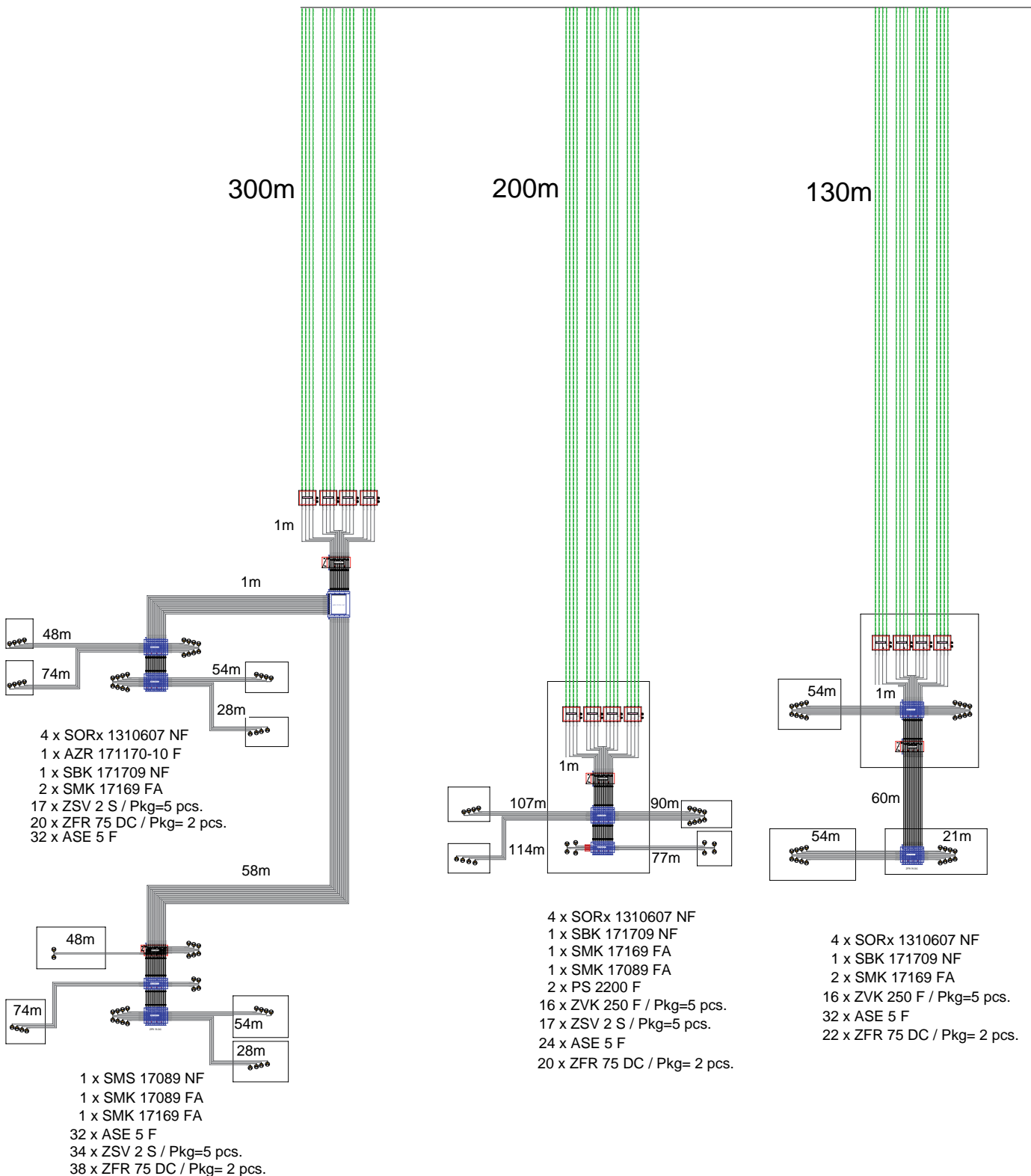



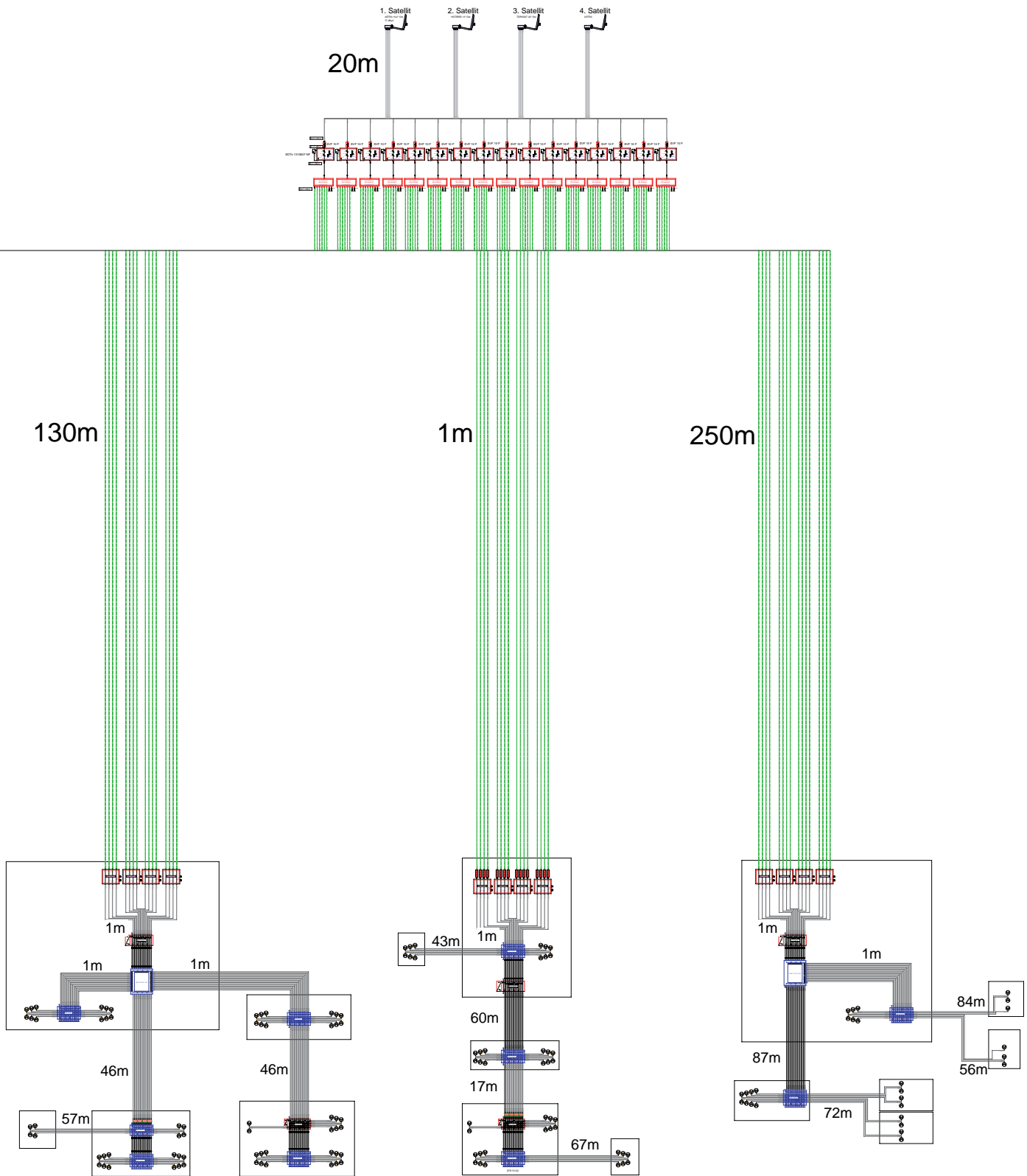

- 4 x SORx 1310607 NF
- 1 x SBK 171709 NF
- 1 x AZR 172170-10 F
- 3 x SMK 17129 F
- 1 x SMS 17089 NF
- 4 x LE 4420 / 6 F
- 2 x SMK 17129 FA
- 1 x SMK 17089 FA
- 17 x ZVK 250 F / Pkg=5 pcs.
- 64 x ASE 5 F
- 60 x ZFR 75 DC / Pkg= 2 pcs.

- 1 x SBK 171709 NF
- 4 x SORx 1310607 NF
- 16 x SODE 15 dB
- 3 x SMK 17129 FA
- 4 x LE 4420 / 6 F
- 1 x SMS 17089 NF
- 17 x ZVK 250 F / Pkg=5 pcs.
- 17 x ZSV 2 S / Pkg=5 pcs.
- 36 x ASE 5 F
- 38 x ZFR 75 DC / Pkg= 2 pcs.

- 1 x SBK 171709 NF
- 4 x SORx 1310607 NF
- 1 x AZR 171170-10 F
- 1 x SMK 17169 FA
- 1 x SMK 17129 FA
- 17 x ZVK 250 F / Pkg=5 pcs.
- 38 x ZFR 75 DC / Pkg= 2 pcs.
- 28 x ASE 5 F

## Project reference 2

A satellite system with 4 satellite position and an FM antenna for radio reception.

The distribution system has a total of 752 TV socket outlets and is scheduled for two phases. The first phase consists of 12 corridor entrances. The antenna park is approximately 60 m away from the main building and is fed into the center of the entire distribution. In each corridor entrance, a floor or central distribution is applied. For installing the trunklines a underground cable was used and for the cable runs between the multiswitches and the TV socket outlets a standard coaxial cable. By using our active and passive multiswitch technology, we are able to realize such a distribution system with a large number of outlets but with a small number of additional inline amplifiers.

- 88 x ASE 5 F
- 19 x ZFR 75 DC
- 68 x ZSV 2 S
- 1 x SMK 17129 F
- 1 x SMS 17089 NF
- 1 x SMK 17089 FA
- 1 x SMK 17129 FA
- 1 x SMK 17169 FA
- 1 x SMK 17169 F
- 2 x SMK 17089 F
- 2 x HNV 30 UPE
- 2 x VTS 17217
- 1 x HLV 40/30 FPE
- 33 x ZVK 250 F
- 1 x AZR 172170-10 F
- 2 x SBK 171709 NF

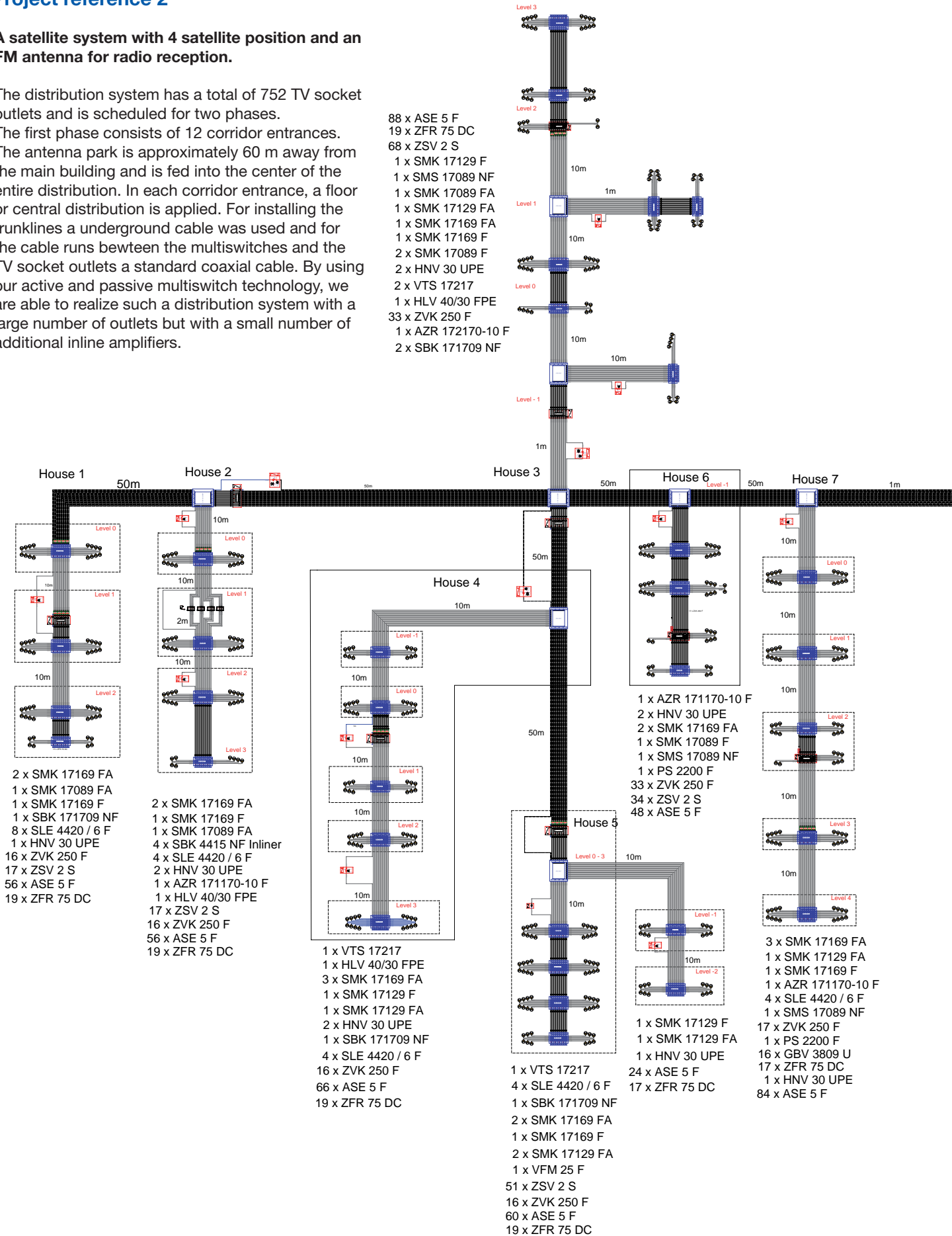

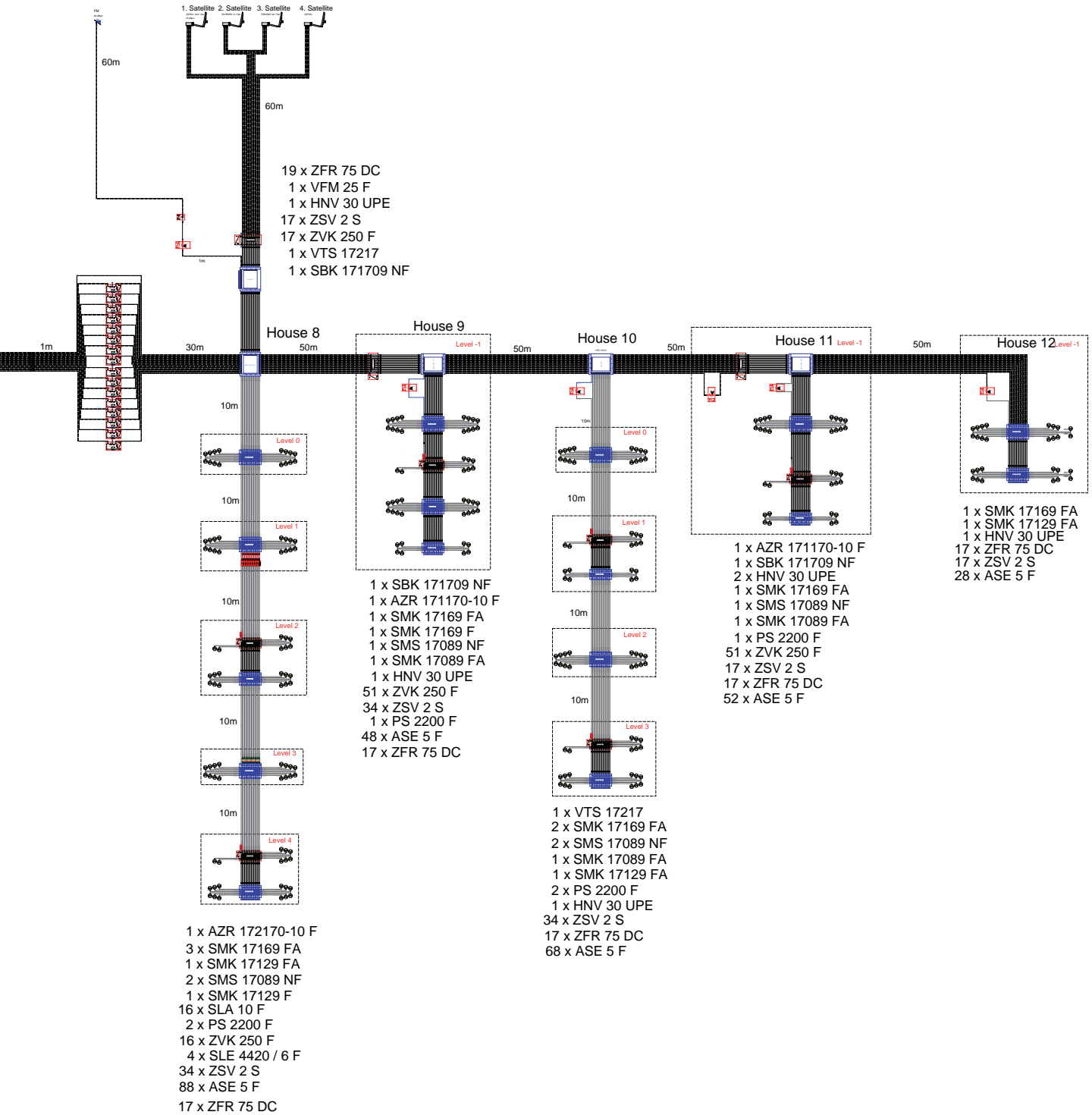

## Guidelines and standards

The product standards of the EN 50083 and EN 60728 series apply for antenna reception and distribution systems.

### Overview of the European standard EN 50083 & EN 60728

Cable distribution systems for television and audio signals and interactive multi-media services

EN 60728-11:	Safety requirements
EN 50083-2:	Electromagnetic compatibility of equipment
EN 60728-3:	Active broadband equipment for coaxial distribution networks
EN 60728-4:	Passive broadband equipment for coaxial distribution networks
EN 60728-5:	Equipment for headend stations
EN 60728-6:	Optical equipment
EN 60728-1:	System requirements
EN 50083-8:	Electromagnetic compatibility of cable distribution networks
EN 50083-9:	Interfaces for CATV/SMATV headend stations and comparable professional equipment for DVB/MPEG 2 transportation streams
EN 60728-10:	Return channel system requirements

**EN 60728 Part 11** covers all the relevant safety regulations such as earthing, lightning protection, potential equalisation, mechanical stability etc. and refers inter alia to EN 60065 and EN 60950 which applies to power supply units.

**EN 50083 Part 2** contains all the important regulations pertaining to EMC such as screening factor, noise emission, irradiation, input flow, interference suppression etc.

The CE labelling of SPAUN products confirms the conformity with these norms.

## Screening factor / Classification

With introduction of the addition of the EN 50083-2 classification for passive devices new increased values were specified as minimum requirements:

Frequency range	Screening factor		Interference
	Class A	Class B	
5 ... 30 MHz	≥ 85 dB	≥ 75 dB	27 ... 20 dBpW <sup>1) 2)</sup> ≤ 33 dBpW <sup>3)</sup>
30 ... 300 MHz	≥ 85 dB	≥ 75 dB	≤ 20 dBpW
300 ... 470 MHz	≥ 80 dB	≥ 75 dB	≤ 20 dBpW
470 ... 950 MHz	≥ 75 dB	≥ 65 dB	≤ 20 dBpW
from 950 MHz	≥ 55 dB	≥ 50 dB	≤ 43 dBpW

1) Linear response with logarithmic frequency decrement

2) For active devices, which are not supplied with a mains cable

3) For devices with power supply



**SPAUN Headquarters - Germany****Distribution**

Represented by over 30 global **S2 // SPAUN™** distribution partners

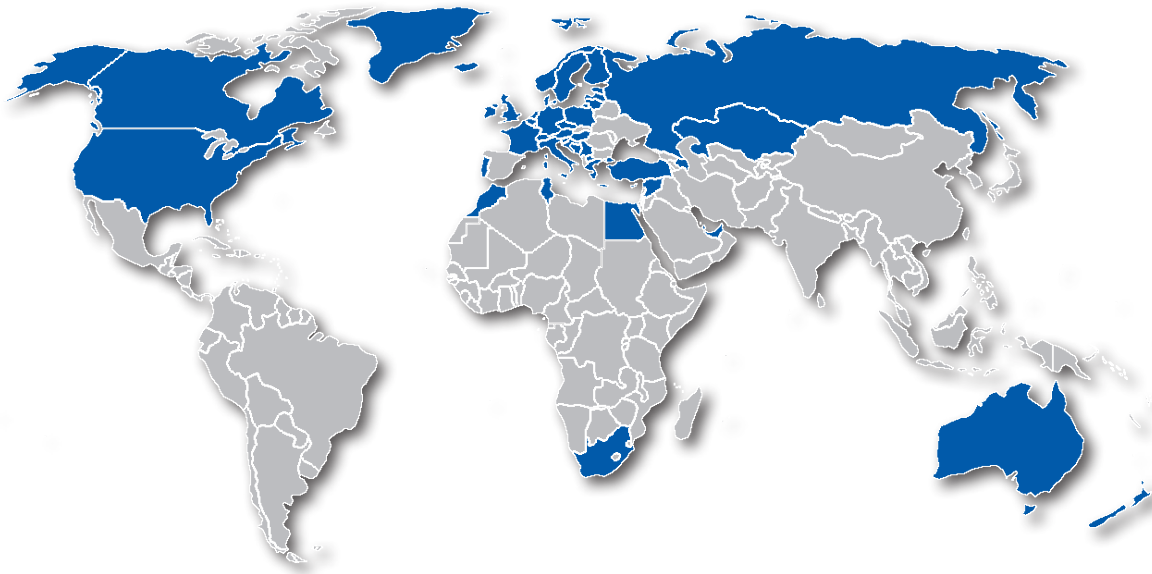

**You are interested in becoming a distribution partner of SPAUN?  
Please get in touch with us.**

**Email: [export@spaun.de](mailto:export@spaun.de) · Phone +49 (0) 77 31 - 86 73 - 46**

**Disclaimer**

Specifications and design are subject to change without notice. Errors excepted. All rights on pictures and written content remain exclusive property of SPAUN electronic GmbH & Co. KG, Singen. Copies and modifications of content from this page for editorial purposes must be marked with copyright © SPAUN electronic GmbH & Co. KG.

## Technical Hotline

for installers and wholesalers only

### Planning for the future - with SPAUN

The requirements for SAT IF distribution technology are becoming increasingly diverse and complex. In addition, customers are becoming more demanding and require timely solutions.

We can help with brand- and manufacturer- independent know-how and practical knowledge. To guarantee your customers a fast and effective problem solving to high customer satisfaction. SPAUN electronic is not only a manufacturer of high quality products. The staff of our technical support hotline are attending you during the planning phase of your projects.

By using a modern CAD design software SPAUN electronic offers you also for large distribution networks tailor-made and customized solutions. The international field of activity of SPAUN electronic ensure that country-specific guidelines are taken into account from the beginning of the planning phase and will be implemented effectively.



Steffen Kuck



Markus Morath

The request form for RF and IF plannings can be downloaded here:

<http://formulare.spaun.de/>

Phone: +49 (0) 77 31 - 86 73 - 18

Fax: +49 (0) 77 31 - 86 73 - 28

Email: [hotline@spaun.de](mailto:hotline@spaun.de)

## Repair Service

Defective SPAUN products will be checked and repaired free of charge within the warranty period.

Please return the defective product only with a detailed error description together with our repair form to our Service Department:

**SPAUN electronic GmbH & Co. KG**  
**-Service-**  
**Byk-Gulden-Strasse 22**  
**78224 Singen**  
**Germany**

Please be aware that our service department does not accept freight collect shipments.

Our service staff are always striving to do repairs within five working days. Missing or inaccurate fault descriptions can lead to longer processing times due to a complex fault localization or required long-term tests.



Claudio Saura



Peter Fuchs

The repair form can be downloaded here:

<http://formulare.spaun.de/>

Phone: +49 (0) 77 31 - 86 73 - 39

Fax: +49 (0) 77 31 - 86 73 - 17

Email: [service@spaun.de](mailto:service@spaun.de)

## General Terms and Conditions

of SPAUN electronic GmbH & Co. KG

### Section 1. Application:

- 1.1 Business transactions between us and the commercial buyer shall be governed by the "General Terms and Conditions of Delivery for Products and Services of the Electronics Industry" ["Allgemeinen Lieferbedingungen für Erzeugnisse und Leistungen der Elektroindustrie", ZVEI], except where otherwise provided for below. The following General Terms and Conditions shall apply to all orders concluded between us and the commercial buyer. These Terms and Conditions shall be deemed agreed upon whenever an order is placed with us. Collateral agreements of any kind whatsoever shall only be binding, if laid down and confirmed in writing.
- 1.2 The buyer's terms and conditions of purchase shall only apply in so far as we have expressly consented to them in writing. Unconditional execution of a purchase order despite knowing of conflicting terms and conditions of purchase shall not signify consent.

### Section 2. Quotations

- 2.1 Our quotations will be governed by the selling prices and terms valid on the day of delivery.
- 2.2 The documents forming part of the quotation, such as illustrations, drawings and dimensional data shall only be approximately authoritative, except where they are expressly referred to as binding.
- 2.3 Orders shall be deemed accepted, if they have been expressly acknowledged by us.

### Section 3. Delivery, Dispatch, Periods for Delivery, Default in Delivery, Compensatory Damages

- 3.1 All deliveries shall take place at the buyer's risk and for the buyer's account. In this respect, we shall perform the contract by handing over the goods to the forwarder or carrier or to any other person appointed to carry out the shipment. The buyer agrees that the day of dispatch of the goods, or of hand-over to the forwarder or carrier, shall be deemed equivalent to the day of hand-over and delivery, even if it is no sale by shipment (section 477 of the German Civil Code [BGB]). The risk of deterioration and of accidental destruction of goods delivered by us shall, as provided for above, pass to the buyer upon hand-over or dispatch. The period of liability for defects shall begin on the day of dispatch or hand-over of the goods as stipulated above.
- 3.2 Dates for delivery must be in writing and shall be complied with as far as possible, however, they shall be non-binding, unless they have been expressly guaranteed in writing as fixed dates. Delays in delivery or performance due to force majeure or due to events which make it materially more difficult or impossible for us to make delivery, including in particular strike, lockout, official directives, operational disruptions, unavailability of an important piece of work etc., shall not be imputable to us, even in the case of periods or dates bindingly agreed upon. They shall not entitle the buyer to withdraw orders or assert damage claims of any kind. If the hindrance persists for longer than 3 months, the buyer shall, after having set a reasonable respite period, be entitled to rescind the contract in respect of the part not yet performed, without this resulting in any obligation on our part to compensate for losses.
- 3.3 Partly deliveries shall be permissible.

### Section 4. Notifications of Defects, Complaints, Warranty, Liability, Compensatory Damages

- 4.1 In any event, our liability for defects shall depend on the buyer's examination of the goods for defects upon receipt without undue delay. The buyer must give notification of all apparent defects without undue delay, however no later than 14 days after receipt of the goods. Hidden defects must be notified by the buyer without undue delay, however no later than 14 days after their discovery. Every notification of defects by the buyer must be in writing. The buyer's notification of defects must refer to the respective goods and the respective defect in the goods. The date of receipt of the notification of defects at our company shall be authoritative for observance of the time limit. If the buyer omits to give notification of defects, the goods shall be deemed approved.
- 4.2 Goods containing faults in workmanship and/or in materials shall be repaired or replaced within 5 years of delivery. Excluded from this are processing systems (headends), optical transmitting & receiving equipment as well as their optical accessories, audio-/video modulators, measurement technology, cables and software, which have a guarantee period of 2 years from delivery. Rechargeable batteries are excluded from any guarantee. Our guarantee promise is limited to replacement or reinstatement of the goods and does not include any assembly costs, transport infrastructure charges or other consequential costs. Further claims against us are excluded, as far as permitted by law or otherwise provided for in these terms and conditions. The same applies to compensation for losses which have not arisen in the goods themselves. The cost of sending in the goods for repairs under guarantee shall be borne by the sender.
- 4.3 Liability for normal depreciation is excluded. Immaterial deviations in colour, dimensions and/or other quality and performance characteristics of the goods shall not generate any claims on the part of the buyer, particularly no defect-related rights.
- 4.4 The defect-related rights and the guarantee promise are limited to the goods delivered. Not included are consequential losses, or losses or disruptions which are due to improper handling, storage, transportation, normal wear and tear, non-observance of use instructions or incorrect or negligent handling. This applies in particular to the operation of the goods with the wrong type of electric power or voltage and to the connection to unsuitable electric power sources. The same applies to defects and losses due to fire, lightning, explosion, grid-related excess voltage, moisture of any kind, or incorrect or lack of programming, unless the buyer proves that the respective defect exists regardless of those circumstances. The same applies to normal wear and tear and other causes upon which we have no influence.
- 4.5 The defect-related rights and the guarantee promise shall cease to exist, if and when the buyer tampers with and/or repairs the goods, itself or through persons not authorised by us.
- 4.6 Within one year from the delivery date, we shall, at our option, be entitled to repair or replace, as defined by section 439 of the German Civil Code, in cases where the buyer is an entrepreneur. If repair or replacement fails, the buyer may demand mitigation or rescission of the contract. Repair shall have failed, if and in as far as a time limit which we have been set for the first time for rendering supplementary performance has lapsed to no avail. Defect-related rights shall become time-barred one year after delivery of the goods.

If the buyer demands compensation for expenditures according to sec. 478 para. 2 German Civil Code [BGB], this shall be limited to a maximum of 2 % of the original value of the goods. Claims based on sec. 478 German Civil Code [BGB] are contracted out by the voluntary 5-year guarantee promise for commercial buyers under nos. 4.2. et seq. in the sense of compensation of equal value in accordance with sec. 478 para. 4 sent. 1 German Civil Code [BGB].

- 4.1 Claims for expenditures necessary for the purpose of supplementary performance, particularly transportation costs, transport infrastructure charges, labour costs and costs of materials, are excluded to the extent the increase of expenditures results from the subsequent transportation of the goods to a place other than the buyer's place of establishment, except where this transportation is in accordance with the intended use of the goods.
- 4.2 No new defect-related rights/guarantees shall arise as a result of the exchange of the goods for reasons of repair or after execution of the guarantee promise.
- 4.3 Unjustified complaints of defects and unjustified complaints under the guarantee promise shall entitle SPAUN electronic GmbH & Co KG to charge the buyer for the costs arising in connection with processing, examining and returning.
- 4.4 **Attention with devices containing an integrated power supply unit and/or with power packs:  
Self-made or improper repairs or alterations to the goods may be life-threatening for the user!**
- 4.5 Rescission of the contract and compensatory damages in the event of default on our part shall require the setting of a reasonable respite period by the buyer. In this respect, the respite period must be proportionate to the type and scope of the order. In case of our default, liability for damages shall be limited to an amount equal to 30 % of the foreseeable loss.
- 4.6 Our liability shall be unlimited in cases of intent and gross negligence, as well as in cases of fraud. Any liability arising out of minor negligence on our side shall only give rise to damages that, based on this agreement, were typically predictable and only if an obligation with significant meaning to the achievement of the purpose of this Agreement was violated (material obligation). We shall not assume any liability beyond the foregoing, regardless of the basis of the claim. The above-mentioned limitations and exclusions of liability shall not apply to claims based on losses arising from injury to life, body or health or to claims under the Product Liability Act [Produkthaftungsgesetz]. To the extent our liability is limited or excluded, the personal liability of our agents in contract and agents in tort shall likewise be limited or excluded.

### Section 5. Payment

- 5.1 The prices are understood to be ex works and subject to addition of the respective applicable statutory value-added tax.
- 5.2 Our invoices shall be due as follows: within 14 days of the invoice date less a 3 % cash discount or within 30 days of the invoice date net, free of charge to the supplier's point of payment.
- 5.3 In the event of default of net payment, we shall have the right to charge default interest at the rate of 8 % above the respective valid statutory base interest rate.
- 5.4 If the buyer defaults on payment or if justified doubts about its financial standing arise, all accounts receivable still outstanding may be declared due for payment immediately.
- 5.5 Bills of exchange shall not be accepted as a means of payment.
- 5.6 In the case of first-time purchase orders, we shall be entitled to deliver on the basis of cash on delivery or on the basis of advance payment.
- 5.7 The buyer shall only be entitled to offset on the basis of claims which are uncontested or have been determined with legal finality. The assertion of rights to refuse to perform or rights of retention shall be limited to the same legal relationship.

### Section 6. Retention of Title

- 6.1 All goods and programmes delivered shall remain our property until the buyer has fully paid all accounts receivable (including all balances due on an open account) which have ensued from our business relationship.
- 6.2 The buyer shall properly hold the goods in safekeeping until the transfer of title. The buyer shall be entitled to on-transfer the deliveries in the ordinary course of business. The buyer shall not be permitted to make any other dispositions, particularly pledging or transfer of title as security. In the event of default in payment, the buyer shall be obligated to make known the address of its debtors and the sum of the receivables concerned. As long as the goods are under retention of title, they must not be exported out of the Federal Republic of Germany.
- 6.3 If the goods specified in our order acknowledgement are on-transferred to third parties, whether by reselling or by installation into buildings or land property, the buyer's claim against the third party shall be assigned to us up to the sum of the purchase price, including VAT, shown in the order acknowledgement. We accept the respective assignment. If the buyer defaults on payment of the agreed remuneration, the receivable against the third party shall, furthermore, be deemed assigned beyond the amount of the purchase price, up to the additional amount of our loss caused by default. In the event of default, we shall be entitled to immediately make known to the third party the assignment of the receivable.
- 6.4 In the event of default in payment, we shall be entitled, even without exercising rescission and without setting a respite period, to demand the provisional surrender of the goods belonging to us at the buyer's expense. Subject to prior notice, we shall be entitled to dispose elsewhere of the delivery reclaimed and, following payment, supply the buyer anew within the customary period for delivery.
- 6.5 Loss, damage, attachment or any other encroachment by third parties in respect of the goods under retention of title or attachments of the receivables assigned shall be notified to us without undue delay. Costs arising as a result of the assertion of our claims shall be reimbursed by the buyer.

### Section 7. Place of Performance, Place of Jurisdiction and Applicable Law

- 7.1 The place of performance for the delivery and payment is the registered office of Spaun electronic GmbH & Co KG.
- 7.2 Singen is the exclusive place of jurisdiction for all present and future claims arising from the business relationship with merchants. However, we shall be entitled to bring an action against the buyer at its place of general jurisdiction.
- 7.3 The legal relations in connection with this contract shall be governed by German substantive law, excluding the United Nations Convention on Contracts for the International Sale of Goods (CISG).

Valid: 1st of May 2011



www.spaun.com

Quality made in Germany

**SPAUN electronic GmbH & Co. KG**

**Byk-Gulden-Str. 22 · 78224 Singen · Germany**

Phone: +49 (0)7731 - 8673-0 · Fax: +49 (0)7731 - 8673-17

Email: [contact@spaun.com](mailto:contact@spaun.com) · [www.spaun.com](http://www.spaun.com)



For the latest news please visit our website.

**www.spaun.com**

Presented through: