



NEW MADE IN GERMANY **10 YEARS POWER**
IN STORAGE*

AA
ALKALINE

VARTA

HIGH ENERGY



VARTA HIGH ENERGY

+80% MORE POWER
In Digital Cameras vs. VARTA Simply Alkaline**

GENERAL CATALOGUE 2014/2015

VARTA



GENERAL CATALOGUE 2014/2015

INNOVATION, COMPETENCE, QUALITY

Energy expertise “Made in Germany”

For over 125 years the name VARTA has been synonymous with market-leading battery solutions, and for just as long we have been committed to the values behind the label „Made in Germany“: quality, an innovative spirit and working closely with our customers.

Today, in a time that seems dominated by the digital data stream and mobile internet devices, our products - whether it is primary batteries, chargers or flashlights - hold continuing relevance for the consumer. That is the merit of a strong, experienced team and not for nothing are we counted on as the battery experts. We take pride in getting continuously better: both in view of technical innovation as well as addressing the needs of the consumer.

Our multiple award-winning POS displays, the concise consumer information on VARTA packaging and our attractive promotions sharpen consumers` trust and interest.

Our fast, flexible team offers you tailor-made solutions for POS and category management to support your sales. And last but not least as a full-line distributor for primary batteries we are part of the \$4 billion company Spectrum Brands, a global network that can meet all international requirements.

Quality, innovation spirit and closeness to customers – these values we want to share with you to benefit from each other!



Peter Werner
Managing Director Consumer Batteries
Europe & Middle East/Africa

All mentioned products and specifications are subject to change.

In case of non-availability of any product or item, VARTA Consumer Batteries GmbH & Co. KGaA cannot be held responsible.

This catalogue is for international use.

Some of the products shown may not be available in all countries.

The pictures might be different to the original products. Technical changes and errors reserved.

QUALITY "MADE IN GERMANY"	4
GENERAL PURPOSE Lithium Max Tech High Energy Longlife Superlife	8
RECHARGEABLES AND CHARGERS Rechargeables Special Rechargeables Chargers	20
PORTABLE POWER	32
ELECTRONICS / BUTTON CELLS Professional Lithium (Photo) Professional Electronics Watch Batteries Hearing Aid	40
FLASHLIGHTS AND BULBS Easy Line Power Line Professional Line Bulbs	48
SPECIAL BATTERIES	74
PRODUCT DISPLAY SYSTEMS Please contact your VARTA sales person for optimized POS solutions	78
ASSORTMENT OVERVIEW	82

Innovative developments and best-in-class production standards account for VARTA's outstanding product quality.



VARTA products are honored by leading test magazines again and again. That is owed to our dedicated staff.



QUALITY "MADE IN GERMANY" -



VARTA products withstand all usage conditions due to constantly optimized and inspected material properties.



TRUSTED ALL OVER THE WORLD

VARTA Consumer is one of the most significant battery producers in the world. This is mainly due to the consistent high product quality. "Made in Germany" is not only an indication of product quality, but a value that we hold close to our heart. Despite its international success, VARTA remains true to its roots as the only battery manufacturer in Germany, employing 332 people in alkaline-manganese battery production and product packaging in Dischingen, Germany. Every year, around 1 billion Alkaline batteries are produced for the international market.

You will find the VARTA European central warehouse in Ellwangen, where the 365 members of German Sales, Central Marketing and Administration are based. From the Ellwangen distribution center, customers in 20 countries receive direct deliveries and 70 more are supplied by related companies or distribution partners. The European Headquarters of VARTA Consumer is based in Sulzbach near Frankfurt/Main. VARTA Consumer Batteries GmbH & Co. KGaA employs 1656 staff internationally and is part of the Spectrum Brands Corporate Group, a globally operating corporation in the consumer goods market.

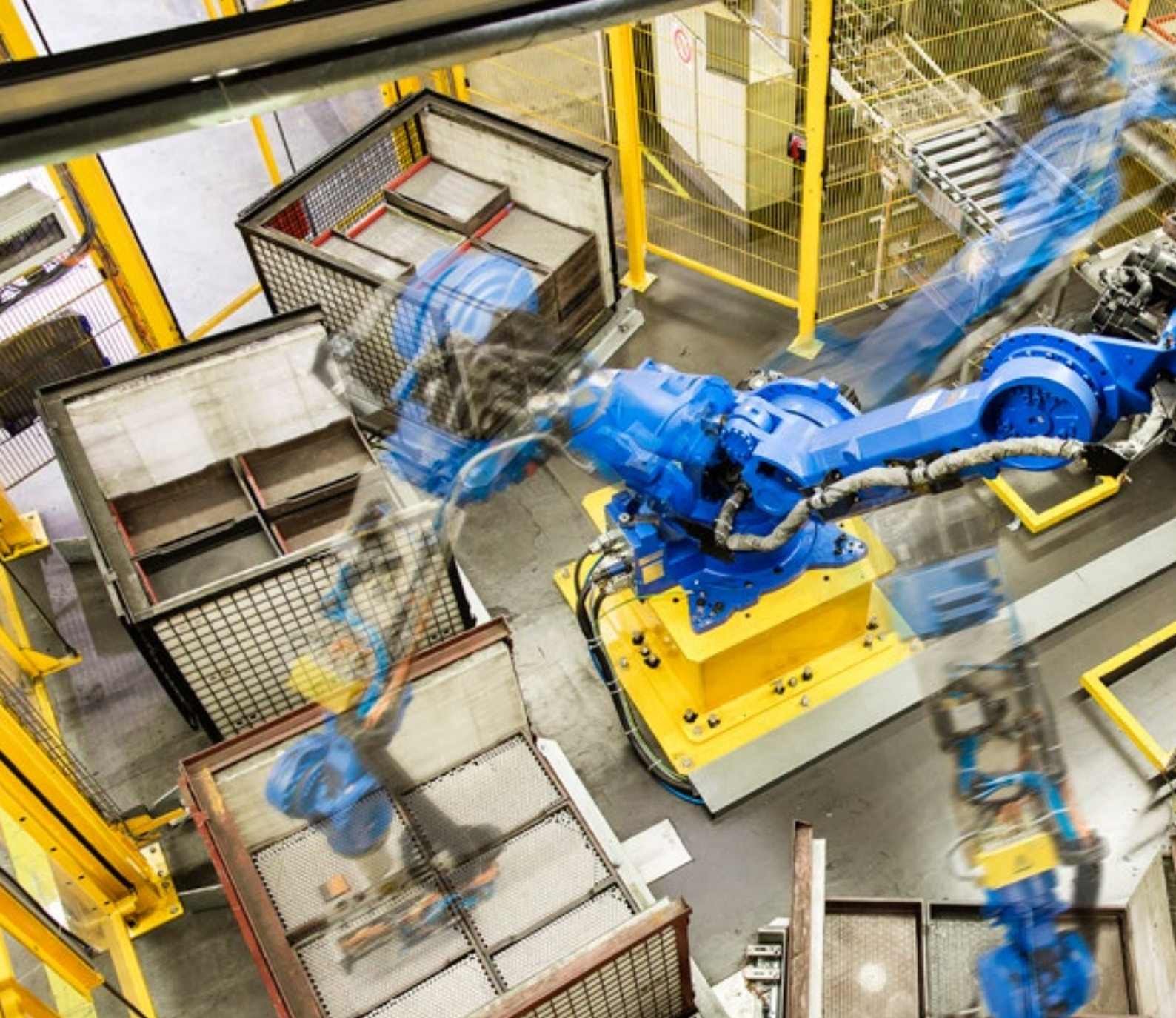

Every day, VARTA Consumer serves more than 1200 orders throughout Europe. 63% of all deliveries are sent to customers in less than 24 hours.



Own research and test labs guarantee highest quality and environmental management standards.



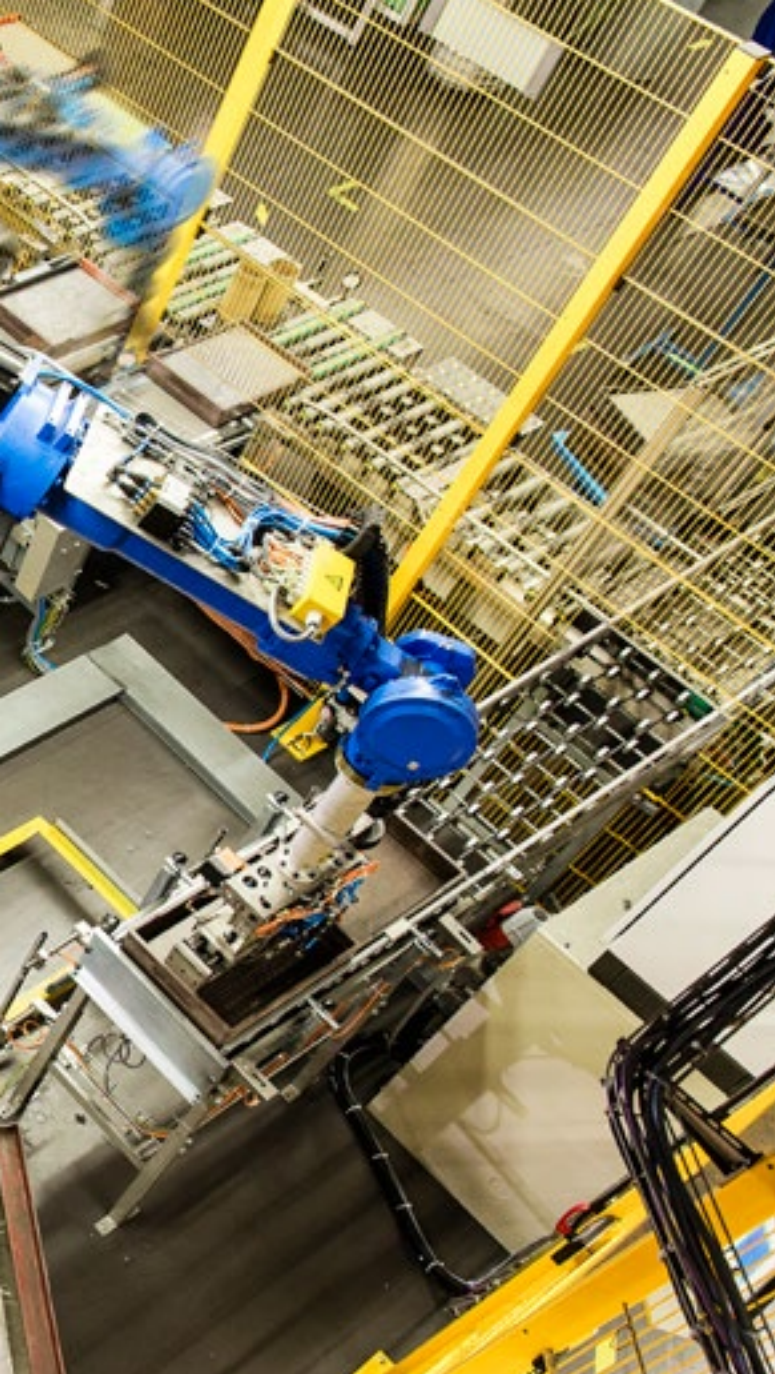

Based on many years of experience and consistent innovation, VARTA Consumer offers a broad range of first-class energy solutions.



INNOVATIVE SOLUTIONS THAT SET NEW STANDARDS!

VARTA Consumer can look back on more than 125 years of experience and constant progress. When Neal Armstrong was the first human being to set foot on the moon, VARTA also wrote history: the astronaut's camera was equipped with VARTA batteries. Today the renowned brand with its forward-looking product ideas sets trends for the complete industry sector. VARTA sets global standards for battery quality: the performance reliability and the product life of batteries are constantly improved and optimized for the demands of modern devices.

For example, VARTA's Lithium cells can be used under extreme temperature conditions, from -40 to +60 degrees Celsius. VARTA Consumer belongs to the top three innovation leaders in the industry sector in Europe, with individual and high-quality energy solutions that combine optimal performance and sustainability.



GENERAL PURPOSE

BEST ENERGY FOR EVERY DEVICE



NEW MADE IN GERMANY 10 YEARS GUARANTEED

AA ALKALINE

VARTA

LONG LIFE

VARTA LONG LIFE AA

VARTA LONG LIFE AA

+80% MORE POWER

MADE IN GERMANY

AA ALKALINE

VARTA

HIGH ENERGY

VARTA HIGH ENERGY AA

VARTA HIGH ENERGY AA

VARTA HIGH ENERGY AA

VARTA HIGH ENERGY AA

+80% MORE POWER

NEW MADE IN GERMANY 10 YEARS GUARANTEED

AA ALKALINE

VARTA

MAX TECH

VARTA MAX TECH AA

VARTA MAX TECH AA

VARTA MAX TECH AA

VARTA MAX TECH AA

+100% MORE POWER

MADE IN GERMANY 15 YEARS GUARANTEED

AA LITHIUM

VARTA

LITHIUM

VARTA LITHIUM AA

VARTA LITHIUM AA

+100% MORE POWER



VARTA LITHIUM

PROFESSIONAL ENERGY



VARTA's Lithium assortment fulfills the highest quality and performance demands in all areas of modern life. The perfect solution for energy-intensive fields of application like digital cameras, GPS systems and smoke detectors, Lithium batteries also work exceptionally well under extreme conditions. VARTA Lithium batteries master temperature ranges from -40 degrees Celsius up to + 60 degrees Celsius. High-tech devices are supplied with maximum performance and endurance. Up to 38% reduced weight in comparison to alkaline: perfect for sport and outdoor usages. In addition, VARTA's Lithium technology allows a guaranteed storage time of 15 years (except 9V).

Digital Camera



1. For a faster orientation: battery size and chemical system

2. To better communicate the "Best Energy Concept", product name and icons displayed as one unit.

3. Comparable performance claims across product tiers for product differentiation

4. Guaranteed storage time of 15 years (except 9V)

5. Improved consumer guidance: one large and easy to understand icon to identify recommended use at first glance

6. Single Press Out for improved storage

7. Best before date is indicated on each battery



Digital cameras

GPS systems

Withstands extreme temperatures

Indoors or outdoors - professional solutions for ultimate needs

VARTA Lithium batteries are available in different sizes so that the maximum performance can be reached for every kind of application.

Available as:

Type	Voltage (V)	System	Width (mm)	Height (mm)	Depth (mm)	Diameter (mm)	Weight (g)	IEC	Others
6103	1.5	Lithium	-	44.5	-	10.5	7.7	-	Micro, AAA
6106	1.5	Lithium	-	50.5	-	14.5	14.5	-	Mignon, AA
6122	9.0	Lithium	26.5	49.2	17.5	-	36.4	-	9V, E-Block

For more details, see page 84

GENERAL PURPOSE

RECHARGEABLE

PORTABLE POWER

PROFESSIONAL/BUTTON CELLS

FLASHLIGHTS AND BULBS

PRODUCT DISPLAY SYSTEMS

ASSORTMENT OVERVIEW



VARTA MAX TECH

PRECISE ENERGY

Get the best possible precision for your digital devices with VARTA Max Tech. Developed for devices that need precise energy in changing requirements, VARTA Max Tech delivers precise, flexible levels of energy.



VARTA Max Tech AA, AAA, C and D batteries are produced in Germany - quality you can trust and rely on at any time.



VARTA guarantees an extended storage time of 10 years (except 9V).

Photoflash

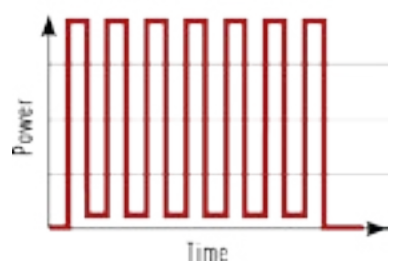

1. "MADE IN GERMANY" as proof of origin and quality

2. For a faster orientation: battery size and chemical system

3. To better communicate the "Best Energy Concept", product name and icons displayed as one unit

4. Comparable performance claims across product tiers for product differentiation

5. Guaranteed storage time of 10 years (except 9V)

6. Improved consumer guidance: one large and easy to understand icon to identify recommended use at first glance

7. Single Press Out for improved storage

8. Best before date is indicated on each battery



Photoflash



Digital cameras



Game controller

Precise energy for high-tech devices

VARTA Max Tech batteries are available in different sizes so that the maximum performance can be reached in every application.

Available as:

Type	Voltage (V)	System	Width (mm)	Height (mm)	Depth (mm)	Diameter (mm)	Weight (g)	IEC	Others
4703	1.5	Alkaline	-	44.5	-	10.5	11.5	LR03	Micro, AAA, MN2400, Ministilo
4706	1.5	Alkaline	-	50.5	-	14.5	23.8	LR6	Mignon, AA, MN1500, Stilo
4714	1.5	Alkaline	-	50.0	-	26.2	65.8	LR14	Baby, C, MN1400, 1/2 Torcia
4720	1.5	Alkaline	-	61.5	-	34.2	136.9	LR20	Mono, D, MN1300, Torcia
4722	9.0	Alkaline	26.5	48.5	17.5	-	46.0	6LP3146	E-Block, PP3, MN1604, Transistor

For more details, see page 86

GENERAL PURPOSE

RECHARGEABLE

PORTABLE POWER

PROFESSIONAL/BUTTON CELLS

FLASHLIGHTS AND BULBS

PRODUCT DISPLAY SYSTEMS

ASSORTMENT OVERVIEW



VARTA HIGH ENERGY

POWERFUL ENERGY

High Energy is the powerful of the VARTA batteries. Developed especially for use in devices like toys, computer equipment or flashlights, VARTA High Energy offers the powerful energy needed for devices with high energy consumption.



VARTA Max Tech AA, AAA, C and D batteries are produced in Germany - quality you can trust and rely on at any time.



VARTA guarantees an extended storage time of 10 years (except 4.5V and 9V).

Remote Controlled Toy

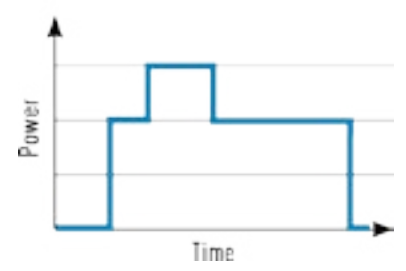

1. "MADE IN GERMANY" as proof of origin and quality
2. For a faster orientation: battery size and chemical system
3. To better communicate the "Best Energy Concept", product name and icons displayed as one unit.
4. Comparable performance claims across product tiers for product differentiation
5. Guaranteed storage time of 10 years (except 4.5V and 9V)
6. Improved consumer guidance: one large and easy to understand icon to identify recommended use at first glance
7. Single Press Out for improved storage
8. Best before date is indicated on each battery



Remote-controlled toys



Wireless mouse



Flashlights

The powerful High Energy for power hungry devices

VARTA High Energy batteries are available in different sizes so that the maximum performance can be achieved in every application.

Available as:

Type	Voltage (V)	System	Width (mm)	Height (mm)	Depth (mm)	Diameter (mm)	Weight (g)	IEC	Others
4903	1.5	Alkaline	-	44.5	-	10.5	11.4	LR03	Micro, AAA, MN2400, Ministilo
4906	1.5	Alkaline	-	50.5	-	14.5	23.8	LR6	Mignon, AA, MN1500, Stilo
4914	1.5	Alkaline	-	50.0	-	26.2	65.8	LR14	Baby, C, MN1400, 1/2 Torcia
4920	1.5	Alkaline	-	61.5	-	34.2	136.9	LR20	Mono, D, MN1300, Torcia
4922	9.0	Alkaline	26.5	48.5	17.5	-	46.0	6LP3146	E-Block, PP3, MN1604, Transistor
4912	4.5	Alkaline	62.0	67.0	22.0	-	168.5	3LR12	Normal, MN1203

For more details, see page 88

GENERAL PURPOSE

RECHARGEABLE

PORTABLE POWER

PROFESSIONAL/BUTTON CELLS

FLASHLIGHTS AND BULBS

PRODUCT DISPLAY SYSTEMS

ASSORTMENT OVERVIEW



VARTA LONGLIFE

LONG-LASTING ENERGY

VARTA Longlife is the long-lasting in VARTA's battery range. It performs especially well in devices with constant and low energy needs, for example remote controls, wall clocks or radios. Here, the Longlife battery range stands out with long run times and reliable energy delivery.



VARTA Max Tech AA, AAA, C and D batteries are produced in Germany - quality you can trust and rely on at any time.



VARTA guarantees an extended storage time of 10 years (except 4.5V and 9V).

Remote Control



1. "MADE IN GERMANY" as proof of origin and quality
2. For a faster orientation: battery size and chemical system
3. To better communicate the "Best Energy Concept", product name and icons displayed as one unit
4. Comparable performance claims across the product tiers for product differentiation
5. Guaranteed storage time of 10 years (except 4.5V and 9V)
6. Improved consumer guidance: one large and easy to understand icon to identify recommended use at first glance
7. Single Press Out for improved storage
8. Best before date is indicated on each battery



Remote controls



Wall clocks



Radios

The long-lasting Longlife for low-drain devices

VARTA Longlife batteries are available in different sizes so that the maximum performance can be achieved in every application.

Available as:

Type	Voltage (V)	System	Width (mm)	Height (mm)	Depth (mm)	Diameter (mm)	Weight (g)	IEC	Others
4103	1.5	Alkaline	-	44.5	-	10.5	11.3	LR03	Micro, AAA, MN2400, Ministilo
4106	1.5	Alkaline	-	50.5	-	14.5	23.2	LR6	Mignon, AA, MN1500, Stilo
4114	1.5	Alkaline	-	50.0	-	26.2	65.8	LR14	Baby, C, MN1400, 1/2 Torcia
4120	1.5	Alkaline	-	61.5	-	34.2	135.1	LR20	Mono, D, MN1300, Torcia
4122	9.0	Alkaline	26.5	48.5	17.5	-	46.0	6LP3146	E-Block, PP3, MN1604, Transistor
4112	4.5	Alkaline	62.0	67.0	22.0	-	89.5	3LR12	Normal, MN1203

For more details, see page 94

GENERAL PURPOSE

RECHARGEABLE

PORTABLE POWER

PROFESSIONAL/BUTTON CELLS

FLASHLIGHTS AND BULBS

PRODUCT DISPLAY SYSTEMS

ASSORTMENT OVERVIEW



VARTA SUPERLIFE

FOR THE PRICE-CONSCIOUS



Reliable and affordable – the VARTA Superlife zinc carbon range combines excellent VARTA quality with the chance to save money. VARTA Superlife is the ideal companion for low-drain appliances like wall clocks, alarm clocks or remote controls.

Wall Clock





Reliable energy for basic requirements

VARTA Superlife zinc carbon batteries are available in different sizes so that the maximum performance can be achieved in every application.

Available as:

Type	Voltage (V)	System	Width (mm)	Height (mm)	Depth (mm)	Diameter (mm)	Weight (g)	IEC	Others
2003	1.5	Zinc Carbon	-	44.5	-	10.5	7.75	R03P	Micro, AAA
2006	1.5	Zinc Carbon	-	50.5	-	14.5	18.0	R6P	Mignon, AA
2014	1.5	Zinc Carbon	-	50.0	-	26.2	48.0	R14P	Baby, C
2020	1.5	Zinc Carbon	-	61.5	-	34.2	100.0	R20P	Mono, D
2022	9.0	Zinc Carbon	26.5	48.5	17.5	-	38.0	6F22	E-Block
2012	4.5	Zinc Carbon	62.0	67.0	22.0	-	101.0	3R12P	Normal

For more details, see page 98

GENERAL PURPOSE

RECHARGEABLE

PORTABLE POWER

PROFESSIONAL/BUTTON CELLS

FLASHLIGHTS AND BULBS

PRODUCT DISPLAY SYSTEMS

ASSORTMENT OVERVIEW



RECHARGEABLE

THE GREEN PRODUCT LINE. THE BEST CONSUMER ORIENTATION
COMBINED WITH INNOVATIVE, FORWARD-LOOKING TECHNOLOGY





RECHARGEABLE BATTERIES

The simplified VARTA rechargeable assortment focusses on high-sellers including more special products and the broadest Ready To Use range.

The VARTA blister design leads the consumer to a faster and easier purchasing decision.

Pre-Charged and stays charged

Straight from the pack!



Low Self Discharge



6 compelling advantages of Ready To Use Rechargeable Batteries

1. VARTA Ready to Use Rechargeable Batteries are ready to be used straight from the pack without requiring charging first.
2. VARTA Ready to Use Rechargeable Batteries have a very low self-discharge and an extremely long shelf life (e.g. up to 75% remaining capacity after 12 months).
3. It's possible to keep VARTA Ready to Use Rechargeable Batteries in your device for a long time without recharging.
4. Due to different capacities it's possible to use VARTA Ready to Use Rechargeable Batteries for energy-hungry as well as low drain devices.
5. All VARTA Ready to Use Rechargeable Batteries are rechargeable in all chargers.
6. 74% of consumers understand the "Ready to Use" claiming the most* vs other pre-charged claims.

*Source: Independent European Market Research Study, 2012. (Germany, France, Poland. N=900)



1. For a faster orientation: battery size and electrochemical system

2. Self-explanatory icon for pre-charged cells

3. „SAVE MONEY“ claim to communicate the key benefit of Rechargeable Batteries



4. Visible labelling of the minimum capacity for better differentiation

5. Easier navigation thanks to icons referring to respective devices and applications

6. „PRE-CHARGED“ Supporting the Ready To Use claim



Microphone



Alarm clock



Toy



Computer mouse



GPS systems



Photoflash



Baby monitor



Game controller



L.E.D. Flashlights

All capacities and sizes

VARTA offers rechargeable cells for every application. All common sizes up to the highest capacities are Ready To Use. An environmentally-friendly product assortment to meet the highest consumer demands.

Available as:

Type	Voltage (V)	Electrochemical System	Typical capacity (mAh)	Width (mm)	Height (mm)	Depth (mm)	Diameter (mm)	Weight (g)	IEC	Others
56703	1.2	Ni-MH	800	-	44.5	-	10.5	12.0	HR 03	AAA, Micro
5703	1.2	Ni-MH	1000	-	44.5	-	10.5	14.0	HR 03	AAA, Micro
56716	1.2	Ni-MH	1600	-	50.5	-	14.5	25.0	HR 6	AA, Mignon
56706	1.2	Ni-MH	2100	-	50.5	-	14.5	29.0	HR 6	AA, Mignon
56756	1.2	Ni-MH	2400	-	50.5	-	14.5	30.0	HR 6	AA, Mignon
5716	1.2	Ni-MH	2600	-	50.5	-	14.5	30.0	HR 6	AA, Mignon
56714	1.2	Ni-MH	3000	-	50.0	-	26	66.0	HR 14	C, Baby
56720	1.2	Ni-MH	3000	-	61.5	-	34.2	82.0	HR 20	D, Mono
56722	9.0	Ni-MH	200	26.6	15.7	48.5	-	36.0	HR 9V	9V, E-Block

For more details, see page 100

GENERAL PURPOSE

RECHARGEABLE

PORTABLE POWER

PROFESSIONAL/BUTTON CELLS

FLASHLIGHTS AND BULBS

PRODUCT DISPLAY SYSTEMS

ASSORTMENT OVERVIEW



NEW ENERGY SOLUTIONS: VARTA SPECIAL BATTERIES

Innovative application-specific products complete the VARTA rechargeable assortment. Whether you use low drain devices like solar lights or power-hungry toys, VARTA has the matching special battery for every battery-driven device. Tailor-made solutions to satisfy consumer needs, to save money and to protect the environment.



VARTA Rechargeable TOYS ACCU

- Especially developed to meet the requirements of toys
- High capacity for power-hungry toys and long-lasting fun
- Ready To Use technology, low self-discharge, high current capability and long durability
- Fits in every battery-driven toy (AA, AAA)
- Child warning symbol and improved +/- poles indication for more safety

VARTA Rechargeable PHONE ACCU

- Premium quality for the growing analog and digital cordless phone market
- Optimized capacity for cordless phones which need to recharge their batteries every day
- Rechargeable hundreds of times without memory effect
- Precise energy and durable power supply
- A VARTA BEST SELLER in electronics stores and DIY channel

VARTA Rechargeable SOLAR ACCU

- Especially developed for solar garden lights
- Optimized capacity for solar lights which charge their batteries with low current
- With NiMH long-lasting energy
- Fast-growing market of solar lights
- Ideal for garden centers and DIY channel



All capacities and sizes

The pre-charged cells are available in the most common sizes AA and AAA. The capacity of VARTA special batteries - from 550 mAh up to 2400 mAh - is optimized for different applications.

Available as:

	Type	Voltage (V)	Electrochemical System	Typical capacity (mAh)	Height (mm)	Diameter (mm)	Weight (g)	IEC	Others
Toy Accu	56783	1.2	Ni-MH	800	44.5	10.5	12.0	HR 03	AAA, Micro
	56786	1.2	Ni-MH	2400	50.5	14.5	30.0	HR 6	AA, Mignon
Phone Accu	58397	1.2	Ni-MH	550	44.5	10.5	12.0	HR 03	AAA, Micro
	58398	1.2	Ni-MH	800	44.5	10.5	12.0	HR 03	AAA, Micro
	58399	1.2	Ni-MH	1600	50.5	14.5	25.0	HR 6	AA, Mignon
Solar Accu	56733	1.2	Ni-MH	550	44.5	10.5	12.0	HR 03	AAA, Micro
	56736	1.2	Ni-MH	800	50.5	14.5	19.0	HR 6	AA, Mignon

For more details, see page 106

GENERAL PURPOSE

RECHARGEABLE

PORTABLE POWER

PROFESSIONAL/BUTTON CELLS

FLASHLIGHTS AND BULBS

PRODUCT DISPLAY SYSTEMS

ASSORTMENT OVERVIEW



CHARGERS

MODERN DESIGN FOR HIGHEST DEMANDS

Our in-depth analysis of the latest consumer needs and retailer requirements has led to the optimization of our charger assortment, from simple user friendly easy chargers at best price to innovative high end chargers like the new VARTA LCD charger range which has a special focus on transparency in the charging process, security and design.



1. Information about new products

2. Easy understandable icon for the charging time

3. „SAVE MONEY“ claim communicating the key benefit of Rechargeable Batteries

4. Rechargeable battery sizes and additional charging features

5. Highlighted safety and charging characteristics

6. Pre-charged Ready To Use cells included





7. Garnishing of Rechargeable pre-charged Batteries



-  Charging time
-  Timer cut-off
-  Trickle charge
-  Temperature control
-  Bad cell and alkaline detection
-  Minus Delta V Cut Off



The most important safety features:

-  **Timer cut-off:**
A timer switches off after a specified time irrespective of charging status.
-  **Minus Delta V Cut Off:**
Method for cutting off the charging process, which takes advantage of the fact that the cell voltage reduces slightly in a rechargeable battery (- Delta V), as soon as the cell is completely charged.
-  **Trickle charge:**
Prevents the natural self-discharging process of rechargeable cells.
-  **Temperature control:**
The temperature of the rechargeable battery is measured whilst it is charging. If this rises above a defined maximum temperature level the charger switches itself off.

GENERAL PURPOSE

RECHARGEABLE

PORTABLE POWER

PROFESSIONAL/BUTTON CELLS

FLASHLIGHTS AND BULBS

PRODUCT DISPLAY SYSTEMS

ASSORTMENT OVERVIEW



LCD Plug Charger

Type 57677



- ▼ Charges AA/AAA/9V and USB device at the same time!
- ▼ LED backlit blue LCD display: charging level, 9V and USB indication
- ▼ Comprehensive safety features: Minus Delta V cut-off, safety timer, short circuit protection, alkaline detection
- ▼ Handy format: direct plug-in
- ▼ Ergonomic and unique design

Available in following versions:
with 4x AA 2100 mAh 56706



For more details, see page 108



LCD charger range: modern,
user optimized design,
comprehensive safety features
and precise technology

LCD Ultra Fast Charger

Type 57675

- ✔ Extremely short charging times for AA/AAA
- ✔ Large LCD display to easily check the charging process: Volts, capacity (mAh) and minutes
- ✔ Comprehensive safety features
- ✔ 4 different functions: charge, discharge, capacity test and refresh
- ✔ Single slot charging
- ✔ Incl. AC and 12V car adapter

Available in following versions:
with 4x AA 2400 mAh 56756



For more details, see page 108



LCD Universal Charger

Type 57678

- ✔ Charges AA/AAA/C/D/9V
- ✔ LED backlit blue LCD display: charging level and USB indication
- ✔ Comprehensive safety features: Minus Delta V cut-off, safety timer, short circuit protection, alkaline detection
- ✔ Charges AA/AAA/C/D/9V and USB device at the same time!
- ✔ Modern and high-quality design

Available in following versions:
without garnishing

For more details, see page 108



LCD Charger

Type 57070

- ✔ Charges 2/4 AA or 2/4 AAA batteries
- ✔ High-quality blue LCD display
- ✔ Comprehensive safety features: Minus Delta V cut-off, safety timer, alkaline detection, temperature control
- ✔ Charging level indication
- ✔ USB charging (via Laptop, USB cable included)
- ✔ Global voltage - worldwide use (100 - 240V)
- ✔ Incl. AC and 12V car adapter

Available in following versions:
with 4x AA 2400 mAh 56756
with 4x AA 2600 mAh 05716
without garnishing



For more details, see page 108



GENERAL PURPOSE

RECHARGEABLE

PORTABLE POWER

PROFESSIONAL/BUTTON CELLS

FLASHLIGHTS AND BULBS

PRODUCT DISPLAY SYSTEMS

ASSORTMENT OVERVIEW

Mini Charger

Type 57666

- ▼ User-friendliness with high functionality at the best price
- ▼ LED light shows charging status
- ▼ Charges 2AA/AAA at the same time

Available in following versions:

with 2x AAA 800mAh 56703

with 2x AA 2100mAh 56706

with 2x AA 2400mAh 56756

without garnishing



Pocket Charger

Type 57662

- ▼ For 2 or 4 AA/AAA cells in a handy and compact design
- ▼ 2 LEDs show the charging status (1 LED for each battery pair)
- ▼ Safety timer - to avoid overcharging

Available in following versions:

with 4x AA 1600mAh 56716

with 4x AA 2100mAh 56706

with 4x AA 2600mAh 5716

with 4x AA 2100mAh 56706 + 2x AAA 800mAh 56703

without garnishing



Plug Charger

Type 57667

- ▼ For 2 or 4 AA/AAA cells
- ▼ 2 LEDs show charging status (1 LED for each battery pair)
- ▼ Safety timer - to avoid overcharging
- ▼ Global voltage- worldwide use (100-240V)

Available in following versions:

with 4x AA 2100 mAh 56706



Universal Charger

Type 57668

- ▼ The compact Universal desk charger for all sizes
- ▼ For 2 or 4 AA, AAA, C, D or 1x 9V rechargeable batteries
- ▼ 3 LEDs show charging status
- ▼ Safety timer - to avoid overcharging
- ▼ Global voltage- worldwide use (100-240V)

Available in following versions:
without garnishing

For more details, see page 109



GENERAL PURPOSE

RECHARGEABLE

PORTABLE POWER

PROFESSIONAL/BUTTON CELLS

FLASHLIGHTS AND BULBS

PRODUCT DISPLAY SYSTEMS

ASSORTMENT OVERVIEW



PORTABLE POWER

STAY CONNECTED. ANYTIME. ANYWHERE.



NEW
from October
2014



PORTABLE POWER

THE HIGH-END SOLUTION FOR THE MOBILE GENERATION

VARTA Portable Power – stay connected, wherever life takes you.

Today's generation are more and more "on the go": business professionals, outdoor enthusiasts and young people always need their mobile devices to be charged at every moment of the day. The bigger energy demand of the latest devices makes it important to always have an "energy backup" ready to hand. Whether in daily life or in emergency situations like a car breakdown, the VARTA Portable Powerpacks are very helpful when extra energy is needed.

VARTA Portable Power keeps smartphones, tablets, MP3-Players, GPS and other key devices powered - anywhere and anytime.

The practical Powerpacks come pre-charged and Ready To Use straight from the pack.

1. Constantly up-to-date assortment

2. Apple MFi compatibility and certification

3. Extra talk time or extra power indication



4. Compatibility with the most devices on the market

5. Connector types: Apple Lightning, 30-pin, Micro USB

6. Ideal to power your devices anytime, anywhere

EXTRA POWER! ANYTIME. ANYWHERE.



Did you know:

- 91% of all people on earth have a mobile phone
- 56% of people own a smart phone
- 50% of mobile phone users, use their mobile as their primary Internet source
- 79% of people aged 18-44 have their smartphones with them 22 hours a day
- People check their mobile phones every 6 minutes, 150 times a day
- Over 36% of people charge their mobile phone more than once a day

Source:
<http://www.digitalbuzzblog.com/infographic-2013-mobile-growth-statistics/>; Always Connected, IDC Research Report March 2013

GENERAL PURPOSE

RECHARGEABLE

PORTABLE POWER

PROFESSIONAL/BUTTON CELLS

FLASHLIGHTS AND BULBS

PRODUCT DISPLAY SYSTEMS

ASSORTMENT OVERVIEW

Phone Power 800

The new powerful Mini Powerpack for Apple Lightning, 30-pin or Micro USB-devices

Type 57923, 57922 and 57921

- ▼ Rechargeable pocket-sized mobile device charger
- ▼ Available in 3 versions: for Apple Lightning, 30-pin and Micro USB devices
- ▼ Charger holds enough power to recharge your mobile phone for 150 minutes of talk time*
- ▼ Powered by an 800 mAh Lithium Ion rechargeable battery
- ▼ Keychain attached for convenience and portability
- ▼ 4 LED battery gauge indicators show charge and discharge status
- ▼ Recharging by using a USB port
- ▼ Holds up to 80% charge up to 6 months
- ▼ MFi certified – Made for iPhone & iPod (57923 and 57922)
- ▼ Rechargeable 100's of times

*Based on Blackberry Curve Model 8900, iPhone 4S, and iPhone 5

For more details, see page 112

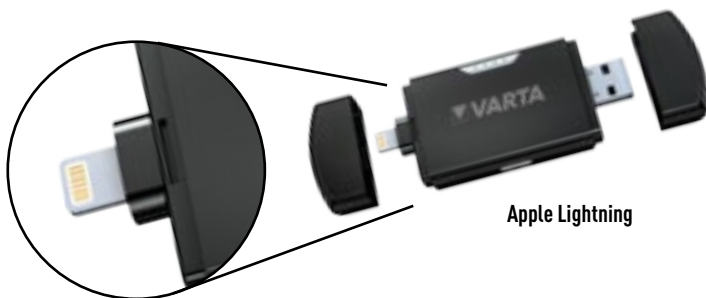

Apple Lightning

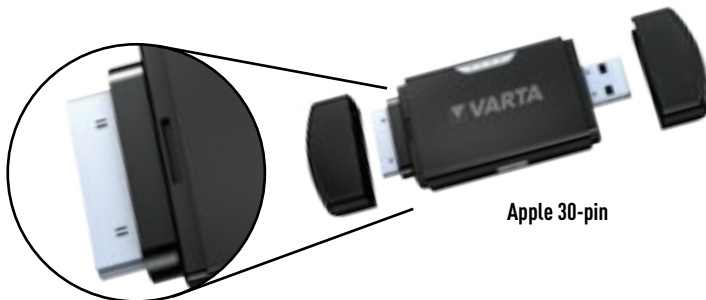

Apple 30-pin

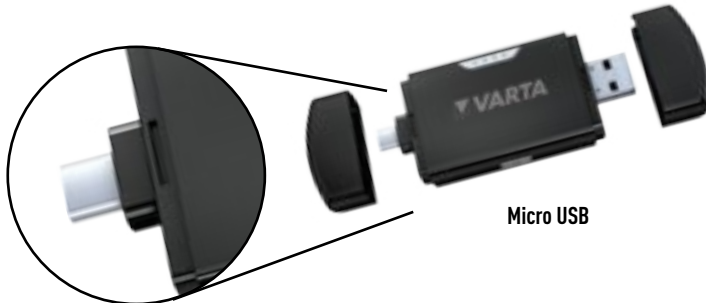

Micro USB

NEW
from October
2014

READY TO USE



NEW
from October
2014

READY TO USE



NEW
from October
2014

READY TO USE



Indestructible Powerpack 2000

The Daytripper: The tough companion to power all your mobile devices

Type 57954

- ▶ Compact and powerful 2000 mAh Lithium Ion rechargeable mobile device charger
- ▶ New: 2m drop tested, dust proofed and water resistant IP67 highest standard - ideal in rough situations
- ▶ Durable construction in ABS and aluminium alloy
- ▶ Charger holds enough power to recharge your mobile phone up to 100%*
- ▶ Holds charge up to 6 months
- ▶ USB port to charge devices (1.0A) - MFi compliant
- ▶ 4 LED battery gauge indicators show charge and discharge status
- ▶ Compatible with most USB power cords and most USB powered devices
- ▶ Recharge the powerpack hundreds of times by using a USB port/charger
- ▶ Button turns charger on – if inactive for 4 min, it automatically turns off to save battery power
- ▶ Incl. 1m Micro USB charge & sync cable and a travel bag

*Based on iPhone 5, performances may vary by device

For more details, see page 112



Indestructible Powerpack 6000

The Weekender: The best companion when travelling and outdoor

Type 57952

- ▶ Compact and powerful 6000 mAh Lithium Ion rechargeable mobile device charger
- ▶ New: 2m drop tested, dust proofed and water resistant IP67 highest standard - ideal in rough situations
- ▶ Durable construction in ABS and aluminium alloy
- ▶ Charger holds enough power to give your mobile phone 3 full charges*
- ▶ Holds charge up to 6 months
- ▶ Powerful charger provides 3.4A total output - MFi compliant
- ▶ Features dual USB ports to charge two devices simultaneously (2.4A + 1.0A)
- ▶ Charges at max. speed via 2.4A port, including tablets
- ▶ 4 LED battery gauge indicators show charge and discharge status
- ▶ Compatible with most USB power cords and most USB powered devices
- ▶ Recharge the powerpack hundreds of times by using a USB port/charger
- ▶ Button turns charger on – if inactive for 4 min, automatically turn off to save battery power
- ▶ Incl. 1m Micro USB charge & sync cable and a travel bag

*Based on iPhone 5, performances may vary by device

For more details, see page 112



Car Power

Flexible and independent for on the go

Type 57931

- ▶ Compact and powerful 12V car adapter provides 3.4A total output (17W)
- ▶ Features dual USB ports to charge two devices simultaneously (2.4A + 1.0A)
- ▶ 4x more power vs. a standard 2.5W car charger / 500 mAh USB output
- ▶ Blue LED light indicates available charge
- ▶ MFi compliant
- ▶ Compatible with most USB cables, including Apple Lightning, Apple 30-pin, Micro USB, and Mini USB cables
- ▶ Charges most USB devices at maximum speed via 2.4 port, including tablets
- ▶ Incl. 1m Micro USB charge & sync cable

For more details, see page 113



GENERAL PURPOSE

RECHARGEABLE

PORTABLE POWER

PROFESSIONAL/BUTTON CELLS

FLASHLIGHTS AND BULBS

PRODUCT DISPLAY SYSTEMS

ASSORTMENT OVERVIEW

Wall Charger

A boost in power for all your devices at home or while travelling

Type 57957

- ▼ Compact and powerful charger provides 3.4A total output (17W)
- ▼ Features dual USB ports to charge 2 devices simultaneously (2.4A + 1.0A)
- ▼ Compatible with most USB cables, including Apple Lightning, Apple 30-pin, Micro USB and Mini USB cables
- ▼ MFi compliant
- ▼ Blue LED light indicates charge
- ▼ Global voltage - worldwide use (100 - 240V)
- ▼ Charges most USB devices at maximum speed via 2.4 port, including tablets
- ▼ 4x more power vs. a standard 2.5W charger / 500 mAh USB output
- ▼ Incl. 1m Micro USB charge & sync cable

For more details, see page 113



2 in 1 Powerpack & Charger

No power, no problem! Outlet-free device charging and charger

Type 57920

- ▼ Powered by 4 AA batteries (alkaline, rechargeable or lithium)
- ▼ Each set of alkaline batteries provides up to 7 hours talk time*
- ▼ Charges NiMH AA batteries – use micro USB port and connect to a USB charger
- ▼ 4 LED battery gauge indicators show discharge status for alkaline AA batteries and charge status for NiMH AA batteries
- ▼ Incl. 1m Micro USB charge & sync cable and alkaline batteries
- ▼ Batteries are replaceable. Use charger over and over!
- ▼ Instant power. Plug in & go!
- ▼ Compatible with most USB cords - MFi compliant

*Results may vary by device. 7 hours of extended talk time based on iPhone 5

For more details, see page 112

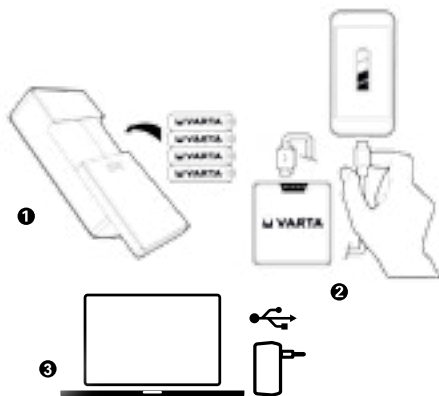

How to charge mobile devices:

- ❶ Insert 4 AA cells (Alkaline, Lithium or Rechargeable batteries)
- ❷ Connect to the mobile device. Use the included Micro USB or your existing original charging cable. Stop charging at any time you want in order to save battery charge. Simply remove always after charging the USB cable from the 2 in 1 Powerpack & Charger.

How to charge rechargeable batteries:

- ❶ Insert 4 AA rechargeable batteries.
- ❷ Connect the 2 in 1 Powerpack & Charger to a USB power source.

Phone Power 400

The Mini Powerpack provides instant power for an extra hour of talk time - at home or on the go

Type 57916

- ▶ Powered by a 400 mAh Lithium Ion Rechargeable Battery
- ▶ Each charge provides 60 minutes of talk time*
- ▶ Holds charge up to 12 months
- ▶ Compatible with Micro USB and Apple 30-pin devices
- ▶ Use and recharge hundreds of times
- ▶ LED indicator for charging and power output
- ▶ Keychain attached for convenient power on the go

*Based on iPhone 4S model

For more details, see page 113



1

2

How to Recharge:

- 1** Move switch to IN/OFF position. Plug charger into your computer or USB wall plug adapter. (e.g. USB Wall Charger VARTA Type-Nr. 57957, Page 40). Charging will complete in 30-60 minutes.
- 2** Connect Charger to Device. Move switch to OUT position. Plug Apple or Micro-USB adapter into phone.

Charge & Sync Cable

Cables for charging and data synchronization

Type 57941, 57940 and 57942

- ▶ Charge & Sync Cable with lightning connector: works with iPhone 5, iPhone 5C, iPhone 5S, iPhone 6, iPad Air, iPad (4th generation), iPad mini, iPod touch (5th generation), and iPod nano (7th generation)
- ▶ Charge & Sync Cable with 30 pin connector: works with iPhone 4S, iPhone 4, iPhone 3GS, iPhone 3G, iPhone, iPad (3rd generation), iPad 2, iPad, iPod touch (1st through 4th generation), iPod classic, and iPod nano (1st through 6th generation).
- ▶ Charge & Sync Cable with Micro USB connector: works with all Micro USB devices: smartphones, navigation systems, e-readers, Bluetooth headsets etc.

For more details, see page 113



GENERAL PURPOSE
RECHARGEABLE
PORTABLE POWER
PROFESSIONAL/BUTTON CELLS
FLASHLIGHTS AND BULBS
PRODUCT DISPLAY SYSTEMS
ASSORTMENT OVERVIEW



PROFESSIONAL/BUTTON CELLS

AN EXCELLENT QUALITY ASSORTMENT



S



PROFESSIONAL LITHIUM



Capture every moment with the right energy

Cameras capture the most important moments in our lives. VARTA Photo Lithium batteries provide Consumers with the excellent performance they demand and the real value they expect for all their camera needs.

- Supreme performance
- Operation over a wide temperature range
- Different sizes to meet market requirements
- 0% lead, 0% mercury and 0% cadmium

Optimize your assortment

VARTA Photo Lithium batteries are able to quickly provide a high output, perfectly suitable for today's high-tech cameras and flashlights.



Digital cameras



Photoflash

Available as:

Type	Voltage (V)	Electrochemical System	Typical Capacity (mAh)	Width (mm)	Height/Depth (mm)	Depth (mm)	Diameter (mm)	Weight (g)	IEC
2 CR 5	6.0	Lithium	1600	17.0	45.0	34.0	-	42.0	2 CR 5
CR P2	6.0	Lithium	1450	19.5	34.5	35.0	-	38.0	CR P2
CR 123 A	3.0	Lithium	1480	-	34.5	-	17.0	16.0	CR 17345
CR 2	3.0	Lithium	920	-	27.0	-	15.6	11.0	CR 15 H270
CR V3	3.0	Lithium	3100	14.5	52.0	29.0	-	38.0	CR 17355

For more details, see page 114

GENERAL PURPOSE

RECHARGEABLE

PORTABLE POWER

PROFESSIONAL/BUTTON CELLS

FLASHLIGHTS AND BULBS

PRODUCT DISPLAY SYSTEMS

ASSORTMENT OVERVIEW



PROFESSIONAL ELECTRONICS/ BUTTON CELLS

A premium assortment for a wide range of remote controls, eBooks, fitness devices, medical applications, cameras, watches, electronic calculators and a lot more.

The widest button cell range fulfilling a multitude of consumer needs - with the best quality and duration guaranteed. Focused on the requirements of modern electronic devices, VARTA offers one of the most complete ranges of Electronics on the market. Our wide range of products consists of lithium, silver and alkaline button cells to give consumers optimal battery selection. High-Tech Primary Button Batteries offer reliable, long-lasting power meeting highest quality and performance demands. Button cells supply power to a broad scope of small electronic devices:

- Security devices
- Alarm systems
- Car stereos
- Timers
- Car keys
- Garage openers
- Electronic calculators
- Computers
- Toys
- Electronic games
- Electronic databases
- Personal organizers
- EBook readers
- Remote controls
- Fitness devices
- Watches (digital & analog)
- Medical applications (blood sugar indicator, digital thermometer, insulin pump, glucometer...)



Available in all blister variants (for different channel needs and requirements):

- Small, space-saving, 6,5 x 5,6 cm blister
- Big, double standard blister
- OEM-specific J-packs

For more details, see page 115



GENERAL PURPOSE

RECHARGEABLE

PORTABLE POWER

PROFESSIONAL/BUTTON CELLS

FLASHLIGHTS AND BULBS

PRODUCT DISPLAY SYSTEMS

ASSORTMENT OVERVIEW



HEARING AID BATTERIES FROM RAYOVAC



Rayovac, the No. 1 selling Hearing Aid Battery in the world, dominates with excellent brand awareness. The patented technology with high endurance performance and consumer friendly packaging results in high acceptance among consumers and professionals. New: mercury-free and corrosion resistant shell for more performance and improved conductivity

Why Rayovac?

- ▼ Rayovac is the No. 1 selling Hearing Aid Battery in the world*
- ▼ It's the world's longest lasting mercury-free Hearing Aid Battery: lasts up to 30% longer than comparable mercury-free Hearing Aid Batteries from competitors
- ▼ Rayovac is the first choice for Professionals and Retailers*
- ▼ Due to the mercury-free production, Rayovac is particularly environmentally-friendly
- ▼ Rayovac Hearing Aid Batteries have a voltage of 1,45V with which modern devices often work more efficiently
- ▼ Working perfect with wireless transmitting Hearing Aids

* Source: Internal Rayovac data & company estimation August 2014
** Source: Internal IEC Test July 2013



Rayovac: environment-friendly and powerful

Rayovac's engineers and technical experts have overcome the challenge of completely reducing mercury and still beating competitive products in performance and runtime. Consumers and retailers get an environmentally alternative without compromises.

The quality range from the world market leader*

Available as:

Type	Voltage (V)	Electrochemical system	Height (mm)	Diameter (mm)	Weight (g)	IEC
10	1.45	Zinc-Air	3.6	5.8	0.31	PR 70
13	1.45	Zinc-Air	5.4	7.9	0.86	PR 48
312	1.45	Zinc-Air	3.6	7.9	0.53	PR 41
675	1.45	Zinc-Air	5.4	11.6	1.77	PR 44

For more details, see page 124



GENERAL PURPOSE

RECHARGEABLE

PORTABLE POWER

PROFESSIONAL/BUTTON CELLS

FLASHLIGHTS AND BULBS

PRODUCT DISPLAY SYSTEMS

ASSORTMENT OVERVIEW



FLASHLIGHTS AND BULBS

BETTER ORIENTATION. BETTER PERFORMANCE.





FLASHLIGHTS AND BULBS

**VARTA makes it easy for everyone to understand the world of flashlights.
Capitalize on the facilitation of the flashlight business.**

Consequent consumer orientation and catering to the needs of retailers have always been top priorities at VARTA. To enable consumers to make the right choice when purchasing a flashlight, the VARTA light strategy consists of five key factors for success:

- 1) Range divided into three distinct categories according to price and features: Easy Line, Power Line and Professional Line
- 2) Clearly structured information with symbols for comparing and contrasting different items
- 3) Focus on best-selling items with an optimum quality (features) to price ratio
- 4) Contemporary range comprising almost 100% LED flashlights
- 5) Focus on sustainability through the use of FSC-certified packaging material and less PET



1. Name of the flashlight for easy identification

2. Clear and easy-to-understand symbols to indicate the special features of the flashlights

3. Application symbol to help guide consumers

4. Opening for accessing the light (selected products only)

5. Comparable general performance features

The innovative and functional packaging concept used in the VARTA flashlight range conveys the most important information about the products quickly and effectively. The contemporary basic design of all the blister packs offers a high recognition value and provides consumers with maximum orientation so they are able to make the right choice.

Comparison: LEDs vs. incandescent bulbs

High-performance LEDs 60% of the VARTA flashlight range



- Virtually shatterproof, highly resistant to impact
- Very bright white light (high color temperature)
- Long battery life thanks to high level of energy efficiency
- Service life of up to 50,000 hours
- Also suitable for long distances thanks to high outputs
- Ability to focus the light beam

5mm/standard LEDs 38% of the VARTA flashlight range



- Virtually shatterproof, highly resistant to impact, barely heat up at all during use
- Very white, sometimes blue-tinged, light (high color temperature)
- Significantly longer battery run time thanks to high level of energy efficiency
- Service life of up to 100,000 hours
- Suitable for shorter distances (low output of approx. 150 mW)

Incandescent bulbs 2% of the VARTA flashlight range



- Glass body breaks easily
- Light tends to be red/yellow in color (low color temperature)
- Low efficiency - shorter battery run time with the same luminous flux in comparison with LEDs
- Bulb service life approx. 20 to 30 hours (the filament is a wear part that melts during use)

GENERAL PURPOSE

RECHARGEABLE

PORTABLE POWER

PROFESSIONAL/BUTTON CELLS

FLASHLIGHTS AND BULBS

PRODUCT DISPLAY SYSTEMS

ASSORTMENT OVERVIEW



ANSI FL1 STANDARD – FOR AN OBJECTIVE COMPARISON

In August 2009, the American National Standards Institute (ANSI) published the ANSI FL1 "Flashlight Basic Performance" standard (developed by the Flashlight Standards Committee). Although originally only intended for use in the United States, the world's first flashlight norm has become the world's leading flashlight standard. It includes precise definitions of terms, marking rules and test methods for measuring the relevant performance parameters of portable lights.

The clearly defined test methods and marking rules help retailers and consumers to understand and compare performance features more easily. That is why VARTA has become one of the first manufacturers in Europe to adapt its measurements of flashlight performance consequently to this new standard.

The American National Standards Institute (ANSI) is a private non-profit organization that monitors the development of voluntary standards for products, services and processes in the United States. The organization coordinates US standards with international standards to enable international product comparisons to be made.



GENERAL PURPOSE		
BEAM RANGE	RUNTIME	LIGHT OUTPUT IN LUMENS
		
RECHARGEABLE		
PORTABLE POWER		
PROFESSIONAL/BUTTON CELLS		
FLASHLIGHTS AND BULBS		
PRODUCT DISPLAY SYSTEMS		
ASSORTMENT OVERVIEW		

The comparable features of VARTA flashlights in accordance with the ANSI standard

- **Beam Range:** ANSI states that the beam range is measured as the distance between the flashlight and the point where the light beam is a minimum of 0.25 lux (0.25 lux roughly corresponds to light emitted by a full moon on a clear night in an open field).
- **Battery runtime:** This is defined as the amount of time between switching the flashlight on and the moment when the light output drops to just 10% of its initial value. It refers to the battery run time with the flashlight in constant use, without being switched off.
- **Light output/luminous flux:** This is measured in lumens. It refers to the total quantity of visible energy emitted by the LED within a particular frequency range that we perceive as light.

VARTA communications and performance data fully conform with the ANSI standard. Fair comparisons can, however, only be made if the other products being compared also conform with this standard.



FLASHLIGHTS

EASY LINE



LED Day Light 2AA

Type 16610

- ▼ 3x 5mm LEDs provide an improved light beam
- ▼ Shock-resistant three-component casing (aluminium, rubber, ABS plastic)
- ▼ Lanyard for optimum comfort during use

For more details, see page 129



42m
0.25 lux | 65h | 25Lm | 3x5mm
L.E.D. | incl.
2AA

Mini Day Light LED 1AAA

Type 16601

- White 5mm LED provides an improved light beam
- Shock-resistant three-component casing (aluminium, rubber, ABS plastic)
- Incl. key ring

For more details, see page 129



Indestructible LED Key Chain 1AAA

Type 16701

- White 5mm LED provides an improved light beam
- Highly robust (9m drop test) and water resistant (IPX4)
- Rubber head and end cap for maximum durability
- Incl. key ring

For more details, see page 128



LED Lipstick Light 1AA

Type 16617

- Elegant and handy LED flashlight with aluminium casing and a ribbed rubber grip
- 0.5 Watt high performance LED provides a high light output
- Can be found quickly even in the dark thanks to fluorescent parts on the grip and the on/off switch
- Lanyard for optimum comfort during use
- Available in two stylish colors (turquoise and pink) in mixed multipack and sorted

 (3)  (3)

For more details, see page 130



LED Pen Light 1AAA

Type 16611

- Extremely slim and lightweight flashlight with aluminium casing
- White 5mm LED provides an improved light beam
- Practical attachment clip

For more details, see page 132



LED Spot Light 2AA

Type 16600

- Handy all-purpose LED flashlight made from durable ABS plastic
- White 5mm LED with magnifying lens
- Includes anti-roll protection and hanging ring

For more details, see page 130



GENERAL PURPOSE

RECHARGEABLE

PORTABLE POWER

PROFESSIONAL/BUTTON CELLS

FLASHLIGHTS AND BULBS

PRODUCT DISPLAY SYSTEMS

ASSORTMENT OVERVIEW

LED Gelly Light 2AA

Type 16616

- ▼ Stylish LED flashlight with innovative gel-filled grip
- ▼ Perfectly adapts to the shape of the user's hand
- ▼ Available in a mixed multipack (2x blue, 2x red, 2x silver)

 (2)  (2)  (2)

For more details, see page 130



Trilogy LED Light 3AAA

Type 16615

- ▼ Elegant LED flashlight made from durable plastic
- ▼ Ergonomic grip for optimum comfort during use
- ▼ Optimized light beam thanks to special lens technology
- ▼ Available in a mixed multipack (3x silver/red and 3x silver/blue)

 (3)  (3)

For more details, see page 130



Multi LED Aluminium Light 2AA

Type 16627

- ▼ Impact resistant general purpose light made of aluminium
- ▼ 5x 5mm LEDs for a better light output
- ▼ Robust and at the same time elegant design
- ▼ Textured housing surface for maximum grip

For more details, see page 131



Multi LED Aluminium Light 2C

Type 16628

- ▼ Impact resistant general purpose light made of aluminium
- ▼ 7x 5mm LEDs for a better light output
- ▼ Robust and at the same time elegant design
- ▼ Textured housing surface for maximum grip

For more details, see page 131



Industrial LED Light 2D

Type 16604

- ▼ 0.5 Watt high performance LED provides a far-reaching light beam and ensures an extremely long battery runtime
- ▼ Water resistant casing
- ▼ Resistant to chemical fluids such as oil, petrol and diesel
- ▼ Three light-beam focusing levels (spot-to-flood)
- ▼ Anti-slip rubberized grip and metal hanging ring

For more details, see page 130



52m 0.25 lux | 160h | 25Lm | 0.5 Watt L.E.D.

GENERAL PURPOSE

RECHARGEABLE

Palm Light 3R12

Type 16645

- ▼ Stylish metal all-purpose flashlight
- ▼ Slide switch (on/off)
- ▼ Practical hanging clip

For more details, see page 131



75m 0.25 lux | 3.5h | 15Lm | incl. 1x 3R12

PORTABLE POWER

PROFESSIONAL/BUTTON CELLS

LED Silver Light 3AAA

Type 16647

- ▼ Compact and handy flashlight in a stylish design with 3x 5mm LEDs
- ▼ Three separate magnifying lenses provide a wide light beam
- ▼ Robust ABS plastic casing with rubberized grip insert
- ▼ Practical hanging clip

For more details, see page 131



41m 0.25 lux | 12h | 28Lm | 3x5mm L.E.D. | incl. 3AAA

FLASHLIGHTS AND BULBS

LED Book Light 2CR2032

Type 16618

- ▼ The flexible light for a relaxing reading experience
- ▼ Provides full and even illumination of the page
- ▼ Flexible 150mm neck enables the head to be positioned to suit the user's requirements
- ▼ With practical attachment clip

For more details, see page 132



7.5m 0.25 lux | 26h | 9Lm | 5mm L.E.D. | incl. 2CR2032

PRODUCT DISPLAY SYSTEMS

XS Camping Lantern LED 4AA

Type 16664

- ▼ Lightweight and highly robust LED camping light
- ▼ Extremely handy and compact
- ▼ 8x 5mm LEDs provide excellent 360° illumination
- ▼ Two light modes: 100% and energy-saving
- ▼ Practical handle can also be used to hang up the lantern
- ▼ Includes a carabiner for hanging

For more details, see page 133



(360°) 3.20m 0.25 lux | up to 15h | up to 24Lm | 8x5mm L.E.D.

ASSORTMENT OVERVIEW

FLASHLIGHTS

POWER LINE

Premium LED Light 3AAA

Type 17634



- ▼ Premium-quality, water resistant (IPX4) aluminium casing
- ▼ 0.5 Watt high performance LED provides a high light output while consuming very little energy
- ▼ Elegant design combined with maximum compactness

For more details, see page 130



 36m
 13h |
  30Lm |
 0.5Watt L.E.D. |
  incl. 3AAA

1 Watt LED Outdoor Pro 3AAA

Type 17628

- ▶ Premium outdoor flashlight with 1 Watt high performance LED
- ▶ Water resistant (IPX4), anodized aluminium casing for maximum durability
- ▶ Anti-slip grip and lanyard for optimum comfort during use
- ▶ Easy-to-use on/off button on the flashlight's end cap
- ▶ Two light modes: 100% and energy-saving

For more details, see page 129



GENERAL PURPOSE

RECHARGEABLE

1 Watt LED Outdoor Pro 2AA

Type 17629

- ▶ Premium outdoor flashlight with 1 Watt high performance LED
- ▶ Water resistant (IPX4), anodized aluminium casing for maximum durability
- ▶ Anti-slip grip and lanyard for optimum comfort during use
- ▶ Easy-to-use on/off button on the flashlight's end cap
- ▶ Two light modes: 100% and energy-saving

For more details, see page 129



PORTABLE POWER

PROFESSIONAL/BUTTON CELLS

Premium LED Light 2AA

Type 17635

- ▶ Elegant, premium-quality aluminium casing
- ▶ Cree 1 Watt high performance LED provides a very high light output
- ▶ Infinitely focusable light beam (spot-to-flood)

For more details, see page 130

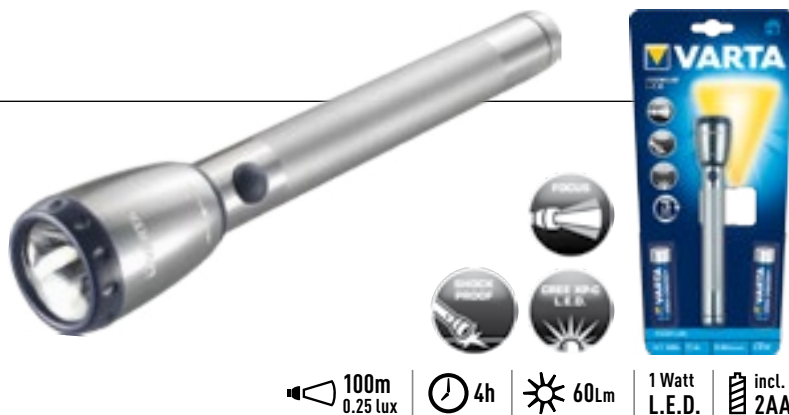

FLASHLIGHTS AND BULBS

PRODUCT DISPLAY SYSTEMS

0.5 Watt LED Day Light 2AA

Type 17651

- ▶ Shock-resistant three-component casing (aluminium, rubber, ABS plastic)
- ▶ 0.5 Watt high performance LED provides a high light output while consuming very little energy
- ▶ Lanyard for optimum comfort during use

For more details, see page 129



ASSORTMENT OVERVIEW

LED Day Light 2D

Type 17611

- ▼ 7x 5mm LEDs provide an improved light beam
- ▼ Shock-resistant three-component casing (aluminium, rubber, ABS plastic)
- ▼ Lanyard for optimum comfort during use

For more details, see page 129



63m | 0.25 lux | 140h | 58Lm | 7x 5mm L.E.D. | incl. 2D

1 Watt LED Day Light 2D

Type 17626

- ▼ Cree 1 Watt high performance LED provides a high light output while consuming very little energy
- ▼ Shock resistant three-component casing (aluminium, rubber, ABS plastic)
- ▼ Lanyard for optimum comfort during use

For more details, see page 129



173m | 0.25 lux | 11h | 96Lm | 1 Watt L.E.D. | incl. 2D

Industrial Focus Control LED 4AA

Type 17640

- ▼ Water-resistant Cree 3 Watt high performance LED flashlight with magnifying lens to provide an extremely wide light beam
- ▼ Resistant to chemical fluids such as oil, petrol and diesel
- ▼ Infinitely focusable light beam
- ▼ Anti-slip rubberized grip insert and hanging ring
- ▼ Shock-resistant up to 3 meters thanks to robust ABS plastic

For more details, see page 130



132m | 0.25 lux | 4h | 120Lm | 3 Watt L.E.D. | incl. 4AA

Swivel Light LED 2AA

Type 17622

- ▼ 0.5 Watt high performance LED provides a high light output and ensures a very long battery runtime
- ▼ Water resistant casing
- ▼ Resistant to chemical fluids such as oil, petrol and diesel
- ▼ Three light-beam focusing levels (spot-to-flood)
- ▼ Swiveling head, anti-slip rubberized grip and hanging ring



For more details, see page 130

Industrial Beam Lantern LED 4D

Type 17652

- ▼ 3 Watt high performance LED provides an extremely long light beam
- ▼ Waterproof up to 1 meter (IPX7)
- ▼ Resistant to chemical fluids such as oil, petrol and diesel
- ▼ Stand can be put in a variety of positions to ensure comfortable working



For more details, see page 133

Dynamo Light LED

Type 17680

- ▼ 100% battery-independent - can therefore provide light at all times
- ▼ One minute of cranking provides 30 minutes of light
- ▼ Shock resistant and water resistant (IPX4) ABS plastic casing
- ▼ Incl. 120 mAh high performance rechargeable lithium-ion battery
- ▼ 3x white 5mm LEDs provide an improved light beam

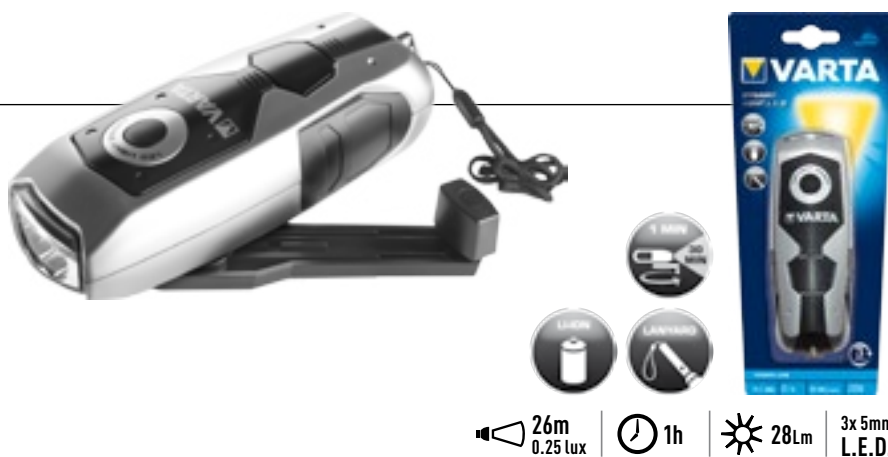

For more details, see page 132

GENERAL PURPOSE

RECHARGEABLE

PORTABLE POWER

PROFESSIONAL/BUTTON CELLS

FLASHLIGHTS AND BULBS

PRODUCT DISPLAY SYSTEMS

ASSORTMENT OVERVIEW

Rechargeable Direct Plug In LED

Type 17682

- ▼ Handy rechargeable LED flashlight that can be plugged into the wall socket (230 V, 50 Hz)
- ▼ With long-lasting NiMH rechargeable battery – no need to ever change the batteries
- ▼ 3x 5mm LEDs with magnifying lenses provide a wide light beam
- ▼ LED charging indicator
- ▼ Protective cap for the plug

For more details, see page 132



LED Solar Light

Type 17690

- ▼ Solar-powered flashlight with robust plastic casing in a premium-quality design
- ▼ 3x white 5mm LEDs with separate magnifying lenses provide an improved light beam
- ▼ Two charging options: Solar energy and pull mechanism
- ▼ One hour of charging in the sun provides 15 to 20 minutes of light
- ▼ Battery runtime when fully charged approx. 2 hours
- ▼ Includes high performance rechargeable lithium-ion battery (only replace with LIR 2450, 3.6 V, 110 mAh)
- ▼ Protection against deep discharging (2.4 V) and overcharging (4.2 V) ensures a long service life

For more details, see page 132



LED Flex Neck Light 2AAA

Type 17646

- ▼ 0.5 Watt high performance LED provides a high light output while consuming very little energy
- ▼ Bendable, 22-cm-long neck enables perfect illumination even in hard-to-access spots
- ▼ Magnetic clip for attaching the light to metal surfaces
- ▼ DC/DC regulator to ensure a consistently high light output
- ▼ Water resistant (IPX4)

For more details, see page 132



LED x4 Head Light 3AAA

Type 17631

- Extremely lightweight LED head light in leisure design
- Fitted with four high-quality LEDs:
 - 3x white LEDs provide optimum brightness (run time up to 30 h)
 - 1x red LED for night vision (run time up to 38 h)
- Water repellent casing made from durable ABS plastic and rubber
- Swiveling head for optimum illumination of the surroundings
- 3-level switching function (white LEDs, red LED, off)



18m 0.25 lux | up to 38h | up to 22Lm | 3x 5mm + 1x red L.E.D. | incl. 3AAA

For more details, see page 131

Indestructible LED x5 Head Light 3AAA

Type 17730

- Extremely robust (9m drop test), water resistant (IPX4) head light with shock-absorbing rubberized casing
- 5x very bright 5mm LEDs with two light modes: 55 lumens and 21 lumens (energy-saving mode)
- Compact and lightweight
- Swiveling head for optimum illumination of the surroundings
- Designed for maximum durability



30m 0.25 lux | up to 38h | up to 55Lm | 5x 5mm L.E.D. | incl. 3AAA

For more details, see page 128

Indestructible 1 Watt LED Head Light 3AAA

Type 17731

- Extremely robust (9m drop test), water resistant (IPX4) head light with shock-absorbing rubberized casing
- Cree 1 Watt high performance LED with two light modes: 120 lumens and 30 lumens (energy-saving mode)
- Compact and lightweight
- Swiveling head for optimum illumination of the surroundings
- Designed for maximum durability



121m 0.25 lux | up to 22h | up to 120Lm | 1 Watt L.E.D. | incl. 3AAA

For more details, see page 128

GENERAL PURPOSE

RECHARGEABLE

PORTABLE POWER

PROFESSIONAL/BUTTON CELLS

FLASHLIGHTS AND BULBS

PRODUCT DISPLAY SYSTEMS

ASSORTMENT OVERVIEW

FLASHLIGHTS

PROFESSIONAL LINE



4 Watt LED Outdoor Pro 3C

Type 18627

- ▼ Premium outdoor flashlight with extremely bright Cree 4 Watt high performance LED
- ▼ Collimator lens provides an impressive light beam (220m)
- ▼ Water resistant (IPX4), anodized aluminium casing for maximum durability
- ▼ With rubberized anti-slip grip
- ▼ Lanyard for optimum comfort during use
- ▼ Two light modes: 100% and energy-saving

For more details, see page 129



220m
0.25 lux

up to
60h

up to
190Lm

4 Watt
L.E.D.



LED Bike Light Set

Type 18803

- ▼ Complete bicycle light set comprising 1x front light, 1x rear light, tool-free mounting brackets and 5x AAA High Energy batteries
- ▼ Front light with a Cree 3 Watt high performance LED and an intelligently designed optical reflector ensuring optimum illumination of the road
- ▼ Rear light with 3x red LEDs and a 220° beam angle resulting in optimum visibility
- ▼ Front light with two different lightmodes: 100% and energy-saving
- ▼ The set fully complies with the German Road Traffic Regulation (StVZO22A)
- ▼ Water resistant (IPX4)
- ▼ Includes LED battery indicator
- ▼ Robust design (1 m drop test)

For more details, see page 132

NEW



Front light: 92m 0.25 lux | 30 lux | 120Lm | 3 Watt L.E.D.

Rear light: 4m 0.25 lux | 60h | 3Lm | 3x3mm L.E.D.

incl. 5AAA

GENERAL PURPOSE

RECHARGEABLE

PORTABLE POWER

PROFESSIONAL/BUTTON CELLS

FLASHLIGHTS AND BULBS

PRODUCT DISPLAY SYSTEMS

ASSORTMENT OVERVIEW

Indestructible 1 Watt LED Light 3AAA

Type 18700

- Extremely robust (9m drop test) and water resistant (IPX4) flashlight with shock-absorbing rubberized head and end cap
- Cree 1 Watt high performance LED with special lens optics and two light modes: 120 lumens and 19 lumens (energy-saving mode)
- Made from premium-quality, specially hardened aircraft-standard aluminium for maximum durability

For more details, see page 128



160m
0.25 lux | up to 40h | up to 120Lm | 1 Watt L.E.D. | incl. 3AAA

Indestructible 1 Watt LED Light 2AA

Type 18701

- Extremely robust (9m drop test) and water resistant (IPX4) flashlight with shock-absorbing rubberized head and end cap
- Cree 1 Watt high performance LED with special lens optics and two light modes: 100 lumens and 18 lumens (energy-saving mode)
- Made from premium-quality, specially hardened aircraft-standard aluminium for maximum durability

For more details, see page 128



150m
0.25 lux | up to 35h | up to 100Lm | 1 Watt L.E.D. | incl. 2AA

Indestructible 3 Watt LED Light 3C

Type 18702

- Extremely robust (9m drop test) and water resistant (IPX4) flashlight with shock-absorbing rubberized head and end cap
- Cree 1 Watt high performance LED with special lens optics and two light modes: 160 lumens and 60 lumens (energy-saving mode)
- Made from premium-quality, specially hardened aircraft-standard aluminium for maximum durability

For more details, see page 128



183m
0.25 lux | up to 78h | up to 160Lm | 3 Watt L.E.D. | incl. 3C

Industrial Rubbermate LED 2D

Type 18641

- Water-resistant Cree 3 Watt high-performance LED flashlight with collimator lens provides a long light beam
- Resistant to chemical fluids such as oil, petrol and diesel
- Infinitely focusable light beam
- Anti-slip rubberized grip insert
- Shock-resistant up to 5m thanks to robust casing made from aluminium and ABS plastic

For more details, see page 130



146m
0.25 lux | up to 11h | up to 180Lm | 3 Watt L.E.D. | incl. 2D

Indestructible 3 Watt LED Lantern 4C

Type 18750

- Extremely robust (4m drop test) and water resistant (IPX4) beam lantern with shock-absorbing rubberized head
- Rebel 100 3 Watt high performance LED with special lens and two light modes: 150 lumens and 50 lumens (energy-saving mode)
- Specially shaped reflector provides an extra long light beam
- Designed for maximum durability

For more details, see page 128



350m 0.25 lux | up to 78h | up to 150Lm | 3 Watt L.E.D. | incl. 4C

GENERAL PURPOSE

RECHARGEABLE

Rechargeable Lantern LED

Type 18682

- Rechargeable, shock-resistant beam lantern with extremely bright Cree 3 Watt high performance LED
- Adjustable stand that can be put in four different positions
- DC/DC regulator to ensure a consistently high light output
- Protection against overcharging and deep discharging

For more details, see page 133



300m 0.25 lux | 10h | 150Lm | 3 Watt L.E.D.

PORTABLE POWER

PROFESSIONAL/BUTTON CELLS

Work Light LED 435

Type 18660

- High-performance working light with Cree 4 Watt light performance LED
- Two light modes: 100% and energy-saving
- 145° height-adjustable head
- Acid- and oil-resistant
- Carry strap for optimum comfort during use
- Includes VARTA High Energy alkaline battery with a runtime of up to 270 hours
- Spare parts: Battery - order no. 00435 101 111

For more details, see page 133



420m 0.25 lux | up to 270h | up to 190Lm | 4 Watt L.E.D. | incl. 4LR25/6V

FLASHLIGHTS AND BULBS

PRODUCT DISPLAY SYSTEMS

1 Watt LED Sports Head Light 2AAA

Type 18632

- Comfortably lightweight head light with Cree 1 Watt high performance LED
- Rotating dispersion lens can provide both a far-reaching light beam and a wide floodlight
- Red lens ensures optimum visibility conditions at night
- 3-level switching function: 100% output, energy-saving mode and flashing mode
- Swiveling head for optimum illumination of the surroundings
- Water resistant (IPX4) and shock resistant for use in extreme conditions
- Infinitely adjustable headband maximizes comfort

For more details, see page 131



90m 0.25 lux | up to 16h | up to 80Lm | 1 Watt L.E.D. | incl. 2AAA

ASSORTMENT OVERVIEW

FLASHLIGHTS

Indestructible 5 Watt LED Lantern 3D

Type 18760

- ▼ Extremely robust (4m drop test) and waterproof (IPX7) camping lantern with rubberized shock-absorbing head/base
- ▼ 6x high performance LEDs with special reflector technology and 3 light modes: 280 lumens (maximum), 110 lumens (medium) and 32 lumens (energy-saving mode)
- ▼ Removable head and a hook integrated into the base allow for hanging up the lantern
- ▼ Extra-wide handle, which can be folded down into the casing on either side for protection, fits perfectly in the hand
- ▼ Designed for maximum durability

For more details, see page 128



 (360°) 13m
 0.25 lux |
  up to 280h |
  up to 280Lm |
 5 Watt L.E.D.

4 Watt LED Camping Lantern 3D

Type 18663

- ▼ Water resistant (IPX4) camping lantern with 3x high performance LEDs (total output: 4 Watts)
- ▼ 3 light modes: 100%, energy-saving mode and flashing mode
- ▼ Removable head and a hook integrated into the base allow for hanging up the lantern
- ▼ 72 hours battery runtime at 100% output; impressive 150 hours runtime in battery-saving mode
- ▼ Rubberized anti-slip grip
- ▼ Robust design made from durable ABS plastic with an extremely stable rubber base

For more details, see page 133



 (360°) 10m
 0.25 lux |
  up to 150h |
  up to 300Lm |
 4 Watt L.E.D.

ASSORTMENT OVERVIEW	PRODUCT DISPLAY SYSTEMS	FLASHLIGHTS AND BULBS	PROFESSIONAL/BUTTON CELLS	PORTABLE POWER	RECHARGEABLE	GENERAL PURPOSE
---------------------	-------------------------	-----------------------	---------------------------	----------------	--------------	-----------------

As good as unbreakable: The VARTA Indestructible Range

Rain, heat, cold, dirt, falls from great heights, hard knocks, enormous pressure – VARTA Indestructible flashlights pass even the hardest endurance tests. Why not let your customers discover this completely new flashlight experience? The flashlights in the Indestructible range are extremely robust and boast a multitude of impressive features: Their extremely high light output means the "Indestructibles" are the only companion you will ever need in the dark. The flashlights' ergonomic design fits perfectly in any hand. The dynamically distinctive design and a wide selection of models further emphasize the range's outstanding quality. No matter whether you are an outdoor adventurer or simply doing your job – you can always rely on the Indestructible range when things start getting rough.

Ideal for ...

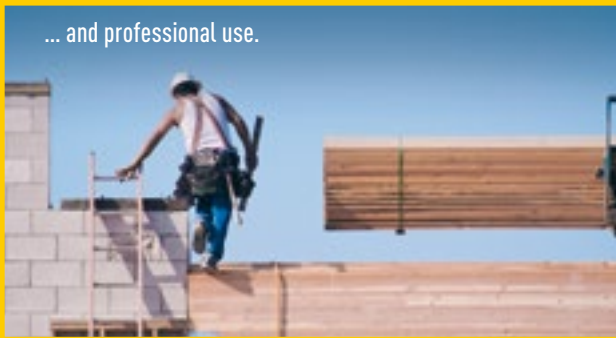

Indestructible LED Key Chain
 Guaranteed drop height 9 m
 Light output in lumens 12 Lumen
 Beam range 10 m
 Runtime 3,5 h



LED x5 Indestructible Head Light 3AAA
 Guaranteed drop height 9 m
 Light output in lumens High: 55 Lumen Low: 21 Lumen
 Beam range High: 30 m Low: 17 m
 Runtime High: 17 h Low: 38 h



1 Watt LED Indestructible Head Light 3AAA
 Guaranteed drop height 9 m
 Light output in lumens High: 120 Lumen Low: 30 Lumen
 Beam range High: 121 m Low: 63 m
 Runtime High: 5 h Low: 22 h



1 Watt LED Indestructible Light 3AAA
 Guaranteed drop height 9 m
 Light output in lumens High: 120 Lumen Low: 19 Lumen
 Beam range High: 160 m Low: 70 m
 Runtime High: 5 h Low: 40 h



1 Watt LED Indestructible Light 2AA
 Guaranteed drop height 9 m
 Light output in lumens High: 100 Lumen Low: 18 Lumen
 Beam range High: 150 m Low: 56 m
 Runtime High: 15 h Low: 35 h



CONSUMERS TEST VARTA INDESTRUCTIBLE FLASHLIGHTS.
 You've never seen anything more impressive and authentic!

▶

At
www.built-to-survive.com
 you can find Best-of cuts from the most interesting endurance tests.

GENERAL PURPOSE

RECHARGEABLE

PORTABLE POWER

PROFESSIONAL/BUTTON CELLS

FLASHLIGHTS AND BULBS

PRODUCT DISPLAY SYSTEMS

ASSORTMENT OVERVIEW



**3 Watt LED
 Indestructible
 Light 3C**

Guaranteed drop height
 9 m

Light output in lumens
 High: 160 Lumen
 Low: 60 Lumen

Beam range
 High: 183 m
 Low: 109 m

Runtime
 High: 33 h
 Low: 78 h



**3 Watt LED
 Indestructible
 Lantern 4C**

Guaranteed drop height
 4 m

Light output in lumens
 High: 150 Lumen
 Low: 50 Lumen

Beam range
 High: 350 m
 Low: 195 m

Runtime
 High: 20 h
 Low: 78 h



**5 Watt LED
 Indestructible Lantern 3D**

Guaranteed drop height
 4 m

Light output in lumens
 High: 280 Lumen
 Medium: 110 Lumen
 Low: 32 Lumen

Beam range
 High: 13 m (360°)
 Medium: 8 m (360°)
 Low: 4.5 m (360°)

Runtime
 High: 42 h
 Medium: 92 h
 Low: 280 h

BULBS

Our selection of spare bulbs, including standard and krypton bulbs, completes the flashlight range.

The unique blister-pack concept makes it easy to find the right bulb

For more details, see page 134

Blister colors and pictograms as shown on the flashlight packaging:

Red = for flashlights with 1 and 2 batteries

Green = for flashlights with 3 batteries

Blue = for flashlights with 4 batteries and more

The labeling system above summarizes the features of each type



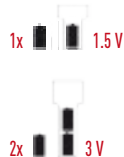

LR03-LR6-LR14-LR20 / 1x 2R10

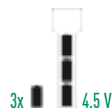

LR03-LR6-LR14-LR20 / 1x 3R8-3R12



LR03-LR6-LR14-LR20 / 1x 4R25/2

Type							
Normal bulbs for HIGH ENERGY Batteries		742 2.50 V; 0.30 A	720 3.70 V; 0.30 A	714 3.50 V; 0.20 A			
Krypton bulbs for HIGH ENERGY Batteries	751 2.40 V; 0.70 A		752 3.60 V; 0.80 A		792 4.80 V; 0.75 A	712 4.80 V; 0.70 A	
Fluorescent Tube for HIGH ENERGY Batteries							794* 9 Watt

* Available as long as stocks last

GENERAL PURPOSE

RECHARGEABLE

PORTABLE POWER

PROFESSIONAL/BUTTON CELLS

FLASHLIGHTS AND BULBS

PRODUCT DISPLAY SYSTEMS

ASSORTMENT OVERVIEW



SPECIAL BATTERIES

POWERFUL BATTERIES FOR SPECIAL NEEDS



SPECIAL BATTERIES

Compact, powerful batteries for continuous operation.

Focus of use in safety devices, e.g. alarm systems, continuous light bulbs or beam lanterns.

For more details, see page 135



Type 430



Type 431



Type 435



Type 540

ASSORTMENT OVERVIEW	PRODUCT DISPLAY SYSTEMS	FLASHLIGHTS AND BULBS	PROFESSIONAL/BUTTON CELLS	PORTABLE POWER	RECHARGEABLE	GENERAL PURPOSE
---------------------	-------------------------	-----------------------	---------------------------	----------------	--------------	-----------------



PRODUCT DISPLAY SYSTEMS

DIFFERENT SOLUTIONS COMPOSED FOR YOU INDIVIDUALLY



VARTA
Rechargeable ACCU

SAVE MONEY

A cylindrical display stand for VARTA rechargeable batteries. It has a green and white color scheme. The top section is white with a yellow banner that says 'SAVE MONEY'. Below that, there are several shelves holding various VARTA battery models. The bottom section is green with the VARTA logo and the text 'Rechargeable ACCU'.

VARTA
THE BATTERY EXPERT

A tall, dark blue display stand for VARTA batteries. It has a 'VARTA THE BATTERY EXPERT' logo at the top. The stand has multiple shelves holding various VARTA battery models. There are also some red and yellow promotional tags attached to the display. The VARTA logo is at the bottom.

VARTA
Made in Germany

Rechargeable
VARTA

SAVE MONEY

A rectangular display stand for VARTA rechargeable batteries. It has a green and blue color scheme. The top section is green with the text 'VARTA Rechargeable' and 'VARTA'. Below that, there are several shelves holding various VARTA battery models. There is also a 'SAVE MONEY' banner and a 'Made in Germany' logo. The VARTA logo is at the bottom.



DISPLAY SYSTEMS



At VARTA, innovation is an ongoing process - especially for point of sale solutions. Take the award-winning (POPAI 2013 and 2014: Gold) Battery-Shaped Displays - having a strong eyecatching effect.

Or the VARTA Battery-Center, an attractive display unit for offering centralized placement of batteries in high traffic areas.

We further offer product display systems for counters, checkouts and for mounting on columns and gondola heads, some of which enable a 360° revolving product display.

Displays encourage incremental impulse purchases in areas with high customer traffic, even in inconvenient locations and tiny spaces.

VARTA product displays – placements that sell!

For more details, see page 136 onwards

Multilocations: The key to a successful battery business!

1. Battery purchase is strongly impulse driven!

4. Up to 80 % of battery sales can be generated with multilocations!

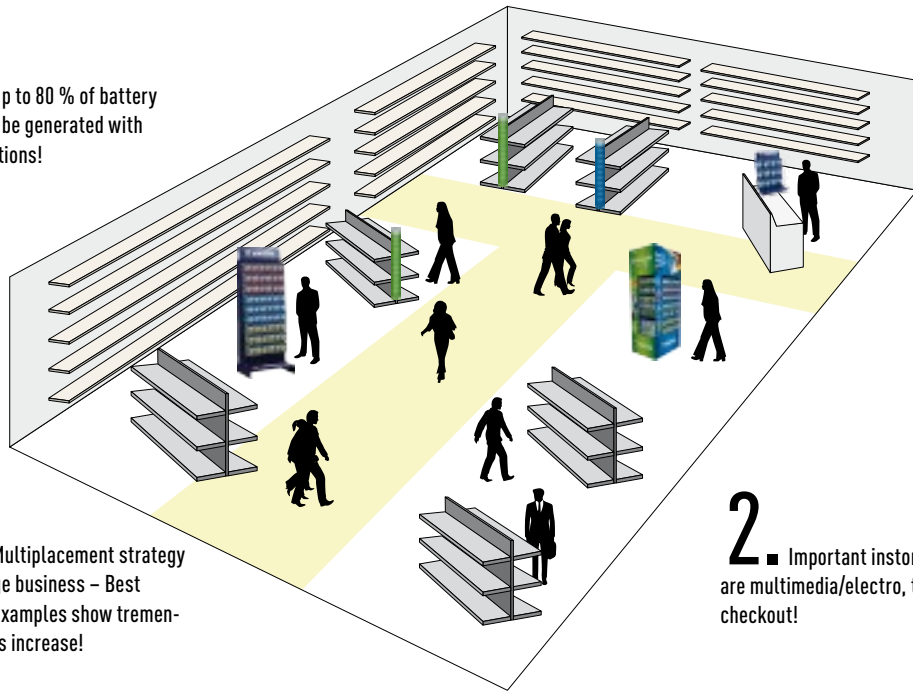

3. Multiplacement strategy to leverage business – Best practice examples show tremendous sales increase!

2. Important instore locations are multimedia/electro, toys – and: checkout!

A customer individual multilocation concept can result in more than 40% sales increase!

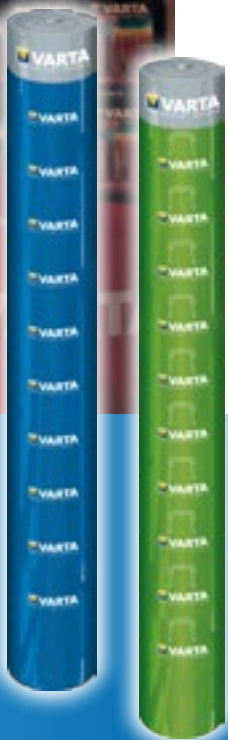

PRIMÄRE RUNDZELLEN

RECHARGEABLE

PORTABLE POWER

PROFESSIONAL/BUTTON CELLS

FLASHLIGHTS AND BULBS

PRODUCT DISPLAY SYSTEMS

ASSORTMENT OVERVIEW

ASSORTMENT OVERVIEW

ALL PRODUCT DETAILS AT A GLANCE

NEW MADE IN GERMANY **10 YEARS POWER** IN STORAGE*

AA ALKALINE

VARTA

HIGH ENERGY

+80% MORE POWER
In Digital Cameras vs. VARTA Super Alkaline**



ASSORTMENT OVERVIEW LITHIUM



Type	6103	6103	6106 *	6106 *	6122 *
Others	AAA, Micro	AAA, Micro	AA, Mignon	AA, Mignon	9V, E-Block
Order-No./ consumer unit	06103 301 402	06103 301 404	06106 301 402	06106 301 404	06122 301 401
Batteries/ consumer unit	2	4	2	4	1
Width (mm) Blister	80	80	80	80	80
Height (mm) Blister	120	120	120	120	120
Depth (mm) Blister	12	12	16	16	19
Weight (g) Blister	20	35	33	62	41
Minimum pieces/shipment unit	10	10	10	10	10
Innecarton	10	10	10	10	10
Mastercarton	50	50	100	100	50
Voltage (V)	1.5	1.5	1.5	1.5	9.0
Electrochemical System	Lithium	Lithium	Lithium	Lithium	Lithium
Width (mm) Battery	-	-	-	-	26.5
Height (mm) Battery	44.5	44.5	50.5	50.5	49.2
Depth (mm) Battery	-	-	-	-	17.5
Diameter (mm) Battery	10.5	10.5	14.5	14.5	-
Weight (g) Battery	7.7	7.7	14.5	14.5	36.4
IEC	-	-	-	-	-
Details	Page 10	Page 10	Page 10	Page 10	Page 10
EAN/GTIN/ consumer unit					

* UL certified. Underwrites Laboratories www.ul.com

- ▼ Practical and user-friendly battery tester
- ▼ Checks all important battery sizes of primary, rechargeables and button cells
- ▼ Results are readable on LCD display
- ▼ Power supply via 2 button cells (LR44)

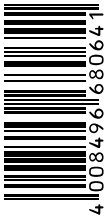

Type	LCD Digital Battery Tester
Order-No./ consumer unit	00891 101 401
Garnished with	2x V13GA
Batteries/ consumer unit	1
Width (mm) Blister	80
Height (mm) Blister	195
Depth (mm) Blister	25
Weight (g) Blister	68
Minimum pieces/ shipment unit	8
Mastercarton	8
EAN/GTIN/ consumer unit	 4 100849 616806 4 1

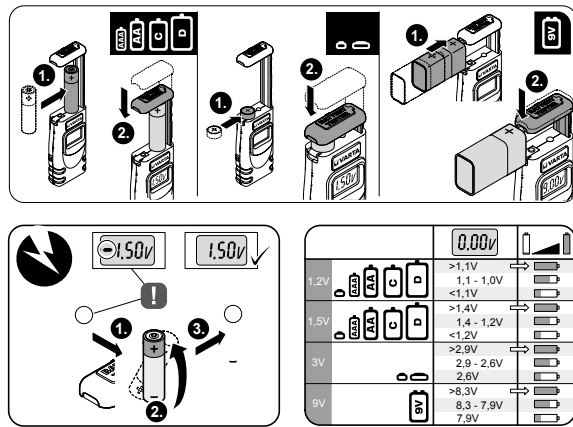

GENERAL PURPOSE

RECHARGEABLE

PORTABLE POWER

PROFESSIONAL/BUTTON CELLS

FLASHLIGHTS AND BULBS

PRODUCT DISPLAY SYSTEMS

ASSORTMENT OVERVIEW

ASSORTMENT OVERVIEW MAX TECH



MADE IN GERMANY

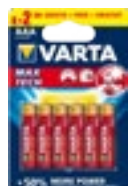

Type	4703	4703	4703	4703	4703	4706
Others	AAA, Micro, MN2400, Ministilo	AAA, Micro, MN2400, Ministilo	AAA, Micro, MN2400, Ministilo	AAA, Micro, MN2400, Ministilo	AAA, Micro, MN2400, Ministilo	AA, Mignon, MN1500, Stilo
Order-No./ consumer unit	04703 101 412	04703 101 404	04703 101 436	04703 101 418	04703 101 428	04706 101 412
Batteries/ consumer unit	2	4	4+2	8	5+3	2
Width (mm) Blister	80	80	80	167	167	80
Height (mm) Blister	120	120	120	120	120	120
Depth (mm) Blister	12	12	12	12	12	16
Weight (g) Blister	27	50	73	105	105	52
Minimum pieces/ shipment unit	10	10	10	20	20	20
Innercarton	10	10	10	-	-	20
Mastercarton	50	50	50	20	20	100
Voltage (V)	1.5	1.5	1.5	1.5	1.5	1.5
Electrochemical System	Alkaline	Alkaline	Alkaline	Alkaline	Alkaline	Alkaline
Width (mm) Battery	-	-	-	-	-	-
Height (mm) Battery	44.5	44.5	44.5	44.5	44.5	50.5
Depth (mm) Battery	-	-	-	-	-	-
Diameter (mm) Battery	10.5	10.5	10.5	10.5	10.5	14.5
Weight (g) Battery	11.5	11.5	11.5	11.5	11.5	23.8
IEC	LR03	LR03	LR03	LR03	LR03	LR6
Details	Page 12	Page 12	Page 12	Page 12	Page 12	Page 12
EAN/GTIN/ consumer unit						

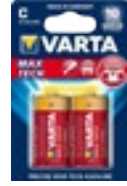

4706	4706	4706	4706	4714	4720	4722
AA, Mignon, MN1500, Stilo	AA, Mignon, MN1500, Stilo	AA, Mignon, MN1500, Stilo	AA, Mignon, MN1500, Stilo	C, Baby, MN1500, 1/2 Torcia	D, Mono, MN1300, Torcia	9V, E-Block, PP3, MN1604, Transistor
04706 101 404	04706 101 436	04706 101 418	04706 101 428	04714 101 402	04720 101 402	04722 101 401
4	4+2	8	5+3	2	2	1
80	80	167	167	80	80	80
120	120	120	120	120	120	120
16	28	16	16	27	35	19
100	148	206	206	137	282	51
20	10	20	20	10	10	10
20	10	-	-	10	10	10
100	50	20	20	100	50	50
1.5	1.5	1.5	1.5	1.5	1.5	9.0
Alkaline	Alkaline	Alkaline	Alkaline	Alkaline	Alkaline	Alkaline
-	-	-	-	-	-	26.5
50.5	50.5	50.5	50.5	50.0	61.5	48.5
-	-	-	-	-	-	17.5
14.5	14.5	14.5	14.5	26.2	34.2	-
23.8	23.8	23.8	23.8	65.8	136.9	46.0
LR6	LR6	LR6	LR6	LR14	LR20	6LP3146
Page 12	Page 12	Page 12	Page 12	Page 12	Page 12	Page 12

GENERAL PURPOSE

RECHARGEABLE

PORTABLE POWER

PROFESSIONAL/BUTTON CELLS

FLASHLIGHTS AND BULBS

PRODUCT DISPLAY SYSTEMS

ASSORTMENT OVERVIEW

ASSORTMENT OVERVIEW HIGH ENERGY



MADE IN GERMANY



Type	4903	4903	4903	4903	4903	4903
Others	AAA, Micro, MN2400, Ministilo	AAA, Micro, MN2400, Ministilo	AAA, Micro, MN2400, Ministilo	AAA, Micro, MN2400, Ministilo	AAA, Micro, MN2400, Ministilo	AAA, Micro, MN2400, Ministilo
Order-No./ consumer unit	04903 121 412	04903 121 414	04903 121 814	04903 121 484	04903 121 415	04903 121 436
Batteries/ consumer unit	2	4	4	3+1	4+1	4+2
Width (mm) Blister	80	80	80	80	80	80
Height (mm) Blister	120	120	120	120	120	120
Depth (mm) Blister	12	12	12	12	12	12
Weight (g) Blister	27	50	50	50	62	73
Minimum pieces/ shipment unit	10	10	14	10	10	10
Innercarton	10	10	-	10	10	10
Mastercarton	50	50	14	50	50	50
Voltage (V)	1.5	1.5	1.5	1.5	1.5	1.5
Electrochemical System	Alkaline	Alkaline	Alkaline	Alkaline	Alkaline	Alkaline
Width (mm) Battery	-	-	-	-	-	-
Height (mm) Battery	44.5	44.5	44.5	44.5	44.5	44.5
Depth (mm) Battery	-	-	-	-	-	-
Diameter (mm) Battery	10.5	10.5	10.5	10.5	10.5	10.5
Weight (g) Battery	11.4	11.4	11.4	11.4	11.4	11.4
IEC	LR03	LR03	LR03	LR03	LR03	LR03
Details	Page 14	Page 14	Page 14	Page 14	Page 14	Page 14
EAN/GTIN/ consumer unit						



4903	4903	4903	4903	4903	4903	4903
AAA, Micro, MN2400, Ministilo	AAA, Micro, MN2400, Ministilo	AAA, Micro, MN2400, Ministilo	AAA, Micro, MN2400, Ministilo	AAA, Micro, MN2400, Ministilo	AAA, Micro, MN2400, Ministilo	AAA, Micro, MN2400, Ministilo
04903 121 446	04903 121 428	04903 121 438	04903 121 418	04903 121 461	04903 121 472	04903 121 482
6	6+2	8	8	10	8+4	12
80	167	80	167	167	167	167
120	120	120	120	120	120	120
12	12	22	12	12	12	12
73	103	98	105	127	150	150
10	20	10	20	20	20	20
10	-	10	-	-	-	-
50	20	30	20	20	20	20
1.5	1.5	1.5	1.5	1.5	1.5	1.5
Alkaline	Alkaline	Alkaline	Alkaline	Alkaline	Alkaline	Alkaline
-	-	-	-	-	-	-
44.5	44.5	44.5	44.5	44.5	44.5	44.5
-	-	-	-	-	-	-
10.5	10.5	10.5	10.5	10.5	10.5	10.5
11.4	11.4	11.4	11.4	11.4	11.4	11.4
LR03	LR03	LR03	LR03	LR03	LR03	LR03
Page 14	Page 14	Page 14	Page 14	Page 14	Page 14	Page 14

GENERAL PURPOSE

RECHARGEABLE

PORTABLE POWER

PROFESSIONAL/BUTTON CELLS

FLASHLIGHTS AND BULBS

PRODUCT DISPLAY SYSTEMS





ASSORTMENT OVERVIEW

ASSORTMENT OVERVIEW HIGH ENERGY

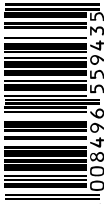

Type	4903	4903	4903	4903	4906	4906
Others	AAA, Micro, MN2400, Ministilo	AAA, Micro, MN2400, Ministilo	AAA, Micro, MN2400, Ministilo	AAA, Micro, MN2400, Ministilo	AA, Mignon, MN1500, Stilo	AA, Mignon, MN1500, Stilo
Order-No./ consumer unit	04903 301 112	04903 121 420	04903 121 492	04903 301 124	04906 121 412	04906 121 414
Batteries/ consumer unit	12	20	14+6	24	2	4
Width (mm) Blister	54	167	167	54	80	80
Height (mm) Blister	22	120	120	42	120	120
Depth (mm) Blister	77	22	22	77	16	16
Weight (g) Blister	142	244	244	279	52	100
Minimum pieces/ shipment unit	24	10	10	12	20	20
Innecarton	-	-	-	-	20	20
Mastercarton	24	10	10	12	100	100
Voltage (V)	1.5	1.5	1.5	1.5	1.5	1.5
Electrochemical System	Alkaline	Alkaline	Alkaline	Alkaline	Alkaline	Alkaline
Width (mm) Battery	-	-	-	-	-	-
Height (mm) Battery	44.5	44.5	44.5	44.5	50.5	50.5
Depth (mm) Battery	-	-	-	-	-	-
Diameter (mm) Battery	10.5	10.5	10.5	10.5	14.5	14.5
Weight (g) Battery	11.4	11.4	11.4	11.4	23.8	23.8
IEC	LR03	LR03	LR03	LR03	LR6	LR6
Details	Page 14	Page 14	Page 14	Page 14	Page 14	Page 14
EAN/GTIN/ consumer unit						

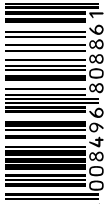
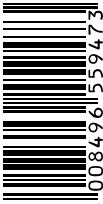
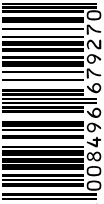

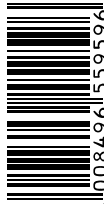
4906	4906	4906	4906	4906	4906	4906
AA, Mignon, MN1500, Stilo	AA, Mignon, MN1500, Stilo	AA, Mignon, MN1500, Stilo	AA, Mignon, MN1500, Stilo	AA, Mignon, MN1500, Stilo	AA, Mignon, MN1500, Stilo	AA, Mignon, MN1500, Stilo
04906 121 814	04906 121 354	04906 121 484	04906 121 415	04906 121 446	04906 121 436	04906 121 438
4	4	3+1	4+1	6	4+2	8
80	60	80	80	80	80	80
120	52	120	120	120	120	120
16	15	16	16	28	28	28
100	96	100	127	148	148	198
11	10	20	10	10	10	10
-	10	20	10	10	10	10
11	100	100	50	50	50	40
1.5	1.5	1.5	1.5	1.5	1.5	1.5
Alkaline	Alkaline	Alkaline	Alkaline	Alkaline	Alkaline	Alkaline
-	-	-	-	-	-	-
50.5	50.5	50.5	50.5	50.5	50.5	50.5
-	-	-	-	-	-	-
14.5	14.5	14.5	14.5	14.5	14.5	14.5
23.8	23.8	23.8	23.8	23.8	23.8	23.8
LR6	LR6	LR6	LR6	LR6	LR6	LR6
Page 14	Page 14	Page 14	Page 14	Page 14	Page 14	Page 14
 4 008496 1559435	 4 008496 1573400	 4 008496 1808861	 4 008496 1559473	 4 008496 1679270	 4 008496 1568772	 4 008496 1559596

GENERAL PURPOSE

RECHARGEABLE

PORTABLE POWER

PROFESSIONAL/BUTTON CELLS

FLASHLIGHTS AND BULBS

PRODUCT DISPLAY SYSTEMS



ASSORTMENT OVERVIEW

ASSORTMENT OVERVIEW HIGH ENERGY



MADE IN GERMANY

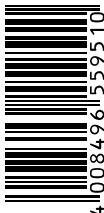
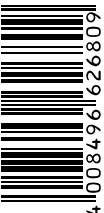

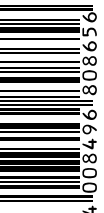
Type	4906	4906	4906	4906	4906	4906
Others	AA, Mignon, MN1500, Stilo	AA, Mignon, MN1500, Stilo	AA, Mignon, MN1500, Stilo	AA, Mignon, MN1500, Stilo	AA, Mignon, MN1500, Stilo	AA, Mignon, MN1500, Stilo
Order-No./ consumer unit	04906 121 418	04906 121 428	04906 121 461	04906 121 482	04906 301 112	04906 121 472
Batteries/ consumer unit	8	6+2	10	12	12	8+4
Width (mm) Blister	167	167	167	167	60	167
Height (mm) Blister	120	120	120	120	29	120
Depth (mm) Blister	16	16	16	16	104	16
Weight (g) Blister	206	200	257	304	293	304
Minimum pieces/ shipment unit	20	20	20	20	24	20
Innecarton	-	-	-	-	-	-
Mastercarton	20	20	20	20	24	20
Voltage (V)	1.5	1.5	1.5	1.5	1.5	1.5
Electrochemical System	Alkaline	Alkaline	Alkaline	Alkaline	Alkaline	Alkaline
Width (mm) Battery	-	-	-	-	-	-
Height (mm) Battery	50.5	50.5	50.5	50.5	50.5	50.5
Depth (mm) Battery	-	-	-	-	-	-
Diameter (mm) Battery	14.5	14.5	14.5	14.5	14.5	14.5
Weight (g) Battery	23.8	23.8	23.8	23.8	23.8	23.8
IEC	LR6	LR6	LR6	LR6	LR6	LR6
Details	Page 14	Page 14	Page 14	Page 14	Page 14	Page 14
EAN/GTIN/ consumer unit	 4 008496 155951 0	 4 008496 155955 8	 4 008496 162680 9	 4 008496 155967 1	 4 008496 180865 6	 4 008496 165923 4



4906	4906	4906	4912	4914	4920	4922
AA, Mignon, MN1500, Stilo	AA, Mignon, MN1500, Stilo	AA, Mignon, MN1500, Stilo	Normal, MN1203	C, Baby, MN1500, 1/2 Torcia	D, Mono, MN1300, Torcia	9V, E-Block, PP3, MN1604, Transistor
04906 121 420	04906 121 492	04906 301 124	04912 121 411	04914 121 412	04920 121 412	04922 121 411
20	14+6	24	1	2	2	1
167	167	60	80	80	80	80
120	120	56	120	120	120	120
30	30	104	23	27	35	19
492	492	579	175	137	282	51
10	10	12	10	10	10	10
-	-	-	10	10	10	10
10	10	12	100	100	50	50
1.5	1.5	1.5	4.5	1.5	1.5	9.0
Alkaline	Alkaline	Alkaline	Alkaline	Alkaline	Alkaline	Alkaline
-	-	-	62	-	-	26.5
50.5	50.5	50.5	67	50.0	61.5	48.5
-	-	-	22	-	-	17.5
14.5	14.5	14.5	-	26.2	34.2	-
23.8	23.8	23.8	168.5	65.8	136.9	46.0
LR6	LR6	LR6	3LR12	LR14	LR20	6LP3146
Page 14	Page 14	Page 14	Page 14	Page 14	Page 14	Page 14
4 008496 160565 1	4 008496 174824 2	4 008496 180750 5	4 008496 155947 1	4 008496 155931 2	4 008496 155923 7	4 008496 155986 2

GENERAL PURPOSE

RECHARGEABLE

PORTABLE POWER

PROFESSIONAL/BUTTON CELLS

FLASHLIGHTS AND BULBS

PRODUCT DISPLAY SYSTEMS

ASSORTMENT OVERVIEW

ASSORTMENT OVERVIEW LONGLIFE

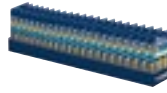

Type	4103	4103	4103	4103	4103	4103	4103
Others	AAA, Micro, MNZ400, Ministilo	AAA, Micro, MNZ400, Ministilo	AAA, Micro, MNZ400, Ministilo	AAA, Micro, MNZ400, Ministilo	AAA, Micro, MNZ400, Ministilo	AAA, Micro, MNZ400, Ministilo	AAA, Micro, MNZ400, Ministilo
Order-No./ consumer unit	04103 101 412	04103 101 414	04103 101 894	04103 101 484	04103 101 416	04103 101 426	04103 101 418
Batteries/ consumer unit	2	4	4	3+1	6	4+2	8
Width (mm) Blister	80	80	80	80	80	80	167
Height (mm) Blister	120	120	120	120	120	120	120
Depth (mm) Blister	12	12	12	12	12	12	12
Weight (g) Blister	27	50	50	50	72	72	104
Minimum pieces/ shipment unit	10	10	28	10	10	10	20
Innercarton	10	10	-	10	10	10	-
Mastercarton	50	50	28	50	50	50	20
Voltage (V)	1.5	1.5	1.5	1.5	1.5	1.5	1.5
Electrochemical System	Alkaline	Alkaline	Alkaline	Alkaline	Alkaline	Alkaline	Alkaline
Width (mm) Battery	-	-	-	-	-	-	-
Height (mm) Battery	44.5	44.5	44.5	44.5	44.5	44.5	44.5
Depth (mm) Battery	-	-	-	-	-	-	-
Diameter (mm) Battery	10.5	10.5	10.5	10.5	10.5	10.5	10.5
Weight (g) Battery	11.3	11.3	11.3	11.3	11.3	11.3	11.3
IEC	LR03	LR03	LR03	LR03	LR03	LR03	LR03
Details	Page 16	Page 16	Page 16	Page 16	Page 16	Page 16	Page 16
EAN/GTIN/ consumer unit							

4103	4103	4103	4103	4103	4106	4106	4106
AAA, Micro, MNZ400, Ministilo	AAA, Micro, MNZ400, Ministilo	AAA, Micro, MNZ400, Ministilo	AAA, Micro, MNZ400, Ministilo	AAA, Micro, MNZ400, Ministilo	AA, Mignon, MN1500, Stilo	AA, Mignon, MN1500, Stilo	AA, Mignon, MN1500, Stilo
04103 101 328	04103 101 461	04103 301 112	04103 214 416	04103 301 124	04106 101 412	04106 101 414	04106 101 894
8	10	12	16	24	2	4	4
55	167	54	167	54	80	80	80
121	120	22	120	42	120	120	120
11	12	77	22	77	16	16	16
92	126	141	198	277	51	98	98
25	20	24	14	12	20	20	22
-	-	-	-	-	20	20	-
25	20	24	14	12	100	100	22
1.5	1.5	1.5	1.5	1.5	1.5	1.5	1.5
Alkaline	Alkaline	Alkaline	Alkaline	Alkaline	Alkaline	Alkaline	Alkaline
-	-	-	-	-	-	-	-
44.5	44.5	44.5	44.5	44.5	50.5	50.5	50.5
-	-	-	-	-	-	-	-
10.5	10.5	10.5	10.5	10.5	14.5	14.5	14.5
11.3	11.3	11.3	11.3	11.3	23.2	23.2	23.2
LR03	LR03	LR03	LR03	LR03	LR6	LR6	LR6
Page 16	Page 16	Page 16	Page 16	Page 16	Page 16	Page 16	Page 16

GENERAL PURPOSE

RECHARGEABLE

PORTABLE POWER

PROFESSIONAL/BUTTON CELLS

FLASHLIGHTS AND BULBS

PRODUCT DISPLAY SYSTEMS

ASSORTMENT OVERVIEW

ASSORTMENT OVERVIEW LONGLIFE



Type	4106	4106	4106	4106	4106	4106	4106
Others	AA, Mignon, MN1500, Stilo	AA, Mignon, MN1500, Stilo	AA, Mignon, MN1500, Stilo	AA, Mignon, MN1500, Stilo	AA, Mignon, MN1500, Stilo	AA, Mignon, MN1500, Stilo	AA, Mignon, MN1500, Stilo
Order-No./ consumer unit	04106 101 354	04106 101 484	04106 101 436	04106 101 416	04106 101 426	04106 101 418	04106 101 328
Batteries/ consumer unit	4	3+1	6	6	4+2	8	8
Width (mm) Blister	60	80	80	167	80	167	64
Height (mm) Blister	52	120	120	120	120	120	155
Depth (mm) Blister	15	16	28	16	28	16	15
Weight (g) Blister	93	98	145	149	145	195	187
Minimum pieces/ shipment unit	10	20	10	20	10	20	25
Innercarton	10	20	10	-	10	-	-
Mastercarton	100	100	50	20	50	20	25
Voltage (V)	1.5	1.5	1.5	1.5	1.5	1.5	1.5
Electrochemical System	Alkaline	Alkaline	Alkaline	Alkaline	Alkaline	Alkaline	Alkaline
Width (mm) Battery	-	-	-	-	-	-	-
Height (mm) Battery	50.5	50.5	50.5	50.5	50.5	50.5	50.5
Depth (mm) Battery	-	-	-	-	-	-	-
Diameter (mm) Battery	14.5	14.5	14.5	14.5	14.5	14.5	14.5
Weight (g) Battery	23.2	23.2	23.2	23.2	23.2	23.2	23.2
IEC	LR6	LR6	LR6	LR6	LR6	LR6	LR6
Details	Page 16	Page 16	Page 16	Page 16	Page 16	Page 16	Page 16
EAN/GTIN/ consumer unit							



4106	4106	4106	4106	4112	4114	4120	4122
AA, Mignon, MN1500, Stilo	AA, Mignon, MN1500, Stilo	AA, Mignon, MN1500, Stilo	AA, Mignon, MN1500, Stilo	Normal, MN1203	C, Baby, MN1500, 1/2 Torcia	D, Mono, MN1300, Torcia	9V, E-Block, PP3, MN1604, Transistor
04106 101 461	04106 301 112	04106 214 416	04106 301 124	04112 101 411	04114 101 412	04120 101 412	04122 101 411
10	12	16	24	1	2	2	1
167	60	167	60	80	80	80	80
120	29	120	56	120	120	120	120
16	104	28	104	23	27	35	19
251	286	391	564	96	137	278	51
20	24	10	12	10	10	10	10
-	-	-	-	10	10	10	10
20	24	10	12	100	100	50	50
1.5	1.5	1.5	1.5	4.5	1.5	1.5	9.0
Alkaline	Alkaline	Alkaline	Alkaline	Alkaline	Alkaline	Alkaline	Alkaline
-	-	-	-	62	-	-	26.5
50.5	50.5	50.5	50.5	67	50.0	61.5	48.5
-	-	-	-	22	-	-	17.5
14.5	14.5	14.5	14.5	-	26.2	34.2	-
23.2	23.2	23.2	23.2	89.5	65.8	135.1	46.0
LR6	LR6	LR6	LR6	3LR12	LR14	LR20	6LP3146
Page 16	Page 16	Page 16	Page 16	Page 16	Page 16	Page 16	Page 16
4 008496 1525232	4 008496 1807833	4 008496 1592111	4 008496 1774579	4 008496 1672622	4 008496 1525263	4 008496 1525348	4 008496 1525423

GENERAL PURPOSE

RECHARGEABLE

PORTABLE POWER

PROFESSIONAL/BUTTON CELLS

FLASHLIGHTS AND BULBS

PRODUCT DISPLAY SYSTEMS



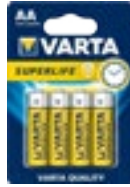

ASSORTMENT OVERVIEW

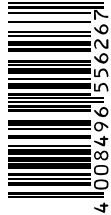
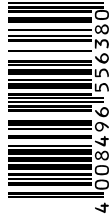
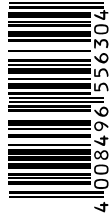
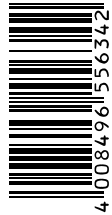
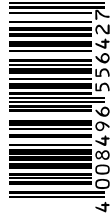
ASSORTMENT OVERVIEW SUPERLIFE

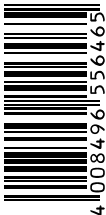
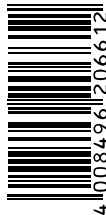

Type	2003	2006	2012	2014	2020	2022
Others	AAA, Micro	AA, Mignon	Normal	C, Baby	D, Mono	9V, E-Block
Order-No./ consumer unit	02003 101 414	02006 101 414	02012 101 411	02014 101 412	02020 101 412	02022 101 411
Batteries/ consumer unit	4	4	1	2	2	1
Width (mm) Blister	80	80	80	80	80	80
Height (mm) Blister	120	120	120	120	120	120
Depth (mm) Blister	11.5	16	23.5	27	35	19
Weight (g) Blister	38	76	106	102	208	43
Minimum pieces/ shipment unit	12	12	10	12	12	10
Innercarton	12	12	10	12	12	10
Mastercarton	24	60	100	60	60	50
Voltage (V)	1.5	1.5	4.5	1.5	1.5	9
Electrochemical System	Zinc Carbon	Zinc Carbon	Zinc Carbon	Zinc Carbon	Zinc Carbon	Zinc Carbon
Width (mm) Battery	-	-	62.0	-	-	26.5
Height (mm) Battery	44.5	50.5	67.0	50.0	61.5	48.5
Depth (mm) Battery	-	-	22.0	-	-	17.5
Diameter (mm) Battery	10.5	14.5	-	26.2	34.2	-
Weight (g) Battery	7.75	18.0	101.0	48.0	100.0	38.0
IEC	R03P	R6P	3R12P	R14P	R20P	6F22
Details	Page 18	Page 18	Page 18	Page 18	Page 18	Page 18
EAN/GTIN/ consumer unit	 4 008496 1676187	 4 008496 1556267	 4 008496 1556380	 4 008496 1556304	 4 008496 1556342	 4 008496 1556427



2006	2006	2012	2014	2020	2022
AA, Mignon	AA, Mignon	Normal	C, Baby	D, Mono	9V, E-Block
02006 101 304	02006 101 308	02012 101 301	02014 101 302	02020 101 302	02022 101 301
4	8	1	2	2	1
60	122	62	54	70	26.5
52	52	64	51	62	48.5
15	15	22	27	35	17.5
72	145	102	96	202	38
12	6	44	12	12	12
12	6	-	12	12	12
60	30	44	60	60	216
1.5	1.5	4.5	1.5	1.5	9
Zinc Carbon	Zinc Carbon	Zinc Carbon	Zinc Carbon	Zinc Carbon	Zinc Carbon
-	-	62.0	-	-	26.5
50.5	50.5	67.0	50.0	61.5	48.5
-	-	22.0	-	-	17.5
14.5	14.5	-	26.2	34.2	-
18.0	18.0	101.0	48.0	100.0	38.0
R6P	R6P	3R12P	R14P	R20P	6F22
Page 18	Page 18	Page 18	Page 18	Page 18	Page 18
 4 008496 1556465	 4 008496 1206612	 4 008496 1556595	 4 008496 1556502	 4 008496 1556540	 4 008496 1556632

GENERAL PURPOSE

RECHARGEABLE

PORTABLE POWER

PROFESSIONAL/BUTTON CELLS

FLASHLIGHTS AND BULBS

PRODUCT DISPLAY SYSTEMS



ASSORTMENT OVERVIEW

ASSORTMENT OVERVIEW ACCUS



Type	56703	56703	56703	56703	56703	5703
Others	AAA, Micro	AAA, Micro	AAA, Micro	AAA, Micro	AAA, Micro	AAA, Micro
Order-No./ consumer unit	56703 101 111	56703 101 402	56703 101 404	56703 101 494	56703 101 436	05703 301 402
Typical capacity (mAh)	800	800	800	800	800	1000
Batteries/ consumer unit	10	2	4	3+1	6	2
Width (mm) Blister	56	80	80	80	80	80
Height (mm) Blister	45	120	120	120	120	120
Depth (mm) Blister	23	12	12	12	12	12
Weight (g) Blister	125	28	52	52	76	32
Minimum pieces/shipment unit	10	10	10	10	10	10
Innercarton	40	10	10	10	10	10
Mastercarton	360	50	50	50	50	50
Voltage (V)	1.2	1.2	1.2	1.2	1.2	1.2
Electrochemical System	Ni-MH	Ni-MH	Ni-MH	Ni-MH	Ni-MH	Ni-MH
Height (mm) Battery	44.5	44.5	44.5	44.5	44.5	44.5
Diameter (mm) Battery	10.5	10.5	10.5	10.5	10.5	10.5
Weight (g) Battery	12	12	12	12	12	14
IEC	HR03	HR03	HR03	HR03	HR03	HR03
Details	Page 22	Page 22	Page 22	Page 22	Page 22	Page 22
EAN/GTIN/ consumer unit						

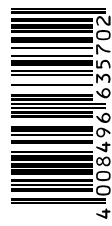
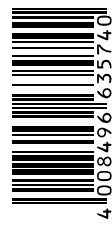

5703	5703	5703	56716	56716
AAA, Micro	AAA, Micro	AAA, Micro	AA, Mignon	AA, Mignon
05703 301 404	05703 301 494	05703 301 405	56716 101 402	56716 101 404
1000	1000	1000	1600	1600
4	3+1	4+1	2	4
80	80	80	80	80
120	120	120	120	120
12	12	12	16	16
60	60	74	54	104
10	10	10	10	10
10	10	10	10	10
50	50	50	100	100
1.2	1.2	1.2	1.2	1.2
Ni-MH	Ni-MH	Ni-MH	Ni-MH	Ni-MH
44.5	44.5	44.5	50.5	50.5
10.5	10.5	10.5	14.5	14.5
14	14	14	25	25
HR03	HR03	HR03	HR6	HR6
Page 22	Page 22	Page 22	Page 22	Page 22
 4 008496 1594375	 4 008496 172926	 4 008496 172889	 4 008496 1635702	 4 008496 1635740

GENERAL PURPOSE

RECHARGEABLE

PORTABLE POWER

PROFESSIONAL/BUTTON CELLS

FLASHLIGHTS AND BULBS

PRODUCT DISPLAY SYSTEMS

ASSORTMENT OVERVIEW

ASSORTMENT OVERVIEW ACCUS



Type	56706	56706	56706	56706	56706	56706
Others	AA, Mignon	AA, Mignon	AA, Mignon	AA, Mignon	AA, Mignon	AA, Mignon
Order-No./ consumer unit	56706 101 111	56706 101 402	56706 101 404	56706 101 494	56706 101 436	56706 101 496
Typical capacity (mAh)	2100	2100	2100	2100	2100	2100
Batteries/ consumer unit	10	2	4	3+1	4	4+2AAA
Width (mm) Blister	144	80	80	80	80	80
Height (mm) Blister	51.5	120	120	120	120	120
Depth (mm) Blister	16	16	16	16	28	25
Weight (g) Blister	298	62	120	120	180	147
Minimum pieces/ shipment unit	10	10	10	10	10	10
Innecarton	10	10	10	10	10	10
Mastercarton	200	100	100	100	50	30
Voltage (V)	1.2	1.2	1.2	1.2	1.2	1.2
Electrochemical System	Ni-MH	Ni-MH	Ni-MH	Ni-MH	Ni-MH	Ni-MH
Height (mm) Battery	50.5	50.5	50.5	50.5	50.5	50.5
Diameter (mm) Battery	14.5	14.5	14.5	14.5	14.5	14.5
Weight (g) Battery	29	29	29	29	29	29
IEC	HR6	HR6	HR6	HR6	HR6	HR6
Details	Page 22	Page 22	Page 22	Page 22	Page 22	Page 22
EAN/GTIN/ consumer unit	 4 008496 115509 133	 4 008496 115506 54	 4 008496 115506 92	 4 008496 116364 19	 4 008496 116742 75	 4 008496 116379 80

GENERAL PURPOSE

RECHARGEABLE

PORTABLE POWER







PROFESSIONAL/BUTTON CELLS

FLASHLIGHTS AND BULBS

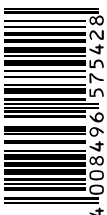
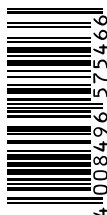
PRODUCT DISPLAY SYSTEMS

ASSORTMENT OVERVIEW



56756	56756	56756	56756	5716	5716	56714
AA, Mignon	AA, Mignon	AA, Mignon	AA, Mignon	AA, Mignon	AA, Mignon	C, Baby
56756 101 402	56756 101 404	56756 101 494	56756 101 405	05716 101 402	05716 101 404	56714 101 402
2400	2400	2400	2400	2600	2600	3000
2	4	3+1	4+1	2	4	2
80	80	80	80	80	80	80
120	120	120	120	120	120	120
16	16	16	16	16	16	27
64	124	124	158	64	124	138
10	10	10	10	10	10	10
10	10	10	10	10	10	10
100	100	100	50	100	100	100
1.2	1.2	1.2	1.2	1.2	1.2	1.2
Ni-MH	Ni-MH	Ni-MH	Ni-MH	Ni-MH	Ni-MH	Ni-MH
50.5	50.5	50.5	50.5	50.5	50.5	50
14.5	14.5	14.5	14.5	14.5	14.5	26
30	30	30	30	30	30	66
HR6	HR6	HR6	HR6	HR6	HR6	HR14
Page 22	Page 22	Page 22	Page 22	Page 22	Page 22	Page 22
 4 008496 575428	 4 008496 575466	 4 008496 661466	 4 008496 747375	 4 008496 745937	 4 008496 745975	 4 008496 550739

ASSORTMENT OVERVIEW ACCUS

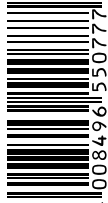
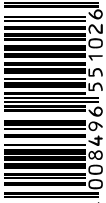
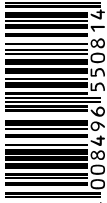

Type	56720	56722	56722
Others	D, Mono	9V, E-Block	9V, E-Block
Order-No./ consumer unit	56720 101 402	56722 101 111	56722 101 401
Typical capacity (mAh)	3000	200	200
Batteries/ consumer unit	2	20	1
Width (mm) Blister	80	71	80
Height (mm) Blister	120	50	120
Depth (mm) Blister	35	132	19
Weight (g) Blister	172	734	41
Minimum pieces/shipment unit	10	20	10
Innercarton	10	20	10
Mastercarton	50	200	50
Voltage (V)	1.2	9	9
Electrochemical System	Ni-MH	Ni-MH	Ni-MH
Height (mm) Battery	61.5	15.7	15.7
Width (mm) Battery	-	26.6	26.6
Depth (mm) Battery	-	48.5	48.5
Diameter (mm) Battery	34.2	-	-
Weight (g) Battery	82	36	36
IEC	HR20	HR9V	HR9V
Details	Page 22	Page 22	Page 22
EAN/GTIN/ consumer unit	 4 1008496 155077 7	 4 1008496 155102 6	 4 1008496 155081 4

ASSORTMENT OVERVIEW SPECIAL ACCUS



Toy Accu

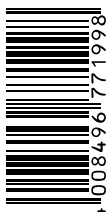
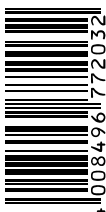
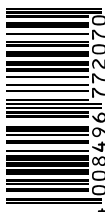
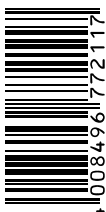

Type	56783	56783	56786	56786
Others	AAA, Micro	AAA, Micro	AA, Mignon	AA, Mignon
Order-No./ consumer unit	56783 101 402	56783 101 404	56786 101 402	56786 101 404
Typical capacity (mAh)	800	800	2400	2400
Batteries/ consumer unit	2	4	2	4
Width (mm) Blister	80	80	80	80
Height (mm) Blister	120	120	120	120
Depth (mm) Blister	12	12	16	16
Weight (g) Blister	28	52	64	124
Minimum pieces/shipment unit	10	10	10	10
Innecarton	10	10	10	10
Mastercarton	50	50	100	100
Voltage (V)	1.2	1.2	1.2	1.2
Electrochemical System	Ni-MH	Ni-MH	Ni-MH	Ni-MH
Height (mm) Battery	44.5	44.5	50.5	50.5
Diameter (mm) Battery	10.5	10.5	14.5	14.5
Weight (g) Battery	12	12	30	30
IEC	HR03	HR03	HR6	HR6
Details	Page 24	Page 24	Page 24	Page 24
EAN/GTIN/ consumer unit	 4 008496 771998	 4 008496 772032	 4 008496 772070	 4 008496 772117

Phone Accu

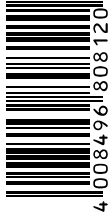

Type	58397	58398	58399
Others	AAA, Micro	AAA, Micro	AA, Mignon
Order-No./ consumer unit	58397 101 402	58398 101 402	58399 201 402
Typical capacity (mAh)	550	800	1600
Batteries/ consumer unit	2	2	2
Width (mm) Blister	80	80	80
Height (mm) Blister	120	120	120
Depth (mm) Blister	12	12	16
Weight (g) Blister	24	28	54
Minimum pieces/ shipment unit	10	10	10
Innecarton	10	10	10
Mastercarton	50	50	100
Voltage (V)	1.2	1.2	1.2
Electrochemical System	Ni-MH	Ni-MH	Ni-MH
Height (mm) Battery	44.5	44.5	50.5
Diameter (mm) Battery	10.5	10.5	14.5
Weight (g) Battery	10	12	25
IEC	HR03	HR03	HR6
Details	Page 24	Page 24	Page 24
EAN/GTIN/ consumer unit	 4 1008496 1808 1201	 4 1008496 13308671	 4 1008496 13309041

Solar Accu

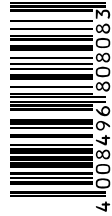
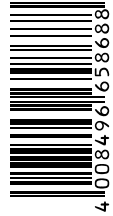

Type	56733	56736
Others	AAA, Micro	AA, Mignon
Order-No./ consumer unit	56733 101 402	56736 101 402
Typical capacity (mAh)	550	800
Batteries/ consumer unit	2	2
Width (mm) Blister	80	80
Height (mm) Blister	120	120
Depth (mm) Blister	12	16
Weight (g) Blister	24	42
Minimum pieces/ shipment unit	10	10
Innecarton	10	10
Mastercarton	50	100
Voltage (V)	1.2	1.2
Electrochemical System	Ni-MH	Ni-MH
Height (mm) Battery	44.5	50.5
Diameter (mm) Battery	10.5	14.5
Weight (g) Battery	10	19
IEC	HR03	HR6
Details	Page 24	Page 24
EAN/GTIN/ consumer unit	 4 1008496 18080831	 4 1008496 16586881

GENERAL PURPOSE

RECHARGEABLE

PORTABLE POWER

PROFESSIONAL/BUTTON CELLS

FLASHLIGHTS AND BULBS

PRODUCT DISPLAY SYSTEMS

ASSORTMENT OVERVIEW

ASSORTMENT OVERVIEW CHARGER

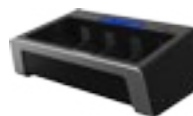

Type	LCD Plug Charger	LCD Ultra Fast Charger	LCD Universal Charger	LCD Charger
Order-No./ consumer unit	57677 101 441	57675 101 441	57678 101 401	57070 201 401
Equipped with	4 x AA 2100 mAh 56706	4 x AA 2400 mAh 56756	-	12V adapter + USB cabel
Width (mm) Blister	120	180	180	120
Height (mm) Blister	230	240	240	230
Depth (mm) Blister	78	111	98	93
Weight (g) Blister	303	596	448	259
Consumer unit	1	1	1	1
Minimum pieces/shipment unit	4	2	2	2
Mastercarton	4	2	2	2
Voltage (V)	220-240	220-240	100 - 240	100-240
Plug	EURO	EURO	EURO	EURO
Charging time (Accus)	4 h	15 min	4 h	2h
Charging time (external devices)	1.5 - 5h	-	1.5 - 5h	-
Shutdown function	Timer & Minus Delta U	Timer & Minus Delta U, control of temperature	Timer & Minus Delta U	Timer & Minus Delta U, control of temperature
Trickle charging	-	✓	-	✓
Charging sizes	2/4 AA, AAA 1x 9V, 1x USB	1-4 AA, AAA	2/4 AA, AAA, C, D, 1x 9V, 1x USB	2/4 AA / AAA
Technology	Ni-MH	Ni-MH	Ni-MH	Ni-MH
Single slot	-	✓	9V	-
Power supply (internal - external)	Internal	External	External	External
Plug charger	✓	-	-	-
LED (indication of charging status)	Display	Display	Display	Display
Charging channels	4	4	4	4
Charging	Pairwise	Single	Pairwise	Pairwise
Bad cell / Alcaline / Wrong polarity detection	✓	✓	✓	✓
USB - In & Out	USB - Out	-	USB - Out	USB - In
Accessoires	-	12V adapter	-	(5V) USB & 12V adapter
Details	Page 28	Page 29	Page 29	Page 29
EAN / GTIN consumer unit	 4 008496 7735 10	 4 008496 7734 80	 4 008496 7735 41	 4 008496 64 13 521



LCD Charger	LCD Charger	Universal Charger	Plug Charger
57070 201 441	57070 201 451	57668 101 401	57667 101 451
4 x AA 56756 2400 mAh + 12V adapter + USB cabel	4 x AA 5716 2600 mAh + 12V adapter + USB cabel	-	4 x AA 2100 mAh 56706
120	120	180	100
230	230	240	195
93	93	87	73
379	379	393	257
1	1	1	1
2	2	2	4
2	2	2	4
100-240	100-240	100-240	100-240
EURO	EURO	EURO	EURO
2h	2h	5h	5h
-	-	-	-
Timer, Minus Delta U, control of temperature	Timer, Minus Delta U, control of temperature	Timer	Timer
✓	✓	✓	-
2/4 AA / AAA	2/4 AA / AAA	2/4 AA, AAA, C, D, 9V	2/4 AA, AAA
Ni-MH	Ni-MH	Ni-MH	Ni-MH
-	-	-	-
External	External	External	Internal
-	-	✓	✓
Display	Display	✓	✓
4	4	4	4
Pairwise	Pairwise	Pairwise	Pairwise
✓	✓	-	-
USB - In	USB - In	-	-
(5V) USB & 12V adapter	(5V) USB & 12V adapter	-	-
Page 29	Page 29	Page 31	Page 30

GENERAL PURPOSE

RECHARGEABLE

PORTABLE POWER

PROFESSIONAL/BUTTON CELLS

FLASHLIGHTS AND BULBS

PRODUCT DISPLAY SYSTEMS

ASSORTMENT OVERVIEW

ASSORTMENT OVERVIEW CHARGER



Type	Mini Charger	Mini Charger	Mini Charger	Mini Charger
Order-No./ consumer unit	57666 101 401	57666 201 421	57666 101 451	57666 101 461
Equipped with	without cells	2 x AAA 800 mAh 56703	2 x AA 2100 mAh 56706	2 x AA 2400 mAh 56756
Width (mm) Blister	80	80	80	80
Height (mm) Blister	195	195	195	195
Depth (mm) Blister	78	78	78	78
Weight (g) Blister	160	184	218	220
Consumer unit	1	1	1	1
Minimum pieces/shipment unit	4	4	4	4
Mastercarton	4	4	4	4
Voltage (V)	230	230	230	230
Plug	EURO	EURO	EURO	EURO
Charging time (Accus)	15 h	15 h	15 h	15 h
Charging time (external devices)	-	-	-	-
Shutdown function	-	-	-	-
Trickle charging	-	-	-	-
Charging sizes	2 AA, AAA	2 AA, AAA	2 AA, AAA	2 AA, AAA
Technology	Ni-MH	Ni-MH	Ni-MH	Ni-MH
Single slot	-	-	-	-
Power supply (internal - external)	Internal	Internal	Internal	Internal
Plug charger	✓	✓	✓	✓
LED (indication of charging status)	✓	✓	✓	✓
Charging channels	2	2	2	2
Charging	Pairwise	Pairwise	Pairwise	Pairwise
Bad cell / Alkaline / Wrong polarity detection	-	-	-	-
USB - In & Out	-	-	-	-
Accessoires	-	-	-	-
Details	Page 30	Page 30	Page 30	Page 30
EAN / GTIN consumer unit				



Pocket Charger	Pocket Charger	Pocket Charger	Pocket Charger	Pocket Charger
57662 101 401	57662 101 441	57662 101 451	57662 101 471	57662 301 431
-	4 x AA 1600 mAh 56716	4 x AA 2100 mAh 56706	4 x AA 2600 mAh 5716	4 x AA 2100 mAh 56706 + 2 x AAA 800 mAh 56703
80	80	80	80	80
195	195	195	195	195
85	85	85	85	85
223	323	339	343	363
1	1	1	1	1
4	4	4	4	4
4	4	4	4	4
230	230	230	230	230
EURO	EURO	EURO	EURO	EURO
7 h	7 h	7 h	7 h	7 h
-	-	-	-	-
Timer	Timer	Timer	Timer	Timer
-	-	-	-	-
2/4 AA, AAA	2/4 AA, AAA	2/4 AA, AAA	2/4 AA, AAA	2/4 AA, AAA
Ni-MH	Ni-MH	Ni-MH	Ni-MH	Ni-MH
-	-	-	-	-
Internal	Internal	Internal	Internal	Internal
✓	✓	✓	✓	✓
✓	✓	✓	✓	✓
4	4	4	4	4
Pairwise	Pairwise	Pairwise	Pairwise	Pairwise
-	-	-	-	-
-	-	-	-	-
-	-	-	-	-
Page 30	Page 30	Page 30	Page 30	Page 30

GENERAL PURPOSE

RECHARGEABLE

PORTABLE POWER

PROFESSIONAL/BUTTON CELLS

FLASHLIGHTS AND BULBS

PRODUCT DISPLAY SYSTEMS

ASSORTMENT OVERVIEW

ASSORTMENT OVERVIEW PORTABLE POWER

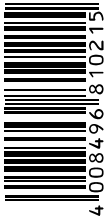
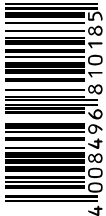
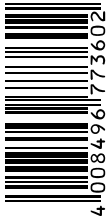
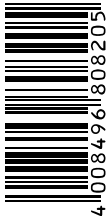
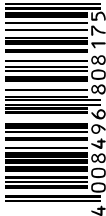
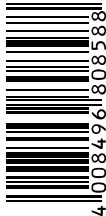

Type	Phone Power 800 Lightning Adapter	Phone Power 800 30-pin Adapter	Phone Power 800 Micro USB Adapter	Indestructible Powerpack 2000	Indestructible Powerpack 6000	2 in 1 Powerpack & Charger
Order-No./ consumer unit	57923 101 401	57922 101 401	57921 101 401	57954 101 401	57952 101 401	57920 101 441
Width (mm) Blister	100	100	100	120	120	120
Height (mm) Blister	230	230	230	230	230	230
Depth (mm) Blister	24	24	24	47	56	36
Weight (g) Blister	78	78	76	192	315	217
Consumer unit	1	1	1	1	1	1
Minimum pieces/ shipment unit	4	4	4	2	2	4
Mastercarton	4	4	4	2	2	4
Ready to Use	✓	✓	✓	✓	✓	✓
Voltage (V)	5V	5V	5V	5V	5V	5V
Capacity (mAh)	800	800	800	2000	6000	-
Output (A)	1.0	1.0	1.0	1.0	1.0 / 2.4	0.45
Technologies	Li-Ion	Li-Ion	Li-Ion	Li-Ion	Li-Ion	Ni-MH, Lithium, Alkaline
LED (indication of charging status)	✓	✓	✓	✓	✓	✓
USB - In & Out	USB - In	USB - In	USB - In	USB - Out	2x USB - Out	USB - Out
Accessoires	-	-	-	Micro USB Charge- and Sync-Cable, bag	Micro USB Charge- and Sync-Cable, bag	4x AA 4906, Micro USB Charge- and Sync-Cable
Details	Page 36	Page 36	Page 36	Page 37	Page 37	Page 38
EAN/GTIN/ consumer unit						

Car Power	Wall Charger	Phone Power 400 black	Charge & Sync Cable with Lightning connector	Charge & Sync Cable with 30-pin connector	Charge & Sync Cable with Micro USB connector
57931 101 401	57957 101 401	57916 101 401	57941 101 401	57940 101 401	57942 101 401
100	100	100	100	100	100
230	230	230	230	230	230
40	61	23	25	25	25
93	144	67	60	60	60
1	1	1	1	1	1
4	2	6	6	6	6
4	2	6	6	6	6
-	-	✓	-	-	-
12V	100 – 240V	5V	5V	5V	5V
-	-	400	-	-	-
1.0 / 2.4	1.0 / 2.4	0.5	2.4	2.1	1
-	-	Li-Ion	-	-	-
✓	✓	✓	-	-	-
2x USB – Out	2x USB – Out	USB – in & Micro USB Out/ 30-pin Out (Apple)	-	-	-
Micro USB Charge- and Sync-Cable	Micro USB Charge- and Sync-Cable	2 adapter	Length: 1m	Length: 1m	Length: 1m
Page 37	Page 38	Page 39	Page 39	Page 39	Page 39
 4 008496 18102 15	 4 008496 18101 85	 4 008496 17736 02	 4 008496 18082 05	 4 008496 18081 75	 4 008496 18085 88

GENERAL PURPOSE

RECHARGEABLE

PORTABLE POWER

PROFESSIONAL/BUTTON CELLS

FLASHLIGHTS AND BULBS





PRODUCT DISPLAY SYSTEMS

ASSORTMENT OVERVIEW

ASSORTMENT OVERVIEW

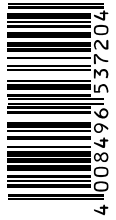
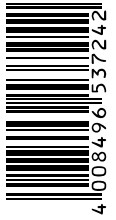
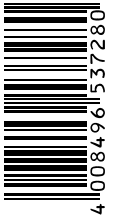
PROFESSIONAL LITHIUM



Type	2 CR 5	CR P2	CR 123 A	CR 123 A	CR 2	CR 2	CR V3
IEC	2 CR 5	CR P2	CR 17345	CR 17345	CR 15 H270	CR 15 H270	CR 17355
Order-No./ consumer unit	06203 301 401	06204 301 401	06205 301 401	06205 301 402	06206 301 401	06206 301 402	06207 301 401
Batteries/ consumer unit	1	1	1	2	1	2	1
Width (mm) Blister	80	80	80	80	80	80	80
Height (mm) Blister	120	120	120	120	120	120	120
Depth (mm) Blister	18	20	18	18	18	18	16
Weight (g) Blister	48.0	44	23	40	17	28	44
Minimum pieces/ shipment unit	10	10	10	10	10	10	10
Innecarton	10	10	10	10	10	10	10
Mastercarton	100	100	100	100	100	100	100
Voltage (V)	6.0	6.0	3.0	3.0	3.0	3.0	3.0
Electrochemical System	Lithium	Lithium	Lithium	Lithium	Lithium	Lithium	Lithium
Typical capacity (mAh)	1600	1450	1480	1480	920	920	3100
Width (mm) Battery	17.0	19.5	-	-	-	-	14.5
Height (mm) Battery	45.0	34.5	34.5	34.5	27.0	27.0	52.0
Depth (mm) Battery	34.0	35.0	-	-	-	-	29.0
Diameter (mm) Battery	-	-	17.0	17.0	15.6	15.6	-
Weight (g) Battery	42.0	38.0	17.0	17.0	11.0	11.0	38.0
Details	Page 42	Page 42	Page 42	Page 42	Page 42	Page 42	Page 42
EAN/GTIN/ consumer unit							

ASSORTMENT OVERVIEW



PROFESSIONAL ELECTRONICS / BUTTON CELLS

ALKALINE / SILVER BATTERIES D-GB-F-I-PL-RUS

LITHIUM BATTERIES D-GB-F-I

INTERNATIONAL VERSION



Type	N	N	V23 GA	V23 GA	V13 GA	V13 GA	CR 2032*	CR 2032*
IEC	LR 1	LR 1	-	-	LR 44	LR 44	CR 2032	CR 2032
Order-No./ consumer unit	04001 101 401	04001 101 402	04223 101 401	04223 101 402	04276 101 401	04276 101 402	06032 101 401	06032 101 402
Order-No./ consumer unit International version	04001 112 401	-	04223 112 401	-	04276 112 401	-	06032 112 401	-
Batteries/ consumer unit	1	2	1	2	1	2	1	2
Width (mm) Blister	56	80	56	80	56	80	56	80
Height (mm) Blister	65	120	65	120	65	120	65	120
Depth (mm) Blister	-	12	-	12	-	7	-	7
Weight (g) Blister	-	25	-	20	-	9	-	11
Minimum pieces/ shipment unit	10	10	10	10	10	10	10	10
Innecarton	-	10	-	10	-	10	-	10
Mastercarton	100	100	100	100	100	100	100	100
Voltage (V)	1.5	1.5	12.0	12.0	1.5	1.5	3.0	3.0
Electrochemical System	Alkaline	Alkaline	Alkaline	Alkaline	Alkaline	Alkaline	Lithium	Lithium
Typical capacity (mAh)	850	850	52	52	125	125	230	230
Height (mm) Battery	30.2	30.2	28.5	28.5	5.4	5.4	3.2	3.2
Diameter (mm) Battery	12	12	10.3	10.3	11.6	11.6	20.0	20.0
Weight (g) Battery	10.0	10.0	7.7	7.7	1.8	1.8	3.0	3.0
Details	Page 42	Page 42	Page 42	Page 42	Page 44	Page 44	Page 44	Page 44
EAN/GTIN/ consumer unit								

GENERAL PURPOSE

RECHARGEABLE

PORTABLE POWER

PROFESSIONAL/BUTTON CELLS

FLASHLIGHTS AND BULBS

PRODUCT DISPLAY SYSTEMS

ASSORTMENT OVERVIEW

* UL certified. Underwrites Laboratories www.ul.com



ASSORTMENT OVERVIEW

PROFESSIONAL ELECTRONICS / BUTTON CELLS

ALKALINE / SILVER BATTERIES D-GB-F-I-PL-RUS

LITHIUM BATTERIES D-GB-F-I



Type	CR 2025*	CR 2025*	CR 2016*	CR 2016*	CR 2430*	CR 2430*	CR 2450*	CR 2450*
IEC	CR 2025	CR 2025	CR 2016	CR 2016	CR 2430	CR 2430	CR 2450	CR 2450
Order-No./ consumer unit	06025 101 401	06025 101 402	06016 101 401	06016 101 402	06430 101 401	06430 101 402	06450 101 401	06450 101 402
Order-No./ consumer unit International version	06025 112 401	-	06016 112 401	-	06430 112 401	-	06450 112 401	-
Batteries/ consumer unit	1	2	1	2	1	2	1	2
Width (mm) Blister	56	80	56	80	56	80	56	80
Height (mm) Blister	65	120	65	120	65	120	65	120
Depth (mm) Blister	-	7	-	7	-	7	-	7
Weight (g) Blister	-	10	-	9	-	13	-	17
Minimum pieces/ shipment unit	10	10	10	10	10	10	10	10
Innercarton	-	10	-	10	-	10	-	10
Mastercarton	100	100	100	100	100	100	100	100
Voltage (V)	3.0	3.0	3.0	3.0	3.0	3.0	3.0	3.0
Electrochemical System	Lithium	Lithium	Lithium	Lithium	Lithium	Lithium	Lithium	Lithium
Typical capacity (mAh)	170	170	90	90	280	280	560	560
Height (mm) Battery	2.5	2.5	1.6	1.6	3.0	3.0	5.0	5.0
Diameter (mm) Battery	20.0	20.0	20.0	20.0	24.5	24.5	24.5	24.5
Weight (g) Battery	2.5	2.5	1.8	1.8	4.0	4.0	6.2	6.2
Details	Page 44	Page 44	Page 44	Page 44	Page 44	Page 44	Page 44	Page 44
EAN/GTIN/ consumer unit								

* UL certified. Underwrites Laboratories www.ul.com

INTERNATIONAL VERSION



Back of the packaging with international version



Type	CR 1216*	CR 1220*	CR 1225*	CR 1616*	CR 1620*	CR 1632*	CR 2320*	CR 1/3 N*	V 28 PXL*	V 8 GS/391
IEC	CR 1216	CR 1220	CR 1225	CR 1616	CR 1620	CR 1632	CR 2320	-	2 CR 11108	SR 55
Order-No./ consumer unit	06216 101 401	06220 101 401	06225 101 401	06616 101 401	06620 101 401	06632 101 401	06320 101 401	06131 101 401	06231 101 401	04173 101 401
Order-No./ consumer unit International version	-	06220 112 401	-	06616 112 401	06620 112 401	06632 112 401	--	-	-	-
Batteries/ consumer unit	1	1	1	1	1	1	1	1	1	1
Width (mm) Blister	56	56	56	56	56	56	56	56	56	56
Height (mm) Blister	65	65	65	65	65	65	65	65	65	65
Depth (mm) Blister	7.5	7.5	7.5	7.5	7.5	7.5	7.5	13.5	17	7.5
Weight (g) Bister	3	3	3	4	4	4	5	6	11	3
Minimum pieces/ shipment unit	10	10	10	10	10	10	10	10	10	10
Innercarton	10	10	10	10	10	10	10	10	10	10
Mastercarton	100	100	100	100	100	100	100	100	100	100
Voltage (V)	3.0	3.0	3.0	3.0	3.0	3.0	3.0	3.0	6.0	1.55
Electrochemical System	Lithium	Lithium	Lithium	Lithium	Lithium	Lithium	Lithium	Lithium	Lithium	Silver oxide
Typical capacity (mAh)	25	35	48	55	70	135	135	170	170	40
Height (mm) Battery	1.6	2.0	2.5	1.6	2.0	3.2	2.0	10.8	25.1	2.1
Diameter (mm) Battery	12.5	12.5	12.5	16.0	16.0	16.0	23.0	11.6	13.0	11.6
Weight (g) Battery	0.7	0.8	0.9	1.2	1.2	1.8	2.9	3.0	8.8	0.9
Details	Page 44	Page 44	Page 44	Page 44	Page 44	Page 44	Page 44	Page 44	Page 44	Page 44
EAN/GTIN/ consumer unit										

GENERAL PURPOSE

RECHARGEABLE

PORTABLE POWER

PROFESSIONAL/BUTTON CELLS

FLASHLIGHTS AND BULBS

PRODUCT DISPLAY SYSTEMS

ASSORTMENT OVERVIEW



ASSORTMENT OVERVIEW

PROFESSIONAL ELECTRONICS / BUTTON CELLS

ALKALINE / SILVER BATTERIES D-GB-F-I-PL-RUS

LITHIUM BATTERIES D-GB-F-I



Type	V 10 GA	V 10 GS/389	V 11 A	V 12 GA	V 12 GS/386	V 13 GS/357	V 27 A	V 28 PX	V 74 PX	V 76 PX
IEC	LR 54	SR 54	-	LR 43	SR 43	SR 44	-	4 SR 44	-	SR 44
Order-No./ consumer unit	04274 101 401	04174 101 401	04211 101 401	04278 101 401	04178 101 401	04176 101 401	04227 101 401	04028 101 401	04074 101 401	04075 101 401
Order-No./ consumer unit International version	04274 112 401	-	-	04278 112 401	-	04176 112 401	-	-	-	-
Batteries/ consumer unit	1	1	1	1	1	1	1	1	1	1
Width (mm) Blister	56	56	56	56	56	56	56	56	56	56
Height (mm) Blister	65	65	65	65	65	65	65	65	65	65
Depth (mm) Blister	7.5	7.5	13.5	7.5	7.5	7.5	13.5	17	17	7.5
Weight (g) Blister	4	4	7	4	4	5	7	14	17	5
Minimum pieces/ shipment unit	10	10	10	10	10	10	10	10	10	10
Innercarton	10	10	10	10	10	10	10	10	10	10
Mastercarton	100	100	100	100	100	100	100	100	100	100
Voltage (V)	1.5	1.55	6.0	1.5	1.55	1.55	12.0	6.2	15.0	1.55
Electrochemical System	Alkaline	Silver oxide	Alkaline	Alkaline	Silver oxide	Silver oxide	Alkaline	Silver oxide	Alkaline	Silver oxide
Typical capacity (mAh)	50	85	38	80	105	155	20	145	45	145
Height (mm) Battery	3.05	3.05	16.5	4.2	4.2	5.4	28.2	25.2	35.0	5.4
Diameter (mm) Battery	11.6	11.6	10.2	11.6	11.6	11.6	8.0	13.0	16.0	11.6
Weight (g) Battery	1.1	1.3	4.0	1.35	1.78	2.33	4.4	11.1	14.0	2.4
Details	Page 44	Page 44	Page 44	Page 44	Page 44	Page 44	Page 44	Page 44	Page 44	Page 44
EAN/GTIN/ consumer unit										

* UL certified. Underwrites Laboratories www.ul.com

INTERNATIONAL VERSION



Back of the packaging with international version

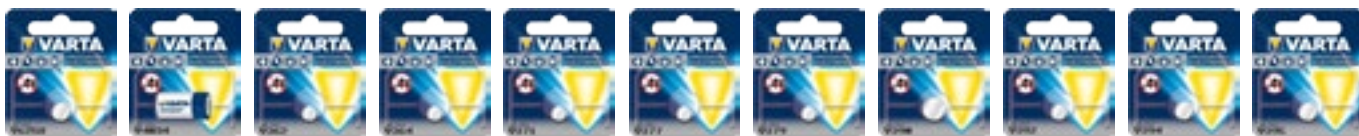

V 625 U	V 4034	V 362	V 364	V 371	V 377	V 379	V 390	V 392	V 394	V 395
LR 9	4 LR 44	SR 58	SR 60	SR 69	SR 66	SR 63	SR 54	SR 41	SR 45	SR 57
04626 101 401	04034 101 401	00362 101 401	00364 101 401	00371 101 401	00377 101 401	00379 101 401	00390 101 401	00392 101 401	00394 101 401	00395 101 401
04626 112 401	04034 112 401	-	00364 112 401	-	00377 112 401	-	-	-	-	-
1	1	1	1	1	1	1	1	1	1	1
56	56	56	56	56	56	56	56	56	56	56
65	65	65	65	65	65	65	65	65	65	65
7.5	17	7.5	7.5	7.5	7.5	7.5	7.5	7.5	7.5	7.5
6	13	3	3	3	3	3	4	3	4	3
10	10	10	10	10	10	10	10	10	10	10
10	10	10	10	10	10	10	10	10	10	10
100	100	100	100	100	100	100	100	100	100	100
1.5	6.0	1.55	1.55	1.55	1.55	1.55	1.55	1.55	1.55	1.55
Alkaline	Alkaline	Silver oxide	Silver oxide	Silver oxide	Silver oxide	Silver oxide	Silver oxide	Silver oxide	Silver oxide	Silver oxide
200	100	21	17	35	24	14	80	40	56	42
6.2	25.2	2.1	2.15	2.1	2.6	2.15	3.05	3.6	3.6	2.7
16.0	13.0	7.9	6.8	9.5	6.8	5.8	11.6	7.9	9.5	9.5
3.3	10.4	0.4	0.33	0.61	0.39	0.23	1.32	0.69	1.04	0.75
Page 44	Page 44	Page 44	Page 44	Page 44	Page 44	Page 44	Page 44	Page 44	Page 44	Page 44
4 008496 273683	4 008496 274055	4 008496 317011	4 008496 317059	4 008496 317097	4 008496 317134	4 008496 317172	4 008496 317219	4 008496 317257	4 008496 336463	4 008496 317295

GENERAL PURPOSE

RECHARGEABLE

PORTABLE POWER







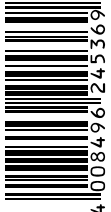

PROFESSIONAL/BUTTON CELLS

FLASHLIGHTS AND BULBS

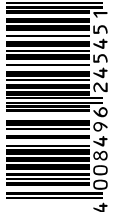
PRODUCT DISPLAY SYSTEMS

ASSORTMENT OVERVIEW

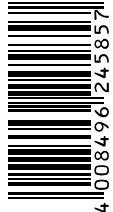
ASSORTMENT OVERVIEW WATCH BATTERIES

Type	V 301	V 303	V 309	V 315	V 317	V 319	V 321	V 329
IEC	SR43	SR44	SR48	SR67	SR62	SR64	SR65	-
Order-No./ consumer unit	00301 101 111	00303 101 111	00309 101 111	00315 101 111	00317 101 111	00319 101 111	00321 101 111	00329 101 111
Minimum pieces/ shipment unit	10	10	10	10	10	10	10	10
Innercarton	100	100	100	100	100	100	100	100
Mastercarton	1000	1000	1000	1000	1000	1000	1000	1000
Voltage (V)	1.55	1.55	1.55	1.55	1.55	1.55	1.55	1.55
Electrochemical System	Silver oxide	Silver oxide	Silver oxide	Silver oxide	Silver oxide	Silver oxide	Silver oxide	Silver oxide
Typical capacity (mAh)	95	160	70	23	12.5	22,5	16	39
Height (mm) Battery	4.2	5.4	5.4	1.65	1.65	2.7	1.65	3.1
Diameter (mm) Battery	11.6	11.6	7.9	7.9	5.8	5.8	6.8	7.9
Weight (g) Battery	1.78	2.33	1.08	0.4	0.18	0.29	0.25	0.6
Details	Page 44	Page 44	Page 44	Page 44	Page 44	Page 44	Page 44	Page 44
EAN/GTIN/ consumer unit	 4 008496 245369	 4 008496 245420	 4 008496 245451	 4 008496 245550	 4 008496 245611	 4 008496 245628	 4 008496 245857	 4 008496 245864

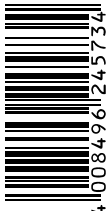
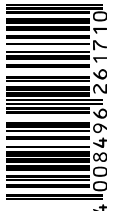
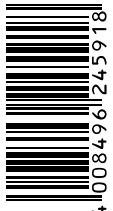
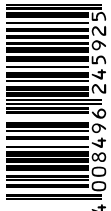
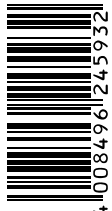
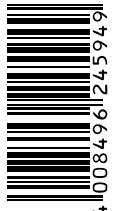
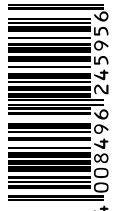
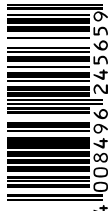
Type	V 364	V 370**	V 371	V 373	V 377	V 379	V 381	V 386**
IEC	SR60	SR69	SR69	SR68	SR66	SR63	SR55	SR43
Order-No./ consumer unit	00364 101 111	00370 101 111	00371 101 111	00373 101 111	00377 101 111	00379 101 111	00381 101 111	00386 101 111
Minimum pieces/ shipment unit	10	10	10	10	10	10	10	10
Innercarton	100	100	100	100	100	100	100	100
Mastercarton	1000	1000	1000	1000	1000	1000	1000	1000
Voltage (V)	1.55	1.55	1.55	1.55	1.55	1.55	1.55	1.55
Electrochemical System	Silver oxide	Silver oxide	Silver oxide	Silver oxide	Silver oxide	Silver oxide	Silver oxide	Silver oxide
Typical capacity (mAh)	17	34	35	30	24	14	45	115
Height (mm) Battery	2.15	2.1	2.1	1.65	2.6	2.15	2.1	4.2
Diameter (mm) Battery	6.8	9.5	9.5	9.5	6.8	5.8	11.6	11.6
Weight (g) Battery	0.33	0.6	0.61	0.5	0.39	0.23	0.9	1.78
Details	Page 44	Page 44	Page 44	Page 44	Page 44	Page 44	Page 44	Page 44
EAN/GTIN/ consumer unit	 4 008496 245734	 4 008496 261710	 4 008496 245918	 4 008496 245925	 4 008496 245932	 4 008496 245949	 4 008496 245956	 4 008496 245659

* High Drain



V 335	V 337	V 339	V 341	V 344	V 346	V 350**	V 357**	V 361**	V 362
-	-	-	-	SR42	-	SR42	SR44	SR58	SR58
00335 101 111	00337 101 111	00339 101 111	00341 101 111	00344 101 111	00346 101 111	00350 101 111	00357 101 111	00361 101 111	00362 101 111
10	10	10	10	10	10	10	10	10	10
100	100	100	100	100	100	100	100	100	100
1000	1000	1000	1000	1000	1000	1000	1000	1000	1000
1.55	1.55	1.55	1.55	1.55	1.55	1.55	1.55	1.55	1.55
Silver oxide	Silver oxide	Silver oxide	Silver oxide	Silver oxide	Silver oxide	Silver oxide	Silver oxide	Silver oxide	Silver oxide
6	8.3	11	15	100	9	110	145	20	21
1.25	1.65	1.4	1.45	3.6	1.29	3.6	5.4	2.1	2.1
5.8	4.8	6.8	7.9	11.6	7.9	11.6	11.6	7.9	7.9
0.15	0.13	0.22	0.28	1.49	0.3	1.49	2.05	0.4	0.4
Page 44	Page 44	Page 44	Page 44	Page 44	Page 44	Page 44	Page 44	Page 44	Page 44

V 389**	V 390	V 391**	V 392**	V 393**	V 394	V 395	V 396**	V 397	V 399**
SR54	SR54	SR55	SR41	SR48	SR45	SR57	SR59	SR59	SR57
00389 101 111	00390 101 111	00391 101 111	00392 101 111	00393 101 111	00394 101 111	00395 101 111	00396 101 111	00397 101 111	00399 101 111
10	10	10	10	10	10	10	10	10	10
100	100	100	100	100	100	100	100	100	100
1000	1000	1000	1000	1000	1000	1000	1000	1000	1000
1.55	1.55	1.55	1.55	1.55	1.55	1.55	1.55	1.55	1.55
Silver oxide	Silver oxide	Silver oxide	Silver oxide	Silver oxide	Silver oxide	Silver oxide	Silver oxide	Silver oxide	Silver oxide
81	80	42	40	75	56	42	27	23	42
3.05	3.05	2.1	3.6	5.4	3.6	2.7	2.6	2.6	2.7
11.6	11.6	11.6	7.9	7.9	9.5	9.5	7.9	7.9	9.5
1.31	1.32	0.9	0.69	1.08	1.04	0.75	0.55	0.5	0.75
Page 44	Page 44	Page 44	Page 44	Page 44	Page 44	Page 44	Page 44	Page 44	Page 44

GENERAL PURPOSE

RECHARGEABLE

PORTABLE POWER

PROFESSIONAL/BUTTON CELLS

FLASHLIGHTS AND BULBS

PRODUCT DISPLAY SYSTEMS

ASSORTMENT OVERVIEW

BUTTON CELLS REFERENCELIST

VARTA Button cells						Other references									
Type	Order-No./ consumer unit	Voltage (V)	Electrochemical System	Diameter (mm)	Height (mm)	Bulova	Citizen	Maxell, Toshiba	Rayovac, Philips, Renata	Timex	Sony	Panasonic	GP	Energizer, Duracell	IEC
V 301	00301 101 111	1.55	Silver oxide	11.6	4.2	226	280-01	SR43SW	301	D	-	SR43	386E	386/301	SR 43
V 303	00303 101 111	1.55	Silver oxide	11.6	5.4	228	280-08	SR44SW	303/357	A	-	-	357F	357/303	SR 44
V 309	00309 101 111	1.55	Silver oxide	7.9	5.4	-	-	SR754SW	-	-	-	-	-	393/309	SR 48
V 315	00315 101 111	1.55	Silver oxide	7.9	1.65	614	280-56	SR716SW	315	HA	SR716SWN-PB	-	-	315	SR 67
V 317	00317 101 111	1.55	Silver oxide	5.8	1.65	616	280-58	SR516SW	317	CA	SR516SWN-PB	SR516	-	317	SR 62
V 319	00319 101 111	1.55	Silver oxide	5.8	2.7	615	280-60	SR527SW	319	-	-	-	-	319	SR 64
V 321	00321 101 111	1.55	Silver oxide	6.8	1.65	611	280-73	SR616SW	321	DA	SR616SWN-PB	SR616	-	321	SR 65
V 329	00329 101 111	1.55	Silver oxide	7.9	3.1	-	-	SR731SW	329	-	SR731SWN-PB	-	-	329	-
V 335	00335 101 111	1.55	Silver oxide	5.8	1.25	622	280-68	SR512SW	335	-	SR512SWN-PB	-	-	335	-
V 337	00337 101 111	1.55	Silver oxide	4.8	1.65	-	-	SR416SW	337	-	-	-	-	337	-
V 339	00339 101 111	1.55	Silver oxide	6.8	1.4	-	-	SR614SW	-	-	-	-	-	339	-
V 341	00341 101 111	1.55	Silver oxide	7.9	1.45	627	-	SR714SW	341	-	SR714SWN-PB	-	-	341	-
V 344	00344 101 111	1.55	Silver oxide	11.6	3.6	242	-	SR1136SW	344	-	-	-	-	344/350	SR 42
V 346	00346 101 111	1.55	Silver oxide	7.9	1.29	628	280-66	SR712SW	346	-	-	-	-	346	-
V 350*	00350 101 111	1.55	Silver oxide	11.6	3.6	604	-	-	-	-	-	-	-	344/350	SR 42
V 357*	00357 101 111	1.55	Silver oxide	11.6	5.4	228	280-62	SR44W	357	J	-	SR44	357E	357/303	SR 44
V 361*	00361 101 111	1.55	Silver oxide	7.9	2.1	601	280-53	SR721W	361	X	SR721SWN-PB	SR721	-	362/361	SR 58
V 362	00362 101 111	1.55	Silver oxide	7.9	2.1	601	280-29	SR721SW	362	S	SR721SWN-PB	SR721	-	362/361	SR 58
V 364	00364 101 111	1.55	Silver oxide	6.8	2.15	602	280-34	SR621SW	364	T	SR621SWN-PB	SR621	364F, 364E	364/363	SR 60
V 370*	00370 101 111	1.55	Silver oxide	9.5	2.1	620	280-51	SR920W	370	Z	SR920SWN-PB	SR920	371F	371/370	SR 69
V 371	00371 101 111	1.55	Silver oxide	9.5	2.1	605	280-31	SR920SW	371	-	SR920SWN-PB	SR920	371F	371/370	SR 69
V 373	00373 101 111	1.55	Silver oxide	9.5	1.65	617	280-45	SR916SW	373	WA	-	-	-	373	SR 68
V 377	00377 101 111	1.55	Silver oxide	6.8	2.6	606	280-39	SR626SW	376/377	BA	SR626SWN-PB	SR626	377F, 377E	377/376	SR 66
V 379	00379 101 111	1.55	Silver oxide	5.8	2.15	618	280-59	SR521SW	379	JA	SR521SWN-PB	SR521	379F	379	SR 63
V 381	00381 101 111	1.55	Silver oxide	11.6	2.1	317	280-27	SR1120SW	381	-	-	SR1120	-	391/381	SR 55
V 384	00384 101 111	1.55	Silver oxide	7.9	3.6	247	280-18	SR41SW	384	-	-	SR41	392F, 392E	392/384	SR 41
V 386*	00386 101 111	1.55	Silver oxide	11.6	4.2	260	280-41	SR43W	386	H	-	SR43	386F	386/301	SR 43
V 389*	00389 101 111	1.55	Silver oxide	11.6	3.05	626	280-15	SR1130W	389	M	-	SR1130	389F, 389E	390/389	SR 54
V 390	00390 101 111	1.55	Silver oxide	11.6	3.05	603	280-24	SR1130SW	390	-	-	SR1130	389F, 389E	390/389	SR 54
V 391*	00391 101 111	1.55	Silver oxide	11.6	2.1	609	280-30	SR1120W	391	L	-	SR1120	-	391/381	SR 55
V 392*	00392 101 111	1.55	Silver oxide	7.9	3.6	247	280-13	SR41W	392	K	-	SR41	392F, 392E	392/384	SR 41
V 393*	00393 101 111	1.55	Silver oxide	7.9	5.4	255	-	SR48W	393	F	-	-	-	393/309	SR 48
V 394	00394 101 111	1.55	Silver oxide	9.5	3.6	625	280-17	SR936SW	394	-	SR936SWN-PB	SR936	394F	394/380	SR 45
V 395	00395 101 111	1.55	Silver oxide	9.5	2.7	610	280-48	SR927SW	395	LA	SR927WN-PB	SR927	395F	395/399	SR 57
V 396*	00396 101 111	1.55	Silver oxide	7.9	2.6	612	280-52	SR726W	396	V	-	SR726	-	397/396	SR 59
V 397	00397 101 111	1.55	Silver oxide	7.9	2.6	607	280-28	SR726SW	397	N	-	SR726	-	397/396	SR 59
V 399	00399 101 111	1.55	Silver oxide	9.5	2.7	613	280-44	SR927W	399	W	SR927SWN-PB	SR927	395F	395/399	SR 57

* HighDrain



VARTA Electronics						Other references						
Type	Order-No./ consumer unit	Voltage (V)	Electrochemical System	Diameter (mm)	Height (mm)	Engerizer	Duracell	GP Sylva Cell	Kodak	Panasonic	Renata	IEC
CR 1216	06216 101 401	3.0	Lithium	12.5	1.6	CR 1216	-	-	-	CR 1216	CR 1216	CR 1216
CR 1220	06220 101 401	3.0	Lithium	12.5	2.0	CR 1220	DL 1220	CR 1220	-	CR 1220	CR 1220	CR 1220
CR 1225	06225 101 401	3.0	Lithium	12.5	2.5	-	-	-	-	-	-	CR 1225
CR 1616	06616 101 401	3.0	Lithium	16.0	1.6	CR 1616	DL 1616	CR 1616	-	CR 1616	CR 1616	CR 1616
CR 1620	06620 101 401	3.0	Lithium	16.0	2.0	CR 1620	DL 1620	-	-	CR 1620	CR 1620	CR 1620
CR 1632	06632 101 401	3.0	Lithium	16.0	3.2	CR 1632	-	-	-	CR 1632	CR 1632	CR 1632
CR 2016	06016 101 401	3.0	Lithium	20.0	1.6	CR 2016	DL 2016	CR 2016	KCR 2016	CR 2016	CR 2016	CR 2016
CR 2025	06025 101 401	3.0	Lithium	20.0	2.5	CR 2025	DL 2025	CR 2025	KCR 2025	CR 2025	CR 2025	CR 2025
CR 2032	06032 101 401	3.0	Lithium	20.0	3.2	CR 2032	DL 2032	CR 2032	KCR 2032	CR 2032	CR 2032	CR 2032
CR 2320	06320 101 401	3.0	Lithium	23.0	2.0	-	-	-	-	-	CR 2320	CR 2320
CR 2430	06430 101 401	3.0	Lithium	24.5	3.0	CR 2430	DL 2430	CR 2430	-	CR 2430	CR 2430	CR 2430
CR 2450	06450 101 401	3.0	Lithium	24.5	5.0	CR 2450	DL 2450	CR 2450	-	CR 2450	N	CR 2450
CR 1/3 N	06131 101 401	3.0	Lithium	11.6	10.8	2 L 76	DL 1/3 N	CR 1/3N	K 58 L	-	-	-
V 28 PXL	06231 101 401	6.0	Lithium	13.0	25.1	-	-	-	K 28 L	-	-	-
V 8 GS/391	04173 101 401	1.55	Silver oxide	11.6	2.1	LR 55/191	391	-	-	SR 1120	391	SR 55
V 10 GA	04274 101 401	1.5	Alkaline	11.6	3.05	LR 54/189	LR 54/ER 89A	189	-	LR 1130	-	LR 54
V 10 GS/389	04174 101 401	1.55	Silver oxide	11.6	3.05	389	D 389	389E	-	SR 1130	389	SR 54
V 11 A	04211 101 401	6.0	Alkaline	10.22	16.5	-	-	-	-	-	-	-
V 12 GA	04278 101 401	1.5	Alkaline	11.6	4.2	LR 43/186	LR 43	186	-	LR 43	-	LR 43
V 12 GS/389	04178 101 401	1.55	Silver oxide	11.6	4.2	386/301	D 386/301	386F	-	SR 43	386	SR 43
V 13 GA	04276 101 401	1.5	Alkaline	11.6	5.4	LR44/A 76	LR44	A 76	KA 76	LR 44	LR 44	LR 44
V 13 GS/357	04176 101 401	1.55	Silver oxide	11.6	5.4	357/303	D 357/303	357/F	-	LRV08	357	SR 44
V 23 GA	04223 101 401	12.0	Alkaline	10.3	28.5	A 23/E23A	MN 21	23 AE	-	-	-	-
V 27 A	04227 101 401	12.0	Alkaline	8.0	28.2	-	-	27 A	-	-	-	-
V 28 PX	04028 101 401	6.2	Silver oxide	13.0	25.2	544/4SR44	-	476 F/476E	KS 28	4 SR 44	-	4 SR 44
V 74 PX	04074 101 401	15.0	Alkaline	16.0	35.0	-	-	-	-	-	-	-
V 76 PX	04075 101 401	1.55	Silver oxide	11.6	5.4	EPX 76/8R 44	D 357/7	-	KS 76	SR 44	-	SR 44
V 625 U	04626 101 401	1.5	Alkaline	16	6.2	EPX 625 G	625 A	PX 625 A	KA 625	-	-	LR 9
V 4034	04034 101 401	6.0	Alkaline	13.0	25.2	4 LR/A 544	-	476 A	-	4 LR 44	-	4 LR 44
LR1/4001/N	04001 101 401	1.5	Alkaline	12.0	30.2	LR1/E 90	N	910 A	KN	LR1	-	LR 1

GENERAL PURPOSE

RECHARGEABLE

PORTABLE POWER

PROFESSIONAL/BUTTON CELLS

FLASHLIGHTS AND BULBS

PRODUCT DISPLAY SYSTEMS

ASSORTMENT OVERVIEW

ASSORTMENT OVERVIEW

HEARING AID BATTERIES



Produkt	10	10	13	13	312	312
IEC	PR70	PR70	PR48	PR48	PR41	PR41
Order-No./ consumer unit	04610 945 416	04610 745 418	04606 945 416	04606 745 418	04607 945 416	04607 745 418
Batteries	6	8	6	8	6	8
Consumer unit	1	1	1	1	1	1
Minimum pieces/ shipment unit	10	10	10	10	10	10
Mastercarton	100	100	100	100	100	100
Voltage (V)	1.45	1.45	1.45	1.45	1.45	1.45
Electrochemical System	Zinc-Air	Zinc-Air	Zinc-Air	Zinc-Air	Zinc-Air	Zinc-Air
Height (mm) Battery	3.5	3.5	5.35	5.35	3.45	3.45
Diameter (mm) Battery	5.8	5.8	7.8	7.8	7.8	7.8
Weight (g) Battery	0.3	0.3	0.80	0.80	0.50	0.50
Details	Page 46	Page 46	Page 46	Page 46	Page 46	Page 46
EAN/GTIN/ consumer unit						
		ONLY FOR MASS RETAIL		ONLY FOR MASS RETAIL		ONLY FOR MASS RETAIL



675	675
PR44	PR44
04600 945 416	04600 745 418
6	8
1	1
10	10
100	100
1.45	1.45
Zinc-Air	Zinc-Air
5.35	5.35
11.6	11.6
1.80	1.80
Page 46	Page 46
	ONLY FOR MASS RETAIL



Produkt	Rayovac 5 in 1 Hearing Aid Cleaner	Rayovac 5 in 1 Hearing Aid Cleaner EE Version
Order-No./ consumer unit	00895 945 401	00895 945 411
Batteries	1	1
Consumer unit	1	1
Minimum pieces/ shipment unit	4	4
Mastercarton	24	24
Width (mm) Blister	115	115
Height (mm) Blister	203	203
Depth (mm) Blister	54	54
Weight (g) Blister	26	26
EAN/GTIN/ consumer unit		

GENERAL PURPOSE

RECHARGEABLE

PORTABLE POWER

PROFESSIONAL/BUTTON CELLS

FLASHLIGHTS AND BULBS

PRODUCT DISPLAY SYSTEMS

ASSORTMENT OVERVIEW

ASSORTMENT OVERVIEW

HEARING AID BATTERIES DISPLAYS

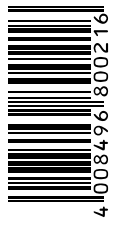

Produkt	Counter Display 37 BL.
Order-No./ consumer unit	93249 745 851
Total Blister	37
Width (mm) Display	26.5
Height (mm) Display	32
Depth (mm) Display	22
Weight (g)	777
Width (mm) Mastercarton	277
Height (mm) Mastercarton	100
Depth (mm) Mastercarton	375
EAN/GTIN/ consumer unit	 4 008496 800216
ONLY FOR MASS RETAIL	

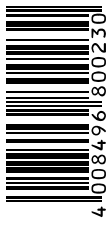
Produkt	Counter Display 40 BL.
Order-No./ consumer unit	93249 945 851
Total Blister	40
Width (mm) Display	26.5
Height (mm) Display	32
Depth (mm) Display	22
Weight (g)	650
Width (mm) Mastercarton	277
Height (mm) Mastercarton	100
Depth (mm) Mastercarton	375
EAN/GTIN/ consumer unit	 4 008496 800230

Garnishing	10	13	312	675	10	13	312	675
	04610 745 418	04606 745 418	04607 745 418	04600 745 418	04610 945 416	04606 945 416	04607 945 416	04600 945 416
Total Blister	10	10	10	7	10	10	10	10
EAN/GTIN/ consumer unit	 5 000252 003809	 5 000252 003786	 5 000252 003793	 5 000252 003779	 5 000252 003212	 5 000252 003199	 5 000252 003205	 5 000252 003182

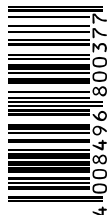

Produkt	Counter Display
Order-No./ consumer unit	91324 745 004
Total Blister	-
Width (mm) Display	26.5
Height (mm) Display	32
Depth (mm) Display	22
Weight (g)	330
Width (mm) Mastercarton	277
Height (mm) Mastercarton	100
Depth (mm) Mastercarton	375
EAN/GTIN/ consumer unit	 4 008496 800377

GENERAL PURPOSE

RECHARGEABLE

PORTABLE POWER

PROFESSIONAL/BUTTON CELLS

FLASHLIGHTS AND BULBS

PRODUCT DISPLAY SYSTEMS

ASSORTMENT OVERVIEW

ASSORTMENT OVERVIEW FLASHLIGHTS

Indestructible LED



Produkt	Indestructible LED Key Chain 1AAA	Indestructible LED x5 Head Light 3AAA	Indestructible 1 Watt LED Head Light 3AAA	Indestructible 1 Watt LED Light 3AAA	Indestructible 1 Watt LED Light 2AA	Indestructible 3 Watt LED Light 3C	Indestructible 3 Watt LED Lantern 4C	Indestructible 5 Watt LED Lantern 3D
Order-No./ consumer unit	16701 101 421	17730 101 421	17731 101 421	18700 101 421	18701 101 421	18702 101 421	18750 101 421	18760 101 111
Line	Easy	Power	Power	Professional	Professional	Professional	Professional	Professional
Flashlights	1	1	1	1	1	1	1	1
Dimensions inclusive Blister	Width (mm) Blister	100	100	100	135	150	180	122
	Height (mm) Blister	230	230	230	230	280	330	340
	Depth (mm) Blister	24	40	40	43	40	50	102
	Weight (g) Blister	47	124	123	192	225	531	884
Dimensions exclusive Blister	Length (mm) Flashlight	83	40	40	136	163.5	246	215
	Width (mm) Flashlight	-	62	62	-	-	-	102
	Depth (mm) Flashlight	-	44	44	-	-	-	-
	Diameter (mm) Flashlight	23	-	-	41	38	47.5	84
Weight (g) Flashlight	19	65	64	137	145	293	540	715
Housing	ABS Plastic, Rubber	ABS Plastic, PC, TPR Rubber	ABS Plastic, PC, TPR Rubber	Aluminium, TPR Rubber, PC	Aluminium, TPR Rubber, PC	Aluminium, TPR Rubber, PC	PC, TPR Rubber	PC, PA, TPE Rubber
Bulb equipment	1x 5mm LED	5x 5mm LED	1 Watt LED	1 Watt LED	1 Watt LED	3 Watt LED	3 Watt LED	5 Watt LED
Equipped with	incl. 1x AAA High Energy	incl. 3x AAA High Energy	incl. 3x AAA High Energy	incl. 3x AAA High Energy	incl. 2x AA High Energy	incl. 3x C High Energy	incl. 4x C High Energy	-
Minimum pieces/ shipment unit	6	4	4	4	4	3	2	4
Beam range	10m	30m	121m	160m	150m	183m	350m	(360°) 13m
Runtime	3.5h	(up to) 38h	(up to) 22h	(up to) 40h	(up to) 35h	(up to) 78h	(up to) 78h	(up to) 280h
Luminous intensity (Lumens)	12lm	(up to) 55lm	(up to) 120lm	(up to) 120lm	(up to) 100lm	(up to) 160lm	(up to) 150lm	(up to) 280lm
Details	Page 55	Page 63	Page 63	Page 66	Page 66	Page 66	Page 67	Page 68
EAN/GTIN/ consumer unit	 4 008496 1808052	 4 008496 1682836	 4 008496 1682867	 4 008496 1682713	 4 008496 1682744	 4 008496 1682775	 4 008496 1682805	 4 008496 1807086

LED Day Light



Produkt	Mini Day Light LED 1AAA	LED Day Light 2AA	0.5 Watt LED Day Light 2AA	LED Day Light 2D	1 Watt LED Day Light 2D	
Order-No./ consumer unit	16601 101 421	16610 101 421	17651 101 421	17611 101 421	17626 101 421	
Line	Easy	Easy	Power	Power	Power	
Flashlights	1	1	1	1	1	
Dimensions inclusive Blister	Width (mm) Blister	100	100	100	150	
	Height (mm) Blister	230	230	230	330	
	Depth (mm) Blister	33	46	46	65	
	Weight (g) Blister	70	159	159	501	512
Dimensions exclusive Blister	Length (mm) Flashlight	94.5	164	164	196	196
	Width (mm) Flashlight	-	-	-	-	-
	Depth (mm) Flashlight	-	-	-	-	-
	Diameter (mm) Flashlight	32	44	44	63	63
Housing	ABS Plastic, Aluminium, TPR Rubber	ABS Plastic, Aluminium, TPR Rubber	ABS Plastic, Aluminium, TPR Rubber	Aluminium, ABS, HIPS Plastic, TPR Rubber	Aluminium, ABS, HIPS Plastic, TPR Rubber	
Bulb equipment	1x 5mm LED	3x 5mm LED	0.5 Watt LED	7x 5mm LED	1 Watt LED	
Equipped with	incl. 1x AAA High Energy	incl. 2x AA High Energy	incl. 2x AA High Energy	incl. 2x D High Energy	incl. 2x D High Energy	
Minimum pieces/ shipment unit	6	6	4	4	4	
Beam range	18m	42m	67m	63m	173m	
Runtime	3.5h	65h	6h	140h	11h	
Luminous intensity (Lumens)	9lm	25lm	40lm	58lm	96lm	
Details	Page 55	Page 54	Page 59	Page 60	Page 60	
EAN/GTIN/ consumer unit						

LED Outdoor Pro



Produkt	1 Watt LED Outdoor Pro 3AAA	1 Watt LED Outdoor Pro 2AA	4 Watt LED Outdoor Pro 3C	
Order-No./ consumer unit	17628 101 421	17629 101 421	18627 101 401	
Line	Power	Power	Professional	
Flashlights	1	1	1	
Dimensions inclusive Blister	Width (mm) Blister	100	135	150
	Height (mm) Blister	230	280	330
	Depth (mm) Blister	38	32	44
	Weight (g) Blister	161	167	268
Dimensions exclusive Blister	Length (mm) Flashlight	115	154	246
	Width (mm) Flashlight	-	-	-
	Depth (mm) Flashlight	-	-	-
	Diameter (mm) Flashlight	35	30	44
Housing	Aluminium, PC, Silicon Rubber	Aluminium, PC, Silicon Rubber	Aluminium, PC, Silicon Rubber	
Bulb equipment	1 Watt LED	1 Watt LED	4 Watt LED	
Equipped with	incl. 3x AAA High Energy	incl. 2x AA High Energy	-	
Minimum pieces/ shipment unit	4	4	3	
Beam range	50m	87m	220m	
Runtime	(up to) 20h	(up to) 24h	(up to) 60h	
Luminous intensity (Lumens)	(up to) 80lm	(up to) 110lm	(up to) 190lm	
Details	Page 59	Page 59	Page 64	
EAN/GTIN/ consumer unit				

GENERAL PURPOSE

RECHARGEABLE

PORTABLE POWER

PROFESSIONAL/BUTTON CELLS

FLASHLIGHTS AND BULBS

PRODUCT DISPLAY SYSTEMS

ASSORTMENT OVERVIEW

ASSORTMENT OVERVIEW FLASHLIGHTS

Flashlights



Produkt	LED Spot Light 2AA	LED Lipstick Light 1AA	Trilogy LED Light 3AAA	Industrial LED Light 2D	LED Gelly Light 2AA	Swivel Light LED 2AA	Premium LED Light 3AAA	Premium LED Light 2AA	Industrial Focus Control LED 4AA	Industrial Rubbermate LED 2D	
Order-No./ consumer unit	16600 101 401	16617 101 421	16615 101 421	16604 101 401	16616 101 421	17622 101 421	17634 101 421	17635 101 421	17640 101 421	18641 101 421	
Line	Easy	Easy	Easy	Easy	Easy	Power	Power	Power	Power	Professional	
Flashlights	1	1	1	1	1	1	1	1	1	1	
Dimensions inclusive Blister	Width (mm) Blister	100	100	100	150	100	100	135	135	150	
	Height (mm) Blister	230	230	230	330	230	230	280	280	330	
	Depth (mm) Blister	39	21	50	72	48	55	36	61	72.5	
	Weight (g) Blister	63	71	134	235	151	226	146	125	317	590
Dimensions exclusive Blister	Length (mm) Flashlight	152	95	167	204	172	204	114	175	194	210
	Width (mm) Flashlight	-	-	-	-	-	-	-	-	-	
	Depth (mm) Flashlight	-	-	-	-	-	-	-	-	-	
	Diameter (mm) Flashlight	36.5	21	48	68	45	52	32	30	60	68
	Weight (g) Flashlight	43	31	75	193	83	146	87	45	189	264
Housing	ABS Plastic, PS Plastic	Aluminium, Silicon Rubber	ABS, PP Plastic, TPR Rubber, SAN	TPR Rubber, PC, PP Plastic	ABS Plastic, Silicon, SAN, PP	TPR Rubber, PP, PC Plastic	Aluminium, ABS, PC Plastic	Aluminium, ABS, PC Plastic	ABS Plastic, PC, PMMA Plastic, TPR Rubber	Aluminium, ABS Plastic, TPR Rubber, PC	
Bulb equipment	1x 5mm LED	0.5 Watt LED	1x 5mm LED	0.5 Watt Plug-in LED	1x 5mm LED	0.5 Watt Plug-in LED	0.5 Watt LED	1 Watt LED	3 Watt LED	3 Watt LED	
Equipped with	-	incl. 1x AA High Energy	incl. 3x AAA High Energy	-	incl. 2x AA High Energy	incl. 2x AA High Energy	incl. 3x AAA High Energy	incl. 2x AA High Energy	incl. 4x AA High Energy	incl. 2x D High Energy	
Minimum pieces/ shipment unit	6	6	6	4	6	6	4	4	4	4	
Beam range	25m	25m	39m	52m	50m	40m	36m	100m	132m	146m	
Runtime	45h	3h	42h	160h	50h	35h	13h	4h	4h	(up to) 11h	
Luminous intensity (Lumens)	10lm	19lm	12lm	25lm	5lm	23lm	30lm	60lm	120lm	(up to) 180lm	
Details	Page 55	Page 55	Page 56	Page 57	Page 56	Page 61	Page 58	Page 59	Page 60	Page 66	
EAN/GTIN/ consumer unit											

Flat Lights

Head Lights



Multi LED Aluminium Light 2AA	Multi LED Aluminium Light 2C	Produkt	Palm Light 3R12	LED Silver Light 3AAA	LED x4 Head Light 3AAA	1 Watt LED Sports Head Light 2AAA	Indestructible LEDx5 Head Light 3AAA	Indestructible 1 Watt LED Head Light 3AAA
16627 101 421	16628 101 421	Order-No./ consumer unit	16645 101 421	16647 101 421	17631 101 421	18632 101 421	17730 101 421	17731 101 421
Easy	Easy	Line	Easy	Easy	Power	Professional	Power	Power
1	1	Flashlights	1	1	1	1	1	1
100	135	Dimensions inclusive Blister	100	100	100	100	100	100
230	280		230	230	230	230	230	
25	44		42	30	40	41	40	40
102	278	Dimensions exclusive Blister	213	106	104	106	124	123
142	182		110	98	42	40	40	40
-	-		69	53	68	65	62	62
-	-		37	29	37	40	44	44
23.5	42		-	-	-	-	-	-
35.5	113		85	53	45	58	65	64
Aluminium, ABS Plastic, PC	Aluminium, ABS Plastic, PC	Housing	Metal, PS, PP Plastic	ABS Plastic, POM, TPR Rubber, SAN	ABS Plastic, Rubber	PC, PMMA Plastic	ABS Plastic, PC, TPR Rubber	ABS Plastic, PC, TPR Rubber
5x 5mm LED	7x 5mm LED	Bulb equipment	3.70V; 0.30A Normal (Order-No. 00720 000 402)	3x 5mm LED	3x 5mm LED + 1x red LED	1 Watt LED	5x 5mm LED	1 Watt LED
incl. 2x AA High Energy	incl. 2x C High Energy	Equipped with	incl. 1x 3R12 SuperLife	incl. 3x AAA High Energy	incl. 3x AAA High Energy	incl. 2x AAA High Energy	incl. 3x AAA High Energy	incl. 3x AAA High Energy
6	4	Minimum pieces/ shipment unit	6	6	4	4	4	4
23m	32m	Beam range	75m	41m	18m	90m	30m	121m
10h	35h	Runtime	3.5h	12h	(up to) 38h	(up to) 16h	(up to) 38h	(up to) 22h
30lm	55lm	Luminous intensity (Lumens)	15lm	28lm	(up to) 22lm	(up to) 80lm	(up to) 55lm	(up to) 120lm
Page 56	Page 56	Details	Page 57	Page 57	Page 63	Page 67	Page 63	Page 63
		EAN/GTIN/ consumer unit						

GENERAL PURPOSE

RECHARGEABLE

PORTABLE POWER

PROFESSIONAL/BUTTON CELLS

FLASHLIGHTS AND BULBS

PRODUCT DISPLAY SYSTEMS

ASSORTMENT OVERVIEW

ASSORTMENT OVERVIEW FLASHLIGHTS

Special Lights



Produkt	LED Pen Light 1AAA	LED Book Light 2CR2032	Dynamo Light LED	Rechargeable Direct Plug in LED	LED Solar Light	LED Flex Neck Light 2AAA	LED Bike Light Set
Order-No./ consumer unit	16611 101 421	16618 101 421	17680 101 401	17682 101 401	17690 101 401	17646 101 421	18803 101 421
Line	Easy	Easy	Power	Power	Power	Power	Professional
Flashlights	1	1	1	1	1	1	1
Dimensions inclusive Blister	Width (mm) Blister	100	100	100	100	135	180
	Height (mm) Blister	230	230	230	230	280	240
	Depth (mm) Blister	16	33	44	30	32	60
	Weight (g) Blister	47	59	170	83	162	289
Dimensions exclusive Blister	Length (mm) Flashlight	117	255	142	105	375	87 / 116
	Width (mm) Flashlight	18	28	52	44	-	51 / 65
	Depth (mm) Flashlight	-	35	42	27	-	102 / 52
	Diameter (mm) Flashlight	14	-	-	-	21	-
	Weight (g) Flashlight	16	30	145	63.5	62	114 / 52.5
Housing	Aluminium, ABS Plastic, TPR Rubber	ABS Plastic, PC	ABS Plastic, PC, TPR Rubber	ABS Plastic, PC	ABS Plastic, PC, PA	PC, Aluminium	ABS Plastic, PC, TPR Rubber, Aluminium
Bulb equipment	1x 5mm LED	1x 5mm LED	3x 5mm LED	3x 5mm LED	3x 5mm LED	0.5 Watt LED	3 Watt LED / 3 red LED
Equipped with	incl. 1x AAA High Energy	incl. 2x CR2032 Electronics	-	-	-	incl. 2x AAA High Energy	3x AAA High Energy / 2x AAA High Energy
Minimum pieces/ shipment unit	6	6	4	4	4	4	3
Beam range	11m	7.5m	26m	20m	24m	56m	(up to) 92m / 4m
Runtime	15h	26h	1h	1h	2h	17h	(up to) 2h / 60h
Luminous intensity (Lumens)	3lm	9lm	28lm	15lm	10lm	30lm	(up to) 120lm / 3lm
Details	Page 55	Page 57	Page 61	Page 62	Page 62	Page 62	Page 65
EAN/GTIN/ consumer unit							

Camping Lantern

Beam Lantern



Camping Lantern			Beam Lantern						
Produkt	XS Camping Lantern LED 4AA	4 Watt LED Camping Lantern 3D	Indestructible 5 Watt LED Lantern 3D	Produkt	Industrial Beam Lantern 4D	Rechargeable Lantern LED	Work Light LED 435	Indestructible 3 Watt LED Lantern 4C	
Order-No./ consumer unit	16664 101 111	18663 101 111	18760 101 111	Order-No./ consumer unit	17652 101 111	18682 101 401	18660 101 421	18750 101 421	
Line	Easy	Professional	Professional	Line	Power	Professional	Professional	Professional	
Flashlights	1	1	1	Flashlights	1	1	1	1	
Dimensions inclusive Blister	Width (mm) Blister	74	122	Dimensions inclusive Blister	Width (mm) Blister	232	322	280	180
	Height (mm) Blister	216	355		Height (mm) Blister	271	250	390	240
	Depth (mm) Blister	60	88		Depth (mm) Blister	121	130	130	91
	Weight (g) Blister	182	432		Weight (g) Blister	781	1626	2057	884
Dimensions exclusive Blister	Length (mm) Flashlight	152	185	Length (mm) Flashlight	232	197	240	147	
	Width (mm) Flashlight	-	100	Width (mm) Flashlight	165	145	128	84	
	Depth (mm) Flashlight	-	-	Depth (mm) Flashlight	120	125	270	132	
	Diameter (mm) Flashlight	74	88	Diameter (mm) Flashlight	-	-	-	84	
Weight (g) Flashlight	175	422	Weight (g) Flashlight	751	431	617	540		
Housing	ABS Plastic, PS, TPR Rubber	ABS Plastic, PC, TPR Rubber, Aluminium	PC, PA, TPE Rubber	Housing	ABS Plastic, POM, TPR Rubber, SAN	ABS Plastic, PC, PVC	Aluminium, ABS Plastic, POM, PC, Metal, Rubber	PC, TPR Rubber	
Bulb equipment	8x 5mm LED	3x 1.3 Watt LED	5 Watt LED	Bulb equipment	3 Watt LED	3 Watt LED	4 Watt LED	3 Watt LED	
Equipped with	-	-	-	Equipped with	-	Pb Accu	incl. 1x 4LR25-2 High Energy	incl. 4x C High Energy	
Minimum pieces/ shipment unit	4	4	4	Minimum pieces/ shipment unit	4	2	2	2	
Beam range	(360°) 3.20m	(360°) 10m	(360°) 13m	Beam range	265m	300m	420m	350m	
Runtime	(up to) 15h	(up to) 150h	(up to) 280h	Runtime	75h	10h	(up to) 270h	(up to) 78h	
Luminous intensity (Lumens)	(up to) 24lm	(up to) 300lm	(up to) 280lm	Luminous intensity (Lumens)	135lm	150lm	(up to) 190lm	(up to) 150lm	
Details	Page 57	Page 68	Page 68	Details	Page 61	Page 67	Page 67	Page 67	
EAN/GTIN/ consumer unit				EAN/GTIN/ consumer unit					

GENERAL PURPOSE

RECHARGEABLE

PORTABLE POWER

PROFESSIONAL/BUTTON CELLS

FLASHLIGHTS AND BULBS

PRODUCT DISPLAY SYSTEMS

ASSORTMENT OVERVIEW

ASSORTMENT OVERVIEW BULBS



Type	712	714	720	742	751	752	792	794*
Order-No./ consumer unit	00712 000 402	00714 000 402	00720 000 402	00742 000 402	00751 000 402	00752 000 402	00792 000 402	00794 000 401
Voltage (V)	4.80	3.50	3.70	2.5	2.40	3.60	4.80	-
Technology	Krypton	Normal	Normal	Normal	Krypton	Krypton	Krypton	Fluorescent Tube 9 Watt
Amperage (A)	0.70	0.20	0.30	0.30	0.70	0.80	0.75	-
Bulbs	2	2	2	2	2	2	2	1
Width (mm)	80	80	80	80	80	80	80	140
Height (mm)	120	120	120	120	120	120	120	245
Depth (mm)	15	15	15	15	15	15	15	23
Weight (g)	9	8	9	9	9	9	9	50
Minimum pieces/ shipment unit	10	10	10	10	10	10	10	5
For VARTA Flashlights	12630	604	10645, 10640 16645, 16640	13625, 14610	10600, 16600, 13601, 11610, 11611, 13600, 12604, 12623, 16623	10646	12660, 12651, 17652	11662, 18662
Details	Page 72	Page 72	Page 72	Page 72	Page 72	Page 72	Page 72	Page 72
EAN / GTIN consumer unit								

* Available as long as stocks last

ASSORTMENT OVERVIEW SPECIAL BATTERIES

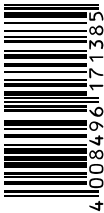
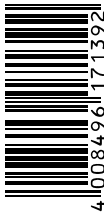
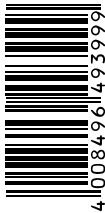
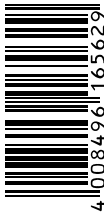
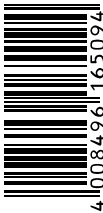

Type	430	431	435	540*	540**
Order-No./ consumer unit	00430 101 111	00431 101 111	00435 101 111	00540 101 111	00540 101 121
Voltage (V)	6.0	6.0	6.0	6.0	6.0
Capacity (mAh)	7.5	8.5	35	19	19
Width (mm)	67	67	136	130	130
Height (mm)	115	115	125	120	120
Depth (mm)	67	67	73	70	70
Weight (g)	572	560	1293	1147	1147
Minimum pieces/ shipment unit	1	1	1	1	1
Innercarton	-	-	-	5	5
Mastercarton	20	20	6	10	10
IEC	4R25X	4R25X	4LR25-2	4R25-2	4R25-2
Electrochemical System	Zinc-chlorid	Zinc-chlorid	Alkaline	Zinc-chlorid	Zinc-chlorid
Details	Page 76	Page 76	Page 76	Page 76	Page 76
EAN / GTIN consumer unit	 4 008496 171385	 4 008496 171392	 4 008496 149399	 4 008496 165629	 4 008496 165094

* Plastic housing
** Metal housing

GENERAL PURPOSE

RECHARGEABLE

PORTABLE POWER

PROFESSIONAL/BUTTON CELLS

FLASHLIGHTS AND BULBS

PRODUCT DISPLAY SYSTEMS

ASSORTMENT OVERVIEW

ASSORTMENT OVERVIEW

BATTERY SHAPED DISPLAY



METAL







CARD-BOARD



PLASTIC

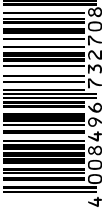

METAL

Type	Battery Shaped Sales Stand, Metal 9026 260 001 delivered empty	Battery Shaped Sales Stand, Cardboard 91560 112 050 delivered empty	Battery Shaped Dispenser, Plastic 9026 270 001 delivered empty	Battery Shaped, Metal 9026 160 006 delivered empty
Order-No./ consumer unit	9026 260 001	91560 112 050	9026 270 001	9026 160 006
Height (cm)	165	176	145	61
Ground area (cm)	60x40	60x40	60x40	25x19
Hooks (incl.)	40	32	-	6
Hooks length (cm)	20	20	-	20
Hook refills	Order No. 9006 255 220 Hook length: 20 cm Shipping unit: 20 pieces/box	-	-	-
EAN / GTIN consumer unit	 4 1008496 1732708	 4 1008496 1727544	 4 1008496 1732722	 4 1008496 1737734

If required, please contact your representative at VARTA Sales.

ASSORTMENT OVERVIEW

TOWER DISPLAY

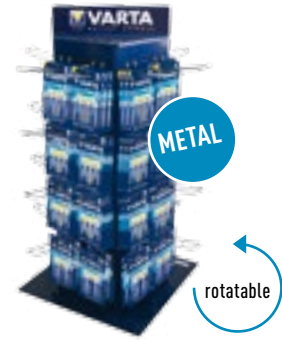
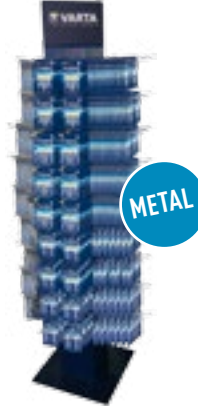

Type	Small Battery Center 9026 300 190 delivered empty	Metal Floor Display 9026 255 072 delivered empty	Metal Counter Display 9026 150 032 delivered empty
Order-No./ consumer unit	9026 300 190	9026 255 072	9026 150 032
Height (cm)	165	164	66
Ground area (cm)	99x54	38x38	32x32
Hooks (incl.)	184	72	32
Hooks length (cm) -25	54	-	-
Hooks length (cm) -20	130	72	-
Hooks length (cm) -12	-	-	32
Hooks refills	Order No. 9006 255 220 Hook length: 20 cm Shipping unit: 20 pieces/box Order No. 9006 255 225 Hook length: 25 cm Shipping unit: 20 pieces/box	Order No. 9006 255 220 Hook length: 20 cm Shipping unit: 20 pieces/box Order No. 9006 255 225 Hook length: 25 cm Shipping unit: 20 pieces/box	-
EAN / GTIN consumer unit			

View from above

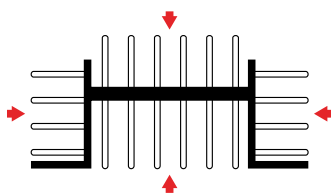

Four sides can be stocked with products

- ▼ Inclusive information panels (left and right)
- ▼ Inclusive basket for additional product placement

If required, please contact your representative at VARTA Sales.

GENERAL PURPOSE

RECHARGEABLE

PORTABLE POWER

PROFESSIONAL/BUTTON CELLS

FLASHLIGHTS AND BULBS

PRODUCT DISPLAY SYSTEMS

ASSORTMENT OVERVIEW

ASSORTMENT OVERVIEW

SPEARHEAD FLOOR DISPLAY



Type	Metal Sales Stand 9026 200 036	Metal Sales Stand 9026 200 054
Order-No./ consumer unit	9026 200 036	9026 200 054
Height (cm)	164	164
Ground area (cm)	40x40	60x40
Hooks (incl.)	36	54
Hooks length (cm)	20	20
Hook refills	Order No. 9006 255 220 Hook length: 20 cm Shipping unit: 20 pieces/box	Order No. 9006 255 220 Hook length: 20 cm Shipping unit: 20 pieces/box
EAN / GTIN consumer unit	 4 10084961732609	 4 10084961732623



Type	Refill basket 9026 210 060	Refill basket 9026 210 040
Order-No./ consumer unit	9026 210 060	9026 210 040
Height (cm)	12.5	12.5
Width (cm)	58.5	39
Depth (cm)	22	22
EAN / GTIN consumer unit	 4 10084961732661	 4 10084961732647



Type	Side Panels 9026 215 001 (compatible with sales stand 9026 200 054 and 9026 200 036)
Order-No./ consumer unit	9026 215 001
Height (cm)	102
Width (cm)	15.5
Depth (cm)	0.5
EAN / GTIN consumer unit	 4 10084961732685



Side panels installation
optional sidewise (distant) or
forward-facing

If required, please contact your representative at VARTA Sales.

ASSORTMENT OVERVIEW

SPEARHEAD FLOOR DISPLAY



METAL

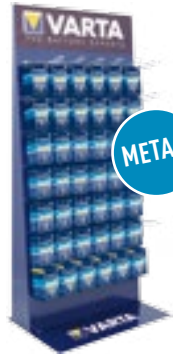

METAL



METAL

Type	Spear Head Sales Stand Metal 9026 200 066 delivered empty	Spear Head Sales Stand Metal 9026 202 042 delivered empty	Spear Head Sales Stand Metal 9026 202 018 delivered empty
Order-No./ consumer unit	9026 200 066	9026 202 042	9026 202 018
Height (cm)	190	127	164
Ground area (cm)	60x40	59x38	38x38
Hooks (incl.)	66	42	18
Hooks length (cm) -20	66	42	18
Hooks refills	Order No. 9006 255 220 Hook length: 20 cm Shipping unit: 20 pieces/box	Order No. 9006 255 220 Hook length: 20 cm Shipping unit: 20 pieces/box	Order No. 9006 255 220 Hook length: 20 cm Shipping unit: 20 pieces/box
EAN / GTIN consumer unit	 4 1008496 180033 9	 4 1008496 180035 3	 4 1008496 179983 1

Will be ordered on demand

Will be ordered on demand

GENERAL PURPOSE

RECHARGEABLE

PORTABLE POWER

PROFESSIONAL/BUTTON CELLS

FLASHLIGHTS AND BULBS

PRODUCT DISPLAY SYSTEMS

ASSORTMENT OVERVIEW

ASSORTMENT OVERVIEW

SPEARHEAD COUNTER DISPLAY



METAL



METAL



METAL

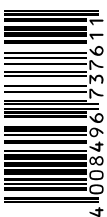
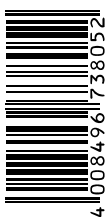
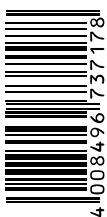
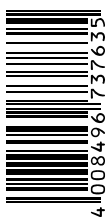

METAL

Type	Metal Counter Display 9026 100 008 delivered empty	Metal Counter Display 9026 100 108 delivered empty	Metal Counter Display 9026 100 012 delivered empty	Metal Counter Display 9026 100 020 delivered empty
Order-No./ consumer unit	9026 100 008	9026 100 108	9026 100 012	9026 100 020
Height (cm)	51	51	51	80
Ground area (cm)	20x23	20x23	38x26	38x26
Hooks (incl.)	8	8	12	20
Hooks length (cm) -10	-	8	-	-
Hooks length (cm) -20	8	-	12	20
Hook refills	Order No. 9006 295 210 Hook length: 10 cm Shipping unit: 20 pieces/box Order No. 9006 255 215 Hook length: 15 cm Shipping unit: 20 pieces/box Order No. 9006 255 220 Hook length: 20 cm Shipping unit: 20 pieces/box	Order No. 9006 295 210 Hook length: 10 cm Shipping unit: 20 pieces/box Order No. 9006 255 215 Hook length: 15 cm Shipping unit: 20 pieces/box Order No. 9006 255 220 Hook length: 20 cm Shipping unit: 20 pieces/box	Order No. 9006 295 210 Hook length: 10 cm Shipping unit: 20 pieces/box Order No. 9006 255 215 Hook length: 15 cm Shipping unit: 20 pieces/box Order No. 9006 255 220 Hook length: 20 cm Shipping unit: 20 pieces/box	Order No. 9006 295 210 Hook length: 10 cm Shipping unit: 20 pieces/box Order No. 9006 255 215 Hook length: 15 cm Shipping unit: 20 pieces/box Order No. 9006 255 220 Hook length: 20 cm Shipping unit: 20 pieces/box
EAN / GTIN consumer unit	 4 008496 17376 11	 4 008496 17380 52	 4 008496 1737 178	 4 008496 17376 35

If required, please contact your representative at VARTA Sales.

ASSORTMENT OVERVIEW

METAL SIDE RAILS (HANG-UP)

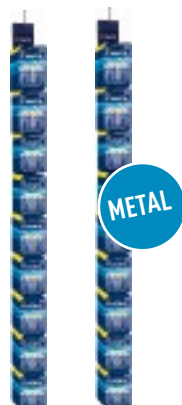

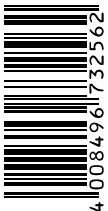
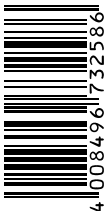
Type	Set of 2 rails with 9 hooks per rail 9026 170 009 delivered empty	Set of 2 rails with 18 hooks per rail 9026 170 018 delivered empty
Order-No./ consumer unit	9026 170 009	9026 170 018
Height (cm)	115	115
Width (cm)	8	14
Hooks (incl.) per set	18	36
Hook length (cm)	20	20
EAN / GTIN consumer unit	 4 008496 173256 2	 4 008496 173258 6

GENERAL PURPOSE

RECHARGEABLE

PORTABLE POWER

PROFESSIONAL/BUTTON CELLS

FLASHLIGHTS AND BULBS

PRODUCT DISPLAY SYSTEMS

ASSORTMENT OVERVIEW

ASSORTMENT OVERVIEW

METAL SIDE RAIL (HANG-UP) - HOOK FIXATION

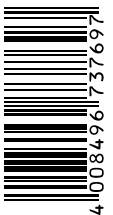
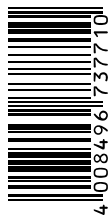

Type	Set of rails (5 hooks per rail) 9026 172 005 delivered empty	Set of 2 rails with 10 hooks per rail 9026 172 010 delivered empty
Order-No./ consumer unit	9026 172 005	9026 172 010
Height (cm)	73	73
Width (cm)	8	18
Hooks (incl.) per set	10	20
Hook length (cm)	20	20
Hook refills	Order No. 9006 255 210 Hook length: 10 cm Shipping unit: 20 pieces/box Order No. 9006 255 220 Hook length: 20 cm Shipping unit: 20 pieces/box	Order No. 9006 255 210 Hook length: 10 cm Shipping unit: 20 pieces/box Order No. 9006 255 220 Hook length: 20 cm Shipping unit: 20 pieces/box
EAN / GTIN consumer unit	 4 1008496 173769 7	 4 1008496 173771 0

If required, please contact your representative at VARTA Sales.

ASSORTMENT OVERVIEW DISPLAY BASIC LINE

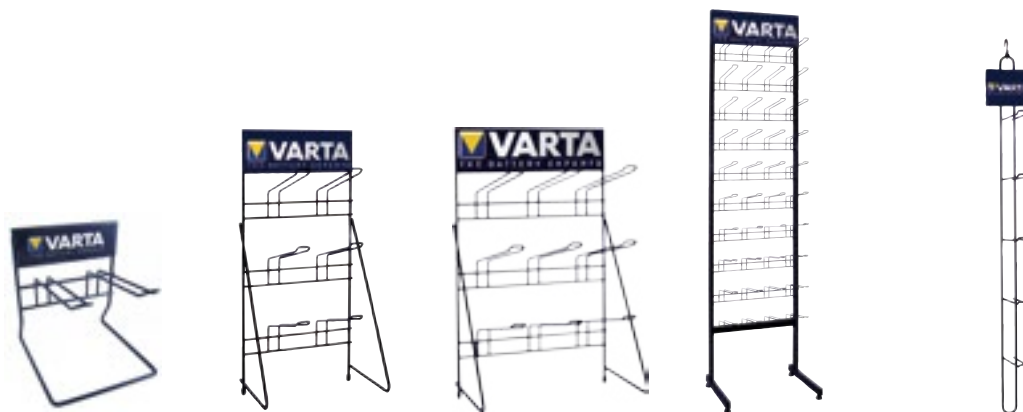

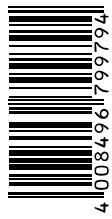
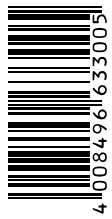
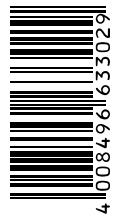
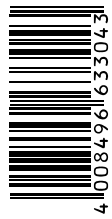
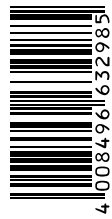
Type	Product basic display system for counter 9017 100 002	Product basic display system for counter 9017 100 006	Product basic display system for counter 9017 100 009	Floor placement 9017 200 040	Wall placement 9017 950 005
Order-No./ consumer unit	9017 100 002	9017 100 006	9017 100 009	9017 200 040	9017 950 005
Height (cm)	21	51	51	164	78.5
Width (cm)	18	24	31	40	10
Depth (cm)	19	18	22	36	13
Hooks (fix)	2	6	9	40	5
Hook length (cm)	16	17	20	20	12
EAN / GTIN consumer unit	 4 008496 1799794	 4 008496 633005	 4 008496 633029	 4 008496 633043	 4 008496 632985

GENERAL PURPOSE

RECHARGEABLE

PORTABLE POWER

PROFESSIONAL/BUTTON CELLS

FLASHLIGHTS AND BULBS

PRODUCT DISPLAY SYSTEMS

ASSORTMENT OVERVIEW

ASSORTMENT OVERVIEW

UNIVERSAL PRODUCT DISPLAY FOR SELF-SERVICE STORES

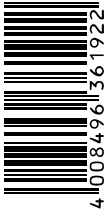
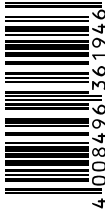
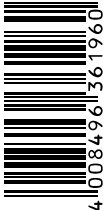
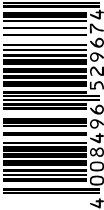
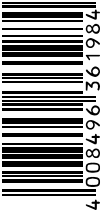

Type	Basic module 140 cm* 9000 120 036	Shelf height 160 cm 1 x 9000 120 036 + 1 x 9000 122 006	Shelf height 180 cm 1 x 9000 120 036 + 1 x 9000 121 018	Construction module 1 9000 121 018	Construction module 2 9000 122 006	EPOS/Barcode rails 9000 123 044	Light strip 9000 123 004
Order-No./ consumer unit	9000 120 036 * Incl. crowner sign	1 x 9000 120 036 + 1 x 9000 122 006	1 x 9000 120 036 + 1 x 9000 121 018	9000 121 018	9000 122 006	9000 123 044 Shipping unit: 4 scanning rails/box	9000 123 004 Shipping unit: 4 light strips/box
Height (cm)	140*	160	180	40	20	-	-
Width (cm)	57	57	57	57	57	57	57
Depth (cm)	44.5	44.5	44.5	-	-	-	-
Hooks (incl.)	6 hooked racks with 6 hooks each 2 EPOS/Barcode rails	6 hooked racks with 6 hooks each 2 EPOS/Barcode rails	6 hooked racks with 6 hooks each 2 EPOS/Barcode rails	3 hooked racks with 6 hooks each 2 EPOS/Barcode rails	1 hooked rack with 6 hooks	-	4 adjustable hooks
Hook length (cm)	25	25	25	25	25	-	25
EAN / GTIN consumer unit	 4 008496 1361922			 4 008496 1361946	 4 008496 1361960	 4 008496 1529674	 4 008496 1361984

If required, please contact your representative at VARTA Sales.

ASSORTMENT OVERVIEW

FLASHLIGHT TESTING STATION / PRODUCT DISPLAY SYSTEMS FOR BUTTON CELLS

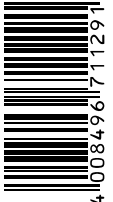
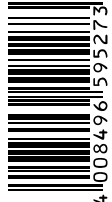

Type	Flashlight Testing Station 9016 930 001 delivered empty and without support for peg walls	Counter display for watch cells 9016 800 001
Order-No./ consumer unit	9016 930 001	9016 800 001
Height (cm)	130	3.8
Width (cm)	460	28.7
Depth (cm)	345	21.8
Support for peg walls	9016 700 002	-
EAN / GTIN consumer unit	 4 1008496 171129 1	 4 1008496 59527 3

GENERAL PURPOSE

RECHARGEABLE

PORTABLE POWER

PROFESSIONAL/BUTTON CELLS

FLASHLIGHTS AND BULBS



PRODUCT DISPLAY SYSTEMS

ASSORTMENT OVERVIEW

ASSORTMENT OVERVIEW

CLIP STRIPS PLASTIC / CLIP STRIPS CARDBOARD

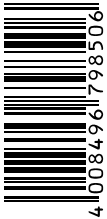
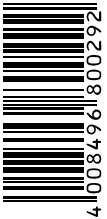
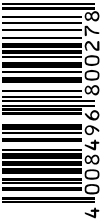
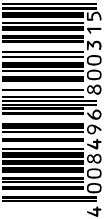
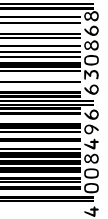

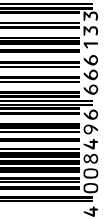

Type	Clip Strip Empty 9050 112 010 delivered empty	Clip Strip Empty 9050 112 012 delivered empty	Clip Strip Empty 9050 112 011 delivered empty	Clip Strip Empty 9050 112 013 delivered empty	Clip Strip 97600 HE AA/AAA 97600 121 801 delivered garnished	Clip Strip 97600 HE AA 97600 121 811 delivered garnished	Clip Strip 97601 HE AAA 97601 112 811 delivered garnished
Order-No./ consumer unit	9050 112 010 (to fit 10 blister per clip strip) Size of clip strip: 120 x 960	9050 112 012 (to fit 10 blister per clip strip) Size of clip strip: 120 x 960	9050 112 011 (to fit 10 blister per clip strip) Size of clip strip: 120 x 960	9050 112 013 (to fit 10 blister per clip strip) Size of clip strip: 120 x 960	97600 121 801 Size of clip strip: 80 x 840	97600 121 811 Size of clip strip: 80 x 840	97601 112 811 Size of clip strip: 80 x 840
Clip Strip per packaging	10	2	10	2	-	-	-
Content: Blister per innercarton	-	-	-	-	8 x AAA 12 x AA	20 x AA	20 x AAA
Batteries per blister	-	-	-	-	4	4	4
Packaging size:							
Width (cm)	257	257	257	257	160	160	160
Height (cm)	126	126	126	126	142	142	142
Depth (cm)	293	293	293	293	172	172	172
Weight (g)	548	514	548	514	1772	2166	1186
EAN/GTIN consumer unit	 4 008496 798506	 4 008496 800292	 4 008496 800278	 4 008496 800315	 4 008496 630868	 4 008496 666805	 4 008496 666133

If required, please contact your representative at VARTA Sales.

ASSORTMENT OVERVIEW

BULK DISPLAYS (CARDBOARD)

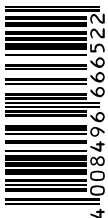

Type	Low cost bulk display empty 98000 112 811	Cardboard bulk display empty 98000 112 801
Order-No./ consumer unit	98000 112 811 (Dimensions for assembled displays)	98000 112 801 (Dimensions for assembled displays)
Height (cm)	800	800
Width (cm)	600	520
Depth (cm)	800	520
Weight (g)	4600	3495
EAN/GTIN consumer unit	 4 008496 666522	 4 008496 633227

GENERAL PURPOSE

RECHARGEABLE

PORTABLE POWER

PROFESSIONAL/BUTTON CELLS











FLASHLIGHTS AND BULBS





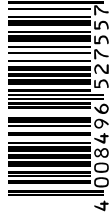





PRODUCT DISPLAY SYSTEMS

ASSORTMENT OVERVIEW

ASSORTMENT OVERVIEW

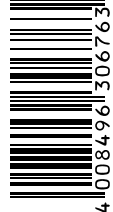
PRODUCT DISPLAY UNIT ACCESSOIRES

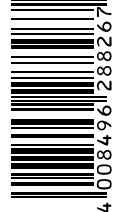
Type	 Standard hook without bar	 Standard hook with bar	 Standard hook with bar	 Standard hook with bar	 Standard hook with bar
Order-No./ consumer unit	9006 255 210	9006 295 210	9006 255 215	9006 255 220	9006 255 225
Hook length (cm)	10	10	15	20	25
Shipping unit pieces/box	20	20	20	20	20
Dimensions	-	-	-	-	-
EAN/GTIN consumer unit	 4 008496 313402	 4 008496 527557	 4 008496 313433	 4 008496 313464	 4 008496 313495

Type	 Scanning hooks	 Scanning hooks	 Hook shortener, plastic	 Price flags, transparent	 Hook lock
Order-No./ consumer unit	9006 256 220	9006 256 225	9026 700 200	9000 033 005	9016 700 001
Hook length (cm)	20	25	-	-	-
Shipping unit pieces/box	30	30	50	100	10 pieces/poly bag
Dimensions (cm)	5.2 x 4 Scanner bag	5.2 x 4 Scanner bag	-	2.7 x 2.7	5 x 2 x 3.5
EAN/GTIN consumer unit	 4 008496 306732	 4 008496 306763	 4 008496 798216	 4 008496 288267	 4 008496 583423

If required, please contact your representative at VARTA Sales.

ASSORTMENT OVERVIEW CARDBOARD DISPLAYS



Type	Premium (Spearhead) P60 small Ready-To-Sell	Premium (Spearhead) P60 Ready-To-Sell
Order-No./ consumer unit	958xx 112 xxx	957xx 112 xxx
Height (cm)	136	175
Width (cm)	60	60
Depth (cm)	40	40
Hooks (incl.)	36 (20cm)	54 (20cm)



Type	Standard S60 T2 Ready-To-Sell	Standard S60 T3 Ready-To-Sell
Order-No./ consumer unit	983xx 112 xxx	982xx 112 xxx
Height (cm)	127	154
Width (cm)	60	60
Depth (cm)	40	40
Facings	24	36

If required, please contact your representative at VARTA Sales.

GENERAL PURPOSE

RECHARGEABLE

PORTABLE POWER

PROFESSIONAL/BUTTON CELLS

FLASHLIGHTS AND BULBS

PRODUCT DISPLAY SYSTEMS

ASSORTMENT OVERVIEW

ASSORTMENT OVERVIEW

CARDBOARD DISPLAYS



Type	Standard S40 T2 Ready-To-Sell	Standard S40 T2 NOT Ready-To-Sell	Standard S40 T3 NOT Ready-To-Sell
Order-No./ consumer unit	955xx 112 xxx	987xx 112 xxx	988xx 112 xxx
Height (cm)	135	123	148
Width (cm)	40	40	40
Depth (cm)	40	40	40
Facings	16	16	24



Type	Counter 1/2 Eco	Counter 1/1 Eco	Counter 2/1 Eco	Counter Mini Spearhead
Order-No./ consumer unit	938xx 112 xxx	937xx 112 xxx	939xx 112 xxx	931xx 112 xxx
Height (cm)	27	28	43	50
Width (cm)	18	36	36	20
Depth (cm)	17	17	29	14.5
Facings	2	4	8	4

If required, please contact your representative at VARTA Sales.

Addresses

AFRICA

VARTA Consumer
Batteries GmbH & Co.KGaA
Otto-Volger-Str. 7c
65843 Sulzbach
Germany
Phone: +49 (0) 6196 90 240
Fax: +49 (0) 6196 9024 400

GERMANY

VARTA Consumer
Batteries GmbH & Co.KGaA
Alfred-Krupp-Str. 9
73479 Ellwangen
Germany
Phone: +49 (0) 79 61 83 770
Fax: +49 (0) 0800 827827 -4/-6

AUSTRALIA

Spectrum Brands
Australia Pty Ltd
Chifley Business Park
1 Chifley Drive
Mentone VIC 3194
Australia
Phone: +61 (0) 3 8551 5000
Fax: +49 (0) 3 8551 5001

AUSTRIA

Spectrum Brands
Austria GmbH
Campus 21, Europaring A04 501
2345 Brunn am Gebirge
Austria
Phone: +43 1 86 339-0
Fax: +43 1 86 339-125

BALTICS

VARTA Consumer
Batteries GmbH & Co.KGaA
Māras iela 12/1
Mārupe
LV 2167
Latvia

BELGIUM

Spectrum Brands
Benelux B.V.
't Hofveld 6F
1702 Groot-Bijgaarden
Belgium
Phone: +32 (2) 4818500
Fax: +32 (2) 4632569

BULGARIA

VRR Bulgaria EOOD
161 Iztochna Tangenta Blvd.
1592 Sofia, Slatina district
Bulgaria
Phone: +359 2 979 04 01
Fax: +359 2 889 27 00

CROATIA

VARTA Remington
Rayovac d.o.o.
Tratinska 13
10 000 Zagreb
Croatia
Phone: +385 (1) 2341 653
Fax: +385 (1) 2304 646

CZECH REPUBLIC + SLOVAKIA

Spectrum Brands Czech
spol.s.r.o.
Jindřicha z Lipé 108
47001 Česká Lipa
Czech Republik
Phone: +420 (487) 754 605
Fax: +420 (487) 754 604

DENMARK

Spectrum Brands Denmark A/S
Industrivej 9 / D
2605 Brøndby
Denmark
Phone: +45 47 19 33 33
Fax: +45 47 19 33 30

FINLAND

Spectrum Brands Finland Oy
Ayritie 12 A
01510 Vantaa
Finland
Phone: +358 20 771 0840
Fax: +358 97 591 559

FRANCE

Spectrum Brands France SAS
157, rue Jean-Pierre Timbaud
B.P. 15
92403 Courbevoie Cedex
France
Phone: +33 (1) 4691 6600
Fax: +33 (1) 5637 0629

HUNGARY

Spectrum Brands Hungaria Kft.
Ady Endre út 42 - 44
1191 Budapest
Hungary
Phone: +36 (1) 347 9000
Fax: +32 (1) 347 9001

ITALY

Spectrum Brands Italia Srl
Via Ludovico il Moro, 6
Palazzo Pacinotti
20080 Basiglio (MI)
Italy
Phone: +39 (02) 90 44 83 11
Fax: +39 (02) 90 75 60 96

NETHERLANDS

Spectrum Brands Benelux B.V.
Computerweg 8
3542 DR Utrecht
Netherlands
Phone: +31 (0) 30 248 0480
Fax: +31 (0) 30 241 1770

NORWAY

Spectrum Brands Norway AS
Dronning Eufemias Gate 16
0191 Oslo
Norway
Phone: +45 47 19 33 33
Fax: +45 47 19 33 90

POLAND

Spectrum Brands Poland
sp. z o.o.
ul. Bitwy Warszawskiej 7a
02-366 Warszawa
Poland
Phone: +48 (22) 598 07 00
Fax: +48 (22) 598 07 01

PORTUGAL

VARTA Remington Rayovac S.L.
C/ Provenza, 277 7° 1a
08037 Barcelona
Spain
Phone: +34 932070166
Fax: +34 932074913

ROMANIA

VARTA Rayovac Remington
Romania Srl.
Str. Ardealului nr. 7
075100-Otopeni, Jud. Ilfov
Romania
Phone: +40 (21) 352 29 49
Fax: +40 (21) 35 29 767

RUSSIA

ZAO Spectrum Brands
Varshavskoe shosse 9,
build. 1B
117105 Moscow
Russia
Phone: +7 495 933 31 77
Fax: +7 495 933 31 76

SLOVENIA

VARTA Remington Rayovac d.o.o.
Trazaska Cest 132
1000 Ljubljana
Slovenia
Phone: +386 (1) 564 72 47
Fax: +386 (1) 564 72 47

SPAIN / IBERIA

VARTA Remington Rayovac S.L.
C/ Provenza, 277 7° 1a
08037 Barcelona
Spain
Phone: +34 932070166
Fax: +34 932074913

SWEDEN

SPB Sweden AB
Arenavägen 39, 5tr.
121 77 Johanneshov
Sweden
Phone: +46 (8) 587 130 00
Fax: +46 (8) 587 130 35

SWITZERLAND

Spectrum BRANDS Schweiz GmbH
Stationsstr. 3
8306 Brüttisellen
Switzerland
Phone: +41 (0) 43 288 28 00
Fax: +41 (0) 43 288 28 01

TURKEY

VARTA Pilleri Ticaret Limited
Sirketi
Istoc 25. Ada Sonu
Kuzey Plaza Kat 1 No 4
34217 Mahmutbey / Istanbul
Turkey
Phone: +90 (212) 659 01 24
Fax: +90 (212) 659 48 40

UK

Spectrum Brands (UK) Ltd.
Fir Street
Failsworth
Manchester M35 0HS
UK
Phone: +44 (0) 161 947 3000

UK - Hearing Aid Batteries

Spectrum Brands (UK) Ltd.
Union 2 A Stepherson Estate
Unit 12
Washington, Tyne & Wear NE 37
3HW
UK
Phone: +44 (0) 191 4196010

UKRAINE

VARTA Consumers Batteries GmbH
& KGaA
Ochakovskaya Str. 5/6
Office 308
03151 Kiev
Ukraine



Like us on Facebook.

www.facebook.com/VARTA.Consumer

**More Interaction.
More Information.
More Energy.**



www.varta-consumer.com