



P330i/P430i ROHS Spare Parts List





P330i/P430i ROHS Spare Parts List

Power Supply & A.C. Input

[Page 3](#)

P330i Printer Enclosures

[Page 11](#)

Print Engine Front

[Page 20](#)

Card Feeder

[Page 60](#)

Printhead Parts

[Page 83](#)

Smart Card Components

[Page 100](#)

P430i Printer Enclosures

[Page 109](#)

P430i Flipper Module

[Page 118](#)



P330i/P430i ROHS Spare Parts List

POWER SUPPLY & A.C. INPUT



P330i/P430i ROHS Spare Parts List

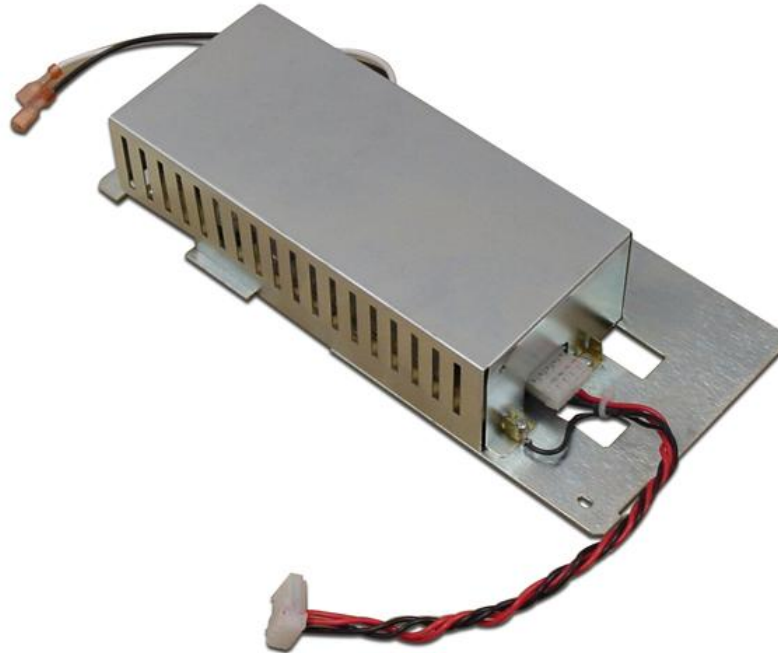

Spares Kit No	Description	List Price
105912G-152	KIT,POWER SUPPLY W/PLATE, P330I	125.00*
105912G-157	KIT,POWER SUPPLY W/PLATE, P430I	128.00*



P330i/P430i ROHS Spare Parts List



105912G-774	C/A, PWR SPLY/CPU, P330i	47.00
-------------	--------------------------	-------



P330i/P430i ROHS Spare Parts List



105912G-516	A/C POWER SWITCH (5 per kit)	33.00
-------------	------------------------------	-------



P330i/P430i ROHS Spare Parts List



105912G-889	ENTRY MODULE,PWR,250VAC,IEC	22.00
-------------	-----------------------------	-------



P330i/P430i ROHS Spare Parts List

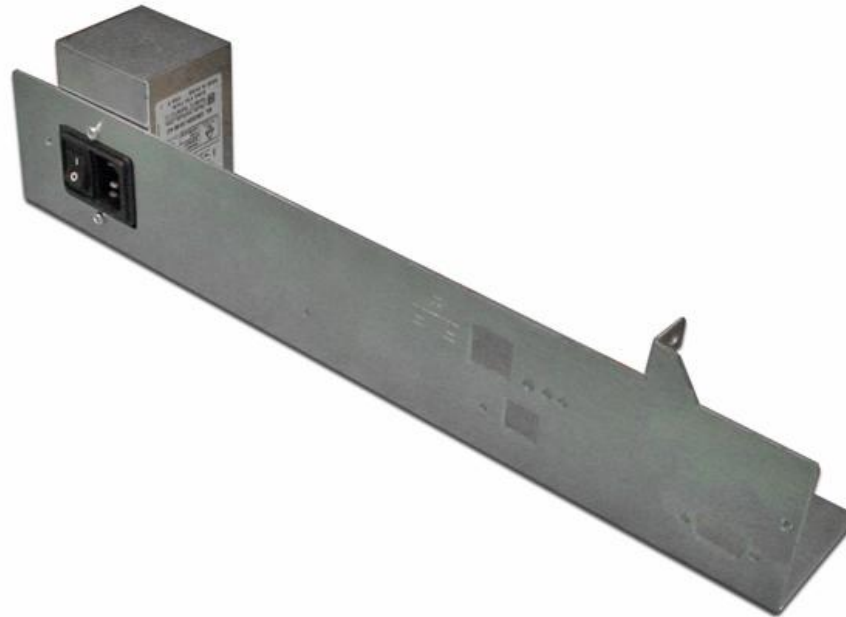

105912G-153	KIT,PWR SWTCH,W/BACK,P330I	60.00*
-------------	----------------------------	--------



P330i/P430i ROHS Spare Parts List

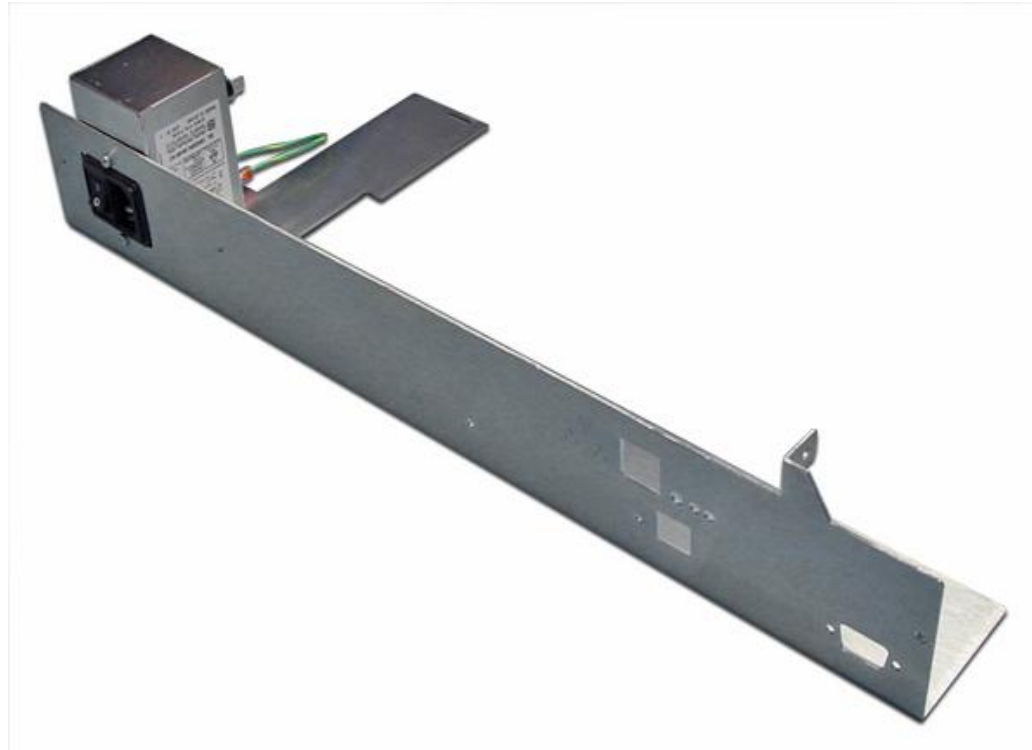

105912G-154	KIT,PWR SWTCH,W/BACK,P430I	60.00*
-------------	----------------------------	--------



P330i/P430i ROHS Spare Parts List

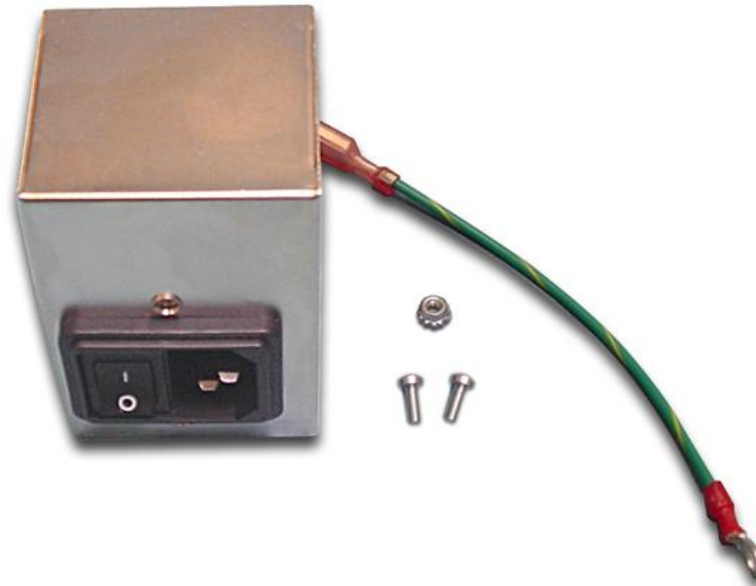

105912G-155	KIT,PWR SWTCH,P3XX/P4XX	40.00*
-------------	-------------------------	--------



P330i/P430i ROHS Spare Parts List

P330i PRINTER ENCLOSURES



P330i/P430i ROHS Spare Parts List



SEE NEXT SLIDE FOR KIT NUMBERS



P330i/P430i ROHS Spare Parts List

	Spares Kit No	Description	List Price
1	105912G-670	LOWER MOLDING P330i	56.00
2	105912G-680	FEEDER ASSEMBLY P330i	394.00
3	105912G-675	FEEDER COVER P330i	27.00
4	105912G-674	LID P330i	33.00
5	105912G-673	TOP MOLDING P330i	90.00



P330i/P430i ROHS Spare Parts List

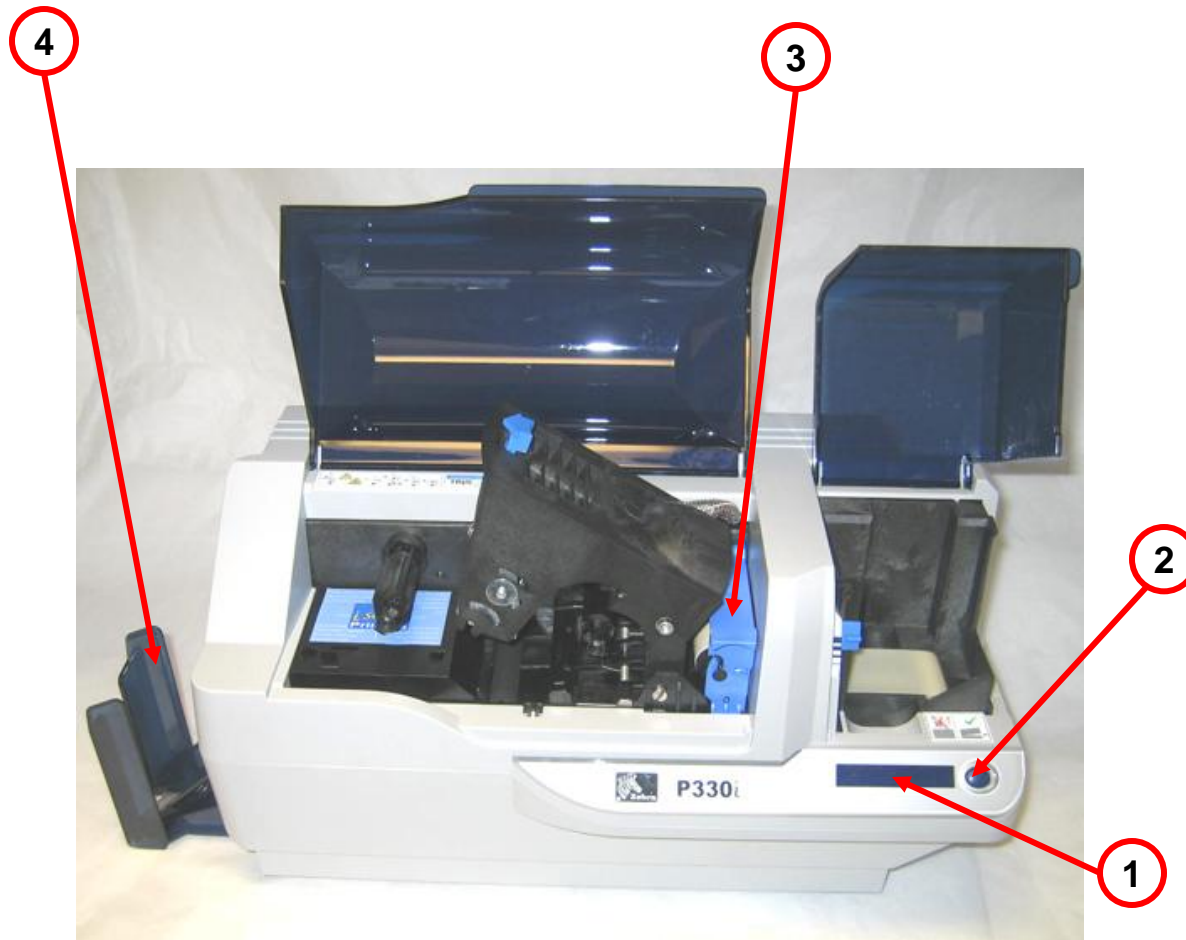

SEE NEXT SLIDE FOR KIT NUMBERS



P330i/P430i ROHS Spare Parts List

1	105912G-669	PCBA LCD MODULE P330i	90.00
1A	105912G-665	CABLE LCD MODULE	83.00
2	105912G-676	OVAL LCD SWITCH COVER (20)	62.00
3	105912G-708	CLEANING ROLLER ASSEMBLY	89.00
4	105912G-671	HOPPER ASSEMBLY P330i	33.00



P330i/P430i ROHS Spare Parts List

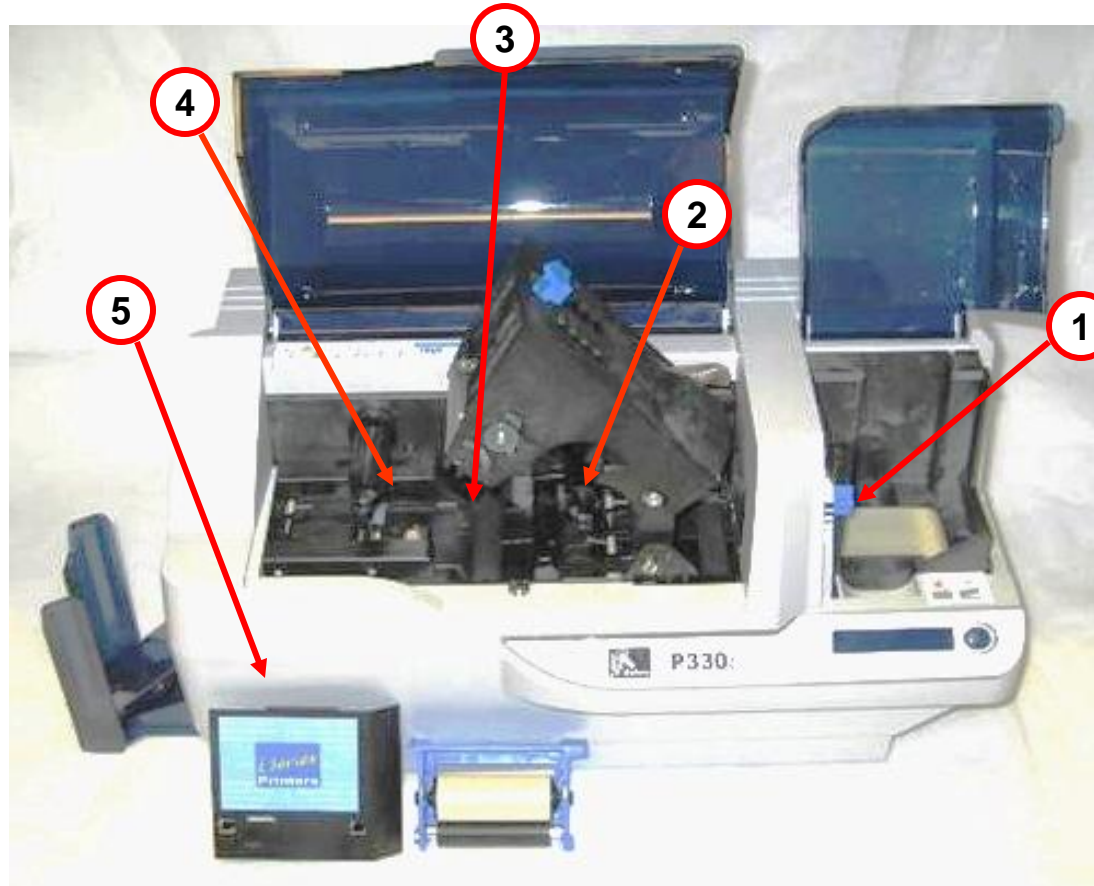

SEE NEXT SLIDE FOR KIT NUMBERS



P330i/P430i ROHS Spare Parts List

1	105912G-858	BELT, FEEDDER, P330i	71.00
2	105912G-757	ENTRY PRESSURE ROLLER	26.00
3	105912G-590	PLATEN ROLLER PRINT HEAD	46.00
4	105912G-012	MAG PRESSURE ROLLER	27.00
5	105912G-681	SHORT ENCODER SHROUD	26.00



P330i/P430i ROHS Spare Parts List

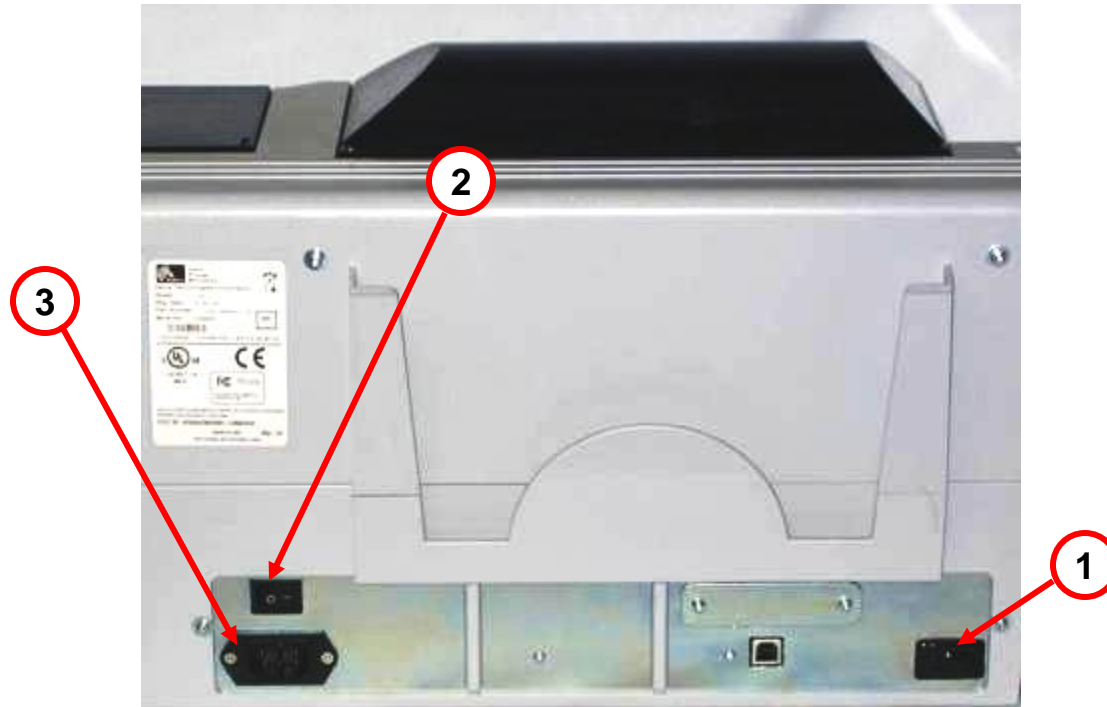

SEE NEXT SLIDE FOR KIT NUMBERS



P330i/P430i ROHS Spare Parts List

1	105912G-667	DB9 VINYL PLATE (set of 20)	23.00
2	105912G-516	AC POWER SWITCH (5 per kit)	33.00
3	105912G-889	ENTRY MODULE,PWR,250VAC,IEC	22.00
-	105912G-894	PACKING SET, P330i	85.00



P330i/P430i ROHS Spare Parts List

PRINT ENGINE FRONT



P330i/P430i ROHS Spare Parts List

TOP VIEW

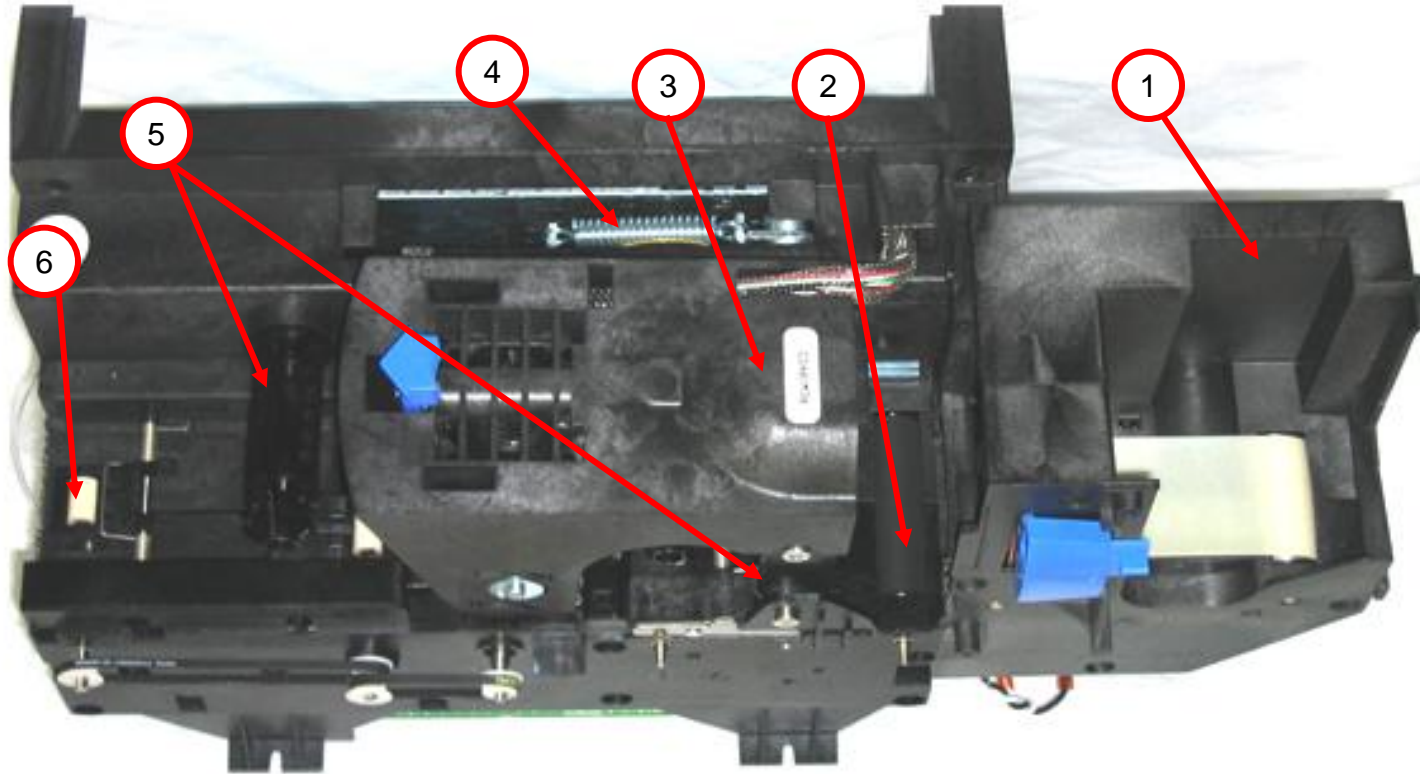

SEE NEXT SLIDE FOR KIT NUMBERS



P330i/P430i ROHS Spare Parts List

1	105912G-680	KIT, ASSY FEEDER COMPLETE, P330I	394.00
2	105912G-764	CLEAN DRIVE ROLLER, P310 (5 per kit)	47.00
3	105912G-842	BRKT, HEAD U-SUPPORT,P330I	32.00
4	105912G-794	SPRING, PRINT HEAD PRESSURE	23.00
5	105912G-001	SPINDLE RIBBON MOLDED	38.00
6	105912G-758	ASSY, EXIT PRESSURE ROLLER	26.00



P330i/P430i ROHS Spare Parts List



105912G-764	ROLLER, CLEAN DRIVE, P310 (5 per kit)	47.00
-------------	---------------------------------------	-------



P330i/P430i ROHS Spare Parts List



105912G-680	KIT, ASSY, FEEDER (Complete) P330i	394.00
-------------	------------------------------------	--------



P330i/P430i ROHS Spare Parts List



© 2010 Zebra Technologies Corporation. All rights reserved. Zebra, the Zebra logo, and Zebra Technologies are trademarks of Zebra Technologies Corporation. All other marks are the property of their respective owners.

105912G-794	SPRING, PRINTHD PRESSURE	23.00
-------------	--------------------------	-------



P330i/P430i ROHS Spare Parts List



© 2010 Zebra Technologies Corporation. All rights reserved. Zebra, the Zebra logo, and other marks contained herein are trademarks of Zebra Technologies Corporation or its affiliates. All other marks contained herein are the property of their respective owners.

105912G-001	SPINDLE, RIBBON, MLDED P310 C/P	38.00
-------------	---------------------------------	-------



P330i/P430i ROHS Spare Parts List

PRINT ENGINE FRAMES

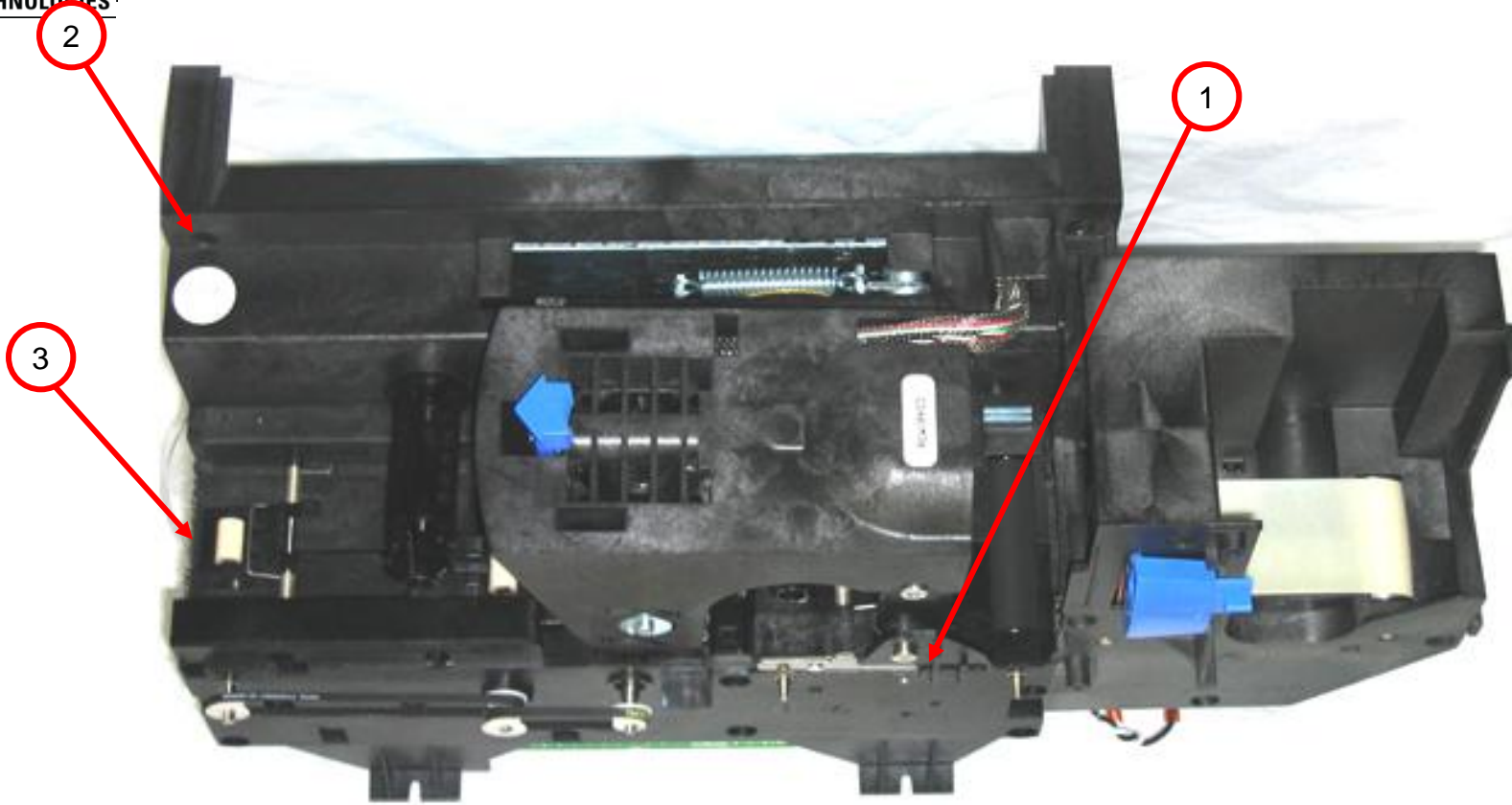

SEE NEXT SLIDE FOR KIT NUMBERS



P330i/P430i ROHS Spare Parts List

1	105912G-657	ASSY, FRONT FRAME	113.00
2	105912G-658	ASSY, CENTER FRAME	208.00
3	105912G-521	KIT, ESD BRUSH 70MM (5/KIT) and 10 push-nuts	75.00



P330i/P430i ROHS Spare Parts List

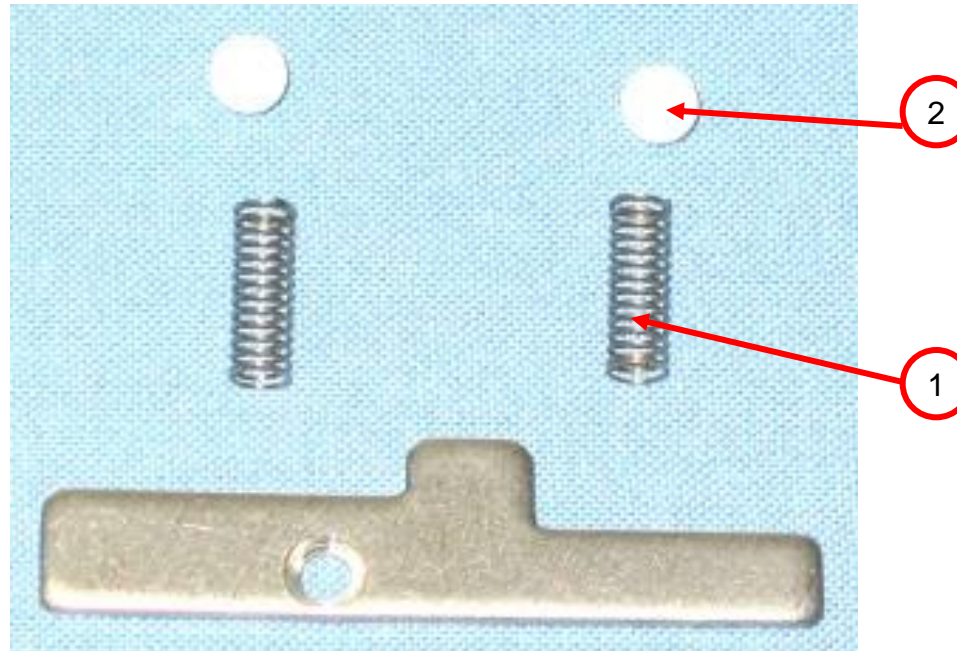

1	105912G-528	SPRINGS,GUIDE (PKG OF 10)	19.00
2	105912G-529	KIT,BALL,5MM,WHT,(20 PER KIT)	29.00



P330i/P430i ROHS Spare Parts List

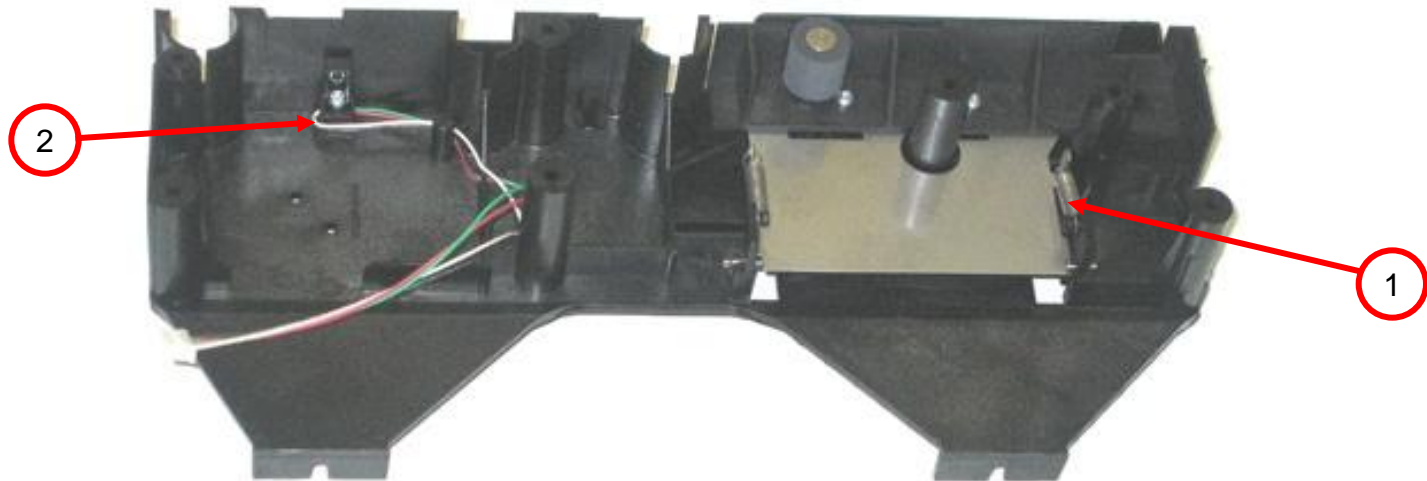

1	105912G-011	SPRINGS CARD PRESSURE	41.00
2	105912G-786	Kit C/A SENSOR CARD	38.00



P330i/P430i ROHS Spare Parts List

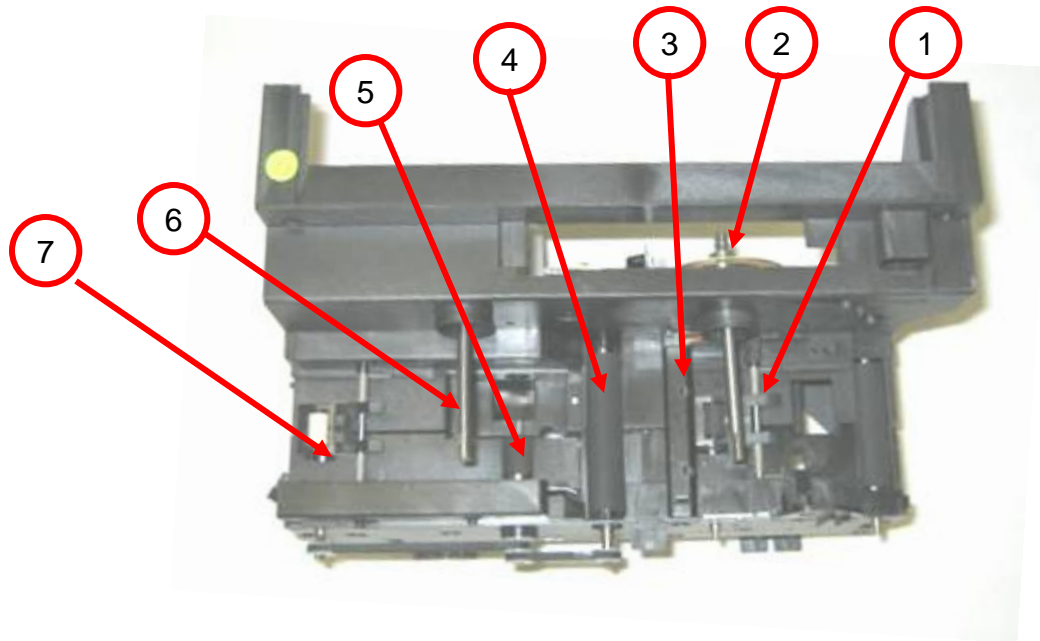

SEE NEXT SLIDE FOR KIT NUMBERS



P330i/P430i ROHS Spare Parts List

Item	Kit Number	Description	Price
01	105912G-757	Entry Pressure Roller Assembly	26.00
02	105912G-629	Assy, Clutch "I" Series	39.00
03	105912G-668	Assy ,Ribbon Color Sensor ,P330i	54.00
04	105912G-590	Roller P/H Platen (5/kit)	46.00
05	105912G-594	Roller, Mag Encoder P310 (5/kit)	49.00
06	105912G-759	Assy Ribbon Pulley Upper	85.00
07	105912G-758	Exit Pressure Roller Assy	26.00



P330i/P430i ROHS Spare Parts List



01	Exit Pressure Roller Assembly	105912G-758	26.00
02	Entry Pressure Roller Assembly	105912G-757	26.00



P330i/P430i ROHS Spare Parts List



ENCODER PRESSURE ROLLER	105912G-012	27.00
-------------------------	--------------------	-------



P330i/P430i ROHS Spare Parts List



ASSY, CLUTCH "I" SERIES	105912G-629	39.00
-------------------------	-------------	-------



P330i/P430i ROHS Spare Parts List



FLAG ENCODER DISC (only) (set of 5)	105912G-534	44.00
-------------------------------------	--------------------	-------



P330i/P430i ROHS Spare Parts List



ASSY,RIBBON COLOR SENSOR,P330i	105912G-668	54.00
--------------------------------	-------------	-------



P330i/P430i ROHS Spare Parts List

FRONT VIEW

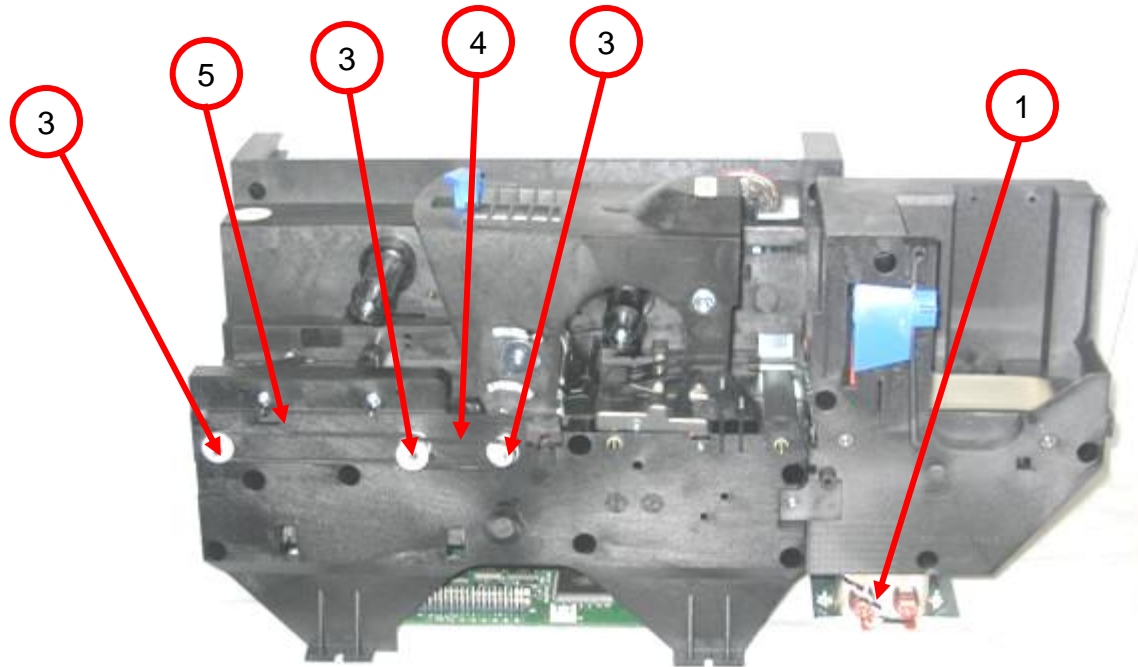

SEE NEXT SLIDE FOR KIT NUMBERS



P330i/P430i ROHS Spare Parts List

Item	Kit Number	Description	Price
01	105912G-890	Filter, EMI Standalone AC	50.00
03	105912G-549	Pulley, 17T, 5MM ID, White (10/kit)	23.00
04	105912G-009	Timing, Belt, 56TX1/8, P310 (5/kit) Front Right Side	30.00
05	105912G-010	Timing, Belt, 104TX1/8, P310 (5/kit) Front Left Side	48.00



P330i/P430i ROHS Spare Parts List

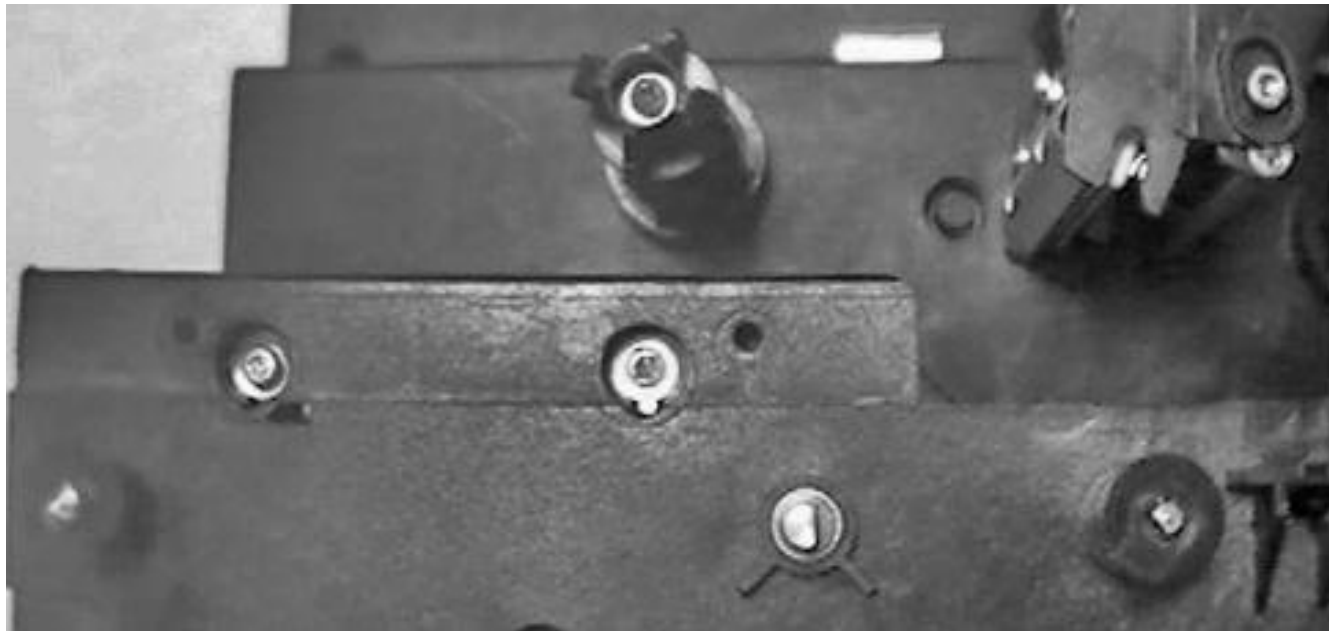

105912G-785	Kit Bearing Ball 8x5x2.5 Qty of 5	20.00
--------------------	-----------------------------------	-------



P330i/P430i ROHS Spare Parts List

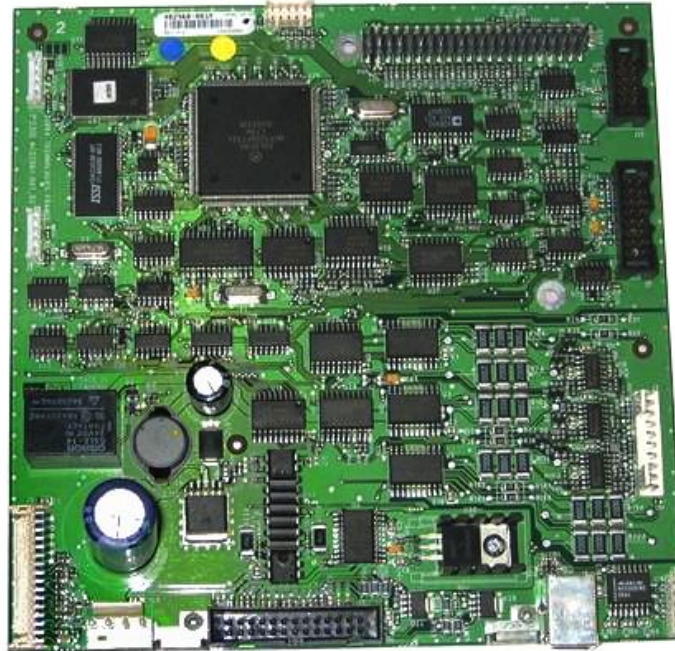

Kit PCBA with Mag P330i	105912G-664	600.00
Kit PCBA with Mag P330m	105912G-664m	600.00
Kit PCBA with Mag P430i	105912G-112	600.00



P330i/P430i ROHS Spare Parts List



PULLEY, 17T, 5MM ID, WHITE 10/kit	105912G-549	23.00
-----------------------------------	--------------------	-------



P330i/P430i ROHS Spare Parts List

Print Engine's Belts

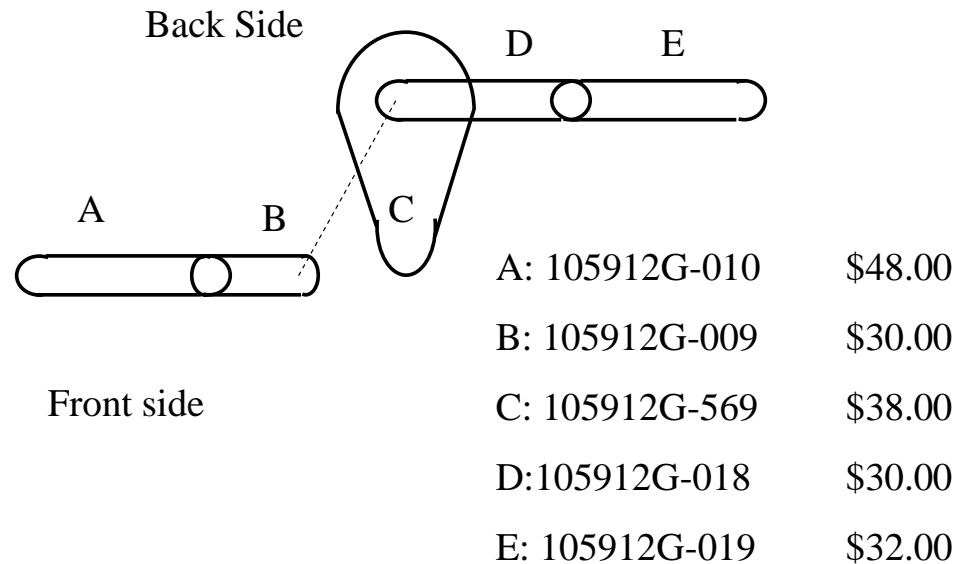



P330i/P430i ROHS Spare Parts List

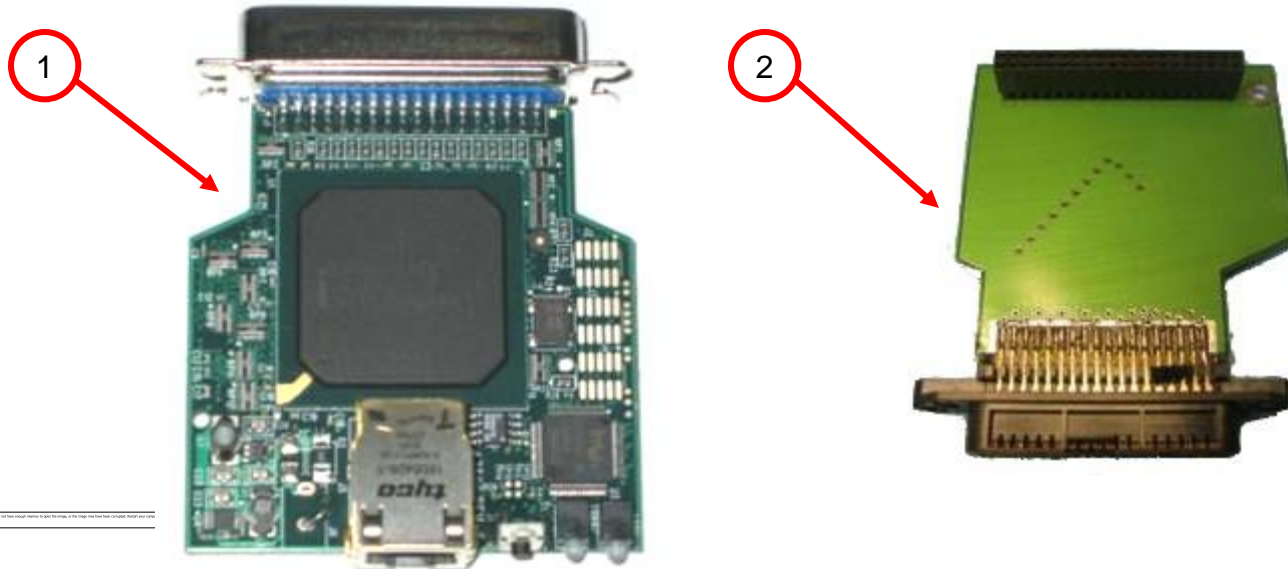

01	ASSY, PRINTSERVER, 100 SMT	105912G-904	375.00
02	ASSY, PRINTSERVER, interface to Main PCBA	105912G-903	264.00



P330i/P430i ROHS Spare Parts List

PRINT ENGINE REAR VIEW

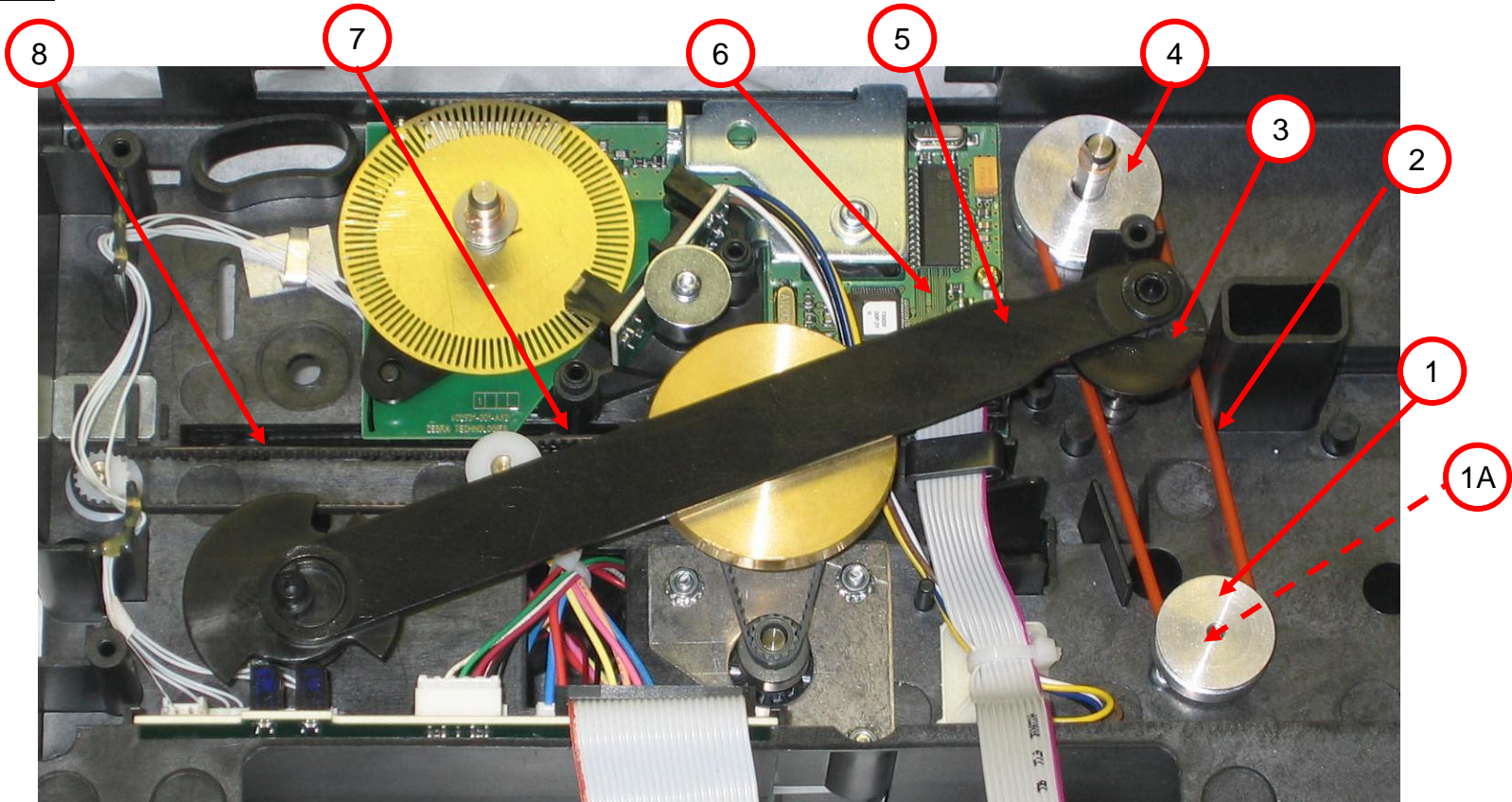

SEE NEXT SLIDE FOR KIT NUMBERS



P330i/P430i ROHS Spare Parts List

Item	Kit Number	Description	Price
01	105912G-760	Assy, Film Motor Pulley	22.00
1A	105912G-787	C/A, Motor, DC, 12V, Low Torque	85.00
02	105909G-038	O-Ring Drive Belt, Ribbon C/P (5/kit)	37.00
03	105912G-551	Upper, Cam, P310 (5/kit)	27.00
04	105912G-759	Assy, Ribbon Pulley, Upper	85.00
05	105912G-538	Cam Follower Arm (5/kit)	27.00
06	105912G-628	RFID Reader, PCBA	111.00
07	105912G-018	Timing Belt, 65T (5/kit) (Rear Right as seen from the back side)	30.00
08	105912G-019	Timing, Belt, 90TX1/8, P310 (5/kit) (Rear Left as seen from the back side)	32.00



P330i/P430i ROHS Spare Parts List

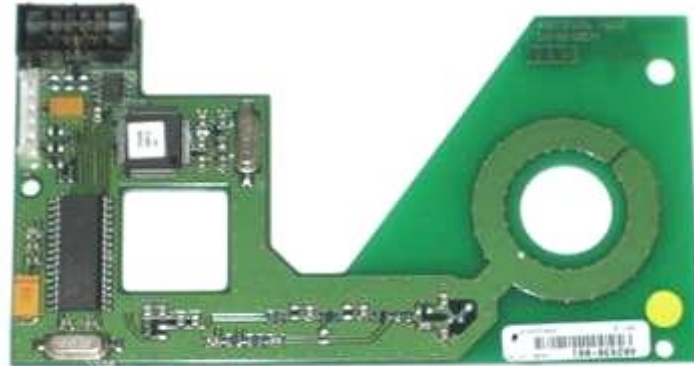

PCBA, P310 RFID READER	105912G-628	111.00
------------------------	-------------	--------



P330i/P430i ROHS Spare Parts List

PRINT ENGINE REAR VIEW

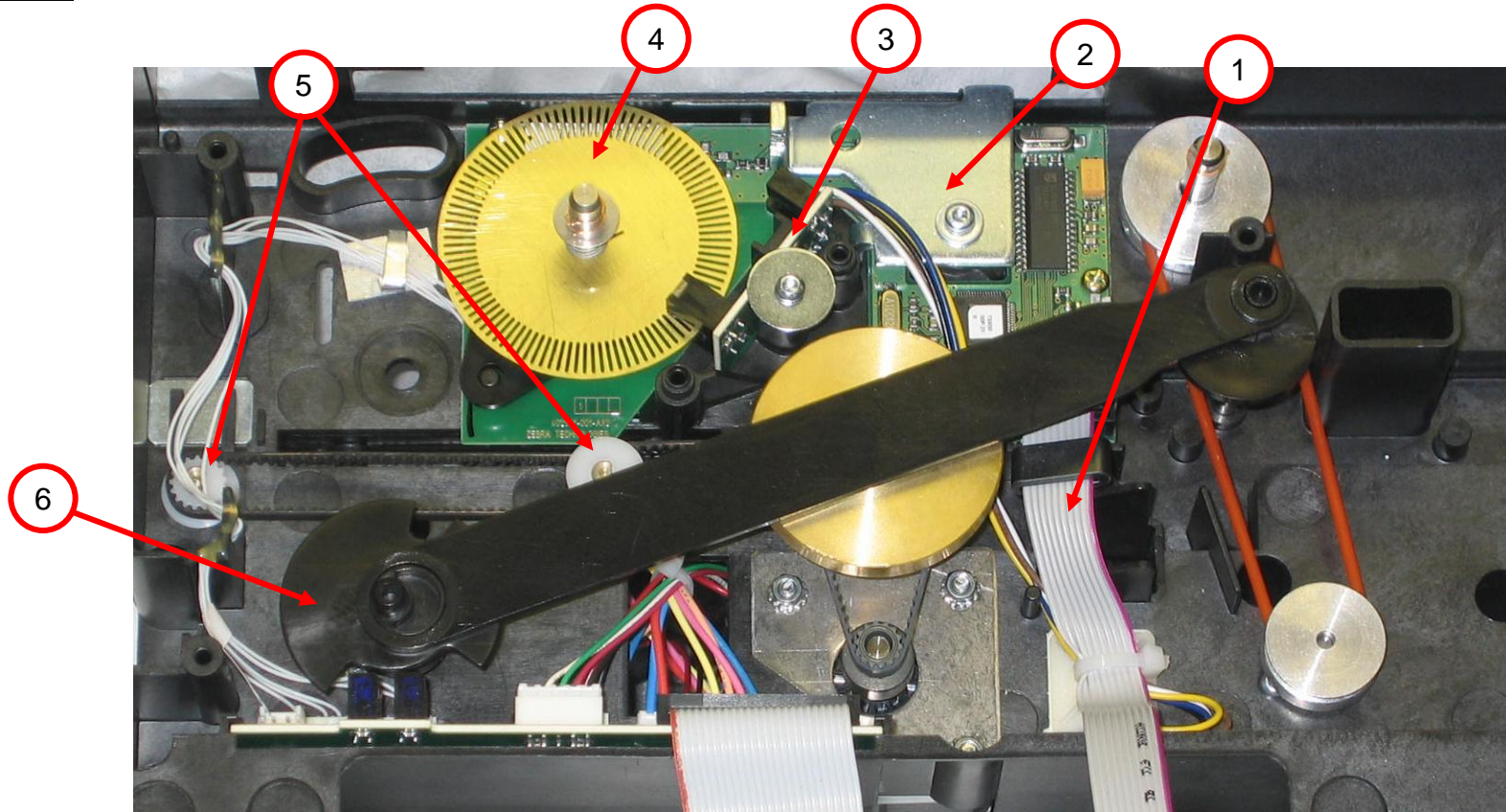

SEE NEXT SLIDE FOR KIT NUMBERS



P330i/P430i ROHS Spare Parts List

Item	Kit Number	Description	Price
01	105912G-766	Cable, Assy, RFID, P330i	48.00
02	105912G-765	Plate Pressure Spring, P330i	32.00
03	105912G-678	PCBA, Film/Bracket Sensor	42.00
04	105912G-534	Flag Encoder Disc (only) (5/kit)	44.00
05	105912G-549	Pulley, 17T, 5MM ID, White (10/kit)	23.00
06	105912G-799	Cam, Print Head Lift, P330i	33.00*



P330i/P430i ROHS Spare Parts List

PRINT ENGINE REAR VIEW

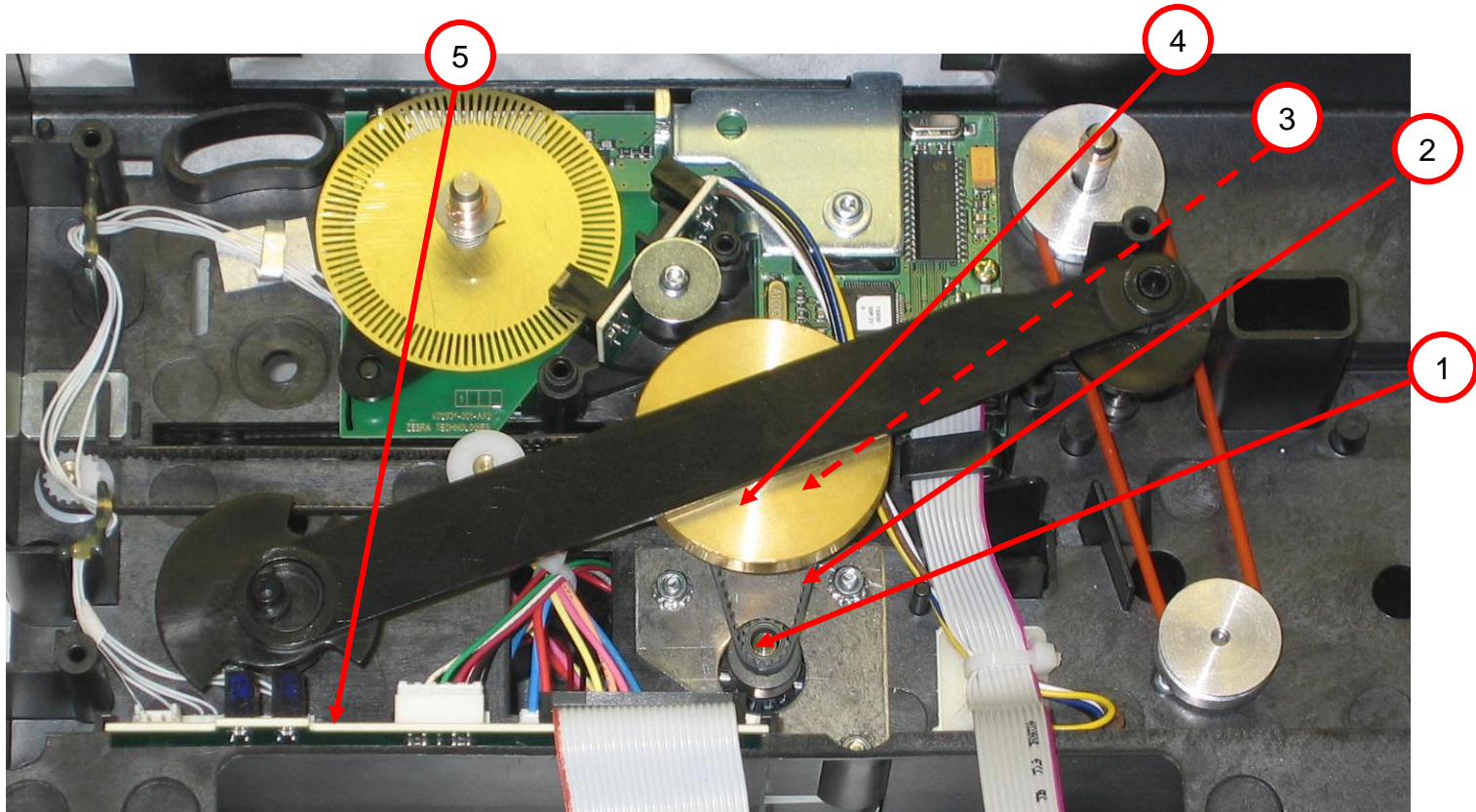

SEE NEXT SLIDE FOR KIT NUMBERS



P330i/P430i ROHS Spare Parts List

Item	Kit Number	Description	Price
01	105909G-103	Motor, Stepper and Cable	209.00
02	105912G-569	Belt, 63T, 4MMW, PU/Kevlar (5/kit) (Stepper Motor Belt)	38.00
03	105912G-547	Pulley, 42T, 5MM ID, White (5/kit)	31.00
04	105912G-545	Inertia, Roller/Set Screw	27.00
05	105912G-679	PCBA, I/O Daughter, P330i	73.00



P330i/P430i ROHS Spare Parts List



MOTOR, STEPPER and CABLE	105909G-103	209.00
--------------------------	-------------	--------



P330i/P430i ROHS Spare Parts List



PULLEY, 42T, 5MM ID, WHITE 5/kit	105912G-547	31.00
----------------------------------	--------------------	-------



P330i/P430i ROHS Spare Parts List



PCBA, I/O DAUGHTER, P330i	105912G-679	73.00
---------------------------	-------------	-------



P330i/P430i ROHS Spare Parts List

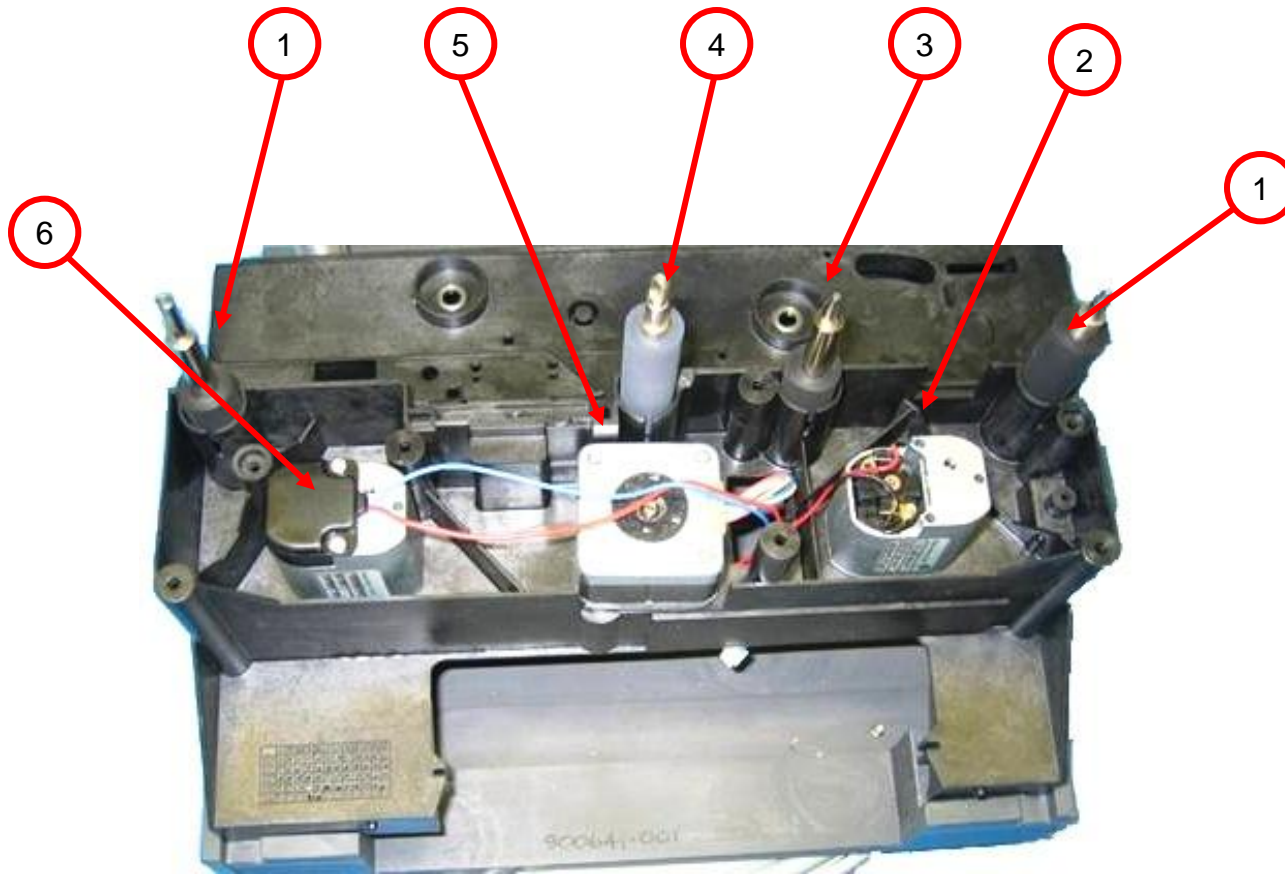



P330i/P430i ROHS Spare Parts List

Item	Kit Number	Description	Price
01	105912G-764	Roller, Clean, Drive (5/kit)	47.00
02	105912G-787	C/A, Motor, DC, HIGH TORQUE	85.00
03	105912G-586	Roller, Card Drive (5/kit)	45.00
04	105912G-590	Roller, Printhead, Platen, P310 (5/kit)	46.00
05	105909G-103	Motor, Stepper and Cable	209.00
06	105912G-006	Motor, D.C. & Cable LOW TORQUE	85.00



P330i/P430i ROHS Spare Parts List



BEARING, BALL, FLANGED (17/kit)	105912G-180	76.00



P330i/P430i ROHS Spare Parts List



Item #	Kit Number	Description	Price
01	105912G-594	Magnetic Encoder Roller (5/kit)	49.00
02	105912G-591	Magnetic Encoder Roller, Reversed (EA.)	24.00



P330i/P430i ROHS Spare Parts List



Item #	Kit Number	Description	Price
01	105912G-031	PCBA Magnetic Sensor (only)	64.00
02	105912G-323`	Complete Mag Upgrade for non-mag printers (may require -664)	500.00
02A	105912G-754	Encoder ISO Stripe Down/Normal P330i (Encoder Module Only)	500.00



P330i/P430i ROHS Spare Parts List

CARD FEEDER



P330i/P430i ROHS Spare Parts List

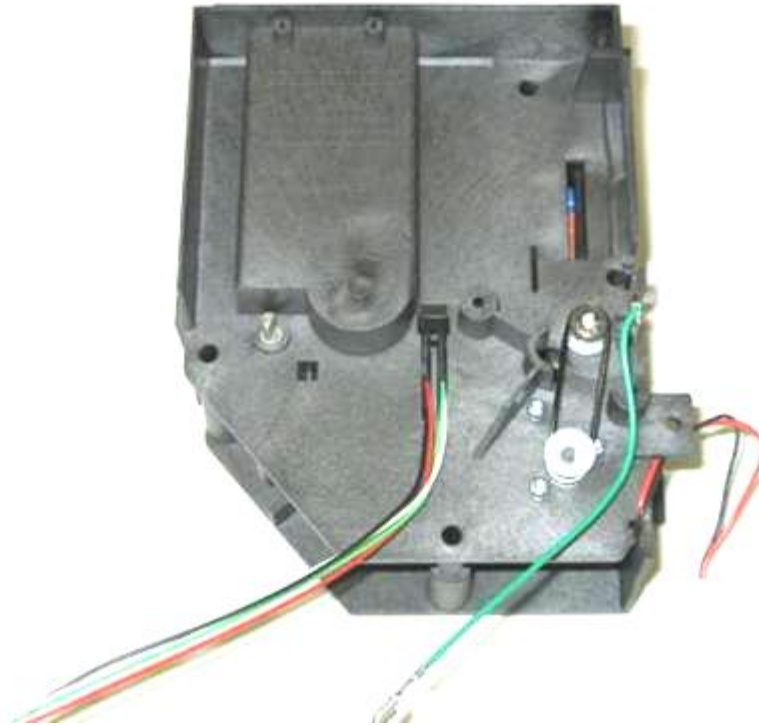

DESCRIPTION	KIT NUMBER	PRICE
KIT, ASSY, FEEDER (COMPLETE) P330i	105912G-680	394.00



P330i/P430i ROHS Spare Parts List



DESCRIPTION	KIT NUMBER	PRICE
FEEDER, FRONT HALF	105912G-808	45.00



P330i/P430i ROHS Spare Parts List

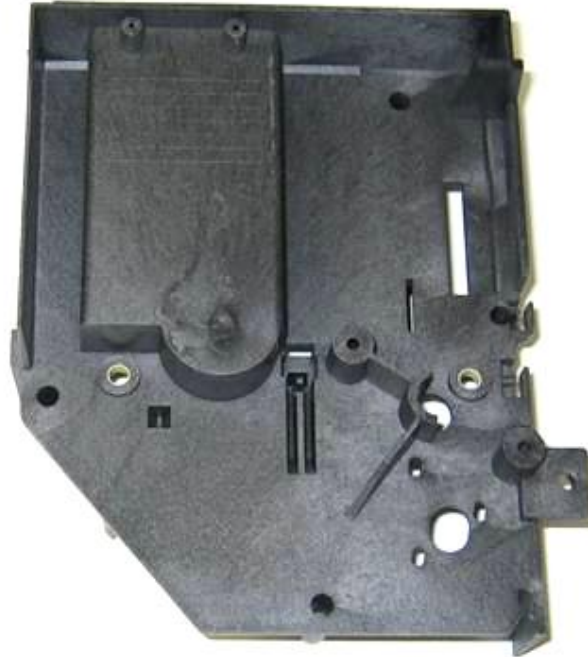

DESCRIPTION	KIT NUMBER	PRICE
ASSY, REAR FEEDER W/BEARING	105912G-809	53.00



P330i/P430i ROHS Spare Parts List



DESCRIPTION	KIT NUMBER	PRICE
C/A MOTOR DC, HI TORQ	105912G-787	85.00



P330i/P430i ROHS Spare Parts List



DESCRIPTION	KIT NUMBER	PRICE
KIT, ERING RIBBON DC MOTOR, Set of 10	105912G-891	20.00



P330i/P430i ROHS Spare Parts List



DESCRIPTION	KIT NUMBER	PRICE
ESD, BRUSH, 70MM (5) and 10 PUSH-NUTS	105912G-521	75.00



P330i/P430i ROHS Spare Parts List

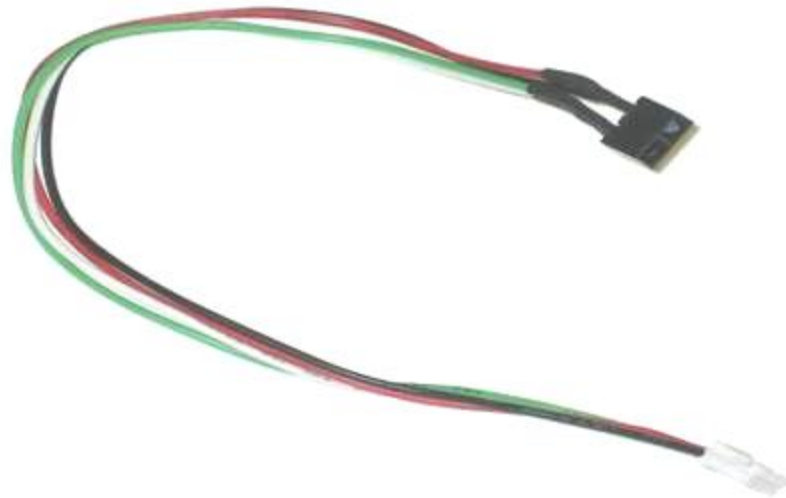

DESCRIPTION	KIT NUMBER	PRICE
C/A CARD SINGLE FEED SENSOR	105912G-806	36.00



P330i/P430i ROHS Spare Parts List

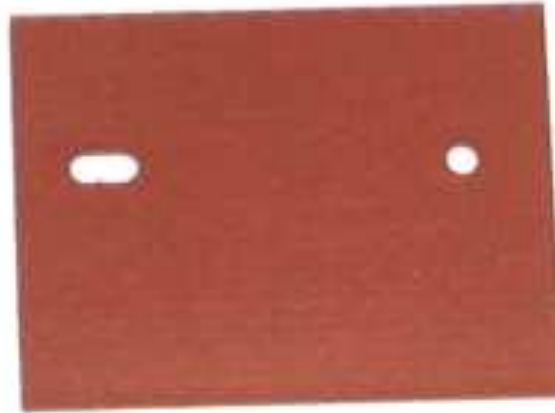

DESCRIPTION	KIT NUMBER	PRICE
GATE, RUBBER, FDR, P330i	105912G-859	27.00



P330i/P430i ROHS Spare Parts List



DESCRIPTION	KIT NUMBER	PRICE
BLOCK, FDR, 330i	105912G-862	19.00



P330i/P430i ROHS Spare Parts List



DESCRIPTION	KIT NUMBER	PRICE
PLATE, GATE, FDR P330i	105912G-861	20.00



P330i/P430i ROHS Spare Parts List



DESCRIPTION	KIT NUMBER	PRICE
LEVER, GATE, FDR, P330i	105912G-860	19.00



P330i/P430i ROHS Spare Parts List



DESCRIPTION	KIT NUMBER	PRICE
BELT, FDR, 330i	105912G-858	71.00



P330i/P430i ROHS Spare Parts List



DESCRIPTION	KIT NUMBER	PRICE
SPRING,STACKING ROLLER AXIAL P330i (10/kit)	105912G-776	21.00



P330i/P430i ROHS Spare Parts List



DESCRIPTION	KIT NUMBER	PRICE
PUSHNUT, 05MM,Kit of 20	105912G-783	35.00



P330i/P430i ROHS Spare Parts List



DESCRIPTION	KIT NUMBER	PRICE
FEEDER BELT, TIMING, 56T, 2MM, 4MM (5/kit)	105912G-897	44.00



P330i/P430i ROHS Spare Parts List



DESCRIPTION	KIT NUMBER	PRICE
PULLEY, 17T, 5MM ID, WHITE(10/KIT)	105912G-549	23.00



P330i/P430i ROHS Spare Parts List



DESCRIPTION	KIT NUMBER	PRICE
PULLEY, 17T, 3MM (10/KIT)	105912G-525	29.00



P330i/P430i ROHS Spare Parts List



DESCRIPTION	KIT NUMBER	PRICE
ROLLER, FDR, P330i	105912G-857	48.00



P330i/P430i ROHS Spare Parts List



DESCRIPTION	KIT NUMBER	PRICE
TAPE, TEFLON, PSA BACKED	105912G-829	19.00



P330i/P430i ROHS Spare Parts List

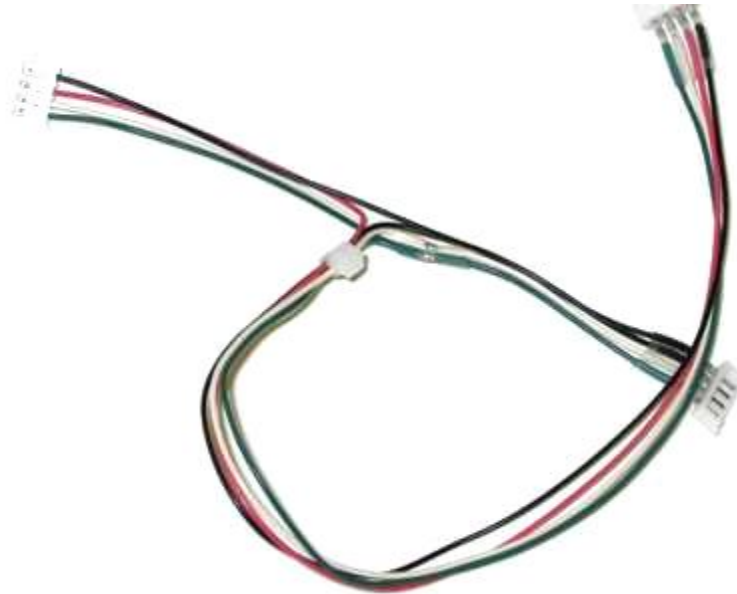

DESCRIPTION	KIT NUMBER	PRICE
C/A, FEEDER SENSOR, "Y" CABLE	105912G-805	75.00



P330i/P430i ROHS Spare Parts List



DESCRIPTION	KIT NUMBER	PRICE
C/A CARD SINGLE FEED SENSOR	105912G-806	36.00



P330i/P430i ROHS Spare Parts List

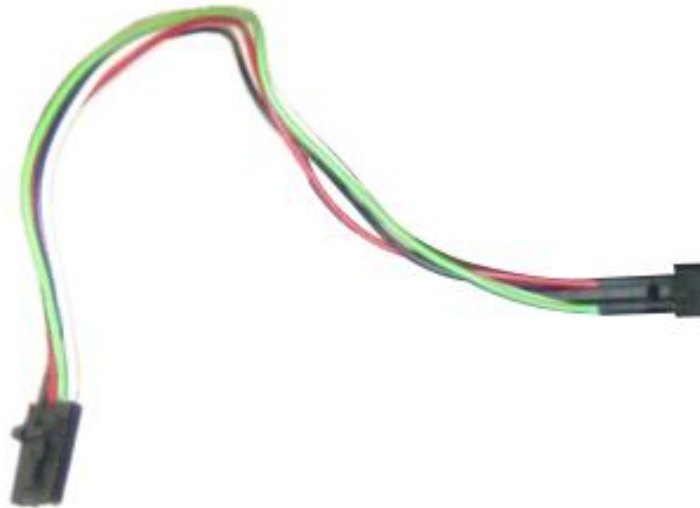

DESCRIPTION	KIT NUMBER	PRICE
C/A, FEEDER SENSOR	105912G-132	75.00



P330i/P430i ROHS Spare Parts List

PRINthead SPARE PARTS



P330i/P430i ROHS Spare Parts List

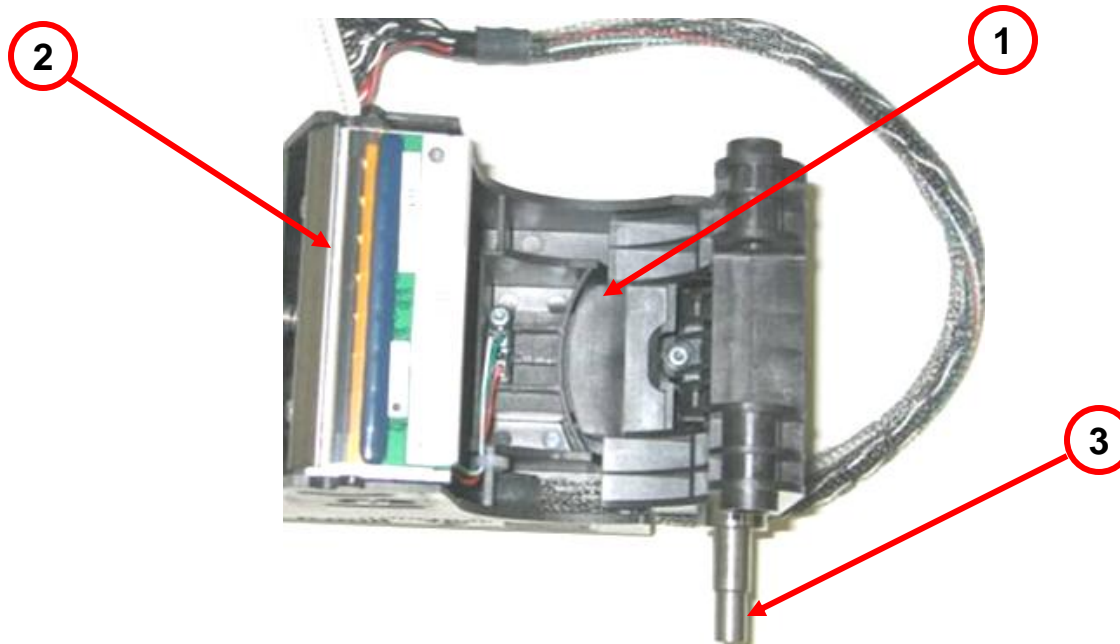

01	Brkt,Head U-Support,P330i	105912G-842	32.00
02	Kit, Print Head Assembly G4A	105912G-346A	599.00
03	Shaft, Ball Joint, P330i	105912G-851	87.00



P330i/P430i ROHS Spare Parts List



DESCRIPTION	KIT NUMBER	PRICE
C/A, P/H BRKT/ FAN, P330i	105912G-877	147.00



P330i/P430i ROHS Spare Parts List



© 2010 Zebra Technologies Corporation. All rights reserved. Zebra, the Zebra logo, and other marks contained herein are trademarks of Zebra Technologies Corporation or its affiliates. All other marks contained herein are the property of their respective owners.

DESCRIPTION	KIT NUMBER	PRICE
SPRING, ANGLE-ADJUSTMENT, P330i (10/kit)	105912G-848	24.00



P330i/P430i ROHS Spare Parts List



DESCRIPTION	KIT NUMBER	PRICE
P/H ANGLE ADJ SCREW (10/kit)	105912G-711	26.00



P330i/P430i ROHS Spare Parts List



DESCRIPTION	KIT NUMBER	PRICE
SHAFT, ANGLE ADJUSTMENT, P330i	105912G-850	32.00



P330i/P430i ROHS Spare Parts List

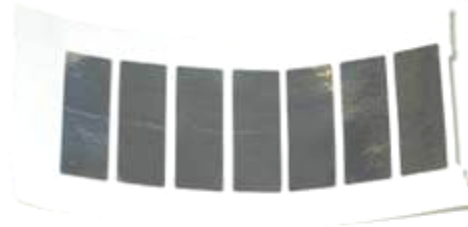

DESCRIPTION	KIT NUMBER	PRICE
TAPE, REFLECTIVE	105912G-828	21.00



P330i/P430i ROHS Spare Parts List



© 2010 Zebra Technologies Corporation. All rights reserved. Zebra, the Zebra logo, and the Zebra head logo are trademarks of Zebra Technologies Corporation. All other marks are the property of their respective owners.

DESCRIPTION	KIT NUMBER	PRICE
BRKT,HEAD U-SUPPORT,P330i	105912G-842	32.00



P330i/P430i ROHS Spare Parts List



© 2010 Zebra Technologies Corporation. All rights reserved. Zebra Technologies Corporation, 1000 Zebra Drive, Wakefield, MA 01880. Zebra Technologies Corporation is not responsible for errors or for any consequences arising from the use of the information contained in this document. Zebra Technologies Corporation is not responsible for errors or for any consequences arising from the use of the information contained in this document.

DESCRIPTION	KIT NUMBER	PRICE
BRACKET, PIVOT, P330i	105912G-843	25.00



P330i/P430i ROHS Spare Parts List



DESCRIPTION	KIT NUMBER	PRICE
CAP, BALL JOINT, P330i	105912G-844	20.00



P330i/P430i ROHS Spare Parts List



DESCRIPTION	KIT NUMBER	PRICE
LATCH, P330i (5/kit)	105912G-845	37.00



P330i/P430i ROHS Spare Parts List



© 2010 Zebra Technologies Corporation. All rights reserved. Zebra Technologies Corporation, 1000 Zebra Drive, Wakefield, MA 01880. Zebra Technologies Corporation is an Equal Opportunity Employer. All other trademarks are the property of their respective owners.

DESCRIPTION	KIT NUMBER	PRICE
SHAFT, BALL JOINT, P330i	105912G-851	87.00



P330i/P430i ROHS Spare Parts List



© 2010 Zebra Technologies Corporation. All rights reserved. Zebra, the Zebra logo, and other marks contained herein are trademarks of Zebra Technologies Corporation or one of its direct or indirect subsidiaries. All other marks contained herein are the property of their respective owners.

DESCRIPTION	KIT NUMBER	PRICE
BUTTON,LATCH,P330I (5/Kit)	105912G-846	28.00



P330i/P430i ROHS Spare Parts List



© 2010 Zebra Technologies Corporation. All rights reserved. Zebra, the Zebra logo, and P330i are trademarks of Zebra Technologies Corporation. All other marks are the property of their respective owners.

DESCRIPTION	KIT NUMBER	PRICE
SPRING, LATCH, HIGH FORCE, P330i (5/kit)	105912G-777	43.00



P330i/P430i ROHS Spare Parts List



© 2010 Zebra Technologies Corporation. All rights reserved. Zebra, the Zebra logo, and P330i are trademarks of Zebra Technologies Corporation. All other marks are the property of their respective owners.

DESCRIPTION	KIT NUMBER	PRICE
GUIDE, REFLECTOR, P330i	105912G-853	26.00



P330i/P430i ROHS Spare Parts List



© 2010 Zebra Technologies Corporation. All rights reserved. Zebra Technologies Corporation, 1000 Zebra Way, Lincoln, NE 68504. Zebra Technologies Corporation is not responsible for errors or for any consequences arising from the use of the information contained in this document. Zebra Technologies Corporation is not responsible for errors or for any consequences arising from the use of the information contained in this document.

DESCRIPTION	KIT NUMBER	PRICE
BAR, PEEL, P330i	105912G-852	27.00



P330i/P430i ROHS Spare Parts List

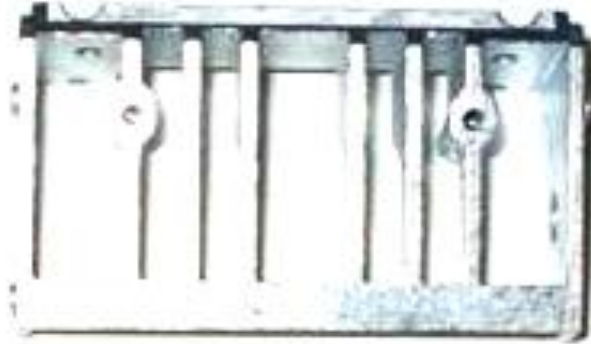

DESCRIPTION	KIT NUMBER	PRICE
SUPPORT, HEAD, TOSHIBA, P330i	105912G-849	31.00



P330i/P430i ROHS Spare Parts List

SMART CARD COMPONENTS



P330i/P430i ROHS Spare Parts List



105912G-037	CONTACT STATION GEM+	70.00
-------------	----------------------	-------



P330i/P430i ROHS Spare Parts List



105912G-039	SMART CARD CONTACT STATION	36.00
-------------	----------------------------	-------



P330i/P430i ROHS Spare Parts List



105912G-045	CABLE I/F TO CONTACT STATION	36.00
-------------	------------------------------	-------



P330i/P430i ROHS Spare Parts List

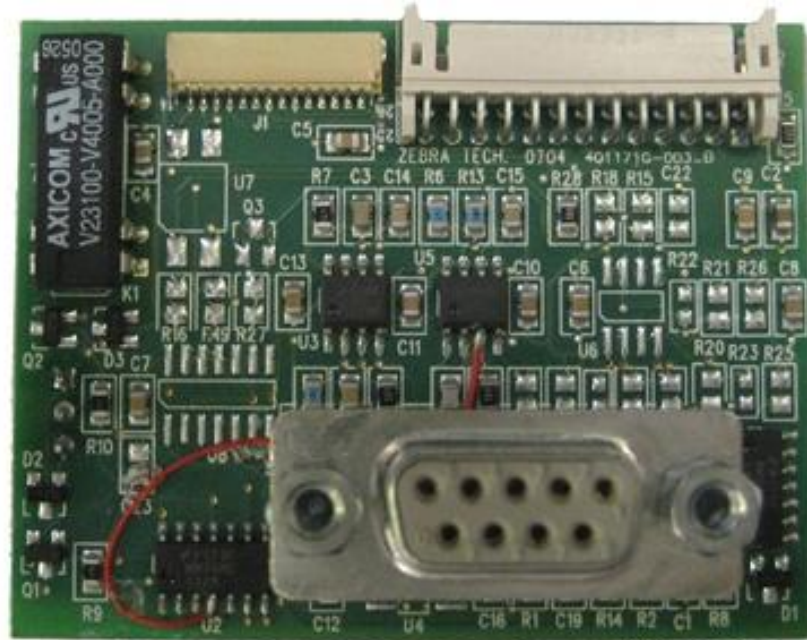

105912G-048	SOLENOID STATION	100.00
-------------	------------------	--------



P330i/P430i ROHS Spare Parts List

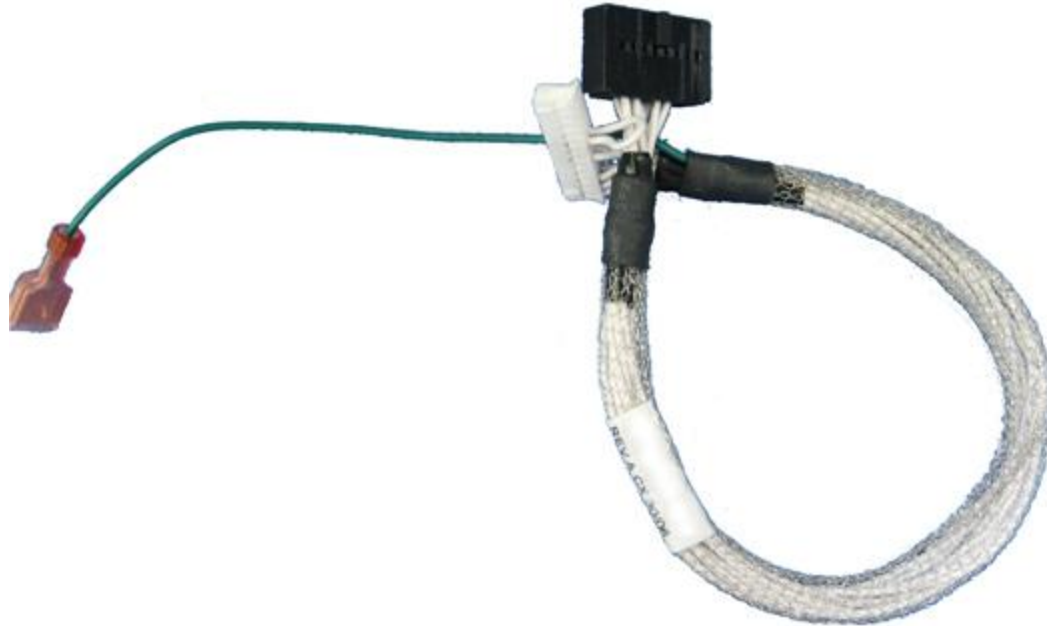

105912G-049	CABLE SMART CARD	80.00
-------------	------------------	-------



P330i/P430i ROHS Spare Parts List

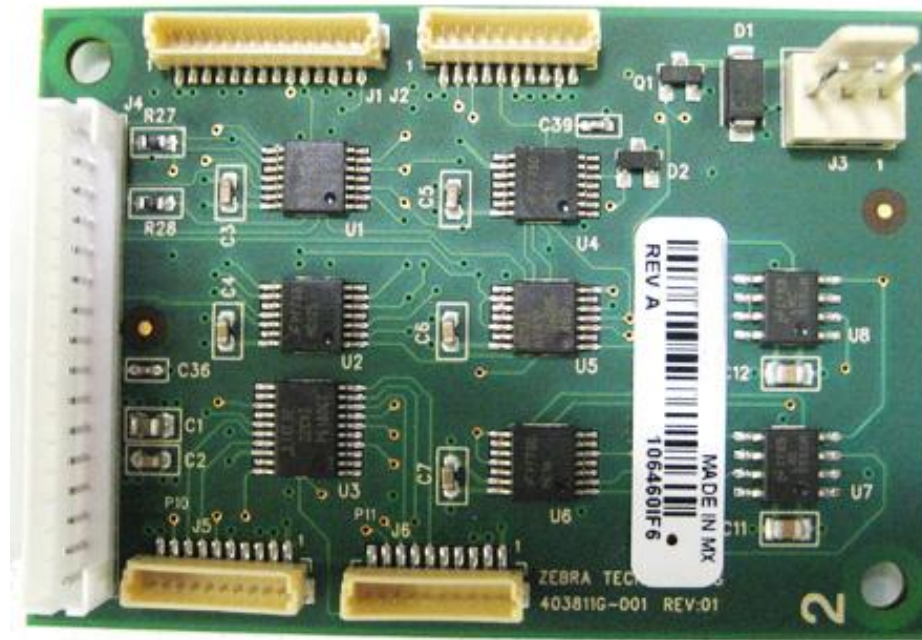

105912G-052	PCBA I/O INTERFACE	66.00
-------------	--------------------	-------



P330i/P430i ROHS Spare Parts List



105912G-054	CABLE GEM+	75.00
-------------	------------	-------



P330i/P430i ROHS Spare Parts List

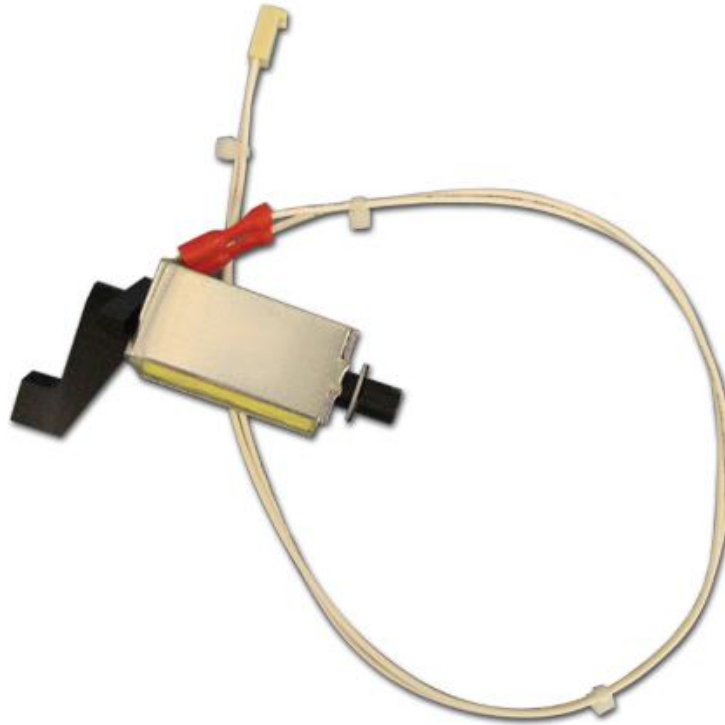

105912G-892	SOLENOID STATION	210.00
-------------	------------------	--------



P330i/P430i ROHS Spare Parts List

P430i PRINTER ENCLOSURES



P330i/P430i ROHS Spare Parts List

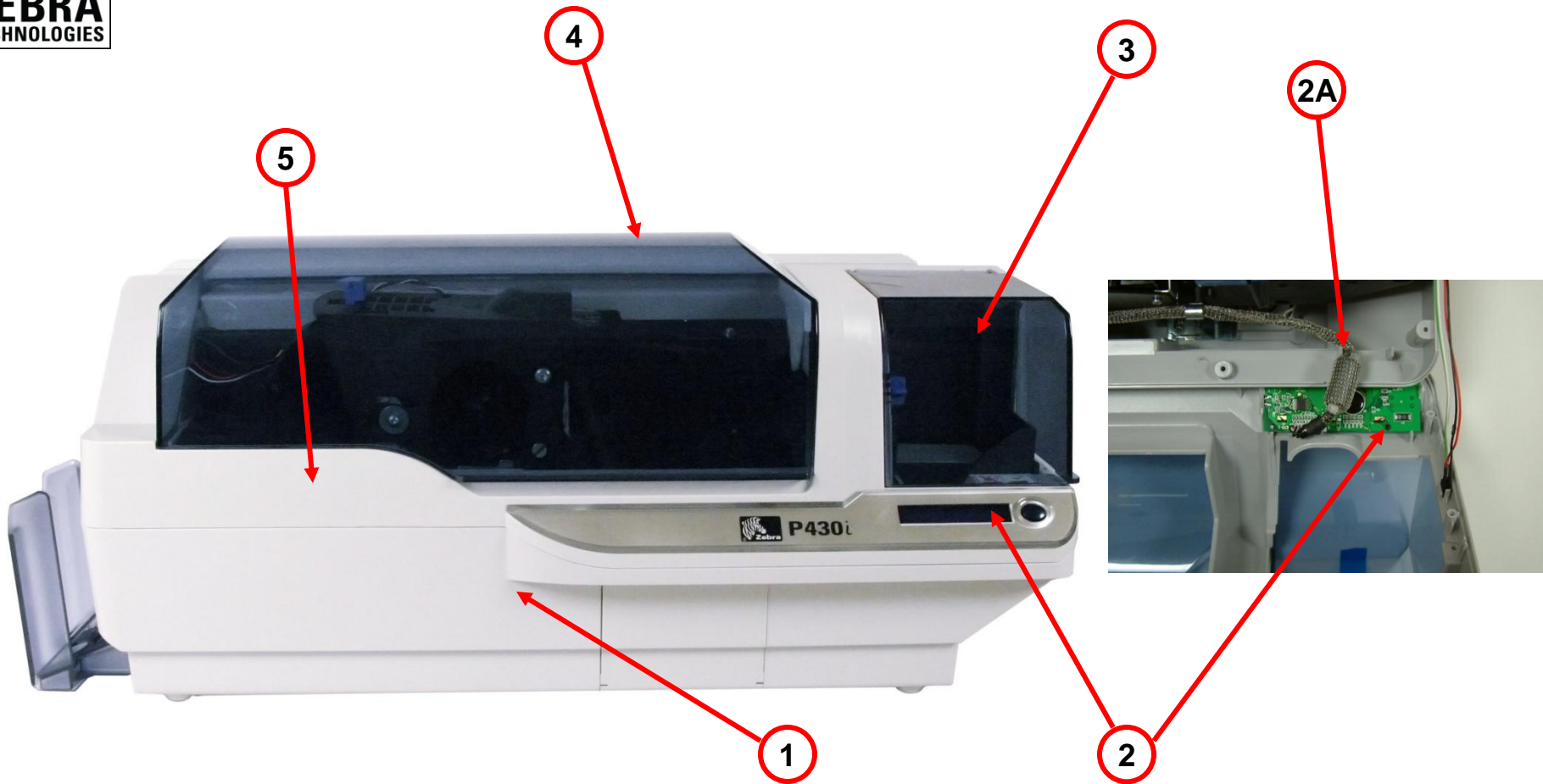

SEE NEXT SLIDE FOR KIT NUMBERS



P330i/P430i ROHS Spare Parts List

ITEM #	DESCRIPTION	KIT NUMBER	PRICE
01	LOWER MOLDING P430i	105912G-109	91.00
02	LCD PANEL	105912G-669	90.00
02A	P430 LCD CABLE	105912G-115	29.00
03	FEEDER COVER P330i	105912G-675	27.00
04	TOP COVER P430i	105912G-110	56.00
05	TOP MOLDING P430i	105912G-108	114.00



P330i/P430i ROHS Spare Parts List



SEE NEXT SLIDE FOR KIT NUMBERS



P330i/P430i ROHS Spare Parts List

ITEM #	DESCRIPTION	KIT NUMBER	PRICE
01	OVAL LCD SWITCH COVER (20)	105912G-676	62.00
02	HOPPER ASSEMBLY P330i	105912G-671	33.00



P330i/P430i ROHS Spare Parts List

Picture is P330i but parts are valid for both printers

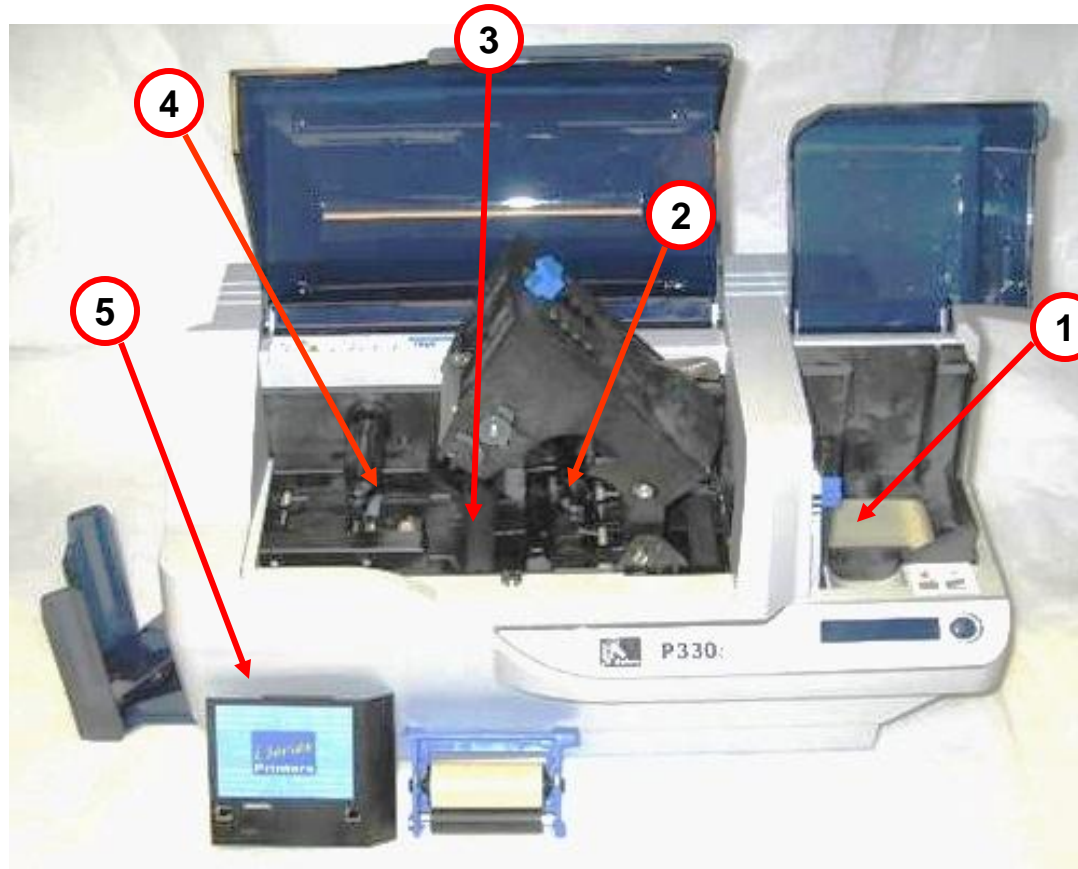

SEE NEXT SLIDE FOR KIT NUMBERS



P330i/P430i ROHS Spare Parts List

ITEM #	DESCRIPTION	KIT NUMBER	PRICE
01	BELT, FEEDDER, P330i	105912G-858	71.00
02	ENTRY PRESSURE ROLLER	105912G-757	26.00
03	PLATEN ROLLER PRINT HEAD	105912G-590	46.00
04	MAG PRESSURE ROLLER	105912G-012	27.00
05	SHORT ENCODER SHROUD	105912G-681	26.00



P330i/P430i ROHS Spare Parts List

Picture is P330i but parts are valid for both printers

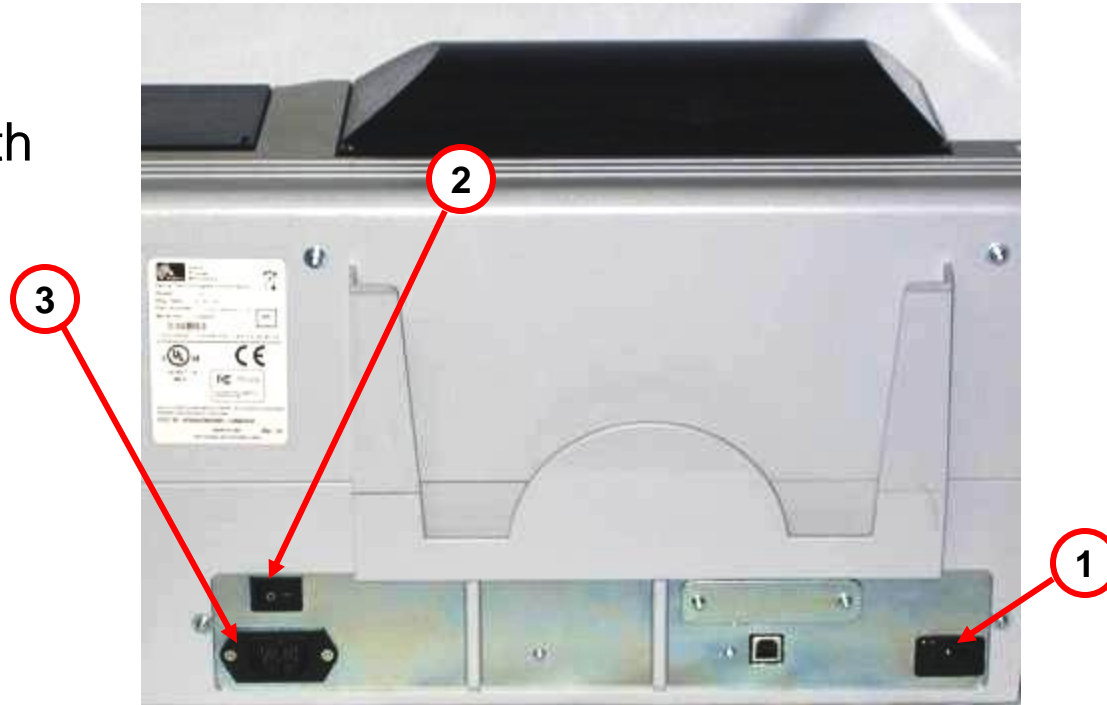

SEE NEXT SLIDE FOR KIT NUMBERS



P330i/P430i ROHS Spare Parts List

ITEM #	DESCRIPTION	KIT NUMBER	PRICE
01	DB9 VINYL PLATE (set of 20)	105912G-667	23.00
02	AC POWER SWITCH (5/kit)	105912G-516	33.00
03	ENTRY MODULE,PWR,250VAC,IEC	105912G-889	22.00
	PACKING SET, P430i	105912-328 (no G)	85.00



P330i/P430i ROHS Spare Parts List

P430i FLIPPER MODULE



P330i/P430i ROHS Spare Parts List

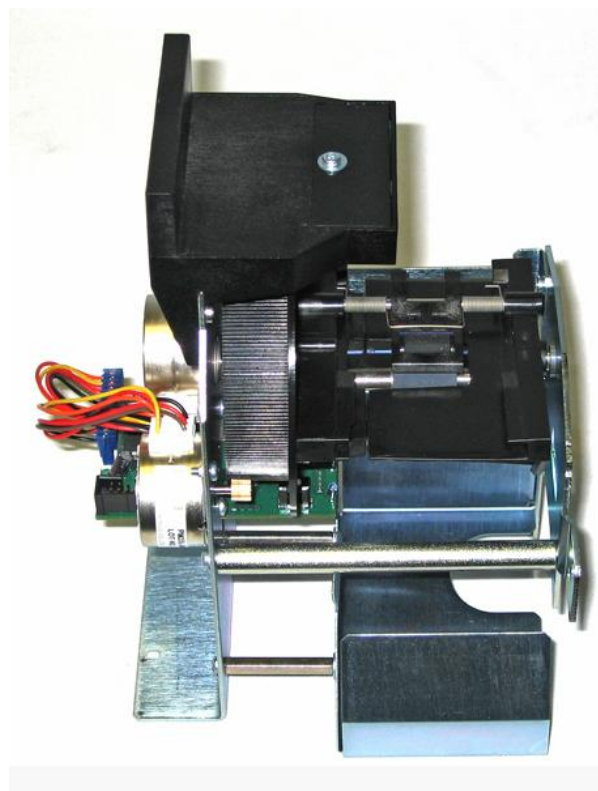

Kit Number	Description	Price
105912G-113	Flipper Unit (complete)	331.00



P330i/P430i ROHS Spare Parts List

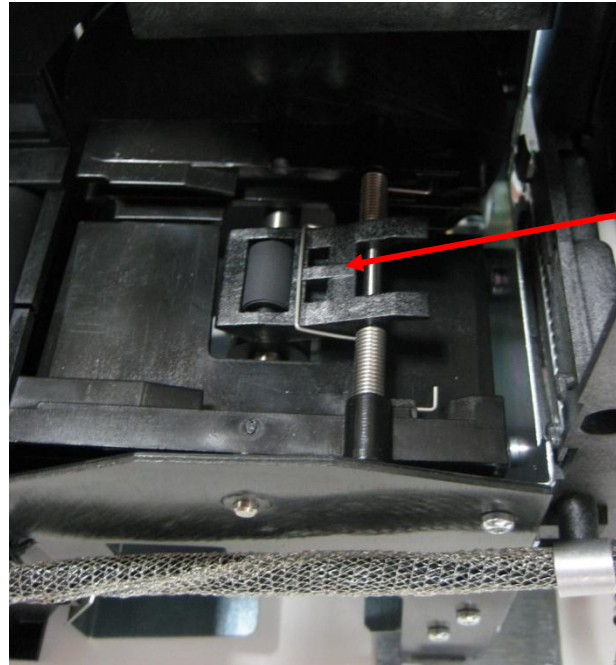

Kit Number	Description	Price
105912G-057	Kit,Roller, Pressure, Flip Over (Set of 5)	51.00



P330i/P430i ROHS Spare Parts List

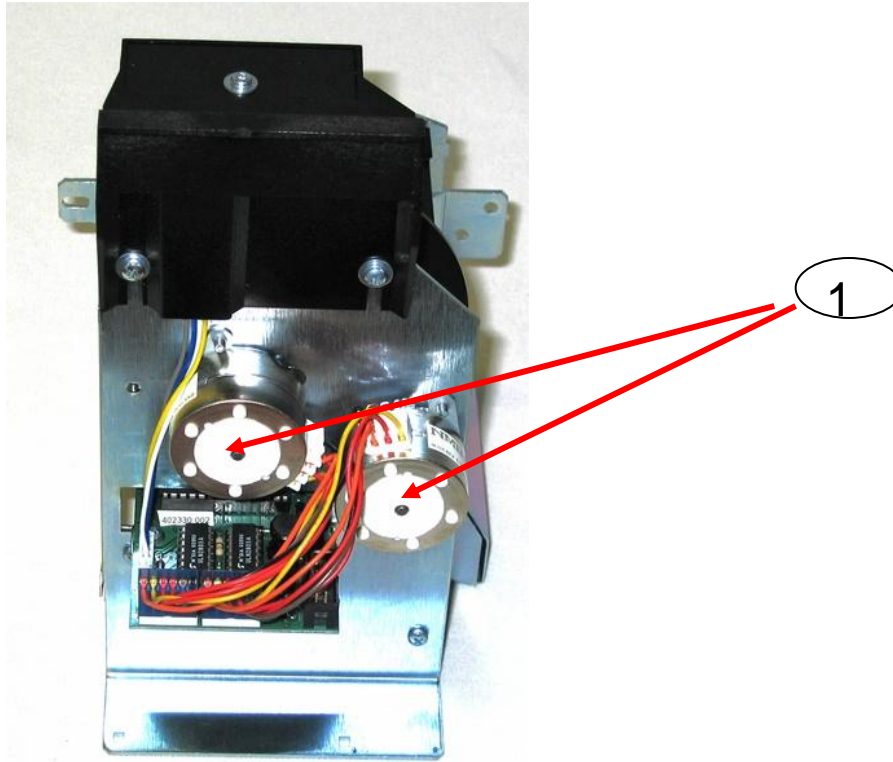

Item #	Kit Number	Description	Price
1	105912G-072	Motor Stepper Each	42.00



P330i/P430i ROHS Spare Parts List

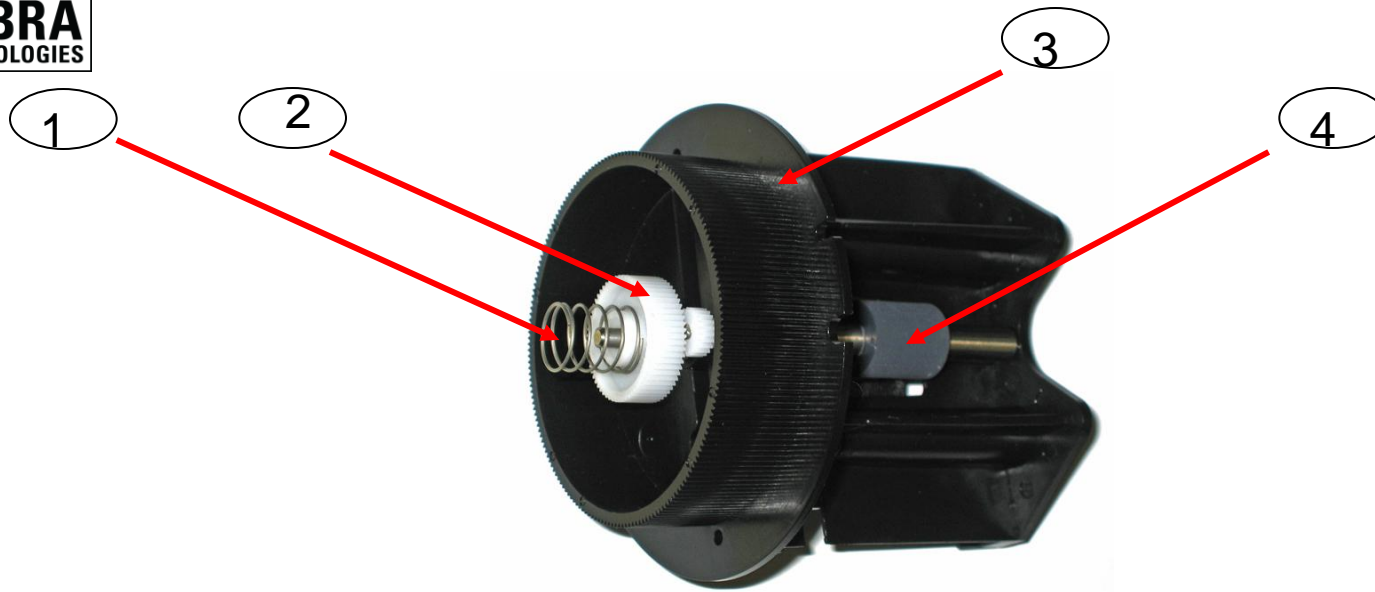

Item #	Kit Number	Description	Price
1	105912G-552	Spring, Flip Over (Set of 20)	30.00
2	105912G-555	Pinion Gear Pair, (Set of 5)	48.00
3	105912G-553	Assembly Module 1	26.00
4	105912G-863	Roller Flip Over (Set of 5)	74.00



P330i/P430i ROHS Spare Parts List

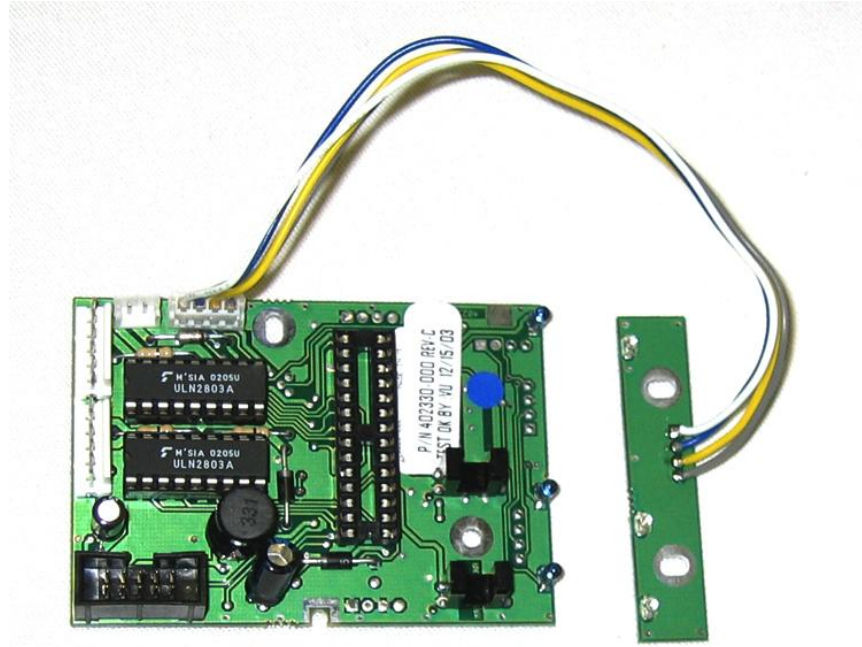

Kit Number	Description	Price
105912G-114	PCBA Flip Over & Sensor Kit	71.00