

SIEMENS



Gigaset C380 - C385

Issued by
Gigaset Communications GmbH
Schlavenhorst 66, D-46395 Bocholt
Gigaset Communications GmbH is a trademark licensee of Siemens AG

© Gigaset Communications GmbH 2008
All rights reserved.
Subject to availability. Rights of modifications reserved.

www.gigaset.com

Gigaset

The handset at a glance

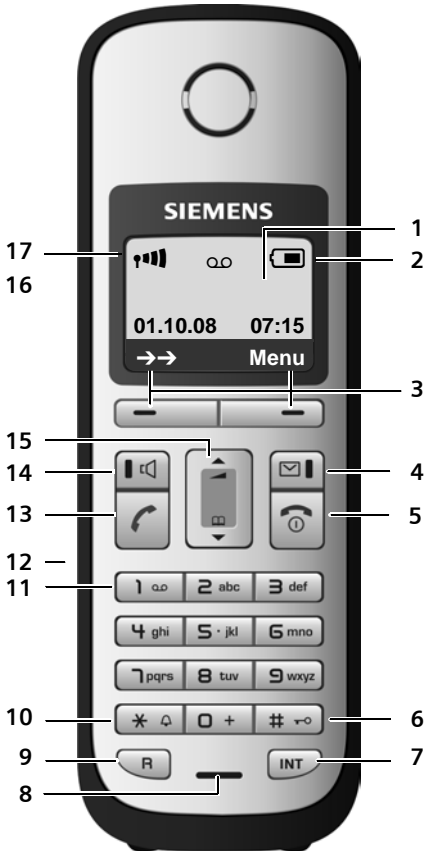

- 1 **Display** in idle status (example)
- 2 **Charge status of the batteries** (→ page 11)
- 3 **Display keys** (→ page 17)
- 4 **Message key** (→ page 27)
Access to calls and message lists;
Flashes: new message or new call
- 5 **End call key, On/Off key**
End call, cancel function, go back one menu level (press briefly), back to idle status (press and hold), activate/deactivate handset (press and hold in idle status)
- 6 **Hash key**
Keypad lock on/off (press and hold in idle status);
toggle between upper/lower case and digits
- 7 **Internal key**
Make an internal call (→ page 43)
- 8 **Microphone**
- 9 **Recall key** (→ page 49)
- Recall (flash)
- Insert a dialling pause (press and hold)
- 10 **Star key**
Ringer tones on/off (press and hold),
With an existing connection:
Switch between dial pulsing/touch tone dialling (press briefly)
- 11 **Key 1** (→ page 40)
Dial answer machine (C385 only)/network mailbox (press and hold)
- 12 **Connection socket** for headset (→ page 15)
- 13 **Talk key**
Answer a call, open last number redial list (press briefly), start dialling (press and hold)
When writing an SMS: send SMS
- 14 **Handsfree key**
Switch between earpiece and handsfree mode;
Lights up: handsfree activated
Flashes: incoming call
- 15 **Control key** (→ page 17)
- 16 **Answer machine icon** (C385 only)
Answer machine switched on;
Flashes: Answer machine is recording a message or is being operated by another internal party
- 17 **Signal strength** (→ page 11)

The base station at a glance

You can use the keys on the base station to register handsets to the base station, search for handsets (paging), → page 43 and operate the integrated answer machine (Gigaset C385 only).

Gigaset C385 base station

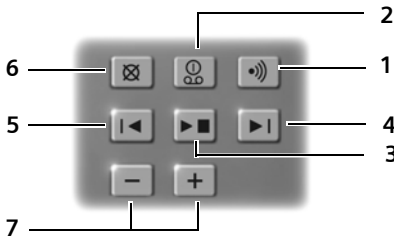

- 1 Registration/paging key:**
Press **briefly**: Search for handsets (paging), → page 43.
Press and **hold**: Register handsets and DECT devices, → page 42.
- 2 On/Off key:** Activate/deactivate answer machine.
LED lights up: Answer machine is activated.
LED flashes: The answer machine is recording a new message.

During message playback:

- 3 Play/Stop key:**
Play back new messages from answer machine or cancel the playback (press **briefly**).
Play back new and old messages (press and **hold**).
LED flashes: At least one new message is present.
LED flickers: Memory is full.
- Skip to next message (press once) or next message but one (press twice).
- Skip back to beginning of message (press once) or to previous message (press twice).
- Delete current message.
- Adjust volume during message playback:
[-] = quieter; [+] = louder.
While an external call is being signalled: adjust ringer tone volume.

Please note:

- ◆ If the answer machine is being operated from a handset or if it is recording a message, it cannot be operated from the base station.
- ◆ If the LED flashes although the answer machine is switched off, it means that there is still at least one new message that has not been played back yet.

Gigaset C380 base station



Registration/Paging key:

- Press **briefly**: Search for handsets (paging), → page 43.
- Press and **hold**: Register handsets and DECT devices, → page 42.

Contents

The handset at a glance	1
The base station at a glance	2
Safety precautions	6
First steps	7
Check the package contents	7
Setting up the base station and charging cradle (if included)	8
Connecting the base station	8
Connecting the charging cradle (if included)	9
Setting up the handset for use	10
Connecting the headset	15
What would you like to do next?	16
Using the phone	17
Control key	17
Display keys	17
Keys on the keypad	18
Correcting incorrect entries	18
Menu guidance	18
Activating/deactivating the handset	19
Activating/deactivating the keypad lock	19
Illustration of operating steps in the user guide	20
Menu tree	21
Making calls	23
Making an external call	23
Ending a call	23
Answering a call	23
Calling Line Identification	23
Handsfree talking	24
Muting	24
Using the directory and lists	25
Directory	25
Last number redial list	27
Opening lists with the message key	27
Making cost-effective calls	29
Automatic network provider code (preselection)	29
Displaying the call duration	30

- SMS (text messages) 31**
- Writing/sending an SMS 31
- Receiving an SMS 32
- Setting SMS centres 34
- SMS on a PABX 34
- Activating/deactivating SMS function 34
- SMS troubleshooting 35

- Operating the answer machine of the
Gigaset C385 base station 36**
- Operation via the handset 36
- Activating/deactivating call screening 38
- Setting up the answer machine 38
- Resetting fast access for the answer machine using key 1 38
- Operating when on the move (remote operation) 39

- Using the network mailbox 40**
- Configuring fast access for the network mailbox 40
- Viewing the network mailbox report 40

- ECO DECT 41**

- Setting the alarm clock 42**

- Using several handsets 42**
- Registering handsets 42
- De-registering handsets 43
- Locating a handset ("paging") 43
- Making internal calls 43
- Listening in to an external call (conference) 44

- Handset settings 44**
- Changing date and time 44
- Changing the display language 44
- Setting the display 45
- Activating/deactivating auto answer 45
- Changing the handsfree/earpiece volume 45
- Changing ringer tones 45
- Advisory tones 46
- Restoring the handset to the factory settings 47

- Base station settings 47**
- Protecting against unauthorised access 47
- Changing ringer tones 47
- Repeater support 47
- Restoring the base station to the factory settings 48

- Connecting the phone to a PABX 49**
- Dialling modes and recall 49
- Setting pauses 49
- Switching temporarily to touch tone dialling (DTMF) 49

Customer service & product warranty –	
Australia and New Zealand	50
Product Warranty	50
Questions and answers	51
Environment	52
Appendix	53
Care	53
Contact with liquid	53
Specifications	54
Writing and editing text	55
Accessories	56
Mounting the base station to the wall	58
Mounting the charging cradle to the wall	58
Index	59

Safety precautions

Warning

Read the safety precautions and the user guide before use.

Explain their contents and the potential hazards associated with using the telephone to your children.



Only use the mains adapter supplied, as indicated on the underside of the base station or charging cradle.



Only use the **recommended, rechargeable batteries** (→ page 54), i.e. never use a conventional (non-rechargeable) battery or other battery types as this could result in significant health risks and personal injury.



The operation of medical appliances may be affected. Be aware of the technical conditions in your particular environment, e.g. doctor's surgery.



Do not hold the rear of the handset to your ear when it is ringing or when the handsfree function is activated. Otherwise you risk serious and permanent damage to your hearing.

The handset may cause an unpleasant humming noise in hearing aids.



Do not install the base station or charging cradle in bathrooms or shower rooms. The base station and charging cradle are not splash proof (→ page 53).



Do not use your phone in environments with a potential explosion hazard (e.g. paint shops).



If you give your Gigaset to someone else, make sure you also give them the user guide.



Please remove faulty base stations from use or have them repaired by our service, as they could interfere with other wireless services.

Please note

Not all of the functions described in this user guide are available in all countries.

First steps

Check the package contents

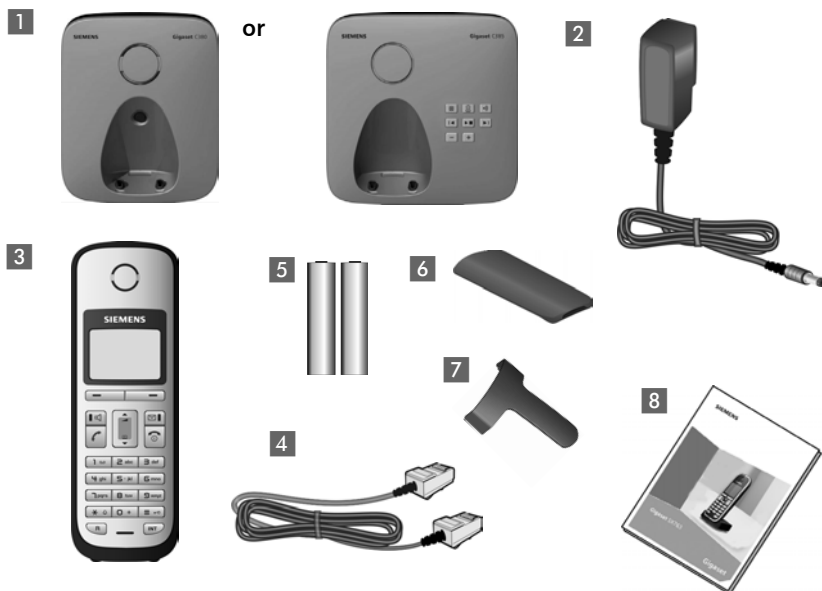

- 1 one Gigaset C380/C385 base station,
- 2 one mains adapter,
- 3 one Gigaset C38H handset,
- 4 one phone cord,
- 5 two batteries,
- 6 one battery cover,
- 7 one belt clip,
- 8 one user guide.

If you have purchased a **model with multiple handsets** the package should contain two batteries, a battery cover, a belt clip and a charging cradle **9** with mains adapter **10** for each additional handset.

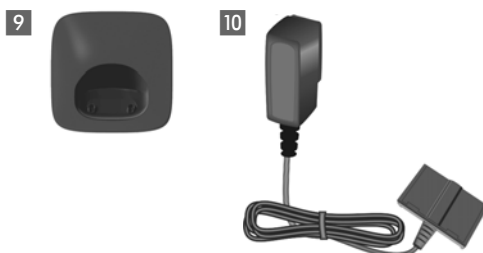

Setting up the base station and charging cradle (if included)

The base station and charging cradle are designed for use in enclosed dry rooms with a temperature range of +5 °C to +45 °C.

- ▶ Set up the base station and charging cradles at a central location on a flat, non-slip surface in your house or apartment.

Please note

Pay attention to the range of the base station.

This is up to 300 m in unobstructed outdoor areas and up to 50 m inside buildings. The range is reduced when Eco Mode (→ page 41) is activated.

The bottom of the phones do not usually leave any marks on surfaces. However, due to the multitude of different varnishes and polishes used on today's furnishings, the occurrence of marks on the surfaces cannot be completely ruled out.

Instructions on how to mount the base station and charging cradle to a wall, see → page 58.

Please note:

- ◆ Never expose the telephone to the influence of heat sources, direct sunlight or other electrical devices.
- ◆ Protect your Gigaset from moisture, dust, corrosive liquids and vapours.

Connecting the base station

- ▶ **First** connect the mains adapter **1**.
- ▶ **Then** connect the telephone jack **2** and insert the cables into the cableducts.



Please note:

- ◆ The mains adapter must **always be connected**, as the phone will not operate without mains connection.
- ◆ Only use the mains adapter and phone cord **supplied**. Pin connections on telephone cables can vary (pin connections → page 55).

Connecting the charging cradle (if included)

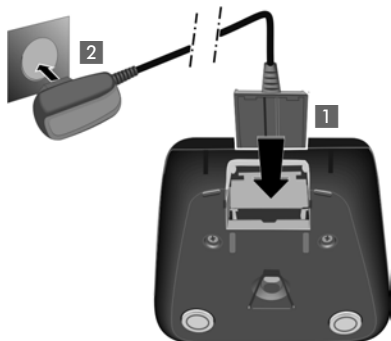

- ▶ Connect the flat plug of the mains adapter **1**.
- ▶ Plug the mains adapter into the plug socket **2**.

If you need to disconnect the plug from the charging cradle, press the release button **1** and disconnect the plug **2**.

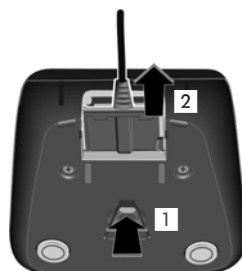

Setting up the handset for use



The display is protected by a plastic film. **Please remove the protective film!**

Inserting the batteries and closing the battery cover

Warning

Use only the rechargeable batteries recommended by Gigaset Communications GmbH * (→ page 54). Never use a conventional (non-rechargeable) battery or other battery types as this could result in significant health risks and personal injury. For example, the batteries could explode. The phone could also malfunction or be damaged as a result of using batteries that are not of the recommended type.

* Gigaset Communications GmbH is a trademark licensee of Siemens AG.

- ▶ Insert the batteries the right way round. The polarity is indicated in/on the battery compartment.

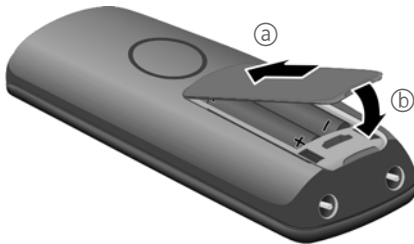

- ▶ First insert the battery cover at the top (a).
- ▶ Then press the cover (b) until it clicks into place.

If you need to open the battery cover, for instance to replace the batteries, place your fingertip in the cavity on the casing and pull the battery cover upwards.



Attaching the belt clip

The handset has notches on each side to accommodate the belt clip.

- ▶ Press the belt clip onto the back of the handset so that the notches on the belt clip click into position.



Placing the handset in the base station and registering



Before you can use the phone, you must first register the handset to the base station.

- ▶ Place the handset with the **display facing up** in the base station.

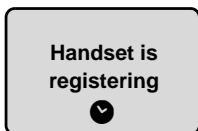

The handset registers automatically. Registration can take **up to 5 minutes**. **Do not remove the handset from the base station during this time.**



The following is displayed after successful registration:

- ◆ the strength of the reception signal between base station and handset:
 - good to poor:
 - no reception: flashes
- ◆ battery charge status:
 - (flat to full)
 - flashes: batteries almost flat
 - flashes: charging procedure

If you have purchased a **model with multiple handsets**, repeat the registration process for each handset. Handsets are assigned the lowest available internal number (1-4). If more than one handset is registered to the base station the internal handset number appears on the display, e.g. INT 2. If the internal numbers 1-4 are already assigned to other devices, the number 4 will be overwritten.

Please note

- ◆ Each key press interrupts the automatic registration.
- ◆ If automatic registration does not work, the handset will have to be registered manually (→ page 42).

To charge the batteries, leave the handset in the charging cradle.

Please note

Only place the handset in the base station or charging cradle that is intended for it.

Should you have any questions and problems → page 51.

Initial charging and discharging of batteries

The correct charge level can only be displayed if the batteries are first fully charged **and** discharged.



- ▶ Place the handset in the base station or charging cradle for **eleven** hours.



- ▶ Then remove the handset from the base station or charging cradle and do not replace it until the batteries are completely discharged.

Please note

- ◆ After the first battery charge **and** discharge you may replace your handset in its base station or charging cradle after every call.
- ◆ Always repeat the charging and discharging procedure if you remove the batteries from the handset and reinsert them.
- ◆ The batteries may warm up during charging. This is not dangerous.
- ◆ After a while, the charge capacity of the batteries will decrease for technical reasons.

Setting the date and time

Set the date and time so that the correct date and time can be assigned to incoming calls, and so that the alarm can be used.



- ▶ Press the key below **Menu** on the display screen to open the main menu.



- ▶ Press the bottom of the control key ...

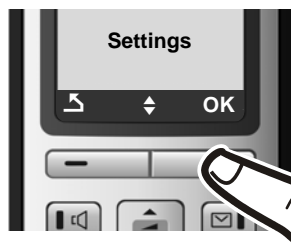

... until the **Settings** menu item appears.

- ▶ Press the key below **OK** on the display screen to confirm your selection.

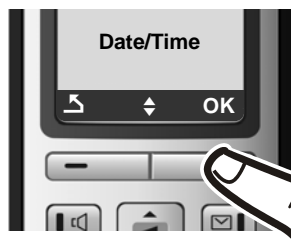

The **Date/Time** menu item appears on the display.

- ▶ Press the key below **OK** on the display screen to open the input field.



- ▶ The active line is marked [...]. Enter day, month and year as an 8-digit number via the handset, e.g. for 01/10/08.



If you want to correct an entry, press the top or bottom of the control key to toggle between fields.

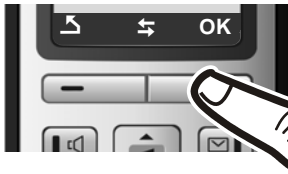

- ▶ Press the key below **OK** on the display screen to confirm your selection.



- ▶ Enter the hours and minutes as four digit numbers via the handset e.g. for 7:15 hours. If necessary, use the control key to toggle between fields.

- ▶ Press the key below **OK** on the display screen to confirm your selection.



The display shows Saved. You will hear a confirmation tone.

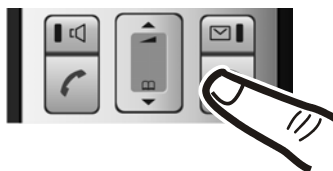

- ▶ Press and **hold** the end call key to return to the idle status.

Display in idle status

Once the phone is registered and the time set, the idle display is shown as in this example. If the answer machine is activated, the answer machine icon  will also be displayed in the header.

Your answer machine is set with a pre-recorded announcement.



Please note

The range icon is only displayed in idle status if Eco Mode+ (→ page 41) is deactivated.

Your phone is now ready for use.

Connecting the headset



You can connect various headset types (with 2.5 mm jack connector).

What would you like to do next?

Now you have successfully started your Gigaset you will probably want to adapt it to your personal requirements. Use the following guide to quickly locate the most important subjects.

If you are unfamiliar with menu-driven devices such as other Gigaset telephones you should first read the section entitled "Using the phone"

→ page 17.

Information on is located here.
Setting the ringer tone melody and volume	▶ page 45
Setting the handset volume	▶ page 45
Recording a personal message for the answer machine	▶ page 36
Setting Eco Mode / Eco Mode+	▶ page 41
Preparing the telephone for SMS reception	▶ page 31
Operating the telephone on a PABX	▶ page 49
Registering existing Gigaset handsets to a base station	▶ page 42
Transferring directory entries from existing Gigaset handsets to the new handset(s)	▶ page 26

If you have any questions about using your phone, please read the tips on troubleshooting (→ page 51) or contact our Customer Care team (→ page 50).

Using the phone



Control key

In the following description the side of the control key you need to press for each operation is indicated accordingly, e.g.  for "press the top of the control key".

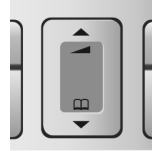

The control key has a number of different functions:





When the handset is in idle status

-  Open the directory.
-  Call up the menu for setting the handset's call volume (→ page 45), ringer tones (→ page 45) and advisory tones (→ page 46).

In the main menu, in submenus and lists

-  /  Scroll up/down line by line.

In input fields

Use the control key to move the cursor to the left  or right .

During an external call

-  Open the directory.
-  Adjust the loudspeaker volume for earpiece and handsfree mode.

Display keys





The function of the display keys changes depending on the particular operating situation. Example:





Current display key functions are shown in the bottom display line.

Display keys

Important display keys:

-  Open a context-dependent menu.
-  Confirm selection.
-  Delete key: deletes one character at a time from right to left.
-  Go back one menu level or cancel operation.
-  Open the last number redial list.

Keys on the keypad

 /  /  etc.

Press the matching key on the handset.



Enter digits or letters.

Correcting incorrect entries

You can correct incorrect characters in the text by navigating to the incorrect entry using the control key. You can then:

- ◆ press  to delete the character to the left of the cursor,
- ◆ insert characters to the left of the cursor,
- ◆ overwrite the character (flashing) when entering the time and date etc.

Menu guidance



Your telephone's functions are accessed using a menu that has a number of levels.

Main menu (first menu level)

- ▶ When the handset is in idle status, press  to open the main menu

The main menu functions are shown on the display as a list with name and icon.



To access a function, i.e. to open the corresponding submenu (next menu level):

- ▶ Navigate to the function using the control key . Press the display key .

Submenus

The functions in the submenus are displayed as lists.

To access a function:

- ▶ Scroll to the function with the control key  and press .

Or:

- ▶ Enter the corresponding digit combination (→ page 21).

Briefly press the end call key  once to return to the previous menu level/cancel the operation.

Reverting to idle status

You can revert to idle status from anywhere in the menu as follows:

- ▶ Press and **hold** the end call key .

Or:

- ▶ Do not press any key: after 2 minutes the display will **automatically** revert to idle status.

Any settings you have not confirmed by pressing  will be discarded.

An example of the display in idle status is shown on → page 15.

Activating/deactivating the handset



With the phone in idle status, press and **hold** the end call key (confirmation tone) to switch off the handset.
Press and **hold** the end call key again to switch the handset on.

Activating/deactivating the keypad lock

The keypad lock prevents any inadvertent use of the phone.



Press and **hold** the hash key to activate or deactivate the keypad lock. You will hear the confirmation tone.

When the keypad lock is activated you will see the  icon on the display and a message when you press a key.

The keypad lock is deactivated automatically if someone calls you. It is reactivated when the call is finished.

Illustration of operating steps in the user guide

The operating steps are shown in abbreviated form.

Example:

The illustration:

Menu → Settings → Handset → Auto Answer (✓ = on)

means:



- ▶ Press the display key **Menu** to open the main menu.



- ▶ Press the bottom of the control key  until the **Settings** menu item appears on the display.

- ▶ Press the display key **OK** to confirm your selection.



- ▶ Press the bottom of the control key  until the **Handset** menu item appears on the display.

- ▶ Press the display key **OK** to confirm your selection.

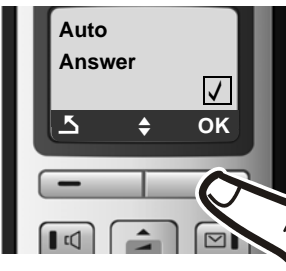

The **Auto Answer** menu item appears on the display.

- ▶ Press the display key **OK** to activate/deactivate the function (✓ = on).

Menu tree

Instead of scrolling to locate a menu function, you can select a function more quickly by opening the menu and keying in a digit combination (or shortcut).

Example: **Menu**    for "Set ringer tone volume".

With the telephone in **idle status**, press **Menu** (open main menu):

1 SMS

1-1	Write Message	→	page 31
1-2	Incoming	→	page 32
1-3	Outgoing	→	page 32
1-4	Settings	1-4-1	Service Centres → page 34
		1-4-2	Register to Srvc. Centres → page 31

4 Alarm Clock

4-1	Activation	→	page 42
4-2	Wake up time	→	page 42

5 Voice Mail

5-1	Set Key 1	5-1-1	Network Mailbox → page 40
		5-1-2	Answer Machine → page 40
5-2	Answer Machine	→	page 36
5-3	Call Screening	5-3-1	Handset → page 38
		5-3-2	Base → page 38
5-4	Announcements	5-4-1	Record Announcement → page 36
		5-4-2	Play Announcement → page 36
		5-4-3	Delete Announcement → page 37
5-5	Message Length	5-5-1	Unlimited → page 38
		5-5-2	1 Minute
		5-5-3	2 Minutes
		5-5-4	3 Minutes
5-6	Ring Delay	5-6-1	Immediately → page 38
		5-6-2	10 sec
		5-6-3	18 sec
		5-6-4	30 sec
		5-6-5	Auto

Menu tree

7 Settings

7-1	Date/Time	→ page 13				
7-2	Audio Settings	7-2-1	Call Volume	→ page 45		
		7-2-2	Ringer Volume	→ page 46		
		7-2-3	Ringer Melody	→ page 46		
		7-2-4	Advisory Tones	→ page 46		
		7-2-5	Battery Low	→ page 46		
7-3	Handset	7-3-1	Display	→ page 45		
		7-3-2	Language	→ page 44		
		7-3-3	Auto Answer	→ page 45		
		7-3-4	Register Handset	→ page 42		
		7-3-5	Reset Handset	→ page 47		
7-4	Base	7-4-1	Audio Settings (C385 base station only)	→ page 47		
		7-4-2	Calls List Type	→ page 28		
		7-4-3	System PIN	→ page 47		
		7-4-4	Base Reset	→ page 48		
		7-4-5	Additional Features	7-4-5-1	Repeater Mode	→ page 47
				7-4-5-3	Eco Mode	→ page 41
				7-4-5-4	Eco Mode+	→ page 41
7-4-6	Listening in	→ page 44				
7-4-7	Preselection	→ page 29				

Making calls

Making an external call

External calls are calls using the public telephone network.



Enter the number and press the talk key.

Or:



Press and **hold** the talk key and then enter the number.

You can cancel the dialling operation with the end call key.

You are shown the duration of the call while the call is in progress.

Please note

- ◆ Dialling with the directory (→ page 25), calls list (→ page 27) and last number redial list (→ page 27) saves repeated typing of numbers.
- ◆ You can assign a number from the directory to a key for speed dialling (→ page 26).

Ending a call



Press the end call key.

Answering a call

The handset indicates an incoming call in three ways: by ringing, by a display on the screen and by the flashing handsfree key.

You can answer the call by:

- ▶ Pressing the talk key.
- ▶ Pressing the handsfree key.

If the handset is in the charging cradle and the **Auto Answer** function is activated (→ page 45), the handset automatically answers the call when you remove it from the charging cradle.

To deactivate the ringer tone, press the **Menu** display key and select **Silent**. You can take the call as long as it is displayed on the screen.

Calling Line Identification

When you receive a call, the caller's number is displayed on the screen if the following conditions are met:

- ◆ Your network provider supports CLIP, CLI.
 - CLI (Calling Line Identification): the caller's number is transmitted.
 - CLIP (Calling Line Identification Presentation): the caller's number is displayed.
- ◆ You have arranged CLIP with your network provider.
- ◆ The caller has arranged CLI with the network provider.

Call display with CLIP/CLI

If the caller's number is saved in your directory, the caller's name will also be displayed.

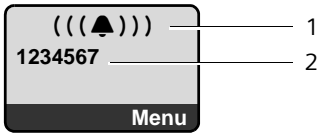

- 1 Ringer tone icon
- 2 Number or name of caller

The following is displayed in place of the number:

- ◆ External Call, if no number is transmitted.
- ◆ Withheld, if the caller has withheld Calling Line Identification.
- ◆ Unavailable, if the caller has not arranged Calling Line Identification.

Handsfree talking

In handsfree mode, instead of holding the handset to your ear you can put it down, for example on the table in front of you. This allows others to participate in the call.

Activating/deactivating handsfree mode

Activating while dialling



Enter the number and press the handsfree key.

- ▶ You should inform your caller before you use the handsfree function so that they know someone else is listening.



Switching between earpiece and handsfree mode



Press the handsfree key.

During a call and when listening to the answer machine (Gigaset C385 only), activate or deactivate handsfree mode.

If you wish to place the handset in the charging cradle during a call:

- ▶ Press and hold the handsfree key  while placing the handset in the base station. If the handsfree key  does not light up, press the key again.

For instructions on how to adjust the loudspeaker volume, see → page 45.

Muting

You can deactivate the microphone in your handset during an external call.



Press the display key to mute the handset.



Press the display key to switch the microphone back on.

Using the directory and lists

The options are:

- ◆ Directory
- ◆ Last number redial list
- ◆ SMS list
- ◆ Call history
- ◆ Answer machine list (Gigaset C385 only)

You can save up to 150 entries in the directory.

You can create a personalised directory for your own individual handset. However, you can send the list or individual entries to other handsets (→ page 26).

Directory

In the **directory** you can save numbers and corresponding names.

- ▶ With the handset in idle status, open the directory by pressing the  key.

Length of entries

Number: max. 32 digits

Name: max. 16 characters

Please note

You can assign a number from the directory to a key for speed dialling → page 26.

Saving the first number in the directory

 → Dir. empty New Entry?

 Enter the number and press **OK**.

 Enter the name and press **OK**.

Storing a number in the directory

 → **Menu** → New Entry

 Enter the number and press **OK**.

 Enter the name and press **OK**.

Order of directory entries

The directory entries are usually sorted in alphabetical order. Spaces and digits take first priority. The sort order is as follows:



1. Space
2. Digits (0–9)
3. Letters (alphabetical)
4. Other characters

To get round the alphabetical order of the entries, insert a space or a digit in front of the name. These entries will then move to the beginning of the directory.

Selecting a directory entry

 Open the directory.

You have the following options:

- ◆ Use  to scroll to the entry until the required name is selected.
- ◆ Enter the first character of the name, or scroll to the entry using  if required.

Dialling with the directory

 →  (Select entry)

 Press the talk key. The number is dialled.

Managing directory entries

 →  (Select entry)

Editing entries

Menu → Edit Entry

 Edit the number if required, and press **OK**.

 Edit the name if required, and press **OK**.

Using the directory and lists

Using other functions

Menu Press the display key.

The following functions can be selected with :

Use Number

Save or modify a saved number and then dial with  or save as a new entry; to do so, press **Menu** → Copy to Directory → **OK** after the number appears on the display.

Delete Entry

Delete selected entry.

Send Entry

Send a single entry to a handset (→ page 26).

Delete List

Delete **all** directory entries.

Send List



Send complete list to a handset (→ page 26).

Shortcut

Assign the current entry for speed dial to a selected key.

Using speed dial keys

You can assign directory entries to the keys 0 and 2-9:



 →  (select entry) → **Menu** → **Shortcut** →  (press the key you want to assign the number to)

To dial, press and **hold** the required speed dial key.

Sending the directory to another handset

Preconditions:

- ◆ The sending and receiving handsets must both be registered to the same base station.
- ◆ The other handset and the base station can send and receive directory entries.

 →  (select entry) → **Menu** (open menu) → Send Entry / Send List

 Enter the internal number of the receiving handset and press **OK**.

Successful transmission is acknowledged with the message **Entry copied.** . You can transfer several individual entries one after the other by responding **OK** to the **Next entry? prompt.**

Please note:

- ◆ Entries with identical numbers are not overwritten on the receiving handset.
- ◆ The transfer is cancelled if the phone rings or if the memory of the receiving handset is full.

Copying a displayed number to the directory

You can copy numbers displayed in a list, e.g. the calls list or redial list, to the directory.

A number is displayed:

Menu → Copy to Directory

▶ Complete the entry → page 25.

Gigaset C385: The message playback is interrupted during the number transfer from the answer machine list.

Using a number from the directory

In some operating situations you can open the directory to copy a number, for example. Your handset need not be in idle status.

 Open the directory.

 Select entry.



OK Press the display key.

Select function with .



Last number redial list

The last number redial list contains the ten numbers last dialled with the handset (max. 32 numbers). If one of the numbers is in the directory, the corresponding name will be displayed.

Manual last number redial

-  Press the key **briefly**.
-  Select entry.
-  Press the talk key again. The number is dialled.

Managing entries in the last number redial list

-  Press the key **briefly**.
-  Select entry.
- Menu** Open menu.

The following functions can be selected with 

Use Number (as in the directory, → page 26)

Copy to Directory

Copy an entry to the directory (→ page 25).

Delete Entry (as in the directory, → page 26)

Delete List (as in the directory, → page 26)

Opening lists with the message key

You can use the message key  to open the following list selection:

- ◆ SMS list
- ◆ Answer machine list (Gigaset C385 only) or network mailbox, if your network provider supports this function and the fast access is set for the network mailbox (→ page 40).
- ◆ Call history

The message key  will flash as soon as a **new entry** is received in a list (switches off when the key is pressed). The message **You have new messages** appears in the display in **idle status**.

Please note

If calls are saved in the network mailbox, you will receive a message if the appropriate settings have been made (see your network provider user guide).

List selection

The lists displayed after pressing the message key  depend on whether there are any new messages.

 **key does not flash (no new messages):**

Select a list with . To open, press **OK**.

 **key flashes (new messages received):**

You see all the lists with new messages. If only one list contains new messages, this will be opened automatically.

Incoming SMS message list

All received SMS messages are saved in the incoming message list, → page 32.

Call history

Precondition: Calling Line Identification (CLIP, → page 23)

The calls list contains the last 25 numbers, depending on the settings

- ◆ all calls
 - answered calls
 - unanswered calls
 - calls recorded by the answer machine (Gigaset C385 only)
- ◆ missed calls
 - unanswered calls and
 - calls not recorded by the answer machine (Gigaset C385 only)

Using the directory and lists

The calls list is displayed as follows:

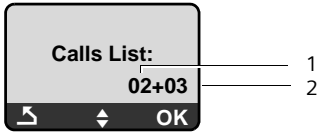

- 1 Number of new entries
- 2 Number of old, read entries

Setting the call history type

Menu → Settings → Base → Calls List

Missed Calls / All Calls

Select and press **OK** (= on).



Press and **hold** (idle status).

The call history entries are retained when you change the list type.

Answer machine list (Gigaset C385)

You can use the answer machine list to listen to the messages that are on the answer machine.

The answer machine list is displayed as follows:

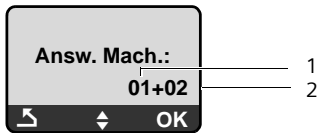

- 1 Number of new entries
- 2 Number of old, read entries

Opening calls/answer machine list (Gigaset C385)

☑ → Calls List / Answ. Mach. 01+02

The last incoming call is displayed in the **calls list**.

The first new message received is displayed in the **answer machine list**. Playback begins. New messages are placed after old messages when they have been played back.

You can scroll through the list with .

List entry

Example of a list entry:



◆ Status of entry

In the calls list

New Call: new missed call.

Old Call: entry already read.

Call recv.: call taken.

In the answer machine list

Answer M (Gigaset C385):

the answer machine took the call.

A message was left.

New Msg. (Gigaset C385):

new message on the answer machine.

Old Msg. (Gigaset C385):

previously played back message on the answer machine.

◆ Entry number

01/02 means e.g.: first of a total of two entries.

◆ Number or name of caller

Press the talk key  to make a return call.

You can add the caller's number to the directory (→ page 26).

◆ Call date and time (if set, page 44).

You can delete the current entry with

Menu → Delete Entry.

Answer machine list (Gigaset C385 only)

You can use the **answer machine list** to listen to the messages that are on the answer machine.

Making cost-effective calls

Automatic network provider code (preselection)

You can specify a call-by-call number (preselection number) that is **automatically** placed in front of numbers when you dial them.

- ◆ The **"with preselection"** list contains the "rule" for dialling code numbers or the first digits of dialling code numbers with which you wish the preselection number to be used.
- ◆ The **"without preselection"** list contains the "exception to the rule".

Example:

You have entered 08 for "with preselection". Now all numbers that start with 08 will be dialled with preselection. If, for example, you want 081 to still be dialled without preselection, enter 081 for "without preselection".

When dialling, the **first** digits of the selected numbers are compared with both lists after the talk/handsfree key is pressed:

- ◆ The preselection number is not prefixed if the dialled number
 - **does not** match any entries in the two lists
 - matches an entry in the **"without preselection"** list
- ◆ The preselection number is prefixed if the first digits of the dialled number match **only** one entry in the **"with preselection"** list.

Saving preselection numbers

Menu → Settings → Base → Preselection
→ Preselection Number



Enter or edit preselection number (call-by-call number).

OK

Press the display key.
The entry is saved.



Press and **hold** (idle status).

Save or change entries in the preselection lists

Each of the two lists can contain 11 entries, each with 4 digits.

Numbers may be prefixed according to the country in the **"with preselection"** list. This means, for example, that all national calls or calls to the mobile network are **automatically** linked to the preselection number you have saved previously.

Menu → Settings → Base → Preselection
→ With Preselection / Without Preselection



Select entry and press **OK**.



Enter or edit first digits of number.

OK

Press the display key.
The entry is saved.



Press and **hold** (idle status).

Temporarily cancelling preselection

(press and **hold**) → **Menu**
→ Automatic Preselect off

Permanently deactivating preselection

Menu → Settings → Base → Preselection
→ Preselection Number



Press **<C>** to delete the preselection number.

OK

Press the display key. The entry is saved.



Press and **hold** (idle status).

Displaying the call duration

The duration of a call is displayed

- ◆ during the conversation,
- ◆ until about three seconds after the call has ended if you do not replace the handset in the base station or charging cradle.

Please note

The actual duration of the call can vary from that shown by a few seconds.

SMS (text messages)

Your phone is supplied ready for sending SMS messages immediately.

Preconditions:

- ◆ Calling Line Identification is enabled for your phone line.
- ◆ Your network provider supports SMS in the fixed line network (information on this can be obtained from your network provider).
- ◆ You are registered with your service provider to send and receive SMS messages.

SMS messages are exchanged between SMS centres operated by service providers. You must enter the SMS centre through which you wish to send and receive SMS messages into your phone. You can receive SMS messages from **every** SMS centre that is entered, provided you have registered with your service provider.

Your SMS messages are sent via the **SMS centre** that is entered as the active send **service centre**. However, you can activate any other SMS centre as the active send service centre to send a current message (→ page 34).

If no SMS service centre is entered, the SMS menu only contains the entry **Settings**. Enter an SMS Service Centre (→ page 34).

Information on writing an SMS can be found in the appendix (→ page 55). An SMS may contain up to 160 characters.

Please note:

- ◆ If your phone is connected to a PABX, please read page 34.
- ◆ To receive SMS messages you must be registered with your service provider.

Registering with the registration assistant

When you open the SMS menu with **Menu** → **SMS** for the first time, you will be asked whether you wish to be registered automatically with all entered SMS centres (→ page 34). Confirm with **Yes** or refuse with **No** to abort automatic registration. You can now receive SMS messages from all SMS centres whose numbers you have entered.

You can call up automatic registration thereafter via the menu:

Menu → **SMS** → **Settings** → **Register to Srv. Centres**

Writing/sending an SMS

Menu → **SMS** → **Write Message**



Write an SMS. For how to enter text, → page 55.

Menu → **Send Text**

Select and press **OK**.



Enter the number with area code (including your local area code) from the directory or key it in manually, and press **OK**. The SMS is sent.

Please note

- ◆ If you are interrupted by an external call while writing an SMS, the text is automatically saved in the draft message list.
- ◆ If the memory is full, or if the SMS function on the base station is being used by another handset, the operation is cancelled. An appropriate message appears in the display. Delete SMS messages you no longer require or send the SMS later.

SMS (text messages)

Draft message list

You can save an SMS in the draft message list, and edit and send it later.

Saving an SMS in the draft message list

Write an SMS (→ page 31).

Menu → Save Text

Opening the draft message list

Menu → SMS → Outgoing

The first entry in the list is displayed, e.g.:

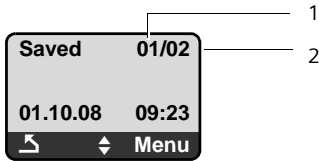

- 1 Current number
- 2 Total number of SMS

Reading or deleting individual SMS messages

► Open the draft message list.

Select SMS.

Menu → Read SMS

Select and press **OK** to read the SMS. Scroll through the SMS using .

Or:

Menu → Delete Entry

Select and press **OK** to delete the message.

Writing/changing an SMS

You are reading an SMS in the draft message list.

Menu Press the display key.

You have the following options:

Write Message

Write and then send a new SMS or save.

Use text

Change the text of the stored SMS and then send it.

Deleting draft message list

► Open the draft message list.

Menu → Delete List

Select and press **OK**.

OK

Press the display key to confirm the delete. The list is cleared.

Press and **hold** (idle status).

Receiving an SMS

All received SMS messages are saved in the incoming message list. Since an SMS remains in the list even after it has been read, you should **regularly delete SMS messages from the list**.

Incoming message list

The incoming message list contains:

- ◆ All received SMS messages, starting with the latest.
- ◆ SMS messages that could not be sent due to an error.

New SMS messages are signalled on all Gigaset C45 handsets by a message in the display, the flashing message key and an advisory tone.

Opening the incoming message list with the key

Press.

The incoming message list is displayed as follows (example):

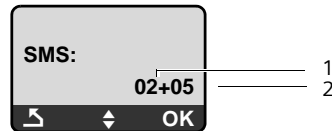

- 1 Number of new entries
- 2 Number of old, read entries

An entry in the list is displayed as in the following example:

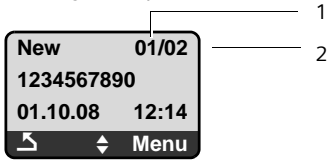

- 1 Number of the SMS currently displayed
- 2 Total number of new SMS messages

Opening the incoming message list via the SMS menu

Menu → SMS → Incoming

Reading or deleting individual SMS messages

- ▶ Open the incoming message list.

Select SMS.

Menu → Read SMS

Select and press **OK** to read the SMS. Scroll through the SMS using .

After you have read a new SMS, its status turns to "old".

Or:

Menu → Delete Entry

Select and press **OK** to delete the SMS.

Deleting the incoming message list

All **new and old** SMS messages in the list are deleted.

- ▶ Open the incoming message list.

Menu → Delete List

Select and press **OK**.

OK Press the display key to confirm the delete. The list is cleared.

Adding the number of the message sender to the directory

- ▶ Open the incoming message list.

Select SMS.

Menu → Copy to Directory

- ▶ Complete the entry → page 25.

Replying to or forwarding SMS messages

You are reading an SMS.

Menu Press the display key.

You have the following options:

Reply

Write and send a reply SMS directly (→ page 31).

Use text

Edit the text of the SMS and then send it.

Send Text

Forward the text of an SMS to another recipient.

Changing the character set

You are reading an SMS.

Menu Press the display key.

Character Set

Text is shown in the selected character set.

Setting SMS centres

Entering/changing SMS centres

- ▶ You should find out about the services and special functions offered by your service provider **before you make a new application** and before you delete preconfigured phone numbers.

Menu → SMS → Settings
→ Service Centres

 Select an SMS centre (e.g. SMS Centre No 1) and press **OK**.

You have the following options:

Active Send Srv. Cent.

If the SMS messages are to be sent through this SMS centre, press **OK** to activate the SMS centre (✓ = on). If a different SMS centre was active previously, then this will be deactivated. For the SMS centres 2 and 3, the setting only applies to the next SMS.

SMS Centre No

Enter the number of the SMS centre and press **OK**.

Sending an SMS via another SMS centre

- ▶ Activate the SMS centre (2 or 3) as the active send service centre (→ page 34).
- ▶ Send the SMS.

This setting only applies to the next SMS to be sent. After that, the setting returns to SMS Centre No 1.

SMS on a PABX

- ◆ You can only receive an SMS when the **Calling Line Identification is forwarded** to the extension of the PABX (CLIP). The CLIP evaluation of the phone number for the SMS centre takes place in your **Gigaset**.
- ◆ If required, you must prefix the number for the SMS centre with the access code (depending on your PABX).
If in doubt, test your PABX, e.g. by sending an SMS to your own number: once with and once without the access code.
- ◆ When you send SMS messages, your sender number may be sent without your extension number. In this case the recipient cannot reply to you directly.

Sending and receiving SMS messages on **ISDN PABXs** is only possible via the MSN number assigned to your base station.

Activating/deactivating SMS function

The SMS function is active by default. If you deactivate the SMS function, you cannot send or receive any SMS messages with your phone.

The settings you have made for sending and receiving SMS messages (e.g. the numbers of the SMS centres) and the entries in the incoming and draft message lists are saved even after you turn off your phone.

Menu Press the display key.

Enter the digits.

 **OK** Deactivate SMS function.

Or:

 **OK** Activate SMS function.

SMS troubleshooting

Error codes when sending

EO	Calling Line Identification permanently withheld (CLIR) or Calling Line Identification not activated.
FE	Error occurred during SMS transfer.
FD	Connection to SMS centre failed; see self-help.

Self-help with errors

The following table lists error situations and possible causes and provides notes on troubleshooting.

<p>You cannot send messages.</p> <ol style="list-style-type: none"> 1. You have not requested the CLIP service (Calling Line Identification Presentation). <ul style="list-style-type: none"> ▶ Ask your service provider to enable this service. 2. SMS transmission has been interrupted (e.g. by a call). <ul style="list-style-type: none"> ▶ Re-send the SMS. 3. Network provider does not support this feature. 4. No number or an invalid number is entered for the SMS centre set as the active send service centre. <ul style="list-style-type: none"> ▶ Enter the number (→ page 34).
<p>You receive an incomplete SMS.</p> <ol style="list-style-type: none"> 1. Your phone's memory is full. <ul style="list-style-type: none"> ▶ Delete old SMS messages (→ page 33). 2. The service provider has not yet sent the rest of the SMS.

The SMS is played back.

1. The "display call number" service is not activated.
 - ▶ Ask your service provider to enable this feature (there is a charge for this).
2. Your mobile phone operator and your fixed line network SMS service provider have not agreed on a co-operation.
 - ▶ Obtain information from your fixed line network SMS service provider.
3. Your end device has been recorded by your SMS provider as having no fixed line network SMS functionality, i.e. you are no longer registered with the provider.
 - ▶ Start the registration assistant for automatic registration (→ page 31).
 - ▶ Have the device (re-)registered to receive SMS messages.

Messages are only received during the day.

- The terminal is recorded in your SMS provider's database as having no fixed network SMS functionality, i.e. you are no longer registered with the provider.
- ▶ Start the registration assistant for automatic registration (→ page 31).
 - ▶ Obtain information from your fixed line network SMS service provider.
 - ▶ Have the device (re-)registered to receive SMS messages.

Operating the answer machine of the Gigaset C385 base station



You can operate the answer machine that is integrated into the base station using the keys on the base station (→ page 2), via the handset or by remote operation (other phone/mobile phone). You can only record your own announcement messages using the handset.

Operation via the handset

The handset loudspeaker activates **automatically** if you receive an acoustic prompt or message while operating. You can switch it off with the handsfree key .

Activating/deactivating the answer machine

Menu → Voice Mail → Answer Machine
(√ = on)

When the answer machine is activated, the remaining memory time is announced. The  icon appears in the display. The  key lights up on the base station.

The telephone is supplied with a pre-recorded announcement. This pre-recorded announcement is used if no personal announcement is available.

If the memory is full, a corresponding message will appear on the display and the answer machine is automatically deactivated. It activates again automatically when you delete old messages.



Recording your own announcement

Menu → Voice Mail → Announcements
→ Record Announcement

OK Press the display key to start the recording.

You hear the ready tone (short tone).

- ▶ Now speak your announcement (at least 3 sec.).

Cancel recording with  or .
Restart the recording with **OK**.

OK Press the display key to end the recording.

After recording, the announcement is played back for you to check.

Please note:

- ◆ Recording ends automatically when the max. recording time of 170 seconds is reached or if there is a break in speaking of more than 2 seconds.
- ◆ If you cancel the recording, the pre-recorded announcement will be used again.
- ◆ The recording is cancelled if the answer machine memory is full.
 - ▶ Delete old messages and repeat recording if required.

Playing back announcements

Menu → Voice Mail → Announcements
→ Play Announcement

 Press and **hold** (idle status).

You will hear the pre-recorded announcement if you have not recorded one of your own.

Deleting announcements

Menu → Voice Mail → Announcements
→ Delete Announcement



OK Press the display key to confirm the prompt.

 Press and **hold** (idle status).

The pre-recorded announcement is used again after a personal announcement is deleted.

Playing back messages

The date and time of each message is logged (provided this has been set, → page 13). If Calling Line Identification is activated, the caller's number is displayed. If the caller's number is saved in the directory, their name is displayed.

New messages that have not yet been played back are indicated by a message in the display and by the  key flashing on the handset. The  key flashes on the base station.

To listen to messages:

 Press the message key.

Answ. Mach.



Select as required and press **OK**.

If you have new messages, playback will start with the first new message, otherwise with the first old message.

See also answer machine list → page 28.

Stopping and controlling playback

During message playback:

 Pause playback. Press  again to resume.
or

Menu Stop playback. Press **OK** to resume.

 or 

Return to the start of the current message.
Press twice to go back to the previous message.

 or 

Skip to the next message.
Press twice to skip to the next but one message.

If playback is interrupted for over a minute, the answer machine returns to idle status.

Copying the phone number of a message to the directory

During playback or pause:

Menu → Copy to Directory

▶ Complete the entry → page 25.

Deleting messages

You can either delete all old messages together or individually.

Deleting all old messages

During playback or pause:

Menu → Delete all

OK Press the display key to confirm the prompt.



Deleting individual old messages

While playback is paused:

 Press the display key.

Picking up a call from the answer machine

You can take a call while the answer machine is recording it:

 /  Press the talk or handsfree key.

Recording stops and you can speak to the caller.

If 3 seconds of the call have already been recorded when you pick it up, the call will be displayed as a new message. The  key on the handset flashes.

You can answer the call even if it is not signalled on the handset.

Activating/deactivating call screening

During recording of a message you can screen calls via the loudspeaker of the base station and registered handsets.

Permanently activating/deactivating call screening

Menu → Voice Mail → Call Screening
→ Handset / Base (✓ = on)

 Press and **hold** (idle status).

Call screening can be simultaneously activated on the base station and handset.

Deactivating call screening for the current recording

 Press the end call key.

Setting up the answer machine

The answer machine has already been preset at the factory. Make individual settings using the handset.

Setting call acceptance

You can set when you want the answer machine to answer a call.

The options are: Immediately, 10 sec, 18 sec or 30 sec and Auto.

In Auto mode, the following applies for call acceptance:

- ◆ If there are no new messages, the answer machine answers a call after **18 seconds**.
- ◆ If new messages are present, the answer machine accepts a call after just **10 seconds**.

Menu → Voice Mail → Ring Delay

 Select an option Immediately / 10 sec / 18 sec / 30 sec / Auto and press **OK** (✓ = on).

 Press and **hold** (idle status).

Setting the recording time

You can set the maximum recording time of a message.

The options are: 1 Minute, 2 Minutes, 3 Minutes or Unlimited.

Menu → Voice Mail → Message Length

 Select a recording time and press **OK** (✓ = on).

 Press and **hold** (idle status).

Resetting fast access for the answer machine using key 1

The integrated answer machine has already been preset for fast access at the factory. However, if you have set the network mailbox for fast access (→ page 40), you can reset this setting.

Menu → Voice Mail → Set Key 1

Answer Machine

Select and press **OK**.

 Press and **hold** (idle status).

When you have selected the answer machine, press and **hold** key 1. You will be connected directly.

The setting for fast access applies to all registered handsets.

Operating when on the move (remote operation)

You can check and activate your answer machine from any other telephone (hotel, pay phone etc.).

Preconditions:

- ◆ You have set a system PIN other than 0000 (→ page 47).
- ◆ The phone you are using for remote operation has touch tone dialling (DTMF), i.e. you hear different tones when you press the keys. Alternatively, you can use a code transmitter (available from your mobile phone retailer).

Calling the answer machine and playing back messages



Dial your own number.



When you hear your announcement, press **9** and enter the system PIN.

You will be informed whether any new messages have been recorded. The messages are now played back. You can now operate the answer machine with the keypad.

The following keys are used for operation:

- 1** To return to the start of the current message.
Press twice to go back to the previous message.
- 2** Stop playback. Press again to resume.
- 3** Go to the next message.
- 0** Delete current message.

Activating the answer machine

- ▶ Phone home and let the phone ring until you hear: "Please enter PIN".



Enter system PIN.

Your answer machine is activated. It tells you how much memory time is left.

The messages are now played back.

The answer machine cannot be deactivated remotely.

Using the network mailbox

The network mailbox is your network provider's answer machine within the network. You cannot use the network mailbox unless you have **requested** it from your network provider.

Configuring fast access for the network mailbox

With fast access, you can dial the network mailbox or the integrated answer machine (Gigaset C385 only) directly.

Gigaset C380: Fast access is set for the network mailbox. You only need to enter the number of the network mailbox.

Gigaset C385: The integrated answer machine is set for fast access. Instead, you can define fast access for the network mailbox. Ask your network provider about this.

Configuring fast access for the network mailbox and entering the network mailbox number

Menu → Voice Mail → Set Key 1

Network Mailbox

Select and press **OK** ( = on).



Enter the network mailbox number and press **OK**.



Press and **hold** (idle status).

The setting for fast access applies to all handsets.

Calling the network mailbox



Press and **hold**. You are connected straight to the network mailbox.



Press handsfree key  if required. You will hear the network mailbox announcement.

Viewing the network mailbox report

When a message is recorded, you receive a call from the network mailbox. If you have requested Calling Line Identification, the network mailbox number will be displayed. If you take the call, the new messages are played back. If you do not take the call, the network mailbox number will be saved in the missed calls list and the message key flashes (→ page 27).

ECO DECT

You are helping to protect the environment with your Gigaset C380/C385.

Reduced energy consumption

Your telephone has an energy-saving adapter plug and uses less energy.

Reduced transmission power

The transmission power of your telephone is reduced **automatically**:

- ◆ The handset's transmission power is reduced depending on the distance to the base station.
- ◆ The transmission power at the base station is reduced to virtually zero when only one handset is registered and is standing in the base station.

You can reduce the transmission power of the handset and base station even further by using Eco Mode or Eco Mode+:



- ◆ **Eco Mode**
80% transmission power reduction in standby and talk mode.
- ◆ **Eco Mode+**
100% transmission power deactivation in standby mode.

Activate/deactivate Eco Mode / Eco Mode+:

Menu → Settings → Base → Additional Features → Eco Mode / Eco Mode+

OK Press the display key
( = on).

Status displays

Display icon	
	Reception strength: – good to low – no reception
	Eco Mode+ enabled (displayed instead of the reception strength icon when in idle status)
Icon green	Eco Mode enabled

Please note

- ◆ With **Eco Mode+** enabled, press and **hold** the talk key () to check base station reachability. You will hear the dial tone if the base station is reachable.
- ◆ When **Eco Mode+** is enabled:
 - call setup will be delayed by approx. 2 seconds.
 - handset standby time will be reduced by approx. 50%.
- ◆ Registering handsets that do not support **Eco Mode+** will cause the mode to be deactivated on the base station and all other handsets.
- ◆ Activating **Eco Mode** reduces the range of the base station.
- ◆ **Eco Mode / Eco Mode+** and repeater support (→ page 47) cancel each other out, i.e. you cannot use Eco Mode and Eco Mode+ when using a repeater.

Setting the alarm clock

Precondition: The date and time have already been set (→ page 13).

Activating/deactivating the alarm clock

Menu → Alarm Clock → Activation
(√ = on)

After you activate the alarm clock, the menu for setting the wake-up time opens automatically (→ page 42).

If the alarm clock is set, the wake-up time appears with the  icon in the display instead of the date.

Setting the wake-up time

Menu → Alarm Clock → Wake up time



Enter the wake-up time in hours and minutes, then press **OK**.

When the alarm clock rings...

Alarm repeat after 5 minutes

Snooze Press the display key or any key.

If you press **Snooze** three times, the alarm clock switches off for 24 hours.

Turning off the alarm clock for 24 hours

Off Press the display key.

Using several handsets

Registering handsets

You can register up to four handsets on your base station.

Please note

Each additional handset must be registered on the base station in order for it to work properly!

For how to register your handset automatically, → page 11.

If automatic registration does not work, you will have to register the handset manually.

Manual registration of Gigaset C38H to Gigaset C380/C385

You must activate manual registration of the handset on both the handset and the base station.

Once it has been registered, the handset returns to idle status. The handset's internal number is shown in the display, e.g. INT 1. If it does not appear, repeat the procedure.

On the handset

Menu → Settings → Handset
→ Register Handset



Enter the system PIN of the base station (the default is 0000) and press **OK**. Handset is registering flashes on the display.

On the base station

Within 60 sec., press and **hold** the registration/paging key on the base station(→ page 2) (approx. 3 sec.).

Registering other handsets

You can register other Gigaset handsets and handsets for other devices with GAP functionality as follows.

On the handset

- ▶ Start to register the handset as described in its user guide.

On the base station

Press and **hold** the registration/paging key on the base station (→ page 2) (approx. 3 sec.).

De-registering handsets

Handsets can only be de-registered by resetting the base station to its default settings. **This will also reset every other setting** → page 48.

Locating a handset ("paging")

You can locate your handset using the base station.

- ▶ **Briefly** press the registration/paging key on the base station (→ page 2).
- ▶ All handsets will ring simultaneously ("paging"), even if the ringer tones are deactivated.

Ending paging

- ▶ **Briefly** press the registration/paging key on the base station or press the talk key  on the handset.

Making internal calls

Internal calls to other handsets registered on the same base station are free.

Calling other handsets



Start internal call. The display shows **Insert INT No.**



Enter the internal number of the receiving handset. The handset is called.

or:



Press the display key. All handsets are called.

Ending a call



Press the end call key.

Transferring a call to another handset/ making an internal consultation call

You are talking to an external participant and can call an internal participant at the same time to forward the call or to consult.

- ▶ Calling internal participants

When an internal participant answers:

- ▶ If necessary announce the external call.

Either



Press the end call key. The call is transferred.

or





Press the display key. You are reconnected with the external participant.

When transferring a call you can also press the end call key  before the internal participant answers. Then, if the internal participant does not answer or the line is busy, the call will automatically return to you (the display will show **Recall**).

Answering a waiting call

If you receive an **external** call during an **internal** call, you will hear the call waiting tone (short tone). The caller's number will appear in the display if phone number identification is enabled.

-  Press the end call key to end the internal call.
-  Press the talk key to take the external call.

Listening in to an external call (conference)

You are conducting an external call. An internal participant can listen in on this call and take part in the conversation. A signal tone and Conference Call on the display indicates the inclusion of a new participant to the conversation to all participants.

Precondition: The Listening in function must be activated.

Activating/deactivating listening in

Menu → Settings → Base
→ Listening in (✓ = on)

-  Press and **hold** (idle status).

Internal listening in

The line is engaged with an external call. Your screen will display information to that effect. You want to listen in to the external call.

-  Press and **hold** the talk key.

You are linked into the call. All participants hear a signal tone. Conference Call appears in the display.

Ending listening in

-  An internal participant presses the end call key.

All participants hear a signal tone.

This does not affect the connection between the other internal participants and the external caller.

Handset settings

Your handset is preconfigured, but you can change the settings to suit your individual requirements.

Changing date and time

To change the time, open the input field with:

Menu → Settings → Date/Time

Enter Date:

Enter the day, month and year in 8-digit format, e.g.

 for 01/10/08.

Enter Time:

Enter hours and minutes as 4 digits, e.g.     for 07:15 a.m.

OK Press the display key

Changing the display language

You can view the display texts in different languages.

Menu → Settings → Handset → Language

The current language is indicated by ✓.

-  Select a language and press **OK**.

-  Press and **hold** (idle status).

If you accidentally choose a language you do not understand:

Menu   

Press keys in sequence.

-  Select the correct language and press **OK**.

Setting the display

You have a choice of four colour schemes and several different contrasts. You can also set a screensaver and backlight.

Menu → Settings → Handset → Display

You have the following options:

Screensaver

The available settings are No Screensaver, Globe or Digital Clock.

Col. Scheme

Four colour schemes are available. When the backlight is turned off, the display is shown in black and white regardless of the selected setting.

Contrast

There are five available contrast levels.

Backlight

In Charger / Out of Charger. Determines whether the backlight stays on permanently or is turned off after a certain time (✓ = permanently switched on).

Please note

If the backlight is turned on outside the charging cradle, the standby time for the handset is considerably reduced!

Activating/deactivating auto answer



When this function is activated, when a call arrives you can simply lift the handset out of the base station without having to press the talk key .

Menu → Settings → Handset

→ Auto Answer (✓ = on)

 Press and **hold** (idle status).

Changing the handsfree/earpiece volume

You can adjust the volume for handsfree talking to one of five settings (1-5, e.g. volume 3 = ) and the earpiece volume to one of three (1-3, e.g. volume 2 = .

Setting the volume during a call

The setting applies to the current mode (earpiece or hands-free).

You are conducting an external call.



Press the control key.



Set the volume.

The setting will automatically be saved after approx. 3 seconds, if not then press the display key **OK**.

Adjusting the volume via the menu

Menu → Settings → Audio Settings

→ Call Volume → Earpiece Volume /

Handsfree Volume









Adjust the volume and press **OK**.



Press and **hold** (idle status).

Changing ringer tones

◆ Volume:

Five volume levels (1–5; e.g. volume 3 =       

Setting the ringer volume

The ringer volume is the same for all types of ring.

Menu → Settings → Audio Settings
→ Ringer Volume

Or in idle status:

 Press **briefly**.

Then:

 Adjust the volume and press **OK**.

 Press and **hold** (idle status).

Setting the ringer melody

Set different ringer melodies for external calls, internal calls and the alarm clock.

Menu → Settings → Audio Settings
→ Ringer Melody

External Calls / Internal Calls / Alarm Clock
Select and press **OK**.



 Select melody (✓ = on) and press **OK**.

 Press and **hold** (idle status).

Activating/deactivating the ringer

You can turn off the ringer on your handset before you take a call or while the phone is in idle status. You can take a call so long as it is displayed on the screen.

Deactivating the ringer

 Press the star key **and hold**, until the  icon appears in the display.

Reactivating the ringer

 Press and **hold** the star key in idle status.

Advisory tones

Your handset uses "advisory tones" to tell you about different activities and statuses. The following tones can be activated and deactivated independently of each other:

◆ Advisory tones:

- **Key click**: every key press is confirmed.
- **Confirmation tone** (rising tone sequence): at the end of an entry/setting, when the handset is placed in the base station and on arrival of an SMS or a new entry in the answer machine list or the calls list.
- **Error tone** (descending tone sequence): when you make an incorrect entry.
- **Menu end tone**: when scrolling at the end of a menu.

◆ Battery low beep: the battery requires charging.

You cannot deactivate the confirmation tone for placing the handset in the base station.

Activating/deactivating advisory tones

Menu → Settings → Audio Settings
→ Advisory Tones

Select and press **OK** (✓ = on).

Setting the battery low beep

Menu → Settings → Audio Settings
→ Battery Low

On / Off / During Call

Select and press **OK** (✓ = on). The battery low beep is activated or deactivated or sounds during a call.

Restoring the handset to the factory settings

You can reset any individual settings and changes that you have made. This will not affect entries in the directory, calls list or SMS lists, or the handset's registration to the base station.

Menu → Settings → Handset
→ Reset Handset

Confirm query with **OK** or reject it with



Press and **hold** (idle status).

Base station settings

The base station settings are carried out using a registered Gigaset C38H handset.

Protecting against unauthorised access

Protect the system settings of the base station with a PIN known only to yourself. You may have to enter the system PIN into the base station when manually registering a handset.

Changing the system PIN

You can change the base station's 4-digit default system PIN ("0000") to a 4-digit PIN known only to yourself.

Menu → Settings → Base → System PIN



Enter the **old** system PIN and press **OK**. For security, the PIN is shown as four stars (****).



Enter your **new** system PIN and press **OK**.



Press and **hold** (idle status).

Resetting the system PIN

If you have forgotten the system PIN, you can reset it to the original code **0000** by resetting the base station to its default settings. **This will also reset every other setting**, see "Restoring the base station to the factory settings" → page 48.

Changing ringer tones

◆ Volume:

You can choose between five volumes and the "crescendo" ring, → page 45. Select "0" to deactivate the base station ringer.

◆ Ringer tones:

You can set a ringer melody for external calls, → page 45.

Menu → Settings → Base → Audio Settings
→ Ringer Volume / Ringer Melody

For how to adjust the settings, → page 45.

Repeater support

With a repeater you can increase the range and reception strength of your base station. You will need to activate repeater mode. This will terminate any calls that are in progress at the time.

Precondition: A repeater is registered. The **Eco Mode / Eco Mode+** mode is deactivated.

Menu → Settings → Base
→ Additional Features → Repeater Mode

Yes Press the display key.

When repeater mode is active, the menu item is marked with .

Please note

Repeater support and **Eco Mode / Eco Mode+** (→ page 41) cancel each other out, i.e. both functions cannot be used at the same time.

Restoring the base station to the factory settings

When restoring factory settings:

- ◆ Handsets are de-registered
 - **When resetting via the menu:**
all Gigaset handsets
 - **When resetting using the key on the base station:** also all handsets of other GAP capable devices
- ◆ Individual settings are reset
- ◆ All lists are deleted
- ◆ The system PIN is reset to the original code **0000**
- ◆ Eco Mode+ is deactivated

Only the date and time are retained.

Resetting the base station via the menu

Menu → Settings → Base → Base Reset

OK Press the display key to confirm.

Resetting the base station using a key on the base station

- ▶ Disconnect the power cord from the base station.
- ▶ Hold down the registration/paging key (→ page 2) on the base station while reconnecting the power cable to the base station. Press and hold the key until you hear a confirmation tone.

The base station has now been reset.

Connecting the phone to a PABX

The following settings are only necessary when your PABX requires them; see the PABX user guide.

You cannot send or receive SMS messages on PABXs that do not support Calling Line Identification.

Dialling modes and recall



The current setting is indicated by .

Changing the dialling mode



The following dialling modes can be selected:

- ◆ Touch tone dialling (DTMF)
- ◆ Dial pulsing (DP)

Menu     

  **OK** Dial pulsing mode (DP).

Or:

  **OK** Touch tone dialling (DTMF).

 Press and **hold** (idle status).

Setting recall

For operation on a PABX, you may have to change this value. Please refer to the user guide for your PABX.

Menu     

 Enter digits for the recall time and press **OK**.

0 = 80 ms; **1** = 100 ms; **2** = 120 ms;
3 = 180 ms; **4** = 250 ms; **5** = 300 ms;
6 = 600 ms; **7** = 800 ms

 Press and **hold** (idle status).

Setting pauses

Changing pause after line seizure

You can change the length of pause that is inserted between pressing the talk key  and sending the number.

Menu     

 Enter digit for the pause length (**1** = 1 sec.; **2** = 3 sec.; **3** = 7 sec) and press **OK**.

 Press and **hold** (idle status).

Changing the pause after the recall key

You can change the length of the pause if your PABX requires this (refer to the user guide for your PABX).

Menu     

 Enter a digit for the length of the pause (**1** = 800 ms; **2** = 1600 ms; **3** = 3200 ms) and press **OK**.

 Press and **hold** (idle status).

Switching temporarily to touch tone dialling (DTMF)

If your PABX still operates with dial pulsing (DP), but you need touch tone dialling (DTMF) for a connection (e.g. to listen to the network mailbox) you must switch to touch tone dialling for the call.

Precondition: You are conducting a call or have already dialled an external number.

 Press the star key.
 After the call is ended, dial pulsing is automatically activated again.

Customer service & product warranty – Australia and New Zealand

Gigaset Communications provides you with product information that can be accessed from the Customer Care section of our website.

www.gigaset.com/au

It provides you with 24/7 support for all our products. It also provides a list of FAQs and answers plus user guides and current software updates (if available for the product) for you to download.

You will also find frequently asked questions and answers in the appendix of this user guide.

Gigaset Cordless telephones come with a 2 Year limited warranty that covers faults with the manufacturing process or components.

Gigaset Communications will at its discretion, repair or replace, any product supplied that is found to have a manufacturing defect.

Please retain your proof of purchase details for warranty purposes.

IMPORTANT

Please retain your sales receipt as proof of the date of purchase.

Customer Service

If you require assistance in operating this product please contact us

AUS: 1300 780 878 or by e-mail at gigasetupport@ingrammicro.com.au

NZ: 0800 780 878

If you are trying to access a Network Service and require assistance specifically related to the network service or would like to subscribe to the service, contact your service provider.

Product Warranty

Subject to the conditions below, this product is guaranteed against any defect in materials or workmanship under conditions of normal use for a period of 24 months from date of purchase.

The benefits conferred by this warranty are in addition to other warranties and remedies that are implied under the Trade Practices Act and similar Country, State and Territory laws (Statutory Rights).

Subject to your Statutory Rights, the goods will not be eligible for service under this warranty if:

- Proof of purchase cannot be provided;
- The defect was caused by an accident, misuse, abuse, improper installation or operation, vermin infestation, lack of reasonable care, unauthorised modification, loss of parts, tampering or attempted repair by a person not authorised by Gigaset Communications; or
- The product has been damaged by lightning or a mains power surge.

To obtain service during the terms of this warranty call the TecHelp Information Line on

AUS: 1300 780 878 or by e-mail at gigasetupport@ingrammicro.com.au

NZ: 0800 780 878

If it is necessary to have the product serviced, the Customer Service Representative will inform you of the product return process.

Please ensure that:

- You provide proof of purchase;
- Your product is suitably packaged; and
- You have included all components from the original purchase.

Subject to your Statutory Rights:

- Any claim under this warranty is limited to the cost of repair or replacement of the product; and
- If the goods are found to be in sound working order by the authorised service centre, you may be charged a fee for service and for any other direct costs associated with having the product delivered for service.

Replacement or repair services are only offered for products purchased in Australia and New Zealand that bear Gigaset Communications GmbH local registered N Number and Telepermit markings.



Please have your proof of purchase ready when calling.

Questions and answers

If you have any questions about using your phone, visit us at www.gigaset.com/customercare at any time. The table below contains a list of common problems and possible solutions.

The display is blank.

1. The handset is not switched on.
 - ▶ Press **and hold** the end call key .
2. The batteries are flat.
 - ▶ Charge or replace the batteries (→ page 10).

"Base" flashes in the display.

1. The handset is outside the range of the base station.
 - ▶ Move the handset closer to the base station.

The base station's range is reduced because Eco Mode mode is activated.

 - ▶ Deactivate Eco Mode (→ page 41) or reduce the distance between the handset and base station.
3. The base station is not turned on.
 - ▶ Check the base station's mains adapter (→ page 8).

Handset does not ring.

1. The ringer is deactivated.
 - ▶ Activate the ringer (→ page 46).

You cannot hear a ringer/dialling tone from the fixed line network.

The phone cord supplied has not been used or has been replaced by a new cord with the wrong pin connections.

- ▶ Please always use the phone cord supplied or ensure that the pin connections are correct when purchasing from a retailer (→ page 55).

Error tone sounds after system PIN prompt.

You have entered the wrong system PIN.

- ▶ Reset the system PIN to 0000 (→ page 47).

<p>Forgotten the system PIN.</p> <ul style="list-style-type: none"> ▶ Reset the system PIN to 0000 (→ page 47).
<p>The other party cannot hear you.</p> <p>You have pressed the Mute display key. The handset is "muted".</p> <ul style="list-style-type: none"> ▶ Activate the microphone again (→ page 24).
<p>The number of the caller is not displayed despite CLIP.</p> <p>Calling Line Identification is not enabled.</p> <ul style="list-style-type: none"> ▶ The caller should ask the network provider to release Calling Line Identification (CLI).
<p>You hear an error tone (descending tone sequence) when inputting.</p> <p>Action has failed/invalid input.</p> <ul style="list-style-type: none"> ▶ Repeat the operation. Watch the display and refer to the user guide if necessary.
<p>You cannot listen to messages on the network mailbox.</p> <p>Your PABX is set for dial pulsing.</p> <ul style="list-style-type: none"> ▶ Set your PABX to touch tone dialling.

Gigaset C385 only:

<p>No time is specified for a message in the answer machine history.</p> <p>Date/time is not set.</p> <ul style="list-style-type: none"> ▶ Set the date/time (→ page 13).
<p>The answer machine announces "PIN is incorrect" during remote operation.</p> <p>1 You have entered the wrong system PIN. · ▶ Enter the system PIN again.</p> <p>2 The system PIN is still set to 0000. · ▶ Change the system PIN (→ page 47).</p>
<p>The answer machine will not record any messages.</p> <p>Its memory is full.</p> <ul style="list-style-type: none"> ▶ Delete old messages. ▶ Play back new messages and delete.

Environment

Our environmental mission statement

We at Gigaset Communications GmbH carry social responsibility and are actively engaged in the interests of a better world. Our ideas, technologies and actions serve people, society and the environment. The aim of our global activity is to secure sustainable life resources for humanity. We are committed to a responsibility for our products that comprises their entire life cycle. The environmental impact of products, including their manufacture, procurement, distribution, utilization, service and disposal, are already evaluated during product and process design.

Further information on environmentally friendly products and processes is available on the Internet under www.gigaset.com.

Environmental management system



Gigaset Communications GmbH is certified pursuant to the international standards EN 14001 and ISO 9001.

ISO 14001 (Environment): certified since September 2007 by TÜV SÜD Management Service GmbH.

ISO 9001 (Quality): certified since 17/02/1994 by TÜV Süd Management Service GmbH.

Ecological energy consumption

The use of ECO DECT (→ page 41) saves energy and is an active contribution towards protecting the environment.

Disposal

Battery packs should not be disposed of in general household waste. Observe the local waste disposal regulations, which you can find out about by contacting your local authority or the dealer you purchased the product from.

All electrical and electronic equipment must be disposed of separately from general household waste using the sites designated by local authorities.



If a product displays this symbol of a crossed-out rubbish bin, the product is subject to European Directive 2002/96/EC.

The appropriate disposal and separate collection of used equipment serve to prevent potential harm to the environment and to health. They are a precondition for the re-use and recycling of used electrical and electronic equipment.

For further information on disposing of your used equipment, please contact your local authority, your refuse collection service or the dealer you purchased the product from.

Appendix

Care

Wipe the base station, charging cradle and handset with a **damp** cloth (do not use solvent) or an antistatic cloth.

Never use a dry cloth. This can cause static.

Contact with liquid

If the handset has come into contact with liquid:

1. **Switch off the handset and remove the battery pack immediately.**
2. Allow the liquid to drain from the handset.
3. Pat all parts dry, then place the handset with the battery compartment open and the keypad facing down in a dry, warm place **for at least 72 hours** (not in a microwave, oven etc.).
4. **Do not switch on the handset again until it is completely dry.**

When it has fully dried out, you will normally be able to use it again.

Specifications

Recommended batteries

Technology:

Nickel-metal-hydride (NiMH)

Size: AAA (Micro, HR03)

Voltage: 1.2 V

Capacity: 550 – 1000 mAh

We recommend the following battery types, because these are the only ones that guarantee the specified operating times, full functionality and long service life:

- ◆ GP 700 mAh
- ◆ Yuasa Phone 700 mAh
- ◆ Yuasa Phone 800 mAh
- ◆ Yuasa AAA 800
- ◆ Peacebay 600 mAh

The device is supplied with two recommended batteries.

Handset operating times/charging times

The operating time of your Gigaset depends on the capacity and age of the batteries and the way they are used. (All times are maximum possible times and apply when the display backlight is switched off).

	Capacity (mAh) approx.			
	550	650	800	1000
Standby time (hours)	210	240	305	380
Talktime (hours)	21	25	31	38
Operating time for 1.5 hrs of calls per day (hours)	85	100	125	155
Charging time, base station (hours)	9	11	14	17
Charging time, charging cradle (hours)	7	8	10	12

At the time of going to print, batteries up to 800 mAh were available and had been tested in the system. Due to the constant progression in battery development, the list of recommended batteries in the FAQ section of the Gigaset Customer Care pages is regularly updated:

www.gigaset.com/customer-care

Base station power consumption

In standby condition	
– Handset in charging cradle	approx. 1.3 W
– Handset outside charging cradle	approx. 1.3 W
During a call	approx. 1.5 W

General specifications

DECT standard	is supported
GAP standard	is supported
No. of channels	60 duplex channels
Radio frequency range	1880–1900 MHz
Duplex method	Time multiplex, 10 ms frame length
Channel grid	1728 kHz
Bit rate	1152 kbit/s
Modulation	GFSK
Language code	32 kbit/s
Transmission power	10 mW, average power per channel
Range	up to 300 m outdoors, up to 50 m indoors
Base station power supply	230 V ~/50 Hz
Environmental conditions in operation	+5 °C to +45 °C, 20 % to 75 % relative humidity
Dialling mode	DTMF (touch tone dialling)/DP (dial pulsing)

Pin connections on the telephone jack

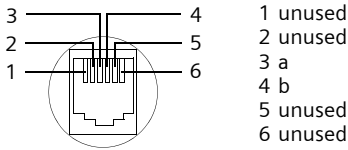

Writing and editing text

The following rules apply when writing text:

- ◆ Use to move the cursor to the right or left.
- ◆ Characters are inserted to the left of the cursor.
- ◆ The first letter of the name of directory entries is automatically capitalised, followed by lower case letters.

Writing an SMS/names

Press the relevant key several times to enter letters/characters.

Standard characters

	1x	2x	3x	4x	5x	6x	7x	8x	9x	10x	11x	12x	13x	14x
				1	€	£	\$	¥	□					
	a	b	c	2	ä	á	à	â	ã	ç				
	d	e	f	3	ë	é	è	ê						
	g	h	i	4	ï	í	ì	î						
	j	k	l	5										
	m	n	o	6	ö	ñ	ó	ò	ô	õ				
	p	q	r	7	ß									
	t	u	v	8	ü	ú	ù	û						
	w	x	y	9	ÿ	ý	æ	ø	å					
	.	,	?	!	0	+	-	:	;	'	"	'	;	-
	*	/	()	<	=	>	%						
			#	@	\	&	§							

- 1) Space
2) Line break

When you press and **hold** a key, the characters of that key appear in the display and are highlighted one after the other. When you release the key, the highlighted character is inserted into the input field.

Setting upper/lower case or digits

Press the hash key **briefly** to switch from "Abc" mode to "123" and from "123" to "abc" and from "abc" to "Abc" (upper case: 1st letter upper case, all others lower case). Press the hash key **before** entering the letter.

You can see briefly in the display whether upper case, lower case or digits is selected.

Accessories

Gigaset handsets

Upgrade your Gigaset to a cordless PABX:

Gigaset A58H handset

- ◆ Illuminated graphic display
- ◆ Illuminated keypad
- ◆ Handsfree talking
- ◆ Polyphonic ringer tones
- ◆ Directory for around 150 entries
- ◆ SMS (precondition: CLIP must be enabled)

www.gigaset.com/gigasetA58H



Gigaset C47H handset

- ◆ Illuminated graphical colour display (65k colours)
- ◆ Illuminated keypad
- ◆ Handsfree talking
- ◆ Polyphonic ringer tones
- ◆ Directory for around 150 entries
- ◆ SMS (precondition: CLIP must be enabled)
- ◆ Headset socket
- ◆ Room monitor

www.gigaset.com/gigasetC47H



Gigaset SL37H handset

- ◆ Illuminated graphical colour display (65k colours)
- ◆ Illuminated keypad
- ◆ Handsfree talking
- ◆ Polyphonic ringer tones
- ◆ Directory for around 250 entries
- ◆ Picture CLIP
- ◆ SMS (precondition: CLIP must be enabled)
- ◆ PC interface. e.g. for managing directory entries, ringer tones and screensavers
- ◆ Headset socket
- ◆ Bluetooth
- ◆ Room monitor
- ◆ Walky-talky function

www.gigaset.com/gigasetSL37H



Ordering Gigaset products

You can order all the Gigaset products shown here and many others from your retail dealer.



Only use original accessories. This will avoid possible health risks and damage to property, and also ensure that all the relevant regulations are complied with.

Mounting the base station to the wall

C380: 40 mm
C385: 46 mm

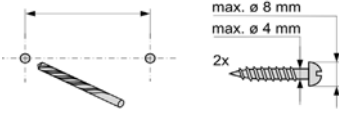

approx.
2.5 mm

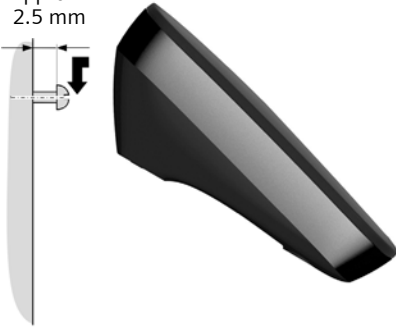

Mounting the charging cradle to the wall

21 mm

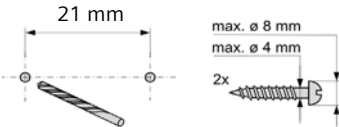

approx.
2.5 mm

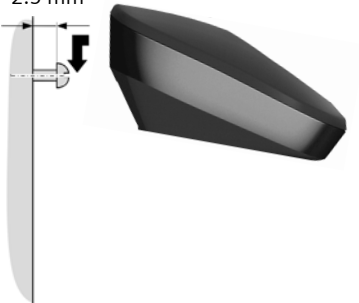

Index

A

- Access protection 47
- Accessories 56
- Activating
 - advisory tones 46
 - answer machine 36
 - answer machine
(remote operation) 39
 - call acceptance 45
 - handset 19
 - internal call screening 44
 - keypad lock 19
- Advisory tones 46
- Alarm 42
- Alarm repeat 42
- Answer machine 36
 - list 27, 28
 - remote operation 39
- Answer machine, see also
 Network mailbox
- Auto answer 45
- Automatic
 - call acceptance 23
 - network provider preselection 29

B

- Backlight 45
- Base station
 - connecting 8
 - connecting to PABX 49
 - power consumption 54
 - restoring to factory settings 48
 - setting 47
 - setting up 8
 - system PIN 47

Battery

- charging 1, 12
- display 1
- icon 1, 11
- inserting 10
- recommended batteries 54
- warning tone 46

C

- Call
 - accepting 23
 - ending 23

- external 23
 - internal 43
 - party listening in 44
 - picking up from answer machine 37
 - transferring (connecting) 43
- Call acceptance 38, 45
 - Call duration 23, 30
 - Call history 27
 - Call screening during recording 38
 - Call waiting during an internal call 44
- Calling
 - external 23
 - internal 43
 - Calling Line Identification 23
 - Cancelling
 - preselection 29
 - Care of the telephone 53
 - Changing
 - dialling mode 49
 - earpiece volume 45
 - handsfree volume 45
 - pause time 49
 - system PIN 47
 - Character set 33, 55
 - Charge status display 1
 - CLI, CLIP 23
 - Colour scheme 45
 - Conference 44
 - Configuring the network mailbox 40
 - Confirmation tone 46
 - Connect headset 15
 - Connecting, base station to PABX 49
 - Contrast 45
 - Control key 1, 17
 - Correcting incorrect entries 18
 - Customer service & product warranty –
 Australia and New Zealand 50

D

- Deactivating
 - advisory tones 46
 - answer machine 36
 - call acceptance 45
 - handset 19
 - internal call screening 44
 - keypad lock 19
- Delete key 17
- Deleting
 - announcement (answer machine) 36
 - characters 18

Index

Dial pulsing	49
Dialling	
directory	25
mode	49
with speed dial	26
Dialling pause	
entering	1
Digital clock	45
Directory	25
copying number	26
copying number from text	26
managing entries	25
opening	17
order of entries	25
saving entry	25
saving sender's (SMS) number	33
saving the first number	25
sending entry/list to handset	26
Display	
backlight	45
call duration	30
changing display language	44
colour scheme	45
contrast	45
in idle status	18
keys	1, 17
network mailbox report	40
number (CLI/CLIP)	23
screensaver	45
setting	45
Disposal	53
DP (dial pulsing)	49
DTMF (touch tone dialling method)	49
E	
Earpiece mode	24
Earpiece volume	45
ECO DECT	41
Eco mode	41
Eco mode+	41
End call key	1, 23
Ending, call	23
Ending, see Deactivating	
Entry	
saving (network mailbox)	40
saving, changing (preselection)	29
selecting from directory	25
Environment	52
Error tone	46

F

Fast access	
answer machine	38
network mailbox	40

G

General troubleshooting	51
-----------------------------------	----

H

Handset

activating/deactivating	19
advisory tones	46
contact with liquid	53
de-registering	42, 48
display language	44
earpiece volume	45
handsfree volume	45
idle status	18
locating	43
muting	24
paging	43
registering	42
restoring to factory settings	47
setting	44
setting up	10
transferring a call	43
using several	42, 43
Handsfree key	1
Handsfree talking	24
Hash key	1, 19
Headset socket	15
Hearing aids	6
Help	51

I

Icon

battery	11
display	17
for new messages	27
keypad lock	19
Idle status	
display	18
returning to	18
Incorrect input (correction)	18
Installing, base station	8
Internal	
call screening	44
key	1
making calls	43
Internal call	43

- call waiting 44
- K**
- Key 1 (fast access) 1, 38
- Key click 46
- Keypad lock 19
- Keys
 - assigning directory entry 26
 - control key 1, 17
 - delete key 17
 - display keys 1, 17
 - end call key 1, 23
 - fast access 1, 38
 - handsfree key 1
 - hash key 1, 19
 - internal key 1
 - message key 1
 - on/off key 1
 - recall key 1
 - speed dial 26
 - star key 1, 46
 - talk key 1, 23
- L**
- Last number redial 27
- Liquid 53
- List
 - answer machine 27, 28
 - answer machine list 28
 - call history 27
 - draft message list (SMS) 32
 - incoming message list (SMS) 32
 - missed calls 27, 28
 - network mailbox 27
 - SMS list 27
- Locating, handset 43
- Lock
 - activating/deactivating keypad lock . 19
- M**
- Mains adapter 6
- Making calls
 - answering a call 23
 - cost-effective calls 29
 - external 23
 - internal 43
- Manual last number redial 27
- Medical appliances 6
- Menu
 - end tone 46
 - overview 21
 - prompting 18
- Message
 - copying number to the
 - directory 37
 - deleting 37
 - playing 37
- Message key 1
- open list 32
- opening lists 27
- Microphone 1
- Missed calls 27, 28
- Muting
 - handset 24
- N**
- Network provider preselection,
 - automatic 29
- Number
 - copying from directory 26
 - copying to directory 26
 - displaying caller's number (CLIP) . . 23
 - entering network mailbox number . 40
 - entering with directory 26
 - saving in the directory 25
 - saving sender in the directory 33
 - setting for SMS centre 34
- O**
- On/Off key 1
- Order in directory 25
- P**
- PABX
 - connecting base station 49
 - setting dialling mode 49
 - setting recall 49
 - SMS 34
 - switching temporarily to touch
 - tone dialling 49
- Pack contents 7
- Paging 43
- Pause 49
- PIN change, system PIN 47
- Pin connections 55
- Playing back
 - announcement (answer machine) . 36
 - message (answer machine) 37
- Power consumption (base station) . . 54
- Preselection 29

Index

cancelling 29
Protecting the phone against access . . 47

Q

Questions and answers 51

R

Range 8
Recall 49
 time 49
Recall key 1
 pause after 49
Reception booster, see Repeater
Recording time (answer machine) . . . 38
Registering (handset) 42
Remote operation 39
Repeater 47
Ringer
 changing 45
 setting melody 46, 47
 setting volume 45, 47

S

Screen protection, see Screensaver
Screening a call 44
Screensaver 45
Searching in directory 25
Sending directory entry to handset . . 26
Setting
 date 13, 44
 melody 47
 melody (ringer) 46
 time 13, 44
 wake-up time 42
Setting up
 handset 10
Shortcut 21
SMS 31
 active send service centre 31
 deleting 32
 draft message list 32
 forwarding 33
 incoming message list 32
 list 27
 reading 32
 registration assistant 31
 replying to and forwarding 33
 saving number 33
 self help with error messages 35
 to a PABX 34

troubleshooting 35
writing 55

SMS centre
 changing number 34
 setting 34
Snooze (alarm clock) 42
Specifications 54
Speed dial 26
Star key 1, 46
System settings 47

T

Talk key 1, 23
Telephone jack, pin connections . . . 55
Telephone system
 setting pauses 49
Text message, see SMS
Touch tone dialling 49
Troubleshooting (SMS) 35

U

Unknown caller 24

V

Viewing the network mailbox report . 40
Volume
 earpiece volume 45
 handset handsfree volume 45
 ringer 45, 47

W

Warning tone (battery) 46
Warranty 52
Writing (SMS) 31
Writing and editing a text message . . 55

