

---

# Connect ID

TV

Connect ID 55

Connect ID 46

Connect ID 40



User guide

---

**LOEWE.**

36321020



## Imprint

Loewe Technologies GmbH  
Industriestraße 11  
D-96317 Kronach  
www.loewe.de

Printed in Germany  
Editorial date 05/14-1.0c TB  
© Loewe Technologies GmbH, Kronach  
ID: 10.2.3.18

All rights including translation, technical modifications and errors reserved.



<b>Imprint.....</b>	<b>2</b>	<b>Audio/Radio .....</b>	<b>60</b>
<b>Welcome.....</b>	<b>5</b>	Audio playback .....	61
Scope of delivery .....	5	Radio mode (DVB radio) .....	64
About this user guide.....	5	Radio mode (Internet radio) .....	65
<b>For your safety.....</b>	<b>6</b>	<b>Photo .....</b>	<b>66</b>
<b>Basic Functions .....</b>	<b>8</b>	Photo display.....	67
<b>Remote control.....</b>	<b>9</b>	<b>Web .....</b>	<b>68</b>
<b>Operating controls on the TV set.....</b>	<b>10</b>	MediaNet .....	68
<b>Connections rear side of the device .....</b>	<b>11</b>	Browser.....	70
<b>Preparing the TV set.....</b>	<b>12</b>	<b>Extras.....</b>	<b>71</b>
Installing the TV set.....	12	Timer .....	71
Set covers.....	12	Conditional Access module (CA module).....	76
Connecting the TV set.....	12	DVB Common Interface Standard (CI) .....	77
Bundling the cables.....	14	Special functions .....	78
Preparing the remote control unit.....	14	Integrated features .....	78
Switching the TV set ON/OFF .....	15	Picture .....	80
Technical information .....	15	Sound.....	84
<b>General information on menu operation.....</b>	<b>16</b>	Stations.....	85
Info display.....	19	Automatic scan TV+Radio.....	86
Operation without remote control.....	19	Manual Scan TV / Radio.....	87
<b>Initial installation.....</b>	<b>20</b>	Station lists TV / Radio .....	89
Initial installation wizard .....	20	Compose / edit Personal list.....	90
TV set as a monitor .....	31	Update station list automatically .....	91
<b>Home view.....</b>	<b>32</b>	Control .....	92
Home - Favourites .....	33	Language .....	93
<b>TV.....</b>	<b>34</b>	EPG.....	93
Setting the volume .....	34	Parental lock .....	94
Select station .....	34	Energy efficiency.....	95
Status display.....	36	Quick start mode.....	95
Function list .....	37	Software update.....	96
AV list.....	37	On-screen displays.....	101
Electronic Programme Guide – EPG.....	38	Time and date .....	101
Teletext.....	41	DVB settings.....	102
HbbTV / MediaText.....	43	DR+ .....	103
Digital Recorder .....	44	Standard Teletext.....	104
Digital-Recorder – Overview of functions .....	44	HbbTV .....	105
Archive recording.....	45	CA module(s).....	106
DR+ archive .....	47	Record .....	107
DR+ Streaming .....	50	Hard disks .....	107
Follow me function .....	50	WEB key function.....	108
<b>Media+.....</b>	<b>51</b>	Network settings.....	109
General information on media reproduction.....	51	Multimedia settings.....	112
Accessing your media.....	51	Renderer .....	112
<b>Video.....</b>	<b>52</b>	Connections.....	113
Video playback.....	53	Sound components .....	114
		Antenna DVB.....	115
		AV connection settings .....	115
		Digital Link.....	116
		Gaming mode .....	116

<b>External devices .....</b>	<b>117</b>
Devices to the HDMI connections.....	117
Digital Link HD.....	118
Devices on AV.....	119
Devices on PC IN .....	121
Connecting the Audio system .....	122
Connecting the HiFi/AV amplifier.....	122
Audio playback from external devices.....	123
Serial interface RS-232C (RJ12).....	123
Operating Loewe units.....	124
<b>Teaching the remote control .....</b>	<b>125</b>
Loewe Apps.....	126
<b>Loewe Apps.....</b>	<b>127</b>
<b>Troubleshooting .....</b>	<b>129</b>
<b>Technical Data .....</b>	<b>131</b>
<b>Technical data .....</b>	<b>131</b>
Function of the connections .....	132
Media.....	133
Signals via PC IN / HDMI .....	134
Signal input groups .....	134
<b>Accessories.....</b>	<b>135</b>
Upgrade kits / conversion kits / cables .....	135
Equipment variants .....	136
Mounting options .....	137
<b>Environment .....</b>	<b>138</b>
<b>Glossary .....</b>	<b>139</b>
<b>EC Declaration of Conformity.....</b>	<b>143</b>
<b>Index .....</b>	<b>145</b>
<b>Service.....</b>	<b>148</b>
<b>Code page .....</b>	<b>149</b>
<b>Notes .....</b>	<b>151</b>

## Thank you,

for choosing a Loewe TV set!

At Loewe we combine the highest requirements regarding technology, design and ease of use. This applies equally for TV, video and accessories.

In addition to sleek design and a varied combination of colour and mounting choices, your Loewe TV set offers a host of technological options.

### Loewe Image+

Image+ and state-of-the-art full HD LCD displays with LED backlit TV technology guarantee the best image quality and high contrast values and all this at lowest possible energy consumption.

### Loewe Digital+

The integrated triple tuner for DVB-T/C/S enables the reception of standard as well as high-definition contents and thanks to the CI Plus interface even from Pay TV.

### Loewe Assist+

The intuitive Loewe user interface Assist Media offers a simple access to all device functions; by means of the HOME key on the remote control you can access all your favourite content as well as all multimedia functions of your TV set.

### Loewe Media+

The Loewe Multimedia functions offer you a multitude of options; you have access to your photos, videos and music in your home network or on the USB stick.

Loewe MediaNet and MediaText help you to access numerous worldwide web-applications and contents from HbbTV services.

### Loewe Connectivity+

Network your TV set by means of numerous interconnection options. Be it HDMI, USB, CI Plus or LAN/WLAN, discover the world of the Loewe networking possibilities.

## Scope of delivery

- LCD TV set
- Mains cable
- Antenna cable
- Table Stand Dynamic (Connect ID 40 / 46)
- Wall mount WM62 (Connect ID 55)
- Remote control Assist with two batteries
- Quick guide

## About this user guide

**i** For best results regarding safety and the longevity of the set, we recommend you read the chapter **For your safety** before switching it on for the first time.

The **glossary** gives explanations of certain terms used in the TV set and the user guide.

Paragraphs which begin with the symbol **i** indicate important instructions, tips or conditions for the following settings.

Terms which you will find in the menus or printed on the remote control or TV set are written in **bold** type.

The necessary control elements are shown in the descriptions to the left of the text containing the instructions for action.

In addition to the remote control, a PC keyboard can be connected to one of the USB ports on your TV and then used to control your TV set.



In the user guide, this symbol indicates places in which the use of a keyboard is particularly advantageous.

Depending on the connected accessory equipment the menus in the TV set can differ from those described here.

All the station names, programme contents, the illustrated photos, titles, albums and album covers in this user guide are examples.

The user guide instructions for your TV set is updated at irregular intervals. We recommend checking now and then, especially after a software update.

## General information on menu operation of the TV set

For further information on the user interface and the general operation of your TV set see chapter **General information on menu operation**.

## Interactive data services

In some countries the stations also broadcast interactive data services with their programmes, leading to the functions of individual buttons not being available or only so to a limited extent. You can find out more about this in chapter **TV**, section **HbbTV / MediaText**.

**For your safety, and to avoid unnecessary damage to your unit, please read and follow the safety advice below:**

### Use for the intended purpose and ambient conditions

This TV set is intended exclusively for receiving and playing visual and audio signals. It must not be used in rooms with a high level of **humidity** (e.g. bathroom, sauna) or a high **dust concentration** (e.g. workshops). The manufacturer's warranty is only valid for use in the specified permissible environment.

If the unit is used outdoors, make sure that it is protected from **moisture** (rain, dripping water and splashing water or dew). High humidity and dust concentrations lead to leakage currents in the device. This can result in a shock hazard by touching it or even fire.

If you have moved the unit out of the **cold** into a warm environment, leave it switched off for about an hour to avoid the formation of **condensation**.



Do not place **objects** containing **liquids** on top of the unit. Protect the appliance against dripping and splashing water.

**Candles** or **naked flames** must be kept away from the TV set at all times to prevent it from catching fire.

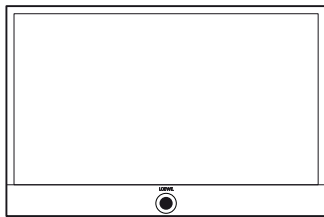

Never place the TV set in a location where it is exposed to **vibrations**. This may lead to damage.

### Transporting

Move the device in **vertical position** only. Grasp the device on the upper and lower edges of the housing.

If the set has to be put down during packing/unpacking, place the TV set with its entire front surface lying flat on soft material such as a blanket or the fleece from the packing material. Use a blanket or the fleece from the packing material as an underlay.

The LCD screen is made of glass or plastic and can break if not handled properly.

Always wear rubber gloves to carry the TV set if the LCD screen is damaged and **liquid** crystal might be leaking out. In the case of **skin contact** immediately rinse thoroughly with water.

### Power supply

**Incorrect voltages** can damage the unit. This device may only be connected to a power supply with the voltage and frequency indicated on the type plate using the supplied mains cable. The **mains plug** of the TV set must be easily accessible so that the device can be disconnected from the mains at any time. When unplugging the unit from the mains, pull at the connector body and not at the **cable**. The cables in the mains plug could otherwise be damaged and could cause a **short-circuit** when plugged in again.

Lay the **mains cable** so that it cannot be damaged. Do not step on the mains cable. The mains cable may not be kinked or laid over sharp edges nor be exposed to **chemicals**; the latter also applies to the unit as a whole. A mains cable with damaged insulation can cause **electric shocks** and poses a **fire risk**.

### Air circulation and high temperatures

The **vent slots** on the **rear panel of the set** must always be kept unobstructed. Please do not place newspapers or cloths on/over the TV set.

Ensure that there is at least 10 cm free space on the sides and above the set for air circulation, if the set is placed in a **cabinet** or on a **shelf**.

Like any electronic device, your TV set requires **air for cooling**. Obstruction of the air circulation can cause fires.

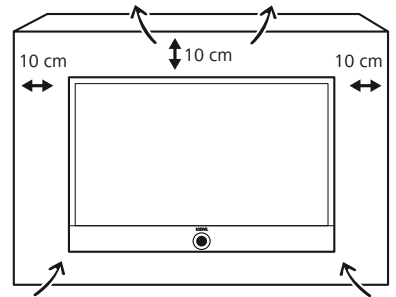

Prevent **metal items**, needles, paper clips, liquids, wax, or similar items, from getting into the interior of the device through the **vent slots** in the rear panel. Such objects can cause **short circuits** in the set, which could possibly cause a fire.

If something should get into the **interior of the set** then immediately unplug the mains plug of the device and contact the **field service** for more information.

### Note on the LCD screen

The TV set with LCD screen you have purchased satisfies the most rigorous quality requirements and has been inspected with respect to **pixel errors**. Despite of thorough care when manufacturing the display, it cannot be 100% guaranteed that no **subpixel** defects will occur due to technical reasons. Please understand that these types of effects, as long as they are within the standard of specified limits, cannot be considered as a device defect in terms of the guarantee.

Avoid displaying still images for long periods of time. It is possible that a copy of the image may remain.

### TV sets with 3D function

Read the following safety instructions before using the 3D function of your TV set.

Please use the Loewe 3D TV sets only with the Loewe 3D glasses which can be purchased as an accessory from your Loewe dealer (see chapter **Accessories**).

People that have a visual disorder may not be able to perceive 3D effects or may only be able to perceive them to a limited extent. People who are sensitive to flickering images (e.g. those with epilepsy) should only use the 3D function after having consulted their doctor.

It might take some time for you to get used to the 3D glasses and before you can perceive the 3D effects properly.

Stop using the 3D function immediately if you experience any feelings of nausea, dizziness or malaise when viewing 3D content.

Supervise children whilst they are viewing 3D content, as they can be particularly sensitive to it.

Allow more time for a break when viewing 3D films, so that you are able to relax. Failure to do this could result in headaches, fatigue, dizziness or malaise.

Position yourself comfortably in front of the 3D TV set and ensure that you are seated firmly. By doing this, you will avoid any injuries that may arise due to reacting to extreme 3D content.

Switch off any artificial light sources (e.g. energy saving lamp) between the 3D TV set and the 3D glasses. These could impair the infrared reception or the TV picture may flicker as a result.

## Set-up

Loewe Flat TV sets are specified for Loewe accessories. The TV set is suitable for different mounting options. Note the assembly instructions regarding the different possible mounting options.

When using accessories from other manufacturers take care that the TV set can be easily inclined or rotated on the respective mounting option.

For mounting options from other manufacturers with motor drive, make sure that the TV set cannot be rotated manually. The use of mounting options from other manufacturers with locks in certain positions is generally discouraged.

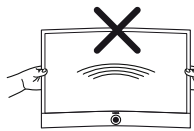

During the adjustment of the TV set it is essential to ensure that the pressure exerted on the device frame is not too large. Especially in case of large-format displays there is a risk to damage the screen.

Before setting up the device, please check that the final location is suitable to bear the load of the device in terms of surface (sensitivity to pressure) and stability (statics).

This is particularly the case for the high-gloss painted surfaces and surfaces that are made from real wood / real wood veneer or plastic surfaces.

Place the TV set with the table or floor stand only on a **level, sturdy, horizontal base**. Particularly ensure that the set does not protrude to the front when placed in or on pieces of furniture.

Place the TV set in a normal position for use. TV set may only be used in an upright **horizontal** position. It may not be tilted by more than 10 degrees. The TV set must never be operated in portrait position, lying flat or hanging overhead from the ceiling.

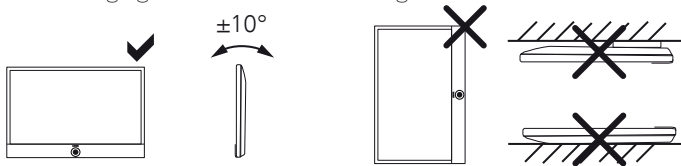

Set up the device where it is not exposed to direct **sunlight** and where it is not exposed to additional warming through heating elements.

Mounting a Loewe flatscreen TV set to a holder according to the VESA standard **necessarily** requires the use of Loewe Vesa adaptor bolts to prevent damage to the TV set.

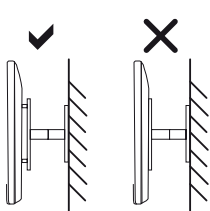

When mounting the TV set, always check that all **four** Loewe Vesa adaptor bolts are used.

The Loewe Vesa adaptor bolts are used to ensure stability and the necessary distance between rear wall of the TV set and Vesa-Holder (at least 5mm).

The Loewe Vesa adaptor bolts are fastened with a torque of about 4 Nm on the TV set. If

you use a Vesa mounting options from other manufacturers, you can order the Vesa adapter bolts M8x32 (No. 90458.957) at your authorized dealer of Loewe.

## Supervision

Do not let **children** loiter and play unsupervised close to the device. The set could tip over, be pushed off or pulled down from the stand surface and injure someone.

Do not allow the switched-on TV set to run **unattended**.

## Volume

Loud music can lead to ear damage. Avoid extreme volume especially over long periods and when using headphones.

## Thunder storms

Pull out the mains plug and all connected **antenna cables** from the TV set in a thunderstorm. Overvoltage caused by **lightning strokes** can damage the set via the antenna system, as well as via the mains. The mains plug and all connected antenna cables should also be pulled out during long periods of **absence**.

## Automatic shutdown

If the TV is not operated for 4 hours (adjustment of volume, programme change, etc.) the TV will automatically switch to stand-by mode to save energy. A prompt to terminate this shutdown process appears one minute before expiry of the 4 hours.

The automatic shutdown is generally active for the TV mode as soon as the energy efficiency mode **Home Mode** is enabled for at least one of the six signal input groups (see chapter **Technical Data**, section **Signal input groups**). This also applies if another energy efficiency mode is selected during initial installation, but one of the signal input groups is subsequently set to **Home Mode**.

Automatic shutdown does **not** occur when using the radio **without** screen display (**screen off**).

## Cleaning and care

**i** Switch off the TV set with the main switch prior to cleaning.

Clean the TV set, the screen, and the remote control unit with a soft, moist, clean and colour-neutral cloth only, **without** any **aggressive** or **scouring cleaning agents**.

The **speaker panel** of your TV set is covered with textile. Vacuum the surface regularly using a soft brush set.

In case of **dirt** or **stains**:

Moisten a soft, colour-neutral cloth with detergent or normal stain remover and gently rub away the stain. You can also treat the mark/stain directly with normal dry stain remover spray (vacuum up powder).

Do not moisten the covering fabric directly with detergent or stain remover (risk of encrustation). Do not use any solvents to clean the fabric.

**i** Follow the manufacturer's instructions when using stain removers.

**i** There is an increased risk of encrustation when cleaning speaker panels with nicotine deposits.

## Repairs and accessories

Never remove the back of the TV set yourself. Have your TV set repaired or serviced by **authorised television technicians** only.

Only use **original accessories** such as Loewe stands, if possible (see chapter **Accessories**).

## On/Off of the television set



Switching the TV set ON / switching it OFF in Standby mode (Mains switch must be switched ON)

When TV set is switched on:  
Press key long: Switch TV set and all CEC-capable devices connected to the **HDMI** interfaces OFF to Standby mode (System Standby).

## General navigation



◀ ▶ ◂ ▸ Navigation on the user interface, select objects

## Select station



**OK** short: Call station list. Or:  
**OK** long: Call expanded station list.

◂ ▸ ◃ ◅ Mark station,  
**OK** switch over to station.

Or:



**P+ / P-** Next/previous channel

Or:



Select station with numerical keys

## Sound



**V+ / V-** Increase/reduce volume



Sound on/off

## Colour key function during TV operation



**Red key:** Start HbbTV or value-added network service

**Yellow key:** Last selected station

**Blue key:** Call function list  
(selection of language/sound, subtitles or channel/video track)

## Function of the coloured keys in audio mode



**Green key:** Switch screen ON/OFF

**Yellow key:** Last selected station in DVB radio mode

## Key functions



TV operation



Call radio mode (standard assignment) <sup>1</sup>



Call **Home** view,  
Select the operating mode or the function



Pressing briefly, during screen fade-in function: Info display,  
info text appropriate to the content that can assist you further, should you have any questions about your TV device;

Pressing briefly without on-screen display: access status display.  
With status display open and repeatedly pressing the key call / close the detailed information on the broadcast

Pressing long: show key explanation



Pressing briefly: Open the DR+ archive  
Pressing long: Call up the timer list



Add current object to **Home** favourites



Call MediaNet (standard assignment) <sup>2</sup>



On/Off EPG (Electronic Programme Guide)



Turn Teletext/MediaText on/off



Pressing briefly: Call function list for the active operating mode  
Pressing long: call System settings



Pressing briefly: step / level back  
Pressing long: close all displays

<sup>1</sup> The assignment of these keys can be changed (see chapter **External devices**, section **Operating Loewe units**).

<sup>2</sup> The assignment of these keys can be changed (see chapter **System settings**, section **Control – Web key function**).



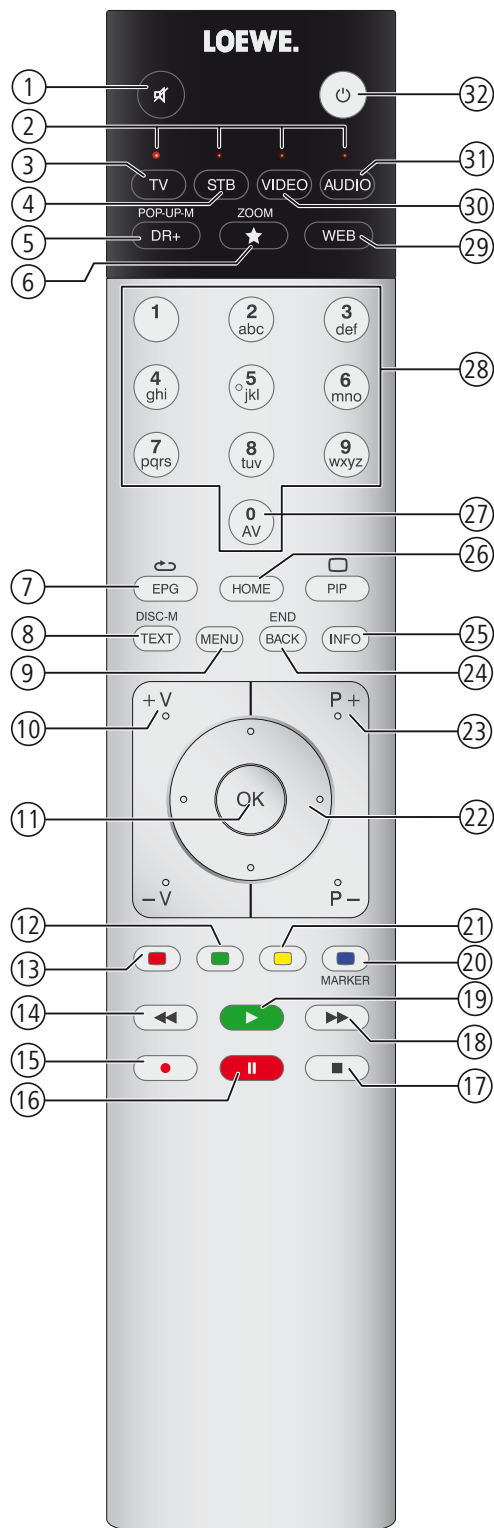

- ① Sound mute/on
- ② LED display for currently operated device
- ③ Switch to TV mode
- ④ Reassign remote control to SetTop-Box (**PACE DS440N**)<sup>(1)</sup>
- ⑤ DR+ archive on/off
- ⑥ Define active object as favourite
- ⑦ Electronic Programme Guide on/off
- ⑧ Teletext/MediaText<sup>(3)</sup> on/off
- ⑨ Call function list
- ⑩ **V+/V-** Increase/reduce volume
- ⑪ Call station list / expanded station list  
In the menu: confirm/call up
- ⑫ Green coloured key: screen on/off
- ⑬ Red coloured key: call preferred value-added network service<sup>(3)</sup>
- ⑭ Jump / wind
- ⑮ Direct recording (One Touch Recording)
- ⑯ Start / interrupt timeshift television
- ⑰ Finish timeshift
- ⑱ Jump / wind
- ⑲ Start / continue timeshift television
- ⑳ Blue coloured key: call station function list with subfunctions
- ㉑ Yellow coloured key: switching to previously received station
- ㉒ In menu / in lists: selecting/setting
- ㉓ **P+/P-** Select stations up/down
- ㉔ Press briefly: back to previous window (step back)  
Press long: close all displays
- ㉕ Status display on/off  
In menu: context-relevant Info on/ off
- ㉖ Open/close **Home** view
- ㉗ AV list
- ㉘ Select station directly  
In the menu: Enter numbers or letters
- ㉙ Call **MediaNet**<sup>(2)</sup>
- ㉚ Reassign remote control to **BluTech Vision 3D**<sup>(1)</sup>
- ㉛ Switch to radio mode<sup>(1)</sup>
- ㉜ Switch ON/OFF to standby mode  
System standby

The key assignment displayed here is valid for the main level of the TV set. The key assignment may vary in certain operating modes (see the corresponding chapter in this user guide).

<sup>(1)</sup> The assignment of these keys can be changed (see chapter **External devices**, section **Operating Loewe units**).

<sup>(2)</sup> The assignment of these keys can be changed (see chapter **System settings**, section **Control – Web key function**).

<sup>(3)</sup> Depending on the corresponding settings.

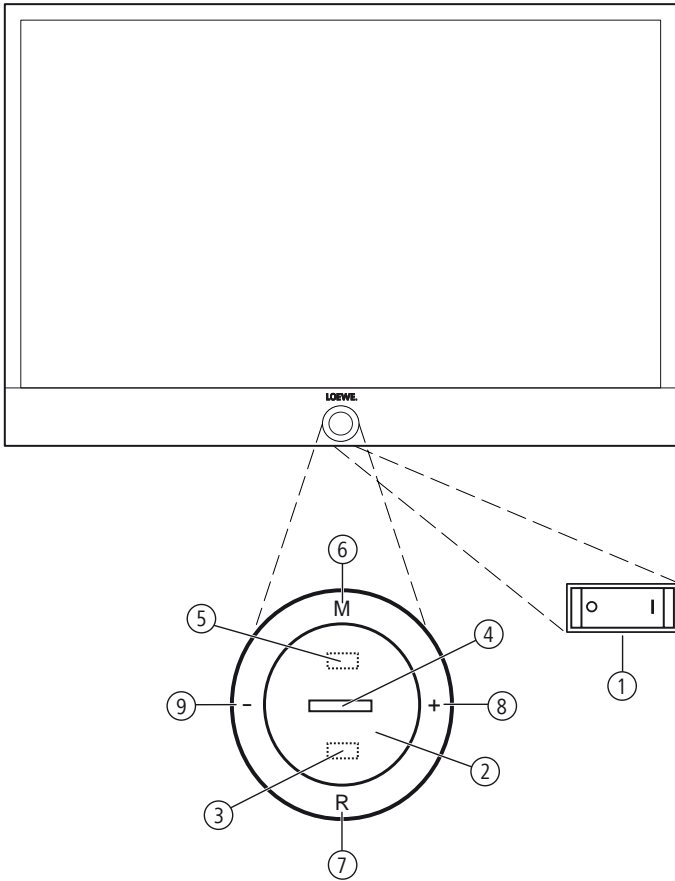

## Functions of the operating elements

### ① Mains switch:

The mains switch is located on the bottom of the set.

■ The TV set will be completely separated from mains only when you unplug the mains cable.

### ② On/Off key:

Switching on in standby mode

Switching off to the standby mode

### ③ IR receiver:

Infrared receiver for receiving the remote control commands.

### ④ Display:

□ white:	TV set in standby
□ white, intermittent:	TV set starts
■ green:	TV set switched on
■ red:	timer recording active
■ blue:	TV set in standby and background operation active (EPG data updating, software update)

### ⑤ Infrared transmitter:

When showing 3D content, the 3D glasses **Loewe Active Glasses 3D** are controlled via the infrared sensor.

### ⑥ Key M:

TV set in standby mode: switch TV set on in TV mode

TV set switched on: call direct control on TV set

in direct control on TV set: up ▲

### ⑦ Key R:

TV set in standby mode: switch TV set on in radio mode

TV set switched on: toggle TV mode and radio mode

Direct control on TV set: down ▼

### ⑧ Key +:

increase volume

Direct control on TV set: to the right ►

### ⑨ Key - :

reduce volume

Direct control on TV set: to the left ◀

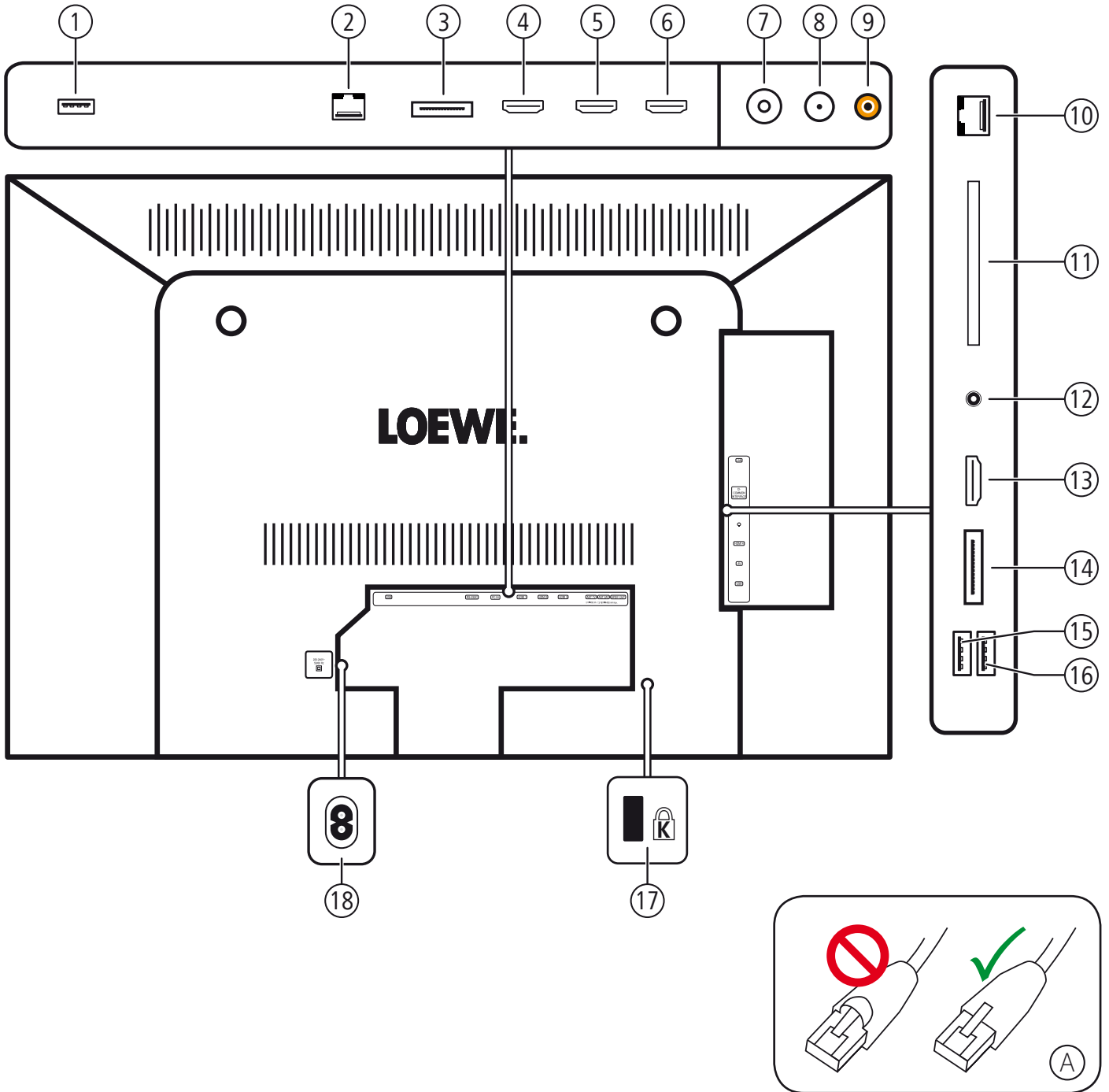

- |  |   |
|--|---|
| ① <b>USB</b> - USB connection                          | ⑩ <b>LAN</b> - Network connection <sup>②</sup>            |
| ② <b>RS-232C</b> - Serial interface                    | ⑪ <b>CI-COMMON INTERFACE</b> - Common Interface (CI slot) |
| ③ <b>PC IN</b> - Mini AV socket <sup>①</sup>           | ⑫ <b>Ω</b> - Headphone connection                         |
| ④ <b>HDMI 1</b> - HDMI input 1 (with HDMI ARC support) | ⑬ <b>HDMI 4</b> - HDMI input 4                            |
| ⑤ <b>HDMI 2</b> - HDMI input 2                         | ⑭ <b>AV</b> - Mini AV socket <sup>①</sup>                 |
| ⑥ <b>HDMI 3</b> - HDMI input 3                         | ⑮ <b>USB</b> - USB connection                             |
| ⑦ <b>ANT TV</b> - Antenna/cable analogue/digital       | ⑯ <b>USB</b> - USB connection                             |
| ⑧ <b>ANT SAT</b> - Satellite antenna (Sat tuner)       | ⑰ Socket for Kensington lock                              |
| ⑨ <b>SPDIF OUT</b> - Digital audio output              | ⑱ <b>AC IN</b> - Mains connection                         |

<sup>①</sup> Adaptor set is available as an accessory (see chapter **Accessories**).

<sup>②</sup> Only use a LAN cable without a cap over the locking mechanism (see image **A**). LAN cables with caps may cause problems when the cable is being disconnected.

## Installing the TV set

### Mounting options

Your Loewe specialist dealer can assist you in finding other mounting options that correspond to your needs. Use exclusively Loewe mounting options (e.g., wall bracket, floor stand), which you will find in the chapter **Accessories**, section **Mounting options**.

After you have decided on a mounting option, follow the directions found in the corresponding assembly instructions.

### Installation notes

Choose a place for installing your TV set where no bright light or sunlight shines directly onto the screen. This could cause reflections which impair the picture.

3 times the screen diagonal can be taken as a guide value for the viewing distance (e.g., for a 46-inch set approx. 3.5 m for SD signal). The viewing distance can be reduced with an HD signal.

## Set covers

### Covers for rear and side connections

In order to remove the rear side cable covers pull them simply from the device.

To fit the cover, insert the lugs at the top edge of the cover into the corresponding cut-outs in the rear panel and push up the cover until it snaps in.

The side cover of the TV set can also be completely removed. For this, open it as far as it will go and gently pull on the open cover.

The cover detaches from the holder and gives free access to the connection area. To replace the cover, simply push it until it latches back into place.

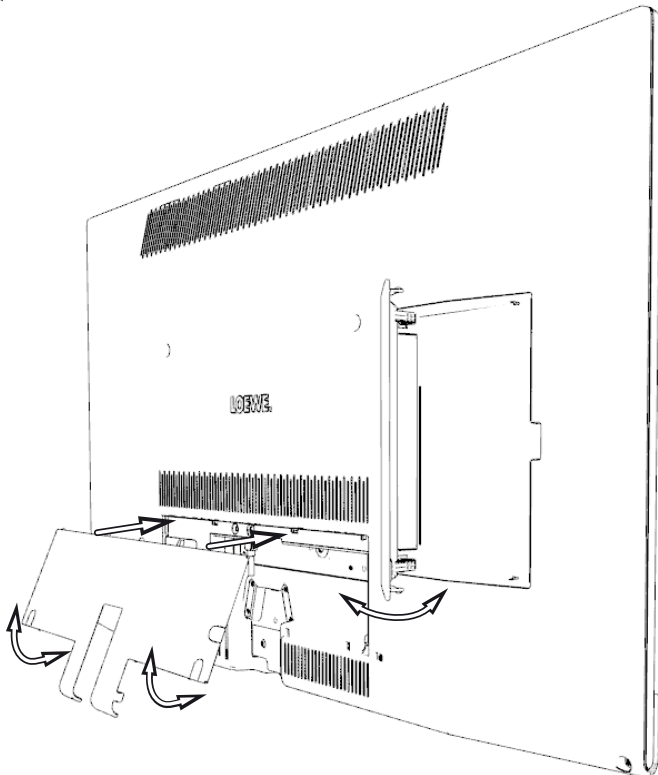

## Connecting the TV set

### Connecting to the mains supply

Remove the cover for the connections.

Connect the TV set to a 220-240V mains socket:

First plug the small plug of the power cable into the mains connection on the back of the TV and then the large mains plug into a mains socket.

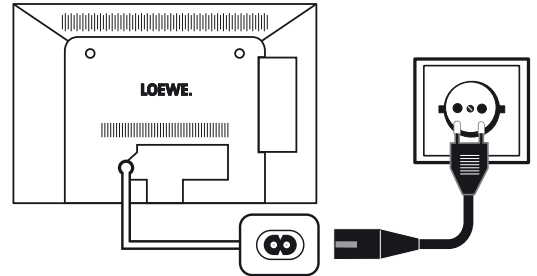

### Connecting antennas

Cable (analogue) / DVB-C / DVB-T antenna:

Plug the cable of antenna, cable TV system or room antenna into the **ANT TV** socket.

If you want to use analogue cables / DVB-C connection and a DVB-T antenna together, use an external antenna switch (available from your dealer).

Satellite antenna DVB-S:

Depending on the used satellite system, connect a connecting cable from the multi-switch or directly from the LNC to the **ANT-SAT** socket of the TV set respectively.

When connecting the TV set to a single cable community antenna, connect the **ANT-SAT** socket directly to the appropriate SAT antenna socket.

Ask your dealer in this regard.

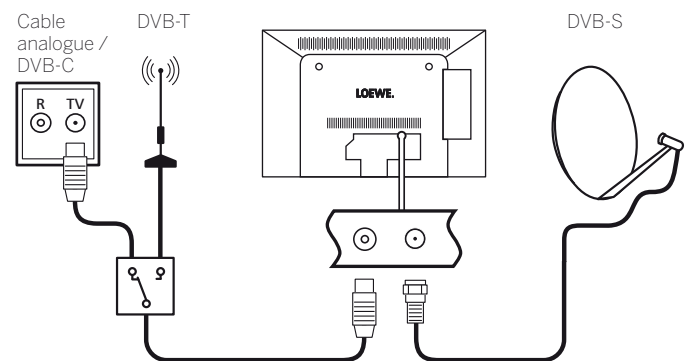

### Connecting the TV set to the Home network

You may link your TV set to the home network by a **wired connection** (Ethernet, Powerline) or by a **wireless radio connection** (WLAN). Please contact your specialist dealer for more information on Powerline.

For the network adaptor configuration, see chapter **System settings**, section **Multimedia / Network – Network settings**.

**■ Under no circumstances** may the TV set be **wired** and at the same time connected by a **wireless connection** to the same network, e.g. router. This may cause severe operational faults!

#### Example for a wired connection

Connect the LAN socket of your TV set to the LAN switch/router of your home network with a network cable (available from your dealer).

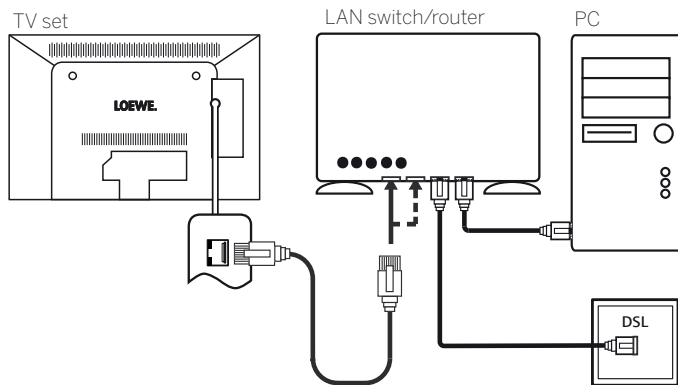

#### Example for a wireless connection

You can connect the TV set to your home network by a wireless radio connection via the WLAN antenna inside the set.

**■** Shadow effects of various materials, such as reinforced concrete, metal surfaces, etc., attenuate the WIFI signal sometimes significantly or completely.

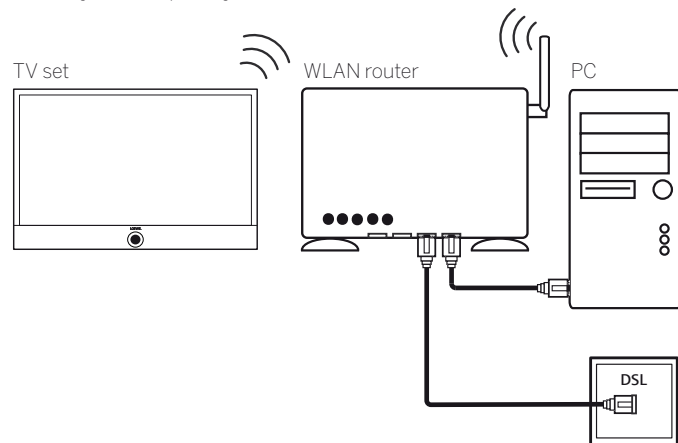

## Bundling the cables

### Connect ID 40/46

When installing the TV set with the mounting option Table Stand Dynamic (included in scope of delivery):

Thread the Velcro cable tie (K) through the holder of the Table Stand, connect the cables to the TV set and secure them with the Velcro cable tie. For more information, refer to the installation instructions of the Table Stand Dynamic.

Then fit the cover for the connections (see chapter **Preparing the TV set**, section **Set covers**).

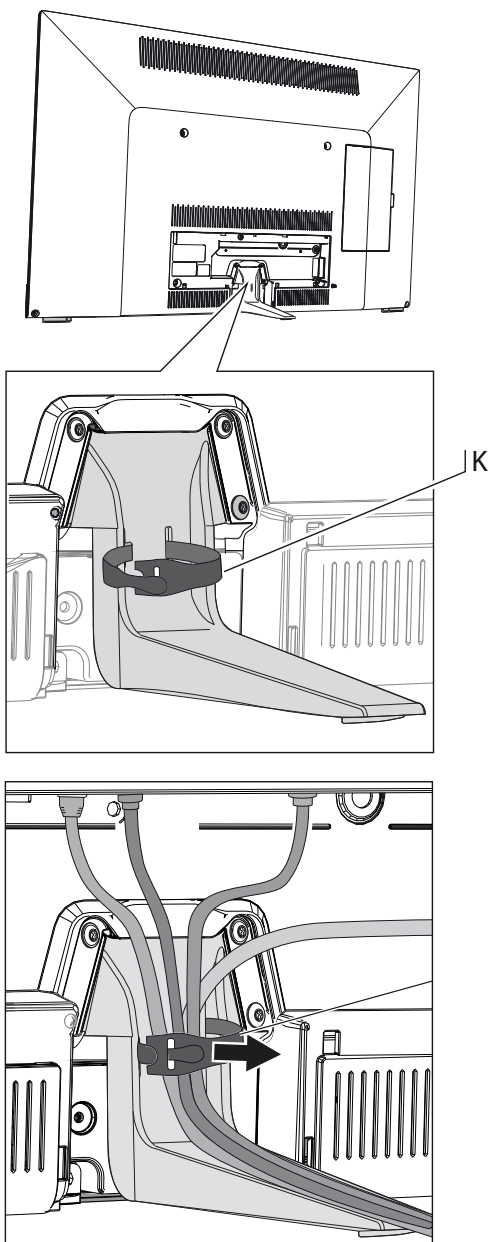

### Connect ID 55

When installing the TV set with the WM62 wall bracket mounting option (included) it is not possible to fix the cables to the TV set.

## Preparing the remote control unit

### Inserting or replacing batteries

Press on the embossed arrow whilst pushing the battery cover down. Only use leak-proof micro-cells of the LR 03 (AAA) Alkali-Manganese type. Do not use different types of batteries and old and new batteries together.

The batteries used must not be exposed to excessive heat such as sunlight, fire or similar!

Pay attention to the correct polarity of + and - when inserting the batteries.

If the batteries are too weak after longer use, the TV set prompts you to change the batteries.

Dispose of used batteries in an environmentally friendly way (see chapter **Environment / Legal information**).

Push the cover back on from below after having inserted the batteries.



### Adjusting the remote control for operating the TV set



Press the **TV key**.

See in chapter **External devices**, section **Operating Loewe units** how to operate other Loewe appliances and how to re-programme the remote control keys.

## Switching the TV set ON/OFF

### Switching TV set to the standby mode

Press the mains switch at the bottom of the set.

The indicator in the control panel on the front side lights up white. The set is now in standby mode.

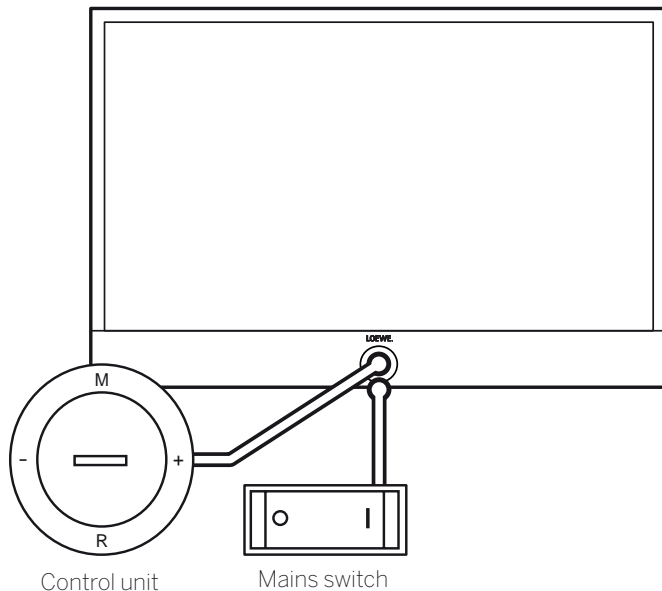



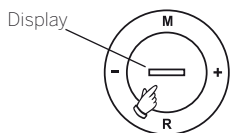

### Switching the TV on/off on the control unit

To switch the TV set into Operating mode or switch it off to Standby mode, press the middle of the On/Off button for about 2 seconds.



Meaning of the colour of the LEDs in the On/Off button:

	white:	TV set in standby
	white, intermittent:	TV set starts
	green:	TV set switched on
	red:	Timer recording active
	blue:	TV set in standby and background operation active (EPG data updating, software update, DR+ streaming server function)

**i** After switching on the TV set, it takes a few seconds for further operating commands to be processed (Exception: Quick start mode, see chapter **System settings**, section **Control – Quick start mode**). Your TV set is ready to operate as soon as the status indicator in the control panel lights up in green.

### Switching the TV set on by means of the remote control



Press the **on/off key**.

Or:



Press the **TV key**.

The previously watched station will be called.

Or:



Press **numerical keys 1-9**.

The corresponding station will be called.

**i** After switching on the TV set, it takes a few seconds for further operating commands to be processed (Exception: Quick start mode, see chapter **System settings**, section **Control – Quick start mode**). Your TV set is ready to operate as soon as the status indicator in the control panel lights up in green.

### Switching the set off with the remote control (Standby)



Press the **on/off key**.

**i** Before switching off the set with the mains switch, we recommend you to switch it to standby mode.

### Switching off the TV set and connected additional devices (System standby)



Press **on/off key** long:

Switch TV set and all CEC-capable devices connected to the **HDMI** interfaces OFF to Standby mode (System Standby).

## Technical information

Switching off the TV set with the mains switch during operation or an inadvertent disruption to the power supply (e.g., power failure) can cause damage to the USB hard disk file system and hence loss of the recorded broadcasts. **Always** return the TV set to Standby mode before switching it off with the main switch.

However, if unexpected problems occur when operating the hard disk, formatting the hard disk may rectify this. You can find the corresponding menu items under **System settings** → **Control** → **more ....** → **Hard disks**.

Loewe is not liable for data being lost from USB hard disks.

## General information on menu operation

Some keys of the remote control for operating the TV set you will use more often than others. The most important keys for navigation will be explained in general. The numbers in the text refer to the figure showing the remote control in chapter **Remote control**.

The **arrow keys** (22) help you to navigate in the menus and lists of the TV set and for selecting menu items. They are arranged in the middle of the remote control in a circle around the **OK** key (11). Later in this quick guide they will be represented as follows:



The **OK** key (11) is used to confirm a selection, for calling the highlighted menu item and for opening the station list. In this quick guide, an instruction for this key looks like the following:



Using the **numerical keys** of your remote control (28) you enter programme channels and teletext pages directly. With key **0** you open the AV list. In this user guide, entering numbers with numerical keys is shown as follows:

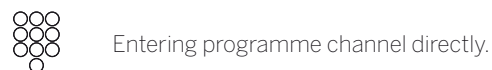

The numerical keys are also used to enter text (see chapter **General information on menu operation**, section **Entry of characters by remote control**).

The **Home** view is the central overview page for all of your TV set's operating modes. You reach **Home** view with the **HOME** key (26).



Pressing the **BACK** key (24) briefly brings you one level up in the wizard. Pressing the **BACK** key longer closes all opened fade-ins. An example for the **BACK** key in this quick guide:



Prolonged pressure on the **INFO** key (25) shows a key guide window that gives you information on the currently most important key functions.

If the function for a key is not available, this will be indicated by an inserted symbol (no) on the right above.

## Structure of the Menu screen

Basically, the structure of the different menu screens is similar, depending on the fact if a wizard, rendering media content or a setup menu are concerned. The structure is explained by means of three different screens.

The functions of these menu screens are explained more detailed in the respective chapters.

### Screen structure: Wizard

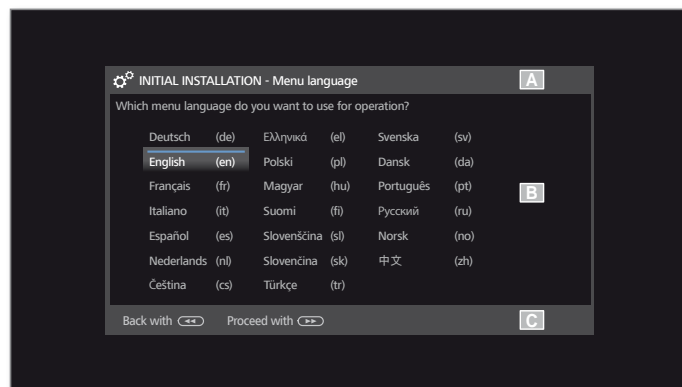

(A) Title bar with name of the wizard and the current operating step.

(B) Selected items, whose number can be different according to the operating step.

(C) Bottom line showing the available operating controls. If required, instructions and information are inserted.

### Screen structure: Rendering of media content (example: Audio player)

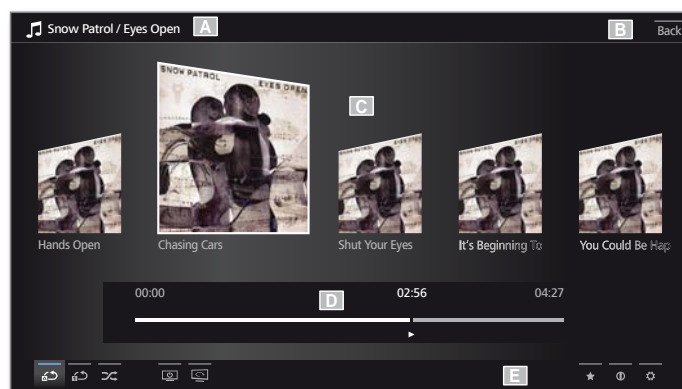

(A) Title bar with selected album / subdirectory.

(B) Menu item **Back** to exit the menu or to go back to the previous menu item.

(C) Selection of album or title

(D) Time bar

(E) Bottom line with the different symbols for controlling the playback function.



## Screen structure: Setup (example: picture)

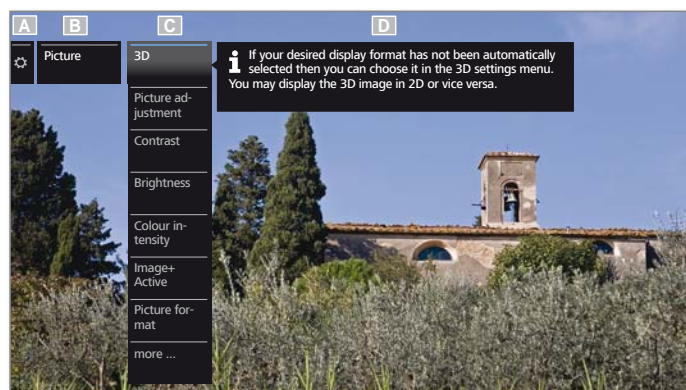

- (A) Selected function in the Home overview (here: system settings)
- (B) Home Menu **System settings**, with selected menu item **Picture**.
- (C) Menu items **Picture** focusing on **3D**
- (D) Help text for the selected menu item **Picture > 3D**

## Navigation: Selection of elements (example: On-screen displays)

Highlighting and thus selecting the symbols/elements or menu items on the screen can be effected by the arrow keys on the remote control. So you can see all the time where you are. As soon as there is a bar above a symbol or text, this is a selected element.

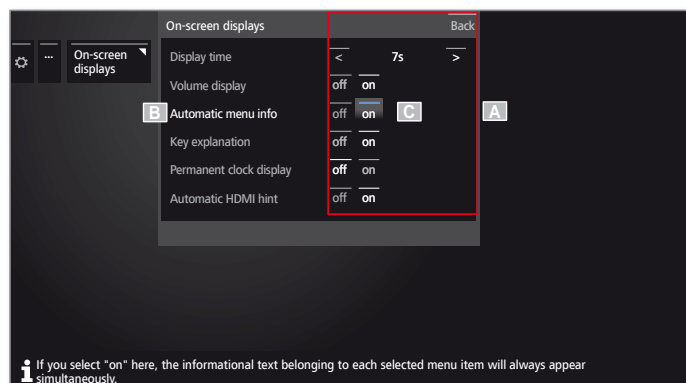

- (A) Selectable elements / menu items.
- (B) The text in the line where the marker is currently located is white.
- (C) Move the selection marking by means of the arrow keys ◀ ▶ ▲ ▼ to the menu item to be set. The position of the marking is easy to see by the blue line.

In most cases, the marked menu item will be automatically adopted. The font colour of the previously active item will change to grey, that of the newly selected item to white.

**i** In a few menus, to confirm a selected menu item is required by pressing **OK**.

## Navigation: Wizards

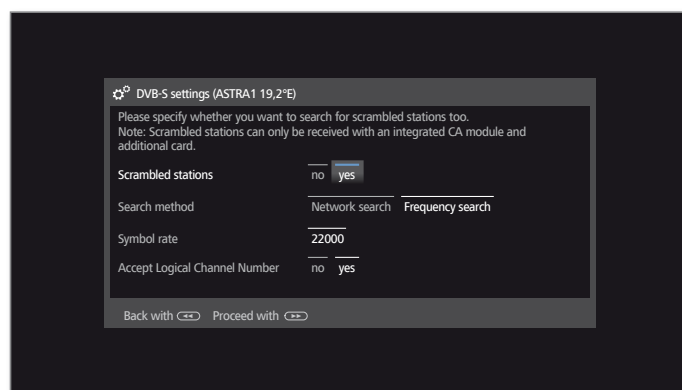

If the menu item(s) (marked white) is/are already correctly preset:



Go to next step.

Otherwise:



◀ ▶ ▲ ▼ Mark the menu items to be changed. The update will be adopted automatically. The font colour of the previously active item will change to grey. If not,

**OK** confirm the selection.



Go to next step.

## Navigation: Element selection in lists using initials

Using the numerical keys of the remote control you can jump into list, e.g., Internet radio station lists.

If the list is sorted in **alphabetical** order, you jump to the entered letter. For example, when pressing the key **7** three times you jump to the first list element starting with letter **R**.

In case of **numerical** sorting, you can directly select the stations with the numerical keys.

### Entering characters with on-screen keyboard

For certain functions, entering letters or characters is required, e.g., for Web addresses (URLs) in the browser or for renaming archive entries. An on-screen keyboard appears for entering text.

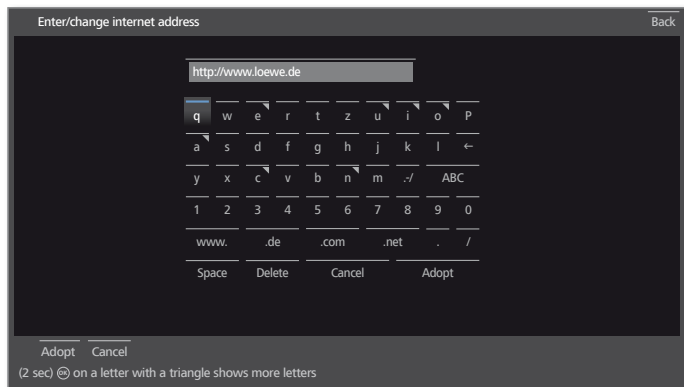

### Table of characters for entering text by means of the remote control

Key	Characters (uppercase - lowercase)
1	[space] 1
2	ABC2ÄÆÅÃÄÁČĀ - abc2äæåãäáčā
3	DEF3ËĚĚĚĚĚĚĚ - def3ěěěěěěě
4	GHI4İİİİİİİİ - ghi4ıııııııı
5	JKL5 - jkl5
6	MNO6ÖOEÖÖÖÖÖÖ - mno6ňñöoeööööóø
7	PQRS7ß - pqrS7ß
8	TUV8ÛŪŪŪŪŪŪŪ - tuv8üüüüüüü
9	WXYZ9 - wxyz9
0	. 0 - / _ : + , ; ? ! = & # % ~ @ \$ * ' ( ) " \$ \ { } [ ] < > ' ` ^



◀ ▶ ▲ ▼ highlight character / on-screen button,  
**OK** Adopt character.

In the event of letters with a triangular, additional letters are displayed when pressing the **OK** button longer (2 sec).  
 For the selection of special characters use the **.-/** field.

To conclude the entry:

◀ ▶ ▲ ▼ Mark **Adopt**.  
**OK** confirm the selection.

### Entry of characters by remote control

Alternatively to the on-screen keyboard you can also enter the desired characters by means of the remote control (as with the keypad of a mobile phone).



◀ ▶ ▲ ▼ Mark text entry field.

Under the 1st letter of the name you will see a line indicating the current input position.

- ▶ Input position one character to the right (also for blanks).
- ◀ Input position one character to the left.



Input the letters one after another. When using the remote control, press the **numerical keys** just as on a mobile phone keypad (0-9) until the desired symbol is displayed. The available letters are printed on the individual numeric buttons.

You find the exact key assignment in the character table in the right column.

To conclude the entry:



◀ ▶ ▲ ▼ Mark **Adopt**.  
**OK** confirm the selection.

## Info display

The info display provides an info text appropriate to the on-screen display that can assist you further with the operation of your TV set.

**i** An on-screen display is faded in.

**INFO**

The factory setting is that the info display is shown automatically for each menu item. In this case you can temporarily hide the info texts with the **INFO** key.

The automatic info display can be hidden via a menu setting. Then it can be displayed temporarily by pressing the **INFO** key.

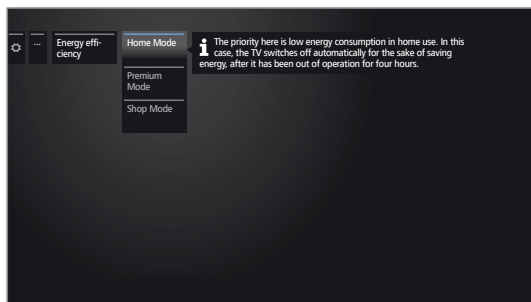

## Permanently display or hide the automatic info display

Once you have become familiar with how to operate the TV set, you can switch off the automatic info display.

**HOME**

**HOME:** Call **Home** view.



◀ ▶ ▲ ▼ Mark **System settings**,  
**OK** call system settings.

▼ ▲ Mark **Control**,  
 ▶ go to next column.

▼ ▲ Mark **more ...**,  
 ▶ move to next column.

▼ ▲ Mark **On-screen displays**,  
 ▶ call on-screen display settings.

▼ ▲ Select **Automatic menu info**,  
 ▶ select **on / off**.

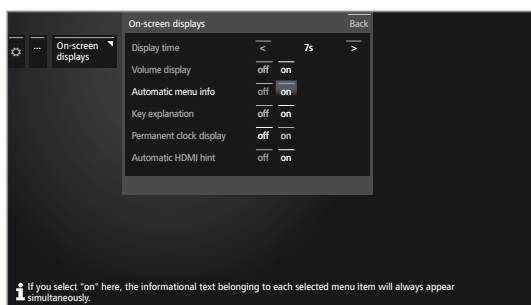

**OK** adopt settings.

## Operation without remote control

### Changing Volume



**+ / -** Increase/reduce volume.

### Switching radio on or off or switching to radio



**R** Radio on or switch between TV and Radio.

### Calling direct control on TV set



**M** Call direct control on TV set.



**R** Scroll down.

**M** Scroll up.

**-** Scroll left.

**+** Scroll right, adopt settings, confirm.

### Close all displays



Press **M** longer.

### Explanations of the settings:

- Operating mode Switch between TV and radio operation.
- Station selection Call Station selection.
- AV selection Select AV interface.
- 3D Calling 3D settings.
- Contrast Set contrast.  
The power consumption of the TV set depends directly on the value set here.
- Picture format Selecting the picture format.
- Service **i** The Service menu item is provided for service purposes by dealers only.

## Initial installation wizard

### Initial installation after switching on for the first time

The Initial installation wizard starts automatically with an initial installation. It may be called repeatedly again (see chapter **Extras**, section **Special functions – Repeat initial installation**).

**i** If at least one station is locked, the access code must be entered before repeating initial installation (see chapter **System settings**, section **Control – Parental lock**).

**i** For information on navigation within the wizard refer to chapter **General information on menu operation**.

### First installation wizard routine

The selected settings affect the routine of the Initial installation wizard.

Menu language

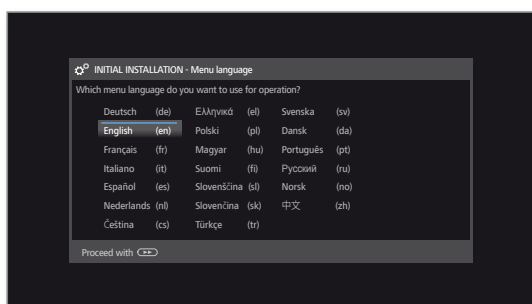

▲ ▼ ◀ ▶ Select desired **Menu language**.

Selecting the language of the user guidance is the wizard's first step. Then you simply follow the instructions on your TV screen.



▶▶ Proceed to next step.

Energy efficiency

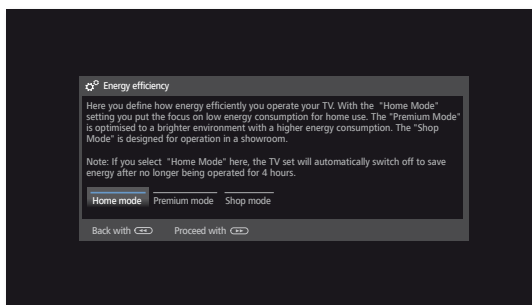

◀ ▶ Select **Energy efficiency**.

Determine how energy efficient your TV set shall be. The value for the contrast (and thus the brightness of the background lighting) is adapted and the automatic dimmer activated or deactivated depending on the presetting.

Choosing **Home mode** automatically activates shutdown. For **Premium mode** or **Shop mode**, automatic shutdown is initially deactivated. See chapter **For your safety** for further information on automatic shutdown.

Energy efficiency (continued)

### Home mode:

The emphasis for home use is on low energy consumption. The automatic dimmer is activated.

### Premium mode:

This mode optimises the settings to a brighter environment at a higher energy consumption. The automatic dimmer is activated.

The use of this energy efficiency setting must be confirmed afterwards once again.

### Shop mode:

The picture settings are aligned to operation in the presentation room. The automatic dimmer is deactivated. If the ambient brightness diminishes, the energy consumption is not reduced.

The use of this energy efficiency setting must be confirmed afterwards once again.

**i** The presetting can be changed later in **Extras** → **Energy efficiency** or in the **System settings** under **Picture** → **Picture adjustment**.



▶▶ Proceed to next step.

Operating mode

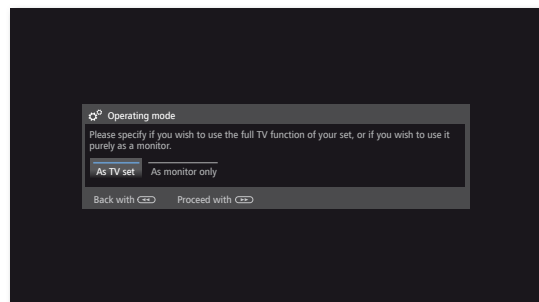

◀ ▶ Select the **Operating mode**.

Use the TV set as a **TV set**: Continued with **Location of TV set** (see below).

Use the TV set **just as a monitor**: see chapter **Initial installation**, section **TV set as a monitor**.

Location of TV set

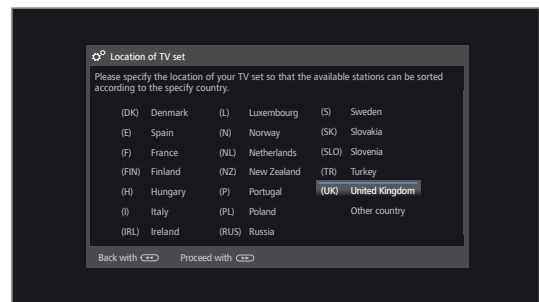

▲ ▼ ◀ ▶ Select **Location of TV set** (national defaults are adopted).

For certain locations (e.g., Australia), there is finally a selection screen where you can indicate in which state/territory the device is being operated.



▶▶ Proceed to next step.

### Selecting antennas

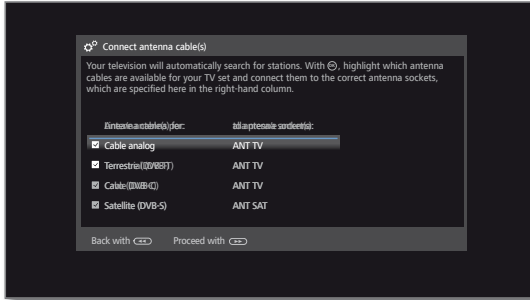

- ▲ ▼ Select antenna cable.
- OK** Connect/disconnect antenna cable. Ahead of each selected antenna, the symbol appears.

- Cable analog:** analogue stations via cable
- Terrestrial (DVB-T):** digital stations via antenna
- Cable (DVB-C):** digital stations via cable
- Satellite (DVB-S):** digital stations via satellite



- ▶▶ Proceed to next step.

### Extent of station search

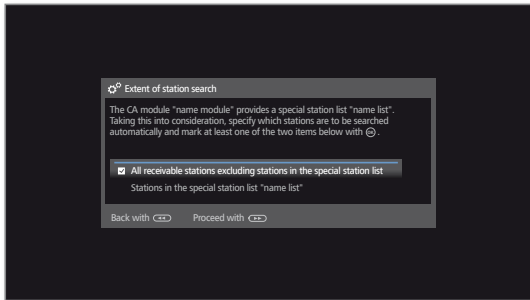

- ▲ ▼ Considering the plugged CA module(s) specify which stations should be searched automatically. If the CA module(s) do(es) not support this function or if no CA module is plugged in, this step will be skipped.



- ▶▶ Proceed to next step.

Depending on the antennas (analogue cable, DVB-T, DVB-C, DVB-S) selected, the appropriate settings appear below.

### Setting options for reception via analogue cable:

If you have not selected Cable analog in the list of available antennas: Proceed to **Setting options for DVB-T reception**.

### TV/col. standard

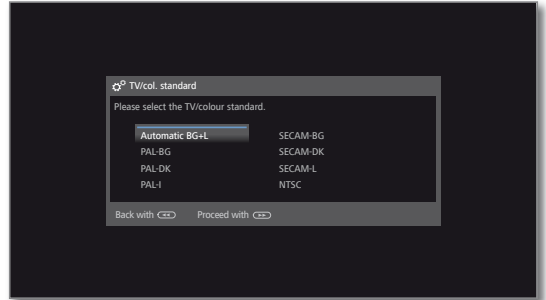

- ▲ ▼ ▶ ◀ ▶ Select appropriate colour standard.



- ▶▶ Proceed to next step.

Depending on the antennas (analogue cable, DVB-T, DVB-C, DVB-S) selected, the appropriate settings appear below.

### Setting options for DVB-T reception:

If you have not selected DVB-T antenna in the list of available antennas: Proceed to Setting options for **DVB-C reception**.

**I** If a CA module is plugged in during Initial installation and if the item **Station of the special station list** was selected in **Extent of station search**, the routine continues with the step **Supply voltage** (see right column).

Network selection

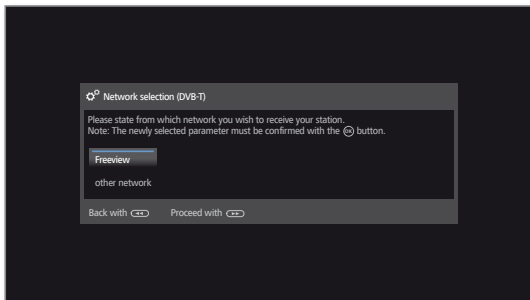

If several networks are available via DVB-T, you can decide which network you want to receive your channels from.



▲ ▼ Select network,  
**OK** Confirm selection.



▶▶ Proceed to next step.

Settings

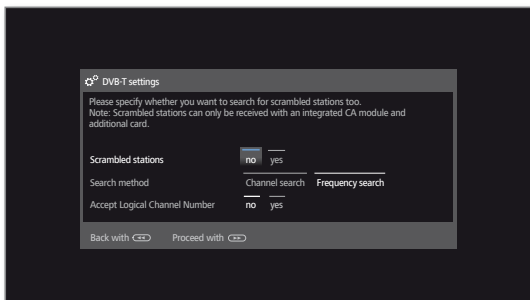

▲ ▼ ◀ ▶ Select and adapt settings for DVB-T reception.

**Scrambled stations** You can state whether coded stations are to be searched for in the search/update. Select **yes** to save all found scrambled stations. However, these stations can only be received in connection with a CA module and the appropriate Smart Card. Handling of the CA module is described in chapter **Extras**, section **CA module**.

**Search method** If you want to run the station search independently of the channel grid, select **Frequency search** for the search method.

**Accept Logical Channel Number** In various countries, digital stations (DVB-T) are transmitted with a preset channel number per station, known as Logical Channel Numbers (LCN). If you select **yes** here, these default channel slots will be used and the channels of the preferred signal source will be sorted as per LCN. The stations in the station list can no longer be shifted.



▶▶ Proceed to next step.

Supply voltage

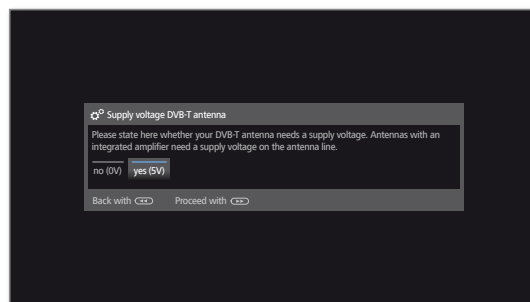

◀ ▶ Select supply voltage **no / yes**.

If you use a DVB-T antenna that requires a supply voltage (active antenna) and which is not already supplied via a power adaptor, then select **yes (5V)** for the antenna's power supply.

How to align your DVB-T antenna is described in chapter **System settings**, section **Connections – Antenna DVB**.



▶▶ Proceed to next step.

### Setting options for DVB-C reception:

If you have not selected DVB-C antenna in the list of available antennas: Proceed to **Setting options for DVB-S reception**.

**I** If a CA module is plugged in during Initial installation and if the item **Stations in the special station list** was selected in **Extent of station search**, the station list of the CA module will be adopted. Further settings described on this page will then be skipped. The procedure of the initial installation will then be continued with the step **Setting options for DVB-S reception**.

Network selection

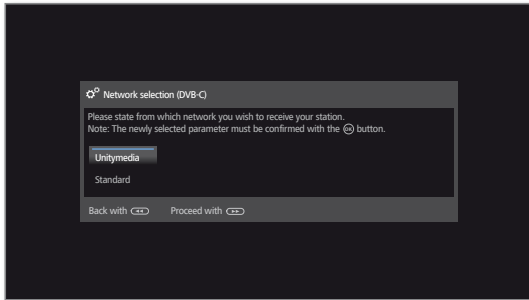

If several networks are available via DVB-C, you can decide which network you want to receive your channels from. The normal DVB-C settings are derived from the selection of the location or network and do not need to be changed. Exactly which of the following settings are present is dependent on which network is selected.



▲ ▼ Select network.  
**OK** Confirm selection.



▶▶ Proceed to next step.

Settings

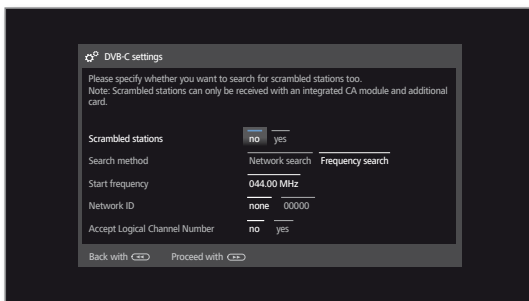

▲ ▼ ◀ ▶ Select and adapt settings for DVB-C reception.

**Scrambled stations** You can state whether coded stations are to be searched for in the search/update. Select **yes** to save all found scrambled stations. However, these stations can only be received in connection with a CA module and the appropriate Smart Card. Handling of the CA module is described in chapter **Extras**, section **CA module**.

**Search method** If you select **Frequency search** here, a search is performed for all receivable stations. With **Network search**, only the stations which the networks supply are searched - either for all receivable networks or only for the particular network specified under **Network ID**.

**Start frequency** The DVB stations are only searched for in the frequency range above the start frequency.

**Network ID** If you select **none** here, DVB signals of all current transmitter networks are searched automatically (recommended for most cable networks). If, on the other hand, you specify a certain network ID (necessary in the cable networks of some countries), only DVB signals of this broadcasting network are searched for automatically. Your cable provider has the information you need.

**Accept Logical Channel Number** In various countries, digital stations (DVB-C) are transmitted with a preset channel number per station, known as Logical Channel Numbers (LCN). If you select **yes** here, these default channel slots will be used and the channels of the preferred signal source will be sorted as per LCN. The stations in the station list can no longer be shifted.



▶▶ Proceed to next step.

### Setting options for DVB-S reception:

If you have not selected DVB-S antenna in the list of available antennas: Proceed to **Setting options for all types of reception.**

Network selection

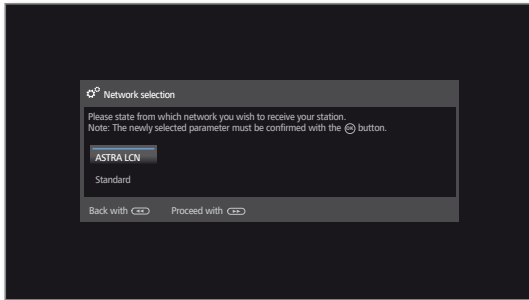

▲ ▼ Select network.  
If several networks are available via DVB-S, you can decide which network you want to receive your channels from.



▶▶ Proceed to next step.

Select satellite installation

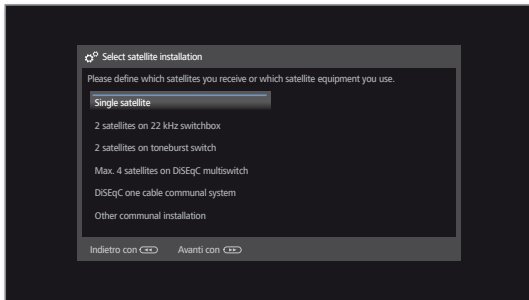

▲ ▼ Selecting the satellite system.  
Specify how you receive which satellite(s) (single satellite or type of satellite system). Ask your dealer in this regard.

The normal DVB-S settings are derived from the selection of the location and do not need to be changed in most cases.

Single satellite Reception of a single satellite via a connected LNC (LNB).

2 satellites on 22 kHz switchbox Reception of two different satellites with two LNCs (LNBs) which are connected to the TV set by a 22 kHz switchbox.

2 satellites on toneburst switch Reception of two different satellites with two LNCs (LNBs) which are connected to the TV set by a toneburst switch.

Max. 4 satellites on DiSEqC multswitch The TV set controls a DiSEqC multswitch to which up to four LNCs (LNBs) for different satellites are connected.

DiSEqC one cable communal system Select setting if the TV set is connected to a DiSEqC single-cable system (according to EN 50494). Several Sat receivers can be connected to one Sat cable.

other communal installation Select setting if the TV set is connected to a single-cable system (without DiSEqC). Several Sat receivers can be connected to one Sat cable. Contrary to a DiSEqC one cable communal system there are restrictions in the range of certain reception frequencies in "common" single-cable community systems.



▶▶ Proceed to next step (to the appropriate page of the satellite system).



### Setting options for the satellite system (single satellite):

Select single satellite

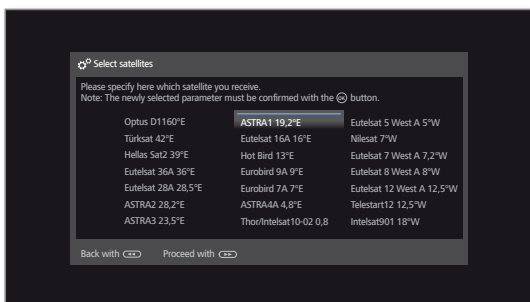

▲▼◀▶ Select satellite,  
**OK** Confirm selection.



▶▶ Proceed to next step.

Dual/Single band

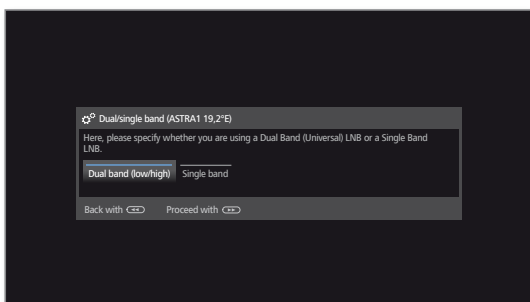

◀▶ Select **Dual band (low/high)** or **Single band**. Here you specify if you use a Dual Band (Universal) LNB or a Single LNB.



▶▶ Proceed to next step.

LNC frequencies

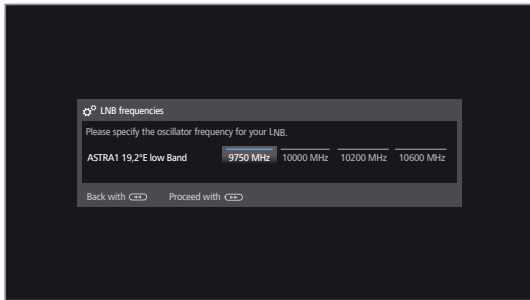

▲▼◀▶ Set LNB frequencies.  
**OK** Adopt settings.

**i** The setting of the LNB frequency is only called when you have used the setting **Single band** in step **Dual / single band**.

Normally, you do not need to change the values for high and low band, unless the LNC (LNB) of your satellite system uses a different oscillator frequency (important for the frequency display).



▶▶ Proceed to next step.

Proceed with **Setting options for DVB-S reception (continued)**.

### Setting options for the satellite system (2 satellites on 22 kHz switchbox / 2 satellites on toneburst switch):

Satellite selection

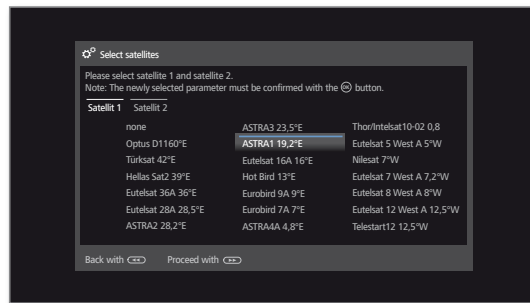

▲▼◀▶ Mark **Satellite 1 / Satellite 2**,  
▶▶ select satellite.  
**OK** Adopt settings.



▶▶ Proceed to next step.

LNC frequency (22 kHz Switch box)

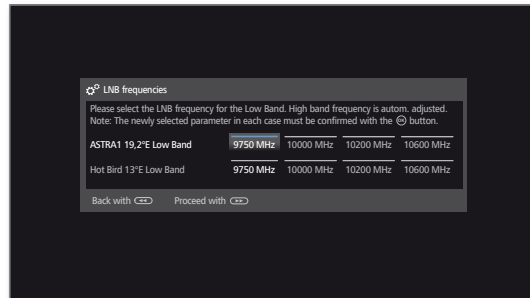

LNC frequencies (Toneburst switch)

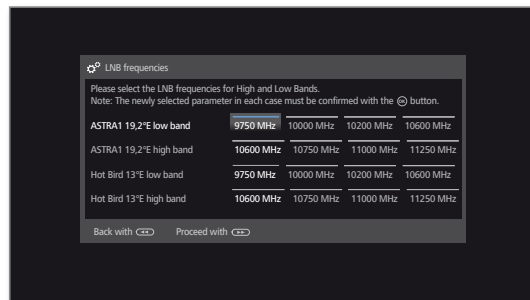

▲▼◀▶ Set LNB frequencies.  
**OK** Adopt settings.

Normally, you do not need to change the values unless the LNC (LNB) of your satellite system uses a different oscillator frequency (important for the frequency display).



▶▶ Proceed to next step.

Proceed with **Setting options for DVB-S reception (continued)**.

## Setting options for the satellite system (max. 4 satellites on DiSEqC multiswitch):

DiSEqC  
multiple  
switch

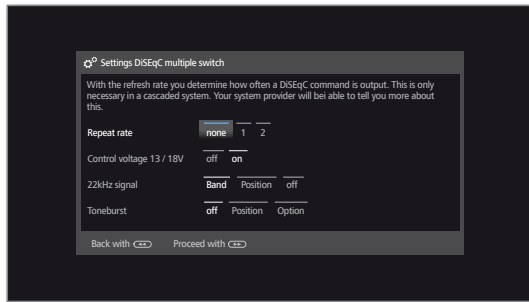

▲ ▼ ◀ ▶ Select and adapt settings for the DiSEqC multiswitch.  
**OK** Adopt settings.

**Repeat rate** The refresh rate determines how often a DiSEqC command is output. A refresh is only necessary with cascaded systems.

**Control voltage** The control voltage controls the switching of the polarisation level (horizontal/vertical) in non-DiSEqC capable components (e.g., control of single LNBs via DiSEqC multiswitch).

**22kHz signal** The 22 kHz signal controls the switching between high and low band in the **Band** setting. The **Position** setting controls the selection of the satellites in non-DiSEqC capable components.

**Toneburst** The Toneburst controls the selection of the satellites in non-DiSEqC but Toneburst capable components with the **Position** and **Option** settings.



▶▶ Proceed to next step.

Satellite  
selection

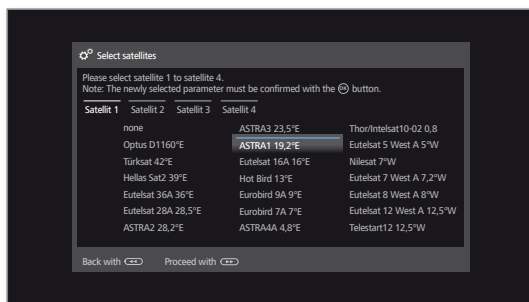

▲ ▼ ◀ ▶ Mark **Satellite 1 ... Satellite 4**.  
▲ ▼ ◀ ▶ Select satellite.  
**OK** Adopt settings.



▶▶ Proceed to next step.

LNC  
frequencies

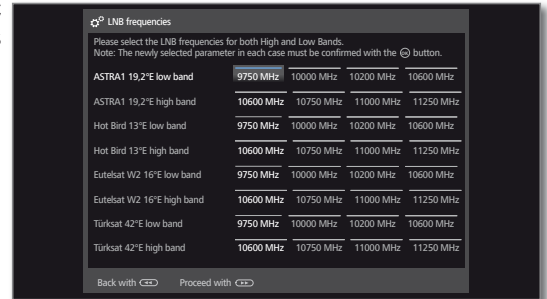

▲ ▼ ◀ ▶ Set LNB frequencies.  
Normally, you do not need to change the values.  
**OK** Adopt settings.



▶▶ Proceed to next step.

Proceed with **Setting options for DVB-S reception (continued)**.

## Setting options for the satellite system (DiSEqC one cable communal system):

Number of system channel used

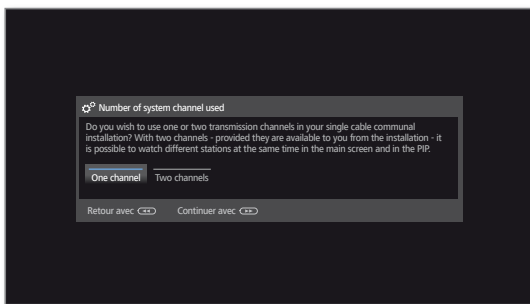

◀ ▶ Select **One channel** or **Two channels**.

Here you specify if you use one or two transmission channels in your one cable communal system.

In case of two channels - as far as they are available in your system - different stations can be simultaneously viewed on the main picture and on PIP.

You get more information on your system from your dealer.



▶▶ Proceed to next step.

DiSEqC one cable communal installation

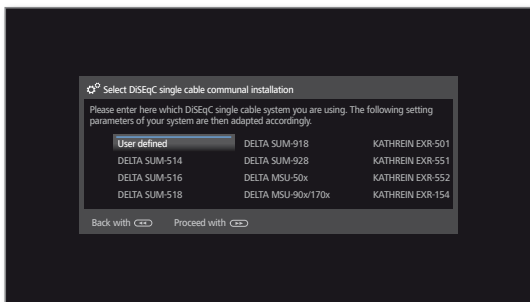

◀ ▶ ◀ ▶ Select DiSEqC single cable communal installation.



▶▶ Proceed to next step.

Satellite selection

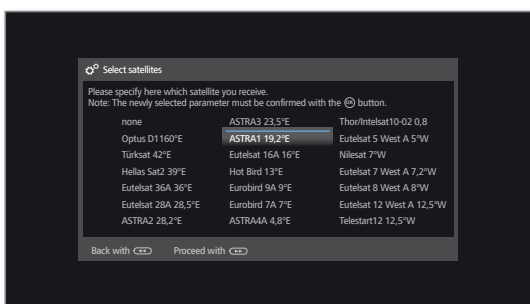

◀ ▶ ◀ ▶ Select satellites from list.

**OK** Confirm selection.



▶▶ Proceed to next step.

LNB frequencies

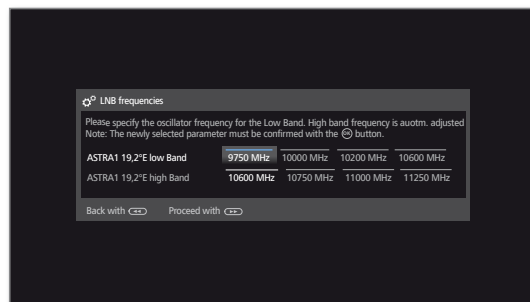

◀ ▶ ◀ ▶ Set LNB frequencies.  
Normally, you do not need to change the values unless the LNC (LNB) of your satellite system uses a different oscillator frequency (important for the frequency display).

**OK** Adopt settings.



▶▶ Proceed to next step.

Manual registration (for socket ANT SAT)

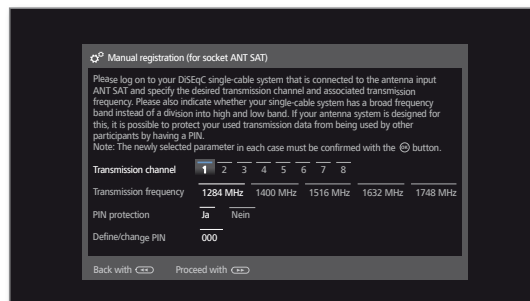

◀ ▶ ◀ ▶ Select and adjust settings for the DiSEqC single cable communal installation.

**OK** Adopt settings.

Transmission channel Select the desired transmission channel.

Transmission frequency Select the corresponding transmission frequency.

PIN protection If your system is designed for it, it is possible to protect your used transmission data from use by other subscribers with a PIN.

Define/change PIN Here you can determine and change the PIN for PIN protection. Only possible, when **yes** has been selected for PIN protection.



▶▶ Proceed to next step.

Proceed with **Setting options for DVB-S reception (continued)**.

### Setting options for the satellite system (other communal installation):

Select single satellite

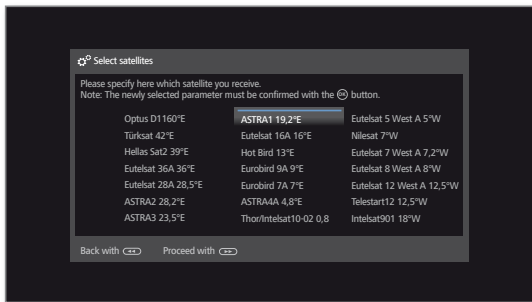

▲ ▼ ◀ ▶ Select satellite.  
**OK** Confirm selection.



▶▶ Proceed to next step.

LNB frequencies

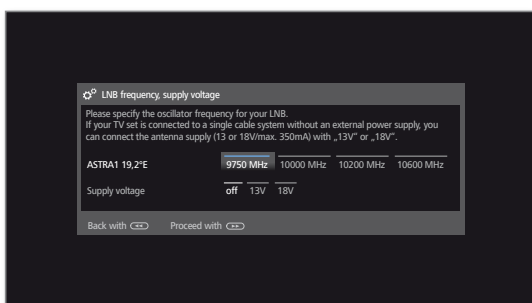

▲ ▼ ◀ ▶ Select and adapt settings.

**LNC frequency** Normally, you do not need to change the values for high and low band, unless the LNC (LNB) of your satellite system uses a different oscillator frequency (important for the frequency display).

**Supply voltage** If your set is connected to a single-cable system without external voltage supply, you can connect the antenna supply (13V or 18V / max. 500mA).



▶▶ Proceed to next step.

Continue with **Setting options for all types of reception.**

**Setting options for DVB-S reception (continued):**

Test reception

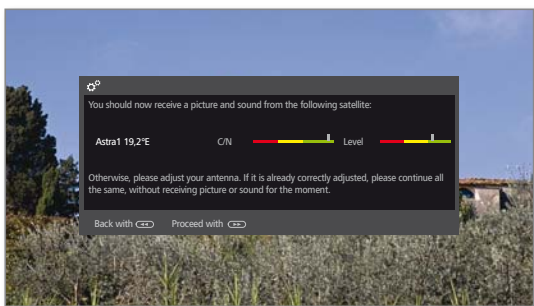

After you have made the previous settings, you should receive picture and sound of the selected satellites (only possible for Astra1 and HOTBIRD).



▶▶ Proceed to next step.

Settings

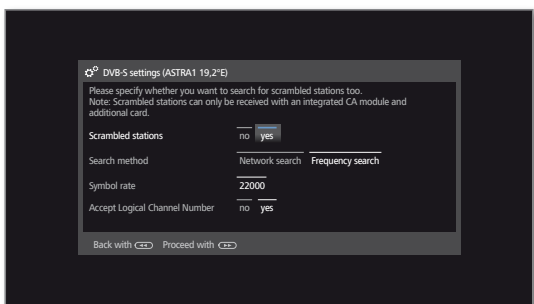

▲ ▼ ◀ ▶ Select and adapt settings.

If several satellites are received, the following settings must be made for every satellite. The type of settings available may differ depending on the selected satellite or network.

**Scrambled stations** You can state whether coded stations are to be searched for in the search/update. Select **yes** to save all found scrambled stations. However, these stations can only be received in connection with a CA module and the appropriate Smart Card. Handling of the CA module is described in chapter **Extras**, section **CA module**.

**Search method** If you select **Frequency search** here, a search is performed for all receivable stations. With **Network search**, from all receivable networks all the stations are searched which are supplied by these networks.

**i** Depending on the selected network, this step might possibly be skipped.

**Symbol rate** The symbol rate is specified by the satellite provider and normally does not need to be changed.

**Accept Logical Channel Number** In various countries, digital stations (DVB-S) are transmitted with a preset channel number per station, known as Logical Channel Numbers (LCN). If you select **yes** here, these default channel slots will be used and the channels of the preferred signal source will be sorted as per LCN. The stations in the station list can no longer be shifted.



▶▶ Proceed to next step.

Continue with **Setting options for all types of reception**.

## Setting options for all types of reception:

Subtitle and audio languages (DVB only)

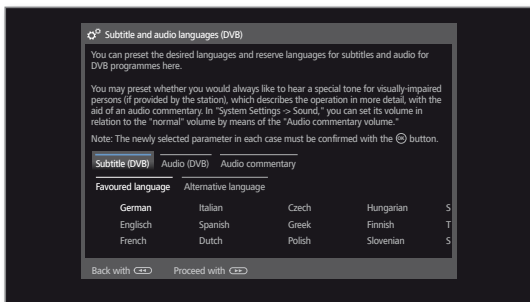

Select desired languages and alternative languages for subtitles and audio for DVB programmes.  
Set up audio commentary for the visually impaired.

**OK** Confirm selection.



Proceed to next step.

Check search settings

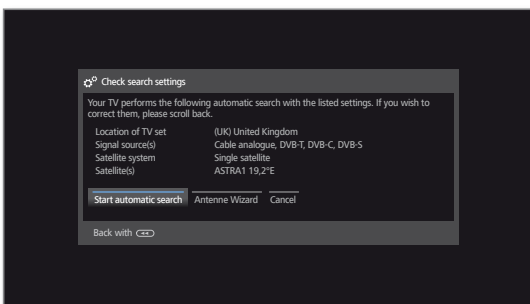

You will see a list of the selected settings. You can go back step by step with the key ◀ to make any changes to the settings.



**OK** Start automatic search.

Now, the TV set searches for TV and radio stations. It searches successively for stations from the selected signal sources. The progress of search is shown by a progress bar.

**i** In case of a repeated initial installation routine (via **Home** view under **Extras** → **Special functions**) **all** stored stations will be first deleted here.

Info station search

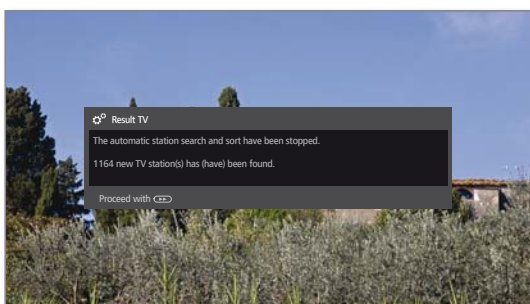

The number of found TV stations is displayed.

Proceed to next step.



The number of found radio stations is displayed.

Proceed to next step.

Age-related lock

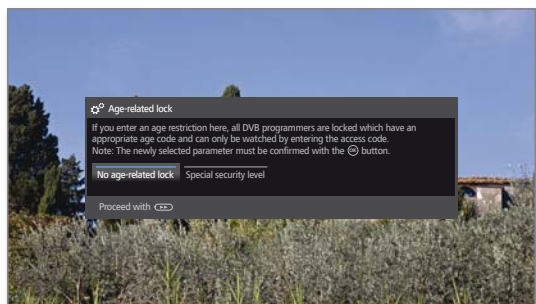

Select **Age-related lock**.  
**OK** Confirm selection.

You can specify an age limit for your TV set here. DVB broadcasts which have an appropriate age identification are locked and can only be watched after entering the access code.

In some countries, the **yes/no** option does not exist for some channels, and a compulsory age check must be entered.



Proceed to next step.

Time and date

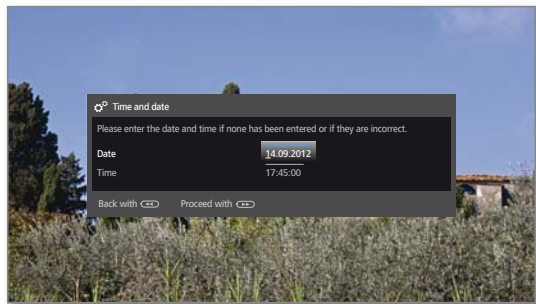

**i** Depending on the selected network, this step may be skipped.

Select time / date.

If no values or no correct values have been entered for date and time, enter the correct values with the numerical keys here.



Proceed to next step.

### Sound playback via ...

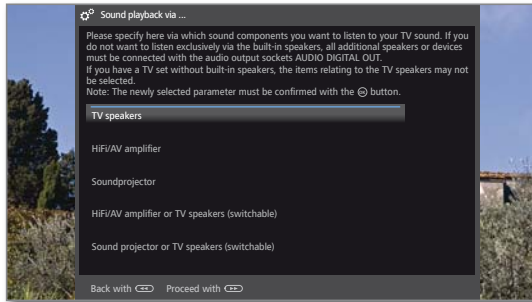

▲ ▼ Select sound components.  
**OK** Confirm selection.

This selection indicates which sound components you want to use to hear your TV sound. Depending on the selection, the sound component wizard starts with which you can make further settings.

The sound component wizard is described in chapter **System settings**, section **Connections – Sound components** and can also be started at any time beyond the initial installation.



▶▶ Proceed to next step.

### Network configuration



◀ ▶ Select option.

With the selection, specify whether you want to configure the available network adaptor now.

**Configure now:** Make settings for network adaptor and proxy server (see chapter **System settings**, section **Multimedia / Network – Network settings**).

**Do not configure or configure later:** Skip network adaptor configuration.



▶▶ Proceed to next step.

### Inform about new software

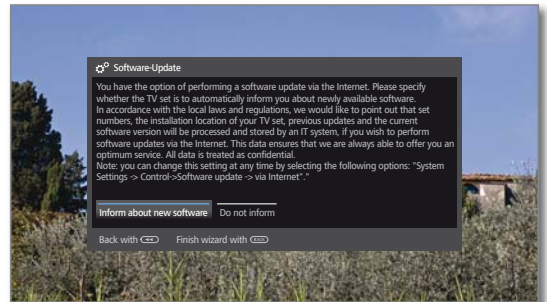

◀ ▶ Select option.

When selecting **Information on new software updates**, your TV set checks at definite intervals whether a newer software than the one installed in the TV set is available in the Internet. A screen message appears when a new software update is found.



**Back:** Exit wizard.

The initial installation wizard is complete.

### TV set as a monitor

You can also use your TV set just as a monitor, i.e. if you only use it with a PC. The tuner in the TV set cannot be used in this mode.

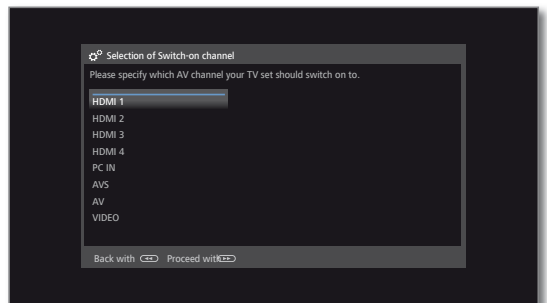

▲ ▼ Select AV connection.

The selected AV connection is shown when switching the TV on.



▶▶ Proceed to next step.

Initial setup continues with the **Time and date** setup.

## Home view

The **Home** view is the central overview page for all of your TV set's operating modes.

The list of options on the left of **Home** view gives you access to TV, Video, Audio/Radio, Photo and Web.

By means of **Extras** and **System settings** you have access to more functions and you can configure your TV set.

On the right side of the screen you find all your favourites (bookmarks) created in the different operating modes.

The number of selectable items varies depending on the TV equipment, network connection, available media/ media servers and connected appliances.

### Call Home view

HOME

**HOME:** Call **Home** view.



▼ ▲ ◀ ▶ Select menu item / favourite,  
**OK** call.

### Description of the individual sections/functions:

- TV:**



Here you call the **TV** mode of your TV set. See chapter **TV** for further information.
- Video:**



The item **Video** gives you access to videos from local (USB, home network) and online sources. See chapter **Video** for further information.
- Audio/Radio:**



With item **Audio/Radio** you find music files from your local server(s) and USB storage media and you access DVB and Internet radio. See chapter **Audio/Radio** for further information.
- Photo:**



Via menu item **Photo** you can view photos from your local media on your TV screen. See chapter **Photo** for further information.
- Web:**



Here you have access to multimedia content in the Internet (MediaNet) as well as a high-quality web browser. See chapter **Web** for further information..
- Extras:**



**Extras** contains additional functions and setting (e.g., Timer list, CA module). See chapter **Extras** for further information.
- System settings:**



In menu item **System settings** you find the configuration menu of the TV set e.g., with setting for picture, sound, connections or sound components. See chapter **System settings** for further information.

### Activated operating mode

The respective activated operating mode will be indicated in the list of options by a small playback symbol in the lower right-hand corner of the **Home** symbol.

Examples:



TV mode activated.



Audio player (Audio mode) activated.

In the opened **Home** view, pressing again on the **HOME** key brings you back to the respective active operating mode.



## Home - Favourites

You will find your favourites on the right of the individual operating modes.

You can create favourites in the operating modes of the TV set. In this way you get a collection of your favourite music titles, your preferred stations and often visited Internet sites on a single overview page.

After an initial installation, TV stations, online links and radio stations will already be automatically created as favourites independent of the installation site of the TV set and of existing Internet links.

### Creating favourites

In the operating modes of the TV set you can define the current object (station, music title, photo, etc.) as favourite by means of your remote control.

The favourite will be added to **Home** view and placed at the end.



Create favourite.

If there are more favourites than can be shown on one page, this will be indicated by rectangular symbols in the upper right corner of **Home** view. Example:



Three pages with favourites exist. The first page of them is indicated.

### Manage favourites

You can edit the existing favourites in **Home** view. Change the sequence of your favourites as you wish or delete favourites you do not need any more.



**HOME:** Call **Home** view.



◀ ▶ ▲ ▼ Mark the favourite to be changed.



**MENU:** Change favourite.

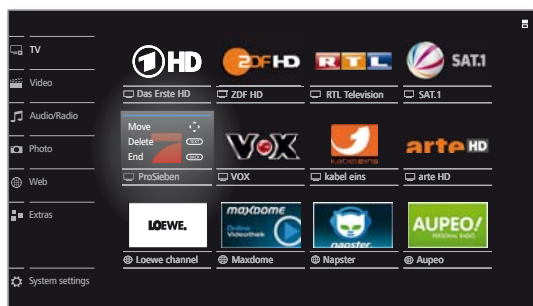

Move favourite or delete it (see below).

### Moving favourites



◀ ▶ ▲ ▼ Move favourite to new position.



**BACK:** Finish procedure.

### Deleting Favourites



**TEXT:** Delete selected favourite.



**BACK:** Finish procedure.

## TV

In TV mode that can be selected via the **Home** view, you can use the basic TV functions of your TV set. In TV mode you will have numerous functionalities at your disposal as, for instance EPG and, if offered by the station, HbbTV (hybrid broadcast broadband television). By means of the function list you may call additional options and settings all around TV operation.

## Setting the volume

### Switching sound off/on



Sound off.  
 Sound on: Press key again or increase the volume using **V+**.

### Setting the volume

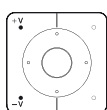

**V+ / V-** Volume up/down.

The volume control bar will be displayed in the upper right corner.

**i** The volume control bar can be deactivated in the menu.

## Select station

### Select station with P+ / P-

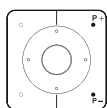

**P+ / P-** Station up/down.

The number and the name of the station along with the title of the programme and that of the next programme will be briefly shown. Also, the status display with time and programme-dependent symbols appears.

**i** The symbols of the status display are described in section **Status display**.

### Select station using the numerical keys



#### 1-digit stations

Press the **numerical key** a little bit longer: The channel will change immediately.

Or:

Press the **numerical key** briefly, the station changes after 2 seconds (changes immediately in case up to 9 stations are stored).



short short long

#### 2-digit and 3-digit stations

Press first (and second) **numerical key** briefly.

Keep the last **numerical key** pressed a little bit longer: The channel will change immediately.

Or:

Press all the **numerical keys** and the channel changes two seconds after the last number was entered (with up to 99 or 999 saved channels it will change immediately).

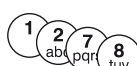

all short

#### 4-digit stations

Press all four **numerical keys** briefly, the station changes immediately.

**i** If you select an unoccupied station slot, the next available station is switched to.

## Selecting a station out of the station list



**i** In normal TV mode, without other displays:

**OK** call station list.

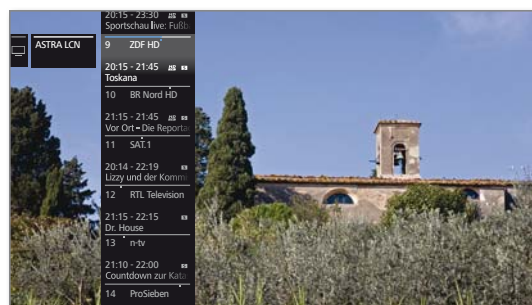

▲ ▼ Mark stations.

**OK** The marked station will be called.

## Length of the station list

There is a possibility to influence the amount of stations by using different station lists.



**i** In normal TV mode, without other displays:

**OK** call station list.

◀ Call overview of station lists.

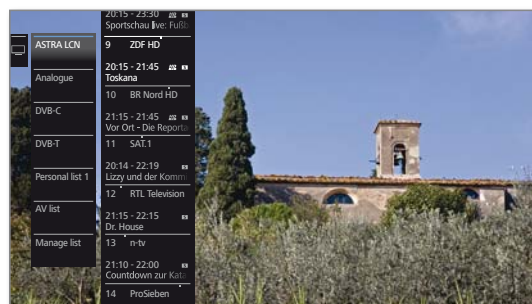

▲ ▼ Mark the desired list.

The station list will be changed according to the available options. The list will be adopted automatically.

▶ Move to the new selected list.

## Explanations of the station lists:

**i** The number and the names of the possible station lists depend on the available signal sources (antennas, TV reception networks, etc.).

Astra LCN Only stations from the selected source / reception network are indicated in the station list.  
 Analog  
 DVB-C  
 DVB-T

AV list Exclusively AV inputs are shown in the station list.

Personal list Only stations of the selected personal list are indicated in the station list.

**i** The name of the list may be changed.

Manage lists Call up the station list editing menu. (**System settings** → **Stations** → **Station lists TV**).

## Selecting stations by means of the expanded station list

**i** In normal TV mode, without other displays:



Press **OK** longer: Call expanded station list.

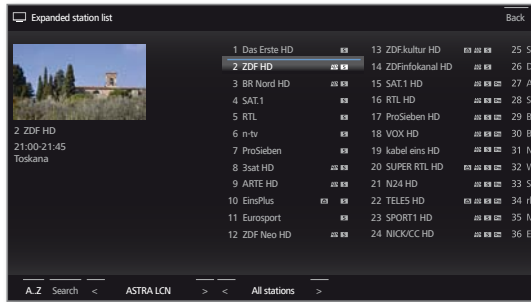

▲ ▼ ◀ ▶ Mark stations.  
 ◀ ▶ Scrolling in the station list is possible.  
**OK** The marked station will be called.

Or:



For numerical sorting: Input the channel number. The marker will switch to the selected station. The marked station is shown as a thumbnail picture.



**OK** The marked station will be called.



For alphabetical sorting: Input the first letter. The first station for the specified letters is marked.



▲ ▼ ◀ ▶ Mark the station.  
**OK** The marked station will be called.

## Filter and sort options of the expanded station list

Using the on-screen buttons on the bottom line of the expanded station list you can filter and sort the station list by various combinations of options.

**i** With open expanded station list:



Toogle between the expanded station list and the list of options on the bottom.

0..9 Numerical sorting of the station list.

A..Z Alphabetical sorting of the station list.

Searching This allows you to do targeted searches for stations. The station name is to be entered via the on-screen keyboard. Entry is described in chapter **General information on menu operation**.

Station lists Select the station list, the stations of which are to be displayed in the extended station list (e.g., Personal station list, ASTRA LCN, DVB-C).

All stations Here you can specify if **All stations**, only **HD** stations, **Locked** stations, **Scrambled** stations, **Unscrambled** stations, **CI+ Protected** stations, **New found** stations or stations **No more** to be **found** from the selected sources shall be indicated.

## Selecting stations by personal lists

You can save your preferred stations in up to six personal lists (e.g., for several users). Each personal list can contain up to 99 stations.



**i** Personal list existing.

**i** In normal TV mode, without other displays:



**OK** call station list.  
 ◀ Open overview of station lists.



▼ ▲ Mark the desired personal list.  
 The station list will be changed according to the available options. The list will be adopted automatically.  
 ▶ Move to the new selected list.

▲ ▼ Mark the station.  
**OK** The marked station will be called. Or:



Select station directly with numerical keys.

## Explanation of the icons following station names:



Locked station



HDTV station



DVB-T station (digital terrestrial via antenna)



DVB-C station (digital via cable)



DVB-S station (digital via satellite)



Coded station

## Status display

**i** In normal TV mode, without other displays.



**INFO:** Show status display.



In the left upper corner you will see in the marked field the number and name of the station, the transmission time and (if available) the title of the current programme. The bar (if available) indicates the progress of the current programme. If information about the current programme is available, this can be called by pressing the **INFO key** again.

In another adjacent field to the right, the programme info of the following programme is displayed additionally for DVB stations.

The field in the upper right corner contains the time, the date and, depending on the DVB station and according to availability, various additional information which is represented by symbols (see column on the right).

A window with button descriptions is displayed in the bottom right corner. The automatic display of the button descriptions can be switched off (see chapter **System settings**, section **Control – On-screen displays**).

The status bar is shown automatically every time you change channels.

The status bar is hidden automatically at the end of the display time.

If you want to hide the status bar manually before the display time ends, you can do this with the **BACK key**.

## Explanations of the symbols in the status display (cont'd):

Transmitted audio signal:

<b>Mono</b>	Mono audio transmission analogue
<b>Dual channel</b>	Dual channel sound transmission (Sound1/Sound2) analogue
<b>1+1</b>	Dual channel sound transmission (Sound1/Sound2) digital
<b>Stereo</b>	Stereo sound transmission analogue
<b>Stereo (AAC+)</b>	Stereo sound transmission (HEAAC)
	Stereo sound transmission digital (PCM)
	Dolby digital sound transmission (DD)
	Dolby digital sound transmission (DD+)
	Dolby digital AAC+ sound transmission (HEAAC)
<b>MPEG</b>	MPEG sound transmission

Transmitted audio channels:

	DD / dts 1.0 / mono
	DD / dts / MPEG 2.0
	DD / dts 3.0
	DD / dts 4.0
	DD / dts 5.0
	DD / dts 2.1
	DD / dts 3.1
	DD / dts 4.1
	DD / dts 5.1

## Explanations of the symbols in the status display:

General symbols:

	Language/sound selection available
	Subtitles available
	Channel selection for multi-channel providers
	3D programme
	HDTV programme
	HbbTV mode available from this station

## Function list

The function list contains settings and additional options. The individual list items will be briefly explained as follows:

**i** The function list can be opened directly in TV mode or via the station list. Depending on this, some list items may possibly not be available.

In TV mode:



**MENU:** Call function list.

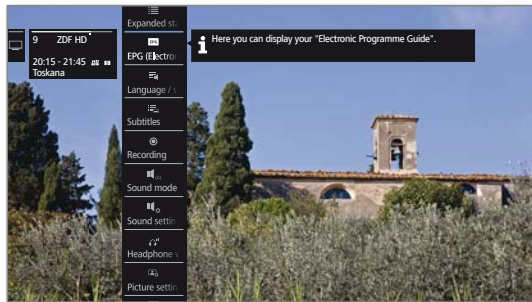











Or:





**OK** Call station list,  
▶ call function list.

▲ ▼ Mark function,  
**OK** call.

### Explanations of the symbols in the function list:

-  Open **Expanded station list**.
-  Call **EPG (Electronic Programme Guide)** wizard.  
**i** Menu item is only displayed as long as the EPG wizard has not yet been executed.
-  Call up **Language / sound**. The sound formats on offer and their designations depend on the programme being broadcast.  
**i** Menu item will only be indicated when other languages / sound tracks are available.
-  Call up selection of **Subtitles**.  
**i** Menu item will only be indicated when subtitles are available.
-  Open recording dialogue to programme a **Recording**.
-  Call up **Sound settings**.
-  Call up and adjust **Headphone volume**.  
**i** Menu item will only be indicated when a headphone is connected to the TV set.
-  Call up **Picture settings**.
-  Activate **PIP** (picture in picture).
-  Move picture vertically up/down.
-  Switch screen off.  
**i** The menu item is only shown when DVB radio or an AV source is active.

### Explanations of the symbols in the function list (continued):

-  Add current station as **Favourite** to **Home** view.
- A-Z** Changes the **Sorting** between numerically and alphabetically.
-  Call up **Edit station list**.  
Delete stations, shift stations, restore deleted stations.

## AV list

### Selecting the AV source via the AV list

**i** In normal TV mode, without other displays:



Open up the station list **AV list**.

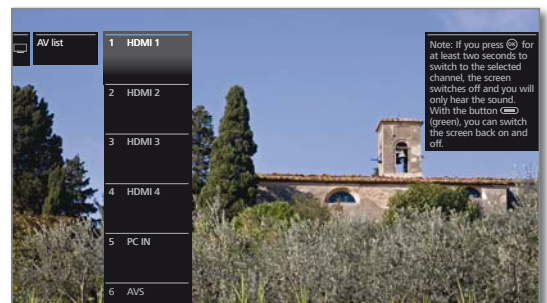

▼ ▲ Select desired connection,  
**OK** switch over.

If the selected AV source provides a signal (picture), it should be visible now.

For the **VIDEO** selection the set switches to **cable analog**, channel **E36**. The TV set shows the signal of a signal source device via antenna.

### Only playback of the audio signal from the AV source (screen is off)

To play only the sound of a connected media player (e.g. MP3 player), the AV sources can be selected so that the screen goes blank.

**i** Switching off the screen reduces the power consumption of the TV set.



Open up the station list **AV list**.



▼ ▲ Select desired connection,  
**OK** press at least for two seconds.

### Selecting the AV source via the station list

**i** In normal TV mode, without other displays:



**OK** call station list.  
◀ Call overview of station lists.

▼ ▲ Mark **AV list**.  
The AV list will be displayed.  
▶ Move to the AV list.

▼ ▲ Mark desired AV source,  
**OK** switch to AV source.

## Electronic Programme Guide – EPG

EPG stands for Electronic Programme Guide and provides you with on-screen programme details. With the system, as with a printed programme guide, you can learn about the current programme. In addition programmes can be sorted according to certain topics, memorised, and also recordings can be programmed.

**i** If a personal list has been selected, only the programmes of stations from the personal list are displayed in the programme list.

### Starting and ending EPG



**EPG:** Switch EPG on / off.

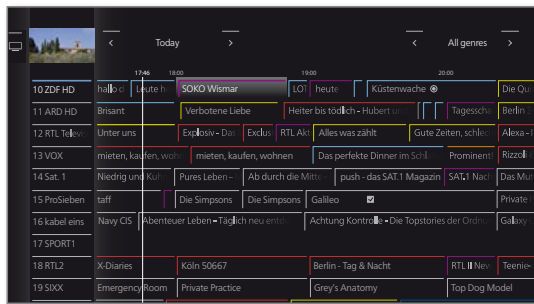

- i** EPG is only available for DVB stations.
- i** The first time you start EPG, a wizard will start that guides you through the necessary presets.
- i** Depending on the number of stations selected for EPG, it may take some time until the programme information is displayed.

### EPG wizard

In this dialogue you decide, for which station EPG data should be collected and displayed. With the number of stations the time for nocturnal data acquisition will increase. We recommend, also for reasons of distinctness to select only those stations, which you receive regularly.

When the EPG is started for the first time:



▶▶ Continue in the wizard and call up the EPG Station selection.



**MENU:** Switch between the station list and the on-screen buttons in the bottom line.

Changing the station list:



◀ ▶ ▶ ▶ Mark station list in the bottom line, **OK** select desired station list.

Select station for EPG:



◀ ▶ ▶ ▶ Mark the the single station, **OK** Select / deselect station for EPG.

For display in the EPG, the selected stations are marked with a check mark .

Or:



◀ ▶ ▶ ▶ select **Mark all**. **OK** All stations of the station list will be activated for EPG.

Or:



◀ ▶ ▶ ▶ select **mark only this one**. **OK** Only the marked station is activated for EPG.

### Meaning of the colours in the EPG

The coloured labels indicate the genre of the respective programme. When filtering with genre selection in the header, the programmes of the selected genre will be highlighted.

- Movies
- News
- Show
- Sports
- Child
- Music
- Arts
- Social
- Education
- Hobby
- Series

### EPG operation

In the left column there is a list of stations of your currently active station list (e.g. DVB-C, personal list etc). With the on-screen buttons in the header of the EPG you can select the day of the programme preview and filter the programmes as to their genre.



**INFO:** short: call up detailed information.  
 long: show key explanations.



▼ ▲ Scrolling in the station list.  
 ◀ ▶ Scrolling through the programmes.

Or:



**P+ / P-** Scrolling in the station list page by page.



**RECORD key:** Schedule the recording of the marked programme for a time.



**MENU:** Go to header.



◀ ▶ Mark selection of date or genre.  
**OK** Accept changes.



**MENU:** Move from date to genre or from genre to station list.

## Programme preview



▲ ▼ Mark desired station in the station list.  
**OK** press long: show preview.

In the top left window, the current programme of the selected station is displayed now.

**i** Stations are only changed in the preview window. When exiting EPG, the previous station is displayed.

## Jumping to time or station

**i** The marking must be in the station list.



Press the **numerical key** (0 through 9). The window **Select Time/Station** is shown.

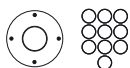
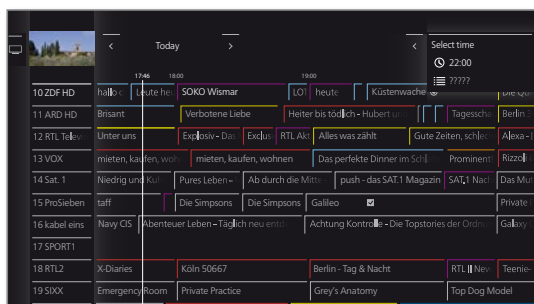

▲ ▼ Select time or station,  
 Enter numbers.

**i** When entering a time, you always jump to the next occurrence of the entered time (24-hour window). If the time is already passed today, the time entered will appear on the following day.

**i** Always enter five digits for station presets, e.g. **00001** for preset 1 or **00134** for preset 134.



**OK** Activate jump.

## Switching to the current broadcast



▲ ▼ Mark current broadcast.  
**OK** press briefly: switch to current broadcast.

The electronic programme guide will be closed.

## Calling additional information about the programmes



**INFO:** Call up detailed information.



If there is more information on the selected programme, it will be indicated here. You find further information on the indicated programme in the bottom line:

View **i** The menu item is only available when the selected programme is on the air. Watch selected TV programme.

Memorise **i** This menu item is only available when the selected programme has not started yet.

Memorise the programme for later watching / listening.

For further information see column on the right.

**i** Depending on the presetting the TV set will switch on by itself when it is in standby.

Delete memo For programmes being memorised you can also delete the memo.

Timer list Call up the timer list.

**●** (Recording) Schedule the recording of the selected programme for a time (see column on the right).

**★** (Favourite) Schedule the recording of the selected programme for a time. Additionally, an entry to the **Home** favourites will be added.

Explanation of the symbols in the programme information:



Programme in 16:9 picture format



Programme in high picture definition (HDTV)



Programme with Dolby-Digital sound



Transmission of subtitles for hearing-impaired persons



Programme with Parental lock (see chapter **System settings**, section **Control – Parental lock**)

The symbols may also appear in combinations.

### Timer programming by means of EPG

You can programme timer recordings of TV programmes conveniently using the EPG.



Mark the desired broadcast.

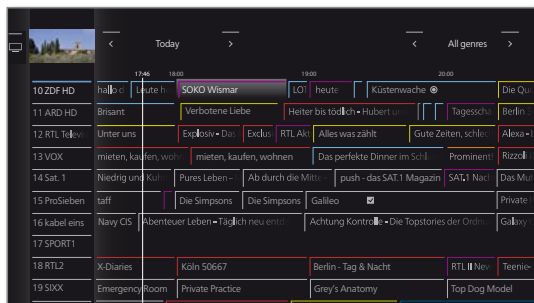

**RECORD key:** Programme timer recording for the TV programme.

Timer data dialogue is opened.

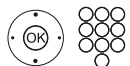
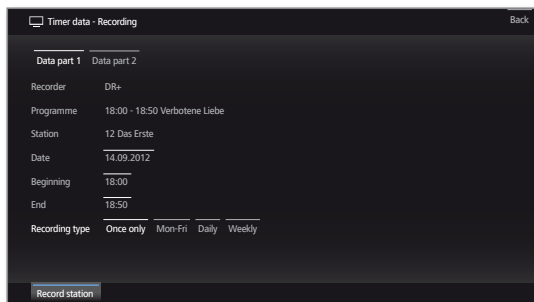

Check the timer data and update it if necessary.

See chapter **Extras**, section **Timer** for explanations of the setting options in the **Timer data** menu.

**i** In the EPG a recording symbol ● is placed behind the title of the programme.

### Memorising a programme via the EPG

A programme that has not started yet can be memorised. For memorised programmes, the TV set will ask at the beginning of a programme if it should change the channel accordingly or switch on from the stand-by mode if this is activated in the **System settings** → **Control** → **EPG** menu.



Mark the desired programme.

**OK** Call up detailed information.

◀ ▶ ◂ ◃ Mark **Memorise**.

**OK** Memorise programme.

**i** In the EPG a memorise symbol ≡ is placed behind the title of the programme.

**i** The memo of programmes can also be started via the timer list instructions (see chapter **Extras**, section **Timer**).

**i** After a software update, it is likely that Memos of programmes are deleted. After a software update, please check your timer list (see chapter **Extras**, section **Timer – Timer list**).

### Adapting the EPG Overview

**i** The options to be selected are in the header, if not, press **MENU key**.



◀ ▶ Select day or genre.

**OK** Confirm selection.

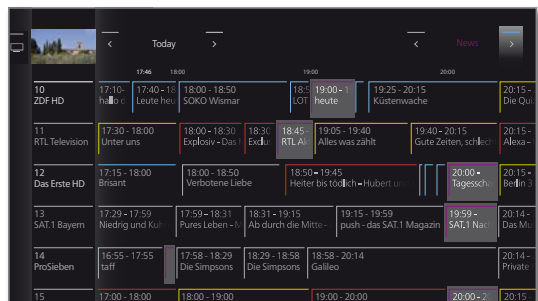

Example If you look for the next newscast select and **news** under genre. Newscasts will be highlighted.



**PIP:** PIP: Switch in EPG view between standard and compact view.

### Configuring EPG

You can find the EPG settings in the chapter **System settings**, section **Control – EPG**.



■ Connect ID 40-55
User guide
TV
Teletext

## Teletext

Your TV set supports the two operating systems TOP text and FLOF. Up to 1,000 / 2,000 pages<sup>1</sup> are stored so that you have quick access.

### Starting and ending Teletext



**TEXT:** Call teletext.

The function of the **TEXT** key can be set. The factory default is **Standard teletext first**.



**TEXT:** Switching between Standard Teletext and MediaText.



Pressing the **BACK** key ends Teletext.

### Key functions for Standard Teletext operation



**0 AV:** Stop self changing pages.



**9:** Zoom in the page (press several times).



**★:** Add active Teletext page to **Home** favourites.

### Page selection with the coloured keys

**Red key:** One page back or back to previous page (depending on Teletext provider).

**Green key:** advance one page.

**Yellow key:** To next topic.

**Blue key:** To next range of topics.

The coloured bars (near TOP) or the coloured writing (near FLOF) in the last to bottom line show you which colour button you need to use to select which topic areas and topics.

### Page selection with P+ / P-



**P+** call next Teletext page.

**P-** call previous Teletext page.

### Additional page selection possibilities



#### First possibility:

**INFO:** Call **overview page 100**.



#### Second possibility:

Directly enter the page number.

#### Third possibility:

**1** The page includes 3-digit page numbers.

▼ ▲ Mark desired page number.



**OK** Call page.

#### Fourth possibility:

**1** The page consists of several sub-pages, indicated by the symbol and the arrows in the bottom line.

▼ ▲ Go to bottom line.

◀ ▶ Mark < or >.

**OK** select previous / next sub-page.

**1** The number of the current sub-page is shown between the arrows.



### Explanation of the symbols in the Teletext bottom line

Symbol (icon)	Remote control key	Description
<	-	For Teletext pages with sub-pages: Show previous sub-page.
>	-	For Teletext pages with sub-pages: Show next sub-page.
	-	Hide TV picture (Teletext as full screen).
	-	Insert TV picture (Split screen Teletext / TV Picture).
	-	Activate Newsflash mode.
	-	Show hidden information on the Teletext page.
	-	Hide information on the Teletext page again.
★		Add current Teletext page to the favourites in <b>Home</b> view.
⚙️		Call function list with Teletext settings.

<sup>1</sup> Depending on the type of TV set (see chapter **Technical Data**).

■	Connect ID 40-55
	User guide
	TV
	Teletext

## Newsflash

Some text pages, e.g., live tickers, will be permanently updated. In order to keep track of changes and also to be able to watch the TV programme at the same time you may hide the Teletext temporarily and can still remain informed on updates of the page.



◀ ▶ ▲ ▼ Mark  **Newsflash**, confirm with **OK**.

The future behaviour of the News function depends on the type of the Teletext page:

In case of Full screen Teletext pages the Teletext will be hidden. In the upper left corner, there will be a symbol for the activated news function. A screen message appears when the contents of the page has changed:



Show updated page,  
◀ ▶ **yes** or **no**.  
**OK** Confirm selection.

In case of Teletext pages which cover only a part of the Teletext page, e.g., News tickers, the respective part will be faded in and permanently updated.

## End News function



**OK** show Teletext again.

Or:



**BACK**: exit Teletext.

## HbbTV / MediaText

HbbTV<sup>1</sup> (Hybrid broadcast broadband television) offers the user comprehensive multimedia contents, e.g., media centres or additional information on the current programme as far as they are provided by the station.

**MediaText** helps you to use the next generation of teletext/videotext for HbbTV.

MediaText/HbbTV text can either be started directly or through an HbbTV application.

- i** The TV must be connected to the Internet to use HbbTV/MediaText. A connection speed of at least 6,000 kbit/s (DSL 6000 or equivalent) is recommended for smooth playback of videos.

### Open HbbTV application

If an HbbTV application is available for the chosen channel after changing channels, this will be loaded during the automatic start process and a red key symbol will appear. When starting manually, the application will only be loaded by pressing the red key.

- i** HbbTV is offered by the selected channel.
- i** Connection to the Internet established.
- i** HbbTV mode is set to **on**.

    **Red key:** Load / display HbbTV application.



The appearance, key assignment and available functions of the HbbTV applications are dependent on the provider.

Under certain circumstances, the recording and bookmarking functions of the applications may not be supported.

Loewe do not guarantee the accessibility, functionality or content of HbbTV applications.

### Hide / Close HbbTV application

 **BACK:** Hide / Close HbbTV application.

Depending on the start behaviour set, the HbbTV application will be hidden (automatically) or closed (manually). In the start behaviour **Automatic**, you need to press the **BACK key** a second time for closure. You will see a screen message after closing.

### Open HbbTV text directly

- i** Depending on the programme provider, the direct Call of MediaText may not be possible. MediaText must then be opened by means of the HbbTV application.
- i** MediaText/HbbTV text is offered by the selected channel.
- i** Connection to the Internet established.



**TEXT:** Call up "standard" Teletext (see chapter **TV**, section **Teletext**).

By pressing the **TEXT key** a second time the MediaText/HbbTV-Text will be called up.

- i** The function of the **TEXT key** can be set.



Navigation within the HbbTV text and how the coloured buttons are assigned can vary depending on the provider.

### Exiting HbbTV-Text



Pressing the **BACK key** ends HbbTV text.

<sup>1</sup> Depending on the settings selected.

## Digital-Recorder – Overview of functions

You can use the Digital Recorder of your Loewe TV set to record programmes on an external hard disk connected via USB (USB recording). USB recording is **only** possible for TV set **without** integrated hard disk.

The various ways in which your Digital Recorder can be used are listed below.

**i** Format USB discs that you wish to use with the TV set before the first use (see chapter **System settings**, section **Control – Hard disks**).

Digital Recorder function	USB Recording
Delay TV in live play mode (timeshift)	–
Archive recording on the integrated hard disk	–
Archive recording on the USB storage device (external hard disk)	●
Recording / Time delay with digital stations (DVB-C/-T/-S)	●
Recording / Time delay with analogue stations	–
View other channels whilst the archive recording is taking place	–
Subsequent archive recording	–
Delay TV when archive recording is running	●
View other channels with delay TV whilst the archive recording is taking place	–
Archive playback from DR+	–
Archive playback from USB storage devices (external hard disk)	●
Copy recorded programmes from DR+ onto a USB storage device	–
Copy recorded programmes onto an external recorder	–
Copy recorded programmes from one USB storage device to another	●
Permit recorded programmes to be viewed on the network	–
View programmes that have been permitted to be viewed over the network	–
Set/delete manual bookmarks	●
Hide parts of a recording	●
Start up „Follow me“	–
Continue to view „follow me“ once it has started	●

- possible
- not possible

## Archive recording

Films that you wish to watch at a later date can be recorded in the Digital Recorder Archive (DR+ archive).

If EPG or teletext data is available, the Digital Recorder stores the title and additional information on each programme in the archive.

If additional languages are being transmitted for a DVB broadcast, these are also recorded. DVB subtitles can also be recorded. Language selection and subtitles are displayed as in TV mode.

You can play back a pre-recorded programme from the archive whilst another TV programme is being recorded into the archive. You can also play back the programme that you are just recording with time delay. During the archive recording, the bar showing the recording progress is red.

- i** Recording of analogue stations is not possible.
- i** Recordings of CI Plus encrypted programmes are perhaps not possible or only to a limited extent.



### Direct recording

Record interesting programmes directly into the DR+ archive by pressing the **RECORD key**.

 Press the **RECORD key** for a short period: Start direct recording.

Recording dialogue for the current broadcast is called.

 ◀ ▶ Select recording time, **OK** proceed.



  Check timer data and correct if necessary.  
**OK** Start recording.

### One Touch Recording

With One Touch Recording, the recording starts immediately at the press of a button.

 Press **RECORD key** longer: Start One Touch Recording.

 ◀ ▶ Select recording time, confirm with **OK**.

  Check timer data and correct if necessary.  
**OK** Adopt broadcast in timer data.

### Timer-controlled recording

Comfortably select your favourite programme for recording from the EPG. The timer overview has room for 50 entries.

You will find further information on timer-recording in chapter **Extras**, section **Timer**.

### Time shift viewing during archive recording

Whilst an archive recording is taking place you can watch the programme that is just being recorded in the archive using time delay.

 **PAUSE key:** Switch to freeze picture. The recording is continued in the background.

Display during time-shift viewing and archive recording:

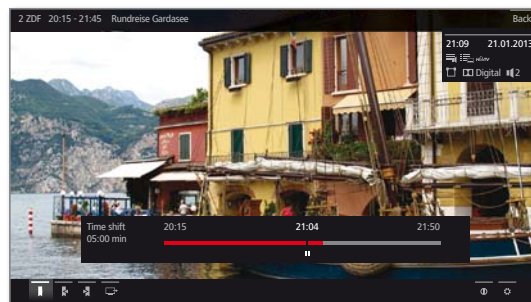

 **PLAY key:** Continue playback. You will now see the time-shift archive recording.

For further options of time-shift watching see chapter **Video**, section **Video playback**.

 **STOP key:** End time shift and return to the live picture of the current archive recording.

### Setting bookmarks during archive recording

During a running archive recording you can create bookmarks (by pressing the **PLAY key** a little longer). You will see a message on the screen.

Bookmarks also serve as starting and end points of intervals.

### Viewing another programme from the archive during archive recording

After you have started the recording, you can also watch a programme you have already recorded.

 Open the **DR+ archive**.

 ▼ ▲ Mark the recorded programme, **OK** view programme.

The recording process is continued in the background.

### Subtitles

Subtitles of a broadcast can also be stored during recording.

- i** The recording of subtitles in DR+ continuous mode must be activated in the settings.

Calling up the subtitles during a later playback is similar to calling subtitles in TV mode.



---

■	Connect ID 40-55
	User guide
	TV
	Digital Recorder

---

### Switching off the TV set during recording

You can switch off the TV to standby whilst recording. The recording is continued in the standby mode.

**i** **Never** switch the TV set off at the mains and do **not** pull out the plug of the TV set out of the socket. Otherwise the recording will be lost!

### Stop recording early

You can end a current archive recording prematurely.



Press **STOP** key.

A message appears in the right upper corner of the screen.



**OK** Stop recording.

The recording process is ended. The portion of the TV broadcast recorded up to this point is saved on the hard disk and can be played back via the DR+ archive.

**i** You can also end a running recording by deleting the corresponding timer entry in the timer overview.

## DR+ archive

With the DR+ archive you have access to all the recorded programmes and start playback.

An automatic Delete Manager always ensures that there is sufficient recording space for new movies.

### Open the DR+ archive



Open the **DR+ archive**.



▼ ▲ Select desired archive,  
**OK** Display archive entries.

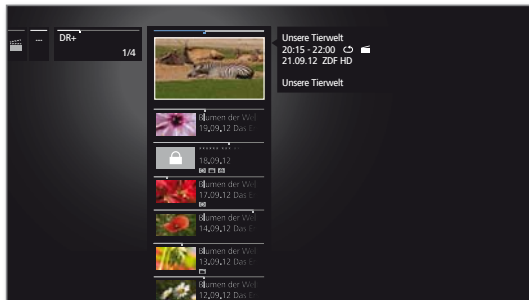

**PIP:** switch in DR+ archive view between standard and compact view.



### Playing from the DR archive



▼ ▲ Mark the required archive entry,  
**OK** Start or continue replaying the selected archive entry.

**i** During the playback of DR+ archive entries, the output signal for external devices at the **AV** connection is switched off.

### Explanation of broadcast information

The progress bar in the upper part of the broadcast information shows you how much of the recording has already been watched.

Further information on the recording, as far as available, can be called via the function list (see column on the right).

Archive entry with set parental lock

Archive entry with set Delete protection

Archive entry with active playback

### DR+ archive function list

The function list of the DR+ archive contains the individual function for its archive entries.



▼ ▲ Mark the recorded broadcast.



**MENU:** call function list.

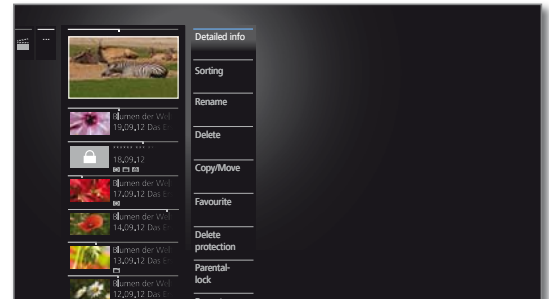

**Detailed info** Show detailed information on the marked archive entry.

**Sorting** Sort archive entries in alphabetical (ascending A-Z or descending Z-A) order or according to recording date (newest entries first).

**Rename** Change title of archive entry.

**Delete** Delete archive entry from hard disk and recover disk space.

**Copy/Move** Copying/moving an archive entry to another external hard disk.  
 When moving, the recording will be deleted automatically from the source after it has been successfully copied.

**Favourite** Add archive entry to **Home** favourites.  
 See chapter **Home view** for further information.

**Delete protection** Activate or deactivate protection against automatic deletion by the Delete Manager.

**Parental lock** Protect recorded broadcast against unauthorised playback.

**i** The menu item is only available when a access code is defined in the parental lock (see chapter **System settings**, section **Control – Parental lock**).

**Repeat** Play archive entry repeatedly (in a loop) when the archive entry is replayed in the future.

**Settings** opens the video settings.

<sup>1</sup> Menu item will only be indicated when a motorized stand is connected to the TV set.

### Displaying detailed information on the recording

If detailed information exists on the recorded broadcast from the EPG, you can display it.

**i** The desired entry in the DR+ archive is marked.



**MENU:** Call function list.

▼ ▲ Mark **Detailed info**,  
**OK** Display detailed information on the broadcast.

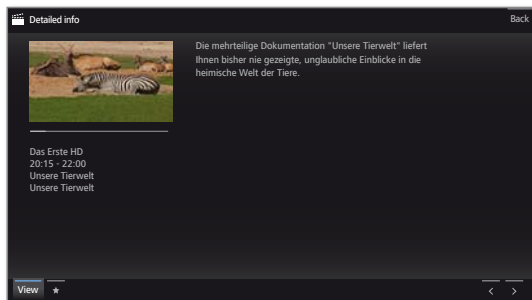

For the explanation of the symbols in the bottom line see chapter **TV**, section **EPG**.

### Deleting recordings from the archive

**i** The desired entry in the DR+ archive is marked.



**STOP key:** Call delete dialogue.

Or:



**MENU:** Call function list.

▼ ▲ Mark **Delete**,  
**OK** call.

**OK** Confirm deletion. The DR+ archive will be displayed again.

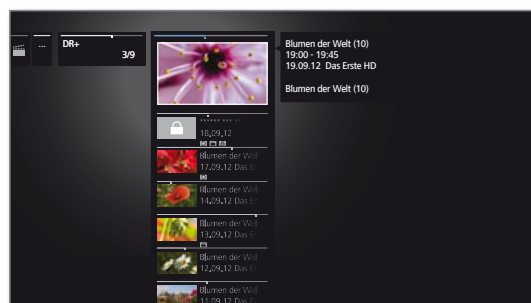

### Changing the title of an archive

**i** The desired entry in the DR+ archive is marked.



**MENU:** Call function list.

▼ ▲ mark **Rename**,  
**OK** Call.

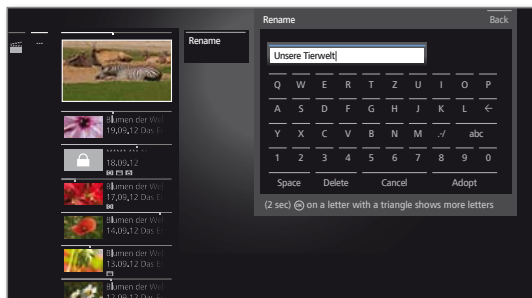

Or:



◀ ▶ Select **no**,  
**OK** Cancel procedure and return to function list.

**i** It may take some time to delete recordings from external hard disks, depending on the length of the programme and recording quality. To ensure a correct deletion process, cancel the presence of the external hard disk via MediaHome, before unplugging it from the TV set. You will see a screen message as soon as the hard disc can be removed.



◀ ▶ ▲ ▼ Select characters,  
**OK** Move character to input line.

**i** For further information on character input see chapter **General information on menu operation**.

End input with **Adopt**. This saves the change permanently.

Or:



**BACK:** Cancel renaming.



## Copying/Moving your recordings

You can also copy/move programmes to a further external hard disk, and archive them in this way.

- i** Copying/moving recordings, which originate from a CI Plus encrypted station, is perhaps not possible or only to a limited extent.
- i** The desired entry in the DR+ archive is marked.



**MENU:** Call funktionlist.

- ▼ ▲ Mark **Copy/Move**.
- OK** Call.

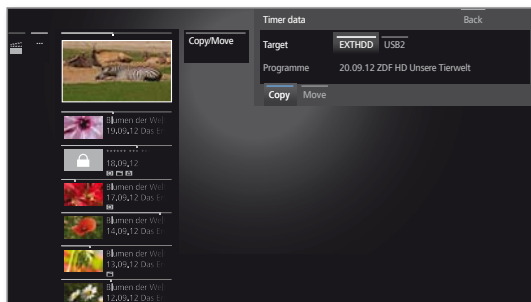

- ◀ ▶ Select target in Timer Data Dialogue.
- ◀ ▶ ▲ ▼ Select **Copy** or **Move**.
- OK** Start the procedure.

- i** When moving, the recording will be deleted automatically from the source after it has been successfully copied.
- i** Copying to an external hard disk takes place in the background and at a significantly higher speed. You see a screen message, when copying has finished.  
The status of copying assignments in progress/pending can be seen in the timer list.
- i** The TV set must **not** be switched off with the mains switch during the copying process!

## Setting/cancelling delete protection

You can provide films with a delete protection to prevent an automatic deletion by the delete manager.

- i** The desired entry in the DR+ archive is marked.



**MENU:** Call function list.

- ▼ ▲ Mark **Delete protection**.
- OK** Call.

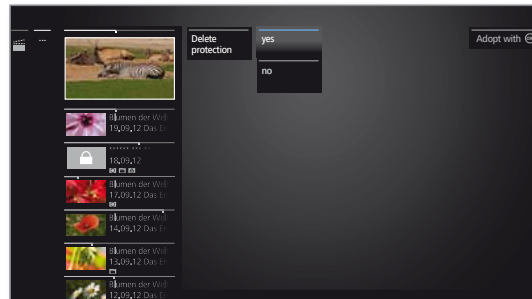

- ▼ ▲ Mark **yes / no**.
- OK** Adopt settings.

## Delete manager

The Delete Manager always makes sure there is enough memory space on the hard disk for new recordings. If the capacity on the hard disk is nearly fully exhausted, the oldest recording(s) are automatically deleted in order to create space on the hard disc. Recordings which have been protected with a delete protection are not deleted by the Delete Manager. However, you can still delete these recordings manually. To avoid data loss, we recommend copying important recordings to an external USB hard disk. Delete the recordings from the Digital Recorder after copying.

- i** Loewe are not liable for data loss from the Digital Recorder's hard disk.



### Locking/unlocking a movie (Parental lock)

You can lock movies that your children are not permitted to view, for instance. Playback is then only possible after entering a PIN.

**i** In order to activate the Parental lock, a code number (PIN) must have been defined beforehand (see chapter **System settings**, section **Control – Parental lock**).

**i** The desired entry in the DR+ archive is marked.



**MENU:** Call function list.

▼ ▲ Mark **Parental lock**,  
**OK** Call.

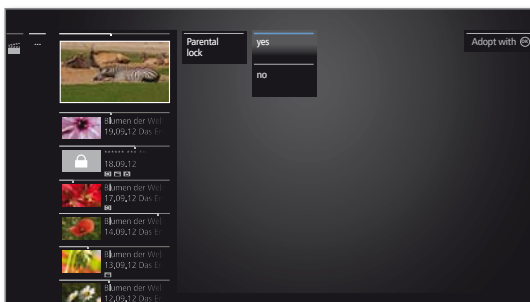

▼ ▲ Select **Yes / No**,  
**OK** Adopt.

**i** The titles of locked films in the DR+ archive will be replaced by asterisks \* when a parental lock is active and thus cannot be read anymore. The detailed information for the recording cannot be called up. The cover of the recording will be replaced by a picture of a lock. In addition, the entry will be labelled with the symbol

### Viewing a locked movie

**i** The desired locked entry in the DR+ archive is marked.

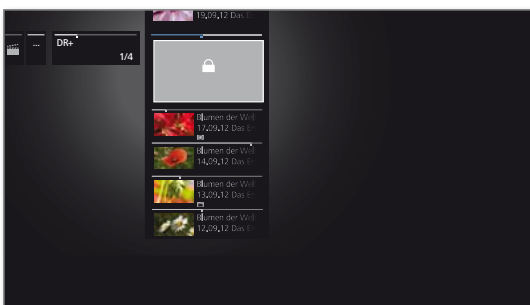

When the access code of the parental lock has not been entered yet:



**OK** call entry of PIN.

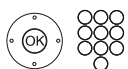

Enter your PIN.

**i** After the access code has been entered, the lock of the archive entries will be temporarily released.



**OK** View film.

### DR+ Streaming

You can use your TV set to view DR+ archive entries via the network provided by „another“ Loewe TV set **with** an integrated hard disk on the network.

**i** To use DR+ Streaming, at least two Loewe TV sets with MB180, SL1xx or SL2xx chassis are required (at least one of which has DR+ integrated). The TV sets also need to be connected via a wireless connection (WLAN) or a cable connection (e.g. Ethernet, PowerLine).

**i** DR+ Streaming must be enabled in the system settings.

**i** Archive entries can only be provided or released in the network by TV sets **with** integrated hard disks (DR+).

**Playback** of released archive entries is possible on all TV sets with MB180, SL1xx (**with/without** DR+) and SL2xx chassis linked to the network.

**i** Functions that would require write access to a released device (parental lock, delete protection, renaming, deleting an entry or bookmark, creating a bookmark, deleting/hiding parts of a recording) are not available during playback of a DR+ archive entry via the network.

### Playback of DR+ archive entry via the network



Open the **DR+ archive**.



▼ ▲ Select desired archive,  
**OK** Display archive entries.

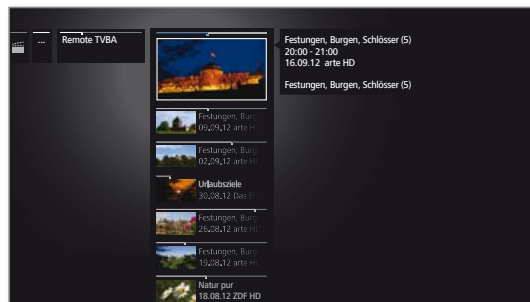

▼ ▲ Mark the required archive entry,  
**OK** View archive entry.

### Follow me function

Using your TV as a second unit you simply continue watching a programme where you have interrupted it on another Loewe TV set (with integrated hard drive).

**i** **Also use other archives** is enabled at the target TV set (see chapter **System settings**, section **Control – DR+**).

**i** You can indicate the beginning of a follow me recording in your network by a screen display.

**i** A programme (follow me recording) is provided and approved by the recording TV set on the network.

### Continue Follow me recording on a second TV set



Open the **DR+ archive**.



▼ ▲ Select archive of the recording TV set,  
**OK** Display archive entries.

▼ ▲ Mark follow me recording,  
**OK** View recording.

## General information on media reproduction

**Home** view gives you access to photos, videos and music from your personal storage media, e.g., from storage media connected via USB and from media servers in your home network to which your TV set is connected.

The item **Web** gives you access to an Internet browser and multimedia data from the Internet.

Please follow also the information below for the **MediaNet** Internet functions which can be called under **Web**.

### Connecting the TV set to your network

To receive media via media servers in your home network or via the Internet, you have to integrate your TV set in your home network. You can connect your TV set both with a **wired connection** (Ethernet, PowerLine) or via a **wireless radio connection** (WLAN). For wireless connections, the TV set has an internal WLAN antenna.

Your Loewe TV set supports the UPnP AV standard for data playback in the home network. You can find more detailed information on this in the chapter **Glossary**.

### Help for configuration problems

Loewe cannot provide any support for PC hardware and software or network components owing to the diverse configuration options with home networks.

Please contact the administrator of your home network and/or specialist dealer for support when setting up and for maintenance of network connections, storage media, media server software and network devices, e.g. routers.

### MediaNet

If you wish to use MediaNet we recommend registering your TV set on our homepage.

<http://support.loewe.tv> (International),

<http://support.loewe.tv/uk> (United Kingdom and Republic of Ireland),

<http://support.loewe.tv/au> (Australia) or

<http://support.loewe.tv/nz> (New Zealand).

(using the **Register free-of-charge** option).

Simply follow the steps in the registration process.

The MAC address of your TV set is required for the registration. You can find this in the TV set under **Extras** → **Special functions** → **Integrated features** → **MAC address (TV)**.

## Accessing your media

HOME

**HOME:** Call **Home** view.



◀ ▶ ▲ ▼ Mark desired function,  
**OK** call function.

**Video:** see chapter **Video**.

**Audio/Radio:** see chapter **Audio/Radio**.

**Photo:** see chapter **Photo**.

**Web:** see chapter **Web**.

### Playing music and videos, displaying images

The windows for playing music and videos and for displaying photos are comparable for all cases irrespective of the media source. The relevant players are therefore grouped together.

### Exit media

HOME

**HOME:** Call **Home** view and select another function (see above).

Or:

TV AUDIO

Press **TV** or **AUDIO key** for TV and radio mode swapping <sup>1</sup>.

<sup>1</sup> The assignment of the AUDIO key can be changed. The description refers to the standard setting.

## Video

The item **Video** gives you access to videos from local (USB, home network) and online sources. The individual subitems are described in detail in the following.

**i** High definition movie material (HD movies) from format 720p upwards (resolution 1280 x 720 or higher) should be played back via a **wired** connection. If there is a **wireless** connection, then technical limitations (e.g., fault liability, bandwidth limitations) can cause disruptions in the playback right up to a complete breakdown of the playback.

### Calling video selection



**HOME:** Call **Home** view.



▼ ▲ Mark **Video**.  
**OK** call list of video sources.



▼ ▲ Mark function,  
**OK** call.

**DR+ archive** Programmes that you have recorded using the Digital Recorder are compiled in the **DR+ archive**. Via the DR+ archive you can replay, edit or delete your recorded programmes.

For further information see in chapter **TV**, section **Digital Recorder – DR+ archive**

**MediaNet** Call **MediaNet → Browse → Video**.

**USB** USB storage media on the USB connections of your TV set. The exact designation depends on the relevant storage medium.

**Twonky-Media** Examples with media servers in your home network. The exact designation depends on the media server used.

**WMP11**

**Timer** Call up the timer list (siehe chapter **Extras**, section **Timer – Timer list**).

**i** Please also observe the notes in chapter **System settings**, section **Control – Software update** regarding USB sticks!

**i** The media sources shown here depend on the devices available/used.

### Video Function list

The video function list contains the individual functions for your videos.



**MENU:** Open function list.

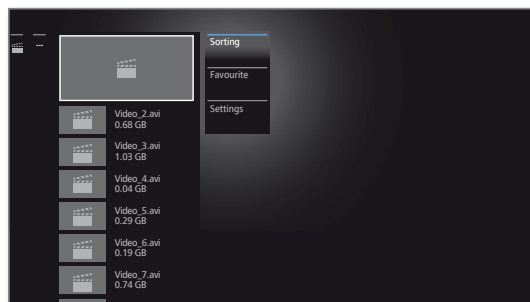

**i** The availability of the following items depends on the currently marked object (data source, directory, file).

- Unmount** Unmount USB data storage medium before removing it in order to prevent data loss.
- Sorting** Sort videos in alphabetical (ascending A-Z or descending Z-A) order, file size or date (newest entries first).
- Favourite** Add video to the **Home** favourites..
- Settings** opens the video settings.



▼ ▲ Mark desired function,  
**OK** Confirm selection.

### Selecting videos



▼ ▲ Mark desired directory,  
**OK** open directory.  
Repeat procedure if necessary.

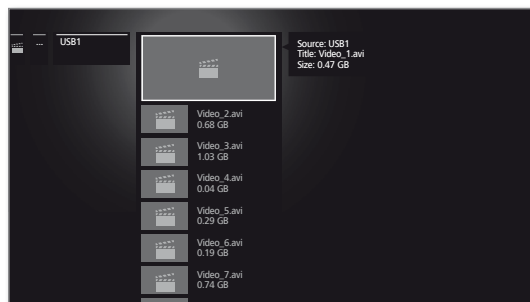

▼ ▲ Mark desired video,  
**OK** Start or continue playback of the selected video

## Video playback

### General information on video playback

The description of the following functions applies to the playback of videos from the DR+ archive as well as for videos from USB storage media or from media servers in the home network.

- i** For playback of DR+ archive entries we have additional playback and editing capabilities. The explanation of these functions you find in section **Additional functions for DR+ archive playback**.
- i** During the playback of DR+ archive entries, the output signal for external devices at the **AV** connection is switched off.



### Video status display

The video status bar provides you with further options on the current playback.



▲ ▼ Show status bar.



**BACK:** Hide the status display again.

### Description of the symbols in the status display for video playback

Symbol	Remote control key	Description
		Call list view (select video).
	-	<b>i</b> For playback of videos from USB storage media or from the home network: Switch repetition (loop playback) of all titles of the current directory ON/OFF.
	-	<b>i</b> For playback of videos from USB storage media or from the home network: Switch ON/OFF repetition (loop playback) of the current title.
	-	Change picture format of the video playback.
	long	<b>i</b> Only for playback from DR+ archive: Set bookmark manually. In case of time-shifted viewing the time-shifted recording will be converted into an archive recording.

Symbol	Remote control key	Description
	long	<b>i</b> only for playback from DR+ archive: Delete bookmark manually. <b>i</b> The function is only available when a manually set bookmark is within five seconds around the playback position.
		<b>i</b> Only for playback from DR+ archive: Skip to next bookmark.
		<b>i</b> only for playback from DR+ archive: Skip to previous bookmark.
	-	<b>i</b> only for playback from DR+ archive: Call dialogue for deleting bookmarks.
	-	<b>i</b> only for playback from DR+ archive: Call interval functions.
	-	<b>i</b> only for playback from DR+ archive: Use current still image at title image in the DR+ archive.
	-	<b>i</b> For playback from DR+ archive: Activate / deactivate again the repetition of the currently played archive entry.
	-	Skip to desired position in the playback.
		Add currently played video to the favourites in Home view.
		Call detailed info on the current playback.
		Call function list with video settings.

### Pause playback (freeze picture)



**PAUSE key:** Switch to freeze picture.

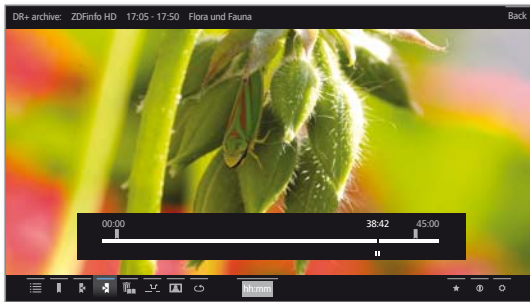

**PLAY key:** Continue playback.

### Jump

By briefly pressing the **◀** or **▶** keys you can skip forwards and backwards in the movie. The jump distance is adjustable.



**▶▶** Skip forwards.

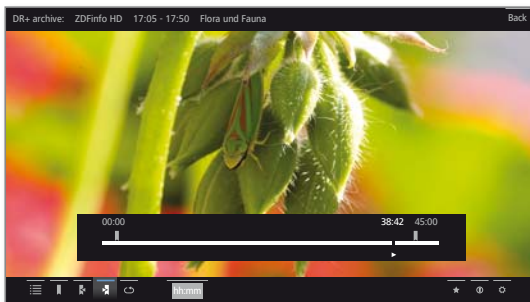

**◀◀** Skip backwards.

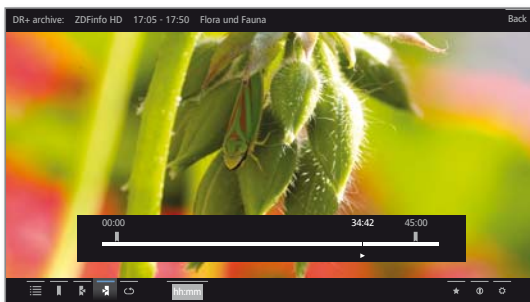

### Skipping with Smart jump

The **Smart jump** function ensures that the jump width is halved each time the jump direction is changed or doubled after three jumps in the same direction (max. 8 minutes). This way you can quickly find a certain spot of the recording.

The settings for Smart jump you find in the **System settings** under **Control** → **more ...** → **DR+** → **Smart jump**.

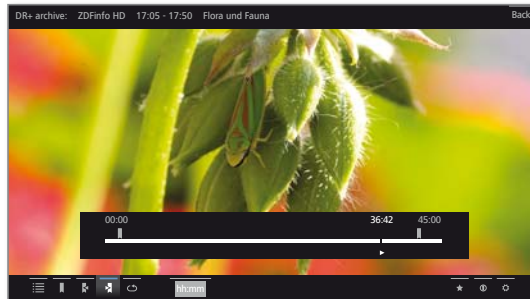

For example, you are searching for the beginning of a broadcast that has already started:



Press **◀◀** repeatedly quickly to jump back.

If you have jumped past the beginning of the programme, jump in the opposite direction:



Press **▶▶**. This jump in the opposite direction is only carried out for half the jump distance. Jump forward using **▶▶**.

If you have jumped past the start of the programme:



**◀◀** Jump back again. In the process, the jump distance is cut in half again.

By halving the jump distance when changing direction again you can find your way to a specific position.

### Jump by entering a time

You can jump to any position in the video by entering a time.



▲ ▼ Show status bar.

▼ ▲ ◀ ▶ mark **hh:mm** (**Jump to ...**).

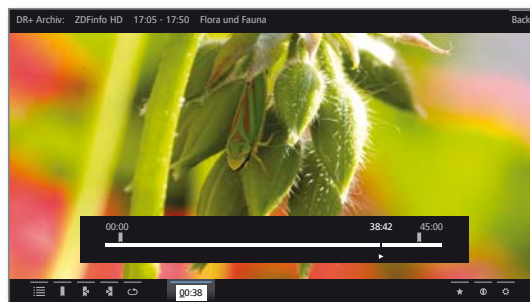

Enter the desired time with the **numerical keys**.



**OK** Execute jump.

## Wind

To search for desired scenes in movies you can fast forward and rewind at three different speeds. Sound is not audible during winding.

  **◀** or **▶** press a little bit longer.



By each brief pressing of **◀** or **▶** the speed will increase until you switch back to the first speed. Available speeds: 2x, 5x, 10x.



**i** In case of time-shift viewing, playback is automatically activated when the end of the recording is reached. You are then about 10 seconds behind the live picture or when rewinding at the beginning of the time shift recording.

**i** In case of Fast forward of archive entries, playback will finish at the end of the recording. The DR+ archive is displayed again.



**PLAY key:** Continue playback.

**i** In the case of Internet videos, please wait until these are buffered in the memory. This can take a few seconds, depending on the bit rate of the film and Internet speed.

## Repeat

Videos can be repeated, i.e., replayed in an endless loop. Depending on the source (DR+ archive, USB storage medium, media server in the network), single or all videos can be replayed in an endless loop.

### Repeated playback of DR+ archive entries



▲ ▼ Show status bar.



▼ ▲ ◀ ▶ mark **Repeat** , confirm with **OK**.

The current archive entry will be replayed repeatedly. The repetition setting remains active for this archive entry even when the playback is finished.

To deactivate playback again:



▼ ▲ ◀ ▶ mark **Repeat off** , confirm with **OK**.

### Repeating videos from USB storage media or media servers



▲ ▼ Show status bar.



▼ ▲ ◀ ▶ mark **Repeat title** ,

**OK** Switch the repetition of the individual video ON/OFF.

**i** The repeat setting remains until it will be deactivated or another video is replayed.

Or:



▼ ▲ ◀ ▶ mark **Repeat all** ,

**OK** Switch repetition of all titles of the current directory ON/OFF.

**i** The repeat setting remains until it will be deactivated or another directory in the overview is selected.

**i** **Repeat title** and **Repeat all** cannot be activated simultaneously. Using one of the two functions deactivates the respective other one.

### Slow motion

At an active pause (freeze frame) you can select from four slow motion speeds (for wind/rewind). There is no sound during slow motion replay. When viewing HDTV slow motion backwards is not possible.



**PAUSE key:** Switch to freeze picture.

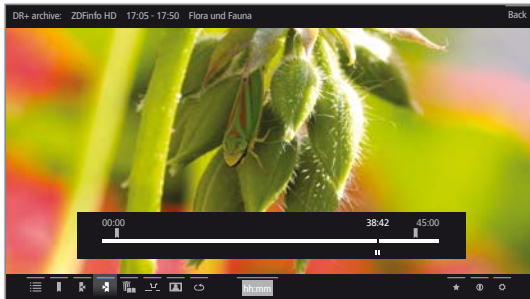

Press ◀ or ▶ briefly.

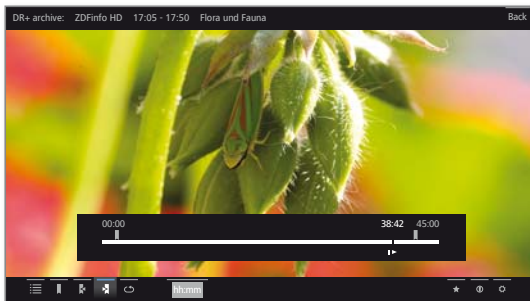

Increase speed:  
Press ◀ or ▶ several times briefly.

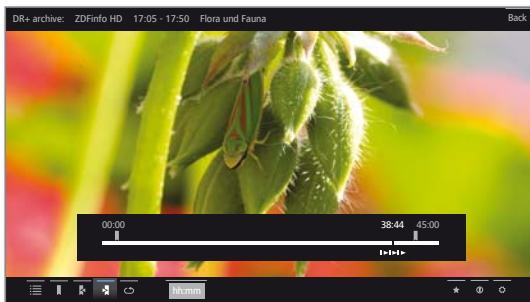

The speed increases every time you press the button until eventually switching back to the initial speed.

### Select language/sound

Videos, especially those recorded from TV broadcasts, can contain several sound tracks. Select sound track/language:



▲ ▼ Show status bar.



▼ ▲ ◀ ▶ mark **Settings** ⚙,  
**OK** Call settings.

▼ ▲ mark **Language/sound**,  
**OK** call Language/Sound selection.

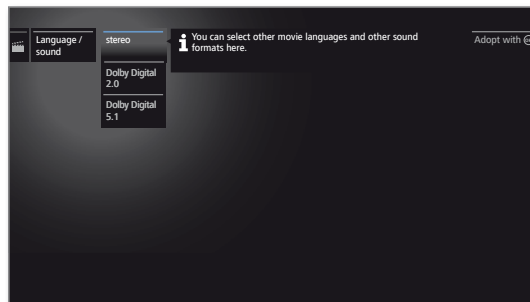

▲ ▼ mark desired sound or desired language,  
**OK** select sound track.

### Changing the picture format



▲ ▼ Show status bar.



▼ ▲ ◀ ▶ Mark **Change Picture format** ⇄,  
**OK** set picture format.

You can choose between small or full image settings. Small image setting shows the video close to the original resolution. The video status bar is permanently shown below the image.

The full image setting enlarges the image to fit the entire screen. The status bar can be set to visible or hidden.



## Additional functions for DR+ archive playback

There are additional editing and playback functions for playback of recorded programmes from the DR+ archive. These are explained as follows.

### Setting bookmarks

To retrieve interesting scenes in a movie later, you can manually set the bookmarks. In addition, there are also automatically set bookmarks every time a broadcast is changed. You can jump to each of the bookmarks in succession by pressing a key.

In case of a running time-shift recording (timeshift television), this will be converted into an archive recording when a blank is set.

 **PLAY key** (press a little bit longer): Set bookmark.

You will see a message on the screen. The drive display is then faded in and you will see the set bookmark above the bar for the playback.

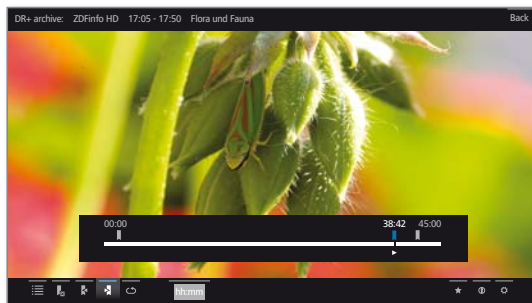

**i** Automatically set bookmarks are white. Manually set bookmarks are blue.

### Determine cover picture

The covers for the display of the entry in the DR+ archive can be freely determined by you during an archive replay:

  Jump / wind to the desired position in the recording.

 **PAUSE key:** Switch to freeze picture.

 **OK** confirm.

You will see a message on the screen. The image will be displayed next to the broadcast in the DR archive in future.

 **PLAY key:** Resume play.

### Interval functions

The intervals between manually or automatically set bookmarks (intervals) can be faded out for future playbacks. In addition to that, unwanted intervals at the beginning or end of your recorded broadcast can be deleted.

**i** An archive entry is replayed.



▲ ▼ Show status bar.

Move to the desired interval in the recorded broadcast by skipping or winding.



**PAUSE:** Stop play.

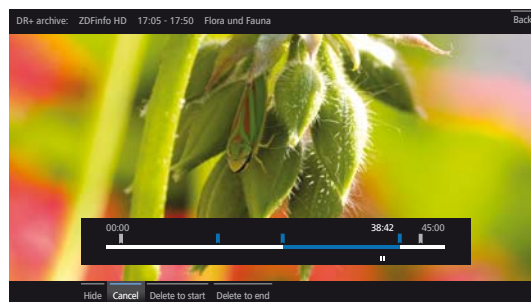

◀ ▶ ▲ ▼ Mark **Interval functions** 1-f.  
**OK** Call interval functions.

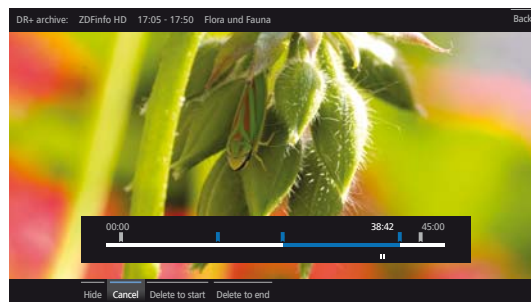

### Hiding intervals

**i** The **Interval functions** are activated.



◀ ▶ mark **Hide**.  
**OK** hide current interval.

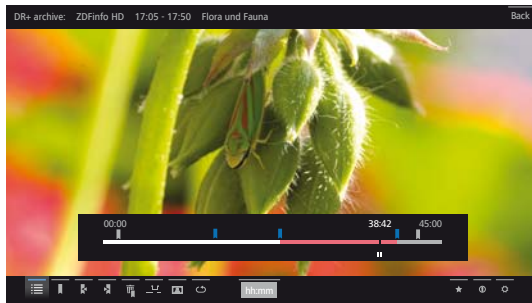

This interval will be skipped when the archive entry is replayed in the future.

### Show hidden section again

**i** In **System settings** → **Control** → **more ...** → **DR+** → **Notify hidden sections** → **yes** must be selected.

A screen message will appear when a hidden section is skipped during replay of a DR+ archive entry.



◀ ▶ Select **yes**.  
**OK** confirm.

During future replays, the hidden section is displayed again.

### Deleting part of the recording



Press **PAUSE key** at such a position from which the recording shall be deleted up to the beginning or to the end.

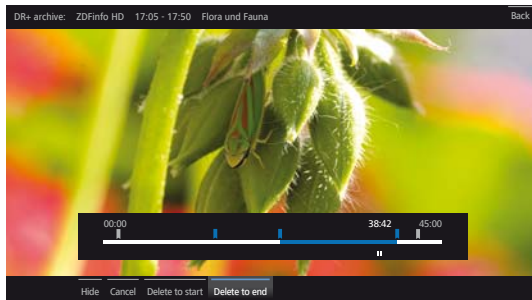

**i** Call Interval functions.



◀ ▶ mark **Delete to start** or **Delete to end**, confirm with **OK**.

◀ ▶ mark **Confirm delete**  
**OK** Delete part of recording.

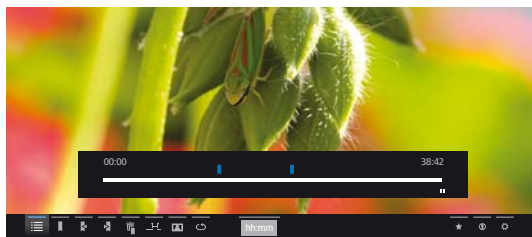

### Deleting intervals

Defined intervals will be deleted when you delete the corresponding bookmark at the beginning or the end of the interval.

### Jumping to Bookmarks



◀ ▶ ▶ ▶ mark next bookmark ▶  
**OK** Jump to next bookmark.

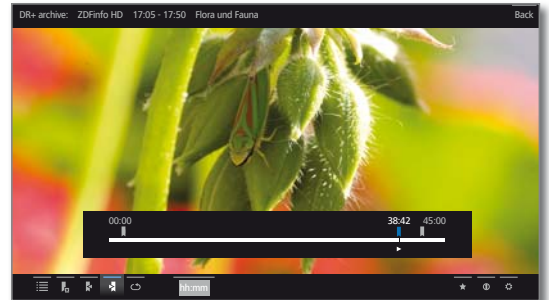

◀ ▶ ▶ ▶ mark previous bookmark ◀  
**OK** Jump to next bookmark.

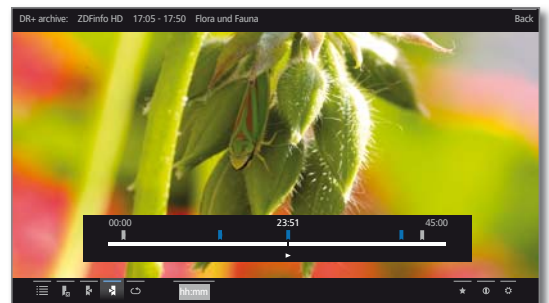

### Deleting individual bookmarks

Jump to the manually set bookmark to be deleted.



Press **PLAY key** for a little bit longer: Delete bookmark.

### Deleting the Bookmark during playback

You can delete your manually set bookmarks during the playback of the DR+ Archive entry.

**i** Manually set bookmarks are blue, automatically set bookmarks are displayed in grey. Automatically set bookmarks cannot be deleted.



**PAUSE key:** Switch to freeze picture.



▼ ▲ ◀ ▶ mark **Delete bookmark**   
**OK** call delete dialogue.

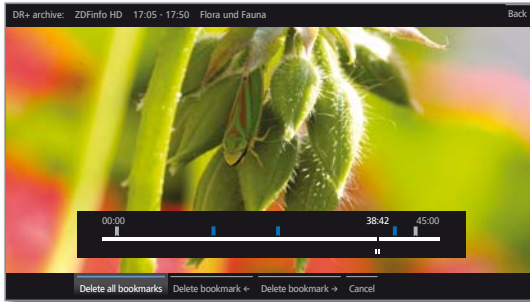

Delete all bookmarks All manually set bookmarks (blue) in the current recording are deleted.

Delete bookmark ← The manually set bookmark to the left of the current position will be deleted.

Delete bookmark → The manually set bookmark to the right of the current position will be deleted.



**OK** Confirm selection.



**PLAY key:** Continue playback.

### Subtitles

Subtitles of a broadcast can also be stored during recording see chapter **Extras**, section **Timer – Entering the Timer data**.

Showing recorded subtitles during playback:



▲ ▼ Show status bar.



▼ ▲ ◀ ▶ mark **Settings**   
**OK** Call settings.

▼ ▲ mark **Subtitles**  
**OK** Call up available subtitles.

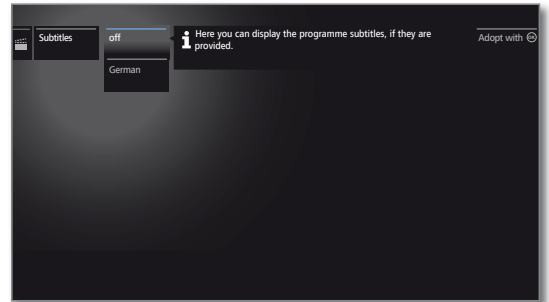

▼ ▲ Mark the desired subtitles,  
**OK** show/hide subtitles.

## Audio/Radio

With item **Audio/Radio** you find music files from your local server(s) and USB storage media and you access DVB and Internet radio. The individual subitems are described in detail in the following.

### Calling Audio selection

HOME

**HOME:** Call **Home** view.



▼ ▲ Mark **Audio/Radio**,  
**OK** call list of audio sources.



▼ ▲ Mark function,  
**OK** call.

**DVB radio** The TV set can receive digital radio stations over DVB. For further information see chapter **Audio/Radio**, section **Radio mode (DVB radio)**.

**Internet radio** The TV set can receive digital radio stations over the Internet. For further information see chapter **Audio/Radio**, section **Radio mode (Internet radio)**.

**MediaNet** Call **MediaNet** → **Browse** → **Music**.

**Media Center** A Loewe media centre connected to your home network.

**Twonky-Media WMP11** Examples with media servers in your home network. The exact designation depends on the media server used.

**USB** USB storage media on the USB connections of your TV set. The exact designation depends on the relevant storage medium.

**i** Please also observe the notes in chapter **System settings**, section **Control – Software update** regarding USB sticks!

**i** The media sources shown here depend on the devices available/used.

### Audio/Radio Function list

The audio/radio function list contains the individual functions for your music titles.

MENU

**MENU:** Open function list.



**i** The availability of the following items depends on the currently marked object (data source, directory, file).

**Unmount** Unmount USB data storage medium before removing it in order to prevent data loss.

**Sorting** Sort music titles in alphabetical (ascending A-Z or descending Z-A) order, title number, file size or date (newest entries first).

**Favourite** Add music title to the **Home** favourites.

**Settings** opens the audio settings.



▼ ▲ Mark desired function,  
**OK** Confirm selection.

### Selecting music titles



▼ ▲ Mark desired directory,  
**OK** open directory.  
Repeat procedure if necessary.



▼ ▲ Mark desired music title,  
**OK** Start or continue playback of the selected music title.

## Audio playback

### Description of the symbols in the status display for audio playback

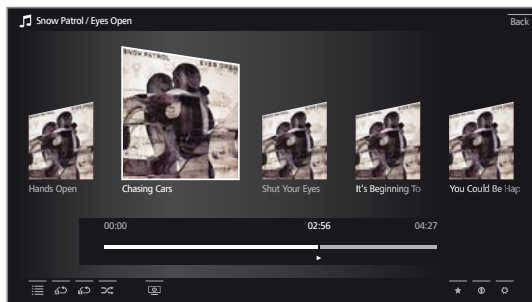

Symbol	Remote control key	Description
		Call list view (select music title / station).
	-	<b>i</b> Only for playback of music titles from USB storage media or from the home network: Switch repetition (loop playback) of all titles of the current directory ON/OFF.
	-	<b>i</b> Only for playback of music titles from USB storage media or from the home network: Switch ON/OFF repetition (loop playback) of the current title.
	-	<b>i</b> Only for playback of music titles from USB storage media or from the home network: Switch shuffle playback for the titles of the current directory ON/OFF.
		Switch off the TV screen.
		Add the current station / music title to the favourites in <b>Home</b> view.
		<b>i</b> In case of DVB radio: Show EPG detailed info on the current broadcast. <b>i</b> For playback of music titles from USB storage media or from the home network: Call detailed info on the played music titles.
		Call function list with audio settings.

### Pause playback



**PAUSE key:** Stop current playback.

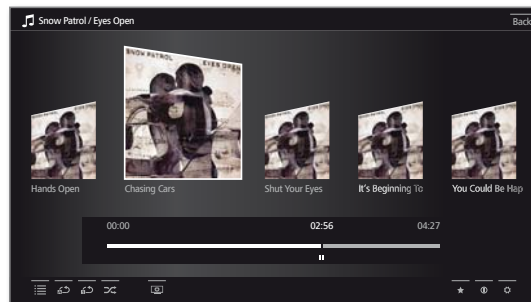

**PLAY key:** Continue playback.

### Wind

You can fast forward music titles at four different speeds. Sound is not audible during winding.



Press **▶▶** a little bit longer.

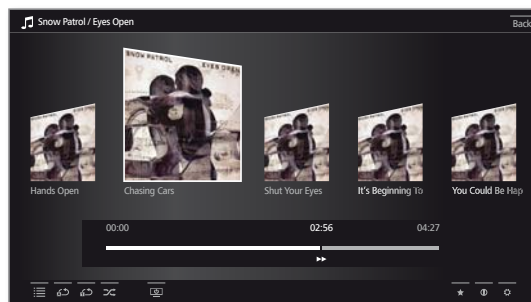

With each brief pressing of **▶▶** the speed will increase until you switch back to the first speed. Available speeds: 2x, 4x, 8x, 16x.

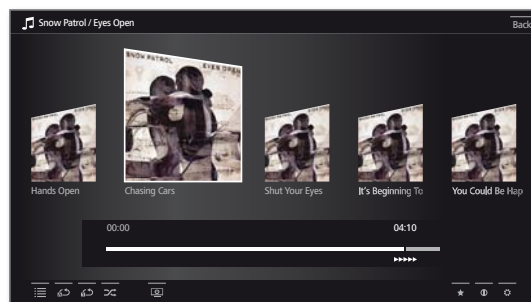

**PLAY key:** Continue playback.

### Select another title / play current title from start



**BACK:** Call music selection.

Select music title as described in chapter **Audio/Radio**, section **Selecting music titles**.

Or:



Press **P+** :

Play next title of current album / directory.

Press **P-** :

Play current title from start.

Press **P-** again:

Play previous title of the current album / directory.

Or:



▲ ▼ Go to line with music titles,

◀ ▶ scroll in music titles.

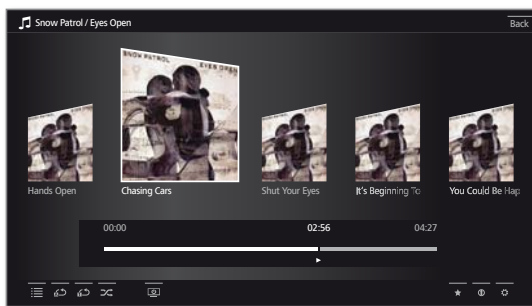

**OK** Start playback of the marked title.

### Repeat

Music titles can be repeated, i.e., replayed in an endless loop.



▲ ▼ Show status bar.



▼ ▲ ◀ ▶ Mark **Repeat title**

**OK** Switch the repetition of the individual music title ON/OFF.

**i** The repeat setting remains until it will be deactivated or another music title is replayed.

Or:



▼ ▲ ◀ ▶ Mark **Repeat all**

**OK** Switch repetition of all music titles of the current directory ON/OFF.

**i** The repeat setting remains until it will be deactivated or another directory in the overview is selected.

**i** **Repeat title** and **Repeat all** cannot be activated simultaneously. Using one of the two functions deactivates the respective other one.

**i** **Repeat** and **Shuffle** (see below) cannot be activated at the same time. Activating a repeat operation deactivates shuffle.

### Shuffle playback

The music titles of your current medium are replayed in random order.



▲ ▼ Show status bar.



▼ ▲ ◀ ▶ Mark **Shuffle** playback

**OK** Switch shuffle playback of the titles in current album / directory ON/OFF.

**i** **Repeat** and **Shuffle** (see above) cannot be activated at the same time. Activating the shuffle playback deactivates repeat.

## Switching the screen ON/OFF

 **Green key:** Switch screen OFF.

Or:

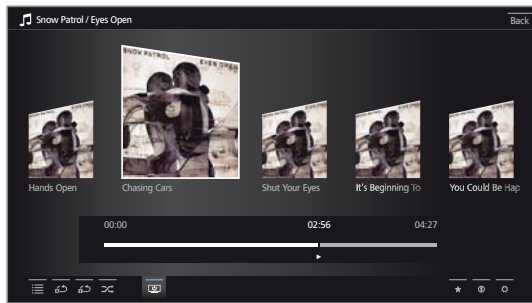

▼ ▲ ◀ ▶ Mark **Screen off**   
**OK** Switch screen off.

**i** Switching off the screen reduces the power consumption of the TV set.

Switch on the screen with the remote control:

 Press **green key**.

Switch on the screen on the TV set:



Press **R** on the ring cursor on the TV set.

## Ending playback



**STOP key:** End playback and return to music selection.



## Radio mode (DVB radio)

The TV set can receive digital radio stations via DVB.

**i** The **AUDIO key** has been preset for radio operation in the factory.

### Radio mode on



**AUDIO key** on the remote control

Or



Press **R** on the ring cursor on the TV set.

Or:



**HOME:** Call **Home** view.



◀ ▶ ▾ ▹ Select **Audio/Radio**,  
**OK** call.

▾ ▹ Select **DVB radio**,  
**OK** call.

You see the radio station list.

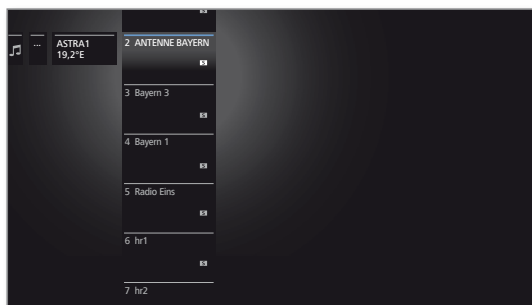

▾ ▹ Select station,  
**OK** call.

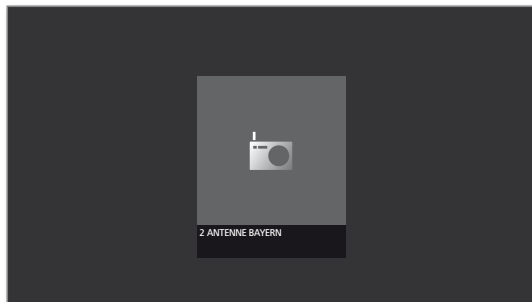

### Station switching

**i** The radio mode is switched on and a radio station has been selected (see above).



**P+ / P-** or press the **numerical keys** on the remote control.

Or:



**OK** call station list.

▾ ▹ Select station,  
**OK** call.

### Setting the volume



**V+ / V-** Volume up/down.

Other sound settings are the same as for the volume setting in TV mode (see chapter **TV**, section **Setting the volume**).

### Switching the screen on/off



**Green key:** Switch screen OFF.

**i** Switching off the screen reduces the power consumption of the TV set.

Switch on the screen with the remote control:



Press **green key**.

Switch on the screen on the TV set:



Press **R** on the ring cursor on the TV set.

### DVB radio function list



**MENU:** Call function list.

Or:



**OK** call station list,  
▶ call function list.

▴ ▾ Mark function,  
**OK** call.

See chapter **TV**, section **Function list** for further information.

### Exit radio mode



**AUDIO key** or



press **TV key** on the remote control (TV mode is called).

Or:



**HOME:** Call **Home** view.



◀ ▶ ▾ ▹ Select another operating mode,  
**OK** call.



## Radio mode (Internet radio)

The TV set can receive digital radio stations via the Internet.

**i** The names of the directories and stations in the Internet radio mode are given by the provider vTuner. Changing the arrangement of stations or renaming them is not possible here.

**i** Internet radio is only accessible if a connection to the Internet has been established.

### Radio mode on



**HOME:** Call **Home** view.



◀ ▶ ▾ ▹ Select **Audio/Radio**,  
**OK** call.

▾ ▹ Select **Internet radio**,  
**OK** call.

You see the radio station list.

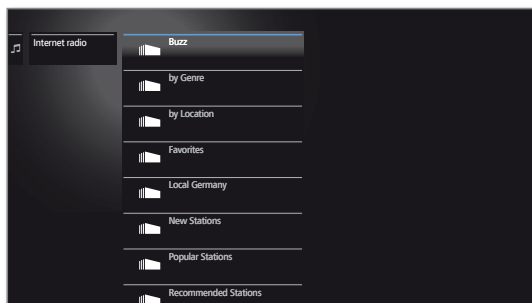

▾ ▹ Mark desired directory,  
**OK** open directory.  
Repeat procedure if necessary.

▾ ▹ Select station,  
**OK** call.

**i** For further information on the control of the Internet radio see chapter **Audio/Radio**, section **Audio playback**.

### Station switching



**BACK:** call station list.

Select stations as described in the left column.

Or:



**P+ / P-** Scroll through the current Internet radio directory to look for stations.

### Setting the volume



**V+ / V-** Volume up/down.

Other sound settings are the same as for the volume setting in TV mode (see chapter **TV**, section **Setting the volume**).

### Switching the screen on/off



**Green key:** Switch screen OFF.

Or:

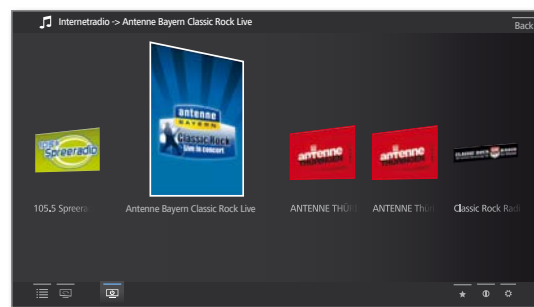

▾ ▹ ▶ ◻ Mark **Screen off**   
**OK** Switch screen off.

**i** Switching off the screen reduces the power consumption of the TV set.

Switch on the screen with the remote control:  
Press **green key**.



Switch the screen on with the remote control:



Press **R** on the ring cursor on the TV set.

### Internet radio function list



**MENU:** Call function list.



▴ ▾ Mark function,  
**OK** call.

See chapter **TV**, section **Function list** for further information.

### Exit radio mode



Press **TV key** on the remote control (TV mode is called).

Or:



**HOME:** Calling the **Home** view.



◀ ▶ ▾ ▹ Select another operating mode,  
**OK** call.



## Photo

Via menu item **Photo** you can view photos from your local media and from online sources on your TV screen. The individual subitems are described in detail in the following.

### Calling Photo selection

HOME

**HOME:** Call **Home** view.



▼ ▲ Mark **Photo**,  
**OK** call list of photo sources.



▼ ▲ Mark function,  
**OK** call.

MediaNet Call **MediaNet** → **Browse** → **Photo**.

Twonky-Media Examples with media servers in your home network. The exact designation depends on the media server used.

USB USB storage media on the USB connections of your TV set. The exact designation depends on the relevant storage medium.

**i** Please also observe the notes in chapter **System settings**, section **Control – Software update** regarding USB sticks!

**i** The media sources shown here depend on the devices available/used.

### Photo function list

The photo function list contains the individual functions for your photos.

MENU

**MENU:** Open function list.

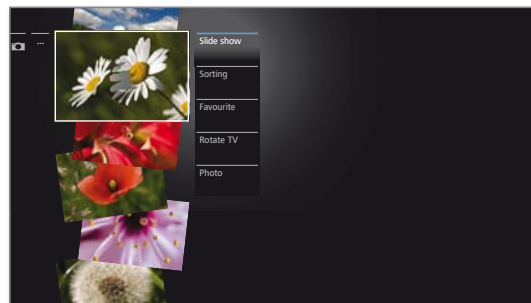

**i** The availability of the following items depends on the currently marked object (data source, directory, file).

- Unmount Unmount USB data storage medium before removing it in order to prevent data loss.
- Slide show Start slide show of the photos in the currently selected directory. See chapter **Photo**, section **Photo display** for further information.
- Sorting Sort photos in alphabetical (ascending A-Z or descending Z-A) order, file size or date (newest entries first).
- Favourite Add music title to the **Home** favourites.
- Photo You can apply frequently used picture settings here.



▼ ▲ Mark desired function,  
**OK** Confirm selection.

### Selecting a photo



▼ ▲ Mark desired directory,  
**OK** open directory.  
 Repeat procedure if necessary.



▼ ▲ Mark desired photo,  
**OK** View photo zoomed to full screen.

## Photo display

### Description of the symbols in the status display for photos



Symbol (icon)	Remote control key	Description
	-	Call list view (select photo).
	-	Rotate photo by 90 degrees to the left.
	-	Rotate photo by 90 degrees to the right.
		Start slide show.
		Pause current slide show.
		Show previous photo.
		Show next photo.
		Add currently displayed photo to the favourites in <b>Home</b> view.
		Call detailed info on the displayed photo.
		Call function list with photo settings.

### Full-screen mode

**I** A photo is marked.



**OK** View photo in full-screen mode.



Show previous / next picture.

### Rotating the photo



On-screen display of status bar.

Mark or .

**OK** rotate photo by 90 degrees to the left/right.

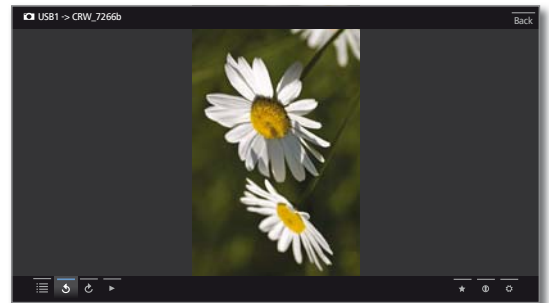

### Slide show



**PLAY key:** Start slide show.

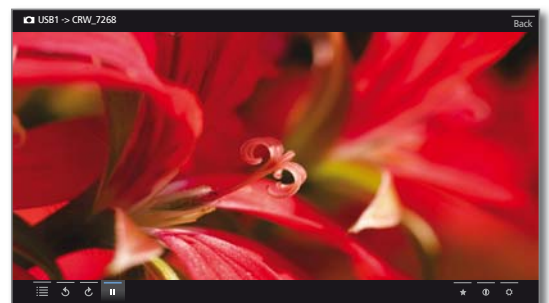

**PAUSE key:** Pause slide show.



**PLAY key:** Continue paused slide show.

### Photo in full-screen mode / exit slide show



**STOP key:** Full-screen mode / end slide show and return to photo selection.

## Web

Here you have access to multimedia content in the Internet (MediaNet) as well as a high-quality web browser.

### Calling the Web selection

HOME

**HOME:** Call **Home** view.



▼ ▲ Mark **Web**,  
**OK** call Web.



▼ ▲ mark function,  
**OK** call.

**MediaNet** Under the menu item **MediaNet** you will find a continually expanding platform for interactive TV applications from the Internet.

All applications are optimised for use on the TV.

**Browser** Call Web browser of the TV set.

For further information see chapter **Web**, section **Browser**.

## MediaNet

### Call MediaNet

WEB

**WEB:** Call **MediaNet**<sup>1</sup>.

or

HOME

**HOME:** Call **Home** view.



◀ ▶ ▼ ▲ Select **Web**,  
**OK** call.

▼ ▲ Mark **MediaNet**,  
 ▶ call.

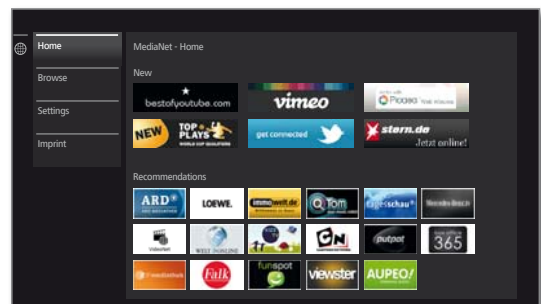

The upper portion of the MediaNet home screen contains new online content.

The lower portion of the MediaNet home screen contains **Recommendations** given by Loewe.

**i** The given content may change from time to time without prior notice.



▲ ▼ Select **Home**,  
**OK** go to the right to choose the online content.

◀ ▶ ▲ ▼ Mark the desired online content,  
**OK** Display/play content.

**i** The navigation within the various applications depends on the provider.

### Functions in the MediaNet home screen

- Home Moves to the right to choose the online content.
- Browse Under **Browse** you can list and call the online content by subjects.
- Settings In the **Settings** for MediaNet you can select countries, for example, to take advantage of various services.
- Imprint Providing the legally required information on the parties responsible for the content.

### Exit MediaNet

HOME

**HOME:** Call **Home** view and select another function.

<sup>1</sup> The assignment of these keys can be changed (see chapter **System settings**, section **Control – Web key function**).

## MediaNet – Browse

MediaNet-Browse is called.

Under the item Browse, you browse the full range of applications by topic.

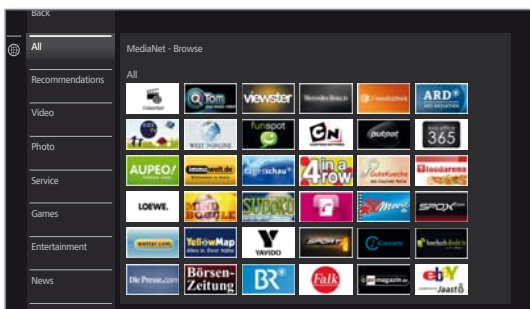

## Filtering applications



▼ ▲ Select the genre / topic,  
**OK** call applications of the genre.

◀ ▶ ▼ ▲ Select desired application,  
**OK** open application.

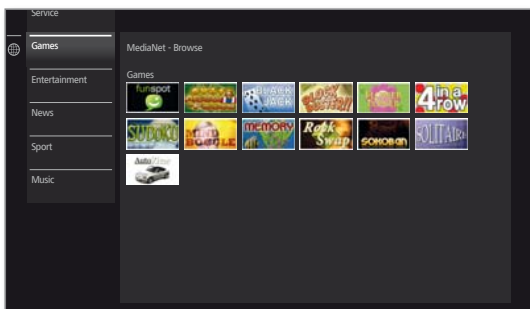

## Change filter



◀ Go to column with genres / topics.

▼ ▲ Select another genre / topic,  
**OK** call applications of the selected genre.

## Exit Browse



**BACK:** Return to the MediaNet home screen.

Or:



◀ Go to column with genres / topics.

▲ ▼ Select **Back**,  
**OK** return to the MediaNet home screen.

## Define application as favourite



◀ ▶ ▼ ▲ Mark the desired application.



Add the marked application to the **Home** favourites.

The favourite will be added to **Home** view and placed at the end.

## MediaNet – Settings

MediaNet settings are called.

Here, you can find setting options for MediaNet.

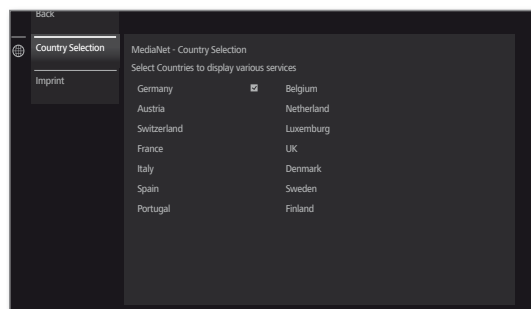

▼ ▲ Select the desired setting,  
**OK** call.

**Country Selection** Select countries from which you want to get information on services (see below).

**Imprint** Providing the legally required information on the parties responsible for the content.

## Country Selection



◀ ▶ ▼ ▲ Mark country,  
**OK** select / deselect country.

Applications from countries that are marked with a tick  here, are offered in **MediaNet**.

## Exit Settings



**BACK:** Return to the MediaNet home screen.

Or:



◀ Go to column with settings.

▼ ▲ Select **Back**,  
**OK** return to the MediaNet home screen.

## Browser

You can access Internet sites directly using the integrated Opera browser. The web browser can also be used without an Internet connection. Thus you can access local devices which provide a web interface (e.g. router, home control, home network server).

### Calling the Web browser

HOME

**HOME:** Call **Home** view.



▼ ▲ Select **Web**,  
**OK** call.

▼ ▲ Select **Browser**,  
**OK** call.

Start page will be opened.



INFO

**INFO:** display browser status.

### Explanation of the symbols in the browser status



Define current site as **homepage**.



**Update** the displayed Internet **site**.

100% Change **zoom** factor of the displayed site / browser.



**Add** displayed Web site **to Home view** (in the **Favourites** area).

### Navigating on Web sites



**P+ / P-** Scroll page vertically.



◀ / ▶ Scroll page horizontally.



◀ ▶ ▲ ▼ Select link or text input field,  
**OK** open link or confirm text input.



For the entry of text, press the numerical key (0-9) repeatedly as with a mobile phone until the desired character appears. The available letters are printed on the individual numeric buttons.

BACK

**BACK:** Stop text entry and exit entry box.

### Entering a URL (Internet address)

**i** Browser status is displayed.



◀ ▶ ▲ ▼ Mark the URL (Internet address) of the indicated Internet site.

**OK** Open address entry box.

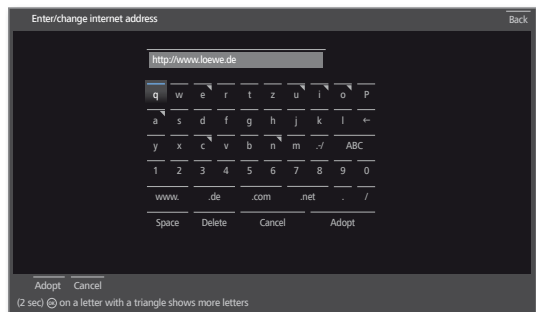

◀ ▶ ▲ ▼ Select required character,

**OK** Adopt character.

In the event of letters with a triangular, additional letters are displayed when pressing the **OK** button longer (2 sec).

← Delete character to the left of the cursor.

.-/ The selection switches to special characters.

abc Switch between upper/lower case.

Space Enter blank space.

Delete Delete all characters.

Cancel Cancel input. The entry box will be closed and the previous Internet site will be displayed again.

Adopt Adopt address and open new Internet site.



**i** The characters may also be entered by the numerical keys of the remote control (see left column).

### Exit Browser

HOME

**HOME:** Call **Home** view and select another function.

## Extras

**Extras** contains additional functions and settings (e.g., Timer list, CA module settings).

### Call Extras

HOME

**HOME:** Call **Home** view.



◀ ▶ ▲ ▼ Mark **Extras**.  
**OK** call Extras.

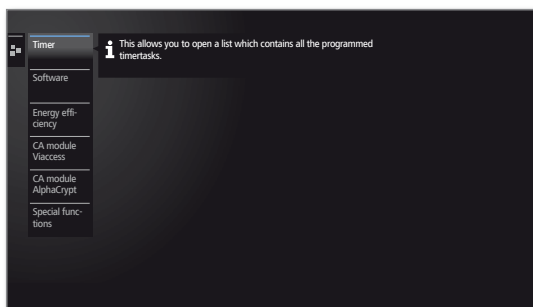

### Explanation of the subitems of Extras

- Timer** Under the menu item **Timer** you find the timer list as well as the timer services such as alarm clock or time-triggered switch-off of the TV set. For further information see column on the right.
- Software** Carry out software update. See chapter **System settings**, section **Control – Software** for further information.
- Energy efficiency** Here you can determine how energy efficient your TV set shall be. See chapter **System settings**, section **Control – Energy efficiency** for further information.
- CA module [Name]** Make settings for your CA module.  
 ⓘ This menu item appears only if at least a CA module is plugged in.  
 ⓘ The exact designation of the menu item and available subitems depends on your CA module.  
 See chapter **Extras**, section **CA module** for further information.
- Special functions** Here, you find the equipment overview of your TV set and repeat the initial installation. Moreover, you reset the various settings to the factory settings here. See chapter **Extras**, section **Special functions** for further information.

## Timer

### Timer list

All programmed recordings, earmarked programmes and copy jobs are listed in the timer list.

You can also programme new recordings, earmark other programmes and copy pre-recorded programmes from the DR+ archive to an external USB hard disk by means of the timer list.

ⓘ When you have programmed timer recordings, the TV set can only be switched off to the standby mode. **Never** switch the TV set off at the mains and do **not** pull out the plug of the TV set out of the socket. Otherwise no timer recordings can be made.

ⓘ After a software update, it is likely that Memos of programmes and Timer entries are deleted. After a software update, please check your timer list.

### Call Timer list

DR+

Long press: call up the timer list.

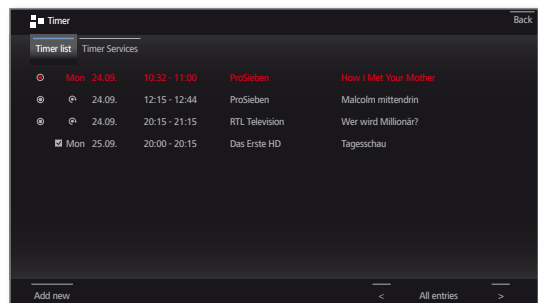

- Create newly** Create new timer instruction (recording, copy, memo).

### Explanation of the symbols in the timer list:

- Recording
- ◐ Recording in progress
- ☑ Marked programme
- 🔄 Repeated recording (daily, weekly or Mon-Fri)
- 📁 Serial recording

### New instruction: New recording

**i** In the Timer list:



◀ ▶ ▲ ▼ Mark **Create newly**,  
**OK** call.

◀ ▶ ▲ ▼ Mark **New recording**,  
**OK** call. The function list for recording will be opened.

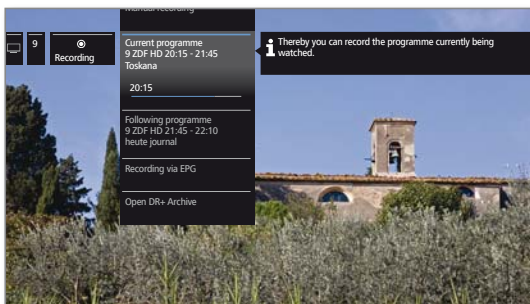

▼ ▲ Mark the desired option,  
▶ proceed.

- Manual recording Programme the recording manually. For further information see column on the right.
- Current programme Record currently watched TV programme.  
**i** Menu item will only be indicated when EPG data are available for the current station.
- Following programme Record following programme.  
**i** Menu item will only be indicated when EPG data are available for the current station.
- Recording via EPG Programme recording of a programme via the electronic programme guide (EPG).
- Open DR+ archive opens the DR+ archive.

### New recording – Manual recording (current station)

**i** In the Timer list, **New recording** is selected.



▼ ▲ Mark recording duration.

**i** The selection of a recording duration programmes always a recording of the currently viewed station. For **Any station and time** see below.



**OK** Call **Timer data** dialogue.

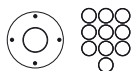

**i** The selected recording duration is preset in the timer data. Check timer data and correct them, if required. In case of a previous selection of **??? Min**, enter definitely the recording duration.



▼ ▲ Mark **Adopt to Timer**.  
**OK** Confirm timer data and adopt timer instruction. Recording has been started.

### New recording – Manual recording (other station)

**i** **Manual recording** has been selected (see above).



▼ ▲ Mark **Any station and time**.  
**OK** Call **Station selection**.

◀ ▶ ▲ ▼ Mark desired station,  
**OK** Adopt station in timer data.

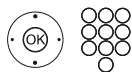

Check timer data and correct them, if required.



▼ ▲ Mark **Adopt to Timer**.  
**OK** Confirm timer data and adopt timer instruction.



### New recording – Current programme

After calling the **Current programme** the timer data dialogue will be displayed. The current programme is preset in the timer data.

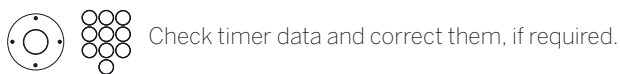

### New recording – Following programme

After calling the **Following programme** the timer data dialogue will be displayed. The following programme of the current station is preset in the timer data.

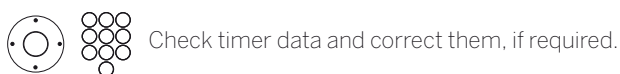

### New copy job

You should copy recordings that you want to save permanently on an external USB hard disk.

**i** Copying recordings, which originate from a CI Plus encrypted station, is perhaps not possible or only to a limited extent.

**i** In the Timer list:

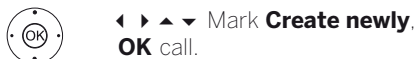

◀ ▶ ▲ ▼ Mark **New copy.**  
**OK** call.

The DR+ archive will be called. For further information on copying refer to chapter **TV**, section **Digital-Recorder**.

### New memo

You memorise interesting programmes, which have not started yet, using the electronic programme guide (EPG).

**i** In the Timer list:

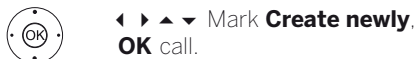

◀ ▶ ▲ ▼ Mark **New memo.**  
**OK** call.

EPG will be called. For further information on Memorise refer to chapter **TV**, section **Electronic Programme Guide**.

### Record conflict

If you wish to programme a new recording which overlaps a timer recording already saved, the **Recording conflict** dialogue will open. Determine whether one or both recordings are to be made here.

If you decide for both, you have to state which of the two programmes is to be recorded fully.

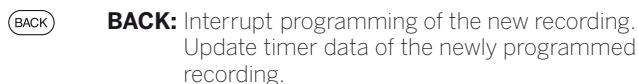

### Delete/change programmed timer instruction

Use this function in the timer list if you want to delete recordings already programmed, to end a running timer recording or to change a timer instruction.

- i** The Timer list is displayed.
- ▼ ▲ Mark desired timer instruction,
- i** The text of a currently active timer instruction is red. If you delete this timer instruction, the recording is stopped.

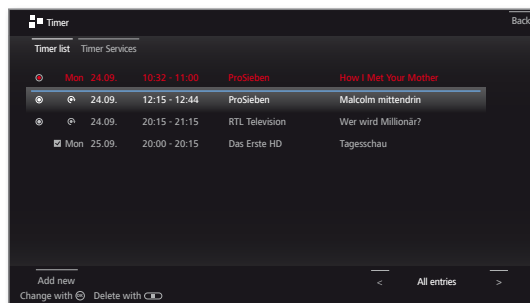

Or:



## Entering the Timer data

After selecting the station you wish to record, timer data will be displayed.

The setting options for the timer data differ depending on the recorder selection, whether an analogue or DVB station is to be recorded or via which route (EPG, manually) the recording has been programmed.

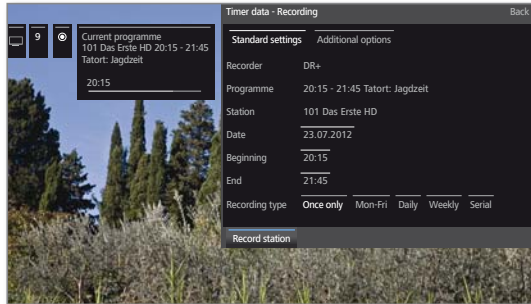

▲ ▼ ◀ ▶ Update **timer data**, if required, or press **OK** for confirmation.

**i** If an external DVD recorder was selected as recording source, start replay at the connected device manually from the beginning of the entered recording time.

**i** Please also read the instructions in chapter **Extras**, section **CA-Modul** concerning the recording of encoded programmes.

## Explanations of the setting options in the menu Timer data-part1 – Standard settings

- Station (only available when the selected station can be received via different signal sources, e.g. DVB-T and DVB-S)  
Select the signal source for the recording.
- Date Day of recording.
- Beginning Starting time of the recording.
- End End time of the recording.
- Recording type Programmes can be recorded in different ways:  
**Once only:** The programme will be recorded at the specified time.  
**Mon-Fri:** The programme will always be recorded from Monday to Friday at the specified time.  
**Daily:** The programme will be recorded every day at the specified time.  
**Weekly:** The programme will be recorded every week at the specified time.  
**Serial** <sup>1</sup>: A programme running regularly, but with different start times, can be conveniently programmed. In this case, the TV set is checking every day at the specified time, whether the programme is available in the EPG data. If so, the program is recorded, if not, the next review will be made the following day.

## Explanations of the setting options in the menu Timer data-part 2 – Additional options

- Lock recording Only allow later playback of this recording after entering the PIN number (Parental lock).  
**i** If a PIN still has not been entered under **System settings → Control → Parental lock**, the **Parental lock** will at first be activated.
- Delete protection Safeguard the recording from being deleted automatically by using the delete manager.
- Auto time control <sup>1</sup> Your TV set can use the automatic time control (Accurate Recording) for recording a programme. The **automatic time control** takes control of the corresponding monitoring of the start and end time for DVB stations. The recording is started at the beginning of the broadcast and switched off at the end, even if the start and/or end time have been changed by the programme provider.  
**i** The automatic time control is not supported by all stations.  
**i** If **yes** is selected and automatic time control is **not** supported by the recorded channel then **no** recording is made.  
**i** If the programme information (Event-ID) should not be available any more for the recording of a programmed broadcast, e.g., due to a programme change or because the Event-ID has been changed by the station, the programme **cannot** be recorded. The broadcasters alone are responsible for the transfer of this data for using **automatic time control**. The availability of the appropriate data cannot be guaranteed by Loewe.
- Recording subtitles Select whether broadcast subtitles are to be recorded too.  
**i** In case of a **direct recording** the presetting is taken from **System settings → Control → more ... → DR+ → Recording subtitles**.
- Favourite When selecting **yes** the recording will be added to the **Home** favourites.

<sup>1</sup> only available if EPG data exists.

## Timer Services

This menu offers you convenient alarm services. Programmed alarms are also active when the TV set has been switched off to standby. If the TV set is switched on from the standby mode by alarm, a screen message appears. If this is not confirmed within 5 minutes with the **OK key**, the TV set switches automatically off again for safety reasons. The TV set can also be switched off automatically at certain times. A screen warning appears one minute before automatic switch off. The automatic switch off can be interrupted by pressing any key.

### Call Timer Services



Pressing long: Call up the timer.



◀ ▶ ▲ ▼ Mark **Timer Services**.

Or:



**HOME:** Call **Home** view.



◀ ▶ ▲ ▼ Mark **Extras**,  
**OK** call Extras.

▲ ▼ Mark **Timer**,

▶ go to next column.

◀ ▶ ▲ ▼ Mark **Timer Services**.

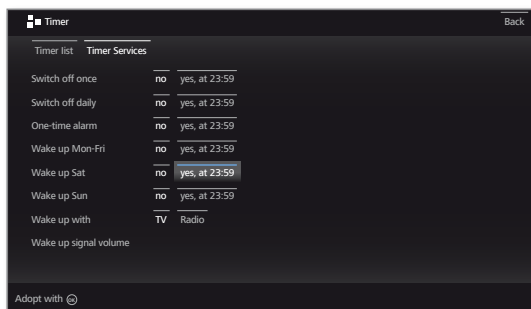

◀ ▶ ▲ ▼ Select the desired setting,  
**OK** change.

**OK** adopt.

### Explanations of the setting options in the timer functions menu:

- Switch off once The set switches to the standby mode automatically at the specified time.  
If a time is specified which has already passed on the same day, the set switches off at this time the next day.
- Switch off daily The set switches to the standby mode automatically every day at the specified time.
- One time alarm The set alerts you once today at the specified time.  
If a time was specified which has already passed on the same day, the alarm is saved for the next day.
- Wake up Mon-Fri The set regularly alerts you from Monday to Friday at the set time.
- Wake up Sat The set alerts you regularly every Saturday at the specified time.
- Wake up Sun Explanations of setting possibilities in the Timer functions menu.
- Wake up with Specify whether the TV set switches on in the event of an alarm from the standby mode in **TV** or **Radio** mode with the respectively last active station.
- Wake up signal volume Set the desired volume of the alarm tone. The alarm tone is emitted as a continuous tone as a guide during the setting.

## Conditional Access module (CA module)

In order to receive coded digital stations, a Conditional Access module (CA module) and a Smart Card must be inserted in the CI slot of your TV set.

The CA module and the Smart Card are not part of the set of equipment supplied with the TV set. They are usually available from your dealer. Loewe does not provide any guarantee for the functioning of the CA module.

The TV set must first recognise and set up the CA module during initial operation. Therefore, it can take up to a minute until decoding starts during initial operation.

### Inserting the Smart Card into the CA module

Push the side of the card with the gold chip on it should be pointing towards the thicker side of the insertion slot (see illustration). Note the direction of the arrow printed on the Smart Card.

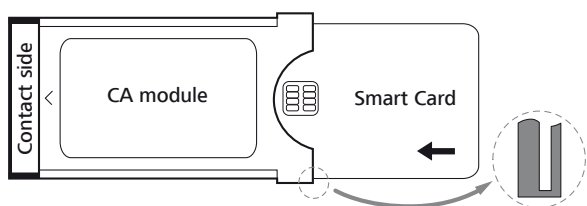

### Inserting the CA module into the TV set's CI slot

**i** Switch off TV set using the mains switch.

Remove the cover from the rear of the set.

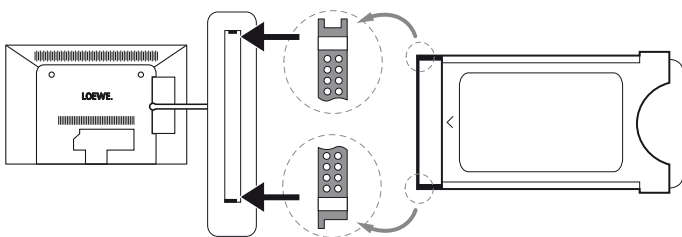

Insert the CA module carefully into one of the two CI slots, ensuring that the contact side goes in first. Do not use force. Make sure the module is not twisted in the process. Push the CA module in as far as it will go.

Finally, close the side cover.

### Searching for scrambled stations

HOME



**HOME:** Call Home view.

◀ ▶ ▾ ▹ Select **System settings**.

**OK** call System settings.

▼ ▲ Mark **Stations**,

▶ go to next column.

▼ ▲ **Automatic scan TV+Radio**,

▶ go to next column.

◀ ▶ Select **Change search settings**.

**OK** wizard guides you through the search settings.

**i** Under **scrambled stations** you have to select **yes**.

◀ ▶ Next select **Start search/update**.

**OK** start updating the station list.

### Calling CA module information

**i** This menu is only available when a CA module is plugged in.

HOME



**HOME:** Call Home view.

▼ ▲ Mark **Extras**.

**OK** call Extras.

▼ ▲ Select desired CA module.

**i** The indicated name depends on the inserted CA module.

▶ go to next column.

▼ ▲ Select **CA module**.

**OK** call information.

The content of this menu depends on the provider of the CA module.

### Removing the CA module

**i** Switch off TV set using the mains switch.

Remove the cover from the rear of the set.

Pull the CA module out of the CI slot.

Replace the cover.

## Troubleshooting (CA module)

The following information can help, if problems should occur when running a CA module:

Switch the TV set off to the standby mode. Remove the CA-module from the TV set. Switch the TV set off completely. Wait a few seconds. Reinsert the CA module. Switch the TV set on again.

If errors continue to occur, make a note of the displayed two-digit error code (only possible for CI Plus capable CA modules) and contact your dealer.

## DVB Common Interface Standard (CI)

Selection possibilities in the CA module menu and performance capability of your CA module depend on the type of module used and the software installed on it. Consult the manufacturer of the module if you have any questions.

## DVB Common Interface Plus Standard (CI Plus)

CI Plus is an advanced development of the DVB Common Interface Standard. CI Plus slots are in principle downward compatible to the previous CI standard, i.e. CA modules and Smart Cards according to the past CI standard can continue to be used in CI Plus slots, as far as the programme provider permits this.

Programme providers, who use the CI Plus standard, can assign different rights for their broadcast programmes. For instance, the programme provider can restrict or completely prevent recording or later watching of an encoded programme. If there are such regulations, these also apply to time-shifted watching of television programmes. A screen message informs you of this fact, if you would like to record such a programme. Recording is carried out in such a case (an appropriate entry is displayed in the DR+ archive), later watching of the programme is however not possible at all or only for a limited period (e.g., 10 days). A possible time limitation of the playback will also appear in the corresponding entry in the DR+ archive.

**i** All restrictions mentioned here are the responsibilities of the broadcaster. The TV set simply values the broadcaster set signalling as neutral.

Furthermore, the programme provider can prevent external copying of protected programmes.

It could be necessary to enter the parental protection PIN of the CA module when programming the data, if you want to record a CI Plus protected programme, which has been protected against viewing by minors. The Parental lock PIN can also be store in the TV set. The secret number of the TV set is required for watching the programme later.

The appearance of the CA module menu depends on the manufacturer of the module.

### Software update for CI Plus capable CA modules

Every now and then, there will be new system software for your CA module software. There are two software update types.

Recommended update:

Information on an available update is displayed. You can either run this or cancel the procedure. If you do not install the update, the information will reappear in regular intervals until the update has been installed.

Forced update:

Information on an available update is displayed. The module does not decode any more until the update has been successfully implemented.

## Special functions

### Calling special functions

HOME

**HOME:** Call **Home** view.



◀ ▶ ▲ ▼ Mark **Extras**,  
**OK** call Extras.

▼ ▲ Mark **Special functions**,  
▶ go to next column.

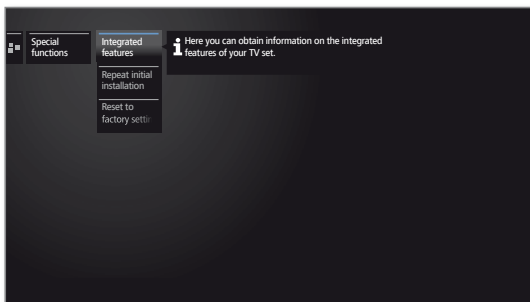

▲ ▼ Select desired function,  
▶ proceed to next column.

### Explanations of the setting options in the Special functions menu:

Integrated features See right-hand column.

Repeat initial installation You can repeat the Initial installation again at any time. You are guided through the various menus where i.a. an automatic TV/radio station search is automatically carried.

**Caution:** All stored stations and all created personal lists will be deleted by this!

**i** If a parental lock is activated, the access code must be entered before repeating initial installation.

Reset to factory settings Reset the settings of Picture/Sound, Speaker system or Network to factory settings.

## Integrated features

Here you can obtain information on the integrated features of the TV set.

**i** See the rating plate on the rear of the set for the precise product designation.

### Call Integrated features

HOME

**HOME:** Calling the **Home** view.



◀ ▶ ▲ ▼ Mark **Extras**,  
**OK** call Extras.

▼ ▲ Mark **Special functions**,  
▶ go to next column.

▲ ▼ Mark **Integrated features**,  
**OK** call Integrated features.

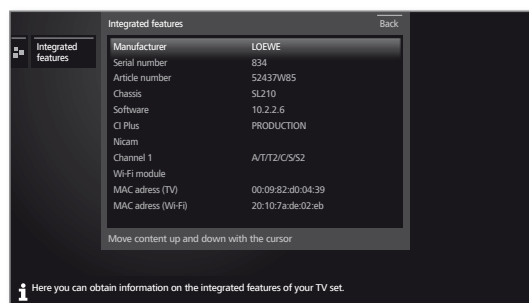

▲ ▼ Scroll content up and down.

## System settings

Under the menu item **System settings** in the **Home** menu you find all settings and adaptabilities of your TV set. These are explained to you more in detail as follows.

### Calling System settings

HOME

**HOME:** Call **Home** view.



◀ ▶ ▲ ▼ Mark **System settings**,  
**OK** call.

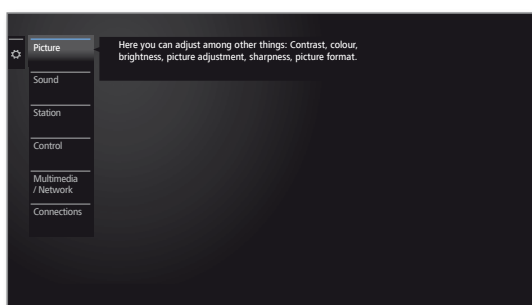

Or:

MENU

Press **MENU key** longer: call System settings.

### Explanations of the setting options:

- Picture** Here you do the settings referring to the representation of the picture signal on your TV set. See chapter **System settings**, section **Picture** for further information.
- Sound** Under this menu item you find the settings for sound playback. The subitems of the menu depend on the currently selected sound component. See chapter **System settings**, section **Sound** for further information.
- Stations** Move and delete TV and radio stations. In addition to that you can automatically and manually update the complete station list. Your stations can also be arranged and optionally sorted in personal lists. See chapter **System settings**, section **Stations** for further information.
- Control** In this menu you find settings for additional functions of your TV set like picture in picture (PIP) and digital recorder (DR+) as well as interfunctional settings like time and date, parental lock or software update. See chapter **System settings**, section **Control** for further information.
- Multimedia / Network** By means of the Multimedia / Network menu you configure your network adaptor and network access. Moreover, you can make settings for video and music playback here. See chapter **System settings**, section **Multimedia/Network** for further information.
- Connections** Using this menu you configure external devices that are connected to one of the numerous connections of the TV set. See chapter **System settings**, section **Connections** for further information.



## Picture

Here you do the settings referring to the representation of the picture signal on your TV set.

### Calling picture settings

HOME

**HOME:** Call **Home** view.



◀ ▶ ▲ ▼ Mark **System settings**,  
**OK** call System settings.

▼ ▲ Mark **Picture**,  
 ▶ go to next column.

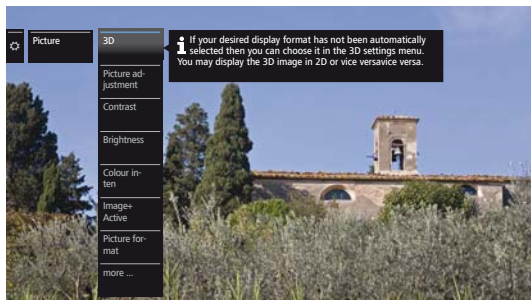

▲ ▼ Select desired picture function,  
 ▶ proceed to next column.

### Explanations of the picture settings:

**3D** Do the settings for your TV set's 3D display.

**Picture adjustment** You can switch between three preset picture settings and the three personal picture values that you have adjusted.

**Contrast** The contrast setting depends on the brightness of the room. The brighter the surroundings the higher the contrast should be set.  
 The power consumption of the TV set depends directly on the value set here.

**Brightness** Set the brightness so that the black areas of the picture only just appear black.

**Colour intensity** Set the colour intensity to suit your personal taste.

**Image+ Active** Picture enhancement on/off.

**Picture format** Set picture format.

**more ...** call with **OK** (see right-hand column).

### Explanations of the picture settings (continuation):

**Colour temperature** Here, you can give the TV picture a warmer or colder hue according to your personal taste.

**Sharpness** Here you can adjust picture sharpness to obtain the best definition.

**Move picture up/down** When using the TV aspect ratios Panorama or Zoom, the text or graphic displays at the top and bottom are not or only partially visible. You can move the picture up or down with the up/down menu control keys to make the displays visible.

**Auto dimming** depending on video (VBD+):  
 The background lighting is reduced depending on the current video content and the video signal is simultaneously amplified in order to get an improved contrast of your TV picture.

depending on the environment (OPC):  
 The contrast of your TV picture is automatically reduced vs. decreasing room brightness (Optical Power Control – OPC).

**i** The automatic dimming also results in a lower power consumption of the TV set.

**i** Due to a reduction in the luminance in 3D mode for technical reasons, this function is deactivated when showing 3D content.

**Film quality improvement (DMM)** DMM reduces jolt in rapid picture object movements and rolling text displays. This applies especially for movies.

**Digital Noise Control (DNC)** With active DNC (Digital Noise Control) you can eliminate or reduce picture noise.

**Skin tone** Adjust the skin tone so that the most natural facial skin colour is achieved.

**Deblocking filter** To minimise the visible interference to the picture caused by modern compression methods for images and image sequences (formation of small blocks), a so-called deblocking filter can be activated which counteracts this interference.

**PC IN display** For some PC image formats, horizontal as well as vertical position and the phase position of the image can be corrected.



## Picture adjustment

By selecting one of the three presets (**Home Mode**, **Premium Mode** or **Shop Mode**), the picture settings for whichever signal input group that is currently active will be set to predefined settings.

You can use **Personal Mode** to specify individual settings for contrast, colour intensity, colour temperature, sharpness and digital noise suppression. Here you can enter your own specifications for each signal input group.

### Calling picture adjustment

HOME

**HOME:** Call **Home** view.



◀ ▶ ▲ ▼ Mark **System settings**.

**OK** call System settings.

▼ ▲ Mark **Picture**.

▶ go to next column.

◀ ▶ Mark **Picture adjustment**.

▶ go to next column.

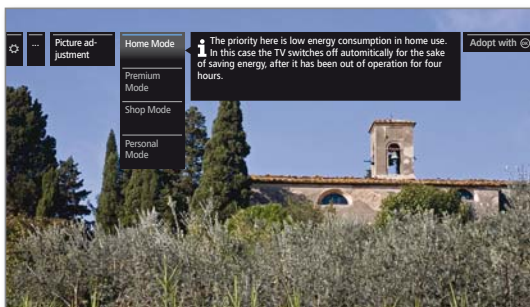

▼ ▲ Select mode.

**OK** adopt selected mode.

**i** When selecting one of the three preset picture adjustment modes you have to specify additionally if the mode shall be set only for the currently selected signal source, e.g., **Only for HD Digital** or **for the entire TV**.

### Explanations of the picture adjustment modes:

- |               |   |
|---------------|---|
| Home Mode     | The emphasis for the picture settings is here on low energy consumption for home use. In this case, the TV set switches automatically off after 4 hours of unattended time. |
| Premium Mode  | The picture settings in Premium Mode are optimised for a brighter environment at the cost of higher energy consumption.   |
| Shop Mode     | The picture settings in Shop Mode are adjusted to operation in the presentation room.   |
| Personal Mode | Here, you can recall your last personal picture settings.   |

## Selecting the picture format

**i** The setting options depend on the transmitted picture content.

HOME

**HOME:** Call **Home** view.



◀ ▶ ▲ ▼ Mark **System settings**.

**OK** call System settings.

▼ ▲ Mark **Picture**.

▶ go to next column.

◀ ▶ Mark **Picture format**.

▶ go to next column.

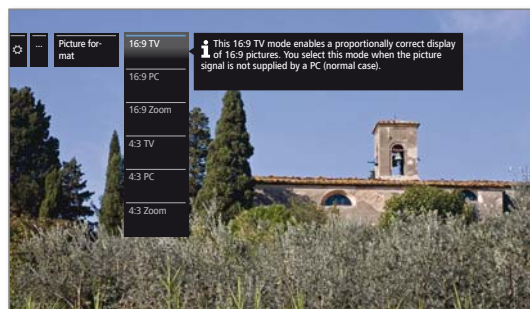

▼ ▲ Select format.

**OK** adopt selected format.

### Explanations of the picture formats for HD signals:

- |           |  |
|-----------|--|
| 4:3 TV    | Proportionally correct display of 4:3 or 16:9 broadcasts. You select this mode when the signal is not supplied by a PC (normal case). A small part of the picture is truncated. This may be necessary to hide possible interference at the edge of the picture, which arises from the signal supplied. |
| 16:9 TV   | Proportionally correct display of 4:3 or 16:9 broadcasts without loss of information. You select this mode when the signal is supplied by a PC.  |
| 16:9 PC   | Proportionally correct display of 4:3 or 16:9 broadcasts without loss of information. You select this mode when the signal is supplied by a PC.  |
| 16:9 Zoom | Proportionally correct display. Maximum picture magnification. Displayed text may get lost.  |
| 4:3 Zoom  | Proportionally correct display. Maximum picture magnification. Displayed text may get lost.  |

### Explanations of the picture formats for SD signals:

- |            |   |
|------------|---|
| 16:9       | Proportionally correct display of 16:9 broadcasts.  |
| 4:3        | Proportionally correct display of 4:3 broadcasts.   |
| Panorama 1 | Proportionally correct display of 4:3 broadcasts on the 16:9 screen. Station logo and subtitles remain visible.           |
| Panorama 2 | Format filling display (factory default) of 4:3 broadcasts on the 16:9 screen. Station logo and subtitles remain visible. |
| Zoom       | Proportionally correct display. Maximum picture magnification. Displayed text may get lost.                               |
| PALplus    | Is a 4:3-compatible 16:9 picture broadcast supplied by the station which is detected automatically.                       |



### 3D function

You can use the 3D functionality of your TV set to display 3D material transmitted by a channel or from an external player that is connected.

You require a pair of **Loewe Active Glasses 3D** to be able to use the 3D functionality in its entirety (see chapter **Accessories**). Please read the operating instructions included with the 3D glasses.

### 3D settings

Using the 3D settings you can select the correct display format, should this not have been detected automatically. What's more, you can choose to view 3D material in 2D or "traditional" 2D material in 3D.

For 3D content that is being played back from an external HDMI player, the 3D display format is normally recognised correctly when the factory setting **3D mode → Automatic** is selected. You may need to set the 3D mode manually to view 3D content from broadcasters.

**i** Owing to a reduction in the luminance in 3D mode for technical reasons, **Auto-dimming - Room** and **Auto-Dimming- Video (VBD+)** are deactivated when 3D contents is displayed.

**i** If the TV set is operated with the remote control during a 3D playback, flicker effects can occur in the 3D glasses when doing this.

### Calling 3D settings

HOME

**HOME:** Call **Home** view.



◀ ▶ ▲ ▼ Mark **System settings**,  
**OK** call System settings.

▼ ▲ Mark **Picture**,  
 ▶ go to next column.

◀ ▶ Mark **3D**,  
 ▶ go to next column.

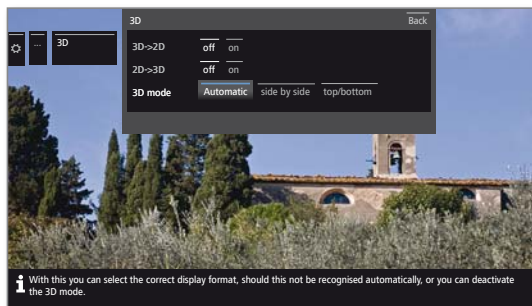

◀ ▶ ▲ ▼ Select settings,  
**OK** adopt.

### Explanations of the 3D settings:

#### 3D->2D

off/on If you set 3D->2D to **on**, the 3D material from TV stations as well as from external players will be changed into 2D and played back. The three dimensional (3D) effect will disappear. You will not need to wear the 3D glasses to view it properly.

#### 2D->3D

off/on If you set 2D->3D to **on**, all 2D image material will be displayed in 3D. You will need to wear the 3D glasses to view it properly.

#### 3D mode

**Automatic** If the TV is set to this setting (factory setting), then the TV set automatically switches over to the correct 3D mode, if this is possible and supported by the broadcaster.  
 Only change the setting if the 3D content is not displayed correctly.

**side by side** To display 3D content in **side by side** format. When viewing 3D content with this setting, two almost identical images are displayed **next to each other** and put together correctly by the TV set.

**i** The 3D mode is **Automatic** reset the next time you switch on the TV set.

**top/bottom** To display 3D content in **top/bottom** format. When viewing 3D content with this option, two almost identical images are displayed **one above the other** and put together correctly by the TV set.

**i** The 3D mode is **Automatic** reset the next time you switch on the TV set.

■	Connect ID 40-55
	User guide
	System settings
	Picture

**Picture format / 3D mode**

If 3D contents are recognised by the TV device, the picture format cannot be subsequently changed. The picture format when in 3D operation is always 16:9 PC.

**Instruction / Symbol**

If 3D content is detected by the TV set, a corresponding message appears. The instruction text will disappear after the display time has elapsed.



In the status display, 3D content is indicated by an icon.



## Sound

### Calling the sound settings

**i** The selectable menu items depend on the selected station and the connected sound components.

HOME

**HOME:** Call **Home** view.



◀ ▶ ▲ ▼ Mark **System settings**,  
**OK** call System settings.

▼ ▲ Mark **Sound**,  
 ▶ go to next column.

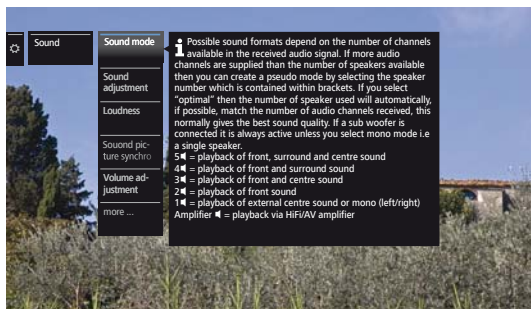

▲ ▼ Select sound function,  
 ▶ proceed to next column.

### Explanations of the sound settings:

**Sound via** Playback over the TV speakers or an external hi-fi amplifier.

**i** The menu item **Sound via** only appears if **HiFi/AV amplifier or TV speakers (switchable)** is set in the audio components wizard (see Kapitel **System settings**, section **Connections – Sound components**).

**Sound adjustment** Here, you can adapt preset sound characteristics of the respective broadcast. Selectable are, e.g., Speech, Classical, Pop, Custom music and Film soundtracks. For personal music and film sound you can do the settings for pitch and bass sound (high and low frequencies).

**Audio commentary volume** Set the volume of the audio commentary to be relative to the volume of the programme being transmitted.

Should negative values result (those in the area of **-50... -1**), the audio commentary is quieter than the programme sound. Should positive values result (those in the area of **+1... +50**), the audio commentary is louder than the programme sound. If the value **0** results, then the audio commentary is at the exactly the same volume as the programme sound.

**i** The menu item only appears if audio commentary is activated (see chapter **System settings**, section **Control – DVB settings**) and is offered by the current station.

Additionally, the **Loudspeaker sound** or **Headphone sound** must be set to **normal + audio commentary** must be switched on (see next page).

**Loudness** Proper boost of bass and treble tones at low volume.

### Explanations of the sound settings (continued):

**Sound picture synchronisation** If the sound and picture are not precisely in sync, you may correct this here. Move the mark on the bar downwards, slowing down the sound compared with the picture. Move the mark upwards, speeding it up compared with the picture. Time adjustment of the sound occurs in steps of 10 ms in each case.

**i** only available for DVB stations.

**Volume adjustment** The volume can differ according to the individual stations. If the sound is too loud or too quiet in relation to other stations, adjust the volume. When the menu is open, you can select the stations one after another with **P+/P-** and adjust every single station conveniently.

**more ...** call with **OK**.

**Loudspeaker/Headphone sound** For analogue stations: Selection options for Mono/ Stereo or Sound 1 or Sound 2 for bilingual programmes, separately for the loudspeakers and the headphones.

For DVB channels: You can choose here if you wish to listen to a special soundtrack for the visually impaired over the speakers. This soundtrack uses an audio commentary to describe the action taking place on-screen.

**i** The menu item only appears if an audio commentary is offered by the current channel.

**Auto volume** The volume may vary when receiving stations with different standards, when switching from station to station or during commercials. You can reduce these differences in volume by selecting auto volume **on**. For music and live broadcasts you get a better sound spectrum with auto volume **off**.

**AV output signal** You can indicate here which sound is output via the AV socket for dual sound programmes: Sound 1 (e.g. main language), sound 2 (e.g. foreign language), or sound 1+2 (both simultaneously).

**Maximum volume** You can limit the volume adjustment of the loudspeakers. This prevents selecting a volume which is too loud.

**Maximum switch on volume** Set the sound level to be heard after switching on the TV set with the mains switch or after a power failure. When switching on the TV set in standby mode, the volume last used is retained unless it was above this switch-on level. Otherwise it is limited by this.

**Balance** Set stereo balance so that the volume impression is identical on the left and right.

**Auto speech detection** If the automatic speech detection is activated, the sound of the current programme is automatically output with optimum comprehensibility when speech is detected.

## Stations

Under the item Stations you find all settings concerned with station search for TV and DVB radio as well as functions for creating and editing the various station lists.

- i** Station management is not possible as long as a programmed timer recording is active.
- i** If at least one station is locked, the access code must be entered prior to automatic search.
- i** The procedure for radio stations or Station lists Radio is similar to that for TV stations or Station lists TV. Therefore, this procedure is described only for TV stations.

### Call Stations menu

HOME

**HOME:** Call **Home** view.



◀ ▶ ▲ ▼ Mark **System settings**.  
**OK** call System settings.

▼ ▲ Mark **Stations**.  
 ▶ go to next column.

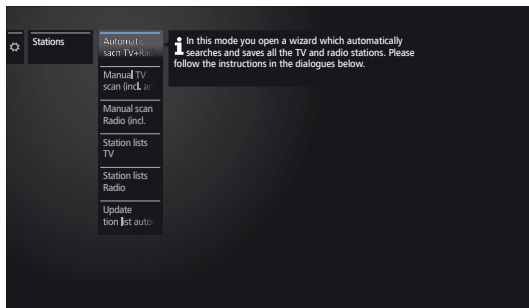

▲ ▼ Select desired function,  
 ▶ proceed to next column.

### Explanations of setting possibilities in the Stations menu:

- |                                   |   |
|-----------------------------------|---|
| Automatic scan TV+Radio           | Here you start the wizard that searches and stores all TV and DVB radio stations.   |
| Manual scan TV                    | Here, you can enter all the settings available for a TV station.  |
| Manual scan Radio                 | Here, you can enter all the settings available for a DVB radio station.   |
| Station lists TV                  | Here you can move and delete TV stations in all lists. You can put together your most frequently watched programmes in one or more lists of personal favourites.        |
| Station lists Radio               | Here you can move and delete DVB radio stations in all lists. You can put together your most frequently watched programmes in one or more lists of personal favourites. |
| Update station list automatically | If the channel list is not up to date, it will be updated automatically, provided the parameter <b>Allow</b> is selected.   |



## Automatic scan TV+Radio

For automatic scan TV+Radio, a search wizard will be started that searches for new stations which are not yet stored.

**I** You have to repeat the initial installation and automatically search for new stations if you want to delete all the existing stations and automatically search for new ones.

HOME



**HOME:** Call **Home** view.

▼ ▲ Mark **System settings**.  
**OK** call System settings.

▼ ▲ Mark **Stations**.  
 ▶ go to next column.

▼ ▲ Mark **Automatic scan TV+Radio**.  
 ▶ go to next column.

In the upper info text the current search settings will now be displayed:

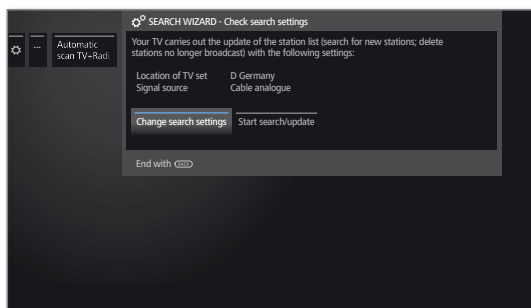

If you want to change these search settings:



◀ ▶ Select **Change search settings**.  
**OK** wizard guides you through the search settings (see column on the right).

If you agree with these settings:

◀ ▶ Select **Start search/update**.  
**OK** start scan.

BACK

**BACK:** Cancel current search/update.

### Explanations of some search settings:

**Age-related lock** You can specify an age limit for your TV set here. DVB broadcasts that have an appropriate age identification are locked and can only be watched after entering the access code.

**Signal source** Select cable (analogue), DVB-T, DVB-C or DVB-S depending on which signal source you want to search for new stations. Use the **Antenna wizard** to call the configuration of the DVB-T and DVB-S antennas.  
**I** Calling up the DVB antenna configuration causes the Change search settings dialogue to be quit. You must call up the dialogue again after finishing the configuration.

**Cable (analogue) TV/colour standard** With the selection of TV set location the conventional TV standard/colour standard is the default. This should only be changed if stations with other standards are to be searched.

### Explanations of some search settings (continued):

**DVB-T/C/S Network selection** If several networks are available, you can decide which network you want to receive your channels from.

**DVB-T/C/S Settings** With the selection of set location the conventional settings will be preset. Only change these defaults if you are familiar with other parameters.

#### Scrambled stations: (DVB-T/C/S)

You can state whether scrambled stations are to be searched for in the search/update. If you select **yes**, coded stations will also be searched for. However, these stations can only be received in connection with a CA module and the appropriate Smart Card. Ask your dealer which Smart Card you need to receive certain stations.

#### Search method: (DVB-T)

If you want to run the station search independently of the channel grid, select **Frequency search** for the search method.

#### Search method: (DVB-C)

If you select **Frequency search** here, a search is performed for all receivable stations. With **Network search**, only the stations which the networks supply are searched - either for all receivable networks or only for the particular network specified under **Network ID**.

#### Network ID: (DVB-C)

If you select **none** here, DVB signals of all current broadcasting networks are scanned automatically (recommended for most cable networks). If, on the other hand, you specify a certain network ID (necessary in the cable networks of some countries), only DVB signals of this broadcasting network are searched for automatically. Your cable provider has the information you need.

#### Search method: (DVB-S)



If you select **Frequency search** here, a search is performed for all receivable stations. With **Network search**, from all receivable networks all the stations are searched which are supplied by these networks.

#### Accept Logical Channel Number: (DVB-T/C/S)





In various countries, digital stations (DVB-T/C/S) are transmitted with a preset channel number per station, known as Logical Channel Numbers (LCN). If you select **yes** here, these default channel slots will be used and the channels of the preferred signal source will be sorted as per LCN. The stations in the station list can no longer be shifted.

## Search for/update stations – handling of new and no longer found stations

The number of new TV stations found is displayed after the automatic search / update has been completed.





-  ► Proceed. The number of new radio stations found is displayed.
-  ► Call list of new TV stations found.



-  Select station.  
**OK** Mark / unmark station.
-  ► stores the marked TV stations. The list of new radio stations found is displayed.
-  Select station.  
**OK** Mark / unmark station.
-  ► Proceed.

Afterwards, a list of the stations which are saved but which are temporarily not broadcasting or no longer exist is displayed, if available. The number of the memory location used is displayed in front of the station. Please select the stations you really want to delete.





-  Select station.  
**OK** Mark / unmark station.
-  ► Proceed. The marked stations will be deleted. The list of radio stations no longer found is displayed.
-  Select station.  
**OK** Mark / unmark station.
-  ► End search wizard.

## Manual Scan TV / Radio

Here, you can enter all the settings available for a station. However, this requires detailed knowledge.

**i** The manual search of radio stations is similar to that of TV stations. Therefore, the manual search for radio station is not dealt with separately.

### Calling manual search

-  **HOME:** Call Home view.
-  ▼ ▲ Mark **System settings**.  
**OK** call System settings.
- ▼ ▲ Mark **Stations**.  
► go to next column.
- ▼ ▲ Mark **Manual Scan TV**.  
**OK** call Manual Scan.

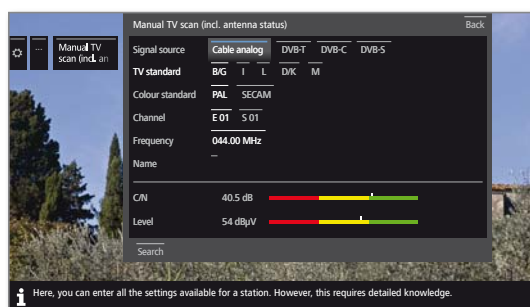

Select the menu item **Signal source** to decide in which area you want to search for stations. Depending on the selected source, various setting possibilities will be available. On the next page, the settings for analogue cable and DVB-T/C/S sources are described separately.

### Status bar for manual search

Status bars are displayed for manual search, which show the reception quality of the individual stations during the station scan. The markers in all bars should preferably be in the green area.

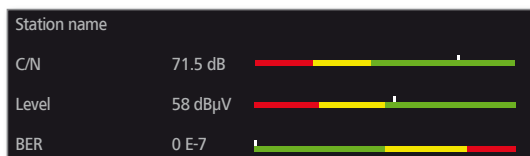

**C/N:** (Carrier/Noise) The bar shows the signal-to-noise ratio. The value indicated in dB should be preferably high.

**Level:** The bar shows the receiving level of the station. The value displayed in dBµV should be preferably high.

**BER:** (Bit Error Rate) The bar shows the bit error rate of the station. The value for BER should be as low as possible.

### Manual search for cable analogue (analogue cable reception):

- i** Manual search is called.
- i** **Cable analogue** has been selected as signal source.

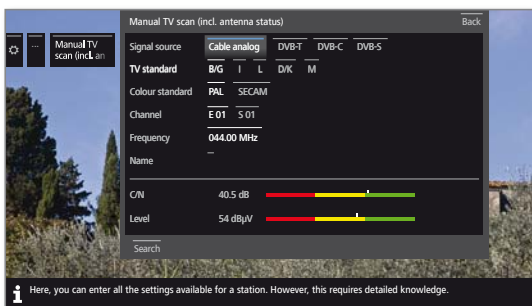

▲ ▼ ◀ ▶ Mark and adjust settings,  
**OK** confirm as the case may be.

▲ ▼ ◀ ▶ Mark Search,  
**OK** start search.

If a station has been found:

▲ ▼ ◀ ▶ Mark **Store/Overwrite**,  
**OK** store station.

### Explanations on the search settings for cable analogue:

Signal source	Selection of range in which you want to search for the station.
TV standard	If necessary, ask your dealer which standard to select for specific channels or AV equipment.
Colour standard	If necessary, ask your dealer which standard to select for specific channels or AV equipment.
Channel	Direct input of channel.
Frequency	Direct input of station frequency. Range for entry: 044.75 MHz - 859.25 MHz.
Name	Here, the name of the found station is displayed. You can change the name of the station.

### Manual DVB-T/C/S search:

- i** Manual search is called.

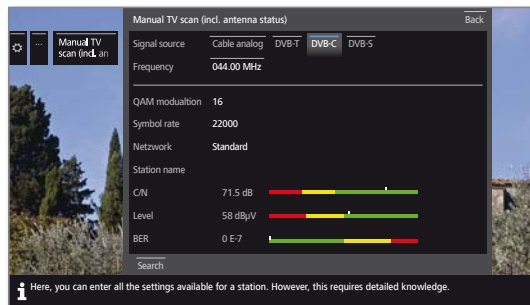

▲ ▼ ◀ ▶ Mark and adjust settings,  
**OK** confirm as the case may be.

▲ ▼ ◀ ▶ Mark Search,  
**OK** start search.

When a DVB transponder has been found:

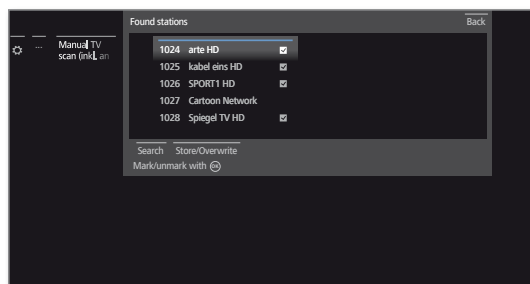

▲ ▼ ◀ ▶ Mark the station,  
**OK** Station will be ticked with . If necessary, repeat for several stations.

**i** Stations that already exist in the station overview will be displayed with their station number on the left.

▲ ▼ ◀ ▶ Mark **Store/Overwrite**,  
**OK** Stations marked with  will be stored.

### Explanations of some search settings:

<b>Signal source</b> (DVB-T/C/S)	Selection of range in which you want to search for the station.
<b>Channel</b> (DVB-T)	Direct input of channel.
<b>Satellite</b> (DVB-S)	Here you can select the satellite where the stations are to be searched for.
<b>Band</b> (DVB-S)	Here you can select the frequency band in which shall be searched. Setting ranges:   horiz/low   10694 - 11906 MHz horiz/high  11544 - 12756 MHz vert/low    10694 - 11906 MHz vert/high  11544 - 12756 MHz
<b>Frequency</b> (DVB-T/C/S)	DVB-T/C: Direct input of station frequency. DVB-S: Direct input of LNC frequency
<b>Symbol rate</b> (DVB-S)	Here you can specify the symbol rate Range: 1000-45000



## Station lists TV / Radio

Under the menu item **Station lists TV** or **Station lists Radio** you can edit (delete block, move block, restore deleted stations) various lists, e.g., **DVB-T**, **ASTRA LCN**, **DVB-C**, etc. You can also create and edit new **Personal lists**.

**i** The function of Station lists Radio is similar to that of Station lists TV. Therefore, editing of Station lists Radio will not be dealt with separately.

### Change station list

**i** If at least one station is locked, the access code must be entered before changing stations.

HOME

**HOME:** Call **Home** view.



▼ ▲ Mark **System settings**,  
**OK** call system settings.

▼ ▲ Mark **Stations**,  
▶ go to next column.

▼ ▲ Select **Station lists TV**,  
▶ go to next column.

▼ ▲ Mark desired station list,  
▶ call list.

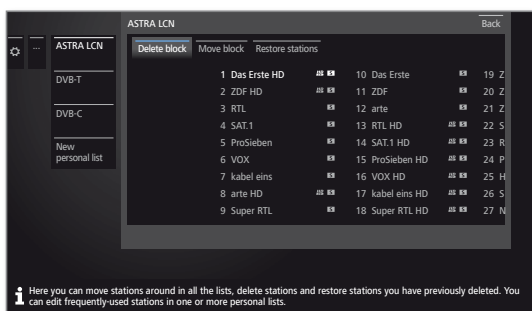

Here, you can delete and move station blocks as well as restore deleted stations.

The following section describes how to proceed if you wish to **Delete block**, **Move block** and **Restore stations**.

### Delete block



◀ ▶ ▲ ▼ Select **Delete Block**,  
▼ move to list.

◀ ▶ ▲ ▼ Select beginning of block,  
**OK** mark beginning of block.

◀ ▶ ▲ ▼ Select end of block,  
**OK** mark end of block (selected stations are coloured blue).

◀ ▶ ▲ ▼ Select **Execute delete**,  
**OK** block will be deleted, or

◀ ▶ ▲ ▼ select **Cancel procedure**,  
**OK** cancel delete.

### Move block / Change order



**i** Stations with LCN cannot be reordered. In this case, the function **Move block** is hidden.

◀ ▶ ▲ ▼ Select **Move block**,  
▼ move to list.

◀ ▶ ▲ ▼ Select beginning of block,  
**OK** mark beginning of block.

◀ ▶ ▲ ▼ Select end of block,  
**OK** mark end of block (selected stations are coloured blue).

◀ ▶ ▲ ▼ Select insert position,  
**OK** Confirm insert position.

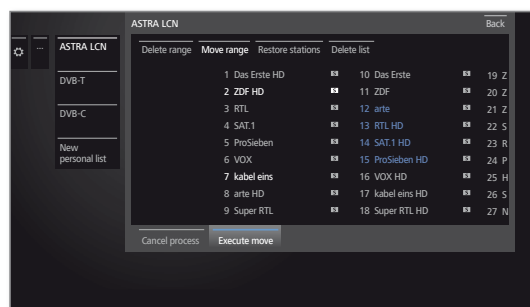

◀ ▶ ▲ ▼ Select **Execute move**,  
**OK** block will be moved, or

◀ ▶ ▲ ▼ select **Cancel procedure**,  
**OK** cancel move.

### Restore stations



◀ ▶ ▲ ▼ Select **Restore stations**,  
▼ move to list.

◀ ▶ ▲ ▼ Select beginning of block,  
**OK** mark beginning of block.

◀ ▶ ▲ ▼ Select end of block,  
**OK** mark end of block (selected stations are coloured blue).

◀ ▶ ▲ ▼ Select **Restore stations**,  
**OK** stations will be added again to the station list, or

◀ ▶ ▲ ▼ select **Cancel procedure**,  
**OK** cancel restore.



## Compose / edit Personal list

Each personal list can contain up to 99 stations. You can compose the personal lists to suit your convenience (e.g., topic lists). Other persons using this TV set can create their own personal lists. You can create up to six personal lists.

**i** Creating and updating personal station lists is not possible as long as a programmed timer recording is active.

### Create / edit New personal list

**HOME**

**HOME:** Call **Home** view.



▼ ▲ Mark **System settings**,  
**OK** call System settings.

▼ ▲ Mark **Stations**,  
▶ go to next column.

▼ ▲ Mark **Station lists TV**,  
▶ go to next column.

▼ ▲ Mark **New personal list**,  
**OK** New personal list x will be created.

**i** x stands for the number of the personal list.  
The number depends on how many list were already created.

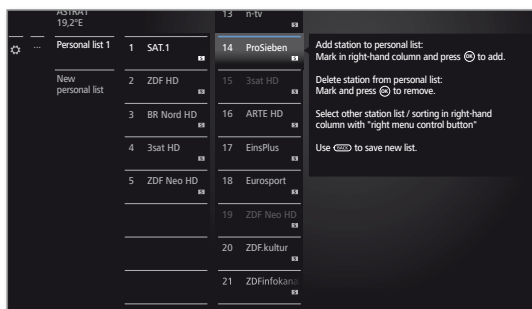

▲ ▼ Mark the station in the station list which is to be added to the personal list.

**OK** adds the station to the personal list.  
The new station will be added at the end of the personal list. Proceed in the same way with additional stations.

▶ Call up additional options.

**ASTRA LCN** Examples of station lists. Select the station list from which you add stations to the personal list. In the personal list you can store stations from different sources.

**Sorting** The sorting procedure for the source station list may be changed between numerical and alphabetical.

**BACK**

**BACK:** Store and close station list.

### Adding stations to Personal list



**i** The Personal list must be opened to add new stations to it.

▼ ▲ Select **Add/remove Stations** in the function list.

How to add stations is described in the left column.

### Deleting stations from the Personal list



**i** The Personal list must be opened to delete stations in it.

▼ ▲ Select **Add/remove Stations** in the function list,  
**OK** activate.

◀ go to personal list.

▲ ▼ Mark the station to be deleted in the personal list,  
**OK** activate. Function of the coloured keys in standard PIP functionality.

**BACK**

**BACK:** Store and close station list.

### Move / reorder stations in the Personal list



**i** The personal list must be opened to move stations in it.

▼ ▲ Select **Move stations** in the function list,  
**OK** activate.

▲ ▼ Select station to be moved in the Personal list,  
**OK** mark (station will be coloured red).

▲ ▼ Select insert position (insert position will be marked with a red line),

**OK** Execute move. Proceed in the same way with additional stations.

**BACK**

**BACK:** Store and close station list.

### Renaming the Personal list



**i** The Personal list to be renamed must be opened.

▼ ▲ Select **Rename list** in the function list,  
**OK** activate.



Enter new name.



◀ ▶ ▲ ▼ Select **Adopt**.

**OK** New name for the personal list will be adopted.

### Delete Personal list



**i** The Personal list to be deleted must be opened.  
Deleting of the list is irrevocable.

▼ ▲ Select **Delete list** in the function list,  
**OK** activate.

## Update station list automatically

Some programme providers offer an automatic update of the station lists (Dynamic Channel Management). You may **Allow** or **Block** an automatic station list update. If automatic updating is allowed, a screen message about an available update appears whenever the list is changed.

### Allow/block updates

HOME

**HOME:** Call **Home** view.



▼ ▲ Mark **System settings**,  
**OK** call System settings.

▼ ▲ Mark **Stations**,  
 ▶ go to next column.

▼ ▲ Mark **Update station list automatically**,  
 ▶ go to next column.

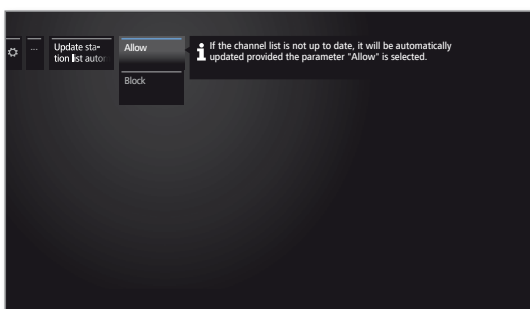

▼ ▲ Select **Allow** or **Block**,  
**OK** adopt.

If the channel list is not up to date, it will be updated automatically, provided the option **Allow** is selected.

### Updating the station list

A message appears whenever the TV is switched on if the network provider changes their channel list.

**i** In **Update station list automatically**, **Allow** must be selected.

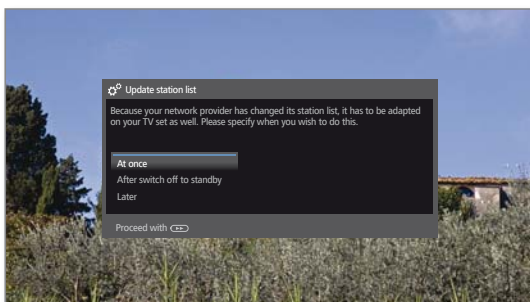

▲ ▼ Select the desired procedure.

**At once** The station list will be immediately updated. Normally this occurs in the background without interfering further with the TV's operation. In exceptional cases, it is however possible that during this process an automatic station change may be necessary.

**After switch off to standby** The channel list will be updated the next time the TV set is switched off into standby mode.

**Later** Updating the channel list will be postponed to a later date. When the TV set is switched on and off, the update message will appear again.



**OK** Confirm selection.



## Control

In the chapter Control you find settings for the various operating modes like PIP and DR+ as well as settings referring in an interfunctional way to your TV set like, for example, time and date and on-screen displays.

### Calling Control

HOME

**HOME:** Call **Home** view.



◀ ▶ ▲ ▼ Mark **System settings**.  
**OK** call System settings.

▼ ▲ Select **Control**.  
 ▶ go to next column.

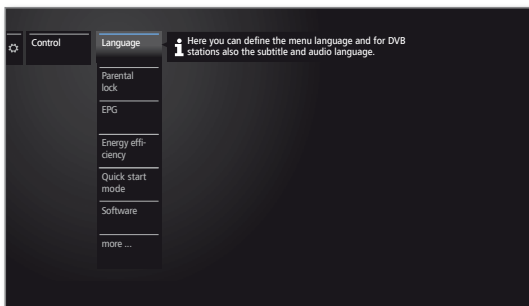

▼ ▲ Select desired menu item,  
 ▶ go to next column.

### Explanations of setting possibilities in the Control menu:

**Language** Here you can define the menu language and for DVB stations also the subtitle and audio language.

**Parental lock** With the parental lock you can bar access to all stations immediately or daily for a certain period of time. The stations can also be locked individually. Age-dependent locking of programs with an appropriate age code is also possible.

**EPG** Here you can do all EPG settings.

**Energy efficiency** Here you can determine how energy efficient your TV set shall be.

**Quick start mode** Here you can enable the Quick Start Mode. The TV set will then immediately switch on from standby without delay.

**Software** Here you can download new software from a USB storage medium or from the Internet (as far as requirements exist for this).

**more ...** After confirmation with the **OK** key you will be offered additional not so frequently used sub items for the current menu item (see right hand column).

### more ...

**On-screen displays** Here you can make settings for the duration, position and existence of special on-screen displays.

**Time and date** The time and date are normally obtained automatically from the TV.

**DVB settings** Here you can make settings which only refer to DVB stations (subtitles and audio mode, DVB character set).

**DR+** Here you can do all the settings for the digital recorder.

**Standard Teletext** Here you can do all Standard Teletext settings.

**HbbTV** Here you can do all settings for the HbbTV mode.

**CA module(s)** Here you can allocate stations to a CA module or assign the PIN for recordings.

**Recording** Here you can specify the lead time and follow-up time for recordings.

**Hard disks** Here you find tools to format or check the hard disks.

**WEB key function** Here you can assign another function to the **Web key**. The selected function will then be called directly when the key is pressed.

## Language

Specify the language for all menus in the TV set in the language menu. The language for the DVB subtitles and the film language can be set for DVB programmes.

### Call language

HOME

**HOME:** Call **Home** view.



◀ ▶ ▲ ▼ Mark **System settings**.  
**OK** call System settings.

▼ ▲ Mark **Control**,  
 ▶ go to next column.

▼ ▲ Mark **Language**,  
 ▶ go to next column.

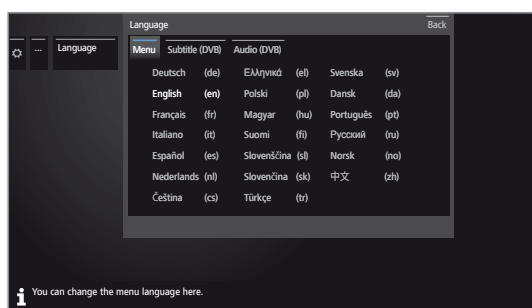

◀ ▶ ▲ ▼ Select desired setting and make changes.  
**OK** Adopt settings.

### Explanations of setting possibilities in the Language menu:

Menu You can change the menu language here.

Subtitle (DVB) If subtitles are provided by the DVB station, you can set your desired language in advance here. If this is included in the range of languages of the station, it will be shown automatically.

You can also specify an alternative language under this menu item, in case your chosen language is not offered by the station.

Audio (DVB) Specify your desired film language in advance here. If this is included in the range of languages of the station, it will be shown automatically.

You can also specify an alternative language under this menu item, in case your chosen language is not offered by the station.

## EPG

### Calling EPG settings

HOME

**HOME:** Call **Home** view.



◀ ▶ ▲ ▼ Mark **System settings**.  
**OK** call System settings.

▼ ▲ Mark **Control**,  
 ▶ go to next column.

▼ ▲ Mark **EPG**,  
 ▶ go to next column.

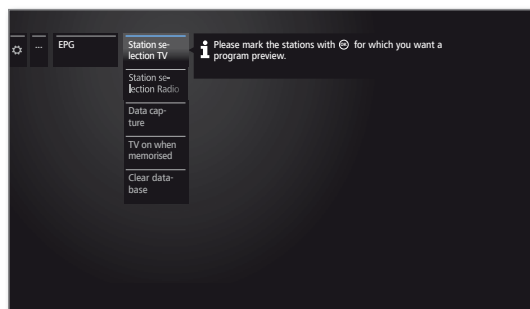

### Explanation of the EPG setting options:

Station selection TV In the **Station selection** you can determine for which station in the programme guide, information is to be displayed. Programme information is only displayed for stations with  in the EPG list. Using the on-screen buttons in the bottom line you can mark all stations or unmark the stations or select stations from specific (e.g., personal) lists.

Further information on EPG station selection you find in chapter **TV**, section **Electronic Programme Guide – EPG wizard**.

Due to the large number of receivable stations you should restrict the station selection. This reduces the data entry time and increases the clarity in the EPG.

Data capture Here you can switch the data entry for the electronic programme guide (EPG) on and off.

If the data capture is switched on, your TV set tries to update the database overnight (normally between 2 and 5 am) or, if required, two minutes after switching to stand-by mode. The TV set must be on stand-by for this and not switched off at the mains switch.

The indicator on the TV set lights blue during data capture in stand-by mode.

The data are also updated while you are watching the EPG station.

TV on when memorised When **yes** is selected in the setting, the switched off TV switches on automatically in standby mode at the beginning of a memorised programme. A screen message appears when switching on. If this is not confirmed within 5 minutes with the **OK key**, the TV switches automatically off again for safety reasons.

Clear data base This menu item allows you to remove all data from EPG database. It will take some time to retrieve this data again.

## Parental lock

You can select and set various security options to prevent unauthorised use of the TV set and to protect your children from unsuitable programmes.

### Call Parental lock menu

HOME

**HOME: Call Home** view.



◀ ▶ ▲ ▼ Mark **System settings**,  
**OK** call System settings.

▼ ▲ Mark **Control**,  
 ▶ go to next column.

▼ ▲ Mark **Parental lock**,  
 ▶ go to next column.

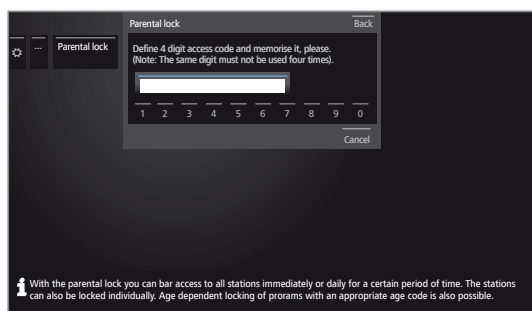

Define a four digit access code (PIN) the first time you open it. Note the access code (PIN) well.

**i** The access code must not consist of the same four digits.



◀ ▶ ▲ ▼ Mark **Confirm**,  
**OK** activate.

The new PIN must be entered and confirmed again.

The **Parental lock** menu will be opened.

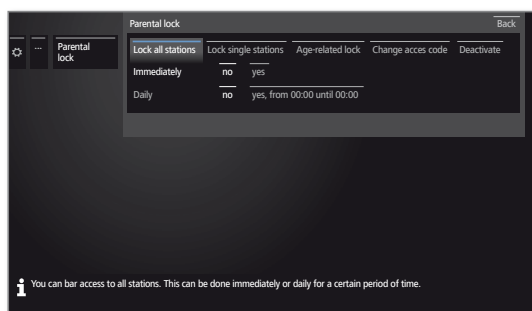

The four-digit access code (PIN) must be entered when the parental lock is opened in future. For security reasons, it appears encrypted (**\*\*\*\***) when entering.

### Explanations of setting possibilities in the Parental lock menu:

- Lock all stations** The TV set is locked immediately the menu is exited. All programmes can then only be watched after entering the access code. The lock can be activated both **Immediately** and for a **Daily** defined period. The lock remains active until it is switched off in the menu.
- Lock single stations** You can lock / unlock individual or all of the stations in the station list specifically. The lock remains active until it is switched off in the menu.
- Age-related lock** Some DVB stations also broadcast an age classification. If the age set here is below the broadcast age limit, the programme can only be watched after entering the access code.
- Change access code** You can change your access code at any time. Enter the new access code in place of the old one.
- Deactivate** All set parental locks (locked stations, age-dependent locks, locked films in the DR+ archive) are cancelled. The current secret code is deleted. When the parental lock is reactivated all the previous parental locks are set again automatically.
- Reset** All currently set parental locks are finally cancelled. The access code is deleted.

### Protection of minors for CI Plus programmes

Youth-protected broadcasts of programme providers with CI Plus encoding possibly require you to enter the secret number (PIN) of the CA module.

**i** The Parental lock PIN of the CA module can be store in the TV set. We recommend selecting the secret number of the TV set according to the secret number of the CA module, since the secret number of the CA module cannot be changed. This means that you must only remember one secret number.

### Code number

The code number cancels all entered access codes. It can be used for example if you have forgotten your PIN. In the supplied quick guide you find a note on the access code number. Remove this one from the quick guide and keep it in a safe place.

### Note for unlocking

As soon as the PIN has once been entered to unlock your TV set, all currently set parental locks will be disabled temporarily. Besides of the general locks described in this chapter, this is also valid for parental lock of DR+ archive entries. Parental locks will only be re-enabled when the TV set is switched off.

## Energy efficiency

Determine how energy efficient your TV set shall be. The value for the contrast (and thus the brightness of the background lighting) is adapted and the automatic dimmer activated or deactivated depending on the presetting.

### Call Energy efficiency

HOME

**HOME:** Call **Home** view.



◀ ▶ ▲ ▼ Mark **System settings**,  
**OK** call System settings.

▼ ▲ Mark **Control**,  
▶ go to next column.

▼ ▲ Mark **Energy efficiency**,  
▶ go to next column.

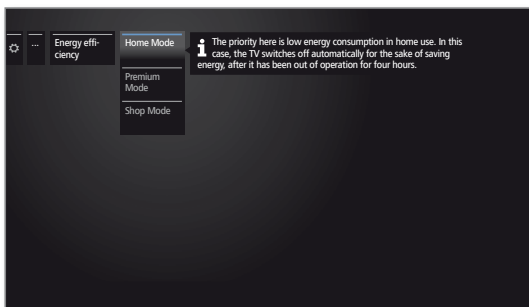

◀ ▶ ▲ ▼ Select desired setting and make changes.  
**OK** Adopt settings.

### Explanations of the setting options in the energy efficiency menu:

Choosing **Home Mode** activates automatic shutdown. For **Premium Mode** or **Shop Mode**, automatic shutdown is initially deactivated.

**Home Mode** The emphasis for home use is on low energy consumption. The automatic dimmer is activated.

**Premium Mode** This mode optimises the settings to a brighter environment at a higher energy consumption. The automatic dimmer is activated.  
The use of this energy efficiency setting must be confirmed afterwards once again.

**Shop Mode** The picture settings are aligned to operation in the presentation room. The automatic dimmer is deactivated. If the ambient brightness diminishes, the energy consumption is not reduced.  
The use of this energy efficiency setting must be confirmed afterwards once again.

## Quick start mode

If you enable the Quick Start Mode and you switch on the TV set from standby, the TV picture can be immediately seen without delay. You can specify the times at which your device will be in the Quick Start Mode.

Please note that in this case you will have a higher energy consumption.

**i** Default setting for the Quick Start Mode: **off**

### Call Quick start mode

HOME

**HOME:** Call **Home** view.



◀ ▶ ▲ ▼ Mark **System settings**,  
**OK** call System settings.

▼ ▲ Mark **Control**,  
▶ go to next column.

▼ ▲ Mark **Quick start mode**,  
▶ go to next column.

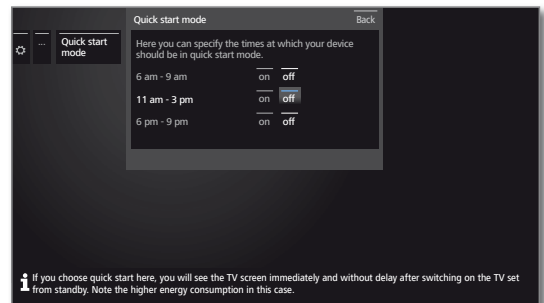

◀ ▶ ▲ ▼ Select desired setting and make changes.  
**OK** Adopt settings.



## Software update

It is possible to update the software on your Loewe TV set.

In the software update (package update) all the software releases in the TV are scanned and updated as required.

**i** Updating the software is not possible as long as a programmed timer recording is active.

**i** When a software update occurs it may happen that timer entries and memorised programmes are deleted. After such a software update, check your timer list (see chapter **Extras**, section **Timer – Timer list**).

Here you can download a new piece of software from different sources (if existing):

Current software versions can be downloaded from the Loewe Internet site (see below) and installed on your TV set using a USB stick.

**i** Please be aware of the requirements of your USB stick in section **Technical data – Media**.

If your TV set is connected to the Internet, the TV set can be updated directly via the Internet.

### Software download from the Loewe Internet site for update via USB

Where available, you can download new software for your TV set from our homepage.

Visit our homepage under:

**http://support.loewe.tv** (International),  
**http://support.loewe.tv/uk** (United Kingdom and Republic of Ireland),  
**http://support.loewe.tv/au** (Australia) or  
**http://support.loewe.tv/nz** (New Zealand).

(using the **Register free-of-charge** option).

Simply follow the steps in the registration process.

After the successful registration process and subsequent login to the support homepage you have to register your TV set (have the article number and serial number ready – both of these are on a label stuck to the back of the set or can be looked up under **Extras – Special-functions – Integrated features**).

Then you will get a list of downloadable contents for your TV set including the software. Download the data and unpack all the files in this ZIP archive into the main directory of your USB stick.

Then carry out the software update as described below.

### USB stick - requirements

USB sticks tested by Loewe and compatible in type and format can be ordered from the Loewe dealer using the article no. 90456.900.

If you would like to use your own USB stick, please follow these tips/conditions:

- Formatting in FAT32.
- Just one partition.
- Do not use encrypted USB sticks.
- Do not use USB sticks that simulate a CD ROM drive.
- There may be no hidden files on the device.
- For some types of device, the construction of the USB stick is significant. Maximum dimensions in mm: 70x20x10.
- If in doubt, the USB stick should be formatted as "FAT32" without "extended attributes".

**i** In order to avoid problems during the software update of the tv set the USB stick in use should meet the requirements.





## Software update via USB storage device

To do this, plug the USB stick with the downloaded software into a free USB port of the TV set.

### Calling Software update

HOME

**HOME:** Call **Home** view.



◀ ▶ ▲ ▼ Mark **System settings**.  
**OK** call System settings.

▼ ▲ Mark **Control**.  
 ▶ go to next column.

▼ ▲ Mark **Software**.  
 ▶ go to next column.

▼ ▲ Mark **Software update**.  
 ▶ go to next column.

▼ ▲ Mark **Via USB**.  
 ▶ call Software update.  
 The version of the software package that is currently installed will be displayed.

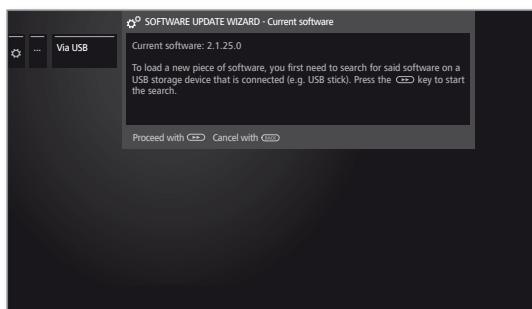

▶▶

▶▶ **Proceed.**  
 The TV set searches for a new software package on the USB stick.

If a new software version is available after the search, an on-screen message appears (see right hand column).

If several different software packages are found on the USB stick, the latest software package is always used.

If no new software package was found in the search:

BACK

**BACK: End of wizard.**

### New software package found

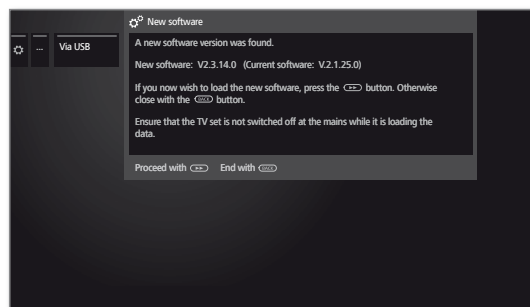

▶▶

▶▶ **Proceed** starts loading of the new software.

Or:

BACK

**BACK: End of wizard.**  
 The update will then **not** be carried out.

### Load new software package

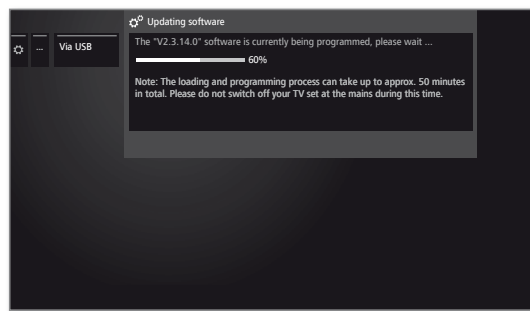

The software is loaded in several steps. The total loading and programming process can take up to approx. 50 minutes in total.

Please do **not** switch off your TV set with the mains switch during the entire loading and programming process.

You will be informed at the end of the update. To make your TV set completely ready for use again, please turn it off and on again at the mains.

## Manual update via the Internet

If an Internet connection is available, new software can be downloaded directly and installed onto the TV set.

### Calling Software update

HOME

**HOME:** Call **Home** view.



◀ ▶ ▲ ▼ Mark **System settings**.  
**OK** call System settings.

▼ ▲ Mark **Control**.  
 ▶ go to next column.

▼ ▲ Mark **Software**.  
 ▶ go to next column.

▼ ▲ Mark **Software update**.  
 ▶ go to next column.

▼ ▲ Mark **Via Internet**.  
 ▶ go to next column.  
 You will see a message on the screen regarding data protection.

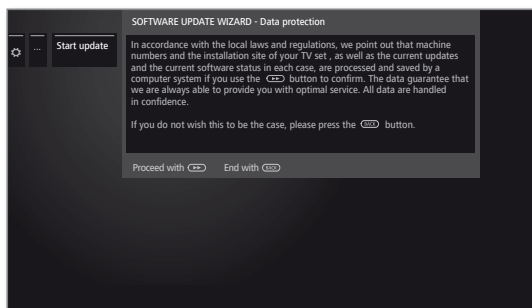

If you are not in agreement with the relevant data being passed on:

BACK

**BACK:** Exit the update process.  
 The update will then **not** be carried out.



Otherwise: Confirm data protection message by pressing ▶▶.

The version of the software package that is currently installed will be displayed.

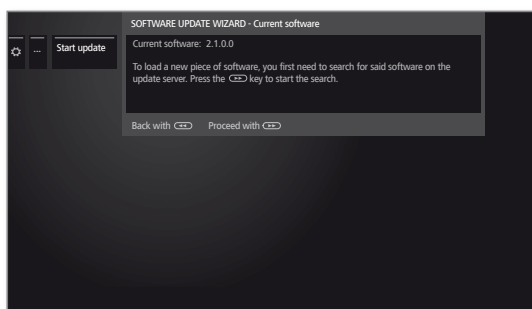

▶▶ **Proceed.**

The TV set connects to the Internet and scans the update server for new software.

If a new software version is available after the search, an on-screen message appears (see right hand column).

If no new software package was found in the search:

BACK

**BACK: End of wizard.**

### New software package found

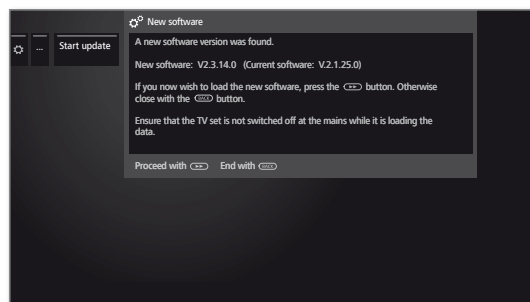

▶▶ **Proceed** starts loading of the new software.

Or:



**BACK: End of wizard.**  
 The update will then **not** be carried out.

### Load new software package

Only the parts of the software package that are not up to date will be automatically downloaded from the Internet and updated.

Each part of the software is downloaded individually from the Internet and is then programmed.

The total time required for all the software parts to be downloaded from the Internet is dependent on the speed of data transfer that is being used.

The total programming process can take up to 50 minutes in total.

Please do **not** switch off your TV set with the mains switch during the entire loading and programming process.

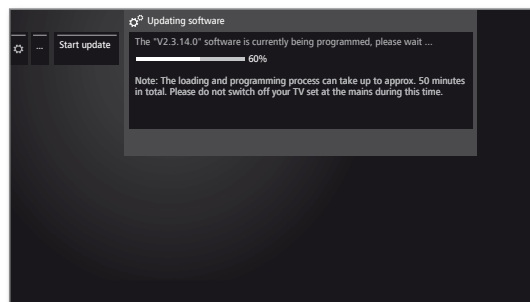

You will be informed once the loading and programming process is complete.

To make your TV set completely ready for use again, please turn it off and on again at the mains.

## Software update via Antenna

**i** A software update via antenna is only available for stations of the Freeview DVB-T platform in the UK and Ireland.

### Calling Software update

HOME

**HOME:** Call **Home** view.



◀ ▶ ▲ ▼ Mark **System settings**.

**OK** call System settings.

▼ ▲ Mark **Control**,

▶ go to next column.

▼ ▲ Mark **Software**,

▶ go to next column.

▼ ▲ Mark **Software update**,

▶ go to next column.

▼ ▲ Mark **Via Antenna**,

▶ call Software update.

You will see a message on the screen regarding data protection.

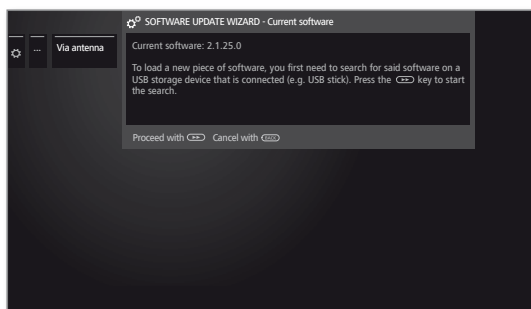

**Proceed.**

The TV set searches for a new software package.

If a new software version is available after the search, an on-screen message appears (see right hand column).

If no new software package was found in the search:

BACK

**BACK: End of wizard.**

### New software package found

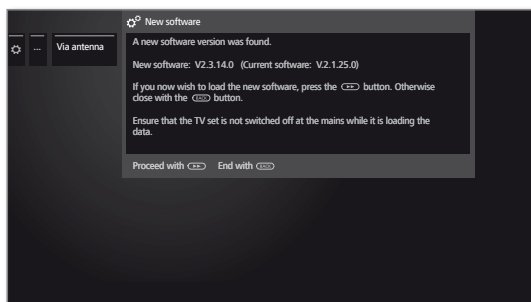

**Proceed** starts loading of the new software.

Or:

BACK

**BACK: End of wizard.**

The update will then **not** be carried out.

### Load new software package

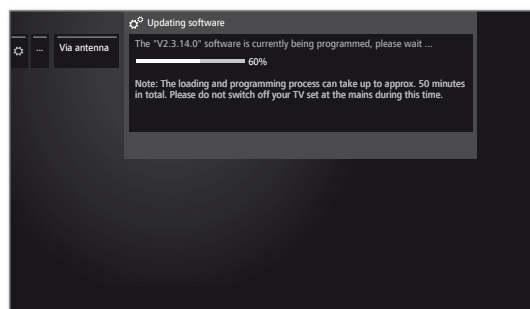

The software is downloaded in several steps. The total downloading and programming process can take up to approx. 50 minutes in total.

Please do **not** switch off your TV set with the mains switch during the entire loading and programming process.

You will be informed at the end of the update.

To make your TV set completely ready for use again, please turn it off and on again with the mains switch.



## Automatic update via the internet

**i** At the end of the initial installation, **Information on new software updates** was selected.

**i** This item cannot be called up via the menu, but appears automatically when a new version is found in the search for software.

### New software package found

If the TV set has found a new software version during the check, you will be informed about this via a screen message.



▲ ▼ Select the desired procedure.

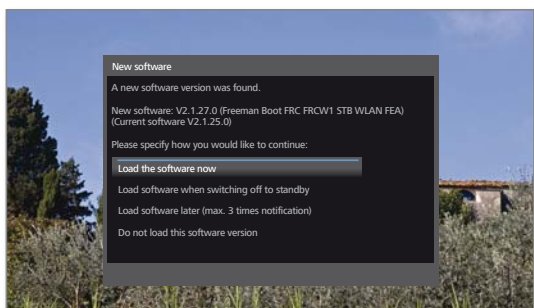

Load the software now  
After confirmation, the new TV software will be loaded from the internet and then programmed.

Load the software when switch off to standby  
The software will be loaded and programmed after the TV set has been switched off into standby mode for the next time. The display on the control panel will light up blue during the update. The TV set must **not** be switched off at the mains before the downloading process is complete (control panel display lights up white)!

Load the software later (at most three-fold notification)  
Loading the software will be postponed to a later date. The new software message will be displayed the next time the TV set is switched on. If the loading process is postponed three times then the message will only be shown again once the next software version is available.

Do not load this software version  
The new software will not be loaded. The on-screen message will only be shown again for the next software version.



Confirm selection.

## On-screen displays

You can select different settings in this menu which affect the on-screen displays.

### Call On-screen displays

HOME

**HOME:** Call **Home** view.



◀ ▶ ▲ ▼ Mark **System settings**.  
**OK** call System settings.

▼ ▲ Mark **Control**.  
 ▶ go to next column.

▼ ▲ Mark **more ...**.  
 ▶ call other settings.

▼ ▲ Mark **On-screen displays**.  
 ▶ go to next column.

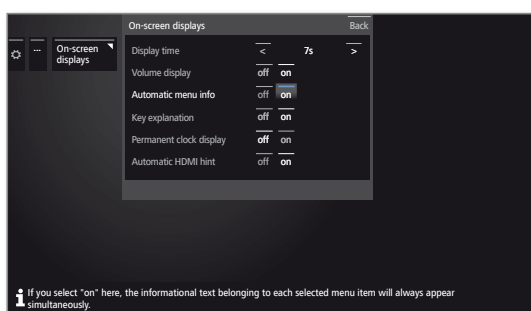

◀ ▶ ▲ ▼ Select desired setting and make changes.  
**OK** Adopt settings.

### Explanations of setting possibilities in the On-screen displays menu:

Display time	Here you set the duration of the display, e.g. for the volume or the station display when changing stations. The duration can be set between 2 and 9 seconds.
Volume display	Here you set whether a volume change is also to be indicated visibly on the screen.
Automatic menu info	Herewith you activate/deactivate the info text displays for the currently selected menu item.
Key explanation	By default, the window will appear with key explanations along with the status bar. Here, you can disable this automatic display.
Permanent clock display	The time display can be permanently shown. It is always visible as long as no other display is made.
Automatic HDMI hint	If <b>yes</b> is set here, a message about the adapted function of the remote control is shown whenever you switch over to an HDMI channel position to which a <b>Digital Link HD</b> capable TV set is connected.

## Time and date

Time and date are automatically detected and set via the DVB programme provider (e.g. Astra, UPC) or, during an Internet connection, via Internet time services.

**i** If a definite time has been detected by the TV set (depending on the programme provider), time and date cannot be changed.

### Call Time and date

HOME

**HOME:** Call **Home** view.



◀ ▶ ▲ ▼ Mark **System settings**.  
**OK** call System settings.

▼ ▲ Mark **Control**.  
 ▶ go to next column.

▼ ▲ Mark **more ...**.  
 ▶ call other settings.

▼ ▲ Mark **Time and date**.  
 ▶ go to next column.

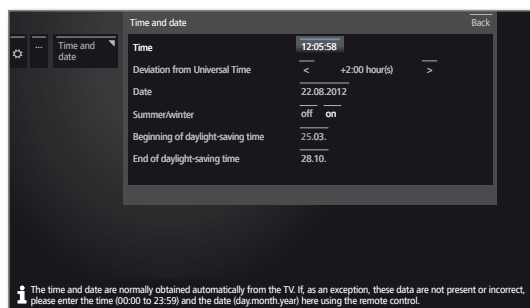

◀ ▶ ▲ ▼ Select desired setting and make changes.  
**OK** Adopt settings.

### Explanations of setting possibilities in the Time and date menu:

**i** If a definite time has been identified by the TV set (dependent on the channel), certain menu items may not be available.

Time	Enter the time (00:00 to 23:59) with the numeric buttons of the remote control.
Deviation from Universal Time	The current time at the Greenwich Meridian 0 is to be understood as world time. The time shift in relation to this time must be given in hours (-11 to +13) (with the keys ◀ ▶ or the numerical keys of the remote control). Summer time is ignored.
Date	Enter the date (day.month.year) with the numeric buttons on the remote control.
Summer/winter	If the summer time in your country is changed to Daylight-saving time, select <b>yes</b> please.
Beginning of daylight-saving time	Enter the date on which the time is switched over to summer time if it deviates from the automatically calculated date. This menu item appears only if <b>yes</b> was selected for Daylight-saving time.
End of daylight-saving time	Enter the date on which the summer time ends if it deviates from the automatically calculated date. This menu item appears only if <b>yes</b> was selected for Daylight-saving time.

## DVB settings

You can make general pre-settings for DVB stations.

### Calling DVB settings

HOME

**HOME:** Call **Home** view.



◀ ▶ ▲ ▼ Mark **System settings**,  
**OK** call System settings.

▼ ▲ Mark **Control**,  
▶ go to next column.

▼ ▲ Mark **more ...**,  
▶ call other settings.

▼ ▲ Mark **DVB settings**,  
▶ go to next column.

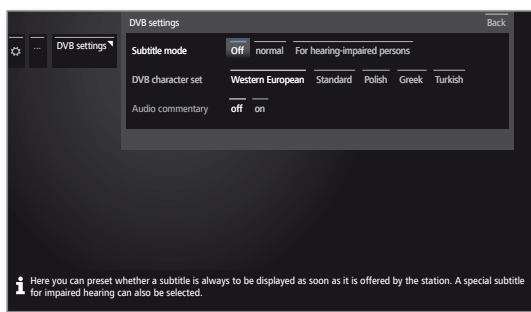

### Explanation of the DVB setting options:

**Subtitle mode** Here you can preset whether a subtitle is always to be displayed as soon as it is offered by the station. A special subtitle for impaired hearing can also be selected. Subtitles are not offered by all stations. Many stations only broadcast subtitles by teletext.

**DVB character set** Select the DVB character set so that the title of the broadcast of your favourite received station or the texts of your CA module are displayed correctly.

**Audio commentary** You can preset the system here to always play a special soundtrack for the visually impaired whenever one is available. This soundtrack uses an audio commentary to describe the action taking place on-screen.

## DR+

Here you can make settings for the Digital recorder. The settings are related to USB recording (externally connected USB hard disk) or DR+ streaming (shared use of other Loewe TV sets).

### Call settings for the digital recorder

HOME

**HOME:** Call **Home** view.



◀ ▶ ▲ ▼ Mark **System settings**,  
**OK** call System settings.

▼ ▲ Mark **Control**,  
▶ go to next column.

▼ ▲ Mark **more ...**,  
▶ call other settings.

▼ ▲ Mark **DR+**,  
▶ go to next column.

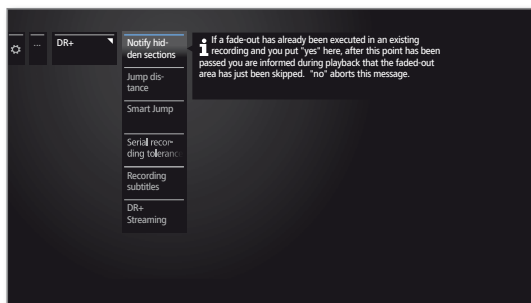

▼ ▲ Mark desired setting,  
▶ go to next column.

▼ ▲ Make settings,  
**OK** confirm setting.

### Explanation of the DR+ setting options

**Notify hidden sections** If an entry has been hidden in an archive recording, you can get informed by a screen message when skipping a hidden area.  
Factory setting: **yes**.

**Jump distance** Set the standard jump distance (in minutes) used for jumping forwards or backwards in the movie by briefly pressing the ◀ or ▶ keys.  
Factory setting: **02 min**.

**Smart jump** Activate or deactivate Smart jump function.  
Factory setting: **on**.

**Serial recording tolerance** A broadcast programmed with the recording type series is recorded only if it begins within the programmed start time ± series recording tolerance. Use the numeric button on the remote control to enter the time (always two-digit for 01 to 60 min.).  
Factory setting: **± 30 min**.

**Recording subtitles** Select here whether subtitles are to be recorded for DVB stations.  
Factory setting: **no**<sup>1</sup>.

**DR+ Streaming** For setting options see right hand column.

### Call DR+ streaming settings

■ The **DR+** settings are called (see left column).



▼ ▲ Mark **DR+ Streaming**,  
▶ go to next column.

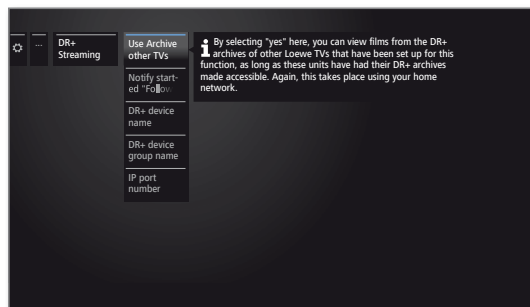

▼ ▲ Mark desired setting,  
▶ go to next column.

▼ ▲ Make settings,  
**OK** confirm setting.

### Explanation of the setting options for DR+ streaming

**Use Archive other TVs** Setting yes enables you, via the archive, to also view recordings from other TV sets that have accessible movies within the home network (client function).

**Notify started „Follow me“ recording** Your TV set can issue a message if a follow-me recording has been started on another TV set, which you can view on this TV set..

**DR+ device name** Give your TV set a unique name for quick identification in DR+ Streaming.

**DR+ device group name** Give a name for your TV set group. Using different group names enables you to group your TV sets as required. Only TV sets under the same group name can exchange data.

**IP port number** IP port numbers are preset ex-factory. Under normal circumstances they do not require amending.

<sup>1</sup> for devices in DK, FIN, N or S: **yes**.

## Standard Teletext

In the **Standard Teletext** menu you can configure the Teletext.

### Call Teletext settings

HOME

**HOME:** Call **Home** view.



◀ ▶ ▲ ▼ Mark **System settings**.  
**OK** call System settings.

▼ ▲ Mark **Control**.  
▶ go to next column.

▼ ▲ Mark **more ...**.  
▶ call other settings.

▼ ▲ Mark **Standard Teletext**.  
▶ go to next column.

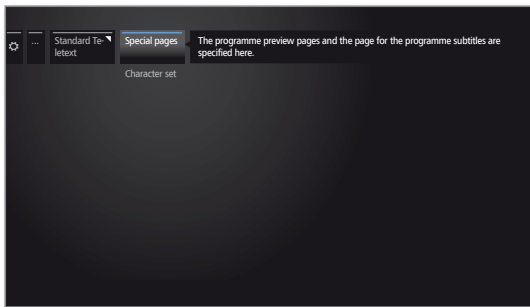

### Explanations of the Standard Teletext menu functions:



Character set Teletext character set can be switched to other languages (Russian, Greek, Polish and Turkish).



## HbbTV

### HbbTV mode on/off

When the HbbTV mode is active (factory setting), additional services and further information (e.g., also from the Internet) can be viewed if these are offered by the current station.

HOME

**HOME:** Call Home view.



◀ ▶ ▲ ▼ Mark **System settings**,  
**OK** call System settings.

▼ ▲ Mark **Control**,  
 ▶ go to next column.

▼ ▲ Mark **more ...**,  
 ▶ call other settings.

▼ ▲ Mark **HbbTV**,  
 ▶ go to next column

▼ ▲ Mark **HbbTV mode**,  
 ▶ call.

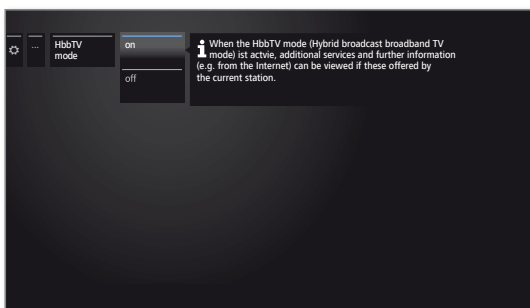

▼ ▲ Select the desired setting,  
 confirm with **OK**.

### Start behaviour of HbbTV-stations

If **HbbTV mode** → **on** has been selected (see left column), you can specify if an available HbbTV application should be loaded **automatically** after the channel has been changed or if this should only occur **manually** after the red key has been pressed once. After loading the HbbTV application, an on screen instruction is displayed depending on the programme provider.

HOME

**HOME:** Call Home view.



◀ ▶ ▲ ▼ Mark **System settings**,  
**OK** call System settings.

▼ ▲ Mark **Control**,  
 ▶ go to next column.

▼ ▲ Mark **more ...**,  
 ▶ call other settings.

▼ ▲ Mark **HbbTV**,  
 ▶ go to next column

▼ ▲ Mark **Start behaviour of HbbTV**,  
 ▶ call.

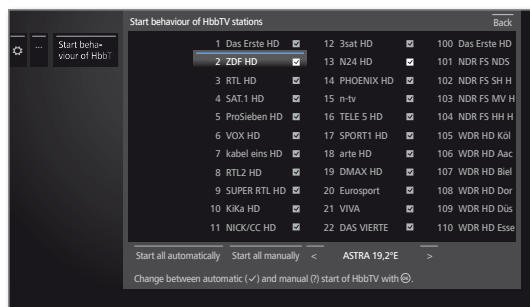

◀ ▶ ▲ ▼ Mark station,  
**OK** switch between manual (?) and automatic (☑)  
 start of the HbbTV application of the marked  
 station.

Or:



◀ ▶ ▲ ▼ Mark **Start all automatically**,  
**OK** start HbbTV application on all stations auto-  
 matically.

Or:



◀ ▶ ▲ ▼ Mark **Start all manually**,  
**OK** start HbbTV application on all stations manually.

■ Using the on-screen buttons in the bottom line you can display stations from specific (e.g., personal) lists.



### Feature of the TEXT key

With the setting **Standard Teletext first** (factory setting), the standard Teletext is opened when the **TEXT key** is pressed for the first time. Pressing the **TEXT key** for a second time will then display the MediaText. Pressing the **TEXT key** for a third time will bring you back to the TV picture. If **MediaText first** is selected, the **TEXT key** will do the exact opposite.

**i** Depending on the programme provider, the direct Call of MediaText may not be possible. MediaText must then be opened by means of the HbbTV application.



**HOME:** Call **Home** view.



◀ ▶ ▲ ▼ Mark **System settings**.  
**OK** call System settings.

▼ ▲ Mark **Control**.

▶ go to next column.

▼ ▲ Mark **more ...**.

▶ call other settings.

▼ ▲ Mark **HbbTV**.

▶ go to next column

▼ ▲ Mark **Function of the TEXT key**.

▶ call.



◀ ▶ Select **Standard Teletext first** or **MediaText first**.

### CA module(s)

**i** This menu is only available when at least one CA module is plugged in.



**HOME:** Call **Home** view.



◀ ▶ ▲ ▼ Mark **System settings**.  
**OK** call System settings.

▼ ▲ Mark **Control**.

▶ go to next column.

▼ ▲ Mark **more ...**.

▶ call other settings.

▼ ▲ Mark **CA module(s)**.

▶ go to next column.

### Station mapping

If two CA modules are both used for the decoding of stations, you decide here which station shall be decoded by which CA module.

**i** The station mapping settings will only be taken into account, if two CA modules are inserted.

**i** This statement refers explicitly to the CI slots of the TV set and **not** to the modules plugged into it! When the modules are exchanged, the mapping must be repeated.



▼ ▲ Mark **Station mapping**.  
▶ call station list.

◀ ▶ ▼ ▲ Select CA module for mapping.



◀ ▶ ▼ ▲ Mark the station,

**OK** map station to the selected CA module / cancel mapping.

The icon  indicates mapped stations.

### Saving the PIN for recordings

**i** This menu item is only available if a CI Plus CA module is inserted into one of the two CI slots of the TV set that supports the recording of broadcasts with parental lock.

Store the programme provider PIN belonging to your CA module in order to decode CI plus programmes with parental lock for recording.



▼ ▲ mark **Saving the PIN for recordings**.  
▶ call PIN entry box.

◀ ▶ ▼ ▲ Mark the desired CA module in the headline.

▼ Go to the PIN entry box, enter the programme provider PIN using the numerical keys.

Or:



◀ ▶ ▼ ▲ Mark figure,  
**OK** adopt figure to input line.

Conclude the entry:



◀ ▶ ▼ ▲ Mark **Adopt**.  
**OK** save PIN.

## Record

You can set a pre-record and post-record time for timer recordings made without auto time control. This minimizes the risk that a part of the broadcast is not recorded due to the broadcast starting earlier and/or finishing later.

### Call Recording settings

HOME

**HOME:** Call **Home** view.



◀ ▶ ▲ ▼ Mark **System settings**.  
**OK** call System settings.

- ▼ ▲ Mark **Control**.
  - ▶ go to next column.
- ▼ ▲ Mark **more ...**.
  - ▶ call other settings.
- ▼ ▲ Mark **Recording**.
  - ▶ go to next column.

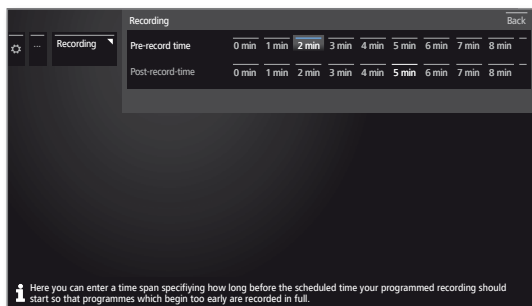

- ▼ ▲ Select **Pre-record time** or **post-record time**.
- ◀ ▶ Mark the desired duration of the pre-record time or of the post-record time.

Factory setting: pre-record time: **1 min.**  
 post-record time: **5 min.**

## Hard disks

### Formatting the hard disk

If you want to use an external hard disk on your TV, you must format it on the TV.

Additionally, you can re-format the hard disk in order to quickly and easily delete all the data stored on it.

### Warning!

Formatting the hard disk will erase all data stored on it!

HOME

**HOME:** Call **Home** view.



◀ ▶ ▲ ▼ Mark **System settings**.  
**OK** call System settings.

- ▼ ▲ Mark **Control**.
  - ▶ go to next column.
- ▼ ▲ Mark **more ...**.
  - ▶ call other settings.
- ▼ ▲ Mark **Hard disks**.
  - ▶ go to next column.
- ▼ ▲ Mark **Format integrated one** or **Format external one**.
  - ▶ confirm.

A warning note will be displayed.



**OK** Press at least for three seconds to start formatting.

BACK

Or:  
**BACK:** Cancel procedure

- ⓘ Never ever switch off the TV set during a formatting process.

After the formatting, a message will appear on the screen showing the results of the formatting and tips on how to resolve any problems that exist, should there be any.

- ⓘ After the formatting the TV set must be switched off and on again.

### Note on formatting external USB disks:

The TV set supports the two hard disk file systems FAT 32 and NTFS. External hard disks are formatted by the TV in the FAT32 file system to full capacity.

- ⓘ With FAT32, the maximum size of a file is 4 GB.
- ⓘ For a parallel use of TV and PC, we recommend that you reformat the hard disk on a PC to NTFS.

## WEB key function

You can assign the Web key on the remote control unit a particular function.

The selected function will then be called directly when the key is pressed.

### Call WEB key settings

**i** Default setting: **MediaNet**

HOME

**HOME:** Call **Home** view.



◀ ▶ ▲ ▼ Mark **System settings**.  
**OK** call System settings.

▼ ▲ Mark **Control**.  
▶ go to next column.

▼ ▲ Mark **more ...**.  
▶ call other settings.

▼ ▲ Mark **WEB** key function.  
▶ go to next column.

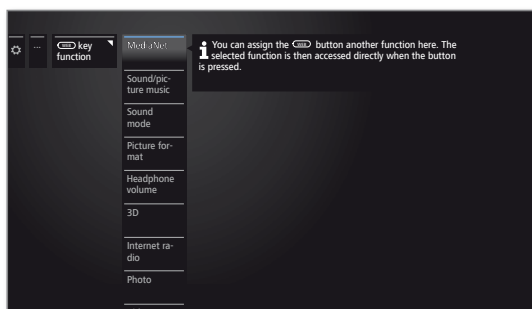

▼ ▲ Select **function**.

## Network settings

Under Network settings you make settings to your network adaptors and the various types of media.

### Call network settings

HOME

**HOME:** Call **Home** view.



◀ ▶ ▲ ▼ Mark **System settings**,  
**OK** call System settings.

▼ ▲ Mark **Multimedia / Network**,  
 ▶ go to next column.

▼ ▲ Mark **Network settings**,  
 ▶ go to next column.

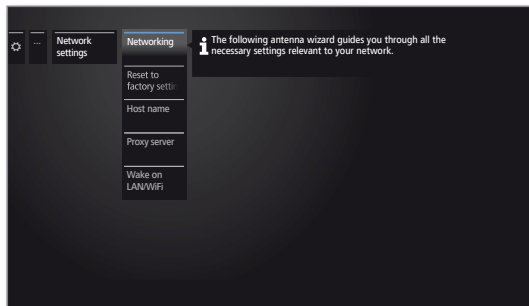

▼ ▲ Select desired menu item,  
 ▶ go to next column.

### Explanations of the setting options in the network menu:

Networking	Here, the network wizard starts that guides you through all necessary settings to your network (see right hand column).
Reset to factory settings	Here, all network settings are reset to factory defaults.
Host name	Give your TV set a name so that it can be uniquely identified in the network.
Proxy server	Do the settings for using a proxy server. The proxy server wizard will be called.
Wake on LAN/WiFi	If you <b>allow</b> Switch on via LAN/WLAN, the TV set can be switched on via the network when it is in standby. <b>i</b> Thus, energy consumption of the TV set will increase when it is in standby mode!

### Network

The Network wizard will be started. You see the current network status.



▶▶ Change network settings.

### Network selection

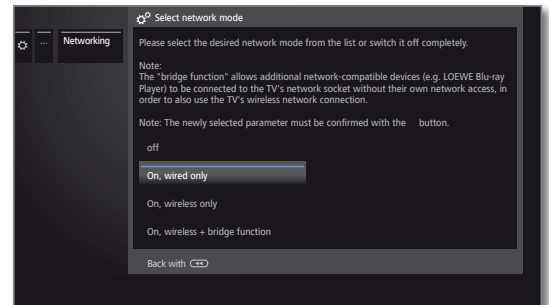

▼ ▲ Select network access.

### Explanations of the setting options:

Off	deactivates all existing network adaptors of your TV set.
On, wired only	Access to the network only via a network cable. The wireless access is deactivated. The network wizard will be opened.
On, wireless only	Access to the network only via WLAN. The access via a network cable is deactivated. The network wizard will be opened.
On, wireless + bridge function	Both network adaptors are activated. Wireless Internet access is possible (WLAN). Internet-enabled devices connected to the network socket (LAN) (e.g., Loewe MediaCenter, Loewe BluTechVision 3D) can use the wireless connection of the TV set to access the Internet via the WLAN bridge function. The network wizard will be opened.

**i** **Under no circumstances** may the TV set be **wired** and at the same time connected by a **wireless connection** to the same network, e.g. router. This may cause severe operational faults!



**OK** proceed.



### Configuration of the built-in LAN adaptor

**i** The network wizard was called via the network access setting **On, wired only**.

#### IP configuration



◀ ▶ Select type of **IP configuration**.

**automatic:** Automatic configuration of the IP address via DHCP server or via multiple protocols according to UPnP specification (including DHCP).



**OK** proceed to network status (see below).

**manual:** Enter your fixed static IP addresses manually (see below).



**OK** proceed to **Manual IP configuration**.

#### Manual IP configuration

If **manual** has been selected under **IP configuration**:

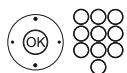

▲ ▼ Enter IP, Subnet mask, Gateway and DNS server addresses in succession with the numerical keys on the remote control.

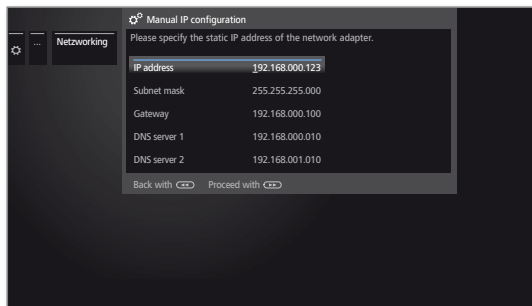

▶▶ proceed to **network status**.

#### Network status

You see the current network status again.



**BACK:** End of wizard.

### Configuration of the built-in WLAN bridge adaptor

**i** The network wizard was called via the network access setting **On, wireless only** or **Wireless + bridge function**.

#### Search for Access points

The TV set now searches for wireless routers.



**BACK:** Stop search.

#### Access point selection

After the end of the search:



▲ ▼ Select required access point from the options found.

**OK** Proceed to entry of WLAN password.

#### No access point found

If the desired access point is not found:



◀ ▶ ▼ ▲ Mark **Search again**,  
**OK** repeat search for wireless routers.



Or:  
◀ ▶ ▼ ▲ Mark **Enter access point manually**,  
**OK** enter manually the SSID of the desired access point, e.g., when the SSID of the access point is not transferred.

**OK** Proceed to entry of WLAN password.

#### WLAN password (WPA password / WEP password / WEP index)

If your wireless network is not encrypted: Proceed to **IP configuration**.

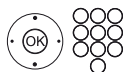

Enter WLAN password.

**i** In case of an unknown WLAN key, contact your network administrator.

**i** For encryption types supported, see chapter **Technical data**, section **Media**.

For WEP encryption



◀ ▶ Select the **WEP index**,  
**OK** proceed to **IP configuration**.

#### IP configuration



◀ ▶ Select type of **IP configuration**.  
For the further workflow of the network wizard see left column under IP configuration.

#### Network status

At the end of the network wizard you see your current network status again.



**BACK:** End of wizard.

### Explanation of the adaptor settings:

Network	shows the current type of connection ( <b>wireless</b> or <b>wired</b> ).
IP configuration	The current assignment method for the IP address of your TV set ( <b>automatic</b> or <b>manual</b> ).
IP address	Your current IP address.
Subnet mask	Your current subnet-mask IP address.
Gateway	The IP address of your gateway.
DNS server 1	Your current first DNS server IP address.
DNS server 2	Your current second DNS server IP address.
Network SSID	(for wireless connection only) The name of your network.
MAC address (TV)	(for wired connection only) Indicates the MAC address that is built into the hardware of your TV set's wired network adaptor (LAN).
MAC address (WLAN)	(for wireless connection only) Indicates the MAC address that is built into the hardware of your TV set's wireless network adaptor (WLAN).
Connection status	Gives you information about the current status of your wireless connection (save settings, connecting, login failed, access point not found, not connected, connection established).
Link quality	Specifies the signal strength as a percentage.

### Proxy server settings

In the proxy server wizard your TV set establishes the link with a home network with proxy server.

- A proxy server is not necessary for most home networks.
- Contact your home network administrator if you are unclear about the proxy server settings.

#### Use proxy server

Specify if a Proxy server is used in your home network.



◀ ▶ Mark **Use** or **Don't use**.  
**OK** confirm selection.

- The following settings will only be requested after the selection of **Use**.

#### Proxy server name

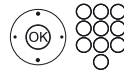

Specify the name or IP address of the proxy server used.

#### Proxy port number

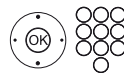

Specify the network port number of the proxy server.

#### Proxy server login

Specify whether your proxy server requires a special login.



◀ ▶ Mark **No login** or **Login necessary**.  
**OK** Confirm selection.

#### User name and password

- User name and password are only requested after the selection of **Login necessary**.

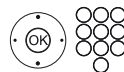

Enter your login data for the proxy server.



## Multimedia settings

Under this menu item you find further settings for Audio, Video and Photo.

### Calling the Multimedia settings menu



**HOME:** Call **Home** view.



◀ ▶ ▲ ▼ Mark **System settings**.  
**OK** call System settings.

▼ ▲ Mark **Multimedia / Network**,  
 ▶ go to next column.

▼ ▲ Mark **Multimedia settings**,  
 ▶ go to next column.



▼ ▲ Select desired settings.

### Explanations of the setting options in the Multimedia settings menu:

**Auto return to music player** The music player will reappear whenever another dialogue, e.g., music selection is called during playback, and no keys are pressed for the set time period. You can specify if and after which time the music player reappears (selection options are **No**, **After 1 min**, **After 5 min**).

## Renderer

Here you can allow external devices to access your TV set (renderer) via app to render (play back) contents there.

### Call up renderer menu

**i** Default setting: **on**



**HOME:** Call **Home** view.



◀ ▶ ▲ ▼ Mark **System settings**.  
**OK** call System settings.

▼ ▲ Mark **Multimedia / Network**,  
 ▶ go to next column.

▼ ▲ Mark **Renderer**,  
 ▶ go to next column.

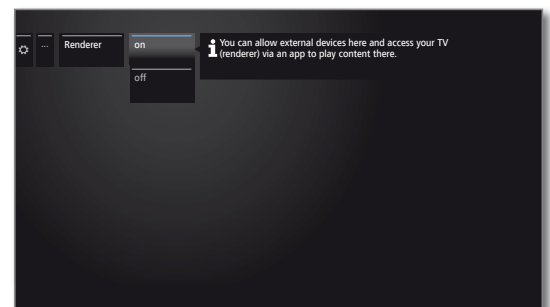

▼ ▲ Select the setting **on** or **off**.



## Connections

Settings for the connection of external appliances are made in this menu.

**i** The menu item **Connections** is not available while a timer recording is active.

### Calling the connections menu



**HOME:** Call **Home** view.



◀ ▶ ▲ ▼ Mark **System settings**.  
**OK** call System settings.

▼ ▲ Mark **Connections**.  
▶ go to next column.



▼ ▲ Select desired settings.

### Explanations of setting possibilities in the Connections menu:

**Sound components** The sound components wizard helps you to configure the components that are used to reproduce the TV sound.

**Antenna DVB** Here you can set the parameters of the DVB-T and the DVB-S antenna with the antenna wizard.

**AV connecting settings** In the AV connecting settings the parameters for the AV connection socket can be adapted.

**Digital Link** All settings for Digital Link are made here.

**Gaming mode** Here you can set a faster display of your activities on the screen for various inputs of the TV set, e.g., for games consoles.



## Sound components

The sound components wizard helps you to configure the components that are used to reproduce the TV sound. For sound reproduction, you can configure the TV loudspeakers as well as digital HiFi/AV amplifiers.

### Calling the sound components wizard

**i** For information on navigation within the wizard, see chapter **General information on menu operation**.

HOME

**HOME:** Call Home view.



◀ ▶ ▲ ▼ Mark **System settings**.  
**OK** call System settings.

▲ ▼ Select **Connections**,  
 ▶ go to next column.

▲ ▼ Select **Sound components**,  
 ▶ go to next column.

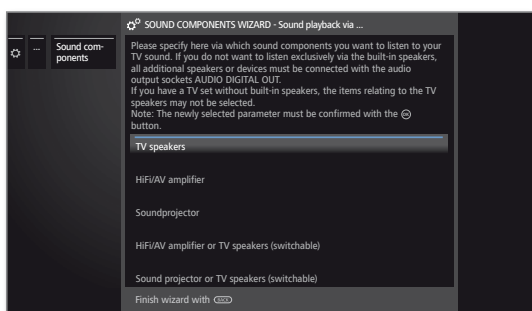

▲ ▼ Select **Sound component**.  
 For selectable items see right hand column.  
**OK** Confirm selection.



▶▶ Proceed to next step.

### Sound playback via ...

**TV speakers** Sound reproduction via the built-in TV speakers (factory setting).  
 With the selection of TV speakers the wizard will end.

**HiFi/AV amplifier** Sound reproduction via an external digital audio amplifier.

Connecting HiFi/AV amplifier: see chapter **External devices**, section **Connecting the HiFi/AV amplifier**.

**Sound projector** Sound reproduction via a Loewe Individual Sound Projector. For further information, refer to the operating instructions of the sound projector.

**HiFi/AV amplifier or TV speakers (switchable)** Sound reproduction optionally via an external digital audio amplifier or via the built-in TV loudspeakers.

**i** The selection options for switching between sound components can be called via the function list under **Sound settings**.

**Sound projector or TV speakers (switchable)** Sound reproduction optionally via a sound projector or via the built-in TV loudspeakers.

**i** The selection options for switching between sound components can be called via the function list under **Sound settings**.

## Setting the HiFi/AV amplifier

### Sound playback via ... - HiFi/AV amplifier

The sound components wizard permits configuration of different audio amplifiers (stereo amplifiers, surround amplifiers, analogue or digital) with different digital audio formats (Dolby Digital, dts, MPEG, and stereo/PCM). See the user guide of the audio amplifier for more information.

**i** For information on navigation within the wizard see chapter **General information on menu operation**.

HOME

**HOME:** Call Home view.



◀ ▶ ▲ ▼ Mark **System settings**.  
**OK** call System settings.

▲ ▼ Select **Connections**,  
 ▶ go to next column.

▲ ▼ Select **Sound components**,  
 ▶ Call sound components wizard.

Sound reproduction via ...

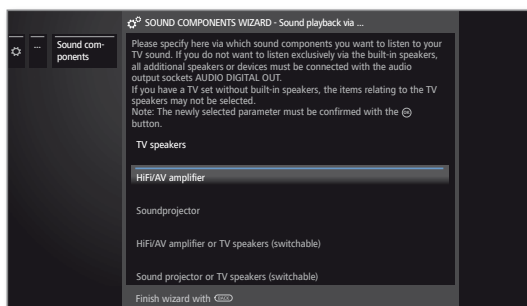

▼ ▲ Mark **HiFi/AV amplifier** or **HiFi/AV amplifier or TV speakers (switchable)**.  
**OK** Confirm selection.

**HiFi/AV amplifier** Select setting when an amplifier is connected and the TV speakers are not used.

**HiFi/AV amplifier or TV speakers (switchable)** Select setting when an amplifier is connected and the TV speakers are used. In the sound mode selection the audio reproduction can then be switched between the amplifier and the TV speakers.



▶▶ Proceed to next step.

Sound formats

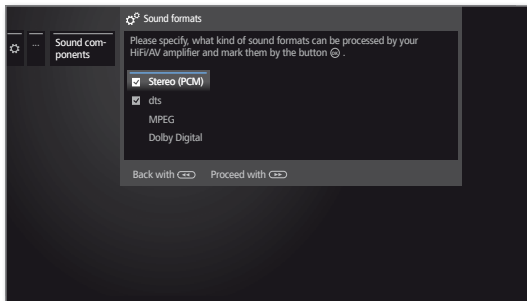

▼ ▲ Select sound formats which can be decoded with the digital amplifier (see operating manual of the used amplifier).

**OK** adopt sound formats.



**Back:** Finish wizard.

## Antenna DVB

Here you can make settings for the DVB-T antenna and call the antenna wizard for the DVB-S antenna.

### Call Antenna DVB

HOME

**HOME:** Call **Home** view.



◀ ▶ ▲ ▼ Mark **System settings**.  
**OK** call System settings.

▼ ▲ Mark **Connections**,  
▶ go to next column.

▼ ▲ Mark **Antenna DVB**,  
▶ go to next column.



▼ ▲ Select the desired setting,  
▶ call.

### Explanations of the setting options in the antenna DVB menu:

**Antenna DVB-S** Here the antenna wizard starts guiding you through all the settings relevant to the DVB-S antenna. The settings of the DVB-S antenna wizard are explained in the procedure of initial installation.

**Antenna DVB-T** Here you can set whether your DVB-T antenna needs a supply voltage. Antennas with an integrated amplifier need a supply voltage on the antenna line. In this case, select **Supply voltage 5V** and confirm with **OK**. Otherwise, select **No supply voltage** and confirm also with **OK**.

### Positioning/aligning DVB-T antenna

If you are receiving one or more DVB-T stations with picture and sound interference then you should change the installation location and alignment of the antenna. Ask your dealer to tell you which channels are used to broadcast the DVB-T stations in your region.

A DVB-T station is received and selected. Calling manual search (see chapter **System settings**, section **Stations – Manual TV/Radio scan**).

Due to the preset stations, the signal source is already selected as DVB-T. Position and align the antenna so that maximum **C/N** values and **levels** are reached.

Search for DVB-T stations one after the other and compare values for **C/N** and **Level**. Then position/align the antenna to the weakest station so that maximum values for **C/N** and **Level** are obtained. The value for **BER** should be as low as possible.

Thereafter, perform an automatic search for all DVB-T stations.

## AV connection settings

In the AV connection settings menu the parameters for the AV connection socket can be adapted.

### Calling the connections menu

HOME

**HOME:** Call **Home** view.



◀ ▶ ▲ ▼ Mark **System settings**.  
**OK** call System settings.

▼ ▲ Mark **Connections**,  
▶ go to next column.

▼ ▲ Mark **AV connecting settings**,  
▶ go to next column.



▼ ▲ Select the desired setting,  
▶ call.

### Explanations of setting possibilities in the AV connecting settings menu:

**Device at connection AV** Indicate here whether a set and, if yes, which one is connected to the **AV** socket.

**Signal type** You set the signal type of the device connected to AV or AVS here. Normally, you should leave the setting to **Automatic VHS/SVHS**; otherwise select a suitable signal type. You can find out more from your dealer.

**Allow switching voltage** If this function is activated, the video and audio of an external unit connected to the **AV** connector (not at AVS) will immediately be reproduced on all TV broadcast sites when playback is started up, provided that the external unit supplies a switching voltage.



## Digital Link

In the digital link menu you make further setting for comfortably linking external devices to the TV set.

### Call Digital Recorder Link menu

HOME

**HOME:** Call Home view.



◀ ▶ ▲ ▼ Mark **System settings**,  
**OK** call System settings.

▼ ▲ Mark **Connections**,  
▶ go to next column.

▼ ▲ Mark **Digital Link**,  
**OK** call Digital Link.

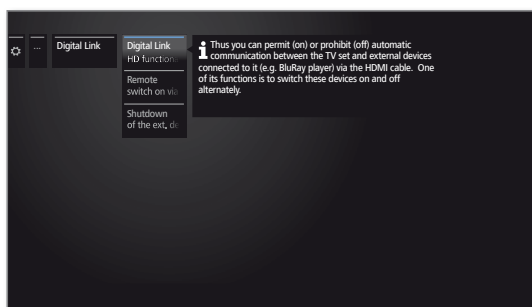

▼ ▲ Select the desired setting,  
▶ call.

## Gaming mode

For the inputs of your TV set on which game consoles, PC applications or even Karaoke machines are operated, we recommend you to activate the **Gaming mode**. Your activities are then displayed quicker on the screen by reducing the complex picture improving techniques. This mode can be set separately for every input of your TV set.

### Call Gaming mode menu

HOME

**HOME:** Call Home view.



◀ ▶ ▲ ▼ Mark **System settings**,  
**OK** call System settings.

▼ ▲ Mark **Connections**,  
▶ go to next column.

▼ ▲ Select **Gaming mode**,  
**OK** call.

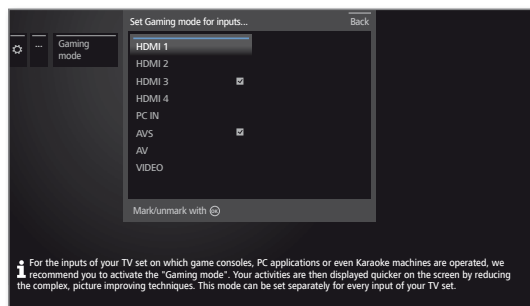

▲ ▼ Select connection,  
**OK** Gaming mode for selected connection on/off.

### Explanations of the setting options in the Digital Link menu:

**Digital Link HD functionality** Herewith you can allow or forbid the automatic communication between the TV set and linked external devices (e.g., BluRay player). Among other things, its role is that these devices switch mutually on and off.

**Remote TV switch on of the TV set** Here you can select whether the TV set is to switch on automatically from Standby mode, if **Digital Link HD** or **Digital Link Plus** capable devices connected to an HDMI or to AV inputs start playback or display a screen menu.

**i** Menu item only available if at **Digital Link HD - Functionality → on** has been selected.

**Shutdown of the ext. device via TV button** You can select here whether the external **Digital Link HD** device that is currently playing back should be automatically shut down as soon as you switch back to the TV or another AV channel.

**i** Menu item only available if at **Digital Link HD - Functionality → on** has been selected.

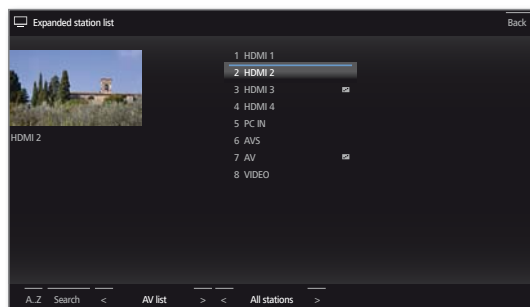

## Devices to the HDMI connections

The HDMI connections (High Definition Multimedia Interface) allow the transmission of digital video and audio signals from a player (e.g. DVD player, Blu-ray player, game console, camcorder, set-top box) via a single cable.

The digital video and audio data are transmitted without data compression digitally and therefore lose none of their quality.

A maximum of five devices can be connected in cascade to every HDMI socket. The devices are arranged in the AV list and in the station list below the appropriate HDMI socket. If the respective device sends its own device name, this appears in place of the connection name.

Your TV set can show optimally 24p movies, which are output from a connected HDMI player, e.g., Loewe BluTech Vision 3D.

Digital video signals from a DVI player can be also reproduced by the HDMI connection using a DVI/HDMI adaptor cable. The sound must be piped in additionally (see right column).

HDMI and DVI both use the same copy protection method HDCP.

### Connecting the device

Switch off all devices before connecting them.

Connect the device by an HDMI cable (Type A, 19-pole) to one of the **HDMI** sockets of the TV set.

An HDMI device is connected to the side HDMI socket (e.g. camcorder) in the same way as shown in the figure.

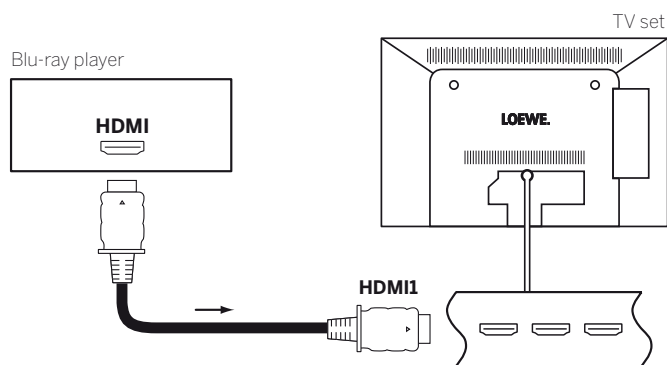

Connection example of an HDMI device (e.g. Blu-ray Player)

### Connecting an external device via HDMI/DVI adaptor

If your external device, e.g., a PC has an HDMI interface, you can also connect this via an HDMI socket to your TV set.

If a DVI/HDMI adaptor cable is used, the corresponding sound can be piped through the AUDIO IN socket of the VGA adaptor<sup>1</sup> to the **PC IN** socket on the TV set.

### Connecting an external device via HDMI

If your external device has an HDMI interface, the sound signal will usually be transmitted via the HDMI connection.

If this is not the case, connect the analogue or digital sound as described above. Refer to the appropriate operating manual for further information on the version of the HDMI interface on your external device, e.g., PC.

### Playback from the device

If the device at **HDMI** supports the **Digital Link HD** functionality, the TV set will automatically switch to the corresponding HDMI input after starting the replay at the HDMI device.

The HDMI input can also be called up manually:



Call **AV list**.

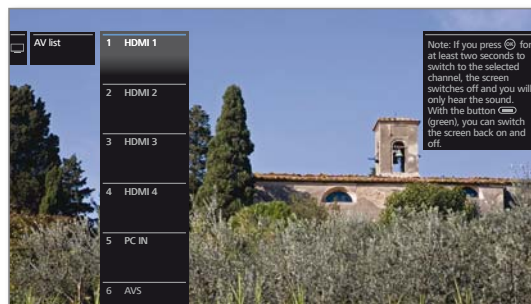

▲ ▼ Select **HDMI** socket.



With **Digital Link HD**-capable devices the device name may possibly appear in place of the connection name.

**OK** switch over.

Start playback on the connected HDMI device. The best possible format for the picture is detected and set automatically.

### Operation of Digital Link HD (HDMI CEC) enabled devices

For playback with an external Digital Link HD enabled device connected to the HDMI socket of the TV set, user commands are transmitted to the external device with a few exceptions (volume, sound on/off). You will also be informed by an on-screen display as soon as you switch to the corresponding HDMI input.

-  Pressing briefly **TV** switches to TV mode (back to previous station).
-  Pressing **TV** for a longer period switches between HDMI and TV operation.  
A message on the screen informs you about the currently selected mode.

### Automatically switching off external devices

When returning to TV mode by briefly pressing the **TV** key (see above) the external device can be switched off.

You can find the settings in the **System settings → Connections → Digital Link → Shutdown of the ext. device via TV-button**.

 Menu item only available if at **Digital Link HD - Functionality → on** has been selected.

### Remote TV switch via Digital Link

You can select whether the TV set is to switch on automatically from Standby mode if a disc is played or a screen menu displayed on a **Digital Link HD**-enabled device.

You can find the settings in the **System settings → Connections → Digital Link → Remote switch on of TV set**.

 Menu item only available if at **Digital Link HD - Functionality → on** has been selected.

### Switching off the TV set and connected devices (system standby)

 The operation of the TV set must be enabled (see above).

-  Press the key long: TV set and all CEC-enabled devices connected to the **HDMI** ports will be switched off to standby (system standby).

## Digital Link HD

### Digital Link HD (HDMI CEC)

The **Digital Link HD** (HDMI CEC) system operation allows Loewe television sets to transmit the remote control signals via the HDMI connection of a TV set to compatible HDMI devices, such as e.g. Loewe AudioVision. You can therefore set up a concealed CEC capable HDMI device.

### Concealed installation of HDMI devices

To this end, first assign the **HDMI CEC function** with Code **22** to the required device key (**STB**, **VIDEO** or **AUDIO**) as described in chapter **External devices**, section **Setting the remote control for other Loewe devices**.

Now assign the **Digital Link HD** function to the used HDMI device.

### Assign HDMI device

 The CEC capable HDMI device is connected to one of the HDMI sockets of the TV set and switched on.

   Press required button for 5 seconds.

A selection menu appears on the TV set.

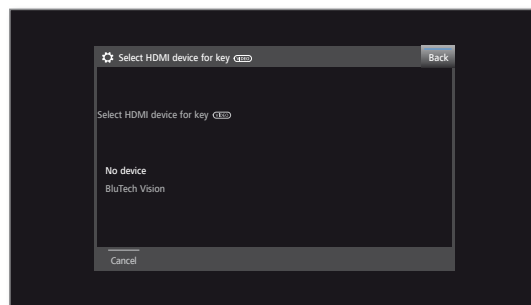

▲ ▼ Select required device from the list.  
**OK** Accept.

From now on, the commands of the remote control are communicated from the TV set to the HDMI device, if the corresponding device button (**STB**, **VIDEO** or **AUDIO**) has been pressed previously.

## Devices on AV

An additional device such as a DVD player, VCR/DVD recorder etc. can be connected to the TV set by means of an adaptor at the **AV** socket. The required Scart adaptor is part of the adaptor set. The adaptor set is available as an accessory from your Loewe dealer (see chapter **Accessories**).

The AV sockets can process different signal types. Which signal type your accessory device provides can be found in the operating manual of the appropriate device.

Owing to the large number of AV devices available on the market, we can only mention a few examples for the connection of accessory equipment to the AV sockets here.

### Remote TV switch on via Digital Link

You can select whether the TV set is to switch on automatically from Standby mode if a disc is played or a screen menu displayed on a **Digital Link Plus-enabled** device connected to **AV**.

You can find the settings in the **System settings** → **Connections** → **Digital Link** → **Remote switch on of TV set**.

### Connecting a DVD player to the TV set

■ A **DVD player** has been selected in the **System settings** → **AV connecting settings** → **Device at connection AV**.

Switch off all devices before connecting them.

Connect the Scart output of the DVD player to the TV set's **AV** socket using the Scart adaptor <sup>1</sup>.

Plug the adaptor plug into the **AV** socket of the TV set so that the arrow on the plug is visible.

Use a fully equipped Scart cable (available from your dealer) for this.

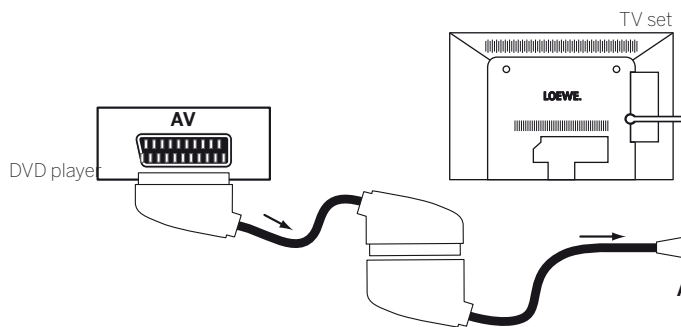

Connection example of a DVD player

### Playback from AV device

If the device at AV supports the Digital Link Plus functionality or if in the **System settings** → **Connections** → **AV connecting settings** → **Allow switching voltage** → **yes**, the TV set will automatically switch to the corresponding AV input after starting the replay at the AV device. The AV input can also be called manually, however.



Call **AV list**.



▲ ▼ Select **AV**,  
**OK** switch over.

Start playback on the connected device.

<sup>1</sup> Adaptor set is available as an accessory (see chapter **Accessories**).

### Connecting a DVD recorder to the TV set

■ A DVD recorder has been selected in the **System settings** → **Connections** → **AV connecting settings** → **Device at connection AV**.

Switch off all devices before connecting them.

Connect the Scart output of the DVD player to the TV set's **AV** socket using the Scart adaptor <sup>1</sup>. Use a fully equipped Scart cable (available from your dealer) for this.

Plug the adaptor plug into the **AV** socket of the TV set so that the arrow on the plug is visible.

If you want to receive and record analogue stations with the receiver (tuner) built into the recorder, the recorder must be looped into the aerial cable.

Connect the DVD recorder as shown in the connection example below.

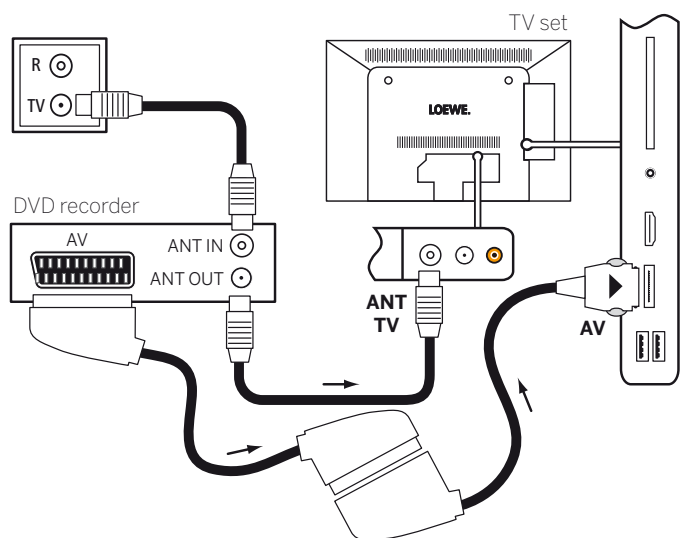

Connection example of a DVD recorder

### Playback from AV device



Call **AV list**.



▲ ▼ Select **AV**,  
**OK** switch over.

Start playback on the connected device.

### Connecting Camcorder/camera to the tv set

■ Choose **Other equipment** in the **System settings** → **Connections** → **AV connecting settings** → **Device at connection AV**.

Switch off all devices before connecting them.

Connect the video output of the camcorder to the TV set's **AV** socket using the S-video adaptor <sup>1</sup>. Use the AV cable supplied with the camcorder for this.

Plug the adaptor plug into the **AV** socket of the TV set so that the arrow on the plug is visible.

Depending on the type of plug, an additional cable is required for the audio connection. Connect the analogue audio signal of the camcorder to the S-video adaptor via the jack plug socket.

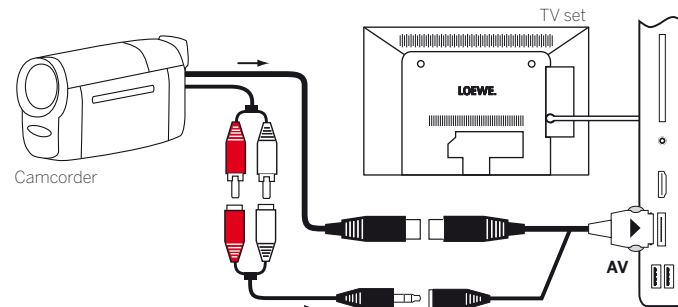

Connection example of a camcorder

If your camcorder has an HDMI output, you can also connect the device to the HDMI socket **HDMI4** on the side of the TV set.

### Playback from AV device



Call **AV list**.



▲ ▼ Select **AVS**,  
**OK** switch over.

Start playback on the connected device.

<sup>1</sup> Adaptor set is available as an accessory (see chapter **Accessories**).



## Devices on PC IN

The AV input **PC IN** offers the possibility to connect a PC or set-top box to the TV and thus use the TV screen as the output device.

### Connecting PC / Set-top box

**I** When connecting a PC or auxiliary device to the **PC IN** socket of the TV set, adjust the output signal on your PC first so that it matches one of the signals in the table in chapter **Technical data**, section **Signals via PC IN / HDMI**.

Switch off all devices before connecting them.

Connect the PC to the TV set's PC IN socket with a VGA cable and the VGA adaptor<sup>1</sup>. Plug the adaptor plug into the PC IN socket of the TV set so that the arrow on the plug is visible.

Connect the analogue audio signal of the PC to the VGA adaptor via the stereo jack socket.

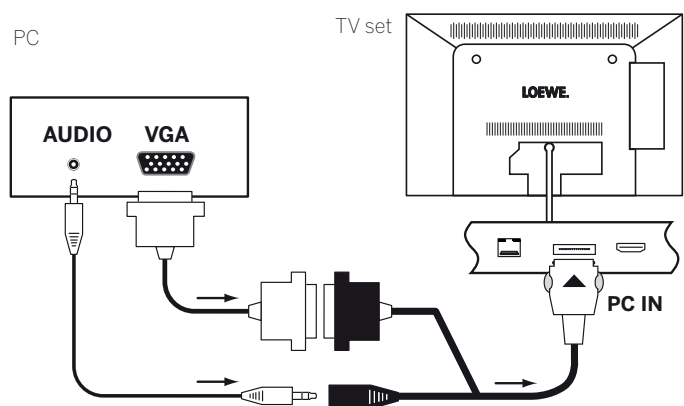

Connection example of a PC

### Connecting devices with component connection (YPbPr / YUV)

External units with component connection **YPbPr** (often informally referred to as YUV; see also **Glossary** on page) can be connected to the **PC IN** socket of the TV set using two adaptors. In addition to the VGA adaptor, a component VGA adaptor is required (available in stores).

The other units are connected as described in the left column.

### Playback from the device



Call **AV list**.



▲ ▼ Select **PC IN**,  
**OK** switch over.

### Adjusting the geometry of the PC picture

You can set the position (vertical, horizontal) and the phase position of your PC. The settings you find under **System settings** → **Picture** → **more ...** → **PC IN - Display**.

## Connecting the Audio system

### Connect digital audio (pre) amplifier via audio return channel (HDMI ARC)

Connect the **HDMI1** socket of the TV using an HDMI cable with the HDMI socket of the ARC-compatible audio (pre) amplifier (e.g. **Loewe MediaVision 3D**). It is not necessary to log-in the amplifier separately with the TV set.

The TV sound can be played back via the Media Vision 3D/Subwoofer-System.

More information on the wiring of the MediaVision 3D, speakers and the subwoofer you find in the instruction manual of the corresponding device.

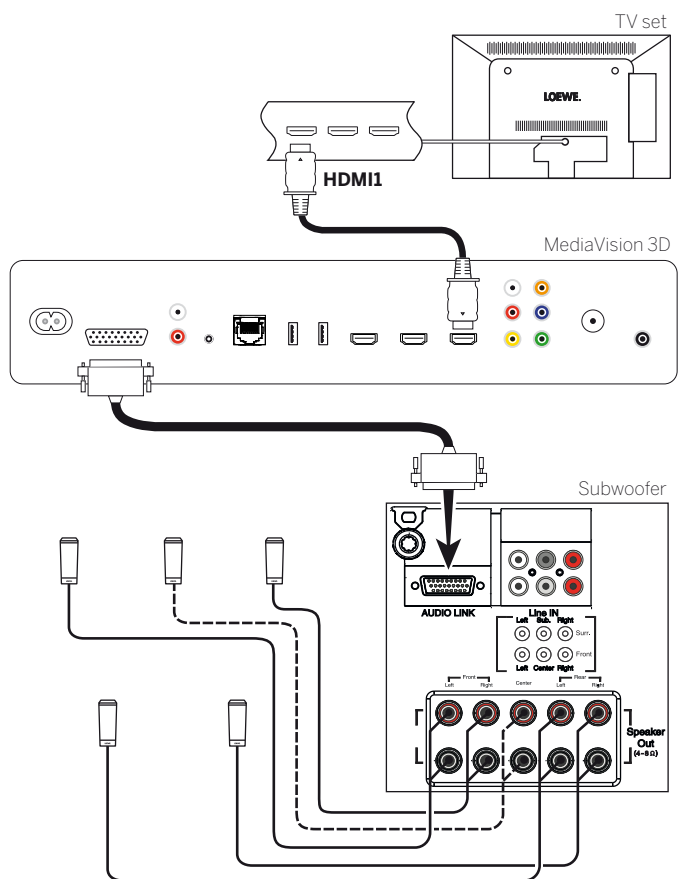

Connecting audio system to the tv set

## Connecting the HiFi/AV amplifier

### Connecting digital HiFi/AV amplifiers

Connect the digital audio output of the TV set **SPDIF OUT** to the digital audio input of the amplifier via a cinch cable:

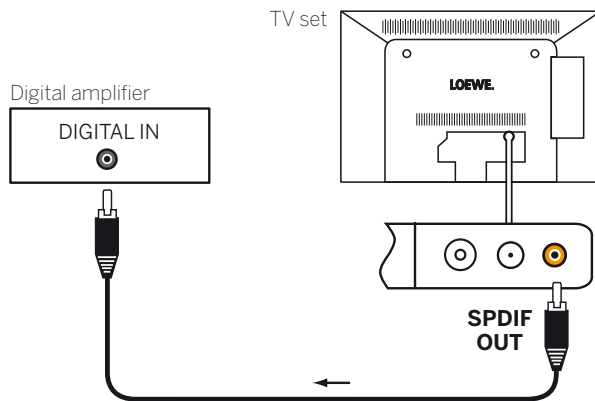

Connection example of a digital amplifiers

### Reproducing sound via an HiFi/AV amplifier

The sound reproduction via connected HiFi/AV amplifier can be adjusted in the sound components wizard (see chapter **System settings**, section **Connections – Sound components**).

## Audio playback from external devices

Connect external AV devices (e.g., MP3 player, DVD player) for sound reproduction to the AV input of the TV set.

### Connecting an external appliance (e.g. MP3 player)

Connect the output (jack receptacle) of the MP3 player via S-video adaptor<sup>1</sup> to the **AV** socket of the TV set.

Plug the adaptor plug into the **AV** socket of the TV set so that the arrow on the plug is visible.

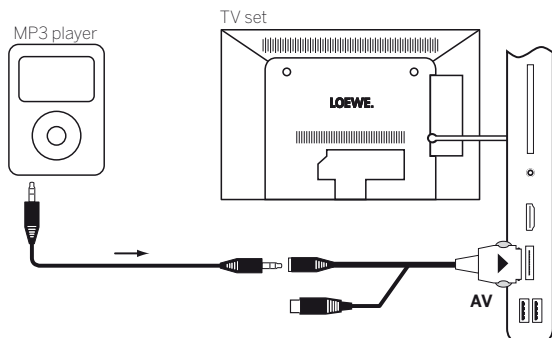

Connection example of an MP3 player

### Select AV input

**i** The selection of the AV input for a device at the **AV** socket (connection as described above) is describe here as an example. The procedure is similar to the selection of the other AV inputs.

HOME

**HOME:** Call **Home** view.



◀ ▶ ▲ ▼ Mark **Extras**.

**OK** call Extras.

▲ ▼ Mark **AV list**.

**OK** call AV selection.



▼ ▲ Mark desired AV source.

**OK** switch to AV source.

Start playback on the external device after selecting the AV input.

### Only playback of the audio signal from the AV source (screen is off)

To play only the sound of a connected media player (e.g. MP3 player), the AV sources can be selected so that the screen goes blank.

**i** Switching off the screen reduces the power consumption of the TV set.



Open the **AV** station list.



▼ ▲ Select desired connection.

**OK** press at least for two seconds.

## Serial interface RS-232C (RJ12)

You can connect either the Loewe Individual Sound Projector ID or a home network system of different manufacturers (e.g. AMX, Crestron) to your TV set via the RS-232C (RJ12) interface.

As to the configuration of the RS-232C (RJ12) interface and for further information on the various home networking systems contact your dealer please.

<sup>1</sup> Adapter set is available as an accessory (see chapter **Accessories**).

## Operating Loewe units

### Using the remote control for the TV mode of the TV set

**TV** Press the **TV key**, the LED above it will light for approx. 5 seconds.

### Using the remote control for a Loewe recorder

**STB** Press the **STB key**, the LED above it will light for approx. 5 seconds.

### Using the remote control for a Loewe player

**VIDEO** Press the **VIDEO key**, the LED above it will light for approx. 5 seconds.

### Using the remote control for the radio mode of the TV set

**AUDIO** Press the **AUDIO key**, the display above it will light for approx. 5 seconds.

As long as a key is pressed, the LED for the selected operating mode lights up (**TV** – **STB** – **VIDEO** – **AUDIO**). This allows you to check which operating mode the remote control is set to every time you press a button.

The **factory setting** of the keys is described above (see also table in right hand column). The assignment of the buttons can be changed to suit the existing accessory devices (see right hand column).

### Set unit for sound control function on the remote control

The keys for the sound control functions Volume (10) and Sound on/off (1) are programmed ex-factory to interact with the TV set. The unit to be operated can be modified.

■ The device must **first** be placed on one of the device key of the remote control (see right column) before the tone-control functions can be changed to the appropriate device.

**TV** **3 def** Press the **TV key** and the numerical key simultaneously for minimum 5 seconds. The LED above the selected **TV** key flashes twice.

Function	Buttons	Unit
Audio Functions	TV + 3	Auro/AudioVision/MediaVision 3D
	TV + 4	Mediacenter
	TV + 5	<b>Loewe TV</b>
	TV + 6	Loewe TV with sound projector without system connection

### Setting the remote control for other Loewe devices

You can operate various Loewe devices with the remote control. The device keys **STB** – **VIDEO** – **AUDIO** can be reassigned to operate different Loewe devices.

**STB** ■ Press the required device key and the **STOP key** simultaneously for 5 sec. until the corresponding LED display flashes twice.

Then enter the two-digit device code from the list below. The corresponding LED indicator light flashes twice.

Unit	Code	Factory setting
Loewe ViewVision 8106 H	10	
Loewe Viewvision, Centros 21x2	12	
Loewe ViewVision DR+ DVB-T	13	
Loewe Auro 2216 PS/8116 DT	14	
Loewe BluTech Vision Interactive	15	
Loewe Sound Projector	17	
<b>SetTopBox (STB) data base</b>	<b>18</b>	<b>STB</b>
<b>Loewe TV - Digital radio</b>	<b>19</b>	<b>Audio</b>
Loewe Mediacenter	20	
<b>Loewe BluTech Vision 3D</b>	<b>21</b>	<b>VIDEO</b>
HDMI CEC mode	22	
Loewe AudioVision	24	
Loewe Individual Sound Projector ID	25	
Apple IR codes	26	
Apple IR codes (Apple TV-2G)	27	
Loewe Soundbox	28	
Loewe SoundVision	29	
Loewe AirSpeaker	30	
Loewe Soundport	31	
Loewe MediaVision 3D	35	
Restore defaults	99	

■ The codes shown here only apply to direct operation of the auxiliary device device.

■ The available codes may vary depending on the status of the firmware in the remote control.

## Teaching the remote control

By means of key code **18** (Set-Top Box data base) your remote control Assist may be taught for your Set-Top Box (e.g., decoder, external cable tuner). Thus, you spare yourself the use of several remote controls.

**i** For the use of 2-digit key codes see chapter **External devices**, section **Operating Loewe units**.

The following options are available for teach-in:

- Entering a 3-digit code number
- Set-Top Box read-out
- Teaching individual keys
- Delete learned codes

**i** In the following, the **STB** key is dealt with as an example since device code 18 is preset for this key ex-works. Code 18 may also be assigned to the **AUDIO** and **RADIO** keys; the following description applies accordingly.

### Entering a 3-digit code number

The **STB** key can be programmed directly by means of a device-dependent 3-digit code. You find a list of these codes in chapter **Code page** at the end of this instruction manual.

**STB** **OK** Keep the **STB** and **OK** keys depressed for five seconds. The LED above the **STB** key flashes twice.

Enter the 3-digit code from the list. The LED above the **STB** key lights up for 1 second.

**OK** end the programming mode. After a successful programming the LED flashes twice.

**i** When entering a wrong code number, the LED lights up for 2 seconds. Do this programming once again.

### Read-out of programmed Set-Top Box

The code of the currently programmed device on the **STB** key can be indicated by the remote control.

**STB** **OK** Keep the **STB** and **OK** keys depressed for five seconds. The LED above the **STB** key flashes twice.

**INFO** Press **INFO** key.

The LED above the **STB** key shows the programmed code by flashing. The figure "0" will be indicated by flashing 5 times.

### Teaching individual keys

All keys (except the **TV**, **STB**, **VIDEO** and **AUDIO** device keys as well as the **V+/-** keys **⏪** and **⏩**) can be taught for the operation of units which are not contained in the integrated data base. The functions of the selected button are then completely or partially overwritten with the new codes.

**i** Place the TV remote control and the remote control to be replaced in such a way that the infrared windows face each other at a distance of 1-5 cm (see sketch).

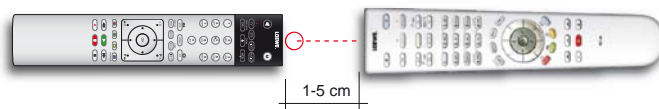

**STB** **Red key** Keep the **STB** and the **red key** simultaneously depressed for five seconds. The LED above the **STB** key lights up permanently.

**⊙** Press key to be taught on the TV remote control.

The LED above the **STB** key flashes.

**⊙** On the original remote control press the button which is to be taught.

The LED above the selected **STB** key flashes twice.

If the code is not correctly recognised, the LED above the **STB** key flashes ten times. Then repeat your entry on the original remote control. If necessary correct the allocation of the two remote controls. Continue with the other buttons as described above.

**STB** To end the teaching mode, press the **STB** key again.



**i** After 10 seconds without an entry the teaching mode is automatically terminated.

**i** It is possible that not all remote control codes can be taught.

**i** You can make a note of the functions, which you have allocated to the keys, on the notes pages at the end of this instruction manual.

### Deleting individual key functions

You can delete the taught function of an individual button.

  Press **STB** and **green key** simultaneously for five seconds. The LED above the **STB** key lights up permanently.



Press key to be deleted on the TV remote control.

The LED above the **STB** key flashes twice.

Continue with the deletion of other buttons as described above.



To end the deletion mode, press the **STB** key again.

The LED above the **STB** key flashes once.



### Deleting all functions of the key for a device

You can delete all taught functions which you have set on the **STB** key.

  Press **STB** and **yellow key** simultaneously for five seconds. The LED above the **STB** key flashes twice.

### Deleting all functions of the keys for all devices

You can delete all taught functions which you have set on the **TV**, **STB**, **VIDEO** or **AUDIO** buttons.

  Press **STB** and **blue key** simultaneously for five seconds. The LEDs above the keys for the devices flash twice.

## Loewe Apps

Loewe provides various Apps for your mobile devices:

### Loewe Internet Radio App

**Loewe Internet Radio App** provides you with the Internet radio offers of vTuner for your Apple products iPhone, iPad or iPod touch (from iOS 3.0). Your personal settings such as the vTuner favourites are synchronised with those of the TV set after registering your Apple product via the Loewe Support homepage.

### Loewe VideoNet App

The **Loewe VideoNet App** enables free and direct access to the best videos in the Web. The App streams live Podcasts, Screencasts and Web-Shows without loop route onto your iPad. You can use the Favourites function to add videos to your personal favourites list with just one click. In this way you can watch the latest episodes live. You can use the "Send-to-TV" function to sent selected videos to your Loewe TV set and play them there.

This App is available for Apple iPad (from iOS 3.2) via the Appstore.

To use the full functionality, you need to connect the VideoNet App on your TV set (can be found in the **MediaNet** area) and the VideoNet App of your iPad to each other (pairing). You can find a precise description of the steps necessary in the instructions of the iPad-App under the point **Pairing**.

### Loewe Assist Media App

The **Loewe Assist Media App** is a powerful App, which can not only replace your remote control in your home network, but also **EPG** and **DR+** archive provided by the TV set to your iPad. You can also transfer the station list of your TV set to your iPad, programme timer entries, start an immediate recording and add personal favourites to the start screen of the App.

In the course of the **Loewe Assist Media app**, the keyboard of your iPad can be used with restrictions for inputting text on the screen (e.g. in the browser). Text which has been input is moved to the TV set after confirmation.

This App is available for Apple iPad (iOS 4.0 or higher) via the Appstore.

## Overview of the prerequisites for the use of the Assist Media app for the Apple iPad

### 1. WLAN router and home network

A WLAN router must be connected and installed.

### 2. The Loewe TV set is connected to the home network via LAN / WLAN

Your reach the network setting of the Loewe TV set via **HOME view → System settings → Multimedia / Network → Network settings → Networking**.



Select whether the TV device should be connected to the Internet using a LAN (cable) or WLAN (wireless) connection. Here you also see the name of the network and the IP address of the TV set. This address will be indicated in the **Assist Media App (Settings → Connect)** and is used to make a difference between the devices registered in the network.

### 3. A digital Cable / Satellite connection (DVB-C/-S) is available

Loewe recommend a DVB-C- or DVB-S connection of your TV set. You have the possibility to fully use the **Assist Media App** for iPad. In case of analogue TV reception, **Assist Media** cannot fully use the EPG, for instance.

### 4. The DR+ Streaming settings are checked

Please set in the **DR+ Streaming** settings under **HOME → System settings → Control → more ... → DR+ → DR+ Streaming** the first two items **Share DR+ archive with other devices** and **Also use other archives**.

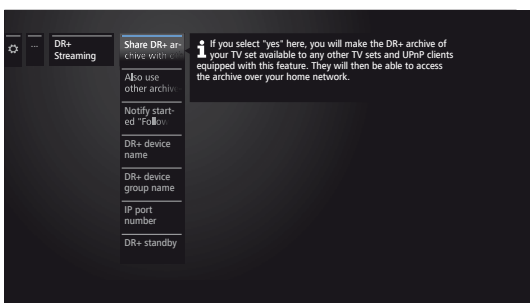

In the DR+ Streaming setting you can also set the name of the TV set under which it will be displayed in the App. After renaming please switch the TV set off and on again using the power switch.

### 5. Creating an Apple ID

If it has not been done yet, create a user account (Apple ID) on your iPad in the **Settings** under item **iTunes & App Stores**.

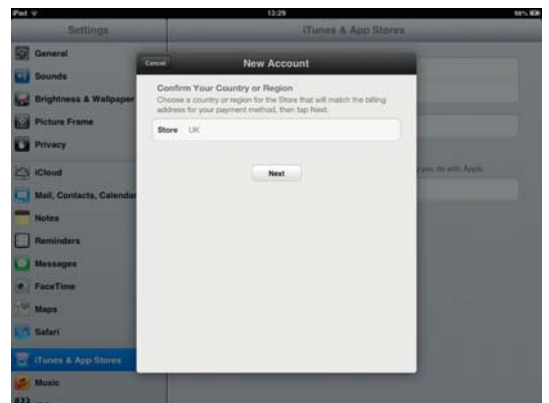

Follow the instructions.

You can then download the Loewe **Assist Media App** for iPad from the App Store.

## 6. Install Loewe Assist Media App

Open the **App Store**.



Enter the keyword **Loewe** in the browse list on the right above. Start searching by pressing on **Search**.



Install the **Assist Media** App by pressing on **FOR FREE**. Follow the instructions on the installation of the app.

## 7. Install the Assist Media App

Activate the location services for the apps **Assist Media** and **Maps** in your iPad under **Settings** → **Data protection** → **Location service**. This is essential for using country-specific functions. Thus, you can use the maxdome video service, for example.



Open the **Assist Media** app on your iPad. It scans your home network for Loewe TV sets. Follow the instructions and select the desired TV set.



In another step, you choose which station list the app shall load: the unsorted main list or one of your personal lists. Thereafter, loading of the EPG starts. The app is available to you after a few minutes of loading time. Further EPG data packages are loaded in the background.





Problem	Possible cause	Remedy / Instructions
The TV set switches off automatically.	The <b>automatic shutdown</b> switches off the TV set to save energy after 4 hours of inactivity as soon as at least one signal input group is set up in the energy efficient mode <b>Home Mode</b> .	Using automatic shutdown is recommended for the purposes of energy saving and safety.
All menus are displayed in the <b>wrong language</b> .	The menu language was set incorrectly.	<b>Set the menu language:</b> Press <b>HOME</b> key. Call last menu item  (bottom left). Mark the fourth item from above in the following list and move to next column to the right. Call first list item with <b>OK</b> . Select the language and confirm it with <b>OK</b> .
General problems when connecting <b>external devices</b> via an <b>AV input</b> .	The <b>Signal type</b> is set incorrectly.	Set the correct signal type ( <b>System settings</b> → <b>Connections</b> → <b>AV connection settings</b> → <b>Signal type</b> ). If <b>AV standard</b> or <b>Signal type</b> is set to " <b>Automatic</b> " then this can lead to false detections with non-standard signals. In this case standard and signal must be set according to the information in the operating manual of the external device.
With <b>Teletext</b> various <b>characters</b> are displayed incorrectly.	The wrong character set has been set in the <b>System settings</b> .	Set the correct character set: <b>System settings</b> → <b>Control</b> → <b>more ...</b> → <b>Standard Teletext</b> → <b>Character set</b> → <b>Standard</b> or select the appropriate character set.
Errors occurred when running a CA module.		Switch the TV set off. Remove the CA-module from the TV set. Wait a few seconds. Reinsert the CA module. Switch the TV set on again.
<b>No sound</b> via the external digital <b>audio amplifier</b> .	The external digital audio amplifier does not support the selected sound format (Dolby Digital, dts, MPEG).	Set PCM stereo on the DVD player in the sound selection. For DVB stations switch <b>Language/Sound</b>
A programmed <b>recording</b> was not made.	The provider deleted the programme from the EPG data, for example due to a programme change. The station from which the recording was made does not support <b>automatic time control (Accurate Recording)</b> .	Only the broadcasting organisations are responsible for transmitting data for the <b>automatic time control</b> . The availability of the appropriate data cannot be guaranteed.
There is no start or end of a programmed recording although the <b>automatic time control (Accurate Recording)</b> was used.	The transmission time of the program was delayed and the channel from which the recording was made has not updated the data.	Only the broadcasting organisations are responsible for transmitting data for the <b>automatic time control</b> . The availability of the appropriate data cannot be guaranteed.
No IP address will be issued to your TV set in spite of <b>automatic</b> IP configuration.	No DHCP server is working on your network.	Set up a DHCP server. Assign the IP addresses for the TV set <b>manually</b> .
Despite video or music file being played back, no sound can be heard.	a) The TV set is set to mute or the volume has been turned down too much. b) An audio device that does not exist or that is not connected, is registered under <b>System settings</b> → <b>Connections</b> → <b>Sound components</b> (e.g., <b>HiFi/AV amplifier</b> ).	a) Increase the volume by pressing the <b>V+ key</b> on the remote control for a longer time. This will also cancel any mute setting. b) Connect the audio device and switch it on. In the <b>Sound components wizard</b> change back to <b>TV speakers</b> .

Problem	Possible cause	Remedy / Instructions
Although the file is visible on the media server, it is not displayed in the MediaPortal.	The file is not made available by your media server.	Change to your media server. For this, also read the chapter <b>Technical data</b> , section <b>Media – Media server software</b> .
A media file that is displayed can not be played back.	The format of the file is not supported (see also limitations in chapter <b>Technical data</b> , section <b>Media – File formats supported</b> ).	No remedy.
Characters received in the WLAN code of the wireless router cannot be entered for the network configuration at the TV set.	The device does not support all special characters.	Change the WLAN key of the router.
When searching for wireless routers, no device is found.	The router is not ready for wireless communication.	Check your wireless router. Try to make the connection again a few minutes later.

Should there be any **interference** during **wireless** network operation such as **disruptions** during playback or **slow reactions** by devices to commands, you could try the following:













- Keep at least three metres **distance** from microwave ovens, bluetooth devices, mobile telephones and Wi-Fi compatible devices such as printers and PDAs.
- Change the active channel on the WiFi Router.

## Technical data

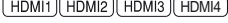
Type	Connect ID 55 	Connect ID 46 	Connect ID 40 
Part number	52465x85	52464x85	52463x85
Device dimensions without stand (W x H x D) Device dimensions with stand (W x H x D)	125,8 x 78,4 x 8,8 cm 125,8 x 78,4 x 12,7 cm	106,4 x 67,4 x 7,8 cm 106,4 x 68,2 x 24,1 cm	93,1 x 59,8 x 7,8 cm 93,1 x 60,8 x 24,1 cm
Weight without stand (approximate) Weight with stand (approximate)	30,1 kg 31,1 kg	19,5 kg 19,8 kg	16,1 kg 16,4 kg
Display technology	Full HD LCD with edge LED backlight technology		
Screen diagonal / Picture format	140 cm / 16:9	117 cm / 16:9	101 cm / 16:9
Resolution / Motion Response	1920 x 1080 px / 200 Hz		
Contrast (static / dynamic)	7.000 : 1 / 7.000.000 : 1		6.000 : 1 / 6.000.000 : 1
Viewing angle (horizontal / vertical)	178° / 178°		
Power consumption On-Mode max. (Audio output 1/8 of the maximum value) Power consumption On-Mode (Home) Power consumption in Standby Mode Power consumption when set is switched off	105 W 78 W < 0,5 W 0 W	89 W 65 W < 0,5 W 0 W	79 W 61 W < 0,5 W 0 W
Ambient temperature	5° C – 35° C		
Relative humidity (non-condensing)	20 – 80%		
Air pressure	800 – 1114 hPa (0 – 2000 m above sea level)		
Chassis designation:	SL 212		
Power supply:	220 V – 240 V/50–60 Hz		
Tuner:	terr./cable: Satellite:	VHF/Hyperband/UHF 4 levels: 13/18V/22kHz / 16 levels: DiSEqC 1.0 / single-cable system: EN 50494	
Range:	terr./cable: Satellite:	Terr./cable: 45 MHz up to 860 MHz Satellite: 950 MHz up to 2150 MHz	
Station storage locations incl. AV and radio:	6000		
TV standards:	analogue: digital:	B/G, I, L, D/K, M, N DVB-T/T2, DVB-C, DVB-S/S2	
Colour standards:	SECAM, PAL, NTSC, NTSC-V, PAL-V (60 Hz)		
Sound standards:	analogue: BG, DK, MN: BG, I, DK: L, L1: digital:	Mono, Stereo, Dual channel FM-A2 FM-Nicam AM-Nicam Mono, Stereo, Dual channel, PCM, Dolby Digital, Dolby Digital Plus, Dolby Digital Pulse	
Audio output power (sine/music):	2 x 20W / 2 x 40W		
Teletext:	TOP FLOF		
Page memory:	1000		

## Function of the connections

The following table shows the name, type and function of the ports.

Designation	Type	Function / Signal
 220-240V~ 50/60 Hz	Mains socket	220-240 V ~ 50 / 60 Hz Supply voltage
	RJ12	Data I/O: serial interface
	Mini AV	Video IN: with S-Video adaptor: Y/C (S-VHS/Hi 8) CVBS (VHS/8 mm) with VGA adaptor: PC/STB video signal Component (YPbPr) Audio IN: L/R
 5 V ± 80 mA	IEC socket	75 Ohm / 5 V / 80 mA: Antenna (analogue) / Cable (analogue) / DVB-T/T2 / DVB-C
 13/18 V ± 400 mA max	F socket	75 Ohm / 13/18 V / 400 mA: ANT-SAT DVB-S/S2
	Cinch (orange)	SPDIF OUT: Digital audio output
	HDMI type A (4x)	Digital Video/Audio IN (HDMI1, HDMI2, HDMI3, HDMI4): Digital Audio OUT (HDMI1 via HDMI ARC): Digital video and audio
	RJ-45	Ethernet / Fast Ethernet: Network interface
	USB type A (3x)	USB 2.0 (max. 500 mA): Multimedia files/software update
	Mini AV	Video IN: with scart adaptor: Y/C (S-VHS/Hi 8) CVBS (VHS/8 mm) RGB Audio IN: L/R
	Jack 3.5 mm	Headphones 32-200 Ohm
	CI Slot	Common Interface: Slot for CA module

## Media

### File formats supported

**Pictures: JPEG, PNG**

**Audio: MP3, M4A** (AAC LC), **WMA** (without lossless), **FLAC, WAV (PCM)**

**Video: AVI** (MPEG-1/2, XviD, AC3, MP3), **WMV** (WMV9, VC-1, WMA9, WMA Pro), **MP4** (XviD, H.264/MPEG-4 AVC, AAC LC), **MOV** (H.264/MPEG-4 AVC, AAC LC), **MKV** (H.264/MPEG-4 AVC, AC3), **FLV** (H.264/MPEG-4 AVC, H.263, MP3, AAC LC), **MPG** (MPEG-1, MPEG Audio), **TS/PS** (MPEG-2, H.264/MPEG-4 AVC, MPEG2 Audio, AC3), **VOB** (MPEG-2, MPEG2 Audio, AC3)

**H.264/MPEG-4 AVC** upto Profil High (Level 4.2)

### Ethernet (wired network)

Supported standards: 10 Mbit/sec Ethernet (10Base-T), 100 Mbit/sec Fast Ethernet (100Base-T)

### WLAN (wireless network)

#### Standards supported:

IEEE 802.11b/g/n

#### Frequency range used:

2400-2483,5 MHz and 5180-5730 MHz

#### Types of encoding that are supported:

WEP 64 and 128 Bit (ASCII and HEX), WPA PSK, WPA2 AES

### Supported home network standard

Universal Plug and Play Audio / Video (UPnP AV)

### Media server software

To play multimedia contents from devices in your home network, you require media server software which makes the relevant files available to you. Handling of individual files depends on the technical properties and also on the media server software used.

You can download a test version of the **TwonkyMedia** Mediaserver from our homepage. With your TV set, you have also acquired the option of obtaining a free licence for the currently available version of the Twonky media server. Alternatively, you can also use other media servers, e.g., the **Windows Media Player (WMP) from Version 11**.

For communication with your PC, certain **port addresses** of the network connection are required. They may not be blocked by a firewall if there is one, otherwise this could cause serious connection errors. Windows Media Player 11 requires the port addresses 1900 and the block of 10280 up to and including 10284 (all for UDP) as well as 2869 and 10243 (both for TCP). For TwonkyMedia the port addresses 1030, 1900 and 9080 (all for UDP) and 9000 (for TCP) must be available.

Other ports to be kept free depend on the operating system you are using.

Contact your network administrator about configuring the firewall.

## Signals via PC IN / HDMI

The following table lists the compatible signals which your TV set can show via the **PC IN** connection or via the HDMI connections (**HDMI1, HDMI2, HDMI3, HDMI4**).

Set the output signal on your PC, HDMI or DVI device so that it matches one of the signals in the table.

Format	Horizontal	x	Vertical	Frame frequency	connection
480i60	720	x	480i	60Hz	PC IN, HDMI
576i50	720	x	576i	50Hz	PC IN, HDMI
480p60	720	x	480p	60Hz	PC IN, HDMI
576p50	720	x	576p	50Hz	PC IN, HDMI
	1440	x	480p	60Hz	HDMI
	1440	x	576p	50Hz	HDMI
720p50	1280	x	720p	50Hz	PC IN, HDMI
720p60	1280	x	720p	60Hz	PC IN, HDMI
1080i50	1920	x	1080i	50Hz	PC IN, HDMI
1080i60	1920	x	1080i	60Hz	PC IN, HDMI
1080p24	1920	x	1080p	24Hz	PC IN, HDMI
1080p25	1920	x	1080p	25Hz	PC IN, HDMI
1080p30	1920	x	1080p	30Hz	PC IN, HDMI
1080p50	1920	x	1080p	50Hz	PC IN, HDMI
1080p60	1920	x	1080p	60Hz	PC IN, HDMI
VGA	640	x	480	60Hz	PC IN, HDMI
SVGA	800	x	600	60Hz	PC IN, HDMI
XGA	1024	x	768	60Hz	PC IN, HDMI
WXGA	1360	x	768	60Hz	PC IN, HDMI
SXGA	1280	x	1024	60Hz	PC IN, HDMI

## Signal input groups

In your TV set the signals are sorted in various signal input groups according to their source. In addition to the source, the type of signal is also distinguished.

For each signal input group, there are individual values for the picture settings.

Signal group name	Signal source/Signal type
SD Analog	cable analogue, interfaces AV, PC IN (SD)
SD Digital	DVB (SD), DR+ (SD), MPEG-Encoder
SD Media Player	full screen display of SD videos via USB, Network, VOD and media centre (incl. HbbTV media centre)
SD HDMI	Playback of SD video via HDMI, e.g., DVD player
HD Analog	PC IN (HD)
HD Digital	DVB (HD), DR+ (HD)
HD Media Player	full screen display of HD videos via USB, Network, VOD and media centre (incl. HbbTV media centre)
HD HDMI	Playback of HD videos via HDMI, e.g., Blu-Ray player
3D HD	3D playback of HD videos (analogue or digital)
3D SD	3D playback of SD videos (analogue or digital)
3D Media Player	full screen display of 3D videos (SD/HD) via USB, Network, VOD and media centre (incl. HbbTV media centre)
3D HDMI	Playback of 3D videos via HDMI, e.g., 3D Blu-Ray player
Photo Player	Playback of Photos via USB and network
Browser	Display of Web sites in the Browser (incl. Media apps)
VGA	PC IN (PC) or HDMI (PC)

## Accessories

The following accessories are obtainable from your Loewe dealer.

### Mounting options:

A variety of options for mounting your TV set on the floor, table, and wall are available.

An overview of the available placement options can be found in the chapter **accessories**, section **placement options**.

### Loewe 3D Blu-ray player:

With the Loewe Blu-ray player BluTech Vision 3D you're fully kitted out to watch Blu-ray discs with 2D and 3D material. With the Loewe system integration you control BluTech Vision 3D and your Loewe TV set simultaneously using the Assist remote control.

### Loewe MediaVision 3D:

Loewe MediaVision 3D is partly an audio system: It plays your favourite sound via the integrated iPod/iPhone dock and automatically identifies songs or film music with the MusicID function. Loewe MediaVision 3D is also a home cinema system, ensuring a perfect all-round audio visual experience - thanks to the fast and precise Full-HD 3D Blu-ray drive and a 5.1 decoder. Not least, Loewe MediaVision 3D is a colourful feast for the eyes: because it can be beautifully customised by individual intarsia.

### Loewe 3D glasses (part. no. 71133082):

The Loewe 3D shutter **Active 3D Glasses** give you clear 3D enjoyment and are compatible with all Loewe 3D flat screen TVs.

### Loewe Assist Easy:

The reduced focused design of Loewe Assist Easy remote control guarantees survey at first sight, nevertheless all important functions are controllable with one hand. Therefore it is the optimal control centre of the new user interface Loewe Assist Media. As a multifunctional remote control it is able to control further Loewe products in addition.

### Loewe Vesa adaptor bolts M8x32 (part. no. 90458957):

Mounting a Loewe flatscreen TV set to a holder according to the VESA standard **necessarily** requires the use of Loewe Vesa adaptor bolts to prevent damage to the TV set.

The Loewe Vesa adaptor bolts are fastened with a torque of about 4 Nm on the TV set. If you use a Vesa mounting options from other manufacturers, you can order the Vesa adapter bolts at your authorized dealer of Loewe.

## Upgrade kits / conversion kits / cables

### USB extension (part no. 70167080):

To ensure the accessibility of the USB connections or to be able to insert USB sticks with a large housing, a USB extension can be connected to the TV set. You can purchase the USB extension via your Loewe dealer.

### Adaptor Set AV SL 2xx (part no. 71678080):

The Loewe adaptor set contains three AV adaptors: The Loewe **Scart** adaptor allows you to extend your TV set by adding an AV socket to connect, e.g., DVD players or DVD recorders. The **VGA** adaptor enables the connection of a PC monitor or a Set-top box. By means of the **S-video** adaptor you connect your video camera to the TV set. Additionally to the video inputs, the adaptors for VGA and S-video are equipped with a 3.5mm stereo jack socket for analogue sound.

### Adapter Mini-Scart/25cm/Scart (part no. 71480080):

The Loewe scart adaptor allows you to extend your TV set by adding an AV socket to connect, e.g., DVD players or DVD recorders.

### Adapter RJ12/2.5m/RS232C (part no. 70499081):

Adapterkabel von RJ12 auf 9 poligen Sub-D Stecker zur Integration des TV-Gerätes in professionelle Home Automation Systeme, wie z.B. von GIRA, CRESTRON, AMX.

## Equipment variants

The equipment of the individual set variants and their upgrade/conversion possibilities is listed in the table below.

Set variants	Connect ID 55 DR <sup>+</sup>	Connect ID 55	Connect ID 46 DR <sup>+</sup>	Connect ID 46	Connect ID 40 DR <sup>+</sup>	Connect ID 40
DR <sup>+</sup>	●	–	●	–	●	–
USB Recording	–	●	–	●	–	●
DVB-T/C Single	–	●	–	●	–	●
DVB-T/C Twin	●	–	●	–	●	–
DVB-T2 Single	–	●	–	●	–	●
DVB-T2 Twin	○ <sup>1</sup> /● <sup>1</sup>	–	○ <sup>1</sup> /● <sup>1</sup>	–	○ <sup>1</sup> /● <sup>1</sup>	–
DVB-S/S2 Single	–	●	–	●	–	●
DVB-S/S2 Twin	●	–	●	–	●	–
Digital audio decoder	●	–	●	–	●	–
HbbTV	●	●	●	●	●	●
WLAN	●	●	●	●	●	●
RJ12	○	●	○	●	○	●
IR Link	○	–	○	–	○	–

● ex factory

○ optionally available as an upgrade kit

– not available

<sup>1</sup> Depending on the type of TV set



## Mounting options



### Wall Mount Slim/Vesa Size 400

Connect ID 55: 71361T10  
Connect ID 46: 71361T10  
Connect ID 40: 71361T10



### Wall Mount WM 62

Connect ID 55: As delivered state  
Connect ID 46: 69747B00  
Connect ID 40: 69747B00



### Wall Mount Isoflex<sup>1</sup>

Art 60: 71363B00  
Art 50: 71363B00  
Art 40: 71363B00



### Table Stand Connect ID Dynamic

Connect ID 46: As delivered state  
Connect ID 40: As delivered state



### Table Stand Connect ID Comfort

Connect ID 55: 71632B00  
Connect ID 46: 71384B00  
Connect ID 40: 71384B00



### Table Stand Connect ID Tableau

Connect ID 46: 71548000 (Walnut)  
Connect ID 40: 71548000 (Walnut)  
Connect ID 46: 71354U00 + 71728W00 (Porcelain)  
Connect ID 40: 71354U00 + 71728W00 (Porcelain)



### Floor Stand Universal<sup>1</sup>

Connect ID 55: 71355B00  
Connect ID 46: 71355B00  
Connect ID 40: 71355B00



### Floor Stand Connect ID 32-55

Connect ID 55: 71333B00  
Connect ID 46: 71333B00  
Connect ID 40: 71333B00



### Floor Stand Connect ID 32-55 with Equipmentboard

Connect ID 55: 71333B00 + 71365T00  
Connect ID 46: 71333B00 + 71365T00  
Connect ID 40: 71333B00 + 71365T00



### Screen Lift Plus<sup>2</sup>

Connect ID 55: 65486B10  
Connect ID 46: 65486B10  
Connect ID 40: 65486B10



### Wall Stand Flex<sup>2</sup>

Connect ID 46: 71277B00  
Connect ID 40: 71277B00



### Loewe Rack<sup>3</sup>

Various designs, sizes and colors  
suitable for Loewe TV sets, Sound  
components and Equipment

<sup>1</sup> Only in connection with appropriate adapter to be ordered separately.

<sup>2</sup> Only in connection with VESA Size 400 an adapter.

<sup>3</sup> Depending on the rack system in connection with appropriate adapter to be ordered separately.

## Environmental protection

### Energy consumption

Your TV set is equipped with an eco-standby power supply. In the standby mode, the power consumption drops to low power (see chapter **Technical Data**). If you want to save even more energy then switch the device off with the mains switch. Please also note that the EPG data (Electronic Programme Guide) is lost under certain circumstances and possibly programmed timer recordings **cannot** be carried out via the TV set.

**i** The TV set will be completely separated from mains only when you unplug the mains cable.

The power consumed by the TV set during operation depends on the energy efficiency preset in the initial installation or on the setting in the System settings.

If you activate the automatic dimming, your TV picture will adapt to the ambient brightness. This reduces the power consumption of the TV set.

If the TV is not operated for 4 hours (adjustment of volume, programme change, etc.) the TV will automatically switch to stand-by mode to save energy. A prompt to terminate this shutdown process appears one minute before expiry of the 4 hours. The automatic shutdown is only active in the energy efficiency mode **Home Mode**.

### Cardboard box and packaging

You have made a decision to purchase a high-quality technical product with a long service life. For disposal of the packaging, in accordance with national legislation we have paid a fee to a commissioned recycler to pick up the packaging from the dealer.

### The device



The EU directive 2002/96/EC regulates the proper way to recycle, handle and utilise used electronic devices. **Old electronic appliances** must therefore be disposed of separately. **Never** dispose of this device in normal **domestic waste**!

You can hand in your old unit free of charge at identified collection points or to your dealer if you buy a similar new unit. Other details about reacceptance (also for non-EU countries) are available from your local administration.

### Batteries



The batteries supplied as initial equipment do not contain any pollutants such as cadmium, lead, or mercury. In accordance with the Battery Directive, used batteries should **no** longer be disposed of in the **domestic waste**. Dispose of your batteries at no charge in the **collection containers** which are set up for this purpose in retail stores.

## Licences

Manufactured under licence from Dolby Laboratories. "Dolby", "Pro Logic" and the double-D symbol are trademarks of Dolby Laboratories.



This set contains a software which is based partly on the work of the Independent JPEG Group.

iPad, iPhone, iPod are registered trademarks of Apple Inc. in the USA and other countries.

HDMI, the HDMI logo and High-Definition Multimedia Interface are trademarks or registered trademarks of HDMI licensing LLC in the United States and other countries.



This product includes software developed by the OpenSSL Project for use in the OpenSSL Toolkit (<http://www.openssl.org>).

This software is provided by the OpenSSL project "as is" and any expressed or implied warranties, including, but not limited to, the implied warranties of merchantability and fitness for a particular purpose are disclaimed. In no event shall the OpenSSL project or its contributors be liable for any direct, indirect, incidental, special, exemplary, or consequential damages (including, but not limited to, procurement of substitute goods or services; loss of use, data, or profits; or business interruption) however caused and on any theory of liability, whether in contract, strict liability, or tort (including negligence or otherwise) arising in any way out of the use of this software, even if advised of the possibility of such damage.

This product includes cryptographic software written by Eric Young ([ey@cryptsoft.com](mailto:ey@cryptsoft.com)).

This product includes software written by Tim Hudson ([tjh@cryptsoft.com](mailto:tjh@cryptsoft.com)).

This product contains software which was developed by third parties and / or software which is subject to GNU General Public License (GPL) and/or GNU Lesser General Public License (LGPL). You can pass on and modify them in accordance with Version 2 of the GNU General Public License or optionally every later version which is published by the Free Software Foundation.

The publication of this program by Loewe is carried out WITHOUT ANY GUARANTEE OR SUPPORT, particularly without an implicit guarantee concerning MARKET MATURITY or the USABILITY FOR A SPECIFIC PURPOSE. Details can be found in the GNU General Public License. You can obtain the software via the Loewe customer service department. The GNU General Public License can be downloaded from: <http://www.gnu.org/licenses/>.

## 0-9

**24p motion picture display:** Movies released on Blu-ray Disc support the 24p motion picture display. The Blu-ray player transfers the original film format to the television with 24 frames per second. The DMM (DigitalMovieMode) set in the factory calculates and inserts additional intermediate pictures, which suppress film jerking typical for the cinema, thereby providing for a smooth motion sequence.

## A

**Accurate Recording:** See **Automatic time control**.

**Administrator:** Person who administers the network, i.e. takes care of setting up and maintaining all components belonging to the network.

**Active antenna:** An antenna with its own power supply or amplification which can improve the reception in areas with a poor coverage.

**ARC:** Abbreviation for **Audio Return Channel**.

**Audio Return Channel:** The audio return channel which was introduced with the **HDMI Standard 1.4** is used when an audio system with audio (pre) amplifier, e.g. Loewe MediaVision 3D, is connected to a TV set via HDMI. The digital audio signal of the TV set (e.g. the sound of the current TV program) can be transferred to the audio amplifier via the audio return channel of the HDMI cable. Thus the same cable which is normally responsible for transferring image data from a connected media player to the TV set transfers the audio data in the opposite direction. In this way, the audio return channel makes the cinch cable, which has previously been required in addition to the HDMI cable, redundant.

**Automatic time control:** Also called **Accurate Recording**. Similar to **VPS** for analogue stations the automatic time control monitors the start and end times of programmes from DVB stations. If these times deviate from the data programmed in the timer data, the running time of the recording is adapted automatically. The automatic time control is not supported by all DVB stations.

**AV socket:** Socket for audio and video signals.

**AV sources:** Audio/Video source.

**AVI:** Abbreviation for Audio Video Interleave, a video container file format developed by Microsoft. A single AVI video file can contain several audio, video and text data streams (thus the name container format).

**AVS:** Audio/video sockets on the side of the TV set (cinch and mini-DIN).

## B

**Band:** Name for a transmission range.

**Blu-ray Disc:** The follow-up format of **DVD**. The contents of about five DVDs fit onto one Blu-ray Disc (abbreviated BD). Therefore, the Blu-ray disc provides enough space for high-resolution images and multi-channel sound formats.

**BMP:** Abbreviation for Bitmap, a grid graphics format designed for Microsoft Windows and OS/2 that is wide spread and therefore supported by almost every popular graphics software package without any problems.

## C

**CA Module:** The **Conditional Access module** contains the coding system and compares the transmitted code with the one on the **Smart Card**. If they match, the appropriate stations or programmes are decoded.

**CEC:** Abbreviation for Consumer Electronics Control. CEC provides universal component control functions for entertainment electronics devices (e.g. System standby, One Touch Play). CEC is referred to by Loewe as **Digital Link HD**.

**Channel (WLAN):** Devices that want to communicate with each other have to use the same WiFi channel. In Europe the WiFi frequency band is currently divided into 13 channels.

**Cinch cable:** Cable for transmitting sound or pictures.

**CI slot:** See **Common Interface**.

**Client:** Also called network client, describes an end device such as your TV set that is connected to the network and gets data from a (media) server to make it accessible to the user.

**Common Interface:** The Common Interface (CI slot) is a standardised interface. By inserting suitable decoding modules (**CA modules**) and a **Smart Card** coded digital programmes can be used.

**Common Interface Plus:** CI Plus is an advancement of the **Common Interface** standard. CI Plus slots are in principle downward compatible to the previous CI standard, i.e. CA modules and Smart Cards according to the past CI standard can continue to be used in CI Plus slots, as far as the programme provider permits this. Additionally, extended regulations apply however to CI Plus.

**Component:** See **Component connection**.

**Component connection:** Also referred to as **Component**. Connection where the video signal is transferred via three separate (Cinch) connections. It comprises the brightness signal **Y** as well as the colour difference signals **Pb** (blue component) and **Pr** (red component).

**Conditional Access module:** See **CA module**.

## D

**Decoder:** Analogue, coded TV signals are passed through a decoder and made visible again.

**DHCP:** Abbreviation for Dynamic Host Configuration Protocol. DHCP allows automatic assignment of IP addresses with the aid of a DHCP server.

**DHCP server:** Network service which takes care of automatic assignment of **IP addresses** to clients.

**Digital Link HD:** System for controlling units via the HDMI connection of the Loewe TV set when they have been set up in a covered position.

**DMM:** Abbreviation for Digital Movie Mode. Whether a studio recording, live broadcast, or feature film – the broadcast images are always displayed optimally. Still images are reproduced in all their sharpness and tranquillity. By creating intermediate images, DMM enables perfect studio quality, even with quick movements.

**DNC:** Abbreviation for "Digital Noise Control". Weak TV signals (analogue) can generate disruptive picture noise. DNC adjusts the effect of digital noise reduction to the picture contents.

**DNS:** Abbreviation for Domain Name System. Readable names (e.g. www.loewe-int.de) are assigned to numerical **IP addresses**. DNS servers are responsible for the resolution of readable addresses into the corresponding IP addresses.

**Dolby Digital:** Digital multi-channel sound. The digital standard for high quality home movie systems. The individual channels are broadcast separately in this standard. The three front channels right, left and centre, the two surround channels right and left and the external subwoofer channels are called a 5.1 signal.

**Dolby Pro Logic:** Analogue multi-channel sound. Converts a Dolby-coded stereo signal into a surround sound. This usually contains four channels (front left, centre, front right, surround channel). A special subwoofer channel is not generated in this method.

**Dolby Pro Logic II:** Analogue multi-channel sound. Dolby Pro Logic II is a further development of **Dolby Pro Logic**. This method generates a 6-channel spatial sound from a stereo or Pro-Logic signal (front left, centre, front right, surround left, surround right, subwoofer).

**Dolby Surround:** An analogue surround sound system which uses a matrix coding to fit four sound channels into two sound tracks.

**Dolby Virtual Speaker:** The Dolby Virtual Speaker technology simulates the surround playback of a real 5.1 channel playback with only two speakers.

**DRM:** Digital Rights Management. Processes to control copyright protected data. To be used correctly, DRM protected contents require not only a DRM capable device but also the possession of a license issued by the provider (to be paid for).

**DTS:** Digital Theatre Systems; Digital multi-channel audio.

## D (continued)

**DVB-C/-S/-T:** Digital Video Broadcasting stands for digital television. Technical DVB is the standardised process for transmitting digital content (television, radio, multi-channel audio, room sound, **EPG**, Teletext, and other supplemental services) through digital technology. **CST** for terrestrial or antenna distribution.

**DVD:** Abbreviation for Digital Video Disc and later Digital Versatile Disc.

**DVD preceiver:** Combi device of DVD player and radio without integrated amplifier.

**DVI:** Digital Visual Interface, is an interface for transmitting digital video and graphic data (without audio).

**Dynamic contrast ratio:** Here the light intensity of the display is adapted in case of a high black content in the picture. The so-called backlights are dimmed automatically and the contrast ratio increases temporarily, i.e. dynamically.

## E

**Electronic Programme Guide:** See **EPG**.

**EPG:** Electronic Programme Guide is the electronic variant of a printed TV guide. Using the EPG you can watch the TV programme of the TV station, transfer the appropriate data. The list of programmes contains the title, beginning and end and duration of the programme. In addition brief descriptions of the content of the programmes are also displayed.

**Ethernet:** Cable linked data net technology for local networks (LANs). Also covers standards for e.g. plug connectors and transfer speeds.

**Euro AV socket:** Interface for connecting video devices to a TV set. This socket is also referred to as Scart socket.

**Exif:** Standard format for additional data with modern digital cameras, e.g. date and time, aperture, light sensitivity, alignment of the camera (portrait/landscape).

## F

**FLOF:** Full Level One Facilities. Teletext system in which names and numbers of the jump destinations are transmitted in the bottom line on every page. This guides the reader to related topics for example. An information about which pages exist and which pages have sub-pages is not available in FLOF.

## G

**Gateway:** Transition to another network; in this case connection from the home network to the Internet.

The network device that establishes this connection is normally used as a standard gateway. As a rule, the DSL router also represents the Internet gateway.

## H

**HbbTV:** HbbTV (Hybrid broadcast broadband television) is an industry standard that offers an open platform for technology that is not dependent on manufacturers. HbbTV combines TV programmes with online services seamlessly over broadband Internet (DSL).

**HDCP:** High-bandwidth Digital Content Protection. Coding system provided for the **DVI** and **HDMI** interfaces for secure transmission of audio and video data.

**HDMI:** High Definition Multimedia Interface, represents a newly developed interface for the fully digital transfer of audio and video data.

**HD Ready:** A quality seal that is awarded to products that are capable of displaying high-definition television (**HDTV**).

**HDTV (HD):** High Definition Television is a collective term, designating a series of high-resolution television standards.

**High and low band:** Transmission ranges for satellites.

**Host:** Computer that the server services are provided from, i.e. that makes data available. Refer also to media server.

## I

**ID3 tags:** Additional information for MP3 and WMA audio files. Information about the singer, title, album and album cover can be saved here among other things. This data is then processed by the PC using an ID3 tag editor.

**IP address:** IP addresses (Internet Protocol Addresses) are used to identify devices in an Internet Protocol (IP) network. IP addresses are made up of four groups of numbers of three digits each.

## J

**JPEG/JPG:** Joint Photographic Experts Group is a committee, which has developed a standardised method for the compression of digital images. This method JPEG (**JPG** for short), named after the committee, is a commonly used graphic format for photos.

## L

**LAN:** Abbreviation for Local Area Network. Mainly used as a name for networks with cabling (Ethernet).

**LCD:** Liquid Crystal Display.

**LCN:** Logical Channel Numbers. In stations with LCN, the channel location number belonging to the station is also transmitted by the provider. The stations are sorted according to these channel location numbers.

**L-Link:** Intelligent system connection between Loewe devices for the automatic exchange of information. Makes the operation of TV and Loewe system components even more convenient.

**LNB/LNC:** The crucial electronic component of a satellite antenna is referred to as an LNB (Low Noise Block Converter). It is mounted in the focal point of a parabolic antenna. The designation **LNC** (Low Noise Converter) indicates that conversion to a lower intermediate frequency takes place. The supplemental block in the LNB refers to the fact that a whole frequency range (a block) is converted in each case.

## M

**MAC address:** Hardware address of a network adaptor, e.g., the network card in the PC. It is issued permanently by the manufacturer and is used to uniquely identify devices in networks.

**Mbit/sec:** Information about the transfer rate in networks in megabits, i.e. millions of characters per second. With WLAN the maximum speed is 11 (IEEE 802.11b), 54 (IEEE 802.11g) or 300 (IEEE 802.11n) Mbit/sec, in wired networks 10 Mbit/sec or 100 Mbit/sec (Fast Ethernet).

**Media Server:** Stands for the device on which multimedia content is stored, but is also the name for the service provided by the device that makes this data available to the network.

**Modulator:** Transmitter in the video or DVD recorder so that the devices can receive signals via the tuner of the TV device.

**Mono:** Single channel sound.

**MP3:** Data format for compressed audio files.

**MPEG:** Digital compression method for video.

**Multimedia content:** Videos, music files and photos are grouped together under this term.

## N

**NAS:** The term describes a hard disk which is independently linked to the network (i.e. without a PC).

**Network ID:** NID refers to the so-called programme ID number, also known as network ID – a number between 0 and 8191. This specification is necessary in specific cable networks of some countries. Then only DVB signals of this station network are searched for.

**NICAM:** Audio standard. Is used in Denmark, England, France, Sweden, and Spain.

**NTSC:** American colour standard, stands for National Television Standards Committee.

## P

**Page Catching:** For teletext, refers to marking and calling a page number.

**PAL:** European colour standard, stands for phase alternation line.

**PCM:** Pulse Code Modulation for digital sound.

**Picture in Picture:** See **PIP**.

**PIP:** Picture in Picture; a function which displays two pictures on the screen.

**Pixel:** Also called picture element or pel. Denotes both the smallest unit of a digital graphic grid and its display on a screen with grid control.

**Pixel error:** A pixel error is a defective pixel, usually on an LCD. Pixel errors may be caused by production errors. They are expressed for example by a constantly lit pixel or a constantly black pixel. Single defective pixels however are excluded from a guarantee.

**PNG:** Abbreviation for Portable Network Graphics, a freely available grid graphics format for loss-free compression.

**Port:** It allows assignment of data packages to various services which are running on one device under the same network address.

**Powerline:** Powerline designates a type of wired network connection in which data is transferred via the domestic electricity network using optionally available adaptors.

**Progressive JPEG: Progressive JPEGs** are built up gradually. The quality of the picture increases progressively during the loading process.

**ProScan/Progressive Scan:** Progressive Scan (abbr. PS) or full picture method is a technique in the picture build-up of monitors, TV sets, beamers, and other display devices in which the output device is not sent line interlaced half pictures – unlike in the interlace technique – but real full pictures.

**PSK:** Clients that wish to connect to a wireless network secured with PSK must know this key.

## R

**RGB:** Colour signals Red, Green and Blue.

**Router:** Device for connecting several networks, e.g., home network and Internet.

## S

**Satellite tuner:** Receiver for satellite programmes.

**SDTV:** Standard Definition TeleVision.

**SECAM:** French colour standard, stands for Séquentiel à mémoire.

**Set-top box:** Set-top box (STB for short) refers to a device in entertainment electronics which is connected to another device, usually a TV set, and offers the user additional functional options.

**Signal input group:** Depending on the applied signal, the signal sources are divided into different groups.

**Signal strength:** Strength of the received antenna signal.

**Signal quality:** Quality of the incoming antenna signal.

**Smart Card:** The Smart Card is an electronic chip card issued by the respective programme provider or by the certification free Pay TV operators. It contains the code which is decoded by the **CA module**.

**Static contrast ratio:** Describes the difference between the brightest and darkest picture display.

**Stereo:** Dual channel sound.

**Switch:** Device for connecting several computers to a network.

**Switching voltage:** Video devices supply this voltage to switch the TV set to playback.

**Symbol rate:** Specifies the transmission speed for data transmission.

## T

**Terrestrial:** In data transmission a wireless transmission that does not use satellites as intermediate station is referred to as terrestrial.

**TFT:** Thin Film Transistor. One widely distributed application is control of liquid crystal flat screens, for which a signal transistor is used for each pixel. This design of display is also referred to as active matrix, however it is frequently also referred to as TFT display.

**Tuner:** Another term for receiver.

## U

**USB:** Universal Serial Bus. Serial bus system for connecting external devices (USB card reader, USB stick).

**UPnP AV** Is used to control network devices from all manufacturers. Has become a widespread standard for home networking.

## V

**VGA:** PC interface for connecting a monitor.

**VPS:** The Video Programming System (VPS) is a signal which some (but not all) analogue TV stations transmit in the blanking interval. The signal is used by video and DVD recorders when recording programmes to react to delays in start time, programme changes and excesses of the planned programme time.

## W

**WEP:** Abbreviation for Wired Equivalent Privacy. Former standard process in the WiFi encryption, now outdated.

**Wired network:** see LAN.

**Wireless network:** see WLAN.

**WLAN:** Abbreviation for Wireless Local Area Network. Also abbreviated as wireless network.

**WMA:** Abbreviation for Windows Media Audio, Microsoft own audio data format. As with MP3 files, the content is compressed here as well.

**WMV:** Abbreviation for Windows Media Video, proprietary Microsoft video data format.

**WPA:** Abbreviation for Wi-Fi Protected Access. Replaced WEP as standard encryption for wireless networks.

## Y

### **Ycc/Ypp: Colour standards for Set-top boxes.**

**YCbCr:** Digital colour model, informally also incorrect designation for signals in standard resolution (**SDTV**). The YCbCr colour model, in which, e.g., DVDs are coded, has been developed from the YUV colour model used in analogue television technology. With YCbCr, the data is transferred via digital interfaces such as **DVI** or **HDMI** without being converted.

**YPbPr:** Analogue colour model, see also **Component connection**. The analogue YPbPr signal is generated from the YCbCr signal by a converter in the source player and then output at the 3 component outputs of the source player.

**YUV:** The YUV colour model is used for analogue television in accordance with the standards **PAL** and **NTSC**. YUV is often informally referred to when **YPbPr** (for analogue connections/cables) or **YCbCr** (in digital applications) is actually meant. YUV only occurs in quadrature modulation during PAL or NTSC transfer and is not otherwise used.

- BG** Този уред отговаря на основните изисквания и разширените съответни предпоставки **Директива 1999/5/ЕС**. Разрешено е използването му във всички държави от **ЕС**, и освен това в **Исландия, Норвегия и Швейцария**. Във **Франция и Италия** използването му е разрешено **само в затворени помещения**.
- CZ** Toto zařízení je v souladu se základními požadavky a ostatními odpovídajícími ustanoveními **Směrnice 1999/5/EG**. Může být používán ve všech zemích **EU** dodatečně také na **Islandu, v Norsku a ve Švýcarsku**. Ve **Francii a v Itálii** je použití přístroje dovolené **jenom v interiéru**.
- D** Dieses Gerät entspricht den grundlegenden Anforderungen und den weiteren entsprechenden Vorgaben der Richtlinie **1999/5/EG**. Es darf in allen Ländern der **EU** sowie zusätzlich in **Island, Norwegen** und der **Schweiz** betrieben werden. In **Frankreich und Italien** ist die Nutzung **nur in Innenräumen** zulässig.
- DK** Dette udstyr er i overensstemmelse med de væsentlige krav og andre relevante bestemmelser i **Direktiv 1999/5/EF**. Det må kun anvendes i **EU-landene** samt i **Island, Norge og Schweiz**. I **Frankrig og Italien** er det kun tilladt at anvende det **inden-dørs**.
- E** Este equipo cumple con los requisitos esenciales así como con otras disposiciones de la **Directiva 1999/5/CE**. Puede operar en todos los países de la **UE** y adicionalmente en **Islandia, Noruega y Suiza**. En **Francia e Italia**, su uso está permitido **únicamente en espacios interiores**.
- FIN** Tämä laite täyttää **direktiivin 1999/5/EY** olennaiset vaatimukset ja on siinä asetettujen muiden laitetta koskevien määräysten mukainen. Laitetta saa käyttää kaikissa **EU-maissa** sekä **Islannissa, Norjassa ja Sveitsissä**. **Ranskassa ja Italiassa** laitetta saa käyttää **vain sisätiloissa**.
- F** Cet appareil est conforme aux exigences essentielles et aux autres dispositions pertinentes de la **Directive 1999/5/EC**. L'utilisation est possible dans tous les pays de l'**UE**, en **Islande**, en **Norvège** et en **Suisse**. En **France** et en **Italie** l'utilisation est autorisée **uniquement dans des espaces fermés**.
- GB** This equipment is in compliance with the essential requirements and other relevant provisions of **Directive 1999/5/EC**. It may be operated in all countries in the **EU** and also in **Iceland, Norway and Switzerland**. In **France and Italy** it may only be used **indoors**.
- GR** Αυτός ο εξοπλισμός είναι σε συμμόρφωση με τις ουσιώδεις απαιτήσεις και άλλες σχετικές διατάξεις της **Οδηγίας 1999/5/ΕΚ**. Επιτρέπεται η λειτουργία της σε όλες τις χώρες της **ΕΕ**, καθώς και στην **Ισλανδία**, στην **Νορβηγία** και στην **Ελβετία**. Στην **Γαλλία** και στην **Ιταλία** επιτρέπεται η χρήση **μόνο σε εσωτερικούς χώρους**.
- I** Questo apparato é conforme ai requisiti essenziali ed agli altri principi sanciti dalla **Direttiva 1999/5/CE**. Può essere messo in funzione in tutti i paesi dell'**UE** e inoltre in **Islanda, Norvegia** e in **Svizzera**. In **Francia** e in **Italia** è consentito l'uso **solo in ambienti chiusi**.
- N** Dette utstyret er i samsvar med de grunnleggende krav og andre relevante bestemmelser i **EU-direktiv 1999/5/EF**. Det kan brukes i alle **EU-land** og dessuten i **Island, Norge og Sveits**. I **Frankrike og Italia** er **kun innendørs bruk** tillatt.
- NL** Dit apparaat voldoet aan de essentiële eisen en andere van toepassing zijnde bepalingen van de **Richtlijn 1999/5/EG**. Het gebruik is toegestaan in alle landen van de **EU** en ook in **IJsland, Noorwegen en Zweden**. In **Frankrijk en Italië** is het gebruik **slechts binnenshuis** toegestaan.
- P** Este aparelho está em conformidade com os requisitos fundamentais e todas as restantes disposições da **Diretiva 1999/5/CE**. Pode ser utilizado em todos os países da **UE** assim como na **Islândia, Noruega e Suíça**. Em **França e Itália** a sua utilização apenas é permitida em espaços interiores.
- S** Denna utrustning är i överensstämmelse med de väsentliga kraven och andra relevanta bestämmelser i **Direktiv 1999/5/EC**. Apparaten får användas i alla länder inom **EU** liksom på **Island, i Norge och i Schweiz**. I **Frankrike och Italien** får apparaten användas **endast inomhus**.

Loewe Opta GmbH · Industriestrasse 11 · D-96317 Kronach

## EG-Konformitätserklärung EC Conformity Declaration

Loewe Opta GmbH

Dokument-Nr./Monat . Jahr:  
Document No./Month . Year

52463/52464/52465/ 09-2013

Hersteller:  
Manufacturer:

Loewe Opta GmbH

Handelsname:  
Trade mark:

LOEWE.

Adresse:  
Address:

Industriestrasse 11, 96317 Kronach, Germany

Produkt:  
Product:

Farbf Fernsehgerät mit LCD Flachbildschirm  
Colour Television Receiver with LCD Flat Panel Display

Produktbezeichnung:  
Product designation:

Connect ID 40 / 52463 ; Connect ID 46 / 52464 ; Connect ID 55 / 52465

P.O. Box 15 54  
D-96305 Kronach  
Industriestrasse 11  
D-96317 Kronach  
Phone: +49 9261 99-0  
Fax: +49 9261 95411  
E-mail: loewe@loewe.de  
www.loewe.tv  
Date: 12.09.2013  
Page 1 of 1

Das bezeichnete Produkt stimmt mit den Vorschriften folgender Europäischer Richtlinien überein:  
The designated product conforms to the provisions of the following European directives:

### 2006/95/EG

Richtlinie des Rates vom 12. Dezember 2006 zur Angleichung der Rechtsvorschriften der Mitgliedsstaaten betreffend elektrischer Betriebsmittel zur Verwendung innerhalb bestimmter Spannungsgrenzen - Niederspannungsrichtlinie.  
Electrical equipment designed for use within certain voltages limits - LV-Directive.

### 2004/108/EG

Richtlinie des Rates vom 15. Dezember 2004 zur Angleichung der Rechtsvorschriften der Mitgliedsstaaten über die elektromagnetische Verträglichkeit.  
Electromagnetic compatibility

### 1999/5/EG

Richtlinie des Rates vom 9. März 1999 über Funkanlagen und Telekommunikationsendeinrichtungen und die gegenseitige Anerkennung ihrer Konformität  
Radio equipment and Telecommunications Terminal Equipment and the Mutual Recognition of their Conformity

### 2009/125/EG

Richtlinie des Europäischen Parlaments und des Rates vom 21. Oktober 2009 zur Schaffung eines Rahmens für die Festlegung von Anforderungen an die umweltgerechte Gestaltung energieverbrauchsrelevanter Produkte  
Establishing a framework for the setting of ecodesign requirements for energy-relating products

Anbringung der CE-Kennzeichnung: 13  
Affixing of the CE marking



Die Übereinstimmung des bezeichneten Produkts mit den Vorschriften der Richtlinien wird nachgewiesen durch die vollständige Einhaltung folgender Normen:

The conformity of the designated product with the provisions of Directives is proved by full compliance with the following standards:

#### Richtlinie / Directive 2006/95/EG

EN 60065 2002 + A1 2006, A11 2008, A2 2010, A12 2011

#### Richtlinie / Directive 2004/108/EG

EN 55013 2001 + A1 2003, A2 2006

EN 55020 2007 + A11 2011

EN 55022 2010

EN 55024 2010

EN 61000-3-2 2006 + A1 2009, A2 2009

EN 61000-3-3 2008

#### Richtlinie / Directive 1999/5/EG

EN 62311 2008

EN 301489-1 V1.9.2

EN 301893 V1.6.1

EN 301489-17 V2.1.1

EN 300328 V1.7.1

Aussteller: Loewe Opta GmbH  
Issuer

Ort, Datum: Kronach, den 12.09.2013  
Place, Date

Chairman of the Supervisory Board:  
Michael Blatz

Rechtsverbindliche Unterschrift:  
Legally binding signature

Name: ppa. Roland Bohl  
Director R & D Product Development

i. V. Reiner Nowitzki  
Head of TV Device Development

Board of Management:  
Matthias Harsch (Chairman)  
Rolf Rickmeyer  
Dr. Detlef Teichner

Location of the company: Kronach  
Inferior Court Coburg: HRB 641



<b>0-9</b>		
3D	80	
3D function	82	
<b>A</b>		
Access code	94	
Accurate Recording	74	
Adding stations to personal list	90	
Adjusting the sound	84	
Allow switching voltage	115	
Antenna DVB	113, 115	
Antenna DVB-S	115	
Antenna DVB-T	115	
Archive recording	45	
Audio commentary	102	
Audio commentary volume	84	
AUDIO key	124	
Audio playback		
Playback	61	
Audio playback from external devices	123	
Audio return channel	122	
Auto dimming - Room	80, 82	
Auto dimming - Video (VBD+)	82	
Automatic scan TV+Radio	85	
Automatic shutdown	7	
Auto speech detection	84	
AV connecting setting	115	
AV list	37	
AV output signal	84	
<b>B</b>		
Balance	84	
Batteries	14	
Blu-ray player	117	
Bookmarks		
Delete	59	
Delete individual ones	59	
Jump	58	
Set	45, 57	
Brightness	80	
Browser	70	
Bundling the cables	14	
<b>C</b>		
Calling the Web browser	70	
Camcorder	117, 120	
CA modul	76, 106	
Changing the title of an archive	48	
Character table	18	
CI slot	76	
Cleaning and care	7	
Clear data base	93	
Code number	94	
Coloured keys	41	
Colour intensity	80	
Colour temperature	80	
Component connection	121	
Connecting antennas	12	
Connecting HiFi/AV amplifier	122	
Connecting home network	13	
Connecting the Audio system	122	
Connecting the TV set	12	
Connections	11, 79	
Contrast	80	
Control	79	
Copying/Moving your recordings	49	
Create new personal list	90	
<b>D</b>		
Data capture	93	
Deblocking filter	80	
Delete		
Bookmarks	59	
individual bookmarks	59	
Recording	48	
Delete manager	49	
Set delete protection for timer recording	74	
Setting/cancelling delete protection	49	
Delete personal list	90	
Deleting blocks	89	
Deleting stations from the personal list	90	
Digital Link	116	
Digital Link HD functionality	116	
Digital Link HD (HDMI CEC)	118	
Digital Noise Control (DNC)	80	
Direct recording	45	
One Touch Recording	45	
Display	15	
DR+ archive	47	
DR+ Streaming	50	
Notify started „Follow me“ recording	103	
Playback via the network	50	
DR+ Streaming settings	103	
DR+ device group name	103	
DR+ device name	103	
IP port number	103	
Use Archive other TVs	103	
DVB character set	102	
DVB settings	102	
DVD player	117	
DVI	117	
<b>E</b>		
Edit new personal list	90	
Edit personal list	90	
Energy efficiency	20, 71, 95	
Environment	138	
EPG	38	
Exit Browser	70	
Extras	71	
<b>F</b>		
Favourites	33	
Film quality improvement (DMM)	80	
FLOF	41	
Follow me function	50	
Function list	37	
<b>G</b>		
Game console	116, 117	
Gaming mode	116	
<b>H</b>		
Hard disks	107	
Formatting	107	
HbbTV	43	
HbbTV text	43	
HDMI	117	
HDMI ARC	122	
HDMI CEC	118	
Headphone volume	37	
Home networking systems	123	
Home view	32	

<b>I</b>	
Image+ Active .....	80
Info display .....	19
Installing the TV set .....	12
Integrated features .....	78
Internal WLAN antenna .....	51
Interval functions .....	57
Deleting part of the recording .....	58
Hide .....	58

<b>J</b>	
Jump .....	54
Jump distance .....	103
Jumping to Bookmarks .....	58

<b>L</b>	
Language .....	20, 93, 129
Length of the station list .....	34
LNC/LNB .....	25, 27, 28
Loewe Apps .....	126
Loudness .....	84

<b>M</b>	
Mains switch .....	10, 15
Manual scan Radio .....	85
Manual scan TV .....	85
Maximum volume .....	84
Media	
Access .....	51
Exit .....	51
Overview .....	51
MediaNet	
Browse .....	69
Call .....	68
Exit .....	68
Settings .....	69
Mobile phone keyboard .....	18
Move block .....	89
Move picture up/down .....	80
Move stations in the personal list .....	90
Multimedia / Network .....	79
Multimedia settings .....	112
Music playback	
end .....	63
Radio mode .....	64
Repeat .....	62
Shuffle playback .....	62
Winding .....	61

<b>N</b>	
Network connections	
Wired .....	51
Wireless .....	51
Network selection .....	22, 23
Network settings .....	109
Neue Persönliche Liste anlegen .....	90
Notify hidden sections .....	103
Numerical keys .....	16, 34

<b>O</b>	
One Touch Recording .....	45
On/Off button .....	10, 15
On-screen displays .....	101
OPC .....	80

<b>P</b>	
Page selection .....	41
Parental lock .....	50, 94
PC IN .....	121
PC IN - Display .....	80
Personal list .....	35
Add station .....	90
Create new list .....	90
Delete list .....	90
Delete station .....	90
Move station .....	90
Rename list .....	90
Photo .....	66
Exit .....	67
Full-screen mode .....	67
Rotating the photo .....	67
Slide show .....	67
Picture .....	79, 104
Picture adjustment .....	80, 81
Picture format .....	80, 81
4:3 .....	81
16:9 .....	81
PALplus .....	81
Panorama .....	81
Zoom .....	81
Picture settings .....	80
Positioning/aligning the DVB-T antenna .....	115

<b>Q</b>	
Quick start mode .....	95

<b>R</b>	
Record conflict .....	73
Recording .....	107
Post record time .....	107
Pre-record time .....	107
Remote control .....	9, 14, 124
Remote TV switch on of the TV set .....	116
Renaming the personal list .....	90
Renderer .....	112
Repeat initial installation .....	20, 78
Reset to factory settings .....	78
Network .....	78
Picture/Sound .....	78
Speaker system .....	78
Restore stations .....	89
RS-232C interface .....	123

<b>S</b>	
Safety .....	6, 7
Satellite selection .....	25, 26, 27, 28
Satellite system .....	24
Scope of delivery .....	5
Scrambled stations .....	22, 23, 29, 76, 86
Selecting a station out of the station list .....	34
Select station .....	34
using the numerical keys .....	34
via personal list .....	35
with P+/P- .....	34
Serial recording tolerance .....	103
Service .....	148
Set covers .....	12
Setting the HiFi/AV amplifier .....	114
Setting the volume .....	34
Set-top box .....	117
Sharpness .....	80

Shutdown of the ext. device via TV button .....	116
Side by side .....	82
Signal type .....	115
Skin tone .....	80
Slow motion .....	56
Smart Card .....	76
Smart jump .....	54, 103
Software download .....	96
Software update	
Automatic update via the internet .....	100
Manually via Antenna .....	98
Software update via Antenna .....	99
Via USB memory medium .....	97
Sound .....	79, 84
Sound adjustment .....	84
Sound components .....	114
Special functions .....	78
Standby mode .....	15
Station lists Radio .....	85, 89
Station lists TV .....	85, 89
Stations .....	79, 85
Status display .....	36
STB key .....	124
Stop recording early .....	46
Subtitle .....	45, 59, 102, 103
Supply voltage 5V .....	115
Switching off the TV set during recording .....	46
Switch off .....	15
Switch on .....	15
Switch-on volume .....	84
System settings .....	79

## T

Teletext .....	41
Time and date .....	101
Timer .....	71
Timer list .....	71
Timer Services .....	75
Timer data .....	74
Automatic time control .....	74
Beginning .....	74
Date .....	74
Delete protection .....	74
End .....	74
Favourite .....	74
Lock recording .....	74
Recording subtitles .....	74
Recording type .....	74
Station .....	74
TOP .....	41
Top/bottom .....	82
TV key .....	14, 124
TV on when memorised .....	93
TV viewing with time shift .....	45

## U

UPnP .....	51
USB stick .....	96

## V

VBD+ .....	80
VIDEO key .....	124
Video playback	
Change picture format .....	56
Jump by entering a time .....	54
Playback .....	53
Repeat .....	55
Selecting language/sound .....	56
Winding .....	55
Viewing a locked movie .....	50
Viewing another movie from the archive during archive recording	45

## W

Web .....	68
WEB key function .....	108

## Y

YPbPr .....	121
YUV .....	121

**(A)**  
HB Austria electronic products Vertriebs GmbH  
Pfarrgasse 52  
1230 Wien, Österreich  
Tel +43 - 1 610 48 - 100  
E-mail: support@hb-europe.com

**(AUS)**  
Qualifi Pty Ltd  
24 Lionel Road  
Mt.Waverley VIC 3149 Australia  
Tel +61-03-8542 1111  
Fax +61-03-9543 3677  
E-mail: info@qualifi.com.au

**(B NL L)**  
Loewe Opta Benelux NV/SA  
Uilenbaan 84  
2160 Wommelgem, België  
Tel +32 - 3 - 2 70 99 30  
Fax +32 - 3 - 2 71 01 08  
E-mail: ccc@loewe.be

**(BG)**  
Darlington Service  
193 Kn. Klementina St.  
1612 Sofia, Bulgaria  
Tel +359 - 2 9556399  
E-mail: darlington@psp-bg.com

**(CH)**  
Telion AG  
Rütistrasse 26  
8952 Schlieren, Schweiz  
Tel +41 - 44 732 15 11  
Fax +41 - 44 732 15 02  
E-mail: infoKD@telion.ch

**(CN)**  
Guangdong MG Audio Development Co.Ltd  
No.8 Jinghu Rd. Xinhua St. Huadu Reg.  
GZ, PRC  
Tel +86-(0)20-22675666  
Fax +86-(0)20-22675777  
E-mail: service@loewe-mg.com

Xiamen Tenote Investment Co. Ltd  
26F 3# Xinglin Bay Operation Center,  
No.478 xinglinwan Avenue,  
Jimei District, Xiamen, Fujian, PRC  
Tel +86-400 088 1566  
E-mail: service@loewe-tnt.com

**(CY)**  
Hadjikyriakos & Sons Ltd.  
121 Prodromos Str., P.O Box 21587  
1511 Nicosia, Cyprus  
Tel +357 - 22 87 21 11  
Fax +357 - 22 66 33 91  
E-mail: savvas@hadjikyriakos.com.cy

**(CZ)**  
BaSys CS s.r.o.  
Sodomkova 1478/8  
10200 Praha 10 - Hostivar,  
**Česká republika**  
Tel +420 234 706 700  
Fax +420 234 706 701  
E-mail: office@basys.cz

**(D)**  
Loewe Technologies GmbH,  
Customer Care Center  
Industriestraße 11  
96317 Kronach, Deutschland  
Tel +49 9261 99-500  
Fax +49 9261 99-515  
E-mail: ccc@loewe.de

**(DK)**  
EET Europarts  
Loewe Denmark  
Bregnerødvej 133 D  
3460 Birkerød, Denmark  
Tel +45 - 82 19 19  
E-mail: info@eeteuroparts.dk

**(E)**  
Gaplasa S.A.  
Conde de Torroja, 25  
28022 Madrid, España  
Tel +34 - 917 48 29 60  
Fax +34 - 913 29 16 75  
E-mail: loewe@maygap.com

**(F)**  
Loewe France SAS  
Rue du Dépôt,  
13 Parc de l'Europe, BP 10010  
67014 Strasbourg Cédex, France  
Tel +33 - 3 - 88 79 72 50  
Fax +33 - 3 - 88 79 72 59  
E-mail: loewe.france@loewe-fr.com

**(FIN)**  
EET Europarts  
Loewe Finland  
Metsänneidonkuja 12  
02130 Espoo, Finland  
Tel +358 9 47 850 900  
www.eeteuroparts.fi

**(GB IRL)**  
Loewe UK Limited  
1st Floor, 237A Kensington High St  
London  
W8 6SA, UK  
Tel +44 - (0) 207 368 1100  
Fax +44 - (0) 207 368 1101  
E-mail: enquiries@loewe-uk.com

**(GR RO AL)**  
Issagogiki Emboriki Ellados S.A.  
321 Mesogion Av.  
152 31 Chalandri-Athens, Hellas  
Tel +30 - 210 672 12 00  
Fax +30 - 210 674 02 04  
E-mail: christina\_argyropoulou@  
isembel.gr

**(H)**  
Basys Magyarországi KFT  
Tó park u.9.  
2045 Törökbálint, Magyar  
Tel +36 - 23 887-920  
Fax +36 - 23 41 51 82  
E-mail: ertesites@basys.hu

**(HR)**  
Plug&Play Ltd.  
Bednjanska 8, 10000 Zagreb  
Hrvatska (Kroatia)  
Tel +385 1 4929 683  
Fax +385 1 4929 682  
E-mail: info@loewe.hr

**(I)**  
Loewe Italiana S.r.L.  
Via Monte Baldo, 14/P - 14/N  
37069 Dossobuono di Villafranca di  
Verona  
Tel +39 - 045 82 51 690  
Fax +39 - 045 82 51 622  
E-mail: info@loewe.it

**(IL)**  
Clear electronic entertainment Ltd  
13 Noah Mozes St.  
Agish Ravad Building  
Tel Aviv 67442, Israel  
Tel +972 - 3 - 6091100  
Fax +972 - 3 - 6092200  
E-mail: info@loewe.co.il

**(IND)**  
MIHAUS.  
Plot No.390, M.G.Road  
Near Ghitorni Metro Station  
Opp.Metro Pillar No.112  
Ghitorni, New Delhi-110030, India  
Tel. +91 11 64008851  
Tel. +91 11 64008854  
Fax +91 11 47675615  
E-Mail: corporate@mihaus.in

**(IR)**  
Pars Royal Taramesh  
LOEWE Gallery  
#3 Shariati St. Opp. Soheil St.  
P.O Box 1914965537  
Tehran, Iran  
Tel + 98 21-22391661  
E-Mail: info@tarameshgroup.com

**(JOR)**  
ACCU-TECH Solutions Co.  
1-Kharija Al-Ashja'i Street  
Jabal Al-Weibdeh  
P.O.Box 9668 Amman 1191, Jordan  
Tel: +962-6-465-9985  
Fax: +962-6-465-0119  
E-Mail: info@accutech-solutions.net

**(KSA)**  
LOEWE Show Room  
Olaya Street, Near Kingdom Center  
RIYADH, SAUDI ARABIA  
P.O.Box 92831 Riyadh 11663  
Tel +966-11-4640927  
Fax +966-11-4640759  
E-mail: hkkurkjian@gmail.com

**(LV EST)**  
Kpartners, SIA  
**A.Čaka iela 80**  
**Rīga, LV-1011, Latvia**  
Tel +3 71 - 67 29 29 59  
Fax +3 71 - 67 31 05 68  
E-mail: evgenii.bebnev@loewe.lv

**(LT)**  
A Cappella Ltd.  
Ausros Vartu 5, Pasazo skg.  
01129 Vilnius, Lithuania  
Tel +370 - 52 12 22 96  
Fax +370 - 52 62 66 81  
E-mail: info@loewe.lt

**(M)**  
Doneo Co. Ltd  
34/36 Danny Cremona Street  
Hamrun, HMR1514, Malta  
Tel +356 - 21 - 22 53 81  
Fax +356 - 21 - 23 07 35  
E-mail: service@doneo.com.mt

**(N)**  
Premium Consumer Electronics as  
Østre Kullerød 5  
3241 Sandefjord, Norge  
Tel +47 - 33 29 30 40  
Fax +47 - 33 44 60 44  
E-mail: loewe@loewe.no

**(P)**  
Gaplasa S.A.  
Rua Professor Henrique de Barros  
Edifício Sagres, 2º. C  
2685-338 Prior Velho, Portugal  
Tel +351 - 21 942 78 30  
Fax +351 - 21 940 00 78  
E-mail: geral.loewe@mayro.pt

**(PL)**  
3LOGIC Sp.z o.o.  
**ul. Zakopiańska 153**  
30-435 Kraków  
Tel +48 - 12 640 20 00  
Fax +48 - 12 640 20 01  
www.3logic.pl

**(RI)**  
V2 Indonesia  
5th Intiland tower  
Jl. Jenderal Sudirman 32  
Jakarta 10220, INDONESIA  
Tel +62-21 57853547  
E-mail: service@v2indonesia.com

**(RL)**  
I Control SAL  
Gemmaizeh, Rmeil.  
Building 328 1st Floor Beirut, Lebanon  
Tel +961 1 446777 / 1 587446  
Fax +961 1 582446  
E-mail: info@icontrol-leb.com

**(RUS)**  
Service Center Loewe  
Aptekarsky per.4 podjez 5A  
105005 Moscow, Russia  
Tel +7 - 499 940 42 32 ( ext. 454 )  
Fax +7 - 495 730 78 01  
E-mail: service@loewe-cis.ru

**(S)**  
EET Europarts AB  
Loewe Sweden  
Box 4124  
SE-131 04, Nacka, Sverige  
Tel +46 - 8 507 510 00  
E-mail: Kundservice@eeteuroparts.se

**(SGP)**  
Atlas Care Centre  
11 changi south street 3  
#03-01 builders centre  
Singapore 486122  
Tel +65 - 6745 2028  
Fax +65 - 6546 7861  
E-mail: service@atlas-sv.com

**(SK)**  
BaSys SK, s.r.o.  
Stará Vajnorská 37/C  
83104 Bratislava, Slovakia  
Tel + 421 2 49 10 66 11  
Fax + 421 2 49 10 66 33  
E-mail: loewe@basys.sk

**(TR)**  
ENKAY GROUP  
SERVISPLUS MUSTERI HIZMETLERI  
Alemdag Cad. Site Yolu No:18  
Umraniye, Istanbul, TÜRKIYE  
Tel 444 4 784  
E-mail: info@servisplus.com.tr

**(UAE)**  
Dubai Audio Center  
P.O. Box 32836, Sheikh Zayed Road  
Dubai, UAE  
Tel +971 - 4 343 14 41  
Fax +971 - 4 343 77 48  
E-mail: service@dubaiaudio.com

<b>STB</b>					
<b>ABSAT</b>	166, 169	CONDOR	164, 226	GENEX	317
AEGIR	179	CONNEXIONS	047, 096, 226, 231	GENERAL-INSTRUMENTS	024
AIWA	141	CONRAD	006, 010, 164, 169, 226, 230	GIUCAR RECORD	332
AKAI	033, 104	CONTEC	054, 135, 169	GMI	089
ALBA	060, 017, 067, 104, 111, 126, 180, 201	COSAT	059	GOLDBOX	175
ALCATEL	336	CROWN	175	GOODMANS	128, 191, 211
ALDES	133, 168, 179, 201	CRYPTOVISION	067, 315	GRAETZ	067, 111
ALLSAT	033, 048, 059, 077, 201	CYBERMAXX	116	GRANADA	088, 099
ALLSONIC	133, 168, 226	CYRUS	037	GRANDIN	021, 099
ALLTECH	060, 137, 225	DAERYUNG	047	GRANDIEN	185, 239
ALPHA	033	DAEWOO	060, 017, 025	GROTHUSEN	017, 193
ALTAI	047	DANSAT	048, 077	GRUNDIG	026, 003, 067, 090, 097, 171, 172, 176, 217, 227, 240, 241, 242, 020, 307, 316
AMITRONICA	060	DAUMLING	163	HANSEATIC	197
AMPERE	047, 186, 207	D-BOX	045, 214	HANTOR	017, 094
AMSTRAD	060, 006, 047, 071, 097, 132, 165, 174, 175, 186, 212, 216, 217, 227, 228	DECCA	038	HANURI	179
ANGLO	060	DECSAT	310	HARTING UND HELLING	133
ANKARO	060, 051, 133, 161, 162, 168, 226	DECSAT CANAL	310	HASE & IGEL	161
ANTTRON	017, 077, 180	DELFA	212	HELIOCOM	164
APOLLO	017	DEUTSCHE TELEKOM	056	HIGH PERFORMANCE	085, 122
ARCON	025, 051, 079, 132, 136, 161	DEW	025, 054	HINARI	017, 077
ARMSTRONG	033, 175	DIAMOND	225	HIRSCHMANCE	090
ARTHUR MARTIN	130	DIRECTV	144	HIRSCHMANN	006, 009, 010, 047, 081, 113, 133, 171, 172, 176, 196, 203, 216, 219, 243
ASA	009	DISCOVERER	197	HISAWA	094
ASAT	025, 033	DISEQC	171, 172	HITACHI	067, 106, 111, 120
ASLF	060	DISK EXPRESS	051	HNE	165
AST	127, 194	DISMOND	225	HOUSTON	059, 071, 161, 162, 171
ASTACOM	171, 172	DISTRATEL	119, 146, 147, 149, 185, 217	HUMAX	212, 236, 244, 005
ASTON	032, 095	DISTRISAT	033, 059	HUTH	013, 054, 059, 094, 133, 136, 161, 162, 163, 164, 168, 169, 175, 186
ASTRA	013, 021, 025, 098, 099, 164, 175, 178, 190, 222, 223	DNR	161	HYPERVISION	345
ASTRO	006, 091, 094, 176, 177, 179, 180, 181	DNT	033, 037, 047, 231	ICX	138
AUDIOTON	059, 180	DRAKE	029	IKUSI ALLSAT	136
AUSTAR	212, 332	DST	017	IMEX	185
AVALON	047	DUAL	025	IMPERIAL	126
AXIS	054, 210, 223, 226	DUNE	226	INGELEN	088, 099
<b>BARCOM</b>	021, 051	DYNASAT	196	INNOVATION	116
BEKO	067	<b>E</b> CHOSTAR	060, 021, 047, 086, 088, 128, 211, 213	INTERNATIONAL	186
BEST	051, 226	EIF	014, 198	INTERTRONIC	175
BIRMINGHAM CABLE	343	EINHELL	060, 006, 017, 097, 163, 168, 169, 175, 186, 222	INTERVISION	042, 059, 164, 170
BLAUPUNKT	090, 176	ELEKTA	179	INVIDEO	213
BLUE SKY	060, 217	ELSAT	071	ITALTEL	213
BOCA	163, 169, 175, 186, 199, 207, 222	ELTA	017, 033, 059, 226	ITT	021, 067, 088, 099, 120, 123
BRAIN WAVE	094, 161	ELTASAT	059	ITT NOKIA	009, 010, 021, 067, 088, 099, 120, 123, 214
BRANDT	069	EMANON	017	JEEMON	059
BRITISH SKY BROADCASTING	050, 227	EMME ESSE	133, 213, 226	JERROLD	138, 330, 332, 341, 343
BRITISH TELECOM	341	ENGEL	060	JOHANSSON	059, 094
BROADCAST	013	EP SAT	067	JOK	171, 172, 200, 229
BROCO	060, 223	EURIEULT	185, 217	JSR	059
BRUNS	133	EUROCRYPT	021, 067	JVC	003, 104
BSKYB	227	EURODEC	110, 232	<b>K</b> ABELVISION	330
BT	104, 171, 172, 229, 335	EUROPA	006, 033, 161, 162, 164, 169, 212	KAMM	060, 215
BT SATELLITE	171	EUROPEAN	163	KATHREIN	060, 033, 037, 080, 081, 090, 091, 094, 096, 112, 114, 135, 166, 176, 180, 196, 204, 218, 245, 246
BUBU SAT	060	EUROSAT	175, 225	KEY WEST	163
BUSH	048, 077, 106, 126	EUROSKY	164, 175, 186, 226	KOLON	017
BVV	161	EUROSTAR	164, 215, 233, 234	KONIG	164
<b>C</b> ABLETIME	308, 311, 312, 333, 334	EUTRA	137, 203	KOSCOM	210
CAMBRIDGE	006, 104, 199	EXATOR	017, 104, 180	KOSMOS	080, 081, 133, 193
CANAL	019	<b>F</b> AGOR	059	KR	059, 137, 180, 203
CANAL DIGITAL	128	FERGUSON	023, 048, 067, 077, 106, 108, 111, 124, 206	KREISELMEYER	176
CANAL PLUS	128, 019, 320, 321	FIDELITY	006, 071, 097	K-SAT	060
CANAL SATELLITE	128, 191, 211	FILMNET	318	KYOSTAR	017, 180
CANARY	137	FINLANDIA	021, 067	KYOTO GMI ATLAN	143
CANARAT.SOM	054	FINLUX	009, 010, 021, 067, 220	<b>L</b> GS ELECTRONIC	226
CHAPARRAL	012, 134	FINNSAT	110	LASAT	054, 164, 175, 179, 186, 199, 222, 226
CHESS	197	FLAIR MATE	060	LEMON	161, 162, 247
CITYCOM	135, 164, 203, 204, 230	FORCE	068	LENCO	060, 017, 025, 079, 161, 162, 164, 193, 221, 223, 226
CLARK	180	FOXTEL	235, 022, 319	LENNOX	042, 059
CLATRONIC	094	FRACARRO	017, 087, 196, 213	LENSON	006
CLEMENS KAMPHUS	133, 210	FRANCE TELECOM	344	LEXUS	033
CLYDE CABLE VISION	317	FREECOM	017, 193, 201	LEYCO	104
CNT	179	FREESAT	137	LG (GOLDSTAR)	079, 107, 193
COMCAST	004	FTE	060, 080, 136, 137, 169, 196, 199, 212, 226	LIFESAT	197, 226
COMCRYPT	320, 321	FUBA	010, 014, 017, 021, 047, 051, 088, 135, 176, 220, 226	LIFETEX	116
COMMANDER	161, 162	<b>G</b> SAT	077, 130	LOKIA	088
COMM LINK	168	GALAXI	051		
COMMUNICADO	054	GALAXIS	054, 059, 133, 161, 168, 209, 210, 211, 212, 223, 226, 236, 237, 238		
COMTEC	054, 168	GALAXISAT	127		
		GARDINER	204		
				LORENZEN	161, 162, 163, 164, 165, 186
				LORRAINE	193
				LUPUS	226
				LUXOR	006, 010, 021, 088, 097, 099, 120, 123, 130, 214
				LYONNAISE	110
				<b>M</b> &B1	197
				MACAB	225, 232, 248, 329
				MAGAI	080
				MANATA	060, 171, 172
				MANHATTAN	042, 059, 067, 106, 111, 151, 171, 172, 179, 210, 221
				MARANTZ	033, 037
				MASCOM	081
				MASPRO	060, 026, 003, 093, 096, 106, 108, 113, 137, 161, 176, 242
				MASTER_S	135
				MATSUI	003, 109, 171, 172, 176
				MAX	164
				MB	197
				MEDIABOX	191, 211
				MEDIAMARKT	175
				MEDIASAT	006, 128, 191, 211, 223
				MEDION	060, 226
				MEDISON	060
				MEGA	033
				MELETRONIC	204
				MEMPHIS	054, 134
				METRONIC	060, 017, 117, 119, 121, 131, 146, 147, 149, 151, 152, 153, 154, 156, 157, 168, 175, 179, 180, 185, 204, 217
				METZ	090, 176
				MICRO	164, 180
				MICRO ELECTRONIC	060
				MICRO MAXX	116
				MICRO STAR	116
				MICRO TEC	060
				MICRO TECHNOLOGY	060, 190, 223
				MICRONIK	249
				MINERVA	003, 090
				MITSUBISHI	067, 090
				MITSUMI	222
				MNET	320, 321, 342
				MORGAN	060, 033, 059, 132, 163, 169, 175, 186, 199, 207, 222, 250
				MOVIE TIME	328
				MR ZAPP	329
				MULTICHOICE	100, 235
				MULTISTAR	080
				MURATTO	127, 193
				MYRYAD	037
				MYSAT	060
				<b>N</b> AVEX	094
				NEC	030, 073
				NEIRU	079
				NETA P	140
				NETWORK	077
				NEUHAUS	060, 006, 059, 161, 162, 164, 169, 210, 223, 060, 161, 210
				NEUSAT	060, 175, 201
				NEXTWAVE	138
				NIKKO	060, 175, 201
				NOKIA	009, 010, 021, 045, 067, 088, 099, 105, 120, 123, 211, 214, 242, 251, 346
				NOMEX	221
				NOOS	329
				NORCO	221
				NORDMENDE	017, 067, 179, 206
				NOVIS	094
				NSC	328
				NTC	133, 203
				NTL CABLETELL	332
				<b>O</b> CEANIC	225
				OCTAGON	017, 025, 054, 161, 162, 180
				OKANO	080, 133, 175
				OLYMPIC	133
				ONDIGITAL	187, 188, 189
				ONO	301
				OPTEX	059, 135, 196, 208

OPTIMA	133	SATMASTER	013	191, 205, 206, 211	
OPTUS	332	SATPARTNER	017, 079, 094, 133, 179,	225	
ORBIT	025, 194		180, 193, 201	THORN	067
ORBITECH	006, 017, 103, 169, 181, 224	SATSTATION	151	THORN-FERGUSON	023, 048, 067
ORIGO	126, 221	SAVA	077, 108, 161, 164, 171,	TIOKO	135, 175
OSAT	097		172, 179, 200, 201, 206, 217	TLEWIRE	059
OTTO VERSAND	090	SCHACKE	180	TOKAI	033
OXFORD	104	SCHAUB LORENZ	088, 099	TONNA	060, 006, 013,
<b>P</b>		SCHNEIDER	171, 172, 218		059, 067, 171, 210
PACE	001, 022, 044, 048, 050,	SCHWAIGER	077, 114, 135, 161, 164,	TOPFIELD	011
	067, 077, 098, 108, 124,		169, 197, 217, 255	TORX	341
	189, 202, 227, 242, 252,	SCIENTIFIC ATLANTA	305, 306, 325, 326	TOSHIBA	067, 145
	253, 319, 347	SEDEA-ELECTRONIQUE	017	TPS	129, 205
PACIFIC	225	SEEMANN	047, 104, 175, 223	TRENDLINE	222
PACKSAT	171, 172	SEG	017, 094, 165,	TRENDPLAIN	222
PALCOM	092		178, 190, 197, 226	TRGRA	088
PALLADIUM	003, 006, 017, 175	SELECO	059, 213	TRIAD	085, 101, 127, 193, 194
PALSAT	006	SEPTIMO	146, 151, 154	TRIASAT	006, 220
PANASAT	235, 254	SERVI SAT	059	TRIAx	060, 006, 033,
PANASONIC	031, 067, 124, 227	SIEMENS	090, 176, 199		047, 211, 220, 230
PANDA	021, 048, 067, 164, 176, 210	SILVA	079, 193	TRISTAR	025
PATRIOT	104	SINTRACK	013	TUDI	327
PHILIPS	026, 003, 033, 037, 051,	SKANTIN	060	TWINNER	115, 119
	067, 077, 124, 128, 144,	SKARDIN	223	<b>UNIDEN</b>	058, 071, 080, 148, 208
	156, 161, 162, 169, 171,	SKINSAT	006	UNISAT	033, 054, 175
	172, 176, 180, 187, 188,	SKR	060	UNITED CABLE	330, 341
	191, 204, 211, 218, 229,	SKY	034, 050, 189, 227, 001	UNITOR	051, 094
	242, 313, 323, 329, 345	SKY MASTER	060, 133, 168,	UNIVERSUM	003, 009, 071,
PHOENIX	054, 077		170, 197, 215		164, 165, 176
PHONOTREND	042, 059, 133,	SKY PLUS	002	<b>VAIADIGITAL</b>	078
	142, 168, 212	SKYLAB	051	VARIOSAT	176
PIONEER	128, 191, 211, 302	SKYMAX	033	VARIOSAT	176
PIXX	255	SKYSAT	197	VECTOR	178
PLANET	126, 213	SKYVISION	059	VENTANA	033, 037
POLSAT	110	SL	161, 165, 175, 186	VESTEL	165
POLYTRON	047, 135	SM ELECTRONIC	060	VIASAT	016
PREDKI	017, 094	SMART	186	VIDEOCRYPT	023
PREISNER	047, 103, 163, 169,	SONY	067, 211, 227	VIDEOTRON	331
	175, 186, 199, 222	SR	222	VIDEOWAY	331
PREMIER	059, 133	STARLAND	060	VIDIO WAY	015
PREMIERE	191, 211, 214, 007	STARRING	094	VIPER	054
PROMAX	067	STARSAT	080	VIRGIN MEDIA	063
PROSAT	168, 170	STRONG	017, 025, 179, 180, 186,	VISIOPASS	309, 313, 329
PROSONIC	165		196, 211, 226, 235	VISIOSAT	060, 194, 200
PROTEK	225	STS	328	VIVA	161, 162
PROVISAT	201	STV	014	VORTEC	017, 082, 083, 132, 142
PROVISION	179	STVI	014, 137	VTECH	127, 194, 200, 204
PVP STEREO VISUAL	330	SUMIDA	175	<b>WELA</b>	060, 163, 169, 186
PVP STEREO VISUAL MATRIX	341	SUNNY SOUND	226	WESTMINSTER	335
PYE	003	SUNSAT	060, 223	WETEKOM	006, 197, 207
PYXIS	208, 210	SUNSTAR	163, 175, 186, 222, 226	WEWA	067
<b>Q</b>		SUPERCABLE	343	WIBO	175
QUADRAL	168, 169, 170,	SUPERNOVA	189	WINERSAT	094
	171, 172, 173, 226	<b>T</b>	059	WINTERGARTEN	168
QUELLE	090, 097, 164, 165	TAGRA	008	WISI	006, 047, 067, 088,
QUIERO	110	TANDBERG	085, 122		123, 127, 164, 169,
<b>R</b>		TANDY	067, 108		176, 194, 200, 210
RADIOLA	033, 037	TANTEC	067	WITTENBERG	071
RADIX	047, 137, 216	TATUNG	067	WOLSEY	085, 122
RAINBOW	137, 180	TCM	116	WOORISAT	179
RC	138	TECHNILAND	013, 059	WORLD	094
RC-1000	104	TECHNISAT	006, 028, 033, 047, 102	WORLDSAT	171, 172
RED STAR	226		103, 181, 184, 224, 231	<b>X</b>	169
REDPOINT	223	TECHNOWELT	164	COM	046
REDSTAR	226	TECO	025, 175, 222	XCOM MULTIMEDIA	226
RFT	033, 037, 161, 162, 168, 224	TELASAT	164, 197	XRYPTON	226
ROADSTAR	060	TELECIEL	180, 201	XSAT	060, 046, 166, 169
ROVER	060, 170	TELECOM	060	<b>Y</b>	189
<b>S</b>		TELEDIREKT	077	<b>Z</b>	161
SABA	077, 108, 161, 164,	TELEFUNKEN	017, 083, 171, 172	AUNKONIG	
	171, 172, 179, 200,	TELEKA	026, 006, 047, 081, 103,	ZEHNDER	051, 080, 114, 127, 135
	201, 206, 217, 229		180, 161, 164, 175, 203, 210		165, 179, 204, 226, 255
SABRE	067	TELEMASTER	179	ZENITH	034, 314
SAGEM	205, 329	TELEMAX	018	ZETA-TECHNOLOGY	033
SAKURA	054, 057	TELEPIU	320, 321	ZODIAC	180
SALORA	021, 088, 099, 120, 130, 303	TELE PLUS ONE	320, 321	ZWERGNASE	163, 175
SAMSUNG	017, 080, 127, 132,	TELESAT	164, 197		
	211, 243, 302, 324	TELESERVICE	311, 314		
SAT	006, 071, 127, 194	TELESTAR	006		
SAT PARTNER	017, 094, 133,	TELETECH	215		
	179, 180, 193, 201	TELEVES	006, 067		
SAT TEAM	060	TELEWIRE	059		
SATBOX	304	TENSAI	025, 094		
SATCOM	013, 164, 197	TEVION	116		
SATEC	060, 077, 242	THOMSON	060, 049, 067, 128,		
SATECO	017		155, 164, 171, 172,		
SATELCO	226				
SATFORD	013				
SATLINE	170				









---

---

**LOEWE.**