

Disney Parks Blog

presents

Disney Paper Parks

Sleeping Beauty Castle

designed by Stephanie Jazmines

featuring a
Disney Fireworks Spectacular
drawn by Amy Young and Michelle East



Walt Disney IMAGINEERING

#DisneyMagicMoments | #DisneyPaperParks



Disney Paper Parks

#DisneyMagicMoments | #DisneyPaperParks

SLEEPING BEAUTY CASTLE

Sheet Numbers: 1 - 18

Approximate assembly time: 2-3 hours

HISTORY

Inspired by King Ludwig III's Neuschwanstein Castle in Bavaria, Sleeping Beauty Castle opened on July 17, 1955, along with Disneyland Park. Although inspired by the soaring castles of Europe, the Disneyland Castle was proportioned more to the imagination than history. Walt wanted the scale to be warm and welcoming.

Although this centerpiece was there when the park opened, guests could not actually walk through the castle's interior until 1957. Inside, guests can experience special 3D dioramas and effects that tell the Sleeping Beauty story. We invite you to make your own version of a Sleeping Beauty Castle diorama.

INSTRUCTIONS

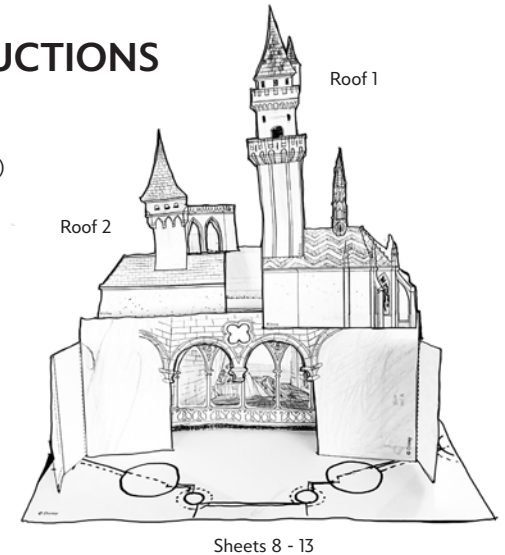
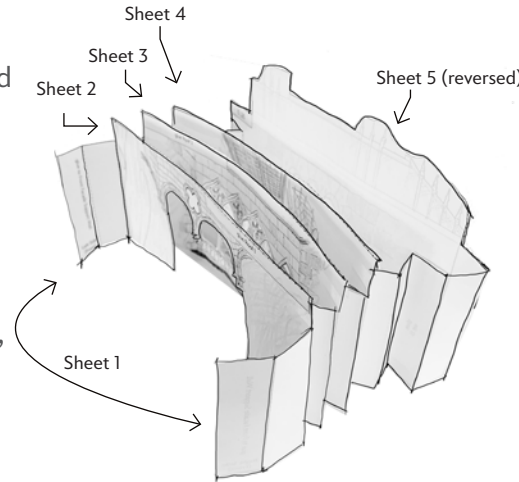

PART I : THE DIORAMA : Sheets 1 - 13

MATERIALS



GUIDE

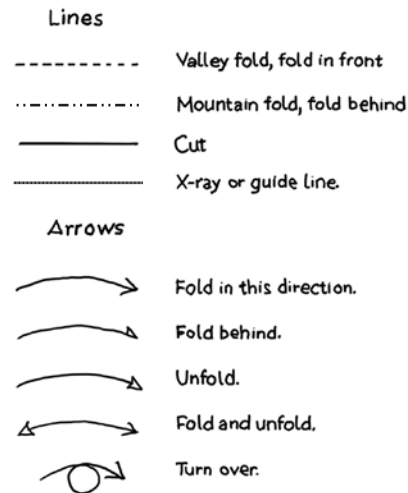

1. Color all of the pages.
2. Cut out the rectangles on Sheet 1. Please note that these pieces will go from edge to edge on the paper. Use the guidelines to make an accordion fold.
3. Cut out the set pieces on sheets 2, 3, 4, and 5. Ask an adult to help cut out the center portions, as these will serve as windows through the diorama. Glue and fold back the tops and bottoms of the rectangles to keep the pages standing straight! Note that Sets A and B face the front while Set D faces the back. Fold and glue Set C, so it faces both front and back.
4. Cut out the roof pieces on sheets 6 & 7. Glue each side to its corresponding set pieces. Pay attention to the notes on each page to avoid confusion. Add craft sticks or toothpicks to the tall pieces for added stability.
5. Using the labels on the accordion pieces as a guide, carefully match the set pieces with the sides and glue together.
6. Arrange sheets 8-13 to form the plan and place the castle on top.

Please Note: When cutting with scissors and working with any of the materials listed above, adult participation and supervision is recommended.



Disney Paper Parks

#DisneyMagicMoments | #DisneyPaperParks

SLEEPING BEAUTY CASTLE

Sheet Numbers: 1 - 18

INSTRUCTIONS, continued

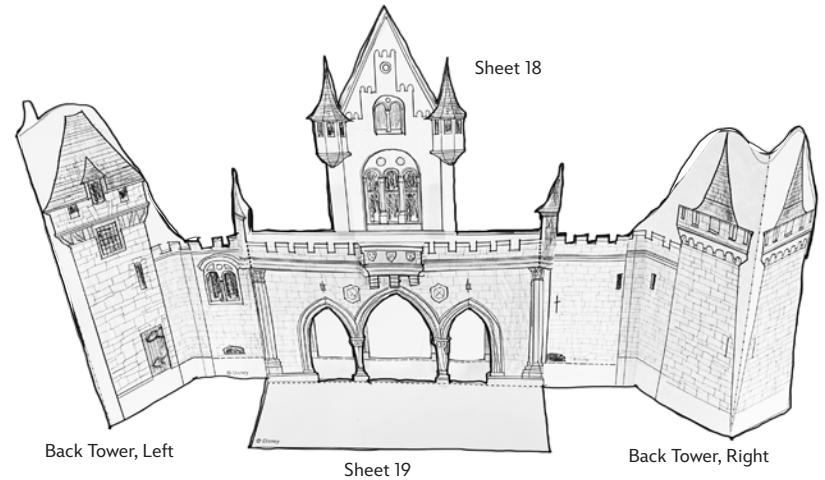
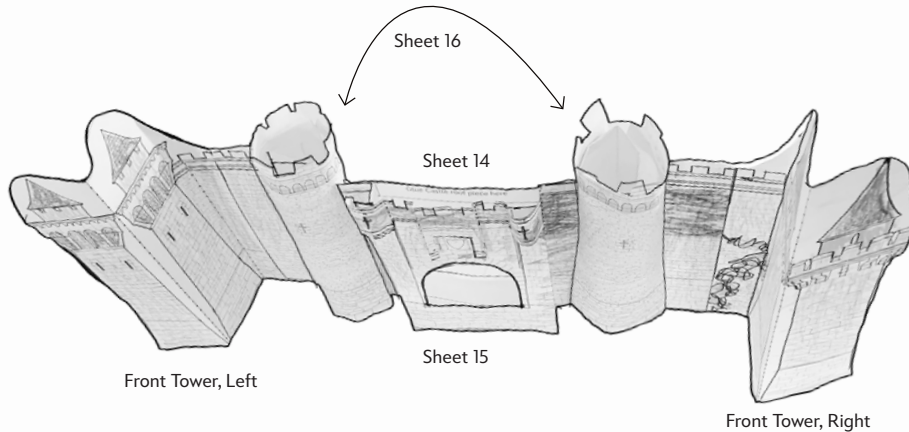

PART II : FRONT FACADE : Sheets 14 - 17

1. Cut out “castle gate” and “front facade support wall.” Set gate aside for later.
2. Cut out facade pieces from sheet 14 and 15. Fold and glue “front facade wall” to the support wall, leaving ends open for now. Cut along the slits.
3. Cut out entry towers 1 and 2 on sheet 16. Fold the top back and forth to form a ledge and roll into a cylinder and glue. Do not forget to cut the slits! Line up the slits with the wall and push down to secure in place. Templates for the conical roofs can be found on Sheet 7.
4. Cut out the Entry Towers on sheet 17. Fold and apply glue to the front of the edge wall and glue to the back of the front facade wall end of the corresponding facade.

PART III : BACK FACADE : Sheets 18 - 20

1. Cut out the back facade support wall. Add craft sticks to help support the tallest central part. You can also use straws or coffee stirrers for longer supports.
2. The construction of the back facade wall will be similar to the front. The white part on the bottom will serve as a ramp to the ground.
3. Cut out the back towers. Fold and apply glue to the back of the wing walls, using the line in front as a guide. Glue to the corresponding sides of the back facade.

PLAN LAYOUT

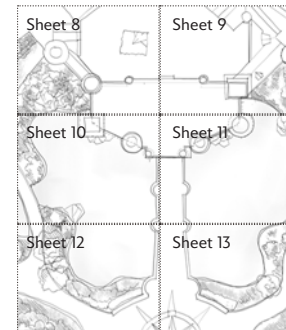



Disney Paper Parks

#DisneyMagicMoments | #DisneyPaperParks

SLEEPING BEAUTY CASTLE

Sheet Numbers: 1 - 18

Approximate assembly time: 2-3 hours

INSTRUCTIONS, continued

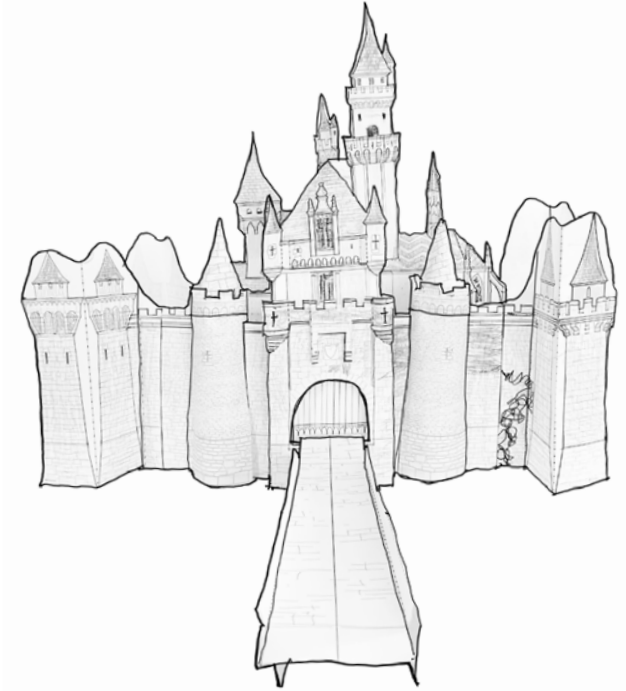
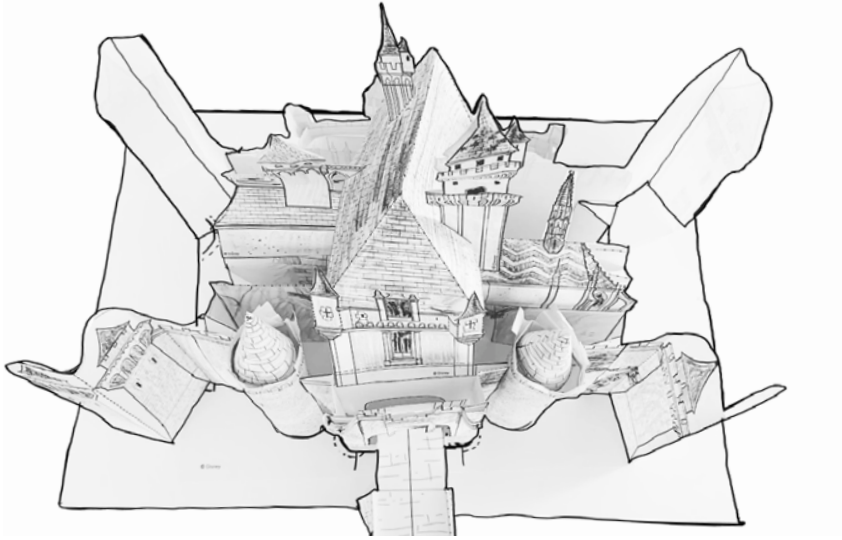

FINAL ASSEMBLY : Sheets 21 - 23

1. First, attach the Front facade to the diorama by applying glue to the accordion ends and fixing it to the back of the front facade support wall. This should sit on either side of the turrets. Attach the back facade the same way.
2. Cut out all pieces. Take the “central window” piece, fold, and glue onto the overall roof facade. Fold the facade and roof pieces, and glue the top of the roof together.
- 3.
4. Attach a straw or craft stick to the back of the facade for stability. When dry, glue the bottom of the facade to the support wall, where labeled.
5. Carefully glue the end tabs of the roof to the back facade, making sure to align the towers into their corresponding slots. Cut out the large spire pieces, crease along the line, carefully lower into the hole in the roof, glue to the underside of the roof along the crease. Glue the tops together.
6. Cut out the bridge piece and follow along the crease lines to form the railing. Glue together. Fold the smaller end to form a 90 degree angle use that to hang the bridge off of the front facade opening. Finally, hang the castle gate in between the front facade wall and front facade supporting wall, where indicated. Lift it up to reveal your finished diorama!
7. Cut out and fold trees into a triangular shape and glue the tops together. Print as many as you'd like to place around the castle.



Disney Paper Parks

#DisneyMagicMoments | #DisneyPaperParks

SLEEPING BEAUTY CASTLE

Sheet Number: 1

DIORAMA SIDES

© Disney

glue to Front Facade Support Wall

glue
set A

glue
set B

glue
set C

glue
set D

Left Side
(Front)

glue
set D

glue
set C

glue
set B

glue
set A

glue to Front Facade Support Wall

Right Side
(Front)

© Disney

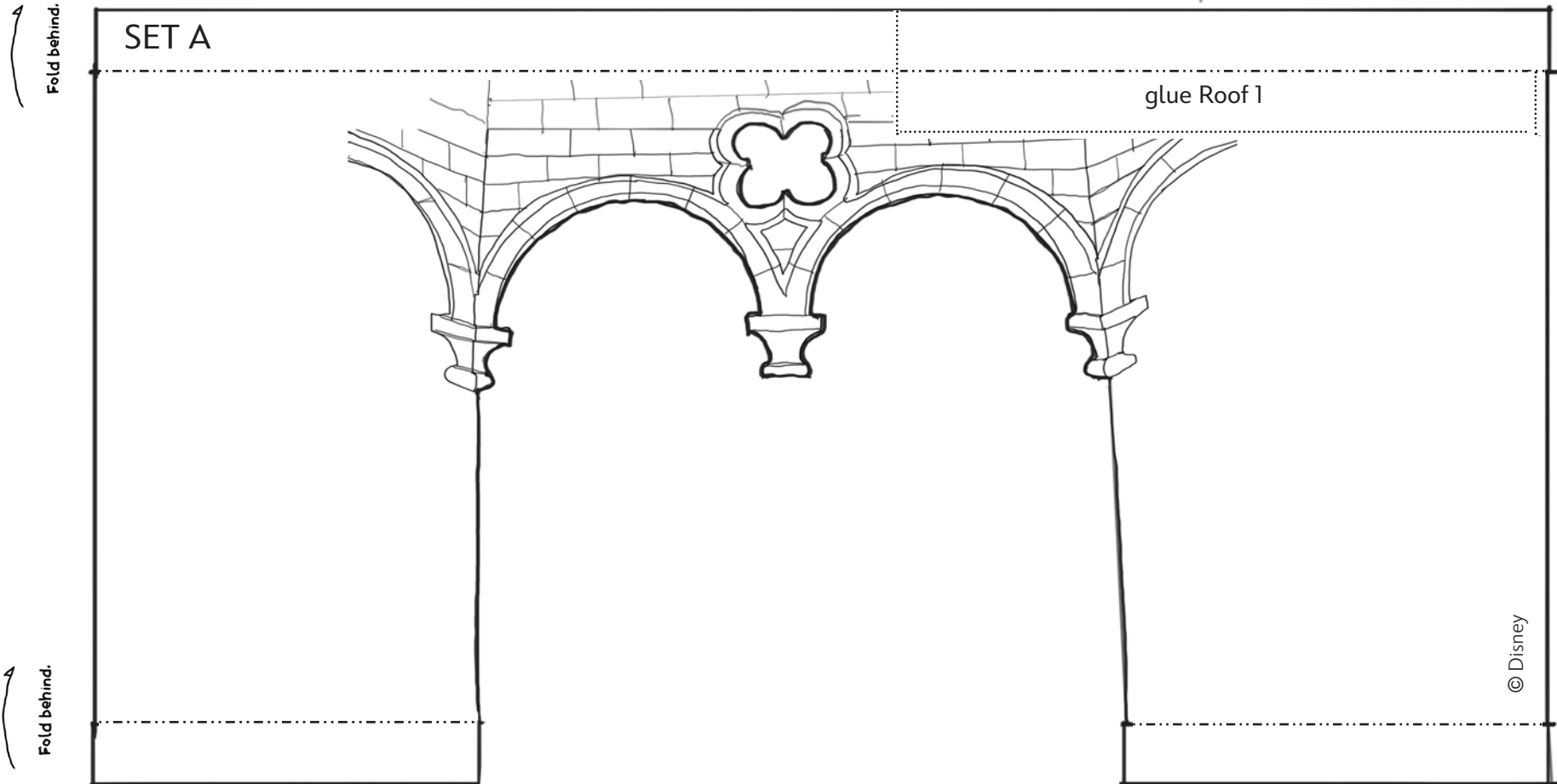

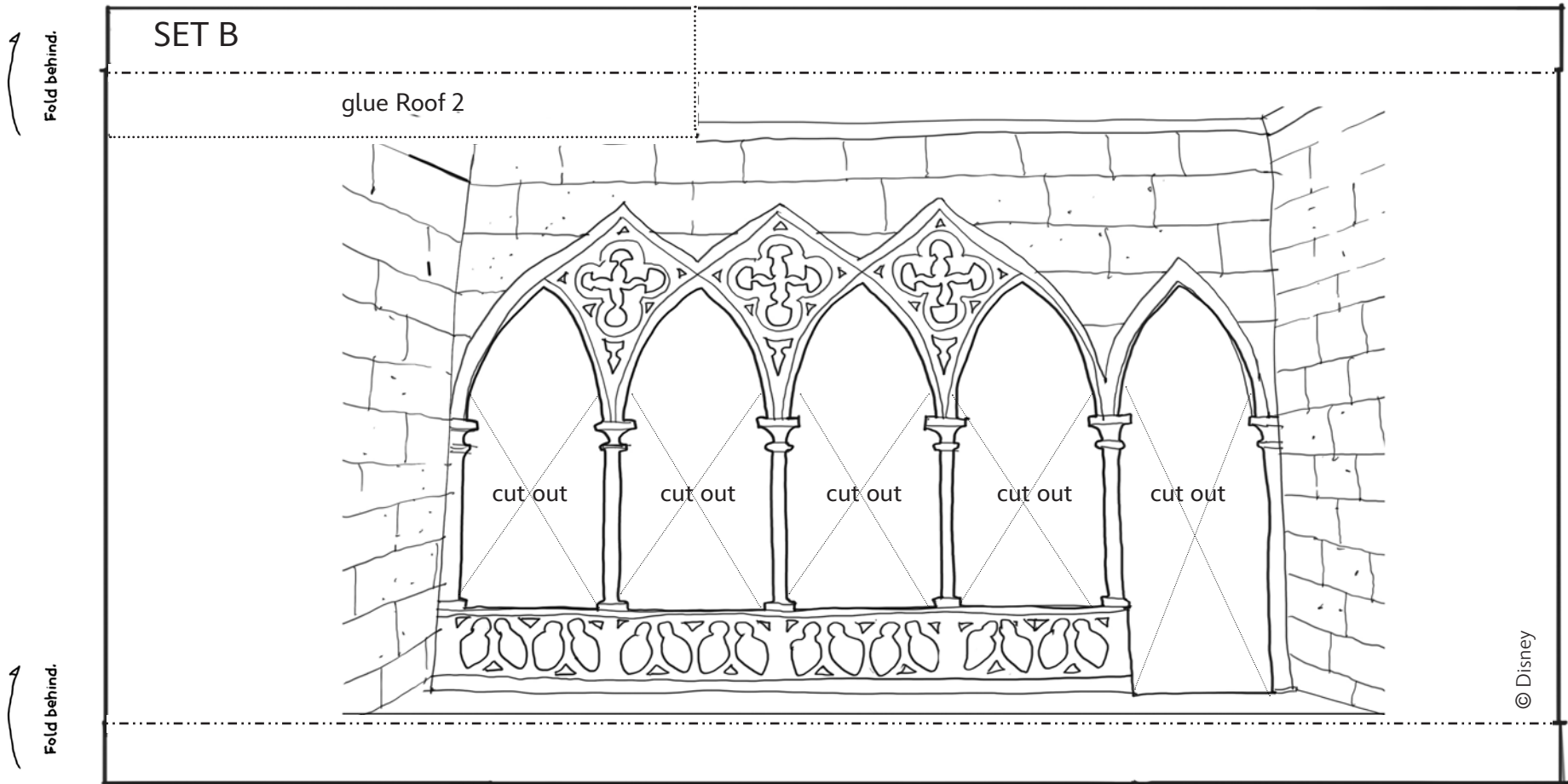



SET C

Fold behind.

Fold behind.

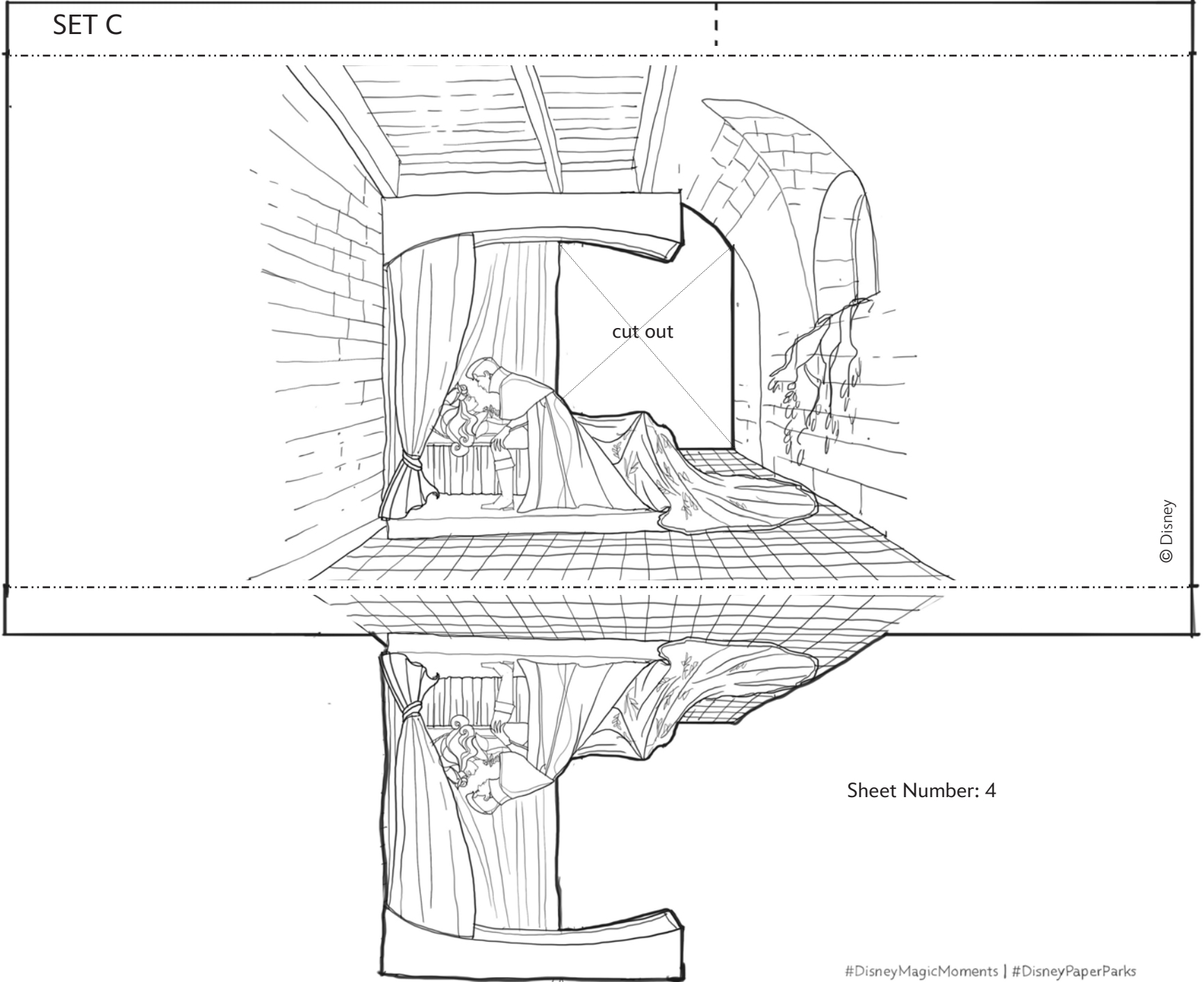

© Disney

Sheet Number: 4



Disney Paper Parks

#DisneyMagicMoments | #DisneyPaperParks

SLEEPING BEAUTY CASTLE

Sheet Number: 5

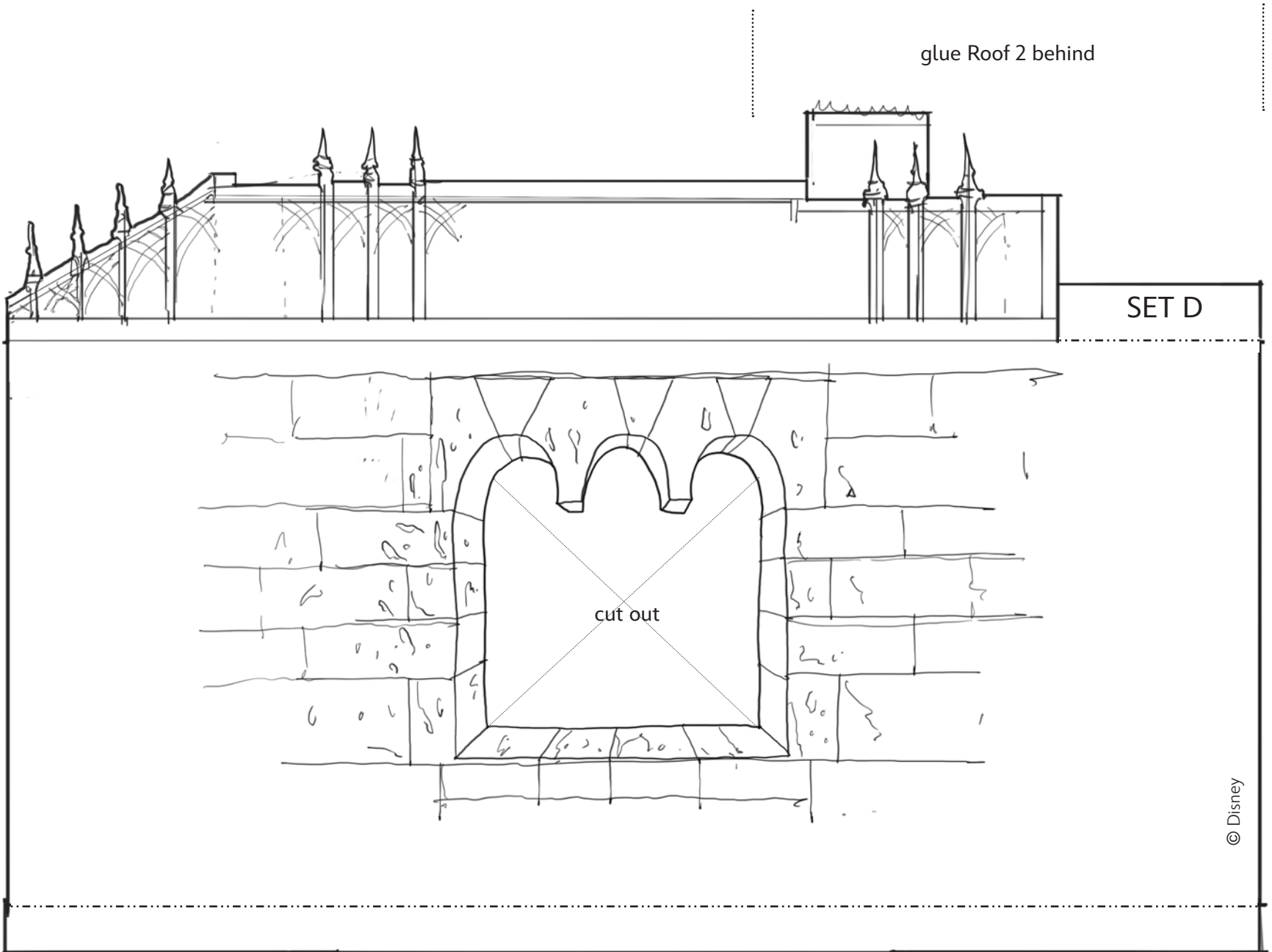

Fold behind.

© Disney



Disney Paper Parks

#DisneyMagicMoments | #DisneyPaperParks

SLEEPING BEAUTY CASTLE

Sheet Number: 6

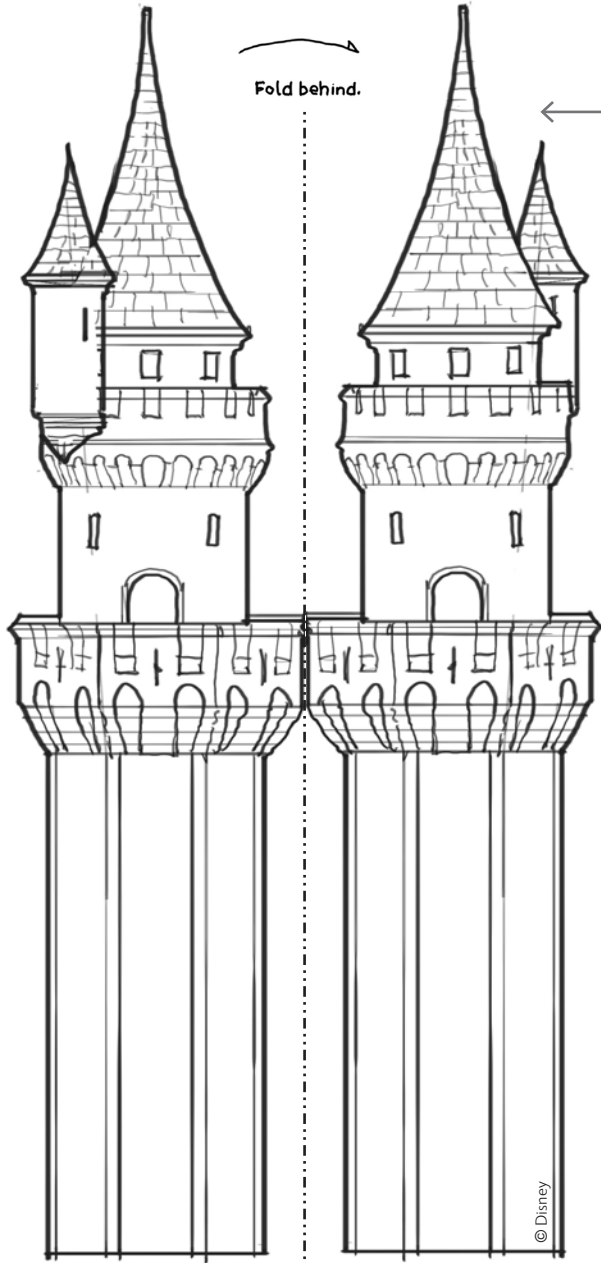

ROUND TOWER

* Tip! glue together with a toothpick or craft stick between for stability

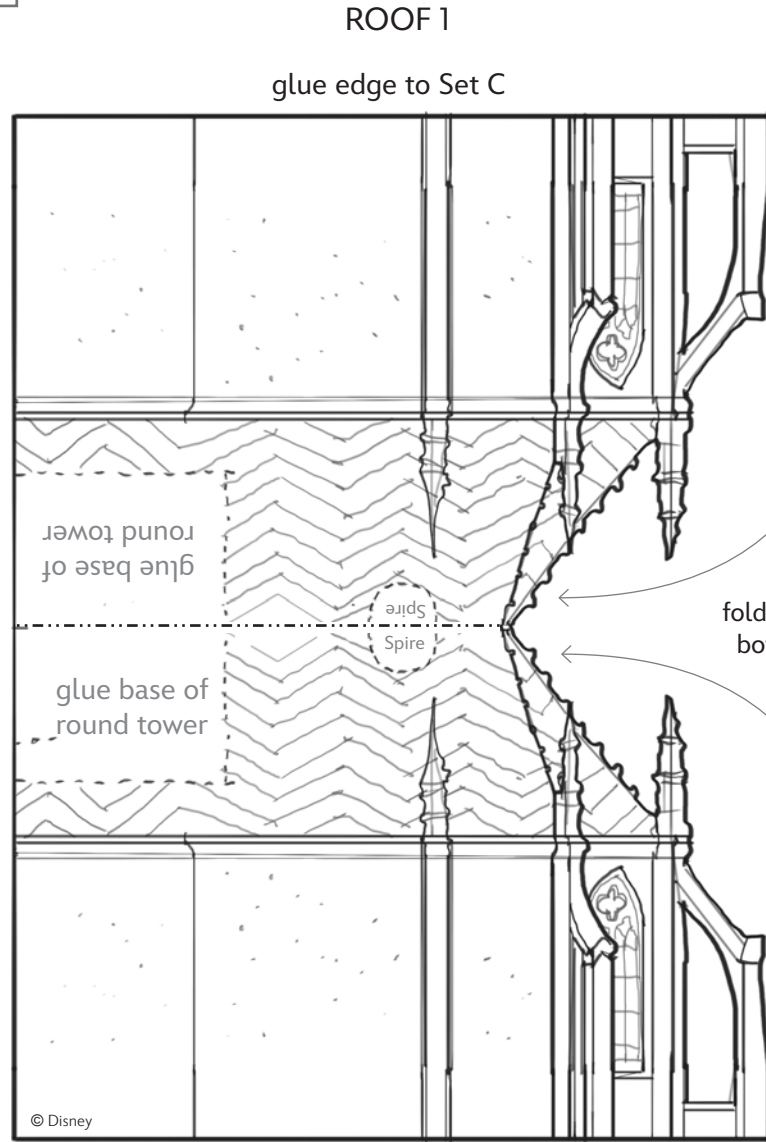

glue edge to Set A



SPIRE



ROOF 2

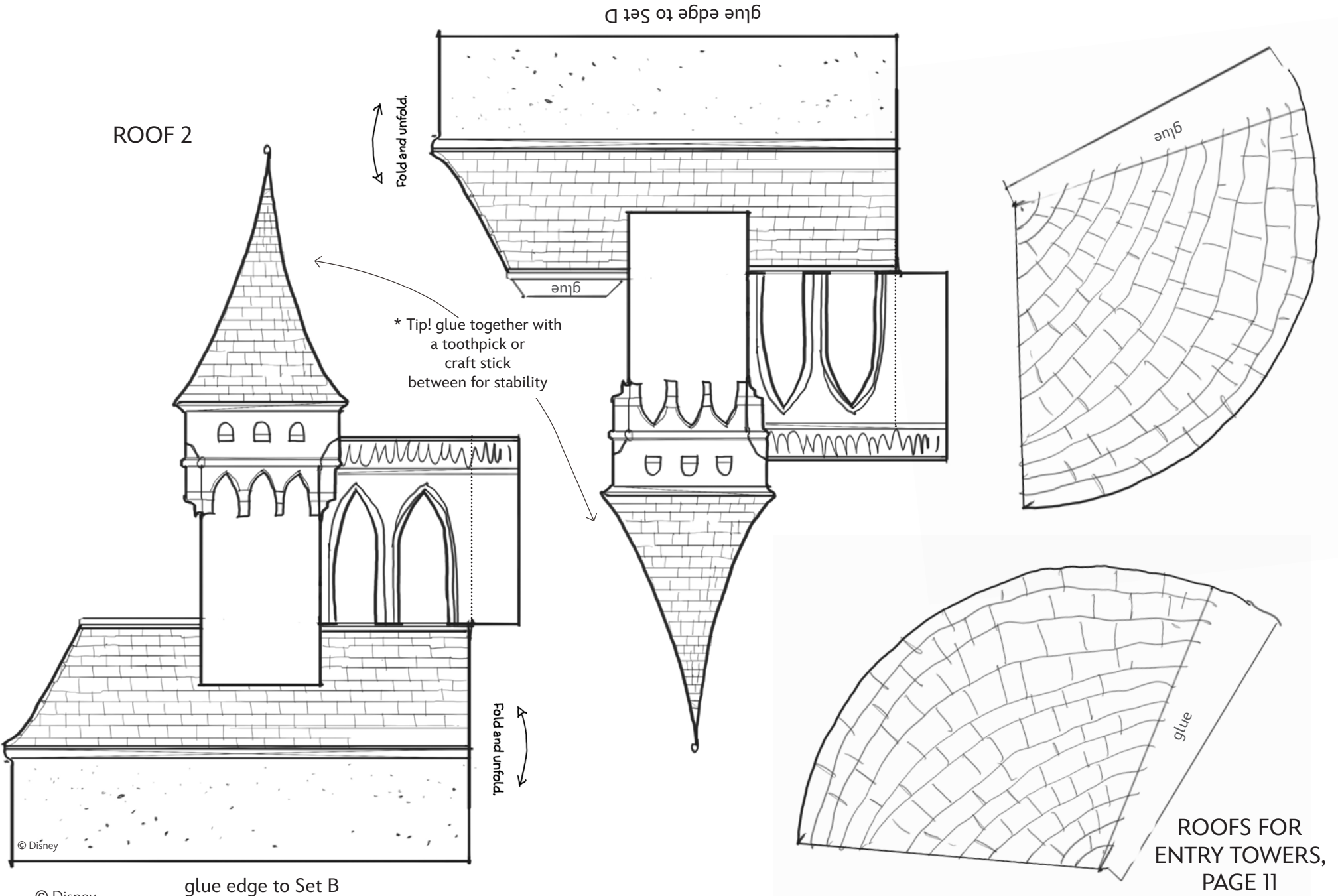

ROOFS FOR
ENTRY TOWERS,
PAGE 11



SLEEPING BEAUTY CASTLE

Sheet Number: 8

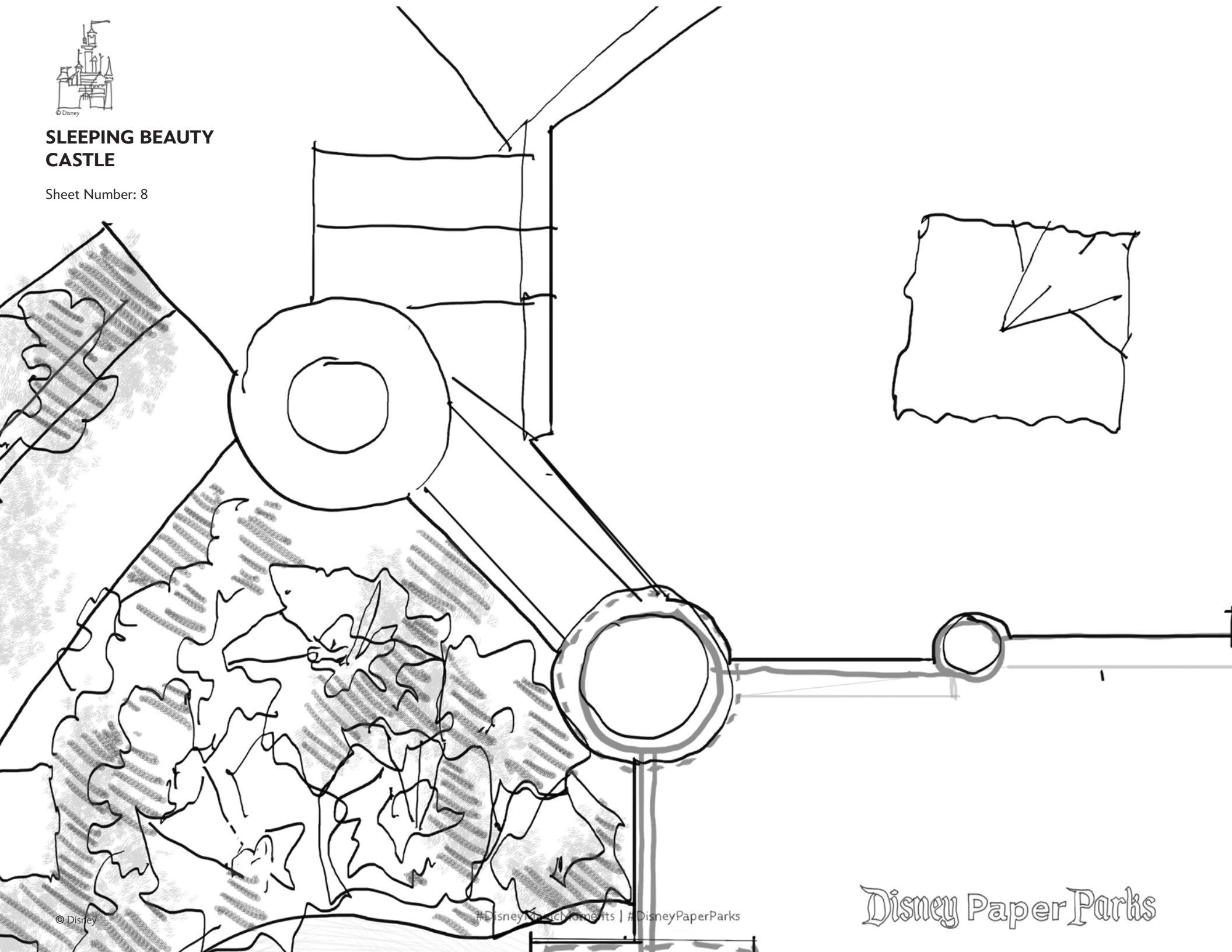



SLEEPING BEAUTY CASTLE

Sheet Number: 9

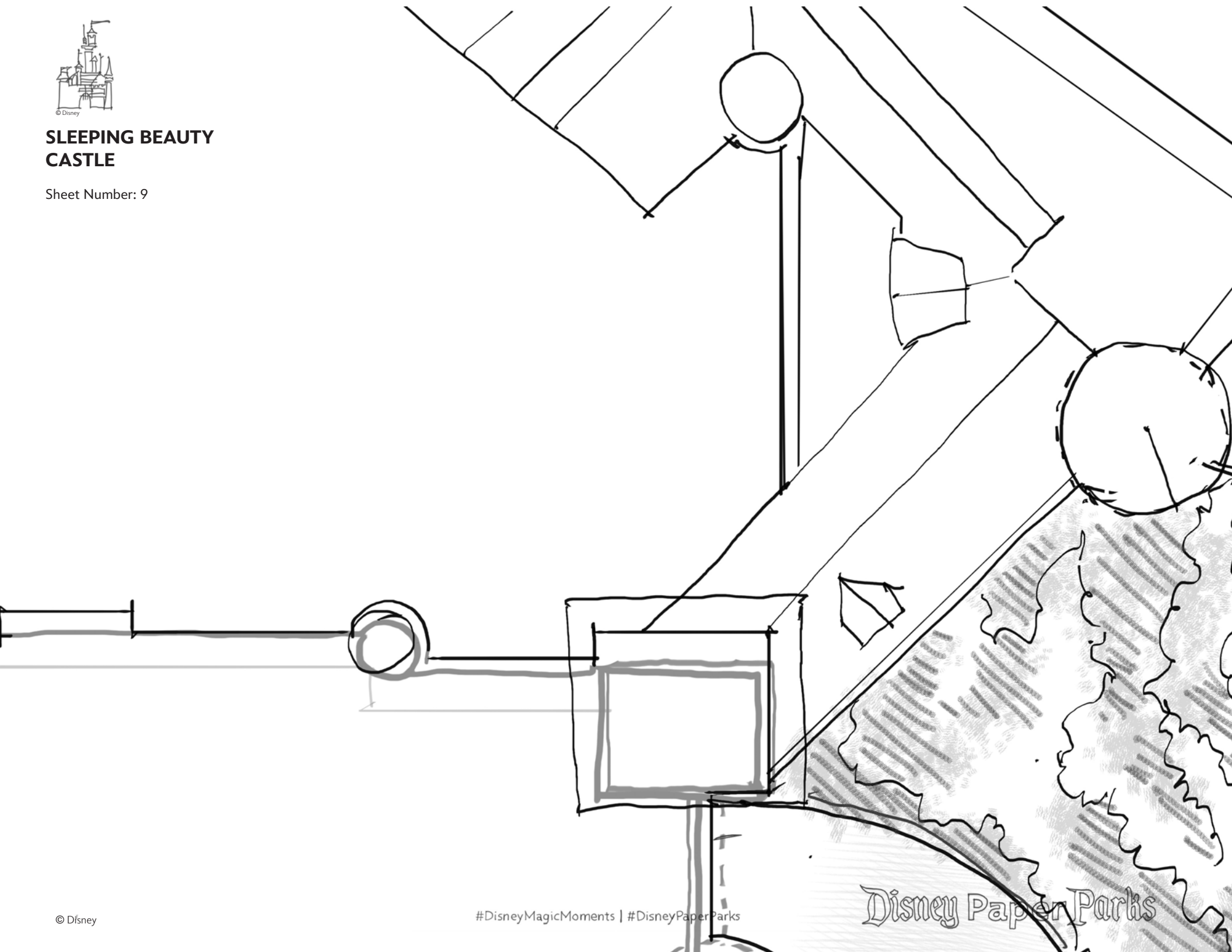

© Disney

SLEEPING BEAUTY CASTLE

Sheet Number: 10

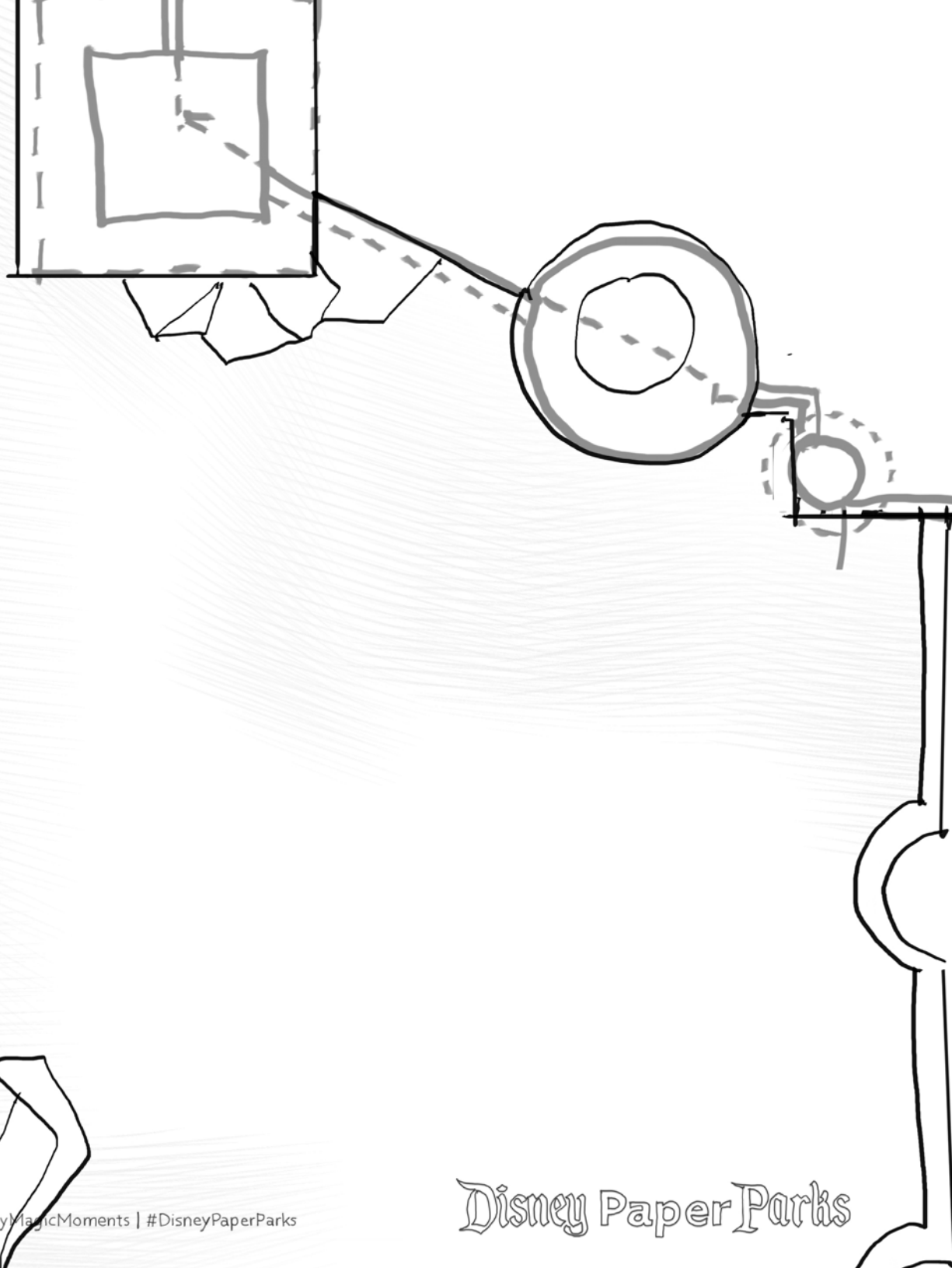

© Disney

#DisneyMagicMoments | #DisneyPaperParks

Disney Paper Parks



SLEEPING BEAUTY CASTLE

Sheet Number: 11

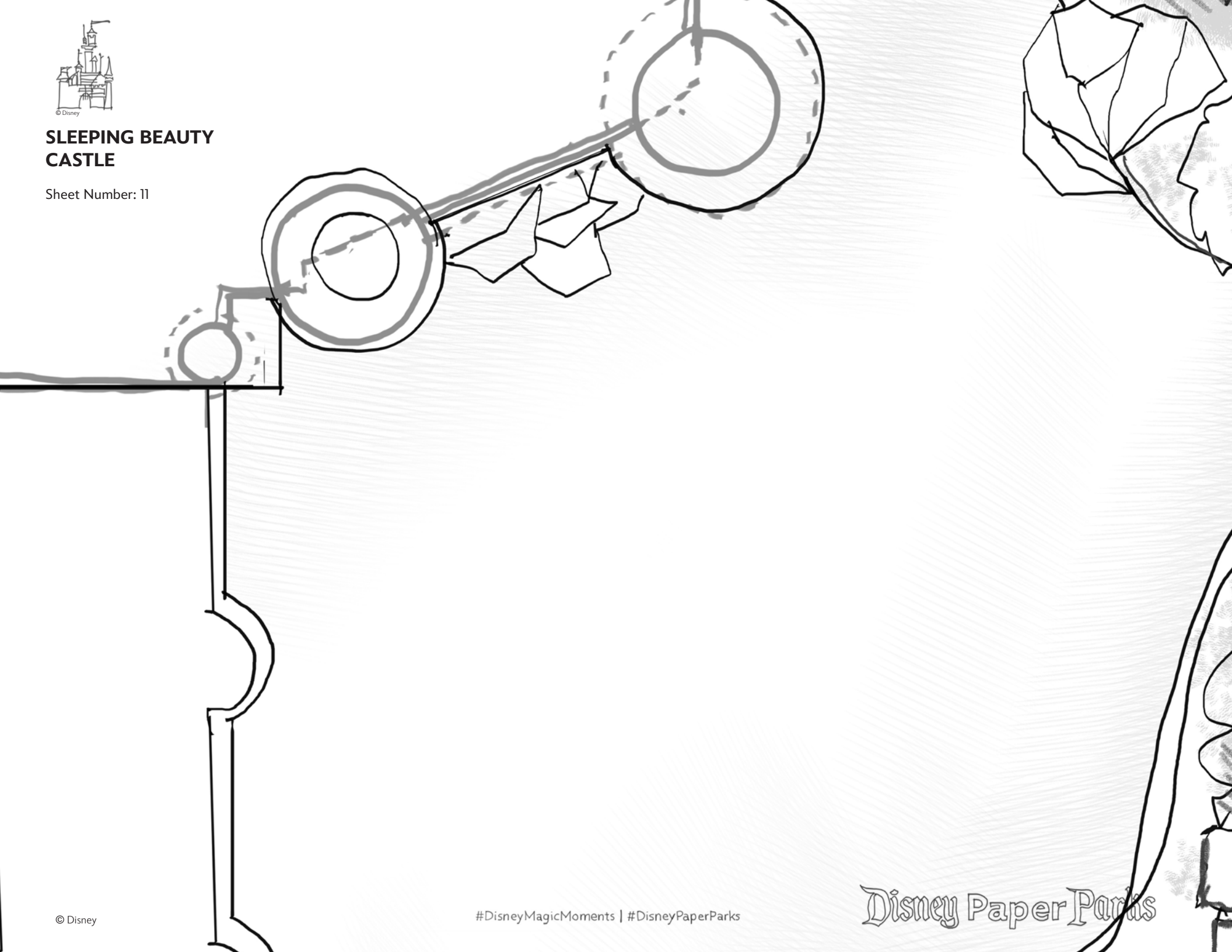



© Disney

SLEEPING BEAUTY CASTLE

Sheet Number: 12



© Disney

#DisneyMagicMoments | #DisneyPaperParks

Disney Paper Parks



SLEEPING BEAUTY CASTLE

Sheet Number: 13

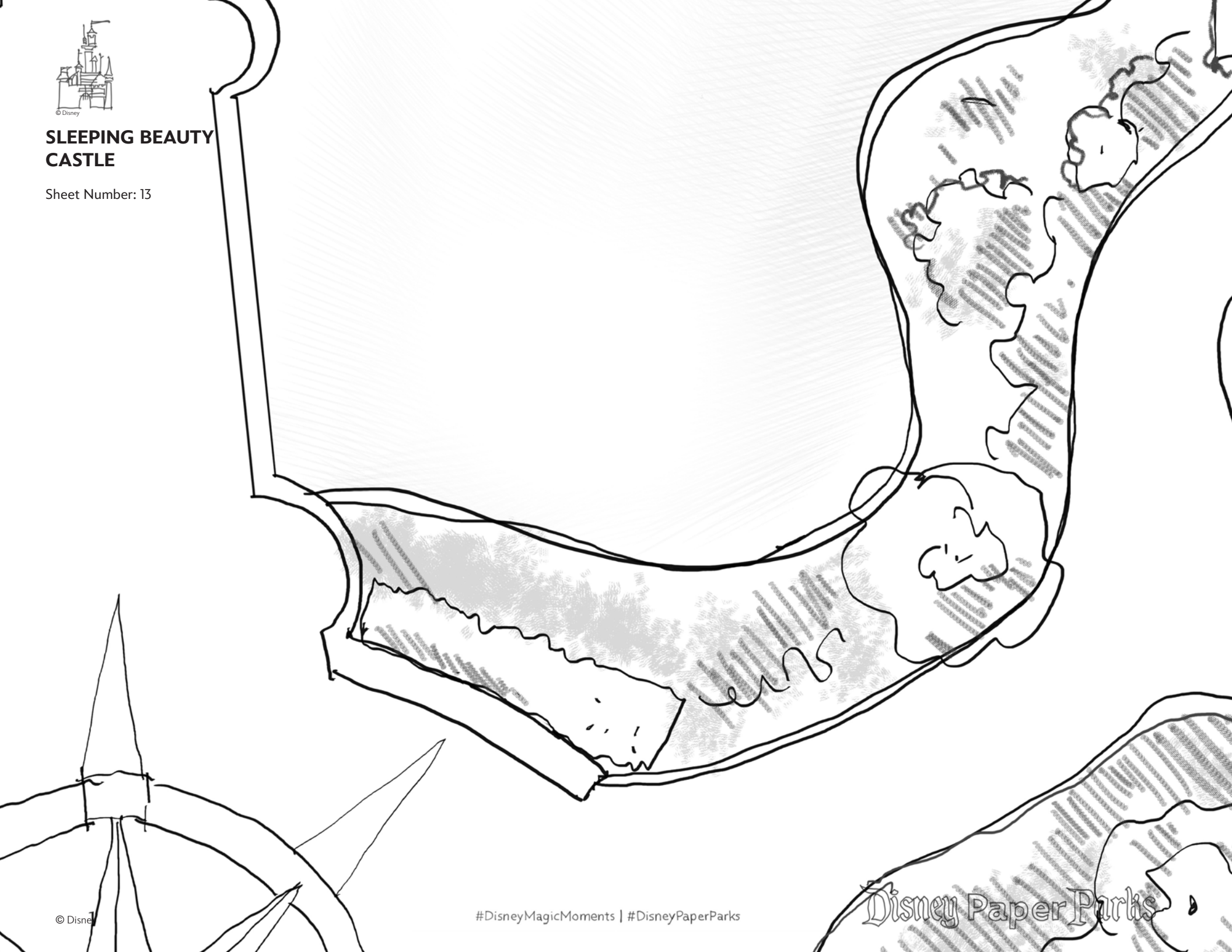



Disney Paper Parks

#DisneyMagicMoments | #DisneyPaperParks

SLEEPING BEAUTY CASTLE

Sheet Number: 14

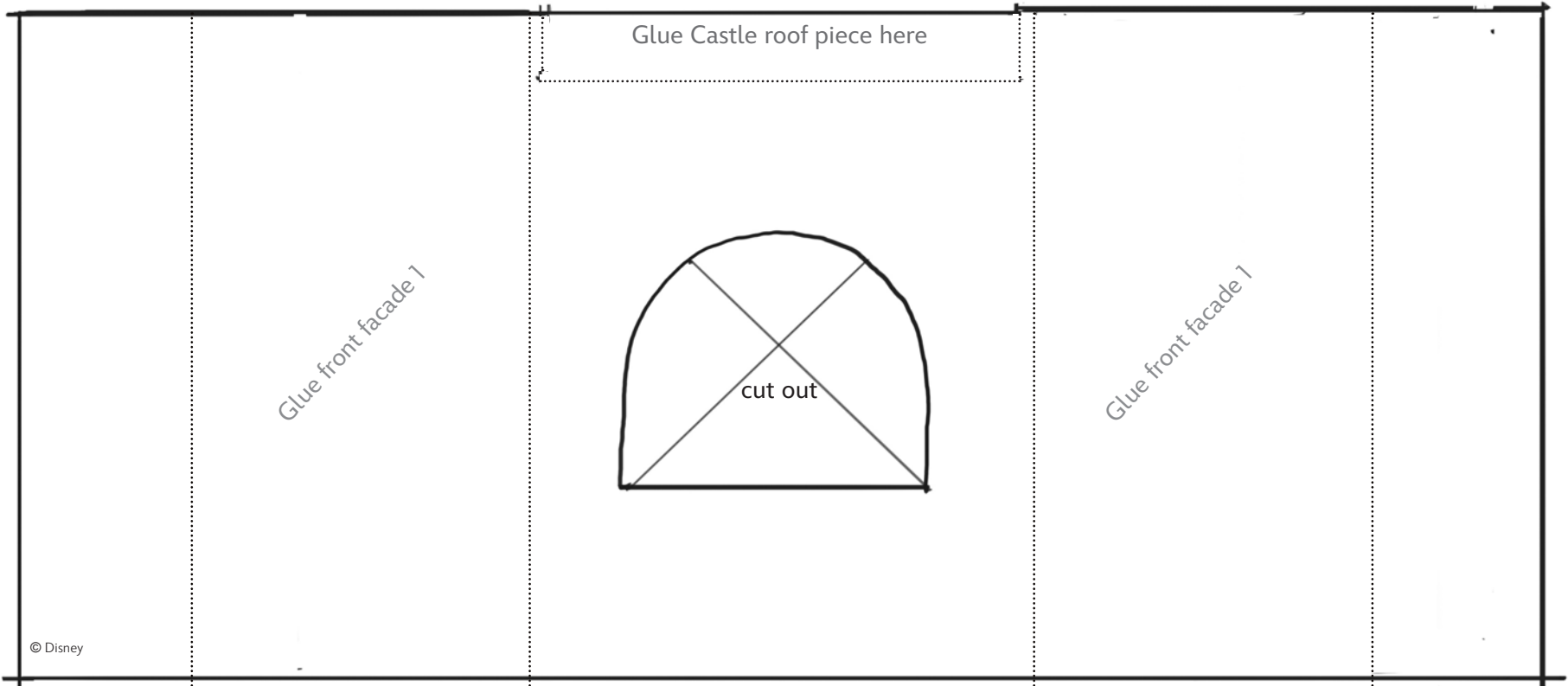
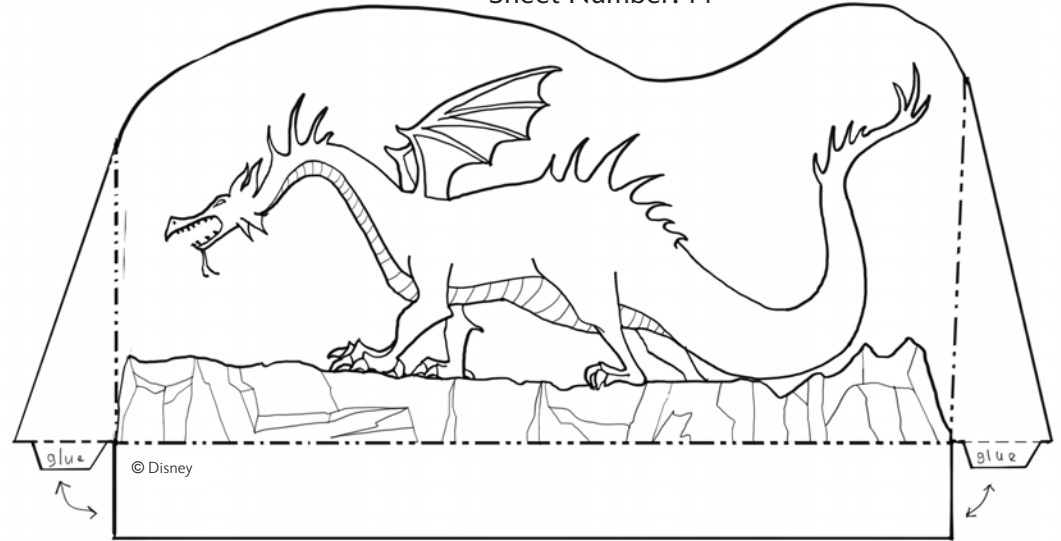
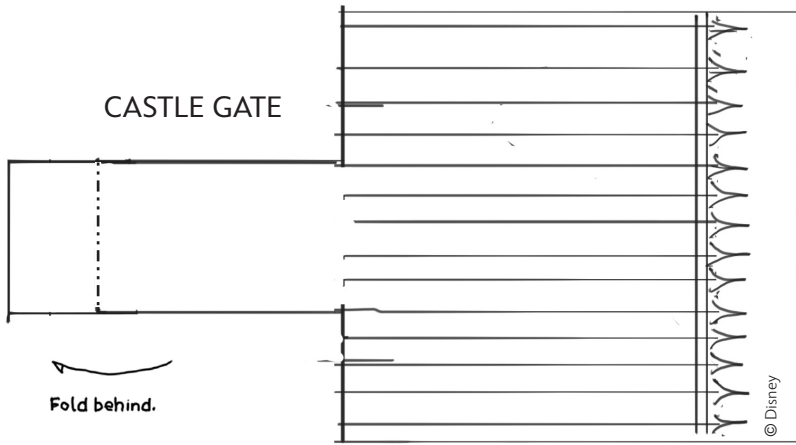



Disney Paper Parks

#DisneyMagicMoments | #DisneyPaperParks

SLEEPING BEAUTY CASTLE

Sheet Number: 15

UPPER WALL TURRETS

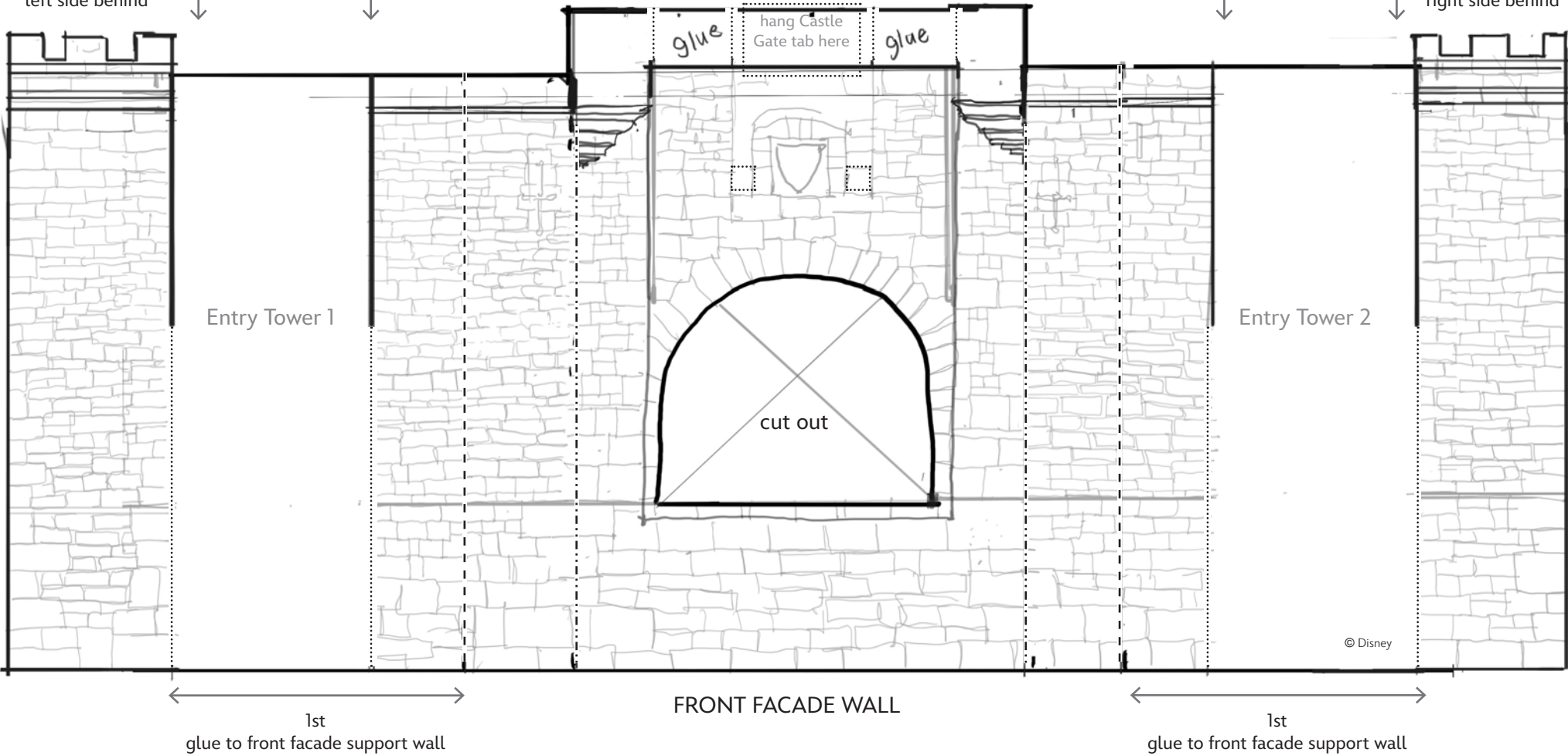
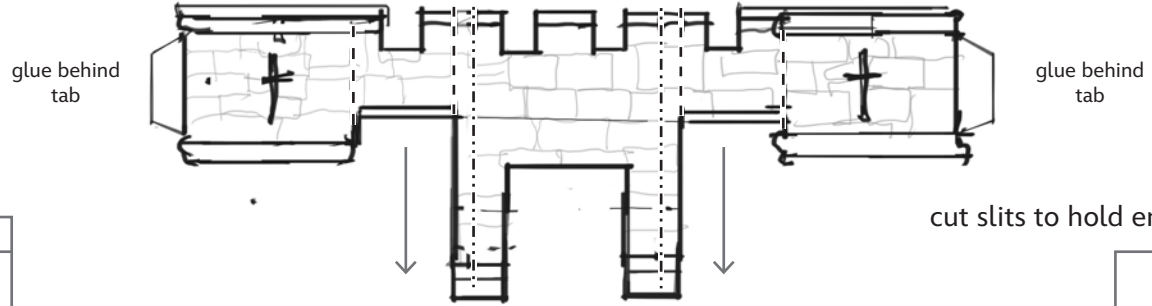

© Disney



Disney Paper Parks

#DisneyMagicMoments | #DisneyPaperParks

SLEEPING BEAUTY CASTLE

Sheet Number: 16

ENTRY TOWER 1

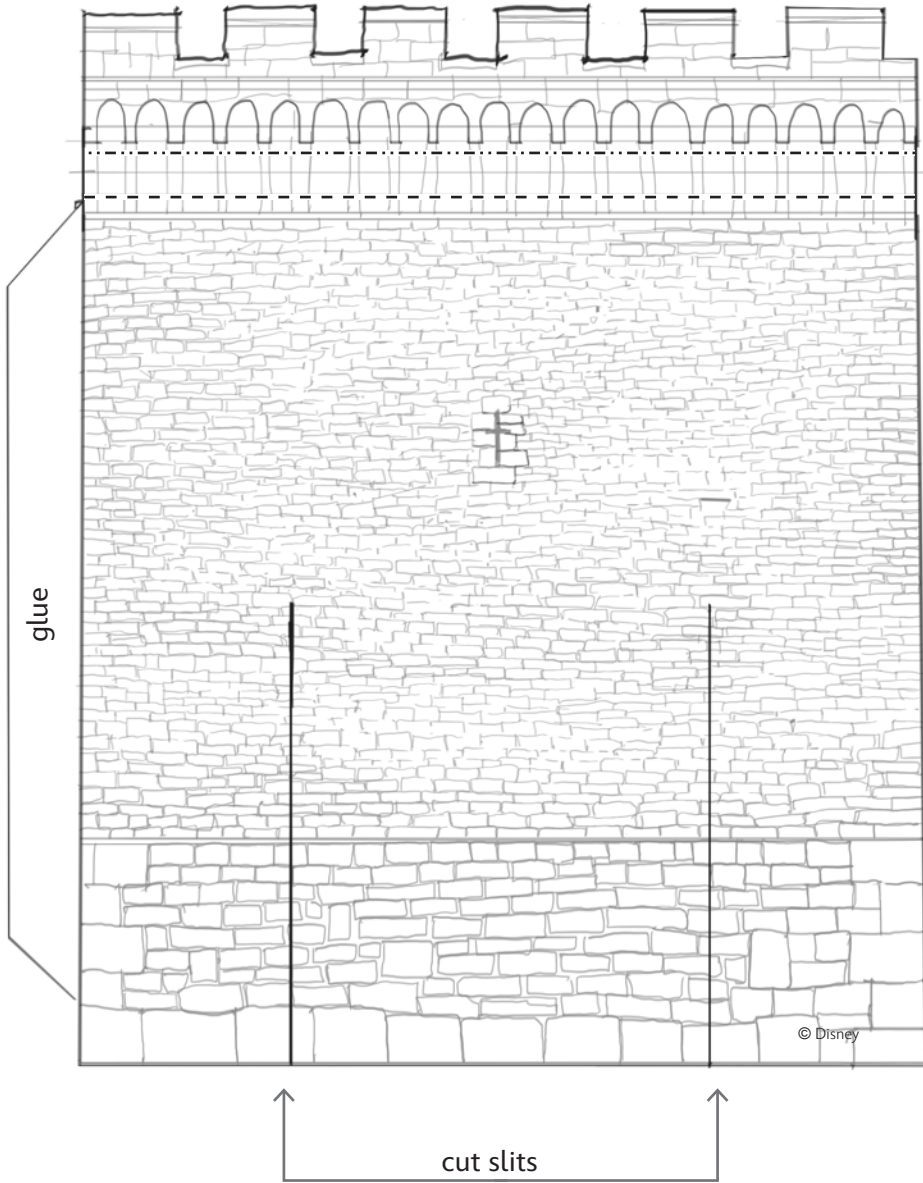

ENTRY TOWER 2

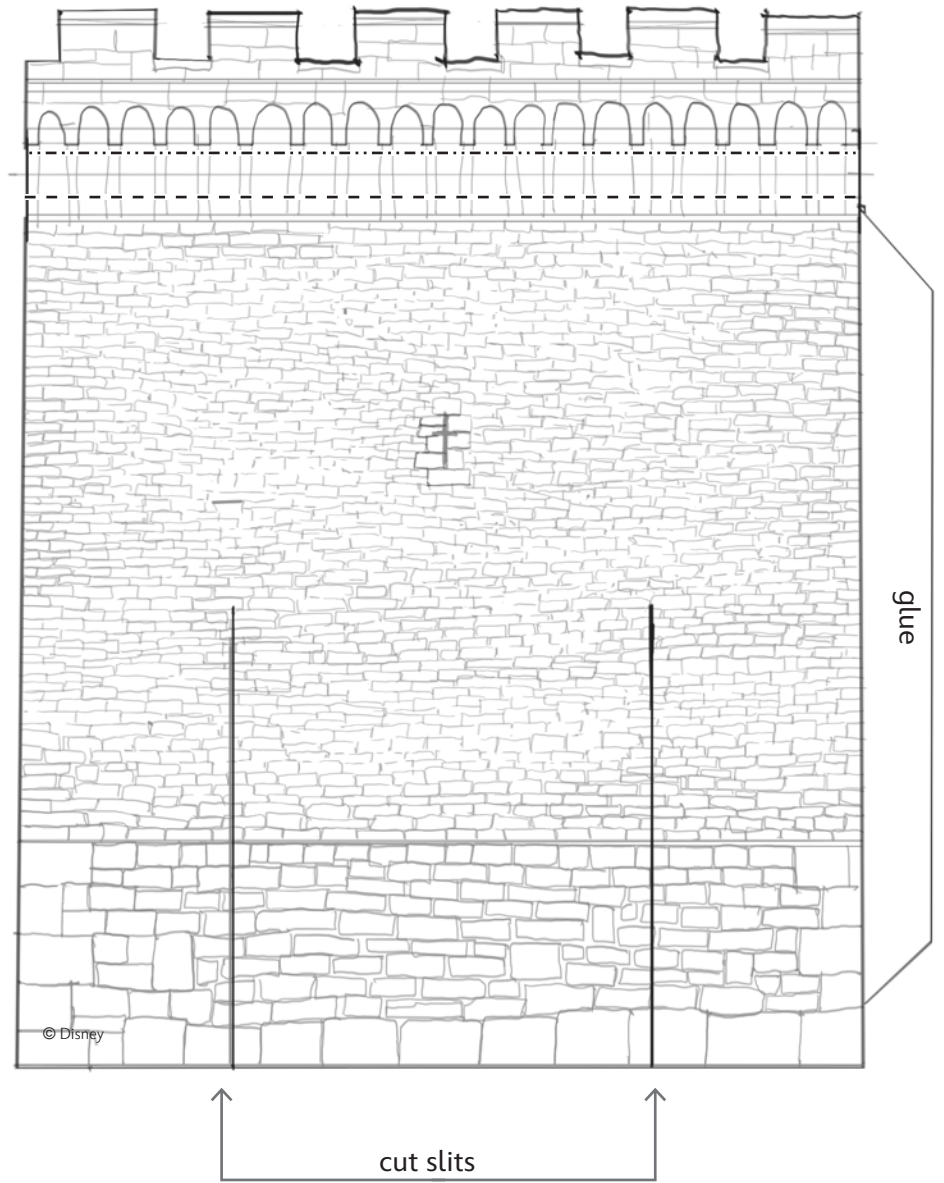



Disney Paper Parks

#DisneyMagicMoments | #DisneyPaperParks

SLEEPING BEAUTY CASTLE

Sheet Number: 17

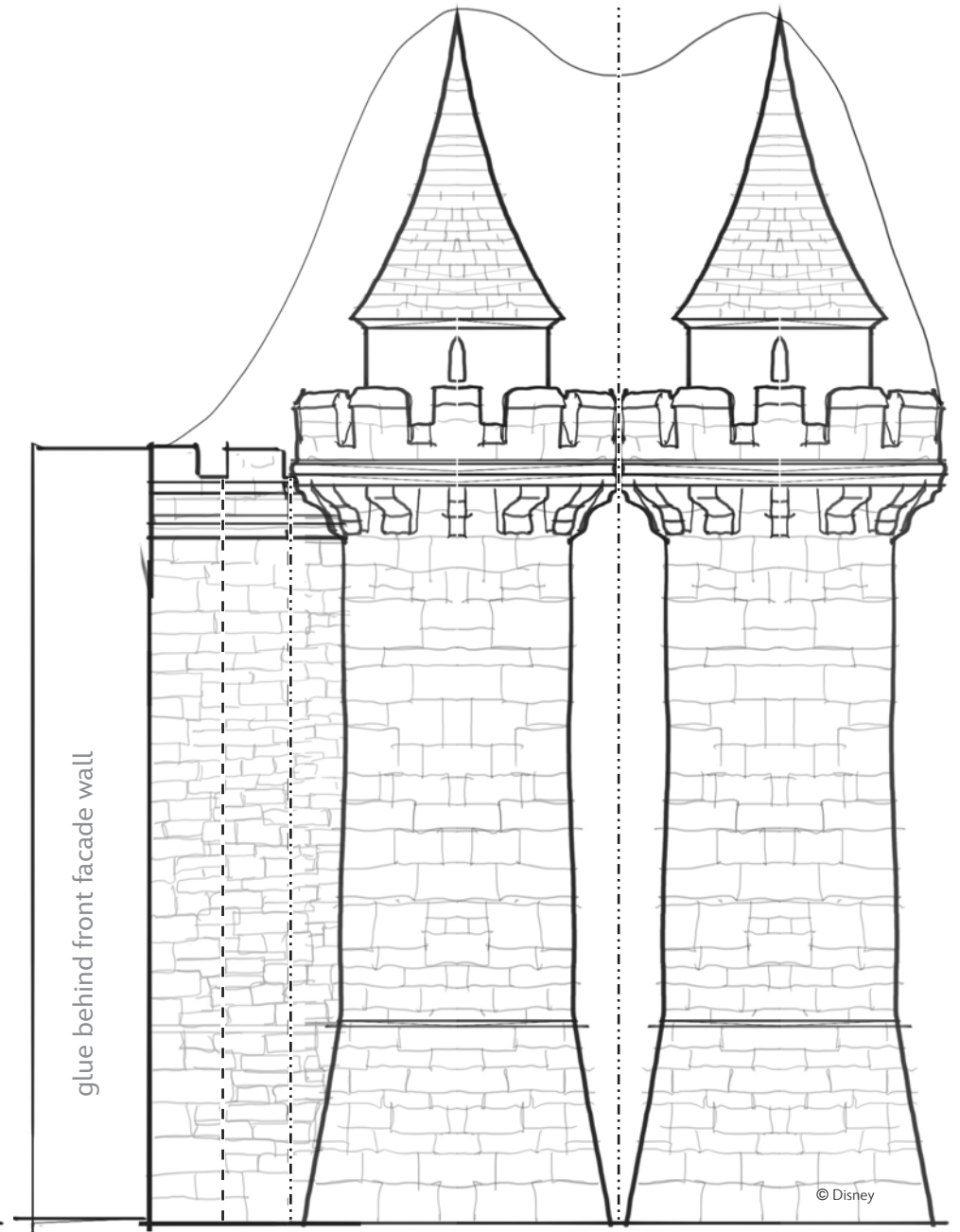
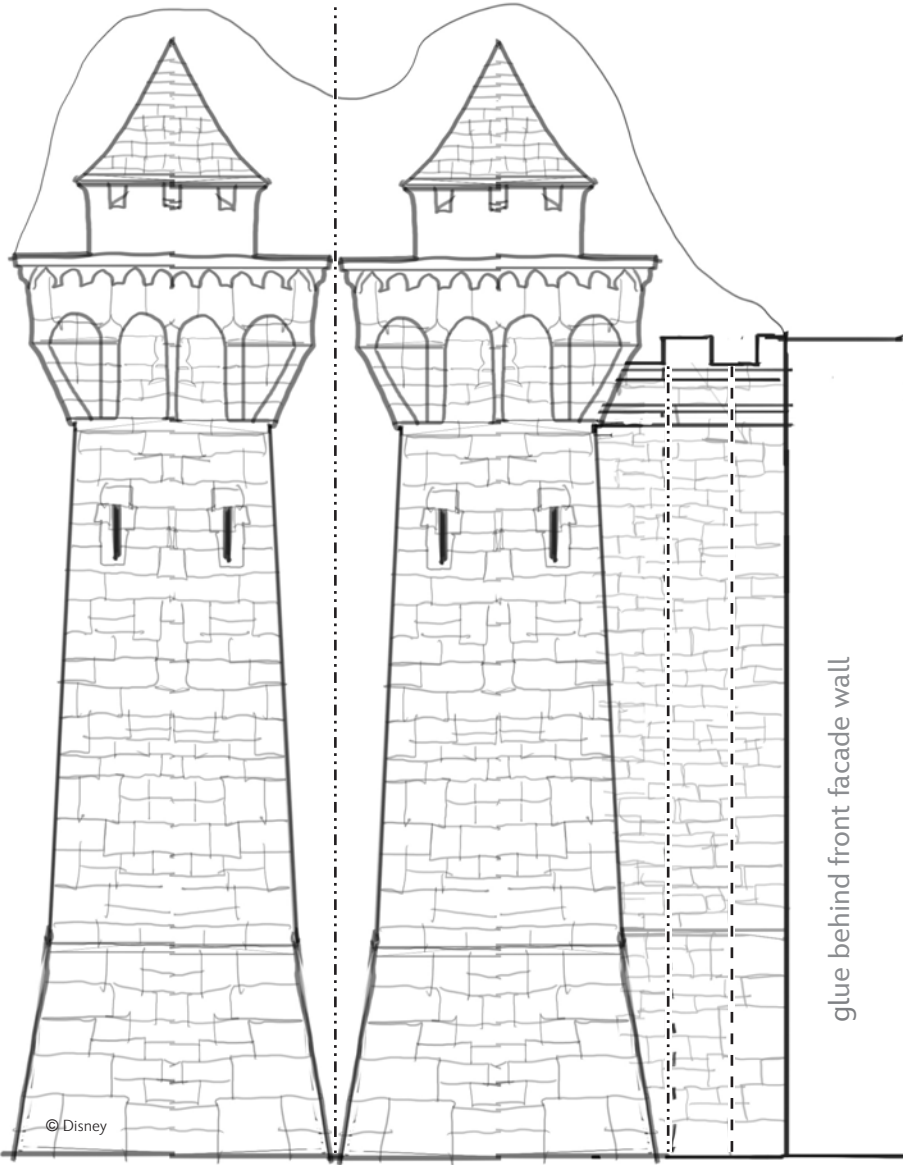

FRONT TOWER, LEFT

FRONT TOWER, RIGHT



* Tip! glue craft sticks behind for added stability

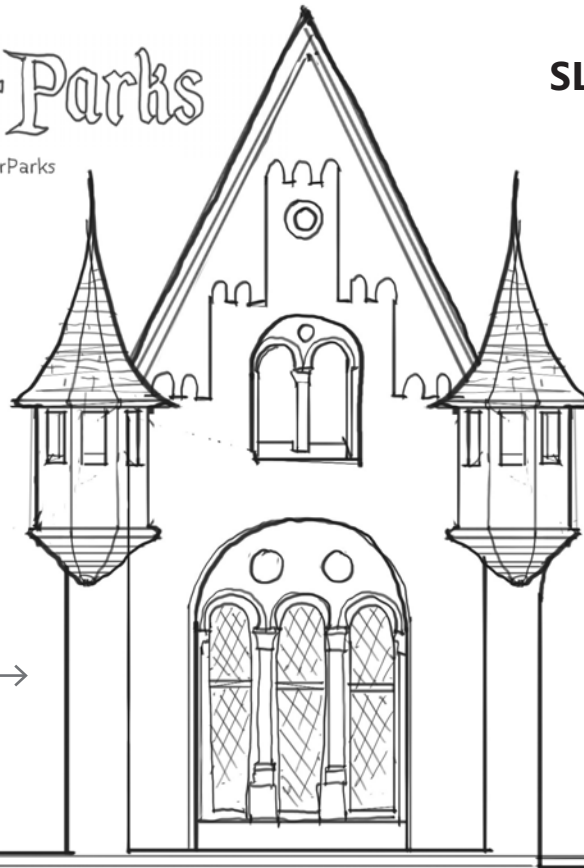

BACK FACADE SUPPORT WALL

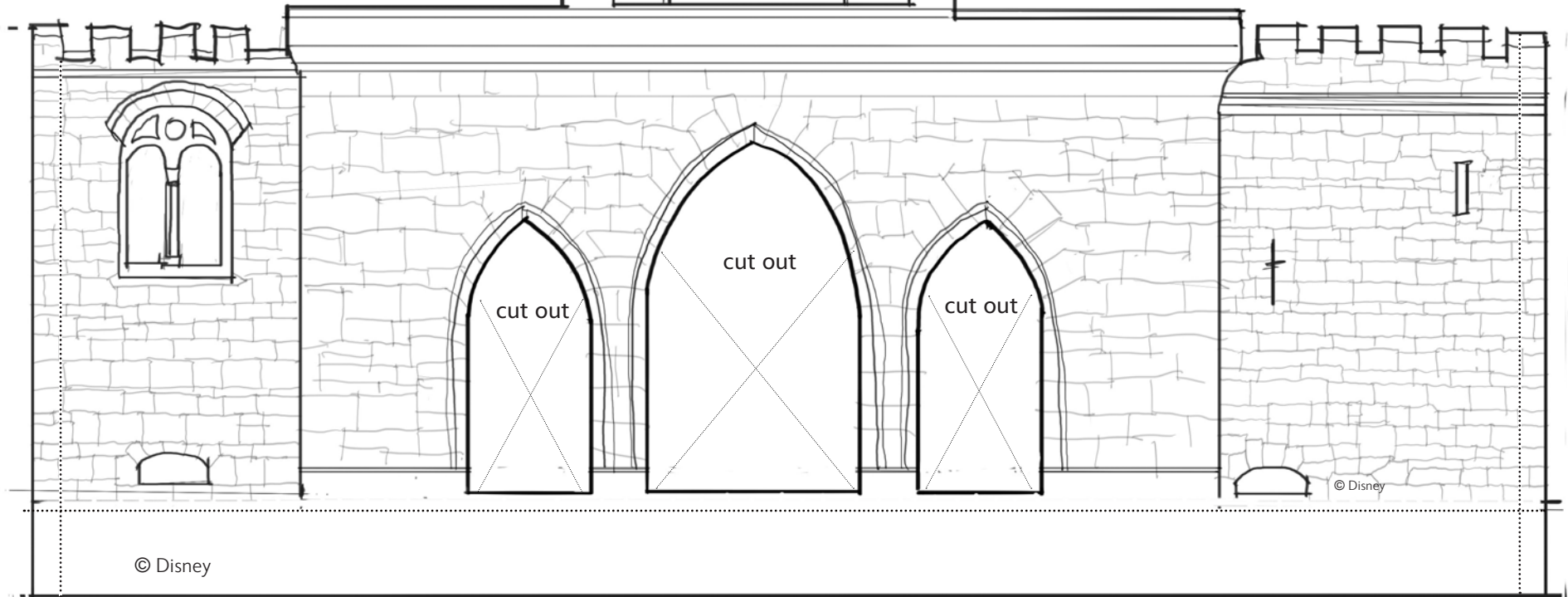



Disney Paper Parks

SLEEPING BEAUTY CASTLE

Sheet Number: 19

#DisneyMagicMoments | #DisneyPaperParks

BACK FACADE WALL

tip! curve this piece around the corner to form the turret →

← tip! curve this piece around the corner to form the turret

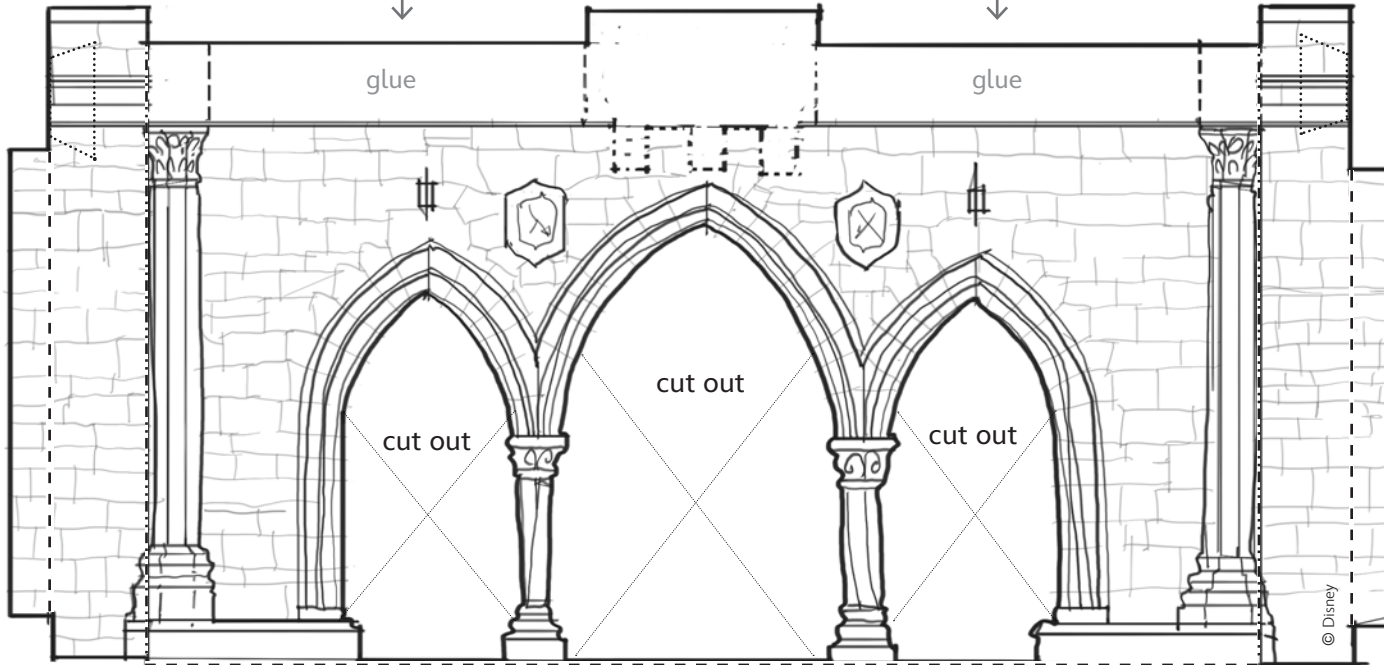
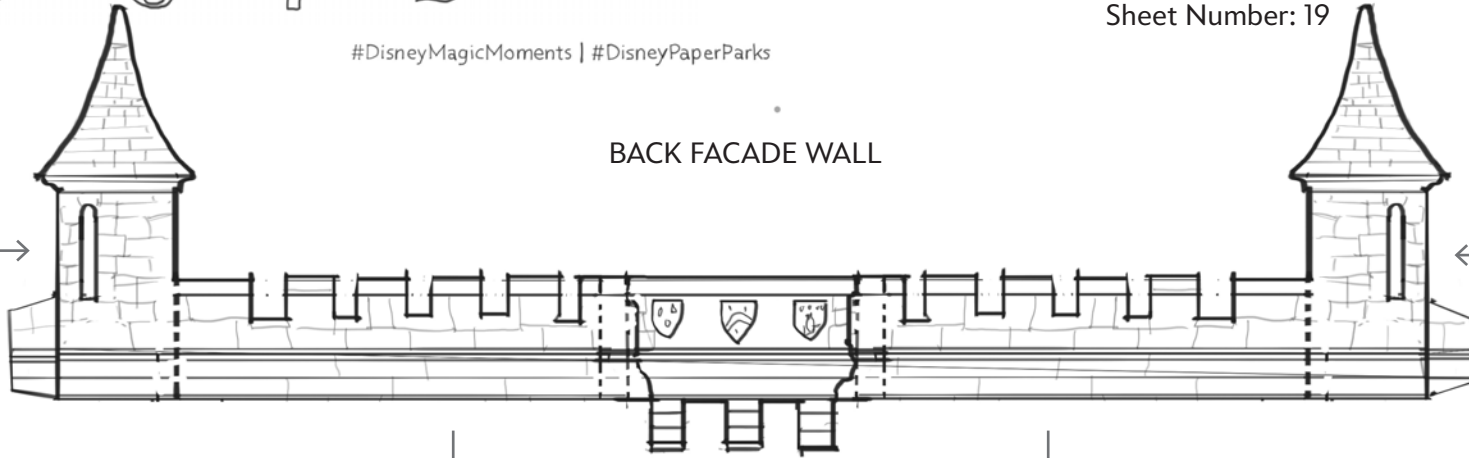



Disney Paper Parks

#DisneyMagicMoments | #DisneyPaperParks

SLEEPING BEAUTY CASTLE

Sheet Number: 20

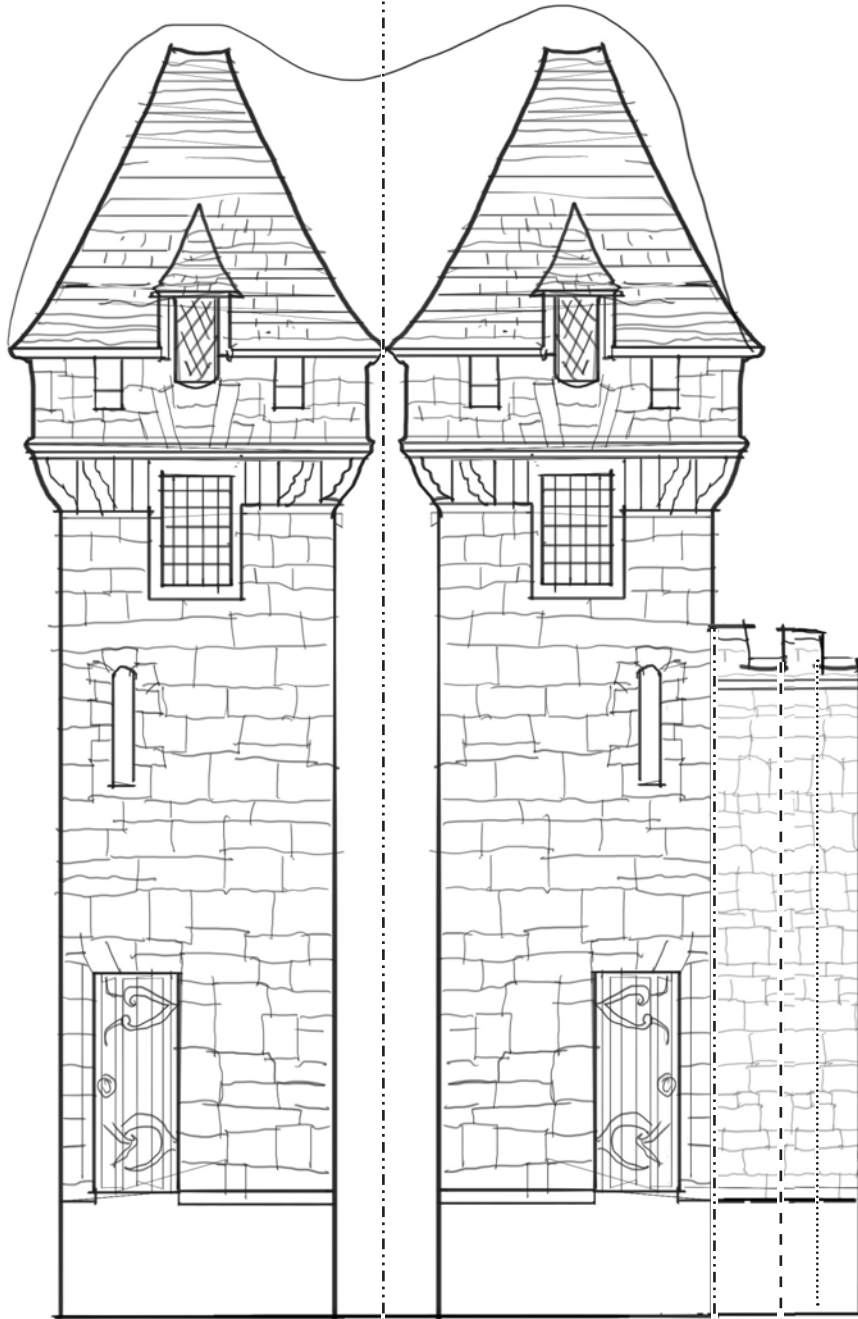

glue to back facade support wall, left side

BACK TOWER, LEFT

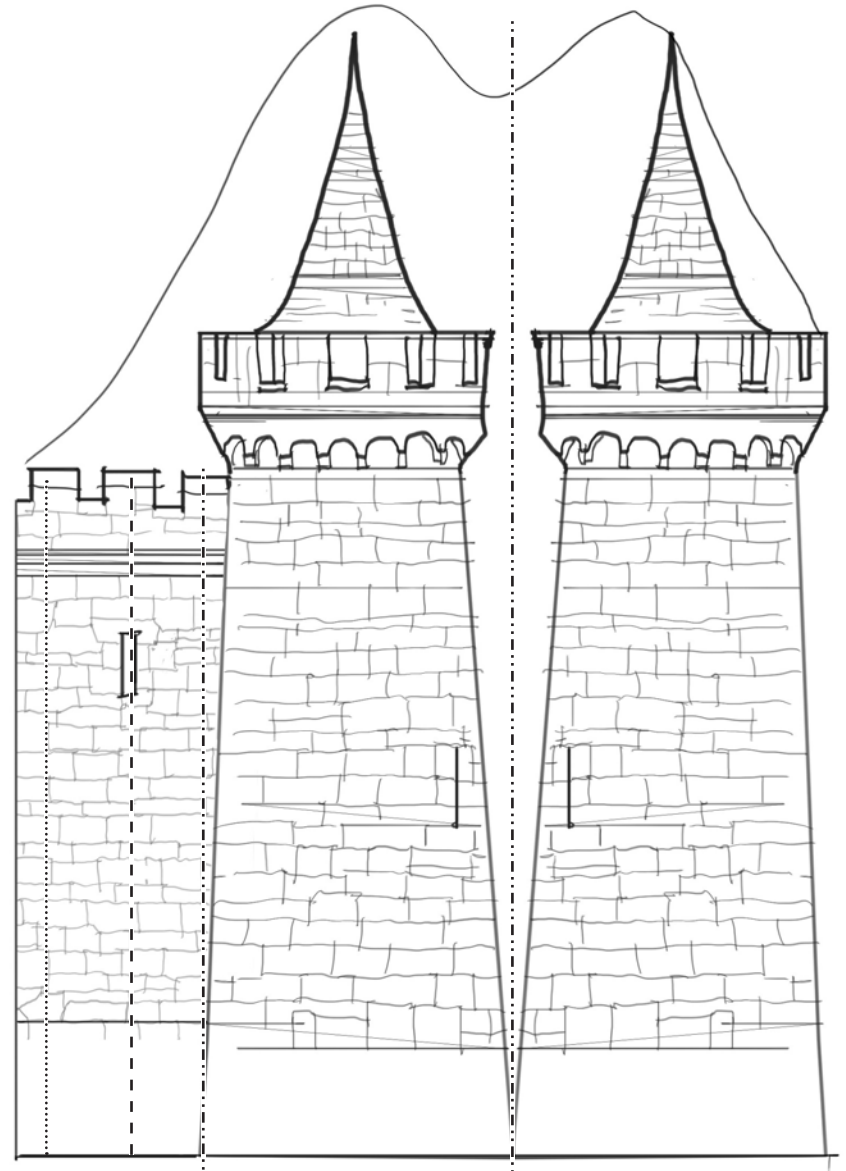

glue to back facade support wall, right side

BACK TOWER, RIGHT



SLEEPING BEAUTY CASTLE

Sheet Number: 21

LARGE SPIRE

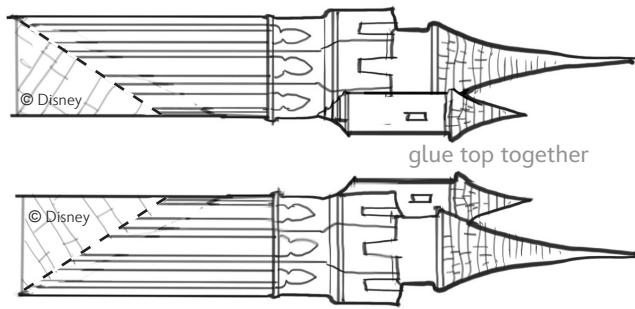

Roof 2 arches slip in here

fold and glue tabs behind overall roof wall



CENTRAL WINDOW

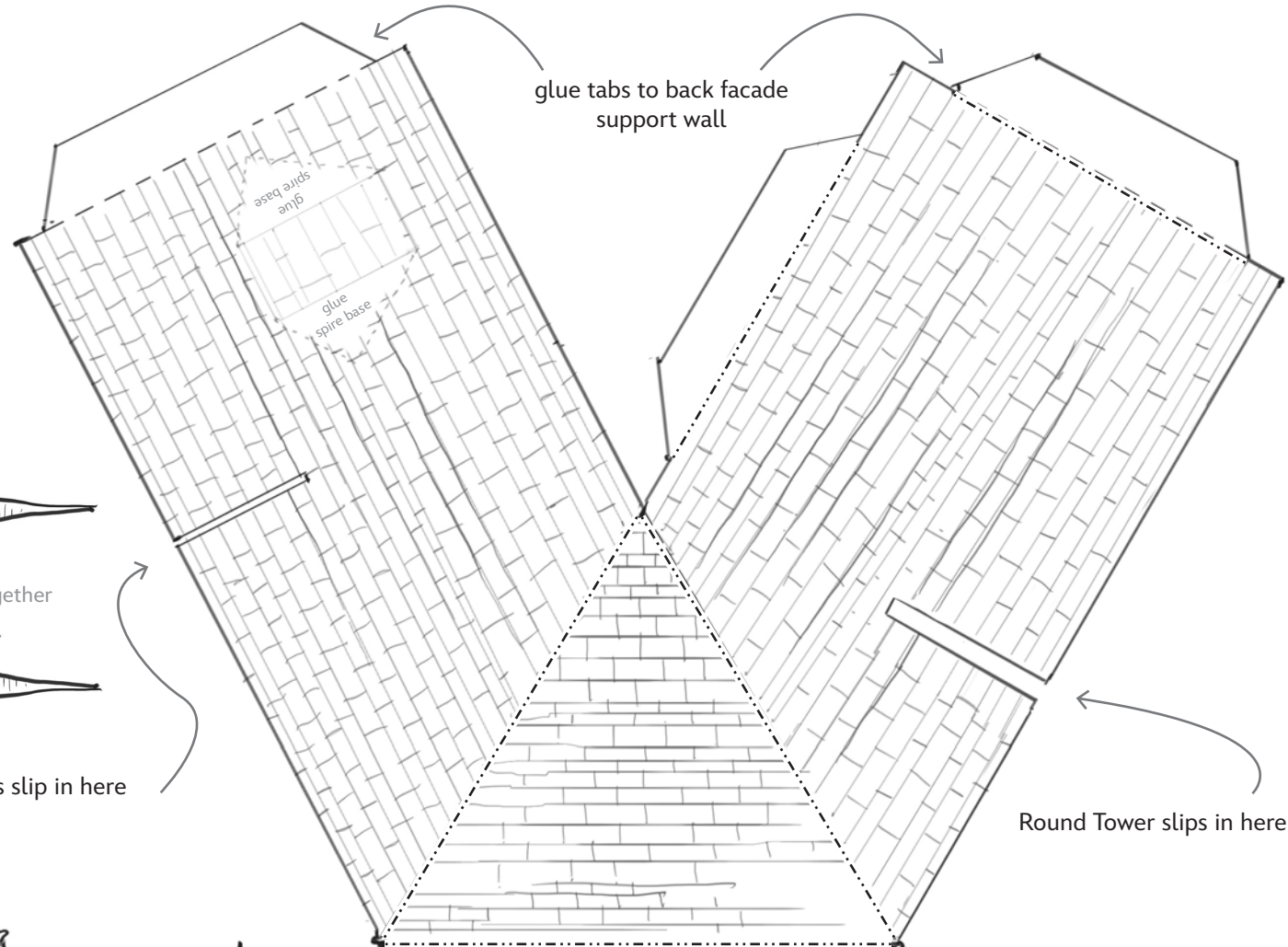

glue central window

OVERALL ROOF

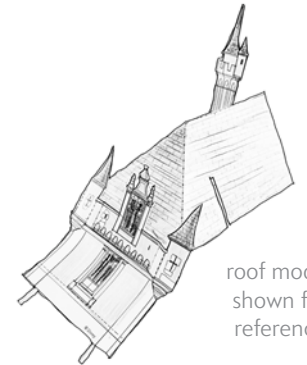

roof model shown for reference

Round Tower slips in here



BRIDGE

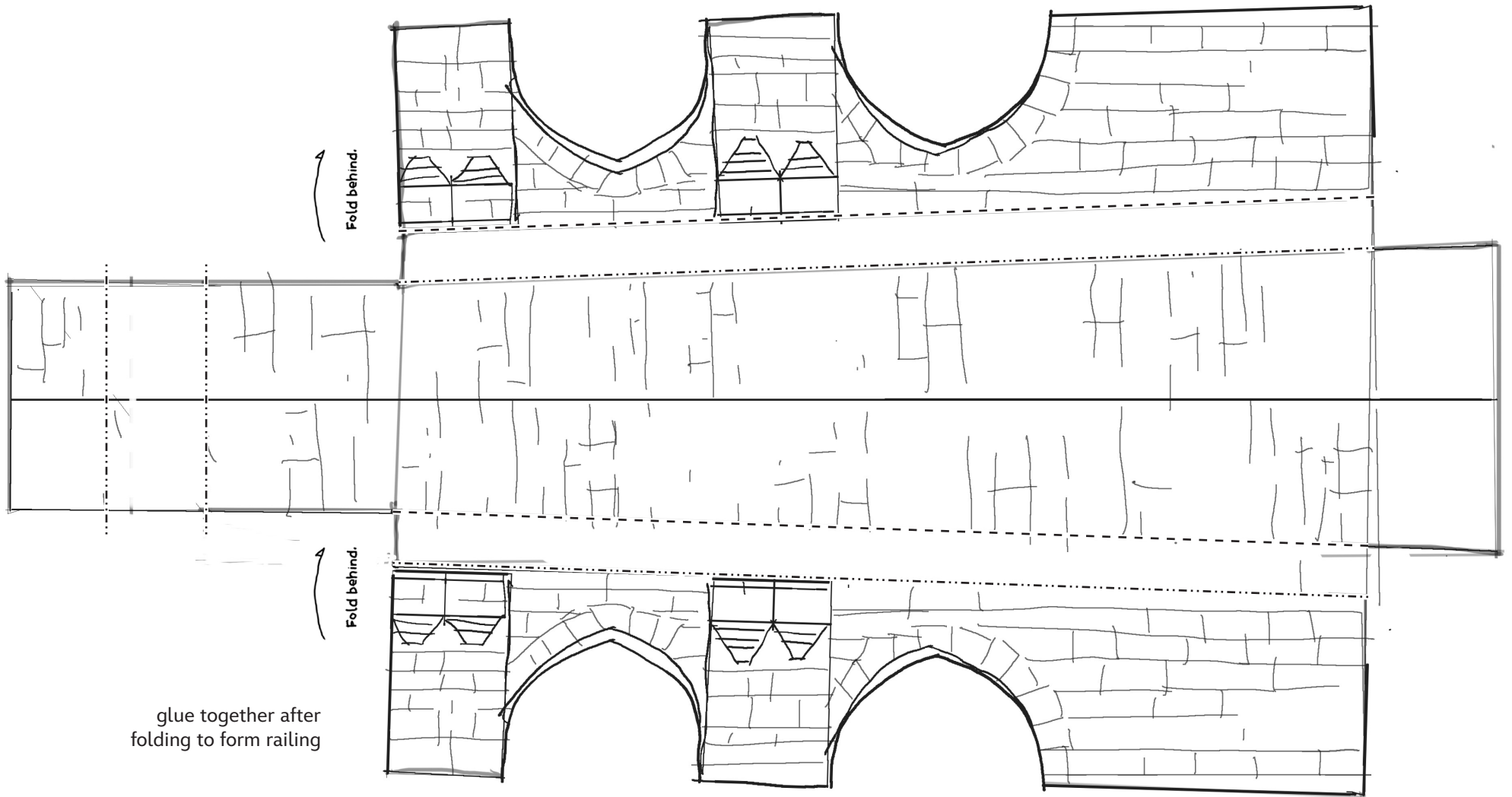

glue together after
folding to form railing



© Disney

SLEEPING BEAUTY CASTLE

Sheet Number: 23

Fold into triangle shape and glue tops together!

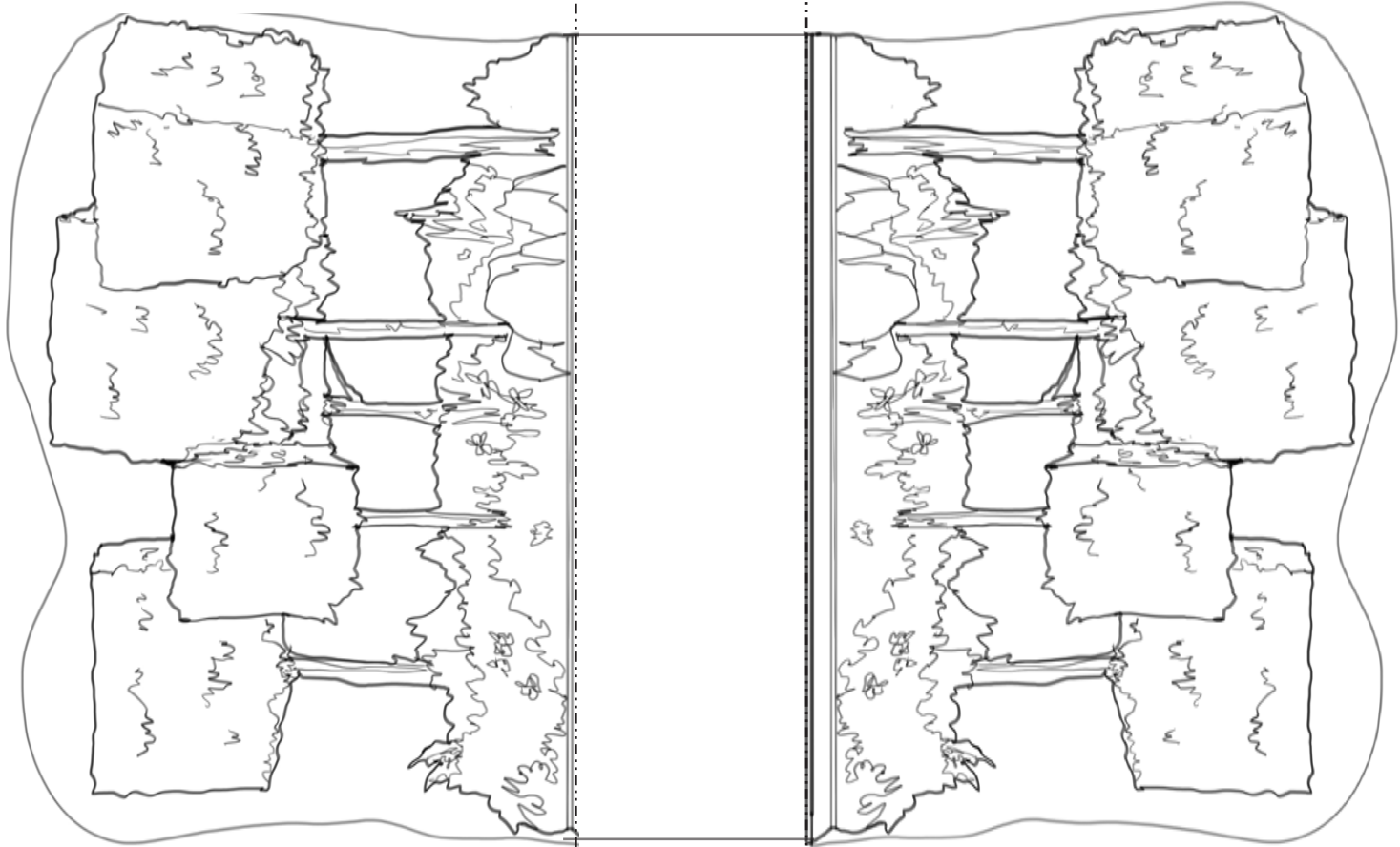
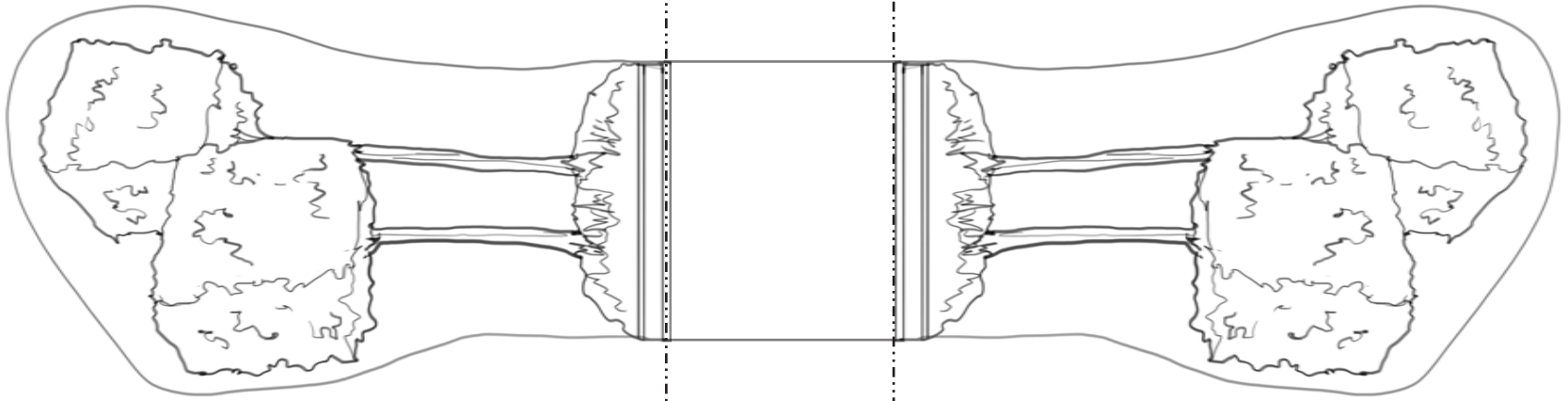



Disney Paper Parks

#DisneyMagicMoments | #DisneyPaperParks

HISTORY

Disneyland premiered its first fireworks show in 1956, one year after opening. Soon after the success of Walt's new television program, in which the introduction sequence featured Tinker Bell flying over the castle, he decided to bring that magic to Disneyland.

For many years past and present, park guests are dazzled and amazed at the innovation and grandeur of the Disneyland fireworks! Have fun creating your fireworks masterpiece!

DISNEY FIREWORKS SPECTACULAR (3 pages total)

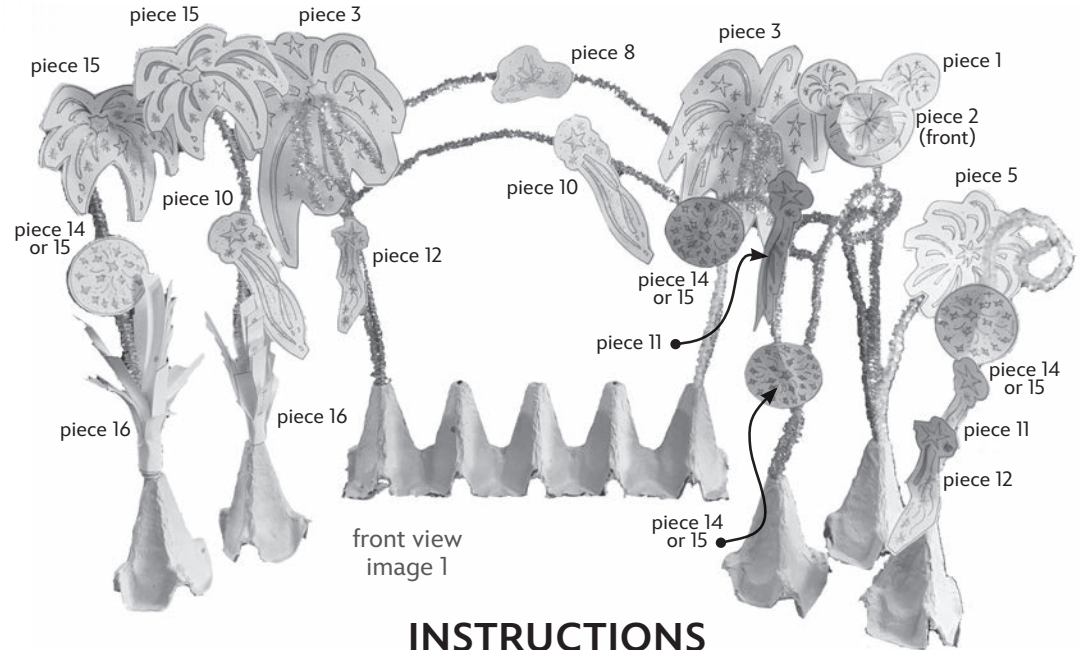

INSTRUCTIONS

1. Color the pages with glitter glue, crayons, colored pencils, or whatever you would like to use. Allow the pages to dry.
2. Cut along solid lines where indicated.
3. Fold tabs and pieces according to Guide.
4. Cut egg cartons as shown. See image 5 and 6.
5. Assemble piece 1 by gluing piece 2 on top of piece 1 as shown in image. Only glue the center so flanges can be bent forward as shown. Glue to pipe cleaner using piece 7b as shown. See image 1, upper right corner.
6. See image 3. Assemble piece 3 by placing 2 pipe cleaners on the back and gluing piece 6a over the pipe cleaners to secure. Notice 2 circles drawn on piece 6a. Take one pipe cleaner and cut in half. Take one half and poke through one of the circles and the other side of the half and poke through the other circle. Do this with the other half of the pipe cleaner also. Arrange the front side as shown in image 1. Repeat step 5 for pieces 4 and 6b.
7. Assemble the pipe cleaners in the connected egg carton piece as shown in image 3. Attach piece 8 (Tinker Bell) and piece 10 (wishing star) to the horizontal stem by gluing the tab as shown to the back of the piece and glue the very ends of the tab together. See image 3 and 4. Leave room for the tab to slide along the pipe cleaner. You will have an extra wishing star and tab, to place wherever you would like.
8. Assemble pieces 11 and 12 by looping the tab around a pipe cleaner and gluing.
9. Assemble pieces 13 and 14 by gluing to a pipe cleaner and securing to back with pieces 9a and 9b. See image 3 for gluing example.
10. Assemble piece 15 by folding and placing a pipe cleaner in between the folded halves. Glue together to secure.
11. Assemble piece 16 by applying glue to (uncut) bottom and rolling around a pipe cleaner, straw or pencil. Start rolling from the right side. See image 3.

MATERIALS

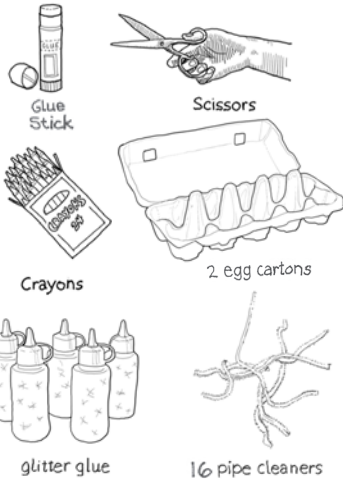

GUIDE

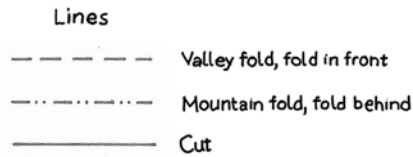

Please Note: When cutting with scissors and working with any of the materials listed above, adult participation and supervision is recommended.









Disney Paper Parks

#DisneyMagicMoments | #DisneyPaperParks

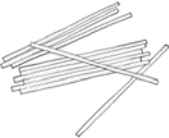
DISNEY FIREWORKS SPECTACULAR

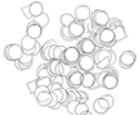
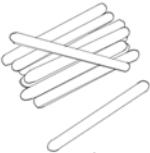
INSTRUCTIONS - REFERENCE SHEET

	Vertical Supports	Base Supports	Extra Decorations
Suggested Materials	 pipe cleaners	 egg carton	 glitter glue
Alternative Materials	 paper straws	 rubber or kneaded erasers	 confetti
	 craft sticks	 modeling clay	 fairy lights



fireworks with castle view
image 2

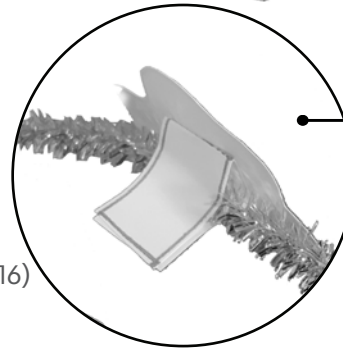

detail of
slider tab
(piece 8a and 16)
image 4

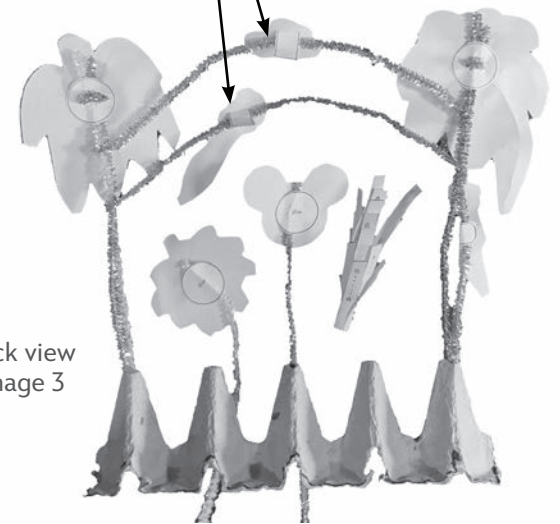

back view
image 3



egg carton
connected
piece, cut line.
image 5

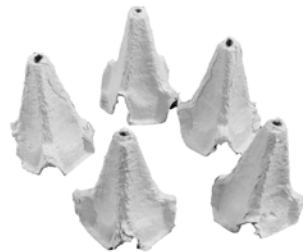

egg carton
5 separate pieces
image 6

#DisneyMagicMoments | #DisneyPaperParks



Disney Paper Parks

#DisneyMagicMoments | #DisneyPaperParks

DISNEY FIREWORKS SPECTACULAR

Page 1 of 3

piece 7a
(back of piece 5)

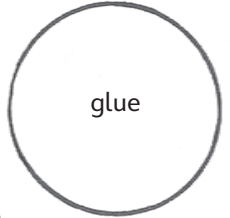

piece 8
Tinker Bell

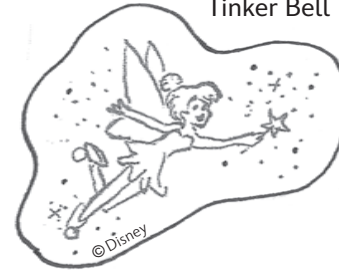

piece 7b
(back of piece 1)

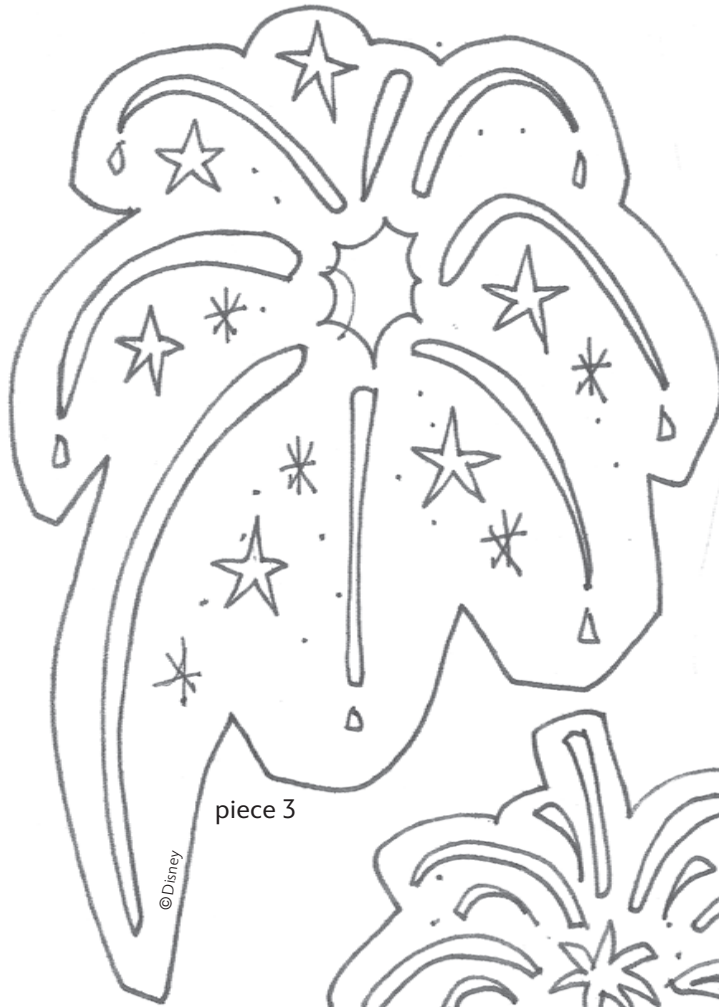
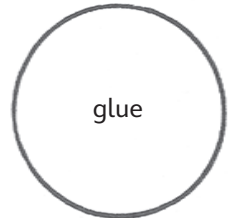

piece 3



piece 1

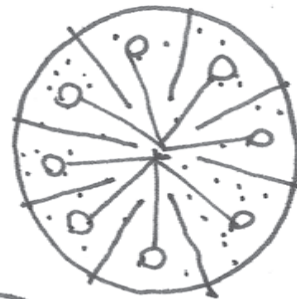

piece 2



piece 4

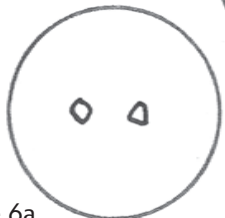

piece 6a
(back of piece 3, glue back side)

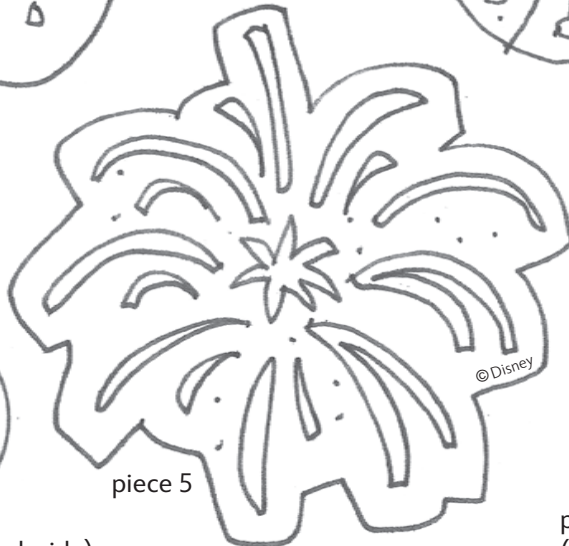

piece 5



piece 6b
(back of piece 4, glue back side)

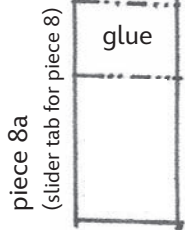

piece 8a
(slider tab for piece 8)

#DisneyMagicMoments | #DisneyPaperParks



© Disney

Disney Paper Parks

#DisneyMagicMoments | #DisneyPaperParks

DISNEY FIREWORKS SPECTACULAR

Page 2 of 3

piece 9a
(back of piece 13)

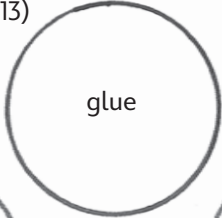

glue

piece 15

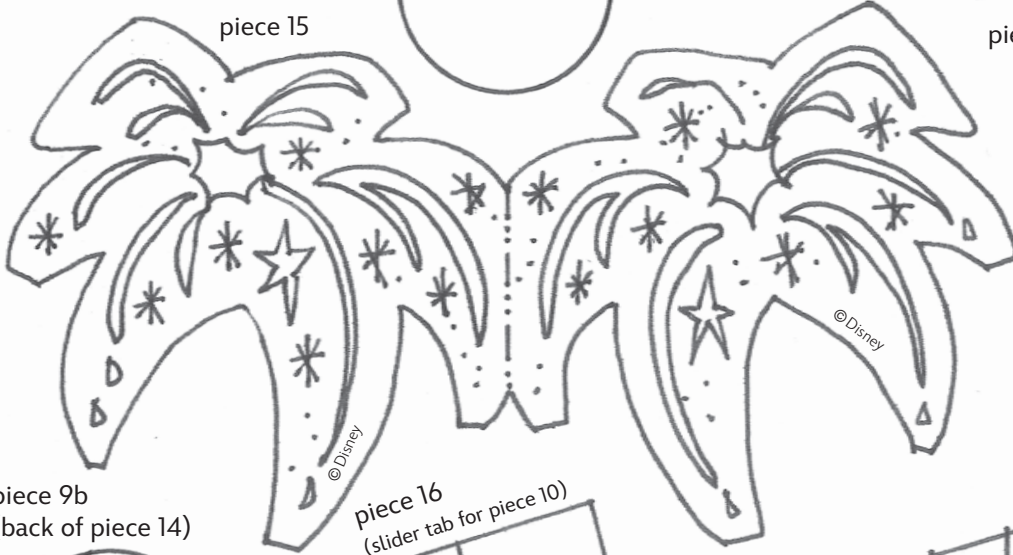

piece 10
wishing star

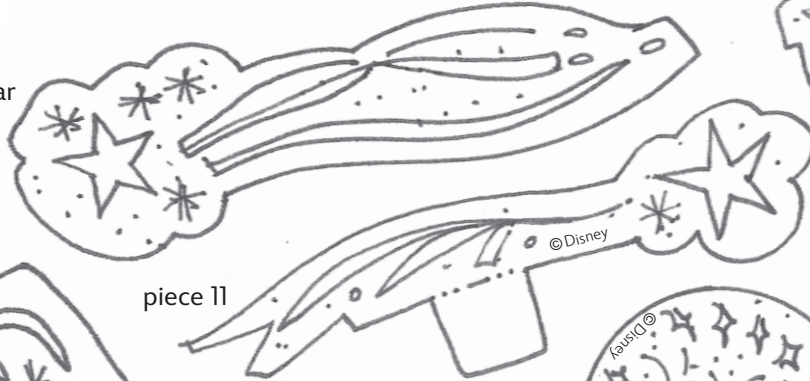

piece 11

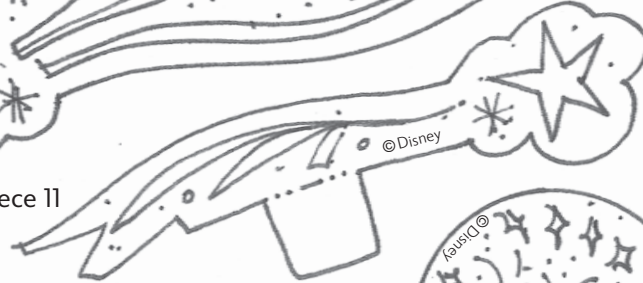

piece 12



piece 13



piece 14

piece 9b
(back of piece 14)

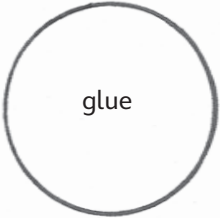

glue

piece 16
(slider tab for piece 10)



glue

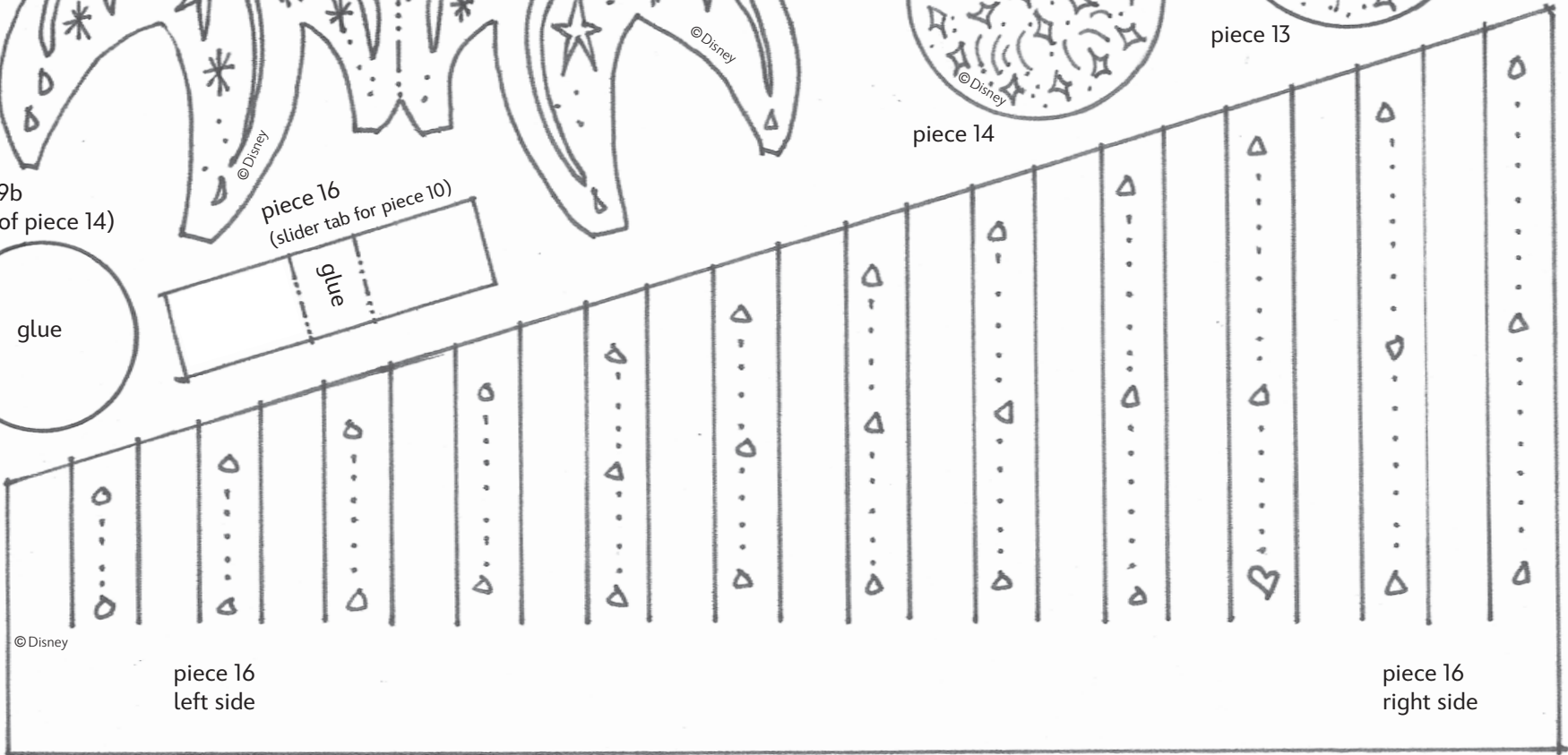

piece 16
left side

piece 16
right side

© Disney

© Disney

#DisneyMagicMoments | #DisneyPaperParks



Disney Paper Parks

#DisneyMagicMoments | #DisneyPaperParks

DISNEY FIREWORKS SPECTACULAR

Page 3 of 3

piece 9a
(back of piece 13)

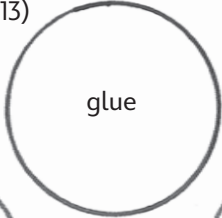

glue

piece 15

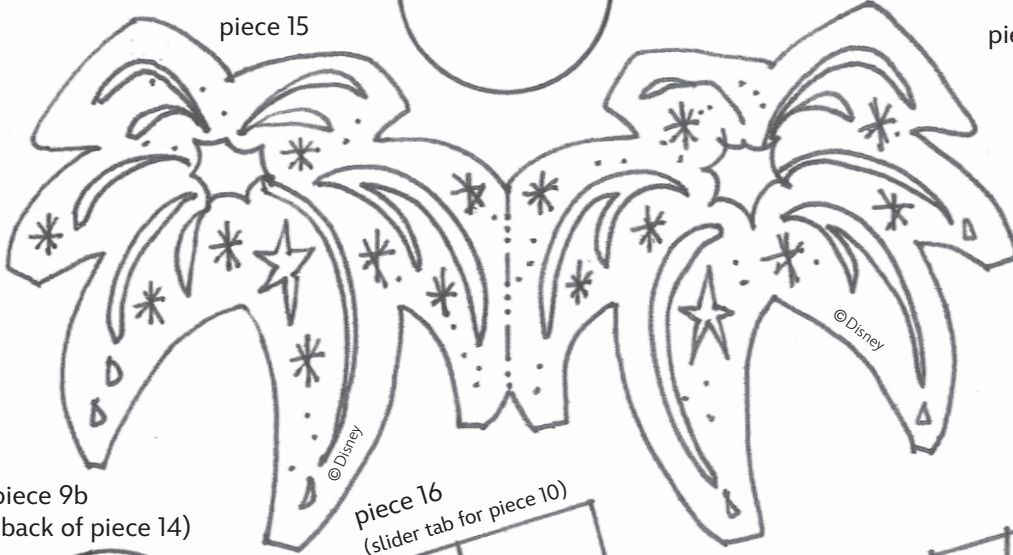

piece 10
wishing star

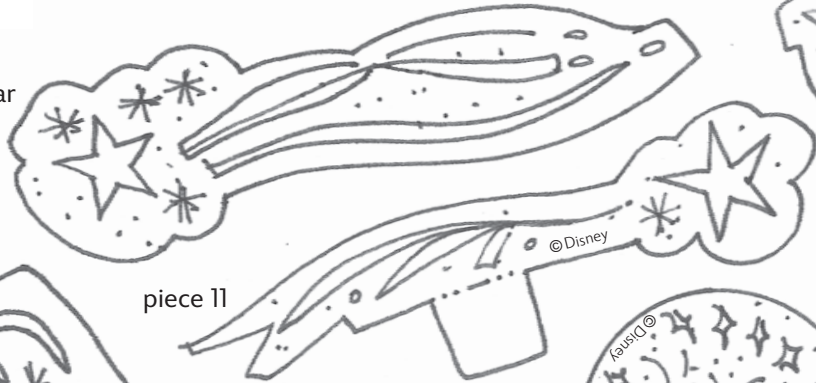

piece 11



piece 12



piece 14

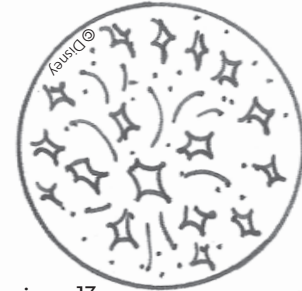

piece 13

piece 9b
(back of piece 14)

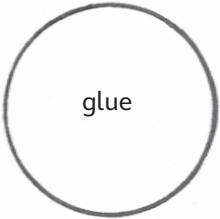

glue

piece 16
(slider tab for piece 10)



glue

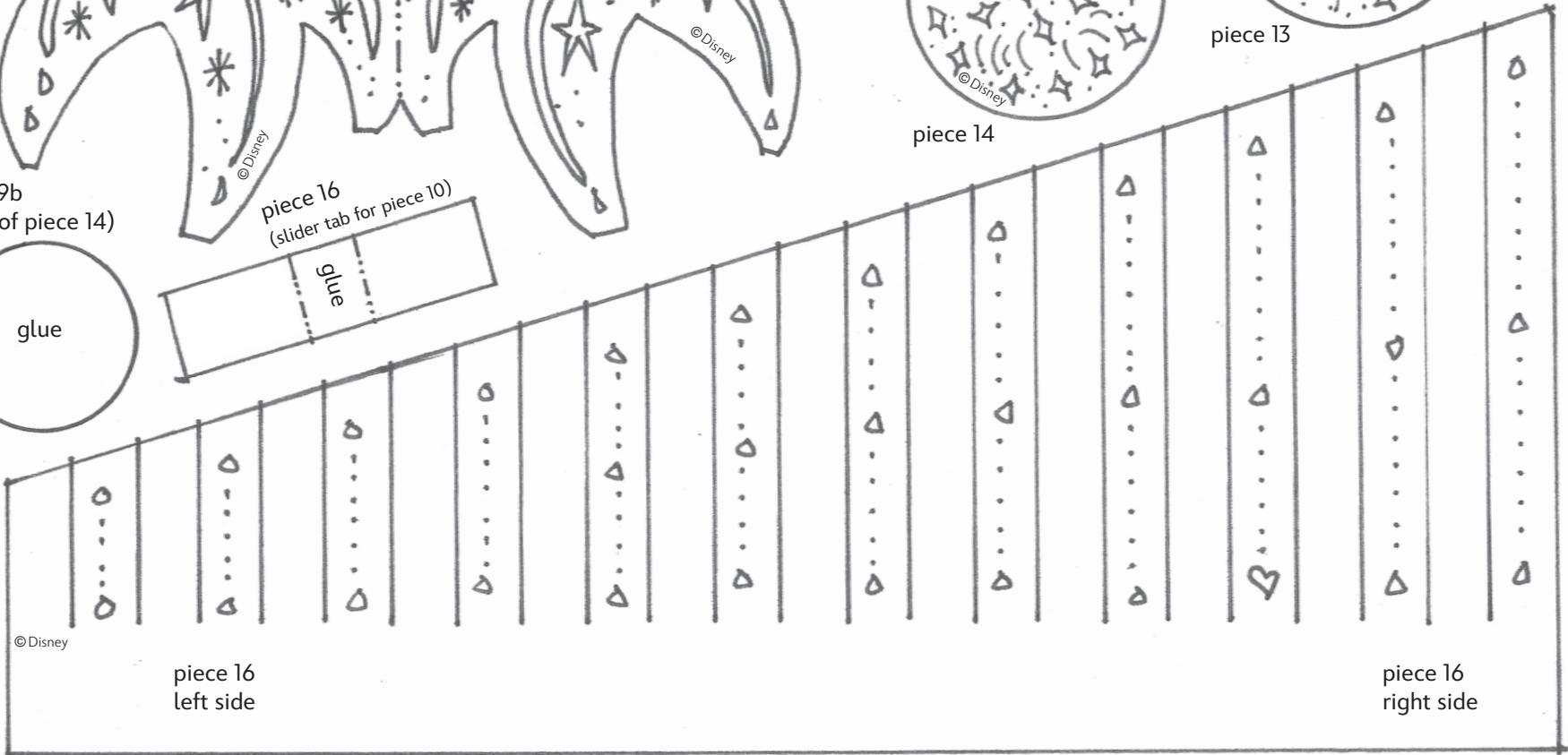

piece 16
left side

piece 16
right side

© Disney