

SURGICAL INSTRUMENTS

CHIRURGIE-INSTRUMENTE
INSTRUMENTS DE CHIRURGIE
INSTRUMENTOS QUIRÚRGICOS
STRUMENTI PER CHIRURGIA

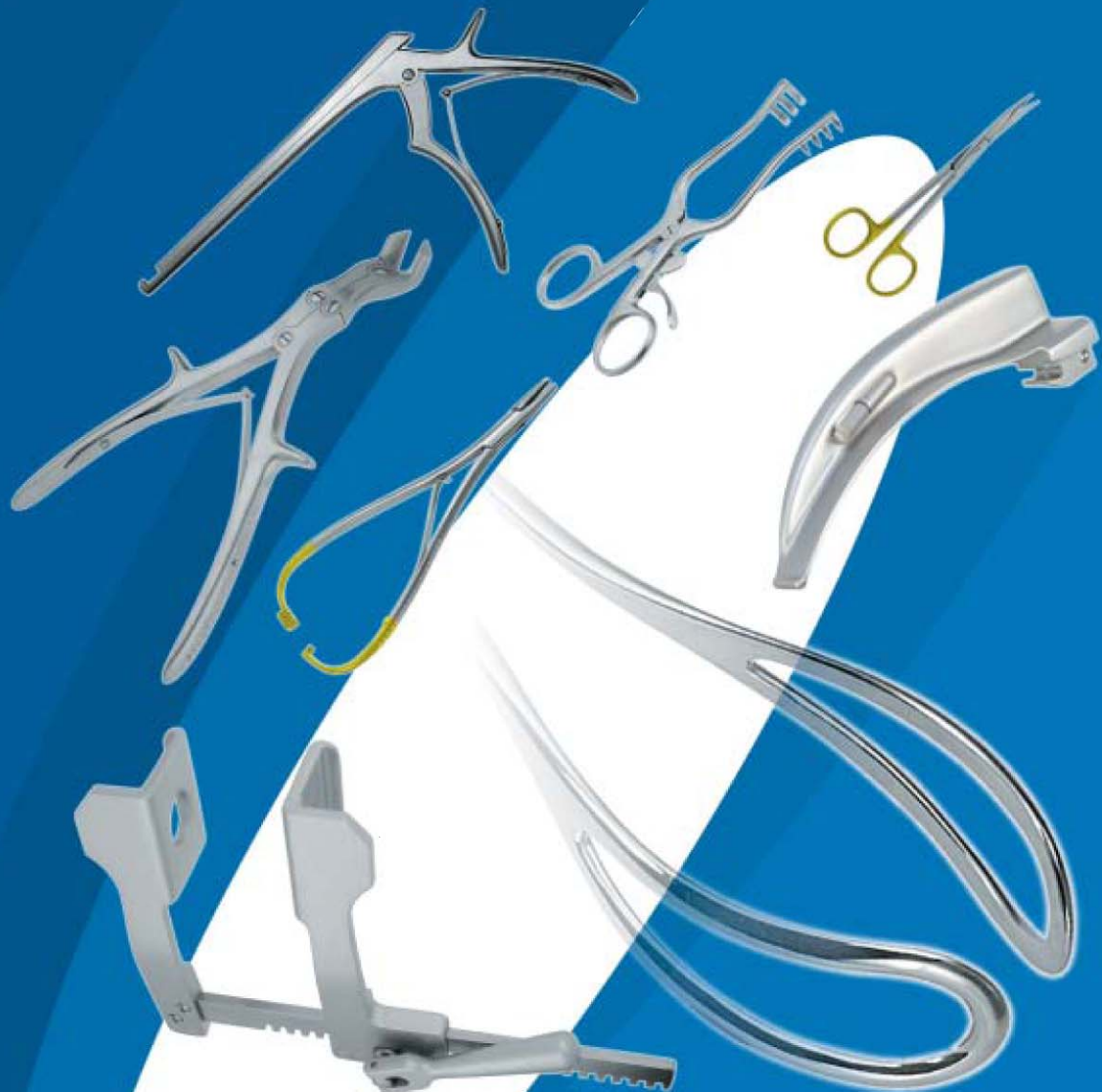

Content

Inhalt
Contenu
Contenido
Contenuto

DIAGNOSTICS

DIAGNOSTIK / DIAGNOSTIC / DIAGNÓSTICO /
DIAGNOSTICA

ANESTHESIA

ANAESTHESIE / ANESTHÉSIE / ANESTESIA /
ANESTESIA

SCALPELS, KNIVES

SKALPELLE, MESSER / BISTOURIS, COUTEAUX /
BISTURIES, CUCHILLOS / BISTURI, COLTELLI

SCISSORS

SCHEREN / CISEAUX / TIJERAS / FORBICI

MICRO SCISSORS

MIKRO SCHEREN / MICRO CISEAUX / MICRO TIJERAS /
MICRO FORBICI

THUMB AND TISSUE FORCEPS

PINZETTEN / PINCES À DISECCION / PINZAS DE
DISECCION / PINZE PER DISSEZIONE

HEMOSTATIC FORCEPS

ARTERIENKLEMMEN / PINCES HÉMOSTATIQUES /
PINZAS HEMOSTÁTICAS / PINZE EMOSTATICHE

ATRAUMATIC FORCEPS

ATRAUMATISCHE KLEMMEN / PINCES ATRAUMATIQUE /
PINZAS ATRAUMATICAS / PINZE ATRAUMATICHE

POLYPUS & DRESSING FORCEPS

TUPFER-/KORNZANGEN / PINCES À PANSEMENTS & À
POLYPPES / PINZAS PARA PÓLIPOS & ESPONJAS / PINZE
PER POLIPI & PER TAMPONI

RETRACTORS

WUNDHAKEN, / ECARTEURS / SEPARADORES /
DIVARICATORI

PROBES, SPATULAS, APPLICATORS

SONDEN, SPATEL, WATTETRÄGER / SONDES, SPATULES,
PORTE-COTON / SONDAS, ESPÁTULAS, PORTA-
ALGODÓN / SONDE, SPATOLE, PORTACOTONE

TROCARS, PUNCTURE NEEDLES

TROKARE, PUNKTIONSNADLEN / TROCARTS
AIGUILLES À PONCTION / TRÓCARES, AGUJAS
PARA PUNCIÓN / TREQUARTI, AGHI DA PUNZIONE

NEEDLE HOLDERS

NADELHALTER / PORTE-AIGUILLES / PORTA-AGUJAS /
PORT'AGHI

SUTURE

NAHT / SUTURE / SUTURA / SUTURA

STERILIZING AIDS

STERILISIERHILFEN / INSTRUMENTS POUR
STÉRILISATION / AUXILIOS PARA LA ESTERILIZACIÓN
UTENSILI PER LA STERILIZZAZIONE

PLASTER OF PARIS

GIPSVERBAND / BANDAGES PLÂTRÉS / VENDAJES
ENYESADOS / BENDAGGI GESSATI

BONE SURGERY, OSTEOSYNTHESIS

ORTHOPÄDIE, OSTEOSYNTHESE / CHIRURGIE OSSEUSE,
OSTÉOSYNTÈSE / CIRUGIA ÓSEA, OSTEOSINTESIS /
CHIRURGIA OSSEA, OSTEOSINTESI

AC NEUROSURGERY, LAMINECTOMY EA

NEUROCHIRURGIE, LAMINEKTOMIE / NEUROCHIRURGIE,
LAMINECTOMIE / NEUROCIURUGIA, LAMINECTOMIA /
NEUROCHIRURGIA, LAMINECTOMIA

AE OPTHALMOLOGY EC - ED

OPHTHALMOLOGIE / OPHTALMOLOGIE /
OFTALMOLOGIA / OFTALMOLOGIA

AG OTOLOGY EE

OTOLOGIE / OTOLOGIE / OTOLOGIA / OTOLOGIA

AH - AI RHINOLOGY EG

RHINOLOGIE / RHINOLOGIE / RINOLOGIA / RINOLOGIA

AJ MOUTH & TONGUE EI

MUND & ZUNGE / BOUCHE & LANGUE /
BOCA & LENGUA / BOCCA & LINGUA

BA - BB TONSILS FA

TONSILLEN / AMYGDALES / AMIGDALAS / TONSILLE

BC LARYNX FC

KEHLKOPF / LARYNX / LARINGE / LARINGE

BC TRACHEOSTOMY, GOITRE FE

TACHEOTOMIE, KROPF / TRACHÉOTOMIE, GOITRE /
TRAQUEOTOMIA, BOCIO / TRACHEOTOMIA, GOZZO

BD THORAX FG

THORAX / THORAX / TÓRAX /TORACE

BG GALL BLADDER, KIDNEY GC

GALLE, NIERE / VESICULE BILIAIRE, REIN / VESICULA
BILIAR, RIÑÓN / VESICOLA BILIARE, RENE

BI INTESTINES, STOMACH GE

DARM, MAGEN / INTESTIN, ESTOMAC /
INTESTINES, ESTÓMAGO / INTESTINI, STOMACO

CA UROLOGY GG

UROLOGIE / UROLOGIE / UROLOGIA / UROLOGIA

CA RECTUM GI

MASTDARM / RECTUM / RECTO / RETTO

CC GYNECOLOGY HA

GYNÄKOLOGIE / GYNÉCOLOGIE / GINECOLOGIA /
GINECOLOGIA

CE OBSTETRICS HC

GEBURTSHILFE / OBSTÉTRIQUE / OBSTETRICIA /
OSTERICIA

CG DERMATOLOGY, HYGIENE HE

DERMATOLOGIE, HYGIÈNE / DERMATOLOGIE,
HYGIÈNE / DERMATOLOGIA, HIGIENE /
DERMATOLOGIA, IGIENE

CI DENTAL INSTRUMENTS IA-IH

DENTAL INSTRUMENTE / INSTRUMENTS DENTAIRES /
INSTRUMENTOS DE ODONTOLOGIA / STRUMENTI
DENTALI

DA DIFFERENT CONTAINERS II

VERSCH. BEHÄLTER / BOÎTES DIVERSES / CONTENEDORES
VARIOS / VASSOI DIVERSI

DC - DG HIGH FREQUENCY SURGERY JA

HOCHFREQUENZ-CHIRURGIE / CHIRURGIE À HAUTE
FRÉQUENCE / ELECTROCIRUGIA/ ELETTRICIRURGIA

D - I INDEX

INHALTSVERZEICHNIS / INDEX / INDICE / INDICE



Gerades Instrument
Straight Instrument
Instrument droit
Instrumento recto
Strumento retto



Gebogenes Instrument
Curved Instrument
Instrument courbe
Instrumento curvo
Strumento curvo



Scharfes Instrument
Sharp Instrument
Instrument pointu
Instrumento agudo
Strumento acuto



Stumpfes Instrument
Blunt Instrument
Instrument mousse
Instrumento romo
Strumento smusso

Mit TC-Einsätzen
TC Lined
A mors TC
Con bocas TC
Con morso TC

Mit TC-Schneiden
TC Cutting Edges
Tanchant TC
Filos de corte TC
Taglio TC

Instrument aus Titan
Instrument from Titanium
Instrument en Titane
Instrumento de Titanio
Strumento in Titanio



SuperCut Scheren
SuperCut Scissors
SuperCut Ciseaux
SuperCut Tijeras
SuperCut Forbici

AC

Diagnostik
Diagnostics
Diagnostic
Diagnóstico
Diagnostica



AC

AC

Blutdruckmessapparate
Blood Pressure Apparatus
Tensiometres
Esfigmomanómetros
Sfigmomanometri



AC-012-00
compl.



Econom
AC-110-00

AC-112-00
compl.



AC-212-00
compl.



AC-312-00
compl.



COLLIN
AC-410-01 Erwachsene • Adult
AC-410-02 Kinder • Child • enfant
niños • bambini



AC-417-00



VARIFOCAL
AC-610-00



MAY
AC-612-00

AC

Diagnostik-Bestecke
Diagnostic Sets
Trousses à diagnostic
Juegos para diagnóstico
Astucci per diagnostica



AC-710-00
Combination



AC-713-00
Econom Universal



AC-714-00
Otoskop • Otopscope • Otoscopio

Stirnlampen
Head Lights
Lampes frontales
Lámparas frontales
Lampade frontali



AC-810-91



ZIEGLER
AC-810-90
compl.



AC-810-92



CLAR
AC-910-00
compl.
6 V.



AC-910-01



AC-915-00
compl.
6 V.

AC-020-00
compl.
Halogen



AC-915-01



6 Volt
AC-919-06

AC

Stethoskope
Stethoscopes
Stéthoscopes
Estetoscopios
Stetoscopi



BOWLES
AC-420-00



FORD
AC-422-00



DUPLEX
AC-426-00



PINARD
AC-620-15
15 cm



PINARD
AC-622-18
18 cm



cm TAYLOR
 17 AC-828-17
 20 AC-828-20



TRAUBE
 AC-920-16



BABINSKY
 AC-922-22
 22 cm



TROEMNER
 AC-924-24
 24 cm



DEJERINE
 AC-032-20



DEJERINE
 AC-034-20



BERLINER
 AC-036-17



BUCK
 AC-038-18

Schädel-Messzirkel
Cephalometer
Céphalomètre
Cefalómetro
Cefalometro



BERTILLON
AC-130-01

Winkelmesser
Goniometer
Goniomètre
Goniómetro
Goniometro



MOELTGEN
AC-132-01



Nadelrad
Pinwheel
Algesimetre
Rueda de espigas
Algesimetro

WARTENBERG
AC-230-19
19 cm

Metall Meßstäbe
Rulers, metal
Règles en métal
Reglas de metal
Regoli in acciaio



cm	inch.	
10	4	AC-430-10
20	8	AC-430-20
30	12	AC-430-30
50	20	AC-430-50



AC-434-15
15 cm

Maßband, Stahl
Tape measure, steel
Ruban métrique en acier
Cinta métrica de acero
Nastro metrico di acciaio



AC-530-15
1,5 m

AE

**Anaesthesia
Anesthesia
Anesthésie
Anestesia
Anestesia**



AE

AE-01



POOLE
AE-310-10
ø 10 mm (30 Charr.)



POOLE
AE-410-06 ø 6 mm (18 Charr.)
AE-410-08 ø 8 mm (23 Charr.)

AE-510-98

Saugspitze
Suction Tip
Pointe de succion
Cabezal para aspiración
Punta per aspirazione

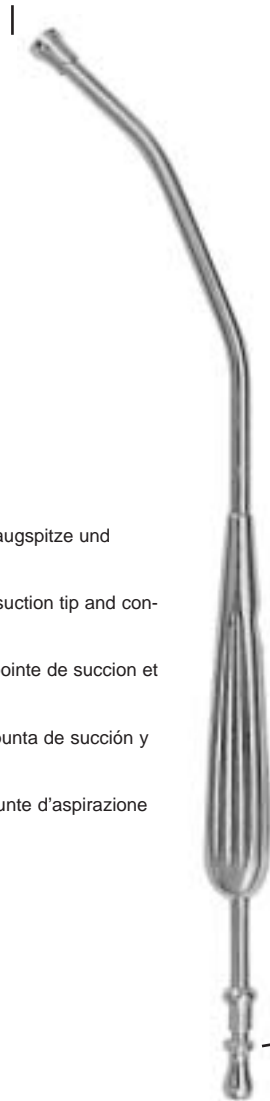

komplett mit Saugspitze und
Schlaucholive

complete with suction tip and
connector

complet avec pointe de succion et
raccord

completo con punta de succión y
conector

completi con punte d'aspirazione
e raccordo

AE-510-99

Schlaucholive
Olive
Olive
Oliva
Oliva

YANKAUER
AE-510-27
27 cm



ANDREW-PYNCHON
AE-511-24
ø 6 mm (18 Charr.)
23 cm



WALTON YANKAUER
AE-512-33
ø 10 mm (30 Charr.)
32 cm

mit Absperrventil und
abschraubbarem Rohr

with stopcock and tube
to be screwed off

avec robinet et canule
extérieure démontable

con interruptor y tubo
desenroscable

con interruttore e tubo
svitabile

Saugkanülen mit Unterbrecher und Mandrin
Suction Cannulae with finger cut-off and stylet
Canules d'aspiration avec interrupteur à doigt
Cánulas para aspiración con interruptor y estilete
Cannule per aspirazione con interruttore e stiletto

Saugspitze ø 5 mm
Suction Tip ø 5 mm
Pointe de succion ø 5 mm
Cabezal para aspiración ø 5 mm
Punta per aspirazione ø 5 mm



Schlaucholive ø 9 mm
Olive ø 9 mm
Olive ø 9 mm
Oliva ø 9 mm
Oliva ø 9 mm

cm	DE BAKEY
16	AE-514-16
26	AE-514-26



cm	DE BAKEY
28	AE-514-27



AE-515-99
Mandrin
Stylet
Doigt
Esfilete
Stiletto

cm	MAGILL	
24,5	AE-515-30	Fig. 1, ø 3,0 mm
24,5	AE-515-35	Fig. 2, ø 3,5 mm
24,5	AE-515-40	Fig. 3, ø 4,0 mm

Saug- und Spülkanüle
Suction and Irrigation Cannula
Canules d'aspiration et d'irrigation
Cánulas para aspiración e irrigación
Cannule per aspirazione e irrigazione



**FINSTERER
AE-518-00**
32 cm

runde Öffnung
round opening
ouverture ronde
abertura redonda
apertura retonda



ø 6 mm

**NUBOER
AE-610-21**
21 cm

ovale Öffnung
oval opening
ouverture ovale
abertura ovalada
apertura ovale



ø 6 mm

**NUBOER
AE-611-21**
21 cm

AE

Kathetereinführzangen
Catheter Introduction Forceps
Pinces pour introduire les sondes
Pinzas para catéteres
Pinze per introdurre le sonde



AE-910-17
für Kleinkinder
for babies
pour nourrissons
para neonatales
per neonati



AE-910-20
für Kinder
for children
pour enfants
para ninos
per bambini



AE-910-25
für Erwachsene
for adults
pour adultes
para adultos
per adulti

cm	MAGILL
17	AE-910-17
20	AE-910-20
25	AE-910-25

Laryngoskope
Laryngoscope
Laryngoscope
Laringoscopio
Laringoscopio



Faseroptik-Laryngoskope **Sigma Lite**
Fiber Optic Laryngoscope **Sigma Lite**
Laryngoscope à fibres optiques **Sigma Lite**
Laryngoscopia fibra optica **Sigma Lite**
Laringoscopia a fibre ottiche **Sigma Lite**

Sigma Lite ist unser Faseroptik- Laryngoskopsystem.

Die Spatel des Faseroptik-Laryngoskopsystems enthalten weder die Glühlampe noch die elektrischen Anschlüsse. Die Glühlampe befindet sich im Batteriegriff. Licht von der Glühlampe wird über Lichtwellenleiterbündel übertragen und tritt an der Spitze des Spatels nach außen.

Wir stellen die komplette Produktpalette faseroptischer MACINTOSH- und MILLER-Spatel her. Die Griffe sind je nach Kundenwunsch in kleineren und mittleren Größen erhältlich.

Sigma Lite Laryngoskopgriffe werden gemäß ISO 7376-3: 1996 hergestellt.

Sigma Lite Laryngoskopspatel

- mit 4 mm Faserbündel ausgestattet, um eine bessere Beleuchtung der Spatelspitze zu gewährleisten.
- sind mit polierten Faserenden für bestmögliche Beleuchtung versehen.
- werden aus nicht magnetischem rostfreien Stahl hergestellt.
- vollständig autoklavierbar.

Sigma Lite is our fiber optic laryngoscope system.

Blades in fiber optic laryngoscope system do not contain the bulb or electrical connections. The bulb is incorporated in the battery handle. Light from the bulb is transmitted through fiber optic bundles, and exits at the tip of the blade.

We manufacture complete range of fiber optic MACINTOSH and MILLER blades. Handles are available in small & medium sizes to suit customer requirements.

Sigma Lite laryngoscope handles are made according to ISO 7376-3: 1996.

Sigma Lite laryngoscope blades

- incorporate 4 mm fiber bundle for more light
- have polished fiber ends for maximum illumination
- are manufactured from non-magnetic stainless steel
- are fully autoclavable

Sigma Lite est notre système de laryngoscope à fibres optiques.

Les spatules du système de laryngoscope à fibres optiques ne contiennent ni l'ampoule, ni les connexions électriques. L'ampoule se trouve dans le manche de la batterie. La lumière de l'ampoule est transmise par les faisceaux des fibres optiques et ressort à l'avant de la spatule.

Nous produisons la palette complète des spatules à fibres optiques MACINTOSH et MILLER. Le client peut obtenir, selon souhait, des manches de petites ou grandes tailles.

Les manches du laryngoscope **Sigma Lite** sont fabriqués selon la norme ISO 7376-3: 1996.

Spatules du laryngoscope **Sigma Lite**

- sont équipées d'un faisceau optique de 4 mm afin d'assurer un meilleur éclairage de la pointe de la spatule
- sont pourvues de fibres polies au bout pour assurer un éclairage optimum
- sont fabriquées dans un acier inoxydable et non magnétique
- sont entièrement utilisables avec autoclave

Sigma Lite es nuestro sistema laringoscopia de fibra óptica.

Las espátulas del sistema laringoscopia de fibra óptica no contienen bombillas ni conexiones eléctricas. La bombilla está ubicada en el mango con baterías. La luz de la bombilla es transmitida a través del haz de fibras ópticas y sale por la punta de la espátula.

Producimos la gama completa de espátulas fibroópticas MACINTOSH y MILLER. Los mangos son disponibles en tamaños pequeños y medianos según el deseo del cliente.

Los mangos **Sigma Lite** para laringoscopios se producen conforme a la norma ISO 7376-3, 1996.

Las espátulas **Sigma Lite** para laringoscopios

- están equipadas con haces fibroópticas de 4 mm para asegurar una mejor iluminación de la punta de la espátula
- están provistas de fibras con extremos pulidos para lograr la mejor iluminación posible
- se hacen de acero inoxidable no magnético
- pueden ser tratados completamente en autoclave

Sigma Lite è il nostro sistema per laringoscopi a fibre ottiche.

Le spatole del sistema per laringoscopi a fibre ottiche non contengono né la lampadina a incandescenza, né i collegamenti elettrici. La lampadina si trova nel manico che contiene le batterie. La luce della lampadina a incandescenza viene trasmessa da un fascio di fibre ottiche e fuoriesce dalla punta della spatola.

Noi produciamo l'intera gamma di spatole a fibre ottiche MACINTOSH e MILLER. I manici sono disponibili in base ai desideri del cliente di dimensioni piccole o medie.

I manici dei laringoscopi **Sigma Lite** vengono prodotti in conformità alle norme ISO 7376-3: 1996.

Le spatole per laringoscopi **Sigma Lite**

- sono dotate di fasci di fibre da 4 mm, per garantire una migliore illuminazione della punta della spatola.
- sono dotate di estremità delle fibre lucidate per ottenere la migliore illuminazione possibile
- vengono prodotte in acciaio inossidabile non magnetico
- sono completamente trattabili con autoclave



Für Anästhesisten, die lieber das Standardsystem verwenden, bieten wir unser **Delta Lite** Laryngoskop an.
Die **Delta Lite** Produktreihe umfaßt alle Größen von MACINTOSH- und MILLER-Spateln mit Griffen in kleineren, mittleren, kurzen und großen Größen.

Delta Lite Laryngoskope und Griffe entsprechen EN 1819:1997.

Die Kontakte zu der Glühlampe in den **Delta Lite** Laryngoskopspateln sind mit Gold plattiert. Der federverspannte Kontakt zur Glühlampe sowie die Verdrahtung befinden sich in einer Röhre aus rostfreiem Stahl, die Teil des Spatels ist. Dadurch kann eine größtmögliche Zuverlässigkeit des elektrischen Kontakts garantiert werden.

For the anaesthetist who prefers using conventional system, we have our **Delta Lite** laryngoscope. **Delta Lite** range includes all sizes of MACINTOSH and MILLER blades along with handles in small, medium, large & stubby sizes.

Delta Lite laryngoscope handles conform to EN 1819:1997.

Delta Lite laryngoscope blades have gold plated contact to the bulb. The spring loaded contact to the bulb and wiring is incorporated in stainless steel tube, which forms part of the blade. This ensures maximum reliability of the electrical contact.

Pour les anesthésistes qui préfèrent se servir d'un système standard, nous proposons notre laryngoscope **Delta Lite**. La série de produits **Delta Lite** comprend toutes les tailles des spatules MACINTOSH et MILLER, avec des manches de petite, moyenne, courte et grande taille.

Les manches du laryngoscope **Delta Lite** correspondent à la norme EN 1819:1997.

Les contacts de l'ampoule dans les laryngoscopes **Delta Lite** sont plaqués avec de l'or. Le contact à ressort de l'ampoule, de même que le câblage, se trouvent dans un tube à acier inoxydable qui fait parti de la spatule. Ainsi, une fiabilité maximale du contact électrique peut être garantie.

Para los anestésistas que prefieren usar los sistemas convencionales tenemos el laringoscopio **Delta Lite**.

La gama de productos **Delta Lite** abarca todos los tamaños de espátulas MACINTOSH y MILLER con mangos en tamaños pequeños, medianos, cortos y grandes.

Los mangos **Delta Lite** para laringoscopios cumplen la norma EN 1819:1997.

Los contactos de las espátulas **Delta Lite** del laringoscopio para conectar la bombilla están recubiertos de oro. El contacto de muelle para conectar la bombilla así como el cableado están ubicados en un tubo de acero inoxidable que forma parte de la espátula. Así es posible garantizar la mayor fiabilidad posible del contacto eléctrico.

Per gli anestesisti che preferiscono utilizzare il sistema standard offriamo il nostro laringoscopio **Delta Lite**.

La serie **Delta Lite** comprende tutte le dimensioni di spatole MACINTOSH e MILLER con manici piccoli, medi, corti e grandi.

I manici dei laringoscopi **Delta Lite** sono conformi alle norme EN 1819:1997.

I contatti della lampadina a incandescenza nelle spatole dei laringoscopi **Delta Lite** sono placcati in oro. Il contatto con molla sotto carico della lampadine a incandescenza così come i cavi sono collocati in un condotto di acciaio inossidabile che è parte della spatola. Ciò consente di garantire la massima affidabilità del contatto elettrico.

Sigma Lite Faseroptik Spatel
 Sigma Lite fibreoptic blades

Größe Size Taille Tamaño Misura	Arbeitslänge (mm) Working Length (mm) Longueur de travail (mm) Largo de trabajo (mm) Lunghezza di lavoro (mm)	Seidenmatt Satin finish mat satinada opaca
0	55	AE-630-00S
1	70	AE-630-01S
2	78	AE-630-02S
2A	90	AE-631-02S
3	108	AE-630-03S
4	133	AE-630-04S
5	150	AE-631-05S



Sigma Lite Faseroptik Spatel mit auswechselbarem Lichtleiter
 Sigma Lite fibreoptic blades with interchangeable fibreoptic light guide

Größe Size Taille Tamaño Misura	Arbeitslänge (mm) Working Length (mm) Longueur de travail (mm) Largo de trabajo (mm) Lunghezza di lavoro (mm)	Glänzend Mirror finish brillant pulida lucida	Seidenmatt Satin finish mat satinada opaca
0	55	AE-030-00M	AE-030-00S
1	70	AE-030-01M	AE-030-01S
2	78	AE-030-02M	AE-030-02S
2A	90	AE-031-02M	AE-031-02S
3	108	AE-030-03M	AE-030-03S
4	133	AE-030-04M	AE-030-04S
5	150	AE-031-05M	AE-031-05S



Delta Lite Standard Spatel
 Sigma Lite conventional blades

Größe Size Taille Tamaño Misura	Arbeitslänge (mm) Working Length (mm) Longueur de travail (mm) Largo de trabajo (mm) Lunghezza di lavoro (mm)	Glänzend Mirror finish brillant pulida lucida	Seidenmatt Satin finish mat satinada opaca
0	55	AE-230-00M	AE-230-00S
1	70	AE-230-01M	AE-230-01S
2	78	AE-230-02M	AE-230-02S
2A	90	AE-231-02M	AE-231-02S
3	108	AE-230-03M	AE-230-03S
4	133	AE-230-04M	AE-230-04S
5	150	AE-231-05M	AE-231-05S



Sigma Lite Faseroptik Spatel
Sigma Lite fibreoptic blades

Größe	Arbeitslänge (mm)	Seidenmatt
Size	Working Length (mm)	Satin finish
Taille	Longueur de travail (mm)	mat
Tamaño	Largo de trabajo (mm)	satinada
Misura	Lunghezza di lavoro (mm)	opaca

0	65	AE-634-00S
1	66	AE-634-01S
2	86	AE-634-02S
3	107	AE-634-03S
3.5	123	AE-634-09S
4	134	AE-634-04S

Sigma Lite Faseroptik Spatel mit auswechselbarem Lichtleiter
Sigma Lite fibreoptic blades with interchangeable fibreoptic light guide

Größe	Arbeitslänge (mm)	Glänzend	Seidenmatt
Size	Working Length (mm)	Mirror finish	Satin finish
Taille	Longueur de travail (mm)	brillant	mat
Tamaño	Largo de trabajo (mm)	pulida	satinada
Misura	Lunghezza di lavoro (mm)	lucida	opaca

0	65	AE-034-00M	AE-034-00S
1	66	AE-034-01M	AE-034-01S
2	86	AE-034-02M	AE-034-02S
3	107	AE-034-03M	AE-034-03S
3.5	123	AE-034-09M	AE-034-09S
4	134	AE-034-04M	AE-034-04S

Delta Lite Standard Spatel
Sigma Lite conventional blades

Größe	Arbeitslänge (mm)	Glänzend	Seidenmatt
Size	Working Length (mm)	Mirror finish	Satin finish
Taille	Longueur de travail (mm)	brillant	mat
Tamaño	Largo de trabajo (mm)	pulida	satinada
Misura	Lunghezza di lavoro (mm)	lucida	opaca

0	65	AE-234-00M	AE-234-00S
1	66	AE-234-01M	AE-234-01S
2	86	AE-234-02M	AE-234-02S
3	107	AE-234-03M	AE-234-03S
3.5	123	AE-234-09M	AE-234-09S
4	134	AE-234-04M	AE-234-04S



Sigma Lite Faseroptik Spatel
 Sigma Lite fibreoptic blades

Größe Size Taille Tamaño Misura	Arbeitslänge (mm) Working Length (mm) Longueur de travail (mm) Largo de trabajo (mm) Lunghezza di lavoro (mm)	Seidenmatt Satin finish mat satinada opaca
3	133	AE-635-03S
4	150	AE-635-04S



Sigma Lite Faseroptik Spatel mit auswechselbarem Lichtleiter
 Sigma Lite fibreoptic blades with interchangeable fibreoptic light guide

Größe Size Taille Tamaño Misura	Arbeitslänge (mm) Working Length (mm) Longueur de travail (mm) Largo de trabajo (mm) Lunghezza di lavoro (mm)	Glänzend Mirror finish brillant pulida lucida	Seidenmatt Satin finish mat satinada opaca
3	133	AE-035-03M	AE-035-03S
4	150	AE-035-04M	AE-035-04S



Delta Lite Standard Spatel
 Sigma Lite conventional blades

Größe Size Taille Tamaño Misura	Arbeitslänge (mm) Working Length (mm) Longueur de travail (mm) Largo de trabajo (mm) Lunghezza di lavoro (mm)	Glänzend Mirror finish brillant pulida lucida	Seidenmatt Satin finish mat satinada opaca
3	133	AE-235-03M	AE-235-03S
4	150	AE-235-04M	AE-235-04S



Laryngoskope **MACINTOSH** Spatel mit integriertem Lichtleiteraustritt und mit flexibler Spitze
 Laryngoscope **MACINTOSH** Blades with integrated light guide and with flexible tip
 Laryngoscope **MACINTOSH**
 Laryngoscopio **MACINTOSH**
 Laringoscopio **MACINTOSH**



Sigma Lite Faseroptik Spatel
 Sigma Lite fibreoptic blades

Größe Size Taille Tamaño Misura	Arbeitslänge (mm) Working Length (mm) Longueur de travail (mm) Largo de trabajo (mm) Lunghezza di lavoro (mm)	Seidenmatt Satin finish mat satinada opaca
0	58	AE-636-00S
1	72	AE-636-01S
2	88	AE-636-02S
3	112	AE-636-03S
4	131	AE-636-04S
5	148	AE-636-05S



MACINTOSH Spatel mit integriertem Lichtleiteraustritt
MACINTOSH Blades with integrated light guide

Sigma Lite Faseroptik Spatel
 Sigma Lite fibreoptic blades

Größe Size Taille Tamaño Misura	Arbeitslänge (mm) Working Length (mm) Longueur de travail (mm) Largo de trabajo (mm) Lunghezza di lavoro (mm)	Seidenmatt Satin finish mat satinada opaca
2	87	AE-034-02S
3	110	AE-034-03S
4	130	AE-034-04S
5	150	AE-034-05S



MACINTOSH Spatel mit flexibler Spitze
MACINTOSH Blades with flexible tip

AE

Laryngoskope **MACINTOSH** Spatel mit spezieller Biegung
Laryngoscope **MACINTOSH** Blades with special curvature
Laryngoscope **MACINTOSH**
Laryngoscopio **MACINTOSH**
Laringoscopio **MACINTOSH**

Delta Lite Standard Spatel
Sigma Lite conventional blades

Größe	Arbeitslänge (mm)	Seidenmatt
Size	Working Length (mm)	Satin finish
Taille	Longueur de travail (mm)	mat
Tamaño	Largo de trabajo (mm)	satinada
Misura	Lunghezza di lavoro (mm)	opaca
0	76	AE-340-00S
1	86	AE-340-01S
2	96	AE-340-02S
3	108	AE-340-03S
4	138	AE-340-04S



MACINTOSH Spatel mit spezieller Biegung
MACINTOSH Blades with special curvature



Sigma Lite Faseroptik Spatel
 Sigma Lite fibreoptic blades

Größe Size Taille Tamaño Misura	Arbeitslänge (mm) Working Length (mm) Longueur de travail (mm) Largo de trabajo (mm) Lunghezza di lavoro (mm)	Seidenmatt Satin finish mat satinada opaca
00	45	AE-730-09S
0	55	AE-730-00S
1	80	AE-730-01S
2	130	AE-730-02S
3	170	AE-730-03S
4	180	AE-730-04S



Sigma Lite Faseroptik Spatel mit auswechselbarem Lichtleiter
 Sigma Lite fibreoptic blades with interchangeable fibreoptic light guide

Größe Size Taille Tamaño Misura	Arbeitslänge (mm) Working Length (mm) Longueur de travail (mm) Largo de trabajo (mm) Lunghezza di lavoro (mm)	Glänzend Mirror finish brillant pulida lucida	Seidenmatt Satin finish mat satinada opaca
00	45	AE-130-09M	AE-130-09S
0	55	AE-130-00M	AE-130-00S
1	80	AE-130-01M	AE-130-01S
2	130	AE-130-02M	AE-130-02S
3	170	AE-130-03M	AE-130-03S
4	180	AE-130-04M	AE-130-04S



Delta Lite Standard Spatel
 Sigma Lite conventional blades

Größe Size Taille Tamaño Misura	Arbeitslänge (mm) Working Length (mm) Longueur de travail (mm) Largo de trabajo (mm) Lunghezza di lavoro (mm)	Glänzend Mirror finish brillant pulida lucida	Seidenmatt Satin finish mat satinada opaca
00	45	AE-330-09M	AE-330-09S
0	55	AE-330-00M	AE-330-00S
1	80	AE-330-01M	AE-330-01S
2	130	AE-330-02M	AE-330-02S
3	170	AE-330-03M	AE-330-03S
4	180	AE-330-04M	AE-330-04S



Sigma Lite Faseroptik Spatel
 Sigma Lite fibreoptic blades

Größe	Arbeitslänge (mm)	Seidenmatt
Size	Working Length (mm)	Satin finish
Taille	Longueur de travail (mm)	mat
Tamaño	Largo de trabajo (mm)	satinada
Misura	Lunghezza di lavoro (mm)	opaca
0	55	AE-731-00S
1	80	AE-731-01S
2	132	AE-731-02S
3	172	AE-731-03S
4	182	AE-731-04S



Delta Lite Standard Spatel
 Sigma Lite conventional blades

Größe	Arbeitslänge (mm)	Glänzend	Seidenmatt
Size	Working Length (mm)	Mirror finish	Satin finish
Taille	Longueur de travail (mm)	brillant	mat
Tamaño	Largo de trabajo (mm)	pulida	satinada
Misura	Lunghezza di lavoro (mm)	lucida	opaca
0	55	AE-331-00M	AE-331-00S
1	80	AE-331-01M	AE-331-01S
2	132	AE-331-02M	AE-331-02S
3	172	AE-331-03M	AE-331-03S
4	182	AE-331-04M	AE-331-04S



Sigma Lite Faseroptik Spatel
 Sigma Lite fibreoptic blades

Größe	Arbeitslänge (mm)	Seidenmatt
Size	Working Length (mm)	Satin finish
Taille	Longueur de travail (mm)	mat
Tamaño	Largo de trabajo (mm)	satinada
Misura	Lunghezza di lavoro (mm)	opaca
1	71	AE-732-01S
2	90	AE-732-02S
3	110	AE-732-03S
4	137	AE-732-04S



Sigma Lite Faseroptik Spatel mit auswechselbarem Lichtleiter
 Sigma Lite fibreoptic blades with interchangeable fibreoptic light guide

Größe	Arbeitslänge (mm)	Glänzend	Seidenmatt
Size	Working Length (mm)	Mirror finish	Satin finish
Taille	Longueur de travail (mm)	brillant	mat
Tamaño	Largo de trabajo (mm)	pulida	satinada
Misura	Lunghezza di lavoro (mm)	lucida	opaca
1	71	AE-132-01M	AE-132-01S
2	90	AE-132-02M	AE-132-02S
3	110	AE-132-03M	AE-132-03S
4	137	AE-132-04M	AE-132-04S



Delta Lite Standard Spatel
 Sigma Lite conventional blades

Größe	Arbeitslänge (mm)	Glänzend	Seidenmatt
Size	Working Length (mm)	Mirror finish	Satin finish
Taille	Longueur de travail (mm)	brillant	mat
Tamaño	Largo de trabajo (mm)	pulida	satinada
Misura	Lunghezza di lavoro (mm)	lucida	opaca
1	71	AE-332-01M	AE-332-01S
2	90	AE-332-02M	AE-332-02S
3	110	AE-332-03M	AE-332-03S
4	137	AE-332-04M	AE-332-04S



Sigma Lite Faseroptik Spatel mit auswechselbarem Lichtleiter
 Sigma Lite fiberoptic blades with interchangeable fibreoptic light guide

Größe Size Taille Tamaño Misura	Arbeitslänge (mm) Working Length (mm) Longueur de travail (mm) Largo de trabajo (mm) Lunghezza di lavoro (mm)	Glänzend Mirror finish brillant pulida lucida	Seidenmatt Satin finish mat satinada opaca
0	52	AE-133-00M	AE-133-00S
1	80	AE-133-01M	AE-133-01S
1.5	90	AE-133-09M	AE-133-09S



WISCONSIN-HIPPLE Spatel
WISCONSIN-HIPPLE Blades

Delta Lite Standard Spatel
 Sigma Lite conventional blades

Größe Size Taille Tamaño Misura	Arbeitslänge (mm) Working Length (mm) Longueur de travail (mm) Largo de trabajo (mm) Lunghezza di lavoro (mm)	Glänzend Mirror finish brillant pulida lucida	Seidenmatt Satin finish mat satinada opaca
0	52	AE-333-00M	AE-333-00S
1	80	AE-333-01M	AE-333-01S
1.5	90	AE-333-09M	AE-333-09S



WISCONSIN-HIPPLE Spatel
WISCONSIN-HIPPLE Blades

Delta Lite Standard Spatel
 Sigma Lite conventional blades

Größe Size Taille Tamaño Misura	Arbeitslänge (mm) Working Length (mm) Longueur de travail (mm) Largo de trabajo (mm) Lunghezza di lavoro (mm)	Glänzend Mirror finish brillant pulida lucida	Seidenmatt Satin finish mat satinada opaca
0	60	AE-238-00M	AE-238-00S
1	70	AE-238-01M	AE-238-01S



PEDIATRIC Spatel
PEDIATRIC Blades

Sigma Lite Faseroptik Spatel
 Sigma Lite fibreoptic blades

Größe	Arbeitslänge (mm)	Seidenmatt
Size	Working Length (mm)	Satin finish
Taille	Longueur de travail (mm)	mat
Tamaño	Largo de trabajo (mm)	satinada
Misura	Lunghezza di lavoro (mm)	opaca
1	72	AE-734-01S
2	95	AE-734-02S
3	111	AE-734-03S
4	135	AE-734-04S



Sigma Lite Faseroptik Spatel mit auswechselbarem Lichtleiter
 Sigma Lite fibreoptic blades with interchangeable fibreoptic light guide

Größe	Arbeitslänge (mm)	Glänzend	Seidenmatt
Size	Working Length (mm)	Mirror finish	Satin finish
Taille	Longueur de travail (mm)	brillant	mat
Tamaño	Largo de trabajo (mm)	pulida	satinada
Misura	Lunghezza di lavoro (mm)	lucida	opaca
1	72	AE-134-01M	AE-134-01S
2	95	AE-134-02M	AE-134-02S
3	111	AE-134-03M	AE-134-03S
4	135	AE-134-04M	AE-134-04S



Delta Lite Standard Spatel
 Sigma Lite conventional blades

Größe	Arbeitslänge (mm)	Glänzend	Seidenmatt
Size	Working Length (mm)	Mirror finish	Satin finish
Taille	Longueur de travail (mm)	brillant	mat
Tamaño	Largo de trabajo (mm)	pulida	satinada
Misura	Lunghezza di lavoro (mm)	lucida	opaca
1	72	AE-334-01M	AE-334-01S
2	95	AE-334-02M	AE-334-02S
3	111	AE-334-03M	AE-334-03S
4	135	AE-334-04M	AE-334-04S



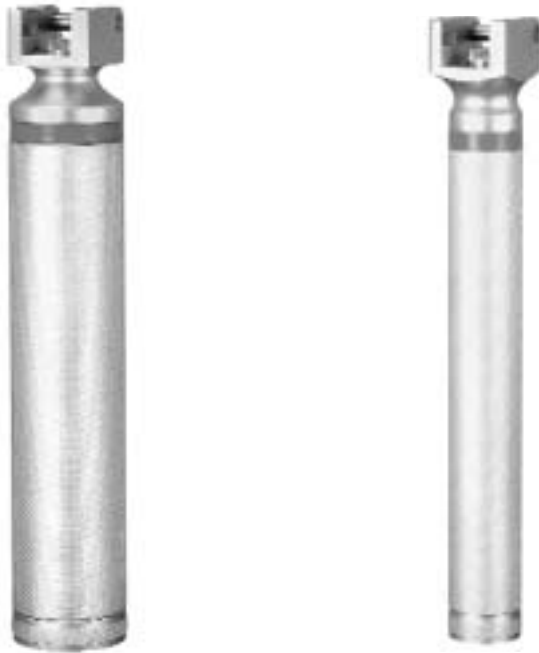

Alle Griffe sind in S = Seidenmatt oder
 M = glänzend erhältlich.
 All handles are available in S = Satin or
 M = Mirror finish.
 Toutes les poignées sont disponibles en S = mat ou en
 M = brillant.
 Todos los mangos disponibles en versión S = satinada o
 M = pulida.
 Tutti i manici sono disponibili nella versione S = opaca o
 M = lucida.

Größe Size Taille Tamaño Misura	Glänzend Mirror finish brillant pulida lucida	Seidenmatt Satin finish mat satinada opaca
Griff mittel, (Lieferung ohne Batterien)	AE-030-50M	AE-030-50S
Griff klein, (Lieferung ohne Batterien)	AE-030-51M	AE-030-51S
Kurzgriff, (Lieferung ohne Batterien)	AE-030-52M	AE-030-52S
Griff groß, (Lieferung ohne Batterien)	AE-030-53M	AE-030-53S
Medium Handle, (supplied without batteries)	AE-030-50M	AE-030-50S
Small Handle, (supplied without batteries)	AE-030-51M	AE-030-51S
Stubby Handle, (supplied without batteries)	AE-030-52M	AE-030-52S
Large Handle, (supplied without batteries)	AE-030-53M	AE-030-53S
Manche moyen, (livrée sans piles)	AE-030-50M	AE-030-50S
Manche petit, (livrée sans piles)	AE-030-51M	AE-030-51S
Manche court, (livrée sans piles)	AE-030-52M	AE-030-52S
Manche grand, (livrée sans piles)	AE-030-53M	AE-030-53S
Mango mediano, (suministro sin baterías)	AE-030-50M	AE-030-50S
Mango pequeño, (suministro sin baterías)	AE-030-51M	AE-030-51S
Mango corte, (suministro sin baterías)	AE-030-52M	AE-030-52S
Mango grande, (suministro sin baterías)	AE-030-53M	AE-030-53S
Manico medio, (consegna senza batterie)	AE-030-50M	AE-030-50S
Manico piccolo, (consegna senza batterie)	AE-030-51M	AE-030-51S
Manico corte, (consegna senza batterie)	AE-030-52M	AE-030-52S
Manico grande, (consegna senza batterie)	AE-030-53M	AE-030-53S

Standard-Laryngoskope **Delta Lite**
 Conventional Laryngoscope **Delta Lite**
 Laryngoscope standard **Delta Lite**
 Laryngoscopio convencional **Delta Lite**
 Laringoscopio standard **Delta Lite**

AE



Alle Griffe sind in S = Seidenmatt oder
 M = glänzend erhältlich.
 All handles are available in S = Satin or
 M = Mirror finish.
 Toutes les poignées sont disponibles en S = mat ou en
 M = brillant.
 Todos los mangos disponibles en versión S = satinada o
 M = pulida.
 Tutti i manici sono disponibili nella versione S = opaca o
 M = lucida.

Größe Size Taille Tamaño Misura	Glänzend Mirror finish brillant pulida lucida	Seidenmatt Satin finish mat satinada opaca
Griff mittel, (Lieferung ohne Batterien)	AE-230-50M	AE-230-50S
Griff klein, (Lieferung ohne Batterien)	AE-230-51M	AE-230-51S
Kurzgriff, (Lieferung ohne Batterien)	AE-230-52M	AE-230-52S
Griff groß, (Lieferung ohne Batterien)	AE-230-53M	AE-230-53S
Medium Handle, (supplied without batteries)	AE-230-50M	AE-230-50S
Small Handle, (supplied without batteries)	AE-230-51M	AE-230-51S
Stubby Handle, (supplied without batteries)	AE-230-52M	AE-230-52S
Large Handle, (supplied without batteries)	AE-230-53M	AE-230-53S
Manche moyen, (livrée sans piles)	AE-230-50M	AE-230-50S
Manche petit, (livrée sans piles)	AE-230-51M	AE-230-51S
Manche court, (livrée sans piles)	AE-230-52M	AE-230-52S
Manche grand, (livrée sans piles)	AE-230-53M	AE-230-53S
Mango mediano, (suministro sin baterías)	AE-230-50M	AE-230-50S
Mango pequeño, (suministro sin baterías)	AE-230-51M	AE-230-51S
Mango corte, (suministro sin baterías)	AE-230-52M	AE-230-52S
Mango grande, (suministro sin baterías)	AE-230-53M	AE-230-53S
Manico medio, (consegna senza batterie)	AE-230-50M	AE-230-50S
Manico piccolo, (consegna senza batterie)	AE-230-51M	AE-230-51S
Manico corte, (consegna senza batterie)	AE-230-52M	AE-230-52S
Manico grande, (consegna senza batterie)	AE-230-53M	AE-230-53S



Delta Lite Standard Griffe für Spatel mit spezieller Biegung
 Sigma Lite conventional handles for blades with special curvature

Größe Size Taille Tamaño Misura	Seidenmatt Satin finish mat satinada opaca
Griff mittel, (Lieferung ohne Batterien) Griff klein, (Lieferung ohne Batterien) Kurzgriff, (Lieferung ohne Batterien)	AE-240-50S AE-240-51S AE-240-52S
Medium Handle, (supplied without batteries) Small Handle, (supplied without batteries) Stubby Handle, (supplied without batteries)	AE-240-50S AE-240-51S AE-240-52S
Manche moyen, (livrée sans piles) Manche petit, (livrée sans piles) Manche court, (livrée sans piles)	AE-240-50S AE-240-51S AE-240-52S
Mango mediano, (suministro sin baterías) Mango pequeño, (suministro sin baterías) Mango corte, (suministro sin baterías)	AE-240-50S AE-240-51S AE-240-52S
Manico medio, (consegna senza batterie) Manico piccolo, (consegna senza batterie) Manico corte, (consegna senza batterie)	AE-240-50S AE-240-51S AE-240-52S

Kaltlicht / Cold light



AE-530-60

Halogenlampe, allein
Halogen lamp, only
Lampe halogène, seule
Lámpara halógeno, sola
Lampadina alogena, sola

Warmlicht / Krypton light



AE-530-71

Kryptonlampe, allein
Krypton lamp, only
Lampe krypton, seule
Lámpara criptón, sola
Lampadina alogena, sola

Warmlicht / Krypton light



AE-530-72

Kryptonlampe, allein
Krypton lamp, only
Lampe krypton, seule
Lámpara criptón, sola
Lampadina alogena, sola

Sicherheitshinweise

- **Delta Lite** und **Sigma Lite** Laryngoskope sind ausschließlich für endotracheale Intubation gedacht.
- Benutzen Sie mit **Sigma Lite** Spateln nur Griffe, die mit der grünen Markierung versehen sind.
- Versuchen Sie nicht, die faseroptische Röhre auszubauen.
- Zur Vorbeugung vor Mischinfektionen sollte das Laryngoskop nach jeder Intubation sorgfältig dekontaminiert werden. Reinigen Sie den Spatel direkt nach jedem Gebrauch mit einer weichen Bürste und Wasser oder einer Seifenlösung.
- Eine Dampfsterilisation kann bei 134°C vorgenommen werden. Standardspatel sollten mit montierter Glühlampe sterilisiert werden.

Benutzungshinweise

- Befestigen Sie den Spatel wie gewohnt am Griff und schwenken Sie ihn nach oben in Arbeitsposition.
- Überprüfen Sie, ob das Licht hell genug ist (Batterien!).
- Fassen Sie das Laryngoskop während der Intubation am Griff.

Instructions for use

Safety Information

- The **Delta Lite & Sigma Lite** laryngoscopes are used exclusively for endotracheal intubation.
- For **Sigma Lite** blades use only laryngoscope handles with the green identification mark.
- Do not attempt to dismantle the fiber optic tube.
- To avoid cross-infection, the laryngoscope must be decontaminated after each intubation. Use a soft brush with water or soap solution immediately after use to clean the blade.
- Steam sterilization can be done at 134°C. Conventional blades should be sterilized with bulb attached.

Using the instruments

- Attach the blade to the handle in the usual way and hinge upwards into the working position.
- Check that the light is bright enough (batteries!).
- During intubation hold the laryngoscope at the handle.

AE

Ersatzlampe für **Delta Lite** und **Sigma Lite**
Spare Lamps for both **Delta Lite** and **Sigma Lite**
Ampoule de rechange **Delta Lite** pour **Sigma Lite**
Bombilla de repuesto **Delta Lite Sigma Lite**
Lampada di ricambio **Delta Lite Sigma Lite**

Notice d'emploi

Consignes de sécurité

- Les laryngoscopes **Delta Lite** et **Sigma Lite** sont uniquement conçus pour les intubations endotracheales.
- Avec les spatules **Sigma Lite**, utilisez uniquement les manches qui sont marqués de vert.
- N'essayez pas de démonter les tubes des fibres optiques.
- Pour prévenir contre les infections mixtes, le laryngoscope devrait être soigneusement décontaminé après chaque intubation. Nettoyez la spatule immédiatement après chaque utilisation, à l'aide d'une brosse douce et d'eau, ou d'une solution savonneuse.
- Une stérilisation à la vapeur peut être envisagée à 134°C. Les spatules standards devraient être stérilisées, assemblées à l'ampoule.

Consignes d'utilisation

- Fixez comme d'usage la spatule au manche et faites la pivoter vers le haut dans la position de travail.
- Vérifiez que la lumière éclaire suffisamment (piles!).
- Durant l'intubation, saisissez le laryngoscope par le manche.

Indicaciones de uso

Indicaciones de seguridad

- Los laringoscopios **Delta Lite** y **Sigma Lite** sólo pueden ser usados para intubaciones endotraqueales.
- Los mangos de las espátulas **Sigma Lite** sólo deben ser usados con los mangos que llevan una marca verde.
- No intentar desmontar el tubo fibroóptico.
- Para prevenir infecciones mixtas el laringoscopio se debería descontaminar cuidadosamente después de cada intubación. Limpie la espátula inmediatamente después de usarla con un cepillo blando y agua o una jabonadura.
- Es posible efectuar una esterilización por vapor a 134°C. Las espátulas convencionales se deberían esterilizar con bombilla puesta.

Indicaciones para el uso del instrumento

- Sujete la espátula como de costumbre en el mango y gírelo hacia arriba a la posición de trabajo.
- Compruebe que la luz es lo suficientemente fuerte (baterías!).
- Agarre el laringoscopio por el mango durante la intubación.

Istruzioni per l'uso

Norme di sicurezza

- I laringoscopi **Delta Lite** e **Sigma Lite** sono concepiti esclusivamente per l'intubazione endotracheale.
- Con le spatole **Sigma Lite** utilizzare esclusivamente manici con il marchio verde.
- Non tentare di smontare il condotto a fibre ottiche.
- Per evitare infezioni miste il laringoscopio deve essere accuratamente decontaminato dopo ogni intubazione. Pulire la spatola subito dopo ogni uso con una spazzola morbida e dell'acqua o una soluzione saponata.
- La sterilizzazione a vapore può essere effettuata a 134°C.
Le spatole standard devono essere sterilizzate con la lampada montata.

Istruzioni per l'uso

- Fissare come di solito la spatola sul manico e orientarla verso l'alto in posizione pronta per l'uso.
- Verificare che la luce sia sufficientemente forte (batterie!).
- Durante l'intubazione tenere il laringoscopio per il manico.



Sigma Lite Faseroptik Spatel
 Sigma Lite fibreoptic blades

Größe
 Size
 Taille
 Tamaño
 Misura

Seidenmatt
 Satin finish
 mat
 satinada
 opaca

Griff mittel mit MACINTOSH-Spatel Größe 1, 2 (78 mm) und 3	AE-630-71S
Griff mittel mit MACINTOSH-Spatel Größe 1, 2A (90 mm) und 3	AE-730-71S
Medium Handle with MACINTOSH Blade size 1, 2 (78 mm) and 3	AE-630-71S
Medium Handle with MACINTOSH Blade size 1, 2A (90 mm) and 3	AE-730-71S
Manche moyen avec spatule MACINTOSH Taille 1, 2 (78 mm) et 3	AE-630-71S
Manche moyen avec spatule MACINTOSH Taille 1, 2A (90 mm) et 3	AE-730-71S
Mango mediano con espátula MACINTOSH tamaño 1, 2 (78 mm) y 3	AE-630-71S
Mango mediano con espátula MACINTOSH tamaño 1, 2 (90 mm) y 3	AE-730-71S
Manico medio con spatola MACINTOSH misura 1, 2 (78 mm) e 3	AE-630-71S
Manico medio con spatola MACINTOSH misura 1, 2 (90 mm) e 3	AE-730-71S
Griff mittel mit MACINTOSH-Spatel Größe 2 (78 mm) 3 und 4	AE-630-72S
Griff mittel mit MACINTOSH-Spatel Größe 2A (90 mm) 3 und 4	AE-730-72S
Medium Handle with MACINTOSH Blade size 2 (78 mm), 3 and 4	AE-630-72S
Medium Handle with MACINTOSH Blade size 2A (90 mm), 3 and 4	AE-730-72S
Manche moyen avec spatule MACINTOSH Taille 2 (78 mm), 3 et 4	AE-630-72S
Manche moyen avec spatule MACINTOSH Taille 2A (90 mm), 3 et 4	AE-730-72S
Mango mediano con espátula MACINTOSH tamaño 2 (78 mm), 3 y 4	AE-630-72S
Mango mediano con espátula MACINTOSH tamaño 2A (90 mm), 3 y 4	AE-730-72S
Manico medio con spatola MACINTOSH misura 2 (78 mm), 3 e 4	AE-630-72S
Manico medio con spatola MACINTOSH misura 2A (90 mm), 3 e 4	AE-730-72S



Sigma Lite Faseroptik Spatel
 Sigma Lite fibreoptic blades

Größe
 Size
 Taille
 Tamaño
 Misura

Seidenmatt
 Satin finish
 mat
 satinada
 opaca

Griff mittel mit MACINTOSH-Spatel Größe 1, 2 (78 mm), 3 und 4
 Griff mittel mit MACINTOSH-Spatel Größe 1, 2A (90 mm), 3 und 4

AE-630-73S
AE-730-73S

Medium Handle with MACINTOSH Blade size 1, 2 (78 mm), 3 and 4
 Medium Handle with MACINTOSH Blade size 1, 2A (90 mm), 3 and 4

AE-630-73S
AE-730-73S

Manche moyen avec spatule MACINTOSH Taille 1, 2 (78 mm), 3 et 4
 Manche moyen avec spatule MACINTOSH Taille 1, 2A (90 mm), 3 et 4

AE-630-73S
AE-730-73S

Mango mediano con espátula MACINTOSH tamaño 1, 2 (78 mm), 3 y 4
 Mango mediano con espátula MACINTOSH tamaño 1, 2 (90 mm), 3 y 4

AE-630-73S
AE-730-73S

Manico medio con spatola MACINTOSH misura 1, 2 (78 mm), 3 e 4
 Manico medio con spatola MACINTOSH misura 1, 2 (90 mm), 3 e 4

AE-630-73S
AE-730-73S

Griff mittel mit MACINTOSH-Spatel Größe 0, 1, 2 (78 mm), 3 und 4
 Griff mittel mit MACINTOSH-Spatel Größe 0, 1, 2A (90 mm), 3 und 4

AE-630-77S
AE-730-77S

Medium Handle with MACINTOSH Blade size 0, 1, 2 (78 mm), 3 and 4
 Medium Handle with MACINTOSH Blade size 0, 1, 2A (90 mm), 3 and 4

AE-630-77S
AE-730-77S

Manche moyen avec spatule MACINTOSH Taille 0, 1, 2 (78 mm), 3 et 4
 Manche moyen avec spatule MACINTOSH Taille 0, 1, 2A (90 mm), 3 et 4

AE-630-77S
AE-730-77S

Mango mediano con espátula MACINTOSH tamaño 0, 1, 2 (78 mm), 3 y 4
 Mango mediano con espátula MACINTOSH tamaño 0, 1, 2 (90 mm), 3 y 4

AE-630-77S
AE-730-77S

Manico medio con spatola MACINTOSH misura 0, 1, 2 (78 mm), 3 e 4
 Manico medio con spatola MACINTOSH misura 0, 1, 2 (90 mm), 3 e 4

AE-630-77S
AE-730-77S



Sigma Lite Faseroptik Spatel
 Sigma Lite fibreoptic blades

Größe
 Size
 Taille
 Tamaño
 Misura

Seidenmatt
 Satin finish
 mat
 satinada
 opaca

Griff mittel mit MACINTOSH-Spatel mit flexibler Spitze Größe 2	AE-630-82S
Griff mittel mit MACINTOSH-Spatel mit flexibler Spitze Größe 3	AE-630-83S
Griff mittel mit MACINTOSH-Spatel mit flexibler Spitze Größe 4	AE-630-84S
Griff mittel mit MACINTOSH-Spatel mit flexibler Spitze Größe 5	AE-630-85S

Medium Handle with MACINTOSH Blade with flexible tip size 2	AE-630-82S
Medium Handle with MACINTOSH Blade with flexible tip size 3	AE-630-83S
Medium Handle with MACINTOSH Blade with flexible tip size 4	AE-630-84S
Medium Handle with MACINTOSH Blade with flexible tip size 5	AE-630-85S

Manche moyen avec spatule MACINTOSH 2	AE-630-82S
Manche moyen avec spatule MACINTOSH 3	AE-630-83S
Manche moyen avec spatule MACINTOSH 4	AE-630-84S
Manche moyen avec spatule MACINTOSH 5	AE-630-85S

Mango mediano con espátula MACINTOSH con 2	AE-630-82S
Mango mediano con espátula MACINTOSH con 3	AE-630-83S
Mango mediano con espátula MACINTOSH con 4	AE-630-84S
Mango mediano con espátula MACINTOSH con 5	AE-630-85S

Manico medio con spatola MACINTOSH con 2	AE-630-82S
Manico medio con spatola MACINTOSH con 3	AE-630-83S
Manico medio con spatola MACINTOSH con 4	AE-630-84S
Manico medio con spatola MACINTOSH con 5	AE-630-85S



Sigma Lite Faseroptik Spatel
 Sigma Lite fibreoptic blades

Größe
 Size
 Taille
 Tamaño
 Misura

Seidenmatt
 Satin finish
 mat
 satinada
 opaca

Griff klein mit MILLER-Spatel Größe 0 und 1	AE-630-74S
Griff mittel mit MILLER-Spatel Größe 2, 3 und 4	AE-630-75S
Griff mittel mit MILLER-Spatel Größe 1, 2, 3 und 4	AE-630-76S
Small Handle with MILLER Blade size 0 & 1	AE-630-74S
Medium Handle with MILLER Blade size 2, 3 & 4	AE-630-75S
Medium Handle with MILLER Blade size 1, 2, 3 & 4	AE-630-76S
Manche petit avec spatule MILLER Taille 0 et 1	AE-630-74S
Manche moyen avec spatule MILLER Taille 2, 3 et 4	AE-630-75S
Manche moyen avec spatule MILLER Taille 1, 2, 3 et 4	AE-630-76S
Mango pequeño con espátula MILLER tamaño 0 y 1	AE-630-74S
Mango mediano con espátula MILLER tamaño 2, 3, y 4	AE-630-75S
Mango mediano con espátula MILLER tamaño 1, 2, 3 y 4	AE-630-76S
Manico piccolo con spatola MILLER misura 0 e 1	AE-630-74S
Manico medio con spatola MILLER misura 2, 3 e 4	AE-630-75S
Manico medio con spatola MILLER misura 1, 2, 3 e 4	AE-630-76S



Sigma Lite Faseroptik Spatel mit auswechselbarem Lichtleiter
 Sigma Lite fibreoptic blades with interchangeable fibreoptic light guide

Größe Size Taille Tamaño Misura	Glänzend Mirror finish brillant pulida lucida	Seidenmatt Satin finish mat satinada opaca
Griff mittel mit MACINTOSH-Spatel Größe 1, 2 (78 mm) und 3 Griff mittel mit MACINTOSH-Spatel Größe 1, 2A (90 mm) und 3	AE-030-71M AE-130-71M	AE-030-71S AE-130-71S
Medium Handle with MACINTOSH Blade size 1, 2 (78 mm) and 3 Medium Handle with MACINTOSH Blade size 1, 2A (90 mm) and 3	AE-030-71M AE-130-71M	AE-030-71S AE-130-71S
Manche moyen avec spatule MACINTOSH Taille 1, 2 (78 mm) et 3 Manche moyen avec spatule MACINTOSH Taille 1, 2A (90 mm) et 3	AE-030-71M AE-130-71M	AE-030-71S AE-130-71S
Mango mediano con espátula MACINTOSH tamaño 1, 2 (78 mm) y 3 Mango mediano con espátula MACINTOSH tamaño 1, 2 (90 mm) y 3	AE-030-71M AE-130-71M	AE-030-71S AE-130-71S
Manico medio con spatola MACINTOSH misura 1, 2 (78 mm) e 3 Manico medio con spatola MACINTOSH misura 1, 2 (90 mm) e 3	AE-030-71M AE-130-71M	AE-030-71S AE-130-71S
Griff mittel mit MACINTOSH-Spatel Größe 2 (78 mm) 3 und 4 Griff mittel mit MACINTOSH-Spatel Größe 2A (90 mm) 3 und 4	AE-030-72M AE-130-72M	AE-030-72S AE-130-72S
Medium Handle with MACINTOSH Blade size 2 (78 mm), 3 and 4 Medium Handle with MACINTOSH Blade size 2A (90 mm), 3 and 4	AE-030-72M AE-130-72M	AE-030-72S AE-130-72S
Manche moyen avec spatule MACINTOSH Taille 2 (78 mm), 3 et 4 Manche moyen avec spatule MACINTOSH Taille 2A (90 mm), 3 et 4	AE-030-72M AE-130-72M	AE-030-72S AE-130-72S
Mango mediano con espátula MACINTOSH tamaño 2 (78 mm), 3 y 4 Mango mediano con espátula MACINTOSH tamaño 2A (90 mm), 3 y 4	AE-030-72M AE-130-72M	AE-030-72S AE-130-72S
Manico medio con spatola MACINTOSH misura 2 (78 mm), 3 e 4 Manico medio con spatola MACINTOSH misura 2A (90 mm), 3 e 4	AE-030-72M AE-130-72M	AE-030-72S AE-130-72S



Sigma Lite Faseroptik Spatel mit auswechselbarem Lichtleiter
 Sigma Lite fibreoptic blades with interchangeable fibreoptic light guide

Größe Size Taille Tamaño Misura	Glänzend Mirror finish brillant pulida lucida	Seidenmatt Satin finish mat satinada opaca
Griff mittel mit MACINTOSH-Spatel Größe 1, 2 (78 mm), 3 und 4 Griff mittel mit MACINTOSH-Spatel Größe 1, 2A (90 mm), 3 und 4	AE-030-73M AE-130-73M	AE-030-73S AE-130-73S
Medium Handle with MACINTOSH Blade size 1, 2 (78 mm), 3 and 4 Medium Handle with MACINTOSH Blade size 1, 2A (90 mm), 3 and 4	AE-030-73M AE-130-73M	AE-030-73S AE-130-73S
Manche moyen avec spatule MACINTOSH Taille 1, 2 (78 mm), 3 et 4 Manche moyen avec spatule MACINTOSH Taille 1, 2A (90 mm), 3 et 4	AE-030-73M AE-130-73M	AE-030-73S AE-130-73S
Mango mediano con espátula MACINTOSH tamaño 1, 2 (78 mm), 3 y 4 Mango mediano con espátula MACINTOSH tamaño 1, 2 (90 mm), 3 y 4	AE-030-73M AE-130-73M	AE-030-73S AE-130-73S
Manico medio con spatola MACINTOSH misura 1, 2 (78 mm), 3 e 4 Manico medio con spatola MACINTOSH misura 1, 2 (90 mm), 3 e 4	AE-030-73M AE-130-73M	AE-030-73S AE-130-73S
Griff mittel mit MACINTOSH-Spatel Größe 0, 1, 2 (78 mm), 3 und 4 Griff mittel mit MACINTOSH-Spatel Größe 0, 1, 2A (90 mm), 3 und 4	AE-030-77M AE-130-77M	AE-030-77S AE-130-77S
Medium Handle with MACINTOSH Blade size 0, 1, 2 (78 mm), 3 and 4 Medium Handle with MACINTOSH Blade size 0, 1, 2A (90 mm), 3 and 4	AE-030-77M AE-130-77M	AE-030-77S AE-130-77S
Manche moyen avec spatule MACINTOSH Taille 0, 1, 2 (78 mm), 3 et 4 Manche moyen avec spatule MACINTOSH Taille 0, 1, 2A (90 mm), 3 et 4	AE-030-77M AE-130-77M	AE-030-77S AE-130-77S
Mango mediano con espátula MACINTOSH tamaño 0, 1, 2 (78 mm), 3 y 4 Mango mediano con espátula MACINTOSH tamaño 0, 1, 2 (90 mm), 3 y 4	AE-030-77M AE-130-77M	AE-030-77S AE-130-77S
Manico medio con spatola MACINTOSH misura 0, 1, 2 (78 mm), 3 e 4 Manico medio con spatola MACINTOSH misura 0, 1, 2 (90 mm), 3 e 4	AE-030-77M AE-130-77M	AE-030-77S AE-130-77S



Sigma Lite Faseroptik Spatel mit auswechselbarem Lichtleiter
 Sigma Lite fibreoptic blades with interchangeable fibreoptic light guide

Größe Size Taille Tamaño Misura	Seidenmatt Satin finish mat satinada opaca	Seidenmatt Satin finish mat satinada opaca
Griff klein mit MILLER-Spatel Größe 0 und 1	AE-030-74M	AE-030-74S
Griff mittel mit MILLER-Spatel Größe 2, 3 und 4	AE-030-75M	AE-030-75S
Griff mittel mit MILLER-Spatel Größe 1, 2, 3 und 4	AE-030-76M	AE-030-76S
Small Handle with MILLER Blade size 0 & 1	AE-030-74M	AE-030-74S
Medium Handle with MILLER Blade size 2, 3 & 4	AE-030-75M	AE-030-75S
Medium Handle with MILLER Blade size 1, 2, 3 & 4	AE-030-76M	AE-030-76S
Manche petit avec spatule MILLER Taille 0 et 1	AE-030-74M	AE-030-74S
Manche moyen avec spatule MILLER Taille 2, 3 et 4	AE-030-75M	AE-030-75S
Manche moyen avec spatule MILLER Taille 1, 2, 3 et 4	AE-030-76M	AE-030-76S
Mango pequeño con espátula MILLER tamaño 0 y 1	AE-030-74M	AE-030-74S
Mango mediano con espátula MILLER tamaño 2, 3, y 4	AE-030-75M	AE-030-75S
Mango mediano con espátula MILLER tamaño 1, 2, 3 y 4	AE-030-76M	AE-030-76S
Manico piccolo con spatola MILLER misura 0 e 1	AE-030-74M	AE-030-74S
Manico medio con spatola MILLER misura 2, 3 e 4	AE-030-75M	AE-030-75S
Manico medio con spatola MILLER misura 1, 2, 3 e 4	AE-030-76M	AE-030-76S



Delta Lite Standard Spatel
 Sigma Lite conventional blades

Größe Size Taille Tamaño Misura	Glänzend Mirror finish brillant pulida lucida	Seidenmatt Satin finish mat satinada opaca
Griff mittel mit MACINTOSH-Spatel Größe 1, 2 (78 mm) und 3 Griff mittel mit MACINTOSH-Spatel Größe 1, 2A (90 mm) und 3	AE-230-71M AE-330-71M	AE-230-71S AE-330-71S
Medium Handle with MACINTOSH Blade size 1, 2 (78 mm) and 3 Medium Handle with MACINTOSH Blade size 1, 2A (90 mm) and 3	AE-230-71M AE-330-71M	AE-230-71S AE-330-71S
Manche moyen avec spatule MACINTOSH Taille 1, 2 (78 mm) et 3 Manche moyen avec spatule MACINTOSH Taille 1, 2A (90 mm) et 3	AE-230-71M AE-330-71M	AE-230-71S AE-330-71S
Mango mediano con espátula MACINTOSH tamaño 1, 2 (78 mm) y 3 Mango mediano con espátula MACINTOSH tamaño 1, 2 (90 mm) y 3	AE-230-71M AE-330-71M	AE-230-71S AE-330-71S
Manico medio con spatola MACINTOSH misura 1, 2 (78 mm) e 3 Manico medio con spatola MACINTOSH misura 1, 2 (90 mm) e 3	AE-230-71M AE-330-71M	AE-230-71S AE-330-71S
Griff mittel mit MACINTOSH-Spatel Größe 2 (78 mm) 3 und 4 Griff mittel mit MACINTOSH-Spatel Größe 2A (90 mm) 3 und 4	AE-230-72M AE-330-72M	AE-230-72S AE-330-72S
Medium Handle with MACINTOSH Blade size 2 (78 mm), 3 and 4 Medium Handle with MACINTOSH Blade size 2A (90 mm), 3 and 4	AE-230-72M AE-330-72M	AE-230-72S AE-330-72S
Manche moyen avec spatule MACINTOSH Taille 2 (78 mm), 3 et 4 Manche moyen avec spatule MACINTOSH Taille 2A (90 mm), 3 et 4	AE-230-72M AE-330-72M	AE-230-72S AE-330-72S
Mango mediano con espátula MACINTOSH tamaño 2 (78 mm), 3 y 4 Mango mediano con espátula MACINTOSH tamaño 2A (90 mm), 3 y 4	AE-230-72M AE-330-72M	AE-230-72S AE-330-72S
Manico medio con spatola MACINTOSH misura 2 (78 mm), 3 e 4 Manico medio con spatola MACINTOSH misura 2A (90 mm), 3 e 4	AE-230-72M AE-330-72M	AE-230-72S AE-330-72S



Delta Lite Standard Spatel
 Sigma Lite conventional blades

Größe Size Taille Tamaño Misura	Glänzend Mirror finish brillant pulida lucida	Seidenmatt Satin finish mat satinada opaca
Griff mittel mit MACINTOSH-Spatel Größe 1, 2 (78 mm), 3 und 4	AE-230-73M	AE-230-73S
Griff mittel mit MACINTOSH-Spatel Größe 1, 2A (90 mm), 3 und 4	AE-330-73M	AE-330-73S
Medium Handle with MACINTOSH Blade size 1, 2 (78 mm), 3 and 4	AE-230-73M	AE-230-73S
Medium Handle with MACINTOSH Blade size 1, 2A (90 mm), 3 and 4	AE-330-73M	AE-330-73S
Manche moyen avec spatule MACINTOSH Taille 1, 2 (78 mm), 3 et 4	AE-230-73M	AE-230-73S
Manche moyen avec spatule MACINTOSH Taille 1, 2A (90 mm), 3 et 4	AE-330-73M	AE-330-73S
Mango mediano con espátula MACINTOSH tamaño 1, 2 (78 mm), 3 y 4	AE-230-73M	AE-230-73S
Mango mediano con espátula MACINTOSH tamaño 1, 2 (90 mm), 3 y 4	AE-330-73M	AE-330-73S
Manico medio con spatola MACINTOSH misura 1, 2 (78 mm), 3 e 4	AE-230-73M	AE-230-73S
Manico medio con spatola MACINTOSH misura 1, 2 (90 mm), 3 e 4	AE-330-73M	AE-330-73S
Griff mittel mit MACINTOSH-Spatel Größe 0, 1, 2 (78 mm), 3 und 4	AE-230-77M	AE-230-77S
Griff mittel mit MACINTOSH-Spatel Größe 0, 1, 2A (90 mm), 3 und 4	AE-330-77M	AE-330-77S
Medium Handle with MACINTOSH Blade size 0, 1, 2 (78 mm), 3 and 4	AE-230-77M	AE-230-77S
Medium Handle with MACINTOSH Blade size 0, 1, 2A (90 mm), 3 and 4	AE-330-77M	AE-330-77S
Manche moyen avec spatule MACINTOSH Taille 0, 1, 2 (78 mm), 3 et 4	AE-230-77M	AE-230-77S
Manche moyen avec spatule MACINTOSH Taille 0, 1, 2A (90 mm), 3 et 4	AE-330-77M	AE-330-77S
Mango mediano con espátula MACINTOSH tamaño 0, 1, 2 (78 mm), 3 y 4	AE-230-77M	AE-230-77S
Mango mediano con espátula MACINTOSH tamaño 0, 1, 2 (90 mm), 3 y 4	AE-330-77M	AE-330-77S
Manico medio con spatola MACINTOSH misura 0, 1, 2 (78 mm), 3 e 4	AE-230-77M	AE-230-77S
Manico medio con spatola MACINTOSH misura 0, 1, 2 (90 mm), 3 e 4	AE-330-77M	AE-330-77S



Delta Lite Standard Spatel
 Sigma Lite conventional blades

Größe Size Taille Tamaño Misura	Seidenmatt Satin finish mat satinada opaca	Seidenmatt Satin finish mat satinada opaca
Griff klein mit MILLER-Spatel Größe 0 und 1	AE-230-74M	AE-230-74S
Griff mittel mit MILLER-Spatel Größe 2, 3 und 4	AE-230-75M	AE-230-75S
Griff mittel mit MILLER-Spatel Größe 1, 2, 3 und 4	AE-230-76M	AE-230-76S
Small Handle with MILLER Blade size 0 & 1	AE-230-74M	AE-230-74S
Medium Handle with MILLER Blade size 2, 3 & 4	AE-230-75M	AE-230-75S
Medium Handle with MILLER Blade size 1, 2, 3 & 4	AE-230-76M	AE-230-76S
Manche petit avec spatule MILLER Taille 0 et 1	AE-230-74M	AE-230-74S
Manche moyen avec spatule MILLER Taille 2, 3 et 4	AE-230-75M	AE-230-75S
Manche moyen avec spatule MILLER Taille 1, 2, 3 et 4	AE-230-76M	AE-230-76S
Mango pequeño con espátula MILLER tamaño 0 y 1	AE-230-74M	AE-230-74S
Mango mediano con espátula MILLER tamaño 2, 3, y 4	AE-230-75M	AE-230-75S
Mango mediano con espátula MILLER tamaño 1, 2, 3 y 4	AE-230-76M	AE-230-76S
Manico piccolo con spatola MILLER misura 0 e 1	AE-230-74M	AE-230-74S
Manico medio con spatola MILLER misura 2, 3 e 4	AE-230-75M	AE-230-75S
Manico medio con spatola MILLER misura 1, 2, 3 e 4	AE-230-76M	AE-230-76S

AG

**Skalpelle, Messer
Scalpels, Knifes
Bistouris, Couteaux
Bisturías, Cuchillos
Bisturi, Coltelli**



AG

Skalpelli, passend für
 auswechselbare Skalpellklingen
 Fig. 10, 11, 12, 13, 15

Scalpel Handles for scalpel
 blades fig. 10, 11, 12, 13, 15

Manches pour bistouris, allant
 avec les lames de bistouris
 interchangeables
 fig. 10, 11, 12, 13, 15

Mangos de bisturi para
 hojas intercambiables
 fig. 10, 11, 12, 13, 15

Manici per bisturi, per fissare
 le lame intercambiabili
 fig. 10, 11, 12, 13, 15

abgewinkelt, lang
 angled, long
 coudé, long
 angulado, largo
 angolaro, lungo

lang
 long
 long
 largo
 lungo

Heftprofil wie Griff Fig. 4
 handle style as fig. 4
 manche selon fig. 4
 mango como fig. 4
 manico come fig. 4

mit Zentimeter-Graduierung
 cm-graduation
 gradué en cm
 graduado en cm
 graduato in cm



AG-013-00
 Fig. 3
 12 cm



AG-013-10
 Fig. 3
 12 cm



AG-013-01
 Fig. 3
 12 cm



AG-013-02
 Fig. 3 L
 21,5 cm



AG-013-06
 Fig. 3 L
 21 cm

**Fig.
3**

Skalpellgriffe
Scalpel Handles
Manches de bistouris
Mangos de bisturios
Manici per bisturi

AG

Skalpellgriffe, passend für
auswechselbare Skalpellschneiden
Fig. 10, 11, 12, 13, 15

Scalpel Handles for scalpel
blades fig. 10, 11, 12, 13, 15

Manches pour bistouris, allant
avec les lames de bistouris
interchangeables
fig. 10, 11, 12, 13, 15

Mangos de bisturi para
hojas intercambiables
fig. 10, 11, 12, 13, 15

Manici per bisturi, per fissare
la lama intercambiabile
fig. 10, 11, 12, 13, 15

rund
round
rond
redondo
rotondo

rund, abgewinkelt
round, angled
rond, coudé
redondo, angulado
rotondo, angolare

rund
round
rond
redondo
rotondo



AG-013-03
Fig. 3
14,5 cm



AG-013-33
Fig. 3
14 cm



AG-013-15
Fig. 3
15 cm

Skalpelli, passend für
 auswechselbare Skalpellklingen
 Fig. 10, 11, 12, 13, 15

Scalpel Handles for scalpel
 blades fig. 10, 11, 12, 13, 15

Manches pour bistouris, allant
 avec les lames de bistouris
 interchangeables
 fig. 10, 11, 12, 13, 15

Mangos de bisturi para
 hojas intercambiables
 fig. 10, 11, 12, 13, 15

Manici per bisturi, per fissare
 le lame intercambiabili
 fig. 10, 11, 12, 13, 15

mit rundem Hohlheft
 with round hollow handle
 avec manche creux rond
 con mango hueco redondo
 con manico vuoto, rotondo

mit Kunststoffheft
 with plastic handle
 avec manche en
 matière plastique
 con mango plástico
 con manico di materia
 plastica

lang
 long
 long
 long
 largo
 lungo

lang
 long
 long
 largo
 lungo

kurz
 short
 corto
 court
 corto

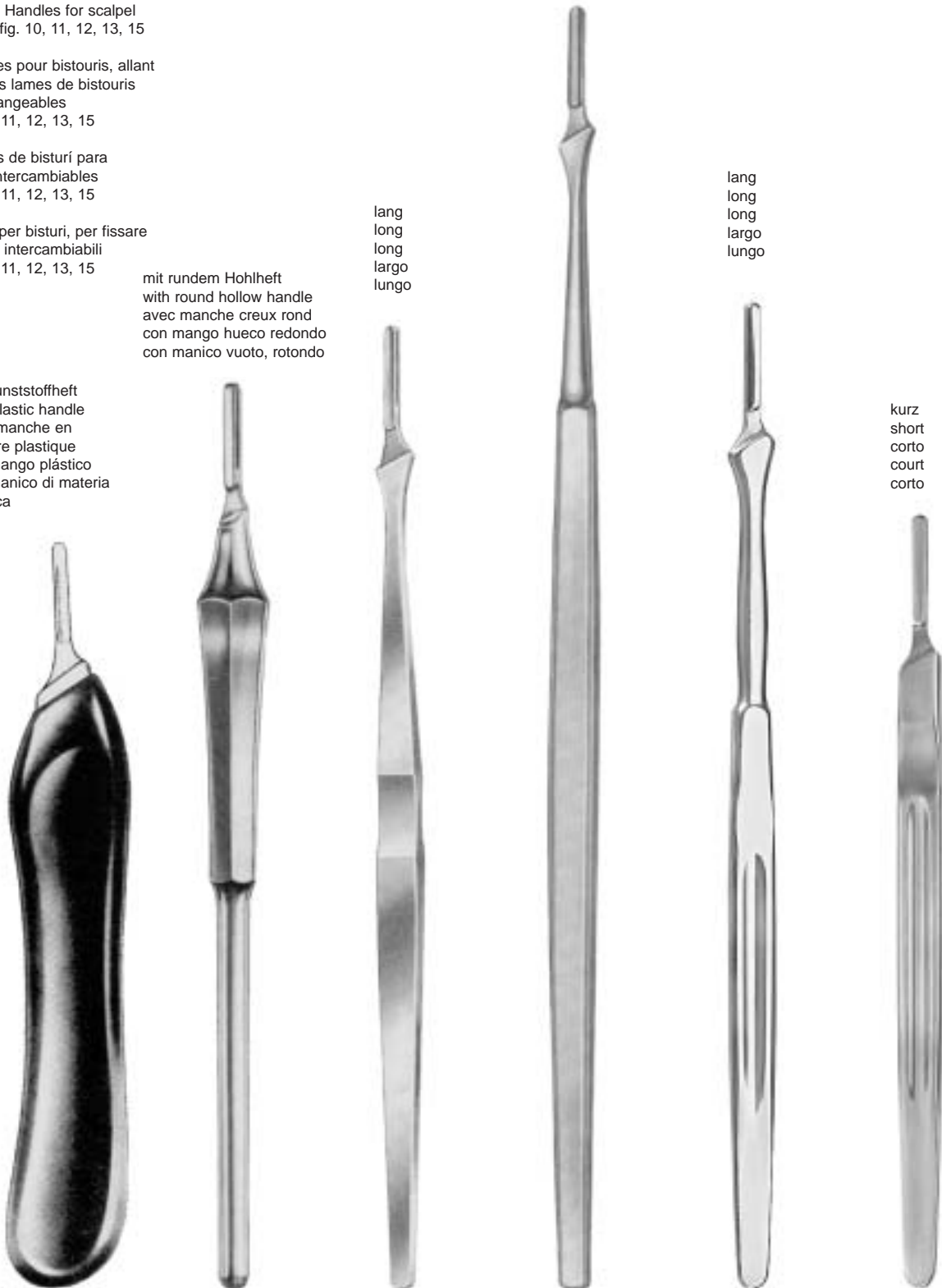

AG-013-08
 Fig. 3
 12,5 cm

AG-013-09
 Fig. 3
 15,5 cm

AG-015-00
 Fig. 5
 16 cm

AG-016-00
 Fig. 5
 21,5 cm

AG-017-00
 Fig. 7
 16 cm

AG-017-01
 Fig. 7 K
 12,5 cm

**Fig.
3**

Skalpelli
Scalpel Handles
Manches de bistouris
Mangos de bisturias
Manici per bisturi

AG

Skalpelli, passend für
auswechselbare Skalpellklingen
Fig. 10, 11, 12, 13, 15

Scalpel Handles for scalpel
blades fig. 10, 11, 12, 13, 15

Manches pour bistouris, allant
avec les lames de bistouris
interchangeables
fig. 10, 11, 12, 13, 15

Mangos de bisturi para
hojas intercambiables
fig. 10, 11, 12, 13, 15

Manici per bisturi, per fissare
le lame intercambiabili
fig. 10, 11, 12, 13, 15



AG-019-00
21 cm



AG-019-16
Fig. 3 + 4
16 cm

Skalpelli, passend für
auswechselbare Skalpellklingen
Fig. 10 - 36

Scalpel Handle for scalpel
blades fig. 10 - 36

Manche pour bistouri, allant
avec les lames de bistouris
interchangeables
fig. 10 - 36

Mango de bisturi para
hojas intercambiables
fig. 10 - 36

Manico per bisturi, per fissare
le lame intercambiabili
fig. 10 - 36

Doppelgriff Fig. 3 + 4
double handle fig. 3 + 4
manche double fig. 3 + 4
mango doble fig. 3 + 4
manico doppio fig. 3 + 4

AG

Skalpellklingen, steril
Scalpel Blades, sterile
Lames des bistouris, stériles
Hojas de bisturíes estériles
Lame da bisturi, sterili

Fig.
3



AG-110-00



AG-111-00



AG-112-00



AG-112-02



AG-115-00



AG-115-01



In Packungen à 100
in packages of 100 ea
en boîtes de 100 pieces
en cajas de 100 c/u
in scatole di 100 pezzi



AG-919-00
Skalpellklingen-Entferner
Scalpel Blade Remover
Enlève-lame
Quita hojas
Distributore lame

**Fig.
4**

Skalpelli
Scalpel Handles
Manches de bistouris
Mangos de bisturios
Manici per bisturi

AG

Skalpelli, passend für
auswechselbare Skalpellklingen
Fig. 18, 19, 20, 21, 22, 23, 24, 25, 36

Scalpel Handles for scalpel
blades fig. 18, 19, 20, 21, 22, 23, 24, 25, 36

Manches pour bistouris, allant
avec les lames de bistouris
interchangeables
fig. 18, 19, 20, 21, 22, 23, 24, 25, 36

Mangos de bisturi para
hojas intercambiables
fig. 18, 19, 20, 21, 22, 23, 24, 25, 36

Manici per bisturi, per fissare
le lame intercambiabili
fig. 18, 19, 20, 21, 22, 23, 24, 25, 36

lang
long
long
largo
lungo

abgewinkelt, lang
angled, long
coudé, long
angulado, largo
angolaro, lungo

mit Zentimeter-Graduierung
cm-graduation
gradué en cm
graduado en cm
graduato in cm



AG-014-00
Fig. 4
13,5 cm

AG-014-01
Fig. 4
13,5 cm

AG-014-03
21,5 cm

AG-014-02
Fig. 4 L
21 cm

AG-014-06
Fig. 4 L
21 cm

AG

Skalpelli
Scalpel Handles
Manches de bistouris
Mangos de bisturíes
Manici per bisturi

Fig.
4

Skalpelli, passend für
auswechselbare Skalpellklingen
Fig. 18, 19, 20, 21, 22, 23, 24, 25, 36

Scalpel Handles for scalpel
blades fig. 18, 19, 20, 21, 22, 23, 24, 25, 36

Manches pour bistouris, allant
avec les lames de bistouris
interchangeables
fig. 18, 19, 20, 21, 22, 23, 24, 25, 36

Mangos de bisturí para
hojas intercambiables
fig. 18, 19, 20, 21, 22, 23, 24, 25, 36

Manici per bisturi, per fissare
le lame intercambiabili
fig. 18, 19, 20, 21, 22, 23, 24, 25, 36

mit Kunststoffheft
with plastic handle
avec manche en matière plastique
con mango plástico
con manico di materia plastica

mit Hohlheft
with hollow handle
avec manche creux
con mango hueco
con manico vuoto



AG-014-08
Fig. 4
13,5 cm

mit Hohlheft
with hollow handle
avec manche creux
con mango hueco
con manico vuoto



COLLIN
AG-018-00
Fig. 8
13,5 cm



COLLIN
AG-018-09
Fig. 9
14,5 cm

Fig.
4

Skalpellslingen, steril
Scalpel Blades, sterile
Lames des bistouris, stériles
Hojas de bisturíes estériles
Lame da bisturi, sterili

AG



AG-118-00



AG-119-00



AG-210-00



AG-211-00



AG-212-00



AG-213-00



AG-214-00



AG-215-00



AG-316-00



In Packungen à 100
in packages of 100 ea
en boîtes de 100 pieces
en cajas de 100 c/u
in scatole di 100 pezzi



AG-919-00
Skalpellslingen-Entferner
Scalpel Blade Remover
Enlève-lame
Quita hojas
Distributore lame

AG

Einmalskalpelle, steril
Disposable Scalpels, sterile
Bistouris usage unique, stériles
Bisturías uso único, estériles
Bisturi monouso, sterili



AG-120-00
Fig. 10



AG-121-00
Fig. 10



AG-122-00
Fig. 12



AG-122-02
Fig. 12 d



AG-123-00
Fig. 13



AG-125-00
Fig. 15



AG-125-01
Fig. 15 c

In Packungen à 10 Stück
in packages of 10 ea
en boîtes de 10 pieces
en cajas de 10 c/u
in scatole di 10 pezzi



AG-128-00
Fig. 18

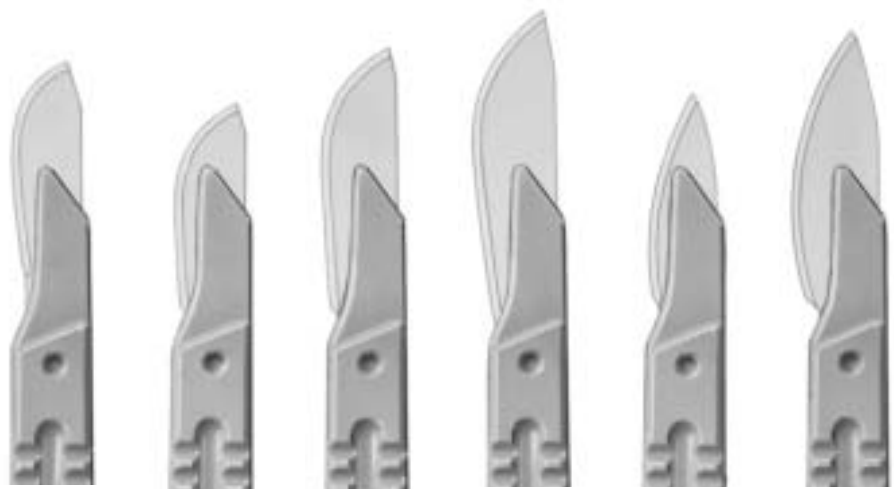

AG-129-00
Fig. 19

AG-220-00
Fig. 20

AG-221-00
Fig. 21

AG-222-00
Fig. 22

AG-223-00
Fig. 23

AG-224-00
Fig. 24

In Packungen à 10 Stück
in packages of 10 ea
en boîtes de 10 pieces
en cajas de 10 c/u
in scatole di 10 pezzi

AG

Skalpellgriffe, Mikro
Scalpel Handles, Micro
Manches pour bistouris, Micro
Mangos de bisturi, Micro
Manici per bisturi, Micro

für Mikro-Skalpellklingen
for micro scalpel blades
pour micro-lame de bisturis
para micro hojas
per micro lame



AG-032-13
13,5 cm



AG-034-15
15,5 cm



CASPAR
AG-036-18
18 cm



AG-038-20
20 cm

Skalpelli-griffe, Mikro-Skalpellklingen
Scalpel Handles, Micro Scalpel Blades
Manches pour bistouris, Micro lame de bistouris
Mangos de bisturí, Micro hojas de bisturí
Manici per bisturi, Micro lame per bisturi

AG

In Packungen à 10 Stück, steril
in packages of 10 ea, sterile
en boîtes de 10 pièces, stériles
en cajas de 10 c/u, estériles
in scatole di 10 pezzi, sterili



EA-589-01
#61



EA-589-02
#62



EA-589-04
#64



EA-589-05
#65



EA-589-07
#67



EA-589-09
#69

LANDOLT
EA-587-25
25 cm

LANDOLT
EA-588-21
21 cm



AG-925-00
 11 cm

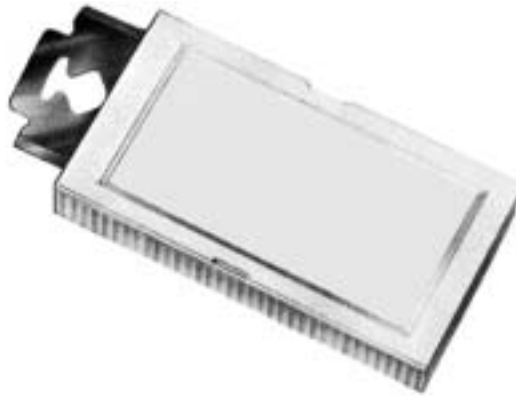

AG-926-00
 Packung = 10
 Package = 10 ea
 Boîte = 10
 Cajita = 10 c/u
 Scatola = 10



TROUTMAN-CHRIS
AG-920-09
 9 cm



DIMEDA
AG-921-09
 11 cm



CASTROVIEJO
AG-924-13
 13 cm

mit Metallheft
 with metal handle
 avec manche en métal
 con mango metálico
 con manico di metallo

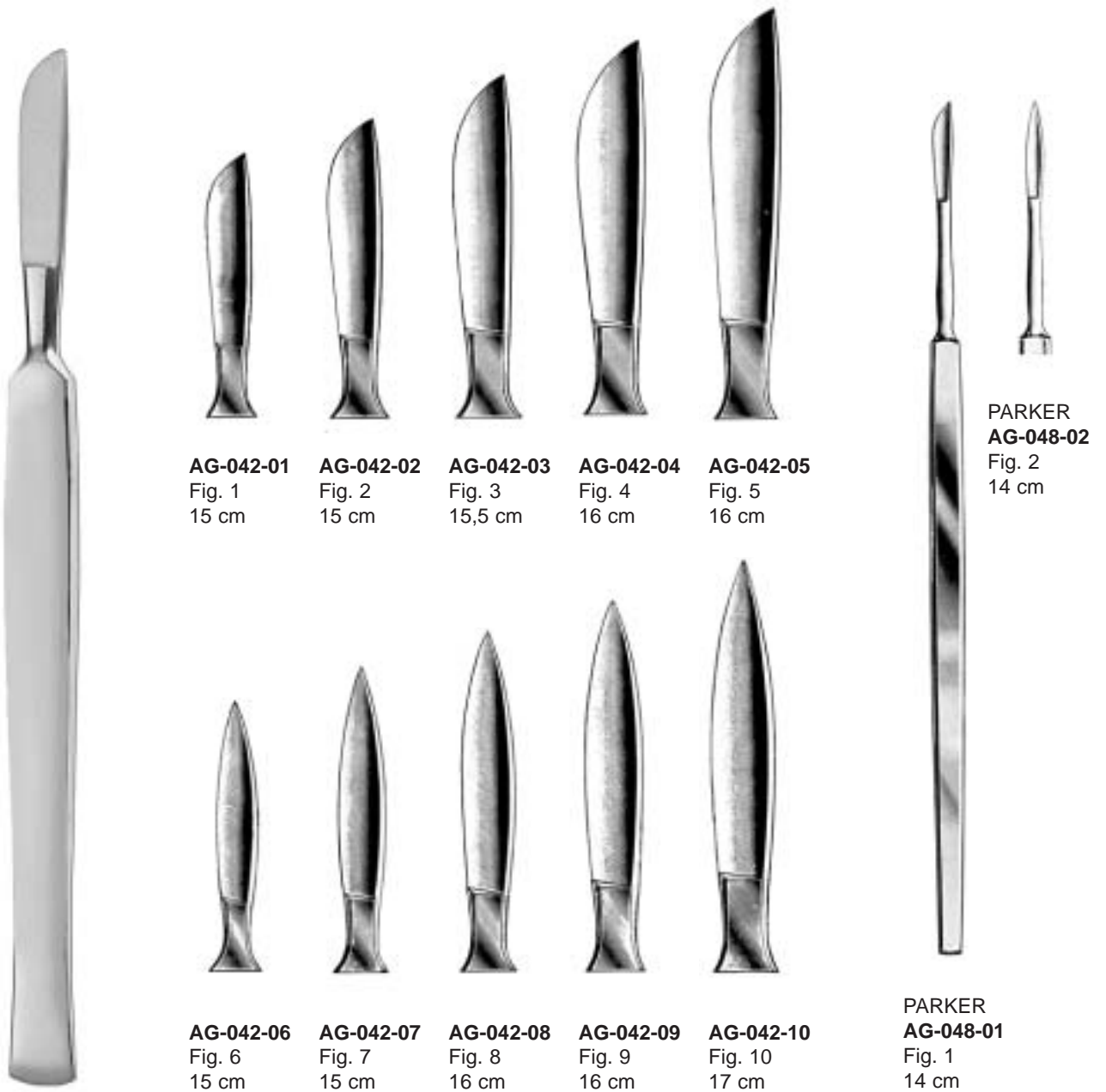

mit Hohlheft
 with hollow handle
 con mango hueco
 avec manche creux
 con manico vuoto

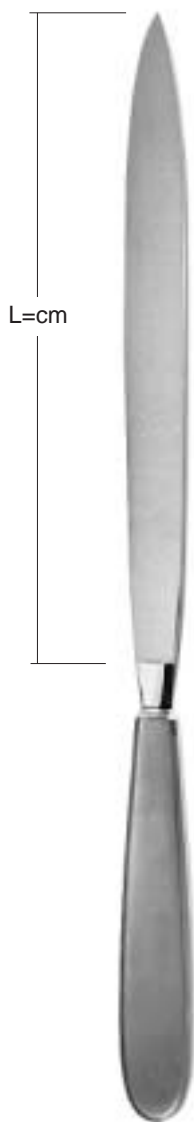

L = cm	
13	AG-240-13
16	AG-240-16
19	AG-240-19
22	AG-240-22
28	AG-240-28



L = cm	LISTON
17	AG-340-17
20	AG-340-20

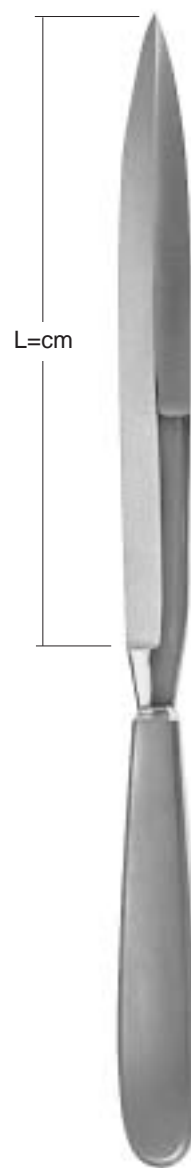

L = cm	CATLIN
16	AG-342-16
19	AG-342-19
22	AG-342-22

L = Klingenlänge/length
of blade/longueur tranchant/
largo de corte/lunghezza di taglio

massives Heft mit Schaber-Ende
solid handle, dissecting end
manche solide à rugine
mango macizo, con periostótomo
con manico pieno con raschino



LANGENBECK
AG-140-05
18 cm



LANGENBECK
AG-142-05
18 cm



LANGENBECK
AG-144-05
18 cm

AG

Knorpel-, Hirnmesser
Cartilage, brain knife
Couteaux à cartilage, à cerveau
Cuchillo para cartílagos y p. cerebro
Coltelli per cartilagini e per il cervello

mit Holzheft
with wooden handle
avec manche en bois
con mango de madera
con manico di legno

mit Schaber
with raspatory
avec râpe
con periostótomo
con raschiatoio

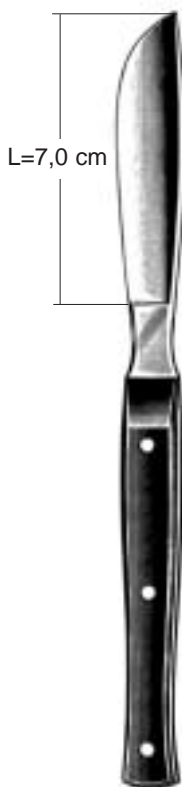

VIRCHOW
AG-690-25
25 cm



AG-790-55



AG-791-55



AG-792-70



L = cm	VIRCHOW
16	AG-890-15
20	AG-890-20
24	AG-890-24

In Packungen à 10 Stück, steril
in packages of 10 ea, sterile
en boîtes de 10 pièces, stériles
en cajas de 10 c/u, estériles
in scatole di 10 pezzi, sterili

Klinge flach/hohl
blade flat/hollow
lame à faces plane/ concave
hoja cóncava/convexa
lama piana/concava

Klinge beidseitig hohl
hollow blades on both sides
lame deux faces concaves
ambos lados cóncavos
lama concava/concava



AG-944-01



AG-946-00



AG-947-00

Abziehstein
Oil stone
Pierre à repasser
Piedra afiladora
Pietra per affilare



**RECORD-ARKANSAS
AG-948-00**

im Holzkasten
in wooden case
en boîte bois
en caja de madera
in astuccio di legno



**ARKANSAS
AG-949-00**

komplett mit Klinge
complete with blade
complet avec lame
completo con hoja
completo con lama



HUMBY
AG-840-00
32 cm

Ersatzklinge
Spare Blade
Lame de rechange, seule
Hoja de repuesto
Lama die ricambio sola



HUMBY
AG-840-01

für handelsübliche Rasierklingen
for usual razor blades
pour lames de rasoir modèle standard
para hojas de afeitar usuales
per lamette da barba normali



SILVER
AG-842-19
19 cm

einstellbar von 0,1 bis 2,0 mm
adjustable from 0,1 to 2,0 mm
réglable en épaisseur de 0,1 à 2,0 mm
ajustable de 0,1 hasta 2,0 mm
regolabile da 0,1 a 2,0 mm



SCHINK
AG-940-00
31 cm

komplett
mit 2 Spannplatten
und einer Klinge

complete
with 2 skin fixing
plates and one
blade

complet
avec deux plaque
pour tendre la peau
et lame

completo
con 2 placas para
extender la piel y
una hoja

completo
con 2 placche per
stendere la pelle es
una lama

Ersatzklinge
Spare Blade
Lame de rechange, seule
Hoja de repuesto
Lama di ricambio sola



AG-940-01

Spannplatte
Skin Fixing Plate
Plaque pour tendre la peau
Placa para extender la piel
Placca per stendere la pelle



AG-940-02

komplett mit Klinge
complete with blade
complet avec lame
completo con hoja
completo con lama



WATSON
AG-842-30
30 cm

komplett mit Klinge
complete with blade
complet avec lame
completo con hoja
completo con lama



BRAITHWAITE
AG-844-00
31,5 cm

AG-844-00

Ersatzklinge
Spare Blade
Lame de rechange, seule
Hoja de repuesto
Lama di ricambio sola

AH

SUPERCUT

**Scheren
Scissors
Ciseaux
Tijeras
Forbici**



AH

AH

Chirurgische Scheren
Operating Scissors
Ciseaux à chirurgie
Tijeras para cirugía
Forbici per chirurgia

SUPERCUT

TC-Schneiden
TC Cutting Edges
Tranchant TC
Filos de corte TC
Taglio TC



cm	Standard
10,5	AH-012-10
11,5	AH-012-11
13,0	AH-012-13
14,5	AH-012-14
15,5	AH-012-15
16,5	AH-012-16
18,5	AH-012-18
20,0	AH-012-20



cm	Standard
10,5	AH-013-10
11,5	AH-013-11
13,0	AH-013-13
14,5	AH-013-14
15,5	AH-013-15
16,5	AH-013-16
18,5	AH-013-18
20,0	AH-013-20



cm	Standard
14,5	AH-014-14
16,5	AH-014-16



cm	Standard
14,5	AH-015-14
16,5	AH-015-16

TC-Schneiden
 TC Cutting Edges
 Tranchant TC
 Filos de corte TC
 Taglio TC



cm	Standard
11,5	AH-110-11
13,0	AH-110-13
14,5	AH-110-14
15,5	AH-110-15
16,5	AH-110-16
18,5	AH-110-18
20,0	AH-110-20



cm	Standard
11,5	AH-111-11
13,0	AH-111-13
14,5	AH-111-14
15,5	AH-111-15
16,5	AH-111-16
18,5	AH-111-18
20,0	AH-111-20



cm	Standard
14,5	AH-114-14
16,5	AH-114-16



cm	Standard
14,5	AH-115-14
16,5	AH-115-16

AH

Chirurgische Scheren
Operating Scissors
Ciseaux à chirurgie
Tijeras para cirugía
Forbici per chirurgia

SUPERCUT

TC-Schneiden
TC Cutting Edges
Tranchant TC
Filos de corte TC
Taglio TC



cm	Standard
10,5	AH-210-10
11,5	AH-210-11
13,0	AH-210-13
14,5	AH-210-14
15,5	AH-210-15
16,5	AH-210-16
18,5	AH-210-18
20,0	AH-210-20



cm	Standard
10,5	AH-211-10
11,5	AH-211-11
13,0	AH-211-13
14,5	AH-211-14
15,5	AH-211-15
16,5	AH-211-16
18,5	AH-211-18
20,0	AH-211-20



cm	Standard
14,5	AH-214-14
16,5	AH-214-16



cm	Standard
14,5	AH-215-14
16,5	AH-215-16



cm DEAVER
 14,0 AH-310-14 AH-311-14



cm DEAVER
 14,0 AH-410-14 AH-411-14



cm DEAVER
 14,0 AH-510-14 AH-511-14

TC-Schneiden
 TC Cutting Edges
 Tranchant TC
 Filos de corte TC
 Taglio TC



cm DEAVER
 14,0 AH-314-14 AH-315-14



cm DEAVER
 14,0 AH-414-14 AH-415-14



cm DEAVER
 14,0 AH-514-14 AH-515-14

AH

Chirurgische Scheren
Operating Scissors
Ciseaux à chirurgie
Tijeras para cirugía
Forbici per chirurgia

SUPERCUT

TC-Schneiden
TC Cutting Edges
Tranchant TC
Filos de corte TC
Taglio TC



cm	MAYO
14,5	AH-610-14
17,0	AH-610-17
23,0	AH-610-23



cm	MAYO
14,5	AH-611-14
17,0	AH-611-17
23,0	AH-611-23



cm	MAYO
14,5	AH-614-14
17,0	AH-614-17
23,0	AH-614-23



cm	MAYO
14,5	AH-615-14
17,0	AH-615-17
23,0	AH-615-23

TC-Schneiden
TC Cutting Edges
Tranchant TC
Filos de corte TC
Taglio TC



cm MAYO-STILLE
15,0 **AH-710-15**
17,0 **AH-710-17**



cm MAYO-STILLE
15,0 **AH-711-15**
17,0 **AH-711-17**



cm MAYO-STILLE
15,0 **AH-714-15**
17,0 **AH-714-17**



cm MAYO-STILLE
15,0 **AH-715-15**
17,0 **AH-715-17**

AH

Chirurgische Scheren
Operating Scissors
Ciseaux à chirurgie
Tijeras para cirugía
Forbici per chirurgia

SUPERCUT

TC-Schneiden
TC Cutting Edges
Tranchant TC
Filos de corte TC
Taglio TC



cm MAYO-NOBLE
17,0 **AH-810-17**

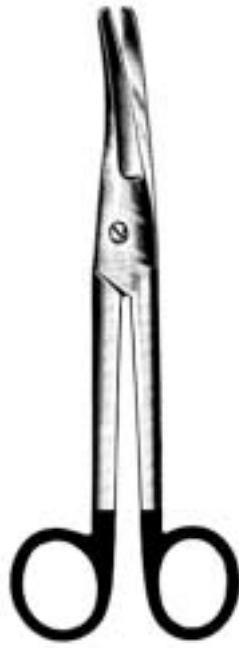

cm MAYO-NOBLE
17,0 **AH-811-17**



cm MAYO-NOBLE
17,0 **AH-814-17**



cm MAYO-NOBLE
17,0 **AH-815-17**

TC-Schneiden
 TC Cutting Edges
 Tranchant TC
 Filos de corte TC
 Taglio TC



cm LEXER
 16,0 **AH-910-16**
 21,0 **AH-910-21**



cm LEXER
 16,0 **AH-911-16**
 21,0 **AH-911-21**



cm LEXER
 16,0 **AH-914-16**
 21,0 **AH-914-21**



cm LEXER
 16,0 **AH-915-16**
 21,0 **AH-915-21**

AH

Präparierscheren
Dissecting Scissors
Ciseaux à dissection
Tijeras de disección
Forbici per dissezione

SUPERCUT

TC-Schneiden
TC Cutting Edges
Tranchant TC
Filos de corte TC
Taglio TC



cm LEXER-BABY
10,0 AH-022-10



cm LEXER-BABY
10,0 AH-023-10



cm LEXER-BABY
10,0 AH-026-10



cm LEXER-BABY
10,0 AH-027-10

TC-Schneiden
 TC Cutting Edges
 Tranchant TC
 Filos de corte TC
 Taglio TC



cm	METZENBAUM
11,5	AH-820-11
15,0	AH-820-15
18,0	AH-820-18
20,0	AH-820-20
23,0	AH-820-23
25,0	AH-820-25
28,0	AH-820-28
30,0	AH-820-30

cm	METZENBAUM
11,5	AH-821-11
15,0	AH-821-15
18,0	AH-821-18
20,0	AH-821-20
23,0	AH-821-23
25,0	AH-821-25
28,0	AH-821-28
30,0	AH-821-30

cm	METZENBAUM
11,5	AH-824-11
15,0	AH-824-15
18,0	AH-824-18
20,0	AH-824-20
23,0	AH-824-23
25,0	AH-824-25
28,0	AH-824-28
30,0	AH-824-30

cm	METZENBAUM
11,5	AH-825-11
15,0	AH-825-15
18,0	AH-825-18
20,0	AH-825-20
23,0	AH-825-23
25,0	AH-825-25
28,0	AH-825-28
30,0	AH-825-30

TC-Schneiden
 TC Cutting Edges
 Tranchant TC
 Filos de corte TC
 Taglio TC



cm	METZENBAUM FINO
15,0	AH-822-15
18,0	AH-822-18
20,0	AH-822-20
23,0	AH-822-23
25,0	AH-822-25
28,0	AH-822-28

cm	METZENBAUM FINO
15,0	AH-823-15
18,0	AH-823-18
20,0	AH-823-20
23,0	AH-823-23
25,0	AH-823-25
28,0	AH-823-28

cm	METZENBAUM FINO
15,0	AH-826-15
18,0	AH-826-18
20,0	AH-826-20
23,0	AH-826-23
25,0	AH-826-25
28,0	AH-826-28

cm	METZENBAUM FINO
15,0	AH-827-15
18,0	AH-827-18
20,0	AH-827-20
23,0	AH-827-23
25,0	AH-827-25
28,0	AH-827-28



cm METZENBAUM "S"
 18,0 AH-921-18



cm SANVENERO
 14,0 AH-032-14



cm SANVENERO
 14,0 AH-033-14

TC-Schneiden
 TC Cutting Edges
 Tranchant TC
 Filos de corte TC
 Taglio TC



cm METZENBAUM "S"
 18,0 AH-925-18



cm SANVENERO
 14,0 AH-036-14



cm SANVENERO
 14,0 AH-037-14

Plastik - Plastic - Plastique - Plástica - Plastica



cm JOSEPH
 14,0 AH-034-14



cm JOSEPH
 14,0 AH-035-14



cm KILNER
 12,0 AH-130-12
 15,0 AH-130-15

TC-Schneiden
 TC Cutting Edges
 Tranchant TC
 Filos de corte TC
 Taglio TC



cm JOSEPH
 14,0 AH-038-14



cm JOSEPH
 14,0 AH-039-14



cm KILNER
 12,0 AH-134-12
 15,0 AH-134-14



cm REYNOLDS
15,0 AH-230-15



cm REYNOLDS
15,0 AH-231-15

TC-Schneiden
TC Cutting Edges
Tranchant TC
Filos de corte TC
Taglio TC



cm REYNOLDS
15,0 AH-234-15



cm REYNOLDS
15,0 AH-235-15

rund
 round
 rond
 redondo
 retondo



cm	IRIS-Standard
9,0	AH-430-09
10,5	AH-430-10
11,5	AH-430-11



cm	IRIS-Standard
9,0	AH-431-09
10,5	AH-431-10
11,5	AH-431-11



cm	IRIS-Standard
9,0	AH-432-09
10,5	AH-432-10
11,5	AH-432-11



cm	IRIS-Standard
9,0	AH-433-09
10,5	AH-433-10
11,5	AH-433-11

TC-Schneiden
 TC Cutting Edges
 Tranchant TC
 Filos de corte TC
 Taglio TC



cm	IRIS-Standard
9,0	AH-434-09
10,5	AH-434-10
11,5	AH-434-11



cm	IRIS-Standard
9,0	AH-435-09
10,5	AH-435-10
11,5	AH-435-11



cm STEVENS
 11,0 AH-632-11



cm STEVENS
 11,0 AH-633-11

TC-Schneiden
 TC Cutting Edges
 Tranchant TC
 Filos de corte TC
 Taglio TC

Strabismus Scheren
 Strabismus Scissors
 Ciseaux à strabisme
 Tijeras para estrabismo
 Forbici per strabismo



cm
 11,0 AH-730-11



cm
 11,0 AH-731-11



cm
 11,0 AH-734-11



cm
 11,0 AH-735-11

AH

Scheren, Ophthal., Nase
Scissors, Ophthal., Nasal
Ciseaux, ophtal., nasaux
Tijeras, oftalmología, nasales
Forbici, oftalmologia, nasali

SUPERCUT



cm HEYMANN
18,0 **AH-041-18**



cm FOMON
15,0 **AH-043-15**



cm COTTLE
16,0 **AH-045-16**



POTTS-SMITH

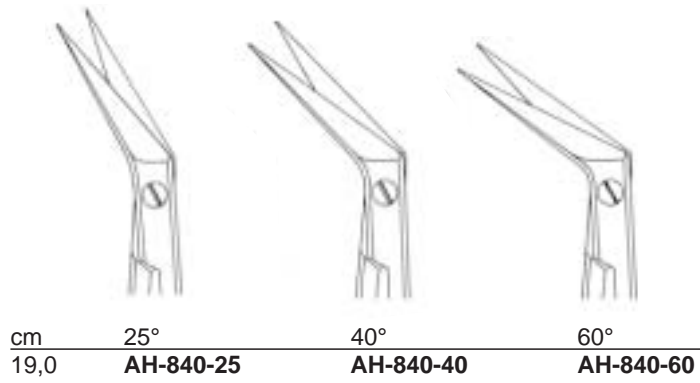

POTTS-SMITH

TC-Schneiden
 TC Cutting Edges
 Tranchant TC
 Filos de corte TC
 Taglio TC

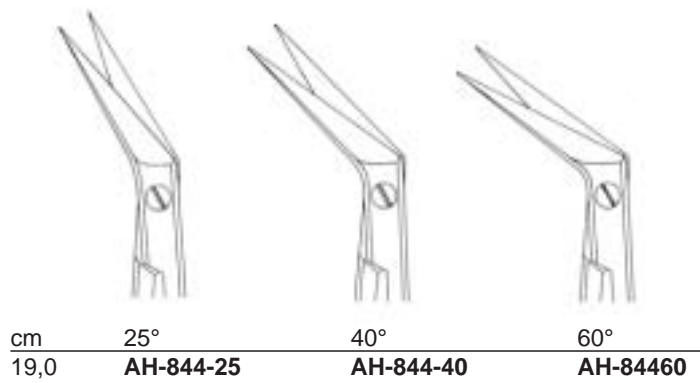

TC-Schneiden
TC Cutting Edges
Tranchant TC
Filos de corte TC
Taglio TC

Parametrium



cm
22,0 **AH-055-22**



cm
23,0 **AH-055-23**



cm	SIMS
20,0	AH-150-20
23,0	AH-150-23



cm	SIMS
20,0	AH-151-20
23,0	AH-151-23



cm	SIEBOLD
24,0	AH-253-24



cm	SIMS
20,0	AH-154-20
23,0	AH-154-23

TC-Schneiden
 TC Cutting Edges
 Tranchant TC
 Filos de corte TC
 Taglio TC



cm	SIMS
20,0	AH-155-20
23,0	AH-155-23



cm KELLY
16,0 AH-450-16
18,0 AH-450-18



cm KELLY
16,0 AH-451-16
18,0 AH-451-18



cm BRAUN-STADLER
14,5 AH-650-14
22,0 AH-650-22

Episiotomie
Episiotomy
Episiotomia



cm WAGNER
12,0 AH-284-12



cm WAGNER
20,0 AH-285-12

TC-Schneiden
TC Cutting Edges
Tranchant TC
Filos de corte TC
Taglio TC



cm	LISTER
14,0	AH-091-14
18,0	AH-091-18
20,0	AH-091-20



cm	LISTER
14,0	AH-095-14
18,0	AH-095-18
20,0	AH-095-20

AI

**Scheren
Scissors
Ciseaux
Tijeras
Forbici**



AI

AI

Chirurgische Scheren
 Operating Scissors
 Ciseaux à chirurgie
 Tijeras para cirugía
 Forbici per chirurgia

TC-Schneiden
 TC Cutting Edges
 Tranchant TC
 Filos de corte TC
 Taglio TC



cm	Standard
10,5	AI-012-10
11,5	AI-012-11
13,0	AI-012-13
14,5	AI-012-14
15,5	AI-012-15
16,5	AI-012-16
18,5	AI-012-18
20,0	AI-012-20

cm	Standard
10,5	AI-013-10
11,5	AI-013-11
13,0	AI-013-13
14,5	AI-013-14
15,5	AI-013-15
16,5	AI-013-16
18,5	AI-013-18
20,0	AI-013-20

cm	Standard TC
14,5	AI-014-14
16,5	AI-014-16
18,5	AI-014-18

cm	Standard TC
14,5	AI-015-14
16,5	AI-015-16
18,5	AI-015-18

TC-Schneiden
 TC Cutting Edges
 Tranchant TC
 Filos de corte TC
 Taglio TC

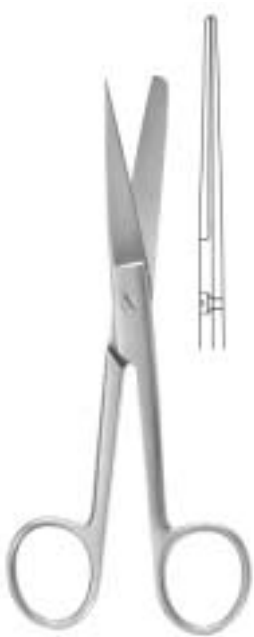

cm	Standard
10,5	AI-110-10
11,5	AI-110-11
13,0	AI-110-13
13,0	AI-110-13L
14,5	AI-110-14
14,5	AI-110-14L
15,5	AI-110-15
16,5	AI-110-16
18,5	AI-110-18
20,0	AI-110-20

cm	Standard
10,5	AI-111-10
11,5	AI-111-11
13,0	AI-111-13
13,0	AI-111-13L
14,5	AI-111-14
14,5	AI-111-14L
15,5	AI-111-15
16,5	AI-111-16
18,5	AI-111-18
20,0	AI-111-20

cm	Standard TC
14,5	AI-114-14
16,5	AI-114-16
18,5	AI-114-18

cm	Standard TC
14,5	AI-115-14
16,5	AI-115-16
18,5	AI-115-18

(L) = Für Linkshänder / For left-handed
 Pour la main gauche / Para zurdo / Per mancini

AI

Chirurgische Scheren
Operating Scissors
Ciseaux à chirurgie
Tijeras para cirugía
Forbici per chirurgia

TC-Schneiden
TC Cutting Edges
Tranchant TC
Filos de corte TC
Taglio TC



<u>cm</u>	<u>Standard</u>
10,5	AI-210-10
11,5	AI-210-11
13,0	AI-210-13
14,5	AI-210-14
15,5	AI-210-15
16,5	AI-210-16
18,5	AI-210-18
20,0	AI-210-20

<u>cm</u>	<u>Standard</u>
10,5	AI-211-10
11,5	AI-211-11
13,0	AI-211-13
14,5	AI-211-14
15,5	AI-211-15
16,5	AI-211-16
18,5	AI-211-18
20,0	AI-211-20

<u>cm</u>	<u>Standard TC</u>
14,5	AI-214-14
16,5	AI-214-16
18,5	AI-214-18

<u>cm</u>	<u>Standard TC</u>
14,5	AI-215-14
16,5	AI-215-16
18,5	AI-215-18

schlanke Modelle
slender patterns
modèles fins
modelos fins
modelli fini



cm
12,0 **AI-214-12**



cm
12,0 **AI-215-12**



cm
12,0 **AI-216-12**
13,0 **AI-216-13**



cm
12,0 **AI-217-12**
13,0 **AI-217-13**

Inzisionscheren
Incision scissors
Ciseaux à incision
Tijeras para incision
Forbici incisione



cm
14,0 **AI-218-14**

AI

Chirurgische Scheren
Operating Scissors
Ciseaux à chirurgie
Tijeras para cirugía
Forbici per chirurgia

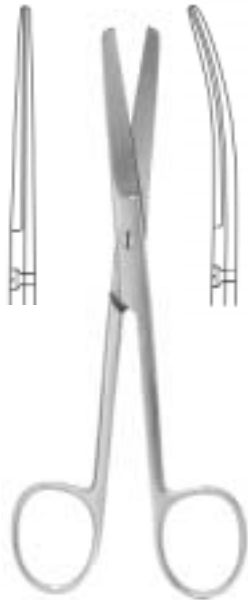

cm — DEAVER —
14,0 AI-310-14 AI-311-14

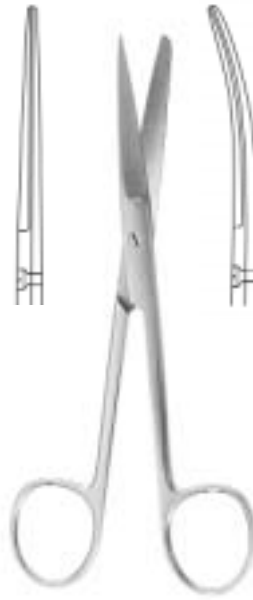

cm — DEAVER —
14,0 AI-410-14 AI-411-14

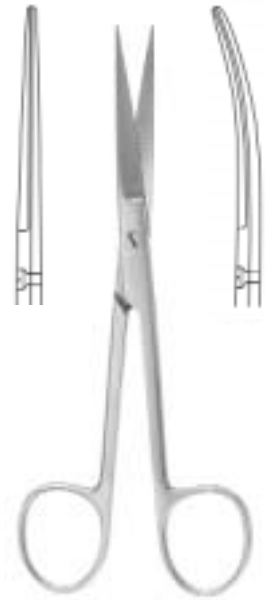

cm — DEAVER —
14,0 AI-510-14 AI-511-14

TC-Schneiden
TC Cutting Edges
Tranchant TC
Filos de corte TC
Taglio TC



cm — DEAVER —
14,0 AI-314-14 AI-315-14



cm — DEAVER —
14,0 AI-414-14 AI-415-14



cm — DEAVER —
14,0 AI-514-14 AI-515-14

TC-Schneiden
 TC Cutting Edges
 Tranchant TC
 Filos de corte TC
 Taglio TC



cm	MAYO
14,5	AI-610-14
14,5	AI-610-14L
17,0	AI-610-17
17,0	AI-610-17L
19,0	AI-610-19
23,0	AI-610-23
28,0	AI-610-28

cm	MAYO
14,5	AI-611-14
14,5	AI-611-14L
17,0	AI-611-17
17,0	AI-611-17L
19,0	AI-611-19
23,0	AI-611-23
28,0	AI-611-28

cm	MAYO
14,5	AI-614-14
17,0	AI-614-17
23,0	AI-614-23

cm	MAYO
14,5	AI-615-14
17,0	AI-615-17
23,0	AI-615-23

L = Für Linkshänder / For left-handed
 Pour la main gauche / Para zurdo / Per mancini

schlanke Modelle
 slender patterns
 modèles fins
 modelos finos
 modelli fini



cm MAYO-STILLE
 16,0 **AI-616-16**
 19,0 **AI-616-19**
 21,5 **AI-616-21**



cm MAYO-STILLE
 16,0 **AI-617-16**
 19,0 **AI-617-19**
 21,5 **AI-617-21**

mit abgeschrägten Schneiden
 with chamfered blades
 avec tranchant biais
 filos en declive
 con lame inclinate



cm MAYO-STILLE
 14,0 **AI-712-14**
 17,0 **AI-712-17**



cm MAYO-STILLE
 14,0 **AI-713-14**
 17,0 **AI-713-17**

TC-Schneiden
 TC Cutting Edges
 Tranchant TC
 Filos de corte TC
 Taglio TC



cm MAYO-STILLE
 15,0 **AI-710-15**
 17,0 **AI-710-17**

cm MAYO-STILLE
 15,0 **AI-711-15**
 17,0 **AI-711-17**



cm MAYO-STILLE
 15,0 **AI-714-15**
 17,0 **AI-714-17**

cm MAYO-STILLE
 15,0 **AI-715-15**
 17,0 **AI-715-17**

AI

Chirurgische Scheren
Operating Scissors
Ciseaux à chirurgie
Tijeras para cirugía
Forbici per chirurgia



cm MAYO-NOBLE
17,0 **AI-810-17**



cm MAYO-NOBLE
17,0 **AI-811-17**



TC-Schneiden
TC Cutting Edges
Tranchant TC
Filos de corte TC
Taglio TC



cm MAYO-NOBLE
17,0 **AI-814-17**



cm MAYO-NOBLE
17,0 **AI-815-17**

TC-Schneiden
 TC Cutting Edges
 Tranchant TC
 Filos de corte TC
 Taglio TC



cm	<u>LEXER</u>
16,0	AI-910-16
21,0	AI-910-21

cm	<u>LEXER</u>
16,0	AI-911-16
21,0	AI-911-21

cm	<u>LEXER</u>
16,0	AI-914-16
21,0	AI-914-21

cm	<u>LEXER</u>
16,0	AI-915-16
21,0	AI-915-21

AI

Präparierscheren
Dissecting Scissors
Ciseaux à dissection
Tijeras de disección
Forbici per dissezione



cm LEXER-FINO
16,0 AI-917-16



cm LEXER-BABY
10,0 AI-022-10



cm LEXER-BABY
10,0 AI-023-10



cm LEXER-BABY
10,0 AI-026-10



cm LEXER-BABY
10,0 AI-027-10

TC-Schneiden
TC Cutting Edges
Tranchant TC
Filos de corte TC
Taglio TC

Präparierschere mit Fadenbohrung in der Spitze
 Dissecting scissors, tips with eye for suture
 Ciseaux à dissection avec chas
 Tijera de disección, con ojal en las puntas
 Forbici per dissezione con foro per il filo alla punta



cm LITTLER
 12,0 **AI-025-12**
 14,0 **AI-025-14**



cm METZENBAUM
 11,5 **AI-120-11**
 15,5 **AI-120-15**



cm METZENBAUM
 11,5 **AI-121-11**
 15,5 **AI-121-15**



cm GORNEY
 12,0 **AI-122-12**
 19,0 **AI-122-19**



cm GORNEY
 19,0 **AI-123-19**

TC-Schneiden
TC Cutting Edges
Tranchant TC
Filos de corte TC
Taglio TC



cm	METZENBAUM
15,0	AI-820-15
15,0	AI-820-15L
18,0	AI-820-18
18,0	AI-820-18L
20,0	AI-820-20
23,0	AI-820-23
23,0	AI-820-23L
25,0	AI-820-25
28,0	AI-820-28
30,0	AI-820-30

cm	METZENBAUM
15,0	AI-821-15
15,0	AI-821-15L
18,0	AI-821-18
18,0	AI-821-18L
20,0	AI-821-20
23,0	AI-821-23
23,0	AI-821-23L
25,0	AI-821-25
28,0	AI-821-28
30,0	AI-821-30

cm	METZENBAUM
15,0	AI-824-15
18,0	AI-824-18
20,0	AI-824-20
23,0	AI-824-23
25,0	AI-824-25
28,0	AI-824-28
30,0	AI-824-30

cm	METZENBAUM
15,0	AI-825-15
18,0	AI-825-18
20,0	AI-825-20
23,0	AI-825-23
25,0	AI-825-25
28,0	AI-825-28
30,0	AI-825-30

L = Für Linkshänder / For left-handed
Pour la main gauche / Para zurdo / Per mancini

TC-Schneiden
 TC Cutting Edges
 Tranchant TC
 Filos de corte TC
 Taglio TC



cm	METZENBAUM FINO
15,0	AI-822-15
18,0	AI-822-18
20,0	AI-822-20
23,0	AI-822-23
25,0	AI-822-25
28,0	AI-822-28

cm	METZENBAUM FINO
15,0	AI-823-15
18,0	AI-823-18
20,0	AI-823-20
23,0	AI-823-23
25,0	AI-823-25
28,0	AI-823-28

cm	METZENBAUM FINO
15,0	AI-826-15
18,0	AI-826-18
20,0	AI-826-20
23,0	AI-826-23
25,0	AI-826-25
28,0	AI-826-28

cm	METZENBAUM FINO
15,0	AI-827-15
18,0	AI-827-18
20,0	AI-827-20
23,0	AI-827-23
25,0	AI-827-25
28,0	AI-827-28

TC-Schneiden
 TC Cutting Edges
 Tranchant TC
 Filos de corte TC
 Taglio TC



cm METZENBAUM "S"
 18,0 AI-921-18



cm METZENBAUM "S"
 18,0 AI-925-18



cm SANVENERO
 14,0 AI-032-14



cm SANVENERO
 14,0 AI-033-14

Plastik
 Plastic
 Plastique
 Plástica
 Plastica



cm JOSEPH
 14,0 AI-034-14



cm JOSEPH
 14,0 AI-035-14

Plastik
Plastic
Plastique
Plástica
Plastica



gerade
straight
croits
rectas
rette

cm KILNER
12,0 AI-038-12



cm KILNER
12,0 AI-130-12
15,0 AI-130-15

TC-Schneiden
TC Cutting Edges
Tranchant TC
Filos de corte TC
Taglio TC



cm KILNER
12,0 AI-134-12
15,0 AI-134-15

eine Schneide gezahnt
 one toothed cutting edge
 une lame dentelée
 una hoja dentada
 una lama dentata



cm LOCKLIN
 16,0 AI-135-16



cm LOCKLIN
 16,0 AI-137-16

Plastik
 Plastic
 Plastique
 Plástica
 Plastica

TC-Schneiden
 TC Cutting Edges
 Tranchant TC
 Filos de corte TC
 Taglio TC



cm REYNOLDS
 15,0 AI-230-15



cm REYNOLDS
 15,0 AI-231-15
 18,0 AI-231-18



cm REYNOLDS
 15,0 AI-234-15



cm REYNOLDS
 15,0 AI-235-15



cm IRIS
9,5 **AI-232-09**



cm IRIS
9,5 **AI-233-09**



cm IRIS
10,5 **AI-236-10**



cm IRIS
9,5 **AI-237-10**



cm IRIS
10,0 **AI-238-10**



cm IRIS
10,0 **AI-239-10**



cm IRIS
9,5 **AI-331-09**



cm IRIS
9,5 **AI-333-09**

AI

Chirurgische Scheren
Operating Scissors
Ciseaux à chirurgie
Tijeras para cirugía
Forbici per chirurgia



cm KNAPP
10,5 **AI-336-10**



cm KNAPP
10,5 **AI-337-10**



cm KNAPP
10,5 **AI-338-10**



cm KNAPP
10,5 **AI-339-10**

rund
 round
 rond
 redondo
 retondo



cm IRIS-Standard
 9,0 **AI-430-09**
 10,5 **AI-430-10**
 10,5 **AI-430-10L**
 11,5 **AI-430-11**
 12,5 **AI-430-12**

cm IRIS-Standard
 9,0 **AI-431-09**
 10,5 **AI-431-10**
 10,5 **AI-431-10L**
 11,5 **AI-431-11**
 12,5 **AI-431-12**

cm IRIS-Standard
 10,5 **AI-432-10**
 11,5 **AI-432-11**

cm IRIS-Standard
 10,5 **AI-433-10**
 11,5 **AI-433-11**

L = Für Linkshänder / For left-handed / Pour la main gauche / Para zurdo / Per mancini

TC-Schneiden
 TC Cutting Edges
 Tranchant TC
 Filos de corte TC
 Taglio TC



cm IRIS-Standard
 11,5 **AI-434-11**

cm IRIS-Standard
 11,5 **AI-435-11**

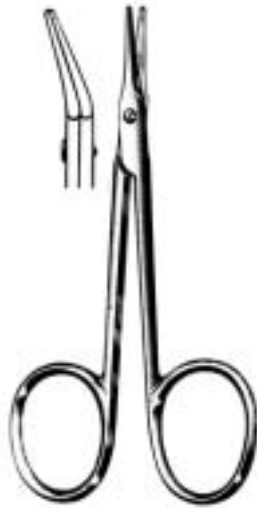

cm AEBLI
 9,0 **AI-437-09**

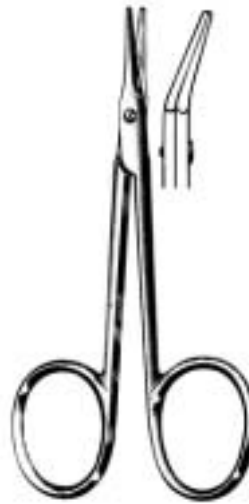

cm AEBLI
 9,0 **AI-439-09**



cm IRIS
 11,5 **AI-531-11**



cm IRIS
 11,5 **AI-534-11**



cm STEVENS
10,5 **AI-630-11**



cm STEVENS
10,5 **AI-631-11**



cm STEVENS
10,5 **AI-632-11**



cm STEVENS
10,5 **AI-633-11**



cm STEVENS
10,5 **AI-634-10**



cm STEVENS
10,5 **AI-635-10**



cm STEVENS
10,5 **AI-636-10**



cm STEVENS
10,5 **AI-637-10**

AI

Scheren, Ophthal., Nase
Scissors, Ophthal., Nasal
Ciseaux, ophtal., nasaux
Tijeras, oftalmología, nasales
Forbici, oftalmologia, nasali



cm
10,0 **AI-639-10**



cm
12,5 **AI-639-12**

Strabismusscheren
Strabismus scissors
Ciseaux à strabisme
Tijeras para estrabismo
Forbici per strabismo

TC-Schneiden
TC Cutting Edges
Tranchant TC
Filos de corte TC
Taglio TC



cm
11,0 **AI-730-11**



cm
11,0 **AI-731-11**



cm
11,0 **AI-734-11**



cm
11,0 **AI-735-11**

Enucleationsscheren
 Enucleation scissors
 Ciseaux à énucléation
 Tijeras para enucleación
 Forbici per enucleazione



cm LANDOLT
 11,0 **AI-831-11**
 13,0 **AI-831-13**



cm LANDOLT
 13,0 **AI-831-13**



cm HEYMANN
 18,0 **AI-041-18**



cm FOMON
 14,0 **AI-043-14**
 15,0 **AI-043-15**



cm COTTLE
 16,0 **AI-045-16**



cm COTTLE
 16,0 **AI-047-16**

TC-Schneiden
 TC Cutting Edges
 Tranchant TC
 Filos de corte TC
 Taglio TC

AI

Tonsillen-, Gefäß-Scheren
Tonsil, Vascular Scissors
Ciseaux amygdal., vasculaires
Tijeras, amígdal., vasculares
Forbici, tonsill., vascolari



cm	BEUSE
14,0	AI-240-14
18,0	AI-240-18



cm	BEUSE
14,0	AI-241-14
18,0	AI-241-18



aufgewinkelt
angled upwards
coudée en haut
angulada
angolari sul piatto

cm	DEAN
17,0	AI-245-17



gezahnt, aufgewinkelt
toothed, angled upwards
dentelés, coudée en haut
dentada, angulada
dentate, angolari sul piatto

cm	DEAN
17,0	AI-247-17

Tonsillen-, Gefäß-Scheren
 Tonsil, Vascular Scissors
 Ciseaux amygdal., vasculaires
 Tijeras, amígdal., vasculares
 Forbici, tonsill., vascolari

AI



cm BOETTCHE
 18,0 **AI-345-18**



cm GOOD
 14,0 **AI-347-19**

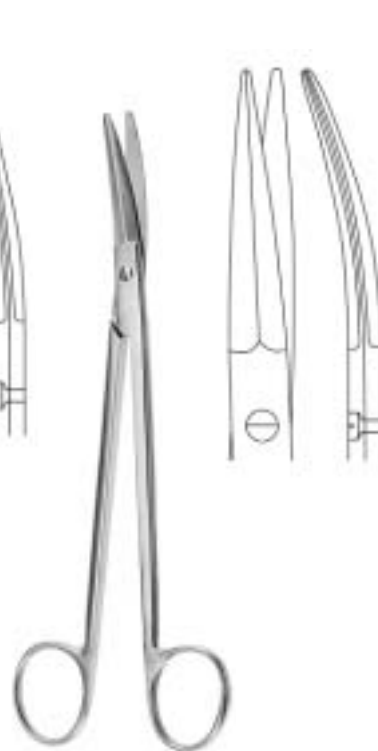

cm PRINCE
 17,0 **AI-349-17**



cm
 15,0 **AI-648-15**



cm
 11,0 **AI-740-11**



cm POTTS-DE MARTEL
 21,0 **AI-743-21**
 24,0 **AI-743-24**



cm MILLS
 22,0 **AI-745-22**

AI

Gefäß-Scheren
Vascular Scissors
Ciseaux vasculaires
Tijeras vasculares
Forbici vascolari



POTTS-SMITH

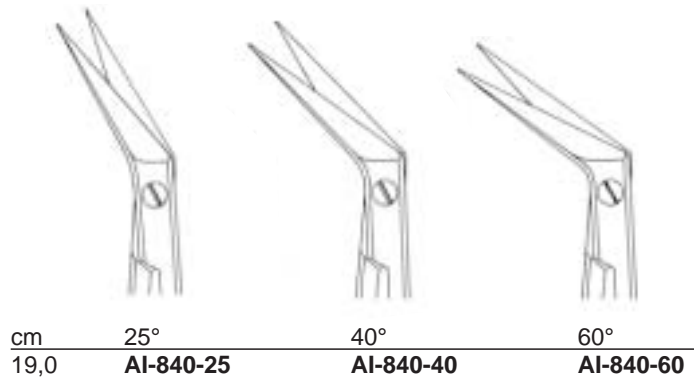

POTTS-SMITH

TC-Schneiden
TC Cutting Edges
Tranchant TC
Filos de corte TC
Taglio TC

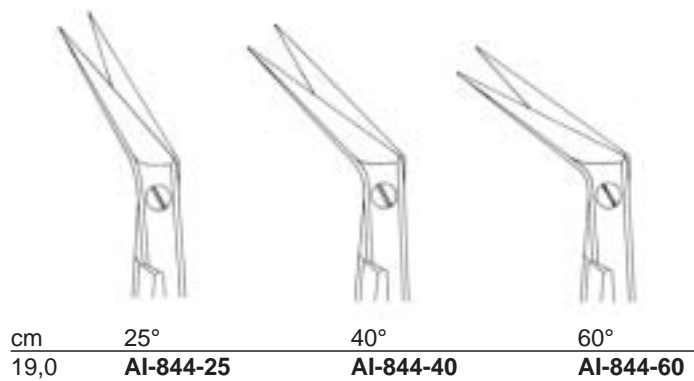



cm DIETHRICH
18,0 **AI-846-25**



cm DIETHRICH
18,0 **AI-846-45**



cm DIETHRICH
18,0 **AI-846-60**



cm DIETHRICH
18,0 **AI-846-90**



cm DIETHRICH
18,0 **AI-847-25**



cm DIETHRICH
18,0 **AI-848-25**

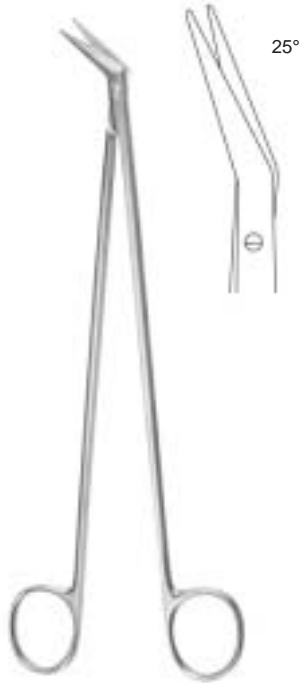

cm	DE BAKEY
16,0	AI-940-16
23,0	AI-940-23
28,0	AI-940-28



cm	DE BAKEY
16,0	AI-941-16
23,0	AI-941-23
28,0	AI-941-28



cm	DE BAKEY
16,0	AI-942-16
23,0	AI-942-23
28,0	AI-942-28

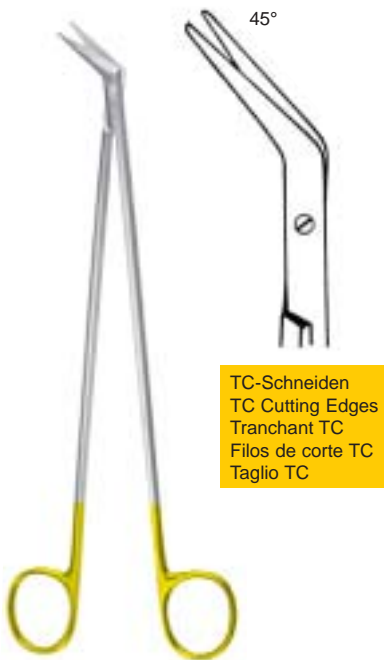

TC-Schneiden
 TC Cutting Edges
 Tranchant TC
 Filos de corte TC
 Taglio TC

cm	DE BAKEY
23,0	AI-943-23



cm	DE BAKEY
15,5	AI-945-15



cm	DE BAKEY
15,5	AI-947-15

Parametrium



cm
22,5 **AI-051-22**



cm
23,0 **AI-051-23**

TC-Schneiden
TC Cutting Edges
Tranchant TC
Filos de corte TC
Taglio TC



cm
22,5 **AI-055-22**



cm
23,0 **AI-055-23**

AI

Gynäkologische Scheren
Gynaecological Scissors
Ciseaux gynécologiques
Tijeras ginecológicas
Forbici ginecologiche



cm SIMS
20,0 **AI-150-20**
23,0 **AI-150-23**



cm SIMS
20,0 **AI-151-20**
23,0 **AI-151-23**



cm SIMS
23,0 **AI-154-23**



cm SIMS
23,0 **AI-155-23**

TC-Schneiden
TC Cutting Edges
Tranchant TC
Filos de corte TC
Taglio TC



cm SIEBOLD
24,0 **AI-253-24**



cm WERTHEIM
22,5 **AI-255-20**



cm WERTHEIM
22,5 **AI-257-22**

TC-Schneiden
TC Cutting Edges
Tranchant TC
Filos de corte TC
Taglio TC



cm DOYEN
17,5 AI-350-17
18,5 AI-350-18



cm DOYEN
17,5 AI-351-17



cm DUBOIS
27,0 AI-356-27



cm DUBOIS
27,0 AI-357-27



cm KELLY
16,0 AI-450-16
18,0 AI-450-18



cm KELLY
16,0 AI-451-16
18,0 AI-451-18

Nabelschnur-Scheren
 Umbilical Scissors
 Ciseaux ombilicaux
 Tijeras umbilicales
 Forbici ombelicali



cm U.S.A Mod.
 10,5 **AI-550-10**



cm BUSCH
 16,0 **AI-551-16**



cm SCHUMACHER
 14,0 **AI-553-16**



cm WALDMANN
 18,0 **AI-555-18**

Episiotomie
 Episiotomy
 Episiotomia



cm BRAUN-STADLER
 14,5 **AI-650-14**
 20,0 **AI-650-20**
 22,0 **AI-650-22**

Nerv-Präparierscheren
 Nerve dissecting Scissors
 Ciseaux pour nerfs
 Tijeras para nervios
 Forbici per nervi



cm
 11,0 **AI-850-11**



cm
 11,0 **AI-851-11**

Neurochirurgie
 Neurosurgery
 Neurocirurgia
 Neurochirurgia



cm
 15,0 **AI-852-15**



cm
 15,0 **AI-853-15**



cm **STRULLY**
 22,0 **AI-062-22**



cm **TOENNIS-ADSON**
 18,0 **AI-160-18**



cm **TOENNIS-ADSON**
 18,0 **AI-161-18**



cm **MC INDOE**
 19,0 **AI-164-19**

AI

Chirurgische Scheren
Operating Scissors
Ciseaux à chirurgie
Tijeras para cirugía
Forbici per chirurgia



cm DANDY
17,0 AI-167-17

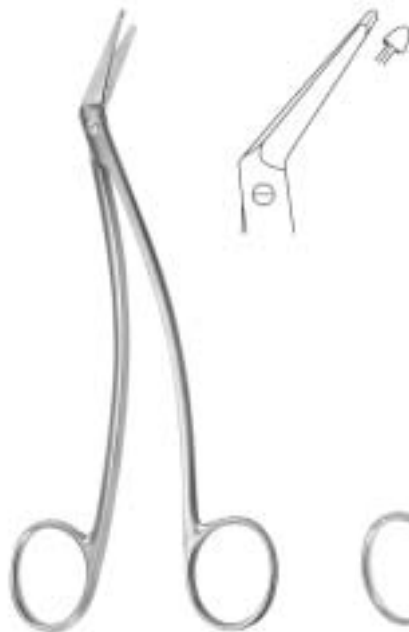

cm SCHMIEDEN-TAYLOR
17,0 AI-169-17



cm CRAFOORD
30,0 AI-461-30



cm THOREK
19,0 AI-463-18
25,0 AI-463-25



cm SATINSKY
21,0 **AI-560-21**



cm SATINSKY
24,5 **AI-561-24**



cm KLINKENBERG-LOTH
23,0 **AI-661-23**

AI

Chirurgische Scheren
Operating Scissors
Ciseaux à chirurgie
Tijeras para cirugía
Forbici per chirurgia

Lungenlappen- und Rektumscheren
Lobectomy and rectal scissors
Ciseaux à lobectomie et pour le rectum
Tijera para lobectomía y recto
Forbici per lobo polmonare e per il retto



cm FINOCHIETTO
27,0 **AI-663-27**

cm STELZNER
30,0 **AI-664-30**

cm STELZNER
30,0 **AI-665-30**

Darmscheren
Enterotomy Scissors
Ciseaux à entérotomie
Enterótomos
Forbici per enterotomia



cm
21,0 **AI-770-21**



cm
21,0 **AI-772-21**



cm
21,0 **AI-774-21**

Ligaturscheren
 Stitch Scissors
 Ciseaux à ligatures
 Tijeras para puntas
 Forbici per legature



cm SPENCER
 9,0 **AI-082-09**
 11,0 **AI-082-11**
 12,0 **AI-082-12**
 15,0 **AI-082-15**



cm SHORTBENT
 9,0 **AI-083-09**



cm NORTHBENT
 13,0 **AI-083-13**



cm LITTAUER
 14,0 **AI-084-14**



cm BUCK
 14,5 **AI-086-14**
 18,0 **AI-086-18**



cm HEATH
 15,0 **AI-089-15**

Zahnfleischscheren
 Gum Scissors
 Ciseaux à gencives
 Tijeras para encías
 Forbici gengivali



cm
 11,5 **AI-185-11**



cm **LAGRANGE**
 11,5 **AI-187-11**



cm **LAGRANGE**
 11,5 **AI-189-11**

gezahnt
 serrated
 dentelé
 dentada
 dentellate



cm **GOLDMANN-FOX**
 13,0 **AI-280-13**



cm **GOLDMANN-FOX**
 13,0 **AI-281-13**

gezahnt
 serrated
 dentelé
 dentada
 dentellate



cm **GOLDMANN-FOX**
 13,0 **AI-282-13**

TC-Schneiden
 TC Cutting Edges
 Tranchant TC
 Filos de corte TC
 Taglio TC

gezahnt
 serrated
 dentelé
 dentada
 dentellate



cm **GOLDMANN-FOX**
 13,0 **AI-283-13**

Zahnfleischscheren
 Gum Scissors
 Ciseaux à gencives
 Tijeras para encías
 Forbici gengivali



cm WAGNER
 12,0 AI-284-12



cm WAGNER
 12,0 AI-285-12



cm QUINBY
 12,0 AI-287-12

Draht-, Blechscheren
 Wire and plate shears
 Ciseaux à fils et plaques métalliques
 Tijeras para alambre y chapas
 Forbice per filo metallo lamiera



cm UNIVERSAL
 12,0 AI-381-12



cm UNIVERSAL
 12,0 AI-385-12

TC-Schneiden
 TC Cutting Edges
 Tranchant TC
 Filos de corte TC
 Taglio TC

Draht-, Blechscheren
 Wire and plate shears
 Ciseaux à fils et plaques métalliques
 Tijeras para alambre y chapas
 Forbice per filo metallo lamiera

gerade
 straight
 droites
 rectas
 rette



cm BEEBE
 10,5 **AI-580-10**

spitz
 pointed
 pointus
 agudas
 acute



cm BEEBE
 10,5 **AI-581-10**

gebogen
 curved
 courbes
 curvas
 curve



cm BEEBE
 10,5 **AI-582-10**

stumpf
 blunt
 mousses
 romas
 smusse



cm BEEBE
 10,5 **AI-583-10**

gerade
 straight
 droites
 rectas
 rette



cm BEEBE
 12,0 **AI-584-12**

gezahnt
 serrated
 dentelé
 dentada
 dentellate



cm BEEBE
 12,0 **AI-585-12**

gebogen
 curved
 courbes
 curvas
 curve



cm LANGE
18,0 **AI-986-18**

Gaze
Gauze
Gaze
Gaza
Garza



cm SMITH US ARMY
15,0 **AI-988-15**
16,0 **AI-988-16**
18,0 **AI-988-18**
20,0 **AI-988-20**

TC-Schneiden
 TC Cutting Edges
 Tranchant TC
 Filos de corte TC
 Taglio TC



cm	LISTER
9,5	AI-091-09
11,0	AI-091-11
14,0	AI-091-14
14,0	AI-091-14L
16,0	AI-091-16
16,0	AI-091-16L
18,0	AI-091-18
18,0	AI-091-18L
20,0	AI-091-20

cm	LISTER
14,0	AI-092-14

cm	LISTER
18,0	AI-093-18
20,0	AI-093-20

cm	LISTER
14,0	AI-095-14
18,0	AI-095-18
20,0	AI-095-20

L = Für Linkshänder / For left-handed / Pour la main gauche / Para zurdo / Per mancini

AI

Verband-Scheren
Bandage Scissore
Ciseaux à bandages
Tijeras para vendajes
Forbici per bendaggi



cm BERGMANN
23,0 **AI-191-23**



cm ESMARCH
20,0 **AI-193-20**
22,0 **AI-193-22**



cm Excenter
16,0 **AI-291-16**
19,0 **AI-291-19**



cm ROTES KREUZ
17,0 AI-297-17



cm KNOWLES
14,0 AI-390-14



cm KNOWLES
14,0 AI-391-14



cm LORENZ
23,0 AI-393-23

AI

Verband-Scheren
Bandage Scissors
Ciseaux à bandages
Tijeras para vendajes
Forbici per bendaggi

eine Schneide gezahnt
one serrated cutting edge
une lame dentelé
una hoja cortante dentada
una lama dentada

TC-Schneiden
TC Cutting Edges
Tranchant TC
Filos de corte TC
Taglio TC



cm BRUNS
23,0 AI-395-23



cm BRUNS
23,0 AI-397-23



cm BRUNS
23,0 AI-399-23

Gipsschere
Plaster Shear
Ciseaux pour plâtre
Tijera para yeso
Forbice per gesso



cm
20,0 **AI-491-20**



cm **FERGUSSON**
18,0 **AI-492-18**

AI

Verband-Scheren
Bandage Scissore
Ciseaux à bandages
Tijeras para vendajes
Forbici per bendaggi



cm
14,5 **AI-592-14**



cm UNIVERSAL

	Black	Blue	Green	Red	Yellow	White
15,0	AI-590-15	AI-590-15B	AI-590-15G	AI-590-15R	AI-590-15Y	AI-590-15W
18,0	AI-590-18	AI-590-18B	AI-590-18G	AI-590-18R	AI-590-18Y	AI-590-18W

AJ

**Mikro Scheren
Micro Scissors
Micro Ciseaux
Micro Tijeras
Micro Forbici**



AJ

Sehnen-Scheren
 Tendon Scissors
 Ciseaux tendons
 Tijeras tendones
 Forbici tendini

Iridectomiescheren
 Iridectomy Scissors
 Ciseaux à iridectomie
 Tijeras para iridectomia
 Forbici per iridectomia

spitz
 sharp
 pointu
 agudo
 appuntato

stumpf
 blunt
 mousse
 romo
 smusso

gerade
 straight
 droits
 rectas
 rette

gebogen
 curved
 courbes
 curvas
 curve



cm WESTCOTT
 11,0 AJ-012-11

cm WESTCOTT
 11,0 AJ-014-11

cm WESTCOTT
 11,0 AJ-016-11

cm WESTCOTT
 11,0 AJ-017-11

Sehnen-, Iris-Scheren
 Tendon, Iris Scissors
 Ciseaux à iris et tendons
 Tijeras iris y para tendones
 Forbici per iride e tendini



cm	NOYES
13,0	AJ-019-13
16,0	AJ-019-16



spitz/spitz
 sharp/sharp
 pointu/pointu
 agudo/agudo
 appuntato/appuntato

Fig. 1

cm	NOYES
12,0	AJ-110-12



spitz/stumpf
 sharp/blunt
 pointu/mousse
 agudo/romo
 appuntato/smusso

Fig. 2

cm	NOYES
12,0	AJ-111-12



stumpf/stumpf
 blunt/blunt
 mousse/mousse
 romo/romo
 smusso/smusso

Fig. 3

cm	NOYES
12,0	AJ-112-12

Sehnen-, Iris-Scheren
Tendon, Iris Scissors
Ciseaux à iris et tendons
Tijeras iris y para tendones
Forbici per iride e tendini



cm WECKER
11,0 AJ-113-11

spitz/spitz
sharp/sharp
pointu/pointu
agudo/agudo
appuntato/appuntato



cm NOYES
12,0 AJ-110-12

spitz/stumpf
sharp/blunt
pointu/mousse
agudo/romo
appuntato/smusso



cm NOYES
12,0 AJ-111-12

stumpf/stumpf
blunt/ blunt
mousse/ mousse
romo/ romo
smusso/ smusso



cm NOYES
12,0 AJ-112-12



cm McPherson-Westcott
10,0 AJ-118-01



spitz
sharp
pointu
agudo
appuntato



cm McPherson-Westcott
10,0 AJ-118-02



stumpf
blunt
mousse
romo
smusso

Blattlänge 10 mm
length of blades 10 mm
longeur des lames 10 mm
largo de hojas 10 mm
lunghezza della lama 10 mm



cm BARRAQUER
5,5 AJ-119-07

Iridektomie, Hornhaut
 Iridectomy, corneal
 Iridectomie, cornéens
 Iridectomía, corneal
 Iridectomia, corneale



cm McGUIRE
 10,0 **AJ-211-10**



spitz
 sharp
 pointu
 agudo
 appuntato

cm CASTROVIEJO
 10,0 **AJ-313-10**



stumpf
 blunt
 mousse
 romo
 smusso

cm CASTROVIEJO
 10,0 **AJ-315-10**



gerade
 straight
 droits
 rectas
 rette

cm VANNAS
 8,0 **AJ-410-08**



gebogen
 curved
 courbes
 curvas
 curve

cm VANNAS
 8,0 **AJ-411-08**



kniegebogen
 angular
 coudés
 acodadas
 angolate

cm VANNAS
 8,0 **AJ-413-08**

Iridektomie, Hornhaut
 Iridectomy, corneal
 Iridectomie, cornéens
 Iridectomía, corneal
 Iridectomia, corneale



links
 left
 gauche
 izquierda
 sinistra

cm CASTROVIEJO
 10,0 AJ-417-10



rechts
 right
 droite
 derecha
 destra

cm CASTROVIEJO
 10,0 AJ-419-10



stumpf
 blunt
 mousse
 romo
 smusso

cm CASTROVIEJO
 11,0 AJ-511-11



stumpf
 blunt
 mousse
 romo
 smusso

cm CASTROVIEJO
 11,0 AJ-513-11



stumpf
 blunt
 mousse
 romo
 smusso

cm CASTROVIEJO
 11,0 AJ-515-11

Mikrochirurgie
 Micro Surgery
 Microchirurgie
 Microcirugía
 Microchirurgia



cm
 10,0 AJ-517-10



rechts
 right
 droite
 derecha
 destra

cm TROUTMAN-CASTROVIEJO
 11,0 **AJ-611-11**



links
 left
 gauche
 izquierda
 sinistra

cm TROUTMAN-CASTROVIEJO
 11,0 **AJ-613-11**



gerade
 straight
 droits
 rectas
 rette

cm
 14,0 **AJ-022-14**
 18,0 **AJ-022-18**



gebogen
 curved
 courbes
 curvas
 curve

cm
 14,0 **AJ-023-14**
 18,0 **AJ-023-18**



gerade
 straight
 droits
 rectas
 rette

cm
 18,0 **AJ-024-18**



stumpf
 blunt
 mousse
 romo
 smusso

cm
 18,0 **AJ-025-18**

AJ

Augen-, Mikro-Scheren
Ophthalmic, Micro Scissors
Ciseaux oculaires, micro-ciseaux
Tijeras oculares, microquirúrgicas
Forbici oculistiche, micro-chirurg.



spitz
sharp
pointu
agudo
appuntato

cm
14,5 **AJ-220-14**
18,0 **AJ-220-18**
23,0 **AJ-220-23**



spitz
sharp
pointu
agudo
appuntato

cm
14,5 **AJ-221-14**
18,0 **AJ-221-18**
23,0 **AJ-221-23**



stumpf
blunt
mousse
romo
smusso

cm
14,5 **AJ-223-14**
18,0 **AJ-223-18**

Augen-, Mikro-Scheren
 Ophthalmic, Micro Scissors
 Ciseaux oculaires, micro-ciseaux
 Tijeras oculares, microquirúrgicas
 Forbici oculistiche, micro-chirurg.

AJ



AJ-224-25
 25°
 18 cm

spitz
 sharp
 pointu
 agudo
 appuntato



AJ-224-45
 45°
 18 cm



AJ-224-60
 60°
 18 cm



AJ-224-90
 90°
 18 cm



09.225.00
 125°
 18 cm



AJ-225-25
 25°
 18 cm

1 Blatt geknöpft
 1 probe-pointed blade
 1 lame boutonnée
 1 hoja botonada
 1 lama bottonnta



AJ-225-45
 45°
 18 cm



AJ-225-60
 60°
 18 cm



AJ-225-90
 90°
 18 cm



AJ-226-00
 125°
 18 cm



AJ

Augen-, Mikro-Scheren
Ophthalmic, Micro Scissors
Ciseaux oculaires, micro-ciseaux
Tijeras oculares, microquirúrgicas
Forbici oculistiche, micro-chirurg.

gerade
straight
droits
rectas
rette



cm YASARGIL
16,5 **AJ-520-16**
20,0 **AJ-520-20**
22,5 **AJ-520-22**

aufgebogen
upwards curved
courbe vers le haut
curvada hacia arriba
curvato verso l'alto



cm YASARGIL
16,5 **AJ-521-16**
20,0 **AJ-521-20**
22,5 **AJ-521-22**
24,5 **AJ-521-24**

abwärts gebogen
upwards curved
courbe en bas
curvada hacia abajo
curvato verso il basso



cm YASARGIL
20,0 **AJ-523-20**
22,5 **AJ-523-22**

stumpf
blunt
mousse
romo
smusso



cm YASARGIL
20,0 **AJ-524-20**
22,5 **AJ-524-22**

stumpf
 blunt
 mousse
 romo
 smusso



cm YASARGIL
 20,0 **AJ-525-20**
 22,5 **AJ-525-22**

gebogen
 curved
 courbes
 curvas
 curve



cm JACOBSON
 19,0 **AJ-527-19**

gerade
 straight
 droits
 rectas
 rette



cm YASARGIL
 12,0 **AJ-620-12**
 16,0 **AJ-620-16**
 18,0 **AJ-620-18**

gebogen
 curved
 courbes
 curvas
 curve



cm YASARGIL
 12,0 **AJ-621-12**
 16,0 **AJ-621-16**
 18,0 **AJ-621-18**

AJ

Augen-, Mikro-Scheren
Ophthalmic, Micro Scissors
Ciseaux oculaires, micro-ciseaux
Tijeras oculares, microquirúrgicas
Forbici oculistiche, micro-chirurg.

gerade
straight
droits
rectas
rette



cm VANNAS
12,0 **AJ-622-12**
16,0 **AJ-622-16**

gebogen
curved
courbes
curvas
curve



cm VANNAS
12,0 **AJ-623-12**
16,0 **AJ-623-16**

gerade
straight
droits
rectas
rette



cm
18,5 AJ-626-16

gebogen
curved
courbes
curvas
curve



cm
18,5 AJ-627-18

gerade
straight
droits
rectas
rette



cm VANNAS
18,5 AJ-628-18

gebogen
curved
courbes
curvas
curve



cm VANNAS
18,5 AJ-629-18

BA

BB

**Pinzetten
Forceps
Pinzes
Pinzas
Pinze**



BA-BB

BA

Pinzetten
Thumb and Tissue Forceps
Pincès à dissection
Pinzas de disección
Pinze per dissezione

	USA		STILLE			POTTS-SMITH	POTTS-SMITH							
cm	11,5	12,0	13,0	14,5	15,0	15,5	16,0	18,0	20,0	21,0	25,0	30,0		
	BA-012-11	BA-014-12	BA-016-13	BA-014-14	BA-016-15	BA-110-11	BA-110-13	BA-110-14	BA-114-14	BA-110-16	BA-114-16	BA-112-18	BA-116-18	BA-216-18
	BA-012-13	BA-014-13	BA-110-13	BA-110-14	BA-114-14	BA-110-16	BA-114-16	BA-112-21	BA-116-21	BA-110-18	BA-114-18	BA-112-25	BA-116-25	BA-216-21
	BA-012-20	BA-016-20	BA-110-20	BA-014-21	BA-016-21	BA-110-25	BA-114-25	BA-112-30	BA-116-30	BA-110-30	BA-114-30	BA-112-30	BA-116-30	BA-216-25
	BA-012-25	BA-014-25	BA-110-25	BA-012-30	BA-014-30	BA-110-30	BA-114-30							

	USA		STILLE													
	1:2	1:2	1:2	1:2	1:2	2:3	3:4	4:5								
cm	11,5	12,0	13,0	14,5	15,0	15,5	16,0	18,0	20,0	21,0	25,0	30,0				
	BA-210-11	BA-212-12	BA-310-11	BA-210-13	BA-212-13	BA-310-13	BA-410-11	BA-410-13	BA-510-13	BA-610-13	BA-210-14	BA-212-14	BA-310-14	BA-410-14	BA-510-14	BA-610-14
	BA-210-16	BA-212-15	BA-310-16	BA-210-18	BA-212-18	BA-310-18	BA-410-16	BA-410-18	BA-510-16	BA-610-16	BA-210-20	BA-214-15	BA-310-20	BA-410-20	BA-510-20	BA-610-20
	BA-210-25	BA-212-21	BA-310-25	BA-210-30	BA-212-25	BA-310-25	BA-410-25	BA-410-25	BA-510-25	BA-610-25	BA-210-30	BA-214-21	BA-310-30	BA-410-30	BA-510-30	BA-610-30

Pinzetten
 Thumb and Tissue Forceps
 Pincès à dissection
 Pinzas de disección
 Pinze per dissezione

BA

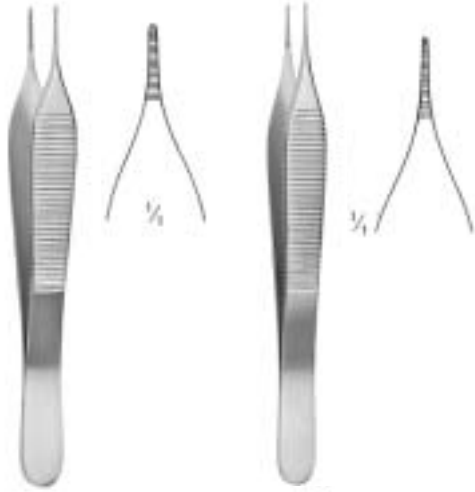

cm	ADSON	ADSON micro
12,0	BA-710-12	BA-716-12
12,0	BA-714-12	
15,0	BA-710-15	BA-716-15
15,0	BA-714-15	



CUSHING
BA-220-17
BA-224-17
 17 cm

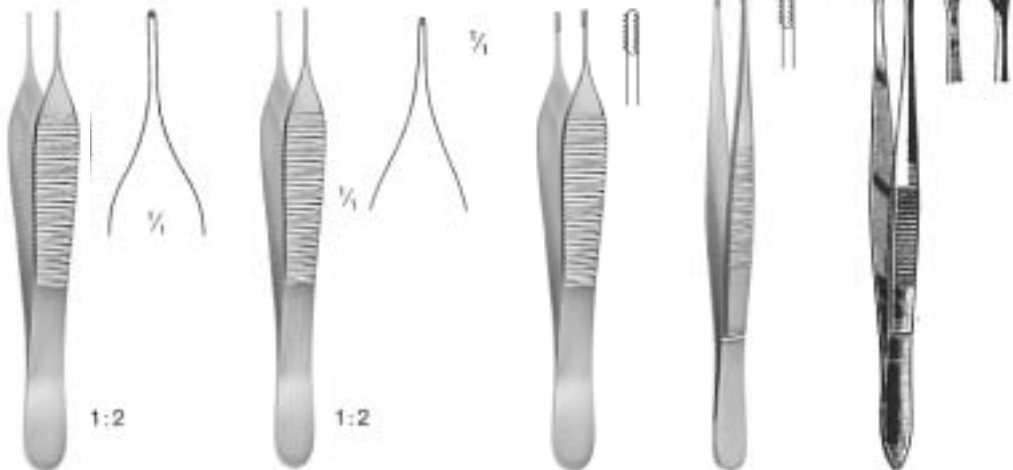

cm	ADSON	ADSON micro	ADSON-BROWN	BROWN	GRAEFE BA910-10
10,5					
12,0	BA-810-12	BA-816-12	BA-818-12	BA-819-12	
15,0	BA-810-15	BA-816-15			
16,0				BA-819-16	
20,0				BA-819-20	
25,0				BA-819-25	



CUSHING
BA-320-17
 17 cm

BA

Pinzetten
Thumb and Tissue Forceps
Pincès à dissection
Pinzas de disección
Pinze per dissezione

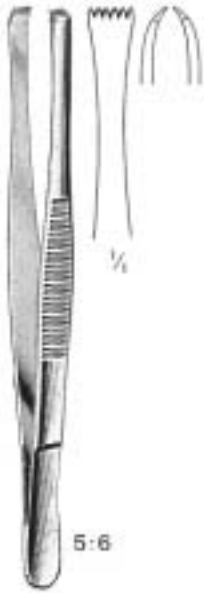

cm LERICHE
14,5 BA-322-15
15,0
18,0
20,0



ADLERKREUTZ
BA-326-15
BA-326-20



LANE
BA-420-14
BA-420-18
BA-420-20



LANE
BA-422-14
BA-422-18



FERRIS-SMITH
BA-426-18



FERRIS-SMITH
BA-428-18



cm DUVAL
14,5 BA-520-14
15,0
20,0
25,0



COLLIN-DUVAL
BA-522-14



Russ. Mod.
BA-526-15
BA-526-18
BA-526-25



McINDOE
BA-528-15

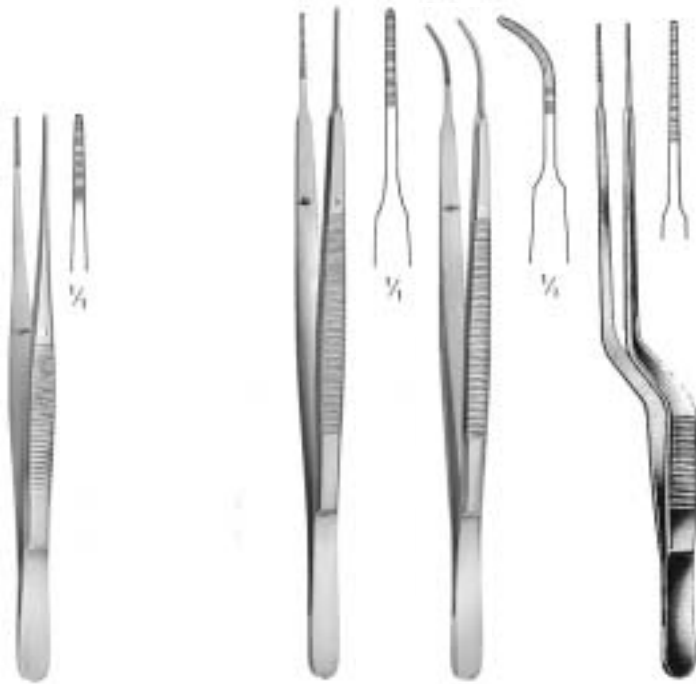

cm	SEMKEN	GERALD	GERALD	GERALD
12,5	BA-620-12			
15,5	BA-620-15			
18,0		BA-032-18	BA-033-18	BA-035-18

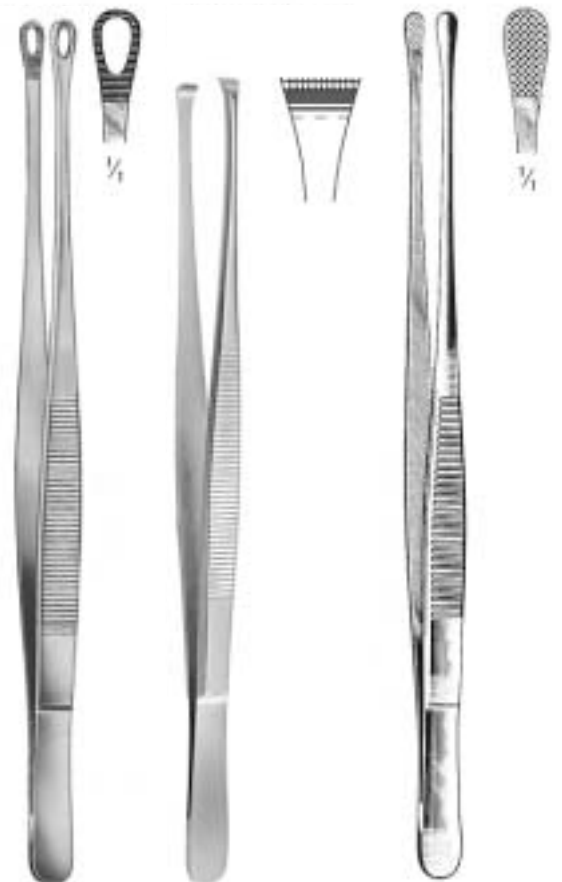

cm	SEMKEN	GILLIES	GERALD	GERALD	GERALD	SINGLEY	NELSON	WANGENSTEEN
12,5	BA-720-12							
15,5	BA-720-15	BA-722-15						
18,0			BA-130-18	BA-131-18	BA-133-18	BA-230-18	BA-232-15	
23,0			BA-130-23			BA-230-23	BA-232-18	BA-234-23
							BA-232-23	

BA

Splitterpinzetten, -zangen
 Splinter Forceps
 Pincès à écharde
 Pinzas para espinas
 Pinze per schegge



BA-330-12
 12 cm
 Fig. 3



BA-331-12
 12 cm
 Fig. 7

cm		FEILCHENFELD	HUNTER	HUNTER		CARMALT	CARMALT
7,5		BA-180-07					
9,5	BA-082-09	BA-180-09					
10,5	BA-082-10		BA-182-10	BA-183-10		BA-186-10	BA-187-10
11,5	BA-082-11	BA-180-11					
12,5					BA-185-12		



PEET
BA-281-11
 11,5 cm



STIEGLITZ
BA-282-13 13,5 cm **BA-283-13**



ARCHER
BA-284-14 14 cm **BA-285-14**



VIRTUS (RALK)
BA-288-15
 15 cm

Mikrochirurgie-Pinzetten
Microsurgery Forceps
Pinces à microchirurgie
Pinzas para microcirugía
Pinze per microchirurgia

BB



BB-012-12 12 cm BB-013-12



BB-014-15 15 cm BB-015-15



BB-018-18 18 cm BB-019-18
BB-018-23 23 cm

BB

Atraumatische Pinzetten
 Atraumatic Tissue Forceps
 Pincès atraumáticos
 Pinzas atraumáticas
 Pinze atraumatiche

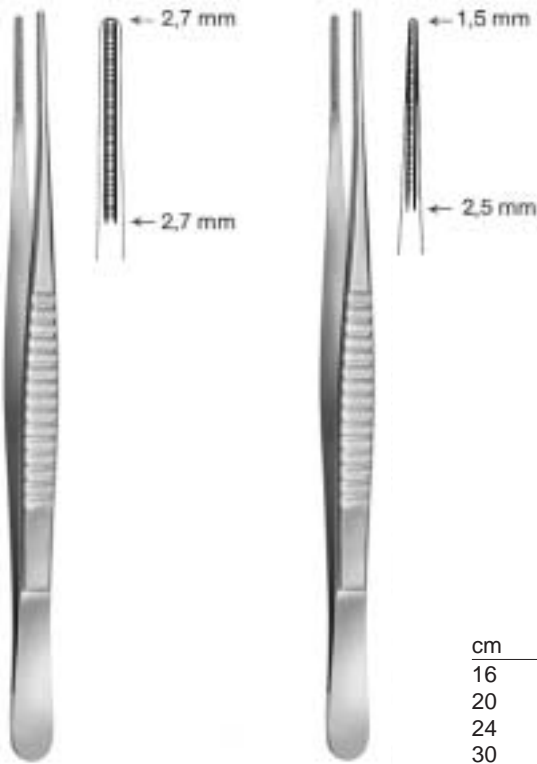

cm	DE BAKEY	DE BAKEY
16	BB-034-16	BB-036-16
20	BB-034-20	BB-036-20
24	BB-034-24	BB-036-24
30	BB-034-30	

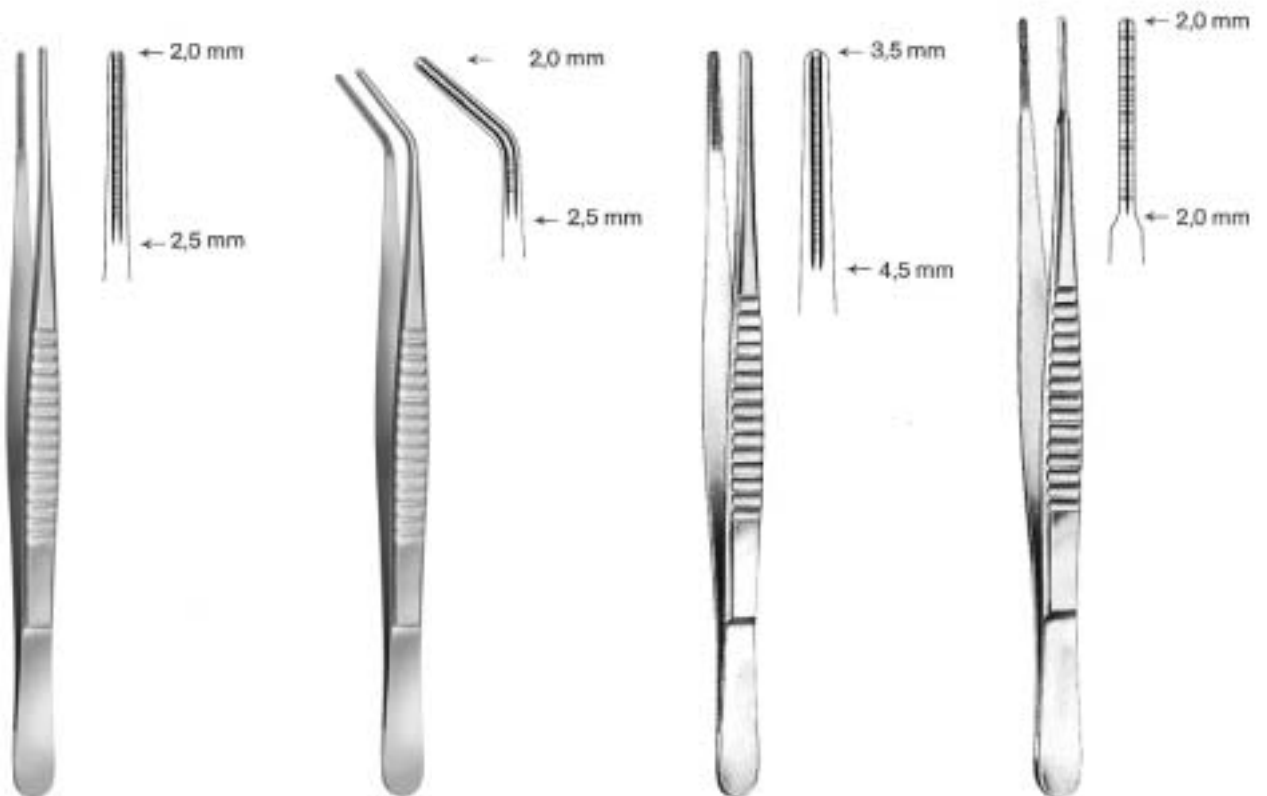

cm	DE BAKEY	DE BAKEY	DE BAKEY	COOLEY
16	BB-038-16	BB-039-16	BB-130-16	BB-134-16
20	BB-038-20	BB-039-20	BB-130-20	BB-134-20
24	BB-038-24	BB-039-24	BB-130-24	BB-134-24
30	BB-038-30	BB-039-30	BB-130-30	BB-134-30

**Arterienklemmen
Hemostatic Forceps
Pinces hémostatiques
Pinzas hemostáticas
Pinze emostatiche**

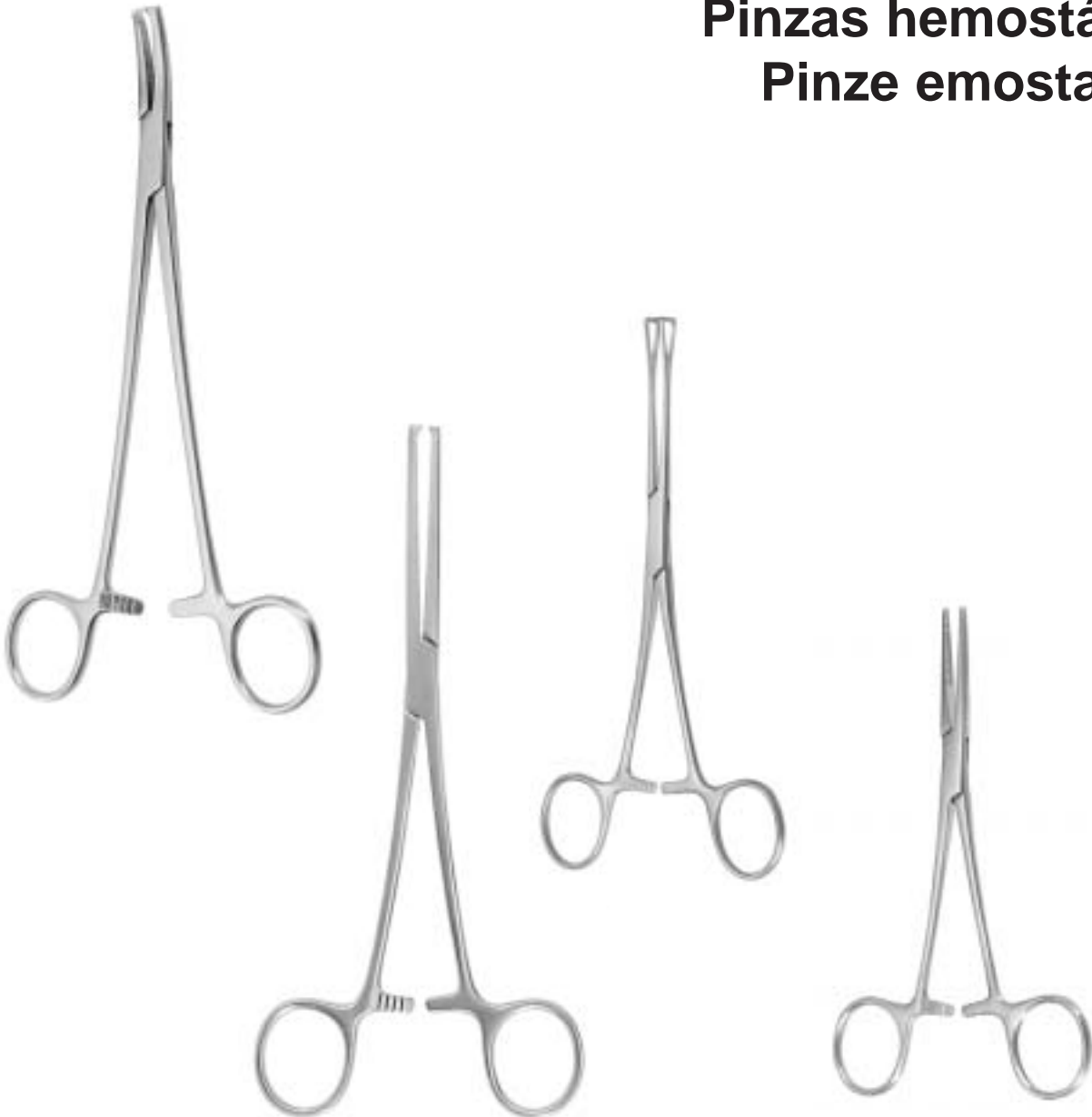

BC

Atrauma-Bulldogklemmen
Atrauma Bulldog Clamps
Clamps Bulldog Atrauma
Clamps Atrauma Bulldog
Pinze Atrauma Bulldog



DE BAKEY
BC-902-07-BC-903-12

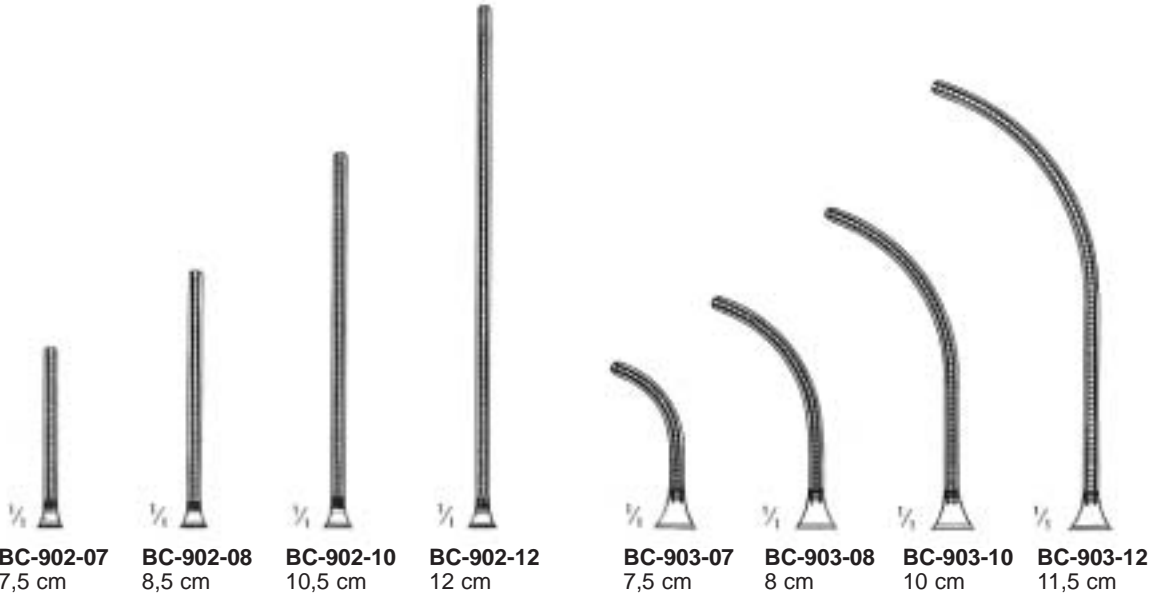

BC-902-07
7,5 cm

BC-902-08
8,5 cm

BC-902-10
10,5 cm

BC-902-12
12 cm

BC-903-07
7,5 cm

BC-903-08
8 cm

BC-903-10
10 cm

BC-903-12
11,5 cm



GLOVER
BC-906-06-BC-907-11

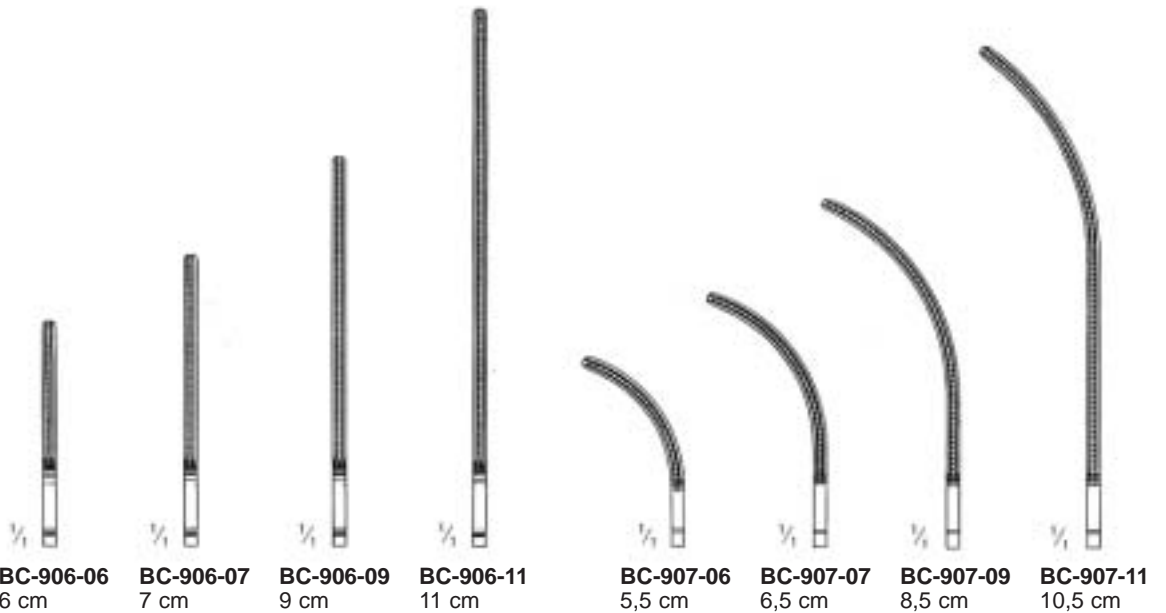

BC-906-06
6 cm

BC-906-07
7 cm

BC-906-09
9 cm

BC-906-11
11 cm



BC-907-06
5,5 cm







BC-907-07
6,5 cm

BC-907-09
8,5 cm

BC-907-11
10,5 cm

Gefäßklemmen
 Serrefines
 Serre-fines
 Serra-finas
 Serrefine

				
	DIEFFENBACH		JOHNS-HOPKINS	
cm	BC-012-04	BC-013-04	BC-110-50	BC-111-50
3,5	BC-012-05	BC-013-05	BC-110-55	BC-111-55
5,0			BC-110-65	BC-111-65
5,5			BC-110-70	BC-111-70
6,5			BC-110-75	BC-111-75
7,0			BC-110-90	BC-111-90
7,5				
9,0				

			
			
HARTMANN		HARTMANN	
BC-120-10	10 cm	BC-122-10	BC-123-10

BC

Arterienklemmen
 Hemostatic Forceps
 Pinces hémostatiques
 Pinzas hemostáticas
 Pinze emostatiche

Titan
 Titanium
 Titane
 Titanio



— HALSTED-MOSQUITO —



— HALSTED-MOSQUITO micro —

cm						
12,5	BC-224-12	BC-220-12	BC-221-12	BC-225-12	BC-222-12	BC-223-12
14,0		BC-220-14	BC-221-14			
18,0		BC-220-18	BC-221-18			
21,0		BC-220-21	BC-221-21			

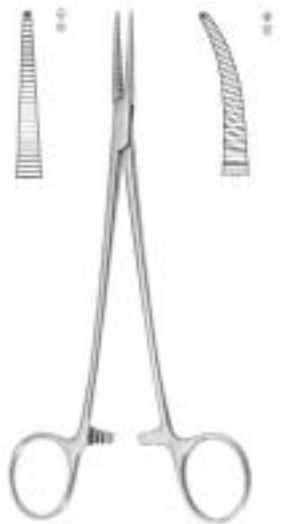

— HALSTED-MOSQUITO —



— HALSTED-MOSQUITO micro —

cm						
12,5	BC-324-12	BC-320-12	BC-321-12	BC-325-12	BC-322-12	BC-323-12
14,0		BC-320-14	BC-321-14			
18,0		BC-320-18	BC-321-18			
21,0		BC-320-21	BC-321-21			

Arterienklemmen
 Hemostatic Forceps
 Pinces hémostatiques
 Pinzas hemostáticas
 Pinze emostatiche

BC

Titan
 Titanium
 Titane
 Titanio



cm **KELLY**
 14,0 **BC-420-14** **BC-421-14**
 14,0 **BC-424-14** **BC-425-14**
 16,0



KELLY-RANKIN
BC-422-16 **BC-423-16**



PROVIDENCE-HOSPITAL
BC-720-14 **BC-721-14**



cm **CRILLE**
 14,0 **BC-520-14** **BC-521-14** **BC-620-14** **BC-621-14**
 14,0 **BC-524-14** **BC-525-14**
 16,0

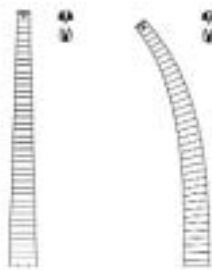

CRILE
BC-620-14 **BC-621-14**

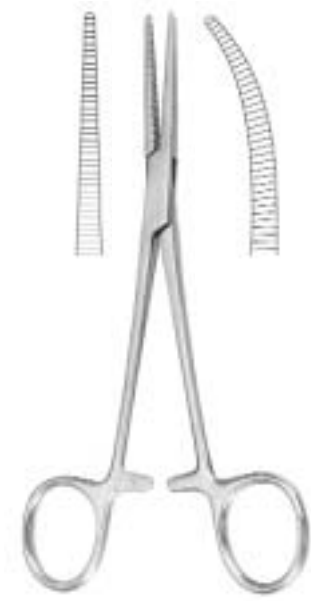

CRILE-RANKIN
BC-622-16 **BC-623-16**

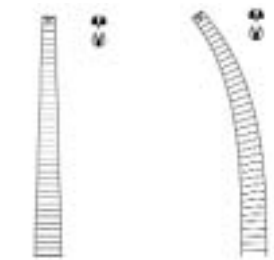

CRILE-RANKIN
BC-624-16 **BC-625-16**

BC

Arterienklemmen
 Hemostatic Forceps
 Pinces hémostatiques
 Pinzas hemostáticas
 Pinze emostatiche



cm	ROCHESTER-PEAN		ROCHESTER-OCHSNER	
13	BC-130-13	BC-131-13	BC-230-13	BC-231-13
14	BC-130-14	BC-131-14	BC-230-14	BC-231-14
16	BC-130-16	BC-131-16	BC-230-16	BC-231-16
18	BC-130-18	BC-131-18	BC-230-18	BC-231-18
20	BC-130-20	BC-131-20	BC-230-20	BC-231-20
22	BC-130-22	BC-131-22	BC-230-22	BC-231-22
24	BC-130-24	BC-131-24	BC-230-24	BC-231-24
26	BC-130-26	BC-131-26	BC-230-26	BC-231-26
30	BC-130-30	BC-131-30	BC-230-30	BC-231-30

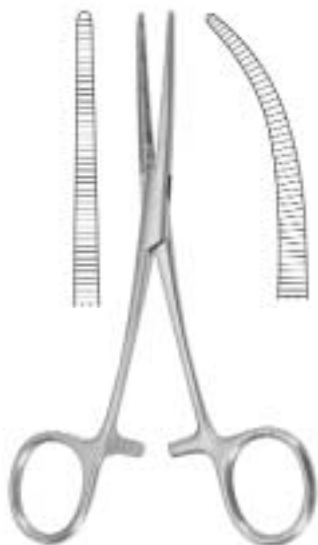

Graziles Modell
 Delicate Model
 Modèle délicat
 Modelo delgado
 Modello delicato

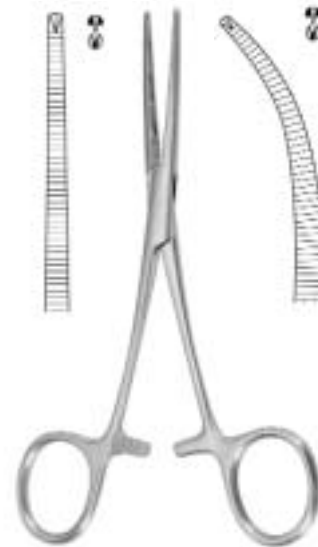

Graziles Modell
 Delicate Model
 Modèle délicat
 Modelo delgado
 Modello delicato

PEAN		
BC-132-14	14 cm	BC-133-14
BC-132-16	16 cm	BC-133-16

KOCHER		
BC-232-14	14 cm	BC-233-14
BC-232-16	16 cm	BC-233-16



SPENCER-WELLS

BC-330-13	13 cm	BC-331-13
BC-330-15	15 cm	BC-331-15
BC-330-15	18 cm	BC-331-18
BC-330-15	20 cm	BC-331-20

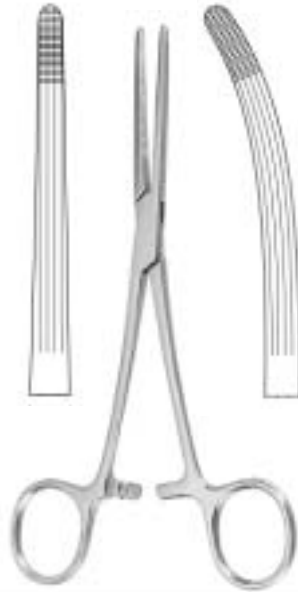

ROCHESTER-CARMALT

BC-430-16	16 cm	BC-431-16
BC-430-20	20 cm	BC-431-20



DANDY
 BC-435-14
 14 cm

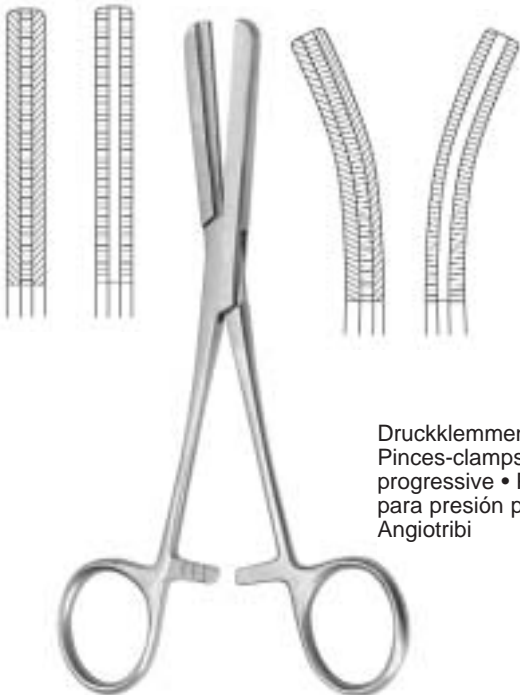

Druckklemmen • Angiotribes
 Pinces-clamps à pression
 progressive • Pinzas-clamps
 para presión progresiva •
 Angiotribi

FERGUSSON

BC-530-16	16 cm	BC-531-16
BC-530-20	20 cm	BC-531-20



LOVELACE
 BC-536-15
 15,5 cm



cm	PENNINGTON
15,5	BC-538-15
20,0	BC-538-20

BC

Arterienklemmen
Hemostatic Forceps
Pincès hémostatiques
Pinzas hemostáticas
Pinze emostatiche



PRATT
BC-630-15
15 cm



MARTEL
BC-634-14
14 cm



WILLET-MARTEL
BC-636-19
19 cm



cm	PEAN
14	BC-638-14
16	BC-638-16



CHAPUT
BC-730-13
13 cm



TUFFIER
BC-732-13
13 cm



COLLIN
BC-734-14
14 cm



COLLIN
BC-736-16
16 cm



LERICHE
BC-830-15 15 cm **BC-831-15**

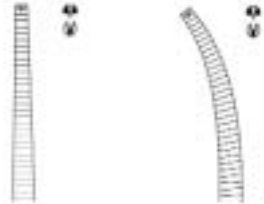

LERICHE
BC-832-15 15 cm **BC-833-15**

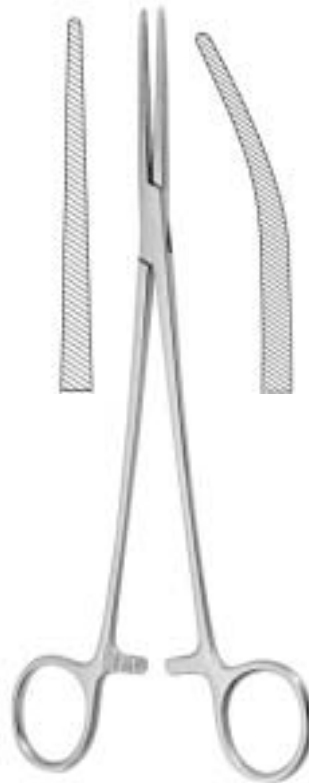

BENGOLEA
BC-834-20 20 cm **BC-835-20**
BC-834-26 26 cm **BC-835-26**

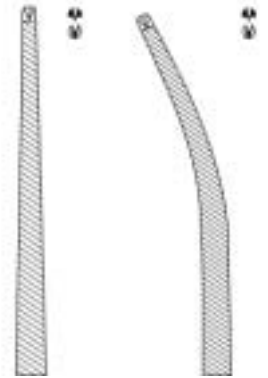

BENGOLEA
BC-836-20 20 cm **BC-837-20**
BC-836-26 26 cm **BC-837-26**

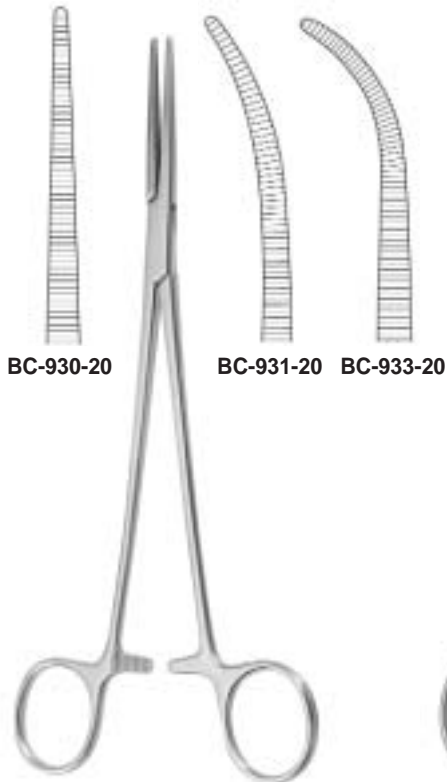

BC-930-20

BC-931-20 **BC-933-20**

HEISS
 20 cm

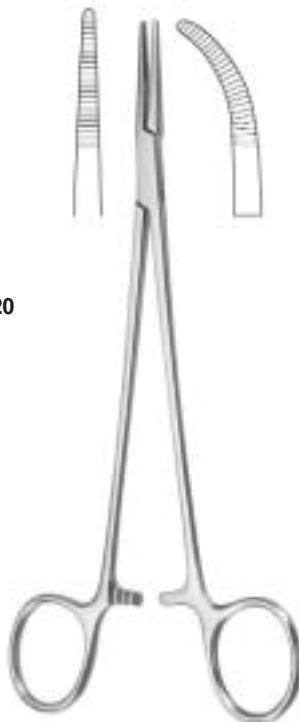

ADSON
BC-140-18 18,5 cm **BC-141-18** **BC-142-18** 18,5 cm **BC-143-18**

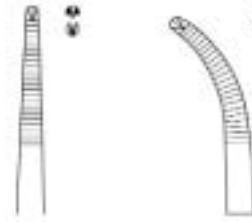

ADSON Baby
BC-145-18
 18 cm

Präparier- und Ligaturklemmen
 Dissecting and Ligature Forceps
 Pincès à dissection et à ligatures
 Pinzas para disección y ligaduras
 Pinze per dissezione e per legature (Passafili)



OVERHOLT-GEISSENDOERFER
 BC-241-01 - BC-247-07

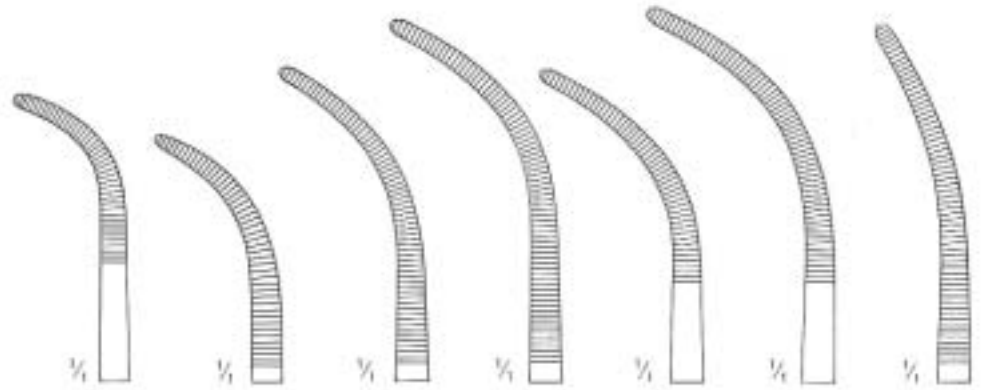

cm	Fig. 1	Fig. 2	Fig. 3	Fig. 4	Fig. 5	Fig. 6	Fig. 7
21	BC-241-01	BC-241-02	BC-241-03	BC-241-04	BC-241-05	BC-241-06	BC-241-07
27	BC-247-01	BC-247-02	BC-247-03	BC-247-04	BC-247-05	BC-247-06	BC-247-07



GEMINI
 GEMINI mini

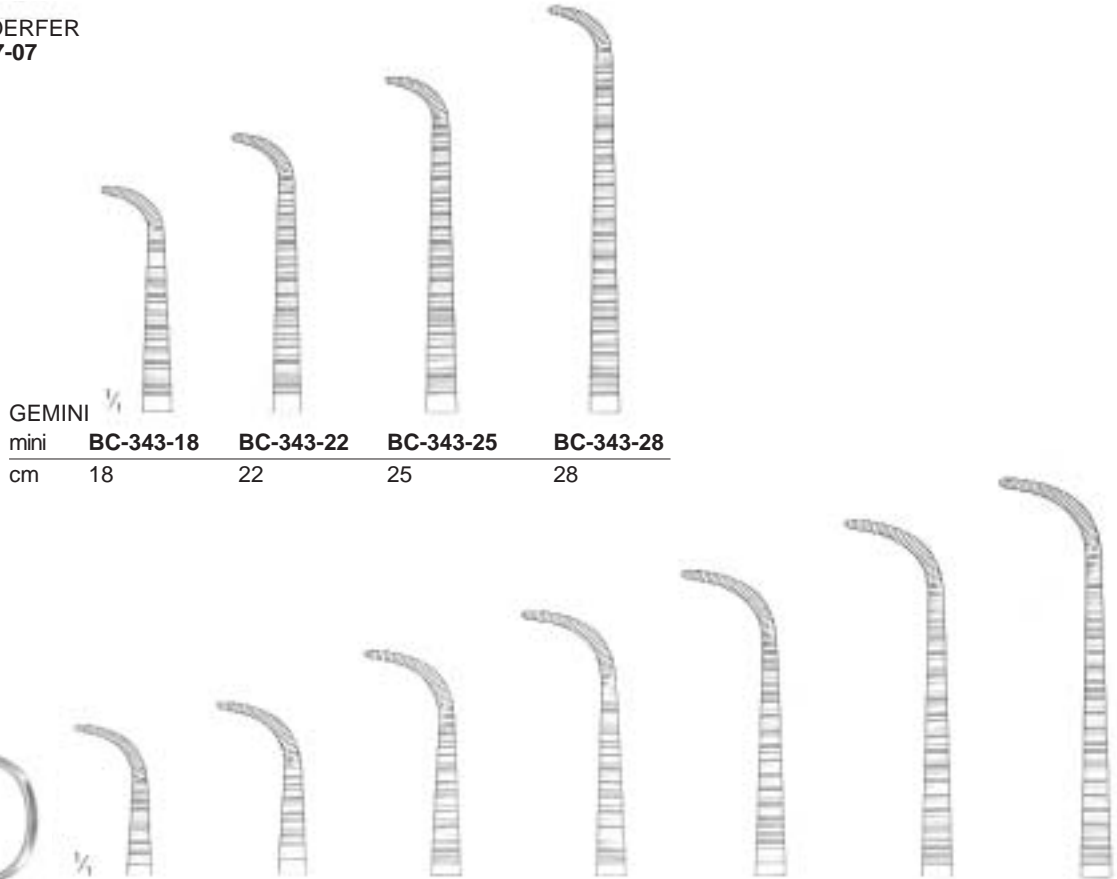

GEMINI	18	22	25	28
mini	BC-343-18	BC-343-22	BC-343-25	BC-343-28
cm	18	22	25	28

GEMINI	13	16	18	20	23	25	28
BC-341-13	BC-341-13	BC-341-16	BC-341-18	BC-341-20	BC-341-23	BC-341-25	BC-341-28
cm	13	16	18	20	23	25	28



BC-441-01



BC-441-02



BC-441-03



BC-441-04



RUMEL
 BC-441-01-BC-441-04
 23 cm



BC-442-21 21 cm
 BC-442-26 26 cm



BC-443-21 21 cm
 BC-443-26 26 cm



BC-444-21 21 cm
 BC-444-26 26 cm



BC-445-21 21 cm
 BC-445-26 26 cm



TOENNIS
 BC-442-21-BC-445-26
 21 cm 26 cm

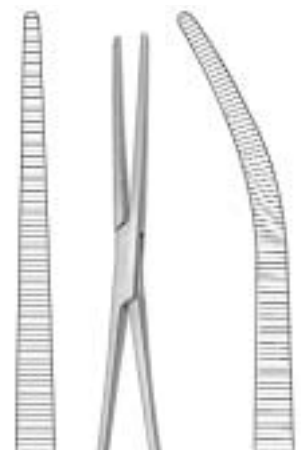

ROBERTS
 BC-448-22 18,5 cm BC-449-22

BC

Arterienklemmen
Hemostatic Forceps
Pinces hémostatiques
Pinzas hemostáticas
Pinze emostatiche

Bronchusklemmen
Bronchus Forceps
Pinces-Clamps à Bronches
Pinzas clamps bronquiales
Pinze per bronchi

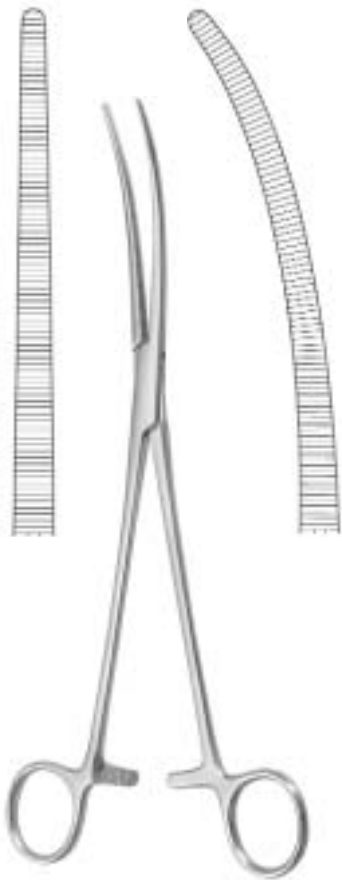

SAROT
BC-540-24 24 cm BC-541-24

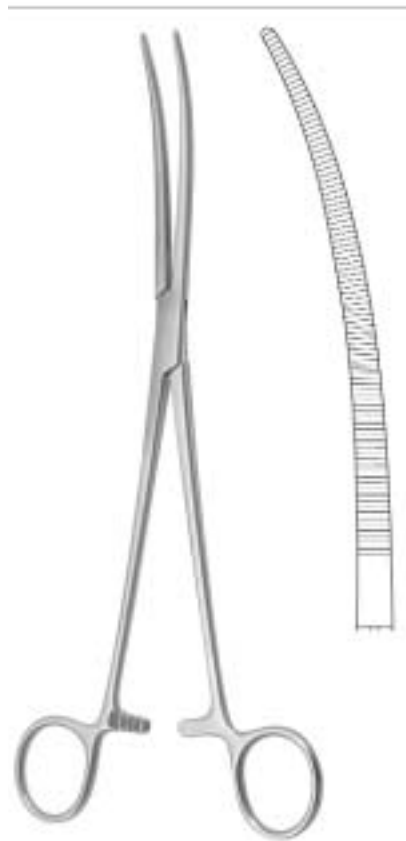

CRAFOORD
BC-543-24
24 cm

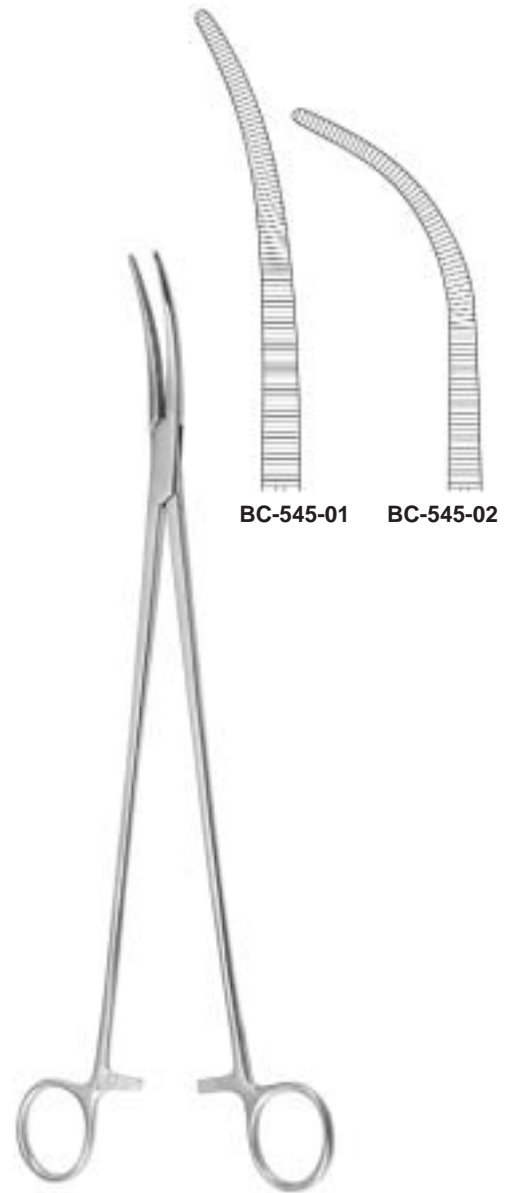

ZENKER
BC-545-01-BC-545-02
29,5 cm



LAWRENCE
BC-547-28
 28 cm



MEEKER
BC-549-28
 28 cm



cm	MIXTER
14	BC-741-14
16	BC-741-16
18	BC-741-18
23	BC-741-23



MIXTER
BC-743-22
 22 cm



MIXTER Baby
BC-745-14
 14 cm



MIXTER Baby
BC-745-18
 18 cm

Arterien, Gallenkanal, Nierenstiel
 Hemostatic, Gall Duct, and Kidney Pedicle
 Hémostatiques, pédicule rénal et voies biliaires
 Hemstáticas, pedículo renal y vías biliares
 Emostatiche, pedunculo renale e vie biliari



cm	MIXTER-O'SHAUGNESSY
15,5	BC-747-15
19,0	BC-747-19



MIXTER
BC-749-22 - BC-749-28

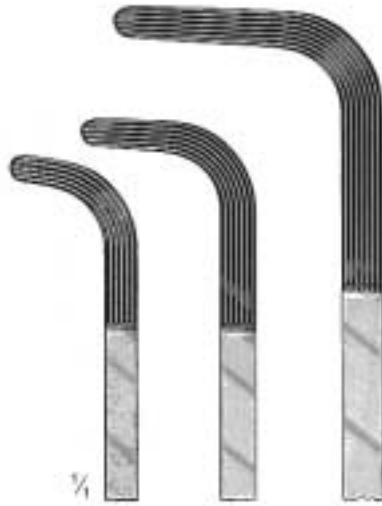

BC-749-22 22 cm
BC-749-25 25 cm
BC-749-28 28 cm

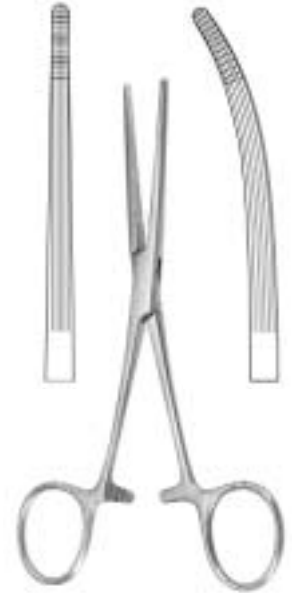

BAINBRIDGE
BC-840-15 15,0 cm **BC-841-15**
BC-840-18 18,5 cm **BC-841-18**



LAHEY
BC-941-19
 19 cm



LAHEY
BC-943-23
 23 cm



LOWER
BC-945-18
 18 cm



JOHNS-HOPKINS
BC-947-20
 20 cm

Gallenkanal • Gall Duct •
 Voies biliaires • Vias
 biliares • Vie biliari



MIXTER
BC-949-16
 16,5 cm



MOYNIHAN
BC-051-23
 23 cm



DESJARDINS
BC-053-21
 21 cm
 (Cysticus)



DESJARDINS
BC-055-21
 21 cm



GRAY
 Cholecystectomie

BC-057-22 **BC-057-23**
 22 cm 23 cm

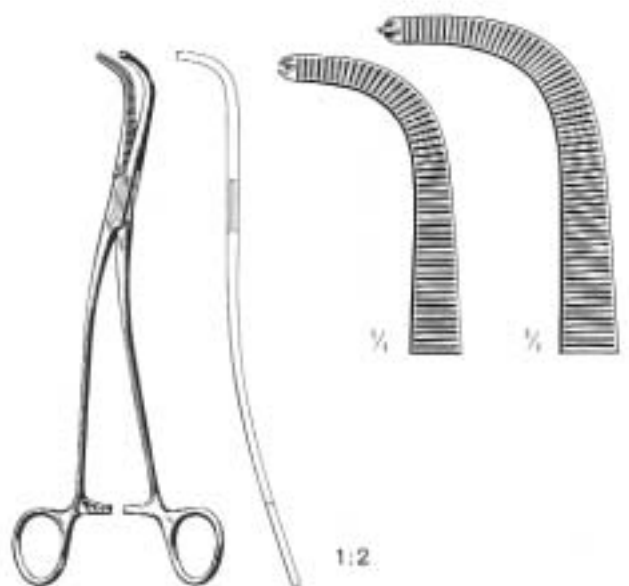

GRAY

BC-059-22 **BC-059-23**
 22 cm 23 cm

Nierenstiel, Gallenkanal
Kidney Pedicle, Gall Duct
Pédicule rénal, conduit biliaire
Pediculo renal, vias biliares
Pedunculo renale, vie biliari



STILLE
BC-153-23
23 cm



MAYO-GUYON
BC-155-23
23 cm



GUYON
BC-157-23
23 cm

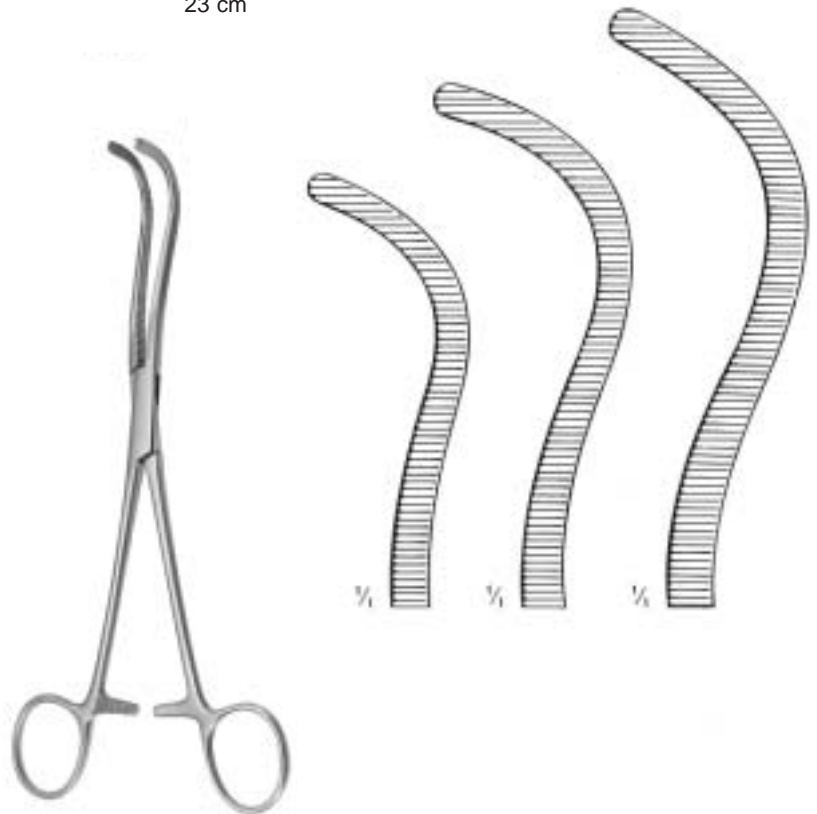

GUYON

BC-159-20
20 cm

BC-159-22
22 cm

BC-159-24
24 cm

Nierenstiel
 Kidney Pedicle
 Pédicule rénal
 Pediculo renal
 Pedunculo renale

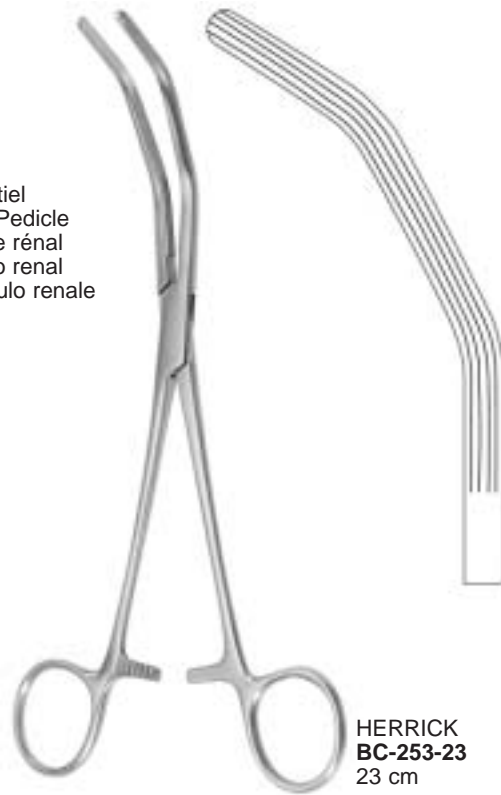

HERRICK
BC-253-23
 23 cm

Peritoneum-Klemmen
 Peritoneum Forceps
 Pinças à péritoine
 Pinzas para peritoneo
 Pinze peritoneali

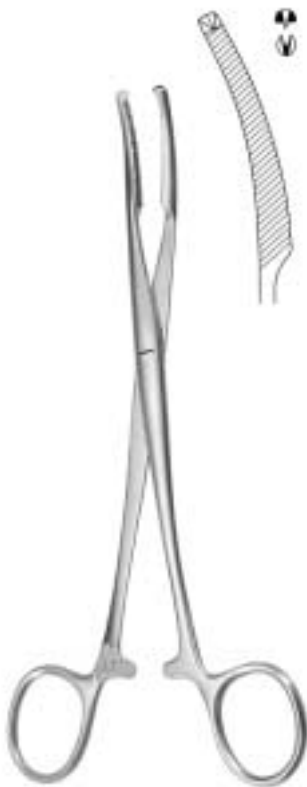

MIKULICZ
BC-551-20
 20 cm

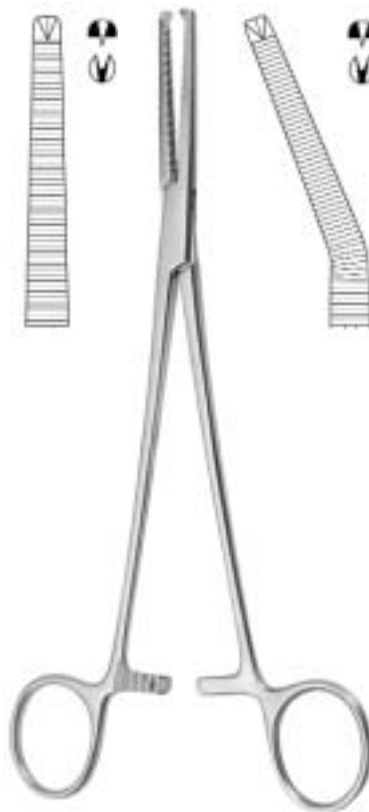

PHANEUF
BC-554-21 21 cm **BC-555-21**



FAURE
BC-651-20 20 cm **BC-653-20**



WERTHEIM
BC-751-25
 25 cm



WERTHEIM		
BC-753-22	22 cm	
	23 cm	BC-755-23



WERTHEIM-CULLEN
BC-759-21
 21,5 cm



HEANEY		
21,5 cm	BC-951-22	BC-953-23

Schlauchklemmen
 Tubing Clamps
 Pinces serre-tubes
 Pinzas cierra-tubos
 Pinze serretubi

BC



WEISS
BC-072-14
 14,5 cm



MURPHY
BC-170-15 - BC-170-20



BC-170-15
 15 cm



BC-170-18
 18 cm



BC-170-20
 20 cm



PRESBYTERIAN HOSPITAL
BC-074-16 16 cm
BC-074-18 18 cm



BC-172-15 - BC-172-20



BC-172-15
 15 cm



BC-172-18
 18 cm



BC-172-20
 20 cm

Atraumatische Klemmen
Atraumatic Forceps
Pinces atraumatique
Pinzas atraumático
Pinze atraumatico



BD

Atraumatische Gefäßklemmen
Atraumatic Hemostatic Forceps
Pincès hémostatiques atraumatiques
Pinzas hemostáticas atraumáticas
Pinze emostatiche atraumatiche



cm — HALSTEAD-MOSQUITO —
12,0 **BD-800-12** **BD-801-12**
15,0 **BD-800-15** **BD-801-15**

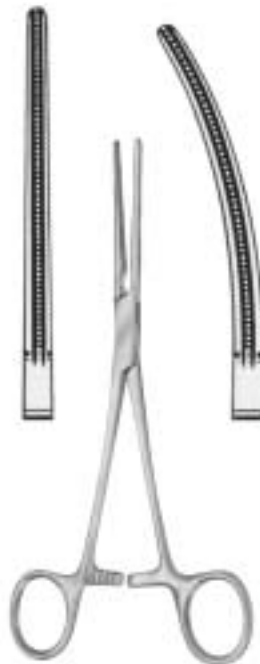

cm — PEAN —
14,0 **BD-802-14** **BD-803-14**
16,0 **BD-802-16** **BD-803-16**
18,0 **BD-802-18** **BD-803-18**
20,0 **BD-802-20** **BD-803-20**



cm — RANKIN —
16,0 **BD-804-16** **BD-805-16**



cm — DE BAKEY —
12,0 **BD-012-12** **BD-013-12**



DE BAKEY
BD-111-12
12,0 cm



DE BAKEY
BD-113-12
12,0 cm



DE BAKEY
BD-211-12
12,0 cm

Atraumatische Gefäßklemmen
Atraumatic Hemostatic Forceps
Pincés hémostatiques atraumatiques
Pinzas hemostáticas atraumáticas
Pinze emostatiche atraumatiche

BD

Bronchusklemmen
Bronchus Forceps
Pincés-Clamps à Bronches
Pinzas clamps bronquiales
Pinze per bronchi



cm	LEES
23,0	BD-311-23
25,0	BD-311-25



BD-311-25

BD-311-23



LEES
BD-313-25
25,0 cm

BD

Atraumatische Gefäßklemmen
Atraumatic Hemostatic Forceps
Pincès hémostatiques atraumatiques
Pinzas hemostáticas atraumáticas
Pinze emostatiche atraumatiche

Coarctationsklemmen
Coarction Clamps
Pincès à coarctacion
Pinzas para coarctación
Pinze per coartazione

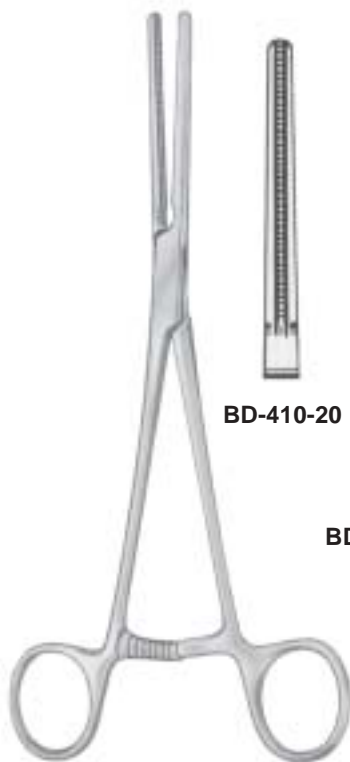

cm	POTTS
20,0	BD-410-20
22,5	BD-410-22
26,0	BD-410-26

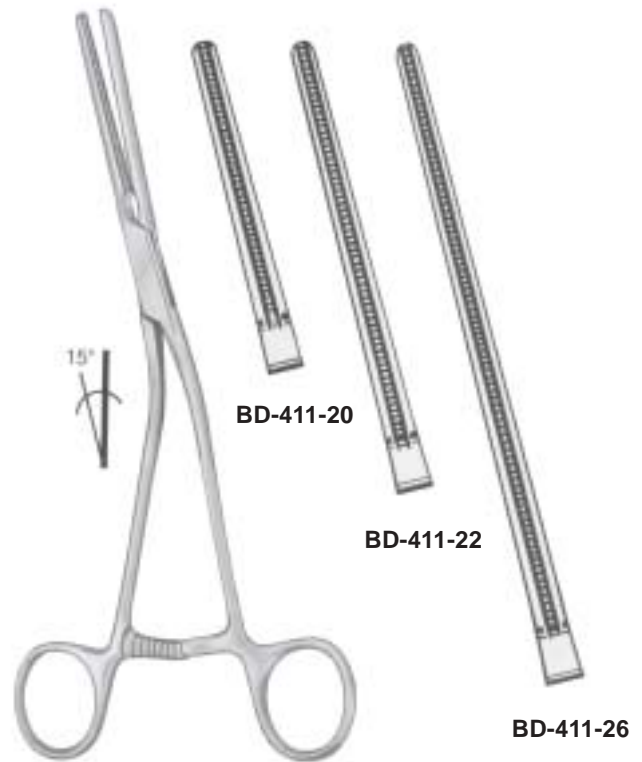

cm	GLOVER
20,0	BD-411-20
22,5	BD-411-22
26,0	BD-411-26

Anastomosenklemmen
 Anastomosis Clamps
 Pincès à anastomose
 Pinzas para anastomosis
 Pinze per anastomosi



cm POTT'S / GLOVER
 21,0 **BD-511-21**
 24,0 **BD-511-24**



BD-511-21



BD-511-24



cm GLOVER
 18,0 **BD-513-18**
 22,0 **BD-513-22**



BD-513-18



BD-513-22

BD

Atraumatische Gefäßklemmen
Atraumatic Hemostatic Forceps
Pinces hémostatiques atraumatiques
Pinzas hemostáticas atraumáticas
Pinze emostatiche atraumatiche

Vascularklemme löffelförmig
Vascular Clamps Spoon Shaped
Pince vasculaire forme cuiller
Pinza vascular forma cuchara
Pinza vascolare forma cucchiaio



BD-611-21



BD-611-26

Peripher-Vascularklemmen
Peripheral Vascular Forceps
Pinces vasculaires périph.
Pinzas vasculares perif.
Pinze vascolari perif.

cm	GLOVER
21,0	BD-611-21
26,0	BD-611-26



BD-710-19

BD-710-22

cm	DE BAKEY
18,0	BD-710-19
22,0	BD-710-22

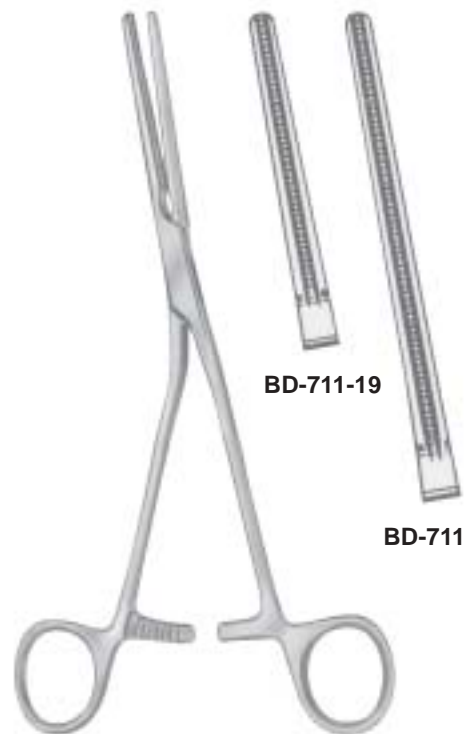

BD-711-19

BD-711-22

cm	DE BAKEY
18,0	BD-711-19
22,0	BD-711-22

Atraumatische Mehrweckklemmen
 Atraumatic Multi-Purpose Clamps
 Pincès-clamps polyvalentes
 Pinzas clamps para usos varios
 Pinze atraumatiche per diversi usi



DARDIK



cm	0°	15°	30°	45°	90°
14,0	--	--	--	--	BD-712-90
15,0	BD-712-00	BD-712-15	BD-712-30	BD-712-45	--

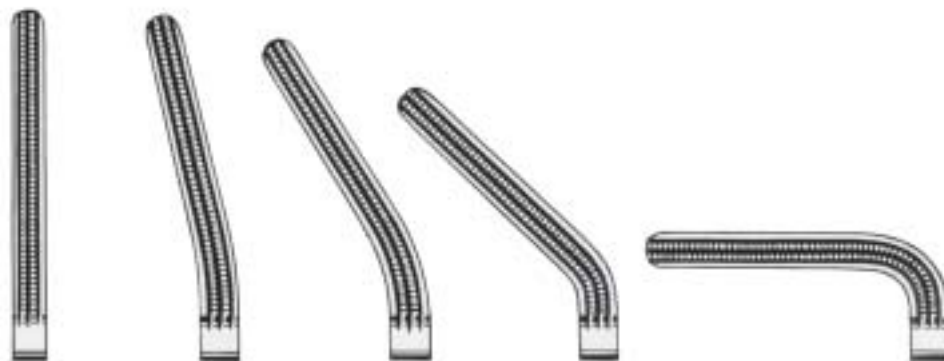

cm	0°	15°	30°	45°	90°
16,0	--	--	--	--	BD-714-90
17,0	BD-714-00	BD-714-15	BD-714-30	BD-714-45	--

BD

Atraumatische Gefäßklemmen
Atraumatic Hemostatic Forceps
Pincès hémostatiques atraumatiques
Pinzas hemostáticas atraumáticas
Pinze emostatiche atraumatiche



LELAND-JONES
BD-811-19
19,0 cm

Peripher-Vascularklemmen
Peripheral Vascular Forceps
Pincès vasculaires périph.
Pinzas vasculares perif.
Pinze vascolari perif.



DE BAKEY
BD-811-26
26,0 cm



cm DE BAKEY
19,0 **BD-813-19**
20,0 **BD-813-20**



BD-813-19

BD-813-20



DE BAKEY
BD-911-16
16,0 cm



BAINBRIDGE



BD-916-15
15,0 cm



BD-916-18
18,0 cm



BD-917-15
15,0 cm



BD-917-18
18,0 cm

Peripher-Vascularklemmen
 Peripheral Vascular Forceps
 Pincès vasculaires périph.
 Pinzas vasculares perif.
 Pinze vascolari perif.



LELAND JONES
BD-022-19
19,0 cm



BD-023-19
19,0 cm

BD-025-19
19,0 cm

LELAND JONES

Aortaklemmen
Aortic Clamp
Pince-clamp à aorte
Pinza clamp para aorta
Pinza per aorta



LIDDLE
BD-029-27
27,0 cm

Aorta-Anastomosenklemmen
Aorta-Anastomosis Clamps
Pinces-clamps pour anastomoses d'aorte
Pinzas clamps para anastomosis de aorta
Pinze aortiche



LAMBERT KAY
BD-121-20
20,0 cm

Iliaca-Klemme
Iliac Clamp
Pince-clamp à iliaque
Pinza clamp para iliaca
Pinza per iliaca



LAMBERT KAY
BD-123-20
20,0 cm



DE BAKEY
BD-125-20
20,0 cm

BD

Atraumatische Gefäßklemmen
Atraumatic Hemostatic Forceps
Pinces hémostatiques atraumatiques
Pinzas hemostáticas atraumáticas
Pinze emostatiche atraumatiche



links gebogen
curved to left
courbe à gauche
curva a la izquierda
curva a sinistra



WEBER
BD-127-26
26,0 cm



rechts gebogen
curved to right
courbe à droite
curva a la derecha
curva a destra



WEBER
BD-129-26
26,0 cm

Aorta-Aneurysma-Klemmen
Aorta-Aneurysm Clamps
Pincés-clamps pour aneurysme d'aorte
Pinzas clamps para aneurisma de aorta
Pinze per aneurisma di aorta



DE BAKEY

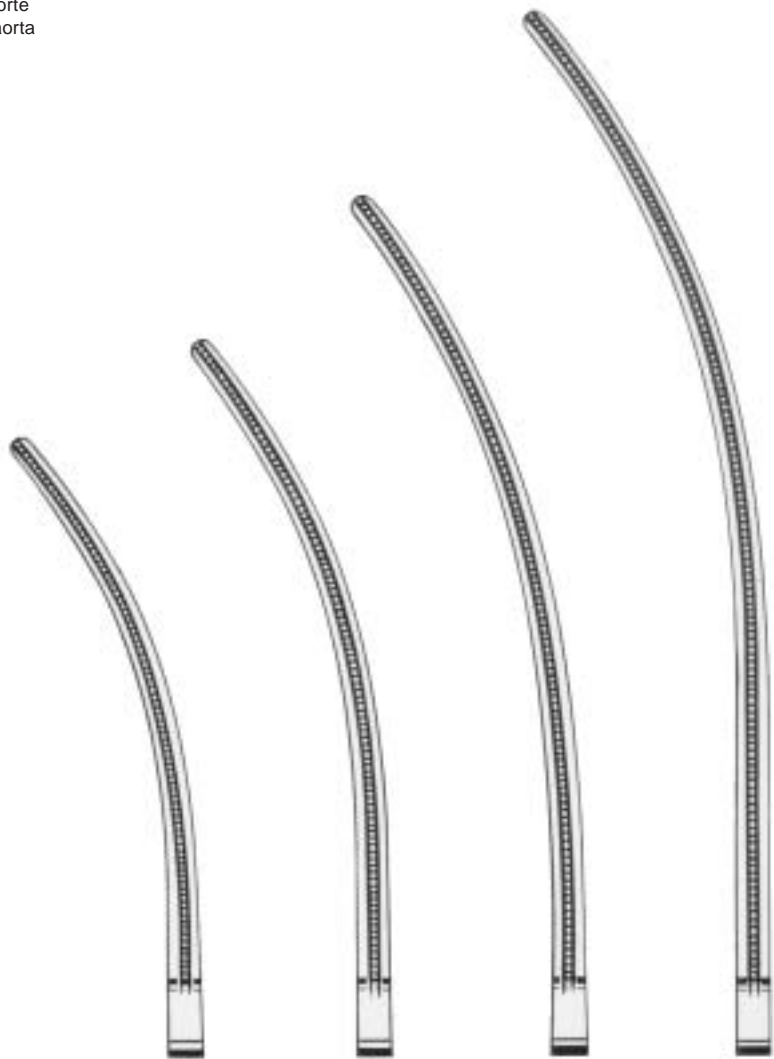

BD-221-24
24,0 cm

BD-221-27
27,0 cm

BD-221-31
31,0 cm

BD-221-35
35,0 cm

BD

Atraumatische Gefäßklemmen
Atraumatic Hemostatic Forceps
Pinces hémostatiques atraumatiques
Pinzas hemostáticas atraumáticas
Pinze emostatiche atraumatiche

Aorta-Aneurysma-Klemmen
Aorta-Aneurysm Clamps
Pinces-clamps pour aneurysme d'aorte
Pinzas clamps para aneurisma de aorta
Pinze per aneurisma di aorta



DE BAKEY BAHNSON



BD-223-24
24,0 cm

BD-223-25
25,0 cm

BD-223-26
26,0 cm

Aorta-Aneurysma-Klemmen
Aorta-Aneurysm Clamps
Pincés-clamps pour aneurysme d'aorte
Pinzas clamps para aneurisma de aorta
Pinze per aneurisma di aorta



DE BAKEY
BD-225-28
28,0 cm



DE BAKEY
BD-227-28
28,0 cm

BD

Atraumatische Gefäßklemmen
Atraumatic Hemostatic Forceps
Pinces hémostatiques atraumatiques
Pinzas hemostáticas atraumáticas
Pinze emostatiche atraumatiche

Atraumatische Mehrzweckklemmen
Atraumatic Multi-Purpose Clamps
Pinces-clamps polyvalentes
Pinzas clamps para usos varios
Pinze atraumatiche per diversi usi



DE BAKEY MORRIS

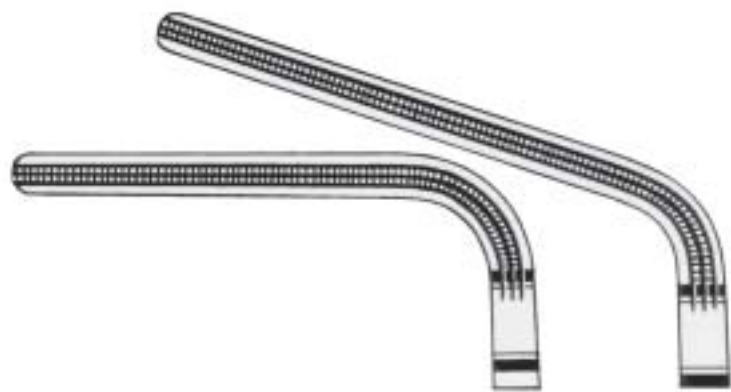

BD-229-18
18,0 cm

BD-229-20
20,0 cm



BD-229-23
23,0 cm

BD-229-25
25,0 cm

Atraumatische Gefäßklemmen
Atraumatic Hemostatic Forceps
Pinces hémostatiques atraumatiques
Pinzas hemostáticas atraumáticas
Pinze emostatiche atraumatiche

BD

Atraumatische Mehrzweckklemmen
Atraumatic Multi-Purpose Clamps
Pinces-clamps polyvalentes
Pinzas clamps para usos varios
Pinze atraumatiche per diversi usi



DE BAKEY



BD-231-18
18,0 cm



BD-231-21
21,0 cm



BD-231-23
23,0 cm

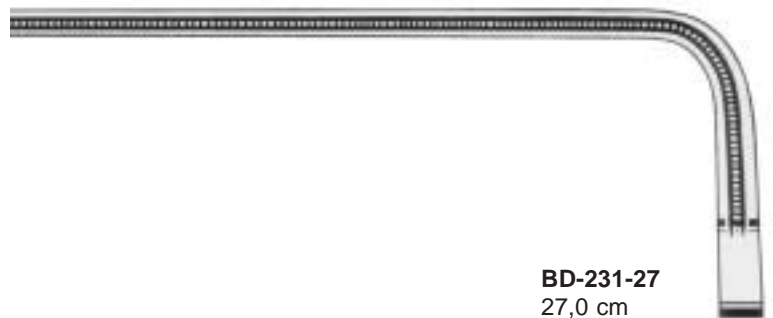

BD-231-27
27,0 cm

BD

Atraumatische Gefäßklemmen
Atraumatic Hemostatic Forceps
Pincés hémostatiques atraumatiques
Pinzas hemostáticas atraumáticas
Pinze emostatiche atraumatiche

Aorta-Aneurysma-Klemmen
Aorta-Aneurysm Clamps
Pincés-clamps pour aneurysme d'aorte
Pinzas clamps para aneurisma de aorta
Pinze per aneurisma di aorta



DE BAKY



BD-421-25
25,0 cm

BD-421-26
26,0 cm

Bronchus-Klemmen
Bronchus Clamps
Pincés pour les bronches
Pinzas bronquiales
Pinze per bronchi



DE BAKEY
BD-427-27
27,0 cm

BD

Atraumatische Gefäßklemmen
Atraumatic Hemostatic Forceps
Pincés hémostatiques atraumatiques
Pinzas hemostáticas atraumáticas
Pinze emostatiche atraumatiche



DE BAKEY

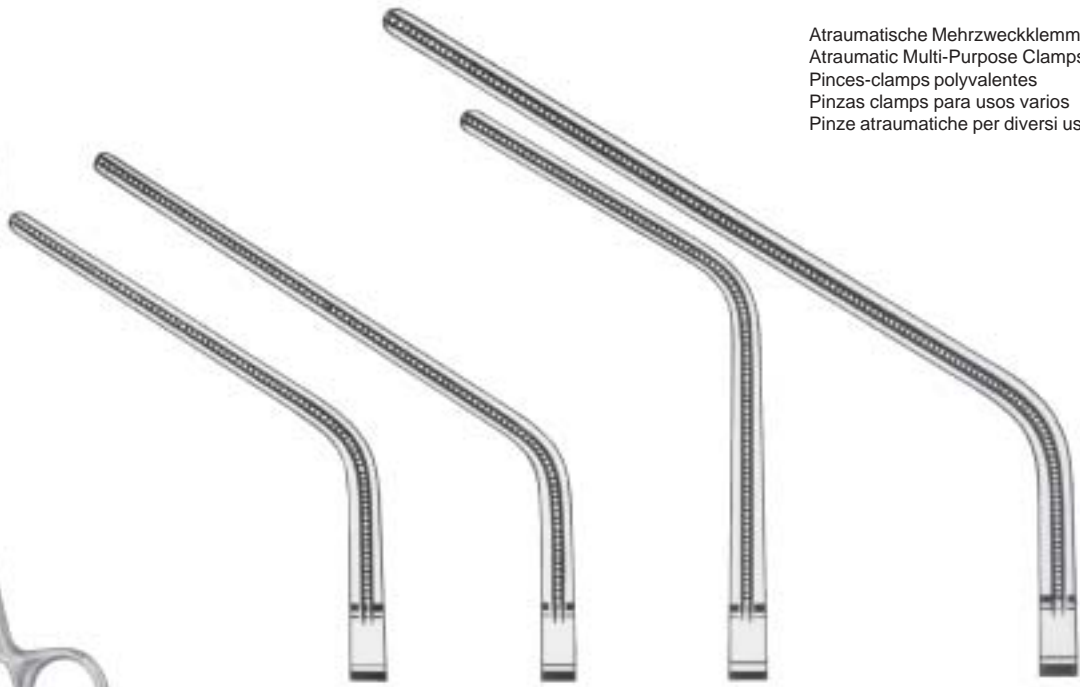

Atraumatische Mehrzweckklemmen
Atraumatic Multi-Purpose Clamps
Pincés-clamps polyvalentes
Pinzas clamps para usos varios
Pinze atraumatiche per diversi usi

BD-521-20
20,0 cm

BD-521-24
24,0 cm

BD-521-25
25,0 cm

BD-521-30
30,0 cm



SATINSKY

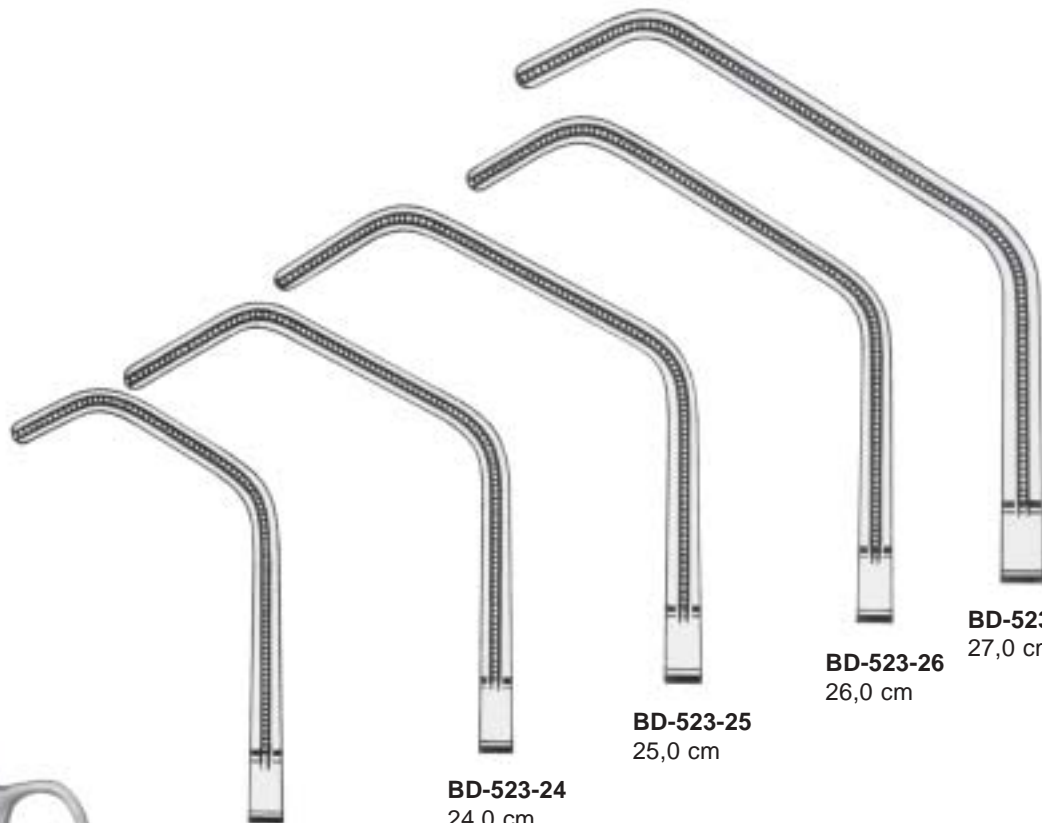

BD-523-20
20,0 cm

BD-523-24
24,0 cm

BD-523-25
25,0 cm

BD-523-26
26,0 cm

BD-523-27
27,0 cm

Anlegezange für Clips
 Applying for Clips
 Appicateur pour clips
 Pinza para aplicar clips
 Applicatore per clips



EDWARDS
BD-528-00

Clips
 Clips
 Clips
 Clips
 Clips



mm	EDWARDS
6	BD-528-06
12	BD-528-12



WYLIE



BD-529-01
 Fig. 1
 21,0 cm



BD-529-02
 Fig. 2
 22,0 cm

BD

Atraumatische Gefäßklemmen
Atraumatic Hemostatic Forceps
Pincès hémostatiques atraumatiques
Pinzas hemostáticas atraumáticas
Pinze emostatiche atraumatiche



DE BAKEY SATINSKY



BD-621-23
Fig. 1
23,0 cm

BD-621- 24
Fig. 2
24,0 cm

BD-621-25
Fig. 3
25,0 cm

Aurikelklemmen
Auricle Clamps
Pincès auriculaires
Pinzas para aurícula
Pinze ventricolari



HARKEN



BD-623-25
Fig. 1
25,0 cm



BD-625-24
Fig. 2
24,0 cm



BD-627-24
Fig. 3
24,0 cm



BD-629-24
Fig. 4
24,0 cm

BD

Atraumatische Gefäßklemmen
Atraumatic Hemostatic Forceps
Pinces hémostatiques atraumatiques
Pinzas hemostáticas atraumáticas
Pinze emostatiche atraumatiche

Peripheal-Gefäßklemmen
Peripheal Vascular Clamps
Pinces-clamps, vasculaires périphériques
Pinzas para vasos periféricos
Pinze vascolari periferali



DALE
BD-721-18
18,0 cm



DALE

BD-723-17
17,0 cm



BD-723-18
18,0 cm



BD-723-19
19,0 cm



DE BAKEY
BD-821-17
17,0 cm



BECK
BD-823-17
17,0 cm

Präparier- und Ligaturklemmen
Dissecting and Ligature Clamps
Pincès à dissection et passe-fil
Pinzas de disección y para ligaduras
Pinze per dissezione e per legature



DE BAKEY
BD-825-24
24,0 cm



DE BAKEY
BD-827-24
24,0 cm

BD

Atraumatische Gefäßklemmen
Atraumatic Hemostatic Forceps
Pinces hémostatiques atraumatiques
Pinzas hemostáticas atraumáticas
Pinze emostatiche atraumatiche

Atraumatische Mehrzweckklemmen
Atraumatic Multi-Purpose Clamps
Pinces-clamps polyvalentes
Pinzas clamps para usos varios
Pinze atraumatiche per diversi usi



POTTS



BD-828-21
21,0 cm



BD-828-23
23,0 cm



BD-828-27
27,0 cm



BD-828-31
31,0 cm

Atraumatische Mehrzweckklemmen
Atraumatic Multi-Purpose Clamps
Pincès-clamps polyvalentes
Pinzas clamps para usos varios
Pinze atraumatiche per diversi usi



POTTS

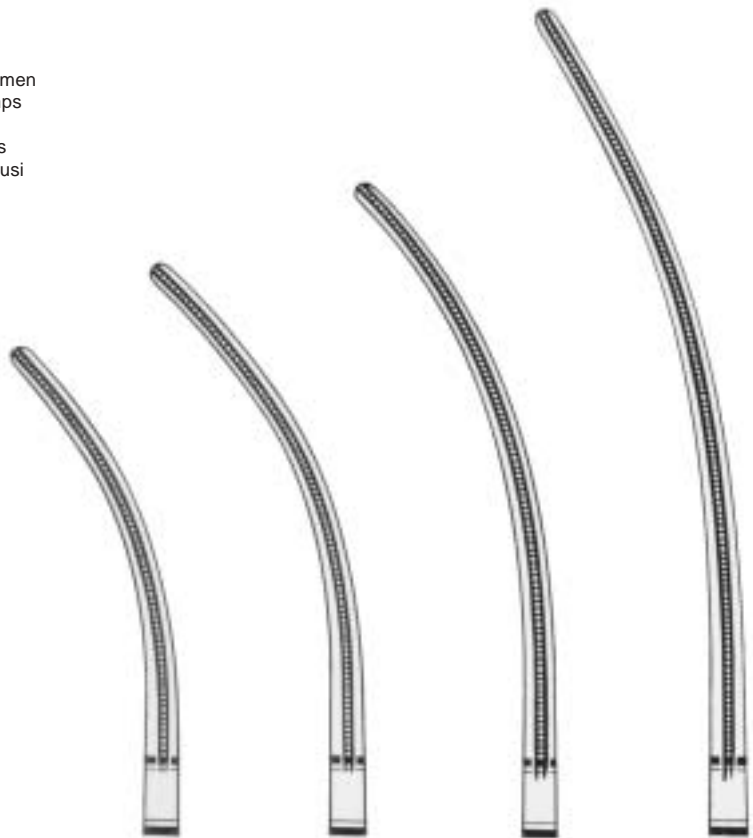

BD-829-21
21,0 cm

BD-829-23
23,0 cm

BD-829-27
27,0 cm

BD-829-31
31,0 cm

Anastomosenklemmen, Kindergrößen
Anastomosis Clamps, Pediatric
Pincés à anastomose, pédiatriques
Pinzas para anastomosis, pediátricas
Pinze per anastomosi, pediatriche



DERRA



BD-921-16
16,0 cm

BD-921-17
17,0 cm

BD-921-18
18,0 cm



DE BAKEY
BD-032-16
16,0 cm

Atraumatische Mehrzweckklemmen
Atraumatic Multi-Purpose Clamps
Pincés-clamps polyvalentes
Pinzas clamps para usos varios
Pinze atraumatiche per diversi usi



DE BAKEY
BD-032-17
17,0 cm



DE BAKEY
BD-033-15
15,0 cm



DE BAKEY
BD-037-17
17,0 cm



BD-039-16
16,0 cm

DE BAKEY

BD-039-17
17,0 cm

Atraumatische Gefäßklemmen
Atraumatic Hemostatic Forceps
Pincès hémostatiques atraumatiques
Pinzas hemostáticas atraumáticas
Pinze emostatiche atraumatiche

Atraumatische Mehrzweckklemmen
Atraumatic Multi-Purpose Clamps
Pincès-clamps polyvalentes
Pinzas clamps para usos varios
Pinze atraumatiche per diversi usi



DE BAKEY



BD-131-14
14,0 cm



BD-131-15
15,0 cm



BD-131-16
16,0 cm



GLOVER
BD-231-17
17,0 cm

Anastomosenklemmen
Anastomosis Clamps
Pincès à anastomose
Pinzas para anastomosis
Pinze per anastomosi



DE BAKEY REYNOLDS



BD-239-01
Fig. 1
17,5 cm



BD-239-02
Fig. 2
17,5 cm



BD-239-03
Fig. 3
16,5 cm



BD-239-04
Fig. 3
16,5 cm



SUBRAMANIAN
BD-331-15
15,0 cm



SUBRAMANIAN
BD-333-16
16,0 cm



SUBRAMANIAN
BD-335-16
16,0 cm



OCHSNER
BD-337-23
23,0 cm

Aortaklemmen
Aortic Clamp
Pince-clamp à aorte
Pinza clamp para aorta
Pinza per aorta



DIETRICH
BD-339-21
21,0 cm

Präparier- und Ligaturklemmen
 Dissecting and Ligature Clamps
 Pincés à dissection et passe-fil
 Pinzas de dissección y para ligaduras
 Pinze per dissezione e per legature



DE BAKEY



BD-431-19
19,0 cm



BD-431-20
20,0 cm



BD-431-23
23,0 cm

Carotis-Shuntklemmen
 Carotid Shunt Clamps
 Pincés pour carotide
 Pinzas para shunt carótido
 Pinze carotis



JAVID
BD-433-18
18,0 cm



JAVID
BD-433-19
19,0 cm

Profunda-Klemmen
 Profunda Clamps
 Pincès-clamps pour profunda
 Pinzas clamps para profunda
 Pinze per profunda



GREGORY

BD-439-14
 14,0 cm



BD-439-16
 16,0 cm



BD-439-18
 18,0 cm

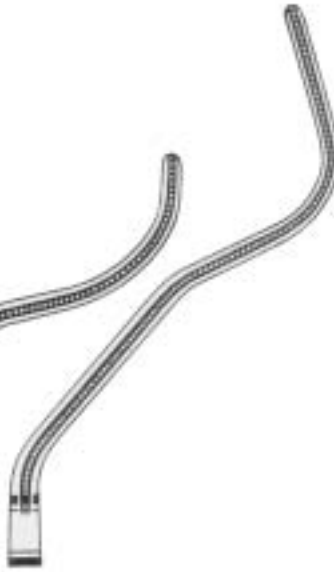

cm — COOLEY —
 13,0 **BD-530-13** **BD-531-13**



COOLEY
BD-533-13
 13,5 cm



COOLEY
BD-535-13
 13,0 cm



COOLEY
BD-537-12
12,5 cm



COOLEY
BD-539-10
10,5 cm



COOLEY
BD-631-12
12,0 cm



COOLEY
BD-633-13
13,5 cm



Fr./Charrière	COOLEY
24	BD-731-24
26	BD-731-26
28	BD-731-28
30	BD-733-30
32	BD-733-32
36	BD-733-36



cm	— COOLEY —
14,0	BD-736-14 BD-737-14
16,0	BD-736-16 BD-737-16



COOLEY
BD-739-14
 14,0 cm



COOLEY
BD-830-14
 14,0 cm



COOLEY
BD-831-14
 14,0 cm

BD

Atraumatische Gefäßklemmen
Atraumatic Hemostatic Forceps
Pinces hémostatiques atraumatiques
Pinzas hemostáticas atraumáticas
Pinze emostatiche atraumatiche



COOLEY
BD-045-27
27,0 cm



COOLEY
BD-140-17
17,0 cm

Atraumatische Mehrzweckklemmen
 Atraumatic Multi-Purpose Clamps
 Pincés-clamps polyvalentes
 Pinzas clamps para usos varios
 Pinze atraumatiche per diversi usi



BD-141-17
17,0 cm

BD-143-17
17,0 cm

BD-146-17
17,0 cm

COOLEY

Iliaca-Klemmen
 Iliac Clamps
 Pincés-clamps à iliaque
 Pinzas clamps para iliaca
 Pinze per iliaca



COOLEY
BD-147-21
21,5 cm

Anastomosenklemmen
 Anastomosis Clamps
 Pincés à anastomose
 Pinzas para anastomosis
 Pinze per anastomosi



COOLEY
BD-149-17
17,0 cm



cm
14,0 **BD-240-14** **BD-241-14**



COOLEY
BD-243-14
14,0 cm



COOLEY
BD-245-14
14,0 cm

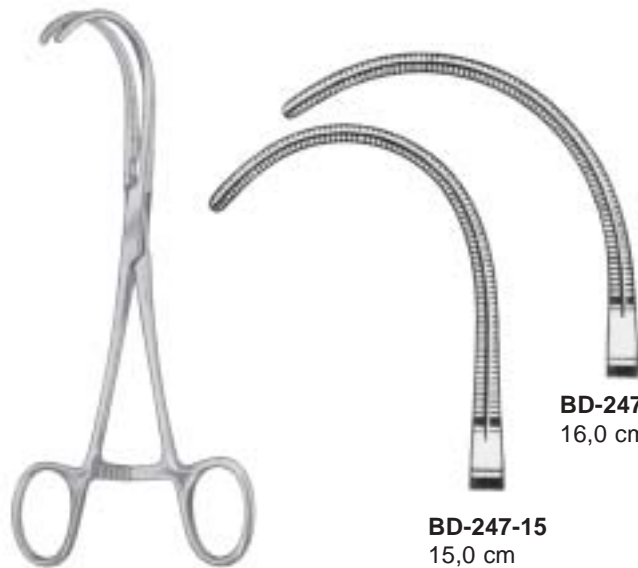

BD-247-15
15,0 cm

BD-247-16
16,0 cm

COOLEY

Atraumatische Mehrzweckklemmen
 Atraumatic Multi-Purpose Clamps
 Pincès-clamps polyvalentes
 Pinzas clamps para usos varios
 Pinze atraumatiche per diversi usi



COOLEY
BD-341-25
 16,5 cm



COOLEY
BD-341-45
 16,5 cm

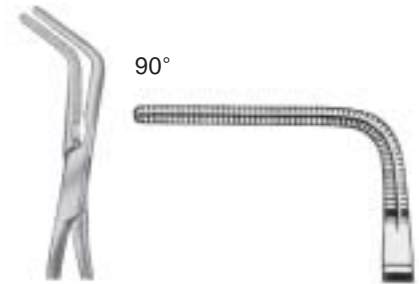

COOLEY
BD-341-90
 16,5 cm

Anastomosenklemmen
 Anastomosis Clamps
 Pincès à anastomose
 Pinzas para anastomosis
 Pinze per anastomosi



COOLEY
BD-343-14
 14,0 cm



COOLEY DERRA



BD-441-16
 16,0 cm



BD-441-17
 17,0 cm



BD-441-18
 18,0 cm

Anastomosenklemmen
Anastomosis Clamps
Pincès à anastomose
Pinzas para anastomosis
Pinze per anastomosi



COOLEY
17,0 cm



BD-447-17
Fig. 1

BD-449-17
Fig. 2



COOLEY

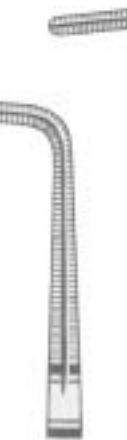

BD-541-16
16,0 cm

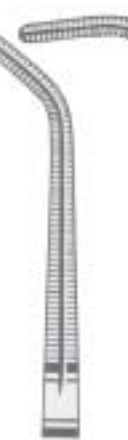

BD-543-16
17,5 cm

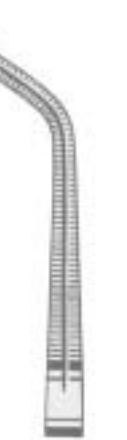

BD-545-17
17,5 cm



COOLEY
BD-547-17
17,0 cm



COOLEY
BD-641-17
17,0 cm



COOLEY
BD-645-18
18,0 cm



COOLEY
BD-645-19
19,0 cm



COOLEY
BD-645-26
26,0 cm



COOLEY
BD-647-27
27,0 cm

Neonatal- und Kinderklemmen, extra feine Modelle
Neonatal and Childrens Clamps, extra delicate patterns
Pincés-clamps pour des nouveaux-nés et des enfants, modèles très fins
Pinzas clamps para recién nacidos y niños, modelos muy finos
Pinze pediatriche, modelli molto fini

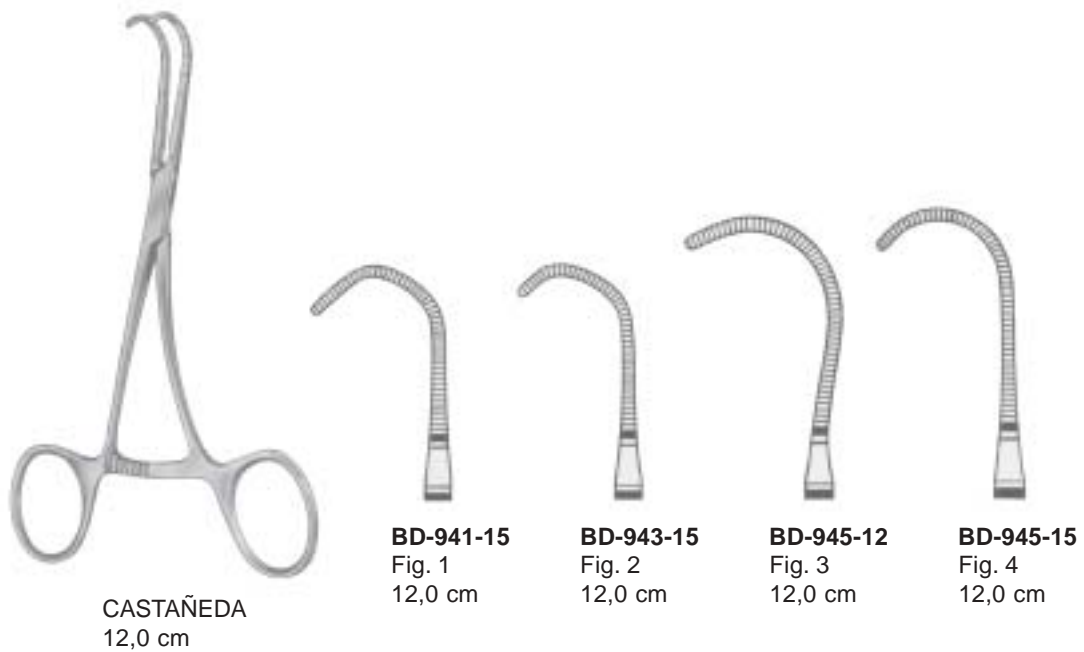
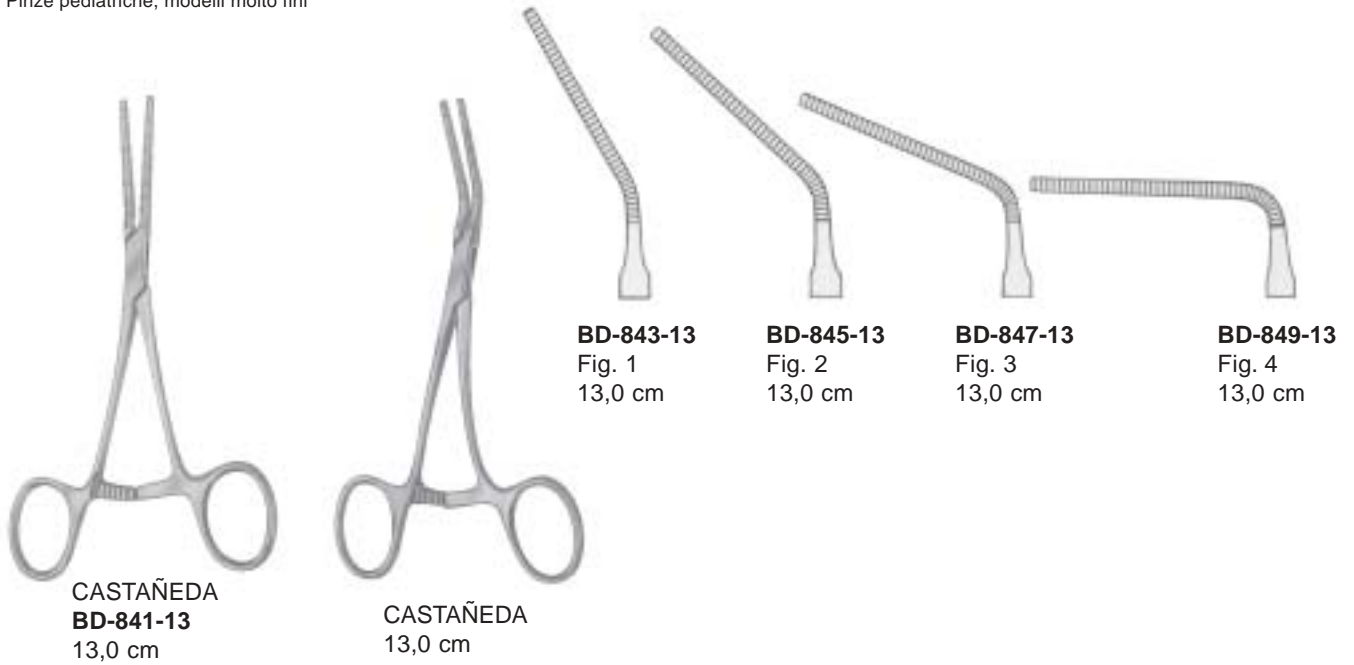

Kinder-Gefäßklemmen
 Pediatric Vascular Clamp
 Pincas vasculaires pédiatriques
 Pinzas vasculares pediátricas
 Pinze vascolari pediatriche



gerade
 straight
 droites
 rectas
 rette

BD-052-01 - BD-052-09
 Fig. 1-9



abgewinkelt
 angled
 coudées
 acodadas
 angolari

BD-053-01 - BD-053-09
 Fig. 1-9



stark abgewinkelt
 strongly angled
 fortement coudées
 fuertemente acodadas
 fortemente angolari

BD-055-01 - BD-055-09
 Fig. 1-9



Fig. 1

BD-052-01
BD-053-01
BD-055-01



Fig. 2

BD-052-02
BD-053-02
BD-055-02



Fig. 3

BD-052-03
BD-053-03
BD-055-03



Fig. 4

BD-052-04
BD-053-04
BD-055-04



Fig. 5 Fig.

BD-052-05
BD-053-05
BD-055-05



Fig. 6

BD-052-06
BD-053-06
Bd-055-06



Fig. 7

BD-052-07
BD-053-07
BD-055-07



Fig. 8

BD-052-08
BD-053-08
BD-055-08



Fig. 9

BD-052-09
BD-053-09
BD-055-09

BD

Flexible Gefäßklemmen
Flexible Vessel Clamps
Pinces vasculaires flexibles
Pinzas vasculares flexibles
Pinze vascolari flessibili



BD-069-12 - BD-161-30
20,0 cm



BD-069-12
12 mm



BD-069-20
20 mm



BD-069-30
30 mm



BD-161-12
12 mm



BD-161-20
20 mm



BD-161-30
30 mm



BD-165-03
ø 3 mm



BD-165-05
ø 5 mm



BD-165-07
ø 7 mm





BD-165-09
ø 9 mm

BD-165-03 - BD-165-09

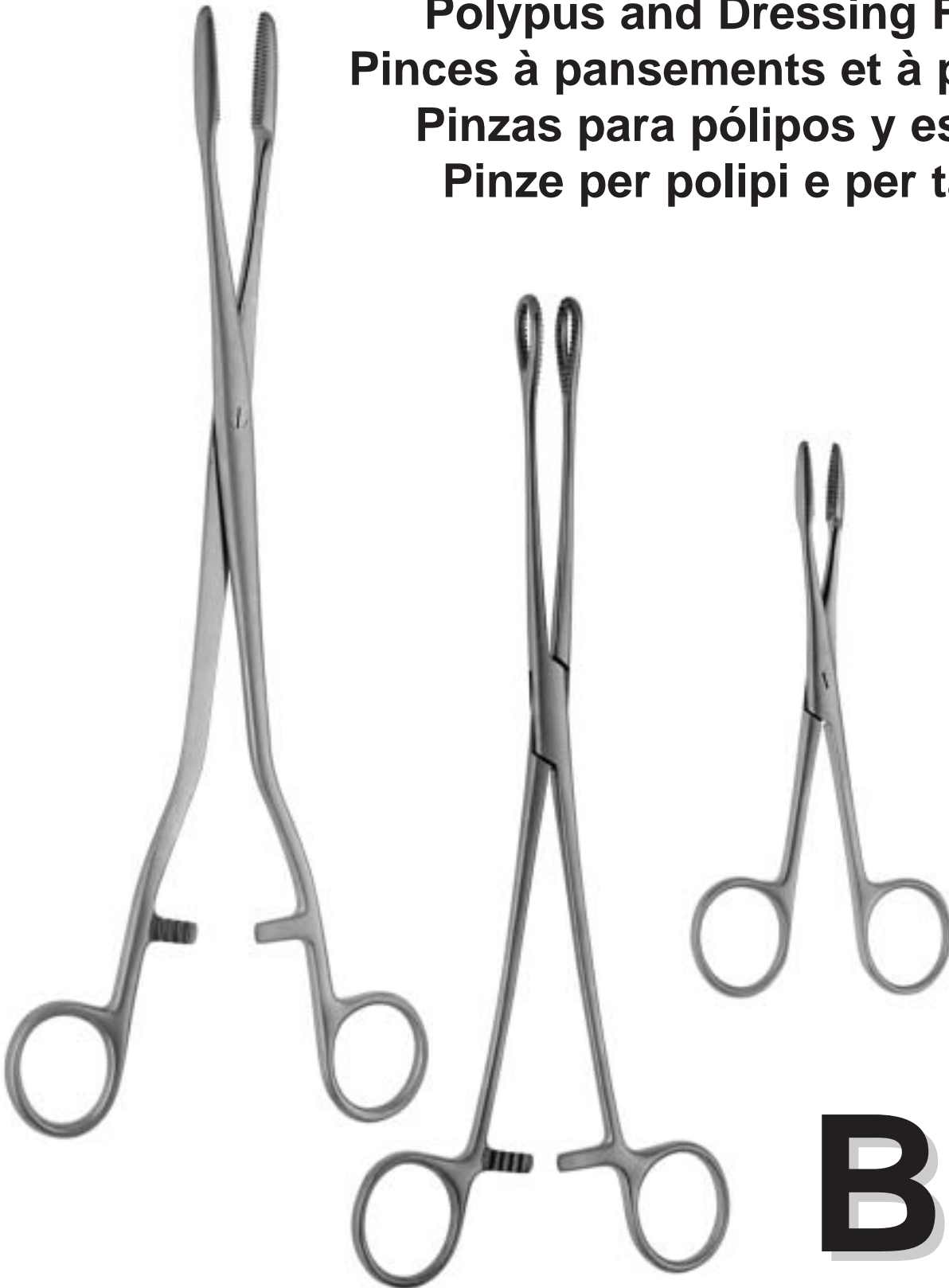

Tupfer-/Kornzangen
Polypus and Dressing Forceps
Pinces à pansements et à polypes
Pinzas para pólipos y esponjas
Pinze per polipi e per tamponi



	
gerade	gebogen
straight	curved
droites	courbes
rectas	curvas
rette	curve





mit Sperre
with ratchet
avec crémaillère
con cremallera
con cremagliera

cm  MARTIN 
25,5 **BG-010-25** **BG-011-25**





ohne Sperre
without ratchet
sans crémaillère
sin cremallera
senza cremagliera

cm  GROSS-MAIER 
18 **BG-014-18** **BG-015-18**
20 **BG-014-20** **BG-015-20**
25 **BG-014-25** **BG-015-25**

Tupferzangen
 Dressing Forceps
 Pinces à pansements
 Pinzas para tapones
 Pinze per medicatura

BG



	
gerade	gebogen
straight	curved
droites	courbes
rectas	curvas
rette	curve







mit Sperre
 with ratchet
 avec crémaillère
 con cremallera
 con cremagliera



ohne Sperre
 without ratchet
 sans crémaillère
 sin cremallera
 senza cremagliera

cm		GROSS-MAIER	
18	BG-016-18		BG-017-18
20	BG-016-20		BG-017-20
25	BG-016-25		BG-017-25



cm		GROSS-MAIER	
13	BG-018-13		BG-019-13
14	BG-018-14		BG-019-14



	
gerade	gebogen
straight	curved
droites	courbes
rectas	curvas
rette	curve



ohne Sperre
without ratchet
sans crémaillère
sin cremallera
senza cremagliera

mit Sperre
with ratchet
avec crémaillère
con cremallera
con cremagliera





cm		GROSS-MAIER	
14	BG-110-14		BG-111-14
18	BG-110-18		BG-111-18
20	BG-110-20		BG-111-20
22	BG-110-22		BG-111-22
25	BG-110-25		BG-111-25
27	BG-110-27		BG-111-27
36	BG-110-36		BG-111-36
40	BG-110-40		BG-111-40

cm		GROSS-MAIER	
20	BG-112-20		BG-113-20
25	BG-112-25		BG-113-25

	
gerade	gebogen
straight	curved
droites	courbes
rectas	curvas
rette	curve





mit Sperre
 with ratchet
 avec crémaillère
 con cremallera
 con cremagliera

cm  GROSS 
 18 **BG-114-18** **BG-115-18**





mit Sperre
 with ratchet
 avec crémaillère
 con cremallera
 con cremagliera

cm  SIMS-MAIER 
 28 **BG-210-28** **BG-211-28**

BG

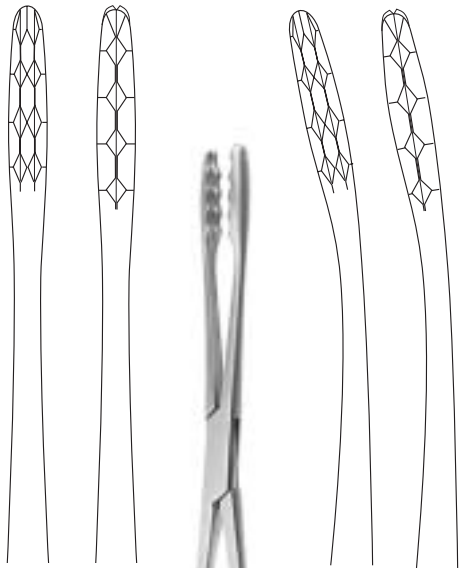

Schwammzangen
Sponge Holding Forceps
Pincès porte-éponges
Pinzas porta esponjas
Pinze per tamponi e spugne

	
gerade	gebogen
straight	curved
droites	courbes
rectas	curvas
rette	curve

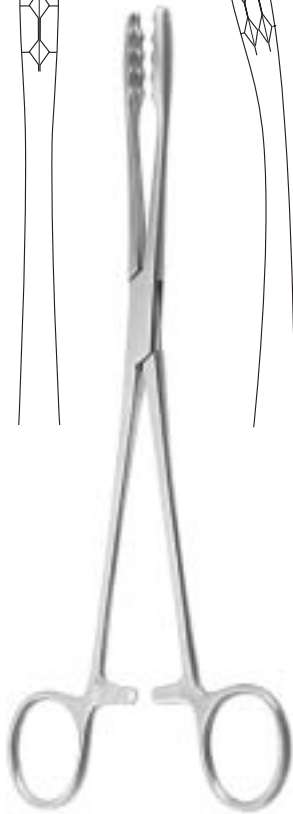

mit Sperre
with ratchet
avec crémaillère
con cremallera
con cremagliera





cm		ULRICH	
22	BG-610-22		BG-611-22
25	BG-610-25		BG-611-25
27	BG-610-27		BG-611-27



mit Sperre
with ratchet
avec crémaillère
con cremallera
con cremagliera

cm	FOERSTER
25	BG-618-25

	
gerade	gebogen
straight	curved
droites	courbes
rectas	curvas
rette	curve



mit Sperre
 with ratchet
 avec crémaillère
 con cremallera
 con cremagliera



mit Sperre
 with ratchet
 avec crémaillère
 con cremallera
 con cremagliera





cm		FOERSTER	
18	BG-710-18		BG-711-18
20	BG-710-20		BG-711-20
25	BG-710-25		BG-711-25
30	BG-710-30		BG-711-30

cm		FOERSTER	
18	BG-712-18		BG-713-18
20	BG-712-20		BG-713-20
25	BG-712-25		BG-713-25
30	BG-712-30		BG-713-30

BG

Schwammzangen
Sponge Holding Forceps
Pincès porte-éponges
Pinzas porta esponjas
Pinze per tamponi e spugne

	
gerade	gebogen
straight	curved
droites	courbes
rectas	curvas
rette	curve

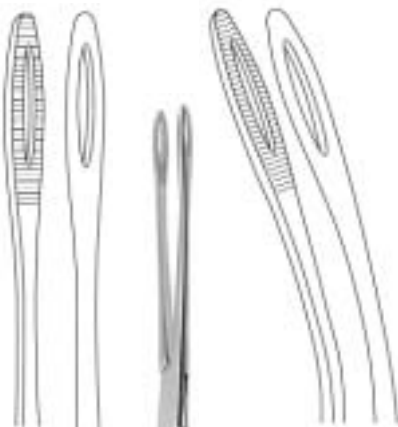

mit Sperre
with ratchet
avec crémaillère
con cremallera
con cremagliera





cm  FORESTER 
25 **BG-714-25** **BG-715-25**



mit Sperre
with ratchet
avec crémaillère
con cremallera
con cremagliera

cm **BONNEY**
24 **BG-716-24**

	
gerade	gebogen
straight	curved
droites	courbes
rectas	curvas
rette	curve



mit Sperre
 with ratchet
 avec crémaillère
 con cremallera
 con cremagliera

cm RAMPLEY
 18 **BG-718-18**
 25 **BG-718-25**





mit Sperre
 with ratchet
 avec crémaillère
 con cremallera
 con cremagliera

cm RAMPLEY
 25 **BG-810-25**

BG

Schwammzangen
Sponge Holding Forceps
Pincès porte-éponges
Pinzas porta esponjas
Pinze per tamponi e spugne

	
gerade	gebogen
straight	curved
droites	courbes
rectas	curvas
rette	curve



cm  FLETCHER JAVERS 
25 **BG-812-25** **BG-813-25**



cm  BERGMANN FOERSTER 
24 **BG-816-24** **BG-817-24**

ohne Sperre
without ratchet
sans crémaillère
sin cremallera
senza cremagliera



cm BRYANT
13 **BG-027-13**

Sinusklemme
Sinus forceps
Pincas à sinus
Pinzas para seno
Pinze sinus

ohne Sperre
without ratchet
sans crémaillère
sin cremallera
senza cremagliera



cm LISTER
13 **BG-120-13**
16 **BG-120-16**
18 **BG-120-18**



mit Sperre
with ratchet
avec crémaillère
con cremallera
con cremagliera



cm COLLIN
25 **BG-220-25**

BG

Tupferzangen
Dressing Forceps
Pincès à pansements
Pinzas para tapones
Pinze per medicatura

	
gerade	gebogen
straight	curved
droites	courbes
rectas	curvas
rette	curve





mit Sperre
with ratchet
avec crémaillère
con cremallera
con cremagliera



cm  PELKMANN 
25 **BG-226-25** **BG-227-25**



cm **CHERON**
25 **BG-229-25**

cm **MAIER**
25 **BG-320-25**

	
gerade	gebogen
straight	curved
droites	courbes
rectas	curvas
rette	curve





mit Sperre
 with ratchet
 avec crémaillère
 con cremallera
 con cremagliera

cm  BOZEMANN 
 26 **BG-320-26** **BG-321-26**





mit Sperre
 with ratchet
 avec crémaillère
 con cremallera
 con cremagliera

cm **BOZEMANN-DOUGLAS**
 26 **BG-323-26**

	
gerade	gebogen
straight	curved
droites	courbes
rectas	curvas
rette	curve





mit Sperre
with ratchet
avec crémaillère
con cremallera
con cremagliera

cm  MARTIN 
17 **BG-424-17** **BG-425-17**



mit Sperre
with ratchet
avec crémaillère
con cremallera
con cremagliera

cm  DUPLAY 
20 **BG-426-20** **BG-427-20**

BI

**Wundhaken
Retractors
Ecarteurs
Separadores
Divaricatori**



BI



FARABEUFI
BI-012-12
12 cm



FARABEUFI
BI-012-15
15 cm



PARKER
BI-110-15
13,5 cm



PARKER
BI-110-18
18 cm



ROUX
BI-210-00

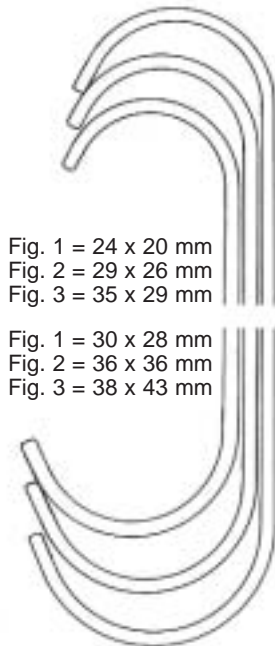

Fig. 1 = 24 x 20 mm
Fig. 2 = 29 x 26 mm
Fig. 3 = 35 x 29 mm

Fig. 1 = 30 x 28 mm
Fig. 2 = 36 x 36 mm
Fig. 3 = 38 x 43 mm



ROUX Baby
BI-212-13
13cm



ROUX mini
BI-214-13
15 cm



CRILE
BI-217-11
11,5 cm

BI-210-00	Fig.	cm
	BI-210-14	1 14
	BI-210-15	2 15
	BI-210-17	3 17



Fig. 2 = 25 x 24 mm
Fig. 1 = 21 x 24 mm



Fig. 2 = 47 x 13 mm
Fig. 1 = 42 x 13 mm



37 x 40 mm

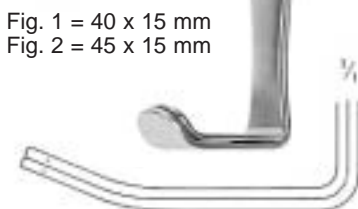

Fig. 1 = 40 x 15 mm
Fig. 2 = 45 x 15 mm

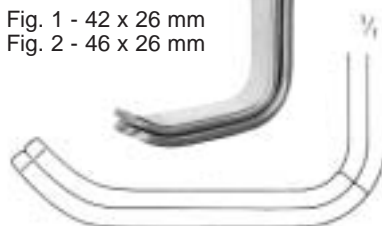

Fig. 1 - 42 x 26 mm
Fig. 2 - 46 x 26 mm

US Army (PARKER-LANGENBECK)
BI-311-21
21cm

MATHIEU
BI-314-20
20cm

GOELET
BI-315-19
19cm



52 x 33 mm

30 x 21 mm

COLLIN-HARTMANN
BI-317-16
16cm

BI

Wundhaken
Retractors
Ecarteurs
Separadores
Divaricatori



RICHARDSON-EASTMAN
BI-410-00



BI-510-01
28 x 20 mm



BI-150-02
36 x 28 mm



BI-510-03
44 x 38 mm



RICHARDSON



RICHARDSON Grip
BI-512-25 20 x 25 mm
BI-512-31 25 x 31 mm
BI-512-38 38 x 38 mm
BI-512-51 19 x 51 mm (Append.)
BI-512-64 41 x 64 mm



85 x 50 mm

KELLY
BI-516-26
26 cm



KELLY Grip
BI-518-51 38 x 51 mm
BI-518-64 51 x 64 mm
BI-518-76 64 x 76 mm
BI-518-82 70 x 82 mm

7 x 8,5 mm



7 x 8,5 mm

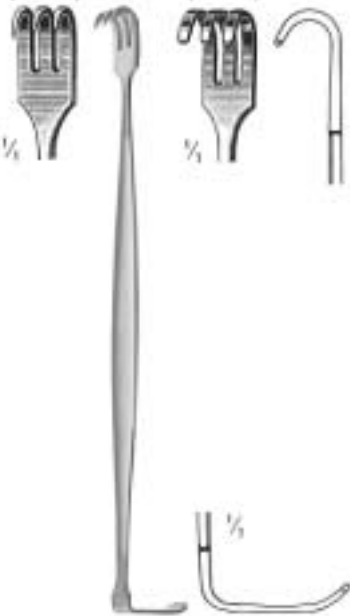

SENN
BI-610-17 17cm **BI-611-17**



RIBBON

BI-618-12 12 x 200 mm
BI-618-17 17 x 200 mm
BI-618-25 25 x 250 mm



RIBBON

BI-710-25 25 x 330 mm
BI-710-32 32 x 330 mm
BI-710-40 40 x 330 mm
BI-710-50 50 x 330 mm



Haberer

BI-714-17 17/25 x 200 mm
BI-714-25 25/30 x 250 mm
BI-714-37 37/45 x 300 mm



REVERDIN

BI-715-28
28 cm



BI

Wundhaken
Retractors
Ecarteurs
Separadores
Divaricatori



GRAEFFE
BI-120-01



GRAEFFE
BI-121-12



GUTHRIE
BI-122-01



GUTHRIE
BI-122-02



cm	FRAZIER
13	BI-124-13
18	BI-124-18

BI-126-01



JOSEPH
16 cm

BI-126-02
2 mm



BI-126-05
5 mm



BI-126-07
7 mm



BI-126-10
10 mm

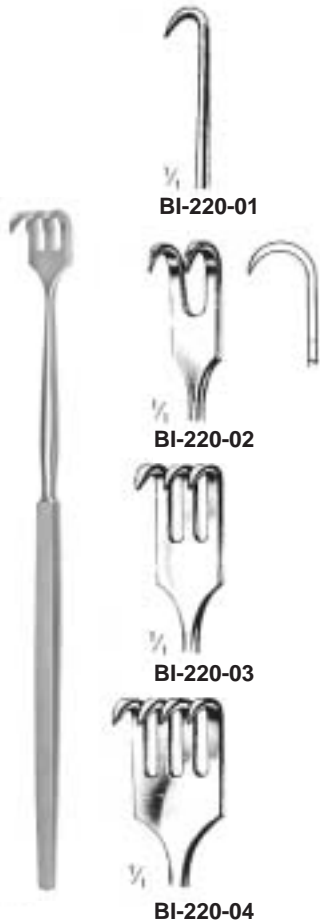

BI-220-01



BI-220-02



BI-220-03



BI-220-04

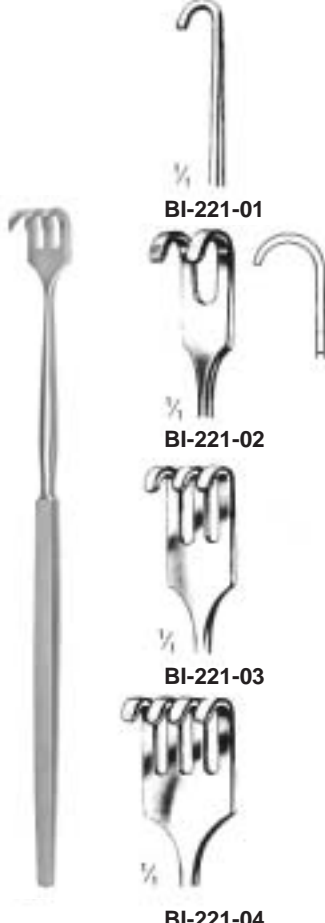

BI-221-01



BI-221-02



BI-221-03



BI-221-04



BI-226-02



BI-226-03



BI-226-04



BI-227-02



BI-227-03



BI-227-04



DESMARRES
16 cm



BI-320-12
12 mm

BI-320-14
14 mm

BI-320-16
16 mm

BI-320-18
18 mm



CUSHING
20 cm

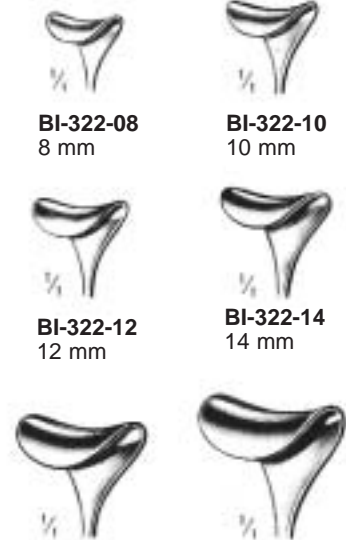

BI-322-08
8 mm

BI-322-10
10 mm

BI-322-12
12 mm

BI-322-14
14 mm

BI-322-16
16 mm

BI-322-18
18 mm



CUSCHING
BI-324-20
20 cm



CUSCHING
BI-324-21
21,5 cm



SENN-GREEN
BI-420-10 10 x 6 mm
BI-420-20 20 x 6 mm



10 x 5 mm

20 x 6 mm



VOLKMANN
11,5 cm

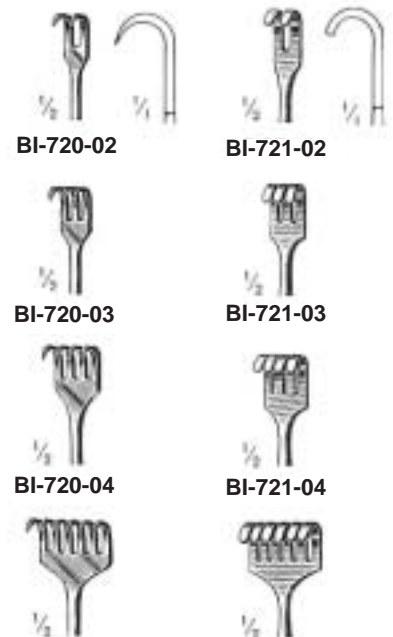

BI-720-02

BI-721-02

BI-720-03

BI-721-03

BI-720-04

BI-721-04

BI-720-06

BI-721-06



VOLKMANN
21,5 cm



1/4



1/2

BI-820-01



3/8

BI-820-02



1/2

BI-820-03



1/2

BI-820-04



1/2

BI-820-06



1/4



1/2

BI-821-01



3/8

BI-821-02



1/2

BI-821-03



1/2

BI-821-04



1/2

BI-821-06



1/4

18 x 7 mm BI-032-01



1/4

16 x 5 mm BI-032-02



1/4

7 x 4 mm BI-032-03



1/4

7 x 4 mm BI-032-04



1/4

10 x 3 mm BI-032-05



1/4

10 x 4 mm BI-032-06



MEYERDING
18 cm



1/4

28 x 6 mm



LAHEY
BI-034-19
19cm

12x 14 mm



1/4



LITTLE
BI-036-20
20cm



BI-130-01
- **BI-130-05**
22 cm

BI-132-01
- **BI-132-05**
21 cm

LANGENBECK

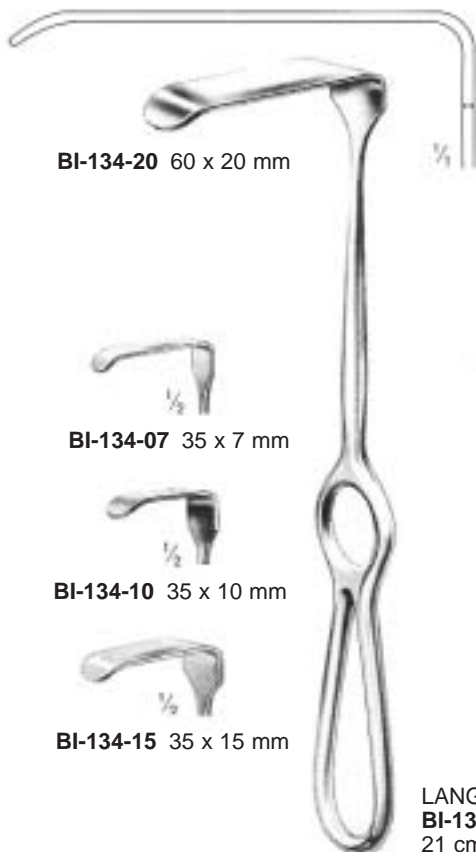
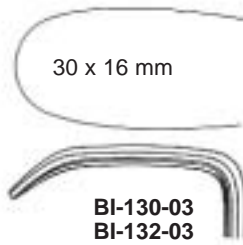
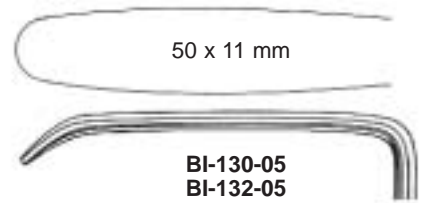
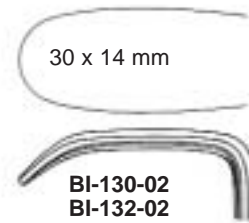
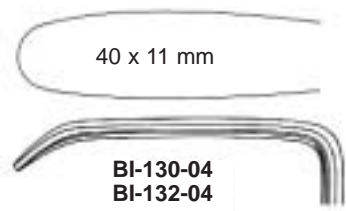
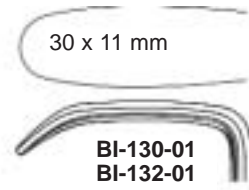

LANGENBECK
BI-134-07 - BI-134-21
21 cm



LANGENBECK
BI-137-21
21 cm

BI

Wundhaken
Retractors
Ecarteurs
Separadores
Divaricatori

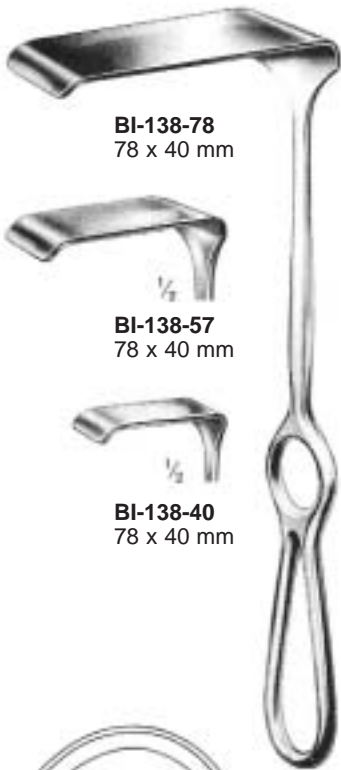

BI-138-78
78 x 40 mm

BI-138-57
78 x 40 mm

BI-138-40
78 x 40 mm

BI-138-40 - BI-138-78
23 cm



BI-330-40
40 x 12 mm

BI-330-50
55 x 11 mm

KOCHER
BI-330-40 - BI-330-55
19cm

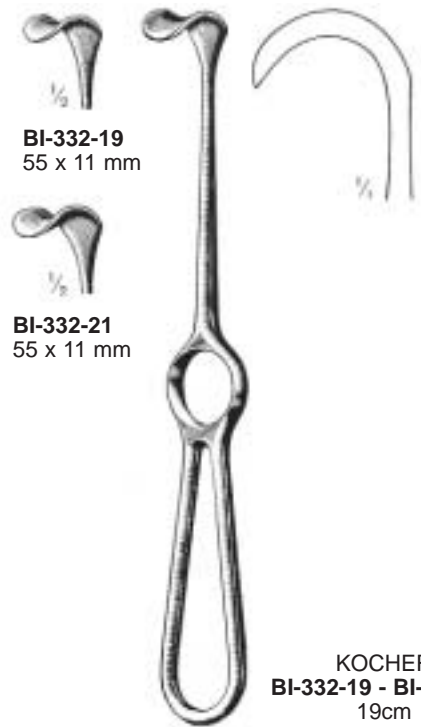

BI-332-19
55 x 11 mm

BI-332-21
55 x 11 mm

KOCHER
BI-332-19 - BI-332-21
19cm



KOCHER	mm
BI-430-10	40 x 10
BI-430-15	40 x 15
BI-430-20	40 x 20

22 cm



BI-434-14
14 x 17 mm
21,5 cm



BI-434-20
20 x 22 mm
22 cm



BI-434-26
26 x 30 mm
23,5 cm



MIDDENDORPF
BI-434-14 - BI-434-26



GREEN
BI-438-22
22 cm



OLLIER
BI-630-02
22,5 cm



BI-634-40 40 x 40 mm



BI-634-50 45 x 50 mm



BI-634-60 50 x 60 mm

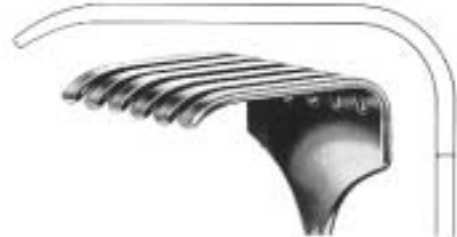

BI-634-70 70 x 70 mm

ISRAEL
25 cm



40 x 30 mm

KOERTE
BI-636-08 23,5cm **BI-637-08**



FRITSCH mm
BI-730-40 45 x 40
BI-730-50 45 x 50
BI-730-60 45 x 60
BI-730-75 45 x 75
24cm



70 x 25 mm

KOCHER
BI-732-22
22,5 cm



KOCHER mm
BI-734-45 80 x 45
BI-734-55 80 x 55
BI-734-65 80 x 65
25cm

BI

Wundhaken
Retractors
Ecarteurs
Separadores
Divaricatori



50 x 85 mm

DOYEN
BI-738-25
25 cm



mm	KELLY
160 x 38	BI-835-38
160 x 57	BI-835-57
	27 cm

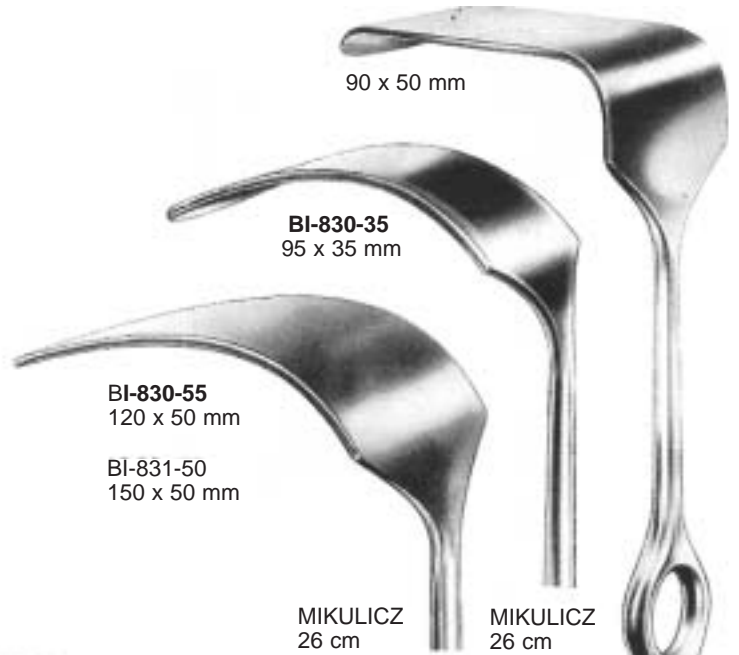

90 x 50 mm

BI-830-35
95 x 35 mm

BI-830-55
120 x 50 mm

BI-831-50
150 x 50 mm

MIKULICZ
26 cm

MIKULICZ
26 cm

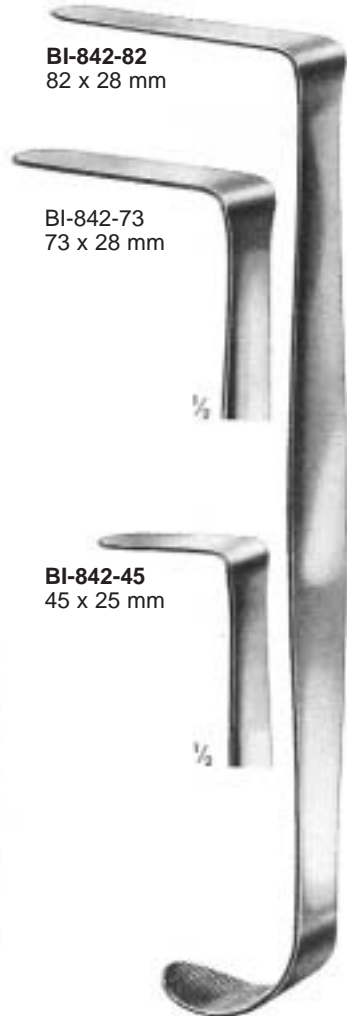

BI-842-82
82 x 28 mm

BI-842-73
73 x 28 mm

BI-842-45
45 x 25 mm

MIKULICZ
BI-832-50
26 cm

SIMON	mm
BI-840-22	115 x 22
BI-840-27	115 x 27
	28 cm

HEANEY
BI-842-45 -BI-842-82
27cm

BI-940-65
115 x 65 mm

BI-940-43
108 x 43 mm

BI-940-22
82 x 22 mm

125 x 37 mm

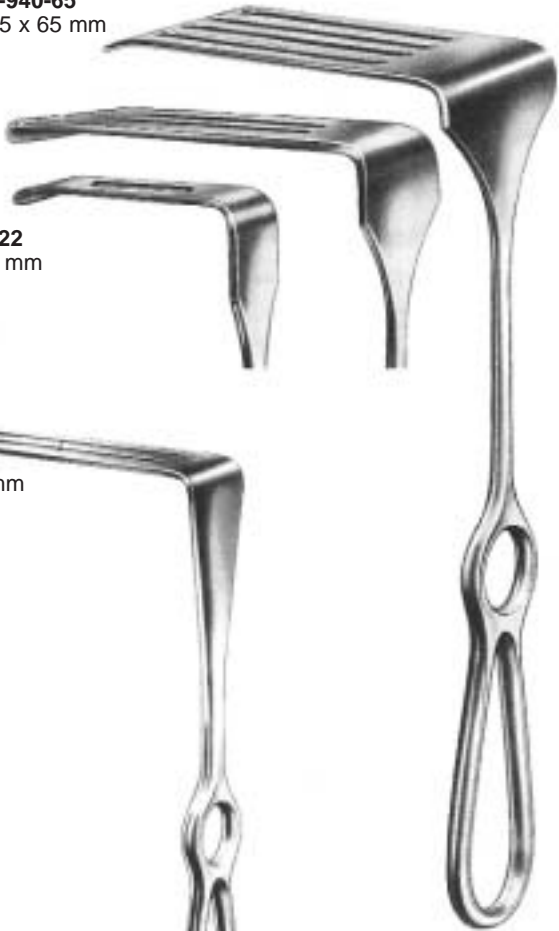

CORYLLOS (Thorax)
BI-940-22 - BI-940-65
24 cm

Sauerbruch
BI-942-25
25 cm

BI-944-45
45 x 15 mm

BI-944-60
60 x 23 mm

BI-944-75
75 x 20 mm

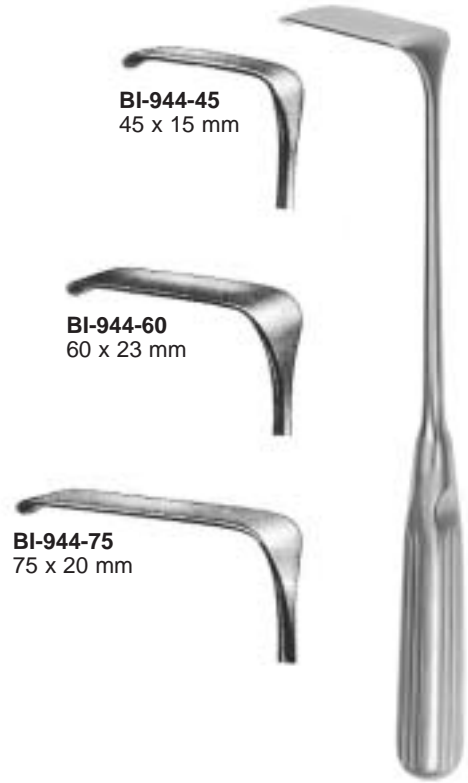

SAUERBRUCH
BI-944-45 - BI-944-75
22,5 cm



DAVIDSON (Scapula)
BI-946-50
75 x 50 mm



DAVIDSON (Scapula)
BI-946-90
75 x 90 mm

BI

Wundhaken
Retractors
Ecarteurs
Separadores
Divaricatori



FINSEN
BI-160-07 7 cm BI-161-07



ALM
BI-260-07 7 cm BI-261-07
BI-260-10 10 cm BI-261-10



JANSEN
BI-360-10
10 cm



JANSEN
BI-361-10
10 cm



BI-364-10 10 cm BI-365-10



WEITLANER
BI-560-10 11,5 cm BI-365-10



WEITLANER-WULLSTEIN
BI-564-13 13 cm BI-565-13



PLESTER
BI-567-11
11 cm



PLESTER
BI-569-11
11 cm



WEITLANER
BI-760-14 14,0 cm BI-761-14
BI-760-16 16,5 cm BI-761-16
BI-760-20 20,0 cm BI-761-20



ADSON
BI-860-19 19 cm BI-861-19



ADSON
BI-862-26 - BI-863-26
26,5 cm

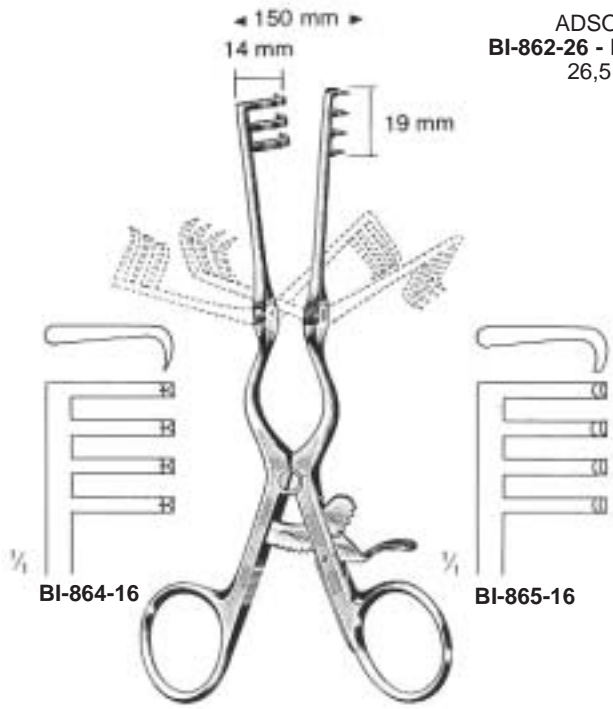
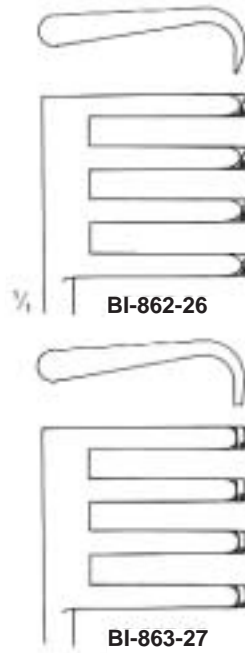

ADSON Baby
BI-864-16 - BI-865-16
16cm



BECKMANN-ADSON
BI-866-32
32 cm



BECKMANN
BI-960-31
31 cm



BECKMANN-EATON
BI-962-32
32 cm



MOLLISON
BI-963-15
15 cm

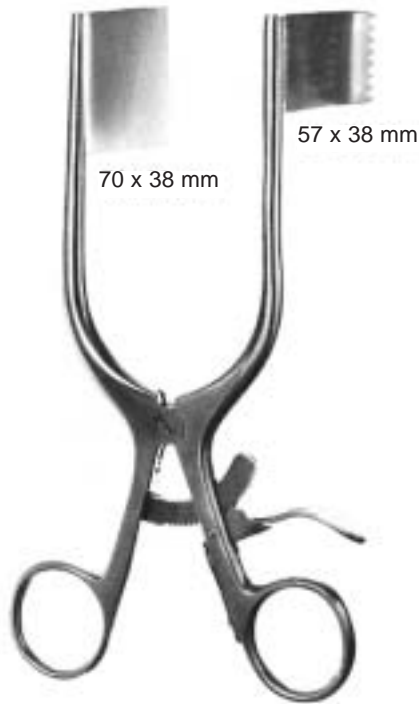

DARLING
BI-966-18
18 cm

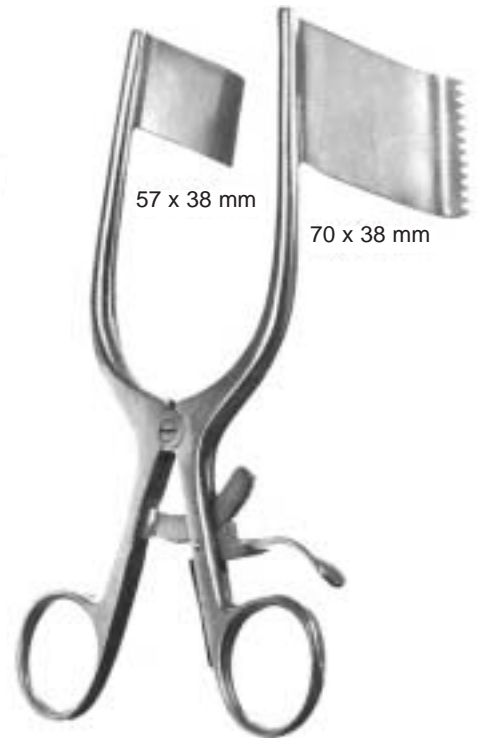

DARLING
BI-968-18
18 cm



CLOWARD
BI-170-00
BI-170-01

ohne Valven • without blades
sans valves • sin valves • senza valve

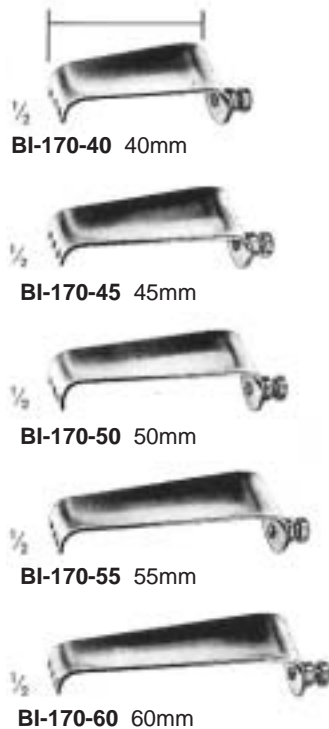

CLOWARD
BI-171-00
BI-171-01

ohne Valven • without blades
sans valves • sin valvas • senza valve

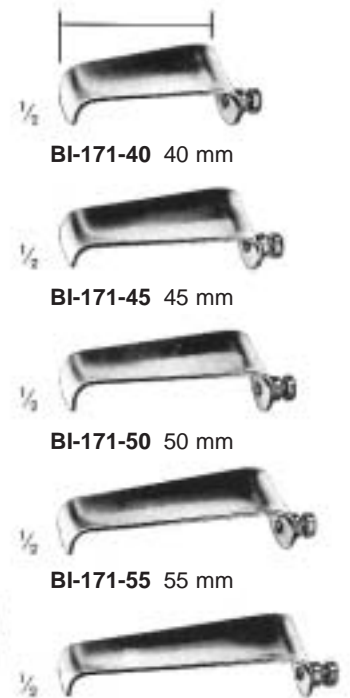



CASPAR
BI-270-00 compl.
BI-270-15 ohne Valven • without blades
sans valves • sin valvas • senza valve



CASPAR
BI-271-00 compl.
BI-271-15 ohne Valven • without blades • sans valves • sin valvas • senza valve



CASPAR
BI-274-00 compl.
BI-274-11



stumpf
blunt
mousse
roma
smussa

mm	CASPAR
45 x 23	BI-176-45
50 x 23	BI-176-50
55 x 23	BI-176-55
60 x 23	BI-176-60
65 x 23	BI-176-65



medial

mm	CASPAR
40 x 23	BI-178-40
45 x 23	BI-178-45
50 x 23	BI-178-50
55 x 23	BI-178-55
60 x 23	BI-178-60



lateral

mm	CASPAR
40 x 23	BI-179-40
45 x 23	BI-179-45
50 x 23	BI-179-50
55 x 23	BI-179-55
60 x 23	BI-179-60

BI-475-40
40 mm



BI-475-45
45 mm



BI-475-50
50 mm



BI-475-55
45 mm



BI-475-60
60 mm



BI-475-65
65 mm



BI-475-70
70 mm



CASPAR

BI-474-00 compl. incl. 5 Valven • blades
valves • valvas • valve

BI-474-17 ohne Valven • without blades • sans valves • sin valvas • senza valve



BI-477-45
45 mm

BI-477-50
50 mm

BI-477-55
55 mm

BI-477-60
60 mm

BI-477-65
65 mm



CASPAR
BI-477-45 - BI-477-65



O'SULLIVAN-O'CONNOR
BI-574-00

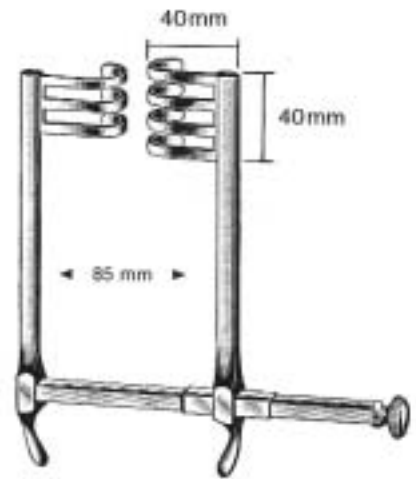

FRAZIER
BI-578-85



GOSSET
BI-670-14



GOSSET
BI-672-16



BALFOUR
BI-674-18
10 cm



BALFOUR
BI-674-20
20 cm

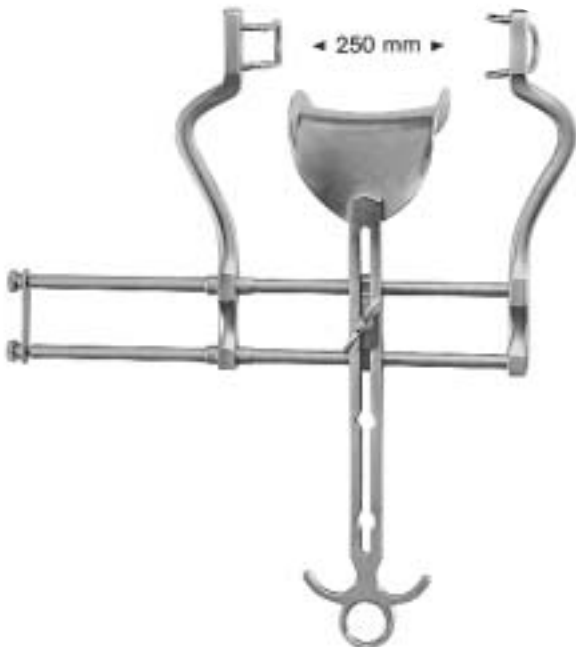

BALFOUR
BI-674-25
25 cm



mm	BALFOUR
45 x 80	BI-675-45
70 x 85	BI-675-70
80 x 90	BI-675-80



BALFOUR Baby
BI-676-90
9 cm

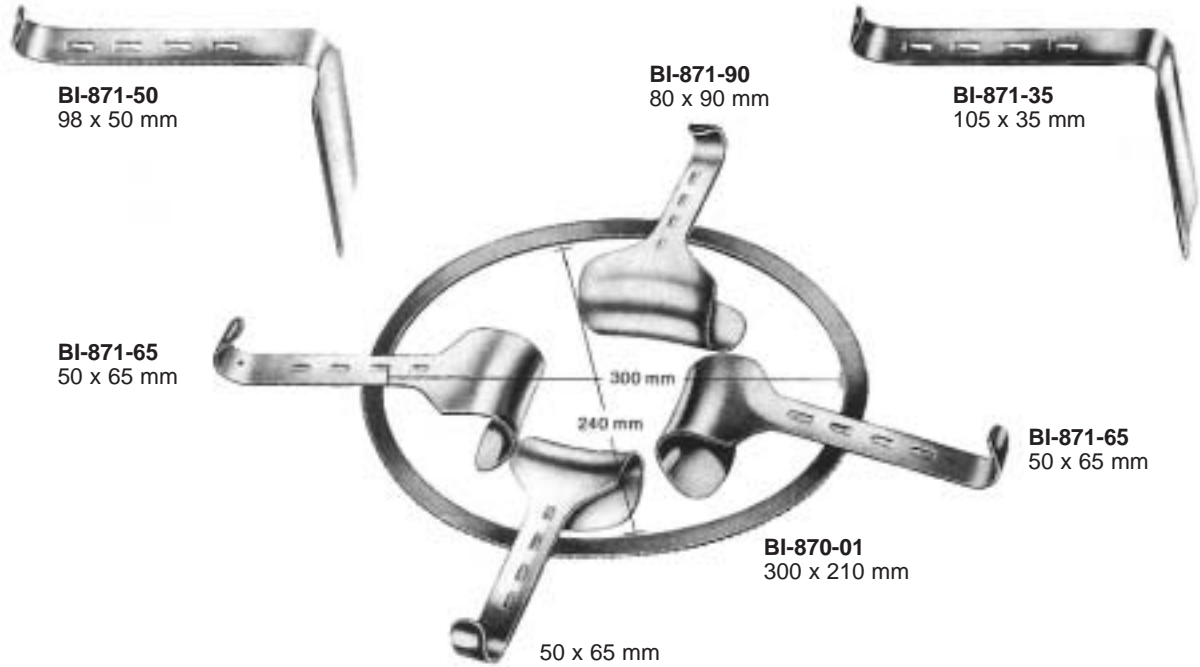

KIRSCHNER
BI-870-00 compl.

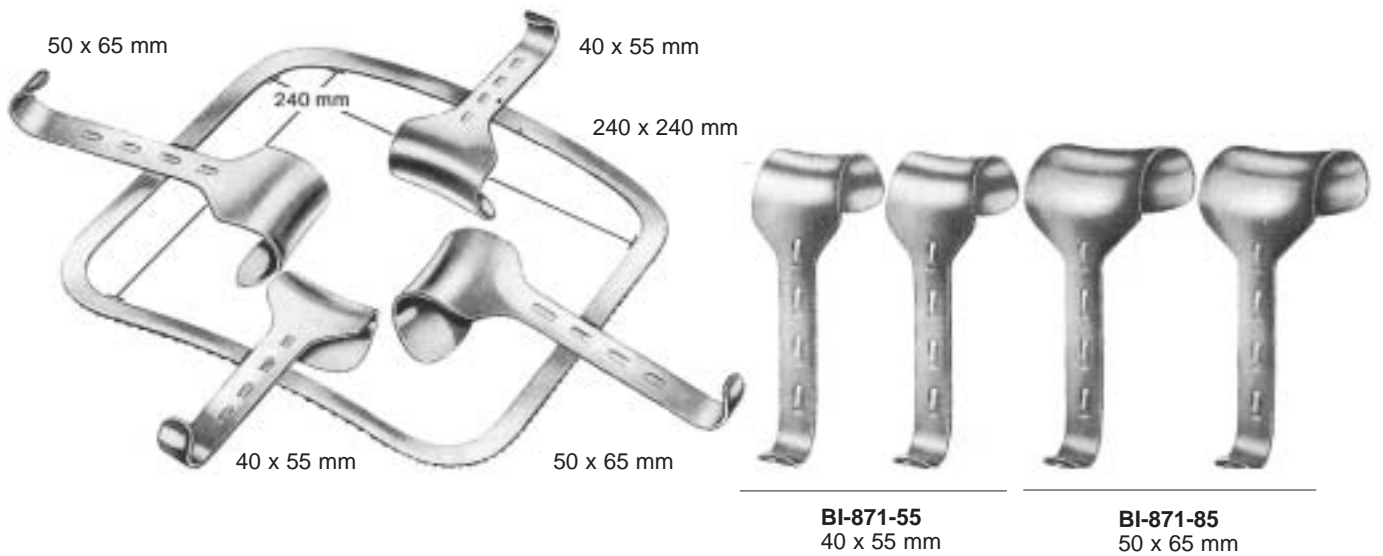

KIRSCHNER
BI-872-00 compl

BI

Wundhaken
Retractors
Ecarteurs
Separadores
Divaricatori



cm	GELPI
9	BI-082-09
14	BI-082-14
16	BI-082-16
18	BI-082-18



GELPI
BI-084-18
18 cm



RIGBY
BI-086-18
18 cm



COLLIN
BI-180-22



Central/mm	COLLIN
38 x 55	BI-182-60
50 x 75	BI-182-80

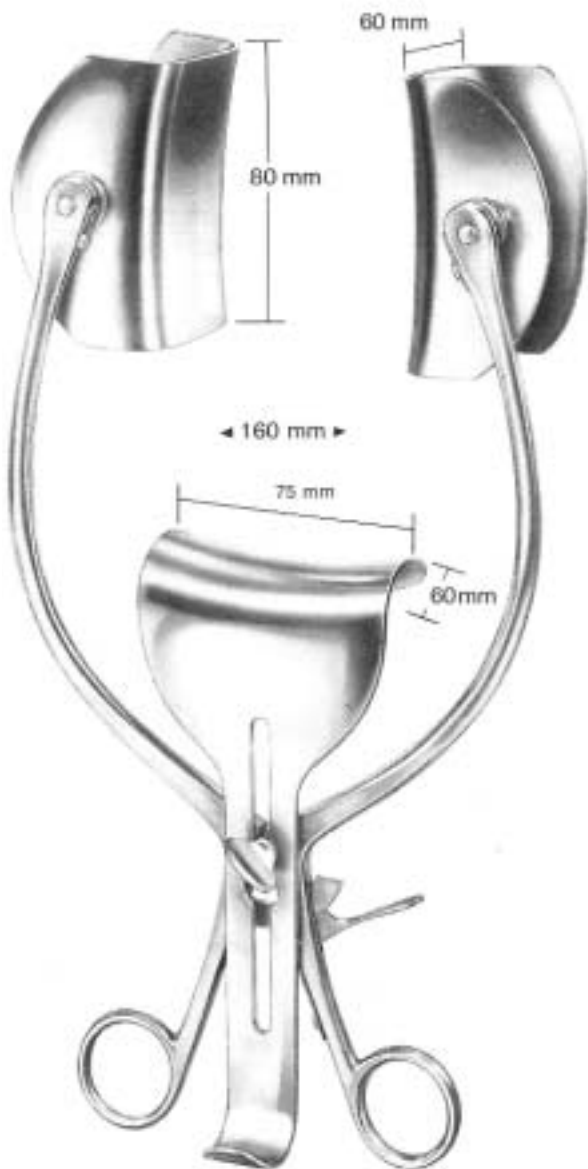

COLLIN Loktite
BI-186-00

Muskelhaken
Muscle Retractors (Hooks)
Ecarteurs musculaires
Separadores (ganchos) musculares
Divaricatori (uncini) muscolari



BI-092-10
10 cm



BI-093-00

CA

**Sonden, Spatel, Watteträger
Probes, Spatulas, Applicators
Sondes, Spatules, porte-coton
Sondas, Espátulas, porta-algodón
Sonde, Spatole, portacotone**

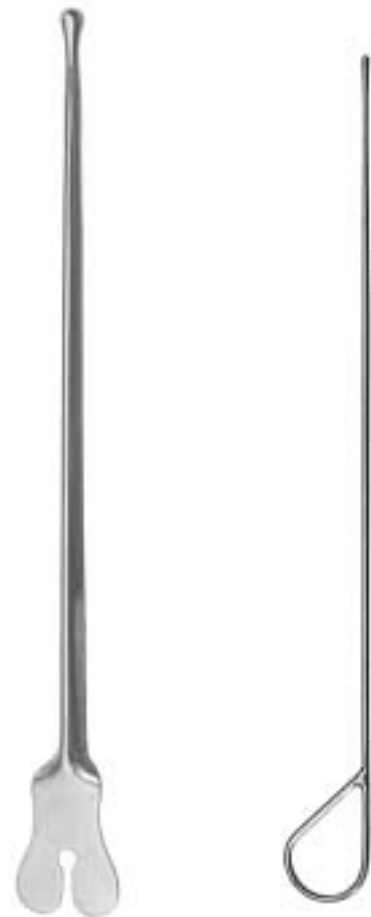

CA

CA

Sonden
Probes, Directors
Stylets, sondes
Sondas, estiletes
Sonde, specilli



cm	2 mm Ø	1 mm Ø	1,5 mm Ø	2 mm Ø		DOYEN		STACKE
10,5					CA-018-10			CA-115-10
11,5	CA-012-11	CA-014-11	CA-015-11	CA-016-11		CA-110-11		
13,0	CA-012-13	CA-014-13	CA-015-13	CA-016-13	CA-018-13	CA-110-13	CA-112-13	
14,0						CA-111-14		
14,5	CA-012-14	CA-014-14	CA-015-14	CA-016-14	CA-018-14	CA-110-14	CA-112-14	
16,0	CA-012-16	CA-014-16	CA-015-16	CA-016-16	CA-018-16	CA-110-16	CA-112-16	
18,0	CA-012-18	CA-014-18	CA-015-18	CA-016-18	CA-018-18	CA-110-18	CA-112-18	
20,0	CA-012-20	CA-014-20	CA-015-20	CA-016-20	CA-018-20	CA-110-20		
25,0	CA-012-25	CA-014-25	CA-015-25	CA-016-25				

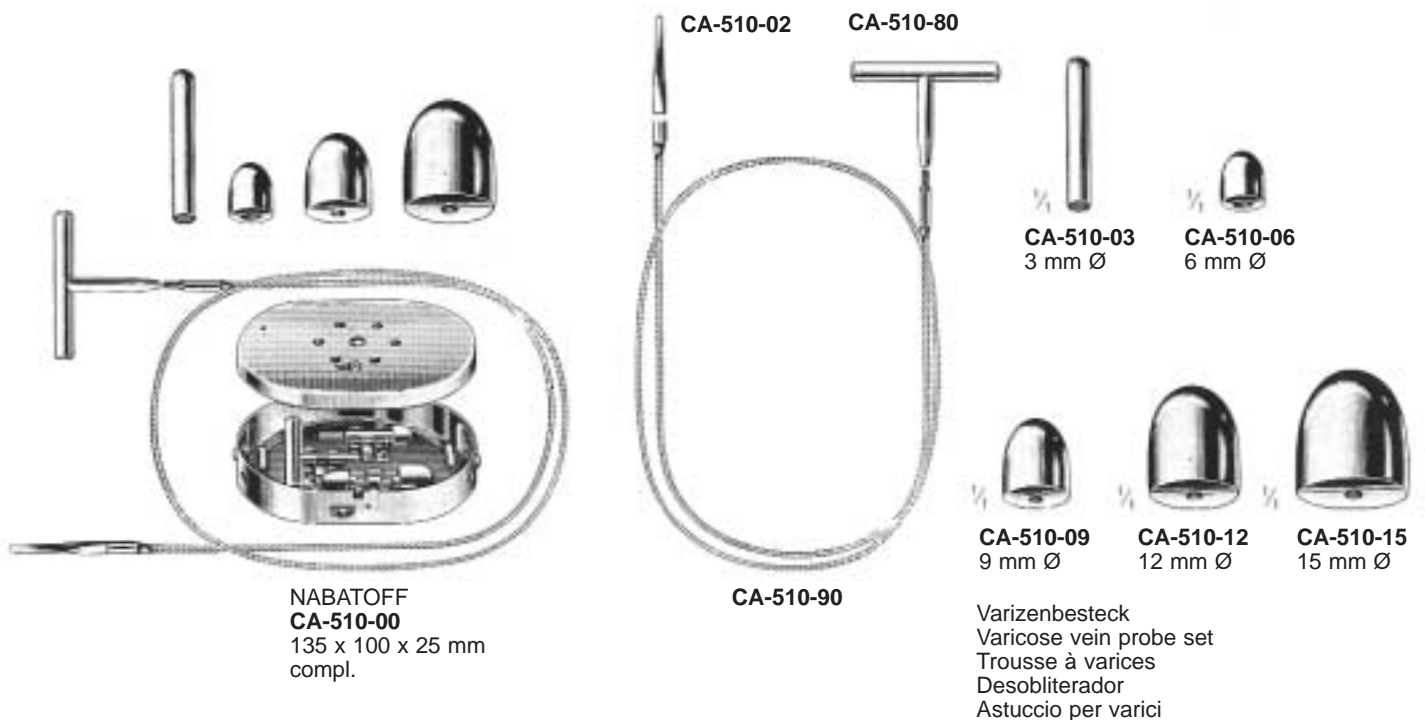

NABATOFF
CA-510-00
135 x 100 x 25 mm
compl.

CA-510-90

Varizenbesteck
Varicose vein probe set
Trousse à varices
Desobliterador
Astuccio per varici

Spatel, Watteträger
 Spatulas, Cotton-Applicators
 Spatules, porte-coton
 Espátulas, porta-algodón
 Spatole, portacotone

CA

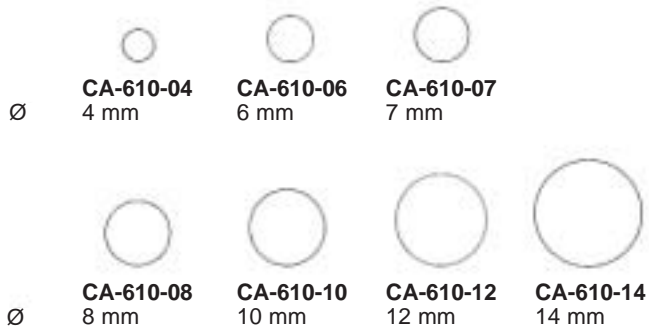

CA-612-12
 12 cm

Pflasterspatel
 Plaster spatula
 Spatules
 Espátulas
 Spatole



cm	
13,0	CA-910-13
14,5	CA-910-14



cm	FARRELL	FARRELL			UCKERMANN	JOBSON-HORNE				
12,0	CA-720-12	CA-722-12	CA-920-12	CA-922-12		CA-230-12				
14,0	CA-720-14	CA-722-14	CA-920-14	CA-920-14						
15,0					CA-130-15					
16,0			CA-920-16	CA-920-16						
16,5	CA-720-16	CA-722-16								
18,0	CA-720-18	CA-722-18	CA-920-18	CA-920-18		CA-230-18				
23,0	CA-720-23	CA-722-23								
25,0										
45,0										CA-430-45

**Trokare, Punktionsnadeln
Trocars, Puncture Needles
Trocart, Aiguilles à ponction
Trócares, Agujas para punción
Trequarti, Aghi da punzione**



CC

CC

Trokare
Trocars
Trocarts
Trócares
Trequarti

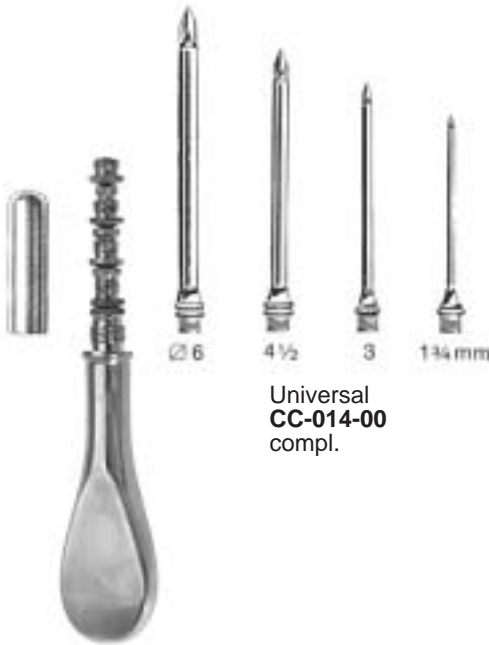

Universal
CC-014-00
compl.



mm	Standard	Standard	PIERCE
3,0	CC-110-30	CC-210-30	CC-213-30
3,5	CC-110-35	CC-210-35	
4,0	CC-110-40	CC-210-40	CC-213-40
4,5	CC-110-45	CC-210-45	
5,0	CC-110-50	CC-210-50	CC-213-50
5,5	CC-110-55	CC-210-55	
6,0	CC-110-60	CC-210-60	

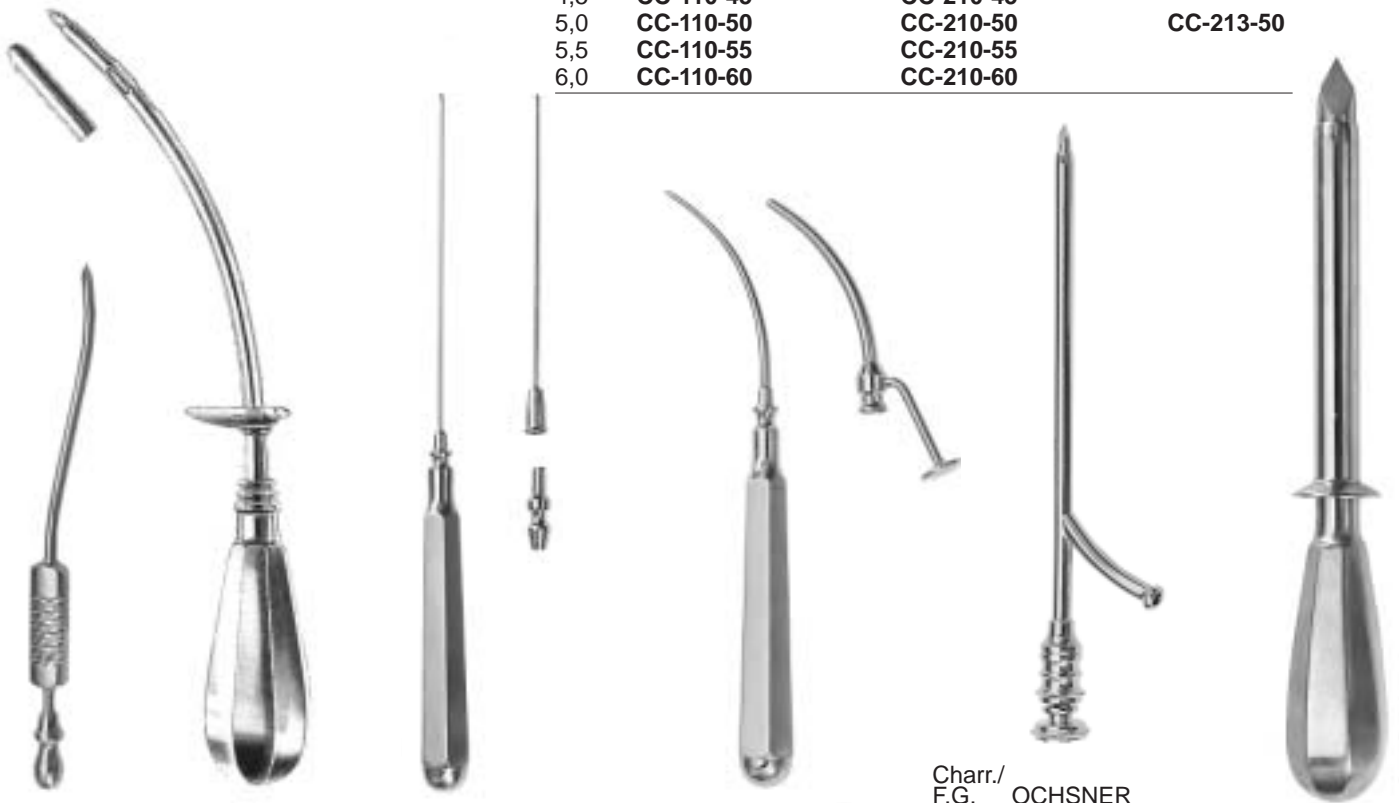

DOUGLAS
CC-215-11
3 mm Ø

FLEURANT
CC-217-23
23 cm
5 mm Ø

LICHTWITZ
CC-218-20
1,70 mm Ø

COAKLEY
CC-410-02
2,25 mm Ø

Charr./ F.G.	OCHSNER
10	CC-510-10
12	CC-510-12
14	CC-510-14
16	CC-510-16
18	CC-510-18
20	CC-510-20

Charr./ F.G.	NELSON
25	CC-710-25
30	CC-710-30
33	CC-710-33
35	CC-710-35

Pneumoperitoneum
Pneumopéritoine
Neumoperitoneo
Pneumoperitoneo



CC-120-00 VERRES
compl. **CC-520-20**
2,0 x 100 mm

Pudendus Anesthesia
anesthesia

mm	QUINKE
1,2 x 76	CC-320-12
1,2 x 89	CC-322-12
1,0 x 76	CC-320-10
1,0 x 89	CC-322-10
0,7 x 76	CC-320-07
0,7 x 89	CC-322-07



mm	MENGHINI	mm	MENGHINI	MENGHINI
1,0 x 35	CC-032-01	1,4 x 168	CC-130-14	CC-132-14
1,0 x 70	CC-032-02	1,8 x 168	CC-130-18	CC-132-18
1,2 x 70	CC-032-03			
1,2 x 100	CC-032-04			
1,4 x 70	CC-032-05			
1,4 x 100	CC-032-06			
1,6 x 70	CC-032-07			
1,8 x 100	CC-032-08			

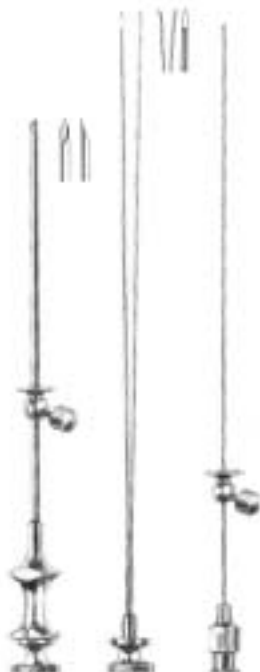

Ø ext. x L. mm	Ø int. x L. mm	FRANKLIN-SILVERMANN
2,0 x 105	1,5 x 155	CC-330-20
2,0 x 130	1,5 x 180	CC-330-14

compl.

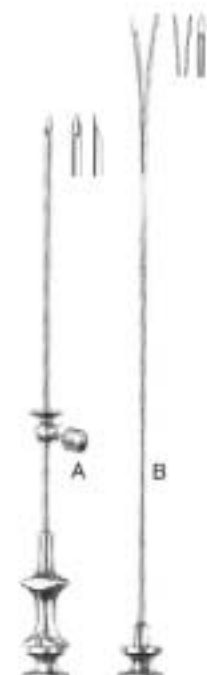

A Ø x L. mm	B Ø x L. mm	A + B FRANKLIN-SILVERMANN	B FRANKLIN-SILVERMANN
2,0 x 100	1,5 x 150	CC-530-20	CC-532-15
2,5 x 145	2,0 x 195	CC-530-30	CC-532-20
2,0 x 100	1,5 x 150	CC-534-20	CC-536-15
2,5 x 145	2,0 x 195	CC-534-25	CC-536-20

CE

**Nadelhalter
Needle Holders
Porte-aiguilles
Porta-agujas
Port'aghi**



CE

CE

Nadelhalter
Needle Holders
Porte-aiguilles
Porta-agujas
Port'aghi



DERF
CE-110-12 12 cm **CE-114-12**



DERF
CE-210-12
12,5 cm



NEIVERT
CE-416-13



BAUMGARTNER
CE-510-12 12,5 cm **CE-514-12**
CE-510-14 14,5 cm **CE-514-14**



COLLIER
CE-212-12
12,5 cm

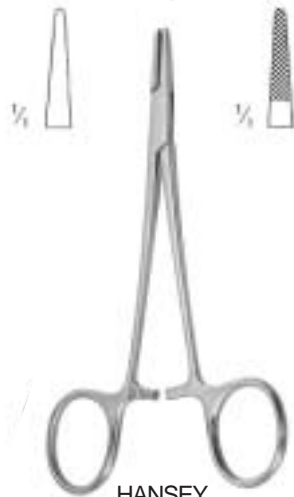

HANSEY
CE-310-13 13 cm **CE-410-13**
CE-314-13 13 cm **CE-414-13**

Mit TC-Einsätzen
TC-Lined
A mors TC
Con bocas TC
Con morso TC



CRILE-WOOD
CE-610-15 15 cm **CE-614-15**
CE-610-18 18 cm **CE-614-18**
CE-610-20 20 cm **CE-614-20**



CRILE-MURRAY
CE-710-15 15 cm **CE-714-15**



MAYO-HEGAR
CE-810-14 14 cm **CE-814-14**
CE-810-16 16 cm **CE-814-16**
CE-810-18 18 cm **CE-814-18**
CE-810-20 20 cm **CE-814-20**
CE-810-24 24 cm **CE-814-24**
CE-810-26 26 cm **CE-814-26**
CE-810-30 30 cm **CE-814-30**



MAYO-HEGAR
CE-910-16 16 cm **CE-914-16**
CE-910-18 18 cm **CE-914-18**
CE-910-20 20 cm **CE-914-20**



cm	DE BAKEY	RYDER
13		CE-224-13
15	CE-124-15	CE-224-15
18	CE-124-18	CE-224-18
20	CE-124-20	CE-224-20
23	CE-124-23	CE-224-23
26	CE-124-26	CE-224-26
31	CE-124-31	
37	CE-124-37	

	JAMISON	HEANEY
CE-320-23	23,5 cm	CE-324-23
CE-421-21	21 cm	CE-425-21



	MASSON	WANGENSTEEN	WANGENSTEEN	BOZEMANN
CE-520-27	27 cm	CE-524-27	CE-620-27	20 CE-825-20
CE-624-27		27 cm	CE-624-27	24 CE-825-24
CE-720-27		27 cm	CE-724-27	26 CE-825-26

CE

Nadelhalter
Needle Holders
Porte-aiguilles
Porta-agujas
Port'aghi



METZENBAUM
CE-920-18
18 cm



ADSON
CE-922-18
18 cm



JOHNSON
CE-923-27
27 cm



FINOCHIETTO
CE-131-20 20 cm **CE-135-20**
CE-131-27 27 cm **CE-135-27**

Mit TC-Einsätzen
TC-Lined
A mors TC
Con bocas TC
Con morso TC



SAROT
CE-230-18 18 cm **CE-234-18**
CE-230-26 26 cm **CE-234-26**



STRATTE
CE-330-23 23 cm **CE-334-23**



CRILE
CE-530-15
15 cm



TOENNIS
CE-630-18 18 cm **CE-634-18**





HOESEL
CE-636-25
25 cm



cm	MATHIEU		MATHIEU		MATHIEU	
14	CE-730-14	CE-734-14			CE-930-14	CE-934-14
17	CE-730-17	CE-734-17	CE-830-17	CE-834-17	CE-930-17	CE-934-17
20	CE-730-20	CE-734-20	CE-830-20	CE-834-20		
24	CE-730-24	CE-734-24				



OLSEN-HEGAR

CE-140-14	14 cm	CE-144-14
CE-140-18	18 cm	CE-144-18



OLSEN-HEGAR

CE-240-17	17 cm	CE-244-17
-----------	-------	-----------



GILLIES

CE-340-16	16 cm	CE-344-16
-----------	-------	-----------

Gefäß-Chirurgie
Vascular surgery
Chirurgie vasculaire
Chirurgia vascular
Chirurgia vascolare



Mit TC-Einsätzen
TC-Lined
A mors TC
Con bocas TC
Con morso TC

cm	DIETRICH
16	CE-444-16
18	CE-444-18
20	CE-444-20
23	CE-444-23
26	CE-444-26

Ophthalmologie
Ophthalmology
Ophtalmologie
Oftalmología
Oftalmologia



STEVENS
CE-160-11
11 cm



cm	STEVENS
13	CE-162-13
15	CE-162-15



BOYNTON
CE-164-12
12 cm



cm	ARRUGA
16	CE-264-16



KALT-ARRUGA
CE-267-14
 14 cm



KALT
CE-268-14
CE-362-14
 14 cm



BARRAQUER
CE-560-10
 10 cm



BARRAQUER
CE-561-10
 10 cm



BARRAQUER
CE-661-13 13 cm **CE-665-13**



CASTROVIEJO
CE-760-14 14 cm **CE-761-14**
CE-764-14 14 cm **CE-765-14**



CASTROVIEJO
CE-860-13 13 cm **CE-864-13**

CG

**Naht
Suture
Suture
Sutura
Sutura**



CG



R	DESCHAMPS	L
CG-110-21	21 cm	CG-111-21
CG-110-24	24 cm	CG-111-24
CG-110-27	27 cm	CG-111-27

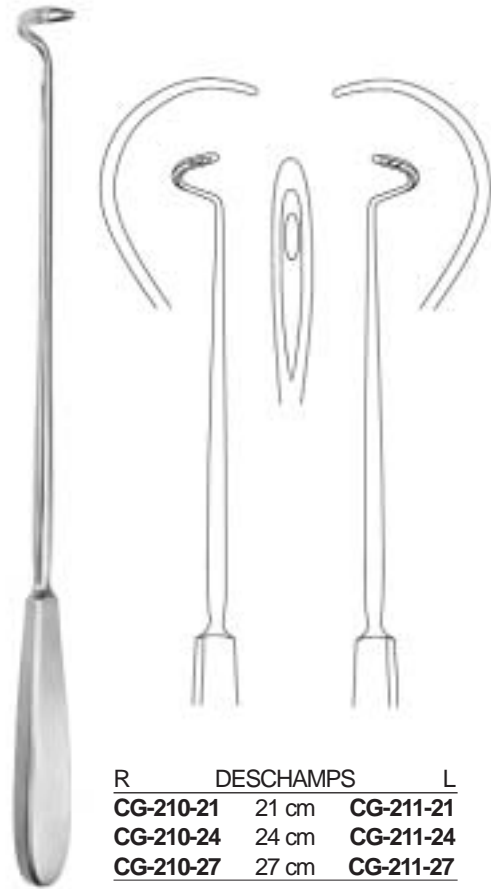

R	DESCHAMPS	L
CG-210-21	21 cm	CG-211-21
CG-210-24	24 cm	CG-211-24
CG-210-27	27 cm	CG-211-27

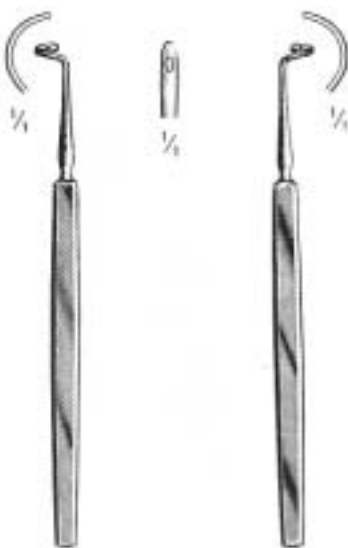

R	KRONECKER	L
CG-310-13	13 cm	CG-311-13



R	NELSON	L
CG-313-24	24,5 cm	CG-315-24



COOPER
CG-319-19
19 cm



REVERDIN	cm	Fig. 1	Fig. 2	Fig. 3	Fig. 4
CG-021-15 - CG-024-23	15	CG-021-15	CG-022-15	CG-023-15	CG-024-15
	19	CG-021-19	CG-022-19	CG-023-19	CG-024-19
	21	CG-021-21	CG-022-21	CG-023-21	CG-024-21
	23	CG-021-23	CG-022-23	CG-023-23	CG-024-23



YOUNG Boomerang
CG-420-00
25 cm



Fig. 1
CG-420-01



Fig. 2
CG-420-02



Fig. 3
CG-420-03



SCHMIEDEN
CG-721-19
 19 cm



SCHMIEDEN-PAYR
CG-723-19
 19 cm



BRUNNER
CG-725-30
 30 cm



KIRSCHNER
CG-727-25
 25,5 cm



KOENIG
CG-825-20
 20 cm



PAYR
CG-828-22
 22 cm



PAYR
CG-829-22
 22 cm



cm	BRUNNER
18	CG-921-18
27	CG-921-27

Plastik
 from plastic material
 matière plastique
 de materia plástica
 in plastica

In Packungen zu 1 Dutzend
in packages of 1 dozen
en enveloppes de 1 douzaine
en sobres de 1 dozena
bustine di 1 dozzina

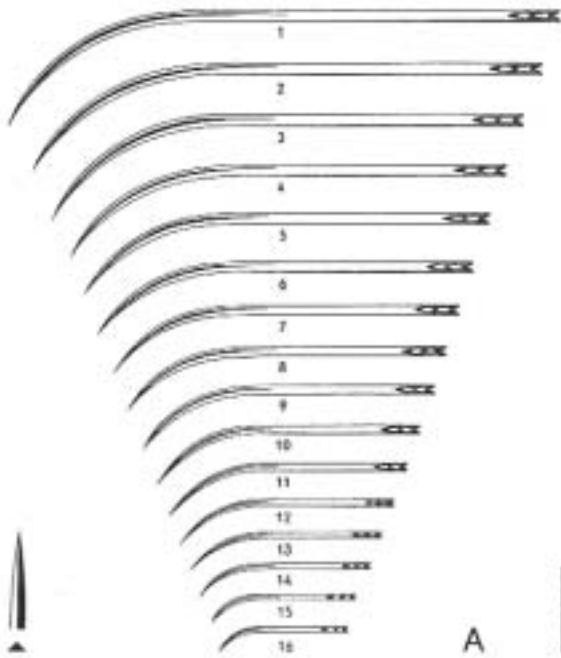

CG-043-01 - CG-043-16

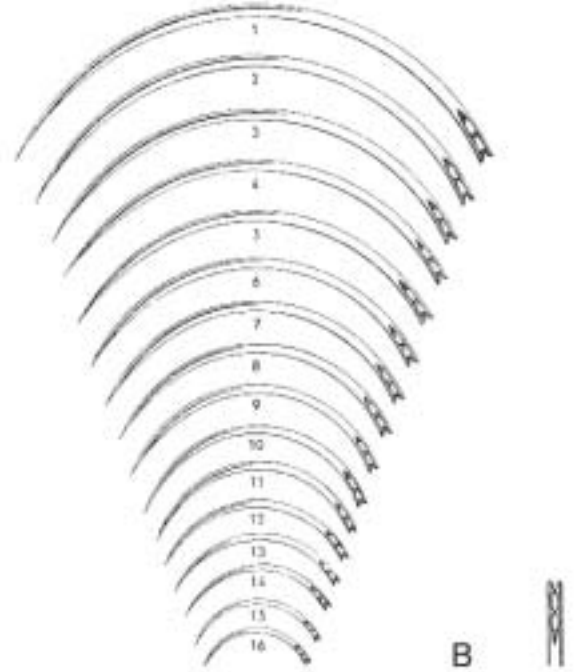

CG-143-01 - CG-143-16

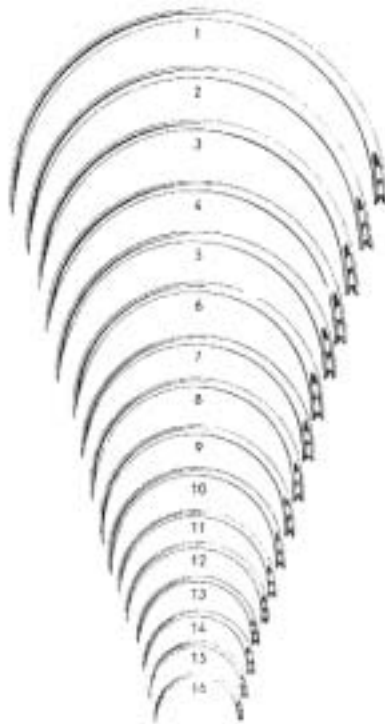

CG-243-01 - CG-243-16

Alle Nadeln mit Federöhr
all the needles with spring eye
toutes les aiguilles à chas à ressort
todas las agujas con ojo de resorte
tutti gli aghi con cruna aperta

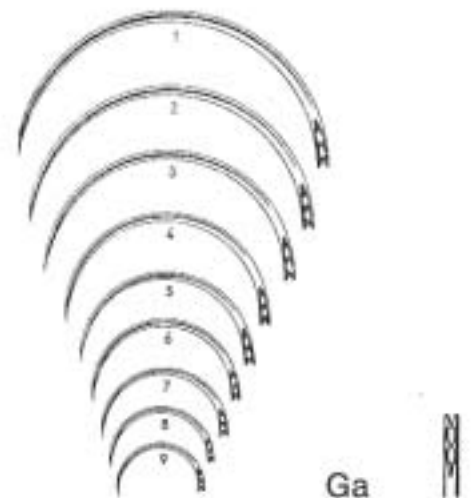

CG-343-01 - CG-343-09

Fig.	1	2	3	4	5	6	7	8	9	10	11	12	13	14	15	16
A	CG-043-01	CG-043-02	CG-043-03	CG-043-04	CG-043-05	CG-043-06	CG-043-07	CG-043-08	CG-043-09	CG-043-10	CG-043-11	CG-043-12	CG-043-13	CG-043-14	CG-043-15	CG-043-16
B	CG-143-01	CG-143-02	CG-143-03	CG-143-04	CG-143-05	CG-143-06	CG-143-07	CG-143-08	CG-143-09	CG-143-10	CG-143-11	CG-143-12	CG-143-13	CG-143-14	CG-143-15	CG-143-16
G	CG-243-01	CG-243-02	CG-243-03	CG-243-04	CG-243-05	CG-243-06	CG-243-07	CG-243-08	CG-243-09	CG-243-10	CG-243-11	CG-243-12	CG-243-13	CG-243-14	CG-243-15	CG-243-16
GA	CG-343-01	CG-343-02	CG-343-03	CG-343-04	CG-343-05	CG-343-06	CG-343-07	CG-343-08	CG-343-09							

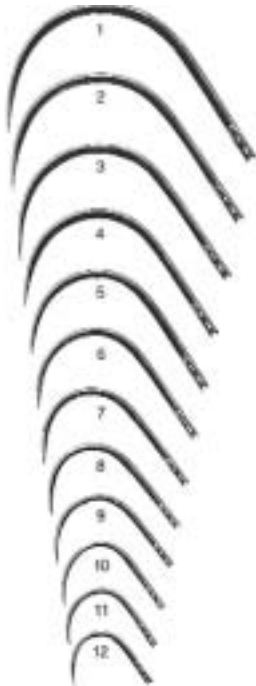

KOENIG
CG-441-01 - CG-441-12



CG-443-30 - CG-443-05

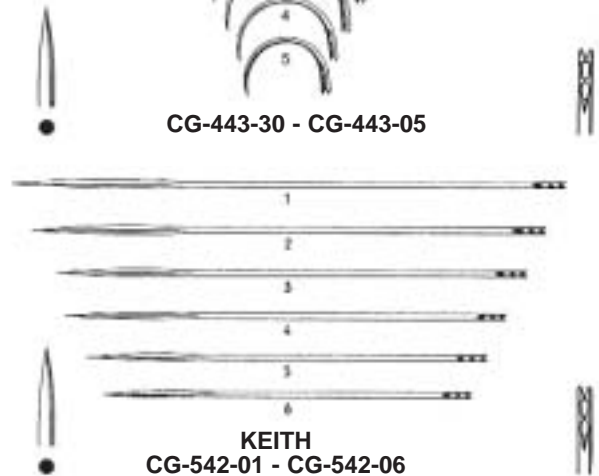

KEITH
CG-542-01 - CG-542-06

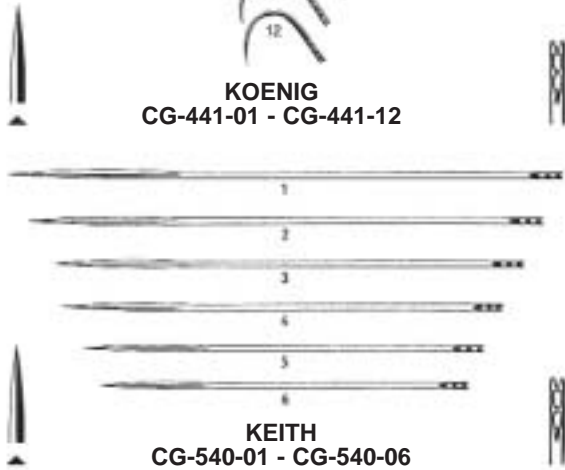

KEITH
CG-540-01 - CG-540-06

Alle Nadeln mit Federöhr
all the needles with spring eye
toutes les aiguilles à chas à ressort
todas las agujas con ojo de resorte
tutti gli aghi con cruna aperta

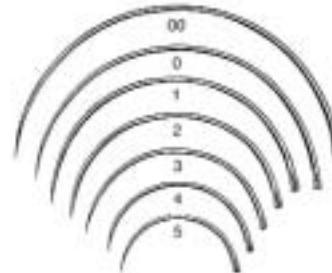

CG-645-20 - CG-647-05 **Pb**

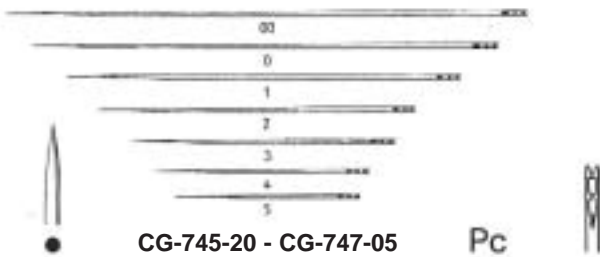

CG-745-20 - CG-747-05 **Pc**

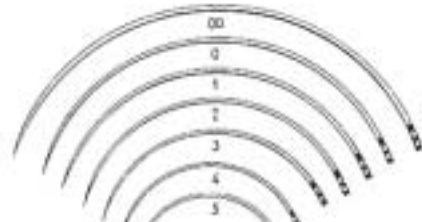

CG-845-20 - CG-847-05 **Pd**

Fig.	000	00	0	1	2	3	4	5	6	7	8	9	10	11	12
KOENIG				CG-441-01	CG-441-02	CG-441-03	CG-441-04	CG-441-05	CG-441-06	CG-441-07	CG-441-08	CG-441-09	CG-441-10	CG-441-11	CG-441-12
E	CG-443-30	CG-443-20	CG-443-10	CG-443-01	CG-443-02	CG-443-03	CG-443-04	CG-443-05							
KEITH				CG-540-01	CG-540-02	CG-540-03	CG-540-04	CG-540-05	CG-540-06						
KEITH				CG-542-01	CG-542-02	CG-542-03	CG-542-04	CG-542-05	CG-542-06						
Pb		CG-645-20	CG-645-10	CG-647-01	CG-647-02	CG-647-03	CG-647-04	CG-647-05	CG-647-06	CG-647-07	CG-647-08				
Pc		CG-745-20	CG-745-10	CG-747-01	CG-747-02	CG-747-03	CG-747-04	CG-747-05							
Pd		CG-845-20	CG-845-10	CG-847-01	CG-847-02	CG-847-03	CG-847-04	CG-847-05							



MICHEL
CG-160-12
12 cm



WACHENFELDT
CG-162-12
12,5 cm



WACHENFELDT
CG-164-12
12,5 cm



HEGENBARTH
CG-166-12
12,5 cm



CHILDE
CG-260-18
18 cm



MICHEL
CG-360-12
12 cm



MICHEL
CG-361-13
13 cm



COLLIN
CG-460-13
13 cm



RICHTER-HEATH
CG-462-14
14 cm



MICHEL

	mm
CG-660-07	7,5 x 1,75
CG-660-11	11 x 2
CG-660-12	12 x 3
CG-660-14	14 x 3
CG-660-16	16 x 3
CG-660-18	18 x 3
CG-660-20	20 x 3
CG-660-22	22 x 3

CG

Taschen-, Nahtbesteck
Pocket, Suturing Kits
Trousses à poche et à suture
Estuche de bolsillo y de sutura
Astucci tascabili e per sutura



Mini
CG-760-00
130 x 45 x 18 mm



Standard
CG-860-00
165 x 90 x 28 mm

Sterilisierhilfen
Sterilizing Aids
Instrumente pour Sterilisation
Auxilios para la esterilización
Utensili per las sterilizzazione



CI

Sterilisationsinstrumente
 Sterilization Instruments
 Instruments à stérilisation
 Instrumentos para esterilización
 Strumenti per la sterilizzazione

Sterilisationsinstrumente
 Sterilization Instruments
 Instruments à stérilisation
 Instrumentos para la esterilización
 Strumenti per la sterilizzazione



cm	DAVIS
16	CI-012-16
20	CI-012-20
24	CI-012-24



CHEATLE
 CI-110-27
 27 cm



Universal		
CI-210-20	20 cm	CI-211-20
CI-210-28	28 cm	CI-211-28



ROGGE
 CI-310-23
 23 cm



cm	
20	CI-410-20
30	CI-410-30



BUNT
 CI-510-12
 12 cm



MAYO
 CI-512-14
 14 cm



SAUERBRUCH
CI-610-55
55 cm



CM-Instrumente
CI-710-58
58 cm



- CI-135-13** 215x 60x13 mm
- CI-135-15** 215x 65x15 mm
- CI-135-20** 215x 95x20 mm
- CI-135-25** 215x 95x25 mm
- CI-135-28** 215x100x28 mm

CI-135-00
 Satz mit 5 Bürsten CI-135-13 - CI-135-28
 set of 5 brushes CI-135-13 - CI-135-28
 jeu de 5 brosses CI-135-13 - CI-135-28
 juego de 5 cepillos CI-135-13 - CI-135-28
 set a 5 spazzole CI-135-13 - CI-135-28



- CI-138-12** 275x65x12mm
- CI-138-15** 275x80x15mm
- CI-138-30** 300x120x30mm
- CI-138-50** 320x130x50mm
- CI-234-35** 360x140x35mm
- CI-236-40** 420x180x40mm
- CI-237-60** 500x180x60mm



CI-333-80
490x180x80 mm



CI-335-60
450x180x60 mm



CI-430-75
420x130x75 mm



CI-531-50
330x130x50 mm

konisch
conical
conical
conique
cónico
conico

konisch
conical
conical
conique
cónico
conico

konisch
conical
conical
conique
cónico
conico

konisch
conical
conical
conique
cónico
conico



CI-536-15
400x190x8/20 mm



CI-539-18
300x110x18/33 mm



CI-631-15
320x70x15/25 mm



CI-635-08
420x60x8/15 mm



CI-637-15
1000x180x16 mm



CI-730-95
210x95 mm

DA

**Gipsverband
Plaster of Paris
Bandages plâtrés
Vendajes enyesados
Bendaggi gessati**



DA

DA

Gipsverband
Plaster of Paris
Appareils plâtrés
Vendajes enyesados
Bendaggi gessati

Gipsscheren
Plaster Shears
Ciseaux pour plâtre
Cizallas para yeso
Forbici per gesso



STILLE
DA-011-24
24 cm



cm	STILLE
18,0	DA-013-18
20,0	DA-013-20
23,0	DA-013-23
26,0	DA-013-26
37,0	DA-013-37



SEUTIN
DA-014-23
23 cm



WIGMORE
DA-210-19
19 cm

Gipssägen
Plaster Saws
Scies pour plâtre
Sierra para yeso
Seghe per gesso



ENGEL
DA-310-14



BERGMANN
DA-314-18

Gipsspreizer
Plaster Spreaders
Pince pour plâtre
Separadores para yeso
Pinze per gesso



HENNIG
DA-530-28
28 cm



HERMANN
DA-530-48
48 cm



QUATTRO
DA-532-23
23 cm



BEESON
DA-630-30
30 cm



HAGLUND-STILLE
DA-632-28
28 cm



DA-636-23
23 cm

Gipsmesser
Plaster Knives
Couteaux pour plâtre
Cuchillos para yeso
Coltelli per gesso



HOPKINS
DA-730-20
20 cm



ESMARCH
DA-830-18
18 cm



REINER
DA-930-19
18 cm



DA-930-21
21 cm

Gipsabreißzangen
Plaster Breakers
Pince pour rompre plâtre
Pinzas para romper yeso
Pinze per rompere gesso



WOLFF
DA-935-18
18 cm



WOLFF
DA-937-24
24 cm

Oszillierende Gipssäge
Oscillating Plaster Saw
Scie oscillante
Sierra oscilante
Sega oscillante

DA



DA-120-21
110 Volt

DA-120-22
230 Volt

komplett mit 2 Sägeblättern und 2 Schraubenschlüsseln
complete with 2 saw blades and 2 wrenches
complet avec 2 lames de scie et clé à écrou
completo con 2 hojas de sierra y 2 llaves de tuercas
completa con lame e 2 chiavi



DA-122-02

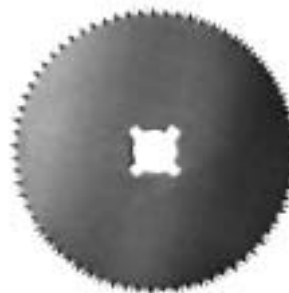

		Typ
50 mm Ø	DA-120-50	normal
65 mm Ø	DA-120-65	normal

DA

Oszillierende Gipssäge
Oscillating Plaster Saw
Scie oscillante
Sierra oscilante
Sega oscillante

Stufenlos regelbar
Fully adjustable
Réglable sans arrêt
Regulare con progresión
Regolabile con processione continua



DA-020-10
110 Volt

DA-020-20
230 Volt

komplett mit 2 Sägeblättern DA-120-50, DA-120-65 und 2 Schraubenschlüsseln DA-120-02
complete with 2 saw blades DA-120-50, DA-120-65 and 2 wrenches DA-120-02
complet avec 2 lames de scie DA-120-50, DA-120-65 et clé à écrou DA-120-02
completo con 2 hojas de sierra DA-120-50, DA-120-65 y 2 llaves de tuercas DA-120-02
completa con 2 lame DA-120-50, DA-120-65 e 2 chiavi DA-120-02



DA-120-02

Kreissägeblätter
Circular saw blades
Lames de scie circulaires
Hojas de sierra circular
Lame circolari per fasciature

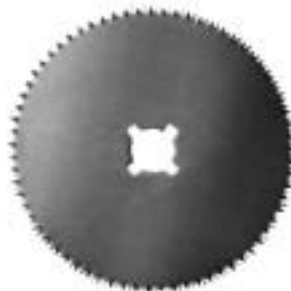

		Typ
45 mm Ø	DA-120-45	normal
50 mm Ø	DA-120-50	normal
65 mm Ø	DA-120-65	normal
45 mm Ø	DA-121-45	hart
50 mm Ø	DA-121-50	hart
65 mm Ø	DA-121-65	hart
45 mm Ø	DA-122-45	Teflon
50 mm Ø	DA-122-50	Teflon
65 mm Ø	DA-122-65	Teflon

**Orthopädie, Osteosynthese
Bone Surgery, Osteosynthesis
Chirurgie osseuse, Ostéosynthèse
Cirugía òsea, Osteosíntesis
Chirurgia ossea, Osteosintesi**





FRIEDMAN Mini
DC-011-12
12 cm



FRIEDMAN
DC-011-14
14 cm



CLEVELAND
DC-015-17
17 cm Fig. 4 A



MEAD
DC-017-16
16 cm Fig. 1 A



FRIEDMAN
DC-012-14
14 cm



CLEVELAND
DC-013-14
14 cm Fig. 4

FRIEDMAN
DC-012-15
15 cm



MEAD
DC-019-16
16,5 cm



BLUMENTHAL
DC-115-15
15,5 cm



BLUMENTHAL
DC-117-15
15,5 cm



BLUMENTHAL
DC-119-15
15,5 cm



LUER
DC-311-15
 15 cm



LUER
DC-313-15
 15 cm



LUER
DC-316-17 17 cm **DC-317-17**



ADSON
DC-412-20 20 cm **DC-413-20**



OLIVECRONA
DC-417-20
 20 cm



LEMPERT
DC-510-16 16 cm **DC-511-16**



LEMPERT
DC-514-18 18,5 cm **DC-515-18**

DC

Hohlmeißelzangen
Bone Rongeurs
Pincès-gouges
Pinzas-gubias
Pinze sgorbie



BEYER
DC-021-18
18 cm



ZAUFAL-JANSEN
DC-025-18
18 cm



BÖHLER
DC-120-15 15 cm/2 mm **DC-121-15**
DC-122-15 15 cm/3 mm **DC-123-15**



RUSKIN
DC-126-18 18 cm **DC-127-18**



RUSKIN
DC-128-23 23 cm **DC-129-23**



STILLE-LUER
22 cm **DC-321-22**
DC-320-26 26 cm **DC-321-26**



STILLE-LUER
DC-325-23
23 cm



STILLE-RUSKIN
DC-327-23
 23 cm

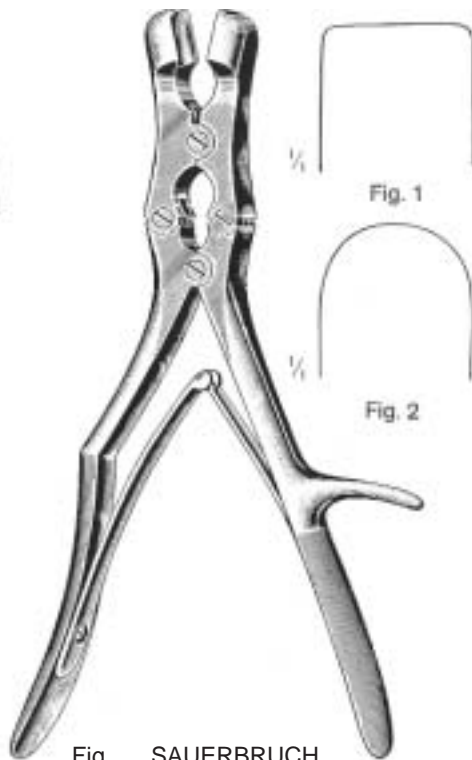

Fig. SAUERBRUCH
 1 **DC-421-30**
 2 **DC-423-30**
 30 cm



Fig. LEKSELL (STILLE)
 1 **DC-425-23** 8 mm
 2 **DC-427-23** 4 mm
 23 cm



R SCAGLIETTI L
DC-521-26 26 cm **DC-523-26**
 à droite à gauche
 derecha izquierda
 a destra a sinistra



FRYKHOLM
DC-525-24
 24 cm



mm ECHLIN
 2 **DC-529-02**
 3 **DC-529-03**
 4 **DC-529-23**
 23 cm

DC

Knochensplitterzangen
Bone Cutting Forceps
Pincès coupantes à os
Pinzas cortantes para huesos
Cesoie per ossa



cm	SEMB
22,5	DC-621-22
27,0	DC-621-27



— LISTON —

DC-724-14	14 cm	DC-725-14
DC-724-17	17 cm	DC-725-17
DC-724-19	19 cm	DC-725-19
DC-724-22	22 cm	DC-725-22



— BÖHLER —

DC-820-15	15 cm	DC-821-15
-----------	-------	-----------



COTTLE-KAZANJIAN
DC-822-19
19 cm



— RUSKIN-LISTON —

DC-826-18	18,5 cm	DC-829-18
-----------	---------	-----------



— STILLE-LISTON —

DC-920-27	27 cm	DC-921-27
-----------	-------	-----------

Knochensplitterzangen
 Bone Cutting Forceps
 Pinces coupantes à os
 Pinzas cortantes para huesos
 Cesioie per ossa

DC



STILLE-HORSLEY
DC-923-27
 27 cm



SEMB
DC-925-24
 24 cm

Knochenhalte-
 zangen
 Bone Holding
 Forceps
 Daviers porte-
 os
 Pinzas para
 huesos
 Tenaglie per
 ossa



FERGUSON
DC-630-21
 21 cm



LANGENBECK
DC-632-21
 21 cm



SEMB
DC-635-19
 19 cm



cm	FARABEUF
23	DC-636-23
26	DC-636-26

DC

Knochenhalte­zangen
 Bone Holding Forceps
 Daviers porte os
 Pinzas para huesos
 Tenaglie per ossa



FARABEUF-LAMBOTTE
DC-638-26
 26 cm



cm	LAMBOTTE
22	DC-730-22
27	DC-730-27
30	DC-730-30



cm	LAMBOTTE
22	DC-732-22
26	DC-732-26
33	DC-732-33



cm	LAMBOTTE
19	DC-733-19
23	DC-733-23
26	DC-733-26



cm	KERN
15	DC-738-15
17	DC-738-17
21	DC-738-21



cm	KERN
15	DC-830-15
17	DC-830-17
21	DC-830-21



cm	LANE
33	DC-832-33
45	DC-832-45



cm	LANE
33	DC-834-33
45	DC-834-45





DC-931-15 - DC-931-28

Selbstzentrierend
 self-centering
 autocentrant
 autocentrantes
 autocentranti



DC-931-15
 15 cm



DC-931-19
 19 cm



DC-931-24
 24 cm



DC-931-26
 26 cm



DC-931-28
 28 cm



VERBRUGGE
DC-935-17 - DC-935-27



DC-935-17
 17,5 cm

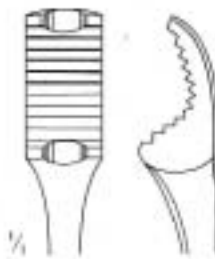

DC-935-25
 25 cm

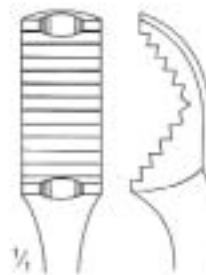

DC-935-26
 26 cm

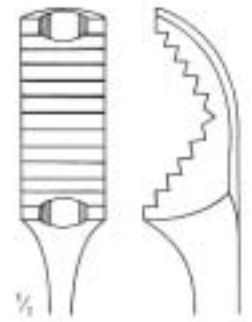

DC-935-27
 27 cm

DC

Knochenhalte-, Sequesterzangen
Bone Holding, Sequester Forceps
Pinces à os, à séquestres
Pinzas para huesos y secuestros
Pinze per ossa e sequestri



LEWIN
DC-042-17
17,5 cm

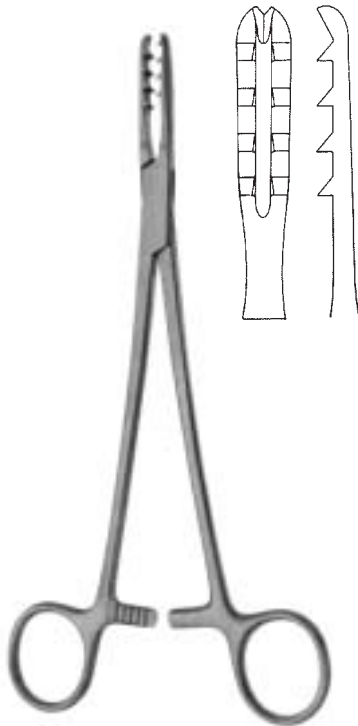

BIRCHER-GANSKE
DC-044-20 20 cm DC-045-20



DINGMANN
DC-047-19
19 cm



DC-049-13
13,5 cm



MARTIN
DC-140-19
19 cm

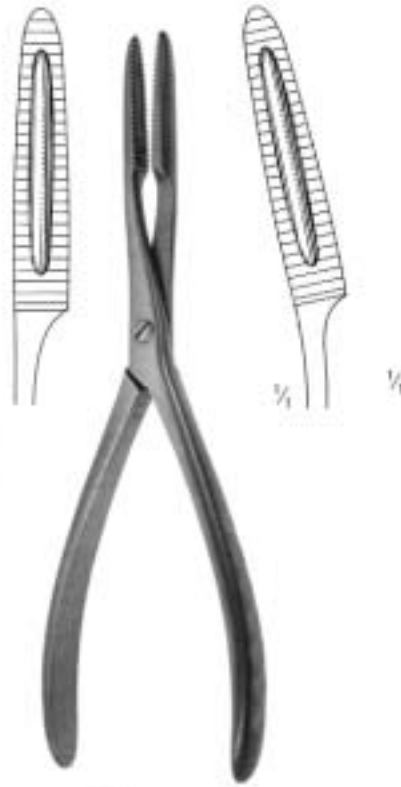

DC-240-20 20 cm DC-241-20



VAN BUREN
DC-243-23
23 cm



cm	LOWMAN
13	DC-441-13
18,5	DC-441-18
20	DC-441-20

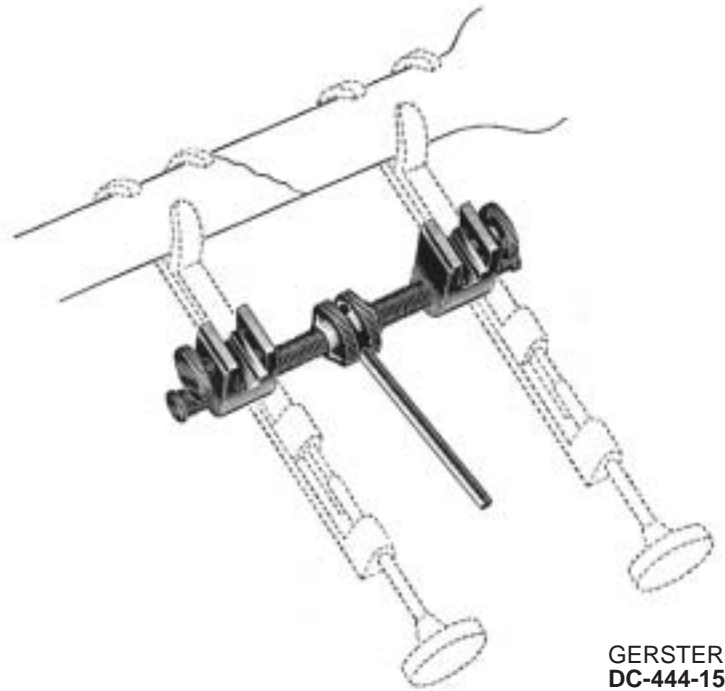

GERSTER
 DC-444-15



PARHAM
 DC-446-24



cm	PARHAM
18	DC-448-18
30	DC-448-30

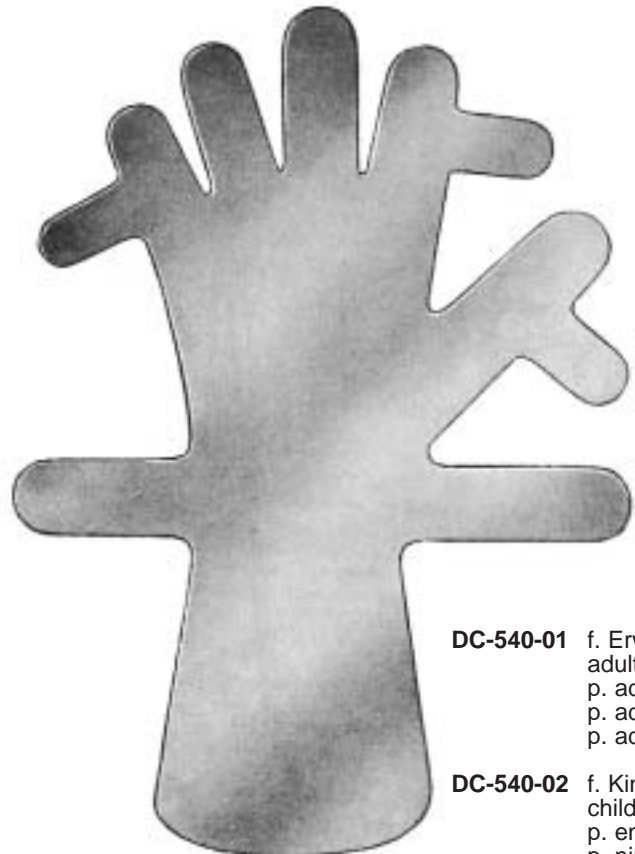

DC-540-01 f. Erwachsene
 adult size
 p. adultes
 p. adultos
 p. adulti

DC-540-02 f. Kinder
 child size
 p. enfants
 p. niños
 p. bambini

DC

Scharfe Löffel
 Bone Currettes
 Curettes à os
 Cucharillas cortantes
 Curette taglienti



SCHÉDE
 DC-647-97 - DC-648-04

SCHÉDE	Fig.	VOLKMANN
	0000	DC-649-96
DC-647-97	000	DC-649-97
DC-647-98	00	DC-649-98
DC-648-00	0	DC-740-00
DC-648-01	1	DC-740-01
DC-648-02	2	DC-740-02
DC-648-03	3	DC-740-03
DC-648-04	4	DC-740-04
	5	DC-740-05
	6	DC-740-06



VOLKMANN
 DC-649-96 - DC-740-06



BRUNS
 DC-741-96 - DC-742-06

BRUNS	Fig.	SPRATT
DC-741-96	0000	DC-744-96
DC-741-97	000	DC-744-97
DC-741-98	00	DC-744-98
DC-742-00	0	DC-745-00
DC-742-01	1	DC-745-01
DC-742-02	2	DC-745-02
DC-742-03	3	DC-745-03
DC-742-04	4	DC-745-04
DC-742-05	5	DC-745-05
DC-742-06	6	



SPRATT
 DC-744-97 - DC-745-05



Fig.	HALLE 23 cm	SIMON 24 cm
000	DC-840-97	
00	DC-840-98	
0	DC-841-00	
1	DC-841-01	DC-845-01
2	DC-841-02	DC-845-02
3	DC-841-03	DC-845-03
4	DC-841-04	DC-845-04
5	DC-841-05	DC-845-05
6	DC-841-06	DC-845-06

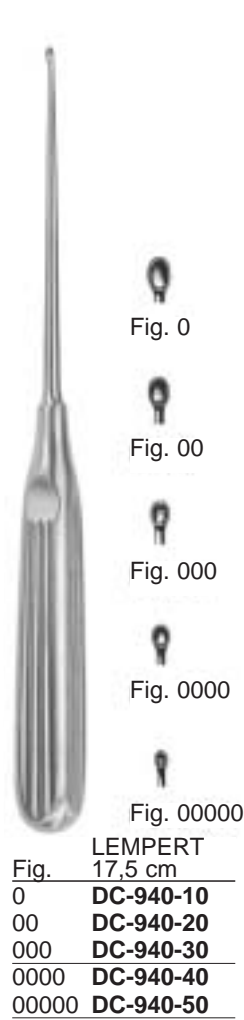

Fig.	LEMPERT 17,5 cm
0	DC-940-10
00	DC-940-20
000	DC-940-30
0000	DC-940-40
00000	DC-940-50

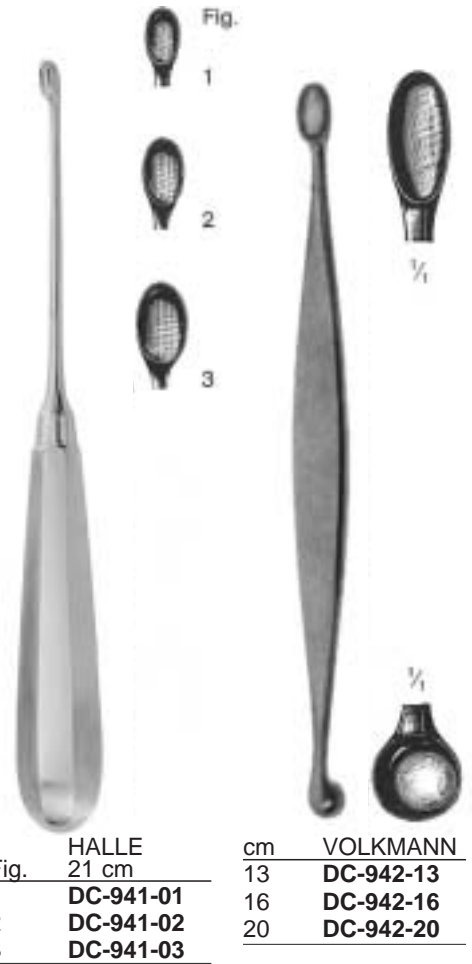

Fig.	HALLE 21 cm	cm	VOLKMANN
1	DC-941-01	13	DC-942-13
2	DC-941-02	16	DC-942-16
3	DC-941-03	20	DC-942-20



cm	VOLKMANN
13	DC-944-13
14	DC-944-14
17	DC-944-17

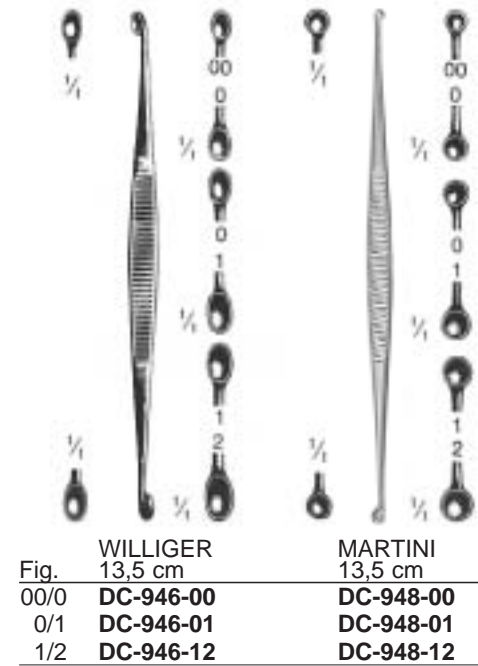

Fig.	WILLIGER 13,5 cm	MARTINI 13,5 cm
00/0	DC-946-00	DC-948-00
0/1	DC-946-01	DC-948-01
1/2	DC-946-12	DC-948-12

DC

Knochenmeißel
 Bone Chisels and Gouges
 Ciseaux-burins, gouges
 Cinceles, gubias
 Scalpelli, sgorbie



mm	13,5 cm	13,5 cm	13,5 cm	ALEXANDER 17 cm	ALEXANDER 17 cm
4	DC-062-04	DC-064-04	DC-065-04	DC-160-04	DC-161-04
6		DC-064-06		DC-160-06	DC-161-06
8	DC-062-08	DC-064-08	DC-065-08	DC-160-08	DC-161-08
10	DC-062-10	DC-064-10	DC-065-10	DC-160-10	DC-161-10
12	DC-062-12	DC-064-12	DC-065-12	DC-160-12	DC-161-12
14	DC-062-14	DC-064-14	DC-065-14	DC-160-14	DC-161-14
16	DC-062-16	DC-064-16	DC-065-16	DC-160-16	DC-161-16



mm	PARTSCH		PARTSCH	
	13,5 cm	17 cm	13,5 cm	17 cm
2	DC-260-02	DC-262-02	DC-263-02	DC-265-02
3	DC-260-03	DC-262-03	DC-263-03	DC-265-03
4	DC-260-04	DC-262-04	DC-263-04	DC-265-04
5	DC-260-05	DC-262-05	DC-263-05	DC-265-05
6	DC-260-06	DC-262-06	DC-263-06	DC-265-06
7	DC-260-07	DC-262-07	DC-263-07	DC-265-07
8	DC-260-08	DC-262-08	DC-263-08	DC-265-08

mm	STILLE		
	13,5 cm	17 cm	13,5 cm
10	DC-360-10	DC-362-10	DC-363-10
15	DC-360-15	DC-362-15	DC-363-15
20	DC-360-20	DC-362-20	DC-363-20
25	DC-360-25	DC-362-25	DC-363-25

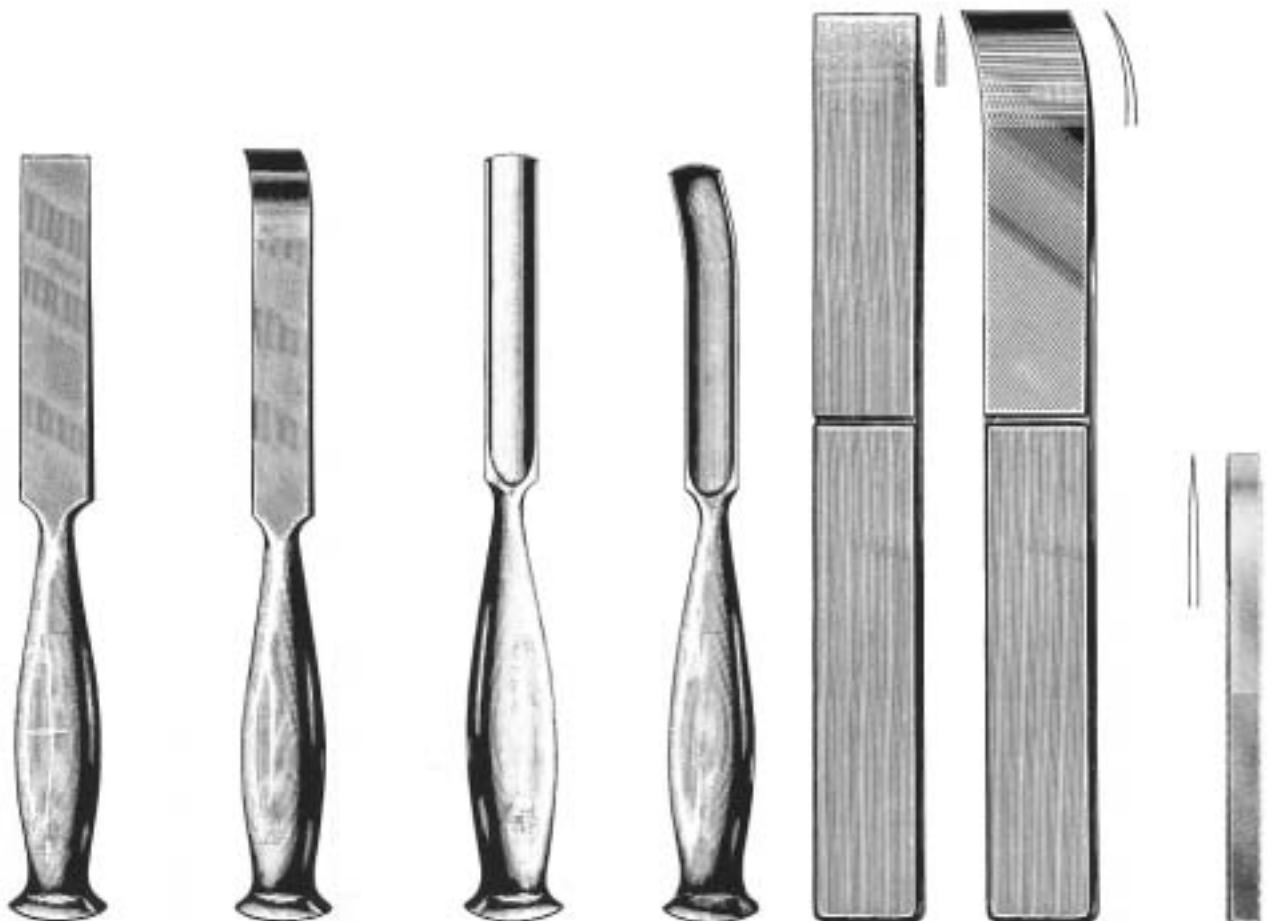

SMITH-PETERSEN					LAMBOTTE		LAMBOTTE mini		
mm					mm				
6	DC-364-06	DC-365-06	DC-367-06	DC-369-06	6,5	DC-560-06	DC-561-06	3	DC-564-03
9	DC-364-09	DC-365-09	DC-367-09	DC-369-09	15,0	DC-560-15	DC-561-15	4	DC-564-04
13	DC-364-13	DC-365-13	DC-367-13	DC-369-13	20,0	DC-560-20	DC-561-20	6	DC-564-06
16	DC-364-16	DC-365-16	DC-367-16	DC-369-16	25,0	DC-560-25	DC-561-25	8	DC-564-08
19	DC-364-19	DC-365-19	DC-367-19	DC-369-19	30,0	DC-560-30	DC-561-30	10	DC-564-10
25	DC-364-25	DC-365-25	DC-367-25	DC-369-25	38,0	DC-560-38	DC-561-38	12	DC-564-12
32	DC-364-32	DC-365-32	DC-367-32	DC-369-32	44,0	DC-560-44	DC-561-44	15	DC-564-15
	20 cm	20 cm	20 cm	20 cm		24 cm	23 cm		12,5 cm

DC

Knochenmeißel
 Bone Chisels and Gouges
 Ciseaux-burins, gouges
 Cinceles, gubias
 Scalpelli, sgorbie



mm	LEXER	LEXER
7	DC-660-07	DC-661-07
10	DC-660-10	DC-661-10
15	DC-660-15	DC-661-15
20	DC-660-20	DC-661-20
25	DC-660-25	DC-661-25
30	DC-660-30	DC-661-30
	22 cm	22 cm



mm	LEXER mini	LEXER mini
4	DC-664-04	DC-665-04
6	DC-664-06	DC-665-06
8	DC-664-08	DC-665-08
10	DC-664-10	DC-665-10
12	DC-664-12	DC-665-12



mm	HOKE
3	DC-668-03
5	DC-668-05
6	DC-668-06
8	DC-668-08
9	DC-668-09
	17 cm

mm	HIBBS					
6	DC-760-06	DC-762-06	DC-761-06	DC-763-06	DC-765-06	
13	DC-760-13	DC-762-13	DC-761-13	DC-763-13	DC-765-13	
19	DC-760-19	DC-762-19	DC-761-19	DC-763-19	DC-765-19	
25	DC-760-25	DC-762-25	DC-761-25	DC-763-25	DC-765-25	
32	DC-760-32	DC-762-32	DC-761-32	DC-763-32	DC-765-32	
	24 cm	24 cm	24 cm	24 cm	24 cm	



LEBSCHKE
DC-768-24
24,5 cm



DC-769-22
22 cm



VIRCHOW
DC-860-12



BURNETTI
DC-861-28
28 cm



BURNETTI
DC-863-28
28 cm

Autopsie-Bestech
Post Mortem Set
Set à autopsie
Juego de autopsia
Set per autopsia



DC-864-00



GERZOG
DC-866-25
18 cm 250 g



KIRK
DC-868-75
19 cm 750 g



g
450 DC-960-45
900 DC-960-90
26,5 cm



COLLIN
DC-962-22
20 cm 220 g



WILLIGER
DC-964-34
24 cm 340 g

DC-967-02
Paar Ersatzbacken
Pair of Spare Faces
Paire de faces de rechange
Pareja de tapas intercambiables
Coppia di teste di ricambio



LUCAE
DC-966-26
19 cm 260 g



MEAD
DC-966-32
17 cm 320 g



g
250 DC-968-25
400 DC-968-40
26 cm



QUISLING
DC-968-75



DC-969-00
23,5 cm



FARABEU
DC-072-15
 15 cm

FARABEU
DC-073-15
 15 cm

mm	LAMBOTTE
10	DC-075-10
15	DC-075-15
20	DC-075-20
25	DC-075-25

21 cm



SEDILLOT
DC-079-21
 21 cm

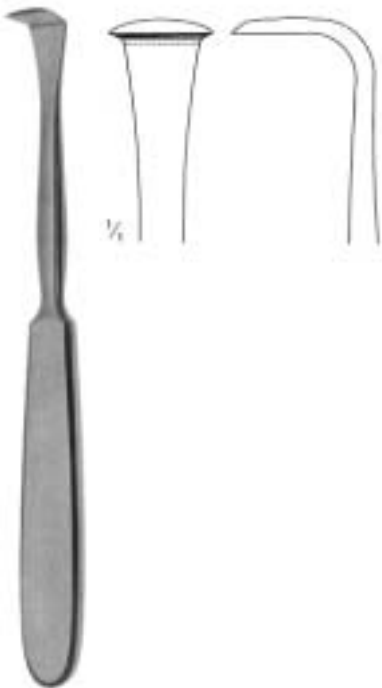

LANGENBECK
DC-171-18
 18 cm



WILLIGER
DC-173-16
 16 cm



cm	ALEXANDER
16	DC-175-16
20	DC-175-20

DC

Raspatorien
Periosteal Elevators
Rugines-raspatoires
Periostótomos
Periostotomi

Für Rippen
Rib
Pour les côtes
Para costillas
Costali



DOYEN DOYEN
DC-271-17 - DC-277-17
17 cm

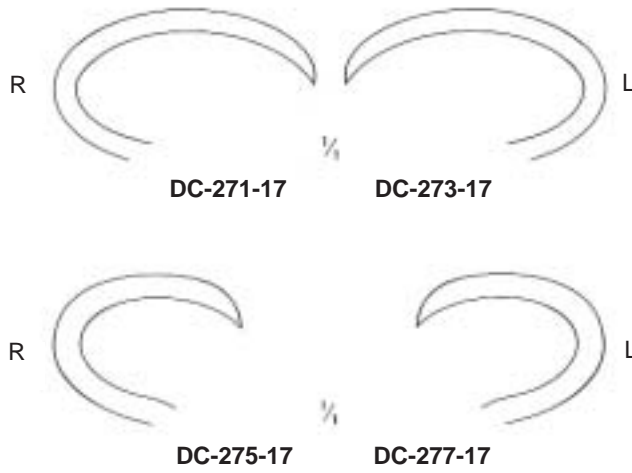

DC-279-01
17,5 cm



DC-279-02
21 cm



DC-279-03
17,5 cm



DC-279-04
21 cm



DC-279-05
20,5 cm



DC-279-06
20,5 cm



DC-279-07
22,5 cm



SEMB
DC-279-01 -
DC-297-07



**MATSON
DC-373-22**
22 cm



**OVERHOLT
DC-375-29**
29,5 cm



**OVERHOLT
DC-377-29**
29,5 cm



**OVERHOLT
DC-379-28**
28,5 cm



**LANGENBECK
DC-571-20**
20 cm



**LANGENBECK
DC-573-20**
20 cm



**ADSON
DC-574-17 -
DC-577-17**
17 cm



DC-574-17



DC-575-17



DC-576-17



DC-577-17



**KEY
DC-579-06 -
DC-579-25**
19 cm



mm	
6	DC-579-06
12	DC-579-12
19	DC-579-19
25	DC-579-25

DC

Elevatoren, Knochenheber
Elevators, Bone Levers
Elévateurs, Leviers à os
Elevadores, E, para huesos
Elevatori, Elevatori per ossa



WATSON-CHEYNE
DC-675-17
17,5 cm



McDONALD
DC-677-19
19 cm



MURPHY-LANE
DC-679-30
30 cm



BENNETT
DC-771-71
65 x 260 mm



BENNETT
DC-771-73
45 x 260 mm



HOHMANN
DC-081-08
8 mm



HOHMANN
DC-081-18
18 mm



HOHMANN
DC-081-43
43 mm



HOHMANN
DC-081-70
70 mm

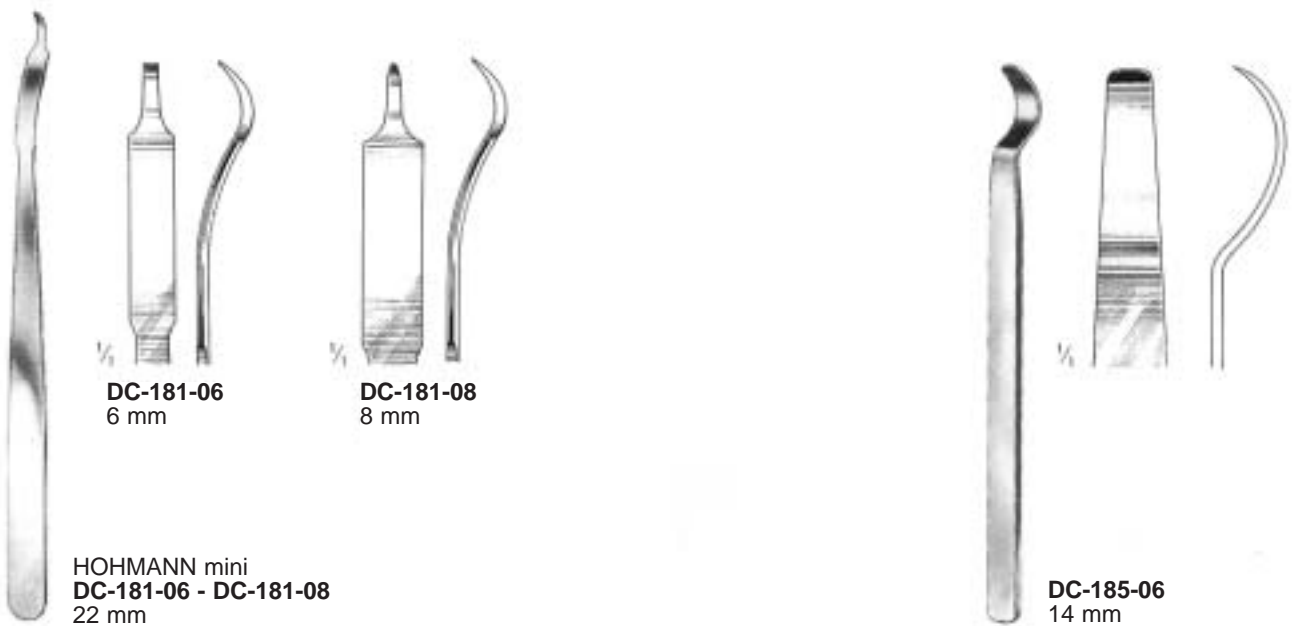
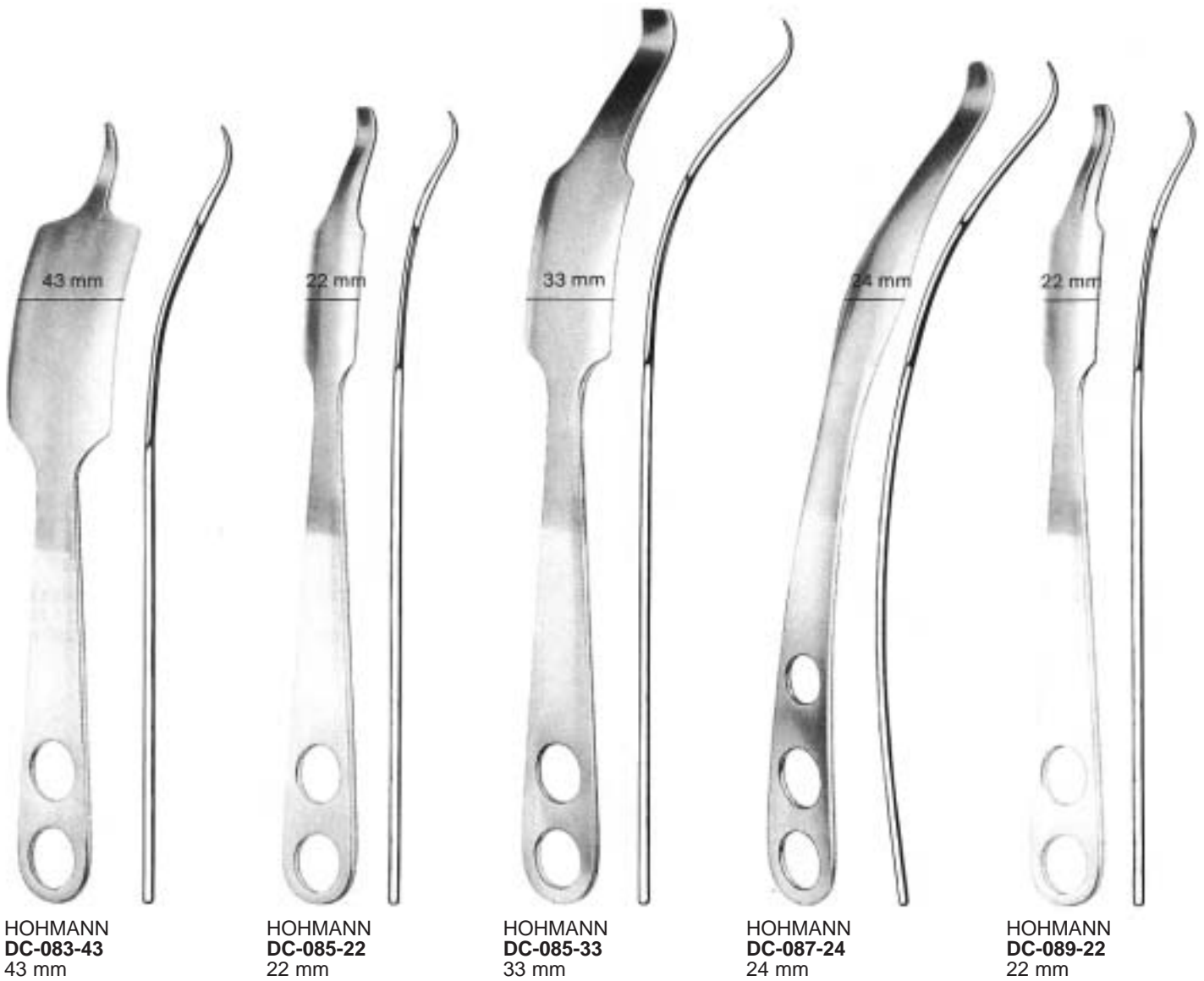

Knochenheber
 Bone Levers
 Leviers à os
 Elevadores para huesos
 Elevatori per ossa



**BLOUNT
 DC-283-26**
 26 mm



**BLOUNT
 DC-285-26**
 26 mm

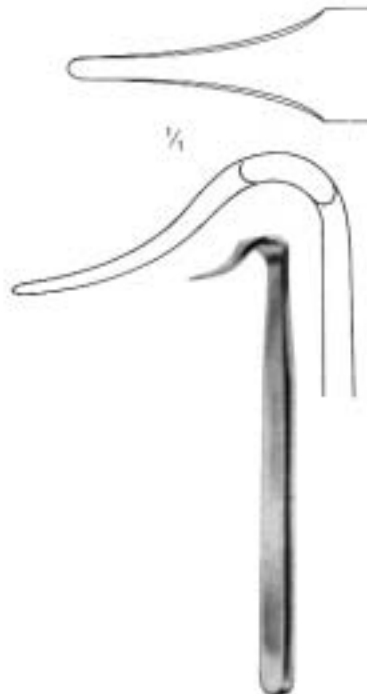

**BLOUNT
 DC-287-17**
 17,5 mm



mm x mm	TAYLOR
75 x 30	DC-381-16
100 x 30	DC-383-16
	16,5 cm

Meniskotome • Meniscotomes
 Meniscotomes • Meniscótomos
 Meniscotomi



**SMILLIE
 DC-190-17**
 17 mm



DC-191-17
 17 mm



DC-193-17
 17 mm



**BIRCHER
 DC-195-19**
 19 mm



**BIRCHER
 DC-197-19**
 19 mm

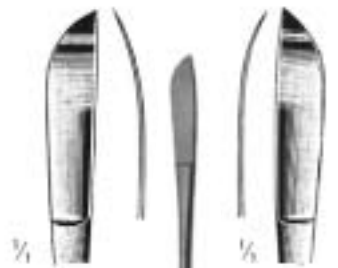

NEFF
DC-291-22 22 cm **DC-293-22**

Sehnenstripper, Knochenfeilen
Tendon Strippers, Bone Files
Instruments a écorcher les tendons, limes à os
Separadores para tendones, limas para huesos
Scollatendini, lime per ossa



- 
DC-590-01
- 
DC-590-02
- 
DC-590-03
- 
DC-590-04
- 
DC-590-05

BUNNELL
DC-590-01 - DC-590-05
15 mm



DC-791-24
24,5 mm



DC-792-22
22 mm



PUTTI
DC-793-27
27 mm



PUTTI
DC-795-30
30 mm

DD

**Orthopädie, Osteosynthese
Bone Surgery, Osteosynthesis
Chirurgie osseuse, Ostéosynthèse
Cirugía òsea, Osteosíntesis
Chirurgia ossea, Osteosintesi**



DD

DD

Komprimeter
Comprimeter
Comprimètre
Torniquete
Apparecchio per vuoto di sangue

Komprimeter zur Erzeugung von Blutleere in den Gliedern
Compression Apparatus for producing blood vacuum in limbs
Appareil compressif permettant d'obtenir un milieu exsangue des membres
Aparato de compresión para producir el vacío de sangre en los miembros
Vacumetro per determinare vuoti di sangue nelle membra



DD-011-01
compl.

Amputation, Finger
 Amputation, Fingers
 Amputation, doigts
 Amputación, dedos
 Amputazione, dita

DD

mm
 12 **DD-112-12**
 15 **DD-112-15**
 18 **DD-112-18**



PERCY
DD-110-00



CHARRIERE
DD-112-00

DD-116-99



CHARRIERE
DD-116-30
 30 cm

DD-118-99



SATTERLEE
DD-118-31
 31 cm



LANGENBECK
DD-210-23
 23 cm



DD-610-01



DD-610-00
 Compl. incl.
DD-610-01

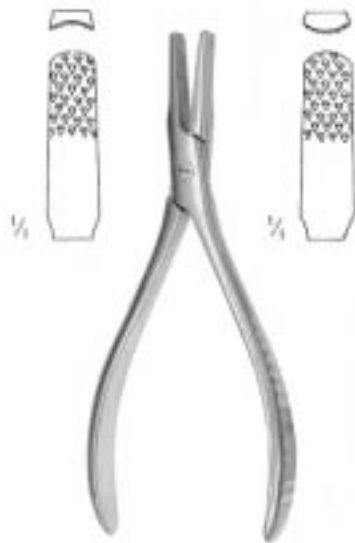

RADOLF
DD-612-13
 13,5 cm

DD-713-01



DD-713-00
 17 cm

DD-715-01









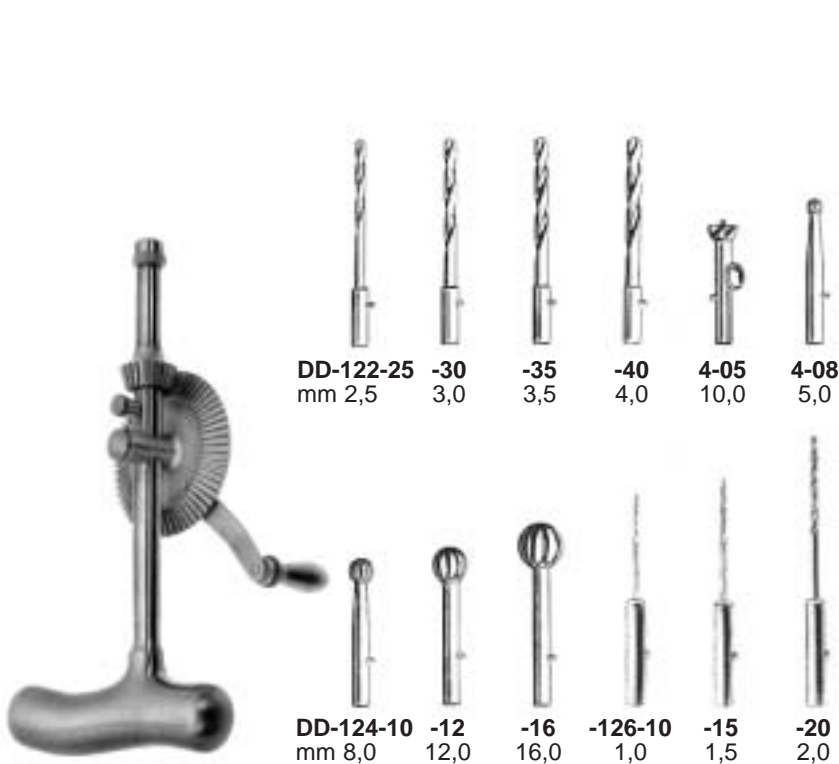





DD-715-00

DD

Handbohrapparate
 Bone Hand Drills
 Perforateurs à main
 Perforadores a mano
 Perforatori a mano





- 
DD-122-25
 mm 2,5
- 
-30
 3,0
- 
-35
 3,5
- 
-40
 4,0
- 
4-05
 10,0
- 
4-08
 5,0

- 
DD-124-10
 mm 8,0
- 
-12
 12,0
- 
-16
 16,0
- 
-126-10
 1,0
- 
-15
 1,5
- 
-20
 2,0

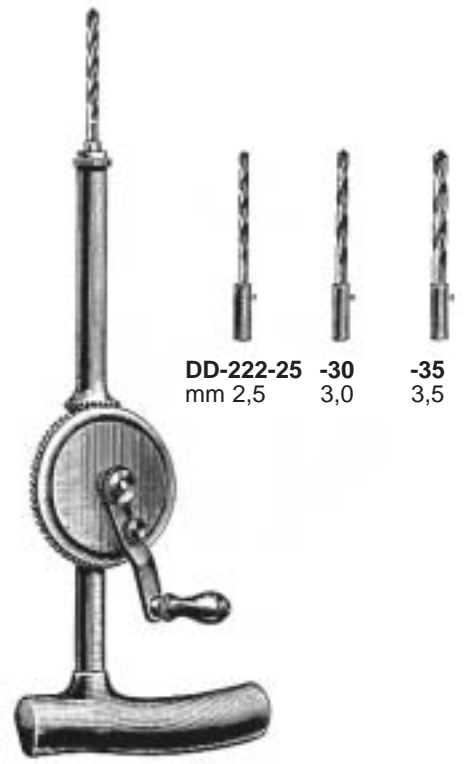
STILLE
DD-120-20
 Compl. 20 cm



- 
DD-222-25
 mm 2,5
- 
-30
 3,0
- 
-35
 3,5

STILLE-SHERMAN
DD-220-24
 Compl. 24 cm

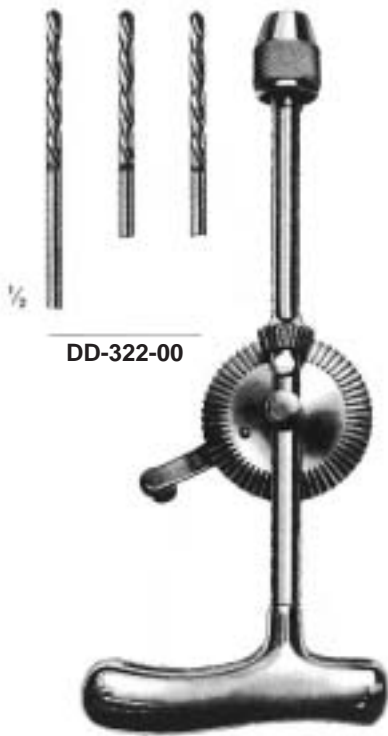

DD-322-00

MOORE
DD-320-28
 Compl. 28 cm



- 
DD-422-09
 9 mm
- 
DD-422-14
 14 mm
- 
DD-422-16
 16 mm
- 
DD-422-22
 22 mm



CUSHING
DD-424-14



DD-426-00



McKINZIE
DD-428-00

HUDSON
DD-420-27
 Compl. incl. **DD-422-09, -14, -16, -22, DD-426-00**
 27 cm



KIRSCHNER
DD-520-00
Compl.



DD-522-00



DD-620-00
Compl.



DD-622-00



BUNNELL
DD-720-00
16 cm



RALK
DD-820-00

DD

Bohrapparate
Bone Drills
Perforateurs à os
Perforadores para huesos
Perforatori per ossa



Handbohrapparat
Bone Hand Drill
Perforateur à main
Perforador a mano
Perforatore a mano

DD-920-00



DD-926-00

Bohrer, Fräser, Trephinen
 Burrs, Drills, Trephines
 Mèches, fraises, trépan
 Taladros, fresas, trefinas
 Trapani, frese, trefine

DD



mm			
1,0		DD-532-10	DD-534-10
1,2		DD-532-12	
1,5		DD-532-15	DD-534-15
1,8		DD-532-18	
2,0	DD-530-20	DD-532-20	DD-534-20
2,2		DD-532-22	
2,5	DD-530-25	DD-532-25	DD-534-25
2,8		DD-532-28	DD-534-28
3,0	DD-530-30	DD-532-30	DD-534-30
3,2	DD-530-32	DD-532-32	DD-534-32
3,5	DD-530-35	DD-532-35	DD-534-35
4,0	DD-530-40	DD-532-40	DD-534-40
5,0	DD-530-50	DD-532-50	DD-534-50
6,0	DD-530-60		DD-534-60
7,0	DD-530-70		



mm Ø	DOYEN	DOYEN	DOYEN	DOYEN	ALBEE	ALBEE	BORCHARDT	TOTI
4	DD-632-04	DD-634-04						
6	DD-632-06	DD-634-06						
7						DD-734-07		
8	DD-632-08	DD-634-08		DD-638-08	DD-732-08			DD-738-08
10	DD-632-10	DD-634-10		DD-638-10	DD-732-10			
12	DD-632-12	DD-634-12	DD-636-12		DD-730-12	DD-732-12		
13							DD-736-13	
14	DD-632-14	DD-634-14						
15				DD-730-15				
16	DD-632-16	DD-634-16						
25								DD-737-25

DD

Bohrinstrumente, Pfrieme
Boring Instruments, Awls
Instruments à percer, poinçons
Instrumental para perforar, Escariadores
Strumenti per perforazione, Lesine

Reibahlen
Reamer
Pointes-carrées
Escariadores
Punteruoli



DD-932-14
14 cm



PERTHES
DD-935-21
21 cm

lieferbar in Packungen à 10 Stück
available in packages with 10 pieces
disponibles en paquets de 10 pièces
disponible en paquets de 10 unidades
disponibili in confezioni da pezzi



Trokarspitze
Trocar tip
Pointe trocart
Punta en forma de trócar
Punte a trequarti

mm Ø	L = 60 mm	L = 120 mm	L = 140 mm	L = 160 mm	L = 310 mm
1,0	DD-046-10	DD-142-10	DD-144-10	DD-146-10	DD-341-10
1,2	DD-046-12	DD-142-12	DD-144-12	DD-146-12	DD-341-12
1,4	DD-046-14	DD-142-14	DD-144-14	DD-146-14	DD-341-14
1,5	DD-046-15	DD-142-15	DD-144-15	DD-146-15	DD-341-15
1,6	DD-046-16	DD-142-16	DD-144-16	DD-146-16	DD-341-16
1,8	DD-046-18	DD-142-18	DD-144-18	DD-146-18	DD-341-18
2,0	DD-046-20	DD-142-20	DD-144-20	DD-146-20	DD-341-20
2,2	DD-046-22	DD-142-22	DD-144-22	DD-146-22	DD-341-22
2,5				DD-146-25	DD-341-25

KIRSCHNER
DD-046-10 - DD-341-16

lieferbar in Packungen à 10 Stück
available in packages with 10 pieces
disponibles en paquets de 10 pièces
disponible en paquets de 10 unidades
disponibili in confezioni da pezzi



Lanzenspitze
Lancet tip
Pointe lancéolaire
Punta lanceolar
Punte lanceolari

mm Ø	L = 310 mm
1,0	DD-342-10
1,2	DD-342-12
1,5	DD-342-15
1,6	DD-342-16
1,8	DD-342-18
2,0	DD-342-20
2,2	DD-342-22
2,5	DD-342-25

KIRSCHNER
DD-342-10 - DD-342-25



STEINMANN Nägel
STEINMANN Pins
STEINMANN clous à os
STEINMANN Clavos p. huesos
STEINMANN chiodi per ossa

L cm	
13	DD-940-13
14	DD-940-14
15	DD-940-15
16	DD-940-16
18	DD-940-18
20	DD-940-20
21	DD-940-21

STEINMANN
DD-940-13 - DD-940-21

DD

Exentionsbügel
Extension Bow
Etriers à exention
Estribos para extensión
Archi per estensione

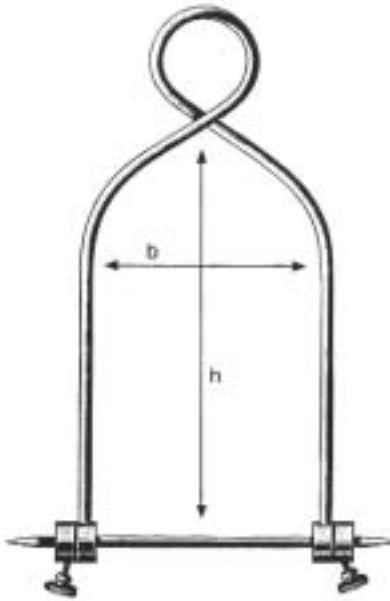

h x b cm	BOEHLER
16 x 9	DD-052-16
21 x 11	DD-052-21



h x b cm	BOEHLER
6,0 x 5,0	DD-152-06
9,5 x 7,0	DD-152-09
10,5 x 10,5	DD-152-10
9,5 x 11,0	DD-152-11
12,0 x 12,0	DD-152-12
13,5 x 13,0	DD-152-13
15,5 x 15,5	DD-152-15
20,0 x 15,5	DD-152-20



h x b cm	
18 x 10	DD-154-18
27 x 16	DD-154-27



DD-155-01



DD-155-02



KIRSCHNER U.S.
DD-158-01
klein • small • petit
pequeño • piccolo

DD-158-02
groß • large size
grand • grande

DD-158-03
extra groß • extra large size
extra grand • extra grande



DD-159-01



DD-159-02



10 m

weich
 soft
 souple
 blando
 morbido

mm Ø

0,2	DD-350-02
0,3	DD-350-03
0,4	DD-350-04
0,5	DD-350-05
0,6	DD-350-06
0,7	DD-350-07
0,8	DD-350-08
0,9	DD-350-09
1,0	DD-350-10
1,1	DD-350-11
1,2	DD-350-12
1,5	DD-350-15



LOUTE
DD-351-21
 21 cm



DD-352-17
 17 cm

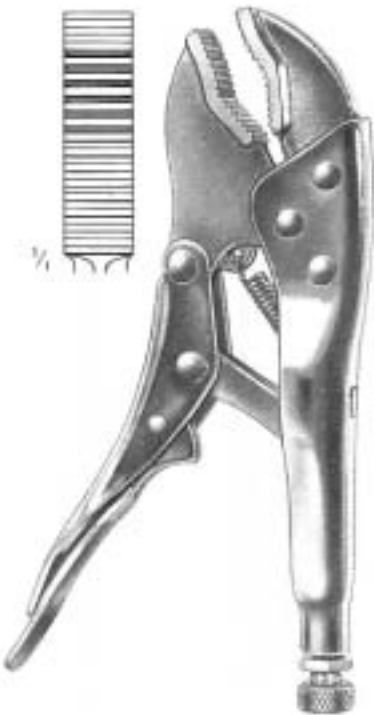

Grip
DD-353-18
 18 cm



DD-354-15
 15 cm



DD-356-14
 14 cm

DD

Knochenchirurgie
Bone Surgery
Chirurgie osseuse
Ciurgia ósea
Chirurgia ossea

Mit TC-Einsätzen
TC-Lined
A mors TC
Con bocas TC
Con morso TC



DD-450-16
16 cm



DD-452-15
15 cm



DD-455-22
22 cm



mm Ø	
2,4	DD-650-24
3,2	DD-650-32
4,8	DD-650-48
6,4	DD-650-64



	DD-652-24	DD-652-32	DD-652-48	DD-652-64
f./p. Ø	2,4 mm	3,2 mm	4,8 mm	6,4 mm



KUENTSCHER
DD-751-26
 26 cm



**DD-851-35 -
 DD-855-60**

mm Ø	L = 35 cm	L = 46 cm	L = 60 cm
2,5	DD-851-35	DD-851-46	
3,0	DD-852-35	DD-852-46	
3,5	DD-853-35	DD-853-46	DD-853-60
4,0	DD-854-35	DD-854-46	DD-854-60
5,0	DD-855-35	DD-855-46	DD-855-60



KUENTSCHER
DD-856-21
 21 cm



KUENTSCHER
DD-858-21
 21 cm

KUENTSCHER
DD-753-35
 35 cm



$\frac{1}{8}$
DD-950-01



$\frac{1}{8}$
DD-950-02



$\frac{1}{8}$
DD-950-03



DD-950-04



KUENTSCHER
DD-950-00
 63 cm



cm	
29	DD-956-29
37	DD-956-37
42	DD-956-42
49	DD-956-49



DD-958-30

DD

Instrumente zur Osteosynthese
Osteosynthesis Instruments
Instruments pour ostéosynthèse
Instrumentos para osteosíntesis
Strumenti per osteosintesi



LLOYD
DD-062-20
20 cm



LANE
DD-260-25
25 cm



WILLIAMS
DD-264-24
24 cm



mm
2,5
3,5

DD-268-25
DD-268-35



LANE
DD-362-25
25 cm



LANE
DD-365-18
18 cm



LANE
DD-367-23
23 cm

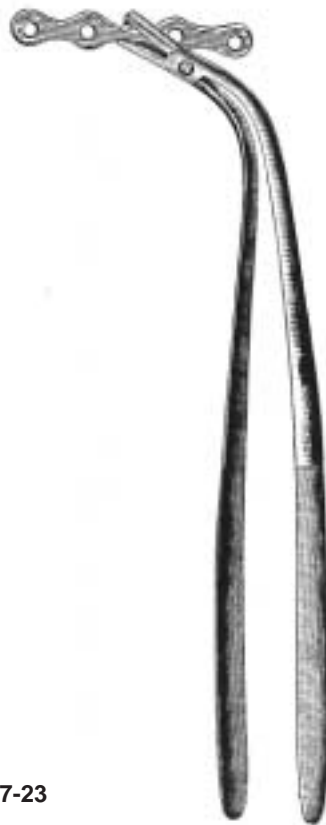

LANE
DD-369-22
22 cm



LANE
DD-460-18
18 cm

Instrumentarium zum Einbringen von Hohlschrauben
 Instrument Set for Cannulated Screws
 Instrumentation pour l'application des vis à perforation longitudinale
 Instrumental para la aplicación de tornillos de perforación longitudinal
 Strumentario per viti cannulate



Ø mm
 4,5 **DD-082-45**
 7,0 **DD-082-70**



DD-180-05
 5 mm

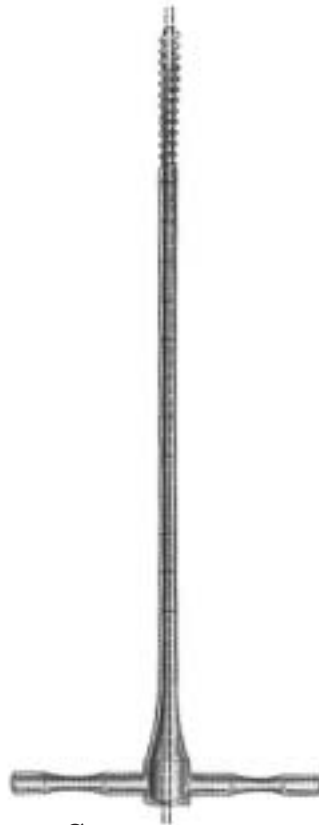

Ø mm
 4,5 **DD-182-45**
 7,0 **DD-182-70**



Ø mm
 2,5 **DD-186-25**
 3,5 **DD-186-35**
 5,0 **DD-186-50**



DD-280-00

**Osteosynthese
Osteosynthesis
Ostéosynthèse
Osteosíntesis
Osteosintesi**

**Verlangen Sie unseren Spezialkatalog für die Osteosynthese
Please ask for our special catalogue for osteosynthesis
Demandez notre catalogue spécial pour ostéosynthèse
Pidan nuestro catálogo especial para osteosíntesis
Chiedete il nostro catalogo speciale per osteosintesi**

**Neurochirurgie, Laminektomie
Neurosurgery, Laminectomy
Neurochirurgie, Laminektomie
Neurocirugía, Laminectomía
Neurochirurgia, Laminectomia**

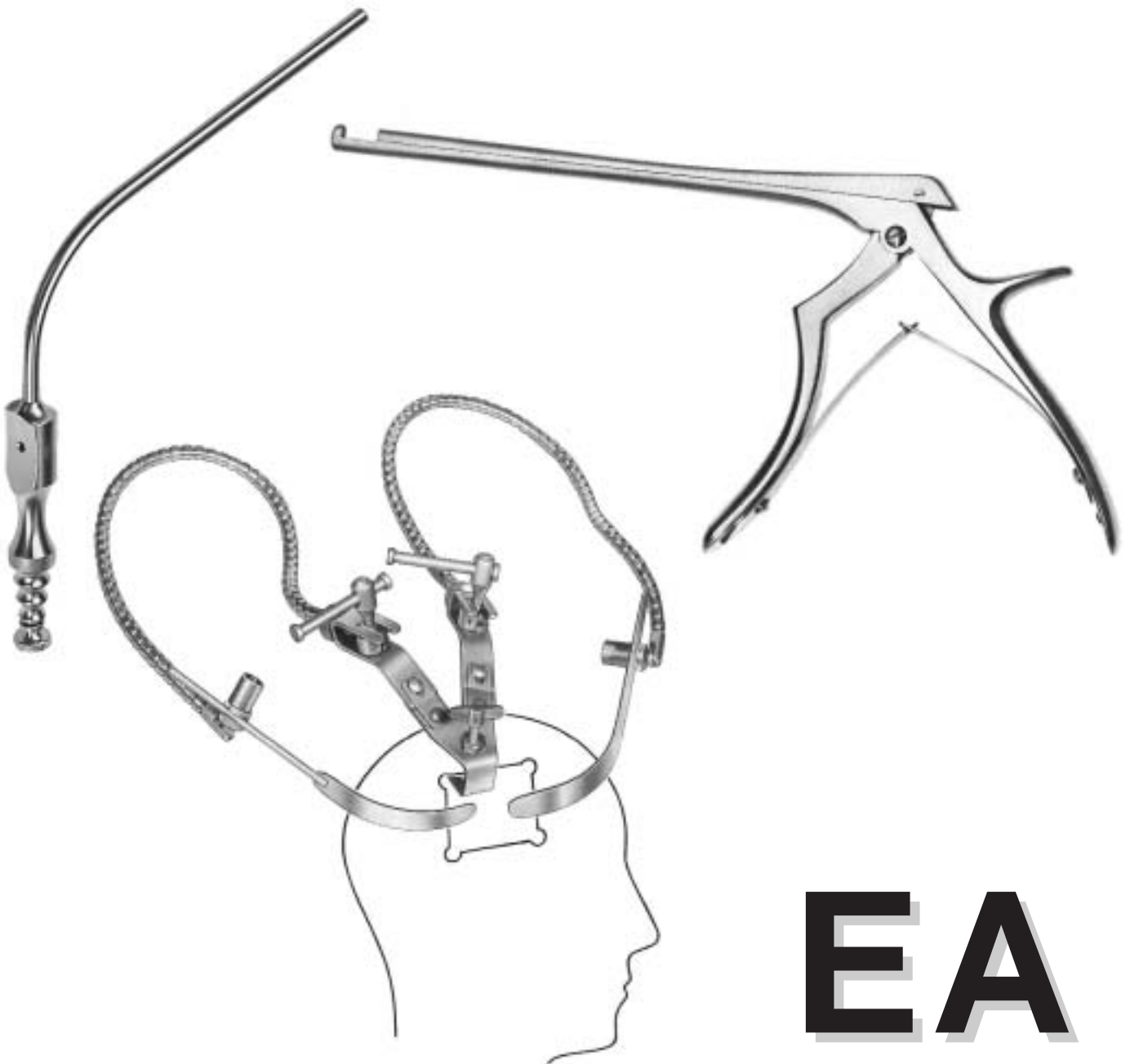



cm McKenzie
15 EA-101-15
19 EA-101-19

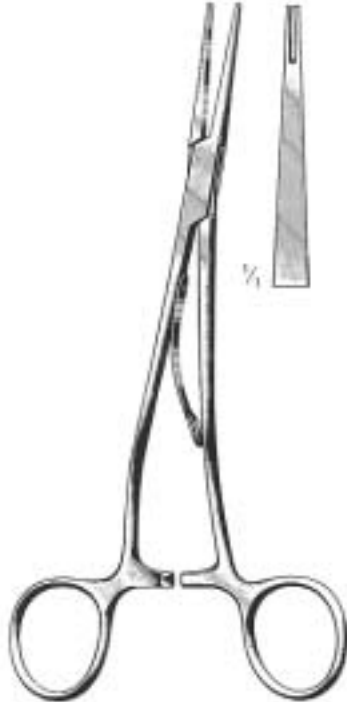

cm McKenzie
15 EA-103-15
19 EA-103-19



cm SMITHWICK
23 EA-105-23
26 EA-105-26

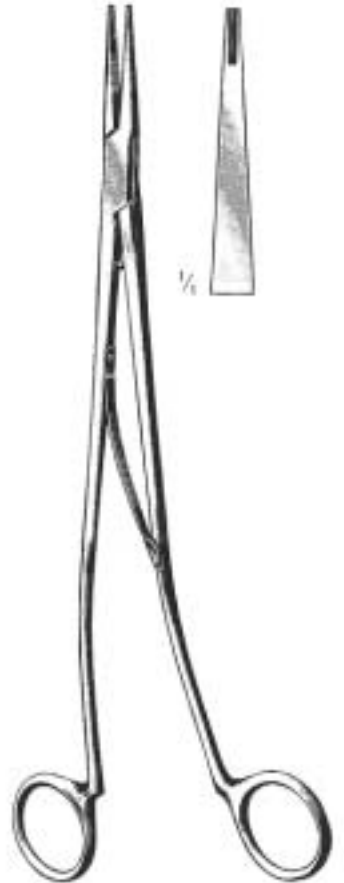

cm SWEET
23 EA-107-23
26 EA-107-26



OLIVECRONA-TOENNIS
EA-109-14



EA-200-00
148x40x6 mm



CRUTCHFIELD
EA-205-01



CRUTCHFIELD
EA-205-02



EA-206-35
3,5 mm ø



EA-206-50
5 mm ø

Kopfhautklammer, -anlegezange
Scalp Hemostasis Clip, Applying Forceps
Pince hémostatique pour le cuir chevelu, pince à poser
Pinza hermostática para cuero cabelludo, pinza para poner
Pinza emostatica per il cuoio capelluto, pinza per applicare e togliere



RANEY
EA-207-00



RANEY
EA-208-00



DANDY
EA-501-20
20 cm



DANDY
EA-502-20
20 cm



DANDY
EA-503-20
20 cm



CUSHING
EA-506-28
28 cm

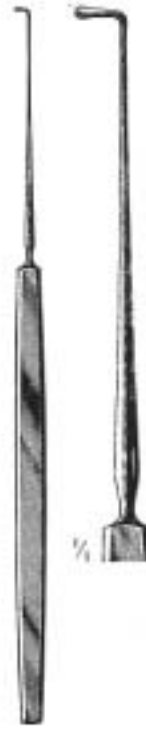

CUSHING
EA-508-28
28 cm



GRAHAM
EA-601-16
16,5 cm



SACHS
EA-604-18
18,5 cm



ADSON
EA-608-20
20 cm



ADSON
EA-609-20
20 cm



SMITHWICK
EA-700-29
29 cm



EA-800-19



EA-801-19



EA-803-19

LOVE
EA-800-19 - EA-803-19



De MARTEL
EA-900-33
33 cm

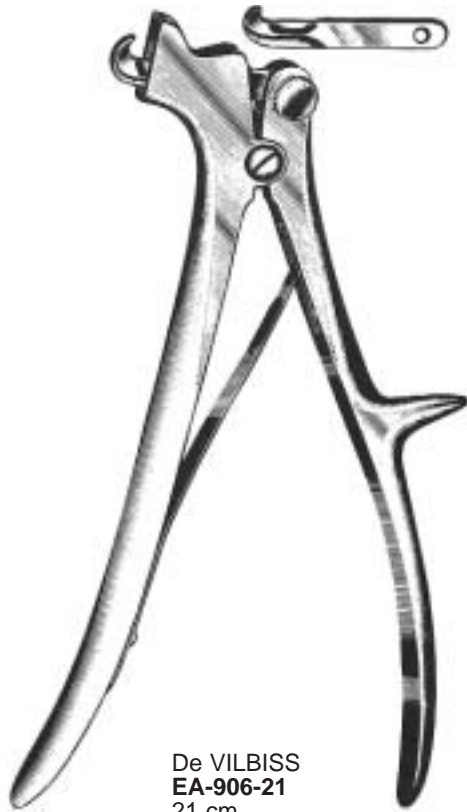

De VILBISS
EA-906-21
21 cm



cm	OLIVECRONA
30	EA-902-30
40	EA-902-40
50	EA-902-50
60	EA-902-60
70	EA-902-70



GIGLI
EA-904-00
1 Paar
1 pair
1 paire
1 par
1 paio

Dura-Dissektoren • Dura Dissectors • Dissecteurs à duremère
Descoladores para la duramadre • Scollatori per la duramadre



TOENNIS
EA-411-25
25 cm



SACHS
EA-413-21



SACHS
EA-415-21



MILLIGAN
EA-417-21



EA-419-22



DAVIS
EA-511-24

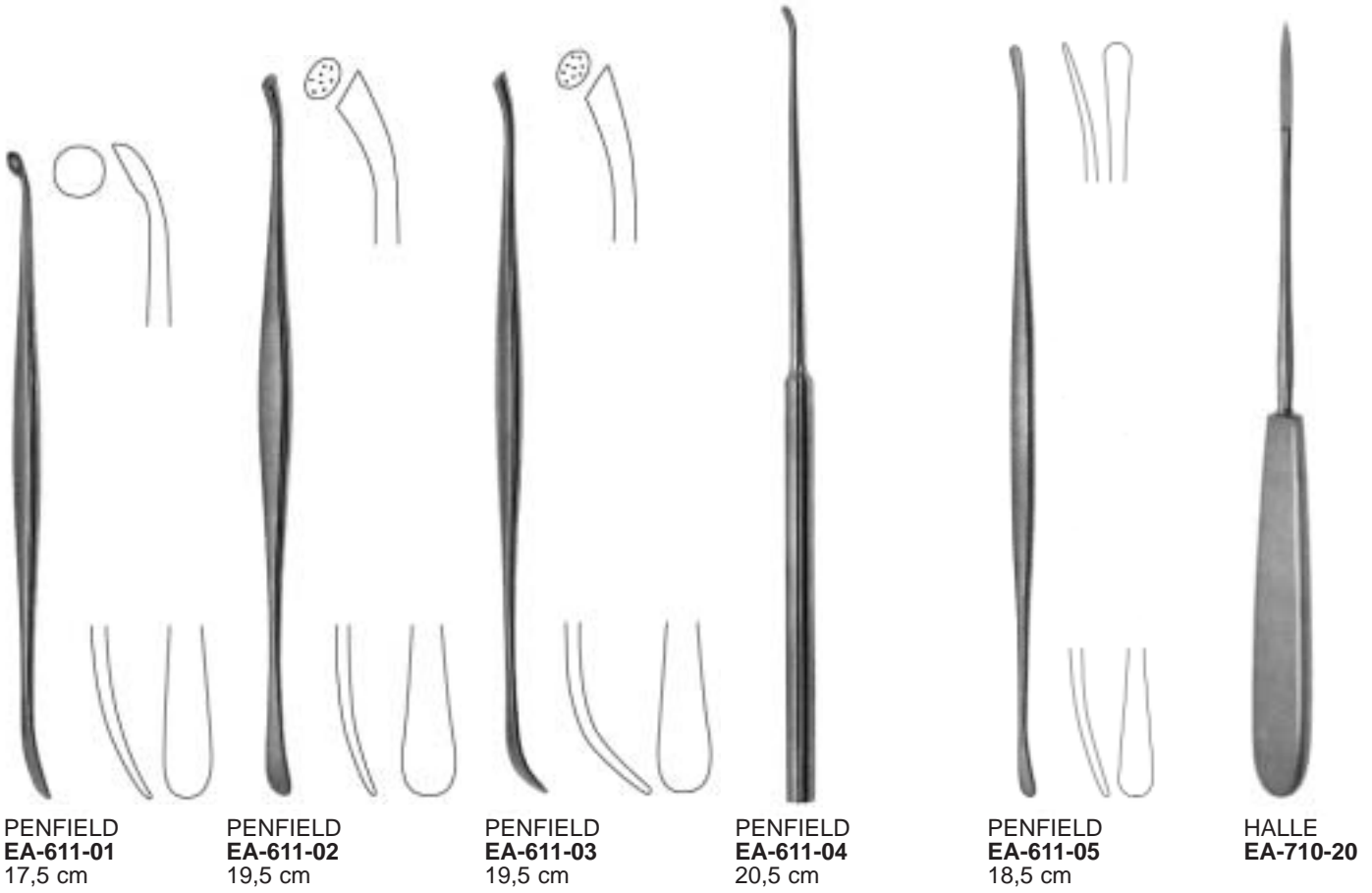

Hypophysenpinzetten • Hypophyseal Forceps • Pincés á hypophyse • Pinzas para hipófisis • Pinze per ipofisi

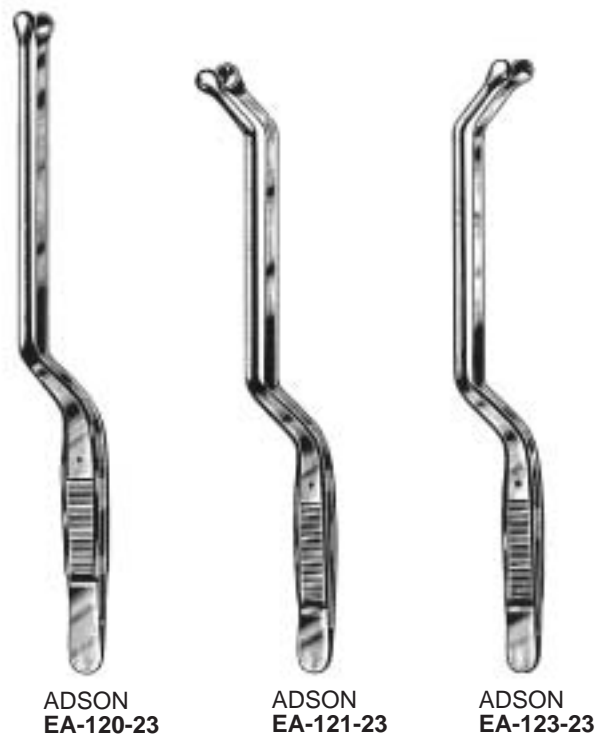
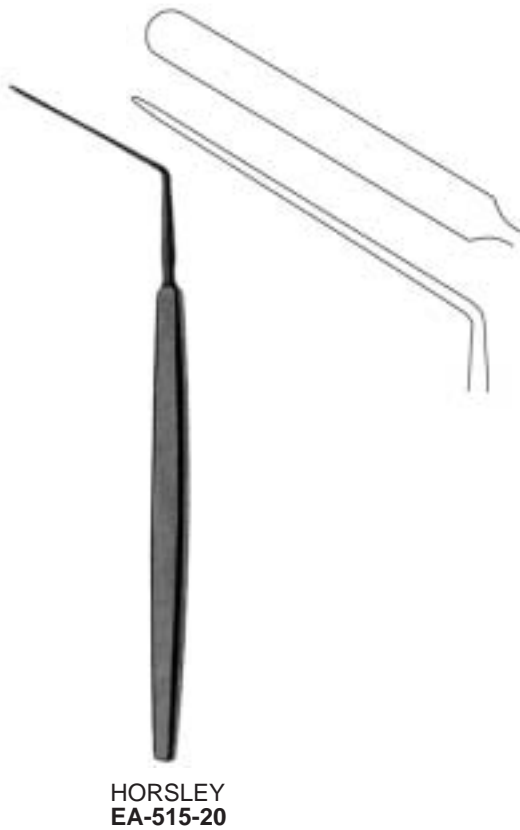

Hirnspatel, Saugrohre
 Brain Spatulas, Aspiration Tubes
 Spatules cérébr., tubes d'aspir.
 Espátulas cerebr., tubos de aspir.
 Spatole cerebr., tubi per aspiraz.

EA

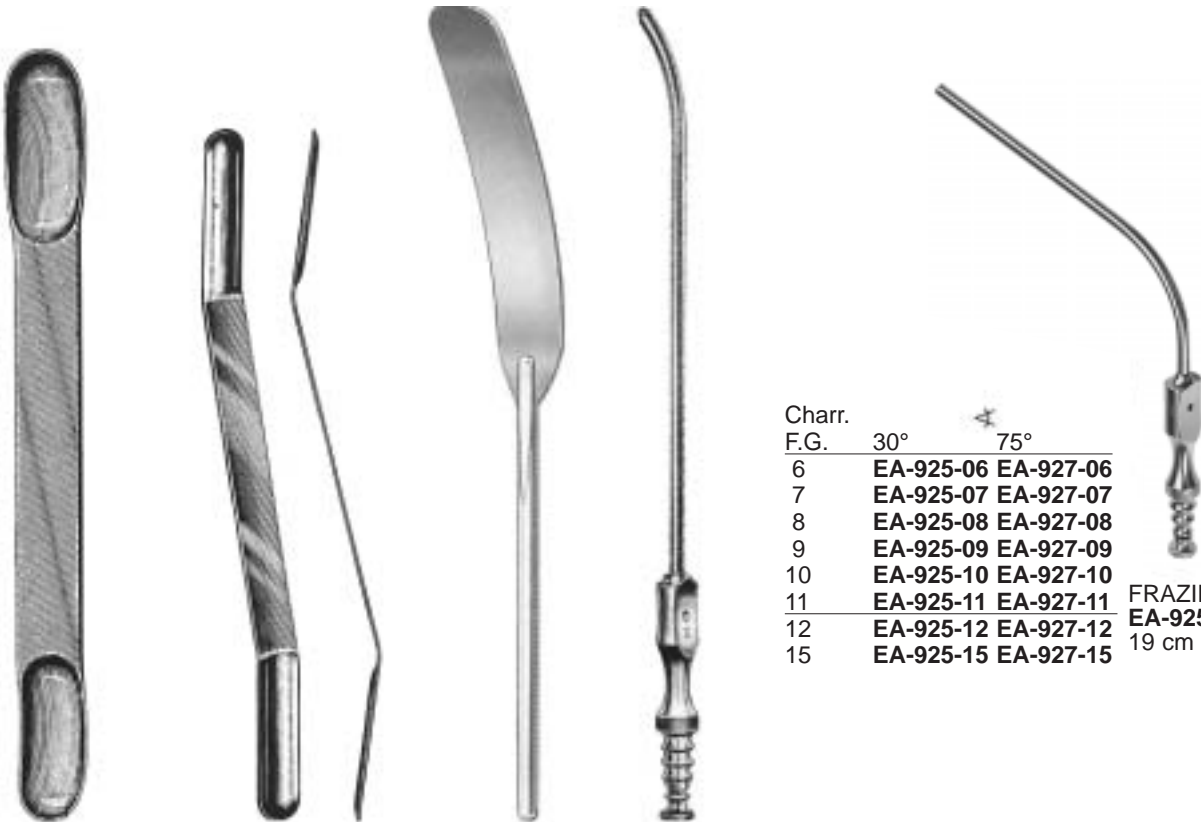

Charr.	30°	75°
6	EA-925-06	EA-927-06
7	EA-925-07	EA-927-07
8	EA-925-08	EA-927-08
9	EA-925-09	EA-927-09
10	EA-925-10	EA-927-10
11	EA-925-11	EA-927-11
12	EA-925-12	EA-927-12
15	EA-925-15	EA-927-15

FRAZIER
 EA-925-06 - EA-927-12
 19 cm

mm	CUSHING	mm	OLIVECRONA	mm	HEIFETZ	ADSON
7/9	EA-520-07	7/9	EA-523-07	8	EA-620-08	EA-920-21
11/13	EA-520-11	11/13	EA-523-11	11	EA-620-11	21cm/4 mm
15/18	EA-520-15	15/18	EA-523-15	14	EA-620-14	
18/22	EA-520-18	18/22	EA-523-18	17	EA-620-17	
	180 mm		180 mm			

Wirbelkörperspreizer • Lamina Spreaders •
 Ecarteurs pour corps vertébraux •
 Speradores para cuerpos vertebrales •
 Divaricatori per corpi vertebrali



FRAZIER
 EA-928-12
 12 cm/3 mm



CLOWARD
 EA-041-16



INGE
 EA-045-17 - EA-045-27

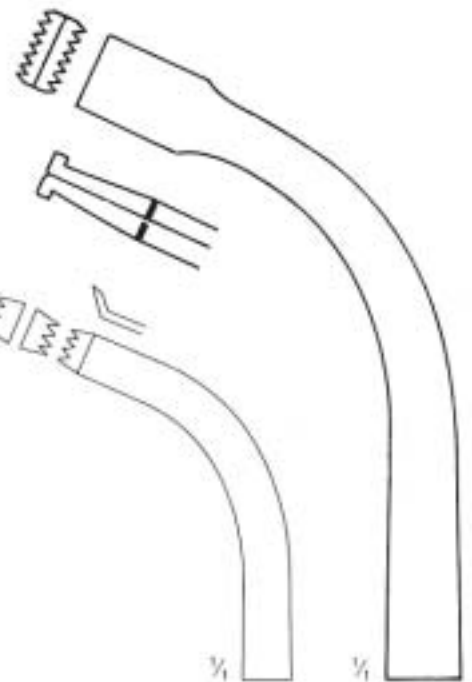

EA-045-17
 17 cm

EA-045-27
 27 cm

Laminektomie-Zangen
Laminectomy Rongeurs
Pinces emporte-pièce á laminectomie
Pinzas cortantes para laminectomia
Pinze taglianti per laminectomia



CUSHING
2 mm



2x10 mm	L
EA-240-01	12,5 cm
EA-242-01	18,0 cm



2x10 mm/45°	L
EA-240-01	12,5 cm
EA-242-01	18,0 cm

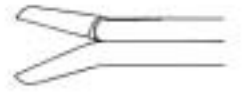

2x10 mm/45°	L
EA-240-03	12,5 cm
EA-242-03	18,0 cm

LOVE-GUENWALD
3 mm



3x10 mm	L
EA-340-01	12,5 cm
EA-342-01	18,0 cm



3x10 mm/45°	L
EA-340-01	12,5 cm
EA-342-01	18,0 cm



3x10 mm/45°	L
EA-340-03	12,5 cm
EA-342-03	18,0 cm

SPURLING
4 mm



4x10 mm	L
EA-440-01	12,5 cm
EA-442-01	18,0 cm



4x10 mm/45°	L
EA-440-01	12,5 cm
EA-442-01	18,0 cm

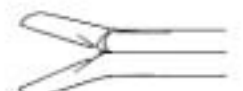

4x10 mm/45°	L
EA-440-03	12,5 cm
EA-442-03	18,0 cm

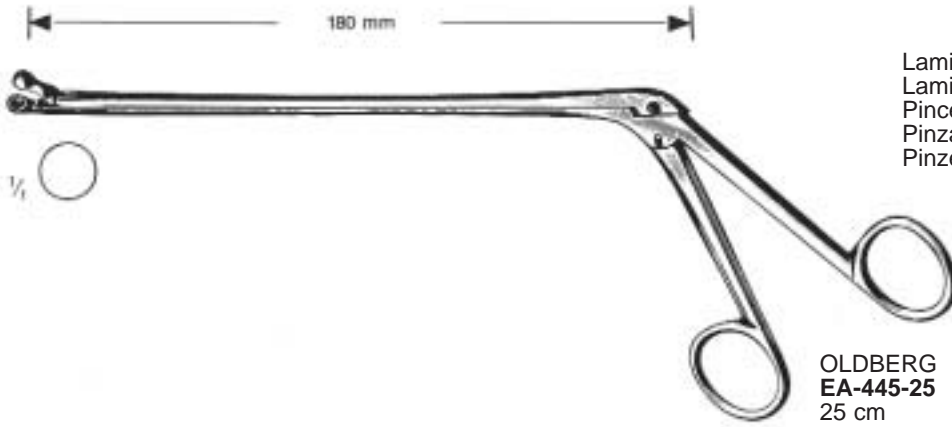

Laminektomie-Zangen
Laminectomy Rongeurs
Pinces emporte-pièce á laminectomie
Pinzas cortantes para laminectomia
Pinze taglianti per laminectomia

OLDBERG
EA-445-25
25 cm

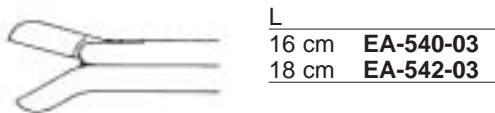
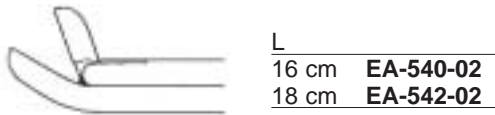
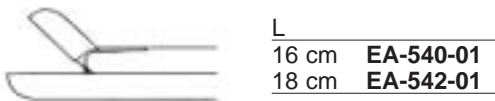

FERRIS-SMITH
EA-540-01 - EA-542-03
3 x 10 mm



WAGNER
EA-548-20
20 cm/ 4 mm

Bandscheiben-Stanzen
Intervertebral Disc, Rongeurs
Pincas emporte-pièce pour lames intervertébrales
Pinzas sacabocado para discos intervertebrales
Pinze taglienti per dischi intervertebrali

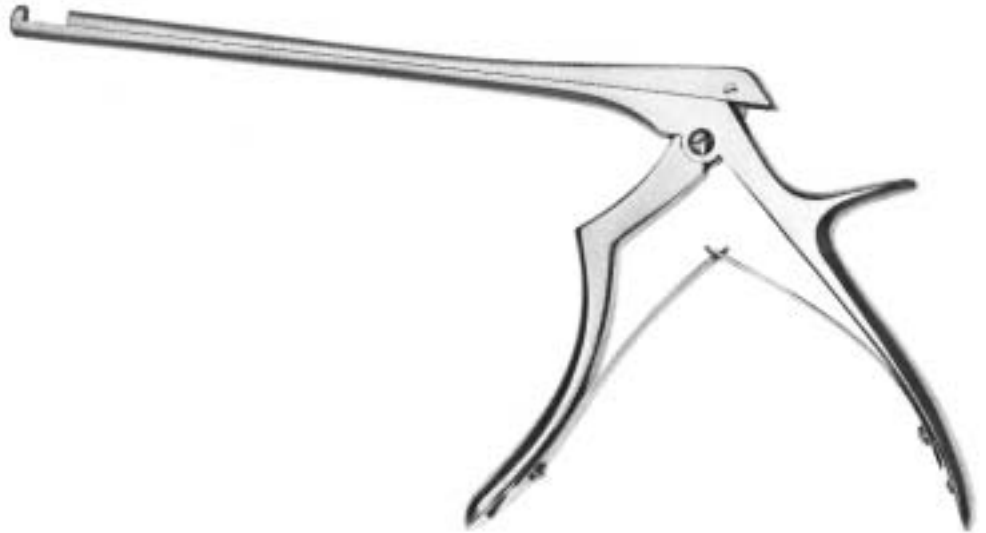

FERRIS-SMITH-Kerrison
EA-150-01 -EA-152-05
18 cm

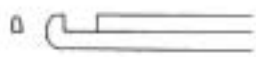

EA-150-01
1 mm



EA-151-01
1 mm

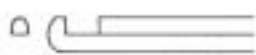

EA-150-02
2 mm

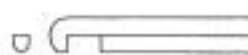

EA-151-02
2 mm

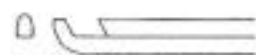

EA-152-02
2 mm

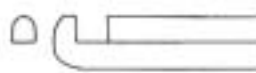

EA-150-03
3 mm

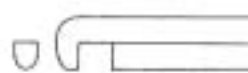

EA-151-03
3 mm



EA-152-03
3 mm

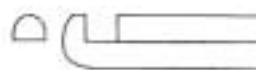

EA-150-04
4 mm

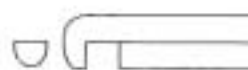

EA-151-04
4 mm

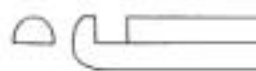

EA-150-05
5 mm



EA-151-05
5 mm



EA-152-05
5 mm

Bandscheiben-Stanzen
Intervertebral Disc, Rongeurs
Pinces emporte-pièce pour lames intervertébrales
Pinzas sacabocado para discos intervertebrales
Pinze taglianti per dischi intervertebrali



COLCLOUGH
EA-250-03 - EA-255-05

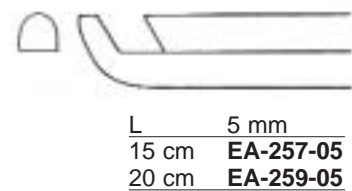
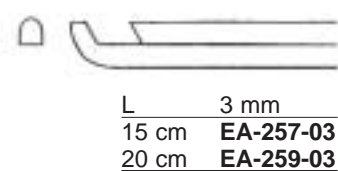
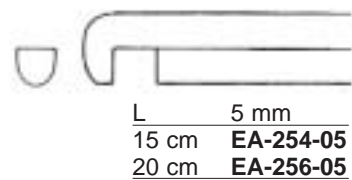
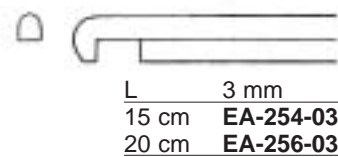
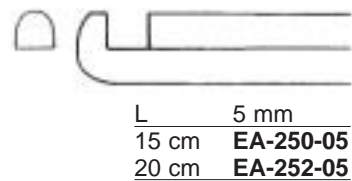
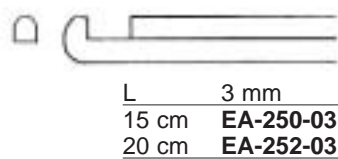

**Verlangen Sie unseren Spezialkatalog für
Please ask for our special catalogue for
Demandez notre catalogue spécial pour
Pidan nuestro catálogo especial para
Chiedete il nostro catalogo speciale per**

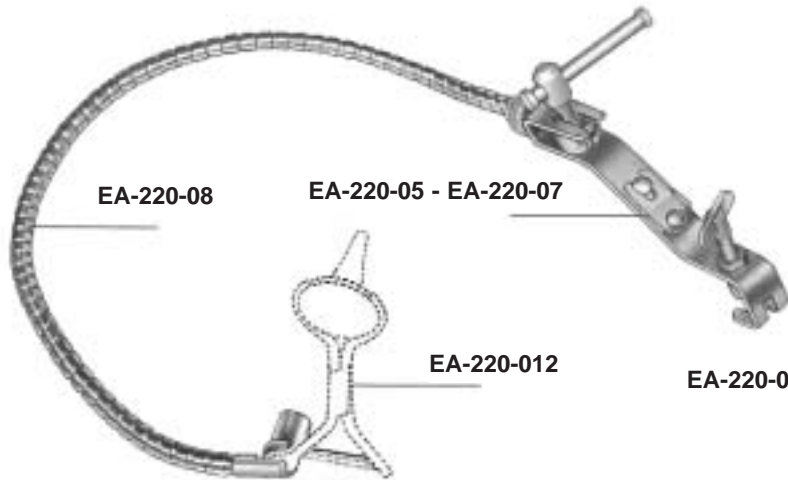

EA-220-08 Spannarm allein
 Flexible arm only
 Bras flexible seul
 Brazo flexible suelto
 Braccio flessibile solo

EA-220-12 Ohrtrichterhalter allein
 Ear specula holder only
 Support pour spéculum auriculaire
 Soporte para espéculo de oídos
 Sostegno per specolo auricolare

EA-220-05 Fixiervorrichtungen für Schädel oder Starrarm
EA-220-06 Fixation bases for skull or rigid holding arm
EA-220-07 Bases pour fixation au crâne ou au bras rigide
 Fijadores para fijación al craneo o al brazo rígido
 Fissatori per fissaggio al cranio o al braccio rigido



EA-220-05

EA-220-05 Fixiervorrichtung am Schädel für 1 Arm
 Fixation base for 1 arm at skull
 Base de fixation pour 1 bras au crâne
 Fijador para 1 brazo al craneo
 Fissatore per 1 braccio al cranio



EA-220-06

EA-220-06 Fixiervorrichtung am Schädel für 2 Arme
 Fixation base for 2 arms at skull
 Base de fixation pour 2 bras au crâne
 Fijador para 2 brazo al craneo
 Fissatore per 2 bracci al cranio



EA-220-07

EA-220-07 Fixiervorrichtung am Starrarm für 1 Arm
 Fixation base for 1 arm at rigid arm
 Base de fixation pour 1 bras au bras rigide
 Fijador para 1 brazo al brazo rígido
 Fissatore per 1 braccio al braccio rigido



EA-221-00

Hirnspatelhalter, selbsthaltend, flexibel,
für flache Spatel,
mit 1 Spannarm, komplett, bestehend aus:
EA-220-05, EA-220-08, EA-220-09

Brain retractor, self retaining, flexible,
for flat spatula
with 1 flexible arm, complete, consisting of:
EA-220-05, EA-220-08, EA-220-09

Ecarteur autostatique, flexible,
pour des spatules plates,
avec un bras flexible, complet, composé de:
EA-220-05, EA-220-08, EA-220-09

Separador autorretentivo, flexible
para espátulas llanas,
con 1 brazo flexible, completo, compuesto de:
EA-220-05, EA-220-08, EA-220-09

Divaricatore autostatico, flessibile,
per spatole piatte,
con 1 braccio flessibile, completo, composto da:
EA-220-05, EA-220-08, EA-220-09

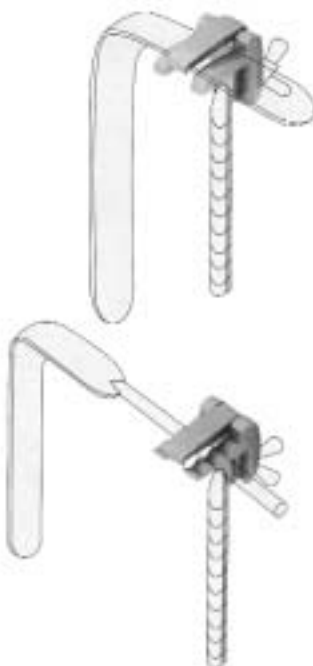

EA-220-09 Halter für flache Hirnspatel
Holder for flat brain spatula
Support pour des spatules plates
Soporte para espátulas llanas
Sostegno per spatole piatte

EA-220-10 Halter für Hirnspatel mit rundem Schaft
Holder for brain spatula with round stem
Support pour des spatules a tige ronde
Soporte para espátulas con vástago redondo
Sostegno per spatole con asta rotonda

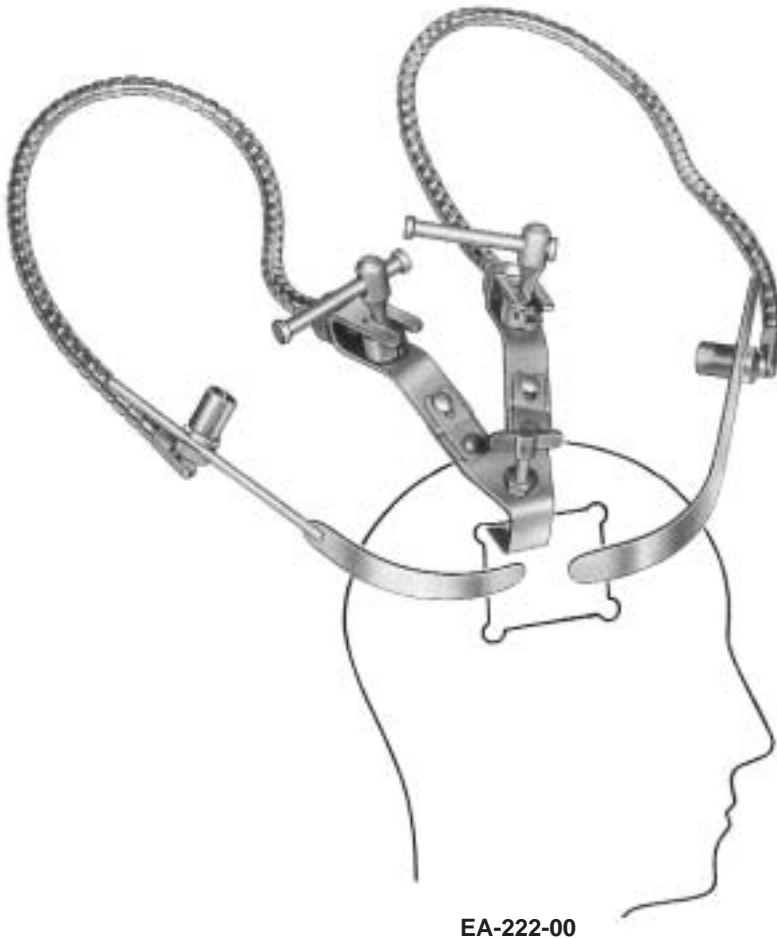

Hirnspatelhalter, selbsthaltend, flexibel,
für flache Spatel,
mit 2 Spannarmen, komplett, bestehend aus:
2 x EA-220-08, EA-220-06, 2 x EA-220-09

Brain retractor, self retaining, flexible,
for flat spatula,
with 2 flexible arms, complete, consisting of:
2 x EA-220.08, EA-220-06, 2 x EA-220-09

Ecarteur autostatique, flexible,
pour des spatules plates,
avec 2 bras flexibles, complet, composé de:
2 x EA-220-08, EA-220-06, 2 x EA-220-09

Separador autorretentivo, flexible,
para espátulas llanas,
con 2 brazos flexibles, completo, compuesto de
2 x EA-220-08, EA-220-06, 2 x EA-220-09

Divaricatore autostatico, flessibile,
per spatole piatte
con 2 bracci flessibili, completo, composto da:
2 x EA-220-08, EA-220-06, 2 x EA-220-09

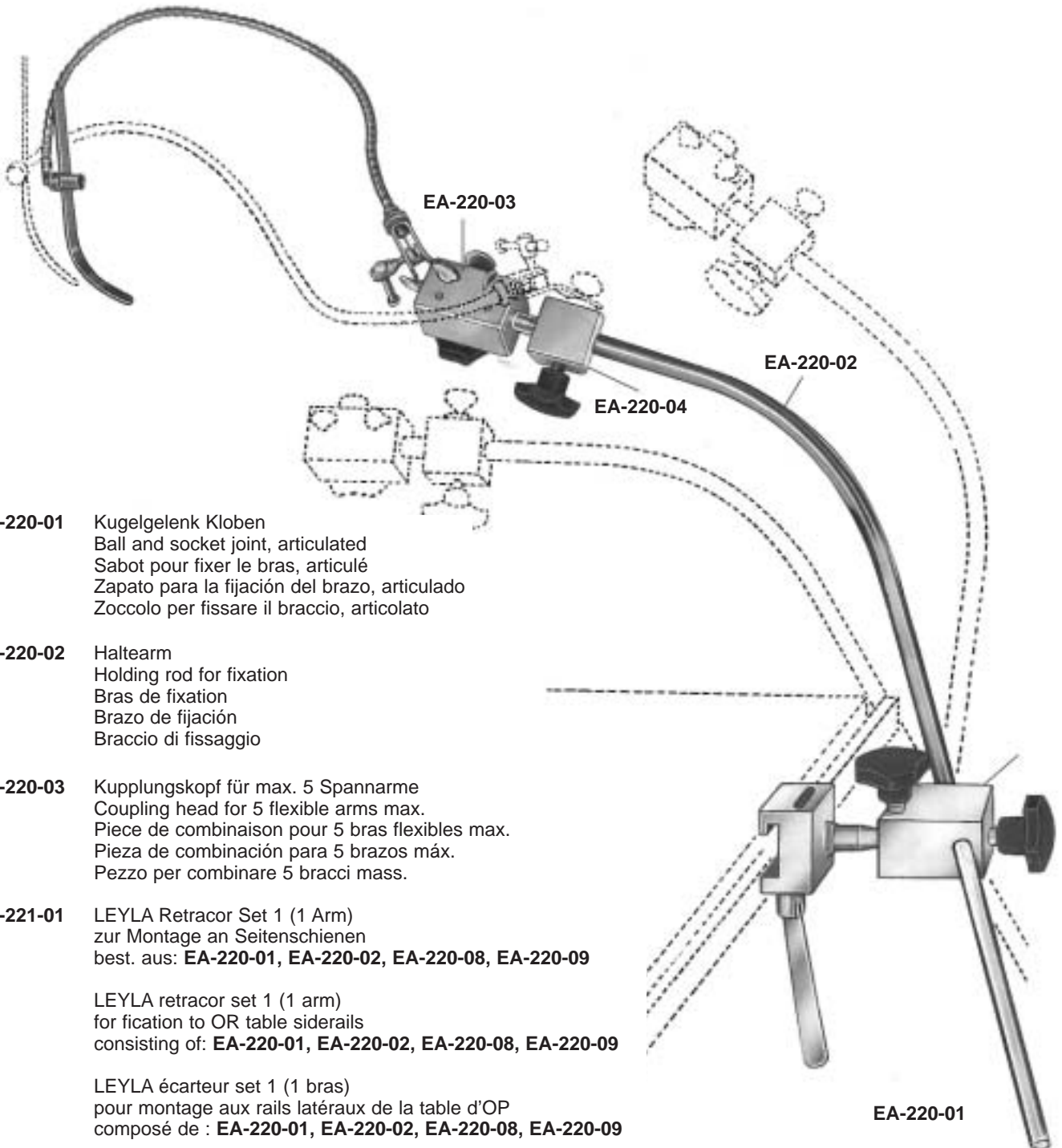

EA-220-01 Kugelgelenk Kloben
 Ball and socket joint, articulated
 Sabot pour fixer le bras, articulé
 Zapato para la fijación del brazo, articulado
 Zoccolo per fissare il braccio, articolato

EA-220-02 Haltearm
 Holding rod for fixation
 Bras de fixation
 Brazo de fijación
 Braccio di fissaggio

EA-220-03 Kupplungskopf für max. 5 Spannarme
 Coupling head for 5 flexible arms max.
 Piece de combinaison pour 5 bras flexibles max.
 Pieza de combinación para 5 brazos máx.
 Pezzo per combinare 5 bracci mass.

EA-221-01 LEYLA Retracor Set 1 (1 Arm)
 zur Montage an Seitenschienen
 best. aus: **EA-220-01, EA-220-02, EA-220-08, EA-220-09**

LEYLA retracor set 1 (1 arm)
 for fixation to OR table siderails
 consisting of: **EA-220-01, EA-220-02, EA-220-08, EA-220-09**

LEYLA écarteur set 1 (1 bras)
 pour montage aux rails latéraux de la table d'OP
 composé de : **EA-220-01, EA-220-02, EA-220-08, EA-220-09**

LEYLA separador set 1 (1 brazo)
 pra montar al carril lateral de la mesa operatoria
 compuesto de: **EA- 220-01, EA-200-02, EA-220-08, EA-220-09**

LEYLA divaricatore set 1 (1 braccio)
 per montaggio al tavolo di operazione
 composto da: **EA-220-01, EA-220-02, EA-220-08, EA-220-09**

EA-220-01 Kugelgelenk Kloben
 Ball and socket joint, articulated
 Sabor pour fixer le bras, articulé
 Zapato para la fijación del brazo, articulado
 Zoccolo per fissare il braccio, articolato

EA-220-02 Haltearm
 Holding rod for fixation
 Bras de fixation
 Brazo de fijación
 Braccio di fissaggio

EA-220-03 Kupplungskopf für max. 5 Spannarme
 Coupling head for 5 flexible arms max.
 Pièce de combinaison pour 5 bras flexibles max.
 Pieza de combinación para 5 brazos máx.
 Pezzo per combinare 5 bracci mass.

EA-220-03 Kupplungskopf drehbar
 Coupling head rotatable
 Pièce de combinaison rotative
 Pieza de combinación giratoria
 Pezzo per combinare girevole

EA-222-02 LEYLA Retractor Set 2 (2 Arme) zur Montage an Seitenschiene
 best. aus: **EA-220-01, EA-220-02, EA-220-03, EA-220-04**
 2 x **EA-220-07, 2 x EA-220-08, 2 x EA-220-09**

LEYLA retractor set 2 (2 arms for fixation to OR table siderails
 consisting of: **EA-220-01, EA-220-02, EA-220-03, EA-220-04**
 2 x **EA-220-07, 2 x EA-220-08, 2 x EA-220-09**

LEYLA écarteur set 2 (2 bras) pour montage aux rails latéraux
 de la table d'OP
 composé de : **EA- 220-01, EA-220-02, EA-220-03, EA-220-04**
 2 x **EA-220-07, 2 x EA-220-08, 2 x EA-220-09**

LEYLA separado set 2 (2 brazos) para montar al carril lateral de la
 mesa operatoria
 compuesto de: **EA-220-01, EA-220-02, EA-220-03, EA-220-04**
 2 x **EA-220-07, 2 x EA-220-08, 2 x EA-220-09**

LEYLA divaricatore set 2 (2 bracci) per montaggio
 al tavolo di operazione
 composto da: **EA-220-01, EA-220-02, EA-220-03, EA-220-04**
 2 x **EA-220-07, 2 x EA-220-08, 2 x EA-220-09**

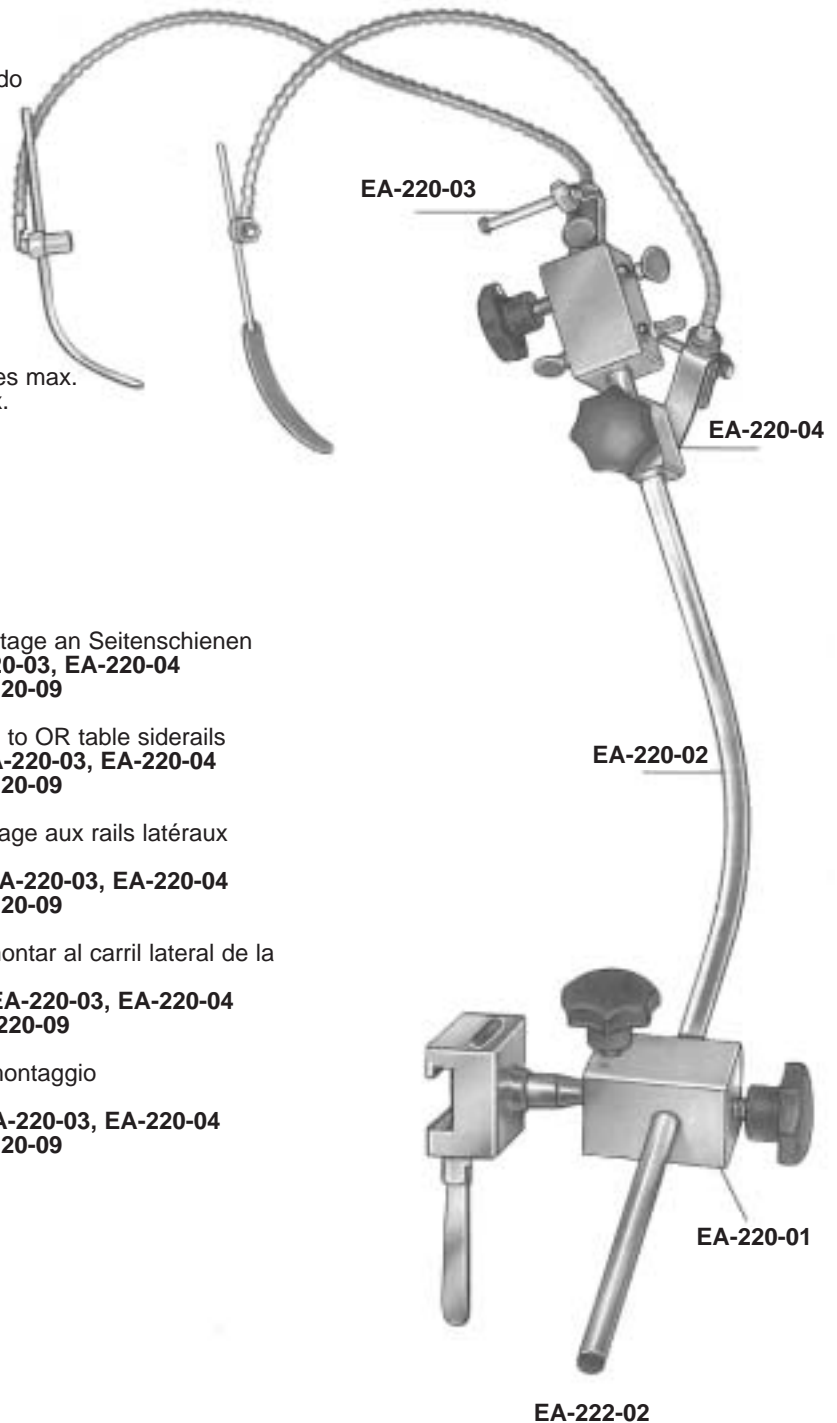

EC
ED

Ophthalmologie
Ophthalmology
Ophthalmologie
Oftalmología
Oftalmologia



EC-ED

Sperrelevatoren
Eye Specula
Blépharostats
Blefarostatos
Blefarostati

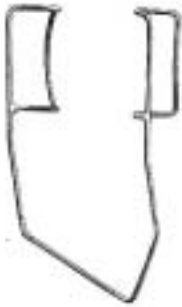

cm BARRAQUER(Collibri)
3 **EC-011-03**
4 **EC-011-04**



BOWMAN
EC-014-07
7 cm



CRITCHETT
EC-015-06
7 cm



SMITH
EC-016-05
5 cm



CLARK
EC-017-08
8 cm



cm GRAEFE
7 **EC-019-06**
9 **EC-019-07**



WEEK
EC-110-08
8 cm



ARRUGA
EC-111-07
7 cm • rechts •
right • à droite •
a la derecha •
destro



ARRUGA
EC-113-07
7 cm • links •
left • à gauche •
a la izquierda •
sinistro



MURDOCK
EC-115-05
5 cm



MELLINGER-AXENFELD
EC-211-07
7 cm



MELLINGER-AXENFELD
EC-213-07
7 cm



cm MELLINGER
5 **EC-215-05**
7 **EC-215-07**



LISTER-BURCH
EC-217-08
8 cm



WILLIAMS
EC-218-08
8 cm

Sperrelevatoren
 Eye Specula
 Blépharostats
 Blefarostatos
 Blefarostati



LANCASTER
 EC-219-07
 7 cm



ZIEGLER
 EC-310-07
 7 cm



CASTROVIEJO
 EC-312-08
 8 cm



PARK
 EC-313-08
 8 cm



MUELLER
 EC-315-07
 7 cm



GOLDSTEIN
 EC-317-07
 3 cm



STEVENSON
 EC-319-07
 7 cm



JAEGER
 EC-510-11
 11 cm

Lidplatte
 Lid Plate
 Plaque à paupières
 Placa para párpados
 Placca per palpebre

Starmesser
 Cataract Knives
 Couteaux à cataracte
 Cuchillos para cataratá
 Coltelli per cataratta

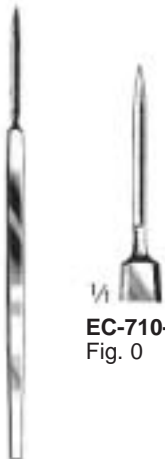

EC-710-00
 Fig. 0



EC-710-01
 Fig. 1



EC-710-02
 Fig. 2



EC-710-03
 Fig. 3

GRAEFE
 EC-710-00 - EC-710-03



DEUTSCHMANN
 EC-712-13
 13 cm



EC-128-12 - EC-810-01



JAEGER
EC-810-01 **EC-810-02** **EC-810-03**
 Fig. 1 Fig. 2 Fig. 3



JAEGER 45°
EC-811-01 **EC-811-02** **EC-811-03**
 Fig. 1 Fig. 2 Fig. 3

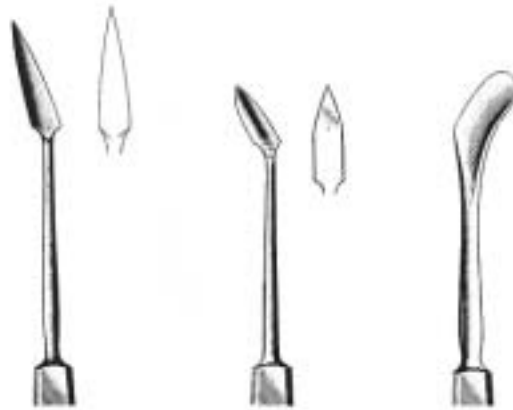

BERENS
EC-813-13
 13 cm

CASTROVIEJO
EC-815-13
 4 x 13 mm
 13 cm

GRAEFE
EC-817-13
 13 cm



KNAPP
EC-022-01 **EC-022-02** **EC-022-03**
 Fig. 1 Fig. 2 Fig. 3



ZIEGLER
EC-120-01 **EC-120-02** **EC-120-03**
 Fig. 1 Fig. 2 Fig. 3
 5 mm 6 mm 7 mm



DEAN
EC-123-12
 12,5 cm



BOWMAN
EC-124-04 **EC-124-08**
 0,4 mm 0,8 mm
 13 cm 13 cm



WHEELER
EC-128-12
 12 cm



ZIEGLER
 EC-221-11
 11 cm, 3,5 mm



SATO
 EC-226-12
 12,5 cm



TOOK
 EC-228-12
 12 cm



GILL
 EC-321-12
 12 cm



ELSCHNIG
 EC-323-13
 13 cm



KUHNT
 EC-420-01
 Fig. 1



KUHNT
 EC-420-02
 Fig. 2



KUHNT
 EC-420-03
 Fig. 3



KUHNT
 EC-420-04
 Fig. 4



PATON
 EC-425-12
 12 cm



LUNDSGAARD
 EC-521-12
 12 cm



GUYTON-
 LUNDSGAARD
 EC-523-12



BARRKAN
 EC-526-12



SCHEIE
 EC-528-12



BURCH
 EC-622-12



PAUFIQUE
 EC-721-11



BARRQUER
 EC-723-13



EC-034-12



EC-035-12



BOWMAN
 EC-038-12



BOWMAN
 EC-039-12



EC-130-13



EC-131-13



LEVINSON
 EC-134-13



FRANCIS
 EC-231-12



DAVIS
 EC-235-13
 13 cm



LA FORCE
EC-237-12



DIX
EC-330-13

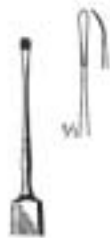

ELLIS
EC-331-11



WALTON
EC-332-12



WALTON
EC-334-12



ALVIS
EC-336-12



GREEN
EC-430-13



ROLLET
EC-432-12



GRAEFE
EC-531-01 Fig. 1
EC-531-02 Fig. 2
EC-531-03 Fig. 3



JAMESON
EC-533-13



GREEN
EC-535-13



STEVENS
EC-537-13

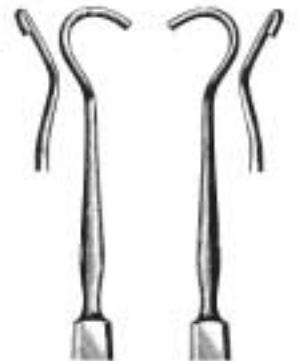

ARRUGA
EC-633-01 Fig. 1
EC-633-02 Fig. 2



O'Connor
EC-730-12



WIENER
EC-732-13



WIENER
EC-733-13



ROLLET
EC-736-13



KNAPP
EC-737-13



EC-830-13



GRAEFE
EC-831-13



EC-833-13



BECKER
EC-836-13



MEYHOEFER

	EC-042-05	EC-042-10	EC-042-15	EC-042-18	EC-042-20	EC-042-25	EC-042-35	EC042-40	EC-042-45
Ø mm	0,5	1,0	1,5	1,8	2,0	2,5	3,5	4,0	4,5

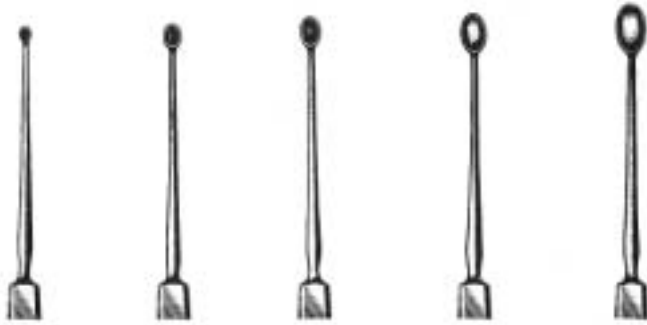

HEBRA

	EC-044-10	EC-044-20	EC-044-25	EC-044-30	EC-044-35
Ø mm	1,0	2,0	2,5	3,0	3,5



AXENFELD
 EC-047-13



GRAEFE
 EC-140-01 EC-140-02



DAVEL
 EC-142-01 EC-142-02



KNAPP
 EC-144-02



BUNGE
 EC-240-01 EC-240-02 EC-240-03



LANG
EC-244-13



WEBER
EC-441-01 Fig. 1 EC-441-02 Fig. 2



SNELLEN
EC-443-13



WILDER
EC-445-13 Fig. 1



EC-447-13 Fig. 2



ARLT

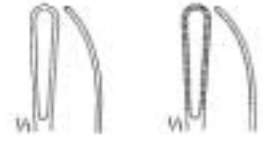

EC-449-01 EC-449-02

Iris • Iride



WECKER
EC-641-13 EC-642-13



CULLER
EC-647-13



WELLS
EC-842-20

Schützer
Protector
Protecteur
Protettore



ARRUGA
EC-845-13

Kauter • Cauter •
Cautère • Cauterio



WADSWORTH-TODD
EC-847-14

Zyklodialyse • Cyclodialysis • Cyclodialyse • Ciclodíalisis • Ciclodialisi

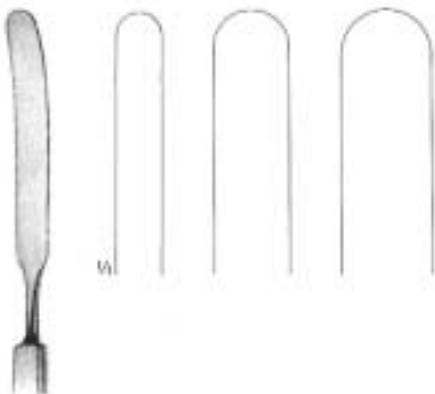

BANGERTER
EC-051-06 6 mm EC-051-10 10 mm EC-051-12 12 mm



EC-151-13 - EC-157-09



CASTROVIEJO
EC-151-13 1,2 x 10 mm



EC-153-14 1,5 x 15 mm



ELSCHNIG
EC-155-14 1,2 x 12 mm



CASTROVIEJO
EC-157-09 0,8 x 15 mm

Zyklodialyse-Spatel, Fremdkörper-Instrumente
 Cyclodialysis Spatulae, Foreign Body Instruments
 Spatules à cyclodialyse, Instruments à corps étranger
 Espátulas para ciclodiálisis, Instrumentos para cuerpos extraños
 Spatole per ciclodialisi, Strumenti per corpi estranei

EC



CASTROVIEJO
 EC-251-12



WHEELER
 EC-253-12



mm	CASTROVIEJO
0,5	EC-255-05
0,75	EC-255-07
1,0	EC-255-10



DIX
 EC-452-12



DIX
 EC-454-12



DIX
 EC-456-13

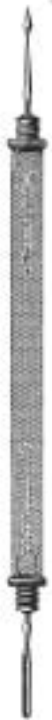

DIX
 EC-458-13

Markier-Instrumente
 Markier
 Marqueurs
 Marcadores
 Marcatori

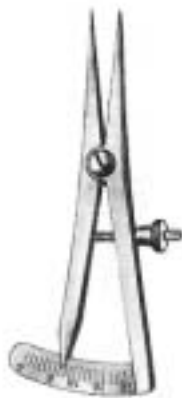

CASTROVIEJO
 EC-853-06
 0-20 mm



CONNIN-AMSLER
 EC-859-13



DASTOOR
 EC-950-06
 6 cm



HOLTH
 EC-953-09

Tränengang-Dilatatoren
Lachrymal Dilators
Dilatateurs pour canal lacrymal
Dilatadores para canal lacrimonal
Dilatatori per canale lacrimale



WILDER
EC-062-01 EC-062-02 EC-062-03



Fig. ZIEGLER
1/2 EC-065-12
3/4 EC-065-34
5/6 EC-065-56



CASTROVIEJO
EC-068-12

Tränenkanal-Sonden
Lachrymal Probes
Stylets pur le canal lacrymal
Estiletes para canal lacrimonal
Specilli per canale lacrimale



BOWMAN	FIG.	BOWMAN
EC-164-00	00/0	EC-166-00
EC-164-01	0/1	EC-166-01
EC-164-12	1/2	EC-166-12
EC-164-23	2/3	EC-166-23
EC-164-34	3/4	EC-166-34
EC-164-45	4/5	EC-166-45
EC-164-56	5/6	EC-166-56
EC-164-67	6/7	EC-166-67
EC-164-78	7/8	EC-166-78

Iris Pinzetten • Iris Forceps •
Pincas à Iris • Pinzas para iris • Pinze per iride

Fig. 00 0 1 2 3 4 5 6 7 8
ø mm 0,7 0,8 0,9 1,1 1,3 1,4 1,5 1,6 1,8 1,9



GRAEFE
EC-082-07
7 cm/1 mm



GRAEFE
EC-083-07
7 cm/1 mm



GRAEFE
EC-084-07
7 cm/1 mm



GRAEFE
EC-085-07
7 cm/1 mm



GRAEFE
EC-180-10
10 cm



GRAEFE
EC-181-10
10 cm



GRAEFE
EC-183-10
10 cm



GRAEFE
EC-280-10
10 cm



GRAEFE
EC-281-10
10 cm



GRAEFE
EC-283-10
10 cm



STEVENS
EC-380-10
10,5 cm



STEVENS
EC-381-10
10,5 cm



STEVENS
EC-383-10
10,5 cm



STEVENS
EC-480-10
10,5 cm



STEVENS
EC-481-10
10,5 cm



STEVENS
EC-483-10
10,5 cm



FOERSTER
EC-580-08
8,5 cm



FOERSTER
EC-581-08
8,5 cm



FOERSTER
EC-582-08
8,5 cm



FOERSTER
EC-583-08
8,5 cm



HESS
EC-585-07
7 cm/0,3 mm



HESS
EC-587-07
7 cm/0,3 mm



GILL
EC-681-07
7,5 cm/0,3 mm



GILL-HEISS
EC-683-07
7,5 cm/0,3 mm

Zähne unten
teeth below
dents en bas
dientes abajo
denti in basso



GILL-HEISS
EC-685-07
7,5 cm/0,3 mm

Zähne seitwärts
lateral teeth
dents latérales
dientes laterales
denti laterali



FISCHER
EC-689-07
 7 cm



BARRAQUER-KATZIN
EC-881-07
 7 cm/0,4 mm



TROUTMAN (Colibri)
EC-883-07
 7 cm/0,12 mm



BARRAQUER (Colibri)
EC-885-07
 7 cm/0,12 mm



BARRAQUER (Colibri)
EC-887-07
 7 cm/0,12 mm



KIRBY-ARTHUR
EC-981-09
 9 cm/0,2 mm



KIRBY-ARTHUR
EC-983-09
 9 cm/0,2 mm



McCULLOUGH
EC-092-09
 9,5 cm



McCULLOUGH
EC-094-09
 9,5 cm



JAMESON
EC-097-10
 L, 10 cm



JAMESON
EC-099-10
 R, 10 cm

EC

Strabismus-Pinzetten
Strabismus Forceps
Pincès à strabisme
Pinzas para estrabismo
Pinze per strabismo



BONACCOLTO
EC-194-10
10 cm



BONACCOLTO
EC-196-10
10 cm



BONACCOLTO
EC-290-11
11 cm



DASTOOR
EC-294-11
11 cm



DASTOOR
EC-296-11
11 cm



BISHOP-HARMAN
EC-490-05
8,5 cm, /0,5 mm



BISHOP-HARMAN
EC-490-08
8,5 cm, /0,8 mm



BISHOP-HARMAN
EC-492-05
8,5 cm, /0,5 mm



BISHOP-HARMAN
EC-492-08
8,5 cm, /0,8 mm



Iris-Pinzetten • Iris Forceps • Pincès à iris •
Pinzas para iris • Pinze per iride



Mod. Bonn
EC-494-07
7 cm, /0,12 mm



Mod. Bonn
EC-496-07
7 cm, /0,12 mm



Iris-, Muskel-Pinzetten • Iris,
Muscle Forceps • Pincés à iris, mus-
culaires • Pinzas para iris, muscu-
lares • Pinze per iride, muscolari



Mod. Bonn
EC-496-10
10 mm/0,12 mm



Mod. Tübingen
EC-590-10
EC-594-10
10 cm



Mod. Bonn
EC-592-10
EC-596-10
10 cm/0,12 mm



Mod. Tübingen
EC-593-10
EC-597-10
10 cm



PRINCE
ED-101-10
 10 cm

PRINCE
ED-103-10
 10 cm



BERKE
ED-105-20 - ED-105-27



ED-105-20



ED-105-27

RECTUS



TROUTMAN
ED-107-08
 0,5 cm/0,8 mm

Vorderkammer-Pinzette
 Anterior Chamber Forceps
 Pince à chambre antérieure
 Pinza para cámara anterior
 Pinza per camera anteriore



BARRAQUER
ED-201-05
 5,5 cm/7 mm



ELSCHING
 ED-406-11
 10 cm



GRAEFE
 ED-500-11 - ED-502-11

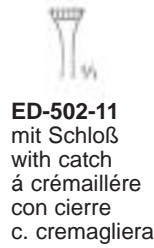

LESTER
 ED-504-09
 9 cm



CASTROVIEJO
 ED-606-09

1:1



CASTROVIEJO
 ED-607-09

1:1



CASTROVIEJO
 ED-608-09

2:2



CASTROVIEJO
 ED-609-09

2:2



BARRAQUER
 ED-704-10
 10 cm



GREEN
 ED-706-05 - ED-708-10
 10 cm



ED-706-05 **ED-706-10**
 5 mm 10mm
 ohne/without/sans
 sin/senza



ED-708-05 **ED-708-10**
 5 mm 10mm
 mit/ with / avec / con

Schloß / catch /
 crémaillère /
 cierre / cremagliera



GILL-ARRUGA
 ED-011-07
 7,5 cm

ED

Kapsel-Pinzetten
Capsular Forceps
Pincès capsulaires
Pinzas capsulares
Pinze capsulare



TERSON
ED-013-09
9 cm



KALT
ED-016-10
10 cm



ELSCHING
ED-019-10
10 cm



ARRUGA
ED-111-10
10 cm



ARRUGA
ED-114-10
10 cm



CASTROVIEJO
ED-115-10
10 cm



SCHWEIGGER
ED-117-10
10 cm



SCHWEIGGER
ED-119-10
10 cm



SCHWEIGGER
ED-121-10
10 cm



HESS
ED-215-06
6 cm



HESS
ED-217-06
6,5 cm



FUCHS
ED-219-07
7 cm

Naht-, Faden-Pinzetten
 Suturing, Ligature Forceps
 Pincès à sutures et à ligature
 Pinzas para suturas y para ligaduras
 Pinze per sutura e per legatura

ED

Zahn
 tooth
 dent
 diente
 dente



CASTROVIEJO

0,12 mm	ED-510-01	
0,3 mm	ED-510-03	
0,5 mm	ED-510-05	ED-511-05
1,0 mm	ED-510-10	ED-511-10
1,5 mm	ED-510-15	ED-511-15



MOORFIELD
ED-614-10
 10 cm



St. MARTIN
ED-616-07
 7 cm



Mod. Tübingen
ED-811-10
ED-815-10
 10 cm



PAUFIQUE
ED-910-08
ED-914-08
 8,5 cm



PAUFIQUE
ED-022-08
ED-026-08
 8,5 cm



McPHERSON
ED-120-10
ED-124-10
 10 cm



McPHERSON
ED-220-10
ED-224-10
 10 cm

Pinzetten für Chalazion, Entropium, Trachom
 Forceps for Chalazio, Entropium, Trachoma
 Pincés à chalazion, à entropion, à granulations du trachome
 Pinzas de chalazión, de entropión y para tracoma
 Pinze per calazio, per entropio e per trichiasi



AYER
 ED-420-09
 9 cm



AYER
 ED-422-09
 9 cm



LAMBERT
 ED-426-09
 9 cm



DESMARRES
 ED-524-09 - ED-528-09
 9 cm



ED-524-09
 Fig. 1



ED-526-09
 Fig. 2



ED-528-09
 Fig. 3



SNELLEN
 ED-625-10
 10 cm

SNELLEN
 ED-627-10
 10 cm



KNAPP-LUER
 ED-724-11
 11 cm



SCHEIE
ED-032-28
 1,0 x 28 mm



SCHEIE
ED-032-33
 1,5 x 33 mm



Mod. Tübingen
ED-033-45



Mod. Hamburg
ED-035-00



SIMCOE
ED-036-00



Mod. Bonn
ED-037-00



Mod. Bonn
ED-039-00

Hornhaut-Trephinen • Corneal Trephines
 Trépans cornéens • Trépanos corneales
 Trefine corneali



CASTROVIEJO
ED-130-50 - ED-131-01

ø mm	CASTROVIEJO
5,0	ED-130-50
5,5	ED-130-55
6,0	ED-130-60
6,5	ED-130-65
7,0	ED-130-70
8,0	ED-130-80
9,0	ED-130-90
10,0	ED-131-00
11,0	ED-131-01



FRANCESCETTI
ED-230-50 - ED-231-01

ø mm	FRANCESCETTI
5,0	ED-230-50
5,1	ED-230-51
6,0	ED-230-60
6,1	ED-230-61
7,0	ED-230-70
7,1	ED-230-71
8,0	ED-230-80
8,1	ED-230-81
9,0	ED-230-90
9,1	ED-230-91
10,0	ED-231-00



ELLIOT
ED-430-00
compl. = 4

Tonometer • Tonometro
Tonométre



SCHIOETZ

ED-044-00

ED-046-00

Skala	gerade	schräg
scale	straight	oblique
échelle	droite	oblique
escala	recta	oblicua
scala	retta	obliqua

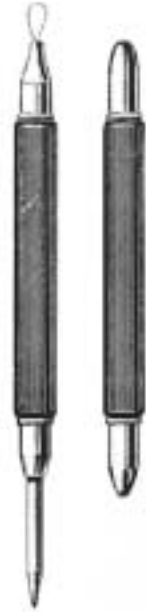

ED-048-00

Augen-Magnet
Eye Magnet
Aimant à corps étrangers
Imán para cuerpos extraños
Calamita per corpi estranei

Cilien-Pinzetten • Cilia Forceps
Pinces à épiler les cils • Pinzas
depilatorias • Pinze depilatorie



BEER
ED-240-09
9cm

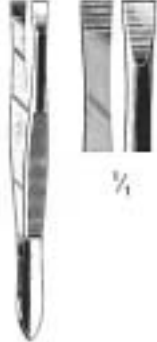

DOUGLAS
ED-242-09
9 cm



LITTAUER
ED-244-08
8,5 cm



DBARRAQUER
ED-245-10
10,5 cm

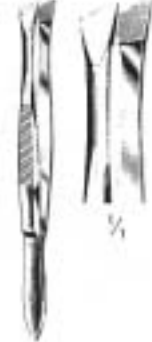

ED-246-09
9 cm



GRADLE
ED-248-09
9,5 cm

EE

**Otologie
Otology
Otologie
Otología
Otologia**



EE



mm Ø
 ④ = 3
EE-100-30
 ① = 4,5
EE-100-45
 ② = 5,5
EE-100-55
 ③ = 6,5
EE-100-65
 ④ = 7,5
EE-100-75

HARTMANN
EE-100-00
 Set = 4



mm Ø
 ② = 5,5
EE-102-55
 ③ = 6,5
EE-102-65
 ④ = 7,5
EE-102-75

TOYNBEE
EE-102-00
 Set = 3



mm Ø
 ① = 4,5
EE-104-45
 ② = 5,5
EE-104-55
 ③ = 6,5
EE-104-65
 ④ = 7,5
EE-104-75

GRUBER
EE-104-00
 Set = 4



mm Ø
 ① = 4,5
EE-105-45
 ② = 5,5
EE-105-55
 ③ = 6,5
EE-105-65
 ④ = 7,5
EE-105-75

GRUBER
EE-105-00
 Set = 3



EE-108-50
 5 mm
EE-108-60
 6 mm
EE-108-70
 7 mm
EE-108-80
 8 mm

BOUCHERON
EE-108-00
 Set = 4



① = 6,5
 ② = 7
 ③ = 8 mm Ø



BRUENINGS
EE-300-04
 compl.



SIEGLE
EE-306-03
 compl.



Alu

EE-600-01
C 128

EE-600-02
C¹ 256

EE-600-03
C² 512

EE-600-04
C³ 1024

EE-600-05
C⁴ 2048



Alu
EE-601-00
compl.

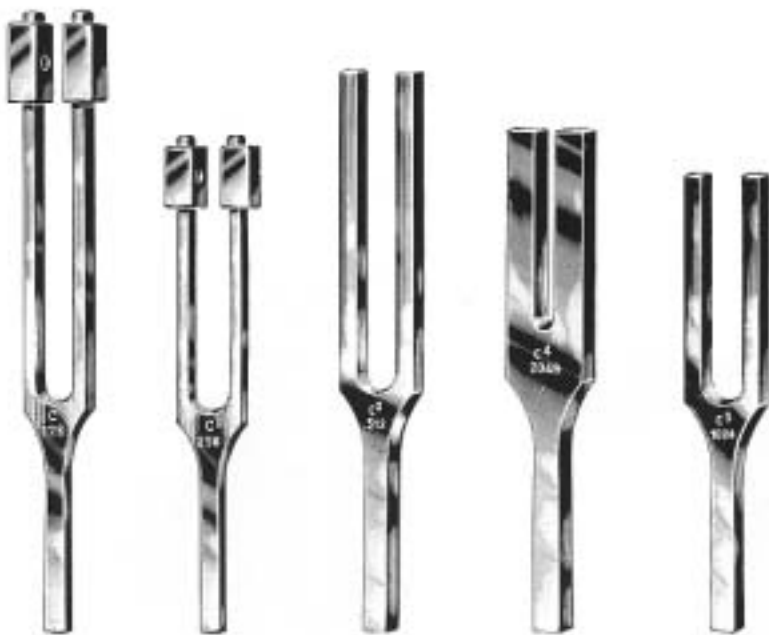

HARTMANN

EE-700-01
C 128

EE-700-02
C¹ 256

EE-700-03
C² 512

EE-700-04
C³ 1024

EE-700-05
C⁴ 2048



HARTMANN
EE-701-00
compl.



LUCAE
EE-704-01
C 128



EE-705-00
neurolog.



RYDEL-SEIFFER
EE-706-01
C 64 / c 128

Lärmapparat
Noise Apparatus
Assourdisseur
Ensordecedor
Assordatore



BARANY
EE-800-00

Pulverbläser
Powder Blowers
Lance-Poudre
Lanzapolvero
Insuffiadori per polvere

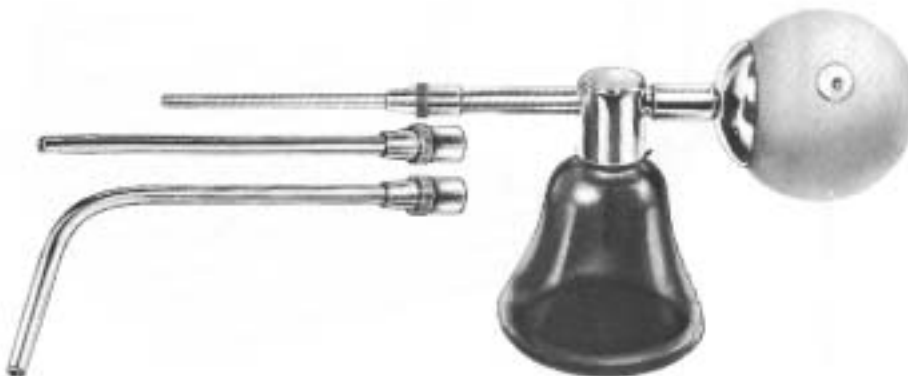

KABIERSKE
EE-900-00
30 cc

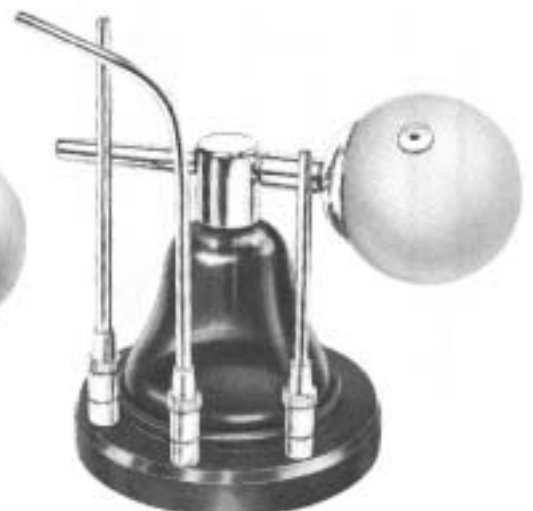

KABIERSKE
EE-900-01
30 cc



EE-901-03



EE-901-04
4 mm Ø



EE-901-15
15 mm Ø



EE-901-17
17 mm Ø



EE-901-22
22 mm Ø

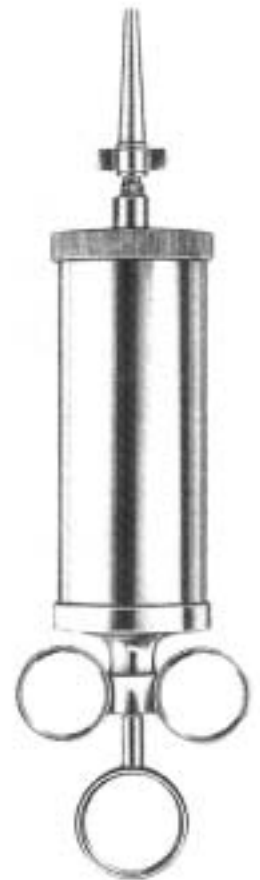

POLITZER

EE-901-00 = EE-901-15, EE-901-17, EE-901-22, EE-901-03

EE-901-01 = EE-901-15, EE-901-17, EE-901-22, EE-901-03, EE-901-04

ml	REINER
50	EE-906-50
75	EE-906-75
100	EE-907-10
150	EE-907-15

**Küretten • Currettes •
 Curettes • Curetas •
 Curette**



Fig. 00



0



1



2



3



4



5

stumpf • blunt
 mousses
 romas
 smusse

EE-019-00	EE-110-00	EE-110-01	EE-110-02	EE-110-03	EE-110-04	EE-110-05
------------------	------------------	------------------	------------------	------------------	------------------	------------------

scharf • sharp
 tranchantes
 cortantes
 taglienti

EE-111-00	EE-112-00	EE-112-01	EE-112-02	EE-112-03	EE-112-04	EE-112-05
------------------	------------------	------------------	------------------	------------------	------------------	------------------

stumpf • blunt
 mousses
 romas
 smusse

EE-114-00	EE-115-00	EE-115-01	EE-115-02	EE-115-03	EE-115-04	EE-115-05
------------------	------------------	------------------	------------------	------------------	------------------	------------------

scharf • sharp
 tranchantes
 cortantes
 taglienti

EE-116-00	EE-117-00	EE-117-01	EE-117-02	EE-117-03	EE-117-04	EE-117-05
------------------	------------------	------------------	------------------	------------------	------------------	------------------



Fig.	HARTMANN	ITARD
0	EE-311-00	
1	EE-311-01	EE-313-01
2	EE-311-02	EE-313-02
3	EE-311-03	EE-313-03
4	EE-311-04	EE-313-04
5	EE-311-05	EE-313-05

POLITZER
 EE-510-18
 18 cm

POLITZER
 EE-511-16
 16,5 cm

POLITZER
 EE-513-16



POLITZER
 EE-610-15
 15 cm

SEXTON
 EE-612-18
 18 cm

SEXTON
 EE-614-17
 17 cm

SEXTON
 EE-615-17
 17 cm

GROSS
 EE-710-12
 12 cm

GROSS
 EE-711-12
 12 cm

Schlingen, Hakchen, Pinzetten, Schnurer
 Loops, Hooklets, Dressing Forceps, Snares
 Anses, Crochets, Pincas, Serrenoed
 Asas, Granchitos, Pinzas, Cierranudos
 Anse, Uncinetti, Pinze, Serranodi

EE

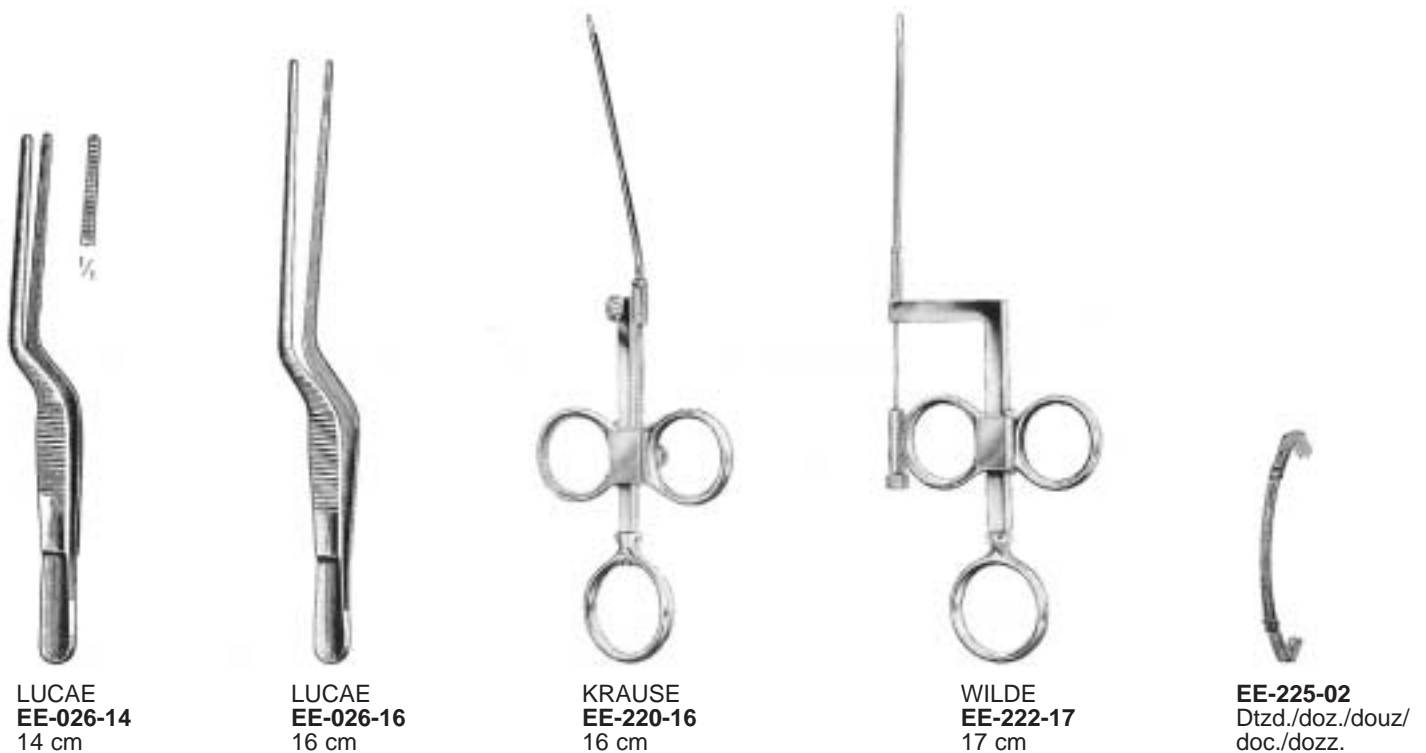
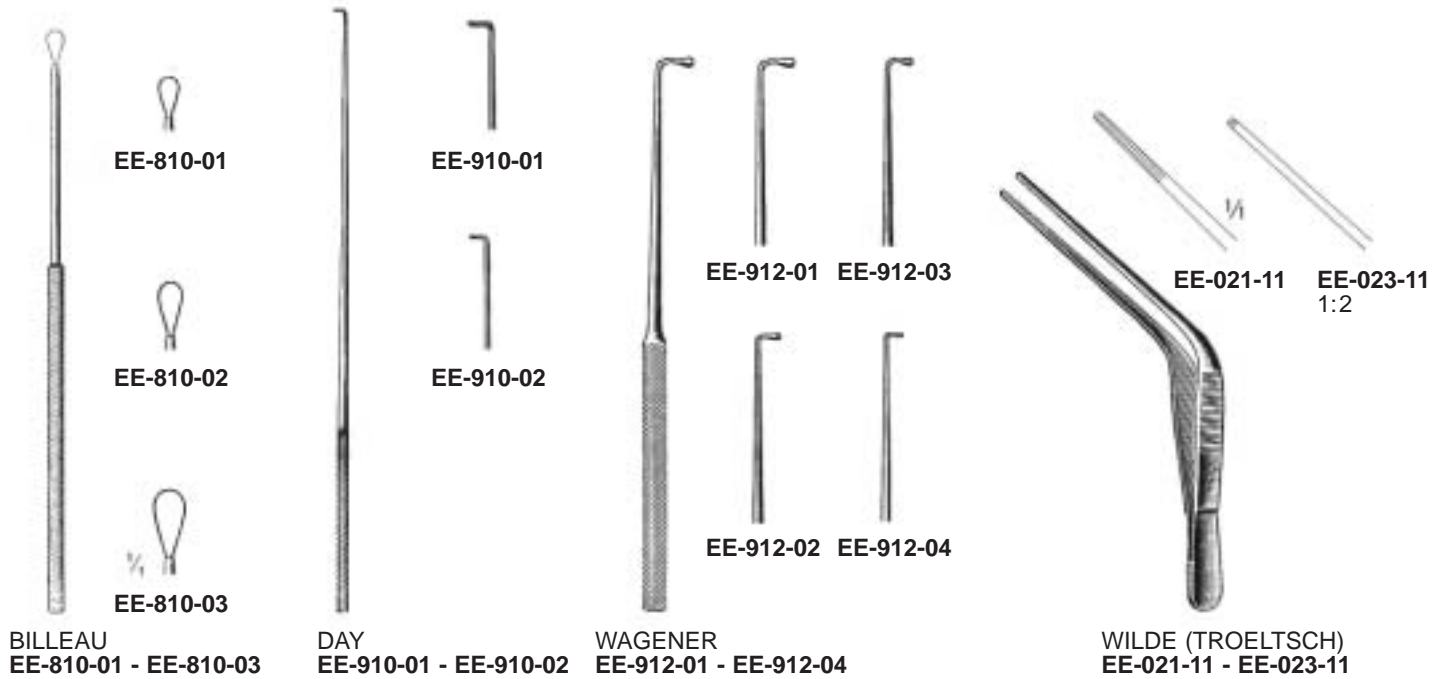

EE

Ohrzangchen
 Ear Forceps
 Pincas auriculaires
 Pinzas auriculares
 Pinze auricolari



TILLEY
EE-423-14
 14 cm



LITTAUER
EE-425-12
 12 cm



HARTMANN
EE-421-12
 12 cm



HARTMANN
EE-421-14
 14 cm



QUIRE
EE-521-10
 10 cm

Fremdkorperhebel
 Foreign Body Levers
 Leviers pour corps etrangers
 Elevadores para cuerpos extranjeros
 Leve per corpi estranei



BUCK
EE-523-11
 11 cm



EE-525-08 - EE-725-08



HARTMANN-WULLSTEIN
EE-525-08
 8,5 cm



HARTMANN-WULLSTEIN
EE-527-08
 8,5 cm



cm	HARTMANN
8,5	EE-621-08
14,0	EE-621-14
16,0	EE-621-16



cm	HARTMANN
8,5	EE-623-08
14,0	EE-623-14



HARTMANN
EE-625-08
 8,5 cm



cm	HARTMANN
2,0	EE-627-20
2,5	EE-627-25
3,0	EE-627-30
8,5 cm	

○ 3 mm



HARTMANN
EE-629-30
 8,5 cm



STRUEMPEL
EE-721-08
 8,5 cm



HARTMANN
EE-723-08
 8,5 cm

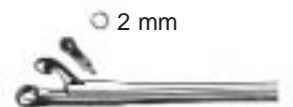

HARTMANN-HOFFMANN
EE-725-08
 8,5 cm

○ 2 mm

Mikro-Ohrscherchen
 Micro Ear Scissors
 Ciseaux auriculaires micro
 Tijeras auriculares micro
 Forbici auricolari micro



EE-130-40 - EE-232-70

gerade
 straight
 droite
 recta
 retta



**BELLUCCI
 EE-130-40**
 micro mini
 4 mm

links
 left
 gauche
 izquierda
 sinistra



**BELLUCCI
 EE-135-55**
 micro standard
 5,5 mm

gerade
 straight
 droite
 recta
 retta



**SHEA
 EE-230-70**
 7,0 mm

gerade
 straight
 droite
 recta
 retta



**BELLUCCI
 EE-132-55**
 micro standard
 5,5 mm

rechts
 right
 droite
 derecha
 retta



**BELLUCCI
 EE-137-55**
 micro standard
 5,5 mm

links
 left
 gauche
 izquierda
 sinistra



**SHEA
 EE-231-70**
 7,0 mm

aufgebogen
 bent upwards
 courbée vers le haut
 curva por arriba
 curva in alto



**BELLUCCI
 EE-133-55**
 micro standard
 5,5 mm

rechts
 right
 droite
 derecha
 retta



**SHEA
 EE-232-70**
 7,0 mm

Mikro-Ohrzängchen
 Micro Ear Forceps
 Pincés auriculaires micro
 Pinzas auriculares micro
 Pinze auricolari micro



EE-530-40 - EE-630-35

gerieft, gerade
 serrated, straight
 striée, droite
 estriada, recta
 con scanalatura, retta



EE-530-40
 4 mm

links, gerieft
 left, serrated
 gauche, striée
 izquierda, estriada
 sinistra, con scanalatura



EE-533-60
 6 mm

abwärts gebogen, gerieft
 downwards, serrated
 courbée en bas, striée
 curva hacia abajo, estriada
 curva in basso, con scanalatura



EE-534-40
 4 mm

gerieft, gerade
 serrated, straight
 striée, droite
 estriada, recta
 con scanalatura, retta



EE-530-70
 7 mm

rechts, gerieft
 right, serrated
 droite, striée
 derecha, estriada
 retta, con scanalatura



EE-535-60
 6 mm

gerieft, gerade
 serrated, straight
 striée, droite
 estriada, recta
 con scanalatura, retta



EE-630-35
 3,5 mm

glatt, gerade
 smooth, straight
 lisse, droite
 lisa, recta
 liscia, retta



EE-532-40
 4 mm

aufgebogen, gerieft
 bent upwards, serrated
 courbée vers le haut, striée
 curva por arriba, estriada
 curva in alto, con scanalatura



EE-537-40
 4 mm

Mikro-Ohrzängchen
 Micro Ear Forceps
 Pincès auriculaires micro
 Pinzas auriculares micro
 Pinze auricolari micro

rechts
 right
 droite
 derecha
 retta



EE-632-45
 4,5 mm

links
 left
 gauche
 izquierda
 sinistra

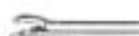

EE-633-45
 4,5 mm

gerade
 straight
 droite
 recta
 retta



EE-635-45
 4,5 mm



EE-637-50
 5,0 mm



EE-639-50
 5,0 mm

abgebogen
 bent downwards
 courbée vers le bas
 curva por abajo
 curva in baso



GREVEN
EE-730-50
 5,0 mm

abgebogen
 bent downwards
 courbée vers le bas
 curva por abajo
 curva in baso

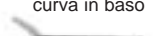

GREVEN
EE-731-40
 0,8 x 4,0 mm



EE-632-45 - EE-731-40

Hammerkopf-Zwickzängchen
 Malleus Nippers
 Pincès pour la tête du marteau
 Pinzas para la cabeza del martillo
 Pinze per la testa del martello

micro



EE-835-01

aufwärts
 upward
 en haut
 arriba
 in alto

mini



EE-837-01



EE-835-02

abwärts
 downward
 en bas
 abajo
 in basso



EE-837-02

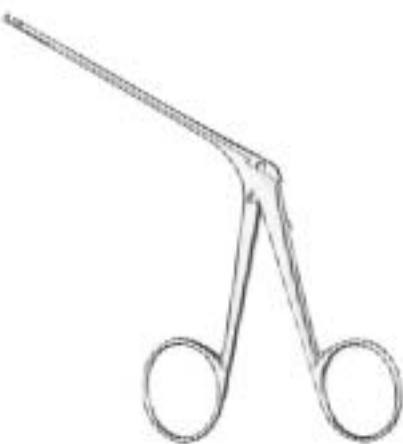

DIETER
EE-835-01 - EE-837-02

Modelle mit Ringgriff
 Ring Handle Patterns
 Modèles manches à anneaux
 Modelos mangos con anillos
 Modelli manici con anelli

Modelle mit Bleistiftgriff
 Pencil Handle Patterns
 Modèles manches crayon
 Modelos mango en forma de lapiz
 Modelli manico forma matita



EE-140-00 - EE-149-00
 micro
 RG

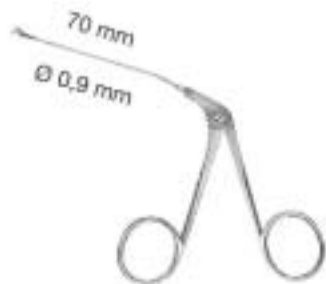

EE-240-00 - EE-249-00
 micro-mini
 RG

EE-140-00



EE-142-00



EE-143-00



EE-145-00



EE-147-00



EE-149-00



EE-340-00

EE-342-00

EE-343-00

EE-345-00

EE-347-00

EE-349-00

EE-349-08

EE-240-00



EE-242-00



EE-243-00



EE-245-00



EE-247-00



EE-249-00



EE-440-00

EE-442-00

EE-443-00

EE-445-00

EE-447-00

EE-449-00

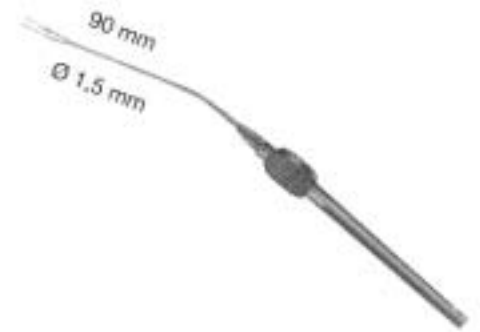

EE-340-00 - EE-349-08
 micro
 BG

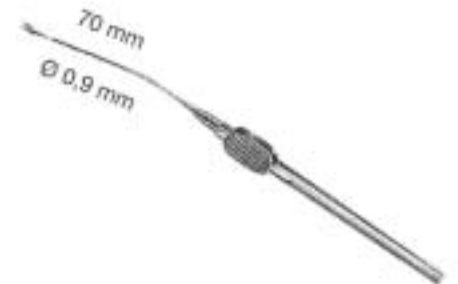

EE-440-00 - EE-449-00
 micro-mini
 BG



Modelle mit Ringgriff
 Ring Handle Patterns
 Modèles manches à anneaux
 Modelos mangos con anillos
 Modelli manici con anelli

EE-150-00 - EE-459-00
 micro
 RG

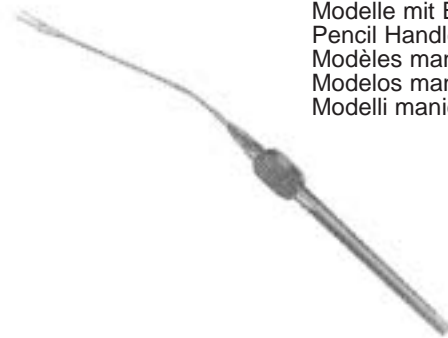

Modelle mit Bleistiftgriff
 Pencil Handle Patterns
 Modèles manches crayon
 Modelos mango en forma de lapiz
 Modelli manico forma matita

EE-160-00 - EE-469-00
 micro
 BG

EE-150-00		EE-160-00
EE-151-00		EE-161-00
EE-153-00		EE-163-00
EE-154-00		EE-164-00
EE-155-00		EE-165-00
EE-156-00		EE-166-00
EE-157-00		EE-167-00
EE-159-00		EE-169-00
EE-250-00		EE-260-00
EE-251-00		

Ø 1 mm Ø 1,5 mm Ø 2 mm Ø 2,5 mm

Ø 1 mm Ø 1,5 mm Ø 2 mm Ø 2,5 mm

EE-252-00	EE-258-00	EE-354-00	EE-450-00		EE-262-00	EE-268-00	EE-364-00	EE-460-00
EE-253-00	EE-259-00	EE-355-00	EE-451-00		EE-263-00	EE-269-00	EE-365-00	EE-461-00
EE-255-00	EE-351-00	EE-357-00	EE-453-00		EE-265-00	EE-361-00	EE-367-00	EE-463-00
EE-257-00	EE-353-00	EE-359-00	EE-455-00		EE-267-00	EE-363-00	EE-399-00	EE-465-00
			EE-456-00					EE-466-00
			EE-457-00					EE-467-00
			EE-458-00					EE-468-00
			EE-459-00					EE-469-00

Modelle mit Ringgriff
 Ring Handle Patterns
 Modèles manches à anneaux
 Modelos mangos con anillos
 Modelli manici con anelli

Modelle mit Bleistiftgriff
 Pencil Handle Patterns
 Modèles manches crayon
 Modelos mango en forma de lapiz
 Modelli manico forma matita



EE-550-00 - EE-859-00
 micro-mini
 RG



EE-560-00 - EE-869-00
 micro-mini
 BG

EE-550-00		EE-560-00
EE-551-00		EE-561-00
EE-553-00		EE-563-00
EE-554-00		EE-564-00
EE-555-00		EE-565-00
EE-556-00		
EE-557-00		EE-567-00
EE-559-00		EE-569-00
EE-650-00		EE-660-00
EE-651-00		
EE-652-00		EE-662-00
EE-653-00		EE-663-00
EE-655-00		EE-665-00
EE-657-00		EE-667-00
EE-856-00		EE-866-00
EE-857-00		EE-867-00
EE-858-00		EE-868-00
EE-859-00		EE-869-00



SCHUKNECHT
 EE-071-01



SCHUKNECHT
 EE-071-02



SCHUKNECHT
 EE-073-15
 15,5 cm



WULLSTEIN
 EE-074-15
 15,5 cm



TABB
 EE-075-15
 15,5 cm



PLESTER
 EE-076-35
 15,5 cm / 3,5 mm Ø



EE-079-10 1,0 mm
 EE-079-14 1,4 mm
 EE-079-16 1,6 mm
 EE-079-20 2,0 mm



EE-079-26 2,6 mm
 EE-079-28 2,8 mm
 EE-079-30 3,0 mm

ROSEN
 EE-079-10 - EE-079-30



BARBARA
 EE-170-15



BARBARA
 EE-171-15



BARBARA
 EE-173-15



ROSEN
 EE-175-15



	25°	45°	90°	
mm	BARBARA	BARBARA	BARBARA	BARBARA
0,3	EE-270-03	EE-272-03	EE-274-03	EE-275-05 = 0,5 mm
0,6	EE-270-06	EE-272-06	EE-274-06	EE-275-10 = 0,5 mm
1,0	EE-270-10	EE-272-10	EE-274-10	
1,2		EE-272-12	EE-274-12	
1,5		EE-272-15	EE-274-15	
2,0		EE-272-20	EE-274-20	
2,5		EE-272-25	EE-274-25	

EE-170-15 - EE-275-10

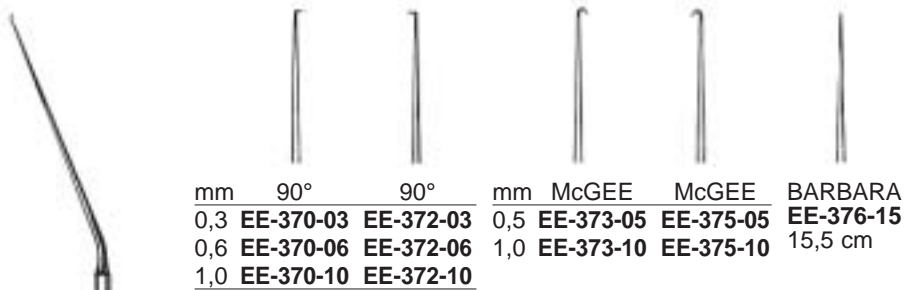

mm	90°	90°	mm	McGEE	McGEE	BARBARA
0,3	EE-370-03	EE-372-03	0,5	EE-373-05	EE-375-05	EE-376-15
0,6	EE-370-06	EE-372-06	1,0	EE-373-10	EE-375-10	15,5 cm
1,0	EE-370-10	EE-372-10				

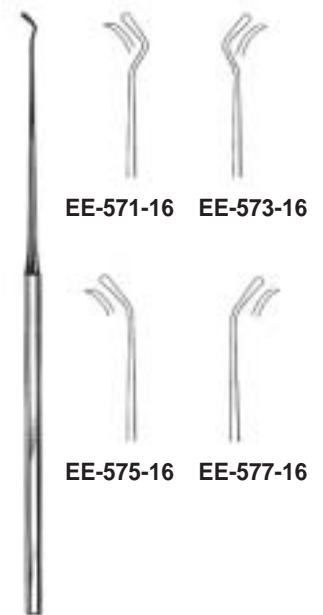

EE-571-16 EE-573-16
 EE-575-16 EE-577-16

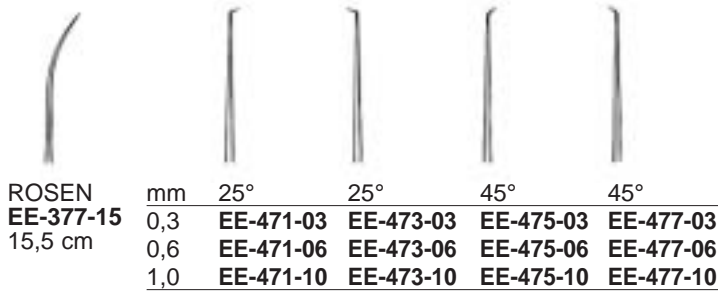

ROSEN	mm	25°	25°	45°	45°
EE-377-15	0,3	EE-471-03	EE-473-03	EE-475-03	EE-477-03
15,5 cm	0,6	EE-471-06	EE-473-06	EE-475-06	EE-477-06
	1,0	EE-471-10	EE-473-10	EE-475-10	EE-477-10

FISCH
 EE-571-16 - EE-577-16

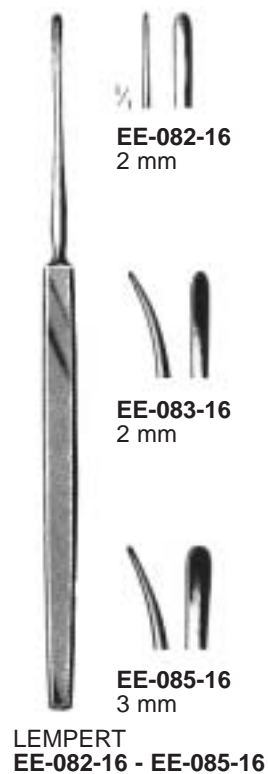

EE-082-16
 2 mm

EE-083-16
 2 mm

EE-085-16
 3 mm

LEMPERT
 EE-082-16 - EE-085-16

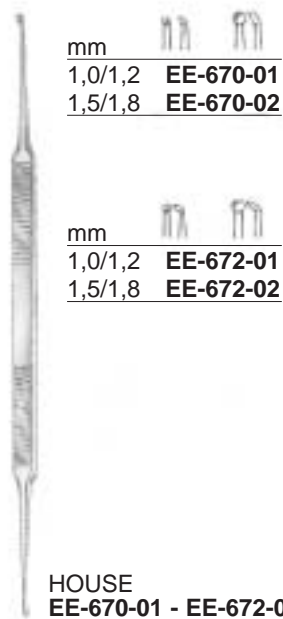

mm	
1,0/1,2	EE-670-01
1,5/1,8	EE-670-02

mm	
1,0/1,2	EE-672-01
1,5/1,8	EE-672-02

HOUSE
 EE-670-01 - EE-672-02

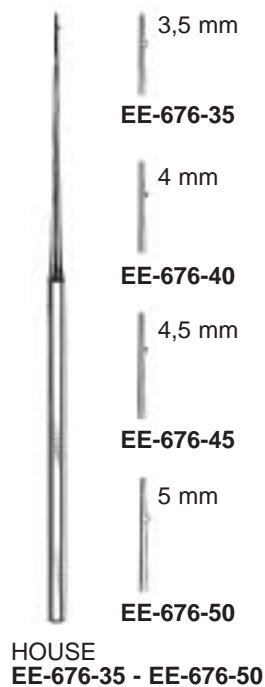

3,5 mm

EE-676-35

4 mm

EE-676-40

4,5 mm

EE-676-45

5 mm

EE-676-50

HOUSE
 EE-676-35 - EE-676-50



LEMPERT
 EE-087-20
 20,5 cm



mm	PASSOW
2 x 2	EE-180-01
3 x 3	EE-180-02

MUCK
 EE-182-13
 13 cm

EG

**Rhinologie
Rhinology
Rhinologie
Rinología
Rinologia**



EG



EG-500-01 Fig. 1
EG-500-02 Fig. 2
EG-500-03 Fig. 3
EG-500-04 Fig. 4

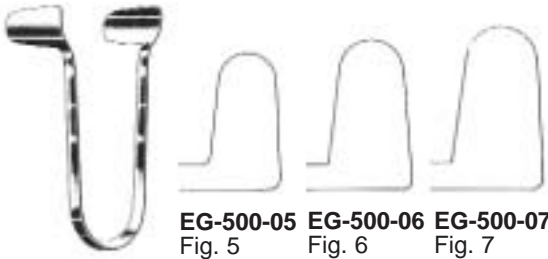

EG-500-05 Fig. 5
EG-500-06 Fig. 6
EG-500-07 Fig. 7

THUDICHUM
 EA-500-01 - EA-500-07



EG-600-01
 Fig. 1



EG-600-02
 Fig. 2



EG-600-03
 Fig. 2



VOLTOLINI
 EG-600-01 - EG-600-03



EG-012-01
 Fig. 1



EG-012-02
 Fig. 2



EG-012-03
 Fig. 3



HARTMANN-HALLE
 EG-012-01 - EG-012-03
 15 cm



Mod. Wien • Vienna •
 Vienne • Viena

Baby • Bébé **EG-112-01**
 Kind • child • enf. • niño • bamb. **EG-112-02**
 Erw. • Adult. **EG-112-03**



Mod. Wien • Vienna
 Vienne • Viena
EG-113-03
 leichtes Modell
 lightweight
 mod. léger
 mod. ligero
 mod. leggero



TIECK-HALLE
EG-116-13
 13,5 cm



KILLIAN
EG-210-35 - EG-210-90
 13,5 cm

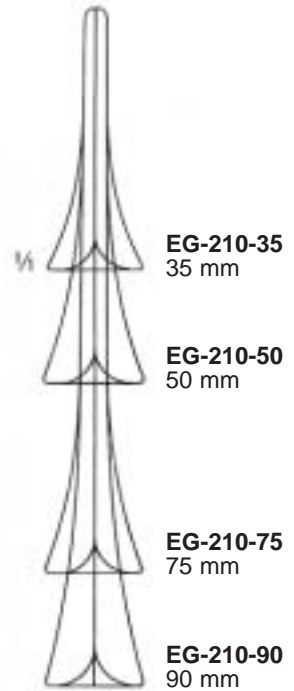

EG-210-35
 35 mm

EG-210-50
 50 mm

EG-210-75
 75 mm

EG-210-90
 90 mm



COTTLE
EG-214-35 - EG-214-90
 14 cm



COTTLE
EG-216-35 - EG-216-90
 schwarz • black • noirs
 negros • neri
 14 cm

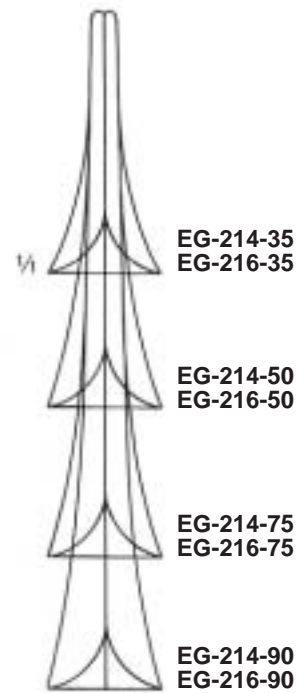

EG-214-35
EG-216-35

EG-214-50
EG-216-50

EG-214-75
EG-216-75

EG-214-90
EG-216-90



YANKAUER
EG-311-19
19 cm



MICHEL
EG-319-12 - EG-319-18
25 cm

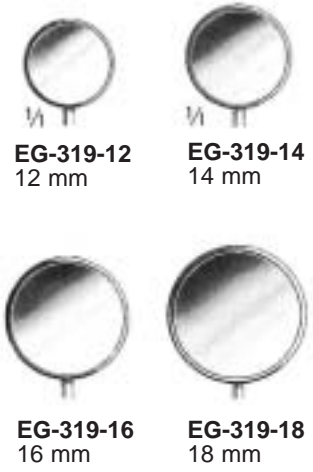

EG-319-12
12 mm

EG-319-14
14 mm

EG-319-16
16 mm

EG-319-18
18 mm



TROELTSCH
EG-511-15
15 cm

TROELTSCH
EG-511-18
18 cm



JANSEN
EG-514-20
20 cm



HARTMANN
EG-611-16
16 cm



HARTMANN
EG-611-20
20 cm



LUBET-BARBON
EG-615-20
 20 cm

LITTAUER
EG-617-18
 18 cm

HEYMANN-KNIGHT
EG-619-18
 18 cm

NOYES
EG-711-14 - EG-713-14
 14,5 cm



EG-811-01

EG-811-02

EG-811-03

HEYMANN
EG-811-01 - EG-811-03
 18 cm

KNIGHT
EG-815-18
 18 cm

BRUENINGS
EG-911-01 - EG-911-04
 19 cm

EG-911-01

EG-911-02

EG-911-03

EG-911-04



EG-915-01 **EG-915-02**
 Fig. 1 Fig. 2

LUC
EG-915-01 - EG-915-02
 19 cm

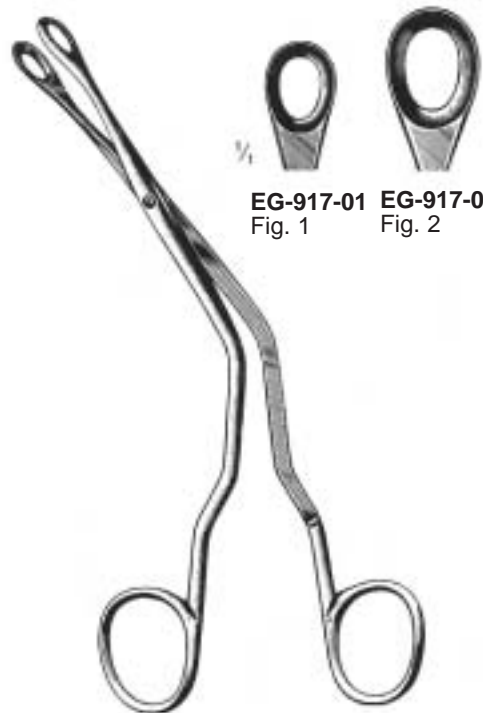

EG-917-01 **EG-917-02**
 Fig. 1 Fig. 2

LUC
EG-917-01 - EG-917-02
 19 cm

ohne Hals
 without neck
 sans cou
 sin cuello
 senza collo



mit Hals
 with neck
 avec cou
 con cuello
 con collo



WEIL-BLAKESLEY
EG-221-01 - EG-223-05

Scharfe Nasenzangen
 Nasal Cutting Forceps
 Pincès coupantes nasales
 Pinzas cortantes nasales
 Pinze taglianti nasali



EG-321-01-EG-327-03
 19 cm



STRUYCKEN
EG-321-01
 Fig. 1



STRUYCKEN
EG-321-02
 Fig. 2

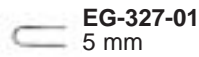

EG-327-01
 5 mm

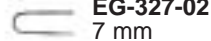

EG-327-02
 7 mm

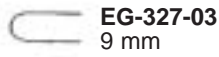

EG-327-03
 9 mm



MYLES



EG-325-05



EG-325-07



EG-325-09



EG-325-11



HARTMANN



Septum- Quetschzange
 Septum Crushing Forceps
 Pince à éraiser la cloison
 Pinza para magullar tabique
 Pinza per ammaccare il setto

RUBIN
EG-521-21
 21 cm



mm x mm	KERRISON
3 x 3	EG-033-03
4 x 4	EG-033-04
5 x 5	EG-033-05
6 x 6	EG-033-06

17 cm

EG-035-01
3, 5 mm

EG-035-02
3, 5 mm



HAJEK-KOFLER
EG-035-01 - EG-035-02



mm	CITELLI
1,0	EG-131-10
2,5	EG-131-25
4,0	EG-131-40



BEYER
EG-135-20
2,0 mm



HAJEK-CLAUS
EG-230-20
20 mm



MIDDLETON-JANSEN
EG-233-19
 19 cm



MIDDLETON-JANSEN
EG-235-19
 19 cm



ø mm	LICHTWITZ
1,5	EG-430-15
1,8	EG-430-18
2,0	EG-430-20

Luer-Lock
 10 cm



KILLIAN
EG-431-03
 14 cm/3 mm ø



KRAUSE
EG-531-26
 26 cm



WILDE
EG-532-24
 24 cm



WILDE
EG-535-03
 0,3 mm



JOSEPF
 EG-730-16 - EG-733-16



EG-730-16
 stumpf • blunt • mousses
 romos • smussi



EG-731-16



EG-732-16
 spitz • pinted • pointus
 puntiagudos • acuti



EG-733-16



FREER
 EG-734-15
 15 cm



FREER
 EG-735-19
 19cm



JOSEPH
 EG-736-16
 16 cm



CONVERSE
 EG-739-16
 16 cm



CONVERSE
 EG-830-15
 15 cm



EG-832-15



COTTLE
 EG-834-15



EG-835-15

Septum-Messer
 Septum Knives
 Couteaux pour la cloison
 Cuchillos para tabique
 Coltelli per setto

EG

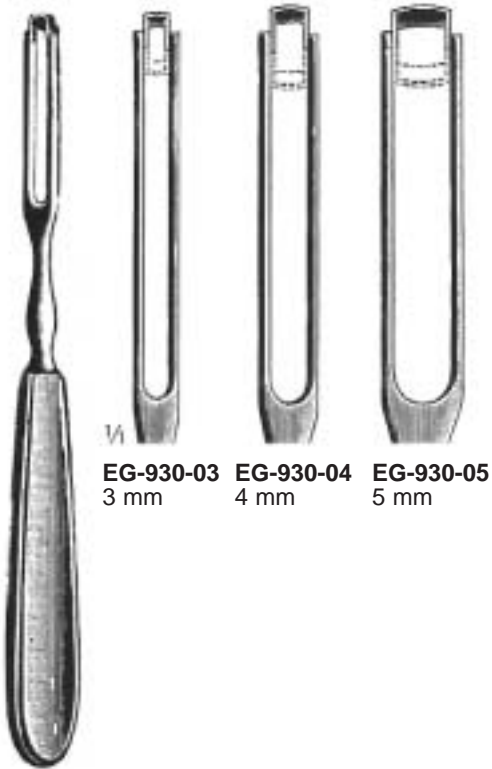

EG-930-03 3 mm
EG-930-04 4 mm
EG-930-05 5 mm



EG-932-03 3 mm
EG-932-04 4 mm
EG-932-05 5 mm



BRUENINGS
EG-938-16
 16,5 cm

BALLENGER
EG-930-03 - EG-932-05
 20 cm

Septum-Elevatorien
 Septum Elevators
 Elevateurs pour la cloison nasale
 Elevadores para tabique
 Elevatori per setto

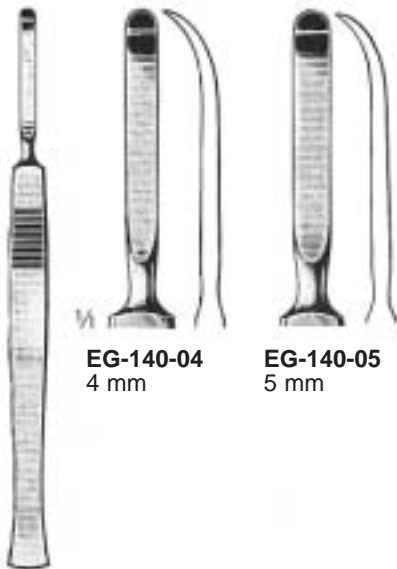

EG-140-04 4 mm
EG-140-05 5 mm

McKENTY
EG-140-04 - EG-140-05
 15 cm

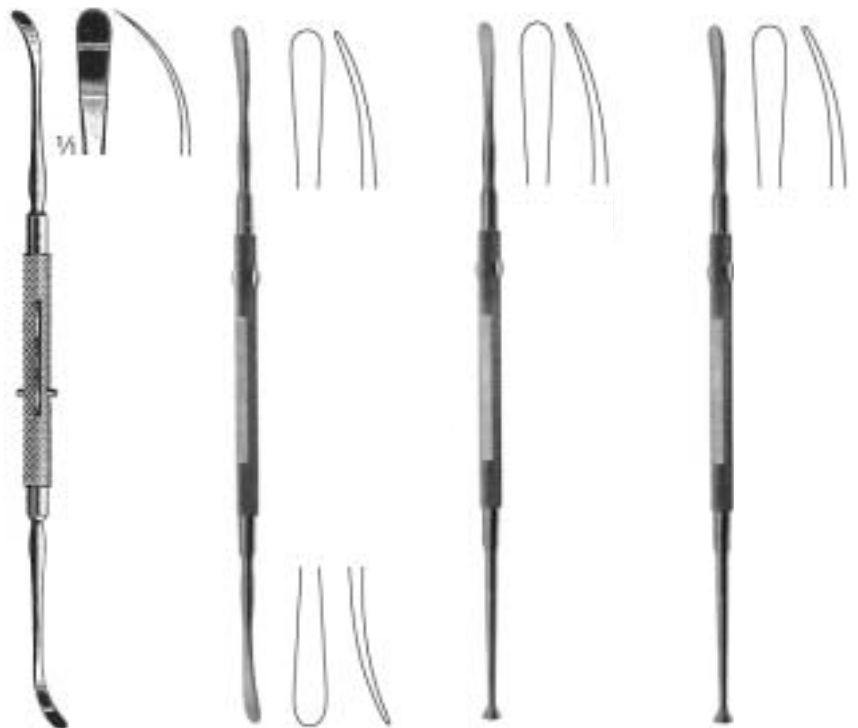

ROGER
EG-143-19
 19 cm

FREER
EG-145-18
 18 cm

FREER
EG-147-19
 19 cm

FREER
EG-149-19
 19 cm



**COTTLE
EG-241-23**
23 cm



**COTTLE
EG-243-22**
22 cm



**JOSEPH
EG-245-16**
16 cm



**COTTLE
EG-245-19**
19cm



**KILLIAN
EG-246-22**
19cm



**HAJEK-BALLENGER
EG-248-21**
22 cm



**BALLENGER
EG-340-22**
2 cm



**FREER
EG-540-04**
4 mm



**FREER
EG-541-04**
4 mm



EG-544-04
4 mm

EG-544-07
7 mm

EG-544-09
9 mm

EG-544-12
12 mm

COTTLE
EG-544-04 - EG-544-12
 18 cm



COTTLE
EG-545-06
 18 cm/6 mm

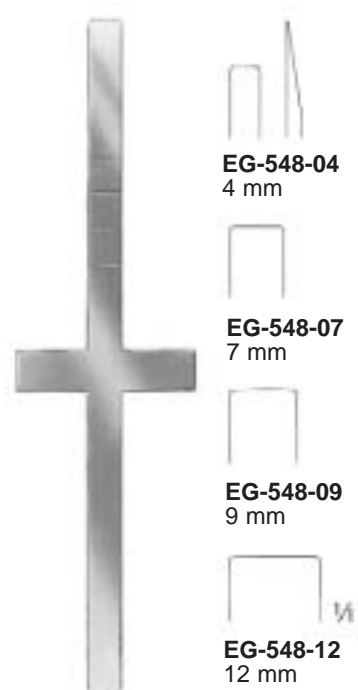

EG-548-04
4 mm

EG-548-07
7 mm

EG-548-09
9 mm

EG-548-12
12 mm

COTTLE
EG-548-04 - EG-548-12

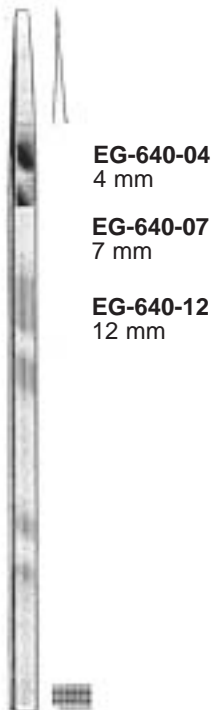

EG-640-04
4 mm

EG-640-07
7 mm

EG-640-12
12 mm

COTTLE
EG-640-04 - EG-640-12
 18 cm

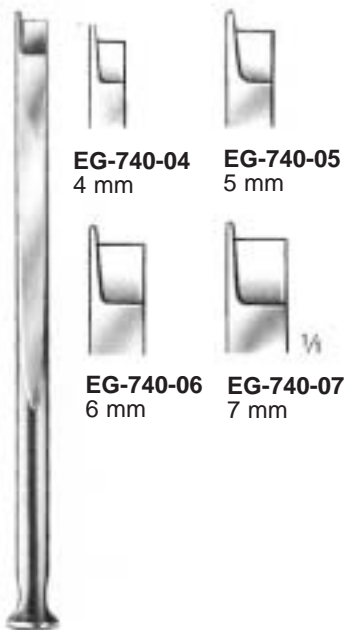

EG-740-04
4 mm

EG-740-05
5 mm

EG-740-06
6 mm

EG-740-07
7 mm

FOMON
EG-740-04 - EG-740-07
 17 cm

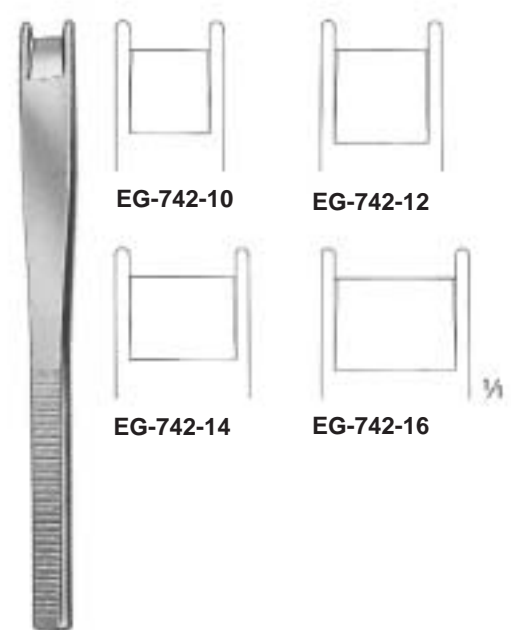

EG-742-10

EG-742-12

EG-742-14

EG-742-16

FOMON
EG-742-10 - EG-742-16

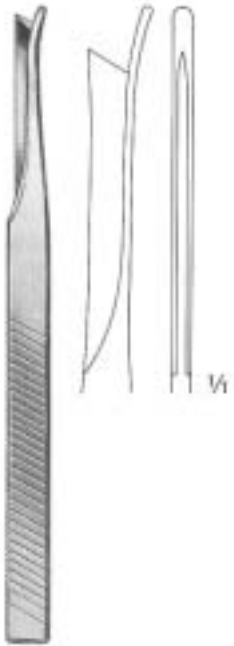

SILVER
EG-743-01
18 cm

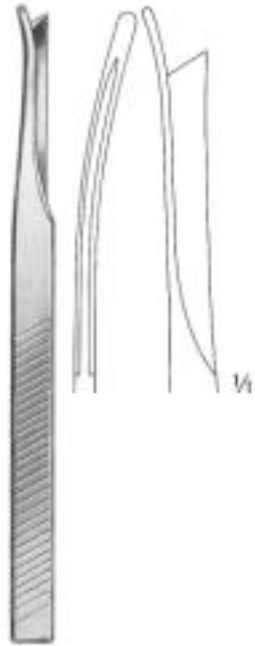

SILVER
EG-743-02
18 cm



SILVER
EG-743-03
18 cm



KILLIAN-CLAUS
EG-842-05
17 cm/5 mm



mm	HAJEK
4	EG-844-04
6	EG-844-06
8	EG-844-08



WEST
EG-846-16
16 cm



WEST
EG-847-16
16 cm



FREER
EG-849-16
6 mm

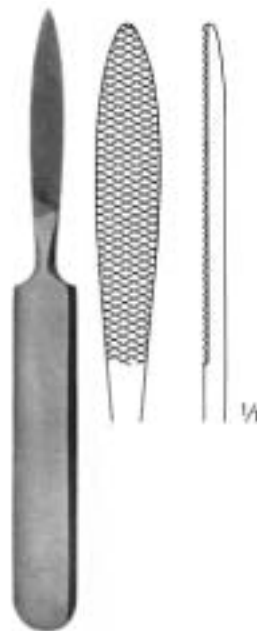

JOSEPH
EG-052-16
16 cm

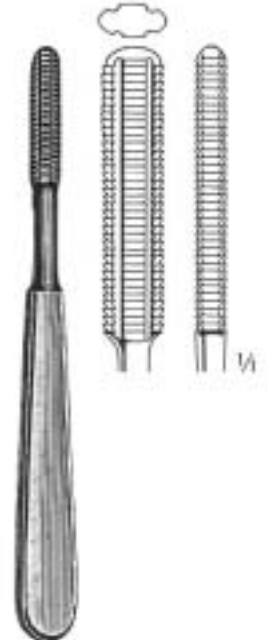

MALTZ
EG-054-18
18 cm



EG-057-18



EG-057-19

WIENER
EG-057-18 - EG-057-19
 18 cm



EG-151-21



EG-153-21

WIENER (AUFRICHT)
EG-151-21 - EG-153-21
 21 cm



EG-154-16
 fein • fine
 fina



EG-156-16
 grob • coarse • gruesa
 entellure grosse
 dentellatura grossa

JOSEPH (LEWIS)
EG-154-16 - EG-156-16
 18 cm

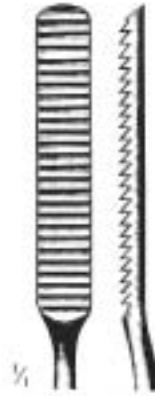

MALTZ (COTTLE)
EG-158-21
 21 cm

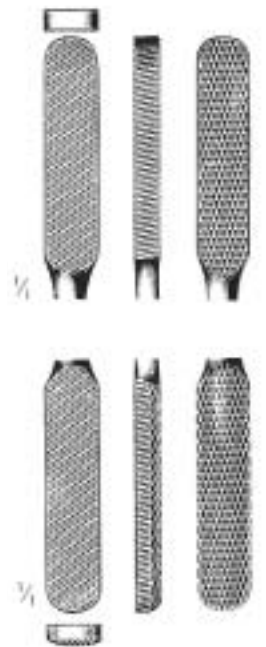

FOMON
EG-250-21
 21 cm



FOMON
20 cm TC

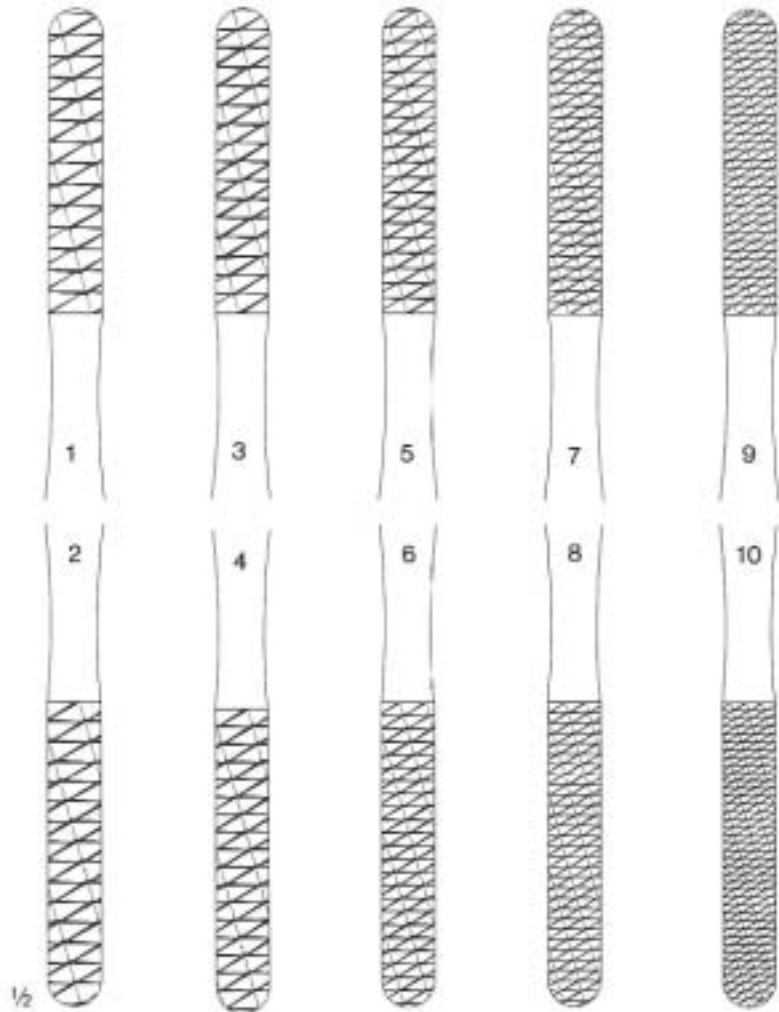

Fig. 1/2

EG-252-01

Fig. 3/4

EG-252-03

Fig. 5/6

EG-252-05

Fig. 7/8

EG-252-07

Fig. 9/10

EG-252-09

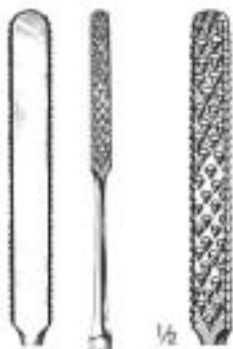

Fig. 1

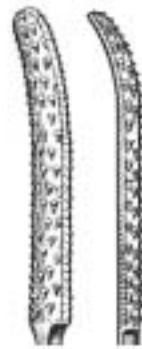

Fig. 2

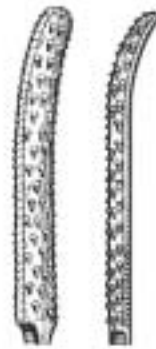

Fig. 3



GALLAHER

EG-256-16

EG-257-16

EG-259-16

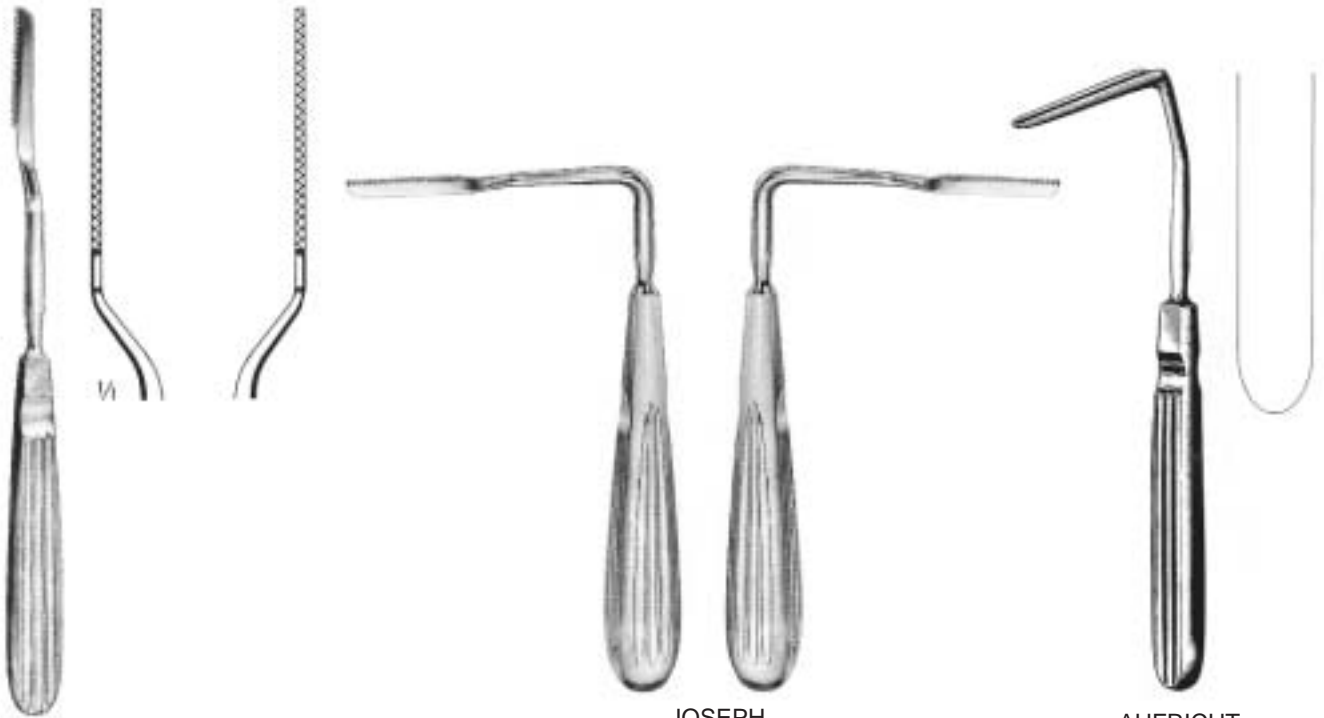

JOSEPH
EG-355-01 17 cm EG-355-01

AUFRICHT
EG-551-16
19 cm

JOSEPH
19 cm
EG-352-19 links • left
à gauche
izquierda
a sinistra
EG-354-19 rechts • right •
á droite
derecha
a destra



COTTLE
EG-556-14

FOMON
EG-556-16

FOMON
EG-557-17

COTTLE-NEIVERT
EG-559-20

Fig. 1 GILLIES
EG-650-18
Fig. 2 EG-652-18
18 cm



ASCH
EG-751-23
23 cm



WALSHAM
EG-752-23 - EG-755-23
23 cm

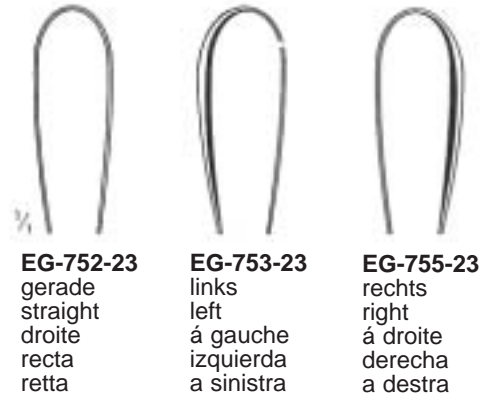

EG-752-23
gerade
straight
droite
recta
retta

EG-753-23
links
left
à gauche
izquierda
a sinistra

EG-755-23
rechts
right
à droite
derecha
a destra



JATHO
EG-955-15



FAULKNER
EG-061-21
21 cm

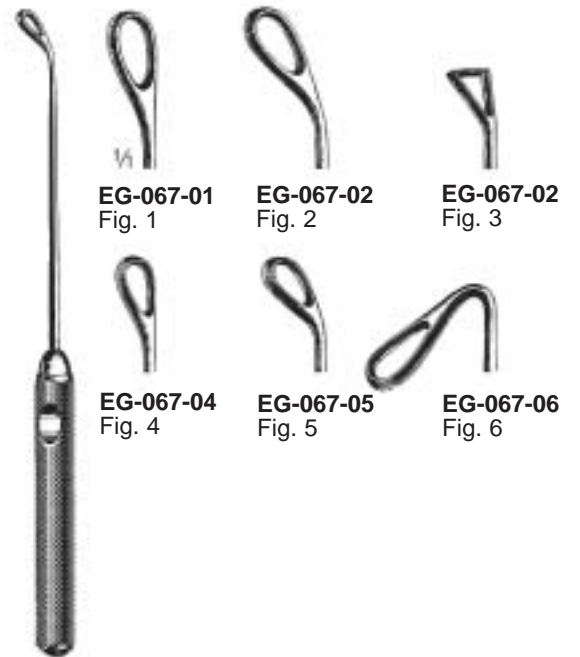

COAKLEY
EG-067-01 - EG-067-06
17 cm

EG-067-01
Fig. 1

EG-067-02
Fig. 2

EG-067-02
Fig. 3

EG-067-04
Fig. 4

EG-067-05
Fig. 5

EG-067-06
Fig. 6



EG-260-01
Fig. 1



EG-260-02
Fig. 2



EG-260-03
Fig. 3



EG-260-04
Fig. 4



EG-260-05
Fig. 5



EG-260-06
Fig. 6



BECKMANN
EG-260-01 - EG-260-06
22 cm



EG-360-01
Fig. 1



EG-360-02
Fig. 2



EG-360-03
Fig. 3



EG-360-04
Fig. 4



BARNHILL
EG-360-01 - EG-360-04
21 cm



EG-461-01
Fig. 1



EG-461-02
Fig. 2



EG-461-03
Fig. 3

Ersatzklingen, gelocht
Spare blades, perforated
Lames de rechange, perforées
Hojas de repuesto, perforadas
Lame di ricambio, forate

Fig.

- | | |
|---|------------------|
| 1 | EG-462-01 |
| 2 | EG-462-02 |
| 3 | EG-462-03 |



St. CLAIR-THOMSON
EG-366-01 - EG-366-04
21 cm

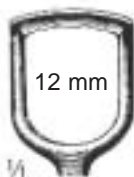

EG-366-01
Fig. 1



EG-366-03
Fig. 3



EG-366-02
Fig. 2



EG-366-04
Fig. 4



LAFORCE
EG-461-01 - EG-641-03
25 cm

**Mund und Zunge
Mouth and Tongue
Bouche et langue
Boca y lengua
Bocca e lingua**





EI-012-16
 16 cm
 Holz • wood •
 bois • madera • legno



FRENZEL
EI-015-16
 16,5 cm



BRUENINGS
EI-017-19
 19 cm



BUCHWALD
EI-019-19
 19 cm



HARTMANN
EI-111-15
 15 cm



EI-115-01 **EI-115-02**
 Fig. 1, 14 cm Fig. 2, 15 cm

WIEDER
EI-115-01 - EI-115-02



ANDREW
EI-117-11
 11 cm



TOBOLD
EI-119-14
 14,5 cm



cm	STERNBERG
14	EI-227-14
16	EI-227-16
18	EI-227-18



cm	STERNBERG
12	EI-229-12
14	EI-229-14
16	EI-229-16

Zungenzangen • Tongue Holding Forceps
 Pinces tire-langue • Pinzas tiralengua
 Pinze tiralingua



EI-320-11
 11 cm



EI-325-19
 19 cm



cm	Collin
16	EI-520-16
18	EI-520-18



EI-525-99
 Ersatz (Paar)
 Spare (Pair)
 Rechange (paire)
 Repuesto (pareja)
 Ricambio (coppia)

YOUNG
EI-525-16
 16 cm

Mundsperrer • Mouth Gags
 Ouvre-bouche • Abrebocas
 Apribocca



DOYEN-JANSEN (MOLT)
EI-625-12
 12 cm



DOYEN-JANSEN (MOLT)
EI-625-14
 14 cm



DENHART cm
EI-627-12 16
 12 cm 19



ROSER-KOENIG
EI-720-16
EI-720-19



HEISTER
EI-722-13
 13 cm



cm	JENNINGS
9	EI-724-09
11	EI-724-11
13	EI-724-13
15	EI-724-15



cm	WHITEHEAD
11	EI-820-11
13	EI-820-13
15	EI-820-15



cm	WHITEHEAD
11	EI-821-11
13	EI-821-13
15	EI-821-15



cm	SEEMANN-SEIFFERT
9	EI-825-09
11	EI-825-11
13	EI-825-13
15	EI-825-15



EI-130-10

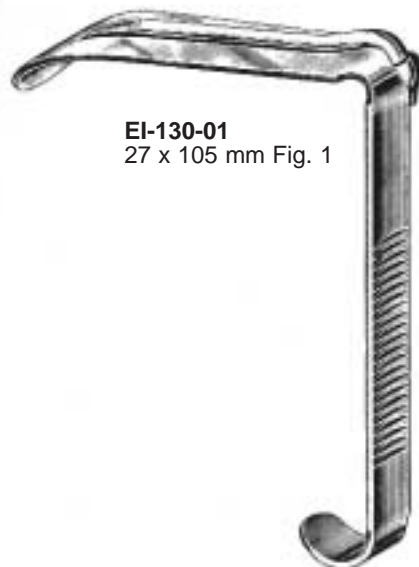

EI-130-01
 27 x 105 mm Fig. 1

DAVIS-BOYLE
EI-130-00
 compl.



EI-130-02
 25 x 90 mm Fig. 2



EI-130-03
 25 x 75 mm Fig. 3



EI-130-04
 22 x 60 mm Fig. 4



EI-130-05
 20 x 25 mm Fig. 5



EI-135-10



EI-135-01
28 x 65 mm
Fig. 1



EI-135-02
32 x 75 mm
Fig. 2



EI-135-03
37 x 80 mm
Fig. 3



EI-135-99

KILNER-DOUGHTY
EI-135-00
compl.



EI-230-10



EI-230-01
27 x 95 mm
Fig. 1



EI-230-02
22 x 85 mm
Fig. 2



EI-230-03
22 x 70 mm
Fig. 3

McIVOR
EI-230-00
compl.



MAUNDER
EI-630-10



PITHA
EI-635-10



LANGENBECK
EI-731-01 Fig. 1 EI-731-02 Fig. 2 EI-731-03 Fig.3

links
left side
côté gauche
izquierda
lato sinistro



rechts
right side
côté droit
derecha
lato destro



cm	ROWE	ROWE	
22,5	EI-051-22	EI-053-22	Säugling • baby • bébé • bebé • lattante
23,5	EI-051-23	EI-053-23	Kinder • child • enfant • niño • bambino
24	EI-051-24	EI-053-24	Erwachsene • adult

**Tonsillen
Tonsils
Amygdales
Amígdalas
Tonsille**





mm	LOVE
18	FA-013-18
20	FA-013-20
22	FA-013-22



HOFER
FA-019-24
24 cm



NAGER
FA-111-23
23 cm



HURD
FA-311-22
glatt • smooth
liso • liscio
22 cm

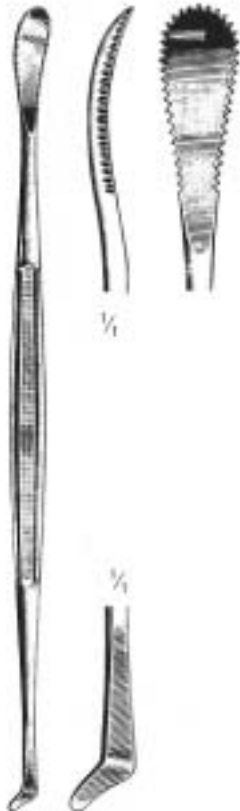

HENKE
FA-315-23
23 cm

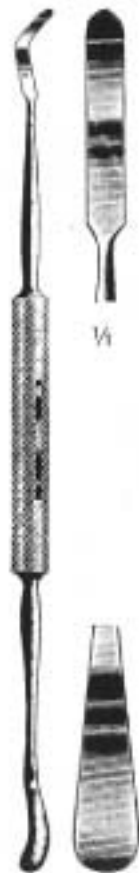

CARPENTER
FA-319-25
25 cm



CARPENTER
FA-413-24
24 cm



LUNIATSCHEK
FA-511-19
19 cm

FA-313-22
gezahnt • serrated
dentelé • dentado
dentellato
22 cm

Tonsillen
Tonsils
Amygdales
Amígdalas
Tonsille

FA



DUPUY-WEISS
FA-615-22 FA-617-22
22 cm

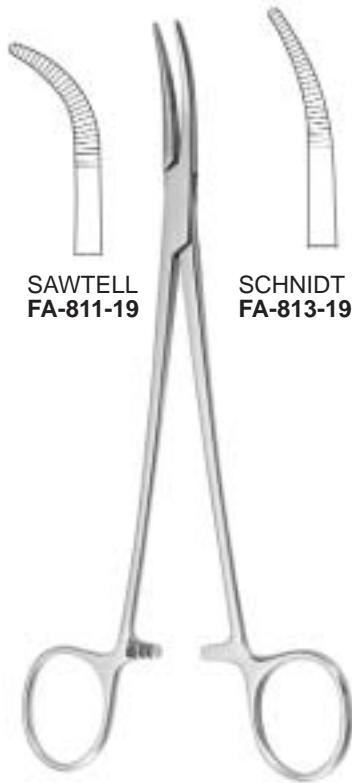

SAWTELL
FA-811-19

SCHNIDT
FA-813-19

FA-811-19 - FA-813-19
19 cm

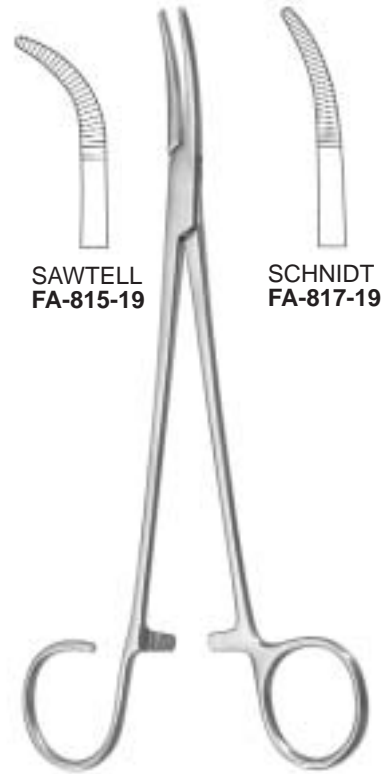

SAWTELL
FA-815-19

SCHNIDT
FA-817-19

FA-815-19 - FA-817-19
19 cm

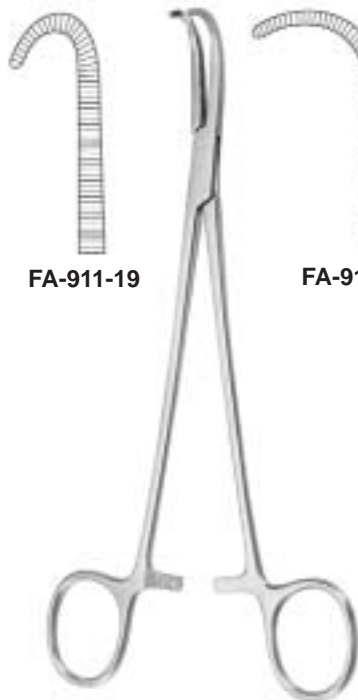

FA-911-19

FA-913-19

NEGUS
FA-911-19 - FA-913-19
19 cm

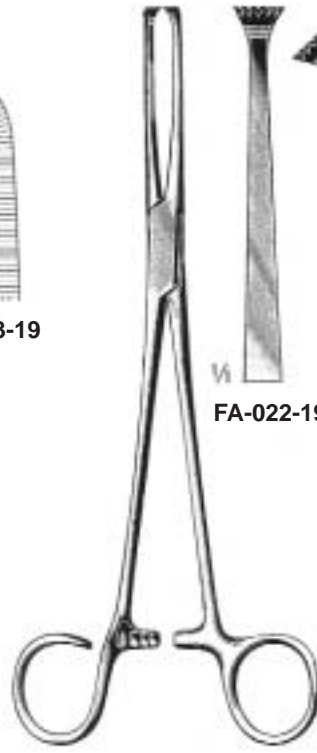

FA-022-19

FA-023-19

COLVER
FA-022-19 - FA-023-19
19 cm



cm **WHITE**
18 **FA-025-18**
23 **FA-025-23**



BALLENGER
FA-027-21
21,5 cm



BLOHMKE
FA-029-20
20 cm

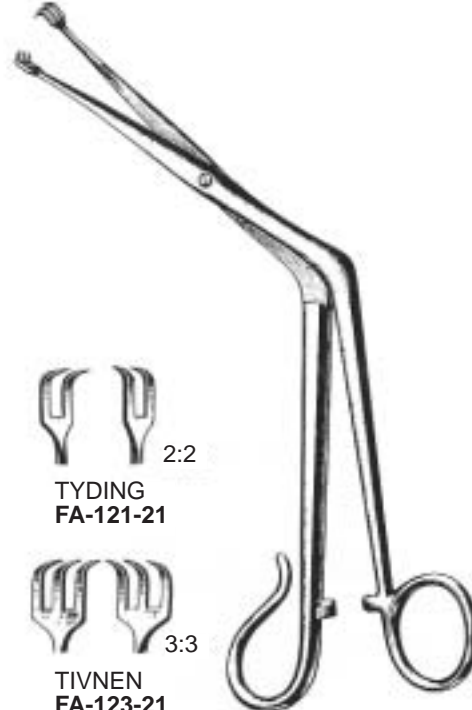

2:2
TYDING
FA-121-21

3:3
TIVNEN
FA-123-21

FA-121-21 - FA-123-21
21 cm



MARSCHIK
FA-129-20
22cm



CORWIN
FA-321-14
14 cm



EVES
FA-520-28
28 cm



EVES
FA-522-28
28 cm



BRUENINGS
FA-526-28
28 cm



mm	
40	FA-527-40
50	FA-527-50
100 x	



FA-529-03
0,3 mm
12 x

Tonsillen
Tonsils
Amygdales
Amígdalas
Tonsille

FA

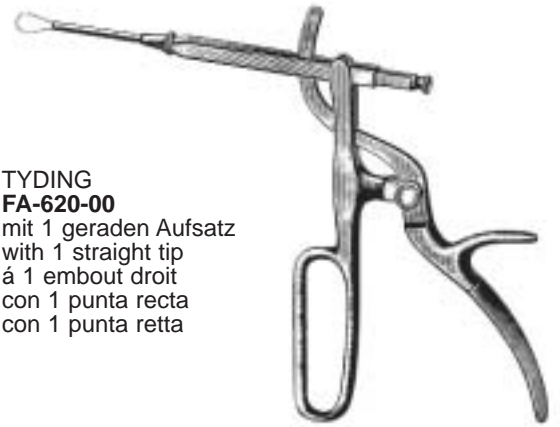

TYDING
FA-620-00
mit 1 geraden Aufsatz
with 1 straight tip
à 1 embout droit
con 1 punta recta
con 1 punta retta

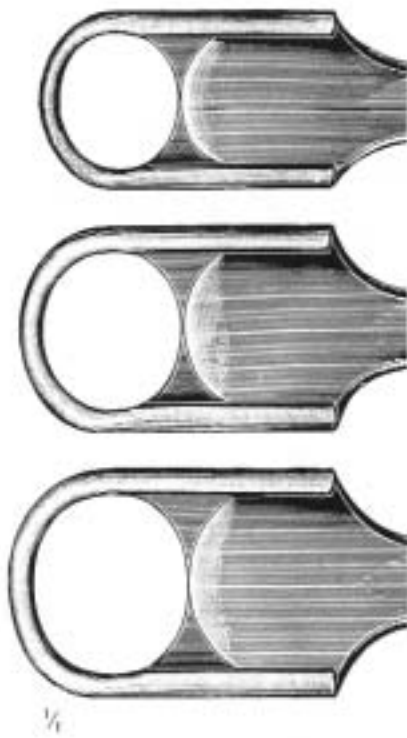

SLUDER-BALLENGER
FA-720-00
mit 3 Aufsätzen
with 3 blades
avec 3 lames
con 3 hojas
con 3 lame



FA-922-00



FA-923-45
45°



FA-923-90
90°



ml
2 **FA-920-02**
5 **FA-920-05**
10 **FA-920-10**

FC

**Kehlkopf
Larynx
Larynx
Laringe
Laringe**



FC

FC

Kehlkopf
Larynx
Larynx
Larynx
Larynx



JACKSON
FC-011-22 - FC-013-22
22 cm



FC-011-22



FC-013-22



FRAENKEL
FC-111-18
18 cm

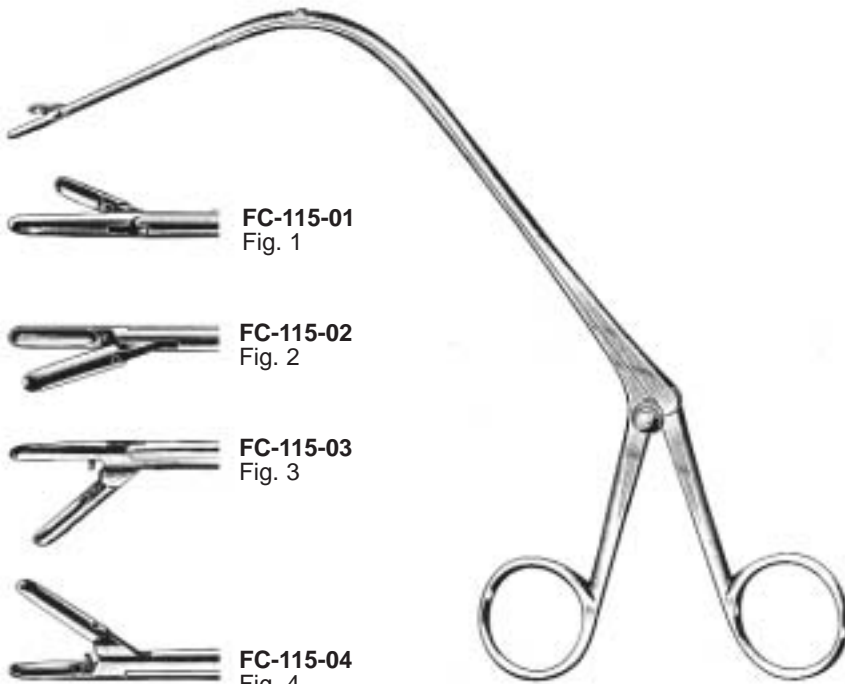

FC-115-01
Fig. 1



FC-115-02
Fig. 2



FC-115-03
Fig. 3



FC-115-04
Fig. 4

JURASZ
FC-115-01 - FC-115-04
23 cm



REICHERT
FC-211-24
24 cm



HUBER
FC-310-00



cm	BRUENINGS
20	FC-312-20
30	FC-312-30
40	FC-312-40
50	FC-312-50
60	FC-312-60

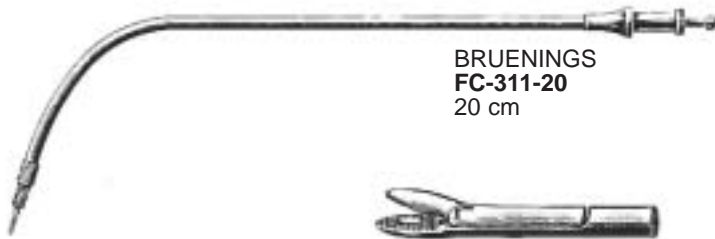

BRUENINGS
FC-311-20
20 cm



FRAENKEL
FC-510-00



SEIFFERT
FC-512-00



FRAENKEL
FC-514-00



SCHEINMANN
FC-515-00



SCHEINMANN
FC-517-00



BRUENINGS
FC-518-02 - FC-518-03

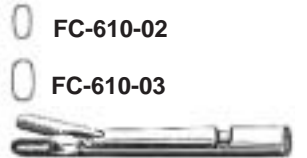

BRUENINGS
FC-610-02 - FC-610-03



LANGE
FC-612-00

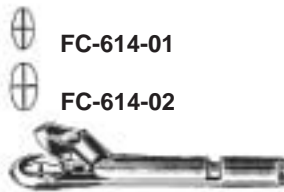

FC-614-01

FC-614-02

KRAUSE
FC-614-01 - FC-614-02



KRAUSE
FC-616-00

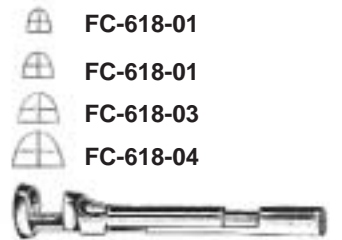

FC-618-01

FC-618-01

FC-618-03

FC-618-04

CORDES
FC-618-01 - FC-618-04



SCHUMACHER
FC-710-00

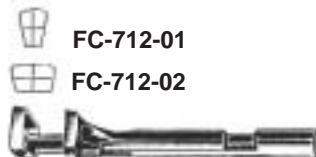

FC-712-01

FC-712-02

GORDES
FC-712-01 - FC-712-02



GORDES
FC-714-00



ROSENBERG
FC-716-00



CHEVALIER-JACKSON
FC-320-01 - FC-620-07



cm	Fig. 1	Fig. 2	Fig. 3	Fig. 4	Fig. 5	Fig. 6	Fig. 7
30	FC-320-01	FC-320-02	FC-320-03	FC-320-04	FC-320-05	FC-320-06	FC-320-07
40	FC-420-01	FC-420-02	FC-420-03	FC-420-04	FC-420-05	FC-420-06	FC-420-07
50	FC-520-01	FC-520-02	FC-520-03	FC-520-04	FC-520-05	FC-520-06	FC-520-07
60	FC-620-01	FC-620-02	FC-620-03	FC-620-04	FC-620-05	FC-620-06	FC-620-07

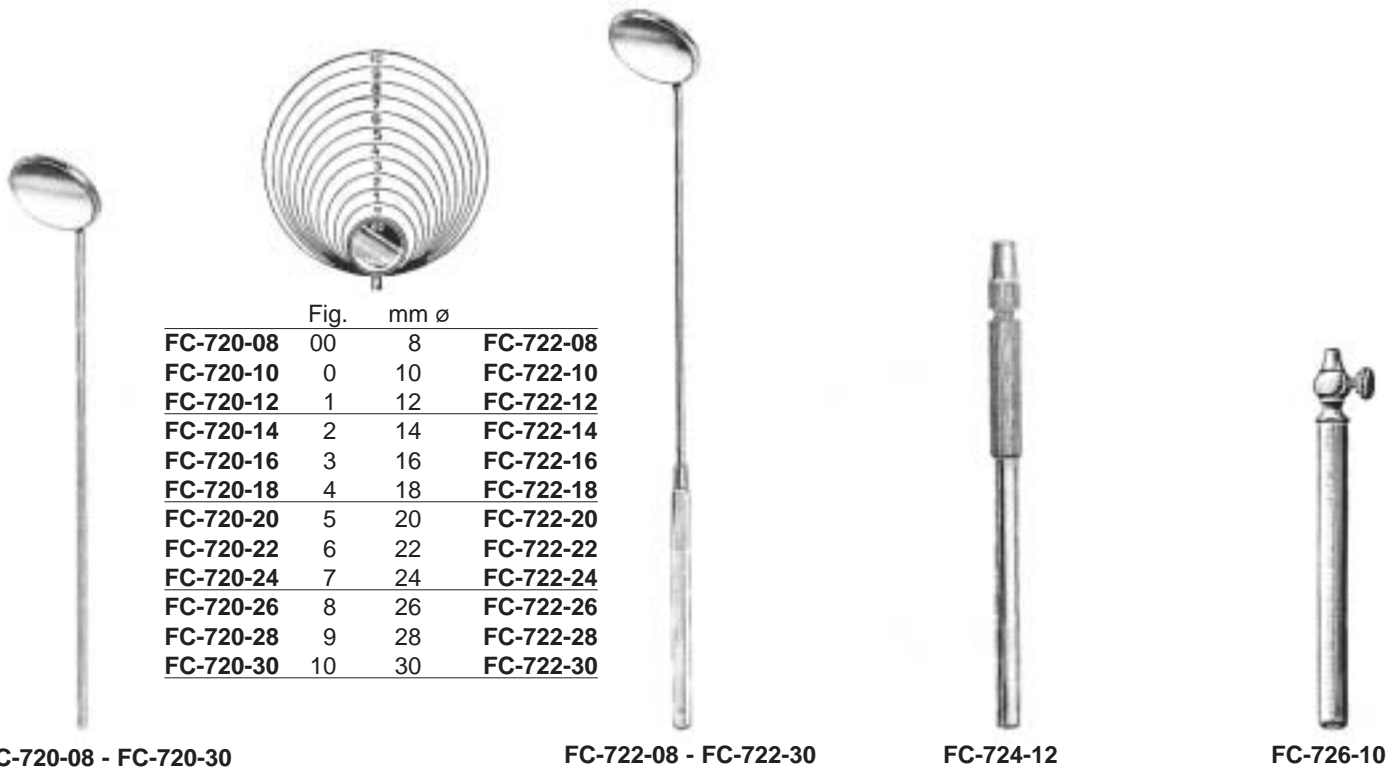

	Fig.	mm ø	
FC-720-08	00	8	FC-722-08
FC-720-10	0	10	FC-722-10
FC-720-12	1	12	FC-722-12
FC-720-14	2	14	FC-722-14
FC-720-16	3	16	FC-722-16
FC-720-18	4	18	FC-722-18
FC-720-20	5	20	FC-722-20
FC-720-22	6	22	FC-722-22
FC-720-24	7	24	FC-722-24
FC-720-26	8	26	FC-722-26
FC-720-28	9	28	FC-722-28
FC-720-30	10	30	FC-722-30

FC-720-08 - FC-720-30

FC-722-08 - FC-722-30

FC-724-12

FC-726-10

FE

**Tracheotomie, Kropf
Tracheostomy, Goitre
Trachéotomie, Goitre
Traqueotomía, Bocio
Tracheotomia, Gozzo**



FE

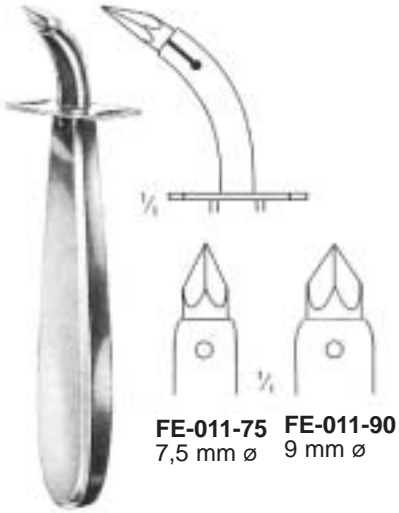

FE-011-75 7,5 mm ø
FE-011-90 9 mm ø

UCKERMANN
FE-011-75 - FE-011-90
13 cm



TROUSSEAU
FE-111-14
14 cm



LABORDE
FE-113-14
14 cm



BOSE
FE-115-07
7 cm



JACKSON
FE-116-15
15 cm



JACKSON
FE-117-17
17 cm



ITERSON
FE-118-16 - FE-119-16
16 cm



BOSE
FE-212-16
16 cm



BOSE
FE-214-16
16 cm



ROSE
FE-310-13
13 cm



mm	WAGENER-MOSHER
5	FE-511-05
7	FE-511-07
9	FE-511-09



FE-720-00



Fig.	mm	LUER
0	4	FE-220-04
1	5	FE-220-05
2	6	FE-220-06
3	7	FE-220-07
4	8	FE-220-08
5	9	FE-220-09
6	10	FE-220-10
7	11	FE-220-11
8	12	FE-220-12
9	13	FE-220-13



Fig.	mm	JACKSON
0	4	FE-420-04
1	5	FE-420-05
2	6	FE-420-06
3	7	FE-420-07
4	8	FE-420-08
5	9	FE-420-09
6	10	FE-420-10
7	11	FE-420-11
8	12	FE-420-12
9	13	FE-420-13



FE-051-15 **FE-053-15**

KOCHER
FE-051-15 - FE-053-15
15 cm



SCHOENBORN
FE-151-21
21 cm



cm	LAHEY
15	FE-250-15
20	FE-250-20



MASTIN
FE-253-17
17 cm

FG

**Thorax
Thorax
Thorax
Tórax
Torace**

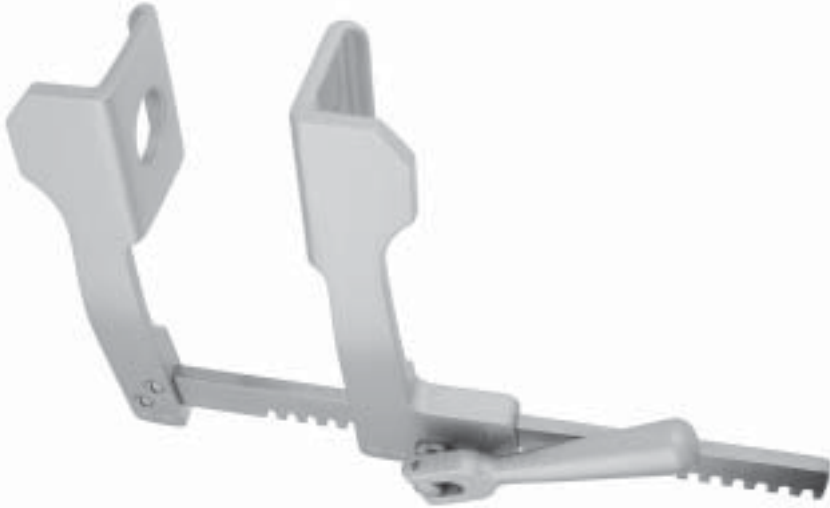

FG

FG

Rippenscheren
Rib Shears
Costotomes
Costótomos
Costotomi



Rippenschere mit ziehendem Schnitt
Rib shears with drawing cut
Costotome avec lame excentrée
Costótomo con hoja de retroacción
Costotomo con lama eccentrica a scorrimento



GLUCK
FG-017-22
22,0 cm



STILLE
FG-111-21
21,0 cm

FG

Rippenscheren
Rib Shears
Costotomes
Costótomos
Costotomi

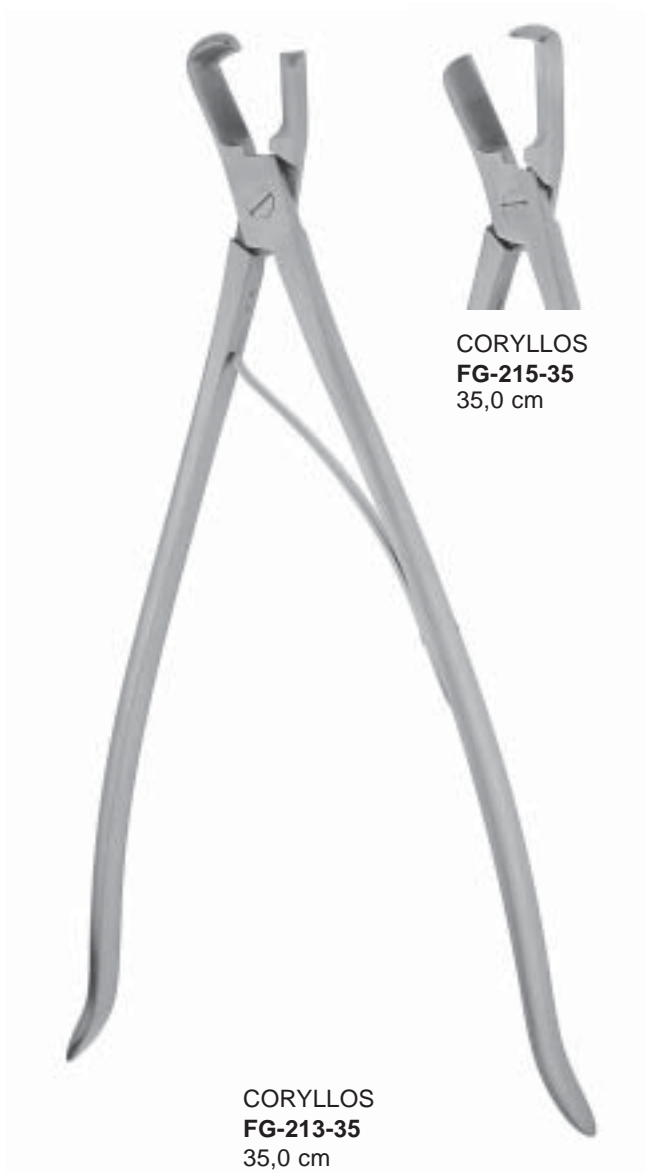



COOLEY
FG-218-35
35,0 cm



SAUERBRUCH
FG-311-26
26,0 cm

für die erste Rippe
for the first rib
pour la première côte
para la primera costilla
per la prima costola



GIERTZ-STILLE
FG-317-27
27,0 cm



SAUERBRUCH-FREY
FG-411-36
36,0 cm



BRUNNER
FG-417-28
32,0 cm

für die rechte Hand
for right hand
pour la main droite
para la mano derecha
per la mano destra

BRUNNER
FG-419-28
32,0 cm

für die linke Hand
for left hand
pour la main gauche
para la mano
izquierda
per la mano sinistra

Sternum Schere
Sternum scissors
Ciseaux a sternum
Tijera de esternón
Forbici per sterno



SCHUMACHER
FG-418-21
21,0 cm

FG

Rippensperrer
Rib Spreaders
Ecarteurs des côtes
Separadores costales
Divaricatori costali

Blatt • Blade • valve • hoja • valva		
Spreizung Spread Ecartement Abertura Apertura	Tiefe Depth profondité profundidad profondità	Breite Width largeur ancho larghezza
A	B	C

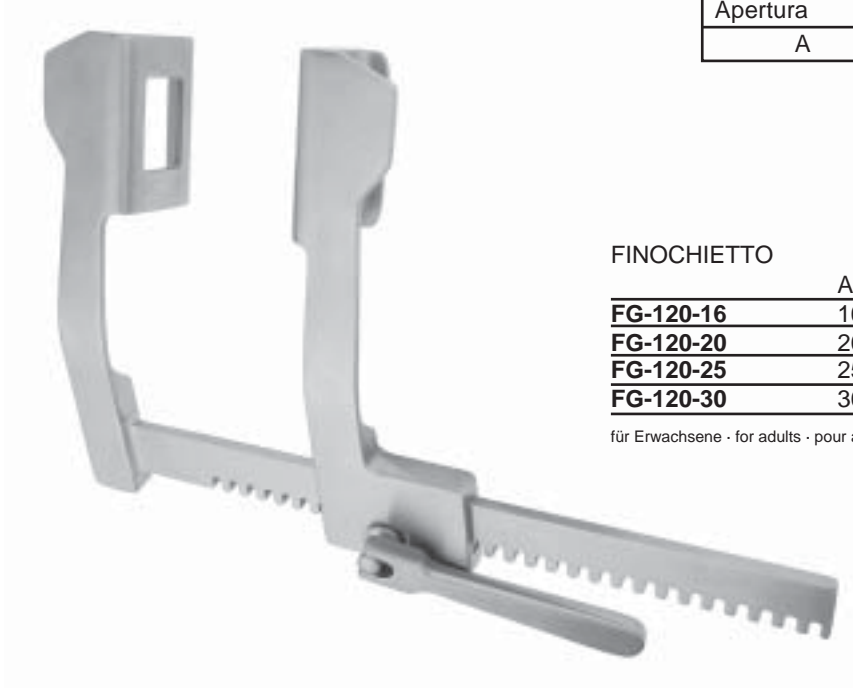

FINOCHIETTO

	A = mm	B = mm	C = mm
FG-120-16	165 mm	40 mm	40 mm
FG-120-20	200 mm	45 mm	65 mm
FG-120-25	250 mm	70 mm	65 mm
FG-120-30	300 mm	70 mm	65 mm

für Erwachsene · for adults · pour adultes · para adultos · per adulti

ALUMINIUM



FINOCHIETTO (modif.)

	A = mm	B = mm	C = mm
FG-122-12	120 mm	14 mm	15 mm

für Kinder · for children · pour enfants · para niños · per bambini

Blatt • Blade • valve • hoja • valva		
Spreizung Spread Ecartement Abertura Apertura	Tiefe Depth profondité profundidad profondità	Breite Width largeur ancho larghezza
A	B	C



FINOCHIETTO-BABY

	A = mm	B = mm	C = mm
FG-124-75	75 mm	18 mm	20 mm

für Säuglinge · for babies · pour bébé · para bebés · per neonati

ALUMINIUM



COOLEY

	A = mm	B = mm	C = mm
FG-220-01	95 mm	12 mm	13 mm

für Säuglinge · for babies · pour bébé · para bebés · per neonati

COOLEY

	A = mm	B = mm	C = mm
FG-220-02	140 mm	15 mm	30 mm
FG-220-03	150 mm	21 mm	44 mm

für Kinder · for children · pour enfants · para niños · per bambini

COOLEY

	A = mm	B = mm	C = mm
FG-220-04	200 mm	35 mm	50 mm

für Erwachsene · for adults · pour adultes · para adultos · per adulti

Blatt • Blade • valve • hoja • valva		
Spreizung Spread Ecartement Abertura Apertura	Tiefe Depth profondité profundidad profondità	Breite Width largeur ancho larghezza
A	B	C

ALUMINIUM

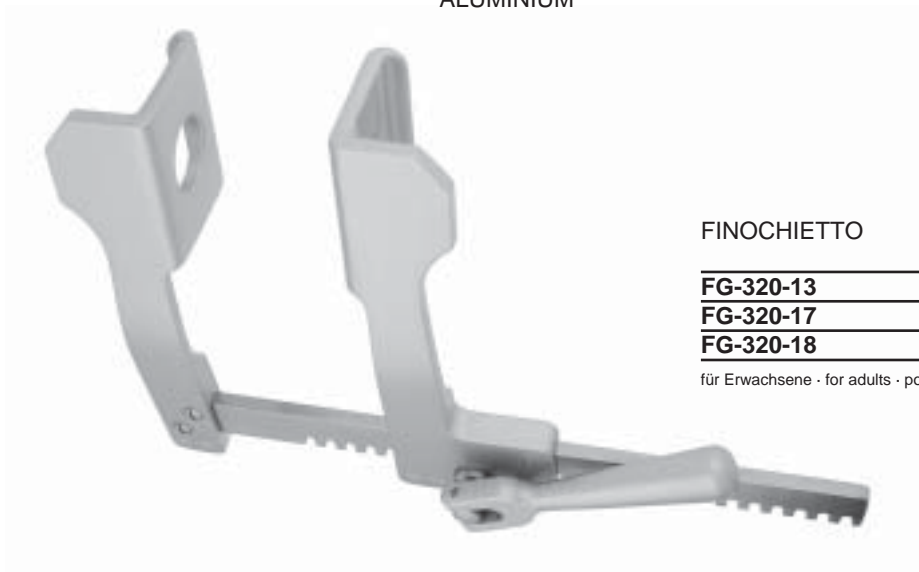

FINOCHIETTO

	A = mm	B = mm	C = mm
FG-320-13	135 mm	38 mm	44 mm
FG-320-17	175 mm	52 mm	62 mm
FG-320-18	175 mm	85 mm	65 mm

für Erwachsene · for adults · pour adultes · para adultos · per adulti

ALUMINIUM



FINOCHIETTO HAIGHT Baby

	A = mm	B = mm	C = mm
FG-322-10	100 mm	31 mm	31 mm

für Kinder · for children · pour enfants · para niños · per bambini

Blatt • Blade • valve • hoja • valva		
Spreizung Spread Ecartement Abertura Apertura	Tiefe Depth profondité profundidad profondità	Breite Width largeur ancho larghezza
A	B	C

ALUMINIUM



FINOCHIETTO

	A = mm	B = mm	C = mm
FG-324-40	100 mm	12 mm	15 mm
FG-324-41	143 mm	28 mm	30 mm
FG-324-42	210 mm	31 mm	45 mm
FG-324-43	245 mm	42 mm	61 mm
FG-324-44	245 mm	74 mm	64 mm

für Erwachsene · for adults · pour adultes · para adultos · per adulti

Blatt • Blade • valve • hoja • valva		
Spreizung Spread Ecartement Abertura Apertura	Tiefe Depth profondité profundidad profondità	Breite Width largeur ancho larghezza
A	B	C

ALUMINIUM



FINOCHIETTO Infant

	A = mm	B = mm	C = mm
FG-324-75	75 mm	15 mm	15 mm

für Säuglinge · for babies · pour bébé · para bebés · per neonati



mit 2 Paar Valven
 with 2 pairs of blades
 avec 2 paires de valves
 con 2 pares de valvas
 con 2 paia di valve

FINOCHIETTO BURFORD

	A = mm	B = mm	C = mm
FG-326-21	210 mm	48/77 mm	64 mm
FG-326-25	260 mm	48/77 mm	64 mm
FG-326-30	300 mm	48/77 mm	64 mm

für Erwachsene · for adults · pour adultes · para adultos · per adulti

Blatt • Blade • valve • hoja • valva		
Spreizung Spread Ecartement Abertura Apertura	Tiefe Depth profondité profundidad profondità	Breite Width largeur ancho larghezza
A	B	C

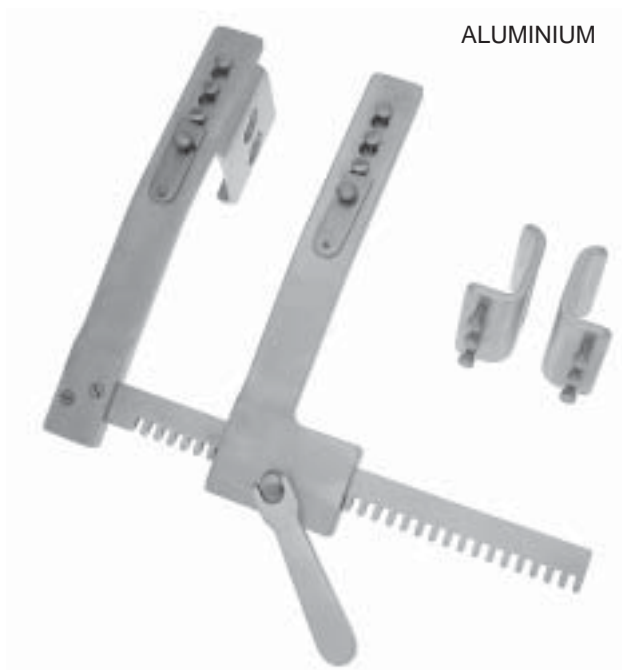

mit 2 Paar Valven
 with 2 pairs of blades
 avec 2 paires de valves
 con 2 pares de valvas
 con 2 paia di valve

FINOCHIETTO BURFORD

	A = mm	B = mm	C = mm
FG-422-18	180 mm	47/65 mm	62 mm
FG-422-26	260 mm	47/65 mm	62 mm
FG-422-30	300 mm	47/65 mm	62 mm

für Erwachsene · for adults · pour adultes · para adultos · per adulti

Blatt • Blade • valve • hoja • valva		
Spreizung Spread Ecartement Abertura Apertura	Tiefe Depth profondité profundidad profondità	Breite Width largeur ancho larghezza
A	B	C



mit 2 Paar Valven
with 2 pairs of blades
avec 2 paires de valves
con 2 pares de valvas
con 2 paia di valve

FINOCHIETTO BURFORD

	A = mm	B = mm	C = mm
FG-424-13	135 mm	34/48 mm	42 mm

für Kinder · for children · pour enfants · para niños · per bambini



CASTAÑEDA

	A = mm	B = mm	C = mm
FG-520-06	65 mm	10,5 mm	32 mm

für Säuglinge · for babies · pour bébé · para bebés · per neonati

CASTAÑEDA

	A = mm	B = mm	C = mm
FG-520-07	70 mm	12 mm	45 mm

für Kinder · for children · pour enfants · para niños · per bambini

CASTAÑEDA

	A = mm	B = mm	C = mm
FG-520-12	120 mm	15 mm	60 mm

für Kinder · for children · pour enfants · para niños · per bambini

Blatt • Blade • valve • hoja • valva		
Spreizung Spread Ecartement Abertura Apertura	Tiefe Depth profondité profundidad profondità	Breite Width largeur ancho larghezza
A	B	C



CHEVALIER

	A = mm	B = mm	C = mm
FG-529-19	190 mm	27 mm	100 mm



HAIGHT

	A = mm	B = mm	C = mm
FG-620-09	90 mm	30 mm	30 mm
FG-620-15	115 mm	30 mm	30 mm



Blatt • Blade • valve • hoja • valva		
Spreizung Spread Ecartement Abertura Apertura	Tiefe Depth profondité profundidad profondità	Breite Width largeur ancho larghezza
A	B	C

TUFFIER

	A = mm	B = mm	C = mm
FG-624-16	165 mm	50 mm	45 mm



Thoraxsperrer
Thoracic retractor
Ecarteur thoracique
Separador torácico
Divaricatore per il torace



MERCEDES FG-720-00

Thoraxsperrer, komplett, bestehend aus:
FG-720-10 1 Sperrer
FG-720-48 2 Seitenvalven 42 x 65 mm
FG-720-70 2 Seitenvalven 75 x 75 mm

Thoracic retractor, complete, consisting of:
FG-720-10 1 Spreader
FG-720-48 2 Lateral blades 42 x 65 mm
FG-720-70 2 Lateral blades 75 x 75 mm

Ecarteur thoracique, complet, compuesto de:
FG-720-10 1 Ecarteur
FG-720-48 2 Valves latérales 42 x 65 mm
FG-720-70 2 Valves latérales 75 x 75 mm

Separador torácico, completo, compuesto de:
FG-720-10 1 Separador
FG-720-48 2 Valvas laterales 42 x 65 mm
FG-720-70 2 Valvas laterales 75 x 75 mm

Divaricatore per il torace, completo, composto da:
FG-720-10 1 Divaricatore
FG-720-48 2 Valve laterali 42 x 65 mm
FG-720-70 2 Valve laterali 75 x 75 mm

Blatt • Blade • valve • hoja • valva		
Spreizung Spread Ecartement Abertura Apertura	Tiefe Depth profondité profundidad profondità	Breite Width largeur ancho larghezza
A	B	C

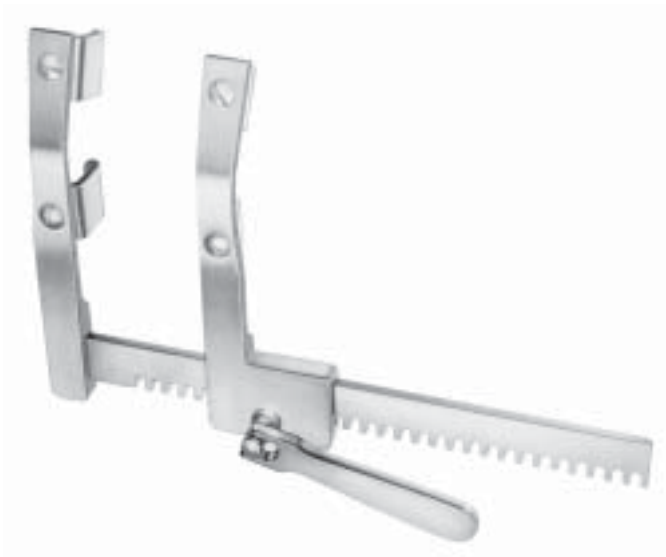

MORSE-FAVOLORO

	A = mm	B = mm	C = mm
FG-723-16	160 mm	17 mm	22 mm

für Kinder · for children · pour enfants · para niños · per bambini

MORSE-FAVOLORO

	A = mm	B = mm	C = mm
FG-723-19	200 mm	22 mm	27 mm

für Erwachsene · for adults · pour adultes · para adultos · per adulti



HERTZLER

	A = mm	B = mm	C = mm
FG-728-00	105 mm	25 mm	25 mm

Rippensperrer und -Kontraktor
 mit drehbaren Klauen

Rib spreader and contractor
 with swivel blades

Ecarteur et rapprocheur des côtes
 avec valves orientables

Separador y contractor costal
 con garras girables

Divaricatore ed approssimatore costale
 con valve orientabili

für Kinder
 for children
 pour enfants;
 para niños
 per bambini

für Erwachsene
 for adults
 pour adultes
 para adultos
 per adulti



SELLORS
FG-820-19
 19,0 cm



BAILEY-BABY
FG-822-14
 15,5 cm



BAILEY
FG-824-16
 20,0 cm



BAILEY-GIBBON
FG-826-16
 20,0 cm

Lungenspatel
Lung Spatulas
Spatule pulmonaire
Espátula para el pulmón
Spatole per polmone



cm **ALLISON**
25,5 **FG-829-30**
32,0 **FG-829-32**

Lungenfaßzangen
Lung Grasping Forceps
Pinces à saisir le poumon
Pinzas para coger el pulmón
Pinze per afferrare il polmone



LOVELACE
FG-920-20
20,0 cm



LOVELACE
FG-921-20
20,0 cm

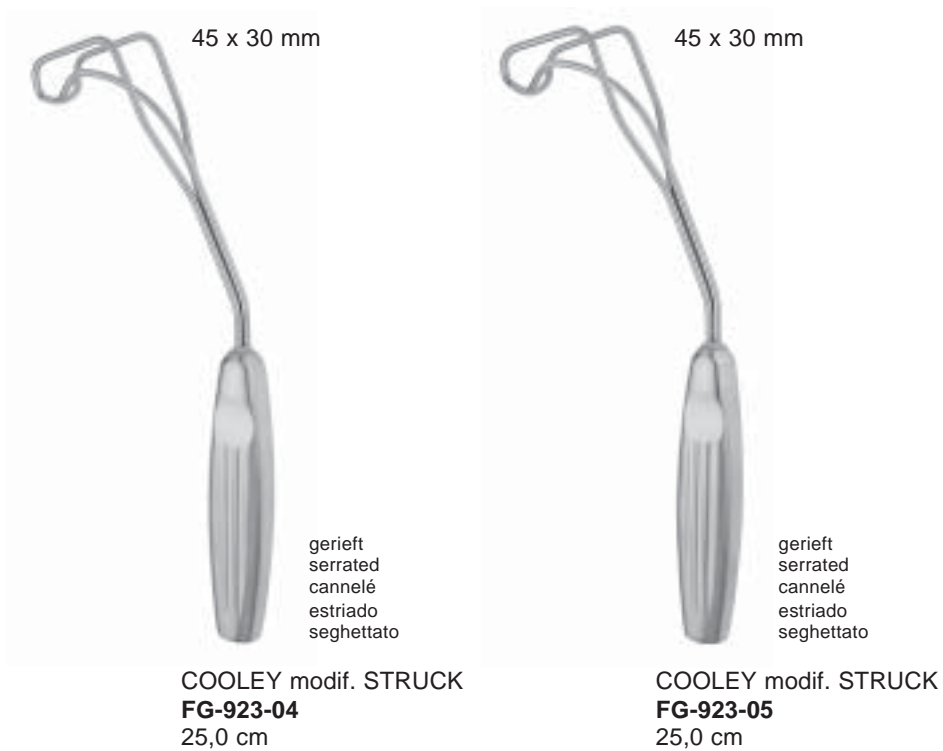
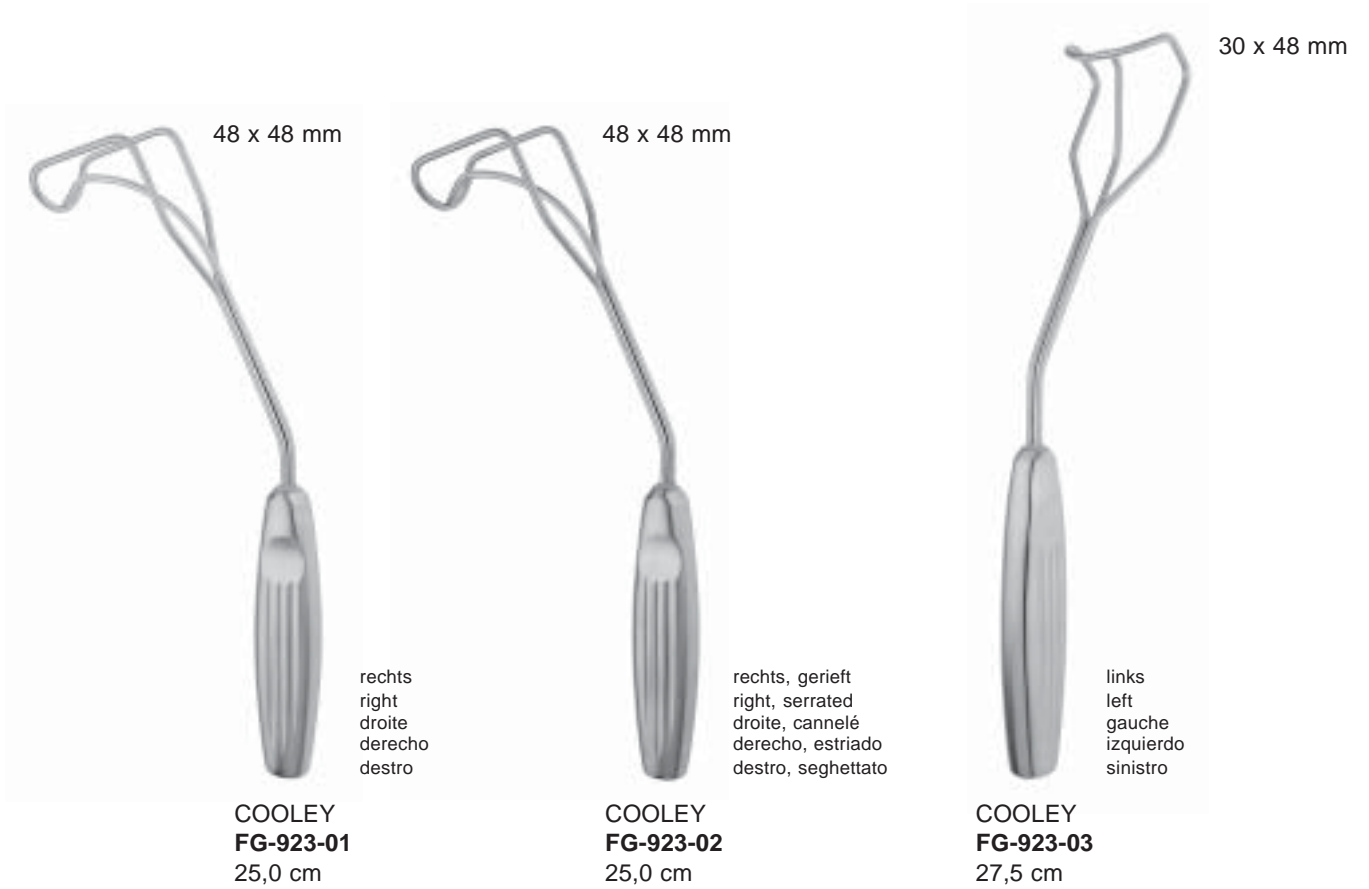

Bronchusklemmen
Bronchus Forceps
Pinces-Clamps à Bronches
Pinzas clamps bronquiales
Pinze per bronchi



HARRINGTON
FG-031-30
30,5 cm



cm HARRINGTON
29,0 **FG-033-29**
31,0 **FG-033-31**



FINOCHIETTO
FG-037-24
24,0 cm

Bronchusklemmen
Bronchus Forceps
Pinces-Clamps à Bronches
Pinzas clamps bronquiales
Pinze per bronchi



PRICE-THOMAS
FG-039-22
22,0 cm



links
left
à gauche
izquierda
sinistra

PRICE-THOMAS
FG-131-22
22,0 cm



rechts
right
à droite
derecha
destra

PRICE-THOMAS
FG-133-22
22,0 cm

Bronchusklemmen
Bronchus Forceps
Pincas-Clamps à Bronches
Pinzas clamps bronquiales
Pinze per bronchi



SAROT
FG-137-23
23,0 cm

SAROT
FG-139-23
23,0 cm



SAROT



SEMB
FG-231-23
23,0 cm

SEMB
FG-233-23
23,0 cm

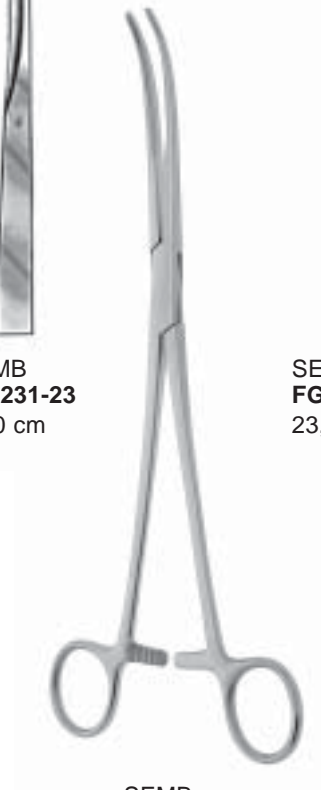

SEMB

Anastomosen- (Vena cava) Klemmen
Anastomosis (Vena Cava) Clamps
Pinces-clamps à anastomose (veine cave)
Pinzas clamps para anastomosis (vena cava)
Pinze per anastomosi (vena cava)



SATINSKY
FG-235-15
15,0 cm



SATINSKY

FG-237-26
Fig. 1
26,5 cm

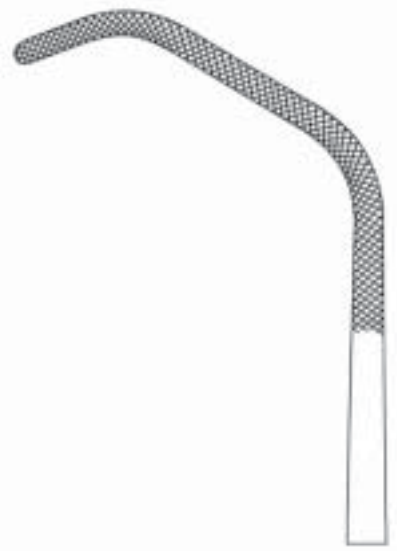

FG-239-26
Fig. 2
26,5 cm

Anastomosen- (Vena cava) Klemmen
Anastomosis (Vena Cava) Clamps
Pinces-clamps à anastomose (veine cave)
Pinzas clamps para anastomosis (vena cava)
Pinze per anastomosi (vena cava)



FG-331-26
Fig. 1
26,5 cm

FG-333-26
Fig. 2
26,5 cm



BROCK
FG-140-00

Griff allein
 Handle only
 Manche seul
 Mango suelto
 Manico solo



BROCK
FG-142-00

Dilatator Spreizweite 8 - 20 mm
 Dilator Opening 8 to 20 mm
 Dilatateur ouverture 8 à 20 mm
 Dilatador abertura 8 a 20 mm
 Dilatatore apertura 8 a 20 mm

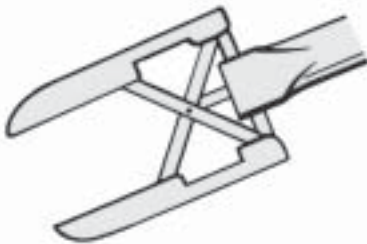

ø mm	BROCK
4,0	FG-144-04
7,5	FG-144-07
10,0	FG-144-10
12,0	FG-144-12

Stanzen
 Punches
 Pincas coupantes
 Pinzas cortantes
 Pinze taglienti

Herz-Dilatatoren
Mitral Valve Dilators
Dilatateurs pour valve mitrale
Dilatadores para válvula mitral
Dilatatori per valvole mitrali

FG

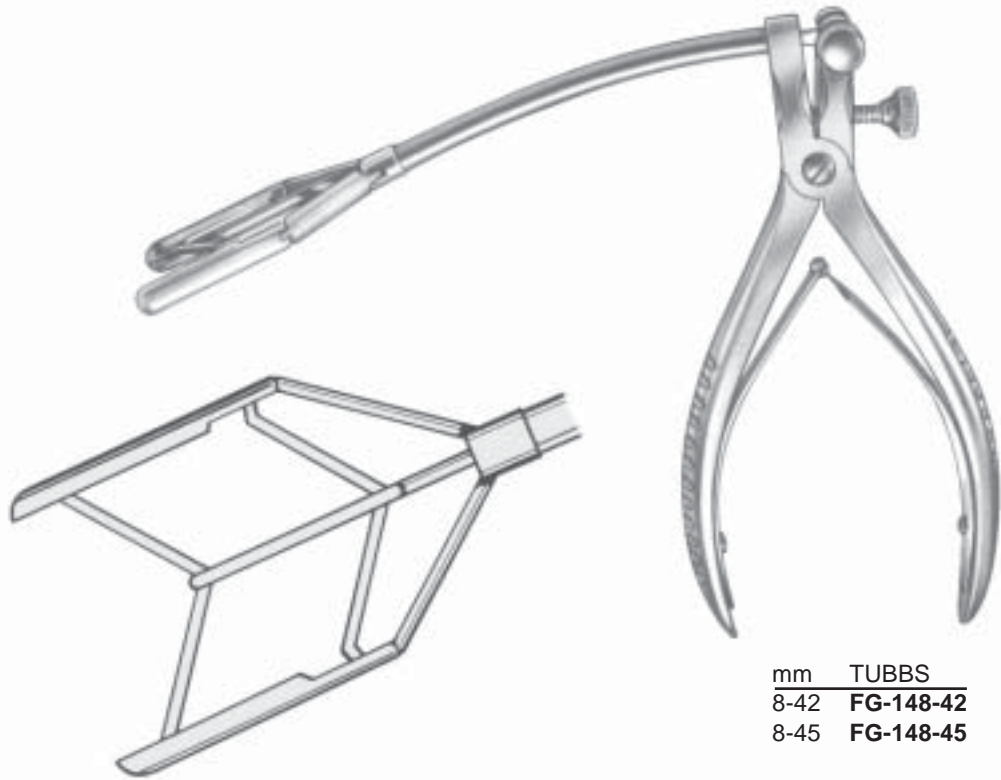

mm	TUBBS
8-42	FG-148-42
8-45	FG-148-45

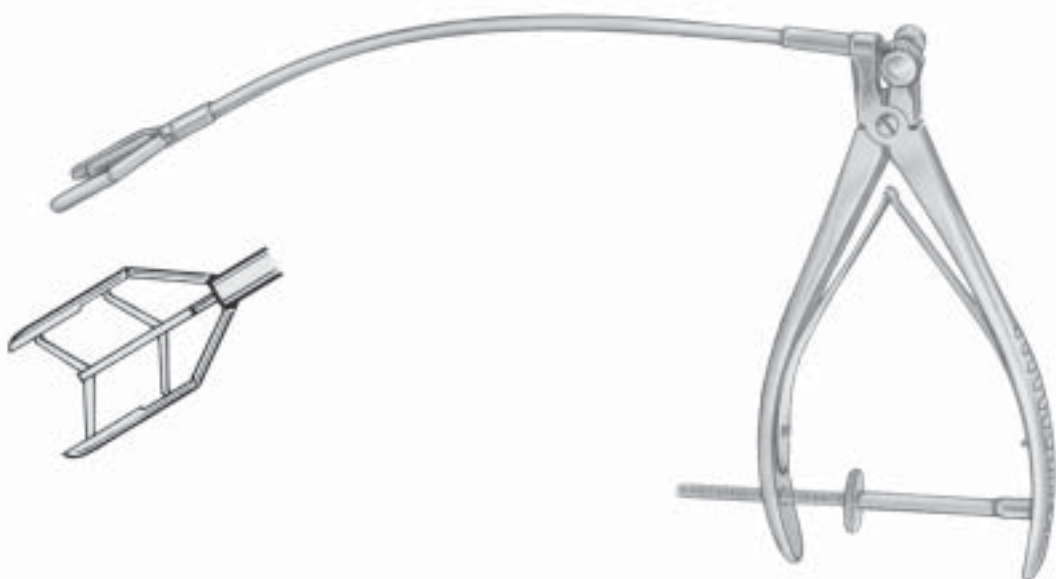

mm	COOLEY
8-15	FG-240-15
8-45	FG-240-45

FG

Herz-Dilatatoren
Mitral Valve Dilators
Dilatateurs pour valve mitrale
Dilatadores para válvula mitral
Dilatatori per valvole mitrali

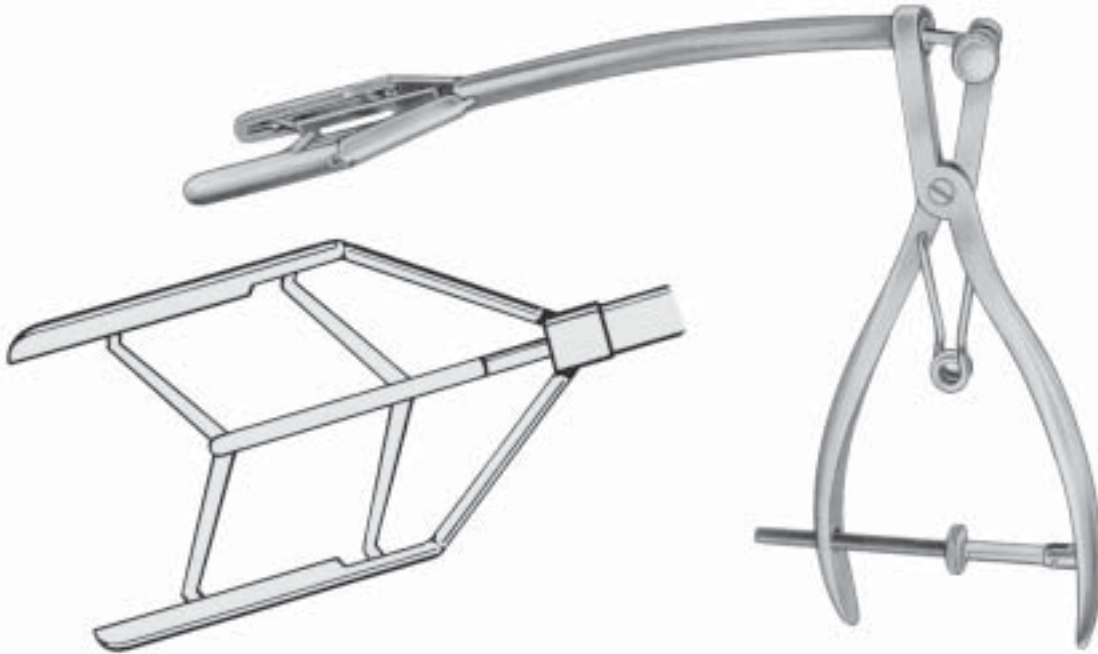

mm GERBODE
9-45 FG-242-45

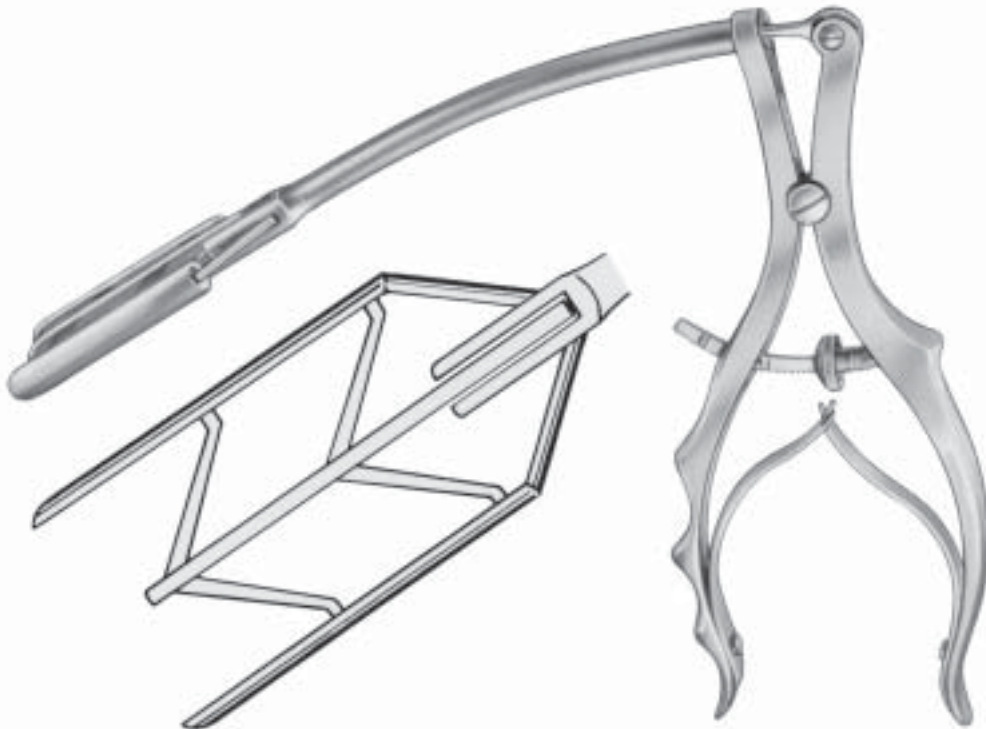

mm COOLEY
7-30 FG-243-30
9-40 FG-243-40

Herz-Dilatatoren
Mitral Valve Dilators
Dilatateurs pour valve mitrale
Dilatadores para válvula mitral
Dilatatori per valvole mitrali

FG



mm COOLEY
5-18 **FG-245-18**
6-20 **FG-245-20**



mm HETZER
4-10 **FG-246-10**

FG

Gefäßdilatoren
Vascular Dilators
Dilatateurs vasculaires
Dilatadores vasculares
Dilatatori vascolari

biegsam, Silber
malleable, silver
malléables, argent
maleables, silver
maleabili, argento



COOLEY	
ø mm	13,0 cm
0,5	FG-740-05
1,0	FG-740-10
1,5	FG-740-15
2,0	FG-740-20
2,5	FG-740-25
3,0	FG-740-30
4,0	FG-740-40
5,0	FG-740-50



FG-740-05

FG-740-10

FG-740-15

FG-740-20

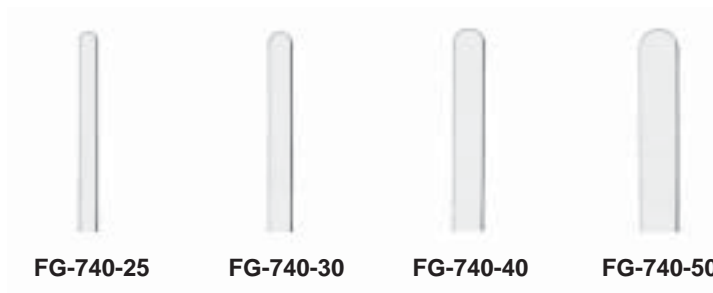

FG-740-25

FG-740-30

FG-740-40

FG-740-50

biegsam
 malleable
 malléables
 maleables
 maleabili

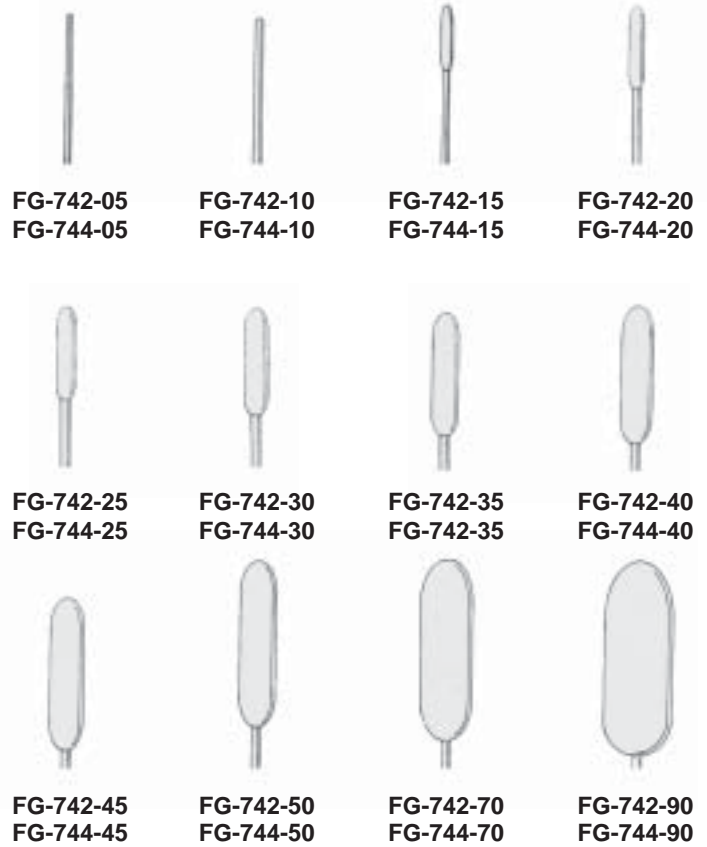

DEBAKEY

ø mm	19,0 cm	35,0 cm
0,5	FG-742-05	FG-744-05
1,0	FG-742-10	FG-744-10
1,5	FG-742-15	FG-744-15
2,0	FG-742-20	FG-744-20
2,5	FG-742-25	FG-744-25
3,0	FG-742-30	FG-744-30
3,5	FG-742-35	FG-744-35
4,0	FG-742-40	FG-744-40
4,5	FG-742-45	FG-744-45
5,0	FG-742-50	FG-744-50
7,0	FG-742-70	FG-744-70
9,0	FG-742-90	FG-744-90

FG

Intima-Spatel
Intima spatula
Spatule pour la tunique interne
Espátula para la íntima
Spatola per intima



cm
18,0 **FG-055-18**
21,0 **FG-055-21**

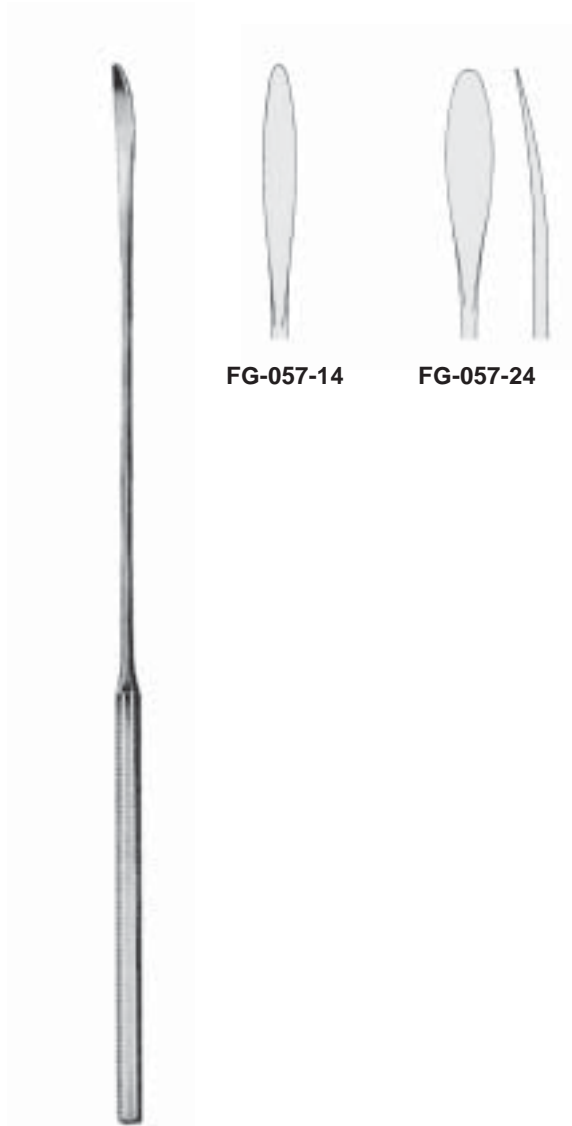

cm 3 mm
14,0 **FG-057-14**
24,0 **FG-057-24**



ROBB
FG-059-01
Fig. 1
24,0 cm



ROBB
FG-059-02
Fig. 2
24,0 cm



ROBB
FG-059-03
Fig. 3
24,0 cm



ROBB
FG-059-04
Fig. 4
24,0 cm

Galle, Niere
Gall Bladder, Kidney
Vesicule biliaire, Rein
Vesicula biliar, Riñón
Vesicola biliare, Rene

**GC**

GC

Gallensteinzangen
Gall Stone Forceps
Pinces pour calculs biliaires
Pinzas para cálculos biliares
Pinze per calcoli biliari



cm DESJARDINS
23,0 **GC-011-23**
23,0 **GC-013-23**

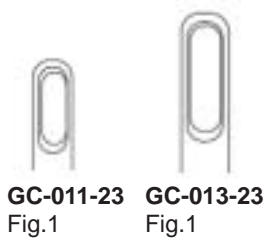

GC-011-23
Fig.1

GC-013-23
Fig.1



cm DESJARDINS
24,0 **GC-013-24**
22,5 **GC-013-25**



GC-013-24



GC-013-25

sehr schlankes Modell
very slender pattern
modèle très fin
modelo muy delgado
modello molto delicato



cm CZERNY
25,0 **GC-015-25**



cm BLAKE
21,0 **GC-017-20**
23,0 **GC-017-23**

cm BLAKE
21,0 **GC-016-20**

GC

Gallensteinzangen
Gall Stone Forceps
Pincès pour calculs biliaires
Pinzas para cálculos biliares
Pinze per calcoli biliari



cm MAYO BLAKE
20,0 **GC-110-20**



cm MAYO BLAKE
20,0 **GC-111-20**



cm MIXTER
22,0 **GC-117-22**

Gallensteinlöffel
 Gall Stone Scoops
 Curettes pour calculs biliaires
 Cucharillas para coger cálculos biliares
 Cuchhiai per calcoli biliari



cm MOORE
 28,0 **GC-215-28**

federnd
 elastic
 élastiques
 elásticas
 elastiche



GC-310-13

GC-310-18

GC-310-21

cm DESJARDINS
 28,0 **GC-310-13**
 28,0 **GC-310-18**
 28,0 **GC-310-21**

Gallensteinsonde
 Gall Stone Probes
 Sondes à calculs biliaires
 Sondas-exploradoras para cálculos biliares
 Sonde per calcoli biliari

biegsam
 malleable
 souples
 maleables
 malleabili



cm MOYNIHAN
 34,0 **GC-412-34**

biegsamer Schaft
 malleable shaft
 tige malléable
 vástago maleable
 gambo flessibile

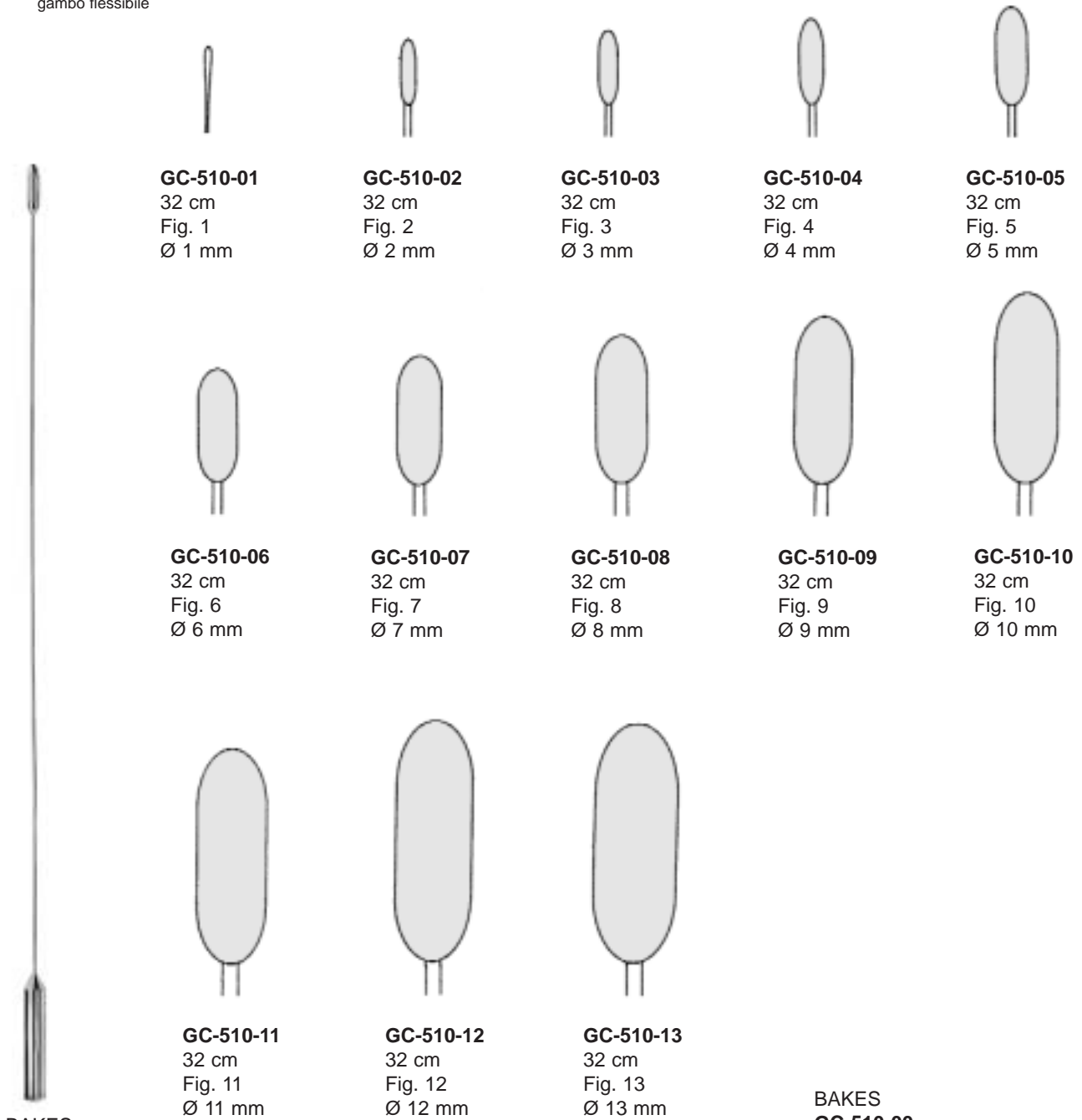

BAKES

GC-510-00

Satz à 9 Stück in Leinentuchtaschen
 set of 9 pieces in canvas pocket
 jeu de 9 pièces dans une poche en toile
 juego de 9 unidades en bolsa de tela
 set di 9 pezzi

GC-510-03 - GC-510-11

Gallensteinlöffel
Gall Stone Scoops
Curettes pour calculs biliars
Cucharas para cálculos biliars
Pinze per calcoli biliari

GC



cm FERGUSSON
21,5 **GC-710-21**



cm MAYO
28,0 **GC-715-27**



cm MAYO
27,0 **GC-718-01**
27,0 **GC-718-02**
27,0 **GC-718-03**

GC

Gallensteinlöffel
Gall Stone Scoops
Curettes pour calculs biliaires
Cucharas para cálculos biliares
Pinze per calcoli biliari



federnd
elastic
élastiques
elásticas
elastiche



GC-810-17



GC-810-21



GC-810-24



GC-810-27

cm	DESJARDINS
30,0	GC-810-17
30,0	GC-810-21
30,0	GC-810-24
30,0	GC-810-27

biegsam
 malleable
 souples
 maleables
 malleabili

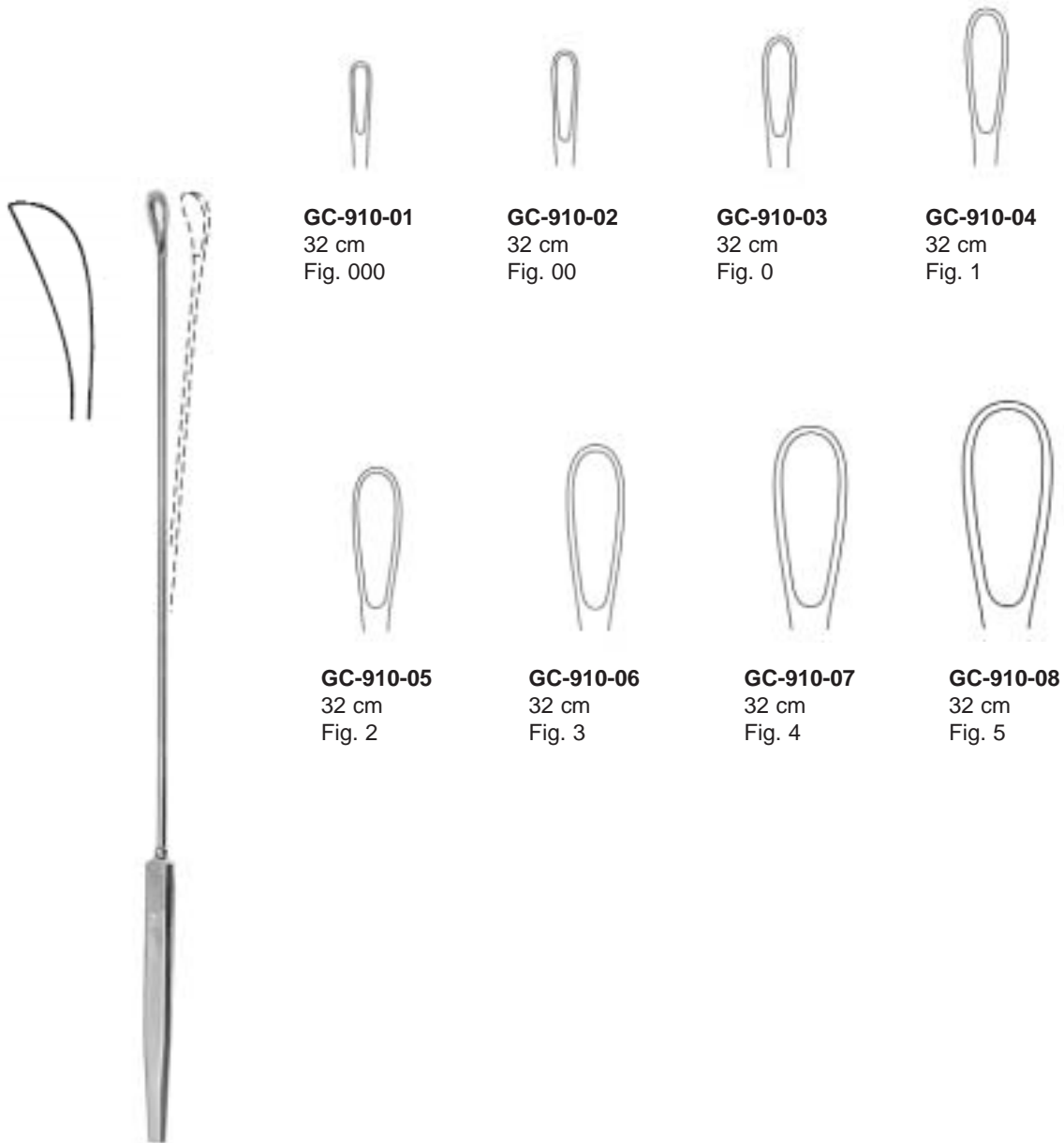

GC-910-01
 32 cm
 Fig. 000

GC-910-02
 32 cm
 Fig. 00

GC-910-03
 32 cm
 Fig. 0

GC-910-04
 32 cm
 Fig. 1

GC-910-05
 32 cm
 Fig. 2

GC-910-06
 32 cm
 Fig. 3

GC-910-07
 32 cm
 Fig. 4

GC-910-08
 32 cm
 Fig. 5

Fig	mm	LUER-KOERTE
000	Ø 2,5	GC-910-01
00	Ø 3,2	GC-910-02
0	Ø 4,2	GC-910-03
1	Ø 5,5	GC-910-04
2	Ø 6,7	GC-910-05
3	Ø 8,0	GC-910-06
4	Ø 11,0	GC-910-07
5	Ø 15,0	GC-910-08

GC

Ureterklemmen
Ureter Clamps
Pinces-clapms uretère
Pinzas clamps para ureter
Pinze per uretere



cm MAYO
32,0 **GC-120-32**



cm LURZ
21,0 **GC-221-21**



cm LURZ
21,0 **GC-223-21**



GC-321-01
23 cm
Fig. 1



GC-321-02
21 cm
Fig. 2



GC-321-03
19 cm
Fig. 3



GC-321-04
18,5 cm
Fig. 4

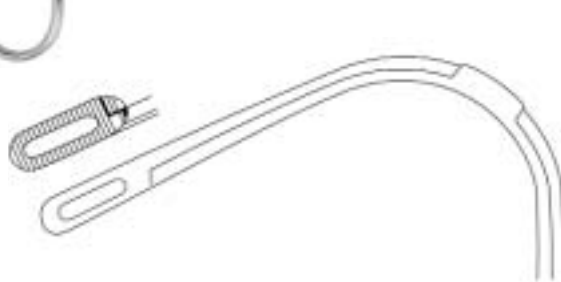

GC-321-05
19 cm
Fig. 5

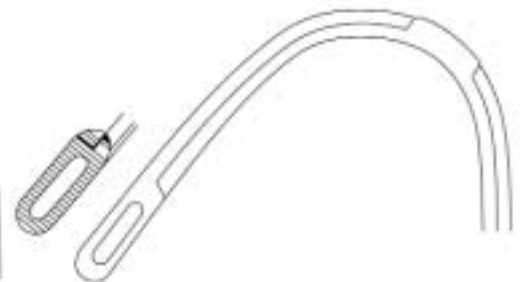

GC-321-06
19 cm
Fig. 6

Fig.	RANDALL
1	GC-321-01
2	GC-321-02
3	GC-321-03
4	GC-321-04
5	GC-321-05
6	GC-321-06

feines Modell
delicate pattern
modèle délicat
modelo fino
modello delicato



Fig. RANDALL
1 **GC-321-23**
2 **GC-321-24**

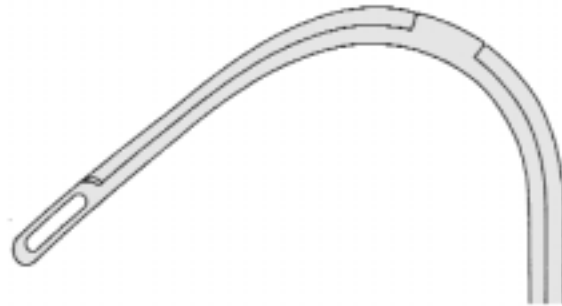

GC-321-23
23 cm
Fig. 1

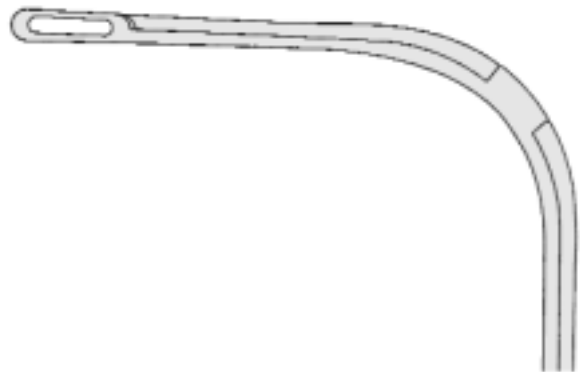

GC-321-24
24,5 cm
Fig. 2

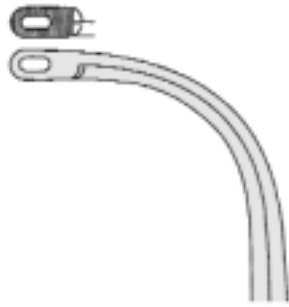

GC-323-16
16 cm
Fig. 1

Nierenfistelzangen
Nephrostomy Forceps
Pinces à néphrostomie
Pinzas para nephrostomie
Pinze per nefrostomia

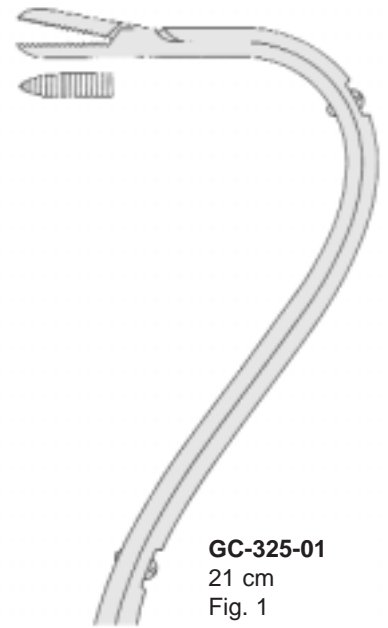

GC-325-01
21 cm
Fig. 1

für Kinder
for children
pour enfants
para niños
per bambini



GC-323-17
17 cm
Fig. 2



GC-325-02
21 cm
Fig. 2

Fig.	<u>HEIMING</u>
1	GC-323-16
2	GC-323-17

Fig.	<u>ELSAESSER</u>
1	GC-325-01
2	GC-325-02

GE

**Darm, Magen
Intestines and Stomach
Intestin, Estomac
Intestines, Estómago
Intestini, Stomaco**



GE



ALLIS-Baby
 GE-012-14
 14 cm



4:5	ALLIS	5:6
GE-110-15	15 cm	GE-210-15
	19 cm	GE-210-19
	22 cm	GE-210-22
	24 cm	GE-210-24

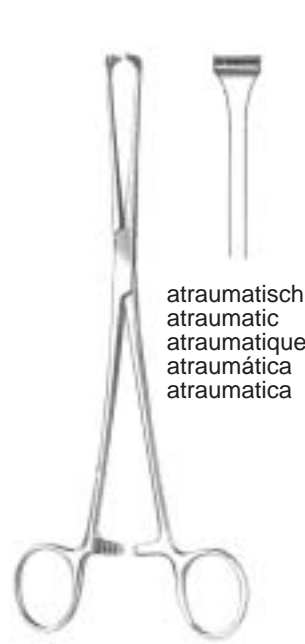

atraumatisch
 atraumatic
 atraumatique
 atraumática
 atraumatica

cm	ALLIS
16	GE-214-16
20	GE-214-20
25	GE-214-25



ALLIS-ADAIR
 GE-310-15
 15,5 cm



cm	JUDD-ALLIS
15	GE-410-15
19	GE-410-19



THOMS-ALLIS
 GE-510-20
 20 cm

Mit TC-Einsätzen
 TC Lined
 A mors TC
 Con bocas TC
 Con morso TC





atraumatisch
 atraumatic
 atraumatique
 atraumática
 atraumatica

cm	BABCOCK	TC	
16	GE-610-16	GE-614-16	GE-618-16
18	GE-610-18		
20	GE-610-20	GE-614-20	GE-618-20
24	GE-610-24		

Darm, Magen
 Intestines and Stomach
 Intestin, Estomac
 Intestines, Estómago
 Intestini, Stomaco

GE

Mit TC-Einsätzen
 TC- Lined
 A mors TC
 Con bocas TC
 Con morso TC

		
	DUVAL 13 mm	DUVAL 25 mm
18	GE-710-18	
20	GE-710-20	GE-712-20
20	GE-714-20	
23		GE-712-23



DUVAL
 GE-710-18 - GE-714-20



WILLIAMS
 GE-810-16
 16,5 cm





SCHOENBURG
 GE-812-22
 22 cm

Darmklemmen
 Intestinal Forceps
 Pinzas intestinales
 Pinzas intestinales
 Pinze intestinali

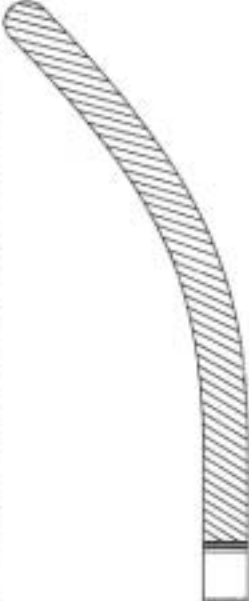
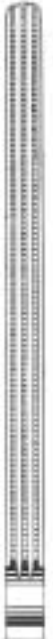
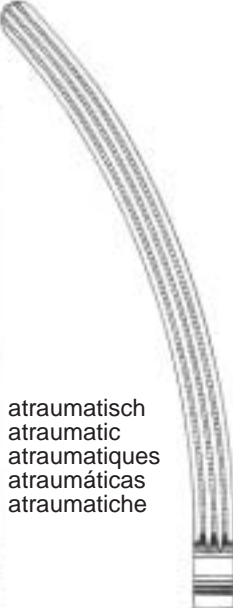

DOYEN
 DOYEN-Baby
 GE-120-18-GE-127-23

						
	DOYEN-Baby		DOYEN		DOYEN	
16					GE-126-16	GE-127-16
18	GE-120-18	GE-121-18			GE-126-18	GE-127-18
21			GE-120-21	GE-121-21	GE-126-21	GE-127-21
23			GE-120-23	GE-121-23	GE-126-23	GE-127-23

atraumatisch
 atraumatic
 atraumatiques
 atraumáticas
 atraumatiche

Darmklemmen
 Intestinal Forceps
 Pincas intestinales
 Pinzas intestinales
 Pinze intestinali

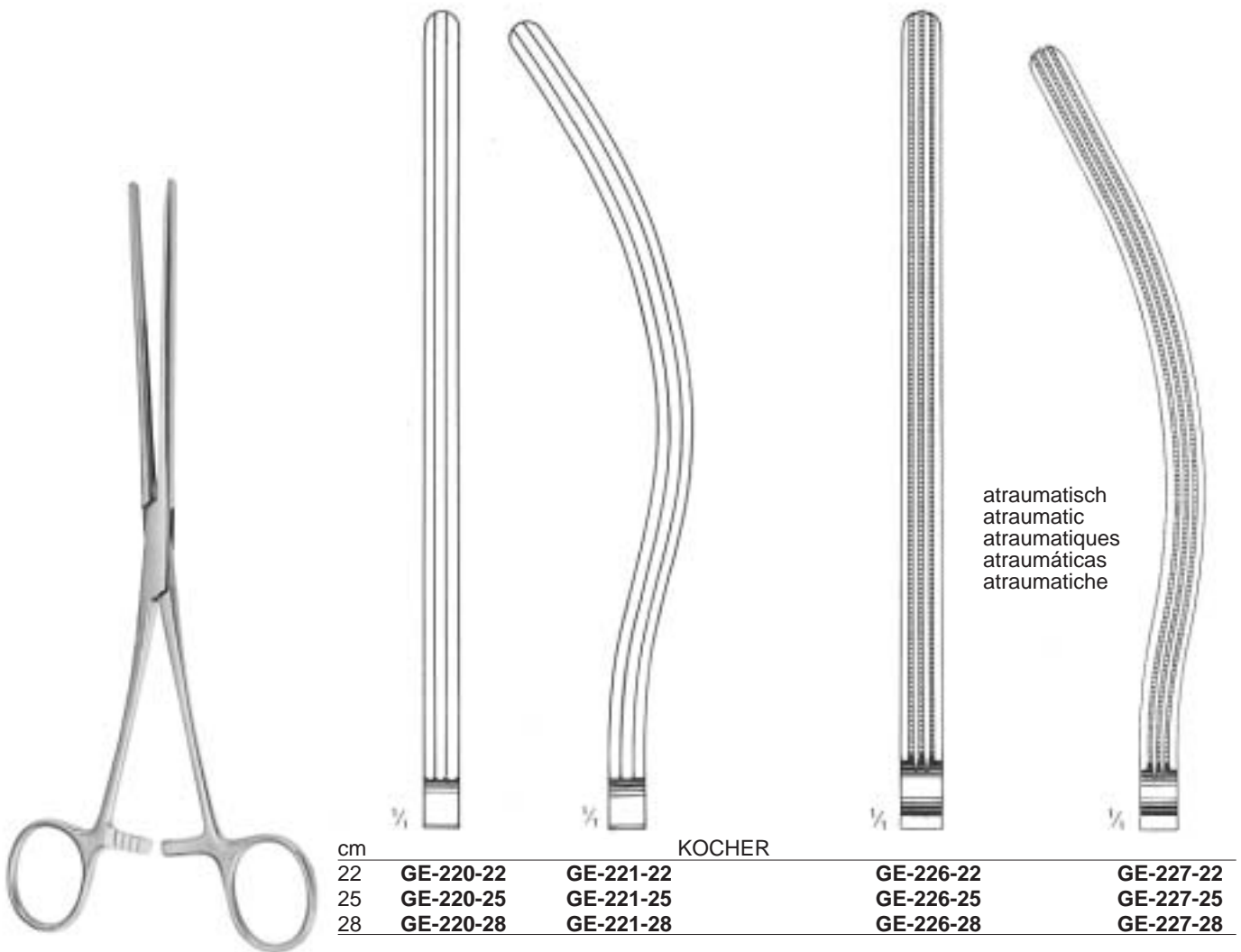

cm	KOCHER			
22	GE-220-22	GE-221-22	GE-226-22	GE-227-22
25	GE-220-25	GE-221-25	GE-226-25	GE-227-25
28	GE-220-28	GE-221-28	GE-226-28	GE-227-28

KOCHER
 GE-220-22 - GE-227-22

Darm, Magen
Intestines and Stomach
Intestin, Estomac
Intestines, Estómago
Intestini, Stomaco

GE

Darmklemmen
Intestinal Forceps
Pinças intestinales
Pinzas intestinales
Pinze intestinali

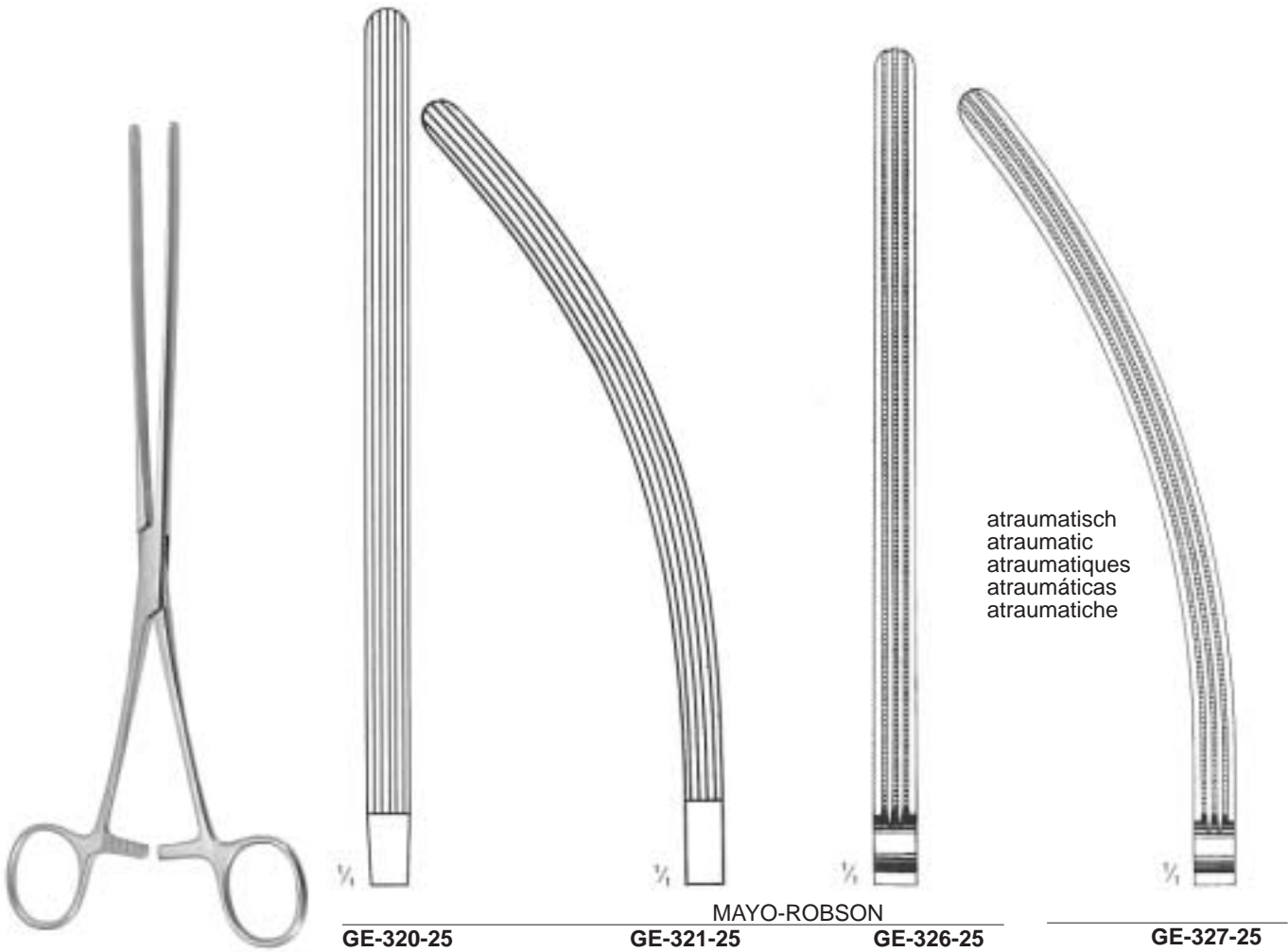

MAYO-ROBSON
GE-320-25 - GE-327-25
25 cm

GE

Darm, Magen
Intestines and Stomach
Intestin, Estomac
Intestines, Estómago
Intestini, Stomaco



normal FEHLAND atraum.
GE-421-23 23,5 cm **GE-427-23**

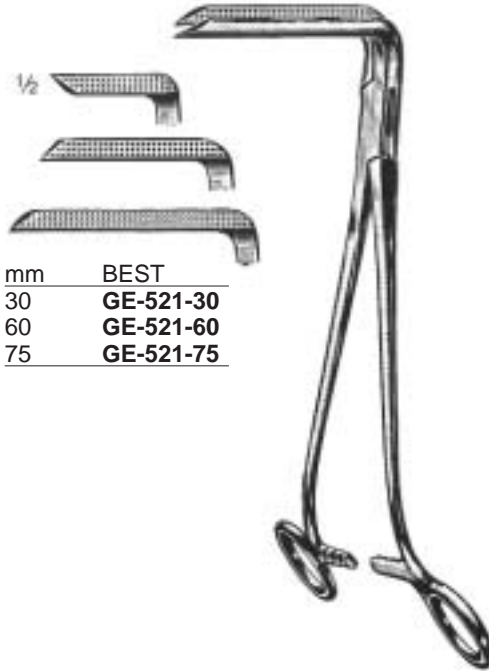

mm	BEST
30	GE-521-30
60	GE-521-60
75	GE-521-75

BEST
GE-521-30 - GE-521-75
26,5 cm

Darm- und Magenklammern
Intestinal and Stomach Clamps
Pincas-clamps intestinales
Pinzas-clamps intestinales y estomacales
Pinze intestinali e stomacali



BRUNNER
GE-620-24 - GE-626-24
24 cm

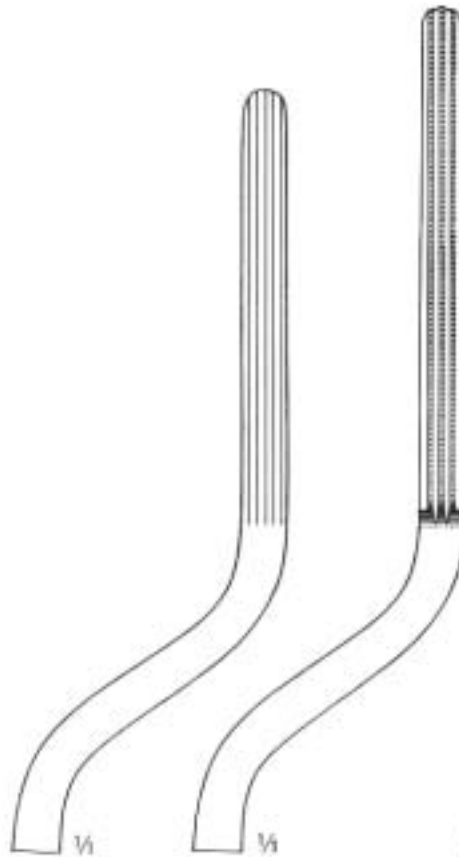

BRUNNER
GE-620-24 GE-626-24

atraumatisch
atraumatic
atraumatique
atraumática
atraumatica



STONE
GE-720-15
15,5 cm



STONE-WATT
GE-724-00



cm STONE-WATT
7,5 **GE-722-07**
10 **GE-722-10**

Anastomosenklemmen und Zubehör
 Anastomosis Clamps and Accessories
 Clamps á anastomose et accessoires
 Clamps para anastomosis y accesorios
 Pinze per anastomosi e accessori

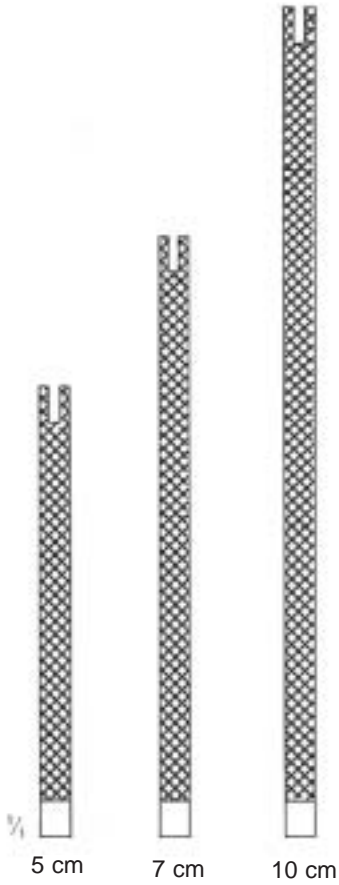

5 cm
 7 cm
 10 cm



cm	DE MARTEL-WOLFSON
5	GE-820-05
7	GE-820-07
10	GE-820-10
	Set/3



DE MARTEL-WOLFSON
GE-822-26
 26 cm



DE MARTEL-WOLFSON	
GE-824-08	GE-824-23
8,5 cm	23 cm

GE

Darm, Magen
Intestines and Stomach
Intestin, Estomac
Intestines, Estómago
Intestini, Stomaco

Magenklemmen
Stomach Clamps
Pincas-clamps stomacales
Pinzas-clamps estomacales
Pinze stomacali

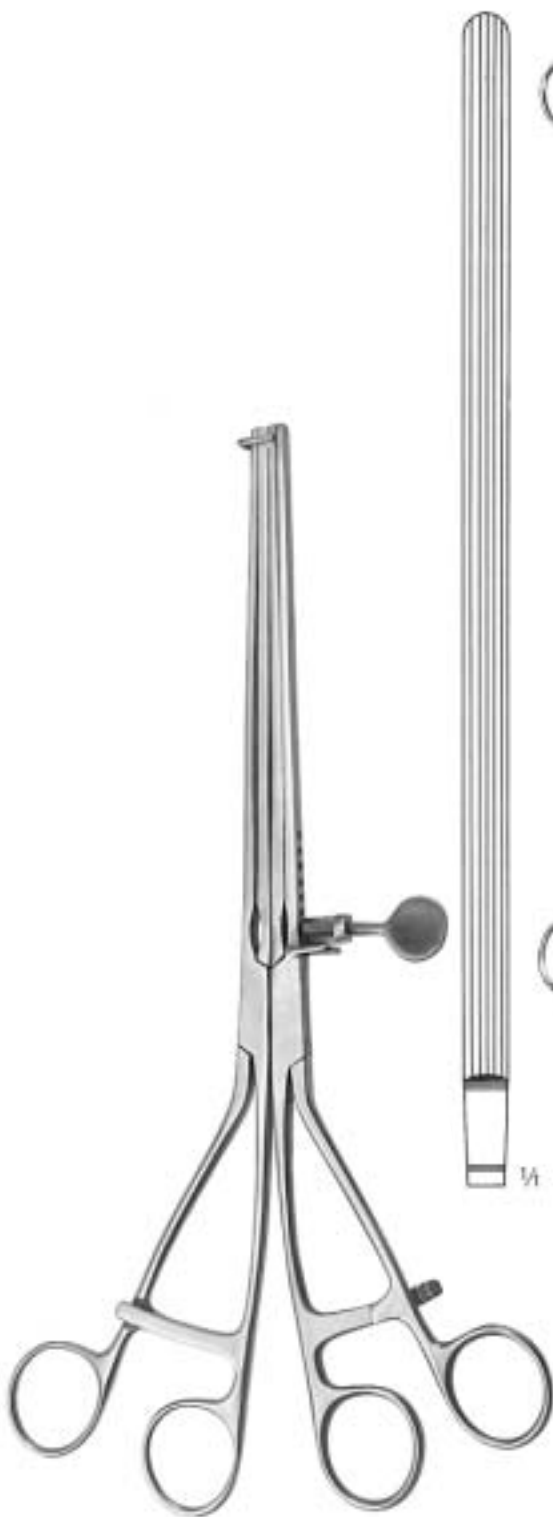

LANE
GE-920-30
30 cm

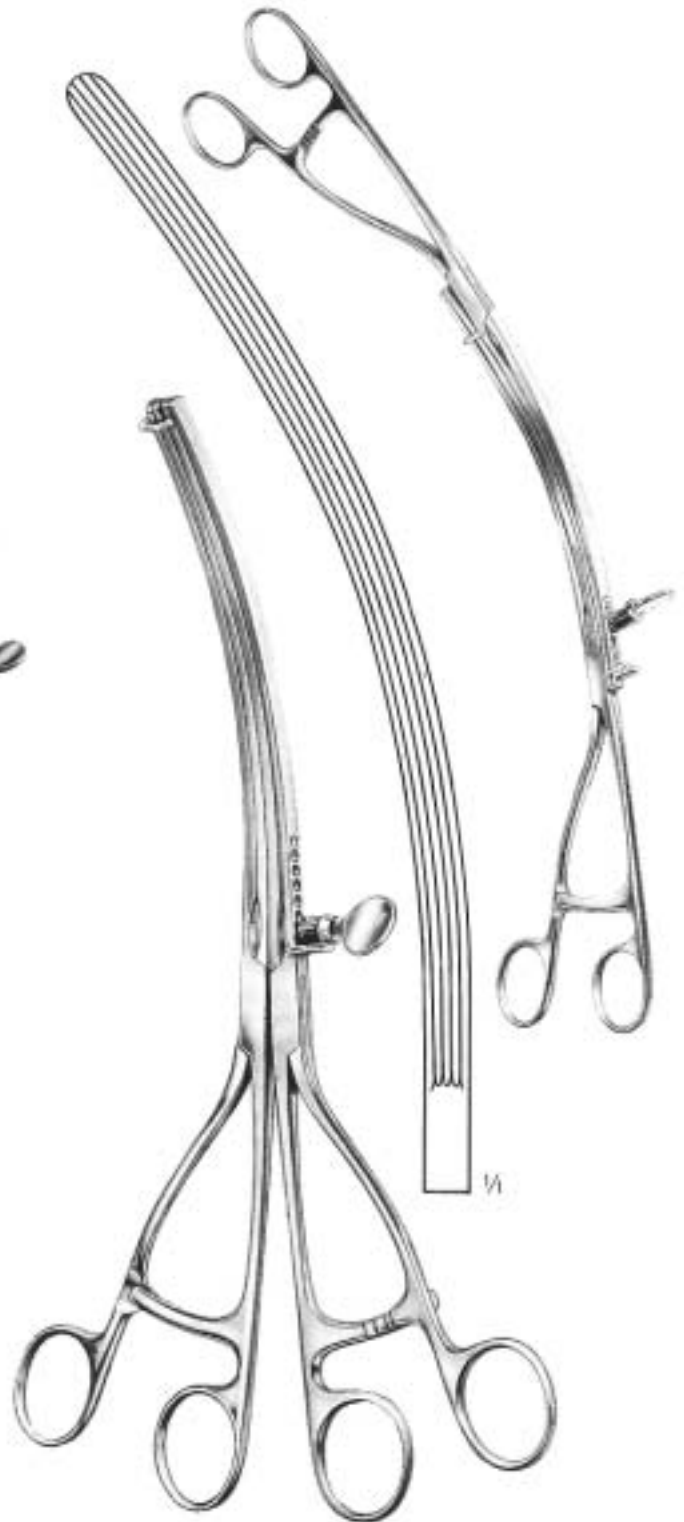

LANE
GE-921-30
30 cm

Darm, Magen
 Intestines and Stomach
 Intestin, Estomac
 Intestines, Estómago
 Intestini, Stomaco

GE

Magenklemmen
 Stomach Clamps
 Pincés-clamps stomacales
 pinzas-clamps estomacales
 Pinze stomacali

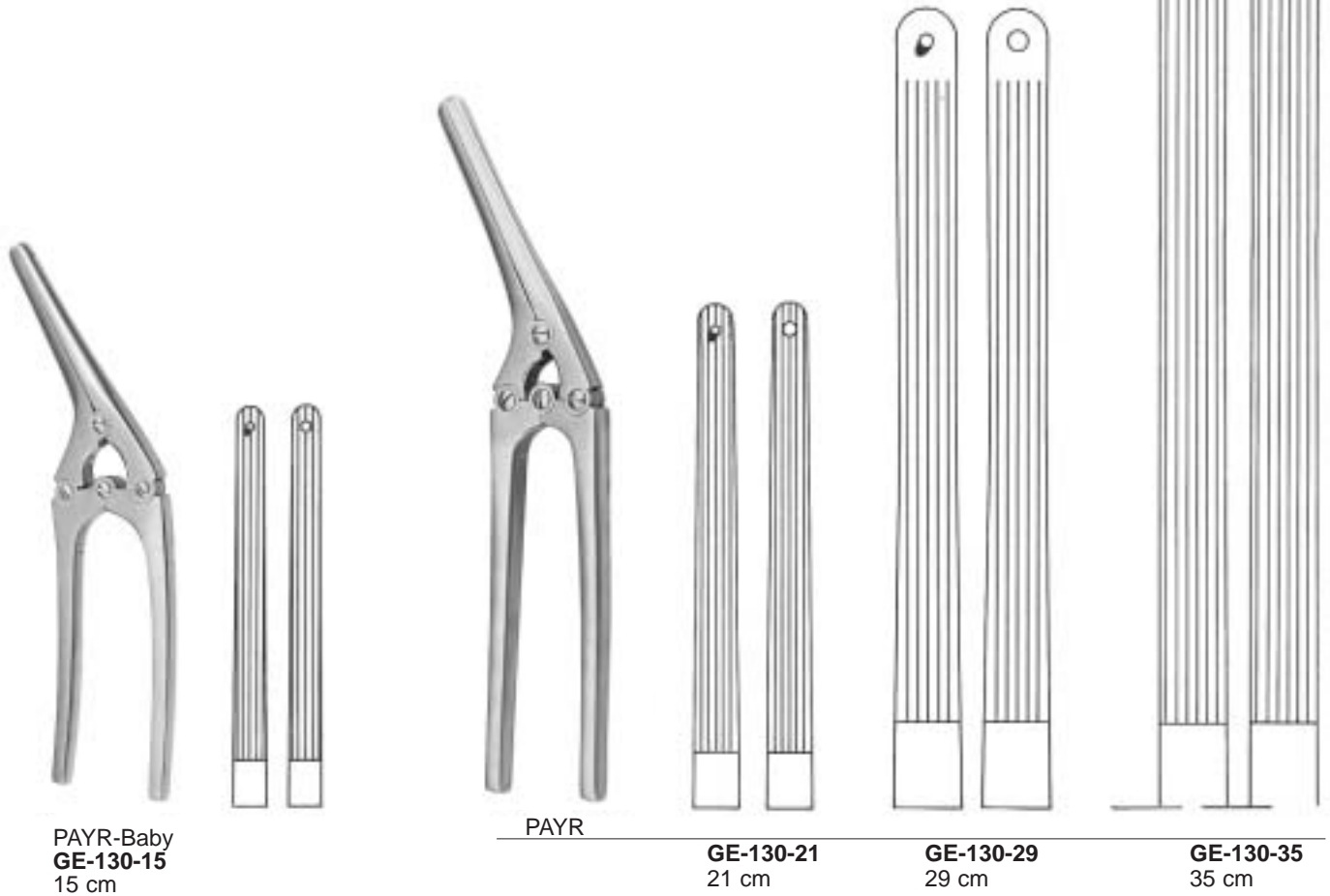

Magen- und Darmnähapparat • Stomach and Intestinal Suturing Apparatus • Appareil á sutures stomacales et intestinales • Aparato para suturas estomacales e intestinales • Apparecchio per suture stomacali e intestinali

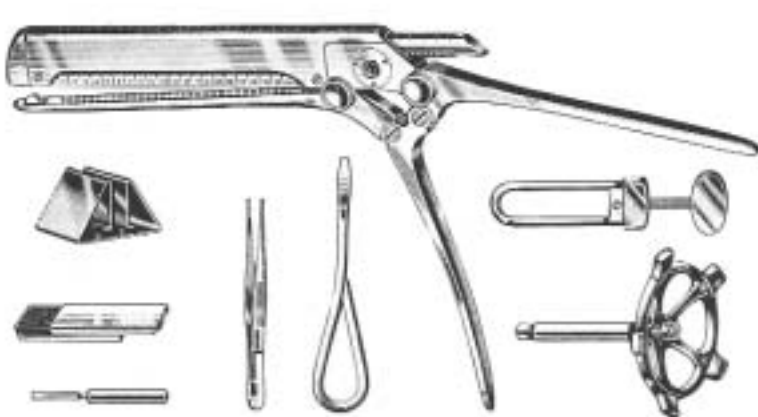

v. PETZ
GE-230-00
 compl.



300 Stück
 300 ea.
 300 pièces
 300 c/u
 300 pezzi

GE-231-00

GG

**Urologie
Urology
Urologie
Urología
Urologia**



GG

GG

Prostata Haken, -Faßzange
Prostatic Retractors, Grasping Forceps
Ecarteurs à prostate, Pince à saisir la prostate
Separadores, Pinza para coger prostata
Divaricatori, Pinza per afferrare la prostata



YOUNG
GG-011-21
21,5 cm



YOUNG
GG-012-22
21,5 cm



YOUNG
GG-013-22
20,5 cm



YOUNG
GG-015-21
22 cm



YOUNG
GG-016-20
20 cm

Kapselfasszangen, Fadenführungszange
 Capsule Forceps, Ligature Carrying Forceps
 Pincés pour saisir les capsules. Pince porte-fil
 Pinzas capsulares, Pinze porta ligaduras
 Pinze per afferrare capsule, Pinza porta-filo

GG



MILLIN
GG-111-23
 24,5 cm



MILLIN
GG-115-24
 24,5 cm



MILLIN
GG-117-23
 22 cm



MILLIN
GG-213-23
 22 cm

Fasszange für vordere Lappen
 Lobe Holding Forceps
 Pince pour saisir les lombeaux
 Pinza para lóbulos anteriores
 Pinza per lobuli anteriori



MILLIN
GG-215-24
 24,5 cm

Fadenführungszange
 Ligature Carrying Forceps
 Pince porte-fil
 Pinze porta ligaduras
 Pinza porta-filo



35 mm

LEGUEU
GG-417-27
27 cm



67 mm

KOCHER
GG-419-27
26 cm



JUDD-MASSON
GG-510-00



MILLIN

MILLIN

GG-511-00

komplett mit je 2 Seitenvalven
57 x 25 mm und 80 x 25 mm,
sowie 1 Mittelvalve 120 x 45 mm
ohne Kaltlichtaufsatz

complete with 2 pairs of lateral
blades 57 x 25 mm and 80 x 25 mm
and 1 central blade 120 x 45 mm
without F.O. Carrier

complet, avec 2 paires de valves laterales,
57 x 25 mm et 80 x 25 mm,
ainsi qu'une valve centrale 120 x 45 mm
sans support lumière froide

completo, con 2 pares de valvas laterales
57 x 25 mm y 80 x 25 mm
y una valva central 120 x 45 mm
sin portador de luz fria

completo, con 2 paia di valve laterali
57 x 25 mm e 80 x 25 mm
in piú 1 valva centrale 120 x 45 mm
senza supporto per luce fredda

MILLIN

GG-511-50

komplett mit je 2 Seitenvalven
57 x 25 mm und 80 x 25 mm,
sowie 1 Mittelvalve 120 x 45 mm
mit Kaltlichtaufsatz

complete with 2 pairs of lateral
blades 57 x 25 mm and 80 x 25 mm
and 1 central blade 120 x 45 mm
with F.O. Carrier

complet, avec 2 paires de valves laterales,
57 x 25 mm et 80 x 25 mm,
ainsi qu'une valve centrale 120 x 45 mm
avec support lumière froide

completo, con 2 pares de valvas laterales
57 x 25 mm y 80 x 25 mm
y una valva central 120 x 45 mm
con portador de luz fria

completo, con 2 paia di valve laterali
57 x 25 mm e 80 x 25 mm
in piú 1 valva centrale 120 x 45 mm
con supporto per luce fredda

MILLIN

GG-511-51

Kaltlichtaufsatz
F.O. Light Carrier
Supporto lumière froide
Portador de luz fria
Supporto per luce fredda

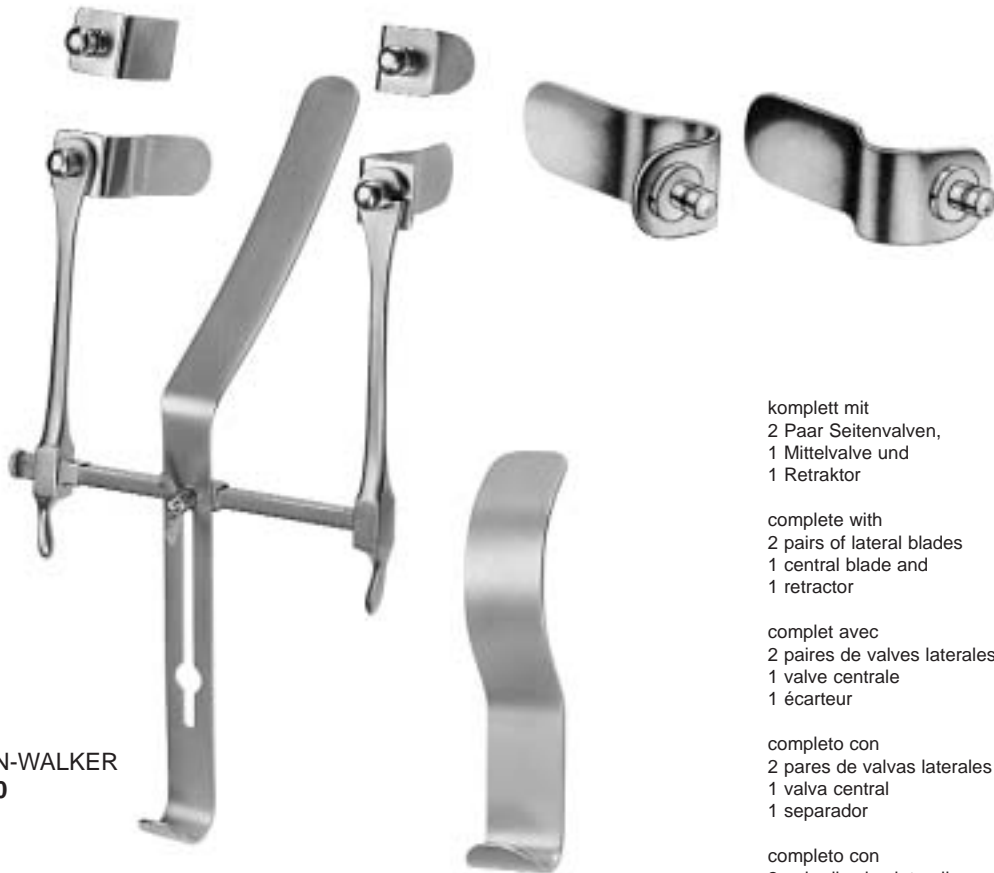

THOMSON-WALKER
GG-610-00

komplett mit
2 Paar Seitenvalven,
1 Mittelvalve und
1 Retraktor

complete with
2 pairs of lateral blades
1 central blade and
1 retractor

complet avec
2 paires de valves laterales
1 valve centrale
1 écarteur

completo con
2 pares de valvas laterales
1 valva central
1 separador

completo con
2 paia di valve laterali
1 valva centrale e
1 retrattore



LEGUEU
GG-613-00



MILLIN
GG-615-00
29 cm

Fremdkörperzangen
Foreign Body Forceps
Pinceps à corps étrangers
Pinzas para cuerpos extranjerros
Pinze per corpi estranei



MATHIEU
GG-618-20
Schaftlänge 20 cm
length of shaft 20 cm
longueur du tige 20 cm
longitud del vástago 20 cm
lunghezza del gambo 20 cm

MATHIEU
GG-618-28
Schaftlänge 28 cm
length of shaft 28 cm
longueur du tige 28 cm
longitud del vástago 28 cm
lunghezza del gambo 28 cm



GG

Urethrotom
Urethrotome
Urétrótome
Uretrótomo
Uretrotomi

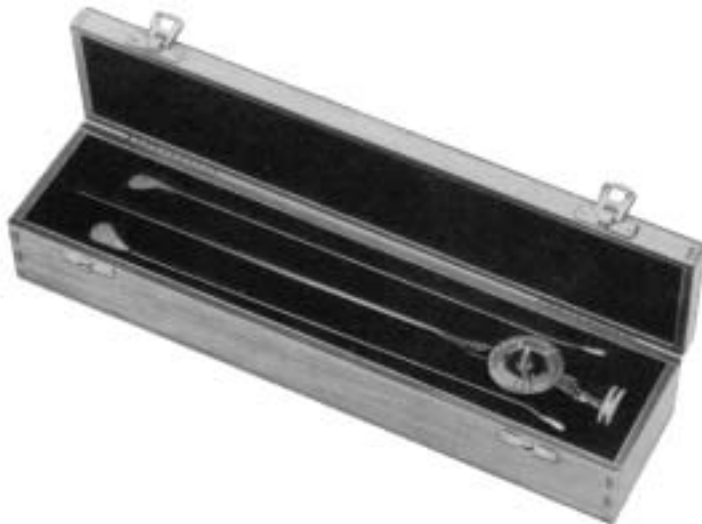

OTIS
GG-619-00

komplett mit Holzetui
mit Dilitator, 2 Messern und 3 Ansätzen

complete in wooden case
with dilator, 2 knives and 3 tips

complet, en boîte métal
avec dilateur, 2 lames et 3 embouts

completo an caja de madera
con dilatador, 2 cuchillos y 3 puntas

completo, in contenitore di legno
con dilatatore, 2 bisturi e 3 punte



OTIS
GG-619-01
Ersatzmesser
Spare Blade
Couteau de rechange
Cuchillo de repuesto
Lama die ricambio

Circumcisionsgerät
 Circumcision Instrument
 Instrument de circoncision
 Instrumento para circuncisión
 Strumento per circoncisione



GG-711-08 Ø 8 mm
GG-711-11 Ø 11 mm
GG-711-13 Ø 13 mm
GG-711-16 Ø 16 mm
GG-711-21 Ø 21 mm
GG-711-26 Ø 26 mm
GG-711-32 Ø 32 mm

Urethrographieinstrument
 Urethrography Instrument
 Instrument pour urétrographie
 Instrumento para uretrografia
 Strumento per uretrografia



KNUTSON-KOCH
GG-712-01

Konus
 Cone
 Cône
 Cono
 Cono

KNUTSON
GG-712-00

Beschneidungsinstrument
 Circumcision Instrument
 Instrument de circoncision
 Instrumento para circuncisión
 Strumento per circoncisione



MOGAN
GG-714-01
 für Erwachsene
 for adults
 pour adultes
 para adultos
 per adulti

MOGAN
GG-714-02
 für Kinder
 for children
 pour enfants
 para niños
 per bambini



WINKELMANN

GG-714-12 Ø 12 mm
GG-714-16 Ø 16 mm
GG-714-20 Ø 20 mm

Penisklemmen
 Meatus Clamps
 Compresseurs de l'urètre
 Compresores uretrales
 Serrapene



STOCKMANN
GG-715-08
 8 cm



STRAUSS
GG-717-11
 11 cm

Zange zum Erfassen der Glans und der Vorhaut
 Forceps for grasping the glans and the foreskin



GG-719-12
 12,5 cm

Klemme zum Fixieren des Samenstranges
 Fixation clamp for the spermatic cord
 Pince pour fixer le cordon
 Pinza para fijar el cordón espermático
 Pinza per fissare il tronco spermatico



GG-719-15
 14,5 cm



GUTTMANN
GG-810-26
26,5 cm



DITTEL
GG-812-46
46 cm



GUYON
GG-813-46
46 cm



GUYON
GG-814-39
39 cm



GUYON
GG-815-35
35 cm

GG

Gleitsonde, Harnröhrenbougies
Filiform Bougiem Urethral Sounds
Bougie conductrice, Bougies urétrales
Sonda filiforme, Bujias uretrales
Candeletta filiforme, Candelette dilatatrice

mit Schraubgewinde-Ansatz
with screw thread
avec ambout fileté
con rosca de tornillo
con attacco filettato

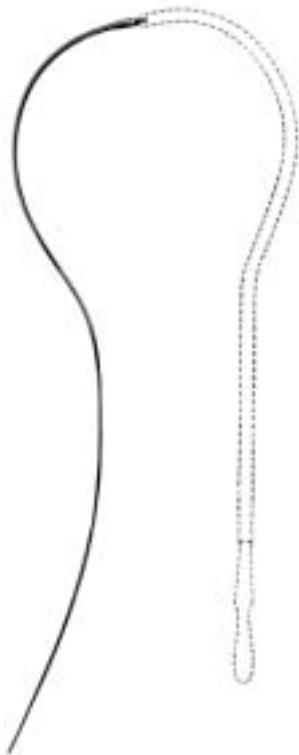

FILIFORM

GG-919-03	3 Ch.
GG-919-04	4 Ch.
GG-919-05	5 Ch.
GG-919-06	6 Ch.

Satz mit 21 Bougies, Charr. 10 bis 30
mit 4 Gleitsonden
im Metalletui 42 x 17,5 x 4 cm

set with 21 bougies, Charr. 10 to 30
with 4 filiform bougies
in metal case 42 x 17,5 x 4 cm

jeu avec 21 bougies, Charr. 10 jusqu' à 30
avec 4 bougies conductrices
en boîte métal 42 x 17,5 x 4 cm

juego de 21 bujias, Charr. 10 a 30
con 4 bujias filiformes
en caja metálica 42 x 17,5 x 4 cm

set di 21 dilatatori, Charr. 10 fino a 30
con 4 candelette dilatatrici
in contenitore metallico 42 x 17,5 x 4 cm



GUYON
GG-020-00
compl.



VAN BUREN
GG-021-00
 Set compl.
 8-36 Charr.

van BUREN	mm Ø	Charrière (French)
GG-021-06	2	6
GG-021-08	2 ² / ₃	8
GG-021-10	3 ¹ / ₃	10
GG-021-12	4	12
GG-021-14	4 ² / ₃	14
GG-021-16	5 ¹ / ₃	16
GG-021-18	6	18
GG-021-20	6 ² / ₃	20
GG-021-22	7 ¹ / ₃	22
GG-021-24	8	24
GG-021-26	8 ² / ₃	26
GG-021-28	9 ¹ / ₃	28
GG-021-30	10	30
GG-021-32	10 ² / ₃	32
GG-021-34	11 ¹ / ₃	34
GG-021-36	12	36
GG-021-38	12 ² / ₃	38

mit Schraubgewinde-Ansatz
 with screw thread
 avec ambout fileté
 con rosca de tornillo
 con attacco filettato



GUYON
GG-023-00
 Set compl.
 10-30 Charr.

GUYON	mm Ø	Charrière (French)
GG-023-10	3 ¹ / ₃	10
GG-023-11	3 ² / ₃	11
GG-023-12	4	12
GG-023-13	4 ¹ / ₃	13
GG-023-14	4 ² / ₃	14
GG-023-15	5	15
GG-023-16	5 ¹ / ₃	16
GG-023-17	5 ² / ₃	17
GG-023-18	6	18
GG-023-19	6 ¹ / ₃	19
GG-023-20	6 ² / ₃	20
GG-023-21	7	21
GG-023-22	7 ¹ / ₃	22
GG-023-23	7 ² / ₃	23
GG-023-24	8	24
GG-023-25	8 ¹ / ₃	25
GG-023-26	8 ² / ₃	26
GG-023-27	9	27
GG-023-28	9 ¹ / ₃	28
GG-023-29	9 ² / ₃	29
GG-023-30	10	30



GUYON

GUYON	mm Ø	Charrière (French)
GG-025-08	2 ² / ₃	8
GG-025-09	3	9
GG-025-10	3 ¹ / ₃	10
GG-025-11	3 ² / ₃	11
GG-025-12	4	12
GG-025-13	4 ¹ / ₃	13
GG-025-14	4 ² / ₃	14
GG-025-15	5	15
GG-025-16	5 ¹ / ₃	16
GG-025-17	5 ² / ₃	17
GG-025-18	6	18
GG-025-19	6 ¹ / ₃	19
GG-025-20	6 ² / ₃	20
GG-025-21	7	21
GG-025-22	7 ¹ / ₃	22
GG-025-23	7 ² / ₃	23
GG-025-24	8	24
GG-025-25	8 ¹ / ₃	25
GG-025-26	8 ² / ₃	26
GG-025-27	9	27
GG-025-28	9 ¹ / ₃	28
GG-025-29	9 ² / ₃	29
GG-025-30	10	30
GG-025-31	10 ¹ / ₃	31
GG-025-32	10 ² / ₃	32
GG-025-33	11	33
GG-025-34	11 ¹ / ₃	34
GG-025-35	11 ² / ₃	35
GG-025-36	12	36
GG-025-37	12 ¹ / ₃	37
GG-025-38	12 ² / ₃	38
GG-025-39	13	39
GG-025-40	13 ¹ / ₃	40
GG-025-50	16 ² / ₃	50

für Männer
 for men
 pour hommes
 para hombres
 per uomini



	mm Ø	Charrière (French)
GG-121-08	2 ² / ₃	8
GG-121-10	3 ¹ / ₃	10
GG-121-12	4	12
GG-121-14	4 ² / ₃	14
GG-121-16	5 ¹ / ₃	16
GG-121-18	6	18
GG-121-20	6 ² / ₃	20
GG-121-22	7 ¹ / ₃	22
GG-121-24	8	24

für Frauen
 for women
 pour femmes
 para mujeres
 per donne



	mm Ø	Charrière (French)
GG-123-08	2 ² / ₃	8
GG-123-10	3 ¹ / ₃	10
GG-123-12	4	12
GG-123-14	4 ² / ₃	14
GG-123-16	5 ¹ / ₃	16
GG-123-18	6	18
GG-123-20	6 ² / ₃	20
GG-123-22	7 ¹ / ₃	22
GG-123-24	8	24



COXETER	mm Ø	Charrière (French)
GG-129-08	2 ² / ₃	8
GG-129-10	3 ¹ / ₃	10
GG-129-12	4	12
GG-129-14	4 ² / ₃	14
GG-129-16	5 ¹ / ₃	16
GG-129-18	6	18
GG-129-20	6 ² / ₃	20
GG-129-22	7 ¹ / ₃	22
GG-129-24	8	24



WALTHER	mm Ø	Charrière (French)
GG-221-12	4	12
GG-221-14	4 ² / ₃	14
GG-221-16	5 ¹ / ₃	16
GG-221-18	6	18
GG-221-20	6 ² / ₃	20
GG-221-22	7 ¹ / ₃	22
GG-221-24	8	24
GG-221-26	8 ² / ₃	26
GG-221-28	9 ¹ / ₃	28
GG-221-30	10	30
GG-221-32	10 ² / ₃	32
GG-221-34	10 ¹ / ₃	34
GG-221-36	12	36
GG-221-38	12 ² / ₃	38

WALTHER
GG-221-00
 34,5 cm

Satz komplett
 complete set
 jeu complet
 juego completo
 set completo
GG-221-12 - GG-221-38



DITTEL	mm Ø	Charrière (French)
GG-225-08	2 ² / ₃	8
GG-225-09	3	9
GG-225-10	3 ¹ / ₃	10
GG-225-11	3 ² / ₃	11
GG-225-12	4	12
GG-225-13	4 ¹ / ₃	13
GG-225-14	4 ² / ₃	14
GG-225-15	5	15
GG-225-16	5 ¹ / ₃	16
GG-225-17	5 ² / ₃	17
GG-225-18	6	18
GG-225-19	6 ¹ / ₃	19
GG-225-20	6 ² / ₃	20
GG-225-21	7	21
GG-225-22	7 ¹ / ₃	22
GG-225-23	7 ² / ₃	23
GG-225-24	8	24
GG-225-25	8 ¹ / ₃	25
GG-225-26	8 ² / ₃	26
GG-225-27	9	27
GG-225-28	9 ¹ / ₃	28
GG-225-29	9 ² / ₃	29
GG-225-30	10	30
GG-225-32	10 ² / ₃	32

DITTEL
GG-225-00

Satz komplett (23)
 complet set (23)
 jeu complet (23)
 juego completo (23)
 set completo (23)
GG-225-08 - GG-225-30

DITTEL
GG-225-98

Satz komplett (6)
 complet set (6)
 jeu complet (6)
 juego completo (6)
 set completo (6)
GG-225-08/12/16/20/24/30



DITTEL
 34,5 cm

DITTEL	mm Ø	Charrière (French)
GG-227-08	2 ² / ₃	8
GG-227-09	3	9
GG-227-10	3 ¹ / ₃	10
GG-227-11	3 ² / ₃	11
GG-227-12	4	12
GG-227-13	4 ¹ / ₃	13
GG-227-14	4 ² / ₃	14
GG-227-15	5	15
GG-227-16	5 ¹ / ₃	16
GG-227-17	5 ² / ₃	17
GG-227-18	6	18
GG-227-19	6 ¹ / ₃	19
GG-227-20	6 ² / ₃	20
GG-227-21	7	21
GG-227-22	7 ¹ / ₃	22
GG-227-23	7 ² / ₃	23
GG-227-24	8	24
GG-227-25	8 ¹ / ₃	25
GG-227-26	8 ² / ₃	26
GG-227-27	9	27
GG-227-28	9 ¹ / ₃	28
GG-227-29	9 ² / ₃	29
GG-227-30	10	30

GI

**Mastdarm
Rectum
Rectum
Recto
Retto**



GI

Mastdarm-Spekula
Rectal Specula
Spéculums rectaux
Espéculos rectales
Specoli rettali



CZERNY
GI-015-22
22 cm



SIMS
GI-110-15
15 cm



BODENHAMMER
GI-115-15
GI-117-15 = Kaltlicht • Cold Light
15 cm
Lumière froide
Luz fria • Luce fredda



PRATT
GI-211-00



BARR
GI-215-17
70 x 22 mm
17 cm



MATHIEU
GI-310-19
17 cm

Mastdarm-Spreizer
Anal Retractors
Dilatateurs p. anus et rectum
Speculadores rectales
Dilatatori per l'ano retto



ALAN-PARKS
GI-417-00
compl.
13,5 cm

SMITH-BUIE
GI-510-15
75 x 23 mm
15 cm

GI-418-00
Kaltlicht-Adapter für **GI-417-00**
Cold Light Attachment for **GI-417-00**
Adaptateur lumière froide pour **GI-417-00**
Adaptador luz fría para **GI-417-00**
Adattatore luce fredda per **GI-417-00**

Rektoskop
Rectoscope
Rectoscope
Rectoscopio
Rettoscopio

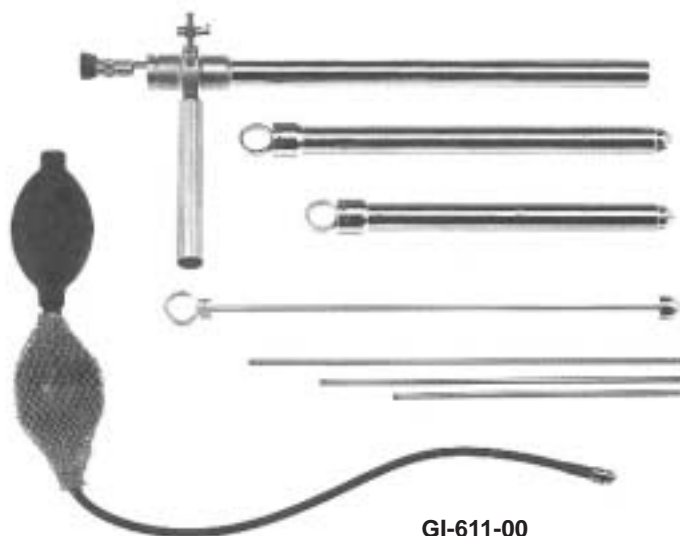

GI-611-00
compl.

Kaltlicht • Cold Light • Lumière froide
Luz fría • Luce fredda

GI

Mastdarm
Rectum
Rectum
Recto
Retto

Anoskope, Proktoskope
Anoscopes, Proctoscopes
Anuscopes, Proctoscopes
Anoscopios, Proctoscopios
Anoscopi, Proctoscopi



IVES-FANSLER
GI-120-22
22 mm Ø
L = 80 mm



Ø mm	HIRSCHMANN
16	GI-122-16
19	GI-122-19
22	GI-122-22
L = 65 mm	



mm	KELLY
Ø x L	
22 x 50	GI-220-05
22 x 100	GI-220-10
22 x 140	GI-220-14
22 x 200	GI-220-20

Cystikus-Haken
Cystic Hooks
Ecarteurs rectaux
Ganchos rectales
Unicini rettali



Ø mm	KELLY
21	GI-224-21
27	GI-224-27
L = 50 mm	



GI-521-01
Fig. 1

GI-521-02
Fig. 2

GI-521-03
Fig. 3

PRATT
GI-521-01 - GI-521-03



Biopsie-Zangen
Biopsy Specimen Forceps
Pinces emporte-pièce à biopsie
Pinzas sacabocado para biopsia
Pinze per biopsia

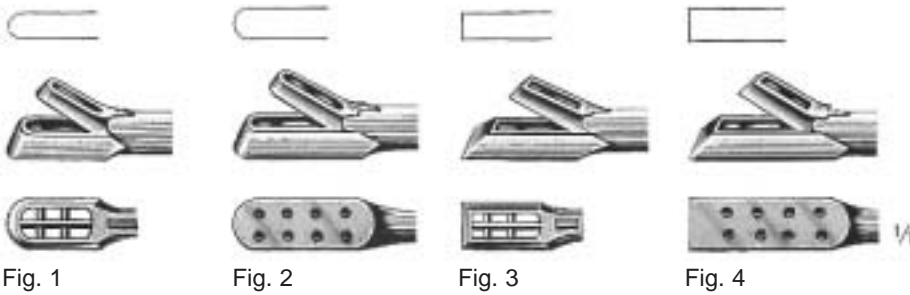
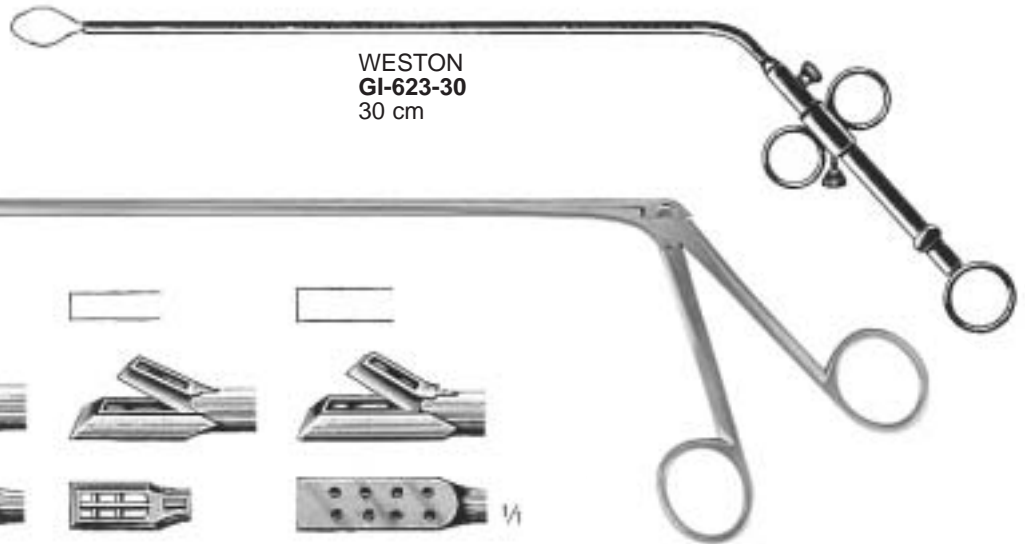

				cm	YEOMAN
GI-031-28	GI-032-28	GI-033-28	GI-034-28	28	
GI-031-35	GI-032-35	GI-033-35	GI-034-35	35	
GI-031-42	GI-032-42	GI-033-42	GI-034-42	42	



cm	YEOMAN
23	GI-131-23
33	GI-131-33
40	GI-131-40



cm	TURREL
23	GI-231-23
33	GI-231-33
40	GI-231-40

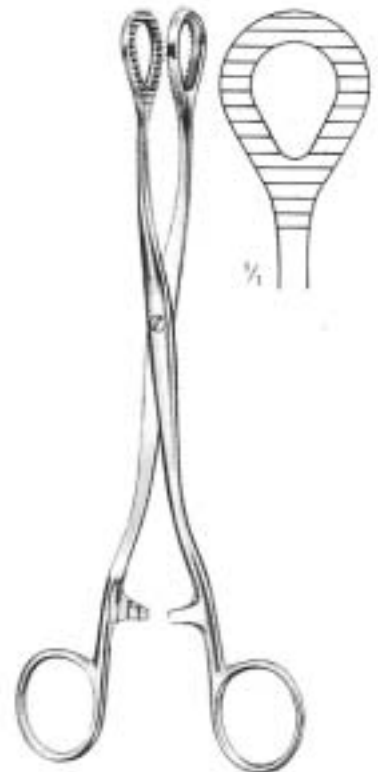

HA

**Gynäkologie
Gynecology
Gynécologie
Ginecología
Ginecologia**



HA



GRAVE			
Fig.	mm	Standard	Laser Mod.
1	75x20	HA-110-01	HA-114-01
2	95x35	HA-110-02	HA-114-02
3	115x35	HA-110-03	HA-114-03



GRAVE		
Fig.	mm	Standard
2	95x35	HA-111-02

mit Absaugung
 with suction
 avec aspiration
 con aspiradoras
 con aspirazione



extra klein
 extra small
 extra petit
 extra pequeno
 extra piccolo

GRAVE
HA-112-01
 76 x 12 mm



extra groß
 extra large
 extra grande
 extra grande
 extra grande

GRAVE
HA-112-02
 120 x 38 mm



PEDERSON

Fig.	mm	
1	75x13	HA-210-01
2	100x22	HA-210-02
3	120x25	HA-210-03



PEDERSON
HA-212-10
100 x 31 mm



COLLIN
 Fig. mm
 1 85x30 **HA-310-01**
 2 100x35 **HA-310-02**
 3 110x40 **HA-310-03**



COLLIN
HA-311-00
 65x20 mm



COLLIN
HA-312-00
 65x10 mm



Seitl. Schraube
 Lateral Screw
 Vis latérale
 Tornillo lateral
 Vite laterale

CUSCO
 Fig. mm Standard Laser Mod.
 0 80x24 **HA-410-00**
 1 75x32 **HA-410-01**
 2 85x35 **HA-410-02** **HA-414-02**
 3 100x35 **HA-410-03** **HA-414-03**

Mittelschraube
Central Screw
Vis centrale
Tornillo central
Vite centrale



CUSCO
HA-412-00
65x20 mm



CUSCO	mm
HA-510-00	80x24
HA-510-01	75x32
HA-510-02	85x36
HA-510-03	95x37
HA-510-04	110x37
HA-511-00	75x17

flache Entenschnabelform
 flat duck beak



CUSCO	mm
HA-512-01	80x32
HA-512-02	90x37
HA-512-03	115x37

Schweizer Modell
 Swiss Pattern
 Modèle suisse
 Modelo suizo
 Modello svizzero



Fig.	mm	CUSCO
1	90x23-25	HA-610-01
2	100x25-27	HA-610-02
3	110x27-30	HA-610-03



FREEWAY GRAVE
HA-612-01
 100 x 32 mm



FREEWAY GRAVE
HA-612-02
 45°

Vaginalspekula
Vaginal Specula
Speculums vaginaux
Espécules vaginales
Specoli vaginali

HA



mm	TRELAT
85x33	HA-810-01
95x35	HA-810-02
115x43	HA-810-03



mm	SEMM
90x14-18	HA-910-00
100x17-20	HA-910-01
100x25-30	HA-910-02



O`SULLIVAN O`CONNOR
HA-916-00
komplett
complete
complet
completo
completo



HA-916-01
Fig. 1
45x17 mm



HA-916-02
Fig. 2
90x37 mm



HA-916-03
Fig. 3
90x45mm



Satz Fig.
 set no.
 jeu no.
 juego no.
 serie no.

bestehend aus
 consisting of
 se compositant de
 consiste de
 composto da

KRISTELLER

HA-120-01	0	HA-121-00 + HA-122-00
HA-120-02	1	HA-121-01 + HA-122-01
HA-120-03	2	HA-121-02 + HA-122-02
HA-120-04	3	HA-121-03 + HA-122-03



Fig.	mm	KRISTELLER
0	70x15	HA-121-00
1	70x27	HA-121-01
2	80x30	HA-121-02
3	90x36	HA-121-03

Spekulum
 Speculum
 Spéculum
 Espéculo
 Specolo

Fig.	mm	KRISTELLER
0	75x10	HA-122-00
1	75x23	HA-122-01
2	85x26	HA-122-02
3	100x32	HA-122-03

Halter
 Retractor
 Valve
 Valva

HA

Vaginalspekula, Scheidenhalter
Vaginal Specula, Vaginal Retractors
Speculums vaginaux, Velves vaginales
Espécules vaginales, Valvas vaginales
Specoli vaginali, Valve vaginali



Mit konischen Blättern, für Jungfrauen
With taper blades, for virgins
A valves coniques, pour vierges
Con hojas cónicas, para vírgenes
Con valve coniche, per vergini

Satz Fig.
set no.
jeu no.
juego no.
serie no.

bestehend aus
consisting of
se compostant de
consiste de
composto da

KRISTELLER

HA-220-01
HA-220-02

1
2

HA-221-01 + HA-222-01
HA-221-02 + HA-222-02



mm KRISTELLER
105x18 HA-221-01
105x21 HA-221-02

Spekulum
Speculum
Spéculum
Espéculo
Specolo



mm KRISTELLER
110x14 HA-222-01
115x17 HA-222-02

Halter
Retractor
Valve
Valva



Satz Fig.
 set no.
 jeu no.
 juego no.
 serie no.

bestehend aus
 consisting of
 se composant de
 consiste de
 composto da

KRISTELLER

HA-320-01	1	HA-321-01 + HA-322-01
HA-320-02	2	HA-321-02 + HA-322-02
HA-320-03	3	HA-321-03 + HA-322-03

Flache Specula
 Specula Flat Hollow
 Spéculums plats
 Espéculos con huecos planos
 Specoli piatti



KRISTELLER	Fig.	mm
HA-321-01	1	105 x 26
HA-321-02	2	105 x 25
HA-321-03	3	105 x 33

Spekulum
 Speculum
 Spéculum
 Espéculo
 Specolo

KRISTELLER	Fig.	mm
HA-322-01	1	115 x 22
HA-322-02	2	115 x 24
HA-322-03	3	115 x 29

Halter
 Retractor
 Valve
 Valva



Satz Fig.
 set no.
 jeu no.
 juego no.
 serie no.

bestehend aus
 consisting of
 se compositant de
 consiste de
 composto da

KRISTELLER

HA-329-99	00	HA-329-97 + HA-329-98
HA-420-00	0	HA-421-00 + HA-422-00
HA-420-01	1	HA-421-01 + HA-422-01
HA-420-02	2	HA-421-02 + HA-422-02
HA-420-03	3	HA-421-03 + HA-422-03



Fig.	mm	KRISTELLER
00	110x18	HA-329-97
0	110x20	HA-421-00
1	110x27	HA-421-01
2	110x30	HA-421-02
3	110x36	HA-421-03

Spekulum
 Speculum
 Spéculum
 Espéculo
 Specolo

Fig.	mm	KRISTELLER
00	115x14	HA-329-98
0	115x17	HA-422-00
1	115x23	HA-422-01
2	115x26	HA-422-02
3	115x32	HA-422-03

Halter
 Retractor
 Valve
 Valva



Für Kinder
For children
Pour enfants
Para niños
Per bambini

Satz Fig.
set no.
jeu no.
juego no.
serie no.

bestehend aus
consisting of
se compositant de
consiste de
composto da

KRISTELLER
HA-424-00

0

HA-425-00 + HA-426-00



KRISTELLER
mm
70x15 HA-425-00

Spekulum
Speculum
Spéculum
Espéculo
Specolo



KRISTELLER
mm
75x10 HA-426-00

Halter
Retractor
Valve
Valva

HA

Vaginalspekula, Scheidenhalter
Vaginal Specula, Vaginal Retractors
Speculums vaginaux, Velves vaginales
Espécules vaginales, Valvas vaginales
Specoli vaginali, Valve vaginali



KRISTELLER
HA-520-00

Satz Fig.
set no.
jeu no.
juego no.
serie no.

bestehend aus
consisting of
se compositant de
consiste de
composto da

0 KRISTELLER
HA-521-01 + HA-522-00



mm KRISTELLER
135x36 HA-521-00

Spekulum
Speculum
Spéculum
Espéculo
Specolo



mm KRISTELLER
140x30 HA-522-00

Halter
Retractor
Valve
Valva



Satz Fig.
 set no.
 jeu no.
 juego no.
 serie no.

bestehend aus
 consisting of
 se compostant de
 consiste de
 composto da

KALLMORGEN

HA-620-01	1	HA-621-01	HA-622-01
HA-620-02	2	HA-621-01	HA-622-02



mm **KALLMORGEN**
 70x40 **HA-621-01**
 90x40 **HA-621-02**
 Spekulum
 Speculum
 Spéculum
 Espéculo
 Specolo

mm **KALLMORGEN**
 70x33 **HA-622-01**
 90x33 **HA-622-02**
 Halter
 Retractor
 Valve
 Valva

56 x 13 mm



mm BRAUN
56x13 **HA-623-01**

60 x 10 mm



mm BRAUN
60x10 **HA-624-01**

flaches Spekulum
flat speculum
spéculum plat
espéculo plano
specolo piatto

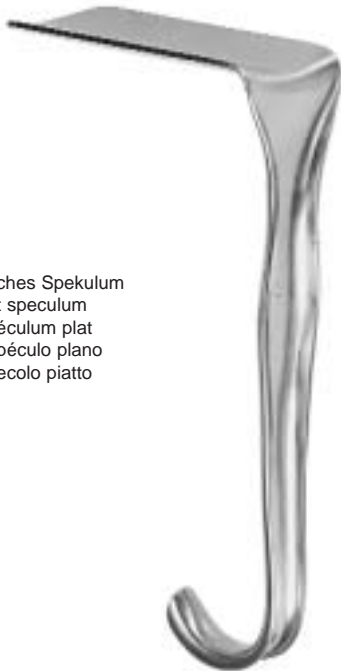

JACKSON



HA-721-01
75 x 40 mm



HA-721-02
90 x 40 mm



HA-721-03
100 x 40 mm



Fig. 1 = klein/small/petit/pequño/piccolo
 Fig. 2 = mittel/medium/moyen/mediano/medio
 Fig. 3 = groß/large/grand/grande

SIMS		
Fig.	mm	
1	70x25	HA-821-01
2	85x30	HA-821-02
3	100x40	HA-821-03

Scheidenspekula, doppelendig
 Vaginal specula, double-ended
 Spéculums vaginaux, doubles
 Espécules vaginales, doubles
 Speculi vaginali, doppi

HA-921-00 = Set

bestehend aus
 consisting of
 consiste de
 se composant de
 composto da

HA-921-01/HA-921-02/HA-921-03



Fig.	mm	SIMS
1	65x25, 70x30	HA-921-01
2	70x30, 70x35	HA-921-02
3	85x35, 90x40	HA-921-03



leicht hohl
 slightly concave
 légèrement concave
 ligeramente cóncavo
 leggermente concavo

Fig.	mm	DOYEN
1	75x45	HA-030-01
2	90x45	HA-030-02
3	110x45	HA-030-03

Fig.	mm	DOYEN
1	55x35	HA-031-01
2	75x35	HA-031-02
3	115x35	HA-032-03
1	55x45	HA-033-01
2	75x45	HA-033-02
3	115x35	HA-033-03
4	160x45	HA-033-04
1	55x60	HA-035-01
2	75x60	HA-035-02
3	115x60	HA-035-03
4	160x60	HA-035-04



AUVARD
HA-037-00
83x38 mm
Loses Gewicht
Detachable Weight
Poids démontable
Pessa desmontable
Peso smontabile

AUVARD
HA-039-00
83 x 38 mm
Festes Gewicht
Fixed Weight
Poids fixe
Pessa fija
Peso fissa

HA

Vaginalspekula
Vaginal Specula
Speculums vaginaux
Espécules vaginales
Specoli vaginali

70 x 30 mm



mm	BREISKY
100x20	HA-130-20
100x25	HA-130-25
100x30	HA-130-30
100x35	HA-130-35
100x40	HA-130-40
130x20	HA-133-20
130x25	HA-133-25
130x30	HA-133-30
130x35	HA-133-35
130x40	HA-133-40
155x40	HA-135-40

DOYEN
HA-137-24
25,0 cm

SCHERBAK

HA-138-00

Satz komplett mit Griff,
 Gewicht (400 g) und 5 Blättern
 complete Set with handle,
 weight (400 g) and 5 blades
 jeu complet avec manche,
 poids (400 g) et 5 valves
 juego completo con mango,
 peso (400 g) y 5 valvas
 Set completo con manico,
 peso (400 g) e 5 valve

Blatt allein
 Specula Blade only
 Valve vaginale, seule
 Valva vaginal, suelta
 Valve vaginale, sola



SCHERBAK

HA-138-01	80x30 mm
HA-138-02	85x35 mm
HA-138-03	90x40 mm

SCHERBAK

HA-138-04	62x40-60 mm
HA-138-05	81x45-70 mm

Gewicht zum Vaginalsepekulum
 Weight for Vaginal Speculum
 Poids pour spéculum vaginal
 Peso para especulo vaginal
 Peso per specolo vaginale



SCHERBAK
HA-138-10
 10,5 cm
 400 g

SCHERBAK
HA-138-12
 13,0 cm
 800 g

Griff zum Vaginalsepekulum
 Handle for Vaginal Speculum
 Manche pour spéculum vaginal
 Mango para especulo vaginal
 Manico per specolo vaginale



SCHERBAK
HA-138-14
 20,0 cm



LANDAU

HA-139-28 100x28 mm
HA-139-38 100x38 mm



HA-230-99

Auffangsieb
 Strainer for Vaginal Speculum
 Tarnis pour spéculum vaginal
 Tamiz para especulo vaginal
 Crivello per specolo vaginale

WEISSBARTH

HA-230-24
 80x42 mm

komplett, mit abnehmbarem Auffangkorb
 complete, with detachable strainer
 complet avec tamis demontable
 completo, con tamiz desmontable
 completo con crivello smontabile



FRIEDMANN

HA-531-10	10,0 cm
HA-531-15	15,0 cm

mit skaliertem Sperre und Fixierschraube
 with graduated ratchet and fixing screw
 avec crémaillère à échelle et vis à fixation
 con cremallera graduada y tornillo de fijacion
 con cremagliera con scala e vite di fissaggio



KOGAN
HA-539-24
 24,5 cm



Standard
HA-630-24

KOGAN
 24,0 cm

Laser
HA-634-24

HEGAR
HA-044-14

Satz mit 14 Stück (ganze Größen)
 von 4,0 - 17,0 mm ohne Etui

set of 14 pieces (full sizes)
 from 4,0 - 17,0 mm without case

jeu de 14 pièces (taille entière)
 de 4,0 - 17,0 mm sans boîte

juego de 14 piezas (tamaños enteros)
 de 4,0 - 17,0 mm sin caja

serie di 14 pezzi (grandezza intera)
 da 4,0 - 17,0 mm senza scatola



HEGAR
HA-044-26

Satz mit 26 Stück (ganze Größen)
 von 1,0 - 26,0 mm ohne Etui

set of 26 pieces (full sizes)
 from 1,0 - 26,0 mm without case

jeu de 26 pièces (taille entière)
 de 1,0 - 26,0 mm sans boîte

juego de 26 piezas (tamaños enteros)
 de 1,0 - 26,0 mm sin caja

serie di 26 pezzi (grandezza intera)
 da 1,0 - 26,0 mm senza scatola

HEGAR	mm	HEGAR	mm
HA-140-01	1	HA-145-01	1,5
HA-140-02	2	HA-145-02	2,5
HA-140-03	3	HA-145-03	3,5
HA-140-04	4	HA-145-04	4,5
HA-140-05	5	HA-145-05	5,5
HA-140-06	6	HA-145-06	6,5
HA-140-07	7	HA-145-07	7,5
HA-140-08	8	HA-145-08	8,5
HA-140-09	9	HA-145-09	9,5
HA-140-10	10	HA-145-10	10,5
HA-140-11	11	HA-145-11	11,5
HA-140-12	12	HA-145-12	12,5
HA-140-13	13	HA-145-13	13,5
HA-140-14	14	HA-145-14	14,5
HA-140-15	15	HA-145-15	15,5
HA-140-16	16	HA-145-16	16,5
HA-140-17	17	HA-145-17	17,5
HA-140-18	18	HA-145-18	18,5
HA-140-19	19	HA-145-19	19,5
HA-140-20	20		
HA-140-21	21		
HA-140-22	22		
HA-140-23	23		
HA-140-24	24		
HA-140-25	25		
HA-140-26	26		
HA-140-27	27		
HA-140-28	28		
HA-140-29	29		
HA-140-30	30		



HEGAR
HA-045-14
4-17 mm
14 Stück/ea./pces./c./u./pezzi



in Metalletui
in metal case
en boîte metal
en caja metalica
in scatola metallica

HEGAR	mm	
HA-046-14	4-17	14 Stück/ea./pces./c./u./pezzi
HA-046-26	1-26	26 Stück/ea./pces./c./u./pezzi

HA

Uterusdilatoren
Uterine Dilators
Dilatateurs du col de l'utérus
Dilataores uterios
Dilatatori uterini

HEGAR
HA-244-08

Satz mit 8 Stück von 3,0 / 4,0 - 17,0 / 18,0 mm
ohne Etui

set of 8 pieces from 3,0 / 4,0 - 17,0 / 18,0 mm
without case

jeu de 8 pièces de 3,0 / 4,0 - 17,0 / 18,0 mm
sans boîte

juego de 8 piezas de 3,0 / 4,0 - 17,0 / 18,0 mm
sin caja

serie di 8 pezzi da 3,0 / 4,0 - 17,0 / 18,0 mm
senza scatola



HEGAR
HA-244-13

Satz mit 13 Stück von 1,0 / 2,0 - 25,0 / 26,0 mm
ohne Etui

set of 13 pieces from 1,0 / 2,0 - 25,0 / 26,0 mm
without case

jeu de 13 pièces de 1,0 / 2,0 - 25,0 / 26,0 mm
sans boîte

juego de 13 piezas de 1,0 / 2,0 - 25,0 / 26,0 mm
sin caja

serie di 13 pezzi da 1,0 / 2,0 - 25,0 / 26,0 mm
senza scatola

HEGAR	mm
HA-240-01	1/ 2
HA-240-03	3/ 4
HA-240-05	5/ 6
HA-240-07	7/ 8
HA-240-09	9/10
HA-240-11	11/12
HA-240-13	13/14
HA-240-15	15/16
HA-240-17	17/18
HA-240-19	19/20
HA-240-21	21/22
HA-240-23	23/24
HA-240-25	25/26



HEGAR
HA-245-08

Satz mit 8 Stück von 3,0 / 4,0 - 17,0 / 18,0 mm
in auskochbarer Stoffrolltasche

set of 8 pieces from 3,0 / 4,0 - 17,0 / 18,0 mm
in boilable canvas roll

jeu de 8 pièces de 3,0 / 4,0 - 17,0 / 18,0 mm
en pochette en treillis stérilisable par ébullition

juego de 8 piezas de 3,0 / 4,0 - 17,0 / 18,0 mm
en bolsa de tela esterilizable por ebullicion

serie di 8 pezzi da 3,0 / 4,0 - 17,0 / 18,0 mm
in busta di tela sterilizzabile

HEGAR
HA-246-08

Satz mit 8 Stück von 3,0 / 4,0 - 17,0 / 18,0 mm
im Metalletui mit Scharnierdeckel

set of 8 pieces from 3,0 / 4,0 - 17,0 / 18,0 mm
in metal case with hinged lid

jeu de 8 pièces de 3,0 / 4,0 - 17,0 / 18,0 mm
en boîte métal à charnière

juego de 8 piezas de 3,0 / 4,0 - 17,0 / 18,0 mm
en caja metálica con tapa de bisagra

serie di 8 pezzi da 3,0 / 4,0 - 17,0 / 18,0 mm
in scatola metallica con coperchio a cerniera



HEGAR
HA-246-13

Satz mit 13 Stück von 1,0 / 2,0 - 25,0 / 26,0 mm
im Metalletui mit Scharnierdeckel

set of 13 pieces from 1,0 / 2,0 - 25,0 / 26,0 mm
in metal case with hinged lid

jeu de 13 pièces de 1,0 / 2,0 - 25,0 / 26,0 mm
en boîte métal à charnière

juego de 13 piezas de 1,0 / 2,0 - 25,0 / 26,0 mm
en caja metálica con tapa de bisagra

serie di 13 pezzi da 1,0 / 2,0 - 25,0 / 26,0 mm
in scatola metallica con coperchio a cerniera



amerikanische Skala
 American scala
 échelle américaine
 escala americana
 scala americana

HANK
HA-345-06

Satz mit 6 Stück
 von 4,5 - 10,0 mm ohne Etui

set of 6 pieces
 from 4,5 - 10,0 mm without case

jeu de 6 pièces
 de 4,5 - 10,0 mm sans boîte

juego de 6 piezas
 de 4,5 - 10,0 mm sin caja

serie di 6 pezzi
 da 4,5 - 10,0 mm senza scatola

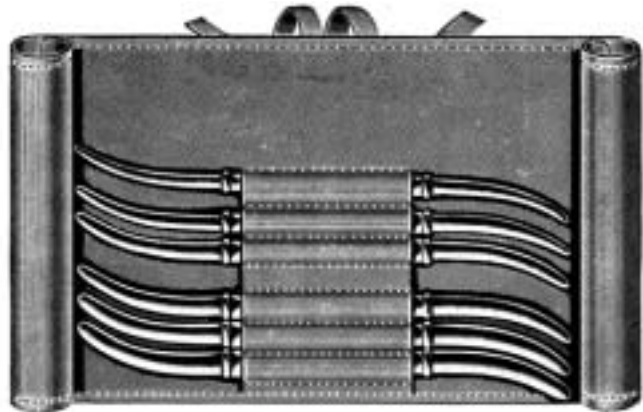

HANK
HA-346-08

Satz mit 6 Stück von 4,5 - 10,0 mm
 in auskochbarer Stoffrolltasche

set of 6 pieces from 4,5 - 10,0 mm
 in boilable canvas roll

jeu de 6 pièces de 4,5 - 10,0 mm
 en pochette en treillis stérilisable par ébullition

juego de 6 piezas de 4,5 - 10,0 mm
 en bolsa de tela esterilizable por ebullicion

serie di 6 pezzi da 4,5 - 10,0 mm
 in busta di tela sterilizzabile

HANK	mm	Fig. US.
HA-340-08	3,5/ 4	7/ 8
HA-340-10	4,5/ 5	9/10
HA-340-12	5,5/ 6	11/12
HA-340-14	6,5/ 7	13/14
HA-340-16	7,5/ 8	15/16
HA-340-18	8,5/ 9	17/18
HA-340-20	9,5/10	19/20
HA-340-22	10,5/11	21/22
HA-340-24	11,5/12	23/24
HA-340-26	12,5/13	25/26



**PRATT
 HA-447-08**

Satz mit 8 Stück von 4,5 / 5,0 - 13,6 / 14,3 mm
 in auskochbarer Stoffrolltasche

set of 8 pieces from 4,5 / 5,0 - 13,6 / 14,3 mm
 in boilable canvas roll

jeu de 8 pièces de 4,5 / 5,0 - 13,6 / 14,3 mm
 en pochette en treillis stérilisable par ébullition

juego de 8 piezas de 4,5 / 5,0 - 13,6 / 14,3 mm
 en bolsa de tela esterilizable por ebullicion

serie di 8 pezzi da 4,5 / 5,0 - 13,6 / 14,3 mm
 in busta di tela sterilizzabile

PRATT	Charr.	mm
HA-447-13	13/15	4,5/ 5,0
HA-447-17	17/19	5,6/ 6,3
HA-447-21	21/23	7,0/ 7,6
HA-447-25	25/27	8,3/ 9,0
HA-447-29	29/31	9,6/10,3
HA-447-33	33/35	11,0/11,6
HA-447-37	37/39	12,3/13,0
HA-447-41	41/43	13,6/14,3
HA-447-45	45/47	14,9/15,6
HA-447-49	49/51	16,3/16,9
HA-447-53	53/55	17,6/18,3
HA-447-57	57/59	19,9/19,6



GOODELL
HA-441-34
34,0 cm



WYLIE
HA-443-29
29,0 cm



SIMS
HA-445-29
29,0 cm

Hakenzangen
Tenaculum Forceps
Pinces pour abaissement du col de l'utérus
Pinzas para coger el cuello del útero
Pinze per abbassare il collo dell'utero

HA



SCHROEDER
HA-052-23 23,0 cm
HA-052-25 25,0 cm



BRAUN
HA-054-25
25,0 cm



SKENE
HA-055-24
24,0 cm



POZZI
HA-056-25
25,0 cm



DUPLAY
HA-057-28
28,0 cm



STAUDE-MOORE
HA-058-17
17,0 cm

Hakenzangen
 Tenaculum Forceps
 Pincés pour abaissement du col de l'uterus
 Pinzas para coger el cuello del útero
 Pinze per abbassare il collo dell'utero



COLLIN-POZZI
HA-059-25
 25,0 cm



BARRETT
HA-150-18
 18,0 cm



JARCHO
HA-152-20
 20,0 cm



2x2 Zähne
 2x2 teeth
 2x2 dents
 2x2 dientes
 2x2 denti

cm **SCHROEDER**
 20,0 **HA-154-20**
 24,0 **HA-154-24**



2x2 Zähne
 2x2 teeth
 2x2 dents
 2x2 dientes
 2x2 denti

SCHROEDER
HA-155-24
 24,0 cm



TIEMANN
HA-158-22
 22,0 cm

2x2 Zähne
 2x2 teeth
 2x2 dents
 2x2 dientes
 2x2 denti



MUSEUX



MUSEUX
HA-254-06
 6 mm
 24,0 cm



MUSEUX
HA-254-08
 8 mm
 24,0 cm



MUSEUX
HA-254-10
 10 mm
 24,0 cm



MUSEUX
HA-255-06
 6 mm
 24,0 cm



MUSEUX
HA-255-08
 8 mm
 24,0 cm



MUSEUX
HA-255-10
 10 mm
 24,0 cm



MUSEUX

2x2 Zähne
 2x2 teeth
 2x2 dents
 2x2 dientes
 2x2 denti



MUSEUX
HA-256-20
 20,0 cm

3x4 Zähne
 3x4 teeth
 3x4 dents
 3x4 dientes
 3x4 denti



cm	TEALE
18,0	HA-351-18
23,0	HA-351-23
26,5	HA-351-26

Hakenzangen
 Tenaculum Forceps
 Pinces pour abaissement du col de l'uterus
 Pinzas para coger el cuello del útero
 Pinze per abbassare il collo dell'utero



2x2 Zähne
 2x2 teeth
 2x2 dents
 2x2 dientes
 2x2 denti

JAKOBS
HA-352-21
 21,0 cm



2x2 Zähne
 2x2 teeth
 2x2 dents
 2x2 dientes
 2x2 denti

JAKOBS
HA-353-21
 21,0 cm



2x3 Zähne
 2x3 teeth
 2x3 dents
 2x3 dientes
 2x3 denti

HENROTIN
HA-354-20
 20,5 cm



4x4 Zähne
 4x4 teeth
 4x4 dents
 4x4 dientes
 4x4 denti

PRATT
HA-356-28
 28,0 cm



4x4 Zähne
 4x4 teeth
 4x4 dents
 4x4 dientes
 4x4 denti

CZERNY
HA-357-21
 21,0 cm

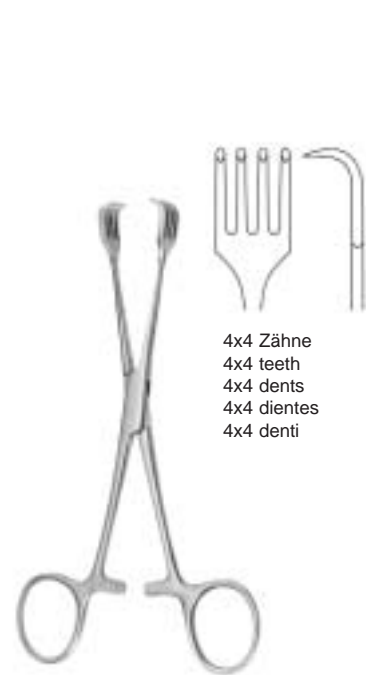

4x4 Zähne
 4x4 teeth
 4x4 dents
 4x4 dientes
 4x4 denti

BRAUN
HA-358-15
 15,5 cm

Hakenzangen
Tenaculum Forceps
Pinces pour abaissement du col de l'utérus
Pinzas para coger el cuello del útero
Pinze per abbassare il collo dell'utero

HA



4x4 Zähne
4x4 teeth
4x4 dents
4x4 dientes
4x4 denti

PRATT
HA-358-26
26,0 cm



5x6 Zähne
5x6 teeth
5x6 dents
5x6 dientes
5x6 denti

IOWA
HA-359-26
26,0 cm

HA

Uterus-Polypenzangen
Uterine Polypus Forceps
Pinces à polypes uterins
Pinzas per polipi uterine



NOTO
HA-450-27
27,0 cm



DOYEN
HA-452-20
20,0 cm



KELLY
HA-453-32
32,0 cm

Uterus-Faßzangen
Uterine Elevating Forceps
Pinces hystérolabes
Pinzas para el útero
Pinzas per afferrare l'utero

HA



DARTIGUES
HA-455-27
27,0 cm



SOMER
HA-457-23
23,0 cm



COLLIN
HA-459-25
25,0 cm



COLLIN
HA-550-28
28,0 cm

HA

Uterus-Faßzangen
Uterine Elevating Forceps
Pincès hystérolabes
Pinzas para el útero
Pinzas per afferrare l'utero



COLLIN
HA-551-25
25,0 cm



BUMM
HA-552-28
28,0 cm



SIEGLER HELLMANN
HA-553-24
24,0 cm

Uterussonden, Uterusdepressor
 Uterine Sounds, Uterine Depressor
 Hystéromètres, Dépresseur utérin
 Histerómetros, Depresor uterino
 Isterometri, Depressore uterino

HA



Anniotom
 Anniotome
 Anniotome
 Anniótomo
 Anniotomo

BEACHMANN
HA-559-26
 26 cm



BRAUN
HA-655-28
 28 cm



SIMS
HA-657-26
 26 cm

Uterus-Depressoren
 Uterine Depressors
 Dépresseurs utérins
 Depressores uterinos
 Depressori uterini



starr
 rigid
 rigide
 rigida
 rigida

SIMS
HA-850-32
 32 cm

Uterus-Sonden
 Uterine Sounds
 Hystéromètres
 Histerómetros
 Isterometri



starr
 rigid
 rigide
 rigida
 rigida

MARTIN
HA-852-32
 32 cm



biegsam
 malleable
 malléable
 maleable
 malleabile

COLLIN
HA-854-28
 28 cm



VALLEIX
HA-855-25
 29,5 cm

HA

Uterus-Biopsie-Saugküretten
Uterine Biopsy Aspirating Curettes
Curettes aspirantes à biopsie de l'utérus
Curetas aspiradoras p. la biopsia uterina
Curette di aspirazione per biopsia



RANDALL
HA-950-04
24 cm/4 mm



mm	NOVAK
1	HA-952-01
2	HA-952-02
3	HA-952-03
4	HA-952-04



mit Korb
with basket
avec grille
con cesto
con cestino

KEVORKIAN	
HA-954-12	1,2 mm
HA-954-40	4,0 mm
	30 cm

Probeexcisionszangen
Biopsy Specimen Forceps
Pincas amporte-pièce pour le col de l'utérus
Pinzas sacabocado para el cuello del útero
Pinze taglienti per biopsia

HA



FAURE
HA-061-21
21 cm



cm SCHUBERT
21 **HA-064-21**
28 **HA-064-28**



SCHUBERT
HA-065-26
26 cm

HA

Biopsiezangen
Biopsy Specimen Forceps
Pinces à biopsie
Pinzas sacabocado p. biopsia
Pinze per biopsia



THOMS-GAYLOR
HA-066-21 23,5 cm
HA-066-24 21,0 cm



GELLHORN
HA-069-23
23 cm



van DOREN
HA-161-24
25 cm

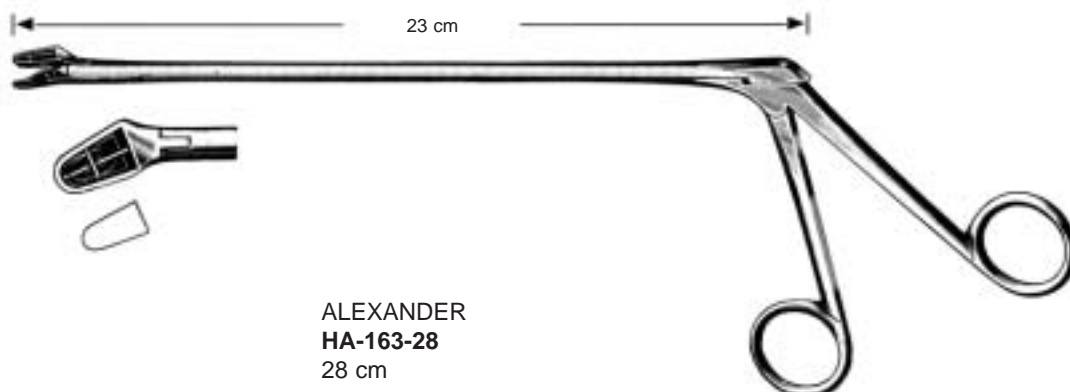

ALEXANDER
HA-163-28
28 cm



HA-165-01

HA-165-02

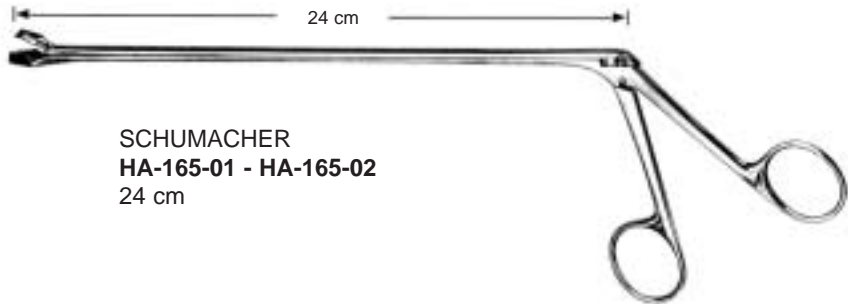

SCHUMACHER
HA-165-01 - HA-165-02
24 cm

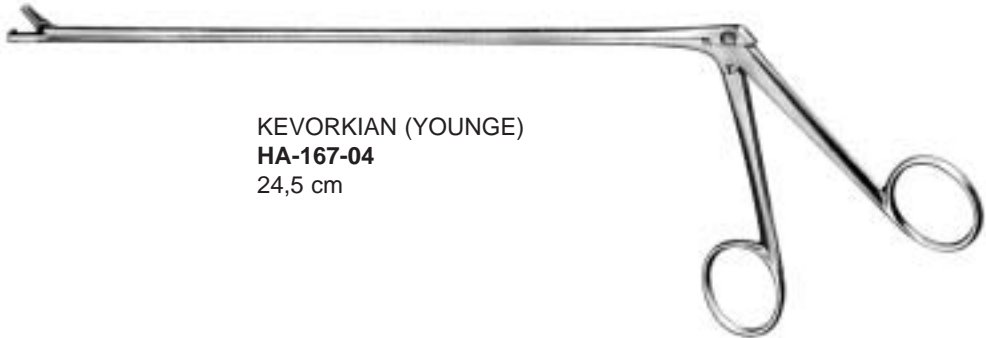

KEVORKIAN (YOUNGE)
HA-167-04
24,5 cm

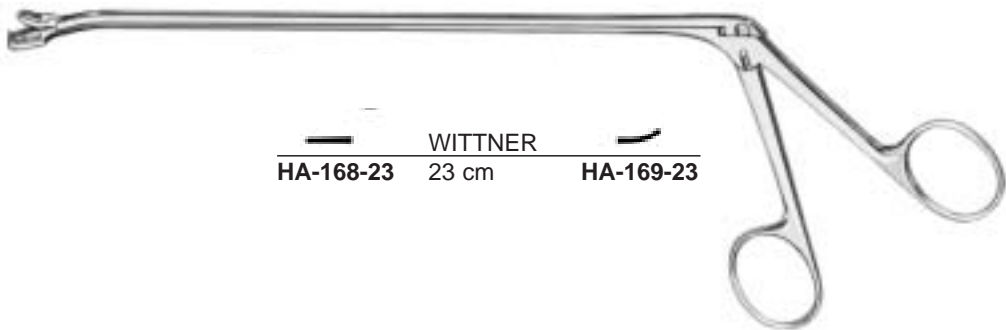

WITTNER
HA-168-23 23 cm HA-169-23



TISCHLER-MORGAN
HA-261-01
20 cm



oval
7 x 5 mm

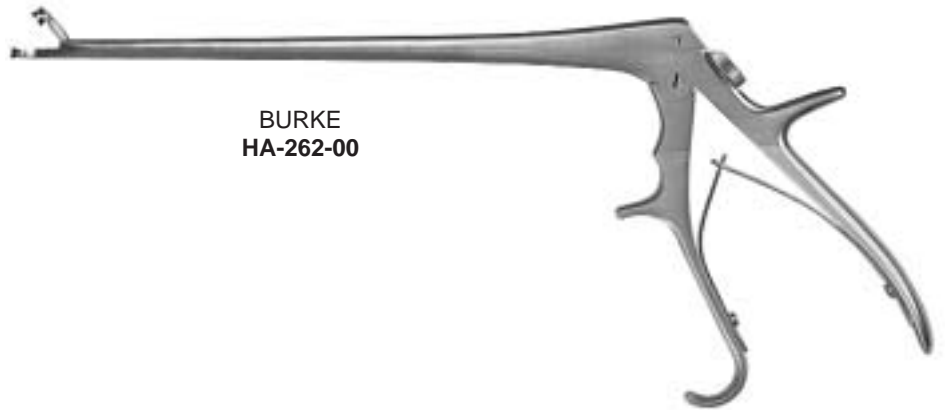

BURKE
HA-262-00



TISCHLER Morgan

Fig. 1



	Instr. kompl.	Aufsatz allein
	compl. instr.	Tip only
	Instrum. compl.	Embout seul
	Strumento completo	Punta sola

Fig. TOWNSEND

Fig.	HA-264-01	HA-264-11
1	HA-264-01	HA-264-11
3	HA-264-03	HA-264-13
4	HA-264-04	HA-264-14
5	HA-264-05	HA-264-15

HA-264-99
 Griff allein
 handle only
 manche seul
 manico solo
 mango suelto



Fig. 3

oval ● 3,7 x 5 mm



mini

Fig. 5



KEVORKAN

Fig. 4



■ 3 x 8 mm

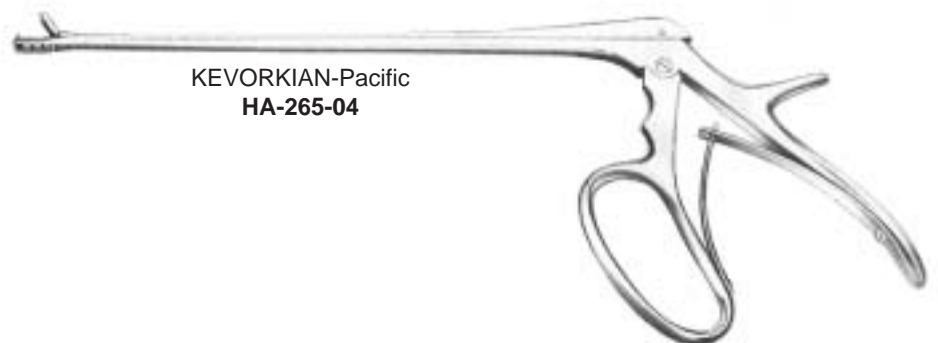

KEVORKIAN-Pacific
HA-265-04



■ 2,3 x 4,2 mm



TOWNSEND-MINI (BABY TISCHLER)
HA-266-00



■ 3,0 x 9,5 mm



TISCHLER-KEVORKIAN
HA-267-00



● 4,0 x 6,5 mm



BAGGISH
HA-268-00



■ 4,5 x 8 mm

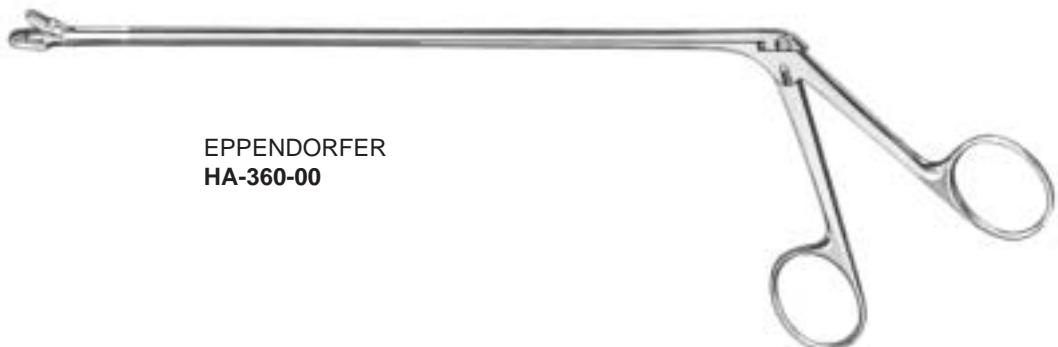

EPPENDORFER
HA-360-00

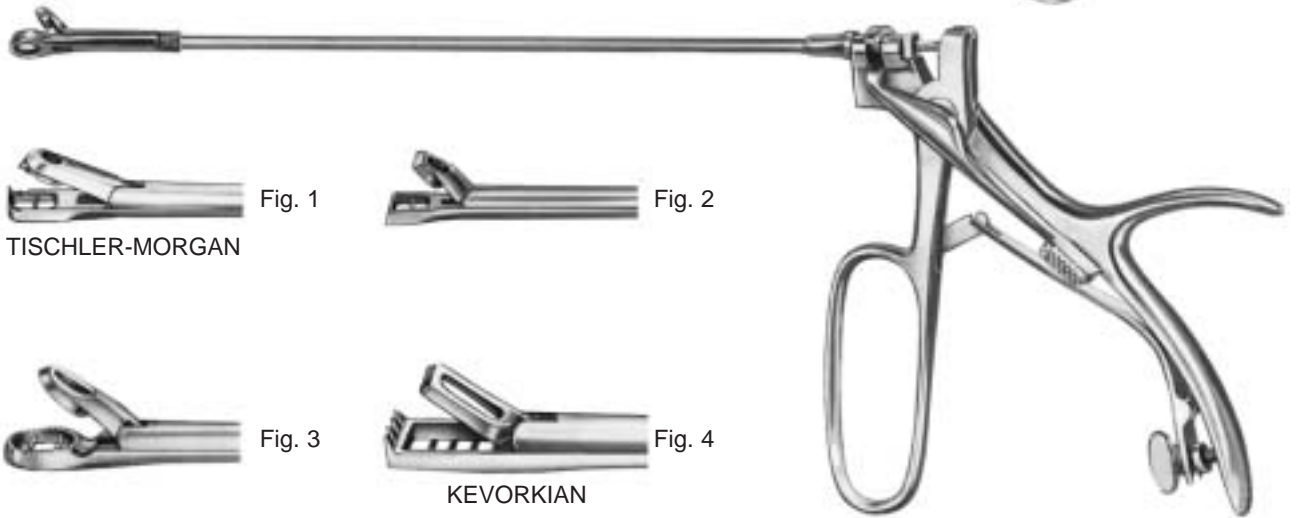
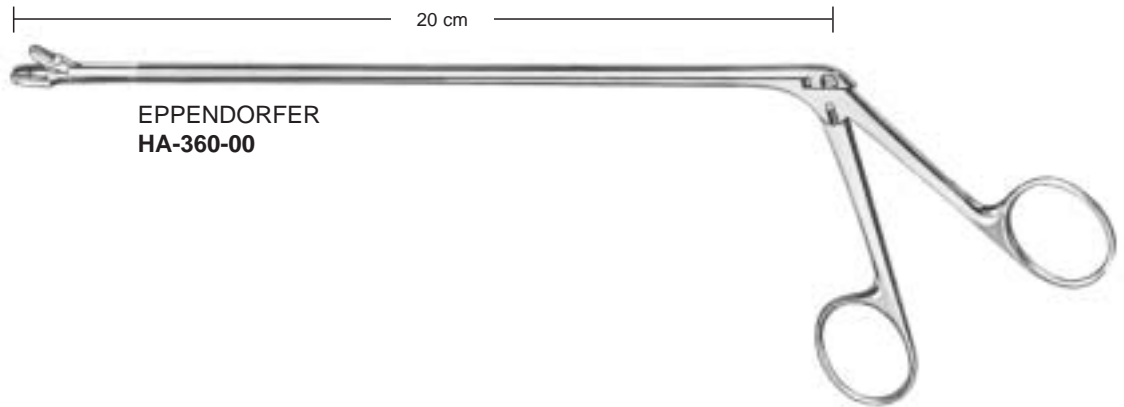

Myom-Heber
 Myoma Screw
 Tracteur pour fibromes
 Tirabuzón para fibromas
 Tiramiomi



**DOYEN
HA-461-17**
15 cm

Myommesser
 Myoma knives
 Evidens pour fibromes
 Cuchillo para fibromas
 Bisturi per fibromi



**SEGOND
HA-463-27**
27 cm



EMMET
22 cm

Fig.	Instr. kompl. compl. instr. Instrum. compl. Strumento completo	Aufsatz allein Tip only Embout seul Punta sola
1	HA-362-01	HA-362-11
2	HA-362-02	HA-362-12
3	HA-362-03	HA-362-13
4	HA-362-04	HA-362-14



Fistelhaken
 Fistula Hooks
 Crochets pour fistules
 Ganchos para fistulas
 Uncini per fistole

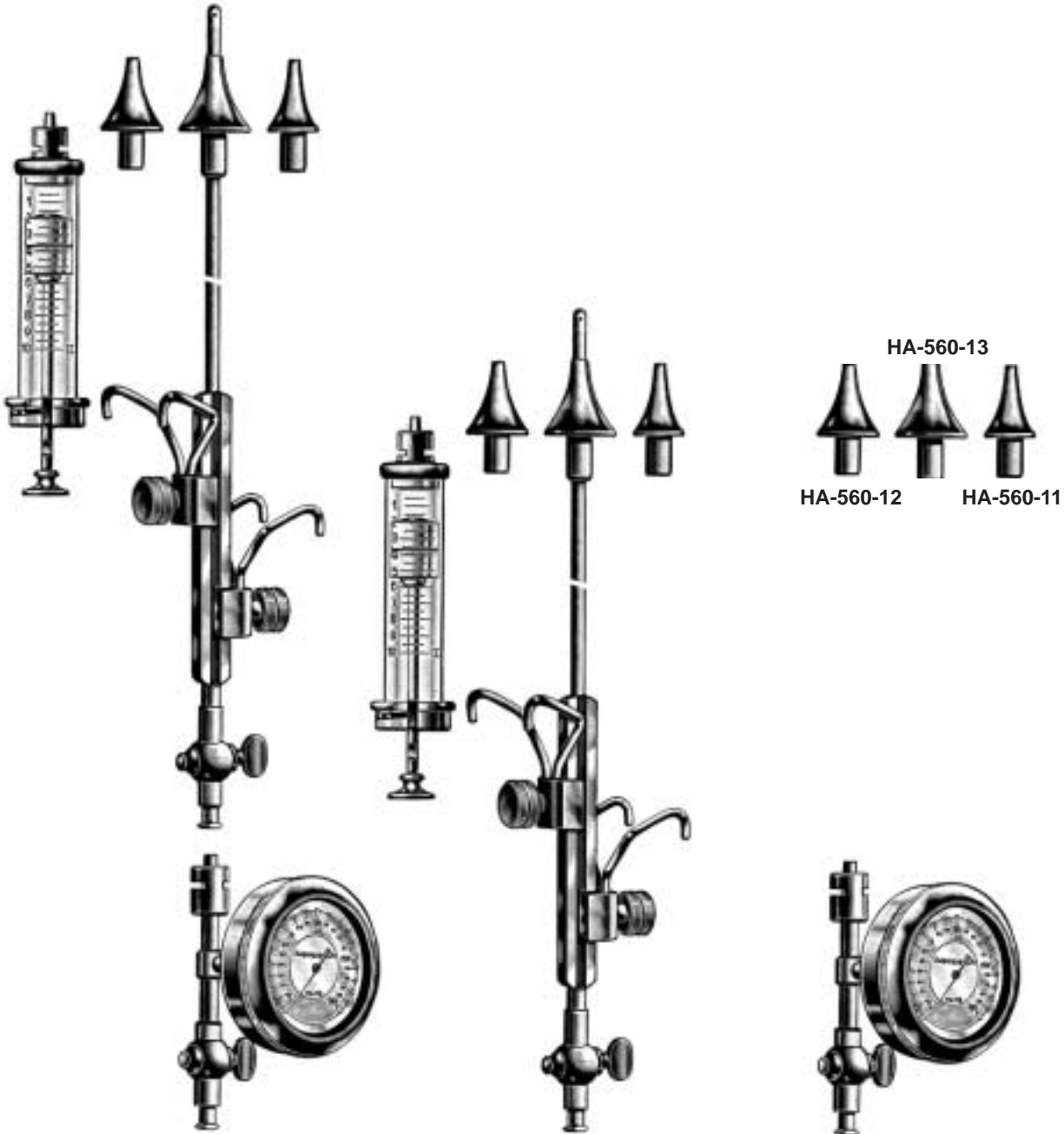

SCHULTZE
HA-560-00
compl.

im Holzetui
in wooden case
en boîte de bois
en estuche de madera
in scatola di legno

SCHULTZE
HA-560-01

ohne Manometer
without manometer
sans manomètre
sin manómetro
senza manometro

SCHULTZE
HA-560-10

Manometer zum Salpingograph
Manometer for Salpingograph
Manomètre pour salpingographe
Manómetro para salpingógrafo
Manometro per salpingografo

scharf
 sharp
 tranchant
 cortante
 tagliente



scharf/stumpf
 sharp/blunt
 tranchant/mousse
 cortante/roma
 tagliente/smussa

Fig.	SIMON
1	HA-072-01
2	HA-072-02
3	HA-072-03
4	HA-072-04
5	HA-072-05
6	HA-072-06

25 cm

Fig.	SCHROEDER
1	HA-073-01
2	HA-073-02
3	HA-073-03
4	HA-073-04
5	HA-073-05
6	HA-073-06

31 cm

BLAKE
HA-074-27

27 cm

Fig.	GOURDET
1	HA-076-01
2	HA-076-02
3	HA-076-03
4	HA-076-04
5	HA-073-05

28 cm



SIMS = 31 cm
 RECAIMER = 31 cm

Fig.	00	0	1	2	3	4	5	6
mm	5	6	7	8	9	11	12	14



SIMS = 31 cm
 RECAIMER = 31 cm

Fig.	7	8	9	10
mm	15	16	19	20



SIMS
 RECAIMER
 BUMM = 34 cm
HA-170-05-HA-377-40

Fig.	14	15	16
mm	30	35	40



SIMS
HA-170-05-HA-177-14
 31 cm



RECAMIER
HA-270-07-HA-277-25
 31 cm



BUMM
HA-370-30-HA-377-40
 34 cm

Ausführung	scharf	stumpf
Features	sharp	blunt
Exécution	tranch.	mousse
Ejecución	cort.	roma
Esecuzione	tagl.	smussa
fest/rig.	A	B
flex./fless.	C	D

Fig.	A	B	C	D	A	B	C	D	A	B	C	D
00	HA-170-05	HA-172-05	HA-175-05	HA-177-05	HA-270-05	HA-272-05	HA-275-05	HA-277-05				
0	HA-170-06	HA-172-06	HA-175-06	HA-177-06	HA-270-06	HA-272-06	HA-275-06	HA-277-06				
1	HA-170-07	HA-172-07	HA-175-07	HA-177-07	HA-270-07	HA-272-07	HA-275-07	HA-277-07				
2	HA-170-08	HA-172-08	HA-175-08	HA-177-08	HA-270-08	HA-272-08	HA-275-08	HA-277-08				
3	HA-170-09	HA-172-09	HA-175-09	HA-177-09	HA-270-09	HA-272-09	HA-275-09	HA-277-09				
4	HA-170-11	HA-172-11	HA-175-11	HA-177-11	HA-270-11	HA-272-11	HA-275-11	HA-277-11				
5	HA-170-12	HA-172-12	HA-175-12	HA-177-12	HA-270-12	HA-272-12	HA-275-12	HA-277-12				
6	HA-170-14	HA-172-14	HA-175-14	HA-177-14	HA-270-14	HA-272-14	HA-275-14	HA-277-14				
7					HA-270-15	HA-272-15	HA-275-15	HA-277-15				
8					HA-270-16	HA-272-16	HA-275-16	HA-277-16				
9					HA-270-19	HA-272-19	HA-275-19	HA-277-19				
10					HA-270-20	HA-272-20	HA-275-20	HA-277-20				HA-377-28
14									HA-370-30	HA-372-30	HA-375-30	HA-377-30
15									HA-370-35	HA-372-35	HA-375-35	HA-377-35
16									HA-370-40	HA-372-40	HA-375-40	HA-377-40



29 cm

HA-180-03	Ø 3,0 mm
HA-180-04	Ø 4,0 mm
HA-180-06	Ø 6,0 mm
HA-180-08	Ø 8,0 mm
HA-180-10	Ø 10,0 mm
HA-180-12	Ø 12,0 mm
HA-180-14	Ø 14,0 mm



HA-180-50

Kupplungsstück
Coupling Piece
Pièce de raccordement
Pieza de acoplamiento
Pezzo di collegamento



Tubenfaßpinzette
Tubal seizing forceps
Pince a saisir les trompes
Pinza para sostener trompas
Pinze per afferare trompe

NEUBÜSSER

20 cm

HA-580-06	Ø 6,0 mm
HA-580-08	Ø 8,0 mm
HA-580-10	Ø 10,0 mm

HC

**Geburtshilfe
Obstetrics
Obstétrique
Obstetricia
Ostetricia**



HC

Geburtszangen für section caesares (Schnittentbindung)
 Forceps for caesarean section
 Forceps pour césarienne
 Fórceps para operación cesárea
 Forcipi per tagli cesarei



cm WRIGLEY
 23 HC-011-23
 28 HC-011-28



SIMPSON
 HC-012-30
 30 cm



SIMPSON
 HC-013-23
 23 cm



cm SIMPSON-BRAUN
 33 HC-015-33
 36 HC-015-36



De LEE
 HC-017-30
 30 cm



cm De LEE
 36 HC-018-36
 39 HC-018-39



KIELLAND
 HC-110-41
 41 cm



cm ELLIOT
 32 HC-115-32
 38 HC-115-38



cm **NAEGELE**
36 **HC-119-36**
40 **HC-119-40**



LUIKART
HC-215-40
40 cm



KIELLAND-LUIKART
HC-217-40
40 cm



SIMPSON-LUIKART
HC-315-36
36 cm



McLEAN-TUCKER-LUIKART
HC-319-40
40 cm



McLEAN-TUCKER
HC-411-39
39 cm



McLEAN-LUIKART
HC-413-39
39 cm



McLEAN
HC-415-36
36 cm



BARTON
HC-417-36
36 cm



BARTON
HC-418-17
17 cm



BOERMA
HC-511-29
29 cm



PIPER
HC-515-44
44 cm

für nachkommenden Kopf bei Steisslagen
for delivery of the after coming head in breech presentation
Spatules pour dégager la tête
Especialmente para partos en presentación de nalgas
Speciale in parti con predentazione di podice



PIPER
HC-517-40
40 cm



DEWEY
HC-610-37
 37 cm



TARNIER
HC-612-40
 40 cm

Geburtszange mit Achsenzugvorrichtung
 Forceps with traction rod
 Forceps avec dispositif de traction
 Fórceps con dispositivo de tracción
 Forcipi con dispositivo di trazione

Kopfhebel für unteres Segment bei Kaiserschnitt
 Head extractor for use in lower segment in caesarean operation
 Levier à tête utilisé en cas de césarienne
 Elevador para cabeza usándose en el segmento inferior del útero
 en casos de operaciones cesáreas
 Elevatore per testa in interventi con taglio cesareo



MURLESS
HC-614-26



BILL
HC-710-00

Zughebel, passend für alle Geburtszangen mit
 gehorntem Standard-Griff
 Traction handle to be used with all forceps
 with standard type handle
 Tracteurs pour tous les forceps avec manches
 ordinaires
 Tractor adecuado para todas las fórceps con
 mango standard
 Manico a trazione adatto a tutte le forcipi con
 manico standard



LUIKART-BILL
HC-711-21
 21 cm

Uterusklemmzange zur Blutstillung
Caesarean section haemostatic forceps
Pince-clamp utérine pour hémostase
Pinza-clamp uterina para hemostasis
Pinza emostatiche per tagli cesarei



SMELLIE
HC-811-33
33 cm



GAUSS
HC-813-27
27 cm



GREEN-ARMYTAGE
HC-814-21
21 cm

Nabelschnurklemmen
Umbilical Cord Clamps
Clamps p. cordon ombilical
Clamps umbilicales
Pinze ombelicali



COLLIN
HC-817-09
9 cm



KANE
HC-819-09
8,5 cm



MARTIN
HC-911-34
34 cm



COLLIER
HC-913-30
30 cm



COLLIN
HC-915-35
35 cm



— SAENGER —
 HC-422-27 HC-423-27



— WINTER —
 28 cm
 Fig.
 HC-424-01 1 HC-425-01
 HC-424-02 2 HC-425-02
 HC-424-03 3 HC-425-03



mit Sperre
 with ratchet
 avec crémaillère
 con cremallera
 con cremagliera

— WINTER — Fig.
 HC-427-02 2
 HC-427-03 3



— LEWKOWITZ —
 HC-428-24 HC-429-24



McCLINTOCK
 HC-520-24
 24 cm

HC

Plazentar- und Abortuslöffel
Placenta and ovum scoops
Curettes à avortement et placenta
Cucharillas para aborto y placenta
Cucchiai per placenta e ovaie



PESTALOZZA
HC-522-30
30 cm



CUZZI
HC-524-14-HC-524-21
30 cm



HC-524-14 HC-524-18 HC-524-21
14,5 mm 18 mm 21 mm



WALLICH
HC-526-42
42 cm



SELLHEIM
HC-529-28
28 cm



BRAUN
HC-032-42
42 cm

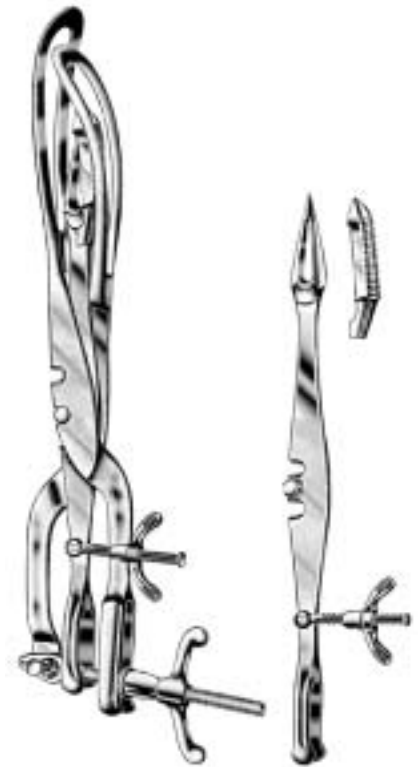

TARNIER
HC-034-46
46 cm



Perforatorium
Perforator
Perce-crâne
Perfora-crâneos
Spezzacrano

SMELLIE
HC-036-25
25 cm



NÄGELE
HC-038-25
25 cm

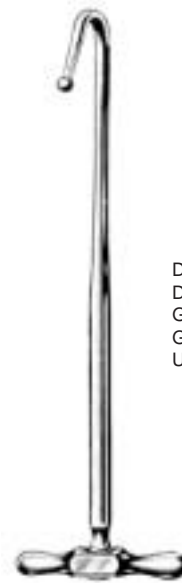

Dekapitationshaken
Decapitating hook
Grochet pour décapitation
Gancho para decapitación
Uncino per detroncazione

BRAUN
HC-039-30
30 cm

HE

**Dermatologie, Hygiene
Dermatology, Hygiene
Dermatologie, Hygiène
Dermatología, Higiene
Dermatologia, Igiene**



HE



KILNER
HE-013-15
15 cm



SCHRAMBERG
HE-111-10
10 cm



UNNA
HE-113-14
14 cm

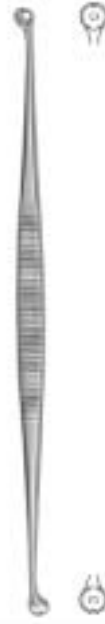

UNNA
HE-115-14
14 cm



WALTON
HE-118-14
14 cm



SAALFELD
HE-211-10
10 cm



mm	FOX
3	HE-218-03
4	HE-218-04
5	HE-218-05
6	HE-218-06



Fig.	PIFFARD
1	HE-310-01
2	HE-310-02
3	HE-310-03



Fig. 1



Fig. 2



Fig. 3



KEYES
HE-318-00
compl.

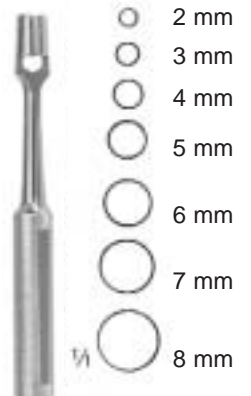

mm	KEYES
2	HE-410-02
3	HE-410-03
4	HE-410-04
5	HE-410-05
6	HE-410-06
7	HE-410-07
8	HE-410-08



HE-031-10



HE-034-10 10 cm HE-035-10



HE-331-14
14 cm



HE-336-14
14 cm



cm TURNBULL
11,5 HE-431-11
13,5 HE-431-13



HE-630-13
13 cm



HE-635-11
11 cm



HE-733-10
10 cm



HE-738-10
10 cm



HE-739-10
10 cm

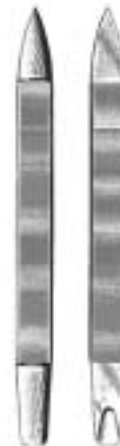

cm
10 HE-836-10
12 HE-836-12



CREDO
HE-935-14
14,5 cm

HE-936-00
10 Ersatzklingen
10 Spare Blades
10 lames de rechange
10 hojas de repuesto
10 lame di ricambio

IA

IH

**Dental Instrumente
Dental Instruments
Instruments dentaires
Instrumentos de odontología
Strumenti dentali**

**Verlangen Sie unseren Dental Spezialkatalog
Please ask for our special catalogue for Dental Instruments
Demandez notre catalogue spécial pour Instruments dentaires
Pidan nuestro catálogo especial para Instrumentos odontología
Chiedete il nostro catalogo speciale per Strumenti dentali**

IA-IH

**Verschiedene Behälter
Different Containers
Boîtes diverses
Contenedores varios
vassoi diversi**





Nadeldosen
Needle Cases
Boîtes pour aiguilles
Estuches para agujas
Scatole per aghi

18/10
Edelstahl rostfrei
Stainless Steel
Acier inoxydable
Acero inoxidable
Acciaio inossidabile

komplett mit perforierter Innendose
complete with perforated interior box
complet avec boîte intérieure perforée
completo con caja interior perforada
completo con scatola interiore perforata



II-112-65
65x15 mm

Innendose
Deckel und Boden perforiert
Interior Box
perforated lid and bottom
Boîte intérieure
couverture et fond perforé
Caja interior
tapa y fondo perforado
Scatola interiore
coperchio e fondo perforati



II-113-65

Nadelkassetten
Needle Cases
Boîtes pour aiguilles
Estuches para agujas
Scatole per aghi

Deckel und Boden perforiert
perforated lid and bottom
couverture et fond perforé
tapa y fondo perforado
coperchio e fondo perforati



SAUERBRUCH
II-110-21
210x125x17 mm

Deckel und Boden perforiert
perforated lid and bottom
couverture et fond perforé
tapa y fondo perforado
coperchio e fondo perforati



II-114-00
150x95x13 mm



	L x B x H
II-210-16	165x 85x 35 mm
II-210-20	200x100x 60 mm
II-210-22	220x120x 60 mm
II-210-23	230x130x 50 mm
II-210-26	260x150x 50 mm
II-210-30	280x140x 60 mm
II-210-50	500x200x120 mm



	L x B x H
II-213-32	320x100x50 mm
II-213-43	430x100x35 mm



	L x B x H
II-214-17	170x120x60 mm
II-214-20	200x 60x40 mm
II-214-22	220x100x50 mm
II-214-23	220x140x60 mm
II-214-27	270x170x60 mm
II-214-30	300x180x65 mm



Verschiedene Behälter
Different Containers
Boîtes diverses
Contenedores varios
Vassoi diversi



	Ø x H
II-217-10	75x 60 mm
II-217-11	75x 75 mm
II-217-20	100x 60 mm
II-217-21	100x100 mm
II-217-30	125x 80 mm
II-217-31	125x125 mm
II-217-40	150x150 mm



	Ø x H	
II-310-04	40x 19 mm	(0.05 Liter)
II-310-06	61x 30 mm	(0.07 Liter)
II-310-08	80x 40 mm	(0.14 Liter)
II-310-12	116x50 mm	(0.35 Liter)
II-310-13	128x55 mm	(0.45 Liter)
II-310-15	147x65 mm	(0.70 Liter)
II-310-16	157x75 mm	(1.10 Liter)
II-310-19	187x85 mm	(1.60 Liter)



	Ø x H
II-311-01	42x 30 mm
II-311-02	53x 34 mm
II-311-03	58x 40 mm
II-311-04	64x 48 mm
II-311-05	68x 47 mm
II-311-06	71x 46 mm
II-311-07	71x 50 mm
II-311-08	81x 51 mm
II-311-09	81x 54 mm
II-311-10	89x 47 mm
II-311-11	100x48 mm
II-311-12	100x53 mm



	Ø x H
II-312-01	300x100 mm
II-312-02	350x100 mm
II-312-03	400x100 mm
II-312-04	330x 90 mm
II-312-05	330x115 mm



	Ø x H	
II-313-16	150x 74 mm	(0.75 Liter)
II-313-17	160x 65 mm	(1.00 Liter)
II-313-22	220x 70 mm	(2.00 Liter)
II-313-23	230x 80 mm	(2.50 Liter)
II-313-24	260x130 mm	(4.50 Liter)
II-313-25	255x115 mm	(3.50 Liter)
II-313-27	275x115 mm	(5.00 Liter)
II-313-29	300x105 mm	(6.00 Liter)
II-313-38	400x150 mm	(14.00 Liter)



	Ø x H
II-313-31	300x120 mm
II-313-34	350x130 mm
II-313-41	400x140 mm



II-314-10	1.00 Liter
II-314-15	1.50 Liter
II-314-20	2.00 Liter



Verschiedene Behälter
Different Containers
Boîtes diverses
Contenedores varios
Vassoi diversi



	L x B x H
II-316-23	380x230x95 mm
II-316-27	350x270x100 mm



II-317-23	235 mm
II-317-30	310 mm



	L x B x H	
II-317-40	300x200x 75 mm	Small (with handle)
II-317-41	300x200x 75 mm	Small (without handle)
II-317-43	350x230x100 mm	Large (with handle)



	Ø x H
II-318-70	100x50 mm



	L x B x H
II-319-17	170x100x30 mm
II-319-20	200x120x35 mm
II-319-25	250x140x40 mm
II-319-27	275x150x50 mm
II-319-30	300x160x50 mm
II-319-40	400x200x60 mm



	Ø x H
II-319-91	100x100 mm
II-319-92	150x150 mm



	Ø x H	
II-410-00	58x30 mm	25ml
II-410-01	52x50 mm	50ml
II-410-03	65x55 mm	100ml



II-410-02	0.25 Liter
II-410-05	0.50 Liter
II-410-10	1.00 Liter
II-410-20	2.00 Liter



Verschiedene Behälter
Different Containers
Boîtes diverses
Contenedores varios
Vassoi diversi



	Ø x H
II-411-06	60x20 mm
II-411-09	90x15 mm
II-411-10	100x20 mm
II-411-12	120x20 mm



	Ø x H
II-412-01	30x 90 mm
II-412-02	50x100 mm
II-412-03	50x130 mm
II-412-04	50x175 mm
II-412-05	75x100 mm
II-412-06	75x130 mm
II-412-07	75x175 mm
II-412-08	100x175 mm
II-412-09	100x200 mm



	L x B x H
II-412-19	190x100x13 mm
II-412-20	200x100x13 mm



	L x B x H
II-413-19	190x100x13 mm
II-413-20	200x100x13 mm
II-413-45	450x300x32 mm



L x B x H

II-414-20	200x150x25 mm
II-414-22	230x155x30 mm
II-414-28	300x175x30 mm
II-414-31	300x175x40 mm
II-414-32	300x200x50 mm
II-414-35	350x220x40 mm
II-414-37	400x300x50 mm
II-414-42	450x350x50 mm



L x B x H

II-415-21	210x160x10 mm
II-415-24	240x180x10 mm
II-415-29	290x190x10 mm
II-415-30	310x150x10 mm
II-415-32	300x200x20 mm
II-415-33	300x245x16 mm
II-415-35	350x240x10 mm
II-415-38	385x265x16 mm
II-415-39	385x210x10 mm
II-415-40	400x270x20 mm
II-415-42	420x280x10 mm
II-415-43	430x295x16 mm
II-415-49	485x320x16 mm
II-415-51	510x380x30 mm
II-415-59	590x380x30 mm



L x B x H

II-416-22	220x170x50 mm
II-416-28	300x175x30 mm
II-416-30	300x175x40 mm
II-416-32	300x200x50 mm
II-416-35	350x240x36 mm
II-416-37	400x300x50 mm
II-416-42	450x350x50 mm



Verschiedene Behälter
Different Containers
Boîtes diverses
Contenedores varios
Vassoi diversi



	L x B x H
II-417-31	230x150x85 mm



	L x B x H
II-417-32	230x150x85 mm



	Ø x H
II-417-33	230x115 mm



	Ø x H	
II-510-02	75x 75 mm	0.25 Liter
II-510-05	100x 85 mm	0.50 Liter
II-510-07	115x100 mm	0.75 Liter
II-510-10	125x125 mm	1.00 Liter



II-574-10	10.00 Liter
II-574-13	13.00 Liter
II-574-15	15.00 Liter
II-574-18	18.00 Liter



II-575-21	210 mm
II-575-24	240 mm
II-575-27	270 mm
II-575-30	300 mm



Sterilisiertrommeln
Sterilizing Drums
Tambours à stérilisation
Tambores p. esterilización
Tambori p. sterilizzazione

18/10

Edelstahl rostfrei
Stainless Steel
Acier inoxydable
Acero inoxidable
Acciaio inossidabile



SCHIMMELBUSCH	Ø x H	KONRICH
II-512-08	125x 80 mm	II-812-08
II-512-10	125x100 mm	II-812-10
II-512-12	125x125 mm	II-812-12
II-515-08	150x 80 mm	
II-515-10	150x100 mm	II-815-10
II-515-13	150x130 mm	II-815-13
II-515-15	150x150 mm	II-815-15
II-515-19	150x190 mm	II-815-19
II-519-14	190x145 mm	II-819-14
II-519-16	190x165 mm	II-819-16
II-519-19	190x190 mm	II-819-19
II-519-24	190x240 mm	II-819-24
II-614-14	240x145 mm	
II-614-16	240x165 mm	II-914-16
II-614-19	240x190 mm	II-914-19
II-614-24	240x240 mm	II-914-24
II-614-29	240x290 mm	II-914-29
II-614-34	240x340 mm	
II-614-39	240x390 mm	
II-619-14	290x145 mm	II-919-14
II-619-16	290x165 mm	II-919-16
II-619-19	290x190 mm	II-919-19
II-619-24	290x240 mm	II-919-24
II-619-29	290x290 mm	II-919-29
II-619-34	290x340 mm	
II-619-39	290x390 mm	
II-714-14	340x145 mm	II-024-14
II-714-16	340x165 mm	II-024-16
II-714-19	340x190 mm	II-024-19
II-714-24	340x240 mm	II-024-24
II-714-29	340x290 mm	II-024-29
II-714-34	340x340 mm	
II-714-39	340x390 mm	
II-714-14	390x145 mm	II-029-14
II-714-16	390x165 mm	II-029-16
II-714-19	390x190 mm	II-029-19
II-719-24	390x240 mm	II-029-24
II-719-29	390x290 mm	II-029-29
II-719-34	390x340 mm	II-029-34
II-719-39	390x390 mm	II-029-39
II-719-49	390x490 mm	
II-719-59	390x590 mm	



18/10
Edelstahl rostfrei
Stainless Steel
Acier inoxydable
Acero inoxidable
Acciaio inossidabile

Aus Drahtgeflecht
Wire Mesh
En fil inox
De alambre
In rete metallica



Aus perforiertem Blech
From Perforated Sheet Metal
En tôle perforée
De chapa de acero perforada
In acciaio perforato



	<u>L x B x H</u>
II-420-24	240x250x 5 mm
II-420-48	480x250x 5 mm
II-420-55	550x250x 5 mm
II-421-24	240x250x 7 mm
II-421-48	480x250x 7 mm
II-422-24	240x250x10 mm
II-422-48	480x250x10 mm

	<u>L x B x H</u>
II-520-26	260x260x 5 mm
II-520-48	480x260x 5 mm
II-520-53	505x305x 4 mm



Container aus Aluminium
Aluminium Containers
Containers en aluminium
Contenedores de aluminio
Container in alluminio



Deckelfarbe
Colour of Lid
Couleur du couvercle
Color de la tapa
Colore del coperchio

A = Silber, silver, argent, plata, argento
B = Gold, gold, or, oro, oro
C = Rot, red, rouge, rojo, rosso
D = Blau, blue, bleu, azul, blu
E = Grün, green, vert, verde, verde
F = Schwarz, black, noir, negro, nero

Bezeichnung
Description
Designation
Descripción
Descrizione



Große Container und Zubehör
 Large Containers and Accessories
 Grands container et accessoires
 Contenedores grandes y accesoris
 Grossi container e accessori

4 - 7



3/4 Container und Zubehör
 3/4 Containers and Accessories
 3/4 Container et accessoires
 3/4 Contenedores y accesorios
 3/4 Container e accessori

8 - 11



Halb-Container und Zubehör
 Half-Size-Containers and Accessories
 Semi-Container et accessoires
 Contenedores medianos y accesorios
 Mezzi container e accessori

12 - 15



Flach-, Halb-, Container und Zubehör
 Flat Half-Size-Containers and Accessories
 Plat-, Semi-, Container et accessoires
 Contenedores medianos y planos y accesorios
 Piatti, Mezzi-, Container e accessori

16 - 17



Kleine Container und Zubehör
 Small Containers and Accessories
 Petit-Container et accessoires
 Contenedores pequeños y accesorios
 Piccoli container e accessori

18 - 19



Spezial Container Set und Zubehör
 Special Container Set and Accessories
 Spécial Container Set et accessoires
 Contenedores especiales y accesorios
 Container speciale e accessori

20



Spezial Container Set und Zubehör
 Special Container Set and Accessories
 Spécial Container Set et accessoires
 Contenedores especiales y accesorios
 Container speciale e accessori

21 - 23



Zubehör
 Accessories
 Accessoires
 Accesorios
 Accessori

24 - 27



Große Container und Zubehör
Large Containers and Accessories
Grands container et accessoires
Contenedores grandes y accesorios
Grossi container e accessori

Deckel gelocht - Boden ungelocht
Lid perforated - Bottom non perforated
Courvercle perforé - Fond non perforé
Tapa perforada - Fondo no perforada
Coperchio forato - Fondo non forato

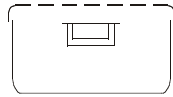

Deckel gelocht - Boden gelocht
Lid perforated - Bottom perforated
Courvercle perforé - Fond perforé
Tapa perforada - Fondo perforada
Coperchio forato - Fondo forato

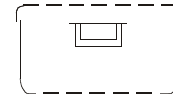

580 x 280 x 100 mm



II-060-01 **A**
II-060-02 **B**
II-060-03 **C**
II-060-04 **D**
II-060-05 **E**
II-060-06 **F**

II-061-01 **A**
II-061-02 **B**
II-061-03 **C**
II-061-04 **D**
II-061-05 **E**
II-061-06 **F**

580 x 280 x 135 mm



II-060-11 **A**
II-060-12 **B**
II-060-13 **C**
II-060-14 **D**
II-060-15 **E**
II-060-16 **F**

II-061-11 **A**
II-061-12 **B**
II-061-13 **C**
II-061-14 **D**
II-061-15 **E**
II-061-16 **F**

580 x 280 x 150 mm



II-060-21 **A**
II-060-22 **B**
II-060-23 **C**
II-060-24 **D**
II-060-25 **E**
II-060-26 **F**

II-061-21 **A**
II-061-22 **B**
II-061-23 **C**
II-061-24 **D**
II-061-25 **E**
II-061-26 **F**

580 x 280 x 200 mm



II-060-31 **A**
II-060-32 **B**
II-060-33 **C**
II-060-34 **D**
II-060-35 **E**
ii-060-36 **F**

II-061-31 **A**
II-061-32 **B**
II-061-33 **C**
II-061-34 **D**
II-061-35 **E**
II-061-36 **F**

580 x 280 x 260 mm



II-060-41 **A**
II-060-42 **B**
II-060-43 **C**
II-060-44 **D**
II-060-45 **E**
II-060-46 **F**

II-061-41 **A**
II-061-42 **B**
II-061-43 **C**
II-061-44 **D**
II-061-45 **E**
II-061-46 **F**



Sicherheitsdeckel - Boden ungelocht
 Safety Lid - Bottom non-perforated
 Courvercle de sécurité - Fond non perforé
 Tapa de seguridad - Fondo no perforada
 Coperchio di Protezione - Fondo non forato

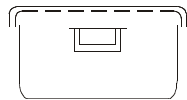

Sicherheitsdeckel - Boden gelocht
 Safety Lid - Bottom perforated
 Courvercle de sécurité - Fond perforé
 Tapa de seguridad - Fondo perforada
 Coperchio di Protezione - Fondo forato

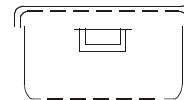

580 x 280 x 100 mm



II-062-01 A
 II-062-02 B
 II-062-03 C
 II-062-04 D
 II-062-05 E
 II-062-06 F

II-063-01 A
 II-063-02 B
 II-063-03 C
 II-063-04 D
 II-063-05 E
 II-063-06 F

580 x 280 x 135 mm



II-062-11 A
 II-062-12 B
 II-062-13 C
 II-062-14 D
 II-062-15 E
 II-062-16 F

II-063-11 A
 II-063-12 B
 II-063-13 C
 II-063-14 D
 II-063-15 E
 II-063-16 F

580 x 280 x 150 mm



II-062-21 A
 II-062-22 B
 II-062-23 C
 II-062-24 D
 II-062-25 E
 II-062-26 F

II-063-21 A
 II-063-22 B
 II-063-23 C
 II-063-24 D
 II-063-25 E
 II-063-26 F

580 x 280 x 200 mm



II-062-31 A
 II-062-32 B
 II-062-33 C
 II-062-34 D
 II-062-35 E
 II-062-36 F

II-063-31 A
 II-063-32 B
 II-063-33 C
 II-063-34 D
 II-063-35 E
 II-063-36 F

580 x 280 x 260 mm



II-062-41 A
 II-062-42 B
 II-062-43 C
 II-062-44 D
 II-062-45 E
 II-062-46 F

II-063-41 A
 II-063-42 B
 II-063-43 C
 II-063-44 D
 II-063-45 E
 II-063-46 F



Große Container und Zubehör
Large Containers and Accessories
Grands container et accessoires
Contenedores grandes y accesorios
Grossi container e accessori

Boden ungelocht
Bottom non-perforated
Fond non perforé
Fondo no perforada
Fondo non forato

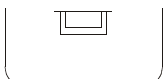

II-064-10	580 x 280 x 100 mm
II-064-20	580 x 280 x 135 mm
II-064-30	580 x 280 x 150 mm
II-064-40	580 x 280 x 200 mm
II-064-50	580 x 280 x 260 mm

Boden gelocht
Bottom perforated
Fond perforé
Fondo perforada
Fondo forato

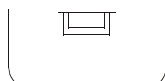

II-065-10	580 x 280 x 100 mm
II-065-20	580 x 280 x 135 mm
II-065-30	580 x 280 x 150 mm
II-065-40	580 x 280 x 200 mm
II-065-50	580 x 280 x 260 mm

Deckel gelocht
Lid perforated
Courvercle perforé
Tapa perforada
Coperchio forato

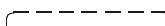

580 x 280 mm



II-066-01	A
II-066-02	B
II-066-03	C
II-066-04	D
II-066-05	E
II-066-06	F

Sicherheitsdeckel
Saftey Lid
Courvercle de securité
Tapa de seguridad
Coperchio di Protezione



580 x 280 mm



II-067-01	A
II-067-02	B
II-067-03	C
II-067-04	D
II-067-05	E
II-067-06	F



Siebkörbe Edelstahl
 Wire baskets, special steel
 Paniers grillagés en acier de haute qualité
 Cestillos de acero fino
 Cestelli in acciaio fino



II-069-11 540 x 255 x 30 mm
II-069-12 540 x 255 x 50 mm
II-069-13 540 x 255 x 70 mm
II-069-14 540 x 255 x 100 mm

Siebkörbe Edelstahl
 Wire baskets, special steel
 Paniers grillagés en acier de haute qualité
 Cestillos de acero fino
 Cestelli in acciaio fino



II-069-01 485 x 255 x 30 mm
II-069-02 485 x 255 x 50 mm
II-069-03 485 x 255 x 70 mm
II-069-04 485 x 255 x 100 mm

Siebboden
 Separate floors
 Fond du crible
 Cestas-cuerpos
 Fondo di Cestello



II-069-21 545 x 255 x 30 mm

Spannrahmen für Einschlagtücher
 Tension Clips for Towels
 Cadre tendeur à champs
 Marcos tensores para paños
 Telaio di fissaggio



II-956-12 545 x 255 mm

Einschlagtücher aus Baumwolle
 Wrapping drapes, cotton
 Champs, coton
 Paños de embalaje de algodón
 Telo, cotone



II-965-07 130 x 60 cm
II-965-08 140 x 100 cm
II-965-09 185 x 45 cm
II-965-10 185 x 60 cm



3/4 Container und Zubehör
3/4 Containers and Accessories
3/4 Container et accessoires
3/4 Contenedores y accesorios
3/4 Container e accessori

Deckel gelocht - Boden ungelocht
Lid perforated - Bottom non perforated
Courvercle perforé - Fond non perforé
Tapa perforada - Fondo no perforada
Coperchio forato - Fondo non forato

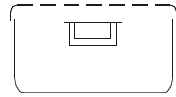

Deckel gelocht - Boden gelocht
Lid perforated - Bottom perforated
Courvercle perforé - Fond perforé
Tapa perforada - Fondo perforada
Coperchio forato - Fondo forato

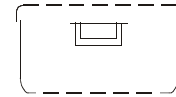

465 x 280 x 100 mm



II-160-01 A
II-160-02 B
II-160-03 C
II-160-04 D
II-160-05 E
II-160-06 F

II-161-01 A
II-161-02 B
II-161-03 C
II-161-04 D
II-161-05 E
II-161-06 F

465 x 280 x 135 mm



II-160-11 A
II-160-12 B
II-160-13 C
II-160-14 D
II-160-15 E
II-160-16 F

II-161-11 A
II-161-12 B
II-161-13 C
II-161-14 D
II-161-15 E
II-161-16 F

465 x 280 x 150 mm



II-160-21 A
II-160-22 B
II-160-23 C
II-160-24 D
II-160-25 E
II-160-26 F

II-161-21 A
II-161-22 B
II-161-23 C
II-161-24 D
II-161-25 E
II-161-26 F



Sicherheitsdeckel - Boden ungelocht
 Safety Lid - Bottom non-perforated
 Courvercle de securité - Fond non perforé
 Tapa de seguridad - Fondo no perforada
 Coperchio di Protezione - Fondo non forato

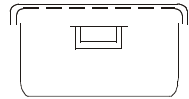

Sicherheitsdeckel - Boden gelocht
 Safety Lid - Bottom perforated
 Courvercle de securité - Fond perforé
 Tapa de seguridad - Fondo no perforada
 Coperchio di Protezione - Fondo forato

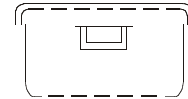

465 x 280 x 100 mm



II-162-01 A
 II-162-02 B
 II-162-03 C
 II-162-04 D
 II-162-05 E
 II-162-06 F

II-163-01 A
 II-163-02 B
 II-163-03 C
 II-163-04 D
 II-163-05 E
 II-163-06 F

465 x 280 x 135 mm



II-162-11 A
 II-162-12 B
 II-162-13 C
 II-162-14 D
 II-162-15 E
 II-162-16 F

II-163-11 A
 II-163-12 B
 II-163-13 C
 II-163-14 D
 II-163-15 E
 II-163-16 F

465 x 280 x 150 mm



II-162-21 A
 II-162-22 B
 II-162-23 C
 II-162-24 D
 II-162-25 E
 II-162-26 F

II-163-21 A
 II-163-22 B
 II-163-23 C
 II-163-24 D
 II-163-25 E
 II-163-26 F



3/4 Container und Zubehör
3/4 Containers and Accessories
3/4 Container et accessoires
3/4 Contenedores y accesorios
3/4 Container e accessori

Boden ungelocht
Bottom non-perforated
Fond non perforé
Fondo no perforada
Fondo non forato

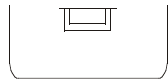

II-164-01 465 x 280 x 100 mm
II-164-02 465 x 280 x 135 mm
II-164-03 465 x 280 x 150 mm

Boden gelocht
Bottom perforated
Fond perforé
Fondo perforada
Fondo forato

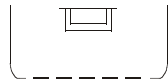

II-165-01 465 x 280 x 100 mm
II-165-02 465 x 280 x 135 mm
II-165-03 465 x 280 x 150 mm

Deckel gelocht
Lid perforated
Courvercle perforé
Tapa perforada
Coperchio forato

465 x 280 mm

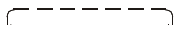

II-166-01 A
II-166-02 B
II-166-03 C
II-166-04 D
II-166-05 E
II-166-06 F

Sicherheitsdeckel
Saftey Lid
Courvercle de securité
Tapa de seguridad
Coperchio di Protezione

465 x 280 mm

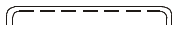

II-167-01 A
II-167-02 B
II-167-03 C
II-167-04 D
II-167-05 E
II-167-06 F



Siebkörbe Edelstahl
Wire baskets, special steel
Paniers grillagés en acier de haute qualité
Cestillos de acero fino
Cestelli in acciaio fino



II-169-01 405 x 255 x 30 mm
II-169-02 405 x 255 x 50 mm
II-169-03 405 x 255 x 70 mm
II-169-04 405 x 255 x 100 mm

Siebboden
Separate floors
Fond du crible
Cestas-cuerpos
Fondo di Cestello



II-169-11 405 x 255 x 30 mm

Spannrahmen für Einschlagtücher
Tension Clips for Towels
Cadre tendeur à champs
Marcos tensores para paños
Telaio di fissaggio



II-965-13 405 x 255 mm

Einschlagtücher aus Baumwolle
Wrapping drapes, cotton
Champs, coton
Paños de embalaje de algodón
Telo, cotone



II-965-08 140 x 100 cm



Halb-Container und Zubehör
Half-Size-Containers and Accessories
Semi-Container et accessoires
Contenedores medianos y accesorios
Mezzi container e accessori

Deckel gelocht - Boden ungelocht
Lid perforated - Bottom non perforated
Courvercle perforé - Fond non perforé
Tapa perforada - Fondo no perforada
Coperchio forato - Fondo non forato

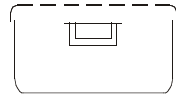

Deckel gelocht - Boden gelocht
Lid perforated - Bottom perforated
Courvercle perforé - Fond perforé
Tapa perforada - Fondo perforada
Coperchio forato - Fondo forato

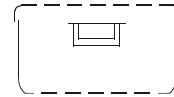

285 x 280 x 100 mm



II-260-01 A
II-260-02 B
II-260-03 C
II-260-04 D
II-260-05 E
II-260-06 F

II-261-01 A
II-261-02 B
II-261-03 C
II-261-04 D
II-261-05 E
II-261-06 F

285 x 280 x 135 mm



II-260-11 A
II-260-12 B
II-260-13 C
II-260-14 D
II-260-15 E
II-260-16 F

II-261-11 A
II-261-12 B
II-261-13 C
II-261-14 D
II-261-15 E
II-261-16 F

285 x 280 x 150 mm



II-260-21 A
II-260-22 B
II-260-23 C
II-260-24 D
II-260-25 E
II-260-26 F

II-261-21 A
II-261-22 B
II-261-23 C
II-261-24 D
II-261-25 E
II-261-26 F

285 x 280 x 200 mm



II-260-31 A
II-260-32 B
II-260-33 C
II-260-34 D
II-260-35 E
II-260-36 F

II-261-31 A
II-261-32 B
II-261-33 C
II-261-34 D
II-261-35 E
II-261-36 F

285 x 280 x 260 mm



II-260-41 A
II-260-42 B
II-260-43 C
II-260-44 D
II-260-45 E
II-260-46 F

II-261-41 A
II-261-42 B
II-261-43 C
II-261-44 D
II-261-45 E
II-261-46 F



Sicherheitsdeckel - Boden ungelocht
 Saftey Lid - Bottom non-perforated
 Courvercle de sécurité - Fond non perforé
 Tapa de seguridad - Fondo no perforada
 Coperchio di Protezione - Fondo non forato

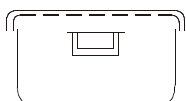

Sicherheitsdeckel - Boden gelocht
 Saftey Lid - Bottom perforated
 Courvercle de sécurité - Fond perforé
 Tapa de seguridad - Fondo no perforada
 Coperchio di Protezione - Fondo forato

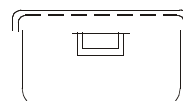

285 x 280 x 100 mm



II-262-01 A
 II-262-02 B
 II-262-03 C
 II-262-04 D
 II-262-05 E
 II-262-06 F

II-263-01 A
 II-263-02 B
 II-263-03 C
 II-263-04 D
 II-263-05 E
 II-263-06 F

285 x 280 x 135 mm



II-262-11 A
 II-262-12 B
 II-262-13 C
 II-262-14 D
 II-262-15 E
 II-262-16 F

II-263-11 A
 II-263-12 B
 II-263-13 C
 II-263-14 D
 II-263-15 E
 II-263-16 F

285 x 280 x 150 mm



II-262-21 A
 II-262-22 B
 II-262-23 C
 II-262-24 D
 II-262-25 E
 II-262-26 F

II-263-21 A
 II-263-22 B
 II-263-23 C
 II-263-24 D
 II-263-25 E
 II-263-26 F

285 x 280 x 200 mm



II-262-31 A
 II-262-32 B
 II-262-33 C
 II-262-34 D
 II-262-35 E
 II-262-36 F

II-263-31 A
 II-263-32 B
 II-263-33 C
 II-263-34 D
 II-263-35 E
 II-263-36 F

285 x 280 x 260 mm



II-262-41 A
 II-262-42 B
 II-262-43 C
 II-262-44 D
 II-262-45 E
 II-262-46 F

II-263-41 A
 II-263-42 B
 II-263-43 C
 II-263-44 D
 II-263-45 E
 II-263-46 F



Halb-Container und Zubehör
Half-Size-Containers and Accessories
Semi-Container et accessoires
Contenedores medianos y accesorios
Mezzi container e accessori

Boden ungelocht
Bottom non-perforated
Fond non perforé
Fondo no perforada
Fondo non forato

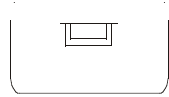

II-264-01	285 x 280 x 100 mm
II-264-02	285 x 280 x 135 mm
II-264-03	285 x 280 x 150 mm
II-264-04	285 x 280 x 200 mm
II-264-05	285 x 280 x 260 mm

Boden gelocht
Bottom perforated
Fond perforé
Fondo perforada
Fondo forato

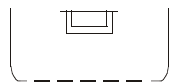

II-265-01	285 x 280 x 100 mm
II-265-02	285 x 280 x 135 mm
II-265-03	285 x 280 x 150 mm
II-265-04	285 x 280 x 200 mm
II-265-05	285 x 280 x 260 mm

Deckel gelocht
Lid perforated
Courvercle perforé
Tapa perforada
Coperchio forato

285 x 280 mm

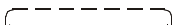

II-262-01	A
II-262-02	B
II-262-03	C
II-262-04	D
II-262-05	E
II-262-06	F

Sicherheitsdeckel
Safety Lid
Courvercle de sécurité
Tapa de seguridad
Coperchio di Protezione

285 x 280 mm

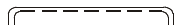

II-267-01	A
II-267-02	B
II-267-03	C
II-267-04	D
II-267-05	E
II-267-06	F



Siebkörbe Edelstahl
 Wire baskets, special steel
 Paniers grillagés en acier de haute qualité
 Cestillos de acero fino
 Cestelli in acciaio fino



II-269-01 255 x 245 x 30 mm
II-269-02 255 x 245 x 50 mm
II-269-03 255 x 245 x 70 mm
II-269-04 255 x 245 x 100 mm

Siebboden
 Separate floors
 Fond du crible
 Cestas-cuerpos
 Fondo di Cestello



II-269-11 255 x 245 x 30 mm

Spannrahmen für Einschlagtücher
 Tension Clips for Towels
 Cadre tendeur à champs
 Marcos tensores para paños
 Telaio di fissaggio



II-965-17 255 x 255 mm

Einschlagtücher aus Baumwolle
 Wrapping drapes, cotton
 Champs, coton
 Paños de embalaje de algodón
 Telo, cotone



II-965-04 90 x 60 cm
II-965-05 90 x 80 cm
II-965-06 130 x 45 cm
II-965-07 130 x 60 cm



Halb-Container und Zubehör
 Half-Size-Containers and Accessories
 Semi-Container et accessoires
 Contenedores medianos y accesorios
 Mezzi container e accessori

Deckel gelocht - Boden ungelocht
 Lid perforated - Bottom non-perforated
 Courvercle perforé - Fond non perforé
 Tapa perforada - Fondo no perforada
 Coperchio forato - Fondo non forato

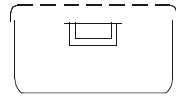

Deckel gelocht - Boden gelocht
 Lid perforated - Bottom perforated
 Courvercle perforé - Fond perforé
 Tapa perforada - Fondo no perforada
 Coperchio forato - Fondo forato

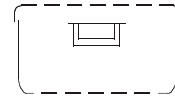

285 x 280 x 55 mm



II-360-01 **A**
II-360-02 **B**
II-360-03 **C**
II-360-04 **D**
II-360-05 **E**
II-360-06 **F**

285 x 280 x 85 mm



II-360-11 **A**
II-360-12 **B**
II-360-13 **C**
II-360-14 **D**
II-360-15 **E**
II-360-16 **F**

II-361-11 **A**
II-361-12 **B**
II-361-13 **C**
II-361-14 **D**
II-361-15 **E**
II-361-16 **F**

Boden ungelocht
 Bottom non-perforated
 Fond non perforé
 Fondo no perforada
 Fondo non forato

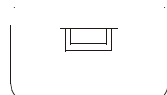

II-362-01 285 x 280 x 55 mm
II-362-02 285 x 280 x 85 mm

Boden gelocht
 Bottom perforated
 Fond perforé
 Fondo perforada
 Fondo forato

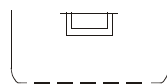

II-362-03 285 x 280 x 85 mm

Deckel gelocht
 Lid perforated
 Courvercle perforé
 Tapa perforada
 Coperchio forato

285 x 280 mm

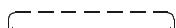

II-362-11 **A**
II-362-12 **B**
II-362-13 **C**
II-362-14 **D**
II-362-15 **E**
II-362-10 **F**



Siebkörbe Edelstahl
 Wire baskets, special steel
 Paniers grillagés en acier de haute qualité
 Cestillos de acero fino
 Cestelli in acciaio fino



II-269-01 255 x 245 x 30 mm
II-269-02 255 x 245 x 50 mm

Siebboden
 Separate floors
 Fond du crible
 Cestas-cuerpos
 Fondo di Cestello



II-269-11 255 x 245 x 30 mm

Silikon-Noppenmatte
 Silicone Mats
 Tapis silicone
 Planchas granuladas de silicona
 Stuoia di silicone



II-965-21 245 x 245 mm

Spannrahmen für Einschlagtücher
 Tension Clips for Towels
 Cadre tendeur à champs
 Marcos tensores para paños
 Telaio di fissaggio



II-965-17 255 x 255 mm

Einschlagtücher aus Baumwolle
 Wrapping drapes, cotton
 Champs, coton
 Paños de embalaje de algodón
 Telo, cotone



II-965-04 90 x 60 cm
II-965-05 90 x 80 cm



Kleine Container und Zubehör
 Small Containers and Accessories
 Petit-Container et accessoires
 Contenedores pequeños y accesorios
 Piccoli container e accessori

Deckel gelocht - Boden ungelocht
 Lid perforated - Bottom non perforated
 Courvercle perforé - Fond non perforé
 Tapa perforada - Fondo no perforada
 Coperchio forato - Fondo non forato

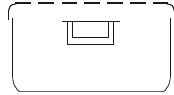

Deckel gelocht - Boden gelocht
 Lid perforated - Bottom perforated
 Courvercle perforé - Fond perforé
 Tapa perforada - Fondo perforada
 Coperchio forato - Fondo forato

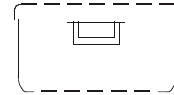

300 x 140 x 40 mm



II-460-01 **A**
II-460-02 **B**
II-460-03 **C**
II-460-04 **D**
II-460-05 **E**
II-460-06 **F**

II-461-01 **A**
II-461-02 **B**
II-461-03 **C**
II-461-04 **D**
II-461-05 **E**
II-461-06 **F**

300 x 140 x 70 mm



II-460-11 **A**
II-460-12 **B**
II-460-13 **C**
II-460-14 **D**
II-460-15 **E**
II-460-16 **F**

II-461-11 **A**
II-461-12 **B**
II-461-13 **C**
II-461-14 **D**
II-461-15 **E**
II-461-16 **F**

300 x 140 x 100 mm



II-460-21 **A**
II-460-22 **B**
II-460-23 **C**
II-460-24 **D**
II-460-25 **E**
II-460-26 **F**

II-461-21 **A**
II-461-22 **B**
II-461-23 **C**
II-461-24 **D**
II-461-25 **E**
II-461-26 **F**

Boden ungelocht
 Bottom non-perforated
 Fond non perforé
 Fondo no perforada
 Fondo non forato

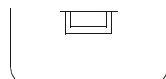

II-462-01 300 x 140 x 40 mm
II-462-02 300 x 140 x 70 mm
II-462-03 300 x 140 x 100 mm

Boden gelocht
 Bottom perforated
 Fond perforé
 Fondo perforada
 Fondo forato

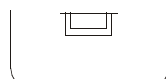

II-462-11 300 x 140 x 40 mm
II-462-12 300 x 140 x 70 mm
II-462-13 300 x 140 x 100 mm



Deckel gelocht
 Lid perforated
 Courvercle perforé
 Tapa perforada
 Coperchio forato

300 x 140 mm



II-462-21
II-462-22
II-462-23
II-462-24
II-462-25
II-462-26

A
B
C
D
E
F

Silikon-Noppenmatte
 Silicone Mats
 Tapis silicone
 Planchas granuladas de silicona
 Stuoia di silicone



II-965-20

270 x 125 mm

Spannrahmen für Einschlagtücher
 Tension Clips for Towels
 Cadre tendeur à champs
 Marcos tensores para paños
 Telaio di fissaggio



II-965-18

280 x 125 mm

Einschlagtücher aus Baumwolle
 Wrapping drapes, cotton
 Champs, coton
 Paños de embalaje de algodón
 Telo, cotone



II-965-01

60 x 40 cm



Spezial Container Set und Zubehör
Special Container Set and Accessories
Spécial Container Set et accessoires
Contenedores especiales y accesorios
Container speciale e accessori

Deckel gelocht - Boden gelocht
Lid perforated - Bottom perforated
Couvercle perforé - Fond perforé
Tapa perforada - Fondo perforada
Coperchio forato - Fondo forato

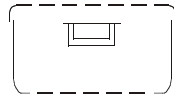

310 x 190 x 40 mm



II-560-01 A

Boden gelocht
Bottom perforated
Fond perforé
Fondo perforada
Fondo forato

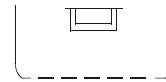

A

II-560-11 310 x 190 x 40 mm
II-560-12 310 x 190 x 65 mm
II-560-13 310 x 190 x 130 mm

310 x 190 x 65 mm



II-560-02 A

Deckel gelocht
Lid perforated
Couvercle perforé
Tapa perforada
Coperchio forato

310 x 190 x 130 mm



II-560-03 A



A

II-560-21 310 x 190 mm

Spannrahmen für Einschlagtücher
Tension Clips for Towels
Cadre tendeur à champs
Marcos tensores para paños
Telaio di fissaggio



II-965-19 310 x 190 mm

Einschlagtücher aus Baumwolle
Wrapping drapes, cotton
Champs, coton
Paños de embalaje de algodón
Telo, cotone



II-965-01 60 x 40 cm
II-965-02 65 x 65 cm
II-965-03 85 x 85 cm



Deckel gelocht - Boden gelocht
 Lid perforated - Bottom perforated
 Courvercle perforé - Fond perforé
 Tapa perforada - Fondo perforada
 Coperchio forato - Fondo forato

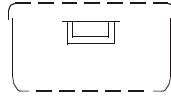

300 x 138 x 65 mm



II-660-01	A
II-660-02	B
II-660-03	C
II-660-04	D
II-660-05	E
II-660-06	F

500 x 155 x 75 mm



II-660-11	A
II-660-12	B
II-660-13	C
II-660-14	D
II-660-15	E
II-660-16	F

Deckel gelocht - Boden gelocht
 Lid perforated - Bottom perforated
 Courvercle perforé - Fond perforé
 Tapa perforada - Fondo perforada
 Coperchio forato - Fondo forato

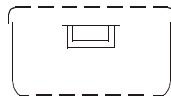

250 x 60 x 50 mm



II-660-21	A
------------------	----------

450 x 70 x 70 mm



II-660-22	A
------------------	----------



Spezial Container Set und Zubehör
Special Container Set and Accessories
Spécial Container Set et accessoires
Contenedores especiales y accesorios
Container speciale e accessori

Deckel ungelocht - Boden ungelocht
Lid non perforated - Bottom non perforated
Courvercle non perforé - Fond non perforé
Tapa no perforada - Fondo no perforada
Coperchio non-forato - Fondo non forato

285 x 280 x 100 mm



II-760-01
II-760-02
II-760-03
II-760-04
II-760-05
II-760-06

A
B
C
D
E
F

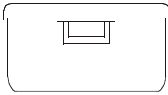

Deckel ungelocht - Boden ungelocht
Lid non perforated - Bottom non perforated
Courvercle non perforé - Fond non perforé
Tapa no perforada - Fondo no perforada
Coperchio non-forato - Fondo non forato

285 x 280 x 150 mm



II-760-11
II-760-12
II-760-13
II-760-14
II-760-15
II-760-16

A
B
C
D
E
F

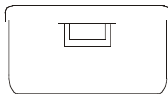

Boden ungelocht
Bottom non-perforated
Fond non perforé
Fondo no perforada
Fondo non forato



A

II-264-01
II-264-03

285 x 280 x 100 mm
285 x 280 x 150 mm

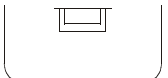

Deckel ungelocht
Lid non perforated
Courvercle non perforé
Tapa no perforada
Coperchio non-forato

285 x 280 mm



II-760-51
II-760-52
II-760-53
II-760-54
II-760-55
II-760-56

A
B
C
D
E
F

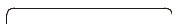



Deckel ungelocht - Boden ungelocht
 Lid non perforated - Bottom non perforated
 Courvercle non perforé - Fond non perforé
 Tapa no perforada - Fondo no perforada
 Coperchio non-forato - Fondo non forato

580 x 280 x 150 mm



II-760-21	A
II-760-22	B
II-760-23	C
II-760-24	D
II-760-25	E
II-760-26	F

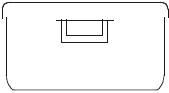

Boden ungelocht
 Bottom non-perforated
 Fond non perforé
 Fondo no perforada
 Fondo non forato



II-064-30 580 x 280 x 150 mm

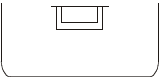

Deckel ungelocht
 Lid non perforated
 Courvercle non perforé
 Tapa no perforada
 Coperchio non-forato

580 x 280 mm



II-760-41	A
II-760-42	B
II-760-43	C
II-760-44	D
II-760-45	E
II-760-46	F

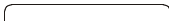



Zubehör
Accessories
Accessoires
Accesorios
Accessori

Bürstenspender
für 20 Bürsten (ohne Bürsten),
mit Aufhängevorrichtung

285 x 280 x 85 mm

Brush dispenser
for 20 Brushes (without brushes)
with suspension hook

Distruteur
pour 20 brosses (sans brosses),
avec crochet de suspension

Distribuidor de cepillos
para 20 cepillos (sin cepillos),
completo con gancho de suspensión

Distributore
per 20 spazzole (spazzole escluse),
con gancio di sospensione



II-860-01
II-860-02
II-860-03
II-860-04
II-860-05
II-860-06

A
B
C
D
E
F

Handwaschbürste,
über 400 Mal im Autoklaven
sterilisierbar

Nailbrush, more than
400 times autoclavable

Brosse à de ongles,
stérilisable à l'autoclave 400 fois ou plus

Cepillo de uñas,
esterilizable más de 400 veces en autoclave

Spazzola per unghie,
sterilizzabile più di 400 volte in
autoclave



HE-938-00



Einmal-Papierfilter
Single use paper filters
Filtres papiers à usage unique
Filtros de papel de un solo uso
Filtri di carta monouso

Verpackungseinheit 100 Stück
Packing unit 100 pieces
Boîtes de 100 pièces
Cajas con 100 piezas
Unità di 100 pezzi



II-960-01

Für 1/1, 3/4 und halbe Container
For 1/1, 3/4 and Half-Size Containers
Pour 1/1, 3/4 et Semi-Container
Para contenedores grandes y medianos
Per grossi container e mezzo container

Langzeit-Textilfilter
Long-term textile filters
Filtres textiles longue
Filtros de tejido de larga duración
Filtri tessili a lunga durata

Verpackungseinheit 1 Stück
Packing unit 1 pieces
Boîtes de 1 pièces
Cajas con 1 piezas
Unità di 1 pezzi



II-960-02

Für 1/1, 3/4 und halbe Container
For 1/1, 3/4 and Half-Size Containers
Pour 1/1, 3/4 et Semi-Container
Para contenedores grandes y medianos
Per grossi container e mezzo container



II-960-03

Für Klein-Set Container (Mini)
For small Container Sets (Mini)
Pour petit-Set Container (Mini)
Para contenedores pequeños (Mini)
Per piccoli container (Mini)



II-960-04

Für Klein-Set Container (Mini)
For small Container Sets (Mini)
Pour petit-Set Container (Mini)
Para contenedores pequeños (Mini)
Per piccoli container (Mini)



II-960-05

Für Klein-Set Container (Dental)
For small Container Sets (Dental)
Pour petit-Set Container (Dental)
Para contenedores pequeños (Dental)
Per piccoli container (Dental)



II-960-06

Für Klein-Set Container (Dental)
For small Container Sets (Dental)
Pour petit-Set Container (Dental)
Para contenedores pequeños (Dental)
Per piccoli container (Dental)

Filterspender
Filter Dispenser
Pièce à rangement
Contenedor de filtros
Distributore filtri



II-960-07



Zubehör
Accessories
Accessoires
Accesorios
Accessori

Filterblech
Filter sheet
Dispositif d'arrêt filtre
Dispositivo de sujetar filtro
Fermafilro



II-960-08

Für Einmal-Papierfilter
For single use paper filters
Pour filtres papiers à usage unique
Para filtros de papel de un solo uso
Per filtri di carta per un solo uso

II-960-09

Für Langzeit-Textilfilter
For long-term textile filters
Pour filtres textiles longue durée
Para filtros de tejido de larga duración
Per filtri tessili a lunga durata

Indikatoretiketten aus Papier
Indications labels, made of paper
Etiquettes-témions, en papier
Etiquetas indicadoras de papel
Etichette di identificazione in carta

Verpackungseinheit 100 Stück
Packing unit 100 pieces
Boîtes de 100 pièces
Cajas con 100 piezas
Unità di 100 pezzi

II-960-10

Für 1/1, 3/4 und halbe Container
For 1/1, 3/4 and Half-Size Containers
Pour 1/1, 3/4 et Semi-Container
Para contenedores grandes y medianos
Per grossi container e mezzo container

II-960-11

Für Klein-Set Container (Mini und Dental)
For small Container Sets (Mini and Dental)
Pour petit-Set Container (Mini et Dental)
Para contenedores pequeños (Mini de Dental)
Per piccoli container (Mini e Dental)

Verschlußblomben aus Kunststoff
Plastic Security Seals
Plombs de verrouillage en matière plastique
Precintos de plástico
Piombi in materia plastica



II-960-12

Verpackungseinheit 100 Stück
Packing unit 100 pieces
Boîtes de 100 pièces
Cajas con 100 piezas
Unità di 100 pezzi

Farbige Kennzeichnungsschilder (ohne Gravur)
Coloured identification labels (without engraving)
Etiquettes d'identification en couleur (sans gravure)
Placas de identificación de color (sin grabación)
Targhette di identificazione colorate (senza incisione)

II-960-21

A

II-960-22

B

II-960-23

C

II-960-24

D

II-960-25

E

II-960-26

F

Gravur auf Anfrage
Engraving as per request
Gravure par demande
Grabación según su deseo
Incisione su richiesta

Sortiermagazin für Kennzeichnungsschilder
Dispenser for identification labels
Magasin à étiquettes pour d'identification
Cajetín clasificador de identificación
Cassetta da selezione targhette di identificazione



II-960-29



Trennblechhaltestift zur Aufnahme von Trennblechen
Fixing bolt for divisions
Plot de cloisonnement pour maintenir les cloisonnements
Piñon para separadores
Perno di fissaggio per separatori



II-960-31



Sortierspieß zur Fixierung von Instrumenten
Fixation shaft for instruments
Attache de fixation pour la fixation d'instruments
Piñon para fijar instrumental
Perno di fissaggio per strumenti



II-960-32

Trennbleche
Divisions
Séparateurs
Separadores
Dvisorì per cesti in rete



II-960-33

50 x 20 mm

II-860-34

130 x 20 mm

II-960-35

225 x 20 mm

II-960-36

460 x 20 mm

Gleitschieber
Sliders
Curseur
Corredor
Cursore



II-960-41



Schiene für
Gleitschieber
Rail for Sliders
Éclisse pour le curseur
Riel para corredor
Sbarra per cursore



II-960-42

232 mm

II-960-43

471 mm

Winkelblech (Anschlagrahmen)
Angled stopper
Separateur en angle
Separador ángulado
Sbarra angolata



II-960-44

232 mm

II-860-45

471 mm

Spiralfeder mit Halterung
Spiral holding support
Support à ressorts spiraux
Apoyo con resorte espiral
Supporto a molle



II-960-46



Doppelte-Spiralfeder mit Halterung
Spiral holding support double
Support à ressorts spiraux double
Apoyo don resorte espiral doble
Supporto doppio a molle



II-960-47

Fixierklammern für Tücher
Fixation clamps for drapes
Clips à champs
Clip de fijación para paños
Clips di fissaggio per teli



II-960-48



JA

**Hochfrequenz-Chirurgie
High Frequency Surgery
Chirurgie à haute fréquence
Electrocirugía
Elettrochirurgia**



JA

Elektroden zum Schneiden und Koagulieren
 Cutting and Coagulation Electrodes
 Electrodes pour la coupe et la coagulation
 Electrodo para cortar y para la coagulación
 Elettrodi di taglio e di coagulazione

Serie MICRO + DENTAL



JA-100-01
Fig. 1



JA-100-02
Fig. 2
45°



JA-100-03
Fig. 3
120°



JA-100-11
Fig. 11
Ø 3 mm



JA-100-12
Fig. 12
Ø 5 mm



JA-100-13
Fig. 13
Ø 8 mm



JA-100-14
Fig. 14



JA-100-15
Fig. 15
7,0 x 1,5 mm
45°



JA-100-16
Fig. 16
7 mm
45°



JA-100-17
Fig. 17
6,0 x 1,3 mm



JA-100-18
Fig. 18
7,0 x 1,7 mm
30°



JA-100-21
Fig. 21
7,0 x 1,7 mm



JA-100-31
Fig. 31
Ø 0,6 mm
45°



JA-100-33
Fig. 33
Ø 1,7 mm
45°



JA-100-34
Fig. 34
Ø 3,0 mm
45°



JA-100-35
Fig. 35



JA-100-36
Fig. 36
90°

Schaft • shaft • tige
 vástago • asta
 Ø 1,6 mm

Elektroden zum Schneiden und Koagulieren
 Cutting and Coagulation Electrodes
 Electrodes pour la coupe et la coagulation
 Electrodo para cortar y para la coagulación
 Elettrodi di taglio e di coagulazione

Serie MICRO + DENTAL



JA-101-51
 Fig. 51
 Ø 3 mm
 45°



JA-101-52
 Fig. 52
 7,0 x 1,7 mm
 45°



JA-101-53
 Fig. 53
 45°



JA-101-54
 Fig. 54



JA-101-55
 Fig. 55



JA-101-56
 Fig. 56
 Ø 5 mm
 45°



JA-101-61
 Fig. 61
 45°



JA-101-62
 Fig. 62
 90°

Schaft • shaft • tige
 vástago • asta
 Ø 4 mm

Serie STANDARD



JA-200-01



JA-200-02



JA-200-03



JA-200-04



JA-202-05



JA-204-05



JA-300-02

Schaft • shaft • tige
 vástago • asta
 Ø 4 mm

Ø mm	JA-202-05	Ø mm	JA-204-05	Ø mm	JA-300-02
5	JA-202-05	5	JA-204-05	2	JA-300-02
10	JA-202-10	10	JA-204-10	4	JA-300-04
20	JA-202-20	20	JA-204-20	6	JA-300-06

Handchirurgie, Ophthalmologie, Plastische Chirurgie, Experimentelle Chirurgie
 Hand Surgery, Ophthalmology, Plastic Surgery, Experimental Surgery
 Chirurgie de la main, Ophtalmologie, Chirurgie plastique, Chirurgie experimentale
 Cirugía de la mano, Oftalmología, Cirugía plástica, Cirugía experimental
 Chirurgia della mano, Oftalmologia, Chirurgia plastica, Chirurgia esperimentale

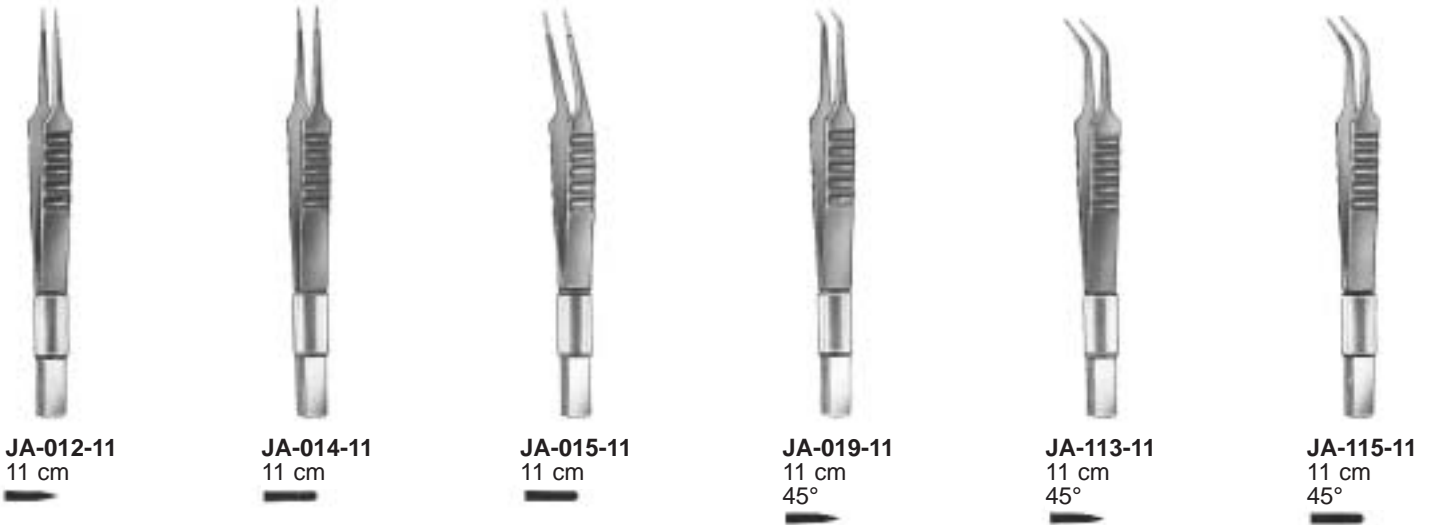

Mikrochirurgie, HNO • Microsurgery, ENT • Microchirurgie, ORL • Microcirugía, ORL • Microchirurgia, ORL

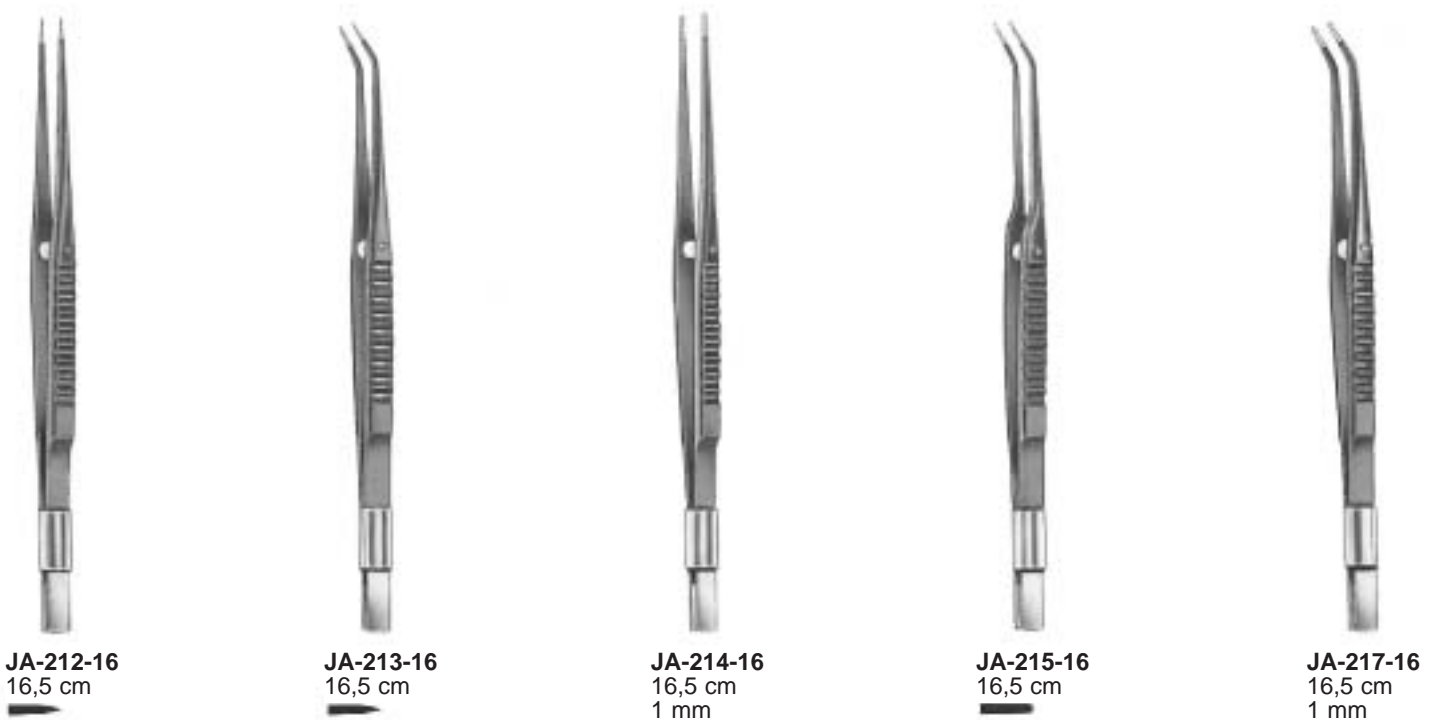

Mikrochirurgie, HNO • Microsurgery, ENT • Microchirurgie, ORL • Microcirugía, ORL • Microchirurgia, ORL



JA-315-16
16,5 cm



JA-319-16
16,5 cm



JA-412-16
16,5 cm



JA-414-16
16,5 cm



JA-416-16
16,5 cm
1 mm

Gynäkologie, HNO, Tonsillen Chirurgie • Gynaecology, ENT, Tonsil Surgery • Gynécologie, ORL, Chirurgie des amygdales
Ginecología, ORL, Cirugía de amígdalas • Ginecologia, ORL, Chirurgia tonsillare



JA-512-19
19,5 cm



JA-514-19
19,5 cm
1 mm



JA-517-19
19,5 cm
1 mm



JA-519-19
19,5 cm
2 mm

JA

Bipolare Koagulation
Bipolar Coagulation
Coagulation bipolaire
Coagulación bipolar
Coagulazione bipolare

Neurochirurgie • Neurosurgery • Neurochirurgie • Neurocirugía • Neurochirurgia



JA-612-19
19,5 cm



JA-614-19
19,5 cm
1 mm



JA-616-19
19,5 cm
2 mm



JA-617-19
19,5 cm
1 mm



JA-619-19
19,5 cm
1 mm



JA-712-03
0,3 mm

JA-712-07
0,7 mm

JA-712-12
1,2 mm

JA-712-03 - JA-712-12
22,5 cm
0,3 - 1,2 mm

Anschlußkabel
Connection Cords
Cordons d'alimentation
Cables de conexión
Cavi da connessione



m
3
5

JA-910-30
JA-910-50
ERBE
SELECT

JA-911-30
AESCULAP

JA-912-30
JA-912-50
USA Mod.

JA-913-30
JA-913-50
MARTIN

HF-Chirurgie-Geräte
Electrosurgery Equipment
Electrobistouris
Electrobisturries
Elettrobisturi

**Inhaltsverzeichnis
Deutsch**

D

Inhaltsverzeichnis Deutsch

A

Abziehstein ARKANSAS	AG-19
Adenotom LAFORCE	EG-19
ADLERKREUTZ Pinzette	BA-04
ADSON Arterien Klemme	BC-09
ADSON BABY	
Arterien Klemme	BC-09
ADSON BABY	
Wund Sperrer	BI-15
ADSON-BROWN Pinzette	BA-03
ADSON	
Elevatoren	DC-21
Hohlmeißel Zange	DC-03
Hypophysen Pinzette	EA-06
Mikro Pinzette	BA-03
Nadelhalter	CE-04
Nerv Haken	EA-04
Pinzette	BA-03
Wund Sperrer	BI-15
AEBLI Hornhaut Schere	AI-22
AESCLAP HF Chirurgie Geräte Kabel	JA-07
ALAN-PARKS Mastdarm Spreizer	GI-03
ALBEE Fräser	DD-07
ALEXANDER	
Flachmeißel	DC-14
Hohlmeißel	DC-14
Probeexcisions Zange	HA-42
Raspatorien	DC-19
ALLIS-ADAIR Darmfaß Zange	GE-02
ALLIS-Baby Darmfaß Zange	GE-02
ALLIS Darmfaß Zange	GE-02
ALLISON Lungen Spatel	FG-19
ALM Wund Sperrer	BI-14
ALVIS Fremdkörper Kürette	EC-06
Amniotom BEACHAM	HA-39
Amputations Messer	AG-16
Anatomische Skalpell	AG-15
ANDREWS-PINCHON Sauger	AE-03
ANDREW Zungen Spatel	EI-02
Anoskop	
HIRSCHMANN Anoskop	GI-04
IVES-FANSLER Anoskop	GI-04
Apparat	
BUNNELL Handbohr Apparat	DD-05
Handbohr Apparat	DD-05
Handbohr Apparat mit Jacobs-Futter	DD-06
HUDSON Handbohr Apparat	DD-04
KIRSCHNER Handbohr Apparat	DD-05
MOORE Handbohr Apparat	DD-04
PETZ Magen- und Darmnäht Apparat	GE-09
RALK Handbohr Apparat	DD-05
STILLE Handbohr Apparat	DD-04
STILLE-SHERMAN Handbohr Apparat	DD-04
ARCHER Splitter Pinzette	BA-06
ARKANSAS Abziehstein	AG-19
ARLT Draht Schlinge	EC-08
ARRUGA	
Extraktion Haken	EC-06
Kapsel Pinzette	ED-04
Nadelhalter	CE-06
Netzhaat Ablös Schützer	EC-08
Sperr Elevator	EC-02
ASCH Septum Zange	EG-18
Atraumatische Klemmen	BD-02 bis BD-43
Atraumatische Kinder-Gefäß Klemme	BD-43
AUFRICHT Nasenrücken Haken	EG-17
Aufsatz MILLIN Kaltlicht	GG-05
AUVARD Vaginal Spekulum	HA-19
AXENFELD Chalazion Löffel	EC-07
AYER Chalazion Pinzette	ED-06

B

BABCOCK Darmfaß Zange	GE-02
BABINSKY Perkussions Hammer	AC-07
BACKHAUS-CLIP Schlauchhalter Tuch Klemme	BE-03
BACKHAUS KOCHER Tuch Klemme	BE-02
BACKHAUS Tuch Klemme	BE-02
BAGGISH Probeexcisions Zange	HA-45
BAILEY-BABY Rippen Kontraktor	FG-18
BAILEY-GIBBON Rippen Kontraktor	FG-18
BAILEY Rippen Kontraktor	FG-18
BAINBRIDGE	
Arterien Klemme	BC-14
Atraumatische Klemme	BD-09
BAKES Gallenkanal Dilatatore	GC-06
BALFOUR Baby Bauch Deckenhalter	BI-22
BALFOUR	
Bauch Deckenhalter	BI-22
Valve	BI-22
BALL AND SOCKET Tuch Klemme	BE-04
BALLENGER	
Schwing Messer	EG-11
Septum Elevatorium	EG-12
Tonsillen Fass Zange	FA-04
Bandmass	AC-08
Band PARHAM	DC-11
Bandschlinge Elektrode	JA-03
BANGERTER Cyclodialyse Spatel	EC-08
BARANY Lärmtrommel	EE-04
BARBARA	
Häkchen	EE-14
Nadel	EE-14
Pick	EE-14 bis EE-15
BARKAN Goniotomie Messer	EC-05
BARNHILL Ring Messer	EG-19
BARRAQUER KATZIN	
Iris Pinzette	EC-13
BARRAQUER Colibri Iris Pinzette	EC-13
BARRAQUER	
Cilien Pinzette	ED-08
Colibri Schere	AJ-04
BARRAQUER Colibri Sperr Elevator	EC-02
BARRAQUER	
Fixier Pinzette	ED-03
Keratoplastik Messer	EC-05
Nadelhalter	CE-07
Vorderkammer Pinzette	ED-02
BARRETT Haken Zange	HA-32
BARR Rektal Spekulum	GI-02
BARTON	
Geburts Zange	HC-04
Zug Hebel	HC-04
BAUMGARTNER Nadelhalter	CE-02
BEACHAM Amniotom	HA-39
Becher	HE-10
Medizin Becher	HE-07
Meß Becher	HE-07
Sputum Becher	HE-06
BECK Atraumatische Peripher-Vascular Klemme	BD-25
Becken	
Plazenta Becken	HE-06
Stech Becken	HE-06
Becken Zirkel	
COLLIN Becken Zirkel	HC-06
COLLYER Becken Zirkel	HC-06
MARTIN Becken Zirkel	HC-06
BECKER Cystotom	EC-06
BECKMANN-ADSON Wund Sperrer	BI-15
BECKMANN-EATON Wund Sperrer	BI-16
BECKMANN	
Ring Messer	EG-19

BECKMANN	
Wund Sperrer	BI-16
BEEBEE Draht und Blech Schere	AI-43
BEER Cilien Pinzette	ED-08
BEESON Gips Spreizer	DA-03
BELLUCCI Ohr Mikro Schere	EE-09
BENGOLEA Arterien Klemme	BC-09
BENNETT Knochen Hebel.....	DC-22
BERENS Lanzen Messer.....	EC-04
BERGMANN FOERSTER Schwamm Zange	BG-10
BERGMANN	
Gips Säge	DA-02
Verband Schere	AI-46
BERKE Muskel Pinzette.....	ED-02
BERLIND-AUVARD Vaginal Spekulum	HA-19
BERLINER Perkussions Hammer.....	AC-07
BERNHARD Tuch Klemme	BE-05
BERTILLON Schädel Messzirkel	AC-08
BEST Darm Klemme.....	GE-06
Besteck	
Autopsie Besteck	DC-17
Mini Naht Besteck.....	CG-08
Standard Naht Besteck.....	CG-08
BETHUNE Rippen Schere	FG-04
BEUSE Schere	AI-26
BEYER	
Hohlmeißel Zange	DC-04
Stanze.....	EG-08
BILLEAU Ohr Schlinge.....	EE-07
BILL Zug Hebel	HC-05
BIRCHER-GANSKE Knochenhalte Zange	DC-10
BIRCHER Meniskotom	DC-24
BISHOP-HARMAN Iris Pinzette.....	EC-14
BLAKE	
Gallenstein Zange	GC-03
Uterus Kürette	HA-48
Bleihand	DC-11
BLOHMKE Tonsillen Fass Zange	FA-04
BLOUNT	
Knie Haken	DC-24
Knochen Hebel	DC-24
BLUMENTHAL Hohlmeißel Zange	DC-02
Blutdruckmesser.....	AC-02
BODENHAMMER Rektal Spekulum	GI-02
BOEHLER Extension Bügel.....	DD-10
BOERMA Geburts Zange.....	HC-04
BOETTCHER Tonsillen Schere	AI-27
BÖHLER	
Hohlmeißel Zange	DC-04
Knochensplitter Zange.....	DC-06
Bohrdrähte KIRSCHNER	DD-09
Bohrer	
Gewinde Bohrer	DD-15
McKENZIE Bohrer	DD-04
BONACCOLTO Strabismus Pinzette	EC-14
BONNEY Schwamm Zange.....	BG-08
BONN	
Iris Pinzette	EC-15
Spül Kanüle.....	ED-07
BONN TITAN Iris Pinzette.....	EC-15
BORCHARDT Fräser.....	DD-07
BOSE	
Tracheal Häkchen	FE-02
Tracheal Sperre.....	FE-02
BOUCHERON Ohr Spekula	EE-02
Bougie	
COXETER Harnröhren Bougie.....	GG-17
DITTEL Harnröhren Bougie	GG-18 bis GG-19
FILIFORM Harnröhren Bougie	GG-12
GUYON Harnröhren Bougie	GG-14 bis GG-15
VAN BUREN Harnröhren Bougie	GG-13
Bougie	
WALTHER Harnröhren Bougie.....	GG-17
BOWLES Stethoskop	AC-06
BOWMAN	
Discisions Messer	EC-04
Discisions Nadel	EC-05
Sperr Elevator	EC-02
Tränenkanal Sonde.....	EC-10
BOYNTON Nadelhalter	CE-06
BOZEMANN-DOUGLAS Tupfer Zange	BG-13
BOZEMANN	
Nadelhalter.....	CE-03
Tupfer Zange	BG-13
BRAITHWAITE Dermatome.....	AG-22
BRAUN	
Dekapitations Haken.....	HC-09
Haken Zange	HA-31, HA-34
Kranioklast	HC-09
BRAUN-STADLER Episiotomie Schere.....	AH-22, AI-34
BRAUN	
Uterus Depressor	HA-39
Vaginal Spekulum	HA-16
BREISKY Vaginal Spekulum	HA-20
BROCK	
Griff für Herz-Dilatatoren	FG-26
Spreizweite für Herz-Dilatatoren	FG-26
Stanze für Herz-Dilatatoren	FG-26
BROWN Pinzette.....	BA-03
BRUENINGS	
Kehlkopf Zange	FC-03
Nasen scharfe Zange	EG-05
Ohr Spekula	EE-02
Septatom	EG-11
Tonsillen Schnürer	FA-04
Verlängerung Rohr	FC-03
Zungen Spatel	EI-02
BRUNETTI Wirbelsäulenmeißel	DC-17
BRUNNER	
Darm Klemme	GE-06
Fuehrungshohl Sonde	CG-04
Rippen Schere	FG-07
BRUNS	
Gips Schere	AI-48
Scharfe Löffel.....	DC-12 bis DC-13
BRYANT Schwamm Zange.....	BG-11
BUCHWALD	
Zungen Spatel	EI-02
BUCK	
Fremdkörper Hebel	EE-08
Ligatur Schere	AI-40
Ohr Kürette.....	EE-05
Perkussions Hammer.....	AC-07
Bügel	
BOEHLER Extension Bügel.....	DD-10
Extension Bügel.....	DD-10
KIRSCHNER Extension Bügel.....	DD-10
BUIE Saug Kanüle	GI-05
BUMM	
Uterus-Faß Zange.....	HA-38
Uterus Kürette	HA-49 bis HA-50
BUNGE Exenterations Löffel.....	EC-07
BUNNELL	
Handbohr Apparat.....	DD-05
Sehnen Stripper.....	DC-25
BUNT	
Sterilisier Klammer	CI-02
BURCH Fixier Gabel.....	EC-05
BURKE-Baby	
Probeexcisions Zange.....	HA-44
BURKE Probeexcisions Zange	HA-44
BUSCH Nabelschnur Schere.....	AI-34

D

Inhaltsverzeichnis Deutsch

C

CARMALT Splitter Pinzette	BA-06
CARPENTER Tonsillen Messer	FA-02
CASPAR	
Cervical Wirbelsäule Wund Spreizer	BI-18
ges. Wirbelsäule Valve	BI-19
ges. Wirbelsäule Wund Sperrer	BI-19
Mikro Skalpellgriff	AG-12
Muskelab Spreizer	BI-20
Valve	BI-20
Wund Sperrer	BI-20
CASTAÑEDA	
Atraumatische Neonatal und Kinder Klemme	BD-42
Rippen Sperrer	FG-14
CASTROVIEJO	
Cyclodialyse Spatel	EC-08 bis EC-09
Fixier Pinzette	ED-03
Hornhaut Schere	AJ-06
Hornhaut Trepheine	ED-07
Iridectomie Schere	AJ-05
Kapsel Pinzette	ED-04
Klingenbrecher	AG-14
Kompass Markier	EC-09
Lanzen Messer	EC-04
Nadelhalter	CE-07
Naht Pinzette	ED-05
Sperr Elevatorium	EC-03
Tränenkanal Dilator	EC-10
CATLIN Amputations Messer	AG-16
CHAPUT Arterien Klemme	BC-08
CHARRIERE	
Amputations Säge	DD-03
Sägeblatt	DD-03
CHEATLE Sterilisier Zange	CI-02
CHERON Tupfer Zange	BG-12
CHEVALIER-JACKSON Kehlkopf Zange	FC-04
CHEVALLIER Rippen Sperrer	FG-15
CHILDE Wundklammer Zange	CG-07
CINELLI Nasenplastik Meißel	EG-13
CITELLI Stanze	EG-08
CLARK	
Sperr Elevator	EC-02
CLAR	
Mini Stirnlampe	AC-05
Stirnlampe	AC-05
CLEVELAND Hohlmeißel Zange	DC-02
Clip	
EDWARDS Clips	BD-21
YASARGIL Standard Clips	EA-13
YASARGIL Temporäre Clips	EA-12
CLOWARD	
Wirbelkoerper Spreizer	EA-07
Wund Sperrer	BI-17
CM Abfall Zange	CI-03
CM Alu Stimmgabel	EE-03
CM-Instrumente	
Augen Magnet	ED-08
Fingerring Säge	DD-03
CM-Instrumente	
Klingenbrecher	AG-14
Verbands Schere	AI-46
Watteträger	CA-03
Wund Sperrer	BI-14
COAKLEY	
Antrum Kürette	EG-18
Trokar	CC-02
COLCLOUGH Bandscheiben Stanze	EA-11
COLLIER Nadelhalter	CE-02
COLLIN	
Arterien Klemme	BC-08
Bauch Deckenhalter	BI-24 bis BI-25
Becken Zirkel	HC-06
COLLIN-DUVAL Pinzette	BA-04
COLLIN	
Dynamometer	AC-03
Hammer	DC-18
COLLIN-HARTMANN Wund Haken	BI-03
COLLIN	
Nabelschnur Klemme	HC-06
COLLIN-POZZI Haken Zange	HA-32
COLLIN	
Skalpell Griff	AG-08
Tupfer Zange	BG-11
Uterus-Faß Zange	HA-37
Uterus Sonde	HA-39
Vaginal Spekulum	HA-04
Wundklammer Zange	CG-07
Zungen Zange	EI-03
COLLYER Becken Zirkel	HC-06
COLVER Tonsillen Fass Zange	FA-03
CONNIN-AMSLER Markier Instrument	EC-09
CONVERSE Nasen Messer	EG-10
COOLEY	
Atraumatische Anastomosen Klemme	BD-37, BD-40
Atraumatische Bulldog Klemme	BD-33 bis BD-34
Atraumatische Iliaca Klemme	BD-37
Atraumatische Kindergrößen Klemme	BD-38 bis BD-39
Atraumatische Klemme	BD-35 bis BD-37, BD-39, BD-41
Atraumatische Pinzette	BB-03
Atrium Haken	FG-20
COOLEY DERRA	
Atraumatische Anastomosen Klemme	BD-39
COOLEY	
Gefäß Dilator	FG-30
Gefäß Klemme	BD-40
Herz Dilator	FG-27 bis FG-29
COOLEY modif. STRUCK Atrium Haken	FG-20
COOLEY	
Rippen Schere	FG-05
Rippen Sperrer	FG-09
COOPER Unterbindungs Nadel	CG-02
CORDES Kehlkopf Zange	FC-03
CORWIN Tonsillen Kompressorium	FA-04
CORYLLOS Rippen Schere	FG-04
CORYLLOS (Thorax) Wund Haken	BI-13
COTTLE-KAZANJIAN Knochensplitter Zange	DC-06
COTTLE	
Nasen Messer	EG-10
Nasenplastik Meißel	EG-13
Nasenrücken Haken	EG-17
Nasen Schere	AH-18, AI-25
Nasen Spekulum	EG-03
COTTLE-NEIVERT Nasenrücken Haken	EG-17
COTTLE	
Periost Elevatorium	EG-12
Septum Elevatorium	EG-12
COXETER Harnröhren Bougie	GG-17
CRAFOORD	
Arterien Bronchus Klemme	BC-12
Lungen und Thorax Schere	AI-36
CREDO Hornhaut Hobel	HE-03
CRILE Arterien Klemme	BC-05
CRILE-MURRAY Nadelhalter	CE-02
CRILE Nadelhalter	CE-04
CRILE-RANKIN Arterien Klemme	BC-05
CRILE TITAN Arterien Klemme	BC-05
CRILE-WOOD Nadelhalter	CE-02
CRILE Wund Haken	BI-02
CRITCHETT Sperr Elevator	EC-02
CRUTCHFIELD Schädelhalter	EA-03
Vorböhrer	EA-03

CULLER Iris Spatel	EC-08
CUSCO Vaginal Spekulum	HA-04 bis HA-06
CUSHING	
Flachbohrer	DD-04
Hirn Spatel	EA-07
Laminektomie Zange	EA-08
CUSHING	
Nerv Haken	EA-04
Pinzette	BA-03
Wund Haken	BI-07
CUZZI Plazentar und Abortus Löffel	HC-08
Cystotom	
BECKER	EC-06
GRAEFE	EC-06
CZERNY	
Gallenstein Zange	GC-03
Haken Zange	HA-34
Rektal Spekulum	GI-02

D

DALE Atraumatische Peripher-Vascular Klemme	BD-24
DANDY	
Arterien Klemme	BC-07
Nerv Haken	EA-04
Neurochirurgische Schere	AI-36
DARDIK Atraumatische Klemme	BD-07
DARLING Wund Sperrer	BI-17
Darm Schere	AI-39
DARTIGUES Uterus-Faß Zange	HA-37
DASTOOR	
Kapsel Sauger	EC-09
Strabismus Pinzette	EC-14
DAVIDSON (Scapula) Wund Haken	BI-13
DAVIEL Star Löffel	EC-07
DAVIS-BOYLE Mund Sperrer	EI-04
DAVIS	
Dura Dissektor	EA-05
Fremdkörper Nadel	EC-05
Sterilisier Zange	CI-02
DAY Ohr Häkchen	EE-07
DEAN	
Iris Messer	EC-04
Tonsillen Schere	AI-26
DEAVER Grip Wund Haken	BI-05
DEAVER	
Schere	AH-05, AI-06
Wund Haken	BI-05
DE BAKEY	
Atraumatische Anastomosen Klemme	BD-25
Atraumatische Aorta-Aneurysma	
Klemme	BD-13, BD-15, BD-18
Atraumatische Bronchus Klemme	BD-19
Atraumatische Bulldog Klemme	BC-02
Atraumatische Iliaca Klemme	BD-11
DE BAKEY Atraumatische Klemme	BD-02, BD-08
DE BAKEY Atraumatische Klemme	BD-16 bis BD-17
DE BAKEY Atraumatische Klemme	BD-20
DE BAKEY	
Atraumatische Klemme	BD-28 bis BD-30
Atraumatische Peripher-Vascular Klemme	BD-06
Atraumatische Pinzette	BB-03
Atraumatische Präparier und Ligatur Klemme	BD-25, BD-32
DE BAKEY BAHNSON	
Atraumatische Aorta-Aneurysma Klemme	BD-14
DE BAKEY	
Gefäß Dilatator	FG-31
Gefäß Schere	AI-30
DE BAKEY MORRIS	
Atraumatische Klemme	BD-16
DE BAKEY Nadelhalter	CE-03
DE BAKEY REYNOLDS	
Atraumatische Anastomosen Klemme	BD-30
DE BAKEY SATINSKY	
Atraumatische Klemme	BD-22
DE BAKEY	
Sauger	AE-04
Deckenhalter (Bauch)	
BALFOUR Baby Bauch Deckenhalter	BI-22
BALFOUR Bauch Deckenhalter	BI-22
COLLIN Bauch Deckenhalter	BI-24 bis BI-25
Deckenhalter (Bauch)	
GELPI Bauch Deckenhalter	BI-24
GOSSET Bauch Deckenhalter	BI-21
KIRSCHNER Bauch Deckenhalter	BI-23
O'SULLIVAN-O'CONNOR Bauch Deckenhalter	BI-21
RIGBY Bauch Deckenhalter	BI-24
DEJERINE Perkussions Hammer	AC-07
De LEE Geburts Zange	HC-02
De MARTEL Umfuehr Instrument	EA-05
De MARTEL-WOLFSON Anastomosen Klemme	GE-07
DENHART Mund Sperrer	EI-03
Depressor	
BRAUN Uterus	HA-39
SIMS Uterus	HA-39
DERF Nadelhalter	CE-02
Dermatom	
BRAITHWAITE Dermatom	AG-22
Ersatz Klinge	AG-21
HUMBY Dermatom	AG-20
SCHINK Dermatom	AG-21
SILVER Dermatom	AG-20
WATSON Dermatom	AG-22
DERRA	
Atraumatische, Anastomosen, Kinder Klemme	BD-28
DESCHAMPS	
Unterbindungs Nadel	CG-02
DESJARDINS	
Gallenkanal Klemme	BC-15
Gallenstein Löffel	GC-08
Gallenstein Sonde	GC-05
Gallenstein Zange	GC-02
DESMARRES	
Chalazion Pinzette	ED-06
Wund Haken	BI-07
DEUTSCHMANN Star Messer	EC-03
DeVILBISS Schädelzange	EA-05
DEWEY	
Geburts Zange, mit Achsenzugvorrichtung	HC-05
Diagnostik Besteck	AC-04
DIAMANT Draht Schneider	DD-12
DIEFFENBACH	
Gefäß Bulldog Klemme	BC-03
DIETER Hammerkopf Stanze	EE-10
DIETHRICH	
Atraumatische Klemme	BD-31
Gefäß Nadelhalter	CE-06
Gefäß Schere	AI-29
Dilatator	
BAKES Gallenkanal Dilatoren	GC-06
CASTROVIEJO Tränenkanal Dilator	EC-10
COOLEY Gefäß Dilator	FG-30
COOLEY Herz Dilator	FG-27 bis FG-29
DE BAKEY Gefäß Dilator	FG-31
GERBODE Herz Dilator	FG-28
GOODELL Uterus Dilator	HA-30
HANK Uterus Dilator	HA-28
HEGAR Uterus Dilator	HA-24 bis HA-27
HETZER Herz Dilator	FG-29
LABORDE Tracheal Dilator	FE-02
PRATT Uterus Dilator	HA-29
SIMS Uterus Dilator	HA-30

D

Inhaltsverzeichnis Deutsch

TROUSSEAU Tracheal Dilator	FE-02
TUBBS Herz Dilator	FG-27
WILDER Tränenkanal Dilator	EC-10
WYLIE Uterus Dilator	HA-30
ZIEGLER Tränenkanal Dilator	EC-10
DINGMANN Knochenhalte Zange	DC-10
Dissektor	
DAVIS Dura Dissektor	EA-05
Dura Dissektor	EA-05
FISCH Dissektor	EE-15
GREEN Hornhaut Dissektor	EC-06
HORSLEY Dura Dissektor	EA-06
HURD Tonsillen Dissektor	FA-02
MILLIGAN Dura Dissektor	EA-05
PATON Hornhaut Dissektor	EC-05
PENFIELD Dura Dissektor	EA-06
ROBB Gefäß Dissektor	FG-33
SACHS Dura Dissektor	EA-05
TOENNIS Dura Dissektor	EA-05
DITTEL	
Harnröhren Bougie	GG-18 bis GG-19
Katheter Spanner	GG-11
DIX	
Flachmeißel Nadel	EC-09
Fremdkörper Flachmeißel	EC-06
Dose	
Nadel Dose	HE-02
SAUERBRUCH Nadel Dose	HE-02
DOUGLAS	
Cilien Pinzette	ED-08
Trokar	CC-02
DOYEN-Baby Darm Klemme	GE-03
DOYEN	
Darm Klemme	GE-03
Fräser	DD-07
Gynäkologische Schere	AI-33
DOYEN-JANSEN Mund Sperrer	EI-03
DOYEN	
Myom Heber	HA-46
Rippen Raspatorien	DC-20
Sonde	CA-02
Tuch Klemme	BE-05
Uterus-Polypen Zange	HA-36
Vaginal Spekulum	HA-18, HA-20
Wund Haken	BI-12
Drahtschlinge Elektrode	JA-03
Dreher	
LANE Schrauben Dreher	DD-14
Schrauben Dreher	DD-14 bis DD-15
WILLIAMS Schrauben Dreher	DD-14
DUBOIS Gynäkologische Schere	AI-33
DUPLAY	
Haken Zange	HA-31
Tupfer Zange	BG-14
Duplex Stethoskop	AC-06
DUPUY-WEISS	
Tonsillen Nadel	FA-03
DUVAL	
Darmfaß Zange	GE-03
Pinzette	BA-04
Dynamometer COLLIN	AC-03
E	
ECHLIN Hohlmeißel Zange	DC-05
EDWARDS	
Clip	BD-21
Clip Anlegezange Klemme	BD-21
Eimer Abfall	HE-11
Einschläger	DD-12
Elektrode Koagulieren Mini	JA-02 bis JA-03

Elevator	
ARRUGA Sperr Elevator	EC-02
BARRAQUER Colibri Sperr Elevator	EC-02
BOWMAN Sperr Elevator	EC-02
CASTROVIEJO Sperr Elevator	EC-03
CLARK Sperr Elevator	EC-02
CRITCHETT Sperr Elevator	EC-02
GOLDSTEIN Sperr Elevator	EC-03
GRAEFE Sperr Elevator	EC-02
HENKE Tonsillen Elevator	FA-02
Elevatoren	
ADSON Elevatoren	DC-21
KEY Elevatoren	DC-21
LANGENBECK Elevatoren	DC-21
McDONALD Elevatoren	DC-22
MURPHY-LANE Elevatoren	DC-22
WATSON-CHEYNE Elevatoren	DC-22
Elevatorium	
BALLENGER Septum Elevatorium	EG-12
COTTLE Periost Elevatorium	EG-12
COTTLE Septum Elevatorium	EG-12
FREER Septum Elevatorium	EG-11
HAJEK-BALLENGER Septum Elevatorium	EG-12
JOSEPH Periost Elevatorium	EG-12
KILLIAN Septum Elevatorium	EG-12
LEMPERT Elevatorium	EE-15
McKENTY Septum Elevatorium	EG-11
ROGER Septum Elevatorium	EG-11
Elevator	
LANCASTER Sperr Elevator	EC-03
LISTER-BURCH Sperr Elevator	EC-02
MELLINGER-AXENFELD Sperr Elevator	EC-02
MELLINGER Sperr Elevator	EC-02
MUELLER Sperr Elevator	EC-03
MURDOCK Sperr Elevator	EC-02
PARK Sperr Elevator	EC-03
SMITH Sperr Elevator	EC-02
STEVENSON Sperr Elevator	EC-03
WEEK Sperr Elevator	EC-02
WILLIAMS Sperr Elevator	EC-02
ZIEGLER Sperr Elevator	EC-03
ELLIOT	
Geburts Zange	HC-02
Hornhaut Trephine	ED-08
ELLIS Fremdkörper Hohlmeißel	EC-06
ELSAESSER	
Nieren Fistel Zange	GC-13
ELSCHNIG	
Cyclodialyse Spatel	EC-08
Fixier Pinzette	ED-03
Hornhaut Messer	EC-05
Kapsel Pinzette	ED-04
EMMET	
Fistel Haken	HA-46
ENGEL Gips Säge	DA-02
EPENDORFER-KEVORKIAN	
Probeexcisions Zange	HA-46
EPENDORFER	
Probeexcisions Zange	HA-45 bis HA-46
EPENDORFER TISCHLER-MORGAN	
Probeexcisions Zange	HA-46
ERBE SELECT HF	
Chirurgie Geräte Kabel	JA-07
ESMARCH	
Gips Messer	DA-04
Verband Schere	AI-46
Etui Edelstahl rostfrei	HE-03
EVES	
Tonsillen Schnürer	FA-04
Extraktor KUENTSCHER	DD-13

F

FARABEUF	
Knochenhalte Zange.....	DC-07
FARABEUF-LAMBOTTE Knochenhalte Zange	DC-08
FARABEUF	
Raspatorien.....	DC-19
Wund Haken.....	BI-02
FARREL Watteträger.....	CA-03
Faseroptik Laryngoskopegriff	AE-11
FAULKNER Kürette	EG-18
FAURE	
Peritoneum Klemme	BC-17
Probeexcisions Zange	HA-41
FEHLAND Darm Klemme	GE-06
FEILCHENFELD Splitter Pinzette	BA-06
Feile	
JOSEPH Knochen Feile	EG-14
Nagel Feile.....	HE-03
Feine Scheren.....	AI-19, AI-24
FERGUSSON	
Arterien Klemme	BC-07
Gallenstein Löffel.....	GC-07
Knochenhalte Zange.....	DC-07
Schere	AI-49
FERRIS Pinzette	BA-04
FERRIS-SMITH-KERRISON Bandscheiben Stanze.....	EA-10
FERRIS-SMITH Laminektomie Zange	EA-09
Fertigschläger KUENTSCHER	DD-13
FILIFORM Harnröhren Bougie	GG-12
Fingerschutz LANGENBECK.....	EI-06
FINOCHIETTO-BABY Rippen Sperrer.....	FG-09
FINOCHIETTO	
Bronchus Klemme.....	FG-21
FINOCHIETTO BURFORD	
Rippen Sperrer.....	FG-12 bis FG-14
FINOCHIETTO-HAIGHT BABY Rippen Sperrer.....	FG-10
FINOCHIETTO INFANT Rippen Sperrer.....	FG-12
FINOCHIETTO (modif) Rippen Sperrer	FG-08
FINOCHIETTO	
Nadelhalter.....	CE-04
Rektum Schere	AI-38
Rippen Sperrer.....	FG-08, FG-10 bis FG-11
FINSSEN Wund Sperrer	BI-14
FINSTERER Saug- und Spül Kanüle.....	AE-05
FISCH Dissektor.....	EE-15
FISCHER Iris Pinzette.....	EC-13
Fixations-System LEYLA.....	EA-14 bis EA-18
Flachbohrer CUSHING	DD-04
Flachmeißel.....	DC-14
ALEXANDER Flachmeißel	DC-14
DIX Fremdkörper Flachmeißel.....	EC-06
HIBBS Flachmeißel	DC-16
HOKE Flachmeißel	DC-16
LEXER Flachmeißel	DC-16
LEXER Mini Flachmeißel.....	DC-16
PARTSCH Flachmeißel	DC-14
SMITH-PETERSEN Flachmeißel	DC-15
STILLE Flachmeißel	DC-14
FLETCHER JAVERTS Schwamm Zange	BG-10
FLEURANT Trokar.....	CC-02
FOERSTER	
Iris Pinzette	EC-12
Schwamm Zange.....	BG-06 bis BG-08
FOMON	
Nasenplastik Meißel	EG-13
Nasen Raspel	EG-15 bis EG-16
Nasenrücken Haken	EG-17
Nasen Schere.....	AH-18, AI-25
FORD BOWLES Stethoskop.....	AC-06
FORD Stethoskop.....	AC-06

FOX Lupus Kürette	HE-02
FRAENKEL	
Kehlkopf Polypus Zange	FC-02
Kehlkopf Zange	FC-03
FRANCESCHETTI Hornhaut Trephine	ED-07
FRANCIS Fremdkörper Nadel	EC-05
FRANKLIN-SILVERMANN Punktions Nadel.....	CC-03
Fräser.....	DD-07
ALBEE Fräser.....	DD-07
BORCHARDT Fräser.....	DD-07
DOYEN Fräser.....	DD-07
HUDSON Kegel Fräser.....	DD-04
Kegel Fräser	DD-04
Kortikalis Fräser.....	DD-15
TOTI Fräser	DD-07
FRAZIER	
Häkchen.....	BI-06
Sauger.....	EA-07
Wund Spreizer	BI-21
FREER	
Mukosa Messer	EG-10
Nasen Hohl Meißel	EG-14
Septum Elevatorium.....	EG-11
Septum Meißel.....	EG-12
Septum Messer.....	EG-10
FREEWAY-GRAVE	
Vaginal Spekulum	HA-06
FRENZEL Zungen Spatel.....	EI-02
FRIEDMAN	
Hohlmeißel Zange	DC-02
Mini Hohlmeißel Zange.....	DC-02
Perineorrhaph Sperrer	HA-23
FRITSCH Wund Haken.....	BI-11
FRYKHOLM Hohlmeißel Zange.....	DC-05
FUCHS Kapsel Pinzette.....	ED-04
Für Faseroptik Laryngoskope Ersatzlampe	AE-20
Für Standard Laryngoskope Ersatzlampe.....	AE-20

G

Gabel BURCH Fixier	EC-05
GALLAHER Antrum Raspel	EG-16
GAUSS Kopfschwarten Zange	HC-06
Gefäß Klemme, flexibel.....	BD-44 bis BD-45
Gefäß Schere	AI-27
Gefäß Schere Mikro.....	AJ-09
GELHORN Probeexcisions Zange.....	HA-42
GELPI Bauch Deckenhalter.....	BI-24
GEMINI MINI Präparier und Ligatur Klemme	BC-10
GEMINI Präparier und Ligatur Klemme	BC-10
GERALD Pinzette.....	BA-05
GERBODE Herz Dilator	FG-28
GERSTER Distractions Klammer.....	DC-11
GERZOG Hammer.....	DC-18
GIERTZ-STILLE Rippen Schere	FG-06
GIGLI für Drahtsäge Griff	EA-05
GILL-ARRUGA Kapsel Pinzette	ED-03
GILL-HESS Iris Pinzette.....	EC-12
GILL	
Hornhaut Messer	EC-05
GILLIES	
Häkchen.....	EG-17
Nadelhalter.....	CE-05
Pinzette	BA-05
GILL	
Iris Pinzette	EC-12
Gips Messer	DA-04
Gipssäge Sägeblatt.....	DA-05 bis DA-06
Gips Schere	AI-49
Gips Spreizer	DA-03
Glasschale.....	HE-03

D

Inhaltsverzeichnis Deutsch

GLOVER			
Atraumatische Anastomosen Klemme	BD-05		
Atraumatische Bulldog Klemme	BC-02		
Atraumatische Coarctation Klemme	BD-04		
Atraumatische Klemme	BD-06, BD-30		
GLUCK Rippen Schere	FG-03		
GOELET Wund Haken	BI-03		
GOLDMAN-FOX Zahnfleisch Schere	AI-41		
GOLDSTEIN Sperr Elevator	EC-03		
GOODSELL Uterus Dilator	HA-30		
GOOD Tonsillen Schere	AI-27		
GORNEY Präparier Schere	AI-13		
GOSSET Bauch Deckenhalter	BI-21		
GOURDET Uterus Kürette	HA-48		
GRADLE Cilien Pinzette	ED-08		
GRAEFE			
Cystotom	EC-06		
Fixier Pinzette	ED-03		
Häkchen	BI-06		
Iris Pinzette	EC-11		
Pinzette	BA-03		
Schiel Haken	EC-06		
Skarifikateur	EC-04		
Sperr Elevator	EC-02		
Star Löffel	EC-07		
Star Messer	EC-03		
GRAEFE-TITAN Schiel Haken	EC-06		
GRAHAM Nerv Haken	EA-04		
GRAVE Vaginal Spekulum	HA-02		
GRAY Gallenkanal Klemme	BC-15		
Graziles Modell Tuch Klemme	BE-02		
GREEN-ARMYTAGE			
Uterus zur Blutstillung Klemme	HC-06		
GREEN			
Fixier Pinzette	ED-03		
Hornhaut Dissektor	EC-06		
Muskel Haken	EC-06		
Wund Haken	BI-10		
GREGORY Atraumatische Profunda Klemme	BD-33		
GREVEN Ohr Mikro Zängchen	EE-10		
Griff			
BROCK Griff für Herz-Dilatatoren	FG-26		
COLLIN Skalpell Griff	AG-08		
GIGLI Griff für Drahtsäge	EA-05		
HUBER Universal Griff	FC-03		
Kehlkopf Spiegel Griff	FC-04		
GRIP Zange	DD-11		
Große Ringe Präparier Schere	AI-19		
GROSS-MAIER Tupfer Zange	BG-02 bis BG-04		
GROSS			
Ohr Löffel	EE-06		
Tupfer Zange	BG-05		
GRUBER Ohr Spekula	EE-02		
GUTHRIE Häkchen	BI-06		
GUTMANN Sekret Löffel	GG-11		
GUYON			
Gleit Sonde	GG-12		
Harnröhren Bougie	GG-14 bis GG-15		
Katheter Spanner	GG-11		
Nierenstiel Klemme	BC-16		
GUYTON-LUNDSGAARD Sklerotom	EC-05		
Gynäkologische Mikro Schere	AJ-07 bis AJ-08		
H			
HABERER Wund Haken	BI-04		
HAGLUND-STILLE Gips Spreizer	DA-03		
HAIGHT Rippen Sperrer	FG-15		
HAJEK-BALLENGER Septum Elevatorium	EG-12		
HAJEK-CLAUS Stanze	EG-08		
HAJEK-KOFLER Stanze	EG-08		
HAJEK Nasen Hohl Meißel	EG-14		
Häkchen	EE-15		
BARBARA Häkchen	EE-14		
BOSE Tracheal Häkchen	FE-02		
DAY Ohr Häkchen	EE-07		
FRAZIER Häkchen	BI-06		
GILLIES Häkchen	EG-17		
GRAEFE Häkchen	BI-06		
GUTHRIE Häkchen	BI-06		
ITERTSON Tracheal Häkchen	FE-02		
JACKSON Tracheal Häkchen	FE-02		
JOSEPH Häkchen	BI-06		
KILNER Haut Häkchen	HE-02		
KNAPP Häkchen	EC-06		
ROLLET Häkchen	EC-06		
ROSE Tracheal Häkchen	FE-03		
WAGENER Ohr Häkchen	EE-07		
Haken			
ADSON Nerv Haken	EA-04		
ARRUGA Extraktion Haken	EC-06		
AUFRICHT Nasenrücken Haken	EG-17		
BLOUNT Knie Haken	DC-24		
BRAUN Dekapitations Haken	HC-09		
COLLIN-HARTMANN Wund Haken	BI-03		
COOLEY Atrium Haken	FG-20		
COOLEY modif. STRUCK Atrium Haken	FG-20		
CORYLLOS (Thorax) Wund Haken	BI-13		
COTTLE Nasenrücken Haken	EG-17		
COTTLE-NEIVERT Nasenrücken Haken	EG-17		
CRILE Wund Haken	BI-02		
CUSHING Nerv Haken	EA-04		
CUSHING Wund Haken	BI-07		
DANDY Nerv Haken	EA-04		
DAVIDSON (Scapula) Wund Haken	BI-13		
DEAVER Grip Wund Haken	BI-05		
DEAVER Wund Haken	BI-05		
DESMARRES Wund Haken	BI-07		
DOYEN Wund Haken	BI-12		
Elektrode mini	JA-02		
EMMET Fistel Haken	HA-46		
Extraktion Haken	DD-13		
FARABEUF Wund Haken	BI-02		
FOMON Nasenrücken Haken	EG-17		
FRITSCH Wund Haken	BI-11		
für Extensionbügel	DD-10		
GOELET Wund Haken	BI-03		
GRAEFE Schiel Haken	EC-06		
GRAEFE-TITAN Schiel Haken	EC-06		
GRAHAM Nerv Haken	EA-04		
GREEN Muskel Haken	EC-06		
GREEN Wund Haken	BI-10		
HABERER Wund Haken	BI-04		
HARRINGTON Wund Haken	BI-05		
HEANEY Wund Haken	BI-12		
HOFER Gaumenbogen Haken	FA-02		
ISRAEL Wund Haken	BI-11		
JAMESON Schiel Haken	EC-06		
KELLY Grip Wund Haken	BI-04		
KELLY Wund Haken	BI-04, BI-12		
KOCHER Wund Haken	BI-10 bis BI-11		
KOERTE Wund Haken	BI-11		
LAHEY Wund Haken	BI-08		
LANGENBECK Wund Haken	BI-09		
LITTLE Wund Haken	BI-08		
LOVE Nerv Haken	EA-04		
LOVE Zäpfchen Haken	FA-02		
MATHIEU Wund Haken	BI-03		
MEYERDING Wund Haken	BI-08		
MIDDELDORPF Wund Haken	BI-10		
MIKULICZ Wund Haken	BI-12		
NAGER Gaumensegel Haken	FA-02		

Haken		HARTMANN	
O' CONNOR Iris Haken	EC-06	Nasen Polypus Zange	EG-04
OLLIER Wund Haken	BI-10	Nasen scharfe Zange	EG-07
PARKER Wund Haken	BI-02	Ohr Katheter	EE-06
PRATT Cystikus Haken	GI-04	Ohr Spekula	EE-02
REVERDIN Wund Haken	BI-04	Ohr Zängchen	EE-08
RIBBON Wund Haken	BI-04	Stimmgabel	EE-03
RICHARDSON-EASTMAN Wund Haken	BI-04	HARTMANN-WULLSTEIN Ohr Zängchen	EE-08
RICHARDSON Grip Wund Haken	BI-04	HARTMANN	
RICHARDSON Wund Haken	BI-04	Zungen Spatel	EI-02
ROUX Baby Wund Haken	BI-02	HEANEY	
ROUX mini Wund Haken	BI-02	Hysterektomie Klemme	BC-18
ROUX Wund Haken	BI-02	Nadelhalter	CE-03
SACHS Nerv Haken	EA-04	Wund Haken	BI-12
SAUERBRUCH Wund Haken	BI-13	HEATH Ligatur Schere	AI-40
SCHOENBORN Schilddrüsen Haken	FE-04	Hebel	
SENN-GREEN Wund Haken	BI-07	BARTON Zug Hebel	HC-04
SENN Wund Haken	BI-04	BENNETT Knochen Hebel	DC-22
SIMON Wund Haken	BI-12	BILL Zug Hebel	HC-05
SMELLIE Geburts Haken	HC-06	BLOUNT Knochen Hebel	DC-24
SMITHWICK Nerv Haken	EA-04	BUCK Fremdkörper Hebel	EE-08
STEVENS Linsen Haken	EC-06	HOHMANN Knochen Hebel	DC-22 bis DC-23
TAYLOR Spinal Haken	DC-24	HOHMANN Mini Knochen Hebel	DC-23
US Army (PARKER-LANGENBECK)		Knochen Hebel	DC-23
Wund Haken	BI-03	LUIKART-BILL Zug Hebel	HC-05
VOLKMANN Wund Haken	BI-07 bis BI-08	MURLESS Kopf Hebel	HC-05
WIENER Iris Haken	EC-06	QUIRE Fremdkörper Hebel	EE-08
YOUNG Prostata Haken	GG-02	Heber DOYEN Myom	HA-46
HALLE		HEBRA Chalazion Löffel	EC-07
Dura Messer	EA-06	HEGAR Uterus Dilatator	HA-24 bis HA-27
Scharf Löffel	DC-13	HEGENBARTH Wundklammer Zange	CG-07
HALSEY Nadelhalter	CE-02	HEIFETZ Hirn Spatel	EA-07
HALSTED-MOSQUITO		HEIMING Nierenstein Zange	GC-13
Arterien Klemme	BC-04	HEISS Arterien Klemme	BC-09
Atraumatische Klemme	BD-02	HEISTER Mund Sperrer	EI-03
HALSTED-MOSQUITO Micro Arterien Klemme	BC-04	HENKE Tonsillen Elevator	FA-02
HALSTED-MOSQUITO TITAN Arterien Klemme	BC-04	HENNIG Gips Spreizer	DA-03
Halter		HENROTIN Haken Zange	HA-34
KALLMORGEN Schneiden Halter	HA-15	HERMANN Gips Spreizer	DA-03
KRISTELLER Schneiden Halter	HA-09 bis HA-14	HERRICK Peritoneum Klemme	BC-17
Lippen und Wangen Halter	EI-03	HERTZLER Rippen Sperrer	FG-17
PITHA Lippen Halter	EI-06	HESS	
REICHERT Kehlkopfpolypendeckel Halter	FC-02	Iris Pinzette	EC-12
STERNBERG Lippen Halter	EI-02	Kapsel Pinzette	ED-04
Wangen Halter	EI-03	HETZER Herz Dilatator	FG-29
Hamburg Knopf Kanüle	ED-07	HEYMANN-KNIGHT Nasen Polypus Zange	EG-05
Hammer	DC-18	HEYMANN	
BABINSKY Perkussions Hammer	AC-07	Nasen scharfe Zange	EG-05
BERLINER Perkussions Hammer	AC-07	Nasen Schere	AH-18, AI-25
BUCK Perkussions Hammer	AC-07	HEYWOOD-SMITH Hämorrhoid Zange	GI-05
COLLIN Hammer	DC-18	HIBBS	
DEJERINE Perkussions Hammer	AC-07	Flachmeißel	DC-16
GERZOG Hammer	DC-18	Hohlmeißel	DC-16
KIRK Hammer	DC-18	Osteotom	DC-16
LUCAE Hammer	DC-18	HIRSCHMANN Anoskop	GI-04
MEAD Hammer	DC-18	Hobel CREDO Hornhaut	HE-03
QUISLING Hammer	DC-18	HOESEL Nadelhalter	CE-05
Schlitz Hammer	DD-13	HOFFER Gaumenbogen Haken	FA-02
TAYLOR Perkussions Hammer	AC-07	HOFF Tuch Klemme	BE-03
TRAUBE Perkussions Hammer	AC-07	Hohlmeißel	DC-14
TROEMNER Perkussions Hammer	AC-07	ALEXANDER Hohlmeißel	DC-14
WILLIGER Hammer	DC-18	ELLIS Fremdkörper Hohlmeißel	EC-06
HANK Uterus Dilatator	HA-28	HIBBS Hohlmeißel	DC-16
HARKEN Atraumatische Aurikel Klemme	BD-23	LEXER Hohlmeißel	DC-16
HARRINGTON		LEXER Mini Hohlmeißel	DC-16
Bronchus Klemme	FG-21	PARTSCH Hohlmeißel	DC-14
Wund Haken	BI-05	SMITH-PETERSEN Hohlmeißel	DC-15
HARTMANN		STILLE Hohlmeißel	DC-14
Arterien Klemme	BC-03	WALTON Fremdkörper Hohlmeißel	EC-06
HARTMANN-HALLE Nasen Spekulum	EG-02	HOHMANN Knochen Hebel	DC-22 bis DC-23
HARTMANN-HOFFMANN Ohr Zängchen	EE-08	HOHMANN Mini Knochen Hebel	DC-23

D

Inhaltsverzeichnis Deutsch

HOKE Flachmeißel	DC-16
HOLTH Kapsel Stanze	EC-09
HOPKINS Gips Messer	DA-04
HORSLEY Dura Dissektor	EA-06
HOUSE Kürette	EE-15
HRYNTSCHAK Prostata Wundsperrer	GG-06
HUBER Universal Griff	FC-03
HUDSON	
Handbohrapparat Apparat	DD-04
Kegel Fräser	DD-04
HUMBY	
Dermatom	AG-20
Dermatom Ersatz Klinge	AG-20
HUNTER Splitter Pinzette	BA-06
HURD Tonsillen Dissektor	FA-02

I

INGE Wirbelkoerper Spreizer	EA-07
Instrument	
Beschneidungs Instrument	GG-09
KNUTSON Urethrographie Instrument	GG-09
LAFORCE Fremdkörper Instrument	EC-06
MOGAN Beschneidungs Instrument	GG-09
Inzisions Schere	AI-05
IOWA Haken Zange	HA-35
IRIS	
Augen Schere	AI-22
Schere	AH-16, AI-21
Schere, mit großen Ringen	AI-19
Irrigator	HE-05
ISRAEL Wund Haken	BI-11
ITARD Ohr Katheter	EE-06
ITERSON Tracheal Häkchen	FE-02
IVES-FANSLER Anoskop	GI-04

J

JACKSON	
Tampon Pinzette	FC-02
Tracheal Häkchen	FE-02
Tracheal Kannule	FE-03
Vaginal Spekulum	HA-16
JACOBS Haken Zange	HA-34
JACOBSON Mikro Schere	AJ-11
JAEGER	
Lanzen Messer	EC-04
Lid Platte	EC-03
JAMESON	
Schiel Haken	EC-06
Strabismus Pinzette	EC-13
JAMISON Nadelhalter	CE-03
JANSEN	
Nasen Zange	EG-04
Wund Sperrer	BI-14
JARCHO Haken Zange	HA-32
JATHO Nasenrachen Zange	EG-18
JAVID Atraumatische Carotis Klemme	BD-32
JENNINGS Mund Sperrer	EI-04
JOBSON-HORNE Watteträger	CA-03
JOHNS-HOPKINS	
Gallenkanal Klemme	BC-14
Gefäß Bulldog Klemme	BC-03
JOHNSON Nadelhalter	CE-04
JONES Schlauchhalter Tuch Klemme	BE-02
JOSEPH	
Häkchen	BI-06
Knochen Feile	EG-14
JOSEPH (LEWIS) Nasen Rasper	EG-15
JOSEPH	
Nasen Messer	EG-10

JOSEPH

Nasen Säge	EG-17
Nasen Skalpell	EG-10
Periost Elevatorium	EG-12
Schere	AH-14, AI-16
JUDD-ALLIS Darmfaß Zange	GE-02
JUDD-MASSON Blasen Wundsperrer	GG-04
JURASZ Kehlkopf Polypus Zange	FC-02

K

Kabel

AESCULAP HF Chirurgie Geräte Kabel	JA-07
ERBE SELECT HF Chirurgie Geräte Kabel	JA-07
MARTIN HF Chirurgie Geräte Kabel	JA-07
USA HF Chirurgie Geräte Kabel	JA-07
KABIERSKE Pulverbläser	EE-04

KALLMORGEN

Schneiden Halter	HA-15
Vaginal Spekulum	HA-15
KALT-ARRUGA Nadelhalter	CE-07

KALT

Kapsel Pinzette	ED-04
Kaltlicht Rectoskop	GI-03

KALT

Nadelhalter	CE-07
KANE Nabelschnur Klemme	HC-06

Kanüle

JACKSON Tracheal Kanüle	FE-03
LUER Tracheal Kanüle	FE-03
WAGENER-MOSHER Tracheal Kanüle	FE-03

Kanüle

Bonn Spül Kanüle	ED-07
BUIE Saug Kanüle	GI-05
FINSTERER Saug- und Spül Kanüle	AE-05
Hamburg Knopf Kanüle	ED-07
KILLIAN Spül Kanüle	EG-09
SCHEIE Augen Kanüle	ED-07
SIMCOE Naht Kanüle	ED-07
Tonsillen Kanüle	FA-05
Tübingen Luft Kanüle	ED-07

Katheter

HARTMANN Ohr Katheter	EE-06
ITARD Ohr Katheter	EE-06
Metall, Katheter Frauen	GG-16
Metall, Katheter Männer	GG-16

Katheter Spanner

DITTEL Katheter Spanner	GG-11
GUYON Katheter Spanner	GG-11
Kauter WADSWORTH-TODD	EC-08

Kegel Verschluss

Kegel Verschluss	HA-47
------------------------	-------

KEITH Naeh Nadel

KEITH Naeh Nadel	CG-06
------------------------	-------

KELLY

Arterien Klemme	BC-05
KELLY Grip Wund Haken	BI-04

KELLY

Gynäkologische Schere	AI-33
Gynäkologische Schere	AH-22
Proktoskop	GI-04
KELLY-RANKIN Arterien Klemme	BC-05
KELLY TITAN Arterien Klemme	BC-05

KELLY

Uterus-Polypen Zange	HA-36
Wund Haken	BI-04, BI-12

KERN Knochenhalte Zange

KERN Knochenhalte Zange	DC-08
-------------------------------	-------

KERRISON Stanze

KERRISON Stanze	EG-08
-----------------------	-------

KEVORKIAN-Pacific Probeexcisions Zange

KEVORKIAN-Pacific Probeexcisions Zange	HA-44
--	-------

KEVORKIAN

Probeexcisions Zange	HA-43, HA-46
Uterus Biopsie Saug Kürette	HA-40

KEY Elevatorien	DC-21	DE BAKEY Atraumatische Bulldog Klemme	BC-02
KEYES Haut Stanzbesteck	HE-02	Kemme	
Kieferhöhlenpunktionskanülen LICHTWITZ	EG-09	DE BAKEY Atraumatische Iliaca Klemme	BD-11
KIELLAND Geburts Zange	HC-02	DE BAKEY Atraumatische Peripher-Vascular	BD-06
KIELLAND-LUIKART Geburts Zange	HC-03	DE BAKEY Atrauma. Präparier und Ligatur ...	BD-25, BD-32
KILLIAN-CLAUS Nasen Hohl Meißel	EG-14	DEBAKEY BAHNSON	
KILLIAN		Atraumatische Aorta-Aneurysma Klemme	BD-14
Septum Elevatorium	EG-12	DE BAKEY MORRIS Atraumatische Klemme	BD-16
Septum Spekulum	EG-03	DE BAKEY REYNOLDS Atrauma. Anastomosen	BD-30
Spül Kanüle	EG-09	DEBAKEY SATINSKY Atraumatische Klemme	BD-22
KILNER-DOUGHTY Mund Sperrer	EI-05	DeMARTEL-WOLFSON Anastomosen Klemme	GE-07
KILNER		DERRA Atrauma. Anastomosen, Kindergrößen	BD-28
Haut Häkchen	HE-02	DESJARDINS Gallenkanal Klemme	BC-15
Schere	AH-14, AI-17	DIEFFENBACH Gefäß Bulldog Klemme	BC-03
KIRBY-ARTHUR Iris Pinzette	EC-13	DIETHRICH Atraumatische Klemme	BD-31
KIRK Hammer	DC-18	DOYEN-Baby Darm Klemme	GE-03
KIRSCHNER		DOYEN Darm Klemme	GE-03
Bauch Deckenhalter	BI-23	DOYEN Tuch Klemme	BE-05
Bohrdrähte	DD-09	EDWARDS Clip Anlegezange	BD-21
Extension Bügel	DD-10	FAURE Peritoneum Klemme	BC-17
Fuehrungshohl Sonde	CG-04	FEHLAND Darm Klemme	GE-06
Handbohr Apparat	DD-05	FERGUSSON Arterien Klemme	BC-07
Rahmen	BI-23	FINOCHIETTO Bronchus Klemme	FG-21
Valve	BI-23	GEMINI MINI Präparier und Ligatur Klemme	BC-10
Klammer LOWMAN Knochenhalte	DC-11	GEMINI Präparier und Ligatur Klemme	BC-10
Klammerblock	EA-02	GLOVER Atraumatische Klemme	BD-06, BD-30
Klammer		GLOVER Atraumatische Anastomosen Klemme	BD-05
BUNT Sterilisier Klammer	CI-02	GLOVER Atraumatische Bulldog Klemme	BC-02
GERSTER Distraktions Klammer	DC-11	GLOVER Atraumatische Coarctation Klemme	BD-04
MAYO Sterilisier Klammer	CI-02	GRAY Gallenkanal Klemme	BC-15
MICHEL Wund Klammer	CG-07	GREEN-ARMYTAGE Uterus zur Blutstillung	HC-06
RANEY Kopfhaut Klammer	EA-03	GREGORY Atraumatische Profunda Klemme	BD-33
Klemme		GUYON Nierenstiel Klemme	BC-16
ADSON Arterien Klemme	BC-09	HALSTED-MOSQUITO Arterien Klemme	BC-04
ADSON BABY Arterien Klemme	BC-09	HALSTED-MOSQUITO Atraumatische Klemme	BD-02
BACKHAUS-CLIP Schlauchhalter Tuch Klemme	BE-03	HALSTED-MOSQUITO Micro Arterien Klemme	BC-04
BACKHAUS KOCHER Tuch Klemme	BE-02	HALSTED-MOSQUITO TITAN Arterien Klemme	BC-04
BACKHAUS Tuch Klemme	BE-02	HARKEN Atraumatische Aurikel Klemme	BD-23
BAINBRIDGE Arterien Klemme	BC-14	HARRINGTON Bronchus Klemme	FG-21
BAINBRIDGE Atraumatische Klemme	BD-09	HARTMANN Arterien Klemme	BC-03
BALL AND SOCKET Tuch Klemme	BE-04	HEANEY Hysterektomie Klemme	BC-18
BECK Atraumatische Peripher-Vascular Klemme	BD-25	HEISS Arterien Klemme	BC-09
BENGOLEA Arterien Klemme	BC-09	HERRICK Peritoneum Klemme	BC-17
BERNHARD Tuch Klemme	BE-05	HOFF Tuch Klemme	BE-03
BEST Darm Klemme	GE-06	JAVID Atraumatische Carotis Klemme	BD-32
BRUNNER Darm Klemme	GE-06	JOHNS-HOPKINS Gallenkanal Klemme	BC-14
CASTAÑEDA Atraumatische Neonatal und Kinder	BD-42	JOHNS-HOPKINS Gefäß Bulldog Klemme	BC-03
CHAPUT Arterien Klemme	BC-08	JONES Schlauchhalter Tuch Klemme	BE-02
COLLIN Arterien Klemme	BC-08	KANE Nabelschnur Klemme	HC-06
COLLIN Nabelschnur Klemme	HC-06	KELLY Arterien Klemme	BC-05
COOLEY Atraumatische	BD-35 bis BD-37, BD-39, BD-41	KELLY-RANKIN Arterien Klemme	BC-05
COOLEY Atraumatische Anastomosen	BD-37, BD-40	KELLY TITAN Arterien Klemme	BC-05
COOLEY Atraumatische Bulldog Klemme	BD-33 bis BD-34	KOCHER Arterien Klemme, grazil	BC-06
COOLEY Atraumatische Iliaca Klemme	BD-37	KOCHER Darm Klemme	GE-04
COOLEY Atraumatische Kindergrößen	BD-38 bis BD-39	LAHEY Gallenkanal Klemme	BC-14
COOLEY DERRA Atraumatische Anastomosen	BD-39	LAMBERT KAY Atraumatische Aorta-Anastomos.	BD-10
COOLEY Gefäß Klemme	BD-40	LAMBERT KAY Atraumatische Iliaca Klemme	BD-11
CRAFOORD Arterien Bronchus Klemme	BC-12	LANE Magen Klemme	GE-08
CRILE Arterien Klemme	BC-05	LANE Tuch Klemme	BE-05
CRILE-RANKIN Arterien Klemme	BC-05	LAWRENCE Präparier und Ligatur Klemme	BC-13
CRILE TITAN Arterien Klemme	BC-05	LEES Atraumatische Bronchus Klemme	BD-03
DALE Atraumatische Peripher-Vascular Klemme	BD-24	LELAND JONES	
DANDY Arterien Klemme	BC-07	Atrauma. Peripher-Vascular Klemme	BD-08 bis BD-09
DARDIK Atraumatische Klemme	BD-07	LERICHE Arterien Klemme	BC-09
DE BAKEY Atraumatische Klemme	BD-02, BD-08	LIDDLE Atraumatische Aorta Klemme	BD-10
DE BAKEY Atraumatische Klemme	BD-16 bis BD-17	LORNA Tuch Klemme	BE-04
DE BAKEY Atraumatische Klemme	BD-20	LOVELACE Arterien Klemme	BC-07
DE BAKEY Atraumatische Klemme	BD-28 bis BD-30	LOWER Gallenkanal Klemme	BC-14
DE BAKEY Atraumatische Anastomosen	BD-25	LURZ Ureter Klemme	GC-10
DE BAKEY Atrauma. Aorta-Aneurys..	BD-13, BD-15, BD-18	MARTEL Kopfhaut Klemme	BC-08
DE BAKEY Atraumatische Bronchus Klemme	BD-19	MASTIN Muskel Klemme	FE-04

D

Inhaltsverzeichnis Deutsch

MAYO-GUYON Nierenstiel Klemme.....	BC-16	TROUTMAN-CHRIS Klängenbrecher.....	AG-14
Klemme		Klinge	
MAYO-ROBSON Darm Klemme.....	GE-05	Skalpell Steril, Mikro Klinge.....	AG-13
MEEKER Präparier und Ligatur Klemme.....	BC-13	KLINKENBERGH-LOTH Lungen und Thorax Schere.....	AI-37
MIKULICZ Peritoneum Klemme.....	BC-17	KNAPP	
MIXTER Arterien Klemme.....	BC-14	Häkchen.....	EC-06
MIXTER Arterien Bronchus Klemme.....	BC-13	Iris Messer.....	EC-04
MIXTER BABY Arterien Bronchus Klemme.....	BC-13	KNAPP-LUER Trachom Pinzette.....	ED-06
MIXTER Gallenkanal Klemme.....	BC-15	KNAPP	
MIXTER O'SHAUGNESSY Arterien Klemme.....	BC-14	Schere.....	AI-20
MOYNIHAN Gallenkanal Klemme.....	BC-15	Star Löffel.....	EC-07
MOYNIHAN Tuch Klemme.....	BE-05	KNIGHT Nasen scharfe Zange.....	EG-05
MURPHY Schlauch Klemme.....	BC-19	Knochendraht.....	DD-11
NEGUS Tonsillen Klemme.....	FA-03	Knochenhalte Zange.....	DC-09 bis DC-10
OCHSNER Atraumatische Aorta Klemme.....	BD-31	Knorpel Messer.....	AG-18
OVERHOLT-GEISSENDOERFER		KNOWLES Verband Schere.....	AI-47
Präparier und Ligatur Klemme.....	BC-10	KNUTSON-KOCH Urethrographie Konus.....	GG-09
PAYR-Baby Magen Klemme.....	GE-09	KNUTSON Urethrographie Instrument.....	GG-09
PAYR Magen Klemme.....	GE-09	KOCHER	
PEAN Arterien Klemme.....	BC-08	Arterien Klemme, grazil.....	BC-06
PEAN Arterien Klemme, grazil.....	BC-06	Blasen Spatel.....	GG-04
PEAN Atraumatische Klemme.....	BD-02	Darm Klemme.....	GE-04
PEERS BERTRAM Tuch Klemme.....	BE-03	Kropf Sonde.....	FE-04
PENNINGTON Arterien Klemme.....	BC-07	Wund Haken.....	BI-10 bis BI-11
PHANEUF Peritoneum Klemme.....	BC-17	KOENIG	
POTTS Atraumatische Klemme.....	BD-26 bis BD-27	Fuehrungshohl Sonde.....	CG-04
POTTS Atraumatische Anastomosen Klemme.....	BD-05	Naeh Nadel.....	CG-06
POTTS Atraumatische Coarctation Klemme.....	BD-04	KOERTE Wund Haken.....	BI-11
PRATT Arterien Klemme.....	BC-08	KOGAN Endo Spekulum.....	HA-23
PRESBYTERIAN HOSPITAL Schlauch Klemme.....	BC-19	Kompressorium CORWIN Tonsillen.....	FA-04
PRICE-THOMAS Bronchus Klemme.....	FG-22	Komprimeter.....	DD-02
PROVIDENCE-HOSPITAL Arterien Klemme.....	BC-05	KONRICH Sterilisier Trommel.....	HE-12
RANKIN Atraumatische Klemme.....	BD-02	Kontraktor	
ROBERTS Arterien Klemme.....	BC-11	BAILEY-BABY Rippen Kontraktor.....	FG-18
ROCHESTER-CARMALT Arterien Klemme.....	BC-07	BAILEY-GIBBON Rippen Kontraktor.....	FG-18
ROCHESTER-OCHSNER Arterien Klemme.....	BC-06	BAILEY Rippen Kontraktor.....	FG-18
ROCHESTER-PEAN Arterien Klemme.....	BC-06	SELLORS Rippen Kontraktor.....	FG-18
ROEDER Tuch Klemme.....	BE-03	Konus KNUTSON-KOCH Urethrographie.....	GG-09
RUMEL Thorax Klemme.....	BC-11	Kranioklast	
SAROT Arterien Bronchus Klemme.....	BC-12	BRAUN Kranioklast.....	HC-09
SAROT Bronchus Klemme.....	FG-23	TARNIER Kranioklast.....	HC-09
SATINSKY Anastomosen (Vena Cava).....	FG-24 bis FG-25	KRAUSE	
SATINSKY Atraumatische Klemme.....	BD-20	Kehlkopf Zange.....	FC-03
SAWTELL Tonsillen Klemme.....	FA-03	Nasen Schnürer.....	EG-09
SCHNIDT Tonsillen Klemme.....	FA-03	Ohrpolypen Schnürer.....	EE-07
SEMB Bronchus Klemme.....	FG-23	KRISTELLER	
SPENCER-WELLS Arterien Klemme.....	BC-07	Schneiden Halter.....	HA-09 bis HA-14
STILLE Nierenstiel Klemme.....	BC-16	Vaginal Spekulum.....	HA-09 bis HA-14
STOCKMANN Penis Klemme.....	GG-10	KRONECKER Unterbindungs Nadel.....	CG-02
STONE Verschluss Klemme.....	GE-06	KUENTSCHER	
STONE-WATT Darm Klemme.....	GE-06	Extraktor.....	DD-13
STRAUSS Penis Klemme.....	GG-10	Fertigschläger.....	DD-13
SUBRAMANIAN Atraumatische Klemme.....	BD-31	Vorböhrer.....	DD-13
TOENNIS Arterien Klemme.....	BC-11	Kugel Koagulieren Elektrode.....	JA-03
TOHOKU Tuch Klemme.....	BE-04	KUHNT Hornhaut Schaber.....	EC-05
TUFFIER Arterien Klemme.....	BC-08	Kürette	
WEBER Atraumatische Klemme.....	BD-12	Absaug Kürette.....	HA-51
WEISS Schlauch Klemme.....	BC-19	ALVIS Fremdkörper Kürette.....	EC-06
WERTHEIM-CULLEN Hysterektomie Klemme.....	BC-18	BLAKE Uterus Kürette.....	HA-48
WERTHEIM Hysterektomie Klemme.....	BC-18	BUCK Ohr Kürette.....	EE-05
WILLET-MARTELL Kopfhaut Klemme.....	BC-08	BUMM Uterus Kürette.....	HA-49 bis HA-50
WINKELMANN Beschneidungs Klemme.....	GG-09	COAKLEY Antrum Kürette.....	EG-18
WYLIE Atraumatische Klemme.....	BD-21	FAULKNER Kürette.....	EG-18
ZENKER Präparier und Ligatur Klemme.....	BC-12	FOX Lupus Kürette.....	HE-02
zum Erfassen der Glans und der Vorhaut.....	GG-10	GOURDET Uterus Kürette.....	HA-48
zum Fixieren des Samenstranges.....	GG-10	HOUSE Kürette.....	EE-15
Klinge Dermatol Ersatz Klinge.....	AG-21	KEVORKIAN Uterus Biopsie Saug Kürette.....	HA-40
HUMBY Dermatol Ersatz Klinge.....	AG-20	NOVAK Uterus Biopsie Saug Kürette.....	HA-40
Klängenbrecher		PIFFARD Lupus Kürette.....	HE-02
CASTROVIEJO Klängenbrecher.....	AG-14	RANDALL Uterus Biopsie Saug Kürette.....	HA-40
DIMEDA Klängenbrecher.....	AG-14	RECAIMER Uterus Kürette.....	HA-49 bis HA-50

SCHROEDER Uterus Kürette.....	HA-48	LELAND JONES Atraumatische	
Kürette		Peripher-Vascular Klemme	BD-08 bis BD-09
SIMON Uterus Kürette	HA-48	LEMPERT	
SIMS Uterus Kürette	HA-49 bis HA-50	Elevatorium	EE-15
L		Hohlmeißel Zange	DC-03
LABORDE Tracheal Dilatator	FE-02	Scharf Löffel.....	DC-13
LAFORCE		LERCHE Pinzette.....	BA-04
Adenotom.....	EG-19	LERICHE Arterien Klemme.....	BC-09
Fremdkörper Instrument	EC-06	LESTER Fixier Pinzette	ED-03
LAGRANGE Zahnfleisch Schere	AI-41	LEVINSON Fremdkörper Nadel.....	EC-05
LAHEY		LEWIN Knochenhalte Zange	DC-10
Gallenkanal Klemme.....	BC-14	LEWKOWITZ Plazentar und Abortus Zange	HC-07
Kropf Fass Zange.....	FE-04	LEXER-BABY	
Wund Haken.....	BI-08	Präparier Schere	AI-12
LAMBERT Chalazion Pinzette	ED-06	Schere.....	AH-10
LAMBERT KAY		LEXER-FINO Präparier Schere	AI-12
Atraumatische Aorta-Anastomosen Klemme	BD-10	LEXER	
Atraumatische Iliaca Klemme.....	BD-11	Flachmeißel	DC-16
LAMBOTTE		Hohlmeißel	DC-16
Knochenhalte Zange.....	DC-08	LEXER Mini	
LAMBOTTE Mini Osteotom	DC-15	Flachmeißel	DC-16
LAMBOTTE		Hohlmeißel.....	DC-16
Osteotom	DC-15	LEXER	
Raspatorien.....	DC-19	Präparier Schere.....	AI-11
LANCASTER Sperr Elevator.....	EC-03	Schere.....	AH-09
LANDAU Vaginal Spekulum.....	HA-22	LEYLA Fixations-System	EA-14 bis EA-18
LANDOLT		LICHTWITZ	
Enukleations Schere.....	AI-25	Kieferhöhlenpunktionskanülen	EG-09
Mikro Skalpellgriff.....	AG-13	Trokar	CC-02
LANE		LIDDLE Atraumatische Aorta Klemme	BD-10
Knochenhalte Zange.....	DC-08	LISTER-BURCH Sperr Elevator.....	EC-02
Knochenschraub Halte Zange	DD-14	LISTER	
Magen Klemme.....	GE-08	Sinus Schwamm Zange	BG-11
Pinzette	BA-04	Verband Schere.....	AH-23, AI-45
Schrauben Dreher	DD-14	LISTON	
Tuch Klemme	BE-05	amputations Messer	AG-16
LANGE		Knochensplitter Zange	DC-06
Kehlkopf Zange	FC-03	LITTAUER	
LANGENBECK		Cilien Pinzette	ED-08
Elevatoren	DC-21	Ligatur Schere	AI-40
Finger Säge	DD-03	Nasen Polypus Zange	EG-05
Fingerschutz	EI-06	Ohr Zängchen	EE-08
Knochenhalte Zange.....	DC-07	LITTLER Präparier Schere	AI-13
Raspatorien.....	DC-19	LITTLE Wund Haken	BI-08
resektions Messer.....	AG-17	LOCKLIN Schere	AI-18
Wund Haken	BI-09	Löffel	
LANGE		AXENFELD Chalazion Löffel	EC-07
Verband Schere	AI-44	BRUNS Scharfe Löffel.....	DC-12 bis DC-13
LANG Tränens Löffel.....	EC-08	BUNGE Exenterations Löffel	EC-07
Lanzette Elektrode	JA-03	CUZZI Plazentar und Abortus Löffel.....	HC-08
Lärmtrommel BARANY	EE-04	DAVIEL Star Löffel	EC-07
Laryngoskopeset		DESJARDINS Gallenstein Löffel	GC-08
MACINTOSH Faseroptik	AE-12 bis AE-13	FERGUSSON Gallenstein Löffel	GC-07
MACINTOSH Standard.....	AE-18 bis AE-19	GRAEFE Star Löffel	EC-07
MILLER Faseroptik	AE-12 bis AE-13	GROSS Ohr Löffel	EE-06
MILLER Standard	AE-18 bis AE-19	GUTMANN Sekret Löffel	GG-11
Laryngoskopespatel		HALLE Löffel, Scharf	DC-13
MACINTOSH Faseroptik	AE-10	HEBRA Chalazion Löffel	EC-07
MACINTOSH Standard	AE-15	KNAPP Star Löffel.....	EC-07
MILLER Faseroptik	AE-10	LANG Tränensack Dissektor- Löffel.....	EC-08
MILLER Standard.....	AE-16	LEMPERT Scharfer Löffel.....	DC-13
LAWRENCE Präparier und Ligatur Klemme.....	BC-13	LUER-KOERTE Gallenstein Löffel	GC-09
LEBSCHKE Sternummeißel	DC-17	MARTINI Scharfer Löffel	DC-13
LEES Atraumatische Bronchus Klemme.....	BD-03	MAYO Gallenstein Löffel.....	GC-07
LEGUEU		MEYHOEFER Chalazion Löffel	EC-07
Blasen Spatel	GG-04	MOORE Gallenstein Löffel	GC-05
Blasen Wundsperrer.....	GG-06	PESTALOZZA Plazentar und Abortus Löffel.....	HC-08
LEKSELL STILLE Hohlmeißel Zange	DC-05	SCHEDE Löffel, Scharf.....	DC-12
		SELLHEIM Geburts Löffel	HC-09
		SIMON Löffel, Scharf	DC-13
		SPRATT Löffel, Scharf.....	DC-12
		VOLKMANN Löffel,Scharf	DC-12 bis DC-13

D

Inhaltsverzeichnis Deutsch

WALLICH Plazentar und Abortus Löffel.....	HC-08
Löffel	
WELLS Eukleation Löffel	EC-08
WILLIGER Löffel, Scharf	DC-13
LORENZ Verband Schere	AI-47
LORNA Tuch Klemme	BE-04
LOUTE Draht Spanner.....	DD-11
LOVE-GRUENWALD Laminektomie Zange.....	EA-08
LOVELACE	
Arterien Klemme	BC-07
Lungenfaß Zange.....	FG-19
LOVE	
Nerv Haken	EA-04
Zäpfchen Haken	FA-02
LOWER Gallenkanal Klemme.....	BC-14
LOWMAN Knochenhalte Klamme.....	DC-11
LUBET-BARBON Nasen Polypus Zange.....	EG-05
LUCAE	
Hammer	DC-18
Ohr Pinzette	EE-07
Stimmgabel	EE-04
LUC Nasen scharfe Zange	EG-06
LUER	
Hohlmeißel Zange	DC-03
LUER-KOERTE Gallenstein Löffel	GC-09
LUER Tracheal Kannule	FE-03
Luftdusche POLITZER	EE-05
LUIKART-BILL Zug Hebel.....	HC-05
LUIKART Geburts Zange.....	HC-03
LUNDSGAARD Sklerotom	EC-05
LUNIATSCHEK Tampon Stopfer	FA-02
LURZ Ureter Klemme	GC-10

M

MACINTOSH	
Faseroptik Laryngoskopeset	AE-12 bis AE-13
Faseroptik Laryngoskopespatel	AE-10
Standard Laryngoskopeset.....	AE-18 bis AE-19
Standard Laryngoskopespatel	AE-15
MAGILL	
Kathetereinführ Zange	AE-06
Mandrin	AE-04
Sauger.....	AE-04
Magnet DIMEDA Augen	ED-08
MAIER Tupfer Zange	BG-12
MALTZ (COTTLE) Nasen Raspel	EG-15
MALTZ	
Knorpel Messer.....	EG-11
Nasen Raspel	EG-14
Mandrin MAGILL	AE-04
Manometer zum Salpingograph.....	HA-47
Markier	
CASTROVIEJO Kompass.....	EC-09
CONNIN-AMSLER Markier Instrument.....	EC-09
MARSCHIK Tonsillen Pinzette.....	FA-04
MARTEL Kopfhaut Klemme	BC-08
MARTIN	
Becken Zirkel	HC-06
HF Chirurgie Geräte Kabel	JA-07
MARTINI Löffel, Scharf	DC-13
MARTIN	
Sequester Zange	DC-10
Tupfer Zange.....	BG-02, BG-14
Uterus Sonde	HA-39
MASSON Nadelhalter	CE-03
MASTIN Muskel Klemme	FE-04
MATHIEU	
Fremdkörper Zange.....	GG-07
Nadelhalter.....	CE-05
Rektal Spekulum	GI-02

Wund Haken	BI-03
MATSON Raspatorien.....	DC-21
MAUNDER Holz Mundkeil	EI-06
MAYO BLAKE Gallenstein Zange	GC-04
MAYO	
Gallenstein Löffel	GC-07
MAYO-GUYON Nierenstiel Klemme	BC-16
MAYO-HEGAR Nadelhalter.....	CE-02
MAYO	
Linkshänder Schere.....	AI-07
Nierenstein Sonde	GC-10
MAYO-NOBLE Schere.....	AH-08, AI-10
MAY Ophthalmoskop.....	AC-03
MAYO-ROBSON Darm Klemme.....	GE-05
MAYO	
Schere	AH-06, AI-07
Sterilisier Klammer	CI-02
MAYO-STILLE Schere.....	AH-07, AI-08 bis AI-09
McCLINTOCK Plazentar und Abortus Zange	HC-07
McCULLOUGH Strabismus Pinzette	EC-13
McDONALD Elevatorien	DC-22
McGEE Ohr Mikro Zängchen	EE-10
McGUIRE Hornhaut Schere.....	AJ-05
McINDOE	
Knorpel Schere.....	AI-35
Pinzette	BA-04
McIVOR	
Mund Sperrer.....	EI-05
Zungen Spatel	EI-05
McKENTY Septum Elevatorium	EG-11
McKENZIE	
Bohrer	DD-04
Clip-Anlege Zange	EA-02
McLEAN Geburts Zange.....	HC-04
McLEAN-LUIKART Geburts Zange	HC-03
McLEAN-TUCKER-LUIKART Geburts Zange	HC-03
McPHERSON Faden Pinzette	ED-05
McPHERSON TITAN Faden Pinzette	ED-05
McPHERSON WESTCOTT Sehnen Schere	AJ-04
MEAD	
Hammer	DC-18
Hohlmeißel Zange	DC-02
MEEKER Präparier und Ligatur Klemme.....	BC-13
Meißel	
CINELLI Nasenplastik Meißel.....	EG-13
COTTLE Nasenplastik Meißel	EG-13
FOMON Nasenplastik Meißel	EG-13
FREER Nasen Hohl Meißel	EG-14
FREER Septum Meißel	EG-12
HAJEK Nasen Hohl Meißel	EG-14
KILLIAN-CLAUS Nasen Hohl Meißel	EG-14
PASSOW Meißel	EE-15
ROLLET Extirpations Meißel	EC-06
SILVER Nasenplastik Meißel.....	EG-14
WEST Nasen Hohl Meißel	EG-14
MELLINGER-AXENFELD Sperr Elevator	EC-02
MELLINGER Sperr Elevator	EC-02
MENGHINI Trokar	CC-03
Meniskotom	
BIRCHER Meniskotom	DC-24
NEFF Meniskotom	DC-24
SMILLIE Meniskotom.....	DC-24
MERCEDES Thorax Sperrer.....	FG-16
Messer	
BALLENGER Schwing Messer	EG-11
BARKAN Goniotomie Messer	EC-05
BARNHILL Ring Messer	EG-19
BARRAQUER Keratoplastik Messer.....	EC-05
BECKMANN Ring Messer	EG-19
BERENS Lanzen Messer.....	EC-04
BOWMAN Discisions Messer	EC-04

CARPENTER Tonsillen Messer.....	FA-02
Messer	
CASTROVIEJO Lanzen Messer.....	EC-04
CATLIN Amputations Messer.....	AG-16
CONVERSE Nasen Messer.....	EG-10
COTTLE Nasen Messer.....	EG-10
DEAN Iris Messer.....	EC-04
DEUTSCHMANN Star Messer.....	EC-03
Elektrode Messer.....	JA-03
ELSCHNIG Hornhaut Messer.....	EC-05
ESMARCH Gips Messer.....	DA-04
FREER Mukosa Messer.....	EG-10
FREER Septum Messer.....	EG-10
GILL Hornhaut Messer.....	EC-05
GRAEFE Star Messer.....	EC-03
HALLE Dura Messer.....	EA-06
HOPKINS Gips Messer.....	DA-04
JAEGER Lanzen Messer.....	EC-04
JOSEPH Nasen Messer.....	EG-10
KNAPP Iris Messer.....	EC-04
LANGENBECK Resektions Messer.....	AG-17
LISTON Amputations Messer.....	AG-16
MALTZ Knorpel Messer.....	EG-11
MOELTGEN Winkel Messer.....	AC-08
MUCK Periost Messer.....	EE-15
OTIS Ersatz Messer.....	GG-08
PAUFIQUE Keratoplastik Messer.....	EC-05
PLESTER Lappen Messer.....	EE-14
POLITZER Ohr Messer.....	EE-06
REINER Gips Messer.....	DA-04
ROSEN Rundschnitt Messer.....	EE-14
SATO Hornhaut Messer.....	EC-05
SCHEIE Goniotomie Messer.....	EC-05
SCHUKNECHT Roll Messer.....	EE-14
SCHUKNECHT Sichel Messer.....	EE-14
SEGOND Myom Messer.....	HA-46
SEXTON Ohr Messer.....	EE-06
St. CLAIR-THOMSON Ring Messer.....	EG-19
TABB Sichel Messer.....	EE-14
TOOK Hornhaut Messer.....	EC-05
VIRCHOW Hirn Messer.....	AG-18
VIRCHOW Knorpel Messer.....	AG-18
WHEELER Diszisions Messer.....	EC-04
WULLSTEIN Sichel Messer.....	EE-14
ZIEGLER Iris Messer.....	EC-04
ZIEGLER Kapsulotomie Messer.....	EC-05
Messzirkel BERTILLON Schädel.....	AC-08
Metall MassStäbe.....	AC-08
METZENBAUM FINO	
Präparier Schere.....	AI-15
Schere.....	AH-12
METZENBAUM	
Nadelhalter.....	CE-04
Präparier Schere.....	AI-13 bis AI-14
Schere.....	AH-11
METZENBAUM "S" Schere.....	AH-13, AI-16
MEYERDING Wund Haken.....	BI-08
MEYHOEFER Chalazion Löffel.....	EC-07
MICHEL	
Spiegel.....	EG-04
Wund Klammer.....	CG-07
Wundklammer Zange.....	CG-07
MIDDELDORPF Wund Haken.....	BI-10
MIDDLETON-JANSEN Nasen scharfe Zange.....	EG-09
Mikro Pinzette.....	BB-02
Mikro Schere.....	AJ-06, AJ-13
Mikro Skalpell Griff.....	AG-12
MIKULICZ	
Peritoneum Klemme.....	BC-17
Wund Haken.....	BI-12

MILLER	
Faseroptik Laryngoskopset.....	AE-12 bis AE-13
MILLER	
Faseroptik Laryngoskopspatel.....	AE-10
Standard Laryngoskopset.....	AE-18 bis AE-19
Standard Laryngoskopspatel.....	AE-16
MILLIGAN Dura Dissektor.....	EA-05
MILLIN	
Blasenhals Sperrer.....	GG-07
Blasen Wundsperrer.....	GG-05
Fadenführungs Zange.....	GG-03
Faß vordere Lappen Zange.....	GG-03
Kaltlicht Aufsatz.....	GG-05
Kapsel Faß Zange.....	GG-03
MILLS Gefäß Schere.....	AI-27
Mini Naht Besteck.....	CG-08
Mini Stirnlampe CLAR.....	AC-05
MIXTER	
Arterien Bronchus Klemme.....	BC-13
Arterien Klemme.....	BC-14
MIXTER BABY Arterien Bronchus Klemme.....	BC-13
MIXTER	
Gallenkanal Klemme.....	BC-15
Gallenstein Zange.....	GC-04
MIXTER O'SHAUGNESSY Arterien Klemme.....	BC-14
MOELTGEN Winkel Messer.....	AC-08
MOGAN Beschneidungs Instrument.....	GG-09
MOLLISON Wund Sperrer.....	BI-17
MOORE	
Gallenstein Löffel.....	GC-05
Handbohr Apparat.....	DD-04
MOORFIELD Naht Pinzette.....	ED-05
MORSE-FAVOLORO Rippen Sperrer.....	FG-17
MOYNIHAN	
Gallenkanal Klemme.....	BC-15
Gallenstein Sonde.....	GC-05
Tuch Klemme.....	BE-05
MUCK Periost Messer.....	EE-15
MUELLER Sperr Elevator.....	EC-03
Mundkeil MAUNDER Holz.....	EI-06
MURDOCK Sperr Elevator.....	EC-02
MURLESS Kopf Hebel.....	HC-05
MURPHY-LANE Elevatorien.....	DC-22
MURPHY Schlauch Klemme.....	BC-19
MUSEUX Haken Zange.....	HA-33
Muskel Haken.....	BI-25
Mutterschlüssel für Extensionbügel.....	DD-10
MYLES Nasen scharfe Zange.....	EG-07

N

NABATOFF Varicen Besteck Ohr Sonde.....	CA-02
Nadel	
BARBARA Nadel.....	EE-14
BOWMAN Diszisions Nadel.....	EC-05
COOPER Unterbindungs Nadel.....	CG-02
DAVIS Fremdkörper Nadel.....	EC-05
DESCHAMPS Unterbindungs Nadel.....	CG-02
DIX Flachmeißel.....	EC-09
DUPUY-WEISS Tonsillen Nadel-, Nadel.....	FA-03
Elektrode.....	JA-03
Elektrode mini.....	JA-02
FRANCIS Fremdkörper Nadel.....	EC-05
FRANKLIN-SILVERMANN Punktions Nadel.....	CC-03
Fremdkörper Nadel.....	EC-05
Nadelhalter	
ADSON Nadelhalter.....	CE-04
ARRUGA Nadelhalter.....	CE-06
BARRAQUER Nadelhalter.....	CE-07
BAUMGARTNER Nadelhalter.....	CE-02
BOYNTON Nadelhalter.....	CE-06
BOZEMANN Nadelhalter.....	CE-03

D

Inhaltsverzeichnis Deutsch

CASTROVIEJO Nadelhalter	CE-07
Nadelhalter	
COLLIER Nadelhalter	CE-02
CRILE Nadelhalter	CE-04
CRILE-MURRAY Nadelhalter.....	CE-02
CRILE-WOOD Nadelhalter	CE-02
DE BAKEY Nadelhalter.....	CE-03
DERF Nadelhalter.....	CE-02
DIETHRICH Nadelhalter	CE-06
FINOCHIETTO Nadelhalter	CE-04
GILLIES Nadelhalter	CE-05
HALSEY Nadelhalter.....	CE-02
HEANEY Nadelhalter	CE-03
HOESEL Nadelhalter	CE-05
JAMISON Nadelhalter.....	CE-03
JOHNSON Nadelhalter	CE-04
KALT Nadelhalter	CE-07
KALT-ARRUGA Nadelhalter.....	CE-07
MASSON Nadelhalter	CE-03
MATHIEU Nadelhalter.....	CE-05
MAYO-HEGAR Nadelhalter	CE-02
METZENBAUM Nadelhalter	CE-04
NEIVERT Nadelhalter	CE-02
OLSEN-HEGAR Nadelhalter	CE-05
RYDER Nadelhalter	CE-03
SAROT Nadelhalter	CE-04
STEVENS Nadelhalter	CE-06
STRATTE Nadelhalter.....	CE-04
TOENNIS Nadelhalter.....	CE-04
WANGENSTEEN Nadelhalter.....	CE-03
Nadel	
KEITH Naeh Nadel.....	CG-06
KOENIG Naeh Nadel.....	CG-06
KRONECKER Unterbindungs Nadel	CG-02
LEVINSON Fremdkörper Nadel.....	EC-05
NELSON Unterbindungs Nadel	CG-02
POLITZER Parazentese Nadeln	EE-06
QUINKE Punktions Nadel.....	CC-03
Nadelrad WARTENBERG	AC-08
Nadel	
REVERDIN Unterbindungs Nadel	CG-03
ROSEN Nadel	EE-14 bis EE-15
Star Nadel	EC-05
VERRES Pneumoperitoneum Punktions Nadel	CC-03
YOUNG Boomerang Unterbindungs Nadel.....	CG-03
NAEGELE Geburts Zange	HC-03
Naeh Nadel	CG-05 bis CG-06
NÄGELE Perforatorium.....	HC-09
Nagel STEINMANN Knochen	DD-09
NAGER Gaumensegel Haken	FA-02
NEFF Meniskotom	DC-24
NEGUS Tonsillen Klemme.....	FA-03
NEIVERT Nadelhalter	CE-02
NELSON	
Pinzette	BA-05
Trokar.....	CC-02
Unterbindungs Nadel.....	CG-02
NEUBÜSER Tuben Faß Pinzette.....	HA-51
Neurochirurgische Schere	AI-35
NORTHBENT Ligatur Schere	AI-40
NOTO Uterus-Polypen Zange.....	HA-36
NOVAK Uterus Biopsie Saug Kürette	HA-40
NOYES	
Iris Schere.....	AJ-03 bis AJ-04
Nasen Polypus Zange	EG-05
Sehnen Schere	AJ-03
NUBOER Sauger	AE-05

O

OCHSNER	
Atraumatische Aorta Klemme	BD-31

OCHSNER	
Trokar.....	CC-02
O' CONNOR Iris Haken	EC-06
OLDBERG Laminektomie Zange	EA-09
OLIVECRONA	
Draht Säge	EA-05
Hirn Spatel	EA-07
Hohlmeißel Zange	DC-03
OLIVECRONA-TOENNIS Clip-Anlege Zange.....	EA-02
OLLIER Wund Haken	BI-10
OLSEN-HEGAR Nadelhalter.....	CE-05
Ophthalmoskop	
MAY Ophthalmoskop	AC-03
VARIFOCAL Ophthalmoskop.....	AC-03
Osteotom	DC-14
HIBBS Osteotom	DC-16
LAMBOTTE Osteotom.....	DC-15
LAMBOTTE Mini Osteotom	DC-15
STILLE Osteotom	DC-14
O'SULLIVAN-O'CONNOR	
Bauch Deckenhalter	BI-21
Vaginal Spekulum	HA-08
Oszillierende Gips Säge.....	DA-05 bis DA-06
OTIS	
Ersatz Messer	GG-08
Urethrotom.....	GG-08
Otoskop	AC-04
OVERHOLT-GEISSENDOERFER	
Präparier und Ligatur Klemme	BC-10
OVERHOLT Raspatorien	DC-21

P

Parametrien Gefäß Schere.....	AI-31
Parametrium Gefäß Schere.....	AH-20
PARHAM Band.....	DC-11
PARKER	
anatomische Skalpell.....	AG-15
Wund Haken	BI-02
PARK Sperr Elevator.....	EC-03
PARTSCH	
Flachmeißel	DC-14
Hohlmeißel.....	DC-14
PASSOW Meißel	EE-15
PATON Hornhaut Dissektor.....	EC-05
PAUFIQUE	
Faden Pinzette	ED-05
Keratoplastik Messer	EC-05
PAUFIQUE TITAN Faden Pinzette.....	ED-05
PAYR-Baby Magen Klemme	GE-09
PAYR	
Fuehrungshohl Sonde	CG-04
Magen Klemme.....	GE-09
PEAN	
Arterien Graziilles Klemme	BC-06
Arterien Klemme	BC-08
Atraumatische Klemme	BD-02
PEDERSON Vaginal Spekulum	HA-03
PEERS BERTRAM Tuch Klemme	BE-03
PEET Splitter Pinzette.....	BA-06
PELKMANN Tupfer Zange.....	BG-12
PENFIELD Dura Dissektor	EA-06
PENNINGTON Arterien Klemme.....	BC-07
PERCY Amputation Retraktor.....	DD-03
Perforatorium	
NÄGELE Perforatorium	HC-09
SMELLIE Perforatorium.....	HC-09
PERTHES Reibhalen	DD-08
PESTALOZZA Plazentar und Abortus Löffel.....	HC-08
PETRI Schale.....	HE-08

PETZ Magen- und Darmnäh Apparat	GE-09	LESTER Fixier Pinzette	ED-03
Pflaster Spatel	CA-03	Pinzette	
PHANEUF Peritoneum Klemme	BC-17	LITTAUER Cilien Pinzette	ED-08
Pick	EE-15	LUCAE Ohr Pinzette	EE-07
BARBARA	EE-14 bis EE-15	MARSCHIK Tonsillen Pinzette	FA-04
PIERCE Trokar	CC-02	McCULLOUGH Strabismus Pinzette	EC-13
PIFFARD Lupus Kürette	HE-02	McINDOE Pinzette	BA-04
PINARD Stethoskop	AC-06	McPHERSON Faden Pinzette	ED-05
Pinzette	BA-02	McPHERSON TITAN Faden Pinzette	ED-05
ADLERKREUTZ Pinzette	BA-04	MOORFIELD Naht Pinzette	ED-05
ADSON Pinzette	BA-03	NELSON Pinzette	BA-05
ADSON-BROWN Pinzette	BA-03	NEUBÜSER Tuben Faß Pinzette	HA-51
ADSON Hypophysen Pinzette	EA-06	PAUFIQUE Faden	ED-05
ADSON Mikro Pinzette	BA-03	PAUFIQUE TITAN Faden Pinzette	ED-05
ARCHER Splitter Pinzette	BA-06	PEET Splitter Pinzette	BA-06
ARRUGA Kapsel Pinzette	ED-04	POTTS-SMITH Pinzette	BA-02
AYER Chalazion Pinzette	ED-06	PRINCE Muskel Pinzette	ED-02
BARRAQUER KATZIN Iris Pinzette	EC-13	RUSSIAN Pinzette	BA-04
BARRAQUER Colibri Iris Pinzette	EC-13	SCHWEIGGER Kapsel Pinzette	ED-04
BARRAQUER Cilien Pinzette	ED-08	SEMKEN Pinzette	BA-05
BARRAQUER Fixier Pinzette	ED-03	SINGLEY Pinzette	BA-05
BARRAQUER Vorderkammer Pinzette	ED-02	SNELLEN Entropium Pinzette	ED-06
BEER Cilien Pinzette	ED-08	STEVENS Iris Pinzette	EC-11
BERKE Muskel Pinzette	ED-02	STIEGLITZ Splitter Pinzette	BA-06
Bipolare Koagulation Pinzette	JA-04 bis JA-06	STILLE Pinzette	BA-02
BISHOP-HARMAN Iris Pinzette	EC-14	St. MARTIN Naht Pinzette	ED-05
BONACCOLTO Strabismus Pinzette	EC-14	TERSON Kapsel Pinzette	ED-04
Bonn Iris Pinzette	EC-15	TROUTMAN Colibri Iris Pinzette	EC-13
Bonn TITAN Iris Pinzette	EC-15	TROUTMAN Rectus Pinzette	ED-02
BROWN Pinzette	BA-03	Tübingen Faden Pinzette	ED-05
CARMALT Splitter Pinzette	BA-06	Tübingen Iris Pinzette	EC-15
CASTROVIEJO Fixier Pinzette	ED-03	Tübingen TITAN Faden Pinzette	ED-05
CASTROVIEJO Kapsel Pinzette	ED-04	Tübingen TITAN Iris Pinzette	EC-15
CASTROVIEJO Naht Pinzette	ED-05	USA Pinzette	BA-02
Cilien Pinzette	ED-08	VIRTUS (RALK) Splitter Pinzette	BA-06
COLLIN-DUVAL Pinzette	BA-04	WANGENSTEEN Pinzette	BA-05
COOLEY Atraumatische Pinzette	BB-03	WILDE (TROELTSCH) Ohr Pinzette	EE-07
CUSHING Pinzette	BA-03	PIPER	
DASTOOR Strabismus Pinzette	EC-14	Geburts Zange, mit Achsenzugvorrichtung	HC-04
DE BAKEY Atraumatische Pinzette	BB-03	Geburts Zange	HC-04
DESMARRES Chalazion Pinzette	ED-06	Platte JAEGER Lid	EC-03
DOUGLAS Cilien Pinzette	ED-08	PLESTER	
DUVAL Pinzette	BA-04	Lappen Messer	EE-14
ELSCHNIG Fixier Pinzette	ED-03	Wund Sperrer	BI-14
ELSCHNIG Kapsel Pinzette	ED-04	POLITZER	
FEILCHENFELD Splitter Pinzette	BA-06	Luftdusche	EE-05
FERRIS Pinzette	BA-04	Ohr Messer	EE-06
FISCHER Iris Pinzette	EC-13	Parazentesenadeln Nadel	EE-06
FOERSTER Iris Pinzette	EC-12	POOLE Sauger	AE-02
FUCHS Kapsel Pinzette	ED-04	POTTS	
GERALD Pinzette	BA-05	Atraumatische Anastomosen Klemme	BD-05
GILL-ARRUGA Kapsel Pinzette	ED-03	Atraumatische Coarctation Klemme	BD-04
GILL-HESS Iris Pinzette	EC-12	Atraumatische Klemme	BD-26 bis BD-27
GILLIES Pinzette	BA-05	POTTS DE MARTEL	
GILL Iris Pinzette	EC-12	Gefäß Schere	AI-27
GRADLE Cilien Pinzette	ED-08	POTTS-SMITH	
GRAEFE Pinzette	BA-03	Gefäs Schere	AH-19
GRAEFE Fixier Pinzette	ED-03	Gefäß Schere	AI-28
GRAEFE Iris Pinzette	EC-11	Pinzette	BA-02
GREEN Fixier Pinzette	ED-03	POZZI Haken Zange	HA-31
HESS Iris Pinzette	EC-12	Präparier Schere	AI-34
HESS Kapsel Pinzette	ED-04	PRATT	
HUNTER Splitter Pinzette	BA-06	Arterien Klemme	BC-08
JACKSON Tampon Pinzette	FC-02	Cystikus Haken	GI-04
JAMESON Strabismus Pinzette	EC-13	Haken Zange	HA-34 bis HA-35
KALT Kapsel Pinzette	ED-04	Rektal Spekulum	GI-02
KIRBY-ARTHUR Iris Pinzette	EC-13	Uterus Dilatator	HA-29
KNAPP-LUER Tracho. Pinzette	ED-06	PRESBYTERIAN HOSPITAL Schlauch Klemme	BC-19
LAMBERT Chalazion Pinzette	ED-06	PRICE-THOMAS Bronchus Klemme	FG-22
LANE Pinzette	BA-04	PRINCE	
LERCHE Pinzette	BA-04	Muskel Pinzette	ED-02

D

Inhaltsverzeichnis Deutsch

Tonsillen Schere	AI-27
Proktoskop KELLY	GI-04
PROVIDENCE-HOSPITAL Arterien Klemme	BC-05
Pulverbläser KABIERESKE	EE-04
PUTTI Knochen Raspel	DC-25

Q

QUATTRO Gips Spreizer	DA-03
Quetscher	
SAALFELD Komedonen Quetscher	HE-02
SCHAMBERG Komedonen Quetscher	HE-02
UNNA Komedonen Quetscher	HE-02
WALTON Komedonen Quetscher	HE-02
QUINBY Zahnfleisch Schere	AI-42
QUINKE Punktions Nadel	CC-03
QUIRE Fremdkörper Hebel	EE-08
QUISLING Hammer	DC-18

R

RADOLF Nagelausreiss Zange	DD-03
Rahmen KIRSCHNER	BI-23
RALK Handbohr Apparat	DD-05
RAMPLEY Schwamm Zange	BG-09
RANDALL	
Nierenstein Zange	GC-11 bis GC-12
Uterus Biopsie Saug Kürette	HA-40
RANEY	
Anlege- und Abnahme Zange	EA-03
Kopfhaut Klammer	EA-03
RANKIN Atraumatische Klemme	BD-02
Rasierer	AG-14
Rasierer Klinge	AG-14
Rasier Messer	AG-19
Rasiermesser Ersatz Klängen	AG-19
Raspatorien	
ALEXANDER Raspatorien	DC-19
DOYEN Rippen Raspatorien	DC-20
FARABEUF Raspatorien	DC-19
LAMBOTTE Raspatorien	DC-19
LANGENBECK Raspatorien	DC-19
MATSON Raspatorien	DC-21
OVERHOLT Raspatorien	DC-21
SADILLOT Raspatorien	DC-19
SEMB Raspatorien	DC-20
WILLIGER Raspatorien	DC-19
Raspel	
FOMON Nasen Raspel	EG-15 bis EG-16
GALLAHER Antrum Raspel	EG-16
JOSEPH (LEWIS) Nasen Raspel	EG-15
Knochen Raspel	DC-25
MALTZ (COTTLE) Nasen Raspel	EG-15
MALTZ Nasen Raspel	EG-14
PUTTI Knochen Raspel	DC-25
WIENER (AUFRICHT) Nasen Raspel	EG-15
WIENER Nasen Raspel	EG-15
RECAIMER Uterus Kürette	HA-49 bis HA-50
Reibhalen	DD-08
PERTHES Reibhalen	DD-08
REICHERT Kehldedeckel Halter	FC-02
REINER	
Gips Messer	DA-04
Ohr Spritze	EE-05
Reinigungs Bürste	CI-04 bis CI-05
Retraktor PERCY Amputation	DD-03
REVERDIN	
Unterbindungs Nadel	CG-03
Wund Haken	BI-04
REYNOLDS Schere	AH-15, AI-18
Rhachiotom	DC-17

RIBBON Wund Haken	BI-04
RICHARDSON-EASTMAN Wund Haken	BI-04
RICHARDSON Grip Wund Haken	BI-04
RICHARDSON Wund Haken	BI-04
RICHTER-HEATH Wundklammer Zange	CG-07
RIGBY Bauch Deckenhalter	BI-24
Ringstripper	CA-03
ROBB Gefäß Dissektor	FG-33
ROBERTS Arterien Klemme	BC-11
ROCHESTER-CARMALT Arterien Klemme	BC-07
ROCHESTER-OCHSNER Arterien Klemme	BC-06
ROCHESTER-PEAN Arterien Klemme	BC-06
ROEDER Tuch Klemme	BE-03
ROGER Septum Elevatorium	EG-11
ROGGE Sterilisier Zange	CI-02
Rohr BRUENINGS Verlängerung	FC-03
ROLLET	
Extirpations Meißel	EC-06
Häkchen	EC-06
ROSENBERG Kehlkopf Zange	FC-03
ROSEN	
Nadel	EE-14 bis EE-15
Rundschnitt Messer	EE-14
ROSER-KOENIG Mund Sperrer	EI-03
ROSE Tracheal Häkchen	FE-03
ROTES KREUZ Verband Schere	AI-47
ROUX Baby Wund Haken	BI-02
ROUX mini Wund Haken	BI-02
ROUX Wund Haken	BI-02
ROWE Mund Zange	EI-06
RUBIN Septum Quetsch Zange	EG-07
RUMEL Thorax Klemme	BC-11
RUSKIN Hohlmeißel Zange	DC-04
RUSKIN-LISTON Knochensplitter Zange	DC-06
RUSSIAN Pinzette	BA-04
RYDEL-SEIFFER Stimmgabel	EE-04
RYDER Nadelhalter	CE-03

S

SAALFELD Komedonen Quetscher	HE-02
SACHS	
Dura Dissektor	EA-05
Nerv Haken	EA-04
SADILLOT Raspatorien	DC-19
SAENGER Plazentar und Abortus Zange	HC-07
Säge	
BERGMANN Gips Säge	DA-02
Sägeblatt CHARRIERE	DD-03
Säge	
CHARRIERE Amputations Säge	DD-03
DIMEDA Fingerring Säge	DD-03
ENGEL Gips Säge	DA-02
Fingerring Säge	DD-03
JOSEPH Nasen Säge	EG-17
LANGENBECK Finger Säge	DD-03
OLIVECRONA Draht Säge	EA-05
WIGMORE Gips Säge	DA-02
SAIRGES Haken Zange	HA-32
Salpingograph SCHULTZE	HA-47
SANVENERO Schere	AH-13, AI-16
SAROT	
Arterien Bronchus Klemme	BC-12
Bronchus Klemme	FG-23
Nadelhalter	CE-04
SATINSKY	
Anastomosen (Vena Cava) Klemme	FG-24 bis FG-25
Atraumatische Klemme	BD-20
Lungen und Thorax Schere	AI-37
SATO Hornhaut Messer	EC-05
SAUERBRUCH	
Abfall Zange	CI-03

SAUERBRUCH-FREY Rippen Schere	FG-06	GORNEY Präparier Schere	AI-13
SAUERBRUCH		Haut Schere	HE-03
Hohlmeißel Zange	DC-05	Schere	
Nadel Dose	HE-02	HEATH Ligatur Schere	AI-40
Rippen Schere	FG-05	HEYMANN Nasen Schere	AH-18, AI-25
Wund Haken	BI-13	IRIS Schere	AH-16, AI-21
Sauger		IRIS Augen Schere	AI-22
ANDREWS-PINCHON Sauger	AE-03	IRIS Schere, große Ringe	AI-19
DASTOOR Kapsel Sauger	EC-09	JACOBSON Mikro Schere	AJ-11
DE BAKEY Sauger	AE-04	JOSEPH Schere	AH-14, AI-16
FRAZIER Sauger	EA-07	KELLY Gynaekologische Schere	AI-33
MAGILL Sauger	AE-04	KELLY Gynäkologische Schere	AH-22
NUBOER Sauger	AE-05	KILNER Schere	AH-14, AI-17
POOLE Sauger	AE-02	KLINKENBERGH-LOTH Lungen- Thorax Schere	AI-37
WALTON YANKAUER Sauger	AE-03	KNAPP Schere	AI-20
YANKAUER Sauger	AE-02	KNOWLES Verband Schere	AI-47
SAWTELL Tonsillen Klemme	FA-03	LAGRANGE Zahnfleisch Schere	AI-41
SCAGLIETTI Hohlmeißel Zange	DC-05	LANDOLT Enukeleations Schere	AI-25
Schaber KUHNT Hornhaut	EC-05	LANGE Verband Schere	AI-44
Schädelhalter CRUTCHFIELD	EA-03	LEXER Schere	AH-09
Schädelzange De VILBISS	EA-05	LEXER-BABY Schere	AH-10
Schale		LEXER-BABY Präparier Schere	AI-12
Instrumenten Schale	HE-08 bis HE-09	LEXER-FINO Präparier Schere	AI-12
Lösungs Schale	HE-04	LEXER Präparier Schere	AI-11
Nieren Schale	HE-07	LISTER Verband Schere	AH-23, AI-45
PETRI Schale	HE-08	LITTAUER Ligatur Schere	AI-40
Spül- Schale	HE-05	LITTLER Präparier Schere	AI-13
SCHAMBERG Komedonen Quetscher	HE-02	LOCKLIN Schere	AI-18
SCHEDE Scharf Löffel	DC-12	LORENZ Verband Schere	AI-47
SCHEIE		MAYO Schere	AH-06, AI-07
Augen Kanüle	ED-07	MAYO Linkshänder Schere	AI-07
Goniotomie Messer	EC-05	MAYO-NOBLE Schere	AH-08, AI-10
SCHEINMANN Kehlkopf Zange	FC-03	MAYO-STILLE Schere	AH-07, AI-08 bis AI-09
SCHERBAK Vaginal Spekulum	HA-21	McGUIRE Hornhaut Schere	AJ-05
Schere	AH-02 bis AH-04, AI-02 bis AI-04	McINDOE Knorpel Schere	AI-35
AEBLI Hornhaut Schere	AI-22	McPHERSON WESTCOTT Sehnen Schere	AJ-04
BARRAQUER Colibri Schere	AJ-04	METZENBAUM Schere	AH-11
BEEBEE Draht und Blech Schere	AI-43	METZENBAUM FINO Schere	AH-12
BELLUCCI Ohr Mikro Schere	EE-09	METZENBAUM FINO Präparier Schere	AI-15
BERGMANN Verband Schere	AI-46	METZENBAUM Präparier Schere	AI-13 bis AI-14
BETHUNE Rippen Schere	FG-04	METZENBAUM "S" Schere	AH-13, AI-16
BEUSE Schere	AI-26	MILLS Gefäß Schere	AI-27
BOETTCHER Tonsillen Schere	AI-27	Nagel Schere	HE-03
BRAUN-STADLER Episiotomie Schere	AH-22, AI-34	NORTHBENT Ligatur Schere	AI-40
BRUNNER Rippen Schere	FG-07	NOYES Iris Schere	AJ-03 bis AJ-04
BRUNS Gips Schere	AI-48	NOYES Sehnen Schere	AJ-03
BUCK Ligatur Schere	AI-40	Ohr Mikro Schere	EE-11
BUSCH Nabelschnur Schere	AI-34	Ohr Mikro Mini Schere	EE-11
CASTROVIEJO Hornhaut Schere	AJ-06	Parametrium Gefäß Schere	AH-20
CASTROVIEJO Iridectomie Schere	AJ-05	POTTS DE MARTEL Gefäß Schere	AI-27
COOLEY Rippen Schere	FG-05	POTTS-SMITH Gefäß Schere	AH-19
CORYLLOS Rippen Schere	FG-04	POTTS-SMITH Gefäß Schere	AI-28
COTTLE Nasen Schere	AH-18, AI-25	PRINCE Tonsillen Schere	AI-27
CRAFOORD Lungen und Thorax Schere	AI-36	QUINBY Zahnfleisch Schere	AI-42
DANDY Neurochirurgische Schere	AI-36	REYNOLDS Schere	AH-15, AI-18
DEAN Tonsillen Schere	AI-26	Rippen Schere	FG-02
DEAVER Schere	AH-05, AI-06	ROTES KREUZ Verband Schere	AI-47
DE BAKEY Gefäß Schere	AI-30	SANVENERO Schere	AH-13, AI-16
DIETHRICH Gefäß Schere	AI-29	SATINSKY Lungen und Thorax Schere	AI-37
DIMEDA Verband Schere	AI-46	SAUERBRUCH-FREY Rippen Schere	FG-06
DOYEN Gynäkologische Schere	AI-33	SAUERBRUCH Rippen Schere	FG-05
DUBOIS Gynäkologische Schere	AI-33	SCHMIEDEN-TAYLOR Schere	AI-36
ESMARCH Verband Schere	AI-46	SCHUMACHER Nabelschnur Schere	AI-34
FERGUSSON Schere	AI-49	SCHUMACHER Sternum Schere	FG-07
FINOCHIETTO Rektum Schere	AI-38	SEUTIN Gips Schere	DA-02
FOMON Nasen Schere	AH-18, AI-25	SHEA Ohr Mikro Schere	EE-09
GIERTZ-STILLE Rippen Schere	FG-06	SHORTBENT Ligatur Schere	AI-40
GLUCK Rippen Schere	FG-03	SIEBOLD Gynäkologische Schere	AI-32
GOLDMAN-FOX Zahnfleisch Schere	AI-41	SIEBOLD Gynäkologische Schere	AH-21
GOOD Tonsillen Schere	AI-27	SIMS Gynäkologische Schere	AI-32
		SIMS Gynäkologische Schere	AH-21

SMITH US ARMY Verband Schere	AI-44	Nabelschnur Schere	AI-34
SPENCER Ligatur Schere	AI-40	SCHUMACHER	
Schere		Probeexcisions Zange	HA-43
STELZNER Rektum Schere	AI-38	Sternum Schere	FG-07
STEVENS Tenotomie Schere	AH-17, AI-23	Schützer ARRUGA Netzhaut Ablös.	EC-08
STILLE Gips Schere	DA-02	Schutzhülse Gewebe	DD-15
STILLE Rippen Schere	FG-03	SCHWEIGGER Kapsel Pinzette	ED-04
Strabismus Schere	AH-17	Schwestern Garnitur	HE-03
STRULLY Neurochirurgische Schere	AI-35	SEEMANN-SEIFFERT Mund Sperrer	EI-04
THOREK Lungen und Thorax Schere	AI-36	SEGOND Myom Messer	HA-46
TOENNIS-ADSON Neurochirurgische Schere	AI-35	SEIFFERT Kehlkopf Zange	FC-03
TROUTMAN-CASTROVIEJO Mikro Schere	AJ-07	SELLHEIM Geburts Löffel	HC-09
UNIVERSAL Draht und Blech Schere	AI-42	SELLORS Rippen Kontraktor	FG-18
UNIVERSAL Verband Schere	AI-50	SEMB	
USA MODEL Nabelschnur Schere	AI-34	Bronchus Klemme	FG-23
VANNAS Iridectomie Schere	AJ-05	Hohlmeißel Zange	DC-06
VANNAS Mikro Schere	AJ-12 bis AJ-13	Knochenhalte Zange	DC-07
WAGNER Schere	AH-22	Knochensplitter Zange	DC-07
WAGNER Zahnfleisch Schere	AI-42	Raspatorien	DC-20
WALDMANN Episiotomie Schere	AI-34	SEMKEN Pinzette	BA-05
WECKER Iris Schere	AJ-04	SEMM Vaginal Spekulum	HA-07
WERTHEIM Praeparier Schere	AI-32	SENN-GREEN Wund Haken	BI-07
WESTCOTT Iridectomie Schere	AJ-02	SENN Wund Haken	BI-04
WESTCOTT Sehnen Schere	AJ-02	Septatom BRUENINGS	EG-11
WULLSTEIN Ohr Mikro Schere	EE-11	Sequester Zange	DC-10
WULLSTEIN Ohr Mikro Mini Schere	EE-11	SEUTIN Gips Schere	DA-02
YASARGIL Mikro Schere	AJ-10 bis AJ-11	SEXTON Ohr Messer	EE-06
SCHIMMELBUSCH Sterilisier Trommel	HE-12	SHEA Ohr Mikro Schere	EE-09
SCHINK Dermatome	AG-21	SHORTBENT Ligatur Schere	AI-40
SCHIOETZ Tonometer	ED-08	Sieb Auffang	HA-22
Schlanke Schere	AI-05	SIEBOLD	
Schlauch Klemme	BC-19	Gynäkologische Schere	AI-32
Schlinge		Gynäkologische Schere	AH-21
ARLT Draht Schlinge	EC-08	Siebschale	
BILLEAU Ohr Schlinge	EE-07	aus Drahtgeflecht	HE-13
Elektrode Mini Schlinge	JA-02 bis JA-03	aus perforiertem Blech	HE-13
Schlingen		SIEGLE Ohr Spekula	EE-02
Nasen Schlingen	EG-09	SIEGLER HELLMANN Uterus-Faß Zange	HA-38
Tonsillen Schlingen	FA-04	SILVER	
Schlinge		Dermatom	AG-20
Ohr Schlinge	EE-07	Nasenplastik Meißel	EG-14
SNELLEN Draht Schlinge	EC-08	SIMCOE Naht Kanüle	ED-07
WEBER Draht Schlinge	EC-08	SIMON	
WILDER Draht Schlinge	EC-08	Scharf Löffel	DC-13
SCHMIEDEN Führungshohl Sonde	CG-04	Uterus Kürette	HA-48
SCHMIEDEN-PAYR Führungshohl Sonde	CG-04	Wund Haken	BI-12
SCHMIEDEN-TAYLOR Schere	AI-36	SIMPSON-BRAUN Geburts Zange	HC-02
Schneider		SIMPSON Geburts Zange	HC-02
DIAMANT Draht Schneider	DD-12	SIMPSON-LUIKART Geburts Zange	HC-03
Draht Schneider	DD-12	SIMS	
SCHNIDT Tonsillen Klemme	FA-03	Gynäkologische Schere	AI-32
Schnürer		Gynäkologische Schere	AH-21
BRUENINGS Tonsillen Schnürer	FA-04	SIMS-MAIER Tupfer Zange	BG-05
EVES Tonsillen Schnürer	FA-04	SIMS	
KRAUSE Nasen Schnürer	EG-09	Rektal Spekulum	GI-02
KRAUSE Ohrpolypen Schnürer	EE-07	Uterus Depressor	HA-39
TYDING Tonsillen Schnürer	FA-05	Uterus Dilatator	HA-30
WESTON Rektal Polypen Schnürer	GI-05	Uterus Kürette	HA-49 bis HA-50
WILDE Nasen Schnürer	EG-09	Uterus Sonde	HA-39
WILDE Ohrpolypen Schnürer	EE-07	Vaginal Spekulum	HA-17
SCHOENBORN Schilddrüsen Haken	FE-04	SINGLEY Pinzette	BA-05
SCHOENBURG Darmfaß Zange	GE-03	Skalpell Abnehmer	AG-06, AG-10
SCHROEDER		Skalpell Griff	AG-02 bis AG-05, AG-07 bis AG-08
Haken Zange	HA-31 bis HA-32	Skalpellgriff	
Uterus Kürette	HA-48	CASPAR Mikro Skalpellgriff	AG-12
SCHUBERT Probeexcisions Zange	HA-41	LANDOLT Mikro Skalpellgriff	AG-13
SCHUKNECHT		Skalpell	
Roll Messer	EE-14	JOSEPH Nasen	EG-10
Sichel Messer	EE-14	Skalpell Klinge	AG-06
SCHULTZE Salpingograph	HA-47	Skalpell	
SCHUMACHER		PARKER anatomische Skalpell	AG-15
Kehlkopf Zange	FC-03		

Steril, Mikro Klinge	AG-13
Skarifrikateur GRAEFE	EC-04
SKENE Haken Zange	HA-31
Sklerotom	
GUYTON-LUNDSGAARD Sklerotom	EC-05
LUNDSGAARD Sklerotom	EC-05
SLUDER-BALLENGER Tonsillotom	FA-05
SMELLIE	
Geburts Haken	HC-06
Perforatorium	HC-09
SMILLIE Meniskotom	DC-24
SMITH-BUIE Mastdarm Spreizer	GI-03
SMITH-PETERSEN	
Flachmeißel	DC-15
Hohlmeißel	DC-15
SMITH Sperr Elevator	EC-02
SMITH US ARMY Verband Schere	AI-44
SMITHWICK	
Clip-Anlege Zange	EA-02
Nerv Haken	EA-04
SNELLEN	
Draht Schlinge	EC-08
Entropium Pinzette	ED-06
SOMER Uterus-Faß Zange	HA-37
Sonde	CA-02
BOWMAN Tränenkanal Sonde	EC-10
BRUNNER Fuehrungshohl Sonde	CG-04
COLLIN Uterus Sonde	HA-39
DESJARDINS Gallenstein Sonde	GC-05
DOYEN Sonde	CA-02
GUYON Gleit Sonde	GG-12
KIRSCHNER Fuehrungshohl Sonde	CG-04
KOCHER Kropf	FE-04
KOENIG Fuehrungshohl Sonde	CG-04
Markierung Sonde	EE-15
MARTIN Uterus Sonde	HA-39
MAYO Nierenstein Sonde	GC-10
MOYNIHAN Gallenstein Sonde	GC-05
NABATOFF Varicen Besteck Ohr Sonde	CA-02
PAYR Fuehrungshohl Sonde	CG-04
SCHMIEDEN Fuehrungshohl Sonde	CG-04
SCHMIEDEN-PAYR Fuehrungshohl Sonde	CG-04
SIMS Uterus Sonde	HA-39
STACKE Ohr Sonde	CA-02
VALLEIX Uterus Sonde	HA-39
Spalter VIRCHOW Schaedel	DC-17
Spanner LOUTE Draht	DD-11
Spannplatte	AG-21
Spannschluessel für Extensionbügel	DD-10
Spatel	
ALLISON Lungen Spatel	FG-19
ANDREW Zungen Spatel	EI-02
BANGERTER Cyclodialyse Spatel	EC-08
BRUENINGS Zungen Spatel	EI-02
BUCHWALD Zungen Spatel	EI-02
CASTROVIEJO Cyclodialyse Spatel	EC-08 bis EC-09
CULLER Iris Spatel	EC-08
CUSHING Hirn Spatel	EA-07
ELSCHNIG Cyclodialyse Spatel	EC-08
FRENZEL Zungen Spatel	EI-02
HARTMANN Zungen Spatel	EI-02
HEIFETZ Hirn Spatel	EA-07
Holz Zungen Spatel	EI-02
Intima Spatel	FG-32
KOCHER Blasen Spatel	GG-04
LEGUEU Blasen Spatel	GG-04
McIVOR Zungen Spatel	EI-05
OLIVECRONA Hirn Spatel	EA-07
TOBOLD Zungen Spatel	EI-02
WECKER Iris Spatel	EC-08

WHEELER Cyclodialyse Spatel	EC-09
WIEDER Zungen Spatel	EI-02
Spekula	
BOUCHERON Ohr Spekula	EE-02
BRUENINGS Ohr Spekula	EE-02
GRUBER Ohr Spekula	EE-02
HARTMANN Ohr Spekula	EE-02
SIEGLE Ohr Spekula	EE-02
TOYNBEE Ohr Spekula	EE-02
Spekulum	
AUVARD Vaginal Spekulum	HA-19
BARR Rektal Spekulum	GI-02
BERLIND-AUVARD Vaginal Spekulum	HA-19
BODENHAMMER Rektal Spekulum	GI-02
BRAUN Vaginal Spekulum	HA-16
BREISKY Vaginal Spekulum	HA-20
COLLIN Vaginal Spekulum	HA-04
COTTLE Nasen Spekulum	EG-03
CUSCO Vaginal Spekulum	HA-04 bis HA-06
CZERNY Rektal Spekulum	GI-02
DOYEN Vaginal Spekulum	HA-18, HA-20
FREEWAY-GRAVE Vaginal Spekulum	HA-06
GRAVE Vaginal Spekulum	HA-02
HARTMANN-HALLE Nasen Spekulum	EG-02
JACKSON Vaginal Spekulum	HA-16
KALLMORGEN Vagina Spekulum	HA-15
KILLIAN Septum Spekulum	EG-03
KOGAN Endo Spekulum	HA-23
KRISTELLER Vaginal Spekulum	HA-09 bis HA-14
LANDAU Vaginal Spekulum	HA-22
MATHIEU Rektal Spekulum	GI-02
O'SULLIVAN-O'CONNOR Vaginal Spekulum	HA-08
PEDERSON Vaginal Spekulum	HA-03
PRATT Rektal Spekulum	GI-02
SCHERBAK Vaginal Spekulum	HA-21
SEMM Vaginal Spekulum	HA-07
SIMS Rektal Spekulum	GI-02
SIMS Vaginal Spekulum	HA-17
STEINER-AUVARD Vaginal Spekulum	HA-19
THUDICHUM Nasen Spekulum	EG-02
TIECK-HALLE Nasen Spekulum	EG-03
TRELAT Vaginal Spekulum	HA-07
Vienna Nasen Spekulum	EG-02
VOLTOLINI Nasen Spekulum	EG-02
WEISSBARTH Vaginal Spekulum	HA-22
YANKAUER Nasenrachen Spekulum	EG-04
SPENCER Ligatur Schere	AI-40
SPENCER-WELLS Arterien Klemme	BC-07
Sperre BOSE Tracheal	FE-02
Sperrer	
ADSON Baby Wund Sperrer	BI-15
ADSON Wund Sperrer	BI-15
ALM Wund Sperrer	BI-14
BECKMANN-ADSON Wund Sperrer	BI-15
BECKMANN-EATON Wund Sperrer	BI-16
BECKMANN Wund Sperrer	BI-16
CASPAR ges. Wirbelsäule Wund Sperrer	BI-19
CASPAR Wund Sperrer	BI-20
CASTAÑEDA Rippen Sperrer	FG-14
CHEVALLIER Rippen Sperrer	FG-15
CLOWARD Wund Sperrer	BI-17
COOLEY Rippen Sperrer	FG-09
DARLING Wund Sperrer	BI-17
DAVIS-BOYLE Mund Sperrer	EI-04
DENHART Mund Sperrer	EI-03
DIMEDA Wund Sperrer	BI-14
DOYEN-JANSEN Mund Sperrer	EI-03
FINOCHIETTO-BABY Rippen Sperrer	FG-09
FINOCHIETTO BURFORD Rippen	FG-12 bis FG-14
FINOCHIETTO-HAIGHT BABY Rippen Sperrer	FG-10
FINOCHIETTO INFANT Rippen Sperrer	FG-12

D

Inhaltsverzeichnis Deutsch

FINOCHIETTO (modif) Rippen Sperrer	FG-08	Flach Halb	HE-30 bis HE-31
FINOCHIETTO Rippen Sperrer	FG-08, FG-10 bis FG-11	Große	HE-18 bis HE-20
Sperrer		Sterilisier Container	
FINSEN Wund Sperrer	BI-14	Halb	HE-26 bis HE-29
FRIEDMAN Perineorrhaph Sperrer	HA-23	Kleine	HE-32 bis HE-33
HAIGHT Rippen Sperrer	FG-15	Spezial	HE-34 bis HE-37
HEISTER Mund Sperrer	EI-03	Sterilisier Zange	CI-02
HERTZLER Rippen Sperrer	FG-17	Steril Skalpell Klinge	AG-09
JANSEN Wund Sperrer	BI-14	STERNBERG Lippen Halter	EI-02
JENNINGS Mund Sperrer	EI-04	Sternummeißel LEBSCHKE	DC-17
KILNER-DOUGHTY Mund Sperrer	EI-05	Stethoskop	
McIVOR Mund Sperrer	EI-05	BOWLES Stethoskop	AC-06
MERCEDES Thorax Sperrer	FG-16	FORD Stethoskop	AC-06
MILLIN Blasenhalshals Sperrer	GG-07	FORD BOWLES Stethoskop	AC-06
MOLLISON Wund Sperrer	BI-17	PINARD Stethoskop	AC-06
MORSE-FAVOLORO Rippen Sperrer	FG-17	STEVENS	
PLESTER Wund Sperrer	BI-14	Iris Pinzette	EC-11
ROSER-KOENIG Mund Sperrer	EI-03	Linsen Haken	EC-06
SEEMANN-SEIFFERT Mund Sperrer	EI-04	Nadelhalter	CE-06
TUFFIER Rippen Sperrer	FG-16	STEVENS Sperr Elevator	EC-03
WEITLANER-WULLSTEIN Wund Sperrer	BI-14	STEVENS	
WEITLANER Wund Sperrer	BI-14	Tenotomie Schere	AH-17, AI-23
WHITEHEAD Mund Sperrer	EI-04	STIEGLITZ Splitter Pinzette	BA-06
Spiegel		STILLE	
Kehlkopf Spiegel	FC-04	Flachmeißel	DC-14
MICHEL Spiegel	EG-04	Gips Schere	DA-02
Spiralbohrer	DD-04	Handbohr Apparat	DD-04
Splitter Pinzette	BA-06	Hohlmeißel	DC-14
SPRATT Scharf Löffel	DC-12	STILLE-HORSLEY Knochensplitter Zange	DC-07
Spreizer		STILLE-LISTON Knochensplitter Zange	DC-06
ALAN-PARKS Mastdarm Spreizer	GI-03	STILLE-LUER Hohlmeißel Zange	DC-04
BEESON Gips Spreizer	DA-03	STILLE	
CASPAR Cervical Wirbelsäule Wund Spreizer	BI-18	Nierenstiel Klemme	BC-16
CASPAR Muskelab Spreizer	BI-20	Osteotom	DC-14
CLOWARD Wirbelkörper Spreizer	EA-07	Pinzette	BA-02
FRAZIER Wund Spreizer	BI-21	Rippen Schere	FG-03
HAGLUND-STILLE Gips Spreizer	DA-03	STILLE-RUSKIN Hohlmeißel Zange	DC-05
HENNIG Gips Spreizer	DA-03	STILLE-SHERMAN Handbohr Apparat	DD-04
HERMANN Gips Spreizer	DA-03	Stimmgabel	EE-04
INGE Wirbelkörper Spreizer	EA-07	DIMEDA Alu	EE-03
QUATTRO Gips Spreizer	DA-03	HARTMANN	EE-03
SMITH-BUIE Mastdarm Spreizer	GI-03	LUCAE	EE-04
Spreizweite BROCK für Herz-Dilatatoren	FG-26	RYDEL-SEIFFER	EE-04
Spritze		Stirnlampe CLAR	AC-05
REINER Ohr Spritze	EE-05	Stirnspiegel ZIEGLER	AC-05
Tonsillen Spritze	FA-05	St. MARTIN Naht Pinzette	ED-05
SPURLING Laminektomie Zange	EA-08	STOCKMANN Penis Klemme	GG-10
STACKE Ohr Sonde	CA-02	STONE Verschluss Klemme	GE-06
Standard Laryngoskopgriff	AE-17	STONE-WATT Darm Klemme	GE-06
Standard Naht Besteck	CG-08	Strabismus Schere	AH-17, AI-24
Standgefäß	HE-08	STRATTE Nadelhalter	CE-04
Stanzbesteck KEYES Haut	HE-02	STRAUSS Penis Klemme	GG-10
Stanze		Stripper BUNNELL Sehnen	DC-25
BEYER Stanze	EG-08	STRUEMPEL Ohr Zängchen	EE-08
BROCK für Herz-Dilatatoren	FG-26	STRULLY Neurochirurgische Schere	AI-35
CITELLI Stanze	EG-08	STRUYCKEN Nasen scharfe Zange	EG-07
COLCLOUGH Bandscheiben Stanze	EA-11	SUBRAMANIAN Atraumatische Klemme	BD-31
DIETER Hammerkopf Stanze	EE-10	SWEET Clip-Anlege Zange	EA-02
FERRIS-SMITH-KERRISON Bandscheiben Stanze	EA-10		
HAJEK-CLAUS Stanze	EG-08	T	
HAJEK-KOFLER Stanze	EG-08	TABB Sichel Messer	EE-14
HOLTH Kapsel Stanze	EC-09	Tampon Stopfer LUNIATSCHEK	FA-02
KERRISON Stanze	EG-08	TARNIER	
STAUDE-MOORE Haken Zange	HA-31	Geburts, mit Achsenzugvorrichtung Zange	HC-05
St. CLAIR-THOMSON Ring Messer	EG-19	Kranioklast	HC-09
STEINER-AUVARD Vaginal Spekulum	HA-19	TAYLOR	
STEINMANN Knochen Nagel	DD-09	Perkussions Hammer	AC-07
STELZNER Rektum Schere	AI-38	Spinal Haken	DC-24
Steril Einmalskalpell	AG-10 bis AG-11	TEALE Haken Zange	HA-33
Sterilisier Container		TERSON Kapsel Pinzette	ED-04
3/4	HE-22 bis HE-24		

THOMS-ALLIS Darmfaß Zange.....	GE-02	TURNBULL Nagel Zange.....	HE-03
THOMS-GAYLOR Probeexcisions Zange.....	HA-42	TURREL Biopsie Zange.....	GI-05
THOMSON-WALKER Blasen Wundsperrer.....	GG-06	TYDING	
THOREK Lungen und Thorax Schere.....	AI-36	Tonsillen Fass Zange.....	FA-04
THUDICHUM Nasen Spekulum.....	EG-02	Tonsillen Schnürer.....	FA-05
TIECK-HALLE Nasen Spekulum.....	EG-03	U	
TIEMANN Haken Zange.....	HA-32	UCKERMANN	
TILLEY Ohr Zängchen.....	EE-08	Tracheal Trokar.....	FE-02
TISCHLER-KEVORKIAN		Watteträger.....	CA-03
Probeexcisions Zange.....	HA-44 bis HA-45	Uhrmacher Pinzette.....	BA-06
TISCHLER-MORGAN		ULRICH Schwamm Zange.....	BG-06
Probeexcisions Zange.....	HA-43 bis HA-44, HA-46	Umfuehr De MARTEL.....	EA-05
TIVNEN Tonsillen Fass Zange.....	FA-04	UNIVERSAL	
TOBOLD		Draht und Blech Schere.....	AI-42
Watteträger.....	CA-03	Sterilisis Zange.....	CI-02
Zungen Spatel.....	EI-02	Trokar.....	CC-02
TOENNIS-ADSON Neurochirurgische Schere.....	AI-35	Verband Schere.....	AI-50
TOENNIS		UNNA Komedonen Quetscher.....	HE-02
Arterien Klemme.....	BC-11	Urethrotom OTIS.....	GG-08
Dura Dissektor.....	EA-05	Urinal.....	HE-10
Nadelhalter.....	CE-04	USA	
TOHOKU Tuch Klemme.....	BE-04	HF Chirurgie Geräte Kabel.....	JA-07
Tonometer SCHIOETZ.....	ED-08	USA MODEL Nabelschnur Schere.....	AI-34
Tonsillotom SLUDER-BALLENGER.....	FA-05	USA	
TOOK Hornhaut Messer.....	EC-05	Pinzette.....	BA-02
TOTI Fräser.....	DD-07	US Army (PARKER-LANGENBECK) Wund Haken.....	BI-03
TOWNSEND-KEVORKIAN Probeexcisions Zange.....	HA-44	V	
TOWNSEND-MINI (BABY TISCHLER) Probeexcisions Zange.....	HA-45	VALLEIX Uterus Sonde.....	HA-39
TOWNSEND-mini Probeexcisions Zange.....	HA-44	Valve	
TOWNSEND Probeexcisions Zange.....	HA-44	BALFOUR Valve.....	BI-22
TOWNSEND-TISCHLER Probeexcisions Zange.....	HA-44	CASPAR Valve.....	BI-20
TOYNBEE Ohr Spekula.....	EE-02	CASPAR Valve ges. Wirbelsäule.....	BI-19
TRAUBE Perkussions Hammer.....	AC-07	KIRSCHNER Valve.....	BI-23
TRELAT Vaginal Spekulum.....	HA-07	VAN BUREN	
Trephine.....	DD-04	Harnröhren Bougie.....	GG-13
CASTROVIEJO Hornhaut Trephine.....	ED-07	Sequester Zange.....	DC-10
ELLIOT Hornhaut Trephine.....	ED-08	Van DOREN Probeexcisions Zange.....	HA-42
FRANCESCETTI Hornhaut Trephine.....	ED-07	VANNAS	
Trichter.....	HE-07	Iridectomie Schere.....	AJ-05
TROELTSCH Nasen Zange.....	EG-04	Mikro Schere.....	AJ-12 bis AJ-13
TROEMNER Perkussions Hammer.....	AC-07	VARIFOCAL Ophthalmoskop.....	AC-03
Trokar.....	CC-02	Venenstauer.....	AC-03
COAKLEY Trokar.....	CC-02	VERBRUGGE Knochenhalte Zange.....	DC-09
DOUGLAS Trokar.....	CC-02	VERRES Pneumoperitoneum Punktions Nadel.....	CC-03
FLEURANT Trokar.....	CC-02	Vienna Nasen Spekulum.....	EG-02
LICHTWITZ Trokar.....	CC-02	VIRCHOW	
MENGHINI Trokar.....	CC-03	Hirn Messer.....	AG-18
NELSON Trokar.....	CC-02	Knorpel Messer.....	AG-18
OCHSNER Trokar.....	CC-02	Schaedel Spalter.....	DC-17
PIERCE Trokar.....	CC-02	VIRTUS (RALK) Splitter Pinzette.....	BA-06
UCKERMANN Tracheal Trokar.....	FE-02	VOLKMANN	
UNIVERSAL Trokar.....	CC-02	Scharf Löffel.....	DC-12 bis DC-13
Trommel		Wund Haken.....	BI-07 bis BI-08
KONRICH Sterilisier Trommel.....	HE-12	VOLTOLINI Nasen Spekulum.....	EG-02
SCHIMMELBUSCH Sterilisier Trommel.....	HE-12	Vorböhrer.....	DD-12
TROUSSEAU Tracheal Dilatator.....	FE-02	CRUTCHFIELD Vorböhrer.....	EA-03
TROUTMAN-CASTROVIEJO Mikro Schere.....	AJ-07	KUENTSCHER Vorböhrer.....	DD-13
TROUTMAN-CHRIS Klängenbrecher.....	AG-14	W	
TROUTMAN Colibri Iris Pinzette.....	EC-13	WACHENFELDT Wundklammer Zange.....	CG-07
TROUTMAN Rectus Pinzette.....	ED-02	WADSWORTH-TODD Kauter.....	EC-08
TUBBS Herz Dilatator.....	FG-27	WAGENER-MOSHER Tracheal Kannule.....	FE-03
Tübingen		WAGENER Ohr Häkchen.....	EE-07
Faden Pinzette.....	ED-05	WAGNER	
Iris Pinzette.....	EC-15	Laminektomie Zange.....	EA-09
Luft Kanüle.....	ED-07	Schere.....	AH-22
Tübingen TITAN			
Faden Pinzette.....	ED-05		
Iris Pinzette.....	EC-15		
TUFFIER			
Arterien Klemme.....	BC-08		
Rippen Sperrer.....	FG-16		

D

Inhaltsverzeichnis Deutsch

Zahnfleisch Schere	AI-42	WINKELMANN Beschneidungs Klemme	GG-09
WALDMANN Episiotomie Schere	AI-34	WINTER Plazentar und Abortus Zange	HC-07
WALLICH Plazentar und Abortus Löffel	HC-08	Wirbelsmeißel BRUNETTI	DC-17
WALSHAM Septum Zange	EG-18	WITTNER Probeexcisions Zange	HA-43
WALTHER Harnröhren Bougie	GG-17	WOLFF Gipsabreiss Zange	DA-04
WALTON		WRIGLEY Geburts Zange	HC-02
Fremdkörper Hohlmeißel	EC-06	WULLSTEIN	
Komedonen Quetscher	HE-02	Ohr Mikro mini Schere	EE-11
WALTON YANKAUER Sauger	AE-03	Ohr Mikro Schere	EE-11
WANGENSTEEN		Sichel Messer	EE-14
Nadelhalter	CE-03	Wund Haken	BI-06, BI-10
Pinzette	BA-05	Wundsperrerr	
WARTENBERG Nadelrad	AC-08	HRYNTSCHAK Prostata Wundsperrerr	GG-06
Waschschüssel	HE-05	JUDD-MASSON Blasen Wundsperrerr	GG-04
WATSON-CHEYNE Elevatorien	DC-22	LEGUEU Blasen Wundsperrerr	GG-06
WATSON Dermatome	AG-22	MILLIN Blasen Wundsperrerr	GG-05
Watteträger	CA-03	THOMSON-WALKER Blasen Wundsperrerr	GG-06
DIMEDA Watteträger	CA-03	WYLIE	
FARREL Watteträger	CA-03	Atraumatische Klemme	BD-21
JOBSON-HORNE Watteträger	CA-03	Uterus Dilator	HA-30
TOBOLD Watteträger	CA-03		
UCKERMANN Watteträger	CA-03	Y	
WEBER		YANKAUER	
Atraumatische Klemme	BD-12	Nasenrachen Spekulum	EG-04
Draht Schlinge	EC-08	Sauger	AE-02
WECKER		YASARGIL	
Iris Schere	AJ-04	MINI Clip-Anlege Zange	EA-12
Iris Spatel	EC-08	Mikro Schere	AJ-10 bis AJ-11
WEEK Sperr Elevator	EC-02	STANDARD Clip-Anlege Zange	EA-12
WEIL-BLAKESLEY Nasen scharfe Zange	EG-06	Standard Clips	EA-13
WEISSBARTH Vaginal Spekulum	HA-22	Temporäre Clips	EA-12
WEISS Schlauch Klemme	BC-19	YEOMAN Biopsie Zange	GI-05
WEITLANER-WULLSTEIN Wund Sperrerr	BI-14	YOUNG Boomerang Unterbindungs Nadel	CG-03
WEITLANER Wund Sperrerr	BI-14	YOUNG	
WELLS Enukektion Löffel	EC-08	Prostata Faß Zange	GG-02
WERTHEIM-CULLEN Hysterektomie Klemme	BC-18	Prostata Haken	GG-02
WERTHEIM		Zungen Zange	EI-03
Hysterektomie Klemme	BC-18	Z	
Praeparier Schere	AI-32	Zahnfleisch Schere	AI-41
WESTCOTT		Zängchen	
Iridektomie Schere	AJ-02	GREVEN Ohr Mikro Zängchen	EE-10
Sehnen Schere	AJ-02	HARTMANN-HOFFMANN Ohr Zängchen	EE-08
WEST Nasen Hohl Meißel	EG-14	HARTMANN Ohr Zängchen	EE-08
WESTON Rektal Polypen Schnürer	GI-05	HARTMANN-WULLSTEIN Ohr Zängchen	EE-08
WHEELER		LITTAUER Ohr Zängchen	EE-08
Cyclodialyse Spatel	EC-09	McGEE Ohr Mikro Zängchen	EE-10
Diszisions Messer	EC-04	Ohr Mikro Zängchen	EE-09 bis EE-10, EE-12
WHITEHEAD Mund Sperrerr	EI-04	Ohr Mikro Mini Zängchen	EE-13
WHITE Tonsillen Fass Zange	FA-03	STRUEMPEL Ohr Zängchen	EE-08
WIEDER Zungen Spatel	EI-02	TILLEY Ohr Zängchen	EE-08
WIENER (AUFRICHT) Nasen Rasper	EG-15	Zange	
WIENER		ADSON Hohlmeißel Zange	DC-03
Iris Haken	EC-06	ALEXANDER Probeexcisions Zange	HA-42
Nasen Rasper	EG-15	ALLIS-ADAIR Darmfaß Zange	GE-02
WIGMORE Gips Sage	DA-02	ALLIS-BABY Darmfaß Zange	GE-02
WILDE		ALLIS Darmfaß Zange	GE-02
Nasen Schnürer	EG-09	ASCH Septum Zange	EG-18
Ohrpolypen Schnürer	EE-07	BABCOCK Darmfaß Zange	GE-02
WILDER		BAGGISH Probeexcisions Zange	HA-45
Draht Schlinge	EC-08	BALLENGER Tonsillen Fass Zange	FA-04
Tränenkanal Dilator	EC-10	BARRETT Haken Zange	HA-32
WILDE (TROELTSCH) Ohr Pinzette	EE-07	BARTON Geburts Zange	HC-04
WILLET-MARTELL Kopfhaut Klemme	BC-08	BERGMANN FOERSTER Schwamm Zange	BG-10
WILLIAMS		BEYER Hohlmeißel Zange	DC-04
Darmfaß Zange	GE-03	BIRCHER-GANSKE Knochenhalte Zange	DC-10
Schrauben Dreher	DD-14	BLAKE Gallenstein Zange	GC-03
Sperr Elevator	EC-02	BLOHMKE Tonsillen Fass Zange	FA-04
WILLIGER		BLUMENTHAL Hohlmeißel Zange	DC-02
Hammer	DC-18		
Raspatorien	DC-19		
Scharf Löffel	DC-13		

BOERMA Geburts Zange	HC-04
BÖHLER Hohlmeißel Zange.....	DC-04
BÖHLER Knochensplitter Zange.....	DC-06
Zange	
BONNEY Schwamm Zange.....	BG-08
BOZEMANN-DOUGLAS Tupfer Zange	BG-13
BOZEMANN Tupfer Zange.....	BG-13
BRAUN Haken Zange	HA-31, HA-34
BRUENINGS Kehlkopf Zange.....	FC-03
BRUENINGS Nasen Zange, scharf.....	EG-05
BRYANT Schwamm Zange.....	BG-11
BUMM Uterus-Faß Zange.....	HA-38
BURKE-Baby Probeexcisions Zange.....	HA-44
BURKE Probeexcisions Zange	HA-44
CHEATLE Sterilisier Zange.....	CI-02
CHERON Tupfer Zange.....	BG-12
CHEVALIER-JACKSON Kehlkopf Zange.....	FC-04
CHILDE Wundklammer Zange	CG-07
CLEVELAND Hohlmeißel Zange	DC-02
COLLIN-POZZI Haken Zange.....	HA-32
COLLIN Tupfer Zange.....	BG-11
COLLIN Uterus-Faß Zange.....	HA-37
COLLIN Wundklammer Zange	CG-07
COLLIN Zungen Zange	EI-03
COLVER Tonsillen Faß Zange	FA-03
CORDES Kehlkopf Zange.....	FC-03
COTTLE-KAZANJIAN Knochensplitter Zange.....	DC-06
CUSHING Laminektomie Zange	EA-08
CZERNY Gallenstein Zange.....	GC-03
CZERNY Haken Zange.....	HA-34
DARTIGUES Uterus-Faß Zange.....	HA-37
DAVIS Sterilisier Zange.....	CI-02
De LEE Geburts Zange	HC-02
DESJARDINS Gallenstein Zange.....	GC-02
DEWEY Geburtszange, mit Achsenzugvorrichtung.....	HC-05
DIMEDA Abfall Zange.....	CI-03
DINGMANN Knochenhalte Zange	DC-10
DOYEN Uterus-Polypen Zange	HA-36
DUPLAY Haken Zange	HA-31
DUPLAY Tupfer Zange	BG-14
DUVAL Darmfaß Zange	GE-03
ECHLIN Hohlmeißel Zange	DC-05
ELLIOT Geburts Zange	HC-02
ELSAESSER Nieren Fistel Zange.....	GC-13
EPPENDORFER-KEVORKIAN	
Probeexcisions Zange	HA-46
EPPENDORFER Probeexcisions Zange.....	HA-45 bis HA-46
EPPENDORFER TISCHLER-MORGAN	
Probeexcisions Zange	HA-46
FARABEUF Knochenhalte Zange.....	DC-07
FARABEUF-LAMBOTTE Knochenhalte Zange	DC-08
FAURE Probeexcisions Zange	HA-41
FERGUSON Knochenhalte Zange	DC-07
FERRIS-SMITH Laminektomie Zange	EA-09
Flach Zange	DD-11
FLETCHER JAVERTS Schwamm Zange.....	BG-10
FOERSTER Schwamm Zange.....	BG-06 bis BG-08
FRAENKEL Kehlkopf Polypus Zange	FC-02
FRAENKEL Kehlkopf Zange	FC-03
FRIEDMAN Hohlmeißel Zange.....	DC-02
FRIEDMAN Mini Hohlmeißel Zange	DC-02
FRYKHOLM Hohlmeißel Zange	DC-05
GAUSS Kopfschwarten Zange	HC-06
GELLHORN Probeexcisions Zange.....	HA-42
GRIP Zange	DD-11
GROSS-MAIER Tupfer Zange.....	BG-02 bis BG-04
GROSS Tupfer Zange	BG-05
HARTMANN Nasen Polypus Zange	EG-04
HARTMANN Nasen Zange, scharf.....	EG-07
HEGENBARTH Wundklammer Zange	CG-07
HEIMING Nierenstein Zange.....	GC-13

HENROTIN Haken v	HA-34
HEYMANN-KNIGHT Nasen Polypus Zange.....	EG-05
HEYMANN Nasen Zange, scharf	EG-05
Zange	
HEYWOOD-SMITH Hämorrhoid. Zange.....	GI-05
IOWA Haken Zange	HA-35
JACOBS Haken Zange	HA-34
JANSEN Nasen Zange	EG-04
JARCHO Haken Zange.....	HA-32
JATHO Nasenrachen Zange.....	EG-18
JUDD-ALLIS Darmfaß Zange	GE-02
JURASZ Kehlkopf Polypus Zange	FC-02
KELLY Uterus-Polypen Zange	HA-36
KERN Knochenhalte Zange.....	DC-08
KEVORKIAN-Pacific Probeexcisions Zange.....	HA-44
KEVORKIAN Probeexcisions Zange	HA-43, HA-46
KIELLAND Geburts Zange	HC-02
KIELLAND-LUIKART Geburts Zange	HC-03
KNIGHT Nasen Zange, scharf.....	EG-05
KRAUSE Kehlkopf Zange	FC-03
LAHEY Kropf Fass Zange	FE-04
LAMBOTTE Knochenhalte Zange	DC-08
LANE Knochenhalte Zange	DC-08
LANE Knochenschraub. Halte Zange.....	DD-14
LANGE Kehlkopf Zange.....	FC-03
LANGENBECK Knochenhalte Zange	DC-07
LEKSELL STILLE Hohlmeißel Zange.....	DC-05
LEMPERT Hohlmeißel Zange.....	DC-03
LEWIN Knochenhalte Zange	DC-10
LEWKOWITZ Plazentar und Abortus Zange	HC-07
LISTER Sinus Schwamm Zange	BG-11
LISTON Knochensplitter Zange.....	DC-06
LITTAUER Nasen Polypus Zange	EG-05
LOVE-GRUENWALD Laminektomie Zange.....	EA-08
LOVELACE Lungenfaß Zange.....	FG-19
LUBET-BARBON Nasen Polypus Zange	EG-05
LUC Nasen Zange, scharf	EG-06
LUER Hohlmeißel Zange	DC-03
LUIKART Geburts Zange.....	HC-03
MAGILL Kathetereinführ Zange	AE-06
MAIER Tupfer Zange	BG-12
MARTIN Sequester Zange	DC-10
MARTIN Tupfer Zange	BG-02, BG-14
MATHIEU Fremdkörper Zange.....	GG-07
MAYO BLAKE Gallenstein Zange	GC-04
McCLINTOCK Plazentar und Abortus Zange	HC-07
McKENZIE Clip-Anlege Zange.....	EA-02
McLEAN Geburts Zange.....	HC-04
McLEAN-LUIKART Geburts Zange	HC-03
McLEAN-TUCKER-LUIKART Geburts Zange	HC-03
MEAD Hohlmeißel Zange	DC-02
MICHEL Wundklammer Zange.....	CG-07
MIDDLETON-JANSEN Nasen Zange, scharf.....	EG-09
MILLIN Fadenführungs Zange	GG-03
MILLIN Faß vordere Lappen Zange.....	GG-03
MILLIN Kapsel Faß Zange	GG-03
MIXTER Gallenstein Zange.....	GC-04
MUSEUX Haken Zange	HA-33
MYLES Nasen Zange, scharf	EG-07
NAEGELE Geburts Zange.....	HC-03
Nagel Zange	HE-03
Nagelhaut Zange	HE-03
NOTO Uterus-Polypen Zange.....	HA-36
NOYES Nasen Polypus Zange.....	EG-05
OLDBERG Laminektomie Zange	EA-09
OLIVECRONA Hohlmeißel Zange	DC-03
OLIVECRONA-TOENNIS Clip-Anlege Zange.....	EA-02
PELMANN Tupfer Zange.....	BG-12
PIPER Geburts Zange	HC-04
PIPER Geburtszange, mit Achsenzugvorrichtung	HC-04
POZZI Haken Zange.....	HA-31

D

Inhaltsverzeichnis Deutsch

PRATT Haken Zange	HA-34 bis HA-35	VERBRUGGE Knochenhalte Zange.....	DC-09
RADOLF Nagelausreiss Zange	DD-03	WACHENFELDT Wundklammer Zange	CG-07
RAMPLEY Schwamm Zange.....	BG-09	WAGNER Laminektomie Zange.....	EA-09
Zange		WALSHAM Septum Zange	EG-18
RANDALL Nierenstein Zange.....	GC-11 bis GC-12	WEIL-BLAKESLEY Nasen Zange, scharf.....	EG-06
RANEY Anlege- und Abnahme Zange	EA-03	WHITE Tonsillen Fass Zange	FA-03
RICHTER-HEATH Wundklammer Zange	CG-07	WILLIAMS Darmfaß Zange	GE-03
ROGGE Sterilisier Zange	CI-02	WINTER Plazentar und Abortus Zange.....	HC-07
ROSENBERG Kehlkopf Zange	FC-03	WITTNER Probeexcisions Zange	HA-43
ROWE Mund Zange	EI-06	WOLFF Gipsabreiss Zange	DA-04
RUBIN Septum Quetsch Zange	EG-07	WRIGLEY Geburts Zange	HC-02
RUSKIN Hohlmeißel Zange.....	DC-04	YASARGIL MINI Clip-Anlege Zange	EA-12
RUSKIN-LISTON Knochensplitter Zange	DC-06	YASARGIL STANDARD Clip-Anlege Zange	EA-12
SAENGER Plazentar und Abortus Zange	HC-07	YEOMAN Biopsie Zange.....	GI-05
SAIRGES Haken Zange	HA-32	YOUNG Prostata Faß Zange	GG-02
SAUERBRUCH Abfall Zange	CI-03	YOUNG Zungen Zange	EI-03
SAUERBRUCH Hohlmeißel Zange	DC-05	ZAUFAL-JANSEN Hohlmeißel Zange	DC-04
SCAGLIETTI Hohlmeißel Zange	DC-05	ZAUFAL-JANSEN Hohlmeißel Zange.....	DC-04
Schneide- und Biege Zange	DD-11	ZENKER Präparier und Ligatur Klemme	BC-12
SCHEINMANN Kehlkopf Zange.....	FC-03	ZIEGLER	
SCHOENBURG Darmfaß Zange.....	GE-03	Iris Messer	EC-04
SCHROEDER Haken Zange	HA-31 bis HA-32	Kapsulotomie Messer	EC-05
SCHUBERT Probeexcisions Zange.....	HA-41	Sperr Elevator	EC-03
SCHUMACHER Kehlkopf Zange	FC-03	Stirnspiegel	AC-05
SCHUMACHER Probeexcisions Zange.....	HA-43	Tränenkanal Dilatatore.....	EC-10
SEIFFERT Kehlkopf Zange.....	FC-03	Zubehör für Sterilisier Container	HE-38 bis HE-41
SEMB Hohlmeißel Zange	DC-06		
SEMB Knochenhalte Zange	DC-07		
SEMB Knochensplitter Zange.....	DC-07		
SIEGLER HELLMANN Uterus-Faß Zange	HA-38		
SIMPSON-BRAUN Geburts Zange	HC-02		
SIMPSON Geburts Zange	HC-02		
SIMPSON-LUIKART Geburts Zange	HC-03		
SIMS-MAIER Tupfer Zange	BG-05		
SKENE Haken Zange	HA-31		
SMITHWICK Clip-Anlege Zange.....	EA-02		
SOMER Uterus-Faß Zange	HA-37		
SPURLING Laminektomie Zange	EA-08		
STAUDE-MOORE Haken Zange	HA-31		
STILLE-HORSLEY Knochensplitter Zange	DC-07		
STILLE-LISTON Knochensplitter Zange.....	DC-06		
STILLE-LUER Hohlmeißel Zange.....	DC-04		
STILLE-RUSKIN Hohlmeißel Zange.....	DC-05		
STRUYCKEN Nasen Zange, scharf	EG-07		
SWEET Clip-Anlege Zange.....	EA-02		
TARNIER			
Geburtszange, mit Achsenzugvorrichtung.....	HC-05		
TEALE Haken Zange	HA-33		
THOMS-ALLIS Darmfaß Zange.....	GE-02		
THOMS-GAYLOR Probeexcisions Zange	HA-42		
TIEMANN Haken Zange	HA-32		
TISCHLER-KEVORKIAN			
Probeexcisions Zange	HA-44 bis HA-45		
TISCHLER-MORGAN			
Probeexcisions Zange.....	HA-43 bis HA-44, HA-46		
TIVNEN Tonsillen Fass Zange	FA-04		
TOWNSEND-KEVORKIAN			
Probeexcisions Zange	HA-44		
TOWNSEND-MINI (BABY TISCHLER)			
Probeexcisions Zange	HA-45		
TOWNSEND-Mini Probeexcisions Zange.....	HA-44		
TOWNSEND Probeexcisions Zange	HA-44		
TOWNSEND-TISCHLER Probeexcisions Zange	HA-44		
TROELTSCH Nasen Zange.....	EG-04		
TURNBULL Nagel Zange.....	HE-03		
TURREL Biopsie Zange	GI-05		
TYDING Tonsillen Fass Zange	FA-04		
ULRICH Schwamm Zange	BG-06		
UNIVERSAL Sterilisier Zange	CI-02		
VAN BUREN Sequester Zange	DC-10		
VAN DOREN Probeexcisions Zange	HA-42		

E

**Index
English**

E

A

- Accessories for sterilization containerHE-38 to HE-41
 Adenotome LAFORCEEG-19
 ADLERKREUTZ thumb and tissue forcepsBA-04
 ADSON BABY hemostatic forcepsBC-09
 ADSON-Baby retractorBI-15
 ADSON
 bone rongeurDC-03
 ADSON-BROWN thumb and tissue forcepsBA-03
 ADSON
 elevatorDC-21
 hemostatic forcepsBC-09
 hypophyseal forcepsEA-06
 needle holderCE-04
 nerve hookEA-04
 retractorBI-15
 thumb and tissue forcepsBA-03
 thumb and tissue, micro forcepsBA-03
 AEBLI corneal scissorsAI-22
 AESCULAP electrosurgery equipment cableJA-07
 Air bag POLITZEREE-05
 ALAN-PARKS anal retractorGI-03
 ALBEE drill burrDD-07
 ALEXANDER
 bone chiselDC-14
 bone gougeDC-14
 periosteal elevatorDC-19
 uterine biopsy specimen forcepsHA-42
 ALLIS-ADAIR tissue forcepsGE-02
 ALLIS-Baby tissue forcepsGE-02
 ALLISON lung spatulaFG-19
 ALLIS tissue forcepsGE-02
 ALM retractorBI-14
 ALVIS foreign body curetteEC-06
 Amniotome BEACHAMHA-39
 Amputation knifeAG-16
 ANDREWS-PINCHON suction tubeAE-03
 ANDREW tongue depressorEI-02
 Anoscope
 HIRSCHMANNGI-04
 IVES-FANSLERGI-04
 Apparatus
 BARANY noiseEE-04
 PETZ stomach and intestinal suturingGE-09
 ARCHER splinter forcepsBA-06
 ARKANSAS grinding stoneAG-19
 ARLT wire loopEC-08
 ARRUGA
 capsular forcepsED-04
 extracting hookEC-06
 eye speculumEC-02
 ophthalmological needle holderCE-06
 protectorEC-08
 ASCH septum forcepsEG-18
 Atraumatic pediatric vascular forcepsBD-43
 AUFRICHT nasal retractorEG-17
 AUVARD vaginal speculumHA-19
 AXENFELD chalazion curetteEC-07
 AYER chalazion forcepsED-06
- B**
- BABCOCK seizing forcepsGE-02
 BABINSKY percussion hammerAC-07
 BACKHAUS-CLIP tube holder towel clampBE-03
 BACKHAUS KOCHER towel clampBE-02
 BACKHAUS towel clampBE-02
 BAGGISH uterine biopsy specimen forcepsHA-45
 BAILEY-BABY rib contractorFG-18
 BAILEY-GIBBON rib contractorFG-18
 BAILEY rib contractorFG-18
 BAINBRIDGE
 atraumatic forcepsBD-09
 hemostatic forcepsBC-14
 BAKES gall duct dilatorGC-06
 BALFOUR
 abdominal retractorBI-22
 BALFOUR Baby abdominal retractorBI-22
 BALFOUR
 bladeBI-22
 BALL AND SOCKET towel clampBE-04
 Ball coagulation electrodeJA-03
 BALLENGER
 septum elevatorEG-12
 swivel knifeEG-11
 tonsil seizing forcepsFA-04
 Band PARHAMDC-11
 BANGERTER cycloidalysis spatulaEC-08
 BARANY noise apparatusEE-04
 BARBARA
 hookletEE-14
 needleEE-14
 pickEE-14 to EE-15
 BARKAN goniotomy knifeEC-05
 BARNHILL adenoid curetteEG-19
 BARRAQUER-KATZIN iris forcepsEC-13
 BARRAQUER Colibri iris forcepsEC-13
 BARRAQUER
 anterior chamber forcepsED-02
 cilia forcepsED-08
 BARRAQUER Colibri eye speculumEC-02
 BARRAQUER
 colibri scissorsAJ-04
 fixation forcepsED-03
 keratoplasty knifeEC-05
 needle holderCE-07
 BARRETT tenaculum forcepsHA-32
 BARR rectal speculumGI-02
 BARTON
 obstetrical forcepsHC-04
 traction handleHC-04
 BAUMGARTNER needle holderCE-02
 BEACHAM amniotomeHA-39
 BeakerHE-10
 BECK atraumatic peripheral vascular forcepsBD-25
 BECKER cystotomeEC-06
 BECKMANN
 adenoid curetteEG-19
 BECKMANN-ADSON retractorBI-15
 BECKMANN-EATON retractorBI-16
 BECKMANN
 retractorBI-16
 BEEBEE wire and plate scissorsAI-43
 BEER cilia forcepsED-08
 BEESON plaster spreaderDA-03
 BELLUCCI ear micro scissorsEE-09
 BENGOLEA hemostatic forcepsBC-09
 BENNETT bone leverDC-22
 BERENS keratomeEC-04
 BERGMANN bandage scissorsAI-46
 BERGMANN FOERSTER sponge holding forcepsBG-10
 BERGMANN plaster sawDA-02
 BERKE muscular forcepsED-02
 BERLIND-AUVARD vaginal speculumHA-19
 BERLINER percussion hammerAC-07
 BERNHARD towel clampBE-05
 BERTILLON cephalometerAC-08
 BEST intestinal forcepsGE-06
 BETHUNE rib shearFG-04
 BEUSE scissors toothedAI-26

- BEYER
bone rongeurDC-04
punchEG-08
- BILLEAU ear loopEE-07
- BILL traction handleHC-05
- BIRCHER-GANSKE bone holding forcepsDC-10
- BIRCHER meniscotomeDC-24
- BISHOP-HARMAN iris forcepsEC-14
- Blade
BALFOURBI-22
- Blade breaker
CASTROVIEJOAG-14
DIMEDAAG-14
TROUTMAN-CHRISAG-14
- Blade
CASPARBI-20
CASPAR vertebral columnBI-19
HUMBY dermatomeAG-20
KIRSCHNER abdominal retractorBI-23
OTIS spareGG-08
- BLAKE
gall stone forcepsGC-03
uterine curetteHA-48
- BLOHMKE tonsil seizing forcepsFA-04
- Blood pressure apparatusAC-02
- BLOUNT
bone leverDC-24
knee retractorDC-24
- BLUMENTHAL bone rongeurDC-02
- BODENHAMMER rectal speculumGI-02
- BOEHLER 16x9 cm extension bowDD-10
- BOERMA obstetrical forcepsHC-04
- BOETTCHER tonsil scissorsAI-27
- BOEHLER
bone cutting forcepsDC-06
bone rongeurDC-04
- BONACCOLTO strabismus forcepsEC-14
- Bone holding forcepsDC-09 to DC-10
- Bone wireDD-11
- BONNEY sponge holding forcepsBG-08
- Bonn
iris forcepsEC-15
irrigating cannulaED-07
- Bonn TITAN iris forcepsEC-15
- BORCHARDT drill burrDD-07
- BOSE
tracheal hookFE-02
tracheal spreaderFE-02
- BOUCHERON ear speculaEE-02
- Bougiem FILIFORMGG-12
- BowlHE-04
- BOWLES stethoscopeAC-06
- Bowl
kidneyHE-07
solutionHE-05
- BOWMAN
discision knifeEC-04
discision needleEC-05
eye speculumEC-02
lachrymal probeEC-10
- BOYNTON ophthalmological needle holderCE-06
- BOZEMANN-DOUGLAS swab forcepsBG-13
- BOZEMANN
swab forcepsBG-13
needle holderCE-03
- BRAIN MINI clip applying forcepsEA-12
- BRAIN
standard clipEA-13
- BRAIN STANDARD clip applying forcepsEA-12
- BRAIN
temporary clipEA-12
- BRAITHWAITE dermatomeAG-22
- BRAUN
cranioclastHC-09
decapitating hookHC-09
- BRAUN-STADLER episiotomy scissorsAH-22, AI-34
- BRAUN
tenaculum forcepsHA-31, HA-34
uterine depressorHA-39
vaginal speculumHA-16
- Breaker WOLFF plasterDA-04
- BREISKY vaginal speculumHA-20
- BROCK
mitral valve dilator handleFG-26
mitral valve dilator openingFG-26
mitral valve dilator punchFG-26
- BROWN thumb and tissue forcepsBA-03
- BRUENINGS
ear speculaEE-02
extension tubeFC-03
larynx forcepsFC-03
nasal cutting forcepsEG-05
septatomeEG-11
tongue depressorEI-02
tonsil snareFA-04
- BRUNETTI spine chiselDC-17
- BRUNNER
intestinal forcepsGE-06
ligature conductorCG-04
rib shearFG-07
- BRUNS
bone curetteDC-12 to DC-13
plaster scissorsAI-48
- BRYANT sponge holding forcepsBG-11
- BUCHWALD tongue depressorEI-02
- BUCK
ear curetteEE-05
foreign body leverEE-08
ligature scissorsAI-40
percussion hammerAC-07
- BUIE aspirating cannulaGI-05
- BUMM
uterine curetteHA-49 to HA-50
uterine elevating forcepsHA-38
- BUNGE exenteration scoopEC-07
- BUNNELL
bone hand drillDD-05
tendon stripperDC-25
- BUNT safety needleCI-02
- BURCH fixation forkEC-05
- BURKE Baby uterine biopsy specimen forcepsHA-44
- BURKE uterine biopsy specimen forcepsHA-44
- BUSCH umbilical scissorsAI-34
- C**
- Cable
AESCULAP electro surgery equipmentJA-07
ERBE SELECT electro surgery equipmentJA-07
MARTIN electro surgery equipmentJA-07
USA electro surgery equipmentJA-07
- Cannula
Bonn irrigatingED-07
BUIE aspiratingGI-05
FINSTERER suction and irrigationAE-05
HamburgED-07
KILLIAN washEG-09
SCHEIE eyeED-07
SIMCOE suturingED-07
Tübingen airED-07
- CARMALT splinter forcepsBA-06
- CARPENTER tonsil knife and dissectorFA-02

E

Index English

- Cartilage knifeAG-18
- Case
- glassHE-03
 - stainless steelHE-03
- CASPAR
- bladeBI-20
 - cervical spine retractorBI-18
 - micro surgical scalpel handleAG-12
 - retractorBI-20
 - vertebral column bladeBI-19
 - vertebral column retractorBI-19
 - vertebral lumbar retractorBI-20
- CASTAÑEDA
- atraumatic neonatal and children forcepsBD-42
 - rib spreaderFG-14
- CASTROVIEJO
- blade breakerAG-14
 - capsular forcepsED-04
 - compass markerEC-09
 - corneal scissorsAJ-06
 - corneal trephineED-07
 - cyclodialysis spatulaEC-08 to EC-09
 - eye speculumEC-03
 - fixation forcepsED-03
 - iridectomy scissorsAJ-05
 - keratomeEC-04
 - lachrymal dilatorEC-10
 - needle holderCE-07
 - suture forcepsED-05
- Catheter
- HARTMANN earEE-06
- Catheter introducer
- DITTELGG-11
 - GUYONGG-11
- Catheter
- ITARD earEE-06
 - metal, femaleGG-16
 - metal, maleGG-16
- CATLIN amputation knifeAG-16
- Cauter WADSWORTH-TODDEC-08
- Cephalometer BERTILLONAC-08
- CHAPUT hemostatic forcepsBC-08
- CHARRIERE
- amputation sawDD-03
 - blade sawDD-03
- CHEATLE sterilizing forcepsCI-02
- CHERON dressing forcepsBG-12
- CHEVALIER-JACKSON larynx forcepsFC-04
- CHEVALLIER rib spreaderFG-15
- CHILDE clip applying forcepsCG-07
- Chisel
- ALEXANDER boneDC-14
 - boneDC-14
 - BRUNETTI spineDC-17
 - CINELLI rhinoplasticEG-13
 - COTTLE rhinoplasticEG-13
 - FOMON rhinoplasticEG-13
 - FREER septumEG-12
 - HIBBS boneDC-16
 - HOKE boneDC-16
 - LEBSCHE sternumDC-17
 - LEXER boneDC-16
 - LEXER mini boneDC-16
 - PARTSCH boneDC-14
 - ROLLET extirpationEC-06
 - SILVER rhinoplasticEG-14
 - SMITH-PETERSEN boneDC-15
 - STILLE boneDC-14
 - WEST nasalEG-14
- CINELLI rhinoplastic chiselEG-13
- CITELLI punchEG-08
- Clamp
- DeMARTEL-WOLFSON anastomosisGE-07
 - LANE stomachGE-08
 - LOWMAN bone holdingDC-11
 - LURZ ureterGC-10
 - PAYR-Baby stomachGE-09
 - PAYR stomachGE-09
 - SATINSKY anastomosis (vena cava)FG-24 to FG-25
- Clamps
- COLLIN umbilical cordHC-06
 - COOLEY atraumatic bulldogBD-33 to BD-34
 - DE BAKEY atraumatic bulldogBC-02
 - DIEFFENBACH serrefine bulldogBC-03
 - GLOVER atraumatic bulldogBC-02
 - JOHNS-HOPKINS serrefine bulldogBC-03
- Clamp
- spermatic cord fixationGG-10
 - STOCKMANN PenileGG-10
 - STRAUSS PenileGG-10
 - WINKELMANN circumcisionGG-09
- CLAR
- head lampAC-05
- CLARK eye speculumEC-02
- CLAR
- mini head lightAC-05
- Cleaning brushCI-04 to CI-05
- CLEVELAND bone rongeurDC-02
- Clip
- BRAIN standardEA-13
 - BRAIN temporaryEA-12
- Clip carrierEA-02
- Clip
- EDWARDSBD-21
 - MICHELCG-07
 - RANEY scalp hemostasisEA-03
- CLOWARD
- lamina spreaderEA-07
 - retractorBI-17
- COAKLEY
- antrum curetteEG-18
 - trocárCC-02
- COLCLOUGH intervertebral disc rongeurEA-11
- COLLIER needle holderCE-02
- COLLIN
- abdominal retractorBI-24 to BI-25
 - clip applying forcepsCG-07
 - dressing forcepsBG-11
 - COLLIN-DUVAL thumb and tissue forcepsBA-04
- COLLIN
- dynamometerAC-03
 - hammerDC-18
- COLLIN-HARTMANN retractorBI-03
- COLLIN
- hemostatic forcepsBC-08
 - pelvimeterHC-06
- COLLIN-POZZI tenaculum forcepsHA-32
- COLLIN
- scalpel handleAG-08
 - tongue holding forcepsEI-03
 - umbilical cord clampsHC-06
 - uterine elevating forcepsHA-37
 - uterine soundHA-39
 - vaginal speculumHA-04
- COLLYER pelvimeterHC-06
- COLVER tonsil seizing forcepsFA-03
- ComprimeterDD-02
- Conductor
- BRUNNER ligatureCG-04
 - KIRSCHNER ligatureCG-04
 - KOENIG ligatureCG-04
 - PAYR ligatureCG-04

SCHMIEDEN ligatureCG-04
 SCHMIEDEN-PAYR ligatureCG-04
 Cone
 KNUTSON-KOCH urethrographyGG-09
 occlusionHA-47
 CONNIN-AMSLER markerEC-09
 Contractor
 BAILEY-BABY ribFG-18
 BAILEY-GIBBON ribFG-18
 BAILEY ribFG-18
 SELLORS ribFG-18
 Conventional laryngoscope handleAE-17
 CONVERSE nasal knifeEG-10
 COOLEY
 atraumatic anastomosis forcepsBD-37, BD-40
 atraumatic bulldog clampsBD-33 to BD-34
 atraumatic forcepsBB-03, BD-35 to BD-37, BD-39, BD-41
 atraumatic iliac forcepsBD-37
 atraumatic pediatric forcepsBD-38 to BD-39
 atrium retractorFG-20
 COOLEY DERRA atraumatic anastomosis forcepsBD-39
 COOLEY
 mitral valve dilatorFG-27 to FG-29
 COOLEY modif- STRUCK atrium retractorFG-20
 COOLEY
 rib first shearFG-05
 rib spreaderFG-09
 vascular dilatorFG-30
 vascular forcepsBD-40
 COOPER ligature needleCG-02
 CORDES larynx forcepsFC-03
 Corn cutter CREDOHE-03
 CORWIN tonsil hemostatFA-04
 CORYLLOS rib shearFG-04
 CORYLLOS (Thorax) retractorBI-13
 COTTLE-KAZANJIAN bone cutting forcepsDC-06
 COTTLE
 nasal knifeEG-10
 nasal retractorEG-17
 nasal scissorsAH-18, AI-25
 nasal speculaEG-03
 COTTLE-NEIVERT nasal retractorEG-17
 COTTLE
 periosteal elevatorEG-12
 rhinoplastic chiselEG-13
 septum elevatorEG-12
 Cotton applicatorCA-03
 DIMEDACA-03
 FARRELCA-03
 JOBSON-HORNECA-03
 TOBOLDCA-03
 UCKERMANNCA-03
 COXETER urethral soundGG-17
 CRAFOORD
 hemostatic bronchus forcepsBC-12
 lung and thorax scissorsAI-36
 Cranioclast
 BRAUNHC-09
 TARNIERHC-09
 CREDO corn cutterHE-03
 CRILE
 hemostatic forcepsBC-05
 CRILE-MURRAY needle holderCE-02
 CRILE
 needle holderCE-04
 CRILE-RANKIN hemostatic forcepsBC-05
 CRILE
 retractorBI-02
 CRILE TITAN hemostatic forcepsBC-05
 CRILE-WOOD needle holderCE-02
 CRITCHETT eye speculumEC-02

CRUTCHFIELD
 cervical traction tongEA-03
 drill bitEA-03
 CULLER iris spatulaEC-08
 Cup
 medicineHE-07
 sputumHE-06
 Curette
 ALVIS foreign bodyEC-06
 AXENFELD chalazionEC-07
 BARNHILL adenoidEG-19
 BECKMANN adenoidEG-19
 BLAKE uterineHA-48
 BRUNS boneDC-12 to DC-13
 BUMM uterineHA-49 to HA-50
 COAKLEY antrumEG-18
 FAULKNEREG-18
 FOX lupusHE-02
 GOURDET uterineHA-48
 HALLE boneDC-13
 HEBRA chalazionEC-07
 HOUSEEE-15
 KEVORKIAN uterine biopsy aspiratingHA-40
 LEMPERT boneDC-13
 MARTINI boneDC-13
 MEYHOEFER chalazionEC-07
 NOVAK uterine biopsy aspiratingHA-40
 PIFFARD lupusHE-02
 RANDALL uterine biopsy aspiratingHA-40
 RECAIMER uterineHA-49 to HA-50
 SCHEDE boneDC-12
 SCHROEDER uterineHA-48
 SIMON boneDC-13
 SIMON uterineHA-48
 SIMS uterineHA-49 to HA-50
 SPRATT boneDC-12
 St- CLAIR-THOMSON adenoidEG-19
 suctionHA-51
 VOLKMANN boneDC-12 to DC-13
 WILLIGER boneDC-13
 Curette BUCK earEE-05
 CUSCO vaginal speculumHA-04 to HA-06
 CUSHING
 brain spatulaEA-07
 drill burrDD-04
 laminectomy rongerEA-08
 nerve hookEA-04
 retractorBI-07
 thumb and tissue forcepsBA-03
 Cutter MCKENZIEDD-04
 CUZZI placenta and ovum scoopHC-08
 Cystotome
 BECKEREC-06
 GRAEFEEC-06
 CZERNY
 gall stone forcepsGC-03
 rectal speculumGI-02
 tenaculum forcepsHA-34

D
 DALE atraumatic peripheral vascular forcepsBD-24
 DANDY
 hemostatic forcepsBC-07
 nerve hookEA-04
 neurosurgical scissorsAI-36
 DARDIK atraumatic forcepsBD-07
 DARLING retractorBI-17
 DARTIGUES uterine elevating forcepsHA-37
 DASTOOR
 erisophakeEC-09

- strabismus forceps EC-14
 DAVIDSON (Scapula) retractor BI-13
 DAVIEL cataract spoon EC-07
 DAVIS-BOYLE mouth gag EI-04
 DAVIS
 dura dissector EA-05
 foreign body needle EC-05
 sterilizing forceps CI-02
 DAY ear hooklet EE-07
 DEAN
 iris knife EC-04
 tonsil scissors AI-26
 DEAVER Grip retractor BI-05
 DEAVER
 retractor BI-05
 scissors AH-05, AI-06
 DE BAKEY
 atraumatic anastomosis forceps BD-25
 atraumatic aortic-aneurysm forceps BD-13, BD-15, BD-18
 atraumatic bronchus forceps BD-19
 atraumatic bulldog clamps BC-02
 atraumatic dissecting and ligature forceps BD-25, BD-32
 atraumatic forceps BB-03, BD-02, BD-08, BD-16 to BD-17,
 BD-20, BD-28 to BD-30
 atraumatic iliac forceps BD-11
 atraumatic peripheral vascular forceps BD-06
 DE BAKEY BAHNSON atraumatic
 aortic-aneurysm forceps BD-14
 DE BAKEY MORRIS atraumatic forceps BD-16
 DE BAKEY
 needle holder CE-03
 DE BAKEY REYNOLDS atraumatic
 anastomosis forceps BD-30
 DE BAKEY SATINSKY atraumatic forceps BD-22
 DE BAKEY
 suction tube AE-04
 vascular dilator FG-31
 vascular scissors AI-30
 DEJERINE percussion hammer AC-07
 De LEE obstetrical forceps HC-02
 Delicate model towel clamp BE-02
 Delicate scissors AI-05, AI-24
 De MARTEL saw conductor EA-05
 DeMARTTEL-WOLFSON anastomosis clamp GE-07
 DENHART mouth gag EI-03
 Depressor
 BRAUN uterine HA-39
 SIMS uterine HA-39
 DERF needle holder CE-02
 Dermatome blade AG-21
 Dermatome
 BRAITHWAITE AG-22
 HUMBY AG-20
 SCHINK AG-21
 SILVER AG-20
 WATSON AG-22
 DERRA atraumatic anastomosis, pediatric forceps BD-28
 DESCHAMPS ligature needle CG-02
 DESJARDINS
 gall duct forceps BC-15
 gall stone forceps GC-02
 gall stone probe GC-05
 gall stone scoop GC-08
 DESMARRES
 Chalazion forceps ED-06
 retractor BI-07
 DEUTSCHMANN cataract knife EC-03
 DeVILBISS skull forceps EA-05
 DEWEY obstetrical, with traction rod forceps HC-05
 Diagnostic set AC-04
 DIAMANT wire cutter DD-12
 DIEFFENBACH serrefine bulldog clamps BC-03
 DIETER malleus nipper EE-10
 DIETRICH
 atraumatic forceps BD-31
 vascular needle holder CE-06
 vascular scissors AI-29
 Dilator
 BAKES gall duct GC-06
 CASTROVIEJO lachrymal EC-10
 COOLEY mitral valve FG-27 to FG-29
 COOLEY vascular FG-30
 DE BAKEY vascular FG-31
 GERBODE mitral valve FG-28
 GOODELL uterine HA-30
 HANK uterine HA-28
 HEGAR uterine HA-24 to HA-27
 HETZER mitral valve FG-29
 LABORDE tracheal FE-02
 PRATT uterine HA-29
 SIMS uterine HA-30
 TROUSSEAU tracheal FE-02
 TUBBS mitral valve FG-27
 WILDER lachrymal EC-10
 WYLIE uterine HA-30
 ZIEGLER lachrymal EC-10
 DIMEDA Alu tuning fork EE-03
 DIMEDA
 bandage scissors AI-46
 blade breaker AG-14
 cotton applicator CA-03
 eye magnet ED-08
 finger ring cutter DD-03
 retractor BI-14
 waste pickup forceps CI-03
 DINGMANN bone holding forceps DC-10
 Director CA-02
 DOYEN CA-02
 KOCHER goitre FE-04
 Dish PETRI HE-08
 Dissecting knife AG-15
 Dissecting large rings scissors AI-19
 Dissecting scissors AI-34
 Dissector
 DAVIS dura EA-05
 dura EA-05
 FISCH EE-15
 GREEN corneal EC-06
 HORSLEY dura EA-06
 HURD tonsil FA-02
 LANG lachrymal EC-08
 MILLIGAN dura EA-05
 PATON corneal EC-05
 PENFIELD dura EA-06
 ROBB vascular FG-33
 SACHS dura EA-05
 TOENNIS dura EA-05
 DITTEL
 catheter introducer GG-11
 urethral sound GG-18 to GG-19
 DIX
 foreign body needle EC-09
 foreign body spud EC-06
 DOUGLAS
 cilia forceps ED-08
 trocar CC-02
 DOYEN-Baby intestinal forceps GE-03
 DOYEN
 director CA-02
 drill burr DD-07
 gynecological scissors AI-33

intestinal forcepsGE-03
 DOYEN-JANSEN mouth gagEI-03
 DOYEN
 myoma screwHA-46
 periosteal, rib elevatorDC-20
 retractorBI-12
 towel clampBE-05
 uterine polypus forcepsHA-36
 vaginal speculumHA-18, HA-20
 Dressing thumb and tissue forcepsBA-02
 Drill bit CRUTCHFIELDEA-03
 Drill burrDD-04, DD-07
 ALBEEDD-07
 BORCHARDTDD-07
 CUSHINGDD-04
 DOYENDD-07
 HUDSONDD-04
 TOTIDD-07
 twistDD-04
 Drums
 KONRICH sterilizingHE-12
 SCHIMMELBUSCH sterilizingHE-12
 DUBOIS gynecological scissorsAI-33
 DUPLAY
 dressing forcepsBG-14
 tenaculum forcepsHA-31
 Duplex stethoscopeAC-06
 DUPUY-WEISS tonsil needleFA-03
 DUVAL
 grasping forcepsGE-03
 thumb and tissue forcepsBA-04
 Dynamometer COLLINAC-03

E

ECHLIN bone rongeurDC-05
 EDWARDS
 clipBD-21
 clip applying forcepsBD-21
 Electrical plaster sawDA-05 to DA-06
 Electrode coagulation miniJA-02 to JA-03
 Elevator
 ADSONDC-21
 ALEXANDER periostealDC-19
 BALLENGER septumEG-12
 COTTLE periostealEG-12
 COTTLE septumEG-12
 DOYEN periosteal, ribDC-20
 FARABEUF periostealDC-19
 FREER septumEG-11
 HAJEK-BALLENGER septumEG-12
 HENKE tonsilFA-02
 JOSEPH periostealEG-12
 KEYDC-21
 KILLIAN septumEG-12
 LAMBOTTE periostealDC-19
 LANGENBECKDC-21
 LANGENBECK periostealDC-19
 LEMPERTEE-15
 MATSON periostealDC-21
 McDONALDDC-22
 McKENTY septumEG-11
 MURLESS headHC-05
 MURPHY-LANEDC-22
 OVERHOLT periostealDC-21
 ROGER septumEG-11
 SADILLOT periostealDC-19
 SEMB periostealDC-20
 WATSON-CHEYNEDC-22
 WILLIGER periostealDC-19
 ELLIOT
 corneal trephineED-08

obstetrical forcepsHC-02
 ELLIS foreign body gougeEC-06
 ELSAESSER nephrostomy forcepsGC-13
 ELSCHNIG
 capsular forcepsED-04
 corneal knifeEC-05
 cyclodialysis spatulaEC-08
 fixation forcepsED-03
 EMMET fistula hookHA-46
 ENGEL plaster sawDA-02
 Enterotomy scissorsAI-39
 EPPENDORFER-KEVORKIAN
 uterine biopsy specimen forcepsHA-46
 EPPENDORFER TISCHLER-MORGAN
 uterine biopsy specimen forcepsHA-46
 EPPENDORFER
 uterine biopsy specimen forcepsHA-45 to HA-46
 ERBE SELECT electrosurgery equipment cableJA-07
 Erisophake DASTOOREC-09
 ESMARCH
 bandage scissorsAI-46
 plaster knifeDA-04
 EVES tonsil snareFA-04
 Extension bowDD-10
 BOEHLER 16x9 cmDD-10
 KIRSCHNERDD-10
 tightenerDD-10
 wrenchDD-10
 Extractor
 KUENTSCHERDD-13
 SAALFELD comedoHE-02
 SCHAMBERG comedoHE-02
 UNNA comedoHE-02
 WALTON comedoHE-02

F

FARABEUF
 bone holding forcepsDC-07
 FARABEUF-LAMBOTTE bone holding forcepsDC-08
 FARABEUF
 periosteal elevatorDC-19
 retractorBI-02
 FARREL cotton applicatorCA-03
 FAULKNER curetteEG-18
 FAURE
 peritoneum forcepsBC-17
 uterine biopsy specimen forcepsHA-41
 FEHLAND intestinal forcepsGE-06
 FEILCHENFELD splinter forcepsBA-06
 FERGUSSON
 angiotribe forcepsBC-07
 bone holding forcepsDC-07
 gall stone scoopGC-07
 scissorsAI-49
 FERRIS-SMITH-KERRISON intervertebral disc rongeurEA-10
 FERRIS-SMITH laminectomy rongeurEA-09
 FERRIS thumb and tissue forcepsBA-04
 Fiber optic laryngoscope handleAE-11
 File
 JOSEPH fileEG-14
 nailHE-03
 FILIFORM bougiemGG-12
 Fine scissorsAI-19
 Finger protector LANGENBECKEI-06
 FINOCHIETTO-BABY rib spreaderFG-09
 FINOCHIETTO
 bronchus forcepsFG-21
 FINOCHIETTO BURFORD rib spreaderFG-12 to FG-14
 FINOCHIETTO-HAIGHT BABY rib spreaderFG-10

E

Index English

- FINOCHIETTO INFANT rib spreaderFG-12
 FINOCHIETTO (modif) rib spreaderFG-08
 FINOCHIETTO
 needle holderCE-04
 rectal scissorsAI-38
 rib spreaderFG-08, FG-10 to FG-11
 FINSEN retractorBI-14
 FINSTERER suction and irrigation cannulaAE-05
 FISCH dissectorEE-15
 FISCHER iris forcepsEC-13
 Fixation system LEYLAEA-14 to EA-18
 FLETCHER JAVERTS sponge holding forcepsBG-10
 FLEURANT trocarCC-02
 FOERSTER
 iris forcepsEC-12
 sponge holding forcepsBG-06 to BG-08
 FOMON
 nasal raspEG-15 to EG-16
 nasal retractorEG-17
 nasal scissorsAH-18, AI-25
 rhinoplastic chiselEG-13
 Forceps
 ADLERKREUTZ thumb and tissueBA-04
 ADSON BABY hemostaticBC-09
 ADSON-BROWN thumb and tissueBA-03
 ADSON hemostaticBC-09
 ADSON hypophysealEA-06
 ADSON thumb and tissueBA-03
 ADSON thumb and tissue, microBA-03
 ALEXANDER uterine biopsy specimenHA-42
 ALLIS-ADAIR tissueGE-02
 ALLIS-Baby tissueGE-02
 ALLIS tissueGE-02
 ARCHER splinterBA-06
 ARRUGA capsularED-04
 ASCH septumEG-18
 AYER chalazionED-06
 BABCOCK seizingGE-02
 BAGGISH uterine biopsy specimenHA-45
 BAINBRIDGE atraumaticBD-09
 BAINBRIDGE hemostaticBC-14
 BALLENGER tonsil seizingFA-04
 BARRAQ-KATZIN irisEC-13
 BARRAQU Colibri irisEC-13
 BARRAQUER anterior chamberED-02
 BARRAQUER ciliaED-08
 BARRAQUER fixationED-03
 BARRETT tenaculumHA-32
 BARTON obstetricalHC-04
 BECK atraumatic peripheral vascularBD-25
 BEER ciliaED-08
 BENGOLEA hemostaticBC-09
 BERGMANN FOERSTER sponge holdingBG-10
 BERKE muscularED-02
 BEST intestinalGE-06
 bipolar coagulationJA-04 to JA-06
 BIRCHER-GANSKE bone holdingDC-10
 BISHOP-HARMAN irisEC-14
 BLAKE gall stoneGC-03
 BLOHMKE tonsil seizingFA-04
 BOERMA obstetricalHC-04
 BÖHLER bone cuttingDC-06
 BONACCOLTO strabismusEC-14
 BONNEY sponge holdingBG-08
 Bonn irisEC-15
 Bonn TITAN irisEC-15
 BOZEMANN-DOUGLAS dressingBG-13
 BOZEMANN dressingBG-13
 BRAIN MINI clip applyingEA-12
 BRAIN STANDARD clip applyingEA-12
 BRAUN tenaculumHA-31, HA-34
 BROWN thumb and tissueBA-03
 BRUENINGS larynxFC-03
 BRUENINGS nasal cuttingEG-05
 BRUNNER intestinalGE-06
 BRYANT sponge holdingBG-11
 BUMM uterine elevatingHA-38
 BURKE-Baby uterine biopsy specimenHA-44
 BURKE uterine biopsy specimenHA-44
 CARMALT splinterBA-06
 CASTAÑEDA atraumatic neonatal and childrenBD-42
 CASTROVIEJO capsularED-04
 CASTROVIEJO fixationED-03
 CASTROVIEJO sutureED-05
 CHAPUT hemostaticBC-08
 CHEATLE sterilizingCI-02
 CHERON dressingBG-12
 CHEVALIER-JACKSON larynxFC-04
 CHILDE clip applyingCG-07
 ciliaED-08
 COLLIN clip applyingCG-07
 COLLIN dressingBG-11
 COLLIN-DUVAL thumb and tissueBA-04
 COLLIN hemostaticBC-08
 COLLIN-POZZI tenaculumHA-32
 COLLIN tongue holdingEI-03
 COLLIN uterine elevatingHA-37
 COLVER tonsil seizingFA-03
 COOLEY
 atraumaticBB-03, BD-35 to BD-37, BD-39, BD-41
 atraumatic anastomosisBD-37, BD-40
 atraumatic iliacBD-37
 atraumatic pediatricBD-38 to BD-39
 COOLEY DERRA atraumatic anastomosisBD-39
 COOLEY vascularBD-40
 CORDES larynxFC-03
 COTTLE-KAZANJIAN bone cuttingDC-06
 CRAFOORD hemostatic bronchusBC-12
 CRILE hemostaticBC-05
 CRILE-RANKIN hemostaticBC-05
 CRILE TITAN hemostaticBC-05
 CUSHING thumb and tissueBA-03
 CZERNY gall stoneGC-03
 CZERNY tenaculumHA-34
 DALE atraumatic peripheral vascularBD-24
 DANDY hemostaticBC-07
 DARDIK atraumaticBD-07
 DARTIGUES uterine elevatingHA-37
 DASTOOR strabismusEC-14
 DAVIS sterilizingCI-02
 DE BAKEY atraumatic
 BB-03, BD-02, BD-08, BD-16 to BD-17, BD-20, BD-28 to BD-30
 DE BAKEY atraumatic anastomosisBD-25
 DE BAKEY atraumatic
 aortic-aneurysmBD-13, BD-15, BD-18
 DE BAKEY atraumatic bronchusBD-19
 DE BAKEY atraumatic
 dissecting and ligatureBD-25, BD-32
 DE BAKEY atraumatic iliacBD-11
 DE BAKEY atraumatic peripheral vascularBD-06
 DE BAKEY BAHNSON atraumatic
 aortic-aneurysmBD-14
 DE BAKEY MORRIS atraumaticBD-16
 DE BAKEY REYNOLDS atraumatic anastomosisBD-30
 DE BAKEY SATINSKY atraumaticBD-22
 De LEE obstetricalHC-02
 DERRA atraumatic anastomosis, pediatricBD-28
 DESJARDINS gall ductBC-15
 DESJARDINS gall stoneGC-02
 DESMARRES chalazionED-06
 DeVILBISS skullEA-05

- DEWEY obstetrical, with traction rod HC-05
 DIETHRICH atraumatic BD-31
 DIMEDA waste pickup CI-03
 DINGMANN bone holding DC-10
 DOUGLAS cilia ED-08
 DOYEN-Baby intestinal GE-03
 DOYEN intestinal GE-03
 DOYEN uterine polypus HA-36
 DUPLAY dressing BG-14
 DUPLAY tenaculum HA-31
 DUVAL grasping GE-03
 DUVAL thumb and tissue BA-04
 ear micro EE-09 to EE-10, EE-12
 ear micro mini EE-13
 EDWARDS clip applying BD-21
 ELLIOT obstetrical HC-02
 ELSAESSER nephrostomy GC-13
 ELSCHNIG capsular ED-04
 ELSCHNIG fixation ED-03
 EPPENDORFER-KEVORKIAN
 uterine biopsy specimen HA-46
 EPPENDORFER TISCHLER-MORGAN
 uterine biopsy specimen HA-46
 EPPENDORFER
 uterine biopsy specimen HA-45 to HA-46
 FARABEUF bone holding DC-07
 FARABEUF-LAMBOTTE bone holding DC-08
 FAURE peritoneum BC-17
 FAURE uterine biopsy specimen HA-41
 FEHLAND intestinal GE-06
 FEILCHENFELD splinter BA-06
 FERGUSSON angiotribe BC-07
 FERGUSSON bone holding DC-07
 FERRIS thumb and tissue BA-04
 FINOCHIETTO bronchus FG-21
 FISCHER iris EC-13
 FLETCHER JAVERTS sponge holding BG-10
 FOERSTER iris EC-12
 FOERSTER sponge holding BG-06 to BG-08
 FRAENKEL larynx FC-03
 FRAENKEL larynx polypus FC-02
 FUCHS capsular ED-04
 GAUSS scalp flap HC-06
 GELLHORN uterine biopsy specimen HA-42
 GEMINI dissecting and ligature BC-10
 GEMINI MINI dissecting and ligature BC-10
 GERALD thumb and tissue BA-05
 GILL-ARRUGA capsular ED-03
 GILL-HESS iris EC-12
 GILLIES thumb and tissue BA-05
 GILL iris EC-12
 glans and the foreskin grasping GG-10
 GLOVER atraumatic BD-06, BD-30
 GLOVER atraumatic anastomosis BD-05
 GLOVER atraumatic coarction BD-04
 GRADLE cilia ED-08
 GRAEFE fixation ED-03
 GRAEFE iris EC-11
 GRAEFE thumb and tissue BA-03
 GRAY gall duct BC-15
 GREEN-ARMYTAGE
 caesarean section haemostatic HC-06
 GREEN fixation ED-03
 GREGORY atraumatic profunda BD-33
 GREVEN ear micro EE-10
 GRIP seizing DD-11
 GROSS dressing BG-05
 GROSS-MAIER dressing BG-02 to BG-04
 GUYON kidney pedicle BC-16
 HALSTED-MOSQUITO atraumatic BD-02
 HALSTED-MOSQUITO hemostatic BC-04
 HALSTED-MOSQUITO micro hemostatic BC-04
 HALSTED-MOSQUITO TITAN hemostatic BC-04
 HARKEN atraumatic auricle BD-23
 HARRINGTON bronchus FG-21
 HARTMANN ear EE-08
 HARTMANN hemostatic BC-03
 HARTMANN-HOFFMANN ear EE-08
 HARTMANN nasal cutting EG-07
 HARTMANN nasal polypus EG-04
 HARTMANN-WULLSTEIN ear EE-08
 HEANEY hysterectomy BC-18
 HEGENBARTH clip applying CG-07
 HEIMING kidney stone GC-13
 HEISS hemostatic BC-09
 HENROTIN tenaculum HA-34
 HERRICK kidney pedicle BC-17
 HESS capsular ED-04
 HESS iris EC-12
 HEYMANN-KNIGHT nasal polypus EG-05
 HEYMANN nasal cutting EG-05
 HEYWOOD-SMITH pile GI-05
 HUNTER splinter BA-06
 IOWA tenaculum HA-35
 JACKSON tampon FC-02
 JACOBS tenaculum HA-34
 JAMESON strabismus EC-13
 JANSEN nasal EG-04
 JARCHO tenaculum HA-32
 JATHO nasopharynx EG-18
 JAVID atraumatic carotid BD-32
 JOHNS-HOPKINS gall duct BC-14
 JUDD-ALLIS tissue GE-02
 JURASZ larynx polypus FC-02
 KALT capsular ED-04
 KELLY hemostatic BC-05
 KELLY-RANKIN hemostatic BC-05
 KELLY TITAN hemostatic BC-05
 KELLY uterine polypus HA-36
 KERN bone holding DC-08
 KEVORKIAN-Pacific uterine biopsy specimen HA-44
 KEVORKIAN uterine biopsy specimen HA-43, HA-46
 KIELLAND-LUIKART obstetrical HC-03
 KIELLAND obstetrical HC-02
 KIRBY-ARTHUR iris EC-13
 KNAPP-LUER trachoma ED-06
 KNIGHT nasal cutting EG-05
 KOCHER hemostatic delicate BC-06
 KOCHER intestinal GE-04
 KRAUSE larynx FC-03
 LAHEY gall duct BC-14
 LAHEY goitre seizing FE-04
 LAMBERT chalazion ED-06
 LAMBERT KAY atraumatic aortic-anastomosis BD-10
 LAMBERT KAY atraumatic iliac BD-11
 LAMBOTTE bone holding DC-08
 LANE bone holding DC-08
 LANE for bone plates DD-14
 LANE for bone screws DD-14
 LANE thumb and tissue BA-04
 LANGE larynx FC-03
 LANGENBECK bone holding DC-07
 LAWRENCE hemostatic BC-13
 LEES atraumatic bronchus BD-03
 LELAND JONES atraumatic
 peripheral vascular BD-08 to BD-09
 LERCHE thumb and tissue BA-04
 LERICHE hemostatic BC-09
 LESTER fixation ED-03
 LEWIN bone holding DC-10
 LEWKOWITZ placenta and ovum HC-07
 LIDDLE atraumatic aortic BD-10

E

Index English

LISTER sponge holding sinus	.BG-11	PIPER obstetrical, with traction rod	.HC-04
LISTON bone cutting	.DC-06	POTTS atraumatic	.BD-26 to BD-27
LITTAUER cilia	.ED-08	POTTS atraumatic anastomosis	.BD-05
LITTAUER ear	.EE-08	POTTS atraumatic coarctation	.BD-04
LITTAUER nasal polypus	.EG-05	POTTS-SMITH thumb and tissue	.BA-02
LOVELACE hemostatic	.BC-07	POZZI tenaculum	.HA-31
LOVELACE lung grasping	.FG-19	PRATT hemostatic	.BC-08
LOWER gall duct	.BC-14	PRATT tenaculum	.HA-34 to HA-35
LUBET-BARBON nasal polypus	.EG-05	PRESBYTERIAN HOSPITAL tubing clamp	.BC-19
LUCAE ear	.EE-07	PRICE-THOMAS bronchus	.FG-22
LUC nasal cutting	.EG-06	PRINCE muscular	.ED-02
LUIKART obstetrical	.HC-03	PROVIDENCE-HOSPITAL hemostatic	.BC-05
MAGILL catheter introducing	.AE-06	RADOLF nail extracting	.DD-03
MAIER dressing	.BG-12	RAMPLEY sponge holding	.BG-09
MARSHIK tonsil	.FA-04	RANDALL kidney stone	.GC-11 to GC-12
MARTEL scalp flap	.BC-08	RANEY clip applying	.EA-03
MARTIN dressing	.BG-02, BG-14	RANKIN atraumatic	.BD-02
MARTIN sequester	.DC-10	RICHTER-HEATH clip applying	.CG-07
MASTIN muscular	.FE-04	ROBERTS hemostatic	.BC-11
MATHIEU foreign body	.GG-07	ROCHESTER-CARMALT hemostatic	.BC-07
MAYO BLAKE gall stone	.GC-04	ROCHESTER-OCHSNER hemostatic	.BC-06
MAYO-GUYON kidney pedicle	.BC-16	ROCHESTER-PEAN hemostatic	.BC-06
MAYO-ROBSON intestinal	.GE-05	ROGGE sterilizing	.CI-02
McCLINTOCK placenta and ovum	.HC-07	ROSENBERG larynx	.FC-03
McCULLOUGH strabismus	.EC-13	ROWE mouth	.EI-06
McGEE ear micro	.EE-10	RUBIN septum crushing	.EG-07
McINDOE thumb and tissue	.BA-04	RUMEL thorax	.BC-11
McKENZIE clip applying	.EA-02	RUSKIN-LISTON bone cutting	.DC-06
McLEAN-LUIKART obstetrical	.HC-03	RUSSIAN thumb and tissue	.BA-04
McLEAN obstetrical	.HC-04	SAENGER placenta and ovum	.HC-07
McLEAN-TUCKER-LUIKART obstetrical	.HC-03	SAIRGES tenaculum	.HA-32
McPHERSON TITAN tying	.ED-05	SAROT bronchus	.FG-23
McPHERSON tying	.ED-05	SAROT hemostatic bronchus	.BC-12
MEEKER hemostatic	.BC-13	SATINSKY atraumatic	.BD-20
MICHEL clip applying	.CG-07	SAUERBRUCH waste pickup	.CI-03
MIDDLETON-JANSEN nasal cutting	.EG-09	SAWTELL tonsil	.FA-03
MIKULICZ peritoneum	.BC-17	SCHEINMANN larynx	.FC-03
MILLIN capsule forceps	.GG-03	SCHNIDT tonsil	.FA-03
MILLIN ligature carrying	.GG-03	SCHOENBURG grasping	.GE-03
MILLIN lobe holding	.GG-03	SCHROEDER tenaculum	.HA-31 to HA-32
MIXTER BABY hemostatic bronchus	.BC-13	SCHUBERT uterine biopsy specimen	.HA-41
MIXTER gall duct	.BC-15	SCHUMACHER larynx	.FC-03
MIXTER gall stone	.GC-04	SCHUMACHER uterine biopsy specimen	.HA-43
MIXTER hemostatic	.BC-14	SCHWEIGGER capsular	.ED-04
MIXTER hemostatic bronchus	.BC-13	SEIFFERT larynx	.FC-03
MIXTER O'SHAUGNESSY hemostatic	.BC-14	SEMB bone cutting	.DC-07
MOORFIELD suture	.ED-05	SEMB bone holding	.DC-07
MOYNIHAN gall duct	.BC-15	SEMB bronchus	.FG-23
MURPHY tubing clamp	.BC-19	SEMKEN thumb and tissue	.BA-05
MUSEUX tenaculum	.HA-33	SIEGLER HELLMANN uterine elevating	.HA-38
MYLES nasal cutting	.EG-07	SIMPSON-BRAUN obstetrical	.HC-02
NAEGELE obstetrical	.HC-03	SIMPSON-LUIKART obstetrical	.HC-03
NEGUS tonsil	.FA-03	SIMPSON obstetrical	.HC-02
NELSON thumb and tissue	.BA-05	SIMS-MAIER dressing	.BG-05
NEUBÜSER tubal seizing	.HA-51	SINGLEY thumb and tissue	.BA-05
NOTO uterine polypus	.HA-36	SKENE tenaculum	.HA-31
NOYES nasal polypus	.EG-05	SMITHWICK clip applying	.EA-02
OCHSNER atraumatic aortic	.BD-31	SNELLEN entropium	.ED-06
OLIVECRONA-TOENNIS clip applying	.EA-02	SOMER uterine elevating	.HA-37
OVERHOLT-GEISSENDOERFER		SPENCER-WELLS hemostatic	.BC-07
dissecting and ligature	.BC-10	STAUDE-MOORE tenaculum	.HA-31
PAUFIQUE TITAN tying	.ED-05	STEVENS iris	.EC-11
PAUFIQUE tying	.ED-05	STIEGLITZ splinter	.BA-06
PEAN atraumatic	.BD-02	STILLE-HORSLEY bone cutting	.DC-07
PEAN hemostatic	.BC-08	STILLE kidney pedicle	.BC-16
PEAN hemostatic delicate	.BC-06	STILLE-LISTON bone cutting	.DC-06
PEET splinter	.BA-06	STILLE thumb and tissue	.BA-02
PELKMANN dressing	.BG-12	St- MARTIN suture	.ED-05
PENNINGTON hemostatic	.BC-07	STONE closing	.GE-06
PHANEUF peritoneum	.BC-17	STONE-WATT intestinal	.GE-06
PIPER obstetrical	.HC-04	STRUEMPPEL ear	.EE-08

- STRUYCKEN nasal cuttingEG-07
SUBRAMANIAN atraumaticBD-31
SWEET clip applyingEA-02
TARNIER obstetrical, with traction rodHC-05
TEALE tenaculumHA-33
TERSON capsularED-04
THOMS-ALLIS tissueGE-02
THOMS-GAYLOR uterine biopsy specimenHA-42
TIEMANN tenaculumHA-32
TILLEY earEE-08
TISCHLER-KEVORKIAN
uterine biopsy specimenHA-44 to HA-45
TISCHLER-MORGAN
uterine biopsy specimenHA-43 to HA-44, HA-46
TIVNEN tonsil seizingFA-04
TOENNIS hemostaticBC-11
TOWNSEND-KEVORKIAN
uterine biopsy specimenHA-44
TOWNSEND-MINI (BABY TISCHLER)
uterine biopsy specimenHA-45
TOWNSEND-mini uterine biopsy specimenHA-44
TOWNSEND-TISCHLER
uterine biopsy specimenHA-44
TOWNSEND uterine biopsy specimenHA-44
TROELTSCH nasalEG-04
TROUTMAN Colibri irisEC-13
TROUTMAN rectusED-02
Tübingen irisEC-15
Tübingen TITAN irisEC-15
Tübingen TITAN tyingED-05
Tübingen tyingED-05
TUFFIER hemostaticBC-08
TURREL biopsy specimenGI-05
TYDING tonsil seizingFA-04
ULRICH sponge holdingBG-06
UNIVERSAL sterilizingCI-02
USA thumb and tissueBA-02
VAN BUREN sequesterDC-10
van DOREN uterine biopsy specimenHA-42
VERBRUGGE bone holdingDC-09
VIRTUS (RALK) splinterBA-06
WACHENFELDT clip applyingCG-07
WALSHAM septumEG-18
WANGENSTEEN thumb and tissueBA-05
WEBER atraumaticBD-12
WEIL-BLAKESLEY nasal cuttingEG-06
WEISS tubing clampBC-19
WERTHEIM-CULLEN hysterectomyBC-18
WERTHEIM hysterectomyBC-18
WHITE tonsil seizingFA-03
WILDE (TROELTSCH) earEE-07
WILLET-MARTELL scalp flapBC-08
WILLIAMS graspingGE-03
WINTER placenta and ovumHC-07
wire cutting and bendingDD-11
WITTNER uterine biopsy specimenHA-43
WRIGLEY obstetricalHC-02
WYLIE atraumaticBD-21
YEOMAN biopsy specimenGI-05
YOUNG prostatic graspingGG-02
YOUNG tongue holdingEI-03
ZENKER hemostaticBC-12
FORD BOWLES stethoscopeAC-06
FORD stethoscopeAC-06
Fork BURCH fixationEC-05
FOX lupus curetteHE-02
FRAENKEL
larynx forcepsFC-03
larynx polypus forcepsFC-02
Frame KIRSCHNER abdominal retractorBI-23
FRANCESCHETTI corneal trephineED-07
FRANCIS foreign body needleEC-05
FRANKLIN-SILVERMANN puncture needleCC-03
FRAZIER
hookletBI-06
retractorBI-21
suction tubeEA-07
FREER
mucosa knifeEG-10
nasal gougeEG-14
septum chiselEG-12
septum elevatorEG-11
septum knifeEG-10
FREEWAY-GRAVE vaginal speculumHA-06
FRENZEL tongue depressorEI-02
FRIEDMAN
bone rongeurDC-02
FRIEDMAN Mini bone rongeurDC-02
FRIEDMAN
perineorr retractorHA-23
FRITSCH retractorBI-11
FRYKHOLM bone rongeurDC-05
FUCHS capsular forcepsED-04
FunnelHE-07
- G**
GALLAHER antrum raspEG-16
GAUSS scalp flap forcepsHC-06
Gauze packer LUNIATSCHEKFA-02
GELLHORN uterine biopsy specimen forcepsHA-42
GELPI abdominal retractorBI-24
GEMINI dissecting and ligature forcepsBC-10
GEMINI MINI dissecting and ligature forcepsBC-10
GERALD thumb and tissue forcepsBA-05
GERBODE mitral valve dilatorFG-28
GERSTER traction barDC-11
GERZOG hammerDC-18
GIERTZ-STILLE rib shearFG-06
GIGLI for wire saw handleEA-05
GILL-ARRUGA capsular forcepsED-03
GILL
corneal knifeEC-05
GILL-HESS iris forcepsEC-12
GILLIES
hookletEG-17
needle holderCE-05
thumb and tissue forcepsBA-05
GILL
iris forcepsEC-12
GLOVER
atraumatic anastomosis forcepsBD-05
atraumatic bulldog clampsBC-02
atraumatic coarctation forcepsBD-04
atraumatic forcepsBD-06, BD-30
GLUCK rib shearFG-03
GOELET retractorBI-03
GOLDMAN-FOX gum scissorsAI-41
GOLDSTEIN eye speculumEC-03
Goniometer MOELTGENAC-08
GOODELL uterine dilatorHA-30
GOOD tonsil scissorsAI-27
GORNEY dissecting scissorsAI-13
GOSSET abdominal retractorBI-21
Gouge
ALEXANDER boneDC-14
boneDC-14
ELLIS foreign bodyEC-06
FREER nasalEG-14
HAJEK nasalEG-14
HIBBS boneDC-16
KILLIAN-CLAUS nasalEG-14

E

Index English

- LEXER boneDC-16
 LEXER mini boneDC-16
 PARTSCH boneDC-14
 SMITH-PETERSEN boneDC-15
 STILLE boneDC-14
 WALTON foreign bodyEC-06
 WEST nasalEG-14
 GOURDET uterine curetteHA-48
 GRADLE cilia forcepsED-08
 GRAEFE
 cataract knifeEC-03
 cataract spoonEC-07
 cystotomeEC-06
 eye speculumEC-02
 fixation forcepsED-03
 hookletBI-06
 iris forcepsEC-11
 scarifierEC-04
 strabismus hookEC-06
 thumb and tissue forcepsBA-03
 GRAEFE-TITAN strabismus hookEC-06
 GRAHAM nerve hookEA-04
 GRAVE vaginal speculumHA-02
 GRAY gall duct forcepsBC-15
 GREEN-ARMYTAGE
 caesarean section haemostatic forcepsHC-06
 GREEN
 corneal dissectorEC-06
 fixation forcepsED-03
 muscular hookEC-06
 retractorBI-10
 GREGORY atraumatic profunda forcepsBD-33
 GREVEN ear micro forcepsEE-10
 Grinding stone ARKANSASAG-19
 GRIP seizing forcepsDD-11
 GROSS
 dressing forcepsBG-05
 ear spoonEE-06
 GROSS-MAIER dressing forcepsBG-02 to BG-04
 GRUBER ear speculaEE-02
 Gum scissorsAI-41
 GUTHRIE hookletBI-06
 GUTMANN secretions scoopGG-11
 GUYON
 catheter introducerGG-11
 kidney pedicle forcepsBC-16
 urethral soundGG-12, GG-14 to GG-15
 GUYTON-LUNDSGAARD sclerotomeEC-05
 Gynecological micro scissorsAJ-07 to AJ-08
- H**
 HABERER retractorBI-04
 HAGLUND-STILLE plaster spreaderDA-03
 HAIGHT rib spreaderFG-15
 HAJEK-BALLENGER septum elevatorEG-12
 HAJEK-CLAUS punchEG-08
 HAJEK-KOFLER punchEG-08
 HAJEK nasal gougeEG-14
 HALLE
 bone curetteDC-13
 dura knifeEA-06
 HALSEY needle holderCE-02
 HALSTED-MOSQUITO
 atraumatic forcepsBD-02
 hemostatic forcepsBC-04
 HALSTED-MOSQUITO micro hemostatic forcepsBC-04
 HALSTED-MOSQUITO TITAN hemostatic forcepsBC-04
 Hamburg cannulaED-07
 HammerDC-18
 COLLINDC-18
- GERZOGDC-18
 KIRKDC-18
 LUCAEDC-18
 MEADDC-18
 QUISLINGDC-18
 slottedDD-13
 WILLIGERDC-18
 Hand drill
 boneDD-05
 BUNNELL boneDD-05
 HUDSON braceDD-04
 KIRSCHNER boneDD-05
 MOORE boneDD-04
 RALK boneDD-05
 STILLE boneDD-04
 STILLE-SHERMAN boneDD-04
 Hand drill with jacobs chuck boneDD-06
 Handle
 BARTON tractionHC-04
 BILL tractionHC-05
 BROCK mitral valve dilatorFG-26
 COLLIN scalpelAG-08
 GIGLI for wire sawEA-05
 HUBER universalFC-03
 laryngeal mirrorFC-04
 LUIKART-BILL tractionHC-05
 HANK uterine dilatorHA-28
 HARKEN atraumatic auricle forcepsBD-23
 HARRINGTON
 bronchus forcepsFG-21
 retractorBI-05
 HARTMANN
 ear catheterEE-06
 ear forcepsEE-08
 ear speculaEE-02
 HARTMANN-HALLE nasal speculaEG-02
 HARTMANN
 hemostatic forcepsBC-03
 HARTMANN-HOFFMANN ear forcepsEE-08
 HARTMANN
 nasal cutting forcepsEG-07
 nasal polypus forcepsEG-04
 tongue depressorEI-02
 tuning forkEE-03
 HARTMANN-WULLSTEIN ear forcepsEE-08
 Head lamp CLARAC-05
 Head light CLAR miniAC-05
 Head mirror ZIEGLERAC-05
 HEANEY
 hysterectomy forcepsBC-18
 needle holderCE-03
 retractorBI-12
 HEATH ligature scissorsAI-40
 HEBRA chalazion curetteEC-07
 HEGAR uterine dilatorHA-24 to HA-27
 HEGENBARTH clip applying forcepsCG-07
 HEIFETZ brain spatulaEA-07
 HEIMING kidney stone forcepsGC-13
 HEISS hemostatic forcepsBC-09
 HEISTER mouth gagEI-03
 Hemostat
 CORWIN tonsilFA-04
 PASSOWEE-15
 HENKE tonsil elevatorFA-02
 HENNIG plaster spreaderDA-03
 HENROTIN tenaculum forcepsHA-34
 HERMANN plaster spreaderDA-03
 HERRICK kidney pedicle forcepsBC-17
 HERTZLER rib spreaderFG-17
 HESS
 capsular forcepsED-04

iris forcepsEC-12
HETZER mitral valve dilatorFG-29
HEYMANN-KNIGHT nasal polypus forcepsEG-05
HEYMANN
nasal cutting forcepsEG-05
nasal scissorsAH-18, AI-25
HEYWOOD-SMITH pile forcepsGI-05
HIBBS
bone chiselDC-16
bone gougeDC-16
osteotomeDC-16
HIRSCHMANN anoscopeGI-04
HOESEL needle holderCE-05
HOFER pillar retractorFA-02
HOFF towel clampBE-03
HOHMANN bone leverDC-22 to DC-23
HOHMANN mini bone leverDC-23
HOKE bone chiselDC-16
HOLTH corneoscleral punchEC-09
Hook
ADSON nerveEA-04
ARRUGA extractingEC-06
BOSE trachealFE-02
BRAUN decapitatingHC-09
CUSHING nerveEA-04
DANDY nerveEA-04
EMMET fistulaHA-46
extensionDD-10
extractionDD-13
GRAEFE strabismusEC-06
GRAEFE-TITAN strabismusEC-06
GRAHAM nerveEA-04
GREEN muscularEC-06
ITERSON trachealFE-02
JACKSON trachealFE-02
JAMESON strabismusEC-06
HookletEE-15
BARBARAEE-14
DAY earEE-07
FRAZIERBI-06
GILLIESEG-17
GRAEFEBI-06
GUTHRIEBI-06
JOSEPHBI-06
WAGENER earEE-07
Hook
LOVE nerveEA-04
mini electrodeJA-02
O'CONNOR irisEC-06
PRATT cysticGI-04
ROSE trachealFE-03
SACHS nerveEA-04
SMELLIE obstetricalHC-06
SMITHWICK nerveEA-04
STEVENS lensEC-06
WIENER irisEC-06
HOPKINS plaster knifeDA-04
HORSLEY dura dissectorEA-06
HOUSE curetteEE-15
HRYNTSCHAK prostatic retractorGG-06
HUBER universal handleFC-03
HUDSON
brace hand drillDD-04
drill burrDD-04
HUMBY
dermatomeAG-20
dermatome bladeAG-20
HUNTER splinter forcepsBA-06
HURD tonsil dissectorFA-02

I

Impactor
KUENTSCHER nailDD-13
nailDD-12
Incision scissorsAI-05
INGE lamina spreaderEA-07
Instrument
circumcisionGG-09
KNUTSON urethrographyGG-09
LAFORCE foreign bodyEC-06
MOGAN circumcisionGG-09
IOWA tenaculum forcepsHA-35
IRIS
eye scissorsAI-22
large rings scissorsAI-19
scissorsAH-16, AI-21
IrrigatorHE-05
ISRAEL retractorBI-11
ITARD ear catheterEE-06
ITERSON tracheal hookFE-02
IVES-FANSLER anoscopeGI-04

J

JACKSON
tampon forcepsFC-02
tracheal hookFE-02
tracheal tubeFE-03
vaginal speculumHA-16
JACOBSON micro scissorsAJ-11
JACOBS tenaculum forcepsHA-34
JAEGER
keratomeEC-04
lid plateEC-03
JAMESON
strabismus forcepsEC-13
strabismus hookEC-06
JAMISON needle holderCE-03
JANSEN
nasal forcepsEG-04
retractorBI-14
JarHE-08
JARCHO tenaculum forcepsHA-32
JATHO nasopharynx forcepsEG-18
JAVID atraumatic carotid forcepsBD-32
JENNINGS mouth gagEI-04
JOBSON-HORNE cotton applicatorCA-03
JOHNS-HOPKINS
gall duct forcepsBC-14
serrefine bulldog clampsBC-03
JOHNSON needle holderCE-04
JONES tube holder towel clampBE-02
JOSEPH
file fileEG-14
hookletBI-06
JOSEPH (LEWIS) nasal raspEG-15
JOSEPH
nasal knifeEG-10
nasal sawEG-17
nasel knifeEG-10
periosteal elevatorEG-12
scissorsAH-14, AI-16
JUDD-ALLIS tissue forcepsGE-02
JUDD-MASSON bladder retractorGG-04
JURASZ larynx polypus forcepsFC-02

K

KABIERSKE powder blowerEE-04

E

Index
English

- KALLMORGEN
vaginal retractorHA-15
vaginal speculumHA-15
KALT-ARRUGA needle holderCE-07
KALT
capsular forcepsED-04
needle holderCE-07
KANE umbilical cord umbilic-cordHC-06
KEITH suturing needleCG-06
KELLY Grip retractorBI-04
KELLY
gynecological scissorsAH-22, AI-33
hemostatic forcepsBC-05
proctoscopeGI-04
KELLY-RANKIN hemostatic forcepsBC-05
KELLY
retractorBI-04, BI-12
KELLY TITAN hemostatic forcepsBC-05
KELLY
uterine polypus forcepsHA-36
Keratome
BERENSEC-04
CASTROVIEJOEC-04
JAEGEREC-04
KERN bone holding forcepsDC-08
KERRISON punchEG-08
KEVORKIAN-Pacific uterine biopsy specimen forcepsHA-44
KEVORKIAN
uterine biopsy aspirating curetteHA-40
uterine biopsy specimen forcepsHA-43, HA-46
KEY elevatorDC-21
KEYES cutaneous punchHE-02
KIELLAND-LUIKART obstetrical forcepsHC-03
KIELLAND obstetrical forcepsHC-02
KILLIAN-CLAUS nasal gougeEG-14
KILLIAN
septum elevatorEG-12
septum speculaEG-03
wash cannulaEG-09
KILNER-DOUGHTY mouth gagEI-05
KILNER
scissorsAH-14, AI-17
skin retractorHE-02
KIRBY-ARTHUR iris forcepsEC-13
KIRK hammerDC-18
KIRSCHNER
abdominal retractorBI-23
abdominal retractor bladeBI-23
abdominal retractor frameBI-23
bone hand drillDD-05
extension bowDD-10
ligature conductorCG-04
wiredrillDD-09
KLINKENBERGH-LOTH lung and thorax scissorsAI-37
KNAPP
cataract spoonEC-07
iris knifeEC-04
KNAPP-LUER tracheoma forcepsED-06
KNAPP
retractorEC-06
scissorsAI-20
Knife and dissector CARPENTER tonsilFA-02
Knife
BALLENGER swivelEG-11
BARKAN goniotomyEC-05
BARRAQUER keratoplastyEC-05
BOWMAN discisionEC-04
cartilageAG-18
CATLIN amputationAG-16
CONVERSE nasalEG-10
COTTLE nasalEG-10
DEAN irisEC-04
DEUTSCHMANN cataractEC-03
dissectingAG-15
electrodeJA-03
ELSCHNIG cornealEC-05
ESMARCH plasterDA-04
FREER mucosaEG-10
FREER septumEG-10
GILL cornealEC-05
GRAEFE cataractEC-03
HALLE duraEA-06
HOPKINS plasterDA-04
JOSEPH nasalEG-10
JOSEPH naselEG-10
KNAPP irisEC-04
LANGENBECK resectionAG-17
LISTON amputationAG-16
MALTZ cartilageEG-11
MUCK periostalEE-15
PARKER dissectingAG-15
PAUFIQUE keratoplastyEC-05
PLESTER flapEE-14
POLITZER earEE-06
REINER plasterDA-04
ROSEN circularEE-14
SATO cornealEC-05
SCHEIE goniotomyEC-05
SCHUKNECHT rollerEE-14
SCHUKNECHT sickleEE-14
SEGOND myomaHA-46
SEXTON earEE-06
TABB sickleEE-14
TOOK cornealEC-05
VIRCHOW brainAG-18
VIRCHOW cartilageAG-18
WHEELER discisionEC-04
WULLSTEIN sickleEE-14
ZIEGLER capsulotomyEC-05
ZIEGLER irisEC-04
KNIGHT nasal cutting forcepsEG-05
KNOWLES bandage scissorsAI-47
KNUTSON-KOCH urethrography coneGG-09
KNUTSON urethrography instrumentGG-09
KOCHER
bladder spatulaGG-04
goitre directorFE-04
hemostatic delicate forcepsBC-06
intestinal forcepsGE-04
retractorBI-10 to BI-11
KOENIG
ligature conductorCG-04
suturing needleCG-06
KOERTE retractorBI-11
KOGAN endo speculumHA-23
KONRICH sterilizing drumsHE-12
KRAUSE
ear polypus snareEE-07
larynx forcepsFC-03
nasal snareEG-09
KRISTELLER
vaginal retractorHA-09 to HA-14
vaginal speculumHA-09 to HA-14
KRONECKER ligature needleCG-02
KUENTSCHER
extractorDD-13
nail impactorDD-13
reamerDD-13
KUHNT corneal scarifierEC-05
L
LABORDE tracheal dilatorFE-02

- LAFORCE**
 adenotomeEG-19
 foreign body instrumentEC-06
LAGRANGE gum scissorsAI-41
LAHEY
 gall duct forcepsBC-14
 goitre seizing forcepsFE-04
 retractorBI-08
LAMBERT chalazion forcepsED-06
LAMBERT KAY
 atraumatic aortic-anastomosis forcepsBD-10
 atraumatic iliac forcepsBD-11
LAMBOTTE
 bone holding forcepsDC-08
LAMBOTTE mini osteotomeDC-15
LAMBOTTE
 osteotomeDC-15
 periosteal elevatorDC-19
LANCASTER eye speculumEC-03
Lancet electrodeJA-03
LANDAU vaginal speculumHA-22
LANDOLT
 enucleation scissorsAI-25
 micro surgical scalpel handleAG-13
LANE
 bone holding forcepsDC-08
 for bone plates forcepsDD-14
 for bone screws forcepsDD-14
 screw driverDD-14
 stomach clampGE-08
 thumb and tissue forcepsBA-04
 towel clampBE-05
LANGE
 bandage scissorsAI-44
 larynx forcepsFC-03
LANGENBECK
 bone holding forcepsDC-07
 elevatorDC-21
 finger protectorEI-06
 finger sawDD-03
 periosteal elevatorDC-19
 resection knifeAG-17
 retractorBI-09
LANG lachrymal dissectorEC-08
Laryngoscope blade
 MACINTOSH conventionalAE-15
 MACINTOSH fiber opticAE-10
 MILLER conventionalAE-16
 MILLER fiber opticAE-10
Laryngoscope set
 MACINTOSH conventionalAE-18 to AE-19
 MACINTOSH fiber opticAE-12 to AE-13
 MILLER conventionalAE-18 to AE-19
 MILLER fiber opticAE-12 to AE-13
Laryngoscope
 Spare lamp conventionalAE-20
 Spare lamp fiber opticAE-20
LAWRENCE hemostatic forcepsBC-13
Lead hand splintDC-11
LEBSCHKE sternum chiselDC-17
LEES atraumatic bronchus forcepsBD-03
LEGUEU
 bladder retractorGG-06
 bladder spatulaGG-04
LEKSELL STILLE bone rongeurDC-05
LELAND JONES atraumatic
 peripheral vascular forcepsBD-08 to BD-09
LEMPERT
 bone curetteDC-13
 bone rongeurDC-03
 elevatorEE-15
LERCHE thumb and tissue forcepsBA-04
LERICHE hemostatic forcepsBC-09
LESTER fixation forcepsED-03
Lever
 BENNETT boneDC-22
 BLOUNT boneDC-24
 boneDC-23
 BUCK foreign bodyEE-08
 HOHMANN boneDC-22 to DC-23
 HOHMANN mini boneDC-23
 QUIRE foreign bodyEE-08
LEVINSON foreign body needleEC-05
LEWIN bone holding forcepsDC-10
LEWKOWITZ placenta and ovum forcepsHC-07
LEXER-BABY scissorsAH-10
LEXER
 bone chiselDC-16
 bone gougeDC-16
 dissecting scissorsAI-11 to AI-12
LEXER mini
 bone chiselDC-16
 bone gougeDC-16
LEXER
 scissorsAH-09
LEYLA fixation systemEA-14 to EA-18
LICHTWITZ trocarCC-02, EG-09
LIDDLE atraumatic aortic forcepsBD-10
Light carrier MILLIN fiber opticGG-05
LISTER
 bandage scissorsAH-23, AI-45
LISTER-BURCH eye speculumEC-02
LISTER
 sponge holding sinus forcepsBG-11
LISTON
 amputation knifeAG-16
 bone cutting forcepsDC-06
LITTAUER
 cilia forcepsED-08
 ear forcepsEE-08
 ligature scissorsAI-40
 nasal polypus forcepsEG-05
LITTLER dissecting scissorsAI-13
LITTLE retractorBI-08
LOCKLIN scissorsAI-18
Loop
 ARLT wireEC-08
 BILLEAU earEE-07
 earEE-07
 mini electrodeJA-02 to JA-03
 nasalEG-09
 SNELLEN wireEC-08
 tonsilFA-04
 WEBER wireEC-08
 WILDER wireEC-08
LORENZ bandage scissorsAI-47
LORNA towel clampBE-04
LOUTE wire twisterDD-11
LOVE-GRUENWALD laminectomy rongeurEA-08
LOVELACE
 hemostatic forcepsBC-07
 lung grasping forcepsFG-19
LOVE
 nerve hookEA-04
 uvula retractorFA-02
LOWER gall duct forcepsBC-14
LOWMAN bone holding clampDC-11
LUBET-BARBON nasal polypus forcepsEG-05
LUCAE
 ear forcepsEE-07
 hammerDC-18
 tuning forkEE-04

E

Index
English

LUC nasal cutting forcepsEG-06
 LUER
 bone rongeurDC-03
 LUER-KOERTE gall stone scoopGC-09
 LUER
 tracheal tubeFE-03
 LUIKART-BILL traction handleHC-05
 LUIKART obstetrical forcepsHC-03
 LUNDGAARD sclerotomeEC-05
 LUNIATSCHEK gauze packerFA-02
 LURZ ureter clampGC-10

M

MACINTOSH
 conventional laryngoscope bladeAE-15
 conventional laryngoscope setAE-18 to AE-19
 fiber optic laryngoscope bladeAE-10
 fiber optic laryngoscope setAE-12 to AE-13
 MAGILL
 catheter introducing forcepsAE-06
 styletAE-04
 suction tubeAE-04
 Magnet DIMEDA eyeED-08
 MAIER dressing forcepsBG-12
 MALTZ
 cartilage knifeEG-11
 MALTZ (COTTLE) nasal raspEG-15
 MALTZ
 nasal raspEG-14
 Manometer for salpingographeHA-47
 Marker
 CASTROVIEJO compassEC-09
 CONNIN-AMSLEREC-09
 MARSCHIK tonsil forcepsFA-04
 MARTEL scalp flap forcepsBC-08
 MARTIN
 dressing forcepsBG-02, BG-14
 electrosurgery equipment cableJA-07
 MARTINI bone curetteDC-13
 MARTIN
 pelvimeterHC-06
 sequester forcepsDC-10
 uterine soundHA-39
 MASSON needle holderCE-03
 MASTIN muscular forcepsFE-04
 MATHIEU
 foreign body forcepsGG-07
 needle holderCE-05
 rectal speculumGI-02
 retractorBI-03
 MATSON periosteal elevatorDC-21
 MAUNDER wooden oral screwEI-06
 MAYO BLAKE gall stone forcepsGC-04
 MAYO
 gall stone scoopGC-07
 MAYO-GUYON kidney pedicle forcepsBC-16
 MAYO-HEGAR needle holderCE-02
 MAYO
 kidney stone probeGC-10
 left handed scissorsAI-07
 MAYO-NOBLE scissorsAH-08, AI-10
 MAY ophthalmoscopeAC-03
 MAYO-ROBSON intestinal forcepsGE-05
 MAYO
 safety needleCI-02
 scissorsAH-06, AI-07
 MAYO-STILLE scissorsAH-07, AI-08 to AI-09
 McClINTOCK placenta and ovum forcepsHC-07
 McCULLOUGH strabismus forcepsEC-13
 McDONALD elevatorDC-22

McGEE ear micro forcepsEE-10
 McGUIRE corneal scissorsAJ-05
 McINDOE
 cartilage scissorsAI-35
 thumb and tissue forcepsBA-04
 McIVOR
 mouth gagEI-05
 tongue depressorEI-05
 McKENTY septum elevatorEG-11
 McKENZIE
 clip applying forcepsEA-02
 cutterDD-04
 McLEAN-LUIKART obstetrical forcepsHC-03
 McLEAN obstetrical forcepsHC-04
 McLEAN-TUCKER-LUIKART obstetrical forcepsHC-03
 McPHERSON TITAN tying forcepsED-05
 McPHERSON tying forcepsED-05
 McPHERSON WESTCOTT tenotomy scissorsAJ-04
 MEAD
 bone rongeurDC-02
 hammerDC-18
 Measure graduatedHE-07
 Measuring tapeAC-08
 MEEKER hemostatic forcepsBC-13
 MELLINGER-AXENFELD eye speculumEC-02
 MELLINGER eye speculumEC-02
 MENGHINI trocarCC-03
 Meniscomote
 BIRCHERDC-24
 NEFFDC-24
 SMILLIEDC-24
 MERCEDES thoracic spreaderFG-16
 Metal rulerAC-08
 METZENBAUM
 dissecting scissorsAI-13 to AI-14
 METZENBAUM FINO
 dissecting scissorsAI-15
 scissorsAH-12
 METZENBAUM
 needle holderCE-04
 scissorsAH-11
 METZENBAUM "S" scissorsAH-13, AI-16
 MEYERDING retractorBI-08
 MEYHOEFER chalazion curetteEC-07
 MICHEL
 clipCG-07
 clip applying forcepsCG-07
 mirrorEG-04
 Micro forcepsBB-02
 Micro scissorsAJ-06, AJ-13
 Micro surgical scalpel handleAG-12
 MIDDELDORPF retractorBI-10
 MIDDLETON-JANSEN nasal cutting forcepsEG-09
 MIKULICZ
 peritoneum forcepsBC-17
 retractorBI-12
 MILLER
 conventional laryngoscope bladeAE-16
 conventional laryngoscope setAE-18 to AE-19
 fiber optic laryngoscope bladeAE-10
 fiber optic laryngoscope setAE-12 to AE-13
 MILLIGAN dura dissectorEA-05
 MILLIN
 bladder neck spreaderGG-07
 bladder retractorGG-05
 capsule forceps forcepsGG-03
 fiber optic light carrierGG-05
 ligature carrying forcepsGG-03
 lobe holding forcepsGG-03
 MILLS vascular scissorsAI-27
 Mini suturing kitCG-08

- Mirror
 laryngealFC-04
 MICHELEG-04
MIXTER BABY hemostatic bronchus forcepsBC-13
MIXTER
 gall duct forcepsBC-15
 gall stone forcepsGC-04
 hemostatic bronchus forcepsBC-13
 hemostatic forcepsBC-14
MIXTER O'SHAUGNESSY hemostatic forcepsBC-14
MOELTGEN goniometerAC-08
MOGAN circumcision instrumentGG-09
MOLLISON retractorBI-17
MOORE
 bone hand drillDD-04
 gall stone scoopGC-05
MOORFIELD suture forcepsED-05
MORSE-FAVOLORO rib spreaderFG-17
Mouth gag
 DAVIS-BOYLEEI-04
 DENHARTEI-03
 DOYEN-JANSENEI-03
 HEISTEREI-03
 JENNINGSEI-04
 KILNER-DOUGHTYEI-05
 McIVOREI-05
 ROSER-KOENIGEI-03
 SEEMANN-SEIFFERTEI-04
 WHITEHEADEI-04
MOYNIHAN
 gall duct forcepsBC-15
 gall stone probeGC-05
 towel clampBE-05
MUCK periosteal knifeEE-15
MUELLER eye speculumEC-03
MURDOCK eye speculumEC-02
MURLESS head elevatorHC-05
MURPHY-LANE elevatorDC-22
MURPHY tubing clamp forcepsBC-19
Muscle hook retractorBI-25
MUSEUX tenaculum forcepsHA-33
MYLES nasal cutting forcepsEG-07
- N**
- NABATOFF probeCA-02
NAEGELE obstetrical forcepsHC-03
NÁGELE perforatorHC-09
NAGER palate retractorFA-02
Needle
 BARBARAEE-14
 BOWMAN discisionEC-05
 BUNT safetyCI-02
Needle caseHE-02
 SAUERBRUCHHE-02
Needle
 cataractEC-05
 COOPER ligatureCG-02
 DAVIS foreign bodyEC-05
 DESCHAMPS ligatureCG-02
 DIX foreign bodyEC-09
 DUPUY-WEISS tonsilFA-03
 electrodeJA-03
 foreign bodyEC-05
 FRANCIS foreign bodyEC-05
 FRANKLIN-SILVERMANN punctureCC-03
Needle holder
 ADSONCE-04
 ARRUGA ophthalmologicCE-06
 BARRAQUERCE-07
 BAUMGARTNERCE-02
 BOYNTON ophthalmologicCE-06
 BOZEMANNCE-03
 CASTROVIEJOCE-07
 COLLIERCE-02
 CRILECE-04
 CRILE-MURRAYCE-02
 CRILE-WOODCE-02
 DE BAKEYCE-03
 DERFCE-02
 DIETHRICH vascularCE-06
 FINOCHIETTOCE-04
 GILLIESCE-05
 HALSEYCE-02
 HEANEYCE-03
 HOESELCE-05
 JAMISONCE-03
 JOHNSONCE-04
 KALTCE-07
 KALT-ARRUGACE-07
 MASSONCE-03
 MATHIEUCE-05
 MAYO-HEGARCE-02
 METZENBAUMCE-04
 NEIVERTCE-02
 OLSEN-HEGARCE-05
 RYDERCE-03
 SAROTCE-04
 STEVENS ophthalmologicalCE-06
 STRATTECE-04
 TOENNISCE-04
 WANGENSTEENCE-03
Needle
 KEITH suturingCG-06
 KOENIG suturingCG-06
 KRONECKER ligatureCG-02
 LEVINSON foreign bodyEC-05
 MAYO safetyCI-02
 mini electrodeJA-02
 NELSON ligatureCG-02
 POLITZER paracentesisEE-06
 QUINKE punctureCC-03
 REVERDIN ligatureCG-03
 ROSENEE-14 to EE-15
 tonsilFA-05
 VERRES pneumoperitoneum punctureCC-03
 YOUNG Boomerang ligatureCG-03
NEFF meniscotomeDC-24
NEGUS tonsil forcepsFA-03
NEIVERT needle holderCE-02
NELSON
 ligature needleCG-02
 thumb and tissue forcepsBA-05
 trocarCC-02
NEUBÜSER tubal seizing forcepsHA-51
Neurosurgical scissorsAI-35
Nipper
 cuticleHE-03
 DIETER malleusEE-10
 nailHE-03
 TURNBULL nailHE-03
NORTHBENT ligature scissorsAI-40
NOTO uterine polypus forcepsHA-36
NOVAK uterine biopsy aspirating curetteHA-40
NOYES
 iris scissorsAJ-03 to AJ-04
 nasal polypus forcepsEG-05
 tendon scissorsAJ-03
NUBOER suction tubeAE-05
Nurse set hospitalHE-03

O

OCHSNER	
atraumatic aortic forceps	.BD-31
trocar	.CC-02
O'CONNOR iris hook	.EC-06
OLDBERG laminectomy rongeur	.EA-09
OLIVECRONA	
bone rongeur	.DC-03
brain spatula	.EA-07
OLIVECRONA-TOENNIS clip applying forceps	.EA-02
OLIVECRONA	
wire saw	.EA-05
OLLIER retractor	.BI-10
OLSEN-HEGAR needle holder	.CE-05
Opening BROCK mitral valve dilator	.FG-26
Ophthalmoscope	
MAY	.AC-03
VARIFOCAL	.AC-03
Oral screw MAUNDER wooden	.EI-06
Osteotome	.DC-14
HIBBS	.DC-16
LAMBOTTE	.DC-15
LAMBOTTE mini	.DC-15
STILLE	.DC-14
O'SULLIVAN-O'CONNOR	
abdominal retractor	.BI-21
vaginal speculum	.HA-08
OTIS	
spare blade	.GG-08
urethrotome	.GG-08
Otoscope	.AC-04
OVERHOLT-GEISSENDOERFER dissecting and ligature forceps	.BC-10
OVERHOLT periosteal elevator	.DC-21

P

Pan	
bed	.HE-06
plazenta	.HE-06
PARHAM band	.DC-11
PARKER	
dissecting knife	.AG-15
retractor	.BI-02
PARK eye speculum	.EC-03
PARTSCH	
bone chisel	.DC-14
bone gouge	.DC-14
PASSOW hemostat	.EE-15
PATON corneal dissector	.EC-05
PAUFIQUE	
keratoplasty knife	.EC-05
PAUFIQUE TITAN tying forceps	.ED-05
PAUFIQUE	
tying forceps	.ED-05
PAYR-Baby stomach clamp	.GE-09
PAYR	
ligature conductor	.CG-04
stomach clamp	.GE-09
PEAN	
atraumatic forceps	.BD-02
hemostatic delicate forceps	.BC-06
hemostatic forceps	.BC-08
PEDERSON vaginal speculum	.HA-03
PEERS BERTRAM towel clamp	.BE-03
PEET splinter forceps	.BA-06
PELKMANN dressing forceps	.BG-12
Pelvimeter	
COLLIN	.HC-06
COLLYER	.HC-06

MARTIN	.HC-06
PENFIELD dura dissector	.EA-06
PENNINGTON hemostatic forceps	.BC-07
Percussion hammer	
BABINSKY	.AC-07
BERLINER	.AC-07
BUCK	.AC-07
DEJERINE	.AC-07
TAYLOR	.AC-07
TRAUBE	.AC-07
TROEMNER	.AC-07
PERCY amputation retractor	.DD-03
Perforator	
NÄGELE	.HC-09
SMELLIE	.HC-09
PERTHES reamer	.DD-08
PESTALOZZA placenta and ovum scoop	.HC-08
PETRI dish	.HE-08
PETZ stomach and intestinal suturing apparatus	.GE-09
PHANEUF peritoneum forceps	.BC-17
Pick	.EE-15
BARBARA	.EE-14 to EE-15
PIERCE trocar	.CC-02
PIFFARD lupus curette	.HE-02
PINARD stethoscope	.AC-06
Pin STEINMANN	.DD-09
Pin-wheel WARTENBERG	.AC-08
PIPER	
obstetrical forceps	.HC-04
obstetrical, with traction rod forceps	.HC-04
Plaster knife	.DA-04
Plaster saw blade	.DA-05 to DA-06
Plaster scissors	.AI-49
Plaster spatula	.CA-03
Plaster spreader	.DA-03
Plate JAEGER lid	.EC-03
PLESTER	
flap knife	.EE-14
retractor	.BI-14
Pliers flat nose	.DD-11
POLITZER	
air bag	.EE-05
ear knife	.EE-06
paracentesis needle	.EE-06
POOLE suction tube	.AE-02
Post mortem set	.DC-17
POTTS	
atraumatic anastomosis forceps	.BD-05
atraumatic coarctation forceps	.BD-04
atraumatic forceps	.BD-26 to BD-27
POTTS DE MARTEL vascular scissors	.AI-27
POTTS-SMITH	
thumb and tissue forceps	.BA-02
vascular scissors	.AH-19, AI-28
Powder blower KABIERSKE	.EE-04
POZZI tenaculum forceps	.HA-31
PRATT	
cystic hook	.GI-04
hemostatic forceps	.BC-08
rectal speculum	.GI-02
tenaculum forceps	.HA-34 to HA-35
uterine dilator	.HA-29
PRESBYTERIAN HOSPITAL tubing clamp forceps	.BC-19
PRICE-THOMAS bronchus forceps	.FG-22
PRINCE	
muscular forceps	.ED-02
tonsil scissors	.AI-27
Probe	.CA-02
BOWMAN lachrymal	.EC-10
DESJARDINS gall stone	.GC-05
MAYO kidney stone	.GC-10

measuringEE-15
 MOYNIHAN gall stoneGC-05
 NABATOFFCA-02
 STACKECA-02
 Proctoscope KELLYGI-04
 Protector
 ARRUGAEC-08
 tissueDD-15
 PROVIDENCE-HOSPITAL hemostatic forcepsBC-05
 Punch
 BEYEREG-08
 BROCK mitral valve dilatorFG-26
 CITELLIEG-08
 HAJEK-CLAUSEG-08
 HAJEK-KOFLEREG-08
 HOLTH corneoscleralEC-09
 KERRISONEG-08
 KEYES cutaneousHE-02
 PUTTI bone raspDC-25

Q

QUATTRO plaster spreaderDA-03
 QUINBY gum scissorsAI-42
 QUINKE puncture needleCC-03
 QUIRE foreign body leverEE-08
 QUISLING hammerDC-18

R

RADOLF nail extracting forcepsDD-03
 RALK bone hand drillDD-05
 RAMPLEY sponge holding forcepsBG-09
 RANDALL
 kidney stone forcepsGC-11 to GC-12
 uterine biopsy aspirating curetteHA-40
 RANEY
 clip applying forcepsEA-03
 scalp hemostasis clipEA-03
 RANKIN atraumatic forcepsBD-02
 Rasp
 boneDC-25
 FOMON nasalEG-15 to EG-16
 GALLAHER antrumEG-16
 JOSEPH (LEWIS) nasalEG-15
 MALTZ (COTTLE) nasalEG-15
 MALTZ nasalEG-14
 PUTTI boneDC-25
 WIENER antrumEG-15
 WIENER (AUFRICHT) nasalEG-15
 RazorAG-14
 Razor bladeAG-14, AG-19
 Razor knifeAG-19
 ReamerDD-08, DD-12
 KUENTSCHERDD-13
 PERTHESDD-08
 RECAMIER uterine curetteHA-49 to HA-50
 Rectoscope cold lightGI-03
 Retractor SCHOENBORN thyroidFE-04
 REICHERT epiglottis retractorFC-02
 REINER
 ear syringeEE-05
 plaster knifeDA-04
 RetractorBI-06, BI-10
 ADSONBI-15
 ADSON-BabyBI-15
 ALAN-PARKS analGI-03
 ALMBI-14
 AUFRICHT nasalEG-17
 BALFOUR abdominalBI-22
 BALFOUR Baby abdominalBI-22

BECKMANNBI-16
 BECKMANN-ADSONBI-15
 BECKMANN-EATONBI-16
 BLOUNT kneeDC-24
 CASPARBI-20
 CASPAR cervical spineBI-18
 CASPAR vertebral columnBI-19
 CASPAR vertebral lumbarBI-20
 cheekEI-03
 CLOWARDBI-17
 COLLIN abdominalBI-24 to BI-25
 COLLIN-HARTMANNBI-03
 COOLEY atriumFG-20
 COOLEY modif- STRUCK atriumFG-20
 CORYLLOS (Thorax)BI-13
 COTTLE nasalEG-17
 COTTLE-NEIVERT nasalEG-17
 CRILEBI-02
 CUSHINGBI-07
 DARLINGBI-17
 DAVIDSON (Scapula)BI-13
 DEAVERBI-05
 DEAVER GripBI-05
 DESMARRSBI-07
 DIMEDABI-14
 DOYENBI-12
 FARABEUFBI-02
 FINSENBI-14
 FOMON nasalEG-17
 FRAZIERBI-21
 FRIEDMAN perineorrHA-23
 FRITSCHBI-11
 GELPI abdominalBI-24
 GOELETBI-03
 GOSSET abdominalBI-21
 GREENBI-10
 HABERERBI-04
 HARRINGTONBI-05
 HEANEYBI-12
 HOFER pillarFA-02
 HRYNTSCHAK prostaticGG-06
 ISRAELBI-11
 JANSENBI-14
 JUDD-MASSON bladderGG-04
 KALLMORGEN vaginalHA-15
 KELLYBI-04, BI-12
 KELLY GripBI-04
 KILNER skinHE-02
 KIRSCHNER abdominalBI-23
 KNAPPEC-06
 KOCHERBI-10 to BI-11
 KOERTEBI-11
 KRISTELLER vaginalHA-09 to HA-14
 LAHEYBI-08
 LANGENBECKBI-09
 LEGUEU bladderGG-06
 lip and cheekEI-03
 LITTLEBI-08
 LOVE uvulaFA-02
 MATHIEUBI-03
 MEYERDINGBI-08
 MIDDELDORPFBI-10
 MIKULICZBI-12
 MILLIN bladderGG-05
 MOLLISONBI-17
 NAGER palateFA-02
 OLLIERBI-10
 O'SULLIVAN-O'CONNOR abdominalBI-21
 PARKERBI-02
 PERCY amputationDD-03
 PLESTERBI-14

- REICHERT epiglottisFC-02
 REVERDINBI-04
 RIBBONBI-04
 RICHARDSONBI-04
 RICHARDSON-EASTMANBI-04
 RICHARDSON GripBI-04
 RIGBY abdominalBI-24
 ROLLETEC-06
 ROUXBI-02
 ROUX BabyBI-02
 ROUX miniBI-02
 SAUERBRUCHBI-13
 SENNBI-04
 SENN-GREENBI-07
 SIMONBI-12
 SMITH-BUIE analGI-03
 STERNBERG lipEI-02
 TAYLOR spinalDC-24
 THOMSON-WALKER bladderGG-06
 US Army (PARKER-LANGENBECK)BI-03
 VOLKMANNBI-07 to BI-08
 WEITLANERBI-14
 WEITLANER-WULLSTEINBI-14
 YOUNG prostaticGG-02
- REVERDIN
 ligature needleCG-03
 retractorBI-04
- REYNOLDS scissorsAH-15, AI-18
 RhachiotomeDC-17
 Ribbon loop electrodeJA-03
 RIBBON retractorBI-04
 RICHARDSON-EASTMAN retractorBI-04
 RICHARDSON Grip retractorBI-04
 RICHARDSON retractorBI-04
 RICHTER-HEATH clip applying forcepsCG-07
 RIGBY abdominal retractorBI-24
- Ring cutter
 DIMEDA fingerDD-03
 fingerDD-03
- Ring stripperCA-03
- ROBB vascular dissectorFG-33
 ROBERTS hemostatic forcepsBC-11
 ROCHESTER-CARMALT hemostatic forcepsBC-07
 ROCHESTER-OCHSNER hemostatic forcepsBC-06
 ROCHESTER-PEAN hemostatic forcepsBC-06
 ROEDER towel clampBE-03
 ROGER septum elevatorEG-11
 ROGGE sterilizing forcepsCI-02
- ROLLET
 extirpation chiselEC-06
 retractorEC-06
- Rongeur
 ADSON boneDC-03
 BEYER boneDC-04
 BLUMENTHAL boneDC-02
 BÖHLER boneDC-04
 CLEVELAND boneDC-02
 ECHLIN boneDC-05
 FRIEDMAN boneDC-02
 FRIEDMAN Mini boneDC-02
 FRYKHOLM boneDC-05
 LEKSELL STILLE boneDC-05
 LEMPERT boneDC-03
 LUER boneDC-03
 MEAD boneDC-02
 OLIVECRONA boneDC-03
 RUSKIN boneDC-04
 SAUERBRUCH boneDC-05
 SCAGLIETTI boneDC-05
 SEMB boneDC-06
 STILLE-LUER boneDC-04
- STILLE-RUSKIN boneDC-05
 ZAUFAL-JANSEN boneDC-04
- ROSENBERG larynx forcepsFC-03
- ROSEN
 circular knifeEE-14
 needleEE-14 to EE-15
- ROSER-KOENIG mouth gagEI-03
 ROSE tracheal hookFE-03
 ROTES KREUZ bandage scissorsAI-47
- Rounger
 COLCLOUGH intervertebral discEA-11
 CUSHING laminectomyEA-08
 FERRIS-SMITH-KERRISON intervertebral discEA-10
 FERRIS-SMITH laminectomyEA-09
 LOVE-GRUENWALD laminectomyEA-08
 OLDBERG laminectomyEA-09
 SPURLING laminectomyEA-08
 WAGNER laminectomyEA-09
- ROUX Baby retractorBI-02
 ROUX mini retractorBI-02
 ROUX retractorBI-02
 ROWE mouth forcepsEI-06
 RUBIN septum crushing forcepsEG-07
 RUMEL thorax forcepsBC-11
 RUSKIN bone rongeurDC-04
 RUSKIN-LISTON bone cutting forcepsDC-06
 RUSSIAN thumb and tissue forcepsBA-04
 RYDEL-SEIFFER tuning forkEE-04
 RYDER needle holderCE-03
- ## S
- SAALFELD comedo extractorHE-02
- SACHS
 dura dissectorEA-05
 nerve hookEA-04
- SADILLOT periosteal elevatorDC-19
 SAENGER placenta and ovum forcepsHC-07
 SAIRGES tenaculum forcepsHA-32
 Salpingograph SCHULTZEHA-47
 SANVENERO scissorsAH-13, AI-16
- SAROT
 bronchus forcepsFG-23
 hemostatic bronchus forcepsBC-12
 needle holderCE-04
- SATINSKY
 anastomosis (vena cava) clampFG-24 to FG-25
 atraumatic forcepsBD-20
 lung and thorax scissorsAI-37
- SATO corneal knifeEC-05
- SAUERBRUCH
 bone rongeurDC-05
 SAUERBRUCH-FREY rib shearFG-06
- SAUERBRUCH
 needle caseHE-02
 retractorBI-13
 rib shearFG-05
 waste pickup forcepsCI-03
- Saw
 BERGMANN plasterDA-02
 CHARRIERE amputationDD-03
 CHARRIERE bladeDD-03
- Saw conductor De MARTELEA-05
- Saw
 ENGEL plasterDA-02
 JOSEPH nasalEG-17
 LANGENBECK fingerDD-03
 OLIVECRONA wireEA-05
- SAWTELL tonsil forcepsFA-03
- Saw
 WIGMORE plasterDA-02

- SCAGLIETTI bone rongeurDC-05
- Scalpel handleAG-02 to AG-05, AG-07 to AG-08
- CASPAR micro surgicalAG-12
- LANDOLT micro surgicalAG-13
- Scalpel removerAG-06, AG-10
- Scalpel, sterile bladeAG-06, AG-09
- Scarifier
- GRAEFEEC-04
- KUHNT cornealEC-05
- SCHAMBERG comedo extractorHE-02
- SCHEDE bone curetteDC-12
- SCHEIE
- eye cannulaED-07
- goniotomy knifeEC-05
- SCHEINMANN larynx forcepsFC-03
- SCHERBAK vaginal speculumHA-21
- SCHIMMELBUSCH sterilizing drumsHE-12
- SCHINK dermatomeAG-21
- SCHIOETZ tonometerED-08
- SCHMIEDEN ligature conductorCG-04
- SCHMIEDEN-PAYR ligature conductorCG-04
- SCHMIEDEN-TAYLOR scissorsAI-36
- SCHNIDT tonsil forcepsFA-03
- SCHOENBORN thyroid retractorFE-04
- SCHOENBURG grasping forcepsGE-03
- SCHROEDER
- tenaculum forcepsHA-31 to HA-32
- uterine curetteHA-48
- SCHUBERT uterine biopsy specimen forcepsHA-41
- SCHUKNECHT
- roller knifeEE-14
- sickle knifeEE-14
- SCHULTZE salpingographHA-47
- SCHUMACHER
- larynx forcepsFC-03
- sternum shearFG-07
- umbilical scissorsAI-34
- uterine biopsy specimen forcepsHA-43
- SCHWEIGGER capsular forcepsED-04
- ScissorsAH-02 to AH-04, AI-02 to AI-04
- AEBLI cornealAI-22
- BARRAQUER colibriAJ-04
- BEEBEE wire and plateAI-43
- BELLUCCI ear microEE-09
- BERGMANN bandageAI-46
- BEUSE scissors toothedAI-26
- BOETTCHER tonsilAI-27
- BRAUN-STADLER episiotomyAH-22, AI-34
- BRUNS plasterAI-48
- BUCK ligatureAI-40
- BUSCH umbilicalAI-34
- CASTROVIEJO cornealAJ-06
- CASTROVIEJO iridectomyAJ-05
- COTTLE nasalAH-18, AI-25
- CRAFOORD lung and thoraxAI-36
- cuticleHE-03
- DANDY neurosurgicalAI-36
- DEAN tonsilAI-26
- DEAVERAH-05, AI-06
- DE BAKEY vascularAI-30
- DIETHRICH vascularAI-29
- DIMEDA bandageAI-46
- DOYEN gynecologicalAI-33
- DUBOIS gynecologicalAI-33
- ear microEE-11
- ear micro-miniEE-11
- ESMARCH bandageAI-46
- FERGUSONAI-49
- FINOCHIETTO rectalAI-38
- FOMON nasalAH-18, AI-25
- GOLDMAN-FOX gumAI-41
- GOOD tonsilAI-27
- GORNEY dissectingAI-13
- HEATH ligatureAI-40
- HEYMANN nasalAH-18, AI-25
- IRISAH-16, AI-21
- IRIS eyeAI-22
- IRIS large ringsAI-19
- JACOBSON microAJ-11
- JOSEPHAH-14, AI-16
- KELLY gynecologicalAH-22, AI-33
- KILNERAH-14, AI-17
- KLINKENBERGH-LOTH lung and thoraxAI-37
- KNAPPAI-20
- KNOWLES bandageAI-47
- LAGRANGE gumAI-41
- LANDOLT enucleationAI-25
- LANGE bandageAI-44
- LEXERAH-09
- LEXER-BABYAH-10
- LEXER dissectingAI-11 to AI-12
- LISTER bandageAH-23, AI-45
- LITTAUER ligatureAI-40
- LITTLER dissectingAI-13
- LOCKLINAI-18
- LORENZ bandageAI-47
- MAYOAH-06, AI-07
- MAYO left handedAI-07
- MAYO-NOBLEAH-08, AI-10
- MAYO-STILLEAH-07, AI-08 to AI-09
- McGUIRE cornealAJ-05
- McINDOE cartilageAI-35
- McPHERSON WESTCOTT tenotomyAJ-04
- METZENBAUMAH-11
- METZENBAUM dissectingAI-13 to AI-14
- METZENBAUM FINOAH-12
- METZENBAUM FINO dissectingAI-15
- METZENBAUM "S"AH-13, AI-16
- MILLS vascularAI-27
- nailHE-03
- NORTHBENT ligatureAI-40
- NOYES irisAJ-03 to AJ-04
- NOYES tendonAJ-03
- POTTS DE MARTEL vascularAI-27
- POTTS-SMITH vascularAH-19, AI-28
- PRINCE tonsilAI-27
- QUINBY gumAI-42
- REYNOLDSAH-15, AI-18
- ROTES KREUZ bandageAI-47
- SANVENEROAH-13, AI-16
- SATINSKY lung and thoraxAI-37
- SCHMIEDEN-TAYLORAI-36
- SCHUMACHER umbilicalAI-34
- SHEA ear microEE-09
- SHORTBENT ligatureAI-40
- SIEBOLD gynecologicalAH-21, AI-32
- SIMS gynecologicalAH-21, AI-32
- SMITH US ARMY bandageAI-44
- SPENCER ligatureAI-40
- STELZNER rectalAI-38
- STEVENS tenotomyAH-17, AI-23
- STRULLY neurosurgicalAI-35
- THOREK lung and thoraxAI-36
- TOENNIS-ADSON neurosurgicalAI-35
- TROUTMAN-CASTROVIEJO microAJ-07
- UNIVERSAL bandageAI-50
- UNIVERSAL wire and plateAI-42
- USA MODEL umbilicalAI-34
- VANNAS iridectomyAJ-05
- VANNAS microAJ-12 to AJ-13
- WAGNERAH-22
- WAGNER gumAI-42

- WALDMANN episiotomy AI-34
 WECKER iris AJ-04
 WERTHEIM preparation AI-32
 WESTCOTT iridectomy AJ-02
 WESTCOTT tendon AJ-02
 WULLSTEIN ear micro EE-11
 WULLSTEIN ear micro-mini EE-11
 YASARGIL micro AJ-10 to AJ-11
- Sclerotome**
- GUYTON-LUNDSGAARD EC-05
 LUNDSGAARD EC-05
- Scoop**
- BUNGE exenteration EC-07
 CUZZI placenta and ovum HC-08
 DESJARDINS gall stone GC-08
 FERGUSSON gall stone GC-07
 GUTMANN secretions GG-11
 LUER-KOERTE gall stone GC-09
 MAYO gall stone GC-07
 MOORE gall stone GC-05
 PESTALOZZA placenta and ovum HC-08
 WALLICH placenta and ovum HC-08
 WELLS enucleation EC-08
- Screw DOYEN myoma** HA-46
- Screw driver** DD-14 to DD-15
- LANE DD-14
 WILLIAMS DD-14
- SEEMANN-SEIFFERT mouth gag EI-04
- SEGOND myoma knife HA-46
- SEIFFERT larynx forceps FC-03
- SELLHEIM elevating spoon HC-09
- SELLORS rib contractor FG-18
- SEMB**
- bone cutting forceps DC-07
 bone holding forceps DC-07
 bone rongeur DC-06
 bronchus forceps FG-23
 periosteal elevator DC-20
- SEMKEN thumb and tissue forceps BA-05
- SEMM vaginal speculum HA-07
- SENN-GREEN retractor BI-07
- SENN retractor BI-04
- Septatome BRUENINGS EG-11
- Sequester forceps DC-10
- SEUTIN plaster shear DA-02
- SEXTON ear knife EE-06
- SHEA ear micro scissors EE-09
- Shear**
- BETHUNE rib FG-04
 BRUNNER rib FG-07
 COOLEY rib first FG-05
 CORYLLOS rib FG-04
 GIERTZ-STILLE rib FG-06
 GLUCK rib FG-03
 rib FG-02
 SAUERBRUCH-FREY rib FG-06
 SAUERBRUCH rib FG-05
 SCHUMACHER sternum FG-07
 SEUTIN plaster DA-02
 STILLE plaster DA-02
 STILLE rib FG-03
- SHORTBENT ligature scissors AI-40
- SIEBOLD gynecological scissors AH-21, AI-32
- SIEGLE ear specula EE-02
- SIEGLER HELLMANN uterine elevating forceps HA-38
- SILVER**
- dermatome AG-20
 rhinoplastic chisel EG-14
- SIMCOE suturing cannula ED-07
- SIMON**
- bone curette DC-13
- retractor BI-12
- uterine curette HA-48
- SIMPSON-BRAUN obstetrical forceps HC-02
- SIMPSON-LUIKART obstetrical forceps HC-03
- SIMPSON obstetrical forceps HC-02
- SIMS**
- gynecological scissors AH-21, AI-32
- SIMS-MAIER dressing forceps BG-05
- SIMS**
- rectal speculum GI-02
 uterine curette HA-49 to HA-50
 uterine depressor HA-39
 uterine dilator HA-30
 uterine sound HA-39
 vaginal speculum HA-17
- SINGLEY thumb and tissue forceps BA-05
- Sinker corticalis DD-15
- SKENE tenaculum forceps HA-31
- Skin fixing plate AG-21
- Skull breaker VIRCHOW DC-17
- SLUDER-BALLENGER tonsillectome FA-05
- SMELLIE**
- obstetrical hook HC-06
 perforator HC-09
- SMILLIE meniscotome DC-24
- SMITH-BUIE anal retractor GI-03
- SMITH eye speculum EC-02
- SMITH-PETERSEN**
- bone chisel DC-15
 bone gouge DC-15
- SMITH US ARMY bandage scissors AI-44
- SMITHWICK**
- clip applying forceps EA-02
 nerve hook EA-04
- Snare**
- BRUENINGS tonsil FA-04
 EVES tonsil FA-04
 KRAUSE ear polypus EE-07
 KRAUSE nasal EG-09
 TYDING tonsil FA-05
 WESTON rectal polypus GI-05
 WILDE ear polypus EE-07
 WILDE nasal EG-09
- SNELLEN**
- entropium forceps ED-06
 wire loop EC-08
- SOMER uterine elevating forceps HA-37
- Sound**
- COLLIN uterine HA-39
 COXETER urethral GG-17
 DITTEL urethral GG-18 to GG-19
 GUYON urethral GG-12, GG-14 to GG-15
 MARTIN uterine HA-39
 SIMS uterine HA-39
 VALLEIX uterine HA-39
 VAN BUREN urethral GG-13
 WALTHER urethral GG-17
- Spare lamp**
- conventional laryngoscope AE-20
 fiber optic laryngoscope AE-20
- Spatula**
- ALLISON lung FG-19
 BANGERTER cyclodialysis EC-08
 CASTROVIEJO cyclodialysis EC-08 to EC-009
 CULLER iris EC-08
 CUSHING brain EA-07
 ELSCHNIG cyclodialysis EC-08
 HEIFETZ brain EA-07
 intima FG-32
 KOCHER bladder GG-04
 LEGUEU bladder GG-04

- OLIVECRONA brainEA-07
WECKER irisEC-08
WHEELER cyclodialysisEC-09
- Specula
- BOUCHERON earEE-02
BRUENINGS earEE-02
COTTLE nasalEG-03
GRUBER earEE-02
HARTMANN earEE-02
HARTMANN-HALLE nasalEG-02
KILLIAN septumEG-03
SIEGLE earEE-02
THUDICHUM nasalEG-02
TIECK-HALLE nasalEG-03
TOYNBEE earEE-02
Vienna nasalEG-02
VOLTOLINI nasalEG-02
YANKAUER postnasalEG-04
- Speculum
- ARRUGA eyeEC-02
AUVARD vaginalHA-19
BARRAQUER Colibri eyeEC-02
BARR rectalGI-02
BERLIND-AUVARD vaginalHA-19
BODENHAMMER rectalGI-02
BOWMAN eyeEC-02
BRAUN vaginalHA-16
BREISKY vaginalHA-20
CASTROVIEJO eyeEC-03
CLARK eyeEC-02
COLLIN vaginalHA-04
CRITCHETT eyeEC-02
CUSCO vaginalHA-04 to HA-06
CZERNY rectalGI-02
DOYEN vaginalHA-18, HA-20
FREEWAY-GRAVE vaginalHA-06
GOLDSTEIN eyeEC-03
GRAEFE eyeEC-02
GRAVE vaginalHA-02
JACKSON vaginalHA-16
KALLMORGEN vaginalHA-15
KOGAN endoHA-23
KRISTELLER vaginalHA-09 to HA-14
LANCASTER eyeEC-03
LANDAU vaginalHA-22
LISTER-BURCH eyeEC-02
MATHIEU rectalGI-02
MELLINGER-AXENFELD eyeEC-02
MELLINGER eyeEC-02
MUELLER eyeEC-03
MURDOCK eyeEC-02
O'SULLIVAN-O'CONNOR vaginalHA-08
PARK eyeEC-03
PEDERSON vaginalHA-03
PRATT rectalGI-02
SCHERBAK vaginalHA-21
SEMM vaginalHA-07
SIMS rectalGI-02
SIMS vaginalHA-17
SMITH eyeEC-02
STEINER-AUVARD vaginalHA-19
STEVENSON eyeEC-03
TRELAT vaginalHA-07
WEEK eyeEC-02
WEISSBARTH vaginalHA-22
WILLIAMS eyeEC-02
ZIEGLER eyeEC-03
- SPENCER ligature scissorsAI-40
SPENCER-WELLS hemostatic forcepsBC-07
Splinter forcepsBA-06
Spoon
- DAVIEL cataractEC-07
GRAEFE cataractEC-07
GROSS earEE-06
KNAPP cataractEC-07
SELLHEIM elevatingHC-09
SPRATT bone curetteDC-12
- Spreader
- BEESON plasterDA-03
BOSE trachealFE-02
CASTAÑEDA ribFG-14
CHEVALLIER ribFG-15
CLOWARD laminaEA-07
COOLEY ribFG-09
FINOCHIETTO-BABY ribFG-09
FINOCHIETTO BURFORD ribFG-12 to FG-14
FINOCHIETTO-HAIGHT BABY ribFG-10
FINOCHIETTO INFANT ribFG-12
FINOCHIETTO (modif) ribFG-08
FINOCHIETTO ribFG-08, FG-10 to FG-11
HAGLUND-STILLE plasterDA-03
HAIGHT ribFG-15
HENNIG plasterDA-03
HERMANN plasterDA-03
HERTZLER ribFG-17
INGE laminaEA-07
MERCEDES thoracicFG-16
MILLIN bladder neckGG-07
MORSE-FAVOLORO ribFG-17
QUATTRO plasterDA-03
TUFFIER ribFG-16
- Spud DIX foreign bodyEC-06
SPURLING laminectomy rongerEA-08
STACKE probeCA-02
Stainer vaginal speculumHA-22
Standard suturing kitCG-08
STAUDE-MOORE tenaculum forcepsHA-31
St- CLAIR-THOMSON adenoid curetteEG-19
STEINER-AUVARD vaginal speculumHA-19
STEINMANN pinDD-09
STELZNER rectal scissorsAI-38
Sterile disposable scalpelAG-10 to AG-11
Sterile, micro surgical scalpel bladeAG-13
Sterilization container
- 3/4HE-22 to HE-24
flat half sizeHE-30 to HE-31
half sizeHE-26 to HE-29
largeHE-18 to HE-20
smallHE-32 to HE-33
specialHE-34 to HE-37
- Sterilizing forcepsCI-02
STERNBERG lip retractorEI-02
Stethoscope
- BOWLESAC-06
FORDAC-06
FORD BOWLESAC-06
PINARDAC-06
- STEVENS
- iris forcepsEC-11
lens hookEC-06
STEVENSON eye speculumEC-03
STEVENS
- ophthalmologic needle holderCE-06
tenotomy scissorsAH-17, AI-23
STIEGLITZ splinter forcepsBA-06
STILLE
- bone chiselDC-14
bone gougeDC-14
bone hand drillDD-04
STILLE-HORSLEY bone cutting forcepsDC-07
STILLE
- kidney pedicle forcepsBC-16

E

Index English

- STILLE-LISTON bone cutting forcepsDC-06
 STILLE-LUER bone rongeurDC-04
 STILLE
 osteotomeDC-14
 plaster shearDA-02
 rib shearFG-03
 STILLE-RUSKIN bone rongeurDC-05
 STILLE-SHERMAN bone hand drillDD-04
 STILLE
 thumb and tissue forcepsBA-02
 St- MARTIN suture forcepsED-05
 STOCKMANN Penile clampGG-10
 STONE closing forcepsGE-06
 STONE-WATT intestinal forcepsGE-06
 Strabismus scissorsAH-17, AI-24
 STRATTE needle holderCE-04
 STRAUSS Penile clampGG-10
 STRUEMPEL ear forcepsEE-08
 STRULLY neurosurgical scissorsAI-35
 STRUYCKEN nasal cutting forcepsEG-07
 Stylet MAGILLAE-04
 SUBRAMANIAN atraumatic forcepsBD-31
 Suction tube
 ANDREWS-PINCHONAE-03
 DE BAKEYAE-04
 FRAZIEREA-07
 MAGILLAE-04
 NUBOERAE-05
 POOLEAE-02
 WALTON YANKAUERAE-03
 YANKAUERAE-02
 Suturing kit
 miniCG-08
 standardCG-08
 Suturing needleCG-05 to CG-06
 SWEET clip applying forcepsEA-02
 Syringe
 REINER earEE-05
 tonsilFA-05
- T**
 TABB sickle knifeEE-14
 Tap screwDD-15
 TARNIER
 cranioclastHC-09
 obstetrical, with traction rod forcepsHC-05
 TAYLOR
 percussion hammerAC-07
 spinal retractorDC-24
 TEALE tenaculum forcepsHA-33
 Tendon stripper BUNNELLDC-25
 TERSON capsular forcepsED-04
 THOMS-ALLIS tissue forcepsGE-02
 THOMS-GAYLOR uterine biopsy specimen forcepsHA-42
 THOMSON-WALKER bladder retractorGG-06
 THOREK lung and thorax scissorsAI-36
 THUDICHUM nasal speculaEG-02
 TIECK-HALLE nasal speculaEG-03
 TIEMANN tenaculum forcepsHA-32
 TILLEY ear forcepsEE-08
 TISCHLER-KEVORKIAN
 uterine biopsy specimen forcepsHA-44 to HA-45
 TISCHLER-MORGAN
 uterine biopsy specimen forcepsHA-43 to HA-44, HA-46
 TIVNEN tonsil seizing forcepsFA-04
 TOBOLD
 cotton applicatorCA-03
 tongue depressorEI-02
 TOENNIS-ADSON neurosurgical scissorsAI-35
 TOENNIS
 dura dissectorEA-05
 hemostatic forcepsBC-11
 needle holderCE-04
 TOHOKU towel clampBE-04
 Tong CRUTCHFIELD cervical tractionEA-03
 Tongue depressor
 ANDREWEI-02
 BRUENINGSEI-02
 BUCHWALDEI-02
 FRENZELEI-02
 HARTMANNEI-02
 McIVOREI-05
 TOBOLDEI-02
 WIEDEREI-02
 woodenEI-02
 Tonometer SCHIOETZED-08
 Tonsillectome SLUDER-BALLENGERFA-05
 TOOK corneal knifeEC-05
 TOTI drill burrDD-07
 TourniquetAC-03
 Towel clamp
 BACKHAUSBE-02
 BACKHAUS-CLIP tube holderBE-03
 BACKHAUS KOCHERBE-02
 BALL AND SOCKETBE-04
 BERNHARDBE-05
 DOYENBE-05
 HOFFBE-03
 JONES tube holderBE-02
 LANEBE-05
 LORNABE-04
 MOYNIHANBE-05
 PEERS BERTRAMBE-03
 ROEDERBE-03
 TOHOKUBE-04
 TOWNSEND-KEVORKIAN
 uterine biopsy specimen forcepsHA-44
 TOWNSEND-MINI (BABY TISCHLER)
 uterine biopsy specimen forcepsHA-45
 TOWNSEND-mini uterine biopsy specimen forcepsHA-44
 TOWNSEND-TISCHLER
 uterine biopsy specimen forcepsHA-44
 TOWNSEND uterine biopsy specimen forcepsHA-44
 TOYNBEE ear speculaEE-02
 Traction bar GERSTERDC-11
 TRAUBE percussion hammerAC-07
 Tray
 instrumentHE-08 to HE-09
 sterilization , sheet metalHE-13
 sterilization , wire meshHE-13
 TRELAT vaginal speculumHA-07
 TrepineDD-04
 CASTROVIEJO cornealED-07
 ELLIOT cornealED-08
 FRANCESCHETTI cornealED-07
 TrocarCC-02
 COAKLEYCC-02
 DOUGLASCC-02
 FLEURANTCC-02
 LICHTWITZCC-02, EG-09
 MENGHINICC-03
 NELSONCC-02
 OCHSNERCC-02
 PIERCECC-02
 UCKERMANN trachealFE-02
 UNIVERSALCC-02
 TROELTSCH nasal forcepsEG-04
 TROEMNER percussion hammerAC-07
 TROUSSEAU tracheal dilatorFE-02
 TROUTMAN-CASTROVIEJO micro scissorsAJ-07
 TROUTMAN-CHRIS blade breakerAG-14

TROUTMAN Colibri iris forcepsEC-13
 TROUTMAN rectus forcepsED-02
 TUBBS mitral valve dilatorFG-27
 Tube
 BRUENINGS extensionFC-03
 JACKSON trachealFE-03
 LUER trachealFE-03
 WAGENER-MOSHER trachealFE-03
 Tubing clamp forcepsBC-19
 Tübingen
 air cannulaED-07
 iris forcepsEC-15
 Tübingen TITAN
 iris forcepsEC-15
 tying forcepsED-05
 Tübingen
 tying forcepsED-05
 TUFFIER
 hemostatic forcepsBC-08
 rib spreaderFG-16
 Tuning forkEE-04
 DIMEDA AluEE-03
 HARTMANNEE-03
 LUCAEEE-04
 RYDEL-SEIFFEREE-04
 TURNBULL nail nipperHE-03
 TURREL biopsy specimen forcepsGI-05
 TYDING
 tonsil seizing forcepsFA-04
 tonsil snareFA-05

U

UCKERMANN
 cotton applicatorCA-03
 tracheal trocarFE-02
 ULRICH sponge holding forcepsBG-06
 Umbilic-cord KANE umbilical cordHC-06
 UNIVERSAL
 bandage scissorsAI-50
 sterilizing forcepsCI-02
 trocarCC-02
 wire and plate scissorsAI-42
 UNNA comedo extractorHE-02
 Urethrotome OTISGG-08
 UrinalHE-10
 USA
 electrosurgery equipment cableJA-07
 USA MODEL umbilical scissorsAI-34
 US Army (PARKER-LANGENBECK) retractorBI-03
 USA
 thumb and tissue forcepsBA-02

V

VALLEIX uterine soundHA-39
 VAN BUREN
 sequester forcepsDC-10
 urethral soundGG-13
 Van DOREN uterine biopsy specimen forcepsHA-42
 VANNAS
 iridectomy scissorsAJ-05
 micro scissorsAJ-12 to AJ-13
 VARIFOCAL ophthalmoscopeAC-03
 Vascular micro scissorsAJ-09
 Vascular, parametrium scissorsAH-20, AI-31
 Vascular scissorsAI-27
 VERBRUGGE bone holding forcepsDC-09
 VERRES pneumoperitoneum puncture needleCC-03
 Vessel flexible clampBD-44 to BD-45
 Vienna nasal speculaEG-02

VIRCHOW
 brain knifeAG-18
 cartilage knifeAG-18
 skull breakerDC-17
 VIRTUS (RALK) splinter forcepsBA-06
 VOLKMANN
 bone curetteDC-12 to DC-13
 retractorBI-07 to BI-08
 VOLTOLINI nasal speculaEG-02

W

WACHENFELDT clip applying forcepsCG-07
 WADSWORTH-TODD cauterEC-08
 WAGENER ear hookletEE-07
 WAGENER-MOSHER tracheal tubeFE-03
 WAGNER
 gum scissorsAI-42
 laminectomy rongeurEA-09
 scissorsAH-22
 WALDMANN episiotomy scissorsAI-34
 WALLICH placenta and ovum scoopHC-08
 WALSHAM septum forcepsEG-18
 WALTHER urethral soundGG-17
 WALTON
 comedo extractorHE-02
 foreign body gougeEC-06
 WALTON YANKAUER suction tubeAE-03
 WANGENSTEEN
 needle holderCE-03
 thumb and tissue forcepsBA-05
 WARTENBERG pin-wheelAC-08
 Wash basinHE-05
 Waste bucketHE-11
 Watchmaker forcepsBA-06
 WATSON-CHEYNE elevatorDC-22
 WATSON dermatomeAG-22
 WEBER
 atraumatic forcepsBD-12
 wire loopEC-08
 WECKER
 iris scissorsAJ-04
 iris spatulaEC-08
 WEEK eye speculumEC-02
 WEIL-BLAKESLEY nasal cutting forcepsEG-06
 WEISSBARTH vaginal speculumHA-22
 WEISS tubing clamp forcepsBC-19
 WEITLANER retractorBI-14
 WEITLANER-WULLSTEIN retractorBI-14
 WELLS enucleation scoopEC-08
 WERTHEIM-CULLEN hysterectomy forcepsBC-18
 WERTHEIM
 hysterectomy forcepsBC-18
 preparation scissorsAI-32
 WESTCOTT
 iridectomy scissorsAJ-02
 tendon scissorsAJ-02
 WEST
 nasal chiselEG-14
 nasal gougeEG-14
 WESTON rectal polypus snareGI-05
 WHEELER
 cyclodialysis spatulaEC-09
 discision knifeEC-04
 WHITEHEAD mouth gagEI-04
 WHITE tonsil seizing forcepsFA-03
 WIEDER tongue depressorEI-02
 WIENER
 antrum raspEG-15
 WIENER (AUFRICHT) nasal raspEG-15
 WIENER

E

Index English

iris hook	.EC-06
WIGMORE plaster saw	.DA-02
WILDE	
ear polypus snare	.EE-07
nasal snare	.EG-09
WILDER	
lachrymal dilator	.EC-10
wire loop	.EC-08
WILDE (TROELTSCH) ear forceps	.EE-07
WILLET-MARTELL scalp flap forceps	.BC-08
WILLIAMS	
eye speculum	.EC-02
grasping forceps	.GE-03
screw driver	.DD-14
WILLIGER	
bone curette	.DC-13
hammer	.DC-18
periosteal elevator	.DC-19
WINKELMANN circumcision clamp	.GG-09
WINTER placenta and ovum forceps	.HC-07
Wire cutter	.DD-12
DIAMANT	.DD-12
Wiredrill KIRSCHNER	.DD-09
Wire loop electrode	.JA-03
Wire twister LOUTE	.DD-11
WITTNER uterine biopsy specimen forceps	.HA-43
WOLFF plaster breaker	.DA-04
WRIGLEY obstetrical forceps	.HC-02
WULLSTEIN	
ear micro-mini scissors	.EE-11
ear micro scissors	.EE-11
sickle knife	.EE-14
WYLIE	
atraumatic forceps	.BD-21
uterine dilator	.HA-30

Y

YANKAUER	
postnasal specula	.EG-04
suction tube	.AE-02
YASARGIL micro scissors	.AJ-10 to AJ-11
YEOMAN biopsy specimen forceps	.GI-05
YOUNG Boomerang ligature needle	.CG-03
YOUNG	
prostatic grasping forceps	.GG-02
prostatic retractor	.GG-02
tongue holding forceps	.EI-03

Z

ZAUFAL-JANSEN bone rongeur	.DC-04
ZENKER hemostatic forceps	.BC-12
ZIEGLER	
capsulotomy knife	.EC-05
eye speculum	.EC-03
head mirror	.AC-05
iris knife	.EC-04
lachrymal dilator	.EC-10

F

**Index
Français**

F

A

- Abaisse-langue
 ANDREWEI-02
 boisEI-02
 BRUENINGSEI-02
 BUCHWALDEI-02
 FRENZELEI-02
 HARTMANNEI-02
 McIVOREI-05
 TOBOLDEI-02
 WIEDEREI-02
- Accessoires pour containers
 pour la stérilisationHE-38 jusque HE-41
- Adenotome LAFORCEEG-19
- ADLERKREUTZ pince à dissectionBA-04
- ADSON Baby
 écarteurBI-15
- ADSON BABY
 pince hémostatiqueBC-09
- ADSON-BROWN pince à dissectionBA-03
- ADSON
 écarteurBI-15
 écarteur à nerfsEA-04
 élévateurDC-21
 pince à dissectionBA-03
 pince à dissection, microBA-03
 pince à hypophyseEA-06
 pince gougeDC-03
 pince hémostatiqueBC-09
 porte-aiguilleCE-04
- AEBLI ciseaux cornéensAI-22
- AESCLAP cordon électrobistourisJA-07
- Aesthésiomètre WARTENBERGAC-08
- Agrafe MICHELCG-07
- Aiguille
 à amygdalesFA-05
 à cataracteEC-05
- Aiguille à suturesCG-05 jusque CG-06
- Aiguille
 BARBARAEE-14
 BOWMAN à dissectionsEC-05
 COOPER à ligaturesCG-02
 DAVIS pour corps étrangersEC-05
 DESCHAMPS à ligaturesCG-02
 DUPUY-WEISS pour les amygdalesFA-03
 électrodeJA-03
 électrode miniJA-02
 FRANCIS pour corps étrangersEC-05
 FRANKLIN-SILVERMANN à ponctionCC-03
 KEITH à suturesCG-06
 KOENIG à suturesCG-06
 KRONECKER à ligaturesCG-02
 LEVINSON pour corps étrangersEC-05
 LICHTWITZEG-09
 NELSON à ligaturesCG-02
 POLITZER paracentèseEE-06
 pour corps étrangersEC-05
 QUINKE à ponctionCC-03
 REVERDIN à ligaturesCG-03
 ROSENEE-14 jusque EE-15
 VERRES à ponction pneumopéritoineCC-03
 YOUNG Boomerang à ligaturesCG-03
- Aimant DIMEDA oculaireED-08
- ALAN-PARKS dilateur pour anus et rectumGI-03
- ALBEE fraiseDD-07
- Alésior
 CRUTCHFIELDEA-03
 KUENTSCHERDD-13
 pour clousDD-12
- ALEXANDER
 ciseaux-burinDC-14
 gougeDC-14
 pince emporte-pièce pour le col de l'utérusHA-42
 rugine raspatoireDC-19
- ALLIS-ADAIR pince pour saisir les tissusGE-02
- ALLIS-Baby pince pour saisir les tissusGE-02
- ALLISON spatule pulmonaireFG-19
- ALLIS pince pour saisir les tissusGE-02
- ALM écarteurBI-14
- ALVIS curette pour corps étrangersEC-06
- Amniotome BEACHAMHA-39
- Ampoule de rechange laryngoscope, fibres optiquesAE-20
- Ampoule de rechange laryngoscope, standardAE-20
- Amygdatome SLUDER-BALLENGERFA-05
- ANDREW abaisse-langueEI-02
- ANDREWS-PINCHON tube d'aspirationAE-03
- Anse
 ARLTEC-08
 auriculaireEE-07
 BILLEAU auriculaireEE-07
 électrode miniJA-02 jusque JA-03
- Anse en bande électrodeJA-03
- Anse en fil électrodeJA-03
- Anse
 à amygdalesFA-04
- Anse
 nasaleEG-09
- Anse
 SNELLENEC-08
 WEBEREC-08
 WILDEREC-08
- Anuscope
 HIRSCHMANNGI-04
 IVES-FANSLERGI-04
- Appareil PETZ à sutures stomacales et intestinalesGE-09
- ARCHER pince à échardesBA-06
- ARKANSAS pierre à repasserAG-19
- ARLT anseEC-08
- ARRUGA
 blépharostatEC-02
 crochet à extractionEC-06
 pince capsulaireED-04
 porte-aiguille pour l'ophtalmologieCE-06
 protecteurEC-08
- ASCH pince à redresser la cloisonEG-18
- Assourdisseur BARANYEE-04
- AUFRIEHT écarteur nasalEG-17
- AUVARD spéculum vaginalHA-19
- AXENFELD curette à chalazionEC-07
- AYER pince à chalazionED-06

B

- BABCOCK pince pour saisir les tissusGE-02
- BABINSKY marteau percuteurAC-07
- BACKHAUS-CLIP pince à champs clamp porte-tubeBE-03
- BACKHAUS KOCHER pince à champsBE-02
- BACKHAUS pince à champsBE-02
- BAGGISH pince emporte-pièce
 pour le col de l'utérusHA-45
- BAILEY-BABY Rapprocheur pour les côtesFG-18
- BAILEY-GIBBON Rapprocheur pour les côtesFG-18
- BAILEY Rapprocheur pour les côtesFG-18
- Baillon MAUNDER boisEI-06
- BAINBRIDGE
 pince atraumatiqueBD-09
 pince hémostatiqueBC-14
- BAKES dilateur pour les voies biliairesGC-06
- BALFOUR Baby écarteur abdominalBI-22
- BALFOUR
 écarteur abdominalBI-22

- valveBI-22
- BALL AND SOCKET pince à champsBE-04
- BALLENGER
couteau mobileEG-11
élevateur pour la cloison nasaleEG-12
pince à préhension amygdalienneFA-04
- BANGERTER spatule cyclodialyseEC-08
- BARANY assourdisseurEE-04
- BARBARA
aiguilleEE-14
crochetEE-14
pickEE-14 jusque EE-15
- BARKAN couteau à goniotomieEC-05
- BARNHILL couteauEG-19
- BARRAQ.KATZIN pince à irisEC-13
- BARRAQU Colibri pince à irisEC-13
- BARRAQUER
ciseaux colibriAJ-04
- BARRAQUER Colibri blépharostatEC-02
- BARRAQUER
couteau pour la kératoplastieEC-05
pince chambre antérieureED-02
pince à épilerED-08
pince à fixationED-03
porte-aiguilleCE-07
- BARRETT pince pour abaissement du col de l'utérusHA-32
- BARR spéculum rectalGI-02
- BARTON
forceps obstétriqueHC-04
tracteur pour manches ordinairesHC-04
- Bassin
de litHE-06
pour placentaHE-06
- BAUMGARTNER porte-aiguilleCE-02
- BEACHAM amniotomeHA-39
- BecherHE-10
- BECKER cystotomeEC-06
- BECKMANN-ADSON écarteurBI-15
- BECKMANN
couteauEG-19
- BECKMANN-EATON écarteurBI-16
- BECKMANN
écarteurBI-16
- BECK pince atraumatique vasculaire périphBD-25
- BEEBEE ciseaux à fils et à plaquesAI-43
- BEER pince à épilerED-08
- BEESON écarteur pour plâtreDA-03
- BELLUCCI ciseaux auriculaires microEE-09
- BENGOLEA pince hémostatiqueBC-09
- BENNETT levier à osDC-22
- BERENS kératomeEC-04
- BERGMANN
ciseaux à bandagesAI-46
- BERGMANN FOERSTER pince porte-épongesBG-10
- BERGMANN
scie pour plâtreDA-02
- BERKE pince musculaireED-02
- BERLIND-AUVARD spéculum vaginalHA-19
- BERLINER marteau percuteurAC-07
- BERNHARD pince à champsBE-05
- BERTILLON céphalomètreAC-08
- BEST pince intestinaleGE-06
- BETHUNE costotomeFG-04
- BEUSE ciseauxAI-26
- BEYER
pince coupante nasaleEG-08
pince gougeDC-04
- BILLEAU anse auriculaireEE-07
- BILL tracteur pour manches ordinairesHC-05
- BIRCHER-GANSKE davier porte-osDC-10
- BIRCHER méniscotomeDC-24
- BISHOP-HARMAN pince à irisEC-14
- Bistouri
CARPENTER à amygdalesFA-02
CONVERSE nasalEG-10
électrodeJA-03
FREER à muqueusesEG-10
HALLE à duremèreEA-06
JOSEPH mousseEG-10
JOSEPH nasalEG-10
MALTZ à cartilage coudeEG-11
- Bistouris à dissectionAG-15
- Bistouris PARKER à dissectionAG-15
- Bistouri stérile à usage uniqueAG-10 jusque AG-11
- BLAKE
curette utérineHA-48
pince pour calculs biliairesGC-03
- Blépharostat
ARRUGAEC-02
BARRAQUER ColibriEC-02
BOWMANEC-02
CASTROVIEJOEC-03
CLARKEC-02
CRITCHETTEC-02
GOLDSTEINEC-03
GRAEFEEC-02
LANCASTEREC-03
LISTER-BURCHEC-02
MELLINGEREC-02
MELLINGER-AXENFELDEC-02
MUELLEREC-03
MURDOCKEC-02
PARKEC-03
SMITHEC-02
STEVENSONEC-03
WEEKEC-02
WILLIAMSEC-02
ZIEGLEREC-03
- BLOHMKE pince à préhension amygdalienneFA-04
- BLOUNT
écarteur à genouDC-24
levier à osDC-24
- BLUMENTHAL pince gougeDC-02
- BODENHAMMER spéculum rectalGI-02
- BOEHLER étrier à extensionDD-10
- BOERMA forceps obstétriqueHC-04
- BOETTCHER ciseaux à amygdalesAI-27
- BÖHLER
pince coupante à osDC-06
pince gougeDC-04
- Boîte
acier inoxydableHE-03
PETRIHE-08
pour aiguilleHE-02
SAUERBRUCH pour aiguilleHE-02
verreHE-03
- BONACCOLTO pince à strabismeEC-14
- Bonn
Canule à irrigationED-07
- BONNEY pince porte-épongesBG-08
- Bonn
pince à irisEC-15
- Bonn TITAN pince à irisEC-15
- BORCHARDT fraiseDD-07
- BOSE écarteur trachéalFE-02
- BOUCHERON spéculum auriculaireEE-02
- Bougie
COXETER urétraleGG-17
DITTEL urétraleGG-18 jusque GG-19
FILIFORM conductriceGG-12
GUYON urétraleGG-12, GG-14 jusque GG-15
VAN BUREN urétraleGG-13

F

Index Français

WALTHER urétrale	GG-17
BOWLES stéthoscope	AC-06
BOWMAN	
aiguille à discision	EC-05
blépharostat	EC-02
couteau à discision	EC-04
stylet pour canal lacrymal	EC-10
BOYNTON porte-aiguille pour l' ophtalmologie	CE-06
BOZEMANN-DOUGLAS pince à pansements	BG-13
BOZEMANN	
pince à pansements	BG-13
porte-aiguille	CE-03
BRAIN	
clip standard	EA-13
clip temporaire	EA-12
BRAIN MINI pince pour poser les clips	EA-12
BRAIN STANDARD pince pour poser les clips	EA-12
BRAITHWAITE dermatome	AG-22
BRAUN	
cranioclaste	HC-09
crochet pour décapitation	HC-09
dépresseur utérin	HA-39
pince pour abaissement du col de l'utérus	HA-31, HA-34
spéculum vaginal	HA-16
BRAUN-STADLER ciseaux pour l'épisiotomie	AH-22, AI-34
BREISKY spéculum vaginal	HA-20
Broche KIRSCHNER	DD-09
BROCK	
dilateur coupant pour valve mitrale	FG-26
manche dilateur pour valve mitrale	FG-26
ouverture dilateur pour valve mitrale	FG-26
Brosse à lavement	CI-04 jusque CI-05
BROWN pince à dissection	BA-03
BRUENINGS	
abaisse-langue	EI-02
couteau pour la cloison nasale	EG-11
pince coupante nasale	EG-05
pince laryngienne	FC-03
rallonge courbée	FC-03
serre-noeud	FA-04
spéculum auriculaire	EE-02
BRUNETTI burin à spinal	DC-17
BRUNNER	
costotome	FG-07
pince intestinale	GE-06
sonde conductrice	CG-04
BRUNS	
ciseaux à plâtre	AI-48
curette	DC-12 jusque DC-13
BRYANT pince porte-éponges	BG-11
BUCHWALD abaisse-langue	EI-02
BUCK	
ciseaux à ligatures	AI-40
curette auriculaire	EE-05
levier pour corps étrangers	EE-08
marteau percuteur	AC-07
BUIE tube d'aspiration	GI-05
BUMM	
curette utérine	HA-49 jusque HA-50
pince hystérolabe	HA-38
BUNGE curette pour exentération	EC-07
BUNNELL	
écorcheur à tendons	DC-25
perforateur à main	DD-05
BUNT épingle de sécurité	CI-02
BURCH fourchette à fixation	EC-05
Burin à spinal BRUNETTI	DC-17
Burin pour crâne VIRCHOW	DC-17
BURKE-Baby pince emporte-pièce pour le col de l'utérus	HA-44
BURKE pince emporte-pièce pour le col de l'utérus	HA-44
BUSCH ciseaux pour le cordon ombilical	AI-34

C

Cadre KIRSCHNER	BI-23
Canule	
Bonn à irrigation	ED-07
Hamburg	ED-07
JACKSON trachéale	FE-03
LUER trachéale	FE-03
SCHEIE oculaire	ED-07
Canules FINSTERER d'aspiration et d'irrigation	AE-05
Canule	
SIMCOE suture	ED-07
Tübingen air	ED-07
WAGENER-MOSHER trachéale	FE-03
Capsula DASTOOR aspirateur	EC-09
CARMALT pince à échardes	BA-06
CARPENTER bistouri à amygdales	FA-02
CASPAR	
écarteur	BI-20
écarteur pour colonne cervicale	BI-18
écarteur pour colonne vertébrale	BI-19
écarteur pour lombaire vertébrale	BI-20
manche de bistouris, micro	AG-12
valve	BI-20
valve pour colonne vertébrale	BI-19
Casse-lames	
CASTROVIEJO	AG-14
DIMEDA	AG-14
TROUTMAN-CHRIS	AG-14
CASTANEDA	
écarteur pour les côtes	FG-14
pince atraumatique p. nouveaux-nés et enfants	BD-42
CASTROVIEJO	
blépharostat	EC-03
casse-lames	AG-14
ciseaux à iridectomie	AJ-05
ciseaux cornéens	AJ-06
dilateur pour canal lacrymal	EC-10
kératome	EC-04
marqueur compass	EC-09
pince capsulaire	ED-04
pince à fixation	ED-03
pince à suture	ED-05
porte-aiguille	CE-07
spatule à cyclodialyse	EC-08 jusque EC-09
trépan cornéen	ED-07
CATLIN couteaux à amputation	AG-16
Cautère WADSWORTH-TODD	EC-08
Céphalomètre BERTILLON	AC-08
CHAPUT pince hémostatique	BC-08
CHARRIERE	
lame	DD-03
scie à amputation	DD-03
CHEATLE pince à stérilisation	CI-02
CHERON pince à pansements	BG-12
CHEVALIER-JACKSON pince laryngienne	FC-04
CHEVALLIER écarteur pour les côtes	EC-08 jusque EC-09
CHILDE pince pour agrafes	CG-07
CINELLI ciseau-burin pour plastique nasale	EG-13
Cisaille SCHUMACHER pour le sternum	FG-07
Ciseau-burin	DC-14
ALEXANDER	DC-14
CINELLI pour plastique nasale	EG-13
COTTLE pour plastique nasale	EG-13
FOMON pour plastique nasale	EG-13
FREER pour la cloison nasale	EG-12
HIBBS	DC-16
HOKE	DC-16
LEXER	DC-16
LEXER mini	DC-16

- PARTSCHDC-14
 SILVER pour plastique nasaleEG-14
 SMITH-PETERSENDC-15
 STILLEDC-14
 WEST nasalEG-14
- Ciseaux
 DIX pour corps étrangersEC-06
 ROLLET à extirpationEC-06
- Ciseaux sternaux LEBSCHÉDC-17
- CiseauxAH-02 jusque AH-04, AI-02 jusque AI-04
- Ciseaux à dissectionAI-19
- Ciseaux
 AEBLI cornéensAI-22
- Ciseaux pour l'entérotomieAI-39
- Ciseaux
 à enviesHE-03
- Ciseaux à gencivesAI-41
- Ciseaux
 à onglesHE-03
- Ciseaux à plâtreAI-49
- Ciseaux
 auriculaires microEE-11
 auriculaires micro miniEE-11
 BARRAQUER colibriAJ-04
 BEEBEE à fils et à plaquesAI-43
 BELLUCCI auriculaires microEE-09
 BERGMANN à bandagesAI-46
 BEUSEAI-26
 BOETTCHER à amygdalesAI-27
 BRAUN-STADLER pour l'épisiotomieAH-22, AI-34
 BRUNS à plâtreAI-48
 BUCK à ligaturesAI-40
- Ciseaux-burin DIXEC-09
- Ciseaux
 BUSCH pour le cordon ombilicalAI-34
 CASTROVIEJO à iridectomieAJ-05
 CASTROVIEJO cornéensAJ-06
- Ciseaux
 ciseaux microAJ-06
- Ciseaux
 Ciseaux microAJ-06
 COTTLE nasauxAH-18, AI-25
 CRAFOORD pulmonairesAI-36
 CROIX ROUGE à bandagesAI-47
 DANDY neurochirurgicauxAI-36
 DEAN à amygdalesAI-26
 DEEVERAH-05, AI-06
 DE BAKEY vasculairesAI-30
 DIETHRICH vasculairesAI-29
 DIMEDA à bandagesAI-46
 DOYEN gynécologiquesAI-33
 DUBOIS gynécologiquesAI-33
 ESMARCH à bandagesAI-46
 FERGUSSONAI-49
 FINOCHIETTO à rectumAI-38
- Ciseaux finsAI-05, AI-19, AI-24
- Ciseaux
 FOMON nasauxAH-18, AI-25
 GOLDMAN-FOX à gencivesAI-41
 GOOD à amygdalesAI-27
 GORNEY à dissectionAI-13
 HEATH à ligaturesAI-40
 HEYMANN nasauxAH-18, AI-25
- Ciseaux incisionsAI-05
- Ciseaux
 IRISAH-16, AI-19, AI-21
 IRIS ophtalmologiquesAI-22
 JACOBSON microAJ-11
 JOSEPHAH-14, AI-16
 KELLY gynécologiquesAH-22, AI-33
 KILNERAH-14, AI-17
- KLINKENBERGH-LOTH thoraciquesAI-37
- KNAPPAI-20
- KNOWLES à bandagesAI-47
- LAGRANGE à gencivesAI-41
- LANDOLT à énucléationAI-25
- LANGE à bandagesAI-44
- LEXERAH-09
 LEXER à dissectionAI-11
 LEXER-BABYAH-10
 LEXER-BABY à dissectionAI-12
 LEXER-FINO à dissectionAI-12
- LISTER à bandagesAH-23, AI-45
- LITTAUER à ligaturesAI-40
- LITTLER à dissectionAI-13
- LOCKLINAI-18
- LORENZ à bandagesAI-47
- MAYOAH-06, AI-07
 MAYO main gaucheAI-07
 MAYO-NOBLEAH-08, AI-10
 MAYO-STILLEAH-07, AI-08 jusque AI-09
- McGUIRE cornéensAJ-05
- McINDOE à cartilageAI-35
- McPHERSON WESTCOTT ténatomieAJ-04
- METZENBAUMAH-11
 METZENBAUM à dissectionAI-13 jusque AI-14
 METZENBAUM FINOAH-12
 METZENBAUM FINO à dissectionAI-15
 METZENBAUM "S"AH-13, AI-16
- Ciseaux microAI-13
- Ciseaux micro gynécologiquesAJ-07 jusque AJ-08
- Ciseaux
 MILLS vasculairesAI-27
- Ciseaux neurochirurgicauxAI-35
- Ciseaux
 NORTHBENT à ligaturesAI-40
 NOYES à irisAJ-03 jusque AJ-04
 NOYES à tendonsAJ-03
- POTTS DE MARTEL vasculairesAI-27
- POTTS-SMITH vasculairesAH-19, AI-28
- Ciseaux pour strabismeAH-17, AI-24
- Ciseaux préparationAI-34
- Ciseaux
 PRINCE à amygdalesAI-27
 QUINBY à gencivesAI-42
 REYNOLDSAH-15, AI-18
 SANVENEROAH-13, AI-16
 SATINSKY thoraciquesAI-37
 SCHMIEDEN-TAYLORAI-36
 SCHUMACHER pour cordon ombilicalAI-34
 SEUTIN pour plâtreDA-02
 SHEA auriculaire microEE-09
 SHORTBENT à ligaturesAI-40
 SIEBOLD gynécologiquesAH-21, AI-32
 SIMS gynécologiquesAH-21, AI-32
 SMITH US ARMY à bandagesAI-44
 SPENCER à ligaturesAI-40
 STELZNER pour le rectumAI-38
 STEVENS pour la ténatomieAH-17, AI-23
 STILLE pour plâtreDA-02
 STRULLY neurochirurgicauxAI-35
 THOREK pulmonairesAI-36
 TOENNIS-ADSON neurochirurgicauxAI-35
 TROUTMAN-CASTROVIEJO microAJ-07
 UNIVERSAL à bandagesAI-50
 UNIVERSAL à fils et plaquesAI-42
 USA MODEL pour le cordon ombilicalAI-34
 VANNAS à iridectomieAJ-05
 VANNAS microAJ-12 jusque AJ-13
- Ciseaux vasculairesAI-27
- Ciseaux vasculaires iris microAJ-09
- Ciseaux vasculaires paramétriumAH-20, AI-31

- Ciseaux
WAGNERAH-22
WAGNER à gencivesAI-42
WALDMANN pour l'épisiotomieAI-34
WECKER à irisAJ-04
WERTHEIM préparationAI-32
WESTCOTT à iridectomieAJ-02
WESTCOTT à tendonsAJ-02
WULLSTEIN auriculaires microEE-11
WULLSTEIN auriculaires micro miniEE-11
YASARGIL microAJ-10 jusque AJ-11
- CITELLI pince coupante nasaleEG-08
- Clamp
COLLIN pour cordon ombilicalHC-06
KANE pour cordon ombilicalHC-06
- Clamps
COOLEY bulldog atraumaBD-33 jusque BD-34
DE BAKEY bulldog atraumaBC-02
DIEFFENBACH bulldog serre-fineBC-03
GLOVER bulldog atraumaBC-02
JOHNS-HOPKINS bulldog serre-fineBC-03
- CLARK blépharostatEC-02
- CLAR
lampe frontaleAC-05
miniAC-05
- Clé à écrousDD-10
- CLEVELAND pince gougeDC-02
- Clip
BRAIN standardEA-13
BRAIN temporaireEA-12
EDWARDSBD-21
- Clou STEINMANN à osDD-09
- CLOWARD
écarteurBI-17
écarteur pour corps vertébrauxEA-07
- COAKLEY
curette pour sinusEG-18
trocartCC-02
- COLCLOUGH pince emporte-pièce pour lames intervertébralesEA-11
- COLLIER porte-aiguilleCE-02
- COLLIN
clamp pour cordon ombilicalHC-06
compas pelvimètreHC-06
- COLLIN-DUVAL pince à dissectionBA-04
- COLLIN
dynamomètreAC-03
écarteur abdominalBI-24 jusque BI-25
- COLLIN-HARTMANN écarteurBI-03
- COLLIN
hystéromètreHA-39
mailletDC-18
manche de bistourisAG-08
pince à pansementsBG-11
pince hystérolabeHA-37
pince pour agrafesCG-07
pince hémostatiqueBC-08
pince tire-langueEI-03
- COLLIN-POZZI pince pour abaissement du col de l'utérusHA-32
- COLLIN
spéculum vaginalHA-04
- COLLYER compas pelvimètreHC-06
- COLVER pince à préhension amygdalienneFA-03
- Compas pelvimètre
COLLINHC-06
COLLYERHC-06
MARTINHC-06
- Compresseur
CORWIN à amygdalesFA-04
STOCKMANN de l'urètreGG-10
STRAUSS de l'urètreGG-10
- ComprimètreDD-02
- Cône KNUTSON-KOCH pour urétrographieGG-09
- Cone occluseurHA-47
- CONNIN-AMSLER marqueurEC-09
- Containers pour la stérilisation
3/4HE-22 jusque HE-24
grandsHE-18 jusque HE-20
petitsHE-32 jusque HE-33
plats semiHE-30 jusque HE-31
semiHE-26 jusque HE-29
spéciauxHE-34 jusque HE-37
- CONVERSE bistouri nasalEG-10
- COOLEY
clamps bulldog atraumaBD-33 jusque BD-34
costotome premièreFG-05
- COOLEY DERRA pince atraumatique p. anastomoseBD-39
- COOLEY
dilatateur pour valve mitraleFG-27 jusque FG-29
dilatateur vasculaireFG-30
écarteur atriumFG-20
écarteur pour les côtesFG-09
- COOLEY modif. STRUCK écarteur atriumFG-20
- COOLAR
pince atraumatique BB-03, BD-35 jusque BD-37, BD-39, BD-41
pince atraumatique pour l'anastomoseBD-37, BD-40
pince atraumatique iliaqueBD-37
pince atraumatique pédiatriqueBD-38 jusque BD-39
pince vasculaireBD-40
- COOPER aiguille à ligaturesCG-02
- CORDES pince laryngienneFC-03
- Cordon
AESCULAP électrobistourisJA-07
ERBE SELECT électrobistourisJA-07
MARTIN électrobistourisJA-07
USA électrobistourisJA-07
- Corte-agravesEA-02
- CORWIN compresseur à amygdalesFA-04
- CORYLLOS costotomeFG-04
- CORYLLOS (Thorax) écarteurBI-13
- CostotomeFG-02
BETHUNEFG-04
BRUNNERFG-07
COOLEY premièreFG-05
CORYLLOSFG-04
GIERTZ-STILLEFG-06
GLUCKFG-03
SAUERBRUCHFG-05
SAUERBRUCH-FREYFG-06
STILLEFG-03
- COTTLE
ciseaux-burin pour plastique nasaleEG-13
ciseaux nasauxAH-18, AI-25
couteau nasalEG-10
écarteur nasalEG-17
élévateur pour la cloison nasaleEG-12
- COTTLE-KAZANJIAN pince coupante à osDC-06
- COTTLE-NEIVERT écarteur nasalEG-17
- COTTLE
spéculum nasalEG-03
- Coupante BROCK dilatateur pour valve mitraleFG-26
- Coupe-bagueDD-03
DIMEDADD-03
- Coupe-cors CREDOHE-03
- Couteau à cartilageAG-18
- Couteau
BALLENGER mobileEG-11
BARKAN à goniotomieEC-05
BARNHILLEG-19
BARRAQUER pour la kératoplastieEC-05
BECKMANNEG-19
BOWMAN à discisionEC-04

- BRUENINGS pour la cloison nasaleEG-11
COTTLE nasalEG-10
DEAN à iridectomieEC-04
DEUTSCHMANN à cataracteEC-03
ELSCHNIG cornéenEC-05
ESMARCH pour plâtreDA-04
FREER pour la cloison nasaleEG-10
GILL cornéenEC-05
GRAEFE à cataracteEC-03
HOPKINS pour plâtreDA-04
KNAPP à iridectomieEC-04
LANGENBECK à résectionAG-17
MUCK à périosteEE-15
OTIS de rechangeGG-08
PAUFIQUE pour la kératoplastieEC-05
PLESTER lobaireEE-14
POLITZER auriculaireEE-06
Couteau pour plâtreDA-04
Couteau
REINER pour plâtreDA-04
ROSEN circulaireEE-14
SATO cornéenEC-05
SCHEIE à goniotomieEC-05
SCHUKNECHT circulaireEE-14
SCHUKNECHT serpetteEE-14
SEXTON auriculaireEE-06
St. CLAIR-THOMSONEG-19
TABB serpetteEE-14
TOOK cornéenEC-05
VIRCHOW à cartilagesAG-18
VIRCHOW pour le cerveauAG-18
WHEELER à dissectionEC-04
WULLSTEIN serpetteEE-14
Couteaux à amputationAG-16
Couteaux
CATLIN à amputationAG-16
LISTON à amputationAG-16
Couteau
ZIEGLER à capsulotomieEC-05
ZIEGLER à iridectomieEC-04
COXETER bougie urétraleGG-17
CrachoirHE-06
CRAFOORD
ciseaux pulmonairesAI-36
pince hémostatique pour les bronchesBC-12
Cranioclaste
BRAUNHC-09
TARNIERHC-09
CREDO coupe-corsHE-03
CRILE
écarteurBI-02
CRILE-MURRAY porte-aiguilleCE-02
CRILE
pince hémostatiqueBC-05
porte-aiguilleCE-04
CRILE-RANKIN pince hémostatiqueBC-05
CRILE TITAN pince hémostatiqueBC-05
CRILE-WOOD porte-aiguilleCE-02
CRITCHETT blépharostatEC-02
CrochetEE-15
à extensionDD-10
à extractionDD-13
ARRUGA à extractionEC-06
BARBARAEE-14
BRAUN pour décapitationHC-09
DAY auriculaireEE-07
électrode miniJA-02
EMMET pour fistulesHA-46
FRAZIERBI-06
GILLIESEG-17
GRAEFEBI-06
GRAEFE à strabismeEC-06
GRAEFE-TITAN à strabismeEC-06
GREEN musculaireEC-06
GUTHRIEBI-06
JAMESON à strabismeEC-06
JOSEPHBI-06
KILNER à peauHE-02
O' CONNOR à irisEC-06
SMELLIE pour les accouchementsHC-06
STEVENSEC-06
WAGENER auriculaireEE-07
WIENER à irisEC-06
CROIX ROUGE ciseaux à bandagesAI-47
CRUTCHFIELD
alésoirEA-03
traction crânienneEA-03
Cuiller GUTMANN à sécrétionGG-11
CULLER spatule à irisEC-08
Curette
ALVIS pour corps étrangersEC-06
AXENFELD à chalazionEC-07
BLAKE utérineHA-48
BRUNSDC-12 jusque DC-13
BUCK auriculaireEE-05
BUMM utérineHA-49 jusque HA-50
BUNGE pour exentérationEC-07
COAKLEY pour sinusEG-18
CUZZI placentaire et pour post-abortionumHC-08
d'aspirationHA-51
DAVIEL à cataracteEC-07
DESJARDINS pour calculs biliairesGC-08
FAULKNEREG-18
FERGUSSON pour calculs biliairesGC-07
FOX pour lupusHE-02
GOURDET utérineHA-48
GRAEFE à cataracteEC-07
GROSS auriculaireEE-06
HALLEDC-13
HEBRA à chalazionEC-07
HOUSEEE-15
KEVORKIAN aspirante pour biopsie de l'utérusHA-40
KNAPP à cataracteEC-07
LANGEC-08
LEMPERTDC-13
LUER-KOERTE pour calculs biliairesGC-09
MARTINIDC-13
MAYO pour calculs biliairesGC-07
MEYHOEFER à chalazionEC-07
MOORE pour calculs biliairesGC-05
NOVAK aspirante pour biopsie de l'utérusHA-40
PESTALOZZA placentaire et pour post-abortionumHC-08
PIFFARD pour lupusHE-02
RANDALL aspirante pour biopsie de l'utérusHA-40
RECAIMER utérineHA-49 jusque HA-50
SCHEDEDC-12
SCHROEDER utérineHA-48
SIMONDC-13
SIMON utérineHA-48
SIMS utérineHA-49 jusque HA-50
SPRATTDC-12
VOLKMANNDC-12 jusque DC-13
WALLICH placentaire et pour post-abortionumHC-08
WILLIGERDC-13
CUSCO spéculum vaginalHA-04 jusque HA-06
CUSHING
écarteurBI-07
écarteur à nerfsEA-04
perforateur platDD-04
pince à dissectionBA-03
pince emporte-pièce pour laminectomieEA-08
spatule cérébraleEA-07

F

Index Français

Cuvette rondeHE-04 jusque HE-05
 CUZZI curette placentaire et pour post-abortumHC-08
 CZERNY
 pince pour abaissement du col de l'utérusHA-34
 pince pour calculs biliairesGC-03
 spéculum rectalGI-02

D

DALE pince atraumatique vasculaire périphBD-24
 DANDY
 ciseaux neurochirurgicauxAI-36
 écarteur à nerfsEA-04
 pince hémostatiqueBC-07
 DARDIK pince atraumatiqueBD-07
 DARLING écarteurBI-17
 DARTIGUES pince hystérolabeHA-37
 DASTOOR
 Aspirateur capsulaireEC-09
 pince à strabismeEC-14
 DAVIDSON (Scapula) écarteurBI-13
 DAVIEL curette à cataracteEC-07
 Davier
 BIRCHER-GANSKE porte-osDC-10
 DINGMANN porte-osDC-10
 FARABEU-F-LAMBOTTE porte-osDC-08
 FARABEU-F porte-osDC-07
 FERGUSSON porte-osDC-07
 KERN porte-osDC-08
 LAMBOTTE porte-osDC-08
 LANE porte-osDC-08
 LANGENBECK porte-osDC-07
 LEWIN porte-osDC-10
 LOWMAN à osDC-11
 Davier porte-osDC-09 jusque DC-10
 Davier
 SEMB porte-osDC-07
 VERBRUGGE porte-osDC-09
 DAVIS
 aiguille pour corps étrangersEC-05
 DAVIS-BOYLE ouvre-boucheEI-04
 DAVIS
 dissecteur duremètreEA-05
 pince à stérilisationCI-02
 DAY crochet auriculaireEE-07
 DEAN
 ciseaux à amygdalesAI-26
 couteau à iridectomieEC-04
 DEEVER
 ciseauxAH-05, AI-06
 écarteurBI-05
 DEEVER Grip écarteurBI-05
 DEBAKEY BAHNSON pince atraumatique pour aneurisme d'aorte
 BD-14
 DE BAKEY
 ciseaux vasculairesAI-30
 clamps bulldog atraumaBC-02
 dilateur vasculaireFG-31
 DE BAKEY MORRIS pince atraumatiqueBD-16
 DE BAKEY
 pince atraumatiqueBB-03
 DEBAKEY pince atraumatiqueBD-02, BD-08, BD-12
 DE BAKEY
 pince atraumatiqueBD-16 jusque BD-17
 DEBAKEY pince atraumatiqueBD-20
 DE BAKEY
 pince atraumatiqueBD-28 jusque BD-30
 pince atraumatique à dissection et à ligatureBD-25, BD-32
 pince atraumatique pour anastomoseBD-25
 pince atraumatique p. aneurisme d'aorteBD-13, BD-15, BD-18
 pince atraumatique pour les bronchesBD-19
 pince atraumatique iliaqueBD-11
 pince atraumatique vasculaire périphBD-06
 porte-aiguilleCE-03
 DE BAKEY REYNOLDS pince atraumatique pour anastomoseBD-30
 DEBAKEY SATINSKY pince atraumatiqueBD-22
 DE BAKEY
 tube d'aspirationAE-04
 Décolleur
 FISCHEE-15
 HURD à amygdalesFA-02
 DEJERINE marteau percuteurAC-07
 De LEE forceps obstétriqueHC-02
 De MARTEL guide-scieEA-05
 DeMARTEL-WOLFSON pince à anastomoseGE-07
 DENHART ouvre-boucheEI-03
 Dépresseur BRAUN utérinHA-39
 Dépresseur
 REICHERT pour l'épiglottisFC-02
 SIMS utérinHA-39
 DERF porte-aiguilleCE-02
 Dermatome
 BRAITHWAITEAG-22
 HUMBYAG-20
 SCHINKAG-21
 SILVERAG-20
 WATSONAG-22
 DERRA pince atraumatique p. anastomose et pédiatrie BD-28
 DESCHAMPS aiguille à ligaturesCG-02
 DESJARDINS
 curette pour calculs biliairesGC-08
 pince pour calculs biliairesGC-02
 pince pour voies biliairesBC-15
 sonde pour calculs biliairesGC-05
 DESMARRES
 écarteurBI-07
 pince à chalazionED-06
 DEUTSCHMANN couteau à cataracteEC-03
 DeVILBISS pince crânienneEA-05
 DEWEY forceps obstétrique avec dispositif de tractionHC-05
 DIAMANT pince coupe-filDD-12
 DiapasonEE-04
 DIMEDA AluEE-03
 HARTMANNEE-03
 LUCAEEE-04
 RYDEL-SEIFFEREE-04
 DIEFFENBACH clamps bulldog serre-fineBC-03
 DIETER pince pour la tête du marteauEE-10
 DIETHRICH
 ciseaux vasculairesAI-29
 pince atraumatiqueBD-31
 porte-aiguille vasculaireCE-06
 Dilatateur
 ALAN-PARKS pour anus et rectumGI-03
 BAKES pour les voies biliairesGC-06
 CASTROVIEJO pour le canal lacrymalEC-10
 COOLEY pour valve mitraleFG-27 jusque FG-29
 COOLEY vasculaireFG-30
 DE BAKEY vasculaireFG-31
 GERBODE pour valve mitraleFG-28
 GOODELL pour col de l'utérusHA-30
 HANK pour col de l'utérusHA-28
 HEGAR pour col de l'utérusHA-24 jusque HA-27
 HETZER pour valve mitraleFG-29
 LABORDE trachéalFE-02
 PRATT pour col de l'utérusHA-29
 SIMS pour col de l'utérusHA-30
 SMITH-BUIE pour anus et rectumGI-03
 TROUSSEAU trachéalFE-02
 TUBBS pour valve mitraleFG-27
 WILDER pour canal lacrymalEC-10

- WYLIE pour col de l'utérusHA-30
ZIEGLER pour canal lacrymalEC-10
- DIMEDA
aimant oculaireED-08
- DIMEDA Alu diapasonEE-03
- DIMEDA
casse-lamesAG-14
ciseaux à bandagesAI-46
coupe-bagueDD-03
écarteurBI-14
pince pour déchetsCI-03
styletCA-03
- DINGMANN davier porte-osDC-10
- Dissecteur
DAVIS duremèreEA-05
duremèreEA-05
GREEN cornéenEC-06
HORSLEY duremèreEA-06
MILLIGAN duremèreEA-05
PATON cornéenEC-05
PENFIELD duremèreEA-06
ROBB vasculaireFG-33
SACHS duremèreEA-05
TOENNIS duremèreEA-05
- DITTEL
bougie urétraleGG-18 jusque GG-19
introduceur de sondesGG-11
- DIX
ciseaux pour corps étrangersEC-06
ciseaux-burinEC-09
- Doigtier LANGENBECKEI-06
- Doigt MAGILLAE-04
- DOUGLAS
Pince à épilerED-08
trocartCC-02
- DOYEN-Baby pince intestinaleGE-03
- DOYEN
ciseaux gynécologiquesAI-33
écarteurBI-12
fraiseDD-07
- DOYEN-JANSEN ouvre-boucheEI-03
- DOYEN
pince à champsBE-05
pince à polypes utérinsHA-36
pince intestinaleGE-03
rugine raspatoire pour les côtesDC-20
sondeCA-02
spéculum vaginalHA-18, HA-20
tracteur pour fibromesHA-46
- DUBOIS ciseaux gynécologiquesAI-33
- DUPLAY
pince à pansementsBG-14
pince pour abaissement du col de l'utérusHA-31
- DUPUY-WEISS aiguille à amygdalesFA-03
- DUVAL
pince à dissectionBA-04
pince à saisir les tissusGE-03
- Dynamomètre COLLINAC-03
- écarteurBI-06, BI-10
- ADSONBI-15
ADSON à nerfsEA-04
ADSON BabyBI-15
ALMBI-14
AUFRIEHT nasalEG-17
BECKMANNBI-16
BECKMANN-ADSONBI-15
BECKMANN-EATONBI-16
BEESON pour plâtreDA-03
BLOUNT pour le genouDC-24
BOSE trachéalFE-02
CASPARBI-20
- CASPAR pour colonne cervicaleBI-18
CASPAR pour colonne vertébraleBI-19
CASPAR pour lombar vertébraleBI-20
CASTAÑEDA pour les côtesFG-14
CHEVALLIER pour les côtesFG-15
CLOWARDBI-17
CLOWARD pour corps vertébrauxEA-07
COLLIN-HARTMANNBI-03
COOLEY atriumFG-20
COOLEY pour les côtesFG-09
COOLEY modif. STRUCK pour l'atriumFG-20
CORYLLOS (Thorax)BI-13
COTTLE nasalEG-17
COTTLE-NEIVERT nasalEG-17
CRILEBI-02
CUSHINGBI-07
CUSHING à nerfsEA-04
DANDY à nerfsEA-04
DARLINGBI-17
DAVIDSON (Scapula)BI-13
DEAVERBI-05
DEAVER GripBI-05
DESMARRESBI-07
DIMEDABI-14
DOYENBI-12
FARABEUFBI-02
FINOCHIETTO-BABY pour les côtesFG-09
FINOCHIETTO BURFORD p. les côtes FG-12 jusque FG-14
FINOCHIETTO p. les côtesFG-08, FG-10 jusque FG-11
FINOCHIETTO-HAIGHT BABY p. les côtesFG-10
FINOCHIETTO INFANT pour les côtesFG-12
FINOCHIETTO (modif) pour les côtesFG-08
FINSENBI-14
FOMON nasalEG-17
FRAZIERBI-21
FRIEDMAN à périnéorrhapieHA-23
FRITSCHBI-11
GERSTER pour daviersDC-11
GOELETBI-03
GRAHAM à nerfsEA-04
GREENBI-10
HABERERBI-04
HAGLUND-STILLE pour plâtreDA-03
HAIGHT pour les côtesFG-15
HARRINGTONBI-05
HEANEYBI-12
HENNIG pour plâtreDA-03
HERMANN pour plâtreDA-03
HERTZLER pour les côtesFG-17
HOFER piliaireFA-02
HRYNTSCHAK pour saisir la prostateGG-06
INGE pour corps vertébrauxEA-07
ISRAELBI-11
ITERSON trachéalFE-02
JACKSON trachéalFE-02
JANSENBI-14
JUDD-MASSON vésicalGG-04
KELLYBI-04, BI-12
KELLY GripBI-04
KNAPPEC-06
KOCHERBI-10 jusque BI-11
KOERTEBI-11
LAHEYBI-08
LANGENBECKBI-09
LEGUEU vésicalGG-06
lèvres et jouesEI-03
LITTLEBI-08
LOVE à nerfsEA-04
LOVE ovulaireFA-02
MATHIEUBI-03
MERCEDES thoraciqueFG-16

F

Index Français

MEYERDING	.BI-08
MIDDELDORPF	.BI-10
MIKULICZ	.BI-12
MILLIN pour le col de la vessie	.GG-07
MILLIN vésical	.GG-05
MOLLISON	.BI-17
MORSE-FAVOLORO pour les côtes	.FG-17
écarteur Musculaire	.BI-25
écarteur	
NAGER pour le palais	.FA-02
OLLIER	.BI-10
PARKER	.BI-02
PITHA pour les lèvres et joues	.EI-06
PLESTER	.BI-14
écarteur Pour plâtre	.DA-03
écarteur	
PRATT cystique	.GI-04
QUATTRO pour plâtre	.DA-03
REVERDIN	.BI-04
RIBBON	.BI-04
RICHARDSON	.BI-04
RICHARDSON-EASTMAN	.BI-04
RICHARDSON Grip	.BI-04
ROLLET	.EC-06
ROSE trachéal	.FE-03
ROUX	.BI-02
ROUX Baby	.BI-02
ROUX mini	.BI-02
SACHS à nerfs	.EA-04
SAUERBRUCH	.BI-13
écarteur	
BALFOUR abdominal	.BI-22
BALFOUR Baby abdominal	.BI-22
écarteur	
SCHOENBORN pour la thyroïde	.FE-04
écarteur	
COLLIN abdominal	.BI-24 jusque BI-25
écarteur	
SENN	.BI-04
SENN-GREEN	.BI-07
écarteur	
GELPI abdominal	.BI-24
GOSSET abdominal	.BI-21
écarteur	
SIMON	.BI-12
écarteur	
KIRSCHNER abdominal	.BI-23
écarteur	
SMITHWICK à nerfs	.EA-04
écarteur	
O'SULLIVAN-O'CONNOR abdominal	.BI-21
RIGBY abdominal	.BI-24
écarteur	
STERNBERG pour lèvres et joues	.EI-02
TAYLOR spinal	.DC-24
THOMSON-WALKER vésical	.GG-06
TUFFIER pour les côtes	.FG-16
US Army (PARKER-LANGENBECK)	.BI-03
VOLKMANN	.BI-07 jusque BI-08
WEITLANER	.BI-14
WEITLANER-WULLSTEIN	.BI-14
YOUNG pour la prostate	.GG-02

E

ECHLIN pince gouge	.DC-05
Ecorcheur BUNNELL à tendons	.DC-25
EDWARDS	
clip	.BD-21
pince à poser clips	.BD-21
Électrode mini pour la coagulation	.JA-02 jusque JA-03

Elévateur

ADSON	.DC-21
BALLENGER pour la cloison nasale	.EG-12
COTTLE pour la cloison nasale	.EG-12
FREER pour la cloison nasale	.EG-11
HAJEK-BALLENGER pour la cloison nasale	.EG-12
HENKE à amygdales	.FA-02
JOSEPH pour la cloison nasale	.EG-12
KEY	.DC-21
KILLIAN pour la cloison nasale	.EG-12
LANGENBECK	.DC-21
LEMPERT	.EE-15
McDONALD	.DC-22
McKENTY pour la cloison nasale	.EG-11
MURPHY-LANE	.DC-22
ROGER pour la cloison nasale	.EG-11
WATSON-CHEYNE	.DC-22
ELLIOT	
forceps obstétrique	.HC-02
trépan cornéen	.ED-08
ELLIS gouge pour corps étrangers	.EC-06
ELSAESSER pince à néphrostomie	.GC-13
ELSCHNIG	
couteau cornéen	.EC-05
pince capsulaire	.ED-04
pince fixation	.ED-03
spatule cyclodialyse	.EC-08
EMMET crochet pour fistules	.HA-46
ENGEL scie pour plâtre	.DA-02
Enlève-lame	.AG-06, AG-10
Entonnoir	.HE-07
Épingle	
BUNT de sécurité	.CI-02
MAYO de sécurité	.CI-02
EPENDORFER-KEVORKIAN pince emporte-pièce pour le col de l'utérus	.HA-46
EPENDORFER pince emporte-pièce pour le col de l'utérus	.HA-45 jusque HA-46
EPENDORFER TISCHLER-MORGAN pince emporte-pièce pour le col de l'utérus	.HA-46
ERBE SELECT cordon électrobistouris	.JA-07
ESMARCH	
ciseaux à bandages	.AI-46
couteau pour plâtre	.DA-04
Etrier	
à extension	.DD-10
BOEHLER à extension	.DD-10
KIRSCHNER à extension	.DD-10
EVES serre-noeud	.FA-04
Evideur SEGOND pour fibromes	.HA-46
Extractor KUENTSCHER	.DD-13

F

FARABEUF	
davier porte-os	.DC-07
écarteur	.BI-02
FARABEUF-LAMBOTTE davier porte-os	.DC-08
FARABEUF	
rugine raspatoire	.DC-19
FARREL stylet	.CA-03
FAULKNER curette	.EG-18
FAURE	
pince emporte-pièce pour le col de l'utérus	.HA-41
pince à péritoine	.BC-17
FEHLAND pince intestinale	.GE-06
FEILCHENFELD pince à échardes	.BA-06
FERGUSSON	
ciseaux	.AI-49
curette pour calculs biliaires	.GC-07
davier porte-os	.DC-07

- pince hémostatiqueBC-07
- FERRIS pince à dissectionBA-04
- FERRIS-SMITH-KERRISON pince emporte-pièce pour lames inter-vertébralesEA-10
- FERRIS-SMITH pince emporte-pièce à laminectomieEA-09
- FILIFORM bougie conductriceGG-12
- Fil pour cerclageDD-11
- FINOCHIETTO-BABY écarteur pour les côtesFG-09
- FINOCHIETTO BURFORD écarteur pour les côtesFG-12 jusque FG-14
- FINOCHIETTO
- ciseaux pour le rectumAI-38
- écarteur pour les côtesFG-08, FG-10 jusque FG-11
- FINOCHIETTO-HAIGHT BABY écarteur p. les côtesFG-10
- FINOCHIETTO INFANT écarteur p. les côtesFG-12
- FINOCHIETTO (modif) écarteur p. les côtesFG-08
- FINOCHIETTO
- pince pour les bronchesFG-21
- porte-aiguilleCE-04
- FINSEN écarteurBI-14
- FINSTERER canules d'aspiration et d'irrigationAE-05
- FISCH décolleurEE-15
- FISCHER pince à irisEC-13
- FLETCHER JAVERTS pince porte-épongesBG-10
- FLEURANT trocartCC-02
- FOERSTER
- pince à irisEC-12
- pince porte-épongesBG-06 jusque BG-08
- FOMON
- ciseaux-burin pour plastique nasaleEG-13
- ciseaux nasauxAH-18, AI-25
- écarteur nasalEG-17
- rape nasaleEG-15 jusque EG-16
- Forceps
- BARTON obstétriqueHC-04
- BOERMA obstétriqueHC-04
- De LEE obstétriqueHC-02
- DEWEY obstétrique avec dispositif de tractionHC-05
- ELLIOT obstétriqueHC-02
- KIELLAND-LUIKART obstétriqueHC-03
- KIELLAND obstétriqueHC-02
- LUIKART obstétriqueHC-03
- McLEAN-LUIKART obstétriqueHC-03
- McLEAN obstétriqueHC-04
- McLEAN-TUCKER-LUIKART obstétriqueHC-03
- NAEGELE obstétriqueHC-03
- PIPER obstétriqueHC-04
- PIPER obstétrique avec dispositif de tractionHC-04
- SIMPSON-BRAUN obstétriqueHC-02
- SIMPSON-LUIKART obstétriqueHC-03
- SIMPSON obstétriqueHC-02
- TARNIER obstétrique avec dispositif de tractionHC-05
- WRIGLEY obstétriqueHC-02
- FORD BOWLES stéthoscopeAC-06
- FORD stéthoscopeAC-06
- Fourchette BURCH à fixationEC-05
- FOX curette lupusHE-02
- FRAENKEL
- pince à polypes laryngiensFC-02
- pince laryngienneFC-03
- FraiseDD-07
- ALBEEDD-07
- BORCHARDTDD-07
- coniqueDD-04
- Fraise conique HUDSONDD-04
- Fraise
- DOYENDD-07
- pour corticalisDD-15
- TOTIDD-07
- FRANCESCHETTI trépan cornéenED-07
- FRANCIS aiguille pour corps étrangersEC-05
- FRANKLIN-SILVERMANN aiguille à ponctionCC-03
- FRAZIER
- crochetBI-06
- écarteurBI-21
- tube d'aspirationEA-07
- FREER
- bistouri à muqueusesEG-10
- ciseaux-burin pour cloison nasaleEG-12
- couteau pour la cloison nasaleEG-10
- élévateur pour la cloison nasaleEG-11
- gouge nasaleEG-14
- FREEWAY-GRAVE spéculum vaginalHA-06
- FRENZEL abaisse-langueEI-02
- FRIEDMAN
- écarteur pour la perinéorrhapieHA-23
- pince gougeDC-02
- pince gouge, miniDC-02
- FRITSCH écarteurBI-11
- FRYKHOLM pince gougeDC-05
- FUCHS pince capsulaireED-04
- G**
- GALLAHER rape pour le sinusEG-16
- GAUSS pince péri crânienneHC-06
- GELLHORN pince emporte-pièce pour le col de l'utérusHA-42
- GELPI écarteur abdominalBI-24
- GEMINI MINI pince à dissection et à ligatureBC-10
- GEMINI pince à dissection et à ligatureBC-10
- GERALD pince à dissectionBA-05
- GERBODE dilateur valve mitraleFG-28
- GERSTER écarteur pour daviersDC-11
- GERZOG mailletDC-18
- GIERTZ-STILLE costotomeFG-06
- GIGLI manche pour scieEA-05
- GILL-ARRUGA pince capsulaireED-03
- GILL
- couteau cornéenEC-05
- GILL-HESS pince à irisEC-12
- GILLIES
- crochetEG-17
- pince à dissectionBA-05
- porte-aiguilleCE-05
- GILL
- pince à irisEC-12
- GLOVER
- clamps bulldog atraumaBC-02
- pince atraumatiqueBD-06, BD-30
- pince atraumatique à coarctationBD-04
- pince atraumatique pour l'anastomoseBD-05
- GLUCK costotomeFG-03
- GOLET écarteurBI-03
- GOLDMAN-FOX ciseaux à gencivesAI-41
- GOLDSTEIN blépharostatEC-03
- Goniomètre MOELTGENAC-08
- GOOD ciseaux à amygdalesAI-27
- GOODELL dilateur du col de l'utérusHA-30
- GORNEY ciseaux à dissectionAI-13
- GOSSET écarteur abdominalBI-21
- GougeDC-14
- ALEXANDERDC-14
- ELLIS pour corps étrangersEC-06
- FREER nasaleEG-14
- HAJEK nasaleEG-14
- HIBBSDC-16
- KILLIAN-CLAUS nasaleEG-14
- LEXERDC-16
- LEXER miniDC-16
- PARTSCHDC-14
- SMITH-PETERSENDC-15
- STILLEDC-14

F

Index Français

- WALTON pour corps étrangersEC-06
 WEST nasaleEG-14
 GOURDET curette utérineHA-48
 GRADLE pince à épilerED-08
GRAEFE
 blépharostatEC-02
 couteau à cataracteEC-03
 crochetBI-06
 crochet à strabismeEC-06
 curette à cataracteEC-07
 kistitomeEC-06
 pince à dissectionBA-03
 pince à irisEC-11
 pince fixationED-03
 scarificateurEC-04
 GRAEFE-TITAN crochet à strabismeEC-06
 GRAHAM écarteur à nerfsEA-04
 GRAVE spéculum vaginalHA-02
 GRAY pince pour voies biliairesBC-15
 GREEN-ARMYTAGE pince-clamp utérine pour hémostase
HC-06
GREEN
 crochet musculaireEC-06
 dissecteur cornéenEC-06
 écarteurBI-10
 pince fixationED-03
 GREGORY pince atraumatique pour profundaBD-33
 GREVEN pince auriculaire microEE-10
 GRIP pince à saisirDD-11
GROSS
 curette auriculaireEE-06
 GROSS-MAIER pince à pansementsBG-02 jusque BG-04
GROSS
 pince à pansementsBG-05
 GRUBER spéculum auriculaireEE-02
 Guide-scie De MARTELEA-05
 GUTHRIE crochetBI-06
 GUTMANN cuillère à sécrétionGG-11
GUYON
 bougie urétraleGG-12, GG-14 jusque GG-15
 introduceur de sondesGG-11
 pince à pédicule rénalBC-16
 GUYTON-LUNDSGAARD sclérotomeEC-05
- H**
 HABERER écarteurBI-04
 HAGLUND-STILLE écarteur pour plâtreDA-03
 HAIGHT écarteur pour les côtesFG-15
 HAJEK-BALLENGER élévateur pour la cloison nasaleEG-12
 HAJEK-CLAUS pince coupante nasaleEG-08
 HAJEK gouge nasaleEG-14
 HAJEK-KOFLER pince coupante nasaleEG-08
HALLE
 bistouri à duremèreEA-06
 curetteDC-13
 HALSEY porte-aiguilleCE-02
 HALSTED-MOSQUITO micro pince hémostatiqueBC-04
HALSTED-MOSQUITO
 pince atraumatiqueBD-02
 pince hémostatiqueBC-04
 HALSTED-MOSQUITO TITAN pince hémostatiqueBC-04
 Hamburg canuleED-07
 HANK dilateur pour col de l'utérusHA-28
 HaricotHE-07
 HARKEN pince atraumatique auriculaireBD-23
HARRINGTON
 écarteurBI-05
 pince pour les bronchesFG-21
HARTMANN
 abaisse-langueEI-02
 diapasonEE-03
 HARTMANN-HALLE spéculum nasalEG-02
 HARTMANN-HOFFMANN pince auriculaireEE-08
HARTMANN
 pince auriculaireEE-08
 pince coupante nasaleEG-07
 pince nasale à polypesEG-04
 pince hémostatiqueBC-03
 sonde auriculaireEE-06
 spéculum auriculaireEE-02
 HARTMANN-WULLSTEIN pince auriculaireEE-08
HEANEY
 écarteurBI-12
 pince à hystérectomieBC-18
 porte-aiguilleCE-03
 HEATH ciseaux à ligaturesAI-40
 HEBRA curette à chalazionEC-07
 HEGAR dilateur pour col de l'utérusHA-24 jusque HA-27
 HEGENBARTH pince pour agrafesCG-07
 HEIFETZ spatule cérébraleEA-07
 HEIMING pince pour les calculs du bassinGC-13
 HEISS pince hémostatiqueBC-09
 HEISTER ouvre-boucheEI-03
 Hémostate PASSOWEE-15
 HENKE élévateur à amygdalesFA-02
 HENNIG écarteur pour plâtreDA-03
 HENROTIN pince pour abaissement du col de l'utérusHA-34
 HERMANN écarteur pour plâtreDA-03
 HERRICK pince à péritoineBC-17
 HERTZLER écarteur pour les côtesFG-17
HESS
 pince à irisEC-12
 pince capsulaireED-04
 HETZER dilateur pour valve mitraleFG-29
HEYMANN
 ciseaux nasauxAH-18, AI-25
 HEYMANN-KNIGHT pince nasale à polypesEG-05
HEYMANN
 pince coupante nasaleEG-05
 HEYWOOD-SMITH pince à hémorroïdesGI-05
HIBBS
 ciseau-burinDC-16
 gougeDC-16
 ostéomeDC-16
 HIRSCHMANN anoscopeGI-04
 HOESEL porte-aiguilleCE-05
 HOFER écarteur pileaireFA-02
 HOFF pince à champsBE-03
 HOHMANN levier à osDC-22 jusque DC-23
 HOHMANN mini levier à osDC-23
 HOKE ciseau-burinDC-16
 HOLTH pince pour capsulotomieEC-09
 HOPKINS couteau pour plâtreDA-04
 HORSLEY dissecteur duremèreEA-06
 HOUSE curetteEE-15
 HRYNTSCHAK écarteur pour saisir la prostateGG-06
 HUBER manche universelFC-03
HUDSON
 fraise coniqueDD-04
 perforateur à mainDD-04
HUMBY
 dermatomeAG-20
 lame dermatome de rechangeAG-20
 HUNTER pince à échardesBA-06
 HURD décolleur à amygdalesFA-02
Hystéromètre
 COLLINHA-39
 MARTINHA-39
 SIMSHA-39
 VALLEIXHA-39

I

Impactor	.DD-12
KUENTSCHER	.DD-13
INGE écarteur vertébral	.EA-07
Instrument	
de circoncision	.GG-09
KNUTSON pour urétrographie	.GG-09
Instrument	
LAFORCE pour corps étrangers	.EC-06
Instrument	
MOGAN de circoncision	.GG-09
WINKELMANN de circoncision	.GG-09
Insufflateur POLITZER d'air	.EE-05
Introduceur de sondes	
DITTEL	.GG-11
GUYON	.GG-11
IOWA pince pour abaissement du col de l'utérus	.HA-35
IRIS	
ciseaux	.AH-16, AI-19, AI-21
ciseaux ophtalmologiques	.AI-22
Irrigateur	.HE-05
ISRAEL écarteur	.BI-11
ITARD sonde auriculaire	.EE-06
ITERSON écarteur trachéal	.FE-02
IVES-FANSLER anoscope	.GI-04

J

JACKSON	
canule trachéale	.FE-03
écarteur trachéal	.FE-02
pince porte tampons	.FC-02
spéculum vaginal	.HA-16
JACOBSON ciseaux micro	.AJ-11
JACOBS pince pour abaissement du col de l'utérus	.HA-34
JAEGER	
kératome	.EC-04
plaque pour paupières	.EC-03
JAMESON	
crochet à strabisme	.EC-06
pince à strabisme	.EC-13
JAMISON porte-aiguille	.CE-03
JANSEN	
écarteur	.BI-14
pince nasale	.EG-04
JARCHO pince pour abaissement du col de l'utérus	.HA-32
JATHO pince nasopharyngienne	.EG-18
JAVID pince atraumatique carotis	.BD-32
JENNINGS ouvre-bouche	.EI-04
JOBSON-HORNE stylet	.CA-03
JOHNS-HOPKINS	
clamps bulldog serre-fine	.BC-03
pince pour voies biliaires	.BC-14
JOHNSON porte-aiguille	.CE-04
JONES pince à champs clamp porte tube	.BE-02
JOSEPH	
bistouri mousse	.EG-10
bistouri nasal	.EG-10
ciseaux	.AH-14, AI-16
crochet	.BI-06
élévateur pour la cloison nasale	.EG-12
JOSEPH (LEWIS) rape nasale	.EG-15
JOSEPH	
lime à os	.EG-14
scie nasale	.EG-17
JUDD-ALLIS pince pour saisir les tissus	.GE-02
JUDD-MASSON écarteur vésical	.GG-04
JURASZ pince à polypes laryngiens	.FC-02

K

KABIERSKE lance-poudre	.EE-04
KALLMORGEN	
spéculum vaginal	.HA-15
valve vaginale	.HA-15
KALT-ARRUGA porte-aiguille	.CE-07
KALT	
pince capsulaire	.ED-04
porte-aiguille	.CE-07
KANE clamp pour cordon ombilical	.HC-06
KEITH aiguille à sutures	.CG-06
KELLY	
ciseaux gynécologiques	.AH-22, AI-33
écarteur	.BI-04, BI-12
KELLY Grip écarteur	.BI-04
KELLY	
pince à polypes utérins	.HA-36
pince hémostatique	.BC-05
proctoscope	.GI-04
KELLY-RANKIN pince hémostatique	.BC-05
KELLY TITAN pince hémostatique	.BC-05
Kératome	
BERENS	.EC-04
CASTROVIEJO	.EC-04
JAEGER	.EC-04
KERN davier porte-os	.DC-08
KERRISON pince coupante nasale	.EG-08
KEVORKIAN	
curette aspirante pour biopsie de l'utérus	.HA-40
KEVORKIAN-Pacific pince emporte-pièce pour le col de l'utérus	.HA-44
KEVORKIAN	
pince emporte-pièce pour le col de l'utérus	.HA-43, HA-46
KEY élévateur	.DC-21
KEYES trépan cutané	.HE-02
KIELLAND forceps obstétrique	.HC-02
KIELLAND-LUIKART forceps obstétrique	.HC-03
KILLIAN-CLAUS gouge nasale	.EG-14
KILLIAN	
Élévateur pour la cloison nasale	.EG-12
sonde	.EG-09
spéculum pour cloison nasale	.EG-03
KILNER	
ciseaux	.AH-14, AI-17
crochet à peau	.HE-02
KILNER-DOUGHTY ouvre-bouche	.EI-05
KIRBY-ARTHUR pince à iris	.EC-13
KIRK maillets	.DC-18
KIRSCHNER	
broche	.DD-09
cadre	.BI-23
écarteur abdominal	.BI-23
étrier à extension	.DD-10
perforateur à main	.DD-05
sonde conductrice	.CG-04
valve	.BI-23
Kistitome	
BECKER	.EC-06
GRAEFE	.EC-06
KLINKENBERGH-LOTH ciseaux thoraciques	.AI-37
KNAPP	
ciseaux	.AI-20
couteau à iridectomie	.EC-04
curette à cataracte	.EC-07
écarteur	.EC-06
KNAPP-LUER pince trachome	.ED-06
KNIGHT pince coupante nasale	.EG-05
KNOWLES ciseaux à bandages	.AI-47
KNUTSON Instrument pour l'urétrographie	.GG-09
KNUTSON-KOCH cône pour l'urétrographie	.GG-09

- KOCHER**
 écarteurBI-10 jusque BI-11
 pince intestinaleGE-04
 pince hémostatique délicateFE-06
 spatule à goitreFE-04
 spatule vésicaleGG-04
- KOENIG**
 aiguille à suturesCG-06
 sonde conductriceCG-04
- KOERTE écarteur**BI-11
KOGAN endospéculumHA-23
KONRICH tambours à stérilisationHE-12
- KRAUSE**
 pince laryngienneFC-03
 serre-noeud auriculaireEE-07
 serre-noeud nasalEG-09
- KRISTELLER**
 spéculum vaginalHA-09 jusque HA-14
 valve vaginaleHA-09 jusque HA-14
- KRONECKER aiguille à ligatures**CG-02
- KUENTSCHER**
 alésoirDD-13
 extracteurDD-13
 impacteurDD-13
- KUHNT rugine cornéenne**EC-05
- L**
- LABORDE dilateur trachéal**FE-02
- LAFORCE**
 adénotomeEG-19
 instrument pour corps étrangersEC-06
- LAGRANGE ciseaux à gencives**AI-41
- LAHEY**
 écarteurBI-08
 pince à saisir le goitreFE-04
 pince pour voies biliairesBC-14
- LAMBERT KAY**
 pince atraumatique pour l'anastomoses d'aorteBD-10
 pince atraumatique iliaqueBD-11
- LAMBERT pince à chalazion**ED-06
- LAMBOTTE**
 davier porte-osDC-08
- LAMBOTTE mini ostéotome**DC-15
- LAMBOTTE**
 ostéotomeDC-15
 rugine raspatoireDC-19
- Lame**
 CHARRIEREDD-03
 Lame dermatome de rechangeAG-21
- Lame**
 HUMBY dermatome de rechangeAG-20
- Lame rasoirAG-19
 Lame scie pour plâtreDA-05 jusque DA-06
 Lame de bistouris, stérileAG-06, AG-09
 Lame de bistouris stérile, microAG-13
 Lame pour rasoirAG-14
- Lampe frontale CLARAC-05
- LANCASTER blépharostat**EC-03
Lance-poudre KABIERSKEEE-04
Lancette électrodeJA-03
- LANDAU spéculum vaginal**HA-22
- LANDOLT**
 ciseaux à énucléationAI-25
 manche de bistouris, microAG-13
- LANE**
 davier porte-osDC-08
 pince à champsBE-05
 pince à dissectionBA-04
 pince pour saisir les attellesDD-14
 pince pour saisir les visDD-14
- pince clamp stomacaleGE-08
 tourne-visDD-14
- LANG curette**EC-08
- LANGÉ**
 ciseaux à bandagesAI-44
- LANGENBECK**
 couteau à resectionAG-17
 davier porte-osDC-07
 doigtierEI-06
 écarteurBI-09
 élévateurDC-21
 rugine raspatoireDC-19
 scie à doigtsDD-03
- LANGÉ**
 pince laryngienneFC-03
- Laryngoscope set**
 MACINTOSH fibres optiquesAE-12 jusque AE-13
 MACINTOSH standardAE-18 jusque AE-19
 MILLER fibres optiquesAE-12 jusque AE-13
 MILLER standardAE-18 jusque AE-19
- Laryngoscope spatule**
 MACINTOSH fibres optiquesAE-10
 MACINTOSH standardAE-15
 MILLER fibres optiquesAE-10
 MILLER standardAE-16
- Lavier MURLESS à tête**HC-05
- LAWRENCE pince à dissection et à ligature**BC-13
- LEBSCHÉ ciseaux sternaux**DC-17
- LEES pince atraumatique pour les bronches**BD-03
- LEGUEU**
 écarteur vésicalGG-06
 spatule vésicaleGG-04
- LEKSELL STILLE pince gouge**DC-05
- LELAND JONES pince atraumatique vasculaire périphérique**BD-08 jusque BD-09
- LEMPERT**
 curetteDC-13
 élévateurEE-15
 pince gougeDC-03
- LERCHE pince à dissection**BA-04
- LERICHE pince hémostatique**BC-09
- LESTER pince à fixation**ED-03
- Levier**
 à osDC-23
 BENNETT à osDC-22
 BLOUNT à osDC-24
 BUCK pour corps étrangersEE-08
 HOHMANN à osDC-22 jusque DC-23
 HOHMANN mini à osDC-23
 QUIRE pour corps étrangersEE-08
 SELLHEIM pour abaissement de la têteHC-09
- LEVINSON aiguille pour corps étrangers**EC-05
- LEWIN davier porte-os**DC-10
- LEWKOWITZ pince placentaire et pour post-abortum**HC-07
- LEXER-BABY**
 ciseauxAH-10
 ciseaux à dissectionAI-12
- LEXER**
 ciseau-burinDC-16
 ciseauxAH-09
 ciseaux à dissectionAI-11
- LEXER-FINO ciseaux à dissection**AI-12
- LEXER**
 gougeDC-16
- LEXER mini**
 ciseau-burinDC-16
 gougeDC-16
- LEYLA système de fixation**EA-14 jusque EA-18
- LICHTWITZ**
 aiguilleEG-09
 trocartCC-02

- LIDDLE pince atraumatique pour l'aorteBD-10
Lien PARHAMDC-11
Lime
à onglesHE-03
JOSEPH à osEG-14
LISTER-BURCH blépharostatEC-02
LISTER
ciseaux à bandagesAH-23, AI-45
pince porte-éponges, sinusBG-11
LISTON
couteaux à amputationAG-16
pince coupante à osDC-06
LITTAUER
ciseaux à ligaturesAI-40
pince auriculaireEE-08
pince à épilerED-08
pince nasale à polypesEG-05
LITTLE écarteurBI-08
LITTLER ciseaux à dissectionAI-13
LOCKLIN ciseauxAI-18
LORENZ ciseaux à bandagesAI-47
LORNA pince à champsBE-04
LOUTE tendeur serre-filDD-11
LOVE
écarteur à nerfsEA-04
écarteur ovulaireFA-02
LOVE-GRUENWALD pince emporte-pièce pour laminectomieEA-08
LOVELACE
pince pulmonaireFG-19
pince hémostatiqueBC-07
LOWER pince pour voies biliairesBC-14
LOWMAN davier à osDC-11
LUBET-BARBON pince nasale à polypesEG-05
LUCAE
diapasonEE-04
mailletDC-18
pince auriculaireEE-07
LUC pince coupante nasaleEG-06
LUER
canule trachéaleFE-03
LUER-KOERTE curette pour calculs biliairesGC-09
LUER
pince gougeDC-03
LUIKART-BILL tracteur pour manches ordinairesHC-05
LUIKART forceps obstétriqueHC-03
LUNDGAARD sclérotomeEC-05
LUNIATSCHEK obturateur à gazeFA-02
LURZ pince urétéraleGC-10
- M**
- MACINTOSH
laryngoscope set fibres optiquesAE-12 jusque AE-13
laryngoscope set standardAE-18 jusque AE-19
laryngoscope spatules fibres optiquesAE-10
laryngoscope spatules standardAE-15
MAGILL
doigtAE-04
pince pour introduire les sondesAE-06
tube d'aspirationAE-04
MAIER pince à pansementsBG-12
MailletsDC-18
COLLINDC-18
GERZOGDC-18
KIRKDC-18
LUCAEDC-18
MEADDC-18
QUISLINGDC-18
WILLIGERDC-18
Main en plombDC-11
MALTZ
bistouri à cartilage coudeEG-11
MALTZ (COTTLE) rape nasaleEG-15
MALTZ
rape nasaleEG-14
Manche
BROCK dilateur pour valve mitraleFG-26
CASPAR de bistouris, microAG-12
COLLIN de bistourisAG-08
Manche de bistouris AG-02 jusque AG-05, AG-07 jusque AG-08
Manche de bistouris, microAG-12
Manche
GIGLI pour scieEA-05
HUBER universelFC-03
LANDOLT de bistouris, microAG-13
miroirs laryngiensFC-04
Manomètre pour salpingographeHA-47
Marqueur
CASTROVIEJO compassEC-09
CONNIN-AMSLEREC-09
MARSCHIK pince à amygdalesFA-04
Marteau à fenteDD-13
Marteau
BABINSKY percuteurAC-07
BERLINER percuteurAC-07
BUCK percuteurAC-07
DEJERINE percuteurAC-07
TAYLOR percuteurAC-07
TRAUBE percuteurAC-07
TROEMNER percuteurAC-07
MARTEL pince pour cuir cheveluBC-08
MARTIN
compas pelvimètreHC-06
cordon électrobistourisJA-07
hystéromètreHA-39
MARTINI curetteDC-13
MARTIN
pince à pansementsBG-02, BG-14
pince à sequestresDC-10
MASSON porte-aiguilleCE-03
MASTIN pince musculaireFE-04
MATHIEU
écarteurBI-03
pince pour corps étrangersGG-07
porte-aiguilleCE-05
spéculum rectalGI-02
MATSON rugine raspatoireDC-21
MAUNDER baillon boisEI-06
MAYO BLAKE pince pour calculs biliairesGC-04
MAYO
ciseauxAH-06, AI-07
ciseaux pour main gaucheAI-07
curette pour calculs biliairesGC-07
épingle de sécuritéCI-02
MAYO-GUYON pince pédicule rénalBC-16
MAYO-HEGAR porte-aiguilleCE-02
MAYO-NOBLE ciseauxAH-08, AI-10
MAY ophtalmoscopeAC-03
MAYO-ROBSON pince intestinaleGE-05
MAYO
sonde pour les calculs du bassinGC-10
MAYO-STILLE ciseauxAH-07, AI-08 jusque AI-09
McCLINTOCK pince placentaire et pour post-abortumHC-07
McCULLOUGH pince à strabismeEC-13
McDONALD élévateurDC-22
McGEE pince auriculaire microEE-10
McGUIRE ciseaux cornéensAJ-05
McINDOE
ciseaux à cartilageAI-35
pince à dissectionBA-04
McIVOR
abaisse-langueEI-05

- ouvre-boucheEI-05
 McKENTY élévateur pour la cloison nasaleEG-11
 McKENZIE
 perforateur platDD-04
 pince pour poser clipsEA-02
 McLEAN forceps obstétriqueHC-04
 McLEAN-LUIKART forceps obstétriqueHC-03
 McLEAN-TUCKER-LUIKART forceps obstétriqueHC-03
 McPHERSON pince à ligaturesED-05
 McPHERSON TITAN pince à ligaturesED-05
 McPHERSON WESTCOTT ciseaux à ténotomieAJ-04
 MEAD
 mailletDC-18
 pince gougeDC-02
 MècheDD-04
 MEEKER pince à dissection et à ligatureBC-13
 MELLINGER-AXENFELD blépharostatEC-02
 MELLINGER blépharostatEC-02
 MENGHINI trocartCC-03
 Méniscotome
 BIRCHERDC-24
 NEFFDC-24
 SMILLIEDC-24
 MERCEDES écarteur thoraciqueFG-16
 Mesure graduéeHE-07
 METZENBAUM
 ciseauxAH-11
 ciseaux à dissectionAI-13 jusque AI-14
 METZENBAUM FINO
 ciseauxAH-12
 ciseaux à dissectionAI-15
 METZENBAUM
 porte-aiguilleCE-04
 METZENBAUM "S" ciseauxAH-13, AI-16
 MEYERDING écarteurBI-08
 MEYHOEFER curette à chalazionEC-07
 MICHEL
 agrafesCG-07
 miroirEG-04
 pince pour agrafesCG-07
 MIDDELDORPF écarteurBI-10
 MIDDLETON-JANSEN pince coupante nasaleEG-09
 MIKULICZ
 écarteurBI-12
 pince à péritoineBC-17
 MILLER
 laryngoscope set fibres optiquesAE-12 jusque AE-13
 laryngoscope set standardAE-18 jusque AE-19
 laryngoscope spatules fibres optiquesAE-10
 laryngoscope spatules standardAE-16
 MILLIGAN dissecteur duremèreEA-05
 MILLIN
 écarteur pour le col de la vessieGG-07
 écarteur vésicalGG-05
 pince porte-filGG-03
 pince capsulaireGG-03
 pince pour saisir lombeauxGG-03
 support lumière froideGG-05
 MILLS ciseaux vasculairesAI-27
 Mini CLARAC-05
 Miroir frontal ZIEGLERAC-05
 Miroir
 laryngienFC-04
 MICHELEG-04
 MIXTER BABY pince hémostatique p. les bronchesBC-13
 MIXTER O'SHAUGNESSY pince hémostatiqueBC-14
 MIXTER
 pince pour calculs biliairesGC-04
 pincettes hémostatiquesBC-14
 pince hémostatique pour les bronchesBC-13
 pince pour voies biliairesBC-15
- MOELTGEN goniomètreAC-08
 MOGAN Instrument de circoncisionGG-09
 MOLLISON écarteurBI-17
 Monde mesurerEE-15
 MOORE
 curette pour calculs biliairesGC-05
 perforateur à mainDD-04
 MOORFIELD pince à sutureED-05
 MORSE-FAVOLORO écarteur pour les côtesFG-17
 MOYNIHAN
 pince à champsBE-05
 pince pour voies biliairesBC-15
 sonde pour calculs biliairesGC-05
 MUCK couteau périosteEE-15
 MUELLER blépharostatEC-03
 MURDOCK blépharostatEC-02
 MURLESS lavier à têteHC-05
 MURPHY-LANE élévateurDC-22
 MURPHY pince serre-tubesBC-19
 MUSEUX pince pour abaissement du col de l'utérusHA-33
 MYLES pince coupante nasaleEG-07
- ## N
- NABATOFF sonde auriculaire en argentCA-02
 NAEGELE forceps obstétriqueHC-03
 NÄGELE perce crâneHC-09
 NAGER écarteur pour le palaisFA-02
 NEFF méniscotomeDC-24
 NEGUS pince à amygdalesFA-03
 NEIVERT porte-aiguilleCE-02
 NELSON
 aiguille à ligaturesCG-02
 pince à dissectionBA-05
 trocartCC-02
 NEUBÜSER pince à saisir les trompesHA-51
 NORTHBENT ciseaux à ligaturesAI-40
 NOTO pince à polypes utérinsHA-36
 NOVAK curette aspirante pour biopsie de l'utérusHA-40
 NOYES
 ciseaux à irisAJ-03 jusque AJ-04
 ciseaux à tendonsAJ-03
 pince nasale à polypesEG-05
 NUBOER tube d'aspirationAE-05
- ## O
- Obturateur à gaze LUNIATSCHEKFA-02
 OCHSNER
 pince atraumatique pour l'aorteBD-31
 trocartCC-02
 O'CONNOR crochet à irisEC-06
 OLDBERG pince emporte-pièce pour laminectomieEA-09
 OLIVECRONA
 pince gougeDC-03
 scieEA-05
 spatule cérébraleEA-07
 OLIVECRONA-TOENNIS pince à poser clipsEA-02
 OLLIER écarteurBI-10
 OLSEN-HEGAR porte-aiguilleCE-05
 Ophthalmoscope
 MAYAC-03
 VARIFOCALAC-03
 OstéotomeDC-14
 HIBBSDC-16
 LAMBOTTEDC-15
 LAMBOTTE miniDC-15
 STILLEDC-14
 O'SULLIVAN-O'CONNOR
 écarteur abdominalBI-21
 spéculum vaginalHA-08

- OTIS
 couteau de rechange .GG-08
 uréthrotome .GG-08
 Otoscope .AC-04
 Ouverture BROCK dilateur pour valve mitrale .FG-26
 Ouvre-bouche
 DAVIS-BOYLE .EI-04
 DENHART .EI-03
 DOYEN-JANSEN .EI-03
 HEISTER .EI-03
 JENNINGS .EI-04
 KILNER-DOUGHTY .EI-05
 McIVOR .EI-05
 ROSER-KOENIG .EI-03
 SEEMANN-SEIFFERT .EI-04
 WHITEHEAD .EI-04
 OVERHOLT-GEISSENDOERFER pince à dissection et à ligature
 BC-10
 OVERHOLT rugine raspatoire .DC-21
- P**
- PARHAM lien .DC-11
 PARK blépharostat .EC-03
 PARKER
 bistouri à dissection .AG-15
 écarteur .BI-02
 PARTSCH
 ciseaux-burin .DC-14
 gouge .DC-14
 PASSOW hémostat .EE-15
 PATON dissecteur cornéen .EC-05
 PAUFIQUE
 couteau pour la kératoplastie .EC-05
 pince à ligatures .ED-05
 PAUFIQUE TITAN pince à ligatures .ED-05
 PAYR-Baby pince clamp stomacale .GE-09
 PAYR
 pince clamp stomacale .GE-09
 sonde conductrice .CG-04
 PEAN
 pince atraumatique .BD-02
 pince hémostatique .BC-08
 pince hémostatique délicate .BC-06
 PEDERSON spéculum vaginal .HA-03
 PEERS BERTRAM pince à champs .BE-03
 PEET pince à échardes .BA-06
 PELKMANN pince à pansements .BG-12
 PENFIELD dissecteur duremère .EA-06
 PENNINGTON pince hémostatique .BC-07
 Perce-crâne
 NÄGELE .HC-09
 SMELLIE .HC-09
 PERCY retracteur à amputation .DD-03
 Perforateur
 à main .DD-05
 à mandrin Jacobs .DD-06
 BUNNELL à main .DD-05
 CUSHING plat .DD-04
 HUDSON à main .DD-04
 KIRSCHNER à main .DD-05
 McKENZIE plat .DD-04
 MOORE à main .DD-04
 RALK à main .DD-05
 STILLE à main .DD-04
 STILLE-SHERMAN à main .DD-04
 PERTHES pointes-carrées .DD-08
 PESTALOZZA curette placentaire et pour post-abortum .HC-08
 PETRI boîte .HE-08
 PETZ appareil à sutures stomacales et intestinales .GE-09
 PHANEUF pince à péritoine .BC-17
- Pick .EE-15
 BARBARA .EE-14 jusque EE-15
 PIERCE trocart .CC-02
 Pierre ARKANSAS à repasser .AG-19
 PIFFARD curette à lupus .HE-02
 PINARD stéthoscope .AC-06
 Pince à champs modèle gracille .BE-02
 Pince
 à couper et à plier le fil .DD-11
 Pince à dissection .BA-02
 Pince
 ADLERKREUTZ à dissection .BA-04
 ADSON à dissection .BA-03
 ADSON à dissection, micro .BA-03
 ADSON à hypophyse .EA-06
 ADSON-BROWN à dissection .BA-03
 ADSON gouge .DC-03
 Pince à échardes .BA-06
 Pince
 à envies .HE-03
 ALEXANDER emporte-pièce pour le col de l'utérus .HA-42
 ALLIS-ADAIR à saisir les tissus .GE-02
 ALLIS à saisir les tissus .GE-02
 ALLIS-Baby à saisir les tissus .GE-02
 à ongles .HE-03
 ARCHER à échardes .BA-06
 ARRUGA capsulaire .ED-04
 ASCH pour redresser cloison .EG-18
 Pince à sequestres .DC-10
 Pince à stérilisation .CI-02
 Pince
 auriculaire micro .EE-09 jusque EE-10, EE-12
 auriculaire micro mini .EE-13
 AYER à chalazion .ED-06
 BABCOCK pour saisir les tissus .GE-02
 BACKHAUS à champs .BE-02
 BACKHAUS-CLIP à champs clamp porte-tube .BE-03
 BACKHAUS KOCHER à champs .BE-02
 BAGGISH emporte-pièce pour le col de l'utérus .HA-45
 BALL AND SOCKET à champs .BE-04
 BALLENGER à préhension amygdalienne .FA-04
 BARRAQ.KATZIN à iris .EC-13
 BARRAQU Colibri à iris .EC-13
 BARRAQUER chambre antérieure .ED-02
 BARRAQUER à épiler .ED-08
 BARRAQUER à fixation .ED-03
 BARRETT pour abaissement du col de l'utérus .HA-32
 BEER à épiler .ED-08
 BERGMANN FOERSTER porte-éponges .BG-10
 BERKE musculaire .ED-02
 BERNHARD à champs .BE-05
 BEST intestinale .GE-06
 BEYER coupante nasale .EG-08
 BEYER gouge .DC-04
 BISHOP-HARMAN à iris .EC-14
 BLAKE pour calculs biliaires .GC-03
 BLOHMKE à préhension amygdalienne .FA-04
 BLUMENTHAL gouge .DC-02
 BÖHLER coupante à os .DC-06
 BÖHLER gouge .DC-04
 BONACCOLTO à strabisme .EC-14
 Bonn à iris .EC-15
 BONNEY porte-éponges .BG-08
 Bonn TITAN à iris .EC-15
 BOZEMANN à pansements .BG-13
 BOZEMANN-DOUGLAS à pansements .BG-13
 BRAIN MINI de pose clip .EA-12
 BRAIN STANDARD de pose clip .EA-12
 BRAUN pour abaissement du col de l'utérus .HA-31, HA-34
 BROWN à dissection .BA-03
 BRUENINGS coupante nasale .EG-05

- BRUENINGS laryngienneFC-03
 BRUNNER intestinaleGE-06
 BRYANT porte-épongesBG-11
 BUMM hystérolabeHA-38
 BURKE emporte-pièce pour le col de l'utérusHA-44
 BURKE-Baby emporte-pièce pour le col de l'utérusHA-44
 CARMALT à échardesBA-06
 CASTROVIEJO capsulaireED-04
 CASTROVIEJO fixationED-03
 CASTROVIEJO sutureED-05
 CHEATLE à stérilisationCI-02
 CHERON à pansementsBG-12
 CHEVALIER-JACKSON laryngienneFC-04
 CHILDE pour agrafesCG-07
 CITELLI coupante nasaleEG-08
 Pince-clamp GREEN-ARMYTAGE utérine pour hémostaseHC-06
 Pince
 CLEVELAND gougeDC-02
 coagulation bipolaireJA-04 jusque JA-06
 COLCLOUGH emporte-pièce pour lames intervertébralesEA-11
 COLLIN à pansementsBG-11
 COLLIN-DUVAL à dissectionBA-04
 COLLIN hystérolabeHA-37
 COLLIN pour agrafesCG-07
 COLLIN-POZZI pour abaissement du col de l'utérusHA-32
 COLLIN tire-langueEI-03
 COLVER à préhension amygdalienneFA-03
 CORDES laryngienneFC-03
 COTTLE-KAZANJIAN coupante à osDC-06
 coupe-filDD-12
 CUSHING à dissectionBA-03
 CUSHING emporte-pièce pour laminectomieEA-08
 CZERNY pour abaissement du col de l'utérusHA-34
 CZERNY pour calculs biliairesGC-03
 DARTIGUES hystérolabeHA-37
 DASTOOR à strabismeEC-14
 DAVIS à stérilisationCI-02
 DeMARTEL-WOLFSON pour anastomoseGE-07
 DESJARDINS pour calculs biliairesGC-02
 DESJARDINS pour voies biliairesBC-15
 DESMARRES à chalazionED-06
 DeVILBISS crânienneEA-05
 Pince d'horlogerBA-06
 Pince
 DIAMANT coupe-filDD-12
 DIETER pour la tête du marteauEE-10
 DIMEDA pour déchetsCI-03
 DOUGLAS à épilerED-08
 DOYEN à champsBE-05
 DOYEN à polypes utérinsHA-36
 DOYEN-Baby intestinaleGE-03
 DOYEN intestinaleGE-03
 DUPLAY à pansementsBG-14
 DUPLAY pour abaissement du col de l'utérusHA-31
 DUVAL à dissectionBA-04
 DUVAL à saisir les tissusGE-03
 ECHLIN gougeDC-05
 EDWARDS pour poser clipsBD-21
 ELSAESSER à néphrostomieGC-13
 ELSCHNIG capsulaireED-04
 ELSCHNIG à fixationED-03
 épilerED-08
 EPPENDORFER emporte-pièce pour le col de l'utérusHA-45
 jusque HA-46
 EPPENDORFER-KEVORKIAN emporte-pièce pour le col de l'u-
 térusHA-46
 EPPENDORFER TISCHLER-MORGAN emporte-pièce pour le
 col de l'utérusHA-46
 FAURE emporte-pièce pour le col de l'utérusHA-41
 FAURE à péritoineBC-17
 FEHLAND intestinaleGE-06
 FEILCHENFELD à échardesBA-06
 FERRIS à dissectionBA-04
 FERRIS-SMITH emporte-pièce pour laminectomieEA-09
 FERRIS-SMITH-KERRISON emporte-pièce pour lames interver-
 tébralesEA-10
 FINOCHIETTO pour les bronchesFG-21
 FISCHER à irisEC-13
 FLETCHER JAVERTS porte-épongesBG-10
 FOERSTER à irisEC-12
 FOERSTER porte-épongesBG-06 jusque BG-08
 FRAENKEL à polypes laryngiensFC-02
 FRAENKEL laryngienneFC-03
 FRIEDMAN gougeDC-02
 FRIEDMAN gouge, miniDC-02
 FRYKHOLM gougeDC-05
 FUCHS capsulaireED-04
 GAUSS péri crânienneHC-06
 GELLHORN emporte-pièce pour le col de l'utérusHA-42
 GEMINI à dissection et à ligatureBC-10
 GEMINI MINI à dissection et à ligatureBC-10
 GERALD à dissectionBA-05
 GILL à irisEC-12
 GILL-ARRUGA capsulaireED-03
 GILL-HESS à irisEC-12
 GILLIES à dissectionBA-05
 GRADLE à épilerED-08
 GRAEFE à dissectionBA-03
 GRAEFE à irisEC-11
 GRAEFE à fixationED-03
 GRAY pour les voies biliairesBC-15
 GREEN à fixationED-03
 GREVEN auriculaire microEE-10
 GRIP à saisirDD-11
 GROSS à pansementsBG-05
 GROSS-MAIER à pansementsBG-02 jusque BG-04
 GUYON pédicule rénalBC-16
 HAJEK-CLAUS coupante nasaleEG-08
 HAJEK-KOFLER coupante nasaleEG-08
 HARRINGTON pour les bronchesFG-21
 HARTMANN auriculaireEE-08
 HARTMANN coupante nasaleEG-07
 HARTMANN-HOFFMANN auriculaireEE-08
 HARTMANN à polypes nasauxEG-04
 HARTMANN-WULLSTEIN auriculaireEE-08
 HEANEY pour l'hystérectomieBC-18
 HEGENBARTH pour agrafesCG-07
 HEIMING pour les calculs du bassinGC-13
 HENROTIN pour abaissement du col de l'utérusHA-34
 HERRICK à péritoineBC-17
 HESS à irisEC-12
 HESS capsulaireED-04
 HEYMANN coupante nasaleEG-05
 HEYMANN-KNIGHT à polypes nasauxEG-05
 HEYWOOD-SMITH pour hémorroïdesGI-05
 HOFF à champsBE-03
 HOLTH capsulaireEC-09
 HUNTER à échardesBA-06
 IOWA pour abaissement du col de l'utérusHA-35
 JACKSON porte-tamponsFC-02
 JACOBS pour abaissement du col de l'utérusHA-34
 JAMESON à strabismeEC-13
 JANSEN nasaleEG-04
 JARCHO pour abaissement du col de l'utérusHA-32
 JATHO nasopharyngienneEG-18
 JOHNS-HOPKINS pour voies biliairesBC-14
 JONES à champs clamp porte-tubeBE-02
 JUDD-ALLIS pour saisir les tissusGE-02
 JURASZ à polypes laryngiensFC-02
 KALT capsulaireED-04
 KELLY à polypes utérinsHA-36
 KERRISON coupante nasaleEG-08

- KEVORKIAN emporte-pièce pour le col de l'utérusHA-43, HA-46
 KEVORKIAN-Pacific emporte-pièce pour le col de l'utérusHA-44
 KIRBY-ARTHUR à irisEC-13
 KNAPP-LUER trachomeED-06
 KNIGHT coupante nasaleEG-05
 KOCHER intestinaleGE-04
 KRAUSE laryngienneFC-03
 LAHEY pour saisir le goitreFE-04
 LAHEY pour les voies biliairesBC-14
 LAMBERT à chalazionED-06
 LANE à champsBE-05
 LANE à dissectionBA-04
 LANE pour saisir les attellesDD-14
 LANE pour saisir les visDD-14
 LANE clamp stomacaleGE-08
 LANGE laryngienneFC-03
 LAWRENCE à dissection et à ligatureBC-13
 LEKSELL STILLE gougeDC-05
 LEMPERT gougeDC-03
 LERCHE à dissectionBA-04
 LESTER à fixationED-03
 LEWKOWITZ placentaire et pour post-abortumHC-07
 LISTER porte-éponges, sinusBG-11
 LISTON coupante à osDC-06
 LITTAUER auriculaireEE-08
 LITTAUER à épilerED-08
 LITTAUER à polypes nasauxEG-05
 LORNA à champsBE-04
 LOVE-GRUENWALD emporte-pièce p. laminectomie .EA-08
 LOVELACE pulmonaireFG-19
 LOWER pour les voies biliairesBC-14
 LUBET-BARBON à polypes nasauxEG-05
 LUCAE auriculaireEE-07
 LUC coupante nasaleEG-06
 LUER gougeDC-03
 LURZ urètreGC-10
 MAIER à pansementsBG-12
 MARSCHIK à amygdalesFA-04
 MARTEL pour cuir cheveluBC-08
 MARTIN à pansementsBG-02, BG-14
 MARTIN à sequestresDC-10
 MASTIN musculaireFE-04
 MATHIEU pour corps étrangersGG-07
 MAYO BLAKE pour calculs biliairesGC-04
 MAYO-GUYON pédicule rénalBC-16
 MAYO-ROBSON intestinaleGE-05
 McCLINTOCK placentaire et pour post-abortumHC-07
 McCULLOUGH à strabismeEC-13
 McGEE auriculaire microEE-10
 McINDOE à dissectionBA-04
 McKENZIE à poser clipsEA-02
 McPHERSON à ligaturesED-05
 McPHERSON TITAN à ligaturesED-05
 MEAD gougeDC-02
 MEEKER à dissection et à ligatureBC-13
 MICHEL pour agrafesCG-07
 Pince microBB-02
 Pince
 MIDDLETON-JANSEN coupante nasaleEG-09
 MIKULICZ à péritoineBC-17
 MILLIN porte-filGG-03
 MILLIN capsulaireGG-03
 MILLIN pour saisir lombeauxGG-03
 MIXTER pour calculs biliairesGC-04
 MIXTER pour voies biliairesBC-15
 MOORFIELD sutureED-05
 MOYNIHAN à champsBE-05
 MOYNIHAN pour voies biliairesBC-15
 MURPHY serre-tubesBC-19
 MUSEUX pour abaissement du col de l'utérusHA-33
 MYLES coupante nasaleEG-07
 NEGUS à amygdalesFA-03
 NELSON à dissectionBA-05
 NEUBÜSER pour saisir les trompesHA-51
 NOTO à polypes utérinsHA-36
 NOYES à polypes nasauxEG-05
 OLDBERG emporte-pièce pour laminectomieEA-09
 OLIVECRONA gougeDC-03
 OLIVECRONA-TOENNIS pour poser clipsEA-02
 OVERHOLT-GEISSENDOERFER à dissection et à ligatureBC-10
 PAUFIQUE à ligaturesED-05
 PAUFIQUE TITAN à ligaturesED-05
 PAYR-Baby clamp stomacaleGE-09
 PAYR clamp stomacaleGE-09
 PEERS BERTRAM à champsBE-03
 PEET à échardesBA-06
 PELKMANN à pansementsBG-12
 PHANEUF à péritoineDC-17
 plateDD-11
 POTTS-SMITH à dissectionBA-02
 pour fixerGG-10
 pour fixer le cordonGG-10
 POZZI pour l'abaissement du col de l'utérusHA-31
 PRATT pour l'abaissement du col de l'utérus.....HA-34
 jusque HA-35
 PRESBYTERIAN HOSPITAL serre-tubesBC-19
 PRICE-THOMAS pour les bronchesFG-22
 PRINCE musculaireED-02
 RADOLF pour extraire les onglesDD-03
 RAMPLEY porte-épongesBG-09
 RANDALL pour les calculs du bassin GC-11 jusque GC-12
 RANEY pour poser et enleverEA-03
 RICHTER-HEATH pour agrafesCG-07
 ROEDER à champsBE-03
 ROGGE à stérilisationCI-02
 ROSENBERG laryngienneFC-03
 ROWE pour la boucheEI-06
 RUBIN pour écraser la cloisonEG-07
 RUMEL thoraciqueBC-11
 RUSKIN gougeDC-04
 RUSKIN-LISTON coupante à osDC-06
 RUSSIAN à dissectionBA-04
 Pince
 ADSON BABY hémostatiqueBC-09
 ADSON hémostatiqueBC-09
 Pince
 SAENGER placentaire et pour post-abortumHC-07
 SAIRGES pour l'abaissement du col de l'utérusHA-32
 SAROT pour les bronchesFG-23
 SATINSKY pour anastomose(veina cava).....FG-24
 jusque FG-25
 Pince atraumatique pédiatrique vasculaireBD-43
 Pince
 SAUERBRUCH gougeDC-05
 SAUERBRUCH pour déchetsCI-03
 SAWTELL à amygdalesFA-03
 Pince
 BAINBRIDGE atraumatiqueBD-09
 BAINBRIDGE hémostatiqueBC-14
 BECK atraumatique vasculaire périphBD-25
 BENGOLEA hémostatiqueBC-09
 Pince
 SCAGLIETTI gougeDC-05
 Pince
 CASTANEDA atraumatique pour nouveaux-nés et enfantsBD-42
 CHAPUT hémostatiqueBC-08
 Pince
 SCHEINMANN laryngienneFC-03
 SCHNIDT à amygdalesFA-03
 SCHOENBURG à saisir les tissusGE-03

- SCHROEDER pour abaissement du col de l'utérus HA-31 jusqu'à HA-32
- SCHUBERT emporte-pièce pour le col de l'utérus HA-41
- SCHUMACHER emporte-pièce p. le col de l'utérus HA-43
- SCHUMACHER laryngienne FC-03
- SCHWEIGER capsulaire ED-04
- Pince
- COLLIN hémostatique BC-08
- COOLEY atraumatique BB-03, BD-35 jusqu'à BD-37, BD-39, BD-41
- COOLEY atraumatique pour anastomose BD-37, BD-40
- COOLEY atraumatique iliaque BD-37
- COOLEY atraumatique pédiatrique BD-38 jusqu'à BD-39
- COOLEY DERRA atraumatique p. anastomose BD-39
- COOLEY vasculaire BD-40
- CRAFOORD hémostatique pour bronches BC-12
- CRILE hémostatique BC-05
- CRILE-RANKIN hémostatique BC-05
- CRILE TITAN hémostatique BC-05
- DALE atraumatique vasculaire périph BD-24
- DANDY hémostatique BC-07
- DARDIK atraumatique BD-07
- DE BAKEY atraumatique BB-03
- DEBAKEY atraumatique BD-02, BD-08, BD-12
- DE BAKEY atraumatique BD-16 jusqu'à BD-17
- DEBAKEY atraumatique BD-20
- DE BAKEY atraumatique BD-28 jusqu'à BD-30
- DE BAKEY atraumatique à dissection et à ligature BD-25, BD-32
- DE BAKEY atraumatique pour l'anastomose BD-25
- DE BAKEY atraumatique pour anévrisme d'aorte BD-13, BD-15, BD-18
- DE BAKEY atraumatique pour les bronches BD-19
- DE BAKEY atraumatique iliaque BD-11
- DE BAKEY atraumatique vasculaire périph BD-06
- DEBAKEY BAHNSON atraumatique pour l'anévrisme d'aorte BD-14
- DE BAKEY MORRIS atraumatique BD-16
- DE BAKEY REYNOLDS atraumatique p. anastomose BD-30
- DEBAKEY SATINSKY atraumatique BD-22
- DERRA atraumatique pour anastomose et pédiatrie BD-28
- DIETRICH atraumatique BD-31
- Pince
- SEIFFERT laryngienne FC-03
- SEMB pour les bronches FG-23
- SEMB coupante à os DC-07
- SEMB gouge DC-06
- SEMKEN à dissection BA-05
- Pince serre-tubes BC-19
- Pince
- FERGUSON hémostatique BC-07
- GLOVER atraumatique BD-06, BD-30
- GLOVER atraumatique à coarctation BD-04
- GLOVER atraumatique pour anastomose BD-05
- GREGORY atraumatique pour profunda BD-33
- HALSTED-MOSQUITO atraumatique BD-02
- HALSTED-MOSQUITO hémostatique BC-04
- HALSTED-MOSQUITO micro hémostatique BC-04
- HALSTED-MOSQUITO TITAN hémostatique BC-04
- HARKEN atraumatique auriculaire BD-23
- HARTMANN hémostatique BC-03
- HEISS hémostatique BC-09
- Pince
- SIEGLER HELLMANN hystérolabes HA-38
- SIMS-MAIER à pansements BG-05
- SINGLEY à dissection BA-05
- Pince
- JAVID atraumatique pour carotis BD-32
- KELLY hémostatique BC-05
- KELLY-RANKIN hémostatique BC-05
- KELLY TITAN hémostatique BC-05
- Pince
- SKENE pour l'abaissement du col de l'utérus HA-31
- Pince
- KOCHER hémostatique délicate BC-06
- LAMBERT KAY atraumatique p. anastomose d'aorte BD-10
- LAMBERT KAY atraumatique iliaque BD-11
- LEES atraumatique pour les bronches BD-03
- LELAND JONES atraumatique vasculaire périph BD-08 jusqu'à BD-09
- LERICHE hémostatique BC-09
- LIDDLE atraumatique pour l'aorte BD-10
- LOVELACE hémostatique BC-07
- MAGILL pour introduire les sondes AE-06
- Pince
- SMITHWICK à poser clips EA-02
- Pince
- MIXTER BABY hémostatique pour les bronches BC-13
- MIXTER hémostatique BC-14
- MIXTER hémostatique pour les bronches BC-13
- MIXTER O'SHAUGNESSY hémostatique BC-14
- Pince
- SNELLEN entropion ED-06
- Pinces
- OCHSNER atraumatique pour l'aorte BD-31
- Pince
- SOMER hystérolabes HA-37
- Pince
- PEAN atraumatique BD-02
- PEAN hémostatique BC-08
- PEAN hémostatique délicate BC-06
- PENNINGTON hémostatique BC-07
- POTTS atraumatique BD-26 jusqu'à BD-27
- POTTS atraumatique à coarctation BD-04
- POTTS atraumatique pour anastomose BD-05
- PRATT hémostatique BC-08
- PROVIDENCE-HOSPITAL hémostatique BC-05
- Pince
- SPURLING emporte-pièce pour laminectomie EA-08
- Pince
- RANEY hémostatique pour le cuir chevelu EA-03
- RANKIN atraumatique BD-02
- ROBERTS hémostatique BC-11
- ROCHESTER-CARMALT hémostatique BC-07
- ROCHESTER-OCHSNER hémostatique BC-06
- ROCHESTER-PEAN hémostatique BC-06
- SAROT hémostatique pour les bronches BC-12
- SATINSKY atraumatique BD-20
- SPENCER-WELLS hémostatique BC-07
- SUBRAMANIAN atraumatique BD-31
- Pince
- STAUDE-MOORE pour l'abaissement du col de l'utérus.... HA-31
- STEVENS à iris EC-11
- STIEGLITZ à échardes BA-06
- STILLE à dissection BA-02
- STILLE-HORSLEY coupante à os DC-07
- STILLE-LISTON coupante à os DC-06
- STILLE-LUER gouge DC-04
- STILLE pédicule rénal BC-16
- STILLE-RUSKIN gouge DC-05
- St. MARTIN suture ED-05
- Pince
- TOENNIS hémostatique BC-11
- Pince
- STONE à fermer GE-06
- STONE-WATT intestinale GE-06
- STRUEMPEL auriculaire EE-08
- STRUYCKEN coupante nasale EG-07
- Pince
- TUFFIER hémostatique BC-08
- Pince vasculaire flexible BD-44 jusqu'à BD-45
- Pince

- SWEET pour poser clipsEA-02
- Pince
- WYLIE atraumatiqueBD-21
- Pince
- TEALE pour l'abaissement du col de l'utérusHA-33
- TERSON capsulaireED-04
- THOMS-ALLIS pour saisir les tissusGE-02
- THOMS-GAYLOR emporte-pièce pour le col de l'utérusHA-42
- TIEMANN pour l'abaissement du col de l'utérusHA-32
- TILLEY auriculaireEE-08
- TISCHLER-KEVORKIAN emporte-pièce pour le col de l'utérus
HA-44 jusque HA-45
- TISCHLER-MORGAN emporte-pièce pour le col de l'utérusHA-
43 jusque HA-44, HA-46
- TIVNEN à préhension amygdalienneFA-04
- TOHOKU à champsBE-04
- TOWNSEND emporte-pièce pour le col de l'utérusHA-44
- TOWNSEND-KEVORKIAN emporte-pièce pour le col de l'utérus
HA-44
- TOWNSEND-mini emporte-pièce pour le col de l'utérusHA-44
- TOWNSEND-MINI (BABY TISCHLER) emporte-pièce pour le col
de l'utérusHA-45
- TOWNSEND-TISCHLER emporte-pièce pour le col de l'utérus
HA-44
- TROELTSCH nasaleEG-04
- TROUTMAN Colibri à irisEC-13
- TROUTMAN rectusED-02
- Tübingen à irisEC-15
- Tübingen à ligaturesED-05
- Tübingen TITAN à irisEC-15
- Tübingen TITAN à ligaturesED-05
- TURNBULL pour les onglesHE-03
- TURREL emporte-pièce pour biopsieGI-05
- TYDING à préhension amygdalienneFA-04
- ULRICH porte-épongesBG-06
- UNIVERSAL à stérilisationCI-02
- USA à dissectionBA-02
- VAN BUREN à sequestresDC-10
- van DOREN emporte-pièce pour le col de l'utérusHA-42
- VIRTUS (RALK) à échardesBA-06
- WACHENFELDT pour agrafesCG-07
- WAGNER emporte-pièce pour laminectomieEA-09
- WALSHAM pour redresser cloisonEG-18
- WANGENSTEEN à dissectionBA-05
- WEIL-BLAKESLEY coupante nasaleEG-06
- WEISS serre-tubesBC-19
- WERTHEIM-CULLEN pour hystérectomieBC-18
- WERTHEIM pour hystérectomieBC-18
- WHITE à préhension amygdalienneFA-03
- WILDE (TROELTSCH) auriculaireEE-07
- WILLET-MARTELL pour cuir cheveluBC-08
- WILLIAMS pour saisir les tissusGE-03
- WINTER placentaire et pour post-abortumHC-07
- WITTNER emporte-pièce pour le col de l'utérusHA-43
- WOLFF pour rompre plâtreDA-04
- YEOMAN emporte-pièce pour biopsieGI-05
- YOUNG pour saisir la prostateGG-02
- YOUNG tire-langueEI-03
- ZAUFAL-JANSEN gougeDC-04
- ZENKER à dissection et à ligatureBC-12
- PIPER
- forceps obstétriqueHC-04
- forceps obstétrique avec dispositif de tractionHC-04
- Plaque JAEGER à paupièresEC-03
- Plaque pour tendre la peauAG-21
- Plateau
- en fil inoxHE-13
- en tôle perforéeHE-13
- pour instrumentsHE-08 jusque HE-09
- PLESTER
- couteau lobaireEE-14
- écarteurBI-14
- Poignée laryngoscope, fibres optiquesAE-11
- Poignée laryngoscope, standardAE-17
- Pointes carréesDD-08
- PERTHESDD-08
- POLITZER
- aiguille paracentèseEE-06
- couteau auriculaireEE-06
- insufflateur d'airEE-05
- POOLE tube d'aspirationAE-02
- Porte-aiguille
- ADSONCE-04
- ARRUGA pour l'ophtalmologieCE-06
- BARRAQUERCE-07
- BAUMGARTNERCE-02
- BOYNTON pour l'ophtalmologieCE-06
- BOZEMANNCE-03
- CASTROVIEJOCE-07
- COLLIERCE-02
- CRILECE-04
- CRILE-MURRAYCE-02
- CRILE-WOODCE-02
- DE BAKEYCE-03
- DERFCE-02
- DIETHRICH vasculaireCE-06
- FINOCHIETTOCE-04
- GILLIESCE-05
- HALSEYCE-02
- HEANEYCE-03
- HOESELCE-05
- JAMISONCE-03
- JOHNSONCE-04
- KALTCE-07
- KALT-ARRUGACE-07
- MASSONCE-03
- MATHIEUCE-05
- MAYO-HEGARCE-02
- METZENBAUMCE-04
- NEIVERTCE-02
- OLSEN-HEGARCE-05
- RYDERCE-03
- SAROTCE-04
- STEVENS pour ophtalmologieCE-06
- STRATTECE-04
- TOENNISCE-04
- WANGENSTEENCE-03
- POTTS DE MARTEL ciseaux vasculairesAI-27
- POTTS
- pince atraumatiqueBD-26 jusque BD-27
- pince atraumatique à coarctationBD-04
- pince atraumatique pour anastomoseBD-05
- POTTS-SMITH
- ciseaux vasculairesAH-19, AI-28
- pince à dissectionBA-02
- POZZI pince pour abaissement du col de l'utérusHA-31
- PRATT
- dilatateur pour col de l'utérusHA-29
- écarteur cystiqueGI-04
- pince pour abaissement du col de l'utérusHA-34 jusque HA-35
- pince hémostatiqueBC-08
- spéculum rectalGI-02
- PRESBYTERIAN HOSPITAL pince serre-tubesBC-19
- PRICE-THOMAS pince pour bronchesFG-22
- PRINCE
- ciseaux à amygdalesAI-27
- pince musculaireED-02
- Proctoscope KELLYGI-04
- Protecteur
- ARRUGAEC-08
- de tissu p.vis cannDD-15
- PROVIDENCE-HOSPITAL pince hémostatiqueBC-05

PUTTI rape à osDC-25

Q

QUATTRO écarteur pour plâtreDA-03
 QUINBY ciseaux à gencivesAI-42
 QUINKE aiguille à ponctionCC-03
 QUIRE levier pour corps étrangersEE-08
 QUISLING mailletDC-18

R

RADOLF pince pour extraire les onglesDD-03
 RALK perforateur à mainDD-05
 Rallonge BRUENINGS courbeFC-03
 RAMPLEY pince porte-épongesBG-09
 RANDALL
 curette aspirante pour biopsie de l'utérusHA-40
 pince pour les calculs du bassinGC-11 jusqu'à GC-12
 RANEY
 pince pour poser et enleverEA-03
 pince hémostatique pour le cuir cheveluEA-03
 RANKIN pince atraumatiqueBD-02
 Rape
 à osDC-25
 FOMON nasaleEG-15 jusqu'à EG-16
 GALLAHER pour le sinusEG-16
 JOSEPH (LEWIS) nasaleEG-15
 MALTZ (COTTLE) nasaleEG-15
 MALTZ nasaleEG-14
 PUTTI à osDC-25
 WIENER (AUFRIEHT) nasaleEG-15
 WIENER nasaleEG-15
 Rapprocheur
 BAILEY-BABY pour les côtesFG-18
 BAILEY pour les côtesFG-18
 BAILEY-GIBBON pour les côtesFG-18
 SELLORS pour les côtesFG-18
 RasoirAG-14, AG-19
 RECAIMER curette utérineHA-49 jusqu'à HA-50
 Récipient cylindriqueHE-08
 Rectoscope lumière froideGI-03
 Règle en métalAC-08
 REICHERT dépresseur pour épiglottisFC-02
 REINER
 couteau pour plâtreDA-04
 seringue auriculaireEE-05
 Rétracteur PERCY à amputationDD-03
 REVERDIN
 aiguille à ligaturesCG-03
 écarteurBI-04
 REYNOLDS ciseauxAH-15, AI-18
 RachiotomeDC-17
 RIBBON écarteurBI-04
 RICHARDSON-EASTMAN écarteurBI-04
 RICHARDSON écarteurBI-04
 RICHARDSON Grip écarteurBI-04
 RICHTER-HEATH pince pour agrafesCG-07
 RIGBY écarteur abdominalBI-24
 ROBB dissecteur vasculaireFG-33
 ROBERTS pince hémostatiqueBC-11
 ROCHESTER-CARMALT pince hémostatiqueBC-07
 ROCHESTER-OCHSNER pince hémostatiqueBC-06
 ROCHESTER-PEAN pince hémostatiqueBC-06
 ROEDER pince à champsBE-03
 ROGER élévateur pour la cloison nasaleEG-11
 ROGGE pince à stérilisationCI-02
 ROLLET
 ciseaux à extirpationEC-06
 écarteurEC-06
 ROSE écarteur trachéalFE-03

ROSEN

aiguilleEE-14 jusqu'à EE-15
 ROSENBERG pince laryngienneFC-03
 ROSEN
 couteau circulaireEE-14
 ROSER-KOENIG ouvre-boucheEI-03
 ROUX Baby écarteurBI-02
 ROUX écarteurBI-02
 ROUX mini écarteurBI-02
 ROWE pince pour la boucheEI-06
 Ruban métriqueAC-08
 RUBIN pince pour écraser la cloisonEG-07
 Rugine
 ALEXANDER raspatoireDC-19
 DOYEN raspatoire pour les côtesDC-20
 FARABEUF raspatoireDC-19
 KUHNHORN cornéenEC-05
 LAMBOTTE raspatoireDC-19
 LANGENBECK raspatoireDC-19
 MATSON raspatoireDC-21
 OVERHOLT raspatoireDC-21
 SADILLOT raspatoireDC-19
 SEMB raspatoireDC-20
 WILLIGER raspatoireDC-19
 RUMEL pince thoraciqueBC-11
 RUSKIN-LISTON pince coupante à osDC-06
 RUSKIN pince gougeDC-04
 RUSSIAN pince à dissectionBA-04
 RYDEL-SEIFFER diapasonEE-04
 RYDER porte-aiguilleCE-03

S

SAALFELD tire comédonsHE-02
 SACHS
 dissecteur duremèreEA-05
 écarteur à nerfsEA-04
 SADILLOT rugine raspatoireDC-19
 SAENGER pince placentaire et pour post-abortumHC-07
 SAIRGES pince pour l'abaissement du col de l'utérusHA-32
 Salpingographe SCHULTZEHA-47
 SANVENERO ciseauxAH-13, AI-16
 SAROT
 pince pour les bronchesFG-23
 pince hémostatique pour les bronchesBC-12
 porte-aiguilleCE-04
 SATINSKY
 ciseaux thoraciquesAI-37
 pince pour l'anastomose (veine cave)FG-24 jusqu'à FG-25
 pince atraumatiqueBD-20
 SATO couteau cornéenEC-05
 SAUERBRUCH
 boîte pour aiguilleHE-02
 costotomeFG-05
 écarteurBI-13
 SAUERBRUCH-FREY costotomeFG-06
 SAUERBRUCH
 pince gougeDC-05
 pince pour déchetsCI-03
 SAWTELL pince à amygdalesFA-03
 SCAGLIETTI pince gougeDC-05
 Scarificateur GRAEFEEC-04
 SCHAMBERG tire comédonsHE-02
 SCHEDE curetteDC-12
 SCHEIE
 canule oculaireED-07
 couteau à goniectomieEC-05
 SCHEINMANN pince laryngienneFC-03
 SCHERBAK spéculum vaginalHA-21
 SCHIMMELBUSCH tambours à stérilisationHE-12
 SCHINK dermatomeAG-21

- SCHIOETZ tonomètre tonomet.echell.obli. .ED-08
SCHMIEDEN-PAYR sonde conductrice .CG-04
SCHMIEDEN sonde conductrice .CG-04
SCHMIEDEN-TAYLOR ciseaux .AI-36
SCHNIDT pince à amygdales .FA-03
SCHOENBORN écarteur pour la thyroïde .FE-04
SCHOENBURG pince pour saisir les tissus .GE-03
SCHROEDER
curette utérine .HA-48
pince pour abaissement du col de l'utérus HA-31 jusque HA-32
SCHUBERT pince emporte-pièce pour le col de l'utérus .HA-41
SCHUKNECHT
couteau circulaire .EE-14
couteau serpette .EE-14
SCHULTZE salpingographe .HA-47
SCHUMACHER
cisaille à sternum .FG-07
ciseaux pour cordon ombilical .AI-34
pince emporte-pièce pour le col de l'utérus .HA-43
pince laryngienne .FC-03
SCHWEIGGER pince capsulaire .ED-04
Scie
BERGMANN pour plâtre .DA-02
CHARRIERE à amputation .DD-03
ENGEL pour plâtre .DA-02
JOSEPH nasale .EG-17
LANGENBECK à doigts .DD-03
OLIVECRONA .EA-05
Scie oscillante pour plâtre .DA-05 jusque DA-06
Scie
WIGMORE pour plâtre .DA-02
Sclerotome
GUYTON-LUNDSGAARD .EC-05
LUNDSGAARD .EC-05
Seaux pour déchets .HE-11
SEEMANN-SEIFFERT ouvre-bouche .EI-04
SEGOND évideur pour fibromes .HA-46
SEIFFERT pince laryngienne .FC-03
SELLHEIM levier pour abaisser la tête .HC-09
SELLORS Rapprocheur des côtes .FG-18
SEMB
davier porte-os .DC-07
pince pour bronches .FG-23
pince coupante à os .DC-07
pince gouge .DC-06
rugine raspatoire .DC-20
SEMKEN pince à dissection .BA-05
SEMM spéculum vaginal .HA-07
SENN écarteur .BI-04
SENN-GREEN écarteur .BI-07
Seringue
à amygdales .FA-05
REINER auriculaire .EE-05
Serre-noeud
BRUENINGS .FA-04
EVES .FA-04
Serre-noeud
KRAUSE auriculaire .EE-07
Serre-noeud
KRAUSE nasal .EG-09
TYDING .FA-05
Serre-noeud
WESTON à polypes rectaux .GI-05
WILDE auriculaire .EE-07
Serre-noeud
WILDE nasal .EG-09
Set à autopsie .DC-17
SEUTIN ciseaux pour plâtre .DA-02
SEXTON couteau auriculaire .EE-06
SHEA ciseaux auriculaires micro .EE-09
SHORTBENT ciseaux à ligatures .AI-40
SIEBOLD ciseaux gynécologiques .AH-21, AI-32
SIEGLER HELLMANN pince hystérolabe .HA-38
SIEGLE spéculum auriculaire .EE-02
SILVER
ciseau-burin pour la plastique nasale .EG-14
dermatome .AG-20
SIMCOE canule à suture .ED-07
SIMON
curette .DC-13
curette utérine .HA-48
écarteur .BI-12
SIMPSON-BRAUN forceps obstétrique .HC-02
SIMPSON forceps obstétrique .HC-02
SIMPSON-LUIKART forceps obstétrique .HC-03
SIMS
ciseaux gynécologiques .AH-21, AI-32
curette utérine .HA-49 jusque HA-50
dépresseur utérin .HA-39
dilatateur pour le col de l'utérus .HA-30
hystéromètre .HA-39
SIMS-MAIER pince à pansements .BG-05
SIMS
spéculum rectal .GI-02
spéculum vaginal .HA-17
SINGLEY pince à dissection .BA-05
SKENE pince pour l'abaissement du col de l'utérus .HA-31
SLUDER-BALLENGER amygdalotome .FA-05
SMELLIE
Crochet pour les accouchements .HC-06
perce-crâne .HC-09
SMILLIE méniscotome .DC-24
SMITH blépharostat .EC-02
SMITH-BUIE dilatateur pour anus et rectum .GI-03
SMITH-PETERSEN
ciseaux-burin .DC-15
gouge .DC-15
SMITH US ARMY ciseaux à bandages .AI-44
SMITHWICK
écarteur à nerfs .EA-04
pince pour poser clips .EA-02
SNELLEN
anse .EC-08
pince entropion .ED-06
SOMER pince hystérolabe .HA-37
Sonde .CA-02
BRUNNER conductrice .CG-04
DESJARDINS pour calculs biliaires .GC-05
DOYEN .CA-02
HARTMANN auriculaire .EE-06
ITARD auriculaire .EE-06
KILLIAN .EG-09
KIRSCHNER conductrice .CG-04
KOENIG conductrice .CG-04
MAYO pour les calculs du bassin .GC-10
métallique pour femmes .GG-16
métallique pour hommes .GG-16
MOYNIHAN pour calculs biliaires .GC-05
NABATOFF auriculaire en argent .CA-02
PAYR conductrice .CG-04
SCHMIEDEN conductrice .CG-04
SCHMIEDEN-PAYR conductrice .CG-04
STACKE auriculaire en argent .CA-02
Spatule .CA-03
ALLISON pulmonaire .FG-19
BANGERTER cyclodialyse .EC-08
CASTROVIEJO cyclodialyse .EC-08 jusque EC-09
CULLER à iris .EC-08
ELSCHNIG cyclodialyse .EC-08
KOCHER à goitre .FE-04
KOCHER vésicale .GG-04
LEGUEU vésicale .GG-04

- pour la tunique interneFG-32
- Spatule
CUSHING cérébraleEA-07
HEIFETZ cérébraleEA-07
OLIVECRONA cérébraleEA-07
- Spatule
WECKER à irisEC-08
WELLS à énucléationEC-08
WHEELER cyclodialyseEC-09
- Spéculum
AUVARD vaginalHA-19
- Spéculum
BARR rectalGI-02
- Spéculum
BERLIND-AUVARD vaginalHA-19
- Spéculum
BODENHAMMER rectalGI-02
BOUCHERON auriculaireEE-02
- Spéculum
BRAUN vaginalHA-16
BREISKY vaginalHA-20
- Spéculum
BRUENINGS auriculaireEE-02
- Spéculum
COLLIN vaginalHA-04
- Spéculum
COTTLE nasalEG-03
- Spéculum
CUSCO vaginalHA-04 jusqu'à HA-06
- Spéculum
CZERNY rectalGI-02
- Spéculum
DOYEN vaginalHA-18, HA-20
FREEWAY-GRAVE vaginalHA-06
GRAVE vaginalHA-02
- Spéculum
GRUBER auriculaireEE-02
HARTMANN auriculaireEE-02
HARTMANN-HALLE nasalEG-02
- Spéculum
JACKSON vaginalHA-16
KALLMORGEN vaginalHA-15
- Spéculum
KILLIAN cloisonEG-03
KOGAN endosHA-23
- Spéculum
KRISTELLER vaginalHA-09 jusqu'à HA-14
LANDAU vaginalHA-22
- Spéculum
MATHIEU rectalGI-02
- Spéculum
O'SULLIVAN-O'CONNOR vaginalHA-08
PEDERSON vaginalHA-03
- Spéculum
PRATT rectalGI-02
- Spéculum
SCHERBAK vaginalHA-21
SEMM vaginalHA-07
- Spéculum
SIEGLE auriculaireEE-02
SIMS rectalGI-02
- Spéculum
SIMS vaginalHA-17
STEINER-AUVARD vaginalHA-19
- Spéculum
THUDICHUM nasalEG-02
TIECK-HALLE nasalEG-03
TOYNBEE auriculaireEE-02
- Spéculum
TRELAT vaginalHA-07
- Spéculum
VIENNA nasalEG-02
VOLTOLINI nasalEG-02
- Spéculum
WEISSBARTH vaginalHA-22
- Spéculum
YANKAUER nasopharyngienEG-04
- SPENCER ciseaux à ligaturesAI-40
SPENCER-WELLS pince hémostatiqueBC-07
Sphérique électrode pour la coagulationJA-03
SPRATT curetteDC-12
SPURLING pince emporte-pièce pour laminectomieEA-08
STACKE sonde auriculaire en argentCA-02
STAUDE-MOORE pince pour l'abaissement du col de l'utérusHA-31
St. CLAIR-THOMSON couteauEG-19
STEINER-AUVARD spéculum vaginalHA-19
STEINMANN clou à osDD-09
STELZNER ciseaux à rectumAI-38
STERNBERG écarteur pour lèvres et jouesEI-02
- Stéthoscope
BOWLESAC-06
- Stéthoscope duplexAC-06
- Stéthoscope
FORDAC-06
FORD BOWLESAC-06
PINARDAC-06
- STEVENS
ciseaux à ténotomieAH-17, AI-23
crochetEC-06
- STEVENSON blépharostatEC-03
- STEVENS
pince à irisEC-11
porte-aiguille pour l'ophtalmologieCE-06
- STIEGLITZ pince à échardesBA-06
- STILLE
ciseau-burinDC-14
ciseaux pour plâtreDA-02
costotomeFG-03
gougeDC-14
STILLE-HORSLEY pince coupante à osDC-07
STILLE-LISTON pince coupante à osDC-06
STILLE-LUER pince gougeDC-04
- STILLE
ostéotomeDC-14
perforateur à mainDD-04
pince à dissectionBA-02
pince pédicule rénalBC-16
- STILLE-RUSKIN pince gougeDC-05
STILLE-SHERMAN perforateur à mainDD-04
- St. MARTIN pince à sutureED-05
- STOCKMANN compresseur de l'urètreGG-10
- STONE pince pour fermerGE-06
STONE-WATT pince intestinaleGE-06
- STRATTE porte-aiguilleCE-04
- STRAUSS compresseur de l'urètreGG-10
- StrippersCA-03
- STRUEMPPEL pince auriculaireEE-08
- STRULLY ciseaux neurochirurgicauxAI-35
- STRUYCKEN pince coupante nasaleEG-07
- Styilet
BOWMAN pour canal lacrymalEC-10
DIMEDACA-03
FARRELCA-03
JOBSON-HORNECA-03
TOBOLDCA-03
UCKERMANNCA-03
- SUBRAMANIAN pince atraumatiqueBD-31
- Support MILLIN lumière froideGG-05
- SWEET pince pour poser clipsEA-02
- Système de fixation LEYLAEA-14 jusqu'à EA-18

T

- TABB couteau serpenteEE-14
Tambour
 KONRICH à stérilisationHE-12
 SCHIMMELBUSCH à stérilisationHE-12
Taraud pour vis canuléesDD-15
Tarmis pour spéculum vaginalHA-22
TARNIER
 cranioclasteHC-09
 forceps obstétrique avec dispositif de tractionHC-05
TAYLOR
 écarteur spinalDC-24
 marteau perceurAC-07
TEALE pince pour abaissement du col de l'utérusHA-33
Tendeur
 à brochesDD-10
 LOUTE serre-filDD-11
TensiomètreAC-02
TERSON pince capsulaireED-04
THOMS-ALLIS pince pour saisir les tissusGE-02
THOMS-GAYLOR pince emporte-pièce pour le col de l'utérusHA-42
THOMSON-WALKER écarteur vésicalGG-06
THOREK ciseaux pulmonairesAI-36
THUDICHUM spéculum nasalEG-02
TIECK-HALLE spéculum nasalEG-03
TIEMANN pince pour abaissement du col de l'utérusHA-32
TILLEY pince auriculaireEE-08
Tire
 SAALFELD comédonsHE-02
 SCHAMBERG comédonsHE-02
 UNNA comédonsHE-02
 WALTON comédonsHE-02
TISCHLER-KEVORKIAN pince emporte-pièce pour le col de l'utérusHA-44 jusqu'à HA-45
TISCHLER-MORGAN pince emporte-pièce pour le col de l'utérusHA-43 jusqu'à HA-44, HA-46
TIVNEN pince à préhension amygdalienneFA-04
TOBOLD
 abaisse-langueEI-02
 styletCA-03
TOENNIS-ADSON ciseaux neurochirurgicauxAI-35
TOENNIS
 dissecteur duremèreEA-05
 pince hémostatiqueBC-11
 porte-aiguilleCE-04
TOHOKU pince à champsBE-04
Tonomètre SCHIOETZ tonomet.echell.obli.ED-08
TOOK couteau cornéenEC-05
TOTI fraiseDD-07
Tourne-vis
 hexagonalDD-14
 LANEDD-14
Tournevis pour vis canuléesDD-15
Tourne-vis
 WILLIAMSDD-14
TourniquetAC-03
TOWNSEND-KEVORKIAN pince emporte-pièce pour le col de l'utérusHA-44
TOWNSEND-MINI (BABY TISCHLER) pince emporte-pièce pour le col de l'utérusHA-45
TOWNSEND-mini pince emporte-pièce pour le col de l'utérusHA-44
TOWNSEND pince emporte-pièce pour le col de l'utérusHA-44
TOWNSEND-TISCHLER pince emporte-pièce pour le col de l'utérusHA-44
TOYNBEE spéculum auriculaireEE-02
Tracteur
 BARTON pour manches ordinairesHC-04
 BILL pour manches ordinairesHC-05
 DOYEN pour fibromesHA-46
 LUIKART-BILL pour manches ordinairesHC-05
Traction CRUTCHFIELD crânienneEA-03
TRAUBE marteau perceurAC-07
TRELAT spéculum vaginalHA-07
TrépanDD-04
 CASTROVIEJO cornéenED-07
 ELLIOT cornéenED-08
 FRANCESCHETTI cornéenED-07
Trépan KEYES cutanéenHE-02
TrocartCC-02
 COAKLEYCC-02
 DOUGLASCC-02
 FLEURANTCC-02
 LICHTWITZCC-02
 MENGHINICC-03
 NELSONCC-02
 OCHSNERCC-02
 PIERCECC-02
 UCKERMANN trachéalFE-02
 UNIVERSALCC-02
TROELTSCH pince nasaleEG-04
TROEMNER marteau perceurAC-07
Trousse à manucure pour les infirmièresHE-03
TROUSSEAU dilateur trachéalFE-02
Trousse de diagnosticAC-04
Trousse mini à poche et à sutureCG-08
Trousse standard à poche et à sutureCG-08
TROUTMAN-CASTROVIEJO ciseaux microAJ-07
TROUTMAN-CHRIS casse-lamesAG-14
TROUTMAN Colibri pince à irisEC-13
TROUTMAN pince rectusED-02
TUBBS dilateur valve mitraleFG-27
Tube
 ANDREWS-PINCHON d'aspirationAE-03
 BUIE d'aspirationGI-05
 DE BAKEY d'aspirationAE-04
 FRAZIER d'aspirationEA-07
 MAGILL d'aspirationAE-04
 NUBOER d'aspirationAE-05
 POOLE d'aspirationAE-02
 WALTON YANKAUER d'aspirationAE-03
 YANKAUER d'aspirationAE-02
Tübingen
 canule airED-07
 pince à irisEC-15
 pince à ligaturesED-05
Tübingen TITAN
 pince à irisEC-15
 pince à ligaturesED-05
TUFFIER
 écarteur pour les côtesFG-16
 pince hémostatiqueBC-08
TURNBULL pince à onglesHE-03
TURREL pince emporte-pièce pour biopsieGI-05
TYDING
 pince à préhension amygdalienneFA-04
 serre-noeudFA-05
U
UCKERMANN
 styletCA-03
 trocart trachéalFE-02
ULRICH pince porte-épongesBG-06
UNIVERSAL
 ciseaux à bandagesAI-50
 ciseaux à fils et à plaquesAI-42
 pince à stérilisationCI-02
 trocartCC-02
UNNA tire comédonsHE-02
Uréthrotome OTISGG-08
UrinalHE-10

F

Index Français

- USA
 cordon électrobistourisJA-07
 USA MODEL ciseaux pour le cordon ombilicalAI-34
 USA
 pince à dissectionBA-02
 US Army (PARKER-LANGENBECK) écarteurBI-03
- V**
- VALLEIX hystéromètreHA-39
 Valve
 BALFOURBI-22
 CASPARBI-20
 CASPAR pour colonne vertébraleBI-19
 KIRSCHNERBI-23
 VAN BUREN
 bougie urétraleGG-13
 pince à sequestresDC-10
 Van DOREN pince emporte-pièce pour le col de l'utérus HA-42
 VANNAS
 ciseaux à iridectomieAJ-05
 ciseaux microAJ-12 jusqu'à AJ-13
 VARIFOCAL ophtalmoscopeAC-03
 Vase à médicamentsHE-07
 Valve
 KALLMORGEN vaginaleHA-15
 KRISTELLER vaginaleHA-09 jusqu'à HA-14
 VERBRUGGE davier porte-osDC-09
 VERRES aiguille à ponction pneumopéritoineCC-03
 VIENNA spéculum nasalEG-02
 VIRCHOW
 burin pour le crâneDC-17
 couteau à cartilageAG-18
 couteau pour le cerveauAG-18
 VIRTUS (RALK) pince à échardesBA-06
 VOLKMANN
 curetteDC-12 jusqu'à DC-13
 écarteurBI-07 jusqu'à BI-08
 VOLTOLINI spéculum nasalEG-02
- W**
- WACHENFELDT pince pour agrafesCG-07
 WADSWORTH-TODD cautèreEC-08
 WAGENER crochet auriculaireEE-07
 WAGENER-MOSHER canule trachéaleFE-03
 WAGNER
 ciseauxAH-22
 ciseaux à gencivesAI-42
 pince emporte-pièce pour laminectomieEA-09
 WALDMANN ciseaux à épisiotomieAI-34
 WALLICH curette placentaire et pour post-abortumHC-08
 WALSHAM pince pour redresser cloisonEG-18
 WALTHER bougie urétraleGG-17
 WALTON
 gouge pour corps étrangersEC-06
 tire comédonsHE-02
 WALTON YANKAUER tube d'aspirationAE-03
 WANGENSTEEN
 pince à dissectionBA-05
 porte-aiguilleCE-03
 WARTENBERG aesthésiomètreAC-08
 WATSON-CHEYNE élévateurDC-22
 WATSON dermatomeAG-22
 WEBER anseEC-08
 WECKER
 ciseaux à irisAJ-04
 spatule à irisEC-08
 WEEK blépharostatEC-02
 WEIL-BLAKESLEY pince coupante nasaleEG-06
 WEISSBARTH spéculum vaginalHA-22
- WEISS pince serre-tubesBC-19
 WEITLANER écarteurBI-14
 WEITLANER-WULLSTEIN écarteurBI-14
 WELLS spatule à énucléationEC-08
 WERTHEIM
 ciseaux préparationAI-32
 WERTHEIM-CULLEN pince pour hystérectomieBC-18
 WERTHEIM
 Pince pour hystérectomieBC-18
 WEST
 ciseaux-burin nasalEG-14
 WESTCOTT
 ciseaux à iridectomieAJ-02
 ciseaux à tendonsAJ-02
 WEST
 gouge nasaleEG-14
 WESTON serre noeud à polypes rectauxGI-05
 WHEELER
 couteau à discisionEC-04
 spatule à cyclodialyseEC-09
 WHITEHEAD ouvre-boucheEI-04
 WHITE pince à préhension amygdalienneFA-03
 WIEDER abaisse-langueEI-02
 WIENER (AUFRIECHT) rape nasaleEG-15
 WIENER
 crochet à irisEC-06
 rape nasaleEG-15
 WIGMORE scie pour plâtreDA-02
 WILDER
 anseEC-08
 dilateur pour canal lacrymalEC-10
 WILDE
 Serre-noeud auriculaireEE-07
 serre-noeud nasalEG-09
 WILDE (TROELTSCH) pince auriculaireEE-07
 WILLET-MARTELL pince cuir cheveluBC-08
 WILLIAMS
 blépharostatEC-02
 pince pour saisir les tissusGE-03
 tourne-visDD-14
 WILLIGER
 curetteDC-13
 mailletDC-18
 rugine raspatoireDC-19
 WINKELMANN Instrument de circoncisionGG-09
 WINTER pince placentaire et pour post-abortumHC-07
 WITTNER pince emporte-pièce pour le col de l'utérusHA-43
 WOLFF pince pour rompre plâtreDA-04
 WRIGLEY forceps obstétriqueHC-02
 WULLSTEIN
 ciseaux auriculaires microEE-11
 ciseaux auriculaires micro miniEE-11
 couteau serpetteEE-14
 WYLIE
 dilateur pour col de l'utérusHA-30
 pince atraumatiqueBD-21
- Y**
- YANKAUER
 spéculum nasopharyngienEG-04
 tube d'aspirationAE-02
 YASARGIL ciseaux microAJ-10 jusqu'à AJ-11
 YEOMAN pince emporte-pièce pour biopsieGI-05
 YOUNG Boomerang aiguille à ligaturesCG-03
 YOUNG
 écarteur pour la prostateGG-02
 pince pour saisir la prostateGG-02
 pince tire-langueEI-03

Z

ZAUFAL-JANSEN pince gougeDC-04
ZENKER pince à dissection et à ligatureBC-12
ZIEGLER	
blépharostatEC-03
couteau à capsulotomieEC-05
couteau à iridectomieEC-04
dilatateur pour canal lacrymalEC-10
miroir frontalAC-05

S

Índice alfabético Español

S

S

A

- Abajalengua
 ANDREWEI-02
 BRUENINGSEI-02
 BUCHWALDEI-02
 FRENZELEI-02
 HARTMANNEI-02
 maderaEI-02
 McIVOREI-05
 TOBOLDEI-02
 WIEDEREI-02
 Abertura BROCK dilatador para válvula mitralFG-26
 Abreboca
 DAVIS-BOYLEEI-04
 DENHARTEI-03
 DOYEN-JANSENEI-03
 HEISTEREI-03
 JENNINGSEI-04
 KILNER-DOUGHTYEI-05
 McIVOREI-05
 ROSER-KOENIGEI-03
 SEEMANN-SEIFFERTEI-04
 WHITEHEADEI-04
 Accesorios para contenedores
 para esterilizaciónHE-38 hasta HE-41
 Adenotomo LAFORCEEG-19
 ADLERKREUTZ pinza de disecciónBA-04
 ADSON BABY
 pinza hemostáticaBC-09
 ADSON Baby
 separadorBI-15
 ADSON-BROWN pinza de disecciónBA-03
 ADSON
 elevadorDC-21
 gancho para nerviosEA-04
 pinza de disecciónBA-03
 pinza gubiaDC-03
 pinza hemostáticaBC-09
 pinza micro de disecciónBA-03
 pinza para hipófisisEA-06
 porta-agujaCE-04
 separadorBI-15
 AEBLI tijera para cornealAI-22
 AESCULAP cable electrobisturíasJA-07
 Aguja
 amígdalasFA-05
 BARBARAEE-14
 BOWMAN para discisionEC-05
 COOPER para ligadurasCG-02
 DAVIS para cuerpos extrañosEC-05
 DESCHAMPS para ligadurasCG-02
 DIXEC-09
 electrodoJA-03
 electrodo miniJA-02
 FRANCIS para cuerpos extrañosEC-05
 FRANKLIN-SILVERMANN para punciónCC-03
 KEITH para suturaCG-06
 KOENIG para suturaCG-06
 KRONECKER para ligadurasCG-02
 LEVINSON para cuerpos extranjEC-05
 LICHTWITZEG-09
 NELSON para ligadurasCG-02
 para catarataEC-05
 para cuerpos extrañosEC-05
 Aguja para suturaCG-05 hasta CG-06
 Aguja
 POLITZER paracentesisEE-06
 QUINKE para punciónCC-03
 REVERDIN para ligadurasCG-03
 ROSENEE-14 hasta EE-15
 VERRES para punción, neumoperitoneoCC-03
 YOUNG Boomerang para ligadurasCG-03
 ALAN-PARKS separadore rectalesGI-03
 ALBEE fresaDD-07
 ALEXANDER
 cincelDC-14
 gubiaDC-14
 periostótomoDC-19
 pinza sacabocado para el cuello del úteroHA-42
 ALLIS-ADAIR pinza para tejidosGE-02
 ALLIS-Baby pinza para tejidosGE-02
 ALLISON espátula pulmónFG-19
 ALLIS pinza para tejidosGE-02
 ALM separadorBI-14
 ALVIS cureta para cuerpos extrañosEC-06
 Amigdalotomo SLUDER-BALLENGERFA-05
 Amniótomo BEACHAMHA-39
 ANDREW abajalenguaEI-02
 ANDREWS-PINCHON tubo de aspiraciónAE-03
 Anoscopio
 HIRSCHMANNGI-04
 IVES-FANSLERGI-04
 Aparato PETZ para suturar
 estomacales e intestinalesGE-09
 Aproximador
 BAILEY-BABY para costillasFG-18
 BAILEY-GIBBON para costillasFG-18
 BAILEY para costillasFG-18
 SELLORS para costillasFG-18
 ARCHER pinza para espinasBA-06
 ARKANSAS Piedra afiladoraAG-19
 ARLT asaEC-08
 ARRUGA
 blefarostatoEC-02
 gancho para extracionEC-06
 pinza capsularesED-04
 porta-aguja de oftalmologíaCE-06
 protectorEC-08
 Asa
 amígdalasFA-04
 ARLTEC-08
 auricularesEE-07
 BILLEAU auricularesEE-07
 Asa de alambre electrodoJA-03
 Asa de cinta electrodoJA-03
 Asa
 electrodo miniJA-02 hasta JA-03
 para nasalesEG-09
 SNELLENEC-08
 WEBEREC-08
 WILDEREC-08
 ASCH pinza enderezar tabiqueEG-18
 AUFRICT separador para nasalesEG-17
 AUVARD espéculo vaginalesHA-19
 AXENFELD cucharilla para chalazionEC-07
 AYER pinza chalaziónED-06
 B
 BABCOCK pinza para tejidosGE-02
 BABINSKY martillos de percusiónAC-07
 BACKHAUS-CLIP pinza para campos
 con porta-tuboBE-03
 BACKHAUS KOCHER pinza para camposBE-02
 BACKHAUS pinza para camposBE-02
 BAGGISH pinza sacabocado
 para el cuello del úteroHA-45
 BAILEY aproximador para costillasFG-18
 BAILEY-BABY aproximador para costillasFG-18
 BAILEY-GIBBON aproximador para costillasFG-18
 BAINBRIDGE

pinza atraumatica.....	BD-09	pinza gubia	DC-04
pinza hemostática	BC-14	pinza sacabocado.....	EG-08
BAKES dilatador para conducto biliar	GC-06	BILLEAU asa auriculares	EE-07
BALFOUR Baby separador abdominales	BI-22	BILL tractor adecuada	
BALFOUR		para todas las pinzas con mango	HC-05
separador abdominales	BI-22	BIRCHER-GANSKE pinza para huesos	DC-10
valva	BI-22	BIRCHER meniscotomo	DC-24
BALL AND SOCKET pinza para campos	BE-04	BISHOP-HARMAN pinza para iris	EC-14
BALLENGER		Bisturi	
cuchillo	EG-11	CONVERSE para nasales	EG-10
elevadores tabique	EG-12	electrodo	JA-03
pinza coger amígdalas.....	FA-04	Bisturías para disección.....	AG-15
Bandeja		Bisturías PARKER para disección	AG-15
de alambre	HE-13	Bisturi	
de chapa de acero perforada.....	HE-13	FREER mucosa	EG-10
para instrumento	HE-08 hasta HE-09	HALLE para duramadre	EA-06
BANGERTER espátula ciclodialálisis	EC-08	JOSEPH para nasales.....	EG-10
BARANY ensordecedor.....	EE-04	JOSEPH romo	EG-10
BARBARA		MALTZ cartilage acodado	EG-11
aguja.....	EE-14	SEGOND para fibroma	HA-46
ganchito.....	EE-14	BLAKE	
pick.....	EE-14 hasta EE-15	cureta uterinas	HA-48
BARKAN cuchillo para goniotomía	EC-05	pinza para cálculos biliares	GC-03
BARNHILL cuchillo.....	EG-19	Blefarostato	
Barra GERSTER de tracción	DC-11	ARRUGA.....	EC-02
BARRAQ.KATZIN pinza para iris.....	EC-13	BARRAQUER Colibri	EC-02
BARRAQU Colibri pinza para iris.....	EC-13	BOWMAN.....	EC-02
BARRAQUER Colibri blefarostato	EC-02	CASTROVIEJO.....	EC-03
BARRAQUER		CLARK	EC-02
cuchillo para queratoplastico	EC-05	CRITCHETT	EC-02
pinza cámara anterior	ED-02	GOLDSTEIN	EC-03
pinza depilatorias	ED-08	GRAEFE	EC-02
pinza fijación	ED-03	LANCASTER.....	EC-03
porta-aguja	CE-07	LISTER-BURCH.....	EC-02
tijeras de colibri.....	AJ-04	MELLINGER	EC-02
BARR espéculo rectales	GI-02	MELLINGER-AXENFELD	EC-02
BARRETT pinza pra coger el cuello de útero.....	HA-32	MUELLER	EC-03
BARTON		MURDOCK.....	EC-02
pinza obstétricas.....	HC-04	PARK.....	EC-03
tractor adecuada para todas las pinzas con mango	HC-04	SMITH.....	EC-02
BAUMGARTNER porta-aguja	CE-02	STEVENSON	EC-03
BEACHAM amniótomo.....	HA-39	WEEK	EC-02
Vaso	HE-10	WILLIAMS	EC-02
BECKER quistotomo.....	EC-06	ZIEGLER.....	EC-03
BECKMANN-ADSON separador	BI-15	BLOHMKE pinza coger amígdalas	FA-04
BECKMANN		BLOUNT	
cuchillo	EG-19	elevador para huesos	DC-24
BECKMANN-EATON separador.....	BI-16	separador para rodilla.....	DC-24
BECKMANN		BLUMENTHAL pinza gubia	DC-02
separador.....	BI-16	BODENHAMMER espéculo rectales.....	GI-02
BECK pinza atraumatica para vasculares perif	BD-25	BOEHLER estribo para extensión	DD-10
BEEBEE tijeras para alambre y chapas.....	AI-43	BOERMA pinzas obstétricas.....	HC-04
BEER pinza depilatorias	ED-08	BOETTCHER tijeras para amígdalas	AI-27
BEESON separador para yesos	DA-03	BÖHLER	
BELLUCCI tijeras auriculares micro.....	EE-09	pinza cortante para huesos	DC-06
BENGOLEA pinza hemostática.....	BC-09	pinza gubia	DC-04
BENNETT elevador para huesos	DC-22	Bola electrodo para coagulación	JA-03
BERENS queratomo	EC-04	Bombilla de repuesto	
BERGMANN FOERSTER pinza porta esponjas	BG-10	para laringoscopia convencional	AE-20
BERGMANN		Bombilla de repuesto	
sierra para yesos	DA-02	para laringoscopia de fibra optica.....	AE-20
tijeras de vendajes.....	AI-46	BONACCOLTO pinza para estrabismo.....	EC-14
BERKE pinza musculares.....	ED-02	Bonn	
BERLIND-AUVARD espéculo vaginales	HA-19	canula irrigacion.....	ED-07
BERLINER martillos de percusión	AC-07	BONNEY pinza porta esponjas	BG-08
BERNHARD pinza para campos.....	BE-05	Bonn	
BERTILLON cefalómetro	AC-08	pinza para iris.....	EC-15
BEST pinza intestinales.....	GE-06	Bonn TITAN pinza para iris	EC-15
BETHUNE costotomo	FG-04	BORCHARDT fresa	DD-07
BEUSE tijeras	AI-26	BOSE	
BEYER		gancho traqueal.....	FE-02

separador traqueal	FE-02
BOUCHERON espéculos auriculares	EE-02
BOWLES estetoscopio	AC-06
BOWMAN	
aguja para discision	EC-05
blefarostato	EC-02
cuchillo para discision	EC-04
sonda canal lacrimonal	EC-10
BOYNTON porta-aguja de oftalmología	CE-06
BOZEMANN-DOUGLAS pinza para tapones	BG-13
BOZEMANN	
pinza para tapones	BG-13
porta-aguja	CE-03
BRAIN	
clip standard	EA-13
clip temporarios	EA-12
BRAIN MINI pinza de aplicación clip	EA-12
BRAIN STANDARD pinza de aplicación clip	EA-12
BRAITHWAITE dermatomo	AG-22
BRAUN	
cranioclasto	HC-09
depresor uterino	HA-39
espéculo vaginales	HA-16
gancho de decapitación	HC-09
pinza pra coger el cuello de útero	HA-31, HA-34
BRAUN-STADLER tijeras para episiotomía	AH-22, AI-34
BREISKY espéculo vaginales	HA-20
BROCK	
abertura dilatador para válvula mitral	FG-26
cortante dilatador para válvula mitral	FG-26
mango dilatador para válvula mitral	FG-26
BROWN pinza de disección	BA-03
BRUENINGS	
abajalengua	EI-02
cierranudos amígdalas	FA-04
cuchillo tabique	EG-11
espéculos auriculares	EE-02
pinza cortantes para nasales	EG-05
pinza laringe	FC-03
tubo alarmiento	FC-03
BRUNETTI cincel espinal	DC-17
BRUNNER	
costotomo	FG-07
pinza intestinales	GE-06
sonda conductora	CG-04
BRUNS	
cucharilla cortante	DC-12 hasta DC-13
tijeras para yeso	AI-48
BRYANT pinza porta esponjas	BG-11
BUCHWALD abajalengua	EI-02
BUCK	
cureta auriculares	EE-05
elevadores cuerpos extraños	EE-08
martillos de percusión	AC-07
tijeras para puntas	AI-40
BUIE tubo de aspiracion	GI-05
Bujía	
COXETER uretrales	GG-17
DITTEL uretrales	GG-18 hasta GG-19
GUYON uretrales	GG-12, GG-14 hasta GG-15
VAN BUREN uretrales	GG-13
WALTHER uretrales	GG-17
BUMM	
cureta uterinas	HA-49 hasta HA-50
pinza para el útero	HA-38
BUNGE cucharilla para exentracion	EC-07
BUNNELL	
perforador a mano	DD-05
separador tendones	DC-25
BUNT clip para esterilización	CI-02
BURCH horquilla fijadora	EC-05

BURKE-Baby pinza sacabocado	
para el cuello del útero	HA-44
BURKE pinza sacabocado para el cuello del útero	HA-44
BUSCH tijeras para umbilicales	AI-34

C

Cable	
AESCULAP electrobisturías	JA-07
ERBE SELECT electrobisturías	JA-07
MARTIN electrobisturías	JA-07
USA electrobisturías	JA-07
Caja	
para agujas	HE-02
SAUERBRUCH para agujas	HE-02
Canula	
Bonn irrigacion	ED-07
Hamburg canula abotonada	ED-07
KILLIAN	EG-09
SCHEIE oculares	ED-07
Cánulas FINSTERER para aspiración e irrigación	AE-05
Canula	
SIMCOE sutura	ED-07
Tübingen aire	ED-07
Capsular DASTOOR aspirador	EC-09
CARMALT pinza para espinas	BA-06
CARPENTER cuchillo para amígdalas	FA-02
CASPAR	
especulo para lumbar vertebral	BI-20
mango de bisturías micro	AG-12
separador	BI-20
separador para columna espinal	BI-18
separador para columna vertebral	BI-19
valva	BI-20
valva para columna vertebral	BI-19
CASTAÑEDA	
pinza atraumatica para nacidos y niños	BD-42
separador costales	FG-14
CASTROVIEJO	
blefarostato	EC-03
dilatador canal lacrimonal	EC-10
espatula ciclodialálisis	EC-08 hasta EC-09
marcador compas	EC-09
pinza capsulares	ED-04
pinza fijación	ED-03
pinza sutura	ED-05
porta-aguja	CE-07
queratomo	EC-04
rompe hojas	AG-14
tijeras para corneal	AJ-06
tijeras para iridectomía	AJ-05
trépano para corneal	ED-07
Cateter	
HARTMANN auriculares	EE-06
ITARD auriculares	EE-06
merálicas para hombre	GG-16
merálicas para mujer	GG-16
CATLIN cuchillo para amputación	AG-16
Cauterio WADSWORTH-TODD	EC-08
Cefalómetro BERTILLON	AC-08
Cepillo de limpieza	CI-04 hasta CI-05
CHAPUT pinza hemostática	BC-08
CHARRIERE	
hoja de recambio	DD-03
sierra para amputacion	DD-03
CHEATLE pinza para esterilización	CI-02
CHERON pinza para tapones	BG-12
CHEVALIER-JACKSON pinza laringe	FC-04
CHEVALLIER separador costales	FG-15
CHILDE pinza para grapas	CG-07
Cierranudo	

KRAUSE auriculares.....	EE-07	COLLIN-DUVAL pinza de disección.....	BA-04
Cierranudos		COLLIN	
BRUENINGS amígdalas.....	FA-04	especulo vaginales.....	HA-04
EVES amígdalas.....	FA-04	COLLIN-HARTMANN separador.....	BI-03
KRAUSE para nasales.....	EG-09	COLLIN	
TYDING amígdalas.....	FA-05	histerómetro.....	HA-39
WILDE para nasales.....	EG-09	mango de bisturíes.....	AG-08
Cierranudo		martillo.....	DC-18
WESTON polipus rectal.....	GI-05	pelvometro.....	HC-06
WILDE auriculares.....	EE-07	pinza hemostática.....	BC-08
Cinzel.....	DC-14	pinza para el útero.....	HA-37
ALEXANDER.....	DC-14	pinza para grapas.....	CG-07
CINELLI plástica para nasales.....	EG-13	pinza para taponos.....	BG-11
COTTLE plástica para nasales.....	EG-13	pinza tiralengua.....	EI-03
DIX para cuerpos extraños.....	EC-06	COLLIN-POZZI pinza para coger el cuello de útero.....	HA-32
Cinzel espinal BRUNETTI.....	DC-17	COLLIN	
Cinzel esternon LEBSCHÉ.....	DC-17	separador abdominales.....	BI-24 hasta BI-25
Cinzel		COLLYER pelvometro.....	HC-06
FOMON plástica para nasales.....	EG-13	COLVER pinza coger amígdalas.....	FA-03
FREER tabique.....	EG-12	Compresor CORWIN amígdalas.....	FA-04
HIBBS.....	DC-16	Compressor	
HOKE.....	DC-16	STOCKMANN uretrales.....	GG-10
LEXER.....	DC-16	STRAUSS uretrales.....	GG-10
LEXER mini.....	DC-16	CONNIN-AMSLER marcador.....	EC-09
PARTSCH.....	DC-14	Cono	
ROLLET para extirpación.....	EC-06	de oclusión.....	HA-47
SILVER plástica para nasales.....	EG-14	KNUTSON-KOCH para uretrografía.....	GG-09
SMITH-PETERSEN.....	DC-15	Contenedores para esterilización	
STILLE.....	DC-14	3/4.....	HE-22 hasta HE-24
WEST para nasales.....	EG-14	especiales.....	HE-34 hasta HE-37
CINELLI cinzel plástica para nasales.....	EG-13	grandes.....	HE-18 hasta HE-20
Cinta de métrica.....	AC-08	medianos.....	HE-26 hasta HE-29
Cinta sola PARHAM.....	DC-11	medianos y planos.....	HE-30 hasta HE-31
CITELLI pinza sacabocado.....	EG-08	pequeños.....	HE-32 hasta HE-33
Cizalla		CONVERSE bisturí para nasales.....	EG-10
SEUTIN para yeso.....	DA-02	COOLEY	
STILLE para yeso.....	DA-02	clamp de bulldog atraumática.....	BD-33 hasta BD-34
Clamp		costotomo primera.....	FG-05
COLLIN para umbilicales.....	HC-06	COOLEY DERRA pinza atraumática anastomosis.....	BD-39
COOLEY de bulldog atraumática.....	BD-33 hasta BD-34	COOLEY	
DE BAKEY de bulldog atraumática.....	BC-02	dilatador para válvula mitral.....	FG-27 hasta FG-29
DIEFFENBACH de bulldog para sierra-fina.....	BC-03	dilatador para vasculares.....	FG-30
GLOVER de bulldog atraumática.....	BC-02	COOLEY modif. STRUCK separador atrium.....	FG-20
JOHNS-HOPKINS de bulldog para sierra-fina.....	BC-03	COOLEY	
KANE para umbilicales.....	HC-06	pinza atraumática BB-03, BD-35 hasta BD-37, BD-39, BD-41	
LOWMAN para huesos.....	DC-11	pinza atraumática anastomosis.....	BD-37, BD-40
CLARK blefarostato.....	EC-02	pinza atraumática iliaca.....	BD-37
CLAR		pinza atraumática pediátricas.....	BD-38 hasta BD-39
lámpara frontal.....	AC-05	pinza para vascular.....	BD-40
mini.....	AC-05	separador atrium.....	FG-20
Clavo para huesos STEINMANN.....	DD-09	separador costales.....	FG-09
CLEVELAND pinza gubia.....	DC-02	COOPER aguja para ligaduras.....	CG-02
Clip		Copa graduada.....	HE-07
BRAIN standard.....	EA-13	CORDES pinza laringe.....	FC-03
BRAIN temporarios.....	EA-12	Corta-anillos.....	DD-03
BUNT para esterilización.....	CI-02	DIMEDA.....	DD-03
EDWARDS.....	BD-21	Corta-callos CREDO.....	HE-03
MAYO para esterilización.....	CI-02	Corta-grapas.....	EA-02
CLOWARD		Cortante BROCK dilatador para válvula mitral.....	FG-26
separador.....	BI-17	CORWIN compresor amígdalas.....	FA-04
separador para cuerpos vertebrales.....	EA-07	CORYLLOS costotomo.....	FG-04
COAKLEY		CORYLLOS (Thorax) separador.....	BI-13
cureta para seno.....	EG-18	Costótomo.....	FG-02
trócar.....	CC-02	Costotomo	
Cobo para desechos.....	HE-11	BETHUNE.....	FG-04
COLCLOUGH pinza sacabocado		BRUNNER.....	FG-07
para discos intervertebrales.....	EA-11	COOLEY primera.....	FG-05
COLLIER porta-aguja.....	CE-02	CORYLLOS.....	FG-04
COLLIN		GIERTZ-STILLE.....	FG-06
clamp para umbilicales.....	HC-06	Costótomo	
dinamometro.....	AC-03	GLUCK.....	FG-03

S

Índice alfabético Español

Costotomo		BARRAQUER para queratoplastico.....	EC-05
SAUERBRUCH.....	FG-05	BECKMANN.....	EG-19
SAUERBRUCH-FREY.....	FG-06	BOWMAN para discision.....	EC-04
Costótomo		BRUENINGS tabique.....	EG-11
STILLE.....	FG-03	CARPENTER para amigdalas.....	FA-02
COTTLE		CATLIN para amputación.....	AG-16
cincel plástica para nasales.....	EG-13	COTTLE para nasales.....	EG-10
cuchillo para nasales.....	EG-10	DEAN para iris.....	EC-04
elevadores periostotomo.....	EG-12	DEUTSCHMANN para catarata.....	EC-03
elevadores tabique.....	EG-12	ELSCHNIG para corneal.....	EC-05
espéculo para nasales.....	EG-03	ESMARCH para yesos.....	DA-04
COTTLE-KAZANJIAN pinza cortante para huesos.....	DC-06	FREER tabique.....	EG-10
COTTLE-NEIVERT separador para nasales.....	EG-17	GILL para corneal.....	EC-05
COTTLE		GRAEFE para catarata.....	EC-03
separador para nasales.....	EG-17	HOPKINS para yesos.....	DA-04
tijeras para nasales.....	AH-18, AI-25	KNAPP para iris.....	EC-04
COXETER bujia uretrales.....	GG-17	LANGENBECK para resección.....	AG-17
CRAFOORD		LISTON para amputación.....	AG-16
pinza hemostática bronquial.....	BC-12	MUCK periostio.....	EE-15
tijeras para pulmonares.....	AI-36	OTIS de repuesto.....	GG-08
Cranioclasto		Cuchillo para amputación.....	AG-16
BRAUN.....	HC-09	Cuchillo para cartílagos.....	AG-18
TARNIER.....	HC-09	Cuchillo para yesos.....	DA-04
CREDO corta-callos.....	HE-03	Cuchillo	
CRILE-MURRAY porta-aguja.....	CE-02	PAUFIQUE para queratoplastico.....	EC-05
CRILE		PLESTER lobar.....	EE-14
pinza hemostática.....	BC-05	POLITZER auriculares.....	EE-06
porta-aguja.....	CE-04	REINER para yesos.....	DA-04
CRILE-RANKIN pinza hemostática.....	BC-05	ROSEN circular.....	EE-14
CRILE		SATO para corneal.....	EC-05
separador.....	BI-02	SCHEIE para goniotomia.....	EC-05
CRILE TITAN pinza hemostática.....	BC-05	SCHUKNECHT circular.....	EE-14
CRILE-WOOD porta-aguja.....	CE-02	SCHUKNECHT forma hoz.....	EE-14
CRITCHETT blefarostato.....	EC-02	SEXTON auriculares.....	EE-06
CRUTCHFIELD		St. CLAIR-THOMSON.....	EG-19
perforador para inicial.....	EA-03	TABB forma hoz.....	EE-14
pinza de tracción craneal.....	EA-03	TOOK para corneal.....	EC-05
CRUZ ROJA tijeras de vendajes.....	AI-47	VIRCHOW para cartílagos.....	AG-18
Cuadro KIRSCHNER.....	BI-23	VIRCHOW para cerebro.....	AG-18
Cubeta		WHEELER para discision.....	EC-04
para placenta.....	HE-06	WULLSTEIN forma hoz.....	EE-14
PETRI.....	HE-08	ZIEGLER capsulotomia.....	EC-05
redonda.....	HE-04 hasta HE-05	ZIEGLER para iridectomia.....	EC-04
Cuchara		CULLER espátula para iris.....	EC-08
DESJARDINS para cálculos biliares.....	GC-08	Cuna.....	HE-06
FERGUSON para cálculos biliares.....	GC-07	Cureta	
LUER-KOERTE para cálculos biliares.....	GC-09	ALVIS para cuerpos extraños.....	EC-06
MAYO para cálculos biliares.....	GC-07	aspiradora.....	HA-51
MOORE para cálculos biliares.....	GC-05	BLAKE uterinas.....	HA-48
Cucharilla		BUCK auriculares.....	EE-05
AXENFELD para chalazion.....	EC-07	BUMM uterinas.....	HA-49 hasta HA-50
BRUNS cortante.....	DC-12 hasta DC-13	COAKLEY para seno.....	EG-18
BUNGE para exentracion.....	EC-07	CUZZI para aborto y placenta.....	HC-08
DAVIEL para cataratas.....	EC-07	FAULKNER.....	EG-18
GRAEFE para cataratas.....	EC-07	FOX para lupus.....	HE-02
GUTMANN para secreciones.....	GG-11	GOURDET uterinas.....	HA-48
HALLE cortante.....	DC-13	GROSS auriculares.....	EE-06
HEBRA para chalazion.....	EC-07	HOUSE.....	EE-15
KNAPP para cataratas.....	EC-07	KEVORKIAN aspiradoras	
LEMPERT cortante.....	DC-13	para la biopsia uterina.....	HA-40
MARTINI cortante.....	DC-13	LANG.....	EC-08
MEYHOEFER para chalazion.....	EC-07	NOVAK aspiradoras para la biopsia uterina.....	HA-40
SCHEDE cortante.....	DC-12	PESTALOZZA para aborto y placenta.....	HC-08
SIMON cortante.....	DC-13	PIFFARD para lupus.....	HE-02
SPRATT cortante.....	DC-12	RANDALL aspiradoras para la biopsia uterina.....	HA-40
VOLKMANN cortante.....	DC-12 hasta DC-13	RECAIMER uterinas.....	HA-49 hasta HA-50
WILLIGER cortante.....	DC-13	SCHROEDER uterinas.....	HA-48
Cuchillo		SIMON uterinas.....	HA-48
BALLENGER.....	EG-11	SIMS uterinas.....	HA-49 hasta HA-50
BARKAN para goniotomia.....	EC-05	WALLICH para aborto y placenta.....	HC-08
BARNHILL.....	EG-19	CUSCO espéculo vaginales.....	HA-04 hasta HA-06

CUSHING	
espátulas cerebral.....	EA-07
gancho para nervios.....	EA-04
perforadores plano.....	DD-04
pinza cortantes para laminectomía.....	EA-08
pinza de disección.....	BA-03
separador.....	BI-07
Cuticular.....	HE-03
CUZZI cureta para aborto y placenta.....	HC-08
CZERNY	
espéculo rectales.....	GI-02
pinza para cálculos biliares.....	GC-03
pinza para coger el cuello de útero.....	HA-34

D

DALE pinza atraumatica para vasculares perif.....	BD-24
DANDY	
gancho para nervios.....	EA-04
pinza hemostática.....	BC-07
tijeras para neuroquirurgicas.....	AI-36
DARDIK pinza atraumatica.....	BD-07
DARLING separador.....	BI-17
DARTIGUES pinza para el útero.....	HA-37
DASTOOR	
capsular aspirador.....	EC-09
pinza para estrabismo.....	EC-14
DAVIDSON (Scapula) separador.....	BI-13
DAVIEL cucharilla para cataratas.....	EC-07
DAVIS	
aguja para cuerpos extraños.....	EC-05
DAVIS-BOYLE abrebooca.....	EI-04
DAVIS	
descolador duramadre.....	EA-05
pinza para esterilización.....	CI-02
DAY ganchito auriculares.....	EE-07
DEAN	
cuchillo para iris.....	EC-04
tijeras para amigdalas.....	AI-26
DEAVER Grip separador.....	BI-05
DEAVER	
separador.....	BI-05
tijeras.....	AH-05, AI-06
DEBAKEY BAHNSON	
pinza atraumatica aneurisma de aorta.....	BD-14
DE BAKEY	
clamp de bulldog atraumatica.....	BC-02
dilatador para vasculares.....	FG-31
DE BAKEY MORRIS pinza atraumatica.....	BD-16
DE BAKEY	
pinza atraumatica.....	BB-03
DEBAKEY pinza atraumatica.....	BD-02, BD-08
DE BAKEY	
pinza atraumatica.....	BD-16 hasta BD-17
DEBAKEY pinza atraumatica.....	BD-20
DE BAKEY	
pinza atraumatica.....	BD-28 hasta BD-30
pinza atraumatica anastomosis.....	BD-25
pinza atraumatica aneurisma	
de aorta.....	BD-13, BD-15, BD-18
pinza atraumatica bronquiales.....	BD-19
pinza atraumatica de disección y ligadura.....	BD-25, BD-32
pinza atraumatica iliaca.....	BD-11
pinza atraumatica para vasculares perif.....	BD-06
porta-aguja.....	CE-03
DE BAKEY REYNOLDS	
pinza atraumatica anastomosis.....	BD-30
DEBAKEY SATINSKY pinza atraumatica.....	BD-22
DE BAKEY	
tijeras para vasculares.....	AI-30
tubo de aspiración.....	AE-04
Dedal LANGENBECK.....	EI-06
DEJERINE martillos de percusión.....	AC-07
De LEE pinza obstétricas.....	HC-02
De MARTEL guía-sierra.....	EA-05
DeMARTEL-WOLFSON pinza para anastomosis.....	GE-07
DENHART abrebooca.....	EI-03
Depresor	
BRAUN uterino.....	HA-39
REICHERT epiglotis.....	FC-02
SIMS uterino.....	HA-39
DERF porta-aguja.....	CE-02
Dermátomo	
BRAITHWAITE.....	AG-22
hoja.....	AG-21
HUMBY.....	AG-20
SCHINK.....	AG-21
SILVER.....	AG-20
WATSON.....	AG-22
DERRA pinza atraumatica anastomosis, pediátricas.....	BD-28
DESCHAMPS aguja para ligaduras.....	CG-02
Descolador	
DAVIS duramadre.....	EA-05
duramadre.....	EA-05
FISCH.....	EE-15
HORSLEY duramadre.....	EA-06
MILLIGAN duramadre.....	EA-05
PENFIELD duramadre.....	EA-06
SACHS duramadre.....	EA-05
TOENNIS duramadre.....	EA-05
DESJARDINS	
cuchara para cálculos biliares.....	GC-08
pinza para cálculos biliares.....	GC-02
pinza via billar.....	BC-15
sonda para cálculos biliares.....	GC-05
DESMARRES	
pinza chalazión.....	ED-06
separador.....	BI-07
Destornillador.....	DD-14 hasta DD-15
LANE.....	DD-14
WILLIAMS.....	DD-14
DEUTSCHMANN cuchillo para catarata.....	EC-03
DeVILBISS pinza craneanea.....	EA-05
DEWEY pinzas obstétricas	
con dispositivo de tracción.....	HC-05
Diagnóstico Juego para.....	AC-04
DIAMANT pinza corta-hilo.....	DD-12
Diapasones.....	EE-04
DIMEDA Alu.....	EE-03
HARTMANN.....	EE-03
LUCAE.....	EE-04
RYDEL-SEIFFER.....	EE-04
DIEFFENBACH clamp de bulldog para serra-fina.....	BC-03
DIETER pinza la cabeza del martillo.....	EE-10
DIETHRICH	
pinza atraumatica.....	BD-31
porta-aguja para vascular.....	CE-06
tijeras para vasculares.....	AI-29
Dilatador	
BAKES para conducto biliar.....	GC-06
CASTROVIEJO canal lacrimal.....	EC-10
COOLEY para válvula mitral.....	FG-27 hasta FG-29
COOLEY para vasculares.....	FG-30
DE BAKEY para vasculares.....	FG-31
GERBODE para válvula mitral.....	FG-28
GOODELL uterinos.....	HA-30
HANK uterinos.....	HA-28
HEGAR uterinos.....	HA-24 hasta HA-27
HETZER para válvula mitral.....	FG-29
KUENTSCHER.....	DD-13
LABORDE traqueal.....	FE-02
MILLIN para el cuello vesical.....	GG-07

S

Índice alfabético Español

PRATT uterinos.....	HA-29
SIMS uterinos.....	HA-30
TROUSSEAU traqueal.....	FE-02
TUBBS para válvula mitral.....	FG-27
WILDER canal lacrimonal.....	EC-10
WYLIE uterinos.....	HA-30
ZIEGLER canal lacrimonal.....	EC-10
DIMEDA Alu diapasones.....	EE-03
DIMEDA	
corta-anillos.....	DD-03
estilete.....	CA-03
iman oculístico.....	ED-08
pinza para desechos.....	CI-03
rompe hojas.....	AG-14
separador.....	BI-14
tijeras de vendajes.....	AI-46
Dinamometro COLLIN.....	AC-03
DINGMANN pinza para huesos.....	DC-10
Disecador	
GREEN para corneal.....	EC-06
HURD para amígdalas.....	FA-02
PATON para la cornea.....	EC-05
Disector ROBB para vasculares.....	FG-33
DITTEL	
bujía uretrales.....	GG-18 hasta GG-19
introdutor de catéter.....	GG-11
DIX	
aguja.....	EC-09
cincel para cuerpos extraños.....	EC-06
DOUGLAS	
pinza depilatorias.....	ED-08
trócar.....	CC-02
DOYEN-Baby pinza intestinales.....	GE-03
DOYEN	
especulo vaginales.....	HA-18, HA-20
fresa.....	DD-07
DOYEN-JANSEN abreboca.....	EI-03
DOYEN	
periotótomos para costillas.....	DC-20
pinza intestinales.....	GE-03
pinza para campos.....	BE-05
pinza para polípe uterino.....	HA-36
separador.....	BI-12
sonda.....	CA-02
tijeras para ginecológicas.....	AI-33
tirabuzón para fibroma.....	HA-46
DUBOIS tijeras para ginecológicas.....	AI-33
DUPLAY	
pinza para tapones.....	BG-14
pinza para coger el cuello de útero.....	HA-31
DUPUY-WEISS pinza aguja.....	FA-03
DUVAL	
pinza de disección.....	BA-04
pinza para tejidos.....	GE-03

E

ECHLIN pinza gubia.....	DC-05
EDWARDS	
clip.....	BD-21
pinza para aplicar clips.....	BD-21
Electrodo para coagulación mini.....	JA-02 hasta JA-03
Elevador	
ADSON.....	DC-21
BENNETT para huesos.....	DC-22
BLOUNT para huesos.....	DC-24
Elevadores	
BALLENGER tabique.....	EG-12
BUCK cuerpos extraños.....	EE-08
COTTLE periotótomos.....	EG-12
COTTLE tabique.....	EG-12

FREER tabique.....	EG-11
HAJEK-BALLENGER tabique.....	EG-12
JOSEPH periotótomos.....	EG-12
KILLIAN tabique.....	EG-12
McKENTY tabique.....	EG-11
QUIRE cuerpos extraños.....	EE-08
ROGER tabique.....	EG-11
Elevador	
HENKE para amígdalas.....	FA-02
HOHMANN mini para huesos.....	DC-23
HOHMANN para huesos.....	DC-22 hasta DC-23
KEY.....	DC-21
LANGENBECK.....	DC-21
LEMPERT.....	EE-15
McDONALD.....	DC-22
MURLESS para cabeza.....	HC-05
MURPHY-LANE.....	DC-22
para huesos.....	DC-23
WATSON-CHEYNE.....	DC-22
ELLIOT	
pinza obstétricas.....	HC-02
trépano para corneal.....	ED-08
ELLIS gubia para cuerpos extraños.....	EC-06
ELSAESSER pinza para nephrostomía.....	GC-13
ELSCHNIG	
cuchillo para corneal.....	EC-05
espatula cicloclálisis.....	EC-08
pinza capsulares.....	ED-04
pinza fijación.....	ED-03
Embudos	HE-07
EMMET gancho para fístula.....	HA-46
ENGEL sierra para yesos.....	DA-02
Ensordecidor BARANY.....	EE-04
EPPENDORFER-KEVORKIAN	
pinza sacabocado para el cuello del útero.....	HA-46
EPPENDORFER pinza sacabocado	
para el cuello del útero.....	HA-45 hasta HA-46
EPPENDORFER TISCHLER-MORGAN	
pinza sacabocado para el cuello del útero.....	HA-46
ERBE SELECT cable electrobisturías.....	JA-07
Escariadores	DD-08
PERTHES.....	DD-08
Escarificador GRAEFE.....	EC-04
Esclerotomo	
GUYTON-LUNDSGAARD.....	EC-05
LUNDSGAARD.....	EC-05
Escupideras	HE-06
Esférica	DD-04
Esfigmomanómetros	AC-02
ESMARCH	
cuchillo para yesos.....	DA-04
tijeras de vendajes.....	AI-46
Espátula	CA-03
ALLISON pulmón.....	FG-19
Espátula	
BANGERTER cicloclálisis.....	EC-08
CASTROVIEJO cicloclálisis.....	EC-08 hasta EC-09
CULLER para iris.....	EC-08
ELSCHNIG cicloclálisis.....	EC-08
KOCHER vesical.....	GG-04
LEGUEU vesical.....	GG-04
Espátula	
para la íntima.....	FG-32
Espátulas	
CUSHING cerebral.....	EA-07
HEIFETZ cerebral.....	EA-07
OLIVECRONA cerebral.....	EA-07
Espatula	
WECKER para iris.....	EC-08
WELLS enucleación.....	EC-08
WHEELER cicloclálisis.....	EC-09

Espéculo	
AUVARD vaginales	HA-19
BARR rectales	GI-02
BERLIND-AUVARD vaginales	HA-19
BODENHAMMER rectales	GI-02
BRAUN vaginales	HA-16
BREISKY vaginales	HA-20
Especulo CASPAR para lumbar vertebral	BI-20
Espéculo	
COLLIN vaginales	HA-04
COTTLE para nasales	EG-03
CUSCO vaginales	HA-04 hasta HA-06
CZERNY rectales	GI-02
DOYEN vaginales	HA-18, HA-20
FREEWAY-GRAVE vaginales	HA-06
GRAVE vaginales	HA-02
HARTMANN-HALLE para nasales	EG-02
JACKSON vaginales	HA-16
KALLMORGEN vaginales	HA-15
KILLIAN tabique	EG-03
KOGAN endocervicales	HA-23
KRISTELLER vaginales	HA-09 hasta HA-14
LANDAU vaginales	HA-22
MATHIEU rectales	GI-02
O'SULLIVAN-O'CONNOR vaginales	HA-08
PEDERSON vaginales	HA-03
PRATT rectales	GI-02
Espéculos	
BOUCHERON auriculares	EE-02
BRUENINGS auriculares	EE-02
Espéculo	
SCHERBAK vaginales	HA-21
SEMM vaginales	HA-07
Espéculos	
GRUBER auriculares	EE-02
HARTMANN auriculares	EE-02
Espéculo	
SIMS rectales	GI-02
SIMS vaginales	HA-17
Espéculos	
SIEGLE auriculares	EE-02
Espéculo	
STEINER-AUVARD vaginales	HA-19
Espéculos	
TOYNBEE auriculares	EE-02
Espéculo	
THUDICHUM para nasales	EG-02
TIECK-HALLE para nasales	EG-03
TRELAT vaginales	HA-07
Vienna para nasales	EG-02
VOLTOLINI para nasales	EG-02
WEISSBARTH vaginales	HA-22
YANKAUER nasofaringe	EG-04
Espejo frontal ZIEGLER	AC-05
Espejo	
laringeos	FC-04
MICHEL	EG-04
Estetoscopio	
BOWLES	AC-06
Estetoscopio duplex	AC-06
Estetoscopio	
FORD	AC-06
FORD BOWLES	AC-06
PINARD	AC-06
Estilete	CA-03
DIMEDA	CA-03
FARREL	CA-03
JOBSON-HORNE	CA-03
MAGILL para tubo	AE-04
TOBOLD	CA-03
UCKERMANN	CA-03

Estríbo	
BOEHLER para extensión	DD-10
KIRSCHNER para extensión	DD-10
para extensión	DD-10
Estuche	
acero inoxidable	HE-03
caja	HE-03
Estuche de bolsillo y de sutura	
mini	CG-08
standard	CG-08
EVES cierranudos amigdalas	FA-04
Extractor KUENTSCHER	DD-13

F

FARABEU-F-LAMBOTTE pinza para huesos	DC-08
FARABEU	
periostótomo	DC-19
pinza para huesos	DC-07
separador	BI-02
FARREL estilete	CA-03
FAULKNER cureta	EG-18
FAURE	
pinza para peritoneo	BC-17
pinza sacabocado para el cuello del útero	HA-41
FEHLAND pinza intestinales	GE-06
FEILCHENFELD pinza para espinas	BA-06
FERGUSSON	
cuchara para cálculos biliares	GC-07
pinza hemostática	BC-07
pinza para huesos	DC-07
tijeras	AI-49
FERRIS pinza de disección	BA-04
FERRIS-SMITH-KERRISON	
pinza sacabocado para discos intervertebrales	EA-10
FERRIS-SMITH pinza cortantes para laminectomía	EA-09
FILIFORM sonda	GG-12
FINOCHIETTO-BABY separador costales	FG-09
FINOCHIETTO BURFORD	
separador costales	FG-12 hasta FG-14
FINOCHIETTO-HAIGTH BABY separador costales	FG-10
FINOCHIETTO INFANT separador costales	FG-12
FINOCHIETTO (modif) separador costales	FG-08
FINOCHIETTO	
pinza bronquiales	FG-21
porta-aguja	CE-04
separador costales	FG-08, FG-10 hasta FG-11
tijera para recto	AI-38
FINSEN separador	BI-14
FINSTERER cánulas para aspiración e irrigación	AE-05
FISCH descolador	EE-15
FISCHER pinza para iris	EC-13
Fleboextractores	CA-03
FLETCHER JAVERTS pinza porta esponjas	BG-10
FLEURANT trócar	CC-02
FOERSTER	
pinza para iris	EC-12
pinza porta esponjas	BG-06 hasta BG-08
FOMON	
cincel plástica para nasales	EG-13
lima para nasales	EG-15 hasta EG-16
separador para nasales	EG-17
tijeras para nasales	AH-18, AI-25
Fórceps	
BARTON obstétricos	HC-04
BOERMA obstétricos	HC-04
De LEE obstétricos	HC-02
DEWEY obstétricos con dispositivo de tracción	HC-05
ELLIOT obstétricos	HC-02
KIELLAND-LUIKART obstétricos	HC-03
KIELLAND obstétricos	HC-02

S

Índice alfabético Español

LUIKART obstétricos	HC-03
McLEAN-LUIKART obstétricos	HC-03
McLEAN obstétricos	HC-04
McLEAN-TUCKER-LUIKART obstétricos	HC-03
NAEGELE obstétricos	HC-03
PIPER obstétricos	HC-04
PIPER obstétricos con dispositivo de tracción	HC-04
SIMPSON-BRAUN obstétricos	HC-02
SIMPSON-LUIKART obstétricos	HC-03
SIMPSON obstétricos	HC-02
TARNIER obstétricos con dispositivo de tracción	HC-05
WRIGLEY obstétricos	HC-02
FORD BOWLES estetoscopio	AC-06
FORD estetoscopio	AC-06
FOX cureta para lupus	HE-02
FRAENKEL	
pinza laringe	FC-03
pinza polipus laringe	FC-02
FRANCESCHETTI trépano para corneal	ED-07
FRANCIS aguja para cuerpos extraños	EC-05
FRANKLIN-SILVERMANN aguja para punción	CC-03
FRAZIER	
ganchito	BI-06
separador	BI-21
tubo de aspiración	EA-07
FREER	
bisturi mucosa	EG-10
cincel tabique	EG-12
cuchillo tabique	EG-10
elevadores tabique	EG-11
gubia	EG-14
FREEWAY-GRAVE espéculo vaginales	HA-06
FRENZEL abajalengua	EI-02
Fresa	DD-07
ALBEE	DD-07
BORCHARDT	DD-07
Fresa cónica HUDSON	DD-04
Fresa	
DOYEN	DD-07
para corticalis	DD-15
TOTI	DD-07
FRIEDMAN MINI pinza gubia, mini	DC-02
FRIEDMAN	
pinza gubia	DC-02
separador perineorraf	HA-23
FRITSCH separador	BI-11
FRYKHOLM pinza gubia	DC-05
FUCHS pinza capsulares	ED-04

G

GALLAHER lima para seno	EG-16
Ganchito	EE-15
BARBARA	EE-14
DAY auriculares	EE-07
FRAZIER	BI-06
GILLIES	EG-17
GRAEFE	BI-06
GUTHRIE	BI-06
JOSEPH	BI-06
KILNER para la piel	HE-02
WAGENER auriculares	EE-07
Gancho	
ADSON para nervios	EA-04
ARRUGA para extracción	EC-06
BOSE traqueal	FE-02
BRAUN de decapitación	HC-09
CUSHING para nervios	EA-04
DANDY para nervios	EA-04
de extracción	DD-13
electrodo mini	JA-02

EMMET para fístula	HA-46
GRAEFE para estrabismo	EC-06
GRAEFE-TITAN para estrabismo	EC-06
GRAHAM para nervios	EA-04
GREEN muscular	EC-06
ITERSON traqueal	FE-02
JAMESON para estrabismo	EC-06
LOVE para nervios	EA-04
O' CONNOR para iris	EC-06
para extensión	DD-10
PRATT cístico	GI-04
ROSE traqueal	FE-03
SACHS para nervios	EA-04
SMELLIE obstetrico	HC-06
SMITHWICK para nervios	EA-04
STEVENS para cristalino	EC-06
WIENER para iris	EC-06
Garrote MAUNDER madera	EI-06
GAUSS pinza para pericraneos	HC-06
GELLHORN pinza sacabocado	
para el cuello del útero	HA-42
GELPI separador abdominales	BI-24
GEMINI MINI pinza de disección y ligadura	BC-10
GEMINI pinza de disección y ligadura	BC-10
GERALD pinza de disección	BA-05
GERBODE dilatador para válvula mitral	FG-28
GERSTER barra de tracción	DC-11
GERZOG martillo	DC-18
GIERTZ-STILLE costotomo	FG-06
GIGLI mango para sierra	EA-05
GILL-ARRUGA pinza capsular	ED-03
GILL	
cuchillo para corneal	EC-05
GILL-HESS pinza para iris	EC-12
GILLIES	
ganchito	EG-17
pinza de disección	BA-05
porta-aguja	CE-05
GILL	
pinza para iris	EC-12
GLOVER	
clamp de bulldog atraumática	BC-02
pinza atraumática	BD-06, BD-30
pinza atraumática anastomosis	BD-05
pinza para coacción atraumática	BD-04
GLUCK costotomo	FG-03
GOELET separador	BI-03
GOLDMAN-FOX tijeras para encías	AI-41
GOLDSTEIN blefarostato	EC-03
Goniómetro MOELTGEN	AC-08
GOODELL dilatador uterinos	HA-30
GOOD tijeras para amígdalas	AI-27
GORNEY tijera de disección	AI-13
GOSSET separador abdominales	BI-21
GOURDET cureta uterinas	HA-48
GRADLE pinza depilatorias	ED-08
GRAEFE	
blefarostato	EC-02
cucharilla para cataratas	EC-07
cuchillo para catarata	EC-03
escarificador	EC-04
ganchito	BI-06
gancho para estrabismo	EC-06
pinza de disección	BA-03
pinza fijación	ED-03
pinza para iris	EC-11
quistotomo	EC-06
GRAEFE-TITAN gancho para estrabismo	EC-06
GRAHAM gancho para nervios	EA-04
Grapas MICHEL	CG-07
GRAVE espéculo vaginales	HA-02

GRAY pinza via billar	BC-15
GREEN-ARMYTAGE pinza-clamp uterina para hemostasis	HC-06
GREEN	
disecador para corneal	EC-06
gancho muscular	EC-06
pinza fijación	ED-03
separador	BI-10
GREGORY pinza atraumatica profunda	BD-33
GREVEN pinza auriculares micro	EE-10
GRIP pinza para agarrar	DD-11
GROSS	
cureta auriculares	EE-06
GROSS-MAIER pinza para tapones	BG-02 hasta BG-04
GROSS	
pinza para tapones	BG-05
GRUBER espéculos auriculares	EE-02
Gubia	DC-14
ALEXANDER	DC-14
ELLIS para cuerpos extraños	EC-06
FREER gubia	EG-14
HAJEK para nasales	EG-14
HIBBS	DC-16
KILLIAN-CLAUS para nasales	EG-14
LEXER	DC-16
LEXER mini	DC-16
PARTSCH	DC-14
SMITH-PETERSEN	DC-15
STILLE	DC-14
WALTON para cuerpos extraños	EC-06
WEST para nasales	EG-14
Guia-sierra De MARTEL	EA-05
GUTHRIE ganchito	BI-06
GUTMANN cucharilla para secreciones	GG-11
GUYON	
bujia uretrales	GG-12, GG-14 hasta GG-15
introdutor de catere	GG-11
pinza para pedícula renal	BC-16
GUYTON-LUNDSGAARD esclerotomo	EC-05

H

HABERER separador	BI-04
HAGLUND-STILLE separador para yesos	DA-03
HAIGHT separador costales	FG-15
HAJEK-BALLENGER elevadores tabique	EG-12
HAJEK-CLAUS pinza seno maxil	EG-08
HAJEK gubia para nasales	EG-14
HAJEK-KOFLER pinza sacabocado	EG-08
HALLE	
bisturi para duramadre	EA-06
cucharilla cortante	DC-13
HALSEY porta-aguja	CE-02
HALSTED-MOSQUITO micro pinza hemostática	BC-04
HALSTED-MOSQUITO	
pinza atraumatica	BD-02
pinza hemostática	BC-04
HALSTED-MOSQUITO TITAN pinza hemostática	BC-04
Hamburg canula abotonada	ED-07
HANK dilatador uterinos	HA-28
HARKEN pinza atraumatica auricula	BD-23
HARRINGTON	
pinza bronquiales	FG-21
separador	BI-05
HARTMANN	
abajalengua	EI-02
cateter auriculares	EE-06
diapasones	EE-03
espéculos auriculares	EE-02
HARTMANN-HALLE espéculo para nasales	EG-02
HARTMANN-HOFFMANN pinza auriculares	EE-08

HARTMANN	
pinza auriculares	EE-08
pinza cortantes para nasales	EG-07
pinza hemostática	BC-03
pinza polipus para nasales	EG-04
HARTMANN-WULLSTEIN pinza auriculares	EE-08
HEANEY	
pinza histerectomía	BC-18
porta-aguja	CE-03
separador	BI-12
HEATH tijeras para puntas	AI-40
HEBRA cucharilla para chalazion	EC-07
HEGAR dilatador uterinos	HA-24 hasta HA-27
HEGENBARTH pinza para grapas	CG-07
HEIFETZ espátulas cerebral	EA-07
HEIMING pinza para cálculos renales	GC-13
HEISS pinza hemostática	BC-09
HEISTER abreboca	EI-03
Hemostata PASSOW	EE-15
HENKE elevador para amígdalas	FA-02
HENNIG separador para yesos	DA-03
HENROTIN pinza para coger el cuello de útero	HA-34
HERMANN separador para yesos	DA-03
HERRICK pinza para peritoneo	BC-17
HERTZLER separador costales	FG-17
HESS	
pinza capsulares	ED-04
pinza para iris	EC-12
HETZER dilatador para válvula mitral	FG-29
HEYMANN-KNIGHT pinza polipus para nasales	EG-05
HEYMANN	
pinza cortantes para nasales	EG-05
tijeras para nasales	AH-18, AI-25
HEYWOOD-SMITH pinza emorroidal	GI-05
HIBBS	
cincel	DC-16
gubia	DC-16
osteotomo	DC-16
Hilo para huesos	DD-11
HIRSCHMANN anoscopio	GI-04
Histerómetro	
COLLIN	HA-39
MARTIN	HA-39
SIMS	HA-39
VALLEIX	HA-39
HOESEL porta-aguja	CE-05
HOFER separador bilar	FA-02
HOFF pinza para campos	BE-03
HOHMANN elevador para huesos	DC-22 hasta DC-23
HOHMANN mini elevador para huesos	DC-23
Hoja	
CHARRIERE de recambio	DD-03
Hoja de bisturíes estériles	AG-06, AG-09
Hoja de bisturíes estériles micro	AG-13
Hoja	
dermatomo	AG-21
HUMBY de repuesto para dermatomo	AG-20
Hoja para navaja	AG-14, AG-19
Hoja sierra para yesos	DA-05 hasta DA-06
HOKE cincel	DC-16
HOLTH pinza para capsuloiridectomía	EC-09
HOPKINS cuchillo para yesos	DA-04
Horquilla BURCH fijadora	EC-05
HORSLEY descolador duramadre	EA-06
HOUSE cureta	EE-15
HRYNTSCHAK separador para prostata	GG-06
HUBER mango universal	FC-03
HUDSON	
fresa cónica	DD-04
perforador a mano	DD-04
HUMBY	

S

Índice alfabético Español

dermatomoAG-20
hoja de repuesto para dermatomoAG-20
HUNTER pinza para espinasBA-06
HURD disecador para amígdalasFA-02

I

Iman DIMEDA oculísticoED-08
ImpactorDD-12
KUENTSCHERDD-13
INGE separador para cuerpos vertebralesEA-07
Instrument LAFORCE para cuerpos extrañosEC-06
Instrumento
KNUTSON para uretrografíaGG-09
MOGAN para circuncisiónGG-09
para circuncisiónGG-09
WINKELMANN para circuncisiónGG-09
Insuflador POLITZER de aireEE-05
Introduccion de catéte
DITTELGG-11
GUYONGG-11
IOWA pinza para coger el cuello de úteroHA-35
IRIS
tijeraAI-19
tijera de oftalmologíaAI-22
tijerasAH-16, AI-21
IrrigadorHE-05
ISRAEL separadorBI-11
ITARD cateter auricularesEE-06
ITERSON gancho traquealFE-02
IVES-FANSLER anoscopioGI-04

J

JACKSON
espéculo vaginalesHA-16
pinza taponesFC-02
separador traquealFE-02
tubo traquealFE-03
JACOBSON tijeras microAJ-11
JACOBS pinza pra coger el cuello de úteroHA-34
JAEGER
placa para párpadosEC-03
queratomoEC-04
JAMESON
gancho para estrabismoEC-06
pinza para estrabismoEC-13
JAMISON porta-agujaCE-03
JANSEN
pinza para nasalesEG-04
separadorBI-14
JARCHO pinza pra coger el cuello de úteroHA-32
JATHO pinza nasofaringeEG-18
JAVID pinza atraumatica carotisBD-32
JENNINGS abreboocaEI-04
Jeringa
amígdalasFA-05
REINER auricularesEE-05
JOBSON-HORNE estileteCA-03
JOHNS-HOPKINS
clamp de bulldog para sierra-finaBC-03
pinza via billarBC-14
JOHNSON porta-agujaCE-04
JONES pinza para campos con porta-tuboBE-02
JOSEPH
bisturi para nasalesEG-10
bisturi romoEG-10
elevadores periostotomoEG-12
ganchitoBI-06
JOSEPH (LEWIS) lima para nasalesEG-15
JOSEPH

lima para huesosEG-14
sierra para nasalesEG-17
tijeraAI-16
tijerasAH-14
JUDD-ALLIS pinza para tejidosGE-02
JUDD-MASSON separador vesicalesGG-04
Juego
de autopsiaDC-17
de manicura para enfermerasHE-03
KEYES de trefinas cutaneousHE-02
Juego para
diagnósticoAC-04
otoscopiaAC-04
JURASZ pinza polipus laringeFC-02

K

KABIERSKE lanzapolvoEE-04
KALLMORGEN
espéculo vaginalesHA-15
valva vaginalesHA-15
KALT-ARRUGA porta-agujaCE-07
KALT
pinza capsularesED-04
porta-agujaCE-07
KANE clamp para umbilicalesHC-06
KEITH aguja para suturaCG-06
KELLY Grip separadorBI-04
KELLY
pinza hemostáticaBC-05
pinza para polipe uterinoHA-36
proctoscopioGI-04
KELLY-RANKIN pinza hemostáticaBC-05
KELLY
separadorBI-04, BI-12
tijeras para ginecológicasAH-22, AI-33
KELLY TITAN pinza hemostáticaBC-05
KERN pinza para huesosDC-08
KERRISON pinza sacabocadoEG-08
KEVORKIAN
cureta aspiradoras para la biopsia uterinaHA-40
KEVORKIAN-Pacific pinza sacabocado
para el cuello del úteroHA-44
KEVORKIAN
pinza sacabocado para el cuello del úteroHA-43, HA-46
KEY elevadorDC-21
KEYES juego de trefinas cutaneosHE-02
KIELLAND pinza obstétricasHC-02
KIELLAND-LUIKART pinzas obstétricasHC-03
KILLIAN
canulaEG-09
KILLIAN-CLAUS gubia para nasalesEG-14
KILLIAN
elevadores tabiqueEG-12
espéculo tabiqueEG-03
KILNER-DOUGHTY abreboocaEI-05
KILNER
ganchito para la pielHE-02
tijeraAI-17
tijerasAH-14
KIRBY-ARTHUR pinza para irisEC-13
KIRK martilloDC-18
KIRSCHNER
cuadroBI-23
estribo para extensiónDD-10
perforador a manoDD-05
separador abdominalesBI-23
sonda conductoraCG-04
taladros filiformesDD-09
valvaBI-23
KLINKENBERGH-LOTH tijeras para toracicaAI-37

- KNAPP
 cucharilla para cataratasEC-07
 cuchillo para irisEC-04
 KNAPP-LUER pinza tracomaED-06
 KNAPP
 separadorEC-06
 tijerasAI-20
 KNIGHT pinza cortantes para nasalesEG-05
 KNOWLES tijeras de vendajesAI-47
 KNUTSON instrumento para uretrografíaGG-09
 KNUTSON-KOCH cono para uretrografíaGG-09
 KOCHER
 espátula vesicalGG-04
 pinza hemostática delgadaBC-06
 pinza intestinalesGE-04
 separadorBI-10 hasta BI-11
 sonda bocioFE-04
 KOENIG
 aguja para suturaCG-06
 sonda conductoraCG-04
 KOERTE separadorBI-11
 KOGAN espéculo endocervicalesHA-23
 KONRICH tambor para esterilizaciónHE-12
 KRAUSE
 cierranudo auricularesEE-07
 cierranudos para nasalesEG-09
 pinza laringeFC-03
 KRISTELLER
 espéculo vaginalesHA-09 hasta HA-14
 valva vaginalesHA-09 hasta HA-14
 KRONECKER aguja para ligadurasCG-02
 KUENTSCHER
 dilatadorDD-13
 extractadorDD-13
 impactorDD-13
 KUHNT legra para la corneaEC-05
- L**
- LABORDE dilatador traquealFE-02
 LAFORCE
 adenotomoEG-19
 instrument para cuerpos extrañosEC-06
 LAGRANGE tijeras para encíasAI-41
 LAHEY
 pinza agarrar bocioFE-04
 pinza via billarBC-14
 separadorBI-08
 LAMBERT KAY
 pinza atraumatica anastomosis de aortaBD-10
 pinza atraumatica iliacaBD-11
 LAMBERT pinza chalaziónED-06
 LAMBOTTE mini osteotomoDC-15
 LAMBOTTE
 osteotomoDC-15
 periostótomoDC-19
 pinza para huesosDC-08
 Lámpara frontal CLARAC-05
 LANCASTER blefarostatoEC-03
 Lanceta electrodoJA-03
 LANDAU espéculo vaginalesHA-22
 LANDOLT
 mango de bisturíes microAG-13
 tijeras enucleaciónAI-25
 LANE
 destornilladorDD-14
 pinza clamp estomacalesGE-08
 pinza de disecciónBA-04
 pinza para camposBE-05
 pinza para huesosDC-08
 pinza para sostener placasDD-14
 pinza para sostener tornilloDD-14
 LANG curetaEC-08
 LANGENBECK
 cuchillo para resecciónAG-17
 dedalEI-06
 elevadorDC-21
 periostótomoDC-19
 pinza para huesosDC-07
 separadorBI-09
 sierra a dedoDD-03
 LANGE
 pinza laringeFC-03
 tijeras de vendajesAI-44
 Lanzapolvo KABIERSKEEE-04
 Laringoscopia conjuntos
 MACINTOSH convencionalAE-18 hasta AE-19
 MACINTOSH de fibra opticaAE-12 hasta AE-13
 MILLER convencionalAE-18 hasta AE-19
 MILLER de fibra opticaAE-12 hasta AE-13
 Laringoscopia espátulas
 MACINTOSH convencionalAE-15
 MACINTOSH de fibra opticaAE-10
 MILLER convencionalAE-16
 MILLER de fibra opticaAE-10
 Laringoscopia mango convencionalAE-17
 Laringoscopia mango de fibra opticaAE-11
 LAWRENCE pinza de disección y ligaduraBC-13
 LEBSCHKE cincel esternonDC-17
 LEES pinza atraumatica bronquialesBD-03
 Legra KUHNT para la corneaEC-05
 LEGUEU
 espátula vesicalGG-04
 separador vesicalesGG-06
 LEKSELL STILLE pinza gubiaDC-05
 LELAND JONES pinza atraumatica
 para vasculares perifBD-08 hasta BD-09
 LEMPERT
 cucharilla cortanteDC-13
 elevadorEE-15
 pinza gubiaDC-03
 LERCHE pinza de disecciónBA-04
 LERICHE pinza hemostáticaBC-09
 LESTER pinza fijaciónED-03
 LEVINSON aguja para cuerpos extrañosEC-05
 LEWIN pinza para huesosDC-10
 LEWKOWITZ pinza para aborto y placentaHC-07
 LEXER-BABY
 tijera de disecciónAI-12
 tijerasAH-10
 LEXER
 cincelDC-16
 LEXER-FINO tijera de disecciónAI-12
 LEXER
 gubiaDC-16
 LEXER mini
 cincelDC-16
 gubiaDC-16
 LEXER
 tijerasAH-09
 tijeras de disecciónAI-11
 LEYLA sistema de fijaciónEA-14 hasta EA-18
 LICHTWITZ
 agujaEG-09
 trocarCC-02
 LIDDLE pinza atraumatica aortaBD-10
 Lima
 FOMON para nasalesEG-15 hasta EG-16
 GALLAHER para senoEG-16
 JOSEPH (LEWIS) para nasalesEG-15
 JOSEPH para huesosEG-14
 MALTZ (COTTLE) para nasalesEG-15

- MALTZ para nasales.....EG-14
para huesos.....DC-25
para unas 10 cm.....HE-03
PUTTI para huesos.....DC-25
WIENER (AUFRIKHT) para nasales.....EG-15
WIENER para el seno.....EG-15
LISTER-BURCH blefarostato.....EC-02
LISTER
pinza para seno, porta esponjas.....BG-11
tijeras de vendajes.....AH-23, AI-45
LISTON
cuchillo para amputación.....AG-16
pinza cortante para huesos.....DC-06
LITTAUER
pinza auriculares.....EE-08
pinza depilatorias.....ED-08
pinza polipus para nasales.....EG-05
tijeras para puntas.....AI-40
LITTLER tijera de disección.....AI-13
LITTLE separador.....BI-08
Llave.....DD-10
LOCKLIN tijera.....AI-18
LORENZ tijeras de vendajes.....AI-47
LORNA pinza para campos.....BE-04
LOUTE tensor tierra-hilo.....DD-11
LOVE
gancho para nervios.....EA-04
LOVE-GRUENWALD pinza cortantes
para laminectomía.....EA-08
LOVELACE
pinza hemostática.....BC-07
pinza para coger el pulmón.....FG-19
LOVE
separador uvula.....FA-02
LOWER pinza via billar.....BC-14
LOWMAN clamp para huesos.....DC-11
LUBET-BARBON pinza polipus para nasales.....EG-05
LUCAE
diapasones.....EE-04
martillo.....DC-18
pinza auriculares.....EE-07
LUC pinza cortantes para nasales.....EG-06
LUER-KOERTE cuchara para cálculos biliares.....GC-09
LUER
pinza gubia.....DC-03
tubo traqueal.....FE-03
LUIKART-BILL tractor adecuada para todas las pinzas con mango
HC-05
LUIKART pinza obstétricas.....HC-03
LUNDSGAARD esclerotomo.....EC-05
LUNIATSCHEK obturador a gaza.....FA-02
LURZ pinza para ureter.....GC-10
- M**
MACINTOSH
laringoscopio conjuntos
convencional.....AE-18 hasta AE-19
laringoscopio conjuntos
de fibra optica.....AE-12 hasta AE-13
laringoscopio espátulas convencional.....AE-15
laringoscopio espátulas de fibra optica.....AE-10
MAGILL
estilete para tubo.....AE-04
tubo de aspiración.....AE-04, AE-06
MAIER pinza para tapones.....BG-12
MALTZ
bisturi cartilage acodado.....EG-11
MALTZ (COTTLE) lima para nasales.....EG-15
MALTZ
lima para nasales.....EG-14
- Mango
BROCK dilatador para válvula mitral.....FG-26
CASPAR de bisturíes micro.....AG-12
COLLIN de bisturíes.....AG-08
Mango
de bisturíes.....AG-02 hasta AG-05, AG-07 hasta AG-08
Mango de bisturíes micro.....AG-12
Mango
espejos laringeos.....FC-04
GIGLI para sierra.....EA-05
HUBER universal.....FC-03
LANDOLT de bisturíes micro.....AG-13
Mano de plomo.....DC-11
Manómetro para salpingógrafo.....HA-47
Marcador
CASTROVIEJO compas.....EC-09
CONNIN-AMSLER.....EC-09
MARSCHIK pinza amigdalas.....FA-04
MARTEL pinza para pericraneos.....BC-08
Martillo.....DC-18
COLLIN.....DC-18
con ranura.....DD-13
GERZOG.....DC-18
KIRK.....DC-18
LUCAE.....DC-18
MEAD.....DC-18
QUISLING.....DC-18
Martillos
BABINSKY de percusión.....AC-07
BERLINER de percusión.....AC-07
BUCK de percusión.....AC-07
DEJERINE de percusión.....AC-07
TAYLOR de percusión.....AC-07
TRAUBE de percusión.....AC-07
TROMNER de percusión.....AC-07
Martillo
WILLIGER.....DC-18
MARTIN
cable electrobisturíes.....JA-07
histerómetro.....HA-39
MARTINI cucharilla cortante.....DC-13
MARTIN
pelvimetro.....HC-06
pinza para secuestros.....DC-10
pinza para tapones.....BG-02, BG-14
MASSON porta-aguja.....CE-03
MASTIN pinza muscular.....FE-04
MATHIEU
espéculo rectales.....GI-02
pinza para cuerpos extraños.....GG-07
porta-aguja.....CE-05
separador.....BI-03
MATSON periostótomo.....DC-21
MAUNDER garrote madera.....EI-06
MAYO BLAKE pinza para cálculos biliares.....GC-04
MAYO
clip para esterilización.....CI-02
cuchara para cálculos biliares.....GC-07
MAY oftalmoscopio.....AC-03
MAYO-GUYON pinza para pedícula renal.....BC-16
MAYO-HEGAR porta-aguja.....CE-02
MAYO-NOBLE tijeras.....AH-08, AI-10
MAYO-ROBSON pinza intestinales.....GE-05
MAYO
sonda para cálculos renales.....GC-10
MAYO-STILLE tijeras.....AH-07, AI-08 hasta AI-09
MAYO
tijeras.....AH-06, AI-07
tijeras zurdo.....AI-07
McCLINTOCK pinza para aborto y placenta.....HC-07
McCULLOUGH pinza para estrabismo.....EC-13

McDONALD elevador	DC-22
McGEE pinza auriculares micro	EE-10
McGUIRE tijeras para corneal	AJ-05
McINDOE	
pinza de disección	BA-04
tijeras para cartilago	AI-35
McIVOR	
abajalengua	EI-05
abreboca	EI-05
McKENTY elevadores tabique	EG-11
McKENZIE	
perforadores plano	DD-04
pinza para poner grapas	EA-02
McLEAN pinza obstétricas	HC-04
McLEAN-LUIKART pinza obstétricas	HC-03
McLEAN-TUCKER-LUIKART pinza obstétricas	HC-03
McPHERSON pinza ligaduras	ED-05
McPHERSON TITAN pinza ligaduras	ED-05
McPHERSON WESTCOTT tijeras para tenotomía	AJ-04
MEAD	
martillo	DC-18
pinza gubia	DC-02
MEEKER pinza de disección y ligadura	BC-13
MELLINGER-AXENFELD blefarostato	EC-02
MELLINGER blefarostato	EC-02
MENGHINI trócar	CC-03
Meniscotomo	
BIRCHER	DC-24
NEFF	DC-24
SMILLIE	DC-24
MERCEDES separador torácico	FG-16
METZENBAUM FINO	
tijera de disección	AI-15
tijeras	AH-12
METZENBAUM	
porta-aguja	CE-04
METZENBAUM "S"	
tijera	AI-16
tijeras	AH-13
METZENBAUM	
tijera de disección	AI-13 hasta AI-14
tijeras	AH-11
MEYERDING separador	BI-08
MEYHOEFER cucharilla para chalazión	EC-07
MICHEL	
espejo	EG-04
grapas	CG-07
pinza para grapas	CG-07
MIDDELDORPF separador	BI-10
MIDDLETON-JANSEN pinza cortantes para nasales	EG-09
MIKULICZ	
pinza para peritoneo	BC-17
separador	BI-12
MILLER	
laringoscopio	
conjuntos convencional	AE-18 hasta AE-19
laringoscopio	
conjuntos de fibra óptica	AE-12 hasta AE-13
laringoscopio espátulas convencional	AE-16
laringoscopio espátulas de fibra óptica	AE-10
MILLIGAN descolador duramadre	EA-05
MILLIN	
dilatador para el cuello vesical	GG-07
pinza capsulares	GG-03
pinza para lóbulos anteriores	GG-03
pinza porta ligaduras	GG-03
Portador de luz fría	GG-05
separador vesicales	GG-05
MILLS tijeras para vasculares	AI-27
Mini	
CLAR	AC-05

estuche de bolsillo y de sutura	CG-08
MIXTER BABY pinza hemostática bronquial	BC-13
MIXTER O'SHAUGNESSY pinza hemostática	BC-14
MIXTER	
pinza hemostática	BC-14
pinza hemostática bronquial	BC-13
pinza para cálculos biliares	GC-04
pinza via billar	BC-15
MOELTGEN goniómetro	AC-08
MOGAN instrumento para circuncisión	GG-09
MOLLISON separador	BI-17
MOORE	
cuchara para cálculos biliares	GC-05
perforador a mano	DD-04
MOORFIELD pinza sutura	ED-05
MORSE-FAVOLORO separador costales	FG-17
MOYNIHAN	
pinza para campos	BE-05
pinza via billar	BC-15
sonda para cálculos biliares	GC-05
MUCK cuchillo periostio	EE-15
MUELLER blefarostato	EC-03
MURDOCK blefarostato	EC-02
MURLESS elevador para cabeza	HC-05
MURPHY-LANE elevador	DC-22
MURPHY pinza para cierra-tubo	BC-19
MUSEUX pinza para coger el cuello de útero	HA-33
MYLES pinza cortantes para nasales	EG-07

N

NABATOFF sonda de plata auricular	CA-02
NAEGELE pinza obstétricas	HC-03
NÁGELE perfora-cráneo	HC-09
NAGER separador paladar	FA-02
Navaja	AG-14, AG-19
NEFF meniscotomo	DC-24
NEGUS pinza para amígdalas	FA-03
NEIVERT porta-aguja	CE-02
NELSON	
aguja para ligaduras	CG-02
pinza de disección	BA-05
trócar	CC-02
NEUBÜSER pinza para sostener trompas	HA-51
NORTHBENT tijeras para puntas	AI-40
NOTO pinza para polipe uterino	HA-36
NOVAK cureta aspiradoras para la biopsia uterina	HA-40
NOYES	
pinza polipus para nasales	EG-05
tijeras para iris	AJ-03 hasta AJ-04
tijeras para tendones	AJ-03
NUBOER tubo de aspiración	AE-05

O

Obturador a gaza LUNIATSCHEK	FA-02
OCHSNER	
pinza atraumática aorta	BD-31
trócar	CC-02
O'CONNOR gancho para iris	EC-06
Oftalmoscopio	
MAY	AC-03
VARIFOCAL	AC-03
OLDBERG pinza cortantes para laminectomía	EA-09
OLIVECRONA	
espátulas cerebral	EA-07
pinza gubia	DC-03
sierra	EA-05
OLIVECRONA-TOENNIS pinza para poner grapas	EA-02
OLLIER separador	BI-10
OLSEN-HEGAR porta-aguja	CE-05

S

Índice alfabético Español

Osteotomo.....	DC-14
HIBBS.....	DC-16
LAMBOTTE.....	DC-15
LAMBOTTE mini.....	DC-15
STILLE.....	DC-14
O'SULLIVAN-O'CONNOR	
espéculo vaginales.....	HA-08
separador abdominales.....	BI-21
OTIS	
cuchillo de repuesto.....	GG-08
uretrotomo.....	GG-08
Otoscopia Juego para.....	AC-04
OVERHOLT-GEISSENDOERFER	
pinza de disección y ligadura.....	BC-10
OVERHOLT periostótomo.....	DC-21

P

Parametrio curvado fuerte.....	AI-31
PARHAM cinta sola.....	DC-11
PARK blefarostato.....	EC-03
PARKER	
bisturíes para disección.....	AG-15
separador.....	BI-02
PARTSCH	
cincel.....	DC-14
gubia.....	DC-14
PASSOW hemostata.....	EE-15
PATON diseccador para la cornea.....	EC-05
PAUFIQUE	
cuchillo para queratoplastico.....	EC-05
pinza ligaduras.....	ED-05
PAUFIQUE TITAN pinza ligaduras.....	ED-05
PAYR-Baby pinza clamp estomacales.....	GE-09
PAYR	
pinza clamp estomacales.....	GE-09
sonda conductora.....	CG-04
PEAN	
pinza atraumatica.....	BD-02
pinza hemostática.....	BC-08
pinza hemostática delgada.....	BC-06
PEDERSON espéculo vaginales.....	HA-03
PEERS BERTRAM pinza para campos.....	BE-03
PEET pinza para espinas.....	BA-06
PELKMANN pinza para tapones.....	BG-12
Pelvimetro	
COLLIN.....	HC-06
COLLYER.....	HC-06
MARTIN.....	HC-06
PENFIELD descolador duramadre.....	EA-06
PENNINGTON pinza hemostática.....	BC-07
PERCY retractor para amputacion.....	DD-03
Perfora-cráneo	
NÄGELE.....	HC-09
SMELLIE.....	HC-09
Perforador	
a mano.....	DD-05
BUNNELL a mano.....	DD-05
con mandril Jacobs.....	DD-06
CRUTCHFIELD para inicial.....	EA-03
Perforadores	
CUSHING plano.....	DD-04
McKENZIE plano.....	DD-04
Perforador	
HUDSON a mano.....	DD-04
KIRSCHNER a mano.....	DD-05
MOORE a mano.....	DD-04
para clavos.....	DD-12
RALK a mano.....	DD-05
STILLE a mano.....	DD-04
STILLE-SHERMAN a mano.....	DD-04
Periostótomo	
ALEXANDER.....	DC-19
DOYEN para costillas.....	DC-20
FARABEUF.....	DC-19
LAMBOTTE.....	DC-19
LANGENBECK.....	DC-19
MATSON.....	DC-21
OVERHOLT.....	DC-21
SADILLOT.....	DC-19
SEMB.....	DC-20
WILLIGER.....	DC-19
PERTHES escariadores.....	DD-08
PESTALOZZA cureta para aborto y placenta.....	HC-08
PETRI cubeta.....	HE-08
PETZ aparato	
para suturar estomacales e intestinales.....	GE-09
PHANEUF pinza para peritoneo.....	BC-17
Pick.....	EE-15
BARBARA.....	EE-14 hasta EE-15
Piedra afiladora ARKANSAS.....	AG-19
PIERCE trócar.....	CC-02
PIFFARD cureta para lupus.....	HE-02
PINARD estetoscopio.....	AC-06
Pinza	
ADLERKREUTZ de disección.....	BA-04
ADSON BABY hemostática.....	BC-09
ADSON-BROWN de disección.....	BA-03
ADSON de disección.....	BA-03
ADSON gubia.....	DC-03
ADSON hemostática.....	BC-09
ADSON micro de disección.....	BA-03
ADSON para hipófisis.....	EA-06
ALEXANDER sacabocado para el cuello del útero.....	HA-42
ALLIS-ADAIR para tejidos.....	GE-02
ALLIS-Baby para tejidos.....	GE-02
ALLIS para tejidos.....	GE-02
ARCHER para espinas.....	BA-06
ARRUGA capsulares.....	ED-04
ASCH enderezar tabique.....	EG-18
auriculares micro.....	EE-09 hasta EE-10, EE-12
auriculares micro mini.....	EE-13
AYER chalazión.....	ED-06
BABCOCK para tejidos.....	GE-02
BACKHAUS-CLIP para campos con porta-tubo.....	BE-03
BACKHAUS KOCHER para campos.....	BE-02
BACKHAUS para campos.....	BE-02
BAGGISH sacabocado para el cuello del útero.....	HA-45
BAINBRIDGE atraumatica.....	BD-09
BAINBRIDGE hemostática.....	BC-14
BALL AND SOCKET para campos.....	BE-04
BALLENGER coger amígdalas.....	FA-04
BARRAQ.KATZIN para iris.....	EC-13
BARRAQU Colibri para iris.....	EC-13
BARRAQUER cámara anterior.....	ED-02
BARRAQUER depilatorias.....	ED-08
BARRAQUER fijación.....	ED-03
BARRETT pra coger el cuello de útero.....	HA-32
BECK atraumatica para vasculares perif.....	BD-25
BEER depilatorias.....	ED-08
BENGOLEA hemostática.....	BC-09
BERGMANN FOERSTER porta esponjas.....	BG-10
BERKE muscular.....	ED-02
BERNHARD para campos.....	BE-05
BEST intestinales.....	GE-06
BEYER gubia.....	DC-04
BEYER sacabocado.....	EG-08
BIRCHER-GANSKE para huesos.....	DC-10
BISHOP-HARMAN para iris.....	EC-14
BLAKE para cálculos biliares.....	GC-03
BLOHMKE coger amígdalas.....	FA-04
BLUMENTHAL gubia.....	DC-02

BÖHLER cortante para huesos	DC-06
BÖHLER gubia	DC-04
BONACCOLTO para estrabismo	EC-14
BONNEY porta esponjas	BG-08
Bonn para iris	EC-15
Bonn TITAN para iris	EC-15
BOZEMANN-DOUGLAS para tapones	BG-13
BOZEMANN para tapones	BG-13
BRAIN MINI de aplicación clip	EA-12
BRAIN STANDARD de aplicación clip	EA-12
BRAUN para coger el cuello de útero	HA-31, HA-34
BROWN de disección	BA-03
BRUENINGS cortantes para nasales	EG-05
BRUENINGS laringe	FC-03
BRUNNER intestinales	GE-06
BRYANT porta esponjas	BG-11
BUMM para el útero	HA-38
BURKE-Baby sacabocado para el cuello del útero	HA-44
BURKE sacabocado para el cuello del útero	HA-44
CARMALT para espinas	BA-06
CASTAÑEDA atraumatica para nacidos y niños	BD-42
CASTROVIEJO capsulares	ED-04
CASTROVIEJO fijación	ED-03
CASTROVIEJO sutura	ED-05
CHAPUT hemostática	BC-08
CHEATLE para esterilización	CI-02
CHERON para tapones	BG-12
CHEVALIER-JACKSON laringe	FC-04
CHILDE para grapas	CG-07
CITELLI sacabocado	EG-08
Pinza-clamp GREEN-ARMYTAGE uterina para hemostasis	HC-06
Pinza	
CLEVELAND gubia	DC-02
coagulación bipolar	JA-04 hasta JA-06
COLCLOUGH sacabocado para discos intervertebrales	EA-11
COLLIN-DUVAL de disección	BA-04
COLLIN hemostática	BC-08
COLLIN para el útero	HA-37
COLLIN para grapas	CG-07
COLLIN para tapones	BG-11
COLLIN-POZZI para coger el cuello de útero	HA-32
COLLIN tiralengua	EI-03
COLVER coger amígdalas	FA-03
COOLEY atraumatica	BB-03, BD-35 hasta BD-37, BD-39, BD-41
COOLEY atraumatica anastomosis	BD-37, BD-40
COOLEY atraumatica iliaca	BD-37
COOLEY atraumatica pediátricas	BD-38 hasta BD-39
COOLEY DERRA atraumatica anastomosis	BD-39
COOLEY para vascular	BD-40
CORDES laringe	FC-03
corta-hilo	DD-12
COTTLE-KAZANJIAN cortante para huesos	DC-06
CRAFOORD hemostática bronquial	BC-12
CRILE hemostática	BC-05
CRILE-RANKIN hemostática	BC-05
CRILE TITAN hemostática	BC-05
CRUTCHFIELD de tracción craneal	EA-03
CUSHING cortantes para laminectomía	EA-08
CUSHING de disección	BA-03
CZERNY para cálculos biliares	GC-03
CZERNY pra coger el cuello de útero	HA-34
DALE atraumatica para vasculares perif	BD-24
DANDY hemostática	BC-07
DARDIK atraumatica	BD-07
DARTIGUES para el útero	HA-37
DASTOOR para estrabismo	EC-14
DAVIS para esterilización	CI-02
DE BAKEY atraumatica	BB-03

DEBAKEY atraumatica	BD-02, BD-08
DE BAKEY atraumatica	BD-16 hasta BD-17
DEBAKEY atraumatica	BD-20
DE BAKEY atraumatica	BD-28 hasta BD-30
DE BAKEY atraumatica anastomosis	BD-25
DE BAKEY atraumatica aneurisma de aorta	BD-13, BD-15, BD-18
DE BAKEY atraumatica bronquiales	BD-19
DE BAKEY atraumatica de disección y ligadura	BD-25, BD-32
DE BAKEY atraumatica iliaca	BD-11
DE BAKEY atraumatica para vasculares perif	BD-06
DEBAKEY BAHNSON atraumatica aneurisma de aorta	BD-14
DE BAKEY MORRIS atraumatica	BD-16
DE BAKEY REYNOLDS atraumatica anastomosis	BD-30
DEBAKEY SATINSKY atraumatica	BD-22
Pinza de disección	BA-02
Pinza DeMARTEL-WOLFSON para anastomosis	GE-07
depilatorias	ED-08
Pinza de relojero	BA-06
Pinza DERRA atraumatica anastomosis, pediátricas	BD-28
DESJARDINS para cálculos biliares	GC-02
DESJARDINS via billar	BC-15
DESMARRES chalazión	ED-06
DeVILBISS cranea	EA-05
DIAMANT corta-hilo	DD-12
DIETER la cabeza del martillo	EE-10
DIETHRICH atraumatica	BD-31
DIMEDA para desechos	CI-03
DINGMANN para huesos	DC-10
DOUGLAS depilatorias	ED-08
DOYEN-Baby intestinales	GE-03
DOYEN intestinales	GE-03
DOYEN para campos	BE-05
DOYEN para polipe uterino	HA-36
DUPLAY para tapones	BG-14
DUPLAY pra coger el cuello de útero	HA-31
DUPUY-WEISS aguja	FA-03
DUVAL de disección	BA-04
DUVAL para tejidos	GE-03
ECHLIN gubia	DC-05
EDWARDS para aplicar clips	BD-21
ELSAESSER para nephrostomíe	GC-13
ELSCHNIG capsulares	ED-04
ELSCHNIG fijación	ED-03
EPPENDORFER-KEVORKIAN sacabocado para el cuello del útero	HA-46
EPPENDORFER sacabocado para el cuello del útero	HA-45 hasta HA-46
EPPENDORFER TISCHLER-MORGAN sacabocado para el cuello del útero	HA-46
FARABEUF-LAMBOTTE para huesos	DC-08
FARABEUF para huesos	DC-07
FAURE para peritoneo	BC-17
FAURE sacabocado para el cuello del útero	HA-41
FEHLAND intestinales	GE-06
FEILCHENFELD para espinas	BA-06
FERGUSSON hemostática	BC-07
FERGUSSON para huesos	DC-07
FERRIS de disección	BA-04
FERRIS-SMITH cortantes para laminectomía	EA-09
FERRIS-SMITH-KERRISON sacabocado para discos intervertebrales	EA-10
FINOCHIETTO bronquiales	FG-21
FISCHER para iris	EC-13
FLETCHER JAVERTS porta esponjas	BG-10
Pinza flexibles para vasculares	BD-44 hasta BD-45
Pinza	

FOERSTER para iris.....	EC-12	JURASZ polipus laringe.....	FC-02
FOERSTER porta esponjas.....	BG-06 hasta BG-08	KALT capsulares.....	ED-04
FRAENKEL laringe.....	FC-03	KELLY hemostática.....	BC-05
FRAENKEL polipus laringe.....	FC-02	KELLY para polipe uterino.....	HA-36
FRIEDMAN gubia.....	DC-02	KELLY-RANKIN hemostática.....	BC-05
FRIEDMAN MINI gubia, mini.....	DC-02	KELLY TITAN hemostática.....	BC-05
FRYKHOLM gubia.....	DC-05	KERN para huesos.....	DC-08
FUCHS capsulares.....	ED-04	KERRISON sacabocado.....	EG-08
GAUSS para pericraneos.....	HC-06	KEVORKIAN-Pacifico	
GELLHORN sacabocado para el cuello del útero.....	HA-42	sacabocado para el cuello del útero.....	HA-44
GEMINI de disección y ligadura.....	BC-10	KEVORKIAN	
GEMINI MINI de disección y ligadura.....	BC-10	sacabocado para el cuello del útero.....	HA-43, HA-46
GERALD de disección.....	BA-05	KIRBY-ARTHUR para iris.....	EC-13
GILL-ARRUGA capsular.....	ED-03	KNAPP-LUER tracoma.....	ED-06
GILL-HESS para iris.....	EC-12	KNIGHT cortantes para nasales.....	EG-05
GILLIES de disección.....	BA-05	KOCHER hemostática delgada.....	BC-06
GILL para iris.....	EC-12	KOCHER intestinales.....	GE-04
GLOVER atraumática.....	BD-06, BD-30	KRAUSE laringe.....	FC-03
GLOVER atraumática anastomosis.....	BD-05	LAHEY agarrar bocio.....	FE-04
GLOVER para coarctación atraumática.....	BD-04	LAHEY via billar.....	BC-14
GRADLE depilatorias.....	ED-08	LAMBERT chalazión.....	ED-06
GRAEFE de disección.....	BA-03	LAMBERT KAY atraumática anastomosis de aorta.....	BD-10
GRAEFE fijación.....	ED-03	LAMBERT KAY atraumática iliaca.....	BD-11
GRAEFE para iris.....	EC-11	LAMBOTTE para huesos.....	DC-08
GRAY via billar.....	BC-15	LANE clamp estomacales.....	GE-08
GREEN fijación.....	ED-03	LANE de disección.....	BA-04
GREGORY atraumática profunda.....	BD-33	LANE para campos.....	BE-05
GREVEN auriculares micro.....	EE-10	LANE para huesos.....	DC-08
GRIP para agarrar.....	DD-11	LANE para sostener placas.....	DD-14
GROSS-MAIER para tapones.....	BG-02 hasta BG-04	LANE para sostener tornillo.....	DD-14
GROSS para tapones.....	BG-05	LANGE laringe.....	FC-03
GUYON para pedícula renal.....	BC-16	LANGENBECK para huesos.....	DC-07
HAJEK-CLAUS seno maxil.....	EG-08	LAWRENCE de disección y ligadura.....	BC-13
HAJEK-KOFLER sacabocado.....	EG-08	LEES atraumática bronquiales.....	BD-03
HALSTED-MOSQUITO atraumática.....	BD-02	LEKSELL STILLE gubia.....	DC-05
HALSTED-MOSQUITO hemostática.....	BC-04	LELAND JONES	
HALSTED-MOSQUITO micro hemostática.....	BC-04	atraumática para vasculares.....	BD-08 hasta BD-09
HALSTED-MOSQUITO TITAN hemostática.....	BC-04	LEMPERT gubia.....	DC-03
HARKEN atraumática aurícula.....	BD-23	LERCHE de disección.....	BA-04
HARRINGTON bronquiales.....	FG-21	LERICHE hemostática.....	BC-09
HARTMANN auriculares.....	EE-08	LESTER fijación.....	ED-03
HARTMANN cortantes para nasales.....	EG-07	LEWIN para huesos.....	DC-10
HARTMANN hemostática.....	BC-03	LEWKOWITZ para aborto y placenta.....	HC-07
HARTMANN-HOFFMANN auriculares.....	EE-08	LIDDLE atraumática aorta.....	BD-10
HARTMANN polipus para nasales.....	EG-04	LISTER para seno, porta esponjas.....	BG-11
HARTMANN-WULLSTEIN auriculares.....	EE-08	LITTON cortante para huesos.....	DC-06
HEANEY histerectomía.....	BC-18	LITTAUER auriculares.....	EE-08
HEGENBARTH para grapas.....	CG-07	LITTAUER depilatorias.....	ED-08
HEIMING para cálculos renales.....	GC-13	LITTAUER polipus para nasales.....	EG-05
HEISS hemostática.....	BC-09	LORNA para campos.....	BE-04
HENROTIN pra coger el cuello de útero.....	HA-34	LOVE-GRUENWALD cortantes para laminectomía.....	EA-08
HERRICK para peritoneo.....	BC-17	LOVELACE hemostática.....	BC-07
HESS capsulares.....	ED-04	LOVELACE para coger el pulmón.....	FG-19
HESS para iris.....	EC-12	LOWER via billar.....	BC-14
HEYMANN cortantes para nasales.....	EG-05	LUBET-BARBON polipus para nasales.....	EG-05
HEYMANN-KNIGHT polipus para nasales.....	EG-05	LUCAE auriculares.....	EE-07
HEYWOOD-SMITH emorroidal.....	GI-05	LUC cortantes para nasales.....	EG-06
HOFF para campos.....	BE-03	LUER gubia.....	DC-03
HOLTH para capsuloiridectomía.....	EC-09	LURZ para ureter.....	GC-10
HUNTER para espinas.....	BA-06	MAIER para tapones.....	BG-12
IOWA pra coger el cuello de útero.....	HA-35	MARSCHIK amigdalas.....	FA-04
JACKSON tapones.....	FC-02	MARTEL para pericraneos.....	BC-08
JACOBS pra coger el cuello de útero.....	HA-34	MARTIN para secuestros.....	DC-10
JAMESON para estrabismo.....	EC-13	MARTIN para tapones.....	BG-02, BG-14
JANSEN para nasales.....	EG-04	MASTIN muscular.....	FE-04
JARCHO pra coger el cuello de útero.....	HA-32	MATHIEU para cuerpos extraños.....	GG-07
JATHO nasofaringe.....	EG-18	MAYO BLAKE para cálculos biliares.....	GC-04
JAVID atraumática carotis.....	BD-32	MAYO-GUYON para pedícula renal.....	BC-16
JOHNS-HOPKINS via billar.....	BC-14	MAYO-ROBSON intestinales.....	GE-05
JONES para campos con porta-tubo.....	BE-02	McCLINTOCK para aborto y placenta.....	HC-07
JUDD-ALLIS para tejidos.....	GE-02	McCULLOUGH para estrabismo.....	EC-13

McGEE auriculares micro	EE-10
McINDOE de disección	BA-04
McKENZIE para poner grapas	EA-02
McPHERSON ligaduras	ED-05
McPHERSON TITAN ligaduras	ED-05
MEAD gubia	DC-02
MEEKER de disección y ligadura	BC-13
MICHEL para grapas	CG-07
Pinza micro	BB-02
Pinza	
MIDDLETON-JANSEN cortantes para nasales	EG-09
MIKULICZ para peritoneo	BC-17
MILLIN capsulares	GG-03
MILLIN para lóbulos anteriores	GG-03
MILLIN porta ligaduras	GG-03
MIXTER BABY hemostática bronquial	BC-13
MIXTER hemostática	BC-14
MIXTER hemostática bronquial	BC-13
MIXTER O'SHAUGNESSY hemostática	BC-14
MIXTER para cálculos biliares	GC-04
MIXTER vía billar	BC-15
MOORFIELD sutura	ED-05
MOYNIHAN para campos	BE-05
MOYNIHAN vía billar	BC-15
MURPHY para cierra-tubo	BC-19
MUSEUX pra coger el cuello de útero	HA-33
MYLES cortantes para nasales	EG-07
NEGUS para amígdalas	FA-03
NELSON de disección	BA-05
NEUBÜSER para sostener trompas	HA-51
NOTO para polipe uterino	HA-36
NOYES polipus para nasales	EG-05
OCHSNER atraumatica aorta	BD-31
OLDBERG cortantes para laminectomía	EA-09
OLIVECRONA gubia	DC-03
OLIVECRONA-TOENNIS para poner grapas	EA-02
OVERHOLT-GEISSENDOERFER	
de disección y ligadura	BC-10
Pinza para campos modelo delicato	BE-02
Pinza para cierra-tubo	BC-19
Pinza	
para cortar y alambre	DD-11
Pinza para espinas	BA-06
Pinza para esterilización	CI-02
Pinza	
para fijar	GG-10
para fijar el cordón espermatoc	GG-10
Pinza para huesos	DC-09 hasta DC-10
Pinza para secuestros	DC-10
Pinza	
para unas 11,5 cm	HE-03
PAUFIQUE ligaduras	ED-05
PAUFIQUE TITAN ligaduras	ED-05
PAYR-Baby clamp estomacales	GE-09
PAYR clamp estomacales	GE-09
PEAN atraumatica	BD-02
PEAN hemostática	BC-08
PEAN hemostática delgada	BC-06
PEERS BERTRAM para campos	BE-03
PEET para espinas	BA-06
PELKMANN para tapones	BG-12
PENNINGTON hemostática	BC-07
PHANEUF para peritoneo	BC-17
picos planos	DD-11
POTTS atraumatica	BD-26 hasta BD-27
POTTS atraumatica anastomosis	BD-05
POTTS para coarctación atraumatica	BD-04
POTTS-SMITH de disección	BA-02
POZZI para coger el cuello de útero	HA-31
PRATT hemostática	BC-08
PRATT para coger el cuello de útero	HA-34 hasta HA-35

PRESBYTERIAN HOSPITAL para cierra-tubo	BC-19
PRICE-THOMAS bronquiales	FG-22
PRINCE muscular	ED-02
PROVIDENCE-HOSPITAL hemostática	BC-05
RADOLF para unas	DD-03
RAMPLEY porta esponjas	BG-09
RANDALL para cálculos renales	GC-11 hasta GC-12
RANEY hemostática para cuero cabell	EA-03
RANEY para poner y quitar	EA-03
RANKIN atraumatica	BD-02
RICHTER-HEATH para grapas	CG-07
ROBERTS hemostática	BC-11
ROCHESTER-CARMALT hemostática	BC-07
ROCHESTER-OCHSNER hemostática	BC-06
ROCHESTER-PEAN hemostática	BC-06
ROEDER para campos	BE-03
ROGGE para esterilización	CI-02
ROSENBERG laringe	FC-03
ROWE boca	EI-06
RUBIN para magullar tabique	EG-07
RUMEL para toracica	BC-11
RUSKIN gubia	DC-04
RUSKIN-LISTON cortante para huesos	DC-06
RUSSIAN de disección	BA-04
SAENGER para aborto y placenta	HC-07
SAIRGES pra coger el cuello de útero	HA-32
SAROT bronquiales	FG-23
SAROT hemostática bronquial	BC-12
SATINSKI atraumatica	BD-20
SATINSKY	
para anastomosis (vena cava)	FG-24 hasta FG-25
Pinzas atraumaticas, pediátricas, vasculares	BD-43
Pinza	
SAUERBRUCH gubia	DC-05
SAUERBRUCH para desechos	CI-03
SAWTELL para amígdalas	FA-03
SCAGLIETTI gubia	DC-05
SCHEINMANN laringe	FC-03
SCHNIDT para amígdalas	FA-03
SCHOENBURG para tejidos	GE-03
SCHROEDER	
para coger el cuello de útero	HA-31 hasta HA-32
SCHUBERT sacabocado para el cuello del útero	HA-41
SCHUMACHER laringe	FC-03
SCHUMACHER sacabocado	
para el cuello del útero	HA-43
SCHWEIGGER capsulares	ED-04
SEIFFERT laringe	FC-03
SEMB bronquiales	FG-23
SEMB cortante para huesos	DC-07
SEMB gubia	DC-06
SEMB para huesos	DC-07
SEMKEN de disección	BA-05
SIEGLER HELLMANN para el útero	HA-38
SIMS-MAIER para tapones	BG-05
SINGLEY de disección	BA-05
SKENE para coger el cuello de útero	HA-31
SMITHWICK para poner grapas	EA-02
SNELLEN entropión	ED-06
SOMER para el útero	HA-37
SPENCER-WELLS hemostática	BC-07
SPURLING cortantes para laminectomía	EA-08
STAUDE-MOORE para coger el cuello de útero	HA-31
STEVENS para iris	EC-11
STIEGLITZ para espinas	BA-06
STILLE de disección	BA-02
STILLE-HORSLEY cortante para huesos	DC-07
STILLE-LISTON cortante para huesos	DC-06
STILLE-LUER gubia	DC-04
STILLE para pedícula renal	BC-16
STILLE-RUSKIN gubia	DC-05

St. MARTIN sutura.....	ED-05	pinza obstétricas.....	HC-04
STONE para cerrar.....	GE-06	pinza obstétricas con dispositivo de tracción.....	HC-04
STONE-WATT intestinales.....	GE-06	Placa JAEGER para párpados.....	EC-03
STRUEMPEL auriculares.....	EE-08	Placa para extender la piel.....	AG-21
STRUYCKEN cortantes para nasales.....	EG-07	PLESTER	
SUBRAMANIAN atraumatica.....	BD-31	cuchillo lobar.....	EE-14
SWEET para poner grapas.....	EA-02	separador.....	BI-14
TEALE para coger el cuello del útero.....	HA-33	POLITZER	
TERSON capsulares.....	ED-04	aguja paracentesis.....	EE-06
THOMS-ALLIS para tejidos.....	GE-02	cuchillo auriculares.....	EE-06
THOMS-GAYLOR sacabocado		insuflador de aire.....	EE-05
para el cuello del útero.....	HA-42	POOLE tubo de aspiración.....	AE-02
TIEMANN para coger el cuello del útero.....	HA-32	Porta-aguja	
TILLEY auriculares.....	EE-08	ADSON.....	CE-04
TISCHLER-KEVORKIAN sacabocado		ARRUGA de oftalmología.....	CE-06
para el cuello del útero.....	HA-44 hasta HA-45	BARRAQUER.....	CE-07
TISCHLER-MORGAN sacabocado		BAUMGARTNER.....	CE-02
para el cuello del útero.....	HA-43 hasta HA-44, HA-46	BOYNTON de oftalmología.....	CE-06
TIVNEN coger amígdalas.....	FA-04	BOZEMANN.....	CE-03
TOENNIS hemostática.....	BC-11	CASTROVIEJO.....	CE-07
TOHOKU para campos.....	BE-04	COLLIER.....	CE-02
TOWNSEND-KEVORKIAN sacabocado		CRILE.....	CE-04
para el cuello del útero.....	HA-44	CRILE-MURRAY.....	CE-02
TOWNSEND-MINI (BABY TISCHLER)		CRILE-WOOD.....	CE-02
sacabocado para el cuello del útero.....	HA-45	DE BAKEY.....	CE-03
TOWNSEND-mini sacabocado		DERF.....	CE-02
para el cuello del útero.....	HA-44	DIETHRICH para vascular.....	CE-06
TOWNSEND sacabocado para el cuello del útero.....	HA-44	FINOCHIETTO.....	CE-04
TOWNSEND-TISCHLER sacabocado		GILLIES.....	CE-05
para el cuello del útero.....	HA-44	HALSEY.....	CE-02
TROELTSCH para nasales.....	EG-04	HEANEY.....	CE-03
TROUTMAN Colibri para iris.....	EC-13	HOESEL.....	CE-05
TROUTMAN rectus.....	ED-02	JAMISON.....	CE-03
Tübingen ligaduras.....	ED-05	JOHNSON.....	CE-04
Tübingen para iris.....	EC-15	KALT.....	CE-07
Tübingen TITAN ligaduras.....	ED-05	KALT-ARRUGA.....	CE-07
Tübingen TITAN para iris.....	EC-15	MASSON.....	CE-03
TUFFIER hemostática.....	BC-08	MATHIEU.....	CE-05
TURNBULL para unas 11,5 cm.....	HE-03	MAYO-HEGAR.....	CE-02
TURREL sacabocado para biopsia.....	GI-05	METZENBAUM.....	CE-04
TYDING coger amígdalas.....	FA-04	NEIVERT.....	CE-02
ULRICH porta esponjas.....	BG-06	OLSEN-HEGAR.....	CE-05
UNIVERSAL para esterilización.....	CI-02	RYDER.....	CE-03
USA de disección.....	BA-02	SAROT.....	CE-04
VAN BUREN para secuestros.....	DC-10	STEVENS de oftalmología.....	CE-06
van DOREN sacabocado para el cuello del útero.....	HA-42	STRATTE.....	CE-04
VERBRUGGE para huesos.....	DC-09	TOENNIS.....	CE-04
VIRTUS (RALK) para espinas.....	BA-06	WANGENSTEEN.....	CE-03
WACHENFELDT para grapas.....	CG-07	Portador MILLIN de luz fria.....	GG-05
WAGNER cortantes para laminectomía.....	EA-09	POTTS DE MARTEL tijeras para vasculares.....	AI-27
WALSHAM enderezar tabique.....	EG-18	POTTS	
WANGENSTEEN de disección.....	BA-05	pinza atraumatica.....	BD-26 hasta BD-27
WEBER atraumatica.....	BD-12	pinza atraumatica anastomosis.....	BD-05
WEIL-BLAKESELEY cortantes para nasales.....	EG-06	pinza para coarctación atraumatica.....	BD-04
WEISS para cierra-tubo.....	BC-19	POTTS-SMITH	
WERTHEIM-CULLEN histerectomía.....	BC-18	pinza de disección.....	BA-02
WERTHEIM histerectomía.....	BC-18	tijeras para vasculares.....	AH-19, AI-28
WHITE coger amígdalas.....	FA-03	POZZI pinza pra coger el cuello de útero.....	HA-31
WILDE (TROELTSCH) auriculares.....	EE-07	P. para unas 11,5 cm.....	HE-03
WILLET-MARTELL para pericraneio.....	BC-08	PRATT	
WILLIAMS para tejidos.....	GE-03	dilatador uterinos.....	HA-29
WINTER para aborto y placenta.....	HC-07	espéculo rectales.....	GI-02
WITTNER sacabocado para el cuello del útero.....	HA-43	gancho cistico.....	GI-04
WOLFF para romper yesos.....	DA-04	pinza hemostática.....	BC-08
WYLIE atraumatica.....	BD-21	pinza pra coger el cuello del útero.....	HA-34 hasta HA-35
YEOMAN sacabocado para biopsia.....	GI-05	PRESBYTERIAN HOSPITAL pinza	
YOUNG para coger prostata.....	GG-02	para cierra-tubo.....	BC-19
YOUNG tiralengua.....	EI-03	PRICE-THOMAS pinza bronquiales.....	FG-22
ZAUFAL-JANSEN gubia.....	DC-04	PRINCE	
ZENKER de disección y ligadura.....	BC-12	pinza musculares.....	ED-02
PIPER		tijeras para amígdalas.....	AI-27

Proctoscopio KELLY.....	GI-04
Protector	
ARRUGA.....	EC-08
de tejido.....	DD-15
PROVIDENCE-HOSPITAL pinza hemostática.....	BC-05
PUTTI lima para huesos.....	DC-25

Q

QUATTRO separador para yesos.....	DA-03
Queratomo	
BERENS.....	EC-04
CASTROVIEJO.....	EC-04
JAEGER.....	EC-04
QUINBY tijeras para encías.....	AI-42
QUINKE aguja para punción.....	CC-03
QUIRE elevadores cuerpos extraños.....	EE-08
QUISLING martillo.....	DC-18
Quistotomo	
BECKER.....	EC-06
GRAEFE.....	EC-06
Quita hojas.....	AG-06, AG-10

R

RADOLF pinza para unas.....	DD-03
RALK perforador a mano.....	DD-05
RAMPLEY pinza porta esponjas.....	BG-09
RANDALL	
cureta aspiradoras para la biopsia uterina.....	HA-40
pinza para cálculos renales.....	GC-11 hasta GC-12
RANEY	
pinza hemostática para cuero cabell.....	EA-03
pinza para poner y quitar.....	EA-03
RANKIN pinza atraumática.....	BD-02
Raquiótomo.....	DC-17
RECAIMER cureta uterinas.....	HA-49 hasta HA-50
Rectoscopio luz fría.....	GI-03
Regla de metal.....	AC-08
REICHERT depresor epiglotis.....	FC-02
REINER	
cuchillo para yesos.....	DA-04
jeringa auriculares.....	EE-05
Retractor PERCY para amputación.....	DD-03
REVERDIN	
aguja para ligaduras.....	CG-03
separador.....	BI-04
REYNOLDS	
tijera.....	AI-18
tijeras.....	AH-15
RIBBON separador.....	BI-04
RICHARDSON-EASTMAN separador.....	BI-04
RICHARDSON Grip separador.....	BI-04
RICHARDSON separador.....	BI-04
RICHTER-HEATH pinza para grapas.....	CG-07
RIGBY separador abdominales.....	BI-24
Riñonera.....	HE-07
ROBB disector para vasculares.....	FG-33
ROBERTS pinza hemostática.....	BC-11
ROCHESTER-CARMALT pinza hemostática.....	BC-07
ROCHESTER-OCHSNER pinza hemostática.....	BC-06
ROCHESTER-PEAN pinza hemostática.....	BC-06
ROEDER pinza para campos.....	BE-03
ROGER elevadores tabique.....	EG-11
ROGGE pinza para esterilización.....	CI-02
ROLLET	
cincel para extirpación.....	EC-06
separador.....	EC-06
Rompecráneo VIRCHOW.....	DC-17
Rompe hojas	
CASTROVIEJO.....	AG-14

DIMEDA.....	AG-14
TROUTMAN-CHRIS.....	AG-14
ROSE gancho traqueal.....	FE-03
ROSEN	
aguja.....	EE-14 hasta EE-15
ROSENBERG pinza laringe.....	FC-03
ROSEN	
cuchillo circular.....	EE-14
ROSER-KOENIG abreboca.....	EI-03
ROUX BABY separador.....	BI-02
ROUX MINI separador.....	BI-02
ROUX separador.....	BI-02
ROWE pinza boca.....	EI-06
RUBIN pinza para magullar tabique.....	EG-07
RUMEL pinza para torácica.....	BC-11
RUSKIN-LISTON pinza cortante para huesos.....	DC-06
RUSKIN pinza gubia.....	DC-04
RUSSIAN pinza de disección.....	BA-04
RYDEL-SEIFFER diapasones.....	EE-04
RYDER porta-aguja.....	CE-03

S

SAALFELD saca comedones.....	HE-02
Saca	
SAALFELD comedones.....	HE-02
SCHAMBERG comedones.....	HE-02
UNNA comedones.....	HE-02
WALTON comedones.....	HE-02
SACHS	
descolador duramadre.....	EA-05
gancho para nervios.....	EA-04
SADILLOT perióstotomo.....	DC-19
SAENGER pinza para aborto y placenta.....	HC-07
SAIRGES pinza para coger el cuello del útero.....	HA-32
Salpingógrafo SCHULTZE.....	HA-47
SANVENERO	
tijera.....	AI-16
tijeras.....	AH-13
SAROT	
pinza bronquiales.....	FG-23
pinza hemostática bronquial.....	BC-12
porta-aguja.....	CE-04
SATINSKI pinza atraumática.....	BD-20
SATINSKY	
pinza para anastomosis (vena cava).....	FG-24 hasta FG-25
tijeras para torácica.....	AI-37
SATO cuchillo para corneal.....	EC-05
SAUERBRUCH	
caja para agujas.....	HE-02
costotomo.....	FG-05
SAUERBRUCH-FREY costotomo.....	FG-06
SAUERBRUCH	
pinza gubia.....	DC-05
pinza para desechos.....	CI-03
separador.....	BI-13
SAWTELL pinza para amígdalas.....	FA-03
SCAGLIETTI pinza gubia.....	DC-05
SCHAMBERG saca comedones.....	HE-02
SCHUDE cucharilla cortante.....	DC-12
SCHIEE	
canula oculares.....	ED-07
cuchillo para goniotomía.....	EC-05
SCHEINMANN pinza laringe.....	FC-03
SCHERBAK espéculo vaginales.....	HA-21
SCHIMMELBUSCH tambor para esterilización.....	HE-12
SCHINK dermatómo.....	AG-21
SCHIOETZ tonómetro.....	ED-08
SCHMIEDEN-PAYR sonda conductora.....	CG-04
SCHMIEDEN sonda conductora.....	CG-04
SCHMIEDEN-TAYLOR tijeras.....	AI-36

SCHNIDT pinza para amígdalas	FA-03
SCHOENBORN separador tiroide.....	FE-04
SCHOENBURG pinza para tejidos.....	GE-03
SCHROEDER	
cureta uterinas	HA-48
pinza para coger el cuello del útero	HA-31 hasta HA-32
SCHUBERT pinza sacabocado	
para el cuello del útero.....	HA-41
SCHUKNECHT	
cuchillo circular.....	EE-14
cuchillo forma hoz	EE-14
SCHULTZE salpingógrafa	HA-47
SCHUMACHER	
pinza larínge.....	FC-03
pinza sacabocado para el cuello del útero	HA-43
tijera para esternón	FG-07
tijeras para umbilicales	AI-34
SCHWEIGGER pinza capsulares	ED-04
SEEMANN-SEIFFERT abreboca.....	EI-04
SEGOND bisturí para fibroma.....	HA-46
SEIFFERT pinza larínge.....	FC-03
SELLHEIM separador para la salida de la cabeza.....	HC-09
SELLORS aproximadore para costillas	FG-18
SEMB	
periostótomo	DC-20
pinza bronquiales	FG-23
pinza cortante para huesos	DC-07
pinza gubia	DC-06
pinza para huesos	DC-07
SEMKEN pinza de disección	BA-05
SEMM espéculo vaginales.....	HA-07
SENN-GREEN separador.....	BI-07
SENN separador.....	BI-04
Sensímetro WARTENBERG	AC-08
Separador	BI-06, BI-10
ADSON	BI-15
ADSON Baby.....	BI-15
ALM	BI-14
AUFRIEHT para nasales	EG-17
BALFOUR abdominales	BI-22
BALFOUR Baby abdominales	BI-22
BECKMANN	BI-16
BECKMANN-ADSON	BI-15
BECKMANN-EATON	BI-16
BEESON para yesos	DA-03
BLOUNT para rodilla	DC-24
BOSE traqueal	FE-02
BUNNELL tendones.....	DC-25
CASPAR	BI-20
CASPAR para columna espinal.....	BI-18
CASPAR para columna vertebral	BI-19
CASTAÑEDA costales	FG-14
CHEVALLIER costales.....	FG-15
CLOWARD.....	BI-17
CLOWARD para cuerpos vertebrales	EA-07
COLLIN abdominales.....	BI-24 hasta BI-25
COLLIN-HARTMANN	BI-03
COOLEY atrium	FG-20
COOLEY costales.....	FG-09
COOLEY modif. STRUCK atrium	FG-20
CORYLLOS (Thorax).....	BI-13
COTTLE-NEIVERT para nasales	EG-17
COTTLE para nasales	EG-17
CRILE	BI-02
CUSHING	BI-07
DARLING.....	BI-17
DAVIDSON (Scapula).....	BI-13
DEAVER	BI-05
DEAVER Grip	BI-05
de labios y mejillas	EI-03
DESMARRES.....	BI-07
DIMEDA.....	BI-14
DOYEN	BI-12
Separadore	
ALAN-PARKS rectales	GI-03
SMITH-BUIE rectales	GI-03
Separador	
FARABEUF	BI-02
FINOCHIETTO-BABY costales.....	FG-09
FINOCHIETTO BURFORD costales	FG-12 hasta FG-14
FINOCHIETTO costales	FG-08, FG-10 hasta FG-11
FINOCHIETTO-HAIGHT BABY costales	FG-10
FINOCHIETTO INFANT costales.....	FG-12
FINOCHIETTO (modif) costales	FG-08
FINSEN	BI-14
FOMON para nasales.....	EG-17
FRAZIER	BI-21
FRIEDMAN perineorraf	HA-23
FRITSCH	BI-11
GELPI abdominales.....	BI-24
GOELET	BI-03
GOSSET abdominales	BI-21
GREEN	BI-10
HABERER	BI-04
HAGLUND-STILLE para yesos.....	DA-03
HAIGHT costales	FG-15
HARRINGTON.....	BI-05
HEANEY	BI-12
HENNIG para yesos	DA-03
HERMANN para yesos	DA-03
HERTZLER costales	FG-17
HOFER para pilar	FA-02
HRYNTSCHAK para prostata	GG-06
INGE para cuerpos vertebrales	EA-07
ISRAEL	BI-11
JACKSON traqueal	FE-02
JANSEN.....	BI-14
JUDD-MASSON vesicales	GG-04
KELLY	BI-04, BI-12
KELLY Grip	BI-04
KIRSCHNER abdominales	BI-23
KNAPP	EC-06
KOCHER	BI-10 hasta BI-11
KOERTE	BI-11
LAHEY	BI-08
LANGENBECK	BI-09
LEGUEU vesicales.....	GG-06
LITTLE	BI-08
LOVE uvula	FA-02
MATHIEU	BI-03
MERCEDES torácico	FG-16
MEYERDING	BI-08
MIDDELDORPF.....	BI-10
MIKULICZ	BI-12
MILLIN vesicales	GG-05
MOLLISON	BI-17
MORSE-FAVOLORO costales	FG-17
Separador ganchos musculares	BI-25
Separador	
NAGER paladar	FA-02
OLLIER	BI-10
O'SULLIVAN-O'CONNOR abdominales.....	BI-21
Separador para yesos.....	DA-03
Separador	
PARKER	BI-02
PITHA de labios.....	EI-06
PLESTER	BI-14
QUATTRO para yesos	DA-03
REVERDIN	BI-04
RIBBON	BI-04
RICHARDSON.....	BI-04
RICHARDSON-EASTMAN	BI-04

RICHARDSON Grip.....	BI-04	gubia.....	DC-15
RIGBY abdominales.....	BI-24	SMITH US ARMY tijeras de vendajes.....	AI-44
ROLLET.....	EC-06	SMITHWICK	
ROUX.....	BI-02	gancho para nervios.....	EA-04
ROUX BABY.....	BI-02	pinza para poner grapas.....	EA-02
ROUX MINI.....	BI-02	SNELLEN	
SAUERBRUCH.....	BI-13	asa.....	EC-08
SCHOENBORN tiroide.....	FE-04	pinza entropión.....	ED-06
SELLHEIM para la salida de la cabeza.....	HC-09	SOMER pinza para el útero.....	HA-37
SENN.....	BI-04	Sonda.....	CA-02
SENN-GREEN.....	BI-07	BOWMAN canal lacrimonal.....	EC-10
SIMON.....	BI-12	BRUNNER conductora.....	CG-04
STERNBERG de labios.....	EI-02	DESJARDINS para cálculos biliares.....	GC-05
TAYLOR espinal.....	DC-24	DOYEN.....	CA-02
THOMSON-WALKER vesicales.....	GG-06	FILIFORM.....	GG-12
TUFFIER costales.....	FG-16	KIRSCHNER conductora.....	CG-04
US Army (PARKER-LANGENBECK).....	BI-03	KOCHER bocio.....	FE-04
VOLKMANN.....	BI-07 hasta BI-08	KOENIG conductora.....	CG-04
WEITLANER.....	BI-14	MAYO para cálculos renales.....	GC-10
WEITLANER-WULLSTEIN.....	BI-14	mesurar.....	EE-15
YOUNG para prostata.....	GG-02	MOYNIHAN para cálculos biliares.....	GC-05
SEUTIN cizalla para yeso.....	DA-02	NABATOFF de plata auricular.....	CA-02
SEXTON cuchillo auriculares.....	EE-06	PAYR conductora.....	CG-04
SHEA tijeras auriculares micro.....	EE-09	SCHMIEDEN conductora.....	CG-04
SHORTBENT tijeras para puntas.....	AI-40	SCHMIEDEN-PAYR conductora.....	CG-04
SIEBOLD tijeras para ginecológicas.....	AH-21, AI-32	STACKE de plata auricular.....	CA-02
SIEGLE espéculos auriculares.....	EE-02	SPENCER tijeras para puntas.....	AI-40
SIEGLER HELLMANN pinza para el útero.....	HA-38	SPENCER-WELLS pinza hemostática.....	BC-07
Sierra		SPRATT cucharilla cortante.....	DC-12
BERGMANN para yesos.....	DA-02	SPURLING pinza cortantes para laminectomía.....	EA-08
CHARRIERE para amputacion.....	DD-03	STACKE sonda de plata auricular.....	CA-02
ENGEL para yesos.....	DA-02	Standard estuche de bolsillo y de sutura.....	CG-08
JOSEPH para nasales.....	EG-17	STAUDE-MOORE pinza	
LANGENBECK a dedo.....	DD-03	para coger el cuello de útero.....	HA-31
OLIVECRONA.....	EA-05	St. CLAIR-THOMSON cuchillo.....	EG-19
Sierra oscilante para yesos.....	DA-05 hasta DA-06	STEINER-AUVARD espéculo vaginales.....	HA-19
Sierra		STEINMANN clavo para huesos.....	DD-09
WIGMORE para yesos.....	DA-02	STELZNER tijera para recto.....	AI-38
SILVER		STERNBERG separador de labios.....	EI-02
cincel plástica para nasales.....	EG-14	STEVENS	
dermátomo.....	AG-20	gancho para cristalino.....	EC-06
SIMCOE canula sutura.....	ED-07	STEVENSON blefarostato.....	EC-03
SIMON		STEVENS	
cucharilla cortante.....	DC-13	pinza para iris.....	EC-11
cureta uterinas.....	HA-48	porta-aguja de oftalmología.....	CE-06
separador.....	BI-12	tijeras para tenotomía.....	AH-17
SIMPSON-BRAUN pinza obstétricas.....	HC-02	tijera tenotomía.....	AI-23
SIMPSON pinza obstétricas.....	HC-02	STIEGLITZ pinza para espinas.....	BA-06
SIMPSON-LUIKART pinza obstétricas.....	HC-03	STILLE	
SIMS		cincel.....	DC-14
cureta uterinas.....	HA-49 hasta HA-50	cizalla para yeso.....	DA-02
depresor uterino.....	HA-39	costótomo.....	FG-03
dilatador uterinos.....	HA-30	gubia.....	DC-14
espéculo rectales.....	GI-02	STILLE-HORSLEY pinza cortante para huesos.....	DC-07
espéculo vaginales.....	HA-17	STILLE-LISTON pinza cortante para huesos.....	DC-06
histerómetro.....	HA-39	STILLE-LUER pinza gubia.....	DC-04
SIMS-MAIER pinza para tapones.....	BG-05	STILLE	
SIMS		osteotomo.....	DC-14
tijeras para ginecológicas.....	AH-21, AI-32	perforador a mano.....	DD-04
SINGLEY pinza de disección.....	BA-05	pinza de disección.....	BA-02
Sisteme LEYLA de fijación.....	EA-14 hasta EA-18	pinza para pedícula renal.....	BC-16
SKENE pinza para coger el cuello del útero.....	HA-31	STILLE-RUSKIN pinza gubia.....	DC-05
SLUDER-BALLENGER amigdalotomo.....	FA-05	STILLE-SHERMAN perforador a mano.....	DD-04
SMELLIE		St. MARTIN pinza sutura.....	ED-05
gancho obstetrico.....	HC-06	STOCKMANN compressor uretrales.....	GG-12
perfora-cráneo.....	HC-09	STONE pinza para cerrar.....	GE-06
SMILLIE meniscotomo.....	DC-24	STONE-WATT pinza intestinales.....	GE-06
SMITH blefarostato.....	EC-02	STRATTE porta-aguja.....	CE-04
SMITH-BUIE separadore rectales.....	GI-03	STRAUSS compressor uretrales.....	GG-10
SMITH-PETERSEN		STRUEMPPEL pinza auriculares.....	EE-08
cincel.....	DC-15	STRULLY tijeras para neuroquirurgicas.....	AI-35

S

STRUYCKEN pinza cortantes para nasales.....EG-07
SUBRAMANIAN pinza atraumaticaBD-31
SWEET pinza para poner grapasEA-02

T

TABB cuchillo forma hozEE-14
Taladros.....DD-04
 KIRSCHNER filiformesDD-09
Tambor
 KONRICH para esterilizaciónHE-12
 SCHIMMELBUSCH para esterilizaciónHE-12
Tamiz para especulo vaginal.....HA-22
TARNIER
 cranioclasto.....HC-09
 pinza obstétricas con dispositivo de tracciónHC-05
TarroHE-08
TAYLOR
 martillos de percusiónAC-07
 separador espinalDC-24
TEALE pinza para coger el cuello del úteroHA-33
Tensor
 LOUTE cierra-hiloDD-11
 para filfDD-10
TerrajaDD-15
TERSON pinza capsularesED-04
THOMS-ALLIS pinza para tejidos.....GE-02
THOMS-GAYLOR pinza sacabocado
 para el cuello del úteroHA-42
THOMSON-WALKER separador vesicalesGG-06
THOREK tijeras para pulmonaresAI-36
THUDICHUM espéculo para nasalesEG-02
TIECK-HALLE espéculo para nasales.....EG-03
TIEMANN pinza pra coger el cuello de úteroHA-32
Tijera
 AEBLI para cornealAI-22
Tijera de disecciónAI-19
Tijera finasAI-19
Tijera
 FINOCHIETTO para rectoAI-38
 GORNEY de disecciónAI-13
 IRISAI-19
 IRIS de oftalmologíaAI-22
 JOSEPHAI-16
 KILNERAI-17
 LEXER-BABY de disecciónAI-12
 LEXER-FINO de disecciónAI-12
 LITTLER de disecciónAI-13
 LOCKLINAI-18
 METZENBAUM de disecciónAI-13 hasta AI-14
 METZENBAUM FINO de disección.....AI-15
 METZENBAUM "S"AI-16
Tijera para enterótomos.....AI-39
Tijera
 REYNOLDSAI-18
Tijeras.....AH-02 hasta AH-04, AI-02 hasta AI-04
Tijera
 SANVENEROAI-16
Tijeras
 auriculares microEE-11
 auriculares micro miniEE-11
 BARRAQUER de colibri.....AJ-04
 BEEBEE para alambre y chapasAI-43
 BELLUCCI auriculares microEE-09
 BERGMANN de vendajesAI-46
 BEUSEAI-26
 BOETTCHER para amígdalas.....AI-27
 BRAUN-STADLER para episiotomía.....AH-22, AI-34
 BRUNS para yesoAI-48
 BUCK para puntas.....AI-40
 BUSCH para umbilicalesAI-34

CASTROVIEJO para cornealAJ-06
CASTROVIEJO para iridectomia.....AJ-05
Tijera
 SCHUMACHER para esternónFG-07
Tijeras
 COTTLE para nasales.....AH-18, AI-25
 CRAFOORD para pulmonaresAI-36
 CRUZ ROJA de vendajes.....AI-47
 cuticularHE-03
 DANDY para neuroquirurgicasAI-36
 DEAN para amígdalasAI-26
 DEAVERAH-05, AI-06
 DE BAKEY para vascularesAI-30
 DIETHRICH para vasculares.....AI-29
 DIMEDA de vendajesAI-46
 DOYEN para ginecológicas.....AI-33
 DUBOIS para ginecológicas.....AI-33
 ESMARCH de vendajesAI-46
Tijeras estrabismo.....AI-24
Tijeras
 FERGUSSONAI-49
Tijeras finas.....AI-24
Tijeras finas.....AI-05
Tijeras
 FOMON para nasalesAH-18, AI-25
 GOLDMAN-FOX para encíasAI-41
 GOOD para amígdalasAI-27
 HEATH para puntas.....AI-40
 HEYMANN para nasalesAH-18, AI-25
Tijeras incisionAI-05
Tijeras
 IRISAH-16, AI-21
 JACOBSON micro.....AJ-11
 JOSEPHAH-14
 KELLY para ginecológicas.....AH-22, AI-33
 KILNERAH-14
 KLINKENBERGH-LOTH para toracicaAI-37
 KNAPPAI-20
 KNOWLES de vendajesAI-47
 LAGRANGE para encíasAI-41
 LANDOLT enucleaciónAI-25
 LANGE de vendajesAI-44
 LEXERAH-09
 LEXER-BABYAH-10
 LEXER de disecciónAI-11
 LISTER de vendajesAH-23, AI-45
 LITTAUER para puntasAI-40
 LORENZ de vendajesAI-47
 MAYOAH-06, AI-07
 MAYO-NOBLEAH-08, AI-10
 MAYO-STILLEAH-07, AI-08 hasta AI-09
 MAYO zurdoAI-07
 McGUIRE para corneal.....AJ-05
 McINDOE para cartilago.....AI-35
 McPHERSON WESTCOTT para tenotomiaAJ-04
 METZENBAUMAH-11
 METZENBAUM FINOAH-12
 METZENBAUM "S"AH-13
Tijeras microAJ-06, AJ-13
Tijeras micro para ginecológicasAJ-07 hasta AJ-08
Tijeras
 MILLS para vascularesAI-27
 NORTHBENT para puntasAI-40
 NOYES para irisAJ-03 hasta AJ-04
 NOYES para tendonesAJ-03
Tijeras para encíasAI-41
Tijeras para estrabismo.....AH-17
Tijeras parametrio para vascularesAH-20
Tijeras para neuroquirurgicasAI-35
Tijeras para preparacionAI-34
Tijeras para vasculares.....AI-27

Tijeras para vasculares micro	AJ-09
Tijeras para yeso	AI-49
Tijeras	
POTTS DE MARTEL para vasculares	AI-27
POTTS-SMITH para vasculares	AH-19, AI-28
PRINCE para amígdalas	AI-27
QUINBY para encías	AI-42
REYNOLDS	AH-15
SANVENERO	AH-13
SATINSKY para torácica	AI-37
SCHMIEDEN-TAYLOR	AI-36
SCHUMACHER para umbilicales	AI-34
SHEA auriculares micro	EE-09
SHORTBENT para puntas	AI-40
SIEBOLD para ginecológicas	AH-21, AI-32
SIMS para ginecológicas	AH-21, AI-32
SMITH US ARMY de vendajes	AI-44
SPENCER para puntas	AI-40
STEVENS para tenotomía	AH-17
STRULLY para neuroquirúrgicas	AI-35
Tijera	
STELZNER para recto	AI-38
STEVENS tenotomía	AI-23
Tijeras	
THOREK para pulmonares	AI-36
TOENNIS-ADSON para neuroquirúrgicas	AI-35
TROUTMAN-CASTROVIEJO micro	AJ-07
UNIVERSAL de vendajes	AI-50
UNIVERSAL para alambre y chapas	AI-42
USA MODEL para umbilicales	AI-34
VANNAS micro	AJ-12 hasta AJ-13
VANNAS para iridectomía	AJ-05
WAGNER	AH-22
WAGNER para encías	AI-42
WALDMANN para episiotomía	AI-34
WECKER para iris	AJ-04
WERTHEIM para preparación	AI-32
WESTCOTT para iridectomía	AJ-02
WESTCOTT para tendones	AJ-02
WULLSTEIN auriculares micro	EE-11
WULLSTEIN auriculares micro mini	EE-11
YASARGIL micro	AJ-10 hasta AJ-11
TILLEY pinza auriculares	EE-08
Tirabuzón DOYEN para fibroma	HA-46
TISCHLER-KEVORKIAN pinza sacabocado	
para el cuello del útero	HA-44 hasta HA-45
TISCHLER-MORGAN pinza sacabocado	
para el cuello del útero	HA-43 hasta HA-44, HA-46
TIVNEN pinza coger amígdalas	FA-04
TOBOLD	
abajalengua	EI-02
estilete	CA-03
TOENNIS-ADSON tijeras para neuroquirúrgicas	AI-35
TOENNIS	
descolador duramadre	EA-05
pinza hemostática	BC-11
porta-aguja	CE-04
TOHOKU pinza para campos	BE-04
Tonómetro SCHIOETZ	ED-08
TOOK cuchillo para corneal	EC-05
Torniquete	AC-03, DD-02
TOTI fresa	DD-07
TOWNSEND-KEVORKIAN pinza sacabocado	
para el cuello del útero	HA-44
TOWNSEND-MINI (BABY TISCHLER) pinza	
sacabocado para el cuello del útero	HA-45
TOWNSEND-mini pinza sacabocado	
para el cuello del útero	HA-44
TOWNSEND pinza sacabocado	
para el cuello del útero	HA-44
TOWNSEND-TISCHLER pinza sacabocado	

para el cuello del útero	HA-44
TOYNBEE espéculos auriculares	EE-02
Tractor	
BARTON adecuada	
para todas las pinzas con mango	HC-04
BILL adecuada para todas las pinzas con mango	HC-05
LUIKART-BILL adecuada	
para todas las pinzas con mango	HC-05
TRAUBE martillos de percusión	AC-07
TRELAT espéculo vaginales	HA-07
Trépano	DD-04
CASTROVIEJO para corneal	ED-07
ELLIOT para corneal	ED-08
FRANCESCHETTI para corneal	ED-07
Trócar	CC-02
COAKLEY	CC-02
DOUGLAS	CC-02
FLEURANT	CC-02
LICHTWITZ	CC-02
MENGHINI	CC-03
NELSON	CC-02
OCHSNER	CC-02
PIERCE	CC-02
Trócar UCKERMANN traqueal	FE-02
Trócar	
UNIVERSAL	CC-02
TROELTSCH pinza para nasales	EG-04
TROEMNER martillos de percusión	AC-07
TROUSSEAU dilatador traqueal	FE-02
TROUTMAN-CASTROVIEJO tijeras micro	AJ-07
TROUTMAN-CHRIS rompe hojas	AG-14
TROUTMAN Colibri pinza para iris	EC-13
TROUTMAN pinza rectus	ED-02
TUBBS dilatador para válvula mitral	FG-27
Tübingen	
canula aire	ED-07
pinza ligaduras	ED-05
pinza para iris	EC-15
Tübingen TITAN	
pinza ligaduras	ED-05
pinza para iris	EC-15
Tubo	
ANDREWS-PINCHON de aspiración	AE-03
BRUENINGS alarmino	FC-03
BUIE de aspiración	GI-05
DE BAKEY de aspiración	AE-04
FRAZIER de aspiración	EA-07
JACKSON traqueal	FE-03
LUER traqueal	FE-03
MAGILL de aspiración	AE-04, AE-06
NUBOER de aspiración	AE-05
POOLE de aspiración	AE-02
WAGENER-MOSHER traqueal	FE-03
WALTON YANKAUER de aspiración	AE-03
YANKAUER de aspiración	AE-02
TUFFIER	
pinza hemostática	BC-08
separador costales	FG-16
TURNBULL pinza para unas 11,5 cm	HE-03
TURREL pinza sacabocado para biopsia	GI-05
TYDING	
cierranudos amígdalas	FA-05
pinza coger amígdalas	FA-04
U	
UCKERMANN	
estilete	CA-03
trocar traqueal	FE-02
ULRICH pinza porta esponjas	BG-06
UNIVERSAL	

S

Índice alfabético Español

pinza para esterilización.....CI-02
 tijeras de vendajes.....AI-50
 tijeras para alambre y chapas.....AI-42
 trócar.....CC-02
 UNNA saca comedones.....HE-02
 Uretrotomo OTIS.....GG-08
 Urinal.....HE-10
 USA
 cable electrobisturías.....JA-07
 USA MODEL tijeras para umbilicales.....AI-34
 USA
 pinza de disección.....BA-02
 US Army (PARKER-LANGENBECK) separador.....BI-03
 Uso único de bisturías estériles.....AG-10 hasta AG-11

V

VALLEIX histerómetro.....HA-39
 Valva
 BALFOUR.....BI-22
 CASPAR.....BI-20
 CASPAR para columna vertebral.....BI-19
 KALLMORGEN vaginales.....HA-15
 KIRSCHNER.....BI-23
 KRISTELLER vaginales.....HA-09 hasta HA-14
 VAN BUREN
 bujía uretrales.....GG-13
 pinza para secuestros.....DC-10
 Van DOREN pinza sacabocado
 para el cuello del útero.....HA-42
 VANNAS
 tijeras micro.....AJ-12 hasta AJ-13
 tijeras para iridectomía.....AJ-05
 VARIFOCAL oftalmoscopio.....AC-03
 Vaso para medicamentos.....HE-07
 VERBRUGGE pinza para huesos.....DC-09
 VERRES aguja para punción, neumoperitoneo.....CC-03
 Viena espéculo para nasales.....EG-02
 VIRCHOW
 cuchillo para cartílagos.....AG-18
 cuchillo para cerebro.....AG-18
 rompecráneo.....DC-17
 VIRTUS (RALK) pinza para espinas.....BA-06
 VOLKMANN
 cucharilla cortante.....DC-12 hasta DC-13
 separador.....BI-07 hasta BI-08
 VOLTOLINI espéculo para nasales.....EG-02

W

WACHENFELDT pinza para grapas.....CG-07
 WADSWORTH-TODD cauterio.....EC-08
 WAGENER ganchito auriculares.....EE-07
 WAGENER-MOSHER tubo traqueal.....FE-03
 WAGNER
 pinza cortantes para laminectomía.....EA-09
 tijeras.....AH-22
 tijeras para encías.....AI-42
 WALDMANN tijeras para episiotomía.....AI-34
 WALLICH cureta para aborto y placenta.....HC-08
 WALSHAM pinza enderezar tabique.....EG-18
 WALTHER bujía uretrales.....GG-17
 WALTON
 gubia para cuerpos extraños.....EC-06
 saca comedones.....HE-02
 WALTON YANKAUER tubo de aspiración.....AE-03
 WANGENSTEEN
 pinza de disección.....BA-05
 porta-aguja.....CE-03
 WARTENBERG sensímetro.....AC-08
 WATSON-CHEYNE elevador.....DC-22

WATSON dermatómo.....AG-22
 WEBER
 asa.....EC-08
 pinza traumática.....BD-12
 WECKER
 espatula para iris.....EC-08
 tijeras para iris.....AJ-04
 WEEK blefarostato.....EC-02
 WEIL-BLAKESLEY pinza cortantes para nasales.....EG-06
 WEISSBARTH espéculo vaginales.....HA-22
 WEISS pinza para cierra-tubo.....BC-19
 WEITLANER separador.....BI-14
 WEITLANER-WULLSTEIN separador.....BI-14
 WELLS espatula enucleación.....EC-08
 WERTHEIM-CULLEN pinza histerectomía.....BC-18
 WERTHEIM
 pinza histerectomía.....BC-18
 tijeras para preparación.....AI-32
 WEST
 cincel para nasales.....EG-14
 WESTCOTT
 tijeras para iridectomía.....AJ-02
 tijeras para tendones.....AJ-02
 WEST
 gubia para nasales.....EG-14
 WESTON cierranudo polipus rectal.....GI-05
 WHEELER
 cuchillo para discisión.....EC-04
 espatula ciclodialálisis.....EC-09
 WHITEHEAD abreboca.....EI-04
 WHITE pinza coger amígdalas.....FA-03
 WIEDER abajalengua.....EI-02
 WIENER (AUFRIEHT) lima para nasales.....EG-15
 WIENER
 gancho para iris.....EC-06
 lima para el seno.....EG-15
 WIGMORE sierra para yesos.....DA-02
 WILDE
 cierranudo auriculares.....EE-07
 cierranudos para nasales.....EG-09
 WILDER
 asa.....EC-08
 dilatador canal lacrimonasal.....EC-10
 WILDE (TROELTSCH) pinza auriculares.....EE-07
 WILLET-MARTELL pinza para pericráneo.....BC-08
 WILLIAMS
 blefarostato.....EC-02
 destornillador.....DD-14
 pinza para tejidos.....GE-03
 WILLIGER
 cucharilla cortante.....DC-13
 martillo.....DC-18
 periostótomo.....DC-19
 WINKELMANN instrumento para circuncisión.....GG-09
 WINTER pinza para aborto y placenta.....HC-07
 WITTNER pinza sacabocado
 para el cuello del útero.....HA-43
 WOLFF pinza para romper yesos.....DA-04
 WRIGLEY pinza obstétricas.....HC-02
 WULLSTEIN
 cuchillo forma hoz.....EE-14
 tijeras auriculares micro.....EE-11
 tijeras auriculares micro mini.....EE-11
 WYLIE
 dilatador uterinos.....HA-30
 pinza traumática.....BD-21

Y

YANKAUER
 espéculo nasofaringeo.....EG-04

tubo de aspiración.....	AE-02
YASARGIL tijeras micro	AJ-10 hasta AJ-11
YEOMAN pinza sacabocado para biopsia	GI-05
YOUNG Boomerang aguja para ligaduras	CG-03
YOUNG	
pinza para coger prostata	GG-02
pinza tiralengua	EI-03
separador para prostata	GG-02

Z

ZAUFAL-JANSEN pinza gubia.....	DC-04
ZENKER pinza de disección y ligadura	BC-12
ZIEGLER	
blefarostato	EC-03
cuchillo capsulotomía	EC-05
cuchillo para iridectomía	EC-04
dilatador canal lacrimal	EC-10
espejo frontal	AC-05

Indice Italiano



A

Mano di piombo	DC-11	per chiodi centromid	DD-12
Abassalingua		ALEXANDER	
ANDREW	EI-02	periototomo	DC-19
BRUENINGS	EI-02	pinza tagliente per biopsia	HA-42
BUCHWALD	EI-02	scalpello	DC-14
FRENZEL	EI-02	sgorbia	DC-14
HARTMANN	EI-02	ALLIS-ADAIR pinza per afferrare tessuti	GE-02
legno	EI-02	ALLIS-Baby pinza per afferrare tessuti	GE-02
McIVOR	EI-05	ALLISON spatola polmone	FG-19
TOBOLD	EI-02	ALLIS pinza per afferrare tessuti	GE-02
WIEDER	EI-02	ALM divaricatore	BI-14
Accessori per contenitori		ALVIS curetta per corpi estranei	EC-06
per sterilizzazione	HE-38 lavorare a HE-41	Amniotomo BEACHAM	HA-39
Ad elettrodo mini	JA-03	ANDREW abassalingua	EI-02
Adenotomo LAFORCE	EG-19	ANDREWS-PINCHON tubi d'aspirazione	AE-03
ADLERKREUTZ pinza dissezione	BA-04	Anoscopio	
ADSON Baby		HIRSCHMANN	GI-04
divaricatore	BI-15	IVES-FANSLER	GI-04
ADSON BABY		Ansa	
pinza emostatica	BC-09	ARLT	EC-08
ADSON-BROWN pinza dissezione	BA-03	auricolare	EE-07
ADSON		BILLEAU auricolare	EE-07
divaricatore	BI-15	di filo	JA-03
divaricatore per nervi	EA-04	di nastro	JA-03
elevatore	DC-21	elettrodo mini	JA-02
pinza dissezione	BA-03	SNELLEN	EC-08
pinza dissezione, micro	BA-03	WEBER	EC-08
pinza emostatica	BC-09	WILDER	EC-08
pinza per ipofisi	EA-06	Anse	EG-09
pinza sgorbia	DC-03	tonsille	FA-04
port'aghi	CE-04	Apparecchio	
AEBLI forbici corneali	AI-22	per vuoto di sangue	DD-02
AESCLAP cavo elettrobisturi	JA-07	PETZ per sutura stomacali e intestinali	GE-09
Affilare ARKANSAS	AG-19	Approssimatori	
Ago		BAILEY-BABY costali	FG-18
BARBARA	EE-14	BAILEY costali	FG-18
BOWMAN per dissezione curva	EC-05	BAILEY-GIBBON costali	FG-18
COOPER per legature	CG-02	SELLORS costali	FG-18
DAVIS per corpi estranei	EC-05	Apribocca	
DESCHAMPS per legature	CG-02	DAVIS-BOYLE	EI-04
DIX	EC-09	DENHART	EI-03
DUPUY-WEISS tonsille	FA-03	DOYEN-JANSEN	EI-03
elettrodo mini	JA-02	HEISTER	EI-03
forma di ago	JA-03	JENNINGS	EI-04
FRANCIS per corpi estranei	EC-05	KILNER-DOUGHTY	EI-05
FRANKLIN-SILVERMANN da punzione	CC-03	MAUNDER legno	EI-06
KEITH suture	CG-06	McIVOR	EI-05
KOENIG suture	CG-06	ROSER-KOENIG	EI-03
KRONECKER per legature	CG-02	SEEMANN-SEIFFERT	EI-04
LEVINSON per corpi estranei	EC-05	WHITEHEAD	EI-04
LICHTWITZ seno	EG-09	ARCHER pinza schegge	BA-06
NELSON per legature	CG-02	Arco per estensione	DD-10
per cataratta stretta retta	EC-05	BOEHLER	DD-10
per corpi estranei retto	EC-05	KIRSCHNER	DD-10
POLITZER auricolare	EE-06	ARKANSAS affilare	AG-19
QUINKE da punzione	CC-03	ARLT ansa	EC-08
REVERDIN per legature	CG-03	ARRUGA	
ROSEN	EE-14 lavorare a EE-15	blefarostato	EC-02
Ago suture	CG-05 lavorare a CG-06	pinza capsulare	ED-04
Ago		port'aghi oftalmologia	CE-06
tonsille	FA-05	protettore	EC-08
VERRES da punzione pneumoperitoneo	CC-03	uncino	EC-06
YOUNG Boomerang per legature	CG-03	ASCH pinza raddrizzare setto	EG-18
Agrafes MICHEL	CG-07	Assordatore BARANY	EE-04
ALAN-PARKS dilatatore per l'ano e il retto	GI-03	Astucci per diagnostica	AC-04
ALBEE fresa	DD-07	Astucci per otoscopia	AC-04
Alesatore		Astucci tascabili e per sutura	
CRUTCHFIELD	EA-03	mini	CG-08
KUENTSCHER	DD-13	standard	CG-08
		AUFRIECHT divaricatore nasale	EG-17
		AUVARD specolo vaginali	HA-19

AXENFELD curetta per calazio EC-07
 AYER pinza calazio ED-06

B

BABCOCK pinza per afferrare tessuti GE-02
 BABINSKY martelli percussori AC-07
 Bacinella HE-05
 per placenta HE-06
 reniforme HE-07
 BACKHAUS-CLIP pinza fissateli porta tubo BE-03
 BACKHAUS KOCHER pinza fissateli BE-02
 BACKHAUS pinza fissateli BE-02
 BAGGISH pinza tagliente per biopsia HA-45
 BAILEY approssimatori costali FG-18
 BAILEY-BABY approssimatori costali FG-18
 BAILEY-GIBBON approssimatori costali FG-18
 BAINBRIDGE
 pinza atraumatica BD-09
 pinza emostatica BC-14
 BAKES dilatatore per condotti biliari GC-06
 BALFOUR Baby divaricatore addominale BI-22
 BALFOUR
 divaricatore addominale BI-22
 valva centrale BI-22
 BALL AND SOCKET pinza fissateli BE-04
 BALLENGER
 coltello girevole EG-11
 elevatore setto EG-12
 pinza tonsille FA-04
 BANGERTER spatola ciclodialisi EC-08
 BARANY assordatore EE-04
 BARBARA
 ago EE-14
 pick EE-14 lavorare a EE-15
 uncinetto EE-14
 BARKAN coltello per goniotomia EC-05
 BARNHILL coltello EG-19
 BARRAQ-KATZIN pinza iride EC-13
 BARRAQU Colibri pinza iride EC-13
 BARRAQUER Colibri blefarostato EC-02
 BARRAQUER
 coltello per cheratopl EC-05
 forbici colibri AJ-04
 pinza camara anteriore ED-02
 pinza depilatorie ED-08
 pinza fissaggio ED-03
 port'aghi CE-07
 BARRETT pinza per abbassare il collo dell'utero HA-32
 BARR specolo rettale GI-02
 BARTON
 forbici obstetriche HC-04
 trattore per manico standard HC-04
 BAUMGARTNER port'aghi CE-02
 BEACHAM amniotomo HA-39
 Becher HE-10
 BECKER cistitomo EC-06
 BECKMANN-ADSON divaricatore BI-15
 BECKMANN
 coltello EG-19
 divaricatore BI-16
 BECKMANN-EATON divaricatore BI-16
 BECK pinza atraumatica vascolare BD-25
 BEEBEE forbici filo metallo lamiera AI-43
 BEER pinza depilatorie ED-08
 BEESON divaricatori per gessi DA-03
 BELLUCCI forbici auricolari micro EE-09
 Benda per emostasi AC-03
 BENGOLEA pinza emostatica BC-09
 BENNETT elevatore per ossa DC-22
 BERENS cheratomo EC-04
 BERGMANN FOERSTER pinza
 per tamponi e spugne BG-10
 BERGMANN
 forbici bendaggi AI-46
 sega per gessi DA-02
 BERKE pinza muscolre ED-02
 BERLIND-AUVARD specolo vaginali HA-19
 BERLINER martelli percussori AC-07
 BERNHARD pinza fissateli BE-05
 BERTILLON cefalometro AC-08
 BEST pinza intestinali GE-06
 BETHUNE costotomo FG-04
 BEUSE forbici AI-26
 BEYER
 pinza osteotomo EG-08
 pinza sgorbia DC-04
 Bicchiere graduato HE-07
 BILLEAU ansa auricolare EE-07
 BILL trattore per manico standard HC-05
 BIRCHER-GANSKE tenaglia per ossa DC-10
 BIRCHER meniscotomo DC-24
 BISHOP-HARMAN pinza iride EC-14
 Bisturi
 CONVERSE nasale EG-10
 dissezione AG-15
 FREER mucosa EG-10
 HALLE per duramadre EA-06
 JOSEPH nasale botton EG-10
 MALTZ cartilage angolat EG-11
 Bisturi per dissezione PARKER AG-15
 Bisturi
 SEGOND per fibromi HA-46
 Bisutri lama sterili AG-09
 Bituri forma di bisturi JA-03
 BLAKE
 curetta uterine HA-48
 pinza per calcoli biliari GC-03
 Blefarostato
 ARRUGA EC-02
 BARRAQUER Colibri EC-02
 BOWMAN EC-02
 CASTROVIEJO EC-03
 CLARK EC-02
 CRITCHETT EC-02
 GOLDSTEIN EC-03
 GRAEFE EC-02
 LANCASTER EC-03
 LISTER-BURCH EC-02
 MELLINGER EC-02
 MELLINGER-AXENFELD EC-02
 MUELLER EC-03
 MURDOCK EC-02
 PARK EC-03
 SMITH EC-02
 STEVENSON EC-03
 WEEK EC-02
 WILLIAMS EC-02
 ZIEGLER EC-03
 BLOHMKE pinza tonsille FA-04
 BLOUNT
 elevatore per ginocchio DC-24
 elevatore per ossa DC-24
 BLUMENTHAL pinza sgorbia DC-02
 BODENHAMMER specolo rettale GI-02
 BOEHLER arco per estensione DD-10
 BOERMA forbici obstetriche HC-04
 BOETTCHER forbici tonsillari AI-27
 BÖHLER
 cesoia per ossa DC-06
 pinza sgorbia DC-04
 BONACCOLTO pinza strabismo EC-14

- Bonn
cannula irrigazioneED-07
BONNEY pinza per tamponi e spugneBG-08
Bonn
pinza irideEC-15
Bonn TITAN pinza irideEC-15
BORCHARDT fresaDD-07
BOSE
divaricatore trachealeFE-02
uncino trachealeFE-02
BOUCHERON specoli auricolareEE-02
BOWLES stetoscopioAC-06
BOWMAN
ago per disisione curvaEC-05
blefarostatoEC-02
coltello per disisioneEC-04
specillo canale lacrimaleEC-10
BOYNTON port'aghi oftalmologiaCE-06
BOZEMANN-DOUGLAS pinza per medicaturaBG-13
BOZEMANN
pinza per medicaturaBG-13
port'aghiCE-03
BRAIN
clip emostatica per il cuoio capellutoEA-12
clip standardEA-13
BRAIN MINI pinza per posizionare clipEA-12
BRAIN STANDARD pinza per posizionare clipEA-12
BRAITHWAITE dermatomoAG-22
BRAUN
cranioclastoHC-09
depressore uterinoHA-39
pinza per abbassare il collo dell'uteroHA-31, HA-34
specolo vaginaliHA-16
BRAUN-STADLER forbici episiotomiaAH-22, AI-34
BRAUN
uncino per detroncazioneHC-09
BREISKY specolo vaginaliHA-20
BROCK
dilatatore per valvole mitraliFG-26
manico per valvole mitraliFG-26
pinza taglienteFG-26
BROWN pinza dissezioneBA-03
BRUENINGS
abassalinguaEI-02
coltello settoEG-11
pinza laringeFC-03
pinza tagliente nasaleEG-05
serranodi tonsilleFA-04
specoli auricolareEE-02
tubo allungoFC-03
BRUNETTI scalpello spinaleDC-17
BRUNNER
costotomoFG-07
pinza intestinaleGE-06
sonda conduttriceCG-04
BRUNS
curetta taglienteDC-12 lavorare a DC-13
forbici gessoAI-48
BRYANT pinza per tamponi e spugneBG-11
BUCHWALD abassalinguaEI-02
BUCK
curetta auricolareEE-05
forbici per legatureAI-40
leva corpi estraneiEE-08
martelli percussoriAC-07
BUIE tubo di aspirazioneGI-05
BUMM
curetta uterinaHA-49 lavorare a HA-50
pinza per afferrare l'uteroHA-38
BUNGE curetta per palpebreEC-07
BUNNELL
perforatore a manoDD-05
scollatendiniDC-25
BUNT pinza per sterilizzazioneCI-02
BURCH forchetta di fissaggioEC-05
BURKE-Baby pinza tagliente per biopsiaHA-44
BURKE pinza tagliente per biopsiaHA-44
BUSCH forbici ombelicaliAI-34
- ## C
- Calamita DIMEDA oculisticaED-08
Candeletta
COXETER dilatatriciGG-17
DITTEL dilatatriciGG-18 lavorare a GG-19
FILIFORMGG-12
GUYON dilatatriciGG-12, GG-14 lavorare a GG-15
VAN BUREN dilatatriciGG-13
WALTHER dilatatriciGG-17
Cannula
Bonn irrigazioneED-07
Hamburg bottonutaED-07
KILLIANEG-09
SCHEIE oculisticaED-07
SIMCOE suturaED-07
Tübingen ariaED-07
Cannula
FINSTERER per aspirazione e irrigazioneAE-05
Capsula diametroHE-04 lavorare a HE-05
Capsulo DASTOOR aspiratoreEC-09
CARMALT pinza scheggeBA-06
CARPENTER coltello tonsilleFA-02
CASPAR
divaricatoreBI-20
divaricatore lombar vertebraleBI-20
divaricatore spina cervicaBI-18
divaricatore spina vertebraleBI-19
manico per bisutri, microAG-12
valvaBI-20
valva spina vertebraleBI-19
CASTAÑEDA
divaricatore costaliFG-14
pinza atraumaticaBD-42
CASTROVIEJO
blefarostatoEC-03
cheratomoEC-04
dilatatore canale lacrimaleEC-10
forbici cornealiAJ-06
forbici iridectomiaAJ-05
marcatore compassoEC-09
pinza capsulareED-04
pinza fissaggioED-03
pinza rompe lametteAG-14
pinza suturaED-05
port'aghiCE-07
spatola ciclodialisiEC-08 lavorare a EC-09
trapano cornealeED-07
CATLIN coltello per amputazioneAG-16
Cauterio WADSWORTH-TODDEC-08
Cavachiodi KUENTSCHERDD-13
Cavo
AESCULAP elettrobisturiJA-07
ERBE SELECT elettrobisturiJA-07
MARTIN elettrobisturiJA-07
USA elettrobisturiJA-07
Cefalometro BERTILLONAC-08
Cesioia
BÖHLER per ossaDC-06
COTTLE-KAZANJIAN per ossaDC-06
LISTON per ossaDC-06
RUSKIN-LISTON per ossaDC-06
SEMB per ossaDC-07

- STILLE-HORSLEY per ossaDC-07
 STILLE-LISTON per ossaDC-06
- Cestelli
 in acciaio perforatoHE-13
 in rete metallicaHE-13
- CHAPUT pinza emostaticaBC-08
- CHARRIERE
 lama di ricambioDD-03
 sega per amputazioneDD-03
- CHEATLE pinza per sterilizzazioneCI-02
- Cheratomo
 BERENSEC-04
 CASTROVIEJOEC-04
 JAEGEREC-04
- CHERON pinza per medicaturaBG-12
- CHEVALIER-JACKSON pinza laringeFC-04
- CHEVALLIER divaricatore costaliFG-15
- ChiaveDD-10
- CHILDE pinza per agrafesCG-07
- Chiodo per ossa STEINMANNDD-09
- CINELLI scalpello plastica nasaleEG-13
- Cistitomo
 BECKEREC-06
 GRAEFEEC-06
- CITELLI pinza osteotomoEG-08
- CLARK blefarostatoEC-02
- CLAR
 lampada frontaleAC-05
 miniAC-05
- CLEVELAND pinza sgorbiaDC-02
- Clip
 BRAIN emostatica per il cuoio capellutoEA-12
 BRAIN standardEA-13
 EDWARDSBD-21
- CLOWARD
 divaricatoreBI-17
 divaricatore per corpi vertebraliEA-07
- COAKLEY
 curretta per senoEG-18
 tre quartiCC-02
- COLCLOUGH pinza tagliente
 per dischi intervertebraliEA-11
- COLLIER port'aghiCE-02
- COLLIN
 dinamometroAC-03
 divaricatore addominaleBI-24 lavorare a BI-25
- COLLIN-DUVAL pinza dissezioneBA-04
- COLLIN-HARTMANN divaricatoreBI-03
- COLLIN
 isterometroHA-39
 manico per bisturiAG-08
 martelloDC-18
 pelvimetroHC-06
 pinza emostaticaBC-08
 pinza ombelicaleHC-06
 pinza per afferrare l'uteroHA-37
 pinza per agrafesCG-07
 pinza per medicaturaBG-11
 pinza tiralinguaEI-03
- COLLIN-POZZI pinza
 per abbassare il collo dell'uteroHA-32
- COLLIN
 specolo vaginaliHA-04
- COLLYER pelvimetroHC-06
- Coltellino KUHNT per cornealeEC-05
- Coltello
 BALLENGER girevoleEG-11
 BARKAN per goniectomiaEC-05
 BARNHILLEG-19
 BARRAQUER per cheratoplEC-05
 BECKMANNEG-19
- BOWMAN per diszisioneEC-04
- BRUENINGS settoEG-11
- CARPENTER tonsilleFA-02
- CATLIN per amputazioneAG-16
- COTTLE nassaleEG-10
- DEAN per iridettomiEC-04
- DEUTSCHMANN per catarattaEC-03
- ELSCHNIG per cornealeEC-05
- ESMARCH per gessiDA-04
- FREER settoEG-10
- GILL per cornealeEC-05
- GRAEFE per catarattaEC-03
- HOPKINS per gessiDA-04
- JOSEPH smussoEG-10
- KNAPP per iridettomiEC-04
- LANGENBECK per resezioneAG-17
- LISTON per amputazioneAG-16
- MUCK periostaleEE-15
- PAUFIQUE per cheratoplEC-05
- Coltello per amputazioneAG-16
- Coltello per cartilaginiAG-18
- Coltello per gessiDA-04
- Coltello
 PLESTER lobareEE-14
 POLITZER auricolareEE-06
 REINER per gessiDA-04
 ROSEN circolareEE-14
 SATO per cornealeEC-05
 SCHEIE per goniectomiaEC-05
 SCHUKNECHT circolareEE-14
 SCHUKNECHT falciformeEE-14
 SEXTON auricolareEE-06
 St. CLAIR-THOMSONEG-19
 TABB falciformeEE-14
 TOOK per cornealeEC-05
 VIRCHOW per cartilaginiAG-18
 VIRCHOW per il cervelloAG-18
 WHEELER per diszisioneEC-04
 WULLSTEIN falciformeEE-14
 ZIEGLER per capsulotomiaEC-05
 ZIEGLER per iridettomiEC-04
- COLVER pinza tonsilleFA-03
- Compressore CORWIN tonsilleFA-04
- CONNIN-AMSLER marcatoreEC-09
- Cono
 di occlusioneHA-47
 KNUTSON-KOCH per uretrografiaGG-09
- Contenitori per sterilizzazione
 3/4HE-22 lavorare a HE-24
 grossiHE-18 lavorare a HE-20
 mezziHE-26 lavorare a HE-29
 piatti mezziHE-30 lavorare a HE-31
 piccoliHE-32 lavorare a HE-33
 specialeHE-34 lavorare a HE-37
- CONVERSE bisturi nassaleEG-10
- COOLEY
 costotomo primaFG-05
- COOLEY DERRA pinza atraumatica anastomosiBD-39
- COOLEY
 dilatatore per valvole mitraliFG-27 lavorare a FG-29
 dilatatore vascolareFG-30
 divaricatore costaliFG-09
 divaricatore per cavitàFG-20
- COOLEY modif- STRUCK divaricatore per cavitàFG-20
- COOLEY pinza atraumatica
BB-03, BD-35 lavorare a BD-37, BD-39, BD-41
 pinza atraumatica anastomosiBD-37, BD-40
 pinza atraumatica bulldogBD-33 lavorare a BD-34
 pinza atraumatica iliacaBD-37
 pinza atraumatica pediatricaBD-38 lavorare a BD-39
 pinza vascolariBD-40

COOPER ago per legature	.CG-02	FAULKNER tagliente	.EG-18
CORDES pinza laringe	.FC-03	FOX per lupus	.HE-02
Corta-agrafes	.EA-02	GOURDET uterine	.HA-48
CORWIN compressore tonsille	.FA-04	GRAEFE per cataratta	.EC-07
CORYLLOS costotomo	.FG-04	GROSS auricolare	.EE-06
CORYLLOS Thorax divaricatore	.BI-13	HALLE tagliente	.DC-13
Costotomi	.FG-02	HEBRA per calazio	.EC-07
GLUCK	.FG-03	HOUSE	.EE-15
STILLE	.FG-03	KEVORKIAN di aspirazione per biopsia	.HA-40
Costotomo		KNAPP per cataratta	.EC-07
BETHUNE	.FG-04	LEMPERT tagliente	.DC-13
BRUNNER	.FG-07	MARTINI tagliente	.DC-13
COOLEY prima	.FG-05	MEYHOEFER per calazio	.EC-07
CORYLLOS	.FG-04	NOVAK di aspirazione per biopsia	.HA-40
GIERTZ-STILLE	.FG-06	per aspirazione	.HA-51
SAUERBRUCH	.FG-05	PESTALOZZA per placenta e per ovaie	.HC-08
SAUERBRUCH-FREY	.FG-06	PIFFARD per lupus	.HE-02
COTTLE		RANDALL di aspirazione per biopsia	.HA-40
coltello nasale	.EG-10	RECAIMER uterine	.HA-49 lavorare a HA-50
divaricatore nasale	.EG-17	SCHEDE tagliente	.DC-12
elevatore periostotomo	.EG-12	SCHROEDER uterine	.HA-48
elevatore setto	.EG-12	SIMON tagliente	.DC-13
forbici nasali	.AH-18, AI-25	SIMON uterine	.HA-48
COTTLE-KAZANJIAN cesoia per ossa	.DC-06	SIMS uterine	.HA-49 lavorare a HA-50
COTTLE-NEIVERT divaricatore nasale	.EG-17	SPRATT tagliente	.DC-12
COTTLE		VOLKMANN tagliente	.DC-12 lavorare a DC-13
scalpello plastica nasale	.EG-13	WALLICH per placenta e per ovaie	.HC-08
specolo nasale	.EG-03	WILLIGER tagliente	.DC-13
COXETER candeletta dilatatrici	.GG-17	Curette LANG	.EC-08
CRAFOORD		CUSCO specolo vaginali	.HA-04 lavorare a HA-06
forbici pulmonari	.AI-36	CUSHING	
pinza emostatica bronchiale	.BC-12	divaricatore	.BI-07
Cranioclasto		divaricatore per nervi	.EA-04
BRAUN	.HC-09	perforatore piano	.DD-04
TARNIER	.HC-09	pinza dissezione	.BA-03
CREDO tagliacalli	.HE-03	pinza tagliente per laminectomia	.EA-08
CRILE		spatole cerebr	.EA-07
divaricatore	.BI-02	CUZZI curretta per placenta e per ovaie	.HC-08
CRILE-MURRAY port'aghi	.CE-02	CZERNY	
CRILE		pinza per abbassare il collo dell'utero	.HA-34
pinza emostatica	.BC-05	pinza per calcoli biliari	.GC-03
port'aghi	.CE-04	specolo rettale	.GI-02
CRILE-RANKIN pinza emostatica	.BC-05		
CRILE TITAN pinza emostatica	.BC-05	D	
CRILE-WOOD port'aghi	.CE-02	DALE pinza atraumatica vascolare	.BD-24
CRITCHETT blefarostato	.EC-02	DANDY	
Crivello per specolo vaginale	.HA-22	divaricatore per nervi	.EA-04
CROCE RSSA forbici bendaggi	.AI-47	forbici neurochirurgia	.AI-36
CRUTCHFIELD		pinza emostatica	.BC-07
alesatore	.EA-03	DARDIK pinza atraumatica	.BD-07
pinza per trazione craniale	.EA-03	DARLING divaricatore	.BI-17
Cucchia GUTMANN per secrezioni	.GG-11	DARTIGUES pinza per afferrare l'utero	.HA-37
Cucchiaio		DASTOOR	
DESJARDINS per calcoli biliari	.GC-08	capsulo aspiratore	.EC-09
FERGUSON per calcoli biliari	.GC-07	pinza strabismo	.EC-14
LUER-KOERTE per calcoli biliari	.GC-09	DAVIDSON Scapula divaricatore	.BI-13
MAYO per calcoli biliari	.GC-07	DAVIEL curretta per cataratta	.EC-07
MOORE per calcoli biliari	.GC-05	DAVIS	
SELLHEIM ostetrico	.HC-09	ago per corpi estranei	.EC-05
CULLER spatola iride	.EC-08	DAVIS-BOYLE apribocca	.EI-04
Curetta		DAVIS	
ALVIS per corpi estranei	.EC-06	dissettore per duramadre	.EA-05
AXENFELD per calazio	.EC-07	pinza per sterilizzazione	.CI-02
BLAKE uterine	.HA-48	DAY uncinetto auricolare	.EE-07
BRUNS tagliente	.DC-12 lavorare a DC-13	DEAN	
BUCK auricolare	.EE-05	coltello per iridettomi	.EC-04
BUMM uterine	.HA-49 lavorare a HA-50	forbici tonsillari	.AI-26
BUNGE per palpebre	.EC-07	DEAVER	
COAKLEY per seno	.EG-18	divaricatore	.BI-05
CUZZI per placenta e per ovaie	.HC-08	forbici	.AH-05, AI-06
DAVIEL per cataratta	.EC-07		

- DEAVER Grip divaricatoreBI-05
- DE BAKEY BAHNSON
pinza atraumatica per aneurisma di aortaBD-14
- DE BAKEY
dilatatore vascolareFG-31
forbici vascolariAI-30
- DE BAKEY MORRIS pinza atraumaticaBD-16
- DE BAKEY pinza atraumatica
.....BB-03, BD-02, BD-08, BD-16 lavorare a BD-17,
BD-20, BD-29 lavorare a BD-30
pinza atraumatica anastomosiBD-25
pinza atraumatica anastomosi, pediatricaBD-28
pinza atraumatica bronchiBD-19
pinza atraumatica bulldogBC-02
pinza atraumatica
dissezione e per legatureBD-25, BD-32
pinza atraumatica iliacaBD-11
pinza atraumatica
per aneurisma di aortaBD-13, BD-15, BD-18
pinza atraumatica vascolareBD-06
port'aghiCE-03
- DE BAKEY REYNOLDS
pinza atraumatica anastomosiBD-30
- DE BAKEY SATINSKY
pinza atraumaticaBD-22
- DE BAKEY
tubi d'aspirazioneAE-04
- DEJERINE martelli percussoriAC-07
- De LEE forcipe obstetriciHC-02
- De MARTEL guida segaEA-05
- DeMARTEL-WOLFSON pinza per anastomosiGE-07
- DENHART apriboccaEI-03
- Depressore
BRAUN uterinoHA-39
SIMS uterinoHA-39
- Depressor REICHERT epiglottideFC-02
- DERF port'aghiCE-02
- Dermatomo
BRAITHWAITEAG-22
HUMBYAG-20
SCHINKAG-21
SILVERAG-20
WATSONAG-22
- DERRA pinza atraumaticaBD-28
- DESCHAMPS ago per legatureCG-02
- DESJARDINS
cucchiaio per calcoli biliariGC-08
pinza per calcoli biliariGC-02
pinza vie biliariBC-15
sonda per calcoli biliariGC-05
- DESMARRES
divaricatoreBI-07
pinza calazioED-06
- DEUTSCHMANN coltello per catarattaEC-03
- DeVILBISS pinza cranecraneaneaEA-05
- DEWEY forcipe obstetrici
con dispositivo di trazioneHC-05
- Diamant tagliafilariDD-12
- DiapasonEE-04
DIMEDA AluEE-03
HARTMANNEE-03
LUCAEEE-04
RYDEL-SEIFFEREE-04
- DIEFFENBACH pinza serrafina bulldogBC-03
- DIETER pinza la testa de mastelloEE-10
- DIETHRICH
forbici vascolariAI-29
Pinza atraumaticaBD-31
port'aghi vascolareCE-06
- Dilatatore
ALAN-PARKS per l'ano e il rettoGI-03
- BAKES per condotti biliariGC-06
- BROCK per valvole mitraliFG-26
- CASTROVIEJO canale lacrimaleEC-10
- COOLEY per valvole mitraliFG-27 lavorare a FG-29
- COOLEY vascolareFG-30
- DE BAKEY vascolareFG-31
- GERBODE per valvole mitraliFG-28
- GOODELL uteriniHA-30
- HANK uteriniHA-28
- HEGAR uteriniHA-24 lavorare a HA-27
- HETZER per valvole mitraliFG-29
- LABORDE trachealeFE-02
- PRATT uteriniHA-29
- SIMS uteriniHA-30
- SMITH-BUIE per l'ano e il rettoGI-03
- TROUSSEAU trachealeFE-02
- TUBBS per valvole mitraliFG-27
- WILDER canale lacrimaleEC-10
- WYLIE uteriniHA-30
- ZIEGLER canale lacrimaleEC-10
- DIMEDA Alu diapasonEE-03
- DIMEDA
calamita oculisticheED-08
divaricatoreBI-14
forbici bendaggiAI-46
pinza per rifiutiCI-03
pinza rompe lametteAG-14
specilloCA-03
taglia anelliDD-03
- Dinamometro COLLINAC-03
- DINGMANN tenaglia per ossaDC-10
- Dissetatore
DAVIS per duramideEA-05
GREEN per cornealeEC-06
HORSLEY per duramideEA-06
HURD tonsilleFA-02
MILLIGAN per duramideEA-05
PATON per cornealeEC-05
PENFIELD per duramideEA-06
per duramideEA-05
ROBB vascolareFG-33
SACHS per duramideEA-05
TOENNIS per duramideEA-05
- Dissezione bisturiAG-15
- Ditale LANGENBECKEI-06
- DITTEL
candeletta dilatatriciGG-18 lavorare a GG-19
mandrino per sonde uretraliGG-11
- DivaricatoreBI-06, BI-10
- ADSONBI-15
ADSON BabyBI-15
ADSON per nerviEA-04
ALMBI-14
AUFRIEHT nasaleEG-17
BALFOUR addominaleBI-22
BALFOUR Baby addominaleBI-22
BECKMANNBI-16
BECKMANN-ADSONBI-15
BECKMANN-EATONBI-16
BOSE trachealeFE-02
CASPARBI-20
CASPAR lombar vertebraleBI-20
CASPAR spina cervicaBI-18
CASPAR spina vertebraleBI-19
CASTAÑEDA costaliFG-14
CHEVALLIER costaliFG-15
CLOWARDBI-17
CLOWARD per corpi vertebraliEA-07
COLLIN addominaleBI-24 lavorare a BI-25
COLLIN-HARTMANNBI-03
COOLEY costaliFG-09

COOLEY modif- STRUCK per cavità	.FG-20
COOLEY per cavità	.FG-20
CORYLLOS Thorax	.BI-13
COTTLE nasale	.EG-17
COTTLE-NEIVERT nasale	.EG-17
CRILE	.BI-02
CUSHING	.BI-07
CUSHING per nervi	.EA-04
DANDY per nervi	.EA-04
DARLING	.BI-17
DAVIDSON Scapula	.BI-13
DEAVER	.BI-05
DEAVER Grip	.BI-05
DESMARRES	.BI-07
DIMEDA	.BI-14
DOYEN	.BI-12
FARABEUF	.BI-02
FINOCHIETTO-BABY costali	.FG-09
FINOCHIETTO BURFORD	
costali	.FG-12 lavorare a FG-14
FINOCHIETTO costali	.FG-08, FG-10 lavorare a FG-11
FINOCHIETTO-HAIGTH BABY costali	.FG-10
FINOCHIETTO INFANT costali	.FG-12
FINOCHIETTO (modif) costali	.FG-08
FINSEN	.BI-14
FOMON nasale	.EG-17
FRAZIER	.BI-21
FRIEDMAN perineorraf	.HA-23
FRTISCH	.BI-11
GELPI addominale	.BI-24
GERSTER per tenaglie	.DC-11
GOELET	.BI-03
GOSSET addominale	.BI-21
GRAHAM per nervi	.EA-04
GREEN	.BI-10
HABERER	.BI-04
HAIGHT costali	.FG-15
HARRINGTON	.BI-05
HEANEY	.BI-12
HERTZLER costali	.FG-17
HOFER pillare	.FA-02
HRYNTSCHAK per prostata	.GG-06
INGE per corpi vertebrali	.EA-07
ISRAEL	.BI-11
JANSEN	.BI-14
JUDD-MASSON vescicale	.GG-04
KELLY	.BI-04, BI-12
KELLY GRIP	.BI-04
KIRSCHNER addominale	.BI-23
KNAPP	.EC-06
KOCHER	.BI-10 lavorare a BI-11
KOERTE	.BI-11
labbra e guance	.EI-03
LAHEY	.BI-08
LANGENBECK	.BI-09
LEGUEU vescicale	.GG-06
LITTLE	.BI-08
LOVE per nervi	.EA-04
LOVE uvula	.FA-02
MATHIEU	.BI-03
MERCEDES per il torace	.FG-16
MEYERDING	.BI-08
MIDDELDORPF	.BI-10
MIKULICZ	.BI-12
MILLIN del collo vecicale	.GG-07
MILLIN vescicale	.GG-05
MOLLISON	.BI-17
MORSE-FAVOLORO costali	.FG-17
Divaricatore muscolari unicini	.BI-25
Divaricatore	
NAGER palat	.FA-02

OLLIER	.BI-10
O'SULLIVAN-O'CONNOR addominale	.BI-21
PARKER	.BI-02
PITHA labbra	.EI-06
PLESTER	.BI-14
REVERDIN	.BI-04
RIBBON	.BI-04
RICHARDSON	.BI-04
RICHARDSON-EASTMAN	.BI-04
RICHARDSON Grip	.BI-04
RIGBY addominale	.BI-24
ROLLET	.EC-06
ROUX	.BI-02
ROUX aortica mini	.BI-02
ROUX BABY	.BI-02
SACHS per nervi	.EA-04
SAUERBRUCH	.BI-13
SCHOENBORN tiroide	.FE-04
SENN	.BI-04
SENN-GREEN	.BI-07
SIMON	.BI-12
SMITHWICK per nervi	.EA-04
STERNBERG labbra	.EI-02
TAYLOR spina	.DC-24
THOMSON-WALKER vescicale	.GG-06
TUFFIER costali	.FG-16
US Army (PARKER-LANGENBECK)	.BI-03
VOLKMANN	.BI-07 lavorare a BI-08
WEITLANER	.BI-14
WEITLANER-WULLSTEIN	.BI-14
YOUNG per prostata	.GG-02
Divaricatori	
BEESON per gessi	.DA-03
HAGLUND-STILLE per gessi	.DA-03
HENNIG per gessi	.DA-03
HERMANN per gessi	.DA-03
Divaricatori per gessi	.DA-03
Divaricatori	
QUATTRO per gessi	.DA-03
Divisore per craneo VIRCHOW	.DC-17
DIX	
ago	.EC-09
scalpello per corpi estranei	.EC-06
DOUGLAS	
pinza depilatoria	.ED-08
tre quarti	.CC-02
DOYEN-Baby pinza intestinali	.GE-03
DOYEN	
divaricatore	.BI-12
forbici ginecologiche	.AI-33
fresa	.DD-07
DOYEN-JANSEN apribocca	.EI-03
DOYEN	
periototomo costali	.DC-20
pinza fissateli	.BE-05
pinza intestinali	.GE-03
pinza per polipi uterine	.HA-36
sonda	.CA-02
specolo vaginali	.HA-18, HA-20
tiramiomi per fibromi	.HA-46
DUBOIS forbici ginecologiche	.AI-33
DUPLAY	
pinza per abbassare il collo dell'utero	.HA-31
pinza per medicatura	.BG-14
DUPUY-WEISS ago tonsille	.FA-03
DUVAL	
pinza dissezione	.BA-04
pinza per afferrare tessuti	.GE-03

E

- ECHLIN pinza sgorbiaDC-05
EDWARDS
clipBD-21
pinza applicatore per clipsBD-21
Elettrodo per coagulazione miniJA-02 lavorare a JA-03
Elevatore
ADSONDC-21
BALLENGER settoEG-12
BENNETT per ossaDC-22
BLOUNT per ginocchioDC-24
BLOUNT per ossaDC-24
COTTLE periostotomoEG-12
COTTLE settoEG-12
FREER settoEG-11
HAJEK-BALLENGER settoEG-12
HENKE tonsilleFA-02
HOHMANN mini per ossaDC-23
HOHMANN per ossaDC-22 lavorare a DC-23
JOSEPH periostotomoEG-12
KEYDC-21
KILLIAN settoEG-12
LANGENBECKDC-21
LEMPERTEE-15
McDONALDDC-22
McKENTY settoEG-11
MURLESS per testaHC-05
MURPHY-LANEDC-22
per ossaDC-23
ROGER settoEG-11
WATSON-CHEYNEDC-22
ELLIOT
forbici obstetricheHC-02
trapano cornealeED-08
ELLIS sgorbia per corpi estraneiEC-06
ELSAESSER pinza per nefrostomiaGC-13
ELSCHNIG
coltello per cornealeEC-05
pinza capsulareED-04
pinza fissaggioED-03
spatola ciclodialiisiEC-08
EMMET uncini per fistoleHA-46
Emostasi PASSOWEE-15
ENGEL sega per gessiDA-02
EPPENDORFER-KEVORKIAN
pinza tagliente per biopsiaHA-46
EPPENDORFER
pinza tagliente per biopsiaHA-45 lavorare a HA-46
EPPENDORFER TISCHLER-MORGAN
pinza tagliente per biopsiaHA-46
ERBE SELECT cavo elettrobisturiJA-07
ESMARCH
coltello per gessiDA-04
forbici bendaggiAI-46
EVES serranodi tonsilleFA-04
F
FARABEUF
divaricatoreBI-02
FARABEUF-LAMBOTTE tenaglia per ossaDC-08
FARABEUF
periostotomoDC-19
tenaglia per ossaDC-07
FARREL specilloCA-03
FAULKNER curetta taglienteEG-18
FAURE
pinza peritonealiBC-17
pinza tagliente per biopsiaHA-41
FEHLAND pinza intestinaliGE-06
FEILCHENFELD pinza scheggeBA-06
FERGUSSON
cucchiaio per calcoli biliariGC-07
forbiciAI-49
pinza emostaticaBC-07
tenaglia per ossaDC-07
FERRIS pinza dissezioneBA-04
FERRIS-SMITH-KERRISON pinza tagliente per dischi intervertebraliEA-10
FERRIS-SMITH pinza tagliente per laminectomiaEA-09
FILIFORM candelettaGG-12
Fili
KIRSCHNERDD-09
per ossaDD-11
FINOCHIETTO-BABY divaricatore costaliFG-09
FINOCHIETTO BURFORD
divaricatore costaliFG-12 lavorare a FG-14
FINOCHIETTO
divaricatore costaliFG-08, FG-10 lavorare a FG-11
forbici retteAI-38
FINOCHIETTO-HAIGTH BABY divaricatore costaliFG-10
FINOCHIETTO INFANT divaricatore costaliFG-12
FINOCHIETTO (modif) divaricatore costaliFG-08
FINOCHIETTO
pinza per bronchiFG-21
port'aghiCE-04
FINSEN divaricatoreBI-14
FINSTERER canunule per aspirazione e irrigazioneAE-05
FISCHER pinza irideEC-13
FISCH scollatoEE-15
FLETCHER JAVERTS pinza per tamponi e spugneBG-10
FLEURANT tre quartiCC-02
FOERSTER
pinza irideEC-12
pinza per tamponi e spugneBG-06 lavorare a BG-08
FOMON
divaricatore nasaleEG-17
forbici nasaliAH-18, AI-25
raspa nasaleEG-15 lavorare a EG-16
scalpello plastica nasaleEG-13
ForbiciAH-02 lavorare a AH-04, AI-02 lavorare a AI-04
AEBLI cornealiAI-22
auricolari microEE-11
auricolari micro miniEE-11
BARRAQUER colibriAJ-04
BEEBEE filo metallo lamieraAI-43
BELLUCCI auricolari microEE-09
BERGMANN bendaggiAI-46
BEUSEAI-26
BOETTCHER tonsillariAI-27
BRAUN-STADLER episiotomiaAH-22, AI-34
BRUNS gessoAI-48
BUCK per legatureAI-40
BUSCH ombelicaliAI-34
CASTROVIEJO cornealiAJ-06
CASTROVIEJO iridectomiaAJ-05
COTTLE nasaliAH-18, AI-25
CRAFOORD pulmonariAI-36
CROCE RSSSA bendaggiAI-47
DANDY neurochirurgiaAI-36
DEAN tonsillariAI-26
DEAVERAH-05, AI-06
DIMEDA bendaggiAI-46
Forbici dissezioneAI-19
Forbici
DOYEN ginecologicheAI-33
DUBOIS ginecologicheAI-33
Forbici enterotomiaAI-39
Forbici
ESMARCH bendaggiAI-46
FERGUSSONAI-49

- Forbici finiAI-05, AI-19, AI-24
- Forbici
- FINOCHIETTO retteAI-38
- FOMON nasaliAH-18, AI-25
- Forbici gessoAI-49
- Forbici ginecologiche microAJ-07 lavorare a AJ-08
- Forbici gengivaliAI-41
- Forbici
- GOLDMAN-FOX gengivaliAI-41
- GORNEY dissezioneAI-13
- HEATH per legatureAI-40
- HEYMANN nasaliAH-18, AI-25
- Forbici incisioneAI-05
- Forbici
- IRISAH-16, AI-19, AI-21
- IRIS oftalmologiaAI-22
- JACOBSON microAJ-11
- JOSEPHAH-14, AI-16
- KELLY ginecologicheAH-22, AI-33
- KILNERAH-14, AI-17
- KLINKENBERGH-LOTH toracaliAI-37
- KNAPPAI-20
- KNOWLES bendaggiAI-47
- LAGRANGE gengivaliAI-41
- LANDOLT enucleazioneAI-25
- LANGE bendaggiAI-44
- LEXERAH-09
- LEXER-BABYAH-10
- LEXER-BABY dissezioneAI-12
- LEXER dissezioneAI-11
- LEXER-FINO dissezioneAI-12
- LISTER bendaggiAH-23, AI-45
- LITTAUER per legatureAI-40
- LITTLE dissezioneAI-13
- LOCKLINAI-18
- LORENZ bendaggiAI-47
- MAYOAH-06, AI-07
- MAYO manciniAI-07
- MAYO-NOBLEAH-08, AI-10
- MAYO-STILLEAH-07, AI-08 lavorare a AI-09
- McGUIRE cornealiAJ-05
- McINDOE cartilagoAI-35
- McPHERSON WESTCOTT tendiniAJ-04
- METZENBAUMAH-11
- METZENBAUM dissezioneAI-13 lavorare a AI-14
- METZENBAUM FINOAH-12
- METZENBAUM FINO dissezioneAI-15
- METZENBAUM "S"AH-13, AI-16
- Forbici microAJ-06
- Forbici
- MICRO microAJ-13
- Forbici neurochirurgiaAI-35
- Forbici
- NORTHBENT per legatureAI-40
- NOYES iridectomiaAJ-03
- NOYES irisAJ-04
- NOYES tendiniAJ-03
- per pelleHE-03
- per unghieHE-03
- POTTS-SMITH vascolariAH-19
- Forbici preparazioniAI-34
- Forbici
- QUINBY gengivaliAI-42
- REYNOLDSAH-15, AI-18
- SANVENEROAH-13, AI-16
- SATINSKY toracaliAI-37
- SCHMIEDEN-TAYLORAI-36
- SCHUMACHER ombelicaliAI-34
- SCHUMACHER per sternoFG-07
- SEUTIN per gessiDA-02
- SHEA auricolari microEE-09
- SHORTBENT per legatureAI-40
- SIEBOLD ginecologicheAH-21, AI-32
- SIMS ginecologicheAH-21, AI-32
- SMITH US ARMY bendaggiAI-44
- SPENCER per legatureAI-40
- STELZNER retteAI-38
- STEVENS tenotomiaAH-17
- STEVENS tenotomyAI-23
- STILLE per gessiDA-02
- Forbici strabismoAH-17, AI-24
- Forbici
- STRULLY neurochirurgiaAI-35
- THOREK pulmonariAI-36
- TOENNIS-ADSON neurochirurgiaAI-35
- TROUTMAN-CASTROVIEJO microAJ-07
- UNIVERSAL bendaggiAI-50
- UNIVERSAL filo metallo lamieraAI-42
- USA MODEL ombelicaliAI-34
- VANNAS iridectomiaAJ-05
- VANNAS microAJ-12 lavorare a AJ-13
- Forbici vascolari microAJ-09
- Forbici vascolari parametriumAH-20
- Forbici
- WAGNERAH-22
- WAGNER gengivaliAI-42
- WALDMANN episiotomiaAI-34
- WECKER tendiniAJ-04
- WERTHEIM preparazionAI-32
- WESTCOTT iridectomieAJ-02
- WESTCOTT tendiniAJ-02
- WULLSTEIN auricolari microEE-11
- WULLSTEIN auricolari micro miniEE-11
- YASARGIL microAJ-10 lavorare a AJ-11
- Forchetta BURCH di fissaggioEC-05
- Forbici
- BARTON obstetricheHC-04
- BOERMA obstetricheHC-04
- De LEE obstetricheHC-02
- DEWEY obstetriche con dispositivo di trazioneHC-05
- ELLIOT obstetricheHC-02
- KIELLAND-LUIKART obstetricheHC-03
- KIELLAND obstetricheHC-02
- LUIKART obstetricheHC-03
- McLEAN-LUIKART obstetricheHC-03
- McLEAN obstetricheHC-04
- McLEAN-TUCKER-LUIKART obstetricheHC-03
- NAEGELE obstetricheHC-03
- PIPER obstetricheHC-04
- PIPER obstetriche con dispositivo di trazioneHC-04
- SIMPSON-BRAUN obstetricheHC-02
- SIMPSON-LUIKART obstetricheHC-03
- SIMPSON obstetricheHC-02
- TARNIER obstetriche con dispositivo di trazioneHC-05
- WRIGLEY obstetricheHC-02
- FORD BOWLES stetoscopioAC-06
- FORD stetoscopioAC-06
- Forbici
- DE BAKEY vascolariAI-30
- DIETHRICH vascolariAI-29
- GOOD tonsillariAI-27
- MILLS vascolariAI-27
- parametrio vascolariAI-31
- POTTS DE MARTEL vascolariAI-27
- POTTS-SMITH vascolariAI-28
- PRINCE tonsillariAI-27
- Forbici vascolariAI-27
- FOX curretta per lupusHE-02
- FRAENKEL
- pinza laringeFC-03
- pinza polipus laringeFC-02
- FRANCESCHETTI trapano cornealeED-07

FRANCIS ago per corpi estranei	EC-05
FRANKLIN-SILVERMANN ago da punzione	CC-03
FRAZIER	
divaricatore	BI-21
tubi d'aspirazione	EA-07
uncinetto	BI-06
FREER	
bisturi mucosa	EG-10
coltello setto	EG-10
elevatore setto	EG-11
scalpello setto	EG-12
sgorbia nasale	EG-14
FREEWAY-GRAVE specolo vaginali	HA-06
FRENZEL abassalingua	EI-02
Fresa	DD-07
ALBEE	DD-07
BORCHARDT	DD-07
Fresa cuneiforme HUDSON	DD-04
Fresa	
DOYEN	DD-07
per corticalis	DD-15
TOTI	DD-07
FRIEDMAN	
divaricatore perineorraf	HA-23
pinza sgorbia	DC-02
pinza sgorbia, mini	DC-02
FRTISCH divaricatore	BI-11
FRYKHOLM pinza sgorbia	DC-05
FUCHS pinza capsulare	ED-04

G

GALLAHER raspa per seno	EG-16
GAUSS pinza per pericranio	HC-06
GELLHORN pinza tagliente per biopsia	HA-42
GELPI divaricatore addominale	BI-24
GEMINI MINI pinza dissezione e per legature	BC-10
GEMINI pinza dissezione e per legature	BC-10
GERALD pinza dissezione	BA-05
GERBODE dilatatore per valvole mitrali	FG-28
GERSTER divaricatore per tenaglie	DC-11
GERZOG martello	DC-18
GIERTZ-STILLE costotomo	FG-06
GIGLI manico per sega	EA-05
GILL-ARRUGA pinza capsulare	ED-03
GILL	
coltello per corneale	EC-05
GILL-HESS pinza iride	EC-12
GILLIES	
pinza dissezione	BA-05
port'aghi	CE-05
uncinetto	EG-17
GILL	
pinza iride	EC-12
Giraviti	DD-14 lavorare a DD-15
LANE	DD-14
WILLIAMS	DD-14
GLOVER	
pinza atraumatica	BD-06, BD-30
pinza atraumatica anastomosi	BD-05
pinza atraumatica bulldog	BC-02
pinza atraumatica coartazione	BD-04
GLUCK costotomi	FG-03
GOELET divaricatore	BI-03
GOLDMAN-FOX forbici gengivali	AI-41
GOLDSTEIN blefarostato	EC-03
Goniometro MOELTGEN	AC-08
GOODELL dilatatore uterini	HA-30
GOOD forbici tonsillari	AI-27
GORNEY forbici dissezione	AI-13
GOSSET divaricatore addominale	BI-21

GOURDET curetta uterine	HA-48
GRADLE pinza depilatoria	ED-08
GRAEFE	
blefarostato	EC-02
cistitomo	EC-06
coltello per cataratta	EC-03
curetta per cataratta	EC-07
pinza dissezione	BA-03
pinza fissaggio	ED-03
pinza iride	EC-11
scarificatore	EC-04
GRAEFE-TITAN uncino per strabismo	EC-06
GRAEFE	
uncinetto	BI-06
uncino per strabismo	EC-06
GRAHAM divaricatore per nervi	EA-04
GRAVE specolo vaginali	HA-02
GRAY pinza vie biliari	BC-15
GREEN-ARMYTAGE pinza emostatica per tagli cesari	HC-06
GREEN	
dissetto per corneale	EC-06
divaricatore	BI-10
pinza fissaggio	ED-03
uncino muscolare	EC-06
GREGORY pinza atraumatica profonda	BD-33
GREVEN pinza auricolare micro	EE-10
GRIP pinza per afferare	DD-11
GROSS	
curetta auricolare	EE-06
GROSS-MAIER pinza per medicatura	BG-2 lavorare a BG-4
GROSS	
pinza per medicatura	BG-05
GRUBER specoli auricolare	EE-02
Guida sega De MARTEL	EA-05
GUTHRIE uncinetto	BI-06
GUTMANN cucchiaria per secrezioni	GG-11
GUYON	
candeletta dilatatrici	GG-12, GG-14 lavorare a GG-15
mandrino per sonde uretrali	GG-11
pinza peduncolo renale	BC-16
GUYTON-LUNDSGAARD sclerotomo	EC-05

H

HABERER divaricatore	BI-04
HAGLUND-STILLE divaricatori per gessi	DA-03
HAIGHT divaricatore costali	FG-15
HAJEK-BALLENGER elevatore setto	EG-12
HAJEK-CLAUS pinza seno	EG-08
HAJEK-KOFLER pinza tagliente nasale	EG-08
HAJEK sgorbia nasale	EG-14
HALLE	
bisturi per duramadre	EA-06
curetta tagliente	DC-13
HALSEY port'aghi	CE-02
HALSTED-MOSQUITO micro pinza emostatica	BC-04
HALSTED-MOSQUITO	
pinza atraumatica	BD-02
pinza emostatica	BC-04
HALSTED-MOSQUITO TITAN pinza emostatica	BC-04
Hamburg cannula bottonuta	ED-07
HANK dilatatore uterini	HA-28
HARKEN pinza atraumatica ventricolari	BD-23
HARRINGTON	
divaricatore	BI-05
pinza per bronchi	FG-21
HARTMANN	
abassalingua	EI-02
diapason	EE-03
HARTMANN-HALLE specolo nasale	EG-02

HARTMANN-HOFFMANN pinza auricolare	EE-08
HARTMANN	
pinza auricolare	EE-08
pinza emostatica	BC-03
pinza nasale polipus	EG-04
pinza tagliente nasale	EG-07
sonda auricolare	EE-06
specoli auricolare	EE-02
HARTMANN-WULLSTEIN pinza auricolare	EE-08
HEANEY	
divaricatore	BI-12
pinza isterectomia	BC-18
port'aghi	CE-03
HEATH forbici per legature	AI-40
HEBRA curetta per calazio	EC-07
HEGAR dilatatore uterini	HA-24 lavorare a HA-27
HEGENBARTH pinza per agrafes	CG-07
HEIFETZ spatole cerebr	EA-07
HEIMING pinza per calcoli renali	GC-13
HEISS pinza emostatica	BC-09
HEISTER apribocca	EI-03
HENKE elevatore tonsille	FA-02
HENNIG divaricatori per gessi	DA-03
HENROTIN pinza per abbassare il collo dell'utero	HA-34
HERMANN divaricatori per gessi	DA-03
HERRICK pinza peritoneali	BC-17
HERTZLER divaricatore costali	FG-17
HESS	
pinza capsulare	ED-04
pinza iride	EC-12
HETZER dilatatore per valvole mitrali	FG-29
HEYMANN	
forbici nasali	AH-18, AI-25
HEYMANN-KNIGHT pinza nasale polipus	EG-05
HEYMANN	
pinza tagliente nasale	EG-05
HEYWOOD-SMITH pinza per ermorridda	GI-05
HIBBS	
osteotome	DC-16
scalpello	DC-16
sgorbia	DC-16
HIRSCHMANN anoscopio	GI-04
HOESEL port'aghi	CE-05
HOFER divaricatore pillare	FA-02
HOFF pinza fissateli	BE-03
HOHMANN elevatore per ossa	DC-22 lavorare a DC-23
HOHMANN mini elevatore per ossa	DC-23
HOKE scalpello	DC-16
HOLTH pinza per capsulo	EC-09
HOPKINS coltello per gessi	DA-04
HORSLEY dissetto per duramadre	EA-06
HOUSE curetta	EE-15
HRYNTSCHAK divaricatore per prostata	GG-06
HUBER manico universale	FC-03
HUDSON	
fresa cuneiforme	DD-04
perforatore a mano	DD-04
HUMBY dermatomo	AG-20
HUNTER pinza schegge	BA-06
HURD dissetto tonsille	FA-02
I	
Imbuti	HE-07
INGE divaricatore per corpi vertebrali	EA-07
Insoffiatore	
KABIERSKE per polvere	EE-04
POLITZER d'aria	EE-05
IOWA pinza per abbassare il collo dell'utero	HA-35
IRIS	
forbici	AH-16, AI-19, AI-21

forbici oftalmologia	AI-22
Irrigatore	HE-05
ISRAEL divaricatore	BI-11
Isterometro	
COLLIN	HA-39
MARTIN	HA-39
SIMS	HA-39
VALLEIX	HA-39
ITARD sonda auricolare	EE-06
ITERSON uncino tracheale	FE-02
IVES-FANSLER anoscopio	GI-04

J

JACKSON	
pinza taponi	FC-02
specolo vaginali	HA-16
tubo tracheale	FE-03
uncino tracheale	FE-02
JACOBSON forbici micro	AJ-11
JACOBS pinza per abbassare il collo dell'utero	HA-34
JAEGER	
cheratomo	EC-04
placca per palpebre	EC-03
JAMESON	
pinza strabismo	EC-13
uncino per strabismo	EC-06
JAMISON port'aghi	CE-03
JANSEN	
divaricatore	BI-14
pinza nasale	EG-04
JARCHO pinza per abbassare il collo dell'utero	HA-32
JATHO pinza nasofarinx tagliente	EG-18
JAVID pinza atraumatica carotis	BD-32
JENNINGS apribocca	EI-04
JOBSON-HORNE specillo	CA-03
JOHNS-HOPKINS	
pinza serratina bulldog	BC-03
pinza vie biliari	BC-14
JOHNSON port'aghi	CE-04
JONES pinza fissateli porta tubo	BE-02
JOSEPH	
bisturi nassale botton	EG-10
coltello smusso	EG-10
elevatore periostotomo	EG-12
forbici	AH-14, AI-16
JOSEPH (LEWIS) raspa nasale	EG-15
JOSEPH	
lima per ossa	EG-14
sega nasale	EG-17
uncinetto	BI-06
JUDD-ALLIS pinza per afferrare tessuti	GE-02
JUDD-MASSON divaricatore vescicale	GG-04
JURASZ pinza polipus laringe	FC-02

K

KABIERSKE insoffiatore per polvere	EE-04
KALLMORGEN	
specolo vaginali	HA-15
valva vaginali	HA-15
KALT-ARRUGA port'aghi	CE-07
KALT	
pinza capsulare	ED-04
port'aghi	CE-07
KANE pinza ombelicale	HC-06
KEITH ago suture	CG-06
KELLY	
divaricatore	BI-04, BI-12
forbici ginecologiche	AH-22, AI-33
KELLY GRIP divaricatore	BI-04

- KELLY
 pinza emostaticaBC-05
 pinza per polipi uterineHA-36
 proctoscopioGI-04
 KELLY-RANKIN pinza emostaticaBC-05
 KELLY TITAN pinza emostaticaBC-05
 KERN tenaglia per ossaDC-08
 KERRISON pinza tagliente nasaleEG-08
 KEVORKIAN
 curetta di aspirazione per biopsiaHA-40
 KEVORKIAN-Pacific pinza tagliente per biopsiaHA-44
 KEVORKIAN
 pinza tagliente per biopsiaHA-43, HA-46
 KEY elevatoreDC-21
 KEYES set di trapani cutaneiHE-02
 KIELLAND forcipe obstetriciHC-02
 KIELLAND-LUIKART forcipe obstetriciHC-03
 KILLIAN
 cannulaEG-09
 KILLIAN-CLAUS sgorbia nasaleEG-14
 KILLIAN
 elevatore settoEG-12
 specolo settoEG-03
 KILNER-DOUGHTY apriboccaEI-05
 KILNER
 forbiciAH-14, AI-17
 uncinetto per pelleHE-02
 KIRBY-ARTHUR pinza irideEC-13
 KIRK martelloDC-18
 KIRSCHNER
 arco per estensioneDD-10
 divaricatore addominaleBI-23
 filiDD-09
 perforatore a manoDD-05
 sonda conduttriceCG-04
 telaioBI-23
 valva per telaioBI-23
 KLINKENBERGH-LOTH forbici toracaliAI-37
 KNAPP
 coltello per iridectomiEC-04
 curetta per catarattaEC-07
 divaricatoreEC-06
 forbiciAI-20
 KNAPP-LUER pinza trichiasiED-06
 KNIGHT pinza tagliente nasaleEG-05
 KNOWLES forbici bendaggiAI-47
 KNUTSON-KOCH cono per uretrografiaGG-09
 KNUTSON strumento per uretrografiaGG-09
 KOCHER
 divaricatoreBI-10 lavorare a BI-11
 pinza emostatica delicateBC-06
 pinza intestinaliGE-04
 sonda gozzoFE-04
 spatola vescicaliGG-04
 KOENIG
 ago sutureCG-06
 sonda conduttriceCG-04
 KOERTE divaricatoreBI-11
 KOGAN specolo endoHA-23
 KONRICH tamburo per sterilizzazioneHE-12
 KRAUSE
 pinza laringeFC-03
 serranodiEG-09
 serranodi auricolareEE-07
 KRISTELLER
 specolo vaginaliHA-09 lavorare a HA-14
 valva vaginaliHA-09 lavorare a HA-14
 KRONECKER ago per legatureCG-02
 KUENTSCHER
 alesatoreDD-13
 cavachiodiDD-13
 strum per conficcDD-13
 KUHNNT coltellino per cornealeEC-05
- L**
- LABORDE dilatatore trachealeFE-02
 LAFORCE
 adenotomoEG-19
 strumenti per corpi estraneiEC-06
 LAGRANGE forbici gengivaliAI-41
 LAHEY
 divaricatoreBI-08
 pinza afferrare gozzoFE-04
 pinza vie biliariBC-14
 Lama bisturi sterili, microAG-13
 Lama bisuttri, steriliAG-06
 Lama
 bisuttri sterileAG-09
 CHARRIERE di ricambioDD-03
 Lama di segaDA-05 lavorare a DA-06
 Lama
 OTIS die ricambioGG-08
 Lama per dermatomoAG-21
 Lama per rasoioAG-19
 Lama per togliereAG-06, AG-10
 LAMBERT KAY
 pinza atraumatica aorticaBD-10
 pinza atraumatica iliacaBD-11
 LAMBERT pinza calazioED-06
 LAMBOTTE mini osteotomoDC-15
 LAMBOTTE
 osteotomoDC-15
 periostotomoDC-19
 tenaglia per ossaDC-08
 Lamette per rasoioAG-14
 Lampada frontale CLARAC-05
 Lampadina ricambio per laringoscopio fibre otticheAE-20
 Lampadina ricambio per laringoscopio standardAE-20
 LANCASTER blefarostatoEC-03
 Lancetta elettrodoJA-03
 LANDAU specolo vaginaliHA-22
 LANDOLT
 forbici enucleazioneAI-25
 manico per bisuttri, microAG-13
 LANE
 giravitiDD-14
 pinza dissezioneBA-04
 pinza fissateliBE-05
 pinza porta placcheDD-14
 pinza porta vitiDD-14
 pinza stomacaliGE-08
 tenaglia per ossaDC-08
 LANG curetteEC-08
 LANGE
 forbici bendaggiAI-44
 LANGENBECK
 coltello per resezioneAG-17
 ditaleEI-06
 divaricatoreBI-09
 elevatoreDC-21
 periostotomoDC-19
 sega a ditaDD-03
 tenaglia per ossaDC-07
 LANGE
 pinza laringeFC-03
 Laringoscopio manico fibre otticheAE-11
 Laringoscopio manico standardAE-17
 Laringoscopio set
 MACINTOSH fibre otticheAE-12 lavorare a AE-13
 MACINTOSH standardAE-18 lavorare a AE-19
 MILLER fibre otticheAE-12 lavorare a AE-13

MILLER standard	.AE-18 lavorare a AE-19
Laringoscopio spatole	
MACINTOSH fibre ottiche	.AE-10
MACINTOSH standard	.AE-15
MILLER fibre ottiche	.AE-10
MILLER standard	.AE-16
LAWRENCE pinza dissezione e per legature	.BC-13
LEBSCHKE scalpello sterno	.DC-17
LEES pinza atraumatica bronchi	.BD-03
LEGUEU	
divaricatore vescicale	.GG-06
spatola vescicali	.GG-04
LEKSELL STILLE pinza sgorbia	.DC-05
LELAND JONES pinza atraumatica vascolare	.BD-08 lavorare a BD-09
LEMPERT	
curetta tagliente	.DC-13
elevatore	.EE-15
pinza sgorbia	.DC-03
LERCHE pinza dissezione	.BA-04
LERICHE pinza emostatica	.BC-09
LESTER pinza fissaggio	.ED-03
Leva	
BUCK corpi estranei	.EE-08
QUIRE corpi estranei	.EE-08
LEVINSON ago per corpi estranei	.EC-05
LEWIN tenaglia per ossa	.DC-10
LEWKOWITZ pinza per placenta e per ovaie	.HC-07
LEXER-BABY	
forbici	.AH-10
forbici dissezione	.AI-12
LEXER-FINO forbici dissezione	.AI-12
LEXER	
forbici	.AH-09
forbici dissezione	.AI-11
LEXER mini	
scalpello	.DC-16
sgorbia	.DC-16
LEXER	
scalpello	.DC-16
sgorbia	.DC-16
LEYLA sistema da fissaggio	.EA-14 lavorare a EA-18
LICHTWITZ	
ago seno	.EG-09
tre quarti	.CC-02
LIDDLE pinza atraumatica aorta	.BD-10
Lima	
JOSEPH per ossa	.EG-14
per ossa	.DC-25
per unghie	.HE-03
PUTTI per ossa	.DC-25
LISTER-BURCH blefarostato	.EC-02
LISTER	
forbici bendaggi	.AH-23, AI-45
pinza sinus per tamponi e spugne	.BG-11
LISTON	
cesoia per ossa	.DC-06
coltello per amputazione	.AG-16
LITTAUER	
forbici per legature	.AI-40
pinza auricolare	.EE-08
pinza depilatoria	.ED-08
pinza nasale polipus	.EG-05
LITTLE divaricatore	.BI-08
LITTLER forbici dissezione	.AI-13
LOCKLIN forbici	.AI-18
LORENZ forbici bendaggi	.AI-47
LORNA pinza fissateli	.BE-04
LOUTE strumento tendifilo	.DD-11
LOVE	
divaricatore per nervi	.EA-04
divaricatore uvula	.FA-02
LOVE-GRUENWALD pinza tagliente per laminectomia	.EA-08
LOVELACE	
pinza emostatica	.BC-07
pinza per afferrare il polmone	.FG-19
LOWER pinza vie biliari	.BC-14
LOWMAN tenaglia per ossa	.DC-11
LUBET-BARBON pinza nasale polipus	.EG-05
LUCAE	
diapason	.EE-04
martello	.DC-18
pinza auricolare	.EE-07
LUC pinza tagliente nasale	.EG-06
LUER-KOERTE cucchiaino per calcoli biliari	.GC-09
LUER	
pinza sgorbia	.DC-03
tubo tracheale	.FE-03
LUIKART-BILL trattore per manico standard	.HC-05
LUIKART forbici ostetriche	.HC-03
LUNDGAARD sclerotomo	.EC-05
LUNIATSCHEK otturatore per garza	.FA-02
LURZ pinza per uretere	.GC-10
M	
MACINTOSH	
laringoscopio set fibre ottiche	.AE-12 lavorare a AE-13
laringoscopio set standard	.AE-18 lavorare a AE-19
laringoscopio spatole fibre ottiche	.AE-10
laringoscopio spatole standard	.AE-15
MAGILL	
pinza per introdurre le sonde	.AE-06
stiletto	.AE-04
tubi d'aspirazione	.AE-04
MAIER pinza per medicatura	.BG-12
MALTZ	
bisturi cartilage angolat	.EG-11
MALTZ (COTTLE) raspa nasale	.EG-15
MALTZ	
raspa nasale	.EG-14
Mandrino	
DITTEL per sonde uretrali	.GG-11
GUYON per sonde uretrali	.GG-11
Manico	
BROCK per valvole mitrali	.FG-26
CASPAR per bisturi, micro	.AG-12
COLLIN per bisturi	.AG-08
GIGLI per sega	.EA-05
HUBER universale	.FC-03
LANDOLT per bisturi, micro	.AG-13
Manico per bisturi	.AG-02 lavorare a AG-05, AG-07 lavorare a AG-08
Manico per bisturi, micro	.AG-12
Manico per specchi laringei	.FC-04
Manometro per salpingografo	.HA-47
Marcatore	
CASTROVIEJO compasso	.EC-09
CONNIN-AMSLER	.EC-09
MARSCHIK pinza tonsille	.FA-04
Martelli percussori	
BABINSKY	.AC-07
BERLINER	.AC-07
BUCK	.AC-07
DEJERINE	.AC-07
TAYLOR	.AC-07
TRAUBE	.AC-07
TROEMNER	.AC-07
Martello	
COLLIN	.DC-18
con fessura	.DD-13

- GERZOGDC-18
 KIRKDC-18
 LUCAEDC-18
 MEADDC-18
 QUISLINGDC-18
 WILLIGERDC-18
 MARTEL pinza cuoio capellutoBC-08
 MARTIN
 cavo elettrobisturiJA-07
 MARTINI curetta taglienteDC-13
 MARTIN
 isterometroHA-39
 pelvimetroHC-06
 pinza per medicaturaBG-02, BG-14
 pinza per sequestriDC-10
 Maschio per viteDD-15
 MASSON port'aghiCE-03
 MASTIN pinza muscolareFE-04
 MATHIEU
 divaricatoreBI-03
 pinza per corpi estraneiGG-07
 port'aghiCE-05
 specolo rettaleGI-02
 MATSON periostotomoDC-21
 MAUNDER apribocca legnoEI-06
 MAYO BLAKE pinza per calcoli biliariGC-04
 MAYO
 cucchiaio per calcoli biliariGC-07
 forbiciAH-06, AI-07
 forbici manciniAI-07
 MAY oftalmoscopioAC-03
 MAYO-GUYON pinza peduncolo renaleBC-16
 MAYO-HEGAR port'aghiCE-02
 MAYO-NOBLE forbiciAH-08, AI-10
 MAYO
 pinza per sterilizzazioneCI-02
 MAYO-ROBSON pinza intestinaliGE-05
 MAYO
 sonda per calcoli renaliGC-10
 MAYO-STILLE forbiciAH-07, AI-08 lavorare a AI-09
 McCLINTOCK pinza per placenta e per ovaieHC-07
 McCULLOUGH pinza strabismoEC-13
 McDONALD elevatoreDC-22
 McGEE pinza auricolare microEE-10
 McGUIRE forbici cornealiAJ-05
 McINDOE
 forbici cartilagoAI-35
 pinza dissezioneBA-04
 McIVOR
 abassalinguaEI-05
 apriboccaEI-05
 McKENTY elevatore settoEG-11
 McKENZIE
 perforatore pianoDD-04
 pinza per applicare e agrafesEA-02
 McLEAN forbici ostetricheHC-04
 McLEAN-LUIKART forbici ostetricheHC-03
 McLEAN-TUCKER-LUIKART forbici ostetricheHC-03
 McPHERSON pinza legatureED-05
 McPHERSON TITAN pinza legatureED-05
 McPHERSON WESTCOTT forbici tendiniAJ-04
 MEAD
 martelloDC-18
 pinza sgorbiaDC-02
 MEEKER pinza dissezione e per legatureBC-13
 MELLINGER-AXENFELD blefarostatoEC-02
 MELLINGER blefarostatoEC-02
 MENGHINI trequartiCC-03
 Meniscotomo
 BIRCHERDC-24
 NEFFDC-24
 SMILLIEDC-24
 MERCEDES divaricatore per il toraceFG-16
 METZENBAUM FINO
 forbiciAH-12
 forbici dissezioneAI-15
 METZENBAUM
 forbiciAH-11
 forbici dissezioneAI-13 lavorare a AI-14
 port'aghiCE-04
 METZENBAUM "S" forbiciAH-13, AI-16
 MEYERDING divaricatoreBI-08
 MEYHOEFER curetta per calazioEC-07
 MICHEL
 agrafesCG-07
 pinza per agrafesCG-07
 specchioEG-04
 MICRO forbici microAJ-13
 MIDDELDORPF divaricatoreBI-10
 MIDDLETON-JANSEN pinza tagliente nasaleEG-09
 MIKULICZ
 divaricatoreBI-12
 pinza peritonealiBC-17
 MILLER
 laringoscopio set fibre otticheAE-12 lavorare a AE-13
 laringoscopio set standardAE-18 lavorare a AE-19
 laringoscopio spatole fibre otticheAE-10
 laringoscopio spatole standardAE-16
 MILLIGAN dissettore per duramadreEA-05
 MILLIN
 divaricatore del collo vescicaleGG-07
 divaricatore vescicaleGG-05
 pinza per afferrare la capsulaGG-03
 pinza per lobuli anterioriGG-03
 pinza porta-filoGG-03
 supporto per luce freddaGG-05
 MILLS forbici vascolariAI-27
 Mini
 astucci tascabili e per suturaCG-08
 CLARAC-05
 MIXTER BABY pinza emostatica bronchialeBC-13
 MIXTER O'SHAUGNESSY pinza emostaticaBC-14
 MIXTER
 pinza emostaticaBC-14
 pinza emostatica bronchialeBC-13
 pinza per calcoli biliariGC-04
 pinza vie biliariBC-15
 MOELTGEN goniometroAC-08
 MOGAN strumento per circoncisioneGG-09
 MOLLISON divaricatoreBI-17
 MOORE
 cucchiaio per calcoli biliariGC-05
 perforatore a manoDD-04
 MOORFIELD pinza suturaED-05
 MORSE-FAVOLORO divaricatore costaliFG-17
 MOYNIHAN
 pinza fissateliBE-05
 pinza vie biliariBC-15
 sonda per calcoli biliariGC-05
 MUCK coltello periostaleEE-15
 MUELLER blefarostatoEC-03
 MURDOCK blefarostatoEC-02
 MURLESS elevatore per testaHC-05
 MURPHY-LANE elevatoreDC-22
 MURPHY pinza serratubiBC-19
 MUSEUX pinza per abbassare il collo dell'uteroHA-33
 MYLES pinza tagliente nasaleEG-07
 N
 NABATOFF sonda auricolare argentoCA-02
 NAEGELE forbici ostetricheHC-03

NÄGELE spezzacraneo	.HC-09
NAGER divaricatore palat	.FA-02
Nastro metrico	.AC-08
Nastro PARHAM solo	.DC-11
NEFF meniscotomo	.DC-24
NEGUS pinza tonsille	.FA-03
NEIVERT port'aghi	.CE-02
NELSON	
ago per legature	.CG-02
pinza dissezione	.BA-05
trequarti	.CC-02
NEUBÜSER pinza per afferare trompe	.HA-51
NORTHBENT forbici per legature	.AI-40
NOTO pinza per polipi uterine	.HA-36
NOVAK curetta di aspirazione per biopsia	.HA-40
NOYES	
forbici iridectomia	.AJ-03
forbici iris	.AJ-04
forbici tendini	.AJ-03
pinza nasale polipus	.EG-05
NUBOER tubi d'aspirazione	.AE-05
O	
OCHSNER	
pinza atraumatica aorta	.BD-31
trequarti	.CC-02
O' CONNOR uncino per iris	.EC-06
Oftalmoscopio	
MAY	.AC-03
VARIFOCALE	.AC-03
OLDBERG pinza tagliente per laminectomia	.EA-09
OLIVECRONA	
pinza sgorbia	.DC-03
sega	.EA-05
spatole cerebr	.EA-07
OLIVECRONA-TOENNIS pinza per applicare e agrafes	.EA-02
OLLIER divaricatore	.BI-10
OLSEN-HEGAR port'aghi	.CE-05
Osteotome HIBBS	.DC-16
Osteotomo	.DC-14
LAMBOTTE	.DC-15
LAMBOTTE mini	.DC-15
STILLE	.DC-14
O'SULLIVAN-O'CONNOR	
divaricatore addominale	.BI-21
specolo vaginali	.HA-08
OTIS	
lama die ricambio	.GG-08
uretrotomo	.GG-08
Otturatore LUNIATSCHEK per garza	.FA-02
OVERHOLT-GEISSENDOERFER pinza dissezione e per legature	.BC-10
OVERHOLT periostotomo	.DC-21
P	
Padella	.HE-06
Parametro forbici vascolari	.AI-31
PARHAM nastro solo	.DC-11
PARK blefarostato	.EC-03
PARKER	
bisturi per dissezione	.AG-15
divaricatore	.BI-02
PARTSCH	
scalpello	.DC-14
sgorbia	.DC-14
PASSOW emostasi	.EE-15
PATON dissetto per corneale	.EC-05
PAUFIQUE	
coltello per cheratopl	.EC-05

pinza legature	.ED-05
PAUFIQUE TITAN pinza legature	.ED-05
PAYR-Baby pinza stomacali	.GE-09
PAYR	
pinza stomacali	.GE-09
sonda conduttrice	.CG-04
PEAN	
pinza atraumatica	.BD-02
pinza emostatica	.BC-08
pinza emostatica delicate	.BC-06
PEDERSON specolo vaginali	.HA-03
PEERS BERTRAM pinza fissateli	.BE-03
PEET pinza schegge	.BA-06
PELMANN pinza per medicatura	.BG-12
Pelvimetro	
COLLIN	.HC-06
COLLYER	.HC-06
MARTIN	.HC-06
PENFIELD dissetto per duramadre	.EA-06
PENNINGTON pinza emostatica	.BC-07
PERCY retrattore per amputazione	.DD-03
Perforatore	
a mano	.DD-05
BUNNELL a mano	.DD-05
HUDSON a mano	.DD-04
KIRSCHNER a mano	.DD-05
McKENZIE piano	.DD-04
MOORE a mano	.DD-04
per mandrino jacobs	.DD-06
RALK a mano	.DD-05
STILLE a mano	.DD-04
STILLE-SHERMAN a mano	.DD-04
Perforatore CUSHING piano	.DD-04
Periostotomo	
ALEXANDER	.DC-19
DOYEN costali	.DC-20
FARABEUF	.DC-19
LAMBOTTE	.DC-19
LANGENBECK	.DC-19
MATSON	.DC-21
OVERHOLT	.DC-21
SADILLOT	.DC-19
SEMB	.DC-20
WILLIGER	.DC-19
Per per intima	.FG-32
PERTHES punteruoli	.DD-08
PESTALOZZA curetta per placenta e per ovaie	.HC-08
PETRI scatola	.HE-08
PETZ apparecchio	
per sutura stomacali e intestinali	.GE-09
PHANEUF pinza peritoneali	.BC-17
Piastra per tendere la pelle	.AG-21
Pick	.EE-15
BARBARA	.EE-14 lavorare a
PIERCE trequarti	.CC-02
PIFFARD curetta per lupus	.HE-02
PINARD stetoscopio	.AC-06
Pinza	
ADLERKREUTZ dissezione	.BA-04
ADSON BABY emostatica	.BC-09
ADSON-BROWN dissezione	.BA-03
ADSON dissezione	.BA-03
ADSON dissezione, micro	.BA-03
ADSON emostatica	.BC-09
ADSON per ipofisi	.EA-06
ADSON sgorbia	.DC-03
ALEXANDER tagliente per biopsia	.HA-42
ALLIS-ADAIR per afferrare tessuti	.GE-02
ALLIS-Baby per afferrare tessuti	.GE-02
ALLIS per afferrare tessuti	.GE-02
ARCHER schegge	.BA-06

ARRUGA capsulare	ED-04
ASCH raddrizzare setto	EG-18
Pinza atraumatica pediatrica vascolare	BD-43
Pinza	
auricolare micro	EE-09 lavorare a EE-10, EE-12
auricolare micro mini	EE-13
AYER calazio	ED-06
BABCOCK per afferrare tessuti	GE-02
BACKHAUS-CLIP fissateli porta tubo	BE-03
BACKHAUS fissateli	BE-02
BACKHAUS KOCHER fissateli	BE-02
BAGGISH tagliente per biopsia	HA-45
BAINBRIDGE atraumatica	BD-09
BAINBRIDGE emostatica	BC-14
BALL AND SOCKET fissateli	BE-04
BALLENGER tonsille	FA-04
BARRAQ-KATZIN iride	EC-13
BARRAQU Colibri iride	EC-13
BARRAQUER camara anteriore	ED-02
BARRAQUER depilatoria	ED-08
BARRAQUER fissaggio	ED-03
BARRETT per abbassare il collo dell'utero	HA-32
BECK atraumatica vascolare	BD-25
BEER depilatoria	ED-08
BENGOLEA emostatica	BC-09
BERGMANN FOERSTER per tamponi e spugne	BG-10
BERKE muscolre	ED-02
BERNHARD fissateli	BE-05
BEST intestinali	GE-06
BEYER osteotomo	EG-08
BEYER sgorbia	DC-04
BISHOP-HARMAN iride	EC-14
BLAKE per calcoli biliari	GC-03
BLOHMKE tonsille	FA-04
BLUMENTHAL sgorbia	DC-02
BÖHLER sgorbia	DC-04
BONACCOLTO strabismo	EC-14
BONNEY per tamponi e spugne	BG-08
Bonn iride	EC-15
Bonn TITAN iride	EC-15
BOZEMANN-DOUGLAS per medicatura	BG-13
BOZEMANN per medicatura	BG-13
BRAIN MINI per posizionare clip	EA-12
BRAIN STANDARD per posizionare clip	EA-12
BRAUN per abbassare il collo dell'utero	HA-31, HA-34
BROCK tagliente	FG-26
BROWN dissezione	BA-03
BRUENINGS laringe	FC-03
BRUENINGS tagliente nasale	EG-05
BRUNNER intestinali	GE-06
BRYANT per tamponi e spugne	BG-11
BUMM per afferrare l'utero	HA-38
BUNT per sterilizzazione	CI-02
BURKE-Baby tagliente per biopsia	HA-44
BURKE tagliente per biopsia	HA-44
CARMALT schegge	BA-06
CASTAÑEDA atraumatica	BD-42
CASTROVIEJO capsulare	ED-04
CASTROVIEJO fissaggio	ED-03
CASTROVIEJO rompe lamette	AG-14
CASTROVIEJO sutura	ED-05
CHAPUT emostatica	BC-08
CHEATLE per sterilizzazione	CI-02
CHERON per medicatura	BG-12
CHEVALIER-JACKSON laringe	FC-04
CHILDE per agrafes	CG-07
CITELLI osteotomo	EG-08
CLEVELAND sgorbia	DC-02
coagulazione bipolare	JA-04 lavorare a JA-06
COLCLOUGH tagliente per dischi intervertebrali	EA-11
COLLIN-DUVAL dissezione	BA-04
COLLIN emostatica	BC-08
COLLIN ombelicale	HC-06
COLLIN per afferrare l'utero	HA-37
COLLIN per agrafes	CG-07
COLLIN per medicatura	BG-11
COLLIN-POZZI	
per abbassare il collo dell'utero	HA-32
COLLIN tiralingua	EI-03
COLVER tonsille	FA-03
COOLEY atraumatica	
.	BB-03, BD-35 lavorare a BD-37, BD-39, BD-41
COOLEY atraumatica anastomosi	BD-37, BD-40
COOLEY atraumatica bulldog	BD-33 lavorare a BD-34
COOLEY atraumatica iliaca	BD-37
COOLEY atraumatica pediatrica	BD-38 lavorare a BD-39
COOLEY DERRA atraumatica anastomosi	BD-39
COOLEY vascolare	BD-40
CORDES laringe	FC-03
CRAFOORD emostatica bronchiale	BC-12
CRILE emostatica	BC-05
CRILE-RANKIN emostatica	BC-05
CRILE TITAN emostatica	BC-05
CRUTCHFIELD per trazione craniale	EA-03
CUSHING dissezione	BA-03
CUSHING tagliente per laminectomia	EA-08
CZERNY per abbassare il collo dell'utero	HA-34
CZERNY per calcoli biliari	GC-03
DALE atraumatica vascolare	BD-24
DANDY emostatica	BC-07
DARDIK atraumatica	BD-07
DARTIGUES per afferrare l'utero	HA-37
DASTOOR strabismo	EC-14
DAVIS per sterilizzazione	CI-02
DE BAKEY atraumatica	
.	BB-03, BD-02, BD-08, BD-16 lavorare a BD-17, BD-20, BD-29 lavorare a BD-30
DE BAKEY atraumatica anastomosi	BD-25
DE BAKEY atraumatica anastomosi, pediatrica	BD-28
DE BAKEY atraumatica bronchi	BD-19
DE BAKEY atraumatica bulldog	BC-02
DE BAKEY atraumatica	
dissezione e per legature	BD-25, BD-32
DE BAKEY atraumatica iliaca	BD-11
DE BAKEY atraumatica	
per aneurisma di aorta	BD-13, BD-15, BD-18
DE BAKEY atraumatica vascolare	BD-06
DE BAKEY BAHNSON atraumatica	
per aneurisma di aorta	BD-14
DE BAKEY MORRIS atraumatica	BD-16
DE BAKEY REYNOLDS atraumatica anastomosi	BD-30
DE BAKEY SATINSKY atraumatica	BD-22
DeMARTEL-WOLFSON per anastomosi	GE-07
depilatoria	ED-08
DERRA atraumatica	BD-28
DESJARDINS per calcoli biliari	GC-02
DESJARDINS vie biliari	BC-15
DESMARRES calazio	ED-06
DeVILBISS crancraneanea	EA-05
DIEFFENBACH serraфина bulldog	BC-03
DIETER la testa de mastello	EE-10
Pinza	
DIETHRICH atraumatica	BD-31
Pinza	
DIMEDA per rifiuti	CI-03
DIMEDA rompe lamette	AG-14
Pinza di orologio	BA-06
Pinza dissezione	BA-02
Pinza	
DOUGLAS depilatorie	ED-08
DOYEN-Baby intestinali	GE-03
DOYEN fissateli	BE-05

DOYEN intestinali	.GE-03	HALSTED-MOSQUITO micro emostatica	.BC-04
DOYEN per polipi uterine	.HA-36	HALSTED-MOSQUITO TITAN emostatica	.BC-04
DUPLAY per abbassare il collo dell'utero	.HA-31	HARKEN atraumatica ventricolari	.BD-23
DUPLAY per medicatura	.BG-14	HARRINGTON per bronchi	.FG-21
DUVAL dissezione	.BA-04	HARTMANN auricolare	.EE-08
DUVAL per afferrare tessuti	.GE-03	HARTMANN emostatica	.BC-03
ECHLIN sgorbia	.DC-05	HARTMANN-HOFFMANN auricolare	.EE-08
EDWARDS applicatore per clips	.BD-21	HARTMANN nasale polipus	.EG-04
ELSAESSER per nefrostomia	.GC-13	HARTMANN tagliente nasale	.EG-07
ELSCHNIG capsulare	.ED-04	HARTMANN-WULLSTEIN auricolare	.EE-08
ELSCHNIG fissaggio	.ED-03	HEANEY isterectomia	.BC-18
EPPENDORFER-KEVORKIAN		HEGENBARTH per agrafes	.CG-07
tagliente per biopsia	.HA-46	HEIMING per calcoli renali	.GC-13
EPPENDORFER		HEISS emostatica	.BC-09
tagliente per biopsia	.HA-45 lavorare a HA-46	HENROTIN per abbassare il collo dell'utero	.HA-34
EPPENDORFER TISCHLER-MORGAN		HERRICK peritoneali	.BC-17
tagliente per biopsia	.HA-46	HESS capsulare	.ED-04
FAURE peritoneali	.BC-17	HESS iride	.EC-12
FAURE tagliente per biopsia	.HA-41	HEYMANN-KNIGHT nasale polipus	.EG-05
FEHLAND intestinali	.GE-06	HEYMANN tagliente nasale	.EG-05
FEILCHENFELD schegge	.BA-06	HEYWOOD-SMITH per ermorrizia	.GI-05
FERGUSSON emostatica	.BC-07	HOFF fissateli	.BE-03
FERRIS dissezione	.BA-04	HOLTH per capsulo	.EC-09
FERRIS-SMITH-KERRISON tagliente per dischi intervertebrali		HUNTER schegge	.BA-06
EA-10		IOWA per abbassare il collo dell'utero	.HA-35
FERRIS-SMITH tagliente per laminectomia	.EA-09	JACKSON tapponi	.FC-02
FINOCHIETTO per bronchi	.FG-21	JACOBS per abbassare il collo dell'utero	.HA-34
FISCHER iride	.EC-13	JAMESON strabismo	.EC-13
Pinza fissateli modello delicato	.BE-02	JANSEN nasale	.EG-04
Pinza		JARCHO per abbassare il collo dell'utero	.HA-32
FLETCHER JAVERTS per tamponi e spugne	.BG-10	JATHO nasofarinx tagliente	.EG-18
FOERSTER iride	.EC-12	JAVID atraumatica carotis	.BD-32
FOERSTER per tamponi		JOHNS-HOPKINS serrafina bulldog	.BC-03
e spugne	.BG-06 lavorare a BG-08	JOHNS-HOPKINS vie biliari	.BC-14
FRAENKEL laringe	.FC-03	JONES fissateli porta tubo	.BE-02
FRAENKEL polipus laringe	.FC-02	JUDD-ALLIS per afferrare tessuti	.GE-02
FRIEDMAN sgorbia	.DC-02	JURASZ polipus laringe	.FC-02
FRIEDMAN sgorbia, mini	.DC-02	KALT capsulare	.ED-04
FRYKHOLM sgorbia	.DC-05	KANE ombelicale	.HC-06
FUCHS capsulare	.ED-04	KELLY emostatica	.BC-05
GAUSS per pericraneo	.HC-06	KELLY per polipi uterine	.HA-36
GELLHORN tagliente per biopsia	.HA-42	KELLY-RANKIN emostatica	.BC-05
GEMINI dissezione e per legature	.BC-10	KELLY TITAN emostatica	.BC-05
GEMINI MINI dissezione e per legature	.BC-10	KERRISON tagliente nasale	.EG-08
GERALD dissezione	.BA-05	KEVORKIAN-Pacific tagliente per biopsia	.HA-44
GILL-ARRUGA capsulare	.ED-03	KEVORKIAN tagliente per biopsia	.HA-43, HA-46
GILL-HESS iride	.EC-12	KIRBY-ARTHUR iride	.EC-13
GILLIES dissezione	.BA-05	KNAPP-LUER trichiasi	.ED-06
GILL iride	.EC-12	KNIGHT tagliente nasale	.EG-05
GLOVER atraumatica	.BD-06, BD-30	KOCHER emostatica delicate	.BC-06
GLOVER atraumatica anastomosi	.BD-05	KOCHER intestinali	.GE-04
GLOVER atraumatica bulldog	.BC-02	KRAUSE laringe	.FC-03
GLOVER atraumatica coartazione	.BD-04	LAHEY afferrare gozzo	.FE-04
GRADLE depilatorie	.ED-08	LAHEY vie biliari	.BC-14
GRAEFE dissezione	.BA-03	LAMBERT calazio	.ED-06
GRAEFE fissaggio	.ED-03	LAMBERT KAY atraumatica aortica	.BD-10
GRAEFE iride	.EC-11	LAMBERT KAY atraumatica iliaca	.BD-11
GRAY vie biliari	.BC-15	LANE dissezione	.BA-04
GREEN-ARMYTAGE emostatica		LANE fissateli	.BE-05
per tagli cesarei	.HC-06	LANE porta placche	.DD-14
GREEN fissaggio	.ED-03	LANE porta viti	.DD-14
GREGORY atraumatica profonda	.BD-33	LANE stomacali	.GE-08
GREVEN auricolare micro	.EE-10	LANGE laringe	.FC-03
GRIP per afferrare	.DD-11	LAWRENCE dissezione e per legature	.BC-13
GROSS-MAIER per medicatura	.BG-02 lavorare a BG-04	LEES atraumatica bronchi	.BD-03
GROSS per medicatura	.BG-05	LEKSELL STILLE sgorbia	.DC-05
GUYON peduncolo renale	.BC-16	LELAND JONES atraumatica	
HAJEK-CLAUS seno	.EG-08	vascolare	.BD-08 lavorare a BD-09
HAJEK-KOFLER tagliente nasale	.EG-08	LEMPET sgorbia	.DC-03
HALSTED-MOSQUITO atraumatica	.BD-02	LERCHE dissezione	.BA-04
HALSTED-MOSQUITO emostatica	.BC-04	LERICHE emostatica	.BC-09

LESTER fissaggio	ED-03	PAYR-Baby stomacali	GE-09
LEWKOWITZ per placenta e per ovaie	HC-07	PAYR stomacali	GE-09
LIDDLE atraumatica aorta	BD-10	PEAN atraumatica	BD-02
LISTER sinus per tamponi e spugne	BG-11	PEAN emostatica	BC-08
LITTAUER auricolare	EE-08	PEAN emostatica delicate	BC-06
LITTAUER depilatorie	ED-08	PEERS BERTRAM fissateli	BE-03
LITTAUER nasale polipus	EG-05	PEET schegge	BA-06
LORNA fissateli	BE-04	PELKMANN per medicatura	BG-12
LOVE-GRUENWALD tagliente per laminectomia	EA-08	PENNINGTON emostatica	BC-07
LOVELACE emostatica	BC-07	per fissare	GG-10
LOVELACE per afferrare il polmone	FG-19	per fissare il tronco spermatico	GG-10
LOWER vie biliari	BC-14	Pinza per sequestri	DC-10
LUBET-BARBON nasale polipus	EG-05	Pinza per sterilizzazione	CI-02
LUCAE auricolare	EE-07	Pinza	
LUC tagliente nasale	EG-06	PHANEUF peritoneali	BC-17
LUER sgorbia	DC-03	piatta	DD-11
LURZ per uretere	GC-10	POTTS atraumatica	BD-26 lavorare a BD-27
MAGILL per introdurre le sonde	AE-06	POTTS atraumatica anastomosi	BD-05
MAIER per medicatura	BG-12	POTTS atraumatica coartazione	BD-04
MARSHCHIK tonsille	FA-04	POTTS-SMITH dissezione	BA-02
MARTEL cuoio capelluto	BC-08	POZZI per abbassare il collo dell'utero	HA-31
MARTIN per medicatura	BG-02, BG-14	PRATT emostatica	BC-08
MARTIN per sequestri	DC-10	PRATT per abbassare il collo dell'utero	HA-34 lavorare a HA-35
MASTIN muscolare	FE-04	PRESBYTERIAN HOSPITAL serratubi	BC-19
MATHIEU per corpi estranei	GG-07	PRICE-THOMAS per bronchi	FG-22
MAYO BLAKE per calcoli biliari	GC-04	PRINCE muscole	ED-02
MAYO-GUYON peduncolo renale	BC-16	PROVIDENCE-HOSPITAL emostatica	BC-05
MAYO per sterilizzazione	CI-02	RADOLF per unghie	DD-03
MAYO-ROBSON intestinali	GE-05	RAMPLEY per tamponi e spugne	BG-09
McCLINTOCK per placenta e per ovale	HC-07	RANDALL per calcoli renali	GC-11 lavorare a GC-12
McCULLOUGH strabismo	EC-13	RANEY emostatica per il cuoio capelluto	EA-03
McGEE auricolare micro	EE-10	RANEY per applicare e togliere	EA-03
McINDOE dissezione	BA-04	RANKIN atraumatica	BD-02
McKENZIE per applicare e agrafes	EA-02	RICHTER-HEATH per agrafes	CG-07
McPHERSON legature	ED-05	ROBERTS emostatica	BC-11
McPHERSON TITAN legature	ED-05	ROCHESTER-CARMALT emostatica	BC-07
MEAD sgorbia	DC-02	ROCHESTER-OCHSNER emostatica	BC-06
MEEKER dissezione e per legature	BC-13	ROCHESTER-PEAN emostatica	BC-06
MICHEL per agrafes	CG-07	ROEDER fissateli	BE-03
Pinza micro	BB-02	ROGGE per sterilizzazione	CI-02
Pinza		ROSENBERG laringe	FC-03
MIDDLETON-JANSEN tagliente nasale	EG-09	ROWE bocca	EI-06
MIKULICZ peritoneali	BC-17	RUBIN per ammaccare il setto	EG-07
MILLIN per afferrare la capsula	GG-03	RUMEL toracale	BC-11
MILLIN per lobuli anteriori	GG-03	RUSKIN sgorbia	DC-04
MILLIN porta-filo	GG-03	RUSSIAN dissezione	BA-04
MIXTER BABY emostatica bronchiale	BC-13	SAENGER per placenta e per ovale	HC-07
MIXTER emostatica	BC-14	SAIRGES per abbassare il collo dell'utero	HA-32
MIXTER emostatica bronchiale	BC-13	SAROT emostatica bronchiale	BC-12
MIXTER O'SHAUGNESSY emostatica	BC-14	SAROT per bronchi	FG-23
MIXTER per calcoli biliari	GC-04	SATINSKY atraumatica	BD-20
MIXTER vie biliari	BC-15	SATINSKY per anastomosi (vena cava)	FG-24 lavorare a FG-25
MOORFIELD sutura	ED-05	SAUERBRUCH per rifiuti	CI-03
MOYNIHAN fissateli	BE-05	SAUERBRUCH sgorbia	DC-05
MOYNIHAN vie biliari	BC-15	SAWTELL tonsille	FA-03
MURPHY serratubi	BC-19	SCAGLIETTI sgorbia	DC-05
MUSEUX per abbassare il collo dell'utero	HA-33	Pinza schegge	BA-06
MYLES tagliente nasale	EG-07	Pinza	
NEGUS tonsille	FA-03	SCHEINMANN laringe	FC-03
NELSON dissezione	BA-05	SCHNIDT tonsille	FA-03
NEUBÜSER per afferrare trompe	HA-51	SCHOENBURG per afferrare tessuti	GE-03
NOTO per polipi uterine	HA-36	SCHROEDER per abbassare il collo dell'utero	HA-31 lavorare a HA-32
NOYES nasale polipus	EG-05	SCHUBERT tagliente per biopsia	HA-41
OCHSNER atraumatica aorta	BD-31	SCHUMACHER laringe	FC-03
OLDBERG tagliente per laminectomia	EA-09	SCHUMACHER tagliente per biopsia	HA-43
OLIVECRONA sgorbia	DC-03	SCHWEIGGER capsulare	ED-04
OLIVECRONA-TOENNIS per applicare e agrafes	EA-02	SEIFFERT laringe	FC-03
OVERHOLT-GEISSENDOERFER dissezione e per legature	BC-10	SEMB per bronchi	FG-23
PAUFIQUE legature	ED-05		
PAUFIQUE TITAN legature	ED-05		

SEMB sgorbia	.DC-06	WEIL-BLAKESLEY tagliente nasale	.EG-06
SEMKEN dissezione	.BA-05	WEISS serratubi	.BC-19
Pinza serratubi	.BC-19	WERTHEIM-CULLEN isterectomia	.BC-18
Pinza		WERTHEIM isterectomia	.BC-18
SIEGLER HELLMANN per afferrare l'utero	.HA-38	WESTON polipus rettali	.GI-05
SIMS-MAIER per medicatura	.BG-05	WHITE tonsille	.FA-03
SINGLEY dissezione	.BA-05	WILDE (TROELTSCH) auricolare	.EE-07
SKENE per abbassare il collo dell'utero	.HA-31	WILLET-MARTELL cuoio capelluto	.BC-08
SMITHWICK per applicare e agrafes	.EA-02	WILLIAMS per afferrare tessuti	.GE-03
SNELLEN entropio	.ED-06	WINTER per placenta e per ovale	.HC-07
SOMER per afferrare l'utero	.HA-37	WITTNER tagliente per biopsia	.HA-43
SPENCER-WELLS emostatica	.BC-07	WOLFF per gessi	.DA-04
SPURLING tagliente per laminectomia	.EA-08	WYLIE atraumatica	.BD-21
STAUDE-MOORE per abbassare il collo dell'utero	.HA-31	YEOMAN per biopsia	.GI-05
STEVENS iride	.EC-11	YOUNG per afferrare la prostata	.GG-02
STIEGLITZ schegge	.BA-06	YOUNG tiralingua	.EI-03
STILLE dissezione	.BA-02	ZAUFAL-JANSEN sgorbia	.DC-04
STILLE-LUER sgorbia	.DC-04	ZENKER dissezione e per legature	.BC-12
STILLE peduncolo renale	.BC-16	PIPER	
STILLE-RUSKIN sgorbia	.DC-05	forbici ostetriche	.HC-04
St. MARTIN sutura	.ED-05	forbici ostetriche con dispositivo di trazione	.HC-04
STONE per serra	.GE-06	Placca JAEGER per palpebre	.EC-03
STONE-WATT intestinali	.GE-06	PLESTER	
STRUEMPEL auricolare	.EE-08	coltello lobare	.EE-14
STRUYCKEN tagliente nasale	.EG-07	divaricatore	.BI-14
SUBRAMANIAN atraumatica	.BD-31	POLITZER	
SWEET per applicare e agrafes	.EA-02	ago auricolare	.EE-06
tagliafili e per piegare	.DD-11	coltello auricolare	.EE-06
TEALE per abbassare il collo dell'utero	.HA-33	insoffiatore d'aria	.EE-05
TERSON capsulare	.ED-04	POOLE tubi d'aspirazione	.AE-02
THOMS-ALLIS per afferrare tessuti	.GE-02	Port'aghi	
THOMS-GAYLOR tagliente per biopsia	.HA-42	ADSON	.CE-04
TIEMANN per abbassare il collo dell'utero	.HA-32	ARRUGA oftalmologia	.CE-06
TILLEY auricolare	.EE-08	BARRAQUER	.CE-07
TISCHLER-KEVORKIAN tagliente		BAUMGARTNER	.CE-02
per biopsia	.HA-44 lavorare a HA-45	BOYNTON oftalmologia	.CE-06
TISCHLER-MORGAN tagliente		BOZEMANN	.CE-03
per biopsia	.HA-43 lavorare a HA-44, HA-46	CASTROVIEJO	.CE-07
TIVNEN tonsille	.FA-04	COLLIER	.CE-02
TOENNIS emostatica	.BC-11	CRILE	.CE-04
TOHOKU fissateli	.BE-04	CRILE-MURRAY	.CE-02
TOWNSEND-KEVORKIAN tagliente per biopsia	.HA-44	CRILE-WOOD	.CE-02
TOWNSEND-MINI (BABY TISCHLER) tagliente per biopsia	HA-45	DE BAKEY	.CE-03
TOWNSEND-mini tagliente per biopsia	.HA-44	DERF	.CE-02
TOWNSEND tagliente per biopsia	.HA-44	DIETHRICH vascolare	.CE-06
TOWNSEND-TISCHLER tagliente per biopsia	.HA-44	FINOCHIETTO	.CE-04
TROELTSCH nasale	.EG-04	GILLIES	.CE-05
TROUTMAN-CHRIS rompe lamette	.AG-14	HALSEY	.CE-02
TROUTMAN Colibri iride	.EC-13	HEANEY	.CE-03
TROUTMAN rectus	.ED-02	HOESEL	.CE-05
Tübingen iride	.EC-15	JAMISON	.CE-03
Tübingen legature	.ED-05	JOHNSON	.CE-04
Tübingen TITAN iride	.EC-15	KALT	.CE-07
Tübingen TITAN legature	.ED-05	KALT-ARRUGA	.CE-07
TUFFIER emostatica	.BC-08	MASSON	.CE-03
TURREL per biopsia	.GI-05	MATHIEU	.CE-05
TYDING tonsille	.FA-04	MAYO-HEGAR	.CE-02
ULRICH per tamponi e spugne	.BG-06	METZENBAUM	.CE-04
UNIVERSAL per sterilizzazione	.CI-02	NEIVERT	.CE-02
USA dissezione	.BA-02	OLSEN-HEGAR	.CE-05
VAN BUREN per sequestri	.DC-10	RYDER	.CE-03
van DOREN tagliente per biopsia	.HA-42	SAROT	.CE-04
Pinza vascolare flessibile	.BD-44 lavorare a BD-45	STEVENS oftalmologia	.CE-06
Pinza		STRATTE	.CE-04
VIRTUS (RALK) schegge	.BA-06	TOENNIS	.CE-04
WACHENFELDT per agrafes	.CG-07	WANGENSTEEN	.CE-03
WAGNER tagliente per laminectomia	.EA-09	POTTS DE MARTEL forbici vascolari	.AI-27
WALSHAM raddrizzare setto	.EG-18	POTTS	
WANGENSTEEN dissezione	.BA-05	pinza atraumatica	.BD-26 lavorare a BD-27
WEBER atraumatica	.BD-12	pinza atraumatica anastomosi	.BD-05
		pinza atraumatica coartazione	.BD-04

POTTS-SMITH	
forbici vascolari	.AH-19
forbici vascolari	.AI-28
pinza dissezione	.BA-02
POZZI pinza per abbassare il collo dell'utero	.HA-31
PRATT	
dilatatore uterini	.HA-29
pinza emostatica	.BC-08
pinza per abbassare il collo dell'utero	.HA-34 lavorare a HA-35
specolo rettale	.GI-02
unicino cistico	.GI-04
PRESBYTERIAN HOSPITAL pinza serratubi	.BC-19
PRICE-THOMAS pinza per bronchi	.FG-22
PRINCE	
forbici tonsillari	.AI-27
pinza muscolre	.ED-02
Proctoscopio KELLY	.GI-04
Protettore	
ARRUGA	.EC-08
di tessuto	.DD-15
PROVIDENCE-HOSPITAL pinza emostatica	.BC-05
Punte	.DD-04
Punteruoli	.DD-08
PERTHES	.DD-08
PUTTI lima per ossa	.DC-25

Q

QUATTRO divaricatori per gessi	.DA-03
QUINBY forbici gengivali	.AI-42
QUINKE ago da punzione	.CC-03
QUIRE leva corpi estranei	.EE-08
QUISLING martello	.DC-18

R

Rachiotomo	.DC-17
RADOLF pinza per unghie	.DD-03
RALK perforatore a mano	.DD-05
RAMPLEY pinza per tamponi e spugne	.BG-09
RANDALL	
curetta di aspirazione per biopsia	.HA-40
pinza per calcoli renali	.GC-11 lavorare a GC-12
RANEY	
pinza emostatica per il cuoio capelluto	.EA-03
pinza per applicare e togliere	.EA-03
RANKIN pinza atraumatica	.BD-02
Rasoio	.AG-14, AG-19
Raspa	
FOMON nasale	.EG-15 lavorare a EG-16
GALLAHER per seno	.EG-16
JOSEPH (LEWIS) nasale	.EG-15
MALTZ (COTTLE) nasale	.EG-15
MALTZ nasale	.EG-14
WIENER (AUFRIKHT) nasale	.EG-15
WIENER per seno	.EG-15
RECAIMER curetta uterine	.HA-49 lavorare a HA-50
Recipiente cylindr	.HE-08
Regolo acciaio	.AC-08
REICHERT depressor epiglottide	.FC-02
REINER	
coltello per gessi	.DA-04
siringa auricolare	.EE-05
Retratore PERCY per amputazione	.DD-03
Rettoscopio luce fredda	.GI-03
REVERDIN	
ago per legature	.CG-03
divaricatore	.BI-04
REYNOLDS forbici	.AH-15, AI-18
RIBBON divaricatore	.BI-04

RICHARDSON divaricatore	.BI-04
RICHARDSON-EASTMAN divaricatore	.BI-04
RICHARDSON Grip divaricatore	.BI-04
RICHTER-HEATH pinza per agrafes	.CG-07
RIGBY divaricatore addominale	.BI-24
ROBB dissetto vascolare	.FG-33
ROBERTS pinza emostatica	.BC-11
ROCHESTER-CARMALT pinza emostatica	.BC-07
ROCHESTER-OCHSNER pinza emostatica	.BC-06
ROCHESTER-PEAN pinza emostatica	.BC-06
ROEDER pinza fissateli	.BE-03
ROGER elevatore setto	.EG-11
ROGGE pinza per sterilizzazione	.CI-02
ROLLET	
divaricatore	.EC-06
scalpello per sacco	.EC-06
ROSEN	
ago	.EE-14 lavorare a EE-15
ROSENBERG pinza laringe	.FC-03
ROSEN	
coltello circolare	.EE-14
ROSER-KOENIG apribocca	.EI-03
ROSE uncino tracheale	.FE-03
ROUX BABY divaricatore	.BI-02
ROUX	
divaricatore	.BI-02
divaricatore aortica mini	.BI-02
ROWE pinza bocca	.EI-06
RUBIN pinza per ammaccare il setto	.EG-07
RUMEL pinza toracale	.BC-11
RUSKIN-LISTON cesoia per ossa	.DC-06
RUSKIN pinza sgorbia	.DC-04
RUSSIAN pinza dissezione	.BA-04
RYDEL-SEIFFER diapason	.EE-04
RYDER port'aghi	.CE-03

S

SAALFELD tiracomedoni	.HE-02
SACHS	
dissetto per duramadre	.EA-05
divaricatore per nervi	.EA-04
SADILLOT periostotomo	.DC-19
SAENGER pinza per placenta e per ovaie	.HC-07
SAIRGES pinza per abbassare il collo dell'utero	.HA-32
Salpingografo SCHULTZE	.HA-47
SANVENERO forbici	.AH-13, AI-16
SAROT	
pinza emostatica bronchiale	.BC-12
pinza per bronchi	.FG-23
port'aghi	.CE-04
SATINSKY	
forbici toracali	.AI-37
pinza atraumatica	.BD-20
pinza per anastomosi (vena cava)	.FG-24 lavorare a FG-25
SATO coltello per corneale	.EC-05
SAUERBRUCH	
costotomo	.FG-05
divaricatore	.BI-13
SAUERBRUCH-FREY costotomo	.FG-06
SAUERBRUCH	
pinza per rifiuti	.CI-03
pinza sgorbia	.DC-05
scatola port'aghi	.HE-02
SAWTELL pinza tonsille	.FA-03
SCAGLIETTI pinza sgorbia	.DC-05
Scalpello	.DC-14
ALEXANDER	.DC-14
CINELLI plastica nasale	.EG-13
COTTLE plastica nasale	.EG-13
DIX per corpi estranei	.EC-06

FOMON plastica nasale	EG-13	SEIFFERT pinza laringe	FC-03
FREER setto	EG-12	SELLHEIM cucchiaino ostetrico	HC-09
HIBBS	DC-16	SELLORS approssimatori costali	FG-18
HOKE	DC-16	SEMB	
LEXER	DC-16	cesoia per ossa	DC-07
LEXER mini	DC-16	periostotomo	DC-20
PARTSCH	DC-14	pinza per bronchi	FG-23
ROLLET per sacco	EC-06	pinza sgorbia	DC-06
SILVER plastica nasale	EG-14	tenaglia per ossa	DC-07
SMITH-PETERSEN	DC-15	SEMKEN pinza dissezione	BA-05
Scalpello spinale BRUNETTI	DC-17	SEMM specolo vaginali	HA-07
Scalpello sterno LEBSCH	DC-17	SENN divaricatore	BI-04
Scalpello		SENN-GREEN divaricatore	BI-07
STILLE	DC-14	Sensimetro WARTENBERG	AC-08
WEST nasale	EG-14	Serranodi	
Scarificatore GRAEFE	EC-04	BRUENINGS tonsille	FA-04
Scatola		EVES tonsille	FA-04
acciaio inossidabile	HE-03	KRAUSE	EG-09
PETRI	HE-08	KRAUSE auricolare	EE-07
port'aghi	HE-02	TYDING tonsille	FA-05
SAUERBRUCH port'aghi	HE-02	WILDE	EG-09
vetro	HE-03	WILDE auricolare	EE-07
SCHAMBERG tiracomedoni	HE-02	Serrapene	
SCHEDE curetta tagliante	DC-12	STOCKMANN	GG-10
SCHEIE		STRAUSS	GG-10
cannula oculistiche	ED-07	Set	
coltello per goniotomia	EC-05	KEYES di trapani cutanei	HE-02
SCHEINMANN pinza laringe	FC-03	Set per autopsia	DC-17
SCHERBAK specolo vaginali	HA-21	Set	
SCHIMMELBUSCH tamburo per sterilizzazione	HE-12	per manicure per infermiere	HE-03
SCHINK dermatomo	AG-21	SEUTIN forbici per gessi	DA-02
SCHIOETZ tonometro	ED-08	SEXTON coltello auricolare	EE-06
SCHMIEDEN-PAYR sonda conduttrice	CG-04	Sfera elettrodo per coagulazione	JA-03
SCHMIEDEN sonda conduttrice	CG-04	Sferica	DD-04
SCHMIEDEN-TAYLOR forbici	AI-36	Sfigmomanometro	AC-02
SCHNIDT pinza tonsille	FA-03	Sgorbia	DC-14
SCHOENBORN divaricatore tiroide	FE-04	ALEXANDER	DC-14
SCHOENBURG pinza per afferrare tessuti	GE-03	ELLIS per corpi estranei	EC-06
SCHROEDER		FREER nasale	EG-14
curetta uterine	HA-48	HAJEK nasale	EG-14
pinza per abbassare il collo dell'utero	HA-31 lavorare a HA-32	HIBBS	DC-16
SCHUBERT pinza tagliante per biopsia	HA-41	KILLIAN-CLAUS nasale	EG-14
SCHUKNECHT		LEXER	DC-16
coltello circolare	EE-14	LEXER mini	DC-16
coltello falciforme	EE-14	PARTSCH	DC-14
SCHULTZE salpingografo	HA-47	SMITH-PETERSEN	DC-15
SCHUMACHER		STILLE	DC-14
forbici ombelicali	AI-34	WALTON per corpi estranei	EC-06
forbici per sterno	FG-07	WEST nasale	EG-14
pinza laringe	FC-03	SHEA forbici auricolari micro	EE-09
pinza tagliante per biopsia	HA-43	SHORTBENT forbici per legature	AI-40
SCHWEIGGER pinza capsulare	ED-04	SIEBOLD forbici ginecologiche	AH-21, AI-32
Sclerotomo		SIEGLER HELLMANN pinza per afferrare l'utero	HA-38
GUYTON-LUNDSGAARD	EC-05	SIEGLE specoli auricolare	EE-02
LUNDSGAARD	EC-05	SILVER	
Scollatendini BUNNELL	DC-25	dermatomo	AG-20
Scollato FISCH	EE-15	scalpello plastica nasale	EG-14
Secchi per rifiuti	HE-11	SIMCOE cannula sutura	ED-07
SEEMANN-SEIFFERT apribocca	EI-04	SIMON	
Sega		curetta tagliante	DC-13
BERGMANN per gessi	DA-02	curetta uterine	HA-48
CHARRIERE per amputazione	DD-03	divaricatore	BI-12
ENGEL per gessi	DA-02	SIMPSON-BRAUN forcipe ostetriche	HC-02
JOSEPH nasale	EG-17	SIMPSON forbici ostetriche	HC-02
LANGENBECK a dita	DD-03	SIMPSON-LUIKART forbici ostetriche	HC-03
OLIVECRONA	EA-05	SIMS	
Sega per gessi oscillante	DA-5 lavorare a DA-6	curetta uterine	HA-49 lavorare a HA-50
Sega		depressore uterino	HA-39
per taglia anelli	DD-03	dilatatore uterini	HA-30
WIGMORE per gessi	DA-02	forbici ginecologiche	AH-21, AI-32
SEGOND bisturi per fibromi	HA-46	isterometro	HA-39

SIMS-MAIER pinza per medicatura	BG-05	TOBOLD	CA-03
SIMS		UCKERMANN	CA-03
specolo rettale	GI-02	Specoli	
specolo vaginali	HA-17	BOUCHERON auricolare	EE-02
SINGLEY pinza dissezione	BA-05	BRUENINGS auricolare	EE-02
Siringa		GRUBER auricolare	EE-02
REINER auricolare	EE-05	HARTMANN auricolare	EE-02
tonsille	FA-05	SIEGLE auricolare	EE-02
Sistema LEYLA da fissaggio	EA-14 lavorare a	TOYNBEE auricolare	EE-02
SKENE pinza per abbassare il collo dell'utero	HA-31	Specolo	
SLUDER-BALLENGER tonsillotomo	FA-05	AUVARD vaginali	HA-19
SMELLIE		BARR rettale	GI-02
spezzacrano	HC-09	BERLIND-AUVARD vaginali	HA-19
uncino uncino ostetrico	HC-06	BODENHAMMER rettale	GI-02
SMILLIE meniscotomo	DC-24	BRAUN vaginali	HA-16
SMITH blefarostato	EC-02	BREISKY vaginali	HA-20
SMITH-BUIE dilatatore per l'ano e il retto	GI-03	COLLIN vaginali	HA-04
SMITH-PETERSEN		COTTLE nasale	EG-03
scalpello	DC-15	CUSCO vaginali	HA-04 lavorare a
sgorbia	DC-15	CZERNY rettale	GI-02
SMITH US ARMY forbici bendaggi	AI-44	DOYEN vaginali	HA-18, HA-20
SMITHWICK		FREEWAY-GRAVE vaginali	HA-06
divaricatore per nervi	EA-04	GRAVE vaginali	HA-02
pinza per applicare e agrafes	EA-02	HARTMANN-HALLE nasale	EG-02
SNELLEN		JACKSON vaginali	HA-16
ansa	EC-08	KALLMORGEN vaginali	HA-15
pinza entropio	ED-06	KILLIAN setto	EG-03
SOMER pinza per afferrare l'utero	HA-37	KOGAN endo	HA-23
Sonda	CA-02	KRISTELLER vaginali	HA-09 lavorare a
BRUNNER conduttrice	CG-04	LANDAU vaginali	HA-22
DESJARDINS per calcoli biliari	GC-05	MATHIEU rettale	GI-02
DOYEN	CA-02	O'SULLIVAN-O'CONNOR vaginali	HA-08
HARTMANN auricolare	EE-06	PEDERSON vaginali	HA-03
ITARD auricolare	EE-06	PRATT rettale	GI-02
KIRSCHNER conduttrice	CG-04	SCHERBAK vaginali	HA-21
KOCHER gozzo	FE-04	SEMM vaginali	HA-07
KOENIG conduttrice	CG-04	SIMS rettale	GI-02
MAYO per calcoli renali	GC-10	SIMS vaginali	HA-17
misurare	EE-15	STEINER-AUVARD vaginali	HA-19
MOYNIHAN per calcoli biliari	GC-05	THUDICHUM nasale	EG-02
NABATOFF auricola argento	CA-02	TIECK-HALLE nasale	EG-03
PAYR conduttrice	CG-04	TRELAT vaginali	HA-07
per uomini metallica	GG-16	Vienna nasale	EG-02
SCHMIEDEN conduttrice	CG-04	VOLTOLINI nasale	EG-02
SCHMIEDEN-PAYR conduttrice	CG-04	WEISSBARTH vaginali	HA-22
STACKE auricola argento	CA-02	YANKAUER nasofarins	EG-04
Spatola	CA-03	SPENCER forbici per legature	AI-40
ALLISON polmone	FG-19	SPENCER-WELLS pinza emostatica	BC-07
BANGERTER ciclodialisi	EC-08	Spezzacrano	
CASTROVIEJO ciclodialisi	EC-08 lavorare a	NÄGELE	HC-09
CULLER iride	EC-08	SMELLIE	HC-09
ELSCHNIG ciclodialisi	EC-08	SPRATT curetta tagliente	DC-12
KOCHER vescicali	GG-04	SPURLING pinza tagliente per laminectomia	EA-08
LEGUEU vescicali	GG-04	Sputacchiera	HE-06
WECKER iride	EC-08	STACKE sonda auricola argento	CA-02
WELLS enucleaciona	EC-08	Standard astucci tascabili e per sutura	CG-08
WHEELER ciclodialisi	EC-09	STAUDE-MOORE pinza	
Spatole		per abbassare il collo dell'utero	HA-31
CUSHING cerebr	EA-07	St. CLAIR-THOMSON coltello	EG-19
HEIFETZ cerebr	EA-07	STEINER-AUVARD specolo vaginali	HA-19
OLIVECRONA cerebr	EA-07	STEINMANN chiodo per ossa	DD-09
Spazzola per pulire	CI-04 lavorare a	STELZNER forbici rette	AI-38
Specchio frontale ZIEGLER	AC-05	STERNBERG divaricatore labbra	EI-02
Specchio		Stetoscopio	
laringei	FC-04	BOWLES	AC-06
MICHEL	EG-04	Stetoscopio duplex	AC-06
Specillo	CA-03	Stetoscopio	
BOWMAN canale lacrimale	EC-10	FORD	AC-06
DIMEDA	CA-03	FORD BOWLES	AC-06
FARREL	CA-03	PINARD	AC-06
JOBSON-HORNE	CA-03	STEVENS	

- forbici tenotomiaAH-17
forbici tenotomyAI-23
STEVENSON blefarostatoEC-03
STEVENS
pinza irideEC-11
port'aghi oftalmologiaCE-06
uncino per cristallinoEC-06
STIEGLITZ pinza scheggeBA-06
Stiletto MAGILLAE-04
STILLE
costotomiFG-03
forbici per gessiDA-02
STILLE-HORSLEY cesoia per ossaDC-07
STILLE-LISTON cesoia per ossaDC-06
STILLE-LUER pinza sgorbiaDC-04
STILLE
osteotomoDC-14
perforatore a manoDD-04
pinza dissezioneBA-02
pinza pedunculo renaleBC-16
STILLE-RUSKIN pinza sgorbiaDC-05
STILLE
scalpelloDC-14
sgorbiaDC-14
STILLE-SHERMAN perforatore a manoDD-04
St. MARTIN pinza suturaED-05
STOCKMANN serrapeneGG-10
STONE pinza per serraGE-06
STONE-WATT pinza intestinaliGE-06
STRATTE port'aghiCE-04
STRAUSS serrapeneGG-10
Stripper anelloCA-03
STRUEMPPEL pinza auricolareEE-08
STRULLY forbici neurochirurgiaAI-35
Strumenti LAFORCE per corpi estraneiEC-06
Strumento
KNUTSON per uretrografiaGG-09
LOUTE tendifiloDD-11
MOGAN per circoncisioneGG-09
per circoncisioneGG-09
WINKELMANN per circoncisioneGG-09
Strum
KUENTSCHER per conficcDD-13
per conficcDD-12
STRUYCKEN pinza tagliente nasaleEG-07
SUBRAMANIAN pinza atraumaticaBD-31
Supporto MILLIN per luce freddaGG-05
SWEET pinza per applicare e agrafesEA-02
- T**
TABB coltello falciformeEE-14
Taglia anelli DIMEDADD-03
Tagliacalli CREDOHE-03
TagliafiliDD-12
DiamantDD-12
Tamburo
KONRICH per sterilizzazioneHE-12
SCHIMMELBUSCH per sterilizzazioneHE-12
TARNIER
cranioclastoHC-09
forbici ostetriche con dispositivo di trazioneHC-05
TAYLOR
divaricatore spinaDC-24
martelli percussoriAC-07
TEALE pinza per abbassare il collo dell'uteroHA-33
Telaio KIRSCHNERBI-23
Tenaglia
BIRCHER-GANSKE per ossaDC-10
DINGMANN per ossaDC-10
FARABEU-FLAMBOTTE per ossaDC-08
FARABEU per ossaDC-07
FERGUSSON per ossaDC-07
KERN per ossaDC-08
LAMBOTTE per ossaDC-08
LANE per ossaDC-08
LANGENBECK per ossaDC-07
LEWIN per ossaDC-10
LOWMAN per ossaDC-11
Tenaglia per ossaDC-09 lavorare a DC-10
Tenaglia
SEMB per ossaDC-07
VERBRUGGE per ossaDC-09
Tenditore di filiDD-10
TERSON pinza capsulareED-04
THOMS-ALLIS pinza per afferrare tessutiGE-02
THOMS-GAYLOR pinza tagliente per biopsiaHA-42
THOMSON-WALKER divaricatore vescicaleGG-06
THOREK forbici pulmonariAI-36
THUDICHUM specolo nasaleEG-02
TIECK-HALLE specolo nasaleEG-03
TIEMANN pinza per abbassare il collo dell'uteroHA-32
TILLEY pinza auricolareEE-08
Tiracomedoni
SAALFELDHE-02
SCHAMBERGHE-02
UNNAHE-02
WALTONHE-02
Tiramiomi DOYEN per fibromiHA-46
TISCHLER-KEVORKIAN pinza
tagliente per biopsiaHA-44 lavorare a HA-45
TISCHLER-MORGAN pinza
tagliente per biopsiaHA-43 lavorare a HA-44, HA-46
TIVNEN pinza tonsilleFA-04
TOBOLD
abassalinguaEI-02
specilloCA-03
TOENNIS-ADSON forbici neurochirurgiaAI-35
TOENNIS
dissettore per duramadreEA-05
pinza emostaticaBC-11
port'aghiCE-04
TOHOKU pinza fissateliBE-04
Tonometro SCHIOETZED-08
Tonsillotomo SLUDER-BALLENGERFA-05
TOOK coltello per cornealeEC-05
TOTI fresaDD-07
TOWNSEND-KEVORKIAN pinza
tagliente per biopsiaHA-44
TOWNSEND-MINI (BABY TISCHLER) pinza
tagliente per biopsiaHA-45
TOWNSEND-mini pinza tagliente per biopsiaHA-44
TOWNSEND pinza tagliente per biopsiaHA-44
TOWNSEND-TISCHLER pinza tagliente per biopsiaHA-44
TOYNEBEE specoli auricolareEE-02
TrapanoDD-04
CASTROVIEJO cornealeED-07
ELLIOT cornealeED-08
FRANCESCHETTI cornealeED-07
Trattore
BARTON per manico standardHC-04
BILL per manico standardHC-05
LUIKART-BILL per manico standardHC-05
TRAUBE martelli percussoriAC-07
TRELAT specolo vaginaliHA-07
TrequartiCC-02
COAKLEYCC-02
DOUGLASCC-02
FLEURANTCC-02
LICHTWITZCC-02
MENGHINICC-03
NELSONCC-02

OCHSNER	.CC-02
PIERCE	.CC-02
UCKERMANN tracheale	.FE-02
UNIVERSAL	.CC-02
TROELTSCH pinza nasale	.EG-04
TROEMNER martelli percussori	.AC-07
Tronchesina	
per pelle	.HE-03
per unghie	.HE-03
TURNBULL per unghie	.HE-03
TROUSSEAU dilatatore tracheale	.FE-02
TROUTMAN-CASTROVIEJO forbici micro	.AJ-07
TROUTMAN-CHRIS pinza rompe lamette	.AG-14
TROUTMAN Colibri pinza iride	.EC-13
TROUTMAN pinza rectus	.ED-02
TUBBS dilatatore per valvole mitrali	.FG-27
Tubi d'aspirazione	
ANDREWS-PINCHON	.AE-03
DE BAKEY	.AE-04
FRAZIER	.EA-07
MAGILL	.AE-04
NUBOER	.AE-05
POOLE	.AE-02
WALTON YANKAUER	.AE-03
YANKAUER	.AE-02
Tübingen	
cannula aria	.ED-07
pinza iride	.EC-15
pinza legature	.ED-05
Tübingen TITAN	
pinza iride	.EC-15
pinza legature	.ED-05
Tubo	
BRUENINGS allungo	.FC-03
BUIE di aspirazione	.GI-05
JACKSON tracheale	.FE-03
LUER tracheale	.FE-03
WAGENER-MOSHER tracheale	.FE-03
TUFFIER	
divaricatore costali	.FG-16
pinza emostatica	.BC-08
TURNBULL tronchesina per unghie	.HE-03
TURREL pinza per biopsia	.GI-05
TYDING	
pinza tonsille	.FA-04
serranodi tonsille	.FA-05
U	
UCKERMANN	
specillo	.CA-03
trequarti tracheale	.FE-02
ULRICH pinza per tamponi e spugne	.BG-06
Uncinetto	.EE-15
BARBARA	.EE-14
DAY auricolare	.EE-07
FRAZIER	.BI-06
GILLIES	.EG-17
GRAEFE	.BI-06
GUTHRIE	.BI-06
JOSEPH	.BI-06
KILNER per pelle	.HE-02
WAGENER auricolare	.EE-07
Uncini EMMET per fistole	.HA-46
Uncino	
ARRUGA	.EC-06
BOSE tracheale	.FE-02
BRAUN per detroncazione	.HC-09
cava chiodi	.DD-13
elettrodo mini	.JA-02
GRAEFE per strabismo	.EC-06

GRAEFE-TITAN per strabismo	.EC-06
GREEN muscolare	.EC-06
ITERTSON tracheale	.FE-02
JACKSON tracheale	.FE-02
JAMESON per strabismo	.EC-06
O' CONNOR per iris	.EC-06
per estensione piccolo	.DD-10
ROSE tracheale	.FE-03
SMELLIE uncino ostetrico	.HC-06
STEVENS per cristallino	.EC-06
WIENER per iris	.EC-06
Uncino PRATT cistico	.GI-04
UNIVERSAL	
forbici bendaggi	.AI-50
forbici filo metallo lamiera	.AI-42
pinza per sterilizzazione	.CI-02
trequarti	.CC-02
UNNA tiracomedoni	.HE-02
Uretrotomo OTIS	.GG-08
Urinal	.HE-10
USA	
cavo elettrobisturi	.JA-07
USA MODEL forbici ombelicali	.AI-34
USA	
pinza dissezione	.BA-02
US Army (PARKER-LANGENBECK) divaricatore	.BI-03
Uso bisturi, sterili	.AG-10 lavorare a AG-11

V

VALLEIX isterometro	.HA-39
Valva	
BALFOUR centrale	.BI-22
CASPAR	.BI-20
CASPAR spina vertebrale	.BI-19
KALLMORGEN vaginali	.HA-15
KIRSCHNER per telaio	.BI-23
KRISTELLER vaginali	.HA-09 lavorare a HA-14
VAN BUREN	
candeletta dilatatrici	.GG-13
pinza per sequestri	.DC-10
Van DOREN pinza tagliente per biopsia	.HA-42
VANNAS	
forbici iridectomia	.AJ-05
forbici micro	.AJ-12 lavorare a AJ-13
VARIFOCAL oftalmoscopio	.AC-03
Vassoio	
per medicamento	.HE-07
per strumenti	.HE-08 lavorare a HE-09
VERBRUGGE tenaglia per ossa	.DC-09
VERRES ago da punzione pneumoperitoneo	.CC-03
Vienna specolo nasale	.EG-02
VIRCHOW	
coltello per cartilagini	.AG-18
coltello per il cervello	.AG-18
divisore per craneo	.DC-17
VIRTUS (RALK) pinza schegge	.BA-06
VOLKMANN	
curetta tagliente	.DC-12 lavorare a DC-13
divaricatore	.BI-07 lavorare a BI-08
VOLTOLINI specolo nasale	.EG-02
W	
WACHENFELDT pinza per agrafes	.CG-07
WADSWORTH-TODD cauterio	.EC-08
WAGENER-MOSHER tubo tracheale	.FE-03
WAGENER uncinetto auricolare	.EE-07
WAGNER	
forbici	.AH-22
forbici gengivali	.AI-42

pinza tagliente per laminectomia	.EA-09
WALDMANN forbici episiotomia	.AI-34
WALLICH curetta per placenta e per ovaie	.HC-08
WALSHAM pinza raddrizzare setto	.EG-18
WALTHER candeletta dilatatrici	.GG-17
WALTON	
sgorbia per corpi estranei	.EC-06
tiracomedoni	.HE-02
WALTON YANKAUER tubi d'aspirazione	.AE-03
WANGENSTEEN	
pinza dissezione	.BA-05
port'aghi	.CE-03
WARTENBERG sensimetro	.AC-08
WATSON-CHEYNE elevatore	.DC-22
WATSON dermatomo	.AG-22
WEBER	
ansa	.EC-08
pinza atraumatica	.BD-12
WECKER	
forbici tendini	.AJ-04
spatola iride	.EC-08
WEEK blefarostato	.EC-02
WEIL-BLAKESLEY pinza tagliente nasale	.EG-06
WEISSBARTH specolo vaginali	.HA-22
WEISS pinza serratubi	.BC-19
WEITLANER divaricatore	.BI-14
WEITLANER-WULLSTEIN divaricatore	.BI-14
WELLS spatola enucleaciona	.EC-08
WERTHEIM-CULLEN pinza isterectomia	.BC-18
WERTHEIM	
forbici preparazion	.AI-32
pinza isterectomia	.BC-18
WESTCOTT	
forbici iridectomie	.AJ-02
forbici tendini	.AJ-02
WESTON pinza polipus rettali	.GI-05
WEST	
scalpello nasale	.EG-14
sgorbia nasale	.EG-14
WHEELER	
coltello per diszisione	.EC-04
spatola ciclodialisi	.EC-09
WHITEHEAD apribocca	.EI-04
WHITE pinza tonsille	.FA-03
WIEDER abassalingua	.EI-02
WIENER (AUFRIEHT) raspa nasale	.EG-15
WIENER	
raspa per seno	.EG-15
uncino per iris	.EC-06
WIGMORE sega per gessi	.DA-02
WILDER	
ansa	.EC-08
dilatatore canale lacrimale	.EC-10
WILDE	
serranodi	.EG-09
serranodi auricolare	.EE-07
WILDE (TROELTSCH) pinza auricolare	.EE-07
WILLET-MARTELL pinza cuoio capelluto	.BC-08
WILLIAMS	
blefarostato	.EC-02
giraviti	.DD-14
pinza per afferrare tessuti	.GE-03
WILLIGER	
curetta tagliente	.DC-13
martello	.DC-18
periostotomo	.DC-19
WINKELMANN strumento per circoncisione	.GG-09
WINTER pinza per placenta e per ovale	.HC-07
WITTMER pinza tagliente per biopsia	.HA-43
WOLFF pinza per gessi	.DA-04
WRIGLEY forbici ostetriche	.HC-02

WULLSTEIN	
coltello falciforme	.EE-14
forbici auricolari micro	.EE-11
forbici auricolari micro mini	.EE-11
WYLIE	
dilatatore uterini	.HA-30
pinza atraumatica	.BD-21

Y

YANKAUER	
specolo nasofarins	.EG-04
tubi d'aspirazione	.AE-02
YASARGIL forbici micro	.AJ-10 lavorare a AJ-11
YEOMAN pinza per biopsia	.GI-05
YOUNG Boomerang ago per legature	.CG-03
YOUNG	
divaricatore per prostata	.GG-02
pinza per afferrare la prostata	.GG-02
pinza tiralingua	.EI-03

Z

ZAUFAL-JANSEN pinza sgorbia	.DC-04
ZENKER pinza dissezione e per legature	.BC-12
ZIEGLER	
blefarostato	.EC-03
coltello per capsulotomia	.EC-05
coltello per iridettomi	.EC-04
dilatatore canale lacrimale	.EC-10
specchio frontale	.AC-05

