

## **IMPORTANT SAFETY NOTICE!**

Coleman Hanna Carwash Systems is keenly aware of the need for safety. We want your wash bay to be a safe environment for your customers. The signs shown below are included with every Coleman Hanna Carwash Systems in-bay automatic wash. Please mount the safety signs in a highly visible location at the entrance and on the interior walls of the automatic wash bay.



**MOUNT INSIDE BAY**

**MOUNT AT THE ENTRANCE**

Keeping your customers and others who may be walking nearby aware of operating carwash equipment will help ensure everyone's safety

Thanks for your support.

Coleman Hanna Carwash Systems





**208/230 Volt 3 Phase System**  
**DOMESTIC SPEC SHEET**

The eFusion electrical requires two electrical connections into the main disconnect switch. The connections go into the Electrical Control Panel and hook up to the Safety Disconnect Switch, located on the upper right. The 3 phase connection goes into the top of the switch. The 110 VAC hot wire goes into the auxiliary contact on the left side of the switch. The Neutral terminal is located directly left of the auxiliary contact. The amperage requirements for the eFusion are explained under “Electrical Required” below:

**Electrical Required:**

**eFusion Main Supply Without Blowers**

- 30 Amp, 3ph , 208/230V (*17/14 Amp Actual Draw*)
- 20Amp, 1 Pole Breaker, 110V (*10 Amp Actual Draw*)

**eFusion Main Supply With Blowers**

- 125 Amp, 3ph, 208/230V (*67 Amp Actual Draw*)  
Fusible Disconnect Switch w/125 Amp Dual Element Fuses
- 20 Amp, 1 Pole Breaker, 110V (*10Amp Actual Draw*)

**Optional 15 GPM High Pressure Wash System**

- 1 - 15 Hp / 18 GPM Pump / 1000 PSI (*69 Bar*)
- 60 Amp, 3 Ph 208/230Volt (*40/37 Amp Actual Draw*)

**Optional 36 GPM High Pressure Wash System**

- 1 - 25 Hp / 36 Gpm Pump
- 125 Amp, 3 Ph 208/230 Volt (*67 Amp Actual Draw*)

**Water Line Required:**

1" (26mm) Water - Min. Pressure 40 psi (2.75bar) - Max. 60 psi (4.5 bar)  
Max Flow Rate: 12 Gpm (*46 Lpm without High Pressure*)  
38 Gpm (*144 Lpm with High Pressure*)

**Air Line Required:**

½" (13mm) Air – Min. Pressure 80 psi (5.5 bar) – Max. 120 psi (8 bar)  
Max Flow Rate: 10 cfm (*.283 cubic meter*)

**Dimensions:**

Chemical System Stand

With High Pressure: 30"wide X 60" long X 70" high  
(*914mm X 762mm*)

Electrical Control Panel: 24" Wide X 24" High  
(*610mm X 610mm*)

Gantry Frame: 154" wide X 62" deep X 117" high  
(*3.92m wide X 1.58m X 2.98m*)

Vehicle Height Clearance: 84" (*2.14m*)

**Recommended Bay Dimensions: (Contact JCC for lesser dimensions)**

Length 35' (*10.67m*)

Width 16'0" (*4.88m*)

Height 12' (*3.66m*)

Min. Door Opening Height 10' (*3.05m*)







## Installation Procedures

### Table of Contents

Tools Required .....	2
eFusion Installation Procedure .....	3
Step 1: Set the Equipment in the Equipment Room .....	3
Step 2: Set the Equipment in the Bay .....	4
Step 3: Install the Plumbing from the Water Supply to the Pump Stand .....	16
Step 4: Install the Electrical from Electrical Panels to the ECC .....	16
Step 5: Hook up the Electrical from the ECC to the Gantry .....	16
Step 6: Hot Wax System Installation Instructions .....	18
Step 7: Wire the Spot-Free to the RO Production Stand .....	19
Step 8: Wire the Stand-Alone Dryers.....	20
Step 9: Wire the Bay Doors .....	21
Step 10: Wire the Freeze Thermostat.....	22
Step 11: Set the Entry Wizard 2.0 or other Auto Cashier .....	23
Step 12: Clearance Bar .....	28
Step 13: Wheel Scrub Features and Set-up Instructions .....	29
Step 14: Description of Tire Glaze System Operation .....	30

## TOOLS REQUIRED

Here are the tools required to perform a proper installation:

- Hammer Drill and bits
- Hammer
- Transit
- Laser Level
- Level
- Chalk line
- Measuring tape
- 2 -Adjustable wrenches 10 (25cm)-12 inch (30cm)
- Phillips and Straight screwdrivers - assorted sizes
- 2 - Mule or Johnson Bars or 1-Mule and 1- floor jack
- 3/4 inch siphon hose - 8 feet long
- Other helpful tools include:
  - 1 3/8ths and 1 1/2 inch open end wrenches
  - Electric impact wrench with 3/4 inch deep well socket
  - Right angle grinder with cut-off wheel
  - Voltmeter with AC & DC scales



## eFusion Installation Procedure

The eFusion Electrical Control Center (ECC) and gantry are pre-plumbed and pre-wired at the factory. This makes the installation a fairly easy and straightforward operation. The only special tools needed for the installation are a hammer drill and bits for installing the track and other bay equipment and a forklift for setting the gantry on the track. The installation can be accomplished by following a simple step-by-step procedure.

The steps you will need to perform are:

1. Install the equipment in the equipment room.
  - a. Set the pump stand.
  - b. Set the eFusion Electrical Control Center (ECC)
2. Install the equipment in the automatic bay.
  - a. Set the track
  - b. Set the guide rails.
  - c. Set the Gantry.
  - d. Install Brushes.
  - e. Install the Wall and Gantry Boom Assembly.
  - f. Install the plumbing from the pump stand to the gantry.
  - g. Set the treadle plate, entrance and treadle plate eyes
  - h. Set the undercarriage bar and ramps ( if applicable )
  - i. Set the 2-position sign
  - j. Install the electrical from the eFusion ECC to the gantry.
3. Wire the Spot-free delivery pump to the RO System pump stand.
4. Wire the Stand-alone Dryers (If applicable)
5. Wire the Bay Doors.
6. Install the plumbing from the incoming water supply to the pump stand.  
**NOTE: Use a licensed plumber for this step.**
7. Install the electrical from the breaker panels to the WW ECC.  
**NOTE: Use a licensed electrician for this step.**
8. Set the Entrance Arch

### Step 1: Set the Equipment in the Equipment Room

- a) Set the pump stand adjacent to the electrical control center
- b) Set the eFusion electrical control center near the center of the wash bay. Avoid setting the panel directly beneath the boom transition box opening.

**Step 2: Set the Equipment in the Bay**



*View from the Exit End*



*View from the entrance end*



### a) Set the Tracks

You will need the blueprint labeled “eFM1.0 & eFM1.A” for setting the equipment in the bay. This gives the dimensions for the layout in the bay for the tracks and guide rails. It also gives the elevations for installing the boom and transition box.

Chalk a line 56 1/8” from the centerline of the bay to mark the center of the first track. Set one of the tracks at the center of this line. Level the track along its full length, using the shims you received in the shipment. If you run out of shims, use either 5/8” washers or some 3/4” galvanized pipe couplings as shims.

**NOTE:** *The track is in two pieces with a stainless centering pin. The pin will ensure both sections are perfectly aligned.*

When mounting the track, always mount one side completely, and then you can measure from one track to the other so that you can set the second track at 112 1/4” on center. This distance will allow the unit to run in the center of the wheels reducing wear on wheels, bearings and track.

Once all bolts have been installed and tightened, set the other track at 112 1/4”. Keep in mind both tracks should be as level as possible with one another as well as along the path of travel.

**NOTE:** Always drill all the way through concrete when possible so that if you make a mistake, you can hammer the bolt through concrete and install a new bolt in the same hole. The pitch in the bay floor may require you to use longer 1/2” concrete bolts. You can purchase longer bolts at most hardware stores.

### b) Set the Guide Rails

**NOTE:** *The guide rails will be in two pieces.* Mount according to print dimensions. When mounting the guide rails you do not need to level the rails. Mount them directly to the floor. There is no problem if you end up with a bow in the rail. Use 1/2” concrete anchor bolts to secure the rail to the floor.

### c) Set the Gantry

Once the tracks are set, pick up the gantry unit with a forklift and set it on the tracks in middle of the bay if possible. We recommend setting it the middle so when you hang the boom assembly you can rest it on the gantry while installing it.

**NOTE:** Be sure you set the gantry so the Electrical Panel is facing the entrance end of the Car Wash.



Once the gantry's in place locate and mount the end of track stops on both the entrance and exit ends. Also secure the gantry lock down brackets.



**End of Track Stop**



**Gantry Lock Down Bracket**

#### **d) Install Top and Side Brushes**

Align each side brush tube with the mounting flange located on the lower portion of the brush carriage. Secure with 4 bolts (included). Make sure all sides are flush with the mounting flange for proper balance. Mount the top brush in the same manner between the two flanges again securing them with 4 bolts.

#### **e) Install the Boom Assembly**

Each boom has two sections. The longer section mounts on the wall, and the shorter section mounts on the gantry. On each section of the boom assembly are multiple stainless steel tubes for the different products delivered to the gantry. Also, on each section there are two 3/8" tubes, one for air and one for tire cleaner.

The 1" stainless steel tube is for the high pressure functions, and the 3/4" Schedule 80 PVC is for spot-free rinse. The anti-freeze system circulates through the square tubing on the frame of the boom. Use one square tube as the supply and the other as the return.

There are two PVC conduits for the electrical. Use one for the 24VAC cable and (2) two communication cables - One analog and one digital. Use the other for the 208\230\380\415 VAC 3ph cable and an additional PVC conduit for the 3 phase electrical used for the blower.

#### **1) Gantry Boom Assembly**

**NOTE: The Gantry Boom is the shorter of the two booms.**

Mount the boom to the gantry first. This will help you line up the two booms when mounting the wall mounted boom assembly. Slide two 1 1/4" pillow block bearings on shaft and mount the bearings to the stainless steel plate that is welded in the center of gantry. The gantry boom needs about 1/4" of clearance between the highest point on the top of gantry (which may be the top boom motor) and bottom of the boom.

**NOTE:** Make sure the wall boom and the gantry boom are at the same height, or as close as possible. If the boom hits the flexible energy chain on the side brush motors, you need to recheck your measurements.

## 2) Wall-Mounted Boom Assembly

Lay out the location for mounting the “boom assembly mounting bracket” on the wall according to the measurements on drawing eFM1.0. Drill holes through the wall and use the back-plate to prevent the bolts from pulling through the wall construction. Once the boom bracket has been installed, slide 1¼” pillow block bearings onto the boom shaft and hang the boom on the bracket. Then bolt the boom to the bracket using ½” stainless steel nylon self-locking nuts.

**NOTE: ALWAYS USE “Never Seize” on bolt threads.**

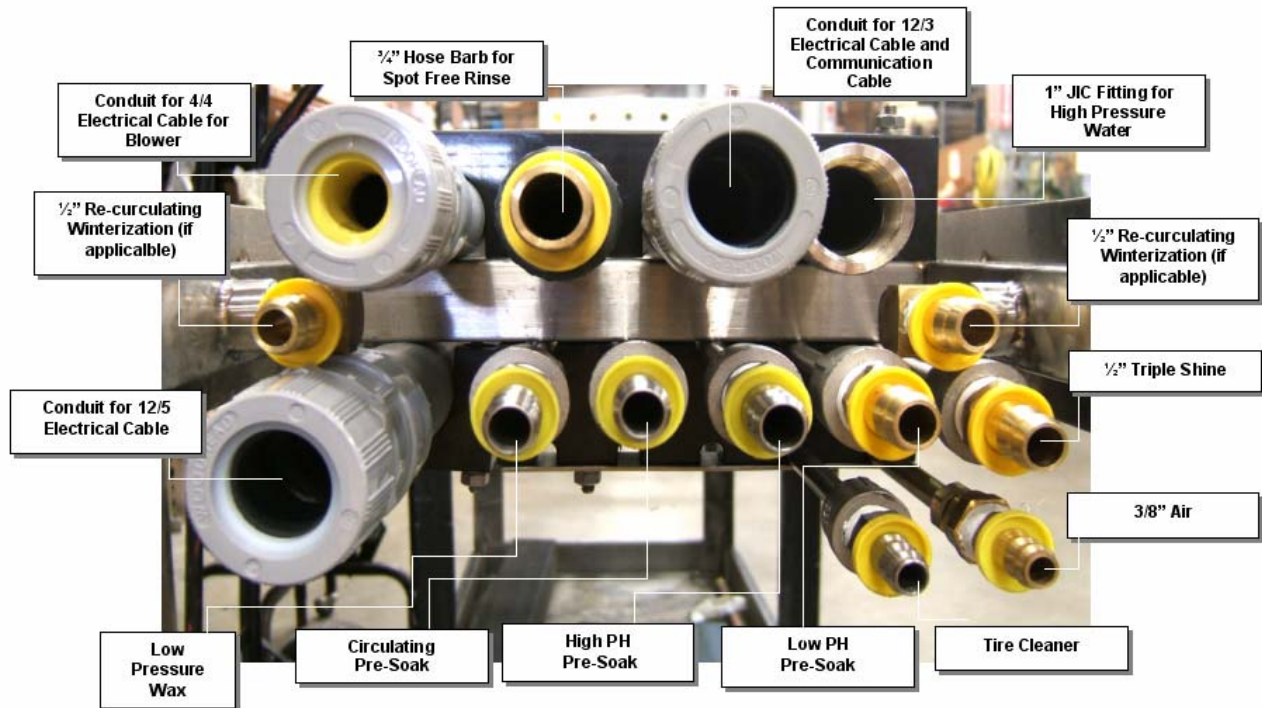

### Boom Assembly

*“Your eFusion may not include all these options.”*

### 3) Transition/Disconnect Box

Lay out the wall for the location of the disconnect box for the boom according to the measurements on drawing eFM1.A. Mount the box so the large opening faces the boom. The hoses go out the side of the Disconnect Box directly to the pipes mounted on the boom. If the equipment room is next to the automatic bay, the disconnect box will have couplings welded to the back of the box.

If the automatic bay is an extended bay not next to the equipment room, the box will have the fittings welded to the opposite side of the hole in the side of the box. It will have 90° fittings facing up to attach the hoses coming from the equipment room. Route the hoses from the equipment room, through the attic or on top of the roof (depending on the roof style of the car wash, then down through the ceiling of the automatic bay into the hose connectors of the disconnect box.

If the automatic bay is next to the equipment room, you will need to cut a hole in the wall, leaving enough space for the disconnect box to be mounted over the hole. Be careful not to cut the hole in the wall larger than 16" X 16". You can confirm the size of the hole with the box before cutting the hole. Once the hole has been cut in the wall, place the disconnect box over the hole with the large hole facing the boom and mount it to the wall using plastic anchors and stainless steel screws.

Once the box is mounted, swing the boom towards the entrance end of the car wash. This will be the maximum extension for the hoses and cables. Then connect all the hoses from the disconnect box to the pipes attached to the boom. Run the SO Cord through the conduits going through the cord grip connectors at each end of the conduit.

### f) Install The Plumbing From The Gantry To The Pumping Plant

***NOTE: Do not connect any hoses to the high-pressure box or low-pressure box until after you flush out the lines during the Startup procedure.***

*An installation kit is shipped with each unit, which includes all of the electrical cables and hoses you need between the gantry and pumping stand. For instructions on where the hoses go, see the portion of this section labeled "Wall Mounted Boom Assembly."*

A standard hook-up is when the automatic bay is next to equipment room. If the automatic bay is not next to the equipment room, you will need a bay extension kit. As a rule of thumb, add 22' of hose for each bay between the equipment room and the automatic bay. The price book lists the hose extension kit with its part number and price.





To hook up the product between the gantry and the pumping stand, you will need to use the hoses from the installation kit. All hoses for the products will hook to appropriate connector on the back of the pumping plant, except the blue 3/4" R. O. hose. The R. O. hose connects to the R. O. pump on the R. O. system. Each hose will then go to the appropriate connector on the back of the disconnect box mounted on the wall. In the case of a remote bay, the connectors will be located on top of the box.

**1) Connect the hoses to the low pressure disconnect plate located in the top of the gantry.**

The following table shows how we identify each hose function by color and size:

Function	Hose Color	Hose Size
Low PH Presoak	Red	1/2"
High PH Presoak	Blue	1/2"
Circulating presoak	Blue	1/2"
Mitter Lube	Yellow	1/2"
Low pressure wax	Green	1/2"
Triple Shine	Gray	1/2"
Tire Cleaner	Green	3/8"
Air	Gray	3/8"
Spot-free Rinse	Blue	3/4"

Begin connecting the hoses for the low-pressure box at the chemical pump on the pump stand and run the hoses to the back of the disconnect box. Then, connect the hoses between the wall-mounted boom and the gantry-mounted boom. Finally, connect the hoses from the low-pressure box to the gantry-mounted boom.

**Low Pressure Box on Gantry (Driver's Side)**

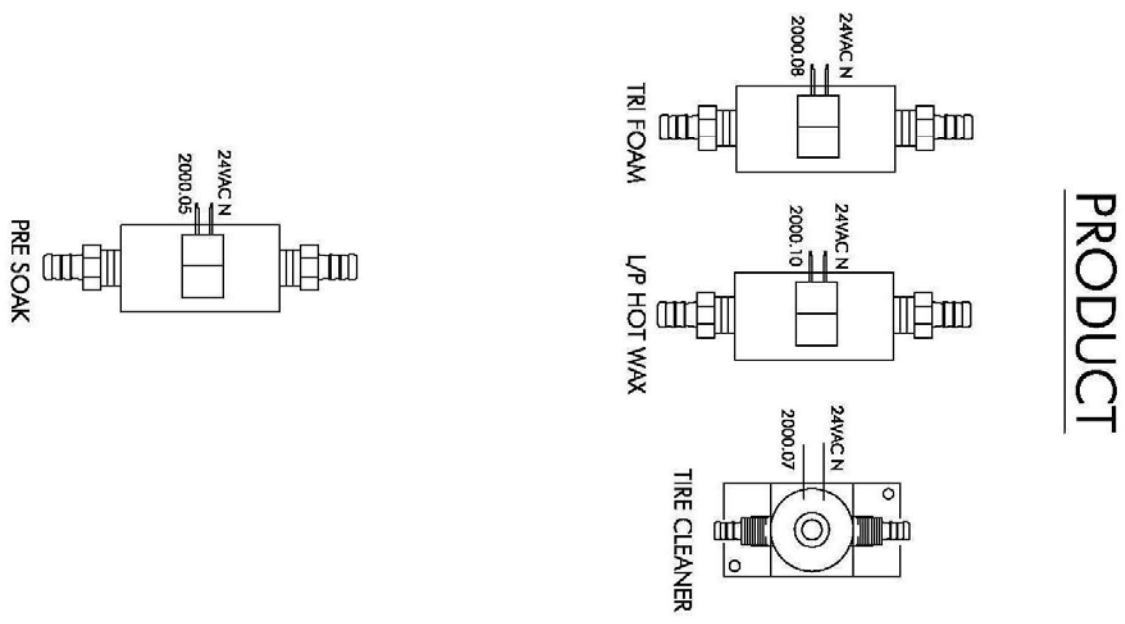
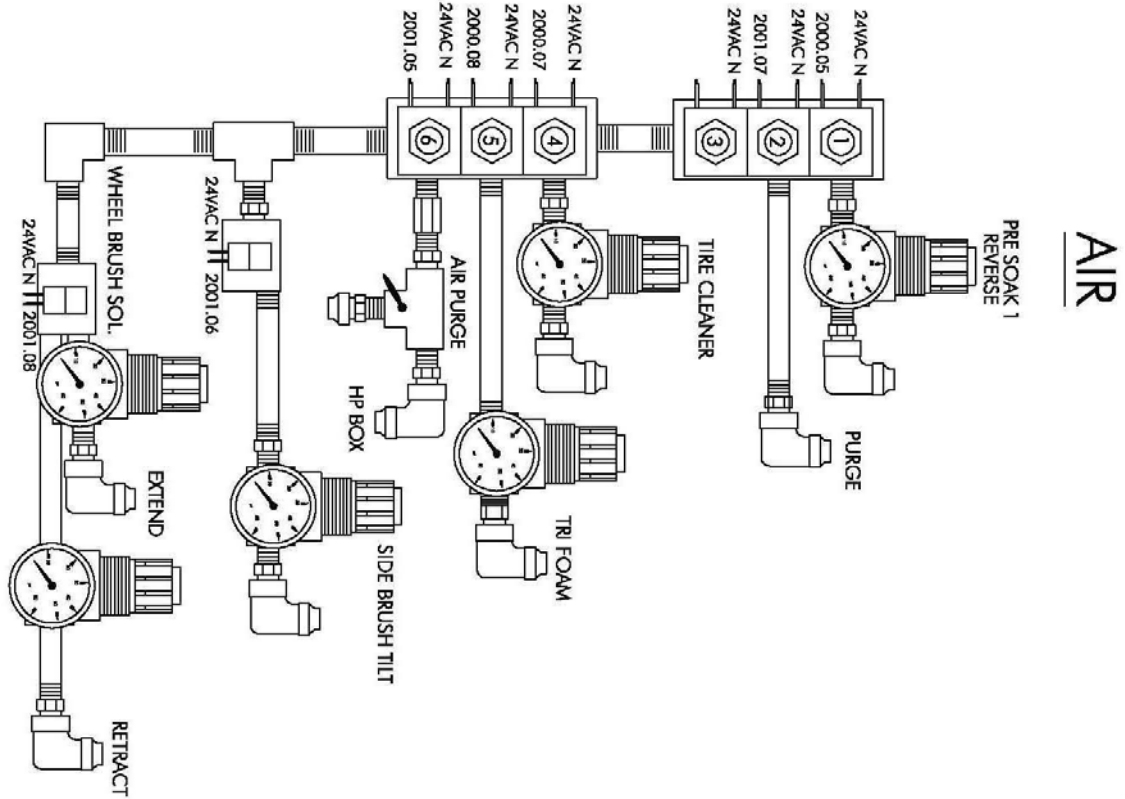

2) Connect hoses to the high-pressure box

**High Pressure Box on Gantry (Passenger's Side)**

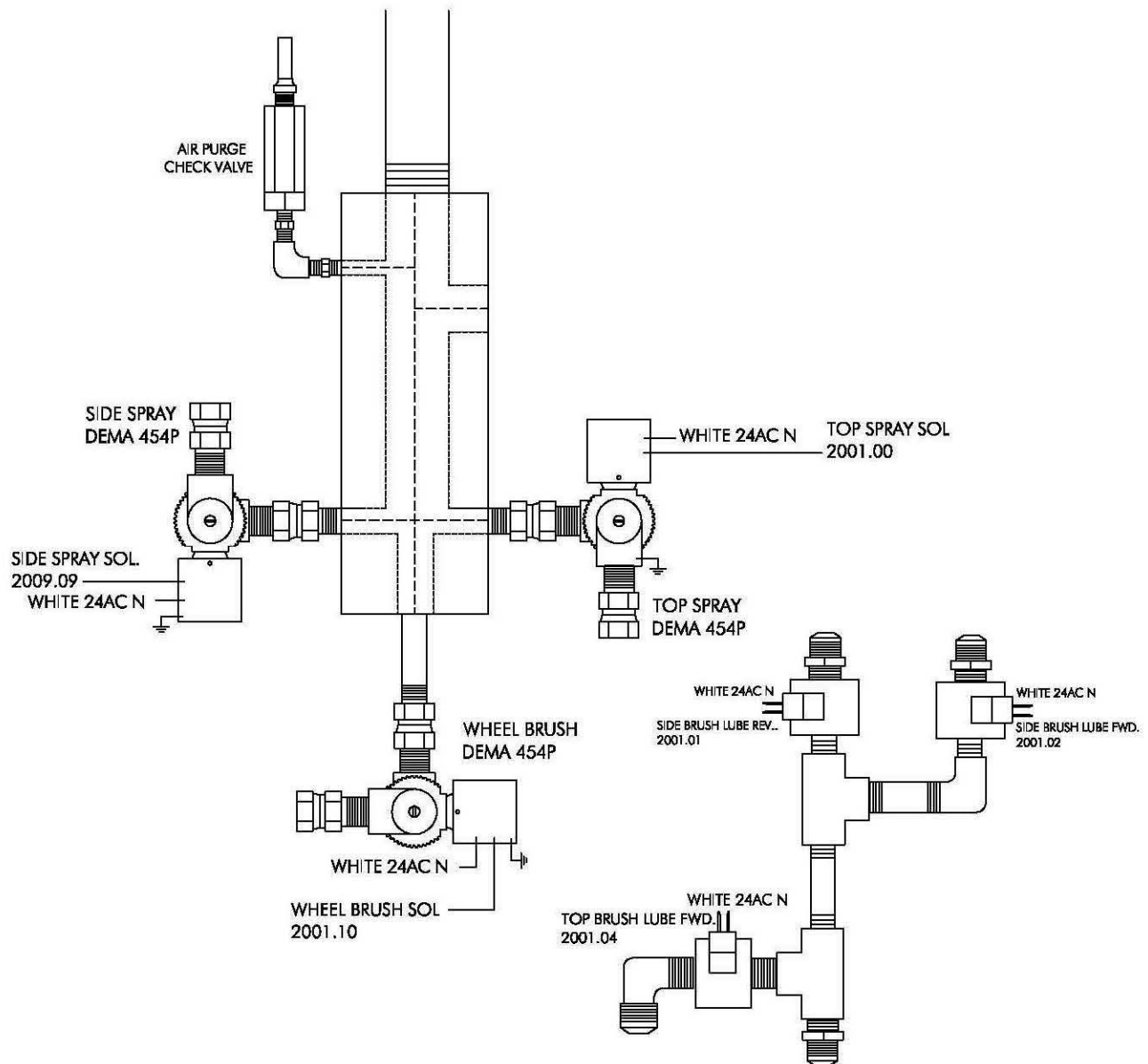

The 3/4" push lock hose connects to the Automatic R.O. Delivery pump on the Self-Serve or Stand Alone R.O. System to the transition box. From inside of the transition box connect a 3/4" push lock hose, run the hose through the wall and gantry boom to the 3/4" fitting on the gantry disconnect plate located at the top of the wash gantry.

### 3) Connect the Undercarriage Bar (if applicable)

The 1/2" wire braid hose will connect to the 1/2" 454P DEMA located in lower front center of pumping plant. This hose will connect to stainless steel undercarriage spray bar. Leave tips out until the hose and bar have been flushed out for 1 minute.

This completes all hose connections.

### g) Set the Treadle Plate, Entrance and Treadle Eyes

Using the print labeled "eFM1.0", set the eye boxes for the entrance and treadle eyes with 1/4" concrete anchors. Set the treadle plate into position. There is an etched centerline on the treadle plate for proper alignment. Secure with 1/2" anchor bolts. Grind the bolts off flush with the nut, to avoid possible tire damage.

### Mechanical Treadle - Electrical Diagram

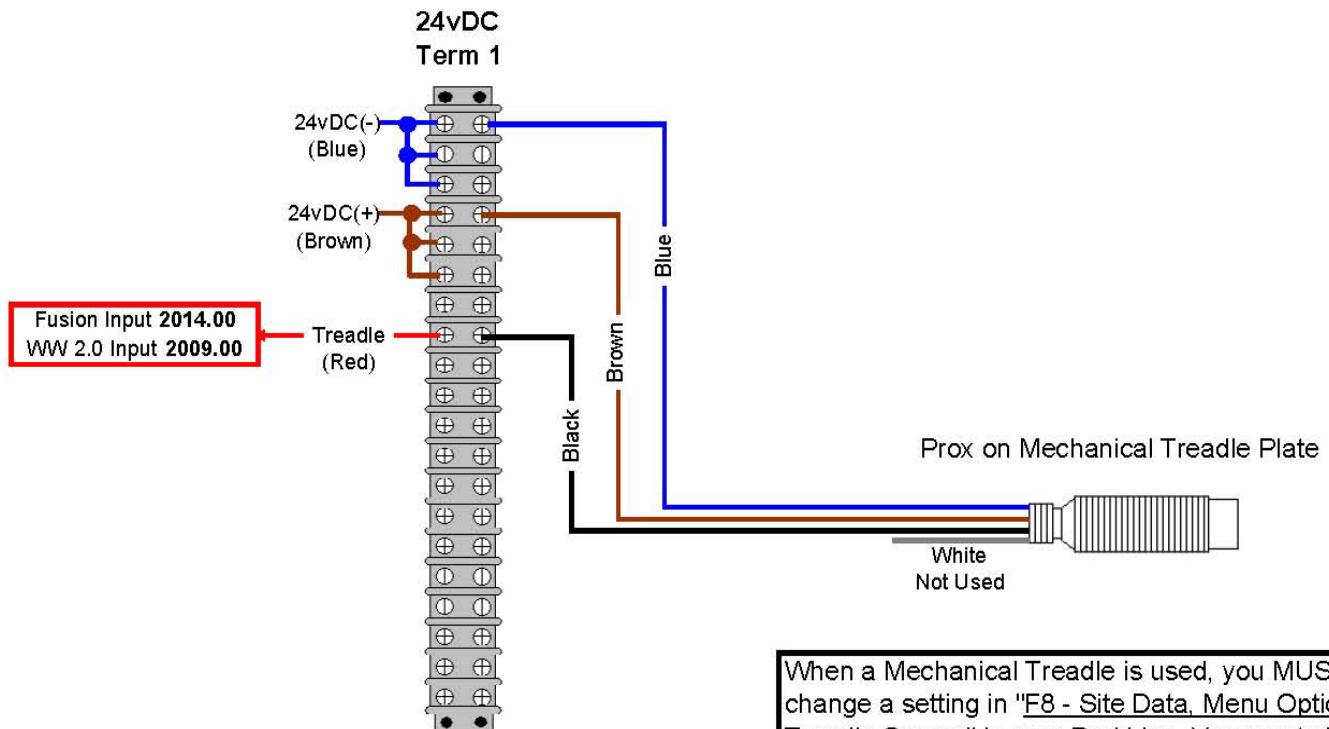

When a Mechanical Treadle is used, you **MUST** change a setting in "F8 - Site Data, Menu Option 17 - Treadle Sensor" in your Red Lion. You must **change it** from Light Operate **to "Dark Operate"**.

## 1) Eye Sensor Wiring

There are four eye sensors sent with each unit (two transmitters and two receivers). These eyes go in the stainless steel eye boxes you just mounted in the bay (see the drawing eFM2.0 and Eyes Wiring Diagram on page 14). Put the receivers in the stainless-steel boxes on the equipment room side of the bay, and the transmitters in the boxes on the opposite side of the bay.

Have your electrician run a conduit from the eFusion ECC to a J-box by each of the receiver eyes. You will also need a conduit going underground (or overhead) to J-boxes by each of the transmitters. You are supplied with four cables that are terminated with a plug on one end. Run the cables in a flexible, watertight conduit from the Eye box to each of the J-boxes provided by the electrician in the bay.

The cables are not long enough to reach to the ECC in the equipment room, so you will need to run the necessary wires to the four J-boxes your electrician installed in the bay. You need two wires [brown for 24 DCV (+) and blue for 24 DCV (-)] for power to the transmitter and receiver eyes. **Note: Wire the 24 vdc- (blue) from the “TREADLE “ emitter eye to the emitter common on the terminal strip. The 24 vdc- (blue) wire from the “ENTRANCE” eye connects to 24vdc- on terminal 1, 2 or 3**

In addition you need another two signal wires for the receiver eyes. One wire will go to the treadle receiver eye, and the other will go to the entrance receiver eye. Both transmitter and receiver eyes are powered by 24 VDC. The two extra wires which go to each of the receiver eyes connects to the black wire of the cable going to the receiver eyes. This will serve as the input wire for each set of eyes, which you will tie into the “**Term #1**” terminal strip in the ECC.

Run the cable from the stainless steel eye boxes in the bay through the conduit from the J-box to the ECC. You need one input for the treadle eye, and one input for the entrance eye. **Refer to drawing on page 14 for correct wiring.**

**NOTE: The remaining white, pink and grey wires should be terminated with the brown 24VDC +. This will eliminate possible signal errors.**

### **h) Set the Undercarriage Pipe and Ramps (Optional)**

Still using the print labeled “eF M1.0”, install the undercarriage pipe. When pouring the concrete for the bay floor, you may wish to build a trench for the undercarriage bar with a lip for a metal grate on top. Anchor the bar to the bottom of the trench with  $\frac{3}{8}$ ” anchor bolts. Install the metal grate over the bar.

If you don't have a trench, anchor the undercarriage bar to the floor in the proper location. Then install the undercarriage ramps over the bar with  $\frac{3}{8}$ ” anchor bolts. Grind the tops of the bolts off to the nut.

### **i) Set the 2-Position Sign**

Mount the **2-Position Light Can** on the passenger's side at a height that can best be seen by the driver.



<b>2 POSITION LIGHT AT ENTRANCE OF AUTOMATIC</b>		
<b>TERM 1 - 24 VDC</b>	<b>WIRE COLOR</b>	<b>DESCRIPTION</b>
18	White	2 Pos. Common
19	Red	"Please Wait"
20	Blue	"Enter Now"
<b>SIGN CAN</b>		
Pigtail	White	2 Pos. Common
Pigtail	Blue	"Enter Now"
Pigtail	Red	"Please Wait"

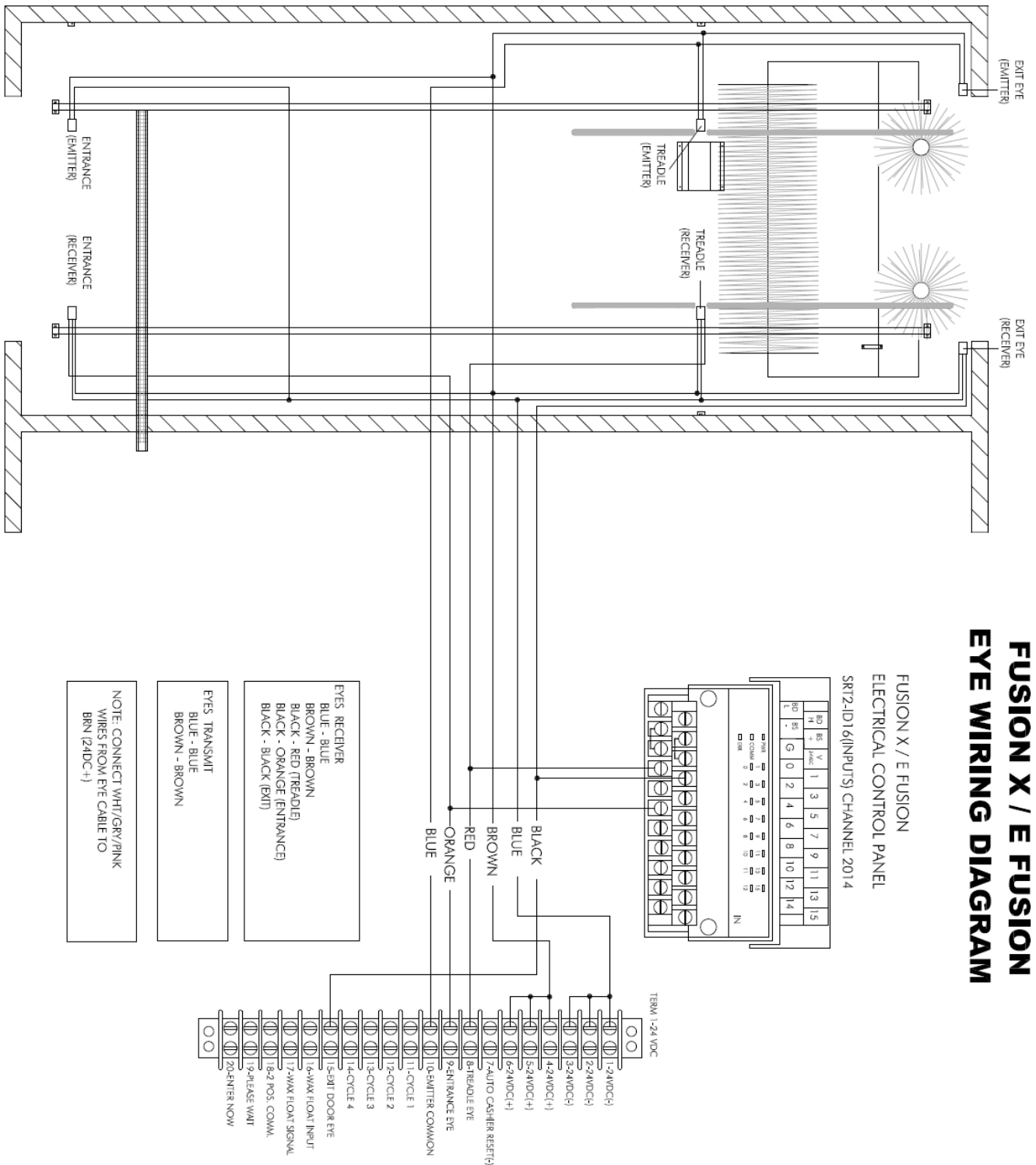

j) Set the Home and End of Track Prox Targets.

See drawing eFM1.0 for detailed the prox target mounting location. This will position the prox so it cannot pass the prox target before the gantry is at the end of the track. Mount them perfectly level to give the prox an even signal as it passes over the target. After mounting the target, carefully move the gantry so the prox is approximately 3/8ths" above the prox target.

### **Step 3: Install the Plumbing from the Water Supply to the Pump Stand**

The eFusion has a simple hook-up procedure. There is a 1" brass tee in the back of the cold-water tank, which serves as the cold soft water hookup.

### **Step 4: Install the Electrical from Electrical Panels to the**

Run the electrical service for the eFusion into the Electrical Control Center (ECC) on either the side or the bottom of the cabinet. Do not put any holes in the top of the cabinet. Metal shavings could fall into a computer component, or water could leak through a hole in the top of the cabinet, damaging the computer and its components.

**NOTE:** If any holes are put in the top resulting in water damage or metal shavings falling into a computer component, causing a short, the warranty will be void.

Terminate the Main 3-phase service for the eFusion into L1, L2, and L3 of the safety disconnect switch in the upper right hand corner of the panel.

The additional single-phase breaker protects the Low Pressure Pumps on the Pump Stand. The three-phase breaker protects the motors/electronic drives on the gantry.

Terminate the 120 VAC (230 VAC International) circuit into the auxiliary, normally open contact on the left side of the safety switch. Terminate the Neutral in the terminal block labeled "**120 or 230 VAC Neutral**". This circuit supplies voltage to the transformer, DC power supply and computers.

### **Step 5: Hook up the Electrical from the ECC to the Gantry**

The gantry needs 208/230/380/415VAC 3 phase, 24VAC, 24VDC, and 2 communication cables. In the installation kit, you will find four electrical cords: one 12/5 SO cord (70'), one 12/3 SO cord (70'), and two Communications Cable (RSM531-30M, 30 meters long). One comm. cable is for digital communications and the other is "analog" communications. These connections will be on separate terminal strip locations in the gantry control panel.

According to the National Electrical Code, Section 400.8, you are not permitted to run flexible SO cords through a wall. To avoid this problem, you can run the SO cords and comm. cables through a seal-tight from the bottom of the FusionX ECC to the back of the transition box.

Run the cord through the grommet holes of disconnect box through the boom with all of the other hoses going to the gantry. Route the wires over to the electrical box on the passenger's side of the gantry.



In the eFusion ECC, terminate one end of the 12/5 SO cord in L1, L2, and L3 3-Ph connections in the bottom side of the 3-phase breaker labeled Gantry. By hooking the gantry up in this manner, you can cut power to the gantry with the main switch or the breaker.

**NOTE:** The white wire in the 12/5 SO cord is not used. This can be used as a spare if you lose one of the legs in your SO cord.

Run 12/5 SO cord to the electrical box on the passenger's side of the gantry. A hole is predrilled in the back of electrical box on the gantry for the 12/5 SO to enter the box. A GC90 cord grip fitting is provided for installation into the cabinet.

Terminate the black, red, and orange wires in L1, L2, and L3 of the safety disconnect switch in the gantry ECC. This will run all three motor starters on the gantry. Terminate the green wire in the ground bar at the bottom of the cabinet.

### Communication Cables

Connect the two comm. cables to the corresponding screw on connectors located on the bottom left hand side of the FusionX ECC. They are clearly marked for Analog and Digital. Analog is on the left and Digital is on the right.

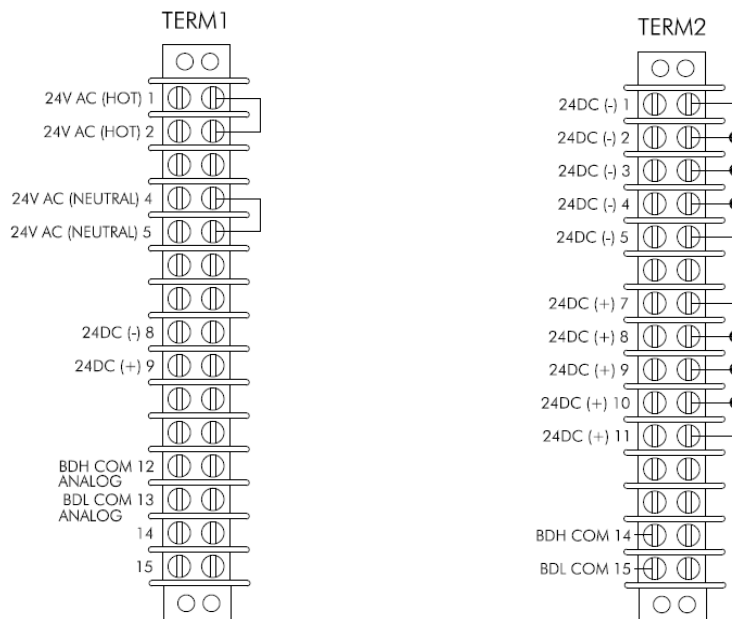

### Gantry Terminal Strips

The 12/3 SO cord and two communication cables terminate on terminal strips located at the bottom side of the electrical panel on the gantry.

### 12/3 SO cord

The 12/3 S.O. cord is used for 24V AC. Terminate the black wire of the 12/3 cord on terminal strip #1 at terminal screw #1 or #2 (labeled 24 VAC hot). Terminate the white wire on terminal screw #3 or #4 (labeled 24 VAC neutral). Terminate the green wire on the ground/earth bus at the bottom of the panel.

### Communication Cables

Each cable has 4 wires plus a shield used for ground/earth. In the gantry, connect the ground wire to the ground bus.

#### *Analog Cable*

Connect the blue and brown wires from the Analog cable to the corresponding terminals on Terminal strip #1. Connect the brown wire [24V DC Positive (+)] to #9 and the blue wire [24V DC Negative (-)] to #8. The black and white wires in the Analog communication cable terminate to terminal screw #12 (BDH Comm). Terminate the white wire to terminal screw #13 (BDL Comm).

#### *Digital Cable*

Connect the blue and brown wires from the digital cable to the corresponding terminals on Terminal strip #2. Connect the brown wire [24V DC Positive (+)] to #7 and the blue wire [24V DC Negative (-)] to #1. The black and white wires in the digital communication cable terminate to terminal screw #14 (BDH Comm). Terminate the white wire to terminal screw #15 (BDL Comm).

## Step 6: Hot Wax System Installation Instructions

The **Hot/Low Pressure Wax System** is an independent system that will need to be wall mounted in an area near the eFusion pumping unit as shown in **Figure A**.



**Figure A**



**Electrical:**

The system requires a 30 Amp 3 phase electrical service if incoming voltage is 208/230. If the incoming voltage is 380 or 415, it would require an 18 amp 3 phase service. The incoming power should connect to the top of the contactor as shown on the M14.0 and the EF-ECC drawings located in the front section of your manual.

***This 3 phase service is not required if using non-heated Low Pressure Wax only.***

The **Hot/Low Pressure Wax System** requires two low voltage electrical connections from the Hot Wax Control Box to the Electrical Control Center. Run a 4 conductor 18 gauge cable from the Hot Wax Control box to the ECC. Connect one end of the Black and White wires to terminals 1 & 2 respectively in the HWCB. At the other end connect the black to 24 VAC Hot and the white to 24 VAC Neutral on terminal 2 in the ECC.

The remaining two wires will connect to terminals 16 and 17 on Terminal strip 1. There will be a factory installed jumper between these terminals that will need to be removed prior to completing this connection.

**Incoming Water and Delivery:**

The wax system should be supplied with a 1/2 inch soft water supply. The mixed product will be delivered from the Hot Wax System pump directly to the gantry. This pump is typically located on the lower left hand area of the pump stand. The outlet hose will connect first to the transition box, through the booms and terminate at the gantry mounted manifold connection.

**Step 7: Wire the Spot-Free to the RO Production Stand{ TC "Step 7: Wire the Spot-Free to the Self-Serve Pump Stand" \f C \l "2" }**

To wire the spot-free, run **two wires** to the spot-free cabinet located at a free standing system or mounted on the Super Saver equipment). Connect one wire to term strip #2 24VAC terminal #8 which is labeled "Spot Free". Connect the other end of the wire to 24VAC Hot in the RO System panel or Super Saver Panel. You can get 24VAC hot from the commons of the output card on the spot-free PLC or from terminal #1 of any of the bay terminal strips if connecting to a Super Saver.

Connect the second wire to terminal #9 on term strip #2. The R.O. PLC can service two automatics. The inputs for the automatic bays are **inputs #10 or #11**. The input wire for the first automatic terminates at **input #10**. The input wire for the **second automatic** terminates at **input #11**. **(See the wiring diagram below).**

TERM 2 – 24VAC	Wire Color	PLC Input
#8 (COMMON)	Pink	24VAC Hot
#9 (N/O)	Pink	#10 or #11

**🔧 NOTE: With Money Manager, wire per instructions inside Supersaver Cabinet.**

## Step 8: Wire the Stand-Alone Dryers

### a) Stand-Alone “Wind Wizard” Dryers with Oscillating Center Nozzle

The Wind Wizard Stand-Alone Dryer is controlled by several outputs from the channel 2006 output card, ROC16. There is also an input signal from a proximity switch on the center oscillating blower nozzle that will be terminated on the channel 2015 input card, ID16. There are eight wires going from the Electrical Control Center (ECC) to the Free-Standing Blower Control Panel. There will be an 18-22 gauge-12 conductor cable provided in the installation kit for Stand-Alone Wind Wizard Dryers for these connections. Terminate these wires according to the following chart:

Wire Color	ECC Connections	Blower Control Panel Connections
White	24 vac Neutral, Term Strip 2	Term.# 96 on the motor overloads
Brown	24 vdc Positive (+), Term Strip 1	Brown wire from prox cable
Blue	24 vdc Negative (-), Term Strip 1	“SC” term on Nozzle VFD & Blue wire from prox cable
Orange	Output 2006.14, ROC16	“A1” on the center motor starter
Red	Output 2006.10, ROC16	“A1” on right and left motor starters
Yellow	Output 2006.09, ROC16	“S1” on Nozzle VFD
Purple	Output 2006.11, ROC16	“S2” on Nozzle VFD
Black	Input 2015.09, ID16	Black wire from prox cable

### b) Stand-Alone Dryers from other manufacturers

Other types of stand-alone dryers are controlled by output 2006.14 of the ROC16. We provide both 24 vac and 120 vac signals to operate your dryers.

#### FOR 24 VAC SIGNAL:

If your dryers require a 24 vac signal to operate, connect your signal wire directly to output 2006.14. You will also need a 24 vac neutral. This connection can be made on Term Strip 2, on one of the terminals labeled “24v neutral”. The length of the signal that is sent to your Blower Control Panel is adjustable through the Red Lion interface (F2 – Timers & Counters).

#### FOR 120 VAC SIGNAL:

If your dryers require a 120 vac signal to operate, connect your signal wire to Term Strip 3, on the terminal labeled “Ext. Blower”. You will also need a 120 vac neutral. This connection can also be made on Term Strip 3, on one of the terminals labeled “120v neutral”. The length of the signal that is sent to your Blower Control Panel is adjustable through the Red Lion interface (F2 – Timers & Counters).

## DIXMOR DIGITAL TIMER WIRING

To wire the Digital timer, you need four wires from the ECC to the timer. You need a black wire for 120 VAC Hot, a white wire for 120 VAC Neutral, and two control wires. **(See the wiring diagram below).**

Terminal 2 24VAC	Terminal 3 120VAC	Wire Color	Dixmor Timer Terminal Strip
	Hot #1	Black	#1
	Neutral #4	White	#2
#10		Purple	#3
#11		Purple	#5

### c) On-Board Dryers

Run the 4/4 S. O. cord from the EF ECC to the Dryer Electrical Panel on the top of the gantry. In the Dryer Electrical Panel, terminate the 4/4 in L1, L2, and L3 of the main disconnect switch. Terminate the green wires to the ground bus of the panel.

### Step 9: Wire the Bay Doors

If the car wash is installed where temperatures will fall below freezing, you may wish to purchase the optional door package. The package includes additional outputs and a set of photo eyes. For the exit door in the ECC, and the outputs and commons come pre-wired to the 24VAC terminal strip #2. The exit door eye signal must be wired to the 24VDC terminal strip #1.

To hook your door controls to the ECC, run three wires to both door controllers. In each controller, terminate one wire on the Door Controller Common. Terminate the other wires to the Door Controller Open contact and the Door Controller Close contact.

In the ECC, hook the wires to the appropriate screws on the “**TERM 2**” terminal strip. See the wiring diagram that follows:

### BAY DOOR WIRING DIAGRAM

Terminal 2 24VAC	Wire Color	Door Control	SRT2-ROC16
#13	White/Yellow	Entrance Common	COM 0
#14	White/Blue	Entrance Open	2004.00
#15	Red/Black	Entrance Close	2004.02
#16	White/Yellow	Exit Common	COM 1
#17	Red/Yellow	Exit Open	2004.01
#18	Red/Green	Exit Close	2004.03



In addition, there is a “windy day” feature that is incorporated in the Red Lion Interface (F8 – Site Data); the doors will close regardless of what the outside temperature is. This feature allows you to close the doors on windy days without activating the blowout feature, even though the temperature is above freezing.

Included with the door package is a set of photo eyes. Install the eyes on the outside of the Exit door high enough to where the eyes will be blocked for at least two seconds. That means you must install the eyes at bumper height. Wire the eyes the same way the treadle and entrance eyes are wired. Terminate the DC power of the eyes to DC (+) (brown wire) and DC (-) (blue wire from receiver eye only). The Emitter/Transmitter eye blue wire will terminate on the “**Emitter Common**” on Term Strip 1, terminal #10. Wiring the emitter this will allow us to detect a short circuit in the receiver eye. Terminate the black wire of the receiver eye cable to Term #2 Screw #17 in the ECC. This screw is pre-wired to input #2014.01 of the SRT2-ID16 in the ECC.

### Step 10: Wire the Freeze Thermostat

#### No Bay Doors or Bay Doors with no Bay Heat

**Inputs 2014.05 and 2014.07** of the SRT2-ID16 of the WW ECC in the equipment room are the two inputs that control the Freeze Blowout and the Bay Door programs. When the temperature rises above the temperature preset on the Thermostat, **Input 2014.05** will come on and **Input 2014.07** will go off (if wired correctly). When the temperature falls below the temperature preset on the thermostat, **Input 2014.05** will go off and **Input 2014.07** will come on. **Inputs 2014.05 and 2014.07** should never be on at the same time.

When **Input 2014.05** first comes on, the car wash controller sends a 3 second signal to open both Bay Doors. When **Input 2014.07** first comes on, the car wash controller sends a 3 second signal to close both bay doors and execute the blowout program. (See the description of the blowout program below).

To wire the **Thermostat**, you will need to run three wires to the **Thermostat** from the **ECC**. Wire one wire to **24 VDC (-)** in the ECC, one wire to the SRT2-ID16 **Input 2014.05**, and one wire to the SRT2-ID16 **Input 2014.07**. In the Thermostat, the **24 VDC (-)** wire goes to the **Common** terminal (**Red screw**). Output 2014.05 of the SRT2-ID16 goes to the **Close on Temperature Rise** contact (White screw), and **Input 2014.07** of the SRT2-ID16 goes to the **Open on Temperature Rise** contact (**Blue screw**).

When the **Blowout Program** is activated, the gantry will blowout all the chemical and water lines once after the temperature drops, and then again once **3 minutes** after each wash after the car leaves the bay and as long as **Input 2009.07** remains lit. The blowout process goes through a sequence of blowing out all the lines on the gantry five times.

The **Blowout Program** will sequence through the following:

- |                         |                          |
|-------------------------|--------------------------|
| Rocker Panel            | Side High Pressure Rinse |
| Top High Pressure Rinse | Tire Cleaner             |
| Presoak                 | Low Pressure Wax         |
| Tri-foam Wax            | Spot Free                |



**NOTE: The undercarriage hose does not get blown out nor does it have a weep system. To protect the undercarriage from freezing, run some sort of heating system along the hose. If you have the winter wizard system, run the uninsulated copper tube from the rail heat along the side of the undercarriage spray bar. You can also run the hoses for the rail heat along with the undercarriage hose to protect it from freezing. If you do not have rail heat, you can run heat tape or something similar along the hose.**

### **Bay Doors with Bay Heat**

If you have Bay Doors with Bay Heat, and you don't want the gantry to blowout the lines, you can wire the thermostat differently. **In this case, you will need two thermostats.** One thermostat will measure the temperature in the bay, and one thermostat will measure the outside air temperature.

Pull two wires to the thermostat in the bay, and pull three wires to the outside air thermostat. Wire the commons of both thermostats to **24 VDC (-)**. You can bring two wires from the panel, one for each thermostat, or you can bring one wire from the panel to the first thermostat terminating the wire on the **Common terminal (Red screw)** of the first Thermostat. Then run a jumper wire from the first thermostat to the second thermostat, and terminate the jumper wire at each thermostat on the **Thermostat Common terminals (Red screw)**.

For the **Bay Thermostat**, Terminate one wire on the **Open on Temperature Rise** contact of the thermostat (**Blue screw**) and terminate the other end of the wire to **Input 2014.07** of the SRT2-ID16 (**Freeze Thermostat**).

For the **Outside Air Thermostat**, terminate one wire on the **Close on Temperature Rise** contact of the thermostat (**White screw**), and terminate the other end of the wire to **Input 2014.05** (Door Thermostat) of the SRT2-ID16 of the ECC in the equipment room.

### **Step 11: Set the Entry Wizard 2.0 or other Auto Cashier**

Using the print labeled "**SHEET M1.0**", set the auto cashier.

**NOTE: Entry Wizard is to have a dedicated 120 volt circuit. DO NOT use power from the eFusion Electrical Control Panel.**

### **Electrical Hookup 120 VAC**

Running from a 20 amp breaker from the main Equipment Room Breaker Panel, you should have one conduit with (3) three #12 AWG wires. These wires are:

- 1-120VAC Hot
- 1-120VAC Neutral (White)
- 1-Ground (Green)

**🔧 NOTE: Refer to Auto Cashier instructions for correct voltage.**

### Cycle Switch and Entry Wizard Reset

In a separate conduit, run (7) seven #18 AWG wires. These wires are:

Cycle 1 – Pink	<b>Term 1</b>
Cycle 2 – Brown	<b>Term 1</b>
Cycle 3 – Purple	<b>Term 1</b>
Cycle 4 – Gray	<b>Term 1</b>
24 VDC (-) Blue	<b>Term 1</b>
24 VAC (Hot) Auto Cashier Reset	<b>Term 2</b>
24 VAC Neutral	<b>Term 2</b>

**NOTE: It is recommended to run 4-5 additional wires for future needs.**

In the eFusion ECC, terminate the above wires on the terminal strip labeled:  
**“TERM 1 - 24VDC” & “TERM 2 – 24VAC”**

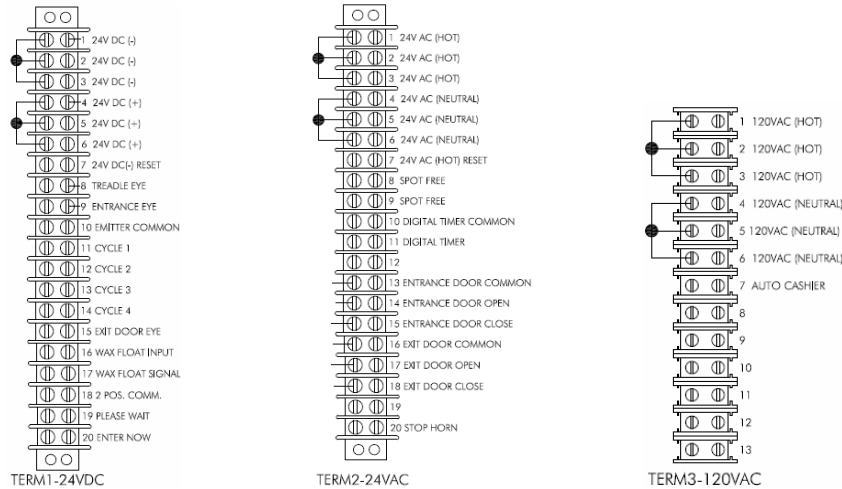

### AUTO CASHIER – HAMILTON

The Hamilton Auto Cashier and Entry Wizard Auto Cashier send and receive the same type of signals to and from the Water Wizard 2.0 Electrical Control Center (ECC). Therefore, the wiring is very similar in both units. Run the Auto Cashier wiring into the (ECC) inside the equipment room. This is where the CPU will accept signals from the Auto Cashier, as well as send reset signals. You will find a terminal strip for the Auto Cashier terminations in the lower right corner of the panel. The terminal strip and all terminations are labeled for your convenience.

You will need a total of 8 wires. They are:

- 1-120V Hot ( To Main Panel – Not WW ECC )
- 1-120V Neutral (To Main Panel – Not WW ECC )
- 1-Ground
- 4-Cycle Wires 24V DC (-)
- 1-Inhibit Signal 120V

**NOTE: Run all low voltage in a separate conduit.**





Inside the Hamilton, there is a single gang box containing the power wires and inhibit wires. Remove the cover and terminate your 120V hot from the ECC to the Hamilton. Then terminate the inhibit signal wire from the ECC to one of the small red wires. This will leave the 120V neutral (white) wire and one small red wire in the single gang box. Twist these two wires together and terminate with the 120V neutral from the ECC. You will then need to wire the signal wires. You will wire the 24V DC (-) from the ECC to terminal #1, on the relay terminal block. Then run jumper wires to terminals #3, #5 and #7. Then wire the cycle wires from the ECC to the relay terminal block. Terminate the wire for cycle #1 wire on terminal #2, cycle #2 on terminal #4, cycle #3 on terminal #6 Cycle #4 on terminal #8.

**HAMILTON WIRING DIAGRAM**

TERM 1 24VDC	Hamilton Auto Cashier	
24VDC (-)	1,3,5,7	
Cycle 1	2	
Cycle 2	4	
Cycle 3	6	
Cycle 4	8	
120VAC Hot	J-box, Black Wire	
120V Cashier Reset	J-box, Red Wire	
120VAC Neutral	J-box, 1 White & 1 Red Wire	
Ground	J-box, Green Wire	

**AUTO CASHIER HAMILTON GOLDLINE**

For the power and cycle switches you will need to run three wires for the main power, five wires cycle switches, and two wires for Cycle Inhibit.

Inside the Hamilton Goldline, locate the relay panel as shown in the figure on the following page. On the relay panel are three terminal strips with six screws each. The terminal strips are labeled **A, B, and C**. All the wires from the WW ECC to the auto cashier hook to these three terminal strips.

**NOTE: (120 V power must come from Main Equipment Room Breaker Panel)**

**Terminal C** is for incoming power and cycle inhibit. For the incoming power, terminate the **120VAC hot** to **L1**, **120 VAC Neutral** to **L2**, and the **ground wire** to **G**. Terminate **Auto Cashier Reset** to **C5** and **120 VAC Neutral** to **C6**.

**Terminals A and B** are for the cycle switches and the **Out of Service Relay**. Terminate the wire for **24 VDC (-)** to terminal **A1**. Then run jumper wires from **A1** to **A3**, from **A3** to **A5** and from **A5** to **B1**. Terminate the four wires for each of the cycles as follows:

**Cycle 1 to A2**  
**Cycle 2 to A4**

**Cycle 3 to A6**  
**Cycle 4 to B2.**

**Terminals B3, B4, and B5** are contacts for an out of service relay. **B3** is the **Common**, **B4** is the **Normally Open Contact**, and **B5** is the **Normally Closed Contact**. If the Goldline goes out of service, this relay is activated. See the diagram below:

### Relay Panel

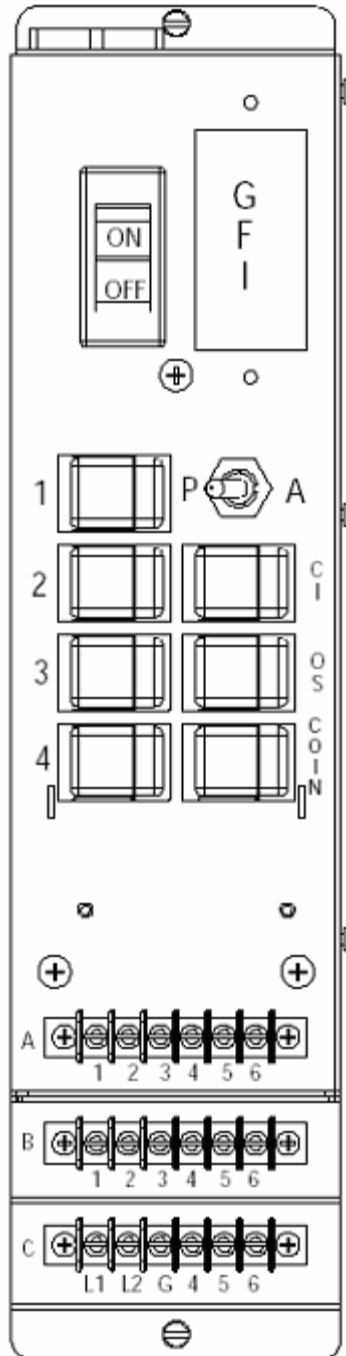

## AUTO CASHIER UNITEC

Run the Unitec Auto Cashier wiring into the Electrical Control Center (ECC) inside the equipment room. This is where we will accept signals from the Auto Cashier, as well as send the reset signal. You will find 3 terminal strips for the Auto Cashier terminations in the lower portion of the panel. Terminal strip #1 is 24Vdc, terminal strip #2 is 24Vac and terminal strip #3 is 120Vac. The terminal strips and all terminations are labeled for your convenience. You will need a total of 10 wires. They are:

### Main Power:

- (1) – 120Vac Hot
- (1) - 120Vac Neutral
- (1) – Earth Ground

### Cycle Selection Wires:

- (4) – Cycle Wires, 24Vdc(-)
- (1) – 24Vdc(-) Common, supply voltage (blue wire)

### Wash in Use Signal:

- (1) – Inhibit Signal (Labeled “Auto Cashier Reset”, available in 24Vdc(-), 24Vac Hot and 120Vac Hot)
- (1) – Inhibit Signal Neutral/Common (Dependant upon selected voltage of Inhibit Signal)

**NOTE:** There is a setting in the Red Lion that will need to be changed for proper operation. You will need to have a “Level-4” access code to be able to make this change. The factory default setting for this access code is “1, 2, 3, 4, Enter”. Press the “F5 – Log in Page” button to enter this code. Now press the “F8 – Site Data” button. Press the “Raise” button 4 times. You will see a sub-heading of “Type Cashier”. Press the “Enter” button to select this screen. At the bottom of the display, you will see the word “Toggle”. Press the arrow button directly under this word and you will observe that “Unitec” has now been selected.

We suggest that you run all low voltage in a separate conduit. If this is not possible, use a shielded conductor cable for the low voltage.

Refer to the Unitec Installation Manual for instructions to terminate the wiring inside of the Unitec cabinet.

To test the Unitec Auto Cashier Reset, press the “F7 – Tech Menu” button. Press “Raise” three times to get to the sub-heading “Test Misc. Functions”. Press “Enter” and this will bring you to the “Auto Cash Reset” output. Press the arrow button under the word “Toggle” and this output will be turned “On”. Check to see that the Unitec will be put “Out of Service”. Once this has been determined, you can toggle this output “Off”.

**UNITEC WIRING DIAGRAM**

Signal	J-18 Connector
Wash-In-Use Hot	1 ( To WW ECC Panel 120 Volt )
Wash-In-Use Neutral	2 ( To WW ECC Panel 120 Volt )
POS4000	J-22 Connector
Pin 1 – White	Pin 1 – White
Pin 2 – Red	Pin 2 – Red
Pin 3 – Black	Pin 3 – Black
Shield-Not connected	Shield, strap to base mounting bolt in case
Signal	J-17 Connector
Cycle Common	9
Cycle #1	4
Cycle #2	3
Cycle #3	2
Cycle #4	1
Spare Option Relays	5-8

**Three-Prong AC Connector For Incoming Power  
(Power must come from Main Equipment Room Breaker Panel)**

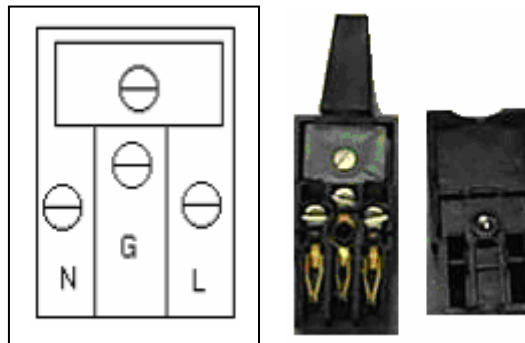

Hook the 120VAC hot to the L screw, the 120 VAC Neutral to the N screw, and the ground to the G screw.

**Step 12: Clearance Bar**

Bolt the clearance bar to the concrete, in front of the automatic and centered with the track, using ½” anchor bolts.

**NOTE:** The clearance bar can be mounted before the auto cashier. This prevents customers with taller vehicles from inserting their money into the auto cashier.

## Step 13: Wheel Scrub Features and Set-up Instructions

You will find a recipe bit titled “Wheel Brushes” in the Program Recipe menu. A custom recipe is required to apply this function to a wash recipe. You cannot perform the wheel brush step on the first pass of a wash recipe. The wheel brush photo eye must first find the rear wheel position.

### ***Air Pressure Adjustments***

There are two air regulators to move the brushes in and out, one of them to extend and one to retract. The extend regulator adjustment is very critical and should be adjusted to the lowest possible operating pressure, usually about 20 psi. Very little pressure is required to clean the vehicle wheels and too much air pressure could cause unnecessary load and wear on the wheel brush spindle gearmotors. The retract regulator should be adjusted so the brushes return smoothly but positively into their home position, usually about 30 psi.

### ***Timers***

There are also two timers and two counters associated with this option. Under “F2-Timers & Counters” on the Red Lion, go to the “Adjust Timers” menu (Menu Option 0) and press the “Enter” button until you see a timer called “Wheel Brush Dwell”. This timer determines how long the brush will stay engaged in the wheel in each direction (clockwise & counter-clockwise). This is factory set to 3 seconds.

Press the “Next” button to advance to the “Wheel Brush Retract Dwell” timer. This timer determines how long the brush disengages from the wheel between direction changes. This timer is factory set to 1 second. You want the brushes to disengage the wheel slightly while it changes directions. If it does not, you would want to increase this timer value.

### ***Counters***

Since we always know where the front tire will be because of the Treadle, we use that to our advantage. Under “F2-Timers & Counters”, go to “Adjust Gantry Counts” menu (Menu Option 1) and press the “Enter” button. There you will see an adjustable counter titled “Treadle Position”.

### ***Setting Front Wheel Counter***

To set this counter, put the gantry in manual mode (turn toggle switch in gantry panel ‘on’), and manually position the gantry until the wheel brush is perfectly aligned with the center of the treadle eye. It is best if there is a vehicle parked properly on the treadle plate to achieve the best result. Manually extend the wheel brush to assure you are in the proper position using the manual push buttons for the Wheel Brush located in the gantry control panel.

Once you have achieved this position go back to the Red Lion and press the arrow key that is located directly below the center of the screen, below the word “Off” on the display. This word will then change to “On”. You will see the value under the word “Treadle” change. You have now set where the wheel brush will position at the front tire when the wheel brush function is performed in a wash recipe.

### ***Setting Rear Wheel Counter***

The wheel brush photo eye will locate the rear wheel position in pass 1. This position is also adjustable. Watch it wash a variety of vehicles to determine if the rear wheel position should be adjusted.

If you determine that this adjustment must be done, Under “F2-Timers & Counters”, go to “Adjust Gantry Counts” menu (Menu Option 1) and press the “Enter” button. Now press the “Next” button repeatedly until you see a counter called “Rear Wheel Offset”.

If you need to adjust the rear wheel brush position closer to the front of the vehicle, you should decrease this counter. If you need to adjust the rear wheel brush position closer to the rear of the vehicle, you should increase this counter. The counters on the eFusion and the FusionX are incremented in inches. If the Wheel Brush always positions about 2 inches past the center of the rear wheels, you can decrease the counter setting by 2 inches.

#### Step 14: Description of Tire Glaze System Operation

- 1) Added Outputs listed above
- 2) Added a "Tire Glaze" recipe bit to the Red Lion and PLC programs. When the "Tire Glaze" bit is turned 'on' in **any pass** of a recipe, the system will operate and the Tire Glaze product will be applied to the tires of the vehicle as it exits the bay.
- 3) Added a Tire Glaze Brush Timer in "F2 - Adjust Timers", 30 - 90 second range (factory set to 50 seconds), that controls how long the brush will spin (2004.05) to apply to exiting vehicle tires. This same timer will give the output time for the air cylinder extension(2004.07).
- 4) Added a Tire Glaze Product Delivery Timer in "F2 - Adjust Timers", 2 - 10 second range (factory set to 4 seconds), to control the length of time product (2004.06) is applied to the brush . Both timers in steps 3 & 4 start together at the end of the wash when the Exit Slowly message is displayed.
- 5) A "Pre-Wet" sequence was added that will spin the brush (2004.05) and apply the product (2004.06) at the start of the wash (when presoak begins) if the purchased wash has the "Tire Glaze" bit selected the **first pass** of the purchased recipe. **The cylinder (2004.07) should not extend in this sequence. The duration of outputs 2004.06 & 2004.05 during this sequence are half of their respective timer set points. For example, if the product timer is set to 4 seconds and the brush timer is set to 50 seconds, then during this sequence they will run for 2 & 25 seconds respectively.** This sequence will only occur when the "Tire Glaze" bit is turned 'on' in **pass #1** of a recipe. If you do not want this "Pre-Wet" step to be performed, do not turn the "Tire Glaze" bit on in pass #1. Turning the "Tire Glaze" recipe bit 'on' in any other pass will cause the Tire Glaze sequence to be followed but the the Pre-Wet sequence will only occur if the bit is 'on' in pass #1.
- 6) Another step will follow the sequence in description #5 above **(in bold type)**, if the tire glaze system has been idle for **"X"** hours, to maintain a saturated Tire Glaze brush. This timer value is adjustable from 0 - 99.9 hours. This value is found in "F2 - Adjust Timers" and is factory set to 12 hours. If you wish to disable this feature set this value to 99.9 hours.
- 7) Each output is available to test manually in "Force PLC Outputs".



eFusion

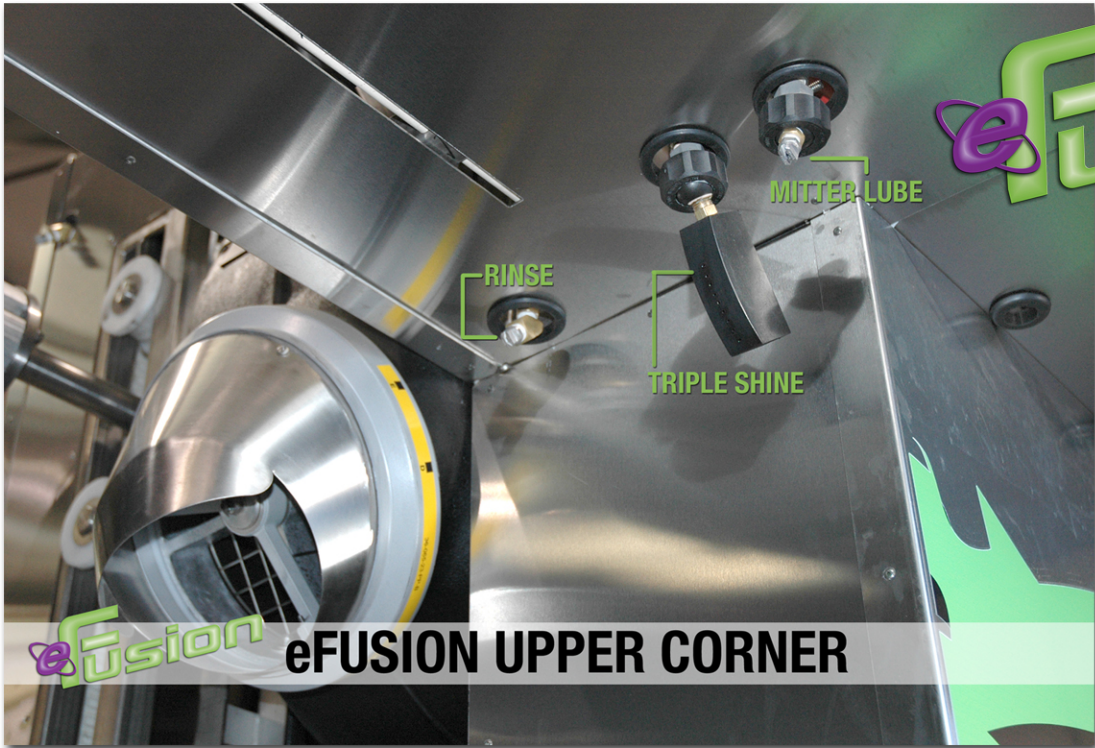

eFUSION UPPER CORNER



eFUSION CENTER GANTRY

# NOZZLE LOCATIONS







# SPARKLE REVERSE OSMOSIS SYSTEMS

## Table of Contents

System Description .....	2
Equipment Installation .....	3
System Check-Out Procedure .....	4
Turn On Procedure .....	5
Ratings .....	6
Bay Delivery And Hook-Up .....	7
Computer Operation Description .....	7
Production	
Delivery	
R.O. Size	
Parts List.....	8-9
Drawing Of Front Of R.O. Systems Board Panel.....	10
Drawing Of Back Of R.O. Systems Board Panel.....	11
Troubleshooting Guide .....	12
Float Switch Hook-Up.....	13
Pressure Booster Pump Installation Instructions & Parts List .....	14-28
Single R.O. Stand.....	RO 1.0

## SPARKLE REVERSE OSMOSIS UNIT SYSTEM DESCRIPTION

The Sparkle Reverse Osmosis (Spot Free Rinse System) is engineered with the best available components on the market to deliver low pressure, spot free water to the car wash bays. The system can be installed on any existing car wash, as well as, new installations. Years of trouble free service, with little maintenance, can be expected.

The following equipment is included in your Sparkle Reverse Osmosis Pumping and Storage Unit.

1. Spot Free Water Storage Tank
2. Blue Charcoal Filter
3. Chlorine Test Kit
4. 10' 3/4" Product Hose
5. R.O. Owner's and Installation Manual.

The following should be installed for the R.O. Unit by its appropriate installer:

1. All electrical hook-ups as required by local Electrical Codes and City Ordinances.
2. 3/4" (Use 1" for 4000 GPD or Above Units) Water Supply Line. This line should be taken off of the existing water softener to provide softened water to the R.O. Unit.

**NOTE: If the water supplied to the R.O. Unit is 50° F, then hot and cold water must be blended together to provide a consistent water temperature between 70° and 90° F.**

3. 1/2" Drain Line.
4. A clean floor and working space for the R.O. Unit and Product Storage Tank.

## SPARKLE REVERSE OSMOSIS UNIT EQUIPMENT INSTALLATION

1. Position fiberglass tank in equipment room as close the Super Saver as possible.

**NOTE: When installing tank, make sure that the area the tank is clean and free of dirt and debris, so as not to damage the Product Storage tank.**

2. Place blue charcoal filter between softened water supply and R.O. unit. Hook-up incoming water into the inlet side then turn on water supply and allow the unit to flush with water for at least 10 minutes or until water that is coming out of filter outlet that is clean and clear. Turn water supply off.
3. Install a 1/2" hose from the outlet side of the charcoal filter to the inlet hook-up on the R.O. unit. This connecting point is located on the back of the R.O. unit behind the 0-100 psi pressure gauge.
4. On the back of the R.O. unit control panel is a blue 1/2" hose that attaches to the top of the product storage tank. This hose provides a route for the spot-free water to get from the R.O. unit to the storage tank.
5. On the back of the R.O. unit control panel is a red 1/2" hose that goes to the 1/2" drain provided for the unit.

**NOTE: This water can be returned to the wash tank if desired.**

6. Inside the R.O. unit control box is a 4-conductor cable coming from the computer. This control cable goes to the float switch that is located in the product storage tank. The proper connection sequence is as follows:

**Red Lead ----- Lower Float Switch  
Green Lead ----- Upper Float Switch  
White Lead ----- Mid Level Float Switch  
Black Lead ----- Upper, Mid and Lower Float**

**(See Appendix A)**

7. Install 3/4" line between the outlet of the product storage tank (lower fitting) and the inlet side of the delivery pumps (elbow located on top of pump).

## SPARKLE REVERSE OSMOSIS UNIT CHECKOUT PROCEDURE

***Before continuing installation, perform the following checks:***

1. Turn on water supply valve and check for leaks of any kind. If any are found, turn off the valve, repair leak and retest. The water pressure should read between 20-60 psi, at the 0-100 psi gauge, depending on the city water pressure.
2. Perform chlorine test according to the instructions provided in the test kit. If any trace of yellow is found, re-check installation of charcoal filter for a reversed hook-up. Properly install charcoal filters, and retest. If the charcoal filter is properly installed and the chlorine test fails again then the charcoal filter is defective and must be replaced.

**<<< CAUTION HIGH VOLTAGE >>>**

3. Check electrical voltage at breaker and verify that 220 Volts single phase is provided to unit.
4. Check that drain hose has been connected from R.O. unit to drain.
5. Check to see if the "run" and "power" lights on the Omron computer are lit.

System Size	Production		Delivery pump	Total amps
	Voltage	Amps		
2000 GPD System	230v single Phase	5.4	9.9 amps/single ph	15.3
4000 GPD System	230v Three Phase	4.7	4.7 amps/ three ph	9.4
6000 GPD System	230v Three Phase	9.4	4.7 amps/ three ph	14.1

## REVERSE OSMOSIS UNIT TURN-ON PROCEDURE

Now that the Sparkle Reverse Osmosis Unit is installed, Spot Free water can be produced. Turn power on to the R.O. unit and it should start to produce SF water (Product Water). There should be a supply of water going to the Product storage tank and a small amount of water coming out of the drain hose (Reject Water). The pressure gauge on the front of the R.O. control panel will indicate the product supply pump pressure. It should read between 130-195 psi. The unit should run for several minutes, allowing air to escape the system.

Do not make any adjustments until the unit has been turned on for about 10-15 minutes. This unit was factory run and tested and should not need any adjustments, but if needed, proceed as follows:

To adjust the amount of Product Water or Reject Water adjust the regulator. The regulator is located in the middle of the R.O. control panel, for the supply pump. When the regulator is increased (turned clockwise) there will be less flow indicated on the reject flow meter and more flow on the product flow meter.

**NOTE: Never exceed 195 psi, or damage will occur to the R.O. Unit pump and membrane.**

To properly set the ratio of Product Water to reject water, adjust the regulator starting out at about 100 psi and increase the pressure in 10-psi increments. You will notice that, even though you keep increasing the pressure, the product water does not increase (only the reject water decreases). At this point, by increasing the pressure, you are only working the membranes harder and harder, but yet not producing any more water. A lot of systems run typically at 150-170 psi.

## SPARKLE REVERSE OSMOSIS UNIT RATINGS

*Typical recovery rates and settings for a Sparkle R.O. System are as follows:*

System Size	Product Water		Reject Water	
	Minimum GPM	Maximum GPM	Minimum GPM	Maximum GPM
200 GPD System	.7	1.0	1.4	1.5
4000 GPD System	1.6	2.0	3.0	3.5
6000 GPD System	2.5	3.0	4.0	4.5

Never exceed the above listed recovery rates or severe fouling will result and membrane warranty will be void. It is best and most economical to have a high rate of reject water, than to take a chance in damaging membranes by pushing the R.O. unit too hard.

If the unit is not producing the anticipated amount of product water, the following factors can usually be contributing to its failure:

- A. TDS (Total Dissolved Solids) above 300 PPM
- B. Water temperature is too cold
- C. Hard water

**Important Note:** Once the product tank has about 2-3' of water, you will need to prime the delivery pump. To do this, simply loosen the hose fitting on the discharge side of the pump, allowing water and air to flow through the pump until all air is purged from the line.

If there are any problems, questions, or concerns on setting up this unit contact Coleman Hanna Carwash Systems at 1-800-999-9878 or 1-713-683-9878.

## **SPARKLE REVERSE OSMOSIS UNIT BAY DELIVERY AND HOOK-UP**

Now the R.O. Unit is producing Spot Free Water and it is time to hook-up the bay delivery system.

Make sure the test switch located in front of the R.O. Unit control box is in the off position. This will allow the unit to automatically shut off when the fiberglass-holding tank is full. The test switch is used to by pass the tank switches so that the operator can verify that the system is working. The by-pass switch is not provided on the Super Saver unit; only the freestanding unit.

### **AUTOMATIC HOOK UP**

You will need to run two wires from the R.O. Electrical Panel to the Water Wizard 2.0 "Electrical Control Center". On "Term 2 24VAC", on the water wizard 2.0 panel, you will find two terminals marked "Spot-Free". Connect one wire to each of these terminals. On the R.O. Electrical panel connect one wire to input # 010 on the OMRON computer and the other wire to 24 VOLT AC hot common on the output side of the OMRON computer. If you have two Water Wizard 2.0s, use input #011 for the second one. All other wires are connected the same.

## **COMPUTER OPERATION DESCRIPTION**

### **PRODUCTION**

Computer receives a signal from upper float switch and the mid-level float switch, that the tank is low on water. If signal is present over 10 seconds the computer will turn on water solenoid valve to production pump. After 10 seconds the computer then determines that if the water pressure is above 20 PSI, to turn on the production pump motor starter. If at any time the computer does not receive a signal from the pressure switch that water pressure is above 20 PSI, then the computer will flash output 107 and turn off the production pump.

### **DELIVERY**

When the computer receives a 24V signal from any bays (inputs 4-11), it has a one second delay in turning on the delivery pump motor starter. If at anytime the computer receives a signal from low water cut off that the poly tank is empty the computer will shut down the delivery pump and flash output 106.

*Power and the run light on the Omron computer must be on for the computer to function properly.*

### **REVERSE OSMOSIS SIZE**

To determine what size your R.O. Unit is, simply measure the membranes mounted on the unit.

If the membrane is 4"x40" the unit is capable of producing 2000 gallons per day.

If the membrane is (2) 4"x40" the unit is capable of producing 4000 gallons per day.

If the membrane is (3) 4"x40" the unit is capable of 6000 gallons per day and so on.



## REVERSE OSMOSIS PARTS LIST

ITEM	PART #	DESCRIPTION
1	47030	.2-2.0 GPM Flow Meter
	47040	.1-1.0 GPM Flow Meter
	47044	.5-5.0 GPM Flow Meter
	47048	1.0-10.0 GPM Flow Meter
3	47010	0-300 PSI Panel-Mount Gauge
4	58020	Pressure Regulator
5	64070	24V ½ Solenoid Valve
6	47011	0-300 PSI Lower-Mount Pressure Gauge
8	64019	Two-Stage Solenoid
	64021	Three-Stage Solenoid
	64023	Four-Stage Solenoid
9	64026	24V Solenoid Coil
10		¼ MPT x 3/8 Poly Flow Tubing Fitting
11	22164	¼ HEX Nipple
12	22052	¼ ST ELL
13	22228	3/8 Hose Fitting Swivel
14		3/8 MP x 3/8 Flare X 90 °
15	22046	3/8 Elbow
16	22200	38 ST Tee
17	22102	3/8 x ½ Bushing
18	64002	½ Solenoid Valve
19	22216	½ MPT x 3/8 Flare
20	22218	½ MPT x ½ Hose Barb
22	34020	3/8 Check Valve
21		3/8 MPT x 3/8 Flare
22	222212	3/8 MP x 3/8 Hose Barb
23	22046	3/8 Elbow
24	22226	¼ Hose Barb Swivel
25		¼ FPT x ¼ Flare x 90°
26		¼ MPT x ¼ Flare x 90°
27	22088	¼ x 3/8 Bushing
28	22102	½ x 3/8 Bushing
29	22176	½ x 3/8 Bushing

### REVERSE OSMOSIS PARTS LIST cont.

ITEMS	PART #	DESCRIPTION
30	62132	Reverse Osmosis Membrane AKA-1600 4"x 40
	62132-2	Reverse Osmosis Element for AKA-1600
31	22084	1/2 MPT x 1/2 FPT Coupling
	57030	Pump for 1600 GPD Reverse Osmosis
35	22056	1/2 ST Ell
37	22172	1/2 Hex Nipple
39	22166	3/8 x 1/4 Hex Nipple
40		Pressure Switch Reverse Action 69WR5
41	66004	3/8 Filter Housing
	66034	3/4 Filter
42	57050	PB-10 Pump
43	22108	3/4 x 1/2 Bushing
NOT	33460	Omron Controller (may vary with unit size)
SHOWN	66054	2 Cubic Feet Charcoal Filter
	66064	Bag Charcoal 2 Cubic Feet

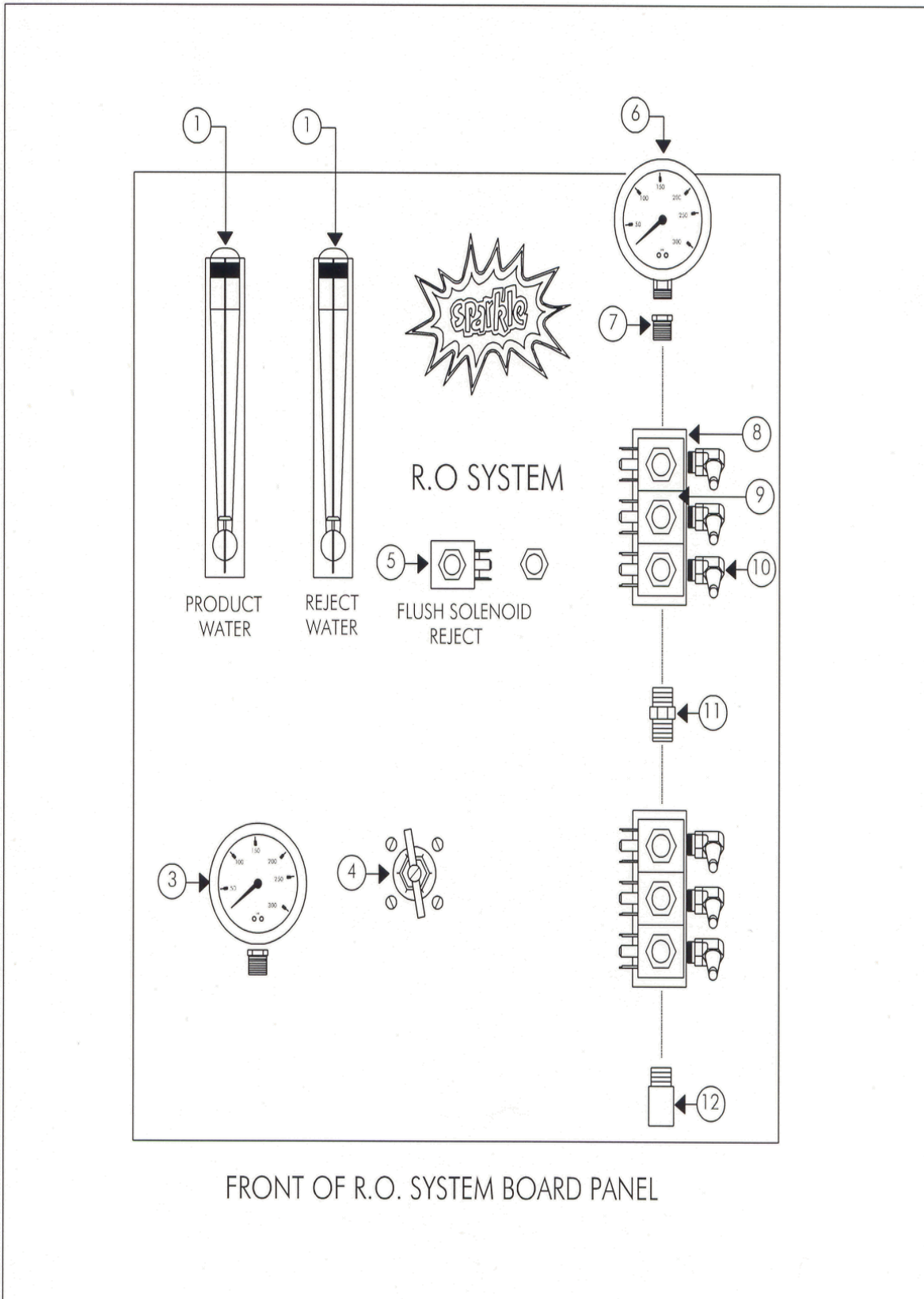

FRONT OF R.O. SYSTEM BOARD PANEL

## BACK OF R.O. SYSTEM BOARD PANEL

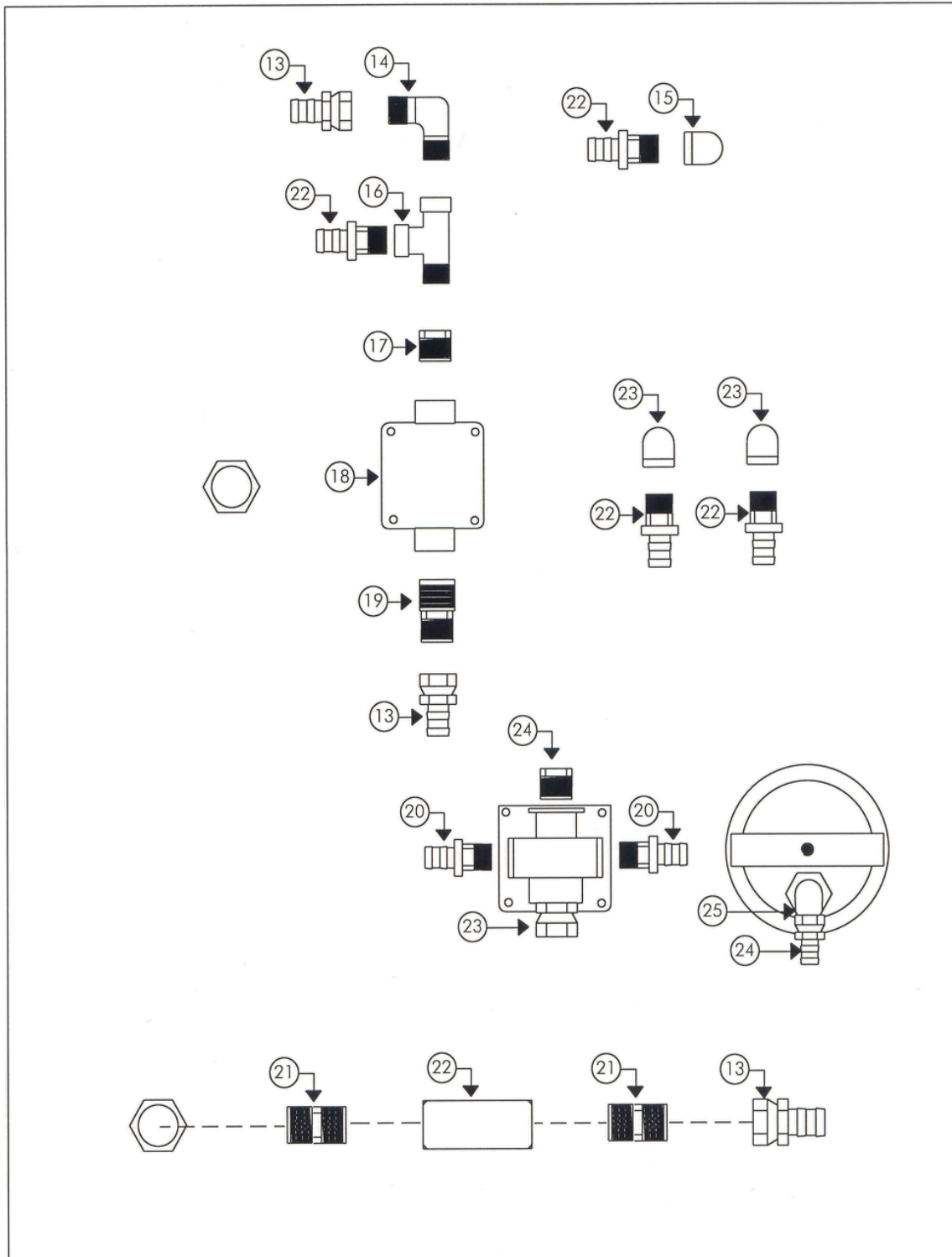

## TROUBLE SHOOTING GUIDE

NO.	INPUTS	LIGHTS	LIGHT OPERATION
0000	Water Pressure Switch	On	Turns off When Pressure is Low
0001	Low Water Float Switch	Off	Turns on When Tank Runs Empty
0002	Upper Water Float Switch	Off	Turns on When Tank is Low on Water
0003	Mid Level Float Switch	Off	Turns on When Water Level Drops Below Float Switch
0004	Bay 1 Input	Off	Turns on When Bay 1 is on SF
0005	Bay 2 Input	Off	Turns on When Bay 2 is on SF
0006	Bay 3 Input	Off	Turns on When Bay 3 is on SF
0007	Bay 4 Input	Off	Turns on When Bay 4 is on SF
0008	Bay 5 Input	Off	Turns on When Bay 5 is on SF
0009	Bay 6 Input	Off	Turns on When Bay 6 is on SF
0010	Bay 7 or Auto 1 Input	Off	Turns on When Auto 1 is on SF
0011	Bay 8 or Auto 2 Input	Off	Turns on When Auto 2 is on SF
	OUTPUTS	LIGHTS	LIGHT OPERATION
100	Self Serve Delivery Pump	Off	Turns on When Bay 1-8 is on SF
101	Water Solenoid	Off	Turns on to Feed Production Pump
102	Production Pump	Off	Turns on Refill Storage Tank
103	Flush Solenoid	Off	Turns on to Flush Membranes
104	Auto #1 Delivery Pump	Off	Turns on When Auto 1 Calls for SF
105	Auto #2 Delivery Pump	Off	Turns on When Auto 2 Calls for SF
106	Flashing Low Water Light	Off	Flashes When Tank is Empty
107	<b>Flashing Low Pressure Light</b>	Off	<b>Flashes When Water Pressure is Low</b>

## FLOAT SWITCH HOOK-UP

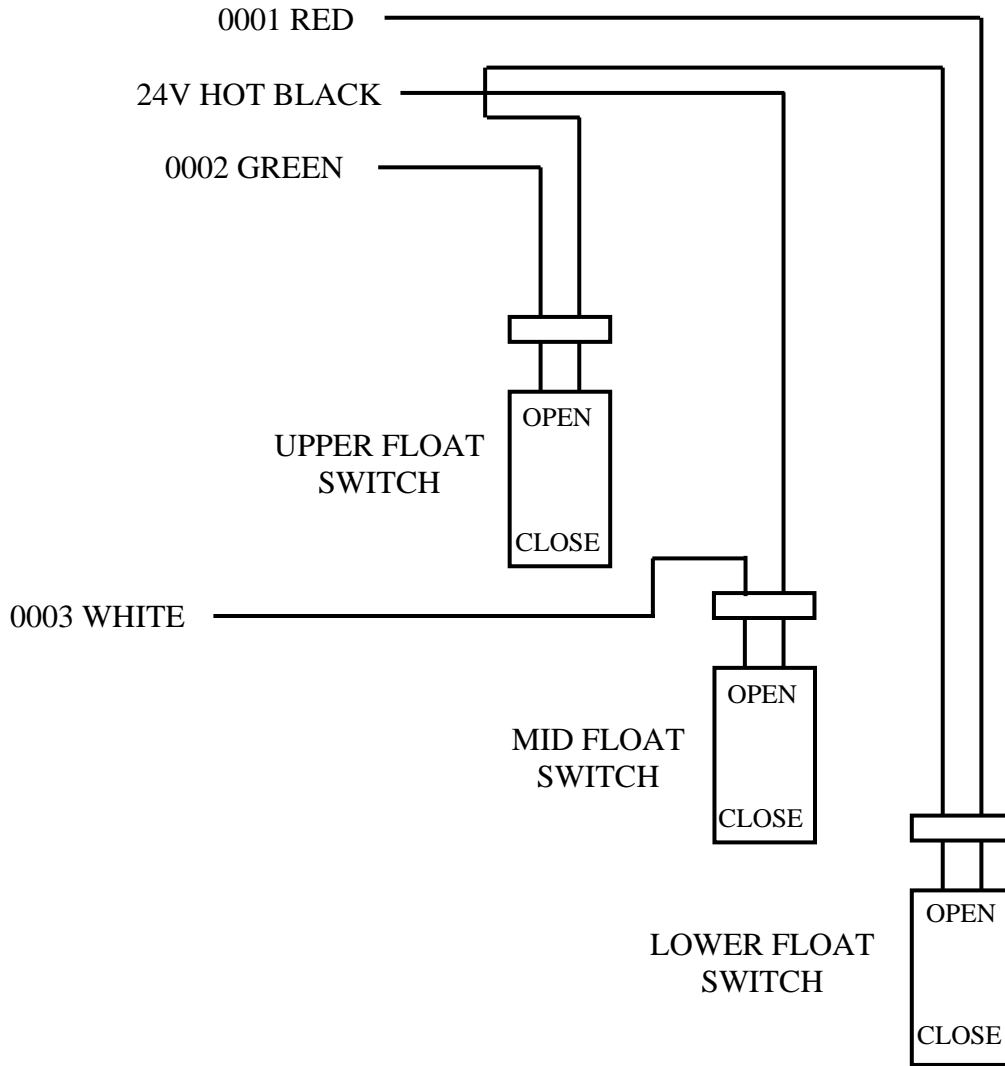

(Appendix A)

Operating Instructions & Parts Manual

FW0154

0112

Supersedes

0907

Please read and save these instructions. Read carefully before attempting to assemble, install, operate or maintain the product described. Protect yourself and others by observing all safety information. Failure to comply with instructions could result in personal injury and/or property damage! Retain instructions for future reference.

# Pressure Booster Pumps

## Description

Pressure booster pumps increase water pressure from city mains or private water systems. Applications include providing high water pressure for washing buildings, dairy walls or floors, hog parlors, poultry houses, rinsing or spray cooling equipment, lawn sprinkling and insecticide spraying. Stainless steel models can handle salt-water and contaminated water in reverse osmosis filter and other aggressive water applications.

Single-phase models are equipped with a capacitor start, thermal protected motor.

Three-phase models require separate overload protection.

## Unpacking

When unpacking the unit, inspect carefully for any damage that may have occurred during transit.

NOTE: Use pump with clear water only.

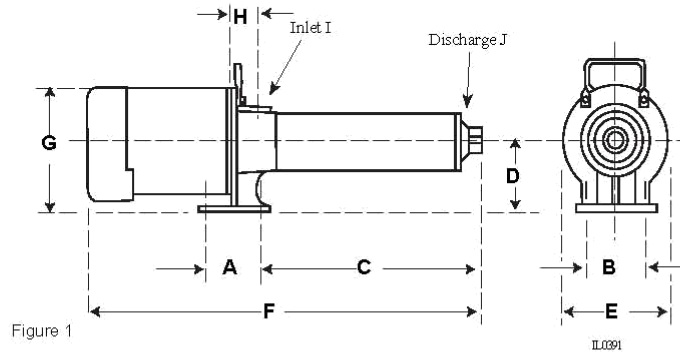

Figure 1

IL0391

60 Hz Motor Driven Pump Dimensions (See Figure 1) •												Chart A		
Stainless Steel Fitted	Powder-Coated Cast Iron Fitted	Cast Iron Fitted	Dimensions In Inches										Lbs. Ship Wt.	
			A	B	C	D	E	F	G	H	I	J		
PB0508S031	PB0508C031	PB0508A031†	3-1/4	3-3/4	10-3/16	3-7/8	6-1/2	19-15/16	7-3/8	1-7/16	3/4	3/4	35	
PB0512S051	PB0512C051	PB0512A051†	3-1/4	3-3/4	13-3/8	3-7/8	6-1/2	23-3/8	7-3/8	1-7/16	3/4	3/4	38	
PB0516S071	PB0516C071	PB0516A071	3-1/4	3-3/4	16-1/2	3-7/8	6-1/2	27	7-3/8	1-7/16	3/4	3/4	43	
PB0712S071	PB0712C071	PB0712A071	3-1/4	3-3/4	13-3/8	3-7/8	6-1/2	23-7/8	7-3/8	1-7/16	3/4	3/4	42	
PB1014S101	PB1014C101	PB1014A101	3-1/4	3-3/4	16-5/16	3-7/8	6-1/2	27-1/4	7-3/8	1-7/16	3/4	3/4	48	
PB1016S151	PB1016C151	PB1016A151	3-1/4	3-3/4	17-5/8	3-7/8	6-1/2	29-3/16	7-3/8	1-7/16	3/4	3/4	51	
PB1914S201	PB1914C201	PB1914A201	3-1/4	3-3/4	18-1/8	3-7/8	6-1/2	29-11/16	7-3/8	1-7/16	3/4	3/4	51	
PB2711S201	PB2711C201	PB2711A201	3-1/4	3-3/4	15-3/8	3-7/8	6-1/2	27-1/2	7-3/8	1-7/16	1	1	52	
PB3506S201	PB3506C201	PB3506A201	3-1/4	3-3/4	13-15/16	3-7/8	6-1/2	25-7/8	7-3/8	1-7/16	1	1	51	
PB2714S301	PB2714C301	PB2714A301	3-1/4	3-3/4	18-1/2	3-7/8	6-1/2	30-9/16	7-3/8	1-7/16	1	1	54	
PB3508S301	PB3508C301	PB3508A301	3-1/4	3-3/4	17-1/8	3-7/8	6-1/2	29-3/16	7-3/8	1-7/16	1	1	53	
-	-	PB5504A201	3-1/4	3-3/4	13-3/4	3-7/8	6-1/2	25-15/16	7-3/8	2-1/8	2	2	57-	
-	-	PB5506A301	3-1/4	3-3/4	18-1/16	3-7/8	6-1/2	30-3/16	7-3/8	2-1/8	2	2	57-	
-	-	PB8504A201	3-1/4	3-3/4	16-1/2	3-7/8	6-1/2	28-5/8	7-3/8	2-1/8	2	2	58-	
-	-	PB8505A301	3-1/4	3-3/4	19-5/16	3-7/8	6-1/2	31-1/2	7-3/8	2-1/8	2	2	58	
50 Hz Motor Driven Pump Dimensions (See Figure 1) •58														
PB0508Y031	-	PB0508X031	3-1/4	3-3/4	10-3/16	3-7/8	6-1/2	20-3/16	7-3/8	1-7/16	3/4	3/4	34	
PB0514Y051	-	PB0514X051	3-1/4	3-3/4	14-7/16	3-7/8	6-1/2	25-7/16	7-3/8	1-7/16	3/4	3/4	41	
PB0714Y071	-	PB0714X071	3-1/4	3-3/4	14-15/16	3-7/8	6-1/2	25-15/16	7-3/8	1-7/16	3/4	3/4	47	
PB1020Y101	-	PB1020X101	3-1/4	3-3/4	21-11/16	3-7/8	6-1/2	33-5/16	7-3/8	1-7/16	3/4	3/4	53	
PB1023Y101	PB1023Z101	PB1023X101	3-1/4	3-3/4	24-3/8	3-7/8	6-1/2	36	7-3/8	1-7/16	3/4	3/4	55	
PB2717Y201	-	-	3-1/4	3-3/4	21-5/16	3-7/8	6-1/2	33-7/16	7-3/8	1-7/16	1	1	56	
-	-	PB3508X151	3-1/4	3-3/4	16-13/16	3-7/8	6-1/2	29-11/16	7-3/8	1-7/16	1	1	52	
PB1021Y101	-	-	3-1/4	3-3/4	22-1/2	3-7/8	6-1/2	34-3/16	7-3/8	1-7/16	3/4	3/4	54	
PB1920Y151	-	-	3-1/4	3-3/4	24-1/16	3-7/8	6-1/2	34-3/8	7-3/8	1-7/16	3/4	3/4	56	
-	PB1922Z201	-	3-1/4	3-3/4	26-1/8	3-7/8	6-1/2	37-3/16	7-3/8	1-7/16	3/4	3/4	59	

(\*) NOTE: Figure 1, holes in mounting base are open slotted 3/8" wide x 1/2" long; dimension A & B are centerline from these open slotted holes. These holes are suitable for 1/4 to 3/8" bolts. Dimensions also apply to three phase models.

(†) Equipped with carrying handle. 132079 handle available as an option on other models. Add 1-3/8" to "G" if handle is included.



**PERFORMANCE SPECIFICATIONS**

PRESSURE ADDED - PSI					10	20	40	60	80	100	120	140	160	180	200	Max. Press. PSI	Suction Pipe Tap NPT	Disch. Pipe Tap NPT
Stainless Steel Fitted	Powder-Coated Cast Iron Fitted	Cast Iron Fitted	HP	Stage	Output - Gallons per Minute													
	PB0508C031	PB0508A031*	1/3	8	9.5	8.7	7.3	5.8	3.5							87	3/4"	3/4"
PB0512S051	PB0512C051	PB0512A051*	1/2	12	9.8	9.2	8.2	7.3	6.3	5.2	3.5					131		
PB0516S071	PB0516C071	PB0516A071	3/4	16	9.9	9.5	8.7	8.0	7.3	6.5	5.8	4.8	3.5			175		
PB0712S071	PB0712C071	PB0712A071*	3/4	12	14.0	13.4	12.2	10.9	9.5	7.9	6.0	3.6				152		
PB1014S101	PB1014C101	PB1014A101	1	14	*	*	14.5	13.4	12.3	11.2	9.8	8.3	6.3	3.3		185		
PB1016S151	PB1016C151	PB1016A151	1-1/2	16	*	*	14.7	13.8	12.9	11.9	10.8	9.7	8.2	6.6	4.3	211		
PB1914S201	PB1914C201	PB1914A201	2	14	27.5	27.0	25.7	24.2	22.6	20.8	18.7	16.2	13.0	7.8		190	1"	1"
PB3506S201	PB3506C201	PB3506A201	2	6	41.5	41.1	40.5	34.2	23.3							90		
PB2711S201	PB2711C201	PB2711A201	2	11	*	*	31.3	29.3	26.8	23.8	19.8	13.0				150		
PB3508S301	PB3508C301	PB3508A301	3	8	41.5	41.1	40.9	40.0	34.2	26.4	10.0					120	2"	2"
PB2714S301	PB2714C301	PB2714A301	3	14	*	*	32.2	30.6	28.9	27.0	24.8	22.0	18.4	12.2		190		
-	-	PB5504A201	2	4	77.6	71.6	52.5									65		
-	-	PB5506A301	3	6	77.8	74.4	65.0	51.1	31.9							69		
-	-	PB8504A201	2	4	105.8	90.0	47.0									49		
-	-	PB8506A301	3	5	108.8	89.8	60.0	25.0								80		

† Example: If PB0508A031 pump is connected to supply line of sufficient capacity, carrying water at 40 PSI, and the output of the pump is held to 7.3 GPM by a gate valve, the pump will add 40 PSI to line pressure for a total output pressure of 80 PSI.

\* Operation of pump in this range may result in reduced pump life and/or motor damage.

To keep pump and seal lubricated, a minimum flow of 1.5 GPM must always be maintained through the pump.

Motor voltage: Single Phase 1/3 - 2 HP - 115/230; 3 HP - 230V 60 Hz.

Three Phase 1/2 - 2 HP - 208-230/460, 50/60Hz.

Three Phase 3 HP - 208-230/460, 60 Hz

For three phase models, use suffix "3" on the model no. Example: PB0512A053

† Handle included with these models only.

Single Phase Motor Data 60HZ							Chart C	
Single Phase† 60 Hz 3450 RPM Capacitor Start								
HP	Motor Voltage	Factory Connected Motor Voltage	Service Factor Motor Amps		Locked Rotor Motor Amps		Code Letter	
			115V	230V	115V	230V		
1/3	115/230	115V	8.6	4.3	26.0	13.0	K	
1/2	115/230	115V	13.0	6.5	36.0	18.0	K	
3/4	115/230	115V	14.0	7.0	52.0	26.0	K	
1	115/230	230V	18.0	9.0	78.0	39.0	L	
1-1/2	115/230	230V	21.0	10.5	98.0	49.0	J	
2	115/230	230V	25.0	12.5	116.0	58.0	H	
3	230	230V	-	13.5	-	53.0	D	

Single Phase Motor Data 50HZ							
Single Phase† 50 Hz 2850 RPM Capacitor Start							
1/2	115/230	115V	10.0	5.0	48.0	24.0	M
3/4	115/230	115V	14.4	7.2	64.0	32.0	L
1	115/230	230V	16.4	8.2	72.0	36.0	K1-1/2
	115/230	230V	23.6	11.8	104.0	52.0	K
2	230	230V	-	13.2	-	55.0	H

†Thermal overload protector - automatic reset

Three Phase Motor Data							Chart D
Three Phase† 60/50 Hz 3450/2850 RPM Capacitor Start							
HP	Motor Voltage	Factory Connected Motor Voltage	Service Factor Motor Amps		Locked Rotor Motor Amps		Code Letter
			230V	460V	230V	460V	
3/4	208-230/460	230V	3.5	1.75	19.0	9.5	K
1	208-230/460	230V	4.5	2.25	26.9	13.5	K
1-1/2	208-230/460	230V	5.7	2.85	33.5	16.8	K
2	208-230/460	230V	7.4	3.70	44.0	22.0	K
3□	208-230/460	230V	9.8	4.90	48.0	24.0	D

††3 HP, 3 Phase motor operable on 60Hz only.

Material Construction		Chart E
Component	Standard Models*	Stainless Steel Models
Motor	Rear access - Nema 56J face	Rear access - Nema 56J face
Bearings	Ball-ball, permanently lubricated	Ball-ball, permanently lubricated
Impellers	Noryl with 304 stainless steel bearing insert	Noryl with 304 stainless steel bearing insert
Diffuser	Noryl	Noryl
Diffuser plates	Delrin	Delrin
Pump shaft	416 Stainless steel	304 Stainless steel
Pump shaft coupling	316 Stainless steel	316 Stainless steel
Pump shell	304 Stainless steel	304 Stainless steel
Discharge & inlet casting	Cast iron	304 Stainless steel
O-Rings	Buna-N	Viton
Seal composition	Carbon-silicon carbide, stainless steel spring and Buna-N	Carbon-silicon carbide, stainless steel spring and Viton

\*Models with powder coated inlet & discharge also available.

Minimum Wire Size Chart (Gauge)								Chart F
Motor HP	Volts	Phase	Distance In Feet From Motor To Service Panel					Breaker Size (Amps)
			0-50	50-100	100-150	150-200	200-300	
Wire Size								
1/3	115/230	1	14/14	14/14	14/14	12/14	12/14	15/15
1/2	115/230	1	12/14	12/14	12/14	12/14	10/14	20/15
3/4	115/230	1	12/14	12/14	10/14	10/12	8/12	20/15
1	115/230	1	10/14	10/14	10/12	8/12	6/10	30/15
1 1/2	115/230	1	10/12	8/12	6/12	*/10	*/10	30/20
2	115/230	1	10/12	8/12	6/12	*/10	*/10	30/20
3	230	1	10	10	10	10	8	30
3/4	230/460	3	14/14	14/14	14/14	14/14	14/14	15/15
1	230/460	3	14/14	14/14	14/14	14/14	12/14	15/15
1 1/2	230/460	3	14/14	14/14	14/14	12/14	12/14	15/15
2	230/460	3	14/14	14/14	14/14	12/14	10/12	15/15 3
3	230/460	3	14/14	14/14	14/14	12/14	10/12	15/15

(\*) Not economical to run in 115V, use 230V.

### General Safety Information

Carefully read and follow all safety instructions in this manual and on pump. Keep safety labels in good condition. Replace missing or damaged safety labels.



This is a SAFETY ALERT SYMBOL. When you see this symbol on the pump or in the manual, look for one of the following signal words and be alert to the potential for personal injury or property damage.

**▲ DANGER** Warns of hazards that WILL cause serious personal injury, death or major property damage if ignored.

**▲ WARNING** Warns of hazards that CAN cause serious personal injury or death, if ignored.

**▲ CAUTION** Warns of hazards that MAY cause minor personal injury, product or property damage if ignored.

**IMPORTANT:** Indicates factors concerned with operation, installation, assembly or maintenance which could result in damage to the machine or equipment if ignored.

**NOTE:** Indicates special instructions which are important but are not related to hazards.

#### ▲ WARNING



Hazardous voltage. Can shock, burn or cause death. Ground pump before connecting to power supply.

▲ Wire motor for correct voltage. See "Electrical" section and Motor Data Charts C&D of this manual, and motor nameplate.

▲ Ground motor before connecting to power supply.

▲ Meet United States National Electrical Code and local codes for all wiring.

▲ Do not handle a pump or pump motor with wet hands or when standing on a wet or damp surface or in water.

▲ Follow wiring instructions in this manual when connecting to power lines.

**▲ WARNING** Always disconnect power source before performing any work on or near the motor or its connected load.



Do not use to pump flammable or explosive fluids such as gasoline, fuel oil, kerosene, etc. Do not use in flammable and/or explosive atmospheres.



Hazardous pressure! Install pressure relief valve in discharge pipe. Release all pressure on system before working on any component.

1. Make workshop child proof - use padlocks, master switches; remove starter keys.
2. Wear safety glasses when working with pumps.
3. Wear a face shield and proper apparel when pumping hazardous chemicals.
4. Keep work area clean, uncluttered and properly lighted; replace all unused tools and equipment.
5. Provide guarding around moving parts.
6. Keep visitors at a safe distance from the work area.
7. Periodically inspect pump and system components.
8. Protect electrical cord. Replace or repair damaged or worn cords immediately.

9. Do not insert finger or any object into pump or motor openings.
10. Secure the discharge line before starting the pump. An unsecured discharge line will whip, possibly causing personal injury and/or property damage or puncture.

**▲ CAUTION** Do not touch an operating motor or engine. They are designed to operate at high temperatures.

**▲ WARNING** This product contains chemicals known to the State of California to cause cancer and birth defects or other reproductive harm.

**▲ WARNING** Risk of Electric Shock. This pump has not been investigated for use in swimming pool areas.  
**NOTE:** Pumps with the "CSA-CUS" mark are tested to UL standard UL778 and certified to CSA standard C22.2 No. 108.

### Pre-Installation HANDLING

1. Use handle supplied to lift pump.
2. Avoid impact on pump or motor. In particular, avoid impact on discharge end of pump or rear motor access cover.

### LOCATION

**▲ WARNING** In any installation where property damage and/or personal injury might result from an inoperative or leaking pump due to power outages, discharge line blockage, or any other reason, a backup system(s) should be used.

1. Locate pump as close to the fluid source as possible, keeping the inlet pipe short as possible.
2. Place unit where the pump and piping are protected from the weather and extremes of heat, humidity and below freezing temperatures.
3. Mount unit in a dry location that is easily accessible for inspection and maintenance. If a dry location is not available, mount it on a foundation well above the wet floor.
4. Allow ample clearance around unit for free air circulation.

### SUCTION LIMITATIONS

1. Units are non self-priming.
2. Pressure booster pumps are not recommended for suction lift applications.

### PIPING

1. Use galvanized piping, rigid plastic or other suitable pipe that will not collapse under suction or rupture due to pressure.

**▲ CAUTION** If hose is used, make sure it is the reinforced industrial type that is rated higher than the shutoff pressure of the system. Ordinary garden hose will collapse and starve the pump of water.

2. The diameter of the inlet and discharge pipe should be no smaller than the corresponding ports of the pump (See Figure 1). Smaller pipe will reduce the capacity of the pump. Increase pipe size on long runs.
3. Avoid air pockets in inlet piping or air will accumulate at high points, making priming difficult.
4. Use pipe compound on all joints and connections. Use Teflon tape or plastic joint stick, on plastic pipe. Draw all pipe up tightly.

**IMPORTANT:** The entire system must be air and water tight for efficient/proper operation.



**Installation  
PUMP INSTALLATION**

**IMPORTANT:** Pump is built to handle clear water only; it is not designed to handle water containing sand, silt or other abrasives.

1. Refer to Figures 6, 7, and 8 for typical installations.

**CAUTION** Support pump and piping when assembling and when installed. Failure to do so may cause piping to break, pump to fail, motor bearing failures, etc.

2. If the pump is used as part of a permanent installation, bolt to a rigid foundation.

**WARNING** Use only components that are rated for maximum pressure pump can produce when used in boosting system or any other system. Do not exceed the total maximum pressure boost as listed per model in Performance Charts B.

**PRESSURE BOOST SYSTEMS**

1. On pressure boost systems, locate the pump so that there will always be a positive supply of water to the pump (See Figures 6, 7 and 8).
2. For service convenience, install a gate valve and union in the inlet and discharge line.

**CAUTION** Do not use a globe valve or other restricting type of valve that will seriously restrict the pumps discharge capacity.

3. Install a check valve as shown in Figure 6. Be sure check valve flow arrows point in the direction of water flow.
4. Whenever dirt, sand or debris is present in the supply water, install a strainer or filter on the inlet side of the pump (See Figure 7).

**NOTE:** For heavy amounts of sediment, install a trap filter on the inlet side of the pump (See Figure 5).

**NOTE:** Pressure gauges installed before and after the filter will show pressure differential indicating the need for filter replacement or cleaning.



Figure 2 - No Air Pockets in Inlet Pipe

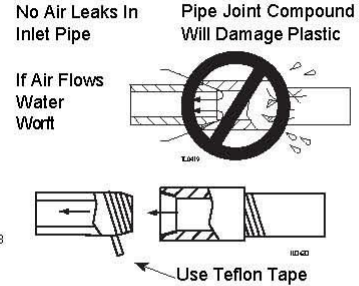

Figure 3 - Inlet Pipe Must Not Leak

**CAUTION** Mount pump in correct position or pump failure will result.

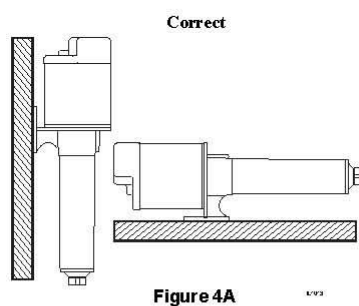

Figure 4A

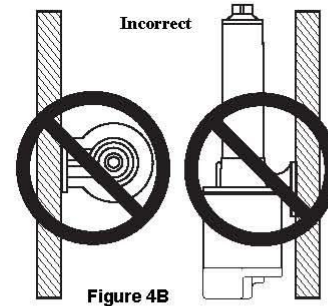

Figure 4B

**SAND AND SEDIMENT TRAP FILTER**

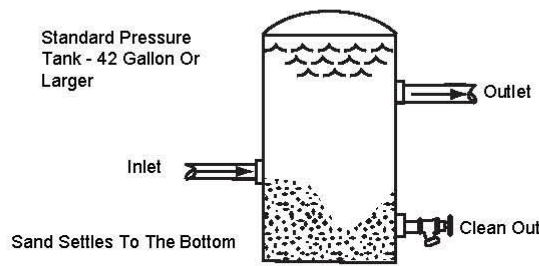

Figure 5

**IMPORTANT:** Clean all filters and strainers on a regular schedule.

### Installation (Continued)

5. A pressure gauge installed in the inlet pipe close to the inlet port, (See Figure 6) will show if enough water is being supplied to the pump. See Operation Section - Priming, Pressure Boost Installations.

6. On installations that are using nozzles for mist spraying, install a filter in the discharge plumbing to prevent the nozzles from becoming plugged. Multiple filters should be plumbed in parallel.

**WARNING** Install a pressure relief valve on any installation where pump pressure can exceed the pressure tank's maximum working pressure or on systems where the discharge line can be shut off or obstructed. Extreme over pressure can result in personal injury or property damage.

**CAUTION** This unit is not waterproof and is not intended to be used in showers, saunas or other potentially wet locations. The motor is designed to be used in a clean dry location with access to an adequate supply of cooling air. Ambient temperature around the motor should not exceed 104°F (40°C). For outdoor installations, motor must be protected by a cover that does not block airflow to and around the motor. This unit is not weatherproof nor is it able to be submerged in water or any other liquid.

**WARNING** To avoid dangerous or fatal electrical shock, turn off power to motor before working on electrical connections.

**WARNING** Supply voltage must be within  $\pm 10\%$  of nameplate voltage. Incorrect voltage can cause fire or seriously damage motor and voids warranty. If in doubt, consult a licensed electrician.

**WARNING** Use wire size specified in wiring Chart F. If possible, connect pump to a separate branch circuit with no other appliances on it. If motor wiring diagram differs from diagram shown below, follow diagram on motor.

Pump used to boost incoming city pressure (automatic operation).

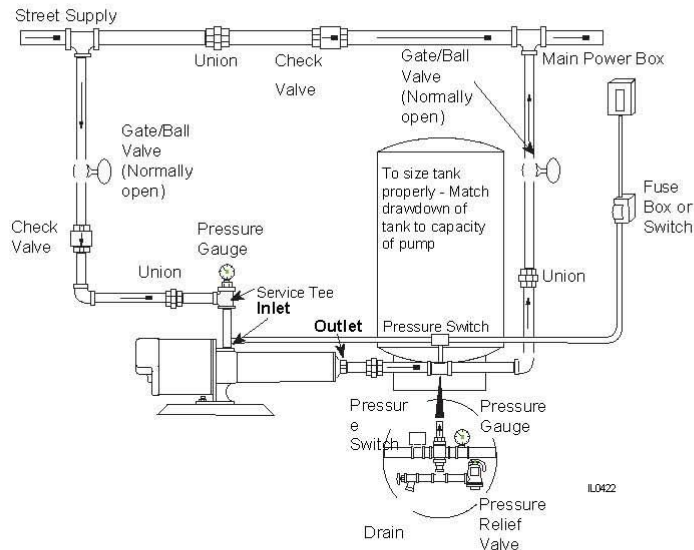

Figure 6

**IMPORTANT:** A contained air pressure tank and pressure switch is required to keep the pump from rapid cycling and prevent the motor from over heating. Install the tank and switch on the house side of system.

Pump used to boost water pressure in mist spray applications (automatic operation).

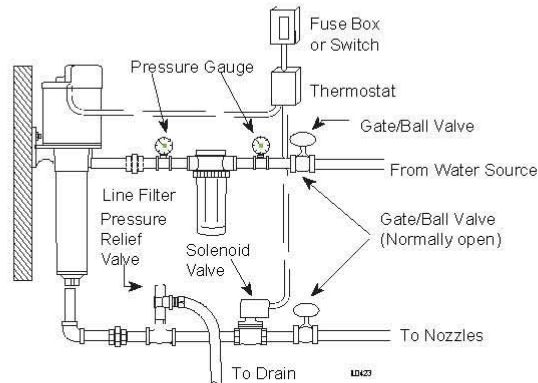

Figure 7

**NOTE:** Install solenoid valve on discharge side of pump.  
**IMPORTANT:** Clean all filters and strainers on a regular schedule.

**Installation (Continued)**

**▲WARNING**



- ▲ Ground motor before connecting to electrical power supply.
- ▲ Failure to ground motor can cause severe or fatal electrical shock hazard.
- ▲ Do not ground to a gas supply line.

**▲CAUTION**

Proper rotation of pump impeller is critical on three phase motors. See Motor Rotation under Operation section and Figure 12.

**WIRING**

1. Install, ground, wire and maintain this pump in accordance with your local electrical code and all other codes and ordinances that apply. Consult your local building inspector for local code information.
  2. Ground the pump permanently using a wire of size and type specified by local or United States National Electrical Code. **Do not ground to a gas supply line.**
  3. Connect ground wire first. Connect to ground first, then to green grounding terminal provided on the motor frame, identified as GRD. Ground connection **MUST** be made to this terminal. Do not connect motor to electrical power supply until unit is permanently grounded; otherwise serious or fatal electrical shock hazard may be caused.
  4. Connect the other end of the ground wire to a properly grounded service panel or to a control panel ground bar if it is connected to the power supply ground.
- IMPORTANT:** Check local and/or United States National Electric Codes for proper grounding information.

**▲CAUTION**

Make certain that the power supply conforms to the electrical specifications of the motor supplied. See Motor Data Charts.

Pump used to boost incoming pressure from a wall hydrant (manual operation).

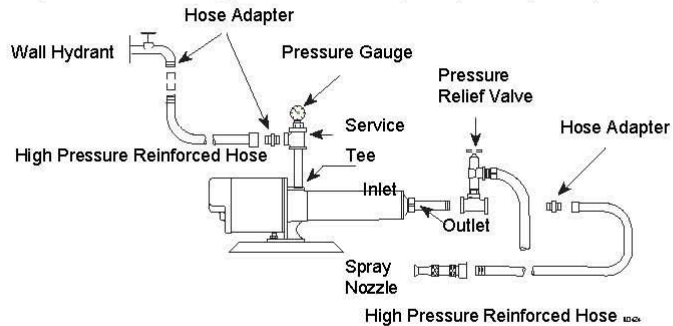
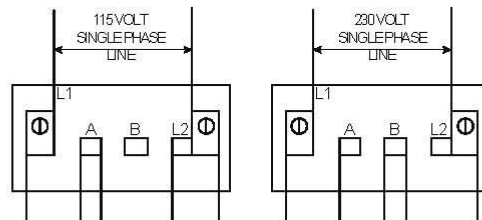
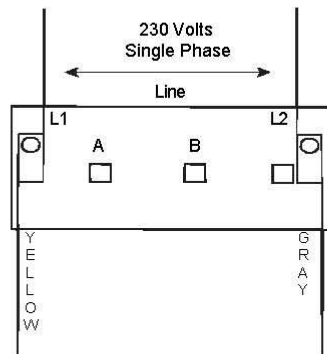

Figure 8



IL0180

**NOTE:** Dual voltage motors, change the red and gray wire to the voltage required.  
Figure 9 - Wiring Diagram for Single Phase 1/3 - 2 HP Motors



IL0181

**NOTE:** Single voltage (230V) motor, and can not be connected to 115V.

Figure 10 - Wiring Diagram for Single Phase 3 HP Motors

**Installation (Continued)**

**3Phase**

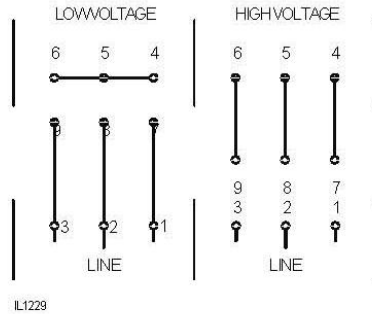

Figure 11 - Wiring Diagram for Baldor TEFC 3 Phase motors

**3Phase**

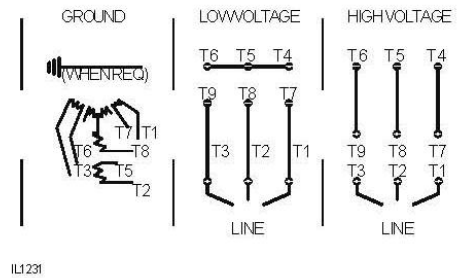

Figure 13 - Wiring Diagram for Marathon TEFC 3 Phase motors

**3Phase**

**1Phase**

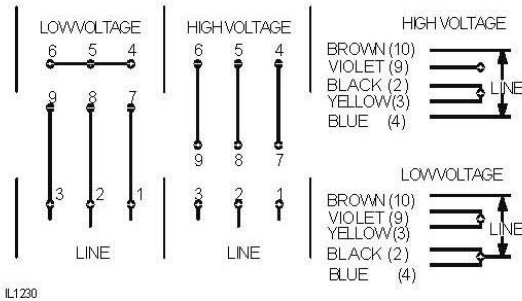
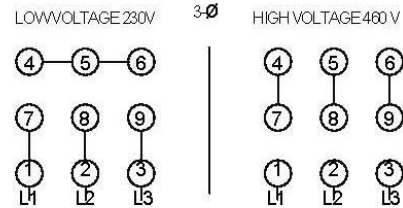

Figure 12 - Wiring Diagram for Franklin Electric TEFC 1 Phase and 3 Phase motors



- 1 - Tan
- 2 - Red
- 3 - Orange
- 4 - Yellow
- 5 - Black
- 6 - Blue
- 7 - Purple
- 8 - Gray
- 9 - White

CONNECTION FOR 3 PHASE, 9 LEADS. IF YOUR 3 PHASE LEADS ARE COLOR CODED, MATCH NUMBER ABOVE TO THE CORRESPONDING COLOR.

NOTE: To reverse rotation, interchange any two incoming lines (Power) leads.

Figure 14 - Wiring Diagram for Three Phase Motors



## Installation (Continued)

5. Specific Wiring Procedure (Refer to Figures 9, 10, 11, 12, 13, 14 and Minimum Wire Size Chart).
- Select the voltage you are to use, either 115V or 230V single phase, 230V or 460V three phase.
  - The 1/3, 1/2 and 3/4 HP single phase pumps are factory connected for 115V at the motor. The 1, 1 1/2, 2 and 3 HP pumps are factory connected for 230V at the motor. Three phase models are factory connected for 230V at the motor.
  - If the motor wiring must be changed to conform to your specific voltage requirements then the motor, pressure switch or other controls should be rewired to conform to one of the wiring diagrams (either 115V or 230V, single phase; 230V or 460V, three phase). Single phase 3 HP motors are 230V only and cannot be wired for 115V service.
  - The motor wiring diagrams are Figures 9, 10, 11, 12, 13 & 14, and also are located on the motor label of the pump.
6. Remove the rear access cover of the motor.  
7. Make the wiring change and replace the rear access cover.

**▲ WARNING** Replace rear access cover before starting or operating pump. Failure to do so can result in personal injury. **IMPORTANT:** Do not use an extension cord or splice wires. Joints should be made in an approved junction box. If the above information or the following wiring diagrams are confusing, consult a licensed electrician.

8. All units are not supplied with pressure switches, float devices, on/off switches, or the like (control devices). Controls should be wired in at this time, utilizing whatever instructions come with the controls. All units supplied with cords, will run whenever cord is plugged into power and will turn off whenever cord is disconnected from power.

### MOTOR PROTECTION

All single phase motors have built in thermal protection for all voltages. The overload protects the motor against burn-out from overload of low voltage, high voltage and other causes. The device is automatic and resets itself once the temperature has dropped to a safe point. Frequent tripping of the device indicates trouble in the motor or power lines and immediate attention is needed.

**▲ WARNING** Never examine, make wiring changes or touch the motor before disconnecting the main electrical supply switch. The thermal device may have opened the electrical circuit.

Three phase motors do not have a built in thermal protection. It is recommended that a properly sized magnetic or manual starter (both with properly sized heaters) be used with all three phase motors. Install starters following instructions of the starter manufacturer. See Motor Rotation under Operation Section for changing rotation on three phase motors.

All motors (single and three phase) should be equipped with a correctly fused disconnect switch to provide protection. Consult local or United States National Electric Codes for proper fuse protection based on motor data chart (See Charts C, D and Wire chart F).

## Operation

**▲ CAUTION** Unit must be full of fluid before operating. Do not run dry, or against a closed discharge. Do not pump dirty water or abrasive liquids. To do so will cause pump failure and will void the warranty.

### VALVES

The inlet valve should be in the full open position and the discharge valve should be partially open, permitting some back pressure to be exerted against the pump when starting up. Open valve after start up is completed.

### PRIMING

**NOTE:** Before starting the pump it is absolutely necessary that both the pump and the inlet pipe be completely filled with water.

### PRESSURE BOOST INSTALLATIONS

Priming is automatic when pump is connected to a pressure source such as a hydrant or city main (See Figures 6, 7 & 8).

- Open valves or nozzle on inlet and discharge side of pump.
- To relieve trapped air, allow water supply to run a minimum of 30 seconds before starting the pump.

**IMPORTANT:** An adequate flow of water going into the pump is required so that the pumps impellers and shaft seal do not run dry and fail.

- If you installed a pressure gauge at the pump inlet, a reading of 2 psi minimum should show whenever the pump is in operation (See Figures 6, 7 & 8).

This reading insures that there is an ample supply of water into the pump inlet housing.

### MOTOR/PUMP ROTATION

- Single phase models are one (1) rotation only (counterclockwise when facing the pump end) and cannot be reversed.
- Proper rotation of pump impeller is critical for three phase pumps. Pump motor should turn counterclockwise (CCW) when facing pump end. Momentarily "bump" (apply power for less than a second) the motor to check for proper rotation. To change rotation on three phase units, interchange any two (2) incoming line (power) leads.

**▲ CAUTION** Do not go over recommended maximum operating pressure (see Specifications), while maintaining minimum flow of 1.5 GPM thru the pump. Do not restrict the inlet line to the pump.

If driver (electric motor) is overloaded, a valve can be installed in the discharge line to increase the back pressure and reduce driver loading.

## Operation (Continued)

### START - UP PROCEDURE

Once the preceding instructions have been completed, the pump can be started.

1. During the first few hours of operation, inspect the pump, piping and any auxiliary equipment used in connection with the unit.
2. Check for leaks, excessive vibration or unusual noises.

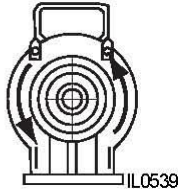

Figure 15 - Correct Motor/Pump Rotation (all units)

**NOTE:** See rotation arrow on inlet casting.

## Maintenance

**CAUTION** Disconnect power supply and depressurize system before servicing pump or removing any component.

### ROUTINE

Pump should be checked routinely for proper operation. Replace or clean all filters and line strainers on a regular basis.

### DRAINING

This pump cannot be completely drained because of internal design. Most of the liquid can be drained by tilting the discharge forward after removing discharge casting; or, the liquid can be drained through the inlet port. Store in heated areas.

### CLEANING

If used for spraying insecticides, pump should be thoroughly flushed with clean water after using.

### LUBRICATION

The motor has prelubricated bearings. No lubrication is required.

### SERVICING THREE-PHASE UNITS

Loctite (thread sealer) is used on the threads between the motor shaft and the pump shaft coupling. When reassembling, reapply thread sealer.

### PUMP DISASSEMBLY

To disassemble the pump, refer to the exploded parts view and Figures 16, 17 & 18

#### Tools Required:

- Block of wood (2" x 4" x 12")
- Piece of 3/4" pipe (12" to 24" long)
- Pipe wrench
- Strap wrench
- 1/4" Dowel rod (about 24" long)
- 9/16" Open end wrench
- 3/8" Open end wrench

1. To stabilize pump during disassembly, place block of wood underneath pump barrel.
2. Thread pipe into pump inlet port. This acts as a handle.
3. Using the pipe wrench, remove the discharge head, turning CCW (counter clockwise).
4. With the strap wrench, loosen the barrel, turning CCW (counter clockwise). DO NOT use pipe wrench on pump

barrel.

5. Holding the impeller stack in place, position pump in upright position, standing unit on the motor end cover. 6. Use the 1/4" dowel rod to hold the stages down and in place on the pump shaft. Remove pump barrel.
7. Slide the stages off the pump shaft onto the 1/4" dowel rod. Leave stages on rod and carefully set aside.

**NOTE:** There may be some small .010" shim washers located next to the pump shaft coupling. Keep these shims for re-assembly.

8. Through the side opening of the mounting frame, hold the motor shaft with 9/16" wrench. Remove the shaft and coupling from the motor using the 3/8" wrench on the hex shaped pump shaft.

**NOTE:** If the hex shaft comes free, leaving the coupling attached to the motor, use vise grips to free the coupling.

### MECHANICAL SEAL REPLACEMENT

1. Follow instructions under "Pump Disassembly".
2. Remove the mechanical seal assembly.
  - a. The rotary portion of the seal assembly (carbon ring, Buna-N gasket and spring will slide easily off the end of shaft).
  - b. Using two (2) screwdrivers, pry the ceramic seal and rubber gasket from the recess of the mounting ring (See Figure 16).

**CAUTION** The precision lapped faces of the mechanical seal are easily damaged. Handle the replacement seal carefully. Short seal life will result if seal faces (ceramic & carbon) are nicked, scratched or dirty.

3. Clean the seal cavity of the mounting ring and the motor thoroughly.
4. Wet outer edge of rubber cup on ceramic seat with liquid soap solution. Use sparingly (one drop only).

**NOTE:** Liquid soap solution - one drop of liquid soap combined with one teaspoonful of water.

5. With thumb pressure, press ceramic seal half firmly and squarely into seal cavity. Polished face of ceramic seat is up. If seal will not seat correctly, remove, placing seal face up on bench. Reclean cavity. Seal should now seat correctly (See Figure 17).
6. If seal does not seat correctly after recleaning cavity, place a cardboard washer over polished seal face and carefully press into place using a piece of standard clean 3/4" pipe as a press (See Figure 18).



### Maintenance (Continued)

**IMPORTANT:** Do not scratch seal face.

7. Dispose of cardboard washer and recheck seal face to be sure it is free of dirt, foreign particles, scratches and grease.
8. Inspect shaft to be sure it is free of nicks and scratches.
9. Apply liquid soap solution sparingly (one drop is sufficient) to inside diameter of rubber rotating member.
10. Slide rotating seal member (carbon face down toward ceramic face) and spring over the shaft.

**IMPORTANT:** Do not nick or scratch carbon face of seal when handling.

#### MOTOR REPLACEMENT

The motor can be replaced with any standard Nema 56J jet pump motor (of proper HP for each pump) by referring to the following instructions.

1. Follow steps as outlined under Rotary Seal Replacement and Pump Disassembly.
2. Remove cap screws that connect the motor to the mounting ring and pull motor away.
3. Replace motor with standard Nema 56J jet pump motor by positioning motor against the mounting frame and assembling with four (4) cap screws.

**IMPORTANT:** Because damage to the shaft seal can occur in disassembly, a new seal will be necessary.

#### PUMP REASSEMBLY

Before reassembling the pump, carefully inspect the component parts of the cartridge (stage) assembly, looking for damage, wear or heat distortion. Pay careful attention to spacing direction of components, and location of shims.

Refer to Figure 19 for proper facing and parts arrangement.

If damage to Stage components is evident, a complete cartridge assembly or individual stage assemblies are available for replacement (See Replacement Parts List).

1. Reassembly should follow the reverse order of the disassembly procedure with special care given to replacement of the rotary seal.
2. Check top and bottom of o-rings for damage. It is recommended that new o-rings be used.
3. Do not use pipe compound or Teflon tape on barrel threads. The o-rings will prevent pump from leaking.
4. After pump is reassembled, tighten the discharge head to a torque of 45-50 ft/lbs. If torque wrench is not available, tighten firmly but avoid distortion or damage to plastic internal parts.
5. After reassembly, apply power momentarily to unit (15 to 30 seconds). The pump and motor should rotate freely or with a light rubbing.



Figure 16 - Remove Mechanical Seal



Figure 17 - Press In Seal

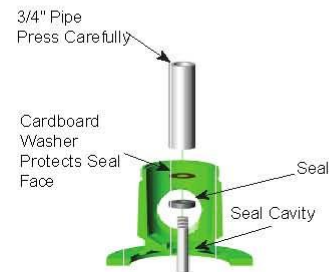

10554  
Figure 18 - If Necessary, Press With Cardboard And Pipe

Troubleshooting Chart		
Symptom	Possible Cause(s)	Corrective Action
Pump won't start or run at full speed	<ol style="list-style-type: none"> <li>Blown fuse or open circuit breaker</li> <li>Power supply in OFF position</li> <li>Incorrect voltage at motor (check voltage with motor running)</li> <li>Loose, broken or incorrect wiring</li> <li>Defective motor</li> <li>Pump hydraulic components clogged/worn/damaged</li> </ol>	<ol style="list-style-type: none"> <li>Replace fuse or close circuit breaker. See wire size chart for proper break/fuse size</li> <li>Turn power on</li> <li>Low voltage               <ol style="list-style-type: none"> <li>Voltage must be within <math>\pm 10\%</math> of motor rated voltage. Check incoming voltage. Contact power company</li> <li>Make certain that voltage of motor matches voltage of power supply. See motor name plate and motor wiring diagrams</li> <li>Check wire size from main switch to pump. See wire size chart for correct wire size</li> </ol> </li> <li>Rewire any incorrect circuits. Tighten connections, replace defective wires</li> <li>Replace motor</li> <li>Replace worn parts or entire pump. Clean parts if required</li> </ol>
Pump operates, but delivers little or no water	<ol style="list-style-type: none"> <li>Manual or solenoid valves plumbed into system restricting flow</li> <li>In-line filter restricting flow</li> <li>Low line voltage</li> <li>Inadequate water supply to booster pump</li> <li>Undersized piping</li> <li>Leak on inlet side of system</li> <li>Inadequate, defective or plugged foot valve and/or strainer</li> <li>Worn or defective pump parts or pump.</li> <li>Suction lift too great</li> <li>Pump not primed</li> <li>Incorrect rotation, motor running backwards</li> </ol>	<ol style="list-style-type: none"> <li> <ol style="list-style-type: none"> <li>Check all valves on pump inlet and discharge sides of system to be sure they are opened properly to allow flow to and from the pump</li> <li>Bleed trapped air in pump which keeps water from reaching the pump. (Normally due to closed valve in discharge plumbing)</li> </ol> </li> <li>Check all in-line filters to be sure they are not plugged or restricted</li> <li>See low line voltage corrective action (above)</li> <li>Check pressure on inlet side of booster to be sure positive pressure is maintained to the booster pump</li> <li>Replace undersized piping</li> <li>Make sure connections are tight. Repair leaks as necessary</li> <li>Clean, repair or replace as needed</li> <li>Replace worn parts or entire plugged impeller Clean parts if</li> <li>Pump should be operated under flooded suction only</li> <li>Prime pump - Make certain inlet pipe is drawn up tight and pump and pipe are full of water</li> <li>Reverse motor rotation can occur on three phase units. To correct, interchange any two incoming power leads.</li> </ol>
Excessive noise while pump in	<ol style="list-style-type: none"> <li>Pump not secured to firm foundation</li> <li>Piping not supported</li> <li>Restricted inlet line</li> <li>Cavitation (noise like marbles in pump)</li> <li>Worn motor bearings</li> </ol>	<ol style="list-style-type: none"> <li>Secure properly</li> <li>Make necessary adjustments</li> <li>Clean or correct</li> <li> <ol style="list-style-type: none"> <li>Reduce speed on direct drive</li> <li>Increase inlet pipe size</li> <li>Too viscous (material being pumped too thick)</li> </ol> </li> <li>Replace bearings or motor</li> </ol>
Pump leaks	<ol style="list-style-type: none"> <li>Worn mechanical seal (leaks at shaft)</li> <li>Worn o-ring seals</li> </ol>	<ol style="list-style-type: none"> <li>Replace shaft (rotary) seal</li> <li>Replace o-ring seals, located inside both ends of the stainless steel shell</li> </ol>

Booster Pump Parts Drawing

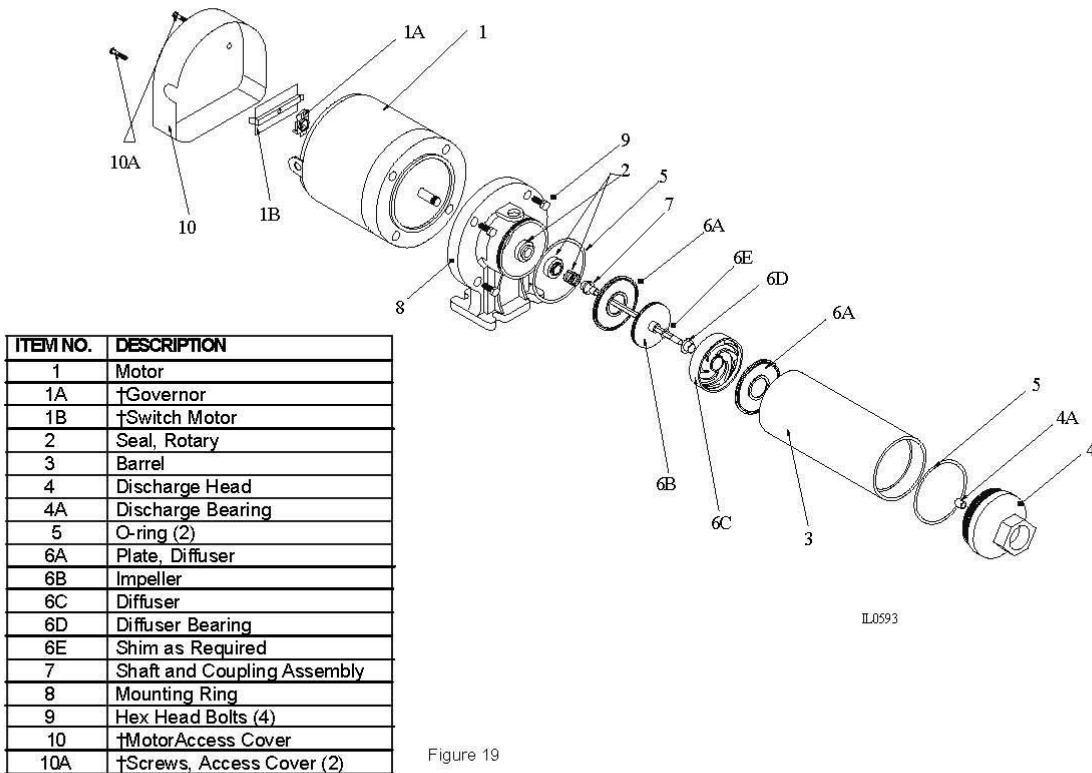

\*See note below parts included in cartridge assembly.  
†ODP Motor Only

Internal Parts Detail

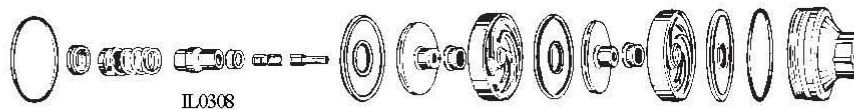
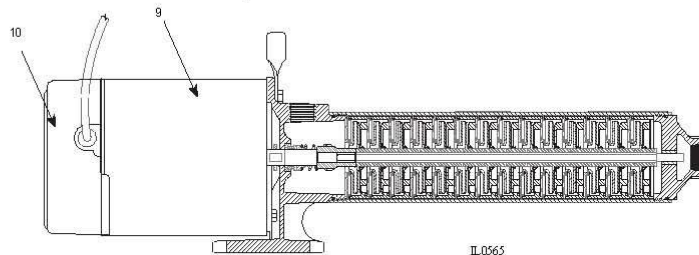

Figure 20 - Cartridge Assembly Includes Discharge Bearing, Shaft & Coupling Assembly, Diffuser Plate, Impellers, Diffuser Bearings, Diffusers and O-rings

**NOTE:** Illustration shows only two stages. Pump has multiple stages. Individual parts are not available separately.

**PRESSURE BOOSTER PUMP REPAIR PARTS**  
(For Pricing Refer To Repair Parts Price List)  
Replacement Motors

FORM NO. FW0045  
02/08  
SUPERSEDES 0907  
PAGE 4-7A REPAIR PARTS



ITEM	REPLACEMENT MOTORS	QTY	CAST IRON	POWDER COATED	STAINLESS STEEL	CAST IRON	POWDER COATED	STAINLESS STEEL
			<b>SINGLE PHASE 60 HZ</b>			<b>THREE PHASE 60 HZ</b>		
9	ODP NEMA J 1/3 HP	1	98J103	98J103	98S103			
	ODP NEMA J 1/2 HP		98J105	98J105	98S105	98J305	98J305	98S305
	ODP NEMA J 3/4 HP		98J107	98J107	98S107	98J307	98J307	98S307
	ODP NEMA J 1 HP		98J110	98J110	98S110	98J310	98J310	98S310
	ODP NEMA J 1-1/2 HP		98J115	98J115	98S115	98J315	98J315	98S315
	ODP NEMA J 2 HP		98J120	98J120	98S120	98J320	98J320	98S320
	ODP NEMA J 3 HP		98J630	98J630	98S630	98J330	98J330	98S330
10	Motor Cover w/Screws	1	136132R	136132R	136132R	136132R	136132R	
*	Screws, Motor Cover	2	136133	136133	136133	136133	136133	
			<b>SINGLE PHASE 50 HZ</b>			<b>THREE PHASE 60/50 HZ</b>		
9	ODP NEMA J 1/3 HP	1	98J003	98J003	98S003			
	ODP NEMA J 1/2 HP		98J005	98J005	98S005	98J305	98J305	98S305
	ODP NEMA J 3/4 HP		98J007	98J007	98S007	98J307	98J307	98S307
	ODP NEMA J 1 HP		98J010	98J010	98S010	98J310	98J310	98S310
	ODP NEMA J 1-1/2 HP		98J015	98J015	98S015	98J315	98J315	98S315
	ODP NEMA J 2 HP		98J620	98J620	98S620	98J320	98J320	98S320
	10		Motor Cover w/Screws	1	136132R	136132R	136132R	136132R
*	Screws, Motor Cover	2	136133	136133	136133	136133	136133	
			<b>SINGLE PHASE 60/50 HZ</b>			<b>THREE PHASE 60/50 HZ</b>		
9	TEFC NEMA J 1/2 HP	1		020691	020691		021011	021011
	TEFC NEMA J 3/4 HP			021008	021008		021012	021012
	TEFC NEMA J 1 HP			021009	021009		020688	020688
	TEFC NEMA J 1-1/2 HP			020692	020692		020647	020647
	TEFC NEMA J 2 HP			020693	020693		020689	020689
	TEFC NEMA J 3 HP			021010	021010		020690	020690

\* Not Shown



FORM NO. FW0046  
0509  
SUPERSEDES 0907  
PAGE 4-8A REPAIR PARTS

**PRESSURE BOOSTER PUMP REPAIR PARTS**  
(For Pricing Refer To Repair Parts Price List)

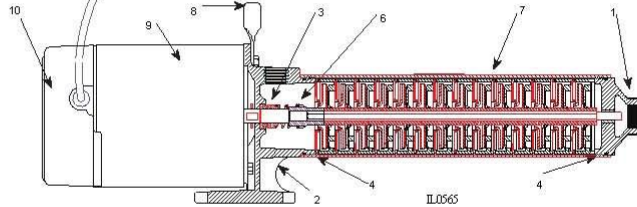

	ITEM	DESCRIPTION	QTY	CAST IRON	POWDER COATED	STAINLESS STEEL	
5 - 7 - 10 - 19 GPM, 60 HZ & 50 HZ	1	Discharge Head 3/4" NPT	1	132000	136905	136640	See replacement motors. ITEMS 9 & 10
	2	Mounting Ring 3/4" NPT	1	132002	136904	136639	
27 - 35 GPM, 60 HZ & 50 HZ	1	Discharge Head 1" NPT	1	136635	137796	139166	
	2	Mounting Ring 1" NPT	1	136634	137794	139100	
55 - 85 GPM, 60 HZ & 50 HZ	1	Discharge Head 2" NPT	1	021585	-	-	
	2	Mounting Ring 2" NPT	1	021584	-	-	
ALL SERIES 60 HZ & 50 HZ	3	Seal, Rotary w/Spring	1	131100 †	131100 †	136682 †	
	4	O-Ring	2	131925 ■	131925 ■	136607 ▲	
	*	Hex Head Cap Screws 3/8" x 3/4"	4	121106	121106	121106	

(†) Buna N - Carbon/Silicon Carbide (‡) Viton - Carbon/Silicon Carbide (■) Buna N (▲) Viton (\*) Not Shown  
(8) 132079 Handle available as an option

ITEM	DESCRIPTION	MATERIAL	PART NUMBER							
			CAST IRON	CI	PB0508AXXX	PB0512AXXX	PB0516AXXX	PB0712AXXX	PB1014AXXX	PB1016AXXX
			POWDER COATED	PC	PB0508CXXX	PB0512CXXX	PB0516CXXX	PB0712CXXX	PB1014CXXX	PB1016CXXX
5	Cartridge Assembly †	CI & PC	135163	132939	138447	134097	134998	136814		
		SS		136683	138450	136684	136685	136686		
6	Shaft & Coupling Assembly	CI & PC	135161	133336	138446	133336	134996	136813		
		SS	138938	136636	138449	136636	136637	136638		
7	Barrel/Shell	CI, PC & SS	135162	132003	138448	132003	134997	136815		

ITEM	DESCRIPTION	MATERIAL	PART NUMBER						
			CAST IRON	CI	PB1914AXXX	PB2711AXXX	PB2714AXXX	PB3506AXXX	PB3508AXXX
			POWDER COATED	PC	PB1914CXXX	PB2711CXXX	PB2714CXXX	PB3506CXXX	PB3508CXXX
5	Cartridge Assembly †	CI & PC	137222	135627	136629	136626	136632		
		SS	139162	139163	138946	139164	139165		
6	Shaft & Coupling Assembly	CI & PC	137221	136624	136628	136625	136631		
		SS	139159	139157	137535	139156	139158		
7	Barrel/Shell	CI, PC & SS	137223	135628	136630	136627	136633		

ITEM	DESCRIPTION	MATERIAL	PART NUMBER					
			CAST IRON	CI	PB5504XX	PB5506XX	PB8504XX	PB8505XX
			POWDER COATED	PC	PB5504XXX	PB5506XXX	PB8504XXX	PB8505XXX
5	Cartridge Assembly †	CI	022293	022294	022296	022296		
6	Shaft & Coupling Assembly	CI	022289	022287	022288	022287 7		
		CI, PC & SS	022291	022292	138151	022290		

ITEM	DESCRIPTION	MATERIAL	PART NUMBER							
			CAST IRON	CI	PB0508XXX	PB0514XXX	PB0714XXX	PB1020XXX	PB1022XXX	PB1023XXX
			POWDER COATED	PC	PB0508ZXXX	PB0514ZXXX	PB0714ZXXX	PB1020ZXXX	PB1022ZXXX	PB1023ZXXX
5	Cartridge Assembly †	CI & PC	135163	138150	021032	135907		135911		
		SS		136682	021033	138883	020280	136684		
6	Shaft & Coupling Assembly	CI & PC	135161	138149	138149	135906	020278	135910		
		SS	138938	138444	138444	138154	020278	137103		
7	Barrel	CI, PC & SS	135162	138151	138151	135098	020094	135912		

ITEM	DESCRIPTION	MATERIAL	PART NUMBER					
			CAST IRON	CI	PB1920XXX	PB2717XXX	PB3508XXX	PB3514XXX
			POWDER COATED	PC	PB1920ZXXX	PB2717ZXXX	PB3508ZXXX	PB3514ZXXX
5	Cartridge Assembly †	CI & PC	020982	020980	136632	021017	139435	
		SS	020095	138949	139165	021026	*	
6	Shaft & Coupling Assembly	CI & PC	020971	020916	136631	021015	139434	
		SS	020093	138948	139158	021020	021425	
7	Barrel	CI, PC & SS	020094	138947	136633	021016	139436	

(†) Cartridge assembly includes: impellers, diffusers and shaft & coupling assembly. Components not available individually. Sold as assembly only.





## SYSTEM START-UP

### Do Not Turn On Power Until Directed To Do So

- Step 1 **(Systems w/ high pressure option)** Flush incoming water line before filling the water tanks on the eFusion. Connect Water Line and fill rinse tank. Check to make sure water is clean with no cloudy residue. If the water is cloudy or dirty, continue to flush lines.
- Step 2 Fill Concentrate Tanks with quality chemicals.
- Step 3 If system has high pressure option, remove the tips in the undercarriage bar and high-pressure gantry arch and then flush the lines. To do this, follow the steps listed in the "Test Screen".
- Step 4 Turn on the air compressor and set to approximately 100 PSI. Adjust pressure on gantry mounted regulator to 100 PSI.
- Step 5 Turn off the Electrical Disconnect Switch on Gantry. Turn on Electrical Disconnect Switch on Electrical Control Center ("ECC") inside Equipment Room. The Red Lion Operator Interface Panel should come on.
- Step 6 Press the F7 "Tech Menu" button and scroll to Test Function. Turn on Presoak for about 2-3 minutes to flush line and get product to the Gantry. Turn on Tire Cleaner for about two (2) minutes. Turn on Rinse to flush lines then turn off. Continue to test services until you test all functions that apply to your machine. Modify low pressure applications by adjusting air pressure using the regulators inside the low pressure box.
- Step 7 Turn on the Manual Operation Toggle Switch located inside the Gantry Control Panel mounted on the gantry. Turn on power at Electrical Disconnect Switch located on Gantry. Check the rotation of the drive motors by pressing the Drive Reverse Switch. This should cause the unit to travel away from home position. If not, then have a qualified electrician change the incoming 3-phase power to correct the rotation.
- Press the Top Brush Down and it should lower. Use these manual buttons to test all the gantry functions for proper operation. Also use the buttons the check brush rotation and operation. **(SEE ROTATION CHARTS ON PAGES 17 & 18)**
- Step 8 Move the unit up and down the track by pressing the Drive Forward and Drive Reverse Switches. Make sure the Prox Switches are set properly to read the Home and End of Track targets. They should have approximately 3/8ths inch clearance.

## INITIALIZING THE SYSTEM

Step 9 First perform a “Wheel test, Side Brush, Top Brush and Boom Test”. These tests can be accessed in the “F7 Tech Menu” of the Red Lion Interface Panel. This test will allow the PLC to store the correct length of travel for each of these components. **THIS MUST BE DONE TO ENSURE PROPER OPERATION**

Next you **MUST** save the Treadle position that is required for the wheel brush to locate vehicle front wheels. This setting is done in “F2 Adjust Gantry Counts”. The best way to accomplish this is to park a vehicle on the treadle plate and with the gantry in manual mode, position the gantry until the wheel brushes are aligned with the exact center of the front wheels. Press the “Wheel Brush Extend” manual push button to confirm alignment. Now press “Save” on the Red Lion Display to store this position.

**Assigning Recipes:** Assign the Recipes in “F1 Recipe Menu” that you wish to use. Factory recipes are listed in your manual for both combination and touchfree wash cycles.

### **IMPORTANT: Brush No Load Tests**

1. Go to “F7-Tech Menu” on your Red Lion. Use the Raise key until you get to Menu Option 30 – “TB No Load Test” and press Enter. See the pictures below.
2. Now you need to switch the Gantry manual toggle switch “On” and **lower the Top Brush about 18-24”** to get the brush **out of the nest** then press the arrow under the display on the Red Lion, where it says “Test”. The word “Off” will change to “Testing”.
3. The Top Brush will begin to spin and you will see the “PV” value begin to change (PV = Present Value).
4. After about 8 seconds, you will see that the “NL” value has now been set (NL = No Load).
5. If the brush components are in good mechanical condition and **the brushes were not in contact with any surface**, the test is complete. You can now press the arrow under the display, where it says “Accept”. The word “Off” will change to “Writing”.
6. When the word “Off” returns under “Accept”, this brush test is complete.
7. You can now press the “Prev” button then raise up to Menu Option 31 – LB No Load Test and Menu Option 32 – RB No Load Test and repeat the procedures above for each brush.
8. These procedures are required to calibrate the acceptable no load brush torque based on the incoming voltage at your site. **NOTE: These procedures will have to be repeated periodically to recalibrate acceptable no load torque after some time in service due to normal mechanical wear. It is recommended repeat at least once within the first 30 days of operation and as needed thereafter.**

```

Technician Menu
Raise/Lower selects..
Menu Option: 30
TB No Load Test
Enter Selects Option
    
```

```

TB No Load Torq
Capture NL torque
PU:      0.1 %
NL:      37.9 %
% NL    - 99.9 %
Test Off  Accept Off
    
```

```

Technician Menu
Raise/Lower selects..
Menu Option: 31
LB No Load Test
Enter Selects Option
    
```

```

LB No Load Torq
Capture NL torque
PU:      0.0 %
NL:      37.9 %
% NL    -100.1 %
Test Off  Accept Off
    
```

```

Technician Menu
Raise/Lower selects..
Menu Option: 32
RB No Load Test
Enter Selects Option
    
```

```

RB No Load Torq
Capture NL torque
PU:      0.0 %
NL:      44.1 %
% NL    - 99.9 %
Test Off  Accept Off
    
```

## SITE DATA SETTINGS

Step 10 Press F5 and enter the "Owner" password. The default password is "1234". Then Press F8 and scroll through each option. Set each option to match your equipment. Example; if you have on-board blowers you must enter "Equipped". If no blowers or if the blowers are free standing, then select "Not equipped".

Scroll through the remaining screens and select the option that matches your equipment package.

Step 11 You are now ready to test the unit on a car. Pull vehicle into bay and place in park position with front wheel on stop station. Press the Cycle 1 button on the Electrical Panel and watch the eFusion go through the wash process. Check for leaks and correct as needed. Once completed, press cycle 2 Button and monitor wash process. Repeat the same procedure for Cycle 3 and 4. Only after washing several vehicles should you need to adjust the different chemicals that are being applied to the car.

- Test the eFusion many times to ensure it is functioning properly.
- Refer to "Brush Position Settings" beginning on Page 5 for adjustments to brush positions.
- Check all Prox Switch settings to ensure there is a gap of at least 3/8".
- Check all Proxes to ensure they are exactly square with their target.

### ***Wheel Scrub Features and Set-up Instructions***

You will find a recipe bit titled “Wheel Brushes” in the Program Recipe menu. A custom recipe is required to apply this function to a wash recipe. You cannot perform the wheel brush step on the first pass of a wash recipe. The wheel brush photo eye must first find the rear wheel position.

#### ***Air Pressure Adjustments***

There are two air regulators to move the brushes in and out, one of them to extend and one to retract. The extend regulator adjustment is very critical and should be adjusted to the lowest possible operating pressure, usually about 20 psi. Very little pressure is required to clean the vehicle wheels and too much air pressure could cause unnecessary load and wear on the wheel brush spindle gearmotors. The retract regulator should be adjusted so the brushes return smoothly but positively into their home position, usually about 30 psi.

#### ***Timers***

There are also two timers and two counters associated with this option. Under “F2-Timers & Counters” on the Red Lion, go to the “Adjust Timers” menu (Menu Option 0) and press the “Enter” button until you see a timer called “Wheel Brush Dwell”. This timer determines how long the brush will stay engaged in the wheel in each direction (clockwise & counter-clockwise). This is factory set to 3 seconds.

Press the “Next” button to advance to the “Wheel Brush Retract Dwell” timer. This timer determines how long the brush disengages from the wheel between direction changes. This timer is factory set to 1 second. You want the brushes to disengage the wheel slightly while it changes directions. If it does not, you would want to increase this timer value.

#### ***Counters***

Since we always know where the front tire will be because of the Treadle, we use that to our advantage. Under “F2-Timers & Counters”, go to “Adjust Gantry Counts” menu (Menu Option 1) and press the “Enter” button. There you will see an adjustable counter titled “Treadle Position”.

#### ***Setting Front Wheel Counter***

To set this counter, put the gantry in manual mode (turn toggle switch in gantry panel ‘on’), and manually position the gantry until the wheel brush is perfectly aligned with the center of the treadle eye. It is best if there is a vehicle parked properly on the treadle plate to achieve the best result. Manually extend the wheel brush to assure you are in the proper position using the manual push buttons for the Wheel Brush located in the gantry control panel.

Once you have achieved this position go back to the Red Lion and press the arrow key that is located directly below the center of the screen, below the word “Off” on the display. This word will then change to “On”. You will see the value under the word “Treadle” change. You have now set where the wheel brush will position at the front tire when the wheel brush function is performed in a wash recipe.

#### ***Setting Rear Wheel Counter***

The wheel brush photo eye will locate the rear wheel position in pass 1. This position is also adjustable. Watch it wash a variety of vehicles to determine if the rear wheel position should be adjusted.

If you determine that this adjustment must be done, Under “F2-Timers & Counters”, go to “Adjust Gantry Counts” menu (Menu Option 1) and press the “Enter” button. Now press the “Next” button repeatedly until you see a counter called “Rear Wheel Offset”.

If you need to adjust the rear wheel brush position closer to the front of the vehicle, you should decrease this counter. If you need to adjust the rear wheel brush position closer to the rear of the vehicle, you should increase this counter. The counters on the eFusion and the FusionX are incremented in inches. If the Wheel Brush always positions about 2 inches past the center of the rear wheels, you can decrease the counter setting by 2 inches.

## FusionX and eFusion

### *Instructions for loading OMRON PLC and Red Lion memory module*

#### **SAVING EXISTING RECIPES and REVENUE (*Recipes and Revenue are stored in the PLC NOT the Red Lion*)**

1. With power on to the PLC, insert memory card into the slot in the PLC. Press the F5/Log In Page button and log in using the owner password. Press F6/Memory Card and select Recipe Mode then press Save Recipes twice. Remove the memory card with power still on.
2. **DO NOT CYCLE POWER ON & OFF.**

#### **RED LION Operator Interface**

1. Turn off power to the display. Plug memory card into the slot located on the side of the Red Lion.
2. Turn on power to display. Wait for display to load program from memory card. (Observe text – LOADING CF). Once the screen is back to the main screen make sure the HMI number matches the version number you are loading.
3. After program is loaded, turn off power and remove card from display. Turn power back on.

#### **OMRON PLC (Loading Program Instructions)**

1. Turn off power to PLC. Open cover plate (located above the memory card slot) on CJ1G-CPU44 PLC module. Here you'll see 8 switches numbered 1-8 from top to bottom. Turn on DIP SW 7. (push switch to left position). Insert memory card into slot. Card is properly seated when the eject button is even with the top.
2. Turn on power to PLC. Wait for “busy” light to extinguish (about 5 to 10 seconds) and the main screen is up.
3. Turn off power to PLC. Remove memory card. Turn off DIP SW 7 (push switch to right position).
4. Turn on power to PLC.

#### **DOWNLOADING SAVED RECIPES**

1. With power on to the PLC, insert the memory card. Press the F5/Log In Page button and log in using the owner password. Press F6/Memory Card and select Recipe Mode then press Load Recipes twice.
2. Remove the memory card with power on. **DO NOT CYCLE POWER ON & OFF**

## Fusion - Gantry Counter Values

Red Lion Description	eFusion Default Settings	FusionX Default Settings	Red Lion Software Limits	
			Minimum Value	Maximum Value
Start Gantry (Boom, Fx) @ Front	(-12.5)	(-12.5)	-30.0	+0.0
Start Gantry (Boom, Fx) @ Rear	(+40.0)	(+40.0)	+20.0	+60.0
Front Brush Pass	(+17.0)	(+42.0)	+10.0	+50.0
Rear Brush Pass	(+44.0)	(+60.0)	+38.0	+75.0
Start Side Brushes @ Front	(+24.0)	(+48.0)	+15.0	+55.0
Start Side Brushes @ Rear	(+30.0)	(+55.0)	+25.0	+65.0
Start Top Brush @ Front	(-18.0)	(-20.0)	-30.0	+0.0
Start Top Brush @ Rear	(-26.0)	(-18.0)	-35.0	+0.0
Rear TB Pass on Long Vehicles	(-18.0)	(-14.0)	-30.0	+5.0
Start LP Wax @ Front	(+4.0)	(+4.0)	-20.0	+20.0
Start LP Wax @ Rear	(+10.0)	(+10.0)	-20.0	+20.0
Start Trifoam @ Front	(+0.0)	(+22.0)	-30.0	+30.0
Start Trifoam @ Rear	(+10.0)	(+30.0)	+0.0	+75.0
Start Presoak @ Front	(-12.0)	(-12.0)	-30.0	+0.0
Start Presoak @ Rear	(+16.0)	(+20.0)	+0.0	+75.0
Start Rocker Panel @ Front	(-7.0)	(-7.0)	-20.0	+10.0
Start Rocker Panel @ Rear	(+28.5)	(+10.0)	+0.0	+50.0
Start Side Sprays @ Front	(-15.0)	(-5.0)	-30.0	+10.0
Start Side Sprays @ Rear	(+25.0)	(+4.0)	-10.0	+50.0
Start TC (tire cleaner) @ Front	(-5.0)	(+0.0)	-20.0	+10.0
Start TC (tire cleaner) @ Rear	(-2.2)	(+10.0)	-20.0	+30.0
Start SB (side brush) Lube @ Front	(+21.0)	(+45.0)	+0.0	+75.0
Start SB (side brush) Lube @ Rear	(+33.0)	(+58.0)	+0.0	+75.0
Start TB (top brush) Lube @ Front	(-21.0)	(-23.0)	-50.0	+10.0
Start TB (top brush) Lube @ Rear	(-23.0)	(-15.0)	-50.0	+10.0
TB (top brush) Lower Limit @ Rear	(+66.0)	(+66.0)	+0.0	+70.0
Wheel Brush Offset @ Rear	(+0.0)	(+0.0)	-20.0	+20.0
Flip Blower @ Front	(+5.0)	(+5.0)	-50.0	+100.0
Flip Blower @ Rear	(+0.0)	(+0.0)	-50.0	+50.0
Presoak Overlap @ middle of car	+3.0	+3.0	+0.0	+20.0



## eFusion Start Up Brush Position Settings

The following settings are based on the center line of the treadle eye being located 70 inches from the entrance end of the home prox target. Any variance in this dimension will require adjustments to the brush start positioners for proper operation. **See the chart on page 7 for factory default settings.**

These settings are located in the F2 Timers and Counters button on the Red Lion.

```

Timers & Counts
Raise/Lower selects..
Menu Option: 1
Adjust Gantry Cntr
Enter selects option
  
```

First set the wheel brush position for the front wheel. Since we always know the position of the front wheel, we can set this dimension as a fixed distance. Manually move the gantry to where the center of the wheel brush is at the center line of the eye on the treadle. Then press Enter. This will lock in this position for all wash cycles.

```

Treadle Position
Center wheel brushes
on centerline of
treadle. Press Enter
Gantry  Enter  Treadle
0.0    Off    34.5
  
```

This screen sets the gantry position when the rinse spray starts at the front of the car. Decrease the number to move the brush closer to the exit end of the wash bay.

```

Start Gantry
at front of car
Stop Gantry in front
of measurement eye...
- 21.0 "
  
```

This screen sets the gantry position when the rinse spray starts at the rear of the car. Decrease the number to move the brush closer to the exit end of the wash bay.



This screen sets the gantry position when the side brushes wash the front of the car. Decrease the number to move the brush closer to the exit end of the wash bay.



This screen sets the gantry position when the side brushes wash the rear of the car. Increase the number to move the brush toward the entrance end of the wash bay.



This screen sets the gantry position at the front when the side brushes wash the sides of car. Decrease the number to start the side brushes more towards the exit end of the wash bay.

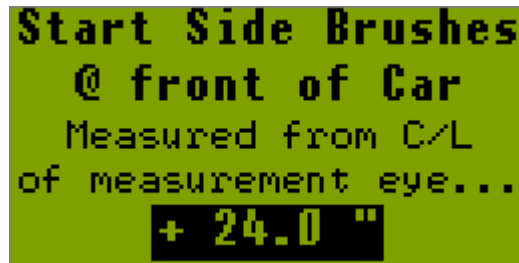

**Start Side Brushes**  
**@ front of Car**  
Measured from C/L  
of measurement eye...  
**+ 24.0 "**

This screen sets the gantry position at the rear when the side brushes wash the sides of car. Increase the number to start the side brushes more towards the entrance end of the wash bay.

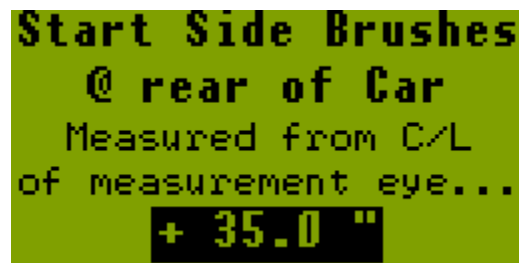

**Start Side Brushes**  
**@ rear of Car**  
Measured from C/L  
of measurement eye...  
**+ 35.0 "**

This screen sets the gantry position at the front where the top brush begins to wash the top of the car. Decrease the number to start the top brush more towards the exit end of the wash bay.

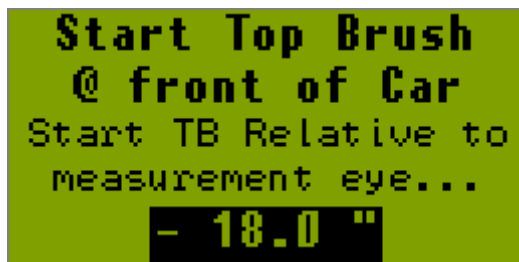

**Start Top Brush**  
**@ front of Car**  
Start TB Relative to  
measurement eye...  
**- 18.0 "**

This screen sets the gantry position at the rear where the top brush begins to wash the top of the car. Increase the number to start the top brush more towards the entrance end of the wash bay.

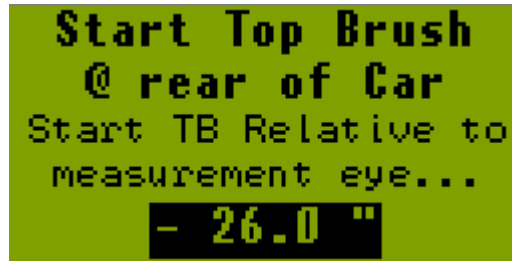

**Start Top Brush  
@ rear of Car**  
Start TB Relative to  
measurement eye...  
**- 26.0 "**

This screen sets the gantry position for the Low Pressure Wax delivery at the vehicle front. Decrease the number to start the LP Wax more towards the exit end of the wash bay.

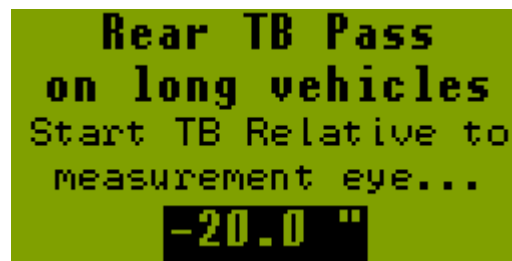

**Rear TB Pass  
on long vehicles**  
Start TB Relative to  
measurement eye...  
**-20.0 "**

This screen sets the gantry position for the Low Pressure Wax delivery at the vehicle front. Decrease the number to start the LP Wax more towards the exit end of the wash bay.

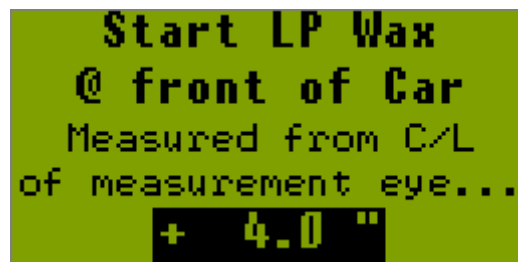

**Start LP Wax  
@ front of Car**  
Measured from C/L  
of measurement eye...  
**+ 4.0 "**

This screen sets the gantry position for the Low Pressure Wax delivery at the vehicle rear. Increase the number to start the LP Wax more towards the entrance end of the wash bay.

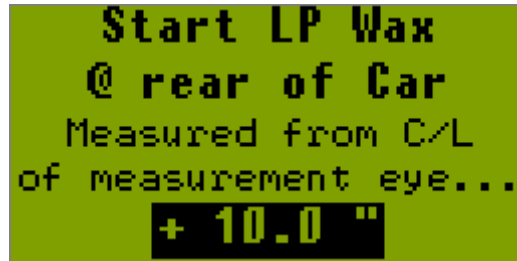

**Start LP Wax  
@ rear of Car**  
Measured from C/L  
of measurement eye...  
**+ 10.0 "**

This screen sets the gantry position for the Triple Shine Conditioner delivery at the vehicle front. Decrease the number to start the LP Wax more towards the exit end of the wash bay.

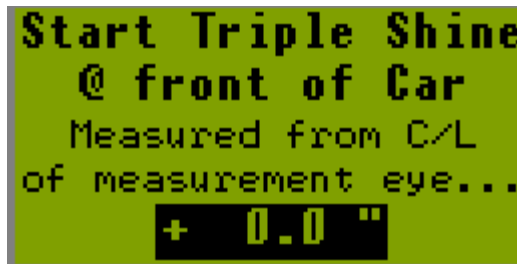

**Start Triple Shine  
@ front of Car**  
Measured from C/L  
of measurement eye...  
**+ 0.0 "**

This screen sets the gantry position for the Triple Shine Conditioner delivery at the vehicle rear. Increase the number to start the LP Wax more towards the entrance end of the wash bay.

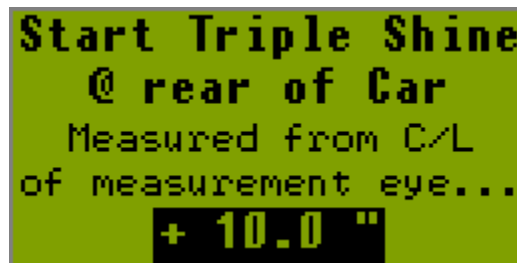

**Start Triple Shine  
@ rear of Car**  
Measured from C/L  
of measurement eye...  
**+ 10.0 "**

This screen sets the gantry position for the Presoak delivery at the vehicle front. Decrease the number to start the Presoak more towards the exit end of the wash bay.

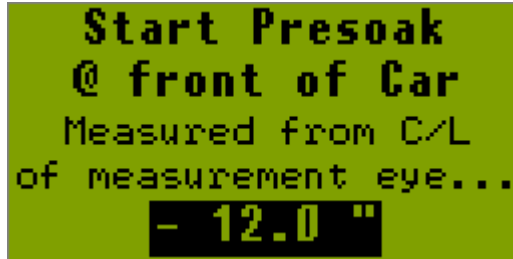

**Start Presoak  
@ front of Car**  
Measured from C/L  
of measurement eye...  
**- 12.0 "**

This screen sets the gantry position for the Presoak delivery at the vehicle rear. Increase the number to start the Presoak more towards the entrance end of the wash bay.

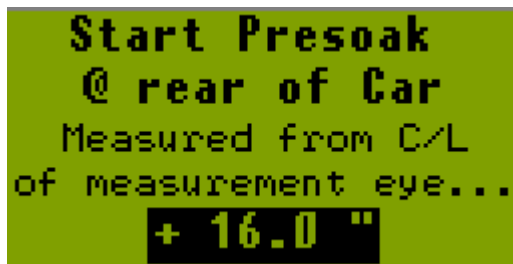

**Start Presoak  
@ rear of Car**  
Measured from C/L  
of measurement eye...  
**+ 16.0 "**

This screen sets the gantry position for the Rocker Panel Sprayers delivery at the vehicle front. Decrease the number to start the RPS more towards the exit end of the wash bay.

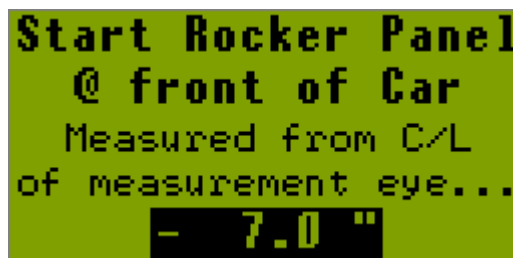

**Start Rocker Panel  
@ front of Car**  
Measured from C/L  
of measurement eye...  
**- 7.0 "**



This screen sets the gantry position for the Rocker Panel Sprayers delivery at the vehicle rear. Increase the number to start the RPS more towards the entrance end of the wash bay.

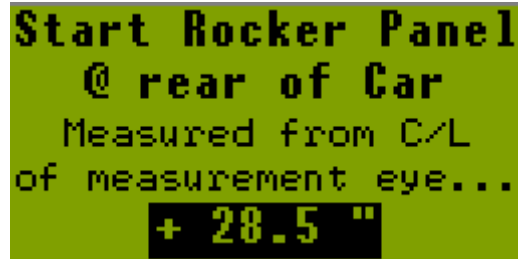

**Start Rocker Panel  
@ rear of Car**  
Measured from C/L  
of measurement eye...  
**+ 28.5 "**

This screen sets the gantry position for the HP Side Spray delivery at the vehicle front. Decrease the number to start the HP Side Spray more towards the exit end of the wash bay.

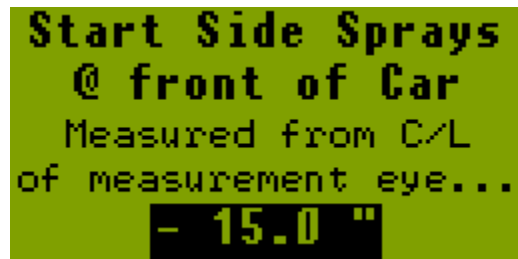

**Start Side Sprays  
@ front of Car**  
Measured from C/L  
of measurement eye...  
**- 15.0 "**

This screen sets the gantry position for the HP Side Spray delivery at the vehicle rear. Increase the number to start the HP Side Spray more towards the entrance end of the wash bay.

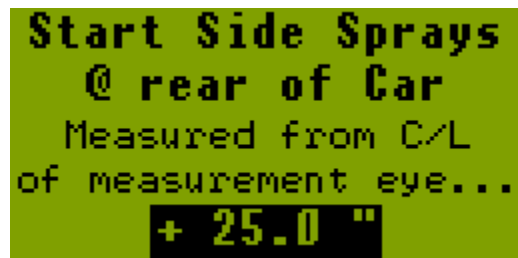

**Start Side Sprays  
@ rear of Car**  
Measured from C/L  
of measurement eye...  
**+ 25.0 "**

This screen sets the gantry position for the Tire Cleaner delivery at the vehicle front. Decrease the number to start the Tire Cleaner more towards the exit end of the wash bay.

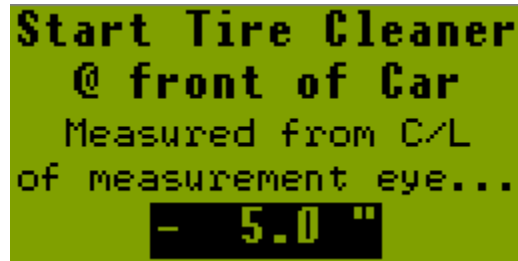

**Start Tire Cleaner  
@ front of Car**  
Measured from C/L  
of measurement eye...  
**- 5.0 "**

This screen sets the gantry position for the Tire Cleaner delivery at the vehicle rear. Increase the number to start the Tire Cleaner more towards the entrance end of the wash bay.

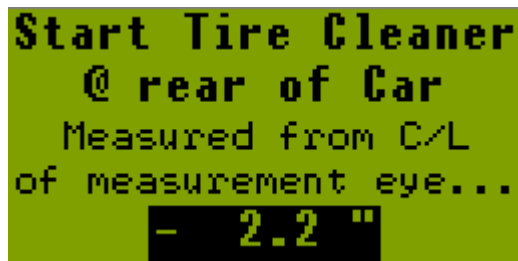

**Start Tire Cleaner  
@ rear of Car**  
Measured from C/L  
of measurement eye...  
**- 2.2 "**

This screen sets the gantry position for the Side Brush Lube delivery at the vehicle front. Decrease the number to start the Side Brush Lube more towards the exit end of the wash bay.

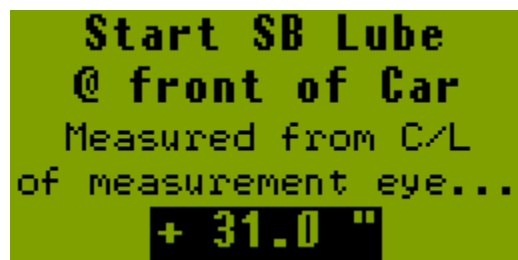

**Start SB Lube  
@ front of Car**  
Measured from C/L  
of measurement eye...  
**+ 31.0 "**

This screen sets the gantry position for the Side Brush Lube delivery at the vehicle rear. Increase the number to start the Side Brush Lube more towards the entrance end of the wash bay.

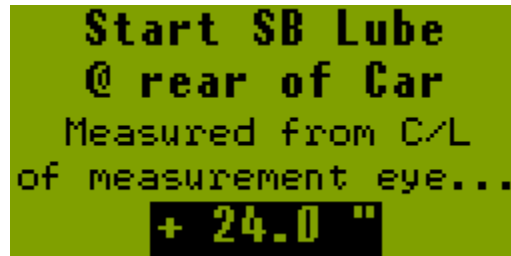

**Start SB Lube  
@ rear of Car**  
Measured from C/L  
of measurement eye...  
**+ 24.0 "**

This screen sets the gantry position for the Top Brush Lube delivery at the vehicle front. Decrease the number to start the Top Brush Lube more towards the exit end of the wash bay.

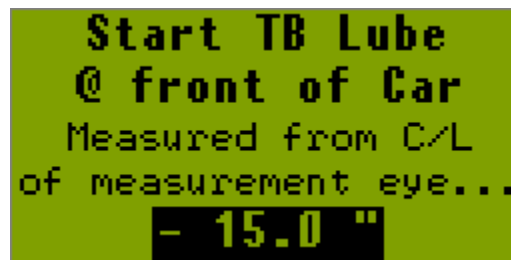

**Start TB Lube  
@ front of Car**  
Measured from C/L  
of measurement eye...  
**- 15.0 "**

This screen sets the gantry position for the Top Brush Lube delivery at the vehicle rear. Increase the number to start the Top Brush Lube more towards the entrance end of the wash bay.

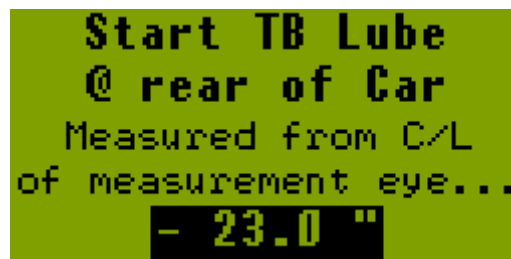

**Start TB Lube  
@ rear of Car**  
Measured from C/L  
of measurement eye...  
**- 23.0 "**

This screen sets the Top Brush Lower Limit at the rear of the vehicle. This is how far the top brush will lower during a rear brush pass that is accomplished with the top brush (when the side brushes cannot reach the rear of a long vehicle). The distance is counted from the Top Brush home position down.



**TB Lower Limit  
@ rear of Car**  
The max dist the TB  
will move on TB pass  
**+ 66.0 "**

This screen adjusts the Wheel Brush position for the rear wheel only. The front wheels are set according to the treadle position. A negative number moves the wheel brush towards the exit end.

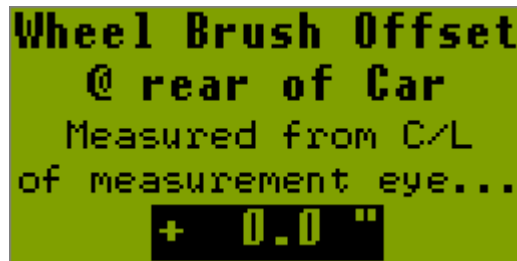

**Wheel Brush Offset  
@ rear of Car**  
Measured from C/L  
of measurement eye...  
**+ 0.0 "**

This screen adjusts the position for the oscillating blower to reverse directions at the front of the car. A lower number moves the flip position towards the exit end.



**Flip Blower  
@ front of Car**  
Measured from C/L  
of measurement eye...  
**+ 90.0 "**

This screen adjusts the Wheel Brush position for the rear wheel only. The front wheels are set according to the treadle position. A negative number moves the wheel brush towards the exit end.



### On-board 3 position LED Light Set-up Instructions

You can change the output pattern of your LED lights on your 3 position sign. They can be on: steady, slow steady flash, or a fast strobe affect flash. The instructions below will explain the procedures for making this change. **You may also need to follow these same instructions if your light does not come on immediately when the signal is sent.**

1. With the plastic light fixture removed from the stainless steel enclosure in the gantry, go to "F7-Tech Menu", and then go to "Test Functions 2 (Menu Option 4) in the Red Lion. Toggle the corresponding function on to turn on the light that you wish to modify the pattern. Toggle on the "Enter Now" for the green light. Toggle on the "Stop" for the red light. Toggle on the "Back-up" for the yellow light.
2. You will need to uncap the LED's white wire and the LED's red wire to make this change. The red wire will have a signal wire connected to it as well. The color of this additional wire varies depending on which light you are changing.
3. With the light turned on, hold the white to the red wire and the signal wire for 5 seconds, then remove the white.
4. Disconnect the red wire and the signal, then reconnect it. The fixture should turn on immediately; if not, repeat step 3.
5. To control the flashing rate, touch the white wire to the red wire while its still connected to the signal wire and observe the pattern change.
6. Repeat touching the white and red wires until desired pattern is selected.
7. Once this is done, install a cap on the white wire. Install a cap on the red wire and the signal wire, which are connected together.
8. Install the plastic light fixture into the stainless steel enclosure.

**EXIT END OF BAY**

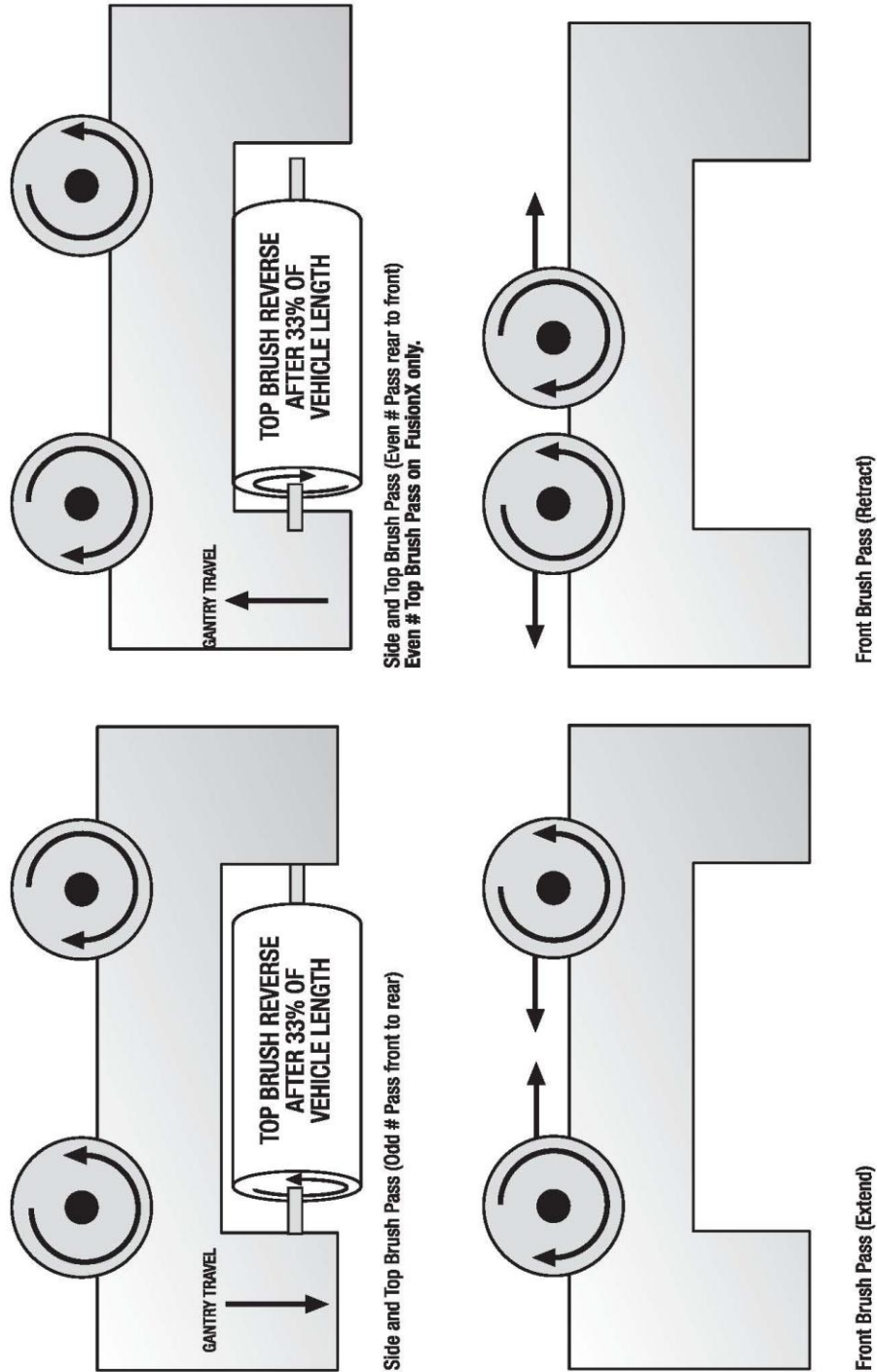



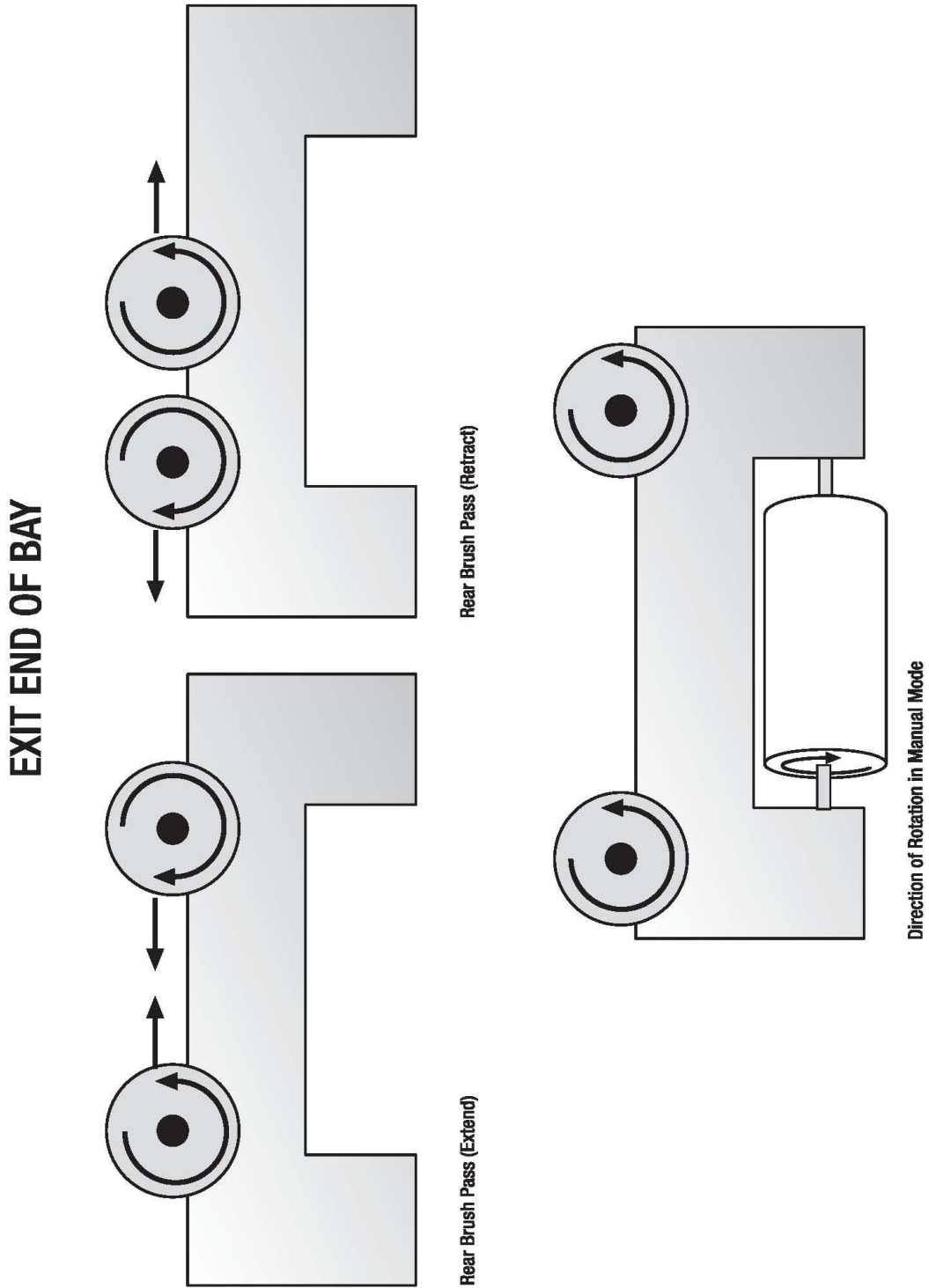

## ***Safety Signs***

Jim Coleman Company recommends that you have **warning** or **safety signs** at the entrance and exit locations of the automatic wash bay. These signs should be mounted where they are visible from the Entrance and Exit locations of the wash bay. These warning signs should warn people... *“Do not enter the wash bay while the unit is washing a vehicle”*.

Jim Coleman Company has 12” x 12” signs available at no charge, if you will install them at the automatic bay. Please call (713) 683-9878 to order these important safety signs. Jim Coleman Company will provide two (2) safety signs at no cost (per automatic purchased). Please provide the serial number of the automatic purchased when ordering the signs. The part number of the safety signs is **#38442**.

Please call the Coleman Hanna Carwash Systems parts department at (713) 683-9878 and order two (2) safety signs using part **#38442**.



## Normal Operation

Under normal operation the eFusion will perform the following functions.

*(We have used a preprogrammed 8 pass wash recipe as an example*

*This recipe includes optional functions):*

**Note:** All gantry speeds are set between max speed of 100% and slow speed at 45% excluding any passes that include a top and/or side brush application.

1. Customer at the entrance controller selects wash and deposits money or if applicable, enters a code. The money acceptor sends a 24-volt DC electronic signal for the corresponding wash recipe to the eFusion to begin operation.
2. Once the eFusion receives a wash signal the following will happen
  - a. The system will perform an eye test before "Enter Now" light illuminates. If any of the eyes fails then the proper error code will be displayed on the operator interface (Red Lion) and the unit will continue without certain functions or remain at home until error is corrected and unit is reset.
  - b. "Enter Now" sign at the entrance of the wash bay will illuminate
  - c. "Drive forward" light on the wash gantry will illuminate.
  - d. *If applicable, Horn will sound twice.*
  - e. The Entrance Timer will start.
  - f. The Overall Wash Timer will start. (This is set at 13 minutes)
3. As the customer drives forward, the vehicles front tires break the beam of the entrance optics turning on the Undercarriage wash cycle (if applicable and selected in the recipe). The undercarriage will stay on for the length of time set by the undercarriage timer or until the vehicle reaches the designated stop station (treadle switch). There is also an additional timer that will shut off the undercarriage. Once the rear vehicle tires have passed the entrance optics, it starts a timer (Under Car Rear Wheel Timer) that will shut off the undercarriage. This is usually set for 4 seconds.
4. In the event the customer drives past the stop station treadle switch and far enough toward the exit end of the wash bay to break the gantry optics, the back up message will display instructing the customer to back up until the customer once again triggers the treadle switch optic which causes the STOP light to illuminate.
5. Once the vehicle is in position on the treadle plate, the following will happen:
  - a. "Drive Forward" light will turn off.
  - b. "Stop"light will turn on.
  - c. "Please Wait" light at the bay entrance will come on.
  - d. *If applicable, Horn will sound once.*
  - e. The Entrance timer will reset.
6. The eFusion will have a four second delay before the first wash pass begins.

*This is there to insure the vehicle is stopped before receiving its wash and to allow time for presoak delivery to be fully pressurized.*

**a) Definition of a Pass.** One time over the vehicle is a pass. Each pass begins with the top and side brushes at their Home position. Once the side brushes complete their travels across the front of the vehicle, the gantry will then continue to travel to the opposite end of the vehicle.

**b) Definition of a Brush Pass.** The brushes are controlled by amp sensing. The system monitors the increased amps caused as the brushes contact the vehicle. Both the side and top brushes will contour the vehicle as they travel. If selected in the recipe, the speed is controlled by the CPU program. This is not adjustable by the operator. Using the brush tilt the operator can choose to have an angled or vertical side brush pass or offer both.

**c) Low Pressure Passes.** During Presoak, Hot Wax, Tri Foam and Spot Free Rinse, the gantry will move at the operator set speed. Each of these products is delivered through a gantry mounted fixed delivery manifold or nozzles. The presoak has 2 arches in the gantry controlled by separate solenoids to ensure complete coverage.

**d) Start Delay.** Each pass can have a delay at the start and the end of each pass.

**7. Pass #1 Presoak, Tri Foam and Tire Cleaner** - The following will happen:

- a. The scrolling sign will read "Presoak" *(If applicable)*
- b. The Presoak and Tri Foam pumps (if applicable) will start and deliver product.
- c. If applicable, the Tire Cleaner pump will start and spray product to cover the tires and lower Rocker panels.
- d. The Gantry will start to travel down the track toward the back of the vehicle. Gantry speed is set at 100%
- e. The two count up proxes (CTU's) adjacent to the counting wheel will send signals for the wheel count as the gantry moves down the track.
- f. The measurement eyes are looking for the front of the car. When the eye sees the front of the vehicle it signals the Omron PLC to store the wheel count.
- g. **Locating the Wheels.** It is necessary to locate the vehicle wheels for proper wheel brush application. The front wheel is known since the treadle plate is in a fixed position. The rear wheel is located using a separate set of eyes.
- h. The measurement eyes also look for the rear of the vehicle. When the eye sees the rear of the vehicle it signals the Omron PLC to store the wheel count.
- i. At the rear of the vehicle, Pass 2 is started
- j. If there is a start delay time then the gantry will dwell the number of seconds as set on start delay for pass #1. This is true for all subsequent passes as well.

8. **Pass #2 Rinse and Wheel Brush** - begins at the rear of the vehicle.
  - a. Rinse will be delivered through gantry mounted nozzles.
  - b. The Gantry will travel toward the front of the vehicle based upon the wheel count. The CTU wheel counts that were collected in pass 1 are now used in the remaining passes. Gantry speed is set at 100%.
  - c. Once the gantry reaches the count location of the rear wheel, it will stop and turn on the wheel brush. The wheel brush will rotate, extend and retract cleaning the rear wheels. When finished with the rear wheels the rinse will begin again. This process is repeated at the front wheel location.
9. **Pass #3 Top and Side Brush** - begins at the front of the vehicle.
  - a. The brushes will rotate at the home position for approximately 10 seconds to establish a base amp setting. It is very important that nothing is in contact with the brush when this is happening.
  - b. Scrolling sign will read - Wash *(If applicable)*
  - c. The top brush will lower to an estimated position at full speed and slow down its travel as it comes in contact with the vehicle. Once the preset amp setting is reached, the gantry will travel toward the rear of the vehicle.
  - d. The gantry travels until the side brushes are in position to wash the front of the vehicle. At this time, the top brush will raise slightly as the counter rotating side brushes travel across the front of the vehicle. They will gently touch each other than shift past center to insure proper cleaning. The brushes continue to rotate and then return to their home position.
  - e. Once at home, the top brush again lowers and the side brushes contact the side of the vehicle. This happens as the gantry travels toward the rear of the vehicle.
  - f. The gantry will travel to the rear of the car based upon the wheel count. Gantry speed is controlled by the CPU according to the brushes amp reading.
  - g. At the rear, the top brush will lower to clean the rear windows of SUV's but not to the bumper level. This area will be cleaned by the side brushes.
10. **Pass #4 Rinse** - begins at the rear of the vehicle.
  - a. Scrolling sign will read Rinse. *(If applicable)*
  - b. Rinse will begin as the gantry travels toward the front of the vehicle.
  - c. The gantry travels toward the front at a 75% speed as selected in the recipe
11. **Pass #5 Low Pressure Hot Wax** - begins at the front of the vehicle.
  - a. The Scrolling sign will read Wax. *(If applicable)*
  - b. The system will deliver a low pressure application of Crystal Polymer Glaze or similar product through boom mounted "Rain Arch".
  - c. Gantry will travel toward the rear of the car
  - d. The wash boom will not travel downward during this pass.

12. **Pass #6 Spot Free Rinse** – begins at the rear of the vehicle.
  - a. The Scrolling sign will read: Spot Free Rinse *(If applicable)*
  - b. The Spot Free Rinse pump will turn on and spray Spot Free rinse water out of the independent gantry mounted nozzles.
  - c. The gantry will travel toward the front of the vehicle applying Spot Free Rinse.
  - d. Gantry speed is set at 75%.
  
13. **Pass #7 Blower** – begins at the front of the vehicle.
  - a. The Scrolling message sign will read Blower. *(If applicable)*
  - b. Blower motors will start alternately.
  - c. Center blower will rotate 360 degrees for set time to allow air scoop to remove excess water residue from gantry top panel.
  - d. Gantry will travel toward the rear of the vehicle with center nozzle sweeping back and forth toward the rear of the vehicle.
  - e. Near the rear of the vehicle and at a set count, the blower nozzle will reverse direction and blow back toward the front effectively drying the rear of the vehicle.
  
14. **Pass #8 Blower** – begins at the rear of the vehicle.
  - a. The gantry travels towards the front of the vehicle.
  - b. Center blower nozzle oscillates back and forth while blower is on.
  - c. Near the windshield and at a set count, the blower will reverse direction and blow back toward the rear of the vehicle as it continues to the gantry home position.
  
15. **End of the Wash** – gantry in the home position.

The “Scrolling sign will read *“Exit Slowly”*. When the vehicle passes through the eyes on the gantry completely, the eFusion will send a 3 second signal to reset the auto cashier allowing the next customer to enter. Also, the Omron PLC is reset so it can wash a different size vehicle with a different wash package.

## Safety Features of the eFusion

- The gantry has redundant proximity switch counters on the gantry movement. This is for safety reasons and allows the processor to always know which direction both are moving.
  
- Both side and top brushes have “over-amping” sensing controls that will back them away from the vehicle if they become too close. Proximity Switches



## Proximity Switches

Proximity switches should be set to have approximately 3/8ths inch clearance from the prox target. Care should also be taken to not allow the face of the prox to come in contact with prox target. This will destroy the prox and will void the warranty.

Prox switches are o-ring fitted with screw on electrical connections and should be filled with electrical grease to keep moisture out.

## Wheel Counts

A rubber wheel is located on the gantry and follows the gantry track. This rubber wheel has a 4-position Stainless Steel target connected to it so that every revolution of the wheel will send a count from both wheel count proxes. Full gantry track travel is approximately 340 counts. This system is used to monitor the length of the vehicle. When the gantry moves down the track the counting wheel is continuously sending electrical pulses to the PLC. The PLC receives a signal from the photo eye sensors where the front or rear of a vehicle is. The PLC stores the count of the counting wheel so that the gantry will be able to return to the Front or Rear of the vehicle using the counts stored in memory and not rely on the eyes.



# Requirements for Coleman Hanna High Speed Configuration

**Obtain the following information from your Service Provider**

Static Public IP Address  
Subnet Mask  
Default Gateway  
Both DNS servers

Please request the ISP (internet service provider) to set their modem in Full Bridged Mode. The NetGear FVS318v3 router provided by Coleman Hanna or purchased from a local retailer will perform all of the firewall functions. If this is a PPOE account, please provide us with user name and password.

The ISP provider can email all the information to [tlofton@colemanhanna.com](mailto:tlofton@colemanhanna.com)

Coleman Hanna Certified Firewall: NetGear FVS318v3

Coleman Hanna Setup: LAN IP for NetGear: 10.137.0.1 Subnet Mask: 255.255.0.0 UserName: admin Password: magpie5842
---

NetGear Default: 192.168.0.1 Subnet Mask: 255.255.255.0 User Name: admin Password: password
--

Configuration of the LAN side of the network should follow:

IP Redlion 1: 10.137.0.15 or 192.168.0.15  
IP Redlion 2: 10.137.0.16 or 192.168.0.16  
IP Redlion 3: 10.137.0.17 or 192.168.0.17  
Subnet Mask: 255.255.0.0  
Gateway: 10.137.0.1 or 192.168.0.1

Either configuration is acceptable for compliance with our standards.

## Coleman Hanna High Speed Configuration

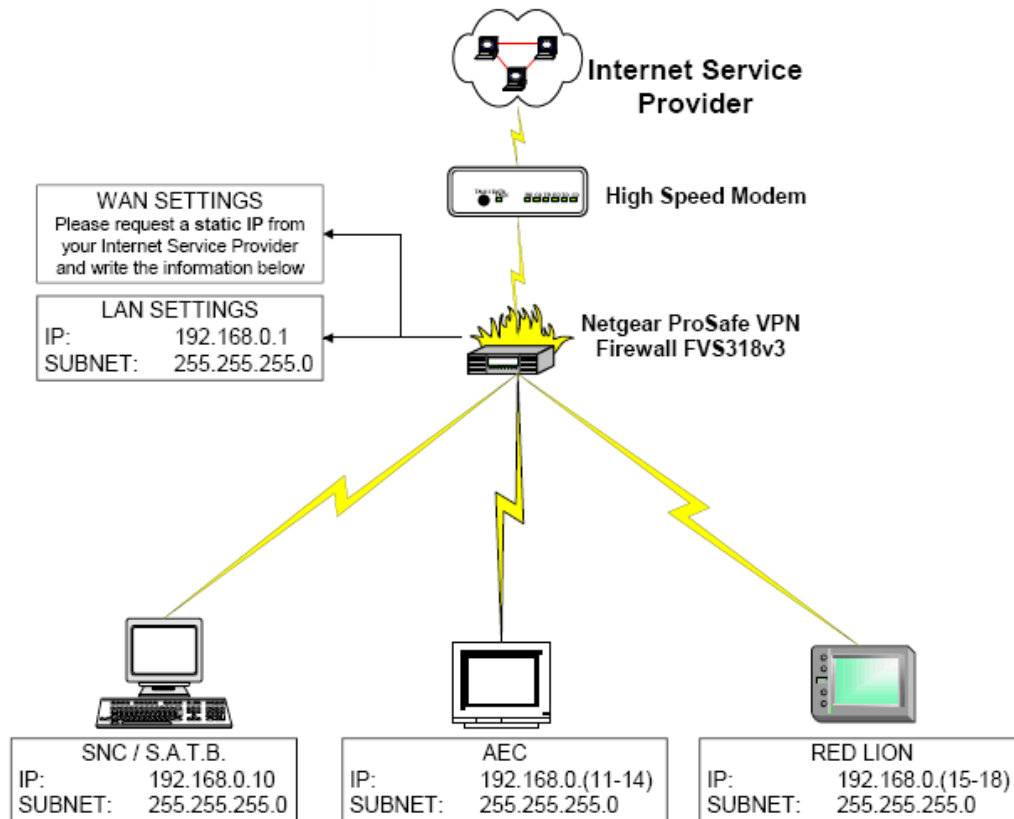

Carwash Name: \_\_\_\_\_

STATIC IP SETTINGS  
(from ISP)

IP: \_\_\_\_\_

SUBNET: \_\_\_\_\_

GATEWAY: \_\_\_\_\_

DNS 1: \_\_\_\_\_

DNS 2 (if any): \_\_\_\_\_

DNS 3 (if any): \_\_\_\_\_

Please Contact JCC Technical Support for High Speed Setup

## FusionX and eFusion Red Lion Operator Interface Function Key Descriptions

**F1/Recipe Menu**

- 0 - Current Recipes
- 1 - Assign Recipes
- 2 - Program Recipes
- 3 - Review Recipes
- 4 - Copy & Save Recipes

**F2/Timers & Counters**

- 0 - Adjust Timers
- 1 - Adjust Gantry Counter
- 2 - View Boom Counters

**F3/Prices & Revenues**

- 0 - View Revenue
- 1 - Set Wash Prices
- 2 - Best Income
- 3 - Last Ten Washes
- 4 - View Total Washes

**F4/Wash Data**

- 0 - Wash Status
- 1 - Washes Today
- 2 - Washes Yesterday
- 3 - Boom Status
- 4 - Display Status
- 5 - Wash Time
- 6 - Car Measurement
- 7 - Car Front Counts
- 8 - Car Rear Counts
- 9 - Last 5 Car Counts
- 10 - Car Front Profile

## FusionX and eFusion

### Red Lion Operator Interface Function Key Descriptions (cont.)

<u>F5/Log In Page</u>	<u>F6/Memory Card</u>	<u>F7/Tech Menu</u>	<u>F8/Site Data</u>
Insert Password	Recipe Mode Revenue Mode	0 - View PLC Inputs 1 - View PLC Outputs 2 - View Torque 3 - Test Functions 1 4 - Test Functions 2 5 - Test Functions 3 6 - Force PLC Outputs 7 - Wheel Test 8 - Boom Test 9 - Top Brush Test 10 - TB Torque Loop 11 - Left Brush Test 12 - LB Torque Loop 13 - Right Brush Test 14 - RB Torque Loop 15 - Front Rear Test 16 - Photo Sensor 17 - Boom Safety Eyes 18 - Nozzle Test 19 - Freeze Test 20 - Door Status 21 - Entry Door Test 22 - Exit Door Test 23 - Dry Wash Test 24 - Test Pager 25 - Set Time Clock 26 - Scrolling Sign 27 - Display Contrast 28 - Reset Wash 29 - CAT Pump Serviced 30 - TB No Load Test 31 - LB No Load Test 32 - RB No Load Test	0 - Change Passwords 1 - Pager Values 2 - Enter IP Address 3 - On-Board Blower 4 - Type Cashier 5 - Enable Cycle Switches 6 - Recirculating High PH 7 - Recirculating Low PH 8 - Undercarriage Sol 1 9 - Undercarriage Sol 2 10 - Profile Option 11 - Profile Mode 12 - Blower Truck Mode 13 - Horn Mute Mode 14 - Static Blower 15 - Treadle Sensor 16 - Undercarriage Eye 17 - Door Mode 18 - Windy Day Bypass 19 - Flip Blower Front 20 - Flip Blower Rear 21 - Min SB TL Position 22 - Off Board Sign Type 23 - Init Gantry Counts 24 - Spin Freeze Protect



# FusionX and eFusion

## *Instructions for loading OMRON PLC and Red Lion memory module*

### **SAVING EXISTING RECIPES and REVENUE (*Recipes and Revenue are stored in the PLC NOT the Red Lion*)**

1. With power on to the PLC, insert memory card into the slot in the PLC. Press the F5/Log In Page button and log in using the owner password. Press F6/Memory Card and select Recipe Mode then press Save Recipes twice. Remove the memory card with power still on. **DO NOT CYCLE POWER ON & OFF.**

### **RED LION Operator Interface**

1. Turn off power to the display. Plug memory card into the slot located on the side of the Red Lion.
2. Turn on power to display. Wait for display to load program from memory card. (Observe text – LOADING CF). Once the screen is back to the main screen make sure the HMI number matches the version number you are loading.
3. After program is loaded, turn off power and remove card from display. Turn power back on.

### **OMRON PLC (Loading Program Instructions)**

1. Turn off power to PLC. Open cover plate (located above the memory card slot) on CJ1G-CPU44 PLC module. Here you'll see 8 switches numbered 1-8 from top to bottom. Turn on DIP SW 7. (push switch to left position). Insert memory card into slot. Card is properly seated when the eject button is even with the top.
2. Turn on power to PLC. Wait for "busy" light to extinguish (about 5 to 10 seconds) and the main screen is up.
3. Turn off power to PLC. Remove memory card. Turn off DIP SW 7 (push switch to right position).
4. Turn on power to PLC.

### **DOWNLOADING SAVED RECIPES**

1. With power on to the PLC, insert the memory card. Press the F5/Log In Page button and log in using the owner password. Press F6/Memory Card and select Recipe Mode then press Load Recipes twice.
2. Remove the memory card with power on. **DO NOT CYCLE POWER ON & OFF**

### **INITIALIZING THE SYSTEM**

1. Perform a "Wheel, Side Brush, Top Brush and Boom Test". These tests can be accessed in the "F7 Tech Menu" of the Red Lion Interface Panel. This test will allow the PLC to store the correct length of travel for each of these components. ***THIS MUST BE DONE TO ENSURE PROPER OPERATION.***
2. Next you ***MUST*** save the Treadle position that is required for the wheel brush to locate vehicle front wheels. This setting is done in "F2 Adjust Gantry Counts". The best way to accomplish this is to park a vehicle on the treadle plate and with the gantry in manual mode, position the gantry until the wheel brushes are aligned with the exact center of the front wheels. Press the "Wheel Brush Extend" manual push button to confirm alignment. Now press "Save" on the Red Lion Display to store this position.
3. Assign the Recipes, in "F1 Recipe Menu", that you wish to use.

**Added Steps necessary for version 3.12 or higher**

1. Go to "F7-Tech Menu" on your Red Lion. Use the Raise key until you get to Menu Option 30 – "TB No Load Test" and press Enter. See the pictures below.
2. Now you need to switch the Gantry manual toggle switch "On" and **lower the Top Brush** about 18-24" to get the brush **out of the nest** then press the arrow under the display on the Red Lion, where it says "Test". The word "Off" will change to "Testing".
3. The Top Brush will begin to spin and you will see the "PV" value begin to change (PV = Present Value).
4. After about 8 seconds, you will see that the "NL" value has now been set (NL = No Load).
5. If the brush components are in good mechanical condition, **the brushes were not in contact with any surface**, the test is complete, you can now press the arrow under the display, where it says "Accept". The word "Off" will change to "Writing".
6. When the word "Off" returns under "Accept", this brush test is complete.
7. You can now press the "Prev" button then raise up to Menu Option 31 – LB No Load Test and Menu Option 32 – RB No Load Test and repeat the procedures above for each brush.
8. These procedures are required to calibrate the acceptable no load brush torque at your site. This addition became necessary due to variations in incoming voltage from one site to the next.

```

Technician Menu
Raise/Lower selects..
Menu Option: 30
TB No Load Test
Enter Selects Option
  
```

```

TB No Load Torq
Capture NL torque
PV:      0.1 %
NL:      37.9 %
% NL    - 99.9 %
Test     Off
Accept   Off
  
```

```

Technician Menu
Raise/Lower selects..
Menu Option: 31
LB No Load Test
Enter Selects Option
  
```

```

LB No Load Torq
Capture NL torque
PV:      0.0 %
NL:      37.9 %
% NL    -100.1 %
Test     Off
Accept   Off
  
```

```

Technician Menu
Raise/Lower selects..
Menu Option: 32
RB No Load Test
Enter Selects Option
  
```

```

RB No Load Torq
Capture NL torque
PV:      0.0 %
NL:      44.1 %
% NL    - 99.9 %
Test     Off
Accept   Off
  
```

## Transferring Programs from Email to Compact Flash Cards

These files are sent in a compressed (zip) file format. This makes them easier to send and receive and reduce the chances of file corruption. Windows XP has a built-in feature that can open a compressed file so the individual files that they contain can be used. There is also software that can be purchased called “WinZip” that can accomplish this task. If you do not use Windows XP and have never used WinZip, you can download a free 45-day evaluation version of WinZip from the Internet that will accomplish this task.

1. Open the email that contains the program updates.
2. Save the compressed file (zip) to your ‘Local Disc(C:)’ on your computer.
3. Create a new folder and rename it, including the program version number such as “Fusion v.3.12” or “WW 2.0 v.2.34”.
4. Move the zip file into this new folder.
5. Open the zip file and save the individual files in this same folder. There will be 8 – 15 program files within the zip file. Four of them are for the Red Lion and the remainder is for the Omron PLC.
6. Place a Compact Flash Card into your card reader and open the window that shows the contents of the card. Make sure that the card does not have other files on it prior to loading the program files onto the card.
7. Hi-light all the individual program files in the new folder that you created and drag & drop them (or copy and paste) onto the Compact Flash window that you have open.
8. Once the status light on your card reader stops flashing, you can now remove the card and follow the Memory Card Loading Instructions that we have provided to update the program in your Red Lion Operator Interface and your Omron PLC.





## eFusion - Factory Assigned Recipes

<b>Factory Assigned Recipes For Units with On-Board Blowers</b>		This is what is already set in the Red Lion when the unit is first programmed.	
<b>Cycle</b>	<b>Recipe</b>		
Cycle 1	4		
Cycle 2	5		
Cycle 3	7		
Cycle 4	9		
<b>Factory Assigned Recipes For Regular Units</b>		You must change cycles 1 & 2 if the unit is NOT EQUIPPED with On-Board Blowers.	
<b>Cycle</b>	<b>Recipe</b>		
Cycle 1	2		
Cycle 2	6		
Cycle 3	7		
Cycle 4	9		

## Fusion Recipe Function Bits

Function #	Red Lion Function Description	Recipe Function Bit Explanation
00	Undercarriage	Turn this ON in Pass 1 to clean the under body of vehicles with High Pressure as they enter the bay.
01	Presoak High pH	Turn this ON to apply an alkaline presoak (or a Foam Bath on eFusion) to the vehicle. This is typically done on Pass 1 and/or Pass2
02	Presoak Low pH	Turn this ON to apply an acid presoak to the vehicle, if equipped. This typically is applied after High pH Presoak and occurs during Pass 2 or Pass 3.
03	Tire Cleaner	Turn this ON to apply a Tire/Wheel Cleaner product to the lower part of the vehicle, if equipped. This is typically applied during a Presoak Pass in Pass 1 or 2.
04	Front Brush Pass	Turn this ON to scrub the front of the vehicle with the brushes. This function is always performed by the Side Brushes.
05	Rear Brush Pass	Turn this ON to scrub the rear of the vehicle with the brushes. This function is performed with the Side Brushes unless the Gantry cannot position far enough behind the vehicle for this to take place. In that case, the unit would automatically scrub the rear of the vehicle with the Top Brush.
06	SB Tilt Solenoid	This would only be turned ON in one Side Brush pass if there are two separate Side Brush passes in your recipe. Turning this ON will hold the Side Brushes vertical to better scrub the lower portion of the vehicle but the upper part of the vehicle will not be cleaned by the brushes.
07	Side Brush Pass	Turn this ON to scrub both sides of the vehicle. This can successfully be done in a single pass provided the "SB Tilt Solenoid" bit is turned OFF.
08	Top Brush Pass	Turn this ON to scrub the top surface of the vehicle. On an eFusion this is required to be done in an odd numbered pass, from front to rear, due to the process used for pick-up truck detection. A FusionX can do this in an even numbered pass, from rear to front, because the boom profile eyes are used for truck detection but we recommend that you do the Top Brush pass in an odd numbered pass whenever possible.
09	Wheel Brushes	Turn this ON to scrub the vehicle wheels. This cannot be done in Pass 1 because the unit has not located the rear wheel until the first pass is complete. We recommend turning this ON during a high pressure pass to limit the number of times the high pressure pump motor is started during a wash.
10	Rocker Panel	Turn this ON to clean the lower portion of the vehicle with high pressure water. (not available on eFusion)
11	High Pressure Wash	Turn this ON to clean/rinse the entire vehicle with high or low pressure water, depending on installed options. Turning this ON will also cause the scrolling sign, if equipped, to display "Washing". This is typically done following the last Presoak or Brush pass.



Function #	Red Lion Function Description	Recipe Function Bit Explanation
12	High Pressure Rinse	Turn this ON to rinse the entire vehicle with high or low pressure water, depending on installed options.
13	High Pressure Wax	Turn this ON to deliver a wax product via the high pressure pump, if equipped. This is commonly done on the pass following a Tri-Foam (conditioner) pass in the latter part of the recipe.
14	Bug Pass	Turn this ON in any high pressure pass, in which the wash boom will be going down in the front and/or the rear. This causes the wash boom to repeat the lower 1/3 of its travel two times in one boom pass (completely down, partially up, completely down, then completely up). This is only needed in a touchless wash recipe, to better clean the front or rear of the vehicle with high pressure water.(not available on the eFusion)
15	MedPress Solenoid	Turn this ON to lower the pressure of the high pressure water, if equipped with the "High Pressure Option". This can be used during a High Pressure Wax pass to improve the delivery of the wax.
16	Reclaim Solenoid	Turn this ON to provide a supply of reclaim water to the high pressure pump, if equipped with the "High Pressure Option". If not equipped, a valve will open to supply reclaim water to the Gantry at low pressure. This is typically used in the early portion of the wash recipe in conjunction with any high pressure function.
17	Cold H2O Solenoid	Turn this ON to provide a supply of cold water to the high pressure pump, if equipped with the "High Pressure Option" and the "Hot Water Option". This is typically used in the latter portion of the wash recipe in conjunction with any high pressure function.
18	Spot Free Rinse	Turn this ON to deliver Spot Free water to the Gantry as a final rinse.
19	Tri-Foam	Turn this ON to deliver a Tri-Color Foam product to the Gantry. If you choose to use Tri-Color Foam Detergent, you would apply this early in the wash recipe, typically during a Presoak pass. This configuration will decrease the cycle time of your recipes due to the decrease in necessary passes. If you choose to use a Tri-Color Foam Conditioner, you would apply this near the middle of your recipe to allow other passes to rinse the product off of the vehicle.
20	Low Pressure Wax	Turn this ON to deliver a wax product, through a low pressure pump, to the Gantry. This is typically done preceding the Spot Free Rinse pass.
21	Blower	Turn this ON to activate either On-Board Blowers or Free-Standing Blowers, if equipped.
22	Side Brush Lube	Turn this ON during a Side Brush, Front Brush or Rear Brush passes to wet the vehicle surface just ahead of the Side Brush travel.
23	Top Brush Lub	Turn this ON during a Top Brush pass to wet the vehicle surface just ahead of the Top Brush travel.

## eFusion Factory Recipes (Quantity-10)

An eFusion CAN NOT perform a "Top Brush" pass in an even numbered pass (from rear to front). This is because the top brush is responsible for truck detection. The top brush must travel from front to rear to safely detect where the truck cab ends and the bed begins.

If your eFusion is not equipped with a High Pressure Option, you still must select the "HP Rinse" recipe bit on your desired rinse passes.

If you assign a recipe with "Tri-Foam" selected in pass #1, we recommend that you use a Tri-Color Foaming Detergent (det.), not a foaming conditioner (cond.) or wax.

To write a custom recipe you must assign it a recipe number from 30 to 59. If there is a factory recipe that is very similar to your desired wash recipe, you can use the "Copy & Save Recipe" feature in the Red Lion. Once you save the factory recipe to a number between 30 & 59, you can then go to "Program Recipes" and enter that number. You can then make the changes you want without having to program an entire recipe.

### Recipe # 0

Pass #	Active "Bits"	Gantry Speed	Preset Values			
			Start Delay	Boom @ Start	Boom @ End	End Delay
1	Undercarriage, Hi pH Presoak, Tire Cleaner, TriFoam (det.)	100%	3.0 sec	0 counts	0 counts	5.0 sec.
2	Rotating HP Rocker, Reclaim Sol.	75%	0.0 sec.	80 counts	80 counts	0.0 sec.
3	Front Brush, Rear Brush, Side Brush Tilt Sol, Side Brush, Top Brush, SB Lube, TB Lube	50%	0.0 sec.	0 counts	0 counts	0.0 sec.
4	Side Brush, SB Lube	75%	0.0 sec.	0 counts	0 counts	0.0 sec.
5	Wheel Brush, HP wash, Reclaim Sol.	75%	0.0 sec.	86 counts	86 counts	0.0 sec.
6	HP Rinse, Cold H2O Sol.	100%	0.0 sec.	86 counts	86 counts	0.0 sec.
7	Low Press Wax	100%	2.0 sec	0 counts	0 counts	0.0 sec.
8	Spot Free Rinse	100%	2.0 sec	0 counts	0 counts	0.0 sec.
9	Blower (on-board)	50%	5.0 sec.	0 counts	0 counts	0.0 sec.
10	Blower (on-board)	60%	5.0 sec.	0 counts	0 counts	0.0 sec.

## Recipe # 1

Pass #	Active "Bits"	Gantry Speed	Preset Values			
			Start Delay	Boom @ Start	Boom @ End	End Delay
1	Undercarriage, Hi pH Presoak, Tire Cleaner	100%	3.0 sec	0 counts	0 counts	5.0 sec.
2	Wheel Brush, Rotating HP Rocker, Reclaim Sol.	75%	0.0 sec.	80 counts	80 counts	0.0 sec.
3	Front Brush, Rear Brush, Side Brush, Top Brush, SB Lube, TB Lube	50%	0.0 sec.	0 counts	0 counts	0.0 sec.
4	HP Wash, Reclaim Sol.	75%	0.0 sec.	86 counts	86 counts	0.0 sec.
5	TriFoam (cond.)	100%	2.0 sec	0 counts	0 counts	2.0 sec.
6	HP Rinse, Cold H2O Sol.	75%	0.0 sec.	80 counts	80 counts	0.0 sec.
7	Low Press Wax	100%	2.0 sec	0 counts	0 counts	0.0 sec.
8	Spot Free Rinse	100%	2.0 sec	0 counts	0 counts	0.0 sec.
9	Blower (on-board)	50%	5.0 sec.	0 counts	0 counts	0.0 sec.
10	Blower (on-board)	60%	5.0 sec.	0 counts	0 counts	0.0 sec.

## Recipe # 2

Pass #	Active "Bits"	Gantry Speed	Preset Values			
			Start Delay	Boom @ Start	Boom @ End	End Delay
<b>1</b>	Undercarriage, Hi pH Presoak, Tire Cleaner, TriFoam (det.)	<b>100%</b>	<b>2.0 sec</b>	0 counts	0 counts	<b>5.0 sec.</b>
<b>2</b>	Rotating HP Rocker, Reclaim Sol.	<b>75%</b>	0.0 sec.	<b>80 counts</b>	<b>80 counts</b>	0.0 sec.
<b>3</b>	Front Brush, Rear Brush, Side Brush Tilt Sol, Side Brush, Top Brush, SB Lube, TB Lube	<b>50%</b>	0.0 sec.	0 counts	0 counts	0.0 sec.
<b>4</b>	Side Brush, SB Lube	<b>75%</b>	0.0 sec.	0 counts	0 counts	0.0 sec.
<b>5</b>	Wheel Brush, HP wash	<b>75%</b>	0.0 sec.	<b>86 counts</b>	<b>86 counts</b>	0.0 sec.
<b>6</b>	HP Rinse, Cold H2O Sol.	<b>100%</b>	0.0 sec.	<b>86 counts</b>	<b>86 counts</b>	0.0 sec.
<b>7</b>	Low Press Wax	<b>100%</b>	<b>2.0 sec</b>	0 counts	0 counts	0.0 sec.
<b>8</b>	Spot Free Rinse, Blower (free-standing)	<b>100%</b>	<b>2.0 sec</b>	0 counts	0 counts	0.0 sec.

### Recipe # 3

Pass #	Active "Bits"	Gantry Speed	Preset Values			
			Start Delay	Boom @ Start	Boom @ End	End Delay
<b>1</b>	Undercarriage, Hi pH Presoak, Tire Cleaner	<b>100%</b>	<b>3.0 sec</b>	0 counts	0 counts	<b>5.0 sec.</b>
<b>2</b>	Wheel Brush, Reclaim Sol, Rotating HP Rocker	<b>75%</b>	0.0 sec.	<b>80 counts</b>	<b>80 counts</b>	0.0 sec.
<b>3</b>	Front Brush, Rear Brush, Side Brush, Top Brush, SB Lube, TB Lube	<b>50%</b>	0.0 sec.	0 counts	0 counts	0.0 sec.
<b>4</b>	HP Wash, Reclaim Sol.	<b>75%</b>	0.0 sec.	<b>86 counts</b>	<b>86 counts</b>	0.0 sec.
<b>5</b>	TriFoam (cond.)	<b>100%</b>	<b>2.0 sec</b>	0 counts	0 counts	<b>2.0 sec.</b>
<b>6</b>	HP Rinse, Cold H2O Sol.	<b>75%</b>	0.0 sec.	<b>80 counts</b>	<b>80 counts</b>	0.0 sec.
<b>7</b>	Low Press Wax	<b>100%</b>	<b>2.0 sec</b>	0 counts	0 counts	0.0 sec.
<b>8</b>	Spot Free Rinse, Blower (free-standing)	<b>100%</b>	<b>2.0 sec</b>	0 counts	0 counts	0.0 sec.

## Recipe # 4

Pass #	Active "Bits"	Gantry Speed	Preset Values			
			Start Delay	Boom @ Start	Boom @ End	End Delay
<b>1</b>	Undercarriage, Hi pH Presoak, Tire Cleaner, TriFoam (det.)	<b>100%</b>	<b>3.0 sec</b>	0 counts	0 counts	<b>5.0 sec.</b>
<b>2</b>	Wheel Brush, HP Wash, Reclaim Sol.	<b>75%</b>	0.0 sec.	<b>80 counts</b>	<b>80 counts</b>	0.0 sec.
<b>3</b>	Front Brush, Rear Brush, Side Brush, Top Brush, SB Lube, TB Lube	<b>50%</b>	0.0 sec.	0 counts	0 counts	0.0 sec.
<b>4</b>	HP Rinse, Cold H2O Sol.	<b>75%</b>	0.0 sec.	<b>80 counts</b>	<b>80 counts</b>	0.0 sec.
<b>5</b>	Cold H2O Sol, Low Press Wax, Rotating HP Rocker	<b>100%</b>	<b>2.0 sec</b>	0 counts	0 counts	0.0 sec.
<b>6</b>	Spot Free Rinse	<b>100%</b>	<b>2.0 sec</b>	0 counts	0 counts	0.0 sec.
<b>7</b>	Blower (on-board)	<b>50%</b>	<b>5.0 sec.</b>	0 counts	0 counts	0.0 sec.
<b>8</b>	Blower (on-board)	<b>60%</b>	<b>5.0 sec.</b>	0 counts	0 counts	0.0 sec.

### Recipe # 5

Pass #	Active "Bits"	Gantry Speed	Preset Values			
			Start Delay	Boom @ Start	Boom @ End	End Delay
1	Undercarriage, Hi pH Presoak, Tire Cleaner	100%	3.0 sec	0 counts	0 counts	5.0 sec.
2	Reclaim Sol, Rotating HP Rocker	75%	0.0 sec.	80 counts	80 counts	0.0 sec.
3	Front Brush, Rear Brush, Side Brush, Top Brush, SB Lube, TB Lube	50%	0.0 sec.	0 counts	0 counts	0.0 sec.
4	Wheel Brush, HP Rinse, Reclaim Sol.	60%	0.0 sec.	80 counts	80 counts	0.0 sec.
5	Low Press Wax	100%	2.0 sec	0 counts	0 counts	0.0 sec.
6	Spot Free Rinse	100%	2.0 sec	0 counts	0 counts	0.0 sec.
7	Blower (on-board)	50%	5.0 sec.	0 counts	0 counts	0.0 sec.
8	Blower (on-board)	60%	5.0 sec.	0 counts	0 counts	0.0 sec.

### Recipe # 6

Pass #	Active "Bits"	Gantry Speed	Preset Values			
			Start Delay	Boom @ Start	Boom @ End	End Delay
1	Undercarriage, Hi pH Presoak, Tire Cleaner	100%	3.0 sec	0 counts	0 counts	5.0 sec.
2	HP Wash, Reclaim Sol.	75%	0.0 sec.	80 counts	80 counts	0.0 sec.
3	Front Brush, Rear Brush, Side Brush, Top Brush, SB Lube, TB Lube	50%	0.0 sec.	0 counts	0 counts	0.0 sec.
4	HP Rinse, Cold H2O Sol.	75%	0.0 sec.	80 counts	80 counts	0.0 sec.
5	Low Press Wax, Rotating HP Rocker, Cold H2O Sol.	100%	2.0 sec	80 counts	80 counts	0.0 sec.
6	Spot Free Rinse, Blower (free-standing)	100%	2.0 sec	0 counts	0 counts	0.0 sec.



## Recipe # 7

Pass #	Active "Bits"	Gantry Speed	Preset Values			
			Start Delay	Boom @ Start	Boom @ End	End Delay
1	Hi pH Presoak	100%	3.0 sec	0 counts	0 counts	5.0 sec.
2	HP Rinse, Reclaim Sol, Rinse Side Only	100%	0.0 sec.	80 counts	80 counts	0.0 sec.
3	Front Brush, Rear Brush, Side Brush, Top Brush, SB Lube, TB Lube	50%	0.0 sec.	0 counts	0 counts	0.0 sec.
4	HP Wash, Reclaim Sol.	100%	0.0 sec.	80 counts	80 counts	0.0 sec.
5	HP Rinse, Cold H2O Sol.	100%	0.0 sec.	80 counts	80 counts	0.0 sec.
6	Spot Free Rinse	100%	2.0 sec	0 counts	0 counts	0.0 sec.

## Recipe # 8

Pass #	Active "Bits"	Gantry Speed	Preset Values			
			Start Delay	Boom @ Start	Boom @ End	End Delay
1	Hi pH Presoak, Tire Cleaner	100%	3.0 sec	0 counts	0 counts	5.0 sec.
2	Wheel Brush, HP wash, Reclaim Sol.	100%	0.0 sec.	86 counts	86 counts	0.0 sec.
3	Front Brush, Rear Brush, Side Brush, Top Brush, SB Lube, TB Lube	50%	0.0 sec.	0 counts	0 counts	0.0 sec.
4	HP Rinse, Spot Free Rinse	100%	2.0 sec	0 counts	0 counts	0.0 sec.

## Recipe # 9

Pass #	Active "Bits"	Gantry Speed	Preset Values			
			Start Delay	Boom @ Start	Boom @ End	End Delay
<b>1</b>	Hi pH Presoak	<b>100%</b>	<b>3.0 sec</b>	0 counts	0 counts	<b>5.0 sec.</b>
<b>2</b>	HP Wash, Reclaim Sol.	<b>100%</b>	0.0 sec.	<b>80 counts</b>	<b>80 counts</b>	0.0 sec.
<b>3</b>	Front Brush, Rear Brush, Side Brush, Top Brush, SB Lube, TB Lube	<b>50%</b>	0.0 sec.	0 counts	0 counts	0.0 sec.
<b>4</b>	HP Rinse, Cold H2O Sol, Spot Free Rinse	<b>100%</b>	<b>2.0 sec</b>	0 counts	0 counts	0.0 sec.





## MAINTENANCE PROGRAM OUTLINE

Regular lubrication is the easiest, least expensive prevention maintenance. Read the eFusion Service Manual for proper material specifications and adjustment settings. **USE ONLY LITHIUM BASED WATERPROOF GREASE.** Failure to follow the greasing and lubrication procedure will void warranty.

### Bi-Weekly

- Check all spray tips for obstruction
- Check all soap and chemical levels in the tanks
- Drain water from the air compressor
- Check hoses for rubbing or cracking
- Check ¾" boom swivel for leaks
- Pick up and remove all debris from the bay floor
- Grease bearings on the drive wheels (8 ea.) – *Use waterproof grease only.*
- Clean all eyes on gantry with a soft cloth
- Clean the optic sensor eyes on the stop and entrance stations
- Check SparkleSoft brush material for damage or wear.
- Observe the unit washing a vehicle and check for proper operation
- Grease the Boom Shaft and Brush Carriage Bearings
- Inspect the Pulley & Boom Belts
- Tighten Allen Screws on Oscillating Shaft Collars
- Check the Lovejoy couplings on the Boom & Drive for Wear and Alignment
- Check 10 Position Sign and replace bulbs as necessary ( if applicable )
- Check 2 position sign and replace bulbs as necessary
- Check water hardness
- Check all Proximity Switches for proper adjustments
- Check Cashier Operation
- Wheel Count Test            Front \_\_\_\_ Rear \_\_\_\_

### Monthly

- Grease the Wall and Gantry boom arm bearings.
- Grease the water swivel on top boom arm (use just a small amount of grease)
- Titrate Presoak
- Check and clean all strainers inside the chemical tanks
- Check oil level on large Cat pump using sight glass located at the back of the pump.

### Semi-Annual (Every 6 months)

- Change the oil in large Cat Pump every 6 months or every 20,000 vehicles
- Check and replace as needed all Hydrominder hoses
- Check all Hydrominder foot valves

The Baldor Gear Boxes on the eFusion are sealed and have a pressure compensation chamber. Therefore, there is no need for periodic oil changes. Replace the oil only when the Gear Box must be disassembled for other maintenance. We recommend using Mobil SNC 634 Synthetic Oil.



## Bi-Weekly Maintenance Checklist

Date: \_\_\_\_\_

✓	X	FUNCTION	COMMENTS
_____	_____	Grease All Bearings	_____
_____	_____	Clean Eyes on Gantry	_____
_____	_____	Clean Eyes on Entrance & Stop Station	_____
_____	_____	Observe eFusion wash a vehicle and check for proper operation	_____
_____	_____	Clean Contouring Eyes	_____
_____	_____	Check all spray tips for obstruction	_____
_____	_____	Check all soap and chemical levels in Tank	_____
_____	_____	Drain Water from Air Compressor	_____
_____	_____	Check Swivels for leaking	_____
_____	_____	Check Hoses for rubbing or cracking	_____
_____	_____	Check Lovejoy coupling on Boom & Drive	_____
_____	_____	Inspect Pulleys and Boom Belts	_____
_____	_____	Tighten Allen Screws on Oscillating Shaft Collars	_____
_____	_____	Inspect Jam Nut on Boom Air Cylinder	_____
_____	_____	Wheel Count Test Front _____ Rear _____	_____

Notes:

\_\_\_\_\_

\_\_\_\_\_

Alarm Codes & Date: \_\_\_\_\_

Car Count on eFusion: \_\_\_\_\_

Unit checked by: \_\_\_\_\_



## Monthly Maintenance Checklist

Date: \_\_\_\_\_

✓	X	FUNCTION	COMMENTS
_____	_____	Grease Bearings on Top Boom Shaft (6ea)	_____
_____	_____	Grease Bearing on Boom Arm on Unit (2ea)	_____
_____	_____	Grease Bearing on Boom Arm on Wall (2ea)	_____
_____	_____	Grease Water Swivel on Top Boom Shaft (use a very small amount)	_____
_____	_____	Titrate Pre-Soak	_____
_____	_____	Check oil level on large Cat Pump & oil plunger wicks	_____
_____	_____	Check All Proximity Switches for proper adjustments	_____
_____	_____	Observe eFusion wash a vehicle	_____
_____	_____	Does everything look normal	_____
_____	_____	Unit rolling smoothly up and down track	_____
_____	_____	Any unusual noises	_____
_____	_____	Proper Presoak Coverage	_____
_____	_____	Any nozzles plugged	_____
_____	_____	Check soap and wash levels	_____
_____	_____	Check Cashier Operation	_____
_____	_____	Check Air Compressor & Drain Tank	_____
_____	_____	Check Operation of all Prox Switches	_____
_____	_____	Check all light packages for burned out bulbs	_____
_____	_____	Check Water Softener for proper operation	_____

Notes:

Alarm Codes & Date: \_\_\_\_\_

Car Count on eFusion: \_\_\_\_\_

Unit checked by: \_\_\_\_\_



## Semi-Annual Maintenance Checklist

Date: \_\_\_\_\_

√	X	FUNCTION	COMMENTS
_____	_____	Change oil in large Cat Pump every 6 months or every 20,000 vehicles	_____
_____	_____	Check and clean all strainers inside chemical tanks	_____
_____	_____	Check and replace as needed all Hydrominder hoses	_____
_____	_____	Check all Hydrominder foot valves	_____
_____	_____	Grease Bearings on Top Boom Shaft (6ea)	_____
_____	_____	Observe eFusion wash a vehicle	_____
_____	_____	Does everything look normal	_____
_____	_____	Unit rolling smoothly up and down track	_____
_____	_____	Any unusual noises	_____
_____	_____	Proper Presoak Coverage	_____
_____	_____	Any nozzles plugged	_____
_____	_____	Check soap and wash levels	_____

Notes:

\_\_\_\_\_

\_\_\_\_\_

\_\_\_\_\_

Alarm Codes & Date: \_\_\_\_\_

Car Count on eFusion: \_\_\_\_\_

Unit checked by: \_\_\_\_\_









## Pump Stand

### Table of Contents

DSI Pump Stand.....	2
DSI Chemical Delivery System DWG.....	3
DSI Chemical Delivery System Description Of Operation.....	4
Troubleshooting.....	5
Electrical Control Center (ECC).....	6
Wiring The Pump Stand To The ECC.....	6
Input Selections On Gantry .....	7
Ecc Input Selections .....	9
Output Selections On Gantry.....	10
Output Selections On Gantry (Cont.).....	11
ECC Output Selections.....	11
ECC Output Selections (Cont.).....	13
ECC Output Selections (Cont.).....	14

## PUMP STAND

The eFusion pump stand is constructed of stainless steel tubing. Each leg has a specially machined 1¼" stainless steel leveling bolt in it so that the unit can be leveled and bolted to the floor.

In the middle of the pump stand you will find a Cat Pump model #3535 that is optional, which is capable of pumping 35 gallons per minute. Driving the pump are 3 V belts connected to a 25 HP Electric motor.

On top of the pump frame is a cold-water rinse tank. There is mounted a 1 ½ HP pump to deliver water to the DSI chemical delivery system. The 1 ½ HP pump will turn on when the gantry is sending a signal to deliver chemicals. Each chemical system has a separate solenoid and injector to deliver consistent chemicals.



## DSI CHEMICAL DELIVERY SYSTEM

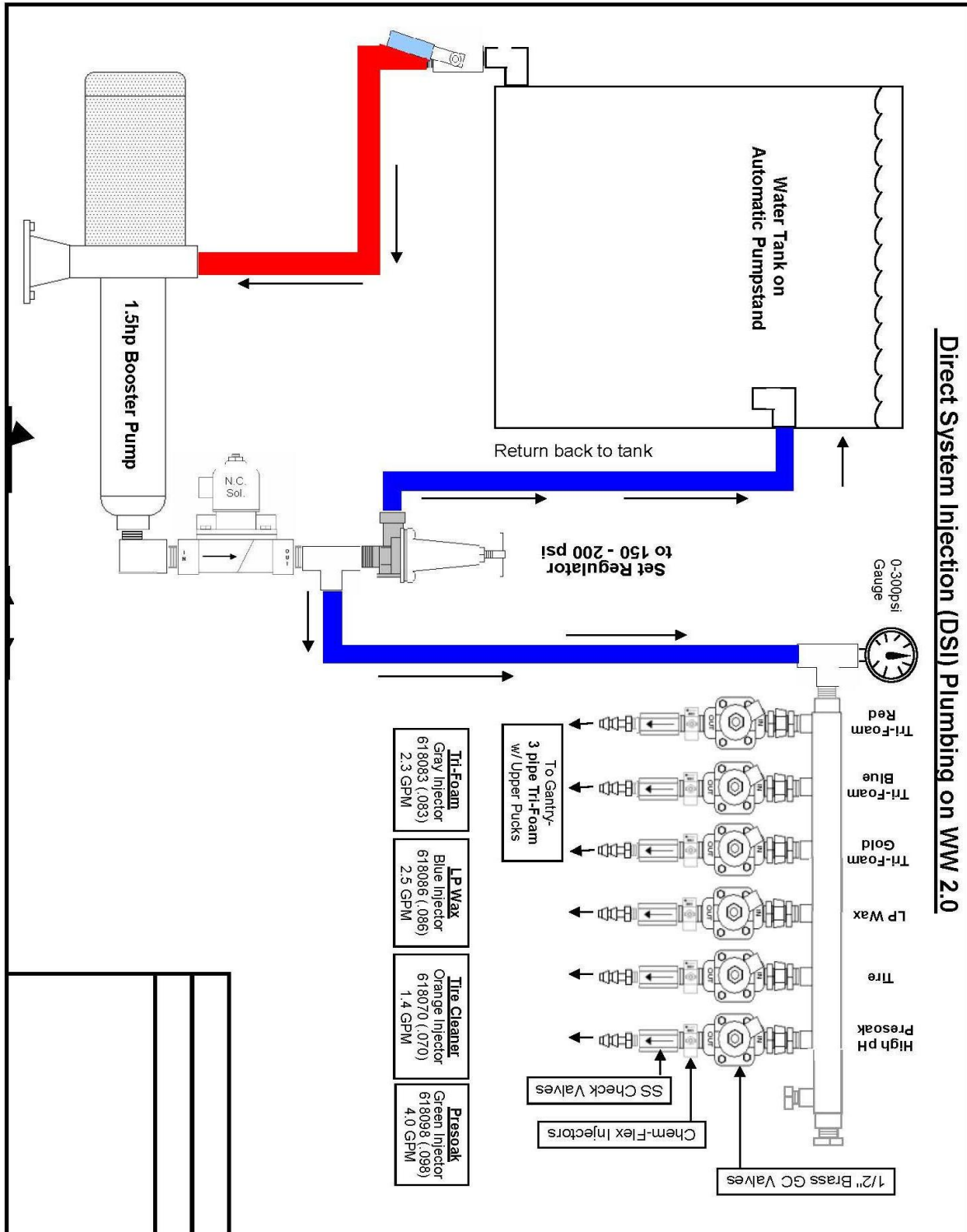

## DESCRIPTION OF OPERATION

The DSI system consist of a 1 1/2hp pump that you can adjust the pressure at the pressure regulator. We recommend that the pressure is set at 175 psi. Do not exceed 190 psi on this system. When the pump is running excess water from the pump regulator is being returned back to the tank.

Each Chemical has a separate solenoid that turns on when the Gantry is delivering the chemical. The water flows through the solenoid and then through an injector. The injector creates the suction to draw the chemical. The Injectors are available in different sizes based upon flow rates. The chart below shows the recommended injector for the Water Wizard and Fusion units. Each injector has a suction hose and hose barb. When you pull off the suction hose you can screw in a metering tip to change the dilution of the chemicals. There are two styles of tips that are available the standard lean tips and the Ultra Lean tips. Please note the GPM flow rates for the different functions on this machine, the injector flow rate is sized to be less than the cumulative flow thru the tips or nozzles for that function. If the cumulative flow of the nozzles is less than the flow rate of the injector it will not work or draw chemical properly. This creates back pressure and stops the suction.

The dilution that you get with your chemicals will vary based upon the viscosity of the chemicals. Your Chemical supplier will set up your machine with the proper tips and dilution ratios for the chemicals you are using.

### DSI System on Automatics Using Chemicals

Low Pressure Product Name	HFI Injector Color	HFI Injector Size - GPM	Listed Ratio on Tip Chart	Metering Tip Color
High pH Presoak	Green	.098 - 4.0 GPM	102:1	Tan
Low pH Presoak	Green	.098 - 4.0 GPM	143:1	Burgundy
Brush Lube	Gray	.083 - 2.3 GPM	230:1	Pumpkin
Tire Cleaner	Red	.057 - 1.0 GPM	75:1	Orange
Red Tri-Foam, Std. puck	Blue	.086 - 2.5 GPM	60:1	Turquoise
Blue Tri-Foam, Std. puck	Blue	.086 - 2.5 GPM	60:1	Turquoise
Gold Tri-Foam, Std. puck	Blue	.086 - 2.5 GPM	60:1	Turquoise
Red Tri-Foam, 3 pipe	Red	.057 - 1.0 GPM	60:1	Turquoise
Blue Tri-Foam, 3 pipe	Red	.057 - 1.0 GPM	60:1	Turquoise
Gold Tri-Foam, 3 pipe	Red	.057 - 1.0 GPM	60:1	Turquoise
Low Press. Wax	Blue	.086 - 2.5 GPM	102:1	Tan
Glass Treatment (RainX)	Gray	.083 - 2.3 GPM	102:1	Tan

ultra-lean  
ultra-lean

## TROUBLESHOOTING THE DSI SYSTEM

### Chemical is not being drawn up the suction tube.

1. Go to the Red lion controller and turn on the chemical that you are having a problem with.
2. Does water flow out the tips on the gantry.
3. If yes then the water solenoid is on and water is flowing through the injector.
4. Pull off the suction hose on the chemical and remove the lean or ultra-lean tip. Make sure the lean or ultra-lean tip is not clogged. Check to see that all of the nozzles are spraying properly and not causing back pressure. Clean Nozzles as required.
5. The best method is to install a vacuum gauge with a short hose on the hose barb and see if the injector is creating suction. If you have 20" of suction then the injector is working properly and the lean tip is clogged or the chemical is too thick to draw properly.
6. If you are not getting any suction or less than 10" there are two causes of the problem. The injector has to flow the proper amount of water to create the suction.

#### Example:

*If the injector is Blue and is sized for 2.5 gallons per minute the tips on the gantry have to be sized to flow at least 2.5 gpm. If some of the tips are clogged then the tips are only flowing 2.0 gpm and then the injector will not create any suction.*

- a. Check to see if the injector is clogged
- b. Check to make sure there are no tips on the gantry that are clogged.
- c. If no tips are clogged then go to the gantry and remove one of the tips and turn on and see if the injector has suction.
- d. Under the barb of the injector is a built in check valve with Teflon ball and spring.
- e. Remove the barb very carefully to make sure you don't lose the ball, spring or o-ring and clean as necessary.

**Notes:** When technicians are having a problem with the injector not drawing up the correct amount of chemical they usually want to increase the size of the injector. This does not solve the problem and only makes the problem worse. The tips or hockey puck foamer have to be sized to dispense more water that the injector is rated to flow. If the tips are too small then there will be back pressure and it will cause the injectors to stop drawing chemicals.

Tip Color	Ratio	Style	Tip Color	Ratio	Style
Copper	230:1	Ultra Lean	Green	16:1	Lean
Pumpkin	175:1	Ultra Lean	Blue	13:1	Lean
Burgundy	143:1	Ultra Lean	Yellow	9:1	Lean
Lime	100:1	Ultra Lean	Black	6:1	Lean
Tan	102:1	Lean	Purple	15:1	Lean
Orange	75:1	Lean	Gray	4:1	Lean
Turquoise	60:1	Lean	None	3.6 :1	Lean
Pink	43:1	Lean			
Light Blue	33:1	Lean			
Brown	28:1	Lean			
Red	22:1	Lean			
White	18:1	Lean			

Ratio is based upon water thin products. Field test to determine the actual ratio.



## ELECTRICAL CONTROL CENTER (ECC)

The Electrical Control Center (ECC) on the eFusion is the main control center for the automatic. It is a cabinet constructed of 14-gauge stainless steel. Inside the box is the CPU controller (CJ1M-CPU44), multiple input and output cards, power supply, transformer, terminal strips, and the safety disconnect switch. The 3 phase electrical power supply ties to L1, L2, and L3 of the safety switch. The Electrical Control Center supplies power to the gantry motors, gantry input/output cards, prox sensors, and eye sensors.

The door of the ECC holds four (4) cycle buttons to enable the operator to test wash cycles with ease, and one reset button that resets the gantry computer and the auto cashier. In the middle of the door, you will find a Red Lion controller. This is where the operator can custom design a wash and test functions on the automatic. Any error codes will also be displayed on the LCD screen. Refer to Red Lion section for more detailed descriptions on the Red Lion.



**Control Center Door w/Red Lion**

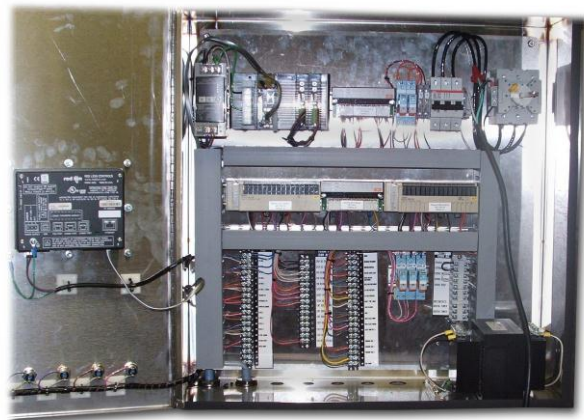

**Electrical Control Center**

### Wiring the Pump Stand to the ECC

Connect the control panel to the pump stand matching terminal #3 in the ECC to the terminal strip in the pump stand junction box (i.e., presoak to presoak, brush lube to brush lube, etc). Inside the junction box is a solid state flasher that supplies a pulsing signal to the pneumatic pumps.

## Input Selections on Gantry

**CONFIGURATION - October 2, 2007**

**Fusion**

**Gantry Inputs**

**Gantry Inputs - SRT2-ID16's**

<b>Gantry Address 0</b>	<b>FusionX &amp; eFusion Inputs</b>	
I_MeasurementEye	2008.00	measurement eye on gantry eye
I_LeftBrush_EncoderProx1	2008.01	prox 1 left brush encoder, INNER PROX prox
I_LeftBrush_EncoderProx2	2008.02	prox 2 left brush encoder, OUTER PROX prox
I_RightBrush_EncoderProx1	2008.03	prox 1 Right brush encoder, INNER PROX prox
I_RightBrush_EncoderProx2	2008.04	prox 2 Right brush encoder, OUTER PROX prox
I_TopBrush_EncoderProx1	2008.05	prox 1 top brush encoder, LOWER PROX prox
I_TopBrush_EncoderProx2	2008.06	prox 2 top brush encoder, UPPER PROX prox
I_Gantry_ExitProx	2008.07	home position of the gantry prox
I_Gantry_EntranceProx	2008.08	reverse limit on gantry prox
I_Gantry_EncoderProx1	2008.09	prox 1 gantry encoder, LOWER PROX prox
I_Gantry_EncoderProx2	2008.10	prox 2 gantry encoder, UPPER PROX prox
I_VacationHomeProx	2008.11	second home prox - for secondary home prox location prox
I_CenterLimitProx	2008.12	center limit prox, for side brushes prox
I_WheelPositionEye	2008.13	finds tire position for Wheel Brush eye
	2008.14	
	2008.15	

<b>Gantry Address 2</b>	<b>FusionX &amp; eFusion Inputs</b>	
I_LeftBrushHomeLimit	2009.00	left brush limit prox sensor - RETRACTED LIMIT prox
I_LeftBrushExtendedLimit	2009.01	left brush limit prox sensor - EXTENDED LIMIT prox
I_RightBrushHomeLimit	2009.02	right brush limit prox sensor - RETRACTED LIMIT prox
I_RightBrushExtendedLimit	2009.03	right brush limit prox sensor - EXTENDED LIMIT prox
I_TopBrushHomeLimit	2009.04	top brush limit prox sensor - UPPER LIMIT prox
I_TopBrushLowerLimit	2009.05	top brush limit prox sensor - LOWER LIMIT prox
I_WheelBrushes_Retracted	2009.06	prox sensor - sensing BOTH cylinders in retracted position prox
I_gantry_fault	2009.07	gantry drive faulted contact
I_SideBrush_Fault	2009.08	left or right brush positioner or spindle faulted contact
I_TopBrush_Fault	2009.09	top brush positioner or spindle faulted contact
I_Oscillator/WheelBrush_Fault	2009.10	oscillating motor or wheel brush spindle faulted contact
I_Blower_Fault	2009.11	on-board blower fault (any one of the MS's or VFD) contact
I_Blower Prox Fwd	2009.12	blower osc prox in forward direction prox
I_Blower Prox Rev	2009.13	blower osc prox in reverse direction prox
	2009.14	
	2009.15	

## Input Selections on Gantry (cont.)

Gantry Address 4		FusionX & eFusion Inputs	
I_JogFwd	2010.00	jog drive forward	SW
I_JogRev	2010.01	jog drive reverse direction	SW
I_JogBoom_Up	2010.02	jog boom up direction	SW
I_JogBoom_Down	2010.03	jog boom down direction	SW
I_JogOscillateMotor	2010.04	jog the oscillator motor	SW
I_JogTilt_Fwd	2010.05	jog the tilt forward	SW
I_JogTilt_Rev	2010.06	jog the tilt arm reverse direction	SW
I_JogLeftBrush_Extend	2010.07	extend left brush	SW
I_JogLeftBrush_Retract	2010.08	retract left brush	SW
I_JogRightBrush_Extend	2010.09	extend right brush	SW
I_JogRightBrush_Retract	2010.10	retract right brush	SW
I_JogTopBrush_Up	2010.11	jog top brush up	SW
I_JogTopBrush_Down	2010.12	jog top brush down	SW
I_JogWheelBrushes	2010.13	jog the wheel brush - bring cylinder forward, spin motor	SW
I_JogWheelVFDs	2010.14	jog the wheel VFDs	SW
I_JogEnable	2010.15	enable switch for jog's	SW
Gantry Address 6		FusionX ONLY	
I_CanEye	2011.00	gantry safety eye in can	eye
I_BoomSafetyRear	2011.01	rear boom safety eye, attached to boom rear direction	eye
I_BoomSafetyFront	2011.02	front boom safety eye, attached to boom front direction	eye
I_Boom_EncoderProx1	2011.03	prox 1 boom encoder, LOWER PROX	prox
I_Boom_EncoderProx2	2011.04	prox 2 boom encoder, UPPER PROX	prox
I_BoomHomeLimit	2011.05	boom limit prox - UPPER LIMIT	prox
I_BoomLowerLimit	2011.06	boom limit prox - LOWER LIMIT	prox
I_BoomBeltSafety	2011.07	detects slack on boom belt	prox
I_height_first	2011.08	top eye at top of boom	eye
I_height_second	2011.09	2nd eye from top	eye
I_height_third	2011.10	3rd eye from top	eye
I_height_fourth	2011.11	bottom eye, 4th from top	eye
I_boom_fault	2011.12	boom faulted	contact
	2011.13		
I_3phPowerDetection	2011.14	detects loss of 3 phase power	contact
	2011.15		

## ECC Input Selections

Control Panel Inputs		
Control Panel, Address 12	FusionX & eFusion Inputs	
I_Treadle_sw	2014.00 switch on floor	eye
I_ExitDoorEye	2014.01 senses door area clear to close exit door	eye
I_EstopSw	2014.02 emergency stop switch	sw
I_ResetSw	2014.03 reset switch on control panel	sw
I_UnderCarriageEye	2014.04 front entrance switch to turn on undercarriage wash	eye
I_TempSwitch	2014.05 closes on rise in temperature, door controller	sw
	2014.06	
I_FreezeTstat	2014.07 freeze thermostat - closes when temp falls	sw
I_TireCleaner_Level_OK	2014.08 level OK in tire cleaner vessel	sw
I_Wax_Level_OK	2014.09 level OK on foaming conditioner tank	sw
I_CashierCycle1	2014.10 pulse from auto cashier, cycle 1	contact
I_CashierCycle2	2014.11 pulse from auto cashier, cycle 2	contact
I_CashierCycle3	2014.12 pulse from auto cashier, cycle 3	contact
I_CashierCycle4	2014.13 pulse from auto cashier, cycle 4	contact
I_PreSoak_Level_OK	2014.14 level OK in presoak vessel	sw
I_H2O_Level_OK	2014.15 water tank level OK	sw
Control Panel, Address 14	FusionX & eFusion Inputs	
I_ManualWash1	2015.00 manually select wash 1	sw
I_ManualWash2	2015.01 manually select wash 2	sw
I_ManualWash3	2015.02 manually select wash 3	sw
I_ManualWash4	2015.03 manually select wash 4	sw
I_BillChanger1Fault	2015.04 bill changer 1 faulted	contact
I_BillChanger2Fault	2015.05 bill changer 2 faulted	contact
I_AutoCashierFault	2015.06 auto cashier faulted	contact
I_ExitDoorOpenProx	2015.07 senses exit door is opened	prox
I_ReclaimTankLevel	2015.08 detects low level in reclaim/cold water tank	sw
I_Blwr Nozzle Prox	2015.09 blower osc nozzle prox	prox
	2015.10	
	2015.11	
I_ExtBlowerShutOff	2015.12 photo to shut off blowers if customer leaves early	eye
	2015.13	
I_25hp OverloadTripped	2015.15 25 hp Overload Tripped	contact

## Output Selections on Gantry

CONFIGURATION - Dec. 27, 2007

### Fusion

GANTRY OUTPUTS, SRT2-ROC16

FusionX & eFusion Outputs

Address 0	Volts	Com	
O_Blower1	24ac	0	2000.00 blower #1, center blower
O_BlowerOsc CW	24dc-	1	2000.01 Blower osc motor, CW Direction
O_Blower2	24ac	0	2000.02 blower #2, outboard blower
O_BlowerOsc CCW	24dc-	1	2000.03 Blower osc motor, CCW Direction
O_Rocker_Sol	24ac	2	2000.04 rocker solenoid valve
O_PreSoak_Sol_1	24ac	3	2000.05 presoak air & liquid solenoids, reverse direction
O_PreSoak_Sol_2	24ac	2	2000.06 presoak air & liquid solenoids, forward direction
O_TireCleaner_Sol	24ac	3	2000.07 tire cleaner solenoid
O_TriColorFoam_Sol	24ac	4	2000.08 Triple Foam air & liquid solenoids
O_Side Spray Sol.	24ac	5	2000.09 side spray rinse solenoid
O_LowPressWax_Sol	24ac	4	2000.10 low pressure wax solenoid
O_Blower3	24ac	5	2000.11 blower #3, outboard blower
		6	2000.12 spare
		7	2000.13 spare
		6	2000.14 spare
		7	2000.15 spare

GANTRY OUTPUTS, SRT2-ROC16

FusionX & eFusion Outputs

Address 2	Volts	Com	
O_TopSprayer_Sol	24ac	0	2001.00 top sprayer solenoid
O_SideBrushLube, Rev	24ac	1	2001.01 side brush friction lubricant solenoid, reverse direction
O_SideBrushLube, Fwd	24ac	0	2001.02 side brush friction lubricant solenoid, forward direction
O_TopBrushLube, Rev	24ac	1	2001.03 top brush friction lubricant solenoid, reverse direction
O_TopBrushLube, Fwd	24ac	2	2001.04 top brush friction lubricant solenoid, forward direction
O_AirPurge_Sol	24ac	3	2001.05 air purge sol
O_Tilt_Brushes_Sol	24ac	2	2001.06 tilt side brushes
O_SpotFreeAirPurge	24ac	3	2001.07 spot free air purge solenoid
O_Wheel_Sol	24ac	4	2001.08 extend wheel brush
O_WheelBrushCW	24dc-	5	2001.09 Wheel brush CW direction
O_Wheel_HP_Sol	24ac	4	2001.10 High pressure water solenoid for wheel brushes
O_WheelBrushCCW	24dc-	5	2001.11 Wheel brush CCW direction
O_ScrollingSignA	24 neut	6	2001.12 white/red wire
O_ScrollingSignB	24 neut	7	2001.13 tan wire
O_ScrollingSignC	24 neut	6	2001.14 yellow wire
O_ScrollingSignD	24 neut	7	2001.15 brown wire

### Alternate 2001 Outputs

O_DriveForwardLight	24dc+	6	2001.12 Green Light, On-Board 3 position sign
O_StopLight	24dc+	7	2001.13 Red Light, On-Board 3 position sign
O-BackUpLight	24dc+	6	2001.14 Yellow Light, On-Board 3 position sign
O_	24dc+	7	2001.15 spare

## Output Selections on Gantry (cont.)

GANTRY OUTPUTS - SRT2-OD16			FusionX & eFusion Outputs
Address 4	Volts	Com	
O_LeftBrushExtend	24dc-		2002.00 left brush extend direction
O_LeftBrushRetract	24dc-		2002.01 left brush retract direction
O_RightBrushExtend	24dc-		2002.02 Right brush extend direction
O_RightBrushRetract	24dc-		2002.03 Right brush retract direction
O_LeftBrushSpindleCW	24dc-		2002.04 left brush spindle drive - CW direction
O_LeftBrushSpindleCCW	24dc-		2002.05 left brush spindle drive - CCW direction
O_RightBrushSpindleCW	24dc-		2002.06 right brush spindle drive - CW direction
O_RightBrushSpindleCCW	24dc-		2002.07 right brush spindle drive - CCW direction
w_PhotoSensorCR	24dc-		2002.08 turn off photo sensors -thru NC contact on relay.
O_Reset_VFDs	24dc-		2002.09 reset contact to the VFDs
O_TopBrushUp	24dc-		2002.10 Top brush upper direction
O_TopBrushDown	24dc-		2002.11 Top brush down direction
O_TopBrushSpindleCW	24dc-		2002.12 Top brush spindle drive - CW direction
O_TopBrushSpindleCCW	24dc-		2002.13 Top brush spindle drive - CCW direction
O_GantryFwd	24dc-		2002.14 move carriage to front of car
O_GantryRev	24dc-		2002.15 move carriage to rear of car

GANTRY OUTPUTS - SRT2-ROC08			FusionX ONLY, Outputs
Address 6	Volts	Com	
O_BoomUp	24dc-	0	2003.00 run boom up direction
O_BoomDown	24dc-	1	2003.01 run boom down direction
O_Oscillator_VFD	24dc-	0	2003.02 run oscillator motor VFD
	24dc-	1	2003.03 spare dc (-) output
O_Tilt_Boom_Front	24ac	2	2003.04 tilt front direction
O_Tilt_Boom_Rear	24ac	3	2003.05 tilt rear direction
NOW VACANT	24ac	2	2003.06 spare, was side spray which moved to 2000.09
O_WaterDumpValve	24ac	3	2003.07 water dump valve on top of boom

CONTROL PANEL OUTPUTS, SRT2-ROC08			FusionX & eFusion Outputs
Address 8	Volts	Com	
O_OpenEntryDoor	?	0	2004.00 entrance door
O_OpenExitDoor	?	1	2004.01 open exit door
O_CloseEntryDoor	?	0	2004.02 close entrance door
O_CloseExitDoor	?	1	2004.03 close exit door
<b>O_Glass Treatment MS</b>	<b>24vac</b>	<b>2</b>	<b>2004.04 Glass Treatment Motor Starter</b>
O_TireGlazeMS	24ac	3	2004.05 Motor Starter to spin Tire Glaze Brush
O_TireGlazeLiquidSol	24ac	2	2004.06 Liquid Product Solenoid to dispense Tire Glaze
O_TireGlazeAirCylSol	24ac	3	2004.07 Solenoid to extend Tire Glaze Air Cylinder



## ECC Output Selections

CONTROL PANEL OUTPUTS, SRT2-ROC16			FusionX & eFusion Outputs
Address 10	Volts	Com	
O_HP_Wash	24ac	0	2005.00 soap (wash) solenoid
O_HiPressWax	24ac	1	2005.01 hi pressure wax solenoid
O_UnderCarriageSol	24ac	0	2005.02 under carriage solenoid
O_MedPressSol	24ac	1	2005.03 medium pressure solenoid
O_SpotFreeMS	24ac	2	2005.04 spot free motor starter
O_PSoakHi_pH_MS	24ac	3	2005.05 high pH presoak MS
O_TireCleanerMS	24ac	2	2005.06 tire cleaner motor starter
O_PreSoakHeater	24ac	3	2005.07 presoak heater contactor
O_TripleShineMS	24ac	4	2005.08 triple shine motor starter
O_ReclaimWaterSol	24ac	5	2005.09 reclaim water solenoid
O_PreSoakRecircSol1	24ac	4	2005.10 Hi pH presoak recirculation sol
O_PSoakLoPH_MS	24ac	5	2005.11 Lo pH presoak MS
O_PhotoSensorCheckPanel	24dc-	6	2005.12 photo sensor safety check relay in control panel
O_PresoakLowPH_recirc	24ac	7	2005.13 low ph presoak recirculation solenoid
O_EW_Reset	24dc-	6	2005.14 reset the Entry Wizard cashier
O_BlowerTimer	24ac	7	2005.15 blower digital timer

CONTROL PANEL OUTPUTS, SRT2-ROC16			FusionX & eFusion Outputs
Address 12	Volts	Com	
O_EnterNowLight	24dc+	0	2006.00 drive forward light at entrance to wash
O_LPWaxMS	24ac	1	2006.01 low pressure wax motor starter
O_PleaseWaitLight1	24dc+	0	2006.02 please wait at entrance of wash
O_ColdWaterSol	24ac	1	2006.03 cold water reservoir
O_Sol1TripleShine	24ac	2	2006.04 solenoid 1 for triple shine
O_Sol2TripleShine	24ac	3	2006.05 solenoid 2 for triple shine
O_Sol3TripleShine	24ac	2	2006.06 solenoid 3 for triple shine
O_InTankWaterHeater	24ac	3	2006.07 Water Heater inside Water Tank
O_FrictionLubeMS	24ac	4	2006.08 Brush Lube Pump MS
O_BlwrNozCW	24dc-	5	2006.09 Blwr Noz CW rotation
O_BlowerExternal(MS2-3)	24ac	4	2006.10 external blower motor starters # 2 & 3 (24vac)
O_BlwrNozCCW	24dc-	5	2006.11 Blwr Noz CCW rotation
O_AlarmHorn	24ac	6	2006.12 announce car on treadle (24vac)
	120ac		25 HP motor starter (110V) <b>(change com7 to 24vac on eFusion)</b>
O_PumpMain	or 24ac	7	2006.13
O_BlowerExternal(MS1)	24ac	6	2006.14 external blower motor starter # 1 (24vac)
	120ac		auto cashier reset (110V) <b>(change com7 to 24vac on eFusion)</b>
O_CashierReset	or 24ac	7	2006.15



## ECC Output Selections (cont.)

CONTROL PANEL OUTPUTS, SRT2-VOM16		FusionX & eFusion Outputs	
Optional 10 Position Sign			
Address 14	Volts	Com	
O_StopLight	120ac		2007.00 stop light
O_EnterLight	120ac		2007.01 drive forward light inside wash bay
O_BackupLight	120ac		2007.02 backup light
O_PresoakLight	120ac		2007.03 presoak light
O_RockerLight	120ac		2007.04 rocker panel light
O_ClearCoatLight	120ac		2007.05 clear coat light
O_TripleShineLight	120ac		2007.06 triple shine light
O_SpotFreeLight	120ac		2007.07 spot free light
O_ExitLight	120ac		2007.08 exit light
O_CleanCarLight	120ac		2007.09 clean car is a happy car light
O_PleaseWaitLight	120ac		2007.10 please wait at entrance of car wash
O_LP_WaxLight	120ac		2007.11 spare
O_2004_12			2007.12 spare
O_2004_13			2007.13 spare
O_2004_14			2007.14 spare
O_2004_15			2007.15 spare

CONTROL PANEL OUTPUTS, SRT2-VOM16 -		FusionX & eFusion Outputs	
Optional 10 Position Sign	Channel	2007 Address	14
Address 14	Volts		
O_StopLight	120ac	2007.00	stop light
O_EnterLight	120ac	2007.01	drive forward light inside wash bay
O_BackupLight	120ac	2007.02	backup light
O_PresoakLight	120ac	2007.03	presoak light
O_RockerLight	120ac	2007.04	rocker panel light
O_ClearCoatLight	120ac	2007.05	clear coat light
O_TripleShineLight	120ac	2007.06	triple shine light
O_SpotFreeLight	120ac	2007.07	spot free light
O_ExitLight	120ac	2007.08	exit light
O_CleanCarLight	120ac	2007.09	clean car is a happy car light
O_PleaseWaitLight	120ac	2007.10	please wait at entrance of car wash
O_LP_WaxLight	120ac	2007.11	spare
O_2004_12		2007.12	spare
O_2004_13		2007.13	spare
O_2004_14		2007.14	spare
O_2004_15		2007.15	spare

## ECC Output Selections (cont.)

### Channel 2027 Output Card - connected to the analog SRM21 module

Optional ROC-08 located in ECC panel in bottom row		Address = 14	Com.	Term.	Voltage
O_ScrollingSign A	Vac neu	com 0	2027.00	"off-board" scrolling sign output A	
O_ScrollingSign B	Vac neu	com 1	2027.01	"off-board" scrolling sign output B	
O_ScrollingSign C	Vac neu	com 0	2027.02	"off-board" scrolling sign output C	
O_ScrollingSign D	Vac neu	com 1	2027.03	"off-board" scrolling sign output D	
		com 2	2027.04		
		com 3	2027.05		
		com 2	2027.06		
		com 3	2027.07		



## GANTRY

### Table of Contents

High Pressure Cabinet .....	3
High Pressure Box.....	4
Low Pressure Box .....	5
Gantry Eyes And Location .....	8
Manual Operation Override .....	9
Sparklesoft Brush Segment Configuration.....	10
Omron Yaskawa User's Manual .....	11
Omron Information.....	20
Input Selections On Gantry .....	26
Ecc Input Selections .....	28
Output Selections On Gantry.....	29
Ecc Output Selections .....	30
Ecc Output Selections .....	31
Analog Outputs And Inputs.....	34

## GANTRY

The eFusion system is designed to effectively clean a vehicle using our unique *SparkleSoft* foam brushes. *SparkleSoft* is a strong, hushed and delicate product that glides over the vehicle's surface, enhancing their gloss and luster, wash after wash. The brushes employ the unique Multi-Axis Coordinated Motion Control to position them.

We've taken the durability factor of the stainless frame and added three (3) soft touch brushes and an optional wheel brush. The system is extremely versatile with performance options such as High Pressure Wash, Hot Wax, Spot Free Rinse and much more. The eFusion is totally programmable to fit your wash needs and to maximize your profits.



## HIGH PRESSURE CABINET

This box is mounted on the passenger's side of the gantry. Rinse water as well as the spot free delivery will plumb into this manifold. From here we will open and close solenoids to direct the water to the proper nozzles when the car wash calls for it.

We use three 454P DEMA Valves in this box. One 454P is used for the high pressure on the wheel brushes. One 454P DEMA valve controls the high pressure on the sides and one for the top nozzles. By using this method, we are able to have rinse from the top, sides or a combination of both.

To get details for the electrical and plumbing, refer to the drawing. Below is a output location chart for the high-pressure cabinet. The "Brush Lube" solenoids are also mounted in this cabinet although they deliver a low-pressure product.

<b>SOLENOIDS IN HIGH PRESSURE BOX (24AC)</b>	
<b>SOLENOID</b>	<b>ROC16</b>
Side Spray	2000.09
Top Spray	2001.00
Rocker Panel Spray (optional)	2000.04
Rotating Rocker Brush Spray	2001.10
Side Brush Lube Rev	2001.01
Side Brush Lube Fwd	2001.02
Top Brush Lube Rev	2001.03
Top Brush Lube Fwd	2001.04

## High Pressure Box

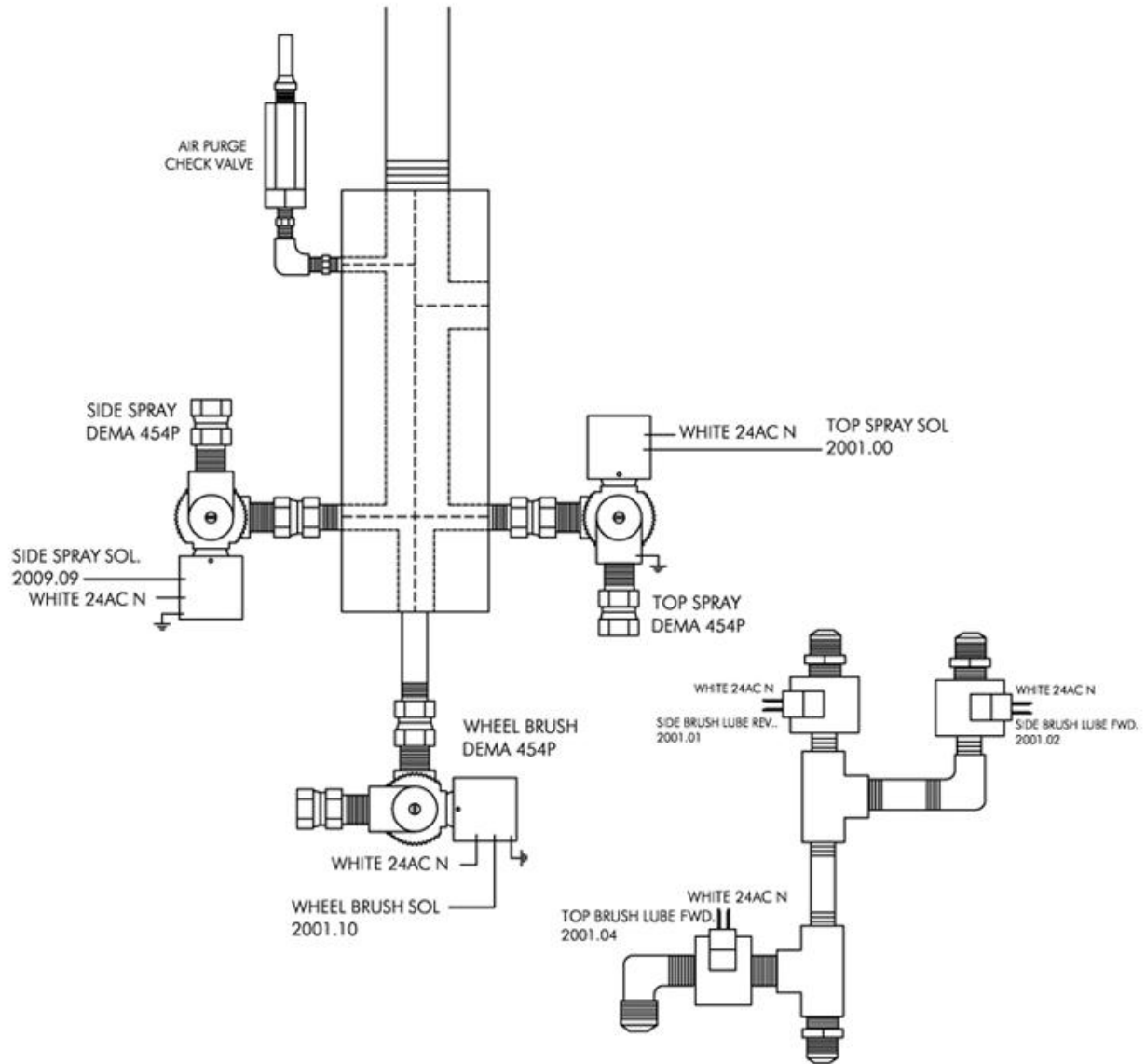

## Low Pressure Box

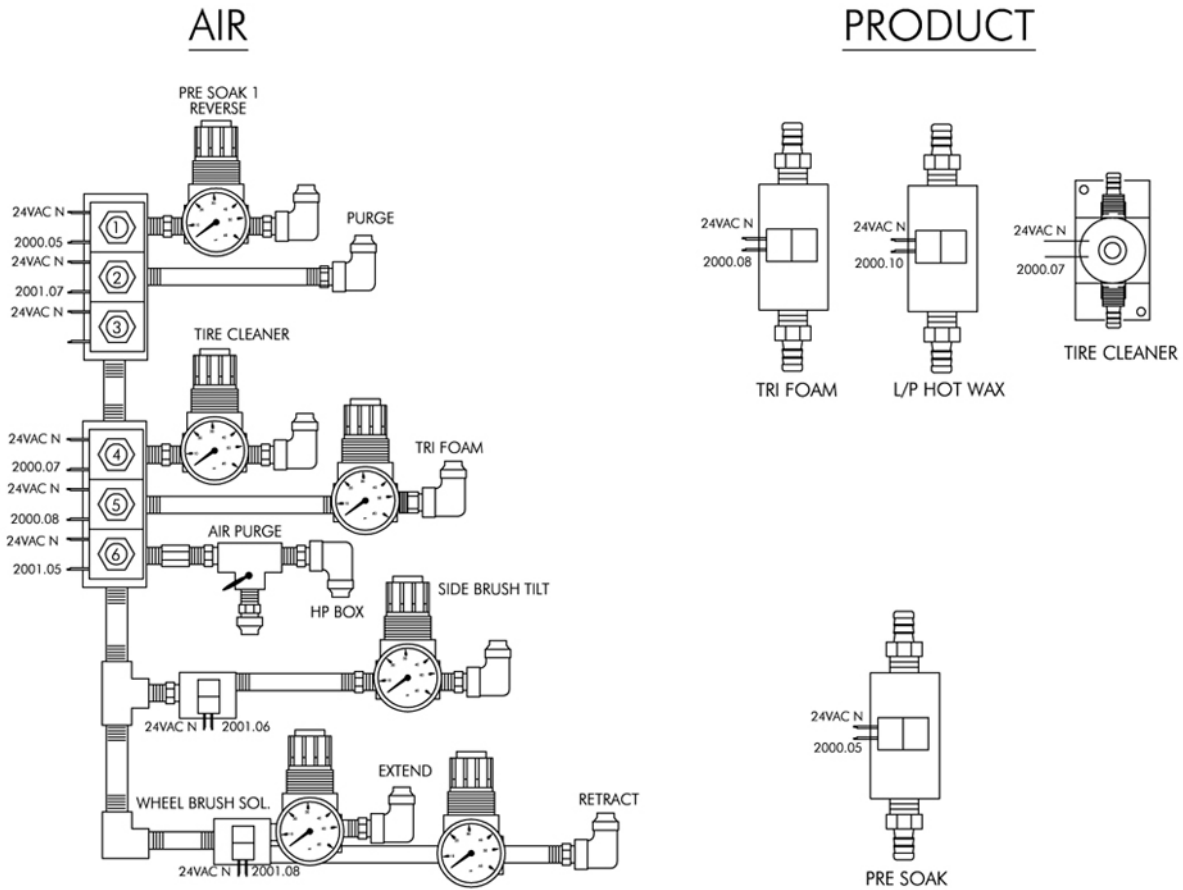



## LOW PRESSURE BOX

There is a low-pressure cabinet located on the driver side end of gantry. Inside the cabinet you will find two rows of solenoids - the product solenoid on the right side, and the air solenoids on the left side. The product solenoids are single solenoids so that different chemicals do not get mixed with each other. On the left is a bank of air solenoids with one common inlet. Each air solenoid has a regulator with a gauge mounted to it, with the exception of the air purge solenoid. This enables the operator to adjust each chemical individually. By mounting the solenoids on the gantry, you are able to have a remote equipment room without compromising chemical changeover time. Refer to drawings for plumbing and electrical wiring.

Below is a wiring chart for the Low Pressure Cabinet.

<b>LOW PRESSURE CABINET</b>		
<b>WIRE COLOR</b>	<b>SOLENOID</b>	<b>ROC16</b>
White	Neutral	
White	Neutral	
Tan	Presoak Air & Product #1	2000.05
Pink	Spot Free Purge	2001.07
Orange	Tire Cleaner	2000.07
Purple	Tri Foam Air & Product	2000.08
Black	Air Purge	2001.05
Yellow	Side Brush Tilt	2001.06
	Wheel Brush Solenoid	2001.08
Gray	Tilt Forward	2003.04
Brown	Low Pressure Wax	2000.10
Green	Ground	

## PROXIMITY SWITCHES

There are several prox switches on the gantry as listed below. To operate properly, each prox switch should be located approximately 3/8" from the metal plate it is sensing. **Note: Be sure to fill screw on prox cable connection with dielectric grease to eliminate moisture from creating conductivity problems.**

Below is a chart of the prox switches and their purpose.

PROX / CABLE LOCATION	SRT2-ID16 INPUT
<b>Gantry</b>	<b>Address 0</b>
Left Brush Count - Inner	2008.01
Left Brush Count - Outer	2008.02
Right Brush Count - Inner	2008.03
Right Brush Count - Outer	2008.04
Top Brush Count - Lower	2008.05
Top Brush Count - Upper	2008.06
Gantry Home Prox	2008.07
Gantry End of Track	2008.08
Gantry Wheel Counting Prox 1	2008.09
Gantry Wheel Counting Prox 2	2008.10
Vacation Home prox	2008.11
Center Limit for side brushes	2008.12
Tire Position for Wheel Brush	2008.13
<b>Gantry</b>	<b>Address 2</b>
Left Brush Home Limit	2009.00
Left Brush Extend Limit	2009.01
Right Brush Home Limit	2009.02
Right Brush Extend Limit	2009.03
Top Brush Home Limit	2009.04
Top Brush Extend Limit	2009.05
Wheel Brushes Retract Limit	2009.06
Blower Nozzle Prox 1 Fwd	2009.12
Blower Nozzle Prox 2 Rev	2009.13
<b>Located in ECC</b>	<b>Address 14</b>
Exit Door Open Prox	2015.07
Blower Nozzle Osc Prox	2015.09

## GANTRY EYES AND LOCATION

Location	Eye #	SRT2-ID16 Input
Measurement Eye	8	2008.00
Wheel Brush Position Eye	9	2008.13

Fusion On-Board Scrolling Sign Outputs/Messages			
Displayed Messages	Output	Wire Color	Scrolling Sign Wire Color
1. Welcome Message, user programmable	None		
2. Wash	2001.12	Brown	Brown
3. Rinse	2001.13	Red	Red
4. Presoak	2001.14	Orange	Orange
5. Stop	2001.15	Blue	Yellow
6. Rocker Panel Blaster	14 & 15		Black = 24vac hot White = 24 vac neutral Green = ground
7. Back Up	13 & 15		
8. Clearcoat Protectant	13 & 14		
9. Drive Forward	12 & 15		
10. Tire Cleaner	12 & 14		
11. Wax	12 & 13		
12. Exit Slowly	13, 14 & 15		
13. Triple Shine	12, 14 & 15		
14. Soaking	12, 13 & 15		
15. Spot Free Rinse	12, 13 & 14		
16. Blower	12, 13, 14 & 15		

## Manual Operation Override

Inside the Gantry Control Panel on the gantry are manual push buttons to manually operate the various mechanical functions of the eFusion system.

To use the manual push button you must first turn ON the toggle switch to the manual position. This operation will allow you to test all mechanical functions on the gantry including moving the gantry, rotating the brushes etc...

Toggle switch must be in the OFF position for the system to operate normally.

PB1 - LEFT BRUSH RETRACT  
PB2 - LEFT BRUSH EXTEND  
PB3 - LEFT BRUSH SPIN  
PB4 - TOP BRUSH DOWN  
PB5 - TOP BRUSH UP

PB6 - TOP BRUSH SPIN  
PB7 - SIDE BRUSH TILT  
PB8 - RIGHT BRUSH SPIN  
PB9 - RIGHT BRUSH EXTEND  
PB10 - RIGHT BRUSH RETRACT

PB11 - GANTRY FOWARD  
PB12 - GANTRY REVERSE  
PB18 - WHEEL BRUSH EXTEND  
PB19 - WHEEL BRUSH SPIN

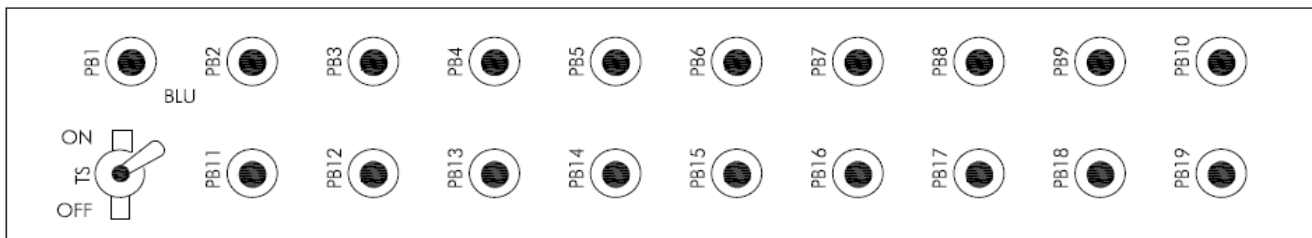

## SparkleSoft Brush Segment Configuration

The Brush segments are in approximately 3 inch high segments. They are in different lengths and different densities to clean all areas of the vehicle. See the chart below for details of brush length and density location.

### Remove and Replace Brush Segments

These segments are very simple to remove and replace. They slide onto the aluminum core. The top and bottom segments are fastened to the core securing the interior segments in place. To replace, simply remove the fastener from the bottom segment and slide the new segments on. Consult the chart for proper placement. The "U" numbers shown for each area is well marked on the inside of each brush segment.

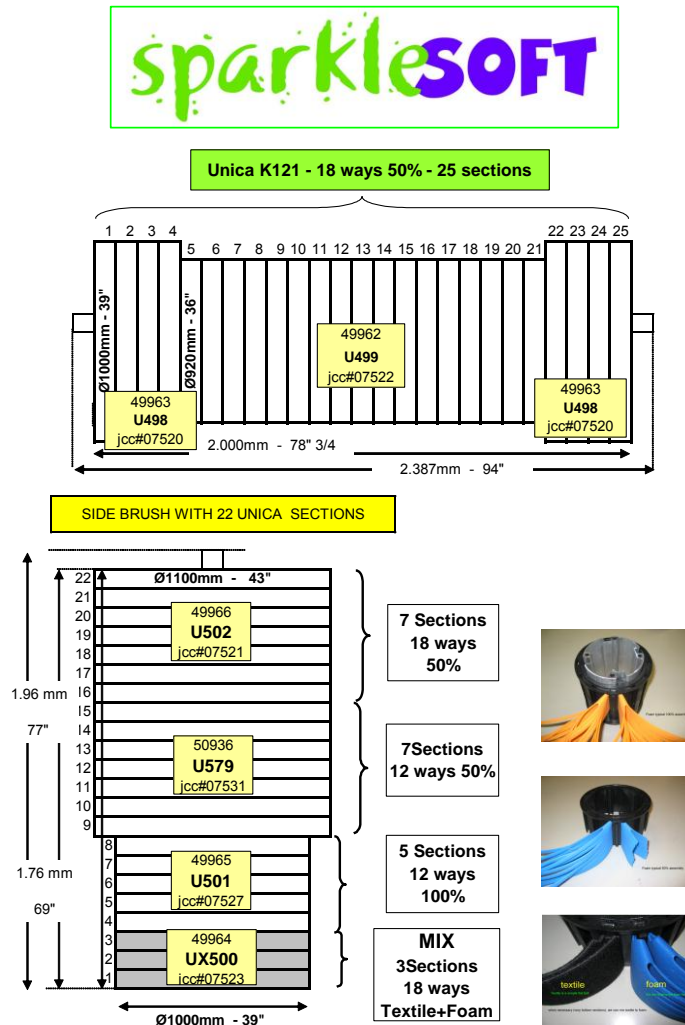

## OMRON Yaskawa User's Manual



# YASKAWA AC Drive Compact V/f Control Drive J1000

100 V CLASS, SINGLE-PHASE INPUT: 0.1 to 1.1 kW  
200 V CLASS, THREE-PHASE INPUT: 0.1 to 5.5 kW  
200 V CLASS, SINGLE-PHASE INPUT: 0.1 to 2.2 kW  
400 V CLASS, THREE-PHASE INPUT: 0.2 to 5.5 kW

Reliable and Smart

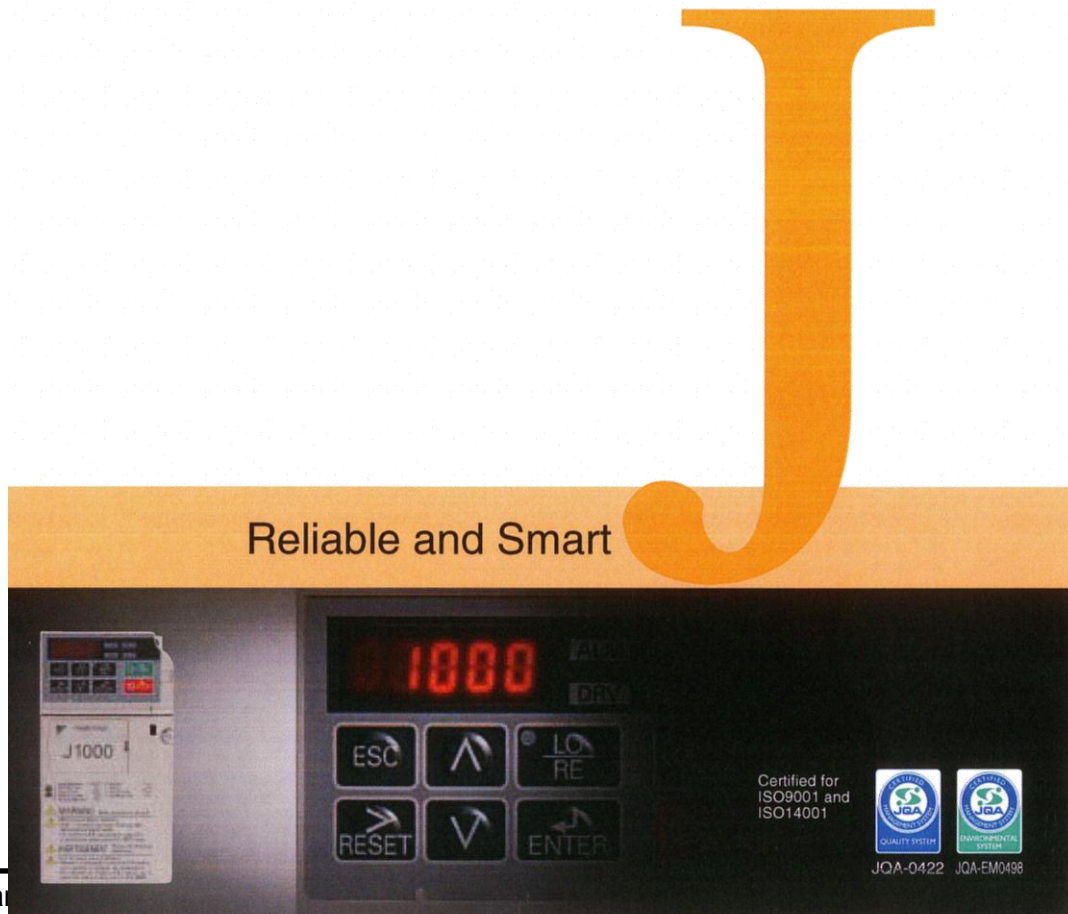



## Parameter List

Refer to J1000 Installation & Start-Up Manual for details.

Function	No.	Name	Range	Default
Initialization Parameters	A1-01	Access Level Selection	0, 2	2
	A1-03	Initialize Parameters	0 to 3330	0
	A1-04	Password 1	0 to 9999	0
	A1-05	Password 2	0 to 9999	0
Operation Mode Selection	b1-01	Frequency Reference Selection	0 to 3	1
	b1-02	Run Command Selection	0 to 2	1
	b1-03	Stopping Method Selection	0, 1	0
	b1-04	Reverse Operation Selection	0, 1	0
	b1-07	LOCAL/REMOTE Run Selection	0, 1	0
	b1-08	Run Command Selection while in Programming Mode	0 to 2	0
	b1-14	Phase Order Selection	0, 1	0
DC Injection Braking	b2-02	DC Injection Braking Current	0 to 75	50%
	b2-03	DC Injection Braking Time/ DC Excitation Time at Start	0.00 to 10.00	0.00 s
	b2-04	DC Injection Braking Time at Stop	0.00 to 10.00	0.50 s
Acceleration and Deceleration Times	C1-01	Acceleration Time 1	0.0 to 6000.0	10.0 s
	C1-02	Deceleration Time 1	0.0 to 6000.0	10.0 s
	C1-03	Acceleration Time 2	0.0 to 6000.0	10.0 s
	C1-04	Deceleration Time 2	0.0 to 6000.0	10.0 s
	C1-09	Fast-Stop Time	0.0 to 6000.0	10.0 s
S-Curve Characteristics	C2-01	S-Curve Characteristic at Accel Start	0.00 to 10.00	0.20 s
	C2-02	S-Curve Characteristic at Accel End	0.00 to 10.00	0.20 s
	C2-03	S-Curve Characteristic at Decel Start	0.00 to 10.00	0.20 s
	C2-04	S-Curve Characteristic at Decel End	0.00 to 10.00	0.00 s
Slip Compensation	C3-01	Slip Compensation Gain	0.0 to 2.5	0.0
Torque Compensation	C3-02	Slip Compensation Primary Delay Time	0 to 10000	2000 ms
	C4-01	Torque Compensation Gain	0.00 to 2.50	1.00
Carrier Frequency	C6-01	Normal/Heavy Duty Selection	0, 1	1
	C6-02	Carrier Frequency Selection	1 to F	*2
	C6-03	Carrier Frequency Upper Limit	1.0 to 15.0	*3
	C6-04	Carrier Frequency Lower Limit	1.0 to 15.0	*3
	C6-05	Carrier Frequency Proportional Gain	00 to 99	*3
Frequency Reference	d1-01	Frequency Reference 1	0.00 to 400.00	0.00 Hz
	d1-02	Frequency Reference 2		0.00 Hz
	d1-03	Frequency Reference 3		0.00 Hz
	d1-04	Frequency Reference 4		0.00 Hz
	d1-05	Frequency Reference 5		0.00 Hz
	d1-06	Frequency Reference 6		0.00 Hz
	d1-07	Frequency Reference 7		0.00 Hz
	d1-08	Frequency Reference 8		0.00 Hz
Frequency Upper and Lower Limits	d1-17	Jog Frequency Reference		6.00 Hz
	d2-01	Frequency Reference Upper Limit	0.0 to 110.0	100.0%
Jump Frequency	d2-02	Frequency Reference Lower Limit	0.0 to 110.0	0.0%
	d3-01	Jump Frequency 1	0.0 to 400.0	0.0 Hz
	d3-02	Jump Frequency 2	0.0 to 400.0	0.0 Hz
Frequency Reference Hold	d3-04	Jump Frequency Width	0.0 to 20.0	1.0 Hz
	d4-01	Frequency Reference Hold Function Selection	0, 1	0
V/f Pattern Characteristics	E1-01	Input Voltage Setting	155 to 255	200 V <sup>*1</sup>
	E1-03	V/f Pattern Selection	F	F
	E1-04	Max Output Frequency	40.0 to 400.0	60.0 Hz
	E1-05	Max Output Voltage	0.0 to 255.0	200.0 V <sup>*1</sup>
	E1-06	Base Frequency	0.0 to E1-04	60.0 Hz <sup>*1</sup>
	E1-07	Mid Output Frequency	0.0 to E1-04	3.0 Hz
	E1-08	Mid Output Frequency Voltage	0.0 to 255.0	16.0 V <sup>*1</sup>
	E1-09	Minimum Output Freq.	0.0 to 400.0	1.5 Hz
	E1-10	Minimum Output Freq. Voltage	0.0 to 255.0	12.0 V <sup>*1</sup>





Function	No.	Name	Range	Default
Motor Parameters	E2-01	Motor Rated Current	10 to 200% of drive rated current	**2
	E2-02	Motor Rated Slip	0.00 to 20.00	**2
	E2-03	Motor No-Load Current	0 to less than E2-01	**2
	E2-05	Motor Line-to-Line Resistance	0.000 to 65.000	**2
Multi-Function Digital Inputs	H1-01	Multi-Function Digital Input Terminal S1 Function Selection	1 to 67	40
	H1-02	Multi-Function Digital Input Terminal S2 Function Selection	1 to 67	41
	H1-03	Multi-Function Digital Input Terminal S3 Function Selection	0 to 67	24
	H1-04	Multi-Function Digital Input Terminal S4 Function Selection	0 to 67	14
	H1-05	Multi-Function Digital Input Terminal S5 Function Selection	0 to 67	3 (0) **4
Multi-Function Digital Outputs	H2-01	Terminal MA, MB and MC Function Selection (relay)	0 to 13D	E
Analog Inputs	H3-01	Terminal A1 Signal Level Selection	0 to 3	0
	H3-03	Terminal A1 Gain Setting	-999.9 to 999.9	100.0%
	H3-04	Terminal A1 Bias Setting	-999.9 to 999.9	0.0%
	H3-13	Analog Input Filter Time Constant	0.00 to 2.00	0.03 s
Multi-Function Analog Outputs	H4-01	Multi-Function Analog Output Terminal AM	000 to 999	0
	H4-02	Multi-Function Analog Output Terminal AM Gain	-999.9 to 999.9	100.0%
	H4-03	Multi-Function Analog Output Terminal AM Bias	-999.9 to 999.9	0.0%
MEMOBUS/Modbus Communications	H5-01	Drive Slave Address	0 to FFH	1F
	H5-02	Communication Speed Selection	0 to 5	3
	H5-03	Communication Parity Selection	0 to 2	0
	H5-04	Stopping Method After Communication Error	0 to 3	3
	H5-05	Communication Fault Detection Selection	0, 1	1
	H5-06	Drive Transmit Wait Time	10 to 65	10 ms
	H5-07	RTS Control Selection	0, 1	1
	H5-12	Run Command Method Selection	0, 1	0
Motor Protection Functions	H5-13	MEMOBUS Frequency Reference and Frequency Monitor Unit	0 to 3	0
	L1-01	Motor Overload Protection Selection	0 to 2	1
	L1-02	Motor Overload Protection Time	0.1 to 5.0	1.0 min
Momentary Power Loss	L1-13	Continuous Electrothermal Operation Selection	0, 1	1
	L2-01	Momentary Power Loss Operation Selection	0 to 2	0
Stall Prevention Functions	L3-01	Stall Prevention Selection during Acceleration	0, 1	1
	L3-02	Stall Prevention Level during Acceleration	0 to 150	**5
	L3-04	Stall Prevention Selection during Deceleration	0, 1, 4	1
	L3-05	Stall Prevention Selection during Run	0 to 2	1
	L3-06	Stall Prevention Level during Run	30 to 150	**5
Frequency Detection	L4-01	Speed Agreement Detection Level	0.0 to 400.0	0.0 Hz
	L4-07	Frequency Detection Conditions	0, 1	0
Fault Reset	L5-01	Number of Auto Restart Attempts	0 to 10	0
Overtorque Detection	L6-01	Torque Detection Selection 1	0 to 4	0
	L6-02	Torque Detection Level 1	0 to 300	150%
	L6-03	Torque Detection Time 1	0.0 to 10.0	0.1 s
Hardware Protection	L8-01	Internal Dynamic Braking Resistor Protection Selection (ERF type)	0, 1	0
	L8-05	Input Phase Loss Protection Selection	0, 1	0
	L8-10	Heatsink Cooling Fan Operation Selection	0, 1	0
	L8-12	Ambient Temperature Setting	-10 to 50	30°C
	L8-18	Soft CLA Selection	0, 1	1
	L8-35	Installation Method Selection	0 to 3	**2
Hunting Prevention	L8-38	Carrier Frequency Reduction	0 to 2	**2
	n1-02	Hunting Prevention Gain Setting	0.00 to 2.50	1.00
High-Slip Braking	n3-13	Overexcitation Deceleration Gain	1.00 to 1.40	1.10
Display Settings	o1-02	User Monitor Selection After Power Up	1 to 4	1
	o1-03	Digital Operator Display Selection	0, 1	0
	o2-02	STOP Key Function Selection	0, 1	1
Operator Keypad Functions	o2-04	Drive Model Selection	0 to FF	**2
	o2-05	Frequency Reference Setting Method Selection	0, 1	0
	o2-06	Operation Selection when Digital Operator is Disconnected	0, 1	0
	o2-09	Initialization Mode	0 to 3	dep. on drive spec.
Copy Functions	o3-01	Copy Function Selection	0 to 3	0
	o3-02	Copy Allowed Selection	0, 1	0
Maintenance Period	o4-01	Accumulated Operation Time Setting	0 to 9999	0 h
	o4-02	Accumulated Operation Time Selection	0, 1	0
	o4-03	Cooling Fan Operation Time Setting	0 to 9999	0 h
	o4-05	Capacitor Maintenance Setting	0 to 150	0%
	o4-07	Soft Charge Bypass Relay Maintenance Setting	0 to 150	0%
	o4-09	IGBT Maintenance Setting	0 to 150	0%
	o4-11	U2 Initialize Selection	0, 1	0

Parameter List

\*\*1: Values shown here are for 288V class drives. Double the value when using a 400V class drive.  
 \*\*2: Default setting value is dependent on parameter o2-04, Drive Model Selection.  
 \*\*3: Default setting value is dependent on parameter C6-02, Carrier Frequency Selection.  
 \*\*4: Value in brackets indicates default when 5-wire initialization is performed (A1-03 = 3330).  
 \*\*5: Default setting value is dependent on C6-01 and L8-38 settings.



## Basic Instructions

Quick Setup,  
Easy to Operate

### Operator Names and Functions

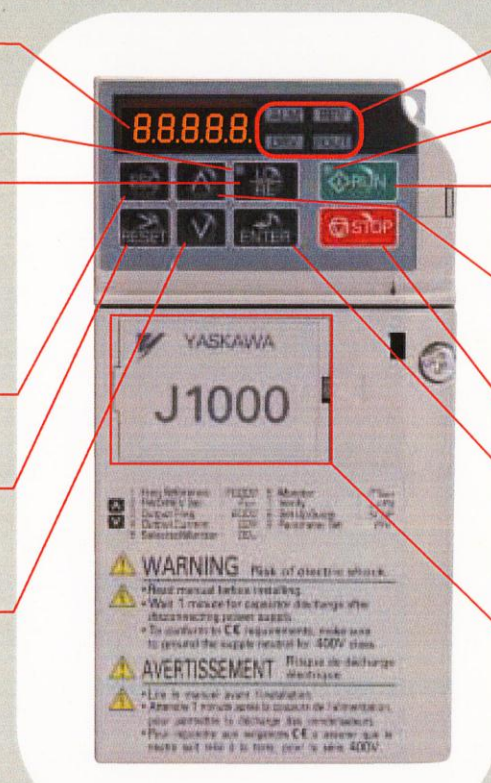

**Data display (5-digit)**  
Displays frequency, parameter number, and other data.

**LO/RE light**  
Lights to indicate that the operator is set for LOCAL.

**LO/RE key**  
Determines where the Run command and frequency reference come from: the keypad (LOCAL) or the control terminals (REMOTE).

**ESC key**  
Lets the user back up to the previous display screen.

**Right arrow key**  
Scrolls the cursor to the right.

**RESET key**  
Resets a fault.

**Down arrow key**  
Scrolls down through the display screen, and decreases a selected value.

**LED panel**  
More information listed below.

**RUN light**  
Lights when the Run command is present.

**RUN key**  
Issues a Run command.

**Up arrow key**  
Scrolls up through the display screen, and increases a selected value.

**STOP key**  
Issues a Stop command.

**ENTER key**  
Press to enter values, edit parameters, and set the control mode. Press this key to proceed to the next screen when scrolling through various menu displays.

**Com port**  
Connect an optional interface for serial communications, remote operator, USB copy unit, or link to a PC using DriveWizard Plus.

### LED Display Guide

LED	ON	Flashing	OFF
<b>ALM</b>	A fault has occurred.	<ul style="list-style-type: none"> <li>Alarm situation detected.</li> <li>Operator error (OPE)</li> </ul>	Normal operation
<b>REV</b>	Motor is rotating in reverse.	---	Motor is rotating forward.
<b>DRV</b>	In the "Drive Mode"	---	Programming Mode
<b>FOUT</b>	Output frequency	---	---
	Run command assigned to the operator (LOCAL)	---	Run command assigned to remote location (REMOTE)
<b>RUN</b>	During run	<ul style="list-style-type: none"> <li>During deceleration</li> <li>Run command is present but the frequency reference is zero.</li> </ul>	Drive is stopped.

### How the RUN light works:

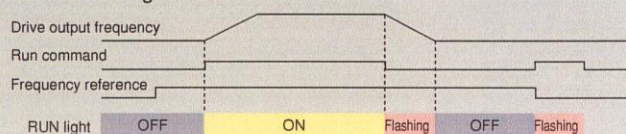





Operation Example

Using the LED Operator to Run the Drive

Steps	Key	Result/Display
1 Turn the power on.		F 000
2 Set the drive for LOCAL. The frequency reference is displayed.		F 000 LO should light.
3 Displays the direction (forward).		For
4 Displays the output frequency.		000
5 Displays the output current.		000A
6 Displays the output voltage.		000V
7 Displays the beginning of the Monitor Menu.		flashing r7on
8 Displays the top of the Verify Menu.		flashing urF4
9 Displays the top of the Setup Mode.		flashing SRUP
10 Displays the top of the parameter settings menu.		PAR
Returns back to the frequency reference display.		

Value will flash when it is possible to change the setting.

**Drive Mode:** Run and Stop commands, displays operation status such as the frequency reference, output frequency, output current, output voltage, etc.

How to Monitor the Frequency Reference

Steps	Key	Result/Display
Use the arrow keys to select the digits to set.		F0000
		F0000
		F0600
		F0600
Press enter to save the new value.		F0600 DRV   DRV lights up.

**Monitor Mode:** Displays operation status and information on faults.

Steps	Key	Result/Display
Selecting a Monitor for Display		U1-01
Displays U1-01, the frequency reference monitor.		600
Re-select the monitor display menu.		U1-01
		U1-02
		U1-26
Back up to the top of the Monitor Menu.		r7on

**Verify Menu:** Displays parameters changed from the default settings.

Steps	Key	Result/Display
Lists parameters that have been changed in order.		C1-01
Pressing Enter displays the parameter value.		00030
Parameters that have been changed from their default values are listed in order.		C1-01
		C1-02
		C6-02
Returns to the top of the Verify Menu.		urF4

Press to go back to the previous display screen.

Setup Mode

The Setup Mode allows you to view and set up the minimum-required parameters to run the drive.

Steps	Key	Result/Display
Parameter check		b1-01
		C1-01
		00100
Setting change		00100
		00200
		C1-01

Scroll using the up arrow key and see which parameters have been selected.

Setup Mode Parameters

No.	Name	No.	Name
b1-01	Frequency Reference Selection 1	d1-17	Jog Frequency Reference
b1-02	Run Command Selection 1	E1-01	Input Voltage Setting
b1-03	Stopping Method Selection	E1-04	Max Output Frequency
C1-01	Acceleration Time 1	E1-05	Max Output Voltage
C1-02	Deceleration Time 1	E1-06	Base Frequency
C6-01	Normal/Heavy Duty Selection	E1-09	Minimum Output Freq.
C6-02	Carrier Frequency Selection	E2-01	Motor Rated Current
d1-01	Frequency Reference 1	H4-02	Multi-Function Analog Output Terminal AM Gain
d1-02	Frequency Reference 2	L1-01	Motor Overload Protection Selection
d1-03	Frequency Reference 3	L3-04	Stall Prevention Selection during Deceleration
d1-04	Frequency Reference 4	-	-

Basic Instructions



# J Standard Specifications

Parameter C6-01 sets the drive for Normal Duty or Heavy Duty performance.

200 V Class (Three-Phase/Single-Phase)

Value in brackets is for a single-phase drive.

Model	Three-Phase CIMR-JA2A		0001	0002	0004	0006	0008	0010	0012	0018	0020		
	Single-Phase*1 CIMR-JABA		0001	0002	0003	0006	-	0010	-	-	-		
Max. Applicable Motor Capacity*2	kW	Normal Duty	0.2	0.4	0.75	1.1	1.5	2.2	3.0	3.7	5.5		
		Heavy Duty	0.1	0.2	0.4	0.75	1.1	1.5	2.2	3.0	3.7		
Input	Rated Input Current*3	A	Three-phase	Normal Duty	1.1	1.9	3.9	7.3	8.8	10.8	13.9	18.5	24.0
			Heavy Duty	0.7	1.5	2.9	5.8	7.0	7.5	11.0	15.6	18.9	
		Single-phase	Normal Duty	2.0	3.6	7.3	13.8	-	20.2	-	-	-	
			Heavy Duty	1.4	2.8	5.5	11.0	-	14.1	-	-	-	
Output	Rated Output Capacity*4	kVA	Normal Duty	0.5	0.7	1.3	2.3	3.0	3.7	4.6	6.7	7.5	
			Heavy Duty	0.3	0.6	1.1	1.9	2.6	3.0	4.2	5.3	6.7	
	Rated Output Current	A	Normal Duty*5	1.2	1.9	3.5(3.3)	6.0	8.0	9.6	12.0	17.5	19.6	
			Heavy Duty	0.8*6	1.6*6	3.0*6	5.0*6	6.9*7	8.0*7	11.0*7	14.0*7	17.5*7	
Overload Tolerance			Normal Duty Rating: 120% of rated output current for 60 s. Heavy Duty Rating: 150% of rated output current for 60 s. (Derating may be required for repetitive loads)										
Carrier Frequency			2 kHz (user-set, up to 15 kHz possible)										
Max. Output Voltage			Three-phase power supply: three-phase 200 to 240 V (relative to input voltage) Single-phase power supply: three-phase 200 to 240 V (relative to input voltage)										
Max. Output Frequency			400 Hz (user-set)										
Rated Voltage/Rated Frequency			Three-phase power supply: three-phase 200 to 240 V 50/60 Hz Single-phase power supply: single-phase 200 to 240 V 50/60 Hz										
Allowable Voltage Fluctuation			-15 to +10%										
Allowable Frequency Fluctuation			±5%										
Power	Power Supply	kVA	Three-phase	Normal Duty	0.5	0.9	1.8	3.3	4.0	4.9	6.4	8.5	11.0
			Heavy Duty	0.3	0.7	1.3	2.7	3.2	3.4	5.0	7.1	8.6	
		Single-phase	Normal Duty	0.5	1.0	1.9	3.6	-	5.3	-	-	-	
			Heavy Duty	0.4	0.7	1.5	2.9	-	3.7	-	-	-	

\*1: Drives with a single-phase power supply input have three-phase output. Single-phase motors cannot be used.

\*2: The motor capacity (kW) refers to a Yaskawa 4-pole, 60 Hz, 200 V motor. The rated output current of the drive output amps should be equal to or greater than the motor rated current.

\*3: Assume operation at rated output current. This value may fluctuate based on the power supply side impedance, as well as the input current, power supply transformer, input side reactor, and wiring conditions.

\*4: Rated output capacity is calculated with a rated output voltage of 220 V.

\*5: This value assumes a carrier frequency of 2 kHz. Increasing the carrier frequency requires a reduction in current.

\*6: This value assumes a carrier frequency of 10 kHz. Increasing the carrier frequency requires a reduction in current.

\*7: This value assumes a carrier frequency of 8 kHz. Increasing the carrier frequency requires a reduction in current.

400 V Class (Three-phase)

Model	CIMR-JA4A		0001	0002	0004	0005	0007	0009	0011		
Max. Applicable Motor Capacity*1	kW	Normal Duty	0.4	0.75	1.5	2.2	3.0	3.7	5.5		
		Heavy Duty	0.2	0.4	0.75	1.5	2.2	3.0	3.7		
Input	Rated Input Current*2	A	Normal Duty	1.2	2.1	4.3	5.9	8.1	9.4	14.0	
			Heavy Duty	1.2	1.8	3.2	4.4	6.0	8.2	10.4	
Output	Rated Output Capacity*3	kVA	Normal Duty*4	0.9	1.6	3.1	4.1	5.3	6.7	8.5	
			Heavy Duty*5	0.9	1.4	2.6	3.7	4.2	5.5	7.0	
	Rated Output Current	A	Normal Duty*4	1.2	2.1	4.1	5.4	6.9	8.8	11.1	
			Heavy Duty*5	1.2	1.8	3.4	4.8	5.5	7.2	9.2	
Overload Tolerance			Normal Duty Rating: 120% of rated output current for 60 s. Heavy Duty Rating: 150% of rated output current for 60 s. (Derating may be required for repetitive loads)								
Carrier Frequency			2 kHz (user-set, up to 15 kHz possible)								
Max. Output Voltage			Three-phase 380 to 480 V (relative to input voltage)								
Max. Output Frequency			400 Hz (user-set)								
Rated Voltage/Rated Frequency			Three-phase 380 to 480 V 50/60 Hz								
Allowable Voltage Fluctuation			-15 to +10%								
Allowable Frequency Fluctuation			±5%								
Power	Power Supply	kVA	Normal Duty	1.1	1.9	3.9	5.4	7.4	8.6	13.0	
			Heavy Duty	1.1	1.6	2.9	4.0	5.5	7.5	9.5	

\*1: The motor capacity (kW) refers to a Yaskawa 4-pole, 60 Hz, 400 V motor. The rated output current of the drive output amps should be equal to or greater than the motor rated current.

\*2: Assume operation at rated output current. This value may fluctuate based on the power supply side impedance, as well as the input current, power supply transformer, input side reactor, and wiring conditions.

\*3: Value displays only for when operating at the rated output current. Rated output capacity is calculated with a rated output voltage of 440 V.

\*4: This value assumes a carrier frequency of 2 kHz. Increasing the carrier frequency requires a reduction in current.

\*5: This value assumes a carrier frequency of 8 kHz. Increasing the carrier frequency requires a reduction in current.





Common Specifications

	Item	Specifications
Control Characteristics	Control Method	V/f Control
	Frequency Control Range	0.01 to 400 Hz
	Frequency Accuracy (Temperature Fluctuation)	Digital input: within $\pm 0.01\%$ of the max. output frequency ( $-10$ to $+50^{\circ}\text{C}$ ) Analog input: within $\pm 0.1\%$ of the max. output frequency ( $25^{\circ}\text{C} \pm 10^{\circ}\text{C}$ )
	Frequency Setting Resolution	Digital input: 0.01 Hz Analog input: 1/1000 of max. frequency
	Output Frequency Resolution	20 bit resolution at maximum output frequency
	Frequency Setting Resolution	Main frequency reference : 0 to +10 Vdc (20 k $\Omega$ ), 4 to 20 mA (250 $\Omega$ ), 0 to 20 mA (250 $\Omega$ )
	Starting Torque	150% / 3 Hz
	Speed Control Range	1:20 to 1:40
	Accel/Decel Time	0.0 to 6000.0 s (4 selectable combinations of independent acceleration and deceleration settings)
	Braking Torque	① Short-time decel torque*1: over 150% for 0.1/0.2 kW motors, over 100% for 0.4/ 0.75 kW motors, over 50% for 1.5 kW motors, and over 20% for 2.2 kW and above motors. ② Continuous regen. torque: approx. 20% (approx. 125% with dynamic braking resistor option*2: 10% ED, 10 s, internal braking transistor)
	V/f Characteristics	User-selected programs, V/f preset patterns possible
Main Control Functions	Momentary power loss ride-thru, Speed search, 9-step speed (max), Accel/dec time switch, S-curve accel/dec, 3-wire sequence, Cooling fan on/off switch, Slip compensation, Torque compensation, Frequency jump, Upper/lower limits for frequency reference, DC injection braking at start and stop, Overexcitation braking, Fault restart ...	
Protection Function	Motor Protection	Motor overheat protection based on output current
	Momentary Overcurrent Protection	Drive stops when output current exceeds 200% of Heavy Duty Rating
	Overload Protection	Drive stops after 60 s at 150% of rated output current (Heavy Duty Rating)*3
	Overvoltage Protection	200 V class: Stops when DC bus exceeds approx. 410 V 400 V class: Stops when DC bus exceeds approx. 820 V
	Undervoltage Protection	Stops when DC bus voltage falls below the following levels: Three-phase 200 V class: approx. 190 V, single-phase 200 V class: approx. 160 V, three-phase 400 V class: approx. 380 V, three-phase 380 V class: approx. 350 V
	Momentary Power Loss Ride-Thru	Stops after approx. 15 ms (default).
	Heatsink Overheat Protection	Protection by thermistor
	Braking Resistor Overheat Protection	Overheat sensor for braking resistor (optional ERF-type, 3% ED)
	Stall Prevention	Separate settings allowed during acceleration and during run. Enable/disable only during deceleration.
	Ground Fault Protection	Protection by electronic circuit *4
Charge LED	Charge LED remains lit until DC bus has fallen below approx. 50 V	
Operating Environment	Area of Use	Indoors
	Ambient Temperature	$-10$ to $+50^{\circ}\text{C}$ (open chassis), $-10$ to $+40^{\circ}\text{C}$ (NEMA Type 1)
	Humidity	95 RH% or less (no condensation)
	Storage Temperature	$-20$ to $+60^{\circ}\text{C}$ (short-term temperature during transportation)
	Altitude	Up to 1000 meters
Shock	10 to less than 20 Hz (9.8 m/s <sup>2</sup> ) max., 20 to 55 Hz (5.9 m/s <sup>2</sup> ) max.	
Safety Standard	UL508C	
Protection Design	IP20 open-chassis, NEMA 1 enclosure (option)	

Standard Specifications

\*1: Momentary average deceleration torque refers to the deceleration torque from 60Hz down to 0 Hz. This may vary depending on the motor.

\*2: Parameter L3-04 should be disabled when a Braking Resistor or Braking Resistor Unit is connected.

\*3: Overload protection may be triggered at lower levels if output frequency is below 6 Hz.

\*4: Protection only works properly under the following conditions as the motor windings are grounded internally during run:

- Low resistance to ground from the motor cable or terminal block.

- Drive already has a short-circuit when the power is turned on.

# J Standard Connection Diagram

## Standard Connection Diagram

Example: 200 V Class

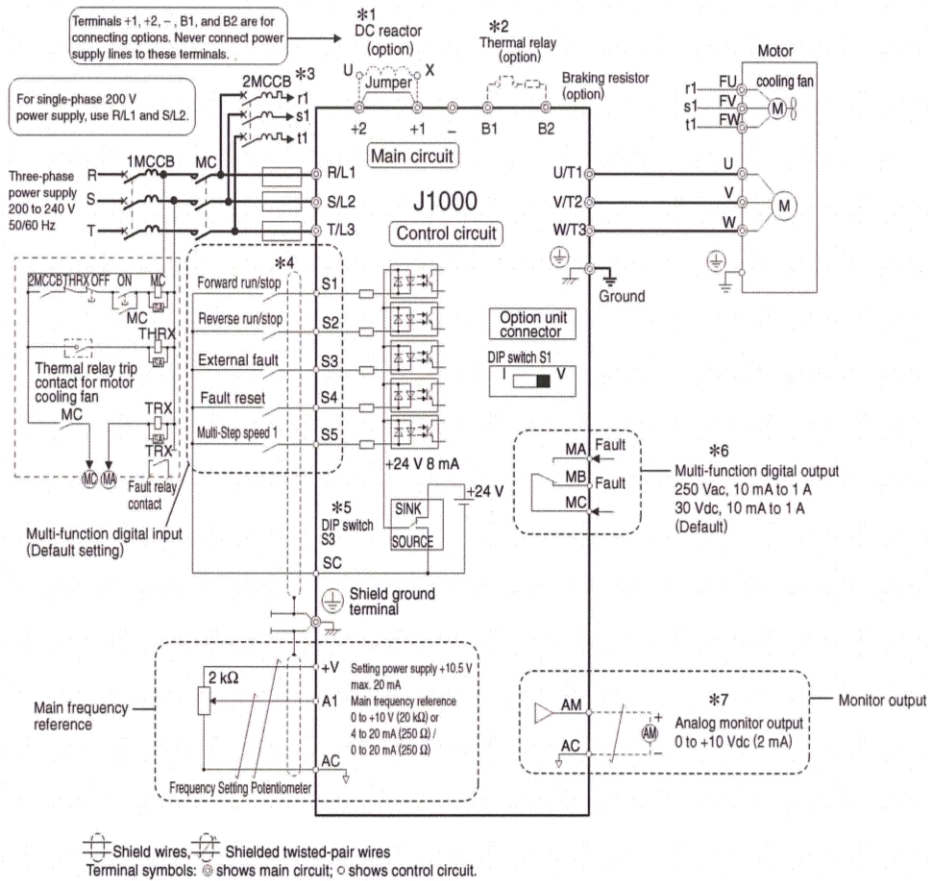

- \*1: Remove the jumper between terminals +1 and +2 when installing an optional DC reactor.
- \*2: The MC on the input side of the main circuit should open when the thermal relay is triggered.
- \*3: Self-cooled motors do not require separate cooling fan motor wiring.
- \*4: Connected using sequence input signal (S1 to S5) from NPN transistor. Default: sink mode (0 V com)
- \*5: Sinking mode requires an internal 24 V power supply. Source mode requires an external power supply. Refer to J1000 Installation & Start-Up Manual for details.
- \*6: Minimum load: 5 Vdc, 10 mA (reference value)
- \*7: Monitor outputs work with devices such as analog frequency meters, current meters, voltmeters and watt meters. They cannot be used in a control system requiring feedback.

### Control Circuit and Terminal Layout

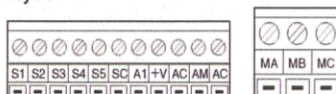



## Terminal Functions

### Main Circuit Terminals

Terminal	Terminal Name	Function (Signal Level)
R/L1	Main circuit power supply input	Connects line power to the drive. Drives with single phase 100 V input or single phase 200 V input power use terminals R/L1 and S/L2 only (do not use T/L3).
S/L2		
T/L3		
U/T1	Drive output	Connects to the motor.
V/T2		
W/T3		
B1	Braking resistor	Available for connecting a braking resistor.
B2		
+1	DC reactor connection	These terminals are shorted for shipment. Remove the jumper creating the short to install a DC choke.
+2		
+1	DC power supply input	For connecting a DC power supply. Note: DC power supply input terminals (+1, -) are not UL/cUL and CE certified.
-		
⊕ Two terminals	Ground	Grounding terminal Grounding resistance for 100 V and 200 V class: 100 Ω or less Grounding resistance for 400 V class: 10 Ω or less

### Control Circuit Input Terminals

Terminal	No.	Terminal Name (Function)	Function (Signal Level)	Default Setting
Multi-function digital input	S1	Multi-function input 1	Closed: Forward run (default) Open: Stop	Photocoupler 24 Vdc, 8 mA  Note: Drive preset to sinking mode. When using source mode, set DIP switch S3 to allow for a 24 Vdc (±10%) external power supply.
	S2	Multi-function input 2	Closed: Reverse run (default) Open: Stop	
	S3	Multi-function input 3	External fault, N.O. (default)	
	S4	Multi-function input 4	Fault reset (default)	
	S5	Multi-function input 5	Multi-step speed reference 1 (default)	
	SC	Multi-function input common (Control common)	Sequence common	
Main frequency reference input	+V	Analog input power supply	+10.5 V (max. allowable current 20 mA)	
	A1	Main frequency reference	Input voltage or input current 0 to +10 Vdc (20 kΩ) resolution: 1/1000 4 to 20 mA or 0 to 20 mA (250 Ω) resolution: 1/500	
	AC	Frequency reference common	0 V	
Multi-function digital output*	MA	N.O. output	Fault (default)	Digital output 30 Vdc, 10 mA to 1 A 250 Vac, 10 mA to 1 A
	MB	N.C. output	Fault (default)	
	MC	Digital output common		
Monitor output	AM	Analog monitor output	0 to 10 Vdc (2 mA or less) Resolution: 1/256	
	AC	Monitor common	0 V	

\*: Refrain from assigning functions to terminals MA and MB that involve frequent switching, as doing so may shorten relay performance life. Switching life is estimated at 200,000 times (assumes 1 A, resistive load).





## OMRON INFORMATION

### **OMRON IDM CONTROLS, INC.**

9510 N. HOUSTON-ROSSLYN RD.  
HOUSTON, TEXAS 77088 USA  
800.395.4106

### **OMRON ELECTRONICS LLC**

1 COMMERCE DRIVE  
SCHAUMBURG, ILLINOIS 60173 USA  
800.55.OMRON (66766)

### **OMRON CANADA, INC.**

885 MILNER AVENUE  
SCARBOROUGH, ONTARIO M1B 5V8  
416.286.6465

### **OMRON ON-LINE**

Global – <http://www.omron.com>  
USA – <http://www.idmcontrols.com>  
USA – <http://www.omron.com/oei>  
Canada – <http://www.omron.com/oci>

### **UNITED STATES**

To locate a Regional Sales Office, local Distributor or  
to obtain product information, call: **800.359.4106 or 713.849.1900**

### **CANADA REGIONAL SALES OFFICES**

Ontario	Toronto	416.286.6465
	Kitchener	519.896.1144
	Kingston	613.376.3968
Quebec	Montreal	514.636.6676
British Columbia		
Vancouver	604.522.8855	
Alberta	Edmonton	403.440.0818
	Calgary	403.257.3095

### **BRAZIL SALES OFFICE**

Sao Paulo 55.11.5564.6488

### **ARGENTINA SALES OFFICE**

Cono Sur 54.114.787.1129

### **MEXICO SALES OFFICE – UNITED STATES**

Florida 954.227.2121

### **MEXICO SALES OFFICE – MEXICO**

Mexico, D.F. 555.534.1195 Monterrey, N.L. 818.377.4281  
1528-E3-1 04/02/100 ©2002 OMRON IDM CONTROLS, INC.

Specifications subject to change without notice.

Printed in the U.S.A.

**\*\*\* IMPORTANT \*\*\***

If only reviewing settings, **DO NOT REVIEW A1-03 on the any of the J1000 VFDs.** This will reset all settings to the VFD manufacturer's factory defaults and you would have to re-enter all settings.

**\*\*Note:** You **MUST** enter the parameters in the **EXACT ORDER** as they are listed below. If the VFD displays an Error while you setting the parameters, you likely entered a parameter in an incorrect order or to an incorrect value.

<b>eFusion - VFD Parameters</b>			
<b>Parameters for Left Brush Positioner Motor VFD</b>			
<b>Yaskawa J1000 Drive</b>			<b>Parameter Descriptions</b>
A1-03	to	2220	2-wire init
b2-04	to	1.0	DC Inj.@ Stop
C1-01	to	1.2	Accel 1
C1-02	to	0.8	Decel 1
H1-05	to	0F	Input S5=Not Used
H1-04	to	0F	Input S4=Not Used
H1-03	to	14	S3 = External Reset
H3-03	to	30	Ana.Freq.Ref.Gain
L1-01	to	2	O/L Protect
L2-01	to	0	Pwr.Loss Ride Thru=Disabled
L5-01	to	2	# auto restarts=2

<b>eFusion - VFD Parameters</b>			
<b>Parameters for Top Brush Positioner Motor VFD</b>			
<b>Yaskawa J1000 Drive</b>			<b>Parameter Descriptions</b>
A1-03	to	2220	2-wire init
b2-04	to	5.0	DC Inj.@ Stop
C1-01	to	1.2	Accel 1
C1-02	to	0.8	Decel 1
H1-05	to	0F	Input S5=Not Used
H1-04	to	0F	Input S4=Not Used
H1-03	to	14	S3 = External Reset
H4-01	to	103	Monitor Current Output
L1-01	to	2	O/L Protect
L2-01	to	0	Pwr.Loss Ride Thru=Disabled
L5-01	to	2	# auto restarts=2

<b>eFusion - VFD Parameters</b>			
<b>Parameters for Right Brush Positioner Motor VFD</b>			
<b>Yaskawa J1000 Drive</b>			<b>Parameter Descriptions</b>
A1-03	to	2220	2-wire init
b2-04	to	1.0	DC Inj.@ Stop
C1-01	to	1.2	Accel 1
C1-02	to	0.8	Decel 1
H1-05	to	0F	Input S5=Not Used
H1-04	to	0F	Input S4=Not Used
H1-03	to	14	S3 = External Reset
H3-03	to	30	Ana.Freq.Ref.Gain
L1-01	to	2	O/L Protect
L2-01	to	0	Pwr.Loss Ride Thru=Disabled
L5-01	to	2	# auto restarts=2

<b>eFusion - VFD Parameters</b>			
<b>Parameters for Left Brush Spindle Motor VFD</b>			
<b>Yaskawa J1000 Drive</b>			<b>Parameter Descriptions</b>
A1-03	to	2220	2-wire init
b1-01	to	0	Freq Reference = d1-01
C1-01	to	0.8	Accel 1
C1-02	to	1.5	Decel 1
d1-01	to	55.0	Freq. Ref.1
H1-05	to	0F	Input S5=Not Used
H1-04	to	0F	Input S4=Not Used
H1-03	to	14	S3 = External Reset
H4-01	to	103	Monitor Current Output
L1-01	to	2	O/L Protect
L2-01	to	0	Pwr.Loss Ride Thru=Disabled
L5-01	to	2	# auto restarts=2

<b>eFusion - VFD Parameters</b>			
<b>Parameters for Top Brush Spindle Motor VFD</b>			
<b>Yaskawa J1000 Drive</b>			<b>Parameter Descriptions</b>
A1-03	to	2220	2-wire init
b1-01	to	0	Freq Reference = d1-01
C1-01	to	0.8	Accel 1
C1-02	to	1.5	Decel 1
d1-01	to	55.0	Freq. Ref.1
H1-05	to	0F	Input S5=Not Used
H1-04	to	0F	Input S4=Not Used
H1-03	to	14	S3 = External Reset
H4-01	to	103	Monitor Current Output
L1-01	to	2	O/L Protect
L2-01	to	0	Pwr.Loss Ride Thru=Disabled
L5-01	to	2	# auto restarts=2

<b>eFusion - VFD Parameters</b>			
<b>Parameters for Right Brush Spindle Motor VFD</b>			
<b>Yaskawa J1000 Drive</b>			<b>Parameter Descriptions</b>
A1-03	to	2220	2-wire init
b1-01	to	0	Freq Reference = d1-01
C1-01	to	0.8	Accel 1
C1-02	to	1.5	Decel 1
d1-01	to	55.0	Freq. Ref.1
H1-05	to	0F	Input S5=Not Used
H1-04	to	0F	Input S4=Not Used
H1-03	to	14	S3 = External Reset
H4-01	to	103	Monitor Current Output
L1-01	to	2	O/L Protect
L2-01	to	<b>0</b>	Pwr.Loss Ride Thru= <b>Disabled</b>
L5-01	to	2	# auto restarts=2

<b>eFusion - VFD Parameters</b>			
<b>Parameters for Wheel Brush Spindle Motor VFD</b>			
<b>Yaskawa J1000 Drive</b>			<b>Parameter Descriptions</b>
A1-03	to	2220	2-wire init
b1-01	to	0	Freq Reference = d1-01
C1-01	to	0.5	Accel 1
C1-02	to	0.5	Decel 1
C6-01	to	0	0 = Heavy Duty Application
d1-01	to	60.0	Freq. Ref.1
E1-04	to	70.0	Max Freq.
<b><u>For 380 - 415 volt Applications ONLY</u></b>			
E1-05	to	230	Volt.Max (for 380-415v)
E1-08	to	12	Volt.Mid (for 380-415v)
E1-10	to	12	Volt.Min (for 380-415v)
E2-01	to	4.0	Mtr. Rated Current (for 380-415v)
H1-05	to	0F	Input S5=Not Used
H1-04	to	0F	Input S4=Not Used
H1-03	to	14	S3 = External Reset
L1-01	to	0	O/L Protect
L2-01	to	2	Pwr.Loss Ride Thru=Indefinite
L5-01	to	2	# auto restarts=2

<b>eFusion - VFD Parameters</b>			
<b>Parameters for Gantry Drive Motor VFD</b>			
<b>Yaskawa J1000 Drive</b>			<b>Parameter Descriptions</b>
A1-03	to	2220	2-wire init
C1-01	to	0.5	Accel 1
C1-02	to	0.5	Decel 1
C6-01	to	0	0 = Heavy Duty Application
d1-01	to	55.0	Freq. Ref.1
E1-04	to	75.0	Max Freq.
E2-01	to	5.2	Mtr. Rated Current
H1-05	to	0F	Input S5=Not Used
H1-04	to	0F	Input S4=Not Used
H1-03	to	14	S3 = External Reset
L1-01	to	2	O/L Protect
L2-01	to	0	Pwr.Loss Ride Thru=Disabled
L5-01	to	2	# auto restarts=2

<b>eFusion - VFD Parameters</b>			
<b>Parameters for Blower Oscillator Motor VFD</b>			
<b>Yaskawa J1000 Drive</b>			<b>Parameter Descriptions</b>
A1-03	to	2220	2-wire init
b1-01	to	0	Freq Reference = d1-01
C1-01	to	0.4	Accel 1
C1-02	to	0.4	Decel 1
d1-01	to	15.0	Freq. Ref.1
H1-05	to	0F	Input S5=Not Used
H1-04	to	0F	Input S4=Not Used
H1-03	to	14	S3 = External Reset
L1-01	to	2	O/L Protect
L2-01	to	2	Pwr.Loss Ride Thru=Indefinite
L5-01	to	2	# auto restarts=2



## INPUT SELECTIONS ON GANTRY

**CONFIGURATION - October 2, 2007**

### Fusion

#### Gantry Inputs

#### Gantry Inputs - SRT2-ID16's

Gantry Address 0	FusionX & eFusion Inputs	
I_MeasurementEye	2008.00 measurement eye on gantry	eye
I_LeftBrush_EncoderProx1	2008.01 prox 1 left brush encoder, INNER PROX	prox
I_LeftBrush_EncoderProx2	2008.02 prox 2 left brush encoder, OUTER PROX	prox
I_RightBrush_EncoderProx1	2008.03 prox 1 Right brush encoder, INNER PROX	prox
I_RightBrush_EncoderProx2	2008.04 prox 2 Right brush encoder, OUTER PROX	prox
I_TopBrush_EncoderProx1	2008.05 prox 1 top brush encoder, LOWER PROX	prox
I_TopBrush_EncoderProx2	2008.06 prox 2 top brush encoder, UPPER PROX	prox
I_Gantry_ExitProx	2008.07 home position of the gantry	prox
I_Gantry_EntranceProx	2008.08 reverse limit on gantry	prox
I_Gantry_EncoderProx1	2008.09 prox 1 gantry encoder, LOWER PROX	prox
I_Gantry_EncoderProx2	2008.10 prox 2 gantry encoder, UPPER PROX	prox
I_VacationHomeProx	2008.11 second home prox - for secondary home prox location	prox
I_CenterLimitProx	2008.12 center limit prox, for side brushes	prox
I_WheelPositionEye	2008.13 finds tire position for Wheel Brush	eye
	2008.14	
	2008.15	

Gantry Address 2	FusionX & eFusion Inputs	
I_LeftBrushHomeLimit	2009.00 left brush limit prox sensor - RETRACTED LIMIT	prox
I_LeftBrushExtendedLimit	2009.01 left brush limit prox sensor - EXTENDED LIMIT	prox
I_RightBrushHomeLimit	2009.02 right brush limit prox sensor - RETRACTED LIMIT	prox
I_RightBrushExtendedLimit	2009.03 right brush limit prox sensor - EXTENDED LIMIT	prox
I_TopBrushHomeLimit	2009.04 top brush limit prox sensor - UPPER LIMIT	prox
I_TopBrushLowerLimit	2009.05 top brush limit prox sensor - LOWER LIMIT	prox
I_WheelBrushes_Retracted	2009.06 prox sensor - sensing BOTH cylinders in retracted position	prox
I_gantry_fault	2009.07 gantry drive faulted	contact
I_SideBrush_Fault	2009.08 left or right brush positioner or spindle faulted	contact
I_TopBrush_Fault	2009.09 top brush positioner or spindle faulted	contact
I_Oscillator/WheelBrush_Fault	2009.10 oscillating motor or wheel brush spindle faulted	contact
I_Blower_Fault	2009.11 on-board blower fault (any one of the MS's or VFD)	contact
I_Blower Prox Fwd	2009.12 blower osc prox in forward direction	prox
I_Blower Prox Rev	2009.13 blower osc prox in reverse direction	prox
	2009.14	
	2009.15	

## INPUT SELECTIONS ON GANTRY (cont.)

Gantry Address 4		FusionX & eFusion Inputs	
I_JogFwd	2010.00	jog drive forward	SW
I_JogRev	2010.01	jog drive reverse direction	SW
I_JogBoom_Up	2010.02	jog boom up direction	SW
I_JogBoom_Down	2010.03	jog boom down direction	SW
I_JogOscillateMotor	2010.04	jog the oscillator motor	SW
I_JogTilt_Fwd	2010.05	jog the tilt forward	SW
I_JogTilt_Rev	2010.06	jog the tilt arm reverse direction	SW
I_JogLeftBrush_Extend	2010.07	extend left brush	SW
I_JogLeftBrush_Retract	2010.08	retract left brush	SW
I_JogRightBrush_Extend	2010.09	extend right brush	SW
I_JogRightBrush_Retract	2010.10	retract right brush	SW
I_JogTopBrush_Up	2010.11	jog top brush up	SW
I_JogTopBrush_Down	2010.12	jog top brush down	SW
I_JogWheelBrushes	2010.13	jog the wheel brush - bring cylinder forward, spin motor	SW
I_JogWheelVFDs	2010.14	jog the wheel VFDs	SW
I_JogEnable	2010.15	enable switch for jog's	SW
Gantry Address 6		FusionX ONLY	
I_CanEye	2011.00	gantry safety eye in can	eye
I_BoomSafetyRear	2011.01	rear boom safety eye, attached to boom rear direction	eye
I_BoomSafetyFront	2011.02	front boom safety eye, attached to boom front direction	eye
I_Boom_EncoderProx1	2011.03	prox 1 boom encoder, LOWER PROX	prox
I_Boom_EncoderProx2	2011.04	prox 2 boom encoder, UPPER PROX	prox
I_BoomHomeLimit	2011.05	boom limit prox - UPPER LIMIT	prox
I_BoomLowerLimit	2011.06	boom limit prox - LOWER LIMIT	prox
I_BoomBeltSafety	2011.07	detects slack on boom belt	prox
I_height_first	2011.08	top eye at top of boom	eye
I_height_second	2011.09	2nd eye from top	eye
I_height_third	2011.10	3rd eye from top	eye
I_height_fourth	2011.11	bottom eye, 4th from top	eye
I_boom_fault	2011.12	boom faulted	contact
	2011.13		
I_3phPowerDetection	2011.14	detects loss of 3 phase power	contact
	2011.15		

## ECC INPUT SELECTIONS

Control Panel Inputs			
Control Panel, Address 12	FusionX & eFusion Inputs		
I_Treadle_sw	2014.00	switch on floor	eye
I_ExitDoorEye	2014.01	senses door area clear to close exit door	eye
I_EstopSw	2014.02	emergency stop switch	sw
I_ResetSw	2014.03	reset switch on control panel	sw
I_UnderCarriageEye	2014.04	front entrance switch to turn on undercarriage wash	eye
I_TempSwitch	2014.05	closes on rise in temperature, door controller	sw
	2014.06		
I_FreezeTstat	2014.07	freeze thermostat - closes when temp falls	sw
I_TireCleaner_Level_OK	2014.08	level OK in tire cleaner vessel	sw
I_Wax_Level_OK	2014.09	level OK on foaming conditioner tank	sw
I_CashierCycle1	2014.10	pulse from auto cashier, cycle 1	contact
I_CashierCycle2	2014.11	pulse from auto cashier, cycle 2	contact
I_CashierCycle3	2014.12	pulse from auto cashier, cycle 3	contact
I_CashierCycle4	2014.13	pulse from auto cashier, cycle 4	contact
I_PreSoak_Level_OK	2014.14	level OK in presoak vessel	sw
I_H2O_Level_OK	2014.15	water tank level OK	sw
Control Panel, Address 14	FusionX & eFusion Inputs		
I_ManualWash1	2015.00	manually select wash 1	sw
I_ManualWash2	2015.01	manually select wash 2	sw
I_ManualWash3	2015.02	manually select wash 3	sw
I_ManualWash4	2015.03	manually select wash 4	sw
I_BillChanger1Fault	2015.04	bill changer 1 faulted	contact
I_BillChanger2Fault	2015.05	bill changer 2 faulted	contact
I_AutoCashierFault	2015.06	auto cashier faulted	contact
I_ExitDoorOpenProx	2015.07	senses exit door is opened	prox
I_ReclaimTankLevel	2015.08	detects low level in reclaim/cold water tank	sw
I_Blwr Nozzle Prox	2015.09	blower osc nozzle prox	prox
	2015.10		
	2015.11		
I_ExtBlowerShutOff	2015.12	photo to shut off blowers if customer leaves early	eye
	2015.13		
I_25hp OverloadTripped	2015.15	25 hp Overload Tripped	contact

## OUTPUT SELECTIONS ON GANTRY

**CONFIGURATION - Dec. 27, 2007**

### Fusion

**GANTRY OUTPUTS, SRT2-ROC16**

**FusionX & eFusion Outputs**

Address 0	Volts	Com	
O_Blower1	24ac	0	2000.00 blower #1, center blower
O_BlowerOsc CW	24dc-	1	2000.01 Blower osc motor, CW Direction
O_Blower2	24ac	0	2000.02 blower #2, outboard blower
O_BlowerOsc CCW	24dc-	1	2000.03 Blower osc motor, CCW Direction
O_Rocker_Sol	24ac	2	2000.04 rocker solenoid valve
O_PreSoak_Sol_1	24ac	3	2000.05 presoak air & liquid solenoids, reverse direction
O_PreSoak_Sol_2	24ac	2	2000.06 presoak air & liquid solenoids, forward direction
O_TireCleaner_Sol	24ac	3	2000.07 tire cleaner solenoid
O_TriColorFoam_Sol	24ac	4	2000.08 Triple Foam air & liquid solenoids
O_Side Spray Sol.	24ac	5	2000.09 side spray rinse solenoid
O_LowPressWax_Sol	24ac	4	2000.10 low pressure wax solenoid
O_Blower3	24ac	5	2000.11 blower #3, outboard blower
		6	2000.12 spare
		7	2000.13 spare
		6	2000.14 spare
		7	2000.15 spare

**GANTRY OUTPUTS, SRT2-ROC16**

**FusionX & eFusion Outputs**

Address 2	Volts	Com	
O_TopSprayer_Sol	24ac	0	2001.00 top sprayer solenoid
O_SideBrushLube, Rev	24ac	1	2001.01 side brush friction lubricant solenoid, reverse direction
O_SideBrushLube, Fwd	24ac	0	2001.02 side brush friction lubricant solenoid, forward direction
O_TopBrushLube, Rev	24ac	1	2001.03 top brush friction lubricant solenoid, reverse direction
O_TopBrushLube, Fwd	24ac	2	2001.04 top brush friction lubricant solenoid, forward direction
O_AirPurge_Sol	24ac	3	2001.05 air purge sol
O_Tilt_Brushes_Sol	24ac	2	2001.06 tilt side brushes
O_SpotFreeAirPurge	24ac	3	2001.07 spot free air purge solenoid
O_Wheel_Sol	24ac	4	2001.08 extend wheel brush
O_WheelBrushCW	24dc-	5	2001.09 Wheel brush CW direction
O_Wheel_HP_Sol	24ac	4	2001.10 High pressure water solenoid for wheel brushes
O_WheelBrushCCW	24dc-	5	2001.11 Wheel brush CCW direction
O_ScrollingSignA	24 neut	6	2001.12 white/red wire
O_ScrollingSignB	24 neut	7	2001.13 tan wire
O_ScrollingSignC	24 neut	6	2001.14 yellow wire
O_ScrollingSignD	24 neut	7	2001.15 brown wire

### Alternate 2001 Outputs

O_DriveForwardLight	24dc+	6	2001.12 Green Light, On-Board 3 position sign
O_StopLight	24dc+	7	2001.13 Red Light, On-Board 3 position sign
O-BackUpLight	24dc+	6	2001.14 Yellow Light, On-Board 3 position sign
O_	24dc+	7	2001.15 spare

## OUTPUT SELECTIONS ON GANTRY (cont.)

### GANTRY OUTPUTS - SRT2-OD16 FusionX & eFusion Outputs

Address 4	Volts	Com	
O_LeftBrushExtend	24dc-		2002.00 left brush extend direction
O_LeftBrushRetract	24dc-		2002.01 left brush retract direction
O_RightBrushExtend	24dc-		2002.02 Right brush extend direction
O_RightBrushRetract	24dc-		2002.03 Right brush retract direction
O_LeftBrushSpindleCW	24dc-		2002.04 left brush spindle drive - CW direction
O_LeftBrushSpindleCCW	24dc-		2002.05 left brush spindle drive - CCW direction
O_RightBrushSpindleCW	24dc-		2002.06 right brush spindle drive - CW direction
O_RightBrushSpindleCCW	24dc-		2002.07 right brush spindle drive - CCW direction
w_PhotoSensorCR	24dc-		2002.08 turn off photo sensors -thru NC contact on relay.
O_Reset_VFDs	24dc-		2002.09 reset contact to the VFDs
O_TopBrushUp	24dc-		2002.10 Top brush upper direction
O_TopBrushDown	24dc-		2002.11 Top brush down direction
O_TopBrushSpindleCW	24dc-		2002.12 Top brush spindle drive - CW direction
O_TopBrushSpindleCCW	24dc-		2002.13 Top brush spindle drive - CCW direction
O_GantryFwd	24dc-		2002.14 move carriage to front of car
O_GantryRev	24dc-		2002.15 move carriage to rear of car

### GANTRY OUTPUTS - SRT2-ROC08 FusionX ONLY, Outputs

Address 6	Volts	Com	
O_BoomUp	24dc-	0	2003.00 run boom up direction
O_BoomDown	24dc-	1	2003.01 run boom down direction
O_Oscillator_VFD	24dc-	0	2003.02 run oscillator motor VFD
	24dc-	1	2003.03 spare dc (-) output
O_Tilt_Boom_Front	24ac	2	2003.04 tilt front direction
O_Tilt_Boom_Rear	24ac	3	2003.05 tilt rear direction
NOW VACANT	24ac	2	2003.06 spare, was side spray which moved to 2000.09
O_WaterDumpValve	24ac	3	2003.07 water dump valve on top of boom

### CONTROL PANEL OUTPUTS, SRT2-ROC08 FusionX & eFusion Outputs

Address 8	Volts	Com	
O_OpenEntryDoor	?	0	2004.00 entrance door
O_OpenExitDoor	?	1	2004.01 open exit door
O_CloseEntryDoor	?	0	2004.02 close entrance door
O_CloseExitDoor	?	1	2004.03 close exit door
<b>O_Glass Treatment MS</b>	<b>24vac</b>	<b>2</b>	<b>2004.04 Glass Treatment Motor Starter</b>
O_TireGlazeMS	24ac	3	2004.05 Motor Starter to spin Tire Glaze Brush
O_TireGlazeLiquidSol	24ac	2	2004.06 Liquid Product Solenoid to dispense Tire Glaze
O_TireGlazeAirCylSol	24ac	3	2004.07 Solenoid to extend Tire Glaze Air Cylinder

## ECC OUTPUT SELECTIONS

CONTROL PANEL OUTPUTS, SRT2-ROC16			FusionX & eFusion Outputs
Address 10	Volts	Com	
O_HP_Wash	24ac	0	2005.00 soap (wash) solenoid
O_HiPressWax	24ac	1	2005.01 hi pressure wax solenoid
O_UnderCarriageSol	24ac	0	2005.02 under carriage solenoid
O_MedPressSol	24ac	1	2005.03 medium pressure solenoid
O_SpotFreeMS	24ac	2	2005.04 spot free motor starter
O_PSoakHi_pH_MS	24ac	3	2005.05 high pH presoak MS
O_TireCleanerMS	24ac	2	2005.06 tire cleaner motor starter
O_PreSoakHeater	24ac	3	2005.07 presoak heater contactor
O_TripleShineMS	24ac	4	2005.08 triple shine motor starter
O_ReclaimWaterSol	24ac	5	2005.09 reclaim water solenoid
O_PreSoakRecircSol1	24ac	4	2005.10 Hi pH presoak recirculation sol
O_PSoakLoPH_MS	24ac	5	2005.11 Lo pH presoak MS
O_PhotoSensorCheckPanel	24dc-	6	2005.12 photo sensor safety check relay in control panel
O_PresoakLowPH_recirc	24ac	7	2005.13 low ph presoak recirculation solenoid
O_EW_Reset	24dc-	6	2005.14 reset the Entry Wizard cashier
O_BlowerTimer	24ac	7	2005.15 blower digital timer

CONTROL PANEL OUTPUTS, SRT2-ROC16			FusionX & eFusion Outputs
Address 12	Volts	Com	
O_EnterNowLight	24dc+	0	2006.00 drive forward light at entrance to wash
O_LPWaxMS	24ac	1	2006.01 low pressure wax motor starter
O_PleaseWaitLight1	24dc+	0	2006.02 please wait at entrance of wash
O_ColdWaterSol	24ac	1	2006.03 cold water reservior
O_Sol1TripleShine	24ac	2	2006.04 solenoid 1 for tiple shine
O_So2TripleShine	24ac	3	2006.05 solenoid 2 for triple shine
O_Sol3TripleShine	24ac	2	2006.06 solenoid 3 for trile shine
O_InTankWaterHeater	24ac	3	2006.07 Water Heater inside Water Tank
O_FrictionLubeMS	24ac	4	2006.08 Brush Lube Pump MS
O_BlwrNozCW	24dc-	5	2006.09 Blwr Noz CW rotation
O_BlowerExternal(MS2-3)	24ac	4	2006.10 external blower motor starters # 2 & 3 (24vac)
O_BlwrNozCCW	24dc-	5	2006.11 Blwr Noz CCW rotation
O_AlarmHorn	24ac	6	2006.12 announce car on treadle (24vac)
	120ac		25 HP motor starter (110V) <b>(change com7 to 24vac</b>
O_PumpMain	or 24ac	7	2006.13 <b>on eFusion)</b>
O_BlowerExternal(MS1)	24ac	6	2006.14 external blower motor starter # 1 (24vac)
	120ac		auto cashier reset (110V) <b>(change com7 to 24vac on</b>
O_CashierReset	or 24ac	7	2006.15 <b>eFusion)</b>



## ECC OUTPUT SELECTIONS (cont.)

CONTROL PANEL OUTPUTS, SRT2-VOM16		FusionX & eFusion Outputs
Optional 10 Position Sign		
Address 14	Volts	Com
O_StopLight	120ac	2007.00 stop light
O_EnterLight	120ac	2007.01 drive forward light inside wash bay
O_BackupLight	120ac	2007.02 backup light
O_PresoakLight	120ac	2007.03 presoak light
O_RockerLight	120ac	2007.04 rocker panel light
O_ClearCoatLight	120ac	2007.05 clear coat light
O_TripleShineLight	120ac	2007.06 triple shine light
O_SpotFreeLight	120ac	2007.07 spot free light
O_ExitLight	120ac	2007.08 exit light
O_CleanCarLight	120ac	2007.09 clean car is a happy car light
O_PleaseWaitLight	120ac	2007.10 please wait at entrance of car wash
O_LP_WaxLight	120ac	2007.11 spare
O_2004_12		2007.12 spare
O_2004_13		2007.13 spare
O_2004_14		2007.14 spare
O_2004_15		2007.15 spare

CONTROL PANEL OUTPUTS, SRT2-VOM16 -		FusionX & eFusion Outputs
Optional 10 Position Sign	Channel 2007	Address 14
Address 14	Volts	
O_StopLight	120ac	2007.00 stop light
O_EnterLight	120ac	2007.01 drive forward light inside wash bay
O_BackupLight	120ac	2007.02 backup light
O_PresoakLight	120ac	2007.03 presoak light
O_RockerLight	120ac	2007.04 rocker panel light
O_ClearCoatLight	120ac	2007.05 clear coat light
O_TripleShineLight	120ac	2007.06 triple shine light
O_SpotFreeLight	120ac	2007.07 spot free light
O_ExitLight	120ac	2007.08 exit light
O_CleanCarLight	120ac	2007.09 clean car is a happy car light
O_PleaseWaitLight	120ac	2007.10 please wait at entrance of car wash
O_LP_WaxLight	120ac	2007.11 spare
O_2004_12		2007.12 spare
O_2004_13		2007.13 spare
O_2004_14		2007.14 spare
O_2004_15		2007.15 spare

## ECC OUTPUT SELECTIONS (cont.)

### Channel 2027 Output Card - connected to the analog SRM21 module

Optional ROC-08 located in ECC panel in bottom row			Com. Term.	Voltage
O_ScrollingSign A	Vac neu	com 0	2027.00	"off-board" scrolling sign output A
O_ScrollingSign B	Vac neu	com 1	2027.01	"off-board" scrolling sign output B
O_ScrollingSign C	Vac neu	com 0	2027.02	"off-board" scrolling sign output C
O_ScrollingSign D	Vac neu	com 1	2027.03	"off-board" scrolling sign output D
		com 2	2027.04	
		com 3	2027.05	
		com 2	2027.06	
		com 3	2027.07	

## ANALOG OUTPUTS AND INPUTS

### BUS-S Comm Channel 2

SRT2-AD041 (Mod 1)                      Address 0

#### Analog Inputs

I_LeftSpindleTorquePV	2208	Left Brush Motor - Torque output
I_RightSpindleTorquePV	2209	Right Brush Motor - Torque output
I_TopSpindleTorquePV	2210	Top Brush (Horizontal) - Torque output
I_GantryTorquePV	2211	Gantry Motor - Torque output

SRT2-DA021 (Mod 2)                      Address 0

#### Analog Outputs

O_LeftBrushAxisSP	2200	Left Brush Positioner - speed command
O_RightBrushAxisSP	2201	Right Brush Positioner - speed command

SRT2-DA021 (Mod 3)                      Address 2

#### Analog Outputs

O_TopBrushAxisSP	2202	Top Brush Positioner - speed command
O_GantryAxisSP	2203	Gantry Positioner - speed command

### eFusion Standard On-Board Three Position LED Sign Outputs

Displayed Messages		eFusion Outputs	Output Wire Color	LED Wire Colors
1.	Drive Forward, Green Light	2001.12	Black	Red
2.	Stop, Red Light	2001.13	Red	Red
3.	Back-Up, Yellow Light	2001.14	Orange	Red
<b>Note</b>		LED Common = Blue		Black (on all 3 LEDs)
On the channel 2001, ROC-16, the common voltage on <b>COM 6</b> and <b>COM 7</b> must be <b>24-volts DC (+)</b> for the sign to operate properly.				White=Flash Selector
				Yellow=Do not Use

### eFusion Optional On-Board Scrolling Sign Outputs/Messages

Displayed Messages		eFusion Outputs	Output Wire Color	Scrolling Sign Wire Color
1.	Welcome Message, user programmable	None		
2.	Wash	2001.12	Brown	Brown
3.	Rinse	2001.13	Red	Red
4.	Presoak	2001.14	Orange	Orange
5.	Stop	2001.15	Blue	Yellow
6.	Rocker Panel Blaster	14 & 15		Black = 24vac hot
7.	Back Up	13 & 15		White = 24 vac neutral
8.	Clearcoat Protectant	13 & 14		Green = ground
9.	Drive Forward	12 & 15		<b>Note</b>
10.	Tire Cleaner	12 & 14		On the channel 2001, ROC-16, the common voltage on <b>COM 6</b> and <b>COM 7</b> must be <b>24 volts AC Neutral</b> for the sign to operate properly.
11.	Wax	12 & 13		
12.	Exit Slowly	13, 14 & 15		
13.	Triple Shine	12, 14 & 15		
14.	Soaking	12, 13 & 15		
15.	Spot Free Rinse	12, 13 & 14		
16.	Blower	12, 13, 14 & 15		





## WIRE THE DRYERS

### a) Stand-Alone “Wind Wizard” Dryers with Oscillating Center Nozzle

The Wind Wizard Stand-Alone Dryer is controlled by several outputs from the channel 2006 output card, ROC16. There is also an input signal from a proximity switch on the center oscillating blower nozzle that will be terminated on the channel 2015 input card, ID16. There are eight wires going from the Electrical Control Center (ECC) to the Free-Standing Blower Control Panel. There will be an 18-22 gauge-12 conductor cable provided in the installation kit for Stand-Alone Wind Wizard Dryers for these connections. Terminate these wires according to the following chart:

Wire Color	ECC Connections	Blower Control Panel Connections
White	24 vac Neutral, Term Strip 2	Term.# 96 on the motor overloads
Brown	24 vdc Positive (+), Term Strip 1	Brown wire from prox cable
Blue	24 vdc Negative (-), Term Strip 1	“SC” term on Nozzle VFD & Blue wire from prox cable
Orange	Output 2006.14, ROC16	“A1” on the center motor starter
Red	Output 2006.10, ROC16	“A1” on right and left motor starters
Yellow	Output 2006.09, ROC16	“S1” on Nozzle VFD
Purple	Output 2006.11, ROC16	“S2” on Nozzle VFD
Black	Input 2015.09, ID16	Black wire from prox cable

### b) Stand-Alone Dryers from other manufacturers

Other types of stand-alone dryers are controlled by output 2006.14 of the ROC16. We provide both 24 vac and 120 vac signals to operate your dryers.

#### FOR 24 VAC SIGNAL:

If your dryers require a 24 vac signal to operate, connect your signal wire directly to output 2006.14. You will also need a 24 vac neutral. This connection can be made on Term Strip 2, on one of the terminals labeled “24v neutral”. The length of the signal that is sent to your Blower Control Panel is adjustable through the Red Lion interface (F2 – Timers & Counters).

#### FOR 120 VAC SIGNAL:

If your dryers require a 120 vac signal to operate, connect your signal wire to Term Strip 3, on the terminal labeled “Ext. Blower”. You will also need a 120 vac neutral. This connection can also be made on Term Strip 3, on one of the terminals labeled “120v neutral”. The length of the signal that is sent to your Blower Control Panel is adjustable through the Red Lion interface (F2 – Timers & Counters).



## DIXMOR DIGITAL TIMER WIRING

To wire the Digital timer, you need four wires from the ECC to the timer. You need a black wire for 120 VAC Hot, a white wire for 120 VAC Neutral, and two control wires. See the wiring diagram below.

Terminal 2 24VAC	Terminal 3 120VAC	Wire Color	Dixmor Timer Terminal Strip
	Hot #1	Black	#1
	Neutral #4	White	#2
#10		Purple	#3
#11		Purple	#5

### c) On-Board Dryers

Run the 4/4 S. O. cord from the WW ECC to the Dryer Electrical Panel on the top of the gantry. In the Dryer Electrical Panel, terminate the 4/4 in L1, L2, and L3 of the main disconnect switch. Terminate the green wires to the ground bus of the panel.

### WIRE THE BAY DOORS

If the car wash is installed where temperatures will fall below freezing, you may wish to purchase the optional door package. The package includes additional outputs and a set of photo eyes. For the exit door in the ECC, and the outputs and commons come pre-wired to the 24VAC terminal strip #2. The exit door eye signal must be wired to the 24VDC terminal strip #1.

To hook your door controls to the ECC, run three wires to both door controllers. In each controller, terminate one wire on the Door Controller Common. Terminate the other wires to the Door Controller Open contact and the Door Controller Close contact.

In the ECC, hook the wires to the appropriate screws on the “**TERM 2**” terminal strip. See the wiring diagram that follows:

### BAY DOOR WIRING DIAGRAM

TERM 2 24VAC	Wire Color	Door Control	SRT2-ROC16
#13	White/Yellow	Entrance Common	COM 0
#14	White/Blue	Entrance Open	2004.00
#15	Red/Black	Entrance Close	2004.02
#16	White/Yellow	Exit Common	COM 1
#17	Red/Yellow	Exit Open	2004.01
#18	Red/Green	Exit Close	2004.03

In addition, there is a “windy day” feature that is incorporated in the Red Lion Interface (F8 – Site Data), the doors will close regardless of what the outside temperature is. This feature allows you to close the doors on windy days without activating the blowout feature, even though the temperature is above freezing.

Included with the door package is a set of photo eyes. Install the eyes on the outside of the Exit door high enough to where the eyes will be blocked for at least two seconds. That means you must install the eyes at bumper height. Wire the eyes the same way the treadle and entrance eyes are wired. Terminate the DC power of the eyes to DC (+) (brown wire) and DC (-) (blue wire from receiver eye only). The Emitter/Transmitter eye blue wire will terminate on the "Emitter Common" on Term Strip 1, terminal #10. Wiring the emitter this will allow us to detect a short circuit in the receiver eye. Terminate the black wire of the receiver eye cable to Term #3 Screw #17 in the WW ECC. This screw is pre-wired to input #2014.01 of the SRT2-ID16 in the ECC.

## WIRE THE FREEZE THERMOSTAT

No Bay Doors or Bay Doors with no Bay Heat

Inputs 2014.05 and 2014.07 of the SRT2-ID16 of the WW ECC in the equipment room are the two inputs that control the Freeze Blowout and the Bay Door programs. When the temperature rises above the temperature preset on the Thermostat, Input 2014.05 will come on and Input 2014.07 will go off (if wired correctly). When the temperature falls below the temperature preset on the thermostat, Input 2014.05 will go off and Input 2014.07 will come on. Inputs 2014.05 and 2014.07 should never be on at the same time.

When Input 2014.05 first comes on, the car wash controller sends a 3 second signal to open both Bay Doors. When Input 2014.07 first comes on, the car wash controller sends a 3 second signal to close both bay doors and execute the blowout program. (See the description of the blowout program below).

To wire the Thermostat, you will need to run three wires to the Thermostat from the ECC. Wire one wire to 24 VDC (-) in the ECC, one wire to the SRT2-ID16 Input 2014.05, and one wire to the SRT2-ID16 Input 2014.07. In the Thermostat, the 24 VDC (-) wire goes to the Common terminal (Red screw). Output 2014.05 of the SRT2-ID16 goes to the Close on Temperature Rise contact (White screw), and Input 2014.07 of the SRT2-ID16 goes to the Open on Temperature Rise contact (Blue screw).

When the **Blowout Program** is activated, the gantry will blowout all the chemical and water lines once after the temperature drops, and then again once **3 minutes** after each wash after the car leaves the bay and as long as **Input 2009.07** remains lit. The blowout process goes through a sequence of blowing out all the lines on the gantry five times.

The **Blowout Program** will sequence through the following:

Rocker Panel	Side High Pressure Rinse
Top High Pressure Rinse	Tire Cleaner
Presoak	Low Pressure Wax
Tri-foam Wax	Spot Free

**NOTE: The undercarriage hose does not get blown out nor does it have a weep system. To protect the undercarriage from freezing, run some sort of heating system along the hose. If you have the winter wizard system, run the uninsulated copper tube from the rail heat along the side of the undercarriage spray bar. You can also run the hoses for the rail heat along with the undercarriage hose to protect it from freezing. If you do not have rail heat, you can run heat tape or something similar along the hose.**

## **Bay Doors with Bay Heat**

If you have Bay Doors with Bay Heat, and you don't want the gantry to blowout the lines, you can wire the thermostat differently. **In this case, you will need two thermostats.** One thermostat will measure the temperature in the bay, and one thermostat will measure the outside air temperature.

Pull two wires to the thermostat in the bay, and pull three wires to the outside air thermostat. Wire the commons of both thermostats to **24 VDC (-)**. You can bring two wires from the panel, one for each thermostat, or you can bring one wire from the panel to the first thermostat terminating the wire on the **Common terminal (Red screw)** of the first Thermostat. Then run a jumper wire from the first thermostat to the second thermostat, and terminate the jumper wire at each thermostat on the **Thermostat Common terminals (Red screw)**.

For the **Bay Thermostat**, Terminate one wire on the **Open on Temperature Rise** contact of the thermostat (**Blue screw**) and terminate the other end of the wire to **Input 2014.07** of the SRT2-ID16 (**Freeze Thermostat**).

For the **Outside Air Thermostat**, terminate one wire on the **Close on Temperature Rise** contact of the thermostat (**White screw**), and terminate the other end of the wire to **Input 2014.05 (Door Thermostat)** of the SRT2-ID16 of the ECC in the equipment room.



**PARTS LIST NO.: EPL-DRYER-JCC-FIXED REV."B"  
JULY 2002**

# **Jim Coleman Producer with Fixed Nozzle**

## **PARTS LIST**

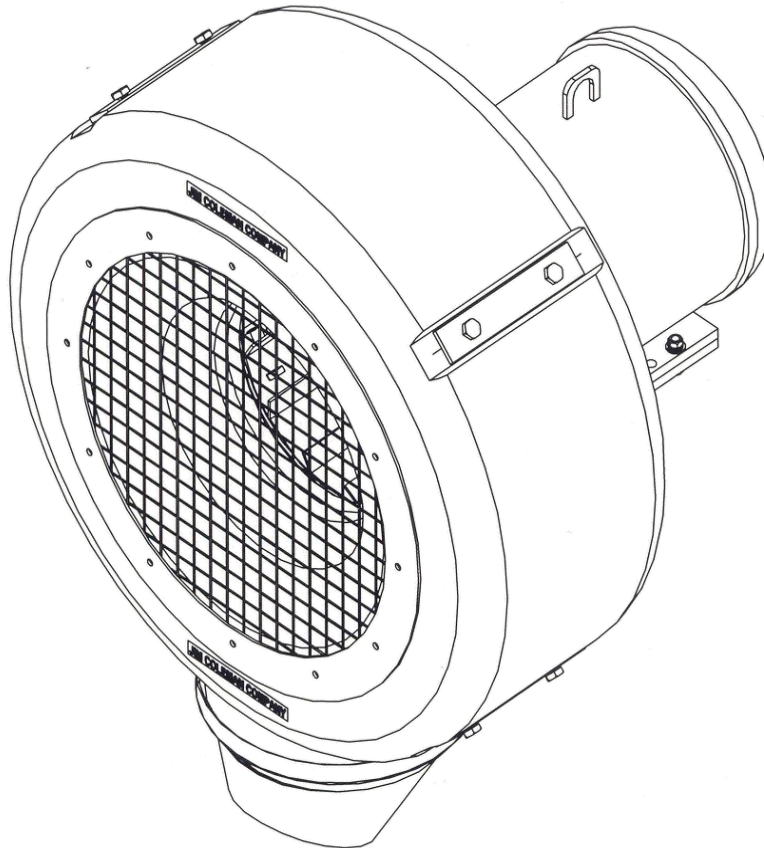

**MAGNEIL WASH SYS.**

**Jim Coleman  
 Producer with  
 Fixed Nozzle**

**REV. "B"  
 JULY 2002  
 Page #1**

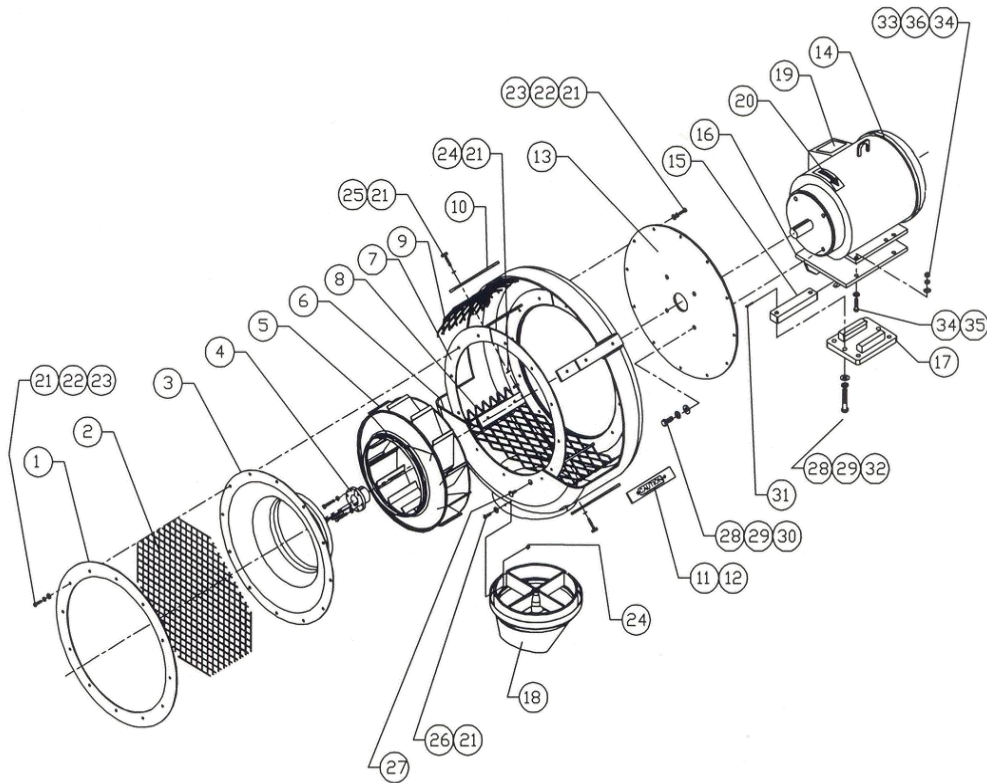

**MACNEIL WASH SYS.**

**Jim Coleman**  
**Producer with**  
**Fixed Nozzle**  
**NOZZLE ASSEMBLY (65-725-00-MP)**

**REV. "B"**  
**JULY 2002**  
**Page #2**

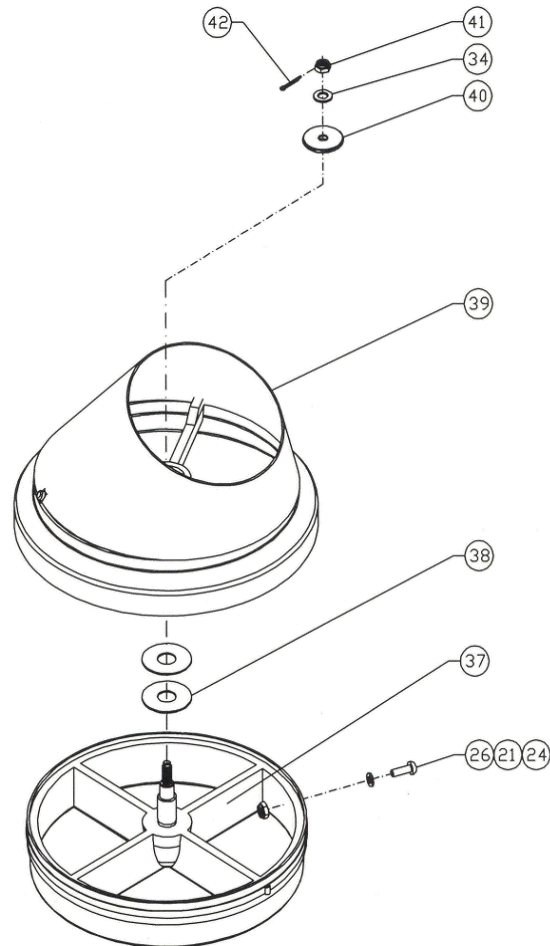

**MACNEIL WASH SYS.**





*Jim Coleman  
Producer with Fixed Nozzle*

REV. "B"

JULY 2002

PAGE#4

<i>Item no.</i>	<i>Req'd</i>	<i>Description</i>	<i>Part no.</i>	<i>Remarks</i>
36	4	3/8" Lock Washer SS	80-906-00-SI	
37	1	Nozzle Wheel Assembly	65-744-00-MP	
38	2	3/4" Flat Washer SS	80-512-00-SI	
39	1	Discharge Cone Assembly	65-780-20-MP	
40	1	Hub Cap - Fixed Nozzle	65-708-02-MP	
41	1	3/8-16 Nylock Nut SS - Thin	85-006-001-SIC	
42	1	5/64 x 3/4" Cotter Pin SS	86-056-012-SI	

MACNEIL WASH SYS.







## WINTERIZATION

### TABLE OF CONTENTS

Winter Wizard Heater Kits.....	2
Winter Wizard Installation Kit.....	3
Heat Source Options.....	4
Winter Wizard Electric Heater Schematic .....	HT1.0
Fusion Winterization Schematic.....	M3.4
Gantry & Rail Heat Wiring Diagram .....	RH1.0
Winter Wizard Electric Water Heater Schematic.....	WWH.0



## WINTER WIZARD HEATER KITS

### COLEMAN 9 KW ELECTRIC SYSTEM:

- ❑ 1 EA. JCC WINTER WIZARD SYSTEM, PRE-PLUMBED & WIRED
- ❑ 1 EA. SUPPLY MANIFOLD
- ❑ 1 EA. 3/4" STREET ELBOW
- ❑ 1 EA. 3/4" HEX NIPPLE
- ❑ 1 EA. THERMOMETER, FOR TANK

### ELECTRIC "WATER HEATER" SYSTEMS :

- ❑ 1 EA. WATER HEATER, PER AKO
- ❑ 1 EA. EXPANSION TANK, PER AKO
- ❑ 1 EA. 1/8 HP CIRCULATION PUMP, 0011-F4
- ❑ 1 EA. FILL TANK W/ CAP & FILL ADAPTER
- ❑ 1 EA. FILL MANIFOLD
- ❑ 1 EA. PRE-WIRED JUNCTION BOX
- ❑ 3 EA. 3/4" x 1" BUSHINGS
- ❑ 2 EA. 1/2" x 3/4" BUSHINGS
- ❑ 2 EA. 3/4" TEE
- ❑ 3 EA. 3/4" HEX NIPPLE
- ❑ 1 EA. 3/4" HEX COUPLING
- ❑ 1 EA. 3/4" HOSE BARB x 3/4" MPT
- ❑ 20 FT. 3/4" PUSH LOCK HOSE, BLUE



## WINTER WIZARD INSTALLATION KIT

### STANDARD KIT INCLUDES:

- 1 EA. INSTRUCTION BOOKLET
- 2 EA. RAIL HEAT TUBES , 30' 6"
- 2 EA. PVC COVERED CROSS TUBES
- 14 EA. RAIL HEAT HOLD DOWN CLIPS
- 1 EA. UNDER CARRIAGE BRIDGE PLATE
- 230 FT. 1/2" PUSH LOCK HOSE , BLACK
- 8 EA. 1/2" HOSE BARB x 1/2" MPT
- 1 EA. 1/2" FEMALE JIC SWIVEL x HOSE BARB
- 15 EA. BL – 17 CLAMPS
- 10 EA. BL – 23 CLAMPS
- 20 EA. #12 PHILLIPS HEAD SCREWS
- 20 EA. BLUE ANCHORS
- 10 EA. S.S. TECH SCREWS ( 3/8" HEX )
- 1 EA. RETURN MANIFOLD
- 1 EA. THERMOSTAT ( THAT MEASURES AIR TEMP.)
- 1 EA. VINYL HOSE COVER ( BETWEEN BOOM & WALL )

### EXTENDED BAY KIT INCLUDES :

- 1 EA. STANDARD KIT ( FROM ABOVE )
- 80 FT. 3/4" PUSH LOCK HOSE , BLUE ( FOR 1 BAY EXTENSION )
- +40 FT. 3/4" PUSH LOCK HOSE , BLUE ( PER BAY OVER 1 )
- 4 EA. 3/4" HOSE BARB x 3/4" MPT
- 1 EA. 3/4" HEX COUPLING
- 1 EA. 3/4" x 1" BUSHING





## **HEAT SOURCE OPTIONS**

If your wash is equipped with floor heat, this system can be plumbed into your existing boiler. If your wash is not equipped with floor heat, there are three other options. We offer a 12kw, 20-gallon electric water heater, which requires 60 amps of 220 volt, single-phase electricity. This same size heater is also available in a natural gas model, if you have gas available at your wash. We also manufacture our own heater, specifically designed for this system, which requires 30 amps of 230 volt, 3-phase electricity. There are flow diagrams provided to aid in proper installation.

## **WINTER WIZARD WINTERIZATION PACKAGE**

**\*Read all instructions and study all drawings before beginning installation.**

1. Connect the hose provided to the heat exchangers and the heater/boiler circulation pump as shown in the flow diagram provided. It is important that the top heat exchanger is the last heat exchanger that the heated fluid flows through to achieve maximum performance.
2. Install ½" rigid copper tubing down one side of each track using the hold down clips provided at every other rail mounting foot. Remove nut & washer; install clip & nut.
3. You will have to cross the bay two times. Cross once at the under carriage spray bar and once at the treadle plate using the bridge plate provided to prevent vehicles from running over the cross pipe. Secure pipe with clamps, screws and anchors provided. Plumb into system, with hose, as shown in the flow diagram.
4. Install the gantry hold down brackets provided.
5. Move gantry manually up and down the track to assure clearance.
6. Plumb into heat source in accordance with the flow diagram that applies to your installation.
7. If you have an existing floor heat system you must replace the thermostat that measures floor temperature with the thermostat provided. (Which measures air temperature.)
8. Fill System with 50/50 mix of anti-freeze and water.
9. You are now ready to test for leaks. Increase the thermostat setting to current air temperature. This will start the heater/boiler and circulation pump. (Which measures air temperature.)
10. Install top cover and hose boot at transition box. (Boot must be trimmed to fit.)

## Fusion Alarm Log

This information is needed to help us in trying to duplicate problems here at the Jim Coleman Company. Record the information as it is displayed on the Red Lion in the Alarm Record. This information can be accessed by pressing the "Alarms" key in the upper left corner of the Red Lion operator interface. Then press the "Next" key in the lower right corner of the Red Lion. This will take you to the Permanent Alarm Record. Pressing the "Raise" key on the lower right side. Each time you press "Raise", it will display the recorded alarms in chronological order.

There are 16 alarm information blocks below. This will usually be enough information to help us BUT if you are experiencing repetitive alarms. Please record all of the information for at least 4 instances of any repetitive alarm.

Alm	Day	Date	Time
Alarm Description:			
Wash	Pass	Boom	Gantry

Alm	Day	Date	Time
Alarm Description:			
Wash	Pass	Boom	Gantry

Alm	Day	Date	Time
Alarm Description:			
Wash	Pass	Boom	Gantry

Alm	Day	Date	Time
Alarm Description:			
Wash	Pass	Boom	Gantry

Alm	Day	Date	Time
Alarm Description:			
Wash	Pass	Boom	Gantry

Alm	Day	Date	Time
Alarm Description:			
Wash	Pass	Boom	Gantry

Alm	Day	Date	Time
Alarm Description:			
Wash	Pass	Boom	Gantry

Alm	Day	Date	Time
Alarm Description:			
Wash	Pass	Boom	Gantry

Alm	Day	Date	Time
Alarm Description:			
Wash	Pass	Boom	Gantry

Alm	Day	Date	Time
Alarm Description:			
Wash	Pass	Boom	Gantry

Alm	Day	Date	Time

Alm	Day	Date	Time



## Program Troubleshooting Worksheet

### Fusion Custom Recipe

This information, as well as the gantry counter values, is needed from the customer who is experiencing a problem so we can attempt to duplicate on one of our units.

Distributor: \_\_\_\_\_ Unit Model: \_\_\_\_\_ Date: \_\_\_\_\_

Site: \_\_\_\_\_ Program Version: \_\_\_\_\_

Vehicle type, problem usually occurs on: \_\_\_\_\_ (if applicable)

Description of Problem:

Recipe # \_\_\_\_\_ # of Passes \_\_\_\_\_

Pass #	Active "Bits"	Gantry Speed in %	Preset Values			
			Start Delay in seconds	Boom counts @ Start	Boom Counts @ End	End Delay in seconds
1				Front	Rear	
				Rear	Front	
2				Front	Rear	
				Rear	Front	
3				Front	Rear	
				Rear	Front	
4				Front	Rear	
				Rear	Front	
5				Front	Rear	
				Rear	Front	
6				Front	Rear	
				Rear	Front	
7				Front	Rear	
				Rear	Front	
8				Front	Rear	
				Rear	Front	
9				Front	Rear	
				Rear	Front	
10				Front	Rear	
				Rear	Front	

### Fusion - Program Troubleshooting Worksheet



### Counter Values

This information as well as their exact recipe is needed from the customer who is experiencing a problem so we can attempt to duplicate on one of our units.

Distributor: \_\_\_\_\_ Unit Model: \_\_\_\_\_ Date: \_\_\_\_\_

Site: \_\_\_\_\_ Program Version: \_\_\_\_\_

Vehicle type problem usually occurs on: \_\_\_\_\_ (if applicable)

Description of Problem:

Red Lion Description	Set Value
Treadle Positon (for Wheel Brush @ Front)	
Start Gantry (Boom, Fx) @ Front	
Start Gantry (Boom, Fx) @ Rear	
Front Brush Pass	
Rear Brush Pass	
Start Side Brushes @ Front	
Start Side Brushes @ Rear	
Start Top Brush @ Front	
Start Top Brush @ Rear	
Rear TB Pass on Long Vehicles	
Start LP Wax @ Front	
Start LP Wax @ Rear	
Start Trifoam @ Front	
Start Trifoam @ Rear	
Start Presoak @ Front	
Start Presoak @ Rear	
Start Rocker Panel @ Front	
Start Rocker Panel @ Rear	
Start Side Sprays @ Front	
Start Side Sprays @ Rear	
Start TC (tire cleaner) @ Front	
Start TC (tire cleaner) @ Rear	
Start SB (side brush) Lube @ Front	
Start SB (side brush) Lube @ Rear	
Start TB (top brush) Lube @ Front	



Red Lion Description	Set Value
Start TB (top brush) Lube @ Rear	
TB (top brush) Lower Limit @ Rear	
Wheel Brush Offset @ Rear	
Flip Blower @ Front	
Flip Blower @ Rear	
Presoak Overlap @ middle of car	

## Fusion - Program Troubleshooting Worksheet

### F8 - Site Data

This information, as well as the recipe & count values, is needed from the customer who is experiencing a problem so we can attempt to duplicate on one of our units.

Distributor: \_\_\_\_\_ Unit Model: \_\_\_\_\_ Date: \_\_\_\_\_

Site: \_\_\_\_\_ Program Version: \_\_\_\_\_

Vehicle type problem usually occurs on: \_\_\_\_\_

Description of Problem:

Menu Option #	Red Lion Description	eF current default	Setting	Fx current default
3	On-Board Blower			
4	Type Cashier			
10	Profile Option			
11	Profile Mode			
14	Static Blower			
15	Treadle Sensor			
16	Undercarriage Eye			
17	Door Mode			
18	Windy Day Bypass			
21	<b>Min SB TL Position</b>			

### Fusion - Brush Spindle Frequency

This value should be displayed on the VFD while the unit is at idle, without having to check it on "n21".

VFD Description	Set Value
Left Brush Spindle Frequency (n21) =	
Top Brush Spindle Frequency (n21) =	
Right Brush Spindle Frequency (n21) =	



## Timer Values

This information, as well as the recipe & count values, is needed from the customer who is experiencing a problem so we can attempt to duplicate on one of our units.

**Distributor:** \_\_\_\_\_ **Unit Model:** \_\_\_\_\_ **Date:** \_\_\_\_\_

**Site:** \_\_\_\_\_ **Program Version:** \_\_\_\_\_

**Vehicle type problem usually occurs on:** \_\_\_\_\_

**Description of Problem:**

Red Lion Description	Set Value
External Blower (delay after wash)	
External Blower (pulse time)	
Triple Shine	
Entrance Watchdog	
Bottom Blaster (undercarriage total time)	
Bottom Blaster (rear wheel timer)	
Wheel Brushes (extend time)	
External Door Control (pulse time)	
Spot Free Purge Time	
High Pressure Purge	
Presoak Purge Time	
Off-Treadle Watchdog	
Exit Door Reclose	
Start Stacked Wash	
Wheel Brushes (retract time)	
Tire Glaze (spin & extend)	
Tire Glaze (liquid dispensed)	
Tire Glaze (wet brushes, inactive)	



## **FUSION ALARMS LISTING**

<b>Alarm</b>	<b>Description</b>	<b>Stored</b>	<b>Limiting Factors</b>
1	no motion detected on gantry when drive enabled	user	OS
2	3x lockout alarm	user	OS
3	exit door open alarm if doors enabled this wash	perm	advisory
4	wheel B phase prox failure	user	OS
5	wheel A phase prox failure	user	OS
6	motion detected when drives are stopped	user	advisory
7	car measurement too small	user	terminate wash, 3x lockout OS
8	car measurement too large	user	terminate wash, 3x lockout OS
9	drive motor ran too long	user	terminate wash, OS if gantry doesn't return home.
10	boom failed to clear top LS. Rewind the top boom for equivalent time period.	user	limit boom function
11	boom prox A failure	user	limit boom function
12	boom prox B failure	user	limit boom function
13	no downward motion detected on boom.	user	limit boom function
14	no upward motion detected on boom when drive running	user	OS, if boom doesn't return home
15	motion detected when boom drive not running	user	limit boom function
16	boom watchdog, too long to move to SP	user	limit boom function
17	when profiling to rear of car, boom safety eyes sensed obstruction	perm	limit boom function
18	when profiling to front of car, boom safety eyes sensed obstruction	perm	limit boom function
19	rear boom cycle, boom safety eyes saw obstruction	perm	limit boom function
20	front boom cycle, boom safety eyes saw obstruction.	perm	limit boom function
21	rear boom cycle, measurement eye sensed obstruction	perm	limit boom function
22	front boom cycle, measurement eye obstructed	perm	limit boom function
23	rear boom cycle, can safety eye sensed obstruction.	perm	limit boom function
24	front boom cycle, can eye sensed an obstruction	perm	limit boom function
25	top prox was ON even though boom count greater than 10 counts.	user	run boom to 0 count
27	Treadle senses car even though wash was idle for > 12 minutes.	perm	advisory
28	Recipe called for undercarriage wash, but car was not detected by entrance eye	perm	advisory
29	jog enable switch left on for longer than 15 minutes	user	OS, when in jog mode
30	one or more manual jog switches left on for longer than 1 minute	user	advisory
31	e-stop switch on	user	OS
32	Reset switch left on for longer than 1 minute.	user	OS
33	one or more start wash switches left on for longer than 60 seconds	user	advisory
34	bill cashier 1 or 2 faulted	user	advisory
35	Auto-Cashier faulted	user	advisory
36	Tire Cleaner low level warning if low longer than 10 seconds	user	advisory
37	Wax low level warning if low for longer than 10 seconds	user	advisory

38	H2O low level warning and out of service if low for longer than 10 seconds	user	OS, after wash in progress completes
39	PreSoak low level warning and out of service if low for longer than 10 seconds	user	OS, after wash in progress completes
40	Gantry OL tripped	user	OS, if vfd doesn't reset
41	Boom OL tripped	user	OS, if vfd doesn't reset and boom can't return home
42	Osc OL tripped	user	no oscillation if vfd doesn't reset
43	advisory - reset button pressed	perm	advisory
44	Side Brush OL tripped	user	OS if brush cannot return home
45	blower nozzle proxes failed to show motion within 5 seconds of starting rotation VFD	perm	advisory
46	Home Prox Abnormal	user	advisory, other alarms may result limiting operation
47	gantry end of travel prox abnormal	user	advisory, other alarms may result limiting operation
48	Run track test before allowing auto cycles to begin	user	advisory
49	overspeed, gantry encoder	user	advisory
50	track test failed	user	advisory
51	treadle hung at end of wash cycle - reset wash after watchdog timer expires	perm	advisory
52	end of car not found during measurement pass	user	advisory
53	Customer did not leave treadle within 90 seconds	perm	advisory
54	13 minute max wash time exceeded. Cancel remaining wash cycle	user	terminate wash
55	treadle switch was on when car wash was started.	perm	advisory
56	car took too long to reach treadle after starting wash	perm	advisory
57	car off treadle for too long while wash in progress. Cancel remaining wash cycle.	user	terminate wash
58	customer failed to leave wash within 3 minutes after wash was completed.	perm	advisory
59	track test OK	user	advisory
60	top boom prox was not ON at start of wash. Do not allow wash to continue.	user	OS
61	Gantry home sensor was not on at start of wash. Do not allow wash to continue	user	OS
62	bottom boom prox ON at start of boom cycle. No boom cycle will result.	perm	limit boom function
63	main pump > 500 hours operation.	user	advisory
64	Pump OL tripped	user	OS
65	no car seen within 36"	user	terminate wash
66	while wash idle, gantry home prox was OFF for > 60 seconds. OS	user	OS
67	while wash idle, top boom prox was OFF for > 60 seconds; OS	user	OS
68	front boom pass, home prox sensed	perm	limit boom function
69	end of track prox sensed on rear boom pass	perm	limit boom function

70	left side brushes - encoder wiring backwards	user	limit brush function
71	right side brushes - encoder wiring backwards	user	limit brush function
72	top brushes - encoder wiring backwards	user	limit brush function
73	wash cycle attempted with job enable switch ON	user	OS when in jog mode
76	Relay for Gantry Eyes test sequence appears abnormal. All eyes were OFF at start of test.	user	OS
77	Relay for control panel eye tests sequence is abnormal. All eyes were OFF at start of test.	user	advisory
78	boom switches are miswired - counts backwards	user	limit boom function
79	gantry count prox switches miswired. Gantry encoder counting backwards	user	OS
80	Profile 1 did not test OFF at start of wash	user	limit boom function
81	Profile 2 did not test OFF at start of wash	user	limit boom function
82	Profile 3 did not test OFF at start of wash	user	limit boom function
83	Profile 4 did not test OFF at start of wash	user	limit boom function
84	Measurement eye did not test OFF at start of wasy	user	OS
85	can eye did not test OFF at start of wash	user	limit boom function
86	rear boom safety eye did not test OFF at start of wash	user	limit boom function
87	front boom safety eye did not test OFF at start of wash	user	limit boom function
88	treadle sensor did not test OFF at start of wash	user	advisory
89	undercarriage eye did not test OFF at start of wash	perm	advisory
90	Exit eye did not test ON at start of wash	perm	advisory
91	WB photo eye not OFF at start of wash	user	
92	TB OL detected	user	limit brush function
93	SB OL detected	user	limit brush function
94	TB no motion detected	user	limit brush function
96	Profile 1 photo (top) was not ON at start of wash	perm	limit boom function
97	Profile 2 photo was not ON at start of wash	perm	limit boom function
98	Profile 3 photo was not ON at start of wash	perm	limit boom function
99	Profile 4 photo was not ON at start of wash	perm	limit boom function
100	Measurement photo was not ON at start of wash cycle	perm	limit boom function
101	Can Eye was not ON at start of wash cycle	perm	limit boom function
102	Rear Boom Safety was not ON at start of wash, 2010.11	perm	limit boom function
103	Front Boom Safety was not ON at start of wash	perm	limit boom function
104	Treadle Eye was not ON at start of wash cycle	perm	advisory
105	UnderCar Eye was not ON at start of wash cycle	perm	advisory
106	exit eye was not ON at start of wash	perm	advisory
107	WB eye not ON at start of wash cycle	user	
108	boom belt safety prox alarm	user	
109	boom prox detected slack in belt	user	
110	pipe rack mode selected this wash	perm	
111	3-phase power fault	user	
112	reclaim water is low level	user	limit solenoid
113	blower tripped out	user	requires manual OL reset for blowers to operate
114	LB no load detected	user	limit brush function
115	RB no load detected	user	limit brush function

116	TB no load detected	user	limit brush function
117	TB home prox not sensed	user	OS
118	LB home prox not sensed	user	OS
119	RB home prox not sensed	user	OS
120	Boom home prox not sensed	user	OS
121	RB no motion detected	user	
122	WB home prox did not test ON at start of wash.	user	
123	Wheel Brush Photo was OFF at the start of wash	user	advisory
124	WB cycle not home	user	
125	gantry EOT prox did not sense at end of track	perm	advisory
126	TB motor current <b>too high</b>	<b>PERM</b>	limit brush function
127	TB motor current too low	USER	OS, Requires Manual Reset
128	wheel brushes did not return home. Terminate wash. Gantry will not move. OS if brushes don't return home	USER	OS, if brushes don't return home
129	center limit prox on brushes defective	USER	limit brush function
130	LB low torque alarm	USER	OS, Requires Manual Reset
131	LB <b>high</b> torque alarm	<b>PERM</b>	advisory
132	RB low torque alarm	USER	OS, Requires Manual Reset
133	RB <b>high</b> torque alarm	<b>PERM</b>	advisory
134	TB lower prox EOT alarm	USER	limit brush function
135	Network Comms Error - Loss or Error in Network Communication occurred	USER	OS



# ***CONTENTS*** .....



## ***TABLE OF***

### ***eFuson Parts Manual***

Gantry Side Brush Carriage - Passenger Side.....	2
Gantry Side Brush Carriage - Driver Side.....	4
Side Brush Carriage - End View.....	6
Gantry Top Brush - Drive Assembly.....	8
Gantry Lower - Inside - Passenger.....	10
Gantry - Driver's Side - Lower (Left Side).....	12
Gantry - Wheel Brush Assembly - Passenger Side (Right Side).....	14
Gantry - Wheel Brush Assembly - Driver's Side (Left Side).....	16
Gantry - Drive and Count Wheels.....	18
Gantry - Oscillating Blower Assembly.....	20
Gantry - Instruction Signs.....	22
Gantry Drive - Passenger Side - (Right Side).....	24
Gantry Drive-Driver's Side.....	26
Gantry Upper - Top Brush Drive.....	28
Gantry Upper - Top Brush.....	30
Low Pressure Box.....	32
High Pressure Box.....	34
Gantry Electrical Panel- Lower.....	36
Low Pressure Pumps.....	38
Pump Stand - Front End View.....	40
Pump Stand - CAT Pump.....	42
Pump Stand - Lower Front.....	44
Pump Stand - Rear.....	46
Control Panel - Pump Stand.....	48
Gantry Control Panel - Upper.....	50



# Gantry Side Brush Carriage Passenger Side

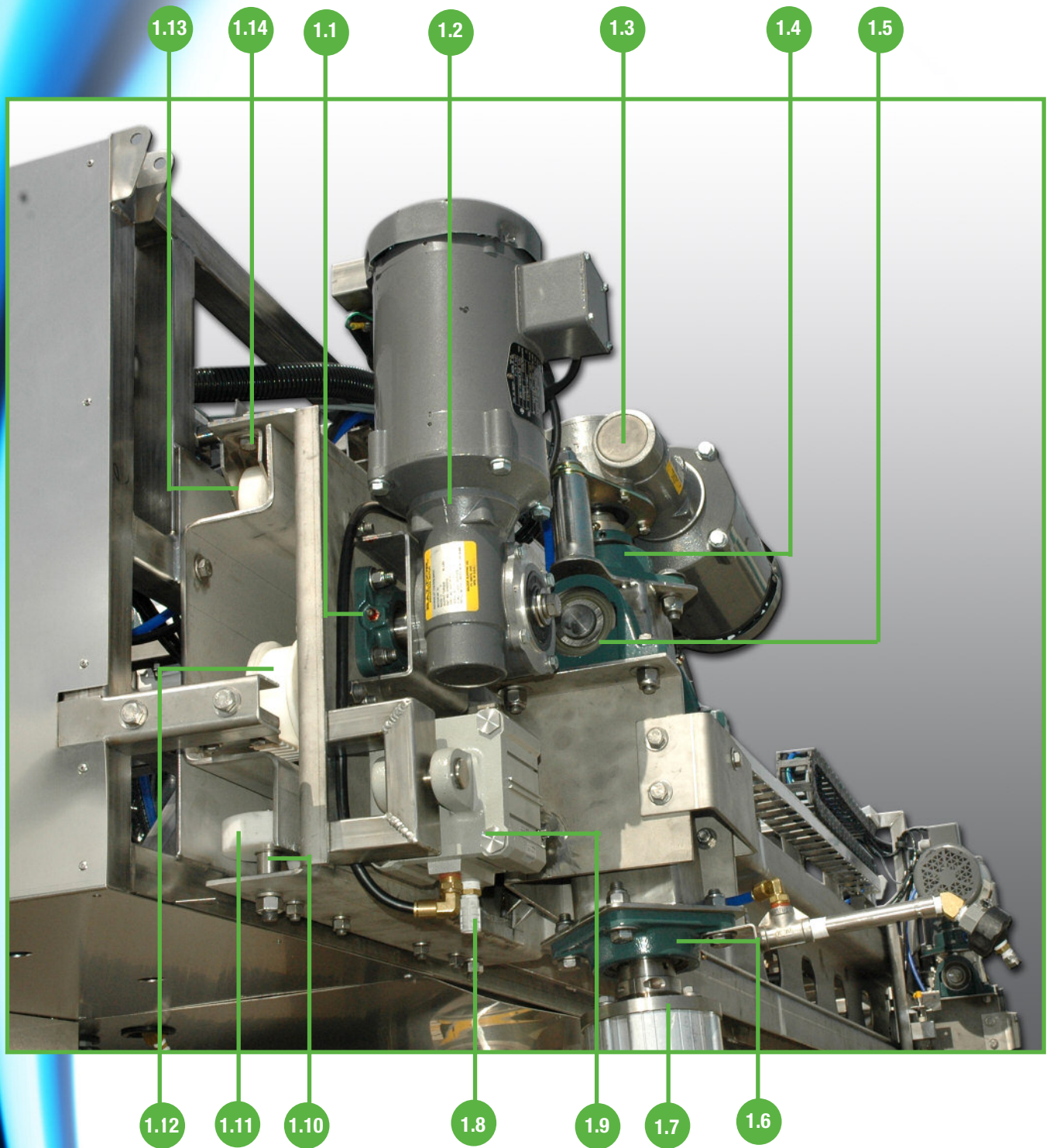

**Gantry Side Brush Carriage - Passenger Side**

ITEM #	PART #	DESCRIPTION
1.1	07511	Bearing, Flange 1" 4 Bolt
1.2	55001	Gear Motor, 10:1 Washdown HS
1.3	55001	Gear Motor, 10:1 Washdown HS
1.4	07514	Bearing, Flange Roller 1-1/2"
1.5	06851	Pillow Block Bearing 1-1/4" -VPS-120
1.6	07531	Bearing, Flange 1-1/2" 4 Bolt
1.7	07574	Side Brush Shaft & Flange (MS-AC11 & MS-AC12)
1.8	07502	Muffler, Pneumatic
1.9	07501	Air Cyl, 100mm Bore X 25 mm
1.10	07827	Side Brush Carriage Roller Bolt Horizontal Roller (MS-AC26)
1.11	07825	Side Brush Carriage Roller (MS-AC51)
1.12	07828	Belt Idler Pulley (MS-AC52)
1.13	07825	Side Brush Carriage Roller (MS-AC51)
1.14	07826	Side Brush Carriage Roller Vertical Bracket (AC004-1)



# Gantry Side Brush Carriage Driver Side

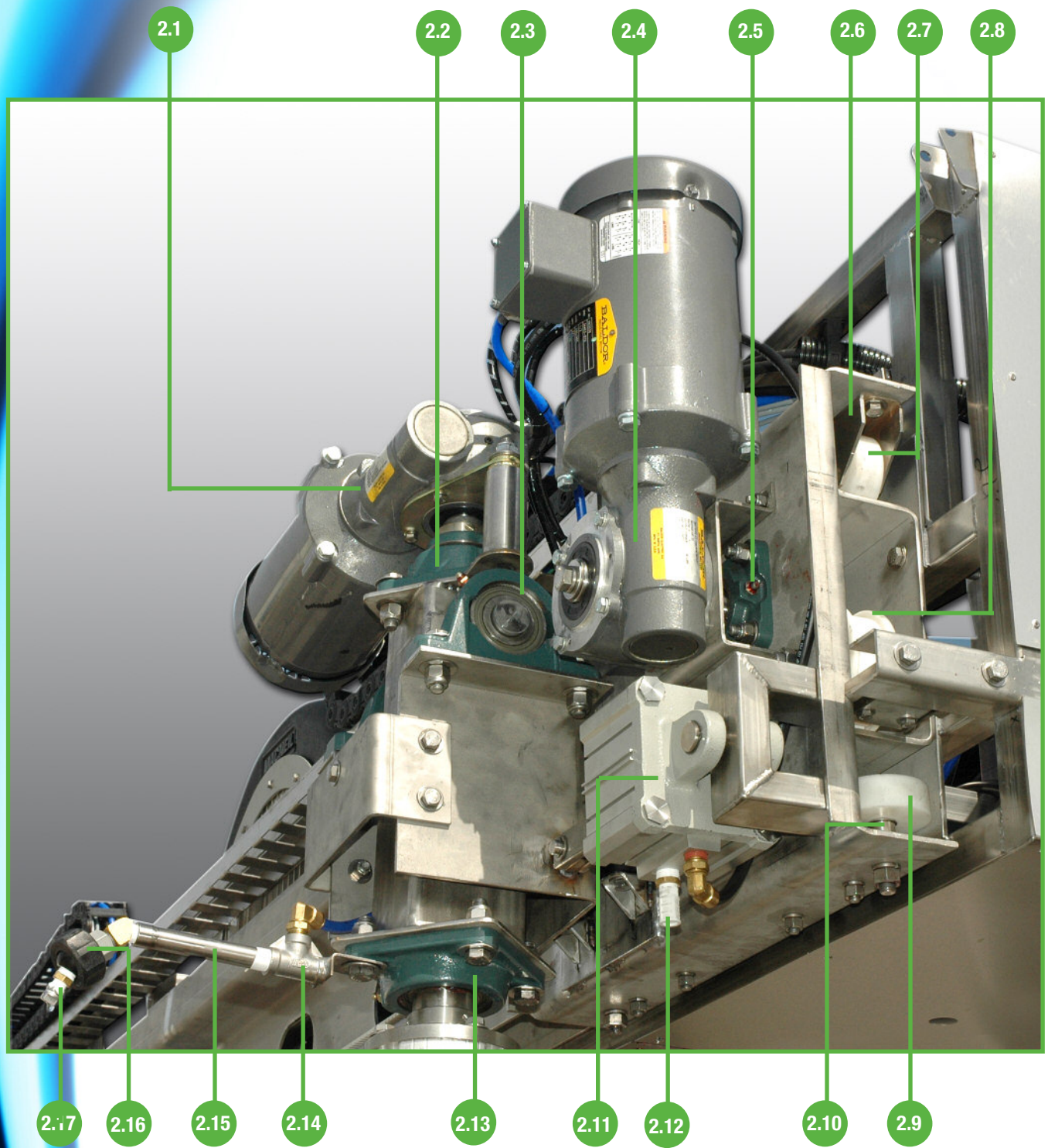

**Gantry Side Brush Carriage - Driver Side**

ITEM #	PART #	DESCRIPTION
2.1	55001	Gear Motor, 10-1 Washdown HS
2.2	07514	Bearing, Flange Roller 1-1/2"
2.3	06851	Pillow Block Bearing 1-1/4" -VPS-120
2.4	55001	Gear Motor, 10-1 Washdown HS
2.5	07511	Bearing, Flange 1" - 4 bolt
2.6	07826	Side Brush Carriage Roller Vertical Bracket (AC004-1)
2.7	07825	Side Brush Carriage Roller (MS-AC51)
2.8	07828	Belt Idler Pulley (MS-AC52)
2.9	07825	Side Brush Carriage Roller (MS-AC51)
2.10	07827	Side Brush Carriage Roller Bolt - Horizontal Roller (MS-AC26)
2.11	07501	Air Cyl, 100mm bore X 25mm
2.12	07502	Muffler, Pneumatic
2.13	07513	Bearing, Flange 1-1/2" 4 Bolt
2.14	07230	Mitter Lube Pipe T Bracket - Stainless Steel (MC018-1 & 22441)
2.15	07829	Mittler Lube Pipe 6" Stainless Steel
2.16	06561 and 06562	Nozzle Adjustable Ball Fitting & Threaded Ball - Plastic
2.17	84104	Mitter Lube Spray Tip # 2507



**Side Brush Carriage  
End View**

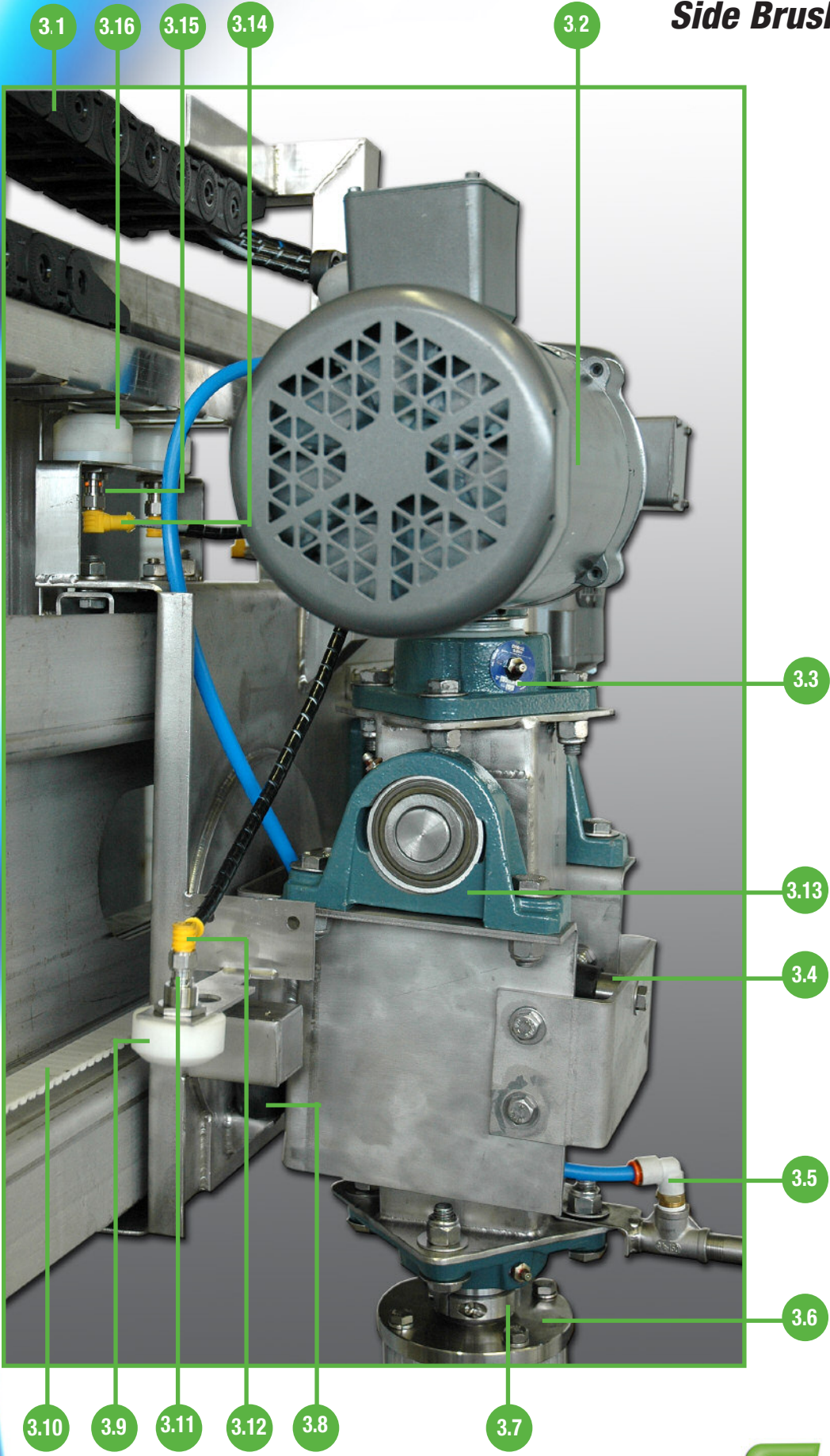

3.1

3.16

3.15

3.14

3.2

3.3

3.13

3.4

3.5

3.6

3.10

3.9

3.11

3.12

3.8

3.7

6

**Side Brush Carriage - End View**

ITEM #	PART #	DESCRIPTION
3.1	07515-1	Cable Carrier - 34 Links
3.2	55001	Gear Motor, 10-1 Washdown HS
3.3	07514	Bearing, Flange Roller 1.5"
3.4	07528	Rubber Stopper
3.5	22-W169-PL-6-6	90 Degree Push Lock Fitting
3.6	07574	Side Brush Shaft & Flange (MS-AC11 & MS-AC12)
3.7	07510	Lock Collar 1-1/2"
3.8	07528	Rubber Stopper
3.9	07821	Prox Protector
3.10	06852	Belt - Kevlar Side Brush Carriage ( 15' )
3.11	06626	Prox 18mm
3.12	06650-12	Cable Prox 90 Degree
3.13	06851	Pillow Block Bearing 1-1/4" - VPS -120
3.14	06650-12	Cable Prox 90 Degree
3.15	06626	Prox 18mm
3.16	07821	Prox Protector
3.16	07821-1	Prox Protector Spacer



# Gantry Top Brush Drive Assembly

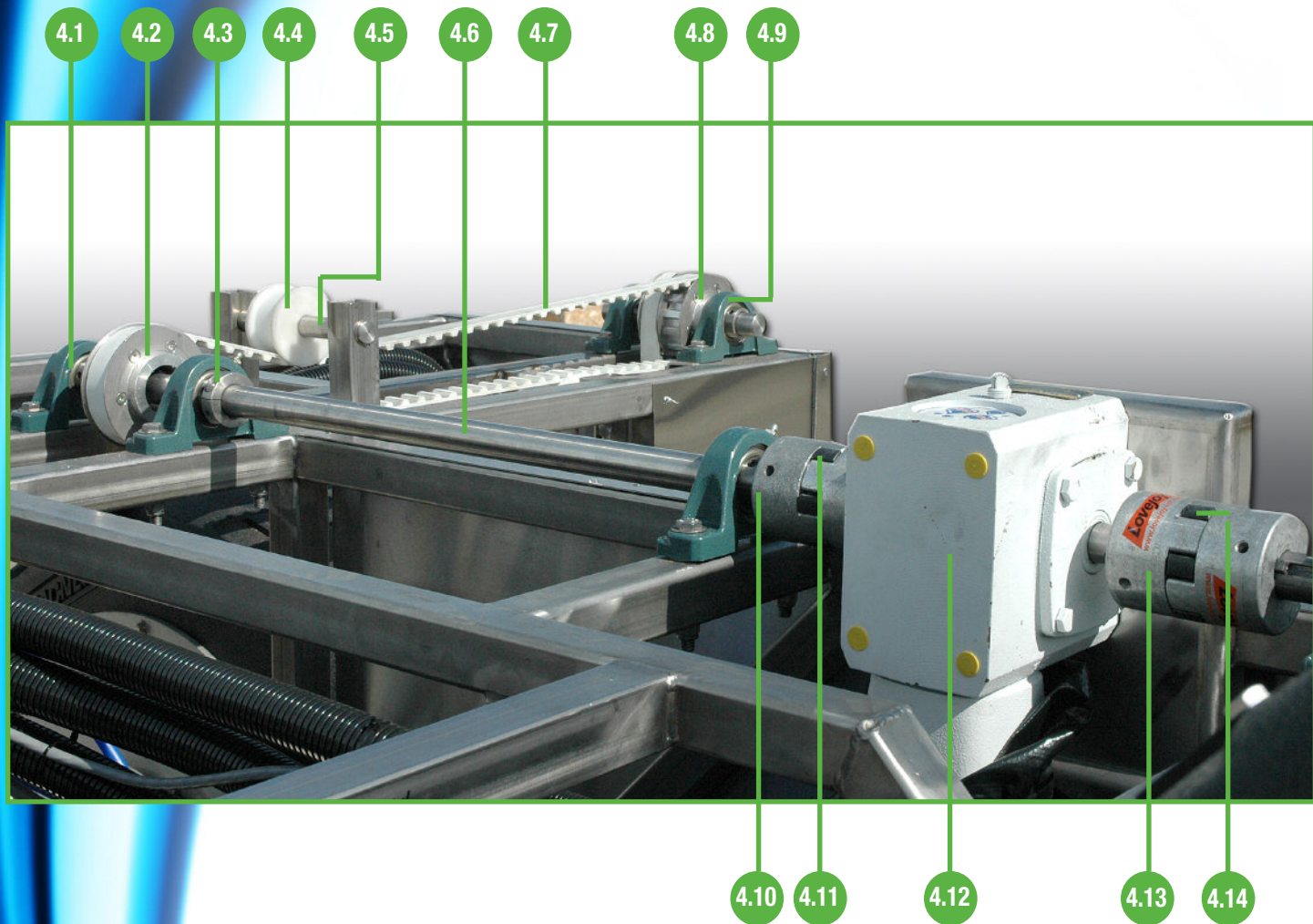

**Gantry Top Brush - Drive Assembly**

ITEM #	PART #	DESCRIPTION
4.1	06850	Pillow Block Bearing 1" - VPS - 116
4.2	18009	Pulley Cog T20 -25mm (Single) - Aluminum
4.3	06830	Lock Collar 1"
4.4	07822	Idler Pulley (MS-AC52)
4.5	07823	Idler Pulley Shaft (MS-AC64)
4.6	07824	Top Brush Drive Shaft - 1" X 31" (MS-107)
4.7	18013	Boom Belt - Continuous Loop
4.8	18010	Pulley Cog T20 - 50mm (Double) - Aluminum
4.9	06850	Pillow Block Bearing 1" - VPS - 116
4.10	06800	Love Joy 1" Drive Shaft
4.11	06803	Love Joy Spider
4.12	55227-1	Gear Box, DBBL Shaft 50:1
4.13	06801	Love Joy 7/8" Gear Box
4.14	06803	Love Joy Spider



# Gantry Lower - Inside Passenger

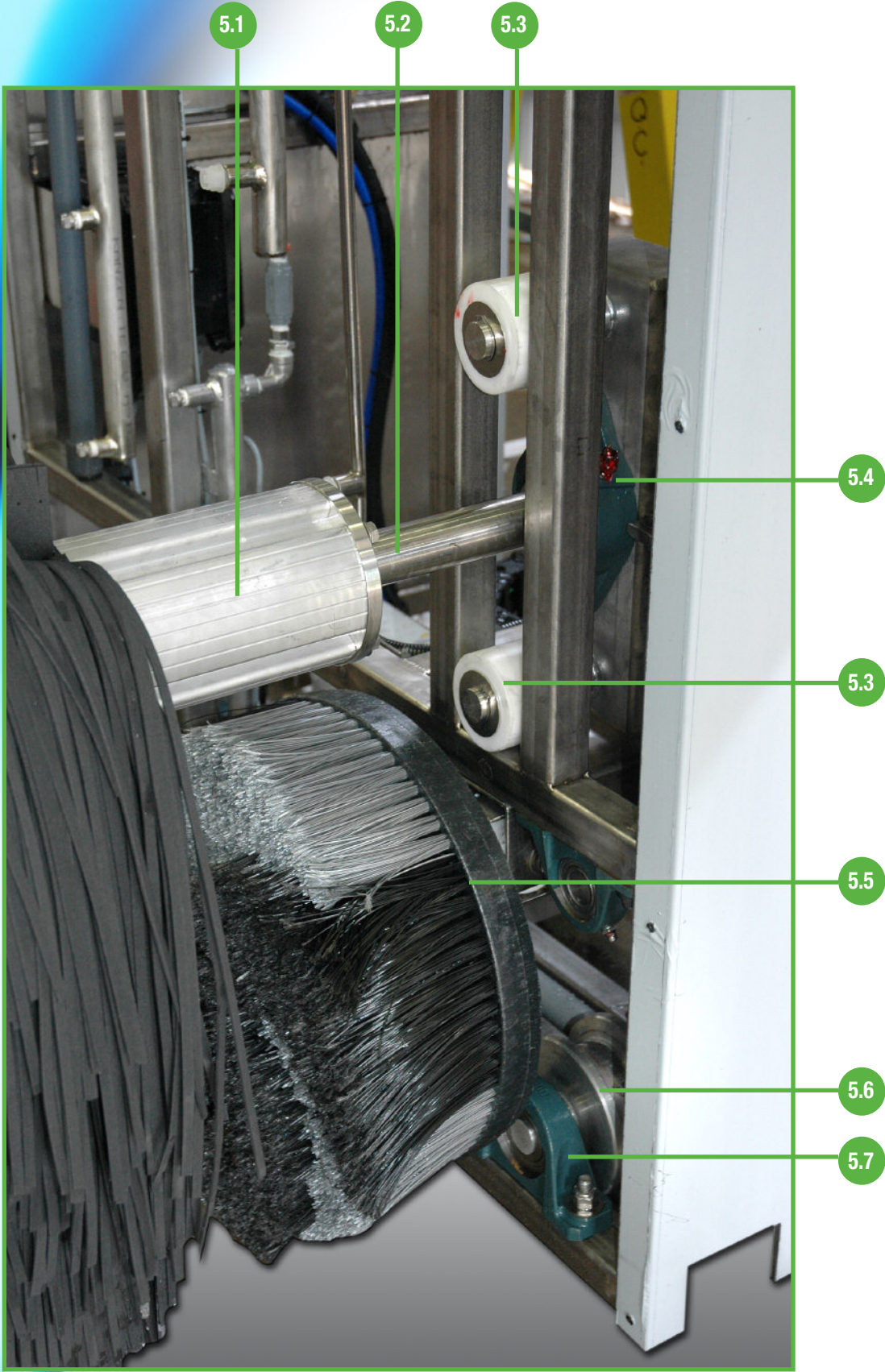



**Gantry Lower - Inside - Passenger**

ITEM #	PART #	DESCRIPTION
5.1	07571	Brush Core - Top Brush Fusion
5.2	07573	Top Brush Shaft & Flange Passenger Side (MS-AC17&MS-AC12)
5.3	07816	Top Brush Rollers (MC-AC55)
5.4	07512	Bearing Flange 1-1/2" - 2 Hole
5.5	07519	Wheel Brush
5.6	06500-W	Drive Wheel
5.7	06851	Pillow Block Bearing 1-1/4" - VPS - 120

**Gantry - Driver's Side  
Lower (Left Side)**

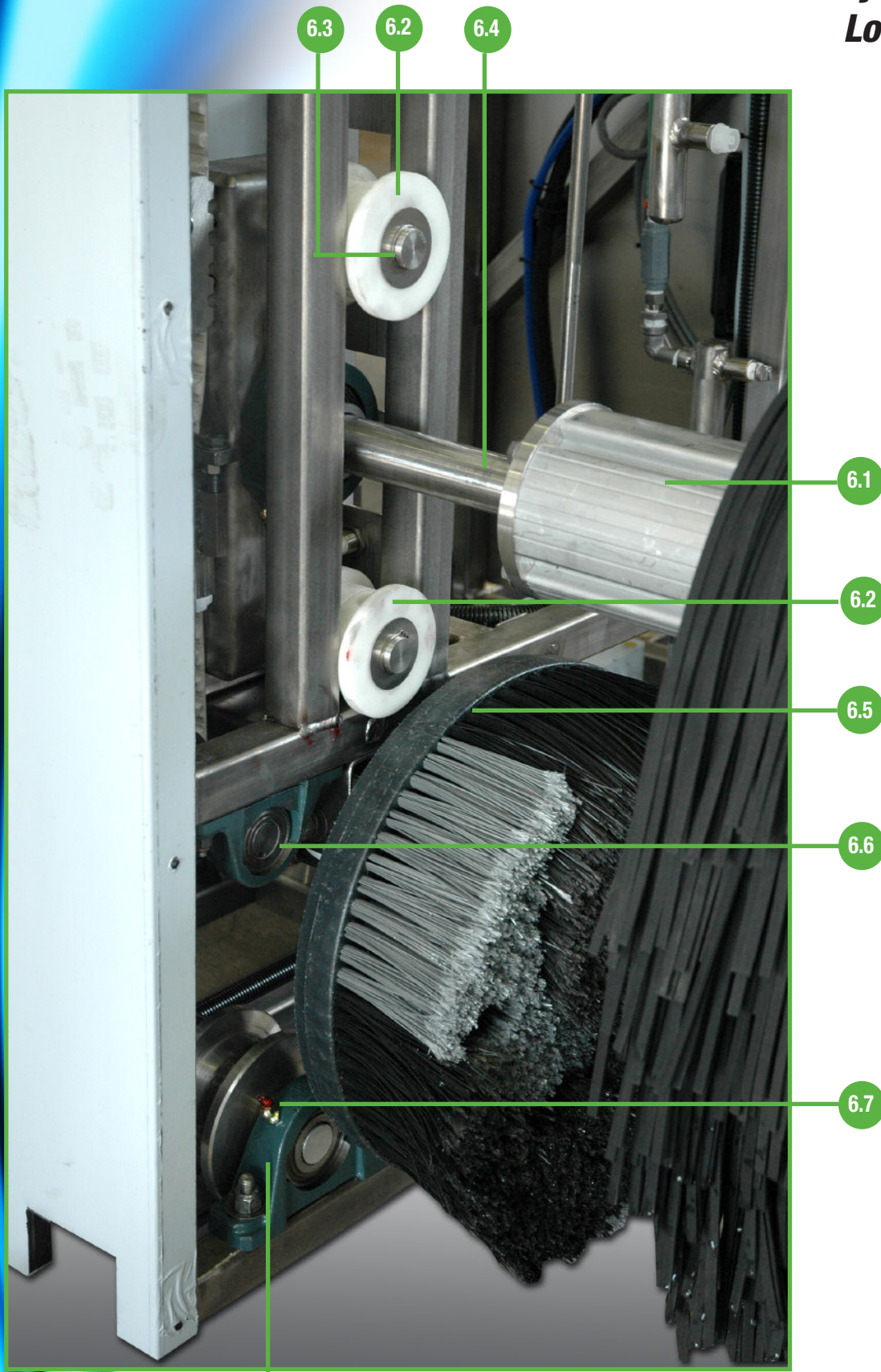

**Gantry - Driver's Side - Lower (Left Side)**

ITEM #	PART #	DESCRIPTION
6.1	07571	Brush Core - Top Brush Fusion
6.2	07820	Guide Rollers Halves (MS-AC56)
6.3	49097	Snap Ring 1"
6.4	07572	Top Brush Shaft & Flange - Drivers Side (MS -AC16&MS-AC12)
6.5	07519	Wheel Brush
6.6	06850	Pillow Block Bearing 1" - VPS - 116
6.7	06500-W	Drive Wheel
6.8	06851	Pillow Block Bearing 1-1/4" - VPS - 120



## Gantry - Wheel Brush Assembly Passenger Side (Right Side)

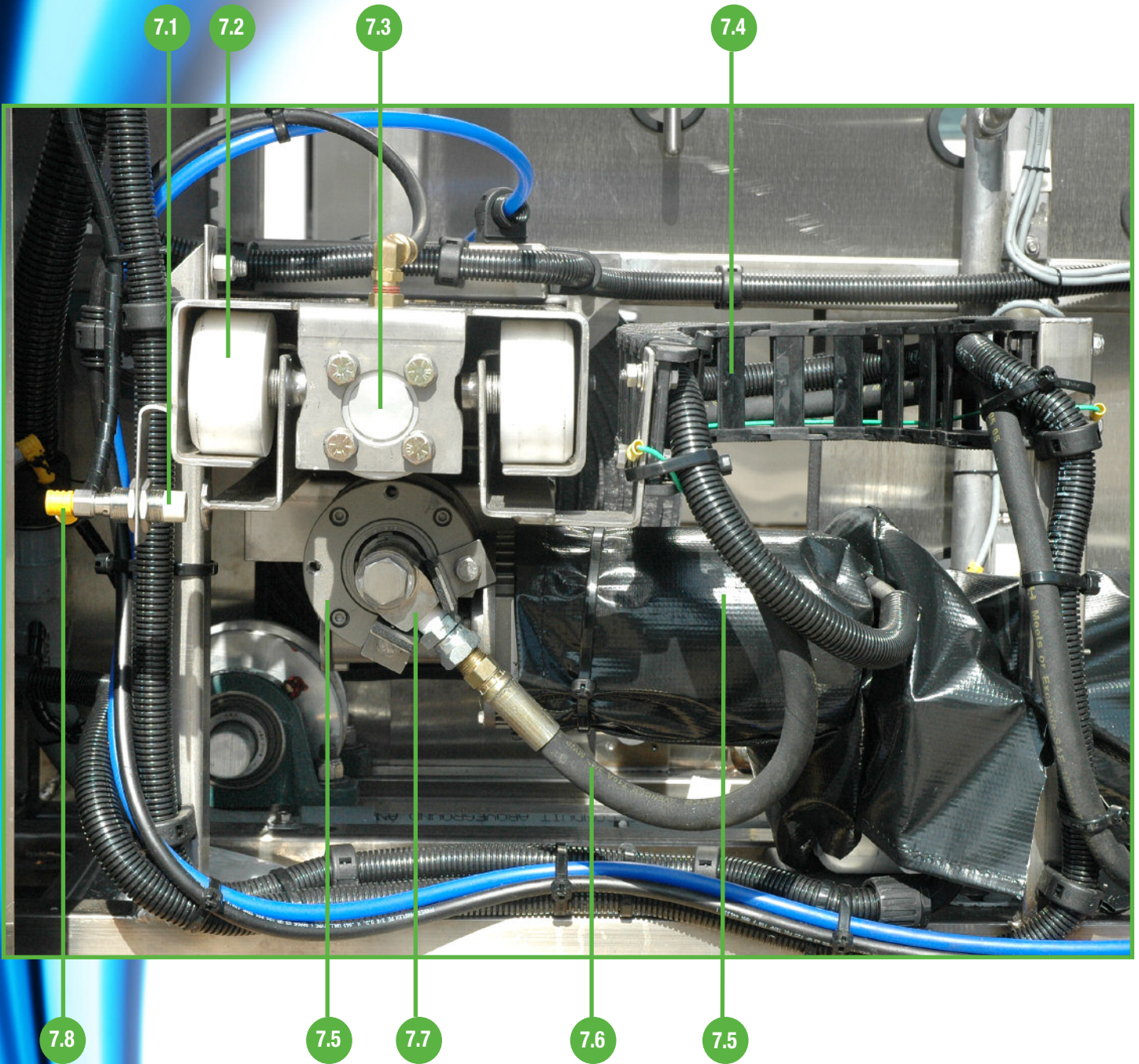

**Gantry - Wheel Brush Assembly - Passenger Side (Right Side)**

ITEM #	PART #	DESCRIPTION
7.1	06626	Prox - 18mm
7.2	07815	Slide Rollers
7.3	07504	Air Cyl, 2.5" X 18"
7.4	07515-2	Wheel Brush Cable Carrier
7.5	55000	Gear Motor, 1/3 Hp 30:1" Hs
7.6	52281	Wheel Brush HP Hose (3/8"x10-1/2' Wire Braid Hose W/F)
7.7	74000	Swivel 3/8ths HP M X F
7.8	06650-12	Cable, Prox 12 meter 90 Deg



## Gantry - Wheel Brush Assembly Driver's Side (Left Side)

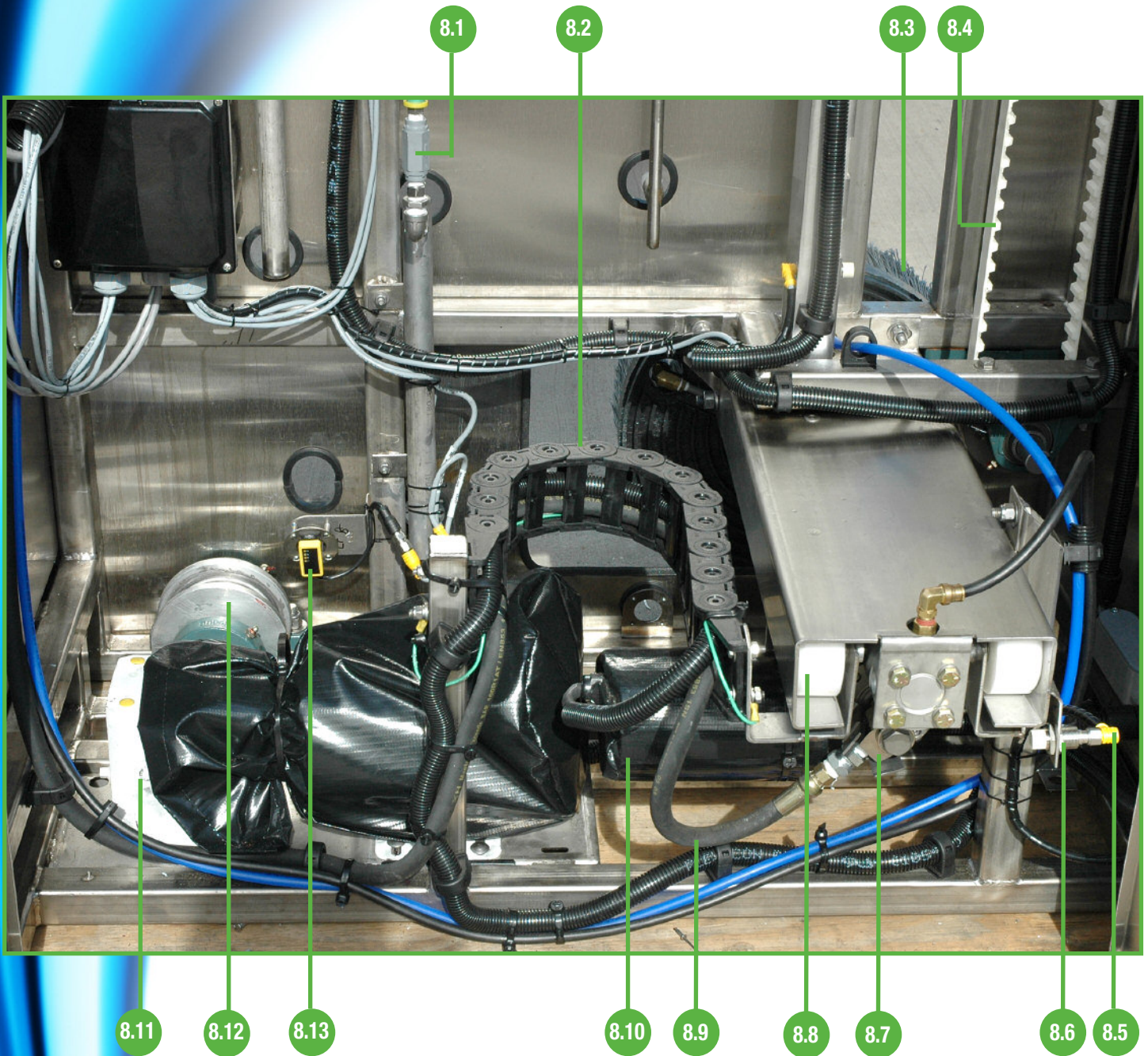



**Gantry - Wheel Brush Assembly - Driver's Side (Left Side)**

ITEM #	PART #	DESCRIPTION
8.1	34025	Check Valve - Poly 1/4"
8.2	07515-2	Wheel Brush Cable Carrier
8.3	07519	Wheel Brush
8.4	18012	Belt, Timing Kevlar 50,000 mm
8.5	06650-12	Cable, Prox 12 meter 90 Deg
8.6	06626	Prox - 18mm
8.7	74000	Swivel, 3/8" HP M X F
8.8	07815	Slide Rollers
8.9	52282	Wheel Brush HP Hose (3/8"x27-1/2' Wire Braid Hose W/F)
8.10	55000	Gear Motor, 1/3 Hp 30:1" Hs
8.11	55230-2	.5 HP 3/60 Inv. Dty Washdown Drive Motor
8.12	06500-W	Drive Wheel
8.13	06742	Emitter, 8 Channel

## Gantry - Drive and Count Wheels

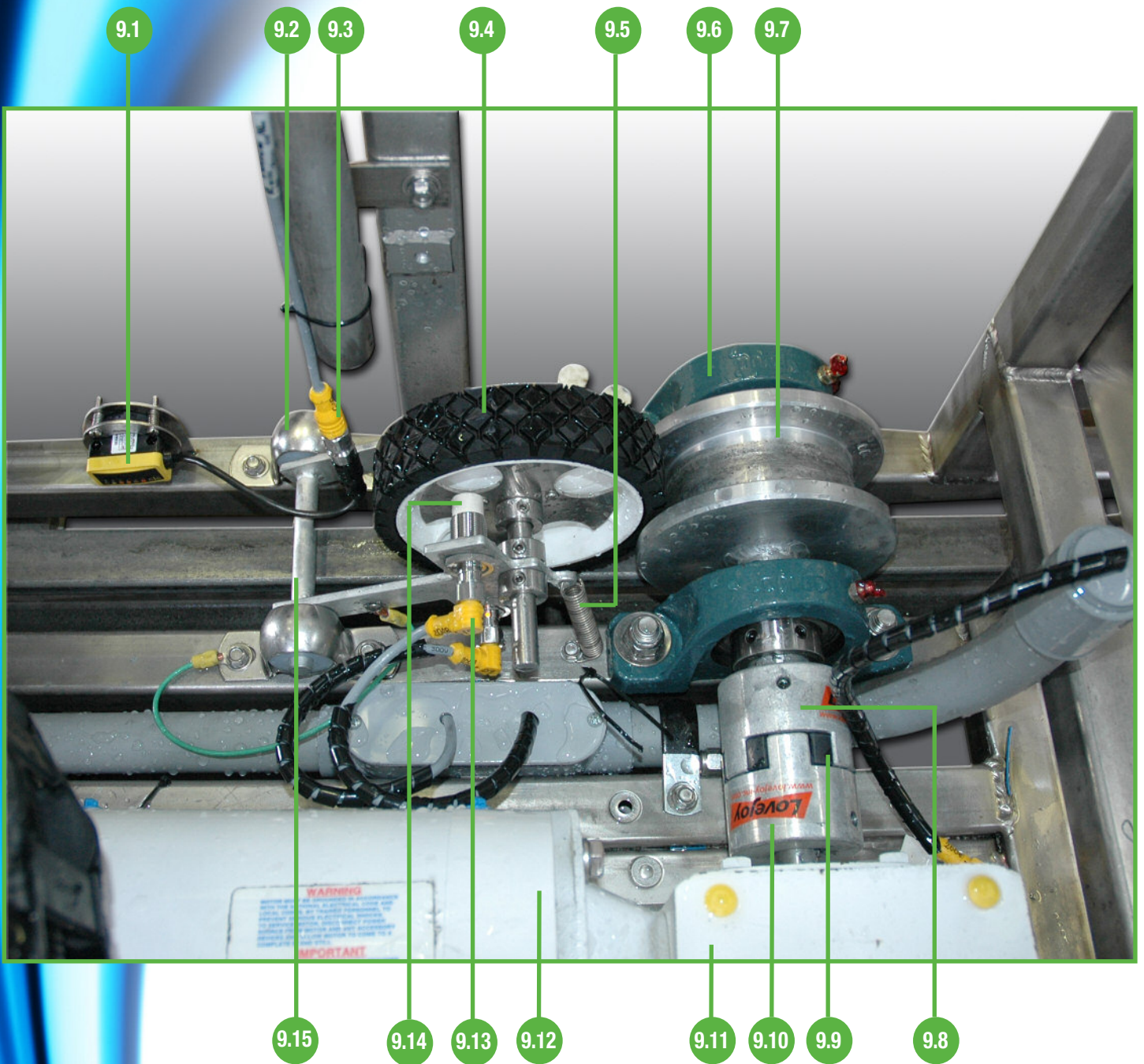

**Gantry - Drive and Count Wheels**

ITEM #	PART #	DESCRIPTION
9.1	06741	Receiver, 8 Channel
9.2	06647	Pillow Block Bearing - Nylon 1/2"
9.3	06716	Eye Cable - 2 Meter
9.4	06834	Count Wheel 1.5" x 6"
9.5	06781	Spring For Count Wheel
9.6	06851	Pillow Block Bearing - 1 1/4"
9.7	6500-W	Drive Wheel
9.8	06805	Love Joy 1 1/4" Wheel Shaft
9.9	06803	Love Joy Spider
9.10	06801	Love Joy 7/8" Gear Box
9.11	55003	Gear Box 30:1/RH - ( For Left Side Or Driver Side) Shown
9.11	55004	Gear Box 30:1/LH - ( For Right Side Or Passenger Side)
9.12	55230-2	Drive Motor - .5HP Washdown
9.13	6650-4	Cable Prox - Rt Angle 4 Meter
9.14	06626	Prox - 18mm
9.15	06835	Count Wheel Bracket



## Gantry - Oscillating Blower Assembly

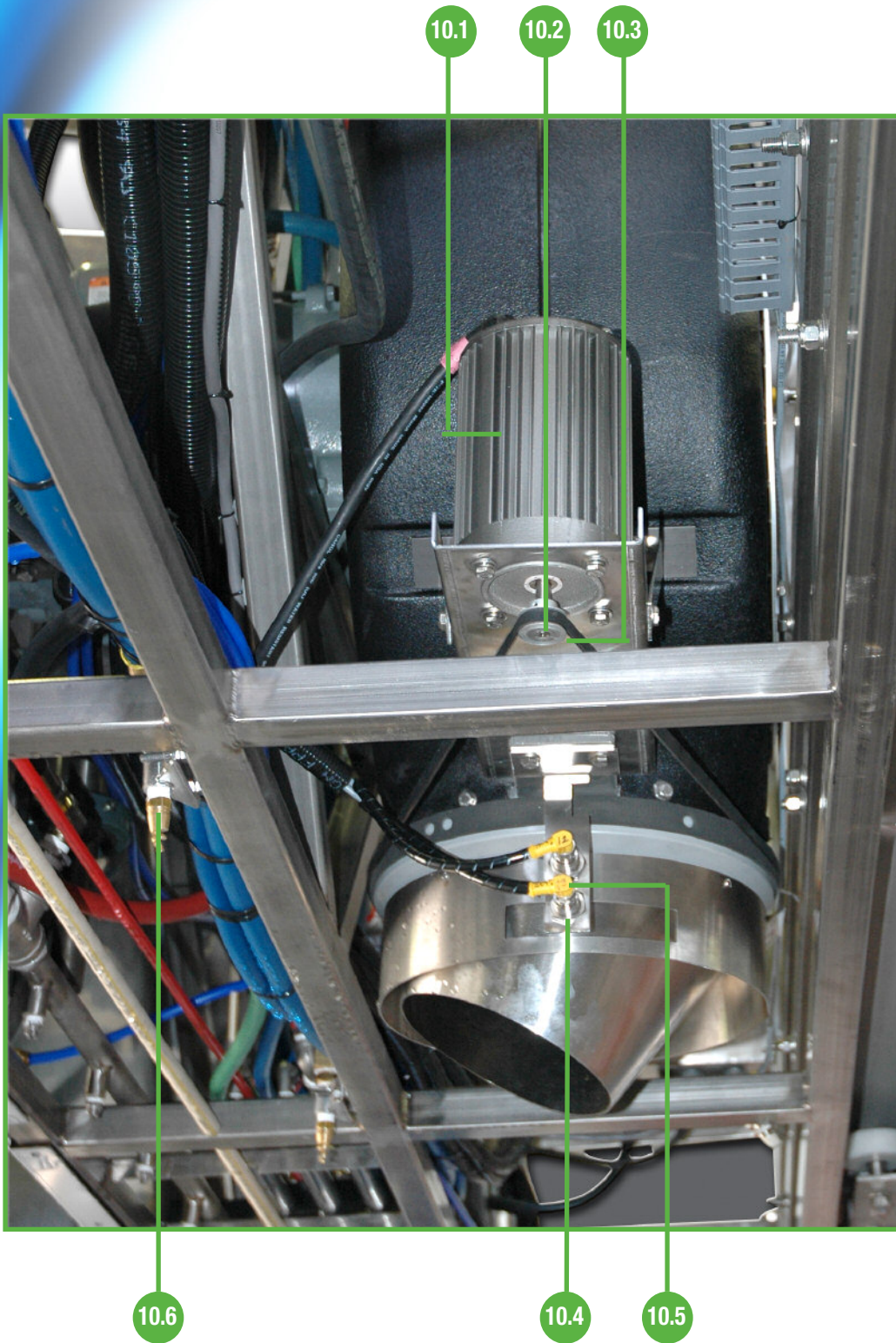

**Gantry - Oscillating Blower Assembly**

ITEM #	PART #	DESCRIPTION
10.1	55239	Motor, Oscillating - Blower
10.2	19808	Pulley For Oscillating Motor
10.3	18240-1	Belt - Smart/Oscillating Nozzle
10.4	06626	Turck Prox - 18mm
10.5	06650-6	Cable, Prox Rt Angle - 6 Meter
10.6	06589	Jet Spiral Tip - Spot Free



# Gantry - Instruction Signs



11.1

11.2

11.3



**Gantry - Instruction Signs**

ITEM #	PART #	DESCRIPTION
11.1	07550	LED Lamp 4" - Red
11.2	07552	LED Lamp 4" - Green
11.3	07551	LED Lamp 4" - Amber
11.4	06100	Scrolling Sign

# Gantry Drive - Passenger Side (Right Side)

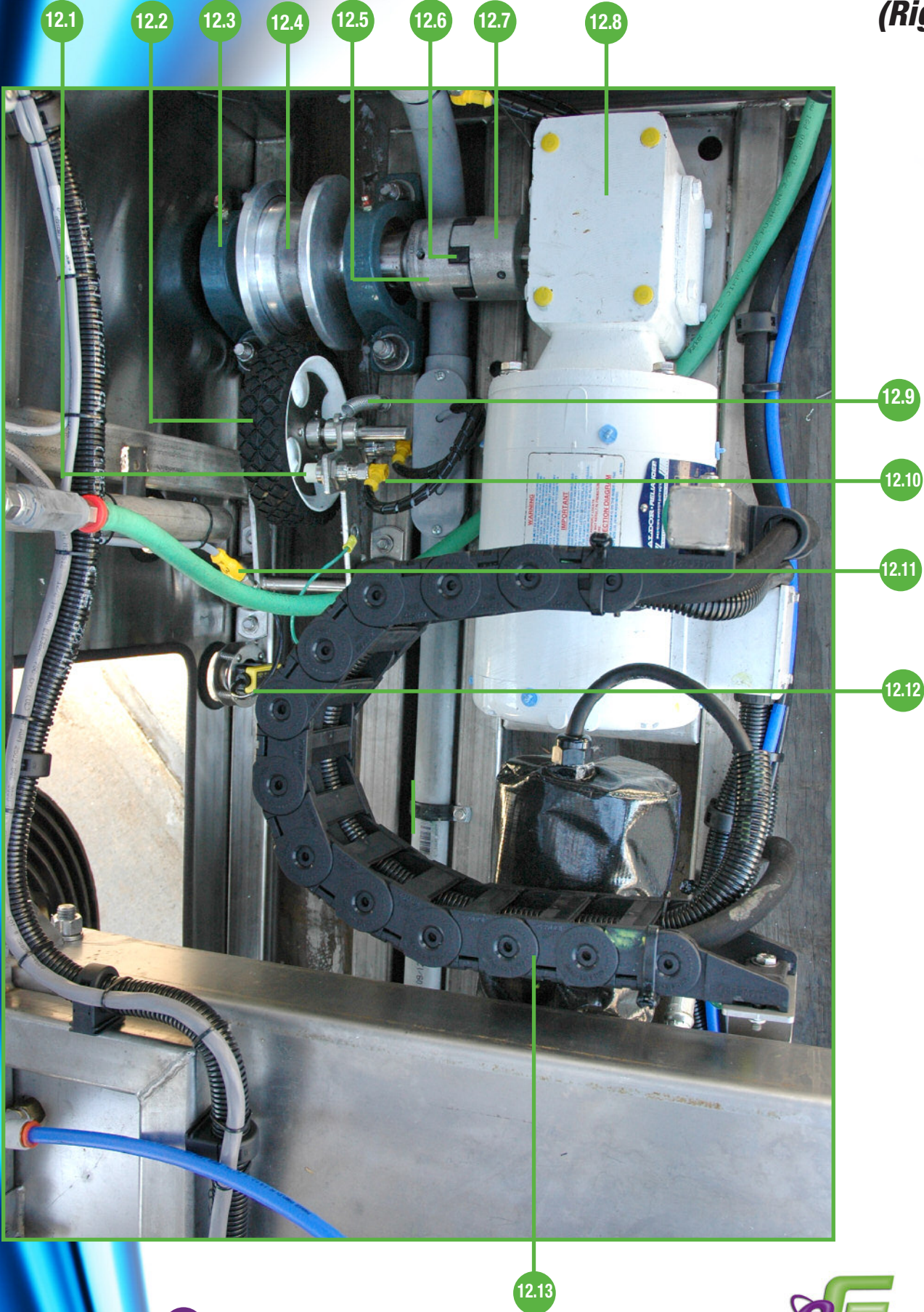



**Gantry Drive - Passenger Side - (Right Side)**

ITEM #	PART #	DESCRIPTION
12.1	06626	Prox 18mm
12.2	06834	Count Wheel 1.5" x 6"
12.3	06851	Pillow Block Bearing 1-1/4" - VPS -120
12.4	06500-W	Drive Wheel
12.5	06805	Love Joy 1 1/4" Wheel Shaft
12.6	06803	Love Joy Spider
12.7	06801	Love Joy 7/8" Gear Box
12.8	55004	Gear Box 30:1/LH (For Right Side Or Passenger Side) Shown
12.8	55003	Gear Box 30:1/RH - (For Left Side Or Driver Side)
12.9	06781	Spring For Count Wheel
12.10	06650-12	Cable Prox 90 Degree
12.11	06716	Eye Cable - 2 Meter
12.12	06741	Reciever, 8 Channel
12.13	07515-2	Wheel Brush Cable Carrier

**Gantry Drive-Driver's Side**

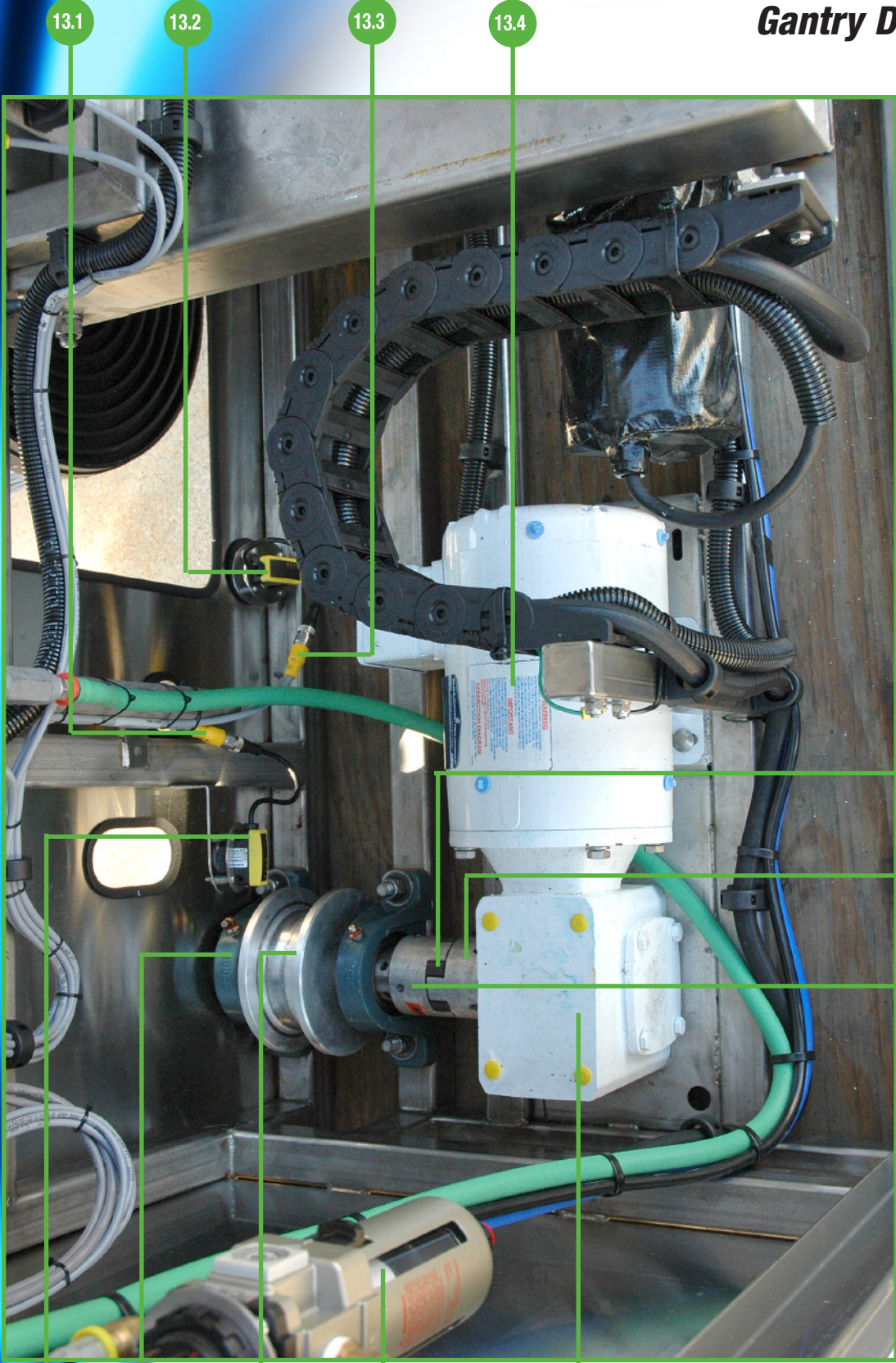

13.1

13.2

13.3

13.4

13.5

13.6

13.7

13.12

13.11

13.10

13.9

13.8



**Gantry Drive-Driver's Side**

ITEM #	PART #	DESCRIPTION
13.1	06715	Eye Cable - 4 Meter
13.2	06715	Eye Cable - 4 Meter
13.3	06742	Emitter, 8 Channel
13.4	55230-2	Drive Motor - .5HP Washdown
13.5	06805	Love Joy 1 1/4" Wheel Shaft
13.6	06803	Love Joy Spider
13.7	06801	Love Joy 7/8" Gear Box
13.8	55003	Gear Box 30:1/RH  (For Left Side Or Driver Side) Shown
13.8	55004	Gear Box 30:1/LH - (For Right Side Or Passenger Side)
13.9	58090-2	Filter Regulator w/Guage & Auto Drain
13.10	06500-W	Drive Wheel
13.11	06851	Pillow Block Bearing 1-1/4" - VPS -120
13.12	06742	Emitter, 8 Channel

## Gantry Upper - Top Brush Drive

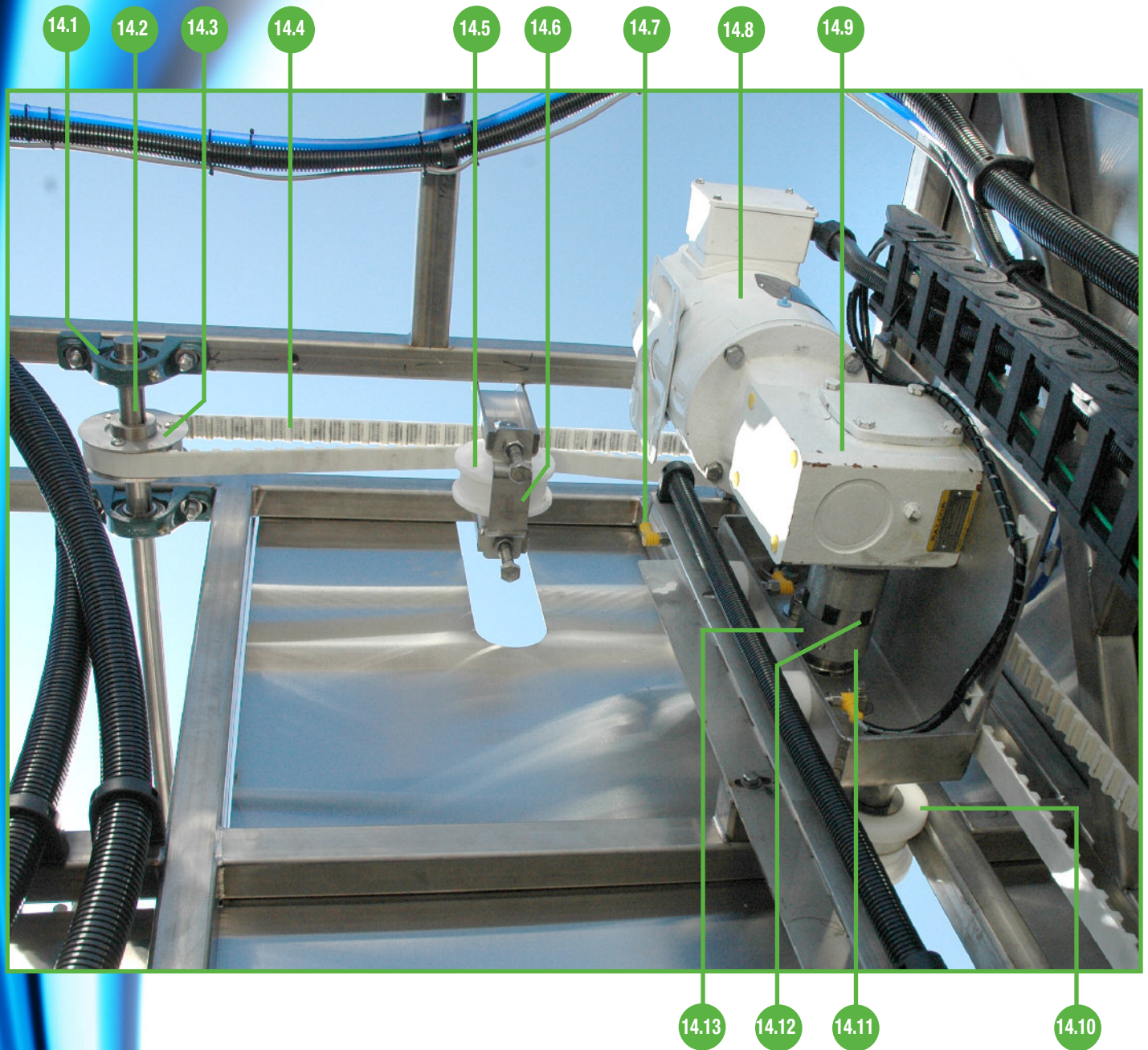



**Gantry Upper - Top Brush Drive**

ITEM #	PART #	DESCRIPTION
14.1	06850	Pillow Block Bearing 1" - VPS - 116
14.2	07824-1	Top Brush Drive Shaft - 1" X 81-1/2" (MS-144)
14.3	18009	Pulley Cog T20 -25mm (Single) - Aluminum
14.4	18013	Boom Belt - Continuous Loop
14.5	07822	Idler Pulley (MS-AC52)
14.6	07231	Belt Tension Brace Top Brush (AC034-3)
14.7	6650-4	Cable Prox - Rt Angle 4 Meter
14.8	55230-2	Drive Motor - .5HP Washdown
14.9	55002	Gear Box 10:1 RH Quill Type
14.10	07820	Guide Rollers Halves (MS-AC56)
14.11	06801	Love Joy 7/8" Gear Box
14.12	06803	Love Joy Spider
14.13	06800	Love Joy 1" Drive Shaft

# Gantry Upper - Top Brush

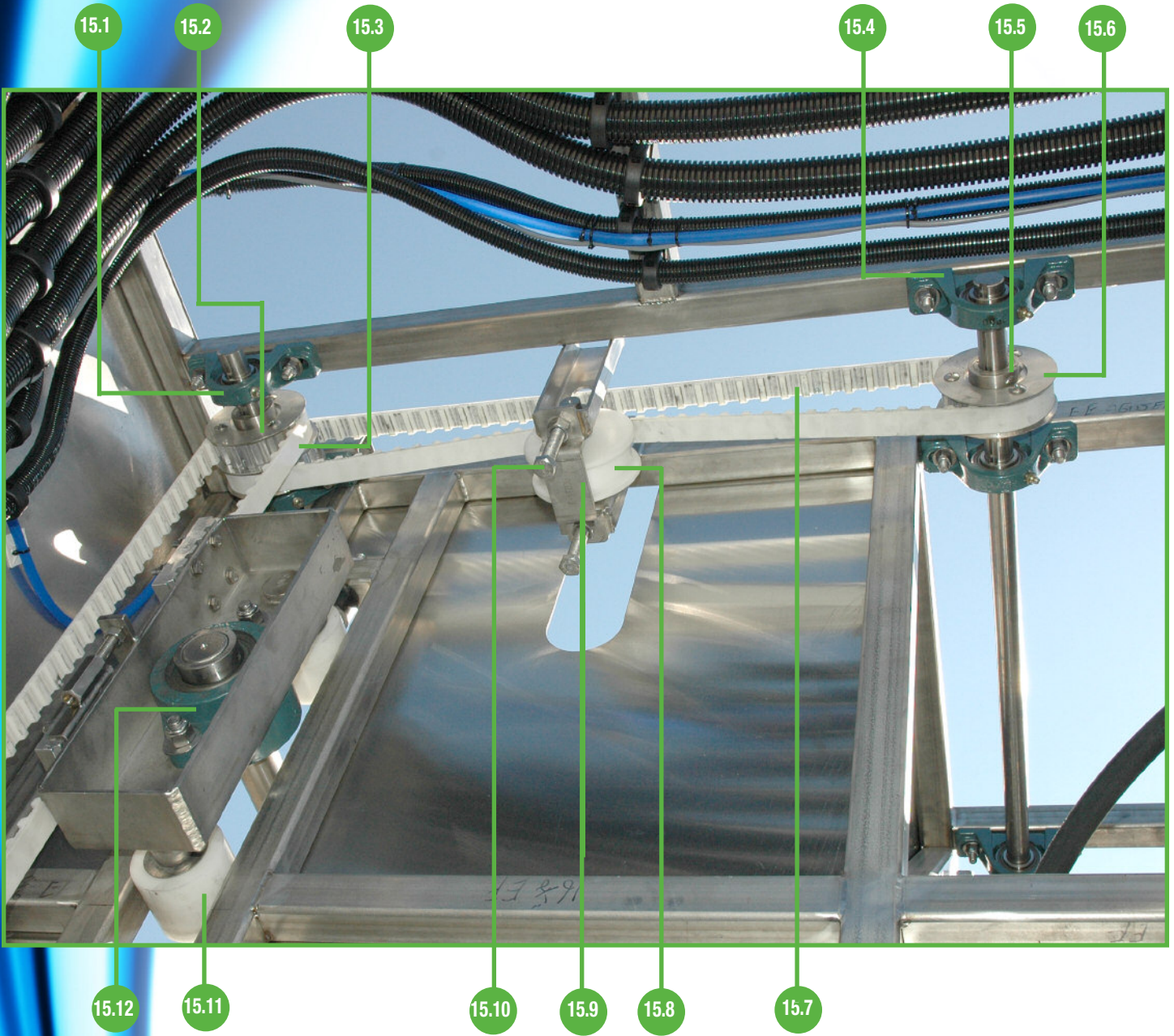

**Gantry Upper - Top Brush**

ITEM #	PART #	DESCRIPTION
15.1	06850	Pillow Block Bearing 1" - VPS - 116
15.2	18010	Pulley Cog T20 - 50mm (Double) - Aluminum
15.3	18012	Belt, Timing Kevlar 50,000 mm (T20 Belt)
15.4	06850	Pillow Block Bearing 1" - VPS - 116
15.5	06830	Lock Collar 1"
15.6	18009	Pulley Cog T20 -25mm (Single) - Aluminum
15.7	18013	Boom Belt - Continuous Loop
15.8	07822	Idler Pulley (MS-AC52)
15.9	07231	Belt Tension Brace Top Brush (AC034-3)
15.10	07232	Belt Tension Bolt w/Machined End 1/2" x 4"
15.11	07816	Top Brush Rollers (MC-AC55)
15.12	07512	Bearing Flange 1-1/2" - 2 Hole



# Low Pressure Box

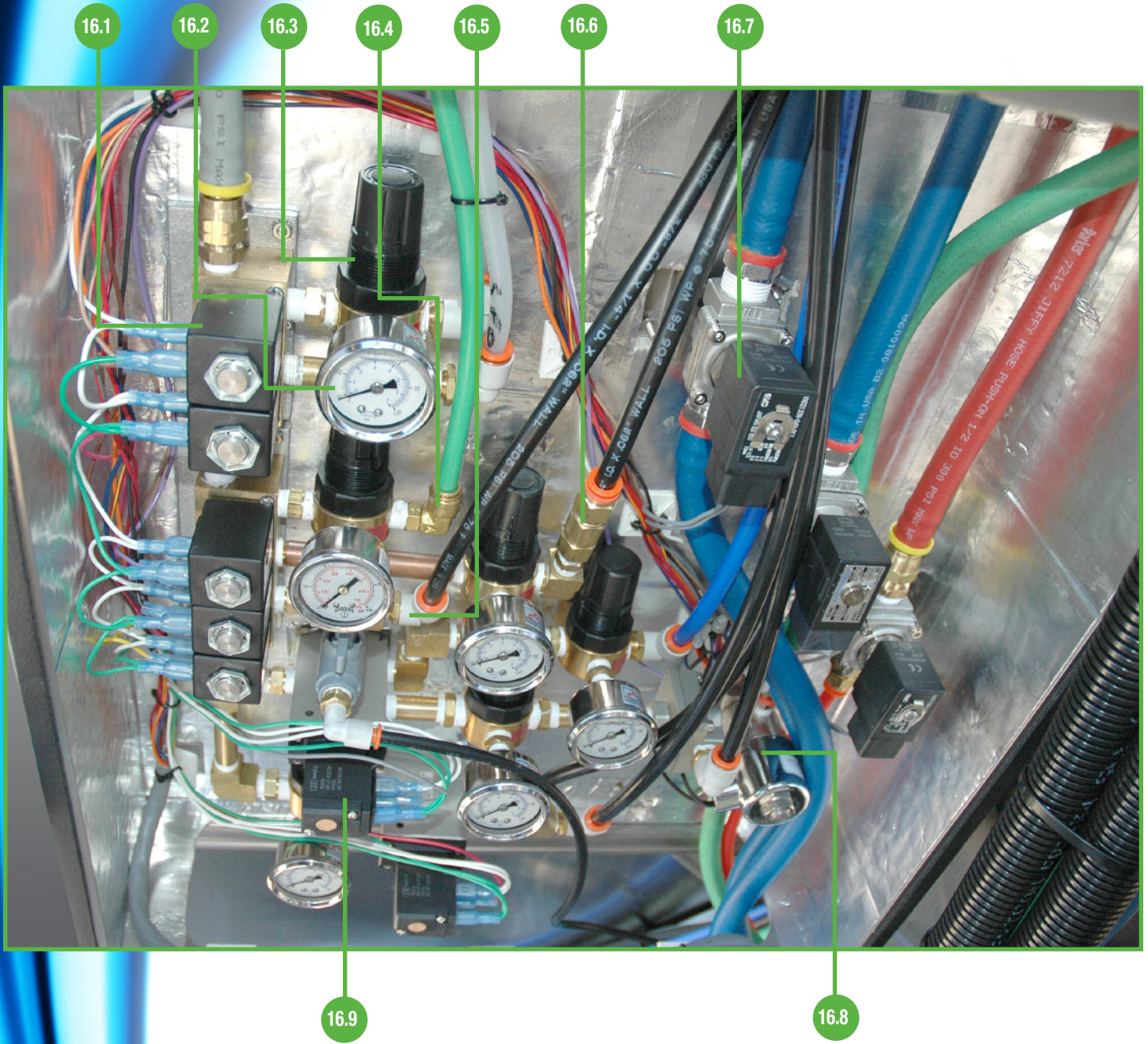

**Low Pressure Box**

ITEM #	PART #	DESCRIPTION
16.1	64021-42	2 Stage Solenoid
16.2	47027	0-100 Pressure Guage
16.3	58055	Regulator 1/4"
16.4	22-W169PL-6-4	3/8" X 1/4" Poly Push Lock Swivel - 90 Degree
16.5	22-W169PL-4-4	1/4" X 1/4" Poly Push Lock Swivel - 90 Degree
16.6	34018	Check Valve - Brass 1/4FX1/4F-SHMP
16.7	06520	Solenoid Valve - 1/2" , 24VAC
16.8	64071	Solenoid Valve - 0-150 1/4" SS
16.9	64000	Solenoid Air - 24VAC



# High Pressure Box

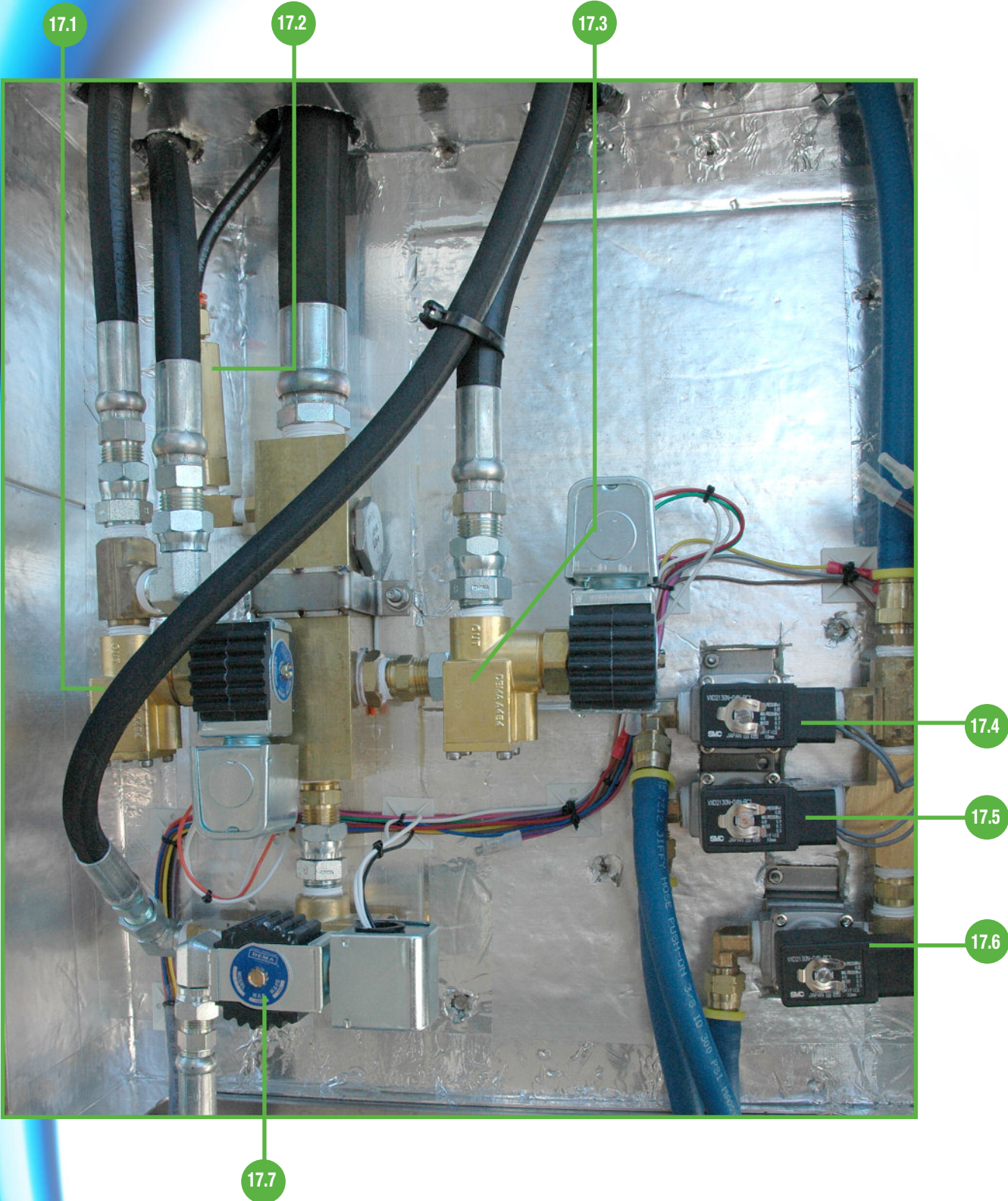

**High Pressure Box**

ITEM #	PART #	DESCRIPTION
17.1	31030	Dema Valve 454P
17.2	34000	Check Valve Brass Super 184"
17.3	31030	Dema Valve 454P
17.4	06520	Solenoid Valve - 1/2" , 24VAC
17.5	06520	Solenoid Valve - 1/2" , 24VAC
17.6	06520	Solenoid Valve - 1/2" , 24VAC
17.7	31030	Dema Valve 454P



# Gantry Electrical Panel- Lower

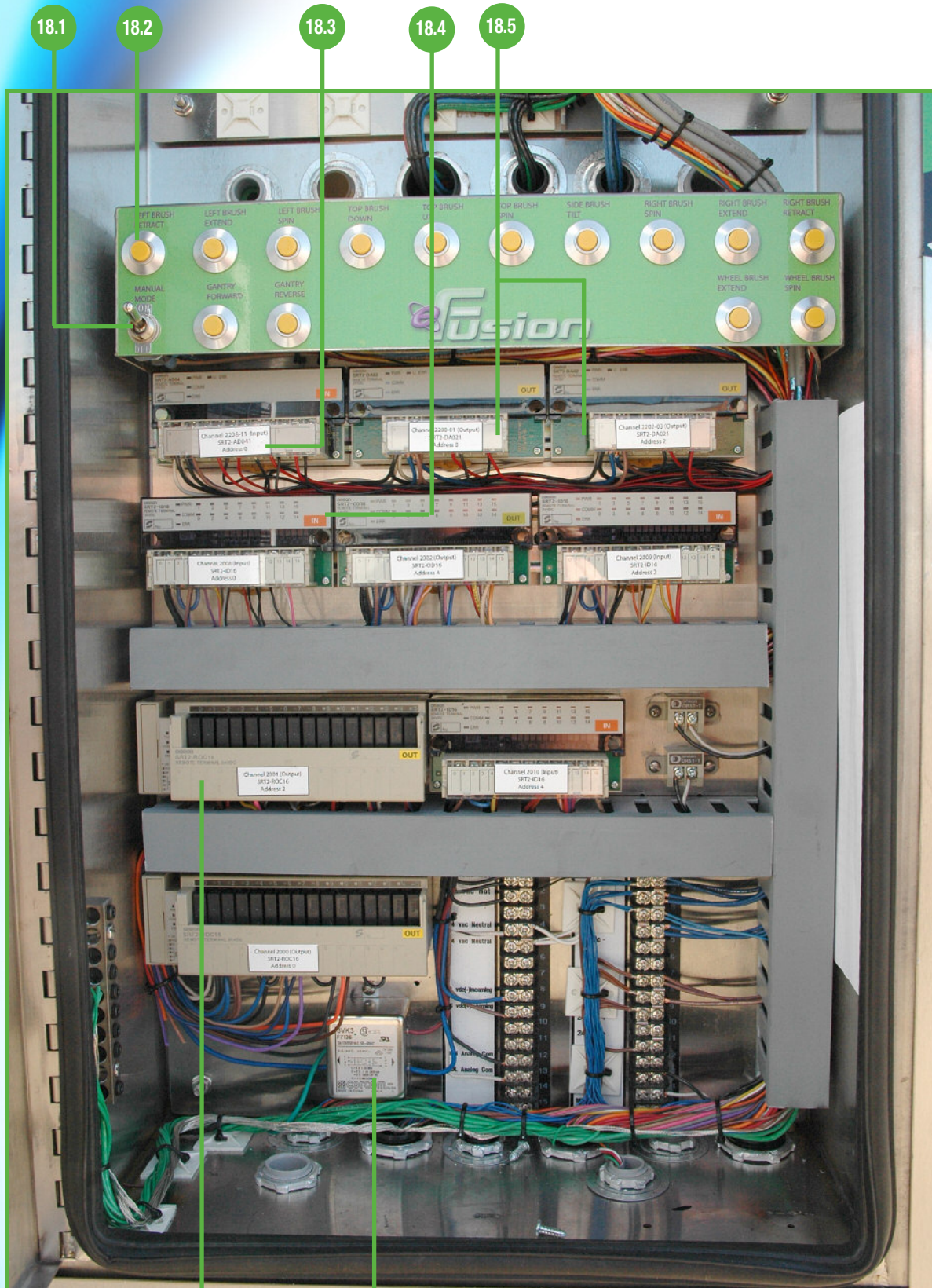

**Gantry Electrical Panel- Lower**

ITEM #	PART #	DESCRIPTION
18.1	40069	Switch, SPST (On-Off) 15A/120
18.2	72026	Push Button Switch (Yellow)
18.3	07524	Analog Input Card - SRTDA004
18.4	06920	Input Card - WW SRT2-ID16
18.5	07525	Analog Output Card - SRT2DA002
18.6	06785	Filter - 3VK3
18.7	06940	Relay Output Card - WW SRT2ROC16



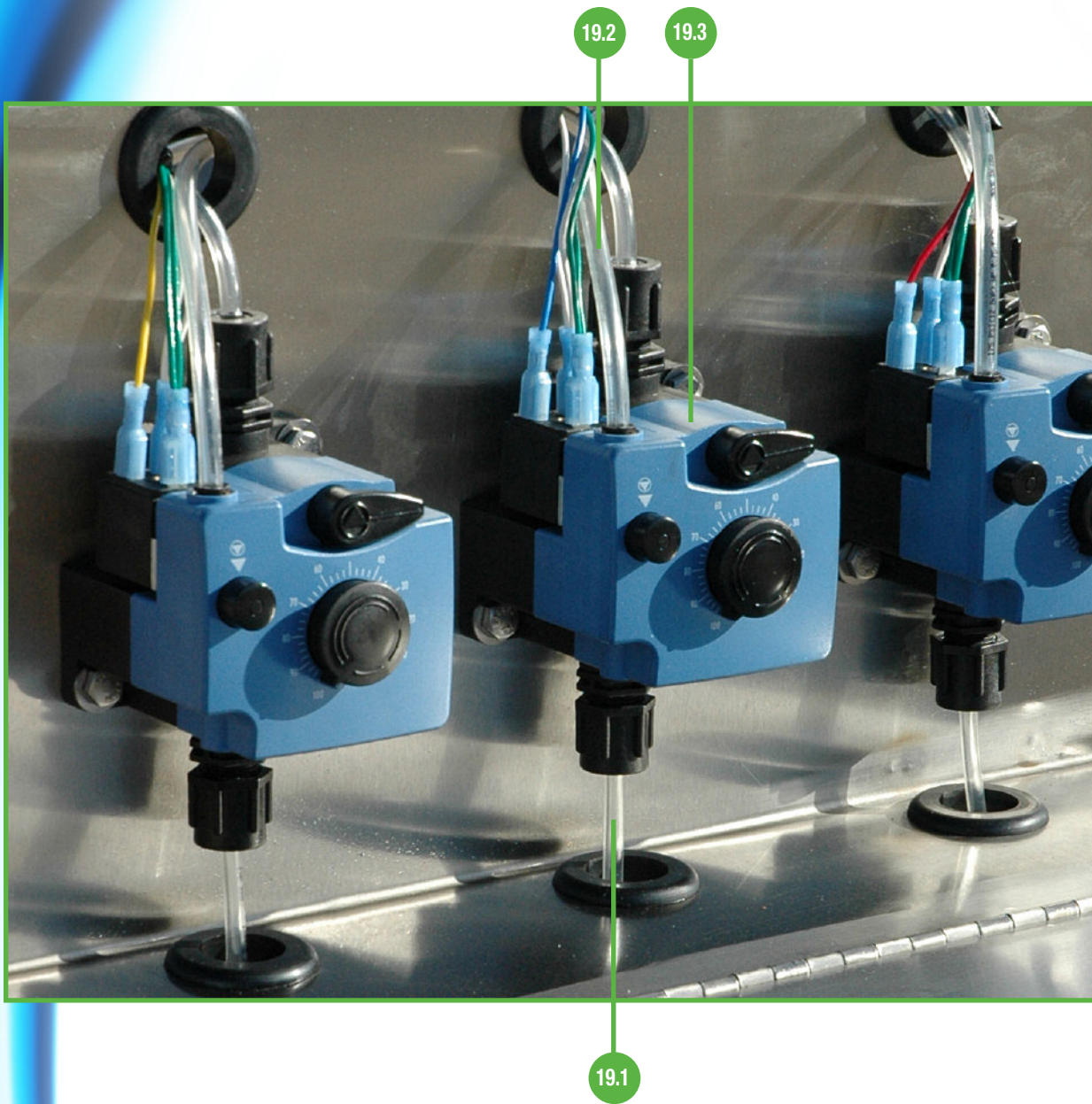



**Low Pressure Pumps**

ITEM #	PART #	DESCRIPTION
19.1	52109	Tubing Clear 3/8" OD x 1/4" ID
19.2	52110	Tubing Clear 1/4" OD x .160" ID
19.3	57020	Pneumatic Metering Pump 24VAC

## Pump Stand - Front End View

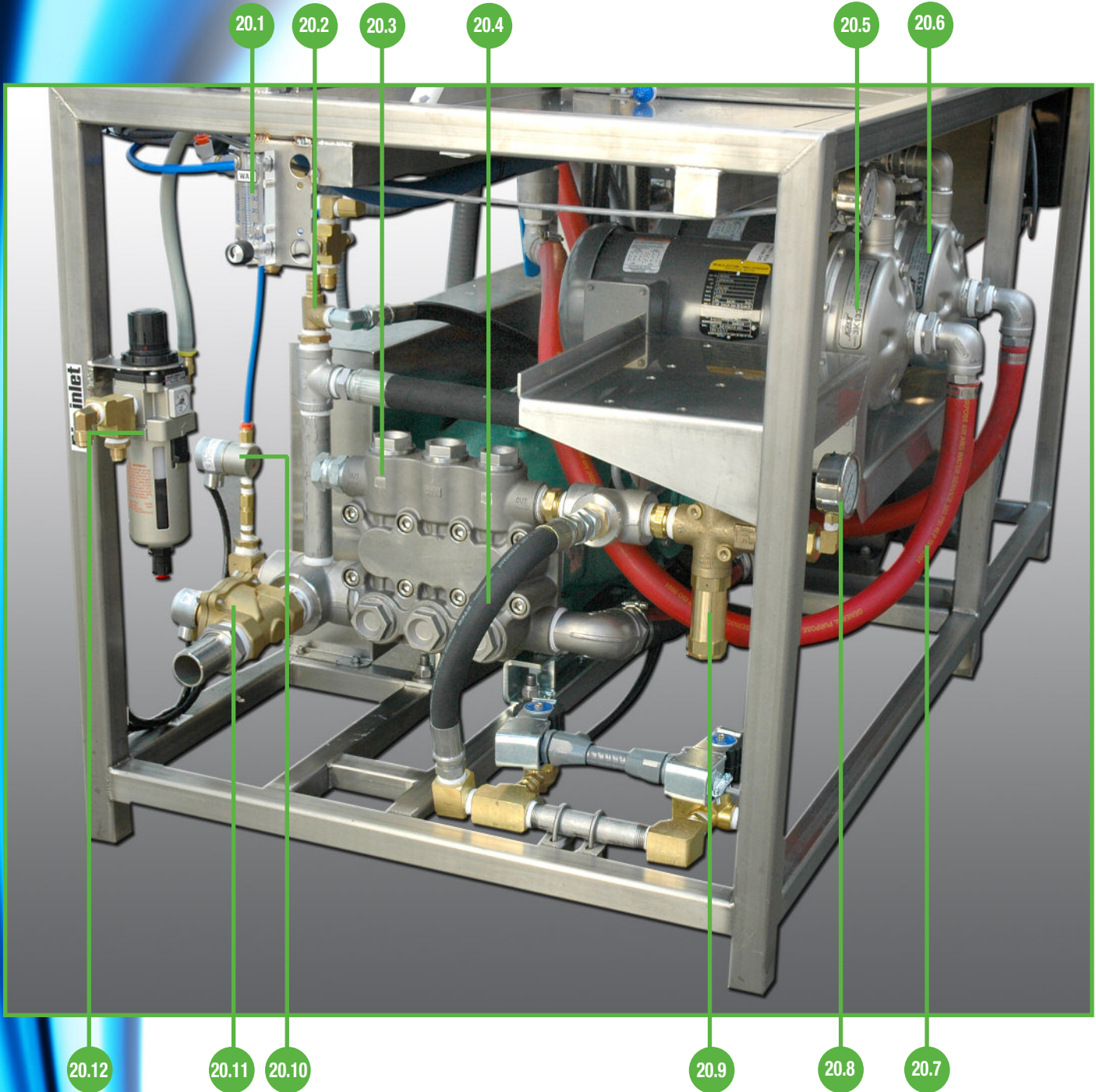

**Pump Stand - Front End View**

ITEM #	PART #	DESCRIPTION
20.1	47075	Flow Meter, 4-40 GPM
20.2	58022	Valve - Pressure Relief
20.3	35000	Pump , 36GPM (Arimitsu # 3612)
20.4	52816	3/4" x 19" Wire Braid Hose R1AT-12X19CW HU12-12MB E/E
20.5	32-3K133MT3	Pump, 2HP/3PH
20.6	32-3K133MT3	Pump, 2HP/3PH
20.7	52022	Hose-1" Push-Loc-Red
20.8	47025	0-3000 PSI LWR MT Gauge
20.9	06760	Unloader - 1"
12.10	64071	3BD7 Solenoid Valve 0-150 1/4" SS
20.11	64001	1-1/2" Solenoid Valve (Reclaim)
20.12	58090-2	Filter Regulator w/Guage & Auto Drain



# Pump Stand - CAT Pump

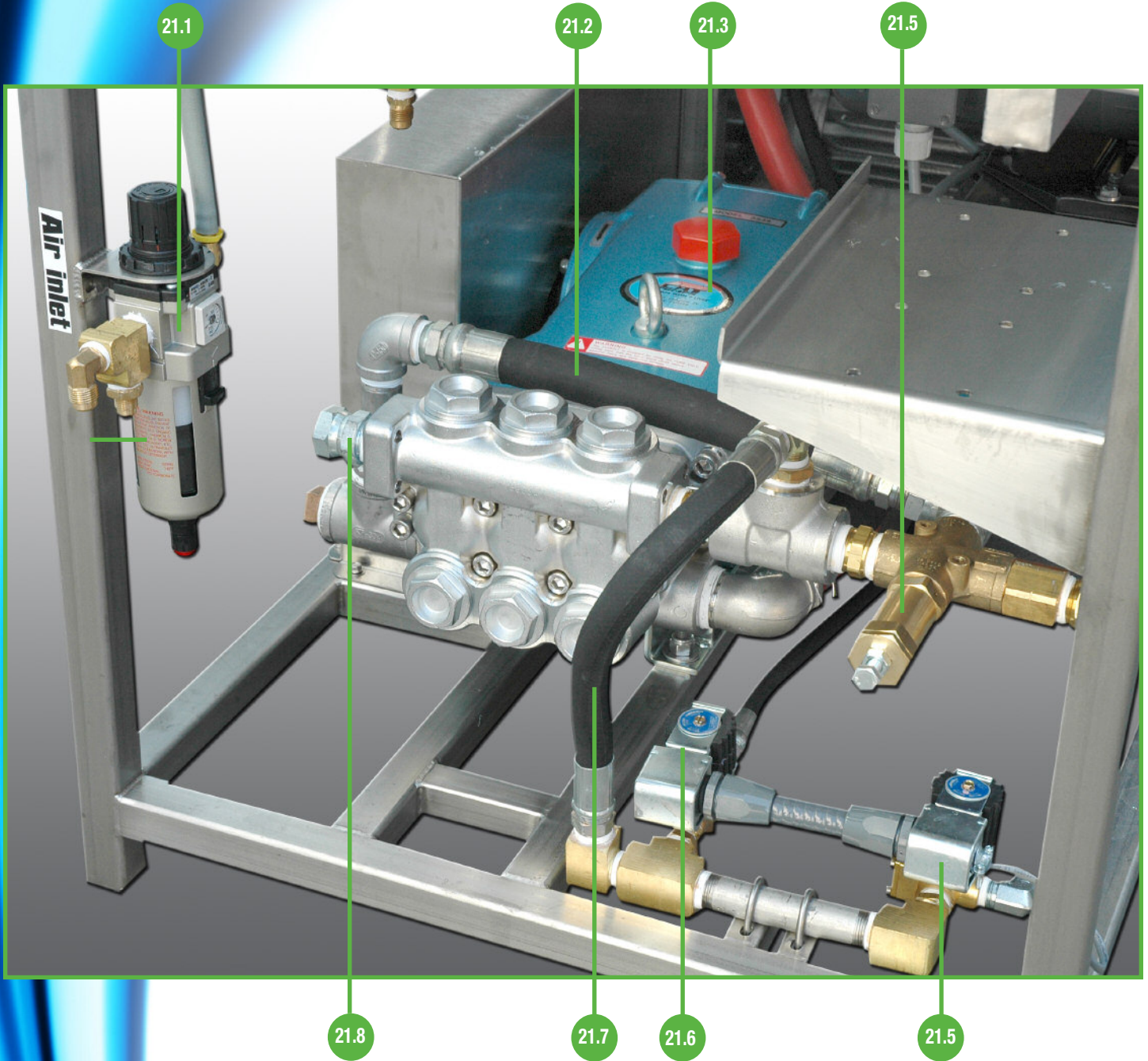

**Pump Stand - CAT Pump**

ITEM #	PART #	DESCRIPTION
21.1	58090-2	Filter Regulator w/Guage & Auto Drain
21.2	52801	1"x17-3/4" Wire Braid Hose R2AT-16X17-3/4CW HU16-16MB E/E
21.3	32-3535	Cat 3535 - 35PFR Pump - 36GPM
21.4	06760	Unloader - 1"
21.5	31030	454P Dema Valve 24VAC - 1/2"
21.6	31020	453P Dema Valve 24VAC - 3/8"
21.7	52816	3/4" x 19" Wire Braid Hose R1AT-12X19CW HU12-12MB E/E
21.8	22-0107-16-16	1" Male To Female Pipe Swivel



# Pump Stand - Lower Front

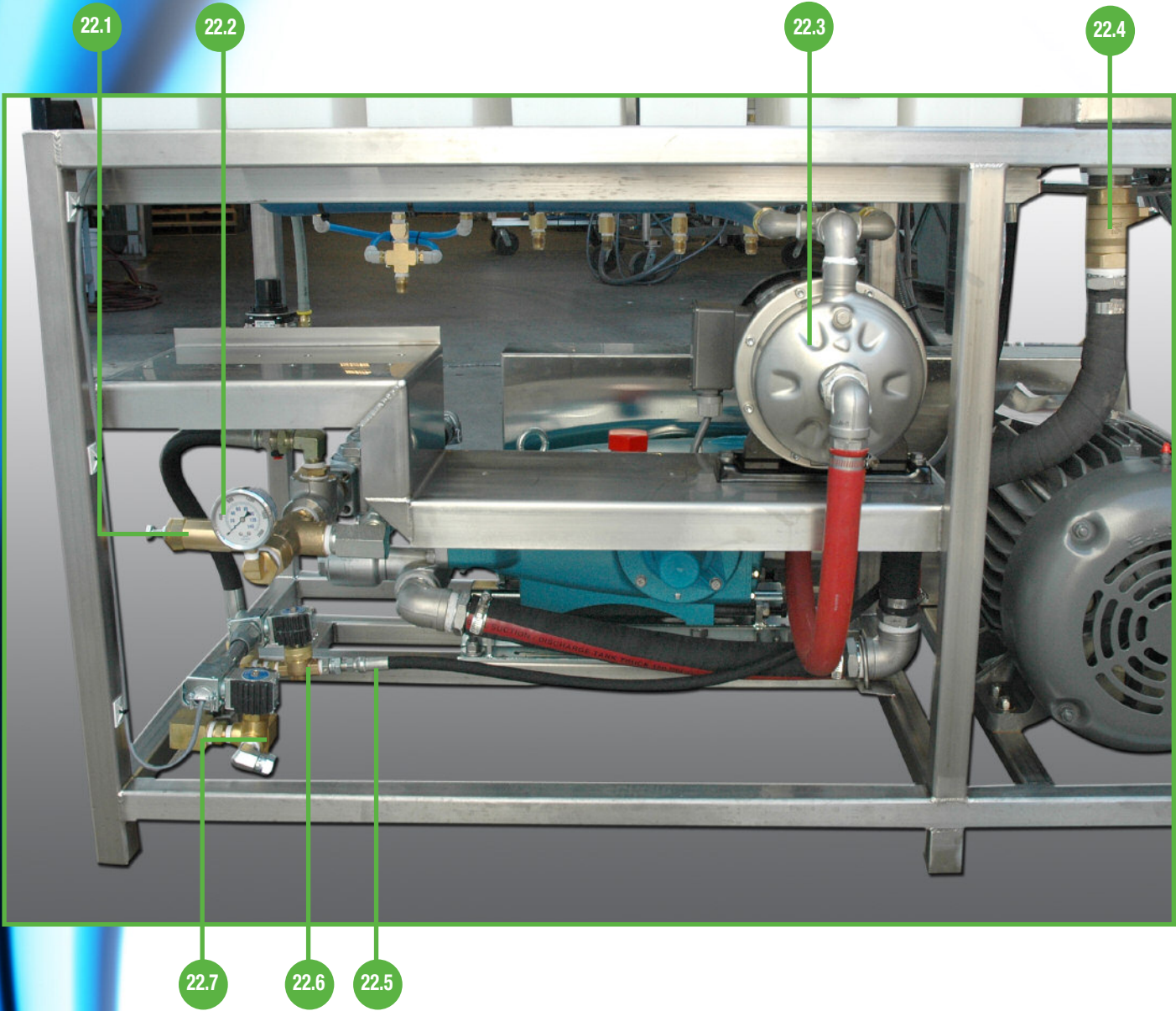

**Pump Stand - Lower Front**

ITEM #	PART #	DESCRIPTION
22.1	06760	Unloader - 1"
22.2	47025	0-3000 PSI LWR MT Gauge
22.3	32-3K133MT3	Pump, 2HP/3PH
22.4	22-V500P-24	Ball Valve - 1-1/2"
22.5	52819	3/8"x56" Wire Braid Hose R1AT-06X56CW HU06-06MB E/E
22.6	31020	453P Dema Valve 24VAC - 3/8"
22.7	31030	454P Dema Valve 24VAC - 1/2"



# Pump Stand - Rear

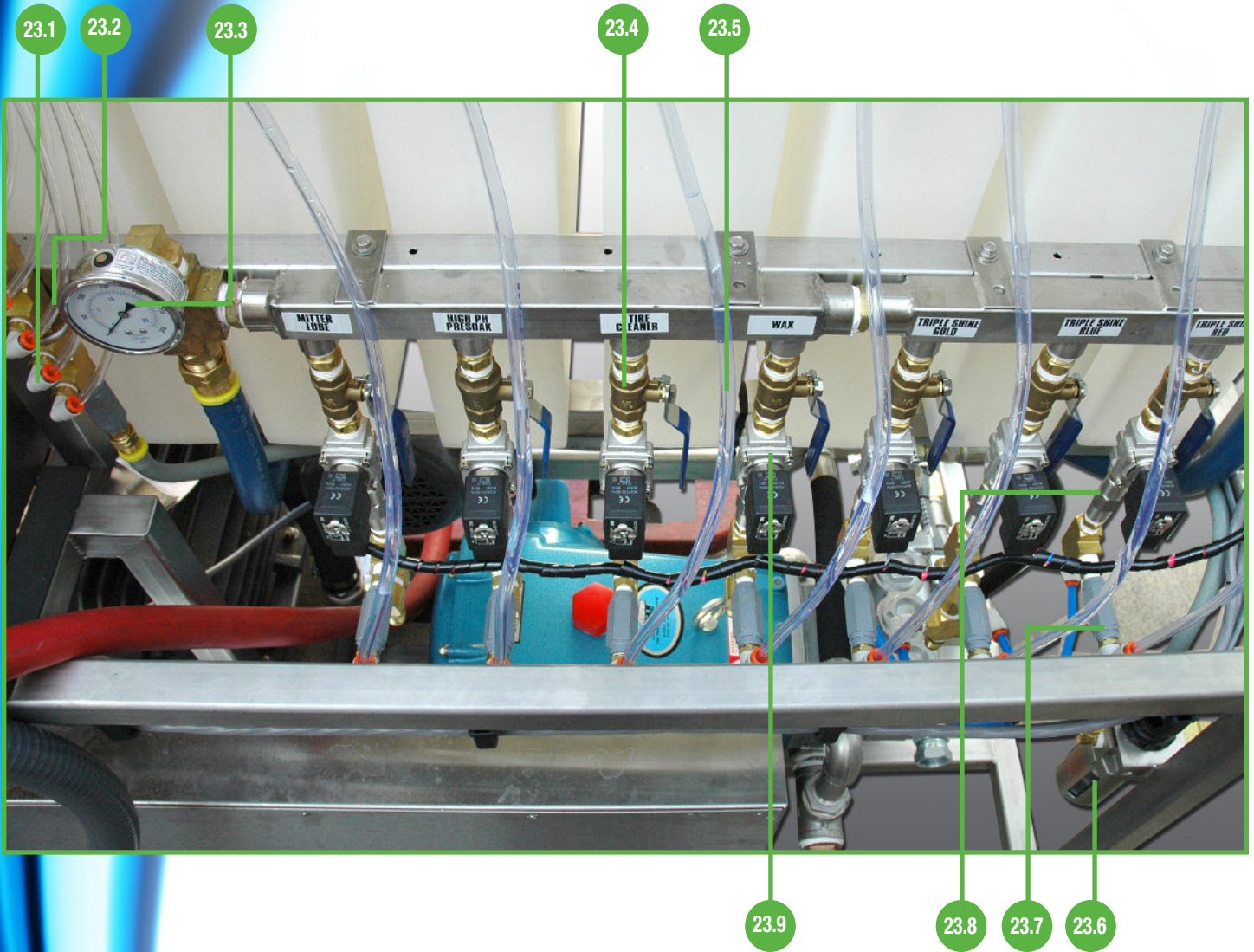

**Pump Stand - Rear**

ITEM #	PART #	DESCRIPTION
23.1	22-W169PL-4-4	Tube 1/4 x 1/4P 90 Connect SWV
23.2	52110	Tubing Clear 1/4" OD x .160" ID
23.3	47010	Gauge, Press 0/300 PNL
23.4	22-V500P-8	Ball Valve 1/2" Brass
23.5	52109	Tubing Clear 3/8" OD x 1/4" ID
23.6	58090-2	Filter Regulator w/Guage & Auto Drain
23.7	34025	Check Valve - Poly 1/4"
23.8	34022	Check Valve , 3/8" SS F/F
23.9	06520	Solenoid Valve - 1/2" , 24VAC
23.1	22-W169PL-4-4	Tube 1/4 x 1/4P 90 Connect SWV
23.2	52110	Tubing Clear 1/4" OD x .160" ID
23.3	47010	Gauge, Press 0/300 PNL
23.4	22-V500P-8	Ball Valve 1/2" Brass
23.5	52109	Tubing Clear 3/8" OD x 1/4" ID
23.6	58090-2	Filter Regulator w/Guage & Auto Drain
23.7	34025	Check Valve - Poly 1/4"
23.8	34022	Check Valve , 3/8" SS F/F
23.9	06520	Solenoid Valve - 1/2" , 24VAC



# Control Panel - Pump Stand

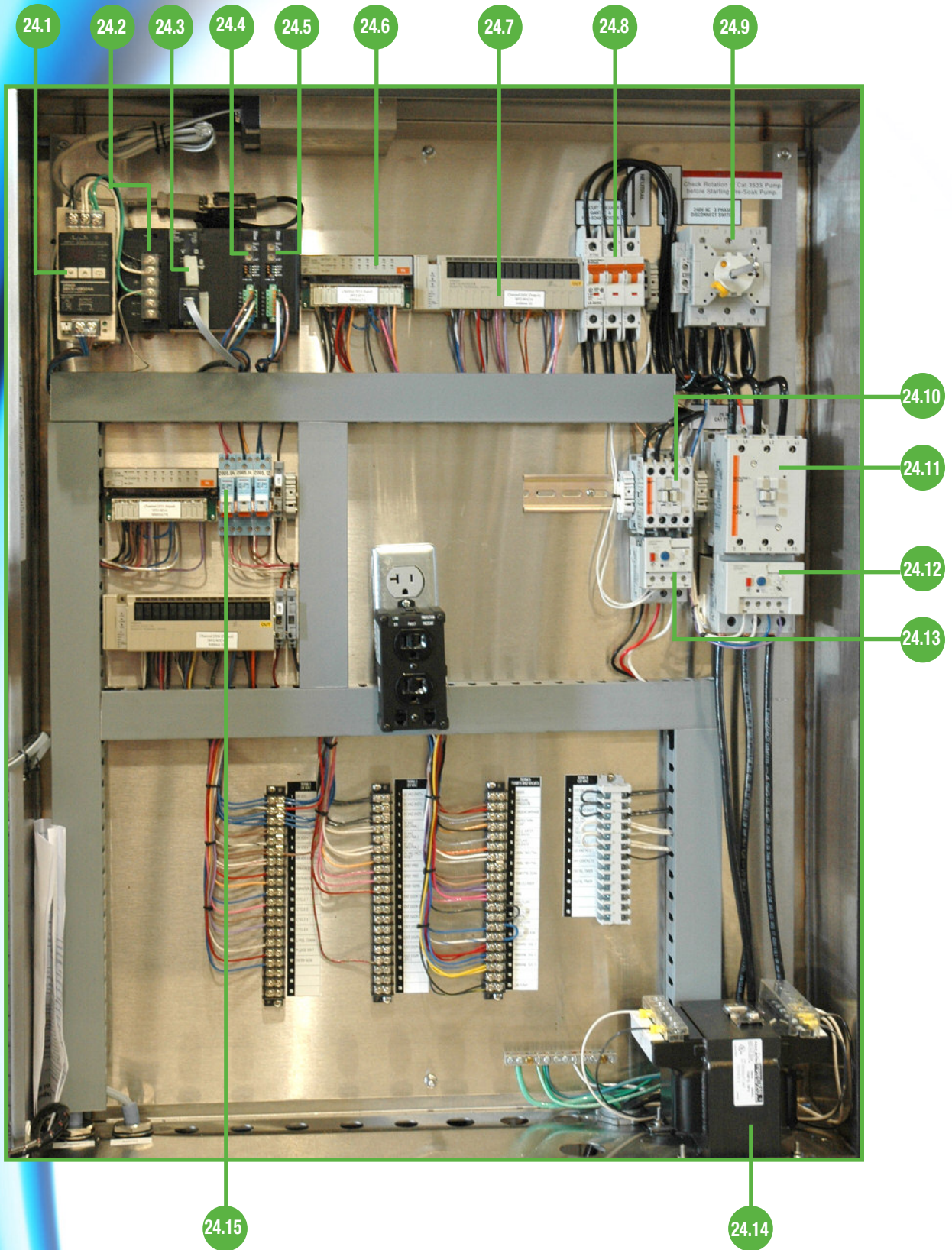



**Control Panel - Pump Stand**

ITEM #	PART #	DESCRIPTION
24.1	06960	DC Power Supply - Omron
24.2	06680-3	PWR 5V & 24VDC Out 100-240VAC (CJ1WPA202)
24.3	07503	CPU (Fusion)
24.4	06680-2	CJ1 - COMPOBUS/S Master
24.5	06680-2	CJ1 - COMPOBUS/S Master
24.6	06920	Input Card - WW SRT2-ID16
24.7	06940	Relay Output Card - WW SRT2ROC16
24.8	40027-2	3P - 30 Amp Breaker (L9-30/3/C)
24.9	06994	Main Disconnect - 100 Amp
24.10	60056	Contactor, 16AMP, 4 Pole
24.11	60065	Contactor, 85AMP, 4 Pole 120V
24.12	60066-1	Overload, 18-90 Amp
24.13	60062-1	Overload, 3.2-16 Amp
24.14	40190-5	Transformer 500VA - 120/240-24V
24.15	06948	Relay

# Gantry Control Panel - Upper

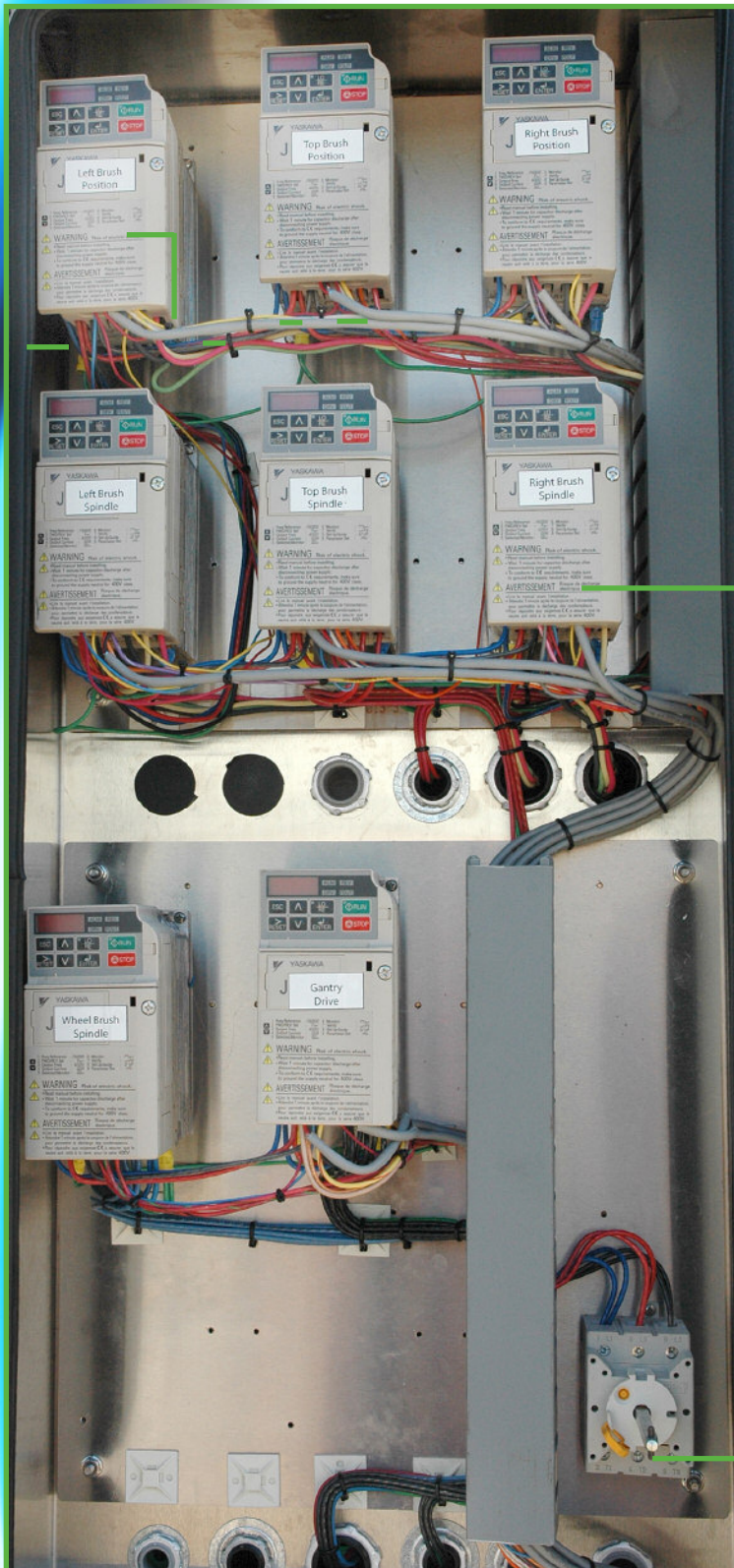

25.1

25.2

**Gantry Control Panel - Upper**

ITEM #	PART #	DESCRIPTION
25.1	06973	Drive, 1HP/230V/5A/3PH/50-60HZ
25.2	06995	63AMP Disconnect Base Mount



# ***NOTES***



# ***NOTES***





## Chemicals

### Table of Contents

Approximate Dilutions at PSI for Water-Thin Products (1.0 CP).....	2
Formulas For Product Usage and Costs.....	3
Turtle Wax Chemical (Tip Chart) .....	4
Single/Double Tip Dilution For Hydrominder Systems -ONLY-.....	5
Double Tip Dilution For Hydrominder Systems -ONLY-.....	6
Single Tip Dilution Hydrominder System -ONLY- .....	7
Turtle Wax Technical Fact Sheets.....	8
Material Safety Data Sheets.....	14



## Approximate Dilutions at PSI for Water-Thin Products (1.0 CP)

Tip Color	Orifice Size	(Std. Drill number)	Ratio
No Tip	.187	3/16	4:1
Grey	.128	30	5:1
Black	.098	40	6:1
Beige	.07	50	8:1
Red	.052	55	17:1
White	.043	57	23:1
Blue	.040	60	25:1
Tan	.035	65	36:1
Green	.028	70	48:1
Orange	.025	72	64:1
Brown	.023	74	75:1
Yellow	.020	76	90:1
Purple	.014	79	120:1
Pink	.010	87	240:1

## Formulas For Product Usage And Costs

<b>Measurements:</b>	<b>1oz</b>	<b>=</b>	<b>29.5 ml</b>
	1 gal	=	128 oz (3776 ml)
	5 gal	=	640 oz (18880 ml)
	30 gal	=	3840 oz (113280 ml)
	55 gal	=	7040 oz (207680 ml)

### Standard Hydro Formula:

$$\frac{\text{stock solution used per cycle}}{\text{product used per cycle}} = \text{amount of cycle per minute}$$

### Bladder Tank Usage Formula:

$$\frac{\text{amount of stock solution used} \times 60 \text{ second}}{\text{time between cycles}} = \text{amount of cycle per minute}$$

### Standard Cost Formula:

$$\frac{\text{price per box (drum)}}{\text{ml per box (drum)}} = \text{cost per ml}$$

### Cost Per Car/Cycle Formula:

$$\text{cost per ml} \times \text{ml used per cycle} = \text{cost per car}$$

### Rectangular Volume:

$$\text{rectangular Volume} = \text{Length} \times \text{Width} \times .00434 = \text{Gal/Inch}$$

### Cylinder Volume:

$$\text{cylinder Volume} = \text{Diameter} \times \text{Diameter} \times .0034 = \text{Gal/ Inch}$$

## CHEMICALS

### Turtle Wax Chemical (Tip Chart)

Chemical	Turtle Wax #	Water Tip	Chemical Tip	Dilution
Presoak	HP 03/5; 16/5	N/A	Brown	75:1
Citrus Prep Presoak (Low pH)	HP 86/5	N/A	Yellow	90:1
*Clear Coat Protectant	HP 73/5; 19/5	N/A	Tan	47:1 In Tank
Poly Triple Shine	HP 20/5; 21/5; 22/5	Orange	Yellow	378:1
Tire Cleaner	HP 78/5	N/A	Tan	42:1
Optional Hot Wax	HP 73	None	Pink	345:1
Lemon Friction Detergent (Brush Lube)	HP 07	None	Purple	

\* This Chemical Solution is delivered at high or medium pressure through the Cat 3535 Pump. There are many variables that affect the dilution as it is delivered on the vehicle, such as pressure, flow and water tank ball valve position. The position of the ball valve under the water tank determines the amount of suction created on the inlet side of the pump.

## Single/Double Tip Dilution For Hydrominder Systems -ONLY-

HP 16/5 and HP 03/5 Frictionless Detergent  
Concentration Factor 2

Dilution	Single Tip
345:1	Pink
158:1	Purple
90:1	Yellow
62:1	Brown
47:1	Green
32:1	Tan
21:1	Blue
16:1	Red
11:1	Beige
7:1	Black
6:1	Gray

Dilution	Usage/gal.	Water Tip	Chemical Tip
1:1888	2 ml	None	Pink
1:1258	3 ml	Gray	Pink
1:944	4 ml	None	Purple
1:755	5 ml	Beige	Pink
1:629	6 ml	Gray	Purple
1:539	7 ml	Blue	Pink
1:472	8 ml	Tan	Pink
1:378	10 ml	Gray	Yellow
1:290	13 ml	Black	Yellow
1:270	14 ml	Red	Purple
1:252	15 ml	White	Purple
1:236	16 ml	Tan	Purple

## Double Tip Dilution For Hydrominder Systems -ONLY-

HP-20/21/22/5 POLY TRIPLE SHINE  
Concentration Factor 8

Dilution	Usage/gal.	Water Tip	Chemical Tip
1:1258	3 ml	Gray	Pink
1:755	5 ml	Black	Pink
1:472	8 ml	Red	Purple
1:420	9 ml	Beige	Purple
1:378	10 ml	Gray	Yellow
1:343	11 ml	Blue	Purple
1:315	12 ml	Tan	Purple
1:290	13 ml	Black	Yellow
1:252	15 ml	Gray	Brown

HP-73/5;19/5 Superfoaming Sealer Wax – Clear Coat Protectant  
Concentration Factor 6

Dilution	Usage/gal.	Water Tip	Chemical Tip
1510:1	2.5 ml	Gray	Pink
1258:1	3 ml	Gray	Purple
944:1	4 ml	Black	Pink
629:1	6 ml	Black	Purple
472:1	8 ml	White	Pink
378:1	10 ml	Beige	Purple
343:1	11 ml	Gray	Yellow
314:1	12 ml	Red	Purple
290:1	13 ml	White	Purple
251:1	15 ml	Black	Yellow



## Single Tip Dilution Hydrominder System -ONLY-

HP-78/5 Foaming Whitewall Cleaner  
Concentration Factor 4.2

Dilution	Usage/gal.	Tip
472:1	8 ml	Pink
290:1	13 ml	Purple
86:1	44 ml	Yellow
63:1	60 ml	Brown
54:1	70 ml	Orange
50:1	75 ml	Green
42:1	90 ml	Tan
24:1	160 ml	Blue
20:1	190 ml	White
14:1	270 ml	Red
9:1	420 ml	Beige
6:1	640 ml	Black
5:1	700 ml	Gray

HP-19/5 CRYSTAL GLAZE

Table One

Tip	Dilution
Pink	345:1
Purple	158:1
Yellow	90:1
Brown	62:1
Green	47:1
Tan	32:1
Blue	21:1
Red	16:1
Beige	11:1
Black	7:1
Gray	6:1

**Note 1: These suggested dilution ratios may vary due to water pressure and flow. It is advised to check your dispensing system flow to ensure proper usage of carwash chemicals.**

## Turtle Wax Technical Fact Sheets

# **TurtleWax** TECHNICAL FACT SHEET

<b>NAME:</b>	FLEX-PAK HYPER-CONCENTRATE Frictionless Detergent (HP-16)												
<b>DESCRIPTION:</b>	A truly unique, dilutable detergent concentrate specifically designed for use in today's new, high tech "touchless" car washes. It works well in tunnel applications as well as power washers, and now it's HYPER-CONCENTRATED.												
<b>BENEFITS:</b>	<p><b>Easy To Use:</b> This one-step product does it all. It functions through foamers, pre-soak arches, bumper blasters, and prep guns. No neutralizers are necessary.</p> <p><b>Fast Acting:</b> An optimum blend of foaming agents and safe alkaline cleaning agents cut through and loosen road film. It is solvent and phosphate free.</p> <p><b>Safe:</b> This new alkaline cleaning chemistry allows the removal of road soils safely from clear coat, conventional, and even repainted surfaces. It won't strip wax and it rinses clean without leaving a residue.</p> <p><b>Unsurpassed Effectiveness:</b> Field tests confirm that HYPER-CONCENTRATED Frictionless Detergent is unsurpassed for cleaning in "touchless" applications.</p> <p><b>EcoLogo<sup>™</sup> Certified:</b> In order to promote the use of more environmentally responsible products and services, the Environmental Choice<sup>™</sup> Program was established in 1988. The Environmental Choice<sup>™</sup> Program is Canada's only national and comprehensive eco-labelling program. The EcoLogo<sup>™</sup> is the recognized seal of approval of the Environmental Choice<sup>™</sup> Program.</p>												
<b>PACKAGING:</b>	A 5-gallon plastic bag and closure in a corrugated cardboard box with a clear poly shrink-wrap cover.												
<b>DILUTION:</b>	Direct Feed: Apply 1 to 2 ounces (29.5-59ml) of product per vehicle.												
<b>SPECIFICATIONS:</b>	<p><b>NOTE:</b> Consult your local Turtle Wax distributor for complete information on the wide range of dilution options for this product. Actual dilution or chemical usage may vary based on desired results.</p> <table><tr><td>Appearance:</td><td>A thin red liquid</td></tr><tr><td>Fragrance:</td><td>None</td></tr><tr><td>pH:</td><td>13.0</td></tr><tr><td>Density:</td><td>10.26 lbs./gal.</td></tr><tr><td>Emulsifier:</td><td>Non-ionic</td></tr><tr><td>DOT Labeling:</td><td>Corrosive PG-III</td></tr></table>	Appearance:	A thin red liquid	Fragrance:	None	pH:	13.0	Density:	10.26 lbs./gal.	Emulsifier:	Non-ionic	DOT Labeling:	Corrosive PG-III
Appearance:	A thin red liquid												
Fragrance:	None												
pH:	13.0												
Density:	10.26 lbs./gal.												
Emulsifier:	Non-ionic												
DOT Labeling:	Corrosive PG-III												

FJ 9/25/01

# TECHNICAL FACT SHEET

<b>NAME:</b>	FLEX-PAK HYPER-CONCENTRATE Crystal Polymer Glaze (HP-19)												
<b>DESCRIPTION:</b>	A concentrated liquid polymer sealant glaze designed for use in automatic car wash equipment, and now it's HYPER-CONCENTRATED.												
<b>BENEFITS:</b>	<p><b>Effective:</b> Hydrophobic (water repellent) sealing agents are deposited on the car's surface to seal out water, weather, salt, and dirt and protect your car's finish.</p> <p><b>Substantive Surfactants:</b> This system of low foaming conditioning surfactants insures a smooth, even deposition of sealant.</p> <p><b>Clear coat Safe:</b> This product has been specifically designed for today's high-tech, finishes. It is also safe for older conventional paint finishes. It's safe for all car finishes.</p> <p><b>Fresh Orange Fragrance:</b> A uniquely fresh, creamy citrus orange fragrance helps signal the application of this unique protective system.</p> <p><b>EcoLogo<sup>M</sup> Certified:</b> In order to promote the use of more environmentally responsible products and services, the Environmental Choice<sup>M</sup> Program was established in 1988. The Environmental Choice<sup>M</sup> Program is Canada's only national and comprehensive eco-labelling program. The EcoLogo<sup>M</sup> is the recognized seal of approval of the Environmental Choice<sup>M</sup> Program.</p> <p><b>NOTE:</b> Apply Crystal Polymer Conditioner (HP-18) as a preliminary wax treatment.</p>												
<b>PACKAGING:</b>	A 5-gallon plastic bag and closure in a corrugated cardboard box with a clear poly shrink-wrap cover.												
<b>DILUTION:</b>	<p>Direct Feed: Dispense 1/8 to 1/4 ounce (approx. 3-7 ml) of concentrate per vehicle through a spray applicator.</p> <p><b>NOTE:</b> Consult your local Turtle Wax distributor for complete information on the wide range of dilution options for this product. Actual dilution or chemical usage may vary based on desired results.</p>												
<b>SPECIFICATIONS:</b>	<table><tr><td>Appearance:</td><td>A thin dark maroon liquid</td></tr><tr><td>Fragrance:</td><td>Orange</td></tr><tr><td>pH:</td><td>n/ap</td></tr><tr><td>Density:</td><td>7.18 Lbs./gal.</td></tr><tr><td>Emulsifier:</td><td>Cationic</td></tr><tr><td>DOT Labeling:</td><td>Flammable (PG-III)</td></tr></table>	Appearance:	A thin dark maroon liquid	Fragrance:	Orange	pH:	n/ap	Density:	7.18 Lbs./gal.	Emulsifier:	Cationic	DOT Labeling:	Flammable (PG-III)
Appearance:	A thin dark maroon liquid												
Fragrance:	Orange												
pH:	n/ap												
Density:	7.18 Lbs./gal.												
Emulsifier:	Cationic												
DOT Labeling:	Flammable (PG-III)												

FJ 9/26/01

# **TurtleWax** TECHNICAL FACT SHEET

- NAME:** FLEX-PAK HYPER-CONCENTRATE NEW & IMPROVED TRIPLE SHINE RED (HP-20), BLUE (HP-21), & GOLD (HP-22).
- DESCRIPTION:** Three high foaming spray conditioners in Red, Blue, and Gold for use in all automatic car wash foam arches that is HYPER-CONCENTRATED.
- BENEFITS:**
- Special Surfactants: A unique substantive surfactant is combined with special biodegradable foaming conditioners in a three color format to deposit a coating on the cars finish.
- Triple Action Formula: This new formula contains a blend of special ingredients that allow for faster rinsing Flash Foam™ and increased tunnel speed, carnauba wax to help enhance the water resistance this formula provides to all vehicle finishes, and optical brighteners to enhance the brightness of the foam.
- Clear Coat Safe: This product has been specifically designed for today's high-tech finishes. It also is effective on conventional and older finishes. It's universally safe for all finishes.
- Color and Fragrance: Unique vibrant red, blue, and gold colors along with cherry fragrance will signal the application of this uniquely protective system.
- NOTE:** Application of HYPER-CONCENTRATE Sealer Wax (HP-10) must be used as a final sealant to prolong durability.
- EcoLogo<sup>M</sup> Certified:** In order to promote the use of more environmentally responsible products and services, the Environmental Choice<sup>M</sup> Program was established in 1988. The Environmental Choice<sup>M</sup> Program is Canada's only national and comprehensive eco-labeling program. The EcoLogo<sup>M</sup> is the recognized seal of approval of the Environmental Choice<sup>M</sup> Program.
- PACKAGING:** A 5-gallon plastic bag and closure in a corrugated cardboard box with a clear poly shrink-wrap cover.
- DILUTION:** Direct Feed: Apply 1/4 ounce (approx. 5-8mls) of each colored product per vehicle through separate foam applicators.
- NOTE:** Consult your local Turtle Wax distributor for complete information on the wide range of dilution options for this product. Actual dilution or chemical usage may vary based on desired results.
- SPECIFICATIONS:**
- |               |  |
|---------------|--|
| Appearance:   | A thin dark red (HP-20), dark blue (HP-21), or dark yellow (HP-22) liquid. |
| Fragrance:    | Cherry   |
| pH:           | 7.5 – 9.25   |
| Density:      | 8.3 – 8.6 Lbs. /gal.   |
| Emulsifier:   | Cationic / Amphoteric  |
| DOT Labeling: | None   |

FJ April 18, 2002

# TECHNICAL FACT SHEET

<b>NAME:</b>	FLEX-PAK HYPER-CONCENTRATE Super Foaming Sealer Wax (HP 73)
<b>DESCRIPTION:</b>	A concentrated liquid foaming wax designed for self-serve car wash applications through high-pressure wands, and now it's HYPER-CONCENTRATED.
<b>BENEFITS:</b>	<p><u>Effective:</u> Hydrophobic Agents (water repellents) plate out on the metal surfaces of the car to seal out water, weather, salt, and dirt and protect your car's finish.</p> <p><u>Substantive Surfactants:</u> A special blend of substantive surfactants and wax are blended with amphoteric and nonionic foamers that cause the waxes to bond stronger and last longer. These surfactants are all biodegradable.</p> <p><u>Concentrated:</u> One five-gallon FLEX-PAK of this new HYPER-CONCENTRATED formula seals up to 2500 cars.</p> <p><u>Glass Protection:</u> This product contains no silicone and is not substantive to glass. It won't smear on windows.</p> <p><u>EcoLogo<sup>M</sup> Certified:</u> In order to promote the use of more environmentally responsible products and services, the Environmental Choice<sup>M</sup> Program was established in 1988. The Environmental Choice<sup>M</sup> Program is Canada's only national and comprehensive eco-labelling program. The EcoLogo<sup>M</sup> is the recognized seal of approval of the Environmental Choice<sup>M</sup> Program.</p>
<b>PACKAGING:</b>	A 5-gallon plastic bag and closure in a corrugated cardboard box with a clear poly shrink-wrap cover.
<b>DILUTION:</b>	Dilute stock solution 1:472 to 1:378 and apply 60 ounces per cycle minute, or apply 4-7 ml (1/8 - 1/4 oz.) of Hyper-Concentrate per cycle minute.
	<b>NOTE:</b> To achieve these dilution rates, a special double tip assembly will be required. Contact your local Turtle Wax Distributor for more details. Actual dilution or chemical usage may vary based on desired results.
<b>SPECIFICATIONS:</b>	Appearance: Clear yellow thin liquid
	Fragrance: Lemon citrus fragrance
	pH: 7.5
	Density: 7.84 Lbs./gal.
	Emulsifier: Cationic/Nonionic/Amphoteric
	DOT Labeling: Flammable (PG-III)

FJ 9/26/01



# TECHNICAL FACT SHEET

- NAME:** FLEX-PAK HYPER-CONCENTRATE Foaming Whitewall Tire Cleaner (HP-78)
- DESCRIPTION:** A HYPER-CONCENTRATED foaming whitewall tire cleaner designed for use in high pressure frictionless washing systems.
- BENEFITS:**
- Fast Acting:** This high sudsing formula quickly penetrates and lift tough soils.
  - Safe:** Special chemicals protect all wheel finishes from attack by caustics.
  - Unique:** It is the only whitewall tire cleaner made today that is designed to clean without friction that is HYPER-CONCENTRATED.
  - EcoLogo<sup>M</sup> Certified:** In order to promote the use of more environmentally responsible products and services, the Environmental Choice<sup>M</sup> Program was established in 1988. The Environmental Choice<sup>M</sup> Program is Canada's only national and comprehensive eco-labelling program. The EcoLogo<sup>M</sup> is the recognized seal of approval of the Environmental Choice<sup>M</sup> Program.
- PACKAGING:** A 5-gallon plastic bag and closure in a corrugated cardboard box with a clear poly shrink-wrap cover.
- DILUTION:** Dilute stock solution at 1:64 - 1:36 and apply direct, or apply 7 - 14 ml (1/4 - 1/2 oz.) Hyper-Concentrate per cycle minute.
- SPECIFICATIONS:**
- |               |                                       |
|---------------|---------------------------------------|
| Appearance:   | A clear thin fluorescent green liquid |
| Fragrance:    | Pine                                  |
| pH:           | 13.5                                  |
| Density:      | 9.38 Lbs./ gal.                       |
| Emulsifier:   | Anionic                               |
| DOT Labeling: | Corrosive (PG-III)                    |

FJ 9/26/01

# TECHNICAL FACT SHEET

<b>NAME:</b>	FLEX-PAK HYPER-CONCENTRATE Acid Pre-Soak Frictionless Detergent (HP-86)	
<b>DESCRIPTION:</b>	A truly unique, dilutable detergent concentrate specifically designed for use in today's new, high tech "touchless" car washes. It is specifically designed to work synergistically with Turtle Wax Frictionless Detergent (HP-16) to maximize the cleaning power and provide the ultimate frictionless cleaning system.	
<b>BENEFITS:</b>	<p><b>Easy To Use:</b> This product functions as the first step in a two step process which features the premier frictionless detergent (HP-16). Together, they go beyond current technology to provide the best frictionless cleaning system yet devised.</p> <p><b>Fast Acting:</b> An optimum blend of foaming agents and safe non-toxic and non-corrosive acids cut through and loosen stubborn road film. It is phosphate free.</p> <p><b>Safe:</b> This break-through technology of a new and effective acid is much safer to handle and use than any other conventional acid currently being used in the industry.</p> <p><b>Hard Water Compatible:</b> The cleaning agents are compatible with hard water minerals.</p> <p><b>Unsurpassed Effectiveness:</b> Field tests confirm that HYPER-CONCENTRATED Acid Pre-Soak Frictionless Detergent is unsurpassed for cleaning in two step "touchless" applications.</p> <p><b>EcoLogo<sup>M</sup> Certified:</b> In order to promote the use of more environmentally responsible products and services, the Environmental Choice<sup>M</sup> Program was established in 1988. The Environmental Choice<sup>M</sup> Program is Canada's only national and comprehensive eco-labelling program. The EcoLogo<sup>M</sup> is the recognized seal of approval of the Environmental Choice<sup>M</sup> Program.</p>	
<b>PACKAGING:</b>	A 5-gallon plastic bag and closure in a corrugated cardboard box with a clear poly shrink-wrap cover.	
<b>DILUTION:</b>	Direct Feed: Apply 1 to 2 ounces (29.5-59ml) of product per vehicle.	
	<b>NOTE:</b> Consult your local Turtle Wax distributor for complete information on the wide range of dilution options for this product. Actual dilution or chemical usage may vary based on desired results.	
<b>SPECIFICATIONS:</b>	Appearance:	A thin reddish liquid
	Fragrance:	Citrus Lemon
	pH:	<1.0
	Density:	9.10 Lbs./ gal.
	Emulsifier:	Non-ionic
	DOT Labeling:	Non-Hazardous

FJ 9/26/01



Turtle Wax  
5655 West 73rd St.  
Chicago, Illinois 60638-6211

## Material Safety Data Sheets

**EMERGENCY SPILL PHONE: 1 (800) 424-9300 (CHEMTREC)      MSDS No: HP-16(C)**

**EMERGENCY MEDICAL PHONE: Contact your local poison control center**

**PRODUCT INFORMATION PHONE: 1 (708) 563-3600**

NFPA Hazard Ratings: Health 3, Flammability 1, Reactivity 0

HMIS Hazard Ratings: Health 3, Flammability 1, Reactivity 0, Protection D

Prepared By: Research and Development, Phone: 1 (708) 563-3600

Date Issued: September 20, 2001

### 1 - MATERIAL IDENTIFICATION

**PRODUCT NAME: HYPER CONCENTRATE FRICTIONLESS DETERGENT, HP-16(C)**

Chemical Family: Water solution: alkalis, detergents.

Material Use or Occurrence: Frictionless car wash soap.

Product Identification No.: UN(3266) Canada

### 2 - IMPORTANT INGREDIENTS

<u>CHEMICAL NAME</u> (Synonyms)	<u>CAS No.</u>	<u>PERCENT</u>	<u>PEL/TLV/TWA</u>		<u>CARCINOGEN</u> (OSHA,NPT,IARC)
			<u>OSHA</u>	<u>ACGIH</u>	
Tetrasodium ethylene-diamine tetraacetate (Na <sub>4</sub> EDTA)	64-02-8	16-20%	None	None	No
Sodium Metasilicate pentahydrate (Metso Pentabead 20)	6834-92-0	5-8%	None	None	No

### 3 - CHEMICAL AND PHYSICAL PROPERTIES

Boiling Point: n/av

Specific Gravity: 1.144

Solubility In Water: complete

Evaporation Rate: n/av

Coefficient of Oil/Water Distribution: n/av

Appearance and Odor: Dark Red Liquid. Odor: Slightly acrid

Melting Point: n/av

Vapor Pressure: n/av

Vapor Density (Air=1): n/av

% Non-volatile: 29.0%

pH: 13.0+

### 4 - FIRE AND EXPLOSION DATA

Flash Point (Cl. Cup): >200°F (98°C)

Explosive Limits: Lower: n/ av

Upper: n/ av

Extinguishing Media: Water, carbon dioxide, foams, dry chemical

Special Fire Fighting Procedures and Hazards: Protect personnel from corrosive alkaline solution, even when diluted.

Avoid flow of contaminated fire waters to storm sewers.

### 5 - REACTIVITY INFORMATION

Stable: X      Unstable:

Precautions: None

Hazardous Polymerization Occurs:

Does Not Occur: X

Incompatibility: Strong acids cause heat and possible spattering.

Hazardous Decomposition Product: If dried and burned: CO<sub>2</sub>, CO, NO<sub>x</sub>, SO<sub>2</sub>, Hydrocarbons.

1-2816-64-8

Turtle Wax, Inc. MSDS No. HP-16(C) –September 20, 2001

## **6 - HEALTH HAZARDS - PROTECTIVE MEASURES - FIRST AID**

### Inhalation:

- Mist or spray of concentrated product can cause corrosive damage to nose, throat, and lungs. No chronic effects known.
- Respiratory - as required to prevent inhalation of concentrated product if misted.
- Remove to fresh air. Use artificial respiration and oxygen if needed.

### Skin:

- Corrosive. Concentrated product can cause skin burns, and effects may be delayed. No chronic effects known.
- Wear alkali resistant gloves, boots, clothing, and/or head covering as needed to prevent exposure to concentrated product.
- Immediately remove contaminated clothing. Immediately wash affected areas thoroughly with soap and water. Wash contaminated clothes separately from other clothes and avoid contact with wash water. Discard any footwear that cannot be decontaminated.

### Eyes:

- Causes eye burns and potential blindness. No chronic effects known.
- Wear splash proof goggles.
- Flush with water for 15 minutes. Get prompt medical attention.

### Ingestion:

- Can cause burns in mouth, throat, and stomach. No chronic effects known.
- Avoid swallowing. Wear face shield if face contact with concentrated product is possible.
- Rinse mouth. Do not induce vomiting. If conscious, drink large amounts of water and milk, followed by citrus juice or dilute vinegar. Get prompt medical attention.

**IN ALL CASES: GET PROMPT MEDICAL ATTENTION IF EFFECTS PERSIST. KEEP OUT OF REACH OF CHILDREN.**

Most likely routes of entry: Skin, Eyes

## **7 - PRECAUTIONS FOR SAFE HANDLING AND USE**

Spills and Leaks: Avoid contact of concentrated product with skin and eyes. If material is neutralized with dilute acid, flush down sewer. Otherwise, take up small spills with absorbent; dike around large spills and pump liquid to recovery containers. Avoid flow of un-neutralized material into storm sewers. Floors may be slippery. See Section 6 for other protective measures.

Storage and Handling: Use good housekeeping practices in storage. Store in a clean dry place. Keep containers closed. Keep from Freezing.

Waste Disposal: In accordance with applicable local, state, and federal regulations. Is a RCRA hazardous waste (D002-Corrosive)

Empty Containers: Rinse thoroughly before handling, reuse, disposal, or recycling. Handle wash water as described above under "Spills and Leaks".

## **8 - REGULATORY INFORMATION**

DOT (HM-181) USA & Int'l: Class and Label - 8, Corrosive  
Shipping Name - Corrosive Liquid, Basic, Inorganic, n.o.s.,  
(Sodium Metasilicate), 8, UN3266, PGIII.

For inner containers of 38.4 oz. or less each, not shipped by air, and for USA only:

Class and Label: None

Shipping description: None required (May use "Limited Quantity").

SARA Title III: Reportable for Section 313(Form R): None

TSCA INVENTORY: All ingredients are commercially available and presumed to be listed by manufacturer.

CALIFORNIA PROP. 65: No listed substances are known to be present.

NEW JERSEY LABEL INGREDIENTS: Water (CAS # 7732-18-5), Tetrasodium ethylenediaminetetraacetate (CAS # 64-02-8), Sodium Metasilicate (CAS # 6834-92-0), Linear Primary Alcohol Ethoxylate (CAS # 68439-46-3), Primary alkane sulfonate (CAS # 5324-84-5).

CANADA EPA DSL INVENTORY: Consult Turtle Wax, Inc. regarding status of ingredients.

EEC SIXTH AMENDMENT INVENTORY: Consult Turtle Wax, Inc. regarding status of ingredients.

The information contained here in has been compiled from sources believed to be reliable and is accurate to the best of our knowledge at this date. It is provided without warranty, expressed or implied, as to the results of use of this information or to the product to which it relates. Recipient assumes all responsibility for the use of this information and the use, storage, or disposal of the product, including any resultant personal injury or property damage.



Turtle Wax  
5655 West 73rd St.  
Chicago, Illinois 60638-6211

## Material Safety Data Sheet

**EMERGENCY SPILL PHONE: 1 (800) 424-9300 (CHEMTREC)      MSDS No: HP-20(C)**  
**EMERGENCY MEDICAL PHONE: Contact Your Local Poison Control Center**  
**PRODUCT INFORMATION PHONE: 1 (708) 563-3600**

NFPA Hazard Ratings: Health 0, Flammability 1, Reactivity 0  
HMIS Hazard Ratings: Health 1, Flammability 1, Reactivity 0, Protection B

Prepared By: Research and Development, Phone: 1 (708) 563-3600  
Date Issued: April 18, 2002

### 1 - MATERIAL IDENTIFICATION

**PRODUCT NAME: TRIPLE SHINE (RED), HP-20(C)**

Chemical Family: Solvent Solution, Solvent, Surfactant, Additives  
Material Use or Occurrence: Foaming Auto Wax

### 2 - IMPORTANT INGREDIENTS

CHEMICAL NAME (Synonyms)	CAS No.	PERCENT	PEL/TLV/TWA		CARCINOGEN (OSHA,NPT,IARC)
			OSHA	ACGIH	
Ethylene Glycol Butyl Ether (Butyl Cellosolve)	111-76-2	5-8%	25 ppm (Skin)	25 ppm (Skin)	No
Isopropyl Alcohol (Isopropanol)	67-63-0	0.5-2%	400 ppm	400 ppm	No

### 3 - CHEMICAL AND PHYSICAL PROPERTIES

Boiling Point: n/av	Melting Point: n/av
Specific Gravity: 1.012	Vapor Pressure: n/av
Solubility In Water: Complete	Vapor Density (Air=1) n/av
Evaporation Rate: n/av	% Non-volatile: 27%
Coefficient of Oil/Water Distribution: n/av	pH: 8.0
Appearance and Odor: Dark Red Liquid, Odor: Typical.	

### 4 - FIRE AND EXPLOSION DATA

Flash Point(Seta Flash Cl. Cup): > 200°F, ( 93°C)      Explosive Limits: Lower:n/av      Upper:n/av  
Extinguishing Media: Water Spray, Alcohol Foam, Carbon Dioxide, Dry Chemical  
Special Fire Fighting Procedures and Hazards: Treat as combustible fluid. Avoid flow to sewers.

### 5 - REACTIVITY INFORMATION

Stable: X      Unstable:  
Hazardous Polymerization Occurs:      Precautions: None  
Incompatibility: None Known      Does Not Occur: X  
Hazardous Decomposition Product: CO<sub>2</sub>, CO, NO<sub>x</sub>, HCl, Hydrocarbons.

1-2820-64-7

Turtle Wax MSDS No. HP-20(C) –April 18, 2002



## **6 - HEALTH HAZARDS - PROTECTIVE MEASURES - FIRST AID**

### Inhalation:

- Repeated or excessive inhalation of vapor, mist, or spray of concentrated product can cause irritation, chemical pneumonia, dizziness, and nausea. No chronic effects known.
- Respiratory - as required to prevent inhalation of concentrated product if misted.
- Remove to fresh air. Use artificial respiration and oxygen if needed.

### Skin:

- Repeated or excessive contact with concentrated product can cause blisters or rash due to defatting action. No chronic effects known.
- Wear oil resistant gloves, boots, clothing, and/or head covering as needed to prevent exposure to concentrated product.
- Remove contaminated clothing. Wash effected area thoroughly with soap and water.

### Eyes:

- Causes irritation. No chronic effects known.
- Wear splash proof goggles.
- Flush with water for 15 minutes. Get prompt medical attention.

### Ingestion:

- Can cause digestive system upset and irritation, nausea. No chronic effects known.
- Avoid swallowing. Wear face shield if face contact with concentrated product is likely.
- Rinse mouth. Do not induce vomiting. Drink large amounts of water. Get prompt medical attention.

**IN ALL CASES: GET PROMPT MEDICAL ATTENTION IF EFFECTS PERSIST.  
KEEP OUT OF REACH OF CHILDREN.**

Most likely routs of entry: Skin, Eyes

## **7 - PRECAUTIONS FOR SAFE HANDLING AND USE**

Spills and Leaks: Remove all ignition sources. Take up small spills with absorbent, and put in closed containers. Dike around large spills and pump to recovery container. Avoid flow to storm sewers. Floors may be slippery. See Sec. 6 for other protective measures.

### Storage and Handling:

Use good housekeeping practices in storage. Store in a clean dry place. Keep containers closed. Keep from Freezing.

Waste Disposal: In accordance with applicable local, state, and federal regulations. This is not a RCRA hazardous waste as of this date.

Empty Containers: Rinse thoroughly before handling, reuse, disposal, or recycling.

## **8 - REGULATORY INFORMATION**

DOT (HM-181) USA: Not regulated as a hazardous material.  
[Int'l. (IMDG)] Not regulated as a hazardous material.

SARA, Title III: Reportable for Section 313(Form R): Glycol Ether (Butyl Cellosolve), (10-15%)

TSCA INVENTORY: All ingredients are commercially available and presumed to be listed by manufacturer.

CALIFORNIA PROP. 65: No listed substances are known to be present.

NEW JERSEY LABEL INGREDIENTS: Cocoamidopropyl betaine (CAS# 61789-40-0), Amine oxide (CAS# 1643-20-5), Water (CAS # 7732-18-5), Ethylene Glycol Butyl Ether (CAS # 111-76-2), Dialkyl-Dimethyl Ammonium Chloride (CAS # 73398-64-8), Isopropyl Alcohol (CAS # 63-67-0), Ethoxylated Amines (CAS # 68155-39-5), Alkanolamide (CAS # 68603-42-9), Montan Wax (CAS # 8002-53-7), Carnauba Wax (CAS # 8015-86-9).

CANADA EPA DSL INVENTORY: Consult Turtle Wax, Inc. regarding status of ingredients.

EEC SIXTH AMENDMENT INVENTORY: Consult Turtle Wax, Inc. regarding status of ingredients.

The information contained here in has been compiled from sources believed to be reliable and is accurate to the best of our knowledge at this date. It is provided without warranty, expressed or implied, as to the results of use of this information or to the product to which it relates. Recipient assumes all responsibility for the use of this information and the use, storage, or disposal of the product, including any resultant personal injury or property damage.



Turtle Wax  
5655 West 73rd St.  
Chicago, Illinois 60638-6211

## Material Safety Data Sheet

EMERGENCY SPILL PHONE: 1 (800) 424-9300 (CHEMTREC)      MSDS No: HP-21(C)  
EMERGENCY MEDICAL PHONE: Contact your local poison control center  
PRODUCT INFORMATION PHONE: 1 (708) 563-3600

NFPA Hazard Ratings: Health 0, Flammability 1, Reactivity 0  
HMIS Hazard Ratings: Health 1, Flammability 1, Reactivity 0, Protection B

Prepared By: Research and Development, Phone: 1 (708) 563-3600  
Date Issued: April 18, 2002

### 1 - MATERIAL IDENTIFICATION

#### PRODUCT NAME: TRIPLE SHINE (BLUE), HP-21(C)

Chemical Family: Solvent Solution, Solvent, Surfactant, Additives  
Material Use or Occurrence: Foaming Auto Wax

### 2 - IMPORTANT INGREDIENTS

CHEMICAL NAME (Synonyms)	CAS No.	PERCENT	PEL/TLV/TWA		CARCINOGEN (OSHA,NPT,IARC)
			OSHA (Skin)	ACGIH (Skin)	
Ethylene Glycol Butyl Ether (Butyl Cellosolve)	111-76-2	5-8%	25 ppm (Skin)	25 ppm (Skin)	No
Isopropyl Alcohol (Isopropanol)	67-63-0	0.5-2%	400 ppm	400 ppm	No

### 3 - CHEMICAL AND PHYSICAL PROPERTIES

Boiling Point: n/av      Melting Point: n/av  
Specific Gravity: 1.008 g/cc      Vapor Pressure: n/av  
Solubility In Water: Complete      Vapor Density (Air=1) n/av  
Evaporation Rate: n/av      % Non-volatile: 27%  
Coefficient of Oil/Water Distribution: n/av      pH: 8.0  
Appearance and Odor: Dark Blue Liquid, Odor: Typical.

### 4 - FIRE AND EXPLOSION DATA

Flash Point (Seta Flash Cl. Cup): >200°F, (93°C)      Explosive Limits: Lower: n/ av      Upper: n/ av  
Extinguishing Media: Water Spray, Alcohol Foam, Carbon Dioxide, Dry Chemical  
Special Fire Fighting Procedures and Hazards: Treat as combustible fluid. Avoid flow to storm sewers.

### 5 - REACTIVITY INFORMATION

Stable: X      Unstable:      Precautions: None  
Hazardous Polymerization Occurs:      Does Not Occur: X  
Incompatibility: None Known  
Hazardous Decomposition Product: CO<sub>2</sub>, CO, NO<sub>x</sub>, HCl, Hydrocarbons.

1-2821-64-7

Turtle Wax, Inc. MSDS No. HP-21(C) –April 18, 2002

## **6 - HEALTH HAZARDS - PROTECTIVE MEASURES - FIRST AID**

### Inhalation:

- Repeated or excessive inhalation of vapor, mist, or spray of concentrated product can cause irritation, chemical pneumonia, dizziness, and nausea. No chronic effects known.
- Respiratory - as required to prevent inhalation of concentrated product if misted.
- Remove to fresh air. Use artificial respiration and oxygen if needed.

### Skin:

- Repeated or excessive contact with concentrated product can cause blisters or rash due to defatting action. No chronic effects known.
- Wear oil resistant gloves, boots, clothing, and/or head covering as needed to prevent exposure to concentrated product.
- Remove contaminated clothing. Wash effected area thoroughly with soap and water.

### Eyes:

- Causes irritation. No chronic effects known.
- Wear splash proof goggles.
- Flush with water for 15 minutes. Get prompt medical attention.

### Ingestion:

- Can cause digestive system upset and irritation, nausea. No chronic effects known.
- Avoid swallowing. Wear face shield if face contact with concentrated product is likely.
- Rinse mouth. Do not induce vomiting. Drink large amounts of water. Get prompt medical attention.

**IN ALL CASES: GET PROMPT MEDICAL ATTENTION IF EFFECTS PERSIST.  
KEEP OUT OF REACH OF CHILDREN.**

Most likely routes of entry: Skin, Eyes

## **7 - PRECAUTIONS FOR SAFE HANDLING AND USE**

Spills and Leaks: Remove all ignition sources. Take up small spills with absorbent, and put in closed containers. Dike around large spills and pump to recovery container. Avoid flow to storm sewers. Floors may be slippery. See Sec. 6 for other protective measures.

### Storage and Handling:

Use good housekeeping practices in storage. Store in a clean dry place. Keep containers closed. Keep from Freezing.

Waste Disposal: In accordance with applicable local, state, and federal regulations. This is not a RCRA hazardous waste as of this date.

Empty Containers: Rinse thoroughly before handling, reuse, disposal, or recycling.

## **8 - REGULATORY INFORMATION**

DOT (HM-181) USA: Not regulated as a hazardous material.  
[Int'l. (IMDG)] Not regulated as a hazardous material.

SARA, Title III: Reportable for Section 313(Form R): Glycol Ether (Butyl Cellosolve), (10-15%)

TSCA INVENTORY: All ingredients are commercially available and presumed to be listed by manufacturer.

CALIFORNIA PROP. 65: No listed substances are known to be present.

NEW JERSEY LABEL INGREDIENTS: Cocoamidopropyl betaine (CAS# 61789-40-0), Amine oxide (CAS# 1643-20-5), Water (CAS # 7732-18-5), Ethylene Glycol Butyl Ether (CAS # 111-76-2), Dialkyl-Dimethyl Ammonium Chloride (CAS # 73398-64-8), Isopropyl Alcohol (CAS # 63-67-0), Ethoxylated Amines (CAS # 68155-39-5), Alkanolamide (CAS # 68603-42-9), Montan Wax (CAS # 8002-53-7), Carnauba Wax (CAS # 8015-86-9).

CANADA EPA DSL INVENTORY: Consult Turtle Wax, Inc. regarding status of ingredients.

EEC SIXTH AMENDMENT INVENTORY: Consult Turtle Wax, Inc. regarding status of ingredients. The information contained here in has been compiled from sources believed to be reliable and is accurate to the best of our knowledge at this date. It is provided without warranty, expressed or implied, as to the results of use of this information or to the product to which it relates. Recipient assumes all responsibility for the use of this information and the use, storage, or disposal of the product, including any resultant personal injury or property damage.



Turtle Wax  
5655 West 73rd St.  
Chicago, Illinois 60638-6211

## Material Safety Data Sheet

EMERGENCY SPILL PHONE: 1 (800) 424-9300 (CHEMTREC) MSDS No: HP-73(C)

EMERGENCY MEDICAL PHONE: Contact Your Local Poison Control Center

PRODUCT INFORMATION PHONE: 1 (708) 563-3600

NFPA Hazard Ratings: Health 0, Flammability 2, Reactivity 0  
HMIS Hazard Ratings: Health 1, Flammability 2, Reactivity 0, Protection B

Prepared By: Research and Development, Phone: 1 (708) 563-3600

Date Issued: October 3, 2001

### 1 - MATERIAL IDENTIFICATION

**PRODUCT NAME: HYPER-CONCENTRATE FOAMING SEALER WAX , HP-73(C)**

Chemical Family: Solvent Solution, Solvent, Surfactant, Additives

Material Use or Occurrence: Auto Wax Sealant

### 2 - IMPORTANT INGREDIENTS

<u>CHEMICAL NAME</u> (Synonyms)	<u>CAS No.</u>	<u>PERCENT</u>	<u>PEL/TLV/TWA</u>		<u>CARCINOGEN</u> (OSHA,NPT,IARC)
			<u>OSHA</u>	<u>ACGIH</u>	
Ethylene Glycol Butyl Ether (Butyl Cellosolve)	111-76-2	8-12%	25 ppm (Skin)	25 ppm (Skin)	No
Petroleum Distillates (Mineral Seal Oil)	64741-44-2	10-15%	5 mg/M <sup>3</sup> (Mist)	5 mg/M <sup>3</sup> (Mist)	No

### 3 - CHEMICAL AND PHYSICAL PROPERTIES

Boiling Point: n/av  
Specific Gravity: 0.950  
Solubility In Water: Complete  
Evaporation Rate: n/av  
Coefficient of Oil/Water Distribution: n/av  
Appearance and Odor: Yellow Liquid. Odor: Citrus

Melting Point: n/av  
Vapor Pressure: n/av  
Vapor Density (Air=1) n/av  
% Non-volatile: 36%  
pH: 7.5

### 4 - FIRE AND EXPLOSION DATA

Flash Point (Cl. Cup): > 200°F, (93°C) Explosive Limits: Lower: n/av Upper: n/av  
Extinguishing Media: Water Spray, Alcohol Foam, Carbon Dioxide, Dry Chemical  
Special Fire Fighting Procedures and Hazards: Treat as combustible fluid. Avoid flow to storm sewers.

### 5 - REACTIVITY INFORMATION

Stable: X Unstable: Precautions: None  
Hazardous Polymerization Occurs: Does Not Occur: X  
Incompatibility: None Known  
Hazardous Decomposition Product: CO<sub>2</sub>, CO, NO<sub>x</sub>, HCl, Hydrocarbons.

1-2873-64-6

Turtle Wax, Inc. MSDS No. HP-73(C) – October 3, 2001

## **6 - HEALTH HAZARDS - PROTECTIVE MEASURES - FIRST AID**

### Inhalation:

- Repeated or excessive inhalation of vapor, mist, or spray of concentrated product can cause irritation, chemical pneumonia, dizziness, and nausea. No chronic effects known.
- Respiratory - as required to prevent inhalation of concentrated product if misted.
- Remove to fresh air. Use artificial respiration and oxygen if needed.

### Skin:

- Repeated or excessive contact with concentrated product can cause blisters or rash due to defatting action. No chronic effects known.
- Wear oil resistant gloves, boots, clothing, and/or head covering as needed to prevent exposure to concentrated product.
- Remove contaminated clothing. Wash effected area thoroughly with soap and water.

### Eyes:

- Causes irritation. No chronic effects known.
- Wear splash proof goggles.
- Flush with water for 15 minutes. Get prompt medical attention.

### Ingestion:

- Can cause digestive system upset and irritation, nausea. May aggravate pre-existing liver and kidney condition. No chronic effects known.
- Avoid swallowing. Wear face shield if face contact with concentrated product is likely.
- Rinse mouth. Do not induce vomiting. Drink large amounts of water. Get prompt medical attention.

**IN ALL CASES: GET PROMPT MEDICAL ATTENTION IF EFFECTS PERSIST.  
KEEP OUT OF REACH OF CHILDREN.**

Most likely routes of entry: Skin, Eyes

## **7 - PRECAUTIONS FOR SAFE HANDLING AND USE**

Spills and Leaks: Remove all ignition sources. Take up small spills with absorbent, and put in closed containers. Dike around large spills and pump to recovery container. Avoid flow to storm sewers. Floors may be slippery. See Sec. 6 for other protective measures.

Storage and Handling: Use good housekeeping practices in storage. Store in a clean dry place. Keep containers closed. Keep from Freezing.

Waste Disposal: In accordance with applicable local, state, and federal regulations. This is not a RCRA hazardous waste.

Empty Containers: Rinse thoroughly before handling, reuse, disposal, or recycling.

## **8 - REGULATORY INFORMATION**

DOT (HM-181) USA & Int'l: None

Shipping Name: None (Non-hazardous)

SARA, Title III: Reportable for Section 313(Form R): Glycol Ether (Butyl Cellosolve),(10-15%)

TSCA INVENTORY: All ingredients are commercially available and presumed to be listed by manufacturer.

CALIFORNIA PROP. 65: No listed substances are known to be present.

NEW JERSEY LABEL INGREDIENTS: Dialkyl-dimethyl ammonium chloride (CAS # 73398-64-8), Petroleum Distillate (CAS# 64741-44-2), Ethylene Glycol Butyl Ether (CAS # 111-76-2), Cocoamidopropyl betaine (CAS# 61789-40-0), Amine oxide (CAS# 1643-20-5), Propylene Glycol (CAS # 57-55-6).

CANADA EPA DSL INVENTORY: Consult Turtle Wax, Inc. regarding status of ingredients.

EEC SIXTH AMENDMENT INVENTORY: Consult Turtle Wax, Inc. regarding status of ingredients.

---

The information contained here in has been compiled from sources believed to be reliable and is accurate to the best of our knowledge at this date. It is provided without warranty, expressed or implied, as to the results of use of this information or to the product to which it relates. Recipient assumes all responsibility for the use of this information and the use, storage, or disposal of the product, including any resultant personal injury or property damage.





Turtle Wax  
5655 West 73rd St.  
Chicago, Illinois 60638-6211

## Material Safety Data Sheet

**EMERGENCY SPILL PHONE: 1 (800) 424-9300 (CHEMTREC) MSDS No: HP-86(C)**

**EMERGENCY MEDICAL PHONE: Contact your local poison control center**

**PRODUCT INFORMATION PHONE: 1 (708) 563-3600**

NFPA Hazard Ratings: Health 3, Flammability 2, Reactivity 0

HMIS Hazard Ratings: Health 3, Flammability 2, Reactivity 0, Protection D

Prepared By: Research and Development, Phone: 1 (708) 563-3600

Date Issued: September 20, 2001

### 1 - MATERIAL IDENTIFICATION

**PRODUCT NAME: CITRUS-PREP™ CITRUS PRE-SOAK, HP-86/5(C)**

Chemical Family: Water solution: organic acid salts, detergents, solvent

Material Use or Occurrence: Automotive Pre-Soak.

Product Identification No.: None (Canada)

### 2 - IMPORTANT INGREDIENTS

<u>CHEMICAL NAME</u> (Synonyms)	<u>CAS No.</u>	<u>PERCENT</u>	<u>PEL/TLV/TWA</u>		<u>CARCINOGEN</u> (OSHA,NPT,IARC)
			<u>OSHA</u>	<u>ACGIH</u>	
Organic Acid Salt (Proprietary)	n/av	12-15%	n/ av	n/ av	No
Ethylene Glycol Butyl Ether (2-Butoxyethanol)	111-76-2	5-8%	25ppm(Skin)	25ppm(Skin)	No

### 3 - CHEMICAL AND PHYSICAL PROPERTIES

Boiling Point: n/av

Specific Gravity: 1.093

Solubility In Water: Complete

Evaporation Rate: n/av

Coefficient of Oil/Water Distribution: n/av

Appearance and Odor: Dark Orange Water Thin Liquid. Odor: Typical citrus.

Melting Point: n/av

Vapor Pressure: n/av

Vapor Density (Air=1): n/av

% Non-volatile: 25%

pH: 1.0

### 4 - FIRE AND EXPLOSION DATA

Flash Point (Cl. Cup): >200°F (93°C)

Explosive Limits: Lower: n/ av

Upper: n/ av

Extinguishing Media: Water, carbon dioxide, foams, dry chemical

Special Fire Fighting Procedures and Hazards: Protect personnel from corrosive acid solution, even when diluted. Avoid flow of contaminated fire waters to storm sewers.

### 5 - REACTIVITY INFORMATION

Stable: X

Unstable:

Precautions: None

Hazardous Polymerization Occurs:

Does Not Occur: X

Incompatibility: Strong alkalis cause heat and possible spattering.

Hazardous Decomposition Product: If burned: CO<sub>2</sub>, CO, and Hydrocarbons. Avoid contact with chlorates, hypochlorites, and nitrates.

1-2886-64-4

Turtle Wax, Inc. MSDS No. HP-86/5(C) – September 20, 2001



## **6 - HEALTH HAZARDS - PROTECTIVE MEASURES - FIRST AID**

### Inhalation:

- Mist or spray of concentrated product can cause corrosive damage to nose, throat, and lungs. No chronic effects known.
- Respiratory - as required to prevent inhalation of concentrated product if misted.
- Remove to fresh air. Use artificial respiration and oxygen if needed.

### Skin:

- Caution. Concentrated product causes skin irritation and burns with prolonged exposure. No chronic effects known.
- Wear acid resistant gloves, boots, clothing, and/or head covering as needed to prevent exposure to concentrated product.
- Immediately remove contaminated clothing. Immediately wash affected areas thoroughly with soap and water. Wash contaminated clothes separately from other clothes and avoid contact with wash water. Discard any footwear that cannot be decontaminated.

### Eyes:

- Causes eye irritation. No chronic effects known.
- Wear splash proof goggles.
- Flush with water for 15 minutes. Get prompt medical attention.

### Ingestion:

- Can cause burns in mouth, throat. No chronic effects known.
- Avoid swallowing. Wear face shield if face contact with concentrated product is possible.
- Rinse mouth. Do not induce vomiting. If conscious, drink large amounts of water and milk. Get prompt medical attention.

**IN ALL CASES: GET PROMPT MEDICAL ATTENTION IF EFFECTS PERSIST.**  
**KEEP OUT OF REACH OF CHILDREN.**

Most likely routes of entry: Skin, Eyes

## **7 - PRECAUTIONS FOR SAFE HANDLING AND USE**

Spills and Leaks: Avoid contact with skin and eyes. If material is neutralized with dilute lime, flush down sewer. Otherwise, take up small spills with absorbent; dike around large spills and pump liquid to recovery containers. Avoid flow of un-neutralized material into storm sewers. Floors may be slippery. See Section 6 for other protective measures.

Storage and Handling: Use good housekeeping practices in storage. Store in a clean dry place. Keep containers closed. Keep from Freezing.

Waste Disposal: In accordance with applicable local, state, and federal regulations. Is a RCRA hazardous waste (D002-Corrosive).

Empty Containers: Rinse thoroughly before handling, reuse, disposal, or recycling.

## **8 - REGULATORY INFORMATION**

DOT (HM-181) USA & Int'l:

Not regulated as a hazardous material.

SARA, Title III: Reportable for Section 313(Form R): Glycol Ethers(2-Butoxyethanol)(3-5%).

TSCA INVENTORY: All ingredients are commercially available and presumed to be listed by manufacturer.

CALIFORNIA PROP. 65: No listed substances are known to be present.

NEW JERSEY LABEL INGREDIENTS: Water (CAS # 7732-18-5), Organic acid salt (CAS # Proprietary), Ethylene Glycol Butyl Ether (CAS # 111-76-2), Nonylphenoxy (ethyleneoxy) ethanol (CAS # 9016-45-9), Sodium Citrate (CAS # 68-04-2), Sodium Xylene Sulfonate (CAS # 1300-72-7).

CANADA EPA DSL INVENTORY: Consult Turtle Wax, Inc. regarding status of ingredients.

EEC SIXTH AMENDMENT INVENTORY: Consult Turtle Wax, Inc. regarding status of ingredients.

The information contained here in has been compiled from sources believed to be reliable and is accurate to the best of our knowledge at this date. It is provided without warranty, expressed or implied, as to the results of use of this information or to the product to which it relates. Recipient assumes all responsibility for the use of this information and the use, storage, or disposal of the product, including any resultant personal injury or property damage.



Turtle Wax  
5655 West 73rd St.  
Chicago, Illinois 60638-6211

## Material Safety Data Sheet

**EMERGENCY SPILL PHONE: 1 (800) 424-9300 (CHEMTREC)**      **MSDS No: HP-22(C)**  
**EMERGENCY MEDICAL PHONE: Contact your local poison control center**  
**PRODUCT INFORMATION PHONE: 1 (708) 563-3600**

NFPA Hazard Ratings: Health 0, Flammability 1, Reactivity 0  
HMIS Hazard Ratings: Health 1, Flammability 1, Reactivity 0, Protection B

Prepared By: Research and Development, Phone: 1 (708) 563-3600  
Date Issued: April 18, 2002

### 1 - MATERIAL IDENTIFICATION

**PRODUCT NAME: TRIPLE SHINE (GOLD), HP-22(C)**  
Chemical Family: Solvent Solution, Solvent, Surfactant, Additives  
Material Use or Occurrence: Foaming Auto Wax

### 2 - IMPORTANT INGREDIENTS

<u>CHEMICAL NAME</u> (Synonyms)	<u>CAS No.</u>	<u>PERCENT</u>	<u>PEL/TLV/TWA</u>		<u>CARCINOGEN</u> (OSHA,NPT,IARC)
			<u>OSHA</u>	<u>ACGIH</u>	
Ethylene Glycol Butyl Ether (Butyl Cellosolve)	111-76-2	5-8%	25 ppm (Skin)	25 ppm (Skin)	No
Isopropyl Alcohol (Isopropanol)	67-63-0	0.5-2%	400 ppm	400 ppm	No

### 3 - CHEMICAL AND PHYSICAL PROPERTIES

Boiling Point: n/av      Melting Point: n/av  
Specific Gravity: 1.010 g/cc      Vapor Pressure: n/av  
Solubility In Water: Complete      Vapor Density (Air=1) n/av  
Evaporation Rate: n/av      % Non-volatile: 32%  
Coefficient of Oil/Water Distribution: n/av      pH: 8.75  
Appearance and Odor: Dark Yellow Liquid, Odor: Typical.

### 4 - FIRE AND EXPLOSION DATA

Flash Point (Seta Flash Cl. Cup): > 200°F, ( 93°C)      Explosive Limits: Lower: n/ av      Upper: n/ av  
Extinguishing Media: Water Spray, Alcohol Foam, Carbon Dioxide, Dry Chemical  
Special Fire Fighting Procedures and Hazards: Treat as combustible fluid. Avoid flow to storm sewers.

### 5 - REACTIVITY INFORMATION

Stable: X      Unstable:      Precautions: None  
Hazardous Polymerization Occurs:      Does Not Occur: X  
Incompatibility: None Known  
Hazardous Decomposition Product: CO<sub>2</sub>, CO, NO<sub>x</sub>, HCl, Hydrocarbons.

1-2822-64-7.

Turtle Wax, Inc. MSDS No. HP-22(C) – April 18, 2002



## **6 - HEALTH HAZARDS - PROTECTIVE MEASURES - FIRST AID**

### Inhalation:

- Repeated or excessive inhalation of vapor, mist, or spray of concentrated product can cause irritation, chemical pneumonia, dizziness, and nausea. No chronic effects known.
- Respiratory - as required to prevent inhalation of concentrated product if misted.
- Remove to fresh air. Use artificial respiration and oxygen if needed.

### Skin:

- Repeated or excessive contact with concentrated product can cause blisters or rash due to defatting action. No chronic effects known.
- Wear oil resistant gloves, boots, clothing, and/or head covering as needed to prevent exposure to concentrated product.
- Remove contaminated clothing. Wash effected area thoroughly with soap and water.

### Eyes:

- Causes irritation. No chronic effects known.
- Wear splash proof goggles.
- Flush with water for 15 minutes. Get prompt medical attention.

### Ingestion:

- Can cause digestive system upset and irritation, nausea. No chronic effects known.
- Avoid swallowing. Wear face shield if face contact with concentrated product is likely.
- Rinse mouth. Do not induce vomiting. Drink large amounts of water. Get prompt medical attention.

**IN ALL CASES:** GET PROMPT MEDICAL ATTENTION IF EFFECTS PERSIST.  
KEEP OUT OF REACH OF CHILDREN.

Most likely routes of entry: Skin, Eyes

## **7 - PRECAUTIONS FOR SAFE HANDLING AND USE**

Spills and Leaks: Remove all ignition sources. Take up small spills with absorbent, and put in closed containers. Dike around large spills and pump to recovery container. Avoid flow to storm sewers. Floors may be slippery. See Sec. 6 for other protective measures.

Storage and Handling: Use good housekeeping practices in storage. Store in a clean dry place. Keep containers closed. Keep from Freezing.

Waste Disposal: In accordance with applicable local, state, and federal regulations. This is not a RCRA hazardous waste as of this date.

Empty Containers: Rinse thoroughly before handling, reuse, disposal, or recycling.

## **8 - REGULATORY INFORMATION**

DOT (HM-181) USA: Not regulated as a hazardous material.

[Int'l. (IMDG)]: Not regulated as a hazardous material.

SARA, Title III: Reportable for Section 313(Form R): Glycol Ether (Butyl Cellosolve),(10-15%)

TSCA INVENTORY: All ingredients are commercially available and presumed to be listed by manufacturer.

CALIFORNIA PROP. 65: No listed substances are known to be present.

NEW JERSEY LABEL INGREDIENTS: Cocoamidopropyl betaine (CAS# 61789-40-0), Amine oxide (CAS# 1643-20-5), Water (CAS # 7732-18-5), Ethylene Glycol Butyl Ether (CAS # 111-76-2), Dialkyl-Dimethyl Ammonium Chloride (CAS # 73398-64-8), Isopropyl Alcohol (CAS # 63-67-0), Ethoxylated Amines (CAS # 68155-39-5), Alkanolamide (CAS # 68603-42-9), Montan Wax (CAS # 8002-53-7), Carnauba Wax (CAS # 8015-86-9).

CANADA EPA DSL INVENTORY: Consult Turtle Wax, Inc. regarding status of ingredients.

EEC SIXTH AMENDMENT INVENTORY: Consult Turtle Wax, Inc. regarding status of ingredients.

The information contained here in has been compiled from sources believed to be reliable and is accurate to the best of our knowledge at this date. It is provided without warranty, expressed or implied, as to the results of use of this information or to the product to which it relates. Recipient assumes all responsibility for the use of this information and the use, storage, or disposal of the product, including any resultant personal injury or property damage.





## LIMITED WARRANTY

The Manufacturer warrants any component or part of the Coleman Hanna Car Wash Systems LLC equipment to be free from defects in material and workmanship for a period of one year from date of shipment, with the exception of such parts as are commonly recognized to be subject to wear in normal usage, such as high pressure hoses, swivels, nozzles, safety shut off guns, etc., which are warranted for ninety (90) days. All electrical parts not manufactured by Jim Coleman Company are warranted to be free from defects in material and workmanship for a period of 90 days. Electrical motors shall be covered under manufacturer's warranty for a period of one year, unless otherwise specified. Jim Coleman Company electronic controls, such as timers, coin acceptors and computer monitoring equipment, carry a one-year warranty. Claims under this warranty must be asserted in writing within the one-year period covered by this warranty.

Any component or part alleged to be defective in material or workmanship shall, at option of Manufacturer, be returned with shipping cost prepaid. If, upon examination, such component or part is found to be defective in workmanship or materials, Manufacturer, at its option, will either repair or replace such component or part, and shall ship such repaired or replaced component or parts F.O.B. factory, Houston, Texas. Manufacturer reserves the right to use "Like New" or Remanufactured parts in repair of warranty items that exceed 6 months in service. The cost of such replacement or repair shall be the exclusive remedy for any breach of any warranty and Manufacturer shall not be liable to any person for consequential damages for injury or commercial loss resulting from any breach of any warranty. This warrant does not cover any labor installation cost, either with respect to the original equipment, the repaired or replaced component, or part defective in workmanship or materials. Coleman Hanna Car Wash Systems LLC does not warrant loss of income should there be any during such time repairs are being made. Coleman Hanna Car Wash Systems LLC shall not be responsible for vehicle damage or repairs as may arise during normal wash cycle operation. Operator acknowledges accepted risks involved with friction in-bay automatic washes.

This warranty does not apply to components or parts which have been misused, altered, neglected, not installed, adjusted, maintained, or used in accordance with applicable codes and ordinances and in accordance with Manufacturer's recommendations as to such factors.

**THIS WARRANTY IS IN LIEU OF ALL WARRANTIES, EXPRESS OR IMPLIED, OF EITHER MANUFACTURER OR SELLER, AND MANUFACTURER MAKES NO WARRANTY AGAINST INFRINGEMENT OF THE LIKE, MAKES NO WARRANTY OF MERCHANTABILITY, MAKES NO WARRANTY OF FITNESS FOR A PARTICULAR PURPOSE, AND MAKES NO OTHER WARRANTY, EXPRESS OR IMPLIED, INCLUDING IMPLIED WARRANTY ARISING FROM COURSE OF DEALING OR USAGE OF TRADE.**

This warranty does not apply to damage resulting from improper operation or abuse, exceeding the rated capacities of the unit, running foreign particles or non related solutions through pumps or valves, using acidic solutions, improper installation or maintenance, operational neglect, neglect of manufacturers recommended maintenance, use of water containing solids in excess of twenty microns in diameter or 2000 PPM, damage caused by customer, unjustifiable nuisance calls, or acts of God.

Compliance with any local governmental laws or regulations relating to the location, use or operation of the equipment, or its use in conjunction with other equipment, shall be the responsibility of the purchaser. The rights and obligations of the parties shall be governed by the State of Texas.