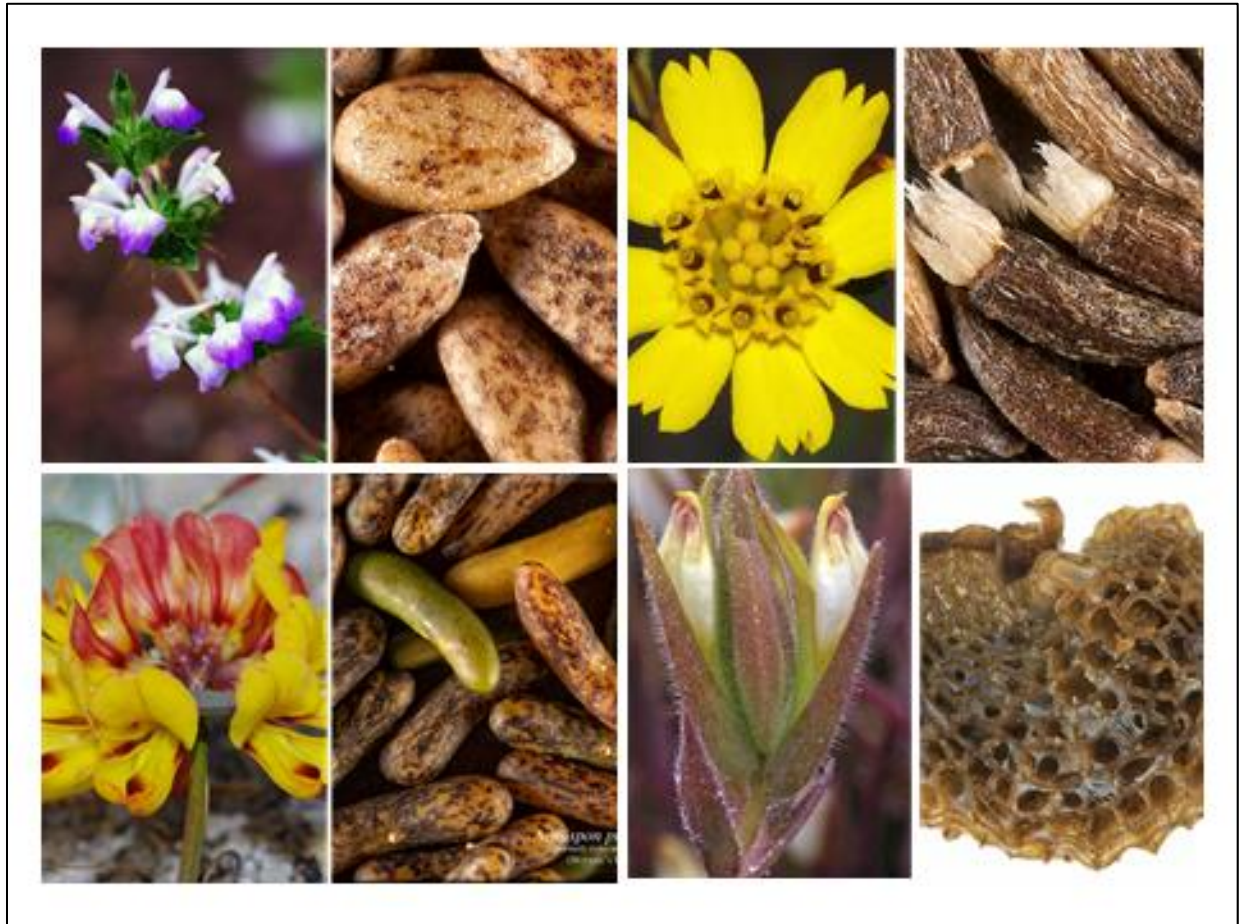


Management Strategic Plan  
Seed Collection, Banking, and Bulking Plan  
for  
Conserved Lands in Western San Diego County



Prepared for  
**San Diego Association of Governments**  
Prepared by  
**Conservation Biology Institute and AECOM**  
*in collaboration with*  
**San Diego Management and Monitoring Program**  
March 2020

## EXECUTIVE SUMMARY

The Conservation Biology Institute (CBI) and AECOM Technical Services, Inc. (AECOM) worked with the San Diego Management and Monitoring Program (SDMMP) and other regional partners to prepare a Management Strategic Plan (MSP) Seed Collection, Banking, and Bulking Plan (SCBBP) for MSP rare plants in the Management Strategic Planning Area in San Diego County, California. The Rare Plant Management Group Steering Committee guided development of the plan, while species Working Groups provided technical expertise (Appendix A). The plan was funded by the San Diego Association of Governments (SANDAG). The SCBBP is a living document that will be updated over time.

The SCBBP provides a strategic approach to managing seed resources for MSP rare plants on conserved lands in western San Diego County. This document does not replace existing NCCP obligations or requirements, and recommendations in the plan are advisory and meant to be implemented voluntarily if land owners and managers so desire. Recommendations are consistent with the intent of regional NCCP plans. The SCBBP fulfills an objective in the regional *Management and Monitoring Strategic Plan for Conserved Lands in Western San Diego County: A Strategic Habitat Conservation Roadmap* (MSP Roadmap), provides guidelines to implement selected management actions in the MSP Framework Rare Plant Management Plan (F-RPMP) related to seed resources, and is informed by regional and preserve-specific monitoring data and studies.

The SCBBP includes a general section and species-specific sections or chapters. In the general section, we discuss (1) the relationship of this plan to the MSP Roadmap and other regional plans, (2) the overall approach to seed management in the region, and (3) key factors for managing seed of rare plants, including regional monitoring, research, seed collection, banking, and bulking priorities and strategies, Best Management Practices, and potential sources of funding for seed-related management. Guidelines or recommendations in the general section are widely applicable to all MSP rare plants.

The species-specific section includes chapters for four MSP rare plants (*MSP target plants*):

- *Acanthomintha ilicifolia* (San Diego thornmint)
- *Acmispon prostratus* (Nuttall's acmispon)
- *Chloropyron maritimum* ssp. *maritimum* (Salt marsh bird's-beak)
- *Deinandra conjugens* (Otay tarplant)

The species chapters summarize relevant information specific to each MSP target plant, and identify species-specific strategies, management actions, and BMPs for seed collection, banking, and bulking. The SDMMP will prepare chapters for additional MSP priority plants in the future.

## ACKNOWLEDGEMENTS

The San Diego Rare Plant Management Group Steering Committee provided guidance on the structure and content of the Seed Collection, Banking, and Bulking Plan (SCBBP), while many biologists and land managers provided expertise through species-specific working groups, interviews, and rare plant data collection (per the San Diego Management and Monitoring Program's Inspect and Manage rare plant program). All of these efforts were critical to plan development. Refer to Appendix A for a list of all participants.

In addition, the following people reviewed and commented on the SCBBP, or provided key information on costing, seed collections, and/or Best Management Practices:

*Stacy Anderson (San Diego Zoo Global)*  
*Mansour Asghari (AB Seed Laboratory, LLC)*  
*Cheryl Birker (Rancho Santa Ana Botanic Garden)*  
*Megan Flaherty (San Diego Audubon Society)*  
*Donna Grubisic (MD Seed Analysis, Inc.)*  
*Tony Gurnoe (San Diego Botanic Garden)*  
*Jenna Hartsook (AECOM)*  
*Christa Horn (San Diego Zoo Global)*  
*Steve Knutson (Stover Seed Company)*  
*Scott McMillan (Dudek & Associates)*  
*Jody Miller (S&S Seeds, Inc.)*  
*Margie Mulligan (Mulligan Biological Consulting)*  
*Tom Oberbauer (AECOM)*  
*Shea O'Keefe (U.S. Department of Agriculture, Natural Resources Conservation Service)*  
*Michelle Ranieri (Hedgerow Farms, Inc.)*  
*Jon Rebman (San Diego Natural History Museum)*  
*Ransom Seed Laboratory*  
*Patrick Reynolds (Hedgerow Farms, Inc.)*  
*Kyle Rice (California Department of Fish and Wildlife)*  
*Heather Schneider (Santa Barbara Botanic Garden)*  
*Jonathan Snapp-Cook (U.S. Fish and Wildlife Service)*  
*Markus Spiegelberg (Center for Natural Lands Management)*  
*Ryan West (Native West Nursery)*

Dr. Kristine Preston of the San Diego Management and Monitoring Program (SDMMP) provided overall direction and resources to develop the SCBBP, and also reviewed and commented on the plan. Emily Perkins and Annabelle Bernabe of SDMMP prepared rare plant data and graphics. Finally, the San Diego Association of Governments (SANDAG) funded the SCBBP.

## PHOTO CREDITS

Photos by Conservation Biology Institute (CBI; Patricia Gordon-Reedy, Jessie Vinje) except as credited in document. Other contributors: Earth Discovery Institute (Mary Duffy, Cathy Chadwick, Colin Richard), Rancho Santa Ana Botanic Garden (RSA; John MacDonald), Recon Native Plant Nursery, San Diego Zoo Global (Stacy Anderson), Santa Barbara Botanic Garden (SBBG; Heather Schneider), Cal Photos (Ron Vanderhoff).

Cover Photos (clockwise from upper left): *Acanthomintha ilicifolia* (Patricia Gordon-Reedy, CBI), *A. ilicifolia* seed (John MacDonald, RSA), *Deinandra conjugens* (Patricia Gordon-Reedy, CBI), *D. conjugens* seed (John MacDonald, RSA), *Chloropyron maritimum* ssp. *maritimum* seed (Heather Schneider, SBBG), *C. maritimum* ssp. *maritimum* (Patricia Gordon-Reedy, CBI), *Acmispon prostratus* seed (John MacDonald, RSA), *A. prostratus* (Patricia Gordon-Reedy, CBI).

## TABLE OF CONTENTS

<u>Section</u>	<u>Page</u>
<b>1.0 Introduction</b>	<b>1</b>
1.1 Overview	7
1.2 Purpose and Need	8
1.3 Relationship to MSP Roadmap and Other Regional Plans	8
1.4 Relationship to Framework Rare Plant Management Plan	11
1.5 Relationship to Preserve Management	11
<b>2.0 Regional Seed Collection Programs</b>	<b>13</b>
<b>3.0 Seed Zones</b>	<b>19</b>
<b>4.0 General Framework for Seed Collection, Banking, and Bulking</b>	<b>22</b>
4.1 Seed Collecting	22
<i>Qualifications for Seed Collectors</i>	22
<i>Sampling Strategy</i>	25
<i>Methods and Materials</i>	28
<i>Documentation</i>	33
<i>Interim Seed Storage and Delivery</i>	37
4.2 Seed Banking	40
<i>Seed Cleaning</i>	40
<i>Seed Testing</i>	41
<i>Seed Storage</i>	46
<i>Seed Institutions</i>	49
<i>Seed Banking Costs</i>	49
4.3 Seed Bulking	52
<i>Seed Selection</i>	52
<i>Diversity of Bulked Samples</i>	53
<i>Limits on Seed Bulking</i>	54
<i>Documentation</i>	55
<i>Interim Seed Storage</i>	56
<i>Germination and Propagation Best Management Practices</i>	57

<u>Section</u>	<u>Page</u>
<i>Seed Bulking Facilities or Nurseries</i>	58
<i>Potential Funding Sources</i>	58
<b>5.0 Species-specific Seed Collection, Banking, and Bulking</b>	<b>64</b>
<b>5.1 San Diego Thornmint (<i>Acanthomintha ilicifolia</i>)</b>	<b>64</b>
<i>Seed Collection</i>	64
<i>Seed Characteristics</i>	64
<i>Priority Occurrences</i>	65
<i>Seed Zones</i>	70
<i>Collecting Plan</i>	70
<i>Seed Banking</i>	77
<i>Existing Conservation and Restoration Collections</i>	77
<i>Best Management Practices</i>	77
<i>Seed Bulking</i>	81
<i>Seed Selection</i>	81
<i>Best Management Practices</i>	81
<b>5.2 Nuttall’s Acmispon (<i>Acmispon prostratus</i>)</b>	<b>83</b>
<i>Seed Collection</i>	83
<i>Seed Characteristics</i>	83
<i>Priority Occurrences</i>	83
<i>Seed Zones</i>	86
<i>Collecting Plan</i>	89
<i>Seed Banking</i>	93
<i>Existing Conservation and Restoration Collections</i>	93
<i>Best Management Practices</i>	93
<i>Seed Bulking</i>	96
<i>Seed Selection</i>	96
<i>Best Management Practices</i>	96
<b>5.3 Salt Marsh Bird’s-beak (<i>Chloropyron maritimum</i> ssp. <i>maritimum</i>)</b>	<b>98</b>
<i>Seed Collection</i>	98
<i>Seed Characteristics</i>	98
<i>Priority Occurrences</i>	99
<i>Seed Zones</i>	102
<i>Collecting Plan</i>	102

<u>Section</u>	<u>Page</u>
<i>Seed Banking</i>	108
<i>Existing Conservation and Restoration Collections</i>	108
<i>Best Management Practices</i>	110
<i>Seed Bulking</i>	111
<i>Seed Selection</i>	111
<i>Best Management Practices</i>	111
<b>5.4 Oat Tarplant (<i>Deinandra conjugens</i>)</b>	<b>113</b>
<i>Seed Collection</i>	113
<i>Seed Characteristics</i>	113
<i>Priority Occurrences</i>	114
<i>Seed Zones</i>	117
<i>Collecting Plan</i>	117
<i>Seed Banking</i>	124
<i>Existing Conservation and Restoration Collections</i>	124
<i>Best Management Practices</i>	124
<i>Seed Bulking</i>	127
<i>Seed Selection</i>	127
<i>Best Management Practices</i>	127
<b>6.0 References</b>	<b>129</b>

<u>Table</u>	<u>Page</u>
1 MSP Rare Plant Species	5
2 Management Focus Groups and Categories	7
3 Regional Plans or Documents Related to MSP Rare Plant Management in the MSPA	9
4 California Plant Rescue Initiative: Participating Institutions and Organizations	14
5 MSP Plant Species: Existing Seed Collections	16
6 Web-based Applications to Match Seed Source to Planting Site	21
7 Detailed Sources for Seed Collection, Banking, and Bulking	23
8 Purpose of Seed Collections	26
9 Seed Collection Type	26
10 Recommended Equipment for Seed Collection	29

<u>Table</u>	<u>Page</u>
11 Facilities with Experience Collecting MSP Rare Plants	31
12 Common Methods for Collecting Seed	34
13 Documentation for Seed Collection	35
14 Seed Cleaning Methods	41
15 Pre-treatment Methods to Break Seed Dormancy	43
16 Seed Banks or Botanic Gardens	49
17 Cost Estimates for Seed-related Activities	50
18 Facilities with Experience Growing MSP Rare Plants	59
19 Potential Funding Sources	61
20 San Diego Thornmint: Management Priorities for Seed-related Activities	66
21 San Diego Thornmint: Seed Zones	72
22 San Diego Thornmint: Existing Seed Collections	78
23 San Diego Thornmint: Documentation for Bulked Seed Samples	82
24 Nuttall’s Acmispon: Management Priorities for Seed-related Activities	84
25 Nuttall’s Acmispon: Seed Zones	88
26 Nuttall’s Acmispon: Existing Seed Collections	94
27 Nuttall’s Acmispon: Documentation for Bulked Seed Samples	97
28 Salt Marsh Bird’s-beak: Management Priorities for Seed-related Activities	100
29 Salt Marsh Bird’s-beak: Seed Zones	104
30 Salt Marsh Bird’s-beak: Existing Seed Collections	109
31 Salt Marsh Bird’s-beak: Documentation for Bulked Seed Samples	112
32 Otay Tarplant: Management Priorities for Seed-related Activities	115
33 Otay Tarplant: Seed Zones	119
34 Otay Tarplant: Existing Seed Collections	125
35 Otay Tarplant: Documentation for Bulked Seed Samples	128

<u>Figure</u>	<u>Page</u>
1 MSP Roadmap Area (MSPA) in Western San Diego County	2
2 Management Units (MUs) within the MSPA	3
3 MSP Rare Plants Detected since 2000 within the MSPA	4



<u>Figure</u>	<u>Page</u>
4 Seed Zone Maps	20
5 Seed Collection: Biologists and Volunteers	34
6 Seed Collection: Photo Documentation	36
7 Seed Cleaning: Volunteer Event	39
8 Tetrazolium (TZ) Test for Seed Viability: Staining Gradient	45
9 Maternal Line Seed Packages	48
10 San Diego Thornmint: Seed	64
11 San Diego Thornmint: Seed Zones	71
12 Nuttall's Acmispon: Seed	83
13 Nuttall's Acmispon: Seed Zones	87
14 Salt Marsh Bird's-beak: Seed	98
15 Salt Marsh Bird's-beak: Dried Plants	99
16 Salt Marsh Bird's-beak: Seed Zones	103
17 Salt Marsh Bird's-beak: Seed Detail	107
18 Otay Tarplant: Seed	113
19 Otay Tarplant: Seed Zone	118
20 Otay Tarplant: Dried Inflorescence	123

<u>Appendices</u>	<u>Page</u>
A Rare Plant Management Group: Meeting Participants	A-1
B Collecting Voucher Specimens	B-1
C Seed Collection Forms	C-1

## ABBREVIATIONS

<i>BLM</i>	Bureau of Land Management
<i>BMP</i>	Best Management Practice
<i>CaPR</i>	California Plant Rescue
<i>CBG</i>	Chicago Botanic Garden
<i>CBI</i>	Conservation Biology Institute
<i>CDFW</i>	California Department of Fish and Wildlife
<i>CMSP</i>	Connectivity Monitoring Specific Plan
<i>CNDDDB</i>	California Natural Diversity Database
<i>CNLM</i>	Center for Natural Lands Management
<i>CPC</i>	Center for Plant Conservation
<i>EMP</i>	Environmental Mitigation Program
<i>GPS</i>	Global Positioning System
<i>IMG</i>	Inspect and Manage
<i>IPSP</i>	Invasive Plant Strategic Plan
<i>MOM</i>	Master Occurrence Matrix
<i>MSBP</i>	The Millennium Seed Bank Partnership
<i>MSCP</i>	San Diego Multiple Species Conservation Plan
<i>MSP</i>	Management Strategic Plan for Conserved Lands in Western San Diego County
<i>MSP F-RPMP</i>	MSP Framework-Rare Plant Management Plan for Conserved Lands in Western San Diego County
<i>MSP priority plant</i>	MSP rare plant in the Species Management Focus Group
<i>MSP rare plant</i>	Rare plant addressed in MSP Roadmap
<i>MSP Roadmap</i>	Management and Monitoring Strategic Plan for Conserved Lands in Western San Diego County: <i>A Strategic Habitat Conservation Roadmap</i>
<i>MSP SCBBP</i>	MSP Rare Plant Seed Collection, Banking, and Bulking Plan for Conserved Lands in Western San Diego County
<i>MSP target plant</i>	MSP rare and priority plant addressed in species chapters in the SCBBP
<i>MSPA</i>	MSP Roadmap Area
<i>MU</i>	Management Unit
<i>NCCP</i>	Natural Community Conservation Plan
<i>NLGRP</i>	National Laboratory for Genetic Resources Preservation
<i>NW</i>	Native West Nursery (formerly Recon Native Plant Nursery)
<i>RBG Kew</i>	Royal Botanic Garden Kew
<i>RSA</i>	Rancho Santa Ana Botanic Garden
<i>SANDAG</i>	San Diego Association of Governments
<i>SBBG</i>	Santa Barbara Botanic Garden
<i>SDBG</i>	San Diego Botanic Garden
<i>SDMMP</i>	San Diego Management and Monitoring Program
<i>SDZG</i>	San Diego Zoo Global
<i>TNC</i>	The Nature Conservancy
<i>TZ</i>	Tetrazolium Test
<i>USDA</i>	U.S. Department of Agriculture
<i>USFWS</i>	U.S. Fish and Wildlife Service
<i>USGS</i>	U.S. Geological Survey

## 1.0 INTRODUCTION

The Conservation Biology Institute (CBI) and AECOM Technical Services, Inc. (AECOM), in coordination with the San Diego Management and Monitoring Program (SDMMP) and other regional partners, developed a Management Strategic Plan (MSP) Rare Plant Seed Collection, Banking, and Bulking Plan (SCBBP) for conserved lands in western San Diego County. This plan was funded by the San Diego Association of Governments (SANDAG), and is a living document that will be updated over time.

The SCBBP fulfills an objective in the regional *Management and Monitoring Strategic Plan for Conserved Lands in Western San Diego County: A Strategic Habitat Conservation Roadmap* (MSP Roadmap, SDMMP and The Nature Conservancy [TNC] 2017) and an achievement milestone in the *TransNet* Environmental Mitigation Program (EMP) Regional Management and Monitoring FY 2019-2020 Work Plan (Strategic Goal 1.1).

The MSP Roadmap applies to conserved lands (excluding military lands) within the MSP Roadmap Area (MSPA; Figure 1). The MSPA is divided into 11 Management Units (MUs) to facilitate coordinated management (Figure 2). The SDMMP delineated MUs by geography, vegetation, and threats and stressors, and MU size varies significantly, with smaller MUs found near the coast and larger MUs found inland (SDMMP and TNC 2017).

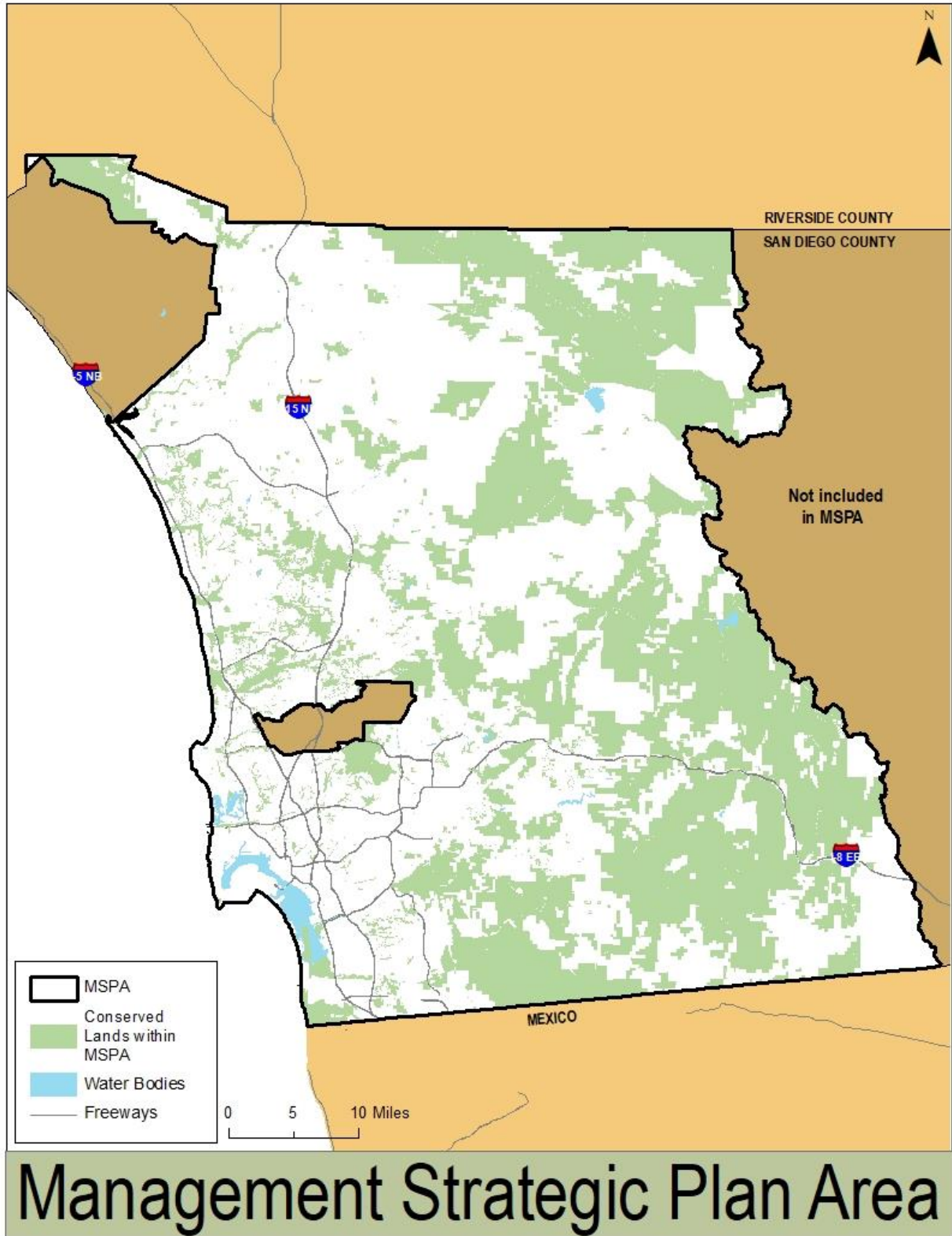
The MSP Roadmap addresses 57 rare plant species (*MSP rare plants*) within the MSPA (Figure 3). All of these species are covered under one or more Natural Community Conservation Plans (NCCPs). The SDMMP placed the 57 MSP rare plants into two management groups depending on the potential level of management needed for their long-term persistence: the Species Management Focus Group (32 species) and the Vegetation Management Focus Group (25 species). Species in the former category will likely require specific management measures, while species in the latter category are expected to persist by managing the vegetation community (SDMMP and TNC 2017).

The 32 MSP rare plants in the Species Management Focus Group are priorities for monitoring and management (*MSP priority plants*). These species are further categorized by potential risk of loss of either the species or significant occurrences<sup>1</sup> from the MSPA.

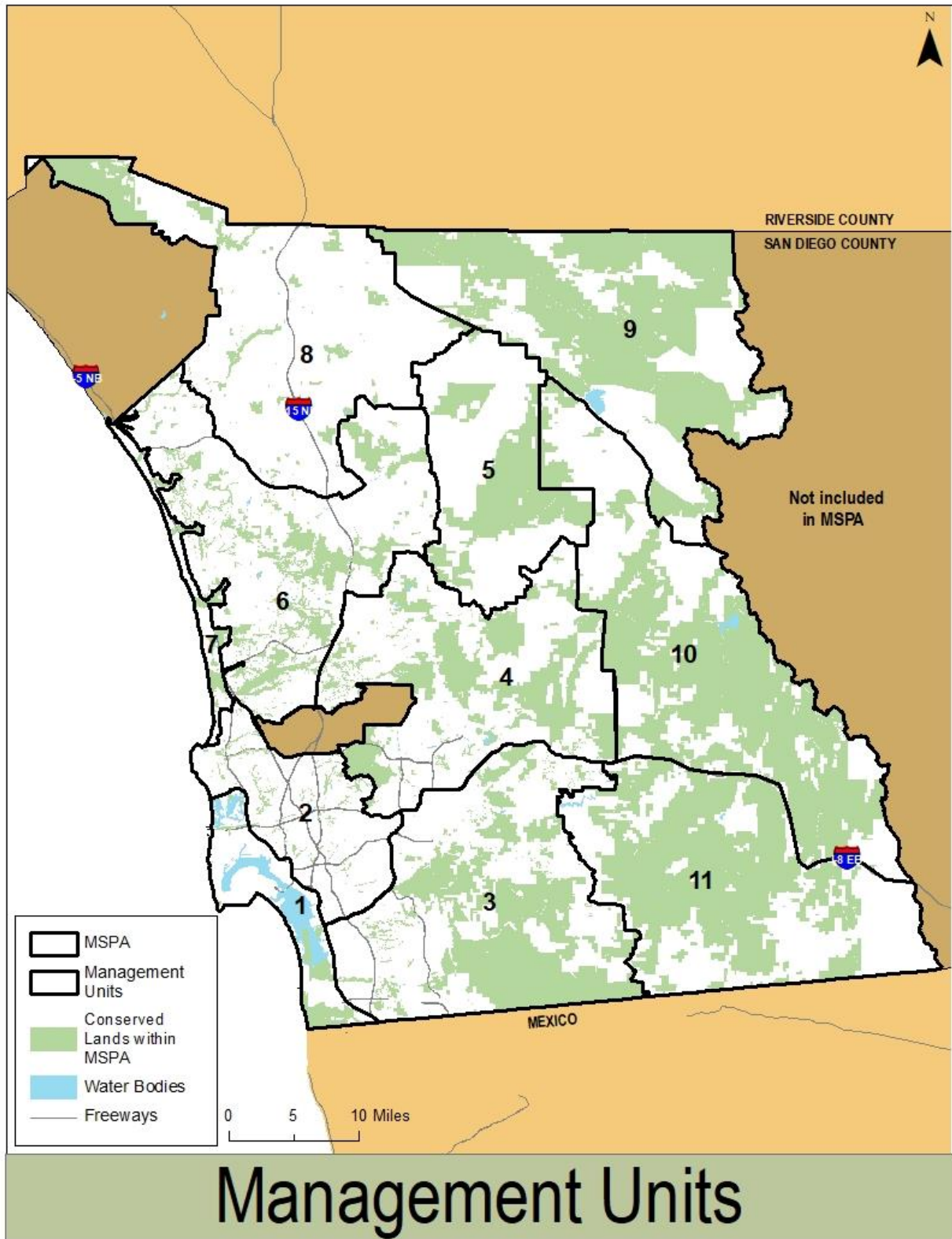
In this document, we develop species-specific seed collection, banking, and bulking guidelines for four MSP priority plants (*MSP target plants*). Refer to Table 1 for a list of all 57 MSP rare plants. Table 1 also indicates which of these species are MSP priority and/or MSP target plants. Table 2 defines management categories for Species and Vegetation Management Focus Groups.

---

<sup>1</sup> A rare plant occurrence is similar to a ‘population’ without regard to whether individuals interbreed. The SDMMP follows California Natural Diversity Database (CNDDDB) guidelines on defining unique occurrences based on distance (SDMMP 2019).

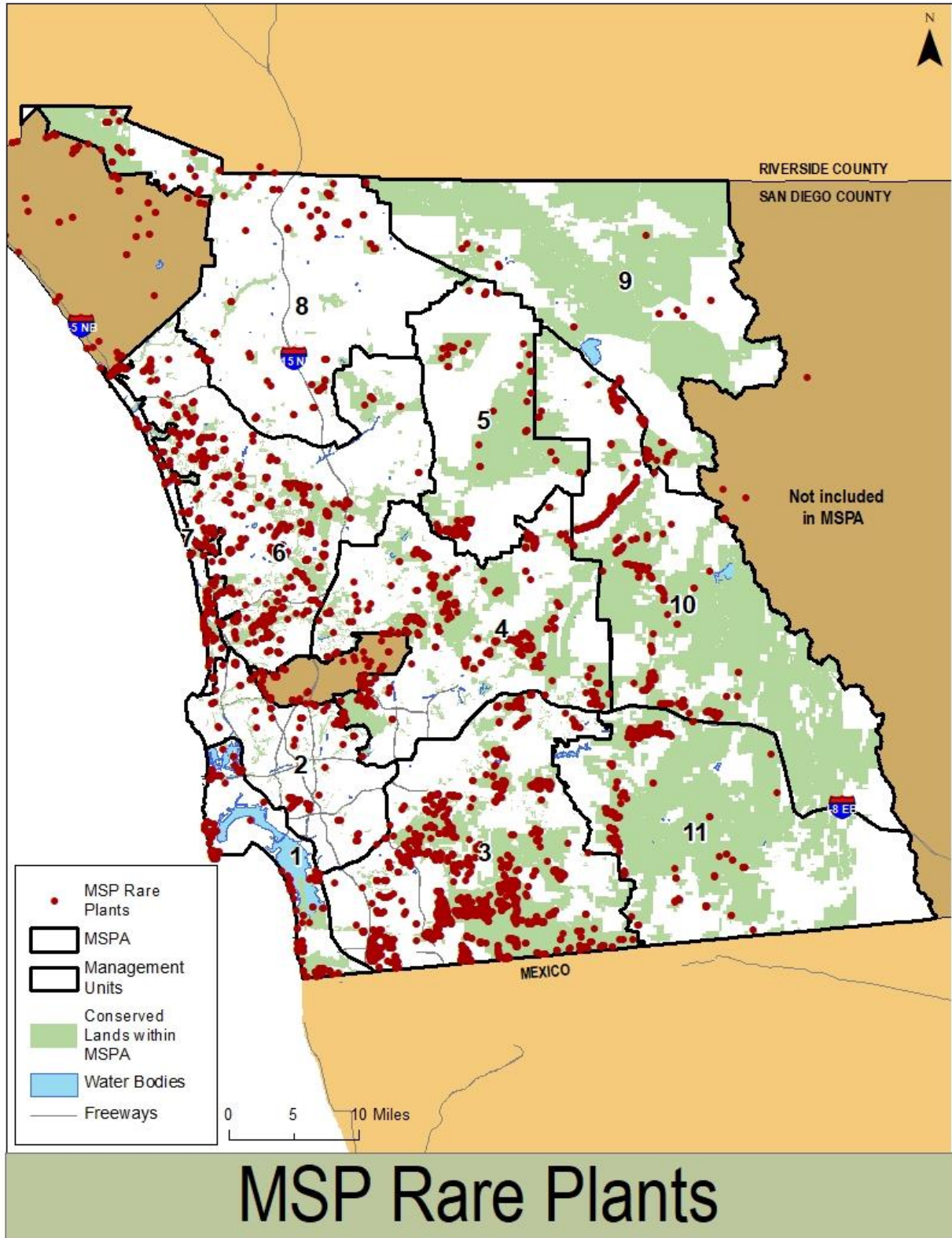


**Figure 1.** MSP Roadmap Area (MSPA) in Western San Diego County.



**Figure 2.** Management Units (MUs) within the MSPA.





**Figure 3.** MSP Rare Plants Detected since 2000 within the MSPA.

**Table 1.** MSP Rare Plant Species.<sup>1</sup>

Scientific Name <sup>2</sup>	Common Name	Management Category <sup>3</sup>	MSP Rare Plants <sup>4</sup>	MSP Priority Plants <sup>5</sup>	MSP Target Plants <sup>6</sup>
<i>Acanthomintha ilicifolia</i>	San Diego thornmint	SO	✓	✓	✓
<i>Acmispon prostratus</i>	Nuttall's acmispon	SO	✓	✓	✓
<i>Adolphia californica</i>	California adolphia	VG	✓		
<i>Agave shawii</i> var. <i>shawii</i>	Shaw's agave	SL	✓	✓	
<i>Ambrosia pumila</i>	San Diego ambrosia	SO	✓	✓	
<i>Aphanisma blitoides</i>	Aphanisma	SL	✓	✓	
<i>Arctostaphylos glandulosa</i> ssp. <i>crassifolia</i>	Del Mar manzanita	VF	✓		
<i>Arctostaphylos otayensis</i>	Otay manzanita	VF	✓		
<i>Arctostaphylos rainbowensis</i>	Rainbow manzanita	VF	✓		
<i>Atriplex coulteri</i>	Coulter's saltbush	VF	✓		
<i>Atriplex parishii</i>	Parish brittle scale	VF	✓		
<i>Baccharis vanessae</i>	Encinitas baccharis	SO	✓	✓	
<i>Bloomeria clevelandii</i>	San Diego goldenstar	SS	✓	✓	
<i>Brodiaea filifolia</i>	Thread-leaved brodiaea	SS	✓	✓	
<i>Brodiaea orcuttii</i>	Orcutt's brodiaea	SO	✓	✓	
<i>Brodiaea santarosae</i>	Santa Rosa brodiaea	SS	✓	✓	
<i>Calochortus dunnii</i>	Dunn's mariposa lily	VG	✓		
<i>Ceanothus cyaneus</i>	Lakeside ceanothus	VF	✓		
<i>Cenaothus verrucosus</i>	Wart-stemmed ceanothus	VF	✓		
<i>Centromadia parryi</i> ssp. <i>australis</i>	Southern tarplant	VF	✓		
<i>Chloropyron maritimum</i> ssp. <i>maritimum</i>	Salt marsh bird's-beak	SL	✓	✓	✓
<i>Chorizanthe orcuttiana</i>	Orcutt's spineflower	SL	✓	✓	
<i>Clinopodium chandleri</i>	San Miguel savory	SL	✓	✓	
<i>Comarostaphylis diversifolia</i> ssp. <i>diversifolia</i>	Summer-holly	VG	✓		
<i>Cylindropuntia californica</i> var. <i>californica</i>	Snake cholla	VF	✓		
<i>Deinandra conjugens</i>	Otay tarplant	SS	✓	✓	✓
<i>Dicranostegia orcuttiana</i>	Orcutt's bird's-beak	SL	✓	✓	
<i>Dudleya blochmaniae</i>	Blochman's dudleya	SL	✓	✓	
<i>Dudleya brevifolia</i>	Short-leaved dudleya	SL	✓	✓	
<i>Dudleya variegata</i>	Variegated dudleya	SS	✓	✓	
<i>Dudleya viscida</i>	Sticky dudleya	SS	✓	✓	
<i>Ericameria palmeri</i> ssp. <i>palmeri</i>	Palmer's goldenbush	VF	✓		

**Table 1.** MSP Rare Plant Species.<sup>1</sup>

Scientific Name <sup>2</sup>	Common Name	Management Category <sup>3</sup>	MSP Rare Plants <sup>4</sup>	MSP Priority Plants <sup>5</sup>	MSP Target Plants <sup>6</sup>
<i>Eryngium aristulatum</i> var. <i>parishii</i>	San Diego button-celery	VF	✓		
<i>Erysimum ammophilum</i>	Coast wallflower	SL	✓	✓	
<i>Euphorbia misera</i>	Cliff spurge	VF	✓		
<i>Ferocactus viridescens</i>	San Diego barrel cactus	VF	✓		
<i>Fremontodendron mexicanum</i>	Mexican flannelbush	SL	✓	✓	
<i>Hazardia orcuttii</i>	Orcutt's hazardia	SL	✓	✓	
<i>Hesperocyparis forbesii</i>	Tecate cypress	VF	✓		
<i>Iva hayesiana</i>	San Diego marsh-elder	VG	✓		
<i>Lepechinia cardiophylla</i>	Heart-leaved pitcher sage	SL	✓	✓	
<i>Lepechinia ganderi</i>	Gander's pitcher sage	VG	✓		
<i>Monardella hypoleuca</i> ssp. <i>lanata</i>	Felt-leaved monardella	VF	✓		
<i>Monardella stoneana</i>	Jennifer's monardella	SL	✓	✓	
<i>Monardella viminea</i>	Willow monardella	SL	✓	✓	
<i>Navarretia fossalis</i>	Spreading navarretia	VF	✓		
<i>Nolina cismontana</i>	Chaparral nolina	SL	✓	✓	
<i>Nolina interrata</i>	Dehesa nolina	SO	✓	✓	
<i>Orcuttia californica</i> *	California Orcutt grass	SL	✓	✓	
<i>Packera ganderi</i>	Gander's ragwort	SO	✓	✓	
<i>Pinus torreyana</i> ssp. <i>torreyana</i>	Torrey pine	VF	✓		
<i>Pogogyne abramsii</i>	San Diego mesa mint	VF	✓		
<i>Pogogyne nudiuscula</i> *	Otay mesa mint	SL	✓	✓	
<i>Quercus dumosa</i>	Nuttall's scrub oak	VF	✓		
<i>Quercus engelmannii</i>	Engelmann oak	VF	✓		
<i>Rosa minutifolia</i>	Small-leaved rose	SS	✓	✓	
<i>Tetracoccus dioicus</i>	Parry's tetracoccus	SS	✓	✓	

<sup>1</sup> MSP plant species as defined in the MSP Roadmap (SDMMP and TNC 2017).

<sup>2</sup> Plant species nomenclature generally follows Baldwin et al. 2012.

<sup>3</sup> Management Category: **SL** = at risk of loss from MSPA, **SO** = significant occurrences at risk of loss from MSPA, **SS** = stable and persistent, but require species-specific management; **VF** = limited distribution or require vegetation management, **VG** = may benefit from management for VF species. See Table 2 for full definitions.

<sup>4</sup> MSP rare plants = all plant species in the MSP Roadmap, which are covered under one or more NCCPs.

<sup>5</sup> MSP priority plants = all MSP rare plants in the Species Management Focus Group. MSP priority plants with an asterisk (\*) are monitored per the Vernal Pool Management and Monitoring Plan (City of San Diego 2017) rather than the Inspect and Manage (IMG) program. All MSP priority plants are also MSP rare plants.

<sup>6</sup> MSP target plants = species included in the species chapters of this document. MSP target plants are also MSP rare and priority plants.



**Table 2.** Management Focus Groups and Categories.

Management Category <sup>1</sup>	Definition
<i>Species Management Focus Group</i>	
SL	Species at high risk of loss from MSP Roadmap Area (MSPA) without immediate management action above and beyond daily maintenance activities.
SO	Species with significant occurrence(s) at high risk of loss from MSPA without immediate management action above and beyond daily maintenance activities.
SS	Species with occurrences stable and persistence at lower risk than SL and SO species, but still require species-specific management actions.
<i>Vegetation Management Focus Group</i>	
VF	Species with limited distribution in the MSPA or needing specific vegetation characteristics requiring management.
VG	Species is not managed specifically, but may benefit from vegetation management for VF species.

<sup>1</sup> Focus group/management category designations and definitions per the MSP Roadmap (SDMMP and TNC 2017).

## 1.1 OVERVIEW

The SCBBP includes a general section and species-specific sections or chapters that provide the framework to manage seed of MSP rare plants within the MSPA. In the general section, we discuss (1) the relationship of this plan to the MSP Roadmap and other regional plans, (2) the overall approach to seed management in the region, and (3) key factors for managing seed of rare plants, including:

- Regional monitoring to inform management
- Seed-oriented research
- Seed collection, banking, and bulking priorities and strategies
- Best management practices (BMPs)
- Potential funding sources

Information in the general section is broadly applicable to all MSP rare plants, with a focus on MSP priority plants. Information in the species chapters is specific to four MSP target plants:

- *Acanthomintha ilicifolia* (San Diego thornmint)
- *Acmispon prostratus* (Nuttall's acmispon)
- *Chloropyron maritimum* ssp. *maritimum* (Salt marsh bird's-beak)
- *Deinandra conjugens* (Otay tarplant)

The species chapters summarize relevant information specific to each MSP target plant, and identify species-specific strategies, management actions, and BMPs for seed collection, banking, and bulking. The SDMMMP will prepare chapters for additional MSP priority plants in the future.

Guidelines in the SCBBP incorporate recommendations from the western San Diego County Regional Rare Plant Management Group Steering Committee (Rare Plant Management Group Steering Committee) and species-specific Working Groups, and from established seed collection programs, monitoring, management, restoration, and research and experimental studies, among others. Refer to Appendix A for a list of Rare Plant Management Group Steering Committee and Working Group participants and the reference section for sources used to develop the SCBBP.

## 1.2 PURPOSE AND NEED

The SCBBP provides a strategic approach to managing seed resources for MSP rare plants that (1) identifies and prioritizes rare plant species and occurrences requiring seed conservation and/or restoration, (2) directs seed management actions and funding where they are most needed or will be most effective, and (3) provides land managers with information to manage seed resources for their occurrences effectively.

Developing the SCBBP is possible because of the efforts of many individuals and institutions over the years, including land managers, biologists, botanists, researchers, ecologists, government and non-governmental entities, seed banks or seed storage facilities, commercial nurseries or growers, private organizations, and others that contribute or provide:

- Rare plant monitoring data
- Research or experimental studies and data
- BMPs for seed collection, banking, and bulking
- Support for seed-related activities (e.g., regional seed banking)
- Supplemental funding for seed management activities

## 1.3 RELATIONSHIP TO MSP ROADMAP AND OTHER REGIONAL PLANS

There are a number of regional strategic plans or documents for western San Diego County that relate directly or indirectly to MSP rare plants. The MSP Roadmap (SDMMMP and TNC 2017) is the overarching document that guides monitoring and management in the region and incorporates elements of many earlier plans. We summarize plans most relevant to this document below; refer to Table 3 for sources and links to these and other regional documents related to rare plant management.

**Table 3.** Regional Plans or Documents Related to MSP Rare Plant Management in the MSPA.<sup>1</sup>

Regional Plan	Source <sup>2</sup>	Link(s) to Document or Relevant Sections
Management Strategic Plan for Conserved Lands in Western San Diego County (MSP)	SDMMP 2013	Volume 1: <a href="https://sdmmp.com/view_article.php?cid=CID_eperkins%40usgs.gov_588f7c6408184">https://sdmmp.com/view_article.php?cid=CID_eperkins%40usgs.gov_588f7c6408184</a> Volume 2: <a href="https://sdmmp.com/view_article.php?cid=CID_eperkins%40usgs.gov_588f7ce9c0f68">https://sdmmp.com/view_article.php?cid=CID_eperkins%40usgs.gov_588f7ce9c0f68</a> Volume 3: <a href="https://sdmmp.com/view_article.php?cid=CID_eperkins%40usgs.gov_588f7d49c7d8b">https://sdmmp.com/view_article.php?cid=CID_eperkins%40usgs.gov_588f7d49c7d8b</a>
Management and Monitoring Strategic Plan for Conserved Lands in Western San Diego County: <i>A Strategic Habitat Conservation Roadmap</i> (MSP Roadmap)	SDMMP and TNC 2017	Volume 2A: <a href="https://sdmmp.com/view_article.php?cid=CID_eperkins%40usgs.gov_590233783f742">https://sdmmp.com/view_article.php?cid=CID_eperkins%40usgs.gov_590233783f742</a> Volume 2B: <a href="https://sdmmp.com/view_article.php?cid=CID_eperkins%40usgs.gov_59024838d1636">https://sdmmp.com/view_article.php?cid=CID_eperkins%40usgs.gov_59024838d1636</a> Volume 2C: <a href="https://sdmmp.com/view_article.php?cid=CID_eperkins%40usgs.gov_590233f2e2c53">https://sdmmp.com/view_article.php?cid=CID_eperkins%40usgs.gov_590233f2e2c53</a>
Connectivity Monitoring Strategic Plan for the San Diego Preserve System (CMSP)	SDMMP 2011 SDMMP 2014	<a href="https://sdmmp.com/view_article.php?cid=CID_tedgarian%40usgs.gov_57acfb763b9ff">https://sdmmp.com/view_article.php?cid=CID_tedgarian%40usgs.gov_57acfb763b9ff</a> <a href="https://sdmmp.com/view_article.php?cid=CID_tedgarian%40usgs.gov_57acf913214cc">https://sdmmp.com/view_article.php?cid=CID_tedgarian%40usgs.gov_57acf913214cc</a>
Management Priorities for Invasive Non-native Plants: A Strategy for Regional Implementation, San Diego County, California (IPSP)	CBI et al. 2012	<a href="https://sdmmp.com/view_article.php?cid=CID_201604011922_38">https://sdmmp.com/view_article.php?cid=CID_201604011922_38</a>
Vernal Pool Management and Monitoring plan	City of San Diego 2017	<a href="https://www.sandiego.gov/sites/default/files/vp-mmp.pdf">https://www.sandiego.gov/sites/default/files/vp-mmp.pdf</a>
Framework Management Plan: Guidelines for Best Practices with Examples of Effective Monitoring and Management	Lewis and Deutschman 2014	<a href="https://sdmmp.com/view_article.php?cid=CID_201604011922_110">https://sdmmp.com/view_article.php?cid=CID_201604011922_110</a>
Adaptive Management Framework for the Endangered San Diego Thornmint ( <i>Acanthomintha ilicifolia</i> ), San Diego County, California	CBI 2014a	<a href="https://sdmmp.com/view_article.php?cid=CiteID_1603251358356080">https://sdmmp.com/view_article.php?cid=CiteID_1603251358356080</a>
Otay Tarplant Management Vision	CBI 2012	<a href="https://databasin.org/groups/92c7bce8d88d43b3a800dd686195007e/">https://databasin.org/groups/92c7bce8d88d43b3a800dd686195007e/</a> (see Supporting documents/South County grasslands/Project documents/OTP Goals and Objectives 10-29-12)

<sup>1</sup> Table includes only regional plans related to MSP priority plants, with a focus on the four target plants covered by this document.

<sup>2</sup> Source: CBI = Conservation Biology Institute, SDMMP = San Diego Management and Monitoring Program, TNC = The Nature Conservancy. Refer to reference section for full citations.

## *Management Strategic Plan for Conserved Lands in Western San Diego County (MSP)*

The MSP provides a comprehensive approach for managing multiple species within the region by establishing biological goals and measurable objectives to implement management actions (SDMMP 2013). The MSP categorizes and prioritizes species and vegetation communities, identifies geographic locations for management actions, provides specific timelines for implementation, and establishes a process for coordination and implementation. For MSP priority species, the document summarizes status, identifies management threats, develops management approaches, and outlines regional and MU goals and objectives.

The SCBBP updates general information in the MSP on seed biology and seed collection, banking, and bulking needs based on IMG monitoring data, research, or other studies.

## *Management and Monitoring Strategic Plan for Conserved Lands in Western San Diego County: A Strategic Habitat Conservation Roadmap (MSP Roadmap)*

The MSP Roadmap expands on the 2013 MSP by including monitoring, adaptive management, additional species, vegetation communities, and threats derived, in part, from other planning documents in the region (e.g., Connectivity Monitoring Strategic Plan [SDMMP 2011], Invasive Plant Strategic Plan [CBI et al. 2012]). The MSP Roadmap also includes a Wildfire Element that addresses plant fire risk and management actions, as well as databases and mapping tools (“MSP Portal”) that are available on the SDMMP interactive website: <https://sdmmp.com/portal.php>

Preparing the SCBBP is an objective in the MSP Roadmap (MGT-PRP-SBPL).<sup>2</sup> The SCBBP addresses specific action items under this objective, including:

- Consult the Rare Plant Working Group Steering Committee and species-specific Working Groups for input and recommendations.
- Prepare a SCBBP for MSP priority species with species-specific chapters that include guidelines and protocols for seed collection, testing, bulking, and storage.
- Prepare protocols and guidelines for collecting and submitting voucher specimens.
- Submit project metadata and the SCBBP to the MSP Web Portal.

---

<sup>2</sup> MGT-PRP-SBPL indicates that this is a Management (MGT) objective to prepare (PRP) a seed banking plan (SBPL).

## *San Diego Thornmint Adaptive Management Framework Plan*

This regional framework plan reviewed status and threats, developed conceptual models for management, identified potential environmental correlates and opportunity areas for restoration, developed detailed goals and objectives, and compiled or developed seed banking and other BMPs and monitoring metrics for San Diego thornmint in San Diego County (CBI 2014).

The SDMMMP incorporated key elements of this plan into the MSP Roadmap. The SCBBP will build on both the Adaptive Management Framework Plan and the MSP Roadmap by updating seed biology information, and refining BMPs for seed banking for San Diego thornmint.

## *Otay Tarplant Management Vision*

CBI, in partnership with TNC and with input from other biologists and land managers, prepared a framework for coordinated management of Otay tarplant in MU 3 of the MSPA (CBI 2012). The Otay Tarplant Management Vision identified key areas to manage or restore Otay tarplant occurrences and to improve connectivity for pollinators, and developed both landscape-level and preserve-specific goals and objectives for this species, including guidelines for seed banking (e.g., seed collection, testing, storage, bulking, and outplanting).

The SDMMMP incorporated elements of the Management Vision into both the MSP and MSP Roadmap. The SCBBP will build on both the Management Vision and the MSP Roadmap by updating seed biology information, and refining BMPs for seed banking for Otay tarplant.

### **1.4 RELATIONSHIP TO FRAMEWORK RARE PLANT MANAGEMENT PLAN**

The MSP Roadmap includes objectives to develop two closely related framework plans for rare plants: a MSP Framework Rare Plant Management Plan for Conserved Lands in Western San Diego County (F-RPMP) and the SCBBP. The F-RPMP identifies priorities, locations, and actions to manage rare plant occurrences, while the SCBBP provides guidelines to implement selected management actions related to seed resources. For example, where the F-RPMP calls for restoring occurrences of a target species, the SCBBP details seed collecting, banking, and bulking practices to maximize both genetic diversity and restoration success.

### **1.5 RELATIONSHIP TO PRESERVE MANAGEMENT**

The SCBBP provides guidelines for managing seed resources for MSP rare plants on conserved lands in western San Diego County. This document does not replace existing NCCP obligations or requirements. Further, recommendations in this plan are advisory and not required. Rather, they are to be implemented voluntarily if land owners and managers so desire. Plan recommendations are also meant to be consistent with the intent of regional NCCP plans. The SCBBP aligns directly with goals, objectives, and management actions in the MSP Roadmap,

and is informed by regional and preserve-specific monitoring data and studies, as detailed in the F-RPMP.

This document provides land managers with general and species-specific guidelines and BMPs to conserve and restore MSP rare plant occurrences using seed resources, and provides links and references to more detailed sources of information. In addition, rare plant occurrences prioritized in the F-RPMP for restoration (e.g., reintroduction using seed) may be eligible for funding assistance for seed-related management actions through SANDAG's *Transnet* EMP land management grants, depending on grant cycle priorities.

## 2.0 REGIONAL SEED COLLECTION PROGRAMS

Seed collection programs that include California native plants (including MSP rare plants) are housed within various institutions or seed banks within and beyond the state. These programs acquire and maintain living seeds for conservation and/or research purposes. In addition, seeds may be distributed for restoration or horticultural activities, depending upon seed availability and policies of the holding institution (California Plant Rescue [CaPR] 2019, Meyer et al. 2014).

In this section, we highlight key programs or institutions that collect, store, or bank seed, and/or conduct research for MSP rare plants *ex situ*. Some institutions also support living plant collections. We limit our discussion of seed banks to those that are widely available to land managers (directly or indirectly), but note that other groups operate seed banks for specific purposes or for their own use (e.g., California Department of Fish and Wildlife [Rancho Jamul Ecological Reserve], Center for Natural Lands Management [CNLM]).

### Conservation Terms

**Ex Situ** refers to the offsite conservation of genetic resources (e.g., plants, seeds), often in a botanic garden, seed bank, or seed storage facility.

**In Situ** refers to the onsite conservation of genetic resources (e.g., plants, seed) in the species' natural habitat.

### California Plant Rescue

The California Plant Rescue (CaPR) is not a seed banking facility per se, but a consortium of institutions that conserve native plants in California and the California floristic province through field work and long-term seed or living plant collections (CaPR 2019). The goal of the CaPR Initiative is to obtain representative samples of all populations of a species to conserve its genetic diversity. The program addresses all California native plant taxa; however, the current focus is on collecting and storing seeds of sensitive plant species. Toward this end, partner institutions work collaboratively to establish priorities, identify target species to collect, share data, and fundraise (CaPR 2019). Some of these institutions also research seed biology and propagation methods. Table 4 lists institutions or groups that participate in the CaPR Initiative.

The CaPR also has an online tool to search collections from partner institutions: <https://www.caplantrescue.org/caseedbanks.html#publicsearch>. We include relevant seed information from the CaPR database in this document.

### Rancho Santa Ana Botanic Garden

Rancho Santa Ana Botanic Garden (RSA) in Claremont, California maintains the largest seed bank for California native plants. RSA currently stores over 5,000 seed accessions representing more than 2,000 California native plant species and cultivars, with a focus on rare plant species

**Table 4.** California Plant Rescue Initiative: Participating Institutions and Organizations.<sup>1</sup>

Institution or Agency	Regional Seed Bank <sup>2</sup>	Website
CaPR Institutions		
California Native Plant Society		<a href="https://www.cnps.org/">https://www.cnps.org/</a>
Center for Plant Conservation		<a href="https://saveplants.org/">https://saveplants.org/</a>
Institute for Conservation Research, San Diego Zoo Global	✓	<a href="https://institute.sandiegozoo.org/plant-conservation">https://institute.sandiegozoo.org/plant-conservation</a>
Rancho Santa Ana Botanic Garden	✓	<a href="https://www.rsabg.org/">https://www.rsabg.org/</a>
Regional Parks Botanic Garden (Tilden Park)		<a href="https://nativeplants.org/">https://nativeplants.org/</a>
San Diego Botanic Garden		<a href="http://www.sdbgarden.org/">http://www.sdbgarden.org/</a>
Santa Barbara Botanic Garden	✓	<a href="https://www.sbbg.org/">https://www.sbbg.org/</a>
University of California Botanical Garden at Berkeley	✓	<a href="https://botanicalgarden.berkeley.edu/">https://botanicalgarden.berkeley.edu/</a>
University of California, Davis Arboretum and Public Garden		<a href="https://arboretum.ucdavis.edu/">https://arboretum.ucdavis.edu/</a>
University of California, Los Angeles, Mildred E. Mathias Botanical Garden		<a href="https://www.botgard.ucla.edu/">https://www.botgard.ucla.edu/</a>
University of California, Santa Cruz Arboretum and Botanic Garden	✓	<a href="https://arboretum.ucsc.edu/">https://arboretum.ucsc.edu/</a>
Supporting Partners		
California Department of Fish and Wildlife Natural Diversity Database		<a href="https://www.wildlife.ca.gov/Data/CNDDB">https://www.wildlife.ca.gov/Data/CNDDB</a>
Consortium of California Herbaria		<a href="http://ucjeps.berkeley.edu/consortium/">http://ucjeps.berkeley.edu/consortium/</a> <a href="http://www.cch2.org/portal/">http://www.cch2.org/portal/</a>
Jepson Herbarium		<a href="http://ucjeps.berkeley.edu/">http://ucjeps.berkeley.edu/</a>
National Laboratory for Genetic Resources Preservation (NLGRP)	✓ <sup>3</sup>	<a href="https://www.ars.usda.gov/plains-area/fort-collins-co/center-for-agricultural-resources-research/paagrpru/">https://www.ars.usda.gov/plains-area/fort-collins-co/center-for-agricultural-resources-research/paagrpru/</a>

<sup>1</sup> Information from CaPR 2019.

<sup>2</sup> Regional Seed Bank: indicates facility functions as a regional seed bank.

<sup>3</sup> The NLGRP serves as backup seed storage facility for regional seed collections.

from southern California (RSA 2019). RSA has long been involved with preserving seeds, and processes and stores seed for both long-term conservation and shorter-term restoration efforts. Seeds are also used for research, and may be distributed to other seed bank institutions for backup storage and/or sharing.

The Seed Conservation Program at RSA has developed policies and guidelines for collecting and storing seed, and data forms to document seed collection in the field. The program maintains lists of seed accessions and germination data that are accessible on the RSA website (<https://www.rsabg.org/conservation/seed-conservation>). In addition, they have produced an extensive collection of seed images (<http://www.hazmac.biz/rsabghome.html>).



RSA currently stores seed of 37 MSP plant species (Table 5). Some of these accessions are from the 1980s and 1990s and represent occurrences that have been lost due to development.

### *San Diego Zoo Global Native Plant Seed Bank*

The Institute for Conservation Research, San Diego Zoo Global (SDZG) maintains a native plant seed bank at the Beckmann Center for Conservation Research at the San Diego Zoo Safari Park in Escondido, California. The native seed bank is dedicated to preserving the floristic diversity of San Diego County by collecting and storing seed of both common and sensitive plant species. The bank currently includes seed accessions for over 375 plant taxa. Accessions in long-term storage act as a hedge against catastrophic loss or extirpation, and provide seed for research and restoration. The seed bank started in the early 2000s in collaboration with the Millennium Seed Bank (Royal Botanic Gardens [RBG] Kew), and more recently joined the CaPR Initiative, which focuses on rare and endangered species.

The seed bank team collects seed of sensitive plants in San Diego County for *ex situ* conservation. They also develop or refine protocols for germination and propagation, and work with land managers and others on projects to restore or conserve sensitive plant species. The seed bank currently stores seed for 44 MSP plant species and maintains an additional MSP species as a living collection (Table 5). While SDZG contains many of the same MSP plants as RSA, their accessions are generally more recent in age (5 years old or less). The seed bank is also in the process of creating high quality images of seeds.

The SDZG was awarded a SANDAG *Transnet* Environmental Mitigation Program (EMP) land management grant in 2017 to establish genetically diverse, high quality seed collections for six MSP rare plant species: San Diego thornmint, salt marsh bird's-beak, Orcutt's bird's-beak, short-leaved dudleya, Mexican flannelbush, and willow monardella. Under this grant, the SDZG has also bulked seed of selected MSP plants for specific restoration projects in the region. For additional information on the SDZG's native seed bank, refer to <https://institute.sandiegozoo.org/resources/native-plant-seed-bank>.

### *Santa Barbara Botanic Garden*

The Santa Barbara Botanic Garden (SBBG) in Santa Barbara, California houses a conservation seed bank for California native species, with a focus on sensitive and disjunct species. The seed bank currently stores over 175,000 seeds representing 106 taxa. The collections may be available for authorized research or species restoration. Although the seed bank does not store any MSP rare plants that are endemic to San Diego County, it does include six more wide-ranging MSP plants (Table 5). For additional information on the SBBG seed bank, refer to <https://www.sbbg.org/explore-garden/pritzlaff-conservation-center/conservation-seed-bank>.

**Table 5.** MSP Plant Species: Existing Seed Collections.<sup>1</sup>

Scientific Name <sup>2</sup>	Common Name	RSA <sup>3</sup>	SBBG <sup>3</sup>	SDBG <sup>3</sup>	SDZG <sup>3</sup>
<i>Acanthomintha ilicifolia</i>	San Diego thornmint	✓			✓
<i>Acmispon prostratus</i>	Nuttall's acmispon	✓			✓
<i>Adolphia californica</i>	California adolphia	✓			✓
<i>Agave shawii</i> var. <i>shawii</i>	Shaw's agave	✓	✓	--- <sup>4</sup>	
<i>Ambrosia pumila</i>	San Diego ambrosia	--- <sup>4</sup>	--- <sup>4</sup>		✓
<i>Aphanisma blitoides</i>	Aphanisma		✓		
<i>Arctostaphylos glandulosa</i> ssp. <i>crassifolia</i>	Del Mar manzanita	--- <sup>4</sup>	--- <sup>4</sup>	✓	
<i>Arctostaphylos otayensis</i>	Otay manzanita	--- <sup>4</sup>	--- <sup>4</sup>		✓
<i>Arctostaphylos rainbowensis</i>	Rainbow manzanita	--- <sup>4</sup>			
<i>Atriplex coulteri</i>	Coulter's saltbush	✓			✓
<i>Atriplex parishii</i>	Parish's brittle scale	✓			✓
<i>Baccharis vanessae</i>	Encinitas baccharis	--- <sup>4</sup>		✓	✓
<i>Bloomeria clevelandii</i>	San Diego goldenstar				✓
<i>Brodiaea filifolia</i>	Thread-leaved brodiaea	✓			✓
<i>Brodiaea orcuttii</i>	Orcutt's brodiaea				✓
<i>Brodiaea santarosae</i>	Santa Rosa brodiaea	--- <sup>4</sup>			
<i>Calochortus dunnii</i>	Dunn's mariposa lily	✓			✓
<i>Ceanothus cyaneus</i>	Lakeside ceanothus	✓			✓
<i>Cenaothus verrucosus</i>	Wart-stemmed ceanothus	✓		✓	✓
<i>Centromadia parryi</i> ssp. <i>australis</i>	Southern tarplant	✓	✓		✓
<i>Chloropyron maritimum</i> ssp. <i>maritimum</i>	Salt marsh bird's-beak	✓	✓		✓
<i>Chorizanthe orcuttiana</i>	Orcutt's spineflower	✓			
<i>Clinopodium chandleri</i>	San Miguel savory				✓
<i>Comarostaphylis diversifolia</i> ssp. <i>diversifolia</i>	Summer-holly	✓			✓
<i>Cylindropuntia californica</i> var. <i>californica</i>	Snake cholla				--- <sup>4</sup>
<i>Deinandra conjugens</i>	Otay tarplant	✓			✓
<i>Dicranostegia orcuttiana</i>	Orcutt's bird's-beak				✓
<i>Dudleya blochmaniae</i>	Blochman's dudleya	✓			✓
<i>Dudleya brevifolia</i>	Short-leaved dudleya	✓			✓
<i>Dudleya variegata</i>	Variegated dudleya	✓			✓
<i>Dudleya viscida</i>	Sticky dudleya	--- <sup>4</sup>	--- <sup>4</sup>		✓
<i>Ericameria palmeri</i> ssp. <i>palmeri</i>	Palmer's goldenbush				✓

**Table 5.** MSP Plant Species: Existing Seed Collections.<sup>1</sup>

Scientific Name <sup>2</sup>	Common Name	RSA <sup>3</sup>	SBBG <sup>3</sup>	SDBG <sup>3</sup>	SDZG <sup>3</sup>
<i>Eryngium aristulatum</i> var. <i>parishii</i>	San Diego button-celery	✓			✓
<i>Erysimum ammophilum</i>	Coast wallflower		✓		✓
<i>Euphorbia misera</i>	Cliff spurge	✓		--- <sup>4</sup>	
<i>Ferocactus viridescens</i>	San Diego barrel cactus	✓		--- <sup>4</sup>	✓
<i>Fremontodendron mexicanum</i>	Mexican flannelbush	✓			✓
<i>Hazardia orcuttii</i>	Orcutt's hazardia	✓		✓	
<i>Hesperocyparis forbesii</i>	Tecate cypress	✓		--- <sup>4</sup>	✓
<i>Iva hayesiana</i>	San Diego marsh-elder	✓		--- <sup>4</sup>	
<i>Lepechinia cardiophylla</i>	Heart-leaved pitcher sage	✓			
<i>Lepechinia ganderi</i>	Gander's pitcher sage	✓			✓
<i>Monardella hypoleuca</i> ssp. <i>lanata</i>	Felt-leaved monardella				✓
<i>Monardella stoneana</i>	Jennifer's monardella				✓
<i>Monardella viminea</i>	Willow monardella	✓		--- <sup>4</sup>	✓
<i>Navarretia fossalis</i>	Spreading navarretia	✓			✓
<i>Nolina cismontana</i>	Chaparral nolina	✓	✓		
<i>Nolina interrata</i>	Dehesa nolina	✓			✓
<i>Orcuttia californica</i>	California Orcutt grass	✓			✓
<i>Packera ganderi</i>	Gander's ragwort				✓
<i>Pinus torreyana</i> ssp. <i>torreyana</i>	Torrey pine	✓		--- <sup>4</sup>	✓
<i>Pogogyne abramsii</i>	San Diego mesa mint	✓			✓
<i>Pogogyne nudiuscula</i>	Otay mesa mint	✓			✓
<i>Quercus dumosa</i>	Nuttall's scrub oak	--- <sup>4</sup>	--- <sup>4</sup>	--- <sup>4</sup>	✓
<i>Quercus engelmannii</i>	Engelmann oak	--- <sup>4</sup>	--- <sup>4</sup>	--- <sup>4</sup>	
<i>Rosa minutifolia</i>	Small-leaved rose	✓		--- <sup>4</sup>	✓
<i>Tetracoccus dioicus</i>	Parry's tetracoccus	✓			✓

<sup>1</sup> MSP plant species as defined in the MSP Roadmap (SDMMP and TNC 2017); information in table is obtained primarily from the California Plant Rescue (CaPR) conservation collection database and from seed bank staff (C. Birker [RSA], S. Anderson [SDZG], H. Schneider [SBBG]).

<sup>2</sup> Nomenclature generally follows Baldwin et al. 2012.

<sup>3</sup> Institutions housing seed collections or other plant material: **RSA** = Rancho Santa Ana Botanic Garden, **SBBG** = Santa Barbara Botanic Garden, **SDBG** = San Diego Botanic Garden, **SDZG** = San Diego Zoo Global.

<sup>4</sup> --- indicates the presence of a living collection (e.g., plants growing in the botanic garden) and is noted only where no seed collection has been identified at any of the three institutions. Where seed collections have been identified, a living collection may or may not occur at RSA, SBBG, or SDBG.

## *San Diego Botanic Garden*

The San Diego Botanic Garden (SDBG) in Encinitas, California has decades of experience working with sensitive species native to San Diego County. Currently, 12 MSP rare plants are represented at SDBG as seed, stock, or living collections. The SDBG is currently working with the California Department of Fish and Wildlife (CDFW) to propagate and establish Encinitas baccharis at the garden and in surrounding, natural areas. The SDBG also supports a population of Orcutt's hazardia that was planted in 1995 in cooperation with the CDFW and CNLM. The SDBG's new horticulture campus includes a seed bank dedicated to research and recovery projects. Collection materials and institutional expertise can be made available for conservation and research purposes.

## *National Laboratory for Genetic Resources Preservation*

The National Laboratory for Genetic Resources Preservation (NLGRP) is located on the campus of Colorado State University in Fort Collins, Colorado, and is run by the U.S. Department of Agriculture (USDA). This facility houses more than 500,000 accessions that represent 12,000 plant species in the plant collection; accessions are stored in a vault-like setting. Like the Svalbard Global Seed Vault in Norway, the NLGRP protects genetic material from loss due to natural or man-made disasters.

In addition to preserving genetic material, seeds at the NLGRP are also used for research and to some degree, for conservation and commercial purposes. The NLGRP offers seed testing services, conducts international seed exchange for research, and develops technology to improve seed storage. Although originally focused on forestry and crop species, the NLGRP now includes native plants. It stores seed of endangered species for future reintroduction efforts and provides backup storage capabilities for some of the seed banks that participate in the CaPR Initiative.

## *Other Institutions*

Although not likely to play a key role in seed conservation for the San Diego region, seed and/or living plant collections of a few MSP rare plants occur at the (1) Millennium Seed Bank at the RBG Kew, (2) University of California Botanical Garden at Berkeley, and (3) University of California, Santa Cruz.

### 3.0 SEED ZONES

A seed zone is defined as an area within which plant material can be moved from one location to another with minimal genetic risk to the population or species (Bower et al. 2014, Miller et al. 2011, McKay et al. 2005, Johnson et al. 2004, Rogers and Montalvo 2004, St. Clair and Johnson 2004, Hufford and Mazer 2003, Lesica & Allendorf 1999). As indicated in the F-RPMP, *seed for restoration purposes should be obtained from the target occurrence, if at all possible*. However, where seed is not available or the occurrence is small, declining, and/or genetically depauperate, then it may be necessary to source seed from another occurrence. Under these conditions, seed zones guide seed movement to minimize potential, adverse effects.

The concept of seed zones arises from forestry practice. More recently, seed zones have been used in restoration to ensure that outplanted material is adapted to current environmental conditions and ideally, contains enough genetic diversity to respond to changing conditions, as well. Introducing poorly adapted seed into a restoration site may affect the success of the effort and/or extant occurrences in proximity (McKay et al. 2005).

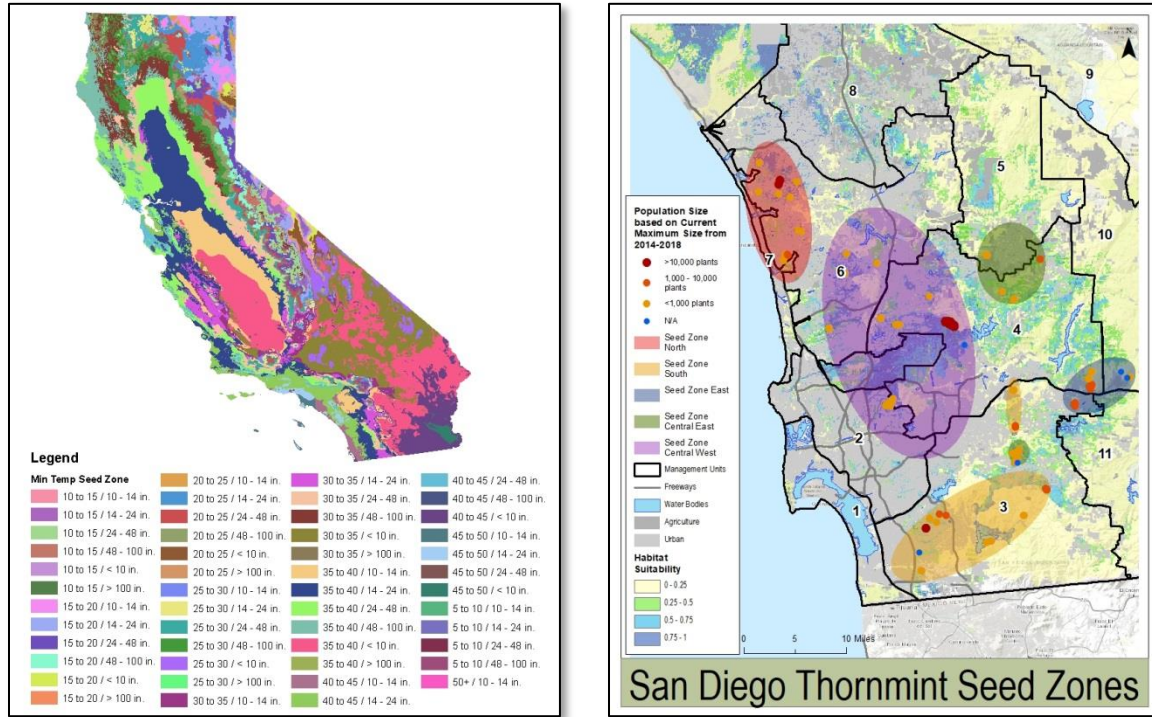
Seed zones are based traditionally on climate, topography, soils, and other broad factors (Bower et al. 2014, Johnson et al. 2010). Some practitioners use ecoregions to estimate seed zones for widespread species (Miller et al. 2011). Bower et al. (2014) combined climate and ecoregion to refine seed zones for selected grasses and forbs in the western U.S. (Bower et al. 2014). Common garden studies provide even more precise zones based on patterns of genetic variation (e.g., St. Clair et al. 2013, Wilson et al. 2008). However, the most precise seed zones are based on studies that examine genetic differentiation and diversity within a species.

Seed zones based on climatic or other broad factors are termed *provisional seed zones*, and they estimate suitable limits for moving seed in the absence of genetic data. Seed zones based on genetic data are referred to as *genetic seed zones*, and they provide more precise limits for moving seed. Seed zones are typically depicted on maps. Refer to Figure 4 for examples of both provisional and genetic seed zone maps.

In the species-specific chapters, we include provisional seed zone maps for species where genetic studies have not yet been conducted and genetic seed zone maps for species with genetic information. Although we show seed zone boundaries as discrete lines or polygons, species often occur along climatic, ecologic, or genetic gradients. Therefore, we provide the following guidelines to further direct seed movement within these zones (e.g., St. Clair and Johnson 2004):

- Move seed only within the designated seed zone (i.e., both the source occurrence and target occurrence should be in the same seed zone).
- Within a seed zone, source seed from large occurrences (if available) to maximize genetic diversity and minimize introducing poorly adapted seed. Where seed zones are large, use source occurrences near the target occurrence, if possible.

- For formerly widespread species that have been fragmented recently, source seed from multiple occurrences within the seed zone (composite seed provenancing) to maximize diversity (Miller et al. 2011).
- Within the target occurrence, outplant seed into microsites that match the source occurrence, to the degree feasible.



**Figure 4.** Seed Zone Maps: (left) Provisional Seed Zones for California Native Plants based on Temperature and Precipitation (<http://www.forestseedlingnetwork.com>), (right) Genetic Seed Zones for San Diego Thornmint in San Diego County.

Several spatial decision-support tools have been developed recently to help restoration practitioners’ select appropriate seed for restoration (Table 6). These tools are generally specific to certain regions and/or a select suite of species. Although none of these tools has been adapted for use in the MSPA or currently includes any MSP rare plants, we provide this information for reference purposes in case these (or similar) tools become available in the future.

**Table 6.** Web-based Applications to Match Seed Source to Planting Site.

Application	Website	Description
Threat and Resource Mapping (TRM) Seed Zone Map	<a href="https://usfs.maps.arcgis.com/apps/webappviewer/index.html?id=cf1136a05dd84ec2bb4f51068b0336aa">https://usfs.maps.arcgis.com/apps/webappviewer/index.html?id=cf1136a05dd84ec2bb4f51068b0336aa</a>	Interactive 2D map that allows users to view/download seed zone to develop sampling and restoration strategies.
Climate Distance Mapper	<a href="https://www.usgs.gov/media/images/climate-distance-mapper-0">https://www.usgs.gov/media/images/climate-distance-mapper-0</a>	Spatial decision support tool to match seed source with restoration site based on current and future climate scenarios. Currently available for four regions in the desert southwest.
Seed Lot Selection Tool	<a href="https://seedlotselectiontool.org/sst/">https://seedlotselectiontool.org/sst/</a>	Web-based mapping application to match seed lots with planting sites based on current or future climatic scenarios. Currently available for the western U.S, Canada, and Mexico; focuses on forest trees.



## 4.0 GENERAL FRAMEWORK FOR SEED COLLECTION, BANKING, AND BULKING

Detailed guidelines for seed collection, banking, and bulking are available through a number of sources, including the Center for Plant Conservation (CPC 2018), Millennium Seed Bank Partnership (MSBP 2015), Rancho Santa Ana Botanic Gardens (Wall 2009, Wall and McDonald 2009), and Royal Botanic Garden Kew (RBG Kew 2001), among others. In Section 4.0, we summarize information from these and other sources that is relevant to the SCBBP; refer to the original documents for more detailed information on the elements discussed below (Table 7).

### 4.1 SEED COLLECTING

#### *Qualifications for Seed Collectors*

We include minimum requirements for seed collectors to ensure that collections are high quality, documented adequately, and represent the range of ecological and phenological conditions within the target species or occurrence. Thus, seed collectors should be able to:

- Develop or follow a seed sampling strategy
- Access the seed collection site safely
- Identify the target species in different phenological stages (e.g., flowering, fruiting)
- Differentiate between ripe and unripe seed
- Differentiate the target species from closely-related or visually similar species
- Monitor occurrences throughout the season to determine the optimal time for seed collection
- Conduct simple field tests for seed viability
- Collect seed using a variety of methods
- Document the seed collection digitally or on paper, using standard seed collection forms
- Record Global Positioning System (GPS) coordinates
- Prepare voucher specimens to deposit at herbaria
- Photograph the occurrence, individual plants, and fruit/seed in the field
- Transport seed to a storage facility immediately or store on a short-term basis.

#### **Seed Collection Terms**

**Accession:** A genetically unique plant sample from a specific location that is stored in a seed bank. Each accession has a unique identifier or number.

**Bulk Collection:** Seeds from all plants are collected and stored together within the same accession.

**Conservation Collection:** A seed collection that captures genetic diversity by collecting and storing seed along maternal lines for at least 50 plants per occurrence.

**Maternal Line Collection:** Seeds from each plant are collected and stored separately within the same accession.

**Restoration Collection:** A seed collection designed to restore a species or occurrence by bulking and/or outplanting seed back into the wild. Seed for restoration may be collected along maternal lines or in bulk.

**Voucher Specimen:** A pressed and dried plant specimen that documents plant identity and occurrence at a specific location.



**Table 7.** Detailed Sources for Seed Collection, Banking, and Bulking.

Document	Seed Collection	Seed Banking	Seed Bulking	Document Link
Bureau of Land Management: Technical protocol for the collection, study and conservation of seeds from native plant species for Seeds of Success (BLM 2016)	✓	✓		<a href="https://www.blm.gov/sites/blm.gov/files/uploads/SOSS%20Protocol%206.20.18.pdf">https://www.blm.gov/sites/blm.gov/files/uploads/SOSS%20Protocol%206.20.18.pdf</a>
Center for Plant Conservation: Best plant conservation practices to support species survival in the wild (CPC 2019)	✓	✓	✓	<a href="https://saveplants.org/wp-content/uploads/2019/05/CPC-Best-Practices-5.22.2019.pdf">https://saveplants.org/wp-content/uploads/2019/05/CPC-Best-Practices-5.22.2019.pdf</a>
Rancho Santa Ana Botanic Garden: Seed collection guidelines for California native plant species (Wall 2009)	✓			<a href="https://uploads-ssl.webflow.com/59613419dcbd9b40dceb57a6/5acd728da1daf8feb5427a0c_Seed%20Collecting%20and%20Storage%20Guidelines.pdf">https://uploads-ssl.webflow.com/59613419dcbd9b40dceb57a6/5acd728da1daf8feb5427a0c_Seed%20Collecting%20and%20Storage%20Guidelines.pdf</a>
Rancho Santa Ana Botanic Garden: Seed storage guidelines for California native plant species (Wall 2009)		✓		<a href="https://uploads-ssl.webflow.com/59613419dcbd9b40dceb57a6/5acd728da1daf8feb5427a0c_Seed%20Collecting%20and%20Storage%20Guidelines.pdf">https://uploads-ssl.webflow.com/59613419dcbd9b40dceb57a6/5acd728da1daf8feb5427a0c_Seed%20Collecting%20and%20Storage%20Guidelines.pdf</a>
Rancho Santa Ana Botanic Garden: Processing seeds of California native plants for conservation, storage, and restoration (Wall and MacDonald 2009)	✓	✓		<a href="http://www.hazmac.biz/Seed%20Processing/2009S.pdf">http://www.hazmac.biz/Seed%20Processing/2009S.pdf</a>
Royal Botanic Garden Kew: A field manual for seed collectors (RBG Kew 2001)	✓			<a href="http://brahmsonline.kew.org/Content/Projects/msbp/resources/Training/English_kppcont_035653_A-field-manual-for-seed-collectors.pdf">http://brahmsonline.kew.org/Content/Projects/msbp/resources/Training/English_kppcont_035653_A-field-manual-for-seed-collectors.pdf</a>
Royal Botanic Garden Kew: Assessing a population for seed collection (Way and Gold 2014a)	✓			<a href="http://brahmsonline.kew.org/Content/Projects/msbp/resources/Training/02-Assessing-population.pdf">http://brahmsonline.kew.org/Content/Projects/msbp/resources/Training/02-Assessing-population.pdf</a>
Royal Botanic Garden Kew: Post-harvest handling of seed collections (Gold 2014)	✓	✓		<a href="http://brahmsonline.kew.org/Content/Projects/msbp/resources/Training/04-Post-harvest-handling.pdf">http://brahmsonline.kew.org/Content/Projects/msbp/resources/Training/04-Post-harvest-handling.pdf</a>

**Table 7.** Detailed Sources for Seed Collection, Banking, and Bulking.

Document	Seed Collection	Seed Banking	Seed Bulking	Document Link
Royal Botanic Garden Kew: Seed collecting techniques (Way and Gold 2014b)	✓			<a href="http://brahmsonline.kew.org/Content/Projects/msbp/resources/Training/03-Collecting-techniques.pdf">http://brahmsonline.kew.org/Content/Projects/msbp/resources/Training/03-Collecting-techniques.pdf</a> <a href="https://sdmmp.com/upload/SDMMP_Repository/0/tj63vwd7xshfgrq205kz9pb4yn18mc.pdf">https://sdmmp.com/upload/SDMMP_Repository/0/tj63vwd7xshfgrq205kz9pb4yn18mc.pdf</a>
Santa Barbara Botanic Garden: Seed propagation of Native California plants (Emery 1988)			✓	<a href="https://calscape.org/seed_propagation.php">https://calscape.org/seed_propagation.php</a>
The Millennium Seed Bank Partnership: Seed Conservation Standards for ‘MSB Partnership Collections’ (Millennium Seed Bank Partnership 2015)	✓	✓		<a href="http://brahmsonline.kew.org/Content/Projects/msbp/resources/Training/MSBP-Seed-Conservation-Standards.pdf">http://brahmsonline.kew.org/Content/Projects/msbp/resources/Training/MSBP-Seed-Conservation-Standards.pdf</a>
U.S. Forest Service: Nursery manual for native plants; a guide for tribal nurseries (Dumroese et al. 2009)			✓	<a href="https://www.fs.fed.us/rm/pubs_series/wo/wo_ah730.pdf">https://www.fs.fed.us/rm/pubs_series/wo/wo_ah730.pdf</a>

## *Sampling Strategy*

The objectives of seed collection are to maximize genetic diversity and provide high quality seed for conservation, research, or restoration purposes. A sampling strategy can help meet these objectives in a cost- and labor-efficient manner. In the context of this document, we focus primarily on seed collection for conservation and restoration.

The quality of a seed collection and thus, its value, depends on many elements, including location and size of the source population, target habitats, timing of seed collection, documentation, and interim storage. We recommend that land managers develop a sampling strategy to ensure that the final collection meets their needs, or that they work with professional seed collectors or a seed bank institution to develop a strategy.

All sampling strategies should address the elements discussed below.

- Collection Purpose
- Collection Type
- Seed Provenance
- Target Sample Size
- Materials and Methods
- Documentation
- Interim Storage
- Associated Costs

Strategies will vary in detail to accommodate differences in species biology, habitat(s), habit, occurrence size(s), and plant productivity. When developing a sampling strategy, it is advisable to include contingency funding or otherwise ensure that sampling may occur over multiple seasons, if needed (e.g., low population size, drought or other events).

### *Collection Purpose*

A first step in developing a sampling strategy is to identify the purpose of the seed collection. For rare plant species, seed is most often collected for conservation (long-term storage), research or developing germination and/or propagation protocols (medium-term storage), and/or restoration (short-term storage) (Table 8).

The purpose of the collection will inform all other elements of the sampling strategy. For example, conservation or restoration collections should be relatively large to capture genetic diversity and account for seed loss during storage, bulking, or outplanting. Conversely, smaller collections may be appropriate for research or protocol development, and may be sourced from existing seed bank collections (if available) (Wall 2009, RBG Kew 2001).

**Table 8.** Purpose of Seed Collections.<sup>1</sup>

Purpose	Description	Duration
Conservation	Stores seed to preserve genetic diversity as a hedge against extinction or extirpation. May provide source material for conservation-related research or restoration if adequate seed is available.	Long-term
Research	Provides seed for research on seed biology or to develop germination/propagation protocols.	Medium-term
Restoration	Provides seed for bulking and/or outplanting to restore species.	Short-term

<sup>1</sup> Sources: CPC 2019, Wall 2009.

### Collection Type

Collection type refers to whether the seed is collected in *bulk* or along *maternal lines*. A bulk collection packages and stores seed from all sampled plants as a single unit. A maternal line collection maintains seed from each parent plant separately. Bulk collections are less expensive to collect, process, and store; however, maternal line collections ensure that maximum genetic diversity will be reintroduced back into the field.

For MSP rare plants, experts recommend collecting along maternal lines for a conservation collection and either in bulk or along maternal lines for a restoration collection (Table 9). For restoration purposes, collecting along maternal lines is warranted where source occurrences are small ( $\leq 1,000$  individuals) and/or genetic diversity is low or presumed low. In contrast, bulk collections are appropriate where occurrences are large ( $> 1,000$  individuals) and genetic diversity is high or presumed high.

**Table 9.** Seed Collection Type.

Collection Purpose	Collection Type	Source Population Size	Genetic Diversity
Conservation	Maternal	---	---
Restoration	Maternal	$< 1,000$ plants	Low or unknown
Restoration	Maternal or Bulk	$> 1,000$ plants	High or unknown

### Seed Provenance

Seed provenance refers to the place of origin of the seed, or where the seed was collected. In developing a sampling strategy, identify (1) whether seed of a target species exists in a seed bank and (2) whether banked seed was collected at the target occurrence or within a suitable seed zone for the target species. If the provenance is suitable, assess the amount of seed available, age of the seed, and use restrictions on the collection to determine if the banked seed is adequate and available to meet specific objectives.

Based on this review, determine whether additional seed collection is warranted. Seed collection would be warranted under the following conditions:

- Collections of the target species do not exist in a seed bank.
- One or more collections exist, but they do not adequately represent genetic diversity across the species.
- A collection exists, but it is not duplicated in other seed banks.
- One or more collections exist, but they do not include adequate numbers of seed for long-term storage and testing.
- One or more collections exist, but they are more than 10 years old.
- Existing collections appear to be losing viability, based on seed testing.
- The provenance of the existing collection does not match the restoration site (i.e., the banked seed was not collected from within the same genetic cluster or seed zone as the target occurrence).
- A collection exists, but is from a translocated occurrence. While well-established translocations may serve as a seed source, these occurrences often have a small genetic pool, particularly if established from a limited number of founders.
- The banked seed is not available for restoration purposes.
- The banked seed is available for use, but there are not enough seeds available to meet seed bulking or restoration goals.

Note that availability of an existing seed collection is subject to many factors, including ownership or permit conditions, number of seeds, and research/recovery value of the requesting project. Contact seed bank managers directly to inquire about or request seed.

### *Target Sample Sizes*

Establish minimum targets for the number of seeds to collect, based on the purpose of the seed collection. For a conservation collection, collect from a minimum of 30-50 unrelated plants per occurrence, with a goal of 2,500-3,000 seeds, to adequately represent the genetic diversity and provide enough material for storage and testing (e.g., CPC 2019, Wall 2009, and others).<sup>3</sup> If collecting seed from listed plant species, follow the requirements in the applicable permit.

---

<sup>3</sup> Guidelines vary on the minimum number of plants necessary for a conservation seed collection. Wall (2009) indicates that 30 plants would capture 95% of the genetic diversity in a population. Meyer (pers. comm.) suggested that sampling 40-50 plants would capture about 90% of the alleles in a population, based on studies at Rancho Santa Ana Botanic Garden. CPC guidelines (1991) recommend sampling 10-50 individuals per population. Within these ranges, minimum sampling size should be dependent on population size and history, life history, and intended use. Refer to Hoban and Schlarbaum 2014 and Hoban and Strand 2015 for additional information on sampling design for seed collection.

For a restoration collection, the same general guidelines apply with the following caveats: (1) the long-term success of the restoration effort depends, in part, on the number of seeds outplanted, so a larger collection (subject to seed availability) or subsequent seed bulking may be warranted to increase the number of seeds available and (2) the collecting location(s) may be more narrowly defined than the entire species range, depending on genetics and other factors (e.g., topography, habitat, climate).

Each occurrence that functions as a seed source will constitute a separate sample or collection, and will be stored in a seed bank (if appropriate) as a unique accession. In some cases, the collection may include seeds from a fragmented occurrence that was formerly connected.

Within an occurrence, collect no more than 5-10 percent (%) of the seed from an individual plant or from the reproductive population per season. Collect and count seed from several individuals first to determine what constitutes 5-10% of an individual for the target species. For both maternal line and bulk collections, collect seed randomly and evenly throughout the occurrence to maximize genetic diversity. For example, collect seed from:

- Plants that are widely spaced (e.g., center of occurrence, edge of occurrence)
- Plants in different habitats
- Plants that are large and small
- Plants that produce many versus few seeds
- Plants that fruit early and late in the season

Collect seed over several days, if needed. For some occurrences, it may be necessary to collect at different times during a growing season, or over multiple seasons to get enough seed. This is especially true for MSP rare plant occurrences that are small (<1,000 individuals), particularly if plant germination, survival, and seed production is affected by climate or other factors (e.g., fire, herbivory). Seed collecting guidelines incorporate safeguards against excessive seed collection; nonetheless, seed collectors should weigh the benefits of collecting seed against potential negative impacts for each occurrence.

Where an occurrence is extremely small (<50 plants) and at risk of extirpation, it may be advisable to collect all seed to preserve the remaining genetic diversity and subsequently, develop a restoration program to maximize diversity (e.g., composite provenancing, seed bulking, and outplanting; CPC 2019). In this case, seed collectors should secure land owner/manager and agency approval as needed for the collection effort before collecting seed.

### *Methods and Materials*

Seed collecting methods are outlined below and discussed in more detail in species-specific chapters, as appropriate. Table 10 provides a list of materials used in the collection process.

**Table 10.** Recommended Equipment for Seed Collection.

Equipment	Description or Purpose
<b>Pre-seed Collection</b>	
Permits	Permission to collect voucher specimens and seed from regulatory agencies (if needed). Carry in the field.
Access letter	Permission to access the collecting location. Carry in the field.
Map or geographic coordinates of the target occurrence	Locate collecting site(s).
Flagging tape, pin flags, or other markers	Mark occurrence boundary or individual plants in flower to relocate easily when in fruit. In areas frequented by the public, use inconspicuous flagging or markers placed close to ground level to avoid drawing attention to rare plant occurrences.
Plant press, blotters, newspaper, notebook	Prepare and document voucher specimen(s).
Camera	Photograph occurrence/habitat and target species in flower.
<b>Seed Collection</b>	
Collecting strategy/instructions	Collect and store seed according to pre-determined strategy and standard collecting guidelines.
Map or geographic coordinates of the target occurrence	Locate collecting site(s).
GPS unit (preferably, sub-meter)	Accurately record location of occurrence and/or plants.
Camera	Photograph fruit and seed of target species.
Labels, markers, pencils	Record relevant information.
Seed collection forms	Record critical seed collection information.
Hand lens	Identify taxon or assess seed viability
Adhesive Tape	Secure small seeds when assessing viability
Safety razor or pocketknife	Cut seeds to assess viability
Container & water (optional)	Float test to assess seed for viability
Scissors, pruning shears, tweezers	Cut inflorescences or plant branches to collect seed, or collect seed from small plants.
Sieve	Recover fruits or seeds from sandy soil (use only for bulk collections).
Gloves	Protect hands while collecting seed.
Paper bags (dry fruit); various sizes	Collect dry seed. In general, use small paper bags or envelopes for maternal line collections and larger paper bags or envelopes for restoration collections.
Plastic bags or containers (fleshy fruit)	Collect fleshy fruit.
Breathable or mesh bags for bagging seed heads (optional)	Bag inflorescences of species with seed that dehisces continuously or explosively.
<b>Post-seed Collection</b>	
Storage container or cooler.	Keep collected seed from overheating.
Additional storage bags or containers.	Divide collected seed (if necessary) to promote air circulation and minimize seed degradation.
Pest strips (optional).	Place in collection bags temporarily if evidence of insects.



- Contact a seed bank or seed facility to obtain assistance/costs for seed collection (if desired), seed processing, seed testing, seed storage, and/or seed bulking, and enter into any agreements for these entities to receive and handle seed once it is collected. Coordinate with the selected entity on specific protocols to collect, document, or ship seeds. Table 11 lists facilities with experience collecting MSP rare plants.
- Obtain any necessary collecting permits from agencies or access agreements from land owners; and carry this documentation into the field. Note that it may take a year or more to obtain a permit.
- Monitor the source occurrence during the growing season to ensure that seeds are collected at the optimal time. For species that are difficult to identify or relocate when not in flower, flag or otherwise document flowering individuals to relocate them easily when in fruit (e.g., annual plants, *Dudleya* spp., *Brodiaea* spp.).

As a general rule of thumb, Wall (2009) suggests that annuals and perennials will be ready for seed collection 2-5 weeks after peak flowering, while trees and shrubs may take 2 months or longer for seeds to mature. Time to maturity is also influenced by weather (warm weather speeds the process; cool weather delays it), elevation, or micro-habitats. In addition, some plants flower continuously over a period of time and thus, seed may ripen continuously over many weeks or months (Wall 2009).



Photo credit: Earth Discovery Institute.

Characteristics of mature seed will vary by species, but may include changes in fruit color, changes in seed coat, fruits splitting or breaking open, seeds rattling, seeds that are hard and dry, or some seeds that have already dispersed (Way and Gold 2014a).

- Collect voucher specimens of the target species, preferably while plants are in bloom. Collect vouchers only if none exist for the occurrence and if enough plants are available so that collecting does not adversely impact the occurrence.

We include links (below) to two sources for collecting, documenting, storing, and labeling vouchers. The Smithsonian link includes instructions and photos for packaging and shipping specimens to an herbarium, which may be helpful for those unfamiliar with the process (note: plants collected in San Diego County should be deposited at the San Diego Natural History Museum).





**Table 11.** Facilities with Experience Collecting MSP Rare Plants.<sup>1</sup>

Scientific Name <sup>2</sup>	Common Name	Seed Banks or Botanic Gardens <sup>3</sup>	Commercial Nurseries <sup>4</sup>
<i>Acanthomintha ilicifolia</i>	San Diego thornmint	SDZG	
<i>Acemison prostratus</i>	Nuttall's acemison	SDBG, SDZG	NW, S&S
<i>Adolphia californica</i>	California adolphia	SDZG	NW
<i>Agave shawii</i> var. <i>shawii</i>	Shaw's agave	SDBG	NW
<i>Ambrosia pumila</i>	San Diego ambrosia	SDZG	NW
<i>Aphanisma blitoides</i>	Aphanisma		NW
<i>Arctostaphylos glandulosa</i> ssp. <i>crassifolia</i>	Del Mar manzanita	SDBG	
<i>Arctostaphylos otayensis</i>	Otay manzanita	SDZG	NW
<i>Arctostaphylos rainbowensis</i>	Rainbow manzanita		
<i>Atriplex coulteri</i>	Coulter's saltbush	SDZG	
<i>Atriplex parishii</i>	Parish brittle scale	SDZG	
<i>Baccharis vanessae</i>	Encinitas baccharis	SDBG, SDZG	NW
<i>Bloomeria clevelandii</i>	San Diego goldenstar	SDBG, SDZG	NW
<i>Brodiaea filifolia</i>	Thread-leaved brodiaea	SDZG	NW
<i>Brodiaea orcuttii</i>	Orcutt's brodiaea	SDZG	NW
<i>Brodiaea santarosae</i>	Santa Rosa brodiaea		
<i>Calochortus dunnii</i>	Dunn's mariposa lily	SDZG	
<i>Ceanothus cyaneus</i>	Lakeside ceanothus	SDZG	NW, S&S
<i>Cenaothus verrucosus</i>	Wart-stemmed ceanothus	SDBG, SDZG	NW, S&S
<i>Centromadia parryi</i> ssp. <i>australis</i>	Southern tarplant	RSA, SDZG	S&S
<i>Chloropyron maritimum</i> ssp. <i>maritimum</i>	Salt marsh bird's-beak	SDZG	S&S
<i>Chorizanthe orcuttiana</i>	Orcutt's spineflower	RSA	
<i>Clinopodium chandleri</i>	San Miguel savory	SDZG	
<i>Comarostaphylis diversifolia</i> ssp. <i>diversifolia</i>	Summer-holly	RSA, SDBG, SDZG	NW, S&S
<i>Cylindropuntia californica</i> var. <i>californica</i>	Snake cholla		NW
<i>Deinandra conjugens</i>	Otay tarplant	SDZG	NW, S&S
<i>Dicranostegia orcuttiana</i>	Orcutt's bird's-beak	SDZG	
<i>Dudleya blochmaniae</i>	Blochman's dudleya		NW
<i>Dudleya brevifolia</i>	Short-leaved dudleya	SDZG	
<i>Dudleya variegata</i>	Variegated dudleya	SDZG	NW
<i>Dudleya viscida</i>	Sticky dudleya	SDZG	

**Table 11.** Facilities with Experience Collecting MSP Rare Plants.<sup>1</sup>

Scientific Name <sup>2</sup>	Common Name	Seed Banks or Botanic Gardens <sup>3</sup>	Commercial Nurseries <sup>4</sup>
<i>Ericameria palmeri</i> ssp. <i>palmeri</i>	Palmer's goldenbush	SDZG	NW, S&S
<i>Eryngium aristulatum</i> var. <i>parishii</i>	San Diego button-celery	SDZG	NW
<i>Erysimum ammophilum</i>	Coast wallflower	SDZG	
<i>Euphorbia misera</i>	Cliff spurge	SDBG	NW
<i>Ferocactus viridescens</i>	San Diego barrel cactus	SDBG, SDZG	NW
<i>Fremontodendron mexicanum</i>	Mexican flannelbush	SDZG	NW
<i>Hazardia orcuttii</i>	Orcutt's hazardia	SDBG	NW
<i>Hesperocyparis forbesii</i>	Tecate cypress	SDBG, SDZG	NW
<i>Iva hayesiana</i>	San Diego marsh-elder		NW, S&S
<i>Lepechinia cardiophylla</i>	Heart-leaved pitcher sage		
<i>Lepechinia ganderi</i>	Gander's pitcher sage	SDZG	
<i>Monardella hypoleuca</i> ssp. <i>lanata</i>	Felt-leaved monardella	SDZG	
<i>Monardella stoneana</i>	Jennifer's monardella	SDZG	
<i>Monardella viminea</i>	Willow monardella	SDZG	
<i>Navarretia fossalis</i>	Spreading navarretia	RSA, SDZG	NW
<i>Nolina cismontana</i>	Chaparral nolina		
<i>Nolina interrata</i>	Dehesa nolina	SDZG	
<i>Orcuttia californica</i> *	California Orcutt grass	SDZG	NW
<i>Packera ganderi</i>	Gander's ragwort	SDZG	
<i>Pinus torreyana</i> ssp. <i>torreyana</i>	Torrey pine	SDBG, SDZG	NW
<i>Pogogyne abramsii</i>	San Diego mesa mint	SDZG	NW
<i>Pogogyne nudiuscula</i> *	Otay mesa mint	SDZG	NW
<i>Quercus dumosa</i>	Nuttall's scrub oak	SDBG, SDZG	NW, S&S
<i>Quercus engelmannii</i>	Engelmann oak		NW, S&S
<i>Rosa minutifolia</i>	Small-leaved rose	SDBG, SDZG	NW
<i>Tetracoccus dioicus</i>	Parry's tetracoccus	SDZG	NW

<sup>1</sup> MSP plant species as defined in the MSP Roadmap (SDMMP and TNC 2017). Note that there may be other institutions or organizations with experience collecting seed in the MSPA.

<sup>2</sup> Nomenclature generally follows Baldwin et al. 2012.

<sup>3</sup> Seed Banks or Botanic Gardens: **SDBG** = San Diego Botanic Garden, **SDZG** = San Diego Zoo Global, **RSA** = Rancho Santa Ana Botanic Garden.

<sup>4</sup> Commercial Nurseries: **NW** = Native West Nursery (formerly Recon Native Plant Nursery), **S&S** = S&S Seeds, Inc.

- San Diego County Plant Atlas project: How to collect and press proper plant specimens (<http://sdplantatlas.org/pdfFiles/CollectPress.pdf>).
- Smithsonian National Museum of Natural History Guide to herbarium specimens for Bureau of Land Management (BLM) Seeds of Success ([https://www.blm.gov/sites/blm.gov/files/programs\\_natural-resources\\_native-plant-communities\\_native-seed-development\\_collection\\_Herbarium%20Tutorial.pdf](https://www.blm.gov/sites/blm.gov/files/programs_natural-resources_native-plant-communities_native-seed-development_collection_Herbarium%20Tutorial.pdf)).

Appendix B provides guidelines on collecting data for voucher specimens from the San Diego Natural History Museum. The ‘Sample of Online Data Entry Form’ is used by parobotanists in the Museum’s Plant Atlas Program to collect specimens, while the ‘Cheat Sheet’ explains each data field in the data entry form.

Submit voucher specimens and documentation to the San Diego Natural History Museum within 4 months of collection.

- Assemble materials for collecting seed, including appropriate bags or other storage containers (Table 10), and scissors, shears, or tweezers (depending on plant/seed size) if necessary to remove seed from the parent plant. In general, collect dry seeds in paper envelopes or bags and moist fruits in plastic bags or buckets.
- Test a small number of seeds in the field to ensure that the collection includes viable seeds. Quick methods for assessing viability are to (1) cut the seed to ensure it contains a well-formed embryo (hollow seeds are not viable), (2) squash the seeds on blotter paper and look for a ring of moisture that indicates a viable embryo, or (3) float a small number of seeds in water; viable (heavier) seeds will sink while nonviable (lighter) seeds will float. Secure very small seeds with tape before cutting or squashing.
- Collect seed using the method most appropriate for the target species (Table 12). Refer to species-specific chapters for more detailed information for each target species. For many species, ripe seed will detach easily from the inflorescence (Wall and MacDonald 2009). Figure 5 depicts volunteers collecting seed for native species in the MSPA.

In general, do not collect seeds from the ground unless the parental plant is known, seeds are recently dispersed and not damaged by pests or pathogens, or other methods are not available or practical (Way and Gold 2014).

## *Documentation*

Detailed and accurate records are a critical component of any seed collection, banking, and bulking process. At a minimum, seed collectors should record species name, collector name, collection date, collection location, and collection number (and maternal line plant numbers, if appropriate). In addition, use separate seed collection forms for maternal line and bulk collections. Refer to Appendix C for seed collection forms.

**Table 12.** Common Methods for Collecting Seed.

Collecting Method	Description
Hand-pick Fruit	Collect fruit individually (e.g., <i>Quercus</i> spp.).
Collect Entire Plant	Collect fruit (and other plant material) by uprooting entire plant (e.g., annual species) ( <i>note: use only for very small plants that are abundant and for which uprooting the plant would not damage soil</i> ).
Clip Inflorescences or Branches	Selectively remove fruit attached to dry inflorescences or branches.
Shake Seed from Fruit	Open dried fruit and empty seeds into collecting container (e.g., <i>Brodiaea</i> spp.).
Strip Seed Head	Hand-strip or cut entire seed head (e.g., grasses).
Bag Fruits	Secure collecting bag around fruit that dehisces explosively or continuously, particularly if seed could be lost between monitoring or collecting visits.
Sieve Fruit	Sieve substrate (e.g., sand) to recover seeds or fruits. This method is most useful for larger seeds and applies only to bulk (not maternal line) collections.



**Figure 5.** Seed Collection: Biologists and Volunteers (Photo credits: Earth Discovery Institute (upper, lower left); Jessie Vinje, CBI (upper, lower right)).



Table 13 lists information to record during seed collection to (1) provide insights into species biology and habitat requirements, (2) allow the seed bank to better assess seed condition and test results, and (3) match seed collections to appropriate sites for outplanting (CBG 2019, CPC 2019, Wall 2009, RBG Kew 2001).

**Table 13.** Documentation for Seed Collection.<sup>1</sup>

Information	Description <sup>2</sup>
Species Name	Record the scientific name of the target species, including subspecies or variety (if applicable).
Occurrence Name	Record the MSP Occurrence Name (if assigned).
Occurrence Identification	Record MSP Occurrence Identification (ID) (if assigned). If the source occurrence does not have an MSP Occurrence ID, record the CNDDDB EO number (if available).
Collection Date	Record seed collection date. If seed is collected at the same occurrence over several dates, include all dates on form and specific date on seed collection container (e.g., envelope, bag).
Collection Number	Assign each collection a unique number. If seeds are collected along maternal lines, number each collection container (e.g., envelope, bag) with both collection number and maternal line number. We recommend that the collection label include the Occurrence ID, collection number, and collecting date (see text for examples).
Collector(s)	Record name of each seed collector.
Collector's Affiliation	Record affiliated organization or institution (if any) of each seed collector.
Land Owner/Manager	Record name or organization of the land owner and land manager for the preserve or property where seed is collected.
Location	Record GPS coordinates of the collecting location. Include datum and coordinate system.
Habitat	Indicate habitat(s) at collecting location.
Associated Species	Indicate associated plant species at collecting location.
Site Conditions	Record site conditions at collecting location, including slope, aspect, elevation, and soil type.
Voucher Specimen(s)	Indicate whether voucher specimens were collected. If yes, provide voucher specimen numbers, and indicate where the specimens will be deposited.
Photographs	Take at least 3 photographs (landscape, plant, fruit/seed), and number photos consecutively. Include Occurrence ID and Collection Number in photo label. Record photograph numbers.
Population Size	Record population size (direct count or estimate) of source occurrence during year of collection.
Number of Plants Sampled	Indicate number of plants sampled for seed collection.
Fruiting Stage	Indicate fruiting stage of plants at time of sampling (early, ripe, late).
Seed Health	Note any signs of damage to fruits or seed from pests or disease.
Seed Viability	Estimate % seed viability based on visual assessment or squash test of 5-10 seeds.

<sup>1</sup> Information from SDMMMP 2019, CBG 2019, CPC 2019, Wall 2009, RBG Kew 2001.

<sup>2</sup> Abbreviations: **CNDDDB** = California Natural Diversity Database, **EO** = Element Occurrence, **GPS** = Global Positioning System, **MSP** = Management Strategic Plan.

Collect one or more voucher specimens of the target species at the collecting location, as discussed earlier. In addition, take at least three photographs at the collecting location to document (1) the occurrence and habitat, (2) the target species, and (3) fruit and/or seed. Figure 6 provides an example of a composite image of photos taken to document seed collecting location, plant, and fruit and seed. While this image includes cleaned fruits and seeds, collectors should document fruits and/or seeds in the field (prior to cleaning). Include photos as part of the documentation for the seed collection.



**Figure 6.** Seed Collection: Photo Documentation (composite photo credit: John MacDonald, RSA).

Many seed banks have a standard form for seed collection or instructions for data collection. Seed collectors should check with the institution where they plan to deposit seed to obtain forms or otherwise ensure that they adequately document the collection.

While seed bank institutions have their own numbering system, and will assign an accession number to incoming collections, we recommend that seed collectors/land managers label and track seed collections of MSP rare plants using a system similar to that used in the SDMMP's Inspect and Manage (IMG) rare plant monitoring program. All seed collected at an occurrence would have the same label, with variations for different collecting dates or maternal lines.

For a bulk seed collection, include the MSP occurrence ID, seed collection number, and collection date. For example, a collection of Otay tarplant seed from the Mother Miguel Grassland on July 14, 2019 would be labeled:

DECO13\_3MMGR010\_SC01\_071419

In this case, **DECO13\_3MMGR010** = MSP Occurrence ID, **SC01** indicates the seed collection code (SC) and number (01), and **071419** indicates the seed collection date (month/date/year). If there is no MSP occurrence ID for the target species, substitute Species\_Preserve Name/Location Name\_Collection Number\_Date.

For a maternal line collection, use the same code but add the parental plant number (PL). In the collection above, envelopes or bags with seed collected from the 1<sup>st</sup> and 15<sup>th</sup> plants, respectively, would be labeled as follows:

DECO13\_3MMGR010\_SC01\_**PL01**\_071419

DECO13\_3MMGR010\_SC01\_**PL15**\_071419

Use similar labeling for voucher specimens (code = Voucher) and photographs (code = Photo) that accompany or support the seed collection. For example, voucher specimen 1 and photograph 1 for the collection above would be labeled as follows:

DECO13\_3MMGR010\_SC01\_**Voucher01**\_071419

DECO13\_3MMGR010\_SC01\_**Photo01**\_071419

When submitting a voucher specimen to an herbarium, label the plant with the established naming convention for that herbarium. Include the voucher label above as supplemental information, and maintain this information in the collector's records.

All MSP rare plant occurrence codes are available through the SDMMP web portal ([https://sdmmp.com/spatial\\_search.php](https://sdmmp.com/spatial_search.php)) or by contacting SDMMP staff.

### *Interim Seed Storage and Delivery*

Once seed is collected, it should be sent to a seed bank or storage facility as soon as possible to retain maximum viability. In some cases, however, it will not be possible to deliver the seed immediately or the seed may need to be cleaned or dried before delivery. In this section, we summarize general guidelines for interim seed storage and delivery (e.g., CBG 2019, CPC 2019, Gold 2014, Wall 2009, RBG Kew 2001). Seed collectors should coordinate with the selected seed bank or storage facility for any additional guidelines. For some guidelines presented below, more detailed information can be found elsewhere in this document (e.g., seed cleaning).



### *Interim Seed Storage*

We provide the following guidelines for seed that is not delivered immediately to a storage facility:

- Store collected seed in a cool, dry location. Avoid exposure to high humidity, heat, or direct light.
- Do not store seed in vehicles.
- Do not freeze seeds.
- Remove moist seeds from plastic collecting containers and pack loosely in breathable collection bags. If necessary, clean and dry prior to shipping, or maintain seed in a refrigerator.
- If the collection is damp, dry seeds or fruits before packaging and sending to a storage facility to prevent mold. Spread fruits or seed on newspaper to dry (Gold 2014, RBG Kew 2001). Seeds can be dried outside (with protection from animals and wind), in a well-ventilated room, or with a fan to gently blow over the seeds (CBG 2019). For fruits that dehisce explosively, dry in sealed bags or otherwise cover so that seeds are not lost during drying.
- Periodically check the seeds for insect damage; where living insects are noted, add no-pest strips to collecting bags overnight. Do not spray insecticide directly onto seeds (CPC 2019).
- In general, seed cleaning for long-term storage or bulking is conducted most efficiently at a seed storage facility, where staff has access to specialized equipment and are experienced in cleaning different types of seeds to minimize damage during the cleaning process (RBG Kew 2001, CBG 2019). However, seed collectors can minimize cleaning time at the storage facility by collecting carefully in the field or by some cleaning prior to sending the collection for storage (Wall 2009; Wall and MacDonald 2009). In some cases, land managers or volunteers can clean seed to an acceptable level for short-term storage and outplanting using relatively simple and cost-effective techniques (Figure 7).

### *Seed Delivery*

Prepare seeds for delivery to a seed bank or seed storage facility as follows:

- Send seeds to a seed facility as soon as possible, or store the seeds in dry conditions free from light and moisture for several weeks before sending them for storage.
- Reduce the bulk of a shipment by removing extraneous plant material (e.g., branches, twigs, empty fruit) from the collection prior to shipping (Wall 2009; Wall and MacDonald 2009).



**Figure 7.** Seed Cleaning: Volunteer Event (Photo credit: Earth Discovery Institute).

- Repackage seeds in appropriate (breathable) bags or containers (if necessary) so that each collection is loose with adequate air circulation.
- Label each collecting bag or container clearly. Make sure bags or containers are closed and/or sealed.
- Contact the seed bank or storage facility to inform them of the schedule for seed delivery and verify they will be able to accept and process the shipment quickly. Use special mail services such as ‘signature confirmation’ or ‘registered mail’ to ensure the seed is delivered to and received by the seed bank.
- Deliver seeds by hand or by mail. If sending by mail, place seed envelopes or bags inside a cardboard box for protection. Use an appropriately-sized box so that the seeds do not spill during shipment; include extra packing material, if needed. Use a ‘breathable’ shipment container (e.g., cardboard box rather than plastic container). Do not package seed until ready to ship (CBG 2019). Use expedited shipping if possible to ensure that seeds arrive at the facility as soon as possible.
- Include collecting forms or other documentation (e.g., photographs) with the shipment. Include one copy of the documentation (e.g., collecting form, photographs) with the shipment and retain a copy as backup.

- Hand-deliver or ship voucher specimens to the San Diego Natural History Museum, along with all documentation (including seed collection number). Label voucher specimens and package them carefully to avoid damage during transport or shipping.

## 4.2 SEED BANKING

We recognize that once seed is deposited at a seed bank or seed storage facility, it will be processed by staff according to specific guidelines and with specific equipment that may not be available to land managers. It is not our intent, nor is it reasonable, to reproduce seed banking guidelines in detail in this document. However, we do discuss key elements of the process so that land managers or others involved in conserving seed of MSP rare plants have sufficient information to assess results, and to plan and budget for specific efforts.

### *Seed Cleaning*

Seed must be cleaned prior to storage to remove undesirable or remaining plant material, including chaff,<sup>4</sup> seeds that are damaged, dead, or immature, or seeds of other species (CPC 2019). Cleaning protects the banked collection from pests or pathogens and reduces the amount of material placed in storage. Seed may be cleaned to different levels. For example, for a long-term conservation collection, seed may be cleaned moderately but retain some chaff. In this case, partial cleaning is cost-effective and enables the seed to be stored quickly. Alternatively, seed set aside for testing may be cleaned completely for easy access at a later date (CPC 2019).



Photo credit: Colin Richard for Earth Discovery Institute.

There are many methods for cleaning seed, and different methods are used for different types of seed (Wall and MacDonald 2009). Refer to Table 14 for examples of cleaning methods for some common fruit types in southern California (Wall and MacDonald 2009). Wall and MacDonald (2009) provide illustrated examples of the cleaning process and equipment, along with specific cleaning methods for many California native plants, including some MSP rare plants or closely related species.

---

<sup>4</sup> Chaff refers to extraneous plant material (e.g., the seed coat or other structures surrounding the seed) that is separated from the seed during cleaning.

**Table 14.** Seed Cleaning Methods.<sup>1</sup>

Fruit Type	Characteristic	Cleaning Method
Dry, Dehiscent Fruit (e.g., capsule, follicle, legume, silique or silicle)	Fruit splits, discharges dry seeds.	Allow seed to shed naturally in collecting bag or on sheeting; remove remaining seed from capsule manually or mechanically.
Dry, Indehiscent Fruit (e.g., caryopsis, nut, utricle)	Fruit does not open to discharge seed, but decays or is eaten by animals.	Rub fruit to clean or to open and release seed.
Composites (Asteraceae)	Fruit an achene; often mixed with other plant material (bracts, pappus).	Collect mature achenes; remove pappus and break up chaff mechanically; separate seed from chaff with blowers or screens.
Fleshy fruit (e.g., drupes, berries)	Fruit is surrounded by pulp.	Soak dry fleshy fruit until soft; macerate moist fleshy fruit or softened dry fleshy fruit; spread onto a screen to dry. Once dry, separate seeds from pulp mechanically. If necessary, blow or sieve fruit to remove remaining pulp.
Cones	Seeds are held in cone scales which may open naturally or require heat to open.	Spread cones on mat or box in warm area to dry; shake or pry out seeds when cone scales open. Where heat is required to open, place cones in an oven for $\leq 20$ minutes at 180°F, or immerse in boiling water for 30 seconds to one minute; remove and dry seeds.
Nutlets	Seeds loosely or tightly held within floral calyx.	Seeds may release in collecting bag. For seeds in calyces, break up mechanically; screen or blow material to separate seed from chaff.

<sup>1</sup> From Wall and MacDonald 2009.

## Seed Testing

Seeds are tested at various stages in the seed banking process for dormancy, germination, viability, and longevity. Seed bank institutions or commercial seed labs will conduct most seed tests. However, understanding the purpose of these tests and test results allows the land manager to make informed decisions about the (1) type of tests needed, (2) quality of seed collected, (3) length of time seed can be stored, (4) barriers to propagation, (5) target number of seeds needed for outplanting, and (6) realistic timeframes and/or metrics for reintroducing seed.



## Seed Dormancy

Dormancy is a physical or chemical adaptation that prevents seeds from germinating under unfavorable conditions. Dormant seeds are alive but not growing actively. Dormancy prevents all seeds from germinating at one time and ensures that seeds germinate only when conditions are favorable for seedling survivorship.

Species that form persistent soil seed banks generally have some type of seed dormancy. Primary types of dormancy include physiological, physical, combinational (physiological + physical), morphological, and morphophysiological. In temperate zones, species that form persistent seed banks most often have seeds with physiological or physical dormancy mechanisms (Baskin and Baskin 1989); thus, we discuss these two types below.

*Physiological Dormancy.* For seeds with physiological dormancy, there is typically an afterripening period, with the seed passing through various states from dormant to non-dormant and possibly, back to dormant if conditions become unfavorable once again (Baskin and Baskin 1989). Many obligate winter annuals exhibit this pattern of dormancy, although each species has a unique set of temperature, light, and/or precipitation cues for germination.

*Physical Dormancy.* For seeds with physical dormancy, the seed coat must become permeable to water before it can germinate. Physical seed coat dormancy is present in species with hard seed coats (e.g., legumes, some composites), and dormancy is relieved only when a portion of the seed coat softens.

### Seed Biology Terms

**Seed Dormancy:** An adaptation to prevent a seed from germinating under unfavorable conditions. Dormant seeds are alive but not growing actively.

**Seed Germination:** The emergence and growth of a plant from a seed, as characterized by a seedling that develops from an embryo.

**Seed Longevity:** The length of time an ungerminated seed can remain viable.

**Seed Viability:** A measure of the potential of a seed to germinate and reproduce under suitable conditions.

**Soil Seed Bank:** All viable, ungerminated seeds present on or in the soil or associated litter which have the potential to form an adult plant.

Recognizing whether a species possesses seed dormancy is important for understanding results of germination and viability tests. Identifying dormancy cues is critical for relieving dormancy to (1) propagate seed efficiently and (2) establish realistic success criteria for outplanting/sowing. In a nursery setting, pre-treating dormant seed will maximize the number of plants that germinate. In the field, seeds with physical seed coat dormancy may experience a lag period of one or more years between sowing and significant seedling emergence.

## Seed Germination

Seed germination occurs when the radicle, or seedling root, emerges from the seed coat. Germination is used as a simple test of seed viability, and can also determine whether the seed

possesses any dormancy. The total number of seeds that germinate in a sample indicates the germination rate. Where all seeds in a sample germinate, we assume little or no dormancy.

In a nursery or lab setting, seeds that show some evidence of dormancy are often subjected to one or more pre-treatments to relieve dormancy and stimulate germination. Pre-treating seeds may relieve dormancy entirely or partially. Seeds that do not germinate after pre-treatment may be viable or nonviable. For seeds that are viable but do not germinate, dormancy has not been fully relieved. In other words, *high germination rates indicate high seed viability, whereas low germination rates require further testing to determine viability.*

Table 15 lists pre-treatment methods used to germinate seeds that are dormant. Note that seeds of some species may require a combination of pre-treatments for optimal germination. Seed banks and research institutions play a key role in identifying or developing germination protocols for native plants, including MSP rare plants.

**Table 15.** Pre-treatment Methods to Break Seed Dormancy.<sup>1</sup>

Treatment Type	Treatment Method(s)	Physiological Dormancy <sup>2</sup>	Physical Dormancy <sup>2</sup>
Acid/Other Chemicals	Soak seeds in bleach, vinegar, gibberellic acid	✓	✓
Charate/Smoke	Place burned plant residue over seeds, expose seeds to smoke	✓	
Fire	Place burning plant material over seeds		✓
Heat	Heat seeds in oven or autoclave	✓	
Light/Temperature	Expose seeds to various combinations of light/temperature	✓	
Scarification	Clip seed coat, excise seed/embryo, abrade seed coat mechanically (e.g., file, sandpaper) or with acid		✓
Stratification	Expose seeds to varying temperature-moisture conditions: warm-dry, warm-moist, cold-moist, warm-cold-warm	✓	
Water	Soak seeds in water (room temperature or boiling), pour boiling water over seeds, leach seeds under running water		✓

<sup>1</sup> Information from RSA 2018, Emery 1988.

<sup>2</sup> ✓ = treatment wholly or partially relieves dormancy.

### Seed Viability

Viability is a measure of the potential for a seed to germinate and reproduce under suitable conditions. Viable seeds will germinate easily and under a range of conditions, unless they possess some type of dormancy. Seeds that are dormant but viable will germinate once conditions are appropriate. Non-viable seeds are dead or damaged and will never germinate.

Viability tests determine the percentage of sound (viable) seed in a collection; these tests range from non-destructive methods that estimate seed condition based on visual assessments to more precise but destructive tests (excision, staining) that examine the embryo.

Seeds are tested for viability at various stages in the seed collection and banking process, including in the field to estimate quality of seed prior to collecting and in a seed bank prior to storing. These tests are repeated on samples of stored seed at intervals to ensure that seeds remain viable and usable. We discuss some of the methods for assessing seed viability below.

*Visual Assessments.* Seed can be assessed visually in the field or at a seed facility. Visual assessments in the field are particularly useful for plant families known to have high levels of non-viable, empty, or damaged seeds (e.g., Asteraceae, Cyperaceae, Lamiaceae, Leguminosae, Poaceae; Way and Gold 2014a). Characteristics of viable seed include:

- Seed coat is hard and dark in color (tan, brown, or black).
- Seed is filled with healthy, firm, generally moist tissue.
- Seeds may rattle in fruit.
- Some seeds may have dispersed already.

Refer to Way and Gold (2014a) and Wall and MacDonald (2009) for additional details on visually assessing seed for viability. The CPC (2018) recommends assessing very small collections (<100 seeds) by visual methods only (rather than by destructive methods) to preserve the limited amount of material available.

*Squash Test.* A ‘squash’ test also estimates seed viability. For this test, a ring of moisture will be present on blotter paper when healthy seeds are squashed. In contrast, seeds that are hollow will crack or pop and fail to leave a moisture residue when squashed (Wall and MacDonald 2009). The squash test is not as precise as other tests, but can be used quickly in the field.



*Cut Test.* A ‘cut’ test or seed dissection is another quick method for assessing seed viability in the field or the lab. In this test, seed is cut open using a pocket knife or safety (single-edge) razor blade and then examined with a hand lens or microscope. In the field, small seed can be held in place with double-sided tape. Viable seed is generally well-developed and fills the seed (Wall 2009).

*Floatation Test.* A floatation test also assesses viability in the field quickly, and is most appropriate for species with large, smooth seeds. In this test, seeds are placed in a container filled with water. Viable seed will typically sink because of the presence of the healthy seed



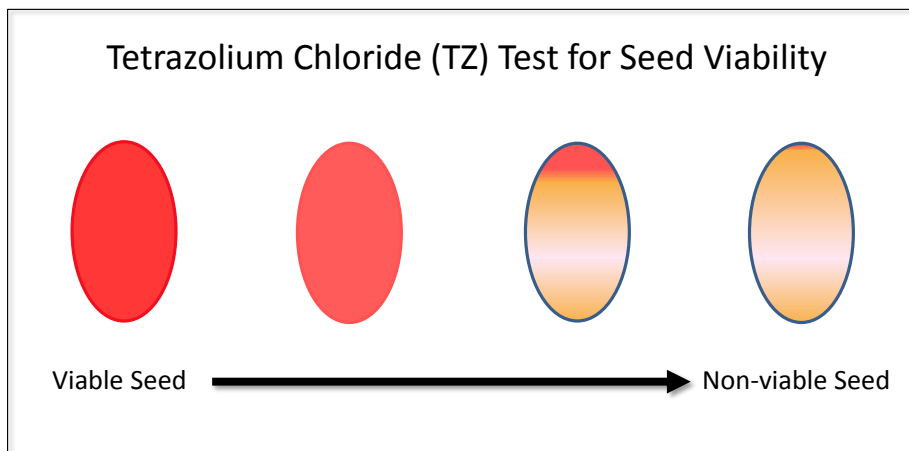
(embryo, endosperm), while non-viable seeds will float because they contain air pockets in place of developing seed (Wall 2009).

*Seed Weight.* Ripe, sound seed is heavier than immature or damaged seed, and can be separated by hand, blowers, or other methods. In a seed bank, seeds are separated by weight, and a small number of heavier seeds are then dissected and examined under a microscope to obtain a more precise measure of viability (CPC 2019, Wall and MacDonald 2009).

*Germination.* As discussed earlier, viability can be estimated, at least in some cases, through germination tests. Germination tests provide a fairly accurate measure of viability for non-dormant seeds. However, seeds that fail to germinate must be examined further to determine if they are viable or not, as illustrated in the following example using a sample of 100 seeds:

- If 30 of 100 seeds germinate in a simple germination test, the germination rate is 30%.
- If we then examine the 70 seeds that did not germinate by dissecting, staining, or other methods and determine that none are viable, then the germination rate is 30% and viability is 30%.
- If we examine the 70 ungerminated seeds and all are viable, then the germination rate is 30% and viability is 100%.

*Tetrazolium Chloride (TZ).* A specific test for seed viability is the tetrazolium chloride, or TZ test, in which a sample of seeds are cut to expose the embryo and then soaked in a solution of tetrazolium chloride (*2,3,5-triphenyl tetrazolium chloride*). Viable seeds stain a red color, whereas seeds with dead tissue stain poorly or not at all (Figure 8). The TZ test provides a good measure of viability and produces results faster than germination tests. The TZ test is often used after germination tests to determine the percentage of non-germinating seeds that are alive and dormant versus dead. However, the test requires specialized training and materials, and may not be practical for large or multiple collections.



**Figure 8.** Tetrazolium (TZ) Test for Seed Viability: Staining Gradient.

## Seed Longevity

Seed longevity is influenced by storage conditions and length of time stored; therefore, seeds in storage are tested at intervals to ensure they retain a certain level of viability. Seeds are tested initially for viability and then monitored at intervals (often, every 10 years). When viability drops to a certain level (e.g., 85% of initial viability), the seed collection may be replaced or regenerated with newly collected seed or bulked seed (MSBP 2015).

Longevity tests provide information on how long seed might reasonably persist under controlled conditions. The USDA (2019) estimates that undamaged, properly dried seeds will survive about 100 years in conventional storage (-18°C) and about 1,000 years in cryopreservation (liquid nitrogen). Seed longevity has not been determined definitively for most MSP rare plants.

F.W. Went started a long-term seed longevity study at the California Institute of Technology in 1947. Seeds from the study were subsequently stored at RSA before being moved to the NLGRP for follow-up testing (Birker pers. comm.). This longevity study includes seed from over 100 California native plant taxa that will be tested at 20-year intervals through 2307 (Went and Munz 1949). Although the study does not include any MSP plants, it does include several congeners and may shed light on potential long-term storage capabilities for these species. Results of the 50-year test are variable, with some species exhibiting higher germination rates than they did initially or at the 20-year mark, some exhibiting lower or no germination compared to previous testing, and others remaining relatively stable over the 50-year period (Wall 2009).

## Seed Storage

Seed must be stored properly to maintain viability. We recommend storing seed at a recognized seed bank or seed storage facility under controlled conditions appropriate for the target species. Store seed as either a short-term ( $\leq 5$  years) restoration collection or long-term ( $> 5$  years) conservation collection. In this section, we describe types of seeds, appropriate storage conditions, and packaging within the facility for long-term storage and testing.

## Seed Type

Seed type influences how seed should be stored (storage conditions) and how long the seed is likely to last in storage (storage duration). We recognize three types of seeds with respect to storage capabilities: *orthodox*, *recalcitrant*, and *intermediate*.

- Orthodox seeds are common to arid regions and characteristic of annual or perennial species that form persistent seed banks, possess some seed dormancy, and have a relatively low seed moisture content when mature (CPC 2019). Orthodox seeds can be dried and safely stored in a conventional, long-term seed bank to retain viability. Most of the MSP rare plants possess orthodox (or presumed) orthodox seeds (RBG Kew 2019).

- Recalcitrant seeds are common in species that occur in wetland or riparian habitats, generally do not form a persistent seed bank, and exhibit no dormancy (CPC 2019). Recalcitrant seeds do not survive drying or freezing well and thus, do not lend themselves to storage in a conventional, long-term seed bank. One method for storing recalcitrant seeds is to remove and store the embryo in liquid nitrogen (CPC 2019). At least two MSP rare plants, Nuttall's scrub oak (*Quercus dumosa*) and Engelmann oak (*Quercus engelmannii*), have (or likely have) recalcitrant seeds.
- Intermediate seeds have a limited tolerance to drying. To retain viability, they are best stored in liquid nitrogen (CPC 2019). We do not currently know of any MSP rare plants that fall into this category.

### Storage Conditions

Storage conditions will vary for each seed type, but all depend on drying seeds to slow the aging process and retain viability. Seed types differ in the amount of desiccation they can undergo and still remain viable.

Orthodox seeds are typically dried to a very low moisture content, frozen, and stored in sealed envelopes or containers at a low temperature (-18°C). The optimal moisture content (expressed as relative humidity or RH) of seeds for storage will depend on both drying and storage temperatures (CPC 2019, Wall 2009). Longevity in storage is typically higher for seeds collected when fully mature versus seeds collected when immature or old (Wall 2009). Refer to source documents (Table 4; e.g., CPC 2019, Wall 2009) for expanded discussions of recommended RH and temperatures for drying seeds. Orthodox seeds are the primary seed type in a conventional, long-term seed storage facility.

Recalcitrant seeds do not lend themselves to long-term storage at low temperatures. However, they can often be maintained at a storage facility for up to two years if kept moist and stored at a temperature just lower than the minimum temperature needed for germination (Wall 2009). Alternative methods to preserve material from recalcitrant seeds include tissue culture and cryopreservation. For example, embryonic tissue can be dried partially and cooled rapidly prior to storage (e.g., Ballesteros et al. 2019, CPC 2019, Walters et al. 2016). The SDZG is initiating a cryopreservation program to conserve recalcitrant and intermediate seeds; however, initial work is limited to Nuttall's scrub oak (*Quercus dumosa*).

Intermediate seeds can be stored for about 5 years in a conventional seed bank. They can withstand more drying than recalcitrant seeds, but not as much drying as orthodox seeds.

### Packaging

After processing (cleaning, drying, testing), the seed collection will be packaged for storage by placing seed into packages as follows:

- *Storage package.* Most of the seed in a collection will be placed into a long-term storage package (or multiple packages if collected along maternal lines; Figure 9).
- *Curation package.* A smaller amount of seed from the same collection will be placed into a curation package. This seed will be tested over time for germination, viability, and longevity.



**Figure 9.** Maternal Line Seed Packages (Photo credit: Stacy Anderson, SDZG).

Seed collections may be split and stored at different facilities to protect against total loss if one facility is damaged or otherwise compromised. In this case, seed that is sent to a backup storage facility as a duplicate seed collection will generally include the same number of seeds as the primary collection, and will include its own curation package. Duplicate collections are most appropriate for conservation collections in long-term storage, but may be prepared for restoration collections if adequate seed and funding are available. The CPC (2018) provides the following guidelines for dividing seeds into primary, duplicate, and curation collections.

- For seed collections with >50 seeds, place 40% of the seed into a storage package and 10% into a curation package for storage at the primary facility, and 40% of the seed into a storage package and 10% of the seed into a curation package for storage at the backup facility.
- For maternal line collections where one or more samples has between 20-50 seeds, divide the seed along a 60:40 ratio for storage and curation packages, respectively, as follows:
  - For a collection of 50 seeds, place 15 seeds (30%) into a storage package and 10 seeds (20%) into a curation package for storage at the primary facility, and the same amount of seed into storage and curation packages for storage at the backup facility.
- For maternal line collections where one or more samples contain fewer than 20 seeds, do not divide for duplicate storage.

Note that the primary seed storage facility will typically arrange for a duplicate collection to be sent to a backup facility, often based on pre-existing agreements, and will provide documentation with that collection.

### Seed Institutions

Table 16 lists seed banks or botanic gardens that currently maintain seed collections of one or more MSP rare plants in their long-term storage facilities or otherwise have seed for these species. This table is not necessarily comprehensive and seed at these facilities may or may not be available for use. Nonetheless, these facilities have the capability to process and store seeds for California native plants, including MSP rare plants. Refer to species-specific chapters for detailed information on stored seed for the target species.

**Table 16.** Seed Banks or Botanic Gardens.

Facility	Contact Information
Institute for Conservation Research, San Diego Zoo Global (SDZG) 15600 San Pasqual Valley Rd, Escondido, CA 92027 (760) 747-8702	Stacy Anderson Research Coordinator Native Plant Seed Bank sanderson@sandiegozoo.org (760) 796-5668
Rancho Santa Ana Botanic Garden (RSA) 1500 N College Avenue, Claremont CA 91711 (909) 625-8767	Cheryl Birker Seed Conservation Program Manager <a href="mailto:cbirker@rsabg.org">cbirker@rsabg.org</a> (909) 625-8767 ext. 259
Santa Barbara Botanic Garden (SBBG) 1212 Mission Canyon Road Santa Barbara, CA 93105-2126 (805) 682-4726	Heather Schneider, Ph.D. Rare Plant Biologist <a href="mailto:hschneider@sbbg.org">hschneider@sbbg.org</a> (805) 682-4726 ext. 148
San Diego Botanic Garden (SDBG) 230 Quail Gardens Drive Encinitas, CA 92024-2702 (760) 436-3036	Tony Gurnoe Director of Horticulture <a href="mailto:tgurnoe@sdbgarden.org">tgurnoe@sdbgarden.org</a> (760) 436-3036 x211

### Seed Banking Costs

Table 17 presents costs from different entities for various seed-related activities, from seed collection through storage. We present cost information in this section because costs for one activity often overlap or are incorporated into costs for another activity. Costs in Table 17 are estimates only for planning purposes and will vary based upon collecting location, amount of seed collected, type of seed, type of collection, and fruit/seed structure, among other factors. We include these estimates to provide land managers and others with a general idea of the costs

**Table 17.** Cost Estimates for Seed-related Activities.<sup>1,2</sup>

Entity	Seed Collection	Seed Cleaning	Seed Testing	Seed Bulking	Seed Storage
<b>Seed Bank Institutions</b>					
San Diego Zoo Global (SDZG)	\$2,500 for one species at one occurrence. SDZG recommends making a full conservation collection (5 occurrences across the range; total cost = \$12,500).	Included in collection cost.	Included in collection cost.	Varies by taxon. Focus is on rare species and research.	Usually included in the collection cost, but depends on the situation.
Rancho Santa Ana Botanic Garden (RSA)	Varies by taxon, collection location, and amount of seed.	\$60.00/hour (varies by species and number of seeds). Viability assessment included.	Germination testing = \$300/test.	Varies by taxon.	Permanent Seed Collection = \$3,000/accession <sup>3</sup> . Price includes germination testing. Temporary Research and Recovery Seed Collection (5 years) = \$750/accession <sup>2</sup> .
Santa Barbara Botanic Garden (SBBG)	Varies by taxon, collection location, and amount of seed.	Cost included in collection, unless species is very difficult to clean.	Germination testing = \$300/collection. Includes testing at 1 and 10 years.	---	Cost varies by amount and length of time.
San Diego Botanic Garden (SDBG)	Varies by taxon, collection location, and amount of seed.	Included in collection cost.	Germination testing = \$300/collection. Includes testing at 1 and 5 years.	Varies by taxon.	Varies by species, quantity, and storage time.
<b>Commercial Seed Facilities</b>					
AB Seed Laboratory, LLC	---	---	Purity + germination = \$45/species; \$5 to count seeds.	---	---
MD Seed Analysis, Inc.	---	---	Purity = \$35/species. Germination = \$35/species. Complete test = \$90/species.	---	---



**Table 17.** Cost Estimates for Seed-related Activities.<sup>1,2</sup>

Entity	Seed Collection	Seed Cleaning	Seed Testing	Seed Bulking	Seed Storage
Ransom Seed Laboratory	---	---	Purity = \$37-\$300/species. Germination = \$46-\$70/species.	---	---
Hedgerow Farms, Inc.	Varies by taxon, collection location, and amount of seed.	Hand cleaning - \$75.00/hour. Machine cleaning - \$150.00/hour. Costs can vary by species though.	Purity + germination = \$150/species (usually performed as part of the bulk seeding process)	\$12,000/1 acre; 8,000/0.5-acre; 6,000/0.25-acre. Cost is usually higher for rare and uncommon species or planting plugs.	Cost is usually included in the collection process. Long-term storage is \$50/month if not included in the original fee.
Native West Nursery (formerly Recon Native Plants)	Varies by taxon, collection location, and amount of seed.	Varies by species and quantity.	No testing unless requested.	Varies by species and quantity.	Varies by species, quantity, and storage time.
S&S Seeds, Inc.	Varies by taxon, collection location, and amount of seed.	Included in the seed collection cost, unless seed is not collected by them.	No testing for site-specific collections unless requested. They test their seed inventory regularly. Will outsource testing if requested by the client.	\$12,000/1 acre 8,000/ ½-acre 6,000/¼-acre. Cost is usually higher for rare and uncommon species or planting plugs.	Cost is usually included in the collection process. Long-term storage is \$50/month if not included in the original fee.
Stover Seed Company	Varies by taxon, collection location, and amount of seed.	Included in the seed collection cost.	No testing for site-specific collections unless requested. They test their seed inventory regularly. Will outsource testing if requested by the client.	---	Cost is usually included in the collection process. Long-term storage is species and duration-specific.

<sup>1</sup> Costs presented in this table are estimates only that are provided for planning purposes. They represent base costs and will vary by species, labor, and testing.

<sup>2</sup> Sources of information: S. Anderson (San Diego Zoo Global), M. Asghari (AB Seed Laboratory, LLC), C. Birker (Rancho Santa Ana Botanic Garden), D. Grubisic (MD Seed Analysis, Inc.), T. Gurnoe (San Diego Botanic Garden), S. Knutson (Stover Seed Company), J. Miller (S&S Seeds, Inc.), M. Ranieri (Hedgerow Farms, Inc.), Ransom Seed Laboratory, P. Reynolds (Hedgerow Farms, Inc.), H. Schneider (Santa Barbara Botanic Garden), and R. West (Native West Nursery).

<sup>3</sup> Discuss cost with RSA since they will depend on the entity submitting the seed, the storage objective, and the size of the collection.



involved in seed-related activities. We encourage land managers to contact one or more of these entities directly to discuss services and costs in greater detail.

### 4.3 SEED BULKING

The purpose of seed bulking is to increase the number of seeds available by growing plants in a nursery setting and harvesting seeds for long-term storage and/or outplanting into the field. For species with a limited distribution and/or small or declining occurrences, *ex situ* seed bulking provides the means to produce enough material to restore a species or occurrence. Seed bulking is most often used to increase the amount of seed available for species with annual or biennial life cycles.

Seed bulking is an important tool for restoring rare plant species. However, it is important to structure the process to maintain (or increase) genetic diversity of the target species and ensure that the bulked seed does not differ significantly from wild seed as a result of bias in seed selection or nursery practice.

While this section deals primarily with *ex situ* seed bulking, we acknowledge that *in situ* (onsite) seed bulking may be appropriate for some occurrences. Onsite seed bulking requires long-term and sustained weed management and supplemental watering of germinated plants to maximize seed production in the field (see F-RPMP). Onsite seed bulking is a viable option where funds are not available for nursery bulking, and is appropriate for sites that are easily accessible and/or have access to a reliable water source, since plants will need to be watered multiple times during the growing season. If bulking seed onsite, consider annual weather patterns to avoid artificially selecting for plants adapted to specific conditions (e.g., drought). In addition, where the target occurrence is very small, consider adding seed from a genetically appropriate occurrence in proximity to maintain or increase diversity.

#### *Seed Selection*

Seed selection begins with seed provenance. As discussed in the F-RPMP and earlier sections of this document, practitioners should select seed for bulking that is sourced from an appropriate genetic cluster or seed zone for the target species. In some cases, it will be necessary or desirable to use a composite seed collection to obtain enough seed for bulking or to increase the genetic diversity of the seed sample used for bulking. Practitioners should not use seed from a seed bank or commercial facility if the provenance is unknown.

A primary concern during seed bulking is directional selection. Directional selection may be intentional or unintentional, but the outcome is to favor certain genotypes over others. As a result, some genes potentially important for species adaptation and survival in the wild may be lost from the bulked collection. Selection occurs under natural conditions. However, selection in the nursery may compound (not replace) natural selection and may select in a different direction than would occur naturally (USDA 2006).

Selection may occur at several points in the growing process. For example, selection may be introduced during seed germination if seeds are not pre-treated to relieve dormancy or the pre-treatment relieves dormancy only partially. In this case, dormant but viable seeds would not be represented in the bulked collection. Likewise, sowing only larger or heavier seeds might reduce the potential for lighter (but viable) seeds in the bulked collection that could be advantageous under certain conditions.

Selection may occur after germination, as well. We expect some phenotypic variation in nursery-grown plants if seeds were collected uniformly and randomly. Favoring some variants over others (e.g., tall plants over short plants, early-germinating plants over late-germinating plants) may influence the genotype of the bulked collection and again, potentially result in loss of genes important for survival.

Although we cannot avoid directional selection completely, we can minimize it by including the range of seeds in the germination process and as many phenotypes as possible in the nursery-grown plants.

### *Diversity of Bulked Samples*

The size and genetic diversity of a seed source will influence the genetic diversity of the bulked seed sample. We can maximize genetic diversity in a bulked sample by (1) collecting seed from a large occurrence (2) collecting an adequate amount of seed (3) collecting seed randomly and uniformly (and possibly, along maternal lines), and (4) using an adequate number of seeds or seeds from an adequate number of plants for bulking. Where any of these conditions are not met, or an occurrence is otherwise known to have low genetic diversity based on genetic testing, the bulked seed may be genetically depauperate. Therefore, we need to structure the source seed appropriately to maximize genetic diversity in the bulked sample.

### *Small Seed Lots*

For bulking purposes, a small seed lot is defined as fewer than 100 seeds or seeds from fewer than 50 plants (CPC 2019). Where the starting seed lot is small, there is a greater chance for bulked seed to have lower genetic diversity than a wild population. Measures to counteract this possibility include:

- Use seed for bulking that has been collected along maternal lines, and sow the same number of seed per maternal line to ensure that each line is adequately represented in the bulked sample.
- Consider collecting additional seed from the source occurrence in subsequent years to increase the amount of seed available for bulking. Alternatively, collect additional seed from a large occurrence within the same genetic cluster or seed zone as the target

occurrence, unless there is evidence of local adaptation at the target occurrence (possibly due to long-term isolation) or different ploidy levels between occurrences.

### *Low Genetic Diversity*

Where there is evidence of low genetic diversity in a small occurrence that is declining even with management, use genetic structure as a guide to develop a bulking program to increase diversity. Refer to the discussions on genetic structure in Milano and Vandergast (2018) and the F-RPMP, and on seed zones in this document for additional guidelines.

- For species with low genetic differentiation among occurrences, use a genetically compatible seed source to increase the amount of seed available for bulking if adequate seed is not available at the target occurrence. Genetically compatible seed sources include large occurrences within the same genetic cluster or seed zone. If there is evidence of inbreeding, consider recovering additional seed from the soil seed bank at the target occurrence to use for bulking (Ottewell et al. 2016, Milano and Vandergast 2018).
- For species with high genetic differentiation, use seed from multiple, genetically compatible seed sources (composite provenancing) to increase the amount of seed available for bulking (if needed). Genetically compatible seed sources include medium or large occurrences within the same genetic cluster or seed zone. Manage potential risks from outbreeding depression by sourcing seed as locally as possible and from plants growing in similar habitats as the target occurrence.
- For occurrences with mixed ploidy levels, use only seed sourced from the restoration site (target occurrence) unless common garden studies indicate no local adaptation in the target occurrence (DeWoody et al. 2018).

### *Limits on Seed Bulking*

Seed bulking is a cost-effective method for increasing the amount of seed available for conservation or restoration. As a result, it can be tempting to bulk seed for several generations to meet specific needs. As discussed above, however, selective pressures in the nursery can influence the genotype of bulked seed, often within one or two generations (e.g., Guerrant 1996, Mistretta and Burkhart 1990). At the same time, we need to balance the needs of rescuing a species or occurrence on the verge of extinction or extirpation against the potential to introduce seed that differs from wild occurrences.

For most MSP rare plants, we do not have data on the loss of diversity (if any) in bulked samples, and we may not know the effects until several years after outplanting. For this reason, we recommend the following approach to seed bulking:

- Bulk seed of MSP rare plants in a nursery setting for one generation only (F1 generation).<sup>5</sup> If more seed is needed, start with wild seed rather than seed from the F1 generation.
- If it is necessary to bulk seed for more than one generation due to lack of availability of wild seed, engage a plant geneticist to test and compare seed from later generations (e.g., F2 generation) to a genetic baseline (if one exists) prior to outplanting to ensure the bulked seed does not differ significantly from wild seed. Alternatively, outplant only a small sample of the F2 seed or sow into a small, discrete area and monitor for at least 5 years to track survival and reproduction. The 5-year monitoring period should include years of both low rainfall and average to above average rainfall to account for seed genotypes that are adapted to dry and wet conditions, respectively. If results are favorable, proceed with additional seeding. Favorable results include germination, flowering, *and* production of viable seed.

## Documentation

Maintain detailed records on bulked seed collections to ensure they will be stored or used appropriately. Track seed after outplanting to provide information on both restoration success and failure to inform future efforts (Knapp and Rice 1994). Seed used in bulking will have source documentation (described above). Record additional, relevant information as the seed goes through the bulking process, including (but not necessarily limited to):

- Seed source (MSP occurrence ID or other site identifier)
- Seed collection date
- Amount of seed bulked
- Propagation method (e.g., pre-treatment, growth medium/containers, maternal lines)
- Propagation conditions
- Harvesting date
- Post-harvest storage location/duration/conditions
- Generation (F1, F2) of the bulked sample
- Receptor site location (if known)

Maintain a complete record of the documentation at the bulking facility and include a copy with seed sent for storage and/or for outplanting.

---

<sup>5</sup> Seed generations are denoted as F1, F2, etc. The F refers to the filial (offspring) of a parental plant and the number (1,2) refers to the generation. For example, the F1 generation is the first set of seed produced from a parental plant. The F1 seed, if grown to maturity, then produces a second, or F2, generation of seed.

## *Interim Seed Storage*

Seed that is bulked but not outplanted immediately should be stored under controlled conditions to retain viability. Seed bank institutions or commercial seed facilities have storage protocols in place to store seed properly. These include storage in a freezer, refrigerator, or warehouse under conditions that maintain low relative humidity, low seed moisture content, and cool temperatures.

There may be cases in which a restoration practitioner or land manager will need to store seed collected and/or bulked for restoration purposes on an interim basis (e.g., a year or less). For those entities that do not have dedicated storage facilities or protocols in place, we provide the following recommendations (see Gold 2014, Dumroese et al. 2009, Houseal 2007, USDA-NRCS no date, and others).

- Dry seeds to reduce the moisture content before packaging them for storage. Refer to Section 4.1 (Seed Collecting, Interim Storage) for guidelines on drying damp seeds. Some seeds will have reached maturity but still have relatively high moisture content. For these seeds, air-drying in shallow trays or on tarps for several weeks should reduce the moisture content sufficiently (e.g., Gold 2014, Dumroese et al. 2009, Wall 2009).
- Store dried seeds in an airtight, moisture-resistant container and label the container. Suitable storage containers include (but are not limited to) sealed jars with rubber gaskets on the lids, envelopes placed into a sealed, plastic tub with an airtight lid, sealed, thick plastic bags, or heat-sealed foil-lined plastic pouches (e.g., the type used for seed storage). For seeds that are stored in a warehouse or open room, make sure the storage container is rodent-proof.
- For small seed lots, use a desiccant (e.g., silica gel packet) inside the storage container to help absorb moisture, particularly if the container is opened frequently. Replace or regenerate desiccants occasionally. Color indicator silica gels change color (e.g., from blue to pink) when saturated, thus providing a visual indicator that the desiccant needs to be replaced or regenerated.
- Store seeds under cool, dry conditions in a freezer, cooler, or at room temperature under low humidity. An appropriate storage unit can be created using a cold storage container with a commercial de-humidifier inside.
  - If using a freezer or refrigerator for storage, consider a backup power supply in case of power outages.
  - If storing seed in a refrigerator, use a self-defrosting refrigerator that maintains relative humidity between 10-40%, and that is not used for other purposes.
  - For seeds stored at room temperature, ensure that the storage area has low relative humidity. Store seeds at room temperature for a short time only because they will

deteriorate faster than seeds stored at lower temperatures. For example, seed stored at 60°F will remain viable twice as long as seed stored at 70°F (Houseal 2007).

### *Germination and Propagation Best Management Practices*

Best Management Practices (BMPs) for seed bulking focus on growing conditions and nursery practices, because both may favor the survival of some seedlings over others and result in a bulked seed collection that differs genetically from the original collection. As described previously, this may reduce survivorship of outplanted seed (Knapp and Rice 1994, Campbell and Sorensen 1984).

Where the growing facility is situated in a different climatic zone than the seed collection site, bulked seed may not necessarily be adapted to the outplanting location. Indeed, genetic shifts have occurred in a single generation in plants from the same seed source grown in different locations (Knapp and Rice 1994).

Nursery growing practices often focus on maximum seed production, with plants subjected to different water, temperature, and nutrient regimes, as well as different soil medium than under natural conditions (USDA 2006, Knapp and Rice 1994). In addition, harvesting all seed at once (rather than over a period of time) can exclude early- and late-maturing seed from the bulked collection (Knapp and Rice 1994). These practices can select for genotypes that are not necessarily adapted to conditions at the outplanting location (USDA 2006, Knapp and Rice 1994). Other practices that may influence the quality of bulked seed and ultimately, outplanting success, include (1) pathogens or weed seeds introduced at the bulking facility and (2) cross-pollination during the growing process (Guerrant 1996).

We include the following guidelines to minimize directional selection and/or loss of genetic diversity and maximize seed quality in seed bulked at a nursery facility:

- Bulk seed at a facility as close to the source occurrence as possible or that is in an area with similar climatic conditions. If the growing facility is in proximity to a wild population of the target species, and there is the potential for cross-pollination, propagate only seed from the same seed zone as the wild population at that facility.
- Select seeds for sowing that represent the range of phenotypic variation in the seed collection, including (but not limited to) heavy and light seeds, large and small seeds, and variously colored seeds.
- Use germination protocols that maximize germination, including pre-treating seeds to relieve dormancy. Where protocols do not exist, conduct experimental germination trials prior to large-scale bulking or work with research or seed bank institutions to develop protocols.

- Sow seed into growing containers or flats at densities that avoid or minimize competition that excessively favors one phenotype over another.
- Grow seed under conditions as close to natural growing conditions as possible with respect to water, temperature, nutrients, and soil type. In some cases, it may be possible to import soil from the donor or receptor site to grow plants in the nursery.
- Follow standard nursery BMPs to minimize pathogens that can affect plant or seed health and survivorship.
- Remove weeds from planting containers to reduce the potential for non-desirable seeds in harvested material.
- If culling plants to improve growth and survivorship, make sure that retained plants represent the phenotypic variation in the sample rather than just the largest or most robust individuals.
- For outcrossing species, maintain a sufficient distance in the nursery to prevent cross-pollination between bulked collections from different seed zones or between bulked collections and other species that may hybridize with the target species.
- Harvest seed continuously throughout growing process.

### *Seed Bulking Facilities or Nurseries*

Table 18 lists facilities with experience germinating, growing, or bulking seed for one or more MSP rare plants. This table is not necessarily comprehensive, nor is it meant to endorse any entity. We include this information only as a guide for land managers interested in bulking seed to restore an occurrence of an MSP rare plant on their preserve. We encourage land managers to contact these or other facilities directly for additional information.

### *Potential Funding Sources*

Table 19 lists potential funding sources that may be available to assist with seed collection, banking, and bulking activities identified as regional priorities in the F-RPMP. This list is not comprehensive, but focuses on sources that have funded activities in the region in the past and that are currently available. Refer to the SDMMP website for regularly updated information on grant opportunities:

<https://sdmmp.com/events.php?type=Grants>



**Table 18.** Facilities with Experience Growing MSP Rare Plants.<sup>1</sup>

Scientific Name <sup>2</sup>	Common Name	Seed Banks or Botanic Gardens <sup>3</sup>	Commercial Nurseries <sup>4</sup>
<i>Acanthomintha ilicifolia</i>	San Diego thornmint	RSA <sup>5</sup> ,SDZG	
<i>Acmispon prostratus</i>	Nuttall's acmispon	SDBG, SDZG	NW
<i>Adolphia californica</i>	California adolphia		NW
<i>Agave shawii</i> var. <i>shawii</i>	Shaw's agave	SDBG	NW
<i>Ambrosia pumila</i>	San Diego ambrosia	SDZG	NW
<i>Aphanisma blitoides</i>	Aphanisma		NW
<i>Arctostaphylos glandulosa</i> ssp. <i>crassifolia</i>	Del Mar manzanita	SDBG	NW
<i>Arctostaphylos otayensis</i>	Otay manzanita	SDZG	NW
<i>Arctostaphylos rainbowensis</i>	Rainbow manzanita		
<i>Atriplex coulteri</i>	Coulter's saltbush	RSA	
<i>Atriplex parishii</i>	Parish brittle scale	RSA	
<i>Baccharis vanessae</i>	Encinitas baccharis	SDBG	NW
<i>Bloomeria clevelandii</i>	San Diego goldenstar	SDBG, SDZG	NW
<i>Brodiaea filifolia</i>	Thread-leaved brodiaea	RSA	NW
<i>Brodiaea orcuttii</i>	Orcutt's brodiaea	SDZG	NW
<i>Brodiaea santarosae</i>	Santa Rosa brodiaea		
<i>Calochortus dunnii</i>	Dunn's mariposa lily		
<i>Ceanothus cyaneus</i>	Lakeside ceanothus	SDZG	NW
<i>Ceanothus verrucosus</i>	Wart-stemmed ceanothus	SDBG, SDZG	NW
<i>Centromadia parryi</i> ssp. <i>australis</i>	Southern tarplant	RSA	
<i>Chloropyron maritimum</i> ssp. <i>maritimum</i>	Salt marsh bird's-beak	SDZG	
<i>Chorizanthe orcuttiana</i>	Orcutt's spineflower	RSA	
<i>Clinopodium chandleri</i>	San Miguel savory		
<i>Comarostaphylis diversifolia</i> ssp. <i>diversifolia</i>	Summer-holly	SDBG, SDZG	NW
<i>Cylindropuntia californica</i> var. <i>californica</i>	Snake cholla		NW
<i>Deinandra conjugens</i>	Otay tarplant		NW
<i>Dicranostegia orcuttiana</i>	Orcutt's bird's-beak	SDZG	
<i>Dudleya blochmaniae</i>	Blochman's dudleya		NW
<i>Dudleya brevifolia</i>	Short-leaved dudleya	SDZG	
<i>Dudleya variegata</i>	Variegated dudleya	SDZG	NW
<i>Dudleya viscida</i>	Sticky dudleya		NW

**Table 18.** Facilities with Experience Growing MSP Rare Plants.<sup>1</sup>

Scientific Name <sup>2</sup>	Common Name	Seed Banks or Botanic Gardens <sup>3</sup>	Commercial Nurseries <sup>4</sup>
<i>Ericameria palmeri</i> ssp. <i>palmeri</i>	Palmer's goldenbush	SDZG <sup>6</sup>	NW
<i>Eryngium aristulatum</i> var. <i>parishii</i>	San Diego button-celery	SDZG	NW
<i>Erysimum ammophilum</i>	Coast wallflower	SDZG	
<i>Euphorbia misera</i>	Cliff spurge	SDBG	NW
<i>Ferocactus viridescens</i>	San Diego barrel cactus	SDBG, SDZG	NW
<i>Fremontodendron mexicanum</i>	Mexican flannelbush	SDZG	NW
<i>Hazardia orcuttii</i>	Orcutt's hazardia	SDBG	NW
<i>Hesperocyparis forbesii</i>	Tecate cypress	RSA, SDBG, SDZG	NW
<i>Iva hayesiana</i>	San Diego marsh-elder	SDBG	NW
<i>Lepechinia cardiophylla</i>	Heart-leaved pitcher sage		
<i>Lepechinia ganderi</i>	Gander's pitcher sage	SDZG	
<i>Monardella hypoleuca</i> ssp. <i>lanata</i>	Felt-leaved monardella	SDZG	
<i>Monardella stoneana</i>	Jennifer's monardella	SDZG	
<i>Monardella viminea</i>	Willowy monardella	SDBG, SDZG	
<i>Navarretia fossalis</i>	Spreading navarretia	RSA, SDZG	NW
<i>Nolina cismontana</i>	Chaparral nolina		
<i>Nolina interrata</i>	Dehesa nolina		NW
<i>Orcuttia californica</i> *	California Orcutt grass	SDZG	NW
<i>Packera ganderi</i>	Gander's ragwort		
<i>Pinus torreyana</i> ssp. <i>torreyana</i>	Torrey pine	SDBG, SDZG	NW
<i>Pogogyne abramsii</i>	San Diego mesa mint	SDZG	NW
<i>Pogogyne nudiuscula</i> *	Otay mesa mint	SDZG	NW
<i>Quercus dumosa</i>	Nuttall's scrub oak	RSA, SDBG, SDZG	NW
<i>Quercus engelmannii</i>	Engelmann oak		NW
<i>Rosa minutifolia</i>	Small-leaved rose	SDBG	NW
<i>Tetracoccus dioicus</i>	Parry's tetracoccus		NW

<sup>1</sup> MSP plant species as defined in the MSP Roadmap (SDMMP and TNC 2017); information in table is obtained primarily from the California Plant Rescue conservation collections.

<sup>2</sup> Nomenclature generally follows Baldwin et al. 2012.

<sup>3</sup> Seed Banks or Botanic Gardens: **SDBG** = San Diego Botanic Garden, **SDZG** = San Diego Zoo Global, **RSA** = Rancho Santa Ana Botanic Garden.

<sup>4</sup> Commercial Nurseries: **NW** = Native West Nursery (formerly Recon Native Plant Nursery).

<sup>5</sup> RSA conducted a series of germination tests and propagated San Diego thornmint in the 1990s (Mistretta and Burkhart 1990, <https://www.rsabg.org/conservation/seed-conservation>).

<sup>6</sup> SDZG conducted germination tests for this species, but these tests were not very successful.

**Table 19.** Potential Funding Sources.

Funding Source	Program	Focus	Eligible Organizations	Cycle
<i>Preserve-specific Programs</i>				
Land owner/manager	Annual budget allocation	Routine management, contingency funds.	Preserve-specific.	Annual
Land owner/manager	Endowments	Routine management, contingency funds.	Preserve-specific.	Annual
<i>Regional Programs</i>				
San Diego Association of Governments (SANDAG)	<i>Transnet</i> Environmental Mitigation Program – land management grants <a href="https://www.sandag.org/index.asp?projectid=447&amp;fuseaction=projects.detail">https://www.sandag.org/index.asp?projectid=447&amp;fuseaction=projects.detail</a>	Projects on conserved lands within MSPA; MSP species, habitats, threats.	Landowner/manager or representative.	Variable
San Diego Association of Governments (SANDAG)	<i>Transnet</i> Environmental Mitigation Program – land acquisition grants <a href="https://www.sandag.org/index.asp?projectid=447&amp;fuseaction=projects.detail">https://www.sandag.org/index.asp?projectid=447&amp;fuseaction=projects.detail</a>	Land acquisition that promotes regional habitat conservation plans.	Local jurisdictions, nonprofit organization, private land owners, consultants.	Variable
The San Diego Foundation	San Diego Foundation grants <a href="https://www.sdfoundation.org/grantseekers/">https://www.sdfoundation.org/grantseekers/</a>	Variable; local or regional projects that benefit local residents (particularly, disadvantaged communities).	Any 501(c)(3) organization in or providing services to San Diego County.	Throughout the year
<i>Federal and State Programs</i>				
California Natural Resource Agency	Environmental enhancement mitigation grants <a href="http://resources.ca.gov/grants/environmental-enhancement-and-mitigation-eem/">http://resources.ca.gov/grants/environmental-enhancement-and-mitigation-eem/</a>	Projects that mitigate the environmental impacts from public transportation facilities.	Local, state and federal governmental agencies and nonprofit organizations.	Annual
California State Coastal Conservancy	Coastal Conservancy grants <a href="https://scc.ca.gov/grants/">https://scc.ca.gov/grants/</a>	Biological diversity, water quality, habitat, and other natural resources in coastal watersheds.	Public agencies, federally-recognized tribes, nonprofit organizations.	Ongoing
California Department of Fish and Wildlife (CDFW)	Local assistance grants <a href="https://www.wildlife.ca.gov/Conservation/Planning/NCCP/Grants">https://www.wildlife.ca.gov/Conservation/Planning/NCCP/Grants</a>	High priority NCCP actions (identified in conjunction with the Wildlife Agencies).	Local jurisdictions or others implementing an approved NCCP.	Annual

**Table 19.** Potential Funding Sources.

Funding Source	Program	Focus	Eligible Organizations	Cycle
California Department of Fish and Wildlife (CDFW)	Prop 1: Watershed Restoration Grant Program (Water Bond 2014) <a href="https://www.wildlife.ca.gov/Conservation/Watersheds/Restoration-Grants">https://www.wildlife.ca.gov/Conservation/Watersheds/Restoration-Grants</a>	Reliable water supplies; resilient, sustainably managed water resources system; important species and habitat.	Public agencies, non-profit organizations, public utilities, Indian tribes, <sup>1</sup> and mutual water companies.	Annual
California Department of Fish and Wildlife (CDFW)	Prop 68: State of California Parks & Water Bond 2018 <a href="https://www.wildlife.ca.gov/Conservation/Watersheds/Prop-68">https://www.wildlife.ca.gov/Conservation/Watersheds/Prop-68</a>	Climate change adaptation; economic development & protection, connectivity, recreation, drought tolerance, landscape resilience, water retention.	Public agencies, non-profit organizations, public utilities, Indian tribes, <sup>1</sup> and mutual water companies.	Annual
Natural Resource Conservation Service	Environmental Quality Incentives Program (EQIP) conservation innovation grants <a href="https://www.nrcs.usda.gov/wps/portal/nrcs/main/national/programs/financial/eqip/">https://www.nrcs.usda.gov/wps/portal/nrcs/main/national/programs/financial/eqip/</a>	Natural resource concerns, environmental benefits.	Agriculture and forestry producers. <sup>2</sup>	Annual
San Diego River Conservancy	Prop 1: Watershed Protection and Restoration Program (Water Bond 2014) <a href="http://sdrc.ca.gov/prop-1/">http://sdrc.ca.gov/prop-1/</a>	Shovel-ready, capital improvement projects in the San Diego River Watershed.	Public agencies, nonprofit organizations, Indian tribes. <sup>1</sup>	Variable
San Diego River Conservancy	San Diego River Conservancy Proposition 68: The California Drought, Water, Parks, Climate, Coastal Protection, and Outdoor Access for all Act of 2018 <a href="http://sdrc.ca.gov/wp-content/uploads/2019/01/SDRC_prop-68-draft-guidelines-draft-012219-COMplete.pdf">http://sdrc.ca.gov/wp-content/uploads/2019/01/SDRC_prop-68-draft-guidelines-draft-012219-COMplete.pdf</a>	Shovel-ready projects in the San Diego River Watershed; climate change adaptation; economic development & protection, connectivity, recreation, drought tolerance, landscape resilience, water retention.	Public agencies, nonprofit organizations, Indian tribes. <sup>1</sup>	Variable
Southern California Wetlands Recovery Project (SCWRP)	Community wetland restoration grant program <a href="https://scwrp.org/community-wetland-restoration-grant-program/">https://scwrp.org/community-wetland-restoration-grant-program/</a>	Community-based restoration projects with an educational component; southern California coast.	Nonprofit organizations, universities, agencies.	Annual
U.S. Fish and Wildlife Service (USFWS)	Coastal Program <a href="https://www.fws.gov/coastal/">https://www.fws.gov/coastal/</a>	Native habitat restoration and acquisition (protection)	Local, state, and federal governmental agencies, Indian tribes, <sup>1</sup> nonprofit organizations, consultants, landowners/managers.	Annual

**Table 19.** Potential Funding Sources.

Funding Source	Program	Focus	Eligible Organizations	Cycle
U.S. Fish and Wildlife Service (USFWS)	Cost-sharing program (e.g., Partners for Fish and Wildlife grants) <a href="https://www.fws.gov/cno/conservation/Partners.html">https://www.fws.gov/cno/conservation/Partners.html</a>	Restore, protect habitat for native fish and wildlife species.	Private landowners, individuals, groups engaged in voluntary conservation efforts on private lands.	Annual
U.S. Fish and Wildlife Service (USFWS)	National Coastal Wetlands Conservation Grant <a href="https://www.fws.gov/coastal/CoastalGrants/">https://www.fws.gov/coastal/CoastalGrants/</a>	Native habitat restoration and acquisition (protection).	State agencies.	Annual
U.S. Fish and Wildlife Service (USFWS)	National Wildlife Refuge System Cooperative Recovery Initiative <a href="https://www.fws.gov/refuges/whm/cri/get-started/">https://www.fws.gov/refuges/whm/cri/get-started/</a>	Restore, recover federally or state-endangered species on National Wildlife Refuges and lands with a Refuge nexus. <sup>3</sup>	Internal grant program. Partners are encouraged to contact local or regional USFWS contacts.	Annual
U.S. Fish and Wildlife Service (USFWS)	Recovery Challenge <a href="http://www.federalgrants.com/FY-2018-Recovery-Challenge-72571.html">http://www.federalgrants.com/FY-2018-Recovery-Challenge-72571.html</a>	Enhance, increase partnerships to implement highest priority recovery actions identified in recovery plans (particular for breeding, rearing, and reintroduction programs).	State and local jurisdictions, public or private universities, Indian tribes, 1, nonprofit organizations, for-profit organizations and small businesses.	Annual
USFWS (funder), CDFW (administrator)	State wildlife grant program <a href="https://wsfrprograms.fws.gov/Subpages/GrantPrograms/SWG/SWG.htm">https://wsfrprograms.fws.gov/Subpages/GrantPrograms/SWG/SWG.htm</a> <a href="https://www.wildlife.ca.gov/Grants/State-Wildlife-Grants">https://www.wildlife.ca.gov/Grants/State-Wildlife-Grants</a>	Programs that benefit wildlife and their habitats as identified in State Wildlife Action Plans.	Nonprofit organizations, local government agencies, colleges and universities, and state departments.	Annual
USFWS (funder), CDFW (administrator)	Cooperative Endangered Species Conservation Fund/Section 6 grants <a href="https://www.fws.gov/endangered/grants/index.html">https://www.fws.gov/endangered/grants/index.html</a> <a href="https://www.wildlife.ca.gov/Conservation/Planning/NCCP/Grants">https://www.wildlife.ca.gov/Conservation/Planning/NCCP/Grants</a>	Endangered species conservation, recovery; habitat acquisition for listed species per approved, draft species recovery plans.	Public agencies, state departments, colleges and universities, tribal governments, nonprofit entities working with resource agencies.	Annual
Wildlife Conservation Board (WCB), CDFW	Monarch butterfly and pollinator rescue program <a href="https://wcb.ca.gov/Programs/Pollinators">https://wcb.ca.gov/Programs/Pollinators</a>	Monarch butterflies and other pollinators.	Private landowners, nonprofit organizations, resource conservation districts, public agencies.	Annual

<sup>1</sup> Including federally recognized Indian tribes, and state Indian tribes listed on the Native American Heritage Commission’s California Tribal Consultation List.

<sup>2</sup> Including nonprofit organizations, indigenous tribes, private land owners, or individuals or groups engaged in conservation efforts on private lands.

<sup>3</sup> Program funds on-the-ground projects with high likelihood of success.

## 5.0 SPECIES-SPECIFIC SEED COLLECTION, BANKING, AND BULKING

### 5.1 SAN DIEGO THORNMINT (*ACANTHOMINTHA ILICIFOLIA*)

#### *Seed Collection*

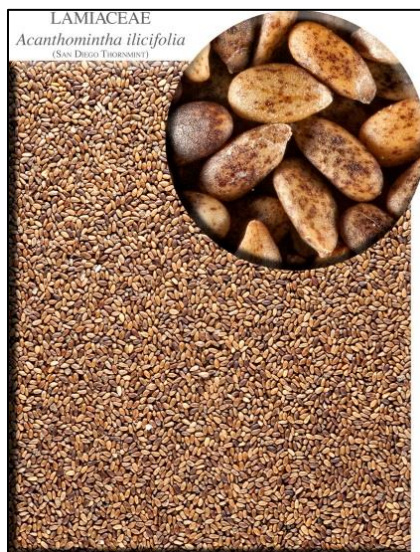
#### *Seed Characteristics*

San Diego thornmint flowers produce a maximum of four smooth, ovoid seeds (nutlets) that are held in a persistent, spine-tipped calyx (Miller and Jokerst 2012). Bauder and Sakrison (1997) observed 3-4 seeds per flower, with most calyces retaining seed.



Seed production is variable, but increases with plant size and flower production. Recent estimates range from 10-200 seeds per plant (DeWoody et al. 2018, Lippett et al. no date), although Bauder and Sakrison (1999) reported much higher seed production in experimentally-grown plants, including one individual that produced over 3,000 seeds.

Seeds mature in late spring and early summer. Mature seeds are light to medium brown with dark mottling (Figure 10). Lippett et al. (no date) found a higher percentage of filled seed and a higher germination rate for dark versus light seed, and suggested that light seed may not be fully mature. Seeds remain on the plants presumably until they desiccate completely or are released from the parental plant by weather (wind, rain), usually within one year. Although dry plants may be present from the previous year, they do not usually contain seeds.



**Figure 10.** San Diego Thornmint: Seed (Photo credit: John MacDonald, RSA).



## Priority Occurrences

Table 20 prioritizes occurrences of San Diego thornmint on conserved lands in the MSPA for seed-related management actions. These priorities were developed in the F-RPMP based on monitoring data and specific studies, including genetic analyses. The decision to implement an action will depend on a number of factors, including status of the occurrence (stable or declining), habitat condition, threats management, and funding, among others.

In general, large occurrences with high genetic diversity are prioritized as potential seed sources, subject to land manager and/or agency approval. Small occurrences are high priority candidates for seed reintroduction, subject to response to management and site conditions, as discussed in the F-RPMP.

Currently, conservation seed collections exist in established seed banks for 14 thornmint occurrences (31%) on conserved lands in the MSPA (Table 20). Seed banks also hold collections for an additional six occurrences that are extirpated or not currently conserved.

We recommend conservation collections as a potential management action for all occurrences that are not currently represented in a seed bank *if adequate seed is available*. For occurrences where plants have not been detected recently, a conservation collection will only be possible if plants are detected in the future (Table 20). Large occurrences are the highest (or most immediate) priorities for seed conservation to maximize the amount of genetic diversity in long-term storage (e.g., ACIL\_3PMA1013).

We recommend restoration collections as a potential management action for occurrences that are high or medium priorities for seed reintroduction as indicated in Table 20 and identified in the F-RPMP. We do not prioritize occurrences for seed reintroduction if they have not yet been monitored or if the location is questionable.<sup>6</sup>

We recommend reintroducing seed only if threats are controlled, habitat is likely to support this species in the future, and funding is available for short- and long-term management. Reintroducing seed is most appropriate for small occurrences that continue to decline, even with management. Seed may be introduced into extirpated occurrences if threats are managed and the habitat is likely to support thornmint in the future. For extirpated occurrences, source seed from a large occurrence in the same seed zone or from an appropriate seed source in storage (if available). Some threats (particularly, invasive plants) will likely require perpetual management; thus, ensure that adequate funding and/or labor are available to manage the occurrence after seed is reintroduced.

---

<sup>6</sup> For a few San Diego thornmint occurrences, the locality information appears to be incorrect based on monitoring data that shows both an absence of plants and a lack of suitable habitat to support the species. These problematic occurrences are included in Table 19, but highlighted with footnotes.

**Table 20.** San Diego Thornmint: Management Priorities for Seed-related Activities.

Occurrence ID <sup>1</sup>	Occurrence Name	Occurrence Size <sup>2</sup>	Genetic Structure <sup>3</sup>	Seed Reintroduction Priority <sup>4</sup>	Existing Seed Collection <sup>5</sup>	Seed-related Activities <sup>6</sup>			
						Seed Source	Conservation Collection	Restoration Collection	Seed Bulking
ACIL_2EDHI001	El Dorado Hills	Small	H+L+L	---			✓ <sup>7</sup>		
ACIL_2EDHI002	El Dorado Hills	Small	H+L+L	---			✓ <sup>7</sup>		
ACIL_3BOME003	Bonita Meadows	Medium	H+L+L	Medium			✓	✓	✓
ACIL_3CERE004	Crestridge Ecological Reserve	Small	H+L+L	High			✓	✓	✓
ACIL_3DREA005	Dennery Ranch East	Small	H+L+L	High	SDZG			✓	✓
ACIL_3HCWA006	Hollenbeck Wildlife Area	Medium	H+L+L	Medium	SDZG			✓	✓
ACIL_3LONC007	Long Canyon (PMA 4-2b)	Small	H+L+L	High			✓	✓	✓
ACIL_3MGMT008	McGinty Mountain	Small	H+L+L	High	SDZG			✓	✓
ACIL_3MGMT009	McGinty Mountain (southwest slope)	Small	H+L+L	High			✓	✓	✓
ACIL_3MGMT010	McGinty Mountain (summit, ridgeline)	Small	H+L+L	High	SDZG			✓	✓
ACIL_3OTLA011	Lower Otay Reservoir	Small	H+L+L	High			✓ <sup>7,8</sup>	✓ <sup>8</sup>	✓ <sup>8</sup>
ACIL_3OTLA012	Lower Otay Reservoir	Small	H+L+L	High			✓	✓	✓
ACIL_3PMA1013	PMA1 (Rice Canyon)	Large	H+L+L	Low		✓			
ACIL_3PMA3014	PMA3 (Poggi Canyon)	Small	H+L+L	---			✓ <sup>7,8</sup>		
ACIL_3RJER015	Rancho Jamul Ecological Reserve	Small	H+L+L	High			✓ <sup>7</sup>	✓	✓
ACIL_3SOCR016	South Crest (Suncrest)	Medium	H+L+L	High	SDZG			✓	✓
ACIL_3WHRI017	Bonita, Wheeler Ridge (Long Canyon PMA 4-1cW)	Small	H+L+L	High			✓	✓	✓
ACIL_3WRFI018	Wright's Field (north & south)	Medium	H+L+L-M	Medium			✓	✓	✓
ACIL_4CSVI019	Canada San Vicente-Daney Canyon	Small	H+L+L	---			✓ <sup>7,8</sup>		

**Table 20.** San Diego Thornmint: Management Priorities for Seed-related Activities.

Occurrence ID <sup>1</sup>	Occurrence Name	Occurrence Size <sup>2</sup>	Genetic Structure <sup>3</sup>	Seed Reintroduction Priority <sup>4</sup>	Existing Seed Collection <sup>5</sup>	Seed-related Activities <sup>6</sup>			
						Seed Source	Conservation Collection	Restoration Collection	Seed Bulking
ACIL_4CSVI020	Canada San Vicente-- Monte Vista (Long's Gulch)	Small	H+L+L	High			✓ <sup>7</sup>	✓	✓
ACIL_4MTRP021	Mission Trails Regional Park (MTRP)	Small	H+L+L	High	SDZG			✓	✓
ACIL_4MTRP022	MTRP (southwest Tierra Santa parcel, northwest of Mission Gorge)	Small	H+L+L	---			✓ <sup>7</sup>		
ACIL_4POGR023	Poway Grade	Small	H+L+L	---			✓ <sup>7,8</sup>		
ACIL_4POMT048	Poser Mountain	Small	H+L+L-M	---			✓ <sup>7</sup>		
ACIL_4POMT049	Poser Mountain 35	Small	H+L+L-M	High			✓	✓	✓
ACIL_4POMT050	Poser Mountain	Small	H+L+L-M	---			✓ <sup>7</sup>		
ACIL_4SASP024	Saber Springs (east)	Small	H+L+L	---			✓ <sup>7</sup>		
ACIL_4SASP025	Sabre Springs (east, subpopulation 1)	Small	H+L+L	High	RSA, SDZG			✓	✓
ACIL_4SIPR026	Simon Preserve	Medium	H+L+L	Medium	SDZG			✓	✓
ACIL_4SYCA027	Sycamore Canyon	Large	H+L+L	---	SDZG	✓			
ACIL_4VIMT0028	Viejas Mountain (northwest slope)	Small	H+L+L-M	High			✓ <sup>7</sup>	✓	✓
ACIL_4VIMT0029	Viejas Mountain (southwest slope)	Medium	H+L+L	Medium	RSA			✓	✓
ACIL_4VIMT0030	Viejas Mountain (west- southwest flank)	Small	H+L+L-M	High			✓	✓	✓
ACIL_5RAGR031	Ramona Grasslands/Hobbes Property	Small	H+L+L	---			✓ <sup>7</sup>		
ACIL_6BLMO032	Black Mountain	Small	H+L+L	High			✓	✓	✓
ACIL_6CAHI033	Calavera Hills	Small	H+L+L	---			✓ <sup>7</sup>		

**Table 20.** San Diego Thornmint: Management Priorities for Seed-related Activities.

Occurrence ID <sup>1</sup>	Occurrence Name	Occurrence Size <sup>2</sup>	Genetic Structure <sup>3</sup>	Seed Reintroduction Priority <sup>4</sup>	Existing Seed Collection <sup>5</sup>	Seed-related Activities <sup>6</sup>			
						Seed Source	Conservation Collection	Restoration Collection	Seed Bulking
ACIL_6CARA034	Carlsbad Racetrack (south)	Small	H+L+L	High			✓	✓	✓
ACIL_6CARL035	Southeast Carlsbad (east)	Small	H+L+L	---			✓ <sup>7</sup>		
ACIL_6CARL036	Southeast Carlsbad (west)	Small	H+L+L	---			✓ <sup>7</sup>		
ACIL_6EMPO037	Emerald Pointe	Small	H+L+L-M	High			✓	✓	✓
ACIL_6LCGR038	La Costa Greens	Small	H+L+L	High			✓	✓	✓
ACIL_6LPCA039	Los Peñasquitos Canyon	Small	H+L+L	High	RSA, SDZG			✓	✓
ACIL_6LUCA040	Lux Canyon (west)	Small	H+L+L-M	---			✓ <sup>7</sup>		
ACIL_6LUCA042	Lux Canyon (east), Manchester Avenue Mitigation Bank	Small	H+L+L-M	---			✓ <sup>7</sup>		
ACIL_6MAMI041	Lux Canyon (west of Manchester Avenue Mitigation Bank)	Medium	H+L+L-M	Medium	RSA			✓	✓
ACIL_6PARO043	Palomar Airport Road	Large	H+L+L-M	Low	SDZG	✓			
ACIL_6RACA044	El Fuerte Street (Rancho Carrillo)	Small	H+L+L	High			✓	✓	✓
ACIL_6RSFE045	Rancho Santa Fe	Small	H+L+L	---			✓ <sup>7</sup>		
ACIL_6THCO046	Thornmint Court	Small	H+L+L	---	RSA				

<sup>1</sup> Occurrence ID: Occurrence identification (ID) code per the San Diego Management and Monitoring Program's (SDMMP) Master Occurrence Matrix (MOM) database.

<sup>2</sup> Occurrence Size: Recent size category as defined in the Framework-Rare Plant Management Plan (F-RPMP). **Small** = <1,000 individuals, **Medium** = 1,000-<10,000 individuals, **Large** = >10,000 individuals.

<sup>3</sup> Genetic Structure (per Milano and Vandergast 2018): Genetic differentiation + genetic diversity + inbreeding. **L** = low, **H** = High, **L-M** = Low or Mixed. Refer to F-RPMP for a discussion of the implications for seed movement.

- <sup>4</sup> Seed Reintroduction Priority (per F-RPMP): **High** = high priority for seed reintroduction, **Medium** = medium priority for seed reintroduction, **Low** = low priority for seed reintroduction, --- = not a priority for seed reintroduction at this time due to stable population (large occurrence) or lack of monitoring data.
- <sup>5</sup> Existing Seed Collection: Indicates location of collection. **RSA** = Rancho Santa Ana Botanic Garden, **SDZG** = San Diego Zoo Global.
- <sup>6</sup> Seed-related Activities: ✓ indicates occurrence is suitable as a seed source (pending authorization from responsible entities) or management action is warranted. Where there is an existing seed collection, a restoration collection may not be needed, but land managers should contact the seed bank directly to make that determination. Likewise, seed bulking may not be necessary depending on the amount of seed available in an existing collection or collected specifically for restoration purposes.
- <sup>7</sup> Occurrence has not been monitored or plants have not been observed recently. In this case, a conservation collection is warranted only if the occurrence is extant and plants are present in the future.
- <sup>8</sup> Occurrence location is questionable (possibly mapped incorrectly) based on monitoring data that indicate an absence of both plants and suitable habitat for thornmint. Resolve issue prior to implementing seed-related management actions.

We recommend seed bulking as a potential management action for all occurrences requiring a restoration collection. However, the need for bulking will depend on the amount of seed available in storage and/or collected specifically for restoration, and the sowing strategy. For example, bulking will not be needed if enough seed is collected to sow directly into the target occurrence.

### *Seed Zones*

We established five seed zones for San Diego thornmint to guide seed collecting, banking, and bulking efforts: North, South, East, Central-east, and Central-west. Seed zones correspond to the five genetic clusters and population groups identified for this species in the F-RPMP. Figure 11 shows the locations of the five seed zones; Table 21 lists the seed zone for each occurrence.

Seed zones place geographic limits on the transfer of seed between occurrences. *We do not recommend transfer of seed beyond a seed zone at this time.* Thus, if a small occurrence requires seed from another occurrence, the source (donor) occurrence should be located within the same seed zone as the target (recipient) occurrence. Within a seed zone, we recommend that seed transfer proceed between occurrences that are close to one another, particularly in larger seed zones. We designate subgroups (Table 21) to identify occurrences in proximity. Where it is not possible or practical to move seed within a subgroup, consider subgroups nearby for sourcing seed. The same limits on seed movement apply when using seed from a seed bank.

### *Collecting Plan*

Refer to Section 4.1 of this document for guidelines on developing a sampling strategy for seed collection. Identify the purpose and type of collection needed for a specific project or restoration effort, as well as timeline and costs. In the section below, we highlight key steps in the process, including those specific to San Diego thornmint.

### Sampling Strategy

Refer to Table 20 for prioritized seed-related activities for the target occurrence to identify whether seed is needed for a conservation collection, a restoration collection, or both.

For restoration, determine if seed is available in a seed bank to reintroduce directly into a target occurrence or for bulking. Proceed with the collecting plan if stored seed is not available, quantities are not sufficient, or the provenance is not appropriate for the target occurrence (e.g., different seed zone).

Assess whether the target occurrence will likely provide an adequate quantity of seed for restoration or if seed will need to be sourced from other occurrences in the seed zone. Refer to seed zones and seed zone subgroups (Figure 11, Table 21) for limits on seed movement and seed sources. Contact the appropriate land managers of potential seed source occurrences to obtain permission for seed collection.



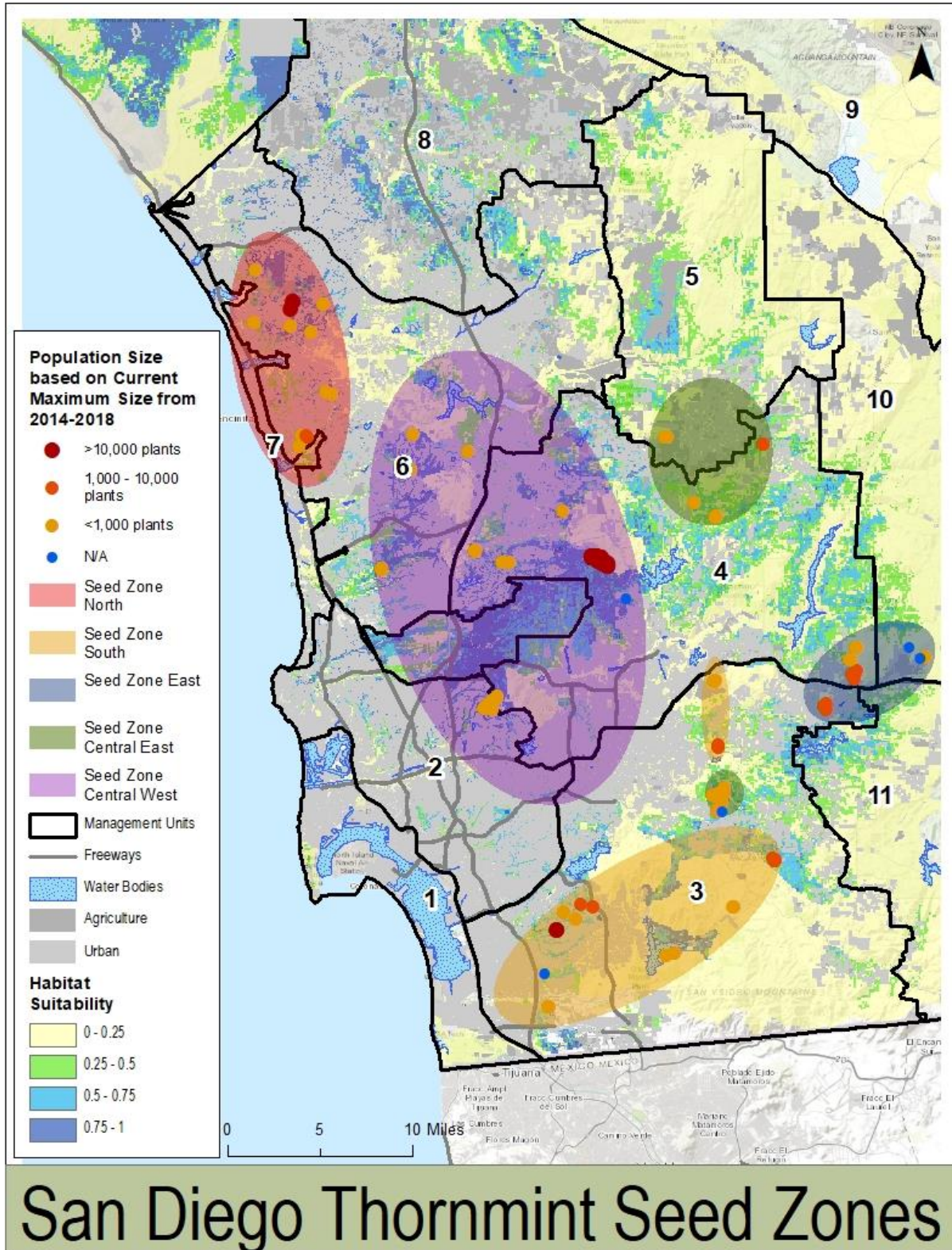


Figure 11. San Diego Thornmint: Seed Zones.

**Table 21.** San Diego Thornmint: Seed Zones.

Occurrence ID <sup>1</sup>	Occurrence Name	Seed Zone <sup>2</sup>	Seed Zone Subgroup <sup>3</sup>	Occurrence Size <sup>4</sup>
ACIL_6PARO043	Palomar Airport Road	North	1	Large
ACIL_6CAHI033	Calavera Hills	North	1	Small
ACIL_6CARA034	Carlsbad Racetrack (south)	North	1	Small <sup>5</sup>
ACIL_6EMPO037	Emerald Pointe	North	1	Small
ACIL_6LCGR038	La Costa Greens	North	1	Small <sup>5</sup>
ACIL_6RACA044	El Fuerte Street (Rancho Carrillo)	North	1	Small
ACIL_6CARL035	Southeast Carlsbad (east)	North	2	Small
ACIL_6CARL036	Southeast Carlsbad (west)	North	2	Small
ACIL_6MAMI041	Lux Canyon (west of Manchester Avenue Mitigation Bank)	North	3	Medium <sup>5</sup>
ACIL_6LUCA040	Lux Canyon (west)	North	3	Small
ACIL_6LUCA042	Lux Canyon (east), Manchester Avenue Mitigation Bank	North	3	Small
ACIL_3PMA1013	PMA1 (Rice Canyon)	South	1	Large
ACIL_3BOME003	Bonita Meadows	South	1	Medium
ACIL_3DREA005	Dennery Ranch East	South	1	Small
ACIL_3LONC007	Long Canyon (PMA 4-2b)	South	1	Small
ACIL_3OTLA012	Lower Otay Reservoir	South	1	Small
ACIL_3PMA3014	PMA3 (Poggi Canyon)	South	1	Small
ACIL_3WHRI017	Bonita, Wheeler Ridge (Long Canyon PMA 4-1cW)	South	1	Small
ACIL_3HCWA006	Hollenbeck Wildlife Area	South	2	Medium <sup>5</sup>
ACIL_3OTLA011	Lower Otay Reservoir	South	2	Small
ACIL_3RJER015	Rancho Jamul Ecological Reserve	South	2	Small
ACIL_3SOCR016	South Crest (Suncrest)	South	3	Medium
ACIL_3CERE004	Crestridge Ecological Reserve	South	3	Small
ACIL_3WRFI018	Wright's Field (north & south)	East	1	Medium
ACIL_4POMT048	Poser Mountain	East	1	Small <sup>5</sup>
ACIL_4POMT049	Poser Mountain 35	East	1	Small
ACIL_4POMT050	Poser Mountain	East	1	Small <sup>5</sup>
ACIL_4VIMT0028	Viejas Mountain (northwest slope)	East	1	Small
ACIL_4VIMT0029	Viejas Mountain (southwest slope)	East	1	Medium <sup>5</sup>
ACIL_4VIMT0030	Viejas Mountain (west-southwest flank)	East	1	Small

**Table 21.** San Diego Thornmint: Seed Zones.

Occurrence ID <sup>1</sup>	Occurrence Name	Seed Zone <sup>2</sup>	Seed Zone Subgroup <sup>3</sup>	Occurrence Size <sup>4</sup>
ACIL_3MGMT008	McGinty Mountain	Central-east	1	Small <sup>5</sup>
ACIL_3MGMT009	McGinty Mountain (southwest slope)	Central-east	1	Small <sup>5</sup>
ACIL_3MGMT010	McGinty Mountain (summit, ridgeline)	Central-east	1	Small <sup>5</sup>
ACIL_4SIPR026	Simon Preserve	Central-east	2	Medium
ACIL_4CSVI019	Canada San Vicente-Daney Canyon	Central-east	2	Small
ACIL_4CSVI020	Canada San Vicente--Monte Vista (Long's Gulch)	Central-east	2	Small
ACIL_5RAGR031	Ramona Grasslands/Hobbes Property	Central-east	2	Small
ACIL_2EDHI001	El Dorado Hills	Central-west	1	Small
ACIL_2EDHI002	El Dorado Hills	Central-west	1	Small
ACIL_4MTRP021	Mission Trails Regional Park (MTRP)	Central-west	1	Small
ACIL_4MTRP022	MTRP (southwest Tierra Santa parcel, northwest of Mission Gorge)	Central-west	1	Small
ACIL_4SYCA027	Sycamore Canyon	Central-west	2	Large
ACIL_4POGR023	Poway Grade	Central-west	2	Small
ACIL_4SASP024	Saber Springs (east)	Central-west	2	Small
ACIL_4SASP025	Sabre Springs (east, subpopulation 1)	Central-west	2	Small <sup>5</sup>
ACIL_6LPCA039	Los Peñasquitos Canyon	Central-west	2	Small <sup>5</sup>
ACIL_6BLMO032	Black Mountain	Central-west	3	Small <sup>5</sup>
ACIL_6RSFE045	Rancho Santa Fe	Central-west	3	Small
ACIL_6THCO046	Thornmint Court	Central-west	3	Small <sup>5</sup>

<sup>1</sup> Occurrence ID: Occurrence identification (ID) code per the San Diego Management and Monitoring Program's (SDMMP) Master Occurrence Matrix (MOM) database.

<sup>2</sup> Seed Zone: seed zones are defined in text and correspond to genetic clusters and population groups in the F-RPMP. Limit seed movement to within the same seed zone. Shading indicates seed zone group and subgroup.

<sup>3</sup> Seed Zone Subgroups are defined in text and correspond to population subgroups in the F-RPMP. Where feasible, limit seed movement to the same subgroup within a population group. Shading indicates seed zone subgroup and subgroup.

<sup>4</sup> Occurrence size: refers to population size category based on multiple years of monitoring data. Recent size category as defined in the Framework-Rare Plant Management Plan (F-RPMP). **Small** = <1,000 individuals, **Medium** = 1,000-<10,000 individuals, **Large** = >10,000 individuals.

<sup>5</sup> Indicates occurrences where monitoring indicates a decline in population size category over time. Refer to F-RPMP for additional details.



Based on the purpose and type of collection, and amount of seed expected to be available, determine whether the seed is likely to be collected along maternal lines or in bulk (Table 9), and set minimum targets for the number of plants to sample and amount of seed to collect. These targets are intended to provide a guide for planning, and may be modified based on the actual seed crop.

### Permitting and Agreements

Ensure that all regulatory permits, memorandums, and access agreements are in place before collecting seed from an occurrence.

If unfamiliar with the collecting location, contact the land owner to obtain a map and coordinates of the occurrence, directions to the occurrence if necessary, gate codes, lock combinations, or keys, and any pertinent information about the occurrence (e.g., informing adjacent land owners, closures due to unsafe conditions).

### Pre-collection Monitoring

Practitioners can collect San Diego thornmint seed as early as April and as late as August, depending on location, elevation, aspect, and weather and temperature conditions during the previous fall, winter, and spring. Visit the target occurrence multiple times to determine the best time to collect seed. Time the first visit when plants are in full flower and easier to locate. Talk to land owners and managers and refer to monitoring data and literature to determine the range of phenological variation for an occurrence to plan the first site visit.

Use pin flags to demarcate the boundary of the occurrence if plants are located in dense grassland, because they are very difficult to locate when dry. If necessary, place pin flags adjacent to a subset of plants to relocate them easily during subsequent visits. Avoid walking within the occurrence to the degree feasible to minimize damage to plants and soils. Return to the occurrence within two to four weeks to check phenology. Weather conditions will determine the rate of desiccation; plants will dry quicker in warm and dry conditions and slower if conditions remain cool and moist. Continue monthly site visits until the majority of plants in an occurrence are fully desiccated and seeds resemble those in Figure 10.

### Voucher Specimens

Collect voucher specimens of San Diego thornmint if none exist for the source occurrence and if enough plants are available so that collecting a few specimens does not adversely affect the occurrence. Check the San Diego Natural History Museum or Consortium of California Herbaria to determine if a voucher specimen already exists:

San Diego Natural History Museum: <http://sdplantatlas.org/publicsearch.aspx>

Consortium of California Herbaria: <http://ucjeps.berkeley.edu/consortium/>

Note that recently collected specimens may not yet be accessed into an herbarium's collection. In addition, older specimens may not include sufficient locality information to definitively determine whether they were collected at the occurrence. If it is not appropriate to collect a voucher specimen, photograph the occurrence (landscape aspect) and an individual plant while in flower, and then again when the plant is in fruit.

Obtain all necessary permits and memorandums before collecting voucher specimens of endangered, threatened, and rare species. Collect specimens while plants are still in flower and before collecting seed. Refer to Section 4.1 of this document (Seed Collecting, Materials and Methods) and instructions and forms in Appendix B to guide your collection. Submit the voucher specimen(s) to the San Diego Natural History Museum as soon as possible.

### Methods and Materials

Refer to Section 4.1 of this document for a detailed discussion of methods and materials and Table 10 for a comprehensive list of recommended equipment for collecting seed. At a minimum, bring the following to each San Diego thornmint collection location:

- Regulatory permits and access agreements
- Directions, map(s)
- Lock combination(s), key(s)
- Collecting strategy/instructions
- GPS unit (preferably, sub-meter)
- Camera
- Labels, markers, pens or pencils
- Seed collection forms
- Hand lens
- Adhesive tape
- Safety razor or pocketknife
- Container and water (optional)
- Scissors, snips
- Gloves
- Small paper envelopes or bags



Before collecting seed, map the seed collection area(s), record data on the seed collection form(s) and count or estimate the number of plants within an occurrence. Collect no more than 5-10% of the seed from an individual plant or from the reproductive population per season. Use the following method to determine the number of seeds to collect by plant and for an occurrence:

- Step 1: Select one verticillaster (groups of flowers on the inflorescence) from 3-5 plants of different sizes spaced randomly across the occurrence (Spiegelberg 2019).
- Step 2: Cut the verticillasters with scissors instead of removing the entire plant, place each verticillaster in a separate seed collection bag, and crush/rub to force seeds from dry calyces.
- Step 3: Count the number of seeds in each verticillaster and multiply by the number of verticillasters on the plant to obtain an estimate of the *number of seeds per sampled plant*.
- Step 4: Divide the total number of seeds per sampled plant (Step 3) by the number of plants sampled (Step 1) to calculate the *average number of seeds per plant* (Spiegelberg 2019).
- Step 6: Multiply the average number of seeds per plant (Step 4) by the occurrence count or estimate to calculate the *estimated number of seeds per occurrence*. In most cases, the amount of seed available for collecting will be higher in years with optimal growing conditions (e.g., average or above-average rainfall) and lower during drought years.
- Step 7: Calculate the maximum number of seeds to collect per plant or occurrence to stay within the 5-10% collecting guidelines.

Collect seeds when San Diego thornmint plants are fully dry. At this stage, plants will be tan to brown with no green parts showing, and seeds will be hard and tan with black patches (Figure 10). Seeds are not ready to collect if they are green, soft, or shriveled. Seeds may be ready to collect as early as one month after peak flowering.

Collect seed during early, mid, and late season to account for differences in maturity times and to capture the phenological variability among the occurrence. Collect seed randomly and evenly throughout the occurrence, taking care to collect from plants of various sizes and with variable inflorescences, as well as plants growing in unique or varying habitat conditions. Wear gloves when collecting seed from San Diego thornmint since the spines on the calyx lobes can easily penetrate skin.

Consider harvesting more seed than recommended by the CPC for small occurrences that are at serious risk of extirpation to capture the highest amount of genetic variation at the occurrence (McMillan 2019). In this case, coordinate with the regulatory agencies prior to the collecting effort.



Ideally, collect seed from 30-50 plants across the occurrence. If the number of plants present in a given year is below this number, then sample over multiple years to produce a genetically robust seed collection for restoration purposes. Where the occurrence is small and not expected to produce an adequate number of plants (and seed) in any given year, consider collecting seed from one or more occurrences within the same seed zone. Depending on project objectives and sampling strategy, collect seed along maternal lines or as a bulk collection.

### Interim Seed Storage and Delivery

Refer to the general section of this document (Seed Collecting) for guidelines on interim seed storage and delivery. We provide additional guidelines for practitioners that choose to keep the seed for future restoration purposes rather than sending it immediately to a storage facility:

- Do not clean and sort seed unless the collection is very small since cleaning seed is time-consuming and often difficult, especially with large amounts of seed.
- Loosely pack the seed collection in envelopes or bags and store them in dark, dry, and moderate to cool conditions for several months before distributing seed onsite.
- If planning to hold seed for longer than one year, store the seed at a recognized seed bank (i.e., RSA, SDZG) to ensure proper storage conditions to retain viability.

## *Seed Banking*

### *Existing Conservation and Restoration Collections*

Refer to Table 22 for existing seed collections of San Diego thornmint. This table includes only thornmint occurrences with seed in storage, including some occurrences that are extirpated or on private lands. For planning purposes, we indicate the seed zone for each collection. We also indicate the number of seeds present in the seed bank and their potential availability for restoration. Note that only a portion of the seeds in a collection will be available for these purposes. Existing permits or contracts may also limit the use of some collections. We obtained information on each collection (seed bank, accession number and year, and seed quantity, provenance, and availability) from seed bank managers. Refer to Table 16 for contact information for these seed banks; we encourage land managers to contact facilities directly to get more information on seed availability or to request seed.

### *Best Management Practices*

#### Seed Cleaning

One method for cleaning and sorting thornmint seed is as follows (per Wall and MacDonald 2009 for a related species of thornmint):

**Table 22.** San Diego Thornmint: Existing Seed Collections.

Occurrence ID <sup>1</sup>	Seed Zone <sup>2</sup>	Seed Bank <sup>3</sup>	Accession Number <sup>4</sup>	Collection Year	Seed Quantity <sup>5</sup>	Provenance Type <sup>6</sup>	Seed Available <sup>7</sup>
ACIL_3DREA005	South	SDZG	S0710	2017	~790	W	Yes
ACIL_3DREA005	South	SDZG	S0710-F12018	2018	~12,950	W	Yes
ACIL_3HCWA006	South	SDZG	S0713	2017	~1,550	W	Yes
ACIL_3MGMT008	Central-east	SDZG	S0773	2019	~2,445	W	Yes
ACIL_3MGMT010	Central-east	SDZG	S0746	2018	~210	W	Yes
ACIL_3MGMT010	Central-east	SDZG	S0780	2019	~150	W	Yes
ACIL_3SOCR016 <sup>7</sup>	South	SDZG	S0792	2019	Unknown	W	Yes
ACIL_4MTRP021	Central-west	SDZG	S0716	2017	~2,496	W	Yes
ACIL_4MTRP021	Central-west	SDZG	S0716-F12018	2018	~1,834	---	No
ACIL_4MTRP021	Central-west	SDZG	S0788	2019	~500	W	Yes
ACIL_4SASP025	Central-west	RSA	16667-42	1991	5,847	W	No
ACIL_4SASP025	Central-west	RSA	19510-2274	1991	15,457	Z	Yes
ACIL_4SASP025	Central-west	RSA	17932-102	1992	209	W	No
ACIL_4SIPR026	Central-east	SDZG	S0768	2019	~500	W	Yes
ACIL_4SYCA027	Central-west	SDZG	S0742	2018	~525	W	Yes
ACIL_4SYCA027	Central-west	SDZG	S0777	2019	~1,200	W	Yes
ACIL_4VIMT0029	East	RSA	17823-216	1992	357	W	No
ACIL_6LPCA039	Central-west	RSA	17934-407	1992	634	W	No
ACIL_6LPCA039	Central-west	RSA	18532-563	1993	2,422	W	No
ACIL_6LPCA039	Central-west	SDZG	S0718	2017	~235	W	Yes
ACIL_6MAMI041	North	RSA	17931-101	1992	3,039	W	Limited
ACIL_6THCO046	Central-west	RSA	17935-280	1992	755	W	No
ACIL_6THCO046	Central-west	RSA	18531-562	1993	497	W	No
ACIL_6PARO043	North	SDZG	S0748	2018	~185	W	Yes

**Table 22.** San Diego Thornmint: Existing Seed Collections.

Occurrence ID <sup>1</sup>	Seed Zone <sup>2</sup>	Seed Bank <sup>3</sup>	Accession Number <sup>4</sup>	Collection Year	Seed Quantity <sup>5</sup>	Provenance Type <sup>6</sup>	Seed Available <sup>7</sup>
<i>Black Mountain Road</i> <sup>8</sup>	Central-west	RSA	15855-1242	1989	31,776	W	Limited
<i>Black Mountain Road</i> <sup>8</sup>	Central-west	RSA	18919-1243	1996	1,623,338	Z	Yes
<i>Black Mountain Road</i> <sup>8</sup>	Central-west	RSA	18920-1244	1996	31,133	Z	Yes
<i>Palos Vista</i> <sup>8</sup>	Between North and Central-west <sup>9</sup>	RSA	16184188	1990	4,606	W	No
<i>San Diego Wild Animal Park</i> <sup>8</sup>	Central-east	RSA	17936-355	1993	2,863	W	No
<i>Southeast of Poway</i>	Central-west	RSA	17933-269	1992	10,610	W	Limited
<i>Southeast Viejas Mountain, lower population</i>	East	RSA	17821-189	1992	585	W	No
<i>Vicinity of Poser Mountain</i>	East	RSA	17822-276	1992	211	W	No

<sup>1</sup> Occurrence identification (ID) per the SDMMP's MOM database. If no occurrence ID exists for a location, we provide the name of the location as indicated on collection in seed bank. The Black Mountain Road location is extirpated.

<sup>2</sup> Seed Zone: Seed zone corresponds to the five genetic clusters and population groups identified in the F-RPMP: South. Occurrences in italics were not addressed specifically in the F-RPMP and are placed in seed zones based on location.

<sup>3</sup> Seed bank: **RSA** = Rancho Santa Ana Botanic Garden, **SDZG** = San Diego Zoo Global.

<sup>4</sup> Accession number = accession number of seed collection assigned by seed bank.

<sup>5</sup> Seed quantity indicates the number of seeds currently in the collection, according to seed bank records.

<sup>6</sup> Provenance type indicates the source location of the seed collection: **W** = seed collected directly from the wild (origin known), **Z** = seed collected from a cultivated plant of known wild origin, --- = information not available.

<sup>7</sup> Seed available: **Yes** = seed is available for restoration use. **No** = seed is not available for restoration use, **Limited** = amount of seed available for restoration use is  $\leq 400$  seeds.

<sup>8</sup> Occurrence is extirpated or presumed extirpated.

<sup>9</sup> The Palos Vista location does not fall within a designated seed zone. This occurrence was located in Escondido, between the North seed zone and northern part of the Central-west seed zone.

- Rub dried verticillasters over a small screen to release seed from the dried calyx.
- Sort the remaining material through a series of increasingly fine filters to remove larger plant material.
- Use a blower at low speed to separate chaff from seed, and at a higher speed to separate hollow seed from filled seed.

Wall and MacDonald (2009) indicate that cleaning seed of thornmint species is easy, since most seed dehisces in the collection bag and the remaining seed separates from the calyx readily.

### Seed Testing

Seed testing methods will vary by facility, but all seed banks conduct baseline germination tests on new accessions and then conduct follow up testing to check seed for viability.

At RSA, baseline tests for seed germination use a typical seed sample of 50 seeds, although sample size may vary depending on the size of the seed collection and methods to break dormancy (if needed). RSA provides abundant time for seeds to germinate and at the end of a germination test they conduct a cut test on a sample of 5 ungerminated seeds (Birker pers. comm.). RSA also conducts follow-up testing on seeds in storage at intervals (e.g., 1 year, 5 years, 10 years, 20 years, and every subsequent 10 years thereafter, as seed quantities allow). In December 2019, RSA conducted a 30-year follow-up germination trial for San Diego thornmint and 100% of the seeds germinated within one week with no pre-treatment (Birker pers. comm.).

At SDZG, a baseline germination test is conducted on all new accessions. The test is conducted primarily on fresh seed. Follow up testing is conducted on frozen seed after 1, 5, and 10 years in storage. Seed is sterilized with bleach and placed in reverse osmosis water at room temperature for 24 hours to fully imbibe (absorb) water. Seed is then plated onto agar trays (10 seeds per tray) and observed for signs of germination. The seed is counted as germinated when the radical emerges. SDZG does not use a cut test to determine viability. Rather, they provide abundant time for seeds to germinate (Anderson pers. comm.).

### Seed Storage

All seed banks contacted store San Diego thornmint seed according to CPC guidelines. For example, SDZG dries seeds down to 23-35% moisture content. Seed is then stored in sealed, foil-lined envelopes in the freezer at a low temperature (-18°C to -23°C).

Each collection is separated into three packages that represent the primary, curation, and duplicate collections, as described in Section 4.1. The primary collection is the active seed collection and seeds in this package are available for research, testing, restoration, and other uses. The curation package is the base collection for long-term storage. This package is not opened and is not available for other uses. It constitutes the long-term conservation collection.

The duplicate collection is sent to another seed bank facility as backup storage to protect against catastrophic loss at the primary storage facility. Both SDZG and RSA send their duplicate seed collections to the NLGRP.

## *Seed Bulking*

### *Seed Selection*

Refer to Section 4.3 for guidelines on seed selection to maximize the quality of the bulked sample. Key considerations include:

- Use seed for bulking from the target occurrence or another occurrence in the same seed zone as the target occurrence. For very small occurrences (fewer than 100 plants), use seed from a large occurrence (if present) or from one or more smaller occurrences (composite provenancing) within the same seed zone.
- Use seed that was collected randomly and uniformly.
- Use an adequate amount of seed for bulking (ideally,  $\geq 1,000$  seeds or seed from 30-50 plants).
- For very small seed samples, use seed collected along maternal lines.

## *Best Management Practices*

### Germination and Propagation Methods

San Diego thornmint seed germinates readily without pre-treatment in the presence of adequate moisture, although some seeds take longer to germinate than others (Lippert et al. no date, Mistretta and Burkhart 1990). Practitioners have germinated seed in both native clay soil collected from near the occurrence and in horticultural potting mix (Lippert et al. [no date], Rice 2017, Vinje pers. obs.). After sowing, water the seeded flats or container pots several times a week to stimulate germination and continue watering, through flowering, until plants begin to senesce.

In a common garden study, Lippert et al. (no date) recorded a 40-60% germination rate for seed sown in a substrate of potting mix and washed sand (3:1), watered in initially with 500 milliliters (ml) of water, misted twice a week during germination, and subsequently irrigated using 1000 ml per pot per irrigation event.

San Diego thornmint is an outcrossing species. Mistretta and Burkhart (1990) observed that increased plant density in a nursery setting encouraged pollinators and possibly, increased seed production.

Limits on Generations

At this time, we recommend bulking thornmint seed for only one generation (F1) in a nursery setting. If additional seed is needed for restoration, start with wild seed rather than the F1 generation. Mistretta and Burkhart (1990) observed a sharp decline in germination between thornmint seed bulked for one generation in a nursery (45% germination rate) and wild-collected seed (95% germination rate). We recommend further studies to determine if these results were an anomaly or to be expected when bulking seed of this species.

Documentation

We encourage growing facilities and others bulking seed of San Diego thornmint for reintroduction purposes to document bulked samples as indicated in Section 4.3 and provide this information to land managers when seed is delivered. Likewise, we encourage land managers to provide information on seed collection and seed reintroductions to the SDMMP (contact information at <https://sdmmp.com/about.php#contact>) and include relevant information on IMG monitoring forms (i.e., translocated occurrence). Refer to Table 23 for key information for bulked seed samples.

**Table 23.** Documentation for Bulked Seed Samples.

Key Information	Primary Responsibility
Seed Source	Seed Collector and/or Land Manager
Seed Collection Date	Seed Collector
Amount of Seed Bulked	Growing Facility
Propagation Method	Growing Facility
Propagation Conditions	Growing Facility
Harvesting Date(s)	Growing Facility
Post-harvest Storage Location/Duration/Conditions	Growing Facility
Generation of Bulked Sample	Growing Facility
Receptor Site Location	Growing Facility and/or Land Manager



## 5.2 NUTTALL'S ACMISPON (*ACMISPON PROSTRATUS*)

### Seed Collection

#### Seed Characteristics

Nuttall's acmispon produces many slender legumes (fruits) that are round in cross-section and taper to a short, straight or curved beak. The fruits are reddish-brown in color and are usually constricted between each seed. Each fruit contains two hard, smooth, kidney-shaped seeds that are mottled tan and black (Figure 12). When the plant dries, fruits fall to the ground and eventually release the seeds. Neither fruits nor seeds have any apparent modifications for wind, water, or animal dispersal.



Photo credit: ©2018 Ron Vanderhoff.

Nuttall's acmispon seeds mature in spring through early fall. Seed production increases with plant size and flower production, with larger plants producing hundreds of seeds. Fruits can remain on dry plants throughout the summer and into early fall.



**Figure 12.** Nuttall's Acmispon: Seed (Photo credit: John MacDonald, RSA).

#### Priority Occurrences

Table 24 prioritizes occurrences of Nuttall's acmispon on conserved lands in the MSPA for seed-related management actions. These priorities were developed in the F-RPMP based on monitoring data and specific studies. The decision to implement an action will depend on a number of factors, including status of the occurrence (stable or declining), habitat condition, threats management, and funding, among others.

In general, large occurrences are prioritized as potential seed sources, subject to land manager and/or agency approval. Small occurrences are high priority candidates for seed reintroduction, subject to response to management and site conditions, as discussed in the F-RPMP.

**Table 24.** Nuttall’s Acmispon: Management Priorities for Seed-Related Activities.

Occurrence ID <sup>1</sup>	Occurrence Name	Occurrence Size <sup>2</sup>	Seed Reintroduction Priority <sup>3</sup>	Existing Seed Collection <sup>4</sup>	Seed-related Activities <sup>5</sup>			
					Seed Source	Conservation Collection	Restoration Collection	Seed Bulking
ACPR_1BFSP014	Border Field SP	Small	M			✓	✓	✓
ACPR_1DSTR010	D Street Fill	Small	M			✓	✓	✓
ACPR_1DUTR005	Dune Triangle	Small	H			✓	✓	✓
ACPR_1FIIS007	Mission Bay (Fiesta Island)	Small	M			✓	✓	✓
ACPR_1FIIS029	Fiesta Island	Small	H			✓	✓	✓
ACPR_1HOPO002	Mission Bay (Hospitality Point)	Medium	L	SDZG				
ACPR_1MAPO004	Mission Bay (Mariner's Point)	Large	---		✓	✓		
ACPR_1NMLA001	Mission Bay (No Man's Land)	Small	M			✓	✓	✓
ACPR_1NOBE015	North Ocean Beach (Dog Beach)	Small	M	SDZG			✓	✓
ACPR_1RRSO003	Mission Bay (Rip Rap)	Small	M			✓	✓	✓
ACPR_1SBSA013	South Bay Salt Works Nuttall's Acmispon	Medium	L			✓		
ACPR_1SOSH006	Mission Bay (east of South Shores)	Medium	L			✓		
ACPR_1SSSB012	Silver Strand SB	Large	---		✓	✓		
ACPR_1SSSB027	Silver Strand SB	Small	M			✓	✓	✓
ACPR_1SSSB028	Silver Strand SB	Small	M			✓	✓	✓
ACPR_7AGHE024	Agua Hedionda	Small	H			✓	✓	✓
ACPR_7BALA020	Batiquitos Lagoon	Small	M			✓	✓	✓

**Table 24.** Nuttall’s Acmispon: Management Priorities for Seed-Related Activities.

Occurrence ID <sup>1</sup>	Occurrence Name	Occurrence Size <sup>2</sup>	Seed Reintroduction Priority <sup>3</sup>	Existing Seed Collection <sup>4</sup>	Seed-related Activities <sup>5</sup>			
					Seed Source	Conservation Collection	Restoration Collection	Seed Bulking
ACPR_7CSPA018	San Elijo Lagoon	Large	---	RSA	✓			
ACPR_7SCSB025	South Carlsbad SB	Small	H			✓	✓	✓
ACPR_7SLRR017	San Luis Rey River	Small	M			✓	✓	✓
ACPR_7TPSR019	Torrey Pines SR (south)	Small	M			✓	✓	✓
ACPR_7TPSR023	Torrey Pines SR (north)	Small	M			✓	✓	✓

<sup>1</sup> Occurrence ID: Occurrence identification (ID) code per the San Diego Management and Monitoring Program’s (SDMMP) Master Occurrence Matrix (MOM) database.

<sup>2</sup> Occurrence Size: Recent size category as defined in the Framework-Rare Plant Management Plan (F-RPMP). **Small** = <1,000 individuals, **Medium** = 1,000-<10,000 individuals, **Large** = >10,000 individuals.

<sup>3</sup> Seed Reintroduction Priority (per F-RPMP): **High** = high priority for seed reintroduction, **Medium** = medium priority for seed reintroduction, **Low** = low priority for seed reintroduction, --- = not a priority for seed reintroduction at this time due to stable population (large occurrence) or lack of monitoring data.

<sup>4</sup> Existing Seed Collection: Indicates location of collection. **RSA** = Rancho Santa Ana Botanic Garden, **SDZG** = San Diego Zoo Global.

<sup>5</sup> Seed-related Activities: ✓ indicates occurrence is suitable as a seed source (pending authorization from responsible entities) or management action is warranted. Where there is an existing seed collection, a restoration collection may not be needed, but land managers should contact the seed bank directly to make that determination. Likewise, seed bulking may not be necessary depending on the amount of seed available in an existing collection or collected specifically for restoration purposes.

Currently, conservation seed collections exist in established seed banks for three acmispon occurrences (14%) on conserved lands in the MSPA (Table 24). Seed banks also hold collections for an additional three occurrences that are extirpated or not currently conserved.

We recommend conservation collections as a potential management action for all occurrences that are not currently represented in a seed bank *if adequate seed is available*. For occurrences where plants have not been detected recently, a conservation collection will be possible only if plants are detected in the future (Table 24). Large occurrences are the highest (or most immediate) priorities for seed conservation to maximize the amount of genetic diversity in long-term storage (e.g., ACPR\_1SSSB012).

We recommend restoration collections as a potential management action for occurrences that are high or medium priorities for seed reintroduction as indicated in Table 24 and identified in the F-RPMP. We do not prioritize occurrences for seed reintroduction if they have not yet been monitored.

We recommend reintroducing seed only if threats are controlled, habitat is likely to support this species in the future, and funding is available for short- and long-term management. Reintroducing seed is most appropriate for small occurrences that continue to decline, even with management. Seed may be introduced into extirpated occurrences if threats are managed and the habitat is likely to support acmispon in the future. For extirpated occurrences, source seed from a large occurrence in the same seed zone or from an appropriate seed source in storage (if available). Some threats (particularly, invasive plants) will likely require perpetual management; thus, ensure that adequate funding and/or labor are available to manage the occurrence after seed is reintroduced.

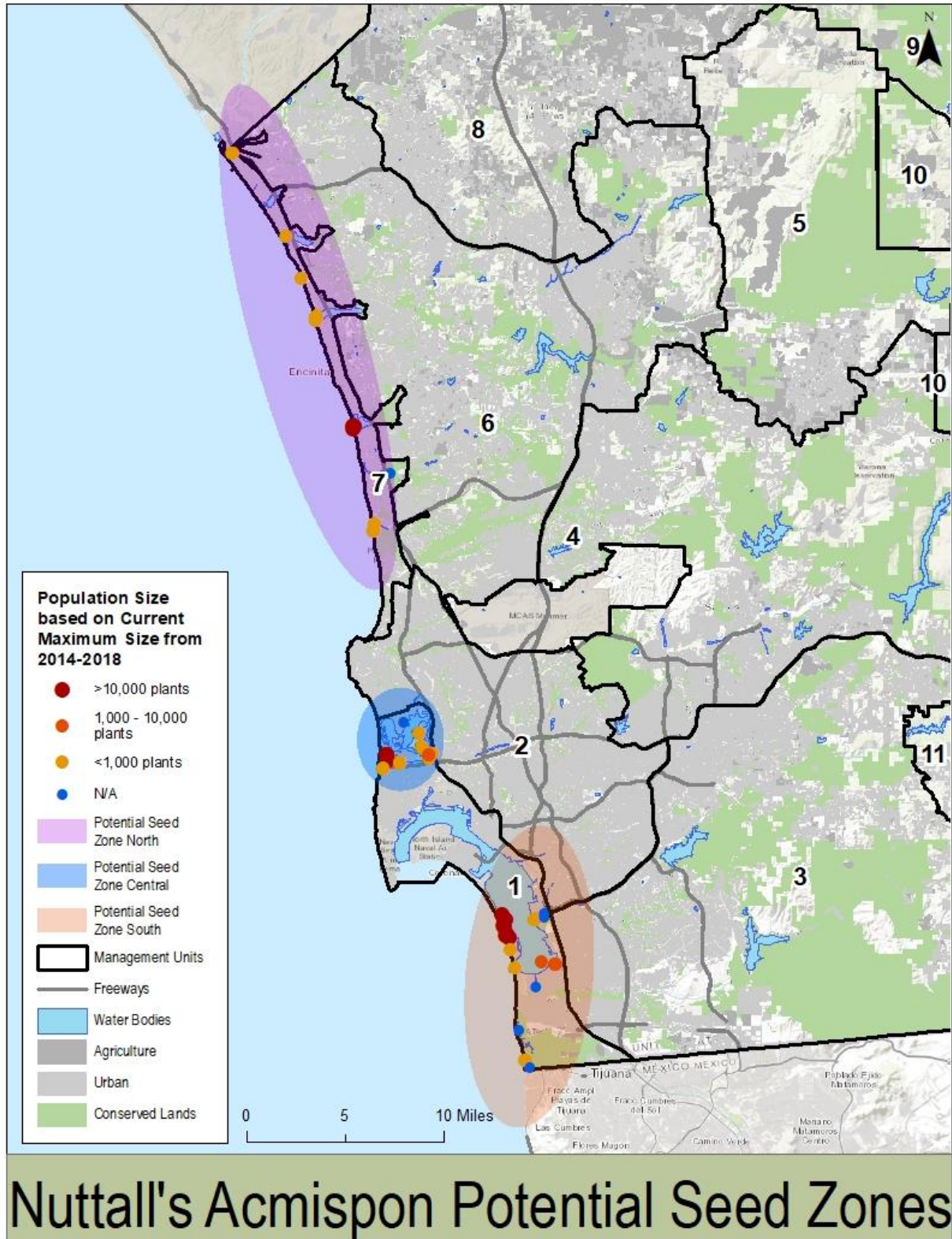
We recommend seed bulking as a potential management action for all occurrences potentially requiring a restoration collection. The need for seed bulking will depend on the amount of seed available in storage and/or collected specifically for restoration, as well as the sowing strategy. For example, bulking will not be needed if adequate seed is collected to sow directly into the target occurrence.

### *Seed Zones*

We established three provisional seed zones for Nuttall's acmispon to guide seed collecting, banking, and bulking efforts: North, Central, South. Seed zones correspond to the three potential genetic clusters and three regional population groups identified for this species in the F-RPMP. Figure 13 shows the locations of the three seed zones; Table 25 lists the seed zone for each occurrence.

Seed zones place geographic limits on the transfer of seed between occurrences. *We do not recommend transfer of seed beyond a seed zone at this time*. Thus, if a small occurrence requires





**Figure 13.** Nuttall's Acmispon: Seed Zones.

**Table 25.** Nuttall's Acmispon: Seed Zones.

Occurrence ID <sup>1</sup>	Occurrence Name	Seed Zone <sup>2</sup>	Occurrence Size <sup>3</sup>
ACPR_7AGHE024	Agua Hedionda	North	Small
ACPR_7BALA020	Batiquitos Lagoon	North	Small
ACPR_7CSPA018	San Elijo Lagoon	North	Large
ACPR_7SCSB025	South Carlsbad SB	North	Small
ACPR_7SLRR017	San Luis Rey River	North	Small
ACPR_7TPSR019	Torrey Pines SR (south)	North	Small
ACPR_7TPSR023	Torrey Pines SR (north)	North	Small
ACPR_1DUTR005	Dune Triangle	Central	Small
ACPR_1FIIS007	Mission Bay (Fiesta Island)	Central	Small
ACPR_1FIIS029	Fiesta Island	Central	Small
ACPR_1HOPO002	Mission Bay (Hospitality Point)	Central	Medium
ACPR_1MAPO004	Mission Bay (Mariner's Point)	Central	Large
ACPR_1NMLA001	Mission Bay (No Man's Land)	Central	Small
ACPR_1NOBE015	North Ocean Beach (Dog Beach)	Central	Small
ACPR_1RRSO003	Mission Bay (Rip Rap)	Central	Small
ACPR_1SOSH006	Mission Bay (east of South Shores)	Central	Medium
ACPR_1BFSP014	Border Field SP	South	Small
ACPR_1DSTR010	D Street Fill	South	Small
ACPR_1SBSA013	South Bay Salt Works	South	Medium
ACPR_1SSSB012	Silver Strand SB	South	Large
ACPR_1SSSB027	Silver Strand SB	South	Small
ACPR_1SSSB028	Silver Strand SB	South	Small

<sup>1</sup> Occurrence ID: Occurrence identification (ID) code per the San Diego Management and Monitoring Program's (SDMMP) Master Occurrence Matrix (MOM) database.

<sup>2</sup> Seed Zone: seed zones are defined in text and correspond to population groups in the F-RPMP. Limit seed movement to within the same seed zone. Shading indicates seed zone group.

<sup>3</sup> Occurrence size: refers to population size category based on multiple years of monitoring data. Recent size category as defined in the Framework-Rare Plant Management Plan (F-RPMP). **Small** = <1,000 individuals, **Medium** = 1,000-<10,000 individuals, **Large** = >10,000 individuals.



seed from another occurrence, the source (donor) occurrence should be located within the same seed zone as the target (recipient) occurrence. Within a seed zone, we recommend that seed transfer proceed between occurrences that are relatively close to one another, particularly in larger seed zones. The same limits on seed movement apply when using seed from a seed bank.

### *Collecting Plan*

Refer to Section 4.1 of this document for guidelines on developing a sampling strategy for seed collection. Identify the purpose and type of collection needed for a specific project or restoration effort, as well as timeline and costs. In the section below, we highlight key steps in the process, including those specific to Nuttall's acmispou.

### Sampling Strategy

Refer to Table 24 for prioritized seed-related activities for the target occurrence to identify whether seed is needed for a conservation collection, a restoration collection, or both.

For restoration, determine if seed is available in a seed bank to reintroduce directly into a target occurrence or for bulking. Proceed with the collecting plan if stored seed is not available, quantities are not sufficient, or the provenance is not appropriate for the target occurrence (e.g., different seed zone).

Assess whether the target occurrence will likely provide an adequate quantity of seed for restoration or if seed will need to be sourced from other occurrences in the seed zone. Refer to seed zones (Figure 13, Table 25) for limits on seed movement and seed sources. Contact the appropriate land managers of potential seed source occurrences to obtain permission for seed collection.

Based on the purpose and type of collection, and amount of seed expected to be available, determine whether the seed is likely to be collected along maternal lines or in bulk (Table 9), and set minimum targets for the number of plants to sample and amount of seed to collect. These targets are intended to provide a guide for planning, and may be modified based on the actual seed crop.

### Permitting and Agreements

Ensure that all regulatory permits, memorandums, and access agreements are in place before collecting seed from an occurrence.

If unfamiliar with the collecting location, contact the land owner to obtain a map and coordinates of the occurrence, directions to the occurrence if necessary, gate codes, lock combinations, or keys, and any pertinent information about the occurrence (e.g., informing adjacent land owners, closures due to unsafe conditions).

### Pre-collection Monitoring

Practitioners can collect Nuttall's acmispon seed as early as April and into early fall, depending on location, habitat, and weather and temperature conditions during the previous fall, winter and spring. Visit the target occurrence multiple times to determine the best time to collect seed. Time the first visit when plants are in full flower and easier to locate. Talk to land owners and managers and refer to monitoring data and literature to determine the range of phenological variation for an occurrence to plan the first site visit.

Use pin flags to demarcate the boundary of the occurrence if plants are located in coastal scrub habitat, because relocating plants after they dry can be difficult. If necessary, place pin flags adjacent to a subset of plants to relocate them easily during subsequent visits. Return to the occurrence within two to four weeks to check phenology. Weather conditions will determine the rate of desiccation; plants will dry quicker in warm and dry conditions and slower if conditions remain cool and moist. Continue monthly site visits until the majority of plants in an occurrence are fully desiccated and seeds resemble those in Figure 12.

### Voucher Specimens

Collect voucher specimens of Nuttall's acmispon if none exist for the source occurrence and if enough plants are available so that collecting a few specimens does not adversely affect the occurrence. Check the San Diego Natural History Museum or Consortium of California Herbaria to determine if a voucher specimen already exists:

San Diego Natural History Museum: <http://sdplantatlas.org/publicsearch.aspx>

Consortium of California Herbaria: <http://ucjeps.berkeley.edu/consortium/>

Note that recently collected specimens may not yet be accessed into an herbarium's collection. In addition, older specimens may not include sufficient locality information to definitively determine whether they were collected at the occurrence. If it is not appropriate to collect a voucher specimen, photograph the occurrence (landscape aspect) and an individual plant while in flower, and then again when the plant is in fruit.

Obtain all necessary permits and memorandums before collecting voucher specimens of endangered, threatened, and rare species. Collect specimens while plants are still in flower and before collecting seed. Refer to Section 4.1 of this document (Seed Collecting, Materials and Methods) and instructions and forms in Appendix B to guide your collection. Submit the voucher specimen(s) to the San Diego Natural History Museum as soon as possible.

## Methods and Materials

Refer to Section 4.1 of this document for a detailed discussion of methods and materials and Table 10 for a comprehensive list of recommended equipment for collecting seed. At a minimum, bring the following to each Nuttall's acmispon collection location:

- Regulatory permits and access agreements
- Directions, map(s)
- Lock combination(s), key(s)
- Collecting strategy/instructions
- GPS unit (preferably, sub-meter)
- Camera
- Labels, markers, pens or pencils
- Seed collection forms
- Hand lens
- Adhesive tape
- Safety razor or pocketknife
- Container and water (optional)
- Scissors, snips, sieve (optional)
- Small paper envelopes or bags



Before collecting seed, map the seed collection area(s), record data on the seed collection form(s) and count or estimate the number of plants within an occurrence. Collect no more than 5-10% of the seed from an individual plant or from the reproductive population per season. Use the following method to determine the number of seeds to collect by plant and for an occurrence:

- Step 1: Select 5 plants of different sizes spaced randomly across the occurrence.
- Step 2: Count the number of fruits on the 5 sample plants.
- Step 3: Divide the total number of fruits counted (Step 2) by the number of plants sampled (Step 1) to calculate the *average number of fruits per plant*.
- Step 4: Multiply the average number of fruits per plant (Step 3) by 2 (2 seeds/fruit) to calculate the *average number of seeds per plant*.

- Step 5: Multiply the average number of seeds per plant (Step 4) by the occurrence count or estimate to calculate the *estimated number of seeds per occurrence*. In most cases, the amount of seed available for collecting will be higher in years with optimal growing conditions (e.g., average or above-average rainfall) and lower during drought years.
- Step 6: Use the numbers above to calculate the maximum number of fruits or seeds to collect to stay within the 5-10% collecting guidelines.

Note that where seed production is very heavy, seed collectors may choose to estimate fruit and seed quantities using subsamples.

Collect fruits when Nuttall's acmispon plants are fully dry. Remove dry fruits from the stems by hand and place them in a seed collecting envelope or bag. Refer to Figure 12 for ripe seeds. Fruits may be ready to collect as early as one month after peak flowering.

Collect seed during early, mid, and late season to account for differences in maturity times and to capture the phenological variability among the occurrence. Collect seed randomly and evenly throughout the occurrence, taking care to collect from plants of various sizes and with variable inflorescences, as well as plants growing in unique or varying habitat conditions.

The San Diego Audubon Society collects Nuttall's acmispon seed by gathering the soil and duff directly beneath senesced plants (Redfern and Flaherty 2018). They place the collected material in bags and save it for restoration purposes. They have had successful recruitment of Nuttall's acmispon using this method. This method does not allow for maternal line collections or an estimate of the percentage of seed collected per plant or occurrence, and is most appropriate where there are limitations on collecting seed at the optimal time.

Depending on the site, collect seed outside of the nesting season for the California least tern (*Sternula antillarum*) and avoid any other conflicts between collecting seed and sensitive resources. In some cases, it may be necessary to collect and bag pods before they are fully ripe.

Consider harvesting more seed than recommended by the CPC for small occurrences that are at serious risk of extirpation to capture the highest amount of genetic variation at the occurrence (McMillan 2019).

Ideally, collect seed from 30-50 plants across the occurrence. If the number of plants present in a given year is below this number, then sample over multiple years to produce a genetically robust seed collection for restoration purposes. Where the occurrence is small and not expected to produce an adequate number of plants (and seed) in any given year, consider collecting seed from one or more occurrences within the same seed zone. Depending on project objectives and sampling strategy, collect seed along maternal lines or as a bulk collection.

### Interim Seed Storage and Delivery

Refer to the general section of this document (Seed Collecting) for guidelines on interim seed storage and delivery. We provide additional guidelines for practitioners that choose to keep the seed for future restoration purposes rather than sending it immediately to a storage facility:

- Do not clean and sort seed unless the collection is very small since cleaning seed is time-consuming and often difficult, especially with large amounts of seed.
- Loosely pack the seed collection in envelopes or bags and store them in dark, dry, and moderate to cool conditions for several months before distributing seed onsite.
- If planning to hold seed for longer than one year, store the seed at a recognized seed bank (i.e., RSA, SDZG) to ensure proper storage conditions to retain viability.

## *Seed Banking*

### *Existing Conservation and Restoration Collections*

Refer to Table 26 for existing seed collections of Nuttall's acmispon. This table includes only acmispon occurrences with seed in storage, including some occurrences that are on lands not included in the MSPA (e.g., military lands). For planning purposes, we indicate the seed zone for each collection. We also indicate the number of seeds present in the seed bank and their potential availability for restoration. Note that only a portion of the seeds in a collection will be available for these purposes. Existing permits or contracts may also limit the use of some collections. We obtained information on each collection (seed bank, accession number and year, and seed quantity, provenance, and availability) from seed bank managers. Refer to Table 16 for contact information for these seed banks; we encourage land managers to contact facilities directly to get more information on seed availability or to request seed.

### *Best Management Practices*

#### Seed Cleaning

Wall and MacDonald (2009) suggest the following methods to clean and sort seeds of *Acmispon* spp.:

- Rub floral material over a medium screen to separate fruits from other plant material.
- Rub fruits over a sieve or rubber mat with a padded wooden block to open fruits and release seed.
- Shake released seed through a series of sieves to remove extraneous plant material.
- Use a blower at low speed to separate chaff from seed, and at a higher speed to separate hollow seed from filled seed.

**Table 26.** Nuttall’s Acmispon: Exiting Seed Collections.

Occurrence ID <sup>1</sup>	Seed Zone <sup>2</sup>	Seed Bank <sup>3</sup>	Accession Number <sup>4</sup>	Collection Year	Seed Quantity <sup>5</sup>	Provenance Type <sup>6</sup>	Seed Available <sup>7</sup>
ACPR_1HOPO002	Central	SDZG	S0671	2016	~740	W	Yes
ACPR_1NOBE015	Central	SDZG	S0670	2016	~1,100	W	Yes
ACPR_7CSPA018	North	RSA	24216-5446	2015	4,877	W	Limited
<i>North Island Naval Air Base)</i>	South <sup>8</sup>	RSA	19341-2239	1996	132	W	No
<i>EO#17 (North Island)</i>	South <sup>8</sup>	SDZG	S0802	2019	Unknown	W	Limited
<i>EO#3 (Silver Strand)</i>	South	SDZG	S0803	2019	Unknown	W	Limited

<sup>1</sup> Occurrence identification (ID) per the SDMMP’s MOM database. If no occurrence ID exists for a location, we provide the name of the location or the CNDDDB element occurrence (EO) number, as indicated on collection in seed bank.

<sup>2</sup> Seed Zone: Seed zone corresponds to the three population groups identified in the F-RPMP: North, Central, and South. Occurrences in are placed in seed zones based on location.

<sup>3</sup> Seed bank: **RSA** = Rancho Santa Ana Botanic Garden, **SDZG** = San Diego Zoo Global.

<sup>4</sup> Accession number = accession number of seed collection assigned by seed bank.

<sup>5</sup> Seed quantity indicates the number of seeds currently in the collection, according to seed bank records. Unknown indicates seed has not yet been processed and counted.

<sup>6</sup> Provenance type indicates the source location of the seed collection: **W** = seed collected directly from the wild (origin known),

<sup>7</sup> Seed available: **Yes** = seed is available for restoration use. **No** = seed is not available for restoration use, **Limited** = amount of seed available for restoration use is ≤400 seeds.

<sup>8</sup> The North Island Naval Air Station lies between the South and Central seed zones and was not included in a population group in the F-RPMP or seed zone in this document because of the absence of monitoring data. Based on location, it would likely be placed into the South seed zone.



Wall and MacDonald (2009) indicate that cleaning seed of *Acmispon* spp. ranges from moderate to high in difficulty, and caution that seeds can be broken during the cleaning process.

### Seed Testing

Seed testing methods will vary by facility, but all seed banks conduct baseline germination tests on new accessions and then conduct follow up testing to check seed for viability.

At RSA, baseline tests for seed germination use a typical seed sample of 50 seeds, although sample size may vary depending on the size of the seed collection, and variable methods to break dormancy (if needed). They conduct follow-up testing on seeds in storage at intervals (e.g., 1 year, 5 years, 10 years, 20 years, and every subsequent 10 years thereafter, as seed quantities allow).

RSA conducted germination test results for two seed samples of Nuttall's acmispon from ACPR\_7CSPA018. They conducted the first test on fresh seed and the second on seed that had been frozen for about a year. Both samples were pre-treated by placing seed in boiling water and then soaking the seed for 24 hours in the cooling water. Seeds were grown in a germination chamber at temperatures of 20°C during the day and 12°C at night. Germination was 70% for the fresh seed and 88% for the frozen seed.

At SDZG, a baseline germination test is conducted on all new accessions. The test is conducted primarily on fresh seed that has been scarified. Follow up testing is conducted on frozen seed after 1, 5, and 10 years in storage. Seed is sterilized with bleach and placed in reverse osmosis water at room temperature for 24 hours to fully imbibe (absorb) water. Seed is then plated onto agar trays (10 seeds per tray) and observed for signs of germination. The seed is counted as germinated when the radical emerges. SDZG does not use a cut test to determine viability. Rather, they provide abundant time for seeds to germinate (Anderson pers. comm.).

### Seed Storage

All seed banks contacted store Nuttall's acmispon seed according to CPC guidelines. For example, SDZG dries seeds down to 23-35% moisture content. Seed is then stored in sealed, foil-lined envelopes in the freezer at a low temperature (-18°C to -23°C).

Each collection is separated into three packages that represent the primary, curation, and duplicate collections, as described in Section 4.1. The primary collection is the active seed collection and seeds in this package are available for research, testing, restoration, and other uses. The curation package is the base collection for long-term storage. This package is not opened and is not available for other uses. It constitutes the long-term conservation collection. The duplicate collection is sent to another seed bank facility as backup storage to protect against catastrophic loss at the primary storage facility. Both SDZG and RSA send their duplicate seed collections to the NLGRP.

## Seed Bulking

### Seed Selection

Refer to Section 4.3 for guidelines on seed selection to maximize the quality of the bulked sample. Key considerations include:

- Use seed for bulking from the target occurrence or another occurrence in the same seed zone as the target occurrence. For very small occurrences (fewer than 100 plants), use seed from a large occurrence (if present) or from one or more smaller occurrences (composite provenancing) within the same seed zone.
- Use seed that was collected randomly and uniformly.
- Use an adequate amount of seed for bulking (ideally,  $\geq 1,000$  seeds or seed from 30-50 plants).
- For very small seed samples, use seed collected along maternal lines.

### Best Management Practices

#### Germination and Propagation Methods

Nuttall's acmispon seed requires pre-treatment to germinate readily. RSA found that softening the seed coat with a boiling water soak resulted in germination rates of  $>70\%$  in fresh and frozen seed. After sowing, water the seeded flats or container pots several times a week to stimulate germination and continue watering, through flowering, until plants begin to senesce.

#### Limits on Generations

At this time, we recommend bulking Nuttall's acmispon seed for only one generation (F1) in a nursery setting. If additional seed is needed for restoration, start with wild seed rather than the F1 generation.

#### Documentation

We encourage growing facilities and others bulking seed of Nuttall's acmispon for reintroduction purposes to document bulked samples as indicated in Section 4.3 and provide this information to land managers when seed is delivered. Likewise, we encourage land managers to provide information on seed collection and seed reintroductions to the SDMMP (contact information at <https://sdmmp.com/about.php#contact>) and include relevant information on IMG monitoring forms (i.e., translocated occurrence). Refer to Table 27 for key information for bulked seed samples.

**Table 27.** Documentation for Bulked Seed Samples.

Key Information	Primary Responsibility
Seed Source	Seed Collector and/or Land Manager
Seed Collection Date	Seed Collector
Amount of Seed Bulked	Growing Facility
Propagation Method	Growing Facility
Propagation Conditions	Growing Facility
Harvesting Date(s)	Growing Facility
Post-harvest Storage Location/Duration/Conditions	Growing Facility
Generation of Bulked Sample	Growing Facility
Receptor Site Location	Growing Facility and/or Land Manager

### 5.3 SALT MARSH BIRD’S-BEAK (*CHLOROPYRON MARITIMUM* SSP. *MARITIMUM*)

#### Seed Collection

##### Seed Characteristics

Salt marsh bird’s-beak plants produce loose to dense spike-like inflorescences that contain many flowers. Each flower produces 15-20 seeds that are approximately 2 millimeters (mm) in size. Seeds are brown to tan, kidney-shaped, and deeply netted (Figure 14).

Seeds are buoyant and may disperse primarily by floating in water, although animals may disperse seed, as well (USFWS 1985). Seed production is highly variable and affected by many factors, including insect pollinators, seed predators, and fungal diseases (USFWS 1985). Seed predators known to drastically and adversely affect seed production include larvae of the leaf roller moth (*Platynota stultana*), geranium plume moth (*Amblyptilia pica*), salt marsh plume moth (*Liphographus fenestrella*), and salt marsh leaf roller moth (*Saphenista* sp.) (USFWS 2013, Anderson 2019a).



**Figure 14.** Salt Marsh Bird’s-beak: Seed (Photo credit: John MacDonald, RSA).

Depending on climatic conditions, salt marsh bird’s-beak plants can bloom from late May through mid-December; thus, seed production may begin in late spring and continue through winter as plants senesce (Figure 15). Seed production increases with plant size and flower production as long as the necessary insect pollinators are present.



**Figure 15.** Salt Marsh Bird's-beak: Dried Plants (arrow points to plant; photo credit: Heather Schneider, SBBG).

### Priority Occurrences

Table 28 prioritizes occurrences of salt marsh bird's-beak on conserved lands in the MSPA for seed-related management actions. These priorities were developed in the F-RPMP based on monitoring data and specific studies, including genetic analyses. The decision to implement an action will depend on a number of factors, including status of the occurrence (stable or declining), habitat condition, threats management, and funding, among others.

In general, large occurrences are prioritized as potential seed sources, subject to land manager and/or agency approval. Small occurrences are high priority candidates for seed reintroduction, subject to response to management and site conditions, as discussed in the F-RPMP.

Currently, conservation seed collections exist in established seed banks for three salt marsh bird's-beak occurrences (30%) on conserved lands in the MSPA (Table 28). Seed banks also hold two additional seed collections without occurrence numbers.

We recommend conservation collections as a potential management action for all occurrences that are not currently represented in a seed bank *if adequate seed is available*. For occurrences where plants have not been detected recently, a conservation collection will be possible only if plants are detected in the future (Table 28). Large occurrences are the highest (or most immediate) priorities for seed conservation to maximize the amount of genetic diversity in long-term storage (e.g., COMAM3\_1TIES002, COMAM3\_1TISO011).

We recommend restoration collections as a potential management action for occurrences that are high or medium priorities for seed reintroduction as indicated in Table 28 and identified in the F-RPMP. We do not prioritize occurrences for seed reintroduction if they have not yet been monitored.

**Table 28.** Salt Marsh Bird's-beak: Management Priorities for Seed-related Activities.

Occurrence ID <sup>1</sup>	Occurrence Name	Occurrence Size <sup>2</sup>	Genetic Structure <sup>3</sup>	Seed Reintroduction Priority <sup>4</sup>	Existing Seed Collection <sup>5</sup>	Seed-related Activities <sup>6</sup>			
						Seed Source	Conservation Collection	Restoration Collection	Seed Bulking
COMAM3_1DOBE007	Dog Beach	Large	L+L+L	---	SDZG	✓			
COMAM3_1IMBE008	Camp Surf	Medium	L+L+L				✓		
COMAM3_1SDBA004	San Diego Bay, Naval Radar Receiving Facility, Naval Base Coronado	Small	L+H+L	High			✓	✓	✓
COMAM3_1SWMA005	Sweetwater Marsh (west of I-5 and north of Sweetwater River)	Large	L+L+L	---	RSA, SDZG <sup>7</sup>	✓			
COMAM3_1TIES001	Tijuana Estuary Area (at Boundary Monument #258)	Small	L+Hr+L				✓		
COMAM3_1TIES002	Tijuana Estuary Area (between mouth of Tijuana River & Coronado Avenue, Imperial Beach)	Large	L+Hr+L			✓	✓		
COMAM3_1TIES003	Tijuana Estuary Area (near mouth of Tijuana River and north part of Border Field State Park)	Small	L+Hr+L*	High			✓	✓	✓
COMAM3_1TIES009	Tijuana Slough	Small	L+Hr+L*	High	RSA, SDZG			✓	✓
COMAM3_1TISO010	Tijuana Slough NWA #2	Medium	L+Hr+L*				✓		
COMAM3_1TISO011	Tijuana Slough NWA #3	Large	L+Hr+L*	---		✓	✓		

<sup>1</sup> Occurrence ID: Occurrence identification (ID) code per the San Diego Management and Monitoring Program's (SDMMP) Master Occurrence Matrix (MOM) database.

<sup>2</sup> Occurrence Size: Recent size category as defined in the Framework-Rare Plant Management Plan (F-RPMP). **Small** = <1,000 individuals, **Medium** = 1,000- <10,000 individuals, **Large** = >10,000 individuals.

<sup>3</sup> Genetic Structure (per Milano and Vandergast 2018): Genetic differentiation + genetic diversity + inbreeding. **L** = low, **H** = High, **Hr** = Higher, \* = some high relatedness. Refer to F-RPMP for a discussion of the implications for seed movement.

<sup>4</sup> Seed Reintroduction Priority (per F-RPMP): **High** = high priority for seed reintroduction. If no priority level is indicated, then management action is not a priority at this time, but may be undertaken at the discretion of the land manager and subject to adequate seed availability.

<sup>5</sup> Existing Seed Collection: Indicates location of collection. **RSA** = Rancho Santa Ana Botanic Garden, **SDZG** = San Diego Zoo Global.



- <sup>6</sup> Seed-related Activities: ✓ indicates occurrence is suitable (e.g., seed source) pending authorization from responsible entities, or action is warranted. In some cases, additional collecting for restoration may not be necessary if enough seed is available in an existing seed collection. Likewise, seed bulking may or may not be necessary depending on amount of seed available in existing collection or collected specifically for restoration purposes.
- <sup>7</sup> Both seed banks (RSA, SDZG) list their collections from this location as COMAM3\_1SWMA005. However, occurrence -005 was subsequently combined with occurrence -006. We now consider -005 and -006 to be the same occurrence, which is referenced as -006 in the IMG monitoring program.

We recommend reintroducing seed only if threats are controlled, habitat is likely to support this species in the future, and funding is available for short- and long-term management. Reintroducing seed is most appropriate for small occurrences that continue to decline, even with management. Seed may be introduced into extirpated occurrences if threats are managed and the habitat is likely to support salt marsh bird's-beak in the future. For extirpated occurrences, source seed from a large occurrence in the same seed zone or from an appropriate seed source in storage (if available). Some threats (particularly, invasive plants) will likely require perpetual management; thus, ensure that adequate funding and/or labor are available to manage the occurrence after seed is reintroduced.

We recommend seed bulking as a potential management action for all occurrences identified as potentially requiring a restoration collection. The need for seed bulking will depend on the amount of seed available in storage and/or collected specifically for restoration, as well as the sowing strategy. For example, bulking will not be needed if adequate seed is collected to sow directly into the target occurrence.

### *Seed Zones*

We established one seed zone for salt marsh bird's-beak to guide seed collecting, banking, and bulking efforts. This seed zone corresponds to the genetic cluster and regional population group identified for this species in the F-RPMP. Figure 16 shows the locations of the seed zone; Table 29 lists all occurrences in the seed zone.

Seed zones place geographic limits on the transfer of seed between occurrences. *We do not recommend transfer of seed beyond the seed zone at this time* (e.g., between occurrences in San Diego County and counties to the north). Thus, if a small occurrence requires seed from another occurrence, the source (donor) occurrence should be located within the same seed zone as the target (recipient) occurrence. Within a seed zone, we recommend that seed transfer proceed between occurrences that are relatively close to one another. We designate subgroups (Table 29) to identify occurrences in proximity. The same limits on seed movement apply when using seed from a seed bank for restoration.

### *Collecting Plan*

Refer to Section 4.1 of this document for guidelines on developing a sampling strategy for seed collection. Identify the purpose and type of collection needed for a specific project or restoration effort, as well as timeline and costs. In the section below, we highlight key steps in the process, including those specific to salt marsh bird's-beak.

### Sampling Strategy

Refer to Table 28 for prioritized seed-related activities for the target occurrence to identify whether seed is needed for a conservation collection, a restoration collection, or both.

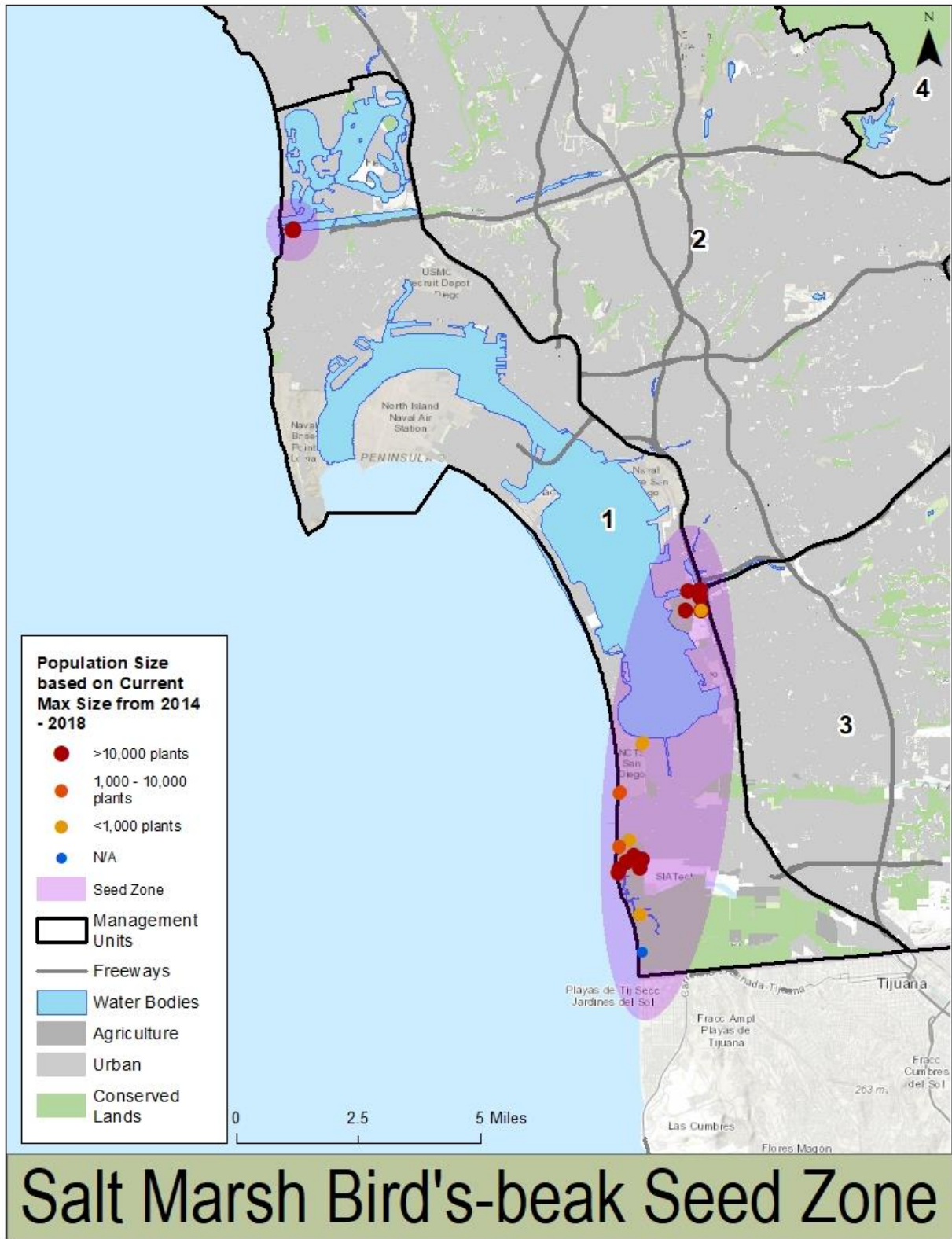


Figure 16. Salt Marsh Bird's-beak: Seed Zones.

**Table 29.** Salt Marsh Bird's-beak: Seed Zones.

Occurrence ID <sup>1</sup>	Occurrence Name	Seed Zone <sup>2</sup>	Seed Zone Subgroup <sup>3</sup>	Occurrence Size <sup>4</sup>
COMAM3_1DOBE007	Dog Beach	South	1	Large
COMAM3_1IMBE008	Camp Surf	South	2	Medium
COMAM3_1SDBA004	San Diego Bay, Naval Radar Receiving Facility, Naval Base Coronado	South	2	Small
COMAM3_1SWMA005	Sweetwater Marsh (west of I-5 and north of Sweetwater River)	South	2	Large
COMAM3_1TIES001	Tijuana Estuary Area (at Boundary Monument #258)	South	2	Small
COMAM3_1TIES002	Tijuana Estuary Area (between mouth of Tijuana River & Coronado Avenue, Imperial Beach)	South	2	Large
COMAM3_1TIES003	Tijuana Estuary Area (near mouth of Tijuana River and north part of Border Field State Park)	South	2	Small <sup>5</sup>
COMAM3_1TIES009	Tijuana Slough	South	2	Small
COMAM3_1TISO010	Tijuana Slough NWA #2	South	2	Medium
COMAM3_1TISO011	Tijuana Slough NWA #3	South	2	Large

<sup>1</sup> Occurrence ID: Occurrence identification (ID) code per the San Diego Management and Monitoring Program's (SDMMP) Master Occurrence Matrix (MOM) database.

<sup>2</sup> Seed Zone: seed zones are defined in text and correspond to genetic clusters and population groups in the F-RPMP. Limit seed movement to within the same seed zone.

<sup>3</sup> Seed Zone Subgroups are defined in text and correspond to population subgroups in the F-RPMP. Where feasible, limit seed movement to the same subgroup within a population group.

<sup>4</sup> Occurrence size: refers to size category based on multiple years of monitoring data. Recent size category as defined in the Framework-Rare Plant Management Plan (F-RPMP). **Small** = <1,000 individuals, **Medium** = 1,000-<10,000 individuals, **Large** = >10,000 individuals.

<sup>5</sup> Indicates occurrences where monitoring indicates a decline in population size category over time. Refer to F-RPMP for additional details.

For restoration, determine if seed is available in a seed bank to reintroduce directly into a target occurrence or for bulking. Proceed with the collecting plan if stored seed is not available, quantities are not sufficient, or the provenance is not appropriate for the target occurrence (e.g., different seed zone).

Assess whether the target occurrence will likely provide an adequate quantity of seed for restoration or if seed will need to be sourced from other occurrences in the seed zone. Refer to seed zones (Figure 16, Table 29) for limits on seed movement and seed sources. Contact the appropriate land managers of potential seed source occurrences to obtain permission for seed collection.

Based on the purpose and type of collection, and amount of seed expected to be available, determine whether the seed is likely to be collected along maternal lines or in bulk (Table 9), and

set minimum targets for the number of plants to sample and amount of seed to collect. These targets are intended to provide a guide for planning, and may be modified based on the actual seed crop.

### Permitting and Agreements

Ensure that all regulatory permits, memorandums, and access agreements are in place before collecting seed from an occurrence.

If unfamiliar with the collecting location, contact the land owner to obtain a map and coordinates of the occurrence, directions to the occurrence if necessary, gate codes, lock combinations, or keys, and any pertinent information about the occurrence (e.g., informing adjacent land owners, closures due to unsafe conditions).

### Pre-collection Monitoring

Practitioners can collect salt marsh bird's-beak seed as early as July and into winter, depending on location, habitat, and weather and temperature conditions during the previous fall, winter, and spring. Visit the target occurrence multiple times to determine the best time to collect seed. Time the first visit when salt marsh bird's-beak is in full flower to make it easier to locate. Talk to land owners and managers and refer to monitoring data and literature to determine the range of phenological variation for an occurrence to plan the first site visit.

Use pin flags to demarcate the boundary of the occurrence and place pin flags adjacent to salt marsh bird's-beak individuals to relocate them easily during subsequent visits. Return to the occurrence within two to four weeks to check phenology. Weather conditions will determine the rate of desiccation; plants will dry quicker in warm and dry conditions and slower if conditions remain cool and moist. Continue monthly site visits until the majority of plants in an occurrence are fully desiccated and seeds resemble those in Figure 15.

### Voucher Specimens

Collect voucher specimens of salt marsh bird's-beak if none exist for the source occurrence and if enough plants are available so that collecting a few specimens does not adversely affect the occurrence. Check the San Diego Natural History Museum or Consortium of California Herbaria to determine if a voucher specimen already exists:

San Diego Natural History Museum: <http://sdplantatlas.org/publicsearch.aspx>

Consortium of California Herbaria: <http://ucjeps.berkeley.edu/consortium/>

Note that recently collected specimens may not yet be accessed into an herbarium's collection. In addition, older specimens may not include sufficient locality information to definitively determine whether they were collected at the occurrence. If it is not appropriate to collect a

voucher specimen, photograph the occurrence (landscape aspect) and an individual plant while in flower, and then again when the plant is in fruit.

Obtain all necessary permits and memorandums before collecting voucher specimens of endangered, threatened, and rare species. Collect specimens while plants are still in flower and before collecting seed. Refer to Section 4.1 of this document (Seed Collecting, Materials and Methods) and instructions and forms in Appendix B to guide your collection. Submit the voucher specimen(s) to the San Diego Natural History Museum as soon as possible.

### Methods and Materials

Refer to Section 4.1 of this document for a detailed discussion of methods and materials and Table 10 for a comprehensive list of recommended equipment for collecting seed. At a minimum, bring the following to each salt marsh bird's-beak collection location:

- Regulatory permits and access agreements
- Directions, map(s)
- Lock combination(s), key(s)
- Collecting strategy/instructions
- GPS unit (preferably, sub-meter)
- Camera
- Labels, markers, pens or pencils
- Seed collection forms
- Hand lens
- Adhesive tape
- Safety razor or pocketknife
- Container and water (optional)
- Scissors, snips
- Small paper envelopes or bags

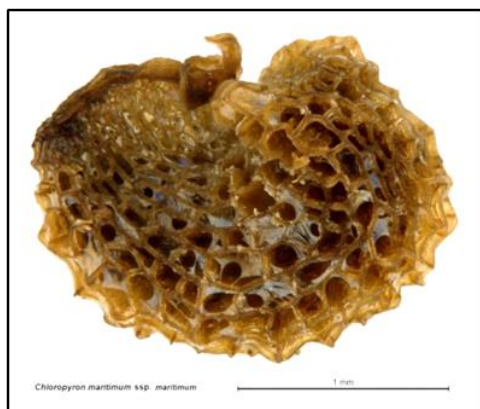


Before collecting seed, map the seed collection area(s), record data on the seed collection form(s) and count or estimate the number of plants within an occurrence. Collect no more than 5-10% of the seed from an individual plant or from the reproductive population per season. Use the following method to determine the number of seeds to collect by plant and for an occurrence:



- Step 1: Select 5 plants of different sizes spaced randomly across the occurrence.
- Step 2: Select 2-3 inflorescences per plant and count the number of seeds per inflorescence.
- Step 3: Divide the total number of seeds counted (Step 2) by the number of sampled inflorescences (Step 2) to calculate the *average number of seeds per inflorescence*.
- Step 4: Count or estimate the number of inflorescences on each sampled plant. Divide the total number of inflorescences by the number of plants sampled (Step 1) to calculate the *average number of inflorescences per plant*.
- Step 5: Multiply the average number of seeds per inflorescence (Step 3) by the average number of inflorescences per plant (Step 4) to obtain an *average number of seeds per plant*.
- Step 6: Multiply the average number of seeds per plant (Step 5) by the occurrence count or estimate to calculate the estimated *number of seeds per occurrence*. In most cases, the amount of seed available for collecting will be higher in years with optimal growing conditions (e.g., average or above-average rainfall) and lower during drought years.
- Step 7: Calculate the maximum number of fruits or seeds to collect per plant and for an occurrence to stay within the 5-10% collecting guidelines.

Collect seeds when salt marsh bird's-beak plants are fully dry. At this stage, plants will be tan to brown with no green parts showing (Figure 15), and seeds will be hard, kidney-shaped, netted, and tan to light brown (Figure 17). Fruits may be ready to collect as early as one month after peak flowering. Remove dry fruits from the stems by hand and place them in a seed collecting envelope or bag.



**Figure 17.** Salt Marsh Bird's-beak: Seed Detail (Photo credit: Heather Schneider, SBBG).

Collect seed during early, mid, and late season to account for differences in maturity times and to capture the phenological variability among the occurrence. Collect seed randomly and evenly

throughout the occurrence, taking care to collect from plants of various sizes and with variable inflorescences, as well as plants growing in unique or varying habitat conditions.

Consider harvesting more seed than recommended by the CPC for small occurrences that are at serious risk of extirpation to capture the highest amount of genetic variation at the occurrence (McMillan 2019). In this case, coordinate with the regulatory agencies prior to the collecting effort.

Ideally, collect seed from 30-50 plants across the occurrence. If the number of plants present in a given year is below this number, then sample over multiple years to produce a genetically robust seed collection for restoration purposes. Where the occurrence is small and not expected to produce an adequate number of plants (and seed) in any given year, consider collecting seed from one or more occurrences within the same seed zone. Depending on project objectives and sampling strategy, collect seed along maternal lines or as a bulk collection.

### Interim Seed Storage and Delivery

Refer to the general section of this document (Seed Collecting) for guidelines on interim seed storage and delivery. We provide additional guidelines for practitioners that choose to keep the seed for future restoration purposes rather than sending it immediately to a storage facility:

- Do not clean and sort seed unless the collection is very small since cleaning seed is time-consuming and often difficult, especially with large amounts of seed.
- Loosely pack the seed collection in envelopes or bags and store them in dark, dry, and moderate to cool conditions for several months before distributing seed onsite.
- If planning to hold seed for longer than one year, store the seed at a recognized seed bank (i.e., RSA, SDZG) to ensure proper storage conditions to retain viability.

## *Seed Banking*

### *Existing Conservation and Restoration Collections*

Refer to Table 30 for existing seed collections of salt marsh bird's-beak. This table includes only bird's-beak occurrences with seed in storage. For planning purposes, we indicate the seed zone for each collection. We also indicate the number of seeds present in the seed bank and their potential availability for restoration. Note that only a portion of the seeds in a collection will be available for these purposes. Existing permits or contracts may also limit the use of some collections. We obtained information on each collection (seed bank, accession number and year, and seed quantity, provenance, and availability) from seed bank managers. Refer to Table 16 for contact information for these seed banks; we encourage land managers to contact facilities directly to get more information on seed availability or to request seed.

**Table 30.** Salt Marsh Bird’s-beak: Exiting Seed Collections.

Occurrence ID <sup>1</sup>	Seed Zone <sup>2</sup>	Seed Bank <sup>3</sup>	Accession Number <sup>4</sup>	Collection Year	Seed Quantity <sup>5</sup>	Provenance Type <sup>6</sup>	Seed Available <sup>7</sup>
COMAM3_1DOBE007	South	SDZG	S0735	2017	~335	W	Yes
COMAM3_1SWMA006 <sup>8</sup>	South	RSA	21772-3317	2005	41,209	W	Limited
COMAM3_1SWMA006 <sup>8</sup>	South	SDZG	S0740	2017	~1,595	W	Yes
COMAM3_1TIES009	South	RSA	21771-3318	2005	4,929	W	Limited
COMAM3_1TIES009	South	SDZG	S0739	2017	~1,615	W	Yes
<i>Sweetwater Marsh</i>	South	SDZG	S0083	2005	~12,000	W	Yes
<i>Tijuana Estuary</i>	South	SDZG	S0082	2005	~15,000	W	Yes

<sup>1</sup> Occurrence identification (ID) per the SDMMMP’s MOM database. If no occurrence ID exists for a location, we provide the name of the location as indicated on collection in seed bank.

<sup>2</sup> Seed Zone: Seed zone corresponds to the one genetic cluster and population group identified in the F-RPMP: South.

<sup>3</sup> Seed bank: **RSA** = Rancho Santa Ana Botanic Garden, **SDZG** = San Diego Zoo Global.

<sup>4</sup> Accession number = accession number of seed collection assigned by seed bank.

<sup>5</sup> Seed quantity indicates the number of seeds currently in the collection, according to seed bank records. Unknown indicates seed has not yet been processed and counted.

<sup>6</sup> Provenance type indicates the source location of the seed collection: **W** = seed collected directly from the wild (origin known).

<sup>7</sup> Seed available: **Yes** = seed is available for restoration use. **No** = seed is not available for restoration use, **Limited** = amount of seed available for restoration use is ≤400 seeds.

<sup>8</sup> For this occurrence, the number -006 was assigned in the early stages of IMG rare plant monitoring. With subsequent monitoring, SDMMMP combined -005 and -006 based on distance. As a result, we addressed only -005 in the F-RPMP and earlier in this document because these two locations were considered to be a single occurrence. For restoration purposes, seed from -005 and -006 are considered the same seed source.

## *Best Management Practices*

### Seed Cleaning

Wall and MacDonald (2009) suggest the following methods to clean and sort seeds of salt marsh bird's-beak:

- Rub dried floral material over a medium screen to open capsules and release seeds.
- Sort material through sieves several times to remove large chaff.
- Use a blower at low speed to separate chaff and sterile seed from viable seed.

Wall and MacDonald (2009) indicate that cleaning seed of this species is moderately difficult and may require some hand-cleaning.

### Seed Testing

Seed testing methods will vary by facility, but all seed banks conduct baseline germination tests on new accessions and then conduct follow up testing to check seed for viability.

At RSA, baseline tests for seed germination use a typical seed sample of 50 seeds, although sample size may vary depending on the size of the seed collection, and variable methods to break dormancy (if needed). They conduct follow-up testing on seeds in storage at intervals (e.g., 1 year, 5 years, 10 years, 20 years, and every subsequent 10 years thereafter, as seed quantities allow).

RSA has conducted a number of seed germination tests on salt marsh bird's-beak (<https://www.rsabg.org/conservation/seed-conservation>). Germination is relatively high in this species. RSA observed germination rates >70% on fresh seed, including 71% germination with no pre-treatment and 81% germination after soaking seed in water. Germination rates were somewhat lower on frozen seed (40-72%), although they appeared to increase over time. For example, 3-year old seed had a germination rate of 40% while 20-year old seed had a germination rate of 72% (Wall 2009).

At SDZG, a baseline germination test is conducted on all new accessions. The test is conducted primarily on fresh seed. Follow up testing is conducted on frozen seed after 1, 5, and 10 years in storage. Seed is sterilized with bleach and placed in reverse osmosis water at room temperature for 24 hours to fully imbibe (absorb) water. Seed is then plated onto agar trays (10 seeds per tray) and observed for signs of germination. The seed is counted as germinated when the radical emerges. SDZG does not use a cut test to determine viability. Rather, they provide abundant time for seeds to germinate (Anderson pers. comm.).

## Seed Storage

All seed banks contacted store salt marsh bird's-beak seed according to CPC guidelines. For example, SDZG dries seeds down to 23-35% moisture content. Seed is then stored in sealed, foil-lined envelopes in the freezer at a low temperature (-18°C to -23°C).

Each collection is separated into three packages that represent the primary, curation, and duplicate collections, as described in Section 4.1. The primary collection is the active seed collection and seeds in this package are available for research, testing, restoration, and other uses. The curation package is the base collection for long-term storage. This package is not opened and is not available for other uses. It constitutes the long-term conservation collection. The duplicate collection is sent to another seed bank facility as backup storage to protect against catastrophic loss at the primary storage facility. Both SDZG and RSA send their duplicate seed collections to the NLGRP.

## *Seed Bulking*

### *Seed Selection*

Refer to Section 4.3 for guidelines on seed selection to maximize the quality of the bulked sample. Key considerations include:

- Use seed for bulking from the target occurrence or another occurrence in the same seed zone as the target occurrence. For very small occurrences (fewer than 100 plants), use seed from a large occurrence (if present) or from one or more smaller occurrences (composite provenancing) within the same seed zone.
- Use seed that was collected randomly and uniformly.
- Use an adequate amount of seed for bulking (ideally,  $\geq 1,000$  seeds or seed from 30-50 plants).
- For very small seed samples, use seed collected along maternal lines.

## *Best Management Practices*

### Germination and Propagation Methods

Salt marsh bird's-beak seed germinates without pre-treatment although the seed does appear to possess some dormancy that is relieved with after-ripening, scarification, or vernalization (artificially cooling seeds to mimic cold temperatures and induce germination), or by germinating in water with lower levels of salinity (Zedler et al. 1992, USFWS 1985). Although seed germinates readily without pre-treatment, soaking seed in water for 24-72 hours may improve the germination rate (Zedler 2001 *in* Zahn 2015).

Limits on Generations

At this time, we recommend bulking salt marsh bird’s-beak seed for only one generation (F1) in a nursery setting. If additional seed is needed for restoration, start with wild seed rather than the F1 generation.

Documentation

We encourage growing facilities and others bulking seed of salt marsh bird’s-beak for reintroduction purposes to document bulked samples as indicated in Section 4.3 and provide this information to land managers when seed is delivered. Likewise, we encourage land managers to provide information on seed collection and seed reintroductions to the SDMMP (contact information at <https://sdmmp.com/about.php#contact>) and include relevant information on IMG monitoring forms (i.e., translocated occurrence). Refer to Table 31 for key information for bulked seed samples.

**Table 31.** Documentation for Bulked Seed Samples.

Key Information	Primary Responsibility
Seed Source	Seed Collector and/or Land Manager
Seed Collection Date	Seed Collector
Amount of Seed Bulk	Growing Facility
Propagation Method	Growing Facility
Propagation Conditions	Growing Facility
Harvesting Date(s)	Growing Facility
Post-harvest Storage Location/Duration/Conditions	Growing Facility
Generation of Bulk Sample	Growing Facility
Receptor Site Location	Growing Facility and/or Land Manager



## 5.4 OTAY TARPLANT (*DEINANDRA CONJUGENS*)

### Seed Collection

#### Seed Characteristics

Otay tarplant inflorescences include both ray and disk flowers. Each inflorescence possesses 7-10 ray flowers and 13-21 disk flowers. Most fruits are produced by ray flowers. Baldwin et al. (2012) indicate that disk flowers are staminate (male) and do not typically produce seed. Where disk flowers do form fruits, however, they germinate more readily than fruit of ray flowers, possibly due to differences in the thickness of the seed coat (USFWS 2009, Bauder et al. 2002).



Otay tarplant fruits (achenes) are dry and indehiscent. Each achene contains one seed. The rough-textured, triangular to obovate seeds are brown, tan, and black (Figure 18). The short, papery pappus (modified calyx) remains attached to each seed and its role is unknown, but it may assist in animal- or possibly, wind-dispersal.



**Figure 18.** Otay Tarplant: Seed. (left: disk seeds with pappus, right: ray seeds; Photo credit: John MacDonald, RSA).

Otay tarplant seed forms in late spring and matures through summer as the plant senesces. Seed production increases with plant size and flower production, with larger plants producing hundreds of seeds. Fruits can remain on dry plants throughout the fall.

## Priority Occurrences

Table 32 prioritizes occurrences of Otay tarplant on conserved lands in the MSPA for seed-related management actions. These priorities were developed in the F-RPMP based on monitoring data and specific studies, including genetic analyses. The decision to implement an action will depend on a number of factors, including status of the occurrence (stable or declining), habitat condition, threats management, and funding, among others.

In general, large occurrences are prioritized as potential seed sources, subject to land manager and/or agency approval. Small occurrences are high priority candidates for seed reintroduction, subject to response to management and site conditions, as discussed in the F-RPMP.

Currently, conservation seed collections exist in established seed banks for six Otay tarplant occurrences (22%) on conserved lands in the MSPA (Table 32). Seed banks also hold collections for an additional occurrence that is extirpated or not currently conserved.

We recommend conservation collections as a potential management action for all occurrences that are not currently represented in a seed bank *if adequate seed is available*. For occurrences where plants have not been detected recently, a conservation collection will be possible only if plants are detected in the future (Table 32). Large occurrences are the highest (or most immediate) priorities for seed conservation to maximize the amount of genetic diversity in long-term storage (e.g., DECO13\_3JABO028, DECO13\_3MMGR010).

We recommend restoration collections as a potential management action for occurrences that are high or medium priorities for seed reintroduction as indicated in Table 32 and identified in the F-RPMP. We do not prioritize occurrences for seed reintroduction if they have not yet been monitored.

We recommend reintroducing seed only if threats are controlled, habitat is likely to support this species in the future, and funding is available for short- and long-term management. Reintroducing seed is most appropriate for small occurrences that continue to decline, even with management. Seed may be introduced into extirpated occurrences if threats are managed and the habitat is likely to support Otay tarplant in the future. For extirpated occurrences, source seed from a large occurrence in the same seed zone or from an appropriate seed source in storage (if available). Some threats (particularly, invasive plants) will likely require perpetual management; thus, ensure that adequate funding and/or labor are available to manage the occurrence after seed is reintroduced.

We recommend seed bulking as a potential management action for all occurrences identified as potentially requiring a restoration collection. The need for seed bulking will depend on the amount of seed available in storage and/or collected specifically for restoration, as well as the sowing strategy. For example, bulking will not be needed if adequate seed is collected to sow directly into the target occurrence.

**Table 32.** Otay Tarplant: Management Priorities for Seed-related Activities.

Occurrence ID <sup>1</sup>	Occurrence Size <sup>2</sup>	Genetic Structure <sup>3</sup>	Seed Reintroduction Priority <sup>4</sup>	Existing Seed Collection <sup>5</sup>	Seed-related Activities <sup>6</sup>			
					Seed Source	Conservation Collection	Restoration Collection	Seed Bulking
DECO13_2PAVA001	Small	L+H+L	High			✓	✓	✓
DECO13_2PAVA030	Small	L+H+L	High			✓	✓	✓
DECO13_3BOME009	Large	L+H+L		RSA	✓		✓	✓
DECO13_3DENC022	Small	L+H+L				✓		
DECO13_3DERA020	Small	L+H+L	High			✓	✓	✓
DECO13_3DREA021	Large	L+H+L		SDZG	✓			
DECO13_3JABO028	Large	L+H+L			✓			
DECO13_3JAHIO06	Medium	L+H+L	Low	SDZG				
DECO13_3JOCA019	Medium	L+H+L	Low			✓		
DECO13_3LOST027	Medium	L+H+L	Low			✓		
DECO13_3MMGR010	Large	L+H+L	Low		✓	✓		
DECO13_3OMEA026	Small	L+H+L	Medium			✓	✓	✓
DECO13_3ORVA017	Small	L+H+L				✓		
DECO13_3ORVA018	Large	L+H+L			✓			
DECO13_3PMA1002	Large	L+H+L			✓			
DECO13_3PMA2003	Medium	L+H+L	Medium			✓	✓	✓
DECO13_3PMA4005	Large	L+H+L	Medium		✓			
DECO13_3PRVA013	Small	L+H+L	Medium			✓	✓	✓
DECO13_3PRVA014	Small	L+H+L				✓		
DECO13_3RHRA012	Medium	L+H+L	Low			✓		
DECO13_3RJER015	Large	L+H+L		RSA, SDZG	✓			

**Table 32.** Otay Tarplant: Management Priorities for Seed-related Activities.

Occurrence ID <sup>1</sup>	Occurrence Size <sup>2</sup>	Genetic Structure <sup>3</sup>	Seed Reintroduction Priority <sup>4</sup>	Existing Seed Collection <sup>5</sup>	Seed-related Activities <sup>6</sup>			
					Seed Source	Conservation Collection	Restoration Collection	Seed Bulking
DEC013_3SCPA016	Small	L+H+L				✓		
DECO13_3SMHA024	Small	L+H+L	Medium			✓	✓	✓
DECO13_3SMHA025	Small	L+H+L	Medium			✓	✓	✓
DECO13_3SVPC007	Large	L+H+L		RSA	✓			
DECO13_3TRIM008	Large	L+H+L		RSA	✓			
DECO13_3WMCA023	Small	L+H+L				✓		

<sup>1</sup> Occurrence ID: Occurrence identification (ID) code per the San Diego Management and Monitoring Program’s (SDMMP) Master Occurrence Matrix (MOM) database.  
<sup>2</sup> Occurrence Size: Recent size category as defined in the Framework-Rare Plant Management Plan (F-RPMP). **Small** = <1,000 individuals, **Medium** = 1,000- <10,000 individuals, **Large** = >10,000 individuals.  
<sup>3</sup> Genetic Structure (per Milano and Vandergast 2018): Genetic differentiation + genetic diversity + inbreeding. **L** = low, **H** = High. Refer to F-RPMP for a discussion of the implications for seed movement.  
<sup>4</sup> Seed Reintroduction Priority (per F-RPMP): **High** = high priority for seed reintroduction, **Medium** = medium priority for seed reintroduction, **Low** = low priority for seed reintroduction. If no priority level is indicated, then management action is not a priority at this time, but may be undertaken at the discretion of the land manager and subject to adequate seed availability.  
<sup>5</sup> Existing Seed Collection: Indicates location of collection. **RSA** = Rancho Santa Ana Botanic Garden.  
<sup>6</sup> Seed-related Activities: ✓ indicates occurrence is suitable (e.g., seed source) pending authorization from responsible entities, or action is warranted. In some cases, additional collecting for restoration may not be necessary if enough seed is available in an existing seed collection. Likewise, seed bulking may or may not be necessary depending on amount of seed available in existing collection or collected specifically for restoration purposes.

## Seed Zones

We established one seed zone for Otay tarplant to guide seed collecting, banking, and bulking efforts. This seed zone corresponds to the genetic cluster and regional population group identified for this species in the F-RPMP. Figure 19 shows the locations of the seed zone, while Table 33 lists all occurrences in the seed zone.

Seed zones place geographic limits on the transfer of seed between occurrences. *We do not recommend transfer of seed beyond the seed zone at this time* (e.g., between occurrences in San Diego County and Baja California). Thus, if a small occurrence requires seed from another occurrence, the source (donor) occurrence should be located within the same seed zone as the target (recipient) occurrence. Within a seed zone, we recommend that seed transfer proceed between occurrences that are relatively close to one another. We designate subgroups (Table 33) to identify occurrences in proximity. The same limits on seed movement apply when using seed from a seed bank for restoration.

## Collecting Plan

Refer to Section 4.1 of this document for guidelines on developing a sampling strategy for seed collection. Identify the purpose and type of collection needed for a specific project or restoration effort, as well as timeline and costs. In the section below, we highlight key steps in the process, including those specific to Otay tarplant.

### Sampling Strategy

Refer to Table 32 for prioritized seed-related activities for the target occurrence to identify whether seed is needed for a conservation collection, a restoration collection, or both.

For restoration, determine if seed is available in a seed bank to reintroduce directly into a target occurrence or for bulking. Proceed with the collecting plan if stored seed is not available, quantities are not sufficient, or the provenance is not appropriate for the target occurrence (e.g., different seed zone).

Assess whether the target occurrence will likely provide an adequate quantity of seed for restoration or if seed will need to be sourced from other occurrences in the seed zone. Refer to seed zones (Figure 19, Table 33) for limits on seed movement and seed sources. Contact the appropriate land managers of potential seed source occurrences to obtain permission for seed collection.



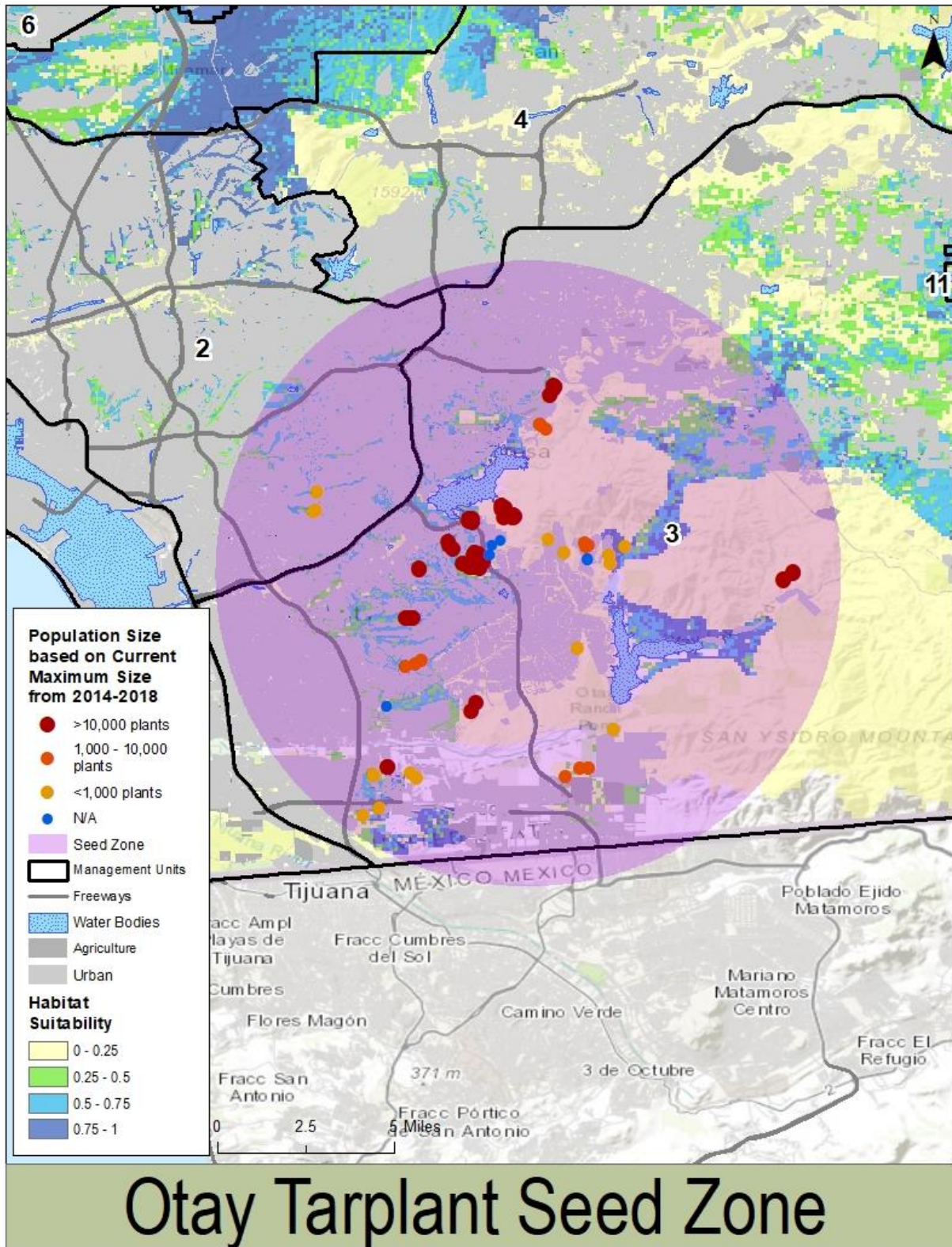


Figure 19. Otay Tarplant: Seed Zone.



**Table 33.** Otay Tarplant: Seed Zones.

Occurrence ID <sup>1</sup>	Occurrence Name	Seed Zone <sup>2</sup>	Seed Zone Subgroup <sup>3</sup>	Occurrence Size <sup>4</sup>
DECO13_3JABO028	Jamacha Boulevard	South	1	Large
DECO13_3JAHIO06	Jamacha Hills	South	1	Medium
DECO13_3PAVA001	Paradise Valley	South	2	Small <sup>5</sup>
DECO13_3PAVA030	Paradise Gardens	South	2	Small
DECO13_3MMGR010	Mother Miguel Grassland	South	3	Large
DECO13_3PRVA013	Proctor Valley	South	3	Small <sup>5</sup>
DECO13_3PRVA014	Proctor Valley (Bella Lago)	South	3	Small <sup>5</sup>
DECO13_3RHRA012	Rolling Hills Ranch	South	3	Medium
DECO13_3SMHA024	San Miguel HMA West - DECO13	South	3	Small
DECO13_3SMHA025	San Miguel HMA West - DECO13	South	3	Small
DECO13_3SVPC007	Shinohara Vernal Pool Complex (southeast Sweetwater Reservoir)	South	3	Large
DECO13_3BOME009	Bonita Meadows	South	4	Small <sup>5</sup>
DECO13_3PMA1002	PMA1 (Rice Canyon & Other Canyons)	South	4	Large
DECO13_3PMA2003	PMA2	South	4	Medium
DECO13_3PMA4005	PMA4	South	4	Large
DECO13_3TRIM008	Trimark/Gobbler's Knob/Horseshoe Bend	South	4	Large
DECO13_3DENC022	Dennery Canyon South	South	5	Small <sup>6</sup>
DECO13_3DERA020	Dennery Ranch	South	5	Small
DECO13_3DREA021	Dennery Ranch East	South	5	Large
DECO13_3OMEA026	Furby North	South	5	Small
DECO13_3WMCA023	West of Moody Canyon	South	5	Small <sup>5</sup>
DECO13_3JOCA019	Johnson Canyon	South	6	Medium <sup>5</sup>
DECO13_3LOST027	Lonestar	South	6	Medium <sup>5</sup>
DECO13_3ORVA017	Otay Valley (east end)	South	6	Small
DECO13_3ORVA018	North side of Otay River Valley near Wolf Canyon	South	6	Large
DECO13_3SCPA016	Salt Creek Parcel	South	6	Small <sup>6</sup>
DECO13_3RJER015	Rancho Jamul ER Subpopulation #1	South	7	Large

<sup>1</sup> Occurrence ID: Occurrence identification (ID) code per the San Diego Management and Monitoring Program's (SDMMP) Master Occurrence Matrix (MOM) database.

<sup>2</sup> Seed Zone: seed zones are defined in text and correspond to genetic clusters and population groups in the F-RPMP. Limit seed movement to within the same seed zone.

<sup>3</sup> Seed Zone Subgroups are defined in text and correspond to population subgroups in the F-RPMP. Where feasible, limit seed movement to the same subgroup within a seed zone.

- <sup>4</sup> Occurrence size: refers to size category based on multiple years of monitoring data. Recent size category as defined in the Framework-Rare Plant Management Plan (F-RPMP). **Small** = <1,000 individuals, **Medium** = 1,000-<10,000 individuals, **Large** = >10,000 individuals.
- <sup>5</sup> Indicates occurrences where monitoring indicates a decline in population size category over time. Refer to F-RPMP for additional details.
- <sup>6</sup> Occurrence size presumed small at this time; no population size data available.

Based on the purpose and type of collection, and amount of seed expected to be available, determine whether the seed is likely to be collected along maternal lines or in bulk (Table 9), and set minimum targets for the number of plants to sample and amount of seed to collect. These targets are intended to provide a guide for planning, and may be modified based on the actual seed crop.

### Permitting and Agreements

Ensure that all regulatory permits, memorandums, and access agreements are in place before collecting seed from an occurrence.

If unfamiliar with the collecting location, contact the land owner to obtain a map and coordinates of the occurrence, directions to the occurrence if necessary, gate codes, lock combinations, or keys, and any pertinent information about the occurrence (e.g., informing adjacent land owners, closures due to unsafe conditions).

### Pre-collection Monitoring

Practitioners can collect Otay tarplant seed as early as June and into early fall, depending on location, habitat, and weather and temperature conditions during the previous fall, winter, and spring. Visit the target occurrence multiple times to determine the best time to collect seed. Talk to land owners and managers and refer to monitoring data and literature to determine the range of phenological variation for an occurrence to plan the first site visit.

Otay tarplant and fascicled tarplant (*Deinandra fasciculata*) co-occur at several San Diego County occurrences. Otay tarplant is also easily confused with paniculate tarplant (*Deinandra paniculata*), a species that typically occurs further north, but occurs sporadically in northern Baja California and southern San Diego County, where it is found in proximity to Otay tarplant occurrences.<sup>7</sup> Differentiating between these three species is possible when they are in flower, but is very difficult after senescence. Therefore, time the first visit when Otay tarplant is in full flower to make it easier to locate and identify this species correctly. Use pin flags to demarcate the boundary of the occurrence, particularly in areas where Otay tarplant and fascicled tarplant co-occur. Place pin flags adjacent to Otay tarplant individuals to relocate them easily during subsequent visits.

---

<sup>7</sup> The Consortium of California Herbaria list four specimens of paniculate tarplant from southern San Diego County, and all were collected prior to 1960. At least two of these locations have been developed.

Return to the occurrence within two to four weeks to check phenology. Weather conditions will determine the rate of desiccation; plants will dry quicker in warm and dry conditions and slower if conditions remain cool and moist. Continue monthly site visits until the majority of plants in an occurrence are fully desiccated and seeds resemble those in Figure 18.

### Voucher Specimens

Collect voucher specimens of Otay tarplant if none exist for the source occurrence and if enough plants are available so that collecting a few specimens does not adversely affect the occurrence. Check the San Diego Natural History Museum or Consortium of California Herbaria to determine if a voucher specimen already exists:

San Diego Natural History Museum: <http://sdplantatlas.org/publicsearch.aspx>

Consortium of California Herbaria: <http://ucjeps.berkeley.edu/consortium/>

Note that recently collected specimens may not yet be accessed into an herbarium's collection. In addition, older specimens may not include sufficient locality information to definitively determine whether they were collected at the occurrence. If it is not appropriate to collect a voucher specimen, photograph the occurrence (landscape aspect) and an individual plant while in flower, and then again when the plant is in fruit.

Obtain all necessary permits and memorandums before collecting voucher specimens of endangered, threatened, and rare species. Collect specimens while plants are still in flower and before collecting seed. Refer to Section 4.1 of this document (Seed Collecting, Materials and Methods) and instructions and forms in Appendix B to guide your collection. Submit the voucher specimen(s) to the San Diego Natural History Museum as soon as possible.

### Methods and Materials

Refer to Section 4.1 of this document for a detailed discussion of methods and materials and Table 10 for a comprehensive list of recommended equipment for collecting seed. At a minimum, bring the following to each Otay tarplant collection location:

- Regulatory permits and access agreements
- Directions, map(s)
- Lock combination(s), key(s)
- Collecting strategy/instructions
- GPS unit (preferably, sub-meter)



- Camera
- Labels, markers, pens or pencils
- Seed collection forms
- Hand lens
- Adhesive tape
- Safety razor or pocketknife
- Container and water (optional)
- Scissors, snips
- Paint sanding respirator mask (optional; for allergic reactions)
- Safety goggles (optional; for allergic reactions)
- Small paper envelopes or bags

Before collecting seed, map the seed collection area(s), record data on the seed collection form(s) and count or estimate the number of plants within an occurrence. Collect no more than 5-10% of the seed from an individual plant or from the reproductive population per season. Use the following method to determine the number of seeds to collect by plant and for an occurrence:

- Step 1: Select 5-10 plants of different sizes spaced randomly across the occurrence.
- Step 2: Count the number of seeds in 3-5 flower heads per plant.
- Step 3: Divide the total number of seeds counted (Step 2) by the total number of flower heads sampled (Step 2) to calculate an *average number of seeds per flower head*.
- Step 4: Count or estimate the number of flower heads on each sampled plant. Divide the total number of flower heads by the number of plants sampled to estimate the *average number of flower heads per plant*.
- Step 5: Multiply the average number of seeds per flower head (Step 3) by the average number of flower heads per plant (Step 4) to generate an *average number of seeds per plant*.
- Step 6: Multiply the average number of seeds per plant (Step 5) by the occurrence count or estimate to calculate the *estimated number of seeds per occurrence*. In most cases, the amount of seed available for collecting will be higher in years with optimal growing conditions (e.g., average or above-average rainfall) and lower during drought years.
- Step 7: Calculate the maximum number of fruits or seeds to collect per plant or occurrence to stay within the 5-10% collecting guidelines.

Collect seeds when plants are fully dry (Figure 20). At this stage, plants will be tan to brown with no green parts showing, and seeds will be hard and tannish-brown to black (Figure 18).



**Figure 20.** Otoy Tarplant: Dried Inflorescence (Photo credit: Stacy Anderson, SDZG).

Fruits may be ready to collect as early as one month after peak flowering. Remove dry fruits from the stems by hand and place them in a seed collecting envelope or bag. Note that some collectors have reported allergic reactions while collecting Otoy tarplant seeds; thus, we recommend wearing a paint sanding respirator mask and goggles if an allergic reaction is suspected.

Collect seed during early, mid, and late season to account for differences in maturity times and to capture the phenological variability among the occurrence. Collect seed randomly and evenly throughout the occurrence, taking care to collect from plants of various sizes and with variable inflorescences, as well as plants growing in unique or varying habitat conditions.

Consider harvesting more seed than recommended by the CPC for small occurrences that are at serious risk of extirpation to capture the highest amount of genetic variation at the occurrence (McMillan 2019). In this case, coordinate with the regulatory agencies prior to the collecting effort.

Ideally, collect seed from 30-50 plants across the occurrence. If the number of plants present in a given year is below this number, then sample over multiple years to produce a genetically robust seed collection for restoration purposes. Where the occurrence is small and not expected to produce an adequate number of plants (and seed) in any given year, consider collecting seed from one or more occurrences within the same seed zone. Depending on project objectives and sampling strategy, collect seed along maternal lines or as a bulk collection.

### Interim Seed Storage and Delivery

Refer to the general section of this document (Seed Collecting) for guidelines on interim seed storage and delivery. We provide additional guidelines for practitioners that choose to keep the seed for future restoration purposes rather than sending it immediately to a storage facility:

- Do not clean and sort seed unless the collection is very small since cleaning seed is time-consuming and often difficult, especially with large amounts of seed.
- Loosely pack the seed collection in envelopes or bags and store them in dark, dry, and moderate to cool conditions for several months before distributing seed onsite.
- If planning to hold seed for longer than one year, store the seed at a recognized seed bank (i.e., RSA, SDZG) to ensure proper storage conditions to retain viability.

## *Seed Banking*

### *Existing Conservation and Restoration Collections*

Refer to Table 34 for existing seed collections of Otay tarplant. This table includes only tarplant occurrences with seed in storage. For planning purposes, we indicate the seed zone for each collection. We also indicate the number of seeds present in the seed bank and their potential availability for restoration. Note that only a portion of the seeds in a collection will be available for these purposes. Existing permits or contracts may also limit the use of some collections. We obtained information on each collection (seed bank, accession number and year, and seed quantity, provenance, and availability) from seed bank managers. Refer to Table 16 for contact information for these seed banks; we encourage land managers to contact facilities directly to get more information on seed availability or to request seed.

### *Best Management Practices*

#### Seed Cleaning

Wall and MacDonald (2009) suggest the following methods to clean and sort seeds of Otay tarplant:

- Rub and sort material through graduated sieves to separate achenes and chaff from other plant material.
- Gently rub material again over a sieve with a padded wooden block to separate ray achenes from involucre and to break up large chaff.
- Use a blower at low speed to separate sterile or parasitized seed from fertile seed.

Wall and MacDonald (2009) indicate that cleaning seed of this species is difficult, and found that most ray achenes but very few disk achenes were fertile.



**Table 34.** Otay Tarplant: Exiting Seed Collections.

Occurrence ID <sup>1</sup>	Seed Zone <sup>2</sup>	Seed Bank <sup>3</sup>	Accession Number <sup>4</sup>	Collection Year	Seed Quantity <sup>5</sup>	Provenance Type <sup>6</sup>	Seed Available <sup>7</sup>
DECO13_3BOME009	South	RSA	23634-5082	2013	1,498	W	No
DECO13_3DREA021	South	SDZG	S0804	2019	Unknown	W	Yes
DECO13_3JAHIO06	South	SDZG	S0805	2019	Unknown	W	Yes
DECO13_3RJER015	South	RSA	23625-5079	2013	530	W	No
DECO13_3RJER015	South	RSA	23626-5080	2013	536	W	No
DECO13_3RJER015	South	RSA	23633-5109	2013	448	W	No
DECO13_3RJER015	South	RSA	24320-5495	2016	52,368	Z	Limited
DECO13_3RJER015	South	SDZG	S0806	2019	Unknown	W	Yes
DECO13_3SVPC007	South	RSA	23632-5085	2013	593	W	No
DECO13_3SVPC007	South	RSA	23632-5086	2013	924	W	No
DECO13_3SVPC007	South	RSA	24322-5496	2016	36,852	Z	Limited
DECO13_3TRIM008	South	RSA	24321-5494	2016	128,760	Z	Limited
<i>State Route 54</i>	South	RSA	20347-2885	1999	56,400	W	No

<sup>1</sup> Occurrence identification (ID) per the SDMMMP’s MOM database. If no occurrence ID exists for a location, we provide the name of the location as indicated on collection in seed bank.

<sup>2</sup> Seed Zone: Seed zone corresponds to the one genetic cluster and population group identified in the F-RPMP: South. Occurrences in italics are placed in seed zones based on location.

<sup>3</sup> Seed bank: **RSA** = Rancho Santa Ana Botanic Garden, **SDZG** = San Diego Zoo Global.

<sup>4</sup> Accession number = accession number of seed collection assigned by seed bank.

<sup>5</sup> Seed quantity indicates the number of seeds currently in the collection, according to seed bank records. Unknown indicates seed has not yet been processed and counted.

<sup>6</sup> Provenance type indicates the source location of the seed collection: **W** = seed collected directly from the wild (origin known), **Z** = seed collected from a cultivated plant of known wild origin.

<sup>7</sup> Seed available: **Yes** = seed is available for restoration use. **No** = seed is not available for restoration use, **Limited** = seed is only available for use by Land IQ/South County land managers.

### Seed Testing

Seed testing methods will vary by facility, but all seed banks conduct baseline germination tests on new accessions and then conduct follow up testing to check seed for viability.

At RSA, baseline tests for seed germination use a typical seed sample of 50 seeds, although sample size may vary depending on the size of the seed collection, and variable methods to break dormancy (if needed). They conduct follow-up testing on seeds in storage at intervals (e.g., 1 year, 5 years, 10 years, 20 years, and every subsequent 10 years thereafter, as seed quantities allow).

RSA has conducted a number of seed germination tests on Otay tarplant (<https://www.rsabg.org/conservation/seed-conservation>). Tarplant seed germinates poorly with no pre-treatment to soften the hard seed coat. However, RSA achieved germination rates between 38-68% with a hot water treatment (i.e., seeds were soaked in hot water for 24 hours).

At SDZG, a baseline germination test is conducted on all new accessions. The test is conducted primarily on fresh seed. Follow up testing is conducted on frozen seed after 1, 5, and 10 years in storage. Seed is sterilized with bleach and placed in reverse osmosis water at room temperature for 24 hours to fully imbibe (absorb) water. Seed is then plated onto agar trays (10 seeds per tray) and observed for signs of germination. The seed is counted as germinated when the radical emerges. SDZG does not use a cut test to determine viability. Rather, they provide abundant time for seeds to germinate (Anderson pers. comm.).

### Seed Storage

All seed banks contacted store Otay tarplant seed according to CPC guidelines. For example, SDZG dries seeds down to 23-35% moisture content. Seed is then stored in sealed, foil-lined envelopes in the freezer at a low temperature (-18°C to -23°C).

Each collection is separated into three packages that represent the primary, curation, and duplicate collections, as described in Section 4.1. The primary collection is the active seed collection and seeds in this package are available for research, testing, restoration, and other uses. The curation package is the base collection for long-term storage. This package is not opened and is not available for other uses. It constitutes the long-term conservation collection. The duplicate collection is sent to another seed bank facility as backup storage to protect against catastrophic loss at the primary storage facility. Both SDZG and RSA send their duplicate seed collections to the NLGRP.

## Seed Bulking

### Seed Selection

Refer to Section 4.3 for guidelines on seed selection to maximize the quality of the bulked sample. Key considerations include:

- Use seed for bulking from the target occurrence or another occurrence in the same seed zone as the target occurrence. For very small occurrences (fewer than 100 plants), use seed from a large occurrence (if present) or from one or more smaller occurrences (composite provenancing) within the same seed zone.
- Use seed that was collected randomly and uniformly.
- Use an adequate amount of seed for bulking (ideally,  $\geq 1,000$  seeds or seed from 30-50 plants).
- For very small seed samples, use seed collected along maternal lines.

### Best Management Practices

#### Germination and Propagation Methods

Otay tarplant seed generally requires pre-treatment (i.e., scarification, hot water soak) to germinate readily. In the absence of pre-treatment, germination rates may be somewhat higher with fresh versus frozen seed. Propagation efforts that do not pre-treat seed should take into account the low germination rate when determining the number of seeds to sow.

In a nursery setting, seeds from mature plants fell into containers and germinated immediately. This suggests that germination occurred before dormancy set in (Recon Native Plant Nursery 2014), and reinforces that germination rates may be higher with fresh seed.



Photo credit: Recon Native Plant Nursery.

#### Limits on Generations

At this time, we recommend bulking Otay tarplant seed for only one generation (F1) in a nursery setting. If additional seed is needed for restoration, start with wild seed rather than the F1 generation.

Documentation

We encourage growing facilities and others bulking seed of Otay tarplant for reintroduction purposes to document bulked samples as indicated in Section 4.3 and provide this information to land managers when seed is delivered. Likewise, we encourage land managers to provide information on seed collection and seed reintroductions to the SDMMP (contact information at <https://sdmmp.com/about.php#contact>) and include relevant information on IMG monitoring forms (i.e., translocated occurrence). Refer to Table 35 for key information for bulked seed samples.

**Table 35.** Documentation for Bulkied Seed Samples.

Key Information	Primary Responsibility
Seed Source	Seed Collector and/or Land Manager
Seed Collection Date	Seed Collector
Amount of Seed Bulkied	Growing Facility
Propagation Method	Growing Facility
Propagation Conditions	Growing Facility
Harvesting Date(s)	Growing Facility
Post-harvest Storage Location/Duration/Conditions	Growing Facility
Generation of Bulkied Sample	Growing Facility
Receptor Site Location	Growing Facility and/or Land Manager

## 6.0 References

- Anderson, S. 2019a. Moth species on *Chloropyron*. Email to J. Vinje, Conservation Biology Institute. June 28.
- Anderson, S. 2019b. Research coordinator, native plant seed bank, Institute for Conservation Research, San Diego Zoo Global. Personal communication with J. Vinje. December 4.
- Asghari, M. 2019. AB Seed Laboratory, LLC. Personal communication with J. Vinje. December 4.
- Baldwin, B.G., D.H. Goldman, D.J. Keil, R. Patterson, T.J. Rosatti, and D.H. Wilken, eds. 2012. The Jepson manual: vascular plants of California, second edition. University of California Press, Berkeley. 1568 pp.
- Ballesteros, D., A. Nebot, and H. Pritchard. 2019. Cryobiotechnology for the long-term preservation of oak (*Quercus* sp.) genetic resources. *Acta Horticulturae* 1234:37-45.
- Baskin, J.M. and C.C. Baskin. 1989. Physiology of dormancy and germination in relation to seed bank ecology. Pages 53-66 in Leck, M.A., V.T. Parker, and R.L. Simpson, eds., *Ecology of soil seed banks*. Academic Press, Inc. 462 pp.
- Bauder, E.T. and J. Sakrison. 1997. Autecology of San Diego thornmint (*Acanthomintha ilicifolia*). Final report: contract # FG5637R5. San Diego State University, Department of Biology. 42 pp.
- Bauder, E.T. and J.A. Sakrison. 1999. Mechanisms of persistence of San Diego thornmint (*Acanthomintha ilicifolia*). Prepared for California Department of Fish and Game, Region 5. Final report: contract #FG7634R5. November. 54 pp.
- Bauder, E.T., J. Snapp-Cook, and J. Sakrison. 2002. Ecology and management of *Deinandra conjugens* (D.D. Keck) B.G. Baldwin (Otay tarplant); final report. Prepared for California Department of Fish and Game, Region 5, Natural Community Conservation Planning program, San Diego, California. San Diego State University, Department of Biology, San Diego, CA.
- Birker, C. 2019. Seed conservation program manager, Rancho Santa Ana Botanic Garden. Personal communication with J. Vinje. December 15.
- Bower, A.D., J.B. St. Clair, and V. Erickson. 2014. Generalized provisional seed zones for native plants. *Ecological Application* 24(5):913-919.
- Bureau of Land Management (BLM). 2018. Seeds of success: technical protocol for the collection, study and conservation of seeds from native plant species. 37 pp.
- California Plant Rescue (CaPR). 2019. <https://www.caplantrescue.org/>
- Campbell, R.K. and F.C. Sorensen. 1984. Genetic implications of nursery practices. Chapter 17 in Duryea, M.L. and T.D. Landis, eds. *Forest nursery manual: production of bare root seedlings*. Forest Research Laboratory, Oregon State University. Corvallis. 386 pp.

- Center for Plant Conservation (CPC). 1991. Genetic sampling guidelines for conservation collections of endangered plants. Pages 225-238 in Falk, D.A. and K.E. Holsinger, eds., Genetics and conservation of rare plants. Oxford University Press: New York.
- Center for Plant Conservation (CPC). 2019. Best plant conservation practices to support species survival in the wild. May. <https://saveplants.org/wp-content/uploads/2019/05/CPC-Best-Practices-5.22.2019.pdf>
- Chicago Botanic Garden (CBG). 2019. Technical protocol for the collection, study and conservation of seeds from native plant species – for seeds of success. 11 pp.
- City of San Diego, Planning Department. 2017. Vernal pool habitat conservation plan: vernal pool monitoring and management plan. Final document. City of San Diego Planning Department. October. 314 pp.
- Conservation Biology Institute (CBI), California Invasive Plant Council (Cal-IPC), and Dendra, Inc. 2012. Management priorities for invasive nonnative plants: a strategy for regional implementation, San Diego County, California. Prepared for San Diego Association of Governments, contract no. 5001322. 83 pp.
- Conservation Biology Institute (CBI). 2012. Otay tarplant management vision. Prepared for the San Diego Association of Governments. October. <https://databasin.org/documents/documents/468ad39dc0b14f7c8c8c623c9dc874ae/>
- Conservation Biology Institute (CBI). 2014. Adaptive management framework for the endangered San Diego thornmint, *Acanthomintha ilicifolia*, San Diego County, California. Prepared in collaboration with San Diego Management and Monitoring Program (SDMMP). Prepared for California Department of Fish and Wildlife. Local assistance grant P1182113. 27 pp. + appendices. March.
- DeWoody, J., D.L. Rogers, V.D. Hipkins, and B.A. Endress. 2018. Spatially explicit and multi-sourced genetic information is critical for conservation of an endangered plant species, San Diego thornmint (*Acanthomintha ilicifolia*). Conservation Genetics (published online), <https://doi.org/10.1007/s10592-018-1062-y>
- Dumroese, R.K., T. Luna, and T.D. Landis, eds. 2009. Nursery manual for native plants: a guide for tribal nurseries. Volume 1: nursery management. U.S. Department of Agriculture, Forest Service. Washington, DC: Agriculture handbook 730. 302 pp.
- Emery, D.E. 1988. Seed propagation of native California plants. Santa Barbara Botanic Garden. 115 pp.
- Gold, K. 2014. Post-harvest handling of seed collections. Royal Botanic Garden Kew. technical information sheet\_04. 4 pp.
- Grubisic, D. 2019. Co-owner, MD Seed Analysis, Inc. Personal communication with J. Vinje. December 4.
- Guerrant, Jr., E.O. 1996. Designing populations: demographic, genetic, and horticultural dimensions. Pages 171-207 in Falk, D.A., C.I. Millar, and M. Olwell, eds. Restoring



- diversity: strategies for reintroduction of endangered plants. Center for Plant Conservation, Missouri Botanical Garden. Island Press: Washington, D.C. 505 pp.
- Hoban, S. and A. Strand. 2015. *Ex situ* seed collections will benefit from considering spatial sampling design and species' reproductive biology. *Biological Conservation* 187:182-191.
- Hoban, S. and S. Schlarbaum. 2014. Optimal sampling of seeds from plant populations for *ex situ* conservation of genetic biodiversity, considering realistic population structure. *Biological Conservation* 177:90-99.
- Houseal, G.A. 2007. Tallgrass Prairie Center native seed production manual. Funded by USDA-NRCS Tallgrass Prairie Center, University of Northern Iowa.
- Hufford, K.M. and S.J. Mazer. 2003. Plant ecotypes: genetic differentiation in the age of ecological restoration. *Trends in Ecology and Evolution* 18:147-155.
- Johnson, G.R., F.C. Sorensen, J.B. St. Clair, and R.C. Cronn. 2004. Pacific Northwest forest tree seed zones: a template for native plants? *Native Plants Journal* 5:131-140.
- Johnson, G.R., L. Stritch, P. Olwell, S. Lambert, M.E. Horning, and R. Cronn. 2010. What are the best seed sources for ecosystem restoration on BLM and USFS lands? *Native Plants Journal* 11:117-131.
- Knapp, E.E. and K.J. Rice. 1994. Starting from seed: genetic issues in using native grasses for restoration. *Restoration and Management Notes* 12(1):40-45.
- Knutson, S. 2019. Chief Executive Officer, Stover Seed Company. Personal communication with J. Vinje. December 4.
- Lesica, P. and F.W. Allendorf. 1999. Ecological genetics and the restoration of plant communities: mix or match? *Restoration Ecology* 7:42-50.
- Lewis, R.L. and D.H. Deutschman. 2014. Framework management plan: guidelines for best practices with examples of effective monitoring and management. Prepared for San Diego Association of Governments, MOU# 5001562. 149 pp. March 17.
- Lippitt, L., S. Anderson, and B. Endress. No date. San Diego thornmint seed and common garden study. Final report. Prepared by San Diego Zoo Global, Institute for Conservation Research. Prepared for Center for Natural Lands Management. 25 pp.
- McKay, J.K., C.E. Christian, S. Harrison, and K.J. Rice. 2005. "How local is local?" A review of practical and conceptual issues in the genetics of restoration. *Restoration Ecology* 13(3):432-440.
- McMillan, S. 2019. Biologist, Dudek. *Acanthomintha ilicifolia*: best management practices (BMPs). Personal communication with J. Vinje. September 19.
- Meyer, E. 2014. Seed bank manager, Rancho Santa Ana Botanic Garden. Personal communication with J. Vinje. January 22.

- Meyer, E., N. Jensen, and N. Fraga. 2014. Seed banking California's rare plants. *California Fish and Game* 100(1):79-85.
- Milano, E.R. and A.G. Vandergast. 2018. Population genomic surveys for six rare plant species in San Diego County, California. U.S. Geological Survey open-file report 2018-1175, 60 pp. <https://doi.org/10.3133/ofr20181175>.
- Miller, J. 2019. Manager, S&S Seeds, Inc. Personal communication with J. Vinje. December 4.
- Miller, J.M. and J.D. Jokerst. 2012. *Acanthomintha ilicifolia* in Jepson eFlora. [http://ucjeps.berkeley.edu/eflora/eflora\\_display.php?tid=11725](http://ucjeps.berkeley.edu/eflora/eflora_display.php?tid=11725). Accessed September 23, 2019.
- Miller, S.A., A. Bartow, M. Gisler, K. Ward, A.S. Young, and T.N. Kaye. 2011. Can an ecoregion serve as a seed transfer zone? Evidence from a common garden study with five native species. *Restoration Ecology* 19(201):268-276.
- Mistretta, O. and B. Burkhart. 1990. San Diego thornmint: propagation, cultivation provides clues to ecology of endangered species (California). *Restoration & Management Notes* 8(1):50.
- Ottewell, K.M., D.C. Bickerton, M. Byrne, and A.J. Lowe. 2016. Bridging the gap: a genetic assessment framework for population-level threatened plant conservation prioritization and decision-making. *Diversity and Distributions* 22:174-188.
- Rancho Santa Ana Botanic Garden (RSA). 2019. <https://www.rsabg.org/conservation/seed-conservation>
- Rancho Santa Ana Botanic Garden (RSABG). 2018. Seed germination data.
- Ranieri, M. 2019. Assistant General Manager, Hedgerow Farms, Inc. Personal communication with J. Vinje. December 4.
- Ransom Seed Laboratory. 2019. Personal communication with J. Vinje. December 4.
- Redfern, C. and M. Flaherty. 2018. Nuttall's lotus: final report. Prepared for San Diego Association of Governments, contract number 5004729. 15 pp. + appendices.
- Reynolds, P. 2019. General Manager. Hedgerow Farms, Inc. Seed Increase Contract and Seed Storage. Email to Jessie Vinje, Conservation Biology Institute, December 4.
- Rice, K.D. 2017. Effects of moisture, nitrogen, and herbicide application on the relationship between an invasive grass and a rare coastal sage scrub species: *Acanthomintha ilicifolia*. Master's thesis, San Diego State University.
- Rogers, D.L. and A.M. Montalvo. 2004. Genetically appropriate choices for plant materials to maintain biological diversity. University of California. Report to the USDA Forest Service, Rocky Mountain Region, Lakewood, CO. <http://www.fs.fed.us/r2/publications/botany/plantgenetics.pdf>

- Royal Botanic Garden (RBG) Kew. 2019. Seed information database. <http://data.kew.org/sid/>
- Royal Botanic Gardens (RBG) Kew. 2001. A field manual for seed collectors: seed collecting for the Millennium seed bank project, Royal Botanic Gardens, Kew.
- San Diego Management and Monitoring Program and The Nature Conservancy (SDMMP and TNC). 2017. Management and monitoring strategic plan for conserved lands in western San Diego County: a strategic habitat conservation roadmap. 3 volumes. Prepared for the San Diego Association of Governments. San Diego.
- San Diego Management and Monitoring Program (SDMMP). 2011. Connectivity monitoring strategic plan for the San Diego preserve system. Prepared for the San Diego Environmental Mitigation Program Working Group. January 11.
- San Diego Management and Monitoring Program (SDMMP). 2013. Management strategic plan for conserved lands in western San Diego County. Prepared for San Diego Association of Governments (SANDAG), version 08.27.2013.
- San Diego Management and Monitoring Program (SDMMP). 2014. Connectivity strategic plan for western San Diego County: science session, workshop materials. [https://sdmmp.com/view\\_article.php?cid=SDMMP\\_CID\\_187\\_5d7c1c9b84da1](https://sdmmp.com/view_article.php?cid=SDMMP_CID_187_5d7c1c9b84da1)
- Schneider, H. 2019. Rare plant biologist, Santa Barbara Botanic Garden. Personal communication with J. Vinje. December 5.
- Spiegelberg, M. 2019. Biologist, Center for Natural Lands Management. *Acanthomintha ilicifolia*: best management practices (BMPs). Email to J. Vinje, Conservation Biology Institute. September 13.
- St. Clair, B. and R. Johnson. 2004. Structure of genetic variation and implications for the management of seed and planting stock. USDA Forest Service Proceedings RMRS-P-33:64-71.
- St. Clair, J.B., F.F. Kilkenny, R.C. Johnson, N.L. Shaw, and G. Weaver. 2013. Genetic variation in adaptive traits and seed transfer zones for *Pseudoroegneria spicata* (bluebunch wheatgrass) in the northwestern United States. *Evolutionary Adaptations* 6:933-938.
- The Millennium Seed Bank Partnership (MSBP). 2015. Seed conservation standards for 'MSB partnership collections.' Final version. February. 4 pp.
- U.S. Department of Agriculture (USDA). 2006. Can genetic diversity be influenced by nursery practices? National Forest Genetics Laboratory (NFGEL), Pacific Southwest Research Station, USDA Forest Service and Genetic Resources Conservation Program, University of California, Davis. 2 pp.
- U.S. Department of Agriculture (USDA)-National Resource Conservation Service (NRCS). No date. Native seed production manual for the Pacific Northwest. Corvallis Plant Materials Center, Corvallis, OR. 192 pp.

- U.S. Fish and Wildlife Service (USFWS). 1985. Salt marsh bird's-beak (*Cordylanthus maritimus* subsp. *maritimus*) recovery plan. USFWS, Portland, Oregon. 92 pp.
- U.S. Fish and Wildlife Service (USFWS). 2009. *Deinandra conjugens* (Otay tarplant) 5-year review: summary and evaluation. Carlsbad Fish and Wildlife Office, Carlsbad, CA. June 30. 59 pp.
- U.S. Forest Service (USFS). 2009. Nursery manual for native plants; a guide for tribal nurseries. Volume one: nursery management. U.S. Department of Agriculture, Forest Service. Agriculture handbook 730. March. 302 pp.  
[https://www.fs.fed.us/rm/pubs\\_series/wo/wo\\_ah730.pdf](https://www.fs.fed.us/rm/pubs_series/wo/wo_ah730.pdf)
- United States Fish and Wildlife Service (USFWS). 2013. Recovery plan for tidal marsh ecosystems of northern and central California. Volume 1. Sacramento, CA, 605 pp.  
[https://ecos.fws.gov/docs/recovery\\_plan/TMRP/20130923\\_TMRP\\_Books\\_Signed\\_FINA\\_L.pdf](https://ecos.fws.gov/docs/recovery_plan/TMRP/20130923_TMRP_Books_Signed_FINA_L.pdf)
- USDA NRCS Tallgrass Prairie Center, University of Northern Iowa. 123 pp.
- Vinje, J. 2019. Botanist, Conservation Biology Institute. Personal observations on germinating and propagating San Diego thornmint.
- Wall, M. 2009. Seed collection guidelines for California Native plant species and seed storage guidelines for California native plant species. Rancho Santa Ana Botanic Garden. 25 pp.
- Wall, M. and J. Macdonald. 2009. Processing seeds of California native plants for conservation, storage, and restoration. Rancho Santa Ana Botanic Garden occasional publication, number 10, Claremont, CA. 216 pp.
- Walters, C.T., J. Crane, L.M. Hill, M. Michalak, J.D. Carstens, and K.P. Conrad. 2016. Preserving oak (*Quercus* sp.) germplasm to promote *ex situ* conservation. *International Oaks* 27:255-266.
- Way, M. and K. Gold. 2014a. Assessing a population for seed collection. Royal Botanic Garden Kew, technical information sheet\_02. 4 pp.
- Way, M. and K. Gold. 2014b. Seed collecting techniques. Royal Botanic Garden Kew, technical information sheet\_03.
- Went, F.W. and P.A. Munz. 1949. A long term test of seed longevity. *Aliso*:2(1):63-75.
- West, R. 2019. President, Native West Nursery. Personal communication with J. Vinje. December 3.
- Wilson, B.L., D.C. Darris, R. Feigner, R. Johnson, M.E. Horning, and K. Kuykendall. 2008. Seed transfer zones of a native grass *Festuca roemerii*: genecological evidence. *Native Plants Journal* 9:287-302.

Zedler, J. B., C. S. Nordby, and B. E. Kus. 1992. The ecology of Tijuana Estuary, California: a national estuarine research reserve. NOAA Office of Coastal Resource Management, Sanctuaries and Reserves Division, Washington, D.C.

Zedler, J.B. 2001. Handbook for restoring tidal wetlands. Boca Raton, FL: CRC Press, LLC.  
*In* Zahn, E. 2015. Salt marsh bird's beak outplanting work plan. Huntington Beach Wetlands – Magnolia Marsh. Prepared for U.S. Fish and Wildlife Service. September. 10 pp.

# Appendix A

## Meeting Participants

*Rare Plant Management Group Steering Committee*

*Rare Plant Working Groups*



**Appendix A**  
**Participants in Rare Plant Management Group,**  
**Steering Committee Meeting and Working Group Meetings**

Rare Plant Management Group Steering Committee Meeting: June 12, 2019.

Steering Committee Participant	Organization
Sara Allen	City of San Diego
Mark Berninger	City of San Diego
Mary Crawford	U.S. Fish and Wildlife Service
Mark Dodero	RECON Environmental
Patricia Gordon-Reedy	Conservation Biology Institute
Jenna Hartsook	AECOM
Christa Horn	San Diego Zoo Global
Joyce Maschinski	San Diego Zoo Global
Sarah McCutcheon	San Diego Management and Monitoring Program
Scott McMillan	Dudek
Thomas Oberbauer	AECOM
Chelsea Ohanesian	AECOM
Kris Preston	San Diego Management and Monitoring Program
Kyle Rice	California Department of Fish and Wildlife
Fred M. Roberts	Botanist
Kim Smith	San Diego Association of Governments
Amy Vandergast	U.S. Geological Survey
Susan Wynn	U.S. Fish and Wildlife Service

### San Diego Thornmint Working Group Meeting: June 25, 2019.

Working Group Participant	Organization
Sara Allen	City of San Diego
Stacy Anderson	San Diego Zoo Global
Mark Berninger	City of San Diego
Cindy Burrascano	California Native Plant Society-San Diego
Carol Crafts	Friends of Goodan Ranch & Sycamore Canyon
Mark Dodero	RECON Environmental
Justin Daniel	California Native Plant Society-San Diego
John Ekhoﬀ	California Department of Fish and Wildlife
Sarah Godfrey	Center for Natural Lands Management
Patricia Gordon-Reedy	Conservation Biology Institute
Christa Horn	San Diego Zoo Global
Mike Kelly	Friends of Los Peñasquitos Canyon Preserve
Anna Leavitt	RECON Environmental
Chris Manzuk	Endangered Habitats Conservancy
John Martin	San Diego National Wildlife Refuge
Joyce Maschinski	San Diego Zoo Global
Sarah McCutcheon	San Diego Management and Monitoring Program
Scott McMillan	Dudek
Margie Mulligan	Mulligan Biological Consulting
Tracie Nelson	California Department of Fish and Wildlife
Thomas Oberbauer	AECOM
Chelsea Ohanesian	AECOM
Meredith Osborne	California Department of Fish and Wildlife
Eric Piehel	AECOM
Kathleen Pollett	San Diego Habitat Conservancy
Kristine Preston	San Diego Management and Monitoring Program
Kyle Rice	California Department of Fish and Wildlife
Jonathan Snapp-Cook	U.S. Fish and Wildlife Service
Markus Spiegelberg	Center for Natural Lands Management
Fred Sproul	AECOM
Amy Vandergast	U.S. Geological Survey
Jessie Vinje	Conservation Biology Institute
Phoenix Von Hendy	Friends of Goodan Ranch & Sycamore Canyon
Gina Washington	City of San Diego

Otay Tarplant Working Group Meeting: June 25, 2019.

Working Group Participant	Organization
Sara Allen	City of San Diego
Mark Berninger	City of San Diego
Mark Dodero	RECON Environmental
John Ekhoﬀ	California Department of Fish and Wildlife
Patricia Gordon-Reedy	Conservation Biology Institute
Christa Horn	San Diego Zoo Global
Anna Leavitt	RECON Environmental
John Martin	San Diego National Wildlife Refuge
Sarah McCutcheon	San Diego Management and Monitoring Program
Margie Mulligan	Mulligan Biological Consulting
Tracie Nelson	California Department of Fish and Wildlife
Chelsea Ohanesian	AECOM
Meredith Osborne	California Department of Fish and Wildlife
Kristine Preston	San Diego Management and Monitoring Program
Trish Smith	The Nature Conservancy
Linnea Spears-Lebrun	ICF
Jessie Vinje	Conservation Biology Institute

Nuttall's Acmispon Working Group Meeting: June 27, 2019.

Working Group Participant	Organization
Sara Allen	City of San Diego
Stacy Anderson	San Diego Zoo Global
Alys Arenas	Nature Collective
Christine Beck	California Department of Fish and Wildlife
Mark Berninger	City of San Diego
Cindy Burrascano	California Native Plant Society-San Diego
Megan Flaherty	San Diego Audubon
Patricia Gordon-Reedy	Conservation Biology Institute
Christa Horn	San Diego Zoo Global
Frank Landis	California Native Plant Society-San Diego
Carolyn Lieberman	U.S. Fish and Wildlife Service
Joyce Maschinski	San Diego Zoo Global
Sarah McCutcheon	San Diego Management and Monitoring Program
Andrew Meyer	Audubon
Margie Mulligan	Mulligan Biological Consulting
Tracie Nelson	California Department of Fish and Wildlife
Thomas Oberbauer	AECOM
Kris Preston	San Diego Management and Monitoring Program
Debbie Schafer	San Diego Gas & Electric
Julie Simonsen	Nature Collective
Darren Smith	California State Parks
Jessie Vinje	Conservation Biology Institute

Salt Marsh Bird's-beak Working Group Meeting: June 27, 2019.

Working Group Participant	Organization
Sara Allen	City of San Diego
Stacy Anderson	San Diego Zoo Global
Alys	Nature Collective
Mark Berninger	City of San Diego
Patricia Gordon-Reedy	Conservation Biology Institute
Christa Horn	San Diego Zoo Global
Carolyn Lieberman	U.S. Fish and Wildlife Service
Sarah McCutcheon	San Diego Management and Monitoring Program
Margie Mulligan	Mulligan Biological Consulting
Thomas Oberbauer	AECOM
Julie Simonsen	Nature Collective
Jessie Vinje	Conservation Biology Institute
Daniel North	Tidal Influence
Mark Hannaford	Tidal Influence
Kris	San Diego Management and Monitoring Program
Bronti Patterson	California State Parks
Sarah Hutmacher	San Diego River Park Foundation
Carol Williams	California Department of Fish and Wildlife
Heather Schneider	Santa Barbara Botanic Garden
Amy Vandergast	U.S. Geological Survey (U.S. Geological Survey)
Cindy	California Native Plant Society-San Diego
Araceli Dominguez	City of San Diego
Chelsea Ohanesian	AECOM

# Appendix B

## Collecting Voucher Specimens

*San Diego Natural History Museum*

*San Diego Zoo Native Plant Seed Bank*





## How to Collect and Press Proper Plant Specimens

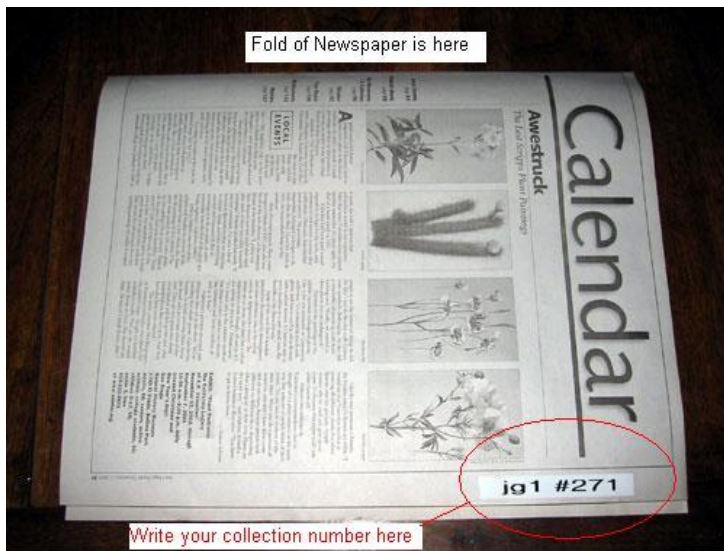
As a parobotanist, your task is to contribute to our overall project goal, which is to curate one flowering/reproducing specimen of each plant species that occurs in each atlas grid square. Once you submit a pressed and dried specimen to the museum, we will mount it on a sheet of special paper with its label, and file it in the SD Herbarium. Herbarium specimens will last for hundreds of years if properly maintained and they are an effective way to scientifically document floristic diversity. Here is some general guidance on how to collect and press museum-quality plant specimens.

### Field Collecting

- Plan ahead. Please review the maps and other information provided in your handout packet, and make sure you carry with you copies of your letter identifying you as a parobotanist, and any permits that are required for access and/or collecting. **Phone your contacts in advance** to make arrangements if you are working on public land.
- Before you go out, visit our website at [www.sdplantatlas.org](http://www.sdplantatlas.org) to check out which plant species have already been collected from your square. You can choose "Search the Database" to find this out. Print the list if you like, and carry it with you for reference.
- Once in the field, evaluate whether or not a species *should* be collected. Be able to recognize any possible "sensitive" species, i.e., those that are rare, threatened, or endangered that may be protected by law and may not be collected legally without special permits. *Do NOT collect sensitive species!*
- Do not endanger the local population if there are only a few individuals present. Use the "1 to 20" rule of thumb: for every one specimen you collect, there should be at least 20 more present in the surrounding population. (For herbs, the rule applies to individual plants; for shrubs and trees, it applies to shoots removed.)
- For herbs, dig up at least one whole plant to show roots that can help the botanist determine whether the plant is an annual, biennial, or perennial and identify the type of root (e.g., fibrous or tap) or underground stem (e.g., corm, bulb, rhizome, etc.).
- For shrubs, trees, or vines, clip one or more branches. The ideal plant specimen includes flowers (or other reproductive parts for ferns and non-vascular plants), fruit, leaves, and branches. Reproductive structures are often necessary to positively identify the plant, but it is not always possible to find flowers and fruit on the same plant at the same time. Do the best you can but do not mix together cuttings from different plants (i.e., don't take a branch from one plant and then take the fruits or flowers from another).
- Get enough of a sample to distribute over your 11x17 sheet in your plant press (e.g., a few branches of larger shrubs, or several small plants that can be distributed over the sheet).

## How to Collect and Press Proper Plant Specimens, Page 2 of 3

- For cacti, slice and press the flowers, but place the stems and fruits into a paper bag. Label the bag with the same collection number as the flowers and submit them both to us. Similarly, large cones cannot be pressed so they may be placed into a paper bag with the same collection number as the rest of the specimen.
- Place each plant specimen inside a folded sheet of newspaper (like *The Reader*) and write its unique collection number on the upper outside edge of the newspaper, facing outwards (please see diagram below).



The "collection number" consists of your own "Login Initials", the # sign, and the specimen's unique collection number. In this example, the assigned login initials were "jg1", and the newspaper contains specimen number 271. Please write each collection number in the location and format shown here.

- Stack the newspapers and place in a field press with a few cardboard ventilators for support, or tie up the bundle with string, straps, or bungee cords.
- Record the field data for each specimen in your field notebook (including the collection number, and detailed information about the collecting location, surrounding vegetation, and characteristics of the plant itself).

### Plant Pressing

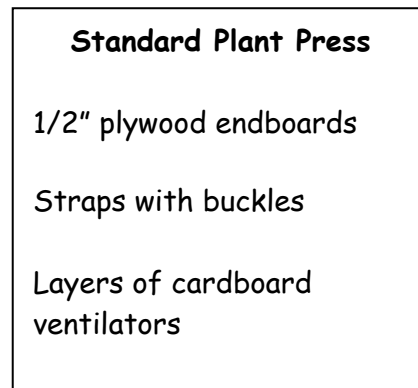
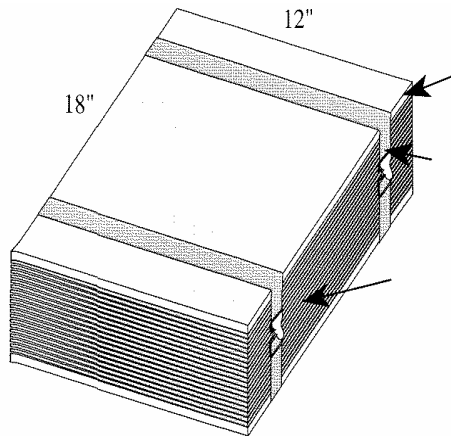
After you get your plants home from the field, they will have relaxed a bit and will be ready for you to transfer from your field setup to a plant press where they can be properly laid out, pressed and dried. Plants should be pressed within about 12 hours of their collection (otherwise the leaves may become moldy or the plant may shrivel up and not press nicely). If the newspaper is wet, you will need to change the paper, ensuring that you also transfer the collection number to the fresh paper.

- A basic plant press consists of two boards 12" by 18" (half-inch plywood or even thinner will do fine), plus two adjustable straps (or even ropes).
- Clean up the specimens (e.g., shake off excess soil from the roots and pick off dead leaves etc.) and if necessary trim or bend into a "V", "N" or "M" shape to neatly fit inside the press.
- Arrange the plants exactly as you want them to appear once they are mounted. Make sure leaves are spread out and not overlapping, that fruits and flowers are

showing, and turn over a few leaves so that the underside of several can be seen.

*How to Collect and Press Proper Plant Specimens, Page 3 of 3*

- Plants are pressed by placing each specimen inside one of the single sheets of folded newspapers, and separating each newspaper sheet with a cardboard ventilator so you have an alternating stack of newspaper and cardboard.
- Place the endboards on the outside of the stack, and tie straps around the outside as shown in diagram below. Tighten the straps down very hard.



From: Simpson, M.G. 1997 *Plant Collecting and Documentation Field Notebook*. SDSU Herbarium Press.

- Air dry by placing the plant press in a well ventilated location. It may take days to weeks for the plants to dry completely.
- Do NOT put the plants or plant press into a microwave or conventional oven. Heat is not necessary but good air circulation is.
- If required, change the paper every few days to prevent molding, especially for succulent plants. Plants are dry when they don't feel cool to the touch.
- For the health of those who must handle the dried plants and the specimens, please do not use chemicals of any kind on the plants (e.g., use no mothballs, insecticides etc.). During the verification, mounting, and accessioning process in the herbarium, all specimens are routinely frozen to kill any insect pests.
- Do not use any tape, glue or other adhesives.
- Sit down ASAP and enter the field data online at our website [www.sdplantatlas.org](http://www.sdplantatlas.org). Timely data entry is important because it will permit other parobotanists sharing your square to see what has already been collected, thus helping to prevent duplication of effort.
- When it is time to submit your pressed and dried plants to the herbarium, please look on our website and print out the handout titled "*Guide to Specimen Submission*" and the "*Specimen Submission Form*".

For more details, refer to Simpson, Michael G. (1997) *Plant Collecting and Documentation Field Notebook*, SDSU Herbarium Press, for an excellent explanation of plant collection techniques.

## Sample of Online Data Entry Form

**Common data for the collection event**

**Jon P. Rebman**

Grid Square:  Collection Date:

Locality:

Others in Team:

Vegetation:

Geology:

Elevation:   Feet  Meters *Indicate feet or meters (elevation will be converted to meters)*

*Enter Latitude and Longitude below.*  
*Enter either deg/min/sec, (32° 46' 25") or decimal degrees, (32.7736°)*  
[Click here to go to TopoZone](#)

Latitude: (North)  
 Degrees  Minutes  Seconds **OR:**  Decimal Degrees

Longitude: (West)  
 Degrees  Minutes  Seconds **OR:**  Decimal Degrees

**Specimen Details**

*Plants will be identified by, or provisional identification will be verified by, SDNHM Dept. of Botany*

[Open Checklist of Vascular Plants of San Diego County](#)  
[Open the Name Finder](#)

**Error messages will appear here**

Specimen #:  Suffix:  Family:

Genus:  Specific Epithet:

var  ssp  N/A  Infraname

Common Name:

Phenology:  Number of Labels for mounting:

Description of Plant:

## CHEAT SHEET: What to Record in Your Field Notebook

Entry	Instructions
Date	Date you collected the specimen
Grid Square	Atlas grid square you are collecting in (e.g., A3, G14)
Locality	Provide directions clear enough to relocate the site on a topographic map by recording approx distance (miles) and compass direction from two or more geographical landmarks (such as the closest town/city, and a natural feature like a mountain, river, or lake). Roads/intersections may be included (e.g., "NW corner of A St and 1st Ave" or "5 mi W of I-5")
Others in Team	Name(s) of people who were with you
Vegetation	The dominant vegetation in the vicinity of the collected specimen. You may use general community or vegetation types (e.g., chaparral, coastal sage scrub etc.) and/or name specific plants if you like (from the tree, shrub, & herb layers).
Geology	Physical habitat/substrate (i.e., the abiotic or non-living factors, like "dry creek bed" or "granite outcrop" etc.). Record other details about the terrain in the vicinity, such as the slope and aspect ("steep S-facing slope") or shading. Record soil texture (e.g., "medium sandy loam") and parent material (e.g., "granitic", "alluvium", "gabbro" etc.) if you know it.
Elevation	Record elevation (from GPS and/or map contours).
Latitude Longitude	Record the coordinates of each collecting location (called the "collection event" on the online data entry form). <b>Mark the spot on your map!</b> Your lat/long can be in either of two formats: Degrees-Minutes-Seconds, for example 32° 46' 25" or Decimal Degrees, for example 32.77361° <i>Note: if using a GPS, routinely verify the readings on a map or by using our Topozone tool on the website!</i>
Specimen Number	The collecting number you have assigned to the specimen (e.g., if this is your specimen #352 then enter 352 in the box). <b>NOTE:</b> Remember to write the "index number" on the outside edge of the newspaper in which you are pressing the specimen (e.g., if your login initials are "jg1" the index number is jg1#352). We <u>will not</u> accept specimens that don't have the index numbers clearly written down on the newspaper along with each specimen that comes in!
Plant Family, Genus, Species	If you know the family, scientific, and/or common name of the plant, record it now. You may correct it or look it up later.
Description of Plant	Describe the plant (esp. info that may be lost when it is mounted, such as height, width, branching pattern etc.) Was it erect, climbing, or prostrate (sprawling)? Was it parasitic (if so, on what host)? Does it have flowers and/or fruits? Include colors of flowers or fruit that often fade when dried. Record the habit (herb, shrub, tree, bulb, vine, etc.) and whether it was an annual, perennial, or biennial. (Max. 255 characters allowed).

*Note: Use field time to record information that is only apparent to you while there. Other items like plant family, elevation, or lat/long can always be looked up and filled in later. For more detailed instructions about what field data to record, visit the FAQ section on our website.*

**Herbarium Voucher & Genetic Sampling Form 2018:  
San Diego Zoo Native Plant Seed Bank**

<i>Soil Sampling (enter data on Locality form)</i>			
Occurrence Accession Code:		Date Collected:	/ /
Notes			

<i>Genetic Sampling (enter data on Locality form)</i>			
Occurrence Accession Code:		Date Collected:	/ /
Number of Plants Sampled:		Notes	
Observers Present:	<input type="checkbox"/> Stacy Anderson <input type="checkbox"/> Joe Davitt <input type="checkbox"/> Tobin Weatherson <input type="checkbox"/> _____, _____, _____, _____		

<i>Herbarium Voucher Collection</i>			
Occurrence Accession Code:		Date Collected:	/ /
Herbarium Collection Code:			
Observers Present:	<input type="checkbox"/> Stacy Anderson <input type="checkbox"/> Joe Davitt <input type="checkbox"/> Tobin Weatherson <input type="checkbox"/> _____, _____, _____, _____		
Phenology	<input type="checkbox"/> Not fertile <input type="checkbox"/> Flowering <input type="checkbox"/> Fruiting <input type="checkbox"/> Fruit & Flower	Plant Form	<input type="checkbox"/> Forb <input type="checkbox"/> Shrub <input type="checkbox"/> Tree <input type="checkbox"/> Grass <input type="checkbox"/> Aquatic
Plant Height		Height units	
Specimen Description (Condition, Color, etc.)			

<i>Seed Collection</i>			
Occurrence Accession Code:		Date Collected:	/ /
Seed Collection Code:		Date of Second Collection:	/ /
Observers Present:	<input type="checkbox"/> Stacy Anderson <input type="checkbox"/> Joe Davitt <input type="checkbox"/> Tobin Weatherson <input type="checkbox"/> _____, _____, _____, _____		
Maternal Lines			
Collection Notes			

# Appendix C

## Seed Collection Forms

*Rancho Santa Ana Botanic Garden*

*Santa Barbara Botanic Garden*

*San Diego Zoo Native Plant Seed Bank*



<b>Collection Date:</b>				<b>Received Date:</b>			
<b>Species Name:</b>							
<b>Collector Name:</b>				<b>Collection #:</b>			
<b>Associate Collectors:</b>							
<b>Voucher? (Yes or No):</b>			<b>Voucher Location:</b>				
<b>Country:</b>		<b>State:</b>		<b>County:</b>			
<b>Jepson Geographic Subregion:</b>			<b>Elevation:</b>			<b>Unit (ft or m):</b>	
<b>Locality:</b>							
<b>CNDDDB EO#:</b>		<b>Land Owner:</b>					
<b>Latitude: N</b>			<b>Longitude: W</b>			<b>Datum:</b> NAD83 NAD27 WGS84	
<b>Map Quad:</b>		<b>T</b>		<b>R</b>		<b>SEC</b>	<b>¼ SEC</b>
<b>Sampled population size:</b>				<b>Collection type (circle/underline one):</b>			
<b>Number of individuals sampled:</b>				Seed	Division	Other: _____	
<b>Local abundance</b> (common, scattered, rare):				Spore	Cutting	_____	
<b>Plant</b>				Bulb/Corm	_____		
<b>Associated species:</b>							
<b>Floristic Province (circle/underline one):</b>			<b>Horticultural Source (if cultivated):</b>			<b>Collection Method (circle/underline one):</b>	
Californian      Sonoran Mojave						Collected Along Maternal Lines Bulk Collected	
<b>Habitat (circle/underline one):</b>			<b>Slope:</b>		<b>Exposure:</b>		<b>Moisture:</b>
Alpine                  Chaparral Sub Alpine              Scrub Forest                  Riparian Woodland      Type: Grassland			Flat Gentle Steep Cliff Aspect:		Full sun Semi shade Shade		Dry Moist Wet Seasonally Moist
<b>Geology (circle/underline one):</b>				<b>Soil:</b>			
Gabbro                  Shale                  Other: _____ Granite                  Volcanic Limestone              Serpentine Sandstone				Sand                  Clay                  Other: _____ Gravel                  Humus Rock                  Alluvium Loam			
<b>Collector notes and observations:</b>							

**FOR OFFICE USE ONLY:** Accession # \_\_\_\_\_ USDA Plants Code: \_\_\_\_\_

Date of survey (mm/dd/yyyy): \_\_\_\_\_ Date of seed collection: \_\_\_\_\_

Field collector name (s): \_\_\_\_\_

Scientific name: \_\_\_\_\_

Rare? Y/N Status if rare \_\_\_\_\_ Voucher collected? Y / N # \_\_\_\_\_

#### *Location information*

Site name: \_\_\_\_\_ Population (circle): wild restored planted

County: \_\_\_\_\_ Land Owner: \_\_\_\_\_

Elevation (m): \_\_\_\_\_ Aspect: \_\_\_\_\_ Slope (circle): flat gentle moderate steep cliff

#### *GPS Coordinates*

Datum: \_\_\_\_\_ Latitude: \_\_\_\_\_ Longitude: \_\_\_\_\_

#### *Habitat description*

Plant community & habitat notes: \_\_\_\_\_

Soil: \_\_\_\_\_

Associated species: \_\_\_\_\_

Pollinators obs.? (if Y, describe): \_\_\_\_\_ #of individuals/stems \_\_\_\_\_

Percent cover of target species: <5% 5-10% 10-25% 25-50% 50-75% 75-100%

Phenology: % vegetative \_\_\_\_\_ % flowering \_\_\_\_\_ % fruiting \_\_\_\_\_ % other (list) \_\_\_\_\_

#### *Site information*

Overall site viability/quality (site + population): Excellent Good Fair Poor

Immediate and surrounding land use: \_\_\_\_\_

Visible disturbances: \_\_\_\_\_

Threats to population: \_\_\_\_\_

Other notes & location information:

#### *Seed information*

Seeds collected? Y / N Collection timing: early perfect late

Type of collection (circle): Individual maternal lines Bulk (seeds from multiple individuals together)

# plants sampled: \_\_\_\_\_ Evidence of seed predation? \_\_\_\_\_

Tissue collected? Y / N Notes: \_\_\_\_\_

#### **FOR LAB USE ONLY**

Cut test results: \_\_\_\_\_ out of 5 filled

Fumigation date:

Total seed count:

Accession data entry date:

Average individual seed weight (g):

Frozen date:

Notes/observations during cleaning:



**Herbarium Voucher & Genetic Sampling Form 2018:  
San Diego Zoo Native Plant Seed Bank**

<i>Soil Sampling (enter data on Locality form)</i>			
Occurrence Accession Code:		Date Collected:	/ /
Notes			

<i>Genetic Sampling (enter data on Locality form)</i>			
Occurrence Accession Code:		Date Collected:	/ /
Number of Plants Sampled:		Notes	
Observers Present:	<input type="checkbox"/> Stacy Anderson <input type="checkbox"/> Joe Davitt <input type="checkbox"/> Tobin Weatherson <input type="checkbox"/> _____, _____, _____, _____		

<i>Herbarium Voucher Collection</i>			
Occurrence Accession Code:		Date Collected:	/ /
Herbarium Collection Code:			
Observers Present:	<input type="checkbox"/> Stacy Anderson <input type="checkbox"/> Joe Davitt <input type="checkbox"/> Tobin Weatherson <input type="checkbox"/> _____, _____, _____, _____		
Phenology	<input type="checkbox"/> Not fertile <input type="checkbox"/> Flowering <input type="checkbox"/> Fruiting <input type="checkbox"/> Fruit & Flower	Plant Form	<input type="checkbox"/> Forb <input type="checkbox"/> Shrub <input type="checkbox"/> Tree <input type="checkbox"/> Grass <input type="checkbox"/> Aquatic
Plant Height		Height units	
Specimen Description (Condition, Color, etc.)			

<i>Seed Collection</i>			
Occurrence Accession Code:		Date Collected:	/ /
Seed Collection Code:		Date of Second Collection:	/ /
Observers Present:	<input type="checkbox"/> Stacy Anderson <input type="checkbox"/> Joe Davitt <input type="checkbox"/> Tobin Weatherson <input type="checkbox"/> _____, _____, _____, _____		
Maternal Lines			
Collection Notes			

## Occurrence Establishment Form 2018: San Diego Native Plant Seed Bank

<b>Locality Information</b>					
<b>Occurrence Accession Code</b>		<b>Date Established:</b>	/ /		
<b>Focal Species:</b>		<b>Locality Short Name:</b>			
<b>Locality Description:</b>					
<b>Landowner/Manager</b>		<b>County</b>			
<b>Observers Present:</b>	<input type="checkbox"/> Stacy Anderson <input type="checkbox"/> Joe Davitt <input type="checkbox"/> Tobin Weatherson <input type="checkbox"/> _____, _____, _____, _____				
<b>Associated Occurrence Codes</b>					
<b>MOM Code(s)</b>		<b>CNDDDB EO(s)</b>			
<b>Site Characteristics</b>					
<b>Immediate Land use</b>	<input type="checkbox"/> Nature Preserve <input type="checkbox"/> Farmland/Ranchland <input type="checkbox"/> Urban Development				
<b>Surrounding Land use</b>	<input type="checkbox"/> Nature Preserve <input type="checkbox"/> Farmland/Ranchland <input type="checkbox"/> Urban Development				
<b>Land use Notes</b>					
<b>Ecological Community:</b>	Southern Foredunes,	Riparian Woodland	Meadow and Seep	Desert Scrub	
	Coastal Sage Scrub	Riparian Forest	Marsh	Desert Chaparral	
	Chaparral	Pinyon Juniper Woodlands	Coniferous Forest	Dry Wash Woodland	
	Grassland	Other Woodlands	Desert Dunes	Water	
	Riparian Scrub	Oak Forest	Playas/Badlands/ Mudhill Forbs	Urban, Disturbed Habitat	
<b>Slope</b>	<input type="checkbox"/> Flat <input type="checkbox"/> Gentle Slope <input type="checkbox"/> Medium Slope <input type="checkbox"/> Steep Slope <input type="checkbox"/> Cliff Face				
<b>Aspect</b>	<input type="checkbox"/> Flat <input type="checkbox"/> North <input type="checkbox"/> South <input type="checkbox"/> East <input type="checkbox"/> West				
<b>Sun Exposure</b>	<input type="checkbox"/> Full Sun <input type="checkbox"/> Semi Shade <input type="checkbox"/> Shade		<b>Elevation (m)</b>		
<b>Geographic Coordinates (Revise at time of Voucher Collection)</b>					
1. Use Geode to take point   2. Longitude should be negative   3. Record in Decimal Degrees (-33.222241)					
<b>Latitude</b>		<b>Longitude</b>			
<b>Horizontal Accuracy (m)</b>		<b>GPS Type</b>	<input type="checkbox"/> Geode <input type="checkbox"/> Phone <input type="checkbox"/> _____		
<b>Data Collection Checklist</b>					
<b>Seed Accession:</b>	<input type="checkbox"/> yes <input type="checkbox"/> no	<b>Genetic Sample</b>	<input type="checkbox"/> yes <input type="checkbox"/> no	<b>Population Polygon:</b>	<input type="checkbox"/> yes <input type="checkbox"/> no
<b>Herbarium Voucher:</b>	<input type="checkbox"/> yes <input type="checkbox"/> no	<b>Soil Voucher:</b>	<input type="checkbox"/> yes <input type="checkbox"/> no		