

Ceiling Diffusers

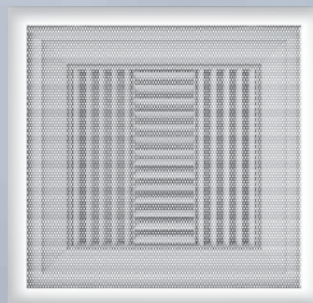

BUILDING VALUE IN AIR.

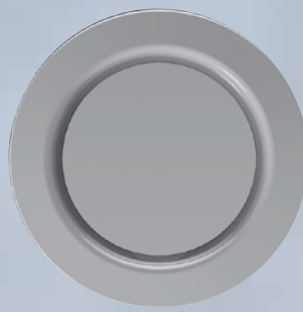
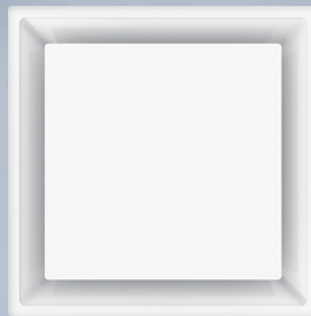

October
2022

TABLE OF CONTENTS

The Greenheck line of ceiling diffusers is designed for flexibility in application. This series covers a full range of ceiling diffusers which include square face cone, louvered face, concentric supply/return, modular, perforated, round and VAV diffusers.



Square face cone diffusers are the most popular and efficient of the ceiling diffusers. The square cone diffuser provides a true 360° radial horizontal air flow pattern.

PAGE 3



Louvered face diffusers provide an aesthetically pleasing solution for applications requiring large volumes of air at low sound levels and low pressure drops. These units are available in 1, 2, 3 and 4-way air pattern variations that are virtually limitless due to the unique assembly of these diffusers.

PAGE 30

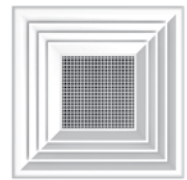

Concentric supply/return diffusers provide an aesthetically pleasing yet functional solution to Roof Top package single outlet air distribution requirements. The high induction design ensures a true horizontal air pattern and rapid mixing of room and primary air.

PAGE 86

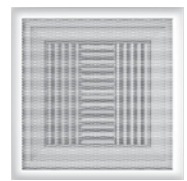

Perforated ceiling diffusers are designed to provide a smooth, even appearance that blends into the ceiling. Perforated supply diffusers are available with adjustable pattern controllers on either the face or neck or modular cores which provide an excellent air pattern.

PAGE 101



Round ceiling diffusers are available in a broad range of sizes and models from the economical to industrial and architectural. These units are typically installed in sheet rock or exposed duct and are available with adjustable deflectors that allow the option for either horizontal or vertical flow. An excellent choice for gymnasiums, industrial facilities and large retail outlets.

PAGE 188



VAV diffusers are designed to provide individual VAV control at the individual diffuser level.

PAGE 207



Ceiling diffuser accessories are primarily designed to improve the overall air handling performance of the system. Proper application of duct and outlet accessories aide in the control of the air distribution system.

PAGE 217

SQUARE CEILING DIFFUSERS

MODELS XG-5700 / XG-5700A



MODELS XG-5800 / XG-5800A



MODEL XG-5750



MODEL XG-PHENOMENATOR



Models XG-5700 / XG-5700A 2 Cone diffusers are designed to efficiently handle cooling temperature differentials of 18-20°F at ceiling heights of 8' to 10'. The round neck to square face design provides a uniform 360° fixed horizontal air diffusion pattern. For applications requiring a vertical air flow, the XG-5700A adjustable model employs movable air deflecting vanes which will provide vertical downward airflow.

PAGE 4

Model XG-5750 offers the architect the often preferred appearance of a single air diffusion panel. The diffuser is designed to efficiently handle cooling temperature differentials of 18-20°F at ceiling heights of 8' to 10'.

PAGE 9

Models XG-5800 / XG-5800A 3 Cone diffusers are designed to efficiently handle cooling temperature differentials of 18-20°F at ceiling heights of 8' to 10'. The round neck to square face design provides a uniform 360° fixed horizontal air diffusion pattern. For applications requiring a vertical air flow, the XG-5800A adjustable model employs movable air deflecting vanes which will provide vertical downward airflow.

PAGE 16

Model XG-Phenomenator has the highest induction ratio of any commercial air diffuser available. It is an excellent selection for providing exceptional comfort, especially in executive offices, conference rooms and board rooms. The XG-Phenomenator is designed for applications calling for minimal temperature differences in a space.

PAGE 23

MODEL XG-5700

Two Cone Square Face Diffuser with Round Neck

XG-5700-1 - Surface Mount XG-5700-6 - T-bar Lay-in
XG-5700-7 - Concealed Spline XG-5700-9 - Donn Finline Lay-in



Non-Adjustable, Horizontal Discharge Pattern

Air inlets shall be model XG-5700 manufactured by GREENHECK shall be constructed of steel.

Air inlets shall be model XG-5700 AS manufactured by GREENHECK shall be constructed of aluminized steel. Air inlets shall be model XG-5700 AL manufactured by GREENHECK shall be constructed of aluminum.

Units shall be square with a formed backpan and two inner cones. Outlet shall have the same appearance from the face regardless of inlet size. The units shall be the size and quantity as outlined in the plans and specifications.

Inlets shall be drawn into the backpan of the diffuser. Welded inlets are not acceptable. Diffusers shall include seismic tabs drawn into the backpan. Inner cone assemble shall be removable without the aid of tools to access the optional damper and for installation if needed. Units requiring tools such as screwdrivers or hex keys to remove the inner cones are not acceptable.

The bottom cone shall have a removable plug in the center to allow access to adjust an optional damper. Units shall include the option to allow a field installed third optional cone accessory model Snap-58. Optional third cone shall be installed into the bottom of the 5700 diffuser without the use of tools.

Units shall be designed to integrate into the specified ceiling system.

Optional for Adjustable Pattern

Outlet shall include adjustable deflector blades located within the cones of the device. Deflectors shall allow the discharge air to be adjusted to obtain a vertical or horizontal air pattern.

XG-5700A-1 - Surface Mount XG-5700A-6 - T-bar Lay-in
XG-5700A-7 - Concealed Spline XG-5700A-9 - Donn Finline Lay-in

Adjustable Discharge Pattern

Air inlets shall be model XG-5700A manufactured by GREENHECK shall be constructed of steel.

Air inlets shall be model XG-5700A AS manufactured by GREENHECK shall be constructed of aluminized steel. Air inlets shall be model XG-5700A AL manufactured by GREENHECK shall be constructed of aluminum.

Optional Dampers and Accessories

Butterfly Damper

GREENHECK model XG-BDS aluminum round butterfly type dampers shall be provided. Damper shall consist of two butterfly style blades that can be adjusted from full open to full closed. Damper shall be adjusted with a screwdriver slot that can be assessed through the face of the diffuser.

Radial Shutter Damper

GREENHECK model XG-RSD steel round radial shutter damper shall be provided. Damper shall consist of gang operated radial blades that slide perpendicular to air flow direction. The damper shall be adjusted from full open to full closed. Damper shall be adjusted with a screw driver slot that can be assessed through the face of the diffuser.

Equalizing Grid

GREENHECK model XG-G3 aluminum round equalizing grid shall be provided. Equalizing grid shall consist of 1/2" x 1/2" x 1/2" aluminum cubed core mounting in an aluminum frame.

Performance Specification

The manufacturer shall provide published performance data. Data shall be tested in accordance to ANSI/ASHRAE Standard 70- 2006

Paint Specification

Process shall be anodic electrodeposition using an anodic acrylic paint. Units shall undergo pre-treatment including a pressurized spray stage using an alkaline cleaner and a de-ionized water rinse.

MODEL XG-5700

Model: XG-5700-1 Square Face - 2 Cone - Round Neck - Flush Surface Mount
 XG-5700-6 Square Face - 2 Cone - Round Neck - T-Bar Lay-In

XG-5700-1 - Flush Surface Mount

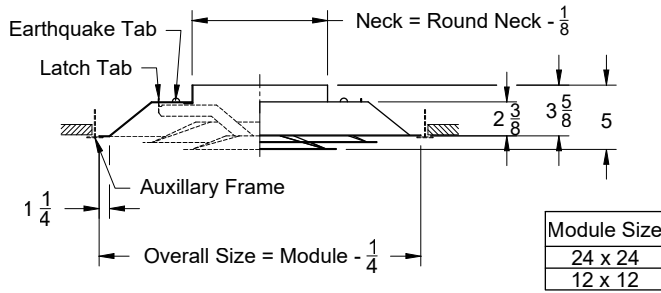

Face View

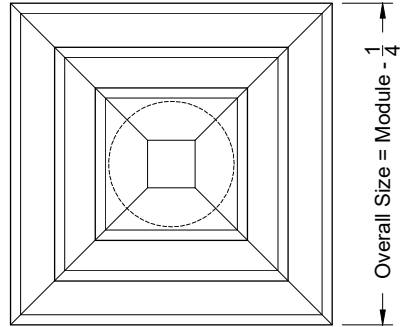

Note: For surface mount installations, use of plaster frame is recommended

XG-5700-6 - T-Bar Lay-In

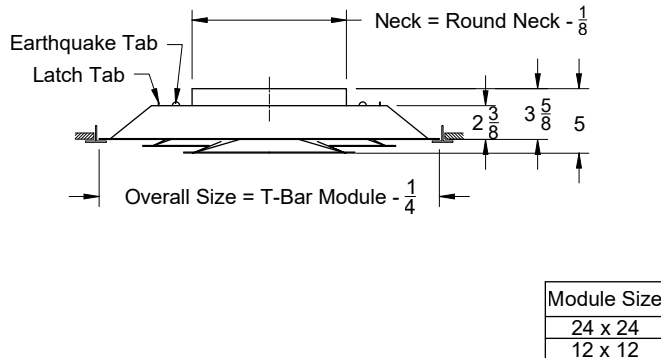

Face View

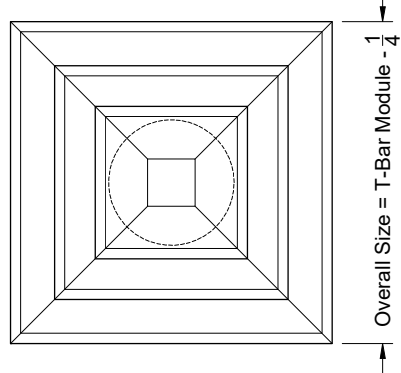

1. Available Finishes	2. Available Accessories	3. Available Options	4. Construction Details
Standard Finish: 01 White Finish 24 Mill Finish Optional Finish 02 Satin Silver 03 Black 28 Custom Color	XG-BDS - Butterfly Damper XG-RSD - Radial Shutter Damper XG-G3 - Equalizing Grid XG-BAF - Directional Baffles XG-TBPF - T-Bar Plaster Frame XG-EQS - Earthquake Straps XG-SNAP 58 - Extra Cone for 5700	XG-FGBP - Fiberglass Backpan	<ul style="list-style-type: none"> Available Sizes Only as Listed Available Neck Sizes as Listed: 6, 8, 10, 12, 14 and 15 Materials: Available in Steel, Aluminum and Aluminized Steel. Consult Software for Available Border Types.

All Dimensions $\pm 1/16"$

MODEL XG-5700

CEILING
DIFFUSERS

SQUARE CEILING DIFFUSERS

XG-5700

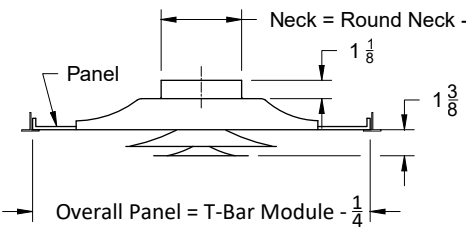
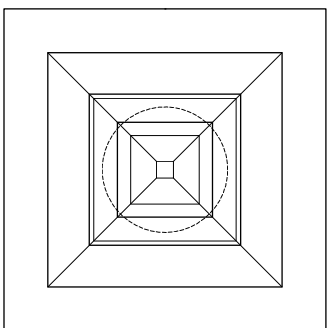
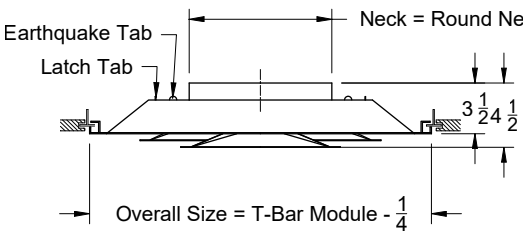
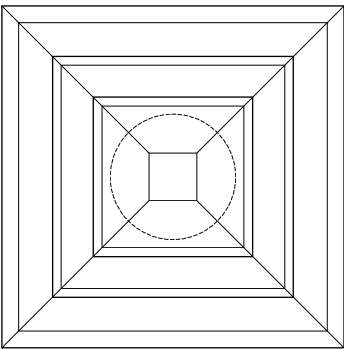
Model: XG-5700-6P XG-5700-7	Square Face - 2 Cone - Round Neck - Lay in T-Bar Panel Square Face - 2 Cone - Round Neck - Concealed T-Bar												
<div style="display: flex; justify-content: space-between;"> <div style="width: 45%;"> <h3 style="text-align: center;">XG-5700-6P - Lay in T-Bar Panel</h3>  <p style="text-align: center;">Overall Panel = T-Bar Module - $\frac{1}{4}$</p> </div> <div style="width: 45%; text-align: center;"> <h3>Face View</h3>  <p style="text-align: center;">Overall Panel = T-Bar Module - $\frac{1}{4}$</p> </div> </div> <table border="1" style="margin: 10px auto; border-collapse: collapse; text-align: center;"> <thead> <tr> <th colspan="2">Listed Module Size</th> </tr> <tr> <th>Face</th> <th>Panel</th> </tr> </thead> <tbody> <tr> <td>12 x 12</td> <td>20 x 20</td> </tr> <tr> <td>12 x 12</td> <td>24 x 24</td> </tr> <tr> <td>12 x 12</td> <td>30 x 30</td> </tr> <tr> <td>24 x 24</td> <td>30 x 30</td> </tr> </tbody> </table>		Listed Module Size		Face	Panel	12 x 12	20 x 20	12 x 12	24 x 24	12 x 12	30 x 30	24 x 24	30 x 30
Listed Module Size													
Face	Panel												
12 x 12	20 x 20												
12 x 12	24 x 24												
12 x 12	30 x 30												
24 x 24	30 x 30												
<div style="display: flex; justify-content: space-between;"> <div style="width: 45%;"> <h3 style="text-align: center;">XG-5700-7 - Concealed T-Bar</h3>  <p style="text-align: center;">Overall Size = T-Bar Module - $\frac{1}{4}$</p> </div> <div style="width: 45%; text-align: center;"> <h3>Face View</h3>  <p style="text-align: center;">Overall Size = T-Bar Module - $\frac{1}{4}$</p> </div> </div> <table border="1" style="margin: 10px auto; border-collapse: collapse; text-align: center;"> <thead> <tr> <th>Module Size</th> </tr> </thead> <tbody> <tr> <td>24 x 24</td> </tr> </tbody> </table>		Module Size	24 x 24										
Module Size													
24 x 24													
1. Available Finishes Standard Finish: 01 White Finish 24 Mill Finish Optional Finish 02 Satin Silver 03 Black 28 Custom Color	2. Available Accessories XG-BDS - Butterfly Damper XG-RSD - Radial Shutter Damper XG-G3 - Equalizing Grid XG-BAF - Directional Baffles XG-TBPF - T-Bar Plaster Frame XG-EQS - Earthquake Straps XG-SNAP 58 - Extra Cone for 5700	3. Available Options XG-FGBP - Fiberglass Backpan	4. Construction Details <ul style="list-style-type: none"> ● Available Sizes Only as Listed ● Available Neck Sizes as Listed: 6, 8, 10, 12, 14 and 15 ● Materials: Available in Steel, Aluminum and Aluminized Steel. ● Consult Software for Available Border Types. <p style="text-align: center; font-size: small;">All Dimensions $\pm 1/16$"</p>										

SERIES XG-5700 PERFORMANCE DATA
MODEL XG-5700/XG-5700A

Listed Size	Neck Size	fpm Vn	400	500	600	700	800	900	1000	1200	1400	2000
		Pv	0.01	0.016	0.022	0.031	0.04	0.05	0.062	0.09	0.122	0.249
12 x 12	6	CFM	80	100	120	135	155	175	195	235	275	395
		Ps	0.021	.033	.048	.061	.080	.102	.127	.184	.253	.521
		Pt	0.031	.049	.071	.091	.120	.153	.189	.274	.375	.770
		Throw*	2-3-6	3-4-7	3-5-7	3-5-8	4-6-8	4-6-9	5-7-9	6-7-10	6-8-11	8-9-13
		Throw	3-4-6	3-5-7	4-5-7	4-6-8	5-6-8	5-6-9	5-7-9	6-7-10	6-8-11	8-10-13
		NC	-	<15	18	20	23	26	28	33	36	44
	8	CFM	140	175	210	245	280	315	350	420	490	700
		Ps	.029	.046	.066	.090	.118	.149	.184	.265	.360	.735
		Pt	.039	.062	.089	.121	.158	.199	.246	.354	.482	.984
		Throw*	3-4-8	3-5-9	4-6-10	5-7-11	5-8-11	6-8-12	7-9-13	8-10-14	9-11-15	10-13-18
		Throw	3-5-8	4-6-9	5-7-10	6-7-11	7-8-11	7-8-12	7-9-13	8-10-14	9-11-15	10-13-18
		NC	-	<15	19	22	25	28	31	36	40	46
24 x 24	6	CFM	80	100	120	135	155	175	195	235	275	395
		Ps	.014	.021	.031	.039	.051	.065	.081	.118	.161	.332
		Pt	.024	.037	.053	.069	.091	.116	.143	.207	.283	.582
		Throw*	2-2-5	2-3-5	2-4-6	3-4-6	3-4-6	4-5-7	4-5-7	5-6-8	5-6-8	6-7-10
		Throw	2-4-7	3-5-8	4-6-9	4-6-10	5-7-10	5-8-11	6-8-12	7-9-13	8-10-14	10-12-17
		NC	-	-	-	-	<15	16	18	23	27	43
	8	CFM	140	175	210	245	280	315	350	420	490	700
		Ps	.016	.025	.036	.048	.063	.080	.099	.142	.194	.395
		Pt	.026	.040	.058	.079	.103	.131	.161	.232	.316	.645
		Throw*	2-3-6	3-4-7	3-5-7	4-6-8	4-6-9	5-6-9	5-7-10	6-7-10	7-8-11	8-10-13
		Throw	3-5-10	4-6-11	5-7-12	6-9-13	6-10-14	7-10-15	8-11-16	10-12-17	11-13-18	13-16-22
		NC	-	-	-	-	<15	18	21	26	30	55

**CEILING
DIFFUSERS**
SQUARE CEILING DIFFUSERS
XG-5700

SERIES XG-5700 PERFORMANCE DATA
MODEL XG-5700/XG-5700A

Listed Size	Neck Size	fpm Vn	400	500	600	700	800	900	1000	1200	1400	2000
		Pv	0.01	0.016	0.022	0.031	0.04	0.05	0.062	0.09	0.122	0.249
24 x 24	10	CFM	220	275	325	380	435	490	545	655	765	1090
		Ps	.019	.030	.042	.057	.075	.096	.118	.171	.233	.473
		Pt	.029	.046	.064	.088	.115	.146	.181	.261	.355	.722
		Throw*	3-4-8	3-5-8	4-6-9	5-7-10	5-8-11	6-8-11	7-8-12	8-9-13	8-10-14	10-12-17
		Throw	4-6-12	5-8-14	6-9-15	7-11-16	8-12-17	9-13-18	10-14-19	12-15-21	13-16-23	16-19-28
		NC	-	-	-	<15	16	20	24	30	35	63
	12	CFM	315	395	470	550	630	705	785	940	1100	1570
		Ps	.021	.033	.046	.063	.083	.104	.129	.185	.253	.515
		Pt	.031	.048	.069	.094	.123	.154	.191	.274	.375	.765
		Throw*	3-5-9	4-6-10	5-7-11	6-8-12	7-9-13	7-10-14	8-10-14	9-11-16	10-12-17	12-14-20
		Throw	5-7-15	6-9-17	7-11-18	8-13-20	10-15-21	11-16-22	12-17-23	14-18-26	16-20-28	19-23-33
		NC	-	-	-	<15	19	23	27	33	39	68
	14	CFM	430	535	640	750	855	960	1070	1285	1495	2140
		Ps	.026	.041	.058	.080	.104	.131	.163	.234	.377	.650
		Pt	.036	.056	.081	.110	.144	.181	.225	.324	.440	.900
		Throw*	4-6-11	5-7-12	6-9-13	7-10-14	8-11-15	9-11-16	10-12-17	11-13-18	11-14-20	14-17-24
		Throw	6-9-17	7-11-19	8-13-21	10-15-23	11-17-24	13-18-26	14-19-27	17-21-30	19-23-32	22-27-39
		NC	-	*	<15	<15	18	23	28	35	40	57
	15	CFM	490	615	735	860	980	1105	1225	1475	1720	2455
		Ps	.032	.051	.072	.099	.129	.164	.201	.292	.396	.808
		Pt	.042	.066	.095	.130	.169	.214	.263	.381	.519	1.057
		Throw*	4-6-11	5-8-13	6-9-14	7-11-15	8-11-16	9-12-17	10-13-18	11-14-20	12-15-21	15-18-25
		Throw	6-9-18	8-11-21	9-14-23	11-16-24	12-18-26	14-20-28	15-21-29	18-23-32	20-24-35	24-29-41
		NC	-	-	<15	16	22	27	31	39	46	68

PERFORMANCE NOTES FOR SERIES XG-5700

All data is tested in accordance with ANSI/ASHRAE 70-2006.

DEFINITION OF UNITS

CFM Cubic Feet per Minute (air)

fpm Velocity of air stream in Feet per Minute

Pv Velocity pressure (inches of water column)

Pt Total pressure (inches of water column)

Ps Static pressure = Pt-Pv (inches of water column)

Throw* Non-isothermal horizontal throw (supply air temperature 15°F colder than average room temperature); values are for 150, 100 and 50fpm velocities

Throw Isothermal throw (supply air temperature the same as average room temperature); values are for 150, 100 and 50fpm velocities

NC Noise criterion, sound pressure level NC ratings are based on sound power level (Lw) re: 10⁻¹² watts minus a 10dB room attenuation in all octave bands

Vn Neck Velocity

MODEL XG-5750

Square Face Plaque Diffuser with Round Neck

XG-5750-1 - Surface Mount

XG-5750-6 - T-bar Lay-in

XG-5750-7 - Concealed Spline

XG-5750-9 - Donn Finline Lay-in

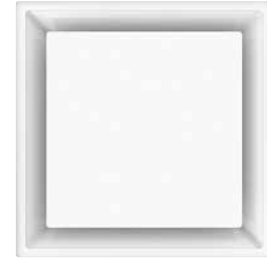

Air inlets shall be model XG-5750 manufactured by GREENHECK and shall be constructed of steel.

Air inlets shall be model XG-5750 AS manufactured by GREENHECK and shall be constructed of aluminized steel. Air inlets shall be model XG-5750 AL manufactured by GREENHECK and shall be constructed of aluminum.

Units shall be square with a formed backpan and a flat face panel. Face panel shall project no more than 1/4" below the ceiling grid or surface. Outlet shall have the same appearance from the face regardless of inlet size. The units shall be the size and quantity as outlined in the plans and specifications.

Inlets shall be drawn into the backpan of the diffuser. Welded inlets are not acceptable. Diffusers shall include seismic tabs drawn into the backpan. Face panel shall be removable without the aid of tools to access optional damper and if needed for installation. Units requiring tools to remove the face panel are not acceptable.

Units shall be designed to integrate into the specified ceiling system.

Optional Dampers and Accessories

Butterfly Damper

GREENHECK model XG-BDS aluminum, round butterfly type dampers shall be provided. Damper shall consist of two butterfly style blades that can be adjusted from full open to full closed. Damper shall be adjusted with a screw driver slot that can be assessed through the face of the diffuser.

Radial Shutter Damper

GREENHECK model XG-RSD steel round radial shutter damper shall be provided. Damper shall consist of gang operated radial blades that slide perpendicular to air flow direction. The damper shall be adjusted from full open to full closed. Damper shall be adjusted with a screw driver slot that can be assessed through the face of the diffuser.

Opposed Blade Damper

GREENHECK model XG-D3 aluminum or XG-SD3 Steel round opposed blade type dampers shall be provided. Damper shall consist of gang operated blades that can be adjusted from full open to full closed. Damper shall be adjusted with a screw driver slot that can be assessed through the face of the diffuser.

Equalizing Grid

GREENHECK model XG-G3 aluminum, round equalizing grid shall be provided. Equalizing grid shall consist of 1/2" x 1/2" x 1/2" aluminum cubed core mounting in an aluminum frame.

Performance Specification

The manufacturer shall provide published performance data. Data shall be tested in accordance to ANSI/ASHRAE Standard 70- 2006

Paint Specification

Process shall be anodic electrodeposition using an anodic acrylic paint. Units shall undergo pre treatment including a pressurized spray stage using an alkaline cleaner and a de ionized water rinse.

MODEL XG-5750

CEILING
DIFFUSERS

SQUARE CEILING DIFFUSERS

XG-5750

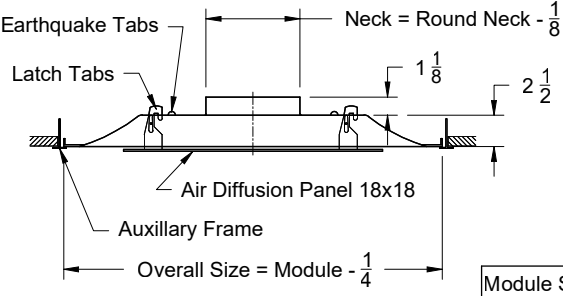
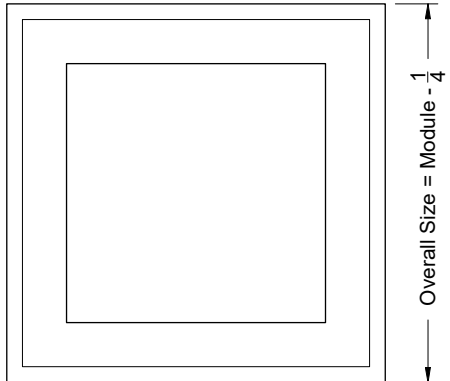
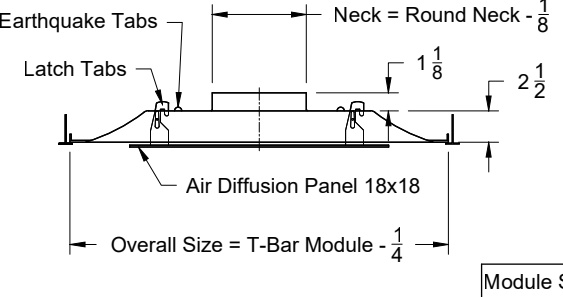
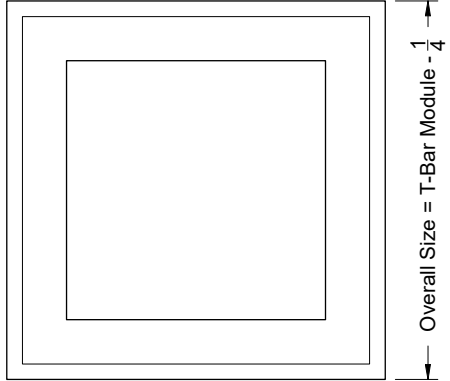
Model: XG-5750-1 Square Face Diffuser - Round Neck - Flush Surface Mount XG-5750-6 Square Face Diffuser - Round Neck - T-Bar Lay-In				
<div style="display: flex; justify-content: space-between;"> <div style="width: 45%;"> <p>XG-5750-1 - Flush Surface Mount</p>  <table border="1" style="margin-left: auto; margin-right: auto;"> <tr><th>Module Size</th></tr> <tr><td>24 x 24</td></tr> <tr><td>12 x 12</td></tr> </table> </div> <div style="width: 45%;"> <p>Face View</p>  </div> </div> <p>Note: For surface mount installations use of plaster frame is recommended</p>		Module Size	24 x 24	12 x 12
Module Size				
24 x 24				
12 x 12				
<div style="display: flex; justify-content: space-between;"> <div style="width: 45%;"> <p>XG-5750-6 - T-Bar Lay-In</p>  <table border="1" style="margin-left: auto; margin-right: auto;"> <tr><th>Module Size</th></tr> <tr><td>24 x 24</td></tr> <tr><td>12 x 12</td></tr> </table> </div> <div style="width: 45%;"> <p>Face View</p>  </div> </div>		Module Size	24 x 24	12 x 12
Module Size				
24 x 24				
12 x 12				
1. Available Finishes	2. Available Accessories	3. Available Options	4. Construction Details	
Standard Finish: 01 White Finish 24 Mill Finish Optional Finish 02 Satin Silver 03 Black 28 Custom Color	XG-BDS - Butterfly Damper XG-RSD - Radial Shutter Damper XG-G3 - Equalizing Grid XG-BAF - Directional Baffles XG-TBPF - T-Bar Plaster Frame XG-EQS - Earthquake Straps	XG-FGBP - Fiberglass Backpan	<ul style="list-style-type: none"> Available Sizes Only as Listed Available Neck Sizes as Listed: 6, 8, 10, 12, 14 and 15 Materials: Available in Steel, Aluminum and Aluminized Steel. Consult Software for Available Border Types. 	
All Dimensions ±1/16"				

MODEL XG-5750

Model: XG-5750-6P Square face - Round Neck - Lay in T-Bar Panel

XG-5750-6P - Lay in T-Bar Panel

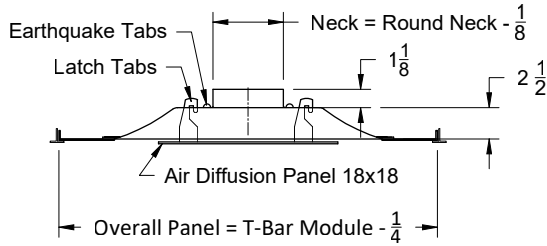

Face View

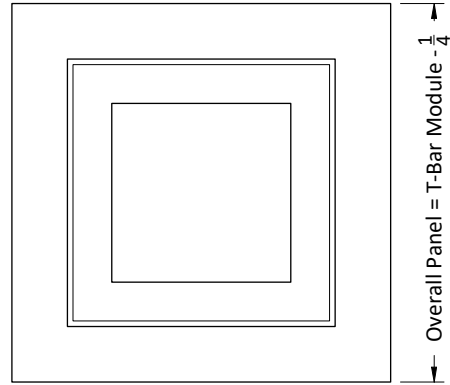

Listed Size Nominal	
Face	Panel
12 x 12	20 x 20
12 x 12	24 x 24
12 x 12	30 x 30
24 x 24	30 x 30

1. Available Finishes	2. Available Accessories	3. Available Options	4. Construction Details
Standard Finish: 01 White Finish 24 Mill Finish Optional Finish 02 Satin Silver 03 Black 28 Custom Color	XG-BDS - Butterfly Damper XG-RSD - Radial Shutter Damper XG-G3 - Equalizing Grid XG-BAF - Directional Baffles XG-TBPF - T-Bar Plaster Frame XG-EQS - Earthquake Straps	XG-FGBP - Fiberglass Backpan	<ul style="list-style-type: none"> Available Sizes Only as Listed Available Neck Sizes as Listed: 6, 8, 10, 12, 14 and 15 Materials: Available in Steel, Aluminum and Aluminized Steel. Consult Software for Available Border Types.
All Dimensions ±1/16"			

**XG-5750 MODEL NUMBER SPECIFICATION
SQUARE FACE DIFFUSER — PLAQUE FACE**

Model		Neck Size	Module	Available Finishes	
XG-5750-1	Surface Mount - Steel	6	12 x 12	Standard Finish	
XG-5750-1 AS	Surface Mount - Aluminized Steel	8		01	White
XG-5750-1 AL	Surface Mount - Aluminum	6	24 x 24	Optional Finishes	
		8		02	Satin Silver
		10		03	Black
		12		28	Custom Color
		14			
		15			

Available Accessories	
XG-G3	Equalizing Grid
XG-BDS	Butterfly Damper
XG-RSD	Radial Damper
XG-BO-1	3-Way Blank Off
XG-BO-2	2-Way Blank Off
XG-BO-3	1-Way Blank Off
XG-LIPF	Lay-in Plaster Frame

XG-5750 MODEL NUMBER SPECIFICATION SQUARE FACE DIFFUSER — PLAQUE FACE

Model		Neck Size	Module	Available Finishes	
XG-5750-6	T-bar Lay-in - Steel	6	12 x 12	Standard Finish	
XG-5750-6 AS	T-bar Lay-in - Aluminized Steel	8		01	White
XG-5750-6	T-bar Lay-in - Steel	6	24 x 24	Optional Finishes	
XG-5750-6 AS	T-bar Lay-in - Aluminized Steel	8		02	Satin Silver
XG-5750-6 AL	T-bar Lay-in - Aluminum	10		03	Black
XG-5750-7	Concealed Spline - Steel	12		28	Custom Color
XG-5750-7 AS	Concealed Spline - Aluminized Steel	14			
XG-5750-9	Donn Finline / Bolt Slot - Steel	15			
XG-5750-9 AS	Donn Finline / Bolt Slot - Aluminized Steel				

Available Accessories	
XG-G3	Equalizing Grid
XG-BDS	Butterfly Damper
XG-RSD	Radial Damper
XG-BO-1	3-Way Blank Off
XG-BO-2	2-Way Blank Off
XG-BO-3	1-Way Blank Off
XG-FGBP	Factory Installed R6 Insulation
XG-TBPF	T-Bar Plaster Frame (-6 Only)

Model		Neck Size	Module	Available Finishes	
XG-M5750-6	Metric T-bar Lay-in - Steel	6	600mm x 600mm	Standard Finish	
XG-M5750-6 AS	Metric T-bar Lay-in - Aluminized Steel	8		01	White
		10		Optional Finishes	
		12		02	Satin Silver
		14		03	Black
		15		28	Custom Color

Available Accessories	
XG-G3	Equalizing Grid
XG-BDS	Butterfly Damper
XG-RSD	Radial Damper
XG-BO-1	3-Way Blank Off
XG-BO-2	2-Way Blank Off
XG-BO-3	1-Way Blank Off
XG-TBPF	T-Bar Plaster Frame

SERIES XG-5750 PERFORMANCE DATA
MODEL XG-5750

Listed Size	Neck Size	fpm Vn	400	500	600	700	800	900	1000	1200	1400	1600
		Pv	0.01	0.016	0.022	0.031	0.04	0.05	0.062	0.09	0.122	0.249
12 x 12	6	CFM	80	100	120	135	155	175	195	235	275	315
		Ps	.009	.014	.021	.024	.032	.041	.051	.075	.104	.137
		Pt	.019	.030	.043	.054	.072	.092	.114	.165	.226	.297
		Throw*	3-4-7	3-5-7	4-6-8	4-6-9	5-6-9	6-7-10	6-7-10	6-8-11	7-9-12	8-9-13
		Throw	3-4-7	4-5-7	4-6-8	5-6-9	5-7-9	6-7-10	6-7-10	7-8-11	7-9-12	8-9-13
		NC	<15	<15	<15	16	18	21	23	27	31	34
	8	CFM	140	175	210	245	280	315	350	420	490	560
		Ps	.017	.027	.039	.053	.069	.087	.108	.155	.212	.276
		Pt	.027	.043	.061	.083	.109	.138	.170	.245	.334	.436
		Throw*	3-5-9	4-7-10	5-8-11	6-8-11	7-9-12	8-9-13	8-10-14	9-11-15	9-11-16	10-12-17
		Throw	4-6-9	5-7-10	6-8-11	7-8-12	7-9-13	8-9-13	8-10-14	9-11-15	10-12-17	10-13-18
		NC	<15	<15	17	20	22	25	27	31	34	37
24 x 24	6	CFM	80	100	120	135	155	175	195	235	275	315
		Ps	.003	.004	.006	.006	.008	.011	.014	.021	.029	.039
		Pt	.013	.020	.029	.036	.048	.061	.076	.110	.151	.198
		Throw*	0-1-4	1-2-6	1-2-7	1-3-8	2-4-8	2-5-9	3-5-9	4-7-10	5-8-11	6-9-12
		Throw	1-2-5	1-3-6	2-4-7	2-4-8	3-5-9	4-5-9	4-6-10	5-7-11	6-8-12	6-9-13
		NC	<15	<15	<15	<15	15	18	21	26	31	35
	8	CFM	140	175	210	245	280	315	350	420	490	560
		Ps	.007	.012	.017	.023	.030	.038	.047	.067	.091	.119
		Pt	.017	.027	.039	.053	.070	.088	.109	.157	.213	.279
		Throw*	1-1-6	1-2-7	1-3-9	2-4-10	3-6-11	3-7-12	4-7-13	6-9-14	7-10-15	8-11-16
		Throw	1-2-6	2-4-8	2-5-10	3-6-11	4-6-12	5-7-13	5-8-13	6-10-14	7-11-16	9-12-17
		NC	<15	<15	<15	17	21	25	28	34	39	42
	10	CFM	220	275	325	380	435	490	545	655	765	875
		Ps	.016	.025	.034	.047	.061	.078	.096	.139	.190	.249
		Pt	.026	.040	.056	.077	.101	.128	.159	.229	.313	.409
		Throw*	1-2-7	1-3-9	2-4-11	2-5-13	3-7-14	4-8-15	5-9-16	7-11-17	9-13-19	10-14-20
		Throw	1-3-8	2-5-10	3-6-12	4-7-14	5-8-15	6-9-16	7-10-17	8-12-18	9-14-20	11-15-21
		NC	<15	15	15	21	26	30	33	37	41	43

CEILING
DIFFUSERS

SQUARE CEILING DIFFUSERS

XG-5750

SERIES XG-5750 PERFORMANCE DATA
MODEL XG-5750

Listed Size	Neck Size	fpm Vn	400	500	600	700	800	900	1000	1200	1400	1600
		Pv	0.01	0.016	0.022	0.031	0.04	0.05	0.062	0.09	0.122	0.249
24 x 24	12	CFM	315	395	470	550	630	705	785	940	1100	1255
		Ps	.027	.042	.059	.081	.107	.133	.165	.236	.324	.422
		Pt	.037	.058	.082	.112	.146	.183	.227	.326	.446	.581
		Throw*	1-2-9	1-3-11	2-5-13	3-7-15	4-9-17	5-10-18	6-11-19	8-13-21	10-15-23	12-17-24
		Throw	2-4-10	2-6-12	4-7-14	5-8-17	6-10-18	7-11-19	8-12-20	10-14-22	11-17-23	13-18-25
		NC	<15	<15	17	22	27	30	33	38	42	45
	14	CFM	430	535	640	750	855	960	1070	1285	1495	1710
		Ps	.031	.049	.069	.095	.124	.156	.194	.280	.378	.495
		Pt	.041	.064	.092	.126	.164	.206	.256	.370	.501	.655
		Throw*	1-3-10	2-4-13	2-6-15	3-8-18	4-10-20	6-12-21	7-13-22	10-15-24	12-18-26	14-20-28
		Throw	2-4-11	3-6-14	4-8-17	6-10-19	7-11-21	8-13-22	9-14-23	11-17-25	13-19-27	15-21-29
		NC	<15	<15	20	25	30	33	36	40	43	46
	15	CFM	490	615	735	860	980	1105	1225	1475	1720	1965
		Ps	.038	.060	.086	.117	.152	.194	.238	.345	.469	.613
		Pt	.048	.076	.108	.148	.192	.244	.300	.435	.592	.772
		Throw*	1-3-11	2-4-14	3-6-16	4-8-19	5-11-21	6-12-23	7-14-24	11-17-26	13-19-28	15-21-30
		Throw	2-4-12	3-7-15	4-9-18	6-10-21	8-12-22	9-13-24	10-15-25	12-18-27	14-21-29	16-22-31
		NC	<15	<15	20	27	32	35	37	41	44	47

PERFORMANCE NOTES FOR SERIES XG-5750

All data is tested in accordance with ANSI/ASHRAE 70-2006.

DEFINITION OF UNITS

CFM Cubic Feet per Minute (air)

fpm Velocity of air stream in Feet per Minute

Pv Velocity pressure (inches of water column)

Pt Total pressure (inches of water column)

Ps Static pressure = Pt-Pv (inches of water column)

Throw* Non-isothermal horizontal throw (supply air temperature 15°F colder than average room temperature); values are for 150, 100 and 50fpm velocities

Throw Isothermal throw (supply air temperature the same as average room temperature); values are for 150, 100 and 50fpm velocities

NC Noise criterion, sound pressure level NC ratings are based on sound power level (Lw) re: 10⁻¹² watts minus a 10dB room attenuation in all octave bands

Vn Neck Velocity

MODEL XG-5800

Three Cone Square Face Diffuser with Round Neck

XG-5800-1 - Surface Mount

XG-5800-6 - T-bar Lay-in

XG-5800-7 - Concealed Spline

XG-5800-9 - Donn Finline Lay-in



Non-Adjustable, Horizontal Discharge Pattern

Air inlets shall be model XG-5800 manufactured by GREENHECK shall be constructed of steel.

Air inlets shall be model XG-5800 AS manufactured by GREENHECK shall be constructed of aluminized steel. Air inlets shall be model XG-5800 AL manufactured by GREENHECK shall be constructed of aluminum.

Units shall be square with a formed backpan and three inner cones. Outlet shall have the same appearance from the face regardless of inlet size. The units shall be the size and quantity as outlined in the plans and specifications.

Inlets shall be drawn into the backpan of the diffuser. Welded inlets are not acceptable. Diffusers shall include seismic tabs drawn into the backpan. Inner cone assemble shall be removable without the aid of tools to access the optional damper and for installation if needed. Units requiring tools such as screwdrivers or hex keys to remove the inner cones are not acceptable.

The bottom cone shall have a removable plug in the center to allow access to adjust an optional damper.

Units shall be designed to integrate into the specified ceiling system.

Optional for Adjustable Pattern

Outlet shall include adjustable deflector blades located within the cones of the device. Deflectors shall allow the discharge air to be adjusted to obtain a vertical or horizontal air pattern.

XG-5800A-1 - Surface Mount
XG-5800A-6 - T-bar Lay-in
XG-5800A-7 - Concealed Spline
XG-5800A-9 - Donn Finline Lay-in

Adjustable Discharge Pattern

Air inlets shall be model XG-5800A manufactured by GREENHECK shall be constructed of steel.

Air inlets shall be model XG-5800A AS manufactured by GREENHECK shall be constructed of aluminized steel. Air inlets shall be model 5800A AL manufactured by GREENHECK shall be constructed of aluminum.

Optional Dampers and Accessories

Butterfly Damper

GREENHECK model XG-BDS aluminum round butterfly type dampers shall be provided. Damper shall consist of three butterfly style blades that can be adjusted from full open to full closed. Damper shall be adjusted with a screwdriver slot that can be assessed through the face of the diffuser.

Radial Shutter Damper

GREENHECK model XG-RSD steel round radial shutter damper shall be provided. Damper shall consist of gang operated radial blades that slide perpendicular to air flow direction. The damper shall be adjusted from full open to full closed. Damper shall be adjusted with a screw driver slot that can be assessed through the face of the diffuser.

Equalizing Grid

GREENHECK model XG-G3 aluminum round equalizing grid shall be provided. Equalizing grid shall consist of 1/2" x 1/2" x 1/2" aluminum cubed core mounting in an aluminum frame.

Performance Specification

The manufacturer shall provide published performance data. Data shall be tested in accordance to ANSI/ASHRAE Standard 70- 2006

Paint Specification

Process shall be anodic electrodeposition using an anodic acrylic paint. Units shall undergo pre-treatment including a pressurized spray stage using an alkaline cleaner and a de-ionized water rinse.

MODEL XG-5800

CEILING
DIFFUSERS

SQUARE CEILING DIFFUSERS

XG-5800

Model: XG-5800-1 Square Face - 3 Cone - Round Neck - Flush Surface Mount
 XG-5800-6 Square Face - 3 Cone - Round Neck - T-Bar Lay-In

XG-5800-1 - Flush Surface Mount

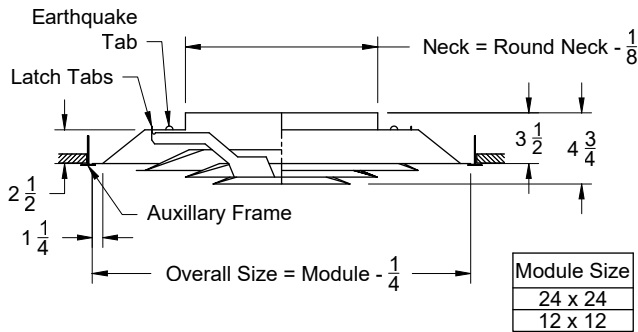

Face View

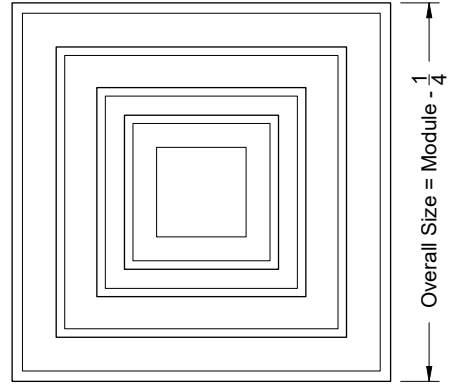

Note: For surface mount installations use of plaster frame is recommended

XG-5800-6 - T-Bar Lay-In

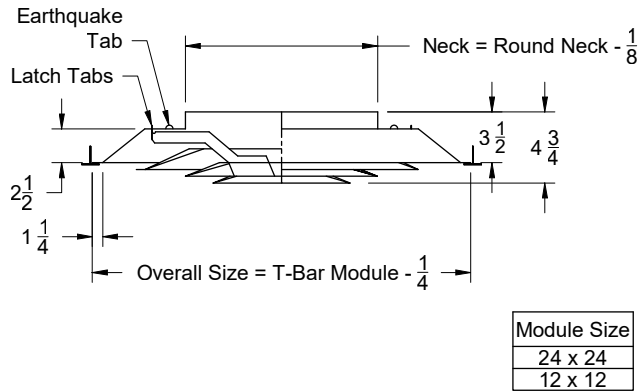

Face View

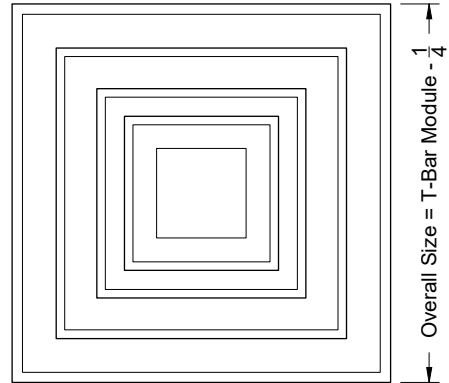

1. Available Finishes	2. Available Accessories	3. Available Options	4. Construction Details
Standard Finish: 01 White Finish 24 Mill Finish Optional Finish 02 Satin Silver 03 Black 28 Custom Color	XG-BDS - Butterfly Damper XG-RSD - Radial Shutter Damper XG-G3 - Equalizing Grid XG-BAF - Directional Baffles XG-TBPF - T-Bar Plaster Frame XG-EQS - Earthquake Straps	XG-FGBP - Fiberglass Backpan	<ul style="list-style-type: none"> Available Sizes Only as Listed Available Neck Sizes as Listed: 6, 8, 10, 12, 14 and 15 Materials: Available in Steel, Aluminum and Aluminized Steel. Consult Software for Available Border Types.

All Dimensions $\pm 1/16"$

MODEL XG-5800

Model: XG-5800-6P Square Face - 3 Cone - Round Neck - Lay In T-Bar Panel

XG-5800-6P - Lay in T-Bar Panel Mount

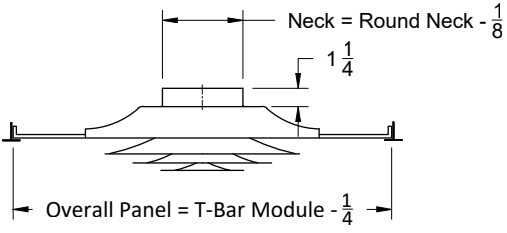

Listed Size	
Face	Panel
12 x 12	20 x 20
12 x 12	24 x 24
12 x 12	30 x 30
24 x 24	30 x 30

Face View

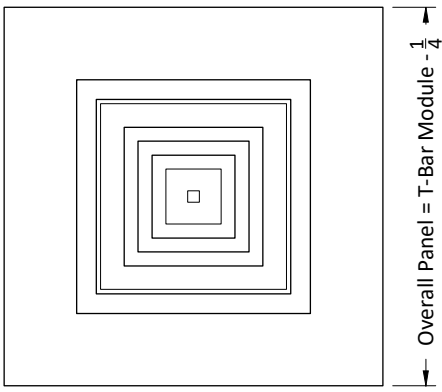

1. Available Finishes	2. Available Accessories	3. Available Options	4. Construction Details
Standard Finish: 01 White Finish 24 Mill Finish Optional Finish 02 Satin Silver 03 Black 28 Custom Color	XG-BDS - Butterfly Damper XG-RSD - Radial Shutter Damper XG-G3 - Equalizing Grid XG-BAF - Directional Baffles XG-TBPF - T-Bar Plaster Frame XG-EQS - Earthquake Straps	XG-FGBP - Fiberglass Backpan	<ul style="list-style-type: none"> ● Available Sizes Only as Listed ● Available Neck Sizes as Listed: 6, 8, 10, 12, 14 and 15 ● Materials: Available in Steel, Aluminum and Aluminized Steel. ● Consult Software for Available Border Types.
All Dimensions ±1/16"			

MODEL XG-5800A

CEILING
DIFFUSERS

SQUARE CEILING DIFFUSERS

XG-5800

Model: XG-5800A-1 Square Face - 3 Cone - Round Neck - Adjustable Deflection Vanes - Flush Surface Mount
 XG-5800A-6 Square Face - 3 Cone - Round Neck - Adjustable Deflection Vanes - T-Bar Lay-In

XG-5800A-1 - Flush Surface Mount

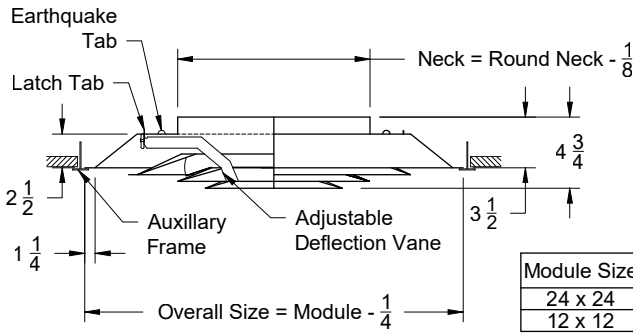

Face View

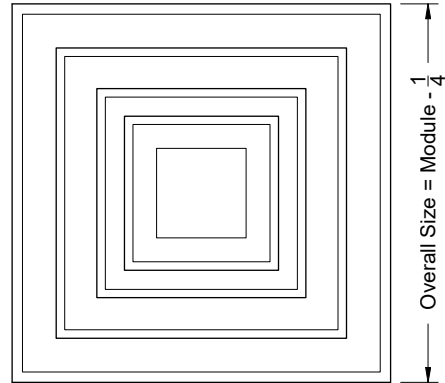

Note: For surface mount installations use of plaster frame is recommended

XG-5800A-6 - T-Bar Lay-In

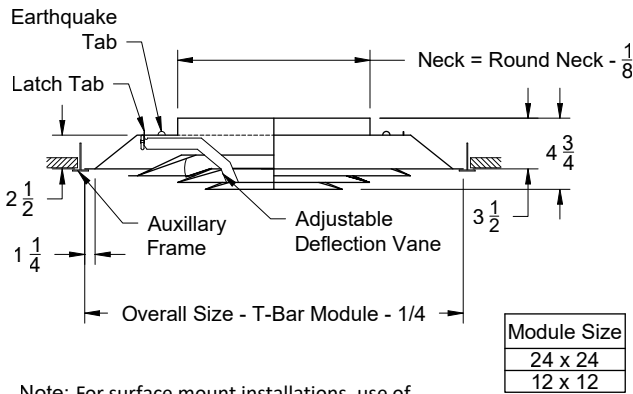

Face View

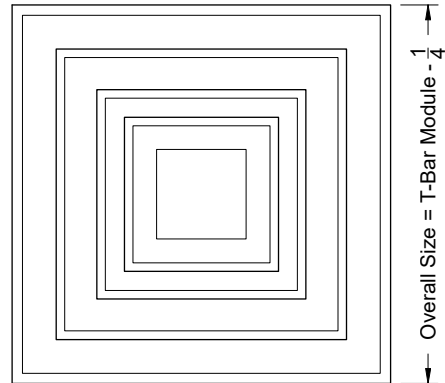

Note: For surface mount installations, use of plaster frame is recommended

T-bar Panel sizes available: 20x20, 24x24, 30x30

1. Available Finishes	2. Available Accessories	3. Available Options	4. Construction Details
Standard Finish: 01 White Finish 24 Mill Finish Optional Finish 02 Satin Silver 03 Black 28 Custom Color	XG-BDS - Butterfly Damper XG-RSD - Radial Shutter Damper XG-G3 - Equalizing Grid XG-BAF - Directional Baffles XG-TBPF - T-Bar Plaster Frame XG-EQS - Earthquake Straps	XG-FGBP - Fiberglass Backpan	<ul style="list-style-type: none"> Available Sizes Only as Listed Available Neck Sizes as Listed: 6, 8, 10, 12, 14 and 15 Materials: Available in Steel, Aluminum and Aluminized Steel. Consult Software for Available Border Types.

All Dimensions ±1/16"

SERIES XG-5800 PERFORMANCE DATA
MODEL XG-5800/XG-5800A

Listed Size	Neck Size	fpm Vn	400	500	600	700	800	900	1000	1200	1400	1600
		Pv	0.01	0.016	0.022	0.031	0.04	0.05	0.062	0.09	0.122	0.249
12 x 12	6	CFM	80	100	120	135	155	175	195	235	275	315
		Ps	.026	.040	.058	.073	.097	.123	.153	.223	.305	.400
		Pt	.036	.056	.080	.104	.137	.174	.216	.312	.427	.559
		Throw*	3-4-6	3-5-7	4-5-7	4-6-8	5-6-8	5-6-9	5-7-9	6-7-10	6-8-11	7-9-12
		Throw	2-4-6	3-5-7	4-5-7	4-6-8	5-6-8	5-6-9	5-7-9	6-7-10	6-8-11	7-9-12
		NC	-	<15	18	21	24	26	29	33	35	37
	8	CFM	140	175	210	245	280	315	350	420	490	560
		Ps	.026	.041	.059	.080	.104	.132	.163	.235	.319	.417
		Pt	.036	.056	.081	.110	.144	.182	.225	.324	.442	.577
		Throw*	3-5-8	4-6-9	5-7-10	6-8-11	7-8-11	7-9-12	7-9-13	8-10-14	9-11-15	9-11-16
		Throw	3-5-8	4-6-9	5-7-10	6-8-11	6-8-11	7-9-12	7-9-13	8-10-14	9-11-15	9-11-16
		NC	-	<15	19	22	25	28	30	34	37	40
24 x 24	6	CFM	80	100	120	135	155	175	195	235	275	315
		Ps	.013	.020	.029	.037	.048	.061	.076	.111	.152	.199
		Pt	.023	.036	.051	.067	.088	.112	.139	.201	.274	.359
		Throw*	3-4-5	3-4-6	4-5-7	4-5-7	4-5-7	5-6-8	5-6-8	5-6-9	6-7-10	6-7-11
		Throw	3-4-7	3-5-8	4-6-9	5-7-10	5-7-10	6-8-11	7-8-11	7-9-13	8-10-14	8-10-15
		NC	-	-	-	<15	<15	18	21	25	28	31
	8	CFM	140	175	210	245	280	315	350	420	490	560
		Ps	.014	.022	.032	.043	.056	.071	.088	.126	.172	.225
		Pt	.024	.038	.054	.074	.096	.122	.150	.216	.294	.384
		Throw*	4-5-7	5-6-8	5-6-9	5-7-9	6-7-10	6-7-11	6-8-11	7-9-12	8-9-13	8-10-14
		Throw	4-5-10	4-7-11	5-8-12	6-9-13	7-10-14	8-10-15	9-11-15	10-12-17	10-13-18	11-14-19
		NC	-	-	-	<15	17	21	24	30	34	35
	10	CFM	220	275	325	380	435	490	545	655	765	875
		Ps	.018	.028	.039	.053	.070	.088	.109	.158	.215	.282
		Pt	.028	.043	.061	.084	.110	.139	.172	.248	.337	.441
		Throw*	5-6-9	6-7-10	6-8-11	7-8-12	7-9-12	8-9-13	8-10-14	9-11-15	9-12-16	10-12-18
		Throw	4-7-12	6-8-14	7-10-15	8-11-16	9-12-17	10-13-18	11-14-19	12-15-21	13-16-23	14-17-24
		NC	-	-	-	<15	19	23	27	33	38	40
	12	CFM	315	395	470	550	630	705	785	940	1100	1255
		Ps	.022	.035	.049	.067	.088	.111	.137	.197	.270	.351
		Pt	.032	.050	.072	.098	.128	.161	.200	.287	.392	.511
		Throw*	6-7-11	7-8-12	7-9-13	8-10-14	9-11-15	9-11-16	10-12-17	11-13-18	11-14-20	12-15-21
		Throw	5-8-15	7-10-16	8-12-18	9-14-19	11-15-21	12-15-22	13-16-23	15-18-25	16-19-27	17-21-29
		NC	-	-	<15	16	21	26	30	36	41	43
14	CFM	430	535	640	750	855	960	1070	1285	1495	1710	
	Ps	.032	.049	.071	.097	.126	.159	.198	.285	.386	.505	
	Pt	.042	.065	.093	.128	.166	.210	.260	.375	.508	.665	
	Throw*	7-9-12	8-10-14	9-11-15	9-12-16	10-12-17	11-13-18	11-14-19	12-15-21	13-16-23	14-17-25	
	Throw	6-9-17	8-12-19	9-14-21	11-16-22	12-17-24	14-18-25	15-19-27	17-21-29	18-22-32	20-24-34	
	NC	-	-	<15	17	22	27	32	39	44	47	
15	CFM	490	615	735	860	980	1105	1225	1475	1720	1965	
	Ps	.036	.056	.080	.109	.142	.181	.222	.322	.438	.571	
	Pt	.046	.072	.102	.140	.182	.231	.284	.412	.560	.731	
	Throw*	7-9-13	9-10-15	9-11-16	10-12-17	11-13-19	11-14-20	12-15-21	13-16-23	14-17-25	15-19-26	
	Throw	7-10-18	8-12-20	10-15-22	12-17-24	13-18-26	15-19-27	17-20-29	18-22-32	20-24-34	21-26-36	
	NC	-	-	<15	18	23	29	33	41	46	49	

**CEILING
DIFFUSERS**
SQUARE CEILING DIFFUSERS
XG-5800

PERFORMANCE NOTES FOR SERIES XG-5800

All data is tested in accordance with ANSI/ASHRAE 70-2006.

DEFINITION OF UNITS

CFM Cubic Feet per Minute (air)

fpm Velocity of air stream in Feet per Minute

Pv Velocity pressure (inches of water column)

Pt Total pressure (inches of water column)

Ps Static pressure = $P_t - P_v$ (inches of water column)

Throw* Non-isothermal horizontal throw (supply air temperature 15°F colder than average room temperature); values are for 150, 100 and 50fpm velocities

Throw Isothermal throw (supply air temperature the same as average room temperature); values are for 150, 100 and 50fpm velocities

NC Noise criterion, sound pressure level NC ratings are based on sound power level (Lw) re: 10^{-12} watts minus a 10dB room attenuation in all octave bands

Vn Neck Velocity

MODEL XG-Phenomenator

Air Outlets shall be model:

XG-Phenom-1 - Surface Mount

XG-Phenom-6 - T-bar Lay-in

XG-Phenom-7 - Concealed Spline

XG-Phenom-9 - Donn Finline Lay-in



XG-Phenom manufactured by GREENHECK. Units shall be constructed of steel.

XG-Phenom AS manufactured by GREENHECK. Units shall be constructed of aluminized steel.

Units shall be square with a formed backpan, flat panel face, and a high induction inner high induction core assembly. The face panel of the outlet shall project no more than 1/4" below the ceiling grid. The units shall be the size and quantity as outline in the plans and specifications.

Inlets shall be drawn into the backpan of the diffuser. Welded inlets are not acceptable. Diffusers shall include seismic tabs drawn into the backpan.

Face panel shall be held in place with hooks are secured through the backpan and be removable without the aid of tools. Units with face panels held in place with springs or clips are not acceptable.

Inner core assembly shall be steel and include a gasket between the core and the backpan. The high induction core assembly shall produce a four way discharge pattern through a series of nozzles to maximize induction and comfort. ADPI for the diffuser shall be a minimum of 97 in typical applications.

Units shall be designed to integrate into the specified ceiling system.

Paint Specification

Process shall be anodic electrodeposition using an anodic acrylic paint. Units shall undergo pre-treatment including a pressurized spray stage using an alkaline cleaner and a de-ionized water rinse.

MODEL XG-Phenomenator

CEILING
DIFFUSERS

SQUARE CEILING DIFFUSERS

PHENOMENATOR

Model: XG-Phenom-LF-1 Square Face - Round Neck - Flush Surface Mount
XG-Phenom-LF-6 Square Face - Round Neck - T-Bar Lay-In

XG-PHENOM-LF-1 - Flush Surface Mount

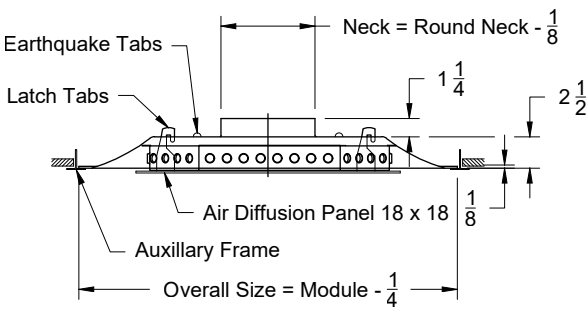

Note: For surface mount installations use of plaster frame is recommended

Face View

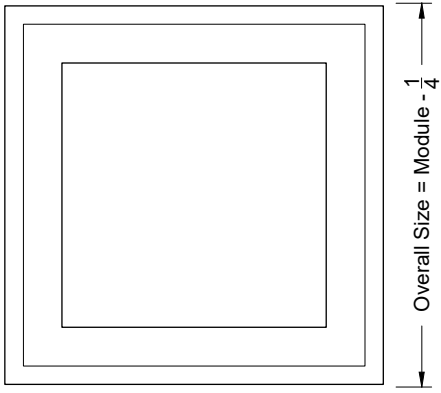

XG-PHENOM-LF-6 - T-Bar Lay-In

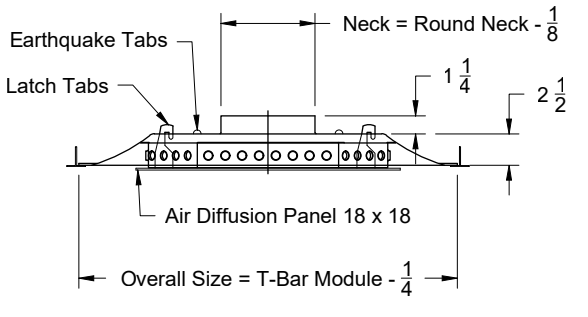

Face View

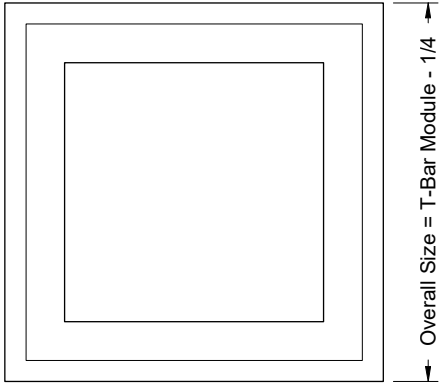

1. Available Finishes	2. Available Accessories	3. Available Options	4. Construction Details
Standard Finish: 01 White Finish 24 Mill Finish Optional Finish 02 Satin Silver 03 Black 28 Custom Color	XG-BDS - Butterfly Damper XG-RSD - Radial Shutter Damper XG-G3 - Equalizing Grid XG-BAF - Directional Baffles XG-TBPF - T-Bar Plaster Frame XG-EQS - Earthquake Straps	XG-FGBP - Fiberglass Backpan	<ul style="list-style-type: none"> ● Available Sizes Only as Listed ● Available Neck Sizes as Listed: 6, 8, 10, 12, 14 and 15 ● Materials: Available in Steel, Aluminum and Aluminized Steel. ● Consult Software for Available Border Types.

All Dimensions ±1/16"

MODEL XG-Phenomenator

Model: XG-Phenom-LF-7 Square Face - Round Neck - Concealed Spline Module
 XG-Phenom-LF-9 Square Face - Round Neck- Bolt Slot / Donn Fineline Module

XG-PHENOM-LF-7 - Concealed Spline Module

Face View

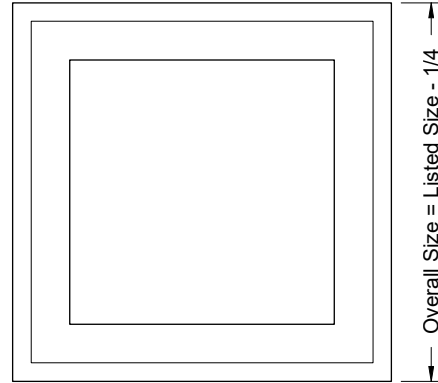
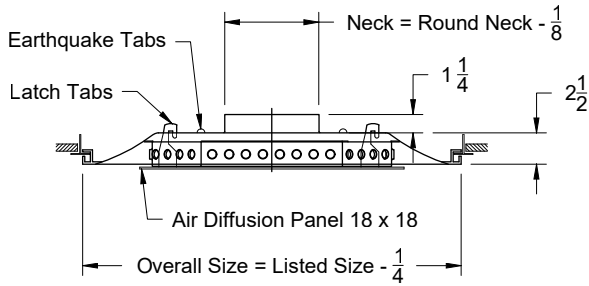

XG-PHENOM-LF-9 - Bolt Slot / Donn Fineline Module

Face View

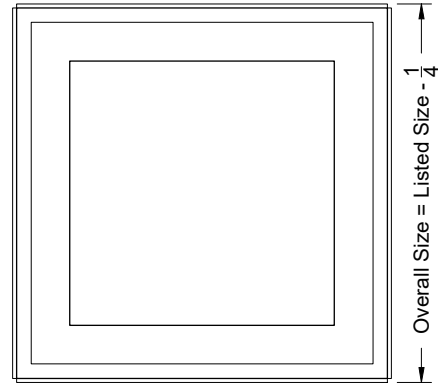
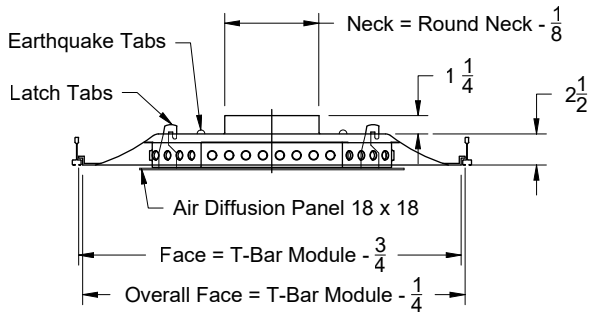

1. Available Finishes

Standard Finish:
 01 White
 Finish
 24 Mill Finish
 Optional Finish
 02 Satin Silver
 03 Black
 28 Custom Color

2. Available Accessories

XG-BDS - Butterfly Damper
 XG-RSD - Radial Shutter Damper
 XG-G3 - Equalizing Grid
 XG-BAF - Directional Baffles
 XG-TBPF - T-Bar Plaster Frame
 XG-EQS - Earthquake Straps

3. Available Options

XG-FGBP - Fiberglass Backpan

4. Construction Details

- Available Sizes Only as Listed
- Available Neck Sizes as Listed: 6, 8, 10, 12, 14 and 15
- Materials: Available in Steel, Aluminum and Aluminized Steel.
- Consult Software for Available Border Types.

All Dimensions $\pm 1/16"$

XG-PHENOMENATOR MODEL NUMBER SPECIFICATION
SQUARE FACE DIFFUSER — PLAQUE FACE — HIGH PERFORMANCE

Model		Neck Size	Module	Available Finishes	
XG-Phenom-1	Surface Mount - Steel	6	24 x 24	Standard Finish	
XG-Phenom-1 AS	Surface Mount - Aluminized Steel	8		01	White
XG-Phenom-1 AL	Surface Mount - Aluminum	10		Optional Finishes	
		12		02	Satin Silver
		14		03	Black
		15		28	Custom Color

Available Accessories	
XG-G3	Equalizing Grid
XG-BDS	Butterfly Damper
XG-RSD	Radial Damper
XG-B0-1	3-Way Blank Off
XG-B0-2	2-Way Blank Off
XG-B0-3	1-Way Blank Off
XG-LIPF	Lay-in Plaster Frame

XG-PHENOMATOR MODEL NUMBER SPECIFICATION SQUARE FACE DIFFUSER – PLAQUE FACE

Model		Neck Size	Module	Available Finishes	
XG-Phenom-6	T-bar Lay-in - Steel	6	24 x 24	Standard Finish	
XG-Phenom-6 AS	T-bar Lay-in - Aluminized Steel	8		01	White
XG-Phenom AL	T-bar Lay-in - Aluminum	10		Optional Finishes	
XG-Phenom-7	Concealed Spline - Steel	12		02	Satin Silver
XG-Phenom-7 AS	Concealed Spline - Aluminized Steel	14		03	Black
XG-Phenom-9	Donn Finline / Bolt Slot - Steel	15		28	Custom Color
XG-Phenom-9 AS	Donn Finline / Bolt Slot - Aluminized Steel				

Available Accessories	
XG-G3	Equalizing Grid
XG-BDS	Butterfly Damper
XG-RSD	Radial Damper
XG-B0-1	3-Way Blank Off
XG-B0-2	2-Way Blank Off
XG-B0-3	1-Way Blank Off
XG-TBPF	T-Bar Plaster Frame (-6 Only)

Model		Neck Size	Module	Available Finishes	
MXG-Phenom-6	Metric T-bar Lay-in - Steel	6	600mm x 600mm	Standard Finish	
MXG-Phenom-6 AS	Metric T-bar Lay-in - Aluminized Steel	8		01	White
		10		Optional Finishes	
		12		02	Satin Silver
		14		03	Black
		15		28	Custom Color

Available Accessories	
XG-G3	Equalizing Grid
XG-BDS	Butterfly Damper
XG-RSD	Radial Damper
XG-B0-1	3-Way Blank Off
XG-B0-2	2-Way Blank Off
XG-B0-3	1-Way Blank Off
XG-TBPF	T-Bar Plaster Frame

SERIES XG-PHENOMENATOR PERFORMANCE DATA
MODEL XG-PHENOMENATOR

Nominal Neck Size	fpm Vn	400	500	600	700	800	900	1000	1200
	Pv	0.01	0.016	0.022	0.031	0.04	0.05	0.062	0.09
6	CFM	-	-	120	135	155	175	195	215
	Ps	-	-	.020	.026	.034	.044	.054	.066
	Pt	-	-	.042	.057	.074	.094	.116	.141
	Throw*	-	-	1-1-2	1-2-3	2-2-4	2-3-5	3-4-6	3-5-7
	Throw	-	-	1-1-1	1-1-2	1-1-3	1-2-4	2-3-5	3-4-6
	NC	-	-	<20	20	21	24	26	29
8	CFM	140	175	210	245	280	315	350	385
	Ps	.020	.031	.045	.061	.080	.101	.125	.152
	Pt	.030	.047	.067	.092	.114	.151	.187	.218
	Throw*	1-2-3	2-3-5	2-5-6	3-6-7	4-6-8	5-7-10	6-8-12	7-9-13
	Throw	1-1-2	1-2-4	1-4-5	2-5-6	3-5-7	4-6-9	5-7-10	6-7-11
	NC	<20	21	25	29	32	35	37	40
10	CFM	220	275	325	380	435	490	545	600
	Ps	.036	.080	.090	.108	.142	.180	.223	.27
	Pt	.046	.096	.110	.139	.182	.300	.285	.345
	Throw*	4-6-9	6-8-10	7-9-12	8-10-13	8-10-14	9-12-16	11-14-17	12-15-18
	Throw	3-5-7	5-7-9	5-8-11	6-9-12	7-9-13	8-11-15	10-13-15	11-13-17
	NC	20	24	27	31	35	38	41	44
12	CFM	315	395	470	550	630	705	785	870
	Ps	.061	.096	.136	.186	.24	.306	.38	.423
	Pt	.071	.112	.156	.217	.28	.356	.442	.495
	Throw*	4-7-11	7-10-13	9-11-14	11-13-16	13-15-18	15-18-20	16-20-22	18-21-24
	Throw	3-6-10	6-9-12	7-10-13	9-11-14	11-14-16	12-15-18	13-17-20	15-19-22
	NC	22	27	32	36	40	43	46	52
14	CFM	430	535	640	750	860	975	1095	1220
	Ps	.089	.138	.166	.271	.284	.293	.306	.336
	Pt	.099	.154	.188	.297	.318	.343	.360	.441
	Throw*	9-10-13	11-14-15	13-15-18	14-17-21	16-19-23	17-21-25	19-23-27	23-26-29
	Throw	6-7-11	7-11-13	11-14-15	12-15-17	16-18-20	18-20-22	20-22-24	21-23-26
	NC	30	35	40	44	50	56	62	68
15	CFM	490	615	735	875	1020	1165	-	-
	Ps	.112	.177	.253	.337	.355	.364	-	-
	Pt	.122	.193	.275	.368	.395	.414	-	-
	Throw*	10-12-14	13-15-17	13-16-20	16-19-22	19-21-25	21-23-27	-	-
	Throw	8-10-12	10-12-14	11-14-17	12-16-19	15-19-22	17-21-23	-	-
	NC	33	39	44	50	56	62	-	-

CEILING
DIFFUSERS

SQUARE CEILING DIFFUSERS

PHENOMENATOR

PERFORMANCE NOTES FOR SERIES XG-PHENOMENATOR

All data is tested in accordance with ANSI/ASHRAE 70-2006.

DEFINITION OF UNITS

CFM Cubic Feet per Minute (air)

fpm Velocity of air stream in Feet per Minute

Pv Velocity pressure (inches of water column)

Pt Total pressure (inches of water column)

Ps Static pressure = $P_t - P_v$ (inches of water column)

Throw* Non-isothermal horizontal throw (supply air temperature 15°F colder than average room temperature); values are for 150, 100 and 50fpm velocities

Throw Isothermal throw (supply air temperature the same as average room temperature); values are for 150, 100 and 50fpm velocities

NC Noise criterion, sound pressure level NC ratings are based on sound power level (Lw) re: 10^{-12} watts minus a 10dB room attenuation in all octave bands

Vn Neck Velocity

LOUVERED FACE DIFFUSERS

CEILING
DIFFUSERS

LOUVERED FACE DIFFUSERS

XG-5000

MODEL XG-5000



MODELS XG-5500 & XG-5000S



MODEL XG-5500DD



MODEL XG-9000

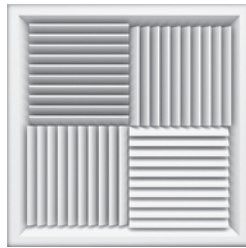

Model XG-5000 deflector blades are straight and do not include a horizontal lip, which makes it an excellent choice for high capacity applications. The high induction feature ensures draft free conditions in high ceiling applications.

PAGE 30

Models XG-5500 and XG-5500S incorporate a horizontal lip to create a high induction rate for rapid mixing of room air and primary air. The high induction feature ensures draft free conditions in low ceiling applications.

PAGE 50

Model XG-5500DD is designed to allow an optional ceiling tile (by others) to be installed from the face of the diffuser without having to remove the plenum. The unique horizontal lip on all sides of the diffuser face provides a horizontal air pattern that is tight to the ceiling.

PAGE 62

Model XG-9000 is a modular adjustable air diffuser engineered for supply air distribution. It is designed for ceiling installation and can be adjusted quickly and easily by rearranging the air pattern cores.

PAGE 67

MODEL XG-5000



- XG-5000-1 – Surface Mount**
- XG-5000-4 – Drop Face**
- XG-5000-46 – Drop Face – T-Bar Lay-in**
- XG- 5000-6 – T-bar Lay-in**
- XG-5000-7 – Concealed Spline**
- XG-5000-8 – Tegular Lay-in**
- XG-5000-9 – Donn Finline**

Air Outlets shall be aluminum model XG-5000 manufactured by GREENHECK. Units shall consist of a fixed pattern louvered core fastened into a border with spring loaded latches. Core shall be removable without the use of tools. Outlets shall be engineered for high capacity applications and include straight deflector blades (without a horizontal lip). Units with a horizontal lip at the ends of the deflector blades are not acceptable. The units shall be the size and quantity as outlined in the plans and specifications.

Outlets shall be available in 1, 2 way opposite, 2 way corner, 3, and 4 way directional air patterns. Units shall be designed to integrate into the specified ceiling system.

Options

Adjustable Pattern (horizontal to vertical)

Outlets shall include adjustable air pattern deflector blades that allows the air pattern to be set from vertical to horizontal (Optional APD Air Pattern Deflectors). Air pattern deflector blades shall be accessible from the face and the diffuser and adjustable without the use of tools.

IV Induction Vanes

Units shall include IV induction vanes factory mounted onto the back side of the deflector vanes. IV vanes shall increase the induction rate of the diffuser.

Accessories

Optional Dampers

Aluminum XG-D5A or Steel XG-D5 opposed blade dampers shall be provided. Damper shall be adjusted using a handle accessible through the face of the diffuser.

Screwdriver slot operators are not allowed.

Performance Specification

The manufacturer shall provide published performance data. Data shall be tested in accordance to ANSI/ASHRAE Standard 70- 2006.

MODEL XG-5000

CEILING
DIFFUSERS

LOUVERED FACE DIFFUSERS

XG-5000

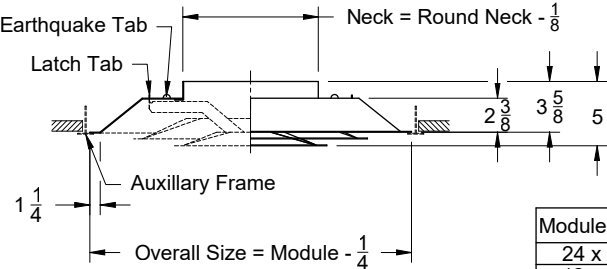
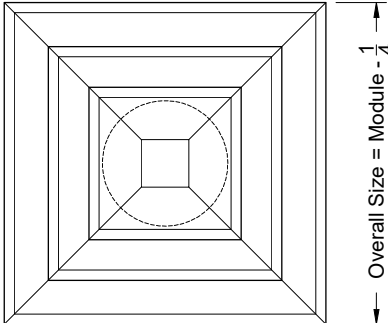
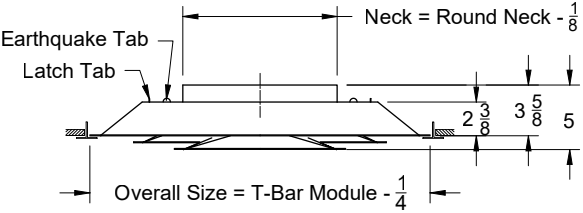
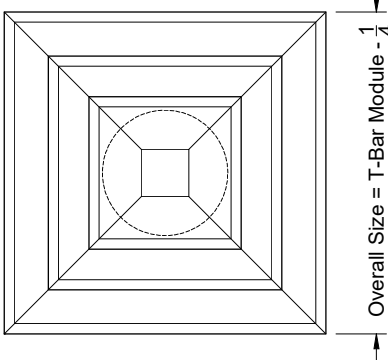
Model: XG-5700-1 XG-5700-6	Square Face - 2 Cone - Round Neck - Flush Surface Mount Square Face - 2 Cone - Round Neck - T-Bar Lay-In			
<h3>XG-5700-1 - Flush Surface Mount</h3>				
	<h3>Face View</h3> 			
<table border="1" style="margin: auto;"> <tr><th>Module Size</th></tr> <tr><td>24 x 24</td></tr> <tr><td>12 x 12</td></tr> </table>		Module Size	24 x 24	12 x 12
Module Size				
24 x 24				
12 x 12				
<p>Note: For surface mount installations, use of plaster frame is recommended</p>				
<h3>XG-5700-6 - T-Bar Lay-In</h3>				
	<h3>Face View</h3> 			
<table border="1" style="margin: auto;"> <tr><th>Module Size</th></tr> <tr><td>24 x 24</td></tr> <tr><td>12 x 12</td></tr> </table>		Module Size	24 x 24	12 x 12
Module Size				
24 x 24				
12 x 12				
1. Available Finishes Standard Finish: 01 White Finish 24 Mill Finish Optional Finish 02 Satin Silver 03 Black 28 Custom Color	2. Available Accessories XG-BDS - Butterfly Damper XG-RSD - Radial Shutter Damper XG-G3 - Equalizing Grid XG-BAF - Directional Baffles XG-TBPF - T-Bar Plaster Frame XG-EQS - Earthquake Straps XG-SNAP 58 - Extra Cone for 5700	3. Available Options XG-FGBP - Fiberglass Backpan	4. Construction Details <ul style="list-style-type: none"> ● Available Sizes Only as Listed ● Available Neck Sizes as Listed: 6, 8, 10, 12, 14 and 15 ● Materials: Available in Steel, Aluminum and Aluminized Steel. ● Consult Software for Available Border Types. 	
All Dimensions ±1/16"				

MODEL XG-5000

Model: XG-5500-2 Louvered Face - Removable Core - Bevel Drop Surface Mount

XG-5500-2 - Flush Surface Mount

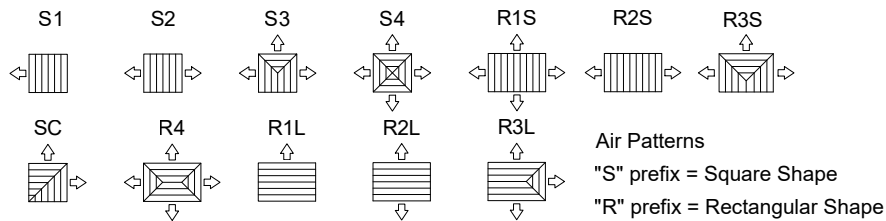
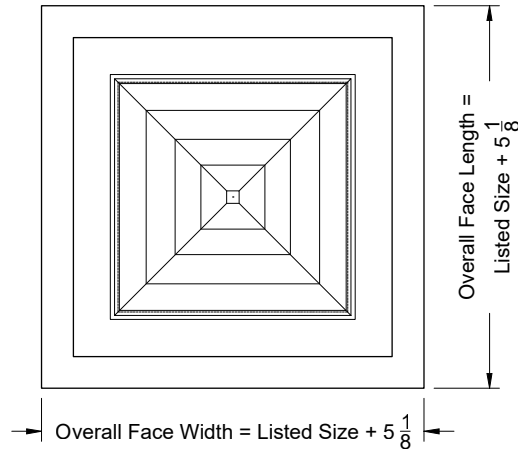
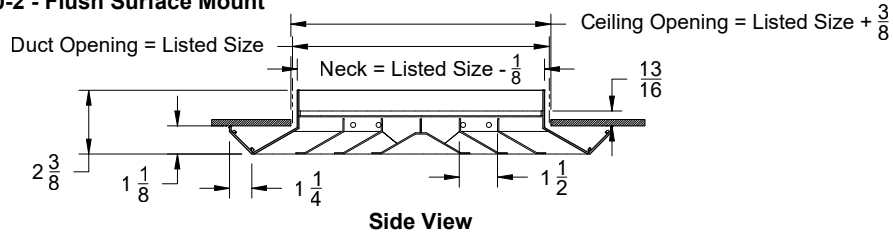

1. Available Finishes	2. Available Accessories	3. Available Options	4. Construction Details
Standard Finish: 01 White Finish 24 Mill Finish Optional Finish 02 Satin Silver 03 Black 28 Custom Color	XG-D5 - Steel Opposed Blade Damper XG-D5A - Aluminum OBD XG-RSD TR - Steel Radial Shutter Damper with Transition Square to Round XG-L9 - Equalizing Grid (Sq / Rect) XG-G3 - Equalizing Grid (Round) XG-TR - Transition Square to Round XG-TBPF - T-Bar Plaster Frame XG-LIPF - Lay-In Plaster Frame	APD - Air Pattern Deflector IV - Induction Vanes	<ul style="list-style-type: none"> Available Sizes Only as Listed Extruded Aluminum Frame and Cores
All Dimensions $\pm 1/16"$			

MODEL XG-5000

CEILING
DIFFUSERS

LOUVERED FACE DIFFUSERS

XG-5000

Model: XG-5500-6 Louvered Face - Removable Core - Lay In T-Bar

XG-5500-6 - Lay In T-Bar

Duct Opening = Listed Size

Neck Size = Listed Size - $\frac{1}{8}$

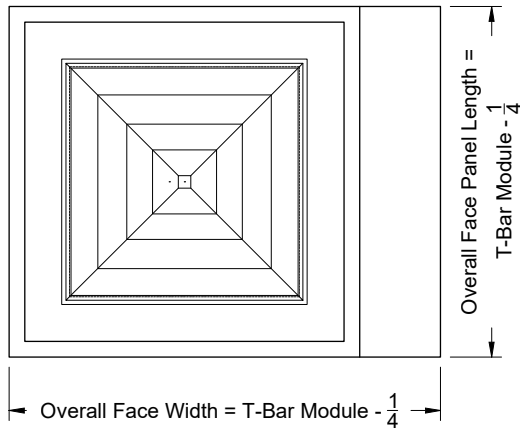
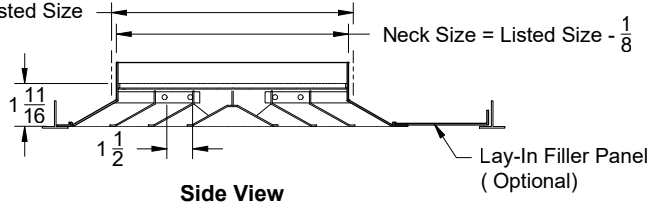

Face View

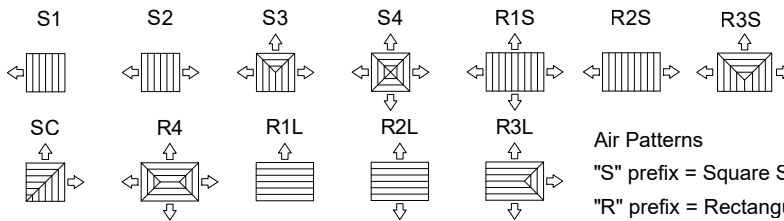

Available Module Size
12 x 12
24 x 24
36 x 24
48 x 24
48 x 48

1. Available Finishes

Standard Finish:
01 White
Finish
24 Mill Finish
Optional Finish
02 Satin Silver
03 Black
28 Custom Color

2. Available Accessories

XG-D5 - Steel Opposed Blade Damper
XG-D5A - Aluminum OBD
XG- RSD TR - Steel Radial Shutter Damper with Transition Square to Round
XG-L9 - Equalizing Grid (Sq / Rect)
XG-G3 - Equalizing Grid (Round)
XG-TR - Transition Square to Round
XG-TBPF - T-Bar Plaster Frame
XG-LIPF - Lay-In Plaster Frame

3. Available Options

APD - Air Pattern Deflector
IV - Induction Vanes

4. Construction Details

- Available Sizes Only as Listed
- Extruded Aluminum Frame and Cores

All Dimensions $\pm 1/16$ "

MODEL XG-5000

Model: XG-5500-8 Louvered Face - Removable Core - Tegular T-Bar

XG-5500-8 - Tegular T-Bar

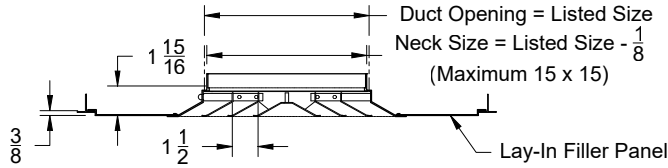

Side View

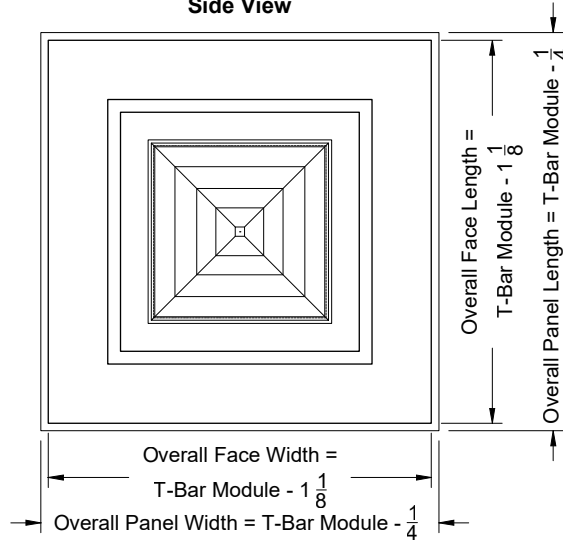

Face View

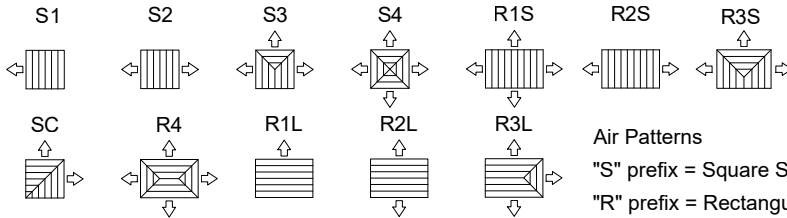

Available Module Size
24 x 24

1. Available Finishes	2. Available Accessories	3. Available Options	4. Construction Details
Standard Finish: 01 White Finish 24 Mill Finish Optional Finish 02 Satin Silver 03 Black 28 Custom Color	XG-D5 - Steel Opposed Blade Damper XG-D5A - Aluminum OBD XG- RSD TR - Steel Radial Shutter Damper with Transition Square to Round XG-L9 - Equalizing Grid (Sq / Rect) XG-G3 - Equalizing Grid (Round) XG-TR - Transition Square to Round XG-TBPF - T-Bar Plaster Frame XG-LIPF - Lay-In Plaster Frame	APD - Air Pattern Deflector IV - Induction Vanes	<ul style="list-style-type: none"> Available Sizes Only as Listed Extruded Aluminum Frame and Cores

All Dimensions ±1/16"

MODEL XG-5000

CEILING
DIFFUSERS

LOUVERED FACE DIFFUSERS

XG-5000

Model: XG-5500-9 Louvered Face - Removable Core - Bolt Slot

XG-5500-9 - Bolt Slot

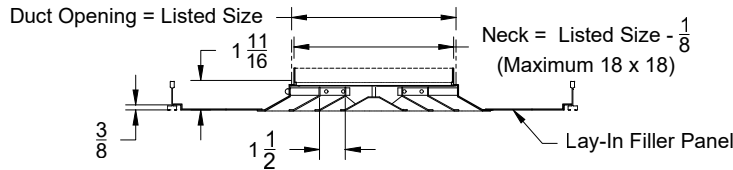

Side View

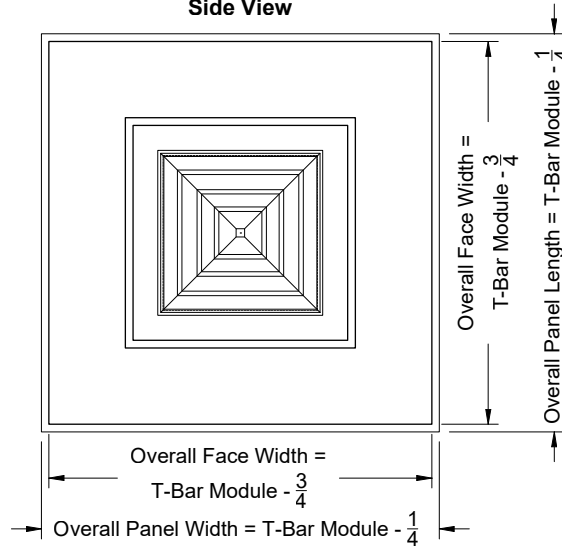

Face View

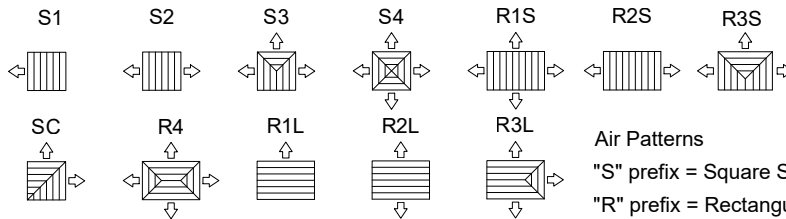

Available
Module Size
24 x 24

1. Available Finishes	2. Available Accessories	3. Available Options	4. Construction Details
Standard Finish: 01 White Finish 24 Mill Finish Optional Finish 02 Satin Silver 03 Black 28 Custom Color	XG-D5 - Steel Opposed Blade Damper XG-D5A - Aluminum OBD XG- RSD TR - Steel Radial Shutter Damper with Transition Square to Round XG-L9 - Equalizing Grid (Sq / Rect) XG-G3 - Equalizing Grid (Round) XG-TR - Transition Square to Round XG-TBPF - T-Bar Plaster Frame XG-LIPF - Lay-In Plaster Frame	APD - Air Pattern Deflector IV - Induction Vanes	<ul style="list-style-type: none"> Available Sizes Only as Listed Extruded Aluminum Frame and Cores

All Dimensions ±1/16"

XG-5000 MODEL NUMBER SPECIFICATION LOUVERED FACE CEILING DIFFUSER

Model		Neck															
		6	9	12	15	18	21	24	27	30	33	36	36	42	45	48	
XG-5000-1	Surface Mount - Extruded Aluminum	6	X														
XG-5000-2	Beveled Drop Surface Mount - Extruded Aluminum	9	X	X													
XG-5000-4	5000-4 Drop Face Surface Mount - Extruded Aluminum	12	X	X	X												
		15	X	X	X	X											
		18	X	X	X	X	X										
		21	X	X	X	X	X	X									
		24	X	X	X	X	X	X	X								
		27	X	X	X	X	X	X	X	X							
		30	X	X	X	X	X	X	X	X	X						
		33	X	X	X	X	X	X	X	X	X	X					
		36	X	X	X	X	X	X	X	X	X	X	X				
		39	X	X	X	X	X	X	X	X	X	X	X	X			
		42	X	X	X	X	X	X	X	X	X	X	X	X	X		
		45	X	X	X	X	X	X	X	X	X	X	X	X	X	X	
		48	X	X	X	X	X	X	X	X	X	X	X	X	X	X	X

Air Pattern		Available Accessories		Available Finishes	
Standard		XG-D5	Steel Opposed Blade Damper	Standard	
S4	Sq 4-Way	XG-D5A	Aluminum Opposed Blade Damper	01	White
Optional		XG-L9	Square / Rectangular Equalizing Grid	Optional	
S1	Sq 1-Way	XG-TR	Square to Round Transition	02	Satin Silver
S2	Sq 2-Way	XG-TR Deep (Used with Damper)	Deep Square to Round Transition	03	Black
S3	Sq 3-Way	XG-G3	Round Equalizing Grid	24	Mill
SC	Sq 2-Way corner	XG-BDS	Butterfly Damper	28	Custom Color
R1S	Rct 1-Way short	XG-RSD	Radial Shutter Damper		
R1L	Rct 1-Way long				
R2S	Rct 2-Way short	Available Options			
R2L	Rct 2-Way long	IV	Induction Vanes		
R3S	Rct 3-Way short	APD	Air Pattern Deflectors		
R3L	Rct 3-Way long	FSM	Facescrew Mount -1 only		
R4	Rct 4-Way				

XG-5000 MODEL NUMBER SPECIFICATION
LOUVERED FACE CEILING DIFFUSER

Model		Panel	Neck															
			6	9	12	15	18	21	24	27	30	33	36	39	42	45		
XG-5000-6	T-bar Lay-in - Extruded Aluminum	12 x 12	6	X														
			9		X													
XG-5000-6 XG-5000-7 XG-5000-8 XG-5000-9	T-bar Lay-in - Extruded Aluminum Concealed Spline - Extruded Aluminum Tegular T-bar - Extruded Aluminum Donn Finline - Extruded Aluminum	24 x 24	6	X														
			9	X	X													
			12	X	X	X												
			15	X	X	X	X											
			18					X										
			21						X									
XG-5000-6	T-bar Lay-in - Extruded Aluminum	36 x 24	6	X														
			9	X	X													
			12	X	X	X												
			15	X	X	X	X											
			18	X	X	X	X	X										
			21	X	X	X	X	X										
			24	X	X	X	X	X										
			27	X	X	X	X	X										
			30						X									
			33						X									
XG-5000-6	T-bar Lay-in - Extruded Aluminum	48 x 24	6	X														
			9	X	X													
			12	X	X	X												
			15	X	X	X	X											
			18	X	X	X	X	X										
			21	X	X	X	X	X										
			24	X	X	X	X	X										
			27	X	X	X	X	X										
			30	X	X	X	X	X	X									
			33	X	X	X	X	X	X									
			36	X	X	X	X	X	X									
			39	X	X	X	X	X	X									
						42						X						
			45							X								
XG-5000-6	T-bar Lay-in - Extruded Aluminum	48 x 48	6	X														
			9	X	X													
			12	X	X	X												
			15	X	X	X	X											
			18	X	X	X	X	X										
			21	X	X	X	X	X	X									
			24	X	X	X	X	X	X	X								
			27	X	X	X	X	X	X	X	X							
			30	X	X	X	X	X	X	X	X	X						
			33	X	X	X	X	X	X	X	X	X	X					
			36	X	X	X	X	X	X	X	X	X	X	X				
			39	X	X	X	X	X	X	X	X	X	X	X	X			
						42											X	
			45													X		

CEILING
DIFFUSERS

LOUVERED FACE DIFFUSERS

XG-5000

XG-5000 MODEL NUMBER SPECIFICATION LOUVERED FACE CEILING DIFFUSER

Air Pattern		Available Accessories		Available Finishes	
Standard		XG-D5	Steel Opposed Blade Damper	Standard	
S4	Sq 4-Way	XG-D5A	Aluminum Opposed Blade Damper	01	White
Optional		XG-L9	Square / Rectangular Equalizing Grid	Optional	
S1	Sq 1-Way	XG-TR	Square to Round Transition	02	Satin Silver
S2	Sq 2-Way	XG-TR Deep (Used with Damper)	Deep Square to Round Transition	03	Black
S3	Sq 3-Way	XG-G3	Round Equalizing Grid	24	Mill
SC	Sq 2-Way corner	XG-BDS	Butterfly Damper	28	Custom Color
R1S	Rct 1-Way short	XG-RSD	Radial Shutter Damper		
R1L	Rct 1-Way long				
R2S	Rct 2-Way short	Available Options			
R2L	Rct 2-Way long	IV	Induction Vanes		
R3S	Rct 3-Way short	APD	Air Pattern Deflectors		
R3L	Rct 3-Way long				
R4	Rct 4-Way				

**SERIES XG-5000 PERFORMANCE DATA/4-WAY SQUARE PATTERN (S4)
MODEL XG-5000**

Neck Size		Neck Velocity					
		200	300	400	500	600	700
		Ps	0.006	0.013	0.022	0.035	0.05
	Pt	0.008	0.018	0.032	0.05	0.072	0.099
6 x 6	Total CFM	50	75	100	125	150	175
	CFM/Side	13	19	25	31	38	44
	Throw	2-4	4-8	7-11	9-13	11-16	13-17
	NC	-	-	-	-	20	25
9 x 9	Total CFM	113	169	225	281	335	394
	CFM/Side	28	42	56	70	84	98
	Throw	3-5	5-9	8-12	10-15	12-17	14-18
	NC	-	-	-	21	26	31
12 x 12	Total CFM	200	300	400	500	600	700
	CFM/Side	50	75	100	125	150	175
	Throw	3-7	6-10	9-14	11-16	13-18	15-20
	NC	-	-	-	24	29	34
15 x 15	Total CFM	313	469	625	781	938	1094
	CFM/Side	78	117	156	195	234	273
	Throw	4-8	7-12	10-15	12-18	15-20	17-22
	NC	-	-	21	26	31	36
18 x 18	Total CFM	450	675	900	1125	1350	1575
	CFM/Side	113	169	225	281	338	394
	Throw	5-10	8-14	11-17	14-20	16-22	18-23
	NC	-	-	22	27	32	37
21 x 21	Total CFM	613	919	1225	1531	1837	2144
	CFM/Side	153	230	306	383	459	536
	Throw	6-12	9-16	12-19	15-21	17-23	19-25
	NC	-	-	23	28	33	38
24 x 24	Total CFM	800	1200	1600	2000	2400	2800
	CFM/Side	200	300	400	500	600	700
	Throw	7-14	10-17	12-20	16-23	18-25	21-27
	NC	-	-	24	29	34	39
27 x 27	Total CFM	1013	1519	2025	2531	3037	3544
	CFM/Side	253	380	506	633	759	886
	Throw	7-15	11-19	14-22	17-25	20-27	22-28
	NC	-	20	25	30	35	4
33 x 33	Total CFM	1513	2269	3025	3781	4537	5294
	CFM/Side	378	567	756	945	1134	1323
	Throw	9-18	13-22	16-25	19-27	22-30	24-31
	NC	-	21	26	31	36	41

CEILING
DIFFUSERS

LOUVERED FACE DIFFUSERS

XG-5000

**SERIES XG-5000 PERFORMANCE DATA/4-WAY RECTANGULAR PATTERN (R4)
MODEL XG-5000**

Neck Size	Side Designation	Neck Velocity															
		200		300		400		500		600		700					
		Ps		.013		.022		.035		.050		.068					
		Pt		.018		.032		.050		.072		.099					
		A	B	A	B	A	B	A	B	A	B	A	B				
6 x 9	Total CFM		75		113		150		185		225		263				
	CFM/Side	13	25	19	38	25	50	31	63	38	75	43	86				
	Throw	2-4	2-5	4-8	5-9	7-11	8-12	9-13	10-14	11-16	12-17	13-17	14-18				
	NC	-		-		-		-		-		-					
6 x 12	Total CFM		100		150		200		250		300		350				
	CFM/Side	13	38	19	56	25	75	31	94	38	113	44	131				
	Throw	2-4	3-6	4-8	6-10	7-11	8-13	9-13	11-15	11-16	13-17	13-17	15-19				
	NC	-		-		-		20		25		30					
9 x 12	Total CFM		150		225		300		375		450		525				
	CFM/Side	28	47	42	70	56	94	70	117	84	141	98	164				
	Throw	3-5	3-7	5-9	6-10	8-12	9-13	10-15	11-16	12-17	13-18	14-18	15-20				
	NC	-		-		-		22		27		32					
9 x 15	Total CFM		188		281		375		469		563		656				
	CFM/Side	28	66	42	98	56	131	70	164	84	197	98	230				
	Throw	3-5	4-8	5-9	7-11	8-12	9-14	10-15	12-17	12-17	14-19	14-18	16-21				
	NC	-		-		-		23		28		33					
9 x 18	Total CFM		225		338		450		563		675		788				
	CFM/Side	28	84	42	127	56	169	70	211	84	253	98	295				
	Throw	3-5	4-9	5-9	7-12	8-12	10-16	10-15	13-18	12-17	15-20	14-18	17-22				
	NC	-		-		-		24		29		34					
9 x 21	Total CFM		263		394		525		656		788		919				
	CFM/Side	28	103	42	155	56	206	70	258	84	309	98	361				
	Throw	3-5	5-10	5-9	8-13	8-12	11-17	10-15	13-19	12-17	16-21	14-18	18-23				
	NC	-		-		20		25		30		35					
12 x 15	Total CFM		250		375		500		625		750		875				
	CFM/Side	50	75	75	113	100	150	125	188	150	225	175	263				
	Throw	3-7	4-8	6-10	7-12	9-14	10-15	11-16	12-18	13-18	14-20	15-20	16-21				
	NC	-		-		20		25		30		35					
12 x 18	Total CFM		300		450		600		750		900		1050				
	CFM/Side	50	100	75	150	100	200	125	250	150	300	175	350				
	Throw	3-7	5-10	6-10	8-13	9-14	11-16	11-16	13-19	13-18	15-21	15-20	17-23				
	NC	-		-		20		25		30		35					

CEILING
DIFFUSERS

LOUVERED FACE DIFFUSERS

XG-5000

**SERIES XG-5000 PERFORMANCE DATA/4-WAY RECTANGULAR PATTERN (R4)
MODEL XG-5000**

CEILING
DIFFUSERS

LOUVERED FACE DIFFUSERS

XG-5000

Neck Size	Side Designation	Neck Velocity																	
		200		300		400		500		600		700							
		Ps		.013		.022		.035		.050		.068							
		Pt		.018		.032		.050		.072		.099							
		A	B	A	B	A	B	A	B	A	B	A	B	A	B				
12 x 21	Total CFM		350		525		700		875		1050		1225						
	CFM/Side	50		125	75	188	100		250	125		313	150		375	175		438	
	Throw	3-7		5-11	6-10		8-14	9-14		11-18	11-16		14-20	13-18		16-22	15-20		18-24
	NC		-			-		21			26			31				36	
12 x 24	Total CFM		400		600		800		1000		1200		1400						
	CFM/Side	50		150	75	225	100		300	125		375	150		450	175		525	
	Throw	3-7		6-12	6-10		9-15	9-14		12-19	11-16		15-21	13-18		17-23	15-20		1-25
	NC		-			-		22			27			32				37	
15 x 18	Total CFM		375		563		750		938		1125		1313						
	CFM/Side	78		109	117	164	156		219	195		273	234		328	273		383	
	Throw	4-8		5-10	7-12		8-14	10-15		11-17	12-18		14-19	15-20		16-22	17-22		18-23
	NC		-			-		21			26			31				36	
15 x 24	Total CFM		500		750		1000		1250		1500		1750						
	CFM/Side	78		172	117	258	156		344	195		430	234		516	273		602	
	Throw	4-8		6-13	7-12		9-16	10-15		13-19	12-18		15-22	15-20		18-24	17-22		20-26
	NC		-			-		22			27			32				37	
18 x 24	Total CFM		600		900		1200		1500		1800		2100						
	CFM/Side	113		188	160	281	225		375	281		469	338		563	394		656	
	Throw	5-10		6-13	8-14		10-17	11-17		13-20	14-20		16-23	16-22		18-25	18-23		20-26
	NC		-			-		23			28			33				38	
21 x 33	Total CFM		963		1444		1925		2406		2888		3369						
	CFM/Side	153		328	230	492	306		656	383		820	459		984	536		1148	
	Throw	6-12		8-17	9-16		12-21	12-19		15-24	15-21		18-26	17-23		21-29	19-25		23-30
	NC		-			20		25			30			35				40	
24 x 30	Total CFM		1000		1500		2000		2500		3000		3500						
	CFM/Side	200		300	300	1500	400		600	500		750	600		900	700		1050	
	Throw	7-14		8-16	10-17		12-20	13-20		15-23	16-23		18-26	18-25		21-28	21-27		23-30
	NC		-			20		25			30			35				40	

SERIES XG-5000 PERFORMANCE DATA/3-WAY SQUARE PATTERN (S3)
MODEL XG-5000

Neck Size		Neck Velocity					
		200	300	400	500	600	700
		Ps	0.006	0.013	0.022	0.035	0.05
	Pt	0.008	0.018	0.032	0.05	0.072	0.099
6 x 6	Total CFM	50	75	100	125	150	175
	CFM/Side	13	19	25	31	38	44
	Throw	2-4	4-8	7-11	9-13	11-16	13-17
	NC	-	-	-	-	20	25
9 x 9	Total CFM	113	169	225	281	335	394
	CFM/Side	28	42	56	70	84	98
	Throw	3-5	5-9	8-12	10-15	12-17	14-18
	NC	-	-	-	21	26	31
12 x 12	Total CFM	200	300	400	500	600	700
	CFM/Side	50	75	100	125	150	175
	Throw	3-7	6-10	9-14	11-16	13-18	15-20
	NC	-	-	-	24	29	34
15 x 15	Total CFM	313	469	625	781	938	1094
	CFM/Side	78	117	156	195	234	273
	Throw	4-8	7-12	10-15	12-18	15-20	17-22
	NC	-	-	21	26	31	36
18 x 18	Total CFM	450	675	900	1125	1350	1575
	CFM/Side	113	169	225	281	338	394
	Throw	5-10	8-14	11-17	14-20	16-22	18-23
	NC	-	-	22	27	32	37
21 x 21	Total CFM	613	919	1225	1531	1837	2144
	CFM/Side	153	230	306	383	459	536
	Throw	6-12	9-16	12-19	15-21	17-23	19-25
	NC	-	-	23	28	33	38
24 x 24	Total CFM	800	1200	1600	2000	2400	2800
	CFM/Side	200	300	400	500	600	700
	Throw	7-14	10-17	12-20	16-23	18-25	21-27
	NC	-	-	24	29	34	39
27 x 27	Total CFM	1013	1519	2025	2531	3037	3544
	CFM/Side	253	380	506	633	759	886
	Throw	7-15	11-19	14-22	17-25	20-27	22-28
	NC	-	20	25	30	35	4

**SERIES XG-5000 PERFORMANCE DATA/3-WAY RECTANGULAR PATTERN (R3S)
MODEL XG-5000**

Neck Size	Side Destination	Neck Velocity															
		200		300		400		500		600		700					
		Ps		.013		.022		.035		.050		.068					
		Pt		.018		.032		.050		.072		.099					
	A	B	A	B	A	B	A	B	A	B	A	B	A	B			
6 x 9	Total CFM		75		113		150		188		225		263		31		
	CFM/Side	28	23	42	35	56	47	70	59	84	70	98	82				
	Throw	3-6	3-6	7-12	7-11	11-18	11-17	16-23	16-23	21-29	20-28	24-32	24-34				
	NC	-	-	-	-	-	-	-	21	-	26	-	31	-	-		
6 x 12	Total CFM		100		150		200		250		300		350				
	CFM/Side	50	25	75	38	100	50	125	63	150	75	175	88				
	Throw	5-9	3-6	8-15	7-12	13-20	11-17	18-26	16-23	22-31	20-28	26-37	24-34				
	NC	-	-	-	-	-	-	-	23	-	28	-	33	-	-		
9 x 12	Total CFM		150		225		300		375		450		525				
	CFM/Side	50	50	75	75	100	100	125	125	150	150	175	175				
	Throw	5-9	5-9	8-15	8-15	13-20	13-20	18-26	18-26	22-31	22-31	26-37	26-37				
	NC	-	-	-	-	20	-	25	-	30	-	35	-	-	-		
9 x 15	Total CFM		188		281		375		469		563		656				
	CFM/Side	78	55	117	82	156	109	195	137	234	164	273	191				
	Throw	4-8	3-7	7-12	6-11	10-15	9-14	12-18	11-16	15-20	14-19	17-22	15-20				
	NC	20	-	20	-	20	-	23	-	28	-	33	-	-	-		
12 x 15	Total CFM		250		375		500		625		750		875				
	CFM/Side	78	86	117	129	156	172	195	215	234	258	273	301				
	Throw	4-8	4-9	7-12	7-12	10-15	10-16	12-18	13-18	15-20	15-20	17-22	17-22				
	NC	20	-	20	-	20	-	25	-	30	-	35	-	-	-		
12 x 18	Total CFM		300		450		600		750		900		1050				
	CFM/Side	113	94	169	141	225	188	281	234	338	281	394	328				
	Throw	5-10	4-9	8-14	7-13	11-17	10-16	14-20	13-19	16-22	15-21	18-23	17-22				
	NC	20	-	20	-	20	-	25	-	30	-	35	-	-	-		
15 x 18	Total CFM		375		563		750		938		1125		1313				
	CFM/Side	113	131	169	197	225	263	281	238	338	394	394	459				
	Throw	5-10	5-11	8-14	8-15	11-17	12-18	14-20	14-20	16-22	17-23	18-23	19-24				
	NC	20	-	20	-	21	-	26	-	31	-	36	-	-	-		
15 x 21	Total CFM		438		656		875		1094		1313		1531				
	CFM/Side	153	142	230	213	306	284	383	355	459	427	536	498				
	Throw	6-12	5-11	9-16	9-15	12-19	12-18	15-21	15-21	17-23	17-23	19-25	19-25				
	NC	20	-	20	-	22	-	27	-	32	-	37	-	-	-		
18 x 24	Total CFM		600		900		1200		1500		1800		2100				
	CFM/Side	200	200	300	300	400	400	500	500	600	600	700	700				
	Throw	7-14	7-14	10-17	10-17	13-20	13-20	16-23	16-23	18-25	18-25	21-27	21-27				
	NC	20	-	20	-	23	-	28	-	33	-	38	-	-	-		
21 x 27	Total CFM		788		1181		1575		1969		2362		2756				
	CFM/Side	253	267	380	401	506	534	633	668	759	802	886	935				
	Throw	7-15	7-15	11-19	11-19	14-22	15-22	17-25	17-25	20-27	20-27	22-28	22-29				
	NC	20	-	20	-	24	-	29	-	34	-	39	-	-	-		
24 x 30	Total CFM		1000		1500		2000		2500		3000		3500				
	CFM/Side	313	344	469	516	625	688	781	859	938	1031	1094	1203				
	Throw	8-17	8-17	12-20	12-11	15-23	16-24	18-26	19-27	21-28	21-29	23-30	23-31				
	NC	20	-	20	-	25	-	30	-	35	-	40	-	-	-		

CEILING
DIFFUSERS

LOUVERED FACE DIFFUSERS

XG-5000

**SERIES XG-5000 PERFORMANCE DATA/3-WAY RECTANGULAR PATTERN (R3L)
MODEL XG-5000**

Neck Size	Side Designation	Neck Velocity																	
		200		300		400		500		600		700							
		Ps		.013		.022		.035		.050		.068							
		Pt		.018		.032		.050		.072		.099							
		A	B	A	B	A	B	A	B	A	B	A	B	A	B				
6 x 9	Total CFM		75		113		150		185		225		263						
	CFM/Side	13		25	19		38	25		50	31		63	38		75	43		86
	Throw	2-4		2-5	4-8		5-9	7-11		8-12	9-13		10-14	11-16		12-17	13-17		14-18
	NC		-				-			-			-			-			-
6 x 12	Total CFM		100		150		200		250		300		350						
	CFM/Side	13		38	19		56	25		75	31		94	38		113	44		131
	Throw	2-4		3-6	4-8		6-10	7-11		8-13	9-13		11-15	11-16		13-17	13-17		15-19
	NC		-				-			20			25					30	
9 x 12	Total CFM		150		225		300		375		450		525						
	CFM/Side	28		47	42		70	56		94	70		117	84		141	98		164
	Throw	3-5		3-7	5-9		6-10	8-12		9-13	10-15		11-16	12-17		13-18	14-18		15-20
	NC		-				-			22			27					32	
9 x 15	Total CFM		188		281		375		469		563		656						
	CFM/Side	28		66	42		98	56		131	70		164	84		197	98		230
	Throw	3-5		4-8	5-9		7-11	8-12		9-14	10-15		12-17	12-17		14-19	14-18		16-21
	NC		-				-			23			28					33	
9 x 18	Total CFM		225		338		450		563		675		788						
	CFM/Side	28		84	42		127	56		169	70		211	84		253	98		295
	Throw	3-5		4-9	5-9		7-12	8-12		10-16	10-15		13-18	12-17		15-20	14-18		17-22
	NC						-			-			24			29			34
9 x 21	Total CFM		263		394		525		656		788		919						
	CFM/Side	28		103	42		155	56		206	70		258	84		309	98		361
	Throw	3-5		5-10	5-9		8-13	8-12		11-17	10-15		13-19	12-17		16-21	14-18		18-23
	NC		-				-			20			25			30			35
12 x 15	Total CFM		250		375		500		625		750		875						
	CFM/Side	50		75	75		113	100		150	125		188	150		225	175		263
	Throw	3-7		4-8	6-10		7-12	9-14		10-15	11-16		12-18	13-18		14-20	15-20		16-21
	NC		-				-			20			25			30			35

CEILING
DIFFUSERS

LOUVERED FACE DIFFUSERS

XG-5000

**SERIES XG-5000 PERFORMANCE DATA/3-WAY RECTANGULAR PATTERN (R3L)
MODEL XG-5000**

Neck Size	Side Designation	Neck Velocity													
		200		300		400		500		600		700			
		Ps		.013		.022		.035		.050		.068			
		Pt		.018		.032		.050		.072		.099			
		A	B	A	B	A	B	A	B	A	B	A	B		
12 x 18	Total CFM		300		450		600		750		900		1050		
	CFM/Side	50		100	75	150	100	200	125	250	150	300	175	350	
	Throw	3-7		5-10	6-10	8-13	9-14	11-16	11-16	13-19	13-18	15-21	15-20	17-23	
	NC		-		-		20		25		30		35		
12 x 21	Total CFM		375		563		750		938		1125		1313		
	CFM/Side	148		78	223	117	297	156	371	195	445	234	520	273	
	Throw	6-12		4-8	9-15	7-12	12-19	10-15	15-21	12-18	17-23	15-20	19-25	17-22	
	NC		20		20		21		26		31		36		
12 x 24	Total CFM		438		656		875		1094		1313		1531		
	CFM/Side	180		78	270	117	359	156	449	195	539	234	629	273	
	Throw	6-13		4-8	10-17	7-12	13-20	10-15	16-22	12-18	18-27	16-22	20-26	17-22	
	NC		20		20		22		27		32		37		
15 x 18	Total CFM		525		788		1050		1313		1575		1837		
	CFM/Side	206		113	309	169	413	225	516	281	619	338	722	394	
	Throw	7-14		5-10	10-17	8-14	13-21	11-17	16-23	14-20	19-25	16-22	21-27	18-23	
	NC		20		20		23		28		33		38		
15 x 24	Total CFM		600		900		1200		1500		1800		2100		
	CFM/Side	244		113	366	169	488	225	609	281	731	338	853	394	
	Throw	7-15		5-10	11-19	8-14	14-22	11-17	17-24	14-20	19-26	17-23	22-28	18-23	
	NC		20		20		23		28		33		38		
18 x 24	Total CFM		788		1181		1575		1969		2362		2756		
	CFM/Side	317		153	476	230	634	306	793	383	952	459	1110	536	
	Throw	8-17		6-12	12-20	9-16	15-24	12-19	18-26	15-21	21-28	18-23	23-30	19-25	
	NC		20		20		24		29		34		39		

CEILING
DIFFUSERS

LOUVERED FACE DIFFUSERS

XG-5000

**SERIES XG-5000 PERFORMANCE DATA/2-WAY SQUARE PATTERN (S2 – SC)
 MODEL XG-5000**

Neck Size		Neck Velocity					
		200	300	400	500	600	700
		Ps	0.006	0.013	0.022	0.035	0.05
	Pt	0.008	0.018	0.032	0.05	0.072	0.099
6 x 6	Total CFM	50	75	100	125	150	175
	CFM/Side	25	38	50	63	75	88
	Throw	2-5	5-9	8-12	10-14	12-17	14-18
	NC	20	20	20	20	20	25
9 x 9	Total CFM	113	169	225	281	338	394
	CFM/Side	56	84	113	141	169	197
	Throw	3-7	6-11	9-14	12-17	14-19	16-20
	NC	20	20	20	21	26	31
12 x 12	Total CFM	200	300	400	500	600	700
	CFM/Side	100	150	200	250	300	350
	Throw	5-10	8-13	11-16	13-19	15-21	17-23
	NC	20	20	20	24	29	34
15 x 15	Total CFM	313	469	625	781	938	1094
	CFM/Side	156	234	313	391	469	547
	Throw	6-12	9-16	12-19	15-21	17-24	19-25
	NC	20	20	21	26	31	36
18 x 18	Total CFM	450	675	900	1125	1350	1575
	CFM/Side	225	338	450	563	675	788
	Throw	7-14	10-18	14-21	17-24	19-26	21-28
	NC	20	20	22	27	32	37
21 x 21	Total CFM	613	919	1225	1531	1837	2144
	CFM/Side	306	459	613	766	979	1072
	Throw	8-17	12-20	15-23	18-26	21-28	23-30
	NC	20	20	23	28	33	38
24 x 24	Total CFM	800	1200	1600	2000	2400	2800
	CFM/Side	400	600	800	1000	1200	1400
	Throw	9-18	13-22	16-25	19-28	22-30	24-30
	NC	20	20	24	29	34	39
27 x 27	Total CFM	1013	1519	2025	2531	3037	3544
	CFM/Side	506	759	1013	1266	1519	1772
	Throw	10-20	14-24	17-27	21-29	23-32	25-33
	NC	20	20	25	30	35	40

**SERIES XG-5000 PERFORMANCE DATA/1-WAY SQUARE PATTERN (S1)
MODEL XG-5000**

Neck Size		Neck Velocity					
		200	300	400	500	600	700
		Ps	0.006	0.013	0.022	0.035	0.05
	Pt	0.008	0.018	0.032	0.05	0.072	0.099
6 x 6	Total CFM	50	75	100	125	150	175
	Throw	3-7	6-10	9-14	11-16	13-18	15-20
	NC	20	20	20	20	20	25
9 x 9	Total CFM	113	169	225	281	338	394
	Throw	5-10	8-14	11-17	14-20	16-22	18-23
	NC	20	20	20	21	26	31
12 x 12	Total CFM	200	300	400	500	600	700
	Throw	7-14	10-17	13-20	16-23	18-25	21-27
	NC	20	20	20	24	29	34
15 x 15	Total CFM	313	469	625	781	938	1094
	Throw	8-17	12-20	15-23	18-26	21-28	23-30
	NC	20	20	21	26	31	36
18 x 18	Total CFM	450	675	900	1125	1350	1575
	Throw	9-19	13-23	17-26	20-29	23-31	25-32
	NC	20	20	22	27	32	37
21 x 21	Total CFM	615	919	1225	1531	1837	2144
	Throw	10-21	14-25	18-28	21-31	24-33	26-35
	NC	20	20	23	28	33	38
24 x 24	Total CFM	800	1200	1600	2000	2400	2800
	Throw	11-23	15-27	19-30	23-32	25-34	28-36
	NC	20	20	24	29	34	39
27 x 27	Total CFM	1013	1519	2025	2531	3037	3544
	Throw	12-24	16-28	20-31	23-34	26-36	29-38
	NC	20	20	25	30	35	40

CEILING
DIFFUSERS

LOUVERED FACE DIFFUSERS

XG-5000

**SERIES XG-5000 PERFORMANCE DATA/
 2-WAY RECTANGULAR PATTERN (R2L – R2S)
 MODEL XG-5000**

Neck Size		Neck Velocity					
		200	300	400	500	600	700
		Ps	0.006	0.013	0.022	0.035	0.05
	Pt	0.008	0.018	0.032	0.05	0.072	0.099
6 x 9	Total CFM	75	113	150	188	225	263
	CFM/Side	38	56	75	94	113	131
	Throw	3-6	6-10	8-13	11-15	13-17	15-19
	NC	20	20	20	20	23	28
6 x 12	Total CFM	100	150	200	250	300	350
	CFM/Side	50	75	100	125	150	175
	Throw	3-7	6-10	9-14	11-16	13-18	15-20
	NC	20	20	20	20	25	30
6 x 15	Total CFM	125	188	250	313	375	438
	CFM/Side	63	94	125	156	188	219
	Throw	4-7	6-11	9-14	12-17	14-19	16-21
	NC	20	20	20	21	26	31
6 x 18	Total CFM	150	225	300	375	450	525
	CFM/Side	75	113	150	188	225	263
	Throw	4-8	7-12	10-15	12-18	14-20	16-21
	NC	20	20	20	22	27	32
9 x 15	Total CFM	188	281	375	469	563	656
	CFM/Side	94	141	188	234	281	328
	Throw	4-9	7-13	10-16	13-19	15-21	17-22
	NC	20	20	20	23	28	33
9 x 18	Total CFM	225	338	450	563	675	788
	CFM/Side	113	169	225	281	338	394
	Throw	5-10	8-14	11-17	14-20	16-22	18-23
	NC	20	20	20	24	29	34
9 x 21	Total CFM	263	394	525	656	788	919
	CFM/Side	131	197	263	328	394	459
	Throw	5-11	8-15	12-18	14-20	17-23	19-24
	NC	20	20	20	25	30	35
12 x 15	Total CFM	250	375	500	625	750	875
	CFM/Side	125	188	250	313	375	438
	Throw	5-11	8-14	11-18	14-20	16-22	18-24
	NC	20	20	20	25	30	35

**SERIES XG-5000 PERFORMANCE DATA/
2-WAY RECTANGULAR PATTERN (R2L – R2S)
MODEL XG-5000**

Neck Size		Neck Velocity					
		200	300	400	500	600	700
		Ps	0.006	0.013	0.022	0.035	0.05
	Pt	0.008	0.018	0.032	0.05	0.072	0.099
12 x 18	Total CFM	300	450	600	750	900	1050
	CFM/Side	150	225	300	375	450	525
	Throw	6-12	9-15	12-19	15-21	17-23	19-25
	NC	20	20	20	25	30	35
12 x 21	Total CFM	350	525	700	875	1050	1225
	CFM/Side	175	263	350	438	525	613
	Throw	6-13	9-16	13-20	15-22	18-24	20-26
	NC	20	20	21	26	31	36
15 x 21	Total CFM	438	656	875	1094	1313	1531
	CFM/Side	219	328	438	547	656	766
	Throw	7-14	10-18	14-21	16-24	19-26	21-27
	NC	20	20	22	27	32	37
15 x 24	Total CFM	500	750	1000	1250	1500	1750
	CFM/Side	250	375	500	625	750	875
	Throw	7-15	11-19	14-22	17-25	20-27	22-28
	NC	20	20	22	27	32	37
18 x 21	Total CFM	525	788	1050	1313	1575	1837
	CFM/Side	263	394	525	656	788	919
	Throw	7-15	11-19	14-22	17-25	20-27	22-29
	NC	20	20	23	28	33	38
18 x 24	Total CFM	600	900	1200	1500	1800	2100
	CFM/Side	300	450	600	750	900	1050
	Throw	8-16	12-20	15-23	18-26	21-28	23-30
	NC	20	20	23	28	33	38
21 x 27	Total CFM	788	1181	1575	1969	2362	2756
	CFM/Side	394	591	788	984	1181	1378
	Throw	9-18	13-22	16-25	19-28	22-30	24-32
	NC	20	20	24	20	34	39

**SERIES XG-5000 PERFORMANCE DATA/
 1-WAY RECTANGULAR PATTERN (R1L – R1S)
 MODEL XG-5000**

Neck Size		Neck Velocity					
		200	300	400	500	600	700
		Ps	0.006	0.013	0.022	0.035	0.05
	Pt	0.008	0.018	0.032	0.05	0.072	0.099
6 x 9	Total CFM	75	113	150	188	225	263
	Throw	4-8	7-12	10-15	12-18	14-20	16-21
	NC	20	20	20	20	23	28
6 x 12	Total CFM	100	150	200	250	300	350
	Throw	5-10	8-13	11-16	13-19	15-21	17-23
	NC	20	20	20	20	25	30
6 x 15	Total CFM	125	188	250	313	375	438
	Throw	5-11	8-14	11-18	14-20	16-22	18-24
	NC	20	20	20	21	26	31
6 x 18	Total CFM	150	225	300	300	450	525
	Throw	6-12	9-15	12-19	12-19	17-23	19-25
	NC	20	20	20	20	27	32
6 x 21	Total CFM	175	263	350	438	525	613
	Throw	6-13	9-16	13-20	15-22	18-24	20-26
	NC	20	20	20	23	28	33
9 x 15	Total CFM	188	281	375	469	563	656
	Throw	6-13	10-17	13-20	16-23	18-25	20-26
	NC	20	20	20	23	28	33
9 x 18	Total CFM	225	338	450	563	675	788
	Throw	7-14	10-18	14-21	17-24	19-26	21-28
	NC	20	20	20	24	29	34
12 x 15	Total CFM	250	375	500	625	750	875
	Throw	7-15	11-19	14-22	17-25	20-27	22-28
	NC	20	20	20	25	30	35
12 x 18	Total CFM	300	450	600	750	900	1050
	Throw	8-16	12-20	15-23	18-26	21-28	23-30
	NC	20	20	20	25	30	35
15 x 21	Total CFM	438	656	875	1094	1313	1531
	Throw	9-19	13-23	17-26	20-28	22-31	25-32
	NC	20	20	22	27	32	37
15 x 24	Total CFM	500	750	1000	1250	1500	1750
	Throw	10-20	14-24	17-27	20-29	23-31	25-33
	NC	20	20	22	27	32	37
18 x 21	Total CFM	525	788	1050	1313	1575	1837
	Throw	10-20	14-24	18-27	21-30	23-32	26-34
	NC	20	20	23	28	33	38
18 x 24	Total CFM	600	900	1200	1500	1800	2100
	Throw	10-21	14-25	18-28	21-31	24-33	26-34
	NC	20	20	23	28	33	38
21 x 27	Total CFM	788	1181	1575	1969	2362	2756
	Throw	11-23	15-26	19-30	23-32	25-34	28-36
	NC	20	20	24	29	34	39

PERFORMANCE NOTES FOR SERIES XG-5000

All data is tested in accordance with ANSI/ASHRAE 70-2006.

DEFINITION OF UNITS

CFM	Cubic Feet Per Minute (air)
Horizontal Throw	Throw distance in feet at terminal velocities of 150fpm, 100fpm and 50fpm
NC	noise criteria, sound pressure level. NC ratings are based on sound power level (Lw) Re 10-12 watts minus a 10dB room attenuation in all octave bands
Ps	Static pressure. Diffuser only
Pt	Total pressure. Includes plenum and inlet size listed and is the sum of velocity and static pressure
Pv	Velocity pressure
fpm	Velocity of air stream in Feet Per Minute
Ps-H	Static pressure horizontal
Ps-V	Static pressure vertical
Pt-V	Total pressure vertical
Throw H C	Throw horizontal cooling
Throw V C	Throw vertical cooling
Throw V H	Vertical heating

MODEL XG-5500

Louvered Face Aluminum Supply Diffuser

XG-5500-1 – Surface Mount

XG-5500-6 – T-bar Lay-in

XG-5500-7 – Concealed Spline

XG-5500-8 – Tegular Lay-in

XG-5500-9 – Donn Fineline Lay-in

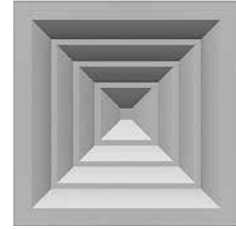

Air Outlets shall be aluminum model XG-5500 manufactured by GREENHECK. Units shall consist of a fixed pattern louvered core fastened into a border with spring loaded latches. Core shall be removable without the use of tools. Outlets shall be engineered to perform in variable volume systems and include deflector blades with a horizontal lip to provide longer throw distances.

Outlets shall be available in 1, 2-way opposite, 2-way corner, 3, and 4-way directional air patterns.

The units shall be the size and quantity as outlined in the plans and specifications.

MODEL XG-5500S

Louvered Face Steel Supply Diffuser

XG-5500S-1 – Surface Mount

XG-5500S-6 – T-bar Lay-in

XG-5500S-8 – Tegular Lay-in

XG-5500S-9 – Donn Finline Lay-in

Air Outlets shall be steel model XG-5500S manufactured by GREENHECK. Units shall consist of a fixed pattern louvered core fastened into a border with spring loaded latches. Core shall be removable without the use of tools. Outlets shall be engineered to perform in variable volume systems and include deflector blades with a horizontal lip to provide longer throw distances.

Outlets shall be available in 1, 2-way opposite, 2-way corner, 3, and 4-way directional air patterns.

The units shall be the size and quantity as outlined in the plans and specifications.

For Surface mounting:

Units shall be designed for surface mounting applications and be provided with counter sunk screw holes on the face of the device.

For T-Bar Lay-in:

Units shall be designed to integrate into the specified ceiling system.

Options:

Adjustable Pattern (horizontal to vertical)

Outlets shall include adjustable air pattern deflector blades that allows the air pattern to be set from vertical to horizontal (Optional XG-APD Air Pattern Deflectors). Air pattern deflector blades shall be accessible from the face and the diffuser and adjustable without the use of tools.

IV Induction Vanes

Units shall include IV induction vanes factory mounted onto the back side of the deflector vanes. IV vanes shall increase the induction rate of the diffuser.

Accessories

Optional Dampers

Aluminum XG-D5A or Steel XG-D5 opposed blade dampers shall be provided. Damper shall be adjusted using a handle accessible through the face of the diffuser. Screwdriver slot operators are not allowed.

Performance Specification

The manufacturer shall provide published performance data. Data shall be tested in accordance to ANSI/ASHRAE Standard 70- 2006

Paint Specification

Process shall be anodic electrodeposition using an anodic acrylic paint. Units shall undergo pre-treatment including a pressurized spray stage using an alkaline cleaner and a de-ionized water rinse.

MODEL XG-5500

Model: XG-5500-1 Louvered Face - Removable Core - Flush Surface Mount

XG-5500-1 - Flush Surface Mount

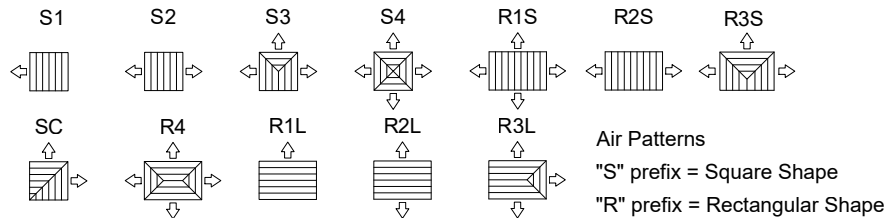
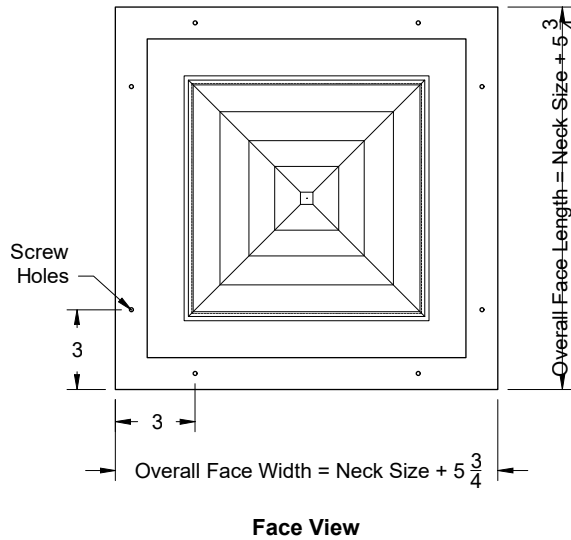
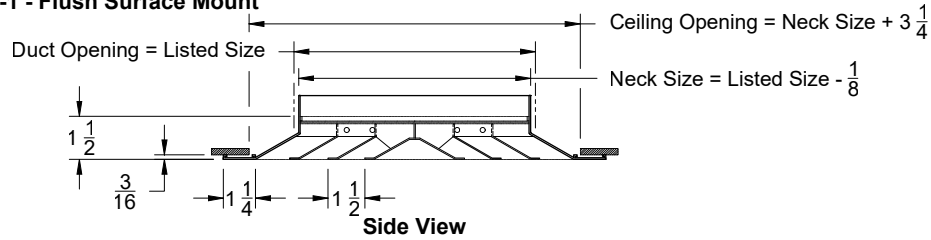

1. Available Finishes

Standard Finish:
 01 White
 Finish
 24 Mill Finish
 Optional Finish
 02 Satin Silver
 03 Black
 28 Custom Color

2. Available Accessories

XG-D5 - Steel Opposed Blade Damper
 XG-D5A - Aluminum OBD
 XG-RSD TR - Steel Radial Shutter Damper with Transition Square to Round
 XG-L9 - Equalizing Grid (Sq / Rect)
 XG-G3 - Equalizing Grid (Round)
 XG-TR - Transition Square to Round
 XG-TBPF - T-Bar Plaster Frame
 XG-LIPF - Lay-In Plaster Frame

3. Available Options

APD - Air Pattern Deflector
 IV - Induction Vanes

4. Construction Details

- Available Sizes Only as Listed
- Extruded Aluminum Frame and Cores

All Dimensions $\pm 1/16"$

MODEL XG-5500

CEILING
DIFFUSERS

LOUVERED FACE DIFFUSERS

XG-5000/XG-5500S

Model: XG-5500-2 Louvered Face - Removable Core - Bevel Drop Surface Mount

XG-5500-2 - Flush Surface Mount

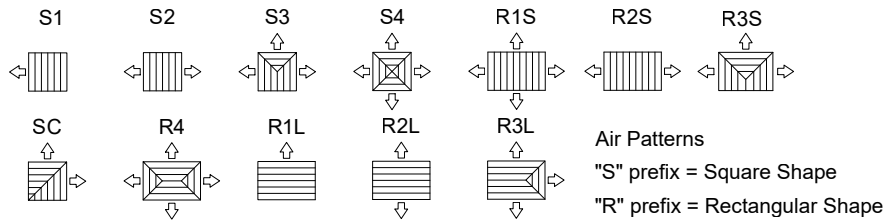
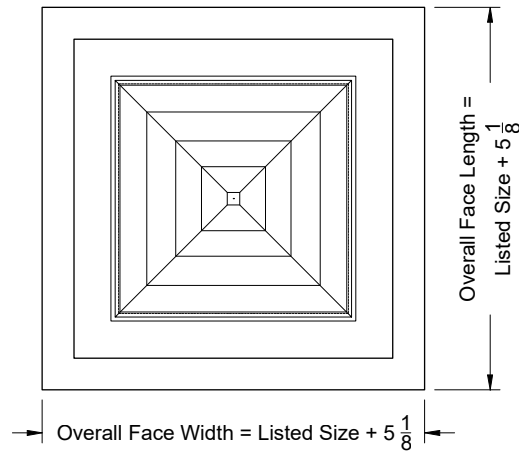
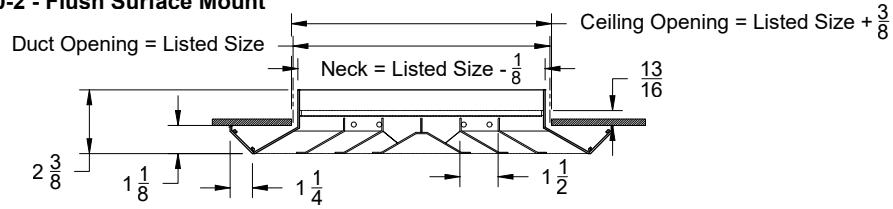

1. Available Finishes	2. Available Accessories	3. Available Options	4. Construction Details
Standard Finish: 01 White Finish 24 Mill Finish Optional Finish 02 Satin Silver 03 Black 28 Custom Color	XG-D5 - Steel Opposed Blade Damper XG-D5A - Aluminum OBD XG- RSD TR - Steel Radial Shutter Damper with Transition Square to Round XG-L9 - Equalizing Grid (Sq / Rect) XG-G3 - Equalizing Grid (Round) XG-TR - Transition Square to Round XG-TBPF - T-Bar Plaster Frame XG-LIPF - Lay-In Plaster Frame	APD - Air Pattern Deflector IV - Induction Vanes	<ul style="list-style-type: none"> Available Sizes Only as Listed Extruded Aluminum Frame and Cores <p style="text-align: right;">All Dimensions $\pm 1/16"$</p>

MODEL XG-5500

Model: XG-5500-6 Louvered Face - Removable Core - Lay In T-Bar

XG-5500-6 - Lay In T-Bar

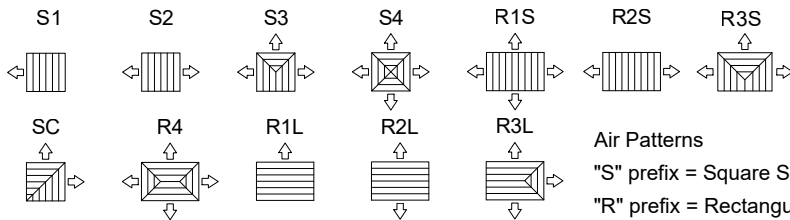
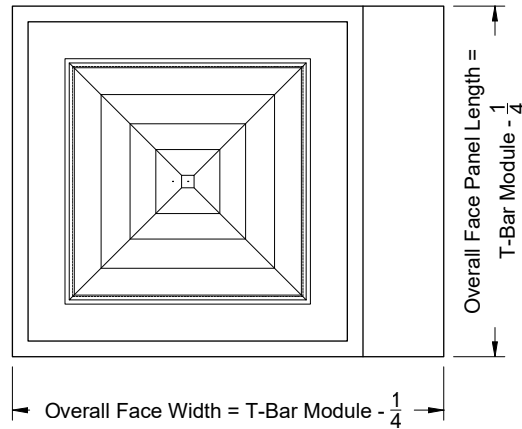
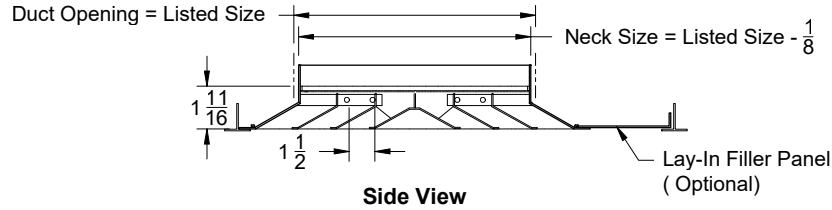

Available Module Size
12 x 12
24 x 24
36 x 24
48 x 24
48 x 48

1. Available Finishes	2. Available Accessories	3. Available Options	4. Construction Details
Standard Finish: 01 White Finish 24 Mill Finish Optional Finish 02 Satin Silver 03 Black 28 Custom Color	XG-D5 - Steel Opposed Blade Damper XG-D5A - Aluminum OBD XG-RSD TR - Steel Radial Shutter Damper with Transition Square to Round XG-L9 - Equalizing Grid (Sq / Rect) XG-G3 - Equalizing Grid (Round) XG-TR - Transition Square to Round XG-TBPF - T-Bar Plaster Frame XG-LIPF - Lay-In Plaster Frame	APD - Air Pattern Deflector IV - Induction Vanes	<ul style="list-style-type: none"> Available Sizes Only as Listed Extruded Aluminum Frame and Cores <p>All Dimensions $\pm 1/16"$</p>

MODEL XG-5500

CEILING
DIFFUSERS

LOUVERED FACE DIFFUSERS

XG-5000/XG-5500S

Model: XG-5500-8 Louvered Face - Removable Core - Tegular T-Bar

XG-5500-8 - Tegular T-Bar

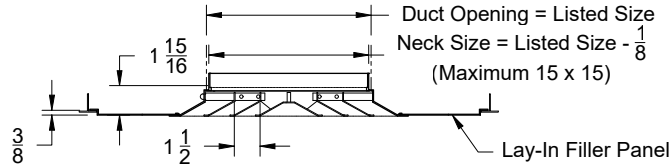

Side View

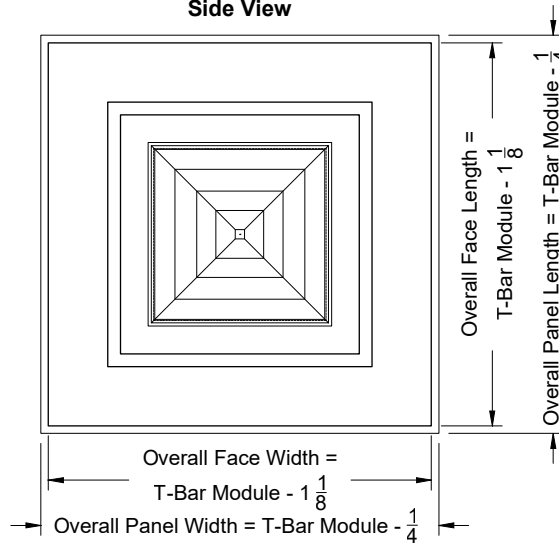

Face View

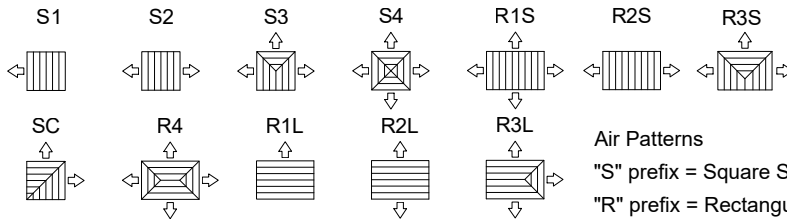

Available
Module Size
24 x 24

1. Available Finishes	2. Available Accessories	3. Available Options	4. Construction Details
<p>Standard Finish: 01 White Finish 24 Mill Finish Optional Finish 02 Satin Silver 03 Black 28 Custom Color</p>	<p>XG-D5 - Steel Opposed Blade Damper XG-D5A - Aluminum OBD XG- RSD TR - Steel Radial Shutter Damper with Transition Square to Round XG-L9 - Equalizing Grid (Sq / Rect) XG-G3 - Equalizing Grid (Round) XG-TR - Transition Square to Round XG-TBPF - T-Bar Plaster Frame XG-LIPF - Lay-In Plaster Frame</p>	<p>APD - Air Pattern Deflector IV - Induction Vanes</p>	<ul style="list-style-type: none"> Available Sizes Only as Listed Extruded Aluminum Frame and Cores

All Dimensions $\pm 1/16"$

MODEL XG-5500

Model: XG-5500-9 Louvered Face - Removable Core - Bolt Slot

XG-5500-9 - Bolt Slot

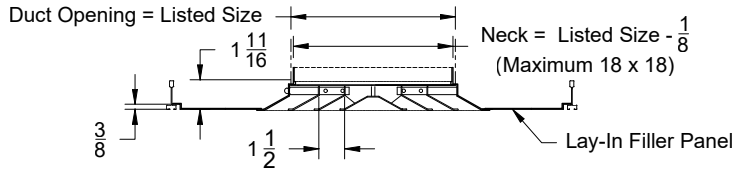

Side View

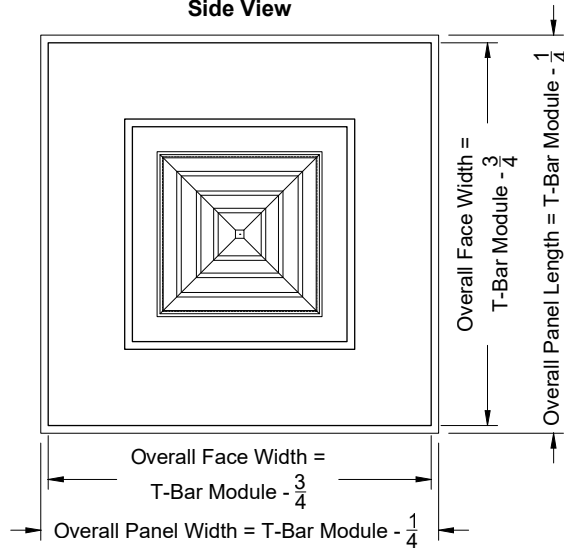

Face View

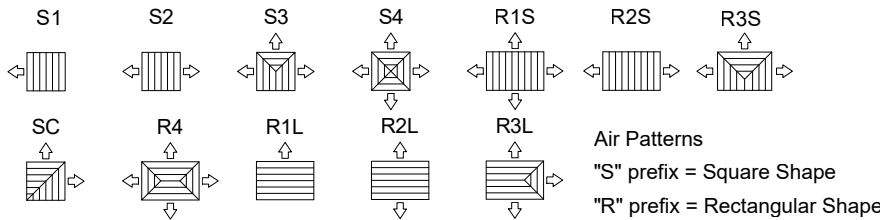

Available Module Size
24 x 24

1. Available Finishes	2. Available Accessories	3. Available Options	4. Construction Details
Standard Finish: 01 White Finish 24 Mill Finish Optional Finish 02 Satin Silver 03 Black 28 Custom Color	XG-D5 - Steel Opposed Blade Damper XG-D5A - Aluminum OBD XG- RSD TR - Steel Radial Shutter Damper with Transition Square to Round XG-L9 - Equalizing Grid (Sq / Rect) XG-G3 - Equalizing Grid (Round) XG-TR - Transition Square to Round XG-TBPF - T-Bar Plaster Frame XG-LIPF - Lay-In Plaster Frame	APD - Air Pattern Deflector IV - Induction Vanes	<ul style="list-style-type: none"> Available Sizes Only as Listed Extruded Aluminum Frame and Cores

All Dimensions ±1/16"

MODEL XG-5500S

CEILING
DIFFUSERS

LOUVERED FACE DIFFUSERS

XG-5000/XG-5500S

Model: XG-5500S-1 Louvered Face - Removable Core - Flush Surface Mount

XG-5500S-1 - Flush Surface Mount

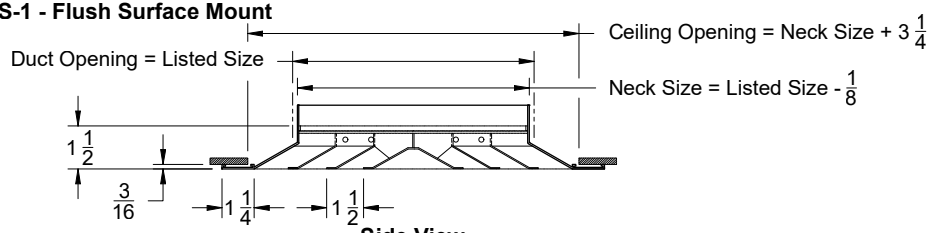

Side View

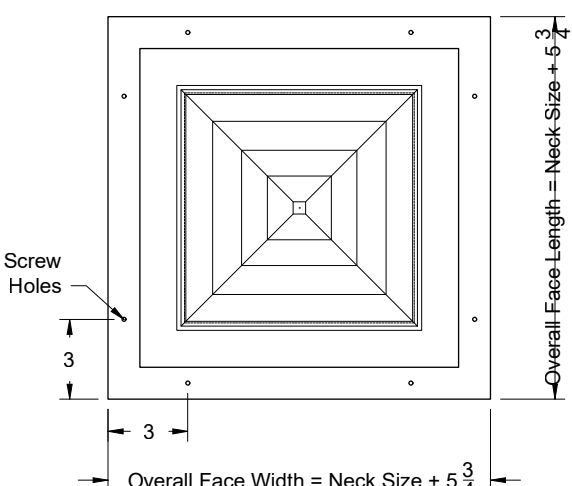

Face View

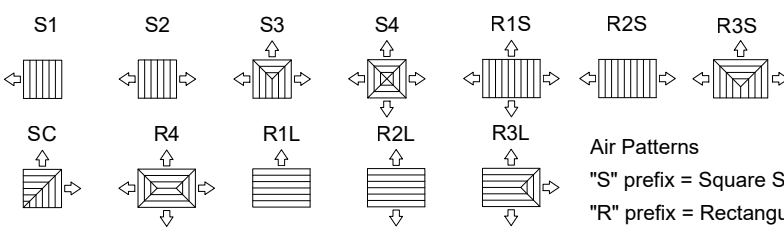

Air Patterns
"S" prefix = Square Shape
"R" prefix = Rectangular Shape

1. Available Finishes	2. Available Accessories	3. Available Options	4. Construction Details
Standard Finish: 01 White Finish 24 Mill Finish Optional Finish 02 Satin Silver 03 Black 28 Custom Color	XG-D5 - Steel Opposed Blade Damper XG-D5A - Aluminum OBD XG-RSD TR - Steel Radial Shutter Damper with Transition Square to Round XG-L9 - Equalizing Grid (Sq / Rect) XG-G3 - Equalizing Grid (Round) XG-TR - Transition Square to Round XG-TBPF - T-Bar Plaster Frame XG-LIPF - Lay-In Plaster Frame	APD - Air Pattern Deflector IV - Induction Vanes	<ul style="list-style-type: none"> Available Sizes Only as Listed Steel Frame and Cores

All Dimensions ±1/16"

MODEL XG-5500S

Model: XG-5500S-2 Louvered Face - Removable Core - Bevel Drop Surface Mount

XG-5500S-2 - Flush Surface Mount

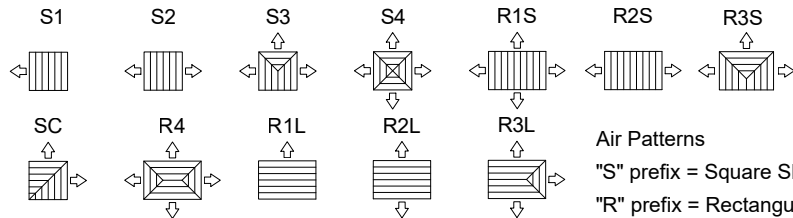
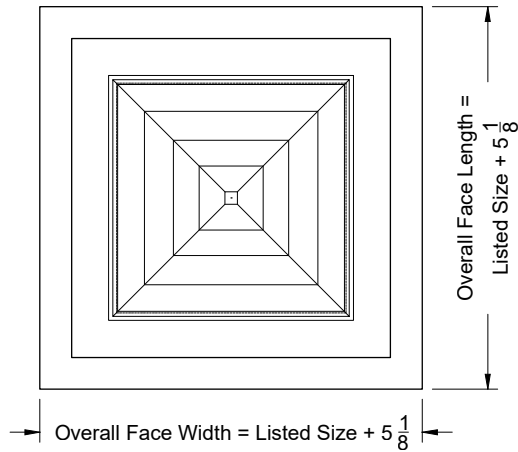
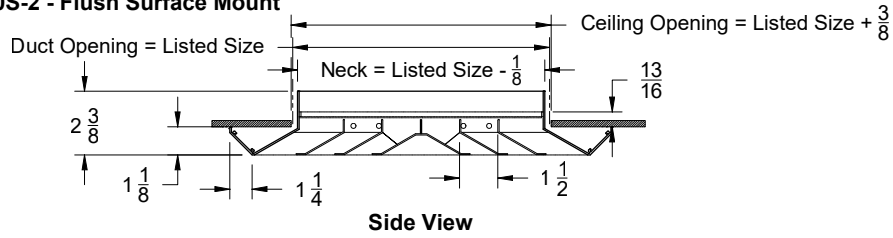

1. Available Finishes	2. Available Accessories	3. Available Options	4. Construction Details
Standard Finish: 01 White Finish 24 Mill Finish Optional Finish 02 Satin Silver 03 Black 28 Custom Color	XG-D5 - Steel Opposed Blade Damper XG-D5A - Aluminum OBD XG-RSD TR - Steel Radial Shutter Damper with Transition Square to Round XG-L9 - Equalizing Grid (Sq / Rect) XG-G3 - Equalizing Grid (Round) XG-TR - Transition Square to Round XG-TBPF - T-Bar Plaster Frame XG-LIPF - Lay-In Plaster Frame	APD - Air Pattern Deflector IV - Induction Vanes	<ul style="list-style-type: none"> Available Sizes Only as Listed Steel Frame and Cores <p style="text-align: right;">All Dimensions ±1/16"</p>

MODEL XG-5500S

CEILING
DIFFUSERS

LOUVERED FACE DIFFUSERS

XG-5000/XG-5500S

Model: XG-5500S-6 Louvered Face - Removable Core - Lay In T-Bar

XG-5500S-6 - Lay In T-Bar

Duct Opening = Listed Size Neck Size = Listed Size - $\frac{1}{8}$

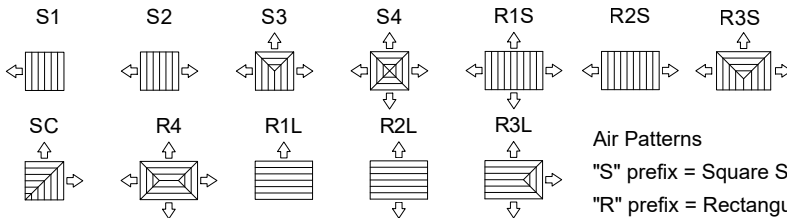
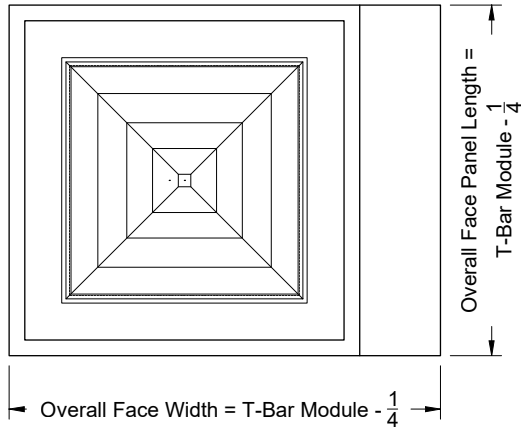
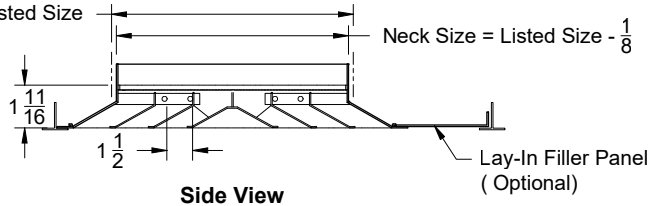

Available Module Size
12 x 12
24 x 24
36 x 24
48 x 24
48 x 48

1. Available Finishes	2. Available Accessories	3. Available Options	4. Construction Details
Standard Finish: 01 White Finish 24 Mill Finish Optional Finish 02 Satin Silver 03 Black 28 Custom Color	XG-D5 - Steel Opposed Blade Damper XG-D5A - Aluminum OBD XG-RSD TR - Steel Radial Shutter Damper with Transition Square to Round XG-L9 - Equalizing Grid (Sq / Rect) XG-G3 - Equalizing Grid (Round) XG-TR - Transition Square to Round XG-TBPF - T-Bar Plaster Frame XG-LIPF - Lay-In Plaster Frame	APD - Air Pattern Deflector IV - Induction Vanes	<ul style="list-style-type: none"> Available Sizes Only as Listed Steel Frame and Cores

All Dimensions $\pm 1/16$ "

MODEL XG-5500S

Model: XG-5500S-8 Louvered Face - Removable Core - Tegular T-Bar

XG-5500S-8 - Tegular T-Bar

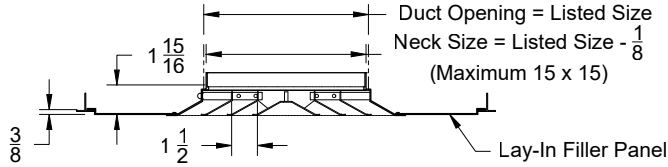

Side View

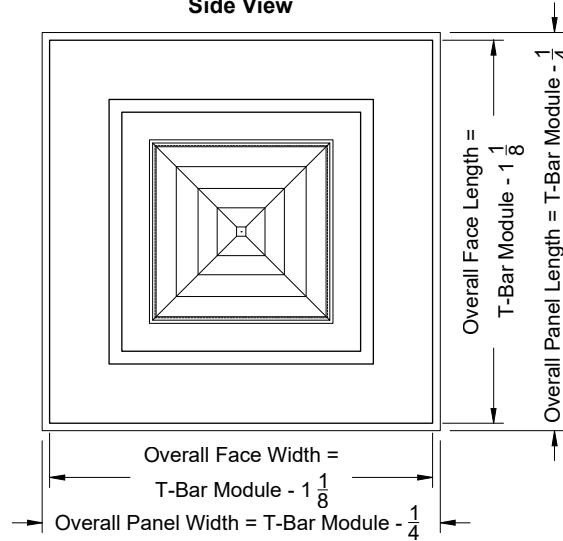

Face View

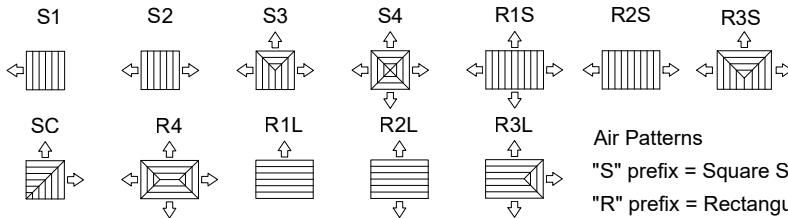

Available
Module Size
24 x 24

1. Available Finishes	2. Available Accessories	3. Available Options	4. Construction Details
Standard Finish: 01 White Finish 24 Mill Finish Optional Finish 02 Satin Silver 03 Black 28 Custom Color	XG-D5 - Steel Opposed Blade Damper XG-D5A - Aluminum OBD XG- RSD TR - Steel Radial Shutter Damper with Transition Square to Round XG-L9 - Equalizing Grid (Sq / Rect) XG-G3 - Equalizing Grid (Round) XG-TR - Transition Square to Round XG-TBPF - T-Bar Plaster Frame XG-LIPF - Lay-In Plaster Frame	APD - Air Pattern Deflector IV - Induction Vanes	<ul style="list-style-type: none"> Available Sizes Only as Listed Steel Frame and Cores

All Dimensions $\pm 1/16"$

MODEL XG-5500S

CEILING
DIFFUSERS

LOUVERED FACE DIFFUSERS

XG-5000/XG-5500S

Model: XG-5500S-9 Louvered Face - Removable Core - Bolt Slot

XG-5500S-9 - Bolt Slot
Duct Opening = Listed Size

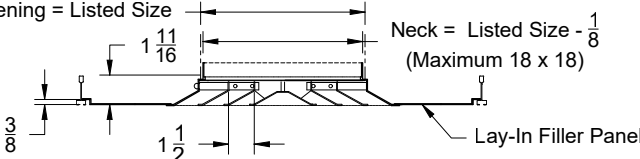

Side View

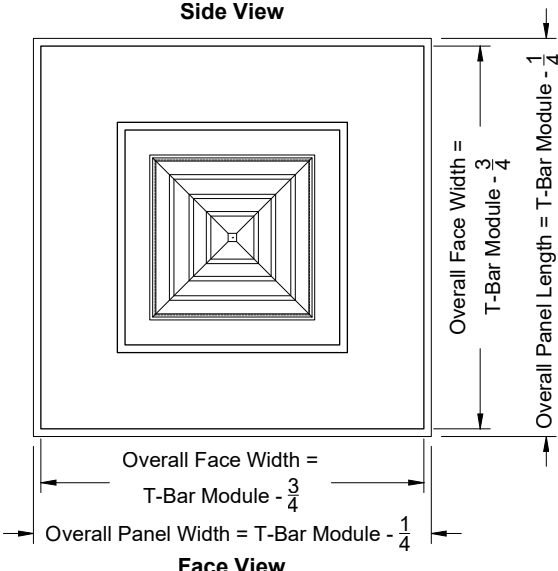

Face View

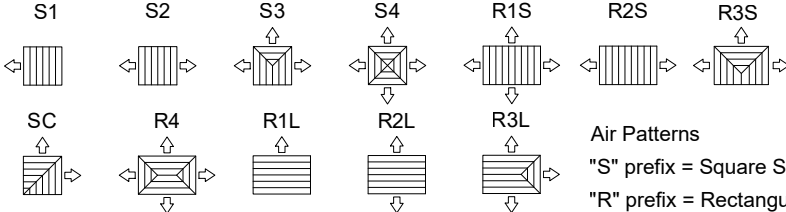

Air Patterns
"S" prefix = Square Shape
"R" prefix = Rectangular Shape

Available Module Size
24 x 24

1. Available Finishes	2. Available Accessories	3. Available Options	4. Construction Details
Standard Finish: 01 White Finish 24 Mill Finish Optional Finish 02 Satin Silver 03 Black 28 Custom Color	XG-D5 - Steel Opposed Blade Damper XG-D5A - Aluminum OBD XG-RSD TR - Steel Radial Shutter Damper with Transition Square to Round XG-L9 - Equalizing Grid (Sq / Rect) XG-G3 - Equalizing Grid (Round) XG-TR - Transition Square to Round XG-TBPF - T-Bar Plaster Frame XG-LIPF - Lay-In Plaster Frame	APD - Air Pattern Deflector IV - Induction Vanes	<ul style="list-style-type: none"> Available Sizes Only as Listed Steel Frame and Cores

All Dimensions ±1/16"

**SERIES XG-5500 PERFORMANCE DATA/1-WAY SQUARE PATTERN (S1)
 MODEL XG-5500/XG-5500S**

Neck Size		Neck Velocity					
		200	300	400	500	600	700
		<i>P_s</i>	<i>P_s</i>	<i>P_s</i>	<i>P_s</i>	<i>P_s</i>	<i>P_s</i>
	<i>P_t</i>	<i>P_t</i>	<i>P_t</i>	<i>P_t</i>	<i>P_t</i>	<i>P_t</i>	
6 x 6	Total CFM	50	75	100	125	150	175
	Throw	5-9	8-15	13-20	18-26	22-31	26-37
	NC	-	-	-	-	23	28
9 x 9	Total CFM	113	169	225	281	338	394
	Throw	8-16	12-21	17-27	22-32	27-38	31-44
	NC	-	-	-	24	29	37
12 x 12	Total CFM	200	300	400	500	600	700
	Throw	11-22	16-27	21-33	26-38	31-44	35-50
	NC	-	-	22	27	32	37
15 x 15	Total CFM	313	469	625	781	938	1094
	Throw	12-24	17-30	23-35	28-41	33-47	37-52
	NC	-	-	24	29	34	39
18 x 18	Total CFM	450	675	900	1125	1350	1575
	Throw	14-26	22-32	33-45	36-48	38-52	40-56
	NC	-	20	25	30	35	40
21 x 21	Total CFM	613	919	1225	1531	1837	2144
	Throw	16-28	26-34	33-43	37-51	40-55	42-58
	NC	-	21	26	31	36	41
24 x 24	Total CFM	800	1200	1600	2000	2400	2800
	Throw	19-29	28-36	39-45	40-53	41-59	44-61
	NC	-	22	27	32	37	42
27 x 27	Total CFM	1013	1519	2025	2531	3037	3544
	Throw	21-31	30-39	35-49	41-55	43-60	46-64
	NC	-	23	28	33	38	43

 CEILING
 DIFFUSERS

LOUVERED FACE DIFFUSERS

XG-55000/XG-5500S

**SERIES XG-5500 PERFORMANCE DATA/2-WAY SQUARE PATTERN (S2 – SC)
MODEL XG-5500/XG-5500S**

Neck Size		Neck Velocity					
		200	300	400	500	600	700
		<i>Ps</i>	<i>Ps</i>	<i>Ps</i>	<i>Ps</i>	<i>Ps</i>	<i>Ps</i>
		0.018	0.040	0.071	0.111	0.160	0.218
		0.020	0.046	0.081	0.127	0.182	0.248
6 x 6	Total CFM	50	75	100	125	150	175
	CFM/Side	25	38	50	63	75	88
	Throw	3-6	7-2	11-17	16-23	20-28	24-34
	NC	-	-	-	-	23	28
9 x 9	Total CFM	113	169	225	281	338	394
	CFM/Side	56	84	113	141	169	197
	Throw	5-10	9-15	13-21	18-27	23-32	27-38
	NC	-	-	-	24	29	34
12 x 12	Total CFM	200	300	400	500	600	700
	CFM/Side	100	150	200	250	300	350
	Throw	7-14	12-20	16-26	21-31	26-37	30-42
	NC	-	-	22	27	32	37
15 x 15	Total CFM	313	469	625	781	938	1094
	CFM/Side	156	234	313	391	469	547
	Throw	10-19	14-25	19-30	25-36	30-41	33-47
	NC	-	-	24	29	34	39
18 x 18	Total CFM	450	675	900	1125	1350	1575
	CFM/Side	225	338	450	563	675	788
	Throw	12-23	16-28	22-34	27-39	32-45	36-51
	NC	-	20	25	30	35	40
21 x 21	Total CFM	613	919	1225	1531	1837	2144
	CFM/Side	306	459	613	766	919	1072
	Throw	12-24	17-30	23-35	28-41	33-47	37-52
	NC	-	21	26	31	36	41
24 x 24	Total CFM	800	1200	1600	2000	2400	2800
	CFM/Side	400	600	800	1000	1200	1400
	Throw	12-22	16-28	21-34	27-39	32-45	36-50
	NC	-	22	27	32	37	42
27 x 27	Total CFM	1013	1519	2025	2531	3037	3544
	CFM/Side	506	759	1013	1206	1519	1772
	Throw	8-15	12-21	17-27	22-32	27-38	31-43
	NC	-	23	28	33	38	43

CEILING
DIFFUSERS

LOUVERED FACE DIFFUSERS

XG-5000/XG-5500S

**SERIES XG-5500 PERFORMANCE DATA/3-WAY RECTANGULAR PATTERN (S3)
 MODEL XG-5500/XG-5500S**

Neck Size		Neck Velocity																	
		200		300		400		500		600		700							
		<i>Ps</i>		<i>0.013</i>		<i>0.030</i>		<i>0.053</i>		<i>0.083</i>		<i>0.120</i>		<i>0.163</i>					
		<i>Pt</i>		<i>0.016</i>		<i>0.036</i>		<i>0.063</i>		<i>0.099</i>		<i>0.142</i>		<i>0.194</i>					
	<i>SD</i>	A		B		A		B		A		B		A		B			
6 x 6	Total CFM		50			75			100			125			150			175	
	CFM/Side	19		13	28		19	38		25	47		31	56		38	66		44
	Throw	3-5		2-4	6-11		6-10	10-16		10-16	15-22		15-21	20-28		19-27	24-33		23-32
	NC		-			-			-			-		23			28		
9 x 9	Total CFM		113			169			225			281			338			394	
	CFM/Side	42		28	63		42	84		56	105		70	127		84	148		98
	Throw	4-8		3-6	8-14		7-12	12-19		11-18	17-25		16-23	22-31		21-29	26-36		24-34
	NC		-			-			-		24			29			34		
12 x 12	Total CFM		200			300			400			500			600			700	
	CFM/Side	75		50	113		75	150		100	188		125	225		150	263		175
	Throw	6-12		5-9	10-17		8-15	15-23		13-20	20-29		18-26	24-34		22-31	28-40		26-37
	NC		-			-		22			27			32			37		
15 x 15	Total CFM		313			469			625			781			938			1094	
	CFM/Side	75		50	176		117	234		156	293		195	352		234	410		273
	Throw	6-12		5-9	12-22		10-18	17-27		15-23	23-33		20-29	27-38		25-35	31-44		29-40
	NC		-			-		24			29			34			39		
18 x 18	Total CFM		450			675			900			1125			1350			1575	
	CFM/Side	169		113	253		169	338		225	422		281	506		338	591		394
	Throw	10-20		8-16	15-25		12-21	20-31		17-27	25-37		22-32	30-42		27-38	34-48		31-44
	NC		-			20			25			30			35			40	
21 x 21	Total CFM		613			919			1225			1531			1837			2144	
	CFM/Side	230		153	345		230	459		306	574		383	689		459	804		536
	Throw	12-23		10-19	16-28		14-24	22-34		19-30	27-40		24-36	32-45		29-41	36-51		33-47
	NC		-			21			16			31			36			41	
24 x 24	Total CFM		800			1200			1600			2000			2400			2800	
	CFM/Side	300		200	450		300	600		400	750		500	900		600	1050		700
	Throw	12-24		11-22	17-30		16-27	23-35		21-33	28-41		26-38	33-47		31-44	37-52		35-50
	NC		-			22			27			32			37			42	
27 x 27	Total CFM		1013			1519			2025			2531			3037			3544	
	CFM/Side	380		253	570		380	759		506	949		633	1139		759	1329		886
	Throw	12-23		12-24	17-29		17-19	22-34		22-35	27-40		28-40	32-46		33-46	36-51		37-52
	NC		-			23			28			33			38			43	

 CEILING
 DIFFUSERS

LOUVERED FACE DIFFUSERS

XG-5000/XG-5500S

**SERIES XG-5500 PERFORMANCE DATA/4-WAY SQUARE PATTERN (S4)
MODEL XG-5500/XG-5500S**

Neck Size		Neck Velocity					
		200	300	400	500	600	700
		<i>Ps</i>	<i>0.013</i>	<i>0.030</i>	<i>0.053</i>	<i>0.083</i>	<i>0.120</i>
	<i>Pt</i>	<i>0.016</i>	<i>0.036</i>	<i>0.063</i>	<i>0.099</i>	<i>0.142</i>	<i>0.194</i>
6 x 6	Total CFM	50	75	100	125	150	175
	CFM/Side	13	19	25	31	38	44
	Throw	2-4	6-10	10-16	15-21	19-27	23-32
	NC	-	-	-	-	23	28
9 x 9	Total CFM	113	169	225	281	338	394
	CFM/Side	28	42	56	70	84	98
	Throw	3-6	7-12	11-18	16-23	21-29	24-34
	NC	-	-	-	24	29	34
12 x 12	Total CFM	200	300	400	500	600	700
	CFM/Side	50	75	100	125	150	175
	Throw	5-9	8-15	13-20	18-26	22-31	26-37
	NC	-	-	22	27	32	37
15 x 15	Total CFM	313	469	625	781	938	1094
	CFM/Side	78	117	156	195	234	273
	Throw	6-12	10-18	15-23	20-29	25-35	29-40
	NC	-	-	24	29	34	39
18 x 18	Total CFM	450	675	900	1225	1350	1575
	CFM/Side	113	169	225	306	338	394
	Throw	8-16	12-21	17-27	22-32	27-38	31-44
	NC	-	20	25	30	35	40
21 x 21	Total CFM	613	919	1225	1531	1837	2144
	CFM/Side	153	230	306	383	459	536
	Throw	10-19	14-24	19-30	24-36	29-41	33-47
	NC	-	21	26	31	36	41
24 x 24	Total CFM	800	1200	1600	2000	2400	2800
	CFM/Side	200	300	400	500	600	700
	Throw	11-22	16-27	21-33	26-38	31-44	35-50
	NC	-	22	27	32	37	42
27 x 27	Total CFM	1013	1519	2025	2531	3037	3544
	CFM/Side	253	380	506	633	759	886
	Throw	12-24	17-29	22-35	28-40	33-46	37-52
	NC	-	23	28	33	38	43
33 x 33	Total CFM	1513	2269	3025	3781	4537	5294
	CFM/Side	378	567	756	945	1134	1323
	Throw	12-23	17-29	22-34	27-40	33-46	36-51
	NC	-	24	29	34	39	44

CEILING
DIFFUSERS

LOUVERED FACE DIFFUSERS

XG-5000/XG-5500S

PERFORMANCE NOTES FOR SERIES XG-5500/XG-5500S

All data is tested in accordance with ANSI/ASHRAE 70-2006

DEFINITION OF UNITS

CFM Cubic Feet per Minute (air)

Horizontal Throw Throw distance in feet at terminal velocities of 150fpm and 50fpm.

NC Noise criterion, sound pressure level NC ratings are based on sound power level (Lw) re: 10^{-12} watts minus a 10dB room attenuation in all octave bands

Ps Static pressure = $P_t - P_v$ (inches of water column)

Pt Total pressure (inches of water column)

Pv Velocity pressure (inches of water column)

fpm Velocity of air stream in Feet per Minute

MODEL XG-5500DD



Supply Square and Rectangular Louvered Face - Aluminum/Series XG-5500DD (DDI)

Insulated Non-Insulated

XG-5500DDI-6 - T-bar Lay-in

XG-5500DD-6 - T-bar Lay-in

XG-5500DDI-9 - Donn Finline

XG-5500DD-9 - Donn Finline

Air Outlets shall be model XG-5500DDI (insulated) or XG-5500DD (non-insulated) manufactured by GREENHECK. Units shall be square face ceiling supply diffusers and shall have a factory attached back. Back pan must be of sufficient height to allow center tile (by the ceiling system manufacturer) to be installed from the diffuser face without disassembling the face from the back pan. Devices without back pan attached to the diffuser face will not be allowed.

The units shall be the size and quantity as outline in the plans and specifications. Diffuser shall be one through four slots. The diffuser shall be designed to integrate with the ceiling type. It shall have horizontal deflection surfaces on the fixed pattern control blades which provide a horizontal ceiling pattern with a twenty degree cooling temperature differential at twenty percent of design volume.

Return Square and Rectangular Louvered Face - Aluminum/Series XG-5500 DDR

Non-Insulated

XG-5500 DDR-6 - T-bar Lay-in

XG-5500 DDR-9 - Donn Finline

Air Inlets shall be model XG-5500DD manufactured by GREENHECK. Units shall be square face ceiling return or exhaust diffusers and shall have a factory attached light shield. Light shield must be of sufficient height to allow center tile (by the ceiling system manufacturer) to be installed from the diffuser face without disassembling the face from the back pan. Devices without light shield attached to the diffuser face will not be allowed. The units shall be the size and quantity as outline in the plans and specifications. Diffuser shall be one through four slots. The diffuser shall be designed to integrate with the ceiling type. Face shall have fixed louvers designed to match the appearance of the supply unit.

Round Neck Optional Dampers and Accessories

Butterfly Damper

GREENHECK model XG-BDS aluminum round butterfly type dampers shall be provided. Damper shall consist of two butterfly style blades that can be adjusted from full open to full closed. Damper shall be adjusted with a screw driver slot that can be assessed through the face of the diffuser.

Radial Shutter Damper

GREENHECK model XG-RSD steel round radial shutter damper shall be provided. Damper shall consist of gang operated radial blades that slide perpendicular to air flow direction. The damper shall be adjusted from full open to full closed. Damper shall be adjusted with a screw driver slot that can be assessed through the face of the diffuser.

Opposed Blade Damper

GREENHECK model XG-D3 aluminum or XG-SD3 Steel round opposed blade type dampers shall be provided. Damper shall consist of gang operated blades that can be adjusted from full open to full closed. Damper shall be adjusted with a screw driver slot that can be assessed through the face of the diffuser.

Equalizing Grid

GREENHECK model XG-G3 aluminum round equalizing grid shall be provided. Equalizing grid shall consist of 1/2" x 1/2" x 1/2" aluminum cubed core mounting in an aluminum frame.

Performance Specification

The manufacturer shall provide published performance data. Data shall be tested in accordance to ANSI/ASHRAE Standard 70- 2006.

MODEL XG-5500DD

Architectural Deflection Diffusers Aluminum - Fixed Louvered Face

- Models: **XG-5500DD (DDI)-6** Supply - Non Insulated (Insulated) - T-Bar Lay in
XG-5500DD (DDI)-8 Supply - Non Insulated (Insulated) - Tegular T-Bar
XG-5500DD (DDI)-9 Supply - Non Insulated (Insulated) - 24x24 Donn (USG) Ceiling Grid
XG-5500 DDR-6 Return - Non Insulated - T-Bar Lay in
XG-5500 DDR-8 Return - Non Insulated - Tegular T-Bar
XG-5500 DDR-9 Return - Non Insulated - 24x24 Donn (USG) Ceiling Grid

Model: XG-5500DD-6 = Lay in T-Bar Non Insulated
 Model: XG-5500DDI-6 = Lay in T-Bar Insulated

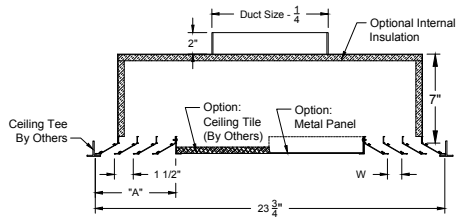

Model: XG-5500DDR-6 = Lay in T-Bar

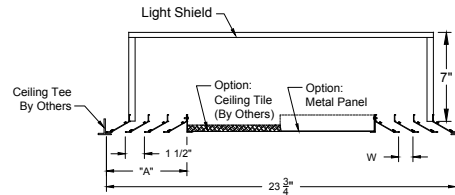

Model: XG-5500DD-8 = Tegular T-Bar Non Insulated
 Model: XG-5500DDI-8 = Tegular T-Bar Insulated

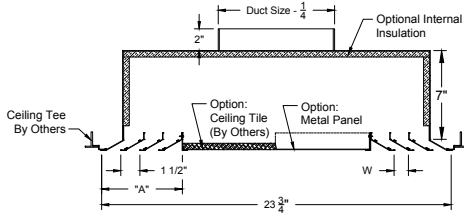

Model: XG-5500DDR-8 = Tegular T-Bar

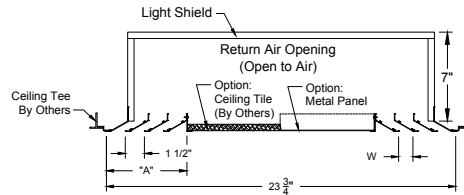

Model: XG-5500DD-9 = 24x24 Donn (USG) Ceiling Grid Non Insulated
 Model: XG-5500DDI-9 = 24x24 Donn (USG) Ceiling Grid Insulated

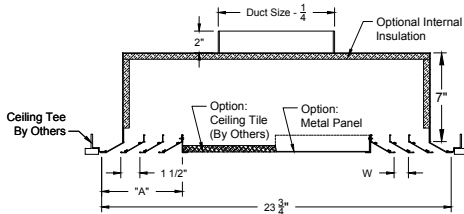

XG-5500DDR-9 = 24x24 Donn (USG) Ceiling Grid

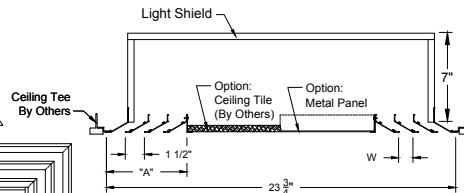

MODEL	Dim. W	1 Slot	2 Slot	3 Slot	4 Slot
		Dim. A	Dim. A	Dim. A	Dim. A
XG-5500DD	1 1/8	3 5/16	4 13/16	6 5/16	7 13/16

Available with 1, 2, 3 and 4 Slots.
 (XG-5500DD 3 SLOT UNIT SHOWN)

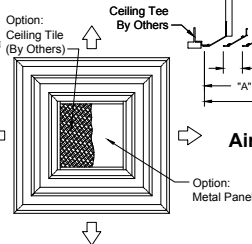

Air Patterns

Notes: (check if provided)

1. Available Finishes	2. Available Accessories	4. Construction Details
Standard Finish <input type="checkbox"/> 01 White with Black Plenum. Optional Finishes (additional charge): <input type="checkbox"/> 03 Black.	Aluminum Radial Opposed Blade Damper. <input type="checkbox"/> XG-BDS - Round Damper. <input type="checkbox"/> XG-RSD - Radial Shutter Round Damper. <input type="checkbox"/> XG-TBPF - T-Bar Plaster Frame.	<ul style="list-style-type: none"> Insulated units have 1/2" Tuffskin insulation. Center Ceiling Tile supplied by others, field installed. Return units are non-ducted, with light shields. Available in 1 1/2" spacers with 1,2,3 and 4 slots (3 slot units shown above).

XG-5500DD MODEL NUMBER SPECIFICATION
SUPPLY FIXED LOUVERED FACE ARCHITECTURAL DIFFUSER

Model		# Slots	Inlet Size	Module	Available Finishes	
XG-5500DD-6	T-Bar Lay-in	1	6	24 x 24	Standard	
XG-5500DDI-6	T-Bar Lay-in Insulated	2	8		01	White
XG-5500DD-8	Tegular T-Bar	3	10		Optional	
XG-5500DDI-8	Tegular T-Bar Insulated	4	12		02	Satin Silver
XG-5500DD-9	Donn Finline		14		03	Black
XG-5500DDI-9	Donn Finline Insulated		16		28	Custom Color

Available Accessories	
XG-D3	Aluminum Radial Opposed Blade Damper
XG-SD3	Steel Radial Opposed Blade Damper
XG-BDS	Butterfly Damper
XG-RSD	Radial Shutter Damper
XG-TBPF	T-Bar Plaster Frame
XG-CP	Center Metal Panel Loose
XG-CPW	Center Metal Panel Welded

Available Options	
CC	Closed Cell foam insulation
EI	External foil back insulation

XG-5500DDR MODEL NUMBER SPECIFICATION
RETURN FIXED LOUVERED FACE ARCHITECTURAL DIFFUSER
MODEL XG-5500DDR

Model		# Slots	Module	Available Finishes	
XG-5500DDR-6	T-Bar Lay-in	1	24 x 24	Standard	
XG-5500DDR-8	Tegular T-Bar	2		01	White
XG-5500DDR-9	Donn Finline	3		Optional	
		4		02	Satin Silver
				03	Black
				28	Custom Color

SERIES XG-5500DD PERFORMANCE DATA
MODEL XG-5500DD, XG-5500DDI SUPPLY

1 Slot 24 x 1 8 Inlet	CFM	50	100	150	200	250	300	350
	Pt	0.01	0.03	0.07	0.13	0.20	0.30	0.40
	Ps	0.007	0.024	0.058	0.109	0.168	0.254	0.337
	NC	<20	<20	22	28	33	38	41
	Throw	2-3-5	4-5-7	5-6-9	6-8-10	7-9-12	8-11-14	9-12-16
2 Slot 24 x 2 8 Inlet	CFM	100	150	200	250	300	350	400
	Pt	0.02	0.05	0.08	0.12	0.18	0.24	0.31
	Ps	0.014	0.038	0.059	0.088	0.134	0.177	0.227
	NC	<20	<20	22	28	33	38	41
	Throw	2-3-5	3-5-7	4-6-8	4-7-9	5-8-11	6-9-12	7-10-13
3 Slot 24 x 3 8 Inlet	CFM	150	200	250	300	350	400	450
	Pt	0.03	0.06	0.09	0.13	0.18	0.23	0.30
	Ps	0.018	0.039	0.058	0.084	0.117	0.147	0.194
	NC	<20	<20	25	30	34	38	41
	Throw	3-4-6	4-5-7	4-6-8	5-7-9	5-8-10	6-9-12	7-10-14
4 Slot 24 x 4 8 Inlet	CFM	200	250	300	350	400	450	500
	Pt	0.05	0.08	0.11	0.16	0.20	0.26	0.32
	Ps	0.029	0.048	0.064	0.097	0.117	0.154	0.195
	NC	<20	23	28	32	36	39	42
	Throw	3-4-9	3-5-7	4-6-8	5-7-10	5-8-11	6-9-12	6-10-13
4 Slot 24 x 4 10 Inlet	CFM	250	300	350	400	450	500	550
	Pt	0.061	0.085	0.123	0.151	0.196	0.247	0.298
	Ps	0.48	0.085	0.123	0.151	0.196	0.247	0.298
	NC	20	25	29	33	36	39	41
	Throw	3-5-7	4-6-8	5-7-10	5-8-11	6-9-12	6-10-13	7-10-14

PERFORMANCE NOTES FOR SERIES XG-5500DD

All data is tested in accordance with ANSI/ASHRAE 70-2006.

DEFINITION OF UNITS

CFM Cubic Feet per Minute (air)

Throw Throw distance in feet at terminal velocities of 150fpm, 100fpm and 50fpm

NC Noise criterion, sound pressure level NC ratings are based on sound power level (Lw) re: 10⁻¹² watts minus a 10dB room attenuation in all octave bands

Ps Static pressure = Pt-Pv (inches of water column)

Pt Total pressure (inches of water column)

Pv Velocity pressure (inches of water column)

fpm Velocity of air stream in Feet per Minute. To determine total pressure for other inlet sizes, divide the CFM by the sq footage of the inlet size (chart above). The result is the duct velocity in fpm. From the Pv chart, determine the Pv and add it to the Ps shown in the performance chart to determine the Pt

SERIES XG-5500DDR PERFORMANCE DATA
MODEL XG-5500DDR RETURN

1 Slot	CFM	100	125	165	200	225	275
	NC	<20	20	27	25	30	35
	-Ps	-.020	-.030	-.060	-.080	-.100	-.150
2 Slot	CFM	155	190	250	310	345	425
	NC	<20	22	24	27	32	37
	-Ps	-.020	-.030	-.060	-.080	-.100	-.150
3 Slot	CFM	225	275	360	450	505	620
	NC	21	24	25	29	34	38
	-Ps	-.020	-.030	-.060	-.080	-.100	-.150
4 Slot	CFM	295	350	430	590	660	810
	NC	22	25	27	30	35	40
	-Ps	-.020	-.030	-.060	-.080	-.100	-.150

PERFORMANCE NOTES FOR SERIES XG-5500DDR

All data is tested in accordance with ANSI/ASHRAE 70-2006.

DEFINITION OF UNITS

CFM Cubic Feet per Minute (air)

NC Noise criterion, sound pressure level NC ratings are based on sound power level (Lw) re: 10^{-12} watts minus a 10dB room attenuation in all octave bands

Ps Static pressure = $P_t - P_v$ (inches of water column)

MODEL XG-9000

- XG-9000-1 - Surface Mounted**
- XG-9000-2 - Beveled**
- XG-9000-6 - T-bar Lay-in**
- XG-9000-7 - Concealed Spline**
- XG-9000-8 - Tegular Lay-in**
- XG-9000-9 - Donn Fineline Lay-in**

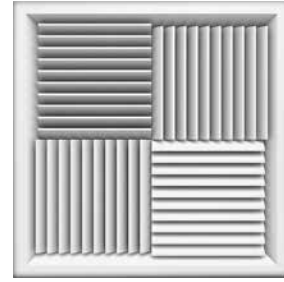

Air Outlets shall be model XG-9000 manufactured by GREENHECK. Units shall consist of an adjustable set of modular core pattern controllers that are removable from the face of the outlet without the use of tools. Outlets shall be extruded aluminum construction. Steel border or cores are not acceptable.

The units shall be the size and quantity as outline in the plans and specifications.

Outlets shall field adjustable to obtain 1, 2-way opposite, 2-way corner, 3, and 4-way directional air patterns. Units shall be designed to integrate into the specified ceiling system.

Accessories

Optional Dampers

Aluminum opposed blade dampers shall be provided. Damper shall be adjusted using a handle accessible through the face of the diffuser.

Screwdriver slot operators are not allowed.

Performance Specification

The manufacturer shall provide published performance data. Data shall be tested in accordance to ANSI/ASHRAE Standard 70- 2006

MODEL XG-9000

CEILING
DIFFUSERS

LOUVERED FACE DIFFUSERS

XG-9000

Model: XG-9000-1 Louvered Face - Modular Core - Flush Surface Mount

XG-9000-1 - Flush Surface Mount

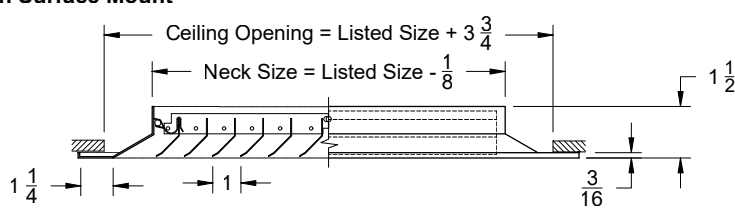

Side View

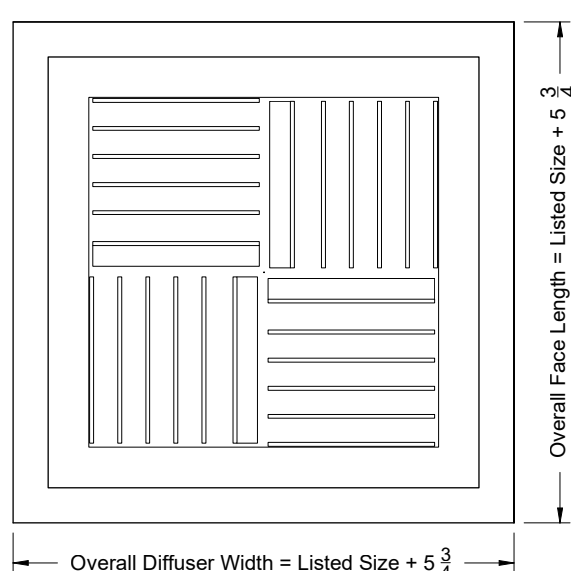

Front View

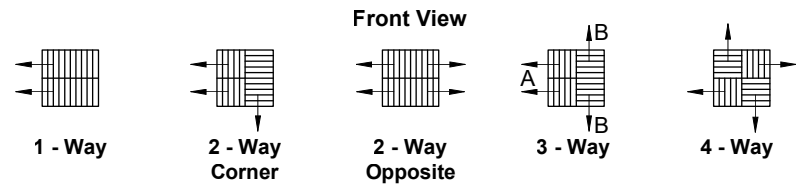

1 - Way 2 - Way Corner 2 - Way Opposite 3 - Way 4 - Way

1. Available Finishes	2. Available Accessories	3. Available Options	4. Construction Details
Standard Finish: 01 White Finish 24 Mill Finish Optional Finish 02 Satin Silver 03 Black 28 Custom Color	XG-OBDA - Steel Opposed Blade Damper XG-OBDA - Aluminum OBD XG-L9 - Equalizing Grid (Sq / Rect) XG-TR - Transition Square to Round XG-TR - Deep Transition XG-PF - Plaster Frame XG-TBPF - T-Bar Plaster Frame XG-LIPF - Lay-In Plaster Frame		<ul style="list-style-type: none"> Available Sizes Only as Listed Aluminum Frame and Cores Units Available with Multiple Cores depending on Neck Size

All Dimensions $\pm 1/16"$

MODEL XG-9000

Model: XG-9000-2 Louvered Face - Modular Core - Beveled Surface Mount

XG-9000-2 - Beveled Surface Mount

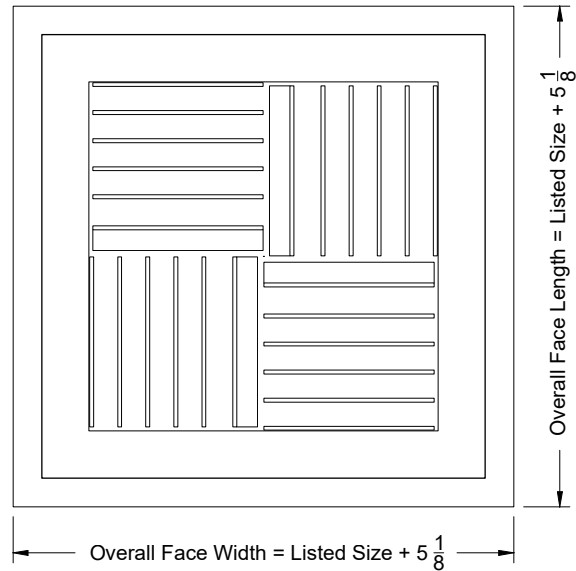
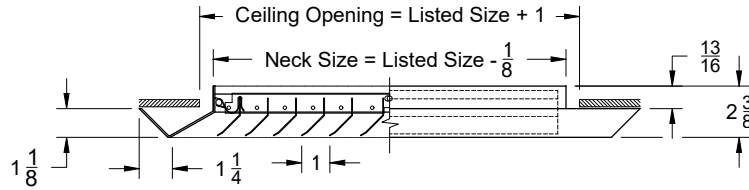

Front View

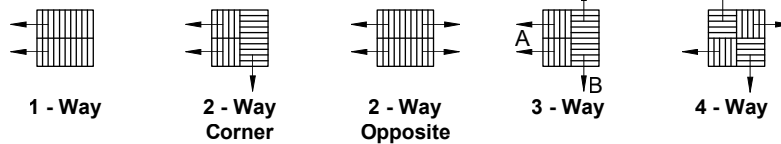

1. Available Finishes	2. Available Accessories	3. Available Options	4. Construction Details
Standard Finish: 01 White Finish 24 Mill Finish Optional Finish 02 Satin Silver 03 Black 28 Custom Color	XG-OBDA - Steel Opposed Blade Damper XG-OBDA - Aluminum OBD XG-L9 - Equalizing Grid (Sq / Rect) XG-TR - Transition Square to Round XG-TR - Deep Transition XG-PF - Plaster Frame XG-TBPF - T-Bar Plaster Frame XG-LIPF - Lay-In Plaster Frame		<ul style="list-style-type: none"> Available Sizes Only as Listed Aluminum Frame and Cores Units Available with Multiple Cores depending on Neck Size
All Dimensions $\pm 1/16"$			

MODEL XG-9000

CEILING
DIFFUSERS

LOUVERED FACE DIFFUSERS

XG-5500DD

Model: XG-9000-6 Louvered Face - Modular Core - Lay In T-Bar

XG-9000-6 - Lay In T-Bar

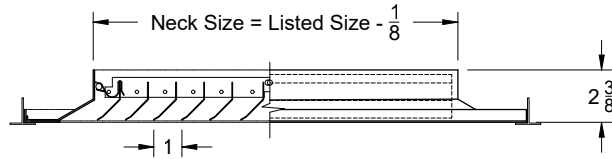

Side View

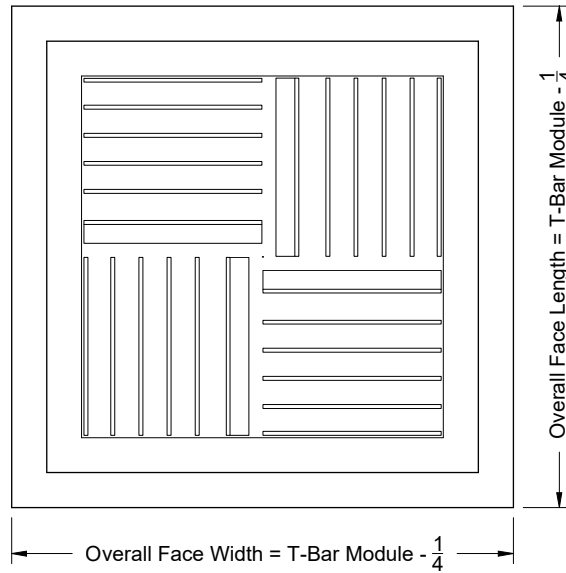

Available Module Size
12 x 12
24 x 24

Front View

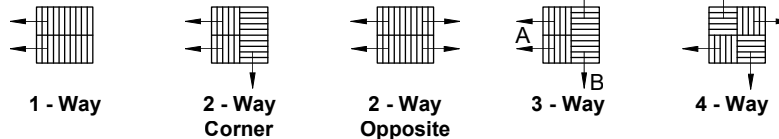

1. Available Finishes	2. Available Accessories	3. Available Options	4. Construction Details
Standard Finish: 01 White Finish 24 Mill Finish Optional Finish 02 Satin Silver 03 Black 28 Custom Color	XG-OBD - Steel Opposed Blade Damper XG-OBDA - Aluminum OBD XG-L9 - Equalizing Grid (Sq / Rect) XG-TR - Transition Square to Round XG-TR - Deep Transition XG-PF - Plaster Frame XG-TBPF - T-Bar Plaster Frame XG-LIPF - Lay-In Plaster Frame		<ul style="list-style-type: none"> Available Sizes Only as Listed Aluminum Frame and Cores Units Available with Multiple Cores depending on Neck Size

All Dimensions $\pm 1/16"$

MODEL XG-9000

Model: XG-9000-8 Louvered Face - Modular Core - Tegular T-Bar

XG-9000-8 - Tegular T-Bar

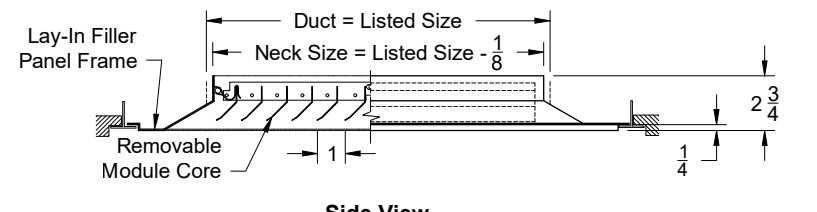

Side View

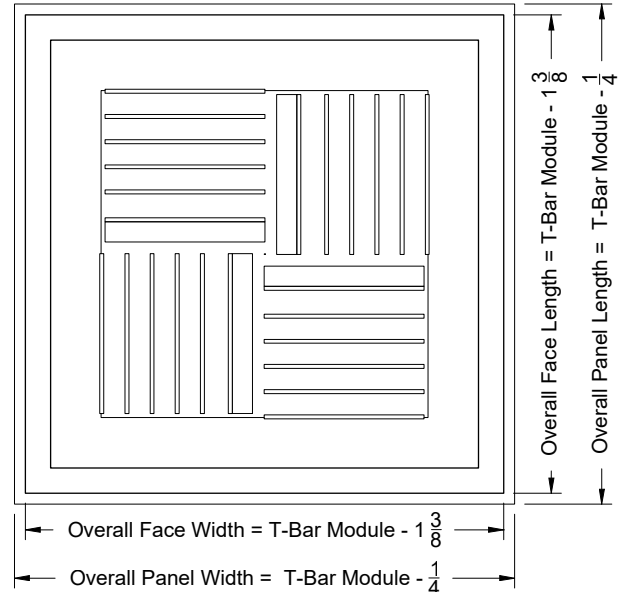

Front View

Overall Face Length = T-Bar Module - $1 \frac{3}{8}$

Overall Panel Length = T-Bar Module - $\frac{1}{4}$

Overall Face Width = T-Bar Module - $1 \frac{3}{8}$

Overall Panel Width = T-Bar Module - $\frac{1}{4}$

Available Module Size
24 x 24

1 - Way **2 - Way Corner** **2 - Way Opposite** **3 - Way** **4 - Way**

1. Available Finishes	2. Available Accessories	3. Available Options	4. Construction Details
Standard Finish: 01 White Finish 24 Mill Finish Optional Finish 02 Satin Silver 03 Black 28 Custom Color	XG-OBDA - Steel Opposed Blade Damper XG-OBDA - Aluminum OBD XG-L9 - Equalizing Grid (Sq / Rect) XG-TR - Transition Square to Round XG-TR - Deep Transition XG-PF - Plaster Frame XG-TBPF - T-Bar Plaster Frame XG-LIPF - Lay-In Plaster Frame		<ul style="list-style-type: none"> Available Sizes Only as Listed Aluminum Frame and Cores Units Available with Multiple Cores depending on Neck Size

All Dimensions $\pm 1/16$ "

CEILING DIFFUSERS

LOUVERED FACE DIFFUSERS

XG-5500DD

MODEL XG-9000

CEILING
DIFFUSERS

LOUVERED FACE DIFFUSERS

XG-5500DD

Model: XG-9000-9 Louvered Face - Modular Core - Bolt Slot

XG-9000-9 - Bolt Slot

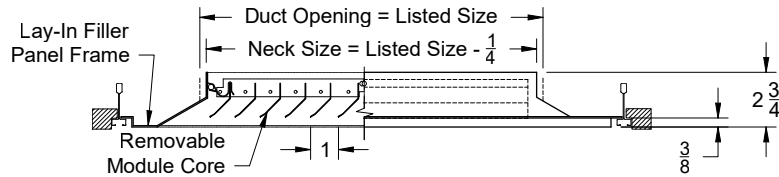

Side View

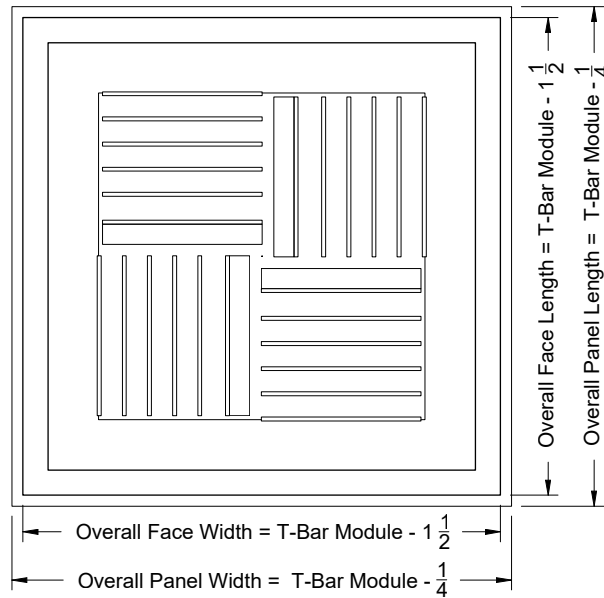

Available Module Size
24 x 24

Front View

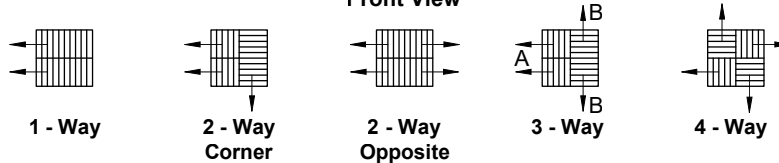

1. Available Finishes	2. Available Accessories	3. Available Options	4. Construction Details
<p>Standard Finish:</p> <ul style="list-style-type: none"> 01 White <p>Finish</p> <ul style="list-style-type: none"> 24 Mill Finish <p>Optional Finish</p> <ul style="list-style-type: none"> 02 Satin Silver 03 Black 28 Custom Color 	<ul style="list-style-type: none"> XG-OBD - Steel Opposed Blade Damper XG-OBDA - Aluminum OBD XG-L9 - Equalizing Grid (Sq / Rect) XG-TR - Transition Square to Round XG-TR - Deep Transition XG-PF - Plaster Frame XG-TBPF - T-Bar Plaster Frame XG-LIPF - Lay-In Plaster Frame 		<ul style="list-style-type: none"> Available Sizes Only as Listed Aluminum Frame and Cores Units Available with Multiple Cores depending on Neck Size

All Dimensions $\pm 1/16"$

XG-9000 MODEL NUMBER SPECIFICATION

MODULAR CORE CEILING DIFFUSER

Model		Neck											
		1 Core											
		6	8	10									
XG-9000-1	Surface Mount	6	X										
XG-9000-2	Beveled Drop Surface Mount	8		X									
		10			X								
		4 Core											
		6	8	10	12	14	16	18	20	22	24		
		6	X										
	8		X										
	10			X									
	12				X								
	14					X							
	16						X						
	18							X					
	20								X				
	22									X			
	24										X		

Available Accessories		Available Finishes	
XG-OBDA	Steel Opposed Blade Damper	Standard	
XG-OBDA	Aluminum Opposed Blade Damper	01	White
XG-L9	Square / Rectangular Equalizing Grid	Optional	
XG-TR Deep	Deep Square to Round Transition	02	Satin Silver
		03	Black
		24	Mill
		28	Custom Color

**XG-9000 MODEL NUMBER SPECIFICATION
MODULAR CORE CEILING DIFFUSER**

Model		Module	Neck																
			6	8	10	12	14	16	18	20									
XG-9000-6	T-bar Lay-in	12 x 12	8	X															
		24 x 24	6	X															
			8		X														
			10			X													
			12				X												
			14					X											
			16						X										
			18							X									
			20									X							
XG-9000-7 XG-9000-8 XG-9000-9	Concealed Spline Tegular Donn Fineline	24 x 24	6	X															
			8		X														
			10			X													
			12				X												
			14					X											
			18							X									

Available Accessories		Available Finishes	
XG-OBDD	Steel Opposed Blade Damper	Standard	
XG-OBDA	Aluminum Opposed Blade Damper	01	White
XG-L9	Square / Rectangular Equalizing Grid	Optional	
XG-TR Deep	Deep Square to Round Transition	02	Satin Silver
		03	Black
		24	Mill
		28	Custom Color

CEILING
DIFFUSERS

LOUVERED FACE DIFFUSERS

XG-9000

SERIES XG-9000/XG-9000S PERFORMANCE DATA
MODEL XG-9000/XG-9000 S (4 CORE)

Listed Size	Neck Vel Side	200		300			400			500			600			700		
		A	B	A	B	A	B	A	B	A	B	A	B	A	B			
6 x 6	CFM	50		75			100			125			150			175		
	NC	<20		<20			<20			<20			<20			20		
	Pt	0.001		0.006			0.018			0.032			0.042			0.061		
	1-Way Throw		2-4-12			2-6-11			4-8-13			8-13-20			9-16-25			13-17-27
	2-Way Throw		1-2-7			1-3-7			2-4-7			4-7-12			5-9-14			7-10-15
	3-Way Throw	1-2-7		1-1-4	1-3-7		1-2-5	2-4-7		2-3-6	4-7-12		2-3-8	5-9-14		3-5-9	7-10-15	4-6-12
	4-Way Throw		1-1-4			1-2-5			2-3-6			2-3-8			3-5-9			4-6-12
8 x 8	CFM	95		140			190			235			285			330		
	NC	<20		<20			<20			<20			<20			21		
	Pt	0.002		0.0075			0.0175			0.03			0.0405			0.058		
	1-Way Throw		3-6-14			6-10-25			8-15-29			14-20-25			15-22-28			20-23-30
	2-Way Throw		2-3-9			4-7-14			8-12-15			9-14-20			10-15-22			12-17-22
	3-Way Throw	2-3-9		1-2-5	4-7-14		2-4-10	8-12-15		3-8-12	9-14-20		4-7-13	10-15-22		5-10-14	12-17-22	7-11-17
	4-Way Throw		1-2-5			2-4-10			3-8-12			4-7-13			5-10-14			7-11-17
10 x 10	CFM	140		205			275			345			415			485		
	NC	<20		<20			<20			<20			<20			23		
	Pt	0.003		0.009			0.017			0.028			0.039			0.055		
	1-Way Throw		4-8-15			11-14-22			12-22-26			20-26-30			24-28-32			28-30-35
	2-Way Throw		2-4-10			7-11-21			9-21-24			15-21-28			15-22-29			18-24-30
	3-Way Throw	1-5-10		1-2-6	7-11-21		2-6-13	9-21-24		3-11-15	15-21-26		5-11-19	17-21-28		8-14-19	22-27-31	10-16-22
	4-Way Throw		1-2-6			2-6-13			3-11-15			5-11-19			8-14-19			10-16-22
12 x 12	CFM	200		305			410			515			620			725		
	NC	<20		<20			21			25			28			32		
	Pt	0.005		0.0135			0.0245			0.0425			0.062			0.084		
	1-Way Throw		4-9-16			12-15-24			18-24-30			20-26-32			25-26-34			28-32-36
	2-Way Throw		2-5-11			7-13-21			14-21-26			17-23-29			18-24-30			20-27-32
	3-Way Throw	2-5-11		1-3-7	7-13-21		3-8-15	14-21-26		4-12-18	17-23-29		6-13-22	18-24-30		10-16-23	20-27-32	12-18-24
	4-Way Throw		1-3-7			3-8-15			4-12-18			6-13-22			10-16-23			12-18-24
14 x 14	CFM	270		405			545			680			815			950		
	NC	<20		<20			22			31			37			42		
	Pt	0.007		0.018			0.032			0.057			0.085			0.113		
	1-Way Throw		4-10-17			13-16-25			20-26-32			22-31-38			26-27-35			29-34-38
	2-Way Throw		2-6-12			8-16-21			15-21-27			19-25-30			21-26-32			23-29-34
	3-Way Throw	2-6-12		2-3-8	8-16-21		4-9-17	15-21-27		5-13-20	19-25-30		7-14-25	21-26-32		11-18-25	23-29-34	13-19-26
	4-Way Throw		2-3-8			4-9-17			5-13-20			7-14-25			11-18-25			13-19-26

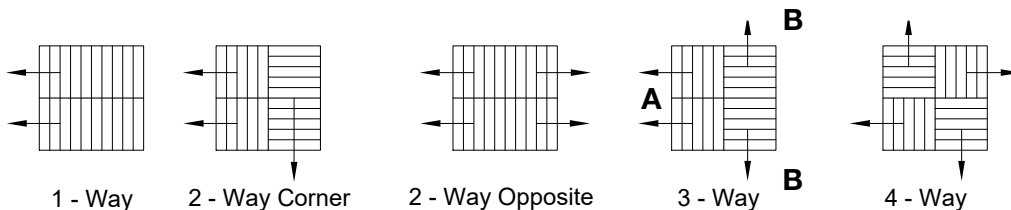

SERIES XG-9000/XG-9000S PERFORMANCE DATA
MODEL XG-9000/XG-9000 S (4 CORE)

Listed Size	Neck Vel Side	200		300		400		500		600		700	
		A	B	A	B	A	B	A	B	A	B	A	B
16 x 16	CFM	360		540		725		900		1080		1260	
	NC	<20		<20		26		36		42		48	
	Pt	0.016		0.031		0.058		0.1		0.154		0.218	
	1-Way Throw	6-12-19		15-20-27		22-28-40		25-32-41		27-32-43		30-35-45	
	2-Way Throw	5-9-15		10-18-25		18-25-32		23-29-34		25-31-36		28-33-39	
	3-Way Throw	5-9-15	3-5-10	10-18-25	5-10-19	18-25-32	7-15-23	23-29-34	7-15-23	25-31-36	12-20-27	28-33-39	14-21-30
	4-Way Throw	3-5-10		5-10-19		7-15-23		7-15-23		12-20-27		14-21-30	
18 x 18	CFM	450		670		900		1120		1345		1570	
	NC	<20		21		29		40		47		53	
	Pt	0.025		0.044		0.084		0.143		0.223		0.323	
	1-Way Throw	11-17-23		14-25-32		24-33-41		30-36-43		33-40-47		35-42-50	
	2-Way Throw	9-13-19		12-21-29		21-29-36		27-33-38		30-36-41		32-38-44	
	3-Way Throw	9-13-19	4-6-12	12-21-29	7-12-21	21-29-36	9-18-26	27-33-38	9-17-32	30-36-41	12-22-29	32-38-44	15-23-33
	4-Way Throw	4-6-12		7-12-21		9-18-26		9-17-32		12-22-29		15-23-33	
20 x 20	CFM	555		830		1110		1390		1670		1945	
	NC	<20		22		31		42		48		54	
	Pt	0.028		0.048		0.092		0.157		0.245		0.355	
	1-Way Throw	12-17-24		14-26-34		25-34-43		31-37-45		33-41-48		36-43-50	
	2-Way Throw	9-14-20		12-22-30		22-29-37		28-34-39		32-37-43		33-38-45	
	3-Way Throw	9-14-20	4-6-12	12-22-30	8-12-23	22-29-37	10-19-27	28-34-39	10-18-33	32-37-43	13-24-30	33-38-45	17-25-35
	4-Way Throw	4-6-12		8-12-23		10-19-27		10-18-33		13-24-30		17-25-35	
22 x 22	CFM	670		1010		1345		1680		2015		2350	
	NC	<20		22		31		42		49		55	
	Pt	0.031		0.054		0.103		0.176		0.275		0.398	
	1-Way Throw	12-18-25		15-27-35		26-35-45		32-38-46		34-43-49		35-44-52	
	2-Way Throw	9-15-21		13-22-31		23-30-38		28-35-40		32-38-44		33-39-46	
	3-Way Throw	9-15-21	5-8-14	13-22-31	9-14-23	23-30-38	11-20-28	28-35-40	10-19-34	32-38-44	14-25-32	33-39-46	18-26-37
	4-Way Throw	5-8-14		9-14-23		11-20-28		10-19-34		14-25-32		18-26-37	
24 x 24	CFM	800		1200		1600		2000		2400		2800	
	NC	21		24		32		42		50		56	
	Pt	0.032		0.056		0.107		0.182		0.285		0.412	
	1-Way Throw	12-19-27		15-27-37		27-35-47		30-36-43		33-40-50		35-42-50	
	2-Way Throw	9-16-22		14-24-33		25-32-40		29-37-42		34-40-46		35-41-47	
	3-Way Throw	9-16-22	6-9-15	14-24-33	8-16-25	25-32-40	12-22-30	29-37-42	12-20-35	34-40-46	14-26-32	35-41-47	20-28-38
	4-Way Throw	6-9-15		8-16-25		12-22-30		12-20-35		14-26-32		20-28-38	

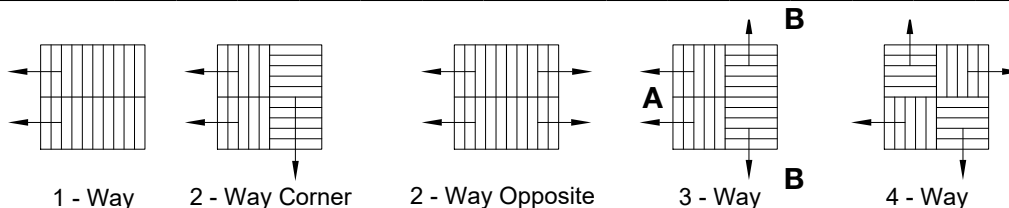

SERIES XG-9000/XG-9000S PERFORMANCE DATA
MODEL XG-9000/XG-9000 S (1 CORE)

Listed Size	Neck Vel	200	300	400	500	600	700
6 x 6	CFM	50	76	103	129	155	181
	NC	<20	<20	21	25	28	32
	Pt	0.005	0.0135	0.0245	0.0425	0.062	0.084
	Throw	4-9-16	12-15-24	18-24-30	20-26-32	25-26-34	28-32-36
7 x 7	CFM	68	101	136	170	204	238
	NC	<20	<20	22	31	37	42
	Pt	0.007	0.018	0.032	0.057	0.085	0.113
	Throw	4-10-17	13-16-25	20-26-32	22-31-38	26-27-35	29-34-38
8 x 8	CFM	90	135	181	225	270	315
	NC	<20	<20	25.5	35.5	42	47.5
	Pt	0.016	0.031	0.058	0.1	0.154	0.218
	Throw	6-12-19	15-20-27	22-28-40	25-32-41	27-32-43	30-35-45
9 x 9	CFM	113	168	225	280	336	393
	NC	<20	21	29	40	47	53
	Pt	0.025	0.044	0.084	0.143	0.223	0.323
	Throw	11-17-23	14-25-32	24-33-41	30-36-43	33-40-47	35-42-50
10 x 10	CFM	139	208	278	348	418	486
	NC	<20	22	31	42	48	54
	Pt	0.028	0.048	0.092	0.157	0.245	0.355
	Throw	12-17-24	14-26-34	25-34-43	31-37-45	33-41-48	36-43-50
12 x 12	CFM	200	300	400	500	600	700
	NC	21	24	32	42	50	56
	Pt	0.032	0.056	0.107	0.182	0.285	0.412
	Throw	12-19-27	15-27-37	27-35-47	30-36-43	33-40-50	35-42-50

PERFORMANCE NOTES FOR SERIES XG-9000/XG-9000S

All data is tested in accordance with ANSI/ASHRAE 70-2006.

DEFINITION OF UNITS

CFM Cubic Feet per Minute

fpm Velocity of air stream in Feet per Minute

Pt Total pressure (inches of water column)

Throw Horizontal distances in feet to the terminal velocity of 150, 100 and 50 fpm

NC Noise criterion, sound pressure level NC ratings are based on sound power level (Lw) re: 10⁻¹² watts minus a 10dB room attenuation in all octave bands

CONCENTRIC SUPPLY / RETURN CEILING DIFFUSER

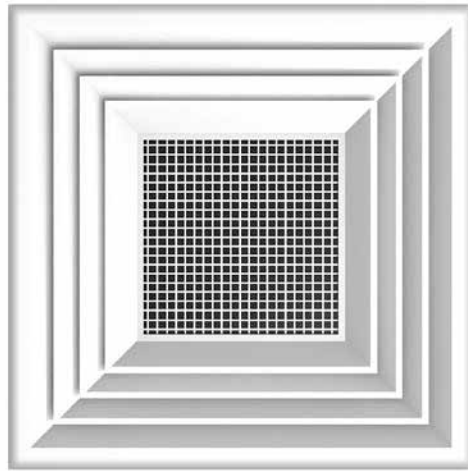

Model XG-DAF-CC5 Supply/Return Ceiling diffusers provide a functional solution to Roof-Top package single outlet air distribution requirements. The louver faced high induction design ensures a true horizontal air pattern for excellent mixing of room and primary air.

The cube core return provides an integrated air return path which minimizes pressure drop and resultant noise levels.

PAGE 87

MODEL XG-5500 XG-DAF-C5

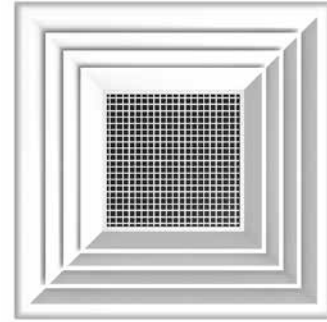

- XG-5500 XG-DAF-CC5-1 - Surface Mount
- XG-5500 XG-DAF-CC5-2 - V-Beveled Drop Face
- XG-5500 XG-DAF-CC5-4 - Deep Drop Frame
- XG-5500 XG-DAF-CC5-6 - T-bar Lay-in
- XG-5500 XG-DAF-CC5-7 - Concealed Spline
- XG-5500 XG-DAF-CC5-8 - Tegular Lay-in

Combination concentric supply/return units shall be model XG-DAF-CC5 manufactured by GREENHECK. Units shall consist of a fixed pattern outer ring of louvers that discharge supply air. The inner return or exhaust core shall consist of aluminum 1/2" x 1/2" x 1/2" cubed core.

Units shall be designed to integrate into the specified ceiling system.

Performance Specification

The manufacturer shall provide published performance data. Data shall be tested in accordance to ANSI/ASHRAE Standard 70- 2006

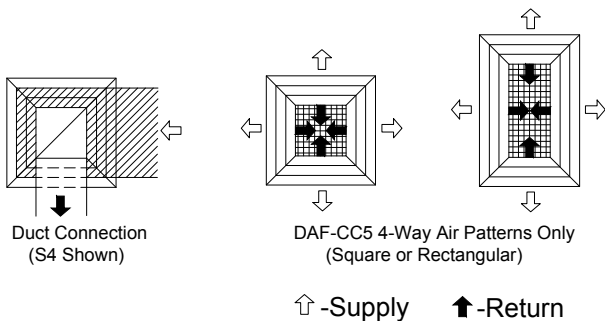
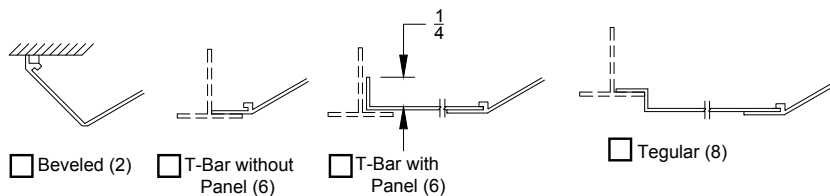
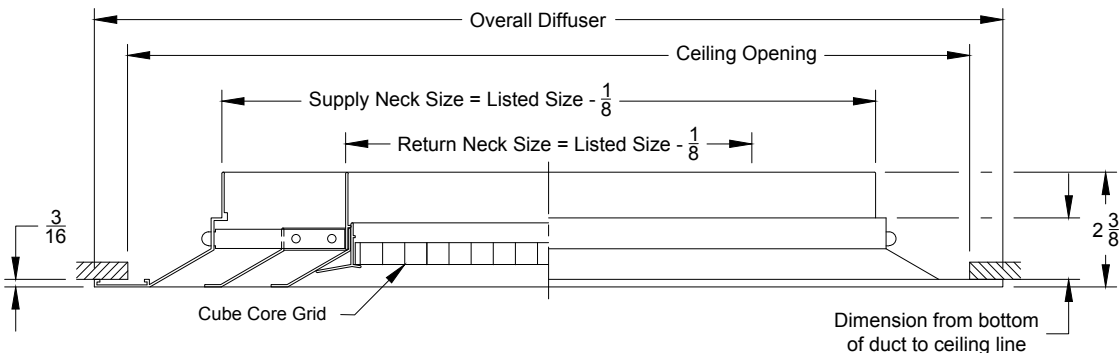

Frame Style	Overall Diffuser Size	Ceiling Opening Dimensions	Bottom of Duct To Ceiling Line
1	Supply Neck + 5 3/4	Supply Neck + 3 3/4	1 1/2
2	Supply Neck + 5 1/8	Supply Neck + 1	13/16
6A	Supply Neck + 5 3/4	T-Bar Module Size	1 11/16
6B	T-Bar Spacing - 1/4	T-Bar Module Size	1 11/16
7	T-Bar Spacing - 1/16	T-Bar Module Size	1 11/16
8	T-Bar Spacing - 1/4	T-Bar Module Size	1 15/16

SERIES XG-DAF-CC5 SPECIFICATIONS

Air Diffusers shall be model:

XG-DAF-CC5-1	Surface Mount
XG-DAF-CC5-2	Beveled Drop Face
XG-DAF-CC5-6	T-bar Lay-in
XG-DAF-CC5-7	Concealed Spline
XG-DAF-CC5-8	Tegular Lay-in

- Combination concentric supply/return units shall be model XG-DAF-CC5 manufactured by GREENHECK. Units shall consist of a fixed pattern outer ring of louvers that discharge supply air. The inner return or exhaust core shall consist of aluminum 1/2" x 1/2" x 1/2" cubed core.
- Units shall be designed to integrate into the specified ceiling system.

Performance Specification

The manufacturer shall provide published performance data. Data shall be tested in accordance to ANSI/ASHRAE Standard 70-2006.

Paint Specification

Process shall be anodic electro-deposition using an anodic acrylic paint. Units shall undergo pre-treatment including a pressurized spray stage using an alkaline cleaner and a de-ionized water rinse.

XG-DAF-CC5 MODEL NUMBER SPECIFICATION CONCENTRIC SUPPLY/RETURN CEILING DIFFUSER

Model		Supply	Return	Available Finishes	
XG-DAF-CC5-1	Surface Mount	12 x 12	6 x 6	Standard	
XG-DAF-CC5-2	Beveled Drop Surface Mount	Thru	Thru	01	White
		60 x 60	45 x 45	Optional	
				02	Satin Silver
				03	Black
				24	Mill
				28	Custom Color

**XG-DAF-CC5 MODEL NUMBER SPECIFICATION
 CONCENTRIC SUPPLY/RETURN CEILING DIFFUSER**

Model		Supply	Return	Module	Available Finishes	
XG-DAF-CC5-6	T-bar Lay-in	12 x 12	6 x 6 9 x 9	24 x 24 or 48 x 24	Standard	
		15 x 15	6 x 6 9 x 9 12 x 12		01	White
			Optional			
		18 x 18	6 x 6 9 x 9 12 x 12 15 x 15	02	Satin Silver	
			21 x 21	6 x 6 9 x 9 12 x 12 15 x 15 18 x 18	03	Black
		24 x 24 27 x 27		18 x 18	24 x 24 Only	24
			28			Custom Color
			30 x 30 33 x 33			48 x 48 Only
			36 x 36			
			39 x 39			
42 x 42						
XG-DAF-CC5-7 XG-DAF-CC5-8	Concealed Spline Tegular	12 x 12	9 x 9	24" x 24" Only		
		15 x 15	9 x 9			
		18 x 18	12 x 12 15 x 15			

 CEILING
 DIFFUSERS

 CONCENTRIC SUPPLY / RETURN
 CEILING DIFFUSER

XG-DAF-CC5

**SERIES XG-DAF-CC5 PERFORMANCE DATA/4-WAY SQUARE PATTERN (S4)
MODEL XG-DAF CC5**

Based on 100% Return of Supply Air for 2-10 Ton Roof Top Packages							
Tonage	2	2.5	3	4	5	7.5	10
Capacity (CFM)	800	1000	1200	1600	2000	3000	4000
Supply Neck Size	21 x 21	21 x 21	24 x 24	27 x 27	30 x 30	39 x 39	45 x 45
Vk	1335	1665	1715	1430	1575	1365	1540
Ps	0.09	.15	.15	.11	.13	.10	.12
Pt	.11	.18	.18	.13	.15	.12	.15
Throw	7-14	8-16	9-17	10-20	12-23	16-31	21-39
Return Neck Size	15 x 15	15 x 15	18 x 18	18 x 18	21 x 21	27 x 27	33 x 33
Inlet Velocity	513	640	535	710	654	590	529
Pt	.04	.06	.04	.07	.06	.05	.04
NC	25	35	37	30	37	37	38

SERIES XG-DAF-CC5 PERFORMANCE DATA/4-WAY RECTANGULAR PATTERN (R4)

Based on 100% Return of Supply Air for 2-10 Ton Roof Top Packages							
Tonage	2	2.5	3	4	5	7.5	10
Capacity (CFM)	800	1000	1200	1600	2000	3000	4000
Supply Neck Size	24 x 18	27 x 18	27 x 21	36 x 21	36 x 27	45 x 36	54 x 36
Vk	1335	1540	1715	1335	1480	1300	1540
Ps	.09	.12	.15	.09	.12	.09	.12
Pt	.11	.15	.18	.11	.14	.11	.15
Throw Side A	6-11	7-12	8-13	10-15	12-14	15-22	16-24
Throw Side B	8-14	11-15	10-16	12-18	14-21	17-25	19-31
Return Neck Size	18 x 12	21 x 12	21 x 15	27 x 12	27 x 18	33 x 24	42 x 24
Inlet Velocity	533	570	550	710	590	545	570
Pt	.04	.05	.04	.07	.05	.04	.05
NC	25	35	37	30	37	32	38

**SERIES XG-DAF-CC5 PERFORMANCE DATA/4-WAY SQUARE PATTERN (S4)
 MODEL XG-DAF CC5**

		Based on 75% Return of Supply Air						
		Neck Velocity						
		200	300	400	500	600	700	800
All Supplies	Face Velocity	500	750	1000	1250	1500	1750	2000
	Ps	.013	.03	.05	.08	.12	.16	.21
	Pt	.016	.04	.06	.10	.14	.19	.25
12 x 12 Supply	Total CFM	90	130	175	220	265	310	350
	Throw	2-4	3-5	5-8	6-10	6-12	7-13	8-14
9 x 9 Return	Total CFM	70	100	130	165	200	230	260
	Inlet Velocity	125	180	230	295	355	410	465
	Ps	.010	.010	.010	.010	.020	.030	.040
	NC	-	-	21	26	31	35	39
15 x 15 Supply	Total CFM	200	300	400	500	600	700	800
	Throw	3-5	5-8	6-10	6-12	7-14	8-17	10-19
9 x 9 Return	Total CFM	150	225	300	375	450	525	600
	Inlet Velocity	265	400	535	670	805	935	1070
	Ps	.010	.020	.040	.060	.090	.120	.160
	NC	-	-	21	26	35	40	45
18 x 18 Supply	Total CFM	250	375	500	625	750	875	1000
	Throw	3-5	4-8	6-11	6-12	8-14	9-16	10-19
12 x 12 Return	Total CFM	190	280	375	470	560	655	750
	Inlet Velocity	190	280	375	470	560	655	750
	Ps	.010	.010	.020	.030	.040	.060	.080
	NC	-	-	24	29	34	38	42
18 x 18 Supply	Total CFM	140	210	280	350	420	490	560
	Throw	4-6	5-8	6-12	7-13	8-15	9-17	11-20
15 x 15 Return	Total CFM	105	155	210	260	315	365	420
	Inlet Velocity	70	100	135	165	200	235	270
	Ps	.010	.020	.030	.050	.070	.090	.010
	NC	-	-	20	25	30	35	40
21 x 21 Supply	Total CFM	300	450	600	750	900	1050	1200
	Throw	3-5	4-8	5-12	7-13	8-15	9-17	11-20
15 x 15 Return	Total CFM	225	340	450	560	675	790	900
	Inlet Velocity	145	220	290	360	430	505	575
	Ps	.010	.010	.010	.020	.030	.010	.050
	NC	-	-	25	30	35	39	43

 CEILING
 DIFFUSERS

 CONCENTRIC SUPPLY / RETURN
 CEILING DIFFUSER

XG-DAF-CC5

**SERIES XG-DAF-CC5 PERFORMANCE DATA/4-WAY SQUARE PATTERN (S4)
MODEL XG-DAF CC5**

		Based on 75% Return of Supply Air						
		Neck Velocity						
		200	300	400	500	600	700	800
All Supplies	Face Velocity	500	750	1000	1250	1500	1750	2000
	Ps	.013	.03	.05	.08	.12	.16	.21
	Pt	.016	.04	.06	.10	.14	.19	.25
24 x 24 Supply	Total CFM	350	525	700	875	1050	1225	1400
	Throw	3-5	4-8	5-11	6-13	8-16	10-20	13-25
18 x 18 Return	Total CFM	260	395	525	655	790	920	1050
	Inlet Velocity	115	175	235	290	350	410	465
	Ps	.010	.010	.010	.010	.020	.030	.040
	NC	-	-	26	31	36	40	43
27 x 27 Supply	Total CFM	560	845	1125	1405	1685	1965	2250
	Throw	3-5	5-10	7-15	8-17	10-20	12-24	14-28
18 x 18 Return	Total CFM	405	610	815	1015	1220	1425	1630
	Inlet Velocity	180	270	360	450	540	635	725
	Ps	.010	.010	.020	.030	.040	.060	.070
	NC	-	-	26	32	37	41	44
30 x 30 Supply	Total CFM	640	955	1275	1595	1915	2235	2550
	Throw	3-7	5-12	7-16	9-17	11-21	13-25	15-30
21 x 21 Return	Total CFM	480	715	955	1195	1435	1675	1910
	Inlet Velocity	155	235	310	390	470	545	625
	Ps	.010	.010	.010	.020	.030	.040	.050
	NC	-	20	27	33	38	42	45
33 x 33 Supply	Total CFM	900	1350	1800	2250	2700	3150	3600
	Throw	4-8	6-13	8-17	11-23	15-30	17-33	19-38
21 x 21 Return	Total CFM	675	1010	1350	1690	2025	2360	2700
	Inlet Velocity	220	330	440	550	660	770	880
	Ps	.010	.020	.030	.040	.060	.080	.100
	NC	-	20	28	34	39	43	46

CEILING
DIFFUSERS

CONCENTRIC SUPPLY / RETURN
CEILING DIFFUSER

XG-DAF-CC5

**SERIES XG-DAF-CC5 PERFORMANCE DATA/4-WAY SQUARE PATTERN (S4)
 MODEL XG-DAF CC5**

		Based on 75% Return of Supply Air						
		Neck Velocity						
		200	300	400	500	600	700	800
All Supplies	Face Velocity	500	750	1000	1250	1500	1750	2000
	Ps	.013	.03	.05	.08	.12	.16	.21
	Pt	.016	.04	.06	.10	.14	.19	.25
36 x 36 Supply	Total CFM	1000	1500	2000	2500	3000	3500	4000
	Throw	4-8	5-13	8-18	12-22	15-30	17-34	21-38
24 x 24 Return	Total CFM	750	1125	1500	1875	2250	2625	3000
	Inlet Velocity	185	280	375	470	560	655	750
	Ps	.010	.010	.020	.030	.050	.060	.080
	NC	-	20	28	34	39	43	47
39 x 39 Supply	Total CFM	1100	1650	2200	2750	3300	3850	4400
	Throw	5-10	8-17	11-21	15-23	18-34	25-39	26-42
27 x 27 Return	Total CFM	825	1240	1650	2060	2475	2890	3300
	Inlet Velocity	165	245	325	410	490	570	650
	Ps	.010	.010	.015	.020	.030	.050	.060
	NC	-	20	29	35	40	44	47
42 x 42 Supply	Total CFM	1440	2160	2875	3595	4315	5035	5750
	Throw	4-10	10-21	14-28	18-34	21-39	25-43	28-49
27 x 27 Return	Total CFM	1080	1615	2160	2695	3235	3775	4310
	Inlet Velocity	215	320	425	530	640	745	850
	Ps	.010	.010	.030	.040	.060	.080	.100
	NC	-	23	30	36	41	45	48
42 x 42 Supply	Total CFM	1200	1800	2400	3000	3600	4200	4800
	Throw	4-10	8-17	11-21	15-24	18-33	24-38	25-44
30 x 30 Return	Total CFM	900	1350	1800	2250	2700	3150	3600
	Inlet Velocity	145	215	290	360	430	505	575
	Ps	.010	.010	.010	.020	.030	.040	.050
	NC	-	-	25	33	35	40	45
42 x 42 Supply	Total CFM	940	1410	1880	2345	2815	3285	3750
	Throw	4-9	6-13	8-18	12-21	15-29	16-33	20-37
33 x 33 Return	Total CFM	705	1055	1410	1760	2110	2460	2815
	Inlet Velocity	95	140	185	230	280	325	370
	Ps	.020	.030	.050	.090	.130	.170	.220
	NC	-	20	25	33	35	40	45

 CEILING
 DIFFUSERS

 CONCENTRIC SUPPLY / RETURN
 CEILING DIFFUSER

XG-DAF-CC5

**SERIES XG-DAF-CC5 PERFORMANCE DATA/4-WAY SQUARE PATTERN (S4)
MODEL XG-DAF CC5**

		Based on 75% Return of Supply Air						
		Neck Velocity						
		200	300	400	500	600	700	800
All Supplies	Face Velocity	500	750	1000	1250	1500	1750	2000
	Ps	.013	.03	.05	.08	.12	.16	.21
	Pt	.016	.04	.06	.10	.14	.19	.25
45 x 45 Supply	Total CFM	1300	1950	2600	3250	3900	4550	5200
	Throw	5-10	9-20	13-24	17-28	20-38	27-45	24-50
33 x 33 Return	Total CFM	975	1460	1950	2440	2925	3410	3900
	Inlet Velocity	130	195	255	320	390	450	515
	Ps	.030	.060	.100	.150	.200	.300	.400
	NC	-	22	28	33	39	44	48
48 x 48 Supply	Total CFM	1690	2530	3380	4220	5065	5910	6750
	Throw	6-11	11-23	16-24	20-30	23-41	30-48	35-55
33 x 33 Return	Total CFM	1265	1900	2530	3165	3800	4430	5065
	Inlet Velocity	170	250	335	420	500	585	670
	Ps	.010	.010	.020	.030	.040	.050	.060
	NC	-	23	32	37	41	45	49
60 x 60 Supply	Total CFM	2190	3280	4375	5470	6565	7660	8750
	Throw	7-13	13-25	18-28	22-32	25-43	32-50	37-56
45 x 45 Return	Total CFM	1640	2460	3280	4100	4925	5745	6565
	Inlet Velocity	115	175	235	290	350	410	465
	Ps	.020	.040	.070	.100	.200	.250	.300
	NC	-	28	32	35	38	41	46

CEILING
DIFFUSERS

CONCENTRIC SUPPLY / RETURN
CEILING DIFFUSER

XG-DAF-CC5

**SERIES XG-DAF-CC5 PERFORMANCE DATA/4-WAY RECTANGULAR PATTERN (R4)
 MODEL XG-DAF CC5**

		Based on 75% Return of Supply Air						
		Neck Velocity						
		200	300	400	500	600	700	800
All Supplies	Face Velocity	500	750	1000	1250	1500	1750	2000
	Ps	.013	.03	.05	.08	.12	.16	.21
	Pt	.016	.04	.06	.10	.14	.19	.25
30 x 24 Supply	Total CFM	640	960	1280	1600	1920	2240	2560
	Throw Side A	5-7	7-10	9-13	11-17	13-20	16-23	18-28
	Throw Side B	4-7	5-9	7-11	9-14	1-17	13-18	15-23
27 x 15 Return	Total CFM	480	720	960	1200	1440	1680	1920
	Inlet Velocity	170	255	340	430	515	600	685
	Ps	.010	.010	.020	.030	.040	.050	.070
36 x 27 Supply	Total CFM	675	1015	1350	1690	2030	2365	2705
	Throw Side A	5-8	7-10	9-13	11-17	13-20	16-24	18-28
	Throw Side B	4-7	6-9	8-12	10-15	11-19	14-20	17-25
27 x 18 Return	Total CFM	505	760	1010	1270	1520	1775	2030
	Inlet Velocity	150	225	300	375	450	525	600
	Ps	.010	.010	.010	.020	.030	.040	.050
36 x 30 Supply	Total CFM	715	1070	1430	1785	2140	2500	2855
	Throw Side A	5-9	7-11	9-13	11-17	13-20	16-23	18-28
	Throw Side B	4-7	6-9	8-12	10-15	12-18	15-21	17-25
27 x 21 Return	Total CFM	535	800	1070	1340	1605	1875	2140
	Inlet Velocity	135	205	270	340	410	480	545
	Ps	.010	.010	.010	.020	.025	.030	.040
42 x 33 Supply	Total CFM	1050	1575	2100	2625	3150	3675	4200
	Throw Side A	6-10	8-12	11-16	13-20	16-24	19-28	22-32
	Throw Side B	4-8	6-10	9-14	12-18	14-21	17-25	19-29
30 x 21 Return	Total CFM	790	1180	1575	1970	2360	2755	3150
	Inlet Velocity	180	270	360	450	540	630	720
	Ps	.010	.010	.020	.030	.040	.060	.070
48 x 21 Supply	Total CFM	750	1125	1500	1875	2250	2625	3000
	Throw Side A	4-8	7-11	10-15	13-19	17-23	18-26	22-31
	Throw Side B	3-6	6-9	7-11	9-14	11-16	13-20	15-23
39 x 12 Return	Total CFM	560	845	1125	1405	1690	1970	2250
	Inlet Velocity	170	260	345	430	520	605	690
	Ps	.010	.010	.020	.030	.040	.050	.070
	Total CFM	20	23	26	30	35	40	45
	NC	20	23	26	30	35	40	45

 CEILING
 DIFFUSERS

 CONCENTRIC SUPPLY / RETURN
 CEILING DIFFUSER

XG-DAF-CC5

**SERIES XG-DAF-CC5 PERFORMANCE DATA/4-WAY RECTANGULAR PATTERN (R4)
MODEL XG-DAF CC5**

		Based on 75% Return of Supply Air						
		Neck Velocity						
		200	300	400	500	600	700	800
All Supplies	Face Velocity	500	750	1000	1250	1500	1750	2000
	Ps	.013	.03	.05	.08	.12	.16	.21
	Pt	.016	.04	.06	.10	.14	.19	.25
48 x 24 Supply	Total CFM	790	1180	1575	1970	2365	2760	3150
	Throw Side A	5-8	7-11	10-15	13-19	15-23	18-27	21-31
	Throw Side B	4-7	6-9	8-11	9-14	11-17	13-20	15-23
39 x 15 Return	Total CFM	590	885	1180	1480	1775	2070	2360
	Inlet Velocity	145	220	290	365	440	510	580
	Ps	.010	.010	.010	.020	.030	.040	.050
	NC	20	23	26	30	35	40	45
48 x 27 Supply	Total CFM	825	1240	1650	2065	2480	2890	3305
	Throw Side A	6-8	8-12	10-15	13-19	15-23	18-27	21-30
	Throw Side B	5-7	7-10	8-12	10-15	13-19	14-21	17-25
39 x 18 Return	Total CFM	620	930	1240	1550	1860	2170	2480
	Inlet Velocity	130	190	255	320	380	445	510
	Ps	.010	.010	.010	.010	.020	.030	.040
	NC	20	23	26	30	35	40	45
48 x 30 Supply	Total CFM	865	1295	1730	2160	2590	3025	3455
	Throw Side A	5-9	7-11	10-15	13-19	15-23	18-27	21-31
	Throw Side B	4-7	6-9	8-12	11-16	13-19	15-22	17-25
39 x 21 Return	Total CFM	650	970	1295	1620	1940	2270	2590
	Inlet Velocity	115	170	230	285	340	400	455
	Ps	.010	.010	.010	.010	.015	.020	.030
	NC	20	23	26	30	35	40	45
48 x 33 Supply	Total CFM	1150	1725	2300	2875	3450	4025	4600
	Throw Side A	7-11	9-13	11-17	15-22	18-26	21-30	23-34
	Throw Side B	5-8	6-10	9-14	12-18	14-21	17-25	19-29
36 x 21 Return	Total CFM	860	1295	1725	2155	2590	3020	3450
	Inlet Velocity	165	250	330	410	495	575	655
	Ps	.010	.010	.015	.020	.030	.050	.060
	NC	20	23	26	30	35	40	45

CEILING
DIFFUSERS

CONCENTRIC SUPPLY / RETURN
CEILING DIFFUSER

XG-DAF-CC5

**SERIES XG-DAF-CC5 PERFORMANCE DATA/4-WAY RECTANGULAR PATTERN (R4)
 MODEL XG-DAF CC5**

		Based on 75% Return of Supply Air						
		Neck Velocity						
		200	300	400	500	600	700	800
All Supplies	Face Velocity	500	750	1000	1250	1500	1750	2000
	Ps	.013	.03	.05	.08	.12	.16	.21
	Pt	.016	.04	.06	.10	.14	.19	.25
48 x 36 Supply	Total CFM	1200	1800	2400	3000	3600	4200	4800
	Throw Side A	7-11	9-13	11-17	15-22	18-26	21-30	23-34
	Throw Side B	5-9	7-11	10-15	13-19	15-21	17-26	20-30
36 x 24 Return	Total CFM	900	1350	1800	2250	2700	3150	3600
	Inlet Velocity	150	225	300	375	450	525	600
	Ps	.010	.010	.010	.020	.030	.040	.050
48 x 39 Supply	Total CFM	1250	1875	2500	3125	3750	4375	5000
	Throw Side A	7-11	9-13	11-17	15-22	16-25	18-27	21-31
	Throw Side B	5-9	7-11	10-15	11-16	13-19	15-23	18-28
36 x 27 Return	Total CFM	940	1405	1875	2345	2810	3280	3750
	Inlet Velocity	140	210	280	350	415	485	555
	Ps	.010	.010	.010	.020	.025	.030	.040
48 x 45 Supply	Total CFM	1625	2440	3250	4065	4880	5690	6500
	Throw Side A	8-13	10-15	13-19	16-24	19-29	23-33	26-38
	Throw Side B	7-12	9-14	12-18	15-23	18-28	21-32	24-35
33 x 30 Return	Total CFM	1220	1830	2440	3050	3660	4270	4875
	Inlet Velocity	180	265	355	445	535	620	710
	Ps	.010	.010	.020	.030	.040	.050	.070
60 x 21 Supply	Total CFM	910	1365	1820	2275	2730	3185	3640
	Throw Side A	6-10	9-13	11-17	17-22	18-26	21-30	23-34
	Throw Side B	4-7	6-9	8-11	10-15	12-18	14-20	15-23
51 x 12 Return	Total CFM	680	1025	1365	1705	2050	2390	2730
	Inlet Velocity	160	240	320	400	480	560	640
	Ps	.010	.010	.010	.020	.030	.050	.060
60 x 27 Supply	Total CFM	975	1465	1950	2440	2930	3415	3900
	Throw Side A	7-11	9-13	11-17	17-22	18-26	21-30	23-35
	Throw Side B	4-7	6-9	8-12	10-15	13-19	14-20	17-25
51 x 18 Return	Total CFM	730	1110	1460	1833	2200	2560	2925
	Inlet Velocity	115	175	230	290	345	400	460
	Ps	.010	.010	.010	.010	.020	.030	.040
	NC	20	23	26	30	35	40	45

**CEILING
DIFFUSERS**
**CONCENTRIC SUPPLY / RETURN
CEILING DIFFUSER**
XG-DAF-CC5

**SERIES XG-DAF-CC5 PERFORMANCE DATA/4-WAY RECTANGULAR PATTERN (R4)
MODEL XG-DAF CC5**

		Based on 75% Return of Supply Air						
		Neck Velocity						
		200	300	400	500	600	700	800
All Supplies	Face Velocity	500	750	1000	1250	1500	1750	2000
	Ps	.013	.03	.05	.08	.12	.16	.21
	Pt	.016	.04	.06	.10	.14	.19	.25
60 x 30 Supply	Total CFM	1015	1520	2030	2535	3040	3550	4055
	Throw Side A	7-11	9-13	11-17	17-32	18-25	21-30	23-35
	Throw Side B	4-7	6-9	8-12	11-16	13-19	15-23	17-25
51 x 21 Return	Total CFM	760	1140	1520	1900	2280	2660	3040
	Inlet Velocity	100	155	205	255	310	360	410
	Ps	.010	.010	.010	.010	.020	.030	.040
	NC	20	23	26	30	35	40	45
60 x 33 Supply	Total CFM	1350	2025	2700	3375	4050	4725	5400
	Throw Side A	8-13	10-15	13-20	17-24	18-30	22-34	26-38
	Throw Side B	5-9	7-11	9-14	12-18	14-21	17-25	19-29
48 x 21 Return	Total CFM	1010	1520	2025	2530	3035	3545	4050
	Inlet Velocity	145	215	290	360	435	505	580
	Ps	.010	.010	.010	.020	.030	.040	.050
	NC	20	23	26	30	35	40	45
60 x 36 Supply	Total CFM	1400	2100	2800	3500	4200	4900	5600
	Throw Side A	8-13	10-15	13-20	17-25	18-30	23-34	27-40
	Throw Side B	5-9	7-11	12-15	13-19	15-22	17-26	20-30
48 x 24 Return	Total CFM	1050	1575	2100	2625	3150	3675	4200
	Inlet Velocity	130	195	260	330	395	460	525
	Ps	.010	.010	.010	.020	.030	.040	.050
	NC	20	23	26	30	35	40	45
60 x 39 Supply	Total CFM	1450	2175	2900	3625	4350	5075	5800
	Throw Side A	8-13	10-15	14-20	17-25	18-30	23-34	27-40
	Throw Side B	5-9	7-11	10-15	13-19	15-23	19-28	20-32
48 x 27 Return	Total CFM	1090	1630	2175	2720	3260	3805	4350
	Inlet Velocity	120	180	240	300	360	420	485
	Ps	.010	.010	.010	.020	.025	.030	.040
	NC	20	23	26	30	35	40	45

CEILING
DIFFUSERS

CONCENTRIC SUPPLY / RETURN
CEILING DIFFUSER

XG-DAF-CC5

**SERIES XG-DAF-CC5 PERFORMANCE DATA/4-WAY RECTANGULAR PATTERN (R4)
 MODEL XG-DAF CC5**

		Based on 75% Return of Supply Air						
		Neck Velocity						
		200	300	400	500	600	700	800
All Supplies	Face Velocity	500	750	1000	1250	1500	1750	2000
	Ps	.013	.03	.05	.08	.12	.16	.21
	Pt	.016	.04	.06	.10	.14	.19	.25
60 x 42 Supply	Total CFM	1810	2720	3625	4530	5435	6340	7250
	Throw Side A	9-15	11-17	15-23	19-29	23-35	27-40	30-45
	Throw Side B	7-11	9-13	11-17	15-23	19-27	22-31	24-35
45 x 27 Return	Total CFM	1360	2040	2720	3400	4080	4755	5440
	Inlet Velocity	160	240	320	405	485	565	645
	Ps	.010	.010	.010	.020	.03	.040	.060
	NC	20	25	30	35	40	45	50
60 x 45 Supply	Total CFM	1875	2815	3750	4690	5630	6565	7500
	Throw Side A	9-15	11-17	15-23	19-28	22-34	26-40	30-45
	Throw Side B	7-12	9-14	12-18	15-23	17-27	21-32	24-36
45 x 30 Return	Total CFM	1400	2110	2810	3520	4220	4925	5625
	Inlet Velocity	150	225	300	375	450	525	600
	Ps	.010	.010	.010	.020	.030	.040	.050
	NC	20	25	30	35	40	45	50
60 x 48 Supply	Total CFM	1940	2910	3880	4850	5820	6790	7760
	Throw Side A	9-15	11-17	15-23	19-29	22-35	27-41	31-46
	Throw Side B	7-12	9-14	13-19	16-24	18-29	23-34	25-39
45 x 33 Return	Total CFM	1455	2180	2910	3640	4365	5090	5820
	Inlet Velocity	140	210	280	355	425	495	565
	Ps	.010	.010	.010	.020	.025	.030	.040
	NC	20	25	30	35	40	45	50
60 x 51 Supply	Total CFM	2000	3000	4000	5000	6000	7000	8000
	Throw Side A	9-15	11-17	15-23	19-29	22-35	27-41	31-46
	Throw Side B	8-13	10-15	13-20	16-25	20-30	23-35	27-40
45 x 36 Return	Total CFM	1500	2250	3000	3750	4500	5250	6000
	Inlet Velocity	135	200	265	335	400	465	535
	Ps	.010	.010	.010	.020	.025	.030	.040
	NC	20	25	30	35	40	45	50
60 x 54 Supply	Total CFM	2400	3600	4800	6000	7200	8400	9600
	Throw Side A	10-16	12-18	16-25	22-32	26-39	31-46	34-52
	Throw Side B	9-15	11-17	15-24	20-30	24-36	27-42	32-48
42 x 36 Return	Total CFM	1800	2700	3600	4500	5400	6300	7200
	Inlet Velocity	170	255	340	430	515	600	685
	Ps	.010	.010	.020	.030	.040	.050	.070
	NC	20	25	30	35	40	45	50

 CEILING
 DIFFUSERS

 CONCENTRIC SUPPLY / RETURN
 CEILING DIFFUSER

XG-DAF-CC5

**SERIES XG-DAF-CC5 PERFORMANCE DATA/4-WAY RECTANGULAR PATTERN (R4)
MODEL XG-DAF CC5**

		Based on 75% Return of Supply Air						
		Neck Velocity						
		200	300	400	500	600	700	800
All Supplies	Face Velocity	500	750	1000	1250	1500	1750	2000
	Ps	.013	.03	.05	.08	.12	.16	.21
	Pt	.016	.04	.06	.10	.14	.19	.25
60 x 57 Supply	Total CFM	2480	3715	4500	6190	7430	8665	9900
	Throw Side A	11-17	13-19	17-26	22-33	26-39	33-49	35-52
	Throw Side B	10-16	12-18	16-24	21-30	25-36	30-46	32-50
42 x 39 Return	Total CFM	1860	2790	3710	4640	5570	6500	7425
	Inlet Velocity	165	245	325	410	490	570	655
	Ps	.010	.010	.010	.020	.030	.050	.060
	NC	20	25	30	35	40	45	50

PERFORMANCE NOTES FOR SERIES XG-DAF-CC5

All data is tested in accordance with ANSI/ASHRAE 70-2006.

DEFINITION OF UNITS

CFM Cubic Feet per Minute (Air)

fpm Velocity of air stream in Feet per Minute

Pv Velocity pressure (inches of water column)



Pt Total pressure (inches of water column)

Ps Static pressure = Pt-Pv (inches of water column)

Throw Cataloged Throw is horizontal distances in feet to the terminal velocities of 150 and 50fpm with ambient supply air temperature

NC Noise criterion, sound pressure level NC ratings are based on sound power level (Lw) re: 10^{-12} watts minus a 10dB room attenuation in all octave bands

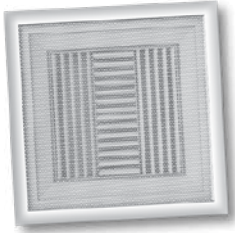
PERFORATED CEILING DIFFUSERS

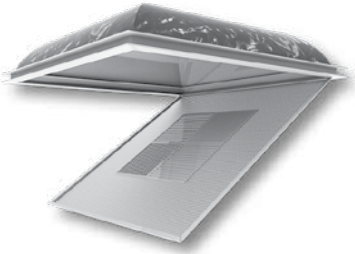
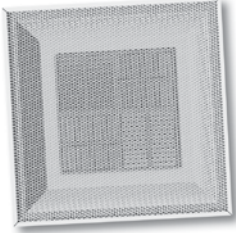
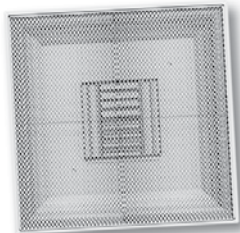
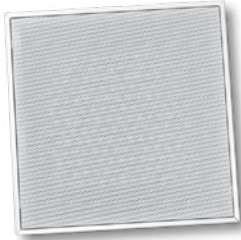
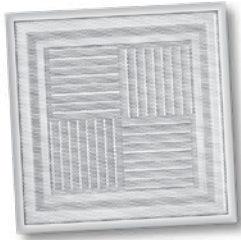
<p>MODEL XG-7000</p> 	<p>MODEL XG-PRTB AND XG-SPRTB</p> 	<p>MODEL XG-7300</p> 
<p>MODEL XG-7350</p> 	<p>MODEL XG-7500 AND XG-7550</p> 	<p>MODEL XG-7600 AND XG-7650</p> 
<p>MODEL XG-7550R-F AND XG-7650R-F</p> 		<p>MODEL XG-7900 AND XG-7950</p> 

Model XG-7000 is designed for use in most types of ceilings for efficient, draft free air distribution. It is ideal for applications requiring a variety of air diffusion configurations, corrosion resistant construction, and square or rectangular face and neck size combinations. Five interchangeable air pattern controllers with individually adjustable curved blades provide full vertical to horizontal air pattern capability. Six frame styles and a large selection of square and rectangular frames and neck sizes make the XG-7000 easy to specify for new or existing buildings. Matching returns are available (Model XG-7000R).

PAGE 103

Model XG-PRTB and XG-SPRTB are an economical choice for non-ducted plenum return application. They are shipped without pattern controllers and are for a T-Bar Grid System.

PAGE 116

Model XG-7300 has a round black air pattern control disc permanently attached to the inside center of a steel perforated face and a 1" thick plenum of molded fiberglass with an external layer of aluminum foil. The disc provides a 360° horizontal air pattern. The 7300 is recommended in locations where more specific air patterns are not required and the room configuration is not likely to change.

PAGE 119

Model XG-7350 is furnished with an extruded aluminum frame to accommodate hinging of the steel perforated face. Four air pattern controllers are centrally pivoted to the inside of the face. Each pattern controller can be rotated 360° to achieve 1, 2, 3 or 4-way air pattern even after the diffuser is installed. The diffuser also features a 1" thick plenum of molded fiberglass with an external layer of aluminum foil.

PAGE 122

Model XG-7500 and XG-7550 are designed for use in ceiling applications which call for air pattern adjustability in the field. The perforated face is hinged to swing open to permit easy access to four air pattern controllers centrally pivoted on the inside face surface. These units are available in both steel and aluminum construction and are also available in round neck, XG-7500, or square neck, 7550. Matching returns are available (Model XG-7500R and Model XG-7550R).

PAGE 125

Model XG-7600 and XG-7650 are available in both steel and aluminum construction. The hinged fully removable face allows access to the curve blade pattern controllers mounted in the neck of the diffuser. These units are available in both round neck, XG-7600, and square neck, XG-7650. Matching returns are available (Model XG-7600R and Model XG-7650R).

PAGE 138

Model XG-7550R-F and XG-7650R-F are perforated return filter diffusers designed to be installed in standard T-Bar ceiling grids. The hinged perforated face allows access to the filter (by others). These units are available with a 1" or 2" filter rack.

PAGE 158

Model XG-7900 and XG-7950 are designed for supply air distribution in applications where air pattern adjustment is desired. The perforated face of the diffuser is secured with spring clips, which allows for easy removal and access to the cores. The modular cores are spring loaded and can be arranged in the diffuser frame before or after installation without the use of tools and without removing the diffuser from the ceiling. These units are available in square neck model XG-7950.

PAGE 169

MODEL XG-7000/XG-7000R

Supply – Perforated Face – Square Neck - Curved Pattern Controllers/Series XG-7000

XG-7000-1 - Surface Mounted
XG-7000-6 - T-bar Lay-in
XG-7000-7 - Concealed Spline
XG-7000-8 - Tegular T-bar
XG-7500-9 - Donn Finline

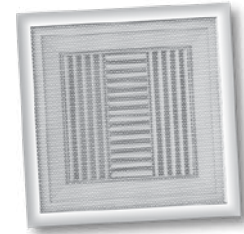

Air Outlets shall be aluminum model XG-7000 manufactured by GREENHECK. Units shall consist of aluminum 51% free area perforated face and an aluminum border and backpan. Perforated holes shall be 3/16" diameter on 1/4" staggered centers.

Outer border of units shall be extruded aluminum construction. The perforated face shall be removable allowing access to aluminum curved blade pattern controller mounted into the neck of the diffusers. Face shall be secured in place with tension spring clips.

Pattern controller blades shall be individually adjustable and allow the discharge pattern to be adjustable from vertical to horizontal. Pattern controller blades shall pivot in friction mounted retainers. Retainers shall hold the deflector blade position throughout the specified operating range of the device. Metal friction wires are not acceptable.

Outlets shall be available in 1, 2-way opposite, 2-way corner, 3, and 4-way directional air patterns. Units shall have square inlets. The units shall be the size and quantity as outline in the plans and specifications.

Units shall be designed to integrate into the specified ceiling system.

Return/Exhaust – Perforated Face – Square Neck/Series XG-7000

XG-7000R-1 - Surface Mounted
XG-7000R-6 - T-bar Lay-in
XG-7000R-7 - Concealed Spline
XG-7000R-8 - Tegular T-bar
XG-7500R-9 - Donn Finline

Air Inlets shall be aluminum model XG-7000R manufactured by GREENHECK. Units shall consist of aluminum 51% free area perforated face and an aluminum border and backpan. Perforated holes shall be 3/16" diameter on 1/4" staggered centers. Units shall be designed for use in ducted return or exhaust applications.

Outer border of units shall be extruded aluminum construction. The perforated face shall be removable allowing access to interior of diffuser. Face shall be secured in place with tension spring clips.

The units shall be the size and quantity as outline in the plans and specifications. Units shall be designed to integrate into the specified ceiling system.

Square Neck Options and Accessories:

Round Neck Optional Dampers and Accessories:

Square to Round Transitions

Units to have square to round transitions allowing installation with round ductwork.

Butterfly Damper

GREENHECK model XG-BDS aluminum round butterfly type dampers shall be provided. Damper shall consist of two butterfly style blades that can be adjusted from full open to full closed. Damper shall be adjusted with a screw driver slot that can be accessed through the face of the diffuser.

Radial Shutter Damper

GREENHECK model XG-RSD steel round radial shutter damper shall be provided. Damper shall consist of gang operated radial blades that slide perpendicular to air flow direction. The damper shall be adjusted from full open to full closed. Damper shall be adjusted with a screw driver slot that can be accessed through the face of the diffuser.

Opposed Blade Damper

GREENHECK model XG-D3 aluminum or XG-SD3 steel round opposed blade type dampers shall be provided. Damper shall consist of gang operated blades that can be adjusted from full open to full closed. Damper shall be adjusted with a screw driver slot that can be accessed through the face of the diffuser.

Equalizing Grid

GREENHECK model XG-G3 aluminum round equalizing grid shall be provided. Equalizing grid shall consist of 1/2" x 1/2" x 1/2" aluminum cubed core mounting in an aluminum frame.

Performance Specification

The manufacturer shall provide published performance data. Data shall be tested in accordance to ANSI/ASHRAE Standard 70- 2006

XG-7000-1 - Flush Ceiling Mount

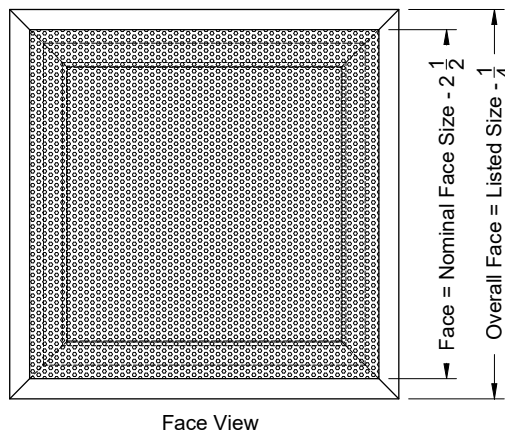
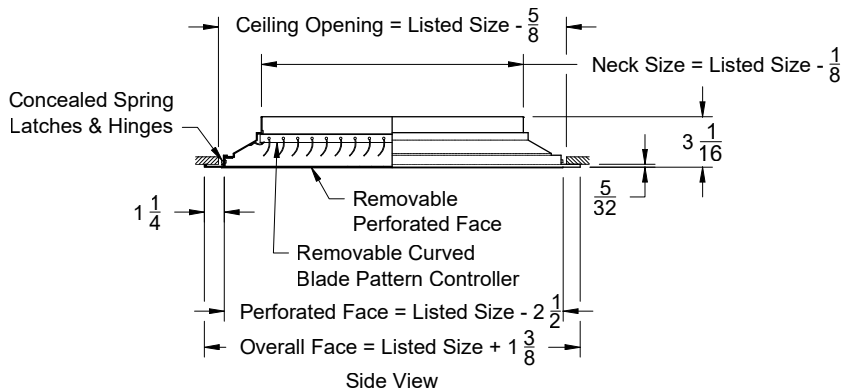

Listed Nominal	Largest Size
Face	Neck
12 x 12	6 x 6
14 x 14	8 x 8
15 x 15	9 x 9
16 x 16	10 x 10
18 x 18	12 x 12
20 x 20	14 x 14
21 x 21	15 x 15
24 x 12	18 x 6
24 x 24	18 x 18
36 x 12	18 x 6
36 x 24	16 x 16
48 x 12	18 x 6
48 x 24	18 x 18

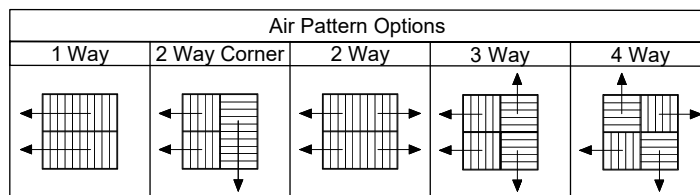

MODEL XG-7000R

Model: XG-7000R-1 Perforated Face - Flush Surface Mount

XG-7000R-1 - Flush Surface Mount

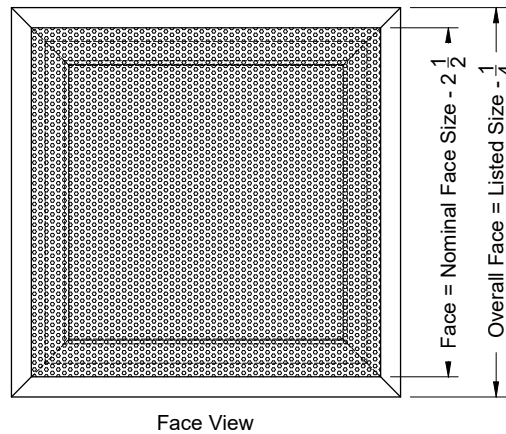
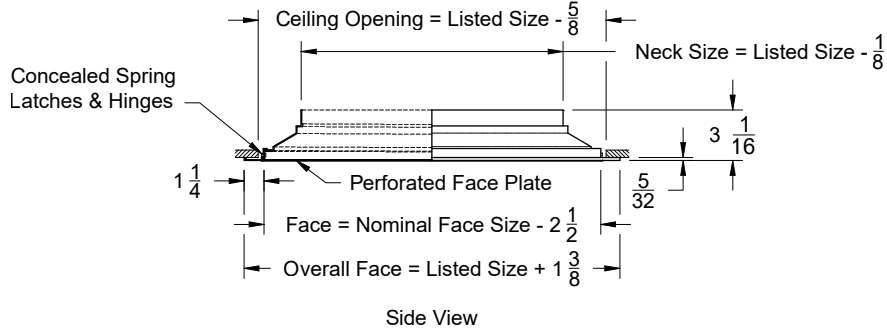

Listed Nominal	Largest Size
Face	Neck
12 x 12	6 x 6
14 x 14	8 x 8
15 x 15	9 x 9
16 x 16	10 x 10
18 x 18	12 x 12
20 x 20	14 x 14
21 x 21	15 x 15
24 x 12	18 x 6
24 x 24	16 x 16
48 x 24	18 x 18

1. Available Finishes

Standard Finish:
 01 White
 Finish
 02 Satin Silver
 03 Black
 22 BBP - Black
 Backpan - White Face
 Optional Finish
 28 Custom Color

2. Available Accessories

XG-D7 - Steel, Opposed Blade Damper
 XG-D7A - Aluminum, OBD
 XG-G3 - Equalizing Grid (Round)
 XG-L9 - Equalizing Grid (Square/Rect.)
 XG-TBPF - T-Bar Plaster Frame
 XG-LIPF - Lay-In Plaster Frame
 XG-TR - Square to Round Transition
 XG-TR-Deep - Deep Transition

3. Available Options

4. Construction Details

- Aluminum Construction
- Perforated Face: $\frac{3}{16}$ Holes on $\frac{1}{4}$ Staggered Centers

All Dimensions $\pm 1/16"$

MODEL XG-7000R

CEILING
DIFFUSERS

CONCENTRIC SUPPLY / RETURN
CEILING DIFFUSER

XG-DAF-CC5

Model: XG-7000R-6 Perforated Face - Lay In T-Bar

XG-7000R-6 - Lay in T-Bar

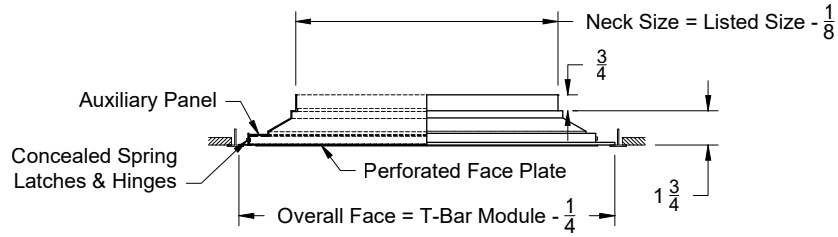

Side View

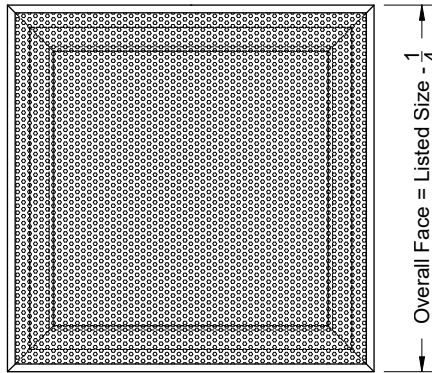

Face View

Listed Nominal	Largest Size
Face	Neck
12 x 12	6 x 6
14 x 14	8 x 8
15 x 15	9 x 9
16 x 16	10 x 10
18 x 18	12 x 12
20 x 20	14 x 14
21 x 21	15 x 15
24 x 12	18 x 6
24 x 24	16 x 16
48 x 24	18 x 18

1. Available Finishes

Standard Finish:
01 White
Finish
02 Satin Silver
03 Black
22 BBP - Black
Backpan - White Face
Optional Finish
28 Custom Color

2. Available Accessories

XG-D7 - Steel, Opposed Blade Damper
XG-D7A - Aluminum, OBD
XG-G3 - Equalizing Grid (Round)
XG-L9 - Equalizing Grid (Square/Rect.)
XG-TBPF - T-Bar Plaster Frame
XG-LIPF - Lay-In Plaster Frame
XG-TR - Square to Round Transition
XG-TR-Deep - Deep Transition

3. Available Options

4. Construction Details

- Aluminum Construction
- Perforated Face: 3/16 Holes on 1/4 Staggered Centers

All Dimensions $\pm 1/16"$

MODEL XG-7000R

Model: XG-7000R-6-24x24 Perforated Face - 24 x 24 Grid Size Only

XG-7000R-6 - 24 X 24 - Lay in T-Bar

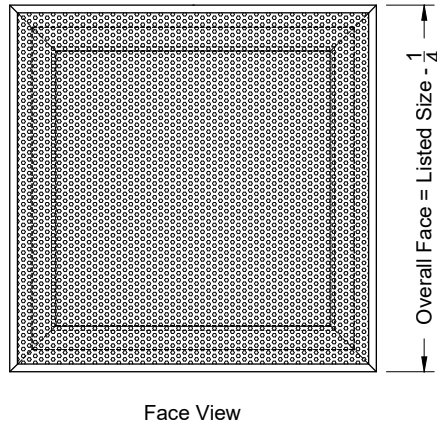
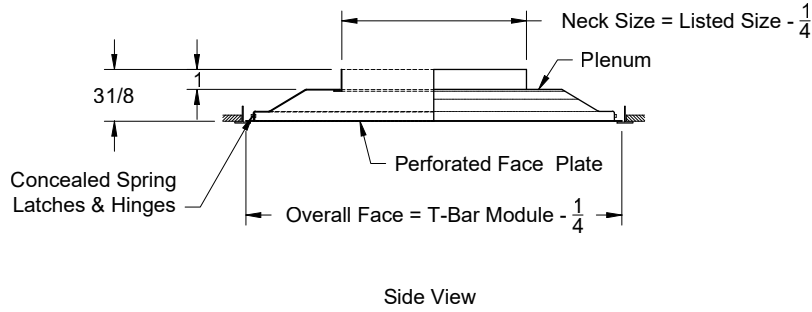

Listed Nominal	Largest Size
Face	Neck
24 x 24	18 x 18

1. Available Finishes	2. Available Accessories	3. Available Options	4. Construction Details
Standard Finish: 01 White Finish 02 Satin Silver 03 Black 22 BBP - Black Backpan - White Face Optional Finish 28 Custom Color	XG-D7 - Steel, Opposed Blade Damper XG-D7A - Aluminum, OBD XG-G3 - Equalizing Grid (Round) XG-L9 - Equalizing Grid (Square/Rect.) XG-TBPF - T-Bar Plaster Frame XG-LIPF - Lay-In Plaster Frame XG-TR - Square to Round Transition XG-TR-Deep - Deep Transition		<ul style="list-style-type: none"> Aluminum Construction Perforated Face: 3/16 Holes on 1/4 Staggered Centers <p>All Dimensions ±1/16"</p>

MODEL XG-7000R

CEILING
DIFFUSERS

CONCENTRIC SUPPLY / RETURN
CEILING DIFFUSER

XG-DAF-CC5

Model: XG-7000R-8 Perforated Face - Tegular T-Bar

XG-7000R-8 - Tegular T-Bar

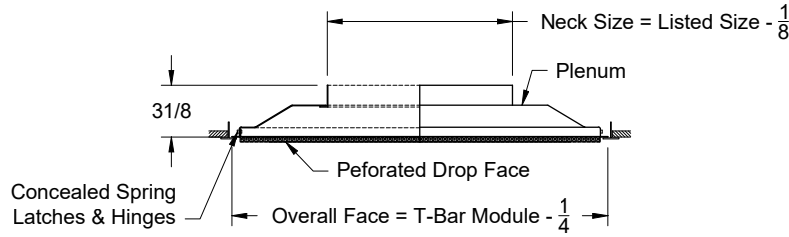

Side View

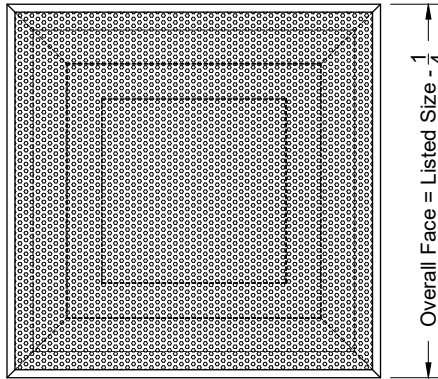

Face View

Listed Nominal	Largest Size
Face	Neck
24 x 24	18 x 18

1. Available Finishes

Standard Finish:
01 White
Finish
02 Satin Silver
03 Black
22 BBP - Black
Backpan - White Face
Optional Finish
28 Custom Color

2. Available Accessories

XG-D7 - Steel, Opposed Blade Damper
XG-D7A - Aluminum, OBD
XG-G3 - Equalizing Grid (Round)
XG-L9 - Equalizing Grid (Square/Rect.)
XG-TBPF - T-Bar Plaster Frame
XG-LIPF - Lay-In Plaster Frame
XG-TR - Square to Round Transition
XG-TR-Deep - Deep Transition

3. Available Options

4. Construction Details

- Aluminum Construction
- Perforated Face: 3/16 Holes on 1/4 Staggered Centers

All Dimensions $\pm 1/16"$

XG-7000 MODEL NUMBER SPECIFICATION
PERFORATED CEILING DIFFUSER – EXTRUDED ALUMINUM

Model		Neck									Module		
		6	8	9	10	12	14	15	16	18			
XG-7000-1	Supply Surface Mount	6	X									12 x 12	
XG-7000R-1	Return Surface Mount	6	X									14 x 14	
		8		X								15 x 15	
		6	X									16 x 16	
		8		X									
		9			X								
		6	X									18 x 18	
		8		X									
		9			X								
		10				X							
		12					X					20 x 20	
		6	X										
		8		X									
		9			X								
		10				X							
		12					X					21 x 21	
		14						X					
		15							X				
		6	X	X	X	X	X	X	X	X	X		24 x 12
		8	X										24 x 24
		9		X									
		10			X								
		12				X							
		14					X						
		15						X					
		16							X				
		18								X			
		6	X	X	X	X	X	X	X	X	X	36 x 12	
		6	X									36 x 24	
		8		X									
		9			X								
		10				X							
		12					X						
		14						X					
		15							X				
		16								X			
		18									X		
		6	X	X	X	X	X	X	X	X	X	48 x 12	
		6	X									48 x 24	
		8		X									
		9			X								
		10				X							
		12					X						
		14						X					
		15							X				
		16								X			
		18									X		

XG-7000 MODEL NUMBER SPECIFICATION
PERFORATED CEILING DIFFUSER – EXTRUDED ALUMINUM

Air Pattern	Available Accessories		Available Finishes	
Standard	XG-D7	Steel Opposed Blade Damper	Standard	
4W	XG-D7A	Aluminum Opposed Blade Damper	01	White
Optional	XG-L9	Equalizing Grid	Optional	
1W	XG-TR	Square to Round Transition	02	Satin Silver
2W	XG-TR Deep	Deep Square to Round Transition	03	Black
2WC	XG-G3	Round Equalizing Grid	22	Black Back Pan
3W	XG-BDS	Butterfly Damper	28	Custom Color
	XG-RSD	Radial Shutter Damper		
	XG-D3	Aluminum Round Opposed Blade Damper		
	XG-SD3	Steel Round Opposed Blade Damper		

CEILING
DIFFUSERS

PERFORATED
CEILING DIFFUSERS

XG-7000/XG-7000R

XG-7000 MODEL NUMBER SPECIFICATION

PERFORATED CEILING DIFFUSER – EXTRUDED ALUMINUM

Model		Neck									Module	
		6	8	9	10	12	14	15	16	18		
XG-7000-6	Supply T-Bar Lay-in	6	X									12 X 12
XG-7000R-6	Return T-Bar Lay-in	6	X	X	X	X	X	X	X	X	X	24 X 12
		6	X									20 X 20
		8		X								
		9			X							
		10				X						
		12					X					
		14						X				
		15							X			
		16								X		
		18									X	
		6	X									24 X 24
		8		X								
		9			X							
		10				X						
		12					X					
		14						X				
		15							X			
		16								X		
		18									X	
		6	X	X	X	X	X	X	X	X	X	48 X 12
		6	X									48 X 24
		8		X								
		9			X							
		10				X						
		12					X					
		14						X				
		15							X			
		16								X		
		18									X	

Air Pattern	Available Accessories		Available Finishes	
Standard	XG-D7	Steel Opposed Blade Damper	Standard	
4W	XG-D7A	Aluminum Opposed Blade Damper	01	White
Optional	XG-L9	Equalizing Grid	Optional	
1W	XG-TR	Square to Round Transition	02	Satin Silver
2W	XG-TR Deep	Deep Square to Round Transition	03	Black
2WC	XG-G3	Round Equalizing Grid	22	Black Back Pan
3W	XG-BDS	Butterfly Damper	28	Custom Color
	XG-RSD	Radial Shutter Damper		
	XG-D3	Aluminum Round Opposed Blade Damper		
	XG-SD3	Steel Round Opposed Blade Damper		

XG-7000 MODEL NUMBER SPECIFICATION
PERFORATED CEILING DIFFUSER — EXTRUDED ALUMINUM

Model		Neck							Module
		6	8	9	10	12	14	15	
XG-7000-7	Concealed Spline	6	X						12 X 12 (-7 Frame Only)
XG-7000-8	Tegular Ceiling	6	X						24 X 24
XG-7000-9	Donn Finline	8		X					
		9			X				
		10				X			
		12					X		
		14						X	
		15							X

Air Pattern	Available Accessories		Available Finishes	
Standard	XG-D7	Steel Opposed Blade Damper	Standard	
4W	XG-D7A	Aluminum Opposed Blade Damper	01	White
Optional	XG-L9	Equalizing Grid	Optional	
1W	XG-TR	Square to Round Transition	02	Satin Silver
2W	XG-TR Deep	Deep Square to Round Transition	03	Black
2WC	XG-G3	Round Equalizing Grid	22	Black Back Pan
3W	XG-BDS	Butterfly Damper	28	Custom Color
	XG-RSD	Radial Shutter Damper		
	XG-D3	Aluminum Round Opposed Blade Damper		
	XG-SD3	Steel Round Opposed Blade Damper		

CEILING
DIFFUSERS

PERFORATED
CEILING DIFFUSERS

XG-7000/XG-7000R

SERIES XG-7000 PERFORMANCE DATA
MODEL XG-7000

Nominal Neck Size	fpm Neck Velocity Pv	200	300	400	500	600	700	800	900	
		.003	.006	.010	.016	.022	.030	.040	.050	
18 x 6	CFM	150	225	300	375	450	525	600	675	
	Pt	.016	.050	.060	.100	.140	.190	.250	.310	
	NC	<	<	20	25	30	35	40	40	
	Throw	4-Way	3-4-5	3-5-6	4-6-8	6-8-11	7-10-13	8-12-15	9-14-18	10-15-20
		3-Way	3-4-5	4-6-8	6-8-11	7-10-13	8-12-16	9-14-18	11-16-21	12-18-24
2-Way		4-6-8	6-8-11	7-11-14	9-13-17	11-16-21	12-18-24	14-21-28	18-27-33	
1-Way		5-7-9	6-9-12	8-12-16	11-16-21	13-19-25	15-22-29	17-25-33	19-28-38	
12 x 12	CFM	200	300	400	500	600	700	800	900	
	Pt	.016	.045	.066	.100	.150	.200	.260	.330	
	NC	<	20	25	25	30	35	40	40	
	Throw	4-Way	3-5-6	4-6-8	5-7-10	6-9-12	8-12-15	9-13-17	10-15-20	12-17-23
		3-Way	3-5-6	5-7-9	6-9-12	8-12-15	9-14-18	11-16-22	13-19-25	14-20-27
2-Way		5-7-9	6-9-12	8-12-16	11-16-21	12-18-24	15-22-29	17-25-33	18-27-36	
1-Way		6-9-12	8-12-16	10-15-20	12-18-24	15-22-29	17-25-33	18-27-36	21-31-42	
14 x 14	CFM	270	410	545	680	815	950	1090	1225	
	Pt	.018	.040	.070	.110	.160	.220	.280	.360	
	NC	<	20	25	28	33	37	40	43	
	Throw	4-Way	4-5-7	4-6-9	6-9-12	7-11-14	9-14-18	10-15-20	12-18-24	14-21-28
		3-Way	4-5-9	5-8-11	6-10-13	8-13-16	10-15-20	11-17-23	13-19-27	16-23-31
2-Way		5-7-10	6-9-13	8-12-18	11-17-22	12-19-26	16-23-31	18-26-36	19-29-39	
1-Way		6-9-12	8-12-18	10-15-22	13-19-26	15-23-30	17-25-35	19-28-39	21-31-43	
15 x 15	CFM	310	470	625	780	935	1090	1250	1405	
	Pt	.018	.050	.070	.110	.160	.210	.280	.350	
	NC	<	20	25	30	35	40	40	45	
	Throw	4-Way	4-6-8	5-7-10	7-10-13	8-12-16	10-15-20	12-17-23	13-19-26	15-23-30
		3-Way	5-7-9	6-9-12	8-12-15	9-14-18	11-16-22	13-19-26	15-23-30	18-26-35
2-Way		6-9-12	9-14-15	12-17-20	13-19-26	16-22-31	18-27-36	20-30-40	23-33-43	
1-Way		7-11-14	9-14-18	11-18-22	14-21-28	16-24-32	19-28-38	21-31-42	23-34-45	
16 x 16	CFM	355	590	710	885	1060	1240	1415	1595	
	Pt	.018	.047	.070	.109	.155	.212	.280	.350	
	NC	<	20	25	30	35	40	40	45	
	Throw	4-Way	5-7-9	6-8-11	8-10-14	9-13-18	10-15-21	13-18-27	14-20-28	16-22-31
		3-Way	5-7-11	6-9-13	8-13-17	10-15-22	13-19-26	15-22-30	18-25-36	19-29-39
2-Way		6-10-12	9-14-16	11-17-24	14-21-28	17-25-32	19-26-34	21-34-40	24-34-44	
1-Way		7-10-16	9-15-18	12-18-26	15-22-32	18-27-36	19-28-37	24-35-42	26-36-46	
18 x 18	CFM	450	675	900	1125	1350	1575	1800	2025	
	Pt	.019	.050	.070	.110	.160	.220	.290	.360	
	NC	<	20	25	30	35	40	40	45	
	Throw	4-Way	5-7-10	6-9-12	8-12-16	10-15-20	12-18-24	14-21-28	16-24-32	18-27-36
		3-Way	5-7-12	7-11-14	9-14-18	11-16-22	13-19-26	16-24-31	18-27-36	21-31-41
2-Way		8-12-18	10-15-20	13-19-26	16-24-32	20-29-39	23-34-45	26-39-52	29-43-58	
1-Way		9-14-22	11-16-24	15-23-30	18-27-36	22-32-43	25-37-49	28-42-56	30-45-60	

**CEILING
DIFFUSERS**
**PERFORATED
CEILING DIFFUSERS**
XG-7000/XG-7000R

SERIES XG-7000 PERFORMANCE DATA
MODEL XG-7000R

Nominal Neck Size	fpm Neck Velocity	200	300	400	500	600	700	800
	Pv	.013	.030	.050	.080	.110	.150	.200
6 x 6	CFM	50	75	100	125	150	175	200
	NC	<	<	<	<	20	25	30
8 x 6	CFM	65	100	130	165	200	230	265
	NC	<	<	<	<	20	25	30
8 x 8	CFM	90	130	175	220	265	310	350
	NC	<	<	<	20	25	30	35
9 x 9	CFM	110	170	225	280	335	390	450
	NC	<	<	<	20	25	30	35
10 x 6	CFM	80	125	165	205	245	290	330
	NC	<	<	<	20	25	30	35
10 x 10	CFM	140	210	275	345	415	485	550
	NC	<	<	<	20	25	30	35
12 x 6	CFM	100	150	200	250	300	350	400
	NC	<	<	<	20	25	30	35
12 x 12	CFM	200	300	400	500	600	700	800
	NC	<	<	<	20	25	30	35
15 x 15	CFM	310	470	625	780	935	1090	1250
	NC	<	<	20	25	30	35	40
18 x 18	CFM	450	675	900	1125	1350	1575	1800
	NC	<	<	20	25	30	35	40
20 x 20	CFM	555	830	1110	1385	1660	1940	2215
	NC	<	<	20	28	33	38	42
22 x 10	CFM	305	455	610	760	910	1065	1215
	NC	<	<	20	25	30	35	40
22 x 22	CFM	670	1010	1345	1680	2015	2350	2690
	NC	<	<	20	28	33	38	42
34 x 22	CFM	1040	1555	2075	2595	3115	3635	4150
	NC	<	<	20	28	35	40	45
46 x 22	CFM	1405	2105	2810	3510	4210	4915	5615
	NC	<	<	23	30	38	42	45

CEILING
DIFFUSERS

PERFORATED
CEILING DIFFUSERS

XG-7000/XG-7000R

PERFORMANCE NOTES FOR SERIES XG7000

All data is tested in accordance with ANSI/ASHRAE 70-2006.

DEFINITION OF UNITS

CFM Cubic Feet per Minute (air)

fpm Velocity of air stream in Feet per Minute

Pv Velocity pressure (inches of water column)

Pt Total pressure (inches of water column)

Ps Static pressure = $P_t - P_v$ (inches of water column)

Throw Cataloged throw is horizontal distances in feet to the terminal velocities of 150, 100 and 50fpm with supply air temp 20° F below room air temp

NC Noise criteria, sound pressure level NC ratings are based on sound power level (Lw)
re: 10^{-12} watts minus a 10dB room attenuation in all octave bands

MODEL XG-PRTB/XG-SPRTB

Return or Exhaust - Perforated Face Only - Non Ducted/ Series XG-PRTB Aluminum Steel

- XG-PRTB-6 - T-bar Lay-in
- XG-SPRTB-6 - T-bar Lay-in
- XG-PRTB-8 - Tegular T-bar
- XG-SPRTB-8 - Tegular T-bar
- XG-PRTB-9 - Donn Finline
- SPRTB-9 - Donn Finline

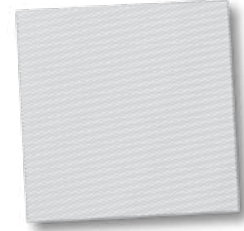

Air Inlets shall be aluminum model XG-PRTB or steel XG-SPRTB manufactured by GREENHECK. Units shall be designed for use in a non- duct return or exhaust applications. Units shall consist of a 51% free area perforated face. Perforated holes shall be 3/16" diameter on 1/4" staggered centers.

The units shall be the size and quantity as outline in the plans and specifications. Units shall be designed to integrate into the specified ceiling system.

Performance Specification

The manufacturer shall provide published performance data. Data shall be tested in accordance to ANSI/ASHRAE Standard 70- 2006

Models: XG-PRTB-6 and XG-SPRTB-6 (Lay in T-Bar)

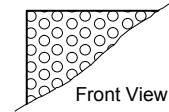
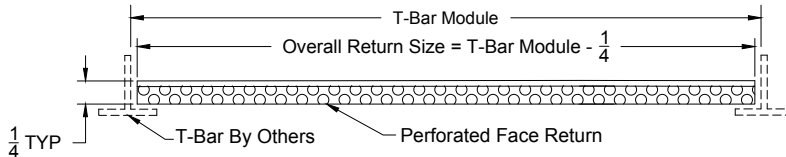

Models: XG-PRTB-8 and XG-SPRTB-8 (Tegular T-Bar)

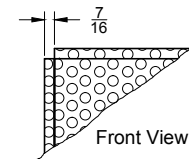
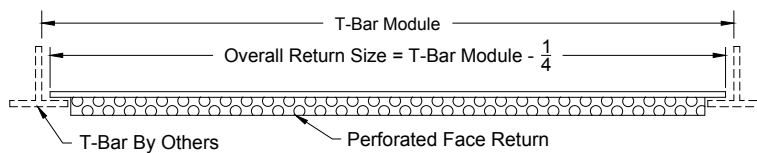

Perforated Face Return
3/16 Diameter Holes ON
1/4 Staggered Centers

Models: XG-PRTB-9 and XG-SPRTB-9 (Donn Finline Ceiling Grid)

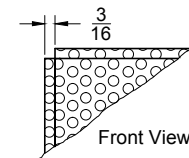
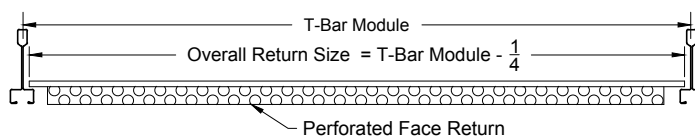

Available Sizes (Width x Height)

Perimeter Style	T-Bar Spacing	Actual Face Size		
		- 6	-8	- 9
-6	12 x 12	11 3/4 x 11 3/4		
- 6, - 8, - 9	24 x 12	23 3/4 x 11 3/4	22 7/8 x 10 7/8	23 3/8 x 11 3/8
- 6, - 8, - 9	24 x 24	23 3/4 x 23 3/4	22 7/8 x 22 7/8	23 3/8 x 23 3/8
- 6	36 x 24	35 3/4 x 23 3/4		
- 6	48 x 12	47 3/4 x 11 3/4		
- 6	48 x 24	47 3/4 x 23 3/4		

XG-PRTB / XG-SPRTB MODEL NUMBER SPECIFICATION NON-DUCTED PERFORATED FACE ONLY ALUMINUM

Model		Module	Available Finishes	
XG-PRTB-6	T-bar Lay-in	12 x 12	Standard	
XG-PRTB-8	Tegular T-bar	24 x 12	01	White
XG-PRTB-9	Donn Finline	24 x 24	Optional	
		36 x 24	02	Satin Silver
		48 x 12	03	Black
		48 x 24	24	MIII
			28	Custom Color

NON-DUCTED PERFORATED FACE ONLY STEEL

Model		Module	Available Finishes	
XG-SPRTB-6	T-bar Lay-in	12 x 12	Standard	
XG-SPRTB-8	Tegular T-bar	24 x 12	01	White
XG-SPRTB-9	Donn Finline	24 x 24	Optional	
		36 x 24	02	Satin Silver
		48 x 12	03	Black
		48 x 24	28	Custom Color

SERIES XG-PRTB PERFORMANCE DATA
MODEL XG-PRTB / XG-SPRTB

Nominal Neck Size	fpm Neck Velocity	200	300	400	500	600	700	800
	Pv	0.01	0.03	0.05	0.08	0.11	0.15	0.19
12 x 12	CFM	170	250	335	420	505	590	670
	NC	<	<	<	20	25	30	35
24 x 12	CFM	350	525	700	875	1050	1225	1400
	NC	<	<	20	25	30	35	40
24 x 24	CFM	735	1100	1470	1835	2200	2570	2935
	NC	<	<	20	28	33	38	42
36 x 24	CFM	1120	1680	2235	2795	3355	3915	4470
	NC	<	<	25	30	35	40	45
48 x 12	CFM	735	1100	1470	1835	2200	2570	2935
	NC	<	<	20	28	33	38	42
48 x 24	CFM	1500	2250	3000	3750	4500	5250	6000
	NC	<	<	20	28	33	38	42

PERFORMANCE NOTES FOR SERIES XG-PRTB / XG-SPRTB

All data is tested in accordance with ANSI/ASHRAE 70-2006.

DEFINITION OF UNITS

- CFM Cubic Feet per Minute (air)
- fpm Velocity of air stream in Feet per Minute
- Pv Velocity pressure (inches of water column)
- Pt Total pressure (inches of water column)
- Ps Static pressure = Pt-Pv (inches of water column)
- NC Noise criterion, sound pressure level NC ratings are based on sound power level (Lw) re: 10⁻¹² watts minus a 10dB room attenuation in all octave bands

MODEL XG-7300



**Supply - Perforated Face -
Integral Fiberglass Backpan -
Fixed Deflector Fixed Steel Face Fixed Aluminum Face**

XG-7300-6 - Surface Mounted

XG-7300-6 AF - Surface Mounted

Air Outlets shall be aluminum face model XG-7300 or steel face model XG-7300 AF manufactured by GREENHECK. Units shall consist of 51% free area perforated face fixed to a formed fiberglass backpan. Exposed fiberglass backpan shall have an aluminum foil liner. The outlet's backpan shall be factory scored to allow field installation of a tab lock collar or spin-in fittings.

Perforated holes shall be 3/16" diameter on 1/4" staggered centers.

Unit shall generate a 360° horizontal pattern with a fixed round pattern disk mounted on the inside face of the perforated face. The units shall be the size and quantity as outline in the plans and specifications.

Units shall be designed to integrate into the specified ceiling system.

Performance Specification

The manufacturer shall provide published performance data. Data shall be tested in accordance to ANSI/ASHRAE Standard 70- 2006

XG-7300-6 - Lay in T-Bar

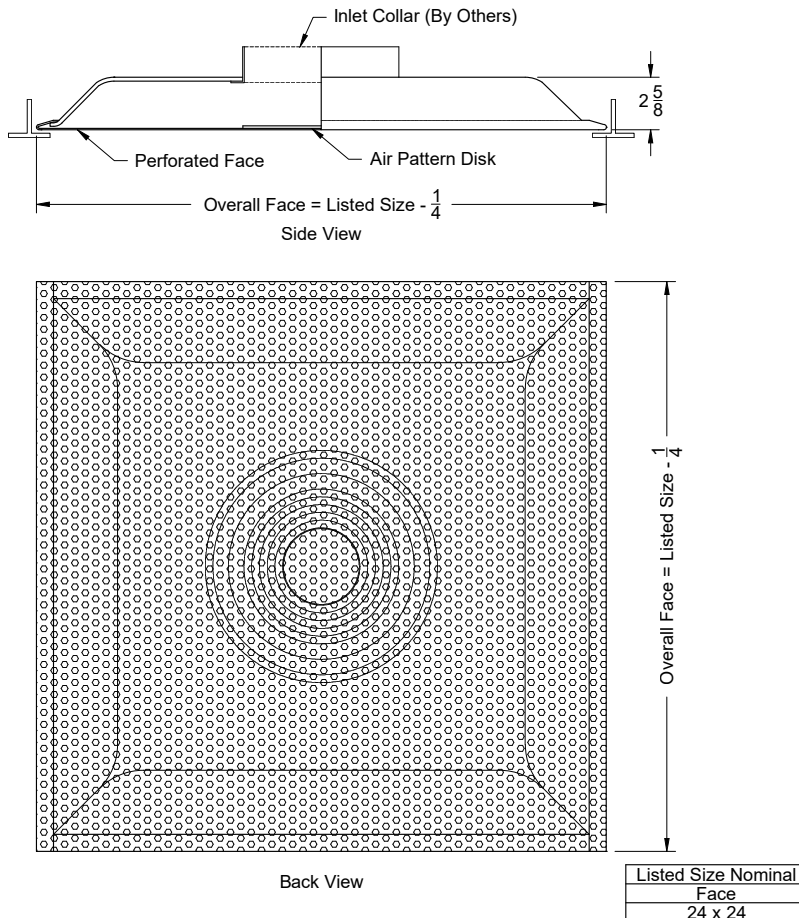

SERIES XG-7300 PERFORMANCE DATA
MODEL XG-7300

Neck Size	fpm Neck Velocity	200	300	400	500	600	700	800	900	1000
	Pv	.002	.006	.010	.016	.022	.030	.040	.050	.062
5	CFM	25	40	55	70	80	95	110	120	138
	Pt	.003	.008	.016	.025	.033	.045	.060	.076	.094
	Throw	1-1-1	1-1-1	1-1-1	1-1-3	1-1-4	1-1-4	1-1-5	1-2-6	1-3-6
	NC	<	<	<	<	<	<	21	24	27
6	CFM	40	60	80	100	115	135	155	175	196
	Pt	.004	.009	.016	.027	.035	.049	.066	.078	.105
	Throw	1-1-1	1-1-1	1-1-4	1-2-4	1-2-5	1-3-6	2-3-7	2-3-8	2-4-10
	NC	<	<	<	<	22	26	30	35	38
7	CFM	50	80	105	135	160	185	210	240	265
	Pt	.005	.013	.026	.036	.050	.068	.088	.115	.140
	Throw	1-1-1	1-1-3	1-1-4	1-2-4	1-2-5	1-3-6	2-3-7	2-3-8	2-4-10
	NC	<	<	<	20	23	26	30	34	37
8	CFM	70	105	140	175	210	245	280	315	350
	Pt	.006	.013	.026	.037	.054	.073	.096	.121	.150
	Throw	1-1-2	1-1-3	1-2-5	2-2-5	2-3-6	2-3-8	2-4-10	3-5-11	3-6-12
	NC	<	<	<	20	23	26	30	34	38
9	CFM	90	130	175	220	265	310	350	395	440
	Pt	.007	.014	.026	.042	.060	.083	.105	.134	.166
	Throw	1-1-2	1-1-3	1-2-5	2-2-5	2-3-6	2-3-8	2-4-10	3-5-11	3-6-13
	NC	-	-	-	22	26	30	34	38	41
10	CFM	110	160	215	270	325	380	435	490	545
	Pt	.008	.018	.033	.052	.075	.111	.135	.171	.212
	Throw	1-2-3	1-2-4	1-2-5	2-3-6	2-3-7	3-4-8	3-4-10	3-5-12	4-7-14
	NC	<	<	20	23	26	29	34	38	41
12	CFM	155	235	315	390	470	550	630	705	785
	Pt	.009	.021	.039	.059	.086	.118	.155	.194	.240
	Throw	1-2-4	1-2-5	1-2-7	2-3-9	2-5-11	3-6-13	4-7-14	6-9-18	7-11-21
	NC	<	20	24	27	30	34	38	42	45
14	CFM	210	320	425	535	640	750	855	960	1070
	Pt	.010	.022	.039	.063	.091	.124	.162	.210	.253
	Throw	1-2-6	1-3-9	2-5-11	3-6-13	4-8-16	5-9-18	7-11-23	9-13-27	10-16-32
	NC	<	20	24	28	32	36	40	45	48
15	CFM	245	370	490	610	735	860	980	1105	1225
	Pt	.015	.034	.060	.093	.135	.185	.240	.305	.375
	Throw	1-3-9	2-5-11	3-6-13	4-8-16	5-10-18	7-11-23	9-13-27	10-16-32	11-16-33
	NC	<	23	28	33	38	43	48	53	55

CEILING
DIFFUSERS

PERFORATED
CEILING DIFFUSERS

XG-7300

PERFORMANCE NOTES FOR SERIES XG-7300

All data is tested in accordance with ANSI/ASHRAE 70-2006.

DEFINITION OF UNITS

CFM Cubic Feet per Minute (air)

fpm Velocity of air stream in Feet per Minute

Pv Velocity pressure (inches of water column)

Pt Total pressure (inches of water column)

Ps Static pressure = Pt-Pv (inches of water column)

Throw Cataloged Throw is horizontal distances in feet to the terminal velocities of 150,100 and 50fpm with supply air temp 20° F below room air temp

NC Noise criterion, sound pressure level NC ratings are based on sound power level (Lw) re: 10⁻¹² watts minus a 10dB room attenuation in all octave bands

XG-7300 MODEL NUMBER SPECIFICATION FOIL LINED FIBERGLASS BACK PERFORATED SUPPLY DIFFUSER

Model		Module	Available Finishes	
XG-7300-6	T-bar Lay-in Steel	24 x 24	Standard	
XG-7300-6 AF	T-bar Lay-in Aluminum Face		01	White
XG-7300R-6	T-bar Lay-in Steel		Optional	
XG-7300R-6 AF	T-bar Lay-in Aluminum Face		02	Satin Silver
			03	Black
			28	Custom Color

MODEL XG-7350

Supply - Perforated Face - Fiberglass Backpan - Adjustable Pattern Controllers/ Series XG-7350 Steel Face Aluminum Face

XG-7350-6 - T-bar Lay-in XG-7350-6 AF - T-bar Lay-in
XG-7350-8 - Tegular T-bar

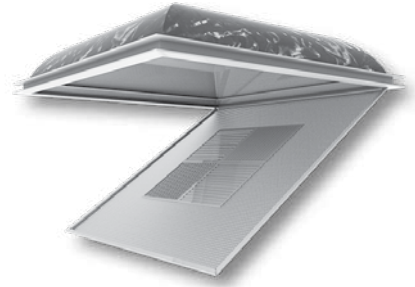

Air Outlets shall be aluminum face model XG-7350 or steel face model XG-7350 AF manufactured by GREENHECK. Units shall consist of 51% free area perforated face fixed to a formed fiberglass backpan. Perforated holes shall be 3/16" diameter on 1/4" staggered centers. Exposed fiberglass backpan shall have an aluminum foil liner. The outlet's backpan shall be factory scored to allow field installation of a tab lock collar or spin-in fittings

Outer border of units shall be extruded aluminum construction. The perforated face shall be hinged allowing access to four adjustable pattern controllers mounted onto the inside face of the outlet. Face shall be secured in place with tension spring clips. Pattern controller blades shall be individually adjustable and allow the discharge pattern to be adjustable from vertical to horizontal. Outlets shall be field adjustable allowing 1, 2-way opposite, 2-way corner, 3, and 4-way directional air patterns.

The units shall be the size and quantity as outline in the plans and specifications. Units shall be designed to integrate into the specified ceiling system.

Performance Specification

The manufacturer shall provide published performance data. Data shall be tested in accordance to ANSI/ASHRAE Standard 70- 2006

- Models: XG-7350-6 (Steel Hinged Face - Lay in T-Bar)
 XG-7350-6 AF (Aluminum Hinged Face - Lay in T-Bar)

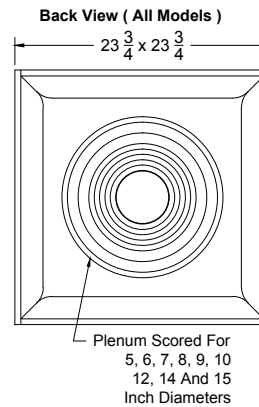
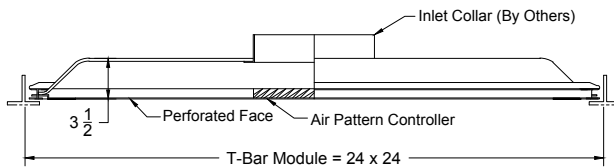

- Models: XG-7350R-6 (Steel Removable Face - Lay in T-Bar)
 XG-7350R-6 AF (Aluminum Removable Face - Lay in T-Bar)

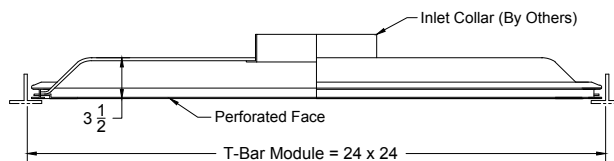

- Model: XG-7350-8 (Steel - Tegular T-Bar - Hinged Drop Face)

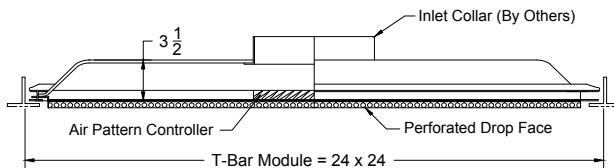

- Model: XG-7350R-8 (Steel - Tegular T-Bar - Hinged Removable Drop Face)

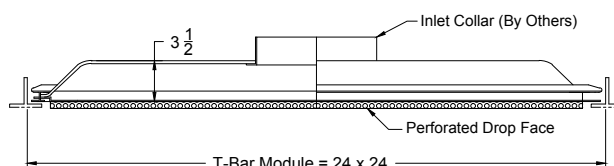

SERIES XG-7350 PERFORMANCE DATA

Nominal Neck Size	fpm Neck Velocity		300	400	500	600	700	800	1000
	Pv		.006	.010	.016	.023	.031	.040	.062
6	CFM		60	80	100	115	135	155	195
	Pt		.012	.022	.034	.045	.062	.083	.131
	NC		<	<	<	-	20	24	31
	Throw	4-Way	1-1-3	1-1-4	1-2-4	1-2-5	1-3-6	2-3-7	2-3-8
		3-Way	1-1-3	1-2-4	2-2-5	2-3-6	2-3-6	2-3-8	2-4-8
2-Way		1-2-4	1-2-5	2-3-5	2-4-6	3-4-7	3-4-9	3-4-9	
1-Way		1-2-5	1-3-5	3-4-6	3-4-7	3-4-8	3-5-9	3-5-10	
8	CFM		105	140	175	210	245	280	350
	Pt		.017	.031	.048	.070	.095	.124	.195
	NC		<	<	<	21	26	30	36
	Throw	4-Way	1-1-3	1-2-5	2-2-5	2-3-6	2-3-8	2-4-10	3-5-11
		3-Way	1-2-3	1-2-5	2-3-5	2-3-6	3-3-8	3-4-11	3-5-12
2-Way		1-2-4	1-3-5	2-4-6	3-4-7	3-4-9	3-5-12	4-6-13	
1-Way		2-3-5	2-4-5	3-4-7	3-5-8	3-5-10	3-6-13	4-6-14	
10	CFM		165	220	270	325	380	435	545
	Pt		.020	.035	.053	.077	.106	.138	.218
	NC		<	<	22	28	33	37	43
	Throw	4-Way	1-2-4	1-2-5	2-3-6	2-3-7	3-4-8	3-4-10	3-5-12
		3-Way	1-2-4	1-3-6	2-3-7	2-4-8	3-5-9	3-5-12	3-6-13
2-Way		1-2-5	2-3-6	3-4-8	3-4-8	3-6-10	3-6-14	4-7-15	
1-Way		2-3-6	2-4-7	3-5-8	3-5-10	4-7-11	4-7-14	5-9-16	
12	CFM		235	315	390	470	550	630	785
	Pt		.032	.059	.090	.131	.180	.236	.367
	NC		<	<	25	29	35	40	46
	Throw	4-Way	1-2-4	2-2-8	3-3-8	3-5-10	3-5-11	4-6-12	5-7-14
		3-Way	2-3-5	2-3-8	3-4-9	3-5-11	4-6-13	4-7-14	5-8-15
2-Way		2-3-6	3-4-8	3-5-11	3-6-12	4-7-13	5-8-15	6-9-16	
1-Way		3-4-8	3-5-9	4-6-12	4-7-13	5-8-14	6-9-16	7-10-18	
14	CFM		320	425	535	640	750	855	1070
	Pt		.039	.068	.108	.156	.213	.277	.435
	NC		<	23	29	34	39	44	50
	Throw	4-Way	2-3-6	3-4-8	3-5-11	4-6-13	4-7-14	5-8-15	6-9-17
		3-Way	2-4-7	3-5-9	3-6-12	4-7-14	5-8-16	5-9-17	6-10-18
2-Way		2-5-8	3-5-10	3-7-13	5-8-15	6-10-17	7-10-18	8-11-19	
1-Way		3-5-9	4-8-11	4-8-14	6-9-16	7-11-18	8-12-19	9-12-20	

CEILING DIFFUSERS

PERFORATED CEILING DIFFUSERS

XG-7350

PERFORMANCE NOTES FOR SERIES XG-7350

All data is tested in accordance with ANSI/ASHRAE 70-2006.

DEFINITION OF UNITS

- CFM Cubic Feet per Minute (air)
 fpm Velocity of air stream in Feet per Minute
 Pv Velocity pressure (inches of water column)
 Pt Total pressure (inches of water column)
 Ps Static pressure = Pt-Pv (inches of water column)
 Throw Cataloged throw is horizontal distances in feet to the terminal velocities of 150, 100 and 50fpm with supply air temp 20°F below room air temp
 NC Noise criterion, sound pressure level NC ratings are based on sound power level (Lw) re: 10⁻¹² watts minus a 10dB room attenuation in all octave bands

XG-7350 MODEL NUMBER SPECIFICATION FOIL LINED FIBERGLASS BACK PERFORATED SUPPLY DIFFUSER — HINGED FACE

Model		Module	Available Finishes	
XG-7350-6	T-bar Lay-in Steel	24 x 24	Standard	
XG-7350-6 AF	T-bar Lay-in Aluminum Face		01	White
XG-7350-8	Tegular T-bar Steel		Optional	
XG-7350R-6	T-bar Lay-in Steel		02	Satin Silver
XG-7350R-6 AF	T-bar Lay-in Aluminum Face		03	Black
XG-7350R-8	Tegular T-bar Steel		28	Custom Color

MODEL XG-7500

**Perforated Diffuser – Round Neck -
Adjustable Face Mounted Pattern Controllers**

Supply – Model XG-7500

XG-7500-1 - Surface Mount Steel

XG-7500-1 AF - Surface Mount Aluminum Face

XG-7500-1 DF - Surface Mount Drop Face

XG-7500-6 - T-bar Lay-in Steel

XG-7500-6 AL - T-bar Lay-in Aluminum

XG-7500-6 AF - T-bar Lay-in Aluminum Face

XG-7500-8 - Tegular T-bar Steel

XG-7500-8 AL - Tegular T-bar Aluminum

XG-7500-8 AF - Tegular T-bar Aluminum Face

XG-7500-9 - Donn Finline Steel

XG-7500-9 AF- Donn Finline Aluminum Face

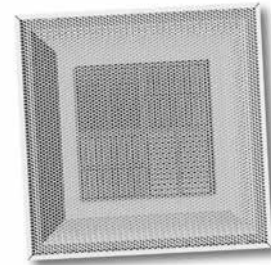

Air Outlets shall be model XG-7500 in steel, XG-7500-AL aluminum, XG-7500-AF with aluminum face or XG-7500-DF with a dropped face manufactured by GREENHECK.

Units shall consist of 51% free area perforated face with 3/16" diameter perforated holes on 1/4" staggered centers. The perforated face shall be hinged allowing access to four adjustable pattern controllers mounted onto the inside face of the outlet. Face shall be secured in place with tension spring clips. Pattern controller blades shall be individually adjustable and allow the discharge pattern to be adjustable from vertical to horizontal.

Outlets shall be field adjustable allowing 1, 2-way opposite, 2-way corner, 3, and 4-way directional air patterns. The units shall be the size and quantity as outlined in the plans and specifications.

Units shall be designed to integrate into the specified ceiling system.

MODEL XG-7500R

- XG-7500R-1 - Surface Mounted Steel**
- XG-7500R-1 AF - Surface Mounted Aluminum Face**
- XG-7500R-1 DF - Surface Mounted Dropped Face**
- XG-7500R-6 - T-bar Lay-in Steel**
- XG-7500R-6 AL - T-bar Lay-in Aluminum**
- XG-7500R-6 AF - T-bar Lay-in Aluminum Face**
- XG-7500R-8 - Tegular T-bar Steel**
- XG-7500R-8 AL - Tegular T-bar Aluminum**
- XG-7500R-8 AF - Tegular T-bar Aluminum Face**
- XG-7500R-9 - Donn Finline Steel**
- XG-7500R-9 AF - Donn Finline Aluminum Face**

Air Outlets shall be model XG-7500R in steel, XG-7500R-AL aluminum, XG-7500R-AF with aluminum face or XG-7500R-DF with a dropped face manufactured by GREENHECK.

Units shall consist of a 51% free area perforated face with 3/16" diameter perforated holes on 1/4" staggered centers. Units shall be designed for use in ducted return or exhaust applications.

The perforated face shall be hinged allowing access to the inside of the backpan. Face shall be secured in place with tension spring clips. The units shall be the size and quantity as outlined in the plans and specifications.

Units shall be designed to integrate into the specified ceiling system.

Optional Dampers and Accessories

Butterfly Damper

GREENHECK model XG-BDS aluminum round butterfly type dampers shall be provided. Damper shall consist of two butterfly style blades that can be adjusted from full open to full closed. Damper shall be adjusted with a screwdriver slot that can be assessed through the face of the diffuser.

Radial Shutter Damper

GREENHECK model XG-RSD steel round radial shutter damper shall be provided. Damper shall consist of gang operated radial blades that slide perpendicular to air flow direction. The damper shall be adjusted from full open to full closed. Damper shall be adjusted with a screwdriver slot that can be assessed through the face of the diffuser.

Opposed Blade Damper

GREENHECK model XG-D3 aluminum or XG-SD3 steel round opposed blade type dampers shall be provided. Damper shall consist of gang operated blades that can be adjusted from full open to full closed. Damper shall be adjusted with a screwdriver slot that can be assessed through the face of the diffuser.

Equalizing Grid

GREENHECK model XG-G3 aluminum, round equalizing grid shall be provided. Equalizing grid shall consist of 1/2" x 1/2" x 1/2" aluminum cubed core mounting in an aluminum frame.

Performance Specification

The manufacturer shall provide published performance data. Data shall be tested in accordance to ANSI/ASHRAE Standard 70- 2006

Paint Specification

Process shall be anodic electrodeposition using an anodic acrylic paint. Units shall undergo pre-treatment including a pressurized spray stage using an alkaline cleaner and a de-ionized water rinse.

MODEL XG-7500

Model: XG-7500-1 Perforated Hinged Face with Face Mounted Pattern Controller - Flush Surface Mount

XG-7500-1 - Flush Surface Mount

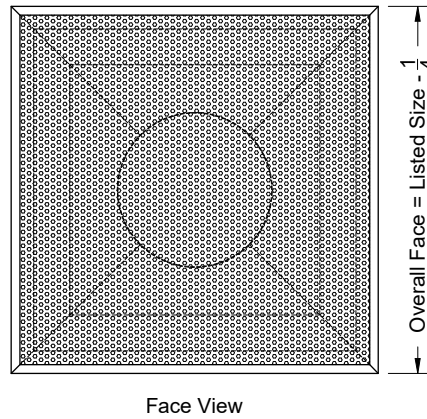
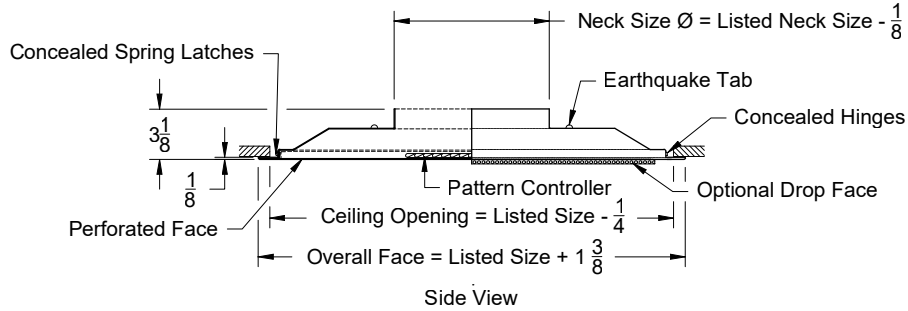

Listed Size
Nominal
Face
24 x 24
12 x 12

Air Pattern Options					Fixed 360° Radial Round Air Controller
1 Way	2 Way Corner	2 Way	3 Way	4 Way	

1. Available Finishes	2. Available Accessories	3. Available Options	4. Construction Details
Standard Finish: 01 White Finish 02 Satin Silver 03 Black 22 BBP - Black Backpan - White Face Optional Finish 28 Custom Color	XG-BDS - Butterfly Damper XG-RDS - Steel Radial Shutter Damper XG-TBPF - T-Bar Plaster Frame XG-G3 - Equalizing Grid (Round)	AF - Aluminum Face DF - Drop Face AL - Aluminum Face and Backpan	<ul style="list-style-type: none"> Steel Construction (Standard) Sizes Available only as listed Neck sizes available: 6, 8, 10, 12, 14 & 16 Face is Hinged

All Dimensions ±1/16"

MODEL XG-7500

CEILING
DIFFUSERS

PERFORATED
CEILING DIFFUSERS

XG-7500/XG-7550

Model: XG-7500-6 Perforated Hinged Face with Face Mounted Pattern Controller - Lay In T-Bar

XG-7500-6 - Lay in T-Bar

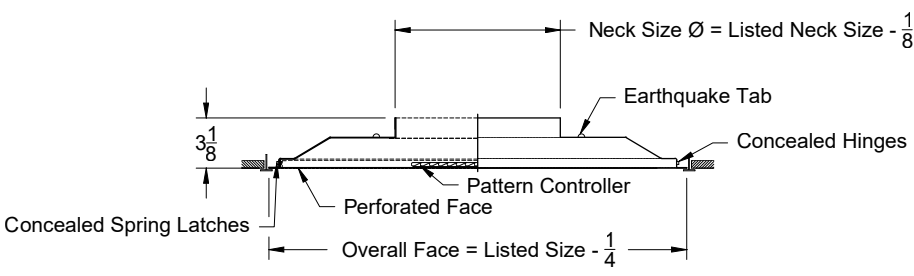

Side View

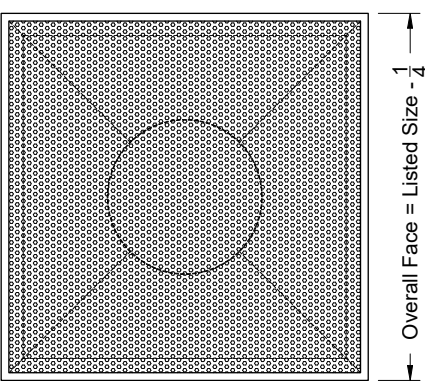

Face View

Listed Size
Nominal
Face
24 x 24
12 x 12

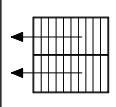
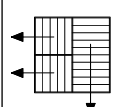
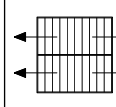
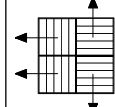
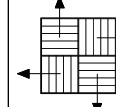
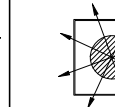
Air Pattern Options					Fixed 360° Radial Round Air Controller
1 Way	2 Way Corner	2 Way	3 Way	4 Way	
					

1. Available Finishes	2. Available Accessories	3. Available Options	4. Construction Details
Standard Finish: 01 White Finish 02 Satin Silver 03 Black 22 BBP - Black Backpan - White Face Optional Finish 28 Custom Color	XG-BDS - Butterfly Damper XG-RDS - Steel Radial Shutter Damper XG-TBPF - T-Bar Plaster Frame XG-G3 - Equalizing Grid (Round) XG-EQ = Earthquake Straps	AF - Aluminum Face DF - Drop Face AL - Aluminum Face and Backpan	<ul style="list-style-type: none"> • Steel Construction (Standard) • Sizes Available only as listed • Neck sizes available: 6, 8, 10, 12, 14 & 16 • Face is Hinged

All Dimensions ±1/16"

MODEL XG-7500

Model: XG-7500-8 Perforated Hinged Face with Face Mounted Pattern Controller - Tegular T-Bar

XG-7500-8 - Tegular T-Bar

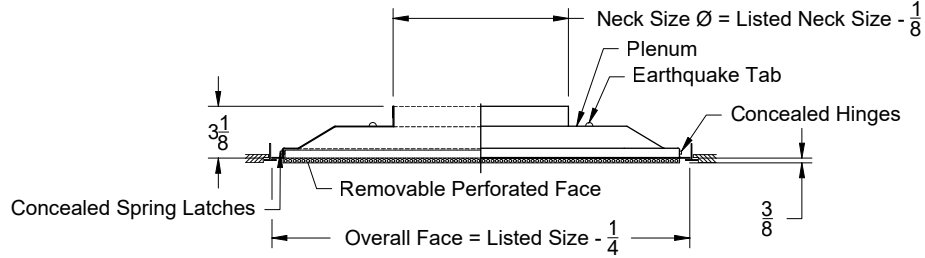

Side View

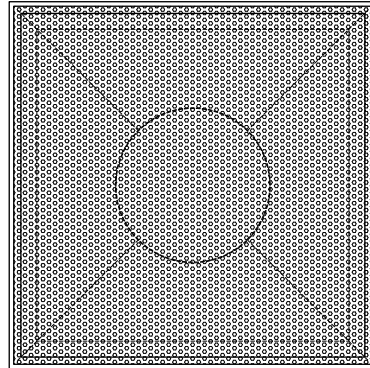

Face View

Listed Size
Nominal
Face
24 x 24
12 x 12

Air Pattern Options					Fixed 360° Radial Round Air Controller
1 Way	2 Way Corner	2 Way	3 Way	4 Way	

1. Available Finishes	2. Available Accessories	3. Available Options	4. Construction Details
Standard Finish: 01 White Finish 02 Satin Silver 03 Black 22 BBP - Black Backpan - White Face Optional Finish 28 Custom Color	XG-BDS - Butterfly Damper XG-RDS - Steel Radial Shutter Damper XG-G3 - Equalizing Grid (Round)	AF - Aluminum Face DF - Drop Face AL - Aluminum Face and Backpan	<ul style="list-style-type: none"> Steel Construction (Standard) Sizes Available only as listed Neck sizes available: 6, 8, 10, 12, 14 & 16 Face is Hinged

All Dimensions ±1/16"

MODEL XG-7500

CEILING
DIFFUSERS

PERFORATED
CEILING DIFFUSERS

XG-7300

Model: XG-7550-9 Perforated Hinged Face with Face Mounted Pattern Controller - Bolt Slot/Donn Finline

XG-7550-9 - Donn Ceiling Grid

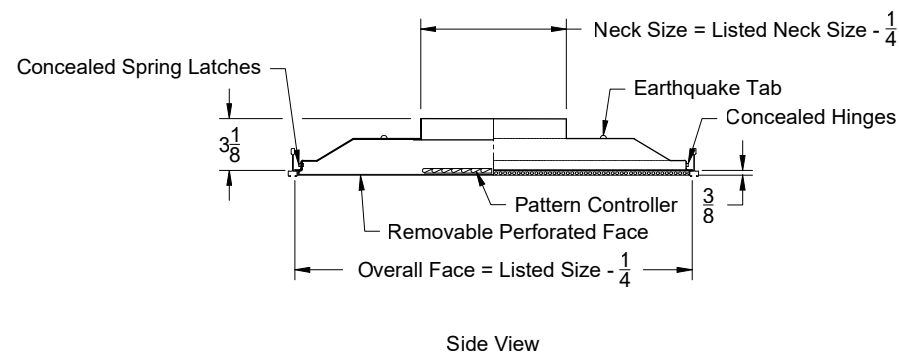

Side View

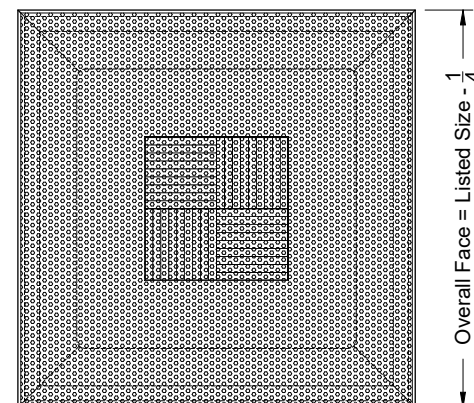

Face View

Listed Size
Nominal
Face
24 x 24

Available Square Inlets
6 x 6
8 x 8
10 x 10
12 x 12
14 x 14
16 x 16

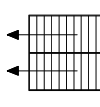
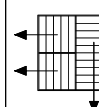
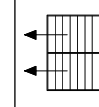
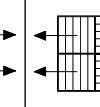
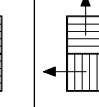
Air Pattern Options				
1 Way	2 Way Corner	2 Way	3 Way	4 Way
				

1. Available Finishes	2. Available Accessories	3. Available Options	4. Construction Details
Standard Finish: 01 White Finish 02 Satin Silver 03 Black 22 BBP - Black Backpan - White Face Optional Finish 28 Custom Color	XG-OBD - Opposed Blade Damper Steel XG-OBDA - OBD Aluminum XG-TBPF - T-Bar Plaster Frame XG-L9 - Equalizing Grid (Sq./Rect.) XG-EQ - Earthquake Straps	AF - Aluminum Face DF - Drop Face AL - Aluminum Backpan and Face	<ul style="list-style-type: none"> Steel Construction (Standard) Sizes Available only as listed Square Neck sizes available: 6, 8, 10, 12, 14 & 16 Face is Hinged

All Dimensions ±1/16"

SERIES XG-7500 PERFORMANCE DATA

Module	Neck Size	fpm Neck Velocity	300	400	500	600	700	800	1000	1200	
		Pv	.006	.010	.016	.022	.031	.040	.062	.090	
12 x 12	6	CFM	60	80	100	120	135	155	195	235	
		Pt	.011	.019	.030	.043	.054	.072	.114	.165	
		NC	<15	<15	<15	17	21	25	31	36	
		Throw	4-Way*	1-2-3	1-2-5	2-3-5	2-3-6	3-4-6	3-4-6	4-5-7	5-6-8
			4-Way	1-2-4	1-2-5	2-3-6	2-4-6	3-4-7	3-5-7	4-6-8	5-6-9
			3-Way	1-2-4	1-3-5	2-3-6	3-4-6	3-5-7	4-5-7	4-6-8	5-6-9
			2-Way	1-2-5	2-3-5	3-4-6	3-5-6	4-5-7	4-5-7	5-6-8	5-6-9
	1-Way	1-2-5	2-3-5	3-4-6	3-5-7	4-5-7	4-5-8	5-6-8	5-7-9		
	8	CFM	105	140	175	210	245	280	350	420	
		Pt	.015	.027	.043	.061	.083	.109	.170	.245	
		NC	<15	<15	<15	20	25	30	37	43	
		Throw	4-Way*	1-2-5	2-3-6	3-4-7	3-5-7	4-5-8	4-6-9	5-7-10	6-7-11
			4-Way	1-2-5	2-3-6	3-4-7	3-5-8	4-6-9	4-6-9	5-7-11	6-8-12
			3-Way	1-2-5	2-4-7	3-5-8	4-5-8	4-6-9	5-7-10	6-8-11	7-8-12
2-Way			2-3-6	3-4-7	4-5-8	4-6-9	5-7-9	6-7-10	6-8-11	7-9-12	
1-Way	2-3-6	3-4-7	4-5-8	4-6-9	5-7-9	6-7-10	7-8-11	7-9-12			
24 x 24	6	CFM	60	80	100	120	135	155	195	235	
		Pt	.010	.019	.029	.042	.053	.070	.110	.160	
		NC	<15	<15	<15	17	21	25	31	36	
		Throw	4-Way*	1-2-4	1-2-5	2-3-5	2-4-6	3-4-6	3-5-7	4-5-8	5-6-8
			4-Way	1-2-4	1-3-5	2-3-6	3-4-7	3-4-7	3-5-7	4-6-8	5-6-9
			3-Way	1-2-4	1-3-5	2-4-6	3-4-7	3-5-7	4-5-8	5-6-8	5-7-9
			2-Way	1-3-5	2-3-6	3-4-6	3-5-7	4-5-7	4-5-8	5-6-9	5-7-9
	1-Way	1-3-5	2-3-6	3-4-6	3-5-7	4-5-7	4-6-8	5-6-9	6-7-10		
	8	CFM	105	140	175	210	245	280	350	420	
		Pt	.016	.028	.043	.063	.085	.111	.174	.250	
		NC	<15	<15	<15	20	25	30	37	43	
		Throw	4-Way*	1-2-5	2-3-6	3-4-7	3-5-8	4-6-9	4-6-9	5-7-10	6-8-11
			4-Way	1-2-5	2-3-7	3-4-8	3-5-9	4-6-9	4-7-10	6-8-11	7-9-12
			3-Way	1-2-6	2-4-7	3-5-8	4-6-9	4-7-10	5-7-10	6-8-11	7-9-12
2-Way			2-3-6	3-5-7	4-6-8	5-6-9	5-7-10	6-7-10	7-8-12	7-9-13	
1-Way	2-3-7	3-5-8	4-6-8	5-7-9	5-7-10	6-8-11	7-8-12	8-9-13			

CEILING
DIFFUSERS

PERFORATED
CEILING DIFFUSERS

XG-7500/XG-7550

SERIES XG-7500 PERFORMANCE DATA

Module	Neck Size	<i>fpm Neck Velocity</i>	300	400	500	600	700	800	1000	1200	
		<i>Pv</i>	.006	.010	.016	.022	.031	.040	.062	.090	
24 x 24	10	CFM	165	220	275	325	380	435	545	655	
		Pt	.023	.041	.064	.090	.123	.161	.252	.365	
		NC	<15	<15	15	22	28	33	42	48	
		Throw	4-Way*	1-3-6	2-4-8	3-5-9	4-6-10	5-7-11	5-8-11	7-9-13	8-10-14
			4-Way	1-3-6	2-4-8	3-5-10	4-6-11	5-7-12	5-8-12	7-10-14	8-11-15
			3-Way	1-3-7	2-5-9	3-6-10	5-7-1	5-8-12	6-9-13	8-10-14	9-11-16
			2-Way	2-4-8	4-6-9	5-7-10	6-8-11	7-9-12	7-9-13	8-10-14	9-11-16
	1-Way		2-4-8	4-6-9	5-7-11	6-8-11	7-9-12	7-9-13	9-11-15	9-12-16	
	12	CFM	235	315	395	470	550	630	785	940	
		Pt	.025	.044	.070	.099	.135	.177	.275	.395	
		NC	<15	<15	17	24	31	37	45	52	
		Throw	4-Way*	1-3-7	3-5-10	4-6-11	5-7-12	6-8-13	6-10-14	8-11-15	10-12-17
			4-Way	1-3-7	3-5-10	4-6-12	5-7-13	6-9-14	7-10-15	8-12-17	10-13-18
			3-Way	1-3-8	3-6-11	4-7-12	6-8-13	7-10-14	8-11-15	9-12-17	11-13-19
			2-Way	3-5-9	5-7-11	6-8-12	7-9-13	8-10-15	9-11-16	10-12-17	11-13-19
	1-Way		3-5-10	5-7-11	6-8-13	7-10-14	8-11-15	9-11-16	10-13-18	11-14-20	
	14	CFM	320	430	535	640	750	855	1070	1285	
		Pt	.033	.059	.091	.131	.179	.233	.365	.527	
		NC	<15	<15	18	27	34	41	50	56	
		Throw	4-Way*	2-4-8	3-6-11	5-7-13	6-8-14	7-10-15	7-11-16	9-13-18	11-14-20
			4-Way	2-4-9	3-6-12	5-7-14	6-8-15	7-10-16	8-12-17	10-14-19	12-15-21
			3-Way	2-4-10	3-7-13	5-8-14	7-10-15	8-12-17	9-13-18	11-14-20	13-15-22
			2-Way	3-6-11	5-8-13	7-10-14	8-11-16	9-12-17	10-13-18	12-14-20	13-16-22
	1-Way		3-6-11	5-8-13	7-10-15	8-11-16	9-12-17	10-13-19	12-15-21	13-16-23	
16	CFM	420	560	700	840	975	1115	1395	1675		
	Pt	.040	.071	.110	.159	.214	.280	.438	.631		
	NC	<15	<15	20	29	36	43	52	60		
	Throw	4-Way*	2-4-10	4-6-13	5-8-14	6-10-16	7-11-17	8-13-18	11-14-20	13-16-22	
		4-Way	2-4-10	3-7-13	5-8-16	7-10-17	8-12-19	9-13-20	11-16-22	13-17-24	
		3-Way	2-4-11	3-8-14	5-9-16	8-11-18	9-13-19	10-14-20	13-16-23	14-18-25	
		2-Way	4-7-13	6-9-15	8-11-16	9-13-18	10-14-19	12-15-21	13-16-23	15-18-25	
1-Way		4-7-13	6-9-15	8-11-17	9-13-18	10-14-20	12-15-21	14-17-24	15-18-26		

CEILING
DIFFUSERS

PERFORATED
CEILING DIFFUSERS

XG-7500/XG-7550

MODEL XG-7550

**Perforated Diffuser - Square Neck -
Adjustable Face Mounted Pattern Controller**

Supply – Model XG-7550

XG-7550-1 - Surface Mount Steel

XG-7550-1 AF - Surface Mount Aluminum Face

XG-7550-1 DF - Surface Mount Drop Face

XG-7550-6 - T-bar Lay-in Steel

XG-7550-6 AL - T-bar Lay-in Aluminum

XG-7550-6 AF - T-bar Lay-in Aluminum Face

XG-7550-8 - Tegular T-bar Steel

XG-7550-8 AL - Tegular T-bar Aluminum

XG-7550-8 AF - Tegular T-bar Aluminum Face

XG-7550-9 - Donn Finline Steel

XG-7550-9 AF- Donn Finline Aluminum Face

Air Outlets shall be model XG-7550 in steel, XG-7550-AL aluminum, XG-7550-AF with aluminum face or XG-7550-DF with a dropped face manufactured by GREENHECK.

Units shall consist of 51% free area perforated face with 3/16" diameter perforated holes on 1/4" staggered centers. The perforated face shall be hinged allowing access to four adjustable pattern controllers mounted onto the inside face of the outlet. Face shall be secured in place with tension spring clips. Pattern controller blades shall be individually adjustable and allow the discharge pattern to be adjustable from vertical to horizontal.

Outlets shall be field adjustable allowing 1, 2-way opposite, 2-way corner, 3, and 4-way directional air patterns. The units shall be the size and quantity as outlined in the plans and specifications.

Units shall be designed to integrate into the specified ceiling system.

SERIES XG-7550 PERFORMANCE DATA

Module	Neck Size	fpm Neck Velocity	300	400	500	600	700	800	1000	1200	
		Pv	.006	.010	.016	.022	.031	.040	.062	.090	
12 x 12	6 x 6	CFM	75	100	125	150	175	200	250	300	
		Pt	.013	.023	.036	.052	.071	.093	.145	.209	
		NC	<15	<15	<15	19	25	29	36	41	
		Throw	4-Way*	1-2-4	1-3-5	2-3-6	3-4-6	3-4-7	3-5-7	4-6-8	5-6-9
			4-Way	1-2-4	1-3-5	2-3-6	3-4-7	3-5-7	4-5-8	4-6-9	5-7-10
			3-Way	1-2-5	1-3-6	2-4-6	3-5-7	4-5-8	4-6-8	5-6-9	6-7-10
			2-Way	1-3-5	2-4-6	3-5-7	4-5-7	4-6-8	5-6-8	5-7-9	6-7-10
	1-Way		2-3-5	2-4-6	3-5-7	4-5-7	4-6-8	5-6-9	6-7-10	6-7-10	
	8 x 8	CFM	135	180	220	265	310	355	445	535	
		Pt	.017	.031	.046	.067	.092	.121	.190	.275	
		NC	<15	<15	<15	20	27	32	39	45	
		Throw	4-Way*	1-2-5	2-3-7	3-4-8	3-5-8	4-6-9	5-7-10	6-8-11	7-8-12
			4-Way	1-2-5	2-4-7	3-4-8	4-5-9	4-6-10	5-7-11	6-8-12	7-9-13
			3-Way	1-2-6	2-4-8	3-5-9	4-6-9	5-7-10	5-8-11	7-9-12	8-9-13
2-Way			2-4-7	3-5-8	4-6-9	5-7-10	6-7-10	6-8-11	7-9-12	8-10-14	
1-Way	2-4-7		3-5-8	4-6-9	5-7-10	6-8-11	6-8-11	7-9-13	8-10-14		

CEILING
DIFFUSERS

PERFORATED
CEILING DIFFUSERS

XG-7500/XG-7550

SERIES XG-7550 PERFORMANCE DATA

Module	Neck Size	<i>fpm Neck Velocity</i>	300	400	500	600	700	800	1000	1200	
		<i>Pv</i>	.006	.010	.016	.022	.031	.040	.062	.090	
24 x 24	6 x 6	CFM	75	100	125	150	175	200	250	300	
		Pt	.013	.023	.036	.052	.071	.093	.145	.209	
		NC	<15	<15	<15	19	25	29	36	41	
		Throw	4-Way*	1-2-4	1-3-5	2-3-6	3-4-7	3-5-7	4-5-8	5-6-9	5-7-9
			4-Way	1-2-4	1-3-6	2-4-7	3-4-7	3-5-8	4-6-8	5-7-9	6-7-10
			3-Way	1-2-5	1-3-6	2-4-7	3-5-7	4-6-8	4-6-9	5-7-10	6-7-11
			2-Way	2-3-5	3-4-6	3-5-7	4-5-8	4-6-8	5-6-9	6-7-10	6-8-11
	1-Way	2-3-6	3-4-6	3-5-7	4-6-8	4-6-8	5-6-9	6-7-10	6-8-11		
	8 x 8	CFM	135	180	220	265	310	355	445	535	
		Pt	.017	.031	.046	.067	.092	.121	.190	.275	
		NC	<15	<15	<15	20	27	32	39	45	
		Throw	4-Way*	1-3-5	2-4-7	3-4-8	4-5-9	4-6-10	5-7-10	5-8-11	7-9-13
			4-Way	1-2-6	2-4-8	3-5-9	4-6-10	4-7-10	5-7-11	6-9-13	7-10-14
			3-Way	1-2-6	2-4-8	3-5-9	4-6-10	5-7-11	6-8-11	7-9-13	8-10-14
			2-Way	2-4-7	3-5-8	4-6-9	5-7-10	6-8-11	7-8-12	8-9-13	8-10-14
	1-Way	2-4-7	3-5-9	4-6-9	5-7-10	6-8-11	7-8-12	8-9-13	8-10-15		
	10 x 10	CFM	210	280	345	415	485	555	695	835	
		Pt	.023	.040	.061	.088	.120	.158	.247	.357	
		NC	<15	<15	15	22	29	34	42	47	
		Throw	4-Way*	1-3-7	3-5-9	4-6-10	4-7-11	5-8-12	6-9-13	8-10-14	9-11-16
			4-Way	1-3-7	2-5-9	4-6-11	5-7-12	5-8-13	6-9-14	8-11-16	9-12-17
			3-Way	1-3-8	2-5-10	4-7-11	5-8-12	6-9-13	7-10-14	9-11-16	10-12-18
			2-Way	3-5-9	4-6-10	5-8-12	6-9-13	7-10-14	8-10-15	9-12-16	10-13-18
	1-Way	3-5-9	4-6-11	5-8-12	6-9-13	7-10-14	8-11-15	10-12-17	11-13-18		
12 x 12	CFM	300	400	500	600	700	800	1000	1200		
	Pt	.023	.040	.063	.090	.123	.160	.250	.360		
	NC	<15	<15	15	23	30	35	44	50		
	Throw	4-Way*	2-4-8	3-5-11	5-7-12	5-8-13	6-9-14	7-11-15	9-12-17	11-13-19	
		4-Way	2-4-8	3-6-11	4-7-13	6-8-15	7-10-16	7-11-17	9-13-19	11-15-21	
		3-Way	2-4-10	3-6-12	4-8-14	6-10-15	7-11-16	9-12-17	11-14-19	12-15-21	
		2-Way	3-6-11	5-8-12	6-10-14	8-11-15	9-12-16	10-12-18	11-14-20	12-15-21	
1-Way	3-6-11	5-8-13	6-10-14	8-11-16	9-12-17	10-13-18	12-14-20	13-16-22			
14 x 14	CFM	410	545	680	815	955	1090	1360	1635		
	Pt	.023	.041	.064	.092	.126	.164	.255	.369		
	NC	<15	<15	16	24	31	37	46	51		
	Throw	4-Way*	2-4-9	3-6-13	5-8-14	6-9-16	7-11-17	8-13-18	10-14-20	13-16-22	
		4-Way	2-4-10	3-7-13	5-8-15	7-10-17	8-11-18	9-13-20	11-15-22	13-17-24	
		3-Way	2-4-11	3-7-14	5-9-16	7-11-17	9-13-19	10-14-20	12-16-22	14-17-25	
		2-Way	4-7-13	6-9-14	7-11-16	9-13-18	10-14-19	12-14-20	13-16-23	14-18-25	
1-Way	4-7-13	6-9-15	7-11-17	9-13-18	10-14-20	12-15-21	14-17-23	15-18-26			
16" x 16"	CFM	535	710	890	1065	1245	1420	1780	2135		
	Pt	.026	.046	.073	.104	.143	.186	.291	.419		
	NC	<15	<15	16	24	33	39	49	53		
	Throw	4-Way*	2-5-11	4-7-14	6-9-16	7-11-18	8-13-19	10-14-21	12-16-23	14-18-25	
		4-Way	2-5-11	4-7-15	6-9-18	7-11-19	9-13-21	10-15-22	12-18-25	15-19-27	
		3-Way	2-5-13	4-9-16	6-11-18	9-13-20	10-15-21	11-16-23	14-18-26	16-20-28	
		2-Way	4-8-14	7-10-17	8-13-18	10-14-20	12-15-22	13-17-23	15-18-26	17-20-29	
1-Way	4-8-15	7-10-17	8-13-19	10-15-21	12-16-22	13-17-24	16-19-27	17-21-29			

**CEILING
DIFFUSERS**
**PERFORATED
CEILING DIFFUSERS**
XG-7500/XG-7550

MODEL XG-7500R

Return – Model XG-7550R

XG-7550R-1 - Surface Mounted Steel

XG-7550R-1 AF - Surface Mounted Aluminum Face

XG-7550R-1 DF - Surface Mounted Dropped Face

XG-7550R-6 - T-bar Lay-in Steel

XG-7550R-6 AL - T-bar Lay-in Aluminum

XG-7550R-6 AF - T-bar Lay-in Aluminum Face

XG-7550R-8 - Tegular T-bar Steel

XG-7550R-8 AL - Tegular T-bar Aluminum

XG-7550R-8 AF - Tegular T-bar Aluminum Face

XG-7550R-9 - Donn Finline Steel

XG-7550R-9 AF - Donn Finline Aluminum Face

Air Outlets shall be model XG-7550R in steel, XG-7550R-AL aluminum, XG-7550R-AF with aluminum face or XG-7550R-DF with a dropped face manufactured by GREENHECK.

Units shall consist of a 51% free area perforated face with 3/16" diameter perforated holes on 1/4" staggered centers. Units shall be designed for use in ducted return or exhaust applications.

The perforated face shall be hinged allowing access to the inside of the backpan. Face shall be secured in place with tension spring clips.

The units shall be the size and quantity as outlined in the plans and specifications. Units shall be designed to integrate into the specified ceiling system.

Square Neck Options and Accessories

Opposed Blade Damper

GREENHECK model XG-OBDA aluminum or XG-OBD steel round opposed blade type dampers shall be provided. Damper shall consist of gang operated blades that can be adjusted from full open to full closed. Damper shall be adjusted with a screwdriver slot accessible by opening the face of the diffuser.

Equalizing Grid

GREENHECK model XG-L9 aluminum square equalizing grid shall be provided. Equalizing grid shall consist aluminum blades mounting in an aluminum frame.

Performance Specification

The manufacturer shall provide published performance data. Data shall be tested in accordance to ANSI/ASHRAE Standard 70- 2006

Paint Specification

Process shall be anodic electrodeposition using an anodic acrylic paint. Units shall undergo pre-treatment including a pressurized spray stage using an alkaline cleaner and a de-ionized water rinse.

SERIES XG-7500R PERFORMANCE DATA
MODEL XG-7500R

Neck Size	Duct Area ft ²	fpm Neck Velocity	300	400	500	600	700	800	900	1000
		Ps	-.023	-.041	-.064	-.092	-.126	-.165	-.209	-.259
06"	.19	CFM	60	80	100	115	135	155	175	195
		NC	-	-	-	-	-	13	16	19
08"	.35	CFM	105	140	175	210	245	280	315	350
		NC	-	-	-	14	18	21	24	27
10"	.55	CFM	165	220	270	325	380	435	490	545
		NC	-	-	-	14	18	21	24	27
12"	.79	CFM	235	315	390	470	550	630	705	785
		NC	-	-	12	16	20	24	27	29
14"	1.07	CFM	320	425	535	640	750	855	960	1070
		NC	-	-	14	19	23	26	29	32
16"	1.40	CFM	420	560	700	835	975	1115	1255	1395
		NC	-	12	16	21	25	28	31	34
18"	1.77	CFM	520	700	870	1045	1220	1395	1570	1740
		NC	12	16	18	23	25	29	33	36

SERIES XG-7550R PERFORMANCE DATA
MODEL XG-7550R

Neck Size	Duct Area ft ²	fpm Neck Velocity	300	400	500	600	700	800	900	1000	1100
		Ps	-.023	-.041	-.064	-.092	-.126	-.165	-.209	-.259	-.314
06 x 06	.25	CFM	58	77	96	116	135	154	173	192	212
		NC	-	-	13	16	18	21	22	24	25
08 x 08	.44	CFM	112	149	186	223	260	297	334	371	409
		NC	-	13	16	19	21	24	25	27	28
10 x 10	.69	CFM	178	237	296	355	414	473	532	591	651
		NC	-	15	18	21	23	25	27	29	30
12 x 12	1.00	CFM	265	353	441	529	617	705	793	881	970
		NC	12	16	20	23	25	27	29	31	32
14 x 14	1.36	CFM	366	488	510	732	854	975	1097	1219	1341
		NC	13	18	21	24	26	28	30	32	33
16 x 16	1.77	CFM	485	647	808	970	1131	1293	1454	1616	1777
		NC	15	19	22	25	28	30	32	33	35
22 x 22	3.36	CFM	942	1258	1589	1883	2196	2510	2823	3137	3450
		NC	17	22	25	28	31	33	34	36	38

PERFORMANCE NOTES FOR SERIES XG-7550R

All data is tested in accordance with ANSI/ASHRAE 70-2006.

DEFINITION OF UNITS

CFM Cubic Feet Per Minute (air)

Nk Vel Neck Velocity of air stream in Feet Per Minute

Ps Negative Static Pressure (inches of water column)

NC Noise criterion, sound pressure level. NC ratings are based on sound power level (Lw) re: 10E-12 watts minus a 10dB room attenuation in all octave bands.

MODEL XG-7600

**Perforated Diffuser – Round Neck -
Adjustable Neck Mounted Pattern Controllers
Supply – Model XG-7600**

**XG-7600-1 - Surface Mount Steel
XG-7600-1 AF - Surface Mount Aluminum Face
XG-7600-1 DF - Surface Mount Drop Face**

**XG-7600-6 - T-bar Lay-in Steel
XG-7600-6 AL - T-bar Lay-in Aluminum
XG-7600-6 AF - T-bar Lay-in Aluminum Face**

**XG-7600-8 - Tegular T-bar Steel
XG-7600-8 AL - Tegular T-bar Aluminum
XG-7600-8 AF - Tegular T-bar Aluminum Face**

**XG-7600-9 - Donn Finline Steel
XG-7600-9 AF- Donn Finline Aluminum Face**

Air Outlets shall be model XG-7600 in steel, XG-7600-AL aluminum, XG-7600-AF with aluminum face or XG-7600-DF with a dropped face manufactured by GREENHECK.

Units shall consist of a 51% free area perforated face with 3/16" diameter perforated holes on 1/4" staggered centers. The perforated face shall be removable allowing access to the neck mounted aluminum curved blade pattern controllers with tension spring clips. Pattern controller blades shall be individually adjustable and allow the discharge pattern to be adjustable from vertical to horizontal. Pattern controller blades shall pivot in adjustable from vertical to horizontal.

Pattern controller blades shall pivot in friction mounting retainers. Retainers shall hold the deflector blade position throughout the specified operating range of the device. Metal friction wires are not acceptable. Outlets shall be available in 1, 2-way opposite, 2-way corner, 3, and 4-way directional air patterns. The units shall be the size and quality as outlined in the plans and specifications. Units shall be designed to integrate into the specified ceiling systems.

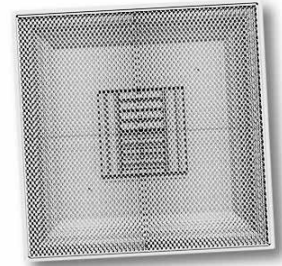

Return – Model XG-7600R

**XG-7600R-1 - Surface Mounted Steel
XG-7600R-1 AF - Surface Mounted Aluminum Face
XG-7600R-1 DF - Surface Mounted Dropped Face**

**XG-7600R-6 - T-bar Lay-in Steel
XG-7600R-6 AL - T-bar Lay-in Aluminum
XG-7600R-6 AF - T-bar Lay-in Aluminum Face**

**XG-7600R-8 - Tegular T-bar Steel
XG-7600R-8 AL - Tegular T-bar Aluminum
XG-7600R-8 AF - Tegular T-bar Aluminum Face**

XG-7600R-9 - Donn Finline Steel

XG-7600R-9 AF - Donn Finline Aluminum Face

Air Outlets shall be model XG-7600R in steel, XG-7600R-AL aluminum, XG-7600R-AF with aluminum face or XG-7600R-DF with a dropped face manufactured by GREENHECK.

Units shall consist of aluminum 51% free area perforated face with 3/16" diameter perforated holes on 1/4" staggered centers. Units shall be designed for use in ducted return or exhaust applications. The perforated face shall be hinged allowing access to the inside of the backpan. Face shall be secured in place with tension spring clips.

The units shall be the size and quality as outlined in the plans and specifications. Units shall be designed to integrate into the specified ceiling systems.

Optional Dampers and Accessories:

Square to Round Transitions

Units to have square to round transitions allowing installation with round ductwork.

Butterfly Damper

GREENHECK model XG-BDS aluminum, round butterfly type dampers shall be provided. Damper shall consist of two butterfly style blades that can be adjusted from full open to full closed. Damper shall be adjusted with a screw driver slot that can be assessed through the face of the diffuser.

Radial Shutter Damper

GREENHECK model XG-RSD steel round radial shutter damper shall be provided. Damper shall consist of gang operated radial blades that slide perpendicular to air flow direction. The damper shall be adjusted from full open to full closed. Damper shall be adjusted with a screwdriver slot that can be assessed through the face of the diffuser.

Opposed Blade Damper

GREENHECK model XG-D3 aluminum or XG-SD3 steel round opposed blade type dampers shall be provided. Damper shall consist of gang operated blades that can be adjusted from full open to full closed. Damper shall be adjusted with a screw driver slot that can be assessed through the face of the diffuser.

Equalizing Grid

GREENHECK model XG-G3 aluminum, round equalizing grid shall be provided. Equalizing grid shall consist of 1/2" x 1/2" x 1/2" aluminum cubed core mounting in an aluminum frame

Performance Specification

The manufacturer shall provide published performance data. Data shall be tested in accordance to ANSI/ASHRAE Standard 70- 2006

Paint Specification

Process shall be anodic electrodeposition using an anodic acrylic paint. Units shall undergo pre-treatment including a pressurized spray stage using an alkaline cleaner and a de-ionized water rinse.

The manufacturer shall provide published performance data. Data shall be tested in accordance to ANSI/ASHRAE Standard 70- 1991.

MODEL XG-7600

CEILING
DIFFUSERS

PERFORATED
CEILING DIFFUSERS

XG-7600/XG-7650

Model: XG-7600-1 Perforated Hinged Face with Curved Blade Core - Flush Surface Mount

XG-7600-1 - Flush Surface Mount

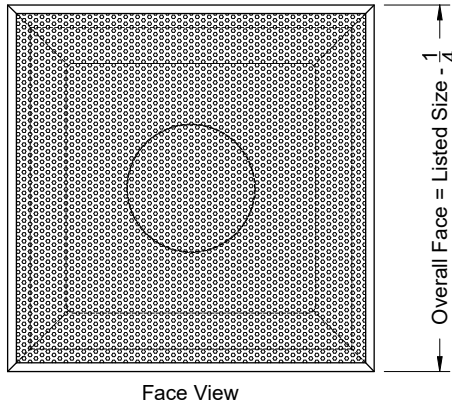
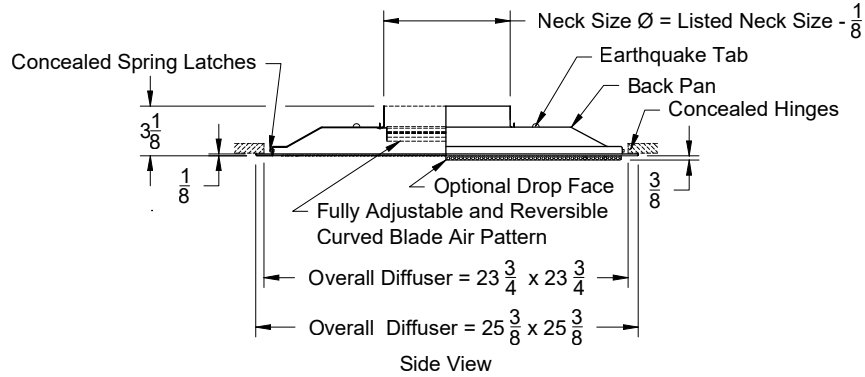

Listed Size
Nominal
Face
24 x 24

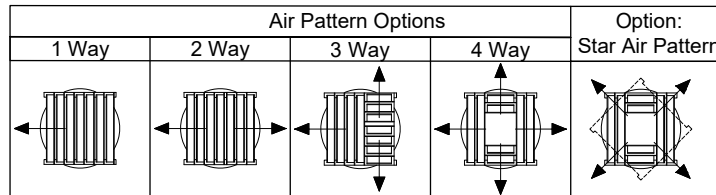

Changing 4-Way Air Pattern to Star Pattern Using Standard 4-Way Diffuser
Rotate Air Pattern Controller 45° for a More Radical "Star" Pattern Max Size 12 x 12

1. Available Finishes	2. Available Accessories	3. Available Options	4. Construction Details
Standard Finish: 01 White Finish 02 Satin Silver 03 Black 22 BBP - Black Backpan - White Face Optional Finish 28 Custom Color	XG-BDS - Butterfly Damper XG-RDS - Steel Radial Shutter Damper XG-TBPF - T-Bar Plaster Frame XG-G3 - Equalizing Grid (Round) XG-FGBP - Fiberglass Backpan	AF - Aluminum Face DF - Drop Face AL - Aluminum Face and Backpan	<ul style="list-style-type: none"> Steel Construction (Standard) Sizes Available only as listed Neck sizes available: 6, 8, 10, 12, 14 & 16 Face is Hinged

All Dimensions $\pm 1/16"$

MODEL XG-7600

Model: XG-7600-6 Perforated Hinged Face with Curved Blade Core - Lay In T-Bar

XG-7600-6 - Lay in T-Bar

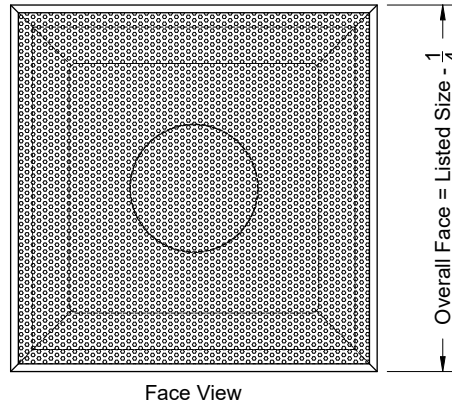
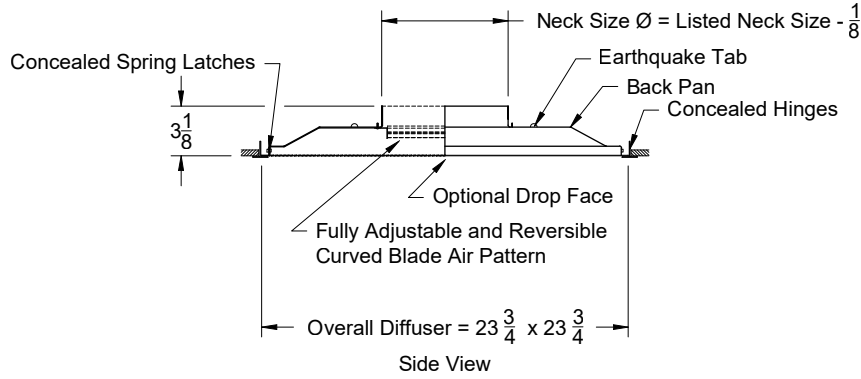

Listed Size
Nominal
Face
24 x 24

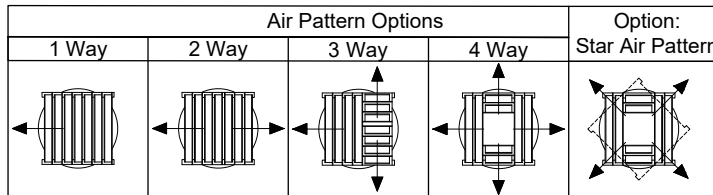

Changing 4-Way Air Pattern to Star Pattern Using Standard 4-Way Diffuser
 Rotate Air Pattern Controller 45° for a More Radical "Star" Pattern Max Size 12 x 12

1. Available Finishes	2. Available Accessories	3. Available Options	4. Construction Details
Standard Finish: 01 White Finish 02 Satin Silver 03 Black 22 BBP - Black Backpan - White Face Optional Finish 28 Custom Color	XG-BDS - Butterfly Damper XG-RDS - Steel Radial Shutter Damper XG-TBPF - T-Bar Plaster Frame XG-G3 - Equalizing Grid (Round) XG-FGBP - Fiberglass Backpan XG-EQ - Earthquake Straps	AF - Aluminum Face DF - Drop Face AL - Aluminum Face and Backpan	<ul style="list-style-type: none"> • Steel Construction (Standard) • Sizes Available only as listed • Neck sizes available: 6, 8, 10, 12, 14 & 16 • Face is Hinged

All Dimensions $\pm 1/16"$

MODEL XG-7600

CEILING
DIFFUSERS

PERFORATED
CEILING DIFFUSERS

XG-7600/XG-7650

Model: XG-7600-8 Perforated Hinged Face with Curved Blade Core - Tegular T-Bar

XG-7600-8 - Tegular T-Bar

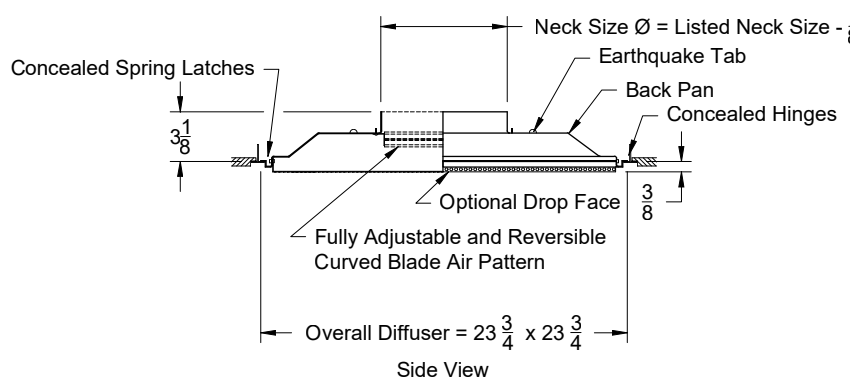

Side View

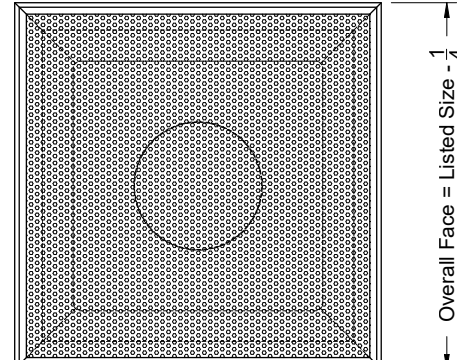

Face View

Listed Size
Nominal
Face
24 x 24

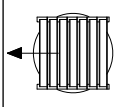
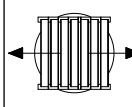
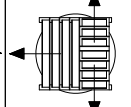
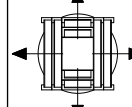
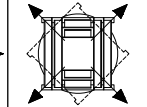
Air Pattern Options				Option:
1 Way	2 Way	3 Way	4 Way	Star Air Pattern
				

Changing 4-Way Air Pattern to Star Pattern Using Standard 4-Way Diffuser
Rotate Air Pattern Controller 45° for a More Radical "Star" Pattern Max Size 12 x 12

1. Available Finishes	2. Available Accessories	3. Available Options	4. Construction Details
Standard Finish: 01 White Finish 02 Satin Silver 03 Black 22 BBP - Black Backpan - White Face Optional Finish 28 Custom Color	XG-BDS - Butterfly Damper XG-RDS - Steel Radial Shutter Damper XG-G3 - Equalizing Grid (Round) XG-FGBP - Fiberglass Backpan	AF - Aluminum Face DF - Drop Face AL - Aluminum Face and Backpan	<ul style="list-style-type: none"> Steel Construction (Standard) Sizes Available only as listed Neck sizes available: 6, 8, 10, 12, 14 & 16 Face is Hinged

All Dimensions ±1/16"

MODEL XG-7600

Model: XG-7600-9 Perforated Hinged Face with Curved Blade Core - Bolt Slot/Donn Finline

XG-7600-9 - Bolt Slot

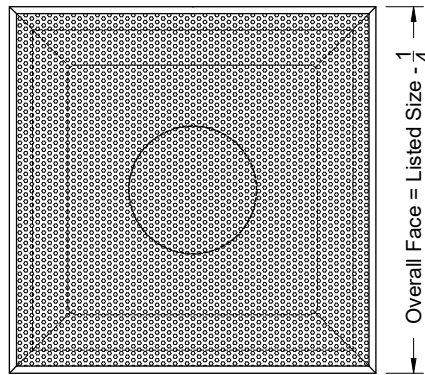
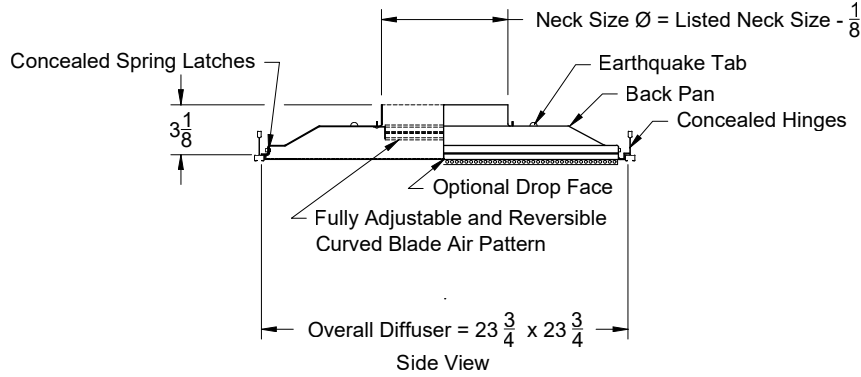

Listed Size
Nominal
Face
24 x 24

Air Pattern Options				Option:
1 Way	2 Way	3 Way	4 Way	Star Air Pattern

Changing 4-Way Air Pattern to Star Pattern Using Standard 4-Way Diffuser
Rotate Air Pattern Controller 45° for a More Radical "Star" Pattern Max Size 12 x 12

1. Available Finishes	2. Available Accessories	3. Available Options	4. Construction Details
Standard Finish: 01 White Finish 02 Satin Silver 03 Black 22 BBP - Black Backpan - White Face Optional Finish 28 Custom Color	XG-BDS - Butterfly Damper XG-RDS - Steel Radial Shutter Damper XG-G3 - Equalizing Grid (Round) XG-FGBP - Fiberglass Backpan XG-EQ - Earthquake Straps	AF - Aluminum Face DF - Drop Face AL - Aluminum Face and Backpan	<ul style="list-style-type: none"> Steel Construction (Standard) Sizes Available only as listed Neck sizes available: 6, 8, 10, 12, 14 & 16 Face is Hinged

All Dimensions ±1/16"

MODEL XG-7600R

CEILING
DIFFUSERS

PERFORATED
CEILING DIFFUSERS

XG-7600/XG-7650

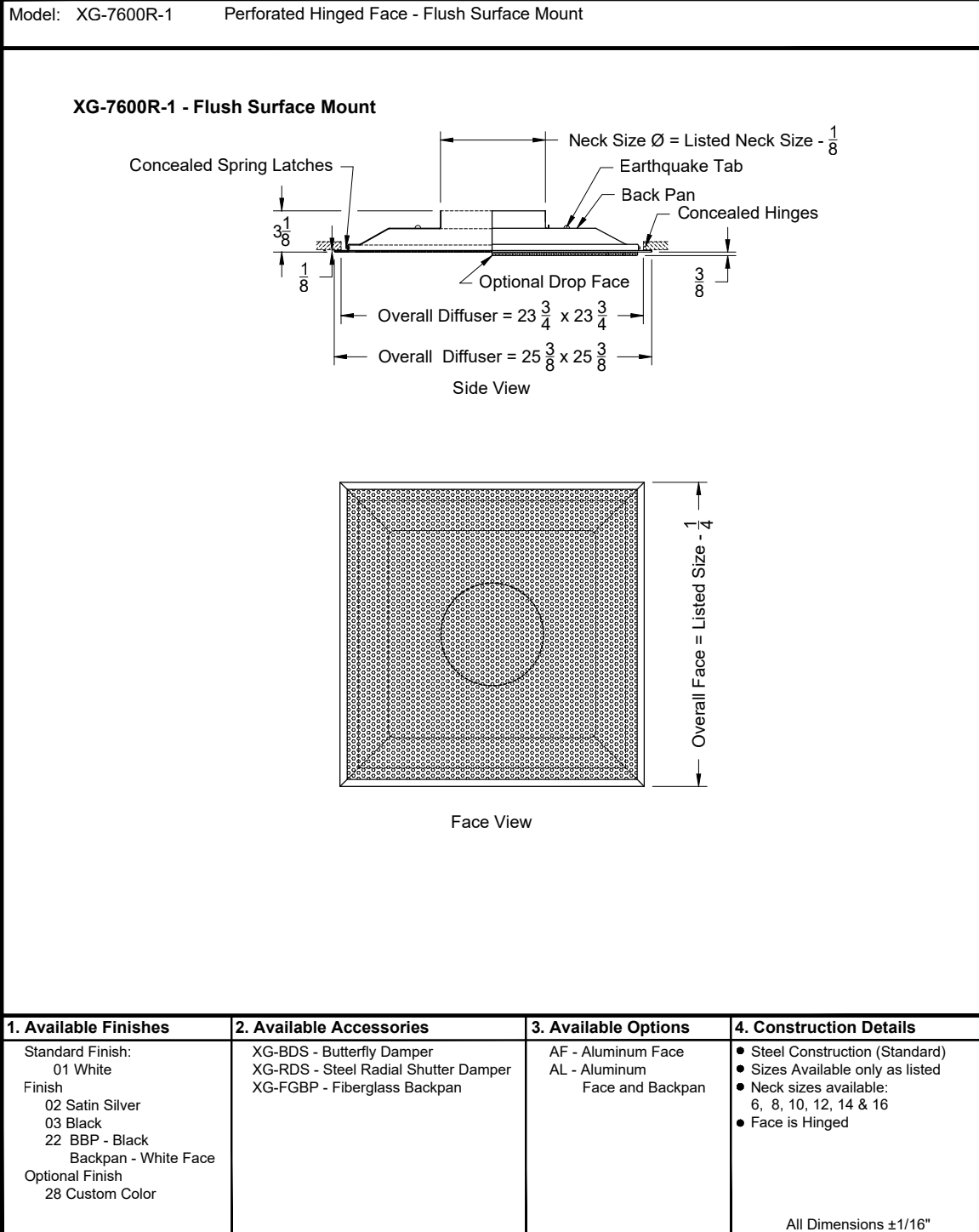

MODEL XG-7600R

Model: XG-7600R-6 Perforated Hinged Face - Lay In T-Bar

XG-7600R-6 - Lay in T-Bar

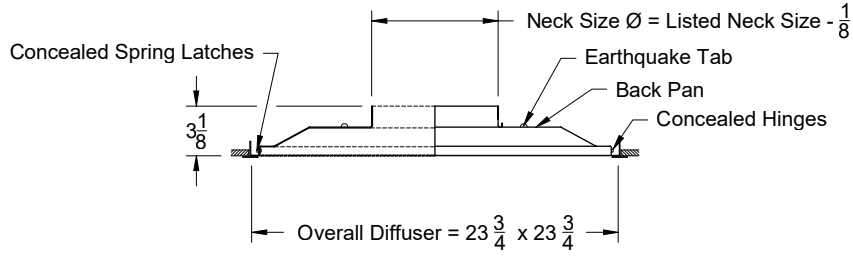

Side View

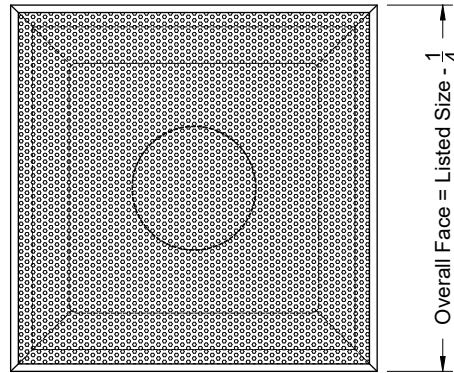

Face View

1. Available Finishes	2. Available Accessories	3. Available Options	4. Construction Details
Standard Finish: 01 White Finish 02 Satin Silver 03 Black 22 BBP - Black Backpan - White Face Optional Finish 28 Custom Color	XG-BDS - Butterfly Damper XG-RDS - Steel Radial Shutter Damper XG-TBPF - T-Bar Plaster Frame XG-EQ - Earthquake Straps	AF - Aluminum Face AL - Aluminum Face and Backpan	<ul style="list-style-type: none"> • Steel Construction (Standard) • Sizes Available only as listed • Neck sizes available: 6, 8, 10, 12, 14 & 16 • Face is Hinged
			All Dimensions $\pm 1/16"$

MODEL XG-7600R

CEILING
DIFFUSERS

PERFORATED
CEILING DIFFUSERS

XG-7600/XG-7650

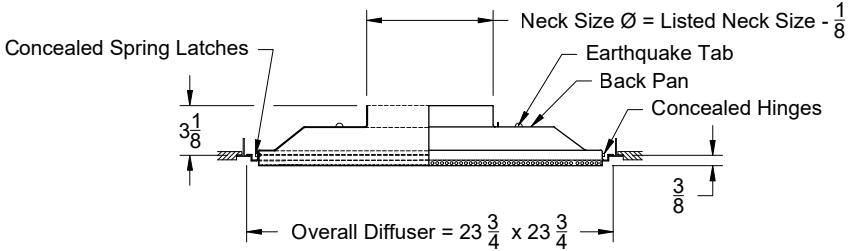
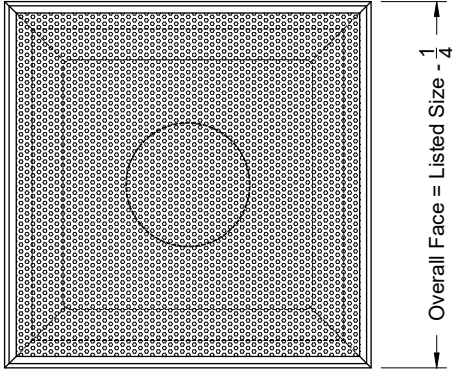
Model: XG-7600R-8 Perforated Hinged Face - Tegular T-Bar			
<p>XG-7600R-8 - Tegular T-Bar</p>  <p>Side View</p>  <p>Face View</p>			
<p>1. Available Finishes</p> <p>Standard Finish: 01 White Finish 02 Satin Silver 03 Black 22 BBP - Black Backpan - White Face Optional Finish 28 Custom Color</p>	<p>2. Available Accessories</p> <p>XG-BDS - Butterfly Damper XG-RDS - Steel Radial Shutter Damper</p>	<p>3. Available Options</p> <p>AF - Aluminum Face AL - Aluminum Face and Backpan</p>	<p>4. Construction Details</p> <ul style="list-style-type: none"> • Steel Construction (Standard) • Sizes Available only as listed • Neck sizes available: 6, 8, 10, 12, 14 & 16 • Face is Hinged <p>All Dimensions ±1/16"</p>

MODEL XG-7600R

Model: XG-7600R-9 Perforated Hinged Face - Bolt Slot/Donn Finline

XG-7600R-9 - Bolt Slot

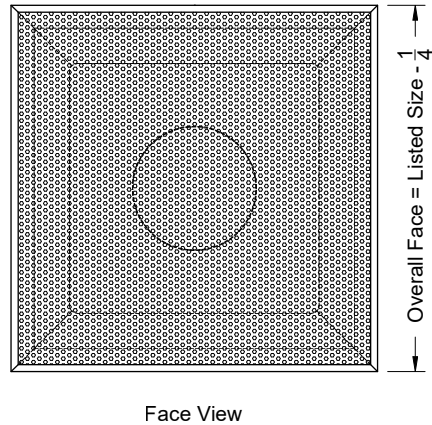
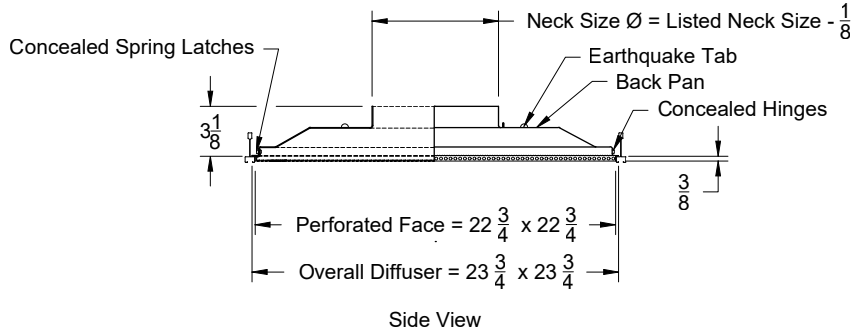

1. Available Finishes	2. Available Accessories	3. Available Options	4. Construction Details
Standard Finish: 01 White Finish 02 Satin Silver 03 Black 22 BBP - Black Backpan - White Face Optional Finish 28 Custom Color	XG-BDS - Butterfly Damper XG-RDS - Steel Radial Shutter Damper XG-EQ - Earthquake Straps		<ul style="list-style-type: none"> Steel Construction (Standard) Sizes Available only as listed Neck sizes available: 6, 8, 10, 12, 14 & 16 Face is Hinged
			All Dimensions $\pm 1/16"$

SERIES XG-7600 PERFORMANCE DATA

Module	Neck Size	fpm Neck Velocity	300	400	500	600	700	800	1000	1200	
		Pv	.006	.010	.016	.022	.031	.040	.062	.090	
12 x 12	6	CFM	60	80	100	120	135	155	195	235	
		Pt	.015	.026	.041	.060	.075	.099	.157	.229	
		NC	<15	<15	<15	19	23	26	30	35	
		Throw	4-Way*	1-1-2	1-2-3	1-2-4	2-2-5	2-3-5	2-3-6	3-4-6	3-5-7
			4-Way	1-2-4	2-3-5	2-4-6	3-4-6	3-5-7	4-5-7	5-6-8	5-6-9
			3-Way	2-2-5	2-3-6	3-4-7	3-5-7	4-5-8	4-6-8	5-6-9	6-7-10
			2-Way	2-3-5	2-3-6	3-4-7	3-5-8	4-6-8	4-6-9	6-7-10	6-8-11
	1-Way	4-6-9	5-7-10	7-8-11	7-9-12	8-9-13	8-10-14	9-11-16	10-12-17		
	8	CFM	105	140	175	210	245	280	350	420	
		Pt	.016	.028	.044	.063	.086	.112	.175	.252	
		NC	<15	<15	<15	19	24	27	31	37	
		Throw	4-Way*	1-2-3	1-2-4	2-3-5	2-3-6	2-4-7	3-4-8	3-5-8	4-6-9
			4-Way	2-3-6	3-4-7	3-5-8	4-6-9	4-7-9	5-7-10	6-8-11	7-9-12
			3-Way	2-3-6	3-4-8	3-5-9	4-6-9	5-7-10	6-8-11	7-9-12	8-9-13
2-Way			2-3-7	3-5-9	4-6-10	5-7-11	5-8-11	6-9-12	8-10-14	9-11-15	
1-Way	5-8-12	7-9-13	9-11-15	9-12-16	10-12-18	11-13-19	12-15-21	13-16-23			
24 x 24	6	CFM	60	80	100	120	135	155	195	235	
		Pt	.015	.026	.041	.060	.075	.099	.157	.229	
		NC	<15	<15	<15	19	23	26	30	35	
		Throw	4-Way*	1-1-2	1-2-3	1-2-4	2-2-5	2-3-6	2-3-6	3-4-7	3-5-7
			4-Way	1-2-5	2-3-6	3-4-6	3-5-7	3-5-7	4-5-8	5-6-9	6-7-10
			3-Way	2-3-5	2-3-6	3-4-7	3-5-7	4-6-8	4-6-9	5-7-10	6-7-10
			2-Way	2-3-5	2-4-7	3-5-8	4-5-8	4-6-9	5-7-10	6-8-11	7-8-12
	1-Way	4-6-9	6-8-11	7-8-12	8-9-13	8-10-14	9-10-15	10-12-17	11-13-18		
	8	CFM	105	140	175	210	245	280	350	420	
		Pt	.016	.028	.044	.063	.086	.112	.175	.252	
		NC	<15	<15	<15	19	24	27	31	37	
		Throw	4-Way*	1-2-3	1-2-4	2-3-5	2-3-7	3-4-7	3-4-8	4-5-9	4-7-10
			4-Way	2-3-6	3-4-7	3-5-8	4-6-9	5-7-10	5-7-10	7-8-12	7-9-13
			3-Way	2-3-7	3-4-8	4-5-9	4-7-10	5-8-11	6-8-11	7-9-13	8-10-14
2-Way			2-4-7	3-5-9	4-6-10	5-7-11	6-8-12	6-9-13	8-10-14	9-11-16	
1-Way	5-8-12	7-10-14	9-11-16	10-12-17	11-13-19	11-14-20	13-16-22	14-17-24			

CEILING
DIFFUSERS

PERFORATED
CEILING DIFFUSERS

XG-7600/XG-7650

SERIES XG-7600 PERFORMANCE DATA

Module	Neck Size	<i>fpm Neck Velocity</i>	300	400	500	600	700	800	1000	1200	
		<i>Pv</i>	.006	.010	.016	.022	.031	.040	.062	.090	
24 x 24	10	CFM	165	220	275	325	380	435	545	655	
		Pt	.017	.030	.047	.066	.090	.118	.186	.268	
		NC	<15	<15	<15	20	25	29	34	39	
		Throw	4-Way*	1-2-4	2-3-5	2-3-7	3-4-8	3-5-9	4-5-10	5-7-11	5-8-12
			4-Way	2-4-8	3-5-9	4-6-10	5-7-11	6-9-12	7-9-13	8-10-15	9-11-16
			3-Way	3-4-8	4-6-10	5-7-11	5-8-12	6-9-13	7-10-14	9-11-16	10-12-18
			2-Way	3-4-9	4-6-11	5-7-13	6-9-14	7-10-15	8-11-16	10-13-18	11-14-20
			1-Way	7-10-15	9-12-18	11-14-20	12-15-21	13-16-23	14-18-25	16-20-28	18-21-30
		12	CFM	235	315	395	470	550	630	785	940
			Pt	.018	.033	.052	.074	.101	.133	.206	.295
	NC		<15	<15	15	22	27	31	36	42	
	Throw		4-Way*	2-2-5	2-3-7	3-4-8	3-5-10	4-6-11	4-7-12	5-8-13	7-10-15
			4-Way	3-5-9	4-6-11	5-8-12	6-9-13	7-10-15	8-11-16	10-12-17	11-13-19
			3-Way	3-5-10	4-7-12	5-8-14	7-10-15	8-11-16	9-12-17	11-14-19	12-15-21
			2-Way	4-5-11	5-7-14	6-9-15	7-11-17	8-12-18	9-14-19	12-15-21	14-17-23
			1-Way	8-12-18	11-15-21	14-17-24	15-18-26	16-20-28	17-21-30	19-24-33	21-26-36
	14		CFM	320	430	535	640	750	855	1070	1285
			Pt	.017	.031	.048	.068	.094	.122	.191	.276
		NC	<15	<15	16	24	29	33	38	44	
		Throw	4-Way*	2-3-6	3-4-8	3-5-10	4-6-11	4-7-13	5-8-14	6-10-16	8-11-17
			4-Way	3-5-11	5-7-13	6-9-14	7-11-16	8-12-17	9-13-18	12-14-20	13-16-22
			3-Way	4-6-11	5-8-14	6-10-16	8-11-17	9-13-19	10-14-20	13-16-22	14-17--25
			2-Way	4-6-12	6-8-16	7-10-18	8-12-19	10-15-21	11-16-22	14-18-25	16-19-27
			1-Way	9-14-21	13-17-25	16-19-27	17-21-30	19-23-33	20-25-35	22-27-39	25-30-43
		16	CFM	420	560	700	840	975	1115	1395	1675
			Pt	.019	.033	.052	.075	.101	.132	.206	.297
	NC		<15	<15	17	25	30	34	39	46	
	Throw		4-Way*	2-3-7	3-4-9	4-5-11	4-7-13	5-8-15	6-9-16	7-11-18	9-13-20
4-Way			4-6-12	5-8-15	7-10-16	8-12-18	9-14-19	11-15-21	13-16-23	15-18-25	
3-Way			4-7-13	6-9-16	7-11-18	9-13-20	10-15-21	12-16-23	15-18-26	16-20-28	
2-Way			5-7-14	6-9-18	8-12-20	9-14-22	11-17-24	13-18-26	16-20-29	18+22-31	
1-Way			10-16-24	15-20-28	18-22-31	20-24-34	21-26-37	23-28-40	26-31-44	28-34-49	

**CEILING
DIFFUSERS**
**PERFORATED
CEILING DIFFUSERS**
XG-7600/XG-7650

MODEL XG-7650

**Perforated Diffuser - Square Neck -
Adjustable Neck Mounted Pattern Controller**

Supply – Model XG-7650

XG-7650-1 - Surface Mount Steel

XG-7650-1 AF - Surface Mount Aluminum Face

XG-7650-1 DF - Surface Mount Drop Face

XG-7650-6 - T-bar Lay-in Steel

XG-7650-6 AL - T-bar Lay-in Aluminum

XG-7650-6 AF - T-bar Lay-in Aluminum Face

XG-7650-8 - Tegular T-bar Steel

XG-7650-8 AL - Tegular T-bar Aluminum

XG-7650-8 AF - Tegular T-bar Aluminum Face

XG-7650-9 - Donn Finline Steel

XG-7650-9 AF- Donn Finline Aluminum Face

Air Outlets shall be model XG-7650 in steel, XG-7650-AL aluminum, XG-7650-AF with aluminum face or XG-7650-DF with a dropped face manufactured by GREENHECK.

Units shall consist of a 51% free area perforated face with 3/16" diameter perforated holes on 1/4" staggered centers. The perforated face shall be removable allowing access to aluminum, curved blade pattern controllers mounted into the neck of the diffusers. Face shall be secured in place with tension spring clips. Pattern controllers shall be individually adjustable and allow the discharge pattern to be adjustable from vertical to horizontal. Pattern controller blades shall pivot in friction mounting retainers. Retainers shall hold the deflector blade position throughout the specified operating range of the device. Metal friction wires are not acceptable.

Outlets shall be available in 1-way, 2-way opposite, 2-way corner, 3-way, and 4-way directional air patterns. The units shall be the size and quantity as outlined in the plans and specifications. Units shall be designed to integrate into the specified ceiling system.

MODEL XG-7650

Model: XG-7650-1 Perforated Hinged Face with Curved Blade Core - Flush Surface Mount

XG-7650-1 - Flush Surface Mount

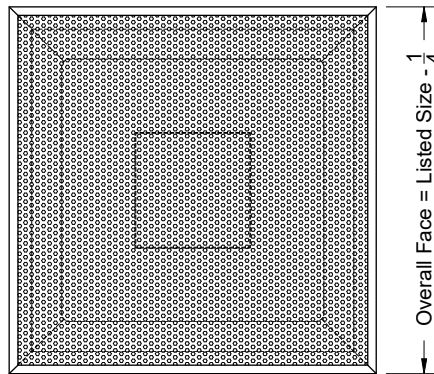
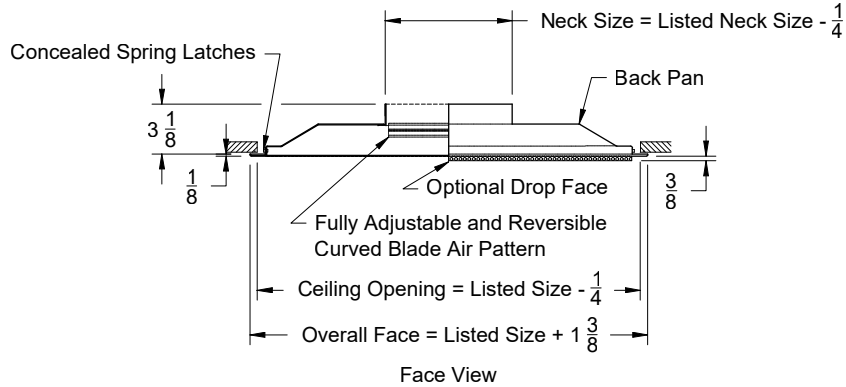

Listed Size
Nominal
Face
24 x 24

Available
Square Inlets
6 X 6
8 X 8
10 X 10
12 X 12
14 X 14
16 X 16

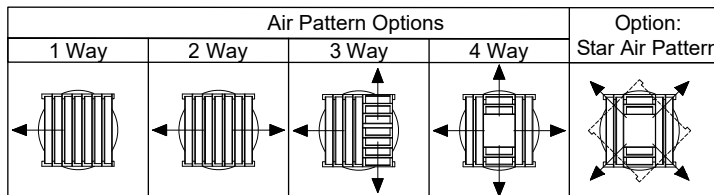

1. Available Finishes	2. Available Accessories	3. Available Options	4. Construction Details
Standard Finish: 01 White Finish 02 Satin Silver 03 Black 22 BBP - Black Backpan - White Face Optional Finish 28 Custom Color	XG-BDS - Butterfly Damper XG-RDS - Steel Radial Shutter Damper XG-TBPF - T-Bar Plaster Frame XG-G3 - Equalizing Grid (Round) XG-FGBP - Fiberglass Backpan	AF - Aluminum Face DF - Drop Face AL - Aluminum Face and Backpan	<ul style="list-style-type: none"> Steel Construction (Standard) Sizes Available only as listed Square Neck sizes available: 6, 8, 10, 12, 14 & 16 Face is Hinged

All Dimensions ±1/16"

MODEL XG-7650

CEILING
DIFFUSERS

PERFORATED
CEILING DIFFUSERS

XG-7600/XG-7650

Model: XG-7650-6 Perforated Hinged Face with Curved Blade Core - Lay In T-Bar

XG-7650-6 - Lay in T-Bar

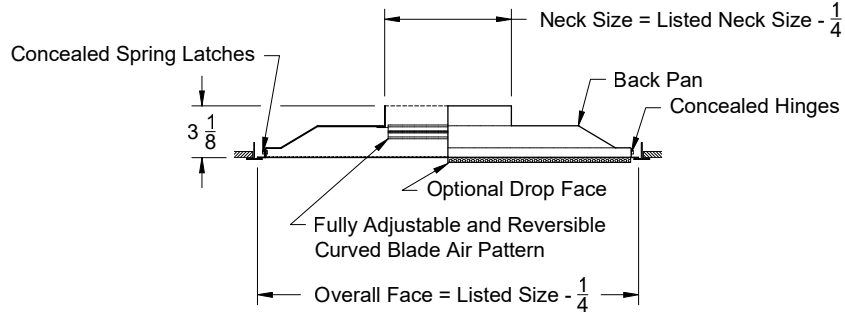

Face View

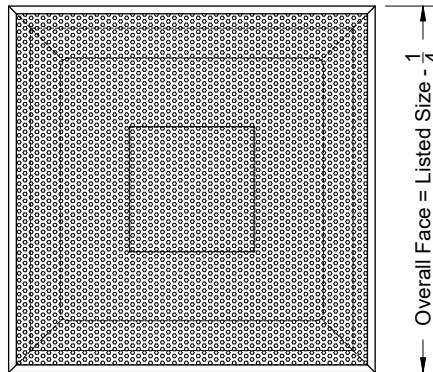

Listed Size
Nominal
Face
24 x 24

Available
Square Inlets
6 X 6
8 X 8
10 X 10
12 X 12
14 X 14
16 X 16

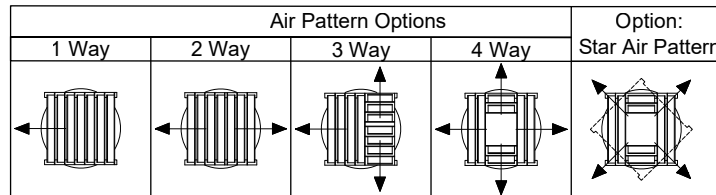

1. Available Finishes

Standard Finish:
01 White
Finish
02 Satin Silver
03 Black
22 BBP - Black
Backpan - White Face
Optional Finish
28 Custom Color

2. Available Accessories

XG-BDS - Butterfly Damper
XG-RDS - Steel Radial Shutter Damper
XG-TBPF - T-Bar Plaster Frame
XG-G3 - Equalizing Grid (Round)
XG-FGBP - Fiberglass Backpan
XG-EQ - Earthquake Straps

3. Available Options

AF - Aluminum Face
DF - Drop Face
AL - Aluminum
Face and Backpan

4. Construction Details

- Steel Construction (Standard)
- Sizes Available only as listed
- Square Neck sizes available: 6, 8, 10, 12, 14 & 16
- Face is Hinged

All Dimensions ±1/16"

MODEL XG-7650

Model: XG-7650-8 Perforated Hinged Face with Curved Blade Core - Tegular T-Bar

XG-7650-8 - Tegular T-Bar

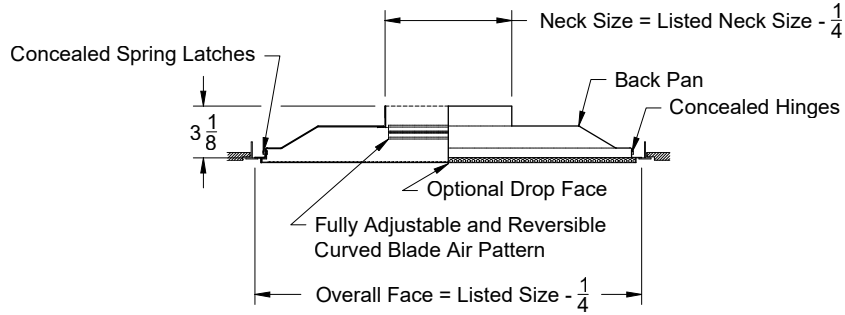

Face View

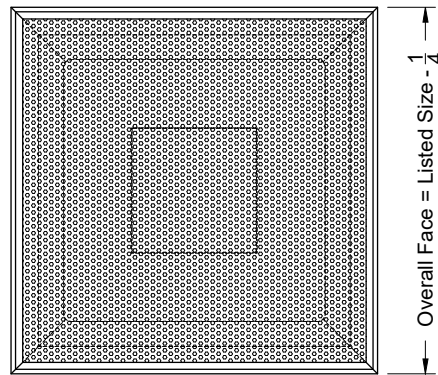

Listed Size
Nominal
Face
24 x 24

Available
Square Inlets
6 X 6
8 X 8
10 X 10
12 X 12
14 X 14
16 X 16

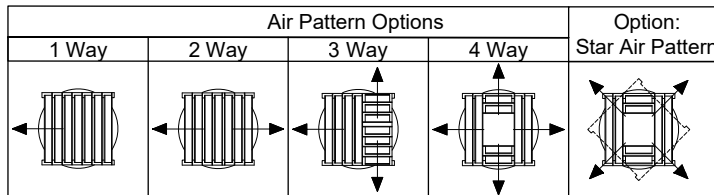

1. Available Finishes	2. Available Accessories	3. Available Options	4. Construction Details
Standard Finish: 01 White Finish 02 Satin Silver 03 Black 22 BBP - Black Backpan - White Face Optional Finish 28 Custom Color	XG-BDS - Butterfly Damper XG-RDS - Steel Radial Shutter Damper XG-G3 - Equalizing Grid (Round) XG-FGBP - Fiberglass Backpan	AF - Aluminum Face DF - Drop Face AL - Aluminum Face and Backpan	<ul style="list-style-type: none"> Steel Construction (Standard) Sizes Available only as listed Square Neck sizes available: 6, 8, 10, 12, 14 & 16 Face is Hinged

All Dimensions ±1/16"

MODEL XG-7650

CEILING
DIFFUSERS

PERFORATED
CEILING DIFFUSERS

XG-7600/XG-7650

Model: XG-7650-9 Perforated Hinged Face with Curved Blade Core - Bolt Slot/Donn Fineline

XG-7650-9 - Bolt Slot/Donn Fineline

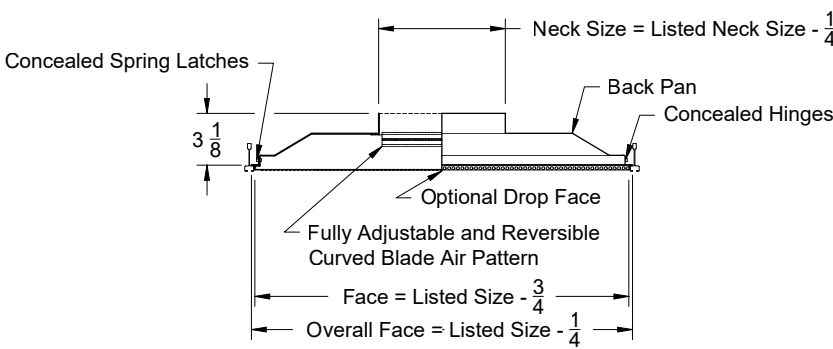

Face View

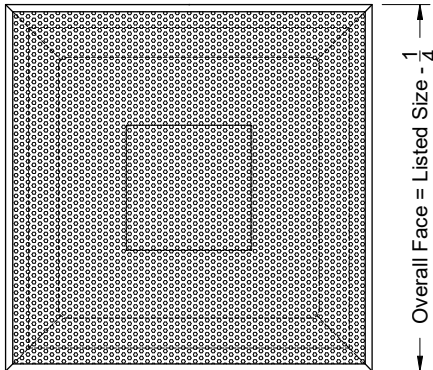

Listed Size
Nominal
Face
24 x 24

Available
Square Inlets
6 X 6
8 X 8
10 X 10
12 X 12
14 X 14
16 X 16

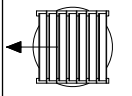
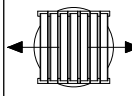
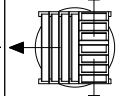
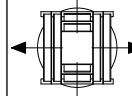
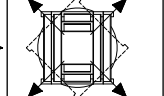
Air Pattern Options				Option:
1 Way	2 Way	3 Way	4 Way	Star Air Pattern
				

1. Available Finishes	2. Available Accessories	3. Available Options	4. Construction Details
Standard Finish: 01 White Finish 02 Satin Silver 03 Black 22 BBP - Black Backpan - White Face Optional Finish 28 Custom Color	XG-BDS - Butterfly Damper XG-RDS - Steel Radial Shutter Damper XG-G3 - Equalizing Grid (Round) XG-FGBP - Fiberglass Backpan XG-EQ - Earthquake Straps	AF - Aluminum Face DF - Drop Face AL - Aluminum Face and Backpan	<ul style="list-style-type: none"> • Steel Construction (Standard) • Sizes Available only as listed • Square Neck sizes available: 6, 8, 10, 12, 14 & 16 • Face is Hinged
All Dimensions ±1/16"			

SERIES XG-7650 PERFORMANCE DATA

Module	Neck Size	fpm Neck Velocity	300	400	500	600	700	800	1000	1200	
		Pv	.006	.010	.016	.022	.031	.040	.062	.090	
12 x 12	6 x 6	CFM	75	100	125	150	175	200	250	300	
		Pt	.017	.031	.048	.070	.095	.124	.194	.279	
		NC	<15	<15	<15	16	21	25	30	36	
		Throw	4-Way*	1-1-3	1-2-3	1-2-4	2-3-5	2-3-6	2-3-6	3-4-7	3-5-8
			4-Way	1-2-5	2-3-6	3-4-7	3-5-7	4-6-8	4-6-8	5-7-9	6-7-10
			3-Way	2-3-5	2-4-7	3-4-7	4-5-8	4-6-9	5-7-9	6-7-10	7-8-11
			2-Way	2-3-6	3-4-7	3-5-8	4-6-9	4-7-10	5-7-10	6-8-11	7-9-13
			1-Way	4-7-10	6-8-11	7-9-13	8-10-14	9-11-15	9-11-16	10-13-18	11-14-20
		8 x 8	CFM	135	180	220	265	310	355	445	535
	Pt		.020	.036	.054	.079	.108	.141	.222	.321	
	NC		<15	<15	<15	16	21	25	30	36	
	Throw		4-Way*	1-1-3	1-2-4	2-2-5	2-3-6	2-3-6	2-4-7	3-5-8	4-6-8
			4-Way	2-3-5	2-3-6	3-4-7	3-5-8	4-6-8	5-6-9	6-7-10	6-8-11
			3-Way	2-3-6	2-4-7	3-5-8	4-6-8	4-6-9	5-7-10	6-8-11	7-8-12
			2-Way	2-3-6	3-4-8	3-5-9	4-6-9	5-7-10	5-8-11	7-9-12	8-9-13
			1-Way	4-7-10	6-8-12	8-9-13	8-10-15	9-11-16	10-12-17	11-13-19	12-15-21
	24 x 24		6 x 6	CFM	75	100	125	150	175	200	250
		Pt		.017	.031	.048	.070	.095	.124	.194	.279
NC		<15		<15	<15	16	21	25	30	36	
Throw		4-Way*		1-1-3	1-2-4	2-2-5	2-3-6	2-3-6	2-4-7	3-5-8	4-6-8
		4-Way		2-3-5	2-3-6	3-4-7	3-5-8	4-6-8	5-6-9	6-7-10	6-8-11
		3-Way		2-3-6	2-4-7	3-5-8	4-6-8	4-6-9	5-7-10	6-8-11	7-8-12
		2-Way		2-3-6	3-4-8	3-5-9	4-6-9	5-7-10	5-8-11	7-9-12	8-9-13
		1-Way		4-7-10	6-8-12	8-9-13	8-10-15	9-11-16	10-12-17	11-13-19	12-15-21
8 x 8		CFM		135	180	220	265	310	355	445	535
		Pt	.020	.036	.054	.079	.108	.141	.222	.321	
		NC	<15	<15	<15	16	21	25	30	36	
		Throw	4-Way*	1-2-4	2-2-5	2-3-6	2-4-7	3-4-8	3-5-9	4-6-10	5-7-11
			4-Way	2-3-7	3-5-8	4-6-9	5-7-10	5-8-11	6-8-12	8-9-13	8-10-14
			3-Way	2-4-7	3-5-9	4-6-10	5-7-11	6-9-12	7-9-13	8-10-14	9-11-16
			2-Way	3-4-8	4-5-10	4-7-11	5-8-12	6-9-13	7-10-14	9-11-16	10-12-18
			1-Way	6-9-14	8-11-16	10-12-18	11-14-19	12-15-21	13-16-22	14-18-25	16-19-27

**CEILING
DIFFUSERS**
**PERFORATED
CEILING DIFFUSERS**
XG-7600/XG-7650

SERIES XG-7650 PERFORMANCE DATA

Module	Neck Size	fpm Neck Velocity	300	400	500	600	700	800	1000	1200	
		Pv	.006	.010	.016	.022	.031	.040	.062	.090	
24 x 24	10 x 10	CFM	210	280	345	415	485	555	695	835	
		Pt	.023	.040	.061	.089	.089	.159	.249	.359	
		NC	<15	<15	<15	20	26	29	36	42	
		Throw	4-Way*	2-2-5	2-3-6	3-4-8	3-5-9	4-5-11	4-6-11	5-8-13	6-9-14
			4-Way	3-4-9	4-6-10	5-7-12	6-8-13	7-10-14	8-10-15	9-12-16	10-13-18
			3-Way	3-5-9	4-6-11	5-8-13	6-9-14	7-11-15	8-11-18	10-13-18	11-14-20
			2-Way	3-5-10	4-7-13	6-8-14	7-10-16	8-12-17	9-13-18	11-14-20	13-16-22
	1-Way		7-12-17	10-14-20	13-16-22	14-17-24	15-18-26	16-20-28	18-22-31	20-24-34	
	12 x 12	CFM	300	400	500	600	700	800	1000	1200	
		Pt	.023	.040	.063	.090	.123	.160	.250	.360	
		NC	<15	<15	<15	18	23	28	34	40	
		Throw	4-Way*	2-3-6	2-4-7	3-5-9	4-6-11	4-6-13	5-7-14	6-9-15	7-11-17
			4-Way	3-5-10	5-7-12	6-9-14	7-10-15	8-12-16	9-12-18	11-14-20	12-15-22
			3-Way	4-6-11	5-7-14	6-9-15	7-11-17	9-13-18	10-14-19	12-15-22	14-17-24
			2-Way	4-6-12	5-8-15	7-10-17	8-12-19	9-14-20	11-15-22	13-17-24	15-19-26
	1-Way		9-14-21	12-17-24	15-19-27	17-21-29	18-22-31	19-24-34	22-27-38	24-29-41	
	14 x 14	CFM	410	545	680	815	955	1090	1360	1630	
		Pt	.023	.040	.062	.089	.121	.159	.248	.356	
		NC	<15	<15	<15	21	28	33	41	49	
		Throw	4-Way*	2-3-6	3-4-9	4-5-11	4-6-13	5-7-15	6-9-16	7-11-18	9-13-19
			4-Way	4-6-12	5-8-15	7-10-16	8-12-18	9-14-19	11-15-21	13-16-23	15-18-25
			3-Way	4-7-13	6-9-16	7-11-18	9-13-20	10-15-21	12-16-23	14-18-25	16-20-28
			2-Way	5-7-14	6-9-18	8-12-20	9-14-22	11-16-24	12-18-25	16-20-28	18-23-31
	1-Way		10-16-24	14-20-28	18-23-31	20-24-34	21-26-37	23-28-29	25-31-44	28-34-48	
	16 x 16	CFM	535	710	890	1070	1245	1425	1780	2135	
		Pt	.027	.047	.074	.108	.146	.191	.298	.428	
		NC	<15	<15	15	23	30	35	42	50	
		Throw	4-Way*	2-4-7	3-5-10	4-6-12	5-7-15	6-9-17	7-10-18	8-12-20	10-15-22
4-Way			4-7-14	6-9-17	8-11-19	9-14-20	11-16-22	12-17-23	15-19-26	17-20-29	
3-Way			5-7-15	7-10-18	8-12-20	10-15-22	12-17-24	13-18-26	16-20-29	18-22-32	
2-Way			5-8-16	7-11-20	9-13-23	11-16-25	12-19-27	14-20-29	18-23-32	20-25-35	
1-Way	12-18-27		16-22-32	20-25-35	22-27-39	24-30-42	26-32-45	29-35-50	32-39-55		

CEILING
DIFFUSERS

PERFORATED
CEILING DIFFUSERS

XG-7600/XG-7650

PERFORMANCE NOTES FOR SERIES XG-7500/XG-7550/XG-7600/XG-7650

All data is tested in accordance with ANSI/ASHRAE 70-2006.

DEFINITION OF UNITS

CFM Cubic Feet per Minute (air)

fpm Velocity of air stream in Feet per Minute

Pv Velocity pressure (inches of water column)

Pt Total pressure (inches of water column)

Ps Static pressure = $P_t - P_v$ (inches of water column)

Throw* Non-isothermal horizontal throw (supply air temperature 15°F colder than average room temperature); values are for 150, 100 and 50fpm velocities

Throw Isothermal throw (supply air temperature the same as average room temperature); values are for 150, 100 and 50fpm velocities

NC Noise criterion, sound pressure level NC ratings are based on sound power level (Lw) re: 10^{-12} watts minus a 10dB room attenuation in all octave bands

MODEL XG-7550R

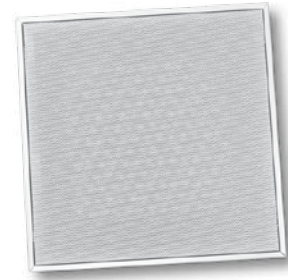

Return – Model XG-7650R

XG-7650R-1 - Surface Mounted Steel

XG-7650R-1 AF - Surface Mounted Aluminum Face

XG-7650R-1 DF - Surface Mounted Dropped Face

XG-7650R-6 - T-bar Lay-in Steel

XG-7650R-6 AL - T-bar Lay-in Aluminum

XG-7650R-6 AF - T-bar Lay-in Aluminum Face

XG-7650R-8 - Tegular T-bar Steel

XG-7650R-8 AL - Tegular T-bar Aluminum

XG-7650R-8 AF - Tegular T-bar Aluminum Face

XG-7650R-9 - Donn Finline Steel

XG-7650R-9 AF - Donn Finline Aluminum Face

Air Outlets shall be model XG-7650R in steel, XG-7650R-AL aluminum, XG-7650R-AF with aluminum face or XG-7650R-DF with a dropped face manufactured by GREENHECK.

Units shall consist of a 51% free area perforated face with 3/16" diameter perforated holes on 1/4" staggered centers. Units shall be designed for use in ducted return or exhaust applications. The perforated face shall be hinged allowing access to the inside of the backpan. Face shall be secured in place with tension spring clips.

The units shall be the size and quantity as outlined in the plans and specifications. Units shall be designed to integrate into the specified ceiling system.

Square Neck Options and Accessories

Opposed Blade Damper

GREENHECK model XG-OBDA aluminum or XG-OBD steel round opposed blade type dampers shall be provided. Damper shall consist of gang operated blades that can be adjusted from full open to full closed. Damper shall be adjusted with a screwdriver slot accessible by opening the face of the diffuser.

Equalizing Grid

GREENHECK model XG-L9 aluminum, square equalizing grid shall be provided. Equalizing grid shall consist aluminum blades mounting in an aluminum frame.

Performance Specification

The manufacturer shall provide published performance data. Data shall be tested in accordance to ANSI/ASHRAE Standard 70- 2006

Paint Specification

Process shall be anodic electrodeposition using an anodic acrylic paint. Units shall undergo pre-treatment including a pressurized spray stage using an alkaline cleaner and a de-ionized water rinse.

MODEL XG-7550R

Model: XG-7550R-1 Perforated Hinged Face - Flush Surface Mount

XG-7550R-1 - Flush Surface Mount

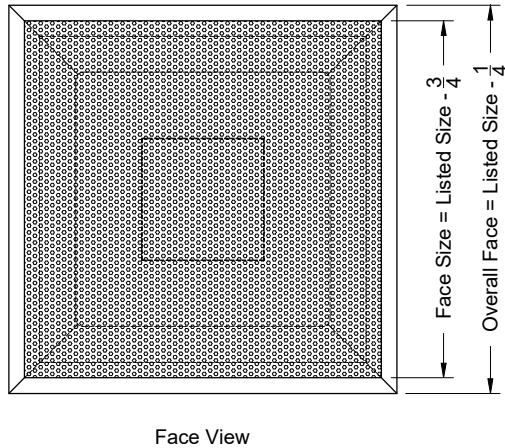
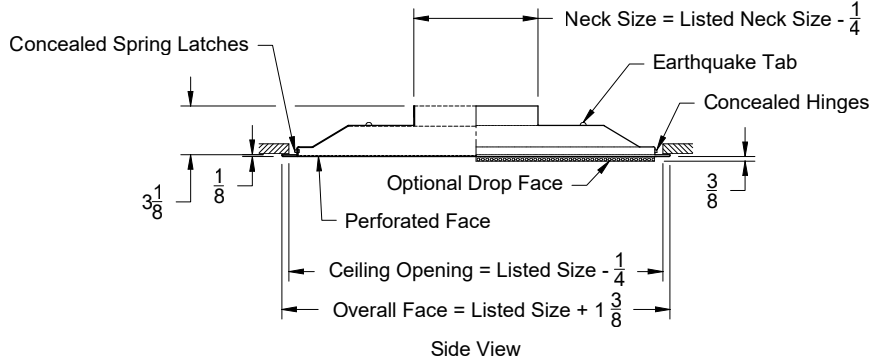

Listed Size
Nominal
Face
24 x 24

Square Neck Inlets
6 x 6
8 x 8
10 x 10
12 x 12
14 x 14
16 x 16
18 x 18
22 x 22

1. Available Finishes	2. Available Accessories	3. Available Options	4. Construction Details
Standard Finish: 01 White Finish 02 Satin Silver 03 Black 22 BBP - Black Backpan - White Face Optional Finish 28 Custom Color	XG-OBDD - Opposed Blade Damper Steel XG-OBDA - OBD Aluminum XG-TBPF - T-Bar Plaster Frame XG-L9 - Equalizing Grid (Sq./Rect.) XG-TR - Square to Round XG-TR DEEP - Deep Square to Round	AF - Aluminum Face DF - Drop Face	<ul style="list-style-type: none"> Steel Construction (Standard) Sizes Available only as listed Face is Hinged

All Dimensions $\pm 1/16$ "

MODEL XG-7550R

CEILING
DIFFUSERS

PERFORATED
CEILING DIFFUSERS

XG-7550R-F/XG-7650R

Model: XG-7550R-6 Perforated Hinged Face - Lay In T-Bar

XG-7550R-6 - Lay in T-Bar

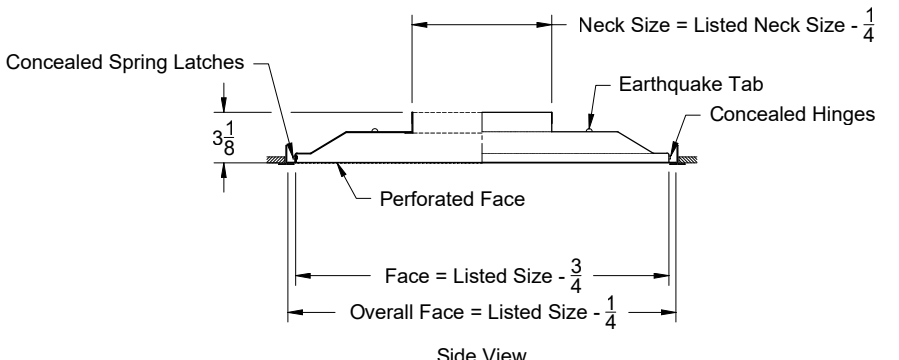

Side View

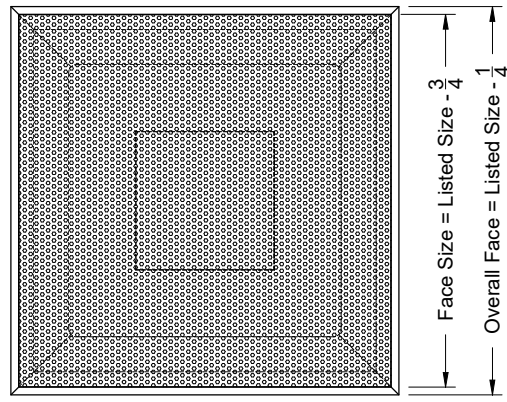

Face View

Listed Size	Nominal Face
24	24

Square Neck Inlets
6 x 6
8 x 8
10 x 10
12 x 12
14 x 14
16 x 16
18 x 18
22 x 22

1. Available Finishes	2. Available Accessories	3. Available Options	4. Construction Details
Standard Finish: 01 White Finish 02 Satin Silver 03 Black 22 BBP - Black Backpan - White Face Optional Finish 28 Custom Color	XG-OBDA - Opposed Blade Damper Steel XG-OBDA - OBD Aluminum XG-TBPF - T-Bar Plaster Frame XG-L9 - Equalizing Grid (Sq./Rect.) XG-EQ - Earthquake Straps XG-TR - Square to Round XG-TR DEEP - Deep Square to Round	AF - Aluminum Face AL - Aluminum Face and Backpan	<ul style="list-style-type: none"> Steel Construction (Standard) Sizes Available only as listed Face is Hinged

All Dimensions ±1/16"

MODEL XG-7550R

Model: XG-7550R-8 Perforated Hinged Face - Tegular T-Bar

XG-7550R-8 - Tegular T-Bar

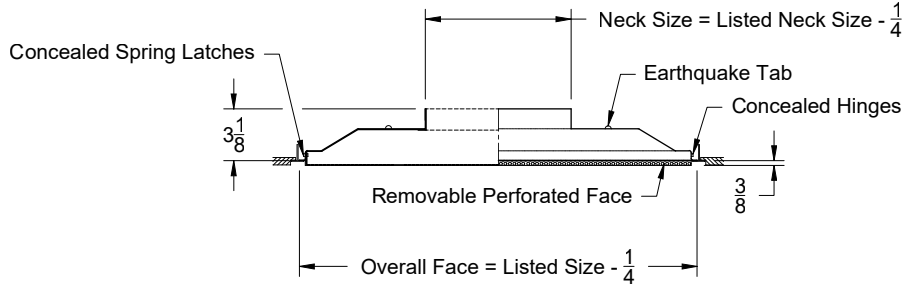

Side View

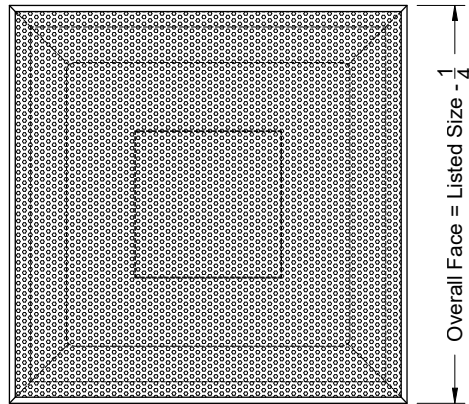

Face View

Listed Size
Nominal Face
24 x 24

Square Neck Inlets
6 x 6
8 x 8
10 x 10
12 x 12
14 x 14
16 x 16
18 x 18
22 x 22

1. Available Finishes	2. Available Accessories	3. Available Options	4. Construction Details
Standard Finish: 01 White Finish 02 Satin Silver 03 Black 22 BBP - Black Backpan - White Face Optional Finish 28 Custom Color	XG-OBD - Opposed Blade Damper Steel XG-OBDA - OBDA Aluminum XG-L9 - Equalizing Grid (Sq./Rect.) XG-TR - Square to Round XG-TR DEEP - Deep Square to Round	AF - Aluminum Face AL - Aluminum Face and Backpan	<ul style="list-style-type: none"> • Steel Construction (Standard) • Sizes Available only as listed • Face is Hinged
All Dimensions ±1/16"			

MODEL XG-7550R

CEILING
DIFFUSERS

PERFORATED
CEILING DIFFUSERS

XG-7600/XG-7650

Model: XG-7550R-9 Perforated Hinged Face - Bolt Slot/Donn Finline

XG-7550R-9 - Donn Ceiling Grid

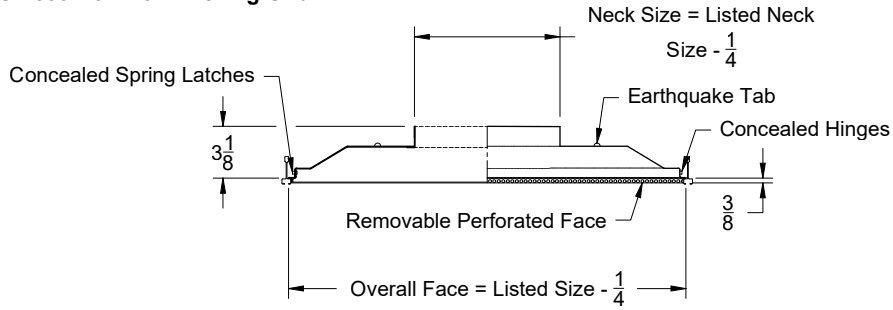

Side View

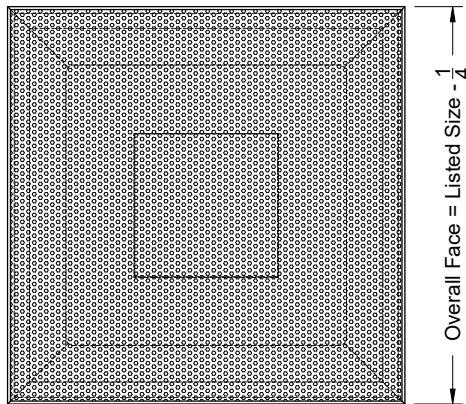

Face View

Listed Size
Nominal
Face
24 x 24

Square
Neck Inlets
6 x 6
8 x 8
10 x 10
12 x 12
14 x 14
16 x 16
18 x 18
22 x 22

1. Available Finishes

Standard Finish:
01 White
Finish
02 Satin Silver
03 Black
22 BBP - Black
Backpan - White Face
Optional Finish
28 Custom Color

2. Available Accessories

XG-OBDA - Opposed Blade Damper Steel
XG-OBDA - OBD Aluminum
XG-L9 - Equalizing Grid (Sq./Rect.)
XG-EQ - Earthquake Straps
XG-TR - Square to Round
XG-TR DEEP - Deep Square to Round

3. Available Options

4. Construction Details

- Steel Construction (Standard)
- Sizes Available only as listed
- Face is Hinged

All Dimensions ±1/16"

MODEL XG-7650R

Return – Model XG-7650R

XG-7650R-1 - Surface Mounted Steel

XG-7650R-1 AF - Surface Mounted Aluminum Face

XG-7650R-1 DF - Surface Mounted Dropped Face

XG-7650R-6 - T-bar Lay-in Steel

XG-7650R-6 AL - T-bar Lay-in Aluminum

XG-7650R-6 AF - T-bar Lay-in Aluminum Face

XG-7650R-8 - Tegular T-bar Steel

XG-7650R-8 AL - Tegular T-bar Aluminum

XG-7650R-8 AF - Tegular T-bar Aluminum Face

XG-7650R-9 - Donn Finline Steel

XG-7650R-9 AF - Donn Finline Aluminum Face

Air Outlets shall be model XG-7650R in steel, XG-7650R-AL aluminum, XG-7650R-AF with aluminum face or XG-7650R-DF with a dropped face manufactured by GREENHECK.

Units shall consist of a 51% free area perforated face with 3/16" diameter perforated holes on 1/4" staggered centers. Units shall be designed for use in ducted return or exhaust applications. The perforated face shall be hinged allowing access to the inside of the backpan. Face shall be secured in place with tension spring clips.

The units shall be the size and quantity as outlined in the plans and specifications. Units shall be designed to integrate into the specified ceiling system.

Square Neck Options and Accessories

Opposed Blade Damper

GREENHECK model XG-OBDA aluminum or XG-OBD steel round opposed blade type dampers shall be provided. Damper shall consist of gang operated blades that can be adjusted from full open to full closed. Damper shall be adjusted with a screwdriver slot accessible by opening the face of the diffuser.

Equalizing Grid

GREENHECK model XG-L9 aluminum, square equalizing grid shall be provided. Equalizing grid shall consist aluminum blades mounting in an aluminum frame.

Performance Specification

The manufacturer shall provide published performance data. Data shall be tested in accordance to ANSI/ASHRAE Standard 70- 2006

Paint Specification

Process shall be anodic electrodeposition using an anodic acrylic paint. Units shall undergo pre-treatment including a pressurized spray stage using an alkaline cleaner and a de-ionized water rinse.

MODEL XG-7650R

CEILING
DIFFUSERS

PERFORATED
CEILING DIFFUSERS

XG-7550R-F/XG-7650R

Model: XG-7650R-1 Perforated Hinged Face - Flush Surface Mount

XG-7650R-1 - Surface Mount

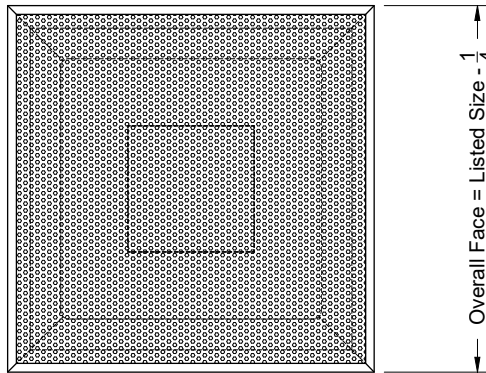
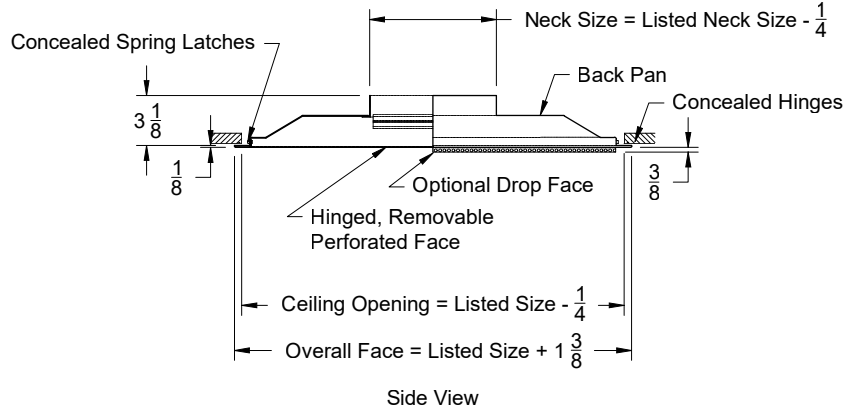

Listed Size
Nominal Face
24 x 24

Square Neck Inlets
6 x 6
8 x 8
10 x 10
12 x 12
14 x 14
16 x 16
22 x 22

1. Available Finishes	2. Available Accessories	3. Available Options	4. Construction Details
Standard Finish: 01 White Finish 02 Satin Silver 03 Black 22 BBP - Black Backpan - White Face Optional Finish 28 Custom Color	XG-OBDD - Opposed Blade Damper XG-OBDA - OBD Aluminum XG-TBPF - T-Bar Plaster Frame XG-L9 - Equalizing Grid (Sq./Rect.) XG-TR - Square to Round XG-TR DEEP - Square to Round Deep	AF - Aluminum Face DF - Drop Face	<ul style="list-style-type: none"> • Steel Construction (Standard) • Sizes Available only as listed • Face is Hinged
All Dimensions $\pm 1/16"$			

MODEL XG-7650R

Model: XG-7650R-6 Perforated Hinged Face - Lay In T-Bar

XG-7650R-6 - Lay in T-Bar

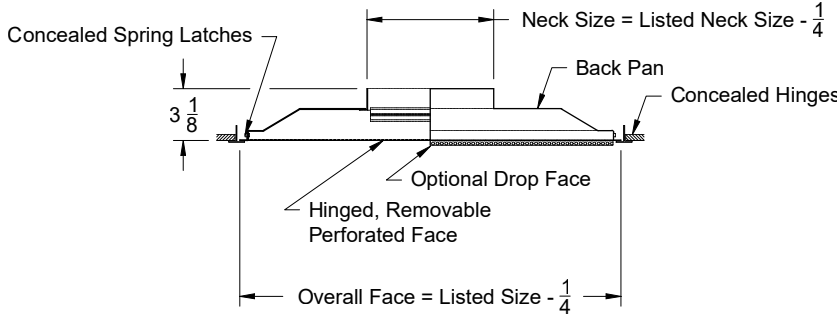

Labels in diagram: Concealed Spring Latches, Neck Size = Listed Neck Size - $\frac{1}{4}$, Back Pan, Concealed Hinges, Optional Drop Face, Hinged, Removable Perforated Face, Overall Face = Listed Size - $\frac{1}{4}$, $3\frac{1}{8}$.

Side View

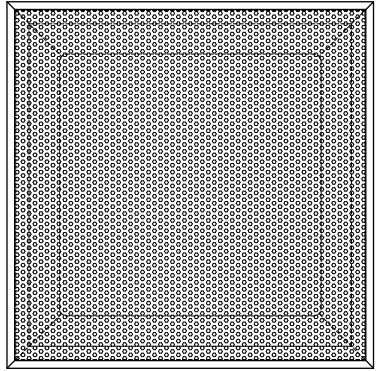

Face View

Overall Face = Listed Size - $\frac{1}{4}$

Listed Size
Nominal Face
24 x 24

Square Neck Inlets
6 x 6
8 x 8
10 x 10
12 x 12
14 x 14
16 x 16
22 x 22

1. Available Finishes	2. Available Accessories	3. Available Options	4. Construction Details
Standard Finish: 01 White Finish 02 Satin Silver 03 Black 22 BBP - Black Backpan - White Face Optional Finish 28 Custom Color	XG-OBD - Opposed Blade Damper XG-OBDA - OBD Aluminum XG-TBPF - T-Bar Plaster Frame XG-L9 - Equalizing Grid (Sq./Rect.) XG-TR - Square to Round XG-TR DEEP - Square to Round Deep XG-EQ - Earthquake Straps	AF - Aluminum Face AL - Aluminum Face and Backpan	<ul style="list-style-type: none"> Steel Construction (Standard) Sizes Available only as listed Face is Hinged
All Dimensions $\pm 1/16"$			

MODEL XG-7650R

CEILING
DIFFUSERS

PERFORATED
CEILING DIFFUSERS

XG-7550R-F/XG-7650R

Model: XG-7650R-8 Perforated Hinged Face - Tegular T-Bar

XG-7650R-8 - Tegular T-Bar

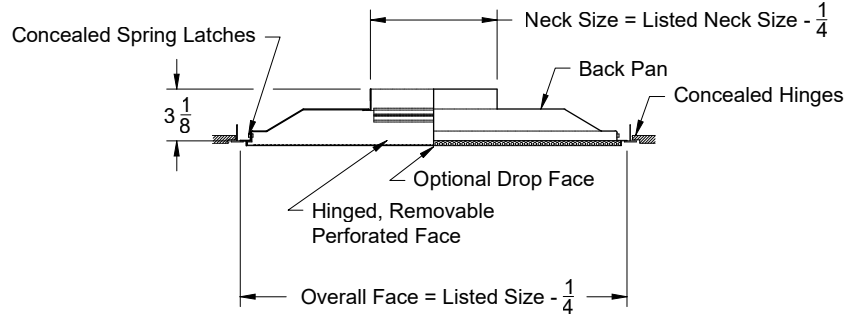

Side View

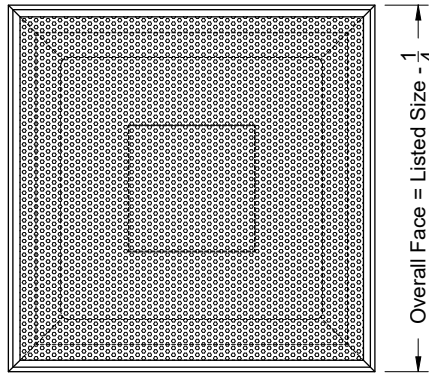

Face View

Listed Size
Nominal
Face
24 x 24

Square
Neck Inlets
6 x 6
8 x 8
10 x 10
12 x 12
14 x 14
16 x 16
22 x 22

1. Available Finishes	2. Available Accessories	3. Available Options	4. Construction Details
Standard Finish: 01 White Finish 02 Satin Silver 03 Black 22 BBP - Black Backpan - White Face Optional Finish 28 Custom Color	XG-OBDA - Opposed Blade Damper XG-OBDA - OBD Aluminum XG-L9 - Equalizing Grid (Sq./Rect.) XG-TR - Square to Round XG-TR DEEP - Square to Round Deep	AF - Aluminum Face AL - Aluminum Face and Backpan	<ul style="list-style-type: none"> • Steel Construction (Standard) • Sizes Available only as listed • Face is Hinged
			All Dimensions ±1/16"

MODEL XG-7650R

Model: XG-7650R-9 Perforated Hinged Face - Bolt Slot/Donn Finline

XG-7650R-9 - Bolt Slot/Donn Finline

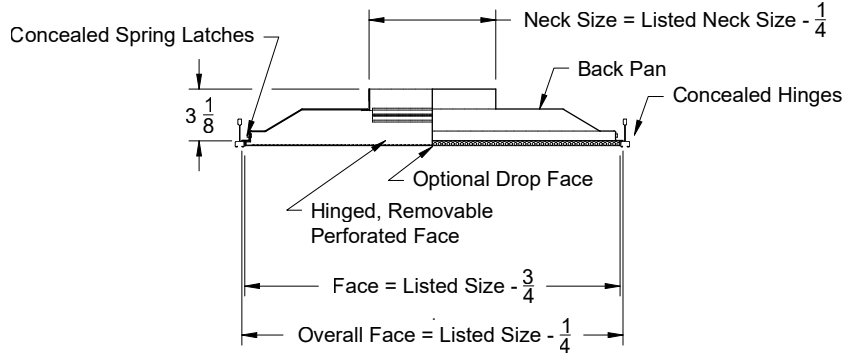

Side View

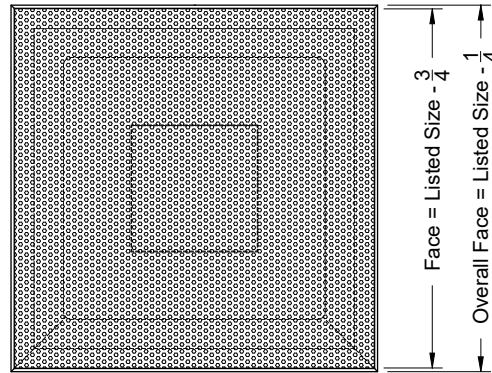

Face View

Listed Size	Nominal Face
24	x 24

Square Neck Inlets
6 x 6
8 x 8
10 x 10
12 x 12
14 x 14
16 x 16
22 x 22

1. Available Finishes	2. Available Accessories	3. Available Options	4. Construction Details
Standard Finish: 01 White Finish 02 Satin Silver 03 Black 22 BBP - Black Backpan - White Face Optional Finish 28 Custom Color	XG-OBD - Opposed Blade Damper XG-OBDA - OBD Aluminum XG-L9 - Equalizing Grid (Sq./Rect.) XG-TR - Square to Round XG-TR DEEP - Square to Round Deep XG-EQ - Earthquake Straps		<ul style="list-style-type: none"> Steel Construction (Standard) Sizes Available only as listed Face is Hinged

All Dimensions ±1/16"

SERIES XG-7550R-F/XG-7650R-F PERFORMANCE DATA
MODEL XG-7550R-F/XG-7650R-F

Neck Size	fpm Neck Velocity	300	400	500	600	700	800	900	1000
	Ps	.008	.015	.020	.030	.050	.060	.080	.080
6 x 6	CFM	75	100	120	150	175	200	225	250
8 x 8	CFM	130	175	220	265	310	350	400	445
10 x 10	CFM	210	275	345	415	485	555	625	695
12 X 12	CFM	300	400	500	600	700	800	900	1000
14 x 14	CFM	410	545	680	815	950	1090	1225	1360
16 x 16	CFM	530	710	885	1060	1240	1415	1600	1770
22 x 22	CFM	1010	1345	1680	2015	2350	2690	3025	3360

PERFORMANCE NOTES FOR SERIES XG-7550R-F/XG-7650R-F

All data is tested in accordance with ANSI/ASHRAE 70-2006.

DEFINITION OF UNITS

CFM Cubic Feet per Minute (air)

fpm Velocity of air stream in Feet per Minute

Pv Velocity pressure (inches of water column)

Pt Total pressure (inches of water column)

Ps Static pressure = Pt-Pv (inches of water column)

Throw* Non-isothermal horizontal throw (supply air temperature 15°F colder than average room temperature); values are for 150, 100 and 50fpm velocities

Throw Isothermal throw (supply air temperature the same as average room temperature); values are for 150, 100 and 50fpm velocities

NC Noise criterion, sound pressure level NC ratings are based on sound power level (Lw) re: 10⁻¹² watts minus a 10dB room attenuation in all octave bands

MODEL XG-7900

Supply - Perforated Modular Core - Extruded Aluminum - Square Neck - 1 to 4 Core/Series XG-7900

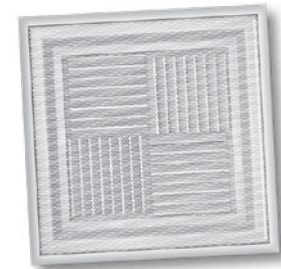

Steel

XG-7900-1 - Surface Mounted

XG-7900-8 - Tegular T-bar

XG-7900-6 - T-bar Lay-in

XG-7900-9 - Donn Finline

Air Outlets shall be aluminum model XG-7900 manufactured by GREENHECK. Units shall consist of an aluminum 51% free area perforated face with 3/16" diameter perforated holes on 1/4" staggered centers. Border of outlet shall be constructed from an aluminum extrusion.

The perforated face shall be removable allowing access to adjustable modular core pattern controllers mounted onto the inside neck of the outlet. Steel modular cores deflectors are not acceptable. Face shall be secured in place with tension spring clips. Outlets shall be field adjustable allowing 1, 2 way opposite, 2 way corner, 3, and 4 way directional air patterns.

The units shall be the size and quantity as outline in the plans and specifications. Units shall be designed to integrate into the specified ceiling system.

Square Neck Options and Accessories

Opposed Blade Damper

GREENHECK model XG-OBDA aluminum and XG-OB steel opposed blade type dampers shall be provided. Damper shall consist of gang operated blades that can be adjusted from full open to full closed. Damper shall be screw slot operated that can be accessed through the damper of the diffuser.

Equalizing Grid

GREENHECK model XG-L9 aluminum square equalizing grid shall be provided. Equalizing grid shall consist aluminum blades mounting in an aluminum frame.

Round Neck Optional Dampers and Accessories

Square to Round Transitions

Units to have square to round transitions allowing installation with round ductwork.

Butterfly Damper

GREENHECK model XG-BDS aluminum round butterfly type dampers shall be provided. Damper shall consist of two butterfly style blades that can be adjusted from full open to full closed. Damper shall be adjusted with a screw driver slot that can be assessed through the face of the diffuser.

Radial Shutter Damper

GREENHECK model XG-RSD steel round radial shutter damper shall be provided. Damper shall consist of gang operated radial blades that slide perpendicular to air flow direction. The damper shall be adjusted from full open to full closed. Damper shall be adjusted with a screw driver slot that can be assessed through the face of the diffuser.

Opposed Blade Damper

GREENHECK model XG-D3 aluminum or XG-SD3 steel round opposed blade type dampers shall be provided. Damper shall consist of gang operated blades that can be adjusted from full open to full closed. Damper shall be adjusted with a screw driver slot that can be assessed through the face of the diffuser.

Equalizing Grid

GREENHECK model XG-G3 aluminum round equalizing grid shall be provided. Equalizing grid shall consist of 1/2" x 1/2" x 1/2" aluminum cubed core mounting in an aluminum frame.

Performance Specification

The manufacturer shall provide published performance data. Data shall be tested in accordance to ANSI/ASHRAE Standard 70- 2006

MODEL XG-7900

CEILING
DIFFUSERS

PERFORATED
CEILING DIFFUSERS

XG-7900

Model: XG-7900-1 Perforated Face - Modular Core - Flush Surface Mount



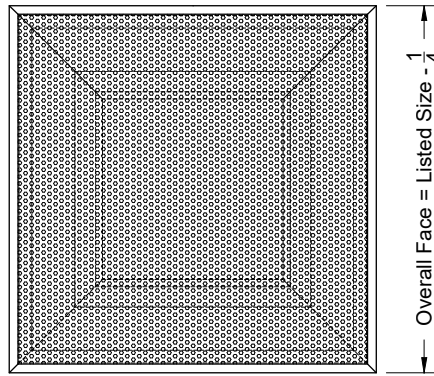
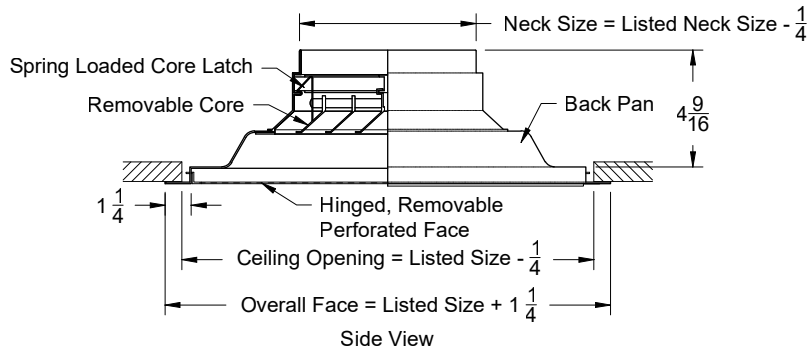

XG-7900-1 - Flush Surface Mount



Face View

Listed Size Nominal Face
12 x 12
20 x 20
24 x 12
24 x 24
48 x 24

Neck Size	
4 x 4	10 x 10
6 x 6	12 x 12
8 x 8	14 x 14
10 x 10	16 x 16
12 x 12	20 x 20
6 x 6	
8 x 8	

Removable Core	
	4 Core Unit
1-Way (1 Core Unit)	
2 - Way Corner	
2 - Way Opposite	
3-Way	
4-Way	

For Simple Direct Job Site Measurements Of Supply Air Delivery, Metal Industries Recommends the Use Of An Appropriate Sizes, Commercially Available Flow Hood Used In Accordance With The Manufacture's Instructions.

1. Available Finishes	2. Available Accessories	3. Available Options	4. Construction Details
Standard Finish: 01 White Finish 02 Satin Silver 03 Black 22 BBP - Black Backpan - White Face Optional Finish 28 Custom Color	XG-OBDD - Opposed Blade Damper XG-OBDA - OBD Aluminum XG-LIPF - Lay-in Plaster Frame XG-G3 - Equalizing Grid (Round) XG-L9 - Equalizing Grid (Sq./Rect.) XG-TR - Square to Round XG-TR DEEP - Deep Square to Round	Air Pattern S1-1 - 1 Modular Cores S4-4 - 4 Modular Cores	<ul style="list-style-type: none"> Aluminum Construction Sizes Available only as listed Neck sizes available: 6, 8, 10, 12, 14 & 16 Face is Hinged

All Dimensions $\pm 1/16"$

MODEL XG-7900

Model: XG-7900-6 Perforated Face - Modular Core - Lay In T-Bar

XG-7900-6 - Lay in T-Bar

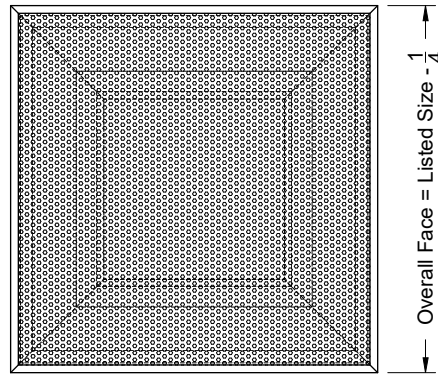
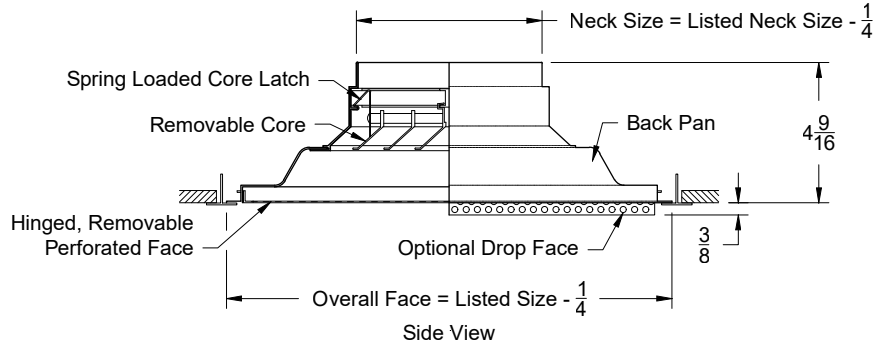

Listed Size Nominal Face	Neck Size	
	12 x 12	4 x 4
20 x 20	6 x 6	12 x 12
24 x 12	8 x 8	14 x 14
24 x 24	10 x 10	16 x 16
48 x 24	12 x 12	20 x 20
	6 x 6	
	8 x 8	

Removable Core	
	4 Core Unit
1-Way (1 Core Unit)	
2 - Way Corner	
2 - Way Opposite	
3-Way	
4-Way	

For Simple Direct Job Site Measurements Of Supply Air Delivery, Metal Industries Recommends the Use Of An Appropriate Sizes, Commercially Available Flow Hood Used In Accordance With The Manufacture's Instructions.

1. Available Finishes	2. Available Accessories	3. Available Options	4. Construction Details
Standard Finish: 01 White Finish 02 Satin Silver 03 Black 22 BBP - Black Backpan - White Face Optional Finish 28 Custom Color	XG-OBD - Opposed Blade Damper XG-OBDA - OBD Aluminum XG-TBPF - T-Bar Plaster Frame XG-G3 - Equalizing Grid (Round) XG-L9 - Equalizing Grid (Sq./Rect.) XG-TR - Square to Round XG-TR DEEP - Deep Square to Round	Air Pattern S1-1 - 1 Modular Cores S4-4 - 4 Modular Cores	<ul style="list-style-type: none"> Aluminum Construction Sizes Available only as listed Neck sizes available: 6, 8, 10, 12, 14 & 16 Face is Hinged

All Dimensions ±1/16"

MODEL XG-7900

CEILING
DIFFUSERS

PERFORATED
CEILING DIFFUSERS

XG-7550R-F/XG-7650R

Model: XG-7900-8 Perforated Face - Modular Core - Tegalur T-Bar

XG-7900-8 - Tegalur T-Bar

Side View

Face View

Listed Size Nominal	Neck Size	
Face 24 x 24	4 x 4	10 x 10
	6 x 6	12 x 12
	8 x 8	14 x 14
	10 x 10	16 x 16
	12 x 12	20 x 20
	6 x 6	
	8 x 8	

Removable Core	
	4 Core Unit
1-Way (1 Core Unit)	
2 - Way Corner	
2 - Way Opposite	
3-Way	
4-Way	

For Simple Direct Job Site Measurements Of Supply Air Delivery, Metal Industries Recommends the Use Of An Appropriate Sizes, Commercially Available Flow Hood Used In Accordance With The Manufacture's Instructions.

1. Available Finishes	2. Available Accessories	3. Available Options	4. Construction Details
Standard Finish: 01 White Finish 02 Satin Silver 03 Black 22 BBP - Black Backpan - White Face Optional Finish 28 Custom Color	XG-OBDA - Opposed Blade Damper XG-OBDA - OBD Aluminum XG-G3 - Equalizing Grid (Round) XG-L9 - Equalizing Grid (Sq./Rect.) XG-TR - Square to Round XG-TR DEEP - Deep Square to Round	Air Pattern S1-1 - 1 Modular Cores S4-4 - 4 Modular Cores	<ul style="list-style-type: none"> Aluminum Construction Sizes Available only as listed Neck sizes available: 6, 8, 10, 12, 14 & 16 Face is Hinged

All Dimensions ±1/16"

MODEL XG-7900

Model: XG-7900-9 Perforated Face - Modular Core - Bolt Slot Ceiling Grid

XG-7900-9 - Bolt Slot Ceiling Grid

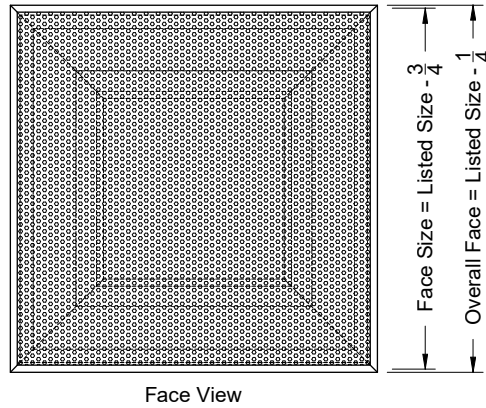
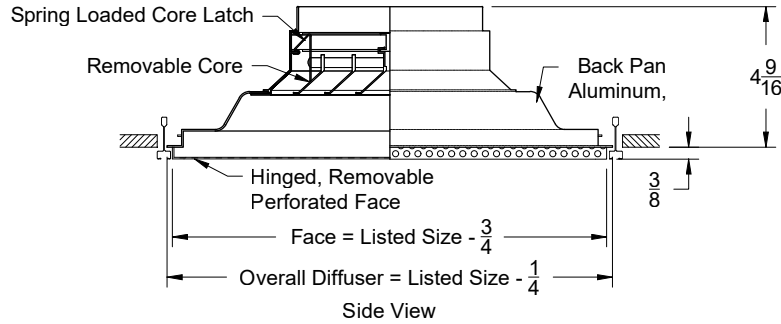

Listed Size
Nominal
Face
24 x 24

Neck Size	
4 x 4	10 x 10
6 x 6	12 x 12
8 x 8	14 x 14
10 x 10	16 x 16
12 x 12	20 x 20
6 x 6	
8 x 8	

Removable Core	
	4 Core Unit
1-Way (1 Core Unit)	
2 - Way Corner	
2 - Way Opposite	
3-Way	
4-Way	

For Simple Direct Job Site Measurements Of Supply Air Delivery, Metal Industries Recommends the Use Of An Appropriate Sizes, Commercially Available Flow Hood Used In Accordance With The Manufacturer's Instructions.

1. Available Finishes	2. Available Accessories	3. Available Options	4. Construction Details
Standard Finish: 01 White Finish 02 Satin Silver 03 Black 22 BBP - Black Backpan - White Face Optional Finish 28 Custom Color	XG-OBD - Opposed Blade Damper XG-OBDA - OB Aluminum XG-G3 - Equalizing Grid (Round) XG-L9 - Equalizing Grid (Sq./Rect.) XG-TR - Square to Round XG-TR DEEP - Deep Square to Round	Air Pattern S1-1 - 1 Modular Cores S4-4 - 4 Modular Cores	<ul style="list-style-type: none"> Aluminum Construction Sizes Available only as listed Neck sizes available: 6, 8, 10, 12, 14 & 16 Face is Hinged

All Dimensions ±1/16"

XG-7900 MODEL NUMBER SPECIFICATION
PERFORATED MODULAR CORE CEILING DIFFUSER – STEEL

Model		Available Neck	Module	Air Pat-tern	Available Finishes	
XG-7900-1	Surface Mount	6 x 6	12 x 12	S1-1 S4-4	Standard	
		6 x 6	20 x 20 24 x 24 48 x 24		01	White
		8 x 8			Optional	
		10 x 10			02	Satin Silver
		12 x 12			03	Black
		14 x 14			24	Mill
		16 x 16	24 x 24	S4-4	28	Custom Color
		18 x 18	48 x 24		Available Accessories	
		20 x 20	24 x 24		OBDXG-	Steel Opposed Blade Damper
					XG-OBDA	Aluminum Opposed Blade Damper
					XG-L9	Square / Rectangular Equalizing Grid
					XG-TR	Square to Round Transition
					XG-TR Deep	Deep Square to Round Transition

CEILING
DIFFUSERS

PERFORATED
CEILING DIFFUSERS

XG-7900

XG-7900 MODEL NUMBER SPECIFICATION

PERFORATED MODULAR CORE CEILING DIFFUSER – STEEL

Model		Available Neck	Module	Air Pat-tern	Available Finishes		
XG-7900-6	T-bar Lay-in	6 x 6	12 x 12	S1-1 S4-4	Standard		
		6 x 6	20 x 20		01	White	
		8 x 8			Optional		
		10 x 10			24 x 24	02	Satin Silver
		12 x 12			48 x 24	03	Black
		14 x 14			24 x 24	22	Black BP / White Face
		16 x 16	28	Custom Color			
		18 x 18	48 x 24	Available Accessories			
		20 x 20	24 x 24	XG-OBDA	Steel Opposed Blade Damper		
				XG-OBDA	Aluminum Opposed Blade Damper		
				XG-L9	Square / Rectangular Equalizing Grid		
				XG-TR	Square to Round Transition		
				XG-TR Deep	Deep Square to Round Transition		

Model		Available Neck	Module	Air Pat-tern	Available Finishes	
XG-7900-7	Concealed Spine	6 x 6	24 x 24	S1-1	Standard	
XG-7900-8	Regular T-bar	8 x 8			01	White
		10 x 10		S4-4	Optional	
		12 x 12			02	Satin Silver
		14 x 14		S4-4	03	Black
		16 x 16			22	Black BP / White Face
		18 x 18			28	Custom Color
		20 x 20			Available Accessories	
				XG-OBDA	Steel Opposed Blade Damper	
				XG-OBDA	Aluminum Opposed Blade Damper	
			XG-L9	Square / Rectangular Equalizing Grid		
			XG-TR	Square to Round Transition		
			XG-TR Deep	Deep Square to Round Transition		

SERIES XG-7900 PERFORMANCE DATA
MODEL XG-7900 (4 CORE)

Listed Size	Vn Neck Velocity fpm	200		300		400		500		600		700	
	Pt	.020		.045		.080		.125		.180		.245	
	Side Designation	A	B	A	B	A	B	A	B	A	B	A	B
6 x 6	CFM	50		75		100		125		150		175	
	NC	<20		<20		21		27		33		37	
	4-Way Throw	1-3		1-4		2-6		3-9		4-12		5-14	
	3-Way Throw	1-3	2-4	1-4	2-6	2-6	3-8	3-9	4-13	4-12	6-17	5-14	7-20
	2-Way Throw	2-4		2-6		3-8		4-13		6-17		7-20	
	1-Way Throw	2-6		2-8		4-12		6-18		12-24		10-28	
8 x 8	CFM	90		130		175		220		265		310	
	NC	<20		<20		25		30		35		40	
	4-Way Throw	1-3		2-6		3-9		4-12		5-15		6-18	
	3-Way Throw	1-3	2-4	2-6	3-8	3-9	4-13	4-12	6-17	5-15	7-21	6-18	8-25
	2-Way Throw	2-4		3-8		4-13		6-17		7-21		8-25	
	1-Way Throw	2-6		4-12		6-18		8-24		10-30		12-36	
10 x 10	CFM	140		205		275		345		415		485	
	NC	<20		<20		26		32		37		42	
	4-Way Throw	1-3		2-7		3-9		5-15		7-20		8-23	
	3-Way Throw	1-3	2-4	2-7	3-10	3-9	4-13	5-15	7-21	7-20	10-28	8-23	11-32
	2-Way Throw	2-4		3-10		4-13		7-21		10-28		11-32	
	1-Way Throw	2-6		4-14		6-18		10-30		14-40		16-46	
12 x 12	CFM	200		300		400		500		600		700	
	NC	<20		20		28		35		40		45	
	4-Way Throw	1-4		2-7		4-11		6-17		8-23		9-26	
	3-Way Throw	1-4	2-6	2-7	3-10	4-11	6-16	6-17	8-24	8-23	11-32	9-26	13-37
	2-Way Throw	2-6		3-10		6-16		8-24		11-32		13-37	
	1-Way Throw	2-8		4-14		8-22		12-34		16-46		18-52	
14 x 14	CFM	270		405		545		680		815		950	
	NC	<20		21		29		36		41		46	
	4-Way Throw	1-4		3-9		5-15		8-23		10-29		11-33	
	3-Way Throw	1-4	2-6	3-9	4-13	5-15	7-21	8-23	11-32	10-29	14-41	11-33	16-47
	2-Way Throw	2-6		4-13		7-21		11-32		14-41		16-47	
	1-Way Throw	2-8		6-18		10-30		16-46		20-58		22-66	
16 x 16	CFM	355		530		710		885		1070		1245	
	NC	<20		22		30		37		42		46	
	4-Way Throw	1-5		3-9		5-15		8-24		11-32		12-35	
	3-Way Throw	1-5	2-7	3-9	4-13	5-15	7-21	8-24	11-34	11-32	16-45	12-35	17-49
	2-Way Throw	2-7		4-13		7-21		11-34		16-45		17-49	
	1-Way Throw	2-10		6-18		10-30		16-48		22-64		24-70	
18 x 18	CFM	450		670		900		1120		1345		1570	
	NC	<20		23		31		37		43		47	
	4-Way Throw	1-6		3-10		5-16		9-27		12-35		13-39	
	3-Way Throw	1-6	2-8	3-10	4-14	5-16	7-23	9-27	13-38	12-35	17-49	13-39	18-55
	2-Way Throw	2-8		4-14		7-23		13-38		17-49		18-55	
	1-Way Throw	2-11		6-20		10-32		18-54		24-70		26-78	
20 x 20	CFM	560		830		1110		1385		1665		1945	
	NC	<20		24		32		38		44		48	
	4-Way Throw	2-6		3-11		6-18		9-27		12-36		13-39	
	3-Way Throw	2-6	3-8	3-11	4-16	6-18	8-25	9-27	13-38	12-36	17-51	13-39	18-55
	2-Way Throw	3-8		4-16		8-25		13-38		17-51		18-55	
	1-Way Throw	4-12		6-22		12-36		18-54		24-72		26-78	

CEILING
DIFFUSERS

PERFORATED
CEILING DIFFUSERS

XG-7900

SERIES XG-7900 PERFORMANCE DATA
MODEL XG-7900 SINGLE CORE

Single Core Size Inches	Neck	200	300	400	500	600	700
	Outlet Vel	310	460	615	770	925	1080
	Pt	.020	.045	.080	.125	.180	.245
3 x 3	CFM	13	19	25	32	38	44
	Throw	1-3	1-4	2-6	3-9	4-12	5-14
	NC	<20	<20	<20	21	27	31
4 x 4	CFM	22	33	44	56	67	78
	Throw	1-3	2-6	3-9	4-12	5-15	6-18
	NC	<20	<20	<20	24	29	34
5 x 5	CFM	35	52	70	87	104	122
	Throw	1-3	2-7	3-9	5-15	7-20	8-23
	NC	<20	<20	20	26	31	36
6 x 6	CFM	50	75	100	125	150	175
	Throw	2-6	2-8	4-12	6-18	12-24	10-28
	NC	<20	<20	21	27	33	37
7 x 7	CFM	68	102	136	170	204	238
	Throw	2-6	3-9	5-15	7-21	10-27	11-33
	NC	<20	<20	23	28	34	38
8 x 8	CFM	89	133	178	222	267	311
	Throw	2-6	4-12	6-18	8-24	10-30	12-36
	NC	<20	<20	25	30	35	40
9 x 9	CFM	112	169	225	281	337	393
	Throw	2-6	4-13	6-18	9-27	12-35	14-42
	NC	<20	<20	25	31	36	41
10 x 10	CFM	139	208	278	347	416	486
	Throw	2-6	4-14	6-18	10-30	14-40	16-46
	NC	<20	<20	26	32	37	42
11 x 11	CFM	168	252	336	420	504	588
	Throw	2-7	4-14	7-20	11-27	15-43	17-49
	NC	<20	<20	27	33	38	43
12 x 12	CFM	200	300	400	500	600	700
	Throw	2-8	4-14	8-22	12-24	16-46	18-52
	NC	<20	20	28	35	40	45

**CEILING
DIFFUSERS**
**PERFORATED
CEILING DIFFUSERS**
XG-7900

PERFORMANCE NOTES FOR SERIES XG-7900

All data is tested in accordance with ANSI/ASHRAE 70-2006.

DEFINITION OF UNITS

CFM Cubic Feet Per Minute (air)

fpm Velocity of air stream in Feet Per Minute

Pt Total pressure (inches of water column)

Throw Non-isothermal horizontal throw (supply air temperature 15°F colder than average room temperature); values are for 150, 100 and 50fpm velocities

NC Noise criterion, sound pressure level NC ratings are based on sound power level (Lw) re: 10^{-12} watts minus a 10dB room attenuation in all octave bands

MODEL XG-7950

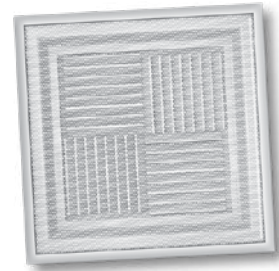

Supply Diffusers - Perforated Modular Core - Square Neck - 4 Core/Series XG-7950

Steel Aluminum Face - Steel Backpan

XG-7950-1 - Surface Mounted

XG-7950-1 AF - Surface Mounted

XG-7950-1 DF - Surface Mounted-Dropped Face

XG-7950-6 - T-bar Lay-in

XG-7950-8 - Tegular T-bar

XG-7950-9 - Donn Fineline

XG-7950-6 AF - T-bar Lay-in

XG-7950-8 AF - Tegular T-bar

XG-7950-9 AF - Donn Fineline

Air Outlets shall be steel model XG-7950 or aluminum face, steel backpan model XG-7950-AF manufactured by GREENHECK.

Units shall consist of aluminum 51% free area perforated face with 3/16" diameter perforated holes on 1/4" staggered centers. The perforated face shall be hinged allowing access to four adjustable aluminum modular core pattern controllers mounted into the neck of the outlet. Steel modular cores deflectors are not acceptable. Face shall be secured in place with tension spring clips. Outlets shall be field adjustable allowing 1, 2-way opposite, 2-way corner, 3, and 4-way directional air patterns.

The units shall be the size and quantity as outline in the plans and specifications. Units shall be designed to integrate into the specified ceiling system.

Square Neck Options and Accessories

Opposed Blade Damper

GREENHECK model XG-OBDA aluminum or XG- OBD steel round opposed blade type dampers shall be provided. Damper shall consist of gang operated blades that can be adjusted from full open to full closed. Damper shall be adjusted with a handle accessible by opening the face of the diffuser.

Equalizing Grid

GREENHECK model XG-L9 aluminum square equalizing grid shall be provided. Equalizing grid shall consist aluminum blades mounting in an aluminum frame.

Round Neck Optional Dampers and Accessories:

Square to Round Transitions

Units to have square to round transitions allowing installation with round ductwork.

Butterfly Damper

GREENHECK model XG-BDS aluminum round butterfly type dampers shall be provided. Damper shall consist of two butterfly style blades that can be adjusted from full open to full closed. Damper shall be adjusted with a screw driver slot that can be assessed through the face of the diffuser.

Radial Shutter Damper

GREENHECK model XG-RSD steel round radial shutter damper shall be provided. Damper shall consist of gang operated radial blades that slide perpendicular to air flow direction. The damper shall be adjusted from full open to full closed. Damper shall be adjusted with a screw driver slot that can be assessed through the face of the diffuser.

Opposed Blade Damper

GREENHECK model XG-D3 aluminum or XG-SD3 steel round opposed blade type dampers shall be provided. Damper shall consist of gang operated blades that can be adjusted from full open to full closed. Damper shall be adjusted with a screw driver slot that can be assessed through the face of the diffuser.

Equalizing Grid

GREENHECK model XG-G3 aluminum round equalizing grid shall be provided. Equalizing grid shall consist of 1/2" x 1/2" x 1/2" aluminum cubed core mounting in an aluminum frame.

Performance Specification

The manufacturer shall provide published performance data. Data shall be tested in accordance to ANSI/ASHRAE Standard 70- 2006

MODEL XG-7950

CEILING
DIFFUSERS

PERFORATED
CEILING DIFFUSERS

XG-7950

Model: XG-7950-1 Perforated Face - Modular Core - Flush Surface Mount

XG-7950-1 - Flush Surface Mount

Side View

Face View

Listed Size Nominal Face	Neck Size	
	12 x 12	4 x 4
20 x 20	6 x 6	8 x 8
24 x 12	8 x 8	10 x 10
24 x 24	10 x 10	12 x 12
48 x 24	12 x 12	14 x 14
		16 x 16

Removable Core	
	4 Core Unit
1-Way (1 Core Unit)	
2 - Way Corner	
2 - Way Opposite	
3-Way	
4-Way	

Overall Face = Listed Size + 1 3/8

For Simple Direct Job Site Measurements Of Supply Air Delivery, Metal Industries Recommends the Use Of An Appropriate Sizes, Commercially Available Flow Hood Used In Accordance With The Manufacture's Instructions.

1. Available Finishes	2. Available Accessories	3. Available Options	4. Construction Details
Standard Finish: 01 White Finish 02 Satin Silver 03 Black 22 BBP - Black Backpan - White Face Optional Finish 28 Custom Color	XG-OBDD - Opposed Blade Damper XG-OBDA - OBD Aluminum XG-LIPF - Lay-in Plaster Frame XG-G3 - Equalizing Grid (Round) XG-L9 - Equalizing Grid (Sq./Rect.) XG-TR - Square to Round XG-TR DEEP - Deep Square to Round	Air Pattern S1-1 - 1 Modular Cores S4-4 - 4 Modular Cores Face Type AF - Aluminum Face DF - Drop Face	<ul style="list-style-type: none"> Steel Construction (Standard) Sizes Available only as listed Neck sizes available: 6, 8, 10, 12, 14 & 16 Face is Hinged

All Dimensions ±1/16"

MODEL XG-7950

Model: XG-7950-6 Perforated Face - Modular Core - Lay in T-Bar

XG-7950-6 - Lay in T-Bar

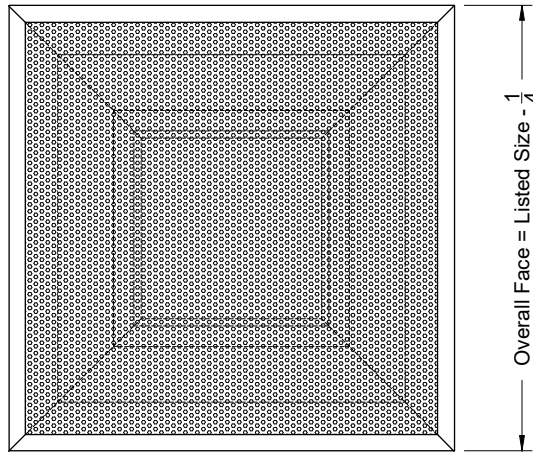
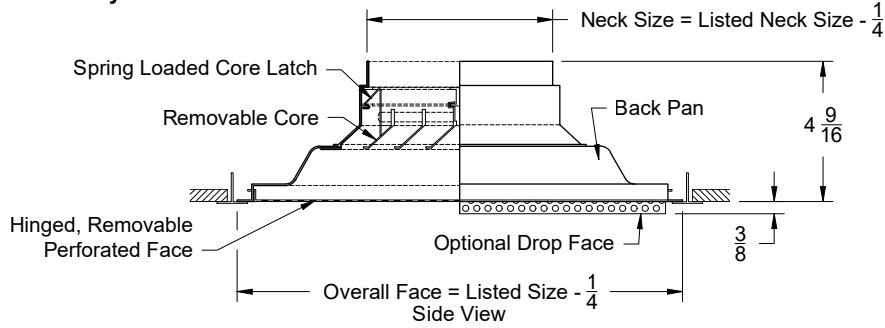

Face View

Listed Size Nominal Face
12 x 12
20 x 20
24 x 12
24 x 24
48 x 24

Neck Size	
4 x 4	6 x 6
6 x 6	8 x 8
8 x 8	10 x 10
10 x 10	12 x 12
12 x 12	14 x 14
	16 x 16

Removable Core	
	4 Core Unit
1-Way (1 Core Unit)	
2 - Way Corner	
2 - Way Opposite	
3-Way	
4-Way	

For Simple Direct Job Site Measurements Of Supply Air Delivery, Metal Industries Recommends the Use Of An Appropriate Sizes, Commercially Available Flow Hood Used In Accordance With The Manufacture's Instructions.

1. Available Finishes	2. Available Accessories	3. Available Options	4. Construction Details
Standard Finish: 01 White Finish 02 Satin Silver 03 Black 22 BBP - Black Backpan - White Face Optional Finish 28 Custom Color	XG-OBDD - Opposed Blade Damper XG-OBDA - OBD Aluminum XG-LIPF - Lay-in Plaster Frame XG-G3 - Equalizing Grid (Round) XG-L9 - Equalizing Grid (Sq./Rect.) XG-TR - Square to Round XG-TR DEEP - Deep Square to Round	Air Pattern S1-1 - 1 Modular Cores S4-4 - 4 Modular Cores Face Type AF - Aluminum Face	<ul style="list-style-type: none"> Steel Construction (Standard) Sizes Available only as listed Neck sizes available: 6, 8, 10, 12, 14 & 16 Face is Hinged

All Dimensions ±1/16"

MODEL XG-7950

CEILING
DIFFUSERS

PERFORATED
CEILING DIFFUSERS

XG-7950

Model: XG-7650-8 Perforated Hinged Face with Curved Blade Core - Tegular T-Bar

XG-7650-8 - Tegular T-Bar

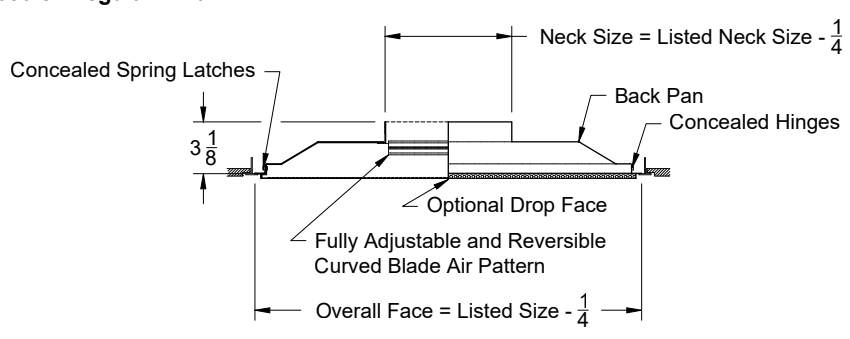

Face View

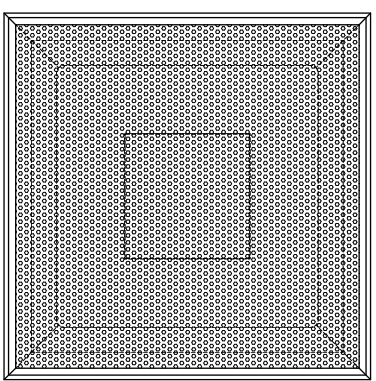

Listed Size	Nominal
Face	24 x 24
Available Square Inlets	
	6 X 6
	8 X 8
	10 X 10
	12 X 12
	14 X 14
	16 X 16

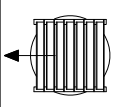
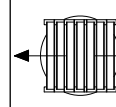
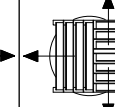
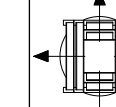
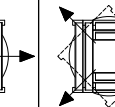
Air Pattern Options				Option:
1 Way	2 Way	3 Way	4 Way	Star Air Pattern
				

1. Available Finishes	2. Available Accessories	3. Available Options	4. Construction Details
Standard Finish: 01 White Finish 02 Satin Silver 03 Black 22 BBP - Black Backpan - White Face Optional Finish 28 Custom Color	XG-BDS - Butterfly Damper XG-RDS - Steel Radial Shutter Damper XG-G3 - Equalizing Grid (Round) XG-FGBP - Fiberglass Backpan	AF - Aluminum Face DF - Drop Face AL - Aluminum Face and Backpan	<ul style="list-style-type: none"> Steel Construction (Standard) Sizes Available only as listed Square Neck sizes available: 6, 8, 10, 12, 14 & 16 Face is Hinged
All Dimensions ±1/16"			

MODEL XG-7950

Model: XG-7950-9 Perforated Face - Modular Core - Bolt Slot Grid

XG-7950-9 - Bolt Slot Grid

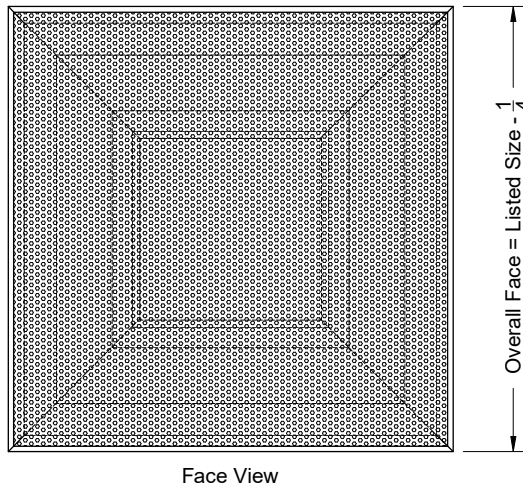
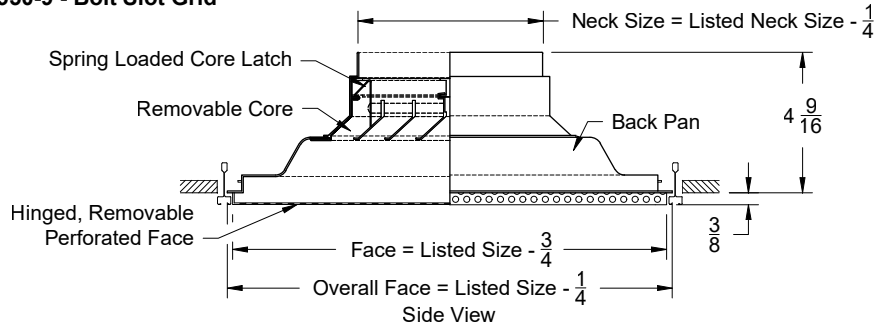

Listed Size
Nominal
Face
24 x 24

Neck Size	
4 x 4	6 x 6
6 x 6	8 x 8
8 x 8	10 x 10
10 x 10	12 x 12
12 x 12	14 x 14
	16 x 16

Removable Core	
	4 Core Unit
1-Way (1 Core Unit)	
2 - Way Corner	
2 - Way Opposite	
3-Way	
4-Way	

For Simple Direct Job Site Measurements Of Supply Air Delivery, Metal Industries Recommends the Use Of An Appropriate Sizes, Commercially Available Flow Hood Used In Accordance With The Manufacturer's Instructions.

1. Available Finishes	2. Available Accessories	3. Available Options	4. Construction Details
Standard Finish: 01 White Finish 02 Satin Silver 03 Black 22 BBP - Black Backpan - White Face Optional Finish 28 Custom Color	XG-OBDD - Opposed Blade Damper XG-OBDA - OBD Aluminum XG-G3 - Equalizing Grid (Round) XG-L9 - Equalizing Grid (Sq./Rect.) XG-TR - Square to Round XG-TR DEEP - Deep Square to Round	Air Pattern S1-1 - 1 Modular Cores S4-4 - 4 Modular Cores Face Type AF - Aluminum Face	<ul style="list-style-type: none"> Steel Construction (Standard) Sizes Available only as listed Neck sizes available: 6, 8, 10, 12, 14 & 16 Face is Hinged
All Dimensions ±1/16"			

XG-7950 MODEL NUMBER SPECIFICATION
PERFORATED MODULAR CORE CEILING DIFFUSER

Model		Available Neck	Module	Air Pat-tern	Available Finishes	
XG-7950-1	Surface Mount Steel	6 x 6	24 x 24	S4-4	Standard	
XG-7950-1 AF	Surface Mount Aluminum Face	8 x 8			01	White
XG-7950-1 DF	Surface Mount Drop face	10 x 10			Optional	
		12 x 12			02	Satin Silver
		14 x 14			03	Black
		16 x 16	22	Black BP / White Face		
			28	Custom Color		
Available Accessories						
			XG-OBD	Steel Opposed Blade Damper		
			XG-OBDA	Aluminum Opposed Blade Damper		
			XG-L9	Square / Rectangular Equalizing Grid		
			XG-TR	Square to Round Transition		
			TR Deep	Deep Square to Round Transition		

Model		Available Neck	Module	Air Pat-tern	Available Finishes	
XG-7950-6	T-bar Lay-in	6 x 6	24 x 24	S4-4	Standard	
XG-7950-6 AF	T-bar Lay-in Aluminum Face	8 x 8			01	White
XG-7950-8	Tegular T-bar	10 x 10			Optional	
XG-7950-8 AF	Tegular T-bar Aluminum Face	12 x 12			02	Satin Silver
		14 x 14			03	Black
		16 x 16	22	Black BP / White Face		
			28	Custom Color		
Available Accessories						
			XG-OBD	Steel Opposed Blade Damper		
			XG-OBDA	Aluminum Opposed Blade Damper		
			XG-L9	Square / Rectangular Equalizing Grid		
			XG-TR	Square to Round Transition		
			XG-TR Deep	Deep Square to Round Transition		

CEILING
DIFFUSERS

PERFORATED
CEILING DIFFUSERS

XG-7950

SERIES XG-7950 PERFORMANCE DATA
MODEL XG-7950 (4 CORE)

Listed Size	Vn Neck Velocity fpm	200		300		400		500		600		700	
	Pt	.020		.045		.080		.125		.180		.245	
	Side Designation	A	B	A	B	A	B	A	B	A	B	A	B
6 x 6	CFM	50		75		100		125		150		175	
	NC	<20		<20		21		27		33		37	
	4-Way Throw	1-3		1-4		2-6		3-9		4-12		5-14	
	3-Way Throw	1-3	2-4	1-4	2-6	2-6	3-8	3-9	4-13	4-12	6-17	5-14	7-20
	2-Way Throw	2-4		2-6		3-8		4-13		6-17		7-20	
	1-Way Throw	2-6		2-8		4-12		6-18		12-24		10-28	
8 x 8	CFM	90		130		175		220		265		310	
	NC	<20		<20		25		30		35		40	
	4-Way Throw	1-3		2-6		3-9		4-12		5-15		6-18	
	3-Way Throw	1-3	2-4	2-6	3-8	3-9	4-13	4-12	6-17	5-15	7-21	6-18	8-25
	2-Way Throw	2-4		3-8		4-13		6-17		7-21		8-25	
	1-Way Throw	2-6		4-12		6-18		8-24		10-30		12-36	
10 x 10	CFM	140		205		275		345		415		485	
	NC	<20		<20		26		32		37		42	
	4-Way Throw	1-3		2-7		3-9		5-15		7-20		8-23	
	3-Way Throw	1-3	2-4	2-7	3-10	3-9	4-13	5-15	7-21	7-20	10-28	8-23	11-32
	2-Way Throw	2-4		3-10		4-13		7-21		10-28		11-32	
	1-Way Throw	2-6		4-14		6-18		10-30		14-40		16-46	
12 x 12	CFM	200		300		400		500		600		700	
	NC	<20		20		28		35		40		45	
	4-Way Throw	1-4		2-7		4-11		6-17		8-23		9-26	
	3-Way Throw	1-4	2-6	2-7	3-10	4-11	6-16	6-17	8-24	8-23	11-32	9-26	13-37
	2-Way Throw	2-6		3-10		6-16		8-24		11-32		13-37	
	1-Way Throw	2-8		4-14		8-22		12-34		16-46		18-52	
14 x 14	CFM	270		405		545		680		815		950	
	NC	<20		21		29		36		41		46	
	4-Way Throw	1-4		3-9		5-15		8-23		10-29		11-33	
	3-Way Throw	1-4	2-6	3-9	4-13	5-15	7-21	8-23	11-32	10-29	14-41	11-33	16-47
	2-Way Throw	2-6		4-13		7-21		11-32		14-41		16-47	
	1-Way Throw	2-8		6-18		10-30		16-46		20-58		22-66	
16 x 16	CFM	355		530		710		885		1070		1245	
	NC	<20		22		30		37		42		46	
	4-Way Throw	1-5		3-9		5-15		8-24		11-32		12-35	
	3-Way Throw	1-5	2-7	3-9	4-13	5-15	7-21	8-24	11-34	11-32	16-45	12-35	17-49
	2-Way Throw	2-7		4-13		7-21		11-34		16-45		17-49	
	1-Way Throw	2-10		6-18		10-30		16-48		22-64		24-70	
18 x 18	CFM	450		670		900		1120		1345		1570	
	NC	<20		23		31		37		43		47	
	4-Way Throw	1-6		3-10		5-16		9-27		12-35		13-39	
	3-Way Throw	1-6	2-8	3-10	4-14	5-16	7-23	9-27	13-38	12-35	17-49	13-39	18-55
	2-Way Throw	2-8		4-14		7-23		13-38		17-49		18-55	
	1-Way Throw	2-11		6-20		10-32		18-54		24-70		26-78	
20 x 20	CFM	560		830		1110		1385		1665		1945	
	NC	<20		24		32		38		44		48	
	4-Way Throw	2-6		3-11		6-18		9-27		12-36		13-39	
	3-Way Throw	2-6	3-8	3-11	4-16	6-18	8-25	9-27	13-38	12-36	17-51	13-39	18-55
	2-Way Throw	3-8		4-16		8-25		13-38		17-51		18-55	
	1-Way Throw	4-12		6-22		12-36		18-54		24-72		26-78	

**CEILING
DIFFUSERS**
**PERFORATED
CEILING DIFFUSERS**
XG-7950

SERIES XG-7950 PERFORMANCE DATA
MODEL XG-7950 (SINGLE CORE)

Single Core Size Inches	Neck	200	300	400	500	600	700
	Outlet Vel	310	460	615	770	925	1080
	Pt	.020	.045	.080	.125	.180	.245
3 x 3	CFM	13	19	25	32	38	44
	Throw	1-3	1-4	2-6	3-9	4-12	5-14
	NC	<20	<20	<20	21	27	31
4 x 4	CFM	22	33	44	56	67	78
	Throw	1-3	2-6	3-9	4-12	5-15	6-18
	NC	<20	<20	<20	24	29	34
5 x 5	CFM	35	52	70	87	104	122
	Throw	1-3	2-7	3-9	5-15	7-20	8-23
	NC	<20	<20	20	26	31	36
6 x 6	CFM	50	75	100	125	150	175
	Throw	2-6	2-8	4-12	6-18	12-24	10-28
	NC	<20	<20	21	27	33	37
7 x 7	CFM	68	102	136	170	204	238
	Throw	2-6	3-9	5-15	7-21	10-27	11-33
	NC	<20	<20	23	28	34	38
8 x 8	CFM	89	133	178	222	267	311
	Throw	2-6	4-12	6-18	8-24	10-30	12-36
	NC	<20	<20	25	30	35	40
9 x 9	CFM	112	169	225	281	337	393
	Throw	2-6	4-13	6-18	9-27	12-35	14-42
	NC	<20	<20	25	31	36	41
10 x 10	CFM	139	208	278	347	416	486
	Throw	2-6	4-14	6-18	10-30	14-40	16-46
	NC	<20	<20	26	32	37	42
11 x 11	CFM	168	252	336	420	504	588
	Throw	2-7	4-14	7-20	11-27	15-43	17-49
	NC	<20	<20	27	33	38	43
12 x 12	CFM	200	300	400	500	600	700
	Throw	2-8	4-14	8-22	12-24	16-46	18-52
	NC	<20	20	28	35	40	45

CEILING
DIFFUSERS

PERFORATED
CEILING DIFFUSERS

XG-7950

PERFORMANCE NOTES FOR SERIES XG-7950

All data is tested in accordance with ANSI/ASHRAE 70-2006.

DEFINITION OF UNITS

CFM Cubic Feet per Minute (air)

fpm Velocity of air stream in Feet per Minute

Pt Total pressure (inches of water column)

Throw Non-isothermal horizontal throw (supply air temperature 15°F colder than average room temperature); values are for 150, 100 and 50fpm velocities

NC Noise criterion, sound pressure level NC ratings are based on sound power level (Lw) re: 10^{-12} watts minus a 10dB room attenuation in all octave bands

ROUND CEILING DIFFUSERS

CEILING
DIFFUSERS

ROUND
CEILING DIFFUSERS

MODEL XG-3000



MODEL XG-3100



MODEL XG-3200

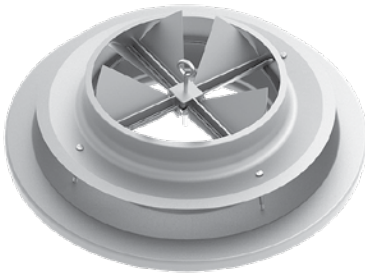

MODEL XG-5750

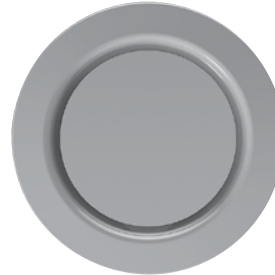

Model XG-3000 is a high induction, high capacity 3 cone adjustable diffuser. It is fully adjustable from horizontal to vertical discharge and is aluminum construction.

PAGE 189

Model XG-3100 is a high induction, high capacity 2 cone diffuser. It is available in both aluminum and steel construction. The 3100A can be adjusted for vertical or horizontal discharge.

PAGE 192

Model XG-3200 is an excellent choice for high capacity applications such as factories, gymnasiums, theaters, and convention halls. It can effectively be applied for either spot heating or cooling

PAGE 198

Model XG-R5750 is an architecturally pleasing round diffuser that blends well into the ceiling surface. It is available in all aluminum, aluminum face with steel backpan and steel construction.

PAGE 203

MODEL XG-3000



Air Outlets shall be model XG-3000 manufactured by GREENHECK Diffuser shall be constructed of 3 round inner cones and a round outer cone. Outlet shall be adjustable to allow the discharge pattern to be set from full horizontal to vertical. Units shall be aluminum construction. The units shall be the size and quantity as outline in the plans and specifications.

Pattern adjustment shall be accomplished by rotating the innermost cone. The inner core assembly shall be removable for installation and for access into the ductwork. The center cone shall include an access hole to allow adjustment of an optional damper.

Model XG-3000-1 - Flush Cone

Outlet shall have an outer cone that allows flush mounting to the ceiling opening.

Model XG-3000-2 - Drop Cone

Outlet shall have a dropped outer cone to move the discharge jet away from the ceiling surface. Dropped cone shall minimize ceiling smudging.

Performance Specification

The manufacturer shall provide published performance data. Data shall be tested in accordance to ANSI/ASHRAE Standard 70- 2006

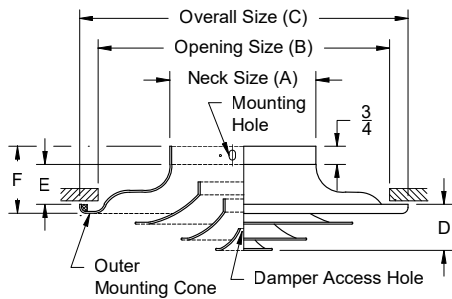

Neck	A	B	C	D	E	F
6	5 7/8	12	13 7/8	2 1/4	1 3/4	3
8	7 7/8	16	18 5/8	2 5/8	2	3 5/8
10	9 7/8	20	22 1/8	3	2 5/8	3 3/4
12	11 7/8	24	27	3 1/2	4 3/8	5
14	13 7/8	28	31 1/4	4 1/4	4 7/16	5 5/8
16	15 7/8	32	36 1/2	4 3/4	4 1/2	6 1/8
18	17 7/8	36	41 3/8	5	4 5/8	6 3/4
20	19 7/8	40	42 1/4	5 3/8	5 1/2	7 1/2
24	23 7/8	40	44 1/4	5 3/8	5 1/2	7 1/2

D = (Full Open) Horizontal Air Pattern

XG-3000-2 - Bevel Drop Surface Mount

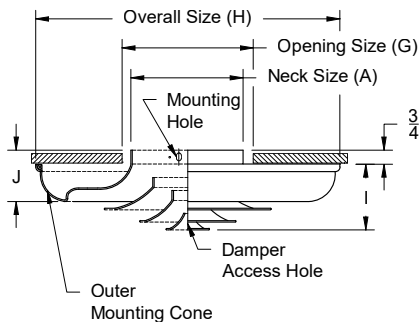

Neck	A	G	H	I	J
6	5 7/8	7	16 1/4	3 7/8	2 5/8
8	7 7/8	9	21	4 3/4	3 5/8
10	9 7/8	11	26 3/8	5 9/16	4
12	11 7/8	13	31 1/2	6 3/4	4 1/4
14	13 7/8	15	36 7/8	8	5 1/4
16	15 7/8	17	42	8 7/8	6
18	17 7/8	19	47 5/8	9 7/8	6 5/8
20	19 7/8	21	52 3/8	10 3/4	7 1/4
24	23 7/8	25	52 3/8	10 3/4	7 1/4

I = (Full Open) Horizontal Air Pattern

Size Designation	Neck Size	A	B	C	D	E	F	G	H	I	J
XG-3006	6	5 7/8	12	13 7/8	2 1/4	1 3/4	3	7	16 1/4	3 7/8	2 5/8
XG-3008	8	7 7/8	16	18 5/8	2 5/8	2	3 5/8	9	21	4 3/4	3 5/8
XG-3010	10	9 7/8	20	22 1/8	3	2 5/8	3 3/4	11	26 3/8	5 9/16	4
XG-3012	12	11 7/8	24	27	3 1/2	4 3/8	5	13	31 1/2	6 3/4	4 5/8
XG-3014	14	13 7/8	28	31 1/4	4 1/4	4 7/16	5 5/8	15	36 7/8	8	5 1/4
XG-3016	16	15 7/8	32	36 1/2	4 3/4	4 1/2	6 1/8	17	42	8 7/8	6
XG-3018	18	17 7/8	36	41 3/8	5	4 5/8	6 3/4	19	47 5/8	9 7/8	6 5/8
XG-3020	20	19 7/8	40	45 1/4	5 3/8	5 1/2	7 1/2	21	52 3/8	10 3/4	7 1/4
XG-3024	24	23 7/8	40	45 1/4	5 3/8	5 1/2	7 1/2	25	52 3/8	10 3/4	7 1/4

XG-3000 MODEL NUMBER SPECIFICATION
ADJUSTABLE ROUND DIFFUSER 3 CONE
MODEL XG-3000 — ALUMINUM

Model		Available Neck	Available Finishes	
XG-3000-1	Surface Mount	6	Standard	
XG-3000-2	Drop Face	8	01	White
		10	Optional	
		12	02	Satin Silver
		14	03	Black
		16	24	Mill
		18	28	Custom Color
		20	Available Accessories	
		24	D3	Aluminum Radial Damper
			SD3	Steel Radial Damper
			G3	Round Equalizing Grid
			GD3	Combo Grid / Damper
			BDS	Butterfly Damper
			RSD	Radial Shutter Damper
			Available Options	
			SC	Safety Chain

CEILING
DIFFUSERS

ROUND
CEILING DIFFUSERS

XG-3000

SERIES XG-3000 PERFORMANCE DATA MODEL XG-3000

Neck Size	fpm Neck Vel	400	500	600	700	800	900	1000	1200	1400	1600
	Pv	0.01	0.016	0.023	0.031	0.04	0.051	0.063	0.09	0.122	0.16
	Ps Horiz.	0.011	0.018	0.026	0.035	0.046	0.059	0.072	0.105	0.145	0.19
	Ps Vert.	0.019	0.03	0.043	0.058	0.075	0.096	0.115	0.17	0.225	0.3
6	CFM	80	100	110	140	160	180	200	240	280	320
	Throw	1-3	2-4	2-5	3-6	3-7	3-8	4-8	4-9	5-10	6-12
	NC	-	-	-	20	24	27	36	36	39	44
8	CFM	140	175	210	245	280	315	350	420	490	560
	Throw	2-4	2-5	3-6	3-7	4-8	4-10	5-11	5-13	6-14	7-16
	NC	-	-	-	20	24	27	31	36	39	44
10	CFM	220	270	330	380	435	490	545	655	765	870
	Throw	2-5	3-6	3-7	4-8	5-10	6-11	6-12	7-14	8-18	9-21
	NC	-	-	-	21	25	28	32	37	40	45
12	CFM	315	390	470	550	630	710	785	940	1100	1260
	Throw	3-7	3-8	4-10	5-11	6-13	7-15	8-17	9-19	10-21	12-25
	NC	-	-	20	22	26	29	33	38	41	46
14	CFM	425	535	640	750	855	965	1070	1285	1500	1710
	Throw	3-8	4-9	5-11	6-13	7-16	8-18	9-20	11-13	13-26	15-30
	NC	-	-	20	23	27	31	34	40	43	48
16	CFM	560	700	840	980	1120	1260	1400	1680	1960	2240
	Throw	4-9	5-10	5-13	6-15	7-17	9-21	10-23	12-27	14-30	16-35
	NC	-	-	21	24	28	33	36	41	44	49
18	CFM	710	885	1060	1240	1420	1595	1770	2120	2480	2830
	Throw	4-10	5-12	6-15	7-17	9-21	11-23	13-26	15-31	16-34	18-38
	NC	-	-	21	25	29	34	37	42	45	51
20	CFM	875	1090	1310	1525	1745	1965	2180	2620	3060	3490
	Throw	4-11	6-14	7-16	8-19	9-23	17-23	13-28	15-33	18-38	20-42
	NC	-	20	22	26	30	36	39	44	47	53
24	CFM	1255	1570	1885	2200	2510	2825	3140	3770	4395	5025
	Throw	12-24	13-26	14-28	15-30	16-33	17-35	18-37	20-40	23-45	25-50
	NC	22	26	28	31	35	38	41	47	51	55

PERFORMANCE NOTES FOR SERIES XG-3000

All data is tested in accordance with ANSI/ASHRAE 70-2006.

DEFINITION OF UNITS

- 1 Tabulated radial throw in feet is based on a 9' ceiling height, ambient supply air, MAX Throw @ Vt = 75fpm, MIN Throw @ Vt = 150fpm, and the diffuser inner cones in down position for 360° horizontal air distribution pattern.
- 2 For vertical down protection air pattern with cooling supply air temperature 20° below room temperature and diffuser inner cones in up position: multiply the tabulated radial throw values by a factor of 0.80 to obtain vertical down projection distances at MIN and MAX (Vt) terminal velocities.
- 3 For vertical down projection air pattern with heating supply air temperatures 20° above room temperature and diffuser inner cones in up position: multiply the tabulated radial throw values by a factor of 0.60 to obtain vertical down projection distances at MIN and MAX (Vt) terminal velocities.
- 4 Velocity Pressure (Pv) and Static Pressure (Ps) are in inches of water.
- 5 Series 3000 Diffusers are tested in accordance with ASHRAE 70-2006. Sound data are calculated in accordance with International Standard ISO 3741 comparison method. The NC values are based on a room absorption of 10dB for sound power level (lw) re: 10⁻¹² watts - symbol indicates NC less than 20.
- 6 All data is applicable for exposed for exposed duct mounting or ceiling installation.

MODEL XG-3100



Fixed Round Diffuser - 2 Cone/Series XG-3100

Air outlets shall be model XG-3100 (aluminum) or XG-3100-S (steel) manufactured by GREENHECK Diffuser shall be constructed of 2 round inner cone assembly and a round outer cone. Outlet shall have a fixed horizontal pattern. Units shall be aluminum construction (model XG-3100) or steel construction (model XG-3100S). The units shall be the size and quantity as outline in the plans and specifications.

The inner core assembly shall be removable for installation and for access into the ductwork. The center cone shall include an access hole to allow adjustment of an optional damper.

Flush Cone Model XG-3100-1 - Aluminum Model XG-3100S-1 - Steel

Outlet shall have an outer cone that allows flush mounting to the ceiling opening.

Drop Cone Model XG-3100-2 - Aluminum Model XG-3100-S-2 - Steel

Outlet shall have a dropped outer cone to move the discharge jet away from the ceiling surface. Dropped cone shall minimize ceiling smudging.

Adjustable Round Diffuser - 2 Cone/Series XG-3100A

Air outlets shall be model XG-3100A (aluminum) or XG-3100A-S (steel) manufactured by GREENHECK Diffuser shall be constructed of 2 round inner cone assembly and a round outer cone. Outlet shall be adjustable to allow the discharge pattern to be set from full horizontal to vertical. Units shall be aluminum construction (model XG-3100) or steel construction (model XG-3100S). The units shall be the size and quantity as outline in the plans and specifications.

Pattern adjustment shall be accomplished by rotating the innermost cone. The inner core assembly shall be removable for installation and for access into the ductwork. The center cone shall include an access hole to allow adjustment of an optional damper.

Flush Cone Model XG-3100A-1 - Aluminum Model XG-3100SA-1 - Steel

Outlet shall have an outer cone that allows flush mounting to the ceiling opening.

Drop Cone Model XG-3100A-2 - Aluminum Model XG-3100A-S-2 - Steel

Outlet shall have a dropped outer cone to move the discharge jet away from the ceiling surface. Dropped cone shall minimize ceiling smudging.

Performance Specification

The manufacturer shall provide published performance data. Data shall be tested in accordance to ANSI/ASHRAE Standard 70- 2006

MODEL XG-3100

Model: XG-3100-1 2 Cone - Round Neck - Flush Surface Mount
 XG-3100-2 2 Cone - Round Neck - Bevel Drop Surface Mount

XG-3100-1 - Flush Surface Mount

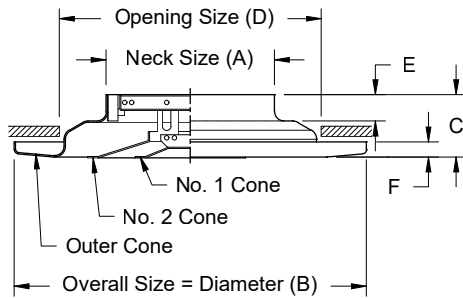

Size	A	B	C	D	E	F
6	5 3/4	10 1/8	2 3/4	12	1	5/8
8	7 3/4	16 1/8	2 3/4	12	1	5/8
10	9 3/4	21 7/8	3 1/8	17	1	3/4
12	11 3/4	21 7/8	3 1/8	17	1	3/4
14	13 3/4	28 3/4	3 7/8	23	1	3/4
16	15 3/4	28 3/4	3 7/8	23	1	3/4
18	17 3/4	34 3/8	5	28	1	3/4
20	19 3/4	34 3/8	5	28	1	3/4
24	23 3/4	40 3/8	5 1/2	34	1	3/4
30	29 3/4	49 3/8	7 3/8	41	2	1
36	35 3/4	58 3/8	8 3/8	50	2	1

XG-3100-2 - Bevel Drop Surface Mount

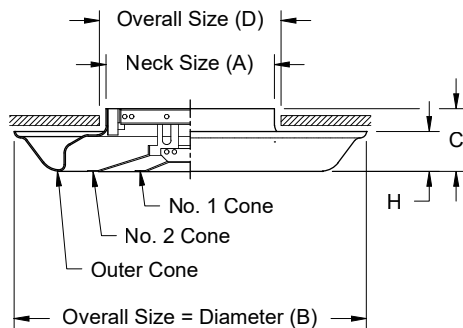

Size	A	B	C	D	H
6	5 3/4	10 1/8	2 3/4	7	1 7/8
8	7 3/4	16 1/8	2 3/4	9	1 7/8
10	9 3/4	21 7/8	3 1/8	11	2 1/4
12	11 3/4	21 7/8	3 1/8	13	2 1/4
14	13 3/4	28 3/4	3 7/8	15	3 3/4
16	15 3/4	28 3/4	3 7/8	17	3 3/4
18	17 3/4	34 3/8	5	19	4
20	19 3/4	34 3/8	5	21	4
24	23 3/4	40 3/8	5 1/2	25	4 1/4
30	29 3/4	49 3/8	7 3/8	31	5 1/8
36	35 3/4	58 3/8	8 3/8	37	6 1/8

1. Available Finishes	2. Available Accessories	3. Available Options	4. Construction Details
Standard Finish: 01 White Finish 24 Mill Finish Optional Finish 02 Satin Silver 03 Black 28 Custom Color	XG-D3 - Aluminum Radial Opposed Blade Damper XG-SD3 - Steel Radial Opposed Blade Damper XG-G3 - Equalizing Grid XG-GD3 - Combination Grid / Damper XG-BDS - Butterfly Damper XG-RSD - Radial Shutter Damper	Safety Chain	<ul style="list-style-type: none"> Model 3100: Available Sizes as Listed Model 3100A: 24"Ø Max size
All Dimensions ±1/16"			

MODEL XG-3100

CEILING
DIFFUSERS

PERFORATED
CEILING DIFFUSERS

XG-7950

Model: XG-3100A-1 2 Cone - Round Neck - Adjustable - Flush Surface Mount
 XG-3100A-2 2 Cone - Round Neck - Adjustable - Drop Cone

XG-3100A-1 - Adjustable - Flush Surface Mount

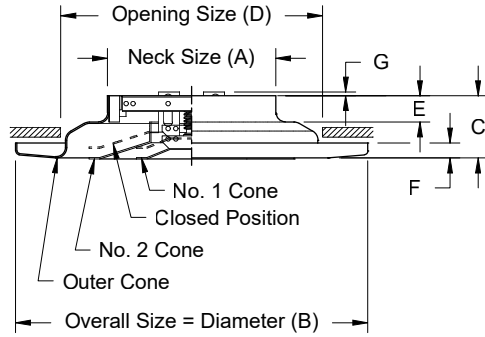

Size	A	B	C	D	E	F	G
6	5 3/4	10 1/8	2 3/4	12	1	5/8	3/4
8	7 3/4	16 1/8	2 3/4	12	1	5/8	3/4
10	9 3/4	21 7/8	3 1/8	17	1	3/4	3/4
12	11 3/4	21 7/8	3 1/8	17	1	3/4	3/4
14	13 3/4	28 3/4	3 7/8	23	1	3/4	3/4
16	15 3/4	28 3/4	3 7/8	23	1	3/4	1 9/16
18	17 3/4	34 3/8	5	28	1	3/4	1 9/16
20	19 3/4	34 3/8	5	28	1	3/4	1 9/16
24	23 3/4	40 3/8	5 1/2	34	1	3/4	1 9/16
30	29 3/4	49 3/8	7 3/8	41	2	1	-
36	35 3/4	58 3/8	8 3/8	50	2	1	-

XG-3100A-2 - Adjustable - Bevel Drop Surface Mount

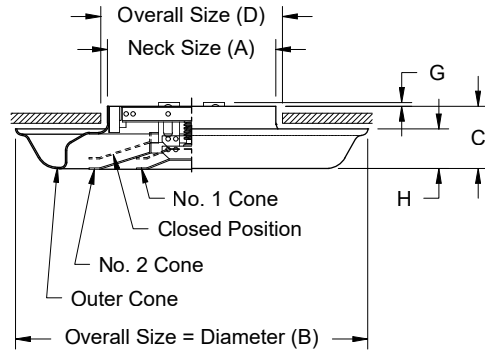

Size	A	B	C	D	G	H
6	5 3/4	10 1/8	2 3/4	7	3/4	1 7/8
8	7 3/4	16 1/8	2 3/4	9	3/4	1 7/8
10	9 3/4	21 7/8	3 1/8	11	3/4	2 1/4
12	11 3/4	21 7/8	3 1/8	13	3/4	2 1/4
14	13 3/4	28 3/4	3 7/8	15	3/4	3 3/4
16	15 3/4	28 3/4	3 7/8	17	1 9/16	3 3/4
18	17 3/4	34 3/8	5	19	1 9/16	4
20	19 3/4	34 3/8	5	21	1 9/16	4
24	23 3/4	40 3/8	5 1/2	25	1 9/16	4 1/4
30	29 3/4	49 3/8	7 3/8	31	-	5 1/8
36	35 3/4	58 3/8	8 3/8	37	-	6 1/8

1. Available Finishes	2. Available Accessories	3. Available Options	4. Construction Details
Standard Finish: 01 White Finish 24 Mill Finish Optional Finish 02 Satin Silver 03 Black 28 Custom Color	XG-D3 - Aluminum Radial Opposed Blade Damper XG-SD3 - Steel Radial Opposed Blade Damper XG-G3 - Equalizing Grid XG-GD3 - Combination Grid / Damper XG-BDS - Butterfly Damper XG-RSD - Radial Shutter Damper	Safety Chain	<ul style="list-style-type: none"> Model 3100: Available Sizes as Listed Model 3100A: 24" Max size
All Dimensions ±1/16"			

XG-3100 MODEL NUMBER SPECIFICATION
FIXED/ADJUSTABLE ROUND DIFFUSER 2 CONE
MODEL XG-3100 – ALUMINUM

Model		Available Neck	Available Finishes	
XG-3100-1	Fixed Surface Mount	6	Standard	
XG-3100A-1	Adjustable Surface Mount	8	01	White
XG-3100-2	Fixed Beveled Drop Face	10	Optional	
XG-3100A-2	Adjustable Beveled Drop Face	12	02	Satin Silver
		14	03	Black
		16	28	Custom Color
		18	Available Accessories	
		20	D3	Aluminum Radial Damper
		24	SD3	Steel Radial Damper
			G3	Round Equalizing Grid
			GD3	Combo Grid / Damper
			BDS	Butterfly Damper
			RSD	Radial Shutter Damper
Available Options				
			SC	Safety Chain

XG-3100S MODEL NUMBER SPECIFICATION
FIXED/ADJUSTABLE ROUND DIFFUSER 2 CONE
MODEL XG-3100S – STEEL

Model		Available Neck	Available Finishes	
XG-3100S-1	Fixed Surface Mount	6	Standard	
XG-3100SA-1	Adjustable Surface Mount	8	01	White
XG-3100S-2	Fixed Beveled Drop Face	10	Optional	
XG-3100SA-2	Adjustable Beveled Drop Face	12	02	Satin Silver
		14	03	Black
		16	28	Custom Color
		18	Available Accessories	
		20	XG-D3	Aluminum Radial Damper
		24	XG-SD3	Steel Radial Damper
			XG-G3	Round Equalizing Grid
			XG-GD3	Combo Grid / Damper
			XG-BDS	Butterfly Damper
			XG-RSD	Radial Shutter Damper
Available Options				
			SC	Safety Chain

SERIES XG-3100 PERFORMANCE DATA
MODELS XG-3100 — XG-3100S

Neck Size	fpm Neck Vel	400	500	600	700	800	900	1000	1200	1400	1600
	Pv	0.01	0.016	0.023	0.031	0.04	0.051	0.063	0.09	0.122	0.16
	Ps Horiz.	0.025	0.039	0.056	0.076	0.1	0.126	0.156	0.225	0.304	0.398
	Ps Vert.	0.049	0.076	0.109	0.149	0.194	0.247	0.305	0.44	0.594	0.777
6	CFM	75	94	113	132	151	169	188	226	264	301
	Throw	2-3-6	3-4-8	3-5-9	4-5-11	4-6-12	5-7-14	5-8-16	6-9-19	7-11-22	9-13-26
	NC	-	-	-	-	-	23	26	32	36	40
8	CFM	135	169	203	237	271	304	338	406	474	541
	Throw	3-5-9	3-5-10	4-6-12	4-7-13	5-8-15	6-9-17	7-10-20	8-12-25	10-14-29	10-15-30
	NC	-	-	-	20	24	28	31	37	42	46
10	CFM	213	266	319	372	425	479	532	638	745	851
	Throw	4-16-12	4-7-13	5-7-15	5-8-17	6-9-18	7-10-20	7-11-23	9-14-27	11-16-32	12-18-36
	NC	-	20	23	26	29	31	34	40	45	49
12	CFM	308	385	461	538	615	692	769	923	1077	1231
	Throw	5-7-15	5-8-16	6-9-18	7-10-20	7-11-22	8-12-24	9-13-26	11-16-32	12-19-37	14-21-43
	NC	-	22	25	28	31	34	37	42	47	51
14	CFM	420	525	630	735	840	945	1050	1260	1470	1680
	Throw	6-9-18	6-10-19	7-11-21	8-12-23	8-13-25	9-14-28	10-15-30	12-18-36	14-21-43	17-25-57
	NC	22	25	28	31	34	37	39	44	48	52
16	CFM	550	687	825	962	1100	1237	1375	1649	1924	2194
	Throw	7-10-21	7-11-22	8-12-25	9-14-27	10-15-30	11-17-33	12-18-37	14-22-43	17-25-50	19-29-57
	NC	24	27	30	32	35	38	40	45	50	54
18	CFM	697	871	1046	1220	1394	1568	1743	2091	2440	2788
	Throw	8-12-24	9-13-27	10-15-32	11-16-32	12-17-35	13-19-38	14-20-43	16-24-48	18-28-55	21-32-64
	NC	25	28	31	33	36	39	41	45	50	54
20	CFM	862	1077	1293	1508	1724	1939	2154	2585	3016	3447
	Throw	9-13-27	10-15-30	11-16-32	12-18-36	13-20-39	14-22-43	16-24-47	19-28-56	22-33-65	24-36-72
	NC	27	30	32	35	37	39	41	45	50	54
24	CFM	1224	1554	1885	2176	2487	2798	3109	3731	4353	4974
	Throw	12-18-36	13-20-40	15-22-45	16-25-49	18-27-54	20-30-59	21-32-64	25-37-75	28-42-84	31-47-93
	NC	28	31	33	36	38	40	42	46	50	54
30	CFM	1947	2434	2921	3408	3894	4381	4868	5842	6815	7789
	Throw	17-26-51	19-29-54	27-32-64	24-35-71	26-39-78	28-42-85	31-46-92	35-53-105	39-58-117	42-63-126
	NC	30	32	35	37	39	41	43	47	51	54
36	CFM	2808	3510	4212	4914	5616	6318	7020	8423	9827	11231
	Throw	24-36-72	27-40-81	30-45-90	33-49-99	36-54-108	39-59-118	42-63-127	48-72-144	53-79-158	58-84-168
	NC	31	33	36	38	40	42	44	48	57	54

CEILING
DIFFUSERS

ROUND
CEILING DIFFUSERS

XG-3100

PERFORMANCE NOTES FOR SERIES XG-3100

All data is tested in accordance with ANSI/ASHRAE 70-2006.

DEFINITION OF UNITS

- 1 Tabulated radial throw in feet is based on a 9' ceiling height, ambient supply air, MAX Throw @ $V_t = 75$ fpm, MIN Throw @ $V_t = 150$ fpm, and the diffuser inner cones in down position for 360° horizontal air distribution pattern.
- 2 For vertical down protection air pattern with cooling supply air temperature 20° below room temperature and diffuser inner cones in up position: multiply the tabulated radial throw values by a factor of 0.80 to obtain vertical down projection distances at MIN and MAX (V_t) terminal velocities.
- 3 For vertical down projection air pattern with heating supply air temperatures 20° above room temperature and diffuser inner cones in up position: multiply the tabulated radial throw values by a factor of 0.60 to obtain vertical down projection distances at MIN and MAX (V_t) terminal velocities.
- 4 Velocity Pressure (P_v) and Static Pressure (P_s) are in inches of water.
- 5 Series 3000 Diffusers are tested in accordance with ASHRAE 70-2006. Sound data are calculated in accordance with International Standard ISO 3741 comparison method. The NC values are based on a room absorption of 10dB for sound power level (l_w) re: 10^{-12} watts - symbol indicates NC less than 20.
- 6 All data is applicable for exposed for exposed duct mounting or ceiling installation.

MODEL XG-3200

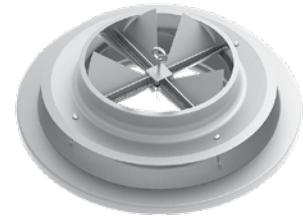

Air outlets shall be model XG-3200 manufactured by GREENHECK Diffusers shall be constructed of an opposed blade damper inner assembly mounted in an inner ring. Outlets shall allow the adjustment of the discharge pattern from full horizontal to full vertical and be adjustable from the face by turning an operator ring. Units shall be steel construction. The units shall be the size and quantity as outline in the plans and specifications.

Pattern adjustment operator shall open the inner opposed blade damper assembly to discharge the air in a vertical pattern or close the damper to allow a tight horizontal pattern. In the horizontal setting, core shall project discharge pattern to minimize ceiling smudging. The inner core assembly shall be removable for installation and for access into the ductwork.

Performance Specification

The manufacturer shall provide published performance data. Data shall be tested in accordance to ANSI/ASHRAE Standard 70- 2006.

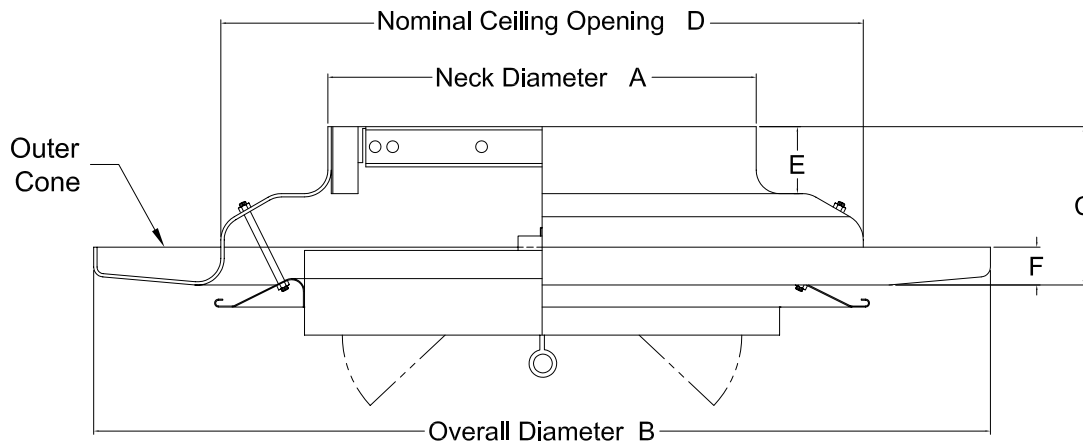

Dimensions						
Size	A	B	C	D	E	F
6	5 3/4	17 1/4	2 1/8	6 3/4	1 1/8	1 1/8
8	7 3/4	17 1/4	2 1/8	8 3/4	1 1/8	1 1/4
10	9 3/4	20 1/4	2 5/8	10 3/4	1 1/4	1 3/4
12	11 3/4	22 1/4	2 5/8	12 3/4	1 1/4	1 3/4
14	13 3/4	29 1/2	2 5/8	14 3/4	1 1/4	2 3/8
16	15 3/4	29 1/2	2 3/4	16 3/4	1 1/4	2 3/8
18	17 3/4	33 1/2	3 5/8	18 3/4	1 1/4	2 1/2
20	19 3/4	36 3/4	3 5/8	20 3/4	1	2 1/2
24	23 3/4	40 3/4	3 5/8	24 3/4	1	2 1/2

XG-3200 MODEL NUMBER SPECIFICATION
ADJUSTABLE ROUND DIFFUSER
W/FACE ACCESSIBLE OPERATING RING AND CENTER OBD

Model		Available Neck	Available Finishes	
XG-3200-1	Adjustable Surface Mount	6	Standard	
		8	01	White
		10	Optional	
		12	02	Satin Silver
		14	03	Black
		16	28	Custom Color
		18	Available Accessories	
		20	XG-G3	Round Equalizing Grid
		24		

Available Options	
SC	Safety Chain

SERIES XG-3200 PERFORMANCE DATA
MODEL XG-3200

Neck Velocity		400	500	600	700	800	900	1000	1200	1400	1600
Velocity Pressure		0.01	0.016	0.022	0.031	0.04	0.05	0.062	0.09	0.122	0.16
6	CFM	80	100	120	135	155	175	195	235	275	315
	Ps - H	0.004	0.007	0.010	0.013	0.017	0.022	0.027	0.039	0.052	0.069
	Pt -H	0.014	0.022	0.032	0.044	0.057	0.072	0.089	0.128	0.175	0.228
	Ps - V	0.02	0.032	0.046	0.062	0.081	0.103	0.127	0.182	0.248	0.324
	Pt -V	0.03	0.047	0.068	0.093	0.121	0.153	0.189	0.272	0.371	0.484
	NC H	-	-	15	16	17	19	21	24	26	29
	NC V	-	-	-	-	15	16	18	22	25	29
	Throw H C	1-1-3	1-2-3	1-2-4	1-2-4	2-2-5	2-3-6	2-3-6	2-4-7	3-4-9	3-5-9
	Throw V C	2-4-8	4-5-11	4-6-13	5-7-14	5-8-16	6-9-19	7-10-21	8-12-25	10-15-29	11-17-33
Throw V H	0-1-3	1-2-4	1-2-4	1-2-5	2-3-6	2-3-6	2-4-7	3-4-8	3-5-10	4-6-11	
8	CFM	140	175	210	245	280	315	350	420	490	560
	Ps - H	0.003	0.004	0.006	0.009	0.011	0.014	0.018	0.026	0.035	0.046
	Pt -H	0.013	0.020	0.029	0.039	0.051	0.065	0.080	0.115	0.157	0.205
	Ps - V	0.012	0.018	0.026	0.036	0.046	0.059	0.073	0.104	0.142	0.186
	Pt -V	0.022	0.034	0.049	0.066	0.086	0.109	0.135	0.194	0.264	0.345
	NC H	-	16	18	20	21	23	25	28	31	34
	NC V	-	-	+	-	-	17	19	24	28	32
	Throw H C	1-2-3	1-2-4	2-2-5	2-3-6	2-3-7	2-4-7	3-4-8	3-5-10	4-6-12	4-7-12
	Throw V C	3-6-11	5-7-14	6-8-17	6-10-19	7-11-22	8-13-25	9-14-28	11-17-33	13-19-39	15-22-45
Throw V H	1-1-4	1-2-5	1-3-6	2-3-7	3-4-8	3-4-9	3-5-9	4-6-11	4-7-13	5-8-15	
10	CFM	220	275	325	380	435	490	545	655	765	875
	Ps - H	0.003	0.004	0.006	0.009	0.011	0.014	0.018	0.026	0.035	0.046
	Pt -H	0.013	0.020	0.029	0.039	0.051	0.065	0.080	0.115	0.157	0.205
	Ps - V	0.012	0.018	0.026	0.036	0.046	0.059	0.073	0.104	0.142	0.186
	Pt -V	0.022	0.034	0.049	0.066	0.086	0.109	0.135	0.194	0.264	0.345
	NC H	-	16	17	19	20	22	23	26	29	32
	NC V	-	-	-	-	-	15	17	23	27	31
	Throw H C	1-2-4	2-3-5	2-3-6	2-4-7	3-4-8	3-5-9	3-5-10	4-6-12	5-7-14	6-8-15
	Throw V C	4-7-14	6-9-18	7-10-21	8-12-24	9-14-28	10-16-31	12-17-35	14-21-42	16-24-49	10-28-56
Throw V H	1-2-5	1-3-6	2-4-7	2-4-8	3-5-9	4-5-11	4-6-12	5-7-14	6-8-17	6-9-19	
12	CFM	315	395	470	550	630	705	785	940	1100	1255
	Ps - H	0.003	0.004	0.006	0.009	0.011	0.014	0.018	0.026	0.035	0.046
	Pt -H	0.013	0.02	0.029	0.039	0.051	0.065	0.080	0.115	0.157	0.205
	Ps - V	0.011	0.017	0.025	0.034	0.044	0.056	0.069	0.099	0.134	0.175
	Pt -V	0.021	0.033	0.047	0.064	0.084	0.106	0.131	0.188	0.257	0.335
	NC H	-	-	15	19	23	26	29	35	40	43
	NC V	-	-	-	17	20	23	27	32	37	41
	Throw H C	2-2-5	2-3-6	2-4-7	3-4-9	3-5-10	4-6-11	4-6-12	5-7-15	6-9-17	7-10-19
	Throw V C	4-8-17	7-10-21	8-12-25	10-15-29	11-17-33	12-19-37	14-21-42	17-25-50	19-29-58	22-33-67
Throw V H	1-2-6	1-3-7	2-4-8	3-5-10	4-6-11	4-6-13	5-7-44	6-8-17	7-10-20	8-11-23	
14	CFM	430	535	640	750	855	960	1070	1285	1495	1710
	Ps - H	0.003	0.004	0.006	0.009	0.011	0.014	0.018	0.026	0.035	0.046
	Pt -H	0.013	0.020	0.029	0.039	0.051	0.065	0.080	0.115	0.157	0.205
	Ps - V	0.011	0.017	0.024	0.033	0.043	0.055	0.068	0.097	0.133	0.173
	Pt -V	0.021	0.033	0.047	0.064	0.083	0.105	0.13	0.187	0.255	0.333
	NC H	-	16	21	25	29	32	36	41	44	46
	NC V	-	15	19	23	27	30	33	38	42	45
	Throw H C	2-3-6	2-4-7	3-4-9	3-5-10	4-6-12	4-6-13	5-7-14	6-9-17	7-10-20	8-12-22
	Throw V C	1-3-13	2-5-21	3-7-28	5-10-33	6-13-38	7-17-43	9-21-48	13-29-57	18-33-67	24-38-71
Throw V H	1-2-5	1-3-7	2-4-8	3-5-9	4-5-11	4-6-12	4-7-13	5-8-16	6-9-19	7-11-22	

SERIES XG-3200 PERFORMANCE DATA
MODEL XG-3200

Neck Velocity		400	500	600	700	800	900	1000	1200	1400	1600
Velocity Pressure		0.01	0.016	0.022	0.031	0.04	0.05	0.062	0.09	0.122	0.16
16	CFM	560	700	840	975	1115	1255	1395	1675	1955	2235
	Ps - H	0.003	0.004	0.006	0.009	0.011	0.014	0.018	0.026	0.035	0.046
	Pt -H	0.013	0.020	0.029	0.039	0.051	0.065	0.080	0.115	0.157	0.205
	Ps - V	0.010	0.016	0.024	0.032	0.042	0.053	0.066	0.094	0.129	0.168
	Pt -V	0.02	0.032	0.046	0.063	0.082	0.104	0.128	0.184	0.251	0.328
	NC H	15	20	25	29	33	37	40	45	48	50
	NC V	16	20	24	28	31	35	38	43	47	49
	Throw H C	2-3-7	3-4-8	3-5-10	4-6-12	4-7-13	5-7-15	6-8-17	7-10-20	8-12-23	9-13-25
	Throw V C	2-4-14	3-6-23	4-8-30	5-11-35	6-14-40	8-18-45	10-22-50	14-30-60	20-35-69	26-40-79
Throw V H	1-2-6	1-3-8	2-4-9	2-5-11	3-6-12	4-7-14	5-8-16	6-9-19	7-11-22	8-12-25	
18	CFM	705	885	1060	1235	1415	1590	1765	2120	2475	2825
	Ps - H	0.003	0.004	0.006	0.009	0.011	0.014	0.018	0.026	0.035	0.046
	Pt -H	0.013	0.02	0.029	0.039	0.051	0.065	0.08	0.115	0.157	0.205
	Ps - V	0.01	0.016	0.023	0.031	0.041	0.051	0.064	0.092	0.125	0.163
	Pt -V	0.02	0.031	0.045	0.062	0.081	0.102	0.126	0.181	0.247	0.322
	NC H	-	19	23	27	31	35	38	44	50	54
	NC V	-	16	21	25	30	34	37	43	49	52
	Throw H C	2-4-7	3-5-9	4-6-11	4-7-13	5-7-15	6-8-17	6-9-19	7-11-22	9-13-26	10-15-28
	Throw V C	2-4-14	3-6-23	4-8-32	5-11-37	6-14-43	8-18-48	10-23-53	14-32-64	20-37-74	26-43-85
Throw V H	1-1-5	1-2-8	1-3-11	2-4-12	2-5-14	3-6-16	4-8-18	5-11-21	7-12-25	9-14-28	
20	CFM	875	1090	1310	1525	1745	1965	2180	2620	3055	3490
	Ps - H	0.003	0.004	0.006	0.009	0.011	0.014	0.018	0.026	0.035	0.046
	Pt -H	0.013	0.02	0.029	0.039	0.051	0.065	0.08	0.115	0.157	0.205
	Ps - V	0.01	0.015	0.022	0.029	0.038	0.049	0.06	0.087	0.118	0.154
	Pt -V	0.02	0.031	0.044	0.06	0.078	0.099	0.123	0.176	0.24	0.314
	NC H	-	19	25	29	34	38	41	48	53	57
	NC V	-	-	20	25	30	35	39	45	50	52
	Throw H C	3-4-8	3-5-10	4-6-12	5-7-14	6-8-17	6-9-19	7-10-21	8-12-25	10-14-29	11-17-31
	Throw V C	2-4-14	2-6-22	4-8-32	5-11-41	6-14-47	8-18-53	10-22-59	14-32-71	19-41-83	25-47-95
Throw V H	0-1-4	1-1-6	1-2-9	1-3-12	2-4-15	2-5-18	3-6-19	4-9-23	5-12-27	7-15-31	
24	CFM	1255	1570	1885	2200	2515	2825	3140	3770	4400	5025
	Ps - H	0.002	0.004	0.005	0.007	0.009	0.012	0.015	0.021	0.029	0.038
	Pt -H	0.012	0.019	0.028	0.038	0.049	0.062	0.077	0.111	0.151	0.197
	Ps - V	0.009	0.014	0.021	0.028	0.037	0.047	0.058	0.083	0.113	0.148
	Pt -V	0.019	0.03	0.043	0.059	0.077	0.097	0.12	0.173	0.236	0.308
	NC H	-	19	25	31	36	40	44	50	54	56
	NC V	-	17	23	28	32	37	40	47	52	56
	Throw H C	3-5-10	4-6-12	5-7-15	6-9-17	7-10-20	7-11-22	8-12-25	10-15-30	12-17-35	13-20-37
	Throw V C	2-4-17	3-7-27	4-10-38	6-13-50	8-17-57	10-21-64	12-27-71	17-38-88	23-50-99	30-57-109
Throw V H	1-1-5	1-2-7	1-3-10	2-3-14	2-5-18	3-6-21	3-7-23	5-10-28	6-14-33	8-18-37	

**CEILING
DIFFUSERS**
**ROUND
CEILING DIFFUSERS**
XG-3200

PERFORMANCE NOTES FOR SERIES XG-3200

All data is tested in accordance with ANSI/ASHRAE 70-2006.

DEFINITION OF UNITS

CFM	Cubic Feet per Minute (air)
Horizontal throw	throw distance in feet at terminal velocities of 150fpm, 100fpm and 50fpm.
NC	Noise criterion, sound pressure level NC ratings are based on sound power level (Lw) re: 10 ⁻¹² watts minus a 10dB room attenuation in all octave bands
fpm	Velocity of air stream in Feet per Minute
Pv	Velocity pressure (inches of water column)
Pt	Total pressure (inches of water column)
Ps	Static pressure = Pt-Pv (inches of water column)
Throw	Isothermal throw (supply air temperature the same as average room temperature); values are for 150, 100 and 50fpm velocities
Ps -H	static pressure horizontal
Ps-V	static pressure vertical
Pt V	total pressure vertical
Throw H C	throw horizontal cooling
Throw V C	throw vertical cooling
Throw V H	vertical heating

MODEL XG-R5750



Air outlets shall be model XG-R5750-AL (all aluminum), XG-R5750-AF (aluminum face, steel backpan) or XG-R5750-S (all steel) manufactured by GREENHECK

Diffuser shall be constructed of a round flat face panel and a round outer cone. Outlet shall have a fixed horizontal pattern. The units shall be the size and quantity as outlined in the plans and specifications.

Round face panel shall be removable to allow access to the round outer cone. Outlet shall be designed for surface mounting applications and have an outer cone that allows flush mounting to the ceiling opening.

Performance Specification

The manufacturer shall provide published performance data. Data shall be tested in accordance to ANSI/ASHRAE Standard 70- 2006.

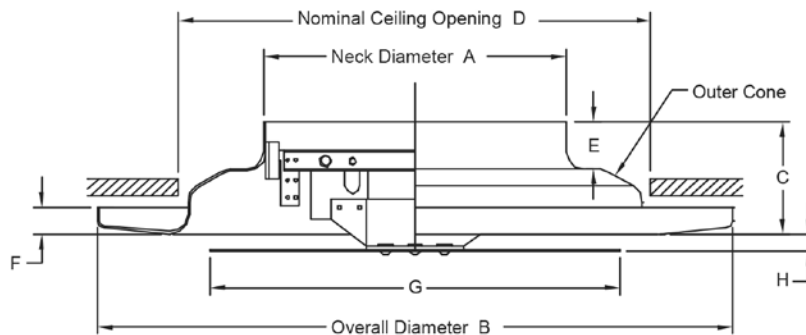

Normal Round Duct Size	Dim. A	Dim. B	Dim. C	Dim. D	Dim. E	Dim. F	Dim. G	Dim. H
6	5 3/4	16 5/8	2 15/16	11	3/4	5/8	9	3/4
8	7 3/4	16 5/8	2 15/16	11	3/4	5/8	9	3/4
10	9 3/4	22 3/16	3 5/16	17	1.0	7/8	14	7/8
12	11 3/4	22 3/16	3 5/16	17	1.0	7/8	14	7/8
14	13 3/4	29 1/4	4 3/16	22	1.0	7/8	19	7/8
16	15 3/4	29 1/4	4 3/16	22	1.0	7/8	19	7/8

**XG-R5750 MODEL NUMBER SPECIFICATION
ROUND PANEL FACE DIFFUSER**

Model		Available Neck	Available Finishes	
XG-R5750-1	Steel	6	Standard	
XG-R5750-AF-1	Aluminum Face/ Steel Backpan		01	White
XG-R5750-AL	Aluminum		Optional	
		10	02	Satin Silver
		12	03	Black
		14	28	Custom Color
		16	Available Accessories	
			XG-D3	Aluminum Radial Damper
			XG-SD3	Steel Radial Damper
			XG-G3	Round Equalizing Grid
			XG-GD3	Combo Grid / Damper
			XG-BDS	Butterfly Damper
			XG-RSD	Radial Shutter Damper
			Available Options	
			SC	Safety Chain

CEILING
DIFFUSERS

ROUND
CEILING DIFFUSERS

XG-R5750

SERIES XG-R5750 PERFORMANCE DATA
MODEL XG-R5750

Neck Size	Nk Velocity	400	500	600	700	800	900	1000	12000
	Pv	0.015	0.024	0.034	0.046	0.06	0.076	0.094	0.136
6	CFM	79	98	118	137	157	177	196	236
	Ps	0.023	0.035	0.052	0.070	0.092	0.117	0.143	0.208
	Pt	0.038	0.059	0.086	0.116	0.152	0.193	0.237	0.344
	Throw	1-2-4	2-3-5	2-3-6	2-3-6	2-4-7	3-4-8	3-5-9	4-6-11
	NC	-	-	19	24	29	31	34	38
8	CFM	140	175	209	244	279	314	349	419
	Ps	0.024	0.037	0.054	0.074	0.096	0.122	0.150	0.216
	Pt	0.039	0.061	0.088	0.120	0.156	0.198	0.244	0.352
	Throw	1-2-4	2-3-6	2-3-7	3-4-8	3-4-9	3-5-10	4-6-11	4-7-13
	NC	-	16	21	26	31	33	35	40
10	CFM	218	273	327	382	436	491	545	654
	Ps	0.026	0.040	0.058	0.080	0.104	0.132	0.162	0.233
	Pt	0.041	0.064	0.092	0.126	0.164	0.208	0.256	0.369
	Throw	3-4-7	4-6-9	4-7-11	5-8-13	6-9-14	7-10-16	7-11-18	9-13-21
	NC	-	-	-	24	28	32	35	41
12	CFM	314	393	471	550	628	707	785	942
	Ps	0.035	0.054	0.078	0.106	0.139	0.175	0.216	0.311
	Pt	0.050	0.078	0.112	0.152	0.199	0.251	0.310	0.447
	Throw	4-5-11	4-7-12	5-8-13	6-9-14	7-11-16	8-12-19	9-13-21	11-16-22
	NC	-	-	-	26	29	34	36	43
14	CFM	428	535	641	748	855	962	1069	1283
	Ps	0.025	0.038	0.055	0.075	0.098	0.124	0.153	0.220
	Pt	0.040	0.062	0.089	0.121	0.158	0.200	0.247	0.356
	Throw	4-6-12	5-7-12	6-9-13	7-10-16	8-12-17	9-13-19	10-15-21	12-18-21
	NC	-	-	22	23	25	26	29	33
16	CFM	559	698	838	977	1117	1257	1396	1676
	Ps	0.038	0.058	0.084	0.114	0.149	0.187	0.230	0.328
	Pt	0.053	0.082	0.118	0.160	0.209	0.263	0.324	0.464
	Throw	4-7-13	6-8-13	7-10-15	8-12-18	9-13-19	10-15-21	11-17-23	13-20-24
	NC	19	19	24	26	32	33	34	37

**CEILING
DIFFUSERS**
**ROUND
CEILING DIFFUSERS**
XG-R5750

PERFORMANCE NOTES FOR SERIES XG-R5750

All data is tested in accordance with ANSI/ASHRAE 70-2006.

DEFINITION OF UNITS

CFM Cubic Feet per Minute (air)

Nk Vel Neck velocity is the airstream velocity in the duct just before it reaches the supply outlet; measured in Feet per Minute

Pv Velocity pressure (inches of water column)

Pt Total pressure (inches of water column)

Ps Static pressure = $P_t - P_v$ (inches of water column)

Throw Isothermal throw (supply air temperature the same as average room temperature); values are for 150, 100 and 50fpm velocities

NC Noise criterion, sound pressure level NC ratings are based on sound power level (Lw) re: 10^{-12} watts minus a 10dB room attenuation in all octave bands

VAV DIFFUSERS

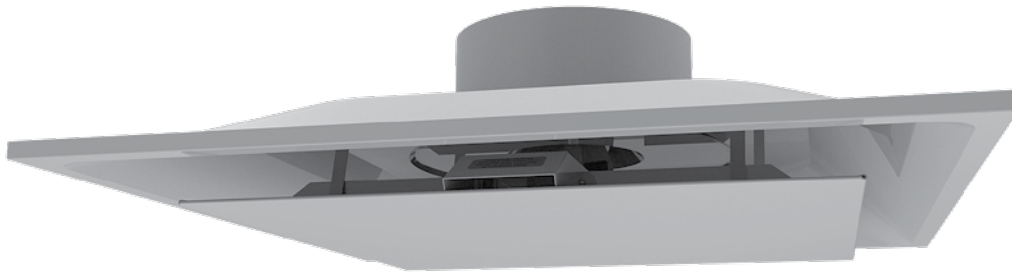

The XG-MS series of variable volume diffusers provides both accurate and individual control for heating and cooling without the use of an air terminal unit. By combining the performance of a diffuser with the function of an air terminal unit, VAV control strategies can be employed at a reduced first cost. Better comfort is obtained by the ability to move the zone control to the diffuser level. Aesthetics are not sacrificed with the sleek, plaque-faced look.

Model XG-MS is for cooling only applications. The self-contained thermal controls, mounted just above the plaque, consist of a single sensor and mechanical mechanism to generate the flow controller. PAGE 208

Model XG-MSCVH is for heating and cooling applications. The XG-MSCVH is the same as the XG-MS with three added thermal controllers utilizing input from four thermal sensors. PAGE 208

Model XG-MSEHC is for heating and cooling applications and uses a duct sensor to communicate with a remote mounted thermostat and an electronic motor to operate the modulating device. PAGE 213

MODEL XG-MSC/ XG-MSCVH



The XG-MSC (cooling only) and the XG-MSCVH (heating/cooling) are thermally powered variable volume air diffusers which are completely self-powered and self-contained.

The thermal control actuators are both the room thermostats and the damper motor. To sense the average room temperature, a continuous sample of room air is induced up and around the face panel. A small amount of supply air is diverted through an orifice against an induction wing then back into the primary air path, creating just enough negative pressure to induce a sample of secondary room air around the edge of the face panel, through the induction trough and across the thermal actuators. The diffusion damper is mechanically opened and closed by the thermal actuators to vary the flow of warm/cool air into the space.

- Each thermal actuator is a precisely calibrated thermostat
- Thermal control actuators allow heat energy to transform into mechanical energy through the movement of a stainless steel piston
- The thermal actuator is a small brass cylinder containing petroleum based wax. The wax expands when heated, driving the piston out. A torsion spring returns the piston as the wax cools and retracts
- Thermal actuators are used in a variety of thermostatic applications. Typical applications include automotive controls, aerospace, marine, medical and many more

VAV room temperature cooling control. Room air is induced past a thermal actuator, which then adjusts airflow based on space requirements. The actuator is mechanical and requires no electrical or pneumatic connectors.

Note:

Units are equipped with a non-adjustable warm-up cycle control function. When the supply air temperature is above 72 degrees F., the disc will be open. At start-up, when the supply temperature maybe warm, the disc will open regardless of the room temperature. When cool air is supplied, the disc will close but only if the room is below the setting.

Actuator Assembly

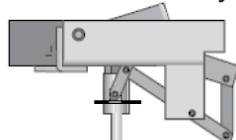

3
Room Sensor
Temp. Adjust

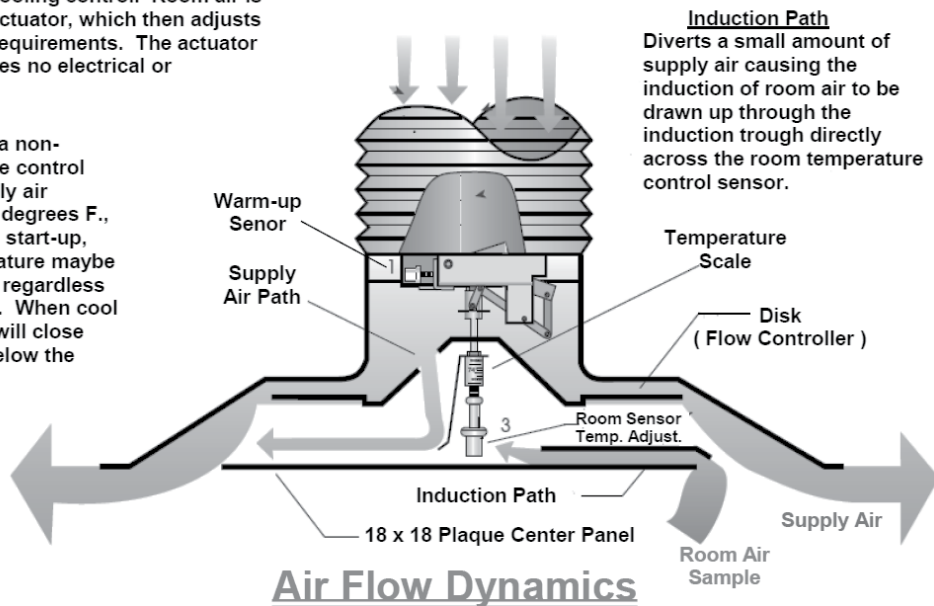

Air Flow Dynamics

Temperature Adjustment:

Factory set-point approximately 74 degrees. For cooler room temperature, turn room actuator clockwise. For warmer room temperature, turn room actuator counter-clockwise. Determine room temperature set-point by aligning end of actuator with the indicators on the temperature scale. Each full rotation for each indicator on the temperature scale equals plus or minus 2 degrees. For 74 degree factory set-point, turn actuator clockwise until it stops, then turn counter-clockwise 3 full turns.

Operation

Change over between heating and cooling modes is determined by supply air temperature. When heating cycle is initiated, element # ① will react first, lowering damper to full open position (full heating).

Then element # ②, the heating slave, reacts at 78 degrees or greater, posing the heating u-arm to engage element # ③, the room thermostat for heating control.

As the room warms, element # ③ begins to sense room temperature to vary the heating supply volume to achieve and sustain the desired room temperature. The factory set point of 74 degrees is adjustable between 72 - 78 degrees. For less heating, turn element # ③ clockwise. For more heating turn element # ③ counter-clockwise. Each full turn will equal plus or minus 2 degrees. A drop in room temperature and unit will respond by opening to increase heating volume until the room temperature reaches the desired set point.

VAV Cooling control is initiated when supply air is below 68 degrees.

In cooling mode elements # ① & # ②, do not react. This engages the cooling control element # ④ which will vary the supply air when cooling. A rise in room temperature and the unit will respond by allowing cool air into the space until the room temperature reaches the desired set point. All units are factory set at 74 degrees, and are adjustable between 72 and 78 degrees. For a cooler room temperature turn element # ④ clockwise. For a warmer room temperature turn element # ④ counter-clockwise.

Determine room temperature set point by aligning the end of the element with the indicators on the temperature scale. Each full turn or indicator will equal plus or minus 2 degrees.

Induction Room air is induced across elements # ③ and # ④ by use of a simple induction wing. This diverts a small amount of supply air which induces a room air sample through trough located on the back side of the appearance panel.

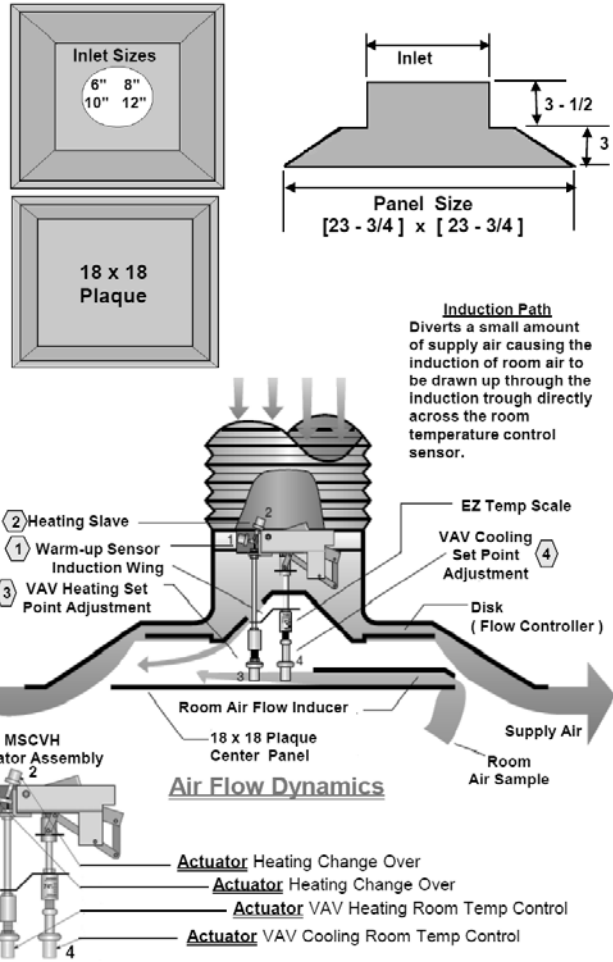

MODEL XG-MSC/ XG-MSCVH

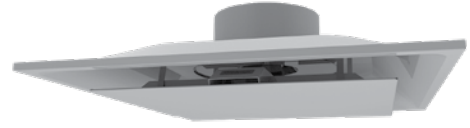

Air Diffusers shall be model:

Cooling Only

XG-MSC-1 Surface Mount

XG-MSC-6 T-bar Lay-in

XG-MSC-8 Tegular Lay-in

XG-MSC-9 Donn Finline / Bolt Slot

Heating and Cooling

XG-MSCVH-1 Surface Mount

XG- MSCVH-6 T-bar Lay-in

XG-MSCVH-8 Tegular Lay-in

XG-MSCVH-9 Donn Finline / Bolt Slot

Units shall be manufactured by GREENHECK and be of steel construction. Units shall be square with a formed backpan and a flat face panel. The face panel shall project no more than 1/4" below the ceiling grid or surface. The diffuser shall have the same appearance from the face regardless of the inlet size. Each diffuser damper shall consist of an aluminum extruded disc to provide a variable unobstructed 360° horizontal discharge for maximum Coanda effect and superior induction. All diffusers shall have a temperature adjustment scale with indicators that range from 70° 78°F. The initial set point shall be factory set at 74°F. No tools shall be required.

Model XG-MSC cooling diffuser shall utilize one thermal actuator to provide VAV room temperature control for cooling.

Model XG-MSCVH heating and cooling diffuser shall utilize four thermal actuators to provide both heating and cooling control. The diffuser is equipped with two room temperature-sensing thermal actuators and two heating change-over thermal actuators. The room temperature settings for heating and cooling shall be separately adjustable. One room actuator shall sense temperature and vary the supply air when cooling. The second actuator shall sense room temperature and vary the supply air when heating. The heating change-over actuators shall be factory set to engage heating mode when supply air temperature rises above 78°F and will return to cooling mode when supply air temperature falls below 68°F.

Performance Specification

The manufacturer shall provide published performance data. Data shall be tested in accordance to ANSI/ASHRAE Standard 70-2006.

Paint Specification

Process shall be anodic electro-deposition using an anodic acrylic paint. Units shall undergo pre-treatment including a pressurized spray stage using an alkaline cleaner and a de-ionized water rinse.

XG-MSC MODEL NUMBER SPECIFICATION

THERMAL PLAQUE DIFFUSER – COOLING ONLY

Model		Neck Size	Module	Available Finishes	
XG-MSC-1	Surface Mount	6	24 x 24	Standard	
XG-MSC-6	T-bar Lay-in	8		01	White
XG-MSC-8	Tegular Lay-in	10		Available Accessories	
XG-MSC-9	Donn Finline/BAFit Slot	12		XG-BAF-1	3-Way (One Baffle)
			XG-BAF-2	2-Way (Two Baffles)	
			XG-BAF-3	1-Way (Three Baffles)	
			XG-TBPF	T-bar Plaster Frame	

XG-MSCVH MODEL NUMBER SPECIFICATION

THERMAL PLAQUE DIFFUSER – HEATING AND COOLING

Model		Neck Size	Module	Available Finishes	
XG-MSCVH-1	Surface Mount	6	24 x 24	Standard	
XG-MSCVH-6	T-bar Lay-in	8		01	White
XG-MSCVH-8	Tegular Lay-in	10		Available Accessories	
XG-MSCVH-9	Donn Finline/BAFit Slot	12		XG-BAF-1	3-Way (One Baffle)
			XG-BAF-2	2-Way (Two Baffles)	
			BAF-3XG-	1-Way (Three Baffles)	
			XG-TBPF	T-bar Plaster Frame	

SERIES XG-MSC PERFORMANCE DATA
MODEL XG-MSC/MSCVH

Listed Size	Inlet Ps	Max. CFM	Throw @ Max. CFM			Throw @ 25% of CFM		NC@ Max. CFM
			150 (fpm)	100 (fpm)	50 (fpm)	100 (fpm)	50 (fpm)	
6	.05	85	1	3	5	1	3	–
	.10	120	2	3	6	2	3	20
	.15	150	2	4	7	3	4	24
	.20	170	3	5	8	4	6	28
	.25	220	5	6	8	4	7	33
8	.05	160	2	4	6	2	4	–
	.10	225	3	5	8	3	5	20
	.15	275	4	5	9	4	6	25
	.20	320	5	6	10	5	8	29
	.25	355	6	7	12	6	9	33
10	.05	250	3	4	7	3	5	–
	.10	355	4	5	9	4	6	22
	.15	450	5	6	11	4	7	26
	.20	500	6	7	12	5	8	29
	.25	580	7	8	13	7	10	32
12	.05	365	4	5	8	4	6	–
	.10	520	6	7	11	5	8	23
	.15	650	6	7	12	6	8	27
	.20	740	7	8	14	7	10	32
	.25	820	9	10	15	8	11	36
	30	890	10	11	17	9	12	40

PERFORMANCE NOTES FOR SERIES XG-MSC

All data is tested in accordance with ANSI/ASHRAE 70-2006.

DEFINITION OF UNITS

CFM Cubic Feet Per Minute (air)

fpm Velocity of air stream in Feet Per Minute

Pt Total pressure (inches of water column)

Throw Non-isothermal horizontal throw (supply air temperature 15°F colder than average room temperature); values are for 150, 100 and 50fpm velocities

NC Noise criterion, sound pressure level NC ratings are based on sound power level (Lw) re: 10⁻¹² watts minus a 10dB room attenuation in all octave bands

Ps Static Pressure (inches of water column)

MODEL XG-MSE-HC

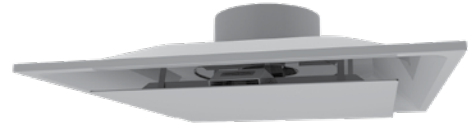

Air Diffusers shall be model:
XG-MSE-HC-6 T-bar Lay-in
XG-MSE-HC-8 Tegular Lay-in
XG-MSE-HC-9 Donn Finline / Bolt Slot

Units shall be manufactured by GREENHECK and be of steel construction. Units shall be square with a formed backpan and a flat face panel. The face panel shall project no more than 1/4" below the ceiling grid or surface. The diffuser shall have the same appearance from the face regardless of the inlet size.

The diffuser shall include an integral modulating disk that continually regulates the volume of supply air in response to the wall mounted thermostat. Diffusers dependent on integral air induction ceiling located sensors or set point adjustment methods other than from wall mounted thermostats shall not be acceptable.

To ensure finite control of temperature by modulation, the electric 24Vac actuators shall be a drive-open, drive-closed motor on the electrically driven units. Actuators that incorporate an expanding material which only drives the unit open when subjected to heat causing electrical current, requiring a spring return mechanism to force the diffuser to a closed position shall not be acceptable.

The electronic modulating wall mounted thermostatic control shall be either a 2 to 10Vdc or floating point. All field wiring, materials and labor shall be supplied and installed by others.

Performance Specification

The manufacturer shall provide published performance data. Data shall be tested in accordance to ANSI/ASHRAE Standard 70-2006.

Paint Specification

Process shall be anodic electro-deposition using an anodic acrylic paint. Units shall undergo pre-treatment including a pressurized spray stage using an alkaline cleaner and a de-ionized water rinse.

MODEL XG-MSE-HC

VAV Electronic Smart Zone Diffuser

Models: **XG-MSE-HC 6-12** Electronically Controlled Variable Air Volume Diffuser - Lay-In Turned Up Edge 12x12 Panel
XG-MSE-HC 6-24 Electronically Controlled Variable Air Volume Diffuser - Lay-In Turned Up Edge 24x24 Panel
XG-MSE-HC 9-12 Electronically Controlled Variable Air Volume Diffuser - Donn Finline Ceiling Grid 12x12 Panel
XG-MSE-HC 9-24 Electronically Controlled Variable Air Volume Diffuser - Donn Finline Ceiling Grid 24x24 Panel

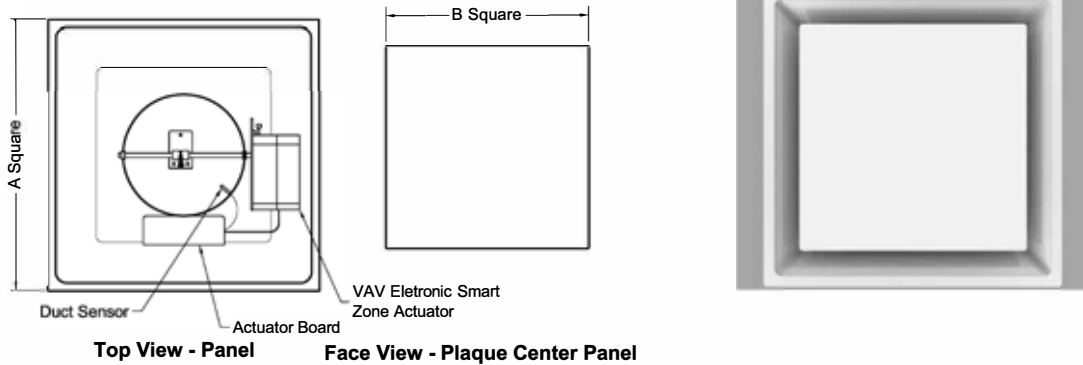

X = Inlet sizes (Dia. in Inches)

Model	A - Diffuser Panel	B - Plaque Panel	X
XG-MSE-HC 6-12	12"	9"	6 & 8
XG-MSE-HC 6-24	24"	18"	6 - 14
XG-MSE-HC 9-12	12"	9"	6 & 8
XG-MSE-HC 9-24	24"	18"	6 - 14

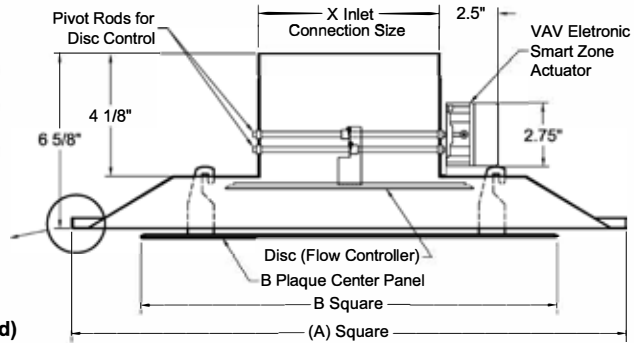
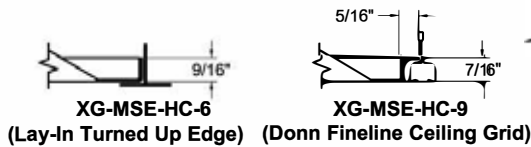

Construction:

Unitary stamped seamless backpan with Removable Face Plate. Steel construction with Baked White Enamel Finish. 4-way discharge pattern.

Operation:

Incorporates an Integral Modulating Disk that continually regulates the volume of Supply Air in response to the Wall-Mounted Thermostat.

Notes: (check if provided)

1. Available Finishes	2. Available Accessories	3. Available Options	4. Construction Details
Standard Finish: <input type="checkbox"/> 01 White Baked Enamel	<input type="checkbox"/> XG-BAF - Directional Baffles <input type="checkbox"/> XG-BPRA - By-Pass Relief Adapter	Standard: <input type="checkbox"/> ST - Auto Changeover Space Thermostat Option: <input type="checkbox"/> BACnet (Network) Thermostat Control <input type="checkbox"/> Transformer	<ul style="list-style-type: none"> • 24 gauge electro-galvanized steel. • Panel size 12x12 & 24x24. • Inlet sizes 6" & 8" for 12x12 Panel • Inlet sizes 6" thru 14" for 24x24 Panel • Controls: Modulating Wall-Mounted Thermostatic Control. • Electrical: 24Volt, 2VA, Floating Point, 90 • Sec. Timing, 44lb.-in.

XG-MSE-HC MODEL NUMBER SPECIFICATION
THERMAL PLAQUE DIFFUSER —
HEATING AND COOLING — ELECTRONICALLY CONTROLLED

Model		Neck Size	Module	Available Finishes	
XG-MSE-HC-6	T-bar Lay-in	6	12 x 12	Standard	
XG-MSE-HC-8	Tegular Lay-in	8		01	White
XG-MSE-HC-9	Donn Finline / Bolt Slot	6	24 x 24	Available Accessories	
		8		XG-BAF-1	3-Way (One Baffle)
		10		XG-BAF-2	2-Way (Two Baffles)
		12		XG-BAF-3	1-Way (Three Baffles)
		14			

SERIES XG-MSE-HC PERFORMANCE DATA
MODEL XG-MSE-HC

Model	fpm vn	300	400	500	600	700	800	900	1000	1200	1400
Inlet Size	Pv	.006	.010	.016	.022	.031	.040	.051	.062	.090	.122
MSE-HC-M MSE-HC-S 6	CFM	60	80	100	120	40	160	180	200	240	280
	Pt	.009	.011	.017	.025	.034	.044	.057	.070	.100	.135
	Throw	1-1-2	1-1-4	1-2-4	1-3-5	2-3-6	2-4-7	3-4-8	3-4-9	4-5-11	4-6-11
	NC	<15	<15	<15	<15	<15	<15	17	21	28	34
MSE-HC-M MSE-HC-S 8	CFM	105	140	175	210	245	280	315	350	420	490
	Pt	.011	.018	.028	.040	.055	.072	.091	.112	.162	.220
	Throw	1-2-4	2-3-6	2-4-7	3-4-9	3-5-10	4-6-11	4-6-12	5-7-13	6-9-14	7-10-15
	NC	<15	<15	<15	<15	<15	17	21	25	32	38
MSE-HC-M MSE-HC-S 10	CFM	165	220	275	330	385	440	495	550	660	770
	Pt	.017	.029	.043	.060	.082	.108	.136	.168	.243	.331
	Throw	2-3-7	3-4-8	3-5-10	4-6-12	5-7-13	5-8-14	6-9-15	7-10-16	8-12-18	10-13-19
	NC	<15	<15	<15	<15	15	20	24	28	35	41
MSE-HC-M MSE-HC-S 12	CFM	2040	310	390	470	550	630	710	790	940	1100
	Pt	.023	.037	.059	.085	.115	.151	.191	.237	.338	.461
	Throw	2-4-7	4-5-11	5-7-14	5-8-15	6-9-16	7-11-17	8-12-18	9-14-19	11-15-21	13-16-23
	NC	<15	<15	<15	<15	18	23	27	31	38	43
MSE-HC-M MSE-HC-S 14	CFM	320	430	530	540	750	860	960	1070	1280	1500
	Pt	.031	.050	.078	.114	.155	.202	.256	.316	.453	.619
	Throw	3-4-8	4-7-13	6-8-16	7-10-17	8-12-19	9-13-20	10-15-21	11-16-23	13-17-25	15-19-27
	NC	<15	<15	<15	<15	20	25	29	33	40	45

PERFORMANCE NOTES FOR SERIES XG-MSE-HC

All data is tested in accordance with ANSI/ASHRAE 70-2006.

DEFINITION OF UNITS

CFM Cubic Feet per Minute (air)

fpm Velocity of air stream in Feet per Minute

Pv Velocity pressure (inches of water column)

Pt Total pressure (inches of water column)

Throw Horizontal distances in feet to the terminal vel of 150 , 100 and 50fpm with supply air temp 20°F below room air temp

NC Noise criterion, sound pressure level NC ratings are based on sound power level (Lw) re: 10⁻¹² watts minus a 10dB room attenuation in all octave bands

CEILING DIFFUSER ACCESSORIES



XG-900D
Butterfly Damper

PAGE 219



XG-BDS
Steel Butterfly Damper

PAGE 219



XG-D3
Aluminum Radial Opposed Blade Damper

PAGE 219



XG-SD3
Steel Radial Opposed Blade Damper

PAGE 220

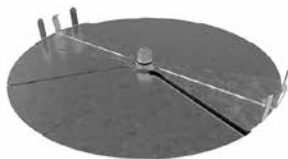

XG-RSD
Radial Shutter Damper

PAGE 220



XG-D5/XG-D7
Opposed Blade Damper

PAGE 220



XG-OBDA
Aluminum Opposed Blade Damper

PAGE 221



XG-OBD
Steel Opposed Blade Damper

PAGE 221

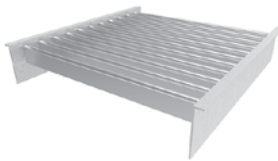

XG-L9
Square / Rectangular Equalizing Grid

PAGE 221

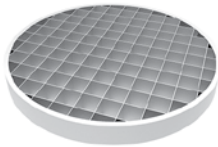

XG-G3
Round Equalizing Grid

PAGE 221



XG-GD3
Round Equalizing Grid

PAGE 222

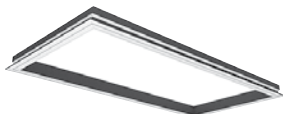

XG-TBPF
T-bar Plaster Frames permit installation

PAGE 222

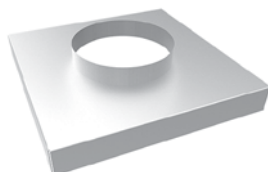

XG-TR/XG-TR DEEP
Deep Square to Round Transitions

PAGE 222

MODEL XG-900D

Model XG-900D opposed blade damper

- Butterfly style blades for sizes 6" to 12"
- 8 blade radial style for size 14"
- Blades adjusted through diffuser face
- Damper supplied with mounting hardware

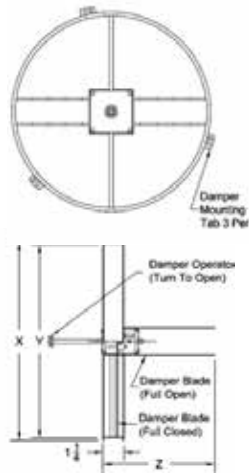

XG-900D & XG-900D* Models			
Damper Sizes	X	Y	Z
6	5 15/16	5 5/8	3
8	7 15/16	7 5/8	4
10	9 15/16	9 5/8	5
12	11 15/16	11 5/8	6
14	13 15/16	13 5/8	7

MODEL XG-BDS

Model XG-BDS butterfly damper

- Two butterfly style blades
- Blades are adjusted through the diffuser face

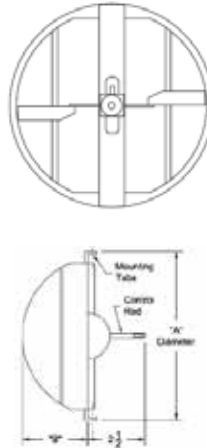

Diffuser Neck Size	XG-BDS Dimension	
	A	B
6	5 3/4	2 1/2
8	7 3/4	3 1/2
10	9 3/4	4 1/2
12	11 3/4	5 1/2
14	13 3/4	6 1/2
15	14 3/4	7
16	15 3/4	7 1/2

MODEL XG-D3

Model XG-D3 radial opposed blade damper

- For use in round diffusers
- Designed to provide full radial volume control resulting in lower than normal pressure losses
- Overlapping blade design ensures positive shut-off when required

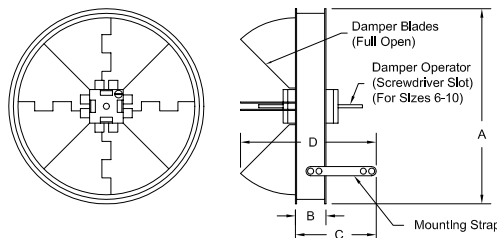

Size	A	B	C	D
6	5 7/8	1 1/4	3 1/4	4 3/4
8	7 7/8	1 1/4	3 3/4	5 1/4
10	9 7/8	1 1/4	3 3/4	6
12	11 7/8	2 1/8	3 7/8	6 5/8
14	13 7/8	2 1/8	3 7/8	7 1/8
16	15 7/8	2 1/8	3 7/8	8 7/8
18	17 7/8	2 1/8	3 7/8	9 3/8
20	19 7/8	2 1/8	3 7/8	9 7/8

MODEL XG-SD3

Model XG-SD3 radial opposed blade damper

- For use in round air diffusers
- Designed to provide full radial volume control resulting in lower than normal pressure losses
- Overlapping blade design ensures positive shut-off when required
- Steel construction

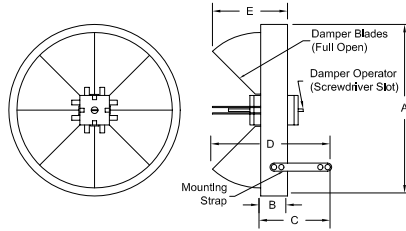

Size	A	B	C	D	E
6	5 7/8	1 1/8	3 7/8	4 1/8	2 1/8
8	7 7/8	1 7/8	3 7/8	4 7/8	2 7/8
10	9 7/8	1 7/8	3 7/8	5 5/8	3 5/8
12	11 7/8	1 7/8	3 5/8	6	4 1/4
14	13 7/8	1 7/8	3 5/8	6 3/4	5
16	15 7/8	1 7/8	3 5/8	7 3/8	5 5/8
18	17 7/8	1 7/8	3 5/8	8 1/8	6 3/8
20	19 7/8	1 7/8	3 5/8	8 7/8	7 7/16
24	23 7/8	1 7/8	3 5/8	7 3/4	6
30	29 7/8	1 7/8	6	11 5/8	7 1/2
36	35 7/8	1 7/8	6	13 1/8	9

MODEL XG-RSD

Model XG-RSD radial shutter damper

- Cost effective alternative to butterfly style damper
- Design permits very precise damper control and does not interfere with diffuser air patterns
- Steel construction

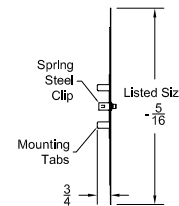
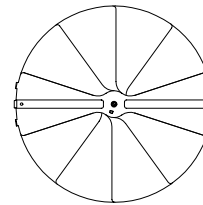

Available Sizes
6
8
10
12

MODEL XG-D5/XG-D7

Model XG-D5/XG-D7 opposed blade damper for XG-5000 and XG-7000

- For use with Series XG-5000, XG-D5, and Series XG-7000, XG-D7.
- Aluminum construction, XG-D5A/ XG-D7A
- Steel construction, XG-D5/XG-D7

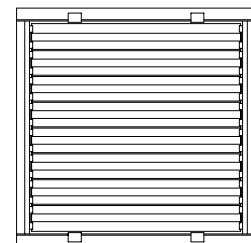
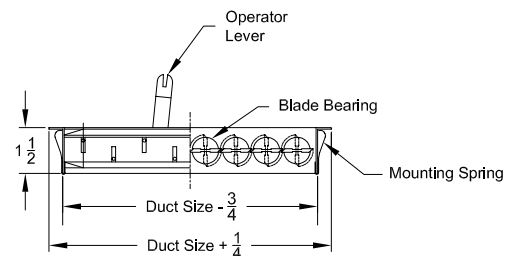

MODEL XG-OBDA/XG-OB

Model XG-OBDA/XG-OB square/rectangular opposed blade damper

- Tapered blades set in a U-channel frame
- Opposed blades on 1" centers
- Screwdriver slot operator
- Aluminum construction, XG-OBDA
- Steel construction, XG-OB

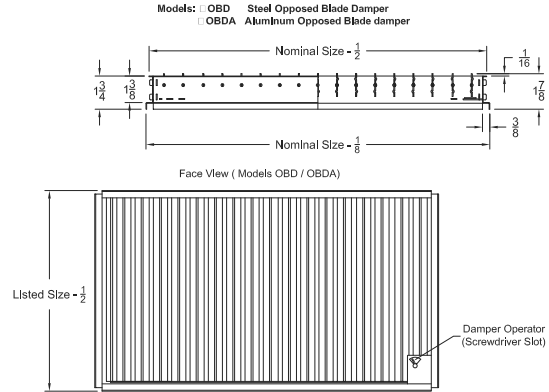

MODEL XG-L9

Model XG-L9 – Square/Rectangular Equalizing Grid

- Designed to provide uniform airflow in branch ducts
- Pre-tensioned blades adjust individually
- Aluminum construction

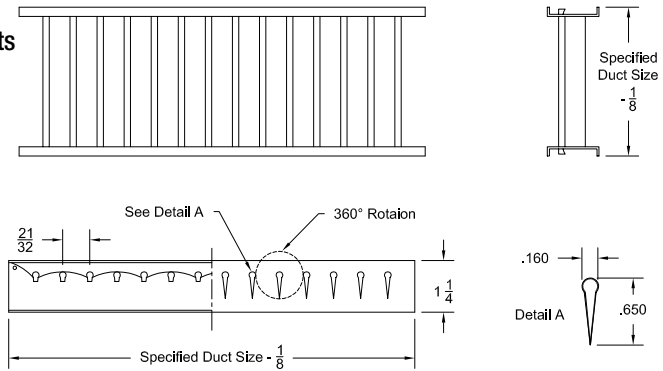

MODEL XG-G3

Model XG-G3 Round Equalizing Grid

- Aluminum construction
- Available in sizes from 6" to 24"

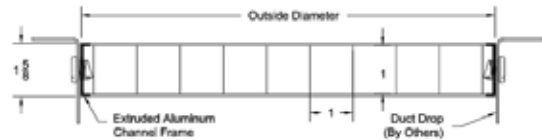

Diffuser Neck Diameter								
6	8	10	12	14	16	18	20	24
XG-G3 Outside Diameter								
5 3/4	7 3/4	9 3/4	11 3/4	13 3/4	15 3/4	17 3/4	19 3/4	23 3/4

MODEL XG-GD3

Model XG-GD3 Round Combination Grid and Damper

- For use with all diffusers
- Aluminum construction
- Sizes available from 6" to 20"

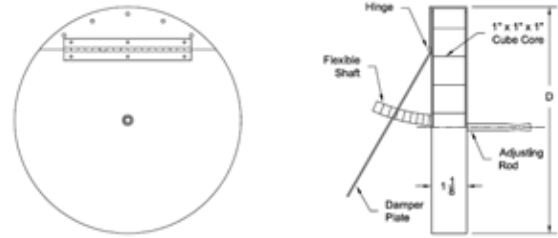

Dimension								
Size	6	6	10	12	14	16	18	20
D	5 7/8	7 7/8	9 7/8	11 7/8	13 7/8	15 7/8	17 7/8	19 7/8

MODEL XG-TBPF

Model XG-TBPF T-bar Plaster Frames permit installation of T-bar frame style ceiling diffusers into plaster frame or gypsum ceilings, and are available in standard T-bar sizes.

- Converts T-bar frame to Surface Mount
- Available in aluminum, XG-TBPF, or steel, XG-STBPF, construction

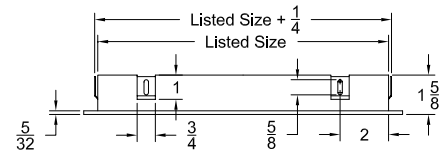

Available Size (XG-TBPF and XG-STBPF Models)	
Nominal	Overall
12 x 12	13 3/16 x 13 3/16
24 x 12	25 3/16 x 13 3/16
24 x 24	25 3/16 x 25 3/16
36 x 24	37 3/16 x 25 3/16
36 x 36	37 3/16 x 37 3/16
48 x 24	49 3/16 x 25 3/16
48 x 48	49 3/16 x 49 3/16
13 x 13	14 3/16 x 14 3/16

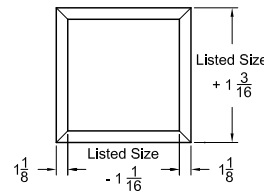

MODEL XG-TR/XG-TR DEEP

Model XG-TR/XG-TR Deep Square to Round Transitions

- Available for all ducted supply and return diffusers
- Provide economical means of adapting square neck diffusers to round neck connections
- TR Deep transitions provide additional depth to accommodate some dampers

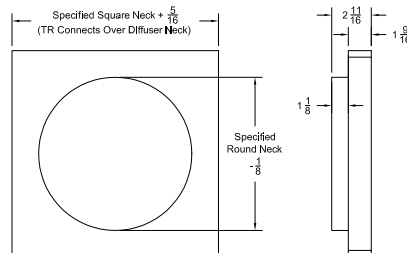

Available Size	
Square Neck Size	Round Neck Size
6 x 6	4, 5 & 6
8 x 8	5, 6, 7 & 8
9 x 9	5, 6, 7, 8 & 9
10 x 10	5, 6, 7, 8, 9 & 10
12 x 12	5, 6, 7, 8, 9, 10, 11 & 12
14 x 14	5, 6, 7, 8, 9, 10, 11, 12 & 14
15 x 15	5, 6, 7, 8, 9, 10, 11, 12, 14 & 15
16 x 16	5, 6, 7, 8, 9, 10, 11, 12, 14, 15 & 16
18 x 18	5, 6, 7, 8, 9, 10, 11, 12, 14, 15, 16 & 18
22 x 22	5, 6, 7, 8, 9, 10, 11, 12, 14, 15, 16, 18, 20 & 22

Design and Selection Support

Enjoy Greenheck's extraordinary service, before, during and after the sale.

Greenheck offers added value to our wide selection of top performing, energy-efficient products by providing several unique service programs.



Our Quick Delivery program ensures shipment of in-stock products within 24 hours of placing your order. Our Quick Build made-to-order products are manufactured in 1-3-5-10-15 or 25-day production cycles, depending upon its complexity.



Greenheck's free computer aided product selection program CAPS®, rated by many as the best in the industry, helps you conveniently and efficiently select the right products for the challenge at hand.



Our 3D service allows you to download, at no charge, easy-to-use AutoDesk® Revit® 3D drawings for many of our ventilation products.

Find out more about these special services at greenheck.com

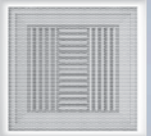

Building Value in Air

Greenheck delivers value to mechanical engineers by helping them solve virtually any air quality challenges their clients face with a comprehensive selection of

top quality, innovative air-related equipment. We offer extra value to contractors by providing easy-to-install, competitively priced, reliable products that arrive on time.

And building owners and occupants value the energy efficiency, low maintenance and quiet dependable operation they experience long after the construction project ends.

Our Commitment

As a result of our commitment to continuous improvement, Greenheck reserves the right to change specifications without notice.

Specific Greenheck product warranties are located on greenheck.com within the product area tabs and in the Library under Warranties.

