



You have downloaded a document from
RE-BUŚ
repository of the University of Silesia in Katowice

Title: Dovyrenite $\text{Ca}_6\text{Zr}[\text{Si}_2\text{O}_7]_2(\text{OH})_4$ - A new mineral from skarned carbonate xenoliths in basic-ultrabasic rocks of the Ioko-Dovyren Massif, Northern Baikal Region, Russia

Author: Evgeny V. Galuskin, Nikolai N. Pertsev, Thomas Armbruster, Milen Kadiyski, Aleksander E. Zadov, Irina O. Galuskina, Piotr Dzierżanowski, Roman Wrzalik, Evgeny V. Kislov

Citation style: Galuskin Evgeny V., Pertsev Nikolai N., Armbruster Thomas, Kadiyski Milen, Zadov Aleksander E., Galuskina Irina O., Dzierżanowski Piotr, Wrzalik Roman, Kislov Evgeny V. (2007). Dovyrenite $\text{Ca}_6\text{Zr}[\text{Si}_2\text{O}_7]_2(\text{OH})_4$ - A new mineral from skarned carbonate xenoliths in basic-ultrabasic rocks of the Ioko-Dovyren Massif, Northern Baikal Region, Russia. "Mineralogia Polonica" (Vol. 38, iss. 1 (2007), s. 15-28), doi 10.2478/v10002-007-0012-y



Uznanie autorstwa - Użycie niekomercyjne - Bez utworów zależnych Polska - Licencja ta zezwala na rozpowszechnianie, przedstawianie i wykonywanie utworu jedynie w celach niekomercyjnych oraz pod warunkiem zachowania go w oryginalnej postaci (nie tworzenia utworów zależnych).



UNIwersYTET ŚLĄSKI
W KATOWICACH



Biblioteka
Uniwersytetu Śląskiego



Ministerstwo Nauki
i Szkolnictwa Wyższego

*Evgeny V. GALUSKIN*¹, *Nikolai N. PERTSEV*², *Thomas ARMBRUSTER*³,
*Milen KADIYSKI*³, *Aleksander E. ZADOV*⁴, *Irina O. GALUSKINA*¹,
*Piotr DZIERŻANOWSKI*⁵, *Roman WRZALIK*⁶, *Evgeny V. KISLOV*⁷

**DOVYRENITE $\text{Ca}_6\text{Zr}[\text{Si}_2\text{O}_7]_2(\text{OH})_4$ – A NEW MINERAL FROM SKARNED
CARBONATE XENOLITHS IN BASIC-ULTRABASIC ROCKS
OF THE IOKO-DOVYREN MASSIF, NORTHERN BAIKAL REGION, RUSSIA**

Received April 15, 2006; accepted May 21, 2006

Abstract. Dovyrenite, simplified formula $\text{Ca}_6\text{Zr}[\text{Si}_2\text{O}_7]_2(\text{OH})_4$, occurs as an accessory mineral in vein skarns developed in carbonate xenoliths in subvolcanic layered plagioclone-troctolite series in the Ioko-Dovyren Massif of Proterozoic age, Northern Baikal Region, Buryatia, Russia. Dovyrenite is a late mineral of altered pyroxene and melilite-monticellite skarns. Associated minerals are Zr-bearing phases: fassaite pyroxene, perovskite and hydrogarnets; and also monticellite, vesuvianite, diopside, foshagite, brucite, calzirtite, tazheranite, baghdadite, apatite, calcite, native bismuth, sphalerite, selenian galena, clausenthalite, safflorite, rammelsbergite, pyrrhotite, pentlandite, valleriite, laitakarite, nickeline, nickel-skutterudite. The average structure of dovyrenite is orthorhombic, space group *Pnmm*, with subcell parameters $A = 5.666(16)$ Å, $B = 18.844(5)$ Å, $C = 3.728(11)$ Å, $V = 398.0(2)$ Å³ and $Z = 1$. Dovyrenite shows a new type of modular structure with stacking of the tobermorite-like and the rosenbuschite-like layers parallel to (010). Single-crystal structural data point to an incompletely occupied Ca(2) site from the rosenbuschite module which is confirmed by microprobe analyses: ZrO₂ 16.47, SiO₂ 32.83, TiO₂ 0.14, HfO₂ 0.16, Cr₂O₃ 0.01, CaO 43.87, FeO 0.25, MgO 0.13, MnO 0.02, Nb₂O₃ 0.03; total 99.38 wt% with calculated H₂O. The empirical formula is $(\text{Ca}_{5.73}\text{Fe}_{0.03}\text{Mg}_{0.02})_{\Sigma 5.78}(\text{Zr}_{0.98}\text{Hf}_{0.01}\text{Ti}_{0.01})_{\Sigma 1}\text{Si}_4(\text{O}_{13.56}\text{OH}_{0.44})_{\Sigma 14}(\text{OH})_4$. The presence of two types of OH group in the dovyrenite structure is corroborated by FTIR and Raman spectroscopy. Dovyrenite is an optically positive biaxial mineral: α 1.659(2), β 1.660(2); γ 1.676(2); $2V_z$ 30(5)° (measured), 28° (calculated).

¹ Faculty of Earth Sciences, Department of Geochemistry, Mineralogy and Petrography, University of Silesia, Będzińska 60, 41-200 Sosnowiec, Poland; e-mail: galuskin@us.edu.pl, irina@wnoz.us.edu.pl

² Institute of Geology of Ore Deposits, Geochemistry, Mineralogy and Petrography (IGEM) RAS, Staromonetny 35, Moscow, Russia.

³ Mineralogical Crystallography, Institute of Geological Sciences, University of Bern, Freiestr. 3, CH-3012 Bern, Switzerland.

⁴ Sci.-Research Center "NEOCHEM", Altuf'evskoye Highway 43, Moscow, Russia.

⁵ Institute of Geochemistry, Mineralogy and Petrology, Warsaw University, al. Żwirki i Wigury 93, 02-089 Warszawa, Poland.

⁶ Institute of Physics, University of Silesia, Uniwersytecka 4, 40-007 Katowice, Poland.

⁷ Institute of Geology, Siberian Branch, RAS, Sakhyanova Str. 6, 670042 Ulan-Ude, Russia.

The coexistence of monticellite, foshagite and dovyrenite points to a narrow interval of crystallization 560–630°C under subvolcanic conditions ($P < 10^8$ Pa).

Key-words: dovyrenite, new mineral, structure, FTIR, Raman, skarn, xenoliths, Ioko-Dovyren Massif, Buryatia, Russia

INTRODUCTION

A new mineral $\text{Ca}_6\text{Zr}[\text{Si}_2\text{O}_7]_2(\text{OH})_4$, named by us as dovyrenite, was discovered during investigations of zirconium mineralization in skarned carbonate xenoliths from sub volcanic rocks in the layered Ioko-Dovyren (Dovyren) dunite-troctolite-gabbro massif (Buryatia, Northern Baikal Region, Russia). Dovyrenite is an accessory mineral that formed as a result of the alteration of zirconium minerals and Zr-bearing minerals. The mineral and its name were approved by the Commission of New Minerals, Mineral Nomenclature and Classification (CNMNC-2007-02). Dovyrenite has been named after the geographical name of the locality – Dovyren Bald Mountain (Ioko-Dovyren layered massif). Dovyrenite represents a new modular structural type, which has no analogue among minerals and synthetic phases. The type specimen has been deposited as the number 3545 in the Fersman Mineralogical Museum, Russian Academy of Sciences, Moscow.

OCCURRENCE

The new mineral dovyrenite was discovered in skarned carbonate xenoliths within the layered Ioko-Dovyren dunite-troctolite-gabbro massif of Proterozoic age (~700 Ma) located 60 km north of Lake Baikal at 56.5°N and 110°E (Gurulev 1983; Konnikov 1986; Kislov 1998; Wenzel et al. 2002; Pertsev et al. 2003; Zadov et al. 2004). The xenoliths trace a dolomitic level in dunite and plagioclone-troctolite layers in the massif. The dovyrenite was discovered in vein-like skarns within a gigantic xenolith penetrated by the dalles Belyi Brook on the north-east flank of the Dovyren Bald Mountain.

The vein skarns are characterized by a central zone of dark brown Zr-bearing titanian aluminous pyroxene (fassaite pyroxene) with acicular hydroxylapatite in-growths. The pyroxene zone is bordered by a zone of mainly melilite-monticellite composition that also contains large crystals of Zr-bearing perovskite (Fig. 1). The fassaite pyroxene and the marginal zones were altered to a different degree by post-magmatic processes resulting in the formation of diopside, vesuvianite, garnet, foshagite and brucite (Fig. 2). Ore minerals are represented by native bismuth, sphalerite, selenian galena, clausthalite, safflorite, rammelsbergite, pyrrothite, pentlandite, valeriite, laitakarite, nickeline, nickel-skutterudite and undefined Ni-Co-As-Sb-minerals occurring in small calcite patches. Dovyrenite is a secondary, low-temperature mineral that formed using zirconium released from early skarn minerals. Different morphological types of dovyrenite occupy distinct positions in the rock (Fig. 2):

1. Xenomorphic dovyrenite crystals, ranging up to 100 μm and associated with dispersed Zr-free perovskite, enrich vesuvianite rims $<3\text{--}4\text{ mm}$ thick on fassaitic pyroxene (Fig. 3A, B). On the junctions of these rims with porous vesuvianite-foshagite skarn fragments, aggregates of acicular dovyrenite, baghdadite, foshagite and skeletal Zr-bearing hydrogarnets (grossular-andradite-schorlomite series) occur in brucite (Fig. 3C) and, occasionally, in calcium hydrosilicates (plombierite?).

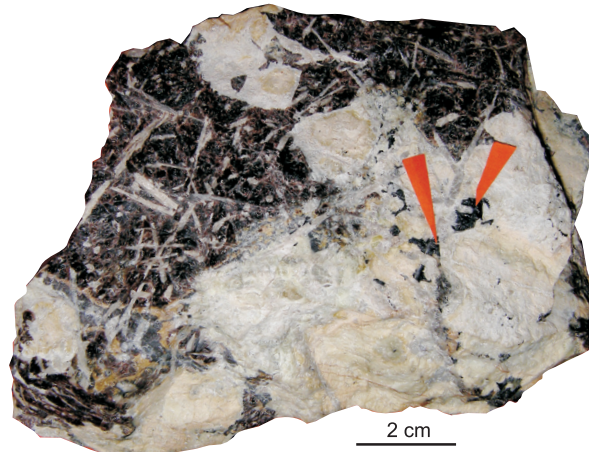

Fig. 1. A dark-brown Zr-bearing fassaitic pyroxene zone is surrounded by white melilite-monticellite zone with Zr-bearing perovskite (red arrows).

The melilite-monticellite zone is replaced by secondary calcium silicates.
The dark crystals (pyroxene, perovskite) host white acicular crystals of hydroxylapatite

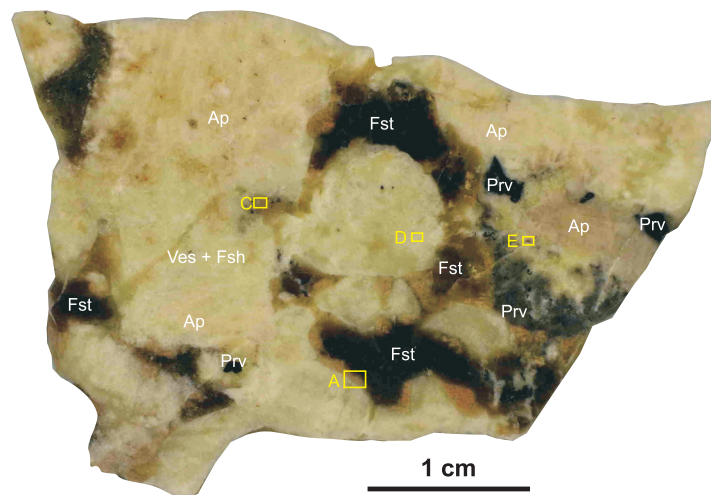

Fig. 2. Polished plate of vesuvianite-foshagite skarn with dark xenomorphic grains of fassaitic pyroxene.

Different morphological types of dovyrenite are marked by frames (see text).

Ap – apatite, Fst – fassaitic pyroxene, Prv – perovskite, Ves – vesuvianite, Fsh – foshagite,
Dov – dovyrenite, Di – diopside, Brc – brucite, Adr – hydrogarnet, Clz – calzirtite, Bgh – baghdadite,
Mtc – monticellite

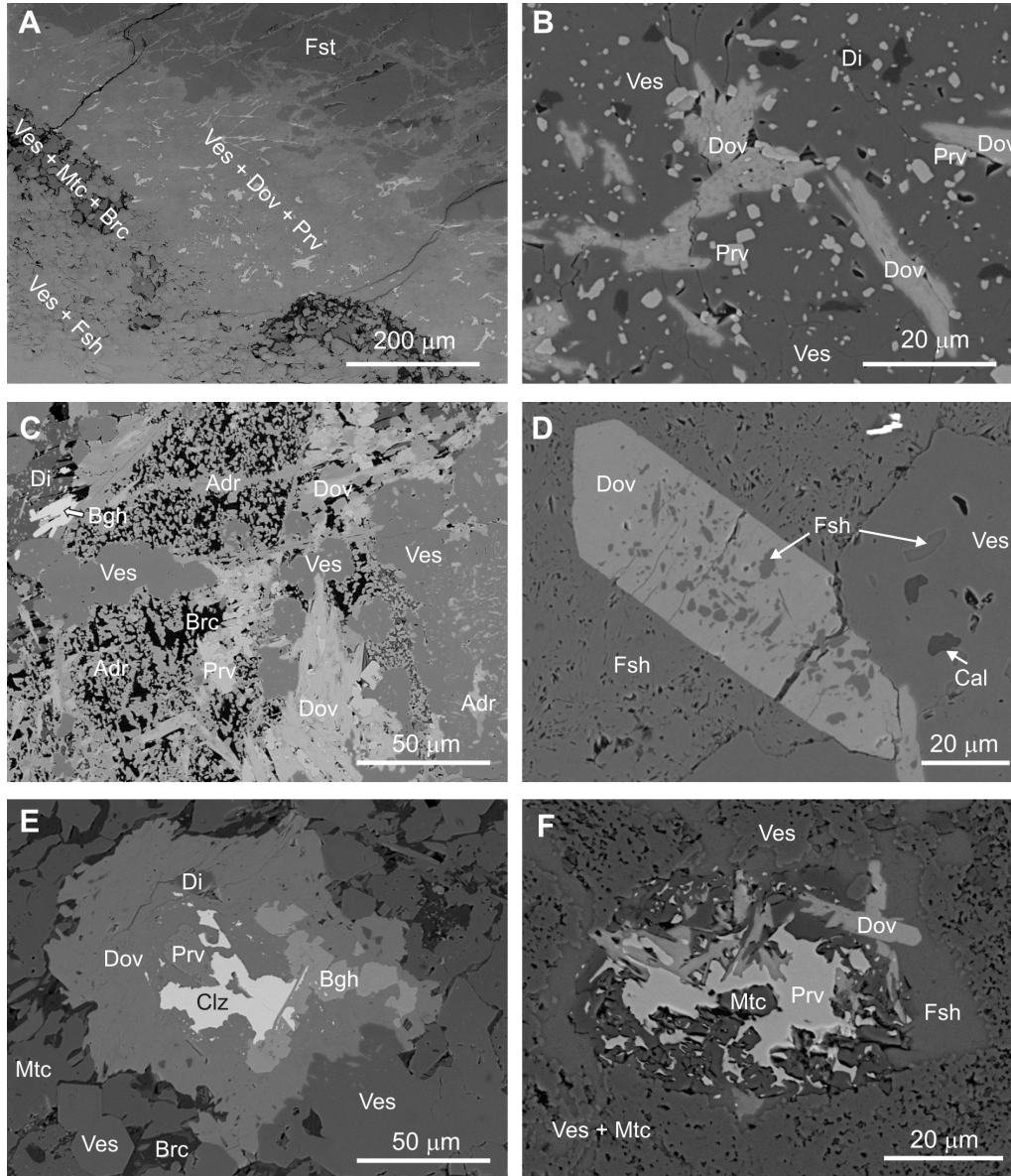

Fig. 3. BSE image of different morphological and genetic types of dovyrenite.

- A – general view of the vesuvianite reaction rim on crystals of fassaitic pyroxene now represented by a paragenesis of Ves+Dov+Prv; B – the magnified fragment of Fig. A – the vesuvianite rim enriched with dispersed perovskite; C – the zone intermediate between the vesuvianite rim on fassaitic pyroxene and zone of vesuvianite-foshagite skarns. Acicular crystals of dovyrenite and baghdadite, and small isometric perovskite and skeletal hydrogarnet crystals occupying holes between vesuvianite crystals; D – large dovyrenite crystal in vesuvianite-foshagite skarn; E – substitution of calzirtite by dovyrenite in monticellite zone; F – dovyrenite in complex pseudomorphs after Zr-bearing perovskite

2. Rare colorless crystals ($< 300 \mu\text{m}$ long, Figs 3D, 4) and stellate growths of dovyrenite are seen in foshagite-vesuvianite skarn.
3. Dovyrenite forms polycrystalline reaction rims ($< 200\text{--}250 \mu\text{m}$ thick) on calzirtite – a mineral characteristic of fragments of vesuvianite-monticellite skarn (Fig. 3e). Single-crystal structural investigations revealed domains of the cubic polymorph (tazheranite) in the tetragonal calzirtite.
4. Small amounts of dovyrenite occur in skarn zones comprising symplectite-like aggregates of vesuvianite and monticellite formed by the breakdown of melilite-group minerals at temperatures below 650°C . The dovyrenite is hosted in pseudomorphs after Zr-bearing perovskite (Fig. 3F).

The skarn sample showing the different dovyrenite morphologies from which dovyrenite crystals were chosen for structural investigations, and from which thin sections were prepared for studies of composition and physical properties, has been registered as a holotype specimen with the number 3545 in the Fersman Mineralogical Museum, Russian Academy of Sciences, Moscow.

It should be emphasized that the characteristic forms of dovyrenite can be distinguished on the naturally-etched surface of the rock, but with difficulty as dovyrenite is similar to foshagite, vesuvianite and other colourless silicates present. Therefore, environmental scanning electron microscopy (Philips XL30 ESEM) was used to distinguish the dovyrenite crystals (Fig. 4).

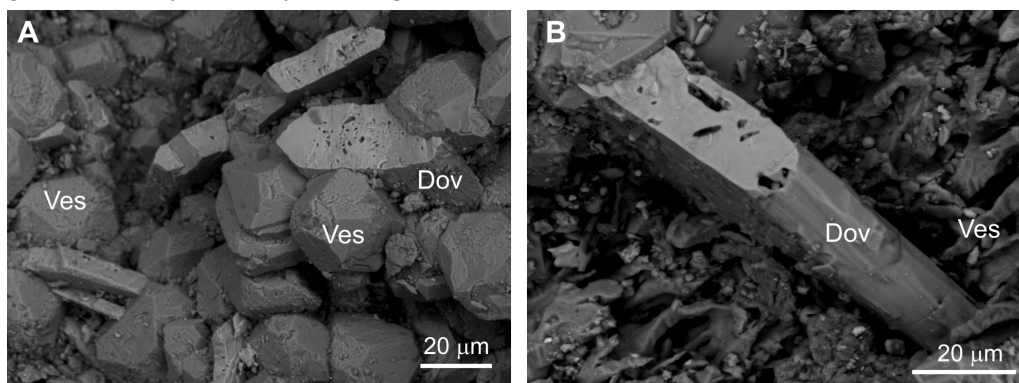

Fig. 4. Dovyrenite crystals on the surface of naturally-etched samples of vesuvianite-foshagite skarn, BSE image, non-coated sample, low vacuum (LV, 0.3 Torr).
 A – dovyrenite crystals with orthorhombic cross-sections;
 B – crystal with preserved orthorhombic prism $\{0kl\}$

MORPHOLOGY AND PHYSICAL PROPERTIES

Dovyrenite is colourless, transparent and has a vitreous luster. It is white in aggregates and in powder. It forms prismatic crystals flattened along $[100]$, elongated along $[001]$ and with an orthorhombic cross-section (Figs 4, 5A, 6A, 7A). Crystals are typically characterized by three simple forms: $\{100\}$, $\{140\}$ and $\{081\}$? The forms $\{010\}$

and {410}? occur as narrow faces. The appearance of irrational indices for the simple forms are due to the fact that single crystal structural investigations allow only the family cell dimensions of the dovyrenite structure to be defined (see description of structure). Dovyrenite has a perfect cleavage on (010) and imperfect cleavages on (100), (001) and (140) (Figs 5, 7A). Fracture on (010) may be even, uneven or stepped.

Dovyrenite is an optically positive mineral with the refractive indices: α 1.659(2), β 1.660(2), γ 1.676(2) and $2V_z$ (measured) $30(5)^\circ$, $2V_z$ (calculated) 28° . The optical orientation is as follows: A = Z (γ , Ng), B = X (α , Np), C = Y (β , Nm) – see Fig. 5B.

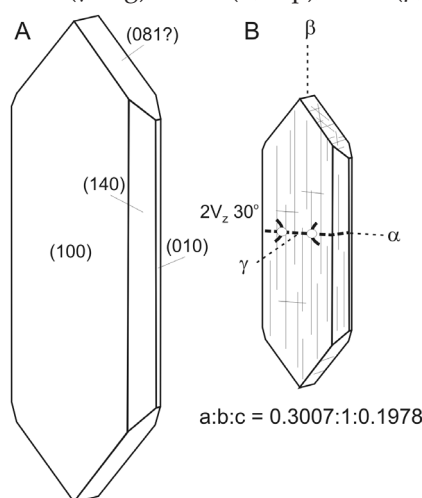

Fig. 5. Simple forms and optical orientation of dovyrenite crystals

Dovyrenite shows a significant micro-indentation hardness anisotropy. The results of VHN_{10} measurements on un-oriented grains divide into two separate populations – $103\text{--}114 \text{ kg/mm}^2$ (the mean from seven measurements is 108 kg/mm^2) and $156\text{--}174 \text{ kg/mm}^2$ (the mean from six measurements is 165 kg/mm^2). Mohs hardness is 3–4. The mineral displays blue cathodoluminescence. It is soluble in dilute HCl but insoluble in water.

The density of dovyrenite was not measured directly because of the small size of its crystals. The calculated density is 3.034 g/cm^3 . The Gladstone-Dale compatibility index (K_p/K_C) is -0.011 (“superior” according to Mandarino (1981) for the calculated density).

CHEMICAL COMPOSITION AND DOVYRENITE FORMULA

The chemical composition of dovyrenite was determined using a microprobe analyzer (CAMECA SX100, Faculty of Geology, Warsaw University) operating under following conditions: 15 kV, 10–20 nA, beam spot 3–10 μm . During the measurements, the following lines and standards were used: $ZrL\alpha$ – zircon, ZrO_2 ; $CaK\alpha$, $SiK\alpha$, $MgK\alpha$ – diopside; $TiK\alpha$ – rutile synth.; $CrK\alpha$ – Cr_2O_3 synth.; $YL\alpha$ – YAG; $AlK\alpha$ – orthoclase; $FeK\alpha$ – hematite; $MnK\alpha$ – rhodochrosite; $HfM\beta$ – HfO_2 ; $NbL\alpha$, $VK\alpha$ – pure metals.

The contents of F, Ta, B, Na, K and other elements are below the detection limit. Correction was calculated according to the PAP procedure. Dovyrenite is a mineral that is unstable under a microprobe beam.

The compositions of different types of dovyrenite crystals and their aggregates, and the theoretical composition of the mineral, are given in Table 1. Dovyrenite has a very stable composition with negligible variation in impurity-element contents.

TABLE 1

Electron microprobe analyses of dovyrenite (wt%)

	1	s.d.	Ranges	2	3	4	5
ZrO ₂	16.47	0.37	15.73–17.25	16.57	15.87	16.46	16.74
SiO ₂	32.83	0.24	32.45–33.32	32.75	32.96	32.46	32.65
TiO ₂	0.14	0.14	0–0.40	0.12	0.35	0.12	
HfO ₂	0.16	0.10	0.07–0.49	0.13	0.45	0.27	
Y ₂ O ₃	n.d.			0.01	0.03	0.01	
Al ₂ O ₃	n.d.			n.d.	n.d.	0.02	
Cr ₂ O ₃	0.01	0.01	0–0.03	0.01	0.01	0.02	
CaO	43.87	0.40	43.19–44.51	43.68	43.81	43.83	45.71
FeO	0.25	0.08	0.12–0.38	0.18	0.14	0.17	
MgO	0.13	0.04	0.06–0.22	0.09	0.23	0.17	
MnO	0.02	0.03	0–0.07	0.05	0.03	0.03	
Nb ₂ O ₅	0.03	0.04	0–0.10	0.01	0.04	n.d.	
V ₂ O ₃	n.m.			n.m.	n.m.	0.02	
H ₂ O	5.47	0.23	5.0–6.0	5.49	5.59	5.18	4.90
Total	99.38		98.87–100.34	99.09	99.51	98.76	100.00
Ca	5.727			5.716	5.696	5.787	
Fe ²⁺	0.025			0.018	0.014	0.018	
Mg	0.024			0.016	0.042	0.031	
Mn ²⁺	0.002			0.005	0.003	0.003	
X	5.778			5.755	5.755	5.839	6
Zr	0.979			0.987	0.939	0.989	
Ti ⁴⁺	0.013			0.011	0.032	0.011	
Hf	0.006			0.005	0.016	0.009	
Cr ³⁺	0.001			0.001	0.001	0.002	
Nb ⁵⁺	0.002			0.001	0.002		
Y				0.001	0.002	0.001	
Al						0.003	
V ³⁺						0.002	
<i>M</i>	1.001			1.006	0.992	1.017	1
<i>Si</i>	4			4	4	4	4
OH	4.446			4.473	4.525	4.258	4

1 – Contents based on mean of 24 analyses of dovyrenite crystals in foshagite-vesuvianite skarn; 2 – dovyrenite (five analyses) replacing calzirtite; 3 – dovyrenite (four analyses) from products of fassaitic pyroxene alteration; 4 – dovyrenite (four analyses) from pseudomorphs after perovskite; 5 – theoretical dovyrenite composition; s.d. – standard deviation, n.m. – not measured, n.d. – not detected.

The crystal chemical formula of dovyrenite was calculated on the number of cations and normalized on four Si, which was defined by the deficiency of calcium at the Ca(2) site (Kadiyski et al. in press). The OH-group content was calculated on the basis of the charge balance. The crystal chemical formula with the structural sites in mind (Kadiyski et al. in press) may be written as follows: $\text{Ca}^{\text{II}}_{1-x}\text{Ca}^{\text{III}}\text{Zr}^{\text{III}}(\text{OH})_4\{\text{Ca}^{\text{I}}_4[\text{Si}_2\text{O}_{7-x}(\text{OH})_x]_2\}$, where $0.06 < x < 0.28$. $\text{Ca}_4[\text{Si}_2\text{O}_7]_2$ is a tobermorite-like module, and $\text{CaCaZr}(\text{OH})_4$ is an octahedral module (see description of the structure). When $x = 0$, the formula takes the form $\text{CaCaZr}(\text{OH})_4\text{Ca}_4[\text{Si}_2\text{O}_7]_2$. A simplified formula for dovyrenite may be written as $\text{Ca}_6\text{ZrSi}_4\text{O}_{14}(\text{OH})_4$ or $\text{Ca}_6\text{Zr}[\text{Si}_2\text{O}_7]_2(\text{OH})_4$.

SPECTROSCOPIC INVESTIGATIONS AND STRUCTURE

Unpolarized FTIR and Raman spectra were obtained from the natural face (100) of the dovyrenite (Fig. 6, 7). Reflectance infrared spectra were investigated using a Bio-Rad FTS-6000 spectrometer equipped with an infrared microscope of the Bio-Rad

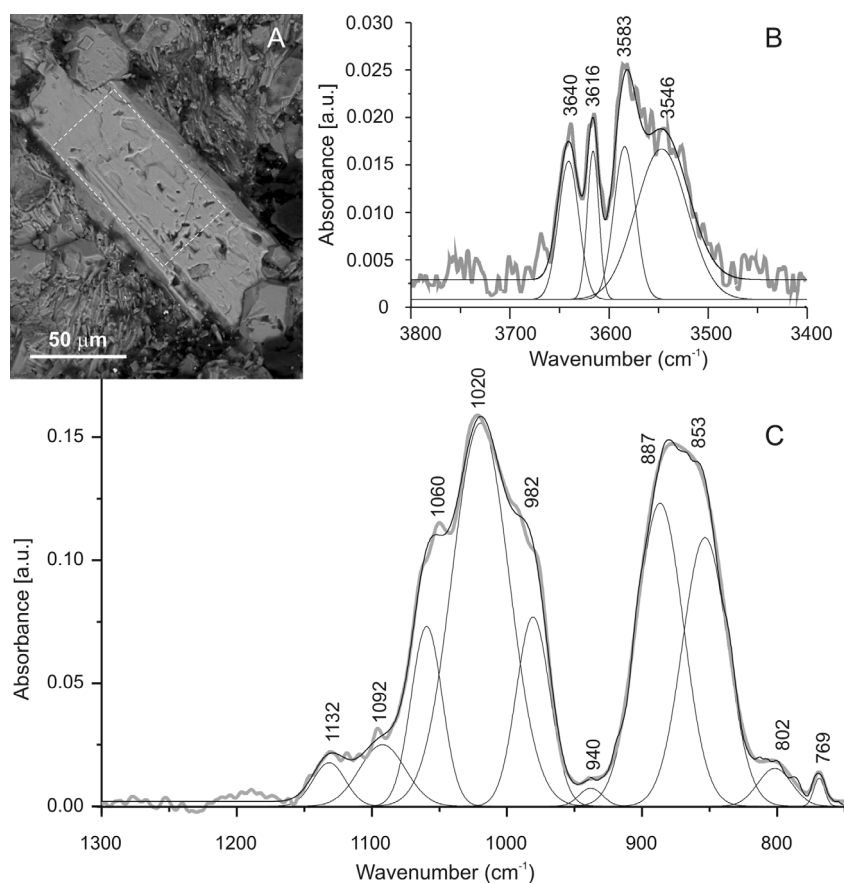

Fig. 6. Infrared spectra (B, C) from the {100} surface of a dovyrenite crystal (A, BSE, LV 0.2 Torr)

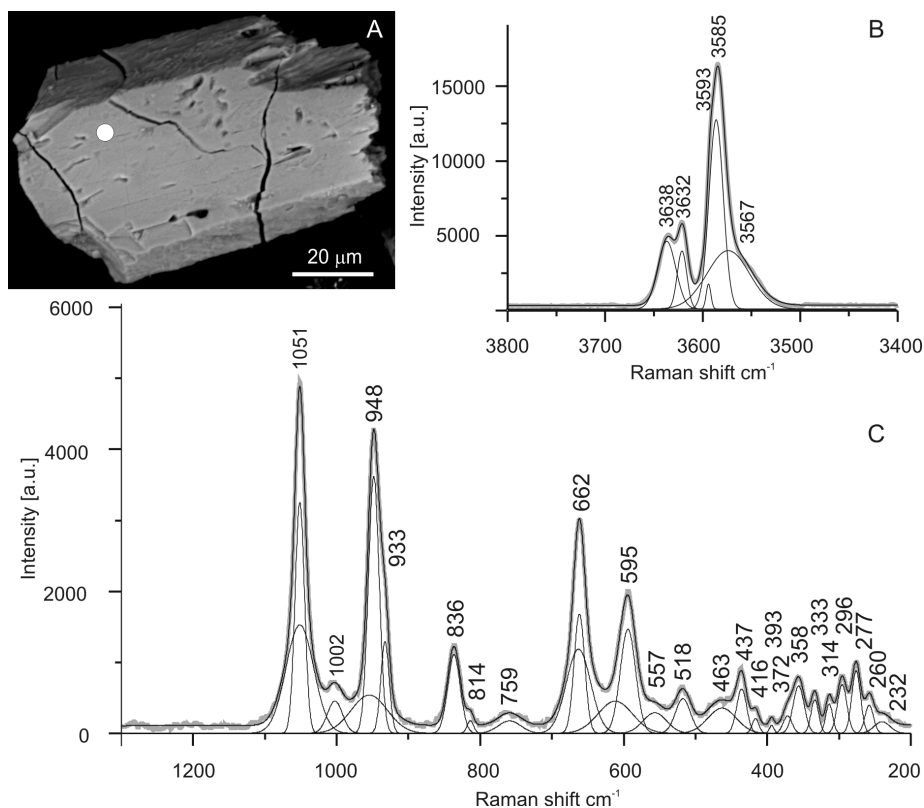

Fig. 7. Raman spectra (B, C) from the {100} surface of a dovyrenite crystal (A, BSE, LV 0.1 Torr) on which traces of perfect (010) cleavage are clear

UMA-500 type. The microscope had its own 250 × 250 mm mercury-cadmium-telluride detector (MTC) cooled to 77 K by liquid nitrogen. The spectra were obtained in the range 6000–750 cm^{-1} with a resolution of 4 cm^{-1} . The recording of the interferograms involved the accumulation of 512 scans. A gold-covered microscope slide was used to obtain the background spectra. The infrared radiation reflected from the (100) face of the dovyrenite crystal ($60 \times 100 \mu\text{m}$) was passed to the spectrometer. Spectra were obtained with a shape similar to standard absorption transmission spectra by applying Fourier and Kramers-Krönig transformations. The following bands were identified in the FTIR spectrum of dovyrenite: 3640 cm^{-1} , 3616 cm^{-1} , 3583 cm^{-1} , 3546 cm^{-1} , 1132 cm^{-1} , 1092 cm^{-1} , 1060 cm^{-1} , 1020 cm^{-1} , 982 cm^{-1} , 940 cm^{-1} , 887 cm^{-1} , 853 cm^{-1} , 802 cm^{-1} , 769 cm^{-1} (Fig. 6; main bands underlined).

Raman spectra of the (100) natural crystal face were recorded using a LabRam System spectrometer (Jobin-Yvone-Horiba) at room temperature. Argon-ion laser light of 514.5 nm was used to excite the spectra (Fig. 7). The power at the sample was below 20 mW. To eliminate the Rayleigh line, the scattered light was passed through a holographic notch filter with a cut-off at 100 cm^{-1} . The Raman spectra were recorded in 0° degree geometry in the range 100–4000 cm^{-1} with a spectral resolution of 3.5 cm^{-1} .

A collection time of 60 s and an accumulation of 4–10 scans were chosen. The monochromator was calibrated using a silicone plate (520.7 cm^{-1}). The following lines were observed in an unpolarized Raman spectrum. In the OH region, there are the neighboring bands: 3638 cm^{-1} , 3632 cm^{-1} , 3593 cm^{-1} , 3585 cm^{-1} and 3567 cm^{-1} . In the region of the fundamental vibrations, Si-O and M-O bands are found at 1051 cm^{-1} , $\sim 1002\text{ cm}^{-1}$, 948 cm^{-1} , 933 cm^{-1} , 836 cm^{-1} , 814 cm^{-1} , $\sim 759\text{ cm}^{-1}$, 662 cm^{-1} , 595 cm^{-1} , $\sim 557\text{ cm}^{-1}$, 518 cm^{-1} , $\sim 463\text{ cm}^{-1}$, 437 cm^{-1} , 416 cm^{-1} , 393 cm^{-1} , 372 cm^{-1} , 358 cm^{-1} , 333 cm^{-1} , 314 cm^{-1} , 296 cm^{-1} , 277 cm^{-1} , 260 cm^{-1} , $\sim 232\text{ cm}^{-1}$ (Fig. 7; main bands underlined).

The Raman spectra for the dovyrenite resemble those of hiortdahlite $\text{Ca}_8(\text{Na,Ca})_4\text{Zr}_2(\text{Zr,Ti,Ca,Mn,Fe})_2(\text{Si}_2\text{O}_7)_4(\text{F,O})_8$ – zirconium diorthosilicate from the cuspidine-låvenite group. The bands $933, 948\text{ cm}^{-1}$ and $662, 595\text{ cm}^{-1}$ belong to the stretched symmetric and bending vibrations in the Si_2O_7 groups, respectively. The bands in the region $200\text{--}400\text{ cm}^{-1}$ are likely to be both translation vibrations of cations and libration modes of the Si_2O_7 dimer. In addition, standard “cuspidine” bands on the dovyrenite spectrum coincide with strong bands characteristic of zirconian cuspidine and hiortdahlite, i.e., 1051 cm^{-1} , 836 cm^{-1} . For example, the bands near $750\text{--}850\text{ cm}^{-1}$ appearing in the spectra of zirconium minerals and Zr-bearing minerals of the cuspidine-låvenite and rosenbuschite groups colligate with the substitution of F by OH groups or by O (Sharygin et al. 1996). The interpretation of the FTIR and Raman spectra shows that there are a few types of the OH-group (of which one is very dominant) and that H_2O and CO_2 are absent.

The dovyrenite structure will be described in detail in a separate paper (Kadyiski et al. in press). Here, we present only a generalized description of the structure and calculated powder diffraction data (Table 2). The single crystal structural data, by its very nature, allowed the reception of “family reflections” only for the possible polytypes of the dovyrenite structural family. The subcell parameters of the generalized structure with the symmetry $Pnmm$ (No. 58) were determined: $A = 5.666(16)$, $B = 18.844(5)$, $C = 3.728(11)\text{ \AA}$, $V = 398.0(2)\text{ \AA}^3$, $Z = 1$. The dovyrenite structure belongs to a new type of modular structure and may embody two modules well known in other minerals (Fig. 8) – the Ca-polyhedron layers of the tobermorite type (Merlino et al. 1999) and the octahedral layers with conjoined disilicate groups which characterize the structure of the rosenbuschite-group minerals (Bellezza et al. 2004). Both types of layers parallel (010) – hence the perfect (010) cleavage in dovyrenite. Topological repetition of the Ca(1)-polyhedron layers explains the observed periodicity of generalized structure (on A and C).

The octahedral module in the generalized dovyrenite structure is formed by three types of octahedrons: the half-filled Ca(3) and Zr(3), agminate in chains, with two alternative variations of the structural ordering, and half-occupied Ca(2) between the chains (Fig. 8), which results in the crystal chemical formula $\text{Ca}_6\text{Zr}[\text{Si}_2\text{O}_7]_2(\text{OH})_4$. However, the refined structure indicates that the Ca(2) site is less than half full (~ 0.36) as is confirmed by the microprobe data (Table 1). The deficiency of Ca at the Ca(2) site is probably balanced by additional H; spectroscopic data indicate that there are two main types of OH group in the structure. In the real dovyrenite structure (i.e., in defined

TABLE 2

X-ray powder data for dovyrenite calculated from refined atomic coordinates (Kadiyski et al. in press) for $\text{CuK}\alpha_1$ radiation and Debye-Scherrer geometry. The d-values of the strongest lines are underlined

hkl	d-value	Intensity	hkl	d-value	Intensity	hkl	d-value	Intensity
1 1 0	<u>5.4260</u>	62.64	2 3 1	2.1229	25.00	1 12 1	1.4021	7.65
1 3 0	<u>4.2072</u>	20.55	2 6 0	2.1036	7.67	2 12 1	1.2887	5.61
0 1 1	3.6571	7.31	1 7 1	2.0366	13.85	3 11 0	1.2689	5.06
1 4 0	3.6224	11.78	2 4 1	2.0344	13.56	3 5 2	1.2514	7.81
0 3 1	<u>3.2059</u>	22.46	1 8 1	<u>1.8786</u>	25.56	2 13 1	1.2194	5.59
0 6 0	<u>3.1406</u>	39.16	0 0 2	<u>1.8640</u>	32.82	4 1 2	1.1258	5.00
1 1 1	<u>3.0727</u>	100.00	2 6 1	1.8321	14.85	3 14 1	1.0516	5.16
1 2 1	<u>2.9570</u>	56.21	0 9 1	1.8255	5.94	3 20 1	0.8223	6.65
2 1 0	<u>2.8015</u>	19.65	2 8 0	1.8112	5.23	6 11 1	0.8074	6.82
1 6 0	<u>2.7468</u>	36.48	2 7 1	<u>1.7289</u>	19.54	1 18 3	0.7928	6.40
2 2 0	2.7130	14.17	3 5 0	1.6885	14.59	5 8 3	0.7890	9.18
0 5 1	2.6504	11.91	3 0 1	<u>1.6848</u>	25.83	3 16 3	0.7788	8.59
1 4 1	<u>2.5979</u>	24.68	0 6 2	1.6029	9.24	4 1 4	0.7779	5.47
2 3 0	2.5825	9.42	1 6 2	1.5424	9.39	4 2 4	0.7759	6.24
1 7 0	2.4315	13.24	2 2 2	1.5363	5.60	5 17 1	0.7751	5.69
2 4 0	2.4278	17.77	3 6 1	1.4847	7.31	6 14 0	0.7730	13.16
1 6 1	2.2114	13.93	1 7 2	1.4793	5.23	2 12 4	<u>0.7712</u>	19.28
2 2 1	2.1936	5.19	2 4 2	1.4785	5.26	1 22 2	0.7710	7.90
1 8 0	2.1750	6.42	4 1 0	1.4125	7.85			

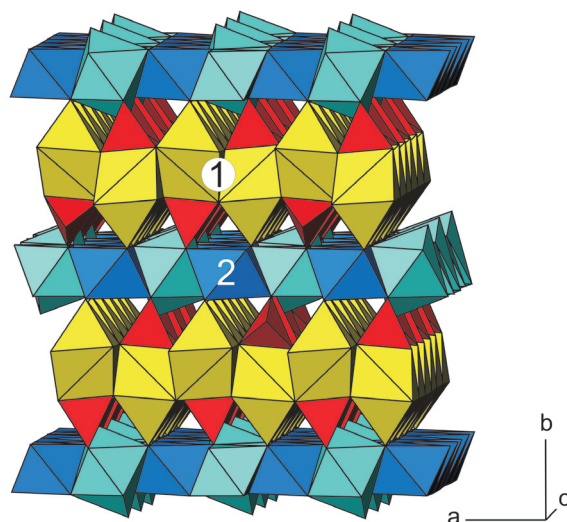

Fig. 8. Stacking of the tobermorite-like layers (1) and the rosenbuschite-like layers (2) in the dovyrenite structure parallel to (010).

Ca(1)-polyhedra – yellow, Si_2O_7 – red, Ca(2)-octahedra – dark blue, Zr(3), Ca(3)-polyhedra – blue

polytypes), the A and C parameters are expected to double (Kadiyski et al. in press). Faces with high indexes (140) and (081?) on the crystal form are a confirmation of this. A doubling (possibly quadrupling) of the A and C parameters leads to rational indexes for the main faces of dovyrenite.

CONCLUSIONS

Dovyrenite $\text{Ca}_6\text{Zr}[\text{Si}_2\text{O}_7]_2(\text{OH})_4$ is a new mineral with a new type of structure. The structure is a modular structure that consists of the tobermorite-like and the rosenbuschite-like modules (Kadiyski et al. in press). Dovyrenite and Zr-bearing hydrogarnet are late zirconian minerals formed at the expense of Zr-bearing perovskite and pyroxene, and of calzirtite (tazheranite) in skarns. The formation of dovyrenite occurred when early high-temperature fassaitic pyroxene and melilite-monticellite skarns were substituted by vesuvianite-foshagite skarns. The zirconium minerals in the skarns of the Dovyren massif formed in the sequence “calzirtite (tazheranite) – baghdadite – dovyrenite”.

The simultaneous presence of foshagite and monticellite may indicate that the subvolcanic ($P < 10^8$ Pa) skarns in the Dovyren Massif formed in the temperature interval 590–630°C (Pertsev et al. 2003; Zadov et al. 2004).

Acknowledgments. Financial support for this project was provided by the Scientific Research Fund of the University of Silesia and by the Russian Foundation for Basic Research 05-05-97246_r_baikal, Russian President Program for leading scientific schools support NSH-2284.2003.5. We thank P. Kennan, A. Manecki, I. Pekov, M. Michalik for their constructive comments on this paper.

REFERENCES

- BELLEZZA M., FRANZINI M., LARSEN A.O., MERLINO S., PERCHIAZZI, N., 2004: Grenmarite, a new member of the götzenite-siedozerite-rosenbuschite group from the Langesundfjord district, Norway: definition and crystal structure. *European Journal of Mineralogy* 16, 971–978.
- GURULEV S.A., 1983: Conditions of mafic differential intrusion formation. Nauka, Moscow, 248 pp. (in Russian).
- KADIYSKI M., ARMBRUSTER T., GALUSKIN E.V., PERTSEV N.N., ZADOV A.E., GALUSKINA I.O., DZIERŻANOWSKI P., KISLOV E.V., WRZALIK R., 2007: The modular structure of dovyrenite, $\text{Ca}_6\text{Zr}[\text{Si}_2\text{O}_7]_2(\text{OH})_4$: alternate stacking of tobermorite and rosenbuschite-like units. *American Mineralogist*, in press.
- KISLOV E.V., 1998: Ioko-Dovyren differentiated massif. Buryat. Sci. Publ. Center, Ulan-Ude, 226 pp. (in Russian).
- KONNIKOV E.G., 1986: Differentiated hyperbasite-basite complexes of Transbaikalia Precambrian. Nauka, Novosibirsk, 217 pp. (in Russian).
- mandarino J.A., 1981: The Gladstone-Dale relationship: IV. The compatibility concept and its applications. *Canadian Mineralogist* 19, 441–450.
- MERLINO S., BONACCORSI E., ARMBRUSTER, T., 1999: Tobermorites: Their real structure and order-disorder (OD) character. *American Mineralogist* 84, 1613–1621.
- PERTSEV N.N., KONNIKOV E.G., KISLOV E.V., ORSOEV D.A., NEKRASOV A.N., 2003: Merwinite facies magnesian skarns in xenoliths from dunite of the Dovyren layered intrusion. *Petrology* 11, 464–475 (in Russian).

- SHARYGIN V.V., STOPPA F., KOLESOV B.A., 1996: Zr-Ti disilicates from the Pian di Celle volcano, Umbria, Italy. *European Journal of Mineralogy* 8, 1199–1212.
- WENZEL TH., BAUMGARTNER L.P., BRÜGMANN G.E., KONNIKOV E.G., KISLOV E.V., 2002: Partial melting and assimilation of dolomitic xenoliths by mafic magma: The Ioko-Dovyren intrusion (North Baikal Region, Russia). *Journal of Petrology* 43, 2049–2074.
- ZADOV A.E., PERTSEV N.N., BELAKOVSKY D.I., CHUKANOV N.V., KUZNETSOVA O.YU., 2004: Foshagite and hillebrandite in xenoliths from Ioko-Dovyrensky Massif (Pribaikalie). *Proceedings of the Russian Mineralogical Society* 1, 73–83 (in Russian).

Evgeny V. GALUSKIN, Nikolai N. PERTSEV, Thomas ARMBRUSTER, Milen KADIYSKI, Aleksander E. ZADOV, Irina O. GALUSKINA, Piotr DZIERŻANOWSKI, Roman WRZALIK, Evgeny V. KISLOV

Dovyrenit $\text{Ca}_6\text{Zr}[\text{Si}_2\text{O}_7]_2(\text{OH})_2$ – nowy minerał ze skarnowych ksenolitów węglanowych z ultrazasadowo-zasadowych skał Masywu Dovyreńskiego, Przybajkale Północne, Rosja

Streszczenie

Nowy minerał dovyrenit $\text{Ca}_6\text{Zr}[\text{Si}_2\text{O}_7]_2(\text{OH})_4$ został stwierdzony w skarnowanych ksenolitach węglanowych w skałach subwulkanicznych, w obrębie warstwowanego ultrabazytowo-bazytowego Masywu Dovyreńskiego wieku proterozoicznego (Buriatia, Przybajkale Północne, Rosja). Dovyrenit jako minerał akcesoryczny tworzy się kosztem minerałów cyrkonowych oraz minerałów zawierających domieszki cyrkonu, które należą do wczesnych asocjacji skarnów piroksenowych i melilitowo-monticellitowych. Minerale zawierające domieszki cyrkonu reprezentowane są przez piroksen fassaitowy, perowskit oraz hydrogranaty, natomiast z cyrkonowych minerałów rozpoznano kalzyrtit, tazheranit, baghdadyt. W asocjacji z dovyrenitem występują także: monticellit, wezuwian, diopsyd, foshagit, brucit, apatyt, kalcyt, bismut rodzimy, sfaleryt, safłoryt, rammelsbergit i inne. Ogólna struktura dovyrenitu ma symetrię rombową (grupa przestrzenna $Pnmm$) z parametrami subkomórki: $A = 5,666(16) \text{ \AA}$, $B = 18,844(5) \text{ \AA}$, $C = 3,728(11) \text{ \AA}$, $V = 398,0(2) \text{ \AA}^3$ and $Z = 1$. Dovyrenit posiada nowy typ struktury modulowanej zbudowanej z warstw podobnych do warstw wyodrębnionych w strukturach tobermorytu oraz rosenbuschitu. Tobermorytopodobne i rosenbuschitopodobne warstwy w strukturze dovyrenitu ułożone są na przemian równoległe do (010). Dane udokładnienia struktury dovyrenitu wskazują na niepełne obsadzenie pozycji Ca(2) w warstwie rosenbuschitopodobnej, co odpowiada danym analizy mikrosondowej: ZrO_2 16,47; SiO_2 32,83; TiO_2 0,14; HfO_2 0,16; Cr_2O_3 0,01; CaO 43,87; FeO 0,25; MgO 0,13; MnO 0,02; Nb_2O_5 0,03; suma tlenków równa się 99,38 % wag. wraz z dodaną

H₂O obliczoną na podstawie bilansu ładunku. Empiryczny wzór krystalochemiczny dovyrenitu $(\text{Ca}_{5,73}\text{Fe}_{0,03}\text{Mg}_{0,02})_{\Sigma 5,78} (\text{Zr}_{0,98}\text{Hf}_{0,01}\text{Ti}_{0,01})_{\Sigma 1}\text{Si}_4(\text{O}_{13,56}\text{OH}_{0,44})_{\Sigma 14}(\text{OH})_4$ potwierdza niedobór wapnia w pozycji Ca(2) w porównaniu ze wzorem idealnym. Dovyrenit jest minerałem optycznie dodatnim, dwuosiowym: $2V_z 30(5)^\circ$ (zmierzony), 28° (obliczony); $\alpha 1,692(2)$, $\beta 1,660$, $\gamma 1,767(2)$. Parageneza „monticellit-foshagit-dovyrenit” wskazuje na wąski przedział temperaturowy krystalizacji dovyrenitu: $560\text{--}630^\circ\text{C}$ w warunkach subwulkanicznych ($P < 10^8 \text{ Pa}$).