

Biology and management of fish stocks in Bahir Dar Gulf, Lake Tana, Ethiopia

Tesfaye Wudneh

Promotor: dr. E.A. Huisman,
Hoogleraar in de Visteelt en Visserij

Co-promotor: dr. ir. M.A.M. Machiels
Universitair docent bij leerstoelgroep Visteelt en Visserij

Biology and management of fish stocks in Bahir Dar Gulf, Lake Tana, Ethiopia

Tesfaye Wudneh

Proefschrift

ter verkrijging van de graad van doctor
op gezag van de rector magnificus
van de Landbouwniversiteit Wageningen,
dr. C.M. Karssen,
in het openbaar te verdedigen
op maandag 22 juni 1998
des namiddags te half twee in de Aula
van de Landbouwniversiteit te Wageningen.

Cover : Traditional fishing with reed boat and a motorised fishing boat (back-cover) on Lake Tana.
Photo: Courtesy Interchurch Foundation Ethiopia/Eritrea (ISEE), Urk, the Netherlands.
Cover design: Wim Valen.

Printing: Grafisch Service Centrum Van Gils b.v., Wageningen

CIP-DATA KONINKLIJKE BIBLIOTHEEK, DEN HAAG

Wudneh, Tesfaye

Biology and management of fish stocks in Bahir Dar Gulf, Lake Tana, Ethiopia / Tesfaye Wudneh. - [S.I. : s.n.]. - III. Thesis Landbouwniversiteit Wageningen. - With ref. - With summary in Dutch.

ISBN 90-5485-886-9

Tesfaye Wudneh 1998. Biology and management of fish stocks in Bahir Dar Gulf, Lake Tana, Ethiopia.

The biology of the fish stocks of the major species in the Bahir Dar Gulf of Lake Tana, the largest lake in Ethiopia, has been studied based on data collected during August 1990 to September 1993. The distribution, reproduction patterns, growth and mortality dynamics and gillnet selectivity of these stocks are described. The major fish categories, *Barbus spp.*, *Clarias gariepinus*, and *Oreochromis niloticus* contribute equally to the catches. *O. niloticus* is most abundant in the shallow littoral zone, while *C. gariepinus* and the larger piscivorous *Barbus* species are found mainly in the deeper open water area of the lake. These larger species are mainly exploited by the motorised boat fishery. The catch from the reed boat fishery, confined to the littoral zone, consists mainly of *O. niloticus* and *Barbus tsanensis*. The breeding activity of all major species is associated with the rainy period and increase in lake water level. *C. gariepinus* has a short breeding period in July whereas *O. niloticus* and *B. tsanensis* show extended activity with peak breeding during July and September-October respectively. They are fully recruited to the fishery at 2 - 4 years of age well beyond the age of maturity. During the breeding period a higher catch rate is observed for *Barbus* species. The sustainable potential yield of 32 kg·ha⁻¹·yr⁻¹ estimated for the Bahir Dar Gulf area, indicates that there is scope for some expansion of the fishery. The shortage in fish storage, distribution and marketing facilities, the limited local market and lack of fishing tradition are major constraints to the development of the fishery.

PhD thesis, Fish Culture and Fisheries Group, Wageningen Institute of Animal Science, Wageningen Agricultural University, P.O. Box 338, 6700 AH Wageningen, The Netherlands.

This research was supported by:

Interchurch Foundation Ethiopia/Eritrea (ISEE), Urk.

Interchurch Coordination Commission for Development Projects (ICCO), Zeist.

Wageningen Agricultural University, Wageningen.

Fisheries Resources Development Department, Ministry of Agriculture, Addis Ababa.

Bureau of Agriculture Bahir Dar, Amhara Regional Administration.

Ethiopian Orthodox Church, Development Department.

Table of contents:

Summary	1
Samenvatting	3
1. General introduction	5
2. Study area, sampling and data handling	21
3. Reproduction patterns of <i>Clarias gariepinus</i> , <i>Oreochromis niloticus</i> and <i>Barbus tsanensis</i>	31
4. Temporal and spatial dynamics in the size-related distribution patterns of <i>Clarias gariepinus</i> , <i>Oreochromis niloticus</i> , <i>Barbus tsanensis</i> and <i>Barbus platydorsus</i>	43
5. Growth and mortality estimates of <i>Clarias gariepinus</i> , <i>Oreochromis niloticus</i> and <i>Barbus tsanensis</i>	53
6. The selective impact of a gillnet fishery on the assemblage of <i>Clarias gariepinus</i> , <i>Oreochromis niloticus</i> and polymorphic <i>Barbus</i> species	71
7. Temporal and spatial patterns in the gillnet fishery for <i>Clarias gariepinus</i> , <i>Oreochromis niloticus</i> and <i>Barbus spp.</i> and the formulation of the catch effort data recording system.	85
8. Zooplankton distribution and production in Bahir Dar Gulf, Lake Tana.	103
9. Options for the management of the fishery in Lake Tana	117
References	129
Acknowledgements	141
Curriculum vitae	143

Summary

Since 1992 Ethiopia has become a land locked country depending only on the inland water resources for the supply of fish as a cheap source of protein. Ethiopia has a number of lakes and rivers with important fish resources. Most of the lakes are in the Rift Valley system. The total area of the lakes is about 7500 km². The exploitation of the different waterbodies is very uneven. Those located near the capital, Addis Ababa, and having good road connections, like Lake Zewai and Lake Awassa, have been heavily exploited to the extent of overfishing. Lake Tana which is located 500 km from Addis Ababa is among the least exploited lakes, in spite of its size of 3200 km² and fish resources. One of the largest Rift Valley lakes, Chamo, contains Nile perch, *Lates niloticus*. Although it is as far from Addis as Lake Tana, the fishing activity is high due to the high price for this fish, being more expensive than beef. Total fish production from all lakes in 1996 was about 7000 tons, corresponding to 10 kg·ha⁻¹·yr⁻¹, to which Lake Tana contributed 17% corresponding to 4 kg·ha⁻¹·yr⁻¹.

For Lake Tana fish, prices are ten times lower than those of beef. The highly priced Nile perch is absent from the lake, which has attracted little attention from fishermen and developers. The fishery is mainly confined to the southern part of the lake, around Bahir Dar Gulf, with an area of ±300 km². There are two types of fisheries. One type is the traditional subsistence fishery using papyrus reed boats and 80 mm stretched meshed monofilament gillnets, totalling 113 reed boats. These exploit the inshore fish community consisting of Nile tilapia, *Oreochromis niloticus* and barbel, *Barbus tsanensis*. The other type is the motorised boat fishery which started in 1986. This exploits a wider lake area including the open water fish community of the large, piscivorous *Barbus spp.* and the African catfish, *Clarias gariepinus* using 100 to 140 mm stretched mesh multifilament gillnets. The number of motor boats amounts to 23.

The introduction of new fishing technology was expected to result in a quick increase in utilisation of the resource. It was, therefore, decided to conduct an accompanying research programme in order to: 1) get biological information on the fish stocks, stock size, species composition, spatial distribution, size structure, recruitment, growth and mortality and exploitation rate; 2) define the state of the developing fishery with motorised boats, its interference with the traditional reed boat fishery and their combined impact on the structure and diversity of the fish community; and 3) identify and assess the options for management given the potential production of the fish stock in the lake, the exploitation patterns and the socio-economic conditions prevailing in the area. For this purpose research was done on the identification and distribution of the major fish species, their reproduction biology, growth and mortality dynamics, the selective impact of the gillnet fishery and fishing patterns in space and time, in order to improve the catch and effort data recording system.

A distinct spatial segregation in the distribution of the fish community was apparent with the large, piscivorous *Barbus platydorsus* being found only in water deeper than 6 m while *O. niloticus* was confined to the littoral area less than 3 m deep. *C. gariepinus* and *B. tsanensis*, appeared in all depth ranges, with greater abundance of *C. gariepinus* in areas over

6 m deep and *B. tsanensis* at depths between 3 and 6 m. Reed boats caught an average of 12 kg·trip⁻¹ with only 2% *C. gariepinus*. The catch of the motorised boats contained *C. gariepinus* with a mean length of 54 cm, *O. niloticus* of 27 cm and *Barbus* spp. of 31 cm, totalling an average 177 kg·trip⁻¹. The *Barbus* spp. in the catch consisted about 50% of *B. tsanensis* and the other 50% contained larger barbs, mostly *B. platydorsus* and *B. megastoma*. The catch rates of 150 kg·trip⁻¹ in the littoral area and 270 kg·trip⁻¹ in river mouth areas exceeded those in the deeper, open water areas, which were of the order of 110 kg·trip⁻¹. During the spawning season fishing intensity peaked in the river mouths. It became evident that the open water fish community was not utilised until the introduction of the motorised fishery.

B. tsanensis and *O. niloticus* had extended spawning periods during the wet season June to October, while *C. gariepinus* had a short spawning period in July. Relatively few ripe *B. tsanensis* were observed which may be explained by their migrating to the river mouth, outside the sampling area. *C. gariepinus* migrate to the periodically inundated lake shore areas for spawning. *O. niloticus* breeds in the littoral area. The average size of all exploited fish species caught by the motorised and reed boat fishery was well above the mean size at maturity. The growth of *O. niloticus* and *C. gariepinus* is comparable to that observed in other African lakes. After the first year, they reach a size of 14 cm and 16 cm and recruit to the fishery when they are 2 and 3 years of age at respective lengths of 23 cm and 40 cm. The growth estimation for *B. tsanensis* was less unequivocal. They may grow to a size of 13 cm in the first year and are captured at a size of 28 cm when they are 3 years old. The instantaneous fishing mortality was estimated 0.5, 0.8, and 1.1 yr⁻¹ for *C. gariepinus*, *O. niloticus* and *B. tsanensis*, corresponding with exploitation rates of 55, 44 and 60% respectively.

The total production of the fishery in the Bahir Dar Gulf was estimated at 640 tons, corresponding to 21 kg·ha⁻¹·yr⁻¹, of which the motorised fishery contributed 60% in weight and targeted larger and more piscivorous fish. On average 90 reed boat trips and 7 motorised boat trips were made daily. There is limited technical interaction and sharing of stocks between the two fisheries as reed boats and motorised boats fish mostly in different areas.

Simulation exercises revealed a potential yield, at a fivefold increase of fishing effort level, without any biological constrain of 32 kg·ha⁻¹·yr⁻¹. No large shifts in species composition could be predicted at that level of exploitation, ensuring the preservation of the unique fish community. Constraints would be of socio-economic nature, preventing fast development. The price paid by the Fish Production and Marketing Enterprise which monopolises trade, storage and transport is as low as 0.8 Birr·kg⁻¹. In fact, fish prices are very low because of limited marketing possibilities, which discourages fishermen from increasing their fishing activities. As a consequence of this overexploitation of Lake Tana fish resource is not anticipated for the years to come.

Samenvatting

Vanaf 1992 is Ethiopië afgesloten van de Rode Zee en is het land voor de aanvoer van vis als goedkope eiwitrijke voedselbron volledig aangewezen op het binnenwater. Het land heeft een aantal meren en rivieren met een aanzienlijke visvoorraad. De meeste meren liggen in de Oost-Afrikaanse Slenk. Hun totale oppervlak bedraagt 7500 km². De visserijdruk verschilt van meer tot meer. Wateren die dicht bij de hoofdstad Addis Abeba zijn gelegen en over een goede verbinding beschikken, zoals Zeway en Awassa, worden zwaar bevestigd tot aan het niveau van overbevissing toe. Het Tanameer, dat 500 km van Addis Abeba ligt, behoort tot de minst bevestigde wateren, ondanks zijn grootte van 3200 km² en de aanwezige visvoorraad. Een van de grootste meren in de Oost-Afrikaanse Slenk, Chamo, bevat Nijlbaars, *Lates niloticus*. Hoewel even ver verwijderd van Addis als het Tanameer, is de visserijactiviteit er groot, hetgeen te verklaren is door de prijs van Nijlbaars, die hoger is dan die van rundvlees. Alle meren samen produceerden in 1996 ongeveer 7000 ton vis, wat overeenkomt met 10 kg·ha⁻¹·jr⁻¹. De bijdrage van het Tanameer was 17% en dit komt overeen met 4 kg·ha⁻¹·jr⁻¹.

Rond het Tanameer zijn de prijzen van vis tien keer lager dan die van rundvlees. De waardevolle Nijlbaars komt niet voor in het meer, dat daarom ook geringe aandacht van vissers en ontwikkelaars krijgt. De visserij is grotendeels geconcentreerd in het zuiden, rond de Golf van Bahir Dar, met een oppervlak van 300 km². Er zijn twee typen visserijen. Ten eerste is er de traditionele 'subsistence' visserij met papyrusboten en 80 mm (gestrekte maaswijdte) monofilament kieuwnetten. Er zijn 113 van dergelijke boten in het gebied actief. Vissers vissen voornamelijk in de oeverzones waar de Nijltilapia, *Oreochromis niloticus*, en de Tanameerbarbeel, *Barbus tsanensis*, voorkomen. Het andere type visserij is in 1986 gestart met gemotoriseerde boten. Deze vissers exploiteren een groter oppervlak, inclusief het open water, waar ze vissen op de Afrikaanse meerval, *Clarias gariepinus*, en enkele piscivore barbeelsoorten. De vissers gebruiken kieuwnetten met maaswijdten van 100 tot 140 mm (gestrekte maas). Het aantal motorboten bedraagt 23.

De verwachting was dat de introductie van de nieuwe visserij zou leiden tot een snelle toename van de benutting van de hulpbron. Daarom werd een begeleidend onderzoeksprogramma gestart gericht op: 1) het verzamelen van biologische gegevens over de vispopulaties, bestandsgrootte, soortsamenstelling, ruimtelijke verspreiding, groottestructuur, rekrutering, groei, sterfte en benuttingsgraad; 2) het definiëren van de toestand van de visserijontwikkeling met motorboten, de interferentie met de traditionele visserij met papyrusboten en hun gecombineerde invloed op samenstelling en diversiteit van de visgemeenschap; en 3) het identificeren en vaststellen van beheersmaatregelen, rekeninghoudend met de theoretische productiecapaciteit van de visstand in het meer, het exploitatiepatroon en de geldende sociaal-economische omstandigheden. Voor dit doel werd onderzoek uitgevoerd naar de identificatie en verspreiding van de voornaamste vissoorten samen met hun voortplantingsbiologie, groei en sterftedynamiek. Ter verbetering van de kwaliteit van de aanlandingsstatistieken werden de selectieve invloed van de kieuwnetvisserij en de visserijpatronen in ruimte en tijd onderzocht.

Binnen de visgemeenschap werd een duidelijke ruimtelijke scheiding waargenomen, waarbij de grotere piscivore *Barbus platydorsus* alleen voorkwam in water dieper dan 6 meter en *O. niloticus* alleen in het litoraal tot 3 meter diep. *C. gariepinus* en *B. tsanensis* kwamen overal voor, *C. gariepinus* vooral dieper dan 6 meter en *B. tsanensis* op dieptes van 3 tot 6 meter. Papyrusboten vingen gemiddeld $12 \text{ kg}\cdot\text{tocht}^{-1}$, waarvan slechts 2% *C. gariepinus*. Vangsten van de gemotoriseerde visserij bevatten *C. gariepinus* met een gemiddelde lengte van 54 cm, *O. niloticus* van 27 cm en *Barbus* soorten van 31 cm en bedroegen gemiddeld $177 \text{ kg}\cdot\text{tocht}^{-1}$. 50% van de barbelen in de vangst was *B. tsanensis* en de rest bestond uit grotere soorten, voornamelijk *B. platidorsus* en *B. megastoma*. De vangsten van gemiddeld $150 \text{ kg}\cdot\text{tocht}^{-1}$ in het litoraal en $270 \text{ kg}\cdot\text{tocht}^{-1}$ nabij riviermondingen overtroffen die van het diepere open water, waar de vangst gemiddeld $110 \text{ kg}\cdot\text{tocht}^{-1}$ bedroeg. Gedurende de paaiperiode was de visserijintensiteit groter nabij de riviermondingen. De visgemeenschap uit het open water werd niet benut vóór de introductie van de gemotoriseerde visserij.

B. tsanensis en *O. niloticus* vertoonden verlengde paaiperioden gedurende de regentijd van juni tot oktober, terwijl *C. gariepinus* een korte paaiperiode had in juli. Er werden relatief weinig paairijpe *B. tsanensis* waargenomen, hetgeen verklaard zou kunnen worden door hun migratie naar riviermondingen buiten het bemonsterde gebied. *C. gariepinus* migreert naar periodiek geïnuundeerde gebieden aan de rand van het meer en paait daar. *O. niloticus* paait in het litoraal. De gemiddelde lengte van geëxploiteerde vissoorten was groter dan hun minimale geslachtsrijpe lengte. De groei van *O. niloticus* en *C. gariepinus* is vergelijkbaar met de groei waargenomen voor andere Afrikaanse meren. Na een jaar bereiken deze soorten een lengte van 14 cm en 16 cm en worden voor het eerst gevangen als ze twee en drie jaar oud zijn bij respectievelijke lengtes van 23 en 40 cm. De groeischatting voor *B. tsanensis* was minder eenduidig. Ze zouden een lengte van 13 cm kunnen bereiken in het eerste jaar en worden gevangen vanaf een grootte van 28 cm als ze drie jaar oud zijn. De momentane visserijmortaliteit werd geschat op 0,5, 0,8, en 1.1 jr^{-1} voor *C. gariepinus*, *O. niloticus* en *B. tsanensis*, hetgeen overeenkomt met een visserijbenuttingsgraad respectievelijk van 55, 44 en 60%.

De totale visserijopbrengst van de Golf van Bahir Dar in 1992/1993 werd geschat op $640 \text{ ton}\cdot\text{jr}^{-1}$, het geen overeenkomt met $21 \text{ kg}\cdot\text{ha}^{-1}\cdot\text{jr}^{-1}$, waarvan 60% voor rekening kwam van de gemotoriseerde visserij, die jacht maakt op de grotere piscivore soorten. Per dag waren gemiddeld 90 papyrusboten en 7 motorboten actief. Er is weinig interactie tussen de twee typen visserij die zich richten op verschillende soorten en verschillende visgronden bezoeken.

Een simulatie berekening suggereert een potentiële vangst van $32 \text{ kg}\cdot\text{ha}^{-1}\cdot\text{jr}^{-1}$, bij een vijfvoudige toename van de visserijinspanning, zonder enige biologische beperkingen. Bij die visserijdruk worden geen grote verschuivingen in soortsaamenstelling voorspeld, zodat het behoud van de unieke visgemeenschap verzekerd lijkt. Beperkingen voor een snelle ontwikkeling van de visserij komen uit de sociaal-economische hoek. De *Fish Production and Marketing Enterprise*, die vishandel, -opslag en -transport monopoliseert, betaalt voor de vis slechts $0,8 \text{ Birr}\cdot\text{kg}^{-1}$. Deze prijs is zo laag vanwege de geringe afzetmogelijkheden en verhinderen een vergroting van de visserijactiviteiten. Als gevolg daarvan hoeft er voor de komende jaren geen rekening gehouden te worden met mogelijke overbevissing van de vispopulaties in het Tanameer.

General introduction

Changes in resource exploitation by the gillnet fishery of Lake Tana, Ethiopia, after the introduction of motorised boats

Ethiopia (3-18°N, 33-48°E) covers a total surface area of 1.1 million square kilometers. The country, which is the ninth largest in Africa (29 x The Netherlands), forms the major portion of the most eastern African landmass, known as the Horn of Africa. It is surrounded by Sudan (North and West), Kenya (South), Somalia and Djibouti (South-east and East) and Eritrea (North-east). The land area comprises twelve river basins of which nine have perennial flows and three are normally dry valleys and lowland areas.

The number of people inhabiting Ethiopia in 1992 was estimated to be 54 million with a 3 percent annual growth rate. The rural population is about 85 percent of the total. Agriculture accounts for 40 percent of the Gross Domestic Production, employing 80 percent of the population. The estimated cereal and livestock production for 1996 was 13 million metric ton, 600 thousand metric tons meat and 1 million metric tons of milk respectively (FAOSTAT 1997). Despite a considerable import of cereals, the calorie consumption covers only 70 percent of the requirements (Bissio 1995). Agricultural production of food crops is limited by climate, soil condition and fertility, and technical and economic constrains. This means that protein resources for the poor part of the society are limited.

Although Ethiopia is a land-locked country fish forms a cheap source of protein. Assessing the potentials of its inland waters is necessary in order to develop a realistic view of their protein production. Water bodies cover only 0.7 percent of the area of Ethiopia and comprise 10 lakes located in the Central Highlands, mostly in the Rift Valley, with a total surface area of 7,500 km². The largest lake is Lake Tana, located outside the Rift Valley on the North-western plateau, with a surface area of 3,200 km². Minor water bodies such as crater lakes and dam reservoirs occupy a total area of about 400 km². The main rivers stretch together a total of approximately 7000 km.

In Ethiopia water resources have so far been developed to a marginal extent (Abate 1994), and are used as drinking water, industrial water, agricultural water (livestock drinking water and irrigation), and for hydropower, fisheries and aquaculture, recreation and, to a limited extent, inland navigation. Water sector development will become of major importance as the country develops. Although expansion of water use for various purposes including hydroelectric power will be most significant in its social and economic effects, emphasis should be given to resource conservation and the rational use of water. The potential of aquatic resources for fish production should also be taken into account.

In the period year 1995/1996 (the Ethiopian year 1988) an estimated 7000 metric tons of fish was caught. The production from the major lakes is shown in Table 1.1. Yield per hectare per year varies between 3 kg for the largest lakes Abaya and Tana and 50 kg for the Rift Valley lakes Awassa and Zewai. Total yearly production from the Rift Valley lakes amounts to 5000 metric tons. The Lake Tana fish production was estimated to be 1200 ton for the year 1995/1996. Given an estimated maximum production level of 50 to 70 kg ha⁻¹.yr⁻¹

(Mebrat 1993), the potential production of the Ethiopian waters would be between 30,000 and 40,000 tons annually (Rift Valley lakes 17,000 tons, Lake Tana 15,000 tons and rivers 5,000 tons).

Table 1.1 Yield of freshwater fish from major Ethiopian lakes for the year 1995/1996. (Data from Statistical Bulletin Lake Fisheries Development Programme 1997).

Lake	Area (km ²)	Total Yield (tonnes·yr ⁻¹)	Yield (kg·ha ⁻¹ ·yr ⁻¹)
Chamo	550	2140	39
Abaya	1185	340	3
Awassa	90	475	54
Langano	230	150	7
Zewai	435	2240	52
Koka	250	550	22
Tana	3160	1190	4

The fish communities in Ethiopian fresh water systems vary according to the river basin (Fig. 1.1). Nile tilapia, *Oreochromis niloticus*, and African catfish, *Clarias gariepinus*, are distributed all over the country. In the Omo and Baro rivers the Nile perch, *Lates niloticus*, is present. The Omo-Ghiba basin connects to Lake Turkana and the Baro-Akobo basin connects to the White Nile. In two Rift Valley lakes, Lake Abaya and Lake Chamo, Nile perch is exploited. Due to the isolation of the Abay river basin, the fish community of Lake Tana differs from that occurring in the southern lakes. Common species such as *O. niloticus* and *C. gariepinus* are found but the species of the genus *Barbus* differ from the species in Lake Abaya. In Lake Tana *C. gariepinus*, *O. niloticus*, and *Barbus spp.* contribute equally to the fishery.

Socio-cultural patterns show that there is not a strong fishing tradition, and particularly little fish marketing. A large part of the population consumes fish during the fasting periods traditional in the Coptic religion. The main fasting period lasts two months during early spring, and a minor one of two weeks, in August. Fishing in Lake Tana was started by the Woito ethnic group, which did not own land. Thereafter, poor members of the farming communities gradually adapted to fish consumption and subsistence fishery. Commercial fishing in the Rift Valley lakes started during the 1950s, responding to the demand for fish from foreigners and upper class Ethiopians in Addis Ababa. The commercial fishery in the Rift Valley lakes now involves 1500 persons (Mebrat 1993). Due to its isolation from the chain of lakes in the Rift Valley system to the South, Lake Tana has received minimal attention in fishery development projects. The Lake Tana fishery remained almost completely subsistence involving approximately 1000 persons, until a fisheries development project assisted by Dutch Non Government Organisations was launched in the mid 1980s.

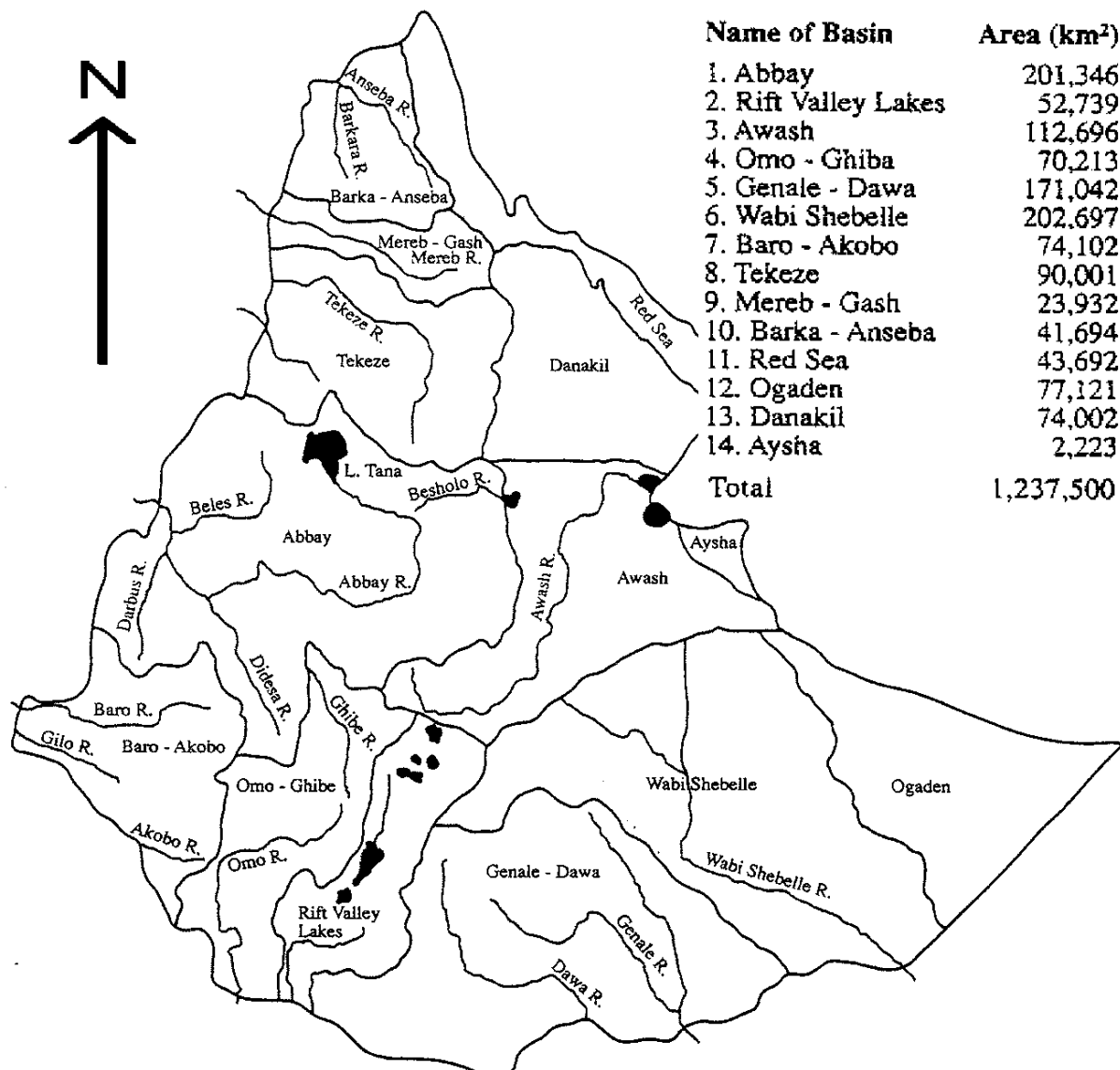

Figure 1.1 River basins in Ethiopia, after Abate (1994).

Convenient road connections and proximity to the capital city had given the Rift Valley lakes priority in fishery development and research programmes. Hence they have been, and still are, the main fish suppliers to the big towns. Especially the major lakes, with important fish resources, viz. Lakes Zewai, Awassa, Langano, Abaya and Chamo have been the subject of several scientific surveys (e.g. Schröder 1984, Wodajo & Belay 1984, Getachew 1987, Tadesse 1988, Dadebo 1988, Teklegiorgis 1990, Mengistou & Fernando 1991a & b, Hailu 1996). The few scientific or biological studies on Lake Tana itself before the nineties were those undertaken during 1938-1940 by a group of Italian scientists (Bini 1940, Brunelli & Cannicci 1940, Lofredo 1940). These studies covered mainly fish taxonomy, and limnological and hydrological aspects of Lake Tana and are documented in the reports of these missions. Recent research on the taxonomy of the *Barbus* spp. include Mina et al. (1996) and Nagelkerke (1997).

Lake Tana

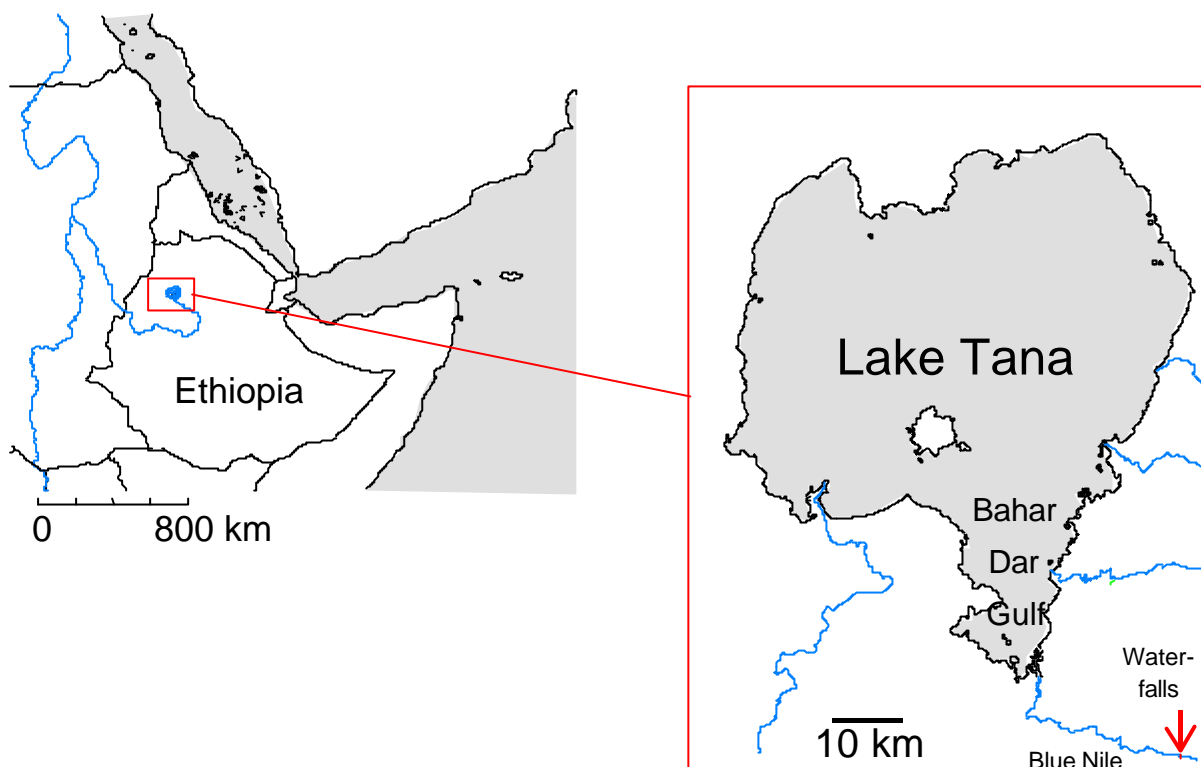

Figure 1.2 Map of Ethiopia and Lake Tana. Bahir Dar Gulf is indicated as well as the Blue Nile. Figure from Nagelkerke (1997).

Lake Tana is situated about 500 km North-west of the capital, Addis Ababa (Fig. 1.2). It has an area of 3200 km² and a mean and maximum depth of 9 m and 14 m respectively. The lake is believed to have originated during the Pliocene (Mohr 1962, quoted by Beadle 1981) and is the source of the Blue Nile, the only river which drains the lake. The Blue Nile, which leaves the lake from the South-east corner at Bahir Dar town, flows over a waterfall (> 30 m high) only 30 km from the lake, forming a barrier and isolating the lake from the downstream Nile system. Rzoska (1976) categorised Lake Tana as oligotrophic and it is considered to have a truncated fish fauna (Greenwood 1976). The major fish categories found in the lake are the cyprinids, with some larger *Barbus* species, the small pelagic *Barbus trispilopleura*, *Varicorhinus bezo*, *Garra quadrimaculata* and *G. dembiensis*, one species of cichlid, Nile tilapia, *Oreochromis niloticus*, and one silurid, African catfish, *Clarias gariepinus*.

The larger species of the genus *Barbus* of Lake Tana include several distinct morphological varieties. Based on morphological appearance of the fish, their local names such as “gobit, afe-dist, afe-muti, lonte” which mean respectively big hunch, big-mouth, pointed mouth, big lip, are used to identify the different types. The genus *Barbus* in Lake Tana was described and classified by Boulenger (1911) and Bini (1940) into several species. However, Banister (1973) classified all the larger barbs of Lake Tana as synonyms of *B. intermedius*, even though wide morphological and size variation was apparent. The taxonomic problem was noted at the start of the present research and a research programme in this field was initiated. This taxonomic research was undertaken by the Experimental Zoology Group of the Department of Animal Sciences, Wageningen Agricultural

University, simultaneously with the present stock assessment study. That study indicated the possibility of several species or even a "unique species flock" existing in Lake Tana (Nagelkerke et al. 1994). During the field work for the present study temporary names such as "White hunch, Acute, Carplike, Intermedius, Big-mouth small-eye, Big-mouth big-eye, Barbell, etc." based on morphological appearance were used to identify the *Barbus* species. A taxonomic study of the large barbs of Lake Tana has meanwhile indicated the existence of fourteen *Barbus* species in the lake of which seven are newly described (Nagelkerke 1997). The list of large barbs found in Lake Tana is presented in Table 1.2.

The foodweb structure of the Lake Tana ecosystem is dominated by a trophically diverse species flock of the genus *Barbus*, by the phytophagous Nile tilapia and by the African catfish, a facultative piscivore, with a most flexible feeding mode (Fig. 1.3). Starting from phytoplankton and detritus, the major energy pathways in the system are:

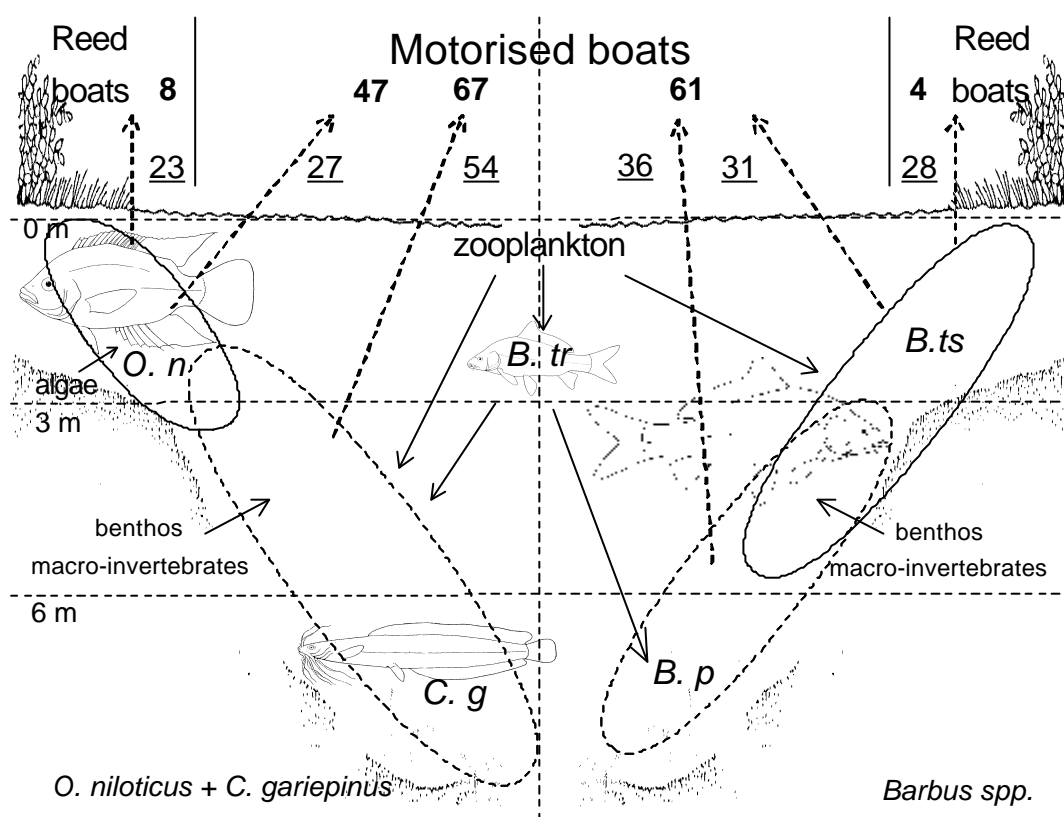

Figure 1. 3 Schematic reconstruction of the Lake Tana ecosystem Abbreviations used are *O. n.*, *O. niloticus*; *C. g.*, *C. gariepinus*; *B. tr.*, *B. trispilopleura*; *B. ts.*, *B. tsanensis*; *B. p.*, *B. platydorsus* as an example of piscivorous *Barbus*. Ellipses represent the distribution of the fish species over the depth zones. Solid arrows represent the food relationships. Broken arrow represent the fishery. Numbers on top represent the catch in kg per trip in bold and the average fish length in cm underlined. *Barbus* spp. are combined in the catches.

1. A direct transfer of phytoplankton and detritus to *O. niloticus*
2. Via molluscs and benthos to 3 benthivorous *Barbus* spp.
3. Via insect larvae and other macro-invertebrates (*Chaoborus*) to *C. gariepinus*.
4. Via zooplankton to zooplanktivorous *Barbus trispilopleura* and barbs smaller than 15 cm.
5. Via small *Barbus trispilopleura* and barbs smaller than 15 cm to the piscivores *C. gariepinus* and 7 *Barbus* spp.

The fish community lacks a real top-predator such as *Lates niloticus* which occurs in some of the Rift Valley lakes. Predation on fish is exerted by a number of piscivorous barbs including *B. platydorsus* and *B. acutirostris* and the bottom-dwelling *C. gariepinus*. The commercial catch is composed of *C. gariepinus*, *Barbus spp.* and *O. niloticus*. The benthivore, *B. tsanensis*, contributes approximately 50 percent of the total *Barbus* catch.

Table 1.2 Newly revised list of the large barbs from the genus *Barbus* of Lake Tana (Nagelkerke 1997).

<u>Species name</u>	<u>Vernacular name</u>
<i>Barbus truttiformis</i> spec. nov.	Trout-like
<i>B. platydorsus</i> spec. nov.	White hunch
<i>B. megastoma</i> spec. nov.	Bigmouth-small eye
<i>B. nedgia</i> (Ruppell 1836)	Lip
<i>B. macrophtalmus</i> (Bini 1940)	Bigmouth-big eye
<i>B. longisimus</i> spec. nov.	Mini-eye
<i>B. dainelli</i> (Bini 1940)	Big-head
<i>B. brevicephalus</i> spec. nov.	Short-head
<i>B. sukris</i> Ruppell 1836	Zurki
<i>B. gorguari</i> Ruppell 1836	Dark
<i>B. crassibarbis</i> spec. nov.	Barbell
<i>B. acutirostris</i> (Bini 1940)	Acute
<i>B. gorgorensis</i> (Bini 1940)	Carp-like
<i>B. tsanensis</i> spec. nov.	Intermedius

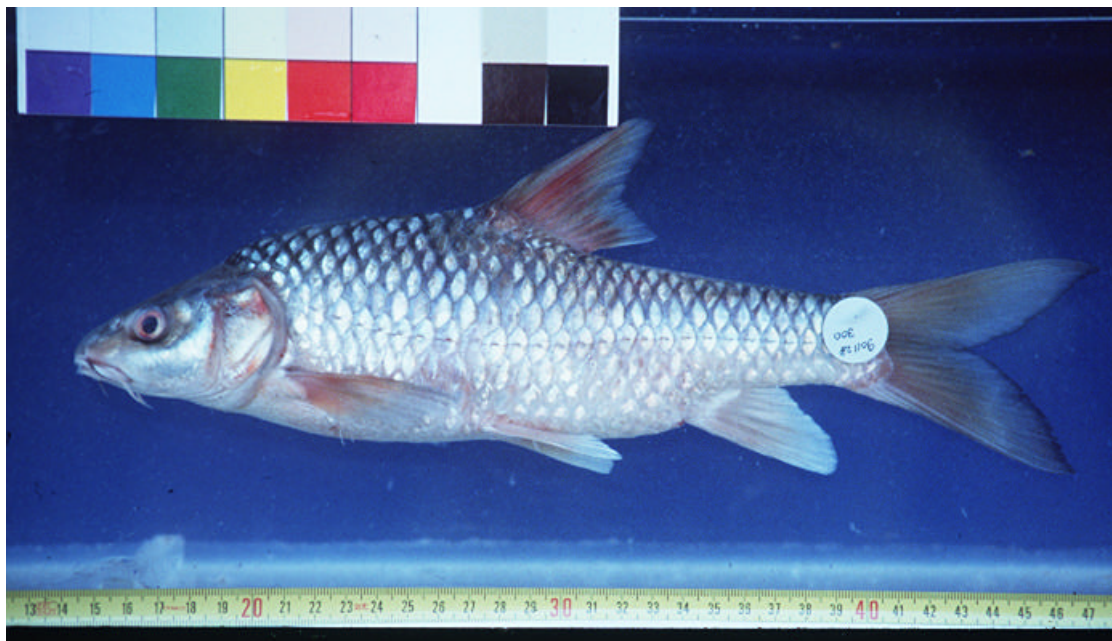

Photo 1.1 *Barbus tsanensis*

Status of the fishery in Lake Tana

Subsistence reed boat fishery

The fishery of Lake Tana is at an early stage of development, compared to that of the lakes in the Rift Valley. The major reason for this has been the limited demand for fish in the area, the low level of technology employed by the traditional fishery and a lack of storage, distribution and marketing facilities. Limited demand results in low fish prices and makes this sector less attractive to private investors.

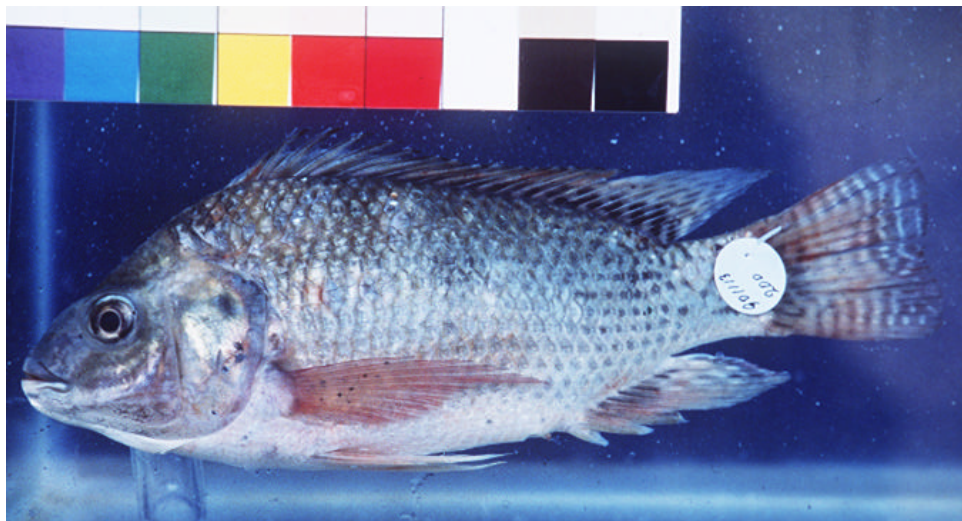

Photo 1.2 *Oreochromis niloticus*

Due to low technology input and capabilities, the mobility of the traditional fishermen using papyrus reed boats operated by one person, is very limited. However, they have easy access to the inshore fish community of *O. niloticus* and *B. tsanensis* which are preferred in the local market and fetch relatively good prices. A reed boat costs 50 Birr (1US\$= 7 Birr, 1997 exchange rate) but has to be replaced after six weeks. Gillnets with a stretched mesh size of 75 to 80 mm and a length of 18 m each are made by the fishermen mostly from monofilament lines obtained from nylon rope. Wigaro (water beating technique) is important in this fishery. Traps and cast-nets are used occasionally. The fish from this traditional fishery are sold by number and prices are negotiable and vary with the seasons. Local fish prices in the Bahir Dar area normally vary from Birr 1.50 to 2.50 per kg during the spring fasting seasons when the demand for fish is higher. Mebrat (1993) estimated the total number of these traditional fishermen around the whole lake to be 1000. Recently, around the Bahir Dar Gulf, there were 113 traditional fishermen (1992/1993 census) with a total of 374 gillnets. There is no historical record of the production of the traditional fishery from the Bahir Dar Gulf area (ca. 30,000 ha). In 1992/1993 production estimated on the basis of sampling

was 224 tonnes·yr⁻¹. Given an area exploited by the reed boat fishery of 7500 ha (25 % of the total Gulf area) this corresponds to a production of 30 kg·ha⁻¹·yr⁻¹. The characteristics of the reed boats imply that it is mostly a subsistence fishery, restricted to the littoral zone, which has left the open water fish community virtually untapped for a long time.



Photo 1.3 *Clarias gariepinus*

Traditional fishermen mainly catch *O. niloticus* and the smaller sizes of *B. tsanensis*, *B. surkis* and a few other species inhabiting the littoral zone. The size distribution of their catch is given in Fig. 1.4. *O. niloticus* is caught at lengths varying from 15 to 30 cm with a mode at 23 cm. *B. tsanensis* is caught at larger sizes, between 20 to 35 cm with an average of 28 cm. Most of the traditional fishermen are farmers engaged in fishing as a part-time profession. They had to make their own fishing nets as these were not available in the market. Even if fishing had been profitable, initial investments required for improving or creating storage and marketing infrastructure were too high for the fishermen. An improvement of the situation was, therefore, unthinkable, without intervention and assistance from either the government or aid organisations.

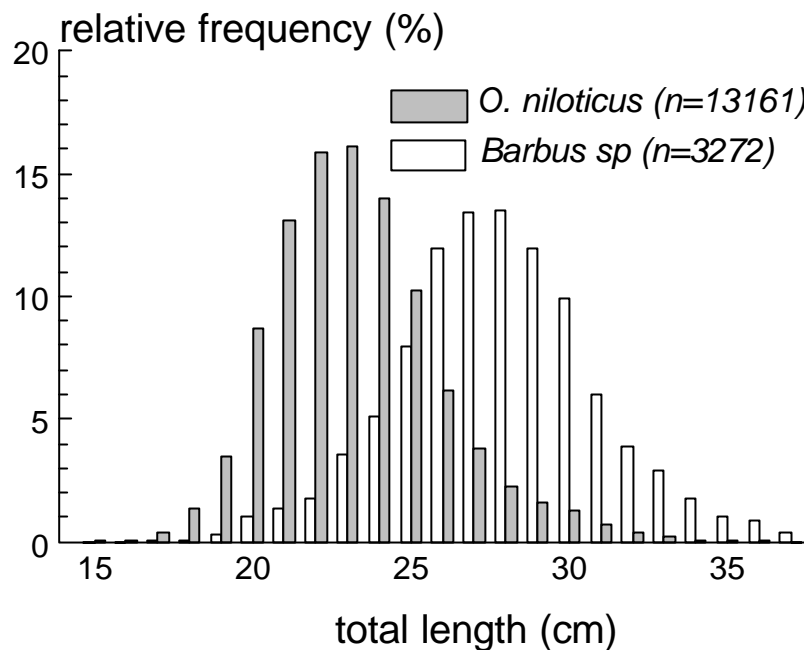

Figure 1.4 Size structure of the fish caught by the reed boat fishery.

Motorised boat fishery

The motorised boat fishery of Lake Tana started with the small-scale fishery development project launched by the Dutch Non Governmental Organisation (NGO), Interchurch Foundation Ethiopia, (ISE - Urk), in 1986. The major objective of the project was to assist the poor fishermen around the Bahir Dar Gulf area and on the nearby Islands by improving their fishing technology and supplying them with modern fishing gear i.e. motorised boats and nylon twine gillnets. The introduction of motorised boats offered new opportunities for the fishermen to exploit the deeper, more offshore waters of the Gulf and the river mouth areas North of the Bahir Dar Gulf. Increasing production was possible because it was supported by a parallel improvement in storage and marketing facilities. Later on, the project was jointly supported by two Dutch NGOs: ISE - Urk and the Interchurch Co-ordinating Committee for Development Projects (ICCO - Zeist) with the co-operation of the Ethiopian Orthodox Church and the Ethiopian Ministry of Agriculture.

Gillnets with a stretched mesh size of 100-120 mm and an average length of 55 m each are used by the motorised boats. There is a collection boat which receives the catch at the fishing grounds. This has facilitated the use of fishing grounds further North of the Gulf, in the river mouth areas, which have a relatively high fish density. Three to four persons work on a boat. There were 130 fishermen working on 23 motorised boats, of which 7 are active on an average day, and the 1992/1993 production estimate was 420 tonnes·yr⁻¹. So the catch per fishermen was ca 3.2 tonnes·yr⁻¹, which is over one and a half times as high as in the traditional reed boat fishery. The fishermen are organised in a co-operative and have a management committee which co-operated with the NGO fishery development project management. All activities and responsibilities were transferred to the co-operative in 1996.

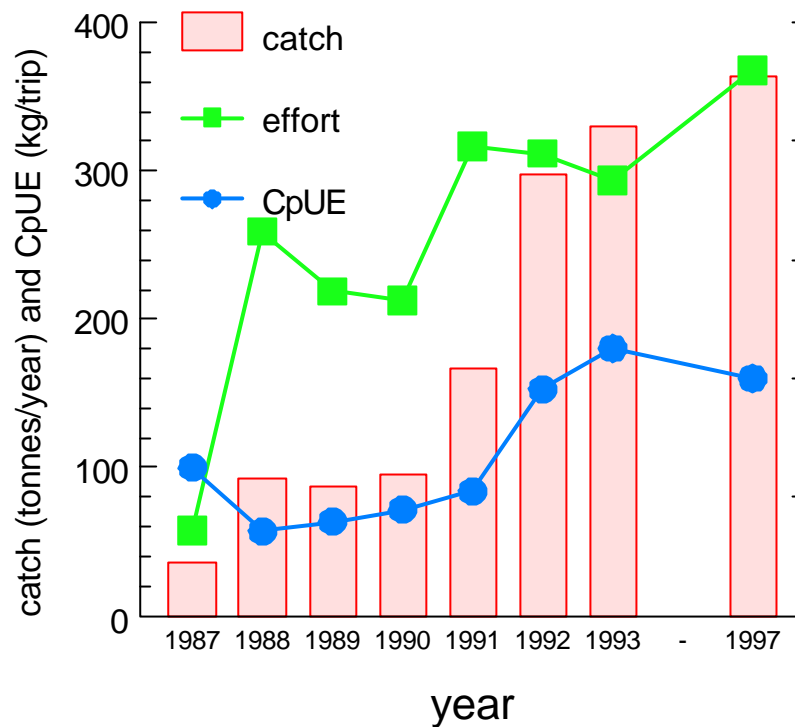

Figure 1.5 Catch, effort and catch per unit of effort (CpUE) of the motorised fishery in the study area. Data from Fish Production and Marketing Enterprise except 1997 which were taken from Lake Fishery Development Project, Statistical Bulletin 1997.

The development in fishing effort, total catch and catch per unit effort (CpUE), in the area, from 1987 to 1993 and 1997 is shown in Fig. 1.5. The introduction of the motorised boats and the large-sized gillnets has substantially increased the total catch from the southern part of the lake. The fishing grounds of the motorised boat fishery do not overlap much with those of the traditional reed boat fishery, which is concentrated in the littoral areas. The species and size composition of the catch from the two types of fishery is different because of the presence of *C. gariepinus* and the large-sized *Barbus* species including *B. megastoma*, *B. platydorsus*, *B. gorgorensis*, *B. macrophthalmus*, *B. crassibarbis* and *B. nedgia* in the catch of the motorised boats (Fig. 1.6). *Barbus tsanensis* contributes about 50% of the *Barbus* catch in the motorised fishery and over 90% of the *Barbus* spp. in the reed boat fishery. The average length of *O. niloticus* (26 cm) and *B. tsanensis* (32 cm) in the motorised fishery is larger than in the traditional reed boat fishery which show an average length of 23 and 28 cm respectively. The average size of *C. gariepinus* is 54 cm.

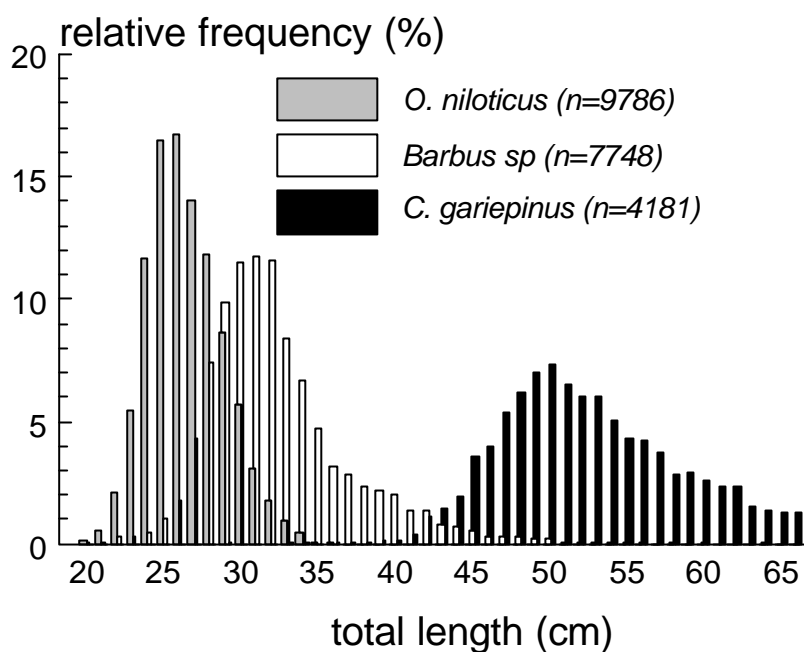

Figure 1.6 Size structure of fish caught by the motorised boats.

The modernisation of the fishery has improved the economic position of the fishermen; it has created an opportunity for them to utilise the new resource of the open water fish community i.e. the *C. gariepinus* and the large-sized piscivorous *Barbus spp.*, mainly *B. megastoma* and *B. platydorsus*. The project has created more jobs in fishing, and also in net making, fish processing, distribution and marketing sectors. It has increased the availability of fish (as a low priced animal protein) to the consumer public. The investment costs of the motorised boats is quite high. The cost for a fishing unit, including the gillnets, is estimated at about 15,000 to 20,000 Birr with an operating cost of 50 Birr per fishing trip. Up to now the fishery has been supported and subsidised organisationally and materially. Without subsidy the cost of a fishing unit would double. At the moment it is not clear whether the economic return is already sufficient to make the fishery viable. Even if it is, it may be marginal which at this stage will not encourage further development or expansion. This assumption is based on knowledge of the current fish prices and investment and operational costs of the fishery. Moreover it is based on the fact that due to shortage of storage and transportation problems, the fishery operates only at a fraction of its capacity.

The catch from the motorised boats is sold to the Fish Production and Marketing Enterprise (FPME), the only market outlet which has the proper facility to store and distribute fish products. The fish price is set by negotiation, but fishermen do not yet have a good bargaining power. *O. niloticus* and *Barbus spp.* fetch prices of 0.90 and 0.75 Birr·kg⁻¹ respectively while *C. gariepinus* fetches less (0.65 Birr·kg⁻¹) from the FPME. So there is a tendency by the motorised fishermen to go for the higher priced species, rather than for *C. gariepinus*.

Initiation and objective of the research

The research programme, described in this thesis, was initiated in connection with the above mentioned development project assisted by the Dutch NGOs, ISE-Urk and ICCO-Zeist. As the assistance programme introduced new and improved fishing technology and gear it was expected that fishing effort would increase sharply and that monitoring of the fish stock and proper management would be required. Also the question of possible interaction between the traditional and the modern technologies arose. Will an expanding motorised fishery exploit simultaneously the same stock as the reed boat fishery and thereby interfere with it? Given the current exploitation level and the uniqueness of the fish community, management objectives should be clearly defined. Aiming at exploitation for maximum protein production would be a rational policy, and the main constraint for this would be infrastructural (investments, marketing channels, transport, processing and conservation). Alternatively, the aim could be improvement or maximising the economic position of the fishermen community in terms of income and employment. In both cases the exploitation level will increase and this will have its impact on the fish community. In general, when the exploitation level increases, the catch per fisherman, the fish stock biomass and the average size of the fish in the catch will decrease as was observed in the Rift Valley lakes with high exploitation rates (Dadebo 1988, Hailu Anja 1996). Lake Tana has a higher biodiversity with larger *Barbus* species, of which several are piscivorous (Nagelkerke 1997). Biodiversity would most probably decline with an increase in exploitation level. Therefore, aspects such as nature conservation, preservation of gene pools and the ecological balance have to be taken into account as well, resulting in the question whether a selective fishery would quickly erode the biodiversity of the Lake Tana fish community.

For a controlled development and proper management of the expanding Lake Tana fisheries, basic knowledge on its fish stocks is needed together with an adequate recording system for catch and effort data to follow developments in the fishery and in the fish stocks on a long-term basis. The overall objective of the described research programme is, therefore, to generate and provide basic biological information on the fish stocks that would assist in evaluating management strategies for a maximum sustainable production of the growing multi-species gillnet fishery. Such research should include a description of the composition and spatial distribution of the fish stocks, a description of the selective impact of the fishery, an estimation of the dynamic parameters i.e. growth, mortality and reproduction, and a design for a catch and effort data recording system.

The existing small-scale reed boat fishery exploits a limited part of the resource base as fishing is restricted to the littoral zone, where the piscivorous species of the system are lacking. Due to the subsistence nature of this fishery, fishing pressure seems rather stable. Further development of Lake Tana fisheries will most likely be governed by an expansion of the fishing effort applied by the motorised boat fishery, which has a potential to grow. Apart from the main question on the fishery potential in terms of maximum sustainable yield, the interaction of the traditional fishery and the motorised fishery should be elucidated. Both gillnet fisheries have selective impacts on the fish community which may lead to (technical) interaction or even competition. When a growing motorised fishery interferes with the existing fishery, by simultaneous exploitation of the same stocks in overlapping areas, its effects

should be quantified. The exploitation rate for large piscivores might increase disproportionately when fishing pressure from the motorised fishery increases. Given the greater concern and awareness of conservation of aquatic biodiversity, which will probably conflict with maximising the production of the system, knowledge on the effects of an expanding fishery with highly selective gears on the fish community structure and erosion of biodiversity is essential both from an ecological and fisheries management point of view.

The specific objectives of the study were:

1. To characterise the spatial and dynamical aspects of the Lake Tana fish community based on fishery-independent observations.
2. To define the current state of the fishery and to identify its impact on the fish community based on fishery-dependent observations.
3. To identify and assess the options for management in view of the potential production of the fish stock in the lake, the management objectives, - measures and -organisation, and in view of the part of the resource base which is exploitable.

The next chapter in this thesis deals with the study area, research methods and data handling. Chapters 3, 4 and 5 deal with fishery-independent observations. Chapters 6 and 7 cover fishery- dependent observations and chapter 8 deals with the resource base of the system. In chapter 9 the research results are summarised and evaluated.

Introduction to the chapters

Reproduction pattern

The reproduction biology of the commercially important species in the lake provides vital information required in designing fisheries management strategies. It answers important questions as to what size, when and where each species spawns. Determination of size at first maturity (L_m), breeding season and area of spawning allow to set the minimum allowable fish size in the catch and to protect the breeding stocks which become vulnerable as they aggregate at the spawning grounds (Ogutu-Ohwayo 1990). Although a number of studies have been carried out on the reproductive biology of *Barbus spp.*, *O. niloticus* and *C. gariepinus* in various tropical water bodies (De Silva, Schut & Kortmulder 1985, Msiska 1990, Payne & Collinson 1983, Lowe-McConnell 1982, Gwahaba 1973, Owiti & Dadzie 1989, Greenwood 1955, Rinne & Winjala 1983, Willoughby & Tweddle 1978) such information has not been available for these species in Lake Tana. **Chapter 3** describes the reproductive biology of the three major fish species, *B. tsanensis*, *O. niloticus* and *C. gariepinus*. The objective for this chapter was to determine the mean size at maturity, L_m , and the timing and duration of spawning. Fish maturity stages derived from monthly trawl survey samples were used to determine L_m and their gonado somatic index was used to assess the periodicity of breeding activity. The peak breeding activity and consequent migration is related to rainfall and water level fluctuation.

Spatial and temporal distribution patterns

Studies on the spatial and temporal distribution patterns of fish provide knowledge about the resource partitioning among species and the nature of inter-specific interactions in a multi-species fisheries (Werner et al. 1977, Wootton 1990). Studies on the biology and ecology of *C. gariepinus* (Clay 1979a & b, Clay 1984, Willoughby & Tweddle 1978, Owiti & Dadzie 1989), cichlids (Ita 1978, Philippart & Ruwet 1982), and cyprinids (Tomasson et al. 1985, Skelton et al. 1991) in various water bodies have indicated that they can have different spatial and temporal distribution patterns. In **Chapter 4** a size-related species distribution pattern in space and time is described for the major fish species in Lake Tana.

Analysis of variance was applied to the abundance of the major species and their size categories in the monthly trawl surveys, to examine significant differences between area and/or season. Sampling locations were grouped into three depth categories and months in four seasons. All species show distinct areas of high abundance and seasonal variations are noted.

Estimation of growth and mortality

Studies on growth and mortality of fish are components in understanding the patterns of population dynamics of fish stocks. The estimations are used to characterise the state of various fish populations and can also be used as input variables for biodemographic models like Beverton & Holt (1957) and Pet et al. (1996). These models are applied to predict consequences of management measures, like changes in effort and mesh size, on the yield.

Growth estimation is based on ageing the fish and reconstruction of the change in length over the age intervals. Seasonal growth marks on hard structures of fish in tropical systems are less distinct than species in temperate areas. Formation of several marks per year could occur depending on seasonality of environmental factors like temperature, rain, water level, turbidity and food availability (Nikolskii 1969, Hopson 1972, Blake & Blake 1978). **Chapter 5** deals with the growth and mortality aspects of the major fish species in Lake Tana. The main objectives were to estimate the growth parameters for each species, assess the total and fishing mortalities and the consequent exploitation rates. Length-age keys provide a comparison of the ages at maturity (t_m) and age at first capture (t_c) indicating the condition of the stock.

The timing of growth mark formation was assessed by evaluating the marginal increment of hard structures (otoliths, opercula and vertebral bones) on a monthly bases. The periodicity of formation, together with back-calculated lengths was used to estimate the growth parameters and these were compared with estimates, from length based modal progression analysis (ELEFAN - method). The growth performances of *C. gariepinus* and *O. niloticus* were compared with stocks from other tropical systems. Mortality estimates were done using the length-based catch curve analysis for total mortality and Pauly's empirical formula (Pauly 1980) for natural mortality. The exploitation rate expressed as the ratio of fishing mortality to the total mortality was estimated.

Estimation of the selective impact of the gillnet fishery

The fishery of Lake Tana relies on gillnet fishing. Gillnets are highly size selective because a deviation in fish length of more than 20% from the optimum length can hardly be retained (Hamley 1975). A good knowledge of the selective character of the gillnets used is essential to predict the impact of change in mesh size as well as for the interpretation and analysis of catch statistics for population parameter estimates (Sprangler & Collins 1992, Machiels, et al. 1994). Controlling the minimum allowable size of the fish in the catch, would require regulations on the minimum mesh size of the gillnets.

In **Chapter 6** the gillnet selectivity parameters for the various fish species in the lake are estimated. The classical indirect methods of Holt (1963), Gulland & Harding (1961) and Sechin (1969) were used for estimation. The *Barbus spp.* in Lake Tana shows a large variation in morphological characters (Nagelkerke et al. 1994) and it is expected that different morphotypes also show different selectivity. The length frequency distribution curves from the gillnet catches were compared with the selectivity curves of gillnets used by the fishery to assess its selective impact. The size ranges of fish from the gillnet catches were compared with the length at first maturity for all species.

Designing a catch and effort data recording system

Developing a suitable catch and effort data recording system (CEDRS) is a first priority in a newly developing fishery (Hilborn & Walters 1992). Dudley & Harris (1987) suggest that fishery statistical data can be used as an alternative source of information on which to base management decisions when detailed biological studies are lacking, as is the case in most tropical countries (Larkin 1982). It is important to carry out a preliminary survey to characterise and describe the fishery thereby providing basic information to design a sampling scheme for long-term monitoring of the fishery. **Chapter 7** characterises and describes the fishery of the Bahir Dar Gulf area of Lake Tana, based on fishery-dependent data.

The seasonal and spatial variations in CpUE and fishing effort were assessed using ANOVA and species composition of the gillnet catches described. Fishing grounds with similar catch rate were grouped for analysis of spatial variation. Temporal variations were based on high and low water level and dry and wet season. The variance was used to determine the sample size required to estimate the annual catch at a desired level of precision. Total annual production from the motorised and reed boat fishery was estimated. A catch and effort data recording system was proposed to give an estimate of total annual catch with a precision of less than 10% maximum relative error.

Zooplankton composition, distribution and production

Zooplankton is an important component in the food chain as a major contributor of the food base for larval fish stocks (Mavuti & Litterick 1981) and some adult fish species. Zooplankton studies provide information that will lead to a better understanding of the trophic relationship in the lake (Borgman et al. 1984). In **Chapter 8** it is attempted to characterise the zooplankton of Lake Tana in terms of its composition and spatial and seasonal variations in abundance. The environmental effect on seasonal distribution pattern is discussed in relation

to the changes in water transparency. The species diversity of the zooplankton in Lake Tana and their size ranges are compared with those of typical tropical freshwater lakes. The biological productivity of the study area in terms of the amount of zooplanktivorous fish it can sustain is indicated.

Options for the management of Lake Tana fishery

Fisheries managers require advice on the amount of fish that can be extracted from a water body and the fishing effort that should be applied. Initially, only generalised advises on potential yield can be given based on morphometric and biotic characteristics of the system. Extended time series of data on catch and effort can also be used for predictions of the maximum sustainable yield and the corresponding effort level. The time series of data with information on the fishery available for Lake Tana are too short. On the other hand, Chapters 3 to 8 provide detailed biological information on the current state of the major fish stocks.

The available knowledge on the Lake Tana system and its fish community is integrated in **Chapter 9**. Potential fish yield estimates have been made, using empirical models as well as a size-structured simulation model based on the work of Pet et al. (1996). Input variables of the simulation model were estimates for the dynamic parameters recruitment, growth and mortality as presented in the specific chapters of this thesis. The model was calibrated with actual 1992/1993 data. Management options under varying fishing effort and mesh size changes were considered and their effect on the total catch, CpUE, size structure and species composition was assessed. Based on simulation, management objectives like expansion of the fishery to reach maximum yield were discussed considering their biological and socio-economic constraints.

Study area, sampling and data handling

Lake Tana and Bahir Dar Gulf

Lake Tana is located to the North-west of Ethiopia at an altitude of 1830 m above sea level and is part of the Abay river basin. The lake is rather circular and has a narrow extension to the South forming the Bahir Dar Gulf. Major cities around the lake are Bahir Dar with 100,000 inhabitants and Gorgora in the North with 10,000 inhabitants. The population scattered in small villages around the lake totals some 50,000 who are engaged in agriculture. There are a few islands towards the South of the lake; the largest, Dek Island is inhabited by about 1000 people. On the other, smaller islands are monasteries containing ancient relics of the Ethiopian Orthodox Church.

The southern shore line around the islands is rocky changing to soft sediment with submerged vegetation towards the North of the Gulf and at the mouth of the tributaries. The shore area around the outflow of the Blue Nile is densely vegetated with papyrus reeds, *Cyprus papyrus*. The major flora prevalent in the area also includes *Ceratophyllum demersum*, *Nymphaea caerulea*, and *Vallisneria spiralis*. Lake Tana has a truncated fish fauna (Greenwood 1976). Cyprinids are abundantly represented with bezo, *Varicorhinus bezo*, *Garra quadrimaculata*, *G. dembiensis*, and 15 species of the genus *Barbus* (barbels) of which *Barbus trispilopleura* and *Barbus tsanensis* are most common. Other species found are the silurid African catfish, *Clarias gariepinus* and the cichlid Nile tilapia, *Oreochromis niloticus*.

The lake area under study in the present research covers the southern part of the lake. This area was selected for the study because: it is the area with the highest fish exploitation rate and basic facilities for the research are available in Bahir Dar town through the cooperation with the Dutch NGO fishery development project, the Bureau of Agriculture and the fishermen cooperative. The study area covers approximately 300 km².

Climate and hydrology

The climate at Lake Tana area is essentially moderate with one rainy season in summer. Average annual rainfall in the Bahir Dar area is 1500 mm (data from National Meteorology Office, Addis Ababa), over 90% of which falls during June to October, with 50% in July-August (Fig 2.1). The water level of the lake fluctuates with the rainfall pattern and level changes of up to 2 m occur between the start and at the end of the rainy season. The highest water level is observed in October. Most of the small rivers dry out shortly after the big rains. Significant inflow comes from three major rivers in the South, the Gilgel Abai, Rib and Gumara, which, during the heavy rains, carry a large amount of silt resulting from severe erosion, thereby increasing the turbidity of the water in the Bahir Dar Gulf, as indicated by the reduced transparency of the Secchi disk depth during the rainy season in Fig. 2.2. The overall mean transparency is 55 cm ranging from 67 cm in April to 39 cm in September. This is low compared to the whole lake average of 103 cm reported by Gasse (1987). Fig. 2.2 also shows the annual variation in water temperature. The average temperature is 21.7 °C, with a maximum yearly variation of 5 °C. Temperature has two peaks, one around May-June at the

start of the rainy season and the other around October-November at the start of the dry winter season.

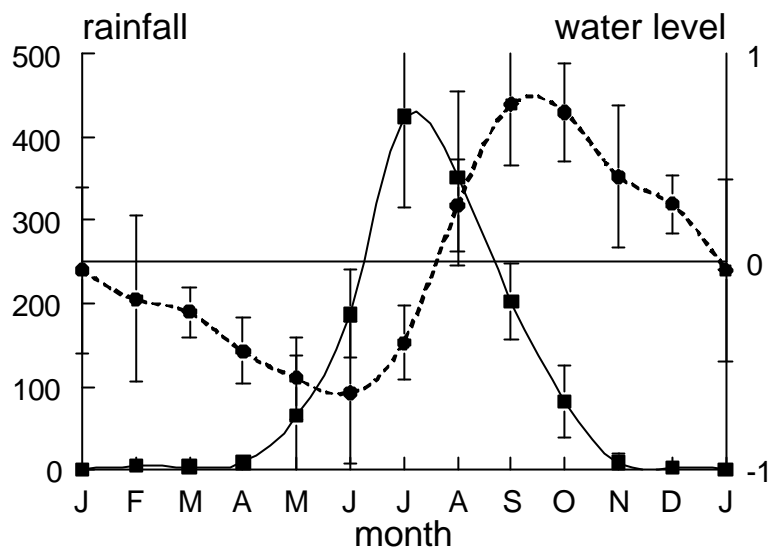

Figure 2.1 Average monthly rainfall (mm) and water level (dotted line, meter around the overall mean = 1830 m above sea level). Bars refer to standard deviations. Data from 1990 - 1993.

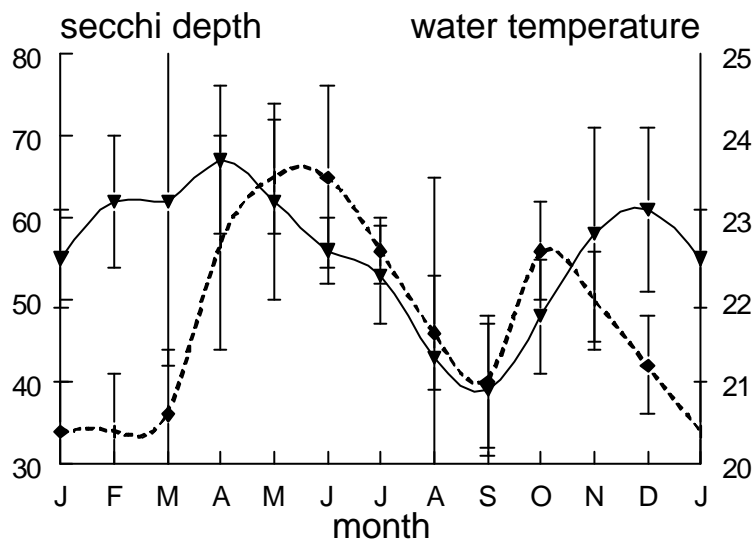

Figure 2.2 Average monthly Secchi disk depth (cm) and water temperature (dotted line, °C). Bars indicate standard deviations. Data from 1990 - 1993.

The major morphometric, hydrological and chemical features of Lake Tana are presented in Table 2.1. Lake Tana has been categorised as oligotrophic (Rzoska 1976). Based on the chemical parameters its trophic status could be categorised as mesotrophic.

Table 2.1 Physical and chemical features of Lake Tana. Data from Rzoska (1976), Serruya & Pollinger (1983) and Wood & Talling (1988).

Location	latitude	11 35N	12 18N
	longitude	37E	
Altitude	m. above sea level		1830
Area	km ²	3156	
Volume	km ³		28.4
Max. length	km	78	
Max width	km	67	
Shoreline	km	385	
Max. depth	m	14	
Mean depth	m	8.9±1.0	
Renewal time	yr	6.1	
Catchment area	km ²	16500	
Precipitation	mm·yr ⁻¹	1500	
Temperature	°C	20	- 24
Secchi disk depth	cm	40	- 70
Conductivity	µS·cm ⁻¹	200	- 240
Na ⁺	mg·l ⁻¹	7	- 9
K ⁺	mg·l ⁻¹	1	- 2
Ca ⁺⁺	mg·l ⁻¹	14	- 15
Mg ⁺⁺)	mg·l ⁻¹	12	- 17
HCO ₃ ⁻ + CO ₃ ⁻⁻	mg·l ⁻¹	91	- 115
Cl ⁻	mg·l ⁻¹	1	- 2.5
pH		8.1	
PO ₄ - P	mg·l ⁻¹	15	- 20
NO ₃ - N	mg·l ⁻¹	0.0	- 80
SO ₄ -	mg·l ⁻¹	1.5	
Chlorophyll	µg·l ⁻¹	3.7	
Total Dissolved Solids	mg·l ⁻¹	150	- 170

Sampling the fish stocks and the fishery.

Sampling area

One of the reasons for selecting the Bahir Dar Gulf as a study area was the availability of adequate research facilities at a convenient location in Bahir Bar town. The research laboratory is located 300 m from the fish landing jetty of the motorised fishery. This jetty was also used for anchoring the research boat. The fishermen co-operative boat and engine repair workshop provided technical services. Gillnets are manufactured at the site by skilled women and specific experimental gillnets were purchased from there. The laboratory

was made available for the research programme by the Bureau of Agriculture. Four fishery officers stationed at the laboratory collaborated and assisted in the research programme.

Sampling the fish stock

The fish stocks were sampled from 13 pre-selected sampling stations in the Bahir Dar Gulf. Sampling stations were selected to include various habitats (depth, bottom type and vegetation). A preliminary survey was carried out to find suitable trawling grounds, avoiding rocky bottoms that would damage the nets. Echo-sounding was used to assess bottom structure and depth. The trawl time in relation to the amount of fish caught was considered in order to set the trawling duration for the sampling programme. The 13 sampling stations are depicted in Fig. 2.3 and their characteristics are presented in Table 2.2. The average depth ranged from 2 to 11.6 m. Bottom types were sand, mud, stone and plant debris.

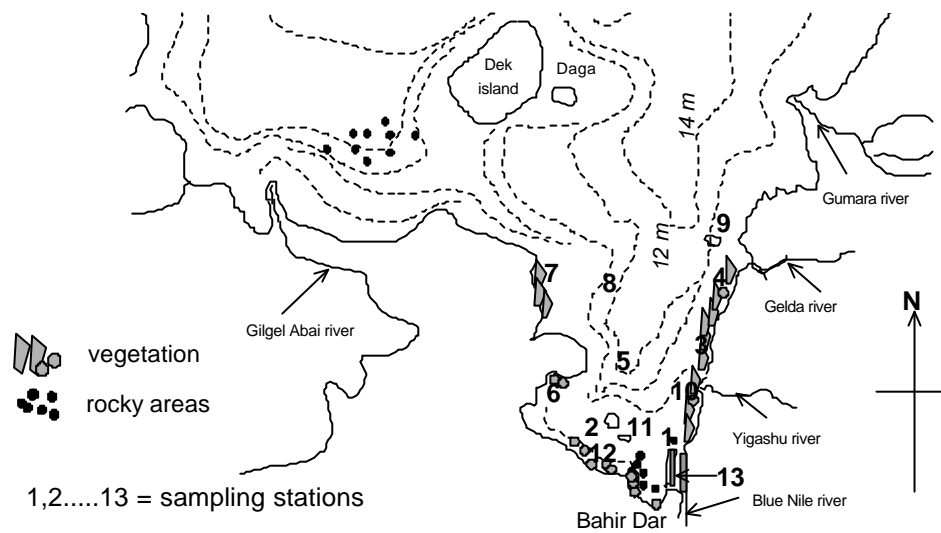

Figure 2.3 Bahir Dar Gulf, the study area and sampling stations.

Table 2.2 Location number and name, bottom type, average depth (m) and depth standard deviation (m) of the 13 sampling sites in Bahir Dar Gulf.

Number	Station	Bottom type	Depth	
	name		Mean	Std
1	D.Mariam	Sand	3.2	0.4
2	Kibran	Mud	6.5	1.0
3	Mebra	Mud	3.1	0.6
4	Betmenzo	Sand	2.8	1.3
5	MehalZegie	Plant debris	11.6	0.6
6	Zegie	Mud	3.7	0.6
7	Ambobahir	Sand	2.4	0.3
8	N.Midgulf	Sand	11.1	0.9
9	Korata	Mud	5.0	0.9
10	Yigashu	Mud	2.0	0.3
11	Kentafami	Mud	6.6	1.8
12	Airport	Mud/stone	5.9	0.5
13	BlueNile	Mud	2.2	0.5

The research boat “Marije” was purchased by ISE, Urk, the Netherlands where the skipper and fisherman were trained on the boat. The boat was fitted with an 80 hp diesel engine and a hydraulic winch with steel warp and otter boards for casting and hauling the net. The boat was 7.8 m long and provided enough open deck space for sorting and measuring the catch on board. A bottom trawl with 15 m head rope, 17 m foot rope, and 2.5 m side panels was used. The trawl net was made of multifilament twine with a ply ranging from 210/12 to 210/46. Mesh sizes ranged from 90 to 40 mm (stretched) at the codend. The trawling speed was 3.6-4.0 km·hr⁻¹. The trawl net had a vertical opening of 1.0-1.5 m and a horizontal opening of 7.5-8.0 m during operation. Sampling the fish stocks was carried out monthly from August 1990 to September 1993 with an interruption from February to August 1991.

On average 3 stations per day were sampled over 5 days at the beginning of each month. Trawling was done in the morning from approximately 07:00 am to 12:00 noon. Equipment carried on board for each sampling trip were trawl net, fish boxes, measuring board, weighing scale, ordinary thermometer, thermister thermometer, zooplankton net 120 µm (8.5 cm diameter), zooplankton sample bottles, formalin 10%, and Secchi disk (20 cm diameter). A 30 minute trawl was carried out at each of the 13 stations. Water temperature, transparency (Secchi depth), oxygen and air temperature were recorded at each station. Zooplankton was sampled by making a vertical haul prior to the start of trawling. The net was lowered to about 60 cm from the bottom to avoid contact with the mud, and hauled vertically at a constant speed ($\approx 0.5 \text{ m}\cdot\text{s}^{-1}$) to the surface. The zooplankton sample was completely transferred into a plastic bottle, labelled and preserved in 4% formalin.

The fish caught were sorted to species immediately on deck. Total weight per species was taken and fish were measured individually to the nearest centimetre above. Total length was measured from *C. gariepinus* and *O. niloticus*, while length of *Barbus spp.*

was measured as fork length. When the catch for a species exceeded 50 kg, a subsample was taken for length measurements. A sample of 10 from each species was systematically taken over the whole size range and kept for further observations in the laboratory during the afternoon. The observations on individual fish in the laboratory were length (mm), girth (mm) and individual weight (g). Moreover after dissecting the fish, its sex, maturity stage and gonad weight (0.1 g) were recorded. Thereafter hard structures were sampled for age determination at a later stage. Otoliths, opercula and vertebrae were taken from *O. niloticus*, *Barbus spp.* and *C. gariepinus* respectively.

Between August 1991 and July 1993, 16 gillnet samplings were carried out for gillnet selectivity studies. Bottom set gillnets were used over night at various locations. Mesh sizes used ranged from 60 to 140 mm stretched mesh. Each gillnet was 1000 mesh long and 30 mesh high. The nets were made of multifilament with a ply of 210/6 connected to a lead line at the bottom and float line at the top. The hanging ratio was 0.5 for all nets. An equal number of meshes for each mesh size was used per sampling date and site. Between sampling dates the number of nets used varied between 1 and 3 nets per mesh size. In the morning the nets were lifted and observations were recorded per mesh size. Total weight per species was recorded and fish were measured individually to the nearest centimetre.

Sampling the fishery

The fishery was sampled at Bahir Dar and the surroundings of the Gulf from August 1990 to September 1993 with a short interruption in 1991. Sampling for assessment of the size distribution of the catch took place in the second week of each month. The motorised and the reed boat fishery were observed simultaneously. In the case of the motorised fishery, the size structure of the catch was sampled separately from catch effort observations. The size distribution was recorded for 3 days each month. The usual landing time at the jetty was from 9:00 to 12:00 AM and a maximum of 3 boats were selected during this time span. The whole catch of the selected boats was used for measuring the individual fish lengths, after sorting, counting and weighing the catch of each species.

Catch and effort observations were obtained from samples taken for two days per week. All boats which had been active during the foregoing night were included. Records were collected simultaneously by fisheries officers at the landing jetty or on board the collection boat at a pre-arranged receiving point. Usually fishermen sort their catch prior to their arrival at the landing point, where they are provided with fish boxes. Records were made of the weight of the fish (catfish, tilapia and barbels) sold to the fish marketing corporation. Additional observations were collected by interviewing the fishermen about fishing grounds, number of gillnets used, crew number, fishing duration and unsold fish being discarded or for their own consumption.

A frame survey on the reed boat fishery was carried out in October 1990 and September 1991. At first the fishermen were collectively informed of the background and objectives of the research and the procedures. Thereafter fishermen were interviewed individually using a questionnaire to establish identity, boat ownership, number size and type of fishing gear, mesh size, active fishing days per month, average catch per fish category, fishing ground and price of the fish sold. Each of the 6 fishing villages around the Gulf was

visited for 3 days. To assess the catch and its size structure from the reed boats a survey was carried out for 4 days each month. Except for the Bahir Dar jetty, landing sites of reed boats were inaccessible. Therefore, reed boat fishermen were intercepted at their way to the market in the morning, where the catches were sampled. Catches were sorted into species, weighted, counted and measured for individual length. Additional observations collected by interviewing the fishermen referred to fishing method, number of nets and fishing ground.

Laboratory observations and data storage

Between field samplings, laboratory observations were made on the zooplankton samples and the hard structures collected for ageing during the trawl surveys at 13 stations. The procedures will be presented in the relevant chapters. Field data as well as laboratory data were entered in raw data files on a spreadsheet and checked for errors. Upon completion of the field sampling, all data were stored in a database system to minimise data redundancy and dispersion during the data analysis phase of the research. The database structure was adapted from a database system developed at Batu Berendam, Malaysia, used for storage of Malaysian reservoir fishery data under a ASEAN-EC Aquaculture Development and Co-ordination Program (AADCP) described by Samingin et al. (1993). The database structure is depicted in Table 2.3.

Table 2.3 Data storage structure.

<u>SAMLOC</u> LOCNO, locna, dep, bottom		
<u>SAMFIBI</u> SAM, date locno, gr, ms, nl, nh, tim, sde, rem		<u>SAMCAEF</u> SAM, date, LOCNO, REGNO, locfish
<u>STOMFULL</u> SAM, SP, sex, SICL, sf	<u>FIBI</u> SAM, SP, le, bw, sex, mat, gw, pre, po, mg, rc	<u>BOAT</u> , REGNO, boattype, boatname, startdate, enddate, hp, cr
<u>STOMCONT</u> SAM, SP, sex, SICL, FI vol	<u>LF</u> SAM, SP, SICL, nof, ssf	<u>EFFORT</u> , SAM, hours, method, tont, ms
<u>BACKCAL</u> SAM, SP, sex, rn, rs	<u>SPECIES</u> SP, sciename, localname	<u>CATCH</u> , SAM, SP ,lc, towt, tono
<u>SAMLIM</u> , SAM, wl, dep, temp, oxy, sechi, volu, rem	<u>ZOOPL</u> , SAM, ZOSP, no, ssf	<u>ZOSP</u> , CODE, name

The whole database consists of 15 tables or files(underlined), which can be related through various links via key-fields (CAPITAL). The database tables are briefly described below.

1. BACKCAL observation on the hard structures for aging used for back-calculation of length at age
2. BOAT characteristics of commercial fishing boats
3. CATCH composition of the commercial catch
4. EFFORT observation on number of boat landings
5. FIBI observation on individual fish originating from either surveys or the commercial catch
6. LF length frequency distribution of fish originating from either surveys or the commercial catch
7. SAMCAEF commercial motorised boat and reed fishing boat sampling characteristics
8. SAMFIBI fishing gear, date and location characteristics from the surveys
9. SAMLIM physico-chemical and zooplankton sampling characteristics
10. SAMLOC sampling location or fishing ground site characteristics
11. SPECIES fish species code, their scientific name and local name
12. STOMCONT stomach content of fish originating from the survey
13. STOMFULL degree of fullness of fish stomach originating from the survey
14. ZOOPL composition of zooplankton samples
15. ZOSP codes of zooplankton species and their scientific name

The variables entered are as follows:

- **bottom** Characteristic of the habitat as bottom type
- **bw** Body weight
- **cr** Number of crew per boat
- **date** Enter as a day/month/year date format
- **dep** Water depth as it was recorded in August 1990, using the water level at the landing jetty as a reference point when recording depth at other locations.
- **dur** Duration of fishing (hr)
- **enddate** End date of boat actively involved in fishing
- **fi** Food item. Refer to a list for code
- **gr** Gear type
- **gw** Gonad weight
- **hp** Boat engine horse power
- **lc** Categories for fish landed (discard, sold, own consumption)
- **locfish** Fishing location
- **locna** Location name, refer to a list for present identified location name or free choice if it is a new sampling site
- **locno** Location number, refer to a list of abbreviations in order to identify the code number for particular location
- **mat** Maturity stage. Refer to a list for code
- **mg** Maximum girth
- **ms** Mesh size
- **name** Scientific name of zooplankton
- **nh** Enter a net height for each mesh size in meter
- **nl** Enter a net length for each mesh size in meter
- **no** Enter a number of zooplankton counted per species
- **nof** Number per sicl
- **po** Post-operculum girth
- **pr** Pre-operculum girth

- **rc** Number of ring counts on hard structure
- **regno** Registration number of the sampled boat
- **rem** Remarks
- **sam** A sample number that is uniquely identified
- **secchi** Secchi disk reading, based upon a upon a measurement
- **sex** Refer to a list for code for male female and unknown
- **sf** Stomach fullness
- **sicl** Size class
- **sn** A species number
- **sp** A species code, uniquely identified
- **ssf** Subsampling factor
- **startdate** Start date of boat actively involved in fishing
- **temp** Temperature
- **tim** Time fishing are set in 24-hour cycle format
- **tl** Length
- **tono** Total number of fish per species
- **towt** Enter total weight of fish per species
- **unit** Enter number of units of gear type
- **vol** Volume of food item
- **volu** Volume of zooplankton sample
- **wl** Water level near the main landing jetty
- **zosp** Refer to zooplankton code

Reproduction patterns of *Clarias gariepinus*, *Oreochromis niloticus* and *Barbus tsanensis*

Abstract

Size at maturity and temporal variations in the gonadosomatic index (GSI) and gonadal maturity were used to assess the reproductive pattern of three of the major species. Sizes at 50% maturity for females were 30.5, 18 and 20.5 cm for *Clarias gariepinus*, *Oreochromis niloticus* and *Barbus tsanensis* respectively. Males of *C. gariepinus* and *O. niloticus* mature at larger sizes of 36 and 20.5 cm respectively.

Periodicity of breeding was most distinct for *C. gariepinus*. Peak breeding occurred in July, when they migrate to newly inundated marginal areas, and lasted 1.5 month. Extended breeding seasons of about 3 to 4 months were observed for *O. niloticus* and *B. tsanensis*. The strongest decrease in average GSI was observed in July for *O. niloticus* and in September-October for *B. tsanensis*. Relatively few ripe *B. tsanensis* were observed, possibly because they migrate to river mouth areas, which were outside the sampling area.

Introduction

Information on the biology of the fish stocks of Lake Tana is scarce. Apart from some papers on the taxonomy of the different fish species found in the lake (Boulenger 1911, Bini 1940, Banister 1973, Nagelkerke & Sibbing 1998a) limited information is available on their biology in Lake Tana. The reproductive biology of *C. gariepinus* (Clay 1979 a,b, Rinne & Wanjala 1983, Willoughby & Tweddle 1978, Greenwood 1955, Owiti & Dadzie 1989) and *O. niloticus* (Gwahaba 1973, Payne & Collinson 1983, Lowe-McConnell 1982) have been studied in various tropical lakes and reservoirs. Apart from a recent study by Nagelkerke & Sibbing (1996), publications on tropical *Barbus spp.* refers to species other than those found in Lake Tana (De Silva et al. 1985, Msiska 1990). It has been noted that there is a wide intra-specific variation in the length or age at maturity. Within a species there may be considerable inter- and intra-population variation reflecting both genetic and environmental influences (Wootton 1990).

Size at first maturity is influenced by changes in environmental factors and size selective mortality from predation or fishing pressure (Bruton & Alanson 1974, Lowe-McConnell 1982, Kolding 1993). It has been noted that seasonal patterns of reproduction in tropical freshwater fishes are frequently related to the effect of changes in water level (Wootton 1990). Under such conditions it may be difficult to apply results obtained for a certain species from one water body to the management of the same species in a water body with a different environment. Lake Tana has a distinctly seasonal environment with respect to rainfall and subsequent fluctuations in water level. Temperature also shows some seasonality but of a smaller scale. The main rainfall season in the Lake Tana area is from June to September during which the water level increases an average of 1.5 m. The water becomes enriched with nutrients from the rivers inflow and by the nutrient released from decaying vegetation and animal droppings in the inundated areas. This would induce an increased growth of plant and animal life and production of juvenile fish is generally timed to coincide with this period (Jones 1982). It is known that most fish species time their spawning period during such seasons to ensure maximum survival of their offspring. In Shire valley, Malawi, *C. gariepinus* spawns in the vegetated littoral zone when the area is newly inundated with rising water (Willoughby & Tweddle 1978). *O. niloticus* also breeds in the shallow weed belt of the lake (Schroder 1984, Lowe-McConnell 1982.). It has a long breeding period, but with peak spawning during the rainy season at high water level. The cyprinids, being of riverine origin, tend to migrate into rivers to find suitable spawning ground, though some species breed in the lake and river mouths (Tomasson, et al. 1985, Skelton et al. 1991). We would expect the species in Lake Tana to respond to the rainfall and water level fluctuations in a similar way. The major rainfall season June to September would be expected to be the peak spawning period for *C. gariepinus* and *O. niloticus* in the littoral vegetated area. *Barbus spp.* could breed in the lake but it is also likely that they migrate to the inflowing rivers to spawn.

The sequence of changes in maturity stages during the year are important in understanding the reproductive pattern of an exploited stock. Information derived from the analyses of maturity stages can be used in establishing the size at which fish attain sexual maturity and the time of spawning. The gonado-somatic index (GSI) is another useful

parameter that can be used to follow reproduction patterns of fish species. The spawning stock is more vulnerable to the fishery during their breeding season because they aggregate on their spawning grounds (Ogutu-Ohwayo 1990). Hence, knowledge of the reproduction biology of a species, including size/age of maturation, season and area of spawning would provide useful information in designing management regulations, such as minimum size, closed area's and/or seasons, for a sustainable development of the fishery.

The aim is, therefore, to obtain an understanding of the reproductive patterns of the major commercial fish species in relation to the seasonal environmental factors and to determine their mean size at first sexual maturity L_m together with the timing and duration of spawning.

Data collection and analysis

Sampling

Fish were sampled monthly by trawling at 13 sampling locations in Bahir Dar Gulf. Approximately 10 fish were selected from each species at regular intervals over the size range for additional observations in the laboratory. Measurements of length (mm) and weight (g) were recorded for individual fish. *C. gariepinus* and *O. niloticus* were measured for total length and *B. tsanensis* for fork length. Each fish was dissected, the gonad examined, sex determined, maturity stage recorded, and weighed (Sartorius digital balance 0.1 gm). The sex of the smaller size classes of *B. tsanensis* (< 15 cm), were difficult to identify, even after dissection. All samples were analysed fresh, on the day they were collected. A total of 6700 fish, comprising 2800 *B. tsanensis*., 2100 *O. niloticus* and 1800 *C. gariepinus* were dissected and examined during the study period.

A maturity index was used to indicate the stage of maturity of the gonads as given in Table 3.1. Maturity indices were recorded after visual examination of the gonad and evaluating the stage of development based on size, shape, texture and colour of the gonads as described in the literature (Nikolsky 1963, Holden & Raitt 1974, Owiti & Dadzie 1989).

Table 3.1 Characteristics considered in classification of maturity stages in *O. niloticus*, *C. gariepinus* and *B. tsanensis* based on the size and general morphological appearance of the gonads. Adaptations of the scheme of Nikolsky (1963) for use in Lake Tana.

Maturity stages and description of gonads

MALES

1. Immature, virgin - A pair of small thread-like, colourless organs (with slightly serrated edges, in *C. gariepinus*). Difficult to distinguish between the sexes (except in *C. gariepinus*).
2. Developing virgin or recovering spent - Long thin, up to 1/2 length of body cavity but distinct opaque white in *B. tsanensis* and *O. niloticus* and translucent white in *C. gariepinus*, with distinct serrated edges and shorter.
3. Maturing or ripening - Long and thicker, 2/3 body cavity (or 1/2 in *C. gariepinus*), firm and more solid. Colour white in *B. tsanensis*, cream or beige in *O. niloticus* and greyish-white in *C. gariepinus*.
4. Ripe and running - Large thick and slimy. Milky white in *B. tsanensis*, creamy in *O. niloticus* and white in *C. gariepinus*. Sperm easily flows when pressed or cut. *C. gariepinus* testis has smoother edge.
5. Spent - testis shrunk and flaccid. Numerous folds appear in *O. niloticus*, and serrated edges revert to original sharpness and colour changes grey in *C. gariepinus*

FEMALES

1. Immature virgin - A pair of small, thread-like colourless organ. Difficult to distinguish between the sexes in *B. tsanensis* and *O. niloticus*. In *C. gariepinus* (size >18 cm) the ovary is discernible as tiny, bulb-like and pinkish in colour.
2. Developing virgin or recovering spent - Long thin, up to 1/2 length of body cavity thicker than the testis and translucent yellowish-white in *B. tsanensis* and *O. niloticus* and pink in *C. gariepinus*. Recovering spent has larger gonad size and a thicker wall.
3. Maturing or ripening - Long and thicker, 2/3 body cavity Colour yellowish in all. Ova discernible in all.
4. Ripe and running - Ovary large, yellow, almost filling the peritoneal cavity in all. Ova well developed and large, may flow out when pressed.
5. Spent - ovary shrunk and flaccid. Some remnants of disintegrating, opaque and ripe eggs appear in ovary of *O. niloticus* and sometimes in *B. tsanensis*; rarely in *C. gariepinus*. Colour changes translucent in *O. niloticus* and *B. tsanensis* but in *C. gariepinus* the ovary changes colour to greyish-red.

Data analysis

Size at maturity

Beverton & Holt (1957) defined the average weight at first maturity as being the weight at which 50% of the individuals first reach maturity. Similarly, the average length at first maturity can be defined as the average length at which 50% become mature, (also referred to as L_m) (Willoughby & Tweddle 1978). The L_m for the Lake Tana species was calculated using the information on the maturity stage of the fish. Thus all fish with maturity stages 1 and 2 were considered immature and stages 3 and above as mature. The proportion of mature fish per length class with class width 1 cm was calculated and the average length at which 50% of

the fish reach maturity was estimated according to Ni & Sandman (1984). Here it is assumed that the relation between the percentage of mature fish per length class and fish length can be described with a logistic curve thus:

$$PM_i = \frac{1}{1 + e^{-r(l_i - l_m)}} \quad 1$$

where:

PM_i = proportion of mature fish in the i^{th} length class

L_i = i^{th} length class (cm)

r = coefficient (cm^{-1})

A linear equation may be obtained by transformation:

$$\ln\left(\frac{1 - PM_i}{PM_i}\right) = -r \cdot (l_i - l_m) \quad 2$$

where the intercept equals $r \cdot L_m$, and $-r$ the slope.

Gonado Somatic Index (GSI)

The gonado-somatic index (GSI), also known as the maturity coefficient, is the weight of the gonad expressed as a percentage of the somatic body weight. The GSI is used to assess the state of gonad maturation and to determine the current reproduction status. A plot of the mean monthly GSI against sampling months indicates the period and frequency of spawning of the species during the year. The GSI has been employed to determine the spawning season of fish stocks (Bagenal 1978, De Silva et al. 1985, Owiti & Dadzie 1989, Abidin 1986). The GSI (%) was calculated from the gonad weight (g) and the somatic weight (g) using the formula:

$$GSI = \frac{\text{gonad weight}}{\text{total weight} - \text{gonad weight}} * 100 \quad 3$$

The monthly geometric mean GSI for mature fish (ie. l_m and above) was considered in the analysis, since immature fish would not be expected to show temporal variation in their monthly GSI.

The maturity index is also used to assess and follow the breeding condition of the fish through time as supporting evidence to the results obtained from GSI. The percentage of fish in different stages of maturity was calculated for the sampling dates according to the formula:

$$MS_i \% = \frac{MS_i}{\sum_{i=1}^5 MS_i} * 100 \quad 4$$

where:

$MS_i\%$ = the percent fish of maturity stage i

MS_i = number of fish of maturity stage i

$\sum MS_i$ = total number of fish of all maturity stages (1 to 5)

Results are plotted for the different months to examine the temporal (cyclical) patterns. Thus, the temporal pattern of reproduction, or spawning cycle, of the different species was studied by observation of the variation with time of the mean monthly GSI and

analysing the monthly percentage maturity stages during the sampling period. High relative abundance of ripe fish, or higher GSI, followed by a decrease in certain months could be an indication of a breeding season.

Results

Size at maturity

The logistic curve which describes the maturity sizes of the major species (females & males) in Lake Tana is depicted in Fig. 3.1. The 50% maturity length, L_m , for *C. gariepinus* was 30.5 cm for females and 36.0 cm for males. Ninety five percent of the females were mature at a length of 45 cm and the males at a length of 50 cm. The L_m for *O. niloticus* was 18.1 cm for females and 20.7 cm for males. At a total length of 25 cm 95% of the females are mature and 95% of the males are mature at a length of 26 cm. The L_m for *B. tsanensis* was calculated to be 20.5 cm and 20.3 cm for females and males respectively. 95% of *B. tsanensis* are mature at 28 cm females and males at 30 cm. The r value giving an indication of the increase in maturity around the L_m is lowest for *C. gariepinus, 0.2 cm^{-1} for both females and males. For *O. niloticus* a r of 0.45 cm^{-1} for females and 0.3 cm^{-1} for males was found. The r -values found for *B. tsanensis* equal 0.4 and 0.6 cm^{-1} for females and males respectively.*

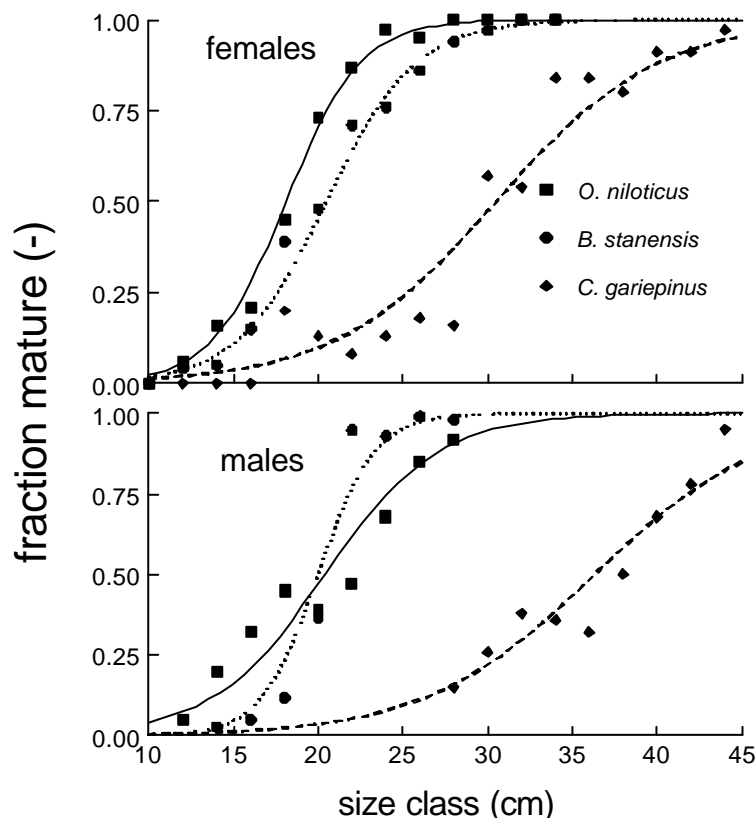

Figure 3.1 Maturity curves for *C. gariepinus*, *O. niloticus* and *B. tsanensis* females (top) and males.

GSI and the reproduction cycle

Clarias gariepinus

Results from the GSI calculation for the monthly samples of *C. gariepinus* are presented in Fig. 3.2. The mean monthly GSI, indicates that *C. gariepinus* has a single distinct spawning peak during the rainy season in June - July, when the water level starts to rise.

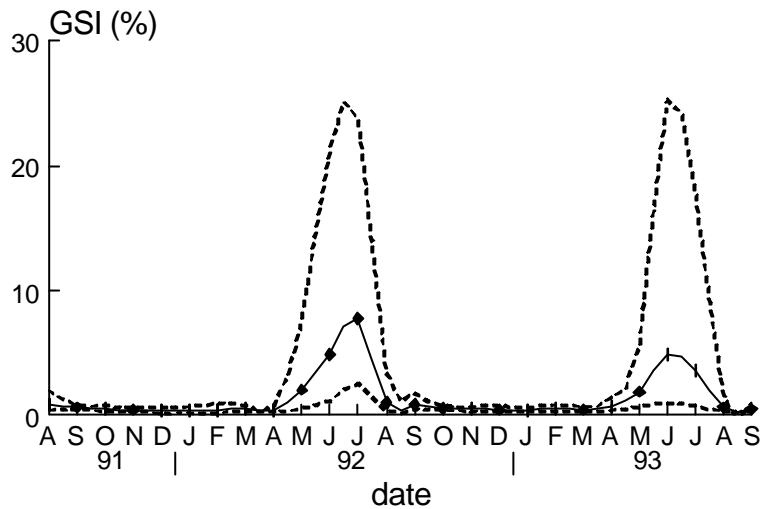

Figure 3.2 Temporal variation in GSI (geometric mean and 95% confidence interval) for female *C. gariepinus*.

The maximum mean GSI for females was 7.7% in 1992 and 4.9% in 1993. A similar pattern is observed over both the sampling years. The highest individual GSI was 42.2% during June 1993. The GSI of male *C. gariepinus* shows periodic peaks during June-July of each year but with a low mean value of 0.5%. The female GSI remains very low between 0.5% and 1.0% from August to May.

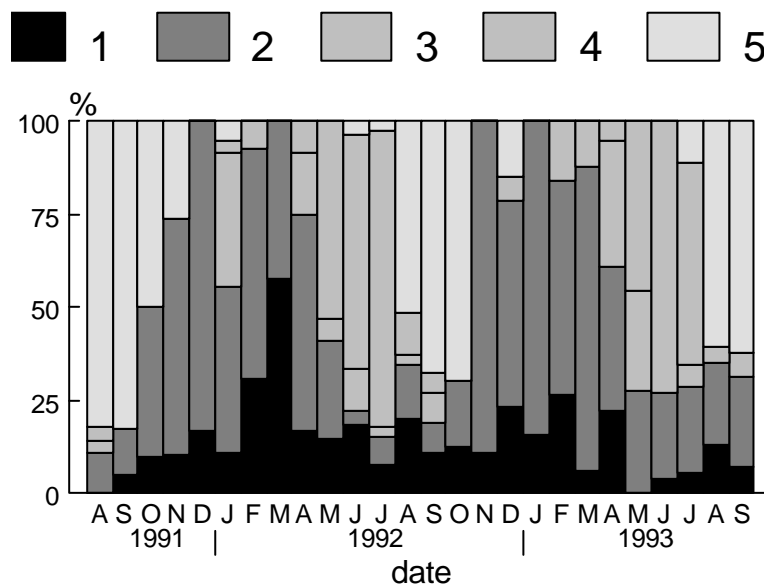

Figure 3.3 Proportion of different maturity stages (1 to 5) per month for *C. gariepinus* females.

This pattern can also be seen in the plot of the annual cycle of the relative maturity stages (%) (Fig. 3.3). High percentages (50% - 79%) of ripe (stage 4) individuals are observed during May-July for both sexes during 1992 and 1993. Over 60% of the individuals were in a spent condition at the beginning of August which indicates that spawning of *C. gariepinus* in Lake Tana takes place in July.

Oreochromis niloticus

The GSI of *O. niloticus* did not show a very consistent pattern over the sampling period as does *C. gariepinus*. Several GSI peaks were observed from January to September in 1992 with a clear peak during July (1.5%) for females (Fig. 3.4). Another, smaller peak was apparent in September. The males showed a gradual build up with two peaks, in June and September (0.9%). Both females and males had a similar GSI pattern in 1993 with a continuous build up, a minor peak in March and a major peak in July and September at 1.0% for females and .05% for males. This suggests that peak spawning was during the period of highest rainfall and water level.

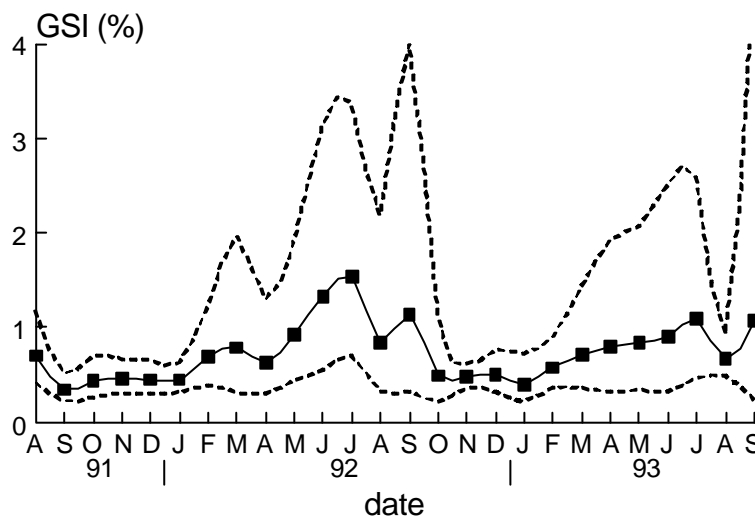

Figure 3.4 Temporal variation in GSI (geometric mean and 95% confidence interval) for female *O. niloticus*.

A similar picture was observed in the monthly records of the maturity stages, with relatively high percentages (40-70%) of ripe and spent individuals during several months from May to September (Fig. 3.5). This relatively high percentage of ripe and spent fish (stages 4 & 5) during such a prolonged period could be taken as an indication of an extended breeding season for *O. niloticus* in Lake Tana. Multiple spawning is possible during this period. But the observations on the maturity stages confirm the peak breeding time to be during July-September.

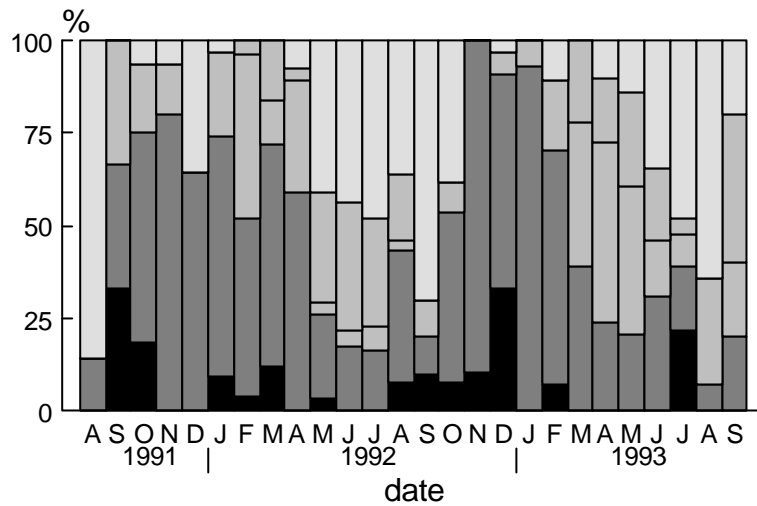

Figure 3.5 Proportion of different maturity stages (1 to 5) per month for *O. niloticus* females. Legend as in Fig. 3.3.

Barbus tsanensis

The results from the GSI observation of *B. tsanensis* indicated major peaks in August and September in 1991 and 1992 and September 1993 (Fig. 3.6). However, the mean monthly GSI values are small 0.8-1.0 % for females with similar values for males. The GSI showed a small increase also during the months - December, January , March 1991/1992 and March 1993. Individuals at maturity stage 4 (5-15%) and small a number of spent fish (5-10%) were also present during these months (Fig. 3.7). This suggests the possibility of prolonged breeding activity during the different months reaching a peak in August/September when the water level is high. The very low number of ripe and spent fish in the samples suggests migration of the breeding individuals of *B. tsanensis* out of the sampling area.

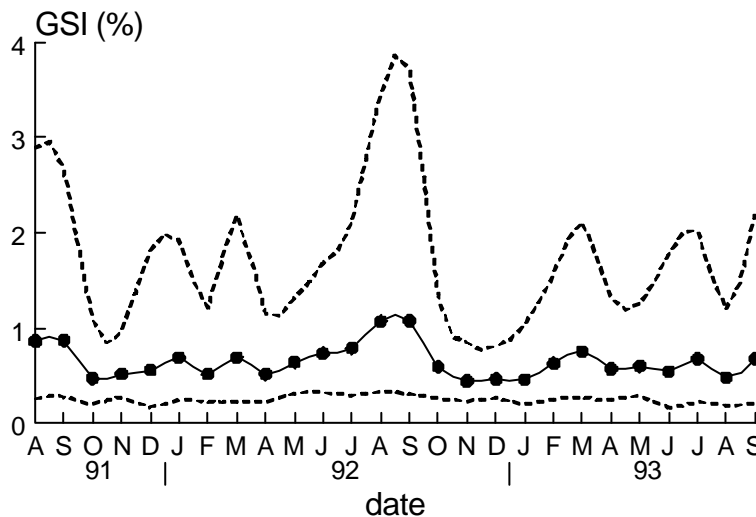

Figure 3.6 Temporal variation in GSI (geometric mean and 95% confidence interval) for female *B. tsanensis*.

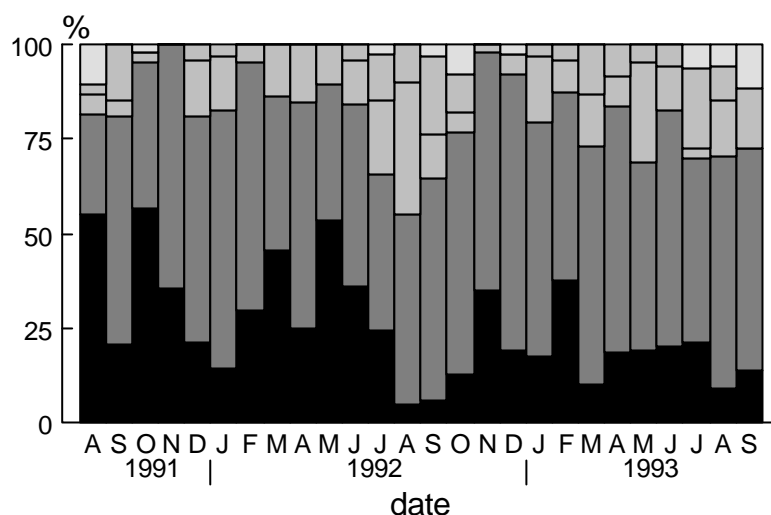

Figure 3.7 Proportion of different maturity stages (1 to 5) per month for *B. tsanensis* females. Legend as in Fig. 3.3.

Discussion

The L_m for *C. gariepinus* in Lake Tana, 30.5 cm and 36.0 cm for females and males respectively shows some difference between the sexes. However, the difference is not large when we consider the r value of 0.2 cm^{-1} which indicates a relatively slow increase for both sexes, in the fraction of the population which was mature. The difference could be in the allocation of resources for gonad development. A female GSI could be as high as 42% but the male GSI would not exceed 2-3%. The L_m is different from that observed for the same species (29 cm and 32 cm) in the Shire Valley, Malawi (Willoughby & Tweddle 1978) and Lake Victoria, 40-45 cm for both sexes, (Rinne & Wanjala 1983, Owiti & Dadzie 1989). Lake Victoria, being much larger and deeper than Lake Tana, and containing large predatory species, could induce larger L_m for the species (Lowe-McConnell 1982).

Populations of *O. niloticus* have been observed with L_m varying between 27 and 14 cm in different water bodies (Lowe-McConnell 1982, Kolding 1993, Admassu 1994). This variation in L_m of *O. niloticus* has been attributed to different factors but mainly to fishing pressure, water level fluctuation the size of the water body and dissolved oxygen level. A change of L_m from 39 cm to 26 cm over a period of 29 years has been reported for *O. niloticus* from Ferguson Gulf of Lake Turkana (Kolding 1993). A similar phenomenon has been reported for the same species in Lake George, Uganda where L_m declined from 27.5 cm to 20 cm in about 20 years attributed to an increase of fishing pressure (Lowe-McConnell 1982). The L_m in Lake Tana 18.1 and 20.7 cm is similar in size range to another population of *O. niloticus*, (18.8 and 19.8 cm female and male respectively) in Lake Awassa, Ethiopia (Admassu 1994). Size selective mortality from predation by cyprinid predators in Lake Tana is unlikely. The mean length of *O. niloticus* in the catch of the traditional reed boat fishery is currently larger than its size at maturity and there are no reasons to assume that an increase in fishing pressure has induced a reduction of the mature sizes.

B. tsanensis is the most important to the fishery among the unique *Barbus* spp. found in Lake Tana. It is widely distributed in the lake and, like *O. niloticus*, it is an important target

fish in the traditional fishery. The size at maturity, L_m , of 20.5 cm for *B. tsanensis* is somewhat lower than the value Nagelkerke & Sibbing (1996) calculated for the same species, 24 cm. This difference might be due to the selective use of only the running individuals in their analysis. In the sample from the Bahir Dar Gulf such running individuals were very few and low in proportion to the stage 3 individuals considered in the calculation. The fishing pressure, however, cannot be considered to have affected the L_m up to now.

Unlike the temperate zone conditions where reproduction patterns of fish species are related to temperature and photoperiod, the reproductive biology of tropical freshwater fishes is influenced mainly by the rainfall pattern and/or water level variations (Lowe-McConnell 1975, Payne 1986, Wootton 1990). The spawning times of all the species in Lake Tana follow the general pattern of breeding in tropical freshwater in that it is coincident with the heavy rainfall and water level increase e.g. *C. gariepinus*, (Willoughby & Tweddle 1978, Clay 1979b) and *O. niloticus* (Schroder 1984, Taddese 1988).

The seasonal changes in gonad development of *C. gariepinus* are well marked in Lake Tana and it seems that this fish goes into a quiescent phase after spawning in August. No gonad development is apparent until the next breeding season, May-August. This is different from observations of Owiti & Dadzie, (1989), on *C. mossambicus* in Nyanza Gulf, Lake Victoria, where they found ripe gonads throughout the year, although spawning took place only with the onset of the rains. The spawning season of *Clarias* differs regionally. Multiple or biannual spawning of *C. mossambicus* have been reported in Lake Victoria during the rainy seasons (Greenwood 1955, Whitehead 1959, Rinne & Winjala 1983). For *C. gariepinus*, Clay (1979b) observed a single short spawning activity coinciding with the first big flood in Lake Mcllwaine, a very similar phenomenon to that observed in Lake Tana. In the Shire Valley, which is at a similar latitude to Lake Tana, in the southern hemisphere, Willoughby & Tweddle (1978) observed one breeding season with a peak in December, a half year shift in time from that of Lake Tana in the North. In Lake Tana, it seems that gonad development of *C. gariepinus* is initiated by the start of the heavy rains and the high water temperature in May, while spawning is triggered by the rising water level and inundation of the dry land, which have some influence on the nutrient and chemical composition of the water (Payne 1986). Van der Waal (1974) suggested that some factor in the run off water from the first rain is the ultimate stimulant for breeding. Whatever the factor that stimulates spawning, it is evident that the breeding pattern of *C. gariepinus* is strictly synchronised to the big rains and water level increase in Lake Tana and that spawning activity takes place during July.

The spawning strategy of most species is to ensure high survival of their offspring. Apart from their physiological and genetic adaptations, they ensure this by responding to the environment in selecting sites of more food availability and minimum predation pressure for the larvae. This condition can be best fulfilled in the flooded inshore vegetated areas which provide more suitable food and protection from predators. *C. gariepinus* is seen flocking into the inundated plain near the town, where it is easily caught by school boys and towns people wading into the water with open-ended conical traps and catching fish by hand. This latter phenomenon indicates how vulnerable the fish can be during the spawning activity.

The spawning period of *O. niloticus* is not quite so sharply delimited as that of *C. gariepinus*. It shows a rather extended breeding period. Babiker & Ibrahim (1979) have

indicated the possibility of *O. niloticus* spawning at least twice during one extended breeding season. *O. niloticus* is found breeding throughout the year in several lakes e.g. Lake Victoria, (Welcomme 1967), Lake George, (Lowe-McConnell 1982), Lake Zewai, Ethiopia (Tadesse 1988), Lake Awasa, Ethiopia (Tudorencea, et al. 1988), but with peak breeding seasons, usually during the rainy periods. In some areas the spawning time is just before the rains. Short breeding seasons are also reported in the lower Nile in Egypt, with a spawning peak in April-May (Paine & Collinson 1983), and in the Nile near Khartoum (Babiker & Ibrahim 1979). Schroder (1984) observed extended breeding of *O. niloticus* in Lake Zewai with peak spawning activity during February, March and April. In both lakes, Zewai and Tana, the reproductive activity of *O. niloticus* is associated with the rainfall period and water level increase. However, in Lake Zewai the peak breeding period appears to be during the small rains of March-April (Schroder 1984), rather than during the major rainy season as in Lake Tana.

The cyprinids are mainly riverine fishes which have become adapted to the lake. However, several studies on lake dwelling cyprinids indicate that many species still migrate upstream to spawn in the rivers (Tomasson et al. 1984, 1985, Skelton et al. 1991). Such behaviour is a clear indication that these fish are not fully adapted to the lake environment and still require riverine conditions to be able to spawn successfully (Skelton et al. 1991). In Lake Tana, even though the rivers flowing into the lake were not sampled to investigate upstream spawning migration, information from the commercial fish catch records indicate that the *Barbus spp.* do congregate near the mouths of the big rivers, Gumara and Rib, during the high water season. Nagelkerke & Sibbing (1996) reported that the catch of *B. tsanensis* from Gumara River mouth during three weeks in September contained over 85% of the individuals in spawning condition. In Lake Le Roux, Cambrey & Bruton (1984) indicate that *Barbus anoplus* migrates upstream but can also spawn near the shore. The occurrence of few gravid females and ripe running males of *B. tsanensis* in the sampling area, and the concentration of these spawning stock at the river mouth, suggests minor breeding activity in the lake and that spawning takes place primarily at the river mouths or upstream. *B. tsanensis* in Lake Tana undergoes a spawning migration during the breeding season when the water level increases with high runoffs from the rivers.

The selective sampling of the bottom trawl fishing only from relatively deeper grounds, excluding rocky and vegetated littoral grounds and the river mouths, could have caused a bias in the observations of the GSI pattern of *B. tsanensis* and *O. niloticus* stocks.

Temporal and spatial dynamics in the size-related distribution patterns of *Clarias gariepinus*, *Oreochromis niloticus*, *Barbus tsanensis* and *Barbus platydorsus*

Abstract

The size-related spatial and seasonal variations in abundance of the major fish species were studied from monthly trawl surveys. *C. gariepinus* was most abundant in areas below 3 m depth, with few individuals of sizes smaller than 30 cm. The average abundance of *O. niloticus* in the littoral zone was 37.5 per haul being 10 times higher than in areas deeper than 6 m. The small and large sizes of *B. tsanensis* were most abundant in areas between 3 m and 6 m, the larger ones occurring deepest. The piscivore, *B. platydorsus*, was most abundant in areas deeper than 6 m.

Temporal effects were observed with catches of *C. gariepinus* being higher during the dry season (December-February), *O. niloticus* during the rainy season (June-August), *B. tsanensis* during the high water season (September-November) and *B. platydorsus* during the dry season. A relative increase in the abundance of *C. gariepinus* was observed in the littoral zone, during the rainy season reflecting a spawning migration. Higher catches of *B. tsanensis* during high water coincide with their breeding season. Thus, the maximum catches of the main species in the lake occurred in succession.

Introduction

Studies of the distribution patterns of fish communities in space and time provide insight into the resource partitioning among the species and the nature of interspecific interactions (Werner et al. 1977, Wootton 1990). The distributions or habitat selection of different fish species, or size classes within a species, in a lake depends on several factors including the physiological adaptation of the species to specific environments (Caulton & Hill 1973), preference for specific feeding and spawning grounds, or refuges and shelter from predators (Philippart & Ruwet 1982). Knowledge of the distribution pattern of a species can provide essential information for the development of models for fisheries management since fishing activities will have different impacts in the varying habitats within a water body (Pet & Piet 1993). Concentration of fishing effort on one type of fish species or restricted lake area, could cause local over-exploitation, destabilise the ecological balance and distort the diversity of the fish community. Pet & Piet (1993) indicated that the result of any management will depend on the size related spatial and temporal distribution patterns of the fish and fishermen (or fishing effort).

Environmental seasonality is apparent in the Lake Tana area and seasonal peaks have been observed in the commercial gillnet catches of the different species. Spatial differences are also noted from the variation in the catch from different fishing grounds. The fish species of commercial interest in Lake Tana, *C. gariepinus*, *O. niloticus* and *Barbus spp.*, are exploited by the shore-based traditional fishery and a modern motorised boat fishery with a wider fishing area. Studies of the biology and ecology of *C. gariepinus*, (Clay 1979, Willoughby & Tweddle 1978, Owitti & Dadzie 1989), cichlids (Philippart & Ruwet 1982, Ita 1978) and cyprinids (Tomasson et al. 1985, Skelton 1991) in different water bodies, have indicated that these different species can have variable spatial and temporal distribution pattern in response to the environment, their size and development stage. The species in Lake Tana may also respond to the seasonal environment which influences their feeding and breeding activities. The breeding activities of most tropical freshwater fish species including *C. gariepinus*, *O. niloticus* and *Barbus spp.* is associated with the rainfall pattern and increase in water level. Different size classes of each species may also have different habitat preferences (Keast 1978, Werner & Gilliam 1984, Pet & Piet 1993), in most cases associated with the availability of suitable food and protection from predators for the young.

The present work attempts to elucidate the dynamic pattern of size-related spatial and temporal distribution of *C. gariepinus*, *O. niloticus*, *Barbus tsanensis* and *B. platydorsus* in the Bahir Dar Gulf of Lake Tana, based on experimental trawl catches over a period of two years (1991-1993).

Methods and data analysis

Data used in the analyses were the numbers, weight and length measurement of the catch from the monthly bottom trawl at 13 locations in the Bahir Dar Gulf. It is assumed that the mean catch in numbers per unit effort (CpUE) of this trawl fishing could be taken as an indication of stock abundance. To study spatial distribution patterns, the 13 sampling

locations were grouped into 3 macro-habitats for all species based on the depth ranges. The 3 macro-habitats were characterised as the shallow, littoral zone (L) with depth <3 m, the intermediate depth zone (I) with depth range 3-6 m, and the deep water zone (D), depth >6 m. The sampling locations grouped were: 3,4,7,10 & 13 (L); 1,6,9 & 12 (I); 2,5,8 & 11 (D). The area covered by the littoral zone is approximately 10% of the total area sampled. The fraction covered by the deep and intermediate zone is estimated to equal 45% each.

To study the temporal distribution pattern the sampling months were grouped into four quarters (seasons) of the year. This was based on the rainfall and water level pattern and the occurrence of peak catches of the different species in the commercial gillnet fishery. Thus:

Season-1	December - February	Dry season, low water temperature, high catch rate for <i>C. gariepinus</i> and <i>O. niloticus</i> in gillnet fishery.
Season-2	March - May	Low water level and small rains, water temperature relatively high, high catch rate for <i>O. niloticus</i> in the gillnet fishery.
Season-3	June - August	Heavy rains, water turbid and level increasing, high catch rate for <i>C. gariepinus</i> in gillnet fishery
Season-4	September-November	End of rainy season, highest water level, and peak catch for <i>Barbus spp.</i> in the gillnet fishery.

The different size classes, particularly the juveniles and adult size classes, may have different spatial distribution patterns. Hence, the catch data (numbers) per species were grouped into size classes and analysed separately for size-related distribution patterns. *B. platydorsus*, a typical piscivore, and important component in the gillnet catch, was included in the analysis. *O. niloticus*, *B. tsanensis*. and *B. platydorsus* were grouped into two size classes of (1) juvenile or immature (≤ 17 cm) and (2) adults (>17 cm). *C. gariepinus* having a larger size range and maturity size, was divided into 3 size classes, (1) the juvenile size class (< 30 cm) (2) the adult size class (30-50 cm) most common in the gillnet catch with a modal length of (50 cm), and (3) size class >50 cm..

Analyses were carried out on the catch per haul (numbers) per species per size group to compare the spatial variations between areas, the temporal variations between seasons, and the interaction of areas and seasons. Data on counts per trawl haul were \log_{10} transformed before applying analysis of variance. The distribution of the counts was positively skewed indicating a log-normal distribution. The arithmetic mean of the log-transformed counts becomes the geometric mean of the original count values after back-transformation. By applying the log-transformation the zero catches are excluded in the analysis. Zero catches of *C. gariepinus*, *O. niloticus*, *B. platydorsus* and *B. tsanensis* were observed in 40, 60, 60 and 1% of the trawl samples respectively. The requirements for an analysis of variance, that variance should be constant and residuals should be normally distributed, were met after the transformation. Moreover, when evaluating temporal and spatial effects the main

interests are proportional changes. By log-transformation the multiplicative scale is translated to an additive scale. Means are presented as geometric means unless stated otherwise.

The most complete model used was :

$$Y_{ijk} = \mu + S_i + A_j + S_i * A_j + \epsilon_{ijk}$$

where Y_{ijk} = the observed counts for a particular species and size category during season(i) in area(j)

μ = overall mean

S_i = effect of i th season ($i=1,2,3,4$)

A_j = effect of j th area ($j=1,2,3$)

ϵ_{ijk} = random term

When a significant effect of the factors and/or interaction were found, group means were compared for significant difference via the confidence intervals for the mean. Pearson correlation coefficients were calculated for counts of a particular species and size category with temperature, depth and transparency at each location and date of sampling. All statistical analysis were carried out with SAS (r) Proprietary Software Release 6.09, SAS 1992.

Results

The overall composition of the trawl catch and the proportion of each species by number and weight (kg) are presented in Table 4.1. *C. gariepinus* constituted only 7% by number but 29% by weight of the total catch. *O. niloticus* was 23.5% by number and 27% by weight. *B. tsanensis* was the most abundant species in the catch, 55% by number and 31% by weight. *B. platydorsus* and other *Barbus spp.* comprised 13%, making up the contribution of all *Barbus spp.* 43% by weight of the total trawl catch.

Table 4.1 Results of the experimental trawl fishery during the sampling period in terms of numbers and weight.

Species	Numbers		Weight	
	total	mean /haul	total (kg)	average weight/fish (g)
<i>C. gariepinus</i>	4277	12	3189	745
<i>O. niloticus</i>	14285	42	2987	209
<i>B. tsanensis</i>	33623	99	3369	100
<i>B. platydorsus</i>	1372	4	324	236
other <i>Barbus</i>	7134	21	1120	156
total	60691	178	10989	181

Table 4.2 Coefficient of variation (sd/mean), average number caught per trawl haul as geometric mean and antilog of standard deviation of log-transformed catches.

Species	CV (-)	Geometric mean	
		N/haul	10 ^{sd}
<i>C. gariepinus</i>	1.6	7.6	3.4
<i>O. niloticus</i>	2.3	21.9	6.0
<i>B. tsanensis</i>	1.0	67.6	2.6
<i>B. platydorsus</i>	1.7	4.9	2.5

Large coefficient of variation (sd/mean) indicates a positively skewed distribution pattern. The geometric means of those catches are presented in Table 4.2. These show a similar pattern as was observed for arithmetic means

The result of the ANOVA, (Table 4.3), indicates that there was a significant effect of season for *B. tsanensis* and the largest size classes of *O. niloticus* and *B. platydorsus*. The effect of area was found to be significant for all species except for the smallest size classes of *C. gariepinus* and *B. platydorsus*. The interaction term was found to be only significant for the medium and large size classes of *C. gariepinus*. r^2 values ranged from 0.07 for the smallest size class of *B. tsanensis* and *B. platidorsus* to 0.39 for the large size class of *O. niloticus*. The reduction of sum of squares was largest from the area effect. The reduction from the temporal effect was four times smaller.

Table 4.3 Results of the analysis of variance (sum of squares) to differences in spatial (area) and temporal (season) distribution of four species

Species	Size Class	Source of variation							
		Season		Area		Season * Area		Error	
		SS	df	SS	df	SS	df	SS	df
<i>C. gariepinus</i>	Small	0.63 ^{NS}	3	0.05 ^{NS}	2	0.46 ^{NS}	4	9.9	116
	Medium	0.78 ^{NS}	3	4.77 ^{**}	2	4.1 ^{**}	4	48.9	227
	Large	0.97 ^{NS}	3	8.35 ^{**}	2	2.56 ^{**}	6	35.9	208
<i>O. niloticus</i>	Small	0.93 ^{NS}	3	10.13 ^{**}	2			51.77	103
	Large	7.07 ^{**}	3	30.98 ^{**}	2			62.44	180
<i>B. tsanensis</i>	Small	4.01 ^{**}	3	1.96 ^{**}	2			64.55	327
	Large	2.63 ^{**}	3	8.38 ^{**}	2			66.15	325
<i>B. platydorsus</i>	Small	0.65 ^{NS}	3	0.82 ^{NS}	2			18.44	95
	Large	0.95 [*]	3	3.74 ^{**}	2			15.91	168

The average abundance of small *C.gariepinus* was not affected by season and area. On average 2.0 fish were caught per haul in this category. For medium and large *C.gariepinus* a significant effect of area and the interaction of season and area were

observed. The average abundance of this species in the catch was 5.6 and 3.5 for medium and large fish respectively. The average catch per season and area for these size classes is presented in Table 4.4. The abundance of medium sizes was highest in the deep and intermediate areas during the dry season. These numbers differ significantly from the abundance in the littoral zone during all seasons except during heavy rains. Large sizes showed highest abundance during high water in the intermediate area, which differed significantly from their abundance in the littoral area.

Table 4.5 Average number in the catch as geometric mean of the trawl hauls, per season and area (deep, intermediate and littoral) for size class 2 and 3 of *C. gariepinus*.

season	Size classes					
	Medium (30 - 50 cm)			Large (>50cm)		
	area			area		
	deep	inter- mediate	Littoral	deep	inter- mediate	littoral
dry season	10.5	10.2	1.1	4.9	6.0	1.4
low water	5.2	5.3	1.9	2.3	6.0	1.7
rainy season	5.6	6.5	5.2	1.7	4.2	2.4
high water	5.7	6.8	3.2	5.2	7.2	2.1

Table 4.4 Average number in the catch as geometric mean of the trawl hauls, per season and area (deep, intermediate and littoral) for size class 1 and 2 of *O. niloticus*

O. niloticus <17 cm

	deep	intermediate	littoral	average
dry season	1.5	3.9	13.5	7.1
low water	1.7	4.5	15.5	8.2
rainy season	1.1	3.0	10.2	6.0
high water	0.5	1.3	4.4	4.0
average	1.4	3.6	10.6	6.5

O. niloticus >17 cm

	deep	intermediate	littoral	average
dry season	2.5	6.2	36.3	17.5
low water	4.1	10.0	58.9	23.7
rainy season	4.5	11.0	64.6	29.9
high water	0.7	1.8	10.5	7.7
average	3.7	7.8	37.5	19.6

The average abundance of the small *O. niloticus* was not affected by season. On average 6.5 fish were caught per haul. A highly significant effect of area was observed in

density distribution of small sized *O. niloticus*. They were most abundant in the littoral area (average 10.6) in contrast with the deep zone (average 1.4). They appeared only 7 times in the catch from the deep zone compared to 67 times in the littoral. *O. niloticus* larger than 17 cm had an overall abundance of 19.6 per haul in the catch. Highly significant effects of season and of area were observed. During high water, significantly lower abundance's were observed than in the other seasons. In the spatial distribution analysis the highest abundance was in the littoral zone (37.5), about ten times the mean number in the deeper zone. The density in the littoral zone was also significantly different from the intermediate zone which was on average 7.9.

The overall abundance for small and large size classes of *B. tsanensis* was 35.8 and 25.9 per haul respectively. A significant effect of season and area was observed in the density distribution of both size classes. Their abundance during high water, being 53.5 and 35.5 respectively was significantly higher than the others. Both sizes show their highest abundance in the intermediate zone. The small *B. tsanensis* occurred in greatest abundance (43.9) in the intermediate zone significantly different from the number (28.8) in the deep zone. Larger sizes also had their highest density in the intermediate zone (34.1) significantly different from the lowest (15.6) in the littoral zone.

Table 4.6 Average number in the catch as geometric mean of the trawl hauls, per season and area (deep, intermediate and littoral) for size class 1 and 2 of *B. tsanensis*

B. tsanensis <17 cm

	deep	intermediate	littoral	average
dry season	27.0	42.1	32.9	33.4
low water	23.2	36.2	28.2	28.7
rainy season	24.5	38.2	29.8	30.3
high water	43.3	67.6	52.7	53.5
average	28.8	43.9	34.9	35.8

B. tsanensis >17 cm

	deep	intermediate	littoral	average
dry season	34.7	36.3	16.6	27.5
low water	27.0	28.6	13.0	21.6
rainy season	26.8	28.3	12.9	21.4
high water	44.7	46.8	21.4	35.5
average	32.5	34.1	15.6	25.9

The average abundance of small *B. platydorsus* was not affected by season and area. On average 3.5 fish were caught per haul. For larger sizes both season and area had a significant effect on the abundance distribution. The abundance during the rainy season (2.1) was significantly lower than during the dry season (3.1). The highest abundance was observed in the deep zone (4.4) significantly different from the littoral zone (1.7).

Table 4.7 Average number in the catch as geometric mean of the trawl hauls, per season and area (deep, intermediate and littoral) for size class 1 and 2 of *B. platydorsis*

<i>B. platydorsis</i> <17 cm				
	deep	intermediate	littoral	average
dry season	3.7	2.9	1.0	3.2
low water	5.4	4.2	1.4	4.9
rainy season	3.8	2.9	1.0	3.3
high water	3.2	2.5	0.9	3.0
average	3.9	3.1	1.0	3.4

<i>B. platydorsis</i> >17 cm				
	deep	intermediate	littoral	average
dry season	5.2	2.8	2.0	3.1
low water	4.8	2.6	1.9	2.8
rainy season	3.5	1.9	1.3	2.1
high water	4.2	2.2	1.6	2.5
average	4.4	2.3	1.7	2.6

The Pearson correlation coefficient of catches of the smallest size class of *B. tsanensis* with secchi disk readings was highly significant: -0.23 (n=328, p<0.01). The correlation's between the appearance of small and medium sized *C. gariepinus* in the catch and water depth were also highly significant, correlation coefficients being 0.32 and 0.14 respectively, similar to those for *B. platydorsis* (0.44 and 0.55 for small and large sizes). The abundance of *O. niloticus* was positively correlated with water temperature ($r = 0.25$) and negatively with depth ($r=-0.41$).

Discussion

The overall results show that spatial variation in the Lake Tana fish community structure is greater than the temporal variation. *O. niloticus* occupies the shallow littoral zone, while *C. gariepinus* and *B. platydorsus* inhabit the deeper parts of the lake. *B. tsanensis* takes an intermediate position with its greatest abundance in the intermediate zone.

C. gariepinus occurs in all the available area with higher abundance in the intermediate and deeper areas. The very low occurrence of juvenile *C. gariepinus* in the samples was due to their distribution in the shallow and vegetated littoral area which was not covered by the trawl sample. This is in line with the observation of Clay (1979a) where the juvenile *C. gariepinus* in Lake Mcllwaine remained in the warmer littoral until 22 cm. In Lake Awassa, Ethiopia, the juveniles could be found only in the adjoining swamp outside the lake (Dadebo 1988). *C. gariepinus* breeds in shallow flooded areas generally associated with rainfall and increased water level (Willoughby & Tweddle 1978, Clay 1979b, Owitti & Dadzie 1989) (Ch. 3). The adult *C. gariepinus* is induced by seasonal changes in water level to

migrate into the shallow littoral breeding grounds. This breeding migration accounts for the reduced abundance of the adult fish in the deeper zone and for the corresponding increase in the abundance of size classes 2 and 3 in the littoral area during the rainy season.

The general characteristics of the spatial distribution of *O. niloticus* in lakes is their restriction to the shallow littoral zones (Philippart & Ruwet 1982). In Lake Kaingi, Nigeria, Ita (1978) observed that *Tilapia zilli*, *O. niloticus* and *Sarotherodon galilaeus* are all found at a depth of 0 to 7 m, even though the lake is up to 50 m deep. In Lake Tana *O. niloticus* is confined to a depth range of 0 to 6 m. Caulton & Hill (1973) indicated that the littoral distribution of lacustrine *O. niloticus* originates essentially from their physiological inability to descend to great depths. The tilapia species are also sensitive to the temperature regime (Caulton & Hill 1973) and they prefer to live in the warmer littoral zone, which agrees with the positive correlation between temperature and abundance found in this study. The submerged vegetation in the littoral zone also provide cover and protection from predators. In Lake Tana *O. niloticus* is thus protected from the large cyprinid predators e.g. *B. platydorsus* and from *C. gariepinus* which inhabit the deeper open water.

B. tsanensis appears to be widely distributed over all the depth ranges of the lake but the intermediate and deep zones are more important to the adult size group than the shallow, littoral zone. The *B. tsanensis* in Lake Tana is referred to as benthivore by Nagelkerke & Sibbing (1997), with a wide distribution over muddy, sandy and rocky substrate. The higher catch rates found during the high water season coincide with the breeding season but also with a period of high turbidity. Both can increase the vulnerability of the fish to the trawl. The juvenile size class of *B. tsanensis*, which also occurs in all habitats, shows a stronger preference for the intermediate and littoral zones. Juveniles of most tropical species prefer to remain in the shallow littoral areas where they find refuge from predators, higher temperatures, and more food of suitable size.

B. platydorsus, which is a piscivore, is found in the deep open water zone mostly. Wootton (1990) points out that an effect of interspecific competition could be a narrowing of the niche width of the competing species along one or more niche dimensions. It is possible that in Lake Tana, the piscivore, *B. platydorsus* is confined to the deeper offshore area where its main prey fish *B. trispilopleura* is found. The small size classes of this species are mainly benthivores (Nagelkerke & Sibbing 1998b).

Growth and mortality estimates of *Clarias gariepinus*, *Oreochromis niloticus* and *Barbus tsanensis*

Abstract

Growth and mortality parameters were estimated to assess the stock dynamics of the fish populations of the major species. Periodicity in the appearance of growth marks in hard structures revealed a formation of 2 rings per year in the vertebrae of *Clarias gariepinus* and in the opercular bones of *Barbus tsanensis*. Periodicity of ring formation in otoliths of *Oreochromis niloticus* could only be determined via counts of the daily growth marks per zone and was on average 52 days per zone.

Growth parameter estimates obtained from back-calculated lengths were compared to those estimated based on length-frequency analysis using ELEFAN. Resulting growth parameter values were $L_{\infty} = 90$ cm and $K = 0.2 \text{ yr}^{-1}$ for *C. gariepinus*, $L_{\infty} = 35.5$ cm and $K = 0.5 \text{ yr}^{-1}$ for *O. niloticus* and $L_{\infty} = 45$ cm and $K = 0.33 \text{ yr}^{-1}$ for *B. tsanensis*. *O. niloticus* recruit to the commercial fishery at an age of 2.3 years, while for the other two species this age was 4 years. Instantaneous total mortality values, Z , were 0.9 yr^{-1} for *C. gariepinus* and 1.8 yr^{-1} for the other two species. The fishery exploitation rates ranged from 45 to 60 % and were considered to be moderate.

Introduction

Growth, recruitment and mortality estimates are the basic parameters needed to quantify the stock dynamics for a particular fish population. When these parameters are used as input parameters in fishery yield models, management alternatives and their consequences for the fish population or community can be quantified in relation to yield predictions. Growth of fish is influenced by both abiotic and biotic factors (Wootton 1990). In the temperate zone growth seasonality is a function of water temperature, food availability and daylength (Winfield & Nelson 1991). The seasonality of growth is often related to the formation of growth marks in hard structures and is associated with the low winter temperature. In the tropics seasonality of growth is mostly a consequence of wet and dry periods (Welcomme 1967, Moreau 1987, Blake & Blake 1978, Nikolskii 1969), although other factors such as temperature, water level, turbidity (Hopson 1972, Nielson 1990) and gonadal activity (Garrod 1959, Nikolskii 1969, Payne & Collinson 1983), do also influence. Studies on several tropical fish species have shown seasonal growth patterns and the formation of growth marks may be one or more per year (Blake & Blake 1978: Garrod 1959, Robben & Thys van den Audenaerde 1984, Bishai & Gideiri 1965, Willoughby & Tweddle 1978, Pivnicka 1974). Different species in the same water body may react differently to the environment e.g. *Lates niloticus* in Lake Chad shows one growth mark per year and *Alestes baremose* in the same water body, shows two marks (Hopson 1972).

The Lake Tana environment has a distinct seasonal pattern, particularly with respect to dry and wet periods. Over 90% of the annual precipitation (ca 1500 mm) falls during the summer months. The water temperature also has a seasonal pattern, even though the differences are small. Studies on the growth of *C. gariepinus* and *O. niloticus*, are available for other African lakes (Willoughby & Tweddle 1978, Pivnicka 1974, El Bolock 1972, Clay 1984, Quick & Bruton 1984) but there is no information on *B. tsanensis* available yet.

A variety of methods have been employed in the study of fish growth in tropical African lakes. These include the analysis of population structure or length frequency analysis (Petersen method), the study of growth marks on calcified hard structures such as scales, otoliths, vertebrae and opercular bones, mark-recapture and growth studies of captive fish in enclosures. The method of length frequency analysis involves the following of cohorts, via modes in the size distribution of the population, over time. Sequential length frequency samples corrected for gear selectivity are used to observe shifts in the modes in the size distributions over time. If the breeding season occurs at distinct time intervals the population size distribution would be expected to show clear modes with a shift in time. Looking into the breeding cycles of the different fish species in Lake Tana (Chapter 3) it is evident that the environmental seasonality is more clearly reflected in *C. gariepinus* than in *O. niloticus* and *B. tsanensis*. In all these species, however, clear marks were evident in their hard structures which could potentially be used for estimating growth parameters of the fish by back-calculation. Defining the periodicity of the formation of the marks would then be important as it affects the age estimate. The present study is the first attempt to estimate the growth of the fish stocks in Lake Tana. The hard structures, otoliths, opercular bones and vertebrae were used for the estimation of growth parameters of *C. gariepinus*, *O. niloticus* and *B. tsanensis*.

At the same time, growth parameter estimates were made from length frequency distributions of the monthly trawl sampling programme, using length frequency distribution analysis ELEFAN (Pauly 1987).

The instantaneous mortality (Z , yr^{-1}) is defined as the part of the population present, which is lost by natural (M , yr^{-1}) and fishing (F , yr^{-1}) mortality ($Z = M+F$) (Nikolskii 1969). The fishing mortality is more important in the adult size group of the population, whereas the natural mortality affects all size/age classes with the greatest impact on the larval and juvenile groups which are more vulnerable to predation, disease, and environmental changes. Since the fishery on Lake Tana was still developing, we might assume that fishing mortality, and consequently the total mortality, was low. The estimation of mortality is usually done by age- or length-based catch curve analysis based on pooled size or age distributions corrected for the fishing effort applied. The main assumption is a linear relationship between numbers in an age category of the population and numbers of the same age category caught per unit of effort (King 1995). For length-based catch curve analysis a length-age key is required.

The objective of the present work is to assess and characterise the dynamics of the major fish stocks in Lake Tana, with respect to growth, mortality and level of exploitation. The results can be used as a reference point for monitoring any future change in the system with the developing fishery i.e. increased effort and technical capability. The results would also be used in the evaluation of various options for managing the fisheries for sustainable yields.

Materials and methods

Data collection

The study of age and growth was made using hard structures, collected from the trawl samples for biological observations, and the length frequency data records from the trawl catches. Hard structures were extracted at the time other dissection work on the fish was carried out. Among the *Barbus* species only *B. tsanensis* was considered in the present study for reasons of its major importance in the commercial fishery and the limited amount of data available for other *Barbus* species.

Fishery-dependent data were obtained from the commercial gillnet fishery. The data used in the present study included effort applied, and catch size distribution corrected for gillnet selectivity, per species.

Extraction and processing of hard structures

Table 5.1 Sample size, structures used and type of observation in ageing of the major species from hard structures.

Species	Structure	Observation	Number of fish	Size range length (cm)
<i>O. niloticus</i>	otolith	zones	705	8-30
		daily marks	12	8-25
<i>C. gariepinus</i>	vertebrae	zones	950	12-87
<i>B. tsanensis</i>	opercula	zones	420	10-35

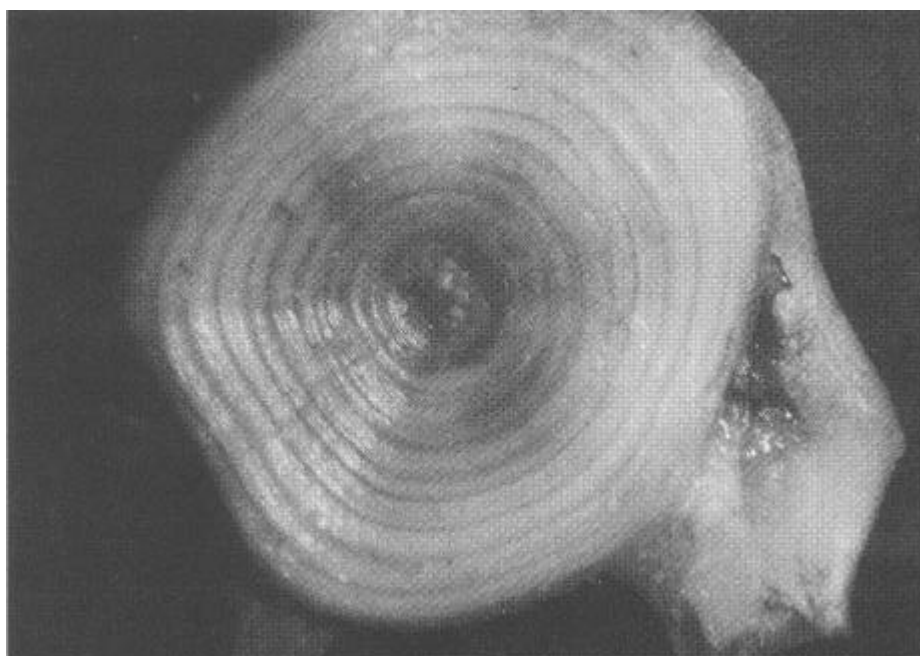

Photo 5.1. Vertebra of *C. gariepinus*, tl = 61 cm, with 10 growth rings.

The first four anterior vertebrae were extracted from *C. gariepinus* (Willoughby & Tweddle 1978) by dissecting the fish and boiling for some time to clear the bones. Otoliths were taken from *O. niloticus* (Bagenal 1978) and opercular bones from *B. tsanensis*. The method of otolith extraction was similar to that described by Gjosæter et al. (1984) and Bagenal (1978). All cleaned and dried hard structures were stored for individual fish in labelled paper packets. The type of observations, sample size and the hard structures used are given in Table 5.1. Recording of the rings on the hard structures and measurement of the width of the zones was carried out simultaneously under a binocular stereo-microscope. A computer programme Tablet which allows the use of an electronic digitiser (Genius Tablet) was used to

register the data in a file and calibrate the measurements. The light wider zone on the hard structure (under reflected light) was characterised as the fast growth zone and the darker narrow zone as the slow growth ring. At the beginning, observations on the same sample were made by two persons separately to evaluate and improve the accuracy.

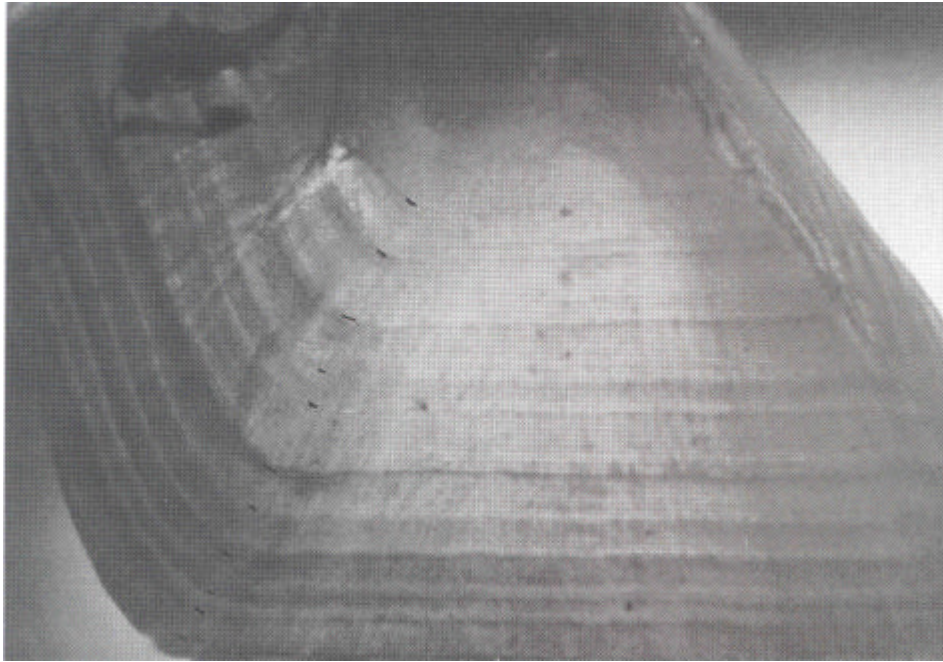

Photo 5.2 Opercular bone of *B. tsanensis*, tl=32 cm, with 11 growth rings.

For *C. gariepinus* true growth marks were defined as distinct, alternating white and dark rings, continuous and concentric to the circumference of the vertebral centre. White zones are wider than dark zones. Accessory marks are dark or white lines which do not form a complete ring or which are too close to the true zone to be considered as a separate growth mark. The vertebrae were examined under reflected light and growth marks measured from the centre to the edge in the lateral direction (Pivnicka 1974).

For *O. niloticus* the otoliths were stored in 95% ethanol for three days followed by seven days in 40% glycerol to enhance the appearance of growth rings. Growth rings (macro-zones) were identified as opaque, white zones, under reflected light, that run all the way round the nucleus. Growth rings were counted and measured from the nucleus towards the outer edge of the otolith, along the longest radial axis. A selected sample of 31 otoliths originating from 7.8 cm to 25.0 cm *O. niloticus* were ground and polished for observation of daily growth rings or microzonation. Otoliths for micro-zone analysis were prepared according to the method described by Secor & Dean (1992). After the macro-zones had been examined and measured the otoliths were embedded in Teflon moulds, 15 mm in diameter, using an embedding solution (Technovit, type 2000 LC). The embedded otolith was kept for 4 minutes under UV-light and then the semi-hard block was removed from the mould and left for an extra 20 minutes under the UV-light to harden. The hardened blocks were ground with a Gatan disc grinder and polished in the sagittal plane with a coarse water-proof grinding paper (P60, P150, P200). Further polishing was done using finer paper (40 μm , 15 μm) and then polishing paste

(5 μm , 1 μm , 0.1 μm) until the nucleus and surroundings gave good resolution. The polished side was then glued to a glass slide and the reverse, convex side of the otolith was polished in a similar way until the section was 100 μm thick. The polished otoliths were viewed under a light microscope and overlapping photographs were taken along the same axis from the nucleus towards the wider edge of the otolith. The photographs of each otolith were then arranged from the nucleus to the anterior edge. The macro-zones data, which gives the distance from the nucleus to each recorded macro-zone along the anterior axis, was then projected onto the photographed axis. The number of micro-zones were counted between two projected macro-zones. A total of 12 polished otoliths were good enough to be used for counting of the daily growth marks. Those otoliths which were not clear or which had material loss of more than 5% from the margin due to grinding were rejected.

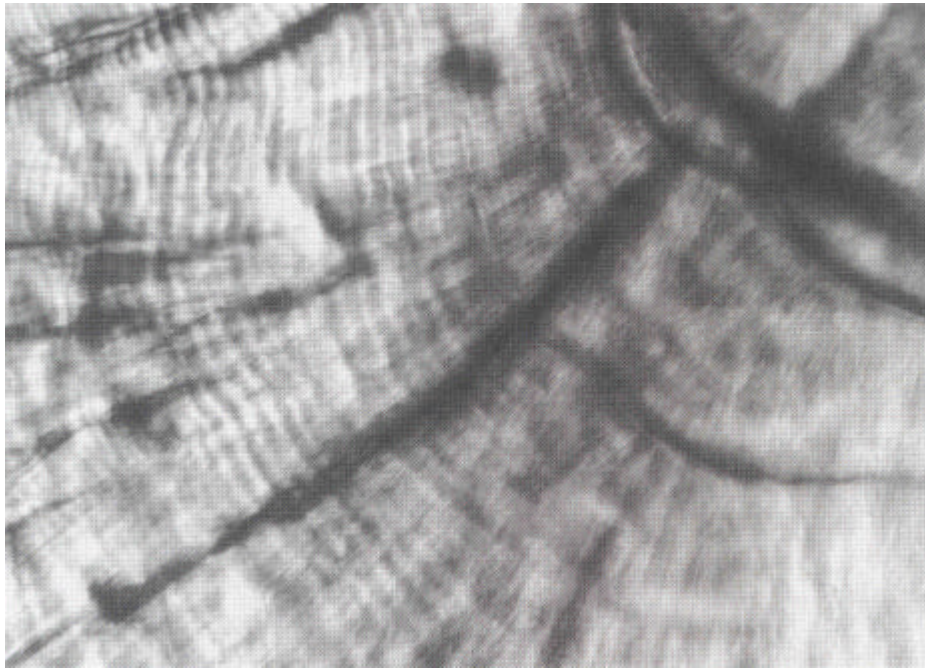

Photo 5.3. Part of an otolith (sagittal) of *O. niloticus* ground and polished showing daily growth zones.

For *B. tsanensis* a growth ring in the opercular bone was characterised as a distinct dark zone, under transmitted light, that runs completely from one side of the operculum to the other (Fagade 1973, Mous 1988). Bones from larger size class fish (>25 cm) had thick ossification near the insertion point which made it sometimes difficult to locate the first two growth rings. In some specimens several lines were observed close together, but some were interrupted and not that distinct. Only the bold dark zones were measured. Each growth ring was measured from the insertion point, (point of attachment to the head), to the border of the dark zone proximal to it. Each growth ring was measured along the same axis to the edge of the operculum.

Data analysis

Estimation of growth parameters via back-calculation.

The pattern of growth-zone development on hard structures can be observed by relating the mean width of the outer zones to the ring counts (RC). An estimate of the relative width of the marginal zone was made by taking the ratio of observed width of the outer zone to expected width for the ring count observed. Then the mean ratio per month was plotted on month of sampling to determine the time of formation of the growth ring.

The relationship between the size of a hard structure and fish length is expected to be proportional (Maceina & Betsill 1987). An allometric function was used to describe the relationship.

$$l_j = a \cdot X_j^b \quad 1$$

where: l_j = length of the fish (j) (mm)

X_j = size of the corresponding hard structure (mm)

The parameters a and b were estimated via linear regression of log-transformed length measurements on size of hard structure. Back-calculations of fish length corresponding to growth marks on hard structures were made using the Fraser-Lee formula (Maceina & Bestil 1987):

$$l_i = \left(\frac{D_i}{D_j} \right)^b \cdot l_j \quad 2$$

where: l_i = back-calculated fish length at the i_{th} growth ring

b = coefficient of the regression of $\ln(l_j)$ on $\ln(X_j)$, (above)

l_j = length at capture of the fish

D_i = distance from origin to i_{th} growth ring of hard structure

D_j = distance from origin to edge of hard structure (ie. size of the hard structure at the time of capture)

Estimates of the von Bertalanffy growth parameters $K(\text{yr}^{-1})$, $L_\infty(\text{cm})$ and $t_0(\text{yr})$ were made from back-calculated lengths. Average body length and average growth between ring counts were calculated. A regression of average growth on average length was calculated, using the number of observations as weight factor. The negative value of the slope of the regression line is the estimated K (RC^{-1}), the curvature parameter. $L_\infty(\text{cm})$, the asymptotic length was estimated taking the negative quotient of the intercept and the slope (Sparre & Venema 1992). The estimate of L_∞ was used in the von Bertalanffy plot in which $-\ln(1-L_{\text{RC}}/L_\infty)$ was linearly related to ring count in order to estimate t_0 (RC).

Estimation of growth parameters via length frequency distribution analysis

Growth parameters were also estimated using the ELEFAN-method for length frequency distribution analysis (Pauly & David 1981, Pauly 1987). This method is based on the principle of modes progression over time, assuming each mode in the length frequency represents a cohort. The shift in the position of the mode with increasing length relates to the growth of the fish. The recruitment period of each species is used as a fixed starting point for

the curve. The starting estimate for L_{∞} was taken at 90% of the maximum size attained for each species. The growth constant K was estimated by forcing the curve through the peaks of relative abundance, of the smaller size classes especially.

Mortality

The instantaneous total mortality was estimated by the method of linearised catch curve analysis based on length composition data (Pauly 1983, 1984a, b, Sparre & Venema 1992). For the commercial fishery a unit of effort was defined as a trip. The monthly pooled size frequency distributions were corrected for effort. The pooled length frequency distributions were also corrected for gillnet selectivity of mesh sizes used (Chapter 6). An overall selection curve was calculated, weighted by the relative occurrence of 80, 100, 110 and 120 mm mesh sizes (at a ratio of 1:1:1:¼). The midpoint of each length class was converted to age class using the inverse von Bertalanffy growth equation relating length to age: $t_L = -1/k * \ln(1-L/L_{\infty})$. The time interval (Δt) from one length to the next was obtained using the equation $\Delta t = 1/k * \ln((L_{\infty}-l_1)/(L_{\infty}-l_2))$. The $\ln(c_L/\Delta t)$ was plotted against age for the catch curve regression analysis. The range for the regression was selected to be within the fully exploited length class, starting with t' (the lowest mean age of fish under full exploitation) from the left and excluding size classes too close to L_{∞} on the right. The lower point of the regression on the age axis, t' indicates lowest mean age of fully recruited fish. The negative slope of the regression line for the descending part of the curve on the right, equals the total instantaneous mortality (Z, yr^{-1}).

Using the same method of catch curve analysis, Z was estimated from the size distribution in trawl catches for comparison of results. The monthly length frequency distributions for littoral, intermediate and deep sampling locations were pooled together. An overall length frequency distribution was derived after weighting the pooled distribution according to the area covered by the zones (littoral : intermediate : deep = 0.1 : 0.45 : 0.45). The resulting catch curve was analysed following the same procedure as for the commercial catch length frequency distributions.

The instantaneous natural mortality, M (yr^{-1}), was estimated using Pauly's empirical formula (Pauly 1980). This equation relates M to L_{∞} (cm), K (yr^{-1}) and the average water temperature (t °C) according to the following formula:

$$\ln(M) = -0.0152 - 0.279 \ln(L_{\infty}) + 0.6543 \ln(K) + 0.463 \ln(t)$$

Water temperature was taken as 22°C being the average observed. The fishing mortality (F, yr^{-1}) is estimated from the difference between the total and natural mortality ($F = Z - M$).

Results

Clarias gariepinus

Growth

The mean width of the outer zones on the vertebrae of *C. gariepinus* diminished with increasing number of growth rings. A plot of the relative width of the outer zone of the vertebrae for the months the samples were taken indicated that the smallest increments were

observed in February-March and July (Fig. 5.1). The relative size was smallest in February 1992 (0.75), significantly ($p < 0.05$) different from the overall ratio 1. This big dip in relative zone width and a smaller dip in July suggest that there are two rings formed per year. The relationship between fish length (TL, mm) and vertebral radius (VR) was $TL = 225 \cdot VR^{0.69}$ ($r^2 = 0.86$, $n = 920$). Fish lengths at each ring count were back-calculated and their means used for the estimation of the von Bertalanffy growth parameters. The Gulland & Holt regression of length increment between ring counts ($\Delta L / \Delta RC$) and the average length (cm) resulted in an estimated K of $0.1 \text{ (RC}^{-1}\text{)}$ with a standard error of 0.01. The intercept of the regression differed significantly ($p = 0.03$) between males and females. The estimated L_∞ value was 90 cm for males and 85 cm for females. The standard error of L_∞ was estimated as 5 cm. The value of t_0 as estimated with the von Bertalanffy regression was -1 RC for males and -0.4 RC for females. Assuming a formation of two rings per year (in February and July), would give an estimate of K to be 0.2 yr^{-1} and t_0 would be -0.5 yr and -0.2 yr for males and females respectively.

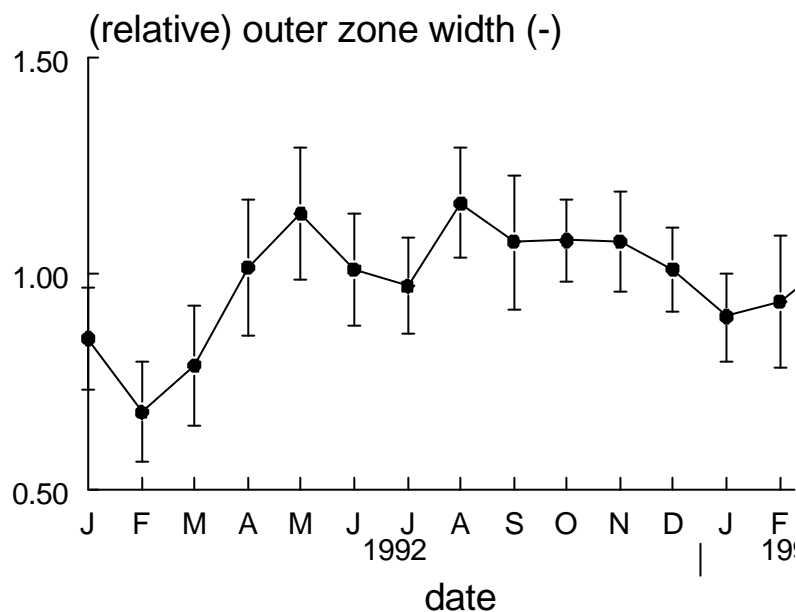

Figure 5.1 The relative width of the marginal zone in the vertebrae of *C. gariepinus* during the sampling period. Error bars represent the 95% confidence interval of the monthly means

The monthly length frequency distributions from the trawl catches were used in the ELEFAN, procedure. By fixing the recruitment period in July an attempt was made to find modes that would help to reconstruct the growth curve. The small size class fish of less than 30 cm were not represented in the trawl catches and no separate modes were visible to be considered as cohorts.

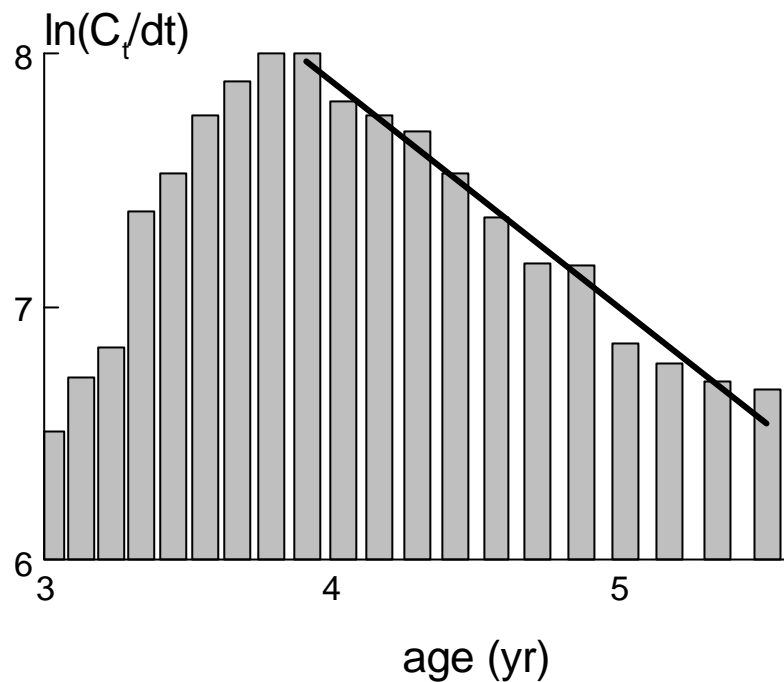

Figure 5.2 Linearised catch curve for *C. gariepinus* from commercial gillnet catches

Mortality

C. gariepinus is fully vulnerable to the fishery at 3.9 years (L' , cut-off-length, = 49 cm). This is the lower limit of the age class used in the catch curve analysis to estimate the total instantaneous mortality Z , yr^{-1} . The catch curve for the commercial catches is depicted in Fig. 5.2 The estimate of Z is 0.9 yr^{-1} ($r^2 = 0.98$) with a standard error of 0.1 yr^{-1} . The catch curve analysis of the experimental trawl catches gave a similar result.

Using Pauly's empirical formula the estimate for the natural mortality was 0.4 yr^{-1} . Thus the fishing mortality, F , was found to be 0.5 yr^{-1} which indicates an exploitation rate of 55% for *C. gariepinus* from 4 years onwards.

Oreochromis niloticus

Growth

The mean width of the outer zone on the otolith of *O. niloticus* shows a progressive decrease as ring counts increase. A plot of the relative width of the marginal zone on the otolith in relation to month the sample was taken indicated narrow zones during several months (Fig. 5.3). These were not seen at regular intervals and could not be related to any environmental or seasonal factor. The relationship between fish length (TL, mm) and otolith radius (OR) was : $TL = 43.8 \cdot OR^{1.13}$, ($r^2 = 0.88$, $n = 1100$).

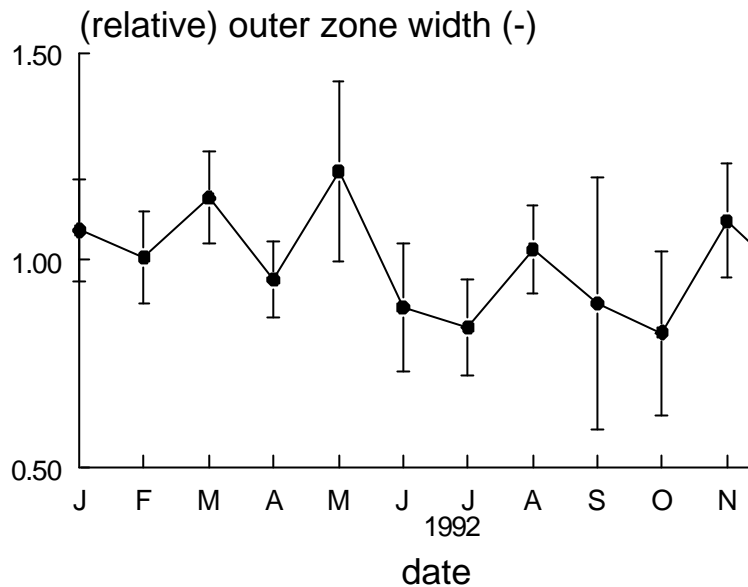

Figure 5.3 The relative width of the marginal zone in the otoliths of *O. niloticus* during the sampling period. Error bars represent the 95% confidence interval of the monthly means

The daily growth marks (dailies) counted per macro zone, of the processed otolith, gave a rather high variability between counts. The mean of the counts was 52.5 ± 7.5 per macro zone. This indicated the formation of between 8 and 6 macro zones per year and each macro growth ring being equivalent to 0.17 to 0.13 year. The Gulland & Holt regression of length increment between ring counts ($\Delta L/\Delta RC$) and the average length, resulted in an estimate of: $K = 0.074 RC^{-1}$ and $K = 0.078 RC^{-1}$ for males and females respectively. The L_{∞} was estimated to be 34.7 cm for males and 36.3 cm for females. There was no significant difference between the sexes for the estimates. The overall result was $L_{\infty} = 35.7$ cm with a standard error of 5 cm and $K = 0.076 RC^{-1}$ with a standard error of $0.005 RC^{-1}$. When RC is converted to time scale this would give an estimate of K to be $0.5 yr^{-1}$ with a standard error of $0.05 yr^{-1}$.

The monthly length frequency distribution from the trawl catch were used in the ELEFAN procedure to estimate the growth parameters. The curve was forced to pass through a fixed recruitment period in August-September (Fig. 5.4). The estimate from the length frequency distribution analysis was a L_{∞} of 34.0 cm and K of $0.6 yr^{-1}$, with a score of ESP/ASP of 8.2 %. The result is similar to the estimates made by the back-calculation method.

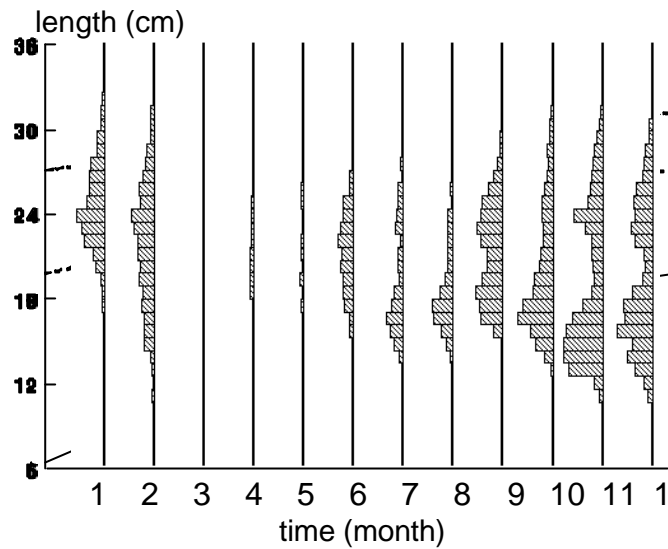

Figure 5.4 Length frequency distributions of *O. niloticus* in monthly trawl samples during the period July 1992 to June 1993. The estimated growth curve is represented by the lines.

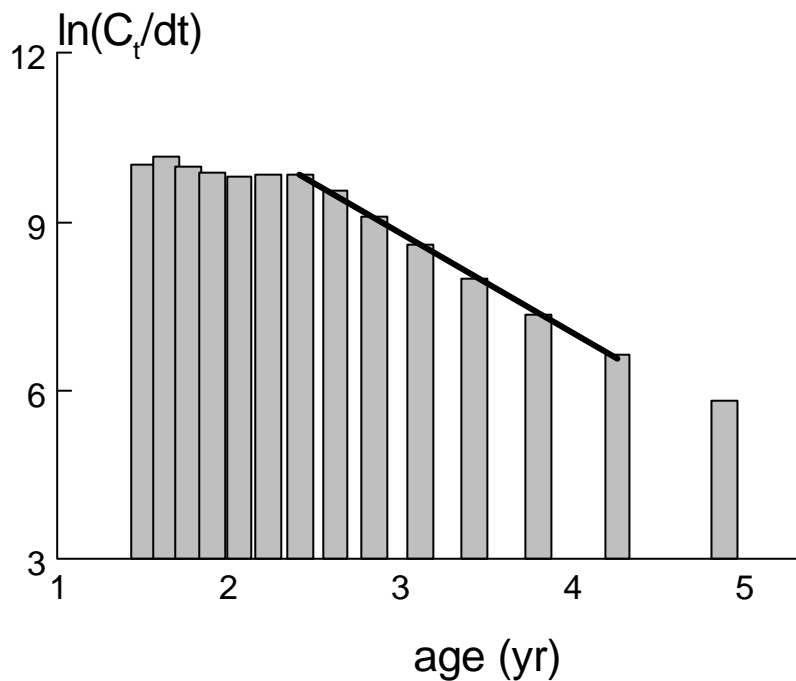

Figure 5.5 Linearised catch curve for *O. niloticus* from commercial gillnet catches

Mortality

O. niloticus is fully vulnerable to the fishery at 2.3 years (L' , cut-off-length, = 24 cm). This is the lower limit of the age classes used in the catch curve analysis to estimate the total mortality Z , yr^{-1} . A plot of the catch curve is depicted in Fig. 5.5 The estimate of Z for *O. niloticus* is 1.8 yr^{-1} with a standard error of 0.08 yr^{-1} . Using Pauly's empirical formula, the estimate for the natural mortality M equals 1.0 yr^{-1} . Thus the fishing mortality, F , is 0.8 yr^{-1} and

the exploitation rate 44% for *O. niloticus* older than 2 yr. The estimate of Z obtained using the experimental trawl catch data was 1.4 yr^{-1} . The estimate of the rate of exploitation would be 50% in that case.

Barbus tsanensis

Growth

A decreasing width of outer zone of the opercula bones of *B. tsanensis* with increasing number of growth rings was observed. A plot of the mean relative width of the marginal zones of the opercula in relation to the date the samples were taken indicated the narrowest zones to be found during June and October (Fig. 5.6). The relative width of the margin during these months (0.7) was significantly lower than the overall ratio 1. The relationship between the fork length (FL, mm) and the opercula radius (OP) was : $FL = 20.8 \times OP^{0.88}$ ($r^2 = 0.94$, $n = 420$). Fish lengths at each ring count were back-calculated and the mean used for the estimation of the von Bertalanffy growth parameters. The regression of length increment between ring count ($\Delta L/\Delta RC$) and the average length resulted in an estimate of $K = 0.11 \text{ RC}^{-1}$ with a standard error of 0.01. The L_∞ estimate was 35.5 cm. The estimates for males and females were similar. The standard error of L_∞ was 5 cm. The value for t_0 as estimated with the von Bertalanffy regression was -2 RC. Assuming two growth rings forming per year would give an estimate of K to be 0.22 yr^{-1} and t_0 of -1 yr. for both sexes.

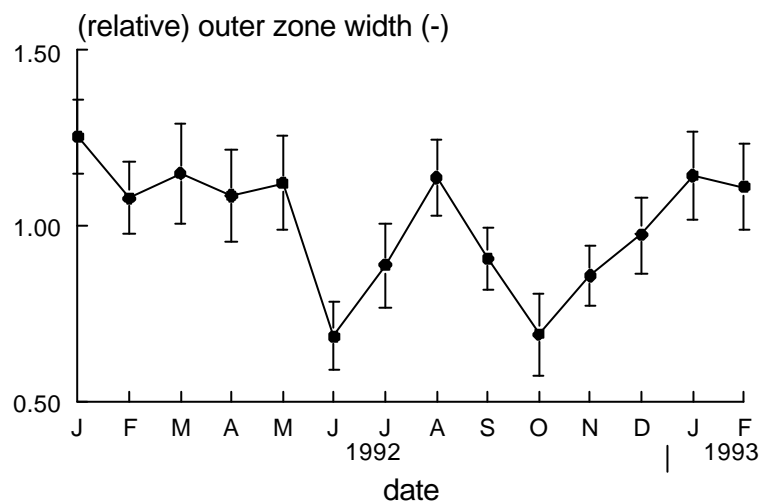

Figure 5.6 The relative width of the marginal zone in the opercula bones of *B. tsanensis* during the sampling period. Error bars represent the 95% confidence interval of the monthly means

The monthly length frequency distributions were examined to find cohorts and shifting modes which could be used for growth parameter estimation using ELEFAN (Pauly 1987). The curve was forced through the data to pass through a fixed recruitment period in September (Fig 5.7). The estimate for *B. tsanensis* was an L_∞ of 45.0 cm and K of 0.33 yr^{-1} with a score of ESP/ASP of 9.2%.

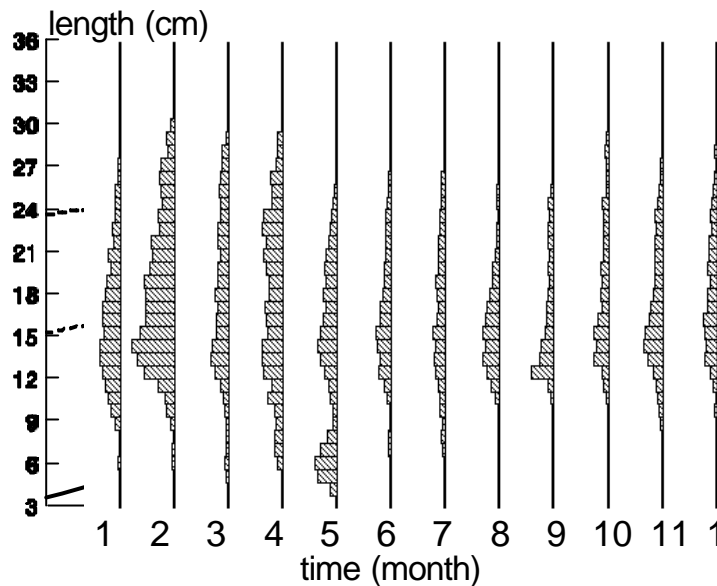

Figure 5.7 Length frequency distributions of *B. tsanensis* in monthly trawl samples during the period July 1992 to June 1993. The estimated growth curve is represented by the lines.

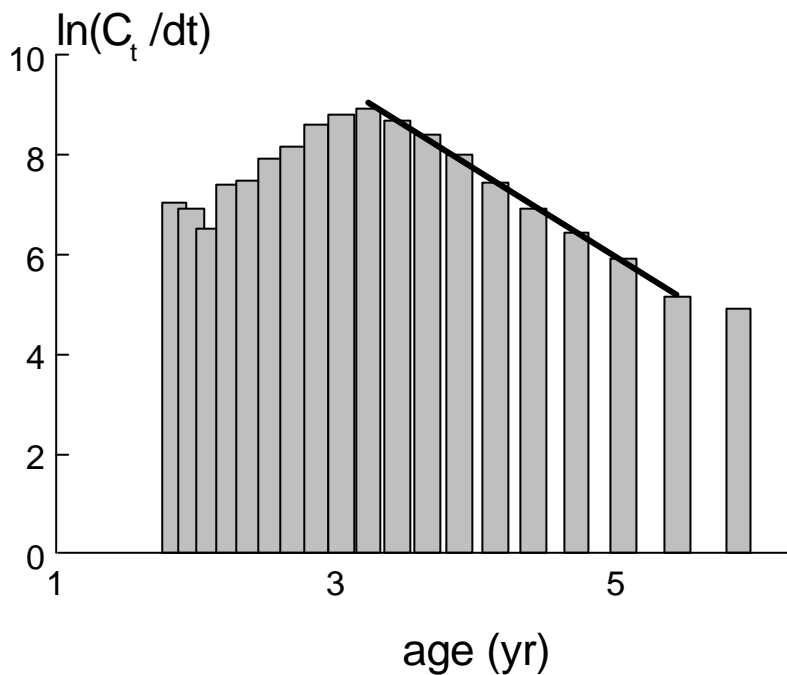

Figure 5.8 Linearised catch curve for *B. tsanensis* from commercial gillnet catches

Mortality

B. tsanensis becomes fully vulnerable to the fishery at 9 years using L_{∞} of 35.5 and K of 0.22 yr^{-1} . The regression analysis from the catch curve resulted in an estimate of Z for *B. tsanensis* of 0.4 yr^{-1} . When $L_{\infty} = 45 \text{ cm}$ and $K = 0.33 \text{ yr}^{-1}$ is used to calculate age t and Δt for each length class, Z was estimated to be 1.8 yr^{-1} with a standard error of 0.2 yr^{-1} and a t of 3.5

yr (Fig. 5.8). The two different sets of K and L_{∞} values were also used as input for catch curve analysis using the experimental trawl length frequency data. The resulting catch curves showed a bend in the decreasing part. Therefore, two regressions were done on separate age ranges. The input L_{∞} of 35.5 and K of 0.22 yr^{-1} resulted in a Z estimate of 0.3 yr^{-1} for *B. tsanensis* aged between 2.5 and 5.5 yr. Z was estimated 0.8 yr^{-1} for *B. tsanensis* aged between 6 and 13 yr. The alternative ($k = 0.33 \text{ yr}^{-1}$ and $L_{\infty} = 45 \text{ cm}$) gave a Z of 0.8 and 3.4 yr^{-1} in the age range from 1 to 3 and 3.5 to 4.5 yr respectively (Fig 5.9).

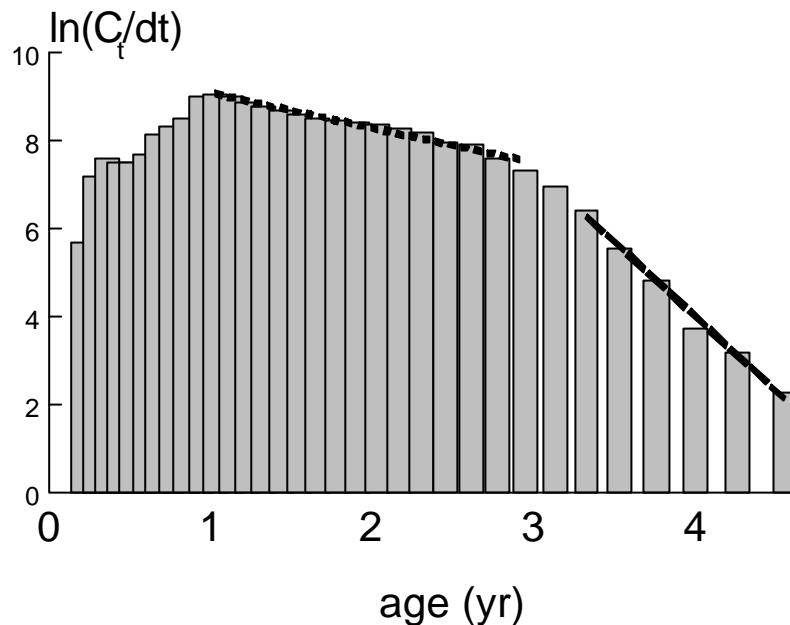

Figure 5.9 Linearised catch curve for *B. tsanensis* from experimental trawl catches

The growth parameters estimates were used in Pauly's empirical formula to estimate the natural mortality. The result were 0.5 yr^{-1} and 0.7 yr^{-1} for the low and the high input parameter values respectively. The resulting F ranged from -0.1 to 2.7 yr^{-1} . The size distribution from the experimental trawl data may be biased, due to the decreasing catchability of *B. tsanensis* above 15 cm, which results in an overestimation of Z . The lower occurrence of *B. tsanensis* over 30 cm in the ageing samples has probably resulted in an underestimation of L_{∞} . When Z equals 1.8 yr^{-1} , F would be 1.1 yr^{-1} resulting in a level of exploitation of 60%

Discussion

Growth.

The presence of rings on the hard structures and the dip in relative increments of the species examined indicates a seasonal growth pattern of these species in Lake Tana, more clearly seen in *B. tsanensis* than the other two species. It was possible to estimate the growth parameters L_{∞} and K from back-calculation. L_{∞} is estimated independently from the interpretation of number of rings formed per year. The periodic rings result from interruptions to or abrupt changes of the growth process. This occurs as a response to environmental or

biotic changes that affect the growth process. The effects and the timing of such changes vary for individual species.

C. gariepinus appears to form two rings per year, in February and July. The ring in February could be related to the drop in water temperature below 20 °C, which reduces growth. The ring formation in July is explained by the rainy season and rising water levels which induce the spawning activity of the fish. This interferes with the normal smooth growth process of the fish. In similar studies on *C. gariepinus* in other African lakes, only one growth ring per year was reported in Lake Kariba (Pivnicka 1974), Serrow ponds, Egypt (El Bolock 1972), and in the Shire Valley, Malawi (Willouby & Tweddle 1978), which was attributed to low winter temperatures in these water bodies. The fact that the deviation of the outer zone width from the average was smaller in July than in February might indicate ring formation in only a part of the population. Validation of the resulting growth parameter estimates by other methods would therefore be necessary. Unfortunately the length frequency distribution analysis gave no clear results because the smaller size categories were underrepresented in the experimental trawl catches.

Marshall (1990) has summarised studies on age and growth of *C. gariepinus* in different water bodies, mainly in southern Africa. The growth performance index, ($\phi' = \log K + 2 \log L_{\infty}$) of Munro & Pauly (1983), calculated for *C. gariepinus* in Lake Tana is, $\phi' = 3.2$, which is close to the mean (3.3), given for the other African Lakes combined. It has a better performance than in Lake Kariba, ($\phi' = 3.0$: Clay 1984). The males grow larger than the females as reported also for Lake le Roux (Quick and Bruton 1984), Lake Sibaya (Bruton & Allanson 1974) and Shire River, Malawi (Willoughby & Tweddle 1978).

Many authors studying *O. niloticus* growth have used the daily increments to determine the age of, particularly, larval and juvenile fish (Campana & Neilson 1985, Teklegiorgis 1988, Casselman 1990), which are considered to produce good results. This method has also been used for age studies on adult fish (Dayaratne & Gjosater 1986, Morales-Nin & Ralston 1990). Morales-Nin (1992), however, indicates the difficulty of interpretation of rings after one year due to the narrowness of the increments and otolith morphology. In the present study, high variation in the counts of rings between the micro zones was observed, indicating a similar problem of interpretation and accompanying uncertainty of the results. The estimated growth parameters L_{∞} and K can be considered reliable within the range of their confidence interval. The correspondence with estimated growth parameters based on length frequency distribution analysis suggests that the daily ring counts did give an accurate result.

The growth of *O. niloticus* in Lake Tana follows a similar pattern to that of *O. niloticus* populations in other African lakes with an average ϕ' - value of 2.8. It has a close similarity to the growth of the same species in Lake Albert and estimates from Payne & Collinson (1983) for Lake Nasser. *O. niloticus* growth has been associated with environmental influences and fishing pressure. Lowe-McConnell (1982) indicated that the size at first maturity and the maximum length (L_{∞}), decreased in time due to intensive fishing pressure, in Lake George, Uganda. She also indicated that the species grows better in larger water bodies than in smaller lakes. The quality of the diet and its digestibility have also been found to determine different growth patterns of *O. niloticus* in natural waters (Bowen 1982, Pullin 1988). Getabu

(1992) attributes the good growth performance of *O. niloticus* in the Nyanza Gulf, Lake Victoria, to overfishing, diet type and its utilisation. The fishing activity in Lake Tana can be considered moderate and *O. niloticus* in Lake Tana shows higher growth than in Lakes Manzala, and Chad (Moreau et al. 1986).

In *B. tsanensis* the two periods of ring formation per year could be associated with the hydrological changes in June and the spawning activities and migration in October. The most realistic estimate of K (0.3 yr^{-1}) corresponds with the formation of 3 growth rings per year. The L_{∞} estimated from back-calculation is probably too low (35 cm) since *B. tsanensis* of over 40 cm are frequently observed in the commercial gillnet catches.

Although there are no references for comparisons with other population of *B. tsanensis*, a similar growth pattern has been observed for the cyprinid, *Labeo senegalensis* in Lake Kainji, Nigeria (Blake & Blake 1978). Using opercular bones for age determination of *Labeo senegalensis*, Blake & Blake (1978) found that two growth rings yr^{-1} were formed in this species. The first ring, formed at the beginning of the rainy season in June-July when several environmental factors change. A second ring is formed in January when water temperature reaches a minimum. They attributed these growth rings to the low temperature and to rainfall patterns and the subsequent negative effect they exerted on available food sources. Hopson (1972, cited in Blake & Blake 1978) also reported formation of two growth rings per year for *Alestes baremose* in Lake Chad. Age and growth studies on the small cyprinid fish, *Barilius moorii* in Lake Kivu, Ruanda (Robben & van den Audenaerde 1984) indicated the possibility of two rings per year on the scale, coinciding with the two rainy periods in the region.

Mortality

Estimation of mortality via length-based catch curve analysis is linked to the estimates of L_{∞} and k . Uncertainty expressed in estimation of the growth parameters would be carried into the estimation of the instantaneous mortality rate .

The age at which the species are fully vulnerable to the fishery, 4 yr, 2.3 yr, and 4 yr for *C. gariepinus*, *O. niloticus* and *B. tsanensis*, respectively is well above the 50% maturity age for all species, indicating that the commercial gillnet fishery is selecting towards the larger size classes of the exploited stock. The exploitation rate, E , indicates moderate to high exploitation (44 - 60%) of the older age classes which have a high mean length/age in the catch. The apparent high natural mortality (1.0 yr^{-1}) for *O. niloticus* is related to the high K value of the growth parameter. Fish with a high growth rate and short life span have high M (Sparre & Venema 1992). *O. niloticus* also has a high relative fishing mortality as it constitutes approximately 40% of the annual total catch. The exploitation rates of *C. gariepinus* 55% and *Barbus* up to 60% indicate exploitation rates approaching the maximum. However, considering the total effort and annual landings, the yield is quite low. The fishing mortality is size-related, being higher for the large size/age class in the stock.

The selective impact of a gillnet fishery on the assemblage of *Clarias gariepinus*, *Oreochromis niloticus* and polymorphic *Barbus* species

Abstract

The size-selective impact of the gillnet fishery was assessed in relation to the length at first maturity (l_m), of the various fish species for which gillnet selectivity was determined through application of the indirect methods of Holt (1963), Gulland & Harding (1961) and Sechin (1969).

The selection factor (k cm/cm stretched mesh), in the Holt-equation, was 2.5 for *O. niloticus*, 5.2 for *C. gariepinus* and for the various *Barbus* spp., between 3.4 for *B. tsanensis* and 4.4 for the more slender piscivore, *B. acutirostris*. Modal lengths in the catch of the motorised boat fishery, using mesh sizes 100-120 mm, were 26, 31 and 49 cm for *O. niloticus*, *B. tsanensis* and *C. gariepinus* respectively. In the reed boat fishery using 80 mm gillnets, modes were formed at 23 cm *O. niloticus* and 27 cm for *B. tsanensis*.

The selection curve of the 80 mm gillnet coincided with the size structure of the catch of *B. tsanensis*, but in *O. niloticus* a higher mode was observed in the catch size structure. In the catch of the motorised boats only *O. niloticus* showed a good resemblance with the combined selectivity curves of the 100-120 mm meshes used by the fishery. *B. tsanensis* and *C. gariepinus* had modes lower than the optimal curve of the selection curve. For all species fished the combined selectivity curves of all the mesh sizes used (80-120 mm) in the gillnet fishery had an optimal selection length greater than the size at maturity, l_m .

Introduction

Fishing is a selective process and has the potential to change age and/or size structure of the fish population. For example, it is common practice that, in a newly developing fishery, many fishers target a particular species or group and target large adults as opposed to juveniles. This has the immediate effect of reducing the proportion of large species and size classes in the stock. Different fishing methods catch different sizes of fish in the same area (Smith 1994). Many lake fisheries use gillnets which selectively remove large fish, producing a non-random mortality with respect to size (Hamley 1975). Further development of a multi-species gillnet fishery can have a strong impact on the fish community size structure and diversity. For example, progressive increase of fishing effort and reduction of mesh size will first reduce the stock of larger, mostly piscivorous species and then begin to reduce the stock of smaller sizes and species with the danger of removing all those fish of breeding size. Proper management requires an understanding of the effect of mesh size regulation on the fish stocks in the system. Basic information on the fishing gear selectivity is necessary to predict the size of the fish, which will be caught in a net of a particular mesh size.

The advantage of gillnets as passive fishing gear is that little investment in equipment is required and they are effective in catching scattered fish. The proportion of the total population of a certain size class of a fish stock, which is caught and retained by a unit operation of the gillnets equals the catchability or net efficiency. Selectivity is the relative efficiency per size category. Gillnets are highly size-selective, which introduce a bias when attempts are made to reconstruct the population size distribution from commercial and/or experimental gillnet catches. By taking into account the selectivity of the nets used, the bias is considerably reduced.

Studies have been made of gillnet selectivity estimates for *C. gariepinus* (Gulland & Harding 1961), *O. niloticus* (Riedel 1963) and some other *Oreochromis* species (Mattson 1994, Pet et al. 1995) but not for *Barbus* whose species show a large variation in morphological character (Nagelkerke et al. 1994) and it is expected that different morphotypes show different gillnet selectivity. Direct estimation of gillnet selectivity by fishing a fish population of known size distribution is most reliable (Hamley 1975) but not often possible. Classical indirect methods for assessing selectivity of gillnets for specific species have been reviewed by Regier & Robson (1966) and Hamley (1975). Recent, newly developed approaches based on iterative non-linear least-square fitting procedures (Helser 1994) require vast amounts of gillnet catch data.

The present study is aimed to establish the selectivity parameters for the commercially important fish species in Lake Tana, using classical indirect estimation methods as described by Holt (1963), Gulland & Harding (1961) and Sechin (1969). The first two methods are based on size distributions of fish caught in various mesh sizes. Sechin's method is based on morphological characteristics. A positive skewed size selection curve is expected for *C. gariepinus* because it is tangled in gillnets. Sechin's as well as Gulland & Harding's methods can cope with skewed selection curves. Wedging and gilling are the main

ways in which *Barbus* species and *O. niloticus* are captured, which is expected to result in a normal symmetrical size selection curve. Gulland & Hardings method was only applied for *C. gariepinus* while Sechins and Holt methods were applied to all species. To assess the selective impact of the fishery in Lake Tana the size at maturity and size distribution of the fish species in the commercial catch were taken into account and related to the selection range of the gillnets used at present.

Material and methods

In 1993 the traditional reed boat and the commercial motor boat fishery yielded together approximately 650 tonnes of fish, mainly from the southern part of the lake. 40% of this was *O. niloticus*, 25% was *C. gariepinus* and 35% *Barbus* species. The appearance of *Barbus* species shows a wide morphological variation and differences in feeding behaviour (Nagelkerke et al. 1994). *Barbus nedgia*, *B. sukris*, *B. gorgorensis*, *B. macrophtalmus*, and *B. tsanensis* are non-piscivorous species. The piscivorous species are *B. longissimus*, *B. acutirostris*, *B. platydorsus*, *B. gorguari*, *B. truttiformis* and *B. megastoma*. The most abundant species, *B. tsanensis*, takes an intermediate position with respect to its morphological appearance and habitat occupation (Nagelkerke & Sibbing 1997), being a benthivore feeding mainly on larvae/worms, detritus/substratum and molluscs.

Sampling

Fish from trawl catches sampled for biological information were used for girth measurements to estimate girth-length relationships of *C. gariepinus*, *O. niloticus* and some piscivorous and non-piscivorous *Barbus* species, including *B. tsanensis*. The sampled fish were individually measured for length to the nearest mm, weight to the nearest gram and girth circumference (maximum, pre- and post operculum) to the nearest mm. Sampling for size at maturity is described in chapter 3 of this thesis.

In addition to data from the 16 experimental gillnet samples taken between August 1991 and July 1993, size frequency data from an other sampling programme (Nagelkerke et al. 1995a) in the period July 1993 to November 1993, were used for the assessment of gillnet selectivity of those *Barbus* species, which rarely occurred in the regular sampling program. Size frequency distributions of species caught in the 60 and 80 mm stretched mesh gillnets were used if these nets were set simultaneously in equal amounts. The multifilament nets, with a ply of 210/6 hanging ratio of 0.5, were 50 m long and 2 m high.

Data analysis

Size at maturity

Size at maturity for the *Barbus* species not considered in chapter 3 was estimated via the procedure described there.

Gillnet selectivity

According to Holt

The starting point of the Holt (1963) method is a proportional relationship between mesh size (m) and fish size being caught most efficiently (l_{opt}) in that particular mesh: $l_{opt}=k \cdot m$, where k is a constant. The selection curve [$S_{i,l}$, selectivity for a certain mesh size (i) as function of fish size (l)], is described using a Gaussian distribution equation, where $\mu = l_{opt}$ and $\sigma = s$ ($s = 0.42 \cdot$ symmetrical selection range), corrected to reach a selectivity equal to 1 for the fish size being caught most efficiently:

$$S_{i,l} = e^{-\frac{(l-l_{opt(i)})^2}{2 \cdot s(i)^2}}$$

The estimates of l_{opt} and s are based on the catch ratio of a range of size classes in two nets which differ in mesh size (Sparre & Venema 1992). Numbers of fish caught in two successive mesh sizes were corrected according to the respective surface area's of the nets.

According to Gulland and Harding

For each size class of fish the best mesh (BM) is selected from the nets set, after correcting for net surface area. A linear relationship between BM and fish size (l) is established. The efficiency per size class is calculated by taking the ratio of the number of fish caught over the maximum number of fish in the same length class caught in the appropriate gillnet with the best mesh for that size category. The efficiency is plotted as a function of BM/MU, where MU= mesh used. This is the generalised selectivity curve which holds for every mesh size and fish length. A Pearson Type 1 curve can be fitted through this scatter plot:

$$S = \left(1 + \frac{\left(\frac{BM}{MU} - 1\right)}{a_1}\right)^{a_1 a_2} \cdot \left(1 - \frac{\left(\frac{BM}{MU} - 1\right)}{a_3}\right)^{a_3 a_4}$$

The parameters a_1 to a_4 were estimated via a non-linear (iterative) procedure. Using the linear relationship between BM and fish size, the ratio BM/MU is converted to size class of fish and the selectivity curve for each mesh size can be drawn.

According to Sechin

The Sechin method takes as its starting point that a fish is caught in a gillnet if its operculum girth is smaller and the maximum girth is larger than the mesh perimeter. Due to variability in operculum and in maximum girth for each length class the length selection differs from a knife-edge selection. Sechin assumes a constant standard deviation in girth for all size classes. The total selectivity curve can be described with:

$$s_j = \frac{I}{s_o \sqrt{2\Pi}} \int_{-\infty}^{l_j} e^{-\frac{(2m - G_o)^2}{2s_o^2}} dl . \frac{I}{s_m \sqrt{2\Pi}} \int_{l_j}^{\infty} e^{-\frac{(2m - G_m)^2}{2s_m^2}} dl$$

where,

- G_{o,m} = girth of the fish at the posterior end of the operculum (o) and at maximum girth (m)
- m = mesh size (stretched mesh)
- s_{o,m} = standard deviation in the post-operculum girth and the maximum girth
- l = fish length (cm)

In contrast with the original method, which assumed s_{o,m} to be constant, a constant coefficient of variation in girth was assumed (Pet et al.1995). For the girth length relationship a power function was used, which was estimated via linear regression of log-transformed length and girth measurements.

Results

Species and size composition

Species caught by the reed boat fishery were mainly *O. niloticus* and *B. tsanensis*, with a mean (modal) length of 23.2 (23) and 27.7 (27) cm. The CV in length was 11.6 and 9.6%. The ratio between numbers of *O. niloticus* and *B. tsanensis* caught was 2.2.

Table 6. 1 Characteristics of the size distributions of the major species in the motorised boat fishery and the survey trawl catches. Length in cm.

		<i>Barbus species</i>				
		<i>O.</i>	<i>B.</i>	Non-	C.	
		<i>niloticu</i>	<i>tsanensi</i>	piscivour	piscivour	<i>gariepinu</i>
		<i>s</i>	<i>s</i>	<i>s</i>	<i>s</i>	<i>s</i>
Motorised boats	Mean length	26.7	30.6	35.4	37.6	54.1
	Modal length	26	31	32	33	49
	CV (%)	9	9	18	17	14
Trawl	Mean length	21.0	17.2	17.6	20.5	46.5
	Modal length	24	14	12	13	48
	CV (%)	24	34	45	40	23

The commercial catch from the motorised boats and the survey trawl catches contained *O. niloticus*, *C. gariepinus* as well as a wide variety of *Barbus* species. Mean length, modal length and CV for the length distributions per species are presented in Table 6.1. Mean length of fish caught in the survey trawl was smaller than fish sizes in the commercial catch. This difference was most distinct for the *Barbus* species, having a mean size ranging from 17 to 20.5 cm in the trawl and 28 to 38 cm in the commercial catch. The coefficient of variation of the size distribution from survey trawl catches, ranging from 23 to 45%, was greater than those found in the commercial catches, where the coefficient of variation ranged from 9 to 18%.

In Fig. 6.1 the abundance of the species groups is depicted per length category in the catch from the motorised boat fishery and the survey trawl catch. The relative abundance of the major species and three categories of *Barbus* species (*B. tsanensis*, piscivorous and non-piscivorous excluded *B. tsanensis*) is also given. In the motorised boat fishery, *Barbus* spp. are most abundant in the length classes between 30 and 45 cm. For smaller and larger length classes *O. niloticus* and *C. gariepinus* are more abundant. Within the *Barbus* species, below 32 cm *B. tsanensis* is dominant. Other *Barbus* species are caught mainly at larger sizes. The proportion of piscivorous *Barbus* species increases with fish length. *B. macrophthalmus*; *B. nedgia*; *B. sukris* and *B. gorgorensis* comprises over 80% of the non-piscivorous *Barbus* species. In the piscivorous group *B. platydorsus* and *B. megastoma* were dominant (> 78 %).

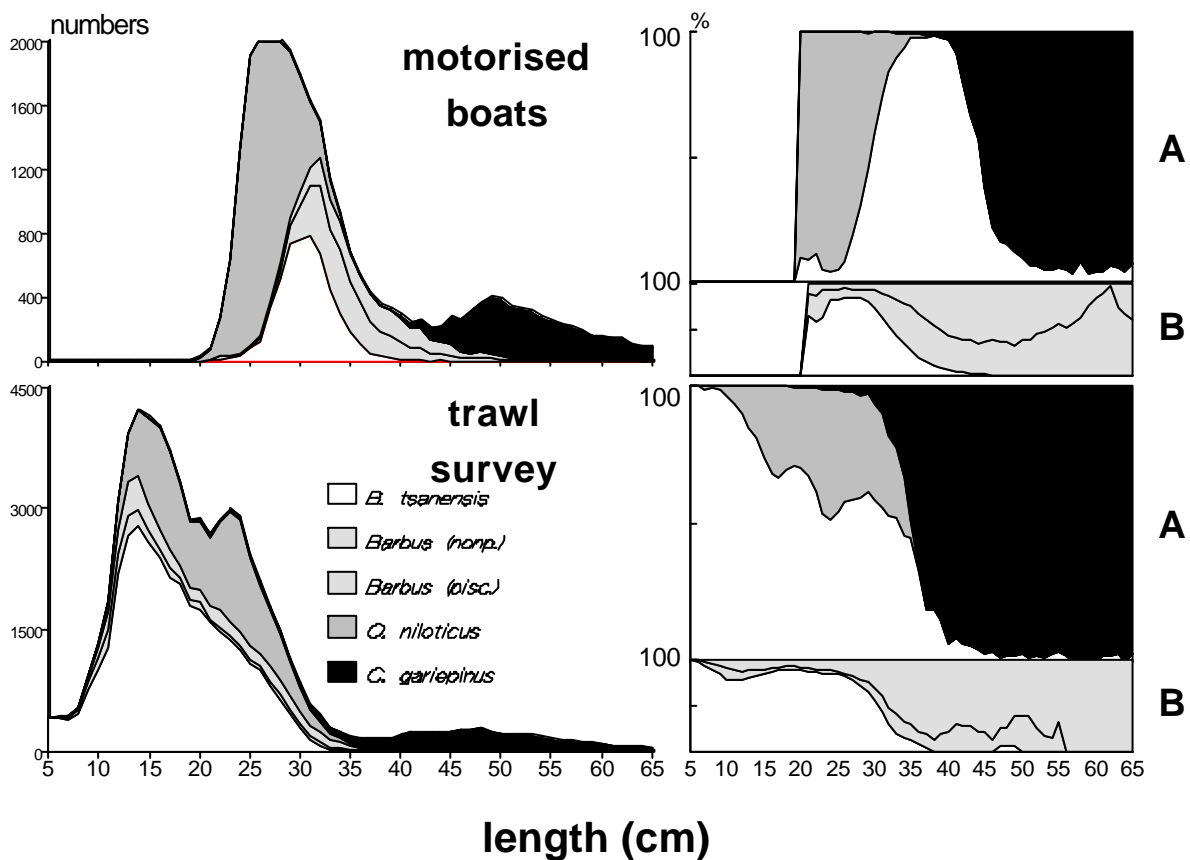

Figure 6.1 Abundance of *C. gariepinus*, *O. niloticus* and *Barbus* species in the motorised boat fishery (top) and the experimental trawl sampling (bottom). Absolute values per size category are depicted at the left. Relative values per size category in % of total numbers present are given at the right. The percentage contribution of each of the *Barbus* categories is shown in distinct diagrams (B).

The survey trawl catches included smaller sizes and ranges from 5 to 80 cm. Up to the 35 cm length class *Barbus* species were most abundant. *C. gariepinus* was caught from 30 cm onwards. For size classes larger than 45 cm the trawl catch was 95 % *C. gariepinus*. *O. niloticus* size classes ranged from 10 to 35 cm, but the highest proportion was found for size classes 25 to 30 cm. The contribution of *B. tsanensis* within the group of *Barbus* species was more than 75% for length classes up to 32 cm. The piscivorous barbs were mostly found above this length class. *B. macrophthalmus* was the most abundant species in the non-piscivorous group (>88%), whereas *B. acutirostris* and *B. platydorsus* comprised for almost 80 % the catch of the piscivorous group.

Size at maturity

The maturity curves for the *B. tsanensis*, *B. acutirostris*, *B. macrophthalmus*, *B. platidorsis* and *B. gorguari* as well as *O. niloticus* and *C. gariepinus* are depicted in Fig. 6.2. The midpoint of the maturity curve was found to be 18.1 and 30.5 cm for female *O. niloticus* and *C. gariepinus*. The l_m of *B. tsanensis* was 20.5 cm. The l_m for the other *Barbus* species ranged from 23.4 to 24.6. The r-values, being the slope of the curve, ranged from 0.21 cm^{-1} for *C. gariepinus* to 0.46 cm^{-1} for *O. niloticus*. For *B. tsanensis* a r-value of 0.38 cm^{-1} was estimated. For the other *Barbus* species estimated r-values ranged from 0.27 to 0.32 cm^{-1} .

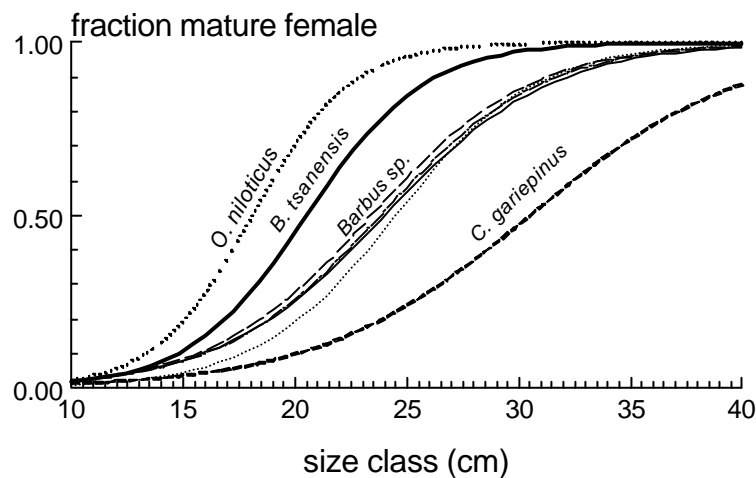

Figure 6.2 Female maturity curves for *C. gariepinus*, *O. niloticus* and *Barbus* spp.

Selectivity of the gillnets

Results of the gillnet selection estimates for the various fish species obtained by applying the Holt and Sechin estimation methods are presented in table 6.2. The estimated l_{opt} for a 100 mm gillnet using the Holt method for *O. niloticus* was 25 cm and 52 cm for *C. gariepinus*. Within the *Barbus* species, *B. tsanensis* had the lowest k: 34 $\text{cm}\cdot\text{cm}^{-1}$. *B. macrophthalmus* and *B. acutirostris* had k-values of 3.8 and 4.4 $\text{cm}\cdot\text{cm}^{-1}$. *B. acutirostris* had the broadest selection range of 9.0 cm.

Table 6.2 Optimum length (cm) and selection range (cm) of the gillnet selection curves for various species in a 100 mm stretched mesh gillnet as estimated with the Holt and Sechin methods

Species	Method			
	Holt		Sechin	
	L_{opt} (cm)	Selection range (cm)	L_{opt} (cm)	Selection range (cm)
<i>C. gariepinus</i>	52.0	10.6	51.5	10.0
<i>O. niloticus</i>	24.7	5.2	23.6	4.2
<i>B. tsanensis</i>	34.4	6.4	31.9	7.4
<i>B. macrophthalmus</i>	38.7	5.2	35.0	9.7
<i>B. acutirostris</i>	44.5	9.0	39.5	9.0
<i>B. platydorsus</i>			31.6	9.1
<i>B. truttiformis</i>			35.8	7.8

The Sechin method gave systematically lower values of L_{opt} for a 100 mm gillnet than the Holt method. The difference was smallest for *C. gariepinus* (0.5 cm) and *O. niloticus* (1.1 cm). *Barbus* gave 7-11 % lower L_{opt} values in case of the Sechin method. The L_{opt} for *B. tsanensis* was 31.9 cm, 2.5 cm lower than that obtained by the Holt method. *B. macrophthalmus* and *B. acutirostris* were 3.7 and 5 cm lower.

The Gulland & Harding method, for *C. gariepinus* gave a L_{opt} of 52.3 cm and an estimated selection range of 25.3 cm which was much wider in comparison with the other two methods applied. The relationship between best mesh (BM mm stretched mesh) and total length (TL mm) found for *C. gariepinus* was: $BM = 0.113 \cdot TL + 41$. In Fig. 6.3 the general, positively skewed selection curve is shown as the fitted Pearson type 1 curve.

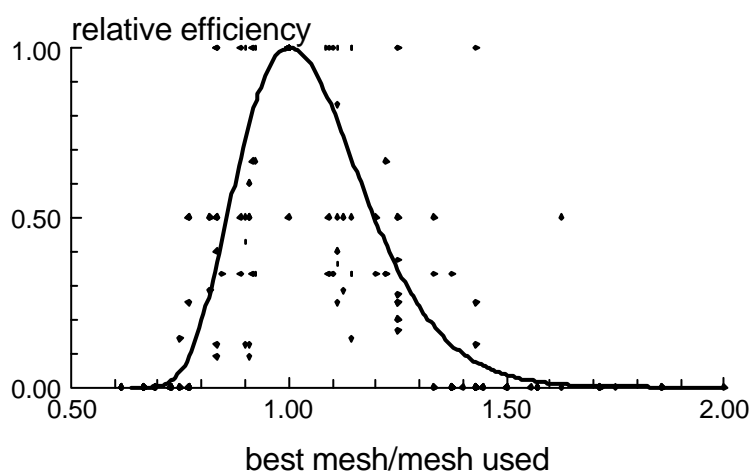

Figure 6.3 Pearson's type I curve, fitted through the scatter of relative retention efficiency of *C. gariepinus* against the ratio best mesh/mesh used.

Discussion

The estimated selection curves for the reed boat fishery on *O. niloticus* and *B. tsanensis* are given in Figs. 6.4 and 6.5, together with the size structure of the catch for these species. In Figs. 6.6 to 6.8 the selection curves of *C. gariepinus*, *O. niloticus* and *B. tsanensis* and their respective size structures in the catch of motorised boats, are shown. The selection curve and size structure of *B. tsanensis* caught in the 80 mm gillnets of the reed boat fishery, and of *O. niloticus* in the motorised fishery are very similar. The optimum length in the selection curve for *O. niloticus* in the reed boat fishery was approximately 4 cm below the mode in the size structure of the catch of that species. The optimum length in the selection curve for *C. gariepinus* and *B. tsanensis* in the motorised boat fishery was approximately 3 to 6 cm above the mode in the size structure of the catch of these species.

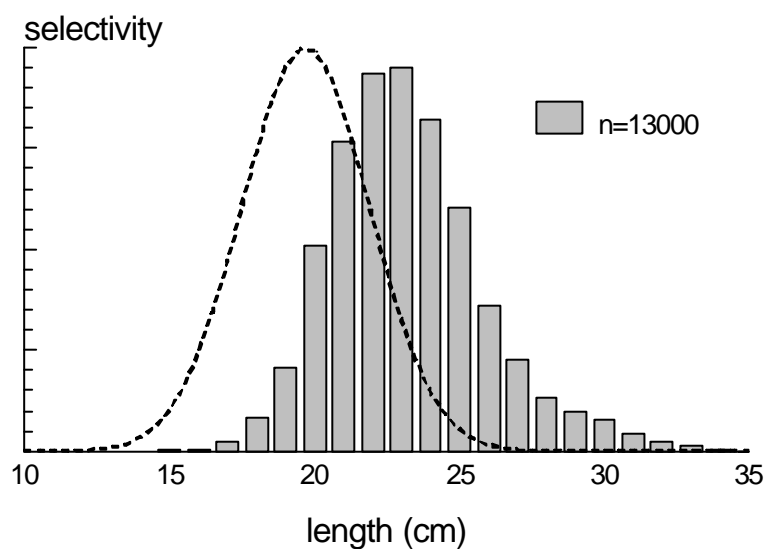

Figure 6.4 Gillnet selectivity curve based on Holt and relative size structure (bars) of *O. niloticus* caught in the 80 mm stretched mesh nets of the reed boat fishery

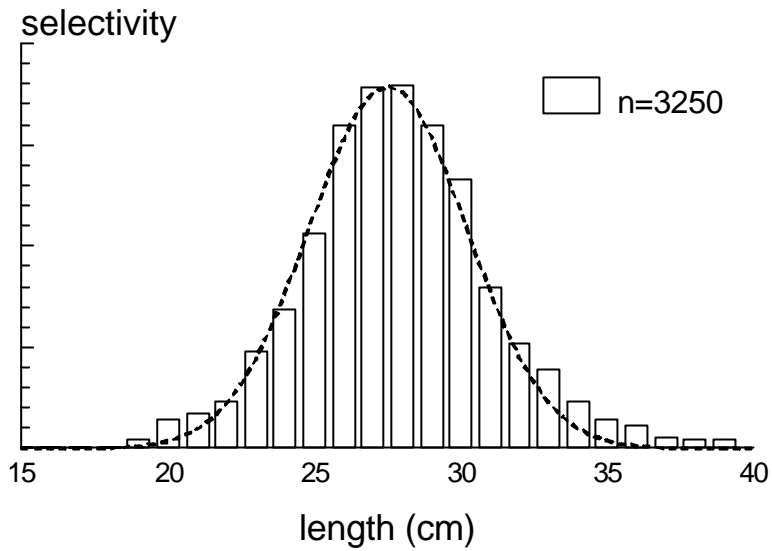

Figure 6.5 Gillnet selectivity curve based on Holt and relative size structure (bars) of *B. tsanensis* caught in the 80 mm stretched mesh nets of the reed boat fishery

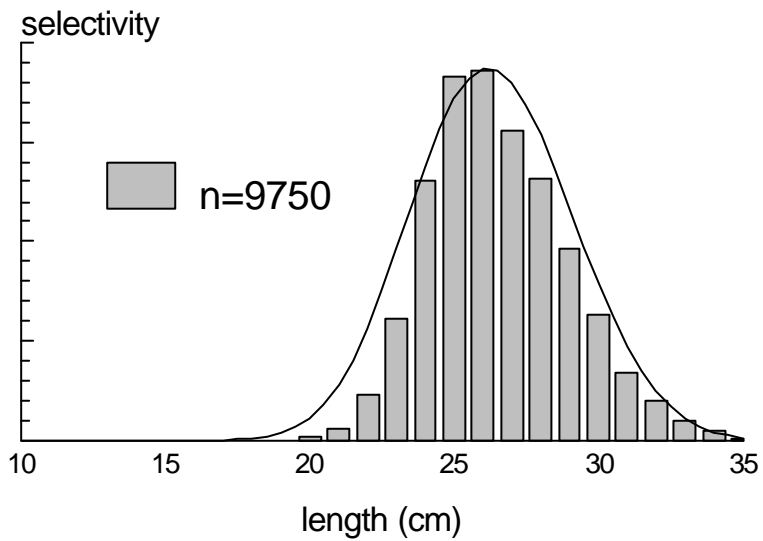

Figure 6.6 Gillnet selectivity curve based on Holt and relative size structure (bars) of *O. niloticus* caught in the combined 100-120 mm stretched mesh nets of the motorised boat fishery

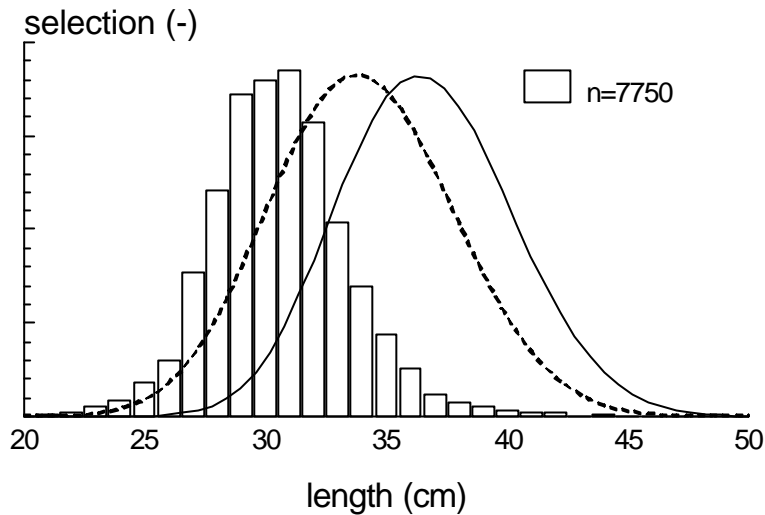

Figure 6.7 Gillnet selectivity curve based on Holt and Sechin (broken line) and relative size structure (bars) of *B. tsanensis* caught in the combined 100-120 mm stretched mesh nets of the motorised boat fishery

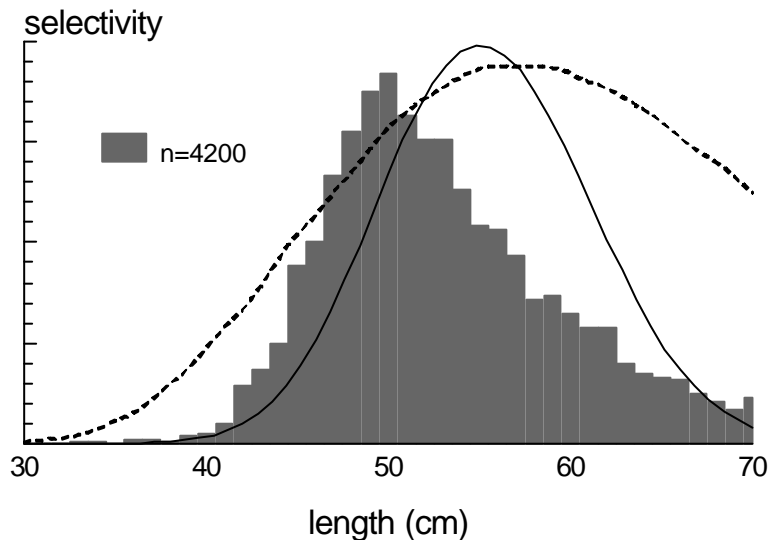

Figure 6.8 Gillnet selectivity curve based on Holt and Gulland & Harding (broken line) and relative size structure (bars) of *C. gariepinus* caught in the combined 100-120 mm stretched mesh nets of the motorised boat fishery

The combined selectivity of all the meshes used (80-120 mm) in the gillnet fishery is very low for length classes below the size at maturity (l_m) of all the species fished. This is confirmed by the fact that the modal and mean lengths of the gillnet catch are larger than the l_m for the various species considered. Thus only the higher length classes of the stock are selectively exploited and there is at present no threat to recruitment overfishing from the gillnet fishery on the lake. Recruitment overfishing for the *Barbus* species could be a threat from the fishing of ripe and running adults during the spawning aggregation at the river mouth or its migration to the rivers (Nagelkerke, et al. 1995b, Nagelkerke & Sibbing 1996), but this is not related to the selectivity of the gillnets used.

The reed boat fishery uses 80 mm mesh gillnets to exploit *O. niloticus* and *B. tsanensis* from the shallow littoral area. The size distribution mode of the *B. tsanensis* catch matched well with the L_{opt} of the selectivity curve for the species, but *O. niloticus* had a mode, at 23 cm, positioned to the right of the optimum length in the selectivity curve. This indicates the abundance of large size classes in the fishing area. The spatial distribution pattern of *O. niloticus* shows that this species is concentrated in the shallow littoral zone (Chapter 4, Gwahaba 1973, Lowe-McConnell 1982). The larger modal length in the size distribution of the catch of *O. niloticus* may have resulted from the Wigaro fishing method.

In the motorised boat fishery, using a combination of mesh sizes (100-120 mm), only the size distribution of *O. niloticus* in the catch corresponded with the mode predicted for the combined selectivity curve. For *Barbus* species and for *C. gariepinus* the modes of size distribution in the catch were lower than the one for the combined selectivity curves. Normally a lower average length in the catch compared to the optimal length of the selectivity curve, implies intensive fishing. In the present case, however, comparing the average length of all species caught in relation to their maximum sizes in the catch, it would be improper to imply growth overfishing or high fishing intensity. The discrepancy between the modes in the catch size distribution and their optimum length predicted for the gillnet selectivity could be due to low abundance of the large size classes of *Barbus* species and *C. gariepinus* in the fishing area. A size dependent habitat preference of the large piscivorous *Barbus* species and *C. gariepinus* for the deeper parts, has been noted (Chapter 4). These parts show also a minimum fishing effort. Pet et al. (1996) have described a similar occurrence affecting the catch size distribution for *Barbus sarana* in Tissawewa reservoir, Sri Lanka. It also indicates that the mesh sizes used were large for the size classes found in the fishing area.

The catch from the trawl contained predominantly the smaller size classes of all the different, commercially exploited, species. It appears that the larger size classes which dominate the gillnet catch have low catchability by the trawl fishing. Possible causes for the lower catchability could be that the big fishes swim fast enough to escape from the trawl net. This behaviour has a direct opposite effect in the passive gillnet fishery by increasing encounter rates and, hence, catchability (Sparre & Venema 1992).

Relatively more of the large sizes of *B. tsanensis* were found in the catch from motorised boats in comparison with the catch from the trawl survey. This difference can be attributed to the spatial distribution pattern. There is a high concentration of these size classes at the river mouth during the spawning season, out of the trawl sampling area. Increased fishing effort at the river mouth during this period accounts for the much higher occurrence of larger *B. tsanensis* in the gillnet catch. An increase in ratio with size of fish is apparent indicating the increase in efficiency of the gillnet in relation to the trawl.

The high mean length of all species in the commercial gillnet catch, indicates the presence of a significant number of the large size classes, indicative of a moderate level of exploitation. The fishery of Lake Tana is in a developing state with a slow increase in its fishing effort. The result of this selective fishing mortality would be, in the long run, to reduce the average length of the adult fish stock in the lake. Such observations have been reported for various fish stocks in different lakes (Smith 1994). Sandlund & Naesje (1989) found that

the commercial pelagic gillnet fishery on Lake Femund, Norway, had a size selective impact on whitefish that resulted in a reduction in fish size and a decrease in size-at-age of the adult pelagic fish stock over the sampling period of four years. In Lake George, Uganda, the mean size of *O. niloticus* decreased from about 900 gm in 1950 to about 400 gm in 1970 (Gwahaba 1973). This reduction in mean size of the catch over time was apparently caused by selective fishing of the larger, fast growing fish, which become more vulnerable to the gillnet.

Temporal and spatial patterns in the gillnet fishery for *Clarias gariepinus*, *Oreochromis niloticus* and *Barbus* spp. and the formulation of the catch effort data recording system.

Abstract

The temporal and spatial variations of catch per unit effort (CpUE) and effort in the gillnet fishery were assessed using ANOVA in order to improve the catch and effort data recording system.

The overall mean CpUE for the motorised boat fishery was 177 kg·trip⁻¹ with a coefficient of variation (CV) of 73% and for the reed boat fishery 12 kg·trip⁻¹ with CV of 72%. CpUE obtained in the littoral and river mouth areas were higher than those in the deeper fishing areas. The mean daily effort of the motorised boat fishery was 7 trips·day⁻¹ with CV of 43%. High catch rates of *Barbus* spp. were observed during July-October, of *O. niloticus* during November-May and of *C. gariepinus* during July and December.

Total annual production in 1992-93 was 224 tonnes from the reed boat fishery and 415 tonnes from the motorised boats. The mean and standard deviation of CpUE and effort were used to estimate the sample sizes required for future catch and effort data recording at the desired level of accuracy. A catch and effort data recording system thus proposed will provide an estimate of the total annual catch with a maximum relative error of less than 10%.

Introduction

Development of the fishery on Lake Tana started relatively recently. Traditionally the lake has been fished only by the shore dwelling communities at subsistence level. Fishing gear and methods used vary around the lake from single hook and line, cast nets and traps to different types of gillnet fishing. In some areas poisonous plant seeds are used. The major method used near the Bahir Dar Gulf in the south is gillnetting with nets of 80 mm stretched mesh. These gillnets are also used for Wigaro' fishing, a water beating technique which chases fish into the net which is checked at short intervals of time. This traditional fishery has several landing points around the villages. The fishermen use reed boats and fishing activity is confined to the shallow littoral area.

The modern fishery with motorised boats and larger nylon gillnets started with a small scale fishery development project in 1986, limited to the southern part of the lake. The boats have engines of 6-15 horse power and the gillnets used have stretched meshes of 100, 110 and 120 mm. They have one major landing point at Bahir Dar. A collection boat is available when fishing grounds are far from the port.

Prior to 1992 the Central Government formulated policies for management of inland water fisheries. Maximisation of yield has highest priority in developing countries with expanding populations and increasing food requirements (Leveque 1997). Ethiopia is no exception in this regard and the main objectives of the government were increased production to the estimated maximum sustainable yield (MSY) and job creation. Now the involvement of the Central Government is limited to issuing nation wide fisheries laws and provision of technical support and professional advice when requested by the regional governments. Policy decisions are made by the Regional Administrative Council and implemented by the regional Bureau of Agriculture. There is no fishery legislation that is presently enforced. The fishery legislation that existed before 1974 has been repealed by change of government. Any control and regulation of fishing activities is made by directives from the Bureau of Agriculture, who prepare and issue fishery regulations based on available biological information. Lake Tana is in the Amhara Regional Administration, of which Bahir Dar is the capital city. There are three fishery officers at the Bureau of Agriculture in Bahir Dar who analyse the data reports coming from the zonal offices. They also give management advice. Fisheries officers from the three administrative zones around the lake submit data reports every three months. The fishery is sampled by 12 fishery officers located at seven Woreda (districts). The collected data is compiled and sent to the zonal office every month. These offices are located in Gorgora for the North Gondar zone, Worota for the South Gondar zone and Bahir Dar for the West Gojam zone. The North Gondar zone covers 3 districts and the others 2.

Establishment of a catch and effort data recording system should be a first priority in a newly developing fishery (Hillborn & Walters 1992). Larkin (1982) has also indicated that catch and effort data are the only relevant information available to managers in most tropical fisheries. At present the data collection, analysis and reporting is assisted by the Lake Fishery Development Project (LFDP), which is financed by the European Union from 1992 to

1998. Quarterly and yearly reports are compiled based on information obtained from the regional fishery officers. The LFDP statistical bulletin from October 1997 indicated an increase in total catch in Lake Tana from 463 tonnes in 1993 to 1200 tonnes in 1995/1996 without indicating the precision of estimated values.

The number of motorised boats have increased by seven since 1993, five around Bahir Dar area and two boats in Gorgora area, at the northern part of the lake, through soft loan investment from LFDP sources. The government-owned Fish Production and Marketing Enterprise (FPME) is the main market outlet channel for the motorised fishery. Its policy is to increase fish production through investments in infrastructure like the recent construction of a cold store at Bahir Dar.

The objectives of the regional Bureau of Agriculture is an increase in catch of 20% per year and creation of jobs for the local community. This will be effected by increasing the motorised fishery by 20% per year. Credit facilities from the LFDP are available for introducing new motorised boats and gillnets. The regional government is considering the licensing of motorised boats in the future as a means of controlled development.

The present work, being a first attempt to characterise the fishery, has two major objectives: (1) To characterise and describe the fishery of the Bahir Dar Gulf of Lake Tana with respect to the temporal and spatial variations in effort and catch per unit of effort (CpUE); (2) To design a catch and effort data recording system to estimate annual catch and effort with a required precision for monitoring the fishery.

Materials and methods

Data collected

The data were collected from the fishery around the Bahir Dar Gulf of Lake Tana from September 1991 to October 1993. The data used includes:

A frame survey of reed boat fishery from September 1991.

- number of boats per fishing method
- average number of trips per fisherman per month
- number of fishing months per year per fisherman

Monthly sampling of reed boats and motorised boats

- the sampling of reed boat catches, for catch per unit of effort
- the sampling for effort and catch per unit of effort of the motorised boat fishery

Daily records of fish sold to the FPME by individual motorised boats

Data analysis

a) *Variations in CpUE and effort in the motorised boats fishery.*

Five fishing areas were identified in the sampling area for statistical analysis, by grouping those fishing grounds with similar catch records, and taking into account their proximity and habitat similarity such as river mouth areas, shore based locations or open, deep water areas (Fig 7.1). Area 1 is Gilgel Abai River mouth; Area 2 is at the West coast; Area 3 at the East coast of the Bahir Dar Gulf; Area 4 is Gumara-Rib River mouths and Area

5 is the open deep-water, the Mid-Gulf, area. The distribution of effort for the motorised boats over these area's is also indicated in Fig. 7.1.

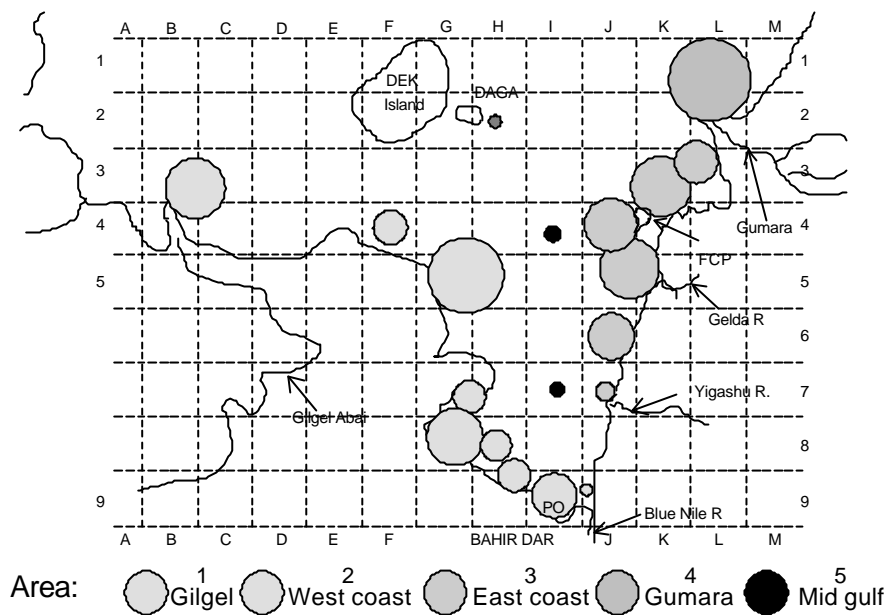

Figure 7.1 Map of the sampling area indicating codes and location of fishing grounds. The area of the circles indicate the relative effort applied.

The relationship between the catch per fishing trip and the number of gillnets carried was examined. The catch per fishing trip was proportional to the number of gillnets used by a factor $9 \text{ kg}\cdot\text{net}^{-1}$ ($R^2=0.22$, $p<0.01$). The unit of effort was a fishing trip with the average number of gillnets carried. Analysis of variance (Sokal & Rolf 1995) was performed on the log-transformed CpUE data, to observe sources of variation in the spatial (area) and temporal (sampling month) distributions. The analysis was carried out for each fish category separately and for the total catch. Based on the same grouping, ANOVA was applied to the effort data in order to study the temporal and spatial variations in effort distribution.

The most complete ANOVA model was:

$$Y_{ijk} = \mu + M_i + A_j + M_i * A_j + \epsilon_{ijk}$$

where:

- Y_{ijk} = observation
- μ = overall mean
- A_j = effect of fishing area ($j = 1..5$)
- M_i = effect of month ($i = 1...21$)
- $M_i * A_j$ = interaction term
- ϵ_{ijk} = random term

When a significant effect of the factors and/or interaction was found, group means were compared for significant difference via the confidence intervals around the group means. All statistical analysis were done with SAS (r) Proprietary Software Release 6.09 (SAS 1992).

b) *Variation in CpUE of the reed boats fishery.*

Three fishing areas were identified of the reed boat fishery to study the temporal and spatial variations in catch per unit effort. Area 1 is at the South-West coast, Area 2 is east coast and Area 3 (K-5 in Fig 7.1) is Gelda River mouth. The unit of effort for the reed boat is a fishing trip. Analysis of variance was applied to the overall CpUE of all species combined using a similar model as for the motorised boats. When a significant effect of the factors and/or an interaction was found, group means were compared for significant difference through the confidence intervals around the group means.

c) *Estimation of annual production of the motorised boat fishery.*

1. Annual production was estimated from the mean CpUE per month and mean effort per day and average fishing days per month. The following formula was used:

$$Y_t = \sum_{m=1}^{12} \overline{CpUE}_m \cdot \overline{f}_m \cdot \overline{D}_m$$

where:

- Y_t = total annual catch
- $CpUE_m$ = monthly mean catch per unit effort
- f_m = mean effort (trips·day⁻¹) and
- D_m = the number of days the fleet is active per month.

The 95% confidence interval for total annual catch was estimated using the confidence intervals of CpUE and total effort.

2. Total annual catch of the motorised boat fishery was also estimated from the daily catch recording from the FPME. The daily catch records were summed on a monthly basis for all species combined to estimate the annual production.

$$C_t = \hat{a}C_m$$

where:

- C_m = recorded catch per month (kg) (m =1...12)
- C_t = estimated total annual catch (kg)

d) *Estimates for annual catch of the reed boat fishery.*

The annual catch for the reed boat fishery was estimated using the mean CpUE estimate for the different fishing methods and information on effort from the frame survey. Annual total catch estimate for the reed boats, ($C_{est.}$) is:

$$C_{est(i)} = B_{n(i)} * D_{m(i)} * M_{y(i)} * CpUE_{(i)}$$

$$C_{est.} = \sum[C_{est(i)}]$$

where:

$B_{n(i)}$	= number of reed boats operating per day and per fishing method (i)
$D_{m(i)}$	= average number of fishing days per month per fishing method (i)
$M_{y(i)}$	= average number of fishing months per year per fishing method (i)
$CpUE_{(i)}$	= estimated catch per trip per method of fishing.
$C_{est(i)}$	= annual catch estimate for fishing method (i).
$C_{est.}$	= annual catch estimate of all reed boat fishery including all fishing methods.

Design for a Catch and Effort Data Recording System (CEDRS).

Based on the results from the present sampling a CEDRS was designed for the fishery of the Bahir Dar Gulf and surrounding areas of Lake Tana. The mean and standard deviations of CpUE and effort were used as input to estimate the maximum relative error (mre) on variable sample sizes. A sample size, n, could be calculated at the required precision, r, of the mean at 5% significance level using the following formula (Caddy & Bazigos 1985):

$$n = [s/r * t_{n-1}/y * 100]^2$$

where:

s	= standard deviation of the mean
t_{n-1}	= t value at an α level of 0.05
r	= % maximum relative error
y	= population mean

Results

Variation in CpUE in the motorised boats fishery

A unit effort for the motorised boat fishery was taken as a 20 gillnet unit, based on the mean number of gillnets carried per trip (19.6 gillnets, sd = 7.2, n = 1563). The mean CpUE for all species combined was 177 kg ·trip⁻¹ with a standard deviation of 130 kg·trip⁻¹ (n = 1563). The CpUE for the individual species was *C. gariepinus* 67.2 kg·trip⁻¹ (sd = 78.2 kg·trip⁻¹), *O. niloticus* 46.8 kg·trip⁻¹ (sd = 73.2 kg·trip⁻¹) and *Barbus spp.* 61.2 kg·trip⁻¹ (sd = 83.5 kg·trip⁻¹).

Analysis of variance, computed separately for the different fish categories, on sampling month, sampling area and the interaction month*area gave highly significant ($P < 0.01$) values for all species on all terms (Table 7.1).

Table 7.1 Analysis of variance (mean squares) of log(CpUE) for 1563 catches of *Barbus* spp. *C. gariepinus* and *O. niloticus* in the motorised boats fishery.

Source	df	<i>C.</i>	<i>O.</i>	<i>Barbus spp.</i>	total
		<i>gariepinus</i>	<i>niloticus</i>	(Mean Squares)	
Date (month)	20	2.41**	6.00**	5.41**	0.81**
Area	4	11.75**	31.50**	9.22**	7.09**
Date * Area	71	0.48**	1.59**	0.42**	0.17**
Error	1467	0.25	0.50	0.22	0.08
R square		0.35	0.5	0.25	0.5

Seasonal patterns in the variation of CpUE were observed for individual species, as depicted in Fig. 7.2. For *C. gariepinus* significantly low CpUE results were observed during January, February, June and September 1992 and during February and August 1993 (40 kg·trip⁻¹). Significantly higher CpUE were apparent during July and December 1992 (100 kg·trip⁻¹). *O. niloticus* showed significantly higher CpUEs of 75 kg·trip⁻¹ in the following months: May, November and December 1992 and January, April and May 1993. Low CpUE of 25 kg·trip⁻¹ were observed during June to October 1992 and July and August 1993. *Barbus spp.* had significantly higher CpUE of 120 kg·trip⁻¹ during the period of August-October 1992 and July-September 1993. Significant low CpUE values, 33 kg·trip⁻¹, were observed from December to June in both years. The temporal variation in the overall catch is presented in Fig 7.3. The overall monthly mean CpUE was high in August of both years (250 kg·trip⁻¹) and November-December 1992 (220 kg·trip⁻¹). Low average CpUE was observed in January-February and June 1992 and February 1993 (120 kg·trip⁻¹)

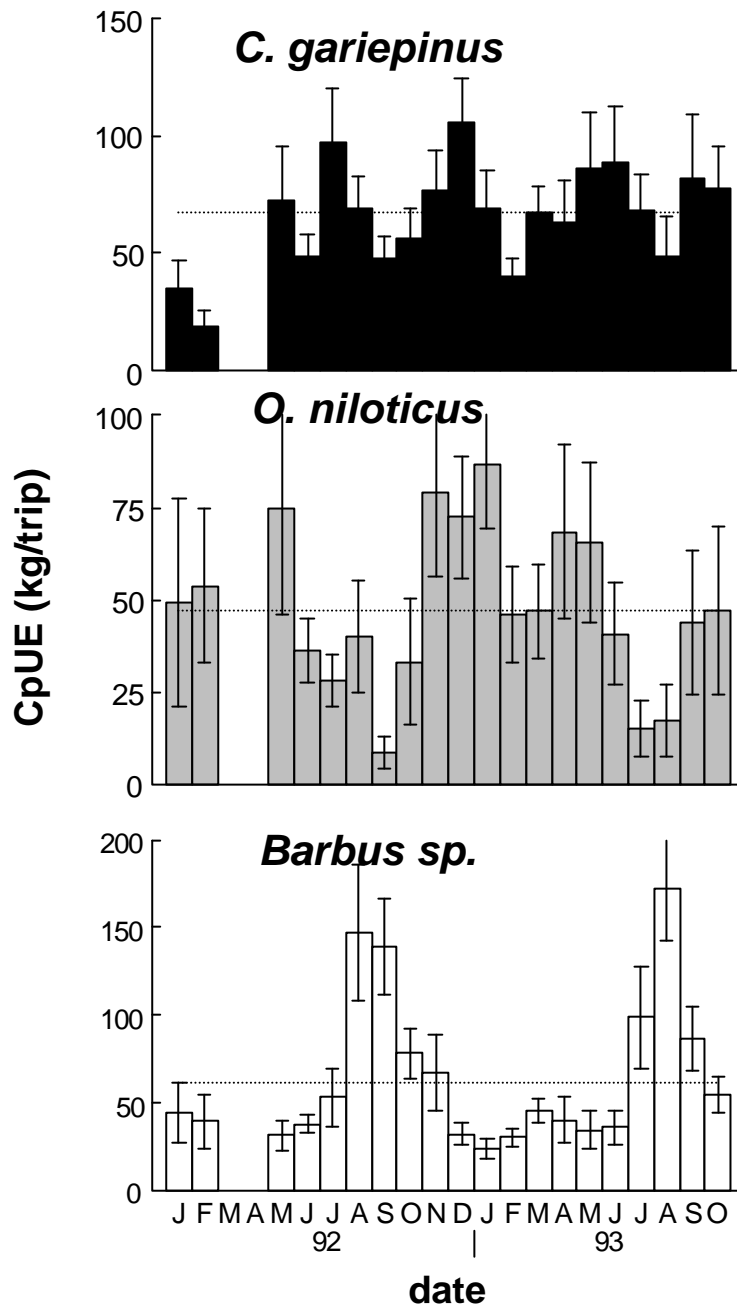

Figure 7.2 Variation of monthly average CpUE ($\text{kg}\cdot\text{trip}^{-1}$) for the three major categories in the motorised fishery. The overall means are indicated by the dotted line. Error bars indicate the 95% confidence intervals.

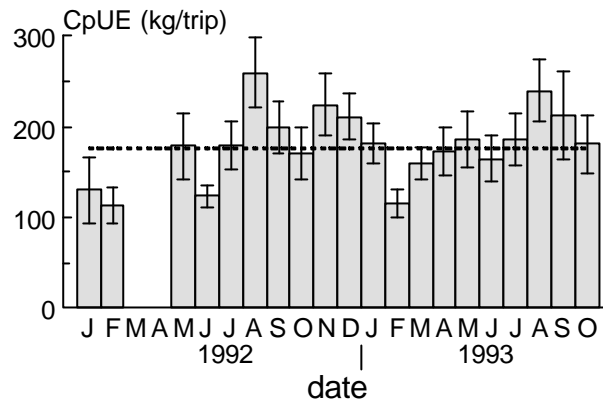

Figure 7.3 Variation of monthly average CpUE ($\text{kg}\cdot\text{trip}^{-1}$) for the total catch in the motorised fishery. The overall means are indicated by the dotted line. Error bars indicate the 95% confidence intervals.

The spatial differences of CpUE are depicted in Fig. 7.4. Significantly higher CpUE was observed in the Gilgel Abai and Gumara-Rib river mouths, for *C. gariepinus* ($110 \text{ kg}\cdot\text{trip}^{-1}$) and *O. niloticus* ($80 \text{ kg}\cdot\text{trip}^{-1}$). For *Barbus spp.* significantly higher CpUE was found at the east coast ($78 \text{ kg}\cdot\text{trip}^{-1}$) and Gumara Rib ($97 \text{ kg}\cdot\text{trip}^{-1}$). The catch per trip from the open water area was low, similar to the low CpUE found for *C. gariepinus* and *O. niloticus* in the east coast area and for *Barbus spp.* in the west coast area. The CpUE for all species combined, showed higher values in the two areas covering both river mouths ($270 \text{ kg}\cdot\text{trip}^{-1}$), than an average trip in either the west coast or the east coast with a catch of $150 \text{ kg}\cdot\text{trip}^{-1}$. Area 5, the deep water zone, had the lowest CpUE of $110 \text{ kg}\cdot\text{trip}^{-1}$ (see Fig. 7.5).

Variations in effort distribution - motorised boats.

The overall mean effort was 7 with a standard deviation of 3 trips day^{-1} . There was no clear temporal pattern observed in effort distribution over the whole area (Fig. 7.6). The result of the ANOVA indicated significant temporal variation that was caused by a single high mean effort ($11.4 \pm 1.9 \text{ trips}\cdot\text{day}^{-1}$) observed in September 1993.

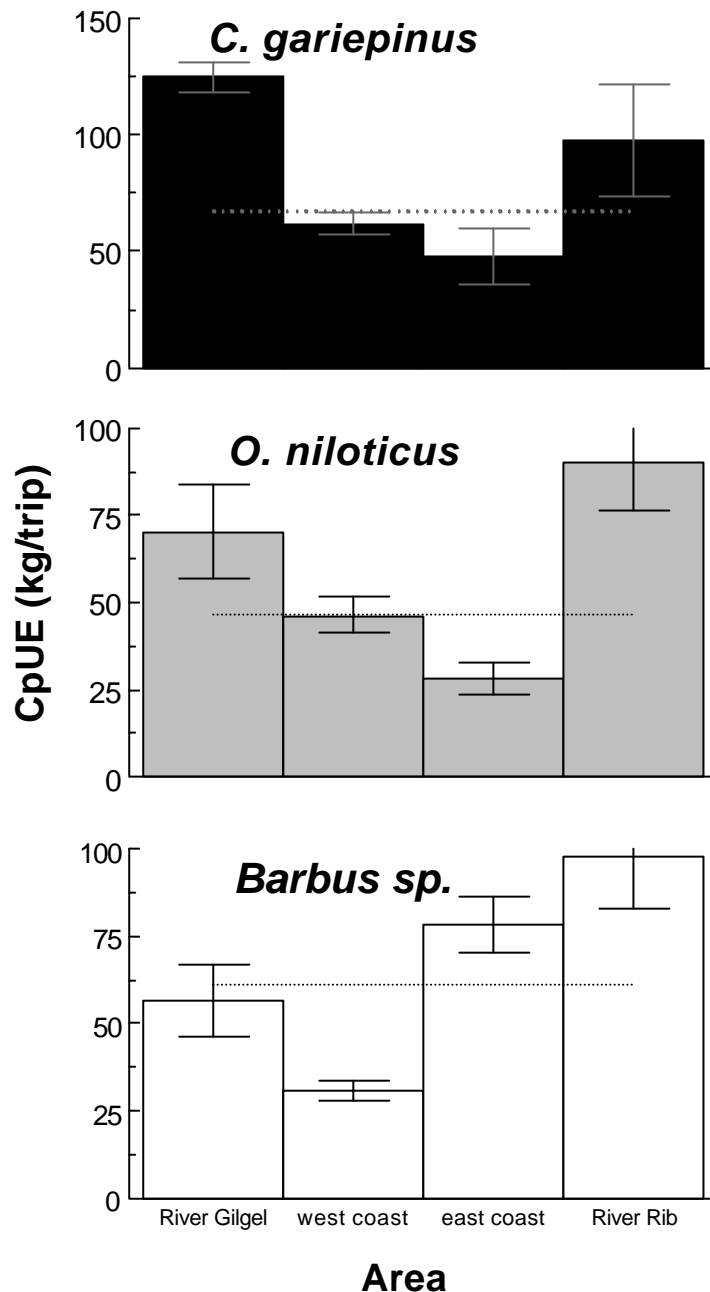

Figure 7.4 Variation of average CpUE ($\text{kg}\cdot\text{trip}^{-1}$) in the various areas for the three major categories in the motorised fishery. The overall means are indicated by the dotted line. Error bars indicate the 95% confidence intervals

Temporal patterns of effort distribution were apparent for individual fishing areas. There was also a distinct difference in effort distribution among areas. The highest concentration of effort was in the east coast area, with 36% of the total effort. Temporal pattern of effort distribution was observed in this area with a greater effort, mean $4\text{-}6 \text{ trips}\cdot\text{day}^{-1}$ during June - September in both 1992 and 1993. Greater effort (33% of the total) was also observed on the west coast area. Temporal variation in effort was also apparent in this area. High effort was observed in the months of May to August 1992 (mean $4 \text{ trip}\cdot\text{day}^{-1}$) and February and April 1993. The other fishing areas near the river mouth Gumara-Rib and Gigel

Abai had 17% and 11% of the total effort distribution respectively. Effort was high in the Gumara-Rib area during September-November. A high proportion of the effort in Gilgel Abai is seen during December to May. The distribution of effort to the areas Gilgel Abai and Gumara-Rib, far from the landing port, are influenced by the availability of the fish collection boat. Area 5, the deep water zone, with low CpUE, was not fished often with only 3% of the observed effort.

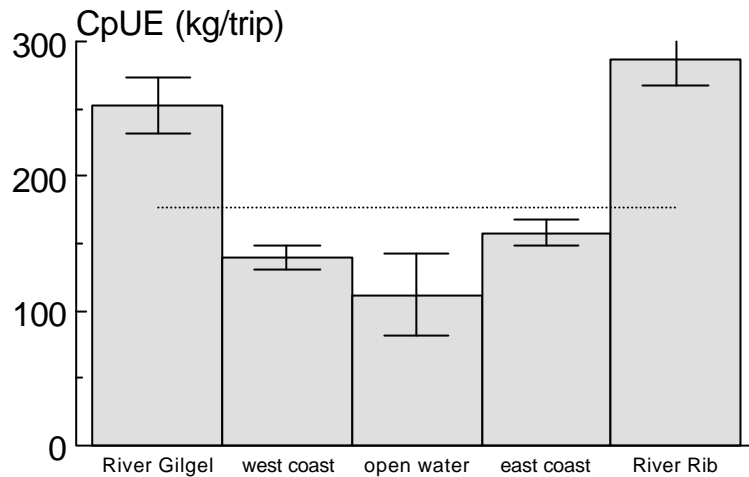

Figure 7.5 Variation of average CpUE ($\text{kg}\cdot\text{trip}^{-1}$) in the various areas for the total catch in the motorised fishery. The overall means are indicated by the dotted line. Error bars indicate the 95% confidence intervals

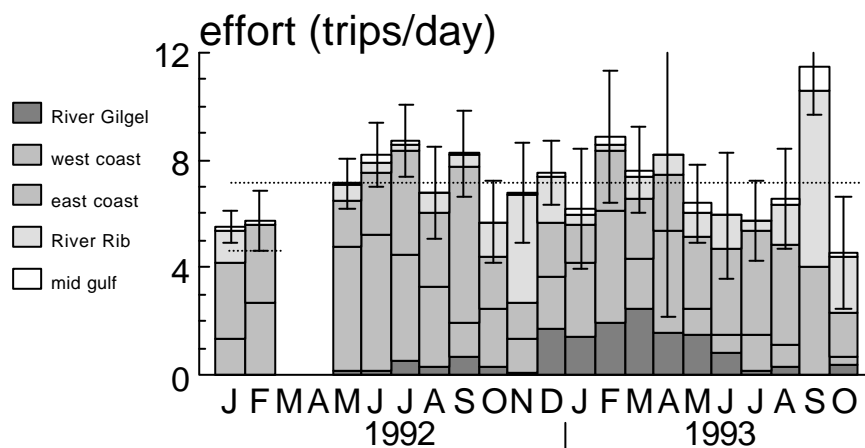

Figure 7.6 Variation in daily effort of the motorised fishery per month period, distributed over the different areas. Error bars indicate the 95% confidence interval of the daily effort.

Variation in CpUE of the reed boats fishery

A fishing trip was used as the unit of fishing effort for the various fishing methods. From the census data it was found that each reed boat used in wigaro fishing had an average

of 2 gillnets and each reed boat used in normal gillnetting had an average of 8 gillnets (18 meters each). The mean CpUE for the wigaro fishing method was 12.9 kg·trip⁻¹ with a standard deviation of 9.0 kg·trip⁻¹, for normal gillnetting 12.2 kg·trip⁻¹ (8.6 standard deviation), and for other fishing methods, like hook and line, cast netting and traps, 9.5 kg·trip⁻¹ (5.6 standard deviation). The overall mean CpUE for the reed boats was 12.3 ± 0.7 kg·trip⁻¹. For the individual species the CpUE was 7.8 and 4.3 kg·trip⁻¹ for *O. niloticus* and *Barbus spp.* respectively with a standard deviation of 8.9 and 7 kg·trip⁻¹. The analysis of variance on the overall CpUE was highly significant (P<0.01) for sampling months and explained 39% of the total variance. The interaction term, date*area was not significant (P>0.05). Fishing area was significant (P<0.01), but explained only 3% of the variance.

Table 7.2 Analysis of variance (mean squares) of log(CpUE) for 641 catches from reed boats fishery.

Source	df	MS	F
Date(month)	24	1.261	7.0**
Area	2	1.16	15.6**
Error	614	0.07	

Temporal variations in the catches of both *Barbus spp.* and *O. niloticus* were apparent (Fig.7.7). The *Barbus spp.* and *O. niloticus* have successive peaks of high catch periods. *Barbus spp.* had high CpUE during the months of January-February 1992 and October -January 1993 and *O. niloticus* showed high CpUE during April - July, 1992 and March - August 1993. The spatial pattern in CpUE of reed boats (Fig. 7.8) shows higher CpUE for Gelda river area, with a mean of 33 kg·trip⁻¹ and a lower one for the west coast area of 11.7 kg·trip⁻¹. The contribution of *O. niloticus* in the catch was 47 and 75 % for Gelda river and the west coast respectively. CpUE observed at the east coast was 12.6 kg·trip⁻¹ and catches consist of *Barbus spp.* only.

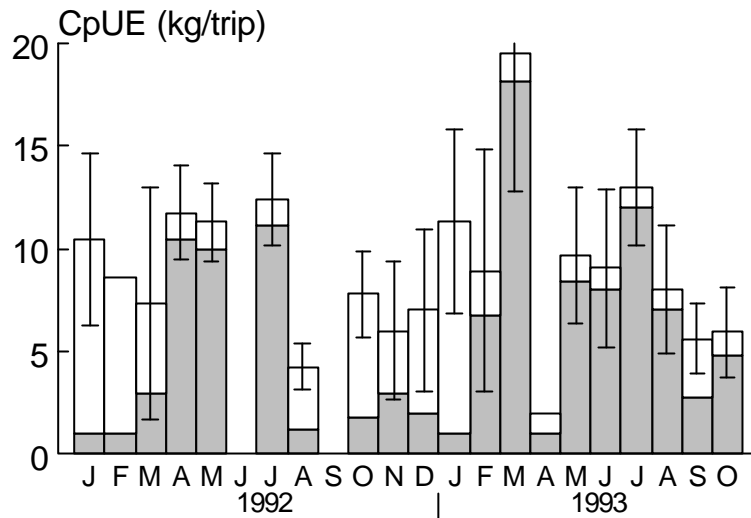

Figure 7.7 Temporal variation (monthly average) of CpUE (kg-trip⁻¹) of reed boat catches for southern Lake Tana. Filled bars, *O. niloticus*, open *B. tsanensis*

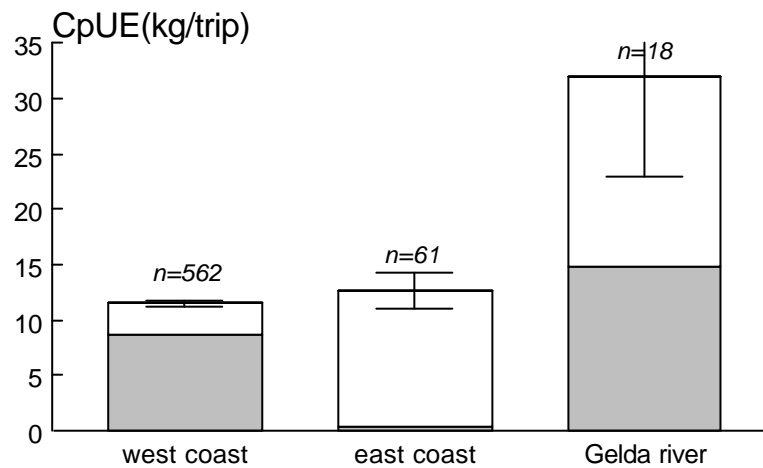

Figure 7.8 Spatial variation of average CpUE (kg-trip⁻¹) of reed boat catches per area. Filled bars, *O. niloticus*, open *B. tsanensis*

The total catch for the reed boat fishery was estimated on the basis of the information from the census data. Total catch per fishing method was calculated from the number of boats used, number of fishing days per month and number of fishing months per year (Table 7.3).

Table 7. 3 Annual catch estimate from the reed boat fishery.

Fishing method	Number of boats	Fishing months per year	Fishing days per month	Trips per year	CpUE	Annual Catch (tonnes)
Wigaro	67	7	18.6	8700	12.9	112
Gillnet	36	10.8	21.3	8250	12.2	101
Others	10	8	15.0	1200	9.5	11
						224

Annual yield estimates

The annual yield estimate based on the overall mean CpUE ($177 \pm 10 \text{ kg} \cdot \text{trip}^{-1}$), mean effort per day (7.0 ± 0.4) and average number of active fishing days per month (26 days) was 385 ± 35 tonnes. An estimate using the monthly mean CpUE and mean effort per day for the specific month, and average active fishing days per month was made for a specific time period of one year from November 1992 to October 1993. This gave a total catch of 415 mt. for the year 1993. The total annual catch for the same time period from the catches recorded by the Fish Production and Marketing Enterprise (FPME), obtained by summing up of the monthly records was 350 mt.

The total annual catch from the reed boat fishery was 224 tonnes. When combined with the estimated total catch from the motorised fishery (415 tonnes) a total production of 640 tonnes per year was estimated. This resulted in a yield of $21 \text{ kg ha}^{-1} \text{ yr}^{-1}$ assuming an area of 300 km^2 covered by the sampling.

Catch and Effort Data Recording System (CEDRS).

Sampling the motorised fishery

The overall mean CpUE, $177 \text{ kg} \cdot \text{trip}^{-1}$ with standard deviation $130 \text{ kg} \cdot \text{trip}^{-1}$ were used to calculate the maximum relative error (mre) on variable sample size (trips) to determine the optimum number of trips at the desired precision with 95% confidence limits. The relationship between mre and sampling days per month is given in Fig 7.9. To detect differences in the total catch estimate of more than 15 %, the mre should not exceed 10 %. A sample size of 660 trips per year will estimate a mean CpUE with 5 % mre. Similarly the overall mean effort, $7.0 \text{ trips} \cdot \text{day}^{-1}$ with standard deviation 3.0 was used as input to calculate the mre on variable number of sampling days per year. Sampling for 95 days per year will estimate a mean effort ($\text{trips} \cdot \text{day}^{-1}$) with a precision of 8 % mre. The product CpUE*effort will give the annual production estimate with a precision of 9.5 % mre at a 95% confidence interval.

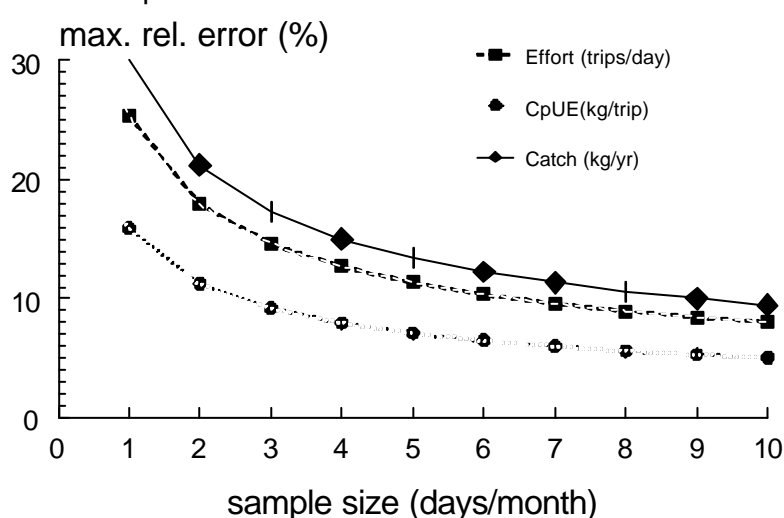

Figure 7.9 Maximum relative error in relation to sample size (average 7 trips·day⁻¹) for effort, CpUE and total catch estimates for the motorised fishery.

The temporal distribution of effort did not show any grouping during the specific months of the year and no particular concentration of effort was observed during specific days of the month. Months were chosen as intervals to quantify temporal variations. Hence, a systematic sampling stratified by months with equal sample size per month is proposed. Since an average of 7 trips·day⁻¹ are expected, the 95 sampling days would cover about 660 trips. These 95 days can be equally divided over 12 months (8 days·month⁻¹). Two fishery officers could do the job with a pre-arranged data collection form. Data for estimating mean CpUE, kg·trip⁻¹ and effort, trips·day⁻¹, can be collected simultaneously from all boat landings on a particular sampling day.

The number of fishery officers around the lake, with full time duty of data collection and reporting, is 12. They also sample for biological information and length frequency of the catch. The present CEDRS is designed for the West Gojam zone, Bahir Dar Gulf area, where about 70% of the total catch from the lake is landed. A similar sampling scheme, as proposed here, could be adopted for the northern part of the lake with sample sizes selected to give the required precision of the estimate.

Sampling the reed boat fishery

The overall mean CpUE, 12.3 kg·trip⁻¹ and standard deviation of 8.6 kg·trip⁻¹ were used to calculate the mre on variable sample sizes. A sample size of 300 trips per year would give an estimate of mean CpUE with a precision of 11%. This would allow detection of an annual change of over 15% in the traditional fishery on the lake. About eight trips per day can be sampled by four persons at different sites. The sampling should be done on a monthly basis to see temporal variations in catch. The sample size would be equally distributed over the sampling months. A systematic stratified sampling of three days per month will give an estimate at the required precision. Since most landing points are not accessible, estimation of effort will still depend on yearly frame surveys and interviewing the fishermen.

Discussion

The temporal patterns of CpUE were more distinct on catches of the individual fish categories than from the total. *C. gariepinus* showed peaks of CpUE during July and December 1992. But this pattern was not consistent during 1993 when high CpUE were observed during May-June. The high CpUE of *C. gariepinus* during June-July can be associated with the breeding period when the species is more vulnerable as it migrates into the shallow inshore areas. The temporal pattern of CpUE for *O. niloticus* also shows two peaks per year during November-January and April-May. These seasons of high CpUE for *O. niloticus* are periods of low water temperature in November-January, and low water level with relatively high water temperature during April-May. High CpUE during December-January may be caused by the recruitment of new cohorts into the fishery. The period April-May is the start of the long breeding period for *O. niloticus* in Lake Tana when part of the population is observed in breeding condition and hence more vulnerable to fishing as they start aggregating. *Barbus spp.* had one annual peak season of CpUE during July-September, the high water level season. This temporal pattern of CpUE for *Barbus spp.* is associated with

the breeding seasons of the species which has a peak spawning period during September (Chapter. 4 Nagelkerke & Sibbing 1996).

The effect of fishing area on the CpUE was similar for all fish types. The high CpUE observed at the river mouths might partly be attributed to the high productivity of such areas (Marten & Polovina 1982), but fishing in these areas mainly during the breeding season, when the fish aggregate there, would also produce high CpUE. The *Barbus spp.* aggregate at the river mouth area during their spawning period (Nagelkerke & Sibbing 1996).

The concentration of effort throughout the sampling period in west coast and east coast, indicates the regular high yield from these coastal fishing areas. The greater production from such littoral areas relative to the deeper parts of the lake is also common in other systems such as Lake Victoria (Kudhongania & Cordone 1974) and Lake Malawi (Turner 1977a,b). In the present situation the proximate location of these fishing areas to the landing site, which reduces operational costs is another influential factor.

The proposed CEDRS has a precision of 9.5 % mre on the annual production. As the management objective of the government is to increase catch by 20% annually, the proposed sampling design would allow the managers to see if a real increase in production is effected. During sampling the catch should be recorded by species categories and all active boats should be recorded on a sampling day. It is emphasised that identification of the unit of fishing effort that best reflects the fishing mortality is important in the use of CpUE as an index of abundance in the study of stock dynamics (FAO 1980, Gulland 1983, Amarasinghe & Pitcher 1986). Amarasinghe & Pitcher (1986) noted that the most appropriate unit of effort is the number of nets, since it directly reflects the fishing mortality experienced by the fish stock. Pet et al. (1995) indicated that the number of fishing trips could also be used as the effort unit when it is proportionally related to the number of nets. This holds only when the number of nets used per trip is stable and shows small variation among trips. In Lake Tana number of nets used by the motorised fishery per fishing trips shows a considerable variation and should be checked to estimate the CpUE.

To improve the precision, say, to 5% of the production estimate, would require an increase in sample size to over 2100 trips.yr⁻¹ (2.2% mre) for CpUE and over 300 days.yr⁻¹ (4.5% mre) for effort sampling. The present manpower allocation in the area is not proportional to the volume of fishing activity around the lake. Three fishery officers are assigned in the Bahir Dar Woreda area, West Gojam zone, where about 70% of the fish is landed. Since there are many fisheries officers around the lake, it will be necessary to organise and co-ordinate the sampling programme with the participation of others from outside the area.

The problem of access to most landing sites makes it difficult to allocate different sampling sizes for the various fishing methods of the reed boat fishery. Therefore, the allocation of an equal sample size per month was the only choice. It is inconvenient and difficult to sample the daily total effort and estimate mean effort per day from the reed boat fishery. It is, therefore, necessary to rely on information from periodic frame surveys and interviewing fishermen to estimate effort. Sampling for CpUE can be carried out by

encountering the fishermen on their way to the market as it is currently practised and the method of fishing can be inquired and recorded.

The official report for annual fish production of the lake for 1992/93 was about 400 tonnes (LFDP Stat. Bull.1995). This is different from the estimate of about 640 tonnes, from our survey, for the same period, but only for the southern part of the lake. This indicates a tendency to under-estimate the fish production. Dudley & Harris (1987) indicated that inaccuracy is often caused by systematic errors in data recording systems. The possible sources of the bias in the annual production estimate were: a) under-estimation of the reed boat fish production by recording only the few boats landing at the main landing jetty; b) under-estimation of the motorised boat fish production by considering only the catch records from the FPME, which lacks the fish quantity discarded and/or used for own consumption. There was no catch data recording in the northern part of the lake at the time. The presence of fishery officers at present on all sides of the lake should improve the data collection system.

The 1995/96 fish production estimate of 1200 tonnes per year (LFDP Stat. Bull. 1997) from Lake Tana is very low for its size. This is an annual yield of less than $4 \text{ kg}\cdot\text{ha}^{-1}$, about 8% of what would be expected from such a system, 50 to $80 \text{ kg}\cdot\text{ha}^{-1}\cdot\text{yr}^{-1}$, (Oglesby 1985). Hence there is still a wide room for expansion of the fishery when the entire lake area is considered. This will be detailed in chapter 9 of this thesis.

Zooplankton distribution and production in Bahir Dar Gulf, Lake Tana

Abstract

The abundance of various zooplankton species was studied from monthly samples to assess their spatial and temporal productivity patterns. The species composition is typical of a tropical freshwater lake, showing little diversity. A total of 17 different species were observed. The copepods, *Mesocyclops*, *Thermocyclops* and *Thermodiaptomus* spp., were most abundant. Variation in spatial distribution was larger than seasonal variation. Densities of copepods and cladocerans were highest in the littoral zone of the lake during March-May, at the start of the rainy season, with low water level and higher water temperatures.

The zooplankton was small-sized. The copepod *Mesocyclops* spp. was the largest organism ranging in size from 0.6 to 1.4 mm, with a mean of 1 mm. The estimated mean biomass was 0.17 g C m⁻², which is lower than in other tropical lakes. It was hypothesised that the high water turbidity during the rainy season, resulting from silt carried by inflowing rivers, was the main reason for this low productivity and for the less pronounced seasonal pattern in zooplankton production.

Introduction

Zooplankton are important food sources for the larvae and some adult fish of many freshwater fish communities (Mavuti & Litterick 1981). In Lake Tana, apart from larval fish, zooplankton are mainly preyed upon by the small cyprinid species, *Barbus trispilopleura*, adult *Clarias gariepinus* and, among the large barbs, adult *Barbus brevicephalus* (Nagelkerke & Sibbing 1998b). *B. trispilopleura*, is a small pelagic cyprinid with a maximum size of about 9 cm, that provides a prey source for a few predator *Barbus spp.* such as *B. platydorsus*, *B. megastoma* and *B. acutirostris*.

The first general account of the aquatic fauna and flora of Lake Tana was given by Brunelli & Cannicci (1940) and some further points were added by Rzoska (1976). The phytoplankton studied by Brunelli & Cannicci (1940) is similar to that of other African lakes (Serruya & Pollingher 1983). The *Cyanophyta* are poorly represented and the phytoplankton is dominated by diatoms. There is no comprehensive quantitative data either on the phytoplankton or zooplankton productivity of the lake. The value of 3.7 mg m⁻³ dry weight of *chlorophyll* as given by Wood & Talling (1988) is low compared to other tropical lakes. Serruya & Pollingher (1983), observed that Lake Tana, being poor in salts and nutrients, as suggested by Bini (1940), does not support an abundant planktonic fauna. However, by comparing the nutrient load with that of other lakes, Beadle (1981) noted that Lake Tana, with total dissolved solids (TDS) of 150 -170 mg·l⁻¹, is not particularly poor in salts. Beadle (1981) further indicated that, although, according to Morandini (1940), short and frequent thermal stratification occurs during the day, the whole water column is well mixed and oxygenated. The morphometric and chemical features of Lake Tana are given in Table 2.1.

The Lake Tana area has an environment with a dry, cool period alternating with a warmer, wet period. The allochthonous dissolved nutrients washed into the lake by streams and rivers, combined with the higher water temperature prevalent at the start of the wet period, should induce higher phytoplankton production which in turn could supports higher zooplankton production (Payne 1986, Morgan et al.1980), but it is also likely that the strong inorganic turbidity, from the silt washed in by the streams, would limit the anticipated high primary production during the wet season (Brillinisky 1980, Hart 1986). Seasonal increase in zooplankton biomass during the rainy periods was reported in Lake Naivasha, Kenya (Mavuti & Litterick 1981) in Lake George, Uganda (Mavuti & Litterck 1981), and in Lake Abiata, Ethiopia (Wodajo & Belay 1984). Therefore, in view of the clear environmental periodicity of Lake Tana, a seasonal distribution pattern could be anticipated.

The aim of this study is to characterise the zooplankton fauna, with regard to its composition, abundance and spatial and temporal distribution patterns in the sampling area. The spatial patterns in zooplankton abundance will indicate the spatial structure in the productivity of the pelagic environment of the Bahir Dar Gulf area. The environmental influence on production and seasonal distribution pattern was examined in relation to the change in water transparency. It is attempted to estimate the zooplankton productivity and assess the carrying capacity for zooplanktivorous fish. In theory one might reasonably expect

(Payne 1986, Sheldon et al. 1977, Borgmann et al. 1984) an approximately 10% transfer efficiency between production of zooplankton and fish production.

Materials and methods

Data collection

The data were collected from August 1991 to August 1993 from the Bahir Dar Gulf of Lake Tana. Hydrological and meteorological data were obtained from the National Meteorology Office and Office of Valleys Development and Study, Addis Ababa.

Zooplankton sampling

Preceding each trawl haul in the experimental fishing survey, zooplankton samples were taken, using a plankton net of 120 μm with an opening diameter of 8.5 cm. The net was towed vertically from about 60 cm above the bottom to the surface at a constant speed ($\approx 0.5 \text{ m}\cdot\text{s}^{-1}$). The zooplankton samples brought from the 13 sampling locations were diluted and sub-sampled in the laboratory for identification and counting. Five sub-samples of 1 ml each were analysed and counted after diluting the original sample to 110 ml, which is the volume of the sample bottles. Sub-samples for counting were taken with a wide mouthed pipette after thoroughly mixing the sample by inverting the closed bottle several times. Identification and counting was done under a stereoscopic microscope using a gridded glass as counting chamber and a multichannel counter (Interface System). Immature Copepoda (copepodids and nauplii) and juvenile Cladocera were counted as separate groups. The estimation of population density, individuals per litre of lake water, was computed after estimating the water volume filtered using the formula of Edmondson & Winberg (1971):

$$V = \frac{\mathbf{p} \cdot \mathbf{R}^2 \cdot \mathbf{d}}{1000}$$

where:

V = volume of water filtered in litres

R = radius of the net opening (cm)

d = the length of the course of the net through the water column measured in cm.

The total number counted (N) in the sub-sample was multiplied by the sub-sample factor (SSF) and divided by the total volume (V, l) of water strained, (N·SSF)/V, to find the density in numbers per litre.

The total length, excluding the antennae and furcal setae, of at least 100 individuals of the most abundant crustacean zooplankton species, *Thermodiaptomus galebi*, *Mesocyclops sp.*, *Thermocyclops sp.*, *Diaphanosoma excisum* and *Bosmina longirostris*, was measured. A mixed sample was used for this measurement. The data on length was used to examine the size structure of the different species and the mean length was used to convert density

($N \Gamma^1$) to biomass using the length-energy relationship for each species (Vijverberg & Frank 1976).

Data analysis

For the analysis of spatial distribution, zooplankton density estimates from different sampling stations were grouped into 3 areas or zones, based on a set of criteria: (a) stations which have low variation in the mean zooplankton density among them, (b) those which have similar morphometric characteristics such as depth range, sheltered or exposed, inshore or pelagic, and (c) proximity of stations to each other. Area 1 is the south-east littoral zone which includes stations 3, 4, 10 and 13, with depth range 1.5-3.0 m. Area 2 includes the south stations 1, 11 and 12 with intermediate depth of 3.0-6.5 m. Area 3 includes stations 2, 5, and 8, the deeper pelagic zone, with depth range of 6-11 m. Stations 6,7 and 9 are not included in the grouping. Station 6 situated in a sheltered bay close to a settlement has an exceptionally high density of zooplankton. Stations 7 and 9, further north, are considered outliers in location. For the analysis of temporal distribution, a similar grouping of months was applied as used for the fish distribution analysis:

Season-1	December - February	Dry season, low water temperature.
Season-2	March - May	Low water level and small rains, water temperature relatively high.
Season-3	June - August	Heavy rains, water turbid and water level increasing
Season-4	September-November	End of rainy season, highest water level

Analysis of variance was applied to determine if the cyclopoid, calanoid and cladoceran zooplankton counts differed among sampling months, sampling areas and the interaction between month and area. Zooplankton counts were analysed after log-transformation, in the first instance, as groups of total copepods and cladocerans. Then they were examined at the species and genera level. The copepod counts were analysed separately for cyclopoid and calanoid distribution. Similarly, the dominant cladoceran species, *Bosmina longirostris* and *Diaphanosoma exisum*, were analysed separately. Group means were compared for significant differences via the confidence interval of the mean zooplankton counts

Standing stock biomass of zooplankton was estimated after converting the density $N \Gamma^1$ to energy content per litre. The conversion was made using the length/calories relationship, $E = a \cdot L^b$, for the different species, where E is energy in millicalories, L is total length (mm) of the zooplankton species and *a* & *b* are the coefficient and exponent of the allometric relationships given in Table 8.1. The conversion to dry weight was based on the energy - dry weight relationship of 1 mcal = 0.2 μ g dry weight, according to Winberg (1971).

Table 8.1 Constants in the energy-length relationship of zooplankton, $E = a \cdot L^b$, L in mm and E in mcal for corresponding taxa with similar shape. (Vijverberg & Frank 1976)

Species	Constants		corresponding taxa
	A	b	
<i>Thermocyclops sp.</i>	10.5	1.72	<i>Cyclopoida</i>
<i>Mesocyclops sp.</i>	10.5	1.72	<i>Cyclopoida</i>
<i>Thermodiaptomus</i>	9.12	3.06	<i>Calanoida</i>
<i>Diaphanosoma exisum</i>	19.5	2.19	<i>Daphnia hyalina</i>
<i>Bosmina longirostris</i>	75.7	2.91	<i>Bosmina coregoni</i>

Results

Species composition and mean density.

A list of the zooplankton species identified is presented in Table 8.2. A total of 17 species, which include 3 Copepoda, 7 Cladocera, and 7 Rotifera have been observed.

Table 8.2 Zooplankton species composition, geometric mean density $N l^{-1}$ and 95% confidence interval given as multiplication factor ($10^{\pm 2SD}$). SD of log-transformed $N l^{-1}$.

Group	Species	density	confidence interval
Copepoda	<i>Mesocyclops sp.</i>	4.1	x/: 1.10
	<i>Thermocyclops sp.</i>	11.7	x/: 1.09
	<i>Thermodiaptomus galebi</i>	14.5	x/: 1.08
Cladocera	<i>Diaphanosoma exisum</i>	7.3	x/: 1.10
	<i>Bosmina longirostris</i>	5.5	x/: 1.14
	<i>Daphnia longispina</i>	0.7	x/: 1.14
	<i>Daphnia similis</i>	1.8	x/: 1.11
	<i>Ceriodaphnia cornuta</i>	0.9	x/: 1.11
	<i>Ceriodaphnia dubia</i>	0.7	x/: 1.14
	<i>Moina sp.</i>	1.9	x/: 1.13
	Rotifera	<i>Keratella quadrata</i>	7.3
<i>Keratella crassa</i>		2.7	x/: 1.16
<i>Brachionus falcatus</i>		2.6	x/: 1.13
<i>Brachionus caudatus</i>		1.5	x/: 1.13
<i>Filinia terminalis</i>		2.8	x/: 1.12
<i>Lacane sp.</i>		1.1	x/: 1.18
<i>Trichocera sp.</i>		1.3	x/: 1.15
	Total	76	x/: 1.08

The cladoceran species *Chydorus sphaericus* and the rotifer *Keratella vulga*, which appeared in the samples occasionally and in low numbers have not been included in the list. Brunelli & Cannicci (1940) listed a total of 26 zooplankton species from Lake Tana, consisting of 3 Copepoda, 11 Cladocera and 12 Rotifera.

The predominant species in the community were found to include the calanoid, *Thermodiaptomus galebi*, the cyclopoids, *Thermocyclops sp.* *Mesocyclops sp.*, the cladocerans, *Bosmina longirostris*, *Diaphanosoma excisum* and the rotifers, *Keratella quadrata*, *K. crassa* and *Brachionus falcatus*. The overall geometric mean for the total zooplankton categories was $76 \times /: 1.08 \text{ Nl}^{-1}$.

Spatial and temporal patterns.

The results of analysis of variance for the dominant crustacean zooplankton, the copepod and cladoceran groups, indicated highly significant differences ($P < 0.01$) of mean densities among sampling areas, and sampling season, except for *Mesocyclops sp.* but no significant difference was found for date*area interaction, except for the cladoceran species, *Bosmina longirostris* (Table 8.3). R^2 ranged from 0.15 to 0.43 and approximately three-quarter of the explained variance was due to the area effect.

Table 8.3 Results of analysis of variance. Mean squares obtained for the major zooplankton species (abbreviations: *Mc* = *Mesocyclops sp.*, *Tc* = *Thermocyclops sp.*, *Td* = *Thermodiaptomus galebi*, *Bl* = *Bosmina longirostris*, *De* = *Diaphanosoma excisum*.)

Source of variation	Species DF	Mc	Tc	Td	Bl	De
		MS				
Season	3	0.35 ^{ns}	1.46 ^{**}	0.51 ^{**}	5.32 ^{**}	1.55 ^{**}
Area	2	2.44 ^{**}	1.20 ^{**}	1.66 ^{**}	13.26 ^{**}	5.37 ^{**}
Interaction	6	0.08 ^{ns}	0.02 ^{ns}	0.12 ^{ns}	1.35 [*]	0.07 ^{ns}
Error	250	0.16	0.10	0.10	0.31	0.17
R^2		0.15	0.21	0.18	0.43	0.28

** = significant

^{ns} = not significant

Geometric mean densities for season and area with their confidence intervals are depicted in Fig 8.1. High zooplankton abundance was observed during the low water season, when the water temperature is relatively high and the rainy season starts. For all zooplankton species the abundance was highest in the littoral zone and lowest in the deeper areas of the lake.

Copepoda

The copepods, containing two cyclopoid species, *Mesocyclops sp.* and *Thermocyclops sp.* and one calanoid species, *Thermodiaptomus galebi*, constituted the major zooplankton fauna in Bahir Dar Gulf. The mean copepod density amounted to 32.4 l⁻¹ x/ 1.07 for the 95% confidence interval. The average densities of cyclopoids and calanoids were 16.2 l⁻¹ and 14.5 l⁻¹ respectively.

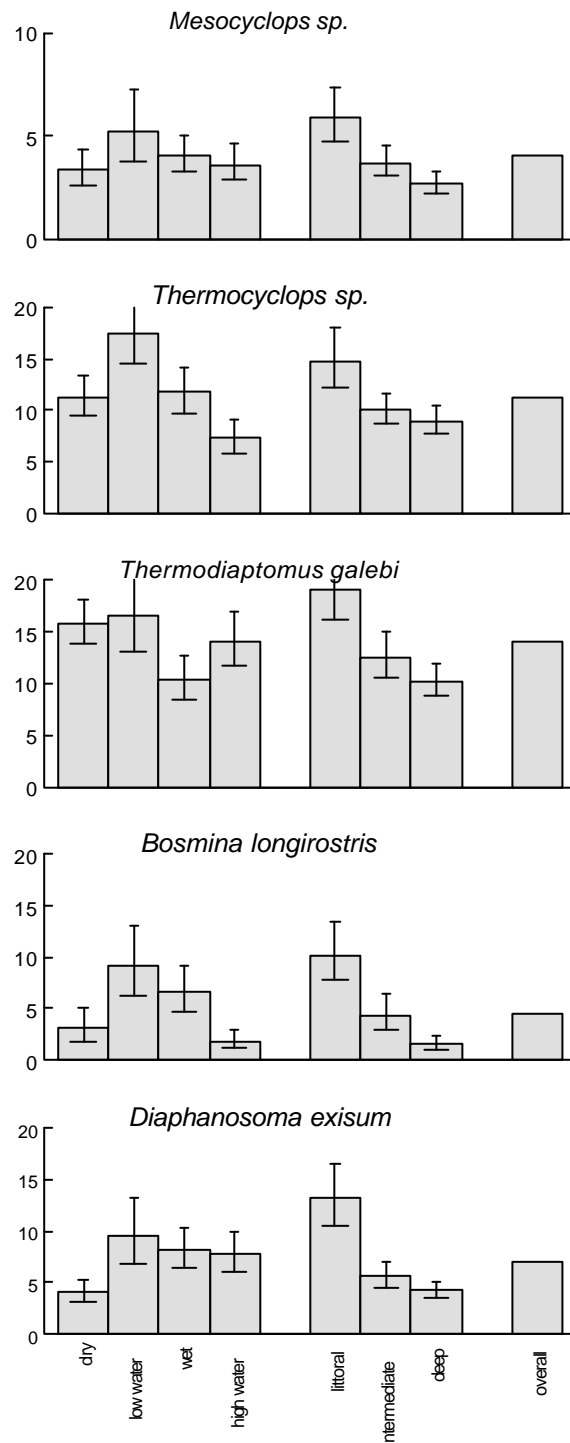

Figure 8.1 Geometric mean densities (N.l⁻¹) (\pm 95% cl) of major zooplankton species per season and area in Bahir Dar Gulf

Cladocera

The Cladocera represented by seven species in the present sample, had a mean of 19.9 l^{-1} with $\times/:$ 1.09 as factor for the confidence interval. The predominant species among the cladoceran species were *Bosmina longirostris* and *Diaphanosoma excisum* with mean densities of 5.5 l^{-1} and 7.3 l^{-1} respectively.

Rotifers

The rotifers, the third major group of the zooplankton community in Lake Tana, are represented by seven species. They contributed about one third of the zooplankton population in number but much less in biomass due to their small size. They had a mean density of 25.5^{-1} with a factor of $\times/:$ 1.08 as confidence interval. The major species among the group were *Keratella quadrata*, *K.crassa* and *Brachionus falcatus*

Crustacean zooplankton

A comparison of mean monthly densities of Crustacean zooplankton over the whole sampling period (Fig 8.2) indicated that the mean for April 1992 was significantly different from the other months. Total zooplankton abundance showed peaks during March - May of both years. The mean abundance during other months was more or less stable. Minor fluctuations in density were observed for the individual species between months. Cladocera had higher abundance in April 1992 and in March-May 1993.

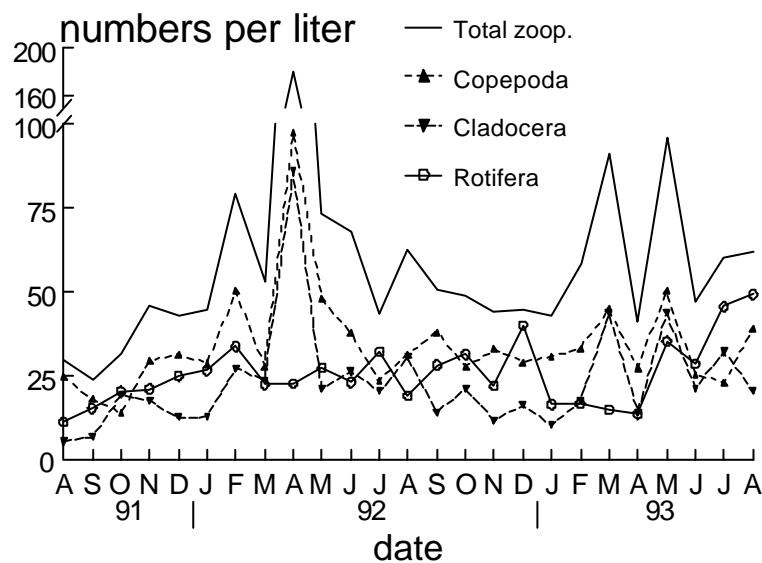

Figure 8.2 Mean densities per month ($\text{N} \cdot \text{l}^{-1}$) during the sampling period of the major zooplankton categories and the total (sum of Copepoda and Cladocera) in Bahir Dar Gulf

The variation in population density between sampling areas is presented in Fig 8.3. The copepods were most abundant in the eastern littoral zone, with an average of 44.6 l^{-1} and least abundant in the deep pelagic zone, with a mean of 23.9 l^{-1} . The Cladocerans and the Rotifers showed a similar pattern. The intermediate zone, which was deeper and more

exposed than the littoral zone, had intermediate population densities of zooplankton groups which was between the limnetic and the littoral stations.

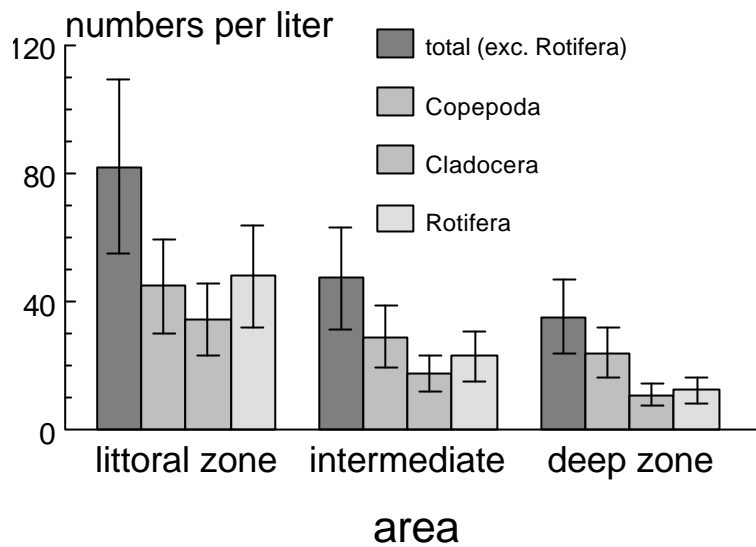

Figure 8.3 Spatial distribution of the major zooplankton categories in Bahir Dar Gulf

Biomass and production estimates.

Results of length measurements which depict the size distribution of the major zooplankton species, is presented in Fig 8.4. All are small as is common in tropical lakes. *Bosmina longirostris*, the smallest among the major group, has a mean size of 0.31 mm and a maximum of 0.4 mm. The largest, the copepod *Mesocyclops sp.*, has a mean size of 1.0 mm and a maximum of 1.4 mm.

The mean total biomass estimated from the densities combined with the length/mass relationship was $106 \pm 17 \mu\text{g dry weight. l}^{-1}$, for the adult copepods and dominant cladoceran species, *D. exisum* and *B. longirostris*, over the whole sampling period. The estimate of the biomass per season and area is presented in Fig 8.5. The biomass of the zooplankton during the low water season was $150 \mu\text{g dry weight. l}^{-1}$, which was significantly higher than the rest of the year ($92 \mu\text{g dry weight. l}^{-1}$). The littoral area showed the highest average biomass, $156 \mu\text{g dry weight. l}^{-1}$, in comparison with the intermediate and deep zones with 87 and $64 \mu\text{g dry weight. l}^{-1}$ respectively. The biomass, expressed as $\text{kg dry weight per ha}$ was highest for the deep zone (5.5 kg. ha^{-1}) and lowest for the littoral zone (2.6 kg. ha^{-1}). In the intermediate zone a biomass of $3.8 \text{ kg dry weight per ha}$ was observed.

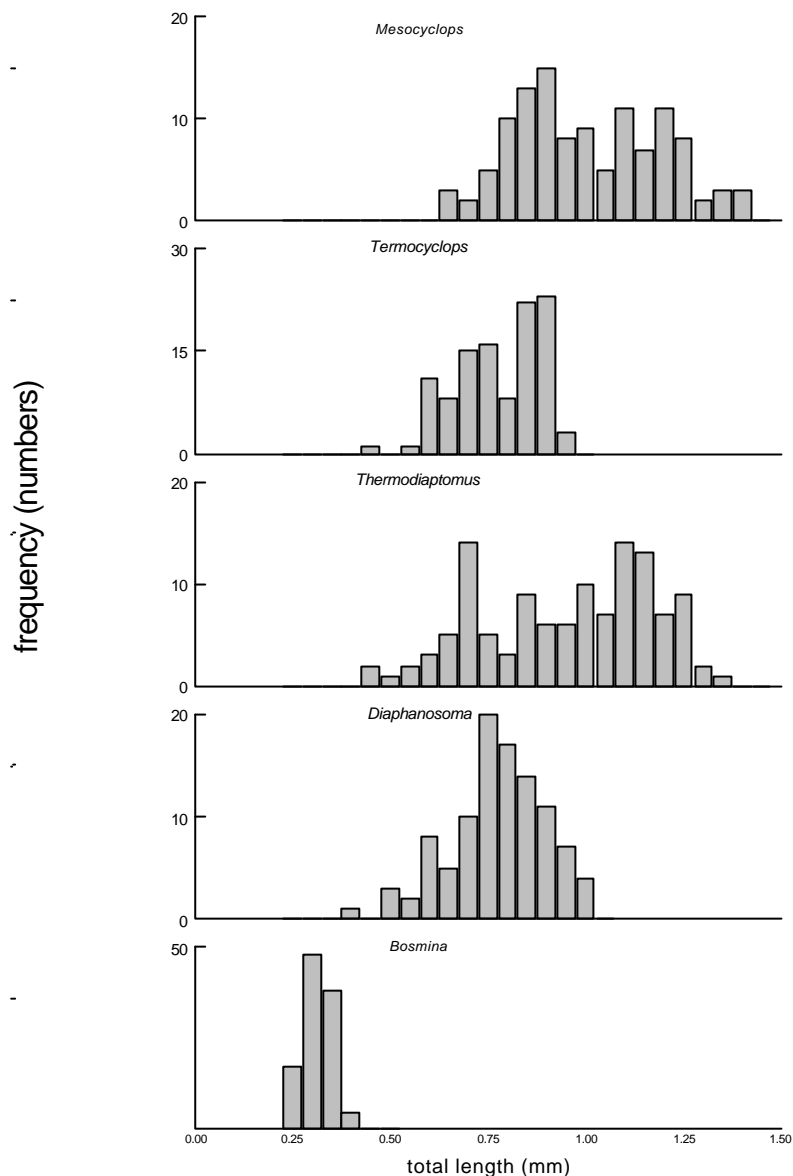

Figure 8.4 Length frequency distribution of the major zooplankton categories in Bahir Dar Gulf

Discussion

The early work of Brunelli & Cannicci (1940), the only available on Lake Tana, listed a total of 26 zooplankton species, consisting of 3 copepods, 11 cladocerans and 12 rotifers. They indicated as predominant species: *Bosmina longirostris*, *Thermodiaptomus galebi*, *Diaphanosoma excisum*, *Ceriodaphnia bicuspidata*, *Daphnia longispina*, *Moina dubia*, *Mesocyclops leuckarti*, *Ceriodaphnia sp*, *C. cornuta*, *Cyclops albidus*, in order of abundance. The first 3 dominant species listed in this early report still dominate the population in the present samples.

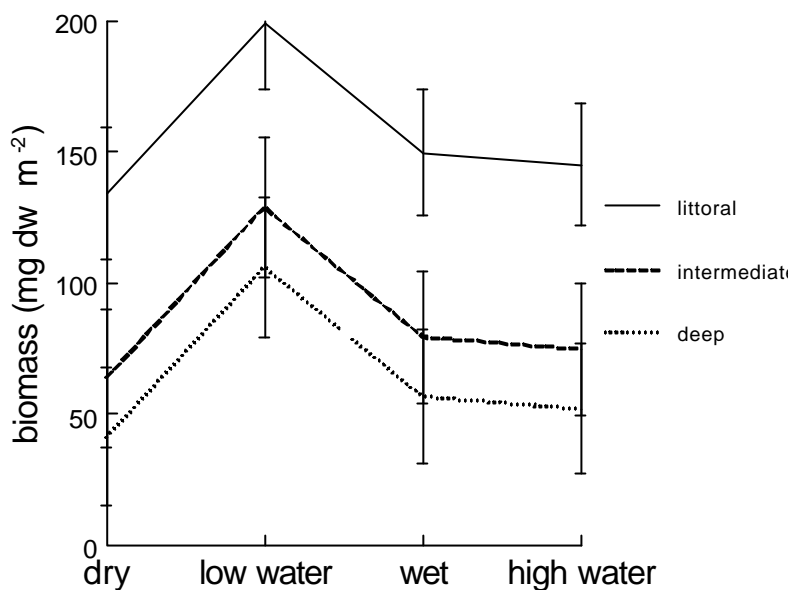

Figure 8.5 Average biomass (mg dry weight·m⁻²) of crustacean zooplankton per area and season in Bahir Dar Gulf.

The species, *Keratella sp.* and *Brachionus sp.* have been found to be important among the rotifers in Lake Tana. Fernando (1980a) indicated the dominance of *Brachionus* and *Keratella tropica* in the reservoirs of Sri Lanka. In most of the Brazilian reservoirs also *Brachionus* and *Keratella* are found as predominant rotifers, (Arcifa 1984, Sendacz 1984).

The size structure of the planktonic Crustacea in the lake covers a smaller size range, with the absence of large copepods and cladocerans in contrast to the temperate fresh water bodies. The size range in Lake Tana was similar to that found in other tropical freshwater bodies in Africa, South-East Asia and Latin America (Burgis et al. 1973, Fernando 1980b, Zaret 1980, Arcifa 1984). In Lake George, the mean size of *Diaphanosoma exisum* was reported as 1.17 mm (Burgis 1973), but in Lake Tana the same species had a mean size of 0.78 mm and maximum of 1.0 mm. The size range of *Bosmina longirostris* in Lake Tana was similar to that of the reservoirs in Brazil which was 0.35 - 0.40 mm (Arcifa 1984).

Seasonal patterns for zooplankton production have been reported for the Rift Valley lakes Awasa, Abjata and Langano in southern Ethiopia (Mengestou & Fernando 1991a, Wodajo & Belay 1984). The seasonality observed in these lakes was due to a long stratification period and change in nutrient content and phytoplankton biomass. A similar situation was also reported for Lake Valencia, Venezuela, by Saunders & Lewis (1988). A significant increase in zooplankton population and biomass was observed in the rainy period for Lake Naivasha, and Lake George, Uganda (Mavuti & Litterick 1981). In Lake Tana, the observed higher biomass just prior to the rains, corresponds to the high water temperature. In Bahir Dar Gulf the water transparency during the summer rains decreases with the increasing water level. The inflow of large rivers from the surrounding highlands with silt loaded water increases the water turbidity with the suspended inorganic material. Hart (1986) found turbidity to be an important factor negatively affecting zooplankton production and asserts that much of the seasonal variation in zooplankton abundance in Lake Le Roux was

linked to changes in turbidity during flooding. Brylinisky (1980) also indicates that non-biological turbidity may be one of the primary limiting factors in many freshwater systems. In the Lake Tana situation also where high turbidity due to inorganic silt was apparent, it is possible that turbidity had a negative effect on zooplankton productivity. The negative impact of turbidity is that it reduces population growth through its shading effect which limits phytoplankton production and indirectly controls zooplankton density (Brylinsky 1980). Thus it is likely that the effect of water turbidity has damped the seasonality of zooplankton abundance that might be expected with an increasing nutrient influx resulting from the rainfall pattern around Lake Tana.

There was a clear spatial pattern in the zooplankton distribution in Lake Tana, densities per litre being high in the littoral zone and reduced toward the deeper open water areas. Patalas & Salki (1993) indicated that wind action was one of the most important factors controlling the horizontal distribution of plankton. Investigating the spatial variation of crustacean zooplankton in lakes of different sizes in Ontario, Canada, they found that the patterns of spatial distribution changed with increasing lake size. Greatest abundance was found offshore in smaller lakes but near-shore in larger lakes. Lake Tana is a large lake comparable in size to Lake Nipigon, Ontario, and shows a similar distribution pattern, with high densities in the littoral zone and lowest at the offshore stations. However, the major factor in Lake Tana could be wind action rather than temperature. A possible additional factor explaining the low abundance of plankton in the deeper part of the lake could be the high predation pressure in the open water. Adult *Clarias gariepinus*, *Barbus brevicephalus* and *Barbus trispilopleura*, are important predators on zooplankton, and are more abundant in the open water. Moreover the presence of *Chaoborus* larvae in this area has been noted from the analysis of gut contents of *Clarias* caught from the same area (unpublished results). Mavuti & Litterick (1981) stress the importance of predation pressure by *Chaoborus* on the zooplankton community in Lake Naivasha. Saunders & Lewis (1988) have also noted that most of the mortality of herbivorous zooplankton in Lake Valencia was attributed to predation by *Chaoborus* larvae. It is likely that high predation pressure by *Chaoborus* contributed to the low abundance of zooplankton in the deeper areas of Lake Tana. The impact of predation on zooplankton abundance is also indicated by Serruya & Pollingher (1983), where significantly lower plankton density was associated with the presence of the planktivore fish, *Gambusia affinis*, in Lake Mariut, Egypt.

Morgan et al., (1980) have shown that a relationship between production (P, g C·m⁻²·yr⁻¹) and biomass (B, g C·m⁻²) can be obtained when their values are plotted against each other. The relationship of P to B values for predator and non-predator zooplankton species established by Morgan et al. (1980), was $P = 9.1 \cdot B^{1.24}$. and this was employed in estimating the approximate annual zooplankton production of Lake Tana. The mean biomass was 3.9 kg DW·ha⁻¹ (=390 mg·m⁻² \equiv 174 mg C·m⁻²). Using the above relationship, the annual production for Lake Tana was estimated at, $P = 14.6$ g DW·m⁻²·yr⁻¹ which is equivalent to 6.7 g C·m⁻²·yr⁻¹. Assuming a 10% conversion efficiency from zooplankton production to fish production (Payne 1986, Sheldon et al. 1977, Borgmann et al. 1984) the zooplankton stock

can sustain an annual production of zooplanktivorous fish equal to $73 \text{ kg}\cdot\text{ha}^{-1}$, assuming a proportional relationship of dry to fresh weight of the fish of 1 to 5.

Table 8.4 Mean biomass, annual production and productivity (P/B) for zooplankton in some tropical and temperate lakes (Data from Saunders & Lewis 1988, Mengistou & Fernando 1991b)

Lakes	Lat.	Biomass (g $\text{C}\cdot\text{m}^{-2}$)	Production (g $\text{C}\cdot\text{m}^{-2}\cdot\text{yr}^{-1}$)	P/B (yr^{-1})	Reference
Sibaya	27.0'S	0.033	1.3	40.6	Hart and Allanson (1975)
Awasa	6.3- 7.3'N	0.040	2.2	55.8	Mengistou (1989)
Tana	11-12'N	0.174	6.7	38.5	Present work
George	0'	0.249	7.2	28.7	Burgis (1974)
Chad	12-14'N	0.380	26.5	69.7	Carmouze et al. (1983)
Lanao	8'N	0.668	27.3	41.0	Lewis (1979)
Tjeukemee r		0.700	20.0	26.0	Vijverberg & Richter (1982)
Valencia	10'N	1.025	39.1	38.1	Saunders & Lewis (1988)
Nakuru	0'	1.135	136.0	119.9	Vareschi & Jacobs (1984)
Flosek	54'N	1.450	41.9	28.9	Kajak et al. (1983)
IBM					

The mean zooplankton biomass of Lake Tana, 0.174 g C m^{-2} , is low compared to other tropical lakes, as shown in Table 8.4, of comparable latitude eg. Lake Chad (Carmouze et al. 1983), Lake Valencia (Saunders & Lewis 1988), and Lake Lanao (Lewis 1979). It is also lower than those of the equatorial Lakes George and Nakuru (Burgis 1974, Vareschi & Jacobs 1984), and the temperate Lake Flosek (results from International Biological Programme, IBP, in Saunders & Lewis 1988). However, it is a higher mean biomass than in Lake Awasa (Mengistou & Fernando 1991b) and than that of the sub-tropical Lake Sibaya of South Africa, (Hart & Allanson 1975).

Options for the management of the fishery in Lake Tana

The current state of the fishery

Fishery in Lake Tana is mainly confined to the southern part, and consists of a traditional reed boat fishery and a fishery using motorised boats, which started in the mid eighties. According to the 1993 estimate for the Bahir Dar Gulf area, one third of the total fish production originated from the reed boat fishery (chapter 7). Reed boat fishing is an inshore activity operated by one fisherman per boat, targeting the herbivorous *O. niloticus*, the macro-invertebrate feeding *B. tsanensis* and other *Barbus* species of the lower trophic levels, which occupy the littoral zone of the lake. In the Bahir Dar Gulf area around 113 reed boat fishermen are active for on average 165 days·yr⁻¹, each catching some 2 tonnes on an annual basis. This corresponds with the average catch in the major African lakes of 2.3 tonnes·yr⁻¹ per fishermen estimated by Crul (1992). Reed boat fishermen produce fish for household subsistence and to a limited extent for the local market. They also practice subsistence agriculture on land bordering the lake in most cases teff, *Eragrostis tef* (Zucc.) which is usually planted in July or August, and matures in about four months.

The motorised boat fishery has a wider fishing area, with some overlap with the reed boats. The species composition of their catches includes *C. gariepinus*, piscivorous *Barbus* species and some species inhabiting the shore area and river mouths. On average seven motorised fishing units are active each day. This is approximately one third of the available capacity. A motor boat is operated by two shifting crews of three fishermen each. The total number of fishermen, which rely on the motorised fishery equals 130, producing 3.2 tonnes of fish annually per fisherman (1993 estimate). An exploitation level using the full capacity of available boats would almost double the annual catch per fisherman, taking into account a reduction of 40 % in catch per unit of effort. Thus, the Lake Tana motorised fishery can be characterised by a high catch per unit of effort, well above the mean seen for comparable African lakes.

The Fish Production and Marketing Enterprise (FPME) is the only market outlet available. This reduces the opportunities for fishermen to negotiate a reasonable price for their fish. Fish is sold for about 0.8 Birr per kilo, which is 10% of the price for beef in the area. Cold store facilities are owned by the Fish Production and Marketing Enterprise and not available for other potential fish traders. Moreover, the transport of frozen fillets to Addis Ababa is irregular, and consequently cold stores are sometimes filled to their maximum capacity.

From the large catches and fish sizes, one could conclude that the fishery is at an early stage of its development (chapters 6 & 7). Further development of the fishery is, however, hindered by the low prices and limited infrastructure. The current motorised fishery is not economically viable. Boat costs and their maintenance are still subsidised by assistance projects. The government aims at a considerable expansion of the fishery for food production and employment. It is unlikely that these objectives are met in the near future. More likely the fishery development in Lake Tana will keep pace with the demographic trend in the

area surrounding the lake. A growing population will result in a higher demand for fish and this may lead to higher fish prices in the future.

Average fish catch for the whole of Lake Tana is low, $4 \text{ kg}\cdot\text{ha}^{-1}\cdot\text{yr}^{-1}$, in comparison with the range of 45 to $180 \text{ kg}\cdot\text{ha}^{-1}\cdot\text{yr}^{-1}$ found for African lakes by Henderson & Welcomme (1974), Martin & Polovina (1982) and Marshall (1984). In the southern part, where the exploitation level is highest, the estimate is $20 \text{ kg}\cdot\text{ha}^{-1}\cdot\text{yr}^{-1}$. A conservative estimate of the maximum sustainable yield of $30 \text{ kg}\cdot\text{ha}^{-1}\cdot\text{yr}^{-1}$ (see below), implies that there is a scope for increasing the exploitation to 5 to 6 times the current one when the total lake area would be exploited and the fishery is intensified. The distribution of fishing effort of motorised boats over the Bahir Dar Gulf area shows that it is concentrated along the edges of the lake. The open water, harbouring *C. gariepinus* and piscivorous *Barbus* species shows a lower catch per unit of effort but also a lower fishing effort. Once the fishery develops further, the CpUE for the shore zone and river mouths will reduce. In that case, the exploitation of the deeper open water areas will provide additional possibilities for the expansion of the fishery.

At present, the surplus production approach to estimate potential sustainable yield for the Lake Tana system can not be used for lack of a time series of catch and effort data. The two alternatives are either to use biotic parameters as indices for fish productivity or to use a simulation model for estimating fish production based on recruitment, growth and mortality estimates as determined in the chapters 3 and 5 in this thesis.

Potential fish yield estimates using productivity indicators

Several methods have been developed for an empirical estimate of potential yields in lakes and reservoirs, when limited data are available (Henderson & Welcomme 1974, Young & Hiembuch 1982, Marshall 1984, Moreau & de Silva 1991, Crul 1992). The estimates are based on correlation between fish yield and morphometric and edaphic characteristics of the water bodies. Alternative approaches correlate yield with biotic parameters like total phosphorus, chlorophyll, zooplankton etc. Estimates based on the various empirical models may give results with low accuracy. According to Marshall (1984) the average output produced by various methods would give a more reliable estimation, useful for policy making and/or management regarding fishery development. The morpho-edaphic index (MEI = total dissolved solids/average depth) was related to fish yield in a number of African lakes by Henderson & Welcomme (1974). The maximum yield for Lake Tana, with total dissolved solids of $160 \text{ mg}\cdot\text{l}^{-1}$, based on this relationship ($7.9\cdot\text{MEI}^{0.6}$) would then be $44 \text{ kg}\cdot\text{ha}^{-1}\cdot\text{yr}^{-1}$, given a MEI of $160/9=17.8$. Various yield estimates based on empirical models are presented in Table 9.1.

Table 9.1 Yield estimates for Lake Tana from various empirical models. MEI = morpho-edaphic index; TDS = total dissolved solids ($\text{mg}\cdot\text{l}^{-1}$), depth (m) and A = lake area km^2 .

Input parameter	Formula	Estimated MSY $\text{kg}\cdot\text{ha}^{-1}\cdot\text{yr}^{-1}$	Reference
MEI=TDS/depth	$Y = 7.9\cdot\text{MEI}^{0.6}$	44	Henderson & Welcome 1974
MEI, A	$Y = 25.5\cdot\text{MEI}^{0.37}\cdot 10^{-0.000046\cdot A}$	53	Toews & Griffith 1979
A	$Y = 350\cdot A^{-0.24}$	50	Young & Hiembuch 1982
A	$Y = 90\cdot A^{-0.08}$	47	Crul 1992
	average:	48.5	

Taking the average, assuming that Lake Tana has the same features as the range of lakes on which these relationships are based and assuming that the turbidity does not reduce the light penetration for primary production (Leach et al. 1987), the potential production would be $15,000 \text{ tonnes}\cdot\text{yr}^{-1}$. This is within Crul's (1992) estimation range for African lakes of 40 to $85 \text{ kg}\cdot\text{ha}^{-1}\cdot\text{yr}^{-1}$. Extremely productive lakes like Lake Kyoga and Lake George have potential yields of more than $150 \text{ kg}\cdot\text{ha}^{-1}\cdot\text{yr}^{-1}$ (Martin & Polovina 1992), probably due to their shallowness.

Potential fish yield estimates and scanning management options using a simulation model

A simulation model was used as a tool to evaluate management strategies for the gillnet fishery of Lake Tana. The size-structured model was developed by Eshete (1995), based on the work of Pet (1995), to serve a multi-species fishery situation. The analytical model simulates the fish population dynamics and the impact of the fishery on the individual species *C. gariepinus*, *O. niloticus* and *B. tsanensis*. Other *Barbus* species were combined in a piscivorous and a non-piscivorous group. A relational diagram representing the general structure of the model for individual species and group is given in Fig 9.1.

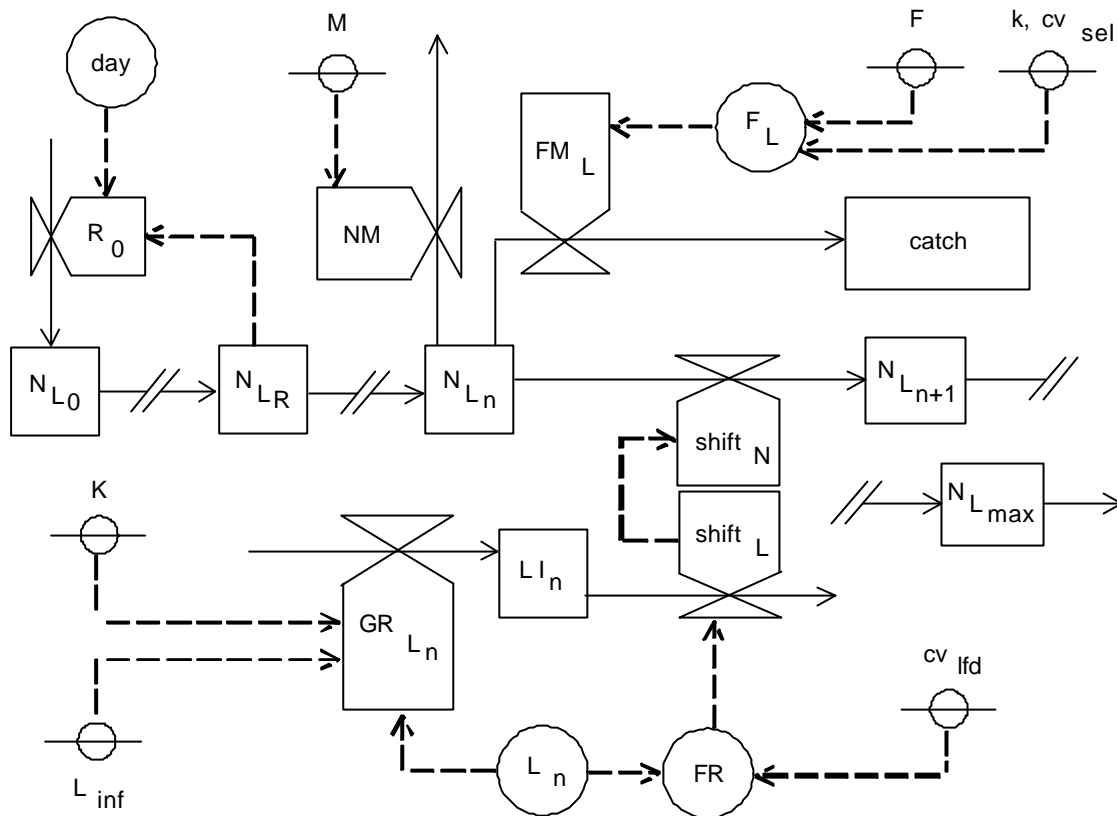

Figure 9.1. Relational diagram of the simulation model used, adapted from Pet (1995). Abbreviations are given in Table 9.2.

Table 9.2 Abbreviations, parameters and variables

cv_{lfd}	coefficient of variation in l-f distribution
cv_{sel}	coefficient of variation in selectivity curve
day	day number of the year
F	maximum instantaneous fishing mortality rate (day^{-1})
F_L	fishing mortality rate per length-class (day^{-1})
FM_L	fishing mortality per length-class (numbers per day)
FR	fraction shifted (controlling the dispersion)
GR_{L_n}	growth rate in length-class n (cm per day)
K	von Bertalanffy growth constant (day^{-1})
k	gillnet selectivity factor
LI_n	length increment in L_n since last shift (cm)
L_{inf}	theoretical (von Bertalanffy) maximum length (cm)
L_n	total length in length-class n (cm)
M	instantaneous natural mortality rate (day^{-1})
N_{L_0}	number of 0 cm recruits
$N_{L_{max}}$	number of fish in largest length-class
N_{L_n}	number of fish in length-class n
N_{L_R}	number of recruits in L_R (the smallest length-class for which absolute numbers can be estimated)
NM	natural mortality (numbers per day)
R_0	recruitment of 0 cm fish (numbers per day)
$shift_L$	reduction of length increment LI_n with fraction FR
$shift_N$	transfer of fraction FR from length-class L_n to L_{n+1}

Recruitment, growth and mortality estimates for the three species and two groups, representing the exploited fish stocks in Lake Tana, were used as input parameters. The values of the input parameters, derived from the preceding chapters in this thesis, are presented in Table 9.3. The species and groups under consideration are assumed to have coinciding spatial distributions patterns and the fishing effort is assumed to be directed to the species assemblage rather than to individual species. Fishing effort is assumed to generate a fishery mortality in each species proportional to the catchability coefficients.

Table 9. 3. Estimated values of input parameters for the simulation model.

Input parameter:	<i>C. gariepinus</i>	<i>O. niloticus</i>	<i>B. tsanensis</i>	other <i>Barbus</i> spp.	
				<u>Non piscivores</u>	<u>Piscivores</u>
L_R (cm)	30	18	20	24	24
N_R	48,000	600,000	160,000	75,000	17,000
L_∞ (cm)	87.5	35.7	45	42	58
K (yr^{-1})	0.22	0.5	0.33	0.3	0.25
M (yr^{-1})	0.4	1.0	0.7	0.3	0.5
F (yr^{-1})	0.5	0.8	1.1	0.7	0.4
k ($cm\cdot mm^{-1}$)	0.52	0.25	0.34	0.35	0.32

Recruitment was estimated via length-based cohort analysis (Jones 1984). The size of the populations was estimated for the smallest size class for which the instantaneous fishing mortality is higher than $0.1 yr^{-1}$ (L_r , cm). These size classes were 30 and 18 cm for *C. gariepinus* and *O. niloticus* respectively, 20 cm for *B. tsanensis* and 24 cm for the piscivorous and non-piscivorous *Barbus* groups. The numbers of recruits of these size categories in the fishing area of 30,000 ha ranged from 17,000 individuals for piscivorous *Barbus* species to 600,000 for *O. niloticus*. Recruitment is simulated by a recruitment rate ($N\cdot day^{-1}$) to the smallest size class, with a midlength of 0.5 cm, which was calibrated in accordance with the estimated L_r . The recruitment pulses are based on the observed temporal patterns in mean GSI as described in chapter 3. Maximum recruitment was set at mid-July for *C. gariepinus* and *O. niloticus* and at early October for the *Barbus* species. Daily recruitment numbers gradually decrease around the peak recruitment according to the Gaussian equation for a normal distribution with a mean of Julian day-number for peak recruitment and a standard deviation in accordance with the total recruitment period. This standard deviation was set at 1 month for *C. gariepinus* and 2 months for the other species (see chapter 3).

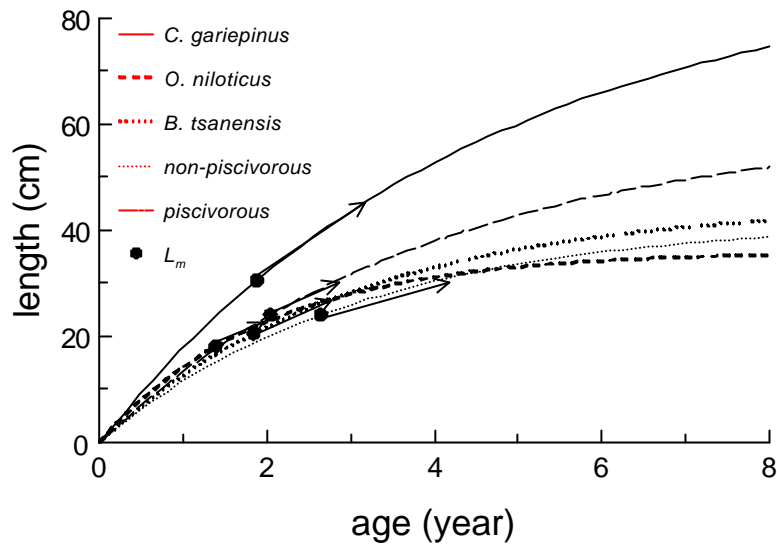

Figure 9.2 Growth curves as used in the model for the major species and groups in the Lake Tana system. Size at maturity L_m is indicated. Arrowheads indicate the size at which the species or group fully recruits to the motorised fishery

Growth of fish in a certain size class L_n is simulated according to the von Bertalanffy growth function, where the length increment ($\text{cm}\cdot\text{day}^{-1}$) is a function of the size class (L_n , cm), the theoretical maximum length (L_∞ , cm) and the growth constant (K , day^{-1}). The mean length as a function of age for the different species and groups, using the input growth parameters, is given in Fig 9.2. A fraction (FR) of the fish in size class L_n is transferred to size class L_{n+1} as soon as the increase in length equals a similar fraction of the width of that size class. In this way the dispersion of fish over a size distribution with a pre-defined standard deviation is simulated with the ‘fractional boxcar train method’. These standard deviations were calculated assuming a constant coefficient of variation of 10% for the size distributions of fish recruited on the same day. The allometric length-weight relationships, used to calculate the biomass of the population and weight of the catch, are depicted in Fig 9.3.

The instantaneous fishing mortality (F , yr^{-1}) is simulated as a function of the gillnet selectivity and the estimated instantaneous fishing mortality for the most vulnerable size class. Five simultaneously operated mesh sizes of 80, 100, 110, 120 and 140 mm stretched mesh were included, in a ratio of 4:4:4:1:1, which resembles that of the current commercial fishery in Lake Tana. Selectivity is simulated using the extended Holt-model with a constant coefficient of variation in the selectivity curve of 10% for all species. The selectivity factor k ($\text{cm}\cdot\text{mm}^{-1}$), which varies according to species or group, was highest for *C. gariepinus* (0.52) and lowest for *O. niloticus* (0.25). The maximum instantaneous fishing mortality, for the most vulnerable size class per species, as estimated using length-based cohort analysis ranged from 1.1 yr^{-1} for *B. tsanensis* to 0.4 yr^{-1} for the piscivorous *Barbus* group. Natural mortality was assumed to be constant for all length classes and ranged from 0.3 yr^{-1} for the non-piscivorous *Barbus* group to 1 yr^{-1} for *O. niloticus*.

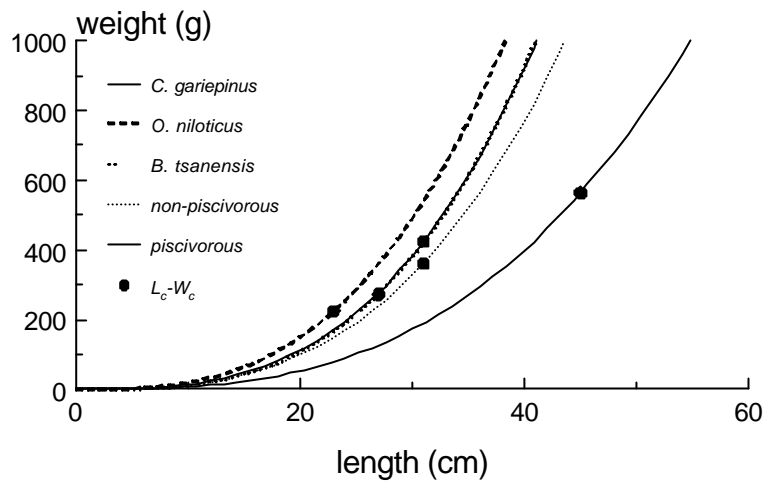

Figure 9. 3. Length weight relations for the species and groups in the model. Length (L_c) and weight (W_c) at recruitment to the motorised fishery is indicated.

Model results were compared with empirical commercial catch data from 1992-1993, which include total catch (tons), average size of the fish and species composition in Bahir Dar Gulf. Model output gave 630 tons for the yearly catch, close to the actual estimate of 640 tons. Average length of the fish and the species composition of the catch were all within 10% of the actual observations. With the model, various management options for the multispecies fishery in Lake Tana were evaluated. Mesh size reduction and enlarging (the current 80-140 mm combination is indicated as 100 mm in Fig 9.4) in combination with fishing effort levels from 0.5 to 5 times the current level were tested for their effects, after equilibrium conditions, on the total catch, CpUE and species composition of the catch.

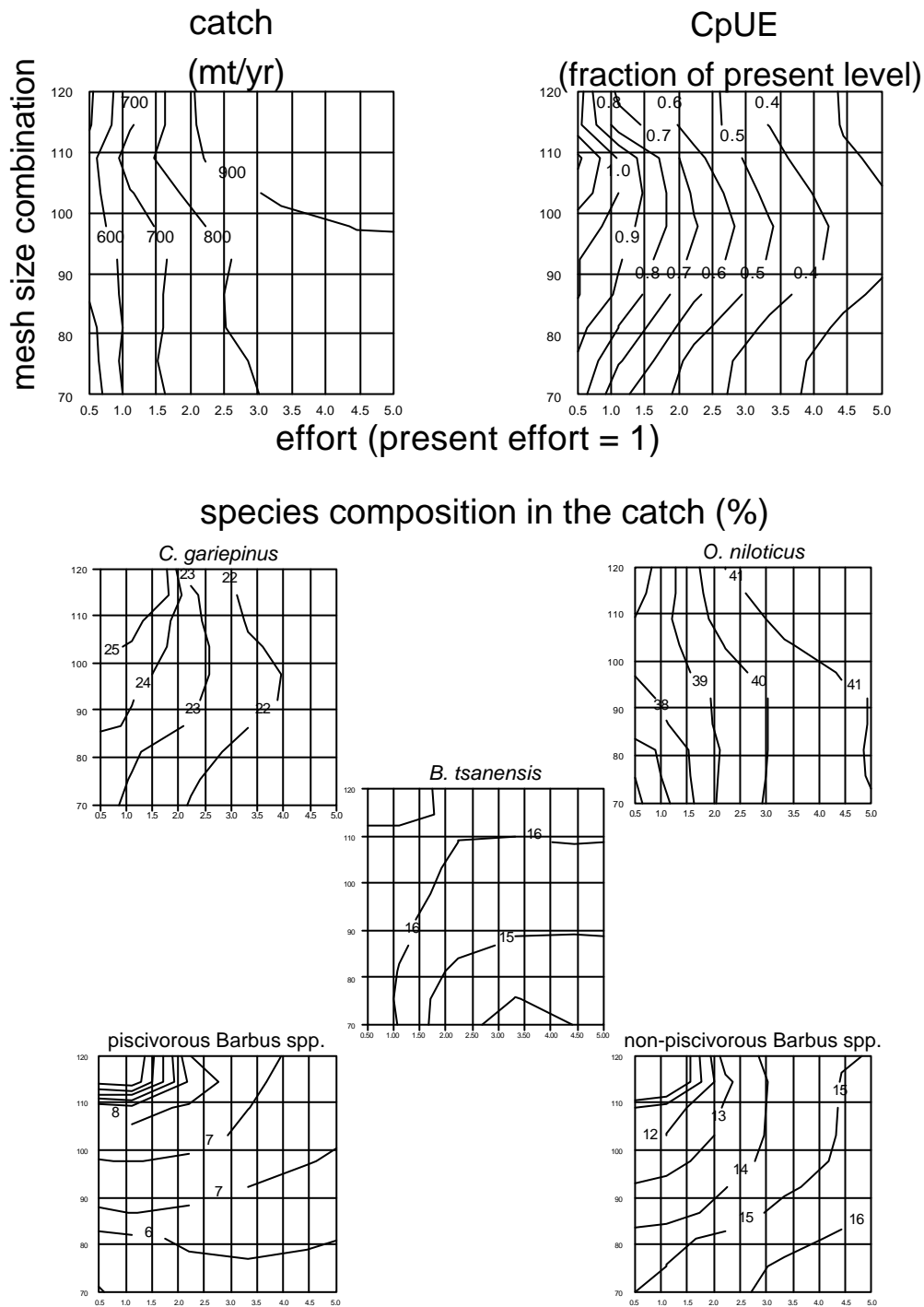

Figure 9.4. Model results. Catch, CpUE and species composition in the catch under various management regimes. Reference is made to the 1993 situation. Mesh size indicates a range: so 100 mm means a combination of 80, 100, 110, 120 and 140 mm with a ratio of 4:4:4:1:1 and 110 means an increase of the whole range with 10 mm. The yearly catch was 640 tonnes, CpUE was 180 and 12 kg·trip⁻¹ for motorised and reed boats respectively, and percentage contribution per species and group was 40 for *O. niloticus* 25 for *C. gariepinus* 16 for *B. tsanensis* and 8 and 11 for the piscivorous and non-piscivorous *Barbus* group respectively.

The catch isopleths in Fig. 9.4 show that mesh size changes within the range from 30 mm reduction to 20 mm expansion are unlikely to produce great changes to the total yield. Highest yields would be achieved with an increase of 10 mm in mesh size. With regard to the options of changing the effort level, the simulation estimates show the possibility of increasing the effort five times, resulting in a total catch of 950 tons for the area under consideration, which would be $32 \text{ kg}\cdot\text{ha}^{-1}\cdot\text{yr}^{-1}$. The species composition will show a change towards a slightly larger proportion of the small-sized species, like *O. niloticus* and *B. tsanensis*.

Mesh size and effort changes have an effect on the average sizes of the fish caught. A reduction with 30 mm resulted in a decrease in average length of 10 cm for *C. gariepinus* and 5 cm for *O. niloticus* and *B. tsanensis*. The model output for the current situation shows a respective average lengths in the catch of 53, 23 and 29 cm for these species. The reduction in average age and weight of fishes in the catch, resulting from a five-fold increase in fishing effort is depicted in Fig. 9.5. The average age of *C. gariepinus* in the catch reduces from 4 to 3 years. *O. niloticus* would be on average be 1.4 year and *Barbus* spp. 2.3 years when caught.

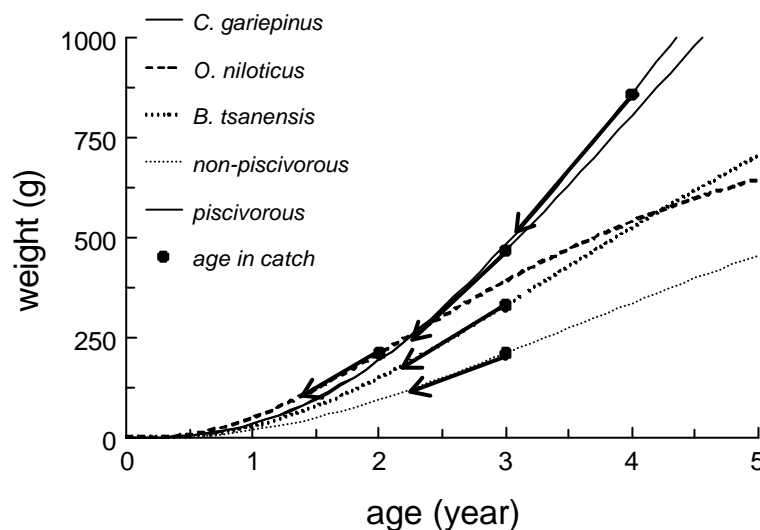

Figure 9.5 Growth curves of the species and groups in the model. Arrows indicate the reduction of their age in the catch when effort would be increased by a factor 5.

On the bases of these predictions by the model, one would expect no great changes in species composition of the catch of the gillnet fishery at increasing levels of fishing effort. Higher mortality rates for each category are possibly balanced by increased productivity of the exploited parts of the stocks, resulting in more or less equal proportions per species or species group in the catch. In other parts of Africa, fishing has led to changes in the species composition of the fish fauna, as summarised by Leveque (1997). Large species with low reproductive capacity and low resilience tend to disappear rapidly as a result of intensified fishing (e.g. *Arius gigas*, large sedentary *Lates mariae* and *L. angustifrons* in Lake Tanganyika). Others, like *Labeo* sp, are particularly vulnerable during their spawning

migrations and may be easily wiped out when nets are set across mouths of spawning rivers. The disappearance of other species from heavily fished areas (*Lates niloticus*, *Heterobranchus* and *Bagrus docmac*) in the lower reaches of the Oueme River or Lake Kyoga indicates that sensitivity to fishing is not restricted to cyprinids. At the level of fish communities, it was noted that bottom trawling in Lake Malawi and Victoria led to a rapid decline in the abundance of the larger cichlid species. In Lake Victoria, native *Oreochromis* species were already reduced to very low levels before the Nile perch explosion. Cichlids species flocks are considered to be impossible to manage for maximum protein yield through the regulation of a multispecies fishery without significant changes in species composition (Turner 1977, Ribbink 1987, Tweddle 1992). A fishery may develop from traditional hook and line fishing on large sized piscivores towards the exploitation of small open water pelagics with active gears with in-between a gillnet fishery shifting from large to small mesh exploiting carnivores and herbivores reducing in size when effort increases. Contrary to this, the fishery in Lake Tana started with exploitation of the fish at the lower trophic levels. The reason for this has been primarily the technical capability of the reed boat used, the distribution pattern of fish and the fish consumption habit of the people. Papyrus reed boats are unstable under windy conditions because they are small and light and accommodate only one person. In the fish consumption habits of the people, tilapia has the highest preference and catfish is traditionally not consumed. Therefore, the fishermen prefer to fish in the littoral area, near their villages where their target species is more abundant. Later, the introduction of motorised boats, allowed the exploitation of the large piscivores. The future might see an exploitation of small sized *Barbus trispilopleura* in the open water.

Spatial and temporal variations in fishing effort have not been included in the simulation. Observations from this study (chapter 7) and other reports (Nagelkerke et al. 1996, LFDP 1996) however, show the relatively high fishing effort at the river mouth areas during the spawning season of the *Barbus* spp., in September-October. According to Nagelkerke et al. (1996), a gillnet catch of *Barbus* spp. from the river mouths during a September sampling was found to contain over 90 % ripe fish close to spawning. Some of the *Barbus* spp. also migrate to spawn in the rivers during the same period. Traditional poison fishing in the rivers during spawning migration has also been reported (Nagelkerke, et al. 1996, LFDP report, 1996). Although the actual fishing effort in the lake is low, giving high CpUE and large mean size of the species group, intensive fishing on the spawning stock during migration could lead to recruitment overfishing in a short period (Craig 1992, Gabriel et al. 1989, Ogutu-Ohwayo 1990). Uncontrolled fishing practices on fish species during their spawning migration to rivers have had a serious damaging effect on the population of *Labeo victorianus* of Lake Victoria (Ogutu-Ohwayo 1990) and on *Labeo mesops* from Lake Malawi (Skelton 1991, Turner 1994). Thus any increase in fishing effort must be accompanied with management regulations that ensure the protection of the spawning stock of the unique *Barbus* species in Lake Tana.

Perspectives

The management objective of the government is to expand the fishery and enhance production. To achieve this objective, a development project was launched to provide shore infrastructure like boat building and repair workshop, fish landing and cleaning facilities at Bahir Dar and to provide credit services. Cooling facilities for fresh fish storage was not provided for rent to the fishermen's co-operative or private traders. This has left the fishermen to depend on FPME as the only market outlet. During the last five years the increase in the number of fishing boats and the use of the credit services has not been as high as was expected at the start of the Lake Fisheries Development Project. The reason for this has been the limited market outlet and the low price for fish which made the business unprofitable and less attractive.

The enhanced expansion of the fishery would require large government inputs. During the last six years, the price of fuel, which forms 75% of the running costs, has increased by about 150% for the motorised boat fishery while the price of fish purchased by FPME has increased by only about 50%. The expansion of the commercial fishery is, therefore, moving at a slow pace, following the demographic trend of the lakes surroundings area. An increase in fishing effort up to five times the present level with concomitant decrease in CpUE will not be economically viable, without a significant increase of the current fish price. A fivefold increase in fishing effort will reduce the CpUE to $60 \text{ kg}\cdot\text{trip}^{-1}$ reaching 30% of the current value. The increase in effort will marginally affect the species composition in the catch favouring the small sized species, *O. niloticus* and non-piscivorous *Barbus* spp. The decline in CpUE and change in species composition might induce more fishing in the deeper open water area. This area is currently least exploited because of relatively low CpUE rates but it harbours the large piscivorous *Barbus* spp. and large *C. gariepinus*.

However, from the bio-economic chart constructed for the annual yield, predicted by the model, Fig 9.6, such smooth expansion of the commercial fishery does not look economically feasible. The figure is a simple representation of the annual yield ($\text{kg}\cdot\text{ha}^{-1}\cdot\text{yr}^{-1}$) from the motorised and the reed boat fishery converted to value (total revenue, $\text{Birr}\cdot\text{ha}^{-1}\cdot\text{yr}^{-1}$) based on current fish prices. The production costs ($\text{Birr}\cdot\text{ha}^{-1}\cdot\text{yr}^{-1}$) for both fisheries is also included. The yield from the two types of fishery is assumed to remain in the present proportion at the different levels of fishing effort. Although there is a big difference in yield between the motorised fishery ($14 \text{ kg}\cdot\text{ha}^{-1}\cdot\text{yr}^{-1}$), and the traditional fishery ($7 \text{ kg}\cdot\text{ha}^{-1}\cdot\text{yr}^{-1}$) the total revenue shows little difference due to the higher fish price the traditional fishery gets by selling directly to consumers or small fish dealers. The traditional fishery has low investment and operation costs, 50 Birr per reed boat, per six weeks and 300 Birr for gillnets over two years, resulting in a higher net income per kg of fish caught than for the motorised fishery. The reed boat fishery remains economically viable at the range of fishing effort levels evaluated.

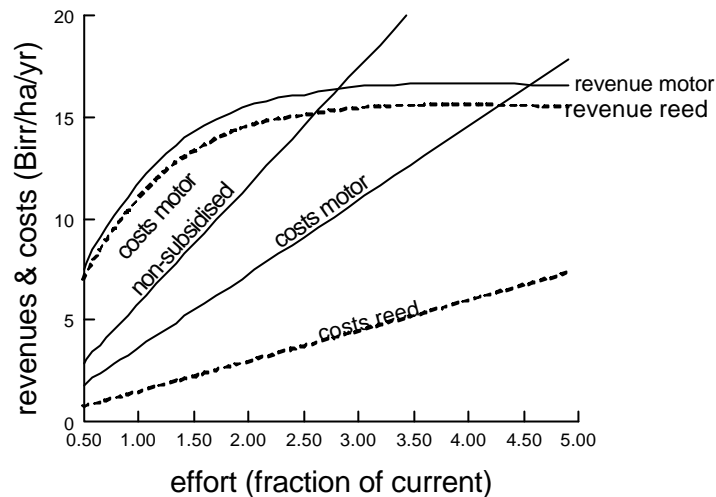

Figure 9.6 The total operation costs and total revenue for the motorised boat and reed boat fishery in Birr·ha⁻¹·yr⁻¹ versus fishing effort as fraction of the 1993 level. If fishing effort increases the total costs increase proportionally. Total revenues show a non-linear increase with increase in fishing effort, resulting from a decreasing CpUE. The cost of the motorised fishery is indicated when subsidised (unit cost 50 Birr·trip⁻¹) and when independently operating (80 Birr·trip⁻¹). The fish price is 0.8 Birr·kg⁻¹ for the motorised fishery and 1.5 Birr·kg⁻¹ for the reed boat fishery.

The marginal gain (costs minus revenues) does not permit the motorised fishery to expand even though the resource potential indicates higher catches when fishing effort increases. With the current high operation costs and low fish price, costs will be equal to revenues at 2.5 times the current fishing intensity, hence the fishery will continue to require subsidy. Expansion of the motorised fishery, after existing boats are used at full capacity, is difficult under the present condition. So while motorization and use of large, wide-mesh gillnets has the advantage of better exploitation and utilisation of the multispecies fish resources including *C. gariepinus* and large piscivorous *Barbus* spp., the high investment and operation costs, coupled with the very low fish price and limited demand, do not allow an economically viable expansion of the fishery.

It is, therefore, important to stress that the Lake Tana fishery finds itself in a unique but a rather problematic situation. On the one hand, fish stocks present allow quite some intensification of the fishing pressure, while on the other hand socio-economic and market conditions are too poor to capitalise on their resources. Hence, the government's objective to expand the motorised fishery can only be met by alleviating the latter constraints. In this respect promotion of fish consumption aiming at higher per caput consumption rates are crucial. If such a goal can be attained a viable intensification of the fishing is anticipated. In that case an increase of fishing effort should be coupled with or preceded by the appropriate fishery legislation and management regulation, to ensure biological sustainability of the fish stock and its environment that are the basis of the fishery.

References

- Abate, Z. 1994. *Water resources development in Ethiopia* pp 1-206. Middle-east Science Policy Series vol. 13. Reading, Ithaca Press.
- Abidin, A.Z. 1986. The reproductive biology of tropical cyprinid, *Hampala macrolepidota* (Van Hasselt), from Zoo Negara Lake, Kuala Lumpur. Malaysia. *Journal of Fish Biology* 29: 381-391.
- Admassu, D. 1994. Maturity, fecundity, brood-size and sex-ratio of tilapia (*Oreochromis niloticus* L.) in Lake Awassa. *Sinet, Ethiopian Journal of Science* 17: 53-69.
- Amarasinghe, U.S. & Pitcher, T.J. 1986. Assessment of fishing effort in Parkrama Samudra, an ancient man-made lake in Sri Lanka. *Fisheries Research* 4: 271-282.
- Arcifa, M.S. 1984. Zooplankton composition of ten reservoirs in southern Brazil. *Hydrobiologia* 113: 137-145.
- Babiker, M.M. & Ibrahim, H. 1979. Studies on the biology of reproduction in the Cichlid *Tilapia nilotica* (L): Gonadal maturation and fecundity. *Journal of Fish Biology* 14: 437-448.
- Bagenal, T. 1978. *Methods for assessment of fish production in fresh waters* pp 1-365. I.B.P. Handbook no. 3. London, Blackwell Scientific Publications.
- Banister, K.E. 1973. A revision of the large *Barbus* (Pisces, Cyprinidae) of East and Central Africa. Studies on African Cyprinidae, part 2. *Bulletin of the British Museum of natural History (Zoology)* 26: 1-148.
- Beadle, L.C. 1981. *The inland waters of tropical Africa: An introduction to tropical limnology*, pp 1-475. Longman. London.
- Beverton, R.J.H. & Holt, S.J. 1957. *On the dynamics of exploited fish populations* pp 1-533. Fisheries and Food. Series 2, Fishery investigations vol. 19. London, Ministry of Agriculture.
- Bini, G. 1940. I pesci del Lago Tana (The fishes of Lake Tana). *Missione di Studio al Lago Tana ricerca limnologiche. B. Chimica e Biologia, Reale Accademia d'Italia* 3: 137-179.
- Bishai, H.M. & Abu Gedieri, Y.B. 1965. Studies on the biology of the Genus *Synodontis* at Khartoum. I. Age and growth. *Hydrobiologia* 26: 85-97.
- Bissio, R.R. 1995. *Third world guide 1993/1994*. pp 1-631. Montevideo, Instituto del tercer mundo.
- Blake, C. & Blake, B. 1978. The use of opercular bones in the study of age and growth in *Labeo senegalensis* from Lake Kainji, Nigeria. *Journal of Fish Biology* 13: 287-295.
- Borgmann, U., Shear, H. & Moore, J. 1984. Zooplankton and potential fish production in lake Ontario. *Canadian Journal of Fisheries and Aquatic Sciences* 41: 1303-1309.
- Boulenger, G.A. 1911. *Freshwater fishes of Africa. Vol. II* pp 1-512. London, British Museum (Natural History).
- Bowen, S.H. 1982. Feeding, digestion and growth - qualitative considerations. In *The biology and culture of tilapias* (Pullin, R.S.V. & Lowe-McConnell, R.H. eds.) pp 141-156. ICLARM Conference Proceedings 7. Manila, ICLARM.

- Brunelli, G. & Cannicci, E.G. 1940. Le Caratteristiche Biologiche del Lago Tana. *Missione di Studio al Lago Tana ricerche limnologiche. B. Chimica e Biologia, Reale Accademia d'Italia* 3: 71-114.
- Bruton, M.N. & Alanson, B.R. 1974. The growth of *Tilapia mossambica* Peters (Pisces:Cichlidae) in Lake Sibaya, South Africa. *Journal of Fish Biology* 6: 701-715.
- Brylinisky, M. 1980. Estimating the productivity of lakes and reservoirs. In *The Functioning of freshwater ecosystems* (Le Cren, E.D. & Lowe-McConnell, R.H eds.). pp 247-340. IBP handbook 22. Cambridge, Cambridge University Press.
- Burgis, M.J., Darlington, J.P.E.C., Dunn, I.G., Ganf, G.C., Gwahaba, J.J. & McGowen, L.M. 1973. The biomass and distribution of organisms in Lake George, Uganda. *Proceedings. of the Royal. Society of London* 184: 271-298.
- Burgis, M.J. 1974. revised estimates for the biomass and production of zooplankton in Lake George, Uganda. *Freshwater Biology* 4:534-541.
- Caddy, J.F. & Bazigos, G.P. 1985. *Practical guidelines for statistical monitoring of fisheries in manpower limited situations* pp 1-257. FAO fisheries technical paper no. 257. Rome, FAO.
- Cambrey, J.A. & Bruton, M.N., 1984. The reproductive strategy of a barb, *Barbus anoplus* (Pisces: Cyprinidae), colonising a man-made lake in South Africa. *Journal of Zoology* 204: 143-168.
- Campana, S.E. & Nielsen, J.D. 1985. Microstructure of fish otoliths. *Canadian Journal of Fisheries and Aquatic Sciences* 42: 1014-1032.
- Carmouze, J.P., Durand, J.R. & Leveque, C. (eds.) 1983. *Lake Chad: Ecology and productivity of a shallow tropical ecosystem* pp 1-575. Monographiae Biologicae. 53 The Hague, Dr. W. Junk Publishers.
- Casselman, J.M. 1990. Growth and relative size of calcified structures of fish. *Transactions of the American Fisheries Society* 119: 673-688.
- Caulton, M.S. & Hill, B.J. 1973. The ability of *Tilapia mossambica* to enter deep water. *Journal of Fish Biology* 5: 783-788.
- Clay, D. 1984. Production of the African catfish (*Clarias gariepinus*) , 1. Growth mortality and yield south of the Zambezi. *Journal. of the Limnological Society of South Africa* 10: 16-24.
- Clay, D. 1979a. Population biology, growth and feeding of African catfish (*Clarias gariepinus*) with special reference to juveniles and their importance in fish culture. *Archiv fuer Hydrobiologie* 87: 453-482.
- Clay, D. 1979b. Sexual maturity and fecundity of the African catfish (*Clarias gariepinus*) with an observation on the spawning behaviour of the Nile catfish (*Clarias lazera*). *Journal of the Linnean Society* 65: 351-365.
- Craig, J.F. 1992. Human-induced changes in the composition of fish communities in the African Great Lakes. *Reviews in Fish Biology and Fisheries* 2: 93-124.
- Crul, R.C.M. 1992. *Models for estimating potential fish yields of African inland waters* pp 1-22. FAO CIFA occasional paper no. 16. Rome, FAO.

- Dadebo, E. 1988. *Studies on the biology and commercial catch of Clarias mossambicus Peters (Pisces: Clariidea) in Lake Awassa, Ethiopia* pp 1-73. M.Sc. thesis, Addis Ababa University.
- Dayaratne, P. & Gjosaeter, J. 1986. Age and growth of four *Sardinella* species from Sri Lanka. *Fisheries Research* 4: 1-13.
- De Silva, S., Schut, J. & Kortmunder, K. 1985. Reproductive biology of six *Barbus* species indigenous to Sri Lanka. *Environmental Biology of fishes* 12: 201-218.
- Dudley, R.G. & Harris, K.C. 1987. The fisheries statistics of Java Indonesia: Operational realities in a developing country. *Aquaculture and Fisheries Management* 18: 365-374.
- Edmondson, W.T. & Winberg, G.C. (eds.) 1971. *A manual on methods for the assessment of secondary productivity in freshwaters* pp 1-358. IBP handbook 17. Oxford, Blackwell Scientific Publications.
- El Bolock, A.R. 1972. The use of vertebrae for determining age and growth of the Nile catfish *Clarias lazera* (Cuv. & Val.). *Bulletin of the institute of oceanography and fisheries* 2: 53-82.
- Eshete, D. 1995. *A length-based simulation model to evaluate management options in a multispecies gillnet fishery of Lake Tana, Ethiopia* pp 1-63. MSc Thesis. Wageningen, Wageningen Agricultural University, Department of Fish Culture and Fisheries.
- Fagade, S. 1973. Age determination in *Tilapia melanocheilus* (Ruppell) in the Lagos lagoon, Lagos, Nigeria. In *The proceedings of an international symposium on the ageing of fish, held at the University of Reading, England on 19 and 20 July, 1973* (Bagenal, T.B. ed.). pp 71-77. Old Working, Unwin.
- FAO 1980. *The collection of catch and effort statistics*. pp 1-63. FAO fisheries circular no. 730. Rome, FAO.
- FAOSTAT 1997. *Statistic database* at <http://apps.fao.org/default.htm>.
- Fernando, C.H. 1980a. The species and size composition of tropical freshwater zooplankton with special reference to the oriental region (South East Asia). *Internationale Revue der gesamten Hydrobiologie* 65: 411-426.
- Fernando, C.H. 1980b. The freshwater zooplankton of Sri Lanka, with a discussion on tropical freshwater zooplankton composition. *Internationale Revue der gesamten Hydrobiologie* 65: 85-125.
- Gabriel, W.L., Sissenwine, M.P. & Overholtz, W.J. 1989. Analyses of spawning stock biomass per recruit: an example for Georges Bank haddock. *North American Journal of Fisheries Management* 9: 383-391.
- Garrod, D.J. 1959. The growth of *Tilapia esculenta* Graham in Lake Victoria. *Hydrobiologia* 12: 268-298.
- Gasse, F. 1987. Ethiopie et Republique de Djibouti. In *African wetlands and shallow water bodies*. (M.J. Burgis & J.J. Symoens eds.). pp 300-311. Travaux et documents / Institut Francais de Recherche Scientifique pour le Developpement en Cooperatin no. 211 Paris, ORSTOM.

- Getabu, A. 1992. Growth parameters and total mortality in *O. niloticus* (Linnaeus) from Nyanza Gulf Lake Victoria. *Hydrobiologia* 232: 91-97.
- Getachew, T. 1987. A study of an herbivorous fish (*Oreochromis niloticus* L.) diet and its quality in two Ethiopian Rift Valley lakes, Awassa and Zewai. *Journal of Fish Biology* 30: 439-449.
- Gjoesaeter, J., Dayaratne, P. & Bergstad, O.A. 1984. *Ageing tropical fish by growth rings in the otoliths* pp 1-54. FAO fisheries circular no 776. Rome, FAO.
- Greenwood, P.H. 1955. Reproduction in the catfish, *Clarias mossambicus*, Peters. *Nature* 176: 516-518.
- Greenwood, P.H. 1976. Fish fauna of the Nile. In *The Nile, Biology of an Ancient River* (Rzoska, J ed.). pp 127-141. The Hague, Dr. W. Junk Publishers.
- Gulland, J.A. 1983. *Fish stock assessment : a manual of basic methods* pp 1-223. FAO / Wiley series on food and agriculture vol. 1. Chichester, Wiley.
- Gulland, J.A. & Harding, D. 1961. The selection of *Clarias mosambicus* (Peters) by nylon gill nets. *Journal du Conseil / Conseil International pour l'Exploration de la Mer* 26: 215-222.
- Gwahaba, J.J. 1973. Effects of fishing on the *Tilapia nilotica* populations of Lake George, Uganda, over the past 20 years. *East African wildlife journal* 11: 317-328.
- Hailu, A. 1996. *Studies on some aspects of the biology of the catfish Bagrus docmac Frsk. (Pisces: Bagridae) in Lake Chamo, Ethiopia* pp 1-63. M.Sc. thesis. Addis Ababa, Addis Ababa University.
- Hamley, J.M. 1975. Review of Gillnet selectivity. *Journal of Fisheries Research Board of Canada* 32: 1943-1969.
- Hamley, J.M. & Regier, H.A. 1973. Direct estimates of gillnet selectivity to walleye (*Stizostedion vitreum vitreum*). *Journal of Fisheries Research Board of Canada* 30: 817-830.
- Hart, R.C. & Allanson, B.R. 1975. Preliminary estimates of production by a calanoid copepod in subtropical Lake Sibaya. *Verhandlungen / Internationale Vereinigung fuer Theoretische und Angewandte Limnologie* 19: 1434-1441.
- Hart, R.C. 1986. Zooplankton abundance, community structure and dynamics in relation to inorganic turbidity, and the implications for a potential fishery in subtropical Lake le Roux, South Africa. *Freshwater Biology* 16: 351-371.
- Helser, T.E. 1994. Estimating size composition and associated variances of a fish population from gillnet selectivity, with an example for spotted seatrout (*Cyloscion nebulosus*). *Fisheries Research* 19: 65-86.
- Henderson, H.F. & Welcomme, R.L. 1974. *The relationship of yield to Morpho-Edaphic index and numbers of fishermen in African inland fisheries* pp 1-35. FAO CIFA occasional paper no. 1. Rome, FAO.
- Hillborn, R. & Walters, C.J. 1992. *Quantitative fisheries stock assessment - choice dynamics and uncertainty* pp 1- 570. New York, Chapman & Hall.

- Holden, M.J. & Raitt, D.F.S. 1974. *Manual of fishery science. Part 2 - Methods of resource investigation and their application* pp 1-214. FAO fisheries technical paper No. 115. Rome, FAO.
- Holt, S.J. 1963. A method for determining gear selectivity and its application. *International Commission for the Northwest Atlantic Fisheries. Special publication 5*: 106-115.
- Hopson, A.J. 1972. *A study of the Nile Perch (Latus niloticus (L.)), Pisces: Centropomidae) in Lake Chad* pp 1-93. Overseas research publication / Foreign and Commonwealth Office, Overseas Development Administration No.19. London, Her Majesty's Stationary Office.
- Ita, E.O. 1978. An analysis of fish distribution in Lake Kainji, Nigeria. *Hydrobiologia* 58: 233-344.
- Jones, R. 1982. Ecosystems, food chains and fish yields. In *Theory and management of tropical fisheries : proceedings of the ICLARM / CSIRO workshop on the theory and management of tropical multispecies stocks, 12 - 21 January 1981, Cronulla, Australia* (Pauly, D. & Murphy, G.I. eds.). Cronulla, ICLARM.
- Jones, R. 1984. *Assessing the effects of changes in exploitation pattern using length composition data (with notes on VPA and cohort analysis)* pp 1-118. FAO fisheries technical paper no. 256. Rome, FAO.
- Keast, A. 1978. Trophic and spatial inter-relationships in the fish species of Ontario temperate lake. *Environmental Biology of Fishes* 3: 7-31.
- King, M. 1995. *Fisheries biology, assessment and management* pp 1-341. Oxford, Fishing News Books.
- Kudhongania, A.W. & Cordone, A.J. 1974. Batho-spatial distribution patterns and biomass estimates of the major demersal fishes in Lake Victoria. *The African journal of tropical hydrobiology and fisheries* 3: 15-31.
- Kolding, J. 1993. Population dynamics and life-history styles of Nile tilapia, *Oreochromis niloticus*, in Ferguson's Gulf, Lake Turkana, Kenya. *Environmental Biology of Fishes* 37:25-46.
- Larkin, P.A. 1982. Directions for future research in tropical multi-species fisheries. in *Theory and management of tropical fisheries* (Pauly, D. & Murphy, G.I. eds.) pp. 309- 328. Manila, ICLARM.
- Leveque, C. 1997. *Biodiversity dynamics and conservation : the freshwater fish of tropical Africa* pp 1-438. Cambridge, Cambridge University Press.
- LFDP 1995. *Fisheries Statistical Bulletin Number 2* Lake Fisheries Development Project Working Paper no 19. Addis Ababa, Ministry of Agriculture.
- LFDP 1996. *Proceedings of the National Fisheries Seminar, Zewai. November 1995* Lake Fisheries Development Project Working Paper no 21. Addis Ababa, Ministry of Agriculture.
- LFDP 1997. *Fisheries Statistical Bulletin Number 5* Lake Fisheries Development Project Working Paper no 25. Addis Ababa, Ministry of Agriculture.
- Lewis, W.M. 1979. *Zooplankton community analysis: studies on a tropical system* pp 1-163. New York, Springer-Verlag.

- Lofredo, S. 1940. Ricerche chimiche sui sedimenti del Lago Tana, *Missione di Studio al Lago Tana ricerche limnologiche. B. Chimica e Biologia, Reale Accademia d'Italia* 3: 52-68.
- Lowe-McConnell, R.H. 1975. *Fish communities in tropical freshwaters: their distribution, ecology, and evolution* pp 1-337. London, Longman.
- Lowe-McConnell, R.H. 1982. Tilapias in Fish Communities. In *The biology and culture of tilapias* (Pullin, R.S.V. & Lowe-McConnell, R.H. eds.). ICLARM Conference Proceedings 7. pp 83-113. Manila, ICLARM.
- Maceina, J. & Bestil, R.K. 1987. Verification and use of the whole otoliths to age white crappie. In *Age and Growth of Fish* (Summerfelt, C. & Hall, G. eds.). pp 267-278. Ames, Iowa State University Press.
- Machiels M.A.M., Klinge, M., Lanters, R. & van Densen, W.L.T. 1994. Effect of snood length and hanging ratio on efficiency and selectivity of bottom-set gillnets for pikeperch, *Stizostedion lucioperca* L. and bream, *Abramis brama*. *Freshwater Fisheries Research* 19: 231-239.
- Marshall, B.E. 1984. *Predicting ecology and fish yields in African reservoirs from pre-impoundment physico-chemical data* pp 1-35. FAO-CIFA technical paper no12. Rome, FAO.
- Marshall, B.E. 1990. Growth performance of the African catfish, *Clarias gariepinus* (Clariidae). *Fishbyte* 8: 17-19.
- Marten, G.G. & Polovina, J.J. 1982. A comparative study of fish yields from various tropical ecosystems In *Theory and management of tropical fisheries : proceedings of the ICLARM / CSIRO workshop on the theory and management of tropical multispecies stocks, 12 - 21 January 1981, Cronulla, Australia* (Pauly, D. & Murphy, G.I. eds.). pp 255-289. Cronulla, ICLARM.
- Mattson, N.S. 1994. Direct estimates of multi-mesh gillnet selectivity to *Oreochromis shiranus chilwae*. *Journal of Fish Biology* 45: 997-1012.
- Mavuti, K.M. & Litterick, M.R. 1981. Species composition and distribution of zooplankton in a tropical lake, Lake Naivasha, Kenya. *Archiv fuer Hydrobiologie* 93: 52-58.
- Mebrat, A. 1993. Overview of the fishery sector in Ethiopia. In *Proceedings of the National Seminar on Fisheries Policy and Strategy. Addis Ababa (Ethiopia)*. pp 45-53. Rome, FAO.
- Mengistou, S. & Fernando, C.H. 1991 a. Seasonality and abundance of some dominant crustacean zooplankton in Lake Awassa, a tropical rift valley lake in Ethiopia. *Hydrobiologia* 226: 137-152.
- Mengistou, S. & Fernando, C.H. 1991 b. Biomass and production of the major dominant crustacean zooplankton in a tropical Rift Valley lake, Awasa, Ethiopia. *Journal of Plankton Research* 13: 831-851.
- Mina, M.V., Mironovsky, A.N. & Dgebuadze, Y.Y. 1996. Lake Tana large barbs: phenetics, growth and diversification. *Journal of Fish Biology* 48: 383-404.

- Mohr, P.A. 1962. *The Geology of Ethiopia*. pp 1-268. Addis Ababa, University College of Addis Ababa Press.
- Morales - Nin, B. 1992. *Determination of growth in bony fishes from otolith microstructure* pp 1-51. FAO Fisheries technical paper no 322. Rome, FAO.
- Morales - Nin, B. & Ralston, S. 1990. Age and growth of *Lutjanus kasmira* (Forsk.) in Hawaiian waters. *Journal of Fish Biology* 36: 191-203.
- Moreau, J., Bambino, C. & Pauly, D. 1986. Indices of overall growth performance of 100 tilapia (Cichlidae) populations. In *Proceedings of the first Asian Fisheries Forum, Manila, Philippines, -26-31-May-1986* (J.L. Maclean, L.B. Dizon & L.V. Hosillos eds.). pp 201-206.
- Moreau, J. 1987. Mathematical and biological expression of growth of fishes: recent trends and further developments. In *Age and Growth of Fish* (Summerfelt, C. & Hall, G. eds.). pp 81-113. Ames, Iowa State University Press.
- Moreau, J. & De Silva, S.S. 1991. *Predictive fish yield for lakes and reservoirs of the Philippines, Sri Lanka and Thailand*. pp 1-42. FAO Fisheries Technical Paper no. 319. Rome, FAO.
- Morgan, N.C., Backiel, T., Bretchko, G., Duncan, A., Hillbricht-Ilkowska, A., Kajak, Z., Kitchell, J.F., Larson, P., Leveque, A., Nauwerck, A., Schiemer, F. & Thorpe, J.E. 1980. Secondary production. In *The Functioning of freshwater ecosystems* (Le Cren, E.D. & Lowe-McConnell, R.H eds.). pp 247-340. IBP 22. Cambridge, Cambridge University Press.
- Mouse, P. 1988. *The growth and reproduction of the Nile Perch, Lates niloticus, in the Mwanza Gulf of Lake Victoria, Tanzania. A report of the first period, March-August 1988* pp 1-53. Wageningen, Wageningen Agricultural University, Department of Fish Culture and Fisheries.
- Msiska, V. 1990. Reproductive strategies of two cyprinid fishes in Lake Malawi and their relevance for aquaculture development. *Aquaculture and Fisheries Management* 21: 67-75.
- Munro, J.J. & Pauly, D. 1983. A simple method for comparing the growth of fishes and invertebrates. *Fishbyte* 1: 5-6.
- Nagelkerke, L.A.J. 1997. *The barbs of Lake Tana, Ethiopia: morphological diversity and its implications for taxonomy, trophic resource partitioning, and fisheries* pp 1-296. Doctoral thesis, Wageningen, Experimental Animal Morphology and Cell Biology, Wageningen Agricultural University.
- Nagelkerke, L.A.J., Mina, M.V., Tesfaye Wudneh, Sibbing, F.A. & Osse J.W.M.. 1995b. In Lake Tana, a Unique Fish Fauna Needs Protection. *Bioscience* 45:772-775.
- Nagelkerke, L.A.J., Sibbing, F.A., van den Boogaart, J.G.M. & Lammens, E.H.R.R. 1994. The barbs (*Barbus* spp.) of Lake Tana: a forgotten species flock? *Environmental Biology of fishes* 39: 1-22.
- Nagelkerke, L.A.J., Sibbing, F.A. & Osse, J.W.M. 1995a. Morphological divergence during growth in the large barbs (*Barbus* spp.) of Lake Tana, Ethiopia. *Netherlands Journal of Zoology* 45: 431-454.

- Nagelkerke, L.A.J. & Sibbing, F.A. 1996. Reproductive segregation among the large barbs (*Barbus intermedius* complex) of Lake Tana, Ethiopia. *Netherlands Journal of Zoology*. 45: 431-454.
- Nagelkerke, L.A.J. & Sibbing, F.A. 1998a. A revision of the large barbs (*Barbus* spp., Cyprinidae, Teleostei) of Lake Tana, Ethiopia, with a description of seven new species. *Zoologische verhandelingen* in press.
- Nagelkerke, L.A.J. & Sibbing, F.A. 1998b. Trophic segregation among the *Barbus* species flock of Lake Tana, Ethiopia. (in preparation).
- Ni, H. & Sandeman, E. 1984. Size at maturity for Northwest Atlantic Redfishes (Sebastes). *Canadian Journal of Fisheries and Aquatic Sciences* 41: 1753-1762.
- Nikolsky, G.V. 1969. *Theory of Fish Population Dynamics as the biological background for rational exploitation and management of fishery resources* Edinburgh, Oliver & Boyd.
- Nikolsky, G.V. 1963. *The ecology of fishes* pp 1-600. London, Academic Press.
- Oglesby, R.T. 1985. Management of lacustrine fisheries in the tropics. *Fisheries* 10: 16-19.
- Ogutu-Ohwayo, R. 1990. The decline of the native fishes of lakes Victoria and Kyoga (East Africa) and the impact of introduced species, especially the Nile perch, *Lates niloticus*, and the Nile tilapia, *Oreochromis niloticus*. *Environmental Biology of Fishes* 27: 81-96.
- Owiti, D.O. & Dadzie S. 1989. Maturity, fecundity and the effect of rainfall on the spawning rhythm of a siluroid catfish, *Clarias mossambicus* (Peters). *Aquaculture and Fisheries Management* 20: 355-368.
- Patalas, K. & Salki, A. 1993. Spatial variation of Crustacean plankton in lakes of different size. *Canadian Journal of Fisheries and Aquatic Sciences* 50: 2626-2640.
- Pauly, D. 1980. On the interrelationships between natural mortality, growth parameters and mean environmental temperature in 175 fish stocks. *Journal du Conseil / Conseil International pour l'Exploration de la Mer* 39: 175-192.
- Pauly, D. 1983. *Some simple methods for the assessment of tropical fish stocks*. pp 1-52. FAO Fisheries technical paper no 234. Rome, FAO.
- Pauly, D. 1983. Length-converted catch curves. A powerful tool for fisheries research in the tropics. Part 1. *Fishbyte* 1(2): 9-13.
- Pauly, D. 1984 a. Length-converted catch curves. A powerful tool for fisheries research in the tropics. Part 2. *Fishbyte* 2(1): 17-19.
- Pauly, D. 1984 b. Length-converted catch curves. A powerful tool for fisheries research in the tropics. Part 3. *Fishbyte* 2(3): 9-10.
- Pauly, D. 1987. A review of the ELEFAN system for analysis of length-frequency data in fish and aquatic invertebrates. *ICLARM conference proceedings / International Center for Living Aquatic Resources Management* 13: 7-34.
- Pauly, D. & David, N. 1981. ELEFAN I, a BASIC program for the objective extraction of growth parameters from length-frequency data. *Meeresforschung* 28: 205-211.
- Payne, A.I. & Collinson, R.I. 1983. A comparison of the biological characteristics of *Sarotherodon niloticus* (L.) with those of *S. aureus* (Steindachner) and other tilapia of the delta and lower Nile. *Aquaculture* 30: 335-351.

- Payne, A.I. 1986. *The ecology of tropical lakes and rivers*. pp 1-301. Chichester, John Wiley & Sons.
- Pet, J.S. 1995. *On the management of a tropical reservoir* pp 1-161. Doctoral thesis, Wageningen, Department of Fish Culture and Fisheries, Wageningen Agricultural University.
- Pet, J.S., & Piet, G.J. 1993. The consequences of habitat overlap of the introduced tilapia *Oreochromis mossambicus* and indigenous fish species for fishery management in a Sri Lankan reservoir. *Journal of Fish Biology* 43: 193-208.
- Pet, J.S., Pet-Soede, C. & van Densen, W.L.T. 1995. Comparison of methods for the estimation of gillnet selectivity to tilapia, cyprinids and other fish species in a Sri Lankan reservoir. *Fisheries Research* 24: 141-164.
- Pet, J.S., Wijsman, J.W.M., Mous, P.J. & Machiels, M.A.M. 1995 Characteristics of a Sri Lankan reservoir fishery and consequences for the estimation of annual yield. *Fisheries Research* 24: 9-33
- Pet, J.S., Machiels, M.A.M. & van Densen W.L.T. 1996. A size structured model for evaluating management strategies in gillnet fisheries exploiting spatially differentiated populations. *Ecological Modelling* 88: 195-214.
- Petr, T. & Kapetsky, J. 1983. *Status of African reservoir fisheries*. pp 1-326. FAO-CIFA technical paper no. 10. Rome, FAO.
- Philippart, J-Cl. & Ruwet, J-CL. 1982. Ecology and distribution of Tilapia. In *The biology and culture of tilapias*. (Pullin, R.S.V. & Lowe-McConnell, R.H. eds.) pp 15-60. ICLARM Conference Proceedings 7. Manila, ICLARM.
- Pivnicka, K. 1974. The Zambezi barbel, *Clarias gariepinus* (Burchell, 1822). In *Lake Kariba : a man-made tropical ecosystem in Central Africa*. (Balon, E.K. & Coche, A.G. eds.) pp 318-325. The Hague, Dr Junk Publishers.
- Pullin, R.S.V. 1988. *Tilapia genetic resources for aquaculture : proceedings of the workshop on Tilapia genetic resources for aquaculture, 23 - 24 March 1987, Bangkok, Thailand* pp 1-108. ICLARM Conference Proceedings, 16. Manila, ICLARM.
- Quick, A.J.R. & Bruton, M.N. 1984. Age and growth of *Clarias gariepinus* (Pisces: Clariidae) in the P. K. le Roux Dam, South Africa. *South African Journal of Zoology* 19: 37-45.
- Regier, H.A. & D.S. Robson. 1966. Selectivity of gillnets, especially to lake whitefish. *Journal of the Fisheries Research Board of Canada* 23: 423-454.
- Ribbink, A.J. 1987. African lakes and their fishes: conservation scenarios and suggestions. *Environmental Biology of Fishes* 19: 3-26.
- Riedel, D. 1963. Contribution to the experimental determination of the selectivity parameter of gillnets. *Archiv fuer Fischereiwissenschaft*. 14: 85-97.
- Rinne, J.N. & Winjala, B. 1983. Maturity, fecundity and breeding of major catfishes (Suborder: Siluroidea) in Lake Victoria, East Africa. *Journal of Fish Biology* 23: 357-363.
- Robben, J. & van den Audenaerde, D.T. 1984. A preliminary study of the age and growth of the Cyprinid fish *Barilius moorii* Blgr. from Lake Kivu. *Hydrobiologia* 108: 153-163.
- Rzoska, J. 1976. Lake Tana, headwater of the Blue Nile. In *The Nile, biology of an ancient river*. (Rzoska, J. ed.) pp 223-232. The Hague, Dr Junk Publishers.

- Samingin, M., Buijse, T. & Vet, F. de 1993. *Manual on database storage system for AADCP Component-2. Version 3.0.* pp 1-26. Freshwater Fish Research Center, Batu Berendam, Malaysia; Department of Fish Culture and Fisheries, Wageningen Agricultural University, The Netherlands.
- Sandlund, O.T. & Naesje, T.F. 1989. Impact of a pelagic gill-net fishery on the polymorphic whitefish (*Coregonus lavaretus* L.s.l.) population in Lake Femund, Norway. *Fisheries Research* 7: 85-97.
- SAS Institute Inc. 1992. *SAS/STAT user's guide* 2 vol. Cary, NC, SAS Institute Inc.
- Saunders, J.F. & Lewis, W.M. 1988. Composition and seasonality of the zooplankton community of Lake Valencia, Venezuela. *Journal of Plankton Research* 10: 957-985.
- Schroder, R. 1984. An attempt to estimate the fish stock and the sustainable yield of Lake Zewai and Lake Abaya, Ethiopian Rift Valley. *Archiv fuer Hydrobiologie Supplement Band* 69: 411-441.
- Sechin, Y T. 1969. A mathematical model for the selectivity curve of a gillnet. *Rbynoje Khoziajstwo* 45: 56-58.
- Secor, D.H. & Dean, J.M. 1992. Comparison of otolith-based back-calculation methods to determine individual growth histories of laval striped bass, *Morone saxatilis*. *Canadian Journal of Fisheries and Aquatic Sciences* 49: 1439-1454.
- Sendacz, S. 1984. A study of the zooplankton community of Billings Reservoir - Sao Paulo. *Hydrobiologia* 113: 113-127.
- Serruya, C. & Pollinger, U. 1983. *Lakes of the warm belt.* pp 1-569. London, Cambridge University Press.
- Sheldon, R.W., Sutcliffe, W.H.Jr., & Paranjape, M.A. 1977. Structure of pelagic food chain and relationship between plankton and fish production. *Journal of the Fisheries Research Board of Canada* 34: 2344-2353.
- Sibbing, F.A., Nagelkerke, L.A.J. & Osse J.W.M. 1994. Ecomorphology as a tool in fisheries: identification and ecotyping of Lake Tana barbs (*Barbus intermedius* complex), Ethiopia. *Netherlands Journal of Agricultural Science* 42: 77-85.
- Skelton, P.H., Tweddle, D. & Jackson, P., 1991. Cyprinids of Africa. In *Cyprinid Fishes Systematics, Biology and Exploitation* (Winfield, I.J. & Nelson, J.S. eds.). pp 211-233. London, Chapman & Hall.
- Smith, P.J. 1994. *Genetic diversity of marine fisheries resources - Possible impacts of fishing* pp 1-53. FAO fisheries technical paper 34. Rome, FAO.
- Sokal, R.R. & Rohlf, F.J. 1995. *Biometry: the principles and practice of statistics in biological research* pp 1-887. New York, Freeman.
- Sparre, P & Venema, S.C. 1992. *Introduction to tropical fish stock assessment, part I rev. 1* pp 1-376. FAO fisheries technical paper no 306/1. Rome, FAO.
- Sprangler, G.R. & Collins, J.J. 1992. Lake Huron community structure based on gillnet catches corrected for selectivity and encounter probability. *North American Journal of Fisheries Management* 12: 585-597.
- Tadesse, Z. 1988. *Studies on some aspects of the biology of Oreochromis niloticus Linn. (Pisces: Cichlidae) in Lake Zewai* MSc. Thesis. Addis Ababa, Addis Ababa University.

- Teklegiorgis, Y. 1988. *Age determination and growth estimation of immature Oreochromis niloticus Linn. (Pisces: Cichlidae) in Lake Awassa, Ethiopia* pp 1-137. M.Sc. thesis. Ontario, University of Waterloo.
- Toews, D.R. & Griffith, J.S. 1979. Empirical estimates of potential fish yield for the lake Banguelu system, Zambia, Central Africa. *Transactions of the American Fisheries Society* 108: 241-252.
- Tomasson, T., Bruton, M.N., & Hamman, K.C.D. 1985. The demography and management of large cyprinids in a reservoir on the Orange River, South Africa. *Fisheries Research* 3: 279-308.
- Tomasson, T., Cambray, J.A. & Jackson, P.B.N. 1984. Reproductive biology of four large riverine fishes (Cyprinidae) in a man-made lake, Orange River South Africa. *Hydrobiologia* 112: 179-195.
- Trippel, E.A. 1995. Age at maturity as a stress indicator in fisheries. *BioScience* 45: 759-771.
- Tudorencea, C., Fernando, C.H. & Paggi, J.C., 1988. Food and feeding ecology of *Oreochromis niloticus* (Linnaeus, 1758) juveniles in Lake Awasa, Ethiopia. *Archiv fuer Hydrobiologie Supplement Band 79*: 267-289.
- Turner, J.L. 1977a. Some effects of demersal trawling in Lake Malawi (Lake Nyasa) from 1968-1974. *Journal of Fish Biology* 10: 261-271.
- Turner, J.L. 1977b. Changes in the size structure of Chichlid populations in Lake Malawi resulting from bottom trawling. *Journal of the Fisheries Research Board of Canada* 34: 232-238.
- Turner, G.F. 1994. Fishing and the conservation of endemic fishes of Lake Malawi. In *Speciation in Ancient Lakes* (Martens, K.F., Goddeers, B. & Coulter, G. eds.). *Archiv fur Hydrobiologie* 44: 481-494.
- Tweddle, D. 1992. Conservation and threats to the resources of Lake Malawi. *Multilungen-Internationale Vereinigung fur Theoretische und Angewandle Limnologie* 23: 17-23.
- van der Waal, B.C.M. 1974. Observations on the breeding habits of *Clarias gariepinus* (Burchel). *Journal of Fish Biology* 6: 23-27.
- Vareschi, E. & Jacobs, J. 1984. The ecology of Lake Nakuru (Kenya). IV. Biomass and spatial distribution of consumer organisms. *Oecologia* 61: 70-82.
- Vijverberg, J. & Frank, Th.H. 1976. The chemical composition and energy contents of copepods and cladocerans in relation to their size. *Freshwater Biology* 6: 333-345.
- Vijverberg, J. & Richter, A.F. 1982. Population dynamics and production of *Acanthocyclops robustus* (Sars) and *Mesocyclops leuckarti* (Claus) in Tjeukemeer. *Hydrobiologia* 95: 261-274.
- Winfield, I.J. & Nelson, J.S. 1991. *Cyprinid fishes : systematics, biology, and exploitation. Fish and fisheries series 3.* pp 1-667. London, Chapman & Hall.
- Welcomme, R.L. 1967. The relationship between fecundity and fertility in the mouth-brooding *Tilapia leucosticta*. *Journal of Zoology* 151: 453-468.
- Werner, E.E. & Gilliam, J.F. 1984. The ontogenetic niche and species interactions in size-structured populations. *Annual review of ecology and systematics* 15: 393-425.

- Werner, E.E., Hall, D.J., Laughlin, D.R., Wagner, D.J., Wilsman, L.A., & Funk, F.C. 1977. Habitat partitioning in a freshwater fish community. *Journal of the Fisheries Research Board of Canada* 34:360-370.
- Whitehead, P.J.P. 1959. The anadromous fishes of Lake Victoria. *Review of Zoology and Botany in Africa* 59: 329-363.
- Willoughby N.G. & Tweddle, D. 1978 The ecology of the catfish *Clarias gariepinus* and *Clarias ngamensis* in the Shire Valley, Malawi. *Journal of Zoology* 186: 507-534.
- Winberg, G.G. 1971. *Symbols, units and conversion factors in studies of fresh water productivity*. pp 1-23. London, IBP.
- Wodajo, K. & Belay, A. 1984. Species composition and seasonal abundance of zooplankton in two Ethiopian Rift Valley lakes - Lakes Abiata and Langano. *Hydrobiologia* 113: 129-136.
- Wood, R.B. & Talling, J.F. 1988. Chemical and algal relationships in a salinity series of Ethiopian waters. *Hydrobiologia* 158: 29-67.
- Wootton R.J. 1990 *Ecology of Teleost Fishes* pp 1-404. Fish and Fisheries series 1. London, Chapman & Hall.
- Youngs, W.D. & Hiembuch, D.G. 1982. Another consideration of the morphoedaphic index. *Transaction of American fisheries Society* 111: 151-153.
- Zaret, T.M. 1980. *Predation and freshwater communities* pp 1-187. New Haven & London, Yale University Press.

ACKNOWLEDGEMENT

This thesis is the result of a study conducted on Lake Tana from 1990 to 1993 with some interruptions due to security problems in the area. Many people have contributed to the work presented here and I would like to extend my appreciation and gratitude.

I would like to thank my Promotor, Prof. Dr. Bram Huisman, for his interest in the research programme and his constant follow up. My Co-Promotor, Dr. Marcel Machiels, has been not only a supervisor but also a friend. Drs. Wim van Densen was my first contact by letter at the inception of the research project. His advice, guidance and encouragement has been invaluable. Ir. Wijsman offered considerable assistance on the statistical data analysis. Ing. Feite van der Veen, Dr. Joep de Leeuw and Drs. Frits Roest contributed in discussions and commenting on the draft manuscript. The MSc students, Mauricio Vargas, Cao Wulling, Aisa van Eer, and Eshete Dejen have contributed to this work in various ways including the preparation of otolith sample for ageing and in the data analysis. Dr. Jeppe Kolding reviewed the earlier manuscript of this thesis and gave constructive comment.

I am indebted to my colleagues, fishery officers in Bahir Dar, Mulualem, Tewodros, Getnet, Tadesse, Haile Selasie, Abatneh, Gemal and Girma who assisted me during the trawl fishing survey, fish dissection, and measurement in the laboratory and collection of data from the fishery. The crew of the research boat, Marije, have been very efficient and helpful. Ato Endale Lemma has been especially helpful in handling administrative matters in addition to his participation as a fishery officer. Mr. Johannes Koornstra, a Dutch master-fisherman, was very helpful during the initial phase of the trawl sampling.

I would like to thank Prof. Dr. Jan Osse and Dr. Nand Sibbing, of Experimental Zoology Group, Wageningen Institute of Animal Science, for their interest and prompt response on the *Barbus* identification problem, in addition to their offer of friendly hospitality during my stay in Wageningen. Dr. Leo Nagelkerke who undertook the taxonomic research on *Barbus* spp. of Lake Tana and his wife Suzanne have been close friends to me and my family. I would like to thank them for kindly accepting to be my paranimfs.

I thank Dr. Getachew Teffera and Dr. Seyoum Mengistu of the Biology Department Addis Ababa University and Ato Zenebe Tadesse of Bahir Dar Pedagogical Teachers' College for kindly availing the laboratory facilities and for the useful discussions we had in the course of the work. I am indebted to many people who have contributed in one way or another during the implementation of the research program, particularly those in the office of the Ethiopian Orthodox Church Development Department, the Fisheries Team, Ministry of Agriculture, Addis Ababa, and the Regional Bureau of Agriculture, Bahir Dar.

I like to thank Jaap Bakker, Henk Oost and other friends of Interchurch Foundation Ethiopia/Eritrea, Urk. I am highly indebted to the family of Marije and Jan Oost in Urk, who have been a substitute of my family in The Netherlands. I have always enjoyed the family atmosphere and I will always cherish the love and hospitality provided me by the family. I can not forget the friendly attitude I have always been offered from the office of Interchurch Co-ordination Commission for Development Projects, Zeist. Gert Jan Geertsema and Bernard Cino have been very good friends to me and my family.

My special thanks to the family of Mimi and Negede, in The Hague, who always provided me the home environment and constantly gave me encouragement.

Last, but not least I thank my wife Sosina and my dear children for their continued patience and encouragement. I am grateful to my brothers who have been a great support to my family and myself. I am thankful to God that I have come so far.

CURRICULUM VITAE

Tesfaye Wudneh Wakayo was born in Addis Ababa, Ethiopia, on 11 June 1946. He attended elementary and secondary education at Medhane Alem School. In 1973 he obtained a Bachelor of Science (BSc) degree in Biology at Addis Ababa University. He joined the Department of Fisheries, Ministry of Agriculture, in August 1973. In 1981 he obtained a Master of Science (MSc) degree in Marine Biology from the University of Wales, United Kingdom. The title of his thesis was " Effect of dietary lipid on the tissue fatty acids composition of the shrimp *Palaemon elegans*". He worked as Assistant Fisheries Biologist in fish stock assessment of Rift Valley lakes during 1982-83 and as Project Co-ordinator of the FAO/UNDP project at the Red Sea during 1984. From 1985 to 1989 he was Team Leader of the Fish Culture and Research Section in the Fisheries Department. He attended a post-graduate programme on Management and Policy Making in the Fishery Industry, at Ostend, Belgium, from September to December 1985.

During 1989 he obtained financial support to start a PhD research programme on the fisheries of Lake Tana in collaboration with Wageningen Agricultural University. The research proposal was formulated in Wageningen during May-October 1989. The field work was carried out from August 1990 to September 1993, with a short interruption due to security problems in 1991. Data analysis took place in Wageningen during 1994-1995. In March 1995 he went back to the Fisheries Office, Ministry of Agriculture, where he worked as Co-ordinator of Fishery Development Programmes. In October 1997 he returned to Wageningen to finalise this thesis. He is married with two girls and two boys.

